

Int. Cl.: 25

Prior U.S. Cls.: 22 and 39

United States Patent and Trademark Office

Reg. No. 3,478,492

Registered Aug. 5, 2008

**TRADEMARK
PRINCIPAL REGISTER**

SOS FALL MIGRATION

SOCIETY OF STRANDERS, INC. (SOUTH CAROLINA CORPORATION)
P.O. BOX 4688
COLUMBIA, SC 29204

FIRST USE 1-0-1988; IN COMMERCE 1-0-1988.

SER. NO. 75-698,872, FILED 5-6-1999.

FOR: CLOTHING, NAMELY, SHIRTS, T-SHIRTS, SWEATSHIRTS, GOLF SHIRTS, SHORTS, WIND RESISTANT JACKETS, SOCKS, CAPS, AND VISORS, IN CLASS 25 (U.S. CLS. 22 AND 39).

REBECCA EISINGER, EXAMINING ATTORNEY

Int. Cl.: 9

Prior U.S. Cls.: 21, 23, 26, 36 and 38

United States Patent and Trademark Office

Reg. No. 3,478,493

Registered Aug. 5, 2008

**TRADEMARK
PRINCIPAL REGISTER**

LASERTRIM

JOHANSON DIELECTRICS, INC (CALIFORNIA
CORPORATION)
15191 BLEDSOE STREET
SYLMAR, CA 91342

FOR: LASER-ADJUSTABLE CERAMIC CHIP CA-
PACITORS, IN CLASS 9 (U.S. CLS. 21, 23, 26, 36 AND
38).

FIRST USE 8-0-1991; IN COMMERCE 8-0-1991.

SEC. 2(F).

SER. NO. 76-143,522, FILED 10-11-2000.

HEATHER THOMPSON, EXAMINING ATTORNEY

Int. Cl.: 36

Prior U.S. Cls.: 100, 101 and 102

United States Patent and Trademark Office

Reg. No. 3,478,494

Registered Aug. 5, 2008

SERVICE MARK
PRINCIPAL REGISTER



LANDMARK NATIONAL BANK (UNITED STATES FEDERAL CHARTER CORPORATION)

800 POYNTZ AVENUE
MANHATTAN, KS 66502

FOR: BANKING SERVICES, IN CLASS 36 (U.S. CLS. 100, 101 AND 102).

FIRST USE 10-9-2001; IN COMMERCE 10-9-2001.

REGISTRATION LIMITED TO THE AREA IN THE UNITED STATES COMPRISING THE STATES OF NEW MEXICO, COLORADO, KANSAS, NEBRASKA, IOWA, AND THE COUNTIES OF VERNON, BATES, CASS, JACKSON, CLAY, PLATTE, BUCHANAN, ANDREW, HOLT, ATCHISON, NOD-

AWAY, WORTH, HARRISON, GENTRY, DEKALB, DAVIESS, CLINTON, CALDWELL, RAY, LAFAYETTE, JOHNSON AND HENRY IN THE STATE OF MISSOURI. CONCURRENT USE PROCEEDING NO. 94002116 WITH REGISTRATION NO. 2171003.

OWNER OF U.S. REG. NOS. 1,875,541, 2,500,301 AND OTHERS.

NO CLAIM IS MADE TO THE EXCLUSIVE RIGHT TO USE "NATIONAL BANK", APART FROM THE MARK AS SHOWN.

SER. NO. 76-349,375, FILED 12-18-2001.

ASMAT KHAN, EXAMINING ATTORNEY

Int. Cl.: 20

Prior U.S. Cls.: 2, 13, 22, 25, 32 and 50

United States Patent and Trademark Office

Reg. No. 3,478,495

Registered Aug. 5, 2008

**TRADEMARK
PRINCIPAL REGISTER**



MÓVEIS CASA VERDE LTDA. (BRAZIL LTD
LIAB CO)
RUA DR. HERNANI GAMA CORREA, 35-00
MIRASSOL, STATE OF SAO PAULO, BRAZIL

FOR: TABLES, CHAIRS, CLOSET ACCESSORIES,
NAMELY, SHOE RACKS, CLOTHES BARS, SLID-
ING CLOTHES RAILS, BELT RACKS, PREFABRI-
CATED CLOSET ORGANIZATION SYSTEMS
MADE OF WOOD, STORAGE RACKS, BEDS, CRA-
DLES, SIDEBOARDS, WARDROBES, KITCHEN CA-
BINETS, COUNTERTOPS, DRESSING TABLES,
CORNER CUPBOARDS, DESKS, COMPUTER FUR-
NITURE, FURNITURE MADE FROM STEEL TUB-
ING, FILING CABINETS, SHELVES,

WORKBENCHES, IN CLASS 20 (U.S. CLS. 2, 13, 22,
25, 32 AND 50).

PRIORITY CLAIMED UNDER SEC. 44(D) ON
BRAZIL APPLICATION NO. 823551083, FILED 8-23-
2001, REG. NO. 823551083, DATED 3-13-2007, EX-
PIRES 3-13-2017.

THE ENGLISH TRANSLATION OF "CASA
VERDE" IS GREEN HOUSE.

SER. NO. 76-362,607, FILED 1-23-2002.

DAVID MILLER, EXAMINING ATTORNEY

Int. Cls.: 36 and 37

Prior U.S. Cls.: 100, 101, 102, 103 and 106

United States Patent and Trademark Office

Reg. No. 3,478,496

Registered Aug. 5, 2008

**SERVICE MARK
PRINCIPAL REGISTER**

ALFA CORPORATION

ALFA CORPORATION (DELAWARE CORPORATION)

2108 E. SOUTH BLVD.

MONTGOMERY, AL 36198

FOR: PROPERTY AND CASUALTY INSURANCE UNDERWRITING SERVICES; REAL ESTATE SERVICES, NAMELY, PROVISION OF COMMERCIAL AND RESIDENTIAL REAL ESTATE BROKERAGE SERVICES; FINANCIAL SERVICES, NAMELY, LOAN FINANCING, OVERDRAFT CHECKING, MORTGAGE LENDING, HOME EQUITY LOANS, COMMERCIAL LOANS, AUTOMOBILE LOANS AND HOME IMPROVEMENT LOANS, IN CLASS 36 (U.S. CLS. 100, 101 AND 102).

FIRST USE 5-1-1987; IN COMMERCE 5-1-1987.

FOR: CONSTRUCTION SERVICES, NAMELY, GENERAL CONTRACTING AND BUILDING SERVICES IN THE CONSTRUCTION INDUSTRY OF NEW HOMES, RESIDENTIAL COMMUNITIES AND COMMERCIAL PROPERTIES, IN CLASS 37 (U.S. CLS. 100, 103 AND 106).

FIRST USE 5-1-1987; IN COMMERCE 5-1-1987.

OWNER OF U.S. REG. NO. 2,088,673.

NO CLAIM IS MADE TO THE EXCLUSIVE RIGHT TO USE "CORPORATION", APART FROM THE MARK AS SHOWN.

SER. NO. 76-372,299, FILED 2-20-2002.

DAVID MILLER, EXAMINING ATTORNEY

Int. Cl.: 36

Prior U.S. Cls.: 100, 101 and 102

United States Patent and Trademark Office

Reg. No. 3,478,497

Registered Aug. 5, 2008

**SERVICE MARK
PRINCIPAL REGISTER**

PATIENT CHOICE

PATIENT CHOICE HEALTHCARE, INC. (DELA-
WARE CORPORATION)
1660 SOUTH HIGHWAY 100
SUITE 250
ST. LOUIS PARK, MN 55416

FOR: ORGANIZING PRE-PAID HEALTH CARE
PLANS; ADMINISTRATION OF PRE-PAID HEALTH
CARE PLANS, IN CLASS 36 (U.S. CLS. 100, 101 AND
102).

FIRST USE 8-0-2000; IN COMMERCE 8-0-2000.

NO CLAIM IS MADE TO THE EXCLUSIVE
RIGHT TO USE "PATIENT", APART FROM THE
MARK AS SHOWN.

SER. NO. 76-449,786, FILED 9-12-2002.

AMOS T. MATTHEWS, JR., EXAMINING ATTOR-
NEY

Int. Cl.: 9

Prior U.S. Cls.: 21, 23, 26, 36 and 38

United States Patent and Trademark Office

Reg. No. 3,478,498

Registered Aug. 5, 2008

**TRADEMARK
PRINCIPAL REGISTER**



JYGA CONCEPT INC. (CANADA CORPORATION)
780, RUE CRAIG
SAINT-NICOLAS (QUÉBEC) G7A 2N2, CANADA

FOR: INTEGRATED COMPUTERIZED SYSTEM INCLUDING SOFTWARE AND HARDWARE FOR USE IN CONNECTION WITH FOOD DISTRIBUTION AND MANAGEMENT FOR ANIMALS, NAMELY, A COMPUTERIZED FEEDING SYSTEM USING CONTROLLED DISTRIBUTION, MEASUREMENT, DETECTION, AND MANAGEMENT MODULES TO DETERMINE AND MEASURE THE FEED INTAKE OF EACH ANIMAL AND TO DETECT AND CONTROL TEMPERATURE, VENTILATION, HEAT, AND DISEASE, IN CLASS 9 (U.S. CLS. 21, 23, 26, 36 AND 38).

PRIORITY CLAIMED UNDER SEC. 44(D) ON CANADA APPLICATION NO. 1164858, FILED 1-17-2003, REG. NO. TMA620194, DATED 9-21-2004, EXPIRES 9-21-2019.

COLOR IS AN IMPORTANT FEATURE OF THE MARK. THE MARK CONSISTS OF THE STYLIZED WORD GESTAL IN BLUE AND TWO CIRCULAR ARROWS IN METAL GRAY.

SER. NO. 76-492,836, FILED 2-6-2003.

JANICE L. MCMORROW, EXAMINING ATTORNEY

Int. Cl.: 11

Prior U.S. Cls.: 13, 21, 23, 31 and 34

Reg. No. 3,478,499

United States Patent and Trademark Office

Registered Aug. 5, 2008

**TRADEMARK
PRINCIPAL REGISTER**



VIBRATION MOUNTINGS & CONTROLS, INC.
(NEW JERSEY CORPORATION)
113 MAIN STREET
BLOOMINGDALE, NJ 07473

FIRST USE 0-0-1988; IN COMMERCE 0-0-1988.

FOR: SPRING, RUBBER, AND CABLE ISOLATORS FOR CONTROL OF VIBRATION, SHOCK, AND NOISE USED ON HEATING, VENTILATION, AND AIR CONDITIONING EQUIPMENT, IN CLASS 11 (U.S. CLS. 13, 21, 23, 31 AND 34).

SER. NO. 76-510,373, FILED 4-11-2003.

CHRISTOPHER BUONGIORNO, EXAMINING ATTORNEY

Int. Cl.: 5

Prior U.S. Cls.: 6, 18, 44, 46, 51 and 52

Reg. No. 3,478,500

United States Patent and Trademark Office

Registered Aug. 5, 2008

**TRADEMARK
PRINCIPAL REGISTER**

TRANSFORMATION

SHANE SHEIBANI, M.D., INC. (CALIFORNIA CORPORATION), DBA NEW ME INSTITUTE
6200 WILSHIRE BOULEVARD, NO. 1710
LOS ANGELES, CA 90048

FOR: MEDICATED COSMETICS, NAMELY, MEDICATED COSMETIC REMOVERS; MEDICATED EYE CREAMS; MEDICATED ACNE TREATMENT GEL; MEDICATED ANTI-WRINKLE CREAM; MEDICATED COSMETIC FACIAL CLEANERS, MEDICATED SKIN MOISTURIZERS; MEDICATED HERBAL BATH GEL FLUID; MEDICATED FOUNDATION MAKEUP; MEDICATED FACE POWDERS; MEDICATED MASCARA; MEDICATED LIP POLISH; MEDICATED LIP GLOSS; MEDICATED EYE MAKEUP POWDERS; MEDICATED EYE SHADOWS; MEDICATED LIP COLOR IN THE

FORM OF LIPSTICKS; MEDICATED NAIL ENAMEL; MEDICATED ROUGE; MEDICATED CONTOUR POWDER FOR USE AS A FOUNDATION MAKEUP ON SKIN; MEDICATED EYEBROW PENCILS; MEDICATED CONTOUR POWDERS FOR USE ON CHEEKS; MEDICATED LIP GLOSS; MEDICATED FACE AND BODY CREAMS AND TONERS; AND MEDICATED FACIAL MASKS, IN CLASS 5 (U.S. CLS. 6, 18, 44, 46, 51 AND 52).

FIRST USE 2-10-2002; IN COMMERCE 2-10-2002.

SER. NO. 76-541,563, FILED 8-18-2003.

DORITT L. CARROLL, EXAMINING ATTORNEY

Int. Cls.: 18 and 25

Prior U.S. Cls.: 1, 2, 3, 22, 39 and 41

Reg. No. 3,478,501

United States Patent and Trademark Office

Registered Aug. 5, 2008

**TRADEMARK
PRINCIPAL REGISTER**



WEST PACIFICA

EFFIGI INC. (CANADA CORPORATION)
1155, AUTOROUTE 13
LAVAL, QUEBEC, CANADA H7W 5J8

FOR: BAGS OF VARIOUS SHAPES AND SIZES, NAMELY, ALL PURPOSE SPORTS BAGS, ATHLETIC BAGS, GYM BAGS, HAND BAGS, SHOULDER BAGS, BACKPACKS, SCHOOL BAGS, FABRIC LUGGAGE BAGS, FANNY PACKS, WRIST MOUNTED CARRYALL BAGS, CARRY-ON BAGS, DUFFEL BAGS, IN CLASS 18 (U.S. CLS. 1, 2, 3, 22 AND 41).

FOR: CLOTHING, NAMELY, SWEATERS, T-SHIRTS, CAMISOLES, JACKETS, CARDIGANS, TURTLENECKS, DRESSES, UNDERCLOTHING, CULOTTES, MIDRIFF TOPS, SLIPS, PANTS, JEANS, JACKETS, BERMUDA SHORTS, SHORTS, SKIRTS, SUITS, JUMPSUITS, OVERALLS, HATS, BERETS, HEADBANDS, BANDANNAS, EAR MUFFS, SCARVES, BLOUSES, ONE-PIECE SKI SUITS, BLAZERS, SKI SUITS, NAMELY, WAIST-LENGTH SKI JACKETS, SKI COATS, SKI PANTS, SKI JACKETS, SKI GLOVES, SKI MITTS, OVERCOATS, PARKAS, ANORAKS; RAINCOATS, RAIN SLICKERS; HOODED SWEATSHIRTS, JERSEYS, JOGGING OUT-

FITS, NAMELY, PANTS, T-SHIRTS, FLEECE-LINED SWEATSHIRTS; MITTS, GLOVES, NECKTIES, PAJAMAS, NIGHTGOWNS, BABY DOLLS, NIGHTIES, DRESSING GOWNS, BATHROBES, TOQUES, PEAK CAPS, UNIFORMS, BEACH WEAR, NAMELY, BEACH SHIRTS AND BEACH DRESSES; BEACH WRAPS, SWIM SUITS, LEOTARDS, COATS, SLIPOVERS, POLO SHIRTS, BOXERS AND BELTS; FOOTWEAR FOR MEN, WOMEN AND CHILDREN, NAMELY, SHOES, BOOTS, SLIPPERS, ATHLETIC SHOES, BASKETBALL SHOES; SPORTS FOOTWEAR, NAMELY, SNEAKERS, RUNNING SHOES, WALKING SHOES, TENNIS SHOES, ALL ATHLETIC FOOTWEAR, GOLF CLEATS FOR ATTACHMENT TO SPORTS SHOES, GOLF SHOES, SANDALS AND RUBBERS, IN CLASS 25 (U.S. CLS. 22 AND 39).

OWNER OF CANADA REG. NO. TMA615255,
DATED 7-20-2004, EXPIRES 7-20-2019.

SER. NO. 76-550,691, FILED 10-10-2003.

LOURDES AYALA, EXAMINING ATTORNEY

Int. Cl.: 25

Prior U.S. Cls.: 22 and 39

United States Patent and Trademark Office

Reg. No. 3,478,502

Registered Aug. 5, 2008

**TRADEMARK
PRINCIPAL REGISTER**

SPA

SCHROEDER & TREMAYNE, INC. (MISSOURI
CORPORATION)
8450 VALCOUR
ST. LOUIS, MO 63123

OWNER OF U.S. REG. NOS. 1,211,588, 2,589,216
AND OTHERS.

FOR: FOOT COZIES, NAMELY, SOCKS AND
BOOTIES; HAND COZIES, NAMELY, GLOVES
AND HATS; WRAPS, IN CLASS 25 (U.S. CLS. 22
AND 39).

SER. NO. 76-552,650, FILED 10-20-2003.

FIRST USE 3-0-2002; IN COMMERCE 3-0-2002.

NORA BUCHANAN WILL, EXAMINING ATTOR-
NEY

Int. Cls.: 37 and 40

Prior U.S. Cls.: 100, 103 and 106

United States Patent and Trademark Office

Reg. No. 3,478,503

Registered Aug. 5, 2008

**SERVICE MARK
PRINCIPAL REGISTER**

THAI

ARCHON TECHNOLOGIES LTD. (CANADA CORPORATION)
SUITE 2600, 240 - 4TH AVENUE SW
CALGARY, ALBERTA, T2P 4H4, CANADA

FOR: OIL PUMPING AND EXTRACTION SERVICES, NAMELY, THE RECOVERY OF OIL FROM SUBTERRANEAN FORMATIONS THROUGH IN-SITU COMBUSTION TECHNIQUES AND METHODOLOGIES AND OIL UPGRADING CATALYSTS, IN CLASS 37 (U.S. CLS. 100, 103 AND 106).

FOR: OIL REFINING SERVICES, NAMELY, THE RECOVERY OF OIL FROM SUBTERRANEAN FORMATIONS THROUGH IN-SITU COMBUSTION TECHNIQUES AND METHODOLOGIES AND OIL

UPGRADING CATALYSTS, IN CLASS 40 (U.S. CLS. 100, 103 AND 106).

THE MARK CONSISTS OF STANDARD CHARACTERS WITHOUT CLAIM TO ANY PARTICULAR FONT, STYLE, SIZE, OR COLOR.

PRIORITY CLAIMED UNDER SEC. 44(D) ON CANADA APPLICATION NO. 1190864, FILED 9-15-2003, REG. NO. TMA674706, DATED 10-13-2006, EXPIRES 10-13-2021.

SER. NO. 76-573,108, FILED 1-30-2004.

TRACY CROSS, EXAMINING ATTORNEY

Int. Cl.: 43

Prior U.S. Cls.: 100 and 101

United States Patent and Trademark Office

Reg. No. 3,478,504

Registered Aug. 5, 2008

**SERVICE MARK
PRINCIPAL REGISTER**

RISING STAR LEARNING CENTER

RISING STAR LEARNING CENTER, INC.
(GEORGIA CORPORATION)

6736 MABLETON PARKWAY

MABLETON, GA 30126

FOR: DAY CARE CENTER SERVICES, IN CLASS
43 (U.S. CLS. 100 AND 101).

FIRST USE 8-1-2001; IN COMMERCE 8-1-2001.

THE MARK CONSISTS OF STANDARD CHAR-
ACTERS WITHOUT CLAIM TO ANY PARTICULAR
FONT, STYLE, SIZE, OR COLOR.

NO CLAIM IS MADE TO THE EXCLUSIVE
RIGHT TO USE "LEARNING CENTER", APART
FROM THE MARK AS SHOWN.

SER. NO. 76-588,682, FILED 4-26-2004.

BILL DAWE, EXAMINING ATTORNEY

Int. Cls.: 24 and 25

Prior U.S. Cls.: 22, 39, 42 and 50

United States Patent and Trademark Office

Reg. No. 3,478,505

Registered Aug. 5, 2008

**TRADEMARK
PRINCIPAL REGISTER**

JELLY GIRLS

PHILHOBAR DESIGN CANADA LTD. (CANADA CORPORATION)
365 LOUVAIN QUEST
MONTREAL, QUEBEC H2N 2J1, CANADA

FOR: BED BLANKETS, PILLOWS, IN CLASS 24 (U.S. CLS. 42 AND 50).

FOR: LADIES', MEN'S, GIRLS', BOYS' AND CHILDREN'S CLOTHING, NAMELY, T-SHIRTS, POLO SHIRTS, SWEATERS, SHIRTS, BLOUSES, PANTS, OVERALLS, SHORTS, SKIRTS, COATS, JACKETS, VESTS, TURTLENECKS, UNDERGARMENTS, SLEEPWEAR AND ROBES, IN CLASS 25 (U.S. CLS. 22 AND 39).

THE MARK CONSISTS OF STANDARD CHARACTERS WITHOUT CLAIM TO ANY PARTICULAR FONT, STYLE, SIZE, OR COLOR.

PRIORITY CLAIMED UNDER SEC. 44(D) ON CANADA APPLICATION NO. 1218779, FILED 6-1-2004, REG. NO. TMA704804, DATED 1-16-2008, EXPIRES 1-16-2023.

NO CLAIM IS MADE TO THE EXCLUSIVE RIGHT TO USE "GIRLS" , APART FROM THE MARK AS SHOWN.

SER. NO. 76-599,134, FILED 6-24-2004.

PRISCILLA MILTON, EXAMINING ATTORNEY

Int. Cl.: 19

Prior U.S. Cls.: 1, 12, 33 and 50

United States Patent and Trademark Office

Reg. No. 3,478,506

Registered Aug. 5, 2008

**TRADEMARK
PRINCIPAL REGISTER**

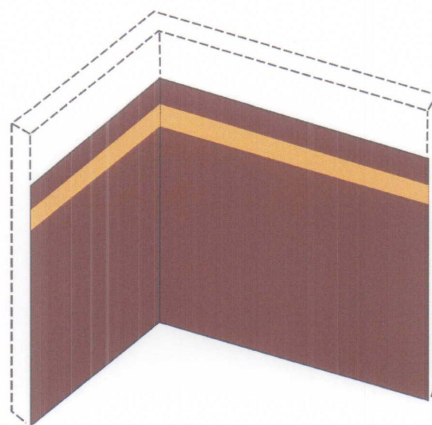

EWALD DÖRKEN AG (FED REP GERMANY CORPORATION)
WETTERSTRASSE 58
58313 HERDECKE, FED REP GERMANY

FOR: PLASTIC DRAINAGE MEMBRANE SHEETS FOR USE IN UNDERGROUND CONSTRUCTION, NAMELY, FOR COVERING AND PROTECTING THE EXTERIOR SURFACES OF BASEMENT AND FOUNDATION WALLS FROM MOISTURE INFILTRATION, IN CLASS 19 (U.S. CLS. 1, 12, 33 AND 50).

FIRST USE 2-15-1996; IN COMMERCE 3-5-1996.

OWNER OF U.S. REG. NO. 2,241,347.

THE COLOR(S) BROWN AND YELLOW IS/ARE CLAIMED AS A FEATURE OF THE MARK.

THE COLOR BROWN APPEARS ACROSS THE MAJORITY OF THE GOODS WITH A YELLOW BAND NEAR THE TOP.

THE MARK BROKEN LINES ARE USED TO SHOW THE POSITION OF THE MARK ON THE GOODS BUT ARE NOT A FEATURE OF THE MARK

SEC. 2(F).

SER. NO. 76-620,293, FILED 11-12-2004.

ANDREW LAWRENCE, EXAMINING ATTORNEY

Int. Cl.: 41

Prior U.S. Cls.: 100, 101 and 107

United States Patent and Trademark Office

Reg. No. 3,478,507

Registered Aug. 5, 2008

**SERVICE MARK
PRINCIPAL REGISTER**

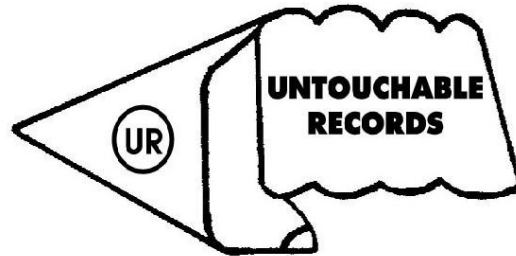

MUSIC IS OUR BUSINESS

MUHAMMAD, GENGHIS KHALID (GKM) (UNITED STATES INDIVIDUAL)
UNTOUCHABLE RECORDS
PO BOX 2129
NEW YORK, NY 101082129

FOR: MUSIC PRODUCTION SERVICES/MUSIC PUBLISHING SERVICES, IN CLASS 41 (U.S. CLS. 100, 101 AND 107).

FIRST USE 0-0-1997; IN COMMERCE 8-0-1998.

NO CLAIM IS MADE TO THE EXCLUSIVE RIGHT TO USE "RECORDS" AND "MUSIC IS OUR BUSINESS", APART FROM THE MARK AS SHOWN.

THE MARK CONSISTS OF UR IS IN A CIRCLE WHICH APPEARS ON AN ARM WITH A FIST AT THE END WITH THE WORDS UNTOUCHABLE RECORDS APPEARING THEREON, THE WORDS MUSIC IS OUR BUSINESS APPEARING BELOW.

SER. NO. 76-638,205, FILED 5-9-2005.

AMOS T. MATTHEWS, JR., EXAMINING ATTORNEY

Int. Cl.: 41

Prior U.S. Cls.: 100, 101 and 107

United States Patent and Trademark Office

Reg. No. 3,478,508

Registered Aug. 5, 2008

SERVICE MARK
PRINCIPAL REGISTER



PROMAN, MATTHEW (UNITED STATES INDIVIDUAL)
1225 FRANKLIN AVE. SUITE 200
GARDEN CITY, NY 11530

FOR: PROVIDING NON-DOWNLOADABLE ONLINE PUBLICATIONS, NAMELY, PERIODICALLY PUBLISHED DIRECTORIES FEATURING BIOGRAPHICAL INFORMATION ABOUT BUSINESS PROFESSIONALS WHO ARE MEMBERS OF A WHO'S WHO WORLDWIDE NETWORK, SAID BIOGRAPHICAL INFORMATION HIGHLIGHTING COMPANY, EXPERTISE AND ACHIEVEMENTS FOR THE PURPOSE OF ALLOWING THE PROFESSIONALS

TO NETWORK AND DO BUSINESS, IN CLASS 41 (U.S. CLS. 100, 101 AND 107).

FIRST USE 5-31-2005; IN COMMERCE 5-31-2005.

NO CLAIM IS MADE TO THE EXCLUSIVE RIGHT TO USE "WHO'S WHO", APART FROM THE MARK AS SHOWN.

SER. NO. 76-642,694, FILED 7-12-2005.

TRACY WHITTAKER-BROWN, EXAMINING ATTORNEY

Int. Cls.: 19 and 40

Prior U.S. Cls.: 1, 12, 33, 50, 100, 103 and 106

United States Patent and Trademark Office

Reg. No. 3,478,509

Registered Aug. 5, 2008

**TRADEMARK
SERVICE MARK
PRINCIPAL REGISTER**

MURICLIC

MURIDAL INC. (CANADA CORPORATION)
316 MARION STREET
LE GARDEUR, QUEBEC, J5Z 4W8, CANADA

FOR: A CURTAIN WALL SYSTEM COMPRISED
PRIMARILY OF GLASS PANELS AND METAL
FRAMING WHICH CAN BE INTERCONNECTED
BY A QUICK CONNECTOR, IN CLASS 19 (U.S. CLS.
1, 12, 33 AND 50).

FOR: CUSTOM MANUFACTURE OF CURTAIN
WALL SYSTEMS TO THE SPECIFICATIONS OF
OTHERS, IN CLASS 40 (U.S. CLS. 100, 103 AND 106).

THE MARK CONSISTS OF STANDARD CHAR-
ACTERS WITHOUT CLAIM TO ANY PARTICULAR
FONT, STYLE, SIZE, OR COLOR.

PRIORITY CLAIMED UNDER SEC. 44(D) ON
CANADA APPLICATION NO. 1246169, FILED 2-4-
2005, REG. NO. TMA706651, DATED 2-6-2008, EX-
PIRES 2-6-2023.

SER. NO. 76-643,055, FILED 7-18-2005.

CURTIS FRENCH, EXAMINING ATTORNEY

Int. Cls.: 19 and 40

Prior U.S. Cls.: 1, 12, 33, 50, 100, 103 and 106

United States Patent and Trademark Office

Reg. No. 3,478,510

Registered Aug. 5, 2008

**TRADEMARK
SERVICE MARK
PRINCIPAL REGISTER**

MURISEAL

MURIDAL INC. (CANADA CORPORATION)
316 MARION STREET
LE GARDEUR, QUEBEC, CANADA J5Z 4W8

FOR: CURTAIN WALL SEALING SYSTEM,
NAMELY, A NON-METAL SEAL AS AN INTEGRAL
COMPONENT IN CURTAIN WALLS MADE PRI-
MARILY OF GLASS, IN CLASS 19 (U.S. CLS. 1, 12, 33
AND 50).

FOR: CUSTOM MANUFACTURER OF CURTAIN
WALL SYSTEMS TO THE SPECIFICATIONS OF
OTHERS, IN CLASS 40 (U.S. CLS. 100, 103 AND 106).

THE MARK CONSISTS OF STANDARD CHAR-
ACTERS WITHOUT CLAIM TO ANY PARTICULAR
FONT, STYLE, SIZE, OR COLOR.

PRIORITY CLAIMED UNDER SEC. 44(D) ON
CANADA APPLICATION NO. 1246168, FILED 2-4-
2005, REG. NO. TMA706650, DATED 2-6-2008, EX-
PIRES 2-6-2023.

SER. NO. 76-643,056, FILED 7-18-2005.

CURTIS FRENCH, EXAMINING ATTORNEY

Int. Cl.: 33

Prior U.S. Cls.: 47 and 49

United States Patent and Trademark Office

Reg. No. 3,478,511

Registered Aug. 5, 2008

TRADEMARK
PRINCIPAL REGISTER



SHANGHAI TOBACCO (GROUP) CORPORATION
(CHINA CORPORATION)
1062 XU CHANG ROAD
SHANGHAI, CHINA

FOR: WINE, GRAPE WINE AND OTHER KINDS OF ALCOHOLIC BEVERAGES OF FRUITS, BRANDY, COGNAC, WHISKY, DISTILLED SPIRITS OF ALCOHOL, DISTILLED SPIRITS, AND ALCOHOLIC BEVERAGES OTHER THAN BEER, NAMELY, UNSTRAINED RICE WINE (TAG-JU), COMPOUND CLEAR RICE WINE, PEPPERMINT LIQUEURS, TRADITIONAL RICE WINE, REFINED RICE WINE (YAG-JU), RUM, YELLOW WINE, CHINESE LIQUEUR (LAO LIQUOR), FLAVORED TONIC LIQUORS, WINE COOLERS, IN CLASS 33 (U.S. CLS. 47 AND 49).

FIRST USE 2-9-2005; IN COMMERCE 3-3-2005.

OWNER OF U.S. REG. NOS. 2,221,208 AND 2,434,448.

NO CLAIM IS MADE TO THE EXCLUSIVE RIGHT TO USE "CHUNGHWA", APART FROM THE MARK AS SHOWN.

THE MARK CONSISTS, IN PART, OF THE WORD "CHUNGHWA" AND THE DESIGN OF PILLAR.

THE ENGLISH TRANSLATION OF THE WORD "CHUNGHWA" IN THE MARK IS MIDDLE CHINA.

SER. NO. 76-643,764, FILED 7-28-2005.

VIVIAN MICZNIK FIRST, EXAMINING ATTORNEY

Int. Cl.: 9

Prior U.S. Cls.: 21, 23, 26, 36 and 38

United States Patent and Trademark Office

Reg. No. 3,478,512

Registered Aug. 5, 2008

**TRADEMARK
PRINCIPAL REGISTER**

CARDIOPLANET

EBIT AET S.P.A. (ITALY CORPORATION)

VIA SIFFREDI 58

I-16153 GENOVA, ITALY

FOR: COMPUTER SOFTWARE PLATFORMS
FOR MEDICAL IMAGING AND DATA ACQUISITION,
VISUALIZATION, PROCESSING, ARCHIVING
AND COMMUNICATION, IN CLASS 9 (U.S.
CLS. 21, 23, 26, 36 AND 38).

THE MARK CONSISTS OF STANDARD CHARACTERS
WITHOUT CLAIM TO ANY PARTICULAR
FONT, STYLE, SIZE, OR COLOR.

PRIORITY CLAIMED UNDER SEC. 44(D) ON
ERPNTM OFC APPLICATION NO. 004304283,
FILED 3-22-2005, REG. NO. 004304283,
DATED 3-15-2006, EXPIRES 3-22-2015.

SER. NO. 76-646,657, FILED 9-13-2005.

ALLISON SCHRODY, EXAMINING ATTORNEY

Int. Cl.: 9

Prior U.S. Cls.: 21, 23, 26, 36 and 38

Reg. No. 3,478,513

United States Patent and Trademark Office

Registered Aug. 5, 2008

TRADEMARK
PRINCIPAL REGISTER

CELL/B.E.
CELL BROADBAND ENGINE

KABUSHIKI KAISHA SONY COMPUTER ENTERTAINMENT (JAPAN CORPORATION), TA SONY COMPUTER ENTERTAINMENT INC.
2-6-21, MINAMI-AOYAMA, MINATO-KU
TOKYO 107-0062, JAPAN

FOR: VIDEO GAME MACHINES FOR USE WITH TELEVISIONS; AUDIO-VISUAL CABLES; AMPLIFIERS; AUTOMATIC PERFORMANCE COMPUTER PROGRAMS FOR ELECTRONIC MUSICAL INSTRUMENTS; BATTERY CHARGERS; BLANK OPTICAL DISCS; ELECTRIC CABLES; CAR ADAPTERS; ELECTRONIC CONTROLLERS ESPECIALLY DESIGNED FOR CD RECORDERS; ELECTRONIC CONTROLLERS ESPECIALLY DESIGNED FOR DVD PLAYERS; ELECTRONIC CONTROLLERS ESPECIALLY DESIGNED FOR DVD RECORDERS; ELECTRONIC CONTROLLERS ESPECIALLY DESIGNED FOR DVD VIDEO RECORDERS; ELECTRONIC CONTROLLERS ESPECIALLY DESIGNED FOR DVD-ROM PLAYERS; DIGITAL STILL CAMERAS; DOWNLOADABLE ELECTRONIC PUBLICATIONS IN THE NATURE OF MAGAZINES IN THE FIELD OF VIDEO GAMES, MUSIC, CINEMA; LIQUID CRYSTAL DISPLAYS; ELECTRONIC TAGS FOR ELECTRONIC DISCERNMENT; OPTICAL SCANNERS; FM TRANSMITTERS; GLOBAL POSITIONING SYSTEM (GPS); HARD DISC RECORDERS; HARD DISK DRIVES; KEYBOARDS; KEYBOARDS FOR USE WITH VIDEO GAMES WITH TELEVISION FOR PERSONAL USE ONLY; LARGE SCALE INTEGRATED CIRCUITS FOR IMAGE PROCESSING; SEMICONDUCTOR MICROCHIPS; LIQUID CRYSTAL DISPLAYS; LIQUID CRYSTAL MONITORS; LOUD SPEAKERS; MEMORY CARDS; MICROPHONES; MODEMS; Mouses FOR COMPUTERS; ONE-SHOT CAMERAS WITH UNEXPOSED FILMS; OPTICAL DISC PLAYERS AND REMOTE CONTROLLERS SOLD AS A UNIT; OPTICAL DISC RECORDERS AND REMOTE CONTROLLERS SOLD AS A UNIT; OPTICAL FIBER

CABLES; PORTABLE DIGITAL AUDIO PLAYERS; COMPUTER PROGRAMS FOR HAND-HELD GAMES WITH LIQUID CRYSTAL DISPLAYS; RECEIVING TUNERS FOR SATELLITE TELEVISION BROADCASTING; RECEIVING TUNERS FOR TERRESTRIAL DIGITAL BROADCASTING; RECHARGEABLE BATTERIES; RECORDED OPTICAL DISCS FEATURING COMPUTER GAME PROGRAMS FOR USE WITH TELEVISIONS FOR BUSINESS AND PERSONAL USE; REMOTE CONTROLLERS FOR USE WITH HAND-HELD GAMES WITH LIQUID CRYSTAL DISPLAYS ONLY; REMOTE CONTROLLERS ESPECIALLY DESIGNED FOR CD PLAYERS; REMOTE CONTROLLERS ESPECIALLY DESIGNED FOR DVD PLAYERS; REMOTE CONTROLLERS FOR USE WITH COMPUTERS; REMOTE CONTROLLERS FOR USE WITH PORTABLE AUDIO-VISUAL PLAYERS ONLY; REMOTE CONTROLLERS FOR USE WITH PORTABLE DIGITAL AUDIO PLAYERS ONLY; REMOTE CONTROLLERS FOR USE WITH VIDEO GAMES WITH TELEVISION FOR PERSONAL USE ONLY; ROUTERS FOR COMPUTER NETWORK COMMUNICATION; SOUND RECORDED COMPACT DISCS FEATURING MUSIC, AUDIO LECTURES AND LIVE AUDIO PERFORMANCES; SOUND RECORDED MAGNETIC CARDS, SHEETS AND TAPES; TUNERS FOR TELEVISION RECEIVERS; VIDEO RECORDED OPTICAL DISCS FEATURING CARTOONS AND MOVIES; VIDEO RECORDED OPTICAL MAGNETIC DISCS FEATURING CINEMA, IN CLASS 9 (U.S. CLS. 21, 23, 26, 36 AND 38).

OWNER OF AUSTRALIA REG. NO. 1084904,
DATED 11-9-2005, EXPIRES 11-9-2015.

SER. NO. 76-650,031, FILED 11-9-2005.

LINDA LAVACHE, EXAMINING ATTORNEY

Int. Cl.: 43

Prior U.S. Cls.: 100 and 101

United States Patent and Trademark Office

Reg. No. 3,478,514

Registered Aug. 5, 2008

**SERVICE MARK
PRINCIPAL REGISTER**

VIVO

DIAZ, ROGER (UNITED STATES INDIVIDUAL)
12411 ASHLEY PLACE
SAN ANTONIO, TX 78247

FOR: RESTAURANT AND BAR SERVICES, IN
CLASS 43 (U.S. CLS. 100 AND 101).

FIRST USE 10-12-2003; IN COMMERCE 10-12-2003.

THE MARK CONSISTS OF STANDARD CHAR-
ACTERS WITHOUT CLAIM TO ANY PARTICULAR
FONT, STYLE, SIZE, OR COLOR.

THE ENGLISH TRANSLATION OF THE WORD
"VIVO" IS ALIVE.

SER. NO. 76-657,550, FILED 3-30-2006.

LINDA ORNDORFF, EXAMINING ATTORNEY

Int. Cl.: 9

Prior U.S. Cls.: 21, 23, 26, 36 and 38

Reg. No. 3,478,515

United States Patent and Trademark Office

Registered Aug. 5, 2008

**TRADEMARK
PRINCIPAL REGISTER**

TUNEBUDS

GRIFFIN TECHNOLOGY, INC. (TENNESSEE CORPORATION)
1930 AIR LANE DRIVE
NASHVILLE, TN 37910

THE MARK CONSISTS OF STANDARD CHARACTERS WITHOUT CLAIM TO ANY PARTICULAR FONT, STYLE, SIZE, OR COLOR.

FOR: EARPHONES AND LANYARD COMBINATION, SOLD AS A UNIT, FOR USE WITH HANDHELD ELECTRONIC DEVICE, IN CLASS 9 (U.S. CLS. 21, 23, 26, 36 AND 38).

SER. NO. 76-658,117, FILED 4-10-2006.

FIRST USE 10-24-2005; IN COMMERCE 10-24-2005.

RONALD AIKENS, EXAMINING ATTORNEY

Int. Cls.: 9, 35, 39, 40 and 42

**Prior U.S. Cls.: 21, 23, 26, 36, 38, 100, 101, 102, 103,
105 and 106**

Reg. No. 3,478,516

United States Patent and Trademark Office

Registered Aug. 5, 2008

**TRADEMARK
SERVICE MARK
PRINCIPAL REGISTER**

BELLITHO

BELL LITHO, INC. (ILLINOIS CORPORATION)
370 CROSSEN AVENUE
ELK GROVE VILLAGE, IL 60007

FOR: COMPUTER SOFTWARE FOR USE IN DATABASE MANAGEMENT, USE AS A SPREAD SHEET, WORD PROCESSING, AND FOR PROCESSING CONTENT, NAMELY, TEXT, DATA, IMAGES AND SOUND, IN CLASS 9 (U.S. CLS. 21, 23, 26, 36 AND 38).

FIRST USE 4-0-1965; IN COMMERCE 1-0-1970.

FOR: ONLINE RETAIL STORE SERVICES FEATURING OFFICE SUPPLIES, IN CLASS 35 (U.S. CLS. 100, 101 AND 102).

FIRST USE 4-0-1965; IN COMMERCE 1-0-1970.

FOR: WAREHOUSING; DISTRIBUTION OF DOCUMENTS FOR OTHERS, IN CLASS 39 (U.S. CLS. 100 AND 105).

FIRST USE 6-2-2005; IN COMMERCE 6-2-2005.

FOR: COMMERCIAL PRINTING SERVICES, NAMELY, THE PRINTING OF VARIED ADVERTISING FOR CUSTOMERS WHILE ALLOWING THE CUSTOMER TO SELECT VARIED ADVERTISING ON A DAY TO DAY OR WEEK TO WEEK OR

MONTH TO MONTH BASIS TO ACCOMMODATE THE NEEDS OF THE CUSTOMER SO THAT THE CUSTOMER CAN EASILY ALTER THE ADVERTISING PROGRAM IN ACCORDANCE WITH THE CUSTOMER'S NEEDS; SHORT-RUN, SMALL SIZE PRINTING, LONG RUN, LARGE FORMAT PRINTING; LABEL PRINTING; CUSTOM DIE CUTTING; BINDERY SERVICES FOR OTHERS, NAMELY, COLLATING, FOLDING, STAPLING, PERFORATING, CUTTING AND BINDING OF PRINTED, PHOTOCOPIED AND TYPEWRITTEN MATERIALS; CD DUPLICATION AND IMPRINTING WITH DESIGNS; PREPRESS DESIGN, NAMELY, ELECTRONIC PREPRESS SERVICES, IN CLASS 40 (U.S. CLS. 100, 103 AND 106).

FIRST USE 6-2-2005; IN COMMERCE 6-2-2005.

FOR: PRINT AND GRAPHIC DESIGN, IN CLASS 42 (U.S. CLS. 100 AND 101).

FIRST USE 6-2-2005; IN COMMERCE 6-2-2005.

THE MARK CONSISTS OF STANDARD CHARACTERS WITHOUT CLAIM TO ANY PARTICULAR FONT, STYLE, SIZE, OR COLOR.

SER. NO. 76-659,775, FILED 5-9-2006.

JAMES STEIN, EXAMINING ATTORNEY

Int. Cl.: 9

Prior U.S. Cls.: 21, 23, 26, 36 and 38

Reg. No. 3,478,517

United States Patent and Trademark Office

Registered Aug. 5, 2008

**TRADEMARK
PRINCIPAL REGISTER**

OMNEX TRUSTED WIRELESS

OMNEX CONTROL SYSTEMS ULC (CANADA
UNLIMITED LIABILITY COMPANY)
C/O PECO, INC.
4784 SE 17TH AVENUE
PORTLAND, OR 97202

FOR: RADIO TRANSMITTERS AND RECEIVERS;
RADIO FREQUENCY REMOTE CONTROLS AND
CONTROL INTERFACES FOR INDUSTRIAL MA-
CHINERY, CONSTRUCTION MACHINES, AND
HEAVY CONSTRUCTION EQUIPMENT; WIRELESS
DATA AND INPUT/OUTPUT LINKAGE DEVICES,
NAMELY, RADIO TRANSMITTERS, RADIO RE-
CEIVERS, AND RADIO TRANSCEIVERS, FOR CON-
NECTING REMOTE INSTRUMENTS, DEVICES,
RECORDERS AND INDUSTRIAL AUTOMATION
EQUIPMENT TO PROGRAMMABLE LOGIC CON-
TROLLERS, HUMAN-MACHINE INTERFACES,

DISTRIBUTED CONTROL SYSTEMS, AND INDUS-
TRIAL LOCAL AREA NETWORKS, IN CLASS 9 (U.S.
CLS. 21, 23, 26, 36 AND 38).

FIRST USE 11-4-2002; IN COMMERCE 2-21-2003.

THE MARK CONSISTS OF STANDARD CHAR-
ACTERS WITHOUT CLAIM TO ANY PARTICULAR
FONT, STYLE, SIZE, OR COLOR.

NO CLAIM IS MADE TO THE EXCLUSIVE
RIGHT TO USE "TRUSTED WIRELESS", APART
FROM THE MARK AS SHOWN.

SER. NO. 76-659,888, FILED 5-11-2006.

ATTIYA MALIK, EXAMINING ATTORNEY

Int. Cls.: 5, 9 and 10

Prior U.S. Cls.: 6, 18, 21, 23, 26, 36, 38, 39, 44, 46, 51 and 52

Reg. No. 3,478,518

United States Patent and Trademark Office

Registered Aug. 5, 2008

**TRADEMARK
PRINCIPAL REGISTER**



DEGUDENT GMBH (FED REP GERMANY LTD
LIAB CO)
RODENBACHER CHAUSSEE 4
D-63457 HANAU/MAIN, FED REP GERMANY

FOR: DENTAL FILLING MATERIALS AND IMPRESSION MASS FOR DENTAL AND DENTAL TECHNICAL PURPOSES; MATERIALS FOR DENTAL PROSTHESES, NAMELY, METAL ALLOYS, PRECIOUS METAL ALLOYS AND METAL COMPOUNDS FOR DENTAL AND DENTAL TECHNICAL PURPOSES; CERAMIC MATERIALS FOR USE IN DENTAL PROSTHETICS, IMPLANTOLOGY AND RESTORATIVE DENTISTRY; DENTAL RESINS, NAMELY, PLASTICS FOR DENTAL PROSTHESES, DENTAL BRIDGES AND DENTAL CROWNS; LOW TEMPERATURE MELTABLE CERAMIC MASSES FOR INLAYS, OVERLAYS, AND VENEERS; METAL CERAMIC MASSES AND THEIR AUXILIARIES, NAMELY, MODELING LIQUIDS, SEPARATING AGENTS; CERAMIC STAINS FOR DENTAL CERAMIC MASSES AND THEIR AUXILIARIES, NAMELY, STAINING FLUIDS AND FLUXES, ALL FOR DENTAL AND DENTAL TECHNICAL PURPOSES; COLOR INDICATORS COMPRISING A REPRODUCTION OF TEETH COLORS AND SPECIFICATION OF COMPONENTS TO BE MIXED FOR PRODUCING DENTAL PROSTHESES IN THE DESIRED COLOR, ALL FOR DENTAL AND DENTAL TECHNICAL PURPOSES, IN CLASS 5 (U.S. CLS. 6, 18, 44, 46, 51 AND 52).

FOR: SCIENTIFIC, ELECTRIC, ELECTRONIC, OPTICAL AND MEASURING APPARATUS AND INSTRUMENTS FOR DENTAL USE, NAMELY, SCANNERS FOR DENTAL USE; COMPUTERS AND DATA PROCESSING EQUIPMENT AND CAD-CAM COMPUTER PROGRAMS FOR THE

COMPUTER AIDED DESIGN AND MANUFACTURE OF DENTAL CROWNS, DENTAL BRIDGES, DENTAL IMPLANTS, DENTAL FILLINGS, DENTAL ABUTMENTS, DENTAL ATTACHMENTS AND PARTIAL DENTURES, IN CLASS 9 (U.S. CLS. 21, 23, 26, 36 AND 38).

FOR: DENTAL APPARATUS AND INSTRUMENTS, NAMELY, DENTAL IMPLANTS, ARTIFICIAL TEETH, DENTAL BRIDGES AND CROWNS; DENTAL PROSTHESES, NAMELY, CROWNS, BRIDGES, INLAYS, ON LAYS, VENEERS, DENTAL ABUTMENTS, DENTAL ATTACHMENTS, AND PARTIAL DENTURES; DENTAL ARTICULATORS; AND PLASTIC MATERIAL FOR PRODUCING, RELINING AND REPAIR OF DENTAL PROSTHESES, IN CLASS 10 (U.S. CLS. 26, 39 AND 44).

PRIORITY CLAIMED UNDER SEC. 44(D) ON FED REP GERMANY APPLICATION NO. 30578164.2, FILED 12-13-2005, REG. NO. 30578164, DATED 4-27-2006, EXPIRES 12-31-2015.

THE COLOR(S) BLACK, SALMON, RED AND LIGHT RED IS/ARE CLAIMED AS A FEATURE OF THE MARK.

ALL OF THE WORDING IN THE MARK IS SHOWN IN BLACK, THE COLORS RED, SALMON AND LIGHT RED APPEAR IN THE DESIGN OF THE SIX QUADRILATERALS.

SER. NO. 76-660,751, FILED 5-30-2006.

SHANNON TWOHIG, EXAMINING ATTORNEY

Int. Cls.: 21 and 35

**Prior U.S. Cls.: 2, 13, 23, 29, 30, 33, 40, 50, 100, 101
and 102**

Reg. No. 3,478,519

United States Patent and Trademark Office

Registered Aug. 5, 2008

**TRADEMARK
SERVICE MARK
PRINCIPAL REGISTER**

STERLING CUT GLASS

STERLING CUT GLASS COMPANY, INC. (OHIO CORPORATION)
3233 MINEOLA PIKE
ERLANGER, KY 41018

FOR: GLASSWARE, NAMELY, GLASS BEVERAGE WARE, GLASS BOWLS, GLASS CARAFES, GLASS BAR WARE, ETCHED GLASS COMMEMORATIVE ITEMS, ETCHED GLASS AWARDS, ETCHED GLASS CRYSTAL, IN CLASS 21 (U.S. CLS. 2, 13, 23, 29, 30, 33, 40 AND 50).

FIRST USE 0-0-1950; IN COMMERCE 0-0-1950.

FOR: MAIL ORDER CATALOG SERVICES FEATURING GLASSWARE, GLASS BOWLS, GLASS DECANTERS, GLASS BAR WARE, GLASS STEM WARE, GLASS TROPHIES AND AWARDS, GLASS PAPERWEIGHTS, GLASS VASES, GLASS PICTURE FRAMES, GIFTWARE, ETCHED GLASS ITEMS; COMPUTERIZED ON-LINE RETAIL STORE SERVICES IN THE FIELD OF GLASSWARE, GLASS BOWLS, GLASS DECANTERS, GLASS BAR WARE, GLASS STEM WARE, GLASS TROPHIES AND AWARDS, GLASS PAPERWEIGHTS, GLASS VASES, GLASS PICTURE FRAMES, GIFTWARE, ETCHED GLASS ITEMS, CERAMIC TABLEWARE; RETAIL STORE SERVICES FEATURING GLASSWARE, GLASS BOWLS, GLASS DECANTERS, GLASS BAR

WARE, GLASS STEM WARE, CRYSTAL, GLASS TROPHIES AND AWARDS, GLASS PAPERWEIGHTS, GLASS VASES, GLASS PICTURE FRAMES, ETCHED GLASS ITEMS, FLATWARE, TABLE LINENS, CERAMICS, WOODENWARE, BOTANICALS, CANDLES, LIGHTING ACCESSORIES, PICTURE FRAMES, WALL ART, JEWELRY, GIFTWARE; GLASSWARE, NAMELY, GLASS BEVERAGE WARE, GLASS BOWLS, GLASS CARAFES, GLASS BAR WARE, ETCHED GLASS COMMEMORATIVE ITEMS, ETCHED GLASS AWARDS, ETCHED GLASS CRYSTAL, IN CLASS 35 (U.S. CLS. 100, 101 AND 102).

FIRST USE 0-0-1950; IN COMMERCE 0-0-1950.

THE MARK CONSISTS OF STANDARD CHARACTERS WITHOUT CLAIM TO ANY PARTICULAR FONT, STYLE, SIZE, OR COLOR.

NO CLAIM IS MADE TO THE EXCLUSIVE RIGHT TO USE "CUT GLASS", APART FROM THE MARK AS SHOWN.

SER. NO. 76-662,683, FILED 7-7-2006.

JENNIFER DIXON, EXAMINING ATTORNEY

Prior U.S. Cl.: B

United States Patent and Trademark Office

Reg. No. 3,478,520

Registered Aug. 5, 2008

**CERTIFICATION MARK
PRINCIPAL REGISTER**

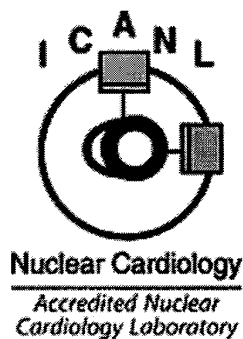

INTERSOCIETAL ACCREDITATION COMMISSION (MARYLAND CORPORATION)

8830 STANFORD BOULEVARD
SUITE 306
COLOMBIA, MD 21045

FOR: NUCLEAR CARDIOLOGY LABORATORIES, IN CLASS B (U.S. CL. B).

FIRST USE 2-1-2006; IN COMMERCE 2-1-2006.

NO CLAIM IS MADE TO THE EXCLUSIVE RIGHT TO USE "NUCLEAR CARDIOLOGY", APART FROM THE MARK AS SHOWN.

THE CERTIFICATION MARK, AS USED BY PERSONS AUTHORIZED BY THE CERTIFIER, CERTIFIES THAT THE LABORATORY HAS UNDERGONE A QUALITY REVIEW THAT INCLUDES PERSONNEL, PHYSICAL FACILITIES, EQUIPMENT AND INSTRUMENTATION, PROTOCOLS AND PROCEDURES, AND IMAGE QUALITY AND REPORTING.

SEC. 2(F) AS TO "ACCREDITED NUCLEAR CARDIOLOGY LABORATORY".

SER. NO. 76-663,031, FILED 7-14-2006.

MICHAEL SOUDERS, EXAMINING ATTORNEY

Int. Cl.: 35

Prior U.S. Cls.: 100, 101 and 102

United States Patent and Trademark Office

Reg. No. 3,478,521

Registered Aug. 5, 2008

**SERVICE MARK
PRINCIPAL REGISTER**

E361

THE EQUUS GROUP, INC. (NEVADA CORPORATION)
24 ROY STREET, STE. 460
SEATTLE, WA 98109

FOR: MARKETING AND RESEARCH SERVICES AND CONSULTING, NAMELY, CONDUCTING CUSTOMER SATISFACTION EVALUATIONS AND SURVEYS; CONDUCTING ONLINE BUSINESS MANAGEMENT RESEARCH SURVEYS TO DETERMINE CUSTOMER SATISFACTION AND WEBSITE USAGE, IN CLASS 35 (U.S. CLS. 100, 101 AND 102).

FIRST USE 8-1-2001; IN COMMERCE 8-1-2001.

THE MARK CONSISTS OF STANDARD CHARACTERS WITHOUT CLAIM TO ANY PARTICULAR FONT, STYLE, SIZE, OR COLOR.

SER. NO. 76-664,117, FILED 8-4-2006.

STEPHANIE ALI, EXAMINING ATTORNEY

Int. Cl.: 35

Prior U.S. Cls.: 100, 101 and 102

United States Patent and Trademark Office

Reg. No. 3,478,522

Registered Aug. 5, 2008

**SERVICE MARK
PRINCIPAL REGISTER**

ENTERPRISE 361

THE EQUUS GROUP, INC. (WASHINGTON CORPORATION)
24 ROY STREET, STE. 460
SEATTLE, WA 98109

FOR: MARKETING AND RESEARCH SERVICES AND CONSULTING, NAMELY, CONDUCTING CUSTOMER SATISFACTION EVALUATIONS AND SURVEYS; CONDUCTING ONLINE BUSINESS MANAGEMENT RESEARCH SURVEYS TO DETERMINE CUSTOMER SATISFACTION AND WEBSITE USAGE, IN CLASS 35 (U.S. CLS. 100, 101 AND 102).

FIRST USE 8-1-2001; IN COMMERCE 8-1-2001.

THE MARK CONSISTS OF STANDARD CHARACTERS WITHOUT CLAIM TO ANY PARTICULAR FONT, STYLE, SIZE, OR COLOR.

NO CLAIM IS MADE TO THE EXCLUSIVE RIGHT TO USE "ENTERPRISE", APART FROM THE MARK AS SHOWN.

SER. NO. 76-664,118, FILED 8-4-2006.

STEPHANIE ALI, EXAMINING ATTORNEY

Int. Cl.: 16

Prior U.S. Cls.: 2, 5, 22, 23, 29, 37, 38 and 50

United States Patent and Trademark Office

Reg. No. 3,478,523

Registered Aug. 5, 2008

**TRADEMARK
PRINCIPAL REGISTER**

KALTOONS

KALLAUGHER, KEVIN (UNITED STATES INDIVIDUAL)
29 CHATSWORTH AVENUE
GLYNDON, MD 21071

THE MARK CONSISTS OF STANDARD CHARACTERS WITHOUT CLAIM TO ANY PARTICULAR FONT, STYLE, SIZE, OR COLOR.

FOR: CARTOON PRINTS REGARDING POLITICAL SATIRE AND COMMENTARY, IN CLASS 16 (U.S. CLS. 2, 5, 22, 23, 29, 37, 38 AND 50).

SER. NO. 76-664,376, FILED 8-9-2006.

FIRST USE 11-1-1992; IN COMMERCE 6-1-2006.

BARBARA GAYNOR, EXAMINING ATTORNEY

Int. Cls.: 7 and 42

Prior U.S. Cls.: 13, 19, 21, 23, 31, 34, 35, 100 and 101

Reg. No. 3,478,524

United States Patent and Trademark Office

Registered Aug. 5, 2008

**TRADEMARK
SERVICE MARK
PRINCIPAL REGISTER**

HELIFLEX

ITI SCOTLAND LIMITED (UNITED KINGDOM CORPORATION)
191 WEST GEORGE STREET
GLASGOW G2 2LB, UNITED KINGDOM

FOR: MACHINES AND MACHINE TOOLS ALL FOR THE MANUFACTURE OF PIPES AND TUBES, NAMELY, PIPELINES, SEAM WELDED PIPES AND TUBES, SPIRAL WOUND PIPES AND TUBES, INTERLOCKING PIPES AND TUBES, SPIRAL WOUND INTERLOCKING PIPES AND TUBES, REINFORCED PIPES AND TUBES, MULTI-LAYER PIPES AND TUBES, COMPOSITE PIPES AND TUBES, ADHESIVELY BONDED PIPES AND TUBES, PIPES AND TUBES HAVING NON-METALLIC PORTIONS THEREOF, FLEXIBLE AND RIGID PIPES AND TUBES, PIPES AND TUBES HAVING END FITTINGS FOR CONNECTION TO FURTHER PIPES AND TUBES OR OTHER CONNECTION DEVICES OR FIXTURES AND/OR FITTINGS, PIPES AND TUBES LINED WITH NON-METALLIC MATERIALS, BARRELS AND BALLISTIC DEVICES COMPRISING PIPES OR TUBES, PLATFORMS, POSTS, MASTS, TUBULAR SUPPORT STRUCTURES, SUPPORT STRUCTURES, TOWERS, PYLONS, METAL PIPE FITTINGS, PARTS AND FITTINGS FOR ALL THE AFORESAID GOODS, IN CLASS 7 (U.S. CLS. 13, 19, 21, 23, 31, 34 AND 35).

FOR: SCIENTIFIC CONSULTATION, TECHNICAL ADVISORY, AND TECHNOLOGICAL CONSULTATION SERVICES AND RESEARCH AND DESIGN SERVICES RELATING TO THE MANUFACTURE OF METAL AND NON-METALLIC PIPES AND TUBES, BARRELS AND BALLISTIC DEVICES COMPRISING PIPES OR TUBES, PLATFORMS, POSTS, MASTS, TUBULAR SUPPORT STRUCTURES, SUPPORT STRUCTURES, TOWERS, PYLONS AND/OR PARTS AND FITTINGS FOR THE AFORESAID GOODS, IN CLASS 42 (U.S. CLS. 100 AND 101).

THE MARK CONSISTS OF STANDARD CHARACTERS WITHOUT CLAIM TO ANY PARTICULAR FONT, STYLE, SIZE, OR COLOR.

PRIORITY CLAIMED UNDER SEC. 44(D) ON UNITED KINGDOM APPLICATION NO. 2417581, FILED 3-23-2006, REG. NO. 2417581A, DATED 3-23-2006, EXPIRES 3-23-2016.

SER. NO. 76-666,319, FILED 9-19-2006.

PRISCILLA MILTON, EXAMINING ATTORNEY

Int. Cl.: 35

Prior U.S. Cls.: 100, 101 and 102

United States Patent and Trademark Office

Reg. No. 3,478,525

Registered Aug. 5, 2008

**SERVICE MARK
PRINCIPAL REGISTER**

NATIONAL EXPRESS CREDIT CLUB

NATIONAL EXPRESS CREDIT CORP. (DELA-
WARE CORPORATION)
800 DELAWARE AVENUE, 1ST FLOOR
WILMINGTON, DE 19801

FOR: MEMBERSHIP SERVICES, NAMELY, AD-
MINISTRATION OF A DISCOUNT PROGRAM FOR
ENABLING PARTICIPANTS TO OBTAIN DIS-
COUNTS AND BENEFITS IN THE FORM OF PRE-
SCRIPTION BENEFIT SERVICES, CAR RENTAL
SERVICE DISCOUNTS, AUTO SERVICE DIS-
COUNTS, HOTEL CHAIN SERVICE DISCOUNTS,
SHOPPING DISCOUNTS, AND FREE CREDIT RE-
PORT SERVICES THROUGH USE OF A MEMBER-
SHIP CARD, IN CLASS 35 (U.S. CLS. 100, 101 AND
102).

FIRST USE 6-0-2004; IN COMMERCE 6-0-2004.

THE MARK CONSISTS OF STANDARD CHAR-
ACTERS WITHOUT CLAIM TO ANY PARTICULAR
FONT, STYLE, SIZE, OR COLOR.

OWNER OF U.S. REG. NOS. 3,022,581 AND
3,069,842.

NO CLAIM IS MADE TO THE EXCLUSIVE
RIGHT TO USE "NATIONAL" AND "CREDIT
CLUB", APART FROM THE MARK AS SHOWN.

SER. NO. 76-667,068, FILED 10-6-2006.

SUNG IN, EXAMINING ATTORNEY

Int. Cls.: 35, 38, 41, 42 and 45

Prior U.S. Cls.: 100, 101, 102, 104 and 107

United States Patent and Trademark Office

Reg. No. 3,478,526

Registered Aug. 5, 2008

**SERVICE MARK
PRINCIPAL REGISTER**

**INFORMATION AS AN
ELEMENT OF POWER**

THE RENDON GROUP INCORPORATED (D.C.
CORPORATION)
1875 CONNECTICUT AVENUE, NW
SUITE 414
WASHINGTON, DC 20009

FOR: SERVICES RELATING TO GOVERNMENT,
MILITARY AND CORPORATE STRATEGIES, OP-
ERATIONS AND TACTICS, NAMELY, PUBLIC RE-
LATIONS, BUSINESS MANAGEMENT
CONSULTING, AND THE DEVELOPMENT OF
PROCESSES FOR THE ANALYSIS AND IMPL-
EMENTATION OF STRATEGY PLANS AND MAN-
AGEMENT PROJECTS, DEVELOPING
PROMOTIONAL CAMPAIGNS AND PRODUCING
PROMOTIONAL VIDEOTAPES, VIDEO DISCS, AND
AUDIO VISUAL RECORDINGS, IN CLASS 35 (U.S.
CLS. 100, 101 AND 102).

FIRST USE 2-0-1995; IN COMMERCE 2-0-1995.

FOR: SERVICES RELATING TO GOVERNMENT,
MILITARY AND CORPORATE STRATEGIES, OP-
ERATIONS AND TACTICS, NAMELY, TELECOM-
MUNICATION CONSULTATION IN THE NATURE
OF TECHNICAL CONSULTING IN THE FIELD OF
AUDIO, VIDEO, TEXT, AND VISUAL DATA
TRANSMISSION AND COMMUNICATION, AND
COMMUNICATION CONSULTATION WITH RE-
GARD TO COMMUNICATING DURING TIMES
OF CRISIS, IN CLASS 38 (U.S. CLS. 100, 101 AND 104).

FIRST USE 2-0-1995; IN COMMERCE 2-0-1995.

FOR: SERVICES RELATING TO GOVERNMENT,
MILITARY AND CORPORATE STRATEGIES, OP-

ERATIONS AND TACTICS, NAMELY, TRAINING
SERVICES IN THE FIELDS OF COMMUNICATION
STRATEGIES AND PUBLIC AND MEDIA RELA-
TIONS, AND PRODUCTION OF AUDIO AND VI-
DEO TAPES, VIDEO DISCS AND RECORDINGS, IN
CLASS 41 (U.S. CLS. 100, 101 AND 107).

FIRST USE 2-0-1995; IN COMMERCE 2-0-1995.

FOR: SERVICES RELATING TO GOVERNMENT,
MILITARY AND CORPORATE STRATEGIES, OP-
ERATIONS AND TACTICS, NAMELY, WEBSITE
DEVELOPMENT FOR OTHERS, IN CLASS 42 (U.S.
CLS. 100 AND 101).

FIRST USE 2-0-1995; IN COMMERCE 2-0-1995.

FOR: SERVICES RELATING TO GOVERNMENT,
MILITARY AND CORPORATE STRATEGIES, OP-
ERATIONS AND TACTICS, NAMELY, MILITARY
SCIENCE SERVICES, SPECIFICALLY ANALYZING
WAR COMMUNICATION STRATEGIES AND PRO-
VIDING INFORMATION IN THE FIELD OF MILI-
TARY, AND MILITARY TACTICS AND
STRATEGIES, IN CLASS 45 (U.S. CLS. 100 AND 101).

FIRST USE 2-0-1995; IN COMMERCE 2-0-1995.

THE MARK CONSISTS OF STANDARD CHAR-
ACTERS WITHOUT CLAIM TO ANY PARTICULAR
FONT, STYLE, SIZE, OR COLOR.

SER. NO. 76-667,518, FILED 10-13-2006.

JOHN DWYER, EXAMINING ATTORNEY

Int. Cl.: 38

Prior U.S. Cls.: 100, 101 and 104

United States Patent and Trademark Office

Reg. No. 3,478,527

Registered Aug. 5, 2008

**SERVICE MARK
PRINCIPAL REGISTER**

get to the good stuff

GOTUIT MEDIA CORP. (DELAWARE CORPORATION)
15A CONSTITUTION WAY
WOBURN, MA 01801

FOR: OVER THE AIR BROADCASTS AND SATELLITE TRANSMISSION OF AUDIO AND VIDEO MATERIAL; VIDEO ON DEMAND TRANSMISSION SERVICES OFFERED VIA CABLE, SATELLITE, INTERNET PROTOCOL TELEVISION AND WIRELESS NETWORKS, IN CLASS 38 (U.S. CLS. 100, 101 AND 104).

FIRST USE 6-1-2001; IN COMMERCE 6-1-2001.

THE MARK CONSISTS OF STANDARD CHARACTERS WITHOUT CLAIM TO ANY PARTICULAR FONT, STYLE, SIZE, OR COLOR.

SER. NO. 76-668,361, FILED 11-1-2006.

ALYSSA PALADINO, EXAMINING ATTORNEY

Int. Cl.: 12

Prior U.S. Cls.: 19, 21, 23, 31, 35 and 44

United States Patent and Trademark Office

Reg. No. 3,478,528

Registered Aug. 5, 2008

**TRADEMARK
PRINCIPAL REGISTER**

A B I N F L A T A B L E S

HEYER, IVOR (VENEZUELA INDIVIDUAL)
CARRETERA LA RAIZA
URBANIZACION INDUSTRIAL DOS LAGUNAS, AVENIDA, 1, GALPON NO. 10
SANTA TERESA DEL TUY, EDO. MIRANDA, VENEZUELA

FOR: INFLATABLE BOATS WITH OR WITHOUT A RIGID HULL, IN CLASS 12 (U.S. CLS. 19, 21, 23, 31, 35 AND 44).

FIRST USE 10-1-1994; IN COMMERCE 6-1-2005.

THE MARK CONSISTS OF STANDARD CHARACTERS WITHOUT CLAIM TO ANY PARTICULAR FONT, STYLE, SIZE, OR COLOR.

NO CLAIM IS MADE TO THE EXCLUSIVE RIGHT TO USE "INFLATABLES", APART FROM THE MARK AS SHOWN.

SER. NO. 76-668,929, FILED 11-13-2006.

DAWN HAN, EXAMINING ATTORNEY

Int. Cls.: 1 and 17

Prior U.S. Cls.: 1, 5, 6, 10, 12, 13, 26, 35, 46 and 50

United States Patent and Trademark Office

Reg. No. 3,478,529

Registered Aug. 5, 2008

**TRADEMARK
PRINCIPAL REGISTER**

PARAPET

KURARAY CO., LTD. (JAPAN CORPORATION)
1621, SAKAZU
KURASHIKI CITY, OKAYAMA PREFECTURE, JAPAN

FOR: (BASED ON 44(E) PURSUANT TO JAPANESE FOREIGN REGISTRATION NUMBER 504163) UNPROCESSED ARTIFICIAL AND SYNTHETIC RESINS; UNPROCESSED PLASTICS, IN CLASS 1 (U.S. CLS. 1, 5, 6, 10, 26 AND 46).

FOR: (BASED ON 44(E) PURSUANT TO JAPANESE FOREIGN REGISTRATION NUMBER 503791) SEMI-FINISHED ARTIFICIAL AND SYNTHETIC RESINS IN BARS, BLOCKS, PELLETS, RODS, SHEETS AND TUBES FOR GENERAL INDUSTRIAL USE; EXTRUDED AND CASTED PLASTIC IN THE FORM OF BARS, BLOCKS, PELLETS, RODS,

SHEETS AND TUBES FOR USE IN MANUFACTURING; AND SEMI-PROCESSED PLASTIC IN THE FORM OF FILMS, SHEETS, TUBES, BARS OR RODS, IN CLASS 17 (U.S. CLS. 1, 5, 12, 13, 35 AND 50).

THE MARK CONSISTS OF STANDARD CHARACTERS WITHOUT CLAIM TO ANY PARTICULAR FONT, STYLE, SIZE, OR COLOR.

OWNER OF JAPAN REG. NO. 5038791, DATED 4-6-2007, EXPIRES 4-6-2017.

OWNER OF JAPAN REG. NO. 5041063, DATED 4-13-2007, EXPIRES 4-13-2017.

SER. NO. 76-669,035, FILED 11-13-2006.

TINA L. SNAPP, EXAMINING ATTORNEY

Int. Cl.: 12

Prior U.S. Cls.: 19, 21, 23, 31, 35 and 44

Reg. No. 3,478,530

United States Patent and Trademark Office

Registered Aug. 5, 2008

**TRADEMARK
PRINCIPAL REGISTER**



HEYER, IVOR (VENEZUELA INDIVIDUAL)

CARRETERA LA RAIZA

URBANIZACION INDUSTRIAL DOS LAGUNASA-
VENIDA, 1, GALPON NO. 10

SANTA TERESA DEL TUY, EDO. MIRANDA, VE-
NEZUELA

FOR: INFLATABLE BOATS WITH OR WITHOUT
A RIGID HULL, IN CLASS 12 (U.S. CLS. 19, 21, 23, 31,
35 AND 44).

FIRST USE 10-1-1994; IN COMMERCE 6-1-2005.

SER. NO. 76-669,530, FILED 11-27-2006.

DAWN HAN, EXAMINING ATTORNEY

Int. Cl.: 5

Prior U.S. Cls.: 6, 18, 44, 46, 51 and 52

Reg. No. 3,478,531

United States Patent and Trademark Office

Registered Aug. 5, 2008

**TRADEMARK
PRINCIPAL REGISTER**

AYURVEDA MADE EASY

KOMAL HERBALS, INC. (PENNSYLVANIA CORPORATION)
207-8 OVERLOOK DRIVE
SEWICKLEY, PA 151432305

FOR: AYURVEDIC DIETARY AND NUTRITIONAL SUPPLEMENTS, IN CLASS 5 (U.S. CLS. 6, 18, 44, 46, 51 AND 52).

FIRST USE 9-21-2006; IN COMMERCE 9-21-2006.

THE MARK CONSISTS OF STANDARD CHARACTERS WITHOUT CLAIM TO ANY PARTICULAR FONT, STYLE, SIZE, OR COLOR.

NO CLAIM IS MADE TO THE EXCLUSIVE RIGHT TO USE "AYURVEDA", APART FROM THE MARK AS SHOWN.

SER. NO. 76-670,280, FILED 12-13-2006.

ALYSSA PALADINO, EXAMINING ATTORNEY

Int. Cl.: 38

Prior U.S. Cls.: 100, 101 and 104

United States Patent and Trademark Office

Reg. No. 3,478,532

Registered Aug. 5, 2008

**SERVICE MARK
PRINCIPAL REGISTER**

SceneMaker

GOTUIT MEDIA CORP. (DELAWARE CORPORATION)
15A CONSTITUTION WAY
WOBURN, MA 01801

FOR: OVER THE AIR BROADCASTS AND SATELLITE TRANSMISSION OF AUDIO AND VIDEO MATERIAL; VIDEO ON DEMAND TRANSMISSION SERVICES OFFERED VIA CABLE, SATELLITE, INTERNET PROTOCOL TELEVISION AND WIRELESS NETWORKS, IN CLASS 38 (U.S. CLS. 100, 101 AND 104).

FIRST USE 12-12-2006; IN COMMERCE 12-12-2006.

THE MARK CONSISTS OF STANDARD CHARACTERS WITHOUT CLAIM TO ANY PARTICULAR FONT, STYLE, SIZE, OR COLOR.

SER. NO. 76-670,944, FILED 12-29-2006.

ALYSSA PALADINO, EXAMINING ATTORNEY

Int. Cls.: 9 and 42

Prior U.S. Cls.: 21, 23, 26, 36, 38, 100 and 101

United States Patent and Trademark Office

Reg. No. 3,478,533

Registered Aug. 5, 2008

**TRADEMARK
SERVICE MARK
PRINCIPAL REGISTER**

TARGETOR

TARGETOR OY (FINLAND CORPORATION)
VOIMATIE 6B
90440 KEMPELE, FINLAND

FOR: COMPUTER SOFTWARE PROGRAMS FOR VISUALIZING, COMMUNICATING, PLANNING, MANAGING, IMPLEMENTING, EXECUTING, MEASURING AND REPORTING STRATEGIES IN THE PUBLIC SECTOR AND CORPORATE SETTINGS; COMPUTER SOFTWARE PROGRAMS FOR PLANNING AND STRATEGIC PERFORMANCE, BUSINESS INTELLIGENCE, SCORE CARDING, BUSINESS DEVELOPMENT AND MANAGEMENT AND BUSINESS PROCESS DEVELOPMENT IN THE PUBLIC SECTOR AND IN CORPORATE SETTINGS; COMPUTER SOFTWARE PROGRAMS THAT MEASURE CUSTOMER AND END USER EXPERIENCES OF STRATEGY AND PERFORMANCE MANAGEMENT IN A PUBLIC SECTOR AND CORPORATE SETTING, IN CLASS 9 (U.S. CLS. 21, 23, 26, 36 AND 38).

FOR: HOSTING OF DIGITAL CONTENT FEATURING STRATEGY, VISUALIZING, COMMUNICATION, PLANNING, MANAGEMENT, IMPLEMENTATION, EXECUTION, MEASURING AND REPORTING, BUSINESS DEVELOPMENT AND MANAGEMENT, PERFORMANCE PLANNING AND MANAGEMENT, BUSINESS INTELLI-

GENCE, SCORE CARDING, BUSINESS PROCESS DEVELOPMENT, PLANNING AND MANAGEMENT AS WELL AS THE MEASUREMENT OF END-USERS' AND CUSTOMERS' EXPERIENCES; APPLICATION SERVICES PROVIDER, NAMELY, HOSTING AND MANAGING APPLICATION FEATURING BUSINESS STRATEGY, VISUALIZING, COMMUNICATION, PLANNING, MANAGEMENT, IMPLEMENTATION, EXECUTION, MEASURING AND REPORTING, BUSINESS DEVELOPMENT AND MANAGEMENT, PERFORMANCE PLANNING AND MANAGEMENT, BUSINESS INTELLIGENCE, SCORE CARDING, BUSINESS PROCESS DEVELOPMENT, PLANNING AND MANAGEMENT AS WELL AS THE MEASUREMENT OF END-USERS' AND CUSTOMERS' EXPERIENCES, IN CLASS 42 (U.S. CLS. 100 AND 101).

THE MARK CONSISTS OF STANDARD CHARACTERS WITHOUT CLAIM TO ANY PARTICULAR FONT, STYLE, SIZE, OR COLOR.

OWNER OF ERPN CMNTY TM OFC REG. NO. 005429667, DATED 1-7-2008, EXPIRES 11-28-2016.

SER. NO. 76-670,945, FILED 1-3-2007.

CHARLES L. JENKINS, EXAMINING ATTORNEY

Int. Cl.: 16

Prior U.S. Cls.: 2, 5, 22, 23, 29, 37, 38 and 50

Reg. No. 3,478,534

United States Patent and Trademark Office

Registered Aug. 5, 2008

**TRADEMARK
PRINCIPAL REGISTER**

FREESMART

MARION, JOSEPH (UNITED STATES INDIVIDUAL)
P.O. BOX 5548
SANTA BARBARA, CA 93150

A SUPRANATURAL LIFESTYLE; PHOTOGRAPHS, PRINTED INSTRUCTIONAL AND TEACHING MATERIALS ON ADVANCED CULTURE CUSTOMS, IN CLASS 16 (U.S. CLS. 2, 5, 22, 23, 29, 37, 38 AND 50).

FOR: PAPER, PRINTED MATTER, NAMELY, NEWSPRINT PAPER, PRODUCT GUIDES, BOOKS, MAGAZINES, POSTERS, PRINTED CERTIFICATES PROMOTING ADVANCED PHILOSOPHIC AND ECOLOGIC PRODUCTS AND PROCESSES FEATURING SUPERCONSCIOUS STEWARDSHIP OF ENVIRONMENT RESOURCES, PROGRESSED HUMAN RIGHTS, PEACEFUL SECURITY, ORGANIC DYNAMIC AGRICULTURE, RENEWABLE ENERGY, BOOMER ECONOMY, NATURAL HEALTH, PROGRESSIVE GOVERNANCE, THE MASTERY OF

FIRST USE 1-5-2006; IN COMMERCE 1-5-2007.

THE MARK CONSISTS OF STANDARD CHARACTERS WITHOUT CLAIM TO ANY PARTICULAR FONT, STYLE, SIZE, OR COLOR.

SER. NO. 76-672,088, FILED 2-1-2007.

ARETHA SOMERVILLE, EXAMINING ATTORNEY

Int. Cl.: 30

Prior U.S. Cl.: 46

United States Patent and Trademark Office

Reg. No. 3,478,535

Registered Aug. 5, 2008

**TRADEMARK
PRINCIPAL REGISTER**

Hot Puppies

HOT TAR, INC. (GEORGIA CORPORATION)
P.O. BOX 786
CAIRO, GA 39828

NO CLAIM IS MADE TO THE EXCLUSIVE
RIGHT TO USE "HOT", APART FROM THE MARK
AS SHOWN.

FOR: HUSH PUPPIES, IN CLASS 30 (U.S. CL. 46).

FIRST USE 10-1-2004; IN COMMERCE 10-1-2004.

SER. NO. 76-672,103, FILED 1-30-2007.

THE MARK CONSISTS OF STANDARD CHAR-
ACTERS WITHOUT CLAIM TO ANY PARTICULAR
FONT, STYLE, SIZE, OR COLOR.

DORITT L. CARROLL, EXAMINING ATTORNEY

Int. Cl.: 28

Prior U.S. Cls.: 22, 23, 38 and 50

United States Patent and Trademark Office

Reg. No. 3,478,536

Registered Aug. 5, 2008

**TRADEMARK
PRINCIPAL REGISTER**

WILD BEARS

SNUGGIE TOY INC. (NEW YORK CORPORATION)

1670 OLD COUNTRY ROAD, STE. 203

PLAINVIEW, NY 11803

FOR: PLUSH TOY STUFFED ANIMAL, IN CLASS 28 (U.S. CLS. 22, 23, 38 AND 50).

FIRST USE 11-1-2006; IN COMMERCE 11-1-2006.

THE MARK CONSISTS OF STANDARD CHARACTERS WITHOUT CLAIM TO ANY PARTICULAR FONT, STYLE, SIZE, OR COLOR.

NO CLAIM IS MADE TO THE EXCLUSIVE RIGHT TO USE "BEARS", APART FROM THE MARK AS SHOWN.

SER. NO. 76-673,553, FILED 3-5-2007.

ALICIA COLLINS, EXAMINING ATTORNEY

Int. Cl.: 28

Prior U.S. Cls.: 22, 23, 38 and 50

United States Patent and Trademark Office

Reg. No. 3,478,537

Registered Aug. 5, 2008

**TRADEMARK
PRINCIPAL REGISTER**

FRUITY BEARS

SNUGGIE TOY INC. (NEW YORK CORPORATION)

1670 OLD COUNTRY ROAD, STE. 203

PLAINVIEW, NY 11803

FOR: PLUSH TOY STUFFED ANIMAL, IN CLASS
28 (U.S. CLS. 22, 23, 38 AND 50).

FIRST USE 11-1-2006; IN COMMERCE 11-1-2006.

THE MARK CONSISTS OF STANDARD CHARACTERS WITHOUT CLAIM TO ANY PARTICULAR FONT, STYLE, SIZE, OR COLOR.

NO CLAIM IS MADE TO THE EXCLUSIVE RIGHT TO USE "BEARS", APART FROM THE MARK AS SHOWN.

SER. NO. 76-673,554, FILED 3-5-2007.

ALICIA COLLINS, EXAMINING ATTORNEY

Int. Cl.: 9

Prior U.S. Cls.: 21, 23, 26, 36 and 38

United States Patent and Trademark Office

Reg. No. 3,478,538

Registered Aug. 5, 2008

**TRADEMARK
PRINCIPAL REGISTER**

TECHNIPPY

WILZIG, IVAN (UNITED STATES INDIVIDUAL)
5 WEST HOUSTON STREET, SUITE 7D
NEW YORK, NY 10022

FOR: DOWNLOADABLE MP3 FILES, MP3 RE-
CORDINGS, WEB CASTS, POD CASTS FEATURING
MUSIC, IN CLASS 9 (U.S. CLS. 21, 23, 26, 36 AND 38).

FIRST USE 3-12-2007; IN COMMERCE 3-12-2007.

THE MARK CONSISTS OF STANDARD CHAR-
ACTERS WITHOUT CLAIM TO ANY PARTICULAR
FONT, STYLE, SIZE, OR COLOR.

SER. NO. 76-674,201, FILED 3-19-2007.

WILLIAM BRECKENFELD, EXAMINING ATTOR-
NEY

Int. Cls.: 9, 21 and 25

**Prior U.S. Cls.: 2, 13, 21, 22, 23, 26, 29, 30, 33, 36, 38,
39, 40 and 50**

Reg. No. 3,478,539

United States Patent and Trademark Office

Registered Aug. 5, 2008

**TRADEMARK
PRINCIPAL REGISTER**

SIR IVAN

WILZIG, IVAN (UNITED STATES INDIVIDUAL)
25 WEST HOUSTON STREET, SUITE 7D
NEW YORK, NY 10022

FOR: DOWNLOADABLE MP3 FILES, WEB
CASTS, POD CASTS FEATURING MUSIC, IN CLASS
9 (U.S. CLS. 21, 23, 26, 36 AND 38).

FIRST USE 5-14-2004; IN COMMERCE 5-14-2004.

FOR: CUPS AND MUGS, IN CLASS 21 (U.S. CLS. 2,
13, 23, 29, 30, 33, 40 AND 50).

FIRST USE 5-14-2004; IN COMMERCE 5-14-2004.

FOR: SHIRTS, BLOUSES, UNDERGARMENTS,
SWEATSHIRTS, GYM CLOTHES, T-SHIRTS, CAPS
AND PANTS, IN CLASS 25 (U.S. CLS. 22 AND 39).

FIRST USE 5-14-2004; IN COMMERCE 5-14-2004.

THE MARK CONSISTS OF STANDARD CHAR-
ACTERS WITHOUT CLAIM TO ANY PARTICULAR
FONT, STYLE, SIZE, OR COLOR.

THE NAME "SIR IVAN" DOES NOT IDENTIFY A
LIVING INDIVIDUAL.

SER. NO. 76-674,203, FILED 3-19-2007.

WILLIAM BRECKENFELD, EXAMINING ATTOR-
NEY

Int. Cls.: 6, 11, 20 and 21

Prior U.S. Cls.: 2, 12, 13, 14, 21, 22, 23, 25, 29, 30, 31, 32, 33, 34, 40 and 50

Reg. No. 3,478,540

United States Patent and Trademark Office

Registered Aug. 5, 2008

**TRADEMARK
PRINCIPAL REGISTER**



ICG LICENSING, LLC (NEW YORK LTD LIAB
CO)
3939 23RD STREET
LONG ISLAND CITY, NY 11101

FOR: METAL HOOKS; METAL CLOTHES
HOOKS; METAL DRAIN PIPES; METAL HINGES;
METAL HOSES FOR PLUMBING USE; METAL PIPE
COUPLINGS AND JOINTS; METAL KNOBS; ME-
TAL PIPE CLIPS; METAL PIPE COLLARS; METAL
PIPE CONNECTORS; METAL PIPE FITTINGS; TO-
WEL DISPENSERS OF METAL, IN CLASS 6 (U.S.
CLS. 2, 12, 13, 14, 23, 25 AND 50).

FIRST USE 5-15-2006; IN COMMERCE 5-15-2006.

FOR: SINKS; FAUCETS; SHOWERS; SHOWER
HEADS; SHOWER DOORS; SHOWER ENCLO-
SURES; PLUMBING SUPPLIES, NAMELY SINK
STRAINERS; PLUMBING FITTINGS, NAMELY,
BIBBS, COCKS, TRAPS, VALVES, IN CLASS 11 (U.S.
CLS. 13, 21, 23, 31 AND 34).

FIRST USE 5-15-2006; IN COMMERCE 5-15-2006.

FOR: FURNITURE; BATHROOM CABINETS;
KITCHEN CABINETS; MEDICINE CABINETS;
SHELVES; DRAWERS; NON-METAL HOOKS; NON-
METAL CLOTHES HOOKS; HAND-HELD MIR-
RORS; FURNITURE MIRRORS; NON-METAL
BINS; BATHROOM SHELVES; SHELVES FOR

HOLDING BATHROOM ACCESSORIES, IN CLASS
20 (U.S. CLS. 2, 13, 22, 25, 32 AND 50).

FIRST USE 5-15-2006; IN COMMERCE 5-15-2006.

FOR: CUPS; PLASTIC CUPS; HOSE NOZZLES;
PLASTIC SPRAY NOZZLES; PLASTIC BATH
RACKS; NAPKIN HOLDERS; SOAP DISPENSERS;
SOAP HOLDERS; SOAP DISH HOLDERS; SOAP
DISHES; LIQUID SOAP DISPENSERS; TOILET PA-
PER HOLDERS; TOILET BRUSHES; TOILET BRUSH
HOLDERS; SHOWER CADDIES; AND WASH BA-
SINS, IN CLASS 21 (U.S. CLS. 2, 13, 23, 29, 30, 33, 40
AND 50).

FIRST USE 5-15-2006; IN COMMERCE 5-15-2006.

THE NAME "KRAUS" DOES NOT IDENTIFY A
LIVING INDIVIDUAL.

THE MARK CONSISTS OF THE WORD "KRAUS"
IN STYLIZED FORM, WITH TWO WHITE LINES
FLOATING THROUGH THE LETTERS IN THE
WORD; TWO "TEARDROPS" ABOVE THE "A" IN
THE WORD; AND TWO CURVED LINES BELOW
THE WORD.

SER. NO. 76-674,396, FILED 3-22-2007.

ROBERT C. CLARK JR., EXAMINING ATTORNEY

Int. Cls.: 11, 20 and 21

**Prior U.S. Cls.: 2, 13, 21, 22, 23, 25, 29, 30, 31, 32, 33,
34, 40 and 50**

Reg. No. 3,478,541

United States Patent and Trademark Office

Registered Aug. 5, 2008

**TRADEMARK
PRINCIPAL REGISTER**

KRAUS

ICG LICENSING, LLC (NEW YORK LTD LIAB
CO)
3939 23RD STREET
LONG ISLAND CITY, NY 11101

FOR: SINKS; FAUCETS; SHOWERS; SHOWER
HEADS; SHOWER DOORS; SHOWER ENCLO-
SURES, IN CLASS 11 (U.S. CLS. 13, 21, 23, 31 AND 34).

FIRST USE 1-15-2001; IN COMMERCE 1-15-2001.

FOR: FURNITURE; BATHROOM CABINETS;
KITCHEN CABINETS; MEDICINE CABINETS;
SHELVES; DRAWERS; NON-METAL HOOKS; NON-
METAL CLOTHES HOOKS; HAND-HELD MIR-
RORS; FURNITURE MIRRORS; NON-METAL
BINS; BATHROOM SHELVES; SHELVES FOR
HOLDING BATHROOM ACCESSORIES, IN CLASS
20 (U.S. CLS. 2, 13, 22, 25, 32 AND 50).

FIRST USE 1-15-2001; IN COMMERCE 1-15-2001.

FOR: CUPS; PLASTIC CUPS; HOSE NOZZLES;
PLASTIC SPRAY NOZZLES; PLASTIC BATH

RACKS; NAPKIN HOLDERS; SOAP DISPENSERS;
SOAP HOLDERS; SOAP DISH HOLDERS; SOAP
DISHES; LIQUID SOAP DISPENSERS; TOILET PA-
PER HOLDERS; TOILET BRUSHES; TOILET BRUSH
HOLDERS; SHOWER CADDIES; AND WASH BA-
SINS, IN CLASS 21 (U.S. CLS. 2, 13, 23, 29, 30, 33, 40
AND 50).

FIRST USE 1-15-2001; IN COMMERCE 1-15-2001.

THE MARK CONSISTS OF STANDARD CHAR-
ACTERS WITHOUT CLAIM TO ANY PARTICULAR
FONT, STYLE, SIZE, OR COLOR.

THE NAME KRAUS DOES NOT IDENTIFY A
LIVING INDIVIDUAL.

SEC. 2(F).

SER. NO. 76-674,397, FILED S.R. 3-22-2007 AM. P.R.
11-21-2007.

ROBERT C. CLARK JR., EXAMINING ATTORNEY

Int. Cl.: 35

Prior U.S. Cls.: 100, 101 and 102

United States Patent and Trademark Office

Reg. No. 3,478,542

Registered Aug. 5, 2008

**SERVICE MARK
PRINCIPAL REGISTER**

BIG BRAND BOOK

CAMPBELL-EWALD COMPANY (DELAWARE
CORPORATION)
30400 VAN DYKE AVENUE
WARREN, MI 48093

FOR: ADVERTISING AND MARKETING SERVICES, NAMELY, DEVELOPMENT AND MANAGEMENT OF CREATIVE CONTENT AND DOCUMENTATION TO SUPPORT ADVERTISING CREATED FOR OTHERS VIA A WEB BASED WORKFLOW AND CONTENT DEVELOPMENT AND MANAGEMENT SYSTEM WHICH ALLOWS THE USER TO SEARCH A DATABASE OF APPROVED ADVERTISING STATEMENTS FOR USE

IN ADVERTISEMENTS TO PROMOTE PRODUCTS, IN CLASS 35 (U.S. CLS. 100, 101 AND 102).

FIRST USE 2-5-2007; IN COMMERCE 2-12-2007.

NO CLAIM IS MADE TO THE EXCLUSIVE RIGHT TO USE "BRAND", APART FROM THE MARK AS SHOWN.

SER. NO. 76-674,417, FILED 3-22-2007.

PRISCILLA MILTON, EXAMINING ATTORNEY

Int. Cls.: 40 and 44

Prior U.S. Cls.: 100, 101, 103 and 106

United States Patent and Trademark Office

Reg. No. 3,478,543

Registered Aug. 5, 2008

**SERVICE MARK
PRINCIPAL REGISTER**

True Reflections for Women

WRIGHT & FILIPPIS, INC. (MICHIGAN CORPORATION)
2845 CROOKS ROAD
ROCHESTER HILLS, MI 48309

FOR: CUSTOM FITTING AND FITTING CONSULTATION SERVICES FOR PATIENTS AFTER BREAST SURGERY, NAMELY, ADVICE FOR THE USE OF BRAS, CAMISOLES, SWIM WEAR, AND LINGERIE ACCESSORIES, NAMELY, REMOVABLE SILICONE BREAST ENHANCER PADS USED IN A BRA, IN CLASS 40 (U.S. CLS. 100, 103 AND 106).

FIRST USE 10-4-2005; IN COMMERCE 1-18-2007.

FOR: FITTING AND CONSULTATION SERVICES FOR PATIENTS AFTER BREAST SURGERY, NAMELY, ADVICE FOR THE USE OF BREAST

PROSTHESES, PNEUMATIC PUMPS, AND LYMPHEDEMA SLEEVES, IN CLASS 44 (U.S. CLS. 100 AND 101).

FIRST USE 10-4-2005; IN COMMERCE 2-18-2007.

THE MARK CONSISTS OF STANDARD CHARACTERS WITHOUT CLAIM TO ANY PARTICULAR FONT, STYLE, SIZE, OR COLOR.

NO CLAIM IS MADE TO THE EXCLUSIVE RIGHT TO USE "FOR WOMEN", APART FROM THE MARK AS SHOWN.

SER. NO. 76-674,614, FILED 3-26-2007.

MARY CRAWFORD, EXAMINING ATTORNEY

Int. Cls.: 14, 25, 36, 41 and 45

Prior U.S. Cls.: 2, 22, 27, 28, 39, 50, 100, 101, 102 and 107

Reg. No. 3,478,544

United States Patent and Trademark Office

Registered Aug. 5, 2008

**TRADEMARK
SERVICE MARK
PRINCIPAL REGISTER**



SPECIAL OPERATIONS WARRIOR FOUNDATION, INC. (FLORIDA CORPORATION)
4409 EL PRADO BLVD
TAMPA, FL 33629

FOR: LAPEL PINS, IN CLASS 14 (U.S. CLS. 2, 27, 28 AND 50).

FIRST USE 8-15-2001; IN COMMERCE 8-15-2001.

FOR: T-SHIRTS, POLO SHIRTS AND BASEBALL CAPS, IN CLASS 25 (U.S. CLS. 22 AND 39).

FIRST USE 8-15-2002; IN COMMERCE 8-15-2002.

FOR: CHARITABLE FUND RAISING SERVICES, NAMELY, PROVIDING COLLEGE SCHOLARSHIPS, IN CLASS 36 (U.S. CLS. 100, 101 AND 102).

FIRST USE 4-15-1995; IN COMMERCE 4-15-1995.

FOR: CHARITABLE SERVICES, NAMELY, PROVIDING EDUCATIONAL COUNSELING TO THE CHILDREN OF SURVIVING SPECIAL OPERATIONS PERSONNEL KILLED IN AN OPERATIONAL MISSION OR DURING TRAINING, IN CLASS 41 (U.S. CLS. 100, 101 AND 107).

FIRST USE 4-15-1995; IN COMMERCE 4-15-1995.

FOR: CASE MANAGEMENT SERVICES, NAMELY, COORDINATION OF SUPPORT AND ASSISTANCE WITH GOVERNMENTAL AND NON-GOVERNMENTAL AGENCIES THAT ADDRESS THE PHYSICAL, EMOTIONAL, EMPLOYMENT AND OTHER NEEDS OF SPECIAL OPERATIONS PERSONNEL WOUNDED DURING OPERATIONAL MISSIONS OR DURING TRAINING, IN CLASS 45 (U.S. CLS. 100 AND 101).

FIRST USE 4-15-1995; IN COMMERCE 4-15-1995.

NO CLAIM IS MADE TO THE EXCLUSIVE RIGHT TO USE "FOUNDATION", APART FROM THE MARK AS SHOWN.

THE MARK CONSISTS OF OVAL PATCH WITH AN ARROW NEXT TO THE SILHOUETTE OF A MAN AND WOMAN HOLDING THE HANDS OF A BOY AND GIRL SUPERIMPOSED OVER A PORTION OF THE AMERICAN FLAG WITH THE WORDS "SPECIAL OPERATIONS" ON TOP AND THE WORDS "WARRIOR FOUNDATION" ON THE BOTTOM.

SEC. 2(F) AS TO "SPECIAL OPERATIONS".

SER. NO. 76-674,922, FILED 3-30-2007.

KAELIE KUNG, EXAMINING ATTORNEY

Int. Cl.: 35

Prior U.S. Cls.: 100, 101 and 102

United States Patent and Trademark Office

Reg. No. 3,478,545

Registered Aug. 5, 2008

**SERVICE MARK
PRINCIPAL REGISTER**

AMOR A LA MÚSICA

UNIVISION COMMUNICATIONS INC. (DELA-
WARE CORPORATION)
5999 CENTER DRIVE
LOS ANGELES, CA 90045

FOR: CONCERT PROMOTION SERVICES, IN
CLASS 35 (U.S. CLS. 100, 101 AND 102).

FIRST USE 9-9-2001; IN COMMERCE 9-9-2001.

THE MARK CONSISTS OF STANDARD CHAR-
ACTERS WITHOUT CLAIM TO ANY PARTICULAR
FONT, STYLE, SIZE, OR COLOR.

NO CLAIM IS MADE TO THE EXCLUSIVE
RIGHT TO USE "MUSICA", APART FROM THE
MARK AS SHOWN.

THE ENGLISH TRANSLATION OF "AMOR A LA
MÚSICA" IS "LOVE FOR MUSIC."

SER. NO. 76-674,949, FILED 4-3-2007.

KAPIL BHANOT, EXAMINING ATTORNEY

Int. Cls.: 35 and 41

Prior U.S. Cls.: 100, 101, 102 and 107

United States Patent and Trademark Office

Reg. No. 3,478,546

Registered Aug. 5, 2008

**SERVICE MARK
PRINCIPAL REGISTER**

LFI

INTERNATIONAL ASSOCIATION OF LIGHTING
DESIGNERS, LTD. (NEW YORK NON-PROFIT
CORPORATION)

IALD HEADQUARTERS OFFICE
MERCHANDISE MART, SUITE 9-104, 200 WORLD
TRADE CENTER

CHICAGO, IL 60654 AND
PORTMAN LIGHTFAIR ASSOCIATES, L.P. (GEOR-
GIA LIMITED PARTNERSHIP)

240 PEACHTREE STREET, N.W., SUITE 2200
ATLANTA, GA 30303 AND

ILLUMINATING ENGINEERING SOCIETY OF
NORTH AMERICA (NEW YORK CORPORA-
TION)

120 WALL STREET
NEW YORK, NY 10005

FOR: ARRANGING AND CONDUCTING TRADE
SHOW EXHIBITIONS IN THE FIELD OF LIGHT-
ING, IN CLASS 35 (U.S. CLS. 100, 101 AND 102).

FIRST USE 5-0-2005; IN COMMERCE 5-0-2005.

FOR: CONDUCTING SEMINARS AND EDUCA-
TIONAL COURSES IN THE FIELD OF LIGHTING,
IN CLASS 41 (U.S. CLS. 100, 101 AND 107).

FIRST USE 5-0-2005; IN COMMERCE 5-0-2005.

THE MARK CONSISTS OF STANDARD CHAR-
ACTERS WITHOUT CLAIM TO ANY PARTICULAR
FONT, STYLE, SIZE, OR COLOR.

SER. NO. 76-675,422, FILED 4-12-2007.

CARYN GLASSER, EXAMINING ATTORNEY

Int. Cl.: 35

Prior U.S. Cls.: 100, 101 and 102

United States Patent and Trademark Office

Reg. No. 3,478,547

Registered Aug. 5, 2008

**SERVICE MARK
PRINCIPAL REGISTER**

WORKNET

J.P. KING AUCTION COMPANY, INC. (ALABAMA CORPORATION)
108 FOUNTAIN AVENUE
GADSDEN, AL 35901

FOR: REAL ESTATE AUCTION MANAGEMENT SERVICES PROVIDED TO OTHERS OVER AN ON-LINE WEB SITE; PROVIDING ON-LINE FACILITIES TO ALLOW OTHERS TO SHARE INFORMATION ABOUT REAL ESTATE AUCTIONS, TO ENTER INFORMATION ABOUT PROSPECTS FOR REAL ESTATE AUCTIONS, AND TO MANAGE REAL

ESTATE AUCTIONS, IN CLASS 35 (U.S. CLS. 100, 101 AND 102).

FIRST USE 2-28-2007; IN COMMERCE 2-28-2007.

THE MARK CONSISTS OF STANDARD CHARACTERS WITHOUT CLAIM TO ANY PARTICULAR FONT, STYLE, SIZE, OR COLOR.

SER. NO. 76-676,085, FILED 4-27-2007.

HEATHER BIDDULPH, EXAMINING ATTORNEY

Int. Cl.: 20

Prior U.S. Cls.: 2, 13, 22, 25, 32 and 50

United States Patent and Trademark Office

Reg. No. 3,478,548

Registered Aug. 5, 2008

**TRADEMARK
PRINCIPAL REGISTER**

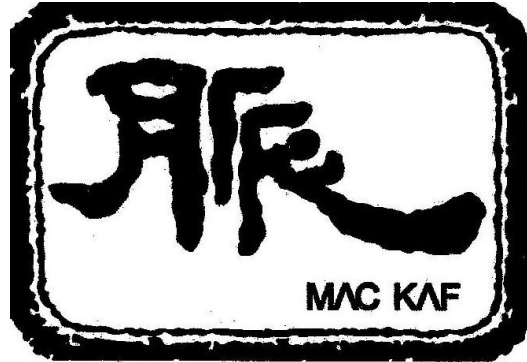

MAC KAF, INC. (CALIFORNIA CORPORATION)
3550 WILSHIRE BLVD., #1120
LOS ANGELES, CA 90010

FOR: KOREAN ANTIQUE FURNITURE, IN
CLASS 20 (U.S. CLS. 2, 13, 22, 25, 32 AND 50).

FIRST USE 5-1-2006; IN COMMERCE 5-1-2006.

THE MARK CONSISTS OF THE CHINESE CHARACTER INSIDE A BOX AND THE WORD "MAC KAF" APPEARING UNDERNEATH THE MARK

WHICH IS NOT IN COLOR AND ANY COLOR GREY CONTAINED IN THE MARK IS INTENDED TO SHOW SHADING ONLY.

THE CHINESE CHARACTER INSIDE A BOX TRANSLITERATES TO "MAC" WHICH IS TRANSLATED AS "TRADITION" IN ENGLISH.

SER. NO. 76-676,406, FILED 5-4-2007.

ZACHARY BELLO, EXAMINING ATTORNEY

Int. Cl.: 24

Prior U.S. Cls.: 42 and 50

United States Patent and Trademark Office

Reg. No. 3,478,549

Registered Aug. 5, 2008

**TRADEMARK
PRINCIPAL REGISTER**



COJAB, JACOBO S. (UNITED STATES INDIVIDUAL)
64 MONTGOMERY AVENUE
LONG BRANCH, NJ 07740

OWNER OF U.S. REG. NO. 3,325,337.

FOR: BATH TOWELS, BED SHEETS, PILLOWCASES, TABLECLOTHS NOT OF PAPER, COMFORTERS, CURTAINS, AND SHOWER CURTAINS, IN CLASS 24 (U.S. CLS. 42 AND 50).

NO CLAIM IS MADE TO THE EXCLUSIVE RIGHT TO USE "HOME FASHIONS", APART FROM THE MARK AS SHOWN.

SER. NO. 76-676,678, FILED 5-11-2007.

FIRST USE 11-0-2005; IN COMMERCE 11-0-2005.

LINDA ESTRADA, EXAMINING ATTORNEY

Int. Cl.: 42

Prior U.S. Cls.: 100 and 101

United States Patent and Trademark Office

Reg. No. 3,478,550

Registered Aug. 5, 2008

**SERVICE MARK
PRINCIPAL REGISTER**

IEASYSITE

IHOST NETWORKS, INC. (WASHINGTON CORPORATION)
11808 NORTHUP WAY, SUITE W320
BELLEVUE, WA 98005

THE MARK CONSISTS OF STANDARD CHARACTERS WITHOUT CLAIM TO ANY PARTICULAR FONT, STYLE, SIZE, OR COLOR.

FOR: WEB SITE HOSTING SERVICES FOR OTHERS ON A SHARED COMPUTER NETWORK, IN CLASS 42 (U.S. CLS. 100 AND 101).

SER. NO. 76-676,820, FILED 5-14-2007.

FIRST USE 7-1-2001; IN COMMERCE 7-1-2001.

TANYA AMOS, EXAMINING ATTORNEY

Int. Cl.: 41

Prior U.S. Cls.: 100, 101 and 107

United States Patent and Trademark Office

Reg. No. 3,478,551

Registered Aug. 5, 2008

**SERVICE MARK
PRINCIPAL REGISTER**

MAXIMUM LIVING

RANDALL S. CORPORATION (WASHINGTON CORPORATION)
1852 1ST STREET
KIRKLAND, WA 98033

FOR: A MULTIMEDIA ENTERTAINMENT FRANCHISE, NAMELY, ENTERTAINMENT IN THE NATURE OF ONGOING TELEVISION PROGRAMS WHERE BY PARTICIPANTS WILL BE SHOWN FUN AND EASY APPLICATIONS TO LIVING LIFE TO THE MAXIMUM IN THE FIELD OF COOKING, INTERIOR DESIGN, GARDENING, FASHION, TRAVEL, PETS, WHILE AT THE SAME TIME GIVEN IDEAS ON HOW TO LIVE ALL AREAS

OF YOUR LIFE BETTER BY LIVING GREEN, "FROM THE PROPERTYLINE TO THE WAISTLINE", IN CLASS 41 (U.S. CLS. 100, 101 AND 107).

FIRST USE 11-15-2005; IN COMMERCE 11-15-2006.

THE MARK CONSISTS OF STANDARD CHARACTERS WITHOUT CLAIM TO ANY PARTICULAR FONT, STYLE, SIZE, OR COLOR.

SER. NO. 76-676,832, FILED 5-14-2007.

TANYA AMOS, EXAMINING ATTORNEY

Prior U.S. Cl.: A

United States Patent and Trademark Office

Reg. No. 3,478,552

Registered Aug. 5, 2008

CERTIFICATION MARK
PRINCIPAL REGISTER



UNION OF ORTHODOX JEWISH CONGREGA-
TIONS OF AMERICA (NEW YORK CORPORA-
TION)

ELEVEN BROADWAY
NEW YORK, NY 10004

FOR: PACKAGING MATERIALS AND WRAPS,
BROILING AND BAKING PANS; FLAVORS, EX-
TRACTS AND FOOD COLORINGS; WINE, LI-
QUEURS AND CORDIALS, NON-ALCOHOLIC
BEVERAGES; SPICES AND SEASONINGS, SOAPS,
FOODS, DETERGENTS AND HOUSEHOLD CLEA-
NERS, IN CLASS A (U.S. CL. A).

FIRST USE 0-0-1961; IN COMMERCE 0-0-1961.

THE MARK CONSISTS OF THE CAPITAL LET-
TERS "U" AND "P" WITH A CIRCLE (A CAPITAL
LETTER "O") APPEARING AROUND THE LETTER
"U".

THE CERTIFICATION MARK, AS USED BY
AUTHORIZED PERSONS, CERTIFIES THAT THE
GOODS WERE MANUFACTURED AND PRO-
DUCED IN ACCORDANCE WITH THE KOSHER
FOR PASSOVER RELIGIOUS PRINCIPLES OF THE
CERTIFIER.

SER. NO. 76-677,437, FILED 5-25-2007.

G. MAYERSCHOFF, EXAMINING ATTORNEY

Int. Cl.: 6

Prior U.S. Cls.: 2, 12, 13, 14, 23, 25 and 50

Reg. No. 3,478,553

United States Patent and Trademark Office

Registered Aug. 5, 2008

**TRADEMARK
PRINCIPAL REGISTER**

INSTA-PLUG

DOUGLAS HOLLAENDER ENTERPRISES, INC.
(OHIO CORPORATION)
8900 GLENDALE MILFORD ROAD, SUITE B-1
LOVELAND, OH 451400504

THE MARK CONSISTS OF STANDARD CHARACTERS WITHOUT CLAIM TO ANY PARTICULAR FONT, STYLE, SIZE, OR COLOR.

FOR: METAL PLUGS FOR HEAT EXCHANGERS,
IN CLASS 6 (U.S. CLS. 2, 12, 13, 14, 23, 25 AND 50).

SER. NO. 76-677,682, FILED 6-1-2007.

FIRST USE 5-8-2007; IN COMMERCE 5-8-2007.

VERNA BETH RIRIE, EXAMINING ATTORNEY

Int. Cl.: 16

Prior U.S. Cls.: 2, 5, 22, 23, 29, 37, 38 and 50

United States Patent and Trademark Office

Reg. No. 3,478,554

Registered Aug. 5, 2008

**TRADEMARK
PRINCIPAL REGISTER**

DISPENSAPAK

ELWOOD PACKAGING, INC. (ILLINOIS CORPORATION)
5200 W. ROOSEVELT ROAD
CHICAGO, IL 60644

THE MARK CONSISTS OF STANDARD CHARACTERS WITHOUT CLAIM TO ANY PARTICULAR FONT, STYLE, SIZE, OR COLOR.

FOR: SOLID FIBERBOARD PACKAGING, NAMELY, BOXES FOR CONTAINING LIQUID FOOD AND BEVERAGE PRODUCTS, IN CLASS 16 (U.S. CLS. 2, 5, 22, 23, 29, 37, 38 AND 50).

SER. NO. 76-677,831, FILED 6-5-2007.

FIRST USE 10-23-2006; IN COMMERCE 10-23-2006.

STEVEN JACKSON, EXAMINING ATTORNEY

Int. Cls.: 15 and 35

Prior U.S. Cls.: 2, 21, 36, 100, 101 and 102

United States Patent and Trademark Office

Reg. No. 3,478,555

Registered Aug. 5, 2008

**TRADEMARK
SERVICE MARK
PRINCIPAL REGISTER**

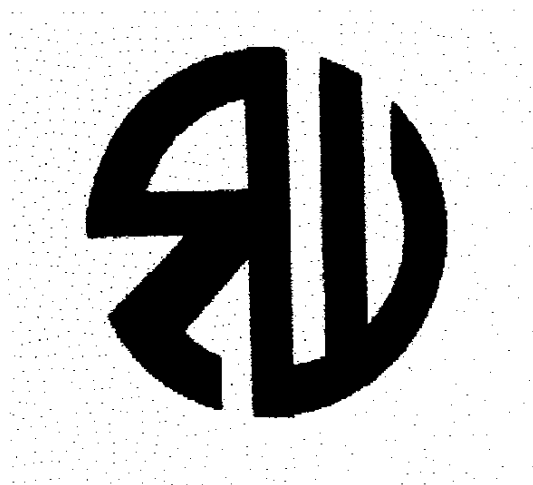

ROBERTO'S WINDS, INC. (NEW YORK CORPORATION)
149 WEST 46TH STREET
NEW YORK, NY 10036

FOR: MUSICAL WIND INSTRUMENTS; AND ACCESSORIES FOR MUSICAL WIND INSTRUMENTS, NAMELY, REEDS, IN CLASS 15 (U.S. CLS. 2, 21 AND 36).

FIRST USE 0-0-2005; IN COMMERCE 0-0-2005.

FOR: ON-LINE RETAIL STORE SERVICES IN THE FIELDS OF MUSICAL INSTRUMENTS AND

ACCESSORIES THEREFOR, MUSICAL PUBLICATIONS, MUSICAL RECORDINGS; RETAIL MUSIC STORES, IN CLASS 35 (U.S. CLS. 100, 101 AND 102).

FIRST USE 0-0-2005; IN COMMERCE 0-0-2005.

THE MARK CONSISTS OF THE STYLIZED LETTERS RW IN A CIRCULAR PRESENTATION, IN THE STYLE OF A MONOGRAM, WITHOUT CLAIM TO COLOR.

SER. NO. 76-678,006, FILED 6-8-2007.

DOMINICK J. SALEMI, EXAMINING ATTORNEY

Int. Cl.: 35

Prior U.S. Cls.: 100, 101 and 102

United States Patent and Trademark Office

Reg. No. 3,478,556

Registered Aug. 5, 2008

SERVICE MARK
PRINCIPAL REGISTER



VISION SELECT, LLC (FLORIDA LIMITED LIABILITY CORPORATION)
3801 SOUTH CONGRESS AVENUE
LAKE WORTH, FL 33461

FOR: ADMINISTRATION OF A DISCOUNT PROGRAM FOR ENABLING PARTICIPANTS TO OBTAIN DISCOUNTS ON OPTICAL GOODS AND SERVICES THROUGH USE OF A DISCOUNT MEMBERSHIP CARD, IN CLASS 35 (U.S. CLS. 100, 101 AND 102).

FIRST USE 4-30-2004; IN COMMERCE 4-30-2004.

NO CLAIM IS MADE TO THE EXCLUSIVE RIGHT TO USE "VISION", APART FROM THE MARK AS SHOWN.

SER. NO. 76-678,262, FILED 6-15-2007.

MARK T. MULLEN, EXAMINING ATTORNEY

Int. Cl.: 25

Prior U.S. Cls.: 22 and 39

United States Patent and Trademark Office

Reg. No. 3,478,557

Registered Aug. 5, 2008

**TRADEMARK
PRINCIPAL REGISTER**



FIST FIRST FIGHTING, LLC (MICHIGAN LTD
LIAB CO)
4516 BROOKMEADOW COURT, SE
KENTWOOD, MI 49512

FOR: CLOTHING, NAMELY, TEE SHIRTS,
SHORTS, FIGHT SHORTS, HOODS, JERSEYS, RASH
GUARDS, PANTS, HATS, JACKETS, SWEAT-
SHIRTS, IN CLASS 25 (U.S. CLS. 22 AND 39).

FIRST USE 2-24-2007; IN COMMERCE 2-24-2007.

THE MARK CONSISTS OF A 3/4-HEIGHT VERTI-
CAL FIGHTER THROWING AN OVERHAND
RIGHT WITH THE TITLE "FIST FIRST FIGHTING"
AND SLOGAN "THE SCIENCE OF VICTORY" WITH
THREE LETTER "FS" JOINED TOGETHER BELOW
THE RAISED FIST OF THE FIGHTER.

SER. NO. 76-678,365, FILED 6-18-2007.

JOHN DWYER, EXAMINING ATTORNEY

Int. Cls.: 43 and 45

Prior U.S. Cls.: 100 and 101

United States Patent and Trademark Office

Reg. No. 3,478,558

Registered Aug. 5, 2008

**SERVICE MARK
PRINCIPAL REGISTER**

SAVOY

SAVOY LINEN SERVICES, INC. (CONNECTICUT CORPORATION)
895 WOODEND ROAD
STRATFORD, CT 06615

FOR: RENTAL OF TABLE LINENS TO RESTAURANTS, HOTELS AND COUNTRY CLUBS, IN CLASS 43 (U.S. CLS. 100 AND 101).

FIRST USE 12-31-1924; IN COMMERCE 12-31-1950.

FOR: RENTAL OF UNIFORMS, IN CLASS 45 (U.S. CLS. 100 AND 101).

FIRST USE 12-31-1924; IN COMMERCE 12-31-1950.

THE MARK CONSISTS OF STANDARD CHARACTERS WITHOUT CLAIM TO ANY PARTICULAR FONT, STYLE, SIZE, OR COLOR.

SER. NO. 76-678,567, FILED 6-22-2007.

EDWARD NELSON, EXAMINING ATTORNEY

Int. Cl.: 32

Prior U.S. Cls.: 45, 46 and 48

Reg. No. 3,478,559

United States Patent and Trademark Office

Registered Aug. 5, 2008

**TRADEMARK
PRINCIPAL REGISTER**

WE

PARK, JEE WOO (REPUBLIC OF KOREA INDIVIDUAL)
6280 W 3RD STREET, #409
LOS ANGELES, CA 90036

THE MARK CONSISTS OF STANDARD CHARACTERS WITHOUT CLAIM TO ANY PARTICULAR FONT, STYLE, SIZE, OR COLOR.

FOR: NON-CARBONATED BEVERAGES MADE WITH PRICKLY PEAR CACTUS EXTRACT, IN CLASS 32 (U.S. CLS. 45, 46 AND 48).

SER. NO. 76-678,581, FILED 6-22-2007.

FIRST USE 1-1-2007; IN COMMERCE 1-1-2007.

PATRICIA EVANKO, EXAMINING ATTORNEY

Int. Cl.: 9

Prior U.S. Cls.: 21, 23, 26, 36 and 38

Reg. No. 3,478,560

United States Patent and Trademark Office

Registered Aug. 5, 2008

**TRADEMARK
PRINCIPAL REGISTER**

ECLIPSE iLM

NEON ENTERPRISE SOFTWARE, INC. (DELA-
WARE CORPORATION)
14100 SOUTHWEST FREEWAY, SUITE 400
SUGAR LAND, TX 77478

THE MARK CONSISTS OF STANDARD CHAR-
ACTERS WITHOUT CLAIM TO ANY PARTICULAR
FONT, STYLE, SIZE, OR COLOR.

FOR: SOFTWARE FOR MANAGING DATABASES,
IN CLASS 9 (U.S. CLS. 21, 23, 26, 36 AND 38).

SER. NO. 76-678,796, FILED 6-27-2007.

FIRST USE 11-0-2005; IN COMMERCE 11-0-2005.

HOWARD SMIGA, EXAMINING ATTORNEY

Int. Cl.: 36

Prior U.S. Cls.: 100, 101 and 102

United States Patent and Trademark Office

Reg. No. 3,478,561

Registered Aug. 5, 2008

**SERVICE MARK
PRINCIPAL REGISTER**

BUY WITHOUT THE BANK

SPS PARTNERS LLC (OHIO LTD LIAB CO)
6685 BETA DRIVE
MAYFIELD VILLAGE, OH 44143

FOR: REAL ESTATE SERVICES, NAMELY, INVESTMENT SERVICES IN THE NATURE OF PURCHASING OF REAL ESTATE FOR OTHERS, REAL ESTATE INVESTING, AND FINANCING OF REAL ESTATE, IN CLASS 36 (U.S. CLS. 100, 101 AND 102).

FIRST USE 2-27-2005; IN COMMERCE 2-27-2005.

THE MARK CONSISTS OF STANDARD CHARACTERS WITHOUT CLAIM TO ANY PARTICULAR FONT, STYLE, SIZE, OR COLOR.

SER. NO. 76-678,845, FILED 6-28-2007.

LESLIE RICHARDS, EXAMINING ATTORNEY

Int. Cls.: 9 and 16

Prior U.S. Cls.: 2, 5, 21, 22, 23, 26, 29, 36, 37, 38 and 50

Reg. No. 3,478,562

United States Patent and Trademark Office

Registered Aug. 5, 2008

**TRADEMARK
PRINCIPAL REGISTER**



THE UNITED METHODIST PUBLISHING
HOUSE (ILLINOIS CORPORATION)
201 EIGHTH AVENUE SOUTH
NASHVILLE, TN 37202

FOR: PRE-RECORDED DVDS AND CD-ROMS IN
THE FIELDS OF RELIGION, CHRISTIANITY, AND
FAMILY VALUES, IN CLASS 9 (U.S. CLS. 21, 23, 26, 36
AND 38).

FIRST USE 4-0-2007; IN COMMERCE 4-0-2007.

FOR: PUBLICATIONS, PRINTED CURRICULUM
AND EDUCATIONAL MATERIALS, NAMELY,

BOOKS, PAMPHLETS AND BROCHURES IN THE
FIELDS OF YOUTH GROUPS, SUNDAY SCHOOL
WORSHIP, BIBLE STUDY, MISSION YOUTH
WORKER DEVELOPMENT, COMMUNITY OUT-
REACH, YOUTH MINISTRIES, CHRISTIANITY,
FAMILY VALUES AND RELIGION, IN CLASS 16
(U.S. CLS. 2, 5, 22, 23, 29, 37, 38 AND 50).

FIRST USE 4-0-2007; IN COMMERCE 4-0-2007.

SER. NO. 76-679,073, FILED 7-3-2007.

CHRISTINE COOPER, EXAMINING ATTORNEY

Int. Cls.: 41, 42 and 44

Prior U.S. Cls.: 100, 101 and 107

United States Patent and Trademark Office

Reg. No. 3,478,563

Registered Aug. 5, 2008

**SERVICE MARK
PRINCIPAL REGISTER**

NATIONAL SAFETY COMPLIANCE

NATIONAL SAFETY COMPLIANCE, INC. (NEW JERSEY CORPORATION)
1970 SWARTHMORE AVENUE, SUITE 8
LAKEWOOD, NJ 08701

FOR: DEPARTMENT OF TRANSPORTATION DRIVER QUALIFICATION SERVICES, NAMELY, EDUCATIONAL TESTING OF DRIVERS; DRIVER TRAINING AND EDUCATIONAL PROGRAMS, NAMELY, DRIVER SAFETY TRAINING; HAZARDOUS MATERIALS TRAINING SEMINARS, IN CLASS 41 (U.S. CLS. 100, 101 AND 107).

FIRST USE 4-0-1988; IN COMMERCE 4-0-1988.

FOR: DEPARTMENT OF TRANSPORTATION VEHICLE INSPECTION SERVICES, IN CLASS 42 (U.S. CLS. 100 AND 101).

FIRST USE 4-0-1988; IN COMMERCE 4-0-1988.

FOR: DEPARTMENT OF TRANSPORTATION DRIVER QUALIFICATION SERVICES, NAMELY, CONTROLLED SUBSTANCE AND ALCOHOL TESTING TO DETERMINE DRUG AND ALCOHOL ABUSE, IN CLASS 44 (U.S. CLS. 100 AND 101).

FIRST USE 4-0-1988; IN COMMERCE 4-0-1988.

THE MARK CONSISTS OF STANDARD CHARACTERS WITHOUT CLAIM TO ANY PARTICULAR FONT, STYLE, SIZE, OR COLOR.

SEC. 2(F).

SER. NO. 76-679,483, FILED 7-13-2007.

MELISSA VALLILLO, EXAMINING ATTORNEY

Int. Cls.: 35 and 36

Prior U.S. Cls.: 100, 101 and 102

United States Patent and Trademark Office

Reg. No. 3,478,564

Registered Aug. 5, 2008

**SERVICE MARK
PRINCIPAL REGISTER**

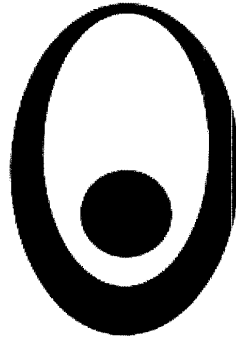

TRANQUIL SPACE FOUNDATION (WASHINGTON NON-PROFIT ORGANIZATION)
1820 T STREET, NW, #2
WASHINGTON, DC 20009

FOR: CHARITABLE SERVICES, NAMELY, ORGANIZING AND CONDUCTING VOLUNTEER PROGRAMS AND COMMUNITY SERVICE PROJECTS, IN CLASS 35 (U.S. CLS. 100, 101 AND 102).

FIRST USE 2-0-2007; IN COMMERCE 2-0-2007.

FOR: CHARITABLE FUNDRAISING, IN CLASS 36 (U.S. CLS. 100, 101 AND 102).

FIRST USE 2-0-2007; IN COMMERCE 2-0-2007.

SER. NO. 76-679,606, FILED 7-17-2007.

ANN E. SAPPENFIELD, EXAMINING ATTORNEY

Int. Cls.: 4, 7 and 42

**Prior U.S. Cls.: 1, 6, 13, 15, 19, 21, 23, 31, 34, 35, 100
and 101**

United States Patent and Trademark Office

Reg. No. 3,478,565

Registered Aug. 5, 2008

**TRADEMARK
SERVICE MARK
PRINCIPAL REGISTER**

WHERE YOU TURN

THE TIMKEN COMPANY (OHIO CORPORATION)
1835 DUEBER AVENUE, S.W.
CANTON, OH 44706

FOR: INDUSTRIAL LUBRICANTS USED IN INDUSTRIAL AND AUTOMOTIVE APPLICATIONS TO ASSIST IN THE SLIDING, ROLLING AND LIFTING MOTION OF MACHINERY, IN CLASS 4 (U.S. CLS. 1, 6 AND 15).

FIRST USE 4-19-2005; IN COMMERCE 4-19-2005.

FOR: MACHINE PARTS, NAMELY, BEARINGS, PRECISION BEARING INSERTS AND MECHANICAL SEALS ALL USED IN INDUSTRIAL AND AUTOMOTIVE APPLICATIONS TO ASSIST IN THE SLIDING, ROLLING AND LIFTING MOTION OF

MACHINERY, IN CLASS 7 (U.S. CLS. 13, 19, 21, 23, 31, 34 AND 35).

FIRST USE 4-19-2005; IN COMMERCE 4-19-2005.

FOR: DESIGN, ENGINEERING AND DEVELOPMENT OF MACHINE PARTS, NAMELY, BEARINGS AND PRECISION COMPONENTS, LUBRICANTS AND SEALS ALL USED IN INDUSTRIAL AND AUTOMOTIVE APPLICATIONS TO ASSIST IN THE SLIDING, ROLLING AND LIFTING MOTION OF MACHINERY, IN CLASS 42 (U.S. CLS. 100 AND 101).

FIRST USE 4-19-2005; IN COMMERCE 4-19-2005.

SER. NO. 76-679,659, FILED 7-19-2007.

KAPIL BHANOT, EXAMINING ATTORNEY

Int. Cl.: 13

Prior U.S. Cls.: 2 and 9

United States Patent and Trademark Office

Reg. No. 3,478,566

Registered Aug. 5, 2008

**TRADEMARK
PRINCIPAL REGISTER**

SENTINEL

WILSON'S GUN SHOP, INC. (ARKANSAS COR-
PORATION)
2234 CR 719
BERRYVILLE, AR 726164573

THE MARK CONSISTS OF STANDARD CHAR-
ACTERS WITHOUT CLAIM TO ANY PARTICULAR
FONT, STYLE, SIZE, OR COLOR.

FOR: HANDGUNS AND PISTOLS AND PARTS
THEREOF, IN CLASS 13 (U.S. CLS. 2 AND 9).

SER. NO. 76-679,871, FILED 7-25-2007.

FIRST USE 1-27-1998; IN COMMERCE 1-27-1998.

DAWN HAN, EXAMINING ATTORNEY

Int. Cl.: 44

Prior U.S. Cls.: 100 and 101

United States Patent and Trademark Office

Reg. No. 3,478,567

Registered Aug. 5, 2008

**SERVICE MARK
PRINCIPAL REGISTER**

The Wallace Method



WALLACE, HEATHER (UNITED STATES INDIVIDUAL)
45 WEST ISLAND AVENUE
MINNEAPOLIS, MN 55401

FOR: BODYWORK THERAPY, IN CLASS 44 (U.S. CLS. 100 AND 101).

FIRST USE 0-0-1991; IN COMMERCE 0-0-1991.

NO CLAIM IS MADE TO THE EXCLUSIVE RIGHT TO USE "METHOD" , APART FROM THE MARK AS SHOWN.

THE NAME "WALLACE" IDENTIFIES A LIVING INDIVIDUAL WHOSE CONSENT IS OF RECORD.

SER. NO. 76-680,176, FILED 8-2-2007.

HENRY S. ZAK, EXAMINING ATTORNEY

Int. Cl.: 36

Prior U.S. Cls.: 100, 101 and 102

United States Patent and Trademark Office

Reg. No. 3,478,568

Registered Aug. 5, 2008

**SERVICE MARK
PRINCIPAL REGISTER**



ALZHEIMER'S FOUNDATION OF AMERICA,
INC. (FLORIDA NOT FOR PROFIT COR-
PORATION)
322 EIGHTH AVENUE
NEW YORK, NY 10001

FOR: CHARITABLE FUND RAISING SERVICES
BY MEANS OF AN ANNUAL FUNDRAISING
EVENT TO RAISE AWARENESS OF AND SUPPORT
TREATMENT OF ALZHEIMER'S DISEASE OR RE-
LATED DEMENTIAS, IN CLASS 36 (U.S. CLS. 100,
101 AND 102).

FIRST USE 1-3-2007; IN COMMERCE 1-3-2007.

THE COLOR(S) GOLD, RED AND WHITE IS/ARE
CLAIMED AS A FEATURE OF THE MARK.

THE COLOR RED APPEARS IN THE WORDING
"LET'S TAKE A STAND". THE LARGE ATHLETE
HAS A RED HEART, RED SHIRT, A GOLD HEAD,
GOLD ARMS, GOLD LEGS AND WHITE SHORTS.
THE LARGE ATHLETE HAS RED SNEAKERS
THAT HAVE WHITE LACES, WHITE INSIDE THE
SNEAKERS, WHITE ON THE SOLES AND GOLD
ON THE FRONT AND SIDE OF THE SNEAKERS
WITH A GOLD CIRCLE. THREE GOLD SMALLER
FIGURES HAVE RAISED ARMS EACH INTER-
SECTING A RED HEART. TWO RED SMALLER
FIGURES HAVE RAISED ARMS EACH INTER-
SECTING A RED HEART.

SER. NO. 76-680,597, FILED 8-13-2007.

RAMONA ORTIGA, EXAMINING ATTORNEY

Int. Cl.: 6

Prior U.S. Cls.: 2, 12, 13, 14, 23, 25 and 50

Reg. No. 3,478,569

United States Patent and Trademark Office

Registered Aug. 5, 2008

**TRADEMARK
PRINCIPAL REGISTER**

ENDURA

EDELBRÖCK CORPORATION (DELAWARE CORPORATION)
2700 CALIFORNIA ST.
TORRANCE, CA 90503

THE MARK CONSISTS OF STANDARD CHARACTERS WITHOUT CLAIM TO ANY PARTICULAR FONT, STYLE, SIZE, OR COLOR.

FOR: METAL ADAPTER FITTINGS FOR COUPLING FLUID HANDLING HOSE TO OTHER FLUID HANDLING COMPONENTS OF LAND VEHICLES, NAMELY, OIL PUMPS, FUEL PUMPS, FUEL FILTERS, IN CLASS 6 (U.S. CLS. 2, 12, 13, 14, 23, 25 AND 50).

OWNER OF U.S. REG. NO. 3,284,152.

SER. NO. 76-680,682, FILED 8-14-2007.

FIRST USE 12-0-1994; IN COMMERCE 12-0-1994.

KRISTINA MORRIS, EXAMINING ATTORNEY

Int. Cls.: 16, 43 and 44

Prior U.S. Cls.: 2, 5, 22, 23, 29, 37, 38, 50, 100 and 101

United States Patent and Trademark Office

Reg. No. 3,478,570

Registered Aug. 5, 2008

**TRADEMARK
SERVICE MARK
PRINCIPAL REGISTER**

VIVE MEJOR

UNILEVER SUPPLY CHAIN, INC. (DELAWARE CORPORATION)
1 JOHN STREET
CLINTON, CT 06413

FOR: MAGAZINES FEATURING ARTICLES DEALING WITH HEALTH, BEAUTY, NUTRITION AND COOKING DIRECTED TO HISPANIC CONSUMERS, IN CLASS 16 (U.S. CLS. 2, 5, 22, 23, 29, 37, 38 AND 50).

FIRST USE 5-0-2007; IN COMMERCE 5-0-2007.

FOR: PROVIDING WEBSITES FEATURING INFORMATION ON COOKING DIRECTED TO HISPANIC CONSUMERS, IN CLASS 43 (U.S. CLS. 100 AND 101).

FIRST USE 5-0-2007; IN COMMERCE 5-0-2007.

FOR: PROVIDING WEBSITES FEATURING INFORMATION ON HEALTH, NUTRITION AND BEAUTY DIRECTED TO HISPANIC CONSUMERS, IN CLASS 44 (U.S. CLS. 100 AND 101).

FIRST USE 5-0-2007; IN COMMERCE 5-0-2007.

THE MARK CONSISTS OF STANDARD CHARACTERS WITHOUT CLAIM TO ANY PARTICULAR FONT, STYLE, SIZE, OR COLOR.

THE ENGLISH TRANSLATION OF "VIVE MEJOR" IS LIVE BETTER.

SER. NO. 76-680,958, FILED 8-21-2007.

KAPIL BHANOT, EXAMINING ATTORNEY

Int. Cl.: 41

Prior U.S. Cls.: 100, 101 and 107

United States Patent and Trademark Office

Reg. No. 3,478,571

Registered Aug. 5, 2008

**SERVICE MARK
PRINCIPAL REGISTER**



ENVIRONMENTAL HEALTH TESTING, LLC
(FLORIDA LTD. LIABILITY)
5728 MAJOR BLVD., STE. 750
ORLANDO, FL 32819

FOR: DEVELOPING AND PRODUCING STANDARDIZED CERTIFICATION EXAMINATIONS, IN CLASS 41 (U.S. CLS. 100, 101 AND 107).

FIRST USE 11-22-1999; IN COMMERCE 11-22-1999.

OWNER OF U.S. REG. NO. 2,476,827.

NO CLAIM IS MADE TO THE EXCLUSIVE RIGHT TO USE "CERTIFIED FOOD SAFETY MANAGER", APART FROM THE MARK AS SHOWN.

THE COLOR(S) GREEN, GOLD, AND WHITE IS/ ARE CLAIMED AS A FEATURE OF THE MARK.

THE DESIGN CONSISTS OF A GREEN OVAL SHAPED GLOBE CONTAINING WHITE MERIDIAN AND PARALLEL LINES. THE LETTERS "F" "S" "P" APPEAR IN GOLD FONT DIAGONALLY WITHIN THE MERIDIAN AND PARALLEL LINES OF THE GREEN OVAL SHAPED GLOBE. A GOLD OVAL OUTLINED IN GREEN SURROUNDS THE GREEN OVAL GLOBE AND CONTAINS THE WORDS "NATIONAL REGISTRY OF FOOD SAFETY PROFESSIONALS" IN GREEN FONT. A GOLD BANNER OUTLINED IN GREEN ENCIRCLES THE BOTTOM OF THE ENTIRE OVAL IMAGE AND CONTAINS THE WORDS "CERTIFIED FOOD SAFETY MANAGER" IN GREEN FONT.

SEC. 2(F).

SER. NO. 76-680,983, FILED 8-22-2007.

MICHELE SWAIN, EXAMINING ATTORNEY

Int. Cl.: 42

Prior U.S. Cls.: 100 and 101

United States Patent and Trademark Office

Reg. No. 3,478,572

Registered Aug. 5, 2008

**SERVICE MARK
PRINCIPAL REGISTER**

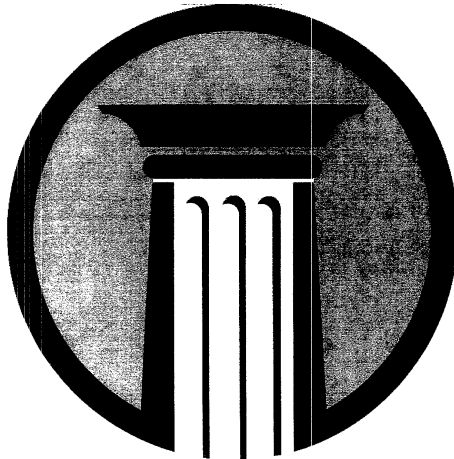

EVO PARTNERS, LP (TEXAS LIMITED PART-
NERSHIP), DBA ENTRUST TECHNOLOGY
CONSULTING SERVICES
3601 BLUEMEL, SUITE 117
SAN ANTONIO, TX 78229

FIRST USE 6-30-2006; IN COMMERCE 6-30-2006.

SER. NO. 76-681,091, FILED 8-24-2007.

FOR: INFORMATION TECHNOLOGY CON-
SULTING SERVICES, IN CLASS 42 (U.S. CLS. 100
AND 101).

PAUL F. GAST, EXAMINING ATTORNEY

Int. Cl.: 43

Prior U.S. Cls.: 100 and 101

United States Patent and Trademark Office

Reg. No. 3,478,573

Registered Aug. 5, 2008

**SERVICE MARK
PRINCIPAL REGISTER**

HOME OF THE D CUP

AISLINN COFFEE ENTERPRISES LLC (OREGON
DOMESTIC LIMITED LIABILITY COMPANY)
P.O. BOX 67213
PORTLAND, OR 97268

FOR: RESTAURANT, CAFÉ, CAFETERIA,
SNACK BAR, COFFEE BAR, AND COFFEE HOUSE
SERVICES, IN CLASS 43 (U.S. CLS. 100 AND 101).

FIRST USE 4-5-2007; IN COMMERCE 4-19-2007.

THE MARK CONSISTS OF STANDARD CHAR-
ACTERS WITHOUT CLAIM TO ANY PARTICULAR
FONT, STYLE, SIZE, OR COLOR.

NO CLAIM IS MADE TO THE EXCLUSIVE
RIGHT TO USE "CUP", APART FROM THE MARK
AS SHOWN.

SER. NO. 76-681,094, FILED 8-24-2007.

JEFF DEFORD, EXAMINING ATTORNEY

Int. Cl.: 9

Prior U.S. Cls.: 21, 23, 26, 36 and 38

United States Patent and Trademark Office

Reg. No. 3,478,574

Registered Aug. 5, 2008

**TRADEMARK
PRINCIPAL REGISTER**



LEAVING EARTH, LLC (NEW YORK LTD LIAB
CO)

C/O WILLIAM S. LEVINSON, ESQ.
36 WEST MAIN STREET SUITE 500
ROCHESTER, NY 14614

FOR: COMPUTER SOFTWARE FOR AN INTE-
GRATED VIRTUAL REALITY WORLD COM-
PRISED OF INTERACTIVE MEMBER
COMMUNITIES, IN CLASS 9 (U.S. CLS. 21, 23, 26,
36 AND 38).

FIRST USE 11-17-2006; IN COMMERCE 11-17-2006.

THE COLOR(S) BLACK AND WHITE IS/ARE
CLAIMED AS A FEATURE OF THE MARK.

ALL IN WHITE FONT COLOR, THE OUTLINE OF
PLANET "EARTH", WITH AN ARROW ENCIR-
CLING THE FRONT, POINTING TO A STAR SHAPE,
WORDS TO THE RIGHT OF PICTURE STATE:
"LEAVING EARTH"; ALL OF WHICH IS ON A
BLACK BACKGROUND.

SER. NO. 76-681,161, FILED 8-27-2007.

DOMINICK J. SALEMI, EXAMINING ATTORNEY

Int. Cl.: 9

Prior U.S. Cls.: 21, 23, 26, 36 and 38

United States Patent and Trademark Office

Reg. No. 3,478,575

Registered Aug. 5, 2008

**TRADEMARK
PRINCIPAL REGISTER**



LEAVING EARTH, LLC (NEW YORK LTD LIAB
CO)

C/O WILLIAM S. LEVINSON, ESQ.
36 WEST MAIN STREET SUITE 500
ROCHESTER, NY 14614

FOR: COMPUTER SOFTWARE FOR AN INTE-
GRATED VIRTUAL REALITY WORLD COM-
PRISED OF INTERACTIVE MEMBER
COMMUNITIES, IN CLASS 9 (U.S. CLS. 21, 23, 26,
36 AND 38).

FIRST USE 11-17-2006; IN COMMERCE 11-17-2006.

THE COLOR(S) BLACK AND WHITE IS/ARE
CLAIMED AS A FEATURE OF THE MARK.

ALL IN BLACK FONT COLOR, THE OUTLINE OF
PLANET "EARTH", WITH AN ARROW ENCIR-
CLING THE FRONT, POINTING TO A STAR SHAPE,
WORDS TO THE RIGHT OF PICTURE STATE:
"LEAVING EARTH"; ALL OF WHICH IS ON A
WHITE BACKGROUND.

SER. NO. 76-681,162, FILED 8-27-2007.

DOMINICK J. SALEMI, EXAMINING ATTORNEY

Int. Cls.: 9 and 42

Prior U.S. Cls.: 21, 23, 26, 36, 38, 100 and 101

United States Patent and Trademark Office

Reg. No. 3,478,576

Registered Aug. 5, 2008

**TRADEMARK
SERVICE MARK
PRINCIPAL REGISTER**

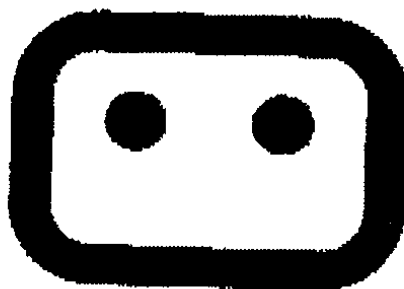

CREATIVE MANAGER, INC. (NEW JERSEY CORPORATION)
721 AUTH AVENUE
OAKHURST, NJ 07755

FOR: PROVIDING ON-LINE, WEB-BASED, DOWNLOADABLE SOFTWARE FOR MANAGING WORKFLOW, NAMELY, PROJECT MANAGEMENT FROM THE PRE-SALE STAGE THROUGH THE FINANCIAL REPORTING STAGE, IN CREATIVE DESIGN BUSINESSES, ADVERTISING AGENCIES AND GRAPHIC DESIGN BUSINESSES, IN CLASS 9 (U.S. CLS. 21, 23, 26, 36 AND 38).

FIRST USE 10-30-2007; IN COMMERCE 10-30-2007.

FOR: PROVIDING TEMPORARY USE OF ON-LINE, WEB-BASED NON-DOWNLOADABLE SOFTWARE FOR MANAGING WORKFLOW, NAMELY, PROJECT MANAGEMENT FROM THE PRE-SALE STAGE THROUGH THE FINANCIAL REPORTING STAGE, IN CREATIVE DESIGN BUSINESSES, ADVERTISING AGENCIES AND GRAPHIC DESIGN BUSINESSES, IN CLASS 42 (U.S. CLS. 100 AND 101).

FIRST USE 10-30-2007; IN COMMERCE 10-30-2007.

SER. NO. 76-681,357, FILED 8-31-2007.

ALEXANDER L. POWERS, EXAMINING ATTORNEY

Int. Cl.: 42

Prior U.S. Cls.: 100 and 101

United States Patent and Trademark Office

Reg. No. 3,478,577

Registered Aug. 5, 2008

**SERVICE MARK
PRINCIPAL REGISTER**

NETWORK STRATEGIES, INC.

NETWORK STRATEGIES, INC. (GEORGIA CORPORATION)
1070 MARTIN RIDGE ROAD
ROSWELL, GA 30076

FOR: COMPUTER CONSULTATION IN THE FIELD OF COMPUTER NETWORK SECURITY, IN CLASS 42 (U.S. CLS. 100 AND 101).

FIRST USE 7-0-2001; IN COMMERCE 7-0-2001.

THE MARK CONSISTS OF STANDARD CHARACTERS WITHOUT CLAIM TO ANY PARTICULAR FONT, STYLE, SIZE, OR COLOR.

NO CLAIM IS MADE TO THE EXCLUSIVE RIGHT TO USE "NETWORK" AND "INC.", APART FROM THE MARK AS SHOWN.

SER. NO. 76-681,455, FILED 9-4-2007.

CURTIS FRENCH, EXAMINING ATTORNEY

Int. Cl.: 37

Prior U.S. Cls.: 100, 103 and 106

United States Patent and Trademark Office

Reg. No. 3,478,578

Registered Aug. 5, 2008

**SERVICE MARK
PRINCIPAL REGISTER**

RUBEN'S TIRES

FELIZ, RUBEN D. (UNITED STATES INDIVIDUAL)

212 MAGNOLIA PARK TRAIL

SANFORD, FL 32773

FOR: AUTOMOBILE REPAIR AND SERVICE, IN CLASS 37 (U.S. CLS. 100, 103 AND 106).

FIRST USE 5-17-1996; IN COMMERCE 5-17-1996.

THE MARK CONSISTS OF STANDARD CHARACTERS WITHOUT CLAIM TO ANY PARTICULAR FONT, STYLE, SIZE, OR COLOR.

NO CLAIM IS MADE TO THE EXCLUSIVE RIGHT TO USE "TIRES", APART FROM THE MARK AS SHOWN.

SER. NO. 76-681,461, FILED 9-4-2007.

JANICE KIM, EXAMINING ATTORNEY

Int. Cl.: 3

Prior U.S. Cls.: 1, 4, 6, 50, 51 and 52

United States Patent and Trademark Office

Reg. No. 3,478,579

Registered Aug. 5, 2008

**TRADEMARK
PRINCIPAL REGISTER**



BEAUTY VENTURE, INC. (CANADA CORPORATION)
146 KINGSWOOD ROAD
TORONTO, ONTARIO, CANADA M4E 3N5 AND
BEAUTYVENTURE, INC. (FLORIDA CORPORATION)
6278 N FEDERAL HIGHWAY #399
FORT LAUDERDALE, FL 33308

FOR: KERATIN-BASED AND OTHER HAIR
STRAIGHTENING PREPARATIONS AND HAIR
CARE PRODUCTS FOR DAMAGED, FRIZZY AND
CURLY HAIR, NAMELY, SHAMPOOS, CONDI-
TIONERS, HAIR LOTIONS, POMADES, HAIR

BALMS, HAIR GELS, HAIR EMOLLIENTS, HAIR
TONICS, HAIR SPRAYS, HAIR MOUSSE, IN CLASS
3 (U.S. CLS. 1, 4, 6, 50, 51 AND 52).

FIRST USE 8-27-2007; IN COMMERCE 8-27-2007.

NO CLAIM IS MADE TO THE EXCLUSIVE
RIGHT TO USE "KERATEIN", APART FROM THE
MARK AS SHOWN.

SER. NO. 76-682,299, FILED 9-25-2007.

MICHAEL WEBSTER, EXAMINING ATTORNEY

Int. Cl.: 25

Prior U.S. Cls.: 22 and 39

United States Patent and Trademark Office

Reg. No. 3,478,580

Registered Aug. 5, 2008

**TRADEMARK
PRINCIPAL REGISTER**

VINDICTIVE

AL RUBA ADRBA SALES LLC (NEW JERSEY
CORPORATION)
290 ANDERSON AVENUE, SUITE 2E
HACKENSACK, NJ 07601

THE MARK CONSISTS OF STANDARD CHAR-
ACTERS WITHOUT CLAIM TO ANY PARTICULAR
FONT, STYLE, SIZE, OR COLOR.

FOR: CLOTHING, NAMELY, T-SHIRTS, IN
CLASS 25 (U.S. CLS. 22 AND 39).

SER. NO. 76-682,503, FILED 10-1-2007.

FIRST USE 8-18-2007; IN COMMERCE 8-18-2007.

CHRIS WELLS, EXAMINING ATTORNEY

Int. Cl.: 2

Prior U.S. Cls.: 6, 11 and 16

United States Patent and Trademark Office

Reg. No. 3,478,581

Registered Aug. 5, 2008

**TRADEMARK
PRINCIPAL REGISTER**

ILLUMINA

XSE GROUP, INC. (CONNECTICUT CORPORATION)
35 PHIL MACK DRIVE
MIDDLETOWN, CT 06457

THE MARK CONSISTS OF STANDARD CHARACTERS WITHOUT CLAIM TO ANY PARTICULAR FONT, STYLE, SIZE, OR COLOR.

FOR: TONER CARTRIDGES, MAGNETIC INK CHARACTER RECOGNITION (MICR) TONER CARTRIDGES, INK CARTRIDGES, IN CLASS 2 (U.S. CLS. 6, 11 AND 16).

SER. NO. 76-682,598, FILED 10-4-2007.

FIRST USE 7-17-2007; IN COMMERCE 7-17-2007.

JASON BLAIR, EXAMINING ATTORNEY

Int. Cl.: 2

Prior U.S. Cls.: 6, 11 and 16

United States Patent and Trademark Office

Reg. No. 3,478,582

Registered Aug. 5, 2008

**TRADEMARK
PRINCIPAL REGISTER**

HYPERION

XSE GROUP, INC. (CONNECTICUT CORPORATION)
35 PHIL MACK DRIVE
MIDDLETOWN, CT 06457

THE MARK CONSISTS OF STANDARD CHARACTERS WITHOUT CLAIM TO ANY PARTICULAR FONT, STYLE, SIZE, OR COLOR.

FOR: TONER CARTRIDGES, MAGNETIC INK CHARACTER RECOGNITION (MICR) TONER CARTRIDGES, INK CARTRIDGES, IN CLASS 2 (U.S. CLS. 6, 11 AND 16).

SER. NO. 76-682,599, FILED 10-4-2007.

FIRST USE 5-1-2007; IN COMMERCE 5-1-2007.

JASON BLAIR, EXAMINING ATTORNEY

Int. Cls.: 24 and 26

Prior U.S. Cls.: 37, 39, 40, 42 and 50

United States Patent and Trademark Office

Reg. No. 3,478,583

Registered Aug. 5, 2008

**TRADEMARK
PRINCIPAL REGISTER**

SNAP DRAPE

SNAP DRAPE INTERNATIONAL, INC. (TEXAS CORPORATION)
2045 WESTGATE DR.
SUITE 100
CARROLLTON, TX 75006

FOR: SKIRTINGS FOR TABLES OR STAGES, IN CLASS 24 (U.S. CLS. 42 AND 50).

FIRST USE 8-0-1971; IN COMMERCE 8-0-1971.

FOR: SNAP FASTENERS FOR SECURING SKIRTINGS AND DRAPES TO TABLES OR STAGES, IN CLASS 26 (U.S. CLS. 37, 39, 40, 42 AND 50).

FIRST USE 8-0-1971; IN COMMERCE 8-0-1971.

THE MARK CONSISTS OF STANDARD CHARACTERS WITHOUT CLAIM TO ANY PARTICULAR FONT, STYLE, SIZE, OR COLOR.

OWNER OF U.S. REG. NO. 1,314,641.

NO CLAIM IS MADE TO THE EXCLUSIVE RIGHT TO USE "DRAPE", APART FROM THE MARK AS SHOWN.

SEC. 2(F).

SER. NO. 76-682,638, FILED 10-5-2007.

KYLE PEETE, EXAMINING ATTORNEY

Int. Cl.: 41

Prior U.S. Cls.: 100, 101 and 107

United States Patent and Trademark Office

Reg. No. 3,478,584

Registered Aug. 5, 2008

**SERVICE MARK
PRINCIPAL REGISTER**

THE PROJECT WAY

CAVALUZZI, FRANK A. (UNITED STATES IN-
DIVIDUAL)
3476 HEMLOCK FARMS
LORDS VALLEY, PA 18428

FOR: TRAINING PROGRAMS IN THE FIELD OF
PROJECT MANAGEMENT AND THE APPLICA-
TION OF THE PRINCIPLES OF PROJECT MANAGE-
MENT TO PROFESSIONAL AND PERSONAL
GOALS AND TASKS, IN CLASS 41 (U.S. CLS. 100,
101 AND 107).

FIRST USE 7-11-2007; IN COMMERCE 9-12-2007.

THE MARK CONSISTS OF STANDARD CHAR-
ACTERS WITHOUT CLAIM TO ANY PARTICULAR
FONT, STYLE, SIZE, OR COLOR.

NO CLAIM IS MADE TO THE EXCLUSIVE
RIGHT TO USE "PROJECT", APART FROM THE
MARK AS SHOWN.

SER. NO. 76-682,705, FILED 10-9-2007.

ANDREA BUTLER, EXAMINING ATTORNEY

Int. Cl.: 5

Prior U.S. Cls.: 6, 18, 44, 46, 51 and 52

Reg. No. 3,478,585

United States Patent and Trademark Office

Registered Aug. 5, 2008

**TRADEMARK
PRINCIPAL REGISTER**

BIO CURCUMA

DOLCAS BIOTECH, LLC (NEW JERSEY LTD
LIAB CO)
29 BEACON HILL DRIVE
CHESTER, NJ 07930

FOR: NUTRITIONAL SUPPLEMENTS IN POW-
DER, TABLET AND CAPSULE FORM, IN CLASS 5
(U.S. CLS. 6, 18, 44, 46, 51 AND 52).

FIRST USE 6-4-2007; IN COMMERCE 6-4-2007.

THE MARK CONSISTS OF STANDARD CHAR-
ACTERS WITHOUT CLAIM TO ANY PARTICULAR
FONT, STYLE, SIZE, OR COLOR.

NO CLAIM IS MADE TO THE EXCLUSIVE
RIGHT TO USE "CURCUMA", APART FROM THE
MARK AS SHOWN.

SER. NO. 76-682,967, FILED 10-15-2007.

ANTHONY RINKER, EXAMINING ATTORNEY

Int. Cl.: 14

Prior U.S. Cls.: 2, 27, 28 and 50

United States Patent and Trademark Office

Reg. No. 3,478,586

Registered Aug. 5, 2008

TRADEMARK
PRINCIPAL REGISTER



BOWERMAN, COURTNEY (UNITED STATES INDIVIDUAL)
668 GREENWICH STREET #511
NEW YORK, NY 10014

FOR: JEWELRY THAT REPRESENTS PREGNANCY, IN CLASS 14 (U.S. CLS. 2, 27, 28 AND 50).

FIRST USE 10-2-2005; IN COMMERCE 10-2-2005.

NO CLAIM IS MADE TO THE EXCLUSIVE RIGHT TO USE "CO.", APART FROM THE MARK AS SHOWN.

THE COLOR(S) LIGHT BLUE AND CHOCOLATE BROWN IS/ARE CLAIMED AS A FEATURE OF THE MARK.

THE MARK CONSISTS OF THE LITERAL ELEMENT "ME AND CO." BENEATH A CURVED FIGURE WITH THE WORDING "ME" IN LIGHT BLUE AND THE WORDING "AND CO." AND CURVED FIGURE IN CHOCOLATE BROWN.

SER. NO. 76-683,085, FILED 10-18-2007.

ANGELA GAW, EXAMINING ATTORNEY

Int. Cl.: 29

Prior U.S. Cl.: 46

United States Patent and Trademark Office

Reg. No. 3,478,587

Registered Aug. 5, 2008

**TRADEMARK
PRINCIPAL REGISTER**

PROTEUS

Improving the way the world eats

PROTEUS INDUSTRIES, INC. (MASSACHU-
SETTS CORPORATION)
15 GREAT REPUBLIC DRIVE
GLOUCESTER, MA 01930

FOR: ANIMAL MUSCLE PROTEIN ISOLATED
FROM ANIMAL MUSCLE FOR USE AS A FOOD
ADDITIVE FOR HUMAN CONSUMPTION ONLY,
IN CLASS 29 (U.S. CL. 46).

FIRST USE 10-23-2006; IN COMMERCE 10-23-2006.

OWNER OF U.S. REG. NOS. 3,322,186 AND
3,322,192.

SER. NO. 76-683,254, FILED 10-24-2007.

DAWN HAN, EXAMINING ATTORNEY

Int. Cl.: 45

Prior U.S. Cls.: 100 and 101

United States Patent and Trademark Office

Reg. No. 3,478,588

Registered Aug. 5, 2008

**SERVICE MARK
PRINCIPAL REGISTER**

SKYWATCH

SKY WATCH, LLC. (VIRGINIA LTD LIAB CO)
6124 DEBORAH DRIVE
WARRENTON, VA 20187

FIRST USE 12-0-2005; IN COMMERCE 12-0-2005.

FOR: SECURITY SERVICES, NAMELY, PROVIDING SECURITY EVALUATION OF PHYSICAL LOCATIONS AND TECHNICAL ASSISTANCE IN THE OPERATION AND DEPLOYMENT OF ELECTRONIC SURVEILLANCE AND OPTICAL SECURITY SYSTEMS FOR A REAL TIME PROTECTION OF PEOPLE, PROPERTY, INFRASTRUCTURE AND BORDERS, IN CLASS 45 (U.S. CLS. 100 AND 101).

THE MARK CONSISTS OF STANDARD CHARACTERS WITHOUT CLAIM TO ANY PARTICULAR FONT, STYLE, SIZE, OR COLOR.

SER. NO. 76-683,327, FILED 10-25-2007.

TINA KUAN, EXAMINING ATTORNEY

Int. Cl.: 38

Prior U.S. Cls.: 100, 101 and 104

United States Patent and Trademark Office

Reg. No. 3,478,589

Registered Aug. 5, 2008

**SERVICE MARK
PRINCIPAL REGISTER**

CONNECT2BUSINESS

KUDER, INC. (IOWA CORPORATION)
302 VISIONS PARKWAY
ADEL, IA 50003

THE MARK CONSISTS OF STANDARD CHAR-
ACTERS WITHOUT CLAIM TO ANY PARTICULAR
FONT, STYLE, SIZE, OR COLOR.

FOR: TRANSMISSION OF INFORMATION VIA
COMPUTER NETWORK IN THE FIELD OF EM-
PLOYMENT OPPORTUNITIES, IN CLASS 38 (U.S.
CLS. 100, 101 AND 104).

SER. NO. 76-683,585, FILED 11-2-2007.

FIRST USE 9-25-2007; IN COMMERCE 9-25-2007.

NAKIA HENRY, EXAMINING ATTORNEY

Int. Cl.: 9

Prior U.S. Cls.: 21, 23, 26, 36 and 38

United States Patent and Trademark Office

Reg. No. 3,478,590

Registered Aug. 5, 2008

**TRADEMARK
PRINCIPAL REGISTER**

SpectraLase

SPECTRA-LASE, INC. (NEBRASKA CORPORATION)
14225 DAYTON CIRCLE
OMAHA, NE 68135

FOR: SCIENTIFIC ANALYTICAL LASER ABLATION EQUIPMENT FOR ABLATING MATERIAL FROM SOLID SAMPLES TO FORM AN AEROSOL FOR ANALYSIS IN ELEMENTAL ANALYZERS SUCH AS INDUCTIVELY COUPLED PLASMA (ICP) AND INDUCTIVELY COUPLED PLASMA (ICP) MASS SPECTROMETER SYSTEMS, INCLUD-

ING COMPUTER OPERATING SOFTWARE FOR USE WITH THE ANALYTICAL LASER ABLATION EQUIPMENT, SPECIFICALLY EXCLUDING LASER EQUIPMENT FOR MEDICAL USAGE, IN CLASS 9 (U.S. CLS. 21, 23, 26, 36 AND 38).

FIRST USE 2-12-2008; IN COMMERCE 2-12-2008.

SER. NO. 76-683,587, FILED 11-2-2007.

NAKIA HENRY, EXAMINING ATTORNEY

Int. Cl.: 36

Prior U.S. Cls.: 100, 101 and 102

United States Patent and Trademark Office

Reg. No. 3,478,591

Registered Aug. 5, 2008

**SERVICE MARK
PRINCIPAL REGISTER**

DATADOE

DATADOE (FLORIDA CORPORATION)

2888 E 25 COURT

FT. LAUDERDALE, FL 33305

FOR: LOW COST CREDIT CARD AND BANKING
SERVICES, IN CLASS 36 (U.S. CLS. 100, 101 AND 102).

FIRST USE 9-26-2007; IN COMMERCE 10-15-2007.

THE MARK CONSISTS OF STANDARD CHAR-
ACTERS WITHOUT CLAIM TO ANY PARTICULAR
FONT, STYLE, SIZE, OR COLOR.

THE TERM "DATADOE" HAS NO MEANING IN
A FOREIGN LANGUAGE

SER. NO. 76-683,655, FILED 11-5-2007.

MICHAEL GAAFAR, EXAMINING ATTORNEY

Int. Cl.: 29

Prior U.S. Cl.: 46

United States Patent and Trademark Office

Reg. No. 3,478,592

Registered Aug. 5, 2008

**TRADEMARK
PRINCIPAL REGISTER**

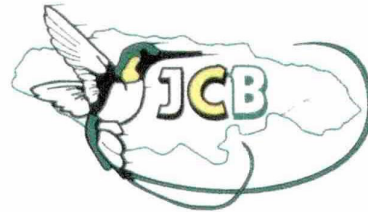

JAMAICAN COUNTRY BRAND

KINGSTON-MIAMI TRADING CO. (FLORIDA CORPORATION)
1465 NW 21 TERRACE
MIAMI, FL 33142

FOR: BEEF AND PORK, IN CLASS 29 (U.S. CL. 46).

FIRST USE 0-0-1992; IN COMMERCE 0-0-1992.

NO CLAIM IS MADE TO THE EXCLUSIVE RIGHT TO USE "JAMAICAN COUNTRY BRAND", APART FROM THE MARK AS SHOWN.

THE COLOR(S) BLACK, WHITE, GREEN AND YELLOW IS/ARE CLAIMED AS A FEATURE OF THE MARK.

THE MARK CONSISTS OF THE LETTERS "J" IN A STYLIZED BLACK AND WHITE FONT, "C" IN A STYLIZED YELLOW AND BLACK FONT AND "B" IN A STYLIZED GREEN AND WHITE FONT, ALL SUPERIMPOSED ON A REPRESENTATION OF THE ISLAND OF "JAMAICA" WITH A GREEN OUTLINE AND TO THE LEFT OF A REPRESENTATION OF A BLACK, WHITE, GREEN AND YELLOW HUMMINGBIRD, ALL ABOVE THE WORDS "JAMAICAN COUNTRY BRAND" IN A STYLIZED BLACK FONT.

SER. NO. 76-683,666, FILED 11-5-2007.

DEZMONA MIZELLE, EXAMINING ATTORNEY

Int. Cl.: 12

Prior U.S. Cls.: 19, 21, 23, 31, 35 and 44

Reg. No. 3,478,593

United States Patent and Trademark Office

Registered Aug. 5, 2008

**TRADEMARK
PRINCIPAL REGISTER**

smartkart

HOME SLICE, LLC (D.C. LTD LIAB CO)
1100 EUCLID STREET, NW
WASHINGTON, DC 20009

THE MARK CONSISTS OF STANDARD CHAR-
ACTERS WITHOUT CLAIM TO ANY PARTICULAR
FONT, STYLE, SIZE, OR COLOR.

FOR: ECO FRIENDLY ELECTRIC VEHICLES
USED FOR VENDING AND SMALL DELIVERY,
NAMELY, ELECTRIC CARS, IN CLASS 12 (U.S. CLS.
19, 21, 23, 31, 35 AND 44).

SER. NO. 76-683,831, FILED 11-8-2007.

FIRST USE 7-1-2007; IN COMMERCE 7-1-2007.

BRENDAN MCCAULEY, EXAMINING ATTORNEY

Int. Cl.: 19

Prior U.S. Cls.: 1, 12, 33 and 50

United States Patent and Trademark Office

Reg. No. 3,478,594

Registered Aug. 5, 2008

**TRADEMARK
PRINCIPAL REGISTER**

STORMBAG

SWISS-LINK, INC. (CALIFORNIA CORPORATION)
5365 CLARK RD BLDG. F
PARADISE, CA 95969

THE MARK CONSISTS OF STANDARD CHARACTERS WITHOUT CLAIM TO ANY PARTICULAR FONT, STYLE, SIZE, OR COLOR.

FOR: SILICA GEL USED AS A SANDBAG ALTERNATIVE SOLD IN BAGS, IN CLASS 19 (U.S. CLS. 1, 12, 33 AND 50).

SER. NO. 76-683,884, FILED 11-9-2007.

FIRST USE 1-0-2004; IN COMMERCE 1-0-2004.

LINDA M. KING, EXAMINING ATTORNEY

Int. Cl.: 38

Prior U.S. Cls.: 100, 101 and 104

United States Patent and Trademark Office

Reg. No. 3,478,595

Registered Aug. 5, 2008

**SERVICE MARK
PRINCIPAL REGISTER**

LINK2COLLEGE

KUDER, INC. (IOWA CORPORATION)
302 VISIONS PARKWAY
ADEL, IA 50003

THE MARK CONSISTS OF STANDARD CHAR-
ACTERS WITHOUT CLAIM TO ANY PARTICULAR
FONT, STYLE, SIZE, OR COLOR.

FOR: TRANSMISSION OF INFORMATION VIA
COMPUTER NETWORK IN THE FIELD OF EDU-
CATIONAL OPPORTUNITIES, IN CLASS 38 (U.S.
CLS. 100, 101 AND 104).

SER. NO. 76-683,935, FILED 11-13-2007.

FIRST USE 10-31-2007; IN COMMERCE 10-31-2007.

NAKIA HENRY, EXAMINING ATTORNEY

Int. Cl.: 6

Prior U.S. Cls.: 2, 12, 13, 14, 23, 25 and 50

Reg. No. 3,478,596

United States Patent and Trademark Office

Registered Aug. 5, 2008

**TRADEMARK
PRINCIPAL REGISTER**

JACKNUT

STEINBOCK MACHINERY CORP. (PENNSYLVANIA CORPORATION)
1000 GREGG STREET
CARNEGIE, PA 15106

THE MARK CONSISTS OF STANDARD CHARACTERS WITHOUT CLAIM TO ANY PARTICULAR FONT, STYLE, SIZE, OR COLOR.

FOR: METAL TORQUE NUTS AND TORQUE BOLTS, IN CLASS 6 (U.S. CLS. 2, 12, 13, 14, 23, 25 AND 50).

SER. NO. 76-684,006, FILED 11-14-2007.

FIRST USE 9-13-1984; IN COMMERCE 9-13-1984.

BRIAN NEVILLE, EXAMINING ATTORNEY

Int. Cl.: 41

Prior U.S. Cls.: 100, 101 and 107

United States Patent and Trademark Office

Reg. No. 3,478,597

Registered Aug. 5, 2008

SERVICE MARK
PRINCIPAL REGISTER

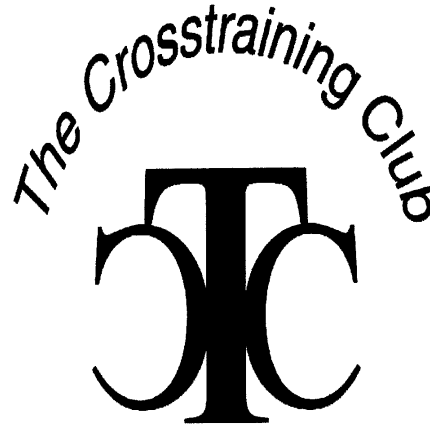

THE CROSSTRaining CLUB FRANCHISE
COMPANY (KANSAS CORPORATION)
28071 PINNACLES COURT
LAGUNA NIGUEL, CA 92677

NO CLAIM IS MADE TO THE EXCLUSIVE
RIGHT TO USE "THE CROSSTRaining CLUB",
APART FROM THE MARK AS SHOWN.

FOR: HEALTH CLUB SERVICES, NAMELY, PRO-
VIDING HEALTH AND FITNESS INSTRUCTION,
IN CLASS 41 (U.S. CLS. 100, 101 AND 107).

SER. NO. 76-684,159, FILED 11-19-2007.

FIRST USE 11-1-1993; IN COMMERCE 11-1-1993.

LINDA MICKLEBURGH, EXAMINING ATTORNEY

Int. Cl.: 43

Prior U.S. Cls.: 100 and 101

United States Patent and Trademark Office

Reg. No. 3,478,598

Registered Aug. 5, 2008

**SERVICE MARK
PRINCIPAL REGISTER**



RESTAURANT DEVELOPERS CORPORATION
(OHIO CORPORATION)
7010 ENGLE ROAD, SUITE 100
MIDDLEBURG HEIGHTS, OH 44130

FIRST USE 5-31-2007; IN COMMERCE 5-31-2007.

SER. NO. 76-684,228, FILED 11-21-2007.

FOR: RESTAURANT SERVICES, IN CLASS 43
(U.S. CLS. 100 AND 101).

MELISSA VALLILLO, EXAMINING ATTORNEY

Int. Cls.: 9 and 41

Prior U.S. Cls.: 21, 23, 26, 36, 38, 100, 101 and 107

Reg. No. 3,478,599

United States Patent and Trademark Office

Registered Aug. 5, 2008

**TRADEMARK
SERVICE MARK
PRINCIPAL REGISTER**

DINASTIA NORTEÑA

GOMEZ, FIDENCIO (MEXICO INDIVIDUAL)
8560 VINEYARD AVE. SUITE 107
RANCHO CUCAMONGA, CA 91730

FOR: SOUND RECORDINGS, NAMELY, PHONO-
GRAPH RECORDS, AUDIO CASSETTES, PRE-RE-
CORDED VIDEO CASSETTES AND COMPACT
DISCS FEATURING MUSIC PERFORMED IN
SPANISH, IN CLASS 9 (U.S. CLS. 21, 23, 26, 36 AND
38).

FIRST USE 3-28-1993; IN COMMERCE 3-28-1995.

FOR: ENTERTAINMENT SERVICES IN THE
NATURE OF LIVE MUSICAL PERFORMANCES,
IN CLASS 41 (U.S. CLS. 100, 101 AND 107).

FIRST USE 3-28-1993; IN COMMERCE 3-28-1995.

THE MARK CONSISTS OF STANDARD CHAR-
ACTERS WITHOUT CLAIM TO ANY PARTICULAR
FONT, STYLE, SIZE, OR COLOR.

THE ENGLISH TRANSLATION OF THE WORD
"DINASTIA NORTEÑA" IN THE MARK IS NORTH-
ERN DYNASTY.

SER. NO. 76-684,378, FILED 11-28-2007.

WARREN L. OLANDRIA, EXAMINING ATTOR-
NEY

Int. Cl.: 31

Prior U.S. Cls.: 1 and 46

United States Patent and Trademark Office

Reg. No. 3,478,600

Registered Aug. 5, 2008

TRADEMARK
PRINCIPAL REGISTER



QUALITY CHRISTMAS TREE, LTD. (TEXAS
LIMITED PARTNERSHIP)
P.O. BOX 273179
HOUSTON, TX 77277

FOR: LIVE PLANTS, LIVE FLOWERS, LIVE
TREES, AND LIVE SHRUBS, IN CLASS 31 (U.S.
CLS. 1 AND 46).

FIRST USE 1-1-1996; IN COMMERCE 1-1-1996.

THE MARK CONSISTS OF A STYLIZED DRAW-
ING OF A MAN WHICH CONTAINS THE STYLIZED
TEXT "BIG STUFF".

SER. NO. 76-684,580, FILED 12-3-2007.

FRANK LATTUCA, EXAMINING ATTORNEY

Int. Cl.: 35

Prior U.S. Cls.: 100, 101 and 102

United States Patent and Trademark Office

Reg. No. 3,478,601

Registered Aug. 5, 2008

**SERVICE MARK
PRINCIPAL REGISTER**

STARFRUIT HAWAIIAN

OHANA CAPITAL, LLC (MARYLAND LTD LIAB
CO)

10601 RIVERS BEND LANE

POTOMAC, MD 20854

FOR: RETAIL GIFT SHOPS, IN CLASS 35 (U.S.
CLS. 100, 101 AND 102).

FIRST USE 11-9-2007; IN COMMERCE 11-25-2007.

THE MARK CONSISTS OF STANDARD CHAR-
ACTERS WITHOUT CLAIM TO ANY PARTICULAR
FONT, STYLE, SIZE, OR COLOR.

NO CLAIM IS MADE TO THE EXCLUSIVE
RIGHT TO USE "HAWAIIAN", APART FROM THE
MARK AS SHOWN.

SER. NO. 76-684,731, FILED 12-7-2007.

MELISSA VALLILLO, EXAMINING ATTORNEY

Int. Cl.: 25

Prior U.S. Cls.: 22 and 39

United States Patent and Trademark Office

Reg. No. 3,478,602

Registered Aug. 5, 2008

**TRADEMARK
PRINCIPAL REGISTER**

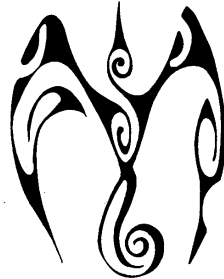

Sincera USA

YOO, BYUNG HAK (REPUBLIC OF KOREA
INDIVIDUAL)

1500 S. SANTEE STREET, # A

LOS ANGELES, CA 90015

FOR: CLOTHING, NAMELY, DRESSES, SKIRTS,
SUITS, BLOUSES, PANTS, SHORTS, JACKETS, T-
SHIRTS, SWEATERS, COATS, SOCKS, HOSIERY,
HATS, SCARVES AND UNDERWEAR, IN CLASS 25
(U.S. CLS. 22 AND 39).

FIRST USE 7-21-2006; IN COMMERCE 7-21-2006.

NO CLAIM IS MADE TO THE EXCLUSIVE
RIGHT TO USE "USA", APART FROM THE MARK
AS SHOWN.

THE MARK CONSISTS OF: A DRAWING OF A
BIRD AND THE WORDS "SINCERA USA" APPEAR
UNDERNEATH IN A STYLIZED FONT.

THE ENGLISH TRANSLATION OF SINCERA IS
"SINCERE".

SER. NO. 76-684,759, FILED 12-10-2007.

PRISCILLA MILTON, EXAMINING ATTORNEY

Int. Cl.: 8

Prior U.S. Cls.: 23, 28 and 44

Reg. No. 3,478,603

United States Patent and Trademark Office

Registered Aug. 5, 2008

**TRADEMARK
PRINCIPAL REGISTER**

OPTIMUS

OPTIMUS ENTERPRISE, INC. (CALIFORNIA CORPORATION)
UNIT #J, 2201 E. WINSTON ROAD
ANAHEIM, CA 92806

HAIR TRIMMERS; SHAVERS FOR WOMEN, IN CLASS 8 (U.S. CLS. 23, 28 AND 44).

FIRST USE 9-15-2007; IN COMMERCE 9-15-2007.

FOR: ELECTRIC PERSONAL CARE PRODUCTS, NAMELY, SHAVERS; BATTERY OPERATED HAIR GROOMERS FOR NOSE, EAR, AND EYEBROW;

SER. NO. 76-684,773, FILED 12-10-2007.

MARY CRAWFORD, EXAMINING ATTORNEY

Int. Cl.: 40

Prior U.S. Cls.: 100, 103 and 106

United States Patent and Trademark Office

Reg. No. 3,478,604

Registered Aug. 5, 2008

**SERVICE MARK
PRINCIPAL REGISTER**

RESTORE



RHODE ISLAND RESOURCE RECOVERY COR-
PORATION (RHODE ISLAND REGIONAL
GOVERNMENT AGENCY)
65 SHUN PIKE
JOHNSTON, RI 02919

THE MARK CONSISTS OF THE WORD "RE-
STORE" IN A STYLIZED BLACK FONT WITH THE
REPRESENTATION OF A HUMAN BESIDE A
TRASHCAN WITHIN THE LETTER "O".

FOR: RECYCLING SERVICES, IN CLASS 40 (U.S.
CLS. 100, 103 AND 106).

SER. NO. 76-684,899, FILED 12-13-2007.

FIRST USE 9-2-2005; IN COMMERCE 9-2-2005.

BRIAN CALLAGHAN, EXAMINING ATTORNEY

Int. Cl.: 16

Prior U.S. Cls.: 2, 5, 22, 23, 29, 37, 38 and 50

United States Patent and Trademark Office

Reg. No. 3,478,605

Registered Aug. 5, 2008

**TRADEMARK
PRINCIPAL REGISTER**

MANAGING YOUR EPILEPSY

ASSOCIATES IN MEDICAL MARKETING CO.,
INC. (PENNSYLVANIA CORPORATION)
3 TERRY DRIVE, SUITE 201
NEWTOWN, PA 189401818

FOR: PERIODICALLY REVISED MEDICAL RE-
FERENCE BOOK, IN CLASS 16 (U.S. CLS. 2, 5, 22, 23,
29, 37, 38 AND 50).

FIRST USE 11-15-2000; IN COMMERCE 11-15-2000.

THE MARK CONSISTS OF STANDARD CHAR-
ACTERS WITHOUT CLAIM TO ANY PARTICULAR
FONT, STYLE, SIZE, OR COLOR.

OWNER OF U.S. REG. NO. 2,521,429.

SEC. 2(F).

SER. NO. 76-684,902, FILED 12-13-2007.

JACLYN KIDWELL, EXAMINING ATTORNEY

Int. Cl.: 16

Prior U.S. Cls.: 2, 5, 22, 23, 29, 37, 38 and 50

United States Patent and Trademark Office

Reg. No. 3,478,606

Registered Aug. 5, 2008

**TRADEMARK
PRINCIPAL REGISTER**

**A PATIENT'S HANDBOOK
ON CHOLESTEROL DISORDERS**

ASSOCIATES IN MEDICAL MARKETING CO.,
INC. (PENNSYLVANIA CORPORATION)
3 TERRY DRIVE, SUITE 201
NEWTOWN, PA 189401818

FOR: PERIODICALLY REVISED MEDICAL RE-
FERENCE BOOK, IN CLASS 16 (U.S. CLS. 2, 5, 22, 23,
29, 37, 38 AND 50).

FIRST USE 11-15-2000; IN COMMERCE 11-15-2000.

THE MARK CONSISTS OF STANDARD CHAR-
ACTERS WITHOUT CLAIM TO ANY PARTICULAR
FONT, STYLE, SIZE, OR COLOR.

OWNER OF U.S. REG. NO. 2,515,949.

NO CLAIM IS MADE TO THE EXCLUSIVE
RIGHT TO USE "HANDBOOK", APART FROM
THE MARK AS SHOWN.

SEC. 2(F).

SER. NO. 76-684,903, FILED 12-13-2007.

JACLYN KIDWELL, EXAMINING ATTORNEY

Int. Cl.: 35

Prior U.S. Cls.: 100, 101 and 102

United States Patent and Trademark Office

Reg. No. 3,478,607

Registered Aug. 5, 2008

**SERVICE MARK
PRINCIPAL REGISTER**

World Link for Law

WORLD LINK FOR LAW. (SWITZERLAND ASSOCIATION)
BAHNHOFSTRASSE 44/46
8001 ZURICH, SWITZERLAND

FOR: ASSOCIATION SERVICES, NAMELY, PROMOTING THE INTERESTS OF LAW FIRMS AROUND THE WORLD, IN CLASS 35 (U.S. CLS. 100, 101 AND 102).

FIRST USE 4-1-2004; IN COMMERCE 4-1-2004.

THE MARK CONSISTS OF STANDARD CHARACTERS WITHOUT CLAIM TO ANY PARTICULAR FONT, STYLE, SIZE, OR COLOR.

NO CLAIM IS MADE TO THE EXCLUSIVE RIGHT TO USE "FOR LAW", APART FROM THE MARK AS SHOWN.

SER. NO. 76-684,995, FILED 12-17-2007.

BARBARA GAYNOR, EXAMINING ATTORNEY

Int. Cl.: 41

Prior U.S. Cls.: 100, 101 and 107

United States Patent and Trademark Office

Reg. No. 3,478,608

Registered Aug. 5, 2008

**SERVICE MARK
PRINCIPAL REGISTER**

BELLE VIE PHOTOGRAPHY

BELLE VIE PHOTOGRAPHY (PENNSYLVANIA
SOLE PROPRIETORSHIP)
415 DELAWARE AVENUE
LANSDALE, PA 19446

FOR: PORTRAIT PHOTOGRAPHY OF NEW-
BORNS, BABIES, CHILDREN, MATERNITY, HIGH
SCHOOL SENIORS, AND FAMILIES, IN CLASS 41
(U.S. CLS. 100, 101 AND 107).

FIRST USE 1-1-2007; IN COMMERCE 1-1-2007.

THE MARK CONSISTS OF STANDARD CHAR-
ACTERS WITHOUT CLAIM TO ANY PARTICULAR
FONT, STYLE, SIZE, OR COLOR.

NO CLAIM IS MADE TO THE EXCLUSIVE
RIGHT TO USE "PHOTOGRAPHY", APART FROM
THE MARK AS SHOWN.

THE ENGLISH TRANSLATION OF THE WORD-
ING "BELLE VIE" IN THE MARK IS "BEAUTIFUL
LIFE".

SER. NO. 76-685,022, FILED 12-17-2007.

BRENDAN MCCAULEY, EXAMINING ATTORNEY

Int. Cl.: 43

Prior U.S. Cls.: 100 and 101

United States Patent and Trademark Office

Reg. No. 3,478,609

Registered Aug. 5, 2008

**SERVICE MARK
PRINCIPAL REGISTER**

MICHEL RICHARD

MICHEL RICHARD, LLC (D.C. LTD LIAB CO)
3000 M STREET NW
WASHINGTON, DC 20007

FOR: RESTAURANT AND BAR SERVICES, IN
CLASS 43 (U.S. CLS. 100 AND 101).

FIRST USE 1-2-2003; IN COMMERCE 1-2-2003.

THE MARK CONSISTS OF STANDARD CHAR-
ACTERS WITHOUT CLAIM TO ANY PARTICULAR
FONT, STYLE, SIZE, OR COLOR.

THE NAME "MICHEL RICHARD" IDENTIFIES A
LIVING INDIVIDUAL WHOSE CONSENT IS OF
RECORD.

SER. NO. 76-685,034, FILED 12-18-2007.

KAREN BRACEY, EXAMINING ATTORNEY

Int. Cl.: 41

Prior U.S. Cls.: 100, 101 and 107

United States Patent and Trademark Office

Reg. No. 3,478,610

Registered Aug. 5, 2008

**SERVICE MARK
PRINCIPAL REGISTER**



iwonder

SMITHSONIAN INSTITUTION (UNITED STATES
TRUST INSTRUMENTALITY)
1000 JEFFERSON DRIVE, S.W.
ROOM 302 MRC 012 P.O. BOX 23286
WASHINGTON, DC 200263286

FOR: EDUCATION SERVICES, NAMELY, PROVIDING CLASSES, SEMINARS, AND WORKSHOPS IN THE FIELD OF PROFESSIONAL DEVELOPMENT AND TRAINING FOR TEACHERS IN GRADES K-12 TO MASTER INQUIRY-BASED TEACHING SKILLS USING MUSEUM COLLECTIONS, IN CLASS 41 (U.S. CLS. 100, 101 AND 107).

FIRST USE 7-26-1996; IN COMMERCE 2-11-1999.

THE COLOR(S) BLUE AND RED IS/ARE CLAIMED AS A FEATURE OF THE MARK.

THE COLOR BLUE APPEARS IN THE LETTERS "IWONDER". THE COLOR RED APPEARS AS THE DOT OVER THE LETTER "I".

SER. NO. 76-685,097, FILED 12-19-2007.

DAVID TOOLEY, EXAMINING ATTORNEY

Int. Cls.: 9, 16, 25, 41 and 44

**Prior U.S. Cls.: 2, 5, 21, 22, 23, 26, 29, 36, 37, 38, 39,
50, 100, 101 and 107**

Reg. No. 3,478,611

United States Patent and Trademark Office

Registered Aug. 5, 2008

**TRADEMARK
SERVICE MARK
PRINCIPAL REGISTER**

CARMICHAEL TRAINING SYSTEMS

CARMICHAEL TRAINING SYSTEMS, INC. (DE-
LAWARE CORPORATION)
110 SOUTH SIERRA MADRE STREET
SUITE B
COLORADO SPRINGS, CO 80903

FOR: ELECTRONIC GOODS, NAMELY, VIDEO CASSETTES, DIGITAL VIDEO DISCS AND CD'S FEATURING ENDURANCE AND AEROBIC TRAINING, PHYSICAL FITNESS AND NUTRITION INSTRUCTION; DOWNLOADABLE ELECTRONIC PUBLICATIONS, NAMELY, NEWSLETTERS FEATURING ARTICLES AND INFORMATION ABOUT ENDURANCE AND AEROBIC TRAINING, NUTRITION, PHYSICAL FITNESS, HEALTH AND WELLNESS, IN CLASS 9 (U.S. CLS. 21, 23, 26, 36 AND 38).

FIRST USE 12-15-2003; IN COMMERCE 12-15-2003.

FOR: PUBLICATIONS, NAMELY, PAMPHLETS, BROCHURES AND NEWSLETTERS FEATURING ARTICLES AND INFORMATION ABOUT ENDURANCE AND AEROBIC TRAINING, NUTRITION, PHYSICAL FITNESS, HEALTH AND WELLNESS, IN CLASS 16 (U.S. CLS. 2, 5, 22, 23, 29, 37, 38 AND 50).

FIRST USE 12-15-2003; IN COMMERCE 12-15-2003.

FOR: CLOTHING, NAMELY, T-SHIRTS, CAPS, SWEAT SHIRTS AND TROUSERS, IN CLASS 25 (U.S. CLS. 22 AND 39).

FIRST USE 12-15-2003; IN COMMERCE 12-15-2003.

FOR: PHYSICAL FITNESS INSTRUCTION, NAMELY, ENDURANCE AND AEROBIC TRAINING FOR ELITE AND RECREATIONAL ATHLETES; PHYSICAL FITNESS CONSULTATION IN THE FIELD OF ENDURANCE AND AEROBIC TRAINING FOR ELITE AND RECREATIONAL ATHLETES, IN CLASS 41 (U.S. CLS. 100, 101 AND 107).

FIRST USE 6-30-1999; IN COMMERCE 6-30-1999.

FOR: FOOD NUTRITION CONSULTATION IN THE FIELD OF ENDURANCE AND AEROBIC TRAINING FOR ELITE AND RECREATIONAL ATHLETES, IN CLASS 44 (U.S. CLS. 100 AND 101).

FIRST USE 6-30-1999; IN COMMERCE 6-30-1999.

THE MARK CONSISTS OF STANDARD CHARACTERS WITHOUT CLAIM TO ANY PARTICULAR FONT, STYLE, SIZE, OR COLOR.

OWNER OF U.S. REG. NOS. 2,524,809 AND 2,988,671.

NO CLAIM IS MADE TO THE EXCLUSIVE RIGHT TO USE "TRAINING SYSTEMS", APART FROM THE MARK AS SHOWN.

SER. NO. 76-685,195, FILED 12-26-2007.

WILLIAM ROSSMAN, EXAMINING ATTORNEY

Int. Cl.: 16

Prior U.S. Cls.: 2, 5, 22, 23, 29, 37, 38 and 50

United States Patent and Trademark Office

Reg. No. 3,478,612

Registered Aug. 5, 2008

**TRADEMARK
PRINCIPAL REGISTER**

Trouble Talk

LUDWIG CREATIVE, INC. (OREGON CORPORATION)
7450 SW PINERIDGE CT.
PORTLAND, OR 97225

FOR: CHILDREN'S BOOKS FEATURING PERSONAL DEVELOPMENT, LEADERSHIP, FRIENDSHIPS, BEHAVIORAL DEVELOPMENT, AND SOCIAL SKILLS, IN CLASS 16 (U.S. CLS. 2, 5, 22, 23, 29, 37, 38 AND 50).

FIRST USE 11-26-2006; IN COMMERCE 11-15-2007.

THE MARK CONSISTS OF STANDARD CHARACTERS WITHOUT CLAIM TO ANY PARTICULAR FONT, STYLE, SIZE, OR COLOR.

SER. NO. 76-685,201, FILED 12-26-2007.

MYRIAH HABEEB, EXAMINING ATTORNEY

Int. Cl.: 16

Prior U.S. Cls.: 2, 5, 22, 23, 29, 37, 38 and 50

Reg. No. 3,478,613

United States Patent and Trademark Office

Registered Aug. 5, 2008

**TRADEMARK
PRINCIPAL REGISTER**

BALABAN AND KATZ

BALABAN, DAVID (UNITED STATES INDIVIDUAL)
55 WALLACE STREET
BELLEVILLE, NJ 07109

FOR: GREETING CARDS AND MAGAZINES ABOUT THE ENTERTAINMENT INDUSTRY, IN CLASS 16 (U.S. CLS. 2, 5, 22, 23, 29, 37, 38 AND 50).

FIRST USE 7-0-2005; IN COMMERCE 7-0-2005.

THE MARK CONSISTS OF STANDARD CHARACTERS WITHOUT CLAIM TO ANY PARTICULAR FONT, STYLE, SIZE, OR COLOR.

OWNER OF U.S. REG. NO. 3,147,294.

SER. NO. 76-685,261, FILED 12-26-2007.

TRACY WHITTAKER-BROWN, EXAMINING ATTORNEY

Int. Cl.: 35

Prior U.S. Cls.: 100, 101 and 102

United States Patent and Trademark Office

Reg. No. 3,478,614

Registered Aug. 5, 2008

**SERVICE MARK
PRINCIPAL REGISTER**



HAWKINS, KEVIN W. (UNITED STATES INDIVIDUAL), DBA JUICE TO LIVE
200 PLYMOUTH STREET
SILVER SPRING, MD 20901

FOR: RETAIL STORE SERVICES, ON-LINE RETAIL STORE SERVICES, AND WHOLESALE DISTRIBUTORSHIP SERVICES ALL FEATURING FRESH FRUIT AND VEGETABLE JUICES, HIGH VITAMIN AND PROTEIN BEVERAGES, NATURAL SPRING BOTTLE WATER, NON-ALCOHOLIC BEVERAGES, ORGANICALLY GROWN FRUITS AND

VEGETABLES, PROCESSED FRUITS AND VEGETABLES PACKED IN PLASTIC AND ALUMINUM CONTAINERS, SANDWICHES, AND HEALTH FOOD SNACKS, IN CLASS 35 (U.S. CLS. 100, 101 AND 102).

FIRST USE 8-6-2005; IN COMMERCE 8-6-2005.

SER. NO. 76-685,263, FILED 12-26-2007.

PAM WILLIS, EXAMINING ATTORNEY

Int. Cl.: 36

Prior U.S. Cls.: 100, 101 and 102

United States Patent and Trademark Office

Reg. No. 3,478,615

Registered Aug. 5, 2008

**SERVICE MARK
PRINCIPAL REGISTER**

PENSION MAXIMA

PENSION MAXIMA INVESTMENT ADVISORY
(CALIFORNIA CORPORATION)

1108 SOUTH BALDWIN AVENUE #210

ARCADIA, CA 91007

FOR: INVESTMENT ADVISORY SERVICES, IN
CLASS 36 (U.S. CLS. 100, 101 AND 102).

FIRST USE 6-8-2007; IN COMMERCE 6-8-2007.

THE MARK CONSISTS OF STANDARD CHAR-
ACTERS WITHOUT CLAIM TO ANY PARTICULAR
FONT, STYLE, SIZE, OR COLOR.

NO CLAIM IS MADE TO THE EXCLUSIVE
RIGHT TO USE "PENSION", APART FROM THE
MARK AS SHOWN.

SER. NO. 76-685,464, FILED 12-28-2007.

NICHOLAS ALTREE, EXAMINING ATTORNEY

Int. Cl.: 37

Prior U.S. Cls.: 100, 103 and 106

United States Patent and Trademark Office

Reg. No. 3,478,616

Registered Aug. 5, 2008

**SERVICE MARK
PRINCIPAL REGISTER**

DELWEST

DELZOTTO, JOSEPH A. (CANADA INDIVIDUAL)
2821 SOUTH PARKER ROAD, SUITE 915
AURORA, CO 80014

FIRST USE 3-16-1993; IN COMMERCE 3-16-1993.

FOR: CONSTRUCTION SERVICES, NAMELY,
PLANNING, LAYING OUT AND CUSTOM CON-
STRUCTION OF RESIDENTIAL AND COMMER-
CIAL COMMUNITIES; REAL ESTATE
DEVELOPMENT; CONSTRUCTION MANAGE-
MENT, IN CLASS 37 (U.S. CLS. 100, 103 AND 106).

THE MARK CONSISTS OF STANDARD CHAR-
ACTERS WITHOUT CLAIM TO ANY PARTICULAR
FONT, STYLE, SIZE, OR COLOR.

SER. NO. 76-685,489, FILED 1-4-2008.

JAMES STEIN, EXAMINING ATTORNEY

Int. Cls.: 7, 9 and 11

Prior U.S. Cls.: 13, 19, 21, 23, 26, 31, 34, 35, 36 and 38

Reg. No. 3,478,617

United States Patent and Trademark Office

Registered Aug. 5, 2008

**TRADEMARK
PRINCIPAL REGISTER**

INTERLINK

HEATCRAFT REFRIGERATION PRODUCTS
LLC (DELAWARE LTD LIAB CO)
2175 WEST PARK PLACE BLVD
STONE MOUNTAIN, GA 30087

FOR: REPAIR AND REPLACEMENT PARTS FOR
SPACE COOLING AND REFRIGERATION EQUIP-
MENT, NAMELY, MOTORS, IN CLASS 7 (U.S. CLS.
13, 19, 21, 23, 31, 34 AND 35).

FIRST USE 1-0-2006; IN COMMERCE 1-0-2006.

FOR: REPAIR AND REPLACEMENT PARTS FOR
SPACE COOLING AND REFRIGERATION EQUIP-
MENT, NAMELY, ELECTRONIC CONTROLS, IN
CLASS 9 (U.S. CLS. 21, 23, 26, 36 AND 38).

FIRST USE 1-0-2006; IN COMMERCE 1-0-2006.

FOR: REPAIR AND REPLACEMENT PARTS FOR
SPACE COOLING AND REFRIGERATION EQUIP-
MENT, NAMELY, ELECTRICAL HEATING ELE-
MENTS, FAN BLADES, DRAIN PANS,
REFRIGERANT CONTROL VALVES, AND RE-
FRIGERANT RECEIVERS, IN CLASS 11 (U.S. CLS.
13, 21, 23, 31 AND 34).

FIRST USE 1-0-2006; IN COMMERCE 1-0-2006.

THE MARK CONSISTS OF STANDARD CHAR-
ACTERS WITHOUT CLAIM TO ANY PARTICULAR
FONT, STYLE, SIZE, OR COLOR.

SER. NO. 76-685,492, FILED 1-4-2008.

PAUL F. GAST, EXAMINING ATTORNEY

Int. Cl.: 44

Prior U.S. Cls.: 100 and 101

United States Patent and Trademark Office

Reg. No. 3,478,618

Registered Aug. 5, 2008

**SERVICE MARK
PRINCIPAL REGISTER**

RUMM COLOR STUDIO

RUMM COLOR STUDIO, LLC (GEORGIA LTD
LIAB CO)

325 ANTEBELLUM PLACE

WOODSTOCK, GA 30188

FOR: PROVIDING HAIR SALON SERVICES, IN
CLASS 44 (U.S. CLS. 100 AND 101).

FIRST USE 11-1-2007; IN COMMERCE 11-1-2007.

THE MARK CONSISTS OF STANDARD CHAR-
ACTERS WITHOUT CLAIM TO ANY PARTICULAR
FONT, STYLE, SIZE, OR COLOR.

NO CLAIM IS MADE TO THE EXCLUSIVE
RIGHT TO USE "COLOR STUDIO", APART FROM
THE MARK AS SHOWN.

SER. NO. 76-685,542, FILED 1-7-2008.

CARYN GLASSER, EXAMINING ATTORNEY

Int. Cl.: 3

Prior U.S. Cls.: 1, 4, 6, 50, 51 and 52

United States Patent and Trademark Office

Reg. No. 3,478,619

Registered Aug. 5, 2008

**TRADEMARK
PRINCIPAL REGISTER**

**HAIR COLOR
FREESIASELIM**

FREESIA USA, INC. (CALIFORNIA CORPORATION)
3680 SOUTH SANTA FE AVENUE
VERNON, CA 90058

FOR: SHAMPOOS, CONDITIONERS, HAIR TREATMENTS, GELS, SPRAYS, MOUSSES AND BALMS FOR HAIR STYLING AND HAIR CARE; HAIR LACQUERS; HAIR COLORING AND HAIR DECOLORANT PREPARATIONS; PERMANENT WAVING AND CURLING PREPARATIONS; ESSENTIAL OILS FOR PERSONAL USE; SOAPS, IN CLASS 3 (U.S. CLS. 1, 4, 6, 50, 51 AND 52).

FIRST USE 1-1-2004; IN COMMERCE 1-1-2004.

THE MARK CONSISTS OF STANDARD CHARACTERS WITHOUT CLAIM TO ANY PARTICULAR FONT, STYLE, SIZE, OR COLOR.

NO CLAIM IS MADE TO THE EXCLUSIVE RIGHT TO USE "HAIR COLOR", APART FROM THE MARK AS SHOWN.

SER. NO. 76-685,565, FILED 1-7-2008.

LINDA M. KING, EXAMINING ATTORNEY

Int. Cl.: 43

Prior U.S. Cls.: 100 and 101

United States Patent and Trademark Office

Reg. No. 3,478,620

Registered Aug. 5, 2008

SERVICE MARK
PRINCIPAL REGISTER

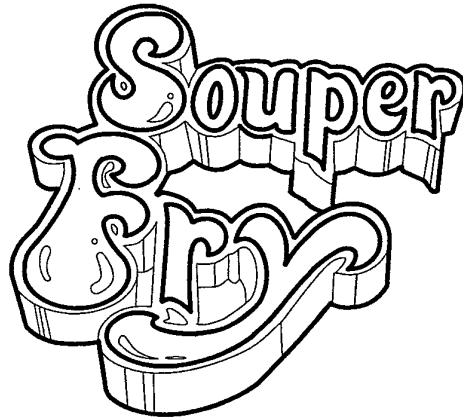

OK COOL, INC. (NEW YORK CORPORATION)
16 TARDY LANE
WANTAGH, NY 11793

FIRST USE 11-0-2007; IN COMMERCE 11-0-2007.

SER. NO. 76-685,576, FILED 12-31-2007.

FOR: RESTAURANT SERVICES, IN CLASS 43
(U.S. CLS. 100 AND 101).

WILLIAM VERHOSEK, EXAMINING ATTORNEY

Int. Cl.: 6

Prior U.S. Cls.: 2, 12, 13, 14, 23, 25 and 50

Reg. No. 3,478,621

United States Patent and Trademark Office

Registered Aug. 5, 2008

**TRADEMARK
PRINCIPAL REGISTER**

DELTATOP

STRUCTURAL GROUP, INC. (MARYLAND CORPORATION)
7455 NEW RIDGE ROAD, SUITE T
HANOVER, MD 21076

THE MARK CONSISTS OF STANDARD CHARACTERS WITHOUT CLAIM TO ANY PARTICULAR FONT, STYLE, SIZE, OR COLOR.

FOR: IRON AGGREGATE FLOORING FOR INDUSTRIAL APPLICATIONS, IN CLASS 6 (U.S. CLS. 2, 12, 13, 14, 23, 25 AND 50).

SER. NO. 76-685,588, FILED 1-7-2008.

FIRST USE 0-0-1995; IN COMMERCE 0-0-1995.

LINDA POWELL, EXAMINING ATTORNEY

Int. Cls.: 37 and 42

Prior U.S. Cls.: 100, 101, 103 and 106

United States Patent and Trademark Office

Reg. No. 3,478,622

Registered Aug. 5, 2008

**SERVICE MARK
PRINCIPAL REGISTER**



DOWNEY CREATIONS, LLC (INDIANA LTD
LIAB CO)
2265 EXECUTIVE DRIVE, SUITE B
INDIANAPOLIS, IN 26241

FOR: JEWELRY REMOUNTING SERVICES ON
BEHALF OF RETAIL STORES, IN CLASS 37 (U.S.
CLS. 100, 103 AND 106).

FIRST USE 3-1-2004; IN COMMERCE 3-1-2004.

FOR: DESIGNING JEWELRY ON BEHALF OF
RETAIL STORES, IN CLASS 42 (U.S. CLS. 100 AND
101).

FIRST USE 3-1-2004; IN COMMERCE 3-1-2004.

THE COLOR(S) BLUE IS/ARE CLAIMED AS A
FEATURE OF THE MARK.

THE COLOR BLUE APPEARS IN THE SECOND
AND THIRD HORIZONTAL LINES FROM THE TOP
OF THE DESIGN D AND IN A THIRD HORIZON-
TAL LINE EXTENDING BENEATH THE LETTERS
"OWNEY CREATIONS".

SER. NO. 76-685,666, FILED 1-11-2008.

KEVON CHISOLM, EXAMINING ATTORNEY

Int. Cl.: 24

Prior U.S. Cls.: 42 and 50

United States Patent and Trademark Office

Reg. No. 3,478,623

Registered Aug. 5, 2008

**TRADEMARK
PRINCIPAL REGISTER**

MICROFEATHER

PACIFIC COAST FEATHER COMPANY (WA-
SHINGTON CORPORATION)

P.O. BOX 80385

SEATTLE, WA 98108

FOR: MATTRESS TOPPERS, IN CLASS 24 (U.S.
CLS. 42 AND 50).

FIRST USE 9-25-1995; IN COMMERCE 8-5-1999.

THE MARK CONSISTS OF STANDARD CHAR-
ACTERS WITHOUT CLAIM TO ANY PARTICULAR
FONT, STYLE, SIZE, OR COLOR.

OWNER OF U.S. REG. NO. 2,523,584.

SEC. 2(F).

SER. NO. 76-685,764, FILED 1-14-2008.

LINDA M. KING, EXAMINING ATTORNEY

Int. Cl.: 35

Prior U.S. Cls.: 100, 101 and 102

United States Patent and Trademark Office

Reg. No. 3,478,624

Registered Aug. 5, 2008

**SERVICE MARK
PRINCIPAL REGISTER**



PLUMADORE, PAUL (UNITED STATES INDIVIDUAL)
5800 ARLINGTON AVE #22T
RIVERDALE, NY 10471

FOR: RETAIL STORE SERVICES, ON-LINE RETAIL STORE SERVICES AND WHOLESALE DISTRIBUTORSHIPS, ALL FEATURING ANTIQUES, NAMELY, FURNITURE, LIGHTING, FINE ART AND HOME FURNISHINGS , IN CLASS 35 (U.S. CLS. 100, 101 AND 102).

FIRST USE 9-0-2005; IN COMMERCE 9-0-2005.

THE COLOR(S) RED IS/ARE CLAIMED AS A FEATURE OF THE MARK.

THE MARK CONSISTS OF A STYLIZED DESIGN OF A WAX SEAL WITH THE LETTER "C" IMPRESSED IN THE SEAL AND THE NUMBER "44" IMPRESSED IN THE SEAL WITHIN THE LETTER "C". THE ENTIRE MARK IS IN THE COLOR RED.

SER. NO. 76-685,871, FILED 1-17-2008.

PAUL CROWLEY, EXAMINING ATTORNEY

Int. Cl.: 44

Prior U.S. Cls.: 100 and 101

United States Patent and Trademark Office

Reg. No. 3,478,625

Registered Aug. 5, 2008

**SERVICE MARK
PRINCIPAL REGISTER**

DIABETES MINE

AMY TENDERICH LLC (CALIFORNIA LTD
LIAB CO)
1094 SPRINGFIELD DRIVE
MILLBRAE, CA 94030

FOR: PROVIDING A WEB SITE WITH MEDICAL
INFORMATION ABOUT DIABETES AND HOW TO
LIVE WITH DIABETES, IN CLASS 44 (U.S. CLS. 100
AND 101).

FIRST USE 0-0-2004; IN COMMERCE 2-0-2005.

THE MARK CONSISTS OF STANDARD CHAR-
ACTERS WITHOUT CLAIM TO ANY PARTICULAR
FONT, STYLE, SIZE, OR COLOR.

NO CLAIM IS MADE TO THE EXCLUSIVE
RIGHT TO USE "DIABETES", APART FROM THE
MARK AS SHOWN.

SER. NO. 76-686,792, FILED 2-12-2008.

JOHN E. MICHOS, EXAMINING ATTORNEY

Int. Cl.: 41

Prior U.S. Cls.: 100, 101 and 107

United States Patent and Trademark Office

Reg. No. 3,478,626

Registered Aug. 5, 2008

**SERVICE MARK
PRINCIPAL REGISTER**



Mission Network

CATHOLIC YOUTH WORLD NETWORK, INC.
(NEW YORK CORPORATION)
590 COLUMBUS AVE.
THORNWOOD, NY 10594

THE COLOR(S) ORANGE, BLUE AND WHITE IS/
ARE CLAIMED AS A FEATURE OF THE MARK.

FOR: EDUCATIONAL SERVICES TO THE GENERAL PUBLIC, NAMELY, TRAINING AND INSTRUCTION BY MEANS OF CLASSES, WORKSHOPS, AND SEMINARS, IN THE AREAS OF CHARACTER DEVELOPMENT, LEADERSHIP SKILL DEVELOPMENT, AND THE DEVELOPMENT OF NATURAL VIRTUE, IN CLASS 41 (U.S. CLS. 100, 101 AND 107).

THE MARK CONSISTS OF A BLUE STYLIZED GLOBE DIVIDED BY LONGITUDINAL AND LATITUDINAL LINES IN THE COLOR WHITE; THE GLOBE INCORPORATES A DEEPER BLUE CROSS DESIGN. SEVEN ORANGE POINTS ARE ARRANGED AT THE INTERSECTION OF CERTAIN LATITUDINAL AND LONGITUDINAL LINES. THE WORDS "MISSION NETWORK" ARE ORANGE.

FIRST USE 5-1-2006; IN COMMERCE 8-1-2006.

SER. NO. 77-000,158, FILED 9-15-2006.

NO CLAIM IS MADE TO THE EXCLUSIVE RIGHT TO USE "MISSION NETWORK", APART FROM THE MARK AS SHOWN.

LINDA ESTRADA, EXAMINING ATTORNEY

Int. Cls.: 36 and 41

Prior U.S. Cls.: 100, 101, 102 and 107

United States Patent and Trademark Office

Reg. No. 3,478,627

Registered Aug. 5, 2008

**SERVICE MARK
PRINCIPAL REGISTER**

MEGA FX

THE GAMES PORTAL LIMITED (UNITED KING-
DOM LIMITED PARTNERSHIP)
THE OLD PRESBYTERY
ALDERNEY, UNITED KINGDOM GY9 3TF

FOR: FINANCIAL SERVICES, NAMELY, THE
PROVISION OF STOCK EXCHANGE INFORMA-
TION, FOREIGN EXCHANGE INFORMATION,
SHARE INDICES INFORMATION, COMMODITY
INFORMATION, COMMODITIES INVESTMENT
ADVICE, COMMODITIES EXCHANGE SERVICES,
STOCK EXCHANGE SERVICES; FOREIGN EX-
CHANGE SERVICES; INFORMATION AND ADVI-
SORY SERVICES REGARDING FINANCIAL
SERVICES AND FOREIGN EXCHANGE SERVICES;
PROVISION OF THE AFORESAID ONLINE FROM
A COMPUTER NETWORK, IN CLASS 36 (U.S. CLS.
100, 101 AND 102).

FOR: PROVISION OF ONLINE ENTERTAIN-
MENT, NAMELY, ON-LINE GAMES; ORGANIZA-

TION OF COMPETITIONS, NAMELY, FINANCIAL
COMPETITIONS; PRODUCTION OF RADIO AND
TELEVISION PROGRAMS IN THE FIELD OF FI-
NANCIAL COMPETITIONS; PUBLICATION OF
BOOKS AND MAGAZINES, IN CLASS 41 (U.S. CLS.
100, 101 AND 107).

THE MARK CONSISTS OF STANDARD CHAR-
ACTERS WITHOUT CLAIM TO ANY PARTICULAR
FONT, STYLE, SIZE, OR COLOR.

PRIORITY CLAIMED UNDER SEC. 44(D) ON
UNITED KINGDOM APPLICATION NO. 2417731,
FILED 3-25-2006, REG. NO. 2417731, DATED 10-20-
2006, EXPIRES 3-25-2016.

SER. NO. 77-005,391, FILED 9-22-2006.

DAVID TAYLOR, EXAMINING ATTORNEY

Int. Cl.: 8

Prior U.S. Cls.: 23, 28 and 44

United States Patent and Trademark Office

Reg. No. 3,478,628

Registered Aug. 5, 2008

**TRADEMARK
PRINCIPAL REGISTER**

Hand Roper

ALLIED PACKAGING CORPORATION (ARIZONA CORPORATION)
5640 S. 16TH ST.
P.O. BOX 8010
PHOENIX, AZ 850668010

FOR: HAND TOOL, NAMELY, A HAND HELD STRETCH PLASTIC FILM WRAPPING UNIT THAT ALLOWS A USER TO DISPENSE WRAP AROUND PALLETS OR PRODUCT FOR THE PURPOSE OF SHIPPING, TRANSPORTING OR STORAGE, IN CLASS 8 (U.S. CLS. 23, 28 AND 44).

FIRST USE 5-12-2006; IN COMMERCE 5-12-2006.

THE MARK CONSISTS OF STANDARD CHARACTERS WITHOUT CLAIM TO ANY PARTICULAR FONT, STYLE, SIZE, OR COLOR.

NO CLAIM IS MADE TO THE EXCLUSIVE RIGHT TO USE "HAND", APART FROM THE MARK AS SHOWN.

SER. NO. 77-005,478, FILED 9-22-2006.

ALLISON SCHRODY, EXAMINING ATTORNEY

Int. Cl.: 7

Prior U.S. Cls.: 13, 19, 21, 23, 31, 34 and 35

Reg. No. 3,478,629

United States Patent and Trademark Office

Registered Aug. 5, 2008

**TRADEMARK
PRINCIPAL REGISTER**

Rapid Roper

ALLIED PACKAGING CORPORATION (ARIZONA CORPORATION)
5640 S. 16TH ST.
PHOENIX, AZ 85040

FOR: WRAPPING MACHINES, NAMELY, A UNIT THAT ATTACHES TO AN AUTOMATED STRETCH-WRAP MACHINE FOR THE PURPOSE OF DISPENSING PLASTIC WRAP AROUND PALLETS OR PRODUCT FOR THE PURPOSE OF SHIPPING, TRANSPORTING OR STORAGE, IN CLASS 7 (U.S. CLS. 13, 19, 21, 23, 31, 34 AND 35).

FIRST USE 5-12-2006; IN COMMERCE 5-12-2006.

THE MARK CONSISTS OF STANDARD CHARACTERS WITHOUT CLAIM TO ANY PARTICULAR FONT, STYLE, SIZE, OR COLOR.

NO CLAIM IS MADE TO THE EXCLUSIVE RIGHT TO USE "RAPID", APART FROM THE MARK AS SHOWN.

SER. NO. 77-005,593, FILED 9-22-2006.

ALLISON SCHRODY, EXAMINING ATTORNEY

Int. Cl.: 36

Prior U.S. Cls.: 100, 101 and 102

United States Patent and Trademark Office

Reg. No. 3,478,630

Registered Aug. 5, 2008

**SERVICE MARK
PRINCIPAL REGISTER**

The logo for LifeNet, featuring the word "LifeNet" in a serif font. The "Life" is in a lighter weight and the "Net" is in a bolder weight. The text is centered within a light gray rectangular background.

FARMERS GROUP, INC. (NEVADA CORPORATION)
4680 WILSHIRE BOULEVARD
LOS ANGELES, CA 90010

FOR: PROVIDING INFORMATION IN INSURANCE REGARDING FINANCIAL MATTERS TO INSURANCE AGENTS, DISTRICT MANAGERS AND EMPLOYEES, NAMELY, A SECURE INTERNET-BASED SYSTEM PROVIDING LEADS, FORMS, POLICY INFORMATION, AND GUIDES FOR AGENTS, DISTRICT MANAGERS AND EMPLOYEES IN THE FIELD OF ANNUITIES, LIFE INSUR-

ANCE, AND MUTUAL FUNDS, IN CLASS 36 (U.S. CLS. 100, 101 AND 102).

FIRST USE 3-20-2000; IN COMMERCE 3-20-2000.

THE MARK CONSISTS OF STANDARD CHARACTERS WITHOUT CLAIM TO ANY PARTICULAR FONT, STYLE, SIZE, OR COLOR.

SER. NO. 77-006,895, FILED 9-25-2006.

LINDA ORNDORFF, EXAMINING ATTORNEY

Int. Cl.: 41

Prior U.S. Cls.: 100, 101 and 107

United States Patent and Trademark Office

Reg. No. 3,478,631

Registered Aug. 5, 2008

**SERVICE MARK
PRINCIPAL REGISTER**

PLANET DANCE

PLANET DANCE LLC (OHIO LTD LIAB CO)
3535 HARRISON AVENUE
CINCINNATI, OH 45211

FOR: DANCE INSTRUCTION; DANCE SCHOOLS;
DANCE STUDIOS, IN CLASS 41 (U.S. CLS. 100, 101
AND 107).

FIRST USE 0-0-2003; IN COMMERCE 0-0-2003.

THE MARK CONSISTS OF STANDARD CHAR-
ACTERS WITHOUT CLAIM TO ANY PARTICULAR
FONT, STYLE, SIZE, OR COLOR.

NO CLAIM IS MADE TO THE EXCLUSIVE
RIGHT TO USE "DANCE", APART FROM THE
MARK AS SHOWN.

SER. NO. 77-007,884, FILED 9-26-2006.

LAURA HAMMEL, EXAMINING ATTORNEY

Int. Cls.: 35 and 42

Prior U.S. Cls.: 100, 101 and 102

United States Patent and Trademark Office

Reg. No. 3,478,632

Registered Aug. 5, 2008

**SERVICE MARK
PRINCIPAL REGISTER**

ANTEO GROUP

ANTEO GROUP, LLC (GEORGIA LTD LIAB CO)
SUITE 20
1230 PEACHTREE STREET
ATLANTA, GA 30309

FOR: COMPUTER EMPLOYMENT OUTPLACE-
MENT SERVICES, NAMELY, COMPUTER TECH-
NOLOGY STAFFING, IN CLASS 35 (U.S. CLS. 100,
101 AND 102).

FIRST USE 8-31-2002; IN COMMERCE 8-31-2002.

FOR: COMPUTER SERVICES, NAMELY, COM-
PUTER TECHNOLOGY CONSULTING SERVICES,
IN CLASS 42 (U.S. CLS. 100 AND 101).

FIRST USE 8-31-2002; IN COMMERCE 8-31-2002.

THE MARK CONSISTS OF STANDARD CHAR-
ACTERS WITHOUT CLAIM TO ANY PARTICULAR
FONT, STYLE, SIZE, OR COLOR.

NO CLAIM IS MADE TO THE EXCLUSIVE
RIGHT TO USE "GROUP", APART FROM THE
MARK AS SHOWN.

SER. NO. 77-008,002, FILED 9-26-2006.

BRENDAN MCCAULEY, EXAMINING ATTORNEY

Int. Cls.: 35 and 42

Prior U.S. Cls.: 100, 101 and 102

United States Patent and Trademark Office

Reg. No. 3,478,633

Registered Aug. 5, 2008

**SERVICE MARK
PRINCIPAL REGISTER**



ANTEO GROUP, LLC (GEORGIA LTD LIAB CO)
SUITE 20
1230 PEACHTREE STREET
ATLANTA, GA 30309

FOR: COMPUTER EMPLOYMENT OUTPLACE-
MENT SERVICES, NAMELY, COMPUTER TECH-
NOLOGY STAFFING, IN CLASS 35 (U.S. CLS. 100,
101 AND 102).

FIRST USE 8-31-2002; IN COMMERCE 8-31-2002.

FOR: COMPUTER SERVICES, NAMELY, COM-
PUTER TECHNOLOGY CONSULTING SERVICES,
IN CLASS 42 (U.S. CLS. 100 AND 101).

FIRST USE 8-31-2002; IN COMMERCE 8-31-2002.

NO CLAIM IS MADE TO THE EXCLUSIVE
RIGHT TO USE "GROUP", APART FROM THE
MARK AS SHOWN.

THE COLOR(S) ORANGE, GRAY, AND WHITE
IS/ARE CLAIMED AS A FEATURE OF THE MARK.

THE MARK CONSISTS OF THE COLOR ORANGE
APPEARING IN THE RECTANGLE AROUND THE
WORD "ANTEO" AND IN THE PERIOD AFTER
"GROUP"; THE COLOR GRAY APPEARS IN THE
WORD "GROUP"; THE COLOR WHITE APPEARS
IN THE WORD "ANTEO".

SER. NO. 77-008,017, FILED 9-26-2006.

BRENDAN MCCAULEY, EXAMINING ATTORNEY

Int. Cl.: 42

Prior U.S. Cls.: 100 and 101

United States Patent and Trademark Office

Reg. No. 3,478,634

Registered Aug. 5, 2008

**SERVICE MARK
PRINCIPAL REGISTER**

China OneCheck

INTEGRASCREEN SINGAPORE PTE LTD (SINGAPORE CORPORATION)
LEVEL 14,
30 CECIL ST, PRUDENTIAL TOWER
SINGAPORE, SINGAPORE 049712

FOR: DATA MINING; DATA WAREHOUSING;
DATABASE DEVELOPMENT SERVICES; LEGAL
RESEARCH; PUBLIC DOCUMENT RETRIEVAL;
RETRIEVING PUBLIC DOCUMENTS , IN CLASS
42 (U.S. CLS. 100 AND 101).

FIRST USE 9-18-2006; IN COMMERCE 9-25-2006.

THE MARK CONSISTS OF STANDARD CHARACTERS WITHOUT CLAIM TO ANY PARTICULAR FONT, STYLE, SIZE, OR COLOR.

NO CLAIM IS MADE TO THE EXCLUSIVE RIGHT TO USE "CHINA", APART FROM THE MARK AS SHOWN.

SER. NO. 77-008,224, FILED 9-27-2006.

ELLEN BURNS, EXAMINING ATTORNEY

Int. Cl.: 42

Prior U.S. Cls.: 100 and 101

United States Patent and Trademark Office

Reg. No. 3,478,635

Registered Aug. 5, 2008

**SERVICE MARK
PRINCIPAL REGISTER**

India OneCheck

INTEGRASCREEN SINGAPORE PTE LTD (SINGAPORE CORPORATION)
LEVEL 14,
30 CECIL ST, PRUDENTIAL TOWER
SINGAPORE, SINGAPORE 049712

FOR: DATA MINING; DATA WAREHOUSING;
DATABASE DEVELOPMENT SERVICES; LEGAL
RESEARCH; PUBLIC DOCUMENT RETRIEVAL;
RETRIEVING PUBLIC DOCUMENTS , IN CLASS
42 (U.S. CLS. 100 AND 101).

FIRST USE 9-18-2006; IN COMMERCE 9-25-2006.

THE MARK CONSISTS OF STANDARD CHARACTERS WITHOUT CLAIM TO ANY PARTICULAR FONT, STYLE, SIZE, OR COLOR.

NO CLAIM IS MADE TO THE EXCLUSIVE RIGHT TO USE "INDIA", APART FROM THE MARK AS SHOWN.

SER. NO. 77-008,225, FILED 9-27-2006.

ELLEN BURNS, EXAMINING ATTORNEY

Int. Cl.: 16

Prior U.S. Cls.: 2, 5, 22, 23, 29, 37, 38 and 50

United States Patent and Trademark Office

Reg. No. 3,478,636

Registered Aug. 5, 2008

**TRADEMARK
PRINCIPAL REGISTER**



MAGNETNOTES, LTD. (OHIO CORPORATION)
SUITE M PMB 386
6725 W. CENTRAL AVE.
TOLEDO, OH 43617

FOR: PAPER PRODUCTS, NAMELY, MAGNETIC
PAPER PRODUCTS, NAMELY, REMOVABLE MAG-
NETIC NOTEPAPER AND REMOVABLE MAGNET-
IC PRINTED FORMS, EACH REMOVABLE SHEET
BEING CO-EXTENSIVELY COATED WITH A THIN

MAGNET LAYER, IN CLASS 16 (U.S. CLS. 2, 5, 22, 23,
29, 37, 38 AND 50).

FIRST USE 1-31-2002; IN COMMERCE 1-31-2002.

THE MARK CONSISTS OF THE WORD "MAG-
NETNOTES" AND A GRAPHIC SWIRL.

SER. NO. 77-009,598, FILED 9-28-2006.

MARGARET POWER, EXAMINING ATTORNEY

Int. Cls.: 25, 35 and 45

Prior U.S. Cls.: 22, 39, 100, 101 and 102

United States Patent and Trademark Office

Reg. No. 3,478,637

Registered Aug. 5, 2008

**TRADEMARK
SERVICE MARK
PRINCIPAL REGISTER**

OPERATION ROMANCE

BOGAN, TRACI (UNITED STATES INDIVIDUAL)
1040 NORTH SUNNYSLOPE DRIVE, #203
RACINE, WI 53406

FOR: CLOTHING, NAMELY, T-SHIRTS AND
HATS, IN CLASS 25 (U.S. CLS. 22 AND 39).

FIRST USE 9-1-2006; IN COMMERCE 9-1-2006.

FOR: ONLINE RETAIL STORE SERVICES FEATURING
SELF-HELP BOOKS, AUDIOTAPES, AND
VIDEOTAPES IN THE FIELD OF ROMANCE AND
LOVE, IN CLASS 35 (U.S. CLS. 100, 101 AND 102).

FIRST USE 9-1-2006; IN COMMERCE 9-1-2006.

FOR: PROVIDING WEBSITE FEATURING INFORMATION
IN THE FIELD OF MARRIAGE
COUNSELING, IN CLASS 45 (U.S. CLS. 100 AND 101).

FIRST USE 9-1-2006; IN COMMERCE 9-1-2006.

THE MARK CONSISTS OF STANDARD CHARACTERS
WITHOUT CLAIM TO ANY PARTICULAR
FONT, STYLE, SIZE, OR COLOR.

SER. NO. 77-010,937, FILED 9-29-2006.

SUNG IN, EXAMINING ATTORNEY

Int. Cls.: 35, 39 and 42

Prior U.S. Cls.: 100, 101, 102 and 105

United States Patent and Trademark Office

Reg. No. 3,478,638

Registered Aug. 5, 2008

**SERVICE MARK
PRINCIPAL REGISTER**

TELE ATLAS CONTENTLINK

TELE ATLAS NORTH AMERICA, INC. (CALIFORNIA CORPORATION)
11 LAFAYETTE STREET
LEBANON, NH 037661445

FOR: PROMOTING THE GOODS AND SERVICES OF OTHERS VIA A GLOBAL COMPUTER NETWORK, IN CLASS 35 (U.S. CLS. 100, 101 AND 102).

FIRST USE 3-15-2007; IN COMMERCE 3-15-2007.

FOR: PROVIDING A DATABASE FEATURING TRAVEL-RELATED GEOGRAPHICAL INFORMATION; STORAGE SERVICES FOR ARCHIVING DATABASES, IMAGES AND ELECTRONIC DATA IN THE FIELD OF GEOGRAPHIC AND TRAVEL-RELATED INFORMATION; PROVIDING A WEB SITE RELATING TO TRAVEL INFORMATION DIRECTED TO DEVELOPERS OF MAP-BASED APPLICATIONS, IN CLASS 39 (U.S. CLS. 100 AND 105).

FIRST USE 3-15-2007; IN COMMERCE 3-15-2007.

FOR: PROVIDING A WEB SITE CONTAINING GEOGRAPHIC INFORMATION DIRECTED TO DEVELOPERS OF MAP-BASED APPLICATIONS, IN CLASS 42 (U.S. CLS. 100 AND 101).

FIRST USE 3-15-2007; IN COMMERCE 3-15-2007.

THE MARK CONSISTS OF STANDARD CHARACTERS WITHOUT CLAIM TO ANY PARTICULAR FONT, STYLE, SIZE, OR COLOR.

NO CLAIM IS MADE TO THE EXCLUSIVE RIGHT TO USE "ATLAS", APART FROM THE MARK AS SHOWN.

SER. NO. 77-011,721, FILED 10-2-2006.

DAVID C. REIHNER, EXAMINING ATTORNEY

Int. Cl.: 42

Prior U.S. Cls.: 100 and 101

United States Patent and Trademark Office

Reg. No. 3,478,639

Registered Aug. 5, 2008

**SERVICE MARK
PRINCIPAL REGISTER**



NAVICORE OY (FINLAND CORPORATION)
TEKNIKANTIE 14
ESPOO, FINLAND FI-02150

FOR: CONSULTATION IN THE FIELD OF COMPUTER SOFTWARE DESIGN; DEVELOPMENT AND DESIGN OF NAVIGATION SYSTEMS, ROUTE PLANNERS, ELECTRONIC MAPS FOR OTHERS; COMPUTER SOFTWARE DESIGN FOR OTHERS; DEVELOPMENT AND DESIGN OF SOFTWARE FOR USE WITH NAVIGATION SYSTEMS, ROUTE

PLANNERS AND THE USE OF ELECTRONIC MAPS FOR OTHERS, IN CLASS 42 (U.S. CLS. 100 AND 101).

FIRST USE 5-14-2007; IN COMMERCE 5-14-2007.

THE MARK CONSISTS OF A STYLIZED STAR DESIGN ON THE LEFT SIDE FOLLOWED BY THE WORD "NAVICORE" IN STYLIZED LETTERING.

SER. NO. 77-013,875, FILED 10-4-2006.

CHARLOTTE CORWIN, EXAMINING ATTORNEY

Int. Cl.: 35

Prior U.S. Cls.: 100, 101 and 102

United States Patent and Trademark Office

Reg. No. 3,478,640

Registered Aug. 5, 2008

SERVICE MARK
PRINCIPAL REGISTER



THE AMERICAN ACADEMY OF ORAL MEDICINE, INC. (NEW YORK NON-PROFIT CORPORATION)

23607 HIGHWAY 99, 2-C
EDMONDS, WA 98026

FOR: ASSOCIATION SERVICES, NAMELY, PROMOTING RESEARCH AND EDUCATION, TRAINING, PATIENT EDUCATION AND CLINICAL SERVICES, ADVANCEMENT AND HONORING OF THOSE IN THE FIELD OF ORAL MEDICINE, IN CLASS 35 (U.S. CLS. 100, 101 AND 102).

FIRST USE 7-0-1966; IN COMMERCE 7-0-1966.

NO CLAIM IS MADE TO THE EXCLUSIVE RIGHT TO USE "ACADEMY OF ORAL MEDICINE" AND "FOUNDED 1945", APART FROM THE MARK AS SHOWN.

THE MARK CONSISTS OF THE TERM "THE AMERICAN ACADEMY OF ORAL MEDICINE" ENCIRCLING A TRIANGLE WITH THE TERM "COOPERATION" ON THE OUTER LEFT-HAND SIDE OF THE TRIANGLE, "KNOWLEDGE" ON THE OUTER RIGHT-HAND SIDE OF THE TRIANGLE, AND "UNDERSTANDING" ON THE OUTER BOTTOM OF THE TRIANGLE. THE INSIDE PORTION OF THE TRIANGLE CONSISTS OF A LANTERN AT THE TOP POINT OF THE TRIANGLE ABOVE "FOUNDED 1945", THE SERPENT OF AESCULAPIUS AT THE BOTTOM LEFT POINT OF THE TRIANGLE, AND THE ROD OF ASCLEPIUS AT THE BOTTOM RIGHT POINT OF THE TRIANGLE.

SEC. 2(F).

SER. NO. 77-015,436, FILED 10-6-2006.

HEATHER SAPP, EXAMINING ATTORNEY

Int. Cls.: 7, 9, 12, 25, 35, 37, 40 and 42

Prior U.S. Cls.: 13, 19, 21, 22, 23, 26, 31, 34, 35, 36, 38, 39, 44, 100, 101, 102, 103 and 106

Reg. No. 3,478,641

United States Patent and Trademark Office

Registered Aug. 5, 2008

**TRADEMARK
SERVICE MARK
PRINCIPAL REGISTER**



COBB TUNING PRODUCTS, LLC (UTAH LTD
LIAB CO)
3362 WEST 1820 SOUTH
SALT LAKE CITY, UT 84104

FOR: AUTOMOBILE EXHAUST SYSTEMS, COMPRISED OF DOWN PIPES, HEAT SHIELDS, TURBO-BACK EXHAUST MANIFOLDS, TURBO UP PIPE, MUFFLERS, INTAKE MANIFOLDS, POWER PULL-
EY, EXHAUST HANGERS AND FLOW PANEL AIR FILTERS, SOLD AS A UNIT; AUTOMOTIVE ENGINE PARTS, NAMELY, FORGED PISTONS, CONNECTING RODS, BILLET CRANKSHAFTS, BEARINGS, HEAD STUDS, AND ASSEMBLED SHORT BLOCKS, IN CLASS 7 (U.S. CLS. 13, 19, 21, 23, 31, 34 AND 35).

FIRST USE 12-0-1999; IN COMMERCE 12-0-1999.

FOR: AUTOMOTIVE PERFORMANCE SOFTWARE, NAMELY, SOFTWARE PRODUCTS THAT ALLOWS THE END USER TO MODIFY AND CUSTOMIZE THE PERFORMANCE PARAMETERS OF THE AUTOMOBILE OR MOTORCYCLE ENGINE AND TRANSMISSION, IN CLASS 9 (U.S. CLS. 21, 23, 26, 36 AND 38).

FIRST USE 3-0-2003; IN COMMERCE 3-0-2003.

FOR: AUTOMOTIVE BRAKE SYSTEMS, NAME-
LY, BRAKE PADS, BRAKE LINES, ROTORS, FRONT AND REAR BIG BRAKES; AUTOMOTIVE SUSPENSION SYSTEMS, NAMELY, TUBULAR ANTI-SWAY BARS, SWAY BAR MOUNTS, SWAY

BAR END LINKS; DRIVE TRAIN SYSTEMS FOR LAND VEHICLES COMPRISED OF GEAR SHIFTER LEVERS, GEAR SHIFTER BUSHINGS TRANSMISSION MOUNTING PLATES, CLUTCH, FLY WHEELS, COIL SHOCK ABSORBING SPRINGS, SUSPENSION STRUTS, CYLINDER HEADS, CAM-SHAFTS SOLD AS A UNIT, IN CLASS 12 (U.S. CLS. 19, 21, 23, 31, 35 AND 44).

FIRST USE 12-0-1999; IN COMMERCE 12-0-1999.

FOR: CLOTHING, NAMELY, T-SHIRTS, SWEAT SHIRTS, HATS, GLOVES, PANTS, SHORTS, AND SHIRTS, IN CLASS 25 (U.S. CLS. 22 AND 39).

FIRST USE 1-0-2004; IN COMMERCE 1-0-2004.

FOR: WHOLESALE DISTRIBUTORSHIP SERVICES FEATURING HIGH PERFORMANCE AUTOMOTIVE AND MOTORCYCLE PRODUCTS , IN CLASS 35 (U.S. CLS. 100, 101 AND 102).

FIRST USE 12-0-1999; IN COMMERCE 12-0-1999.

FOR: ON-TRACK MAINTENANCE SERVICES FOR AUTOMOTIVE RACE VEHICLES, IN CLASS 37 (U.S. CLS. 100, 103 AND 106).

FIRST USE 12-0-1999; IN COMMERCE 12-0-1999.

FOR: CUSTOM MANUFACTURE OF HIGH PERFORMANCE AUTOMOTIVE AND MOTORCYCLE

PRODUCTS AND CONCEPT VEHICLES, IN CLASS 40 (U.S. CLS. 100, 103 AND 106).

FIRST USE 12-0-1999; IN COMMERCE 12-0-1999.

FOR: DESIGN OF CONCEPT VEHICLES, RACE VEHICLES AND AUTOMOTIVE AFTERMARKET PARTS FOR OTHERS; ANALYZING AUTOMOTIVE PERFORMANCE DATA ACQUIRED DURING AU-

TOMOTIVE RACES, IN CLASS 42 (U.S. CLS. 100 AND 101).

FIRST USE 12-0-1999; IN COMMERCE 12-0-1999.

SER. NO. 77-017,186, FILED 10-9-2006.

MARTHA FROMM, EXAMINING ATTORNEY

Int. Cl.: 31

Prior U.S. Cls.: 1 and 46

United States Patent and Trademark Office

Reg. No. 3,478,642

Registered Aug. 5, 2008

**TRADEMARK
PRINCIPAL REGISTER**

MAJOR

MAJOR FARMS, INC. (CALIFORNIA CORPORATION)
P. O. BOX 719
SALINAS, CA 93902

THE MARK CONSISTS OF STANDARD CHARACTERS WITHOUT CLAIM TO ANY PARTICULAR FONT, STYLE, SIZE, OR COLOR.

FOR: FRESH VEGETABLES, EXCLUDING BEETS, BROCCOLI, CARROTS, GARDEN BEANS, MELONS, PEAS, AND PEPPERS, IN CLASS 31 (U.S. CLS. 1 AND 46).

SER. NO. 77-018,660, FILED 10-11-2006.

FIRST USE 1-19-1934; IN COMMERCE 1-19-1934.

MARY CRAWFORD, EXAMINING ATTORNEY

Int. Cls.: 35, 36 and 42

Prior U.S. Cls.: 100, 101 and 102

United States Patent and Trademark Office

Reg. No. 3,478,643

Registered Aug. 5, 2008

**SERVICE MARK
PRINCIPAL REGISTER**

INTERTECH

THE INTERTECH GROUP, INC. (SOUTH CAROLINA CORPORATION)
4838 JENKINS AVENUE
NORTH CHARLESTON, SC 29405

FOR: BUSINESS ACQUISITION AND MERGER CONSULTATION, IN CLASS 35 (U.S. CLS. 100, 101 AND 102).

FIRST USE 4-9-1984; IN COMMERCE 4-9-1984.

FOR: FINANCIAL CONSULTATION FOR MERGERS AND ACQUISITIONS; FINANCIAL CONSULTATION FOR THE MANUFACTURING, RETAIL AND SPORTS INDUSTRIES; FINANCIAL DUE DILIGENCE; FINANCIAL PLANNING, IN CLASS 36 (U.S. CLS. 100, 101 AND 102).

FIRST USE 4-9-1984; IN COMMERCE 4-9-1984.

FOR: TECHNOLOGICAL CONSULTATION IN THE TECHNOLOGY FIELD OF NEW PRODUCT DEVELOPMENT OF POLYMERS, CHEMICALS, AND MATERIAL SCIENCES, IN CLASS 42 (U.S. CLS. 100 AND 101).

FIRST USE 4-9-1984; IN COMMERCE 4-9-1984.

THE MARK CONSISTS OF STANDARD CHARACTERS WITHOUT CLAIM TO ANY PARTICULAR FONT, STYLE, SIZE, OR COLOR.

SER. NO. 77-018,699, FILED 10-11-2006.

KATHRYN COWARD, EXAMINING ATTORNEY

Int. Cls.: 35, 36 and 42

Prior U.S. Cls.: 100, 101 and 102

United States Patent and Trademark Office

Reg. No. 3,478,644

Registered Aug. 5, 2008

**SERVICE MARK
PRINCIPAL REGISTER**

THE INTERTECH GROUP

THE INTERTECH GROUP, INC. (SOUTH CAROLINA CORPORATION)
4838 JENKINS AVENUE
NORTH CHARLESTON, SC 29405

FOR: BUSINESS ACQUISITION AND MERGER CONSULTATION, IN CLASS 35 (U.S. CLS. 100, 101 AND 102).

FIRST USE 4-9-1984; IN COMMERCE 4-9-1984.

FOR: FINANCIAL CONSULTATION FOR MERGERS AND ACQUISITIONS; FINANCIAL CONSULTATION FOR THE MANUFACTURING, RETAIL AND SPORTS INDUSTRIES; FINANCIAL DUE DILIGENCE; FINANCIAL PLANNING, IN CLASS 36 (U.S. CLS. 100, 101 AND 102).

FIRST USE 4-9-1984; IN COMMERCE 4-9-1984.

FOR: TECHNOLOGICAL CONSULTATION IN THE TECHNOLOGY FIELD OF NEW PRODUCT DEVELOPMENT OF POLYMERS, CHEMICALS, AND MATERIAL SCIENCES, IN CLASS 42 (U.S. CLS. 100 AND 101).

FIRST USE 4-9-1984; IN COMMERCE 4-9-1984.

THE MARK CONSISTS OF STANDARD CHARACTERS WITHOUT CLAIM TO ANY PARTICULAR FONT, STYLE, SIZE, OR COLOR.

NO CLAIM IS MADE TO THE EXCLUSIVE RIGHT TO USE "GROUP", APART FROM THE MARK AS SHOWN.

SER. NO. 77-018,733, FILED 10-11-2006.

KATHRYN COWARD, EXAMINING ATTORNEY

Int. Cl.: 31

Prior U.S. Cls.: 1 and 46

United States Patent and Trademark Office

Reg. No. 3,478,645

Registered Aug. 5, 2008

**TRADEMARK
PRINCIPAL REGISTER**

SABER

MAJOR FARMS, INC. (CALIFORNIA CORPORATION)
P. O. BOX 719
SALINAS, CA 93902

THE MARK CONSISTS OF STANDARD CHARACTERS WITHOUT CLAIM TO ANY PARTICULAR FONT, STYLE, SIZE, OR COLOR.

FOR: FRESH VEGETABLES, EXCLUDING PEAS, RICE, SOY BEANS, CARROTS, GARDEN BEANS AND PEPPERS, IN CLASS 31 (U.S. CLS. 1 AND 46).

SER. NO. 77-018,740, FILED 10-11-2006.

FIRST USE 4-16-1934; IN COMMERCE 4-16-1934.

MARY CRAWFORD, EXAMINING ATTORNEY

Int. Cl.: 44

Prior U.S. Cls.: 100 and 101

United States Patent and Trademark Office

Reg. No. 3,478,646

Registered Aug. 5, 2008

SERVICE MARK
PRINCIPAL REGISTER



PROFITABLE SPEECH, LLC (NEW YORK LTD
LIAB CO)
470 CLIFTON CORPORATE PARKWAY
CLIFTON PARK, NY 12065 AND
KLEIN, DALE G. (UNITED STATES INDIVIDUAL)
470 CLIFTON CORPORATE PARKWAY
CLIFTON PARK, NY 12065

FOR: SPEECH AND HEARING THERAPY,
NAMELY, SPEECH PATHOLOGY IN THE SETTING
OF CORPORATE SPEECH AND COMMUNICATION
SERVICES, IN CLASS 44 (U.S. CLS. 100 AND 101).

FIRST USE 3-12-2007; IN COMMERCE 3-12-2007.

NO CLAIM IS MADE TO THE EXCLUSIVE
RIGHT TO USE "SPEECH LLC", APART FROM
THE MARK AS SHOWN.

THE MARK CONSISTS OF A LOGO DESIGN
COMPRISING THE WORDS "PROFITABLE SPEECH
LLC A SOUND INVESTMENT" IN A STYLIZED
FONT AND SUPERIMPOSED OVER A SERIES OF
CONNECTED LINES AND AN ARROW, SIMILAR
TO A RISING ECONOMIC GRAPH.

SER. NO. 77-018,871, FILED 10-11-2006.

JANICE KIM, EXAMINING ATTORNEY

Int. Cl.: 36

Prior U.S. Cls.: 100, 101 and 102

United States Patent and Trademark Office

Reg. No. 3,478,647

Registered Aug. 5, 2008

**SERVICE MARK
PRINCIPAL REGISTER**

IDB BANK

ISRAEL DISCOUNT BANK OF NEW YORK
(NEW YORK CORPORATION)
511 FIFTH AVENUE
NEW YORK, NY 10017

FOR: BANKING, IN CLASS 36 (U.S. CLS. 100, 101
AND 102).

FIRST USE 9-30-2006; IN COMMERCE 9-30-2006.

OWNER OF U.S. REG. NOS. 2,614,561 AND
2,682,420.

NO CLAIM IS MADE TO THE EXCLUSIVE
RIGHT TO USE "BANK", APART FROM THE
MARK AS SHOWN.

SER. NO. 77-020,074, FILED 10-12-2006.

AHSEN KHAN, EXAMINING ATTORNEY

Int. Cl.: 19

Prior U.S. Cls.: 1, 12, 33 and 50

United States Patent and Trademark Office

Reg. No. 3,478,648

Registered Aug. 5, 2008

**TRADEMARK
PRINCIPAL REGISTER**

SYSTEM 636

IPEX INC. (CANADA CORPORATION)
50 VALLEYBROOK DRIVE
DON MILLS., CANADA M3B2S9

FOR: RIGID NON-METAL PIPES AND RIGID
NON-METAL FITTINGS THEREFOR FOR VENTI-
LATION APPLICATIONS, IN CLASS 19 (U.S. CLS. 1,
12, 33 AND 50).

THE MARK CONSISTS OF STANDARD CHAR-
ACTERS WITHOUT CLAIM TO ANY PARTICULAR
FONT, STYLE, SIZE, OR COLOR.

PRIORITY CLAIMED UNDER SEC. 44(D) ON
CANADA APPLICATION NO. 1,315,770, FILED 9-8-
2006, REG. NO. TMA697,797, DATED 10-3-2007, EX-
PIRES 10-3-2022.

SER. NO. 77-021,080, FILED 10-13-2006.

REBECCA EISINGER, EXAMINING ATTORNEY

Int. Cl.: 41

Prior U.S. Cls.: 100, 101 and 107

United States Patent and Trademark Office

Reg. No. 3,478,649

Registered Aug. 5, 2008

**SERVICE MARK
PRINCIPAL REGISTER**

FAB FOREVER

FAB FOREVER LLC (NEVADA LTD LIAB CO)
2505 ANTHEM VILLAGE DRIVE, SUITE E134
HENDERSON, NV 89052

THE MARK CONSISTS OF STANDARD CHAR-
ACTERS WITHOUT CLAIM TO ANY PARTICULAR
FONT, STYLE, SIZE, OR COLOR.

FOR: ENTERTAINMENT IN THE NATURE OF
LIVE PERFORMANCES BY A MUSICAL BAND, IN
CLASS 41 (U.S. CLS. 100, 101 AND 107).

SER. NO. 77-022,317, FILED 10-16-2006.

FIRST USE 7-11-2006; IN COMMERCE 9-28-2006.

DAVID MILLER, EXAMINING ATTORNEY

Int. Cl.: 35

Prior U.S. Cls.: 100, 101 and 102

United States Patent and Trademark Office

Reg. No. 3,478,650

Registered Aug. 5, 2008

**SERVICE MARK
PRINCIPAL REGISTER**

GPS TIMETRACK

XORA, INC. (DELAWARE CORPORATION)
501 ELLIS STREET
MOUNTAIN VIEW, CA 94043

FOR: WORKFORCE PERSONNEL TRACKING
AND RECORDING OF LOCATION, TIME, JOB
ACTIVITY INFORMATION, AND MONITORING
OF SURROUNDING WORK ENVIRONMENT WITH
PICTURES AND VIDEO UTILIZING HOSTED WEB-
BASED SOFTWARE APPLICATIONS, IN CLASS 35
(U.S. CLS. 100, 101 AND 102).

FIRST USE 7-1-2002; IN COMMERCE 2-1-2003.

THE MARK CONSISTS OF STANDARD CHAR-
ACTERS WITHOUT CLAIM TO ANY PARTICULAR
FONT, STYLE, SIZE, OR COLOR.

NO CLAIM IS MADE TO THE EXCLUSIVE
RIGHT TO USE "GPS", APART FROM THE MARK
AS SHOWN.

SEC. 2(F).

SER. NO. 77-027,724, FILED 10-24-2006.

VIVIAN MICZNIK FIRST, EXAMINING ATTOR-
NEY

Int. Cl.: 10

Prior U.S. Cls.: 26, 39 and 44

United States Patent and Trademark Office

Reg. No. 3,478,651

Registered Aug. 5, 2008

**TRADEMARK
PRINCIPAL REGISTER**

RMV

VISUALSONICS, INC. (CANADA CORPORATION)
SUITE 6100; BOX 66
3080 YONGE STREET
TORONTO, CANADA M4N3N1

THE MARK CONSISTS OF STANDARD CHARACTERS WITHOUT CLAIM TO ANY PARTICULAR FONT, STYLE, SIZE, OR COLOR.

FOR: PROBES FOR USE IN CONNECTION WITH ULTRASOUND IMAGING FOR ANIMAL RESEARCH, IN CLASS 10 (U.S. CLS. 26, 39 AND 44).

SER. NO. 77-027,908, FILED 10-24-2006.

FIRST USE 7-0-2003; IN COMMERCE 7-0-2003.

DAVID C. REIHNER, EXAMINING ATTORNEY

Int. Cl.: 20

Prior U.S. Cls.: 2, 13, 22, 25, 32 and 50

United States Patent and Trademark Office

Reg. No. 3,478,652

Registered Aug. 5, 2008

**TRADEMARK
PRINCIPAL REGISTER**

MITRA

SOFTCARE INNOVATIONS, INC. (CANADA
CORPORATION)
675 DAVENPORT ROAD
WATERLOO, CANADA N2V2E2

THE MARK CONSISTS OF STANDARD CHAR-
ACTERS WITHOUT CLAIM TO ANY PARTICULAR
FONT, STYLE, SIZE, OR COLOR.

FOR: FURNITURE FOR HEALTHCARE ENVIR-
ONMENTS, IN CLASS 20 (U.S. CLS. 2, 13, 22, 25, 32
AND 50).

SER. NO. 77-028,131, FILED 10-24-2006.

FIRST USE 6-0-2006; IN COMMERCE 6-0-2006.

IRA J. GOODSaid, EXAMINING ATTORNEY

Int. Cl.: 35

Prior U.S. Cls.: 100, 101 and 102

United States Patent and Trademark Office

Reg. No. 3,478,653

Registered Aug. 5, 2008

**SERVICE MARK
PRINCIPAL REGISTER**



LA UNIDAD LATINA, LAMBDA UPSILON
LAMBDA FRATERNITY, INC. (NEW YORK
CORPORATION)
PMB #39, 511 SIXTH AVENUE
NEW YORK, NY 10011

FOR: ASSOCIATION SERVICES, NAMELY, PRO-
MOTING THE INTERESTS OF MEMBERS OF A

NATIONAL FRATERNITY, IN CLASS 35 (U.S. CLS.
100, 101 AND 102).

FIRST USE 2-19-1982; IN COMMERCE 2-19-1982.

SER. NO. 77-029,567, FILED 10-25-2006.

ROBERT C. CLARK JR., EXAMINING ATTORNEY

Int. Cl.: 9

Prior U.S. Cls.: 21, 23, 26, 36 and 38

Reg. No. 3,478,654

United States Patent and Trademark Office

Registered Aug. 5, 2008

TRADEMARK
PRINCIPAL REGISTER



COSMICSTEP SOFTWARE, INC (WASHINGTON CORPORATION)
7104 NE 181ST ST, SUITE 109
KENMORE, WA 98028

FOR: COMPUTER APPLICATION SOFTWARE FOR MOBILE PHONES; COMPUTER E-COMMERCE SOFTWARE TO ALLOW USERS TO PERFORM ELECTRONIC BUSINESS TRANSACTIONS VIA A GLOBAL COMPUTER NETWORK; COMPUTER SOFTWARE FOR APPLICATION AND DATABASE INTEGRATION; COMPUTER SOFTWARE FOR CREATING SEARCHABLE DATABASES OF INFORMATION AND DATA; COMPUTER SOFTWARE FOR PROVIDING AN ON-LINE DATABASE IN THE FIELD OF TRANSACTION PROCESSING TO UPLOAD TRANSACTIONAL DATA, PROVIDE STATISTICAL ANALYSIS, AND PRODUCE NOTIFICATIONS AND REPORTS; COMPUTER SOFTWARE FOR THE COLLECTION, EDITING, ORGANIZING, MODIFYING, BOOK MARKING, TRANSMISSION, STORAGE AND SHARING OF DATA AND INFORMATION; COMPUTER SOFTWARE FOR THE FIELD OF WAREHOUSING AND DISTRIBUTION, TO MANAGE TRANSACTIONAL DATA, PROVIDE STATISTICAL ANALYSIS, AND PRODUCE NOTIFICATIONS AND REPORTS; COMPUTER SOFTWARE FOR USE IN CUSTOMER RELATIONSHIP MANAGEMENT (CRM); COMPUTER SOFTWARE FOR WIRELESS CONTENT DELIVERY; COMPUTER SOFTWARE THAT PROVIDES REAL-TIME, INTEGRATED BUSINESS MANAGEMENT INTELLIGENCE BY COMBINING INFORMATION FROM VARIOUS DATABASES AND

PRESENTING IT IN AN EASY-TO-UNDERSTAND USER INTERFACE; COMPUTER SOFTWARE, NAMELY, AN APPLICATION ALLOWING SALES AND FIELD SERVICE EMPLOYEES TO UPDATE AND RECEIVE DATA STORED IN AN ENTERPRISE'S COMPUTER DATABASES IN REAL TIME, USING A MOBILE DEVICE, WITH FULL TELEPHONY INTEGRATION WITH THE TELEPHONE AND/OR SOFTWARE FEATURES OF THE MOBILE DEVICE; ENTERPRISE SOFTWARE IN THE NATURE OF A DATABASE FOR NON-TRANSACTIONAL DATA AND A SEARCH ENGINE FOR DATABASE CONTENT, IN CLASS 9 (U.S. CLS. 21, 23, 26, 36 AND 38).

FIRST USE 10-10-2006; IN COMMERCE 10-10-2006.

NO CLAIM IS MADE TO THE EXCLUSIVE RIGHT TO USE "SOFTWARE", APART FROM THE MARK AS SHOWN.

"THE COLOR(S) BLACK AND ORANGE IS/ARE CLAIMED AS A FEATURE OF THE MARK."

THE MARK CONSISTS OF THE COLOR BLACK AS IT APPEARS IN THE WORDING "HIGH" AND "SOFTWARE" AND THE COLOR ORANGE AS IT APPEARS ON THE NUMBER "5".

SER. NO. 77-030,543, FILED 10-26-2006.

KATHRYN COWARD, EXAMINING ATTORNEY

Int. Cls.: 35 and 41

Prior U.S. Cls.: 100, 101, 102 and 107

United States Patent and Trademark Office

Reg. No. 3,478,655

Registered Aug. 5, 2008

**SERVICE MARK
PRINCIPAL REGISTER**

A GALA EVENT

WUNDERMAN, HUGH (UNITED STATES INDIVIDUAL)
2195 REDMOND ROAD
MERRICK, NY 11566

FOR: PUBLIC RELATIONS AND BUSINESS MARKETING SERVICES; RETAIL STORE AND ONLINE RETAIL SERVICES FEATURING CLOTHING, HATS, VISORS, CAPS, T-SHIRTS, SWEAT SHIRTS AND SUITS, SOCKS, UNDERWEAR, JACKETS, COATS, UMBRELLAS, BANDANNAS, DURAGS, BELTS, BACKPACKS, POCKETBOOKS, BATH TOWELS, AND SHEETS, BEDDING, AND PILLOWS, SLEEPING EYE MASKS, CARRYING BAGS, BAGS, BOXES, ACRYLIC AND PLASTIC ITEMS, WOOD, CARDBOARD, PAPER GOODS AND PLASTIC WARE, PENS, STICKY NOTES, PRINTED NOTE PADS, COMPUTER MOUSE PADS, FLYING DISCS, YO-YOS, JEWELRY, KEY CHAINS, BELT BUCKLES, BRACELETS, LIGHTERS, RINGS, TOE RINGS, NECKLACES, PENDANTS, EARRINGS, BOOKS, SCRIPTS, SHOWS, TREATMENTS, POSTERS, PICTURES, PHOTOGRAPHS, SNOW GLOBES, PICTURE FRAMES, CASES, LICENSE PLATE FRAMES, PRE-RECORDED CDS, VIDEO TAPES, LASER DISKS AND DVDS, PHONOGRAPH RECORDS, VINYL RECORDS, VIDEO CASSETTE TAPES, AUDIO CASSETTE TAPES, REEL-TO-REEL TAPES, MOTION PICTURE FILM; SPECIAL EVENT MANAGEMENT SERVICES FOR MEETINGS, CONVENTIONS, WEDDINGS, AND PARTIES; BUSINESS MEETING PLANNING, IN CLASS 35 (U.S. CLS. 100, 101 AND 102).

FIRST USE 1-1-2003; IN COMMERCE 1-1-2003.

FOR: SPECIAL EVENT PLANNING; SPECIAL EVENT PLANNING CONSULTATION SERVICES FOR MEETINGS, CONVENTIONS, WEDDINGS AND PARTIES; MULTIMEDIA ENTERTAINMENT SOFTWARE PRODUCTION SERVICES; PRODUCTION OF VIDEO ONTO DVDS, VIDEO CASSETTES, VIDEO TAPES, AND THE INTERNET, FOR OTHERS; PHOTOGRAPHY SERVICES; ENTERTAINMENT SERVICES, NAMELY, LIGHTING PRODUCTION, AND PRODUCTION OF VARIETY SHOWS; RENTAL OF AUDIO-VISUAL EQUIPMENT; RENTAL OF PORTABLE STAGES; ENTERTAINMENT SERVICES, NAMELY, PERSONAL APPEARANCES BY IMPERSONATORS, BANDS, CLOWNS, JUGGLERS, MAGICIANS, MIMES, MODELS, COMICS, AND MUSICIANS AND NOVELTY AND VARIETY ACTS AND SPECIALTY ACTS BY PERFORMERS, IN CLASS 41 (U.S. CLS. 100, 101 AND 107).

FIRST USE 1-1-2003; IN COMMERCE 1-1-2003.

THE MARK CONSISTS OF STANDARD CHARACTERS WITHOUT CLAIM TO ANY PARTICULAR FONT, STYLE, SIZE, OR COLOR.

SEC. 2(F).

SER. NO. 77-030,805, FILED 10-27-2006.

KELLY BOULTON, EXAMINING ATTORNEY

Int. Cl.: 18

Prior U.S. Cls.: 1, 2, 3, 22 and 41

United States Patent and Trademark Office

Reg. No. 3,478,656

Registered Aug. 5, 2008

TRADEMARK
PRINCIPAL REGISTER

KaiaPeterka

PETERKA, KAIA ELISABETH (NEW YORK SOLE PROPRIETORSHIP)

#61

215 EAST 68TH STREET
NEW YORK, NY 10021

FOR: ALL-PURPOSE CARRYING BAGS; BAGS AND HOLDALLS FOR SPORTS CLOTHING; BEACH BAGS; BRIEFCASE-TYPE PORTFOLIOS; CARRY-ALL BAGS; CARRY-ON BAGS; CARRYALLS; CHANGE PURSES; CLUTCH BAGS; CLUTCH PURSES; CLUTCHES; COSMETIC BAGS SOLD EMPTY; COSMETIC CASES SOLD EMPTY; EVENING HANDBAGS; GYM BAGS; HANDBAGS; LEATHER AND IMITATION LEATHER BAGS; LEATHER BAGS, SUITCASES AND WALLETS; LEATHER BRIEFCASES; LEATHER CASES; LEATHER HANDBAGS; LEATHER PURSES; LEATHER STRAPS; LUGGAGE; MAKE-UP BAGS SOLD EMPTY; MESSENGER BAGS; MULTI-PURPOSE PURSES; OVERNIGHT BAGS; OVERNIGHT CASES; OVERNIGHT SUITCASES; POCKETBOOKS; POUCHES OF LEATHER; PURSES; PURSES; SATCHELS;

SHOULDER BAGS; SHOULDER STRAPS; SMALL CLUTCH PURSES; SMALL PURSES; STRAPS FOR HANDBAGS; TOTE BAGS; TRAVEL BAGS; TRAVELING BAGS; TRAVELLING BAGS; TRAVELING CASES OF LEATHER; WRIST MOUNTED CARRYALL BAGS; WRIST MOUNTED PURSES; WRISTLET BAGS, IN CLASS 18 (U.S. CLS. 1, 2, 3, 22 AND 41).

FIRST USE 11-15-2005; IN COMMERCE 1-13-2006.

THE MARK CONSISTS OF STANDARD CHARACTERS WITHOUT CLAIM TO ANY PARTICULAR FONT, STYLE, SIZE, OR COLOR.

THE NAME SHOWN IN THE MARK IDENTIFIES "KAIA ELISABETH PETERKA" WHOSE CONSENT IS OF RECORD.

SER. NO. 77-031,673, FILED 10-28-2006.

EMILY CHUO, EXAMINING ATTORNEY

Int. Cl.: 41

Prior U.S. Cls.: 100, 101 and 107

United States Patent and Trademark Office

Reg. No. 3,478,657

Registered Aug. 5, 2008

**SERVICE MARK
PRINCIPAL REGISTER**

Hot Pink TV

BECKY LEBEAU (CALIFORNIA SOLE PROPRIETORSHIP), DBA FANTASYONE
SUITE 602
9461 CHARLEVILLE BOULEVARD
BEVERLY HILLS, CA 90212

FOR: ENTERTAINMENT SERVICES, NAMELY, THE PRODUCTION OF ADULT THEMED TELEVISION PROGRAMS DISTRIBUTED VIA DIGITAL, CABLE AND SATELLITE TELEVISION, DIGITAL MEDIA, DVD, AND THE INTERNET, IN CLASS 41 (U.S. CLS. 100, 101 AND 107).

FIRST USE 10-24-2001; IN COMMERCE 1-4-2002.

THE MARK CONSISTS OF STANDARD CHARACTERS WITHOUT CLAIM TO ANY PARTICULAR FONT, STYLE, SIZE, OR COLOR.

NO CLAIM IS MADE TO THE EXCLUSIVE RIGHT TO USE "TV", APART FROM THE MARK AS SHOWN.

SER. NO. 77-031,769, FILED 10-29-2006.

CARRIE GENOVESE, EXAMINING ATTORNEY

Int. Cl.: 35

Prior U.S. Cls.: 100, 101 and 102

United States Patent and Trademark Office

Reg. No. 3,478,658

Registered Aug. 5, 2008

**SERVICE MARK
PRINCIPAL REGISTER**

TIMETRACK

XORA, INC. (DELAWARE CORPORATION)
501 ELLIS STREET
MOUNTAIN VIEW, CA 94043

FOR: WORKFORCE PERSONNEL TRACKING
AND RECORDING OF LOCATION, TIME, JOB
ACTIVITY INFORMATION, AND MONITORING
OF SURROUNDING WORK ENVIRONMENT WITH
PICTURES AND VIDEO UTILIZING HOSTED WEB-
BASED SOFTWARE APPLICATIONS, IN CLASS 35
(U.S. CLS. 100, 101 AND 102).

FIRST USE 2-1-2003; IN COMMERCE 2-6-2003.

THE MARK CONSISTS OF STANDARD CHAR-
ACTERS WITHOUT CLAIM TO ANY PARTICULAR
FONT, STYLE, SIZE, OR COLOR.

SEC. 2(F).

SER. NO. 77-031,897, FILED 10-30-2006.

VIVIAN MICZNIK FIRST, EXAMINING ATTOR-
NEY

Int. Cls.: 9 and 41

Prior U.S. Cls.: 21, 23, 26, 36, 38, 100, 101 and 107

United States Patent and Trademark Office

Reg. No. 3,478,659

Registered Aug. 5, 2008

**TRADEMARK
SERVICE MARK
PRINCIPAL REGISTER**

Wild nature

ATRONIC INTERNATIONAL GMBH (FED REP
GERMANY GMBH)
BORSIGSTR. 26
LÜBBECKE, FED REP GERMANY 32312

FOR: ELECTRIC AND ELECTRONIC, COIN AND
TOKEN-OPERATED GAMING MACHINES, NAME-
LY, SLOT MACHINES WITH OR WITHOUT VIDEO
OUTPUT AND VIDEO LOTTERY TERMINALS;
MULTI-USER AND NETWORKED GAMING MA-
CHINES WITH OR WITHOUT VIDEO OUTPUT OR
VIDEO LOTTERY TERMINALS, COMPUTER PRO-
GRAMS FOR OPERATING ELECTRIC AND ELEC-
TRONIC MACHINES FOR GAMING OR
AMUSEMENT PURPOSES, OR COMBINATION
THEREOF; ACCOUNTING APPARATUS FOR COIN
AND TOKEN OPERATED MACHINES FOR GAM-
ING AND AMUSEMENT PURPOSES, AND PARTS
FOR THE AFORESAID GOODS, IN CLASS 9 (U.S.
CLS. 21, 23, 26, 36 AND 38).

FOR: ENTERTAINMENT IN THE NATURE OF
CASINO SERVICES FEATURING A PROGRESSIVE
GAMING MACHINE JACKPOT INVOLVING ONE
OR MORE GAMING MACHINES, NAMELY, A
JACKPOT OR PRIZE WITH A FIXED MINIMUM
VALUE WHICH INCREASES UNTIL THE JACKPOT
IS WON, IN CLASS 41 (U.S. CLS. 100, 101 AND 107).

THE MARK CONSISTS OF STANDARD CHAR-
ACTERS WITHOUT CLAIM TO ANY PARTICULAR
FONT, STYLE, SIZE, OR COLOR.

PRIORITY CLAIMED UNDER SEC. 44(D) ON
ERPNTY CMNTY TM OFC APPLICATION NO.
005399324, FILED 10-19-2006, REG. NO. 005399324,
DATED 10-15-2007, EXPIRES 10-19-2016.

SER. NO. 77-031,963, FILED 10-30-2006.

DOMINIC FATHY, EXAMINING ATTORNEY

Int. Cl.: 25

Prior U.S. Cls.: 22 and 39

United States Patent and Trademark Office

Reg. No. 3,478,660

Registered Aug. 5, 2008

**TRADEMARK
PRINCIPAL REGISTER**

PETER HUBER

SL MARKETING SA (SWITZERLAND SOCIETE
ANONYME)

VIA BRAMANTINO 1

LOCARNO, SWITZERLAND 6600

FOR: SHOES AND BELTS, IN CLASS 25 (U.S. CLS.
22 AND 39).

FIRST USE 12-31-1993; IN COMMERCE 12-31-1993.

THE MARK CONSISTS OF STANDARD CHAR-
ACTERS WITHOUT CLAIM TO ANY PARTICULAR
FONT, STYLE, SIZE, OR COLOR.

THE NAME SHOWN IN THE MARK IDENTIFIES
PETER HUBER, A LIVING PERSON, WHOSE CON-
SENT IS OF RECORD.

SER. NO. 77-032,861, FILED 10-31-2006.

KEVIN DINALLO, EXAMINING ATTORNEY

Int. Cl.: 9

Prior U.S. Cls.: 21, 23, 26, 36 and 38

Reg. No. 3,478,661

United States Patent and Trademark Office

Registered Aug. 5, 2008

**TRADEMARK
PRINCIPAL REGISTER**



RED STEER GLOVE COMPANY (OREGON CORPORATION)
2895 VALPAK RD NE, PO BOX 1077
SALEM, OR 97303

FOR: SPORTS HELMETS, IN CLASS 9 (U.S. CLS. 21, 23, 26, 36 AND 38).

FIRST USE 10-1-2006; IN COMMERCE 10-1-2006.

NO CLAIM IS MADE TO THE EXCLUSIVE RIGHT TO USE "TECHNOLOGIES", APART FROM THE MARK AS SHOWN.

THE MARK CONSISTS OF A STYLIZED LETTER "A" WITH AN EXTENDING LINE OUTWARD & TO THE RIGHT. ABOVE THE LINE IS "GAME" AND BELOW IT IS "TECHNOLOGIES".

SER. NO. 77-033,155, FILED 10-31-2006.

SAMUEL E. SHARPER JR., EXAMINING ATTORNEY

Int. Cl.: 8

Prior U.S. Cls.: 23, 28 and 44

United States Patent and Trademark Office

Reg. No. 3,478,662

Registered Aug. 5, 2008

**TRADEMARK
PRINCIPAL REGISTER**

SCRUBWRIGHT

FOAMEX ASIA CO., LTD. (THAILAND CORPORATION)
1210 KEYSTONE WAY
SUITE A
VISTA, CA 92081

FOR: NON-MOTORIZED HAND HELD TOOLS, NAMELY, AN ABRASIVE CONTAINING CLEANING PEN FOR CLEANING SEMICONDUCTOR PROCESSING EQUIPMENT AND SEMICONDUCTOR PROCESSING VACUUM CHAMBERS , IN CLASS 8 (U.S. CLS. 23, 28 AND 44).

FIRST USE 3-20-2006; IN COMMERCE 3-20-2006.

THE MARK CONSISTS OF STANDARD CHARACTERS WITHOUT CLAIM TO ANY PARTICULAR FONT, STYLE, SIZE, OR COLOR.

SER. NO. 77-034,161, FILED 11-1-2006.

ALICE BENMAMAN, EXAMINING ATTORNEY

Int. Cl.: 37

Prior U.S. Cls.: 100, 103 and 106

United States Patent and Trademark Office

Reg. No. 3,478,663

Registered Aug. 5, 2008

**SERVICE MARK
PRINCIPAL REGISTER**

Paradise Valley

GLC ENTERPRISES, LLC (CALIFORNIA LTD
LIAB CO)
13181 CROSSROADS PKWY N #530
CITY OF INDUSTRY, CA 91746

FIRST USE 9-1-1999; IN COMMERCE 9-1-1999.

SER. NO. 77-034,204, FILED 11-1-2006.

FOR: PLANNING AND LAYING OUT OF RESI-
DENTIAL COMMUNITIES, IN CLASS 37 (U.S. CLS.
100, 103 AND 106).

RONALD MCMORROW, EXAMINING ATTORNEY

Int. Cl.: 36

Prior U.S. Cls.: 100, 101 and 102

United States Patent and Trademark Office

Reg. No. 3,478,664

Registered Aug. 5, 2008

**SERVICE MARK
PRINCIPAL REGISTER**

MAGNETAR CAPITAL

MAGNETAR CAPITAL L.L.C. (DELAWARE LTD
LIAB CO)
1603 ORRINGTON, 13TH FLOOR
EVANSTON, IL 60201

FOR: FINANCIAL SERVICES, NAMELY, FINANCIAL CONSULTATION; SECURITIES BROKERAGE, NAMELY, PRIVATE OFFERINGS OF SECURITIES FOR ACCREDITED INVESTORS AND QUALIFIED PURCHASERS CONSISTING OF BOTH SEPARATELY MANAGED ACCOUNTS AND POOLED INVESTMENT VEHICLES; INVESTMENT BROKERAGE, NAMELY, TRADING AND INVESTING FOR OTHERS IN THE FIELDS OF PUBLIC AND PRIVATE SECURITIES, FUTURES, OPTIONS, DERIVATIVES, COMMODITIES, REAL ESTATE, AND CURRENCIES; INVESTMENT ADVISORY SERVICES, NAMELY, INVESTMENT MANAGE-

MENT AND CONSULTATION, IN CLASS 36 (U.S. CLS. 100, 101 AND 102).

FIRST USE 5-25-2005; IN COMMERCE 5-25-2005.

THE MARK CONSISTS OF STANDARD CHARACTERS WITHOUT CLAIM TO ANY PARTICULAR FONT, STYLE, SIZE, OR COLOR.

NO CLAIM IS MADE TO THE EXCLUSIVE RIGHT TO USE "CAPITAL", APART FROM THE MARK AS SHOWN.

SER. NO. 77-034,366, FILED 11-1-2006.

EVELYN BRADLEY, EXAMINING ATTORNEY

Int. Cl.: 36

Prior U.S. Cls.: 100, 101 and 102

United States Patent and Trademark Office

Reg. No. 3,478,665

Registered Aug. 5, 2008

**SERVICE MARK
PRINCIPAL REGISTER**

MAGNETAR

MAGNETAR CAPITAL L.L.C. (DELAWARE LTD
LIAB CO)
1603 ORRINGTON, 13TH FLOOR
EVANSTON, IL 60201

FOR: FINANCIAL SERVICES, NAMELY, FINANCIAL CONSULTATION; SECURITIES BROKERAGE, NAMELY, PRIVATE OFFERINGS OF SECURITIES FOR ACCREDITED INVESTORS AND QUALIFIED PURCHASERS CONSISTING OF BOTH SEPARATELY MANAGED ACCOUNTS AND POOLED INVESTMENT VEHICLES; INVESTMENT BROKERAGE, NAMELY, TRADING AND INVESTING FOR OTHERS IN THE FIELDS OF PUBLIC AND PRIVATE SECURITIES, FUTURES, OPTIONS, DERIVATIVES, COMMODITIES, REAL ESTATE,

AND CURRENCIES; INVESTMENT ADVISORY SERVICES, NAMELY, INVESTMENT MANAGEMENT AND CONSULTATION, IN CLASS 36 (U.S. CLS. 100, 101 AND 102).

FIRST USE 5-25-2005; IN COMMERCE 5-25-2005.

THE MARK CONSISTS OF STANDARD CHARACTERS WITHOUT CLAIM TO ANY PARTICULAR FONT, STYLE, SIZE, OR COLOR.

SER. NO. 77-034,369, FILED 11-1-2006.

EVELYN BRADLEY, EXAMINING ATTORNEY

Int. Cls.: 6, 37, 40 and 42

**Prior U.S. Cls.: 2, 12, 13, 14, 23, 25, 50, 100, 101, 103
and 106**

Reg. No. 3,478,666

United States Patent and Trademark Office

Registered Aug. 5, 2008

**TRADEMARK
SERVICE MARK
PRINCIPAL REGISTER**

CIRCORED

OUTOTEC OYJ (FINLAND CORPORATION)
RIIHITONTUNTIE 7
02200 ESPOO, FINLAND

FOR: DIRECTLY REDUCED IRON; IRON ORE,
IN CLASS 6 (U.S. CLS. 2, 12, 13, 14, 23, 25 AND 50).

FOR: CONSTRUCTION OF INDUSTRIAL
PLANTS, IN CLASS 37 (U.S. CLS. 100, 103 AND 106).

FOR: TREATMENT OF MATERIALS, NAMELY,
METAL RAW MATERIAL, METAL ORES, METAL
CONCENTRATORS, IRON, METAL AND METAL
COMPOUNDS USING DIRECTLY REDUCED IRON
PROCESSES, IN CLASS 40 (U.S. CLS. 100, 103 AND
106).

FOR: ENGINEERING SERVICES, TECHNICAL
CONSULTING IN THE FIELD OF CIVIL, MECHAN-
ICAL AND CHEMICAL ENGINEERING; ARCHI-

TECTURAL DESIGN FOR OTHERS OF
INDUSTRIAL PLANTS; ENGINEERING SERVICES,
NAMELY, DEVELOPMENT OF PROCESSES FOR
THE REDUCTION OF FINE ORES, IN CLASS 42
(U.S. CLS. 100 AND 101).

THE MARK CONSISTS OF STANDARD CHAR-
ACTERS WITHOUT CLAIM TO ANY PARTICULAR
FONT, STYLE, SIZE, OR COLOR.

PRIORITY CLAIMED UNDER SEC. 44(D) ON
FINLAND APPLICATION NO. T200603043, FILED
10-17-2006, REG. NO. 238411, DATED 1-15-2007, EX-
PIRES 1-15-2017.

OWNER OF U.S. REG. NO. 3,011,612.

SER. NO. 77-035,102, FILED 11-2-2006.

SAIMA MAKHDOOM, EXAMINING ATTORNEY

Int. Cl.: 35

Prior U.S. Cls.: 100, 101 and 102

United States Patent and Trademark Office

Reg. No. 3,478,667

Registered Aug. 5, 2008

**SERVICE MARK
PRINCIPAL REGISTER**

BE THE LOVE GENERATION

SMITH, KATHARINE (UNITED STATES INDIVIDUAL)
C/O KALA CORPORATION
1655 ELMWOOD AVE.
CRANSTON, RI 02910

FOR: MAIL ORDER SERVICES FEATURING CLOTHING, JEWELRY, SOAPS AND LOTIONS; ON-LINE ORDERING SERVICES FEATURING CLOTHING, JEWELRY, SOAPS AND LOTIONS; WHOLESALE ORDERING SERVICES IN THE FIELD OF CLOTHING, JEWELRY, SOAPS AND LOTIONS, IN CLASS 35 (U.S. CLS. 100, 101 AND 102).

FIRST USE 9-1-2006; IN COMMERCE 9-1-2006.

THE MARK CONSISTS OF STANDARD CHARACTERS WITHOUT CLAIM TO ANY PARTICULAR FONT, STYLE, SIZE, OR COLOR.

SER. NO. 77-037,382, FILED 11-6-2006.

CHRISTINE COOPER, EXAMINING ATTORNEY

Int. Cls.: 35, 36 and 42

Prior U.S. Cls.: 100, 101 and 102

United States Patent and Trademark Office

Reg. No. 3,478,668

Registered Aug. 5, 2008

**SERVICE MARK
PRINCIPAL REGISTER**

ENERGY ADVANTAGE

ENERGY ADVANTAGE INC. (CANADA CORPORATION)
SUITE 501
5420 NORTH SERVICE ROAD
BURLINGTON, ONTARIO, CANADA L7L6C7

FOR: ENERGY USAGE MANAGEMENT; UTILITY BILL MANAGEMENT SERVICES, NAMELY, TRACKING, REPORTING, ANALYZING AND DELIVERING ENERGY INFORMATION BASED ON INPUT DATA FROM UTILITY BILLS AND UTILITY METER DATA RATE SCHEDULES; ENERGY USAGE MANAGEMENT INFORMATION SERVICES, NAMELY, ENERGY USAGE DATA, IN CLASS 35 (U.S. CLS. 100, 101 AND 102).

FIRST USE 12-31-1996; IN COMMERCE 12-31-1996.

FOR: BROKERAGE IN THE FIELD OF ENERGY COMMODITIES, NAMELY, ELECTRICITY, NATURAL GAS AND PETROLEUM PRODUCTS, IN CLASS 36 (U.S. CLS. 100, 101 AND 102).

FIRST USE 12-31-1996; IN COMMERCE 12-31-1996.

FOR: CONSULTING SERVICES IN THE FIELD OF THE ENVIRONMENTAL CARBON AND POLLUTANT EMISSIONS; PROVIDING NON-DOWNLOADABLE COMPUTER SOFTWARE FOR USE IN ANALYZING ENERGY USAGE DATA, IN CLASS 42 (U.S. CLS. 100 AND 101).

FIRST USE 12-31-1996; IN COMMERCE 12-31-1996.

THE MARK CONSISTS OF STANDARD CHARACTERS WITHOUT CLAIM TO ANY PARTICULAR FONT, STYLE, SIZE, OR COLOR.

PRIORITY CLAIMED UNDER SEC. 44(D) ON CANADA APPLICATION NO. 1,322,113, FILED 10-30-2006, REG. NO. TMA705502, DATED 1-23-2008, EXPIRES 1-23-2023.

NO CLAIM IS MADE TO THE EXCLUSIVE RIGHT TO USE "ENERGY", APART FROM THE MARK AS SHOWN.

SER. NO. 77-037,652, FILED 11-6-2006.

JOHN DALIER, EXAMINING ATTORNEY

Int. Cl.: 37

Prior U.S. Cls.: 100, 103 and 106

United States Patent and Trademark Office

Reg. No. 3,478,669

Registered Aug. 5, 2008

**SERVICE MARK
PRINCIPAL REGISTER**

NAVHOUSE

NAVHOUSE CORPORATION (CANADA CORPORATION)
10 LORING DRIVE
BOLTON, CANADA L7E1J9

FOR: AVIONICS REPAIR AND OVERHAUL SERVICES; REPAIR AND OVERHAUL OF INERTIAL NAVIGATION UNITS (INU), SUBASSEMBLIES AND INSTRUMENTS INCLUDING SYSTEMS, PLATFORMS, GYROS, ACCELEROMETERS, CDUS, MSUS AND ELECTRONICS FOR CIVIL AVIATION INDUSTRY, INCLUDING COMMERCIAL AIRLINES, AND LARGE BUSINESS AIRCRAFT AS WELL AS FOR THE DEFENSE INDUSTRY INCLUDING MILITARY AIRCRAFT, NAVAL VESSELS, AND SURFACE VEHICLES; AVIONICS MAINTENANCE, IN CLASS 37 (U.S. CLS. 100, 103 AND 106).

FIRST USE 0-0-1997; IN COMMERCE 0-0-1997.

THE MARK CONSISTS OF STANDARD CHARACTERS WITHOUT CLAIM TO ANY PARTICULAR FONT, STYLE, SIZE, OR COLOR.

PRIORITY CLAIMED UNDER SEC. 44(D) ON CANADA APPLICATION NO. 1321852, FILED 10-27-2006, REG. NO. TMA698583, DATED 10-15-2007, EXPIRES 10-15-2022.

SER. NO. 77-037,816, FILED 11-6-2006.

NATALIE POLZER, EXAMINING ATTORNEY

Int. Cls.: 9, 38 and 41

Prior U.S. Cls.: 21, 23, 26, 36, 38, 100, 101, 104 and 107

Reg. No. 3,478,670

United States Patent and Trademark Office

Registered Aug. 5, 2008

**TRADEMARK
SERVICE MARK
PRINCIPAL REGISTER**

ECOMAN

GIERSCH, DANIEL (MONACO INDIVIDUAL)
14 BIS RUE HONORÉ LABANDE
MONACO 98000, MONACO

FOR: MOTION PICTURE FILMS ABOUT ENVIRONMENTAL ISSUES; PRE-RECORDED VIDEO TAPES, VIDEO CASSETTES, VIDEODISCS, DVDS AND VCDS ABOUT ENVIRONMENTAL ISSUES; PRE-RECORDED AUDIO TAPES ABOUT ENVIRONMENTAL ISSUES; AUDIO CASSETTES AND AUDIO DISCS ABOUT ENVIRONMENTAL ISSUES; COMPUTER SOFTWARE, NAMELY, SOFTWARE DESIGNED TO RUN MACHINES IN THE FIELD OF ENVIRONMENTAL PROTECTION; VIDEO GAME SOFTWARE; COMPUTER AND VIDEO GAME CASSETTES, CARTRIDGES, DISCS, CD-ROMS AND DVDS; COMPUTER AND VIDEO GAME CASSETTES, CARTRIDGES, DISCS, CD-ROMS AND DVDS ADAPTED FOR USE WITH TELEVISION RECEIVERS; MOUSE PADS; COMPACT DISC HOLDERS, NAMELY, CASES; DECORATIVE MAGNETS; ELECTRIC SWITCH PLATE COVERS; EYEGLASSES; EYEGLASS CASES; SUNGLASSES AND SUNGLASS CASES; MOBILE PHONE STRAPS; KEYBOARDS AND CASES FOR MOBILE PHONES; MOBILE PHONE COVERS; BAGS AND CASES ESPECIALLY ADAPTED FOR CARRYING MOBILE TELEPHONES; PRE-PAID TELEPHONE CALLING CARDS MAGNETICALLY ENCODED, IN CLASS 9 (U.S. CLS. 21, 23, 26, 36 AND 38).

FOR: TELEVISION, CABLE TELEVISION, SATELLITE TELEVISION, RADIO AND MUSIC BROADCASTING SERVICES; TRANSMISSION OF RADIO

AND TELEVISION PROGRAMS, IN CLASS 38 (U.S. CLS. 100, 101 AND 104).

FOR: ENTERTAINMENT SERVICES IN THE NATURE OF AN ON-GOING ANIMATED TELEVISION SERIES ABOUT ENVIRONMENTAL ISSUES; ENTERTAINMENT, NAMELY, PRODUCTION AND DISTRIBUTION OF TELEVISION PROGRAMS, MOTION PICTURE FILMS AND RADIO PROGRAMS ABOUT ENVIRONMENTAL ISSUES; PRODUCTION OF PRE-RECORDED AUDIO AND VIDEO TAPES, AUDIO AND VIDEO CASSETTES, AUDIO AND VIDEO DISCS, CD-ROMS AND DVDS ABOUT ENVIRONMENTAL ISSUES; PUBLICATION OF BOOKS, MAGAZINES AND PRINTED MATERIAL, NAMELY, ALMANACS, JOURNALS, PERIODICALS, AND COMICS RELATED TO ENVIRONMENTAL ISSUES; SYNDICATION OF TELEVISION PROGRAMS ON ENVIRONMENTAL ISSUES, IN CLASS 41 (U.S. CLS. 100, 101 AND 107).

THE MARK CONSISTS OF STANDARD CHARACTERS WITHOUT CLAIM TO ANY PARTICULAR FONT, STYLE, SIZE, OR COLOR.

PRIORITY CLAIMED UNDER SEC. 44(D) ON ERPN CMNTY TM OFC APPLICATION NO. 5403597, FILED 10-20-2006, REG. NO. 005403597, DATED 11-10-2007, EXPIRES 10-20-2016.

SER. NO. 77-038,422, FILED 11-7-2006.

JESSICA FATHY, EXAMINING ATTORNEY

Int. Cls.: 9, 16, 18, 20, 21, 25 and 28

Prior U.S. Cls.: 1, 2, 3, 5, 13, 21, 22, 23, 25, 26, 29, 30, 32, 33, 36, 37, 38, 39, 40, 41 and 50

Reg. No. 3,478,671

United States Patent and Trademark Office

Registered Aug. 5, 2008

**TRADEMARK
PRINCIPAL REGISTER**

L A  B O Y

LA-Z-BOY INCORPORATED (MICHIGAN CORPORATION)
1284 N. TELEGRAPH ROAD
MONROE, MI 48162

FOR: TAPE MEASURES; FOOTBALL HELMETS; LAPTOP CARRYING CASES, IN CLASS 9 (U.S. CLS. 21, 23, 26, 36 AND 38).

FIRST USE 10-0-2002; IN COMMERCE 10-0-2002.

FOR: STATIONERY-TYPE PORTFOLIOS; BALL-POINT PENS, IN CLASS 16 (U.S. CLS. 2, 5, 22, 23, 29, 37, 38 AND 50).

FIRST USE 10-0-2002; IN COMMERCE 10-0-2002.

FOR: DUFFEL BAGS; UMBRELLAS; BUSINESS CARD CASES; BRIEFCASE-TYPE PORTFOLIOS; TOTE BAGS; SHOE BAGS FOR TRAVEL; GARMENT BAGS FOR TRAVEL; WINE BAGS FOR CARRYING OR HOLDING WINE, IN CLASS 18 (U.S. CLS. 1, 2, 3, 22 AND 41).

FIRST USE 10-0-2002; IN COMMERCE 10-0-2002.

FOR: PLASTIC CLIPS FOR SEALING BAGS, IN CLASS 20 (U.S. CLS. 2, 13, 22, 25, 32 AND 50).

FIRST USE 4-0-2005; IN COMMERCE 4-0-2005.

FOR: MUGS; INSULATING SLEEVE HOLDERS FOR BEVERAGE CANS, IN CLASS 21 (U.S. CLS. 2, 13, 23, 29, 30, 33, 40 AND 50).

FIRST USE 10-0-2002; IN COMMERCE 10-0-2002.

FOR: SHIRTS, CAPS, VISORS, JACKETS, SWEAT-SHIRTS, POLO SHIRTS, T-SHIRTS, IN CLASS 25 (U.S. CLS. 22 AND 39).

FIRST USE 10-0-2002; IN COMMERCE 10-0-2002.

FOR: PLAYING CARDS; GOLF BALLS; GOLF BAGS; GOLF CLUBS, IN CLASS 28 (U.S. CLS. 22, 23, 38 AND 50).

FIRST USE 10-0-2002; IN COMMERCE 10-0-2002.

SER. NO. 77-039,667, FILED 11-8-2006.

TRICIA SONNEBORN, EXAMINING ATTORNEY

Int. Cl.: 38

Prior U.S. Cls.: 100, 101 and 104

United States Patent and Trademark Office

Reg. No. 3,478,672

Registered Aug. 5, 2008

**SERVICE MARK
PRINCIPAL REGISTER**

STRESS-FREE TV

AVTV NETWORKS, INC. (DELAWARE CORPORATION)
THIRD FLOOR
401 HACKENSACK AVENUE
HACKENSACK, NJ 07601

FOR: AUDIOVISUAL NARROWCASTING SERVICES, IN CLASS 38 (U.S. CLS. 100, 101 AND 104).

FIRST USE 3-1-2005; IN COMMERCE 3-1-2005.

THE MARK CONSISTS OF STANDARD CHARACTERS WITHOUT CLAIM TO ANY PARTICULAR FONT, STYLE, SIZE, OR COLOR.

NO CLAIM IS MADE TO THE EXCLUSIVE RIGHT TO USE "TV", APART FROM THE MARK AS SHOWN.

SER. NO. 77-039,907, FILED 11-8-2006.

RAMONA ORTIGA, EXAMINING ATTORNEY

Int. Cl.: 11

Prior U.S. Cls.: 13, 21, 23, 31 and 34

United States Patent and Trademark Office

Reg. No. 3,478,673

Registered Aug. 5, 2008

**TRADEMARK
PRINCIPAL REGISTER**

TERRAZZO-WARE

ACORN ENGINEERING COMPANY (CALIFORNIA CORPORATION)
P.O. BOX 3527
CITY OF INDUSTRY, CA 91744

FOR: PREFABRICATED SHOWER FLOORS, NAMELY, SHOWER BASE; AND MOB SINK, IN CLASS 11 (U.S. CLS. 13, 21, 23, 31 AND 34).

FIRST USE 0-0-1992; IN COMMERCE 0-0-1992.

THE MARK CONSISTS OF STANDARD CHARACTERS WITHOUT CLAIM TO ANY PARTICULAR FONT, STYLE, SIZE, OR COLOR.

SEC. 2(F).

SER. NO. 77-040,935, FILED 11-9-2006.

DAVID HOFFMAN, EXAMINING ATTORNEY

Int. Cl.: 5

Prior U.S. Cls.: 6, 18, 44, 46, 51 and 52

Reg. No. 3,478,674

United States Patent and Trademark Office

Registered Aug. 5, 2008

**TRADEMARK
PRINCIPAL REGISTER**

SURGE

BIOTEST LABORATORIES, LLC (COLORADO
LTD LIAB CO)
P.O. BOX 60310
COLORADO SPRINGS, CO 80960

THE MARK CONSISTS OF STANDARD CHAR-
ACTERS WITHOUT CLAIM TO ANY PARTICULAR
FONT, STYLE, SIZE, OR COLOR.

FOR: NUTRITIONAL SUPPLEMENTS, IN CLASS
5 (U.S. CLS. 6, 18, 44, 46, 51 AND 52).

SER. NO. 77-042,209, FILED 11-13-2006.

FIRST USE 3-16-2001; IN COMMERCE 3-16-2001.

TANYA AMOS, EXAMINING ATTORNEY

Int. Cls.: 36 and 45

Prior U.S. Cls.: 100, 101 and 102

United States Patent and Trademark Office

Reg. No. 3,478,675

Registered Aug. 5, 2008

**SERVICE MARK
PRINCIPAL REGISTER**

Collateral Facts

KROLL INC. (DELAWARE CORPORATION)
900 THIRD AVENUE
NEW YORK, NY 10022

FOR: EVALUATION AND APPRAISAL OF REAL PROPERTY; PROVIDING REAL ESTATE INFORMATION, NAMELY, REAL ESTATE OWNERSHIP INFORMATION, IN CLASS 36 (U.S. CLS. 100, 101 AND 102).

FIRST USE 6-28-2006; IN COMMERCE 6-28-2006.

FOR: REAL ESTATE RESEARCH SERVICES, NAMELY, REAL ESTATE OWNERSHIP INFORMA-

TION VERIFICATION, IN CLASS 45 (U.S. CLS. 100 AND 101).

FIRST USE 7-1-2006; IN COMMERCE 7-1-2006.

THE MARK CONSISTS OF STANDARD CHARACTERS WITHOUT CLAIM TO ANY PARTICULAR FONT, STYLE, SIZE, OR COLOR.

SER. NO. 77-042,836, FILED 11-13-2006.

DOMINIC FATHY, EXAMINING ATTORNEY

Int. Cl.: 9

Prior U.S. Cls.: 21, 23, 26, 36 and 38

Reg. No. 3,478,676

United States Patent and Trademark Office

Registered Aug. 5, 2008

**TRADEMARK
PRINCIPAL REGISTER**

Childhood Friends

ILIMA CONSIDINE (UNITED STATES INDIVIDUAL)
1324 SE 41ST AVE
PORTLAND, OR 97214 AND
JACOB ROSE (UNITED STATES INDIVIDUAL)
1324 SE 41ST AVE
PORTLAND, OR 97214

FOR: AUDIO RECORDINGS FEATURING A MUSICAL BAND; DOWNLOADABLE MP3 FILES, MP3 RECORDINGS, ONLINE DISCUSSION BOARDS, WEB CASTS, POD CASTS, WEBINARS FEATURING MUSIC, AUDIO BOOKS AND NEWS BROADCASTS; DOWNLOADABLE MUSICAL SOUND RECORDINGS; DOWNLOADABLE VIDEO RECORDINGS FEATURING A MUSICAL BAND; MUSICAL VIDEO RECORDINGS; SOUND RECORDINGS FEATUR-

ING A MUSICAL BAND; VIDEO RECORDINGS FEATURING A MUSICAL BAND; VISUAL RECORDINGS AND AUDIO VISUAL RECORDINGS FEATURING MUSIC AND ANIMATION, IN CLASS 9 (U.S. CLS. 21, 23, 26, 36 AND 38).

FIRST USE 2-15-2005; IN COMMERCE 5-1-2005.

THE MARK CONSISTS OF STANDARD CHARACTERS WITHOUT CLAIM TO ANY PARTICULAR FONT, STYLE, SIZE, OR COLOR.

SER. NO. 77-043,151, FILED 11-14-2006.

KEVIN CORWIN, EXAMINING ATTORNEY

Int. Cls.: 39 and 42

Prior U.S. Cls.: 100, 101 and 105

United States Patent and Trademark Office

Reg. No. 3,478,677

Registered Aug. 5, 2008

**SERVICE MARK
PRINCIPAL REGISTER**



SOURCE MEDICAL SOLUTIONS, INC. (DELAWARE CORPORATION)
100 GRANDVIEW PLACE, SUITE 400
BIRMINGHAM, AL 35243

FOR: COMPUTER AND INTERNET BASED STORAGE SERVICES FOR ARCHIVING DATABASES, IMAGES AND OTHER ELECTRONIC DATA, IN CLASS 39 (U.S. CLS. 100 AND 105).

FIRST USE 9-25-2006; IN COMMERCE 9-25-2006.

FOR: COMPUTER SOFTWARE DESIGN FOR OTHERS, NAMELY, DESIGN OF COMPUTER SOFTWARE FOR FACILITATING AND MANAGING COMPUTER AND INTERNET BASED STORAGE OF DOCUMENTS; SOFTWARE INTEGRATION SERVICES; PROVIDING DESIGN, INTEGRATION, AND CONSULTATION FOR OTHERS IN THE FIELD OF SOFTWARE FOR USE IN SCHEDULING APPOINTMENTS, REGISTRATION OF PATIENTS, CLINICAL DOCUMENTATION OF PATIENT RECORDS, CODING OF DOCUMENTS AND DATA FILES, BILLING, AND ARCHIVING OF DOCUMENTS AND DATA FILES FOR OUTPATIENT SURGERY CENTERS, RADIOLOGY CLINICS, REHABILITATION CENTERS, PHYSICIAN PRACTICES, AND HOSPITALS; RETRIEVAL SERVICES, NAMELY, RETRIEVAL OF RECORDS, DOCUMENTS AND ELECTRONIC MEDIA, IN CLASS 42 (U.S. CLS. 100 AND 101).

FIRST USE 9-25-2006; IN COMMERCE 9-25-2006.

OWNER OF U.S. REG. NOS. 2,786,950, 2,967,454 AND OTHERS.

THE STIPPLING IS A FEATURE OF THE MARK.

THE COLOR(S) BLUE, GRAY, WHITE AND BLACK IS/ARE CLAIMED AS A FEATURE OF THE MARK.

THE MARK CONSISTS OF THE WORDS "SOURCEMEDICAL THE FUTURE STARTS HERE." AND A DIAMOND DESIGN THAT IS COMPRISED OF NUMEROUS SMALLER DIAMONDS. STIPPLING APPEARS IN THE TOP PORTION OF THE DESIGN. THE COLOR BLUE APPEARS INSIDE THE LETTERING FOR THE WORDING "SOURCE" AND INSIDE THE BOTTOM PORTION OF THE DESIGN ELEMENT. THE COLOR GRAY APPEARS IN THE LETTERING FOR THE WORDING "MEDICAL" AND INSIDE THE TOP PORTION OF THE DESIGN ELEMENT. THE COLOR WHITE APPEARS IN THE SPECKLES INSIDE THE TOP PORTION OF THE DESIGN ELEMENT. THE COLOR BLACK APPEARS IN THE LETTERING FOR THE WORDING "THE FUTURE STARTS HERE".

SER. NO. 77-043,269, FILED 11-14-2006.

SETH A. RAPPAPORT, EXAMINING ATTORNEY

Int. Cls.: 5 and 30

Prior U.S. Cls.: 6, 18, 44, 46, 51 and 52

Reg. No. 3,478,678

United States Patent and Trademark Office

Registered Aug. 5, 2008

TRADEMARK
PRINCIPAL REGISTER

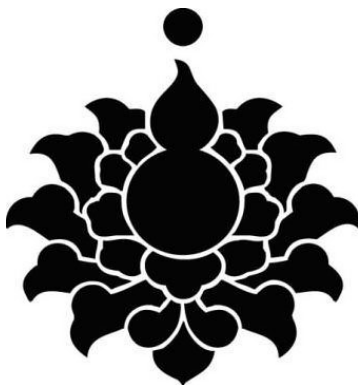

YUNNAN BAIYAO GROUP CO., LTD. (CHINA CORPORATION)
STATE HIGH & NEW TECHNOLOGY ZONE
KUNMING, CHINA

FOR: DIET CAPSULES IN THE NATURE OF PROCESSED GINSENG, PANAX NOTOGINSENG, BEE POLLEN AND BIRD'S NEST USED AS AN HERBAL SUPPLEMENT , IN CLASS 5 (U.S. CLS. 6, 18, 44, 46, 51 AND 52).

FIRST USE 1-31-1999; IN COMMERCE 8-31-2000.

FOR: COFFEE; COCOA; COFFEE SUBSTITUTES; TEA; TEA SUBSTITUTES; SUGAR; CANDY; CHEWING GUM, NOT FOR MEDICAL PURPOSES; HONEY; ALIMENTARY LIQUIDS IN THE NATURE OF HERBAL FOOD BEVERAGES; ALIMENTARY PASTES; ALIMENTARY POWDER, NAMELY, PROCESSED GINSENG IN THE NATURE OF A POWDER FOR USE AS AN HERB, SPICE OR FLAVORING, AND PROCESSED PANAX NOTOGINSENG IN THE NATURE OF A POWDER FOR USE AS AN HERB, SPICE OR FLAVORING; ROYAL JELLY FOR FOOD PURPOSES AND HUMAN CONSUMPTION, NOT FOR MEDICAL PURPOSES; ALIMENTARY PASTES MADE OF BEE POLLEN, NOT

FOR MEDICAL PURPOSES; BREAD; CAKES; PASTRIES; CEREAL PREPARATIONS, NAMELY, BREAKFAST CEREALS, CEREAL-BASED SNACK FOODS, AND PROCESSED CEREALS; NOODLES; POPCORN; SOYA FLOUR; STARCH PRODUCTS FOR FOOD, NAMELY, FOOD STARCH, CORN STARCH, RICE STARCH FLOUR; ICE CREAM; COOKING SALT; VINEGAR; SOYA SAUCE; SEASONINGS; YEAST; ESSENCES FOR FOODSTUFFS, EXCLUDING ETHERIC ESSENCES AND ESSENTIAL OILS, NAMELY, EXTRACTS FOR USE AS FOOD FLAVORING; MEAT TENDERIZERS FOR HOUSEHOLD PURPOSES, IN CLASS 30 (U.S. CL. 46).

FIRST USE 1-31-1999; IN COMMERCE 8-31-2000.

THE MARK CONSISTS OF A CUCURBIT IN THE CENTRAL, A CATHOLICON ABOVE THE CUCURBIT, AND THE LEAVES OF THREE FLOWERS, E.G., THE HERBACEOUS PEONY, THE TREE PEONY, CHRYSANTHEMUM AROUND THE CUCURBIT.

SER. NO. 77-044,152, FILED 11-15-2006.

JAY BESCH, EXAMINING ATTORNEY

Int. Cl.: 41

Prior U.S. Cls.: 100, 101 and 107

United States Patent and Trademark Office

Reg. No. 3,478,679

Registered Aug. 5, 2008

**SERVICE MARK
PRINCIPAL REGISTER**

WRITE READ SUCCEED

GOLDSTEIN, SAMANTHA (UNITED STATES IN-
DIVIDUAL)
23642 OXNARD STREET
WOODLAND HILLS, CA 91367

THE MARK CONSISTS OF STANDARD CHAR-
ACTERS WITHOUT CLAIM TO ANY PARTICULAR
FONT, STYLE, SIZE, OR COLOR.

FOR: CHARITABLE SERVICES, NAMELY, PRO-
VIDING BOOKS TO CHILDREN, IN CLASS 41 (U.S.
CLS. 100, 101 AND 107).

SER. NO. 77-044,165, FILED 11-15-2006.

FIRST USE 10-15-2006; IN COMMERCE 10-15-2006.

LAURIE KAUFMAN, EXAMINING ATTORNEY

Int. Cls.: 5 and 30

Prior U.S. Cls.: 6, 18, 44, 46, 51 and 52

Reg. No. 3,478,680

United States Patent and Trademark Office

Registered Aug. 5, 2008

**TRADEMARK
PRINCIPAL REGISTER**

YNBY

YUNNAN BAIYAO GROUP CO., LTD. (CHINA CORPORATION)
STATE HIGH & NEW TECHNOLOGY ZONE
KUNMING, CHINA

FOR: DIET CAPSULES IN THE NATURE OF PROCESSED GINSENG, PANAX NOTOGINSENG, BEE POLLEN AND BIRD'S NEST USED AS AN HERBAL SUPPLEMENT, IN CLASS 5 (U.S. CLS. 6, 18, 44, 46, 51 AND 52).

FIRST USE 1-31-1999; IN COMMERCE 8-31-2000.

FOR: COFFEE; COCOA; COFFEE SUBSTITUTES; TEA; TEA SUBSTITUTES; SUGAR; CANDY; CHEWING GUM, NOT FOR MEDICAL PURPOSES; HONEY; ALIMENTARY LIQUIDS IN THE NATURE OF HERBAL FOOD BEVERAGES; ALIMENTARY PASTES; ALIMENTARY POWDER, NAMELY, PROCESSED GINSENG IN THE NATURE OF A POWDER FOR USE AS AN HERB, SPICE OR FLAVORING, AND PROCESSED PANAX NOTOGINSENG IN THE NATURE OF A POWDER FOR USE AS AN HERB, SPICE OR FLAVORING; ROYAL

JELLY FOR FOOD PURPOSES AND HUMAN CONSUMPTION, NOT FOR MEDICAL PURPOSES; ALIMENTARY PASTES MADE OF BEE POLLEN, NOT FOR MEDICAL PURPOSES; BREAD; CAKES; PASTRIES; CEREAL PREPARATIONS, NAMELY, BREAKFAST CEREALS, CEREAL-BASED SNACK FOODS, AND PROCESSED CEREALS; NOODLES; POPCORN; SOYA FLOUR; STARCH PRODUCTS FOR FOOD, NAMELY, FOOD STARCH, CORN STARCH, RICE STARCH FLOUR; ICE CREAM; COOKING SALT; VINEGAR; SOYA SAUCE; SEASONINGS; YEAST; ESSENCES FOR FOODSTUFFS, EXCLUDING ETHERIC ESSENCES AND ESSENTIAL OILS, NAMELY, EXTRACTS FOR USE AS FOOD FLAVORING; MEAT TENDERIZERS FOR HOUSEHOLD PURPOSES, IN CLASS 30 (U.S. CL. 46).

FIRST USE 1-31-1999; IN COMMERCE 8-31-2000.

SER. NO. 77-044,210, FILED 11-15-2006.

JAY BESCH, EXAMINING ATTORNEY

Int. Cls.: 9 and 42

Prior U.S. Cls.: 21, 23, 26, 36, 38, 100 and 101

United States Patent and Trademark Office

Reg. No. 3,478,681

Registered Aug. 5, 2008

**TRADEMARK
SERVICE MARK
PRINCIPAL REGISTER**

FacilitiesLink

NETWORK DIGICALITY, INC. (CALIFORNIA CORPORATION)
220 ORANGE AVENUE, #204
CORONADO, CA 92118

FOR: COMPUTER SOFTWARE FOR ACQUIRING, FURNISHING, DEVELOPING, STORING, USING AND DISPOSING OF BUILDINGS, SPACE, EQUIPMENT, FACILITIES AND OTHER REAL PROPERTY, INCLUDING DESIGN, CONSTRUCTION, PLANNING, OPERATION, LEASING, USE REPORTING, MAINTENANCE, MANAGEMENT, REPORTING, AND FINANCIAL TRACKING, IN CLASS 9 (U.S. CLS. 21, 23, 26, 36 AND 38).

FIRST USE 2-24-2000; IN COMMERCE 9-25-2003.

FOR: DESIGN OF COMPUTER NETWORKS AND SOFTWARE FOR OTHERS FOR THE ACQUI-

TION, FURNISHING, DEVELOPMENT, STORING, USING AND DISPOSING OF BUILDINGS, SPACE, EQUIPMENT, FACILITIES AND OTHER REAL PROPERTY, INCLUDING DESIGN, CONSTRUCTION, PLANNING, OPERATION, LEASING, USE REPORTING, MAINTENANCE, MANAGEMENT, REPORTING, AND FINANCIAL TRACKING, IN CLASS 42 (U.S. CLS. 100 AND 101).

FIRST USE 2-24-2000; IN COMMERCE 9-25-2003.

THE MARK CONSISTS OF STANDARD CHARACTERS WITHOUT CLAIM TO ANY PARTICULAR FONT, STYLE, SIZE, OR COLOR.

SER. NO. 77-044,563, FILED 11-15-2006.

JANICE KIM, EXAMINING ATTORNEY

Int. Cl.: 3

Prior U.S. Cls.: 1, 4, 6, 50, 51 and 52

United States Patent and Trademark Office

Reg. No. 3,478,682

Registered Aug. 5, 2008

**TRADEMARK
PRINCIPAL REGISTER**

BRONZE TROPIQUES

LANCOME PARFUMS ET BEAUTE & CIE
(FRANCE SOCIETE EN NOM COLLECTIF)
29, RUE DU FAUBOURG SAINT-HONORE
PARIS, FRANCE 75008

FOR: COSMETICS, NAMELY, CREAMS, GELS, MILKS, POWDERS AND LOTIONS FOR THE FACE, THE BODY AND THE HANDS; MAKEUP PRODUCTS, NAMELY, MASCARA, EYE LINER, EYE SHADOW, EYEBROW PENCILS, LIPSTICKS, NAIL POLISH, BLUSH, FOUNDATION CREAMS AND POWDER, BODY DEODORANTS; SUN CARE PREPARATIONS, NAMELY, TANNING AND AFTER-SUN MILKS, GELS AND OILS; ESSENTIAL OILS FOR COSMETIC USE, IN CLASS 3 (U.S. CLS. 1, 4, 6, 50, 51 AND 52).

THE MARK CONSISTS OF STANDARD CHARACTERS WITHOUT CLAIM TO ANY PARTICULAR FONT, STYLE, SIZE, OR COLOR.

OWNER OF ERPN CMNTY TM OFC REG. NO. 5474374, DATED 11-16-2006, EXPIRES 11-16-2016.

NO CLAIM IS MADE TO THE EXCLUSIVE RIGHT TO USE "BRONZE", APART FROM THE MARK AS SHOWN.

THE FOREIGN WORDING IN THE MARK TRANSLATES INTO ENGLISH AS "TROPICS".

SER. NO. 77-045,321, FILED 11-16-2006.

JAMES GRIFFIN, EXAMINING ATTORNEY

Int. Cl.: 43

Prior U.S. Cls.: 100 and 101

United States Patent and Trademark Office

Reg. No. 3,478,683

Registered Aug. 5, 2008

**SERVICE MARK
PRINCIPAL REGISTER**

CROWD PLEAZERS

99 RESTAURANTS, LLC (MASSACHUSETTS LTD
LIAB CO)
3038 SIDCO DRIVE
NASHVILLE, TN 37204

FOR: RESTAURANT SERVICES, NAMELY, CA-
TERING SERVICES FOR LARGE PARTIES FEAT-
URING FOOD ITEMS FROM PROPRIETOR'S
OWN RESTAURANTS, IN CLASS 43 (U.S. CLS. 100
AND 101).

FIRST USE 7-14-2003; IN COMMERCE 7-14-2003.

THE MARK CONSISTS OF STANDARD CHAR-
ACTERS WITHOUT CLAIM TO ANY PARTICULAR
FONT, STYLE, SIZE, OR COLOR.

SER. NO. 77-045,987, FILED 11-16-2006.

DAWN FELDMAN, EXAMINING ATTORNEY

Int. Cl.: 9

Prior U.S. Cls.: 21, 23, 26, 36 and 38

Reg. No. 3,478,684

United States Patent and Trademark Office

Registered Aug. 5, 2008

TRADEMARK
PRINCIPAL REGISTER

VibroSystem

VIBROSYSTEM INC. (CANADA CORPORATION)
2727 JACQUES-CARTIER BLVD. EAST
LONGUEUIL, CANADA J4N1L7

FOR: APPARATUS COMPRISED OF ELECTRONIC AND SOFTWARE COMPONENTS FOR MONITORING THE DYNAMIC AIR GAP IN HYDRO-ELECTRIC GENERATORS, AS WELL AS OTHER LARGE ROTATING MACHINES AND ALSO FOR MONITORING THE HEIGHT, ALIGNMENT AND LATERAL POSITION OF LINEAR MOTORS AND THE VEHICLES PROPELLED BY SAME; APPARATUS COMPRISED OF ELECTRONIC AND SOFTWARE COMPONENTS FOR THE MONITORING OF ANY DATA RELATING TO THE PERFORMANCE OF LARGE GENERATORS AND OTHER ROTATING MACHINES WITHOUT REQUIRING THE STOPPAGE OF SAME; MEASURING AND MONITORING INSTRUMENTS SUITED FOR THE HARSH ENVIRONMENT INSIDE TURBO GENERATING MACHINES THAT MONITOR TRUE VIBRATION WITHOUT ELECTRICAL RUN OUT AND OTHER INTERFERENCE, MEASURES END-WINDING VIBRATION TO ASSESS BRACING CONDITION, OR FOR ANY APPLICATION IN HIGH VOLTAGE OR EXPLOSIVE ENVIRONMENTS; ELECTRONIC MONITORS FOR ON-LINE STATOR BAR VIBRATION TO DETERMINE WEDGE TIGHTNESS AND WINDING INSULATION CONDITION; MEASURING INSTRUMENTS TO DETERMINE THE MAGNETIC FLUX EMANATING FROM ROTOR POLES OF GENERATORS TO DETECT AND DIAGNOSE ANY MAGNETIC FIELD IMBALANCES; ALARMS FOR THE DETECTION OF ANY EXCESSIVE VALUE FROM THE MONITORED PARAMETERS; ALARM INHIBITOR FOR USE DURING MACHINE TRANSITORY OPERATING CONDITION TO PREVENT FALSE ALARMS AND UNNECESSARY SHUTDOWNS; DETECTORS FOR ROTOR MOVEMENT IN ORDER TO DISPLAY ROTATIONAL SPEED, TO NOTIFY WHEN IT REACHES STANDSTILL DURING SHUTDOWN

AND TO WARN OF UNDESIRED MOVEMENT DURING MAINTENANCE; MEASURING INSTRUMENTS FOR AXIAL DISPLACEMENT OF TURBO GENERATOR SHAFT; MEASURING INSTRUMENTATION AND APPARATUS FOR MISCELLANEOUS APPLICATIONS OF CAPACITIVE TECHNOLOGY TO MEASURE DISPLACEMENT, PROXIMITY, POSITION, OR AIR GAP IN ROTATING MACHINE THAT CAN SHOW MAGNETIC DISTURBANCES WHEN THE VIBRATION IS MONITORED USING MAGNETIC BASE SENSORS SUCH AS EDDY CURRENT PROBES; MEASURING AND MONITORING SYSTEMS FOR HYDROELECTRIC TURBINE-GENERATOR SETS, NAMELY, ELECTRONIC MONITORS TO MEASURE THE TRUE VIBRATION WITHOUT ELECTRICAL RUN OUT AND OTHER INTERFERENCE; ELECTRONIC MONITORS OF ON-LINE STATOR BAR VIBRATION TO DETERMINE WEDGE TIGHTNESS AND WINDING INSULATION CONDITION; MEASURING INSTRUMENTS FOR END-WINDING VIBRATION TO ASSESS BRACING CONDITION, OR FOR ANY APPLICATION IN HIGH VOLTAGE OR EXPLOSIVE ENVIRONMENTS; MEASURING INSTRUMENTS FOR MAGNETIC FLUX EMANATING FROM ROTOR POLES OF GENERATORS TO DETECT AND DIAGNOSE ANY MAGNETIC FIELD IMBALANCES; ELECTRONIC PRODUCTS FOR THE GENERATION OF THERMAL MAPS OF STATOR CORE, STATOR WINDINGS AND ROTOR POLES OF A GENERATOR OF ELECTRICITY OR MOTOR; ALARMS FOR DETECTING A BREAKAGE AND IDENTIFYING THE DEFECTIVE SHEAR PIN IN THE WICKET GATE OPERATING MECHANISM OF HYDRO GENERATORS; DETECTORS FOR ROTOR MOVEMENT IN ORDER TO DISPLAY ROTATIONAL SPEED, TO NOTIFY WHEN IT REACHES STANDSTILL DURING SHUTDOWN, AND TO WARN OF UNDESIRED MOVEMENT DURING MAINTENANCE ON THE MACHINES; MEASURING INSTRUMENTS FOR TESTING THE STATIC TIGHTNESS OF EVERY

STATOR WEDGE WITH A ROBOT TOOL IN LARGE ELECTRICAL GENERATORS OR MOTORS, IN CLASS 9 (U.S. CLS. 21, 23, 26, 36 AND 38).

THE MARK CONSISTS OF STANDARD CHARACTERS WITHOUT CLAIM TO ANY PARTICULAR FONT, STYLE, SIZE, OR COLOR.

SER. NO. 77-046,419, FILED 11-17-2006.

FIRST USE 12-31-1995; IN COMMERCE 12-31-1995.

ALEXANDER L. POWERS, EXAMINING ATTORNEY

Int. Cl.: 9

Prior U.S. Cls.: 21, 23, 26, 36 and 38

Reg. No. 3,478,685

United States Patent and Trademark Office

Registered Aug. 5, 2008

**TRADEMARK
PRINCIPAL REGISTER**



VIBROSYSTEM INC. (CANADA CORPORATION)
2727 JACQUES-CARTIER BLVD. EAST
LONGUEUIL, CANADA J4N1L7

FOR: APPARATUS COMPRISED OF ELECTRONIC AND SOFTWARE COMPONENTS FOR MONITORING THE DYNAMIC AIR GAP IN HYDRO-ELECTRIC GENERATORS, AS WELL AS OTHER LARGE ROTATING MACHINES AND ALSO FOR MONITORING THE HEIGHT, ALIGNMENT AND LATERAL POSITION OF LINEAR MOTORS AND THE VEHICLES PROPELLED BY SAME; APPARATUS COMPRISED OF ELECTRONIC AND SOFTWARE COMPONENTS FOR THE MONITORING OF ANY DATA RELATING TO THE PERFORMANCE OF LARGE GENERATORS AND OTHER ROTATING MACHINES WITHOUT REQUIRING THE STOPPAGE OF SAME; MEASURING AND MONITORING INSTRUMENTS SUITED FOR THE HARSH ENVIRONMENT INSIDE TURBO GENERATING MACHINES THAT MONITOR TRUE VIBRATION WITHOUT ELECTRICAL RUN OUT AND OTHER INTERFERENCE, MEASURES END-WINDING VIBRATION TO ASSESS BRACING CONDITION, OR FOR ANY APPLICATION IN HIGH VOLTAGE OR EXPLOSIVE ENVIRONMENTS; ELECTRONIC MONITORS FOR ON-LINE STATOR BAR VIBRATION TO DETERMINE WEDGE TIGHTNESS AND WINDING INSULATION CONDITION; MEASURING INSTRUMENTS TO DETERMINE THE MAGNETIC FLUX EMANATING FROM ROTOR POLES OF GENERATORS TO DETECT AND DIAGNOSE ANY MAGNETIC FIELD IMBALANCES; ALARMS FOR THE DETECTION OF ANY EXCESSIVE VALUE FROM THE MONITORED PARAMETERS; ALARM INHIBITOR FOR USE

DURING MACHINE TRANSITORY OPERATING CONDITION TO PREVENT FALSE ALARMS AND UNNECESSARY SHUTDOWNS; DETECTORS FOR ROTOR MOVEMENT IN ORDER TO DISPLAY ROTATIONAL SPEED, TO NOTIFY WHEN IT REACHES STANDSTILL DURING SHUTDOWN AND TO WARN OF UNDESIRED MOVEMENT DURING MAINTENANCE; MEASURING INSTRUMENTS FOR AXIAL DISPLACEMENT OF TURBO GENERATOR SHAFT; MEASURING INSTRUMENTATION AND APPARATUS FOR MISCELLANEOUS APPLICATIONS OF CAPACITIVE TECHNOLOGY TO MEASURE DISPLACEMENT, PROXIMITY, POSITION, OR AIR GAP IN ROTATING MACHINE THAT CAN SHOW MAGNETIC DISTURBANCES WHEN THE VIBRATION IS MONITORED USING MAGNETIC BASE SENSORS SUCH AS EDDY CURRENT PROBES; MEASURING AND MONITORING SYSTEMS FOR HYDROELECTRIC TURBINE-GENERATOR SETS, NAMELY, ELECTRONIC MONITORS TO MEASURE THE TRUE VIBRATION WITHOUT ELECTRICAL RUN OUT AND OTHER INTERFERENCE; ELECTRONIC MONITORS OF ON-LINE STATOR BAR VIBRATION TO DETERMINE WEDGE TIGHTNESS AND WINDING INSULATION CONDITION; MEASURING INSTRUMENTS FOR END-WINDING VIBRATION TO ASSESS BRACING CONDITION, OR FOR ANY APPLICATION IN HIGH VOLTAGE OR EXPLOSIVE ENVIRONMENTS; MEASURING INSTRUMENTS FOR MAGNETIC FLUX EMANATING FROM ROTOR POLES OF GENERATORS TO DETECT AND DIAGNOSE ANY MAGNETIC FIELD IMBALANCES; ELECTRONIC PRODUCTS FOR THE GENERATION OF THERMAL MAPS OF STATOR CORE, STATOR WINDINGS AND ROTOR

POLES OF A GENERATOR OF ELECTRICITY OR MOTOR; ALARMS FOR DETECTING A BREAKAGE AND IDENTIFYING THE DEFECTIVE SHEAR PIN IN THE WICKET GATE OPERATING MECHANISM OF HYDRO GENERATORS; DETECTORS FOR ROTOR MOVEMENT IN ORDER TO DISPLAY ROTATIONAL SPEED, TO NOTIFY WHEN IT REACHES STANDSTILL DURING SHUT-DOWN, AND TO WARN OF UNDESIREED MOVEMENT DURING MAINTENANCE ON THE MACHINES; MEASURING INSTRUMENTS FOR TESTING THE STATIC TIGHTNESS OF EVERY

STATOR WEDGE WITH A ROBOT TOOL IN LARGE ELECTRICAL GENERATORS OR MOTORS, IN CLASS 9 (U.S. CLS. 21, 23, 26, 36 AND 38).

FIRST USE 12-31-1995; IN COMMERCE 12-31-1995.

THE MARK CONSISTS OF STYLISED LETTERS.

SER. NO. 77-046,533, FILED 11-17-2006.

ALEXANDER L. POWERS, EXAMINING ATTORNEY

Int. Cl.: 41

Prior U.S. Cls.: 100, 101 and 107

United States Patent and Trademark Office

Reg. No. 3,478,686

Registered Aug. 5, 2008

**SERVICE MARK
PRINCIPAL REGISTER**

FEEL GOOD FAST FOOD

AMANDA'S RESTAURANTS, LLC (CALIFORNIA
CORPORATION)
P.O. BOX 1185
PALO ALTO, CA 943021185

FOR: ON-LINE JOURNALS, NAMELY, BLOGS
FEATURING INFORMATION ON RESTAURANT
SERVICES, IN CLASS 41 (U.S. CLS. 100, 101 AND 107).

FIRST USE 3-6-2006; IN COMMERCE 3-6-2006.

THE MARK CONSISTS OF STANDARD CHAR-
ACTERS WITHOUT CLAIM TO ANY PARTICULAR
FONT, STYLE, SIZE, OR COLOR.

NO CLAIM IS MADE TO THE EXCLUSIVE
RIGHT TO USE "FAST FOOD", APART FROM
THE MARK AS SHOWN.

SER. NO. 77-046,603, FILED 11-17-2006.

MIDGE BUTLER, EXAMINING ATTORNEY

Int. Cl.: 36

Prior U.S. Cls.: 100, 101 and 102

United States Patent and Trademark Office

Reg. No. 3,478,687

Registered Aug. 5, 2008

**SERVICE MARK
PRINCIPAL REGISTER**



BARTON & GRAY LLC (MASSACHUSETTS LTD
LIAB CO)
2 PARK PLAZA, SUITE 409
BOSTON, MA 02116

FOR: FORMATION, BROKERAGE AND MAN-
AGEMENT OF FRACTIONAL OWNERSHIP AND
TIME SHARE INTERESTS IN YACHTS AND BOATS,
IN CLASS 36 (U.S. CLS. 100, 101 AND 102).

FIRST USE 5-1-2006; IN COMMERCE 5-1-2006.

NO CLAIM IS MADE TO THE EXCLUSIVE
RIGHT TO USE "MARINERS CLUB", APART FROM
THE MARK AS SHOWN.

THE COLOR(S) GOLD/YELLOW, LIGHT BLUE,
WHITE, NAVY BLUE IS/ARE CLAIMED AS A
FEATURE OF THE MARK.

THE MARK CONSISTS OF "BARTON & GRAY"
IN GOLD/YELLOW WITH YELLOW AND LIGHT
BLUE STRIPED FLAG ABOVE IT AND "MARINERS
CLUB" BENEATH IN WHITE.

SER. NO. 77-046,811, FILED 11-17-2006.

TRICIA SONNEBORN, EXAMINING ATTORNEY

Int. Cl.: 9

Prior U.S. Cls.: 21, 23, 26, 36 and 38

Reg. No. 3,478,688

United States Patent and Trademark Office

Registered Aug. 5, 2008

**TRADEMARK
PRINCIPAL REGISTER**

ROS

RUGGEDCOM INC. (CANADA CORPORATION)
30 WHITMORE ROAD
WOODBIDGE, CANADA L4L7Z4

THE MARK CONSISTS OF STANDARD CHARACTERS WITHOUT CLAIM TO ANY PARTICULAR FONT, STYLE, SIZE, OR COLOR.

FOR: COMPUTER SOFTWARE, NAMELY, AN EMBEDDED OPERATING SYSTEM FOR COMPUTERS, MANAGED ETHERNET SWITCHES AND/OR SERIAL DEVICE SERVERS FORMING A NETWORK; COMPUTER SOFTWARE, NAMELY, AN OPERATING SYSTEM FOR COMPUTERS AND/OR MANAGED ETHERNET SWITCHES AND/OR SERIAL DEVICE SERVERS CONNECTED TO A NETWORK, IN CLASS 9 (U.S. CLS. 21, 23, 26, 36 AND 38).

PRIORITY CLAIMED UNDER SEC. 44(D) ON CANADA APPLICATION NO. 1302281, FILED 5-19-2006, REG. NO. TMA703453, DATED 12-18-2007, EXPIRES 12-18-2022.

SER. NO. 77-047,135, FILED 11-17-2006.

FIRST USE 4-1-2004; IN COMMERCE 11-13-2006.

MICHAEL WEBSTER, EXAMINING ATTORNEY

Int. Cl.: 40

Prior U.S. Cls.: 100, 103 and 106

United States Patent and Trademark Office

Reg. No. 3,478,689

Registered Aug. 5, 2008

**SERVICE MARK
PRINCIPAL REGISTER**

DIRECT FULFILLMENT

WELDON, WILLIAMS & LICK, INC. (ARKANSAS CORPORATION)
711 NORTH A STREET
FORT SMITH, AR 729012121

FOR: PRINTING OF PROMOTIONAL MATERIALS FOR OTHERS, NAMELY, GIFT CARDS, LOYALTY CARDS, CERTIFICATES, ADMISSION TICKETS AND PASSES, IN CLASS 40 (U.S. CLS. 100, 103 AND 106).

FIRST USE 7-31-2002; IN COMMERCE 7-31-2002.

THE MARK CONSISTS OF STANDARD CHARACTERS WITHOUT CLAIM TO ANY PARTICULAR FONT, STYLE, SIZE, OR COLOR.

SEC. 2(F).

SER. NO. 77-048,899, FILED 11-21-2006.

HEATHER SAPP, EXAMINING ATTORNEY

Int. Cl.: 35

Prior U.S. Cls.: 100, 101 and 102

United States Patent and Trademark Office

Reg. No. 3,478,690

Registered Aug. 5, 2008

**SERVICE MARK
PRINCIPAL REGISTER**

DIRECT FULFILLMENT

WELDON, WILLIAMS & LICK, INC. (ARKANSAS CORPORATION)
711 NORTH A STREET
FORT SMITH, AR 729012121

FOR: PREPARING DISTRIBUTIONS FOR OTHERS OF PRINTED PROMOTIONAL MATERIALS, NAMELY, GIFT CARDS, LOYALTY CARDS, CERTIFICATES, ADMISSION TICKETS AND PASSES, IN CLASS 35 (U.S. CLS. 100, 101 AND 102).

FIRST USE 7-31-2002; IN COMMERCE 7-31-2002.

THE MARK CONSISTS OF STANDARD CHARACTERS WITHOUT CLAIM TO ANY PARTICULAR FONT, STYLE, SIZE, OR COLOR.

SEC. 2(F).

SER. NO. 77-048,917, FILED 11-21-2006.

HEATHER SAPP, EXAMINING ATTORNEY

Int. Cl.: 37

Prior U.S. Cls.: 100, 103 and 106

United States Patent and Trademark Office

Reg. No. 3,478,691

Registered Aug. 5, 2008

**SERVICE MARK
PRINCIPAL REGISTER**

Canaan Technology

CANAAN TECHNOLOGY, LLC (CONNECTICUT
LTD LIAB CO)
194 MAIN STREET
NORWALK, CT 06851 AND
FELTON, DAVID R (UNITED STATES INDIVI-
DUAL)
PO BOX 121
NORWALK, CT 06851

FOR: COMPUTER INSTALLATION AND RE-
PAIR; INSTALLATION OF COMPUTER SYSTEMS;
MAINTENANCE AND REPAIR OF COMPUTER
HARDWARE; MAINTENANCE AND REPAIR OF
COMPUTER NETWORKS; MAINTENANCE AND
REPAIR OF TELECOMMUNICATIONS NETWORKS,
APPARATUS, AND INSTRUMENTS; REPAIR OF
DAMAGED COMPUTERS; REPAIR OR MAINTENANCE
OF COMPUTERS; TELEPHONE INSTAL-

LATION AND REPAIR; TELEPHONE REPAIR, IN
CLASS 37 (U.S. CLS. 100, 103 AND 106).

FIRST USE 4-1-2002; IN COMMERCE 4-1-2002.

THE MARK CONSISTS OF STANDARD CHAR-
ACTERS WITHOUT CLAIM TO ANY PARTICULAR
FONT, STYLE, SIZE, OR COLOR.

NO CLAIM IS MADE TO THE EXCLUSIVE
RIGHT TO USE "TECHNOLOGY", APART FROM
THE MARK AS SHOWN.

SER. NO. 77-049,668, FILED 11-22-2006.

HOWARD SMIGA, EXAMINING ATTORNEY

Int. Cl.: 7

Prior U.S. Cls.: 13, 19, 21, 23, 31, 34 and 35

United States Patent and Trademark Office

Reg. No. 3,478,692

Registered Aug. 5, 2008

**TRADEMARK
PRINCIPAL REGISTER**

Diamond-Trac

MITSUBISHI ELECTRIC CORPORATION (JAPAN
CORPORATION)
7-3 MARUNOUCHI 2-CHOME
CHIYODA-KU, TOKYO, JAPAN

FOR: ELEVATORS, IN CLASS 7 (U.S. CLS. 13, 19,
21, 23, 31, 34 AND 35).

THE MARK CONSISTS OF STANDARD CHAR-
ACTERS WITHOUT CLAIM TO ANY PARTICULAR
FONT, STYLE, SIZE, OR COLOR.

PRIORITY CLAIMED UNDER SEC. 44(D) ON
JAPAN APPLICATION NO. 2006-103850, FILED 11-8-
2006, REG. NO. 5074400, DATED 8-31-2007, EXPIRES
8-31-2017.

SER. NO. 77-049,865, FILED 11-22-2006.

STEPHEN AQUILA, EXAMINING ATTORNEY

Int. Cl.: 41

Prior U.S. Cls.: 100, 101 and 107

United States Patent and Trademark Office

Reg. No. 3,478,693

Registered Aug. 5, 2008

**SERVICE MARK
PRINCIPAL REGISTER**



International Facility Management Association

INTERNATIONAL FACILITY MANAGEMENT
ASSOCIATION (MICHIGAN NOT-FOR-PROF-
IT CORPORATION)
1 EAST GREENWAY PLAZA, SUITE 1100
HOUSTON, TX 77046

FOR: EDUCATION SERVICES, NAMELY, CON-
DUCTING CLASSES AND SEMINARS FOR MEM-
BERS OF THE FACILITIES MANAGEMENT FIELD
REGARDING SUSTAINABILITY TOPICS, NAME-
LY, ADOPTION OF ENERGY AND ENVIRONMEN-
TAL POLICIES THAT HAVE MINIMUM IMPACT
ON THE ENVIRONMENT, COST-EFFECTIVE EN-
VIRONMENTAL STRATEGIES, ENVIRONMENTAL
BUILDING DESIGN, BUILDING ENERGY AND
EFFICIENCY/SAVINGS, INDOOR ENVIRONMEN-
TAL QUALITY, AND ENVIRONMENTALLY
FRIENDLY BUSINESS PRACTICES, NAMELY,
BUILDING MANAGEMENT, CLEANING, PRO-
CUREMENT, MOLD AND MILDEW REDUCTION

AND REMOVAL, TEXTILES, LIGHTING, AND FAB-
RICS, TRENDS, STANDARDS, AND MEASURE-
MENTS; DISTRIBUTION AND DISSEMINATION
OF MATERIALS, RESOURCES AND PRODUCTS
CONCERNING THE FOREGOING, IN CLASS 41
(U.S. CLS. 100, 101 AND 107).

FIRST USE 9-15-2006; IN COMMERCE 9-15-2006.

OWNER OF U.S. REG. NO. 2,620,733.

NO CLAIM IS MADE TO THE EXCLUSIVE
RIGHT TO USE "GREEN" AND "INTERNATIONAL
FACILITY MANAGEMENT ASSOCIATION",
APART FROM THE MARK AS SHOWN.

SER. NO. 77-050,772, FILED 11-27-2006.

CAROLYN CATALDO, EXAMINING ATTORNEY

Int. Cls.: 29 and 30

Prior U.S. Cl.: 46

United States Patent and Trademark Office

Reg. No. 3,478,694

Registered Aug. 5, 2008

**TRADEMARK
PRINCIPAL REGISTER**

山水

VITASOY INTERNATIONAL HOLDINGS LIMITED (HONG KONG CORPORATION)
1 KIN WONG STREET, TUEN MUN
NEW TERRITORIES, HONG KONG

FOR: DIPS; FORMED TEXTURED VEGETABLE PROTEIN FOR USE AS A MEAT EXTENDER OR MEAT SUBSTITUTE; SOYBEAN MILK; YOGURT, IN CLASS 29 (U.S. CL. 46).

FOR: CUSTARDS; PUDDINGS, IN CLASS 30 (U.S. CL. 46).

OWNER OF HONG KONG REG. NO. 300497007, DATED 4-3-2003, EXPIRES 4-3-2013.

OWNER OF U.S. REG. NO. 2,507,378.

THE MARK CONSISTS OF THE STANDARD CHINESE CHARACTERS FOR "MOUNTAIN" AND "WATER".

THE FOREIGN WORDING IN THE MARK TRANSLATES INTO ENGLISH AS MOUNTAIN WATER.

THE NON-LATIN CHARACTER(S) IN THE MARK TRANSLITERATE INTO SAN SUI, AND THIS MEANS MOUNTAIN WATER IN ENGLISH.

SER. NO. 77-050,919, FILED 11-27-2006.

RONALD AIKENS, EXAMINING ATTORNEY

Int. Cl.: 3

Prior U.S. Cls.: 1, 4, 6, 50, 51 and 52

Reg. No. 3,478,695

United States Patent and Trademark Office

Registered Aug. 5, 2008

**TRADEMARK
PRINCIPAL REGISTER**

**COLOR
FEVER
PLUMPER**

LANCOME PARFUMS ET BEAUTE & CIE
(FRANCE SOCIETE EN NOM COLLECTIF)
29, RUE DU FAUBOURG SAINT-HONORE
PARIS, FRANCE 75008

FOR: COSMETICS, NAMELY, CREAMS, GELS, MILKS, POWDERS AND LOTIONS FOR THE FACE, THE BODY AND THE HANDS; MAKEUP PRODUCTS, NAMELY, MASCARA, EYE LINER, EYE SHADOW, EYEBROW PENCILS, LIPSTICKS, NAIL POLISH, BLUSH, FOUNDATION CREAMS AND POWDER, BODY DEODORANTS; SUN CARE PREPARATIONS, NAMELY, TANNING AND AFTER-SUN MILKS, GELS AND OILS; ESSENTIAL OILS FOR COSMETIC USE, IN CLASS 3 (U.S. CLS. 1, 4, 6, 50, 51 AND 52).

THE MARK CONSISTS OF STANDARD CHARACTERS WITHOUT CLAIM TO ANY PARTICULAR FONT, STYLE, SIZE, OR COLOR.

PRIORITY CLAIMED UNDER SEC. 44(D) ON ERPN CMNTY TM OFC APPLICATION NO. 5494695, FILED 11-23-2006, REG. NO. 005494695, DATED 12-20-2007, EXPIRES 11-23-2016.

NO CLAIM IS MADE TO THE EXCLUSIVE RIGHT TO USE "COLOR", APART FROM THE MARK AS SHOWN.

SER. NO. 77-051,070, FILED 11-27-2006.

JAMES GRIFFIN, EXAMINING ATTORNEY

Int. Cl.: 36

Prior U.S. Cls.: 100, 101 and 102

United States Patent and Trademark Office

Reg. No. 3,478,696

Registered Aug. 5, 2008

**SERVICE MARK
PRINCIPAL REGISTER**

SYMBILITY.NET

SYMBILITY SOLUTIONS, INC. (CANADA CORPORATION)

72 VICTORIA STREET SOUTH

SUITE 304

KITCHENER, CANADA N2G4Y9

FOR: INSURANCE CARRIER SERVICE, INSURANCE CLAIMS ADMINISTRATION; CLAIMS ADJUSTMENT IN THE FIELD OF INSURANCE; INSURANCE CLAIMS PROCESSING , IN CLASS 36 (U.S. CLS. 100, 101 AND 102).

FIRST USE 4-1-2005; IN COMMERCE 4-30-2005.

THE MARK CONSISTS OF STANDARD CHARACTERS WITHOUT CLAIM TO ANY PARTICULAR FONT, STYLE, SIZE, OR COLOR.

PRIORITY CLAIMED UNDER SEC. 44(D) ON CANADA APPLICATION NO. 1316060, FILED 9-11-2006, REG. NO. TMA705,291, DATED 1-22-2008, EXPIRES 1-22-2023.

THE WORDING ""SYMBILITY" HAS NO MEANING IN A FOREIGN LANGUAGE.

SER. NO. 77-052,305, FILED 11-28-2006.

DORITT L. CARROLL, EXAMINING ATTORNEY

Int. Cl.: 9

Prior U.S. Cls.: 21, 23, 26, 36 and 38

United States Patent and Trademark Office

Reg. No. 3,478,697

Registered Aug. 5, 2008

TRADEMARK
PRINCIPAL REGISTER



SYMBILITY SOLUTIONS, INC. (CANADA CORPORATION)
SUITE 304
72 VICTORIA STREET SOUTH
KITCHENER, CANADA N2G4Y9

FOR: COMPUTER SOFTWARE FOR INSURANCE CLAIMS ADJUDICATION AND INSURANCE CLAIMS ADJUSTMENT, IN CLASS 9 (U.S. CLS. 21, 23, 26, 36 AND 38).

FIRST USE 4-1-2005; IN COMMERCE 4-30-2005.

PRIORITY CLAIMED UNDER SEC. 44(D) ON CANADA APPLICATION NO. 1316070, FILED 9-11-2006, REG. NO. TMA705289, DATED 1-22-2008, EXPIRES 1-22-2023.

THE COLOR(S) BLUE AND ORANGE IS/ARE CLAIMED AS A FEATURE OF THE MARK.

THE MARK CONSISTS OF THE WORD "SYMBILITY" IN LOWER CASE FONT AT THE BASE OF THE MARK, WITH THREE ROWS OF DOTS, PROGRESSING FROM LIGHT TO DARK BLUE, FROM THE LEFT SIDE OF THE MARK MOVING HORIZONTALLY TOWARD A ROUNDED RECTANGLE SHAPE ON THE RIGHT, WHICH HAS AN INNER ORANGE COLOR; AND A CURVED BLUE LINE BISECTS THE ROUNDED RECTANGLE FROM ABOVE.

THE WORDING "SYMBILITY" HAS NO MEANING IN A FOREIGN LANGUAGE.

SER. NO. 77-052,439, FILED 11-28-2006.

DORITT L. CARROLL, EXAMINING ATTORNEY

Int. Cl.: 33

Prior U.S. Cls.: 47 and 49

United States Patent and Trademark Office

Reg. No. 3,478,698

Registered Aug. 5, 2008

**TRADEMARK
PRINCIPAL REGISTER**

THE FIRST DATE

JC CELLARS (CALIFORNIA CORPORATION)
55 4TH STREET
OAKLAND, CA 94607

THE MARK CONSISTS OF STANDARD CHAR-
ACTERS WITHOUT CLAIM TO ANY PARTICULAR
FONT, STYLE, SIZE, OR COLOR.

FOR: WINE, IN CLASS 33 (U.S. CLS. 47 AND 49).

SER. NO. 77-053,336, FILED 11-29-2006.

FIRST USE 9-25-2005; IN COMMERCE 9-25-2005.

SEAN CROWLEY, EXAMINING ATTORNEY

Int. Cls.: 6, 7, 9 and 37

**Prior U.S. Cls.: 2, 12, 13, 14, 19, 21, 23, 25, 26, 31, 34,
35, 36, 38, 50, 100, 103 and 106**

Reg. No. 3,478,699

United States Patent and Trademark Office

Registered Aug. 5, 2008

**TRADEMARK
SERVICE MARK
PRINCIPAL REGISTER**

seepex.com

SEEPLEX GMBH & CO. KG (FED REP GERMANY
KOMMANDITGESELLSCHAFT (KG))
SCHARNHOLZSTRASSE 344
BOTTROP, FED REP GERMANY 46240

FOR: STEEL PRESSURE TANKS FOR USE WITH
PUMP INSTALLATIONS , IN CLASS 6 (U.S. CLS. 2,
12, 13, 14, 23, 25 AND 50).

FOR: ROTARY POSITIVE DISPLACEMENT
PUMPS AND PARTS THEREFORE; SOLID MATE-
RIAL SHREDDERS; AND SOLID MATERIAL CON-
VEYORS, IN CLASS 7 (U.S. CLS. 13, 19, 21, 23, 31, 34
AND 35).

FOR: MEASURING AND SWITCHING APPARA-
TURE FOR PUMPS AND PUMP INSTALLATIONS,
NAMELY, PRESSURE METERS AND FLOW ME-
TERS, IN CLASS 9 (U.S. CLS. 21, 23, 26, 36 AND 38).

FOR: INSTALLATION, MAINTENANCE AND
REPAIR OF ROTARY POSITIVE DISPLACEMENT
PUMPS, SOLID MATERIAL SHREDDERS, MEA-
SURING AND SWITCHING APPARATUS FOR
PUMPS AND PUMP INSTALLATIONS, IN CLASS
37 (U.S. CLS. 100, 103 AND 106).

PRIORITY CLAIMED UNDER SEC. 44(D) ON
ERPNTY TM OFC APPLICATION NO.
005511928, FILED 11-21-2006, REG. NO. 005511928,
DATED 12-20-2007, EXPIRES 11-21-2016.

OWNER OF U.S. REG. NOS. 1,745,517 AND
1,785,215.

SER. NO. 77-054,797, FILED 12-1-2006.

PATRICIA EVANKO, EXAMINING ATTORNEY

Int. Cls.: 35 and 44

Prior U.S. Cls.: 100, 101 and 102

United States Patent and Trademark Office

Reg. No. 3,478,700

Registered Aug. 5, 2008

**SERVICE MARK
PRINCIPAL REGISTER**



SIGMA ASSESSMENT SYSTEMS, INC. (DELAWARE CORPORATION)

511 FORT STREET SUITE 435

PORT HURON, MI 480610984

FOR: PSYCHOLOGICAL TESTING FOR THE SELECTION OF PERSONNEL, IN CLASS 35 (U.S. CLS. 100, 101 AND 102).

FIRST USE 1-1-1968; IN COMMERCE 1-1-1968.

FOR: PSYCHOLOGICAL TESTING; PSYCHOLOGICAL TESTING SERVICES; PSYCHOLOGICAL TESTS, IN CLASS 44 (U.S. CLS. 100 AND 101).

FIRST USE 1-1-1968; IN COMMERCE 1-1-1968.

NO CLAIM IS MADE TO THE EXCLUSIVE RIGHT TO USE "ASSESSMENT SYSTEMS INC.", APART FROM THE MARK AS SHOWN.

THE MARK CONSISTS OF THE GREEK LETTER "SIGMA" BIASECTED BY AN INCOMPLETE OVAL SLIGHTLY ANGLED APPROXIMATELY 5 DEGREES CLOCKWISE AND INTERTWINED WITH THE LETTER "S" IN THE WORD "SIGMA" AND TO THE RIGHT OF THE DESIGN IS THE WORD "SIGMA" IN STYLIZED CAPITAL LETTERS AND BELOW THE WORD "SIGMA" ARE THE WORDS "ASSESSMENT SYSTEMS INC." IS SMALLER STYLIZED CAPITAL LETTERS.

SER. NO. 77-054,987, FILED 12-1-2006.

ANDREA BUTLER, EXAMINING ATTORNEY

Int. Cl.: 32

Prior U.S. Cls.: 45, 46 and 48

United States Patent and Trademark Office

Reg. No. 3,478,701

Registered Aug. 5, 2008

**TRADEMARK
PRINCIPAL REGISTER**

**AMERICA'S ORIGINAL
HEFEWEIZEN**

WIDMER BROTHERS BREWING COMPANY
(OREGON CORPORATION)
929 NORTH RUSSELL STREET
PORTLAND, OR 97227

FOR: BEER, IN CLASS 32 (U.S. CLS. 45, 46 AND 48).

FIRST USE 6-1-1995; IN COMMERCE 6-1-1995.

THE MARK CONSISTS OF STANDARD CHAR-
ACTERS WITHOUT CLAIM TO ANY PARTICULAR
FONT, STYLE, SIZE, OR COLOR.

OWNER OF U.S. REG. NO. 1,990,522.

NO CLAIM IS MADE TO THE EXCLUSIVE
RIGHT TO USE "HEFEWEIZEN", APART FROM
THE MARK AS SHOWN.

SEC. 2(F).

SER. NO. 77-056,785, FILED 12-4-2006.

SCOTT BIBB, EXAMINING ATTORNEY

Int. Cls.: 37 and 38

Prior U.S. Cls.: 100, 101, 103, 104 and 106

United States Patent and Trademark Office

Reg. No. 3,478,702

Registered Aug. 5, 2008

**SERVICE MARK
PRINCIPAL REGISTER**

**AT&T ALL DISTANCE ONLINE
SELECT**

AT&T INTELLECTUAL PROPERTY II, L.P. (NE-
VADA LIMITED PARTNERSHIP)
645 EAST PLUMB LANE
RENO, NV 89502

FOR: REPAIR SERVICES FOR TELECOMMUNI-
CATIONS WIRING AND JACKS, IN CLASS 37 (U.S.
CLS. 100, 103 AND 106).

FIRST USE 11-28-2006; IN COMMERCE 11-28-2006.

FOR: TELECOMMUNICATIONS SERVICES,
NAMELY, PROVIDING TELEPHONE COMMUNI-
CATION SERVICES, PROVIDING LOCAL AND
LONG DISTANCE TELEPHONE SERVICES, PRO-
VIDING A GROUP OF SPECIALIZED TELEPHONE
SERVICES WITH CUSTOM CALLING FEATURES
AND TELEPHONE CALLING PLANS, IN CLASS 38
(U.S. CLS. 100, 101 AND 104).

FIRST USE 11-28-2006; IN COMMERCE 11-28-2006.

THE MARK CONSISTS OF STANDARD CHAR-
ACTERS WITHOUT CLAIM TO ANY PARTICULAR
FONT, STYLE, SIZE, OR COLOR.

OWNER OF U.S. REG. NOS. 1,296,936, 3,132,122
AND OTHERS.

NO CLAIM IS MADE TO THE EXCLUSIVE
RIGHT TO USE "ONLINE SELECT", APART FROM
THE MARK AS SHOWN.

SER. NO. 77-058,277, FILED 12-6-2006.

JULIE WATSON, EXAMINING ATTORNEY

Int. Cl.: 28

Prior U.S. Cls.: 22, 23, 38 and 50

United States Patent and Trademark Office

Reg. No. 3,478,703

Registered Aug. 5, 2008

**TRADEMARK
PRINCIPAL REGISTER**

TEN PIN POKER

COSMODOG, LTD. (ILLINOIS CORPORATION)
2603 W. BARRY AVENUE
CHICAGO, IL 60618

FOR: NON-WAGERING ARCADE-TYPE ELECTRONIC VIDEO GAMES, IN CLASS 28 (U.S. CLS. 22, 23, 38 AND 50).

FIRST USE 1-31-2006; IN COMMERCE 1-31-2006.

THE MARK CONSISTS OF STANDARD CHARACTERS WITHOUT CLAIM TO ANY PARTICULAR FONT, STYLE, SIZE, OR COLOR.

NO CLAIM IS MADE TO THE EXCLUSIVE RIGHT TO USE "POKER", APART FROM THE MARK AS SHOWN.

SER. NO. 77-060,264, FILED 12-8-2006.

HEATHER THOMPSON, EXAMINING ATTORNEY

Int. Cl.: 33

Prior U.S. Cls.: 47 and 49

United States Patent and Trademark Office

Reg. No. 3,478,704

Registered Aug. 5, 2008

TRADEMARK
PRINCIPAL REGISTER



PIPER-HEIDSIECK, ANCIENNE MAISON HEIDSIECK FONDEE EN 1785, COMPAGNIE CHAMPENOISE (FRANCE CORPORATION)
51 BOULEVARD HENRY-VASNIER
REIMS, FRANCE 51100

FOR: FRENCH WINES, NAMELY, CHAMPAGNE,
IN CLASS 33 (U.S. CLS. 47 AND 49).

FIRST USE 9-30-1997; IN COMMERCE 9-30-1997.

OWNER OF FRANCE REG. NO. 96646287, DATED
10-16-1996, EXPIRES 6-23-2016.

OWNER OF U.S. REG. NOS. 575,785, 3,063,807 AND
OTHERS.

NO CLAIM IS MADE TO THE EXCLUSIVE
RIGHT TO USE "MAISON FONDEE EN 1785",
"CHAMPAGNE BRUT" AND "REIMS FRANCE",
APART FROM THE MARK AS SHOWN.

THE COLOR(S) RED, GOLD, BLACK, AND
WHITE IS/ARE CLAIMED AS A FEATURE OF
THE MARK.

THE MARK CONSISTS OF A RED RECTANGLE
OUTLINED IN GOLD WITH THE WORDS "MAISON
FONDEE EN 1785" APPEARING AT THE TOP POR-
TION OVER A GOLD CROWN, THE WORDS "PI-
PER-HEIDSIECK" IN BLACK LETTERS WITHIN A
GOLD RECTANGLE OUTLINED IN BLACK UN-
DERNEATH THE CROWN, THE WORD CHAM-
PAGNE IN GOLD LETTERS UNDER THE GOLD/
BLACK RECTANGLE AND THE TERM BRUT IN
WHITE LETTERS OVER THE TERM "A REIMS-
FRANCE" IN GOLD LETTERING.

THE ENGLISH TRANSLATION OF THE WORD-
ING "MAISON FONDEE EN 1785" IN THE MARK IS
"HOUSE ESTABLISHED IN 1785".

SER. NO. 77-061,316, FILED 12-11-2006.

LINDA M. KING, EXAMINING ATTORNEY

Int. Cl.: 30

Prior U.S. Cl.: 46

United States Patent and Trademark Office

Reg. No. 3,478,705

Registered Aug. 5, 2008

TRADEMARK
PRINCIPAL REGISTER

NACHO

AUGUST KIRCHNER (FED REP GERMANY IN-
DIVIDUAL)

KLUSER WEG 6

WALDFEUCHT-HAAREN, FED REP GERMANY D-
52525 AND

GOTTHARD KIRCHNER (FED REP GERMANY
INDIVIDUAL)

KLUSER WEG 21

WALDFEUCHT-HAAREN, FED REP GERMANY D-
52525

THE MARK CONSISTS OF STANDARD CHAR-
ACTERS WITHOUT CLAIM TO ANY PARTICULAR
FONT, STYLE, SIZE, OR COLOR.

OWNER OF ERPN CMNTY TM OFC REG. NO.
1611870, DATED 7-5-2001, EXPIRES 7-5-2011.

SER. NO. 77-061,366, FILED 12-11-2006.

FOR: ICE CREAM, IN CLASS 30 (U.S. CL. 46).

VERNA BETH RIRIE, EXAMINING ATTORNEY

Int. Cl.: 36

Prior U.S. Cls.: 100, 101 and 102

United States Patent and Trademark Office

Reg. No. 3,478,706

Registered Aug. 5, 2008

**SERVICE MARK
PRINCIPAL REGISTER**

EOS TWENTY-ONE

ALEXANDRIA CONDOMINIUMS, L.L.C. (DELA-
WARE LTD LIAB CO)
770 LAKE COOK ROAD, SUITE 350
DEERFIELD, IL 60015

FOR: REAL ESTATE SERVICES, NAMELY, LEAS-
ING, RENTAL AND MANAGEMENT OF APART-
MENTS AND CONDOMINIUMS; REAL ESTATE
MANAGEMENT, NAMELY, MANAGEMENT OF
CONDOMINIUMS , IN CLASS 36 (U.S. CLS. 100, 101
AND 102).

FIRST USE 1-20-2005; IN COMMERCE 1-20-2005.

THE MARK CONSISTS OF STANDARD CHAR-
ACTERS WITHOUT CLAIM TO ANY PARTICULAR
FONT, STYLE, SIZE, OR COLOR.

SER. NO. 77-061,711, FILED 12-11-2006.

REBECCA SMITH, EXAMINING ATTORNEY

Int. Cl.: 36

Prior U.S. Cls.: 100, 101 and 102

United States Patent and Trademark Office

Reg. No. 3,478,707

Registered Aug. 5, 2008

**SERVICE MARK
PRINCIPAL REGISTER**



ALEXANDRIA CONDOMINIUMS, L.L.C. (DELA-
WARE LTD LIAB CO)
770 LAKE COOK ROAD, SUITE 350
DEERFIELD, IL 60015

FOR: REAL ESTATE SERVICES, NAMELY, LEAS-
ING, RENTAL AND MANAGEMENT OF APART-
MENTS AND CONDOMINIUMS; REAL ESTATE
MANAGEMENT, NAMELY, MANAGEMENT OF

CONDOMINIUMS , IN CLASS 36 (U.S. CLS. 100, 101
AND 102).

FIRST USE 1-20-2005; IN COMMERCE 1-20-2005.

SER. NO. 77-061,721, FILED 12-11-2006.

REBECCA SMITH, EXAMINING ATTORNEY

Int. Cl.: 25

Prior U.S. Cls.: 22 and 39

United States Patent and Trademark Office

Reg. No. 3,478,708

Registered Aug. 5, 2008

**TRADEMARK
PRINCIPAL REGISTER**

TRIXXI

TRIXXI CLOTHING COMPANY, INC. (CALIFORNIA CORPORATION)
3864 SOUTH SANTA FE
VERNON, CA 90058

THE MARK CONSISTS OF STANDARD CHARACTERS WITHOUT CLAIM TO ANY PARTICULAR FONT, STYLE, SIZE, OR COLOR.

FOR: CLOTHING, NAMELY, SKIRTS, SHIRTS, T-SHIRTS, SWEATERS, PANTS, SHORTS, TOPS, BLOUSES, JACKETS, DRESSES, GOWNS AND FOOTWEAR, IN CLASS 25 (U.S. CLS. 22 AND 39).

SER. NO. 77-062,562, FILED 12-12-2006.

FIRST USE 9-30-1999; IN COMMERCE 9-30-1999.

DAVID YONTEF, EXAMINING ATTORNEY

Int. Cls.: 35 and 41

Prior U.S. Cls.: 100, 101, 102 and 107

United States Patent and Trademark Office

Reg. No. 3,478,709

Registered Aug. 5, 2008

**SERVICE MARK
PRINCIPAL REGISTER**

NEDERLANDER

NEDERLANDER ORGANIZATION, INC. (NEW
JERSEY CORPORATION)
1450 BROADWAY
NEW YORK, NY 10018

FOR: BUSINESS SERVICES IN THE MANAGE-
MENT OF THEATERS, AUDITORIUMS, HALLS
AND ARENAS FOR PRESENTATION OF ENTER-
TAINMENT, IN CLASS 35 (U.S. CLS. 100, 101 AND
102).

FIRST USE 0-0-1904; IN COMMERCE 0-0-1904.

FOR: ENTERTAINMENT SERVICES, IN THE
NATURE OF THE PRESENTATION OF THEATRICAL,
MUSICAL AND PERFORMING ARTS PRO-
DUCTIONS; BOOKING OF SEATS FOR SHOWS

AND BOOKING OF THEATER TICKETS; PROVID-
ING THEATER LISTINGS, IN CLASS 41 (U.S. CLS.
100, 101 AND 107).

FIRST USE 0-0-1904; IN COMMERCE 0-0-1904.

THE MARK CONSISTS OF STANDARD CHAR-
ACTERS WITHOUT CLAIM TO ANY PARTICULAR
FONT, STYLE, SIZE, OR COLOR.

THE ENGLISH TRANSLATION OF "NEDERLAN-
DER" IS THE DUTCHMAN.

SER. NO. 77-062,702, FILED 12-12-2006.

MICHAEL WEBSTER, EXAMINING ATTORNEY

Int. Cl.: 35

Prior U.S. Cls.: 100, 101 and 102

United States Patent and Trademark Office

Reg. No. 3,478,710

Registered Aug. 5, 2008

**SERVICE MARK
PRINCIPAL REGISTER**

endless

AMAZON TECHNOLOGIES, INC. (NEVADA
CORPORATION)
PO BOX 8102
ATTN: TRADEMARKS
RENO, NV 89507

FOR: ONLINE RETAIL STORE SERVICES FEATURING APPAREL AND ACCESSORIES, IN CLASS 35 (U.S. CLS. 100, 101 AND 102).

FIRST USE 12-11-2006; IN COMMERCE 12-11-2006.

THE MARK CONSISTS OF THE WORD "ENDLESS" IN STYLIZED LETTERS.

SER. NO. 77-063,205, FILED 12-13-2006.

CHRIS WELLS, EXAMINING ATTORNEY

Int. Cl.: 28

Prior U.S. Cls.: 22, 23, 38 and 50

Reg. No. 3,478,711

United States Patent and Trademark Office

Registered Aug. 5, 2008

**TRADEMARK
PRINCIPAL REGISTER**

OUTLAW

CUESTIX, INC., DBA CUESTIX, INTERNATIONAL (COLORADO CORPORATION)

#104

1380 OVERLOOK DRIVE
LAFAYETTE, CO 800269551

THE MARK CONSISTS OF STANDARD CHARACTERS WITHOUT CLAIM TO ANY PARTICULAR FONT, STYLE, SIZE, OR COLOR.

FOR: BILLIARD CUES; BILLIARD GAME PLAYING EQUIPMENT; POOL CUE CASES; POOL CUES, IN CLASS 28 (U.S. CLS. 22, 23, 38 AND 50).

SER. NO. 77-064,216, FILED 12-14-2006.

FIRST USE 8-15-2006; IN COMMERCE 8-15-2006.

JOHN DALIER, EXAMINING ATTORNEY

Int. Cl.: 28

Prior U.S. Cls.: 22, 23, 38 and 50

Reg. No. 3,478,712

United States Patent and Trademark Office

Registered Aug. 5, 2008

**TRADEMARK
PRINCIPAL REGISTER**

BLACK PLAGUE

DICKSON, JASON (UNITED STATES INDIVIDUAL)
85 MAHOGANY LANE
SIMI VALLEY, CA 93065

THE MARK CONSISTS OF STANDARD CHARACTERS WITHOUT CLAIM TO ANY PARTICULAR FONT, STYLE, SIZE, OR COLOR.

FOR: SKATEBOARD WHEELS, IN CLASS 28 (U.S. CLS. 22, 23, 38 AND 50).

SER. NO. 77-064,473, FILED 12-14-2006.

FIRST USE 5-27-2004; IN COMMERCE 5-27-2004.

BRENDAN MCCAULEY, EXAMINING ATTORNEY

Int. Cl.: 5

Prior U.S. Cls.: 6, 18, 44, 46, 51 and 52

United States Patent and Trademark Office

Reg. No. 3,478,713

Registered Aug. 5, 2008

**TRADEMARK
PRINCIPAL REGISTER**

FIBER35DIET

RENEW LIFE FORMULAS, INC. (FLORIDA
CORPORATION)
2076 SUNNYDALE BLVD.
CLEARWATER, FL 33765

THE MARK CONSISTS OF STANDARD CHAR-
ACTERS WITHOUT CLAIM TO ANY PARTICULAR
FONT, STYLE, SIZE, OR COLOR.

FOR: DIETARY SUPPLEMENTS; MEAL REPLA-
CEMENT AND DIETARY SUPPLEMENT DRINK
MIXES, IN CLASS 5 (U.S. CLS. 6, 18, 44, 46, 51 AND
52).

SER. NO. 77-064,988, FILED 12-15-2006.

FIRST USE 2-2-2007; IN COMMERCE 2-2-2007.

ROBIN MITTLER, EXAMINING ATTORNEY

Int. Cl.: 16

Prior U.S. Cls.: 2, 5, 22, 23, 29, 37, 38 and 50

United States Patent and Trademark Office

Reg. No. 3,478,714

Registered Aug. 5, 2008

**TRADEMARK
PRINCIPAL REGISTER**

FIBER35DIET

RENEW LIFE FORMULAS, INC. (FLORIDA
CORPORATION)
2076 SUNNYDALE BLVD.
CLEARWATER, FL 33765

THE MARK CONSISTS OF STANDARD CHAR-
ACTERS WITHOUT CLAIM TO ANY PARTICULAR
FONT, STYLE, SIZE, OR COLOR.

FOR: PAMPHLETS AND BROCHURES IN THE
FIELDS OF DIETARY SUPPLEMENTS AND NU-
TRITION, IN CLASS 16 (U.S. CLS. 2, 5, 22, 23, 29, 37, 38
AND 50).

SER. NO. 77-065,001, FILED 12-15-2006.

FIRST USE 2-2-2007; IN COMMERCE 2-2-2007.

ROBIN MITTLER, EXAMINING ATTORNEY

Int. Cl.: 29

Prior U.S. Cl.: 46

United States Patent and Trademark Office

Reg. No. 3,478,715

Registered Aug. 5, 2008

**TRADEMARK
PRINCIPAL REGISTER**

FIBER35DIET

RENEW LIFE FORMULAS, INC. (FLORIDA
CORPORATION)
2076 SUNNYDALE BLVD.
CLEARWATER, FL 33765

THE MARK CONSISTS OF STANDARD CHAR-
ACTERS WITHOUT CLAIM TO ANY PARTICULAR
FONT, STYLE, SIZE, OR COLOR.

FOR: FRUIT-BASED NUTRITIONAL FOOD BARS
THAT ALSO INCLUDE GRAIN-BASED FIBERS
AND SEEDS, IN CLASS 29 (U.S. CL. 46).

SER. NO. 77-065,020, FILED 12-15-2006.

FIRST USE 2-2-2007; IN COMMERCE 2-2-2007.

ROBIN MITTLER, EXAMINING ATTORNEY

Int. Cl.: 44

Prior U.S. Cls.: 100 and 101

United States Patent and Trademark Office

Reg. No. 3,478,716

Registered Aug. 5, 2008

**SERVICE MARK
PRINCIPAL REGISTER**

FIBER35DIET

RENEW LIFE FORMULAS, INC. (FLORIDA
CORPORATION)
2076 SUNNYDALE BLVD.
CLEARWATER, FL 33765

FOR: PROVIDING INFORMATION IN THE
FIELDS OF DIETARY SUPPLEMENTS AND NU-
TRITION VIA THE INTERNET, IN CLASS 44 (U.S.
CLS. 100 AND 101).

FIRST USE 3-1-2007; IN COMMERCE 3-1-2007.

THE MARK CONSISTS OF STANDARD CHAR-
ACTERS WITHOUT CLAIM TO ANY PARTICULAR
FONT, STYLE, SIZE, OR COLOR.

SER. NO. 77-065,034, FILED 12-15-2006.

ROBIN MITTLER, EXAMINING ATTORNEY

Int. Cl.: 41

Prior U.S. Cls.: 100, 101 and 107

United States Patent and Trademark Office

Reg. No. 3,478,717

Registered Aug. 5, 2008

**SERVICE MARK
PRINCIPAL REGISTER**

LA PICOSA

BROADCAST ONE, INC. (ILLINOIS CORPORATION)
1107 HAZILTINE BOULEVARD
CHASKA, MN 55318

FOR: PRODUCTION AND DISTRIBUTION OF RADIO PROGRAMS; ENTERTAINMENT SERVICES, NAMELY, PROVIDING ONGOING RADIO PROGRAMS FEATURING MUSIC, NEWS, INTERVIEWS, INFORMATION, COMMUNITY NEWS, COMMUNITY INFORMATION, UPDATES AND INFORMATION, UPDATES AND INFORMATION ABOUT COMMUNITY EVENTS; PROVIDING INFORMATION IN THE FIELDS OF MUSIC, ENTERTAINMENT, ENTERTAINMENT NEWS, COMMUNITY ENTERTAINMENT AND SPECIAL EVENTS, AND INFORMATION ABOUT ONGOING

RADIO PROGRAMS AND RADIO PERSONALITIES VIA A WEB SITE, IN CLASS 41 (U.S. CLS. 100, 101 AND 107).

FIRST USE 9-10-2006; IN COMMERCE 9-10-2006.

THE MARK CONSISTS OF STANDARD CHARACTERS WITHOUT CLAIM TO ANY PARTICULAR FONT, STYLE, SIZE, OR COLOR.

THE FOREIGN WORDING IN THE MARK TRANSLATES INTO ENGLISH AS "HOT OR SPICY".

SER. NO. 77-065,203, FILED 12-15-2006.

BARBARA BROWN, EXAMINING ATTORNEY

Int. Cl.: 19

Prior U.S. Cls.: 1, 12, 33 and 50

United States Patent and Trademark Office

Reg. No. 3,478,718

Registered Aug. 5, 2008

**TRADEMARK
PRINCIPAL REGISTER**

DECKWAVE

DOIG, DANIEL (CANADA INDIVIDUAL)
UNIT #7
92 COMMERCE PARK DR.
BARRIE, CANADA L4N8W8

PRIORITY CLAIMED UNDER SEC. 44(D) ON
CANADA APPLICATION NO. 1327227, FILED 12-7-
2006, REG. NO. TMA710742, DATED 4-2-2008, EX-
PIRES 4-2-2023.

FOR: BUILDING MATERIALS, NAMELY, DECK-
ING BOARDS, IN CLASS 19 (U.S. CLS. 1, 12, 33 AND
50).

SER. NO. 77-065,373, FILED 12-15-2006.

THE MARK CONSISTS OF STANDARD CHAR-
ACTERS WITHOUT CLAIM TO ANY PARTICULAR
FONT, STYLE, SIZE, OR COLOR.

CAROLYN CATALDO, EXAMINING ATTORNEY

Int. Cl.: 42

Prior U.S. Cls.: 100 and 101

United States Patent and Trademark Office

Reg. No. 3,478,719

Registered Aug. 5, 2008

**SERVICE MARK
PRINCIPAL REGISTER**

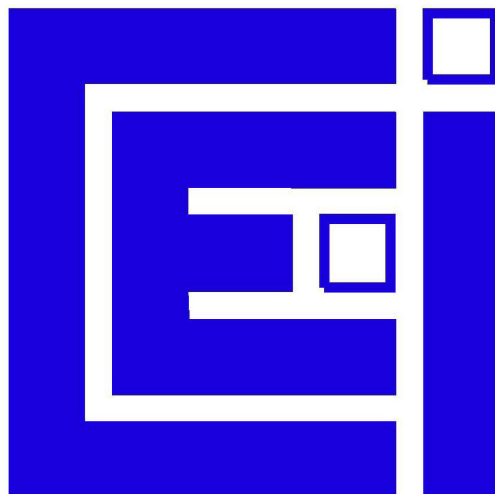

COASTAL ENVIRONMENTS, INCORPORATED
(LOUISIANA CORPORATION)
1260 MAIN STREET
BATON ROUGE, LA 70802

FOR: ENVIRONMENTAL CONSULTING SERVICES; CONSULTING SERVICES IN THE FIELD OF ENVIRONMENTAL PLANNING AND REGULATORY COMPLIANCE; SCIENTIFIC INVESTIGATIONS, NAMELY, ECOLOGICAL, BIOLOGICAL, GEOLOGICAL, HYDROLOGICAL, ARCHAEOLOGICAL AND CULTURAL RESOURCES INVESTIGATIONS; GEOFORENSIC INVESTIGATIONS, IN CLASS 42 (U.S. CLS. 100 AND 101).

FIRST USE 12-1-1967; IN COMMERCE 12-1-1967.

THE COLOR(S) ROYAL BLUE AND WHITE IS/ARE CLAIMED AS A FEATURE OF THE MARK.

THE MARK CONSISTS OF THE COLOR, ROYAL BLUE APPEARING AS A SOLID COLOR IN THE UPPER-CASE "C", THE UPPER-CASE "E" AND THE STROKE PART OF THE LOWER-CASE "I". THE SQUARE BETWEEN THE "E" AND THE "I" AND THE SQUARE THAT SERVES AS THE DOT OVER THE "I" ARE OUTLINED IN ROYAL BLUE AND THE COLOR WHITE IS INSIDE EACH SQUARE.

SER. NO. 77-066,609, FILED 12-18-2006.

PRISCILLA MILTON, EXAMINING ATTORNEY

Int. Cls.: 1, 5 and 44

**Prior U.S. Cls.: 1, 5, 6, 10, 18, 26, 44, 46, 51, 52, 100
and 101**

Reg. No. 3,478,720

United States Patent and Trademark Office

Registered Aug. 5, 2008

**TRADEMARK
SERVICE MARK
PRINCIPAL REGISTER**

RNANTIGEN

CUREVAC GMBH (FED REP GERMANY CORPORATION)
PAUL-EHRLICH-STR. 15
TUBINGEN, FED REP GERMANY 72076

FOR: CHEMICALS USED IN INDUSTRY AND SCIENCE; REAGENTS FOR RESEARCH USE, IN CLASS 1 (U.S. CLS. 1, 5, 6, 10, 26 AND 46).

FOR: CHEMICAL PREPARATIONS FOR MEDICAL PURPOSES; PHARMACEUTICAL AND VETERINARY PREPARATIONS, IN PARTICULAR CHEMOTHERAPEUTICS FOR THE TREATMENT OF TUMORS, CARDIAC DRUGS AND PREPARATIONS FOR THE TREATMENT OF ASTHMA, RECEPTOR AGONISTS AND RECEPTOR ANTAGONISTS FOR MODULATING RECEPTOR-MEDIATED DISORDERS, PHARMACEUTICS FOR THE TREATMENT OF NEUROLOGICAL DISORDERS, FOR THE TREATMENT OF INFECTIOUS DISEASES; SANITARY PREPARATIONS FOR MED-

ICAL PURPOSES; DIETETIC SUBSTANCES ADAPTED FOR MEDICAL USE, IN PARTICULAR SUBSTANCES FOR FOOD SUPPLEMENTS; DISINFECTANTS FOR SANITARY PURPOSES; FUNGICIDES; HERBICIDES FOR MEDICAL PURPOSES, IN CLASS 5 (U.S. CLS. 6, 18, 44, 46, 51 AND 52).

FOR: MEDICAL SERVICES, IN CLASS 44 (U.S. CLS. 100 AND 101).

THE MARK CONSISTS OF STANDARD CHARACTERS WITHOUT CLAIM TO ANY PARTICULAR FONT, STYLE, SIZE, OR COLOR.

OWNER OF ERPN CMNTY TM OFC REG. NO. 005545736, DATED 12-13-2007, EXPIRES 12-4-2016.

SER. NO. 77-067,574, FILED 12-19-2006.

ROBIN CHOSID, EXAMINING ATTORNEY

Int. Cl.: 36

Prior U.S. Cls.: 100, 101 and 102

United States Patent and Trademark Office

Reg. No. 3,478,721

Registered Aug. 5, 2008

**SERVICE MARK
PRINCIPAL REGISTER**

REVOLUTIONIZING CASH
ACCESS TECHNOLOGY FOR THE
GAMING INDUSTRY

CASH SYSTEMS, INC. (DELAWARE CORPORATION)
7350 DEAN MARTIN DRIVE, STE. 309
LAS VEGAS, NV 89139

FOR: FINANCIAL SERVICES, NAMELY, PROVIDING ELECTRONIC CASH TRANSACTIONS, CURRENCY EXCHANGE, CHECK CASHING, ELECTRONIC TRANSFERS OF MONEY, CASH ADVANCES, ELECTRONIC DEBIT AND DEPOSIT TRANSACTIONS, AND AUTOMATED TELLER MACHINE SERVICES, IN CLASS 36 (U.S. CLS. 100, 101 AND 102).

FIRST USE 12-31-2005; IN COMMERCE 12-31-2005.

THE MARK CONSISTS OF STANDARD CHARACTERS WITHOUT CLAIM TO ANY PARTICULAR FONT, STYLE, SIZE, OR COLOR.

SER. NO. 77-068,812, FILED 12-20-2006.

DAVID C. REIHNER, EXAMINING ATTORNEY

Int. Cl.: 31

Prior U.S. Cls.: 1 and 46

United States Patent and Trademark Office

Reg. No. 3,478,722

Registered Aug. 5, 2008

TRADEMARK
PRINCIPAL REGISTER



SAVEN CORPORATION (MICHIGAN CORPORATION)
1410 LEWIS STREET
CHARLESTON, WV 25301

FOR: FRESH ONIONS, IN CLASS 31 (U.S. CLS. 1 AND 46).

FIRST USE 1-10-2007; IN COMMERCE 1-10-2007.

OWNER OF U.S. REG. NOS. 1,636,261, 2,186,268 AND OTHERS.

NO CLAIM IS MADE TO THE EXCLUSIVE RIGHT TO USE "4166" AND "PRODUCE OF CHILE", APART FROM THE MARK AS SHOWN.

THE COLOR(S) YELLOW, BLUE AND RED IS/ARE CLAIMED AS A FEATURE OF THE MARK.

THE MARK CONSISTS OF AN OVAL CONTAINING A BLUE OUTER BORDER OR BAND WITH YELLOW ACCENT LINES WITHIN WHICH IS WRITTEN "PRODUCE OF CHILE" (IN YELLOW AT THE TOP RIGHT) AND "OSOSWEETONIONS.COM" (IN YELLOW AT THE BOTTOM), WITH A YELLOW CENTER FIELD WITHIN WHICH IS WRITTEN "OSO SWEET" (IN RED) AND "4166" (IN BLUE), AND ALSO WITH A PICTURE OF A LLAMA (IN RED AND YELLOW) WITH A RED SADDLE BAG CONTAINING ROUND OBJECTS SHAPED LIKE ONIONS (IN YELLOW AND OUTLINED IN RED).

SEC. 2(F) AS TO "OSO SWEET".

SER. NO. 77-070,405, FILED 12-22-2006.

STEVEN R. FINE, EXAMINING ATTORNEY

Int. Cls.: 9 and 41

Prior U.S. Cls.: 21, 23, 26, 36, 38, 100, 101 and 107

United States Patent and Trademark Office

Reg. No. 3,478,723

Registered Aug. 5, 2008

**TRADEMARK
SERVICE MARK
PRINCIPAL REGISTER**

Chinese Gold

ATRONIC INTERNATIONAL GMBH (FED REP
GERMANY GMBH)
BORSIGSTR. 26
LÜBBECKE, FED REP GERMANY 32312

FOR: ELECTRIC AND ELECTRONIC, COIN AND
TOKEN-OPERATED GAMING MACHINES, NAME-
LY, SLOT MACHINES WITH OR WITHOUT VIDEO
OUTPUT AND VIDEO LOTTERY TERMINALS;
MULTI-USER AND NETWORKED GAMING MA-
CHINES WITH OR WITHOUT VIDEO OUTPUT OR
VIDEO LOTTERY TERMINALS; ACCOUNTING AP-
PARATUS FOR COIN AND TOKEN OPERATED
MACHINES FOR GAMING AND AMUSEMENT
PURPOSES, AND PARTS FOR THE AFORESAID
GOODS; COMPUTER PROGRAMS FOR OPERAT-
ING ELECTRIC AND ELECTRONIC MACHINES
FOR GAMING OR AMUSEMENT PURPOSES, OR
COMBINATION THEREOF; COMPUTER PRO-
GRAMS FOR CASINO APPLICATIONS, NAMELY,
FOR CONTROLLING GAMING MACHINES FOR
WINNING CASINO JACKPOT GAMES , IN CLASS 9
(U.S. CLS. 21, 23, 26, 36 AND 38).

FOR: ENTERTAINMENT IN THE NATURE OF
CASINO SERVICES FEATURING A PROGRESSIVE
GAMING MACHINE JACKPOT INVOLVING ONE
OR MORE GAMING MACHINES, NAMELY, A
JACKPOT OR PRIZE WITH A FIXED MINIMUM
VALUE WHICH INCREASES UNTIL THE JACKPOT
IS WON, IN CLASS 41 (U.S. CLS. 100, 101 AND 107).

THE MARK CONSISTS OF STANDARD CHAR-
ACTERS WITHOUT CLAIM TO ANY PARTICULAR
FONT, STYLE, SIZE, OR COLOR.

PRIORITY CLAIMED UNDER SEC. 44(D) ON
ERPNTY TM OFC APPLICATION NO.
005545983, FILED 12-12-2006, REG. NO. 005545983,
DATED 11-22-2007, EXPIRES 12-12-2016.

SER. NO. 77-070,421, FILED 12-22-2006.

DOMINIC FATHY, EXAMINING ATTORNEY

Int. Cl.: 7

Prior U.S. Cls.: 13, 19, 21, 23, 31, 34 and 35

United States Patent and Trademark Office

Reg. No. 3,478,724

Registered Aug. 5, 2008

**TRADEMARK
PRINCIPAL REGISTER**

TITAN CL LUBER

A.T.S. ELECTRO-LUBE HOLDINGS LTD. (CANADA CORPORATION)
7388 WILSON AVENUE
DELTA, CANADA V4G 1H3

FOR: POWER-OPERATED LUBRICANT DISPENSER FOR MACHINERY, IN CLASS 7 (U.S. CLS. 13, 19, 21, 23, 31, 34 AND 35).

FIRST USE 8-31-2007; IN COMMERCE 8-31-2007.

THE MARK CONSISTS OF STANDARD CHARACTERS WITHOUT CLAIM TO ANY PARTICULAR FONT, STYLE, SIZE, OR COLOR.

PRIORITY CLAIMED UNDER SEC. 44(D) ON CANADA APPLICATION NO. 1308127, FILED 7-6-2006.

SER. NO. 77-073,638, FILED 12-29-2006.

STEVEN JACKSON, EXAMINING ATTORNEY

Int. Cls.: 14, 20 and 35

**Prior U.S. Cls.: 2, 13, 22, 25, 27, 28, 32, 50, 100, 101
and 102**

Reg. No. 3,478,725

United States Patent and Trademark Office

Registered Aug. 5, 2008

**TRADEMARK
SERVICE MARK
PRINCIPAL REGISTER**

Sticki Rice

STICKI RICE, LLC (NORTH CAROLINA LTD
LIAB CO)
2125 SOUTHEND DRIVE #340
CHARLOTTE, NC 28203 AND
JENKINS, AMY (UNITED STATES INDIVIDUAL)
2125 SOUTHEND DRIVE #340
CHARLOTTE, NC 28203

FOR: BRACELETS; CHARMS; COSTUME JEWELRY;
JEWELRY; JEWELRY, NAMELY, AMULETS, IN
CLASS 14 (U.S. CLS. 2, 27, 28 AND 50).

FIRST USE 4-14-2006; IN COMMERCE 6-26-2006.

FOR: BEDROOM FURNITURE; CABINETS;
CUSHIONS; DOORS FOR FURNITURE; ENTERTAINMENT
CENTERS; FURNITURE; FURNITURE CHESTS;
FURNITURE FOR DISPLAYING GOODS;
FURNITURE FOR HOUSE, OFFICE AND GARDEN;
FURNITURE FRAMES; FURNITURE, NAMELY,
DRESSERS; FURNITURE, NAMELY, WALL UNITS;
FURNITURE, NAMELY, WARDROBES; JEWELRY
BOXES NOT OF METAL; LAWN FURNITURE;

LEATHER JEWELRY AND ACCESSORY BOXES;
LIVING ROOM FURNITURE; MIRRORS; OUTDOOR
FURNITURE; SCREENS; SEATING FURNITURE;
TABLES, IN CLASS 20 (U.S. CLS. 2, 13, 22, 25,
32 AND 50).

FIRST USE 4-14-2006; IN COMMERCE 6-26-2006.

FOR: RETAIL FURNITURE STORES; RETAIL
GIFT SHOPS, IN CLASS 35 (U.S. CLS. 100, 101 AND
102).

FIRST USE 4-14-2006; IN COMMERCE 6-26-2006.

THE MARK CONSISTS OF STANDARD CHARACTERS
WITHOUT CLAIM TO ANY PARTICULAR FONT,
STYLE, SIZE, OR COLOR.

SER. NO. 77-073,776, FILED 12-30-2006.

KEVIN CORWIN, EXAMINING ATTORNEY

Int. Cl.: 36

Prior U.S. Cls.: 100, 101 and 102

United States Patent and Trademark Office

Reg. No. 3,478,726

Registered Aug. 5, 2008

**SERVICE MARK
PRINCIPAL REGISTER**

CASINO PC

CASH SYSTEMS, INC. (DELAWARE CORPORATION)
SUITE 309
7350 DEAN MARTIN DRIVE
LAS VEGAS, NV 89139

FOR: FINANCIAL SERVICES, NAMELY, PROVIDING ELECTRONIC CASH TRANSACTIONS, CURRENCY EXCHANGE, CHECK CASHING, ELECTRONIC TRANSFERS OF MONEY, CASH ADVANCES, ELECTRONIC DEBIT AND DEPOSIT TRANSACTIONS, AND RENTAL OF CASH DISPENSING MACHINES AND AUTOMATED TELLER MACHINES, IN CLASS 36 (U.S. CLS. 100, 101 AND 102).

FIRST USE 6-30-2001; IN COMMERCE 6-30-2001.

THE MARK CONSISTS OF STANDARD CHARACTERS WITHOUT CLAIM TO ANY PARTICULAR FONT, STYLE, SIZE, OR COLOR.

SEC. 2(F).

SER. NO. 77-074,003, FILED 1-1-2007.

DAVID C. REIHNER, EXAMINING ATTORNEY

Int. Cl.: 12

Prior U.S. Cls.: 19, 21, 23, 31, 35 and 44

Reg. No. 3,478,727

United States Patent and Trademark Office

Registered Aug. 5, 2008

**TRADEMARK
PRINCIPAL REGISTER**

AMES

AMES TRUE TEMPER PROPERTIES, INC. (MI-
CHIGAN CORPORATION)
SUITE 1704
300 DELAWARE AVENUE
WILMINGTON, DE 19801

FOR: WHEELBARROWS; AND LAWN AND GAR-
DEN CARTS, IN CLASS 12 (U.S. CLS. 19, 21, 23, 31, 35
AND 44).

FIRST USE 1-0-1995; IN COMMERCE 1-0-1995.

THE MARK CONSISTS OF STANDARD CHAR-
ACTERS WITHOUT CLAIM TO ANY PARTICULAR
FONT, STYLE, SIZE, OR COLOR.

OWNER OF U.S. REG. NOS. 262,338, 2,927,060,
AND 3,101,032.

SEC. 2(F).

SER. NO. 77-074,156, FILED 1-2-2007.

STEVEN PEREZ, EXAMINING ATTORNEY

Int. Cl.: 41

Prior U.S. Cls.: 100, 101 and 107

United States Patent and Trademark Office

Reg. No. 3,478,728

Registered Aug. 5, 2008

**SERVICE MARK
PRINCIPAL REGISTER**



SPURR, THURLOW (UNITED STATES INDIVIDUAL)
1176 WINDSONG ROAD
ORLANDO, FL 32809

FIRST USE 11-3-2006; IN COMMERCE 11-3-2006.

FOR: ENTERTAINMENT SERVICES, NAMELY,
CONDUCTING COMPETITIONS IN THE FIELD OF
RELIGIOUS MUSIC, IN CLASS 41 (U.S. CLS. 100, 101
AND 107).

SER. NO. 77-074,492, FILED 1-2-2007.

MELVIN AXILBUND, EXAMINING ATTORNEY

Int. Cl.: 9

Prior U.S. Cls.: 21, 23, 26, 36 and 38

Reg. No. 3,478,729

United States Patent and Trademark Office

Registered Aug. 5, 2008

**TRADEMARK
PRINCIPAL REGISTER**

ENTASIS

OPTIMUM CARE INTERNATIONAL TECH. INC.
(TAIWAN CORPORATION)
8F, NO.28, LANES13, RUEI GUANG GUANG RD.
TAIPEI CITY, TAIWAN 114

FOR: CHIP CARD READERS, CHIP CARRIERS, NAMELY, SEMICONDUCTOR CHIP HOUSINGS, CHIPCARDS, CHROMATOGRAPHY COLUMNS, COMPUTER ACCELERATOR BOARD, COMPUTER APPLICATION SOFTWARE FOR MOBILE PHONES, COMPUTER BASED APPARATUS FOR DESIGNING THE LAYOUT OF ELECTRONIC CIRCUITS, COMPUTER BUFFERS, COMPUTER CABLES, COMPUTER CAMERAS, COMPUTER CARD ADAPTER, COMPUTER CARRYING CASES, COMPUTER CENTRAL PROCESSING UNITS, COMPUTER CHASSIS, COMPUTER CHIPS, COMPUTER COLOR PRINTER USING HEAT SENSITIVE DRY PRINTING PROCESS, COMPUTER COMMUNICATIONS SOFTWARE TO ALLOW CUSTOMERS TO ACCESS BANK ACCOUNT INFORMATION AND TRANSACT BANK BUSINESS, COMPUTER COMPONENT TESTING AND CALIBRATING EQUIPMENT, COMPUTER CURSOR CONTROL DEVICES, NAMELY, COMPUTER MOUSE, COMPUTER CURSOR CONTROL DEVICES, NAMELY, LIGHT PENS, COMPUTER CURSOR CONTROL DEVICES, NAMELY, TOUCH PADS, COMPUTER CURSOR CONTROL DEVICES, NAMELY, TRACKBALLS, COMPUTER DISC DRIVES, COMPUTER DOCKING STATION, COMPUTER EXPANSION BOARDS, COMPUTER E-COMMERCE SOFTWARE TO ALLOW USERS TO PERFORM ELECTRONIC BUSINESS TRANSACTIONS VIA A GLOBAL COMPUTER NETWORK, COMPUTER FAX MODEM CARDS, COMPUTER GRAPHICS BOARDS, COMPUTER GRAPHICS SOFTWARE, COMPUTER HARD DISCS, COMPUTER HARDWARE, COMPUTER KEYBOARDS, COMPUTER KEYPADS, COMPUTER MEMORIES, COMPUTER MEMORY HARDWARE, COMPUTER MONITORS, COMPUTER MOUSE, COMPUTER MOUSE, NAMELY, TRACKBALLS, COMPUTER

MOUSE, NAMELY, TOUCHPADS, BIOS COMPUTER PROGRAMS, CIRCUIT BOARDS, CIRCUIT BOARDS PROVIDED WITH INTEGRATED CIRCUITS, COMPUTER SOFTWARE FOR APPLICATION AND DATABASE INTEGRATION, COMPUTER TERMINALS, COMPUTER TOUCHSCREENS, COMPUTERS, FLASH CARD ADAPTERS, FLASH CARD READERS, FLASH MEMORY CARD, GPS DATA LOGGER FOR RECORDING TRIPS AND CLASSIFYING THEM INTO DIFFERENT ACCOUNTS, GRAMOPHONES, GRAPHICS CARDS, HEADPHONES, HEADSETS FOR TELEPHONES, HEAD-MOUNTED VIDEO DISPLAYS, IMPACT PRINTERS, INFRARED CAMERAS, INK JET PRINTERS, INK-JET COLOR PRINTERS, INTEGRATED CIRCUIT CHIPS FOR MEMORY AS A COMPONENT OF VIDEO GAMES SOFTWARE, INTEGRATED CIRCUIT MODULE, INTEGRATED CIRCUIT MODULES, INTEGRATED CIRCUITS, INTERNET PHONES, LAN ACCESS POINTS FOR CONNECTING NETWORK COMPUTER USERS, LAN COMPUTER CARDS FOR CONNECTING PORTABLE COMPUTER DEVICES TO COMPUTER NETWORKS, LAN OPERATING SOFTWARE, LAN HARDWARE, LAPTOP COMPUTERS, LCD LARGE-SCREEN DISPLAYS, LCD PANELS, LCD PROJECTORS USED TO DISPLAY ADVERTISEMENTS, MEMORY BOARDS, MEMORY CARDS, MEMORY EXPANSION MODULES, MICRO-COMPUTER, MICRO-COMPUTERS, MINICOMPUTERS, MOBILE COMPUTERS, MOUSE PADS, MP3 PLAYERS, MP4 PLAYERS, MULTIFUNCTION KEYBOARDS, PERSONAL COMPUTERS, PERSONAL DIGITAL ASSISTANTS, PERSONAL DIGITAL ASSISTANT COMPUTERS, PRINTED CIRCUIT BOARDS, PRINTED CIRCUITS, SEMICONDUCTOR CHIPS, SEMICONDUCTOR DEVICES, SEMICONDUCTORS, SEMI-CONDUCTOR MEMORIES, SEMI-CONDUCTOR MEMORY UNITS, TELEGRAPHS, TELEPHONE APPARATUS, TELEVISION SETS, VCD MACHINES, VIDEO CAMERAS, VIDEO CAPTURE CARDS, VIDEO DISPLAY CARDS, VI-

SUAL RECORDINGS AND AUDIO VISUAL RECORDINGS FEATURING MUSIC AND ANIMATION, WAN HARDWARE, WIRELESS COMPUTER PERIPHERALS, WIRELESS POS DEVICES, WIRELESS TELEPHONY APPARATUS, IN CLASS 9 (U.S. CLS. 21, 23, 26, 36 AND 38).

FIRST USE 3-15-2007; IN COMMERCE 3-15-2007.

THE MARK CONSISTS OF STANDARD CHARACTERS WITHOUT CLAIM TO ANY PARTICULAR FONT, STYLE, SIZE, OR COLOR.

THE WORDING "ENTASIS" HAS NO MEANING IN A FOREIGN LANGUAGE.

SER. NO. 77-074,782, FILED 1-3-2007.

CHRISTINA SOBRAL, EXAMINING ATTORNEY

Int. Cl.: 9

Prior U.S. Cls.: 21, 23, 26, 36 and 38

United States Patent and Trademark Office

Reg. No. 3,478,730

Registered Aug. 5, 2008

TRADEMARK
PRINCIPAL REGISTER

Kingbridge

OPTIMUM CARE INTERNATIONAL TECH. INC.
(TAIWAN CORPORATION)
8F, NO.28, LANE513, RUEI GUANG GUANG RD.
TAIPEI CITY, TAIWAN 114

FOR: CHIP CARD READERS, CHIP CARRIERS, NAMELY, SEMICONDUCTOR CHIP HOUSINGS, CHIPCARDS, CHROMATOGRAPHY COLUMNS, COMPUTER ACCELERATOR BOARD, COMPUTER APPLICATION SOFTWARE FOR MOBILE PHONES, COMPUTER BASED APPARATUS FOR DESIGNING THE LAYOUT OF ELECTRONIC CIRCUITS, COMPUTER BUFFERS, COMPUTER CABLES, COMPUTER CAMERAS, COMPUTER CARD ADAPTER, COMPUTER CARRYING CASES, COMPUTER CENTRAL PROCESSING UNITS, COMPUTER CHASSIS, COMPUTER CHIPS, COMPUTER COLOR PRINTER USING HEAT SENSITIVE DRY PRINTING PROCESS, COMPUTER COMMUNICATIONS SOFTWARE TO ALLOW CUSTOMERS TO ACCESS BANK ACCOUNT INFORMATION AND TRANSACT BANK BUSINESS, COMPUTER COMPONENT TESTING AND CALIBRATING EQUIPMENT, COMPUTER CURSOR CONTROL DEVICES, NAMELY, COMPUTER MOUSE, COMPUTER CURSOR CONTROL DEVICES, NAMELY, LIGHT PENS, COMPUTER CURSOR CONTROL DEVICES, NAMELY, TOUCH PADS, COMPUTER CURSOR CONTROL DEVICES, NAMELY, TRACKBALLS, COMPUTER DISC DRIVES, COMPUTER DOCKING STATION, COMPUTER EXPANSION BOARDS, COMPUTER E-COMMERCE SOFTWARE TO ALLOW USERS TO PERFORM ELECTRONIC BUSINESS TRANSACTIONS VIA A GLOBAL COMPUTER NETWORK, COMPUTER FAX MODEM CARDS, COMPUTER GRAPHICS BOARDS, COMPUTER GRAPHICS SOFTWARE, COMPUTER HARD DISCS, COMPUTER HARDWARE, COMPUTER KEYBOARDS, COMPUTER KEYPADS, COMPUTER MEMORIES, COMPUTER MEMORY HARDWARE, COMPUTER MONITORS, COMPUTER MOUSE, COMPUTER MOUSE, NAMELY, TRACKBALLS, COMPUTER MOUSE, NAMELY,

TOUCHPADS, BIOS COMPUTER PROGRAMS, CIRCUIT BOARDS, CIRCUIT BOARDS PROVIDED WITH INTEGRATED CIRCUITS, COMPUTER SOFTWARE FOR APPLICATION AND DATABASE INTEGRATION, COMPUTER TERMINALS, COMPUTER TOUCHSCREENS, COMPUTERS, FLASH CARD ADAPTERS, FLASH CARD READERS, FLASH MEMORY CARD, GPS DATA LOGGER FOR RECORDING TRIPS AND CLASSIFYING THEM INTO DIFFERENT ACCOUNTS, GRAMOPHONES, GRAPHICS CARDS, HEADPHONES, HEADSETS FOR TELEPHONES, HEAD-MOUNTED VIDEO DISPLAYS, IMPACT PRINTERS, INFRARED CAMERAS, INK JET PRINTERS, INK-JET COLOR PRINTERS, INTEGRATED CIRCUIT CHIPS FOR MEMORY AS A COMPONENT OF VIDEO GAMES SOFTWARE, INTEGRATED CIRCUIT MODULE, INTEGRATED CIRCUIT MODULES, INTEGRATED CIRCUITS, INTERNET PHONES, LAN ACCESS POINTS FOR CONNECTING NETWORK COMPUTER USERS, LAN COMPUTER CARDS FOR CONNECTING PORTABLE COMPUTER DEVICES TO COMPUTER NETWORKS, LAN OPERATING SOFTWARE, LAN HARDWARE, LAPTOP COMPUTERS, LCD LARGE-SCREEN DISPLAYS, LCD PANELS, LCD PROJECTORS USED TO DISPLAY ADVERTISEMENTS, MEMORY BOARDS, MEMORY CARDS, MEMORY EXPANSION MODULES, MICRO-COMPUTER, MICRO-COMPUTERS, MINI-COMPUTERS, MOBILE COMPUTERS, MOUSE PADS, MP3 PLAYERS, MP4 PLAYERS, MULTI-FUNCTION KEYBOARDS, PERSONAL COMPUTERS, PERSONAL DIGITAL ASSISTANTS, PERSONAL DIGITAL ASSISTANT COMPUTERS, PRINTED CIRCUIT BOARDS, PRINTED CIRCUITS, SEMICONDUCTOR CHIPS, SEMICONDUCTOR DEVICES, SEMICONDUCTORS, SEMI-CONDUCTOR MEMORIES, SEMI-CONDUCTOR MEMORY UNITS, TELEGRAPHS, TELEPHONE APPARATUS, TELEVISION SETS, VCD MACHINES, VIDEO CAMERAS, VIDEO CAPTURE CARDS, VIDEO DISPLAY CARDS, VISUAL RECORDINGS AND AUDIO VISUAL RECORDINGS FEATURING MUSIC AND

ANIMATION, WAN HARDWARE, WIRELESS COMPUTER PERIPHERALS, WIRELESS POS DEVICES, WIRELESS TELEPHONY APPARATUS, IN CLASS 9 (U.S. CLS. 21, 23, 26, 36 AND 38).

FIRST USE 3-15-2007; IN COMMERCE 3-15-2007.

THE MARK CONSISTS OF THE WORD OF "K" WAS BE SPECIAL DESIGNED.

THE WORDING "KINGBRIDGE" HAS NO MEANING IN A FOREIGN LANGUAGE.

SER. NO. 77-074,783, FILED 1-3-2007.

CHRISTINA SOBRAL, EXAMINING ATTORNEY

Int. Cl.: 41

Prior U.S. Cls.: 100, 101 and 107

United States Patent and Trademark Office

Reg. No. 3,478,731

Registered Aug. 5, 2008

**SERVICE MARK
PRINCIPAL REGISTER**

**HOT WHEELS MONSTER TRUCK
SMASHDOWN**

MATTEL, INC. (DELAWARE CORPORATION)
M1-1518
333 CONTINENTAL BLVD.
EL SEGUNDO, CA 902455012

FOR: ENTERTAINMENT SERVICES, NAMELY,
PROVIDING A COMPUTER GAME THAT MAY BE
ACCESSED AND PLAYED VIA INTERACTIVE TEL-
EVISION, BROADBAND, SATELLITE AND CABLE
TELEVISION NETWORKS, IN CLASS 41 (U.S. CLS.
100, 101 AND 107).

FIRST USE 3-0-2007; IN COMMERCE 3-0-2007.

THE MARK CONSISTS OF STANDARD CHAR-
ACTERS WITHOUT CLAIM TO ANY PARTICULAR
FONT, STYLE, SIZE, OR COLOR.

OWNER OF U.S. REG. NOS. 843,156, 1,810,905 AND
OTHERS.

NO CLAIM IS MADE TO THE EXCLUSIVE
RIGHT TO USE "MONSTER TRUCK", APART
FROM THE MARK AS SHOWN.

SER. NO. 77-075,463, FILED 1-3-2007.

JOHN DWYER, EXAMINING ATTORNEY

Int. Cls.: 41 and 44

Prior U.S. Cls.: 100, 101 and 107

United States Patent and Trademark Office

Reg. No. 3,478,732

Registered Aug. 5, 2008

**SERVICE MARK
PRINCIPAL REGISTER**

SPAMEDICA

SPAMEDICA INTERNATIONAL SRL (BARBADOS CORPORATION)
2ND FLOOR, INTERNATIONAL TRADING CENTER
WARRENS, ST. MICHAEL, BARBADOS

FOR: EDUCATIONAL SERVICES, NAMELY, CONDUCTING TRAINING SERVICES IN THE FIELD OF COSMETIC AND PLASTIC SURGERY AND IN THE FIELD OF AESTHETIC BEAUTY SERVICES, IN CLASS 41 (U.S. CLS. 100, 101 AND 107).

FIRST USE 10-2-1997; IN COMMERCE 10-2-1997.

FOR: MEDICAL SERVICES, NAMELY, PLASTIC SURGERY; NONINVASIVE AND MINIMALLY IN-

VASIVE COSMETIC AND AESTHETIC SURGERY SERVICES, IN CLASS 44 (U.S. CLS. 100 AND 101).

FIRST USE 10-2-1997; IN COMMERCE 10-2-1997.

THE MARK CONSISTS OF STANDARD CHARACTERS WITHOUT CLAIM TO ANY PARTICULAR FONT, STYLE, SIZE, OR COLOR.

OWNER OF U.S. REG. NO. 2,408,973.

SER. NO. 77-076,750, FILED 1-5-2007.

ELISSA GARBER KON, EXAMINING ATTORNEY

Int. Cls.: 35, 38 and 44

Prior U.S. Cls.: 100, 101, 102 and 104

United States Patent and Trademark Office

Reg. No. 3,478,733

Registered Aug. 5, 2008

**SERVICE MARK
PRINCIPAL REGISTER**

LAWNSITE

MRP ACQUISITION LLC (DELAWARE LTD
LIAB CO), DBA MOOSE RIVER PUBLISHING
INC.
374 EMERSON FALLS ROAD
ST. JOHNSBURY, VT 05819

FOR: PROVIDING CONSUMER LAWN CARE
AND LANDSCAPE DESIGN AND GARDENING
PRODUCT INFORMATION VIA THE INTERNET;
PROVIDING A WEB SITE THAT ENABLES USERS
TO POST LAWN CARE AND LANDSCAPE DESIGN
AND GARDENING PRODUCTS FOR SALE
THROUGH ON-LINE CLASSIFIED ADVERTISE-
MENTS, IN CLASS 35 (U.S. CLS. 100, 101 AND 102).

FIRST USE 6-1-2000; IN COMMERCE 6-1-2000.

FOR: PROVIDING ON-LINE CHAT ROOMS, FOR-
UMS, AND ELECTRONIC BULLETIN BOARDS FOR
TRANSMISSION OF MESSAGES AMONG USERS IN
THE FIELD OF LAWN CARE AND LANDSCAPE

DESIGN AND GARDENING, IN CLASS 38 (U.S. CLS.
100, 101 AND 104).

FIRST USE 6-1-2000; IN COMMERCE 6-1-2000.

FOR: PROVIDING INFORMATION IN THE
FIELD OF LAWN CARE AND LANDSCAPE DE-
SIGN AND GARDENING, IN CLASS 44 (U.S. CLS.
100 AND 101).

FIRST USE 6-1-2000; IN COMMERCE 6-1-2000.

THE MARK CONSISTS OF STANDARD CHAR-
ACTERS WITHOUT CLAIM TO ANY PARTICULAR
FONT, STYLE, SIZE, OR COLOR.

SER. NO. 77-077,846, FILED 1-8-2007.

JACLYN KIDWELL, EXAMINING ATTORNEY

Int. Cl.: 31

Prior U.S. Cls.: 1 and 46

United States Patent and Trademark Office

Reg. No. 3,478,734

Registered Aug. 5, 2008

**TRADEMARK
PRINCIPAL REGISTER**

CLEVER

GRUPO BIMBO, S.A. B. DE C.V. (MEXICO CORPORATION)

NO. 1000, COL. PENA BLANCA SANTA FE

PROLONGACION PASEO DE LA REFORMA

MEXICO CITY, MEXICO 01210

FOR: PET FOOD, IN CLASS 31 (U.S. CLS. 1 AND 46).

THE MARK CONSISTS OF STANDARD CHARACTERS WITHOUT CLAIM TO ANY PARTICULAR FONT, STYLE, SIZE, OR COLOR.

OWNER OF MEXICO REG. NO. 905913, DATED 10-27-2005, EXPIRES 8-18-2015.

SER. NO. 77-078,245, FILED 1-8-2007.

TAMARA FRAZIER, EXAMINING ATTORNEY

Int. Cl.: 41

Prior U.S. Cls.: 100, 101 and 107

United States Patent and Trademark Office

Reg. No. 3,478,735

Registered Aug. 5, 2008

**SERVICE MARK
PRINCIPAL REGISTER**

JUPITER ONE

JUPITER ONE MUSIC, INC. (NEW YORK CORPORATION)
3000 MARCUS AVENUE SUITE 3W7
LAKE SUCCESS, NY 11042

FOR: ENTERTAINMENT SERVICES, NAMELY, PERFORMANCES BY A LIVE MUSICAL ARTIST AND PROVIDING PRERECORDED MUSIC OF SUCH LIVE MUSICAL ARTIST ONLINE AND INFORMATION REGARDING SUCH MUSICAL ARTIST ONLINE VIA A GLOBAL COMPUTER NETWORK, IN CLASS 41 (U.S. CLS. 100, 101 AND 107).

FIRST USE 5-28-2003; IN COMMERCE 7-28-2003.

THE MARK CONSISTS OF STANDARD CHARACTERS WITHOUT CLAIM TO ANY PARTICULAR FONT, STYLE, SIZE, OR COLOR.

SER. NO. 77-079,181, FILED 1-9-2007.

LINDA ESTRADA, EXAMINING ATTORNEY

Int. Cl.: 16

Prior U.S. Cls.: 2, 5, 22, 23, 29, 37, 38 and 50

United States Patent and Trademark Office

Reg. No. 3,478,736

Registered Aug. 5, 2008

**TRADEMARK
PRINCIPAL REGISTER**

AJM

INTERNATIONAL PRESS OF BOSTON, INC.
(MASSACHUSETTS CORPORATION)
387 SOMERVILLE AVENUE
SOMERVILLE, MA 02143

FOR: PRINTED PUBLICATION, NAMELY, JOURNALS IN THE FIELD OF MATHEMATICS, APPLIED MATHEMATICS AND PHYSICS, IN CLASS 16 (U.S. CLS. 2, 5, 22, 23, 29, 37, 38 AND 50).

FIRST USE 3-31-1997; IN COMMERCE 3-31-1997.

THE MARK CONSISTS OF STANDARD CHARACTERS WITHOUT CLAIM TO ANY PARTICULAR FONT, STYLE, SIZE, OR COLOR.

SER. NO. 77-080,676, FILED 1-11-2007.

TRACY WHITTAKER-BROWN, EXAMINING ATTORNEY

Int. Cl.: 37

Prior U.S. Cls.: 100, 103 and 106

United States Patent and Trademark Office

Reg. No. 3,478,737

Registered Aug. 5, 2008

**SERVICE MARK
PRINCIPAL REGISTER**

VASA

VASA TECHNOLOGY SOLUTIONS, INC. (UTAH CORPORATION)
P. O. BOX 656
WEST JORDAN, UT 84088

FOR: MAINTENANCE, REPAIR, AND INSTALLATION SERVICES RELATING TO DC POWER SYSTEMS, BACK-UP POWER SYSTEMS AND TELECOMMUNICATION ENVIRONMENTS AND CONSULTATION SERVICES IN THE FIELDS OF MAINTENANCE, REPAIR, AND INSTALLATION RELATING TO DC POWER SYSTEMS, BACK-UP POWER SYSTEMS AND TELECOMMUNICATION ENVIRONMENTS, IN CLASS 37 (U.S. CLS. 100, 103 AND 106).

FIRST USE 1-1-2001; IN COMMERCE 1-1-2001.

THE MARK CONSISTS OF STANDARD CHARACTERS WITHOUT CLAIM TO ANY PARTICULAR FONT, STYLE, SIZE, OR COLOR.

"VASA" HAS NO MEANING IN A FOREIGN LANGUAGE.

SER. NO. 77-081,149, FILED 1-11-2007.

NORA BUCHANAN WILL, EXAMINING ATTORNEY

Int. Cl.: 37

Prior U.S. Cls.: 100, 103 and 106

United States Patent and Trademark Office

Reg. No. 3,478,738

Registered Aug. 5, 2008

**SERVICE MARK
PRINCIPAL REGISTER**

**PHYSICAL REALITY FOR AN
ELECTRONIC WORLD**

VASA TECHNOLOGY SOLUTIONS, INC. (UTAH
CORPORATION)
P. O. BOX 656
WEST JORDAN, UT 84088

FOR: MAINTENANCE, REPAIR, AND INSTAL-
LATION SERVICES RELATING TO DC POWER
SYSTEMS, BACK-UP POWER SYSTEMS AND TEL-
ECOMMUNICATION ENVIRONMENTS AND CON-
SULTATION SERVICES IN THE FIELDS OF
MAINTENANCE, REPAIR, AND INSTALLATION
RELATING TO DC POWER SYSTEMS, BACK-UP
POWER SYSTEMS AND TELECOMMUNICATION

ENVIRONMENTS, IN CLASS 37 (U.S. CLS. 100, 103
AND 106).

FIRST USE 1-1-2001; IN COMMERCE 1-1-2001.

THE MARK CONSISTS OF STANDARD CHAR-
ACTERS WITHOUT CLAIM TO ANY PARTICULAR
FONT, STYLE, SIZE, OR COLOR.

SER. NO. 77-081,204, FILED 1-11-2007.

NORA BUCHANAN WILL, EXAMINING ATTOR-
NEY

Int. Cl.: 37

Prior U.S. Cls.: 100, 103 and 106

United States Patent and Trademark Office

Reg. No. 3,478,739

Registered Aug. 5, 2008

**SERVICE MARK
PRINCIPAL REGISTER**

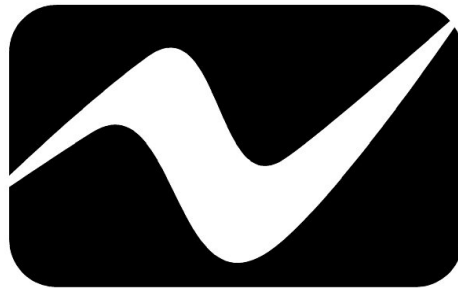

VASA TECHNOLOGY SOLUTIONS, INC. (UTAH CORPORATION)
P. O. BOX 656
WEST JORDAN, UT 84088

FOR: MAINTENANCE, REPAIR, AND INSTALLATION SERVICES RELATING TO DC POWER SYSTEMS, BACK-UP POWER SYSTEMS AND TELECOMMUNICATION ENVIRONMENTS AND CONSULTATION SERVICES IN THE FIELDS OF MAINTENANCE, REPAIR, AND INSTALLATION RELATING TO DC POWER SYSTEMS, BACK-UP POWER SYSTEMS AND TELECOMMUNICATION

ENVIRONMENTS, IN CLASS 37 (U.S. CLS. 100, 103 AND 106).

FIRST USE 1-1-2001; IN COMMERCE 1-1-2001.

THE MARK CONSISTS OF A STYLIZED "V" IN A RECTANGLE WITH ROUNDED CORNERS.

SER. NO. 77-081,259, FILED 1-11-2007.

NORA BUCHANAN WILL, EXAMINING ATTORNEY

Int. Cl.: 9

Prior U.S. Cls.: 21, 23, 26, 36 and 38

Reg. No. 3,478,740

United States Patent and Trademark Office

Registered Aug. 5, 2008

**TRADEMARK
PRINCIPAL REGISTER**

DAIRY DOLLARS

ARISTOCRAT TECHNOLOGIES AUSTRALIA
PTY LTD. (AUSTRALIA CORPORATION)
71 LONGUEVILLE ROAD
LANE COVE, NSW, AUSTRALIA 2066

FOR: GAMING MACHINES; COMPUTER HARD-
WARE; DOWNLOADABLE GAME SOFTWARE;
ELECTRONIC GAME SOFTWARE, IN CLASS 9
(U.S. CLS. 21, 23, 26, 36 AND 38).

THE MARK CONSISTS OF STANDARD CHAR-
ACTERS WITHOUT CLAIM TO ANY PARTICULAR
FONT, STYLE, SIZE, OR COLOR.

PRIORITY CLAIMED UNDER SEC. 44(D) ON
AUSTRALIA APPLICATION NO. 1131923, FILED
10-28-2006, REG. NO. 1131923, DATED 8-28-2006,
EXPIRES 8-28-2016.

NO CLAIM IS MADE TO THE EXCLUSIVE
RIGHT TO USE "DOLLARS", APART FROM THE
MARK AS SHOWN.

SER. NO. 77-082,347, FILED 1-12-2007.

WILLIAM ROSSMAN, EXAMINING ATTORNEY

Int. Cl.: 7

Prior U.S. Cls.: 13, 19, 21, 23, 31, 34 and 35

United States Patent and Trademark Office

Reg. No. 3,478,741

Registered Aug. 5, 2008

**TRADEMARK
PRINCIPAL REGISTER**

Accucapper

ACCUTEK PACKAGING EQUIPMENT COMPAN-
NY, INC. (CALIFORNIA CORPORATION)
1399 SPECIALTY DRIVE
VISTA, CA 92081

FOR: CAPPING MACHINES; CAPPING MACHIN-
ERY; POWER-OPERATED CAPPING DEVICES IN
THE NATURE OF BOTTLE CAPPERS FOR INSERT-
ING CAPS ON BOTTLES; BOTTLE CAPPING SYS-
TEMS, NAMELY, BOTTLE CAPPING MACHINES,
IN CLASS 7 (U.S. CLS. 13, 19, 21, 23, 31, 34 AND 35).

FIRST USE 1-1-1989; IN COMMERCE 1-1-1989.

THE MARK CONSISTS OF STANDARD CHAR-
ACTERS WITHOUT CLAIM TO ANY PARTICULAR
FONT, STYLE, SIZE, OR COLOR.

SER. NO. 77-082,434, FILED 1-12-2007.

ANN E. SAPPENFIELD, EXAMINING ATTORNEY

Int. Cl.: 17

Prior U.S. Cls.: 1, 5, 12, 13, 35 and 50

United States Patent and Trademark Office

Reg. No. 3,478,742

Registered Aug. 5, 2008

**TRADEMARK
PRINCIPAL REGISTER**

SINK SILENCER

COFAIR PRODUCTS, INC. (ILLINOIS CORPORATION)
7301 ST. LOUIS AVENUE
SKOKIE, IL 60076

FOR: SELF-ADHESIVE ACOUSTICAL INSULATION FOR SINKS, IN CLASS 17 (U.S. CLS. 1, 5, 12, 13, 35 AND 50).

FIRST USE 7-1-2006; IN COMMERCE 7-1-2006.

THE MARK CONSISTS OF STANDARD CHARACTERS WITHOUT CLAIM TO ANY PARTICULAR FONT, STYLE, SIZE, OR COLOR.

NO CLAIM IS MADE TO THE EXCLUSIVE RIGHT TO USE "SINK", APART FROM THE MARK AS SHOWN.

SER. NO. 77-082,818, FILED 1-15-2007.

ANNE FARRELL, EXAMINING ATTORNEY

Int. Cl.: 42

Prior U.S. Cls.: 100 and 101

United States Patent and Trademark Office

Reg. No. 3,478,743

Registered Aug. 5, 2008

**SERVICE MARK
PRINCIPAL REGISTER**

AEROTONOMY

AEROTONOMY, INCORPORATED (GEORGIA CORPORATION)
591 THORNTON RD, STE A
LITHIA SPRINGS, GA 30122

FOR: AIRCRAFT DESIGN; DESIGN AND TESTING FOR NEW PRODUCT DEVELOPMENT; DESIGN FOR OTHERS IN THE FIELD OF AEROSPACE ENGINEERING; DESIGN OF COMPUTER PROGRAMS AND SOFTWARE RELATING TO AIRCRAFT; ENGINEERING; MECHANICAL ENGINEERING; TECHNOLOGY CONSULTATION AND RESEARCH IN THE FIELD OF AEROSPACE ENGINEERING; TECHNOLOGY CONSULTATION

IN THE FIELD OF AEROSPACE ENGINEERING, IN CLASS 42 (U.S. CLS. 100 AND 101).

FIRST USE 1-1-2005; IN COMMERCE 1-28-2005.

THE MARK CONSISTS OF STANDARD CHARACTERS WITHOUT CLAIM TO ANY PARTICULAR FONT, STYLE, SIZE, OR COLOR.

SER. NO. 77-083,610, FILED 1-16-2007.

RENEE SERVANCE, EXAMINING ATTORNEY

Int. Cl.: 9

Prior U.S. Cls.: 21, 23, 26, 36 and 38

Reg. No. 3,478,744

United States Patent and Trademark Office

Registered Aug. 5, 2008

**TRADEMARK
PRINCIPAL REGISTER**

BUDDHA-LOUNGE

SEQUOIA RECORDS, INC. (CALIFORNIA CORPORATION)
1106 2ND STREET, SUITE 119
ENCINITAS, CA 92024

THE MARK CONSISTS OF STANDARD CHARACTERS WITHOUT CLAIM TO ANY PARTICULAR FONT, STYLE, SIZE, OR COLOR.

FOR: SERIES OF PRE-RECORDED COMPACT DISCS FEATURING MUSIC, IN CLASS 9 (U.S. CLS. 21, 23, 26, 36 AND 38).

SER. NO. 77-087,259, FILED 1-20-2007.

FIRST USE 4-15-2002; IN COMMERCE 4-15-2002.

HENRY S. ZAK, EXAMINING ATTORNEY

Int. Cl.: 36

Prior U.S. Cls.: 100, 101 and 102

United States Patent and Trademark Office

Reg. No. 3,478,745

Registered Aug. 5, 2008

**SERVICE MARK
PRINCIPAL REGISTER**

The Options Insider

THE OPTIONS INSIDER INCORPORATED (ILLINOIS CORPORATION)
3410 N. LAKE SHORE DRIVE, SUITE 6G
CHICAGO, IL 60657

FOR: PROVIDING A WEBSITE THAT FEATURES INFORMATION ON THE OPTIONS MARKETS, IN CLASS 36 (U.S. CLS. 100, 101 AND 102).

FIRST USE 5-11-2006; IN COMMERCE 5-11-2006.

THE MARK CONSISTS OF STANDARD CHARACTERS WITHOUT CLAIM TO ANY PARTICULAR FONT, STYLE, SIZE, OR COLOR.

NO CLAIM IS MADE TO THE EXCLUSIVE RIGHT TO USE "OPTIONS", APART FROM THE MARK AS SHOWN.

SER. NO. 77-087,493, FILED 1-21-2007.

JESSICA FATHY, EXAMINING ATTORNEY

Int. Cl.: 6

Prior U.S. Cls.: 2, 12, 13, 14, 23, 25 and 50

Reg. No. 3,478,746

United States Patent and Trademark Office

Registered Aug. 5, 2008

**TRADEMARK
PRINCIPAL REGISTER**

PARAMOUNT WINDOWS

PARAMOUNT WINDOWS (ARIZONA CORPORATION)
550 WEST SOUTHERN AVENUE
TEMPE, AZ 85282

FOR: ALUMINUM WINDOWS, METAL WINDOW LOCKS, METAL DOORS, AND METAL EXTRUSIONS FOR USE IN DOOR AND WINDOW CASINGS, IN CLASS 6 (U.S. CLS. 2, 12, 13, 14, 23, 25 AND 50).

FIRST USE 12-29-2003; IN COMMERCE 7-21-2004.

THE MARK CONSISTS OF STANDARD CHARACTERS WITHOUT CLAIM TO ANY PARTICULAR FONT, STYLE, SIZE, OR COLOR.

NO CLAIM IS MADE TO THE EXCLUSIVE RIGHT TO USE "WINDOWS", APART FROM THE MARK AS SHOWN.

SER. NO. 77-088,415, FILED 1-22-2007.

JEFF DEFORD, EXAMINING ATTORNEY

Int. Cl.: 3

Prior U.S. Cls.: 1, 4, 6, 50, 51 and 52

United States Patent and Trademark Office

Reg. No. 3,478,747

Registered Aug. 5, 2008

**TRADEMARK
PRINCIPAL REGISTER**

ARDENT REEL KLEEN

ARDENT OUTDOORS, INC. (MISSOURI CORPORATION)
425 SOUTH WOODS MILL ROAD, SUITE 170
ST. LOUIS, MO 63017

FOR: CLEANER AND DEGREASER FOR SPORTING EQUIPMENT, IN CLASS 3 (U.S. CLS. 1, 4, 6, 50, 51 AND 52).

FIRST USE 12-15-2006; IN COMMERCE 12-15-2006.

THE MARK CONSISTS OF STANDARD CHARACTERS WITHOUT CLAIM TO ANY PARTICULAR FONT, STYLE, SIZE, OR COLOR.

OWNER OF U.S. REG. NO. 3,138,560.

SER. NO. 77-090,133, FILED 1-24-2007.

KATHY DE JONGE, EXAMINING ATTORNEY

Int. Cls.: 35, 36, 37 and 41

Prior U.S. Cls.: 100, 101, 102, 103, 106 and 107

United States Patent and Trademark Office

Reg. No. 3,478,748

Registered Aug. 5, 2008

**SERVICE MARK
PRINCIPAL REGISTER**

WHEATLEY PLAZA

WHEATLEY PLAZA ASSOCIATES (NEW YORK
PARTNERSHIP)
2110 NORTHERN BLVD
MANHASSET, NY 11030

FOR: SHOPPING CENTER SERVICES, NAMELY,
PROMOTING, ADVERTISING AND MARKETING
SERVICES FOR SHOPPING CENTER SPACES, IN
CLASS 35 (U.S. CLS. 100, 101 AND 102).

FIRST USE 2-25-1980; IN COMMERCE 2-25-1980.

FOR: SHOPPING CENTER SERVICES, NAMELY,
RENTAL AND MANAGEMENT OF SHOPPING
CENTER SPACE; CHARITABLE FUND RAISING
SERVICES, IN CLASS 36 (U.S. CLS. 100, 101 AND 102).

FIRST USE 2-25-1980; IN COMMERCE 2-25-1980.

FOR: SHOPPING CENTER SERVICES, NAMELY,
BUILDING MAINTENANCE AND REPAIR FOR
SHOPPING CENTER SPACES, IN CLASS 37 (U.S.
CLS. 100, 103 AND 106).

FIRST USE 2-25-1980; IN COMMERCE 2-25-1980.

FOR: ENTERTAINMENT AND RECREATIONAL
SERVICES, NAMELY, ARRANGING, ORGANIZ-
ING AND PROVIDING FACILITIES FOR COMMU-
NITY AND HOLIDAY EVENTS, EXHIBITIONS,
AND COMMUNITY ACTIVITIES, GATHERINGS
AND FESTIVALS, IN CLASS 41 (U.S. CLS. 100, 101
AND 107).

FIRST USE 10-29-1989; IN COMMERCE 10-29-1989.

THE MARK CONSISTS OF STANDARD CHAR-
ACTERS WITHOUT CLAIM TO ANY PARTICULAR
FONT, STYLE, SIZE, OR COLOR.

NO CLAIM IS MADE TO THE EXCLUSIVE
RIGHT TO USE "PLAZA", APART FROM THE
MARK AS SHOWN.

SEC. 2(F).

SER. NO. 77-091,174, FILED 1-25-2007.

REBECCA EISINGER, EXAMINING ATTORNEY

Int. Cls.: 10 and 20

Prior U.S. Cls.: 2, 13, 22, 25, 26, 32, 39, 44 and 50

United States Patent and Trademark Office

Reg. No. 3,478,749

Registered Aug. 5, 2008

**TRADEMARK
PRINCIPAL REGISTER**

PENTAFLEX

HUNTLEIGH TECHNOLOGY PLC (UNITED
KINGDOM CORPORATION)
310-312 DALLOW ROAD
LUTON,, UNITED KINGDOM LU11TD

FOR: MATTRESSES FOR MEDICAL PURPOSES
MADE WHOLLY OR PRINCIPALLY OF FOAM
MATERIALS, IN CLASS 10 (U.S. CLS. 26, 39 AND 44).

FOR: MATTRESSES, CUSHIONS AND CHAIR
PADS, ALL MADE WHOLLY OR PRINCIPALLY

OF FOAM MATERIALS, IN CLASS 20 (U.S. CLS. 2, 13,
22, 25, 32 AND 50).

OWNER OF UNITED KINGDOM REG. NO.
2129505, DATED 4-12-1997, RENEWED AS REG. NO.
2129505, DATED 4-12-2007, EXPIRES 4-12-2017.

SER. NO. 77-091,814, FILED 1-26-2007.

GENE MACIOL, EXAMINING ATTORNEY

Int. Cl.: 45

Prior U.S. Cls.: 100 and 101

United States Patent and Trademark Office

Reg. No. 3,478,750

Registered Aug. 5, 2008

**SERVICE MARK
PRINCIPAL REGISTER**

**The Episcopal Diocese of
Central Florida**

DIOCESE OF CENTRAL FLORIDA, INCORPORATED (FLORIDA CORPORATION)
1017 E. ROBINSON STREET
ORLANDO, FL 328012023

FOR: RELIGIOUS SERVICES, NAMELY, MINISTERIAL, EVANGELICAL AND MISSIONARY SERVICES, IN CLASS 45 (U.S. CLS. 100 AND 101).

FIRST USE 1-1-1970; IN COMMERCE 1-1-1970.

THE MARK CONSISTS OF STANDARD CHARACTERS WITHOUT CLAIM TO ANY PARTICULAR FONT, STYLE, SIZE, OR COLOR.

SEC. 2(F).

SER. NO. 77-092,531, FILED 1-26-2007.

SALLY SHIH, EXAMINING ATTORNEY

Int. Cl.: 45

Prior U.S. Cls.: 100 and 101

United States Patent and Trademark Office

Reg. No. 3,478,751

Registered Aug. 5, 2008

**SERVICE MARK
PRINCIPAL REGISTER**

**The Episcopal Church in
Central Florida**

DIOCESE OF CENTRAL FLORIDA, INCORPORATED (FLORIDA CORPORATION)
1017 E. ROBINSON STREET
ORLANDO, FL 328012023

FOR: RELIGIOUS SERVICES, NAMELY, MINISTERIAL, EVANGELICAL AND MISSIONARY SERVICES, IN CLASS 45 (U.S. CLS. 100 AND 101).

FIRST USE 1-1-1970; IN COMMERCE 1-1-1970.

THE MARK CONSISTS OF STANDARD CHARACTERS WITHOUT CLAIM TO ANY PARTICULAR FONT, STYLE, SIZE, OR COLOR.

NO CLAIM IS MADE TO THE EXCLUSIVE RIGHT TO USE "CHURCH", APART FROM THE MARK AS SHOWN.

SEC. 2(F).

SER. NO. 77-092,553, FILED 1-26-2007.

SALLY SHIH, EXAMINING ATTORNEY

Int. Cl.: 42

Prior U.S. Cls.: 100 and 101

United States Patent and Trademark Office

Reg. No. 3,478,752

Registered Aug. 5, 2008

**SERVICE MARK
PRINCIPAL REGISTER**

eSpendwise

CLEANWISE, INC. (DELAWARE CORPORATION)

ATTN: KEITH ALSHEIMER
33 BOSTON POST ROAD WEST, SUITE 400
MARLBOROUGH, MA 01750

FOR: PROVIDING A WEB SITE FEATURING TEMPORARY USE OF NON-DOWNLOADABLE E-COMMERCE SOFTWARE TO ALLOW USERS TO PERFORM ELECTRONIC BUSINESS TRANSACTIONS VIA A GLOBAL COMPUTER NETWORK, IN CLASS 42 (U.S. CLS. 100 AND 101).

FIRST USE 1-15-2004; IN COMMERCE 6-27-2005.

THE MARK CONSISTS OF STANDARD CHARACTERS WITHOUT CLAIM TO ANY PARTICULAR FONT, STYLE, SIZE, OR COLOR.

SER. NO. 77-094,968, FILED 1-30-2007.

TEJBIR SINGH, EXAMINING ATTORNEY

Int. Cl.: 36

Prior U.S. Cls.: 100, 101 and 102

United States Patent and Trademark Office

Reg. No. 3,478,753

Registered Aug. 5, 2008

**SERVICE MARK
PRINCIPAL REGISTER**

THE SMARTER BANKING CHOICE
FOR GROWING TECHNOLOGY
COMPANIES

BRIDGE BANK, N.A. (UNITED STATES NA-
TIONAL BANKING ASSOCIATION)
55 ALMADEN BOULEVARD
SAN JOSE, CA 95113

FOR: BANKING SERVICES; ONLINE BANKING
SERVICES; FINANCIAL SERVICES, NAMELY,
COMMERCIAL LENDING SERVICES, CONSTRUC-
TION LENDING SERVICES, SMALL BUSINESS
LENDING SERVICES, COMMERCIAL REAL ES-
TATE FINANCING, DEBT FINANCING, AC-
COUNTS RECEIVABLE FINANCING, ASSET-
BASED LENDING, VENDOR ASSURANCE PRO-
GRAMS, NAMELY, PURCHASE ORDER FINAN-
CING AND LETTERS OF CREDIT, CASH
MANAGEMENT SERVICES, FIDUCIARY MAN-

AGEMENT SERVICES; DIRECT AND ON-LINE
DEPOSIT SERVICES, CERTIFICATE OF DEPOSIT
SERVICES, AND FDIC INSURED DEPOSIT AC-
COUNT SERVICES, IN CLASS 36 (U.S. CLS. 100, 101
AND 102).

FIRST USE 5-24-2005; IN COMMERCE 5-24-2005.

THE MARK CONSISTS OF STANDARD CHAR-
ACTERS WITHOUT CLAIM TO ANY PARTICULAR
FONT, STYLE, SIZE, OR COLOR.

SER. NO. 77-095,090, FILED 1-30-2007.

MARGERY A. TIERNEY, EXAMINING ATTORNEY

Int. Cl.: 41

Prior U.S. Cls.: 100, 101 and 107

United States Patent and Trademark Office

Reg. No. 3,478,754

Registered Aug. 5, 2008

**SERVICE MARK
PRINCIPAL REGISTER**

NEW VISIONS NEW VOICES

TRUSTEES OF THE JOHN F. KENNEDY CENTER FOR THE PERFORMING ARTS (D.C. TRUST)
2700 F STREET, N.W.
WASHINGTON, DC 20566

FOR: EDUCATION AND ENTERTAINMENT SERVICES, NAMELY, A WEEK-LONG THEATRICAL RESIDENCY TRAINING PROGRAM, NAMELY, FOR PLAYWRIGHTS, DIRECTORS, AND THEATRES TO STIMULATE AND SUPPORT THE CREATION OF NEW PLAYS AND MUSICALS FOR YOUNG AUDIENCES AND FAMILIES, CULMINATING IN A WEEKEND FESTIVAL OF STAGED READINGS AND DISCUSSIONS WITH STUDENTS,

ACADEMICS, AND PROFESSIONALS IN THE FIELD FROM AROUND THE COUNTRY, IN CLASS 41 (U.S. CLS. 100, 101 AND 107).

FIRST USE 1-1-1991; IN COMMERCE 1-1-1991.

THE MARK CONSISTS OF STANDARD CHARACTERS WITHOUT CLAIM TO ANY PARTICULAR FONT, STYLE, SIZE, OR COLOR.

SER. NO. 77-095,147, FILED 1-30-2007.

STEPHEN AQUILA, EXAMINING ATTORNEY

Int. Cl.: 11

Prior U.S. Cls.: 13, 21, 23, 31 and 34

United States Patent and Trademark Office

Reg. No. 3,478,755

Registered Aug. 5, 2008

**TRADEMARK
PRINCIPAL REGISTER**

**FOREVER HOT WHITEHAUS
COLLECTION**

WHITE'S PLUMBING SUPPLIES, INC. (CONNEC-
TICUT CORPORATION)
582 ORANGE AVENUE
WEST HAVEN, CT 06516

FOR: PLUMBING SUPPLIES, NAMELY, ELEC-
TRICAL HOT WATER BOILERS; ELECTRICAL HOT
WATER DISPENSERS, IN CLASS 11 (U.S. CLS. 13, 21,
23, 31 AND 34).

FIRST USE 6-1-2007; IN COMMERCE 6-1-2007.

THE MARK CONSISTS OF STANDARD CHAR-
ACTERS WITHOUT CLAIM TO ANY PARTICULAR
FONT, STYLE, SIZE, OR COLOR.

OWNER OF U.S. REG. NOS. 1,954,790 AND
1,985,225.

NO CLAIM IS MADE TO THE EXCLUSIVE
RIGHT TO USE "HOT" AND "COLLECTION",
APART FROM THE MARK AS SHOWN.

SER. NO. 77-095,440, FILED 1-31-2007.

BARBARA RUTLAND, EXAMINING ATTORNEY

Int. Cl.: 35

Prior U.S. Cls.: 100, 101 and 102

United States Patent and Trademark Office

Reg. No. 3,478,756

Registered Aug. 5, 2008

**SERVICE MARK
PRINCIPAL REGISTER**

GREATER DC CARES

GREATER D.C. CARES, INC. (D.C. CORPORATION)
1725 I STREET, NW, SUITE 200
WASHINGTON, DC 20006

FOR: VOLUNTEER AND CHARITABLE SERVICES, NAMELY, COORDINATING THE PROVISION OF VOLUNTEERS, PRO BONO CONSULTANTS, BOARD MEMBERS, AND IN-KIND GOODS AND SERVICES DONATED BY THIRD-PARTY COMPANIES AND INDIVIDUALS TO NON-PROFIT COMPANIES IN THE FIELD OF EMPLOYEE ENGAGEMENT PROGRAMS AND STRATEGIC COMMUNITY INVESTING; COORDINATING EFFECTIVE PARTNERSHIPS BETWEEN VOLUNTEERS, NON-PROFITS AND BUSINESSES, IN CLASS 35 (U.S. CLS. 100, 101 AND 102).

FIRST USE 5-0-1993; IN COMMERCE 5-0-1993.

THE MARK CONSISTS OF STANDARD CHARACTERS WITHOUT CLAIM TO ANY PARTICULAR FONT, STYLE, SIZE, OR COLOR.

OWNER OF U.S. REG. NOS. 1,911,976 AND 1,934,826.

NO CLAIM IS MADE TO THE EXCLUSIVE RIGHT TO USE "GREATER DC", APART FROM THE MARK AS SHOWN.

SER. NO. 77-095,901, FILED 1-31-2007.

BRIAN NEVILLE, EXAMINING ATTORNEY

Int. Cl.: 35

Prior U.S. Cls.: 100, 101 and 102

United States Patent and Trademark Office

Reg. No. 3,478,757

Registered Aug. 5, 2008

**SERVICE MARK
PRINCIPAL REGISTER**

THE NEW CURRENCY OF SOCIAL
CHANGE

GREATER D.C. CARES, INC. (D.C. CORPORATION)
1725 I STREET, NW, SUITE 200
WASHINGTON, DC 20006

FOR: VOLUNTEER AND CHARITABLE SERVICES, NAMELY, COORDINATING THE PROVISION OF VOLUNTEERS, PRO BONO CONSULTANTS, BOARD MEMBERS, AND IN-KIND GOODS AND SERVICES DONATED BY THIRD-PARTY COMPANIES AND INDIVIDUALS TO NON-PROFIT COMPANIES; PROVIDING CONSULTING SERVICES TO COMPANIES IN THE FIELD OF EMPLOYEE ENGAGEMENT PROGRAMS AND STRATEGIC COMMUNITY INVESTING; COORDINATING

EFFECTIVE PARTNERSHIPS BETWEEN VOLUNTEERS, NON-PROFITS AND BUSINESSES, IN CLASS 35 (U.S. CLS. 100, 101 AND 102).

FIRST USE 8-0-2006; IN COMMERCE 8-0-2006.

THE MARK CONSISTS OF STANDARD CHARACTERS WITHOUT CLAIM TO ANY PARTICULAR FONT, STYLE, SIZE, OR COLOR.

SER. NO. 77-095,910, FILED 1-31-2007.

BRIAN NEVILLE, EXAMINING ATTORNEY

Int. Cls.: 3 and 16

**Prior U.S. Cls.: 1, 2, 4, 5, 6, 22, 23, 29, 37, 38, 50, 51
and 52**

Reg. No. 3,478,758

United States Patent and Trademark Office

Registered Aug. 5, 2008

**TRADEMARK
PRINCIPAL REGISTER**

FRESH SMOOTHIE BLANC BY IU

IU COSMETICS S.A. DE C.V. (MEXICO CORPORATION)
BLVD. JUAN ALONSO DE TORRES NO. 106
FRACC. SAN JERONIMO
LEON GTO, MEXICO 37204

FOR: SOAPS FOR PERSONAL USE, PERFUME, ESSENTIAL OILS, COSMETICS AND HAIR LOTIONS, IN CLASS 3 (U.S. CLS. 1, 4, 6, 50, 51 AND 52).

FOR: PAPER POSTERS; PRINTED PAPER SIGNS; PRINTED CARDBOARD SIGNS; PRINTED TICKETS; PAMPHLETS IN THE FIELD OF COSMETICS; PRINTED MATTER, NAMELY, CATALOGS IN THE FIELD OF COSMETICS; PLASTIC BAGS FOR PACKING, IN CLASS 16 (U.S. CLS. 2, 5, 22, 23, 29, 37, 38 AND 50).

PRIORITY CLAIMED UNDER SEC. 44(D) ON MEXICO APPLICATION NO. 801014, FILED 8-17-

2006, REG. NO. 992176, DATED 7-12-2007, EXPIRES 8-17-2016.

PRIORITY CLAIMED UNDER SEC. 44(D) ON MEXICO APPLICATION NO. 800973, FILED 8-17-2006, REG. NO. 980456, DATED 4-19-2007, EXPIRES 8-17-2016.

NO CLAIM IS MADE TO THE EXCLUSIVE RIGHT TO USE "BLANC", APART FROM THE MARK AS SHOWN.

THE FOREIGN WORDING "BLANC" IN THE MARK TRANSLATES INTO ENGLISH AS "WHITE".

SER. NO. 77-096,179, FILED 1-31-2007.

ROBERT LAVACHE, EXAMINING ATTORNEY

Int. Cls.: 35 and 39

Prior U.S. Cls.: 100, 101, 102 and 105

United States Patent and Trademark Office

Reg. No. 3,478,759

Registered Aug. 5, 2008

**SERVICE MARK
PRINCIPAL REGISTER**

VANGUARD LOGISTICS SERVICES

NACA LOGISTICS (USA), INC. (CALIFORNIA CORPORATION)
857 EAST 230TH STREET
CARSON, CA 90745

FOR: TRANSPORTATION LOGISTICS SERVICES, NAMELY, PLANNING AND SCHEDULING SHIPMENTS FOR USERS OF TRANSPORTATION SERVICES AND ARRANGING THE TRANSPORTATION OF GOODS FOR OTHERS, IN CLASS 35 (U.S. CLS. 100, 101 AND 102).

FIRST USE 6-0-1999; IN COMMERCE 6-0-1999.

FOR: FREIGHT CONSOLIDATION AND DISTRIBUTION, NAMELY, PICK-UP AND PACKING FOR SHIPMENT OF DOCUMENTS, PACKAGES, RAW MATERIALS, AND OTHER FREIGHT FOR OTHERS BY AIR, RAIL, SHIP OR TRUCK, INCLUDING FREIGHT DECONSOLIDATION SERVICES, NAMELY, UNLOADING OF FREIGHT CONTAINERS,

PARCELING AND TRANSPORT OF FREIGHT TO DESIGNEE, AND FREIGHT ON FORWARDING SERVICES, IN CLASS 39 (U.S. CLS. 100 AND 105).

FIRST USE 6-0-1999; IN COMMERCE 6-0-1999.

THE MARK CONSISTS OF STANDARD CHARACTERS WITHOUT CLAIM TO ANY PARTICULAR FONT, STYLE, SIZE, OR COLOR.

OWNER OF U.S. REG. NO. 2,358,650.

NO CLAIM IS MADE TO THE EXCLUSIVE RIGHT TO USE "LOGISTIC SERVICES", APART FROM THE MARK AS SHOWN.

SER. NO. 77-096,283, FILED 1-31-2007.

BILL DAWE, EXAMINING ATTORNEY

Int. Cl.: 35

Prior U.S. Cls.: 100, 101 and 102

United States Patent and Trademark Office

Reg. No. 3,478,760

Registered Aug. 5, 2008

**SERVICE MARK
PRINCIPAL REGISTER**



**GREATER D.C. CARES, INC. (D.C. CORPORATION)
1725 I STREET, NW, SUITE 200
WASHINGTON, DC 20006**

FOR: VOLUNTEER AND CHARITABLE SERVICES, NAMELY, COORDINATING THE PROVISION OF VOLUNTEERS, PRO BONO CONSULTANTS, BOARD MEMBERS, AND IN-KIND GOODS AND SERVICES DONATED BY THIRD-PARTY COMPANIES AND INDIVIDUALS TO NON-PROFIT COMPANIES; PROVIDING CONSULTING SERVICES TO COMPANIES IN THE FIELD OF EMPLOYEE ENGAGEMENT PROGRAMS AND STRATEGIC COM-

MUNITY INVESTING; COORDINATING EFFECTIVE PARTNERSHIPS BETWEEN VOLUNTEERS, NON-PROFITS AND BUSINESSES, IN CLASS 35 (U.S. CLS. 100, 101 AND 102).

FIRST USE 8-0-2006; IN COMMERCE 8-0-2006.

THE MARK CONSISTS OF A DESIGN OF THREE HUMAN FIGURES.

SER. NO. 77-096,488, FILED 2-1-2007.

BRIAN NEVILLE, EXAMINING ATTORNEY

Int. Cls.: 3 and 16

**Prior U.S. Cls.: 1, 2, 4, 5, 6, 22, 23, 29, 37, 38, 50, 51
and 52**

Reg. No. 3,478,761

United States Patent and Trademark Office

Registered Aug. 5, 2008

**TRADEMARK
PRINCIPAL REGISTER**

THE FIRM FOR HIM BY IU

IU COSMETICS S.A. DE C.V. (MEXICO CORPORATION)
BLVD. JUAN ALONSO DE TORRES NO. 106
FRACC. SAN JERONIMO
LEON GTO, MEXICO 37204

FOR: SOAPS FOR PERSONAL USE, PERFUME, ESSENTIAL OILS, COSMETICS AND HAIR LOTIONS, IN CLASS 3 (U.S. CLS. 1, 4, 6, 50, 51 AND 52).

FOR: PAPER POSTERS; PRINTED PAPER SIGNS; PRINTED CARDBOARD SIGNS; PRINTED TICKETS; PAMPHLETS IN THE FIELD OF COSMETICS; PRINTED MATTER, NAMELY, CATALOGS IN THE FIELD OF COSMETICS; PLASTIC BAGS FOR PACKING, IN CLASS 16 (U.S. CLS. 2, 5, 22, 23, 29, 37, 38 AND 50).

PRIORITY CLAIMED UNDER SEC. 44(D) ON MEXICO APPLICATION NO. 801015, FILED 8-17-2006, REG. NO. 986190, DATED 5-29-2007, EXPIRES 8-17-2016.

PRIORITY CLAIMED UNDER SEC. 44(D) ON MEXICO APPLICATION NO. 801056, FILED 8-17-2006, REG. NO. 992389, DATED 7-13-2007, EXPIRES 8-17-2016.

NO CLAIM IS MADE TO THE EXCLUSIVE RIGHT TO USE "FOR HIM", APART FROM THE MARK AS SHOWN.

SER. NO. 77-096,799, FILED 2-1-2007.

ROBERT LAVACHE, EXAMINING ATTORNEY

Int. Cl.: 41

Prior U.S. Cls.: 100, 101 and 107

United States Patent and Trademark Office

Reg. No. 3,478,762

Registered Aug. 5, 2008

**SERVICE MARK
PRINCIPAL REGISTER**

**UPSTREAM STANDARDS. BOTTOM
LINE RESULTS.**

ENERGISTICS CONSORTIUM, INC. (DELA-
WARE CORPORATION)
SUITE 1315
24 GREENWAY PLAZA
HOUSTON, TX 77046

FOR: EDUCATIONAL SERVICES, NAMELY, AR-
RANGING AND CONDUCTING SEMINARS, LEC-
TURES AND CONTINUING EDUCATION
PROGRAMS REGARDING THE PRODUCTION
AND USE OF STANDARDS VIA DATA EXCHANGE
FORMATS FOR USE IN THE FIELDS OF ENERGY
EXPLORATION, PRODUCTION AND DISTRIBU-
TION; PUBLICATION OF PRINTED MATERIAL
VIA DATA EXCHANGE FORMATS FEATURING
STANDARDS FOR USE IN THE FIELDS OF EN-
ERGY EXPLORATION, PRODUCTION AND DIS-

TRIBUTION, IN CLASS 41 (U.S. CLS. 100, 101 AND
107).

FIRST USE 11-8-2006; IN COMMERCE 11-8-2006.

THE MARK CONSISTS OF STANDARD CHAR-
ACTERS WITHOUT CLAIM TO ANY PARTICULAR
FONT, STYLE, SIZE, OR COLOR.

NO CLAIM IS MADE TO THE EXCLUSIVE
RIGHT TO USE "UPSTREAM STANDARDS",
APART FROM THE MARK AS SHOWN.

SER. NO. 77-096,827, FILED 2-1-2007.

EVELYN BRADLEY, EXAMINING ATTORNEY

Int. Cl.: 42

Prior U.S. Cls.: 100 and 101

United States Patent and Trademark Office

Reg. No. 3,478,763

Registered Aug. 5, 2008

**SERVICE MARK
PRINCIPAL REGISTER**

**UPSTREAM STANDARDS. BOTTOM
LINE RESULTS.**

ENERGISTICS CONSORTIUM, INC. (DELA-
WARE CORPORATION)
SUITE 1315
24 GREENWAY PLAZA
HOUSTON, TX 77046

FOR: ESTABLISHING, DEVELOPING AND DIS-
SEMINATING VOLUNTARY STANDARDS FOR
DATA EXCHANGE FORMATS FOR USE IN THE
OIL AND GAS INDUSTRY IN THE FIELDS OF
ENERGY EXPLORATION, PRODUCTION AND
DISTRIBUTION; PROVIDING ONLINE INFORMA-
TION ABOUT VOLUNTARY STANDARDS USED IN
THE OIL AND GAS INDUSTRY, FOR DATA EX-
CHANGE FORMATS, FOR USE IN THE FIELDS OF
ENERGY EXPLORATION, PRODUCTION AND

DISTRIBUTION, IN CLASS 42 (U.S. CLS. 100 AND
101).

FIRST USE 11-8-2006; IN COMMERCE 11-8-2006.

THE MARK CONSISTS OF STANDARD CHAR-
ACTERS WITHOUT CLAIM TO ANY PARTICULAR
FONT, STYLE, SIZE, OR COLOR.

NO CLAIM IS MADE TO THE EXCLUSIVE
RIGHT TO USE "UPSTREAM STANDARDS" ,
APART FROM THE MARK AS SHOWN.

SER. NO. 77-096,829, FILED 2-1-2007.

EVELYN BRADLEY, EXAMINING ATTORNEY

Int. Cl.: 45

Prior U.S. Cls.: 100 and 101

United States Patent and Trademark Office

Reg. No. 3,478,764

Registered Aug. 5, 2008

**SERVICE MARK
PRINCIPAL REGISTER**

SECURITY AMERICA

SECURITY AMERICA, INC. (WEST VIRGINIA CORPORATION)

5407 MACCORKLE AVENUE, S.E.

CHARLESTON, WV 25364

FOR: DETECTIVE INVESTIGATIONS; PERSONAL BODY GUARDING; PERSONAL SECURITY CONSULTATION; PRE-EMPLOYMENT BACKGROUND SCREENING; PRIVATE INVESTIGATION; SECURITY GUARD SERVICES, IN CLASS 45 (U.S. CLS. 100 AND 101).

FIRST USE 6-2-1982; IN COMMERCE 6-2-1982.

THE MARK CONSISTS OF STANDARD CHARACTERS WITHOUT CLAIM TO ANY PARTICULAR FONT, STYLE, SIZE, OR COLOR.

OWNER OF U.S. REG. NO. 1,572,553.

NO CLAIM IS MADE TO THE EXCLUSIVE RIGHT TO USE "SECURITY", APART FROM THE MARK AS SHOWN.

SEC. 2(F).

SER. NO. 77-097,079, FILED 2-1-2007.

JORDAN BAKER, EXAMINING ATTORNEY

Int. Cl.: 36

Prior U.S. Cls.: 100, 101 and 102

United States Patent and Trademark Office

Reg. No. 3,478,765

Registered Aug. 5, 2008

**SERVICE MARK
PRINCIPAL REGISTER**

**MICHIGAN FIRST WEALTH
MANAGEMENT GROUP**

MICHIGAN FIRST CREDIT UNION (MICHIGAN
CREDIT UNION)

27000 EVERGREEN ROAD

LATHRUP VILLAGE, MI 48076

FOR: FINANCIAL SERVICES, NAMELY, FINANCIAL AND RETIREMENT PLANNING, ESTATE PLANNING, WILLS AND TRUSTS, EDUCATIONAL LOANS, PENSION ROLLOVERS, LIFE AND LONG TERM CARE INSURANCE, IN CLASS 36 (U.S. CLS. 100, 101 AND 102).

FIRST USE 1-8-2007; IN COMMERCE 1-8-2007.

THE MARK CONSISTS OF STANDARD CHARACTERS WITHOUT CLAIM TO ANY PARTICULAR FONT, STYLE, SIZE, OR COLOR.

OWNER OF U.S. REG. NOS. 2,641,303 AND 2,751,058.

NO CLAIM IS MADE TO THE EXCLUSIVE RIGHT TO USE "MICHIGAN" AND "WEALTH MANAGEMENT GROUP", APART FROM THE MARK AS SHOWN.

SER. NO. 77-097,577, FILED 2-2-2007.

JEFF DEFORD, EXAMINING ATTORNEY

Int. Cl.: 16

Prior U.S. Cls.: 2, 5, 22, 23, 29, 37, 38 and 50

United States Patent and Trademark Office

Reg. No. 3,478,766

Registered Aug. 5, 2008

**TRADEMARK
PRINCIPAL REGISTER**

A LA CARTE COLLECTION

BONITA PACKAGING PRODUCTS, INC. (ORE-
GON CORPORATION)
7333 SW BONITA ROAD
PORTLAND, OR 97224

FOR: GIFT WRAP PAPER; PAPER BAGS; PAPER
BOXES, IN CLASS 16 (U.S. CLS. 2, 5, 22, 23, 29, 37, 38
AND 50).

FIRST USE 1-0-1998; IN COMMERCE 1-0-1998.

THE MARK CONSISTS OF STANDARD CHAR-
ACTERS WITHOUT CLAIM TO ANY PARTICULAR
FONT, STYLE, SIZE, OR COLOR.

NO CLAIM IS MADE TO THE EXCLUSIVE
RIGHT TO USE "COLLECTION", APART FROM
THE MARK AS SHOWN.

SER. NO. 77-098,502, FILED 2-2-2007.

CARRIE GENOVESE, EXAMINING ATTORNEY

Int. Cl.: 21

Prior U.S. Cls.: 2, 13, 23, 29, 30, 33, 40 and 50

United States Patent and Trademark Office

Reg. No. 3,478,767

Registered Aug. 5, 2008

**TRADEMARK
PRINCIPAL REGISTER**

KURVE

ACORN ENGINEERING COMPANY (CALIFORNIA CORPORATION)
P.O. BOX 3527
CITY OF INDUSTRY, CA 91744

THE MARK CONSISTS OF STANDARD CHARACTERS WITHOUT CLAIM TO ANY PARTICULAR FONT, STYLE, SIZE, OR COLOR.

FOR: GROUP HAND-WASHING STATIONS COMPRISED OF HAND WASH BASINS, IN CLASS 21 (U.S. CLS. 2, 13, 23, 29, 30, 33, 40 AND 50).

SER. NO. 77-098,889, FILED 2-5-2007.

FIRST USE 0-0-2002; IN COMMERCE 0-0-2002.

DAVID HOFFMAN, EXAMINING ATTORNEY

Int. Cls.: 36 and 41

Prior U.S. Cls.: 100, 101, 102 and 107

United States Patent and Trademark Office

Reg. No. 3,478,768

Registered Aug. 5, 2008

**SERVICE MARK
PRINCIPAL REGISTER**

INVICTA CAPITAL

INVICTA CAPITAL LIMITED (UNITED KING-
DOM CORPORATION)

80 BROOK STREET

LONDON, UNITED KINGDOM W1K5DD

FOR: FINANCIAL SERVICES, NAMELY, TRADING AND INVESTMENT ADVISING, STRUCTURING AND BROKERING FOR OTHERS; INVESTMENT AND TRADING IN THE FIELD OF MOTION PICTURE FINANCING, DISTRIBUTION, PRODUCTION, PRINT AND ADVERTISING; SALE-LEASEBACK TRANSACTIONS; PROJECT FINANCING, IN CLASS 36 (U.S. CLS. 100, 101 AND 102).

FIRST USE 5-30-2001; IN COMMERCE 3-28-2002.

FOR: ENTERTAINMENT SERVICES, NAMELY, MOTION PICTURE PRODUCTION SERVICES, IN CLASS 41 (U.S. CLS. 100, 101 AND 107).

FIRST USE 5-30-2001; IN COMMERCE 3-28-2002.

THE MARK CONSISTS OF STANDARD CHARACTERS WITHOUT CLAIM TO ANY PARTICULAR FONT, STYLE, SIZE, OR COLOR.

NO CLAIM IS MADE TO THE EXCLUSIVE RIGHT TO USE "CAPITAL", APART FROM THE MARK AS SHOWN.

SER. NO. 77-099,007, FILED 2-5-2007.

SUSAN LESLIE DUBOIS, EXAMINING ATTORNEY

Int. Cls.: 16, 35 and 41

Prior U.S. Cls.: 2, 5, 22, 23, 29, 37, 38, 50, 100, 101, 102 and 107

Reg. No. 3,478,769

United States Patent and Trademark Office

Registered Aug. 5, 2008

**TRADEMARK
SERVICE MARK
PRINCIPAL REGISTER**



MOFFLY PUBLICATIONS, INC. (CONNECTICUT CORPORATION)
39 LEWIS STREET
GREENWICH, CT 06830

FOR: SECTION OF A MAGAZINE FEATURING THE RESULTS OF A READER'S SURVEY ON CONSUMER CHOICES FOR DINING, SHOPPING, ENTERTAINMENT, RECREATION, EVENTS, CULTURE, NEWS, PRODUCTS AND SERVICES; SECTION OF NEWSPAPER LISTING INDIVIDUALS AND BUSINESSES THAT HAVE ACHIEVED EXCELLENCE IN AREAS OF INTEREST TO THE GENERAL PUBLIC; SECTION OF NEWSPAPER FEATURING RESTAURANTS, SHOPPING, ENTERTAINMENT, RECREATION, EVENTS, CULTURE, NEWS, PRODUCTS AND SERVICES OF INTEREST, IN CLASS 16 (U.S. CLS. 2, 5, 22, 23, 29, 37, 38 AND 50).

FIRST USE 12-0-2005; IN COMMERCE 12-0-2005.

FOR: PROVIDING INFORMATION OF INTEREST TO SPECIFIC GEOGRAPHICAL AREAS VIA THE GLOBAL COMPUTER NETWORK, NAMELY, ON-LINE BUSINESS AND RESTAURANT DIRECTORIES AND MEDICAL REFERRALS AND RELATED CONSUMER REVIEWS, IN CLASS 35 (U.S. CLS. 100, 101 AND 102).

FIRST USE 12-0-2005; IN COMMERCE 12-0-2005.

FOR: PROVIDING RECOGNITION OF INDIVIDUALS AND BUSINESSES BY WAY OF AWARDS

TO DEMONSTRATE EXCELLENCE OR DISTINCTION IN AREAS OF INTEREST TO THE GENERAL PUBLIC, INCLUDING THE FIELDS OF FOOD AND DINING SERVICES, BAR AND NIGHT CLUB SERVICES, RETAIL SERVICES, SPA AND SALON SERVICES, BUSINESS SERVICES, HEALTH AND MEDICAL SERVICES, CULTURAL AND EDUCATIONAL FACILITIES, MUSIC, THEATER, ART, LITERATURE, BROADCASTING AND JOURNALISM; CONDUCTING AWARDS PROGRAMS HONORING INDIVIDUALS AND BUSINESSES THAT HAVE DEMONSTRATED EXCELLENCE IN THEIR FIELDS, IN THE QUALITY OF THEIR PRODUCTS AND SERVICES AND IN CUSTOMER SERVICE, IN CLASS 41 (U.S. CLS. 100, 101 AND 107).

FIRST USE 12-0-2005; IN COMMERCE 12-0-2005.

NO CLAIM IS MADE TO THE EXCLUSIVE RIGHT TO USE "BEST OF THE GOLD COAST CONNECTICUT", APART FROM THE MARK AS SHOWN.

THE MARK CONSISTS OF THE WORD "BEST" IS DISPLAYED ON A RIBBON AND THE WORDS "OF THE GOLD COAST CONNECTICUT" IS CENTERED UNDERNEATH WITH THE WORDS "GOLD COAST CONNECTICUT" IN A RECTANGULAR BOX.

SER. NO. 77-099,402, FILED 2-5-2007.

WILLIAM P. SHANAHAN, EXAMINING ATTORNEY

Int. Cls.: 1, 4, 17 and 40

**Prior U.S. Cls.: 1, 5, 6, 10, 12, 13, 15, 26, 35, 46, 50,
100, 103 and 106**

Reg. No. 3,478,770

United States Patent and Trademark Office

Registered Aug. 5, 2008

**TRADEMARK
SERVICE MARK
PRINCIPAL REGISTER**

ND

ND INDUSTRIES, INC. (MICHIGAN CORPORATION)
1000 NORTH CROOKS ROAD
CLAWSON, MI 48017

FOR: SYNTHETIC RESINS, INDUSTRIAL ADHESIVES, AND EPOXY GLUES FOR GENERAL BONDING AND FOR USE AS A SELF-LOCKING FASTENER COMPONENT IN THE MANUFACTURE OF FASTENERS; CHEMICAL DEGREASERS; ANTI-CAM OUT FLUIDS, NAMELY, FRICTIONAL CHEMICALS FOR USE ON FASTENERS TO CREATE A POSITIVE GRIP BETWEEN THE FASTENER AND TOOL; CHEMICAL ADDITIVES IN THE NATURE OF ACTIVATORS AND PRIMERS FOR INDUSTRIAL AND COMMERCIAL USE, NAMELY, CHEMICAL ACTIVATORS FOR ACTIVATING ADHESIVES AND CHEMICAL PRIMERS IN THE NATURE OF A CURING AGENT FOR ACCELERATING CURE TIME OF ADHESIVES, IN CLASS 1 (U.S. CLS. 1, 5, 6, 10, 26 AND 46).

FIRST USE 0-0-1975; IN COMMERCE 0-0-1975.

FOR: WAXES FOR USE IN THE ASSEMBLY OF FASTENERS AND SOLID FILM LUBRICANTS FOR FASTENERS, IN CLASS 4 (U.S. CLS. 1, 6 AND 15).

FIRST USE 0-0-1992; IN COMMERCE 0-0-1992.

FOR: SEALS, GASKETS, AND VIBRATION RESISTERS IN THE NATURE OF SEALS AND GASKETS, ALL MADE OF PLASTISOLS, MASTICS, POLYAMIDES, POLYMERS AND HEAT EXPANDABLE RUBBERS AND ALL FOR USE WITH FASTENERS, IN CLASS 17 (U.S. CLS. 1, 5, 12, 13, 35 AND 50).

FIRST USE 0-0-1975; IN COMMERCE 0-0-1975.

FOR: APPLYING SELF-LOCKING, SEALING, ADHESIVE, MASKING, RETENTIVE, ANTI-SEIZE, PROTECTIVE, IDENTIFYING AND LUBRICATING COATINGS TO METAL FASTENERS AND OTHER DISCRETE METAL OBJECTS TO THE ORDER AND SPECIFICATION OF OTHERS, IN CLASS 40 (U.S. CLS. 100, 103 AND 106).

FIRST USE 0-0-1970; IN COMMERCE 0-0-1970.

THE MARK CONSISTS OF STANDARD CHARACTERS WITHOUT CLAIM TO ANY PARTICULAR FONT, STYLE, SIZE, OR COLOR.

OWNER OF U.S. REG. NOS. 1,999,175, 2,962,978 AND OTHERS.

SER. NO. 77-100,392, FILED 2-6-2007.

PAUL CROWLEY, EXAMINING ATTORNEY

Int. Cls.: 4 and 35

Prior U.S. Cls.: 1, 6, 15, 100, 101 and 102

United States Patent and Trademark Office

Reg. No. 3,478,771

Registered Aug. 5, 2008

**TRADEMARK
SERVICE MARK
PRINCIPAL REGISTER**

WHOLEENERGY

WHOLE ENERGY FUELS CORPORATION (WASHINGTON CORPORATION)
664 EAST LAUREL ROAD
BELLINGHAM, WA 98226

FOR: BIODIESEL FUEL, IN CLASS 4 (U.S. CLS. 1, 6 AND 15).

FIRST USE 1-31-2005; IN COMMERCE 10-1-2005.

FOR: WHOLESALE AND RETAIL STORE SERVICES FEATURING BIODIESEL FUEL; WHOLESALE AND RETAIL DISTRIBUTORSHIP IN THE FIELD

OF BIODIESEL FUEL, IN CLASS 35 (U.S. CLS. 100, 101 AND 102).

FIRST USE 3-2-2005; IN COMMERCE 3-2-2005.

THE MARK CONSISTS OF STANDARD CHARACTERS WITHOUT CLAIM TO ANY PARTICULAR FONT, STYLE, SIZE, OR COLOR.

SER. NO. 77-100,798, FILED 2-6-2007.

TANYA AMOS, EXAMINING ATTORNEY

Int. Cl.: 16

Prior U.S. Cls.: 2, 5, 22, 23, 29, 37, 38 and 50

United States Patent and Trademark Office

Reg. No. 3,478,772

Registered Aug. 5, 2008

**TRADEMARK
PRINCIPAL REGISTER**

**ARTHUR FROMMER'S BUDGET
TRAVEL**

NEWSWEEK BUDGET TRAVEL, INC. (DELA-
WARE CORPORATION)
530 SEVENTH AVENUE, 2ND FLOOR
NEW YORK, NY 10018

FOR: PUBLICATIONS, NAMELY, A MAGAZINE
FEATURING TOPICS AND INFORMATION RE-
LATING TO TRAVEL, IN CLASS 16 (U.S. CLS. 2, 5,
22, 23, 29, 37, 38 AND 50).

FIRST USE 2-0-1998; IN COMMERCE 2-0-1998.

THE MARK CONSISTS OF STANDARD CHAR-
ACTERS WITHOUT CLAIM TO ANY PARTICULAR
FONT, STYLE, SIZE, OR COLOR.

OWNER OF U.S. REG. NOS. 2,322,120, 2,818,783
AND OTHERS.

NO CLAIM IS MADE TO THE EXCLUSIVE
RIGHT TO USE "BUDGET TRAVEL", APART FROM
THE MARK AS SHOWN.

THE NAME SHOWN IN THE MARK IDENTIFIES
ARTHUR FROMMER, A LIVING INDIVIDUAL
WHOSE CONSENT TO REGISTER HIS NAME AS A
TRADEMARK IS OF RECORD.

SER. NO. 77-101,167, FILED 2-7-2007.

EDWARD NELSON, EXAMINING ATTORNEY

Int. Cl.: 35

Prior U.S. Cls.: 100, 101 and 102

United States Patent and Trademark Office

Reg. No. 3,478,773

Registered Aug. 5, 2008

**SERVICE MARK
PRINCIPAL REGISTER**

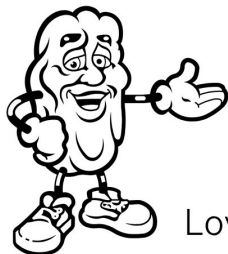

LoveYourRaisins.com

CALIFORNIA RAISIN MARKETING BOARD, AN INSTRUMENTALITY OF THE STATE OF CALIFORNIA, DEPARTMENT OF FOOD AND AGRICULTURE (CALIFORNIA STATE AGENCY)

ROOM A-247
1220 N STREET
SACRAMENTO, CA 942710001

FOR: ASSOCIATION SERVICES, NAMELY, PROMOTING THE INTERESTS OF RAISIN GROWERS, PACKERS, PROCESSORS AND PRODUCERS THROUGH COMMERCIAL ADVERTISEMENTS IN THE FORM OF TELEVISION, PRINT AND ELECTRONIC MEDIA, IN CLASS 35 (U.S. CLS. 100, 101 AND 102).

FIRST USE 10-1-2006; IN COMMERCE 10-1-2006.

OWNER OF U.S. REG. NOS. 1,553,326, 2,784,660 AND OTHERS.

THE MARK CONSISTS OF A RAISIN CHARACTER WITH LEFT HAND OUTSTRETCHED AND THE WORDS "LOVEYOURRAISINS.COM".

SER. NO. 77-103,446, FILED 2-9-2007.

MICHAEL WIENER, EXAMINING ATTORNEY

Int. Cl.: 41

Prior U.S. Cls.: 100, 101 and 107

United States Patent and Trademark Office

Reg. No. 3,478,774

Registered Aug. 5, 2008

**SERVICE MARK
PRINCIPAL REGISTER**

At The End of Your Leash!

JENNIFER M. FREILICH (CALIFORNIA SOLE
PROPRIETORSHIP)
271 COTTONWOOD AVE.
RIVERSIDE, CA 92506

THE MARK CONSISTS OF STANDARD CHAR-
ACTERS WITHOUT CLAIM TO ANY PARTICULAR
FONT, STYLE, SIZE, OR COLOR.

FOR: DOG TRAINING, IN CLASS 41 (U.S. CLS.
100, 101 AND 107).

SER. NO. 77-104,500, FILED 2-10-2007.

FIRST USE 1-15-2003; IN COMMERCE 1-15-2003.

KRISTIN DAHLING, EXAMINING ATTORNEY

Int. Cls.: 26, 28, 31 and 44

**Prior U.S. Cls.: 1, 22, 23, 37, 38, 39, 40, 42, 46, 50, 100
and 101**

Reg. No. 3,478,775

United States Patent and Trademark Office

Registered Aug. 5, 2008

**TRADEMARK
SERVICE MARK
PRINCIPAL REGISTER**



RENTOKIL INITIAL 1927 PLC (UNITED KING-
DOM PUBLIC LIMITED COMPANY (PLC))
BELGRAVE HOUSE, 76 BUCKINGHAM PALACE
RD
LONDON SW1W 9RF, UNITED KINGDOM

FOR: ARTIFICIAL PLANTS, FLOWERS AND
FLORAL DISPLAYS; ARTIFICIAL TREES EXCLUD-
ING ARTIFICIAL CHRISTMAS TREES, IN CLASS 26
(U.S. CLS. 37, 39, 40, 42 AND 50).

FOR: ARTIFICIAL CHRISTMAS TREES, IN
CLASS 28 (U.S. CLS. 22, 23, 38 AND 50).

FOR: LIVE PLANTS, TREES, FLOWERS AND
FLORAL DISPLAYS, IN CLASS 31 (U.S. CLS. 1
AND 46).

FOR: INSTALLATION, REPLACEMENT, MAIN-
TENANCE AND RENTAL OF PLANTS, TREES,
FLOWERS AND FLORAL DISPLAYS; INSTALLA-
TION, REPLACEMENT, MAINTENANCE AND
RENTAL OF ARTIFICIAL PLANTS, ARTIFICIAL
TREES, ARTIFICIAL FLOWERS AND ARTIFICIAL

FLORAL DISPLAYS; HORTICULTURAL SERVI-
CES; GARDENING; LANDSCAPE GARDENING;
LANDSCAPE GARDENING OF FLORAL DIS-
PLAYS; LANDSCAPE GARDENING OF FLORAL
DISPLAYS FOR THE INTERIOR OF BUILDINGS, IN
CLASS 44 (U.S. CLS. 100 AND 101).

PRIORITY CLAIMED UNDER SEC. 44(D) ON
ERPN CMNTY TM OFC APPLICATION NO.
5661335, FILED 2-7-2007, REG. NO. 005661335, DATED
11-19-2007, EXPIRES 2-2-2017.

THE COLOR(S) GREEN IS/ARE CLAIMED AS A
FEATURE OF THE MARK.

THE COLOR GREEN APPEARS IN THE DESIGN
OF THE FIVE LEAVES.

SER. NO. 77-104,727, FILED 2-12-2007.

FRED CARL, EXAMINING ATTORNEY

Int. Cls.: 16 and 43

Prior U.S. Cls.: 2, 5, 22, 23, 29, 37, 38, 50, 100 and 101

United States Patent and Trademark Office

Reg. No. 3,478,776

Registered Aug. 5, 2008

**TRADEMARK
SERVICE MARK
PRINCIPAL REGISTER**

Celebrate
COOKing

BROOKSHIRE GROCERY COMPANY (TEXAS CORPORATION)
1600 W.S.W. LOOP 323
TYLER, TX 75701

FOR: PRINTED PROMOTIONAL NEWSLETTER FEATURING RECIPES AND COOKING INFORMATION FOR STORE CUSTOMERS, IN CLASS 16 (U.S. CLS. 2, 5, 22, 23, 29, 37, 38 AND 50).

FIRST USE 5-1-2007; IN COMMERCE 5-1-2007.

FOR: PROVIDING RECIPES AND COOKING INFORMATION TO STORE CUSTOMERS VIA AN

ONLINE DATABASE, IN CLASS 43 (U.S. CLS. 100 AND 101).

FIRST USE 5-1-2007; IN COMMERCE 5-1-2007.

NO CLAIM IS MADE TO THE EXCLUSIVE RIGHT TO USE "COOKING", APART FROM THE MARK AS SHOWN.

SER. NO. 77-104,865, FILED 2-12-2007.

JUSTINE D. PARKER, EXAMINING ATTORNEY

Int. Cls.: 10, 40 and 42

Prior U.S. Cls.: 26, 39, 44, 100, 101, 103 and 106

United States Patent and Trademark Office

Reg. No. 3,478,777

Registered Aug. 5, 2008

**TRADEMARK
SERVICE MARK
PRINCIPAL REGISTER**

EXTRUMED

EXTRUMED, LLC (CALIFORNIA LTD LIAB CO)
1941 PETRA LANE
PLACENTIA, CA 92870

FOR: PRECISION MEDICAL TUBING FOR USE
IN THE MEDICAL DEVICE INDUSTRY, IN CLASS
10 (U.S. CLS. 26, 39 AND 44).

FIRST USE 12-7-1990; IN COMMERCE 12-7-1990.

FOR: CUSTOM MANUFACTURE OF PRECISION
TUBING FOR USE IN THE MEDICAL DEVICE
INDUSTRY, IN CLASS 40 (U.S. CLS. 100, 103 AND
106).

FIRST USE 12-7-1990; IN COMMERCE 12-7-1990.

FOR: DESIGN OF PRECISION TUBING FOR USE
IN THE MEDICAL DEVICE INDUSTRY, IN CLASS
42 (U.S. CLS. 100 AND 101).

FIRST USE 12-7-1990; IN COMMERCE 12-7-1990.

THE MARK CONSISTS OF STANDARD CHAR-
ACTERS WITHOUT CLAIM TO ANY PARTICULAR
FONT, STYLE, SIZE, OR COLOR.

SER. NO. 77-105,541, FILED 2-12-2007.

BRIAN PINO, EXAMINING ATTORNEY

Int. Cls.: 35, 41 and 44

Prior U.S. Cls.: 100, 101, 102 and 107

United States Patent and Trademark Office

Reg. No. 3,478,778

Registered Aug. 5, 2008

**SERVICE MARK
PRINCIPAL REGISTER**

CCSTAT

BERKLEY ACCIDENT AND HEALTH, LLC (DE-
LAWARE LTD LIAB CO)
2445 KUSER ROAD
HAMILTON SQUARE, NJ 08690

FOR: HEALTH CARE UTILIZATION MANAGE-
MENT, HEALTHCARE COST CONTAINMENT;
MEDICAL PRACTICE MANAGEMENT, MEDICAL
CASE MANAGEMENT, IN CLASS 35 (U.S. CLS. 100,
101 AND 102).

FIRST USE 9-1-2006; IN COMMERCE 9-1-2006.

FOR: PERSONAL COACHING IN THE FIELD OF
ACHIEVING GOOD HEALTH AND WELLNESS, IN
CLASS 41 (U.S. CLS. 100, 101 AND 107).

FIRST USE 9-1-2006; IN COMMERCE 9-1-2006.

FOR: HEALTHCARE SERVICES IN THE NAT-
URE OF DISEASE MANAGEMENT; CONSULTING
SERVICES IN THE FIELDS OF DISEASE MANAGE-
MENT, IN CLASS 44 (U.S. CLS. 100 AND 101).

FIRST USE 9-1-2006; IN COMMERCE 9-1-2006.

THE MARK CONSISTS OF STANDARD CHAR-
ACTERS WITHOUT CLAIM TO ANY PARTICULAR
FONT, STYLE, SIZE, OR COLOR.

SER. NO. 77-105,942, FILED 2-13-2007.

FLORENTINA BLANDU, EXAMINING ATTORNEY

Int. Cl.: 35

Prior U.S. Cls.: 100, 101 and 102

United States Patent and Trademark Office

Reg. No. 3,478,779

Registered Aug. 5, 2008

**SERVICE MARK
PRINCIPAL REGISTER**



Center for Applied Research and Technology, Inc.

CENTER FOR APPLIED RESEARCH & TECHNOLOGY, INC. (WEST VIRGINIA CORPORATION)

P.O. BOX 2182
BLUEFIELD, WV 24701

FOR: BUSINESS CONSULTATION, IN CLASS 35
(U.S. CLS. 100, 101 AND 102).

FIRST USE 6-30-2005; IN COMMERCE 6-30-2005.

NO CLAIM IS MADE TO THE EXCLUSIVE RIGHT TO USE "CENTER FOR APPLIED RESEARCH AND TECHNOLOGY, INC.", APART FROM THE MARK AS SHOWN.

THE MARK CONSISTS OF THE WORD "CART" DISPOSED OVER THE REMAINING WORDS, WHEREIN THE TERM "CART" IS STYLIZED WITH THE "C" HAVING A STYLIZED STAR IN THE INNER "C", THE "A" LACKS A CROSS BAR AND THE "T" HAS A WHITE LINE DOWN THE CENTER.

SER. NO. 77-106,839, FILED 2-13-2007.

KATHERINE E. HALMEN, EXAMINING ATTORNEY

Int. Cl.: 42

Prior U.S. Cls.: 100 and 101

United States Patent and Trademark Office

Reg. No. 3,478,780

Registered Aug. 5, 2008

**SERVICE MARK
PRINCIPAL REGISTER**

IDEASTORM

DELL INC. (DELAWARE CORPORATION)
ONE DELL WAY
ROUND ROCK, TX 78682

FOR: COMPUTER SERVICES, NAMELY, PROVIDING AN ONLINE COMMUNITY FOR REGISTERED USERS WHERE THEY MAY POST COMMENTARY, VOTE AND RANK COMMENTARY, FACILITATE DISCUSSION AND COMMENTARY, ALL CONCERNING COMPUTER HARDWARE, SOFTWARE, ELECTRONICS AND

TECHNICAL SUPPORT SERVICES THEREFOR, IN CLASS 42 (U.S. CLS. 100 AND 101).

FIRST USE 2-16-2007; IN COMMERCE 2-16-2007.

THE MARK CONSISTS OF STANDARD CHARACTERS WITHOUT CLAIM TO ANY PARTICULAR FONT, STYLE, SIZE, OR COLOR.

SER. NO. 77-107,743, FILED 2-14-2007.

JESSICA FATHY, EXAMINING ATTORNEY

Int. Cl.: 35

Prior U.S. Cls.: 100, 101 and 102

United States Patent and Trademark Office

Reg. No. 3,478,781

Registered Aug. 5, 2008

**SERVICE MARK
PRINCIPAL REGISTER**

TOP BRANDS FOR THE
PROFESSIONAL CHEF IN EACH
OF US.

OLIVE BRANDS, LLC (GEORGIA LTD LIAB CO)
4041-A KINGSTON BUSINESS COURT
MARIETTA, GA 30067

THE MARK CONSISTS OF STANDARD CHAR-
ACTERS WITHOUT CLAIM TO ANY PARTICULAR
FONT, STYLE, SIZE, OR COLOR.

FOR: ON-LINE RETAIL STORE SERVICES FEA-
TURING KITCHEN TOOLS AND EQUIPMENT, IN
CLASS 35 (U.S. CLS. 100, 101 AND 102).

SER. NO. 77-108,035, FILED 2-15-2007.

FIRST USE 10-1-2006; IN COMMERCE 10-1-2006.

KATHRYN COWARD, EXAMINING ATTORNEY

Int. Cl.: 35

Prior U.S. Cls.: 100, 101 and 102

United States Patent and Trademark Office

Reg. No. 3,478,782

Registered Aug. 5, 2008

**SERVICE MARK
PRINCIPAL REGISTER**

Clinically Elite

NUCARA MANAGEMENT GROUP (IOWA COR-
PORATION)
126 N. MAIN
CONRAD, IA 50621

THE MARK CONSISTS OF STANDARD CHAR-
ACTERS WITHOUT CLAIM TO ANY PARTICULAR
FONT, STYLE, SIZE, OR COLOR.

FOR: RETAIL PHARMACY SERVICES, IN CLASS
35 (U.S. CLS. 100, 101 AND 102).

SER. NO. 77-108,044, FILED 2-15-2007.

FIRST USE 2-15-2007; IN COMMERCE 2-15-2007.

HOWARD SMIGA, EXAMINING ATTORNEY

Int. Cl.: 30

Prior U.S. Cl.: 46

United States Patent and Trademark Office

Reg. No. 3,478,783

Registered Aug. 5, 2008

**TRADEMARK
PRINCIPAL REGISTER**



BLUE STAR COFFEE ROASTERS (WASHING-
TON LTD LIAB CO)
#3 TWISP AIRPORT ROAD
TWISP, WA 98856

FOR: COFFEE, IN CLASS 30 (U.S. CL. 46).

FIRST USE 11-1-2006; IN COMMERCE 11-1-2006.

NO CLAIM IS MADE TO THE EXCLUSIVE
RIGHT TO USE "COFFEE ROASTERS", APART
FROM THE MARK AS SHOWN.

THE MARK CONSISTS OF CAPITALIZED LET-
TERS SPELLING OUT "BLUE STAR COFFEE
ROASTERS", WITH A STYLIZED 12 POINT STAR
IN BETWEEN THE WORDS "BLUE" AND "STAR",
SET IN A RECTANGULAR BACKGROUND.

SER. NO. 77-108,760, FILED 2-15-2007.

BENJAMIN ALLEN, EXAMINING ATTORNEY

Int. Cls.: 30 and 43

Prior U.S. Cls.: 46, 100 and 101

United States Patent and Trademark Office

Reg. No. 3,478,784

Registered Aug. 5, 2008

**TRADEMARK
SERVICE MARK
PRINCIPAL REGISTER**

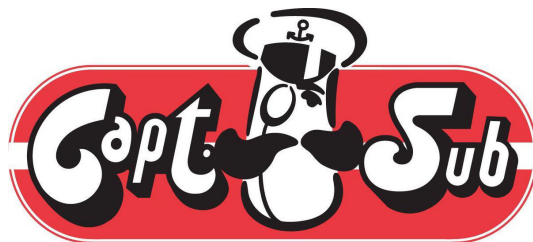

CAPT. SUB CANADA LTD. (CANADA CORPORATION)

P.O. BOX 1040

105 WALKER STREET

TRURO, NOVA SCOTIA, CANADA B2N5G9

FOR: SUBMARINE SANDWICHES, OVEN BAKED SUBMARINE SANDWICHES, WRAPS (TORTILLA WRAPPED SANDWICHES), PITA SANDWICHES, PIZZA, DONAIR SANDWICHES; SUBMARINE SANDWICH ROLLS, PITA BREAD, AND TORTILLAS; FLATBREAD SANDWICHES, AND COOKIES, IN CLASS 30 (U.S. CL. 46).

FOR: RESTAURANT SERVICES; TAKE-OUT FOOD SERVICES, IN CLASS 43 (U.S. CLS. 100 AND 101).

OWNER OF CANADA REG. NO. TMA596417, DATED 12-3-2003, EXPIRES 12-3-2018.

NO CLAIM IS MADE TO THE EXCLUSIVE RIGHT TO USE "SUB", APART FROM THE MARK AS SHOWN.

THE COLOR(S) BLACK, WHITE, AND RED IS/ ARE CLAIMED AS A FEATURE OF THE MARK.

THE MARK CONSISTS OF A RED ELLIPSES WITH THE WHITE LETTERS FOR THE WORDS CAPT. SUB INSIDE ARE OUTLINED IN BLACK, A REPRESENTATION OF A WHITE HUMAN HEAD OUTLINED IN BLACK BETWEEN THE WORDS CAPT. AND SUB. THE HUMAN HEAD IS DONNING A WHITE CAP OUTLINED IN BLACK WITH A BLACK BRIM. THE HUMAN HEAD HAS A MONOCLE ON THE RIGHT EYE AND A BLACK MUSTACHE.

SER. NO. 77-109,757, FILED 2-16-2007.

GINA HAYES, EXAMINING ATTORNEY

Int. Cl.: 35

Prior U.S. Cls.: 100, 101 and 102

United States Patent and Trademark Office

Reg. No. 3,478,785

Registered Aug. 5, 2008

**SERVICE MARK
PRINCIPAL REGISTER**

BOVA

BOVA DIAMONDS, INC. (TEXAS CORPORATION)
12817 PRESTON ROAD, SUITE 104
DALLAS, TX 75230

FOR: RETAIL JEWELRY STORE SERVICES, IN
CLASS 35 (U.S. CLS. 100, 101 AND 102).

FIRST USE 11-19-2001; IN COMMERCE 11-19-2001.

THE MARK CONSISTS OF STANDARD CHARACTERS WITHOUT CLAIM TO ANY PARTICULAR FONT, STYLE, SIZE, OR COLOR.

SEC. 2(F).

SER. NO. 77-110,858, FILED 2-19-2007.

TRICIA SONNEBORN, EXAMINING ATTORNEY

Int. Cl.: 41

Prior U.S. Cls.: 100, 101 and 107

United States Patent and Trademark Office

Reg. No. 3,478,786

Registered Aug. 5, 2008

**SERVICE MARK
PRINCIPAL REGISTER**



CHIPPENDALES USA, LLC (DELAWARE LTD
LIAB CO)
95 EAST BETHAPGE ROAD
PLAINVIEW, NY 11803

FOR: ENTERTAINMENT FOR WOMEN, NAME-
LY, NIGHTCLUB ENTERTAINMENT SERVICES, IN
CLASS 41 (U.S. CLS. 100, 101 AND 107).

FIRST USE 1-1-1988; IN COMMERCE 1-1-1988.

OWNER OF U.S. REG. NOS. 1,197,438, 1,211,893
AND OTHERS.

THE MARK CONSISTS OF "CHIPPENDALES" IN
SCRIPT UNDERLINED.

SER. NO. 77-111,444, FILED 2-20-2007.

BRENDAN REGAN, EXAMINING ATTORNEY

Int. Cl.: 35

Prior U.S. Cls.: 100, 101 and 102

United States Patent and Trademark Office

Reg. No. 3,478,787

Registered Aug. 5, 2008

**SERVICE MARK
PRINCIPAL REGISTER**

One Call Transfer Center

AIR METHODS CORPORATION (DELAWARE CORPORATION)
7301 SOUTH PEORIA STREET
ENGLEWOOD, CO 80155

FOR: OUTSOURCING SERVICES PROVIDED TO HEALTH CARE PROVIDERS AND HOSPITALS THAT MAKE PATIENT REFERRALS, COORDINATE PATIENT TRANSFERS, AND SHARE MEDICAL EXPERTISE, NAMELY, ESTABLISHING, OPERATING AND MANAGING TELEPHONE CALL CENTERS FOR OTHERS, IN CLASS 35 (U.S. CLS. 100, 101 AND 102).

FIRST USE 1-15-2002; IN COMMERCE 1-15-2002.

THE MARK CONSISTS OF STANDARD CHARACTERS WITHOUT CLAIM TO ANY PARTICULAR FONT, STYLE, SIZE, OR COLOR.

NO CLAIM IS MADE TO THE EXCLUSIVE RIGHT TO USE "CALL TRANSFER CENTER", APART FROM THE MARK AS SHOWN.

SER. NO. 77-111,762, FILED 2-20-2007.

SEAN CROWLEY, EXAMINING ATTORNEY

Int. Cls.: 21, 25 and 28

Prior U.S. Cls.: 2, 13, 22, 23, 29, 30, 33, 38, 39, 40 and 50

Reg. No. 3,478,788

United States Patent and Trademark Office

Registered Aug. 5, 2008

TRADEMARK
PRINCIPAL REGISTER



BOBBLE BABES, LLC (WISCONSIN LTD LIAB CO)
14777 COUNTY ROAD 30
ELK RIVER, MN 55330

THE COLOR(S) RED, PEACH, GRAY, GOLD, WHITE AND BLUE IS/ARE CLAIMED AS A FEATURE OF THE MARK.

FOR: FOAM DRINK HOLDERS, IN CLASS 21 (U.S. CLS. 2, 13, 23, 29, 30, 33, 40 AND 50).

FIRST USE 2-12-2007; IN COMMERCE 2-12-2007.

FOR: HATS, IN CLASS 25 (U.S. CLS. 22 AND 39).

FIRST USE 2-12-2007; IN COMMERCE 2-12-2007.

FOR: DOLLS AND GOLF CLUB HEAD COVERS, IN CLASS 28 (U.S. CLS. 22, 23, 38 AND 50).

FIRST USE 2-12-2007; IN COMMERCE 2-12-2007.

NO CLAIM IS MADE TO THE EXCLUSIVE RIGHT TO USE "THE ORIGINAL BOBBLE", APART FROM THE MARK AS SHOWN.

THE MARK CONSISTS OF A STYLIZED FORM OF "THE ORIGINAL BOBBLE BABES", THE WORDS "THE ORIGINAL" ARE IN GRAY AND THE WORDING "BOBBLE BABES" ARE RED WITH GRAY SHADOWING, THE HAIR OF THE FEMALE IS GOLD, HER EYES ARE BLUE, HER LIPS ARE RED, HER SKIN IS PEACH, AND HER CLOTHES ARE WHITE WITH THE WAIST OF HER PANTS CONTAINING A RED BORDER.

SER. NO. 77-111,824, FILED 2-20-2007.

LINDA MICKLEBURGH, EXAMINING ATTORNEY

Prior U.S. Cl.: 200

United States Patent and Trademark Office

Reg. No. 3,478,789

Registered Aug. 5, 2008

COLLECTIVE MEMBERSHIP
PRINCIPAL REGISTER

KNIGHT RIDERS

KNIGHTRIDERS MOTORCYCLE CLUB (ILLI-
NOIS NON-PROFIT CORPORATION)
SUITE 1100
200 S. MICHIGAN AVE.
CHICAGO, IL 60604

THE MARK CONSISTS OF STANDARD CHAR-
ACTERS WITHOUT CLAIM TO ANY PARTICULAR
FONT, STYLE, SIZE, OR COLOR.

FOR: INDICATING MEMBERSHIP IN A MOTOR-
CYCLE CLUB, IN CLASS 200 (U.S. CL. 200).

SER. NO. 77-112,011, FILED 2-20-2007.

FIRST USE 5-21-2006; IN COMMERCE 6-4-2006.

MICHAEL WIENER, EXAMINING ATTORNEY

Int. Cl.: 30

Prior U.S. Cl.: 46

United States Patent and Trademark Office

Reg. No. 3,478,790

Registered Aug. 5, 2008

**TRADEMARK
PRINCIPAL REGISTER**

SCHWARTZ BROTHERS BAKERY

GRETCHEN'S OF SCHWARTZ (WASHINGTON
PARTNERSHIP)
325 118TH AVENUE S.E., SUITE 106
BELLEVUE, WA 98005

FOR: BAKERY GOODS; BAKERY PRODUCTS, IN
CLASS 30 (U.S. CL. 46).

FIRST USE 5-15-1989; IN COMMERCE 5-15-1989.

THE MARK CONSISTS OF STANDARD CHAR-
ACTERS WITHOUT CLAIM TO ANY PARTICULAR
FONT, STYLE, SIZE, OR COLOR.

NO CLAIM IS MADE TO THE EXCLUSIVE
RIGHT TO USE "BAKERY", APART FROM THE
MARK AS SHOWN.

SEC. 2(F).

SER. NO. 77-113,509, FILED 2-22-2007.

CAROLYN CATALDO, EXAMINING ATTORNEY

Int. Cl.: 42

Prior U.S. Cls.: 100 and 101

United States Patent and Trademark Office

Reg. No. 3,478,791

Registered Aug. 5, 2008

**SERVICE MARK
PRINCIPAL REGISTER**

TechNET

CFC TECHNOLOGY CORPORATION (MINNESOTA CORPORATION)
2600 FERNBROOK LANE, #138
PLYMOUTH, MN 55430

FOR: TECHNICAL SUPPORT SERVICES, NAME-
LY, TROUBLESHOOTING OF COMPUTER HARD-
WARE AND SOFTWARE PROBLEMS, IN CLASS 42
(U.S. CLS. 100 AND 101).

FIRST USE 12-23-2002; IN COMMERCE 12-23-2002.

THE MARK CONSISTS OF STANDARD CHAR-
ACTERS WITHOUT CLAIM TO ANY PARTICULAR
FONT, STYLE, SIZE, OR COLOR.

SER. NO. 77-113,650, FILED 2-22-2007.

TINA L. SNAPP, EXAMINING ATTORNEY

Int. Cl.: 35

Prior U.S. Cls.: 100, 101 and 102

United States Patent and Trademark Office

Reg. No. 3,478,792

Registered Aug. 5, 2008

**SERVICE MARK
PRINCIPAL REGISTER**

DISCZILLA

DISCZILLA, LLC (COLORADO LTD LIAB CO)
6050 WAGON WHEEL DRIVE
PEYTON, CO 80831

FOR: RETAIL SPORTING GOODS STORES; RETAIL APPAREL STORES; ON-LINE RETAIL STORE SERVICES FEATURING SPORTING GOODS AND APPAREL, ACCESSORIES FOR DISC GOLF, IN CLASS 35 (U.S. CLS. 100, 101 AND 102).

FIRST USE 2-1-1990; IN COMMERCE 2-1-1999.

THE MARK CONSISTS OF STANDARD CHARACTERS WITHOUT CLAIM TO ANY PARTICULAR FONT, STYLE, SIZE, OR COLOR.

SER. NO. 77-114,497, FILED 2-23-2007.

RENEE SERVANCE, EXAMINING ATTORNEY

Int. Cl.: 9

Prior U.S. Cls.: 21, 23, 26, 36 and 38

United States Patent and Trademark Office

Reg. No. 3,478,793

Registered Aug. 5, 2008

TRADEMARK
PRINCIPAL REGISTER

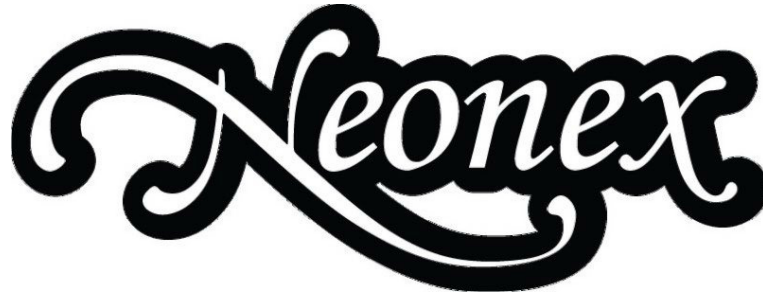

ARTER NEON SIGN, INC. (CALIFORNIA CORPORATION)
2028 MOUNTAIN VIEW ROAD
S. EL MONTE, CA 91733

FOR: ELECTRIC RELAYS; ELECTRIC TRANSFORMERS; LIGHT EMITTING DIODE DISPLAYS; NEON SIGNS; POWER SUPPLY CONNECTORS AND ADAPTORS FOR USE WITH PORTABLE ELECTRONIC DEVICES, IN CLASS 9 (U.S. CLS. 21, 23, 26, 36 AND 38).

FIRST USE 1-22-2007; IN COMMERCE 1-22-2007.

THE MARK CONSISTS OF THE WORD "NEONEX".

SER. NO. 77-115,182, FILED 2-23-2007.

RAMONA ORTIGA, EXAMINING ATTORNEY

Int. Cl.: 25

Prior U.S. Cls.: 22 and 39

United States Patent and Trademark Office

Reg. No. 3,478,794

Registered Aug. 5, 2008

**TRADEMARK
PRINCIPAL REGISTER**



THE BUHL COMPANY INC. (CALIFORNIA CORPORATION)
PO BOX 223
CORTE MADERA, CA 94976

THE MARK CONSISTS OF TWO BULL HORNS BRACKETING THE WORD "BUHL".

FOR: JACKETS; PANTS; SHIRTS, IN CLASS 25 (U.S. CLS. 22 AND 39).

SER. NO. 77-115,264, FILED 2-23-2007.

FIRST USE 1-8-2007; IN COMMERCE 1-8-2007.

ERNEST SHOSHO, EXAMINING ATTORNEY

Int. Cl.: 35

Prior U.S. Cls.: 100, 101 and 102

United States Patent and Trademark Office

Reg. No. 3,478,795

Registered Aug. 5, 2008

**SERVICE MARK
PRINCIPAL REGISTER**

Shoprizer

ST TELECOM INC. (FLORIDA CORPORATION)
18455 MIRAMAR PARKWAY #168
MIRAMAR, FL 33029

FOR: COMMERCIAL INFORMATION AND ADVICE FOR CONSUMERS; ELECTRONIC COMMERCE SERVICES, NAMELY, PROVIDING INFORMATION ABOUT PRODUCTS VIA TELECOMMUNICATION NETWORKS FOR ADVERTISING AND SALES PURPOSES, IN CLASS 35 (U.S. CLS. 100, 101 AND 102).

FIRST USE 12-1-2006; IN COMMERCE 2-1-2007.

THE MARK CONSISTS OF STANDARD CHARACTERS WITHOUT CLAIM TO ANY PARTICULAR FONT, STYLE, SIZE, OR COLOR.

SER. NO. 77-115,671, FILED 2-25-2007.

BARBARA GAYNOR, EXAMINING ATTORNEY

Int. Cl.: 3

Prior U.S. Cls.: 1, 4, 6, 50, 51 and 52

United States Patent and Trademark Office

Reg. No. 3,478,796

Registered Aug. 5, 2008

**TRADEMARK
PRINCIPAL REGISTER**

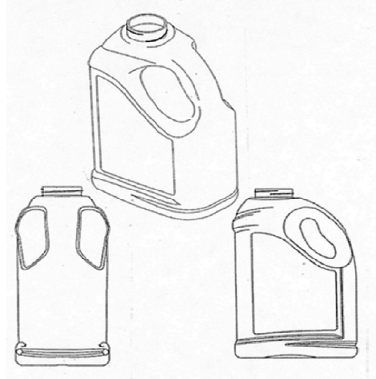

IOIP HOLDINGS, LLC (INDIANA LTD LIAB CO)
1515 DIVIDEND ROAD
FORT WAYNE, IN 46808

FOR: ALL-PURPOSE RUST AND IRON STAIN
REMOVER, IN CLASS 3 (U.S. CLS. 1, 4, 6, 50, 51 AND
52).

FIRST USE 1-15-2007; IN COMMERCE 1-15-2007.

THE MARK CONSISTS OF A THREE DIMEN-
SIONAL BOTTLE WITH AN INDENTED GRIP
AREA, A POURING SPOUT, AN AREA FOR A
LABEL, A RAISED DESIGN EMANATING FROM
THE GRIP AND A RAISED DESIGN AT THE
BOTTOM OF THE BOTTLE.

SER. NO. 77-117,087, FILED 2-27-2007.

KELLY BOULTON, EXAMINING ATTORNEY

Int. Cl.: 19

Prior U.S. Cls.: 1, 12, 33 and 50

United States Patent and Trademark Office

Reg. No. 3,478,797

Registered Aug. 5, 2008

**TRADEMARK
PRINCIPAL REGISTER**

NextStone

CFMT LLC (COLORADO LTD LIAB CO)
4453 PALI WAY
BOULDER, CO 80301

THE MARK CONSISTS OF STANDARD CHAR-
ACTERS WITHOUT CLAIM TO ANY PARTICULAR
FONT, STYLE, SIZE, OR COLOR.

FOR: NON-METAL, NON-ROOFING BUILDING
PRODUCTS THAT HAVE A STONE, BRICK, OR
CEMENT APPEARANCE, NAMELY, SIDING, AND
TRIM, IN CLASS 19 (U.S. CLS. 1, 12, 33 AND 50).

SER. NO. 77-117,259, FILED 2-27-2007.

FIRST USE 1-1-2004; IN COMMERCE 6-1-2004.

CAROLYN GRAY, EXAMINING ATTORNEY

Int. Cl.: 37

Prior U.S. Cls.: 100, 103 and 106

United States Patent and Trademark Office

Reg. No. 3,478,798

Registered Aug. 5, 2008

**SERVICE MARK
PRINCIPAL REGISTER**

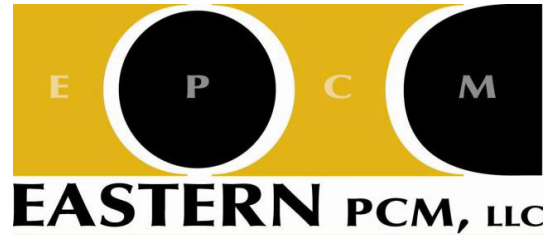

EASTERN PCM, LLC (PENNSYLVANIA LTD
LIAB CO)
212 LOCUST STREET, SUITE 604
HARRISBURG, PA 17101

FOR: CONSTRUCTION MANAGEMENT, IN
CLASS 37 (U.S. CLS. 100, 103 AND 106).

FIRST USE 5-15-2006; IN COMMERCE 8-30-2006.

NO CLAIM IS MADE TO THE EXCLUSIVE
RIGHT TO USE "PCM, LLC", APART FROM THE
MARK AS SHOWN.

THE COLOR(S) GOLD, BLACK AND WHITE IS/
ARE CLAIMED AS A FEATURE OF THE MARK.

THE MARK CONSISTS OF THE DESIGN OF AN
INCOMPLETE RECTANGLE IN GOLD, A WHITE
CIRCLE CONTAINING A BLACK CIRCLE, A
WHITE SEMI-CIRCLE CONTAINING A BLACK
SEMI-CIRCLE ON ALL OF WHICH ARE THE
LETTERS "EPCM" IN GOLD; A GOLD LINE; AND
WORDING EASTERN "PCM, LLC" IN BLACK.

SER. NO. 77-117,384, FILED 2-27-2007.

DAVID C. REIHNER, EXAMINING ATTORNEY

Int. Cl.: 6

Prior U.S. Cls.: 2, 12, 13, 14, 23, 25 and 50

Reg. No. 3,478,799

United States Patent and Trademark Office

Registered Aug. 5, 2008

**TRADEMARK
PRINCIPAL REGISTER**



BLIND DOG PRODUCTIONS, LTD. (TEXAS LTD
LIAB CO)
2526 CHARTER OAK DRIVE
TEMPLE, TX 76502

THE MARK CONSISTS OF A RECTANGLE WITH
THE WORD, "ECHO" IN STYLIZED CHARACTERS.

FOR: NON-LUMINOUS AND NON-MECHANI-
CAL METAL SIGNS, IN CLASS 6 (U.S. CLS. 2, 12,
13, 14, 23, 25 AND 50).

SER. NO. 77-119,272, FILED 3-1-2007.

FIRST USE 11-9-2005; IN COMMERCE 11-9-2005.

DANIEL BRODY, EXAMINING ATTORNEY

Int. Cl.: 6

Prior U.S. Cls.: 2, 12, 13, 14, 23, 25 and 50

Reg. No. 3,478,800

United States Patent and Trademark Office

Registered Aug. 5, 2008

**TRADEMARK
PRINCIPAL REGISTER**

ECHO sierra

BLIND DOG PRODUCTIONS, LTD. (TEXAS LTD
LIAB CO)
2526 CHARTER OAK DRIVE
TEMPLE, TX 76502

THE MARK CONSISTS OF STANDARD CHAR-
ACTERS WITHOUT CLAIM TO ANY PARTICULAR
FONT, STYLE, SIZE, OR COLOR.

FOR: NON-LUMINOUS AND NON-MECHANI-
CAL METAL SIGNS, IN CLASS 6 (U.S. CLS. 2, 12,
13, 14, 23, 25 AND 50).

SER. NO. 77-119,384, FILED 3-1-2007.

FIRST USE 11-9-2005; IN COMMERCE 11-9-2005.

DANIEL BRODY, EXAMINING ATTORNEY

Int. Cl.: 26

Prior U.S. Cls.: 37, 39, 40, 42 and 50

United States Patent and Trademark Office

Reg. No. 3,478,801

Registered Aug. 5, 2008

**TRADEMARK
PRINCIPAL REGISTER**

Sticky Straps

SUNSHINE MARKETING OF N.E. FL., INC.
(FLORIDA CORPORATION)
445-26 SR #13 STE 368
JACKSONVILLE, FL 32259

FOR: BODY AND CLOTHING TAPE TO HOLD UP
STRAPLESS GOWNS, IN CLASS 26 (U.S. CLS. 37, 39,
40, 42 AND 50).

FIRST USE 3-2-1993; IN COMMERCE 3-2-1993.

THE MARK CONSISTS OF STANDARD CHAR-
ACTERS WITHOUT CLAIM TO ANY PARTICULAR
FONT, STYLE, SIZE, OR COLOR.

SEC. 2(F).

SER. NO. 77-119,713, FILED 3-1-2007.

DOMINIC FATHY, EXAMINING ATTORNEY

Int. Cls.: 9 and 28

Prior U.S. Cls.: 21, 22, 23, 26, 36, 38 and 50

Reg. No. 3,478,802

United States Patent and Trademark Office

Registered Aug. 5, 2008

**TRADEMARK
PRINCIPAL REGISTER**

WORLD IN CRISIS

CRYTEK GMBH (FED REP GERMANY CORPORATION)
HANAUER LANDSTRASSE 523
FRANKFURT AM MAIN, FED REP GERMANY
60386

FOR: COMPUTER GAMES SOFTWARE AND ELECTRONIC GAMES, NAMELY, SOFTWARE GAMES RECORDED ON CD-ROM AND DVDS AND OTHER PHYSICAL MEDIAS, AND COMPUTER GAME CARTRIDGES FOR COMPUTERS, CONSOLE AND INDIVIDUAL, PORTABLE GAMING SYSTEMS AND INSTRUCTIONAL MANUALS SOLD TOGETHER AS A UNIT; COMPUTER GAMES DOWNLOADABLE FROM A LOCAL OR GLOBAL COMPUTER NETWORK; COMPUTER GAME PROGRAMS FOR MOBILE PHONES, PERSONAL DIGITAL ASSISTANTS, AND HANDHELD COMPUTERS AND INSTRUCTIONAL MANUALS SOLD TOGETHER AS A UNIT; MOTION PICTURE FILMS, NAMELY, MOTION PICTURE FILMS FEATURING COMEDY, DRAMA, ACTION, ADVENTURE AND/OR ANIMATION, FOR BROADCAST ON TELEVISION, FOR PRIVATE OR HOME VIEWING ON COMPUTERS, TELEVISIONS, HAND-HELD VIEWERS OR PROJECTORS, PRERECORDED IN WHOLE OR IN PART ON DATA MEDIA; DOWNLOADABLE ELECTRONIC PUBLICATIONS IN THE NATURE OF COMPUTER GAME MANUALS, IN CLASS 9 (U.S. CLS. 21, 23, 26, 36 AND 38).

FOR: TOYS, NAMELY, TOY ACTION FIGURES AND ACTION FIGURE ACCESSORIES, NAMELY, POSITIONABLE TOY FIGURES, MUSIC BOX TOYS, INFLATABLE TOYS, PAPER DOLLS, ARTICULATED AND NON-ARTICULATED DOLLS, PUPPETS,

TOY BALLOONS; TOY ACTION BALLS; TOY BANKS, TOY BUILDING BLOCKS, TOY CONSTRUCTION PLAYSETS, TOY MOBILES, TOY VEHICLES, YO-YOS; HAND-HELD UNITS FOR PLAYING ELECTRONIC GAMES, HAND HELD UNITS FOR PLAYING VIDEO GAMES, ELECTRONIC GAMES IN THE NATURE OF A VIRTUAL PET, VIDEO GAME SYSTEMS, COMPRISING HAND-HELD UNITS FOR PLAYING VIDEO GAMES AND ASSOCIATED GAME CARTRIDGES SOLD AS A UNIT; ACTION SKILL GAMES; ELECTRONIC GAME EQUIPMENT WITH A VIEWING FUNCTION; PROMOTIONAL GAME CARDS; STAND ALONE VIDEO GAME MACHINES; HAND-HELD ELECTRIC AND NON-ELECTRIC PINBALL GAMES, AND MANIPULATIVE PUZZLES; SKATES, NAMELY, IN-LINE SKATES, ROLLER SKATES, SKATEBOARDS; JIGSAW PUZZLES; JUMP ROPES; KITES; GAMES, NAMELY, BOARD GAMES, PARLOR GAMES AND ROLE PLAYING GAMES; SNOW BOARDS; SNOW SKIS; SPORTS BALLS, IN CLASS 28 (U.S. CLS. 22, 23, 38 AND 50).

THE MARK CONSISTS OF STANDARD CHARACTERS WITHOUT CLAIM TO ANY PARTICULAR FONT, STYLE, SIZE, OR COLOR.

PRIORITY CLAIMED UNDER SEC. 44(D) ON FED REP GERMANY APPLICATION NO. 30665923.9/0, FILED 10-26-2006, REG. NO. 30665923, DATED 12-5-2006, EXPIRES 10-31-2016.

SER. NO. 77-120,140, FILED 3-1-2007.

GEOFFREY FOSDICK, EXAMINING ATTORNEY

Int. Cl.: 35

Prior U.S. Cls.: 100, 101 and 102

United States Patent and Trademark Office

Reg. No. 3,478,803

Registered Aug. 5, 2008

SERVICE MARK
PRINCIPAL REGISTER



DOHENY ENTERPRISES, INC. (ILLINOIS CORPORATION)
6950 51ST STREET
KENOSHA, WI 53144

FOR: WHOLESALE DISTRIBUTIONSHIP SERVICES, RETAIL STORE SERVICES, ON-LINE RETAIL STORE SERVICES AND MAIL ORDER CATALOG SERVICES, ALL FEATURING RECREATIONAL POOLS, SPAS AND RELATED SUPPLIES, IN CLASS 35 (U.S. CLS. 100, 101 AND 102).

FIRST USE 1-4-2005; IN COMMERCE 1-4-2005.

OWNER OF U.S. REG. NO. 2,033,522.

NO CLAIM IS MADE TO THE EXCLUSIVE RIGHT TO USE "WAREHOUSE", APART FROM THE MARK AS SHOWN.

THE NAME "DOHENY" IDENTIFIES A LIVING INDIVIDUAL WHOSE CONSENT IS OF RECORD.

THE MARK CONSISTS IN PART OF A CARTOON CHARACTERIZATION OF A SUN WITH SMILING FACE WEARING SUNGLASSES.

SEC. 2(F) AS TO "WATER WAREHOUSE".

SER. NO. 77-120,156, FILED 3-1-2007.

GENE MACIOL, EXAMINING ATTORNEY

Int. Cls.: 24 and 25

Prior U.S. Cls.: 22, 39, 42 and 50

United States Patent and Trademark Office

Reg. No. 3,478,804

Registered Aug. 5, 2008

**TRADEMARK
PRINCIPAL REGISTER**



PAROTEX S.R.L. (ITALY SOCIETA A RESPONSABILITA LIMITATA)
VIA NOVARA 62/F
BUSTO ARSIZIO, VARESE, ITALY 21052

FOR: FABRICS, NAMELY, COTTON FABRIC, ELASTIC FABRICS FOR CLOTHING; ADHESIVE FABRICS FOR APPLICATION BY HEAT; FABRICS OF IMITATION ANIMAL SKINS; FIBERGLASS FABRICS FOR TEXTILE USE; WOOLLEN FABRICS; BED BLANKETS; TABLECLOTHS NOT OF PAPER; FABRIC TAPESTRY; LINEN HANDKERCHIEFS; CLOTH FLAGS; TEXTILE TABLE NAPKINS; BED-SPREAD SHEETS; TEXTILE TOWELS, IN CLASS 24 (U.S. CLS. 42 AND 50).

FOR: CLOTHING AND LEATHER CLOTHES, NAMELY, SHIRTS, BLOUSES, SKIRTS, TAILLEURS, JACKETS, TROUSERS, SHORTS, VESTS, T-

SHIRTS, PAJAMAS, SOCKS, STOCKINGS, TANK TOPS, CORSETS, GARTER-BELTS, UNDERPANTS, PANTIES, BRAS, PETTICOATS, FOULARDS, TIES, RAINCOATS, OVERCOATS, COATS, SWIMWEAR, BATHROBES, TRACK SUITS, WIND-RESISTANT JACKETS, SKI-PANTS, BELTS, FUR COATS, SCARVES, GLOVES, DRESSING GOWN, HOUSECOATS, FOOTWEAR AND HEADWEAR, IN CLASS 25 (U.S. CLS. 22 AND 39).

PRIORITY CLAIMED UNDER SEC. 44(D) ON ERPN CMNTY TM OFC APPLICATION NO. 5693197, FILED 2-16-2007, REG. NO. 5693197, DATED 2-27-2008, EXPIRES 2-16-2017.

SER. NO. 77-120,171, FILED 3-1-2007.

GENE MACIOL, EXAMINING ATTORNEY

Int. Cls.: 9, 38 and 42

Prior U.S. Cls.: 21, 23, 26, 36, 38, 100, 101 and 104

United States Patent and Trademark Office

Reg. No. 3,478,805

Registered Aug. 5, 2008

**TRADEMARK
SERVICE MARK
PRINCIPAL REGISTER**

KAVEO

KING PRODUCTS AND SOLUTIONS INC. (CANADA CORPORATION)
2525 MEADOWVALE BOULEVARD
MISSISSAUGA, ONTARIO, CANADA L5N5S2

FOR: INTERACTIVE COMPUTER KIOSKS AND KIOSK ENCLOSURES FOR COMPUTER-BASED DISPLAY SYSTEMS AND ASSOCIATED HARDWARE, NAMELY, COMPUTER MODULES, DISPLAY SCREENS, DISPLAY MODULES, ELECTRONIC TOUCH SENSITIVE DISPLAY SCREENS, NAMELY, SURFACE ACOUSTIC WAVE TOUCH DISPLAY SCREENS AND INFRARED TOUCH DISPLAY SCREENS, HARDWARE ACCESSORIES, NAMELY, ELECTRONIC CARD READERS, KEYBOARDS, CAMERAS, PRINTERS, SCANNERS, WIRELESS CONNECTORS, MICROPHONES, AUDIO SPEAKERS, POWER SUPPLIES, SECURITY DEVICES IN THE NATURE OF FILTERED KEYBOARDS TAMPER PROOF ENCLOSURES, AND INTEGRATED INTRUSION DETECTORS, MODEMS AND POSTER DISPLAY SCREENS; COMMUNICATION DEVICES, NAMELY, TELEPHONE HANDSETS, WIRELESS INTERFACE, ANALOG MODEMS, ELECTRONIC CARD READERS, SCANNERS AND USP CAMERAS; COMPUTER SOFTWARE FOR KIOSK BASED DISPLAY SYSTEMS, NAMELY, SECURITY PROGRAMS, TOUCH SCREEN INTERACTIVE PROGRAMS, COMMUNICATION PROGRAMS, AND OPERATIONAL SOFTWARE PROGRAMS FOR THE COMPUTER ACCESSORIES, IN CLASS 9 (U.S. CLS. 21, 23, 26, 36 AND 38).

FIRST USE 1-14-2007; IN COMMERCE 1-14-2007.

FOR: COMMUNICATION SERVICES, NAMELY, COMMENTS AND DATA EXCHANGE AMONGST USERS AND/OR DEVICES ON THE INTERNET OR LOCAL NETWORKS, IN CLASS 38 (U.S. CLS. 100, 101 AND 104).

FIRST USE 1-14-2007; IN COMMERCE 1-14-2007.

FOR: TECHNICAL SUPPORT SERVICES, NAMELY, TROUBLESHOOTING OF COMPUTER KIOSK-BASED HARDWARE AND SOFTWARE PROBLEMS; COMPUTER SERVICES, NAMELY, REMOTE AND ON-SITE MANAGEMENT OF ELECTRONIC KIOSK-BASED MESSAGING SYSTEMS AND APPLICATIONS FOR OTHERS; CUSTOM HARDWARE AND SOFTWARE ENGINEERING; AND COMPUTER SOFTWARE DEVELOPMENT, IN CLASS 42 (U.S. CLS. 100 AND 101).

FIRST USE 1-14-2007; IN COMMERCE 1-14-2007.

THE MARK CONSISTS OF STANDARD CHARACTERS WITHOUT CLAIM TO ANY PARTICULAR FONT, STYLE, SIZE, OR COLOR.

THE WORDING "KAVEO" HAS NO MEANING IN A FOREIGN LANGUAGE.

SER. NO. 77-121,130, FILED 3-2-2007.

TINA L. SNAPP, EXAMINING ATTORNEY

Int. Cl.: 35

Prior U.S. Cls.: 100, 101 and 102

United States Patent and Trademark Office

Reg. No. 3,478,806

Registered Aug. 5, 2008

**SERVICE MARK
PRINCIPAL REGISTER**

MORGAN TAYLOR

LAS VEGAS WHOLESALE JEWELERS, INC. (NE-
VADA CORPORATION)
SUITE 103
7995 W. SAHARA AVE.
LAS VEGAS, NV 89117

FOR: RETAIL SHOPS FEATURING JEWELRY, IN
CLASS 35 (U.S. CLS. 100, 101 AND 102).

FIRST USE 4-0-2002; IN COMMERCE 4-0-2002.

THE MARK CONSISTS OF STANDARD CHAR-
ACTERS WITHOUT CLAIM TO ANY PARTICULAR
FONT, STYLE, SIZE, OR COLOR.

THE NAME(S), PORTRAIT(S), AND/OR SIGNA-
TURE(S) SHOWN IN THE MARK DOES NOT IDENTI-
FY A PARTICULAR LIVING INDIVIDUAL.

SER. NO. 77-121,584, FILED 3-2-2007.

ANGELA GAW, EXAMINING ATTORNEY

Int. Cl.: 3

Prior U.S. Cls.: 1, 4, 6, 50, 51 and 52

United States Patent and Trademark Office

Reg. No. 3,478,807

Registered Aug. 5, 2008

**TRADEMARK
PRINCIPAL REGISTER**

MOROCCANOIL

TAL, OFER (CANADA INDIVIDUAL)
642 DE COURCELLE STREET, PH#4
MONTREAL, CANADA H4C3C5

FOR: HAIR CONDITIONERS, NAMELY, CURL
CREAMS, HYDRATING STYLING CREAMS, IN-
TENSE MOISTURIZING MASQUES, AND STYLING
AND FINISHING OILS, IN CLASS 3 (U.S. CLS. 1, 4, 6,
50, 51 AND 52).

FIRST USE 1-1-2007; IN COMMERCE 1-1-2007.

THE MARK CONSISTS OF STANDARD CHAR-
ACTERS WITHOUT CLAIM TO ANY PARTICULAR
FONT, STYLE, SIZE, OR COLOR.

SEC. 2(F).

SER. NO. 77-122,509, FILED 3-5-2007.

BARBARA GAYNOR, EXAMINING ATTORNEY

Int. Cl.: 41

Prior U.S. Cls.: 100, 101 and 107

United States Patent and Trademark Office

Reg. No. 3,478,808

Registered Aug. 5, 2008

**SERVICE MARK
PRINCIPAL REGISTER**

CASTABLE TYPES

WHITE, CYNTHIA (UNITED STATES INDIVIDUAL)

#8C

11 MAIDEN LANE
NEW YORK, NY 10038

FOR: PERSONAL COACHING SERVICES IN THE FIELD OF ACTING AND CAREERS FOR ACTORS, IN CLASS 41 (U.S. CLS. 100, 101 AND 107).

FIRST USE 1-5-1999; IN COMMERCE 1-5-1999.

THE MARK CONSISTS OF STANDARD CHARACTERS WITHOUT CLAIM TO ANY PARTICULAR FONT, STYLE, SIZE, OR COLOR.

SER. NO. 77-124,874, FILED 3-7-2007.

DAVID MILLER, EXAMINING ATTORNEY

Int. Cl.: 40

Prior U.S. Cls.: 100, 103 and 106

United States Patent and Trademark Office

Reg. No. 3,478,809

Registered Aug. 5, 2008

**SERVICE MARK
PRINCIPAL REGISTER**

Espressio

THE BOOK DEPOSITORY LTD. (UNITED KING-
DOM LIMITED COMPANY)
UNIT 1 SEVERNSIDE TRADING ESTATE
HEMPSTED, UNITED KINGDOM GL25HS

FOR: PRINTING SERVICES, IN CLASS 40 (U.S.
CLS. 100, 103 AND 106).

THE MARK CONSISTS OF STANDARD CHAR-
ACTERS WITHOUT CLAIM TO ANY PARTICULAR
FONT, STYLE, SIZE, OR COLOR.

PRIORITY CLAIMED UNDER SEC. 44(D) ON
ERPNTM OFC APPLICATION NO.
005605225, FILED 1-10-2007, REG. NO. 005605225,
DATED 11-27-2007, EXPIRES 1-10-2017.

THE WORDING "ESPRESSIO" HAS NO MEAN-
ING IN A FOREIGN LANGUAGE.

SER. NO. 77-125,169, FILED 3-8-2007.

BRIDGETT SMITH, EXAMINING ATTORNEY

Int. Cl.: 25

Prior U.S. Cls.: 22 and 39

United States Patent and Trademark Office

Reg. No. 3,478,810

Registered Aug. 5, 2008

**TRADEMARK
PRINCIPAL REGISTER**

GBRACING

LEWIS BANKS LTD. (UNITED KINGDOM LTD
LIAB CO)
19 HOOPS LANE
THERFIELD, UNITED KINGDOM SG89QH

FOR: FOOTWEAR, HEADWEAR, CLOTHING, NAMELY, WATERPROOF CLOTHING, NAMELY, ANORAKS, JACKETS, TROUSERS, WINDPROOF JACKETS, VESTS, SHIRTS, AND PANTS; LEATHER CLOTHING, NAMELY, JACKETS, TROUSERS, GLOVES AND ONE-PIECE OVERALLS; ARTICLES OF OUTER CLOTHING, NAMELY, JACKETS AND COATS; ARTICLES OF THERMAL CLOTHING, NAMELY, THERMAL UNDERGARMENTS, BODY WARMERS; NECK WARMERS; BALACLAVAS; FOOTWEAR FOR MOTORCYCLISTS, SPORTSWEAR IN GENERAL, NAMELY, JOGGING SUITS; SHOES AND GLOVES FOR GO-KARTING AND MOTORCYCLING; T-SHIRTS, JACKETS AND TROUSERS OF FLEECE, POLO SHIRTS, LUMBER JACKETS, SPORTS JACKETS, COATS, SHIRTS, HOSIERY, JEANS; MOTORCYCLE BOOTS, SPORTS AND LEISURE CLOTHING, NAMELY, SHORTS, T-SHIRTS, JACKETS, TRACK SUITS, JOGGING

PANTS, SINGLETS; APRONS, BANDANAS AND NECKERCHIEFS, BATHING CAPS, BATHING SUITS, BOOTS, BOOTS FOR SPORTS, CLOTHING OF IMITATIONS OF LEATHER, NAMELY, GLOVES, HATS, HEADBANDS, HEADWEAR, JACKETS, JERSEYS, JUMPERS; MOTORISTS' CLOTHING, NAMELY, JACKETS, TROUSERS, GLOVES, ONE-PIECE OVERALLS; NECKTIES, PARKAS, PULLOVERS, TEE-SHIRTS, AND UNDERWEAR, IN CLASS 25 (U.S. CLS. 22 AND 39).

THE MARK CONSISTS OF STANDARD CHARACTERS WITHOUT CLAIM TO ANY PARTICULAR FONT, STYLE, SIZE, OR COLOR.

PRIORITY CLAIMED UNDER SEC. 44(D) ON ERPN CMNTY TM OFC APPLICATION NO. 5720552, FILED 2-27-2007, REG. NO. 5720552, DATED 1-16-2008, EXPIRES 2-27-2017.

SER. NO. 77-126,864, FILED 3-9-2007.

ALICIA COLLINS, EXAMINING ATTORNEY

Int. Cls.: 1, 37, 40 and 42

Prior U.S. Cls.: 1, 5, 6, 10, 26, 46, 100, 101, 103 and 106

United States Patent and Trademark Office

Reg. No. 3,478,811

Registered Aug. 5, 2008

**TRADEMARK
SERVICE MARK
PRINCIPAL REGISTER**

LWP

CANYON TECHNICAL SERVICES LTD. (CANADA CORPORATION)
SUITE 1700
639 - 5TH AVENUE SW
CALGARY, CANADA T2P0M9

FOR: CHEMICALS AND PROPPANTS, NAMELY, SYNTHETIC DEFORMABLE PROPPANTS, FOR USE IN FRACTURING OR STIMULATING OIL AND GAS WELLS, IN CLASS 1 (U.S. CLS. 1, 5, 6, 10, 26 AND 46).

FOR: CEMENTING SERVICES FOR OIL AND GAS WELLS, IN CLASS 37 (U.S. CLS. 100, 103 AND 106).

FOR: OIL AND GAS WELL TREATMENT SERVICES, NAMELY, FRACTURING SERVICES, SAND AND WATER CONTROL SERVICES FOR USE IN FRACTURING SERVICES, CHEMICAL TREAT-

MENT SERVICES FOR OIL AND GAS WELLS, AND WELL STIMULATION SERVICES, IN CLASS 40 (U.S. CLS. 100, 103 AND 106).

FOR: TESTING SERVICES FOR OIL AND GAS WELLS, IN CLASS 42 (U.S. CLS. 100 AND 101).

THE MARK CONSISTS OF STANDARD CHARACTERS WITHOUT CLAIM TO ANY PARTICULAR FONT, STYLE, SIZE, OR COLOR.

PRIORITY CLAIMED UNDER SEC. 44(D) ON CANADA APPLICATION NO. 1338423, FILED 3-8-2007, REG. NO. TMA706988, DATED 2-8-2008, EXPIRES 2-8-2023.

SER. NO. 77-126,887, FILED 3-9-2007.

CHRISTINE COOPER, EXAMINING ATTORNEY

Int. Cl.: 12

Prior U.S. Cls.: 19, 21, 23, 31, 35 and 44

Reg. No. 3,478,812

United States Patent and Trademark Office

Registered Aug. 5, 2008

**TRADEMARK
PRINCIPAL REGISTER**

GBRACING

LEWIS BANKS LTD. (UNITED KINGDOM LTD
LIAB CO)
19 HOOPS LANE
THERFIELD, UNITED KINGDOM SG89QH

FOR: VEHICLES NAMELY MOTORBIKES, MOTORIZED AND NON-MOTORIZED BICYCLES, MOTORCYCLES, MOTORIZED AND NON-MOTORIZED TRICYCLES, QUAD BIKES, DUNE BUGGIES, AND ALL TERRAIN VEHICLES (ATVS); APPARATUS FOR LOCOMOTION BY LAND, AIR OR WATER, NAMELY, MOTORBIKES, MOTORIZED AND NON-MOTORIZED BICYCLES, MOTORCYCLES, MOTORIZED AND NON-MOTORIZED TRICYCLES, QUAD BIKES, DUNE BUGGIES, AND ALL TERRAIN VEHICLES (ATVS); MOTORCYCLES; PARTS AND FITTINGS FOR MOTORCYCLES; PARTS AND REPLACEMENT RACE SPECIFICATION PARTS FOR MOTORBIKES, MOTORIZED AND NON-MOTORIZED BICYCLES, MOTORCYCLES, MOTORIZED AND NON-MOTORIZED TRICYCLES, QUAD BIKES, DUNE BUGGIES, AND ALL TERRAIN VEHICLES (ATVS); MOTORCYCLE PARTS AND COMPONENTS, NAMELY, MOTORCYCLE FRAME PROTECTORS, CHAIN GUARDS, CRANK CASE COVER PROTECTORS, CLUTCH COVER PROTECTORS, GENERATOR COVER PROTECTORS AND REAR BOBBIN PADDOCK STAND PROTECTORS; REPLACEMENT PARTS FOR MOTORS AND ENGINES FOR LAND VEHICLES, HANDLE BAR ENDS FOR MOTORCYCLES, ENGINE COVERS, TECHNICAL FITTINGS FOR MOTORIZED AND NON-MOTORIZED BICYCLES, INCLUDING TRANS-

PORT CONTAINERS AND TRIM, INCLUDING HOLDERS OF PLASTIC OR METAL, LAND VEHICLE REPLACEMENT PARTS FOR GEARS, SEATS, DECORATIVE CHROME PARTS, HORNS, HANDLEBARS AND FOOT RESTS, INCLUDING HOLDING DEVICES OF PLASTIC OR METAL; MOTORCYCLE PARTS, NAMELY, BRAKE HANDLES, CHAIN WHEELS, CHAIN PINIONS, BRAKE LININGS, BRAKE SEGMENTS, CLUTCH LININGS, CLUTCH SPRINGS, FOR SHAFT SEALS, CONTROL HEAD BEARINGS, HANDLEBARS AND FOOT RESTS, TANK PADS, TANK PROTECTORS; PARTS AND FITTINGS FOR THE AFORESAID GOODS; FORK RESTRICTORS, NAMELY, A DEVICE USED TO RESTRICT THE MOVEMENTS OF THE FORKS OF A MOTORIZED VEHICLE AND THUS THE WHEELS SUCH THAT THE WHEELS CANNOT BE TURNED TOO FAR TO THE LEFT OR TO THE RIGHT FROM THE CENTER POINT, IN CLASS 12 (U.S. CLS. 19, 21, 23, 31, 35 AND 44).

THE MARK CONSISTS OF STANDARD CHARACTERS WITHOUT CLAIM TO ANY PARTICULAR FONT, STYLE, SIZE, OR COLOR.

PRIORITY CLAIMED UNDER SEC. 44(D) ON ERPN CMNTY TM OFC APPLICATION NO. 5720552, FILED 2-27-2007, REG. NO. 005720552, DATED 1-16-2008, EXPIRES 2-27-2017.

SER. NO. 77-126,897, FILED 3-9-2007.

ALICIA COLLINS, EXAMINING ATTORNEY

Int. Cl.: 39

Prior U.S. Cls.: 100 and 105

United States Patent and Trademark Office

Reg. No. 3,478,813

Registered Aug. 5, 2008

**SERVICE MARK
PRINCIPAL REGISTER**

BRONZE WORLD TRAVEL

BRONZE WORLD TRAVEL LLC (MARYLAND
LTD LIAB CO)
1110 FIDLER LANE #1108
SILVER SPRING, MD 20910

FOR: ARRANGING TRAVEL TOURS; COORDINATING TRAVEL ARRANGEMENTS FOR INDIVIDUALS AND FOR GROUPS; ORGANIZATION OF EXCURSIONS, SIGHTSEEING TOURS, HOLIDAYS, TOURS AND TRAVEL; PROVIDING LINKS TO WEB SITES OF OTHERS FEATURING TRAVEL; TRAVEL AGENCY SERVICES, NAMELY, MAKING RESERVATIONS AND BOOKINGS FOR TRANSPORTATION; TRAVEL INFORMATION SERVICES; ARRANGING EXCURSIONS FOR TOURISTS; ARRANGING OF CRUISES; PROVIDING A WEBSITE THAT FEATURES INFORMATION ON BEACH TOURISM; PROVIDING AN INTERACTIVE COMPUTER DATABASE IN THE FIELD OF TOURISM VIA A GLOBAL COMPUTER NETWORK; RENTAL CAR RESERVATION; PROVIDING FLIGHT ARR-

IVAL AND DEPARTURE INFORMATION; PROVIDING INFORMATION ABOUT AUTOMOBILES FOR LEASE BY MEAN OF THE INTERNET; TOURIST AGENCY SERVICES; TRANSPORTATION RESERVATION SERVICES, IN CLASS 39 (U.S. CLS. 100 AND 105).

FIRST USE 0-0-2005; IN COMMERCE 0-0-2005.

THE MARK CONSISTS OF STANDARD CHARACTERS WITHOUT CLAIM TO ANY PARTICULAR FONT, STYLE, SIZE, OR COLOR.

NO CLAIM IS MADE TO THE EXCLUSIVE RIGHT TO USE "WORLD TRAVEL", APART FROM THE MARK AS SHOWN.

SER. NO. 77-127,840, FILED 3-11-2007.

MARK PILARO, EXAMINING ATTORNEY

Int. Cl.: 9

Prior U.S. Cls.: 21, 23, 26, 36 and 38

United States Patent and Trademark Office

Reg. No. 3,478,814

Registered Aug. 5, 2008

TRADEMARK
PRINCIPAL REGISTER



ARUZE CORPORATION (JAPAN CORPORATION)
1-25, ARIAKE 3-CHOME
KOTOKU
TOKYO, JAPAN

FOR: SLOT MACHINES AND REPLACEMENT PARTS THEREFOR; VIDEO SLOT MACHINES AND REPLACEMENT PARTS THEREFOR; GAMING MACHINES AND REPLACEMENT PARTS THEREFOR; GAMING MACHINES WITH A LIQUID CRYSTAL DISPLAY AND REPLACEMENT PARTS THEREFOR; MECHANICAL REEL TYPE SLOT MACHINES WITH A LIQUID CRYSTAL DISPLAY AND REPLACEMENT PARTS THEREFOR; MEDIA STORAGE COMPUTER SOFTWARE, AND COMPUTER SOFTWARE FOR CONTROLLING SLOT MACHINES AND GAME MACHINES, AND COMPU-

TER GAME SOFTWARE FOR GAME MACHINES OR SLOT MACHINES, IN CLASS 9 (U.S. CLS. 21, 23, 26, 36 AND 38).

PRIORITY CLAIMED UNDER SEC. 44(D) ON JAPAN APPLICATION NO. 2007-12802, FILED 2-16-2007, REG. NO. 5075515, DATED 9-17-2007, EXPIRES 9-7-2017.

NO CLAIM IS MADE TO THE EXCLUSIVE RIGHT TO USE "PAY", APART FROM THE MARK AS SHOWN.

SER. NO. 77-128,817, FILED 3-12-2007.

HENRY S. ZAK, EXAMINING ATTORNEY

Int. Cl.: 30

Prior U.S. Cl.: 46

United States Patent and Trademark Office

Reg. No. 3,478,815

Registered Aug. 5, 2008

**TRADEMARK
PRINCIPAL REGISTER**

goldilocks

GOLDILOCKS BAKE SHOP, INC. (PHILIPPINES
CORPORATION)

498 SHAW BOULEVARD, MANDALUYONG

METRO, MANILA, PHILIPPINES

FOR: ICE CREAM, IN CLASS 30 (U.S. CL. 46).

FIRST USE 7-31-2004; IN COMMERCE 7-31-2004.

THE MARK CONSISTS OF STANDARD CHAR-
ACTERS WITHOUT CLAIM TO ANY PARTICULAR
FONT, STYLE, SIZE, OR COLOR.

OWNER OF U.S. REG. NOS. 1,358,272, 2,784,683
AND OTHERS.

SER. NO. 77-128,841, FILED 3-12-2007.

FRANK LATTUCA, EXAMINING ATTORNEY

Int. Cl.: 9

Prior U.S. Cls.: 21, 23, 26, 36 and 38

Reg. No. 3,478,816

United States Patent and Trademark Office

Registered Aug. 5, 2008

TRADEMARK
PRINCIPAL REGISTER

UpFlite

LOWE, MARK A (UNITED KINGDOM INDIVIDUAL)
63 MADISON AVE
BRENTWOOD, NY 11717 AND
OLIVER, DWIGHT A (UNITED STATES INDIVIDUAL)
17021 SW 64 CT.
FT LAUDERDALE, FL 33331

FOR: BLANK CD-ROMS FOR SOUND OR VIDEO RECORDING; CD DRIVES FOR COMPUTERS; CD CASES; CD PLAYERS; CD SLEEVES; CD STORAGE RACKS; CD STORAGE WALLETS; CD TRADING CARDS; CD-ROM DRIVES; CD-ROM WRITERS; CHILDREN'S EDUCATIONAL MUSIC CDS AND DVDS; DIGITAL MATERIALS, NAMELY, MP3 AUDIO FILES AND DVDS FEATURING ART HISTORY; DIGITAL MEDIA, NAMELY, DOWNLOADABLE INTERNET RADIO AUDIO FILES IN THE FIELD OF ART HISTORY; MULTIMEDIA SOFTWARE RECORDED ON CD-ROM FEATURING ART HISTORY; PRE-RECORDED CDS, VIDEO TAPES, LASER DISKS AND DVDS FEATURING ART HISTORY; TRADING CARD CDS; TRADING CARDS IN THE FORM OF CDS; ABDOMINAL BELT CONTAINING BUILT-IN SPEAKERS FOR PURPOSES OF TRANSMITTING MUSIC/SOUNDS/EDUCATIONAL MATERIAL TO A FETUS AND A BUILT-IN POCKETS IN WHICH TO CARRY AUDIO TRANSMITTERS; AUDIO RECORDINGS FEATURING ART HISTORY; COMPACT DISC PLAYERS; COMPUTER SOFTWARE FOR PROCESSING DIGITAL MUSIC FILES; DIGITAL PHOTO FRAMES FOR DISPLAYING DIGITAL PICTURES, VIDEO CLIPS AND MUSIC; DOWNLOADABLE MP3 FILES, MP3 RECORDINGS, ONLINE DISCUSSION BOARDS, WEB CASTS, POD CASTS FEATURING MUSIC, AUDIO BOOKS AND NEWS BROADCASTS; DOWNLOADABLE MUSICAL SOUND RECORDINGS; DOWNLOADABLE RING TONES, GRAPHICS AND MUSIC VIA A GLOBAL COMPUTER NETWORK AND WIRELESS DEVICES; DOWNLOADABLE VI-

DEO RECORDINGS FEATURING ART HISTORY; DOWNLOADABLE AUDIO MUSIC AND VISUAL ELECTRONIC GAMES VIA THE INTERNET AND WIRELESS DEVICES; ELECTRICAL CIRCUITS FOR USE IN AMUSEMENT GAME MACHINES FOR REPRODUCING MUSIC, SPEECH AND SPECIAL EFFECTS; ELECTRICAL PICKUPS FOR USE WITH MUSICAL INSTRUMENTS; ELECTRONIC EFFECTS PEDALS FOR USE WITH MUSICAL INSTRUMENTS; JUKE BOXES; MUSIC RECORDINGS SOLD AS A KIT WITH A MASK; MUSIC-COMPOSITION SOFTWARE; MUSICAL INSTRUMENT ADAPTORS; MUSICAL INSTRUMENT AMPLIFIERS; MUSICAL INSTRUMENT CONNECTORS; MUSICAL SOUND RECORDINGS; MUSICAL VIDEO RECORDINGS; PROTECTIVE CARRYING CASES FOR PORTABLE MUSIC PLAYERS NAMELY MP3 PLAYERS; SOUND RECORDINGS FEATURING ART HISTORY; VIDEO RECORDINGS FEATURING ART HISTORY; VISUAL RECORDINGS AND AUDIO VISUAL RECORDINGS FEATURING MUSIC AND ANIMATION; APPARATUS FOR RECORDING, TRANSMISSION OR REPRODUCTION OF SOUND AND IMAGES; APPARATUS FOR SPEECH RECORDING AND REPLAYING; AUDIO CASSETTE RECORDERS; AUDIO TAPE RECORDERS; BLANK INTEGRATED CIRCUIT CARDS FOR RECORDING, TRANSMITTING, AND REPRODUCING SOUND AND IMAGES IN MOBILE TELEPHONE SERVICES; BLANK MAGNETIC TAPES FOR TAPE RECORDERS; BLANK RECORD DISKS; BLANK RECORDABLE DVDS; BLANK RECORDABLE OPTICAL DISC; CAR VIDEO RECORDERS; CASSETTE RECORDERS; CHRONOGRAPHS FOR USE AS SPECIALIZED TIME RECORDING APPARATUSES; COMBINATION VIDEO PLAYERS AND RECORDERS; COMPUTER PROGRAMS FOR PRE-RECORDED GAMES; COMPUTER PROGRAMS RECORDED ON DATA MEDIA (SOFTWARE) DESIGNED FOR USE IN CONSTRUCTION AND AUTOMATED MANUFACTURING (CAD/CAM); DVD RECORD-

ING APPARATUS; DIGITAL AUDIO TAPE RECORDERS; DIGITAL VIDEO RECORDERS; ELECTRONIC CIRCUITS RECORDING PROGRAMS FOR AMUSEMENT APPARATUS FOR USE WITH LIQUID CRYSTAL SCREENS; ELECTRONIC MACHINES FOR READING CREDIT CARDS AND RECORDING FINANCIAL OPERATIONS; ELECTRONIC PUBLICATIONS, NAMELY, MAGAZINES FEATURING ART HISTORY RECORDED ON COMPUTER MEDIA; ELECTRONIC READERS/RECORDERS FOR MEDICAL PATIENT IDENTIFICATION BANDS; ELECTRONIC RECORDERS FOR STORING AND ARCHIVING INFORMATION RELATED TO POWER SYSTEM FAULTS; EVENT RECORDERS; GPS DATA LOGGER FOR RECORDING TRIPS AND CLASSIFYING THEM INTO DIFFERENT ACCOUNTS; HEAD CLEANING TAPES FOR AUDIO AND VISUAL RECORDER; MAGNETIC TAPE RECORDERS; MAGNETIC-TAPE RECORDERS; MEDICAL IMAGING SOFTWARE THAT RECORDS, MONITORS AND ANALYZES DATA USING A CATHETER BASED ULTRASOUND IMAGING PROBE; PHONOGRAPH RECORD PLAYERS; PHONOGRAPH RECORD SLEEVES; PHONOGRAPH RECORDS FEATURING ROCK MUSIC; PLASTIC AND CARDBOARD CASES FOR STORING RECORD ALBUMS; PORTABLE ELECTRONIC RECORDER FOR MEASURING AND RECORDING MULTIPLE VOLTAGE, CURRENT AND THERMOCOUPLE READINGS FROM VARIOUS TRANSDUCERS; PORTABLE VIDEO CAMERAS WITH BUILT-IN VIDEOCASSETTE RECORDERS; PRE-RECORDED ELECTRONIC MEDIA IN THE FIELD OF ART HISTORY; PRESSURE RECORDERS; PROGRAMMABLE DIGITAL TELEVISION RECORDERS; RECORD DECKS; RECORD PLAYERS; RECORD PLAYERS FOR DIGITAL COMPACT DISKS; RECORDING AND PLAYING DEVICES FOR SOUND AND IMAGE CARRIERS; SOUND AND VIDEO RECORDING AND PLAYBACK MACHINES; SOUND RECORDED MAGNETIC CARDS, SHEETS AND TAPES; SOUND RECORDING APPARATUS; SOUND RECORDING APPARATUS AND INSTRUMENTS; TAPE RECORDERS; TELEPHONE RECORDERS; TIME CLOCKS; TRADING CARDS

RECORDED ON COMPUTER DISCS; TYPEFACE FONTS RECORDED ON MAGNETIC MEDIA; VIDEO CASSETTE RECORDERS; VIDEO DISKS AND VIDEO TAPES WITH RECORDED ANIMATED CARTOONS; VIDEO MAGAZINE RECORDED ON ELECTRONIC MEDIA FEATURING ART HISTORY; VIDEO TAPE RECORDERS; VIDEOCASSETTE RECORDERS; VIDEOTAPE RECORDERS; VIDEOTAPES AND VIDEO DISKS RECORDED WITH ANIMATION; WATCHMAN'S TIME RECORDERS, NAMELY, A DEVICE FOR RECORDING THE ACTIVITIES OF SECURITY GUARDS TO INSURE THAT THE SECURITY GUARD ARRIVES AT SCHEDULED CHECKPOINTS; ENCODED MICRO PARTICULATES, TAGS AND TAGGANTS OF PLASTIC, METAL OR SILICATE FOR USE IN THE FIELD OF PASSIVE LABELING, TRACING OR TRACKING OF PERSONS, ANIMALS, VEHICLES OR GOODS OF ANY KIND; COMPUTER COLOR PRINTER USING HEAT SENSITIVE DRY PRINTING PROCESS; DOWNLOADABLE PRINTING FONTS; INTERFACE CARDS FOR DATA PROCESSING EQUIPMENT IN THE FORM OF PRINTED CIRCUITS; PRINTED CIRCUIT BOARDS; PRINTED CIRCUITS; PRINTED ELECTRONIC CIRCUITS FOR APPARATUS AND CARDS BEARING INTEGRATED CIRCUITS; PRINTING FONTS THAT CAN BE DOWNLOADED PROVIDED BY MEANS OF ELECTRONIC TRANSMISSION; REGISTRATION CONTROL APPARATUS FOR PRINTING PRESSES; TEST ADAPTERS FOR TESTING PRINTED CIRCUIT BOARDS; TEST PINS FOR TESTING PRINTED CIRCUIT BOARDS; TESTING APPARATUS FOR TESTING PRINTED CIRCUIT BOARDS, IN CLASS 9 (U.S. CLS. 21, 23, 26, 36 AND 38).

FIRST USE 1-10-2003; IN COMMERCE 7-9-2003.

THE MARK CONSISTS OF STANDARD CHARACTERS WITHOUT CLAIM TO ANY PARTICULAR FONT, STYLE, SIZE, OR COLOR.

SER. NO. 77-129,564, FILED 3-13-2007.

SIMON TENG, EXAMINING ATTORNEY

Int. Cl.: 7

Prior U.S. Cls.: 13, 19, 21, 23, 31, 34 and 35

United States Patent and Trademark Office

Reg. No. 3,478,817

Registered Aug. 5, 2008

**TRADEMARK
PRINCIPAL REGISTER**

Nanofriks

KS KOLBENSCHMIDT GMBH (FED REP GER-
MANY CORPORATION)
KARL-SCHMIDT-STRASSE
NECKARSULM, FED REP GERMANY 74172

FOR: INTERNAL COMBUSTION ENGINE
PARTS, NAMELY, PISTONS, PISTON RINGS, PIS-
TON PINS, SECURING ELEMENTS FOR PISTON
PINS, CONNECTING ENGINE RODS, CRANK
SHAFTS FOR ENGINES, CYLINDER BLOCKS FOR
MOTORS, LINERS FOR ENGINE CYLINDER
BLOCKS, IN CLASS 7 (U.S. CLS. 13, 19, 21, 23, 31, 34
AND 35).

THE MARK CONSISTS OF STANDARD CHAR-
ACTERS WITHOUT CLAIM TO ANY PARTICULAR
FONT, STYLE, SIZE, OR COLOR.

OWNER OF ERPN CMNTY TM OFC REG. NO.
5752613, DATED 1-23-2008, EXPIRES 3-13-2017.

SER. NO. 77-129,636, FILED 3-13-2007.

JASON TURNER, EXAMINING ATTORNEY

Int. Cls.: 9 and 42

Prior U.S. Cls.: 21, 23, 26, 36, 38, 100 and 101

United States Patent and Trademark Office

Reg. No. 3,478,818

Registered Aug. 5, 2008

**TRADEMARK
SERVICE MARK
PRINCIPAL REGISTER**

PIKA

PIKA TECHNOLOGIES INC. (CANADA CORPORATION)
SUITE 400
535 LEGGET DRIVE
OTTAWA, ONTARIO, CANADA K2K3B8

FOR: WIRELESS TELEPHONY APPARATUS; COMPUTER TELEPHONY SOFTWARE; ENCODED SMART CARDS CONTAINING PROGRAMMING USED TO ENABLE COMPUTER TELEPHONY APPLICATIONS, VOICE MESSAGING AND PROCESSING, FACSIMILE TRANSMISSION, SPEECH RECOGNITION AND CONVERSION OF VOICE TO TEXT AND TEXT TO SPEECH; PULSE TO DUAL TONE MULTI FREQUENCY CONVERTERS; TELEPHONE CIRCUIT BOARDS; TELECOMMUNICATIONS AND DATA NETWORKING HARDWARE AND SOFTWARE, NAMELY, DEVICES AND SOFTWARE FOR TRANSPORTING AND AGGREGATING VOICE, DATA AND VIDEO COMMUNICATIONS ACROSS MULTIPLE NETWORK INFRASTRUCTURES AND COMMUNICATIONS PROTOCOLS; MOBILE AND SATELLITE TELEPHONES; TELEPHONE APPARATUS; FACSI-

MILE APPARATUS; DATA PROCESSORS, IN CLASS 9 (U.S. CLS. 21, 23, 26, 36 AND 38).

FIRST USE 11-20-1987; IN COMMERCE 11-20-1987.

FOR: CUSTOM DESIGN AND ENGINEERING OF TELEPHONY SYSTEMS FOR ORIGINAL EQUIPMENT MANUFACTURERS; DESIGN AND ENGINEERING OF TELEPHONY COMPUTER SOFTWARE FOR OTHERS, TECHNICAL SUPPORT SERVICES, NAMELY, TROUBLESHOOTING OF COMPUTER SOFTWARE PROBLEMS FOR SOFTWARE DEVELOPER CUSTOMERS, IN CLASS 42 (U.S. CLS. 100 AND 101).

FIRST USE 11-20-1987; IN COMMERCE 11-20-1987.

THE MARK CONSISTS OF STANDARD CHARACTERS WITHOUT CLAIM TO ANY PARTICULAR FONT, STYLE, SIZE, OR COLOR.

SER. NO. 77-130,555, FILED 3-14-2007.

IRA J. GOODSaid, EXAMINING ATTORNEY

Int. Cls.: 35 and 41

Prior U.S. Cls.: 100, 101, 102 and 107

United States Patent and Trademark Office

Reg. No. 3,478,819

Registered Aug. 5, 2008

**SERVICE MARK
PRINCIPAL REGISTER**



INTERNATIONAL BILLIARDS ASSOCIATION
(MINNESOTA LTD LIAB CO)
P.O. BOX 2531
INVER GROVE HEIGHTS, MN 55076

FOR: PROVIDING A WEBSITE THAT PROVIDES
SPORTS LEAGUE MANAGEMENT, IN CLASS 35
(U.S. CLS. 100, 101 AND 102).

FIRST USE 4-1-2005; IN COMMERCE 4-1-2005.

FOR: PROVIDING A WEBSITE THAT PROVIDES
SPORTS LEAGUE PLAYER STATISTICS, IN CLASS
41 (U.S. CLS. 100, 101 AND 107).

FIRST USE 4-1-2005; IN COMMERCE 4-1-2005.

NO CLAIM IS MADE TO THE EXCLUSIVE
RIGHT TO USE "INTERNATIONAL BILLIARDS

ASSOCIATION", APART FROM THE MARK AS
SHOWN.

THE COLOR(S) PURPLE, BLACK, YELLOW,
GRAY AND WHITE IS/ARE CLAIMED AS A FEAT-
TURE OF THE MARK.

THE COLOR BLACK APPEARS IN THE WORD-
ING "INTERNATIONAL BILLIARDS ASSOCIA-
TION", AND IN THE DESIGN A PURPLE BALL
UPPER LEFT, BLACK BALL LOWER LEFT, YEL-
LOW AND WHITE BALL UPPER RIGHT AND
GRAY WIRE FRAME SURROUNDING THE BALLS.

SER. NO. 77-131,237, FILED 3-14-2007.

ANNE E. GUSTASON, EXAMINING ATTORNEY

Int. Cl.: 35

Prior U.S. Cls.: 100, 101 and 102

United States Patent and Trademark Office

Reg. No. 3,478,820

Registered Aug. 5, 2008

**SERVICE MARK
PRINCIPAL REGISTER**

The logo for iMAP features a lowercase 'i' with a dot, followed by the uppercase letters 'M', 'A', and 'P' in a bold, sans-serif font.

MEDICAL KNOWLEDGE GROUP LLC (DELA-
WARE LTD LIAB CO)
666 THIRD AVENUE, 18TH FLOOR
NEW YORK, NY 10017

POLLING DATA THAT RELATE TO THE HEALTH-
CARE INDUSTRY, IN CLASS 35 (U.S. CLS. 100, 101
AND 102).

FOR: CONDUCTING MARKET RESEARCH,
SURVEYS, INTERVIEWS AND OPINION POLLS
FOR IDENTIFYING OPINION LEADERS IN THE
HEALTHCARE INDUSTRY; CONSULTATION AND
ANALYSIS OF COLLECTED PUBLIC OPINION

FIRST USE 6-1-2006; IN COMMERCE 6-1-2006.

SER. NO. 77-131,742, FILED 3-15-2007.

TANYA AMOS, EXAMINING ATTORNEY

Int. Cls.: 35 and 41

Prior U.S. Cls.: 100, 101, 102 and 107

United States Patent and Trademark Office

Reg. No. 3,478,821

Registered Aug. 5, 2008

**SERVICE MARK
PRINCIPAL REGISTER**



BRISSON, PAUL (UNITED STATES INDIVIDUAL)
624 MCCLELLAN STREET
SCHENECTADY, NY 12304

FOR: DISTRIBUTORSHIP SERVICES IN THE FIELD OF MEDICAL DEVICES, IN CLASS 35 (U.S. CLS. 100, 101 AND 102).

FIRST USE 7-1-2005; IN COMMERCE 7-1-2005.

FOR: EDUCATIONAL SERVICES, NAMELY, CONDUCTING CLASSES, SEMINARS, AND WORKSHOPS AND TRAINING OF MEDICAL PERSONNEL IN THE USE OF LAPAROSCOPIC MEDICAL EQUIPMENT, IN CLASS 41 (U.S. CLS. 100, 101 AND 107).

FIRST USE 7-1-2005; IN COMMERCE 7-1-2005.

NO CLAIM IS MADE TO THE EXCLUSIVE RIGHT TO USE "LAPAROSCOPY INTERNATIONAL", APART FROM THE MARK AS SHOWN.

THE COLOR(S) RED, WHITE, AND BLACK IS/ ARE CLAIMED AS A FEATURE OF THE MARK.

THE WORD "LAPAROSCOPY" APPEARS IN WHITE SURROUNDED BY A RED RECTANGLE; THE WORD "INTERNATIONAL" AND THE PICTORIAL REPRESENTATION OF A LAPAROSCOPIC INSTRUMENT APPEAR IN BLACK; THE PICTORIAL REPRESENTATION OF A GLOBE APPEARS IN BLACK AND WHITE.

SER. NO. 77-132,760, FILED 3-16-2007.

MATTHEW PAPPAS, EXAMINING ATTORNEY

Int. Cl.: 11

Prior U.S. Cls.: 13, 21, 23, 31 and 34

Reg. No. 3,478,822

United States Patent and Trademark Office

Registered Aug. 5, 2008

**TRADEMARK
PRINCIPAL REGISTER**



BOSHART INDUSTRIES, INC. (CANADA CORPORATION)

P.O. BOX 310

25 WHALEY AVENUE

MILVERTON, CANADA N0K1M0

FOR: NON-METAL PLUMBING SUPPLIES, NAMELY, PLASTIC INSERT ADAPTERS, POOL AND SPA ADAPTERS, NAMELY, ADAPTERS FOR JOINING PLASTIC PIPE OR HOSE WITH METAL PIPE, SUMP CHECK VALVES, WELL SEALS, AND CABLE GUARDS; PLUMBING SUPPLIES, NAMELY, TORQUE ARRESTORS AND RUBBER BOOTS, NAMELY, MECHANICAL RUBBER COUPLERS FOR JOINING PIPES AND FITTINGS, IN CLASS 11 (U.S. CLS. 13, 21, 23, 31 AND 34).

OWNER OF CANADA REG. NO. TMA423261, DATED 2-18-1994, EXPIRES 2-18-2009.

NO CLAIM IS MADE TO THE EXCLUSIVE RIGHT TO USE "SEAL WELL PRODUCTS", APART FROM THE MARK AS SHOWN.

THE MARK CONSISTS OF A BORDER WITH ROUNDED EDGES CONTAINING INSIDE IT THE WORDS "SEAL WELL PRODUCTS" IN ALL CAPITAL LETTERS, ADJACENT TO A TEAR DROP SHAPE CONTAINING A MAPLE LEAF AND THE LETTERS "SWP" BELOW THE LEAF.

SER. NO. 77-135,085, FILED 3-20-2007.

CARYN GLASSER, EXAMINING ATTORNEY

Int. Cl.: 14

Prior U.S. Cls.: 2, 27, 28 and 50

United States Patent and Trademark Office

Reg. No. 3,478,823

Registered Aug. 5, 2008

**TRADEMARK
PRINCIPAL REGISTER**

DIRTBOY DESIGNS

DIRTBOY DESIGNS, LLC (WASHINGTON LTD
LIAB CO)
3601 FIR ROAD
ELTOPIA, WA 99330

FOR: BRACELETS; CHARITY BRACELETS; RUB-
BER OR SILICON WRISTBANDS IN THE NATURE
OF A BRACELET, JEWELRY, IN CLASS 14 (U.S. CLS.
2, 27, 28 AND 50).

FIRST USE 2-25-2006; IN COMMERCE 8-10-2006.

THE MARK CONSISTS OF STANDARD CHAR-
ACTERS WITHOUT CLAIM TO ANY PARTICULAR
FONT, STYLE, SIZE, OR COLOR.

NO CLAIM IS MADE TO THE EXCLUSIVE
RIGHT TO USE "DESIGNS", APART FROM THE
MARK AS SHOWN.

SER. NO. 77-135,477, FILED 3-20-2007.

ANGELA M. MICHELI, EXAMINING ATTORNEY

Int. Cl.: 41

Prior U.S. Cls.: 100, 101 and 107

United States Patent and Trademark Office

Reg. No. 3,478,824

Registered Aug. 5, 2008

**SERVICE MARK
PRINCIPAL REGISTER**

JLGphoto

JP STUDIOS INC. (CALIFORNIA CORPORATION)
6139 WILSHIRE BLVD
LOS ANGELES, CA 90048

THE MARK CONSISTS OF STANDARD CHARACTERS WITHOUT CLAIM TO ANY PARTICULAR FONT, STYLE, SIZE, OR COLOR.

FOR: PHOTOGRAPHY SERVICES; PORTRAIT PHOTOGRAPHY, IN CLASS 41 (U.S. CLS. 100, 101 AND 107).

SER. NO. 77-136,143, FILED 3-21-2007.

FIRST USE 3-1-2000; IN COMMERCE 4-1-2000.

TASHIA BUNCH, EXAMINING ATTORNEY

Int. Cl.: 41

Prior U.S. Cls.: 100, 101 and 107

United States Patent and Trademark Office

Reg. No. 3,478,825

Registered Aug. 5, 2008

**SERVICE MARK
PRINCIPAL REGISTER**



FARMS FOR CITY KIDS FOUNDATION, INC.
(NEW YORK CORPORATION)
800 PORT WASHINGTON BOULEVARD
PORT WASHINGTON, NY 11050

FOR: EDUCATIONAL SERVICES, NAMELY,
CONDUCTING EDUCATIONAL PROGRAMS FOR
CHILDREN FEATURING HANDS-ON PRACTICAL
LEARNING EXPERIENCES ON A DAIRY FARM ,
IN CLASS 41 (U.S. CLS. 100, 101 AND 107).

FIRST USE 3-31-2004; IN COMMERCE 3-31-2004.

NO CLAIM IS MADE TO THE EXCLUSIVE
RIGHT TO USE "FARM" AND "READING, VER-
MONT", APART FROM THE MARK AS SHOWN.

SEC. 2(F) AS TO "FARMS FOR CITY KIDS".

SER. NO. 77-139,348, FILED 3-23-2007.

DAVID MURRAY, EXAMINING ATTORNEY

Int. Cl.: 9

Prior U.S. Cls.: 21, 23, 26, 36 and 38

United States Patent and Trademark Office

Reg. No. 3,478,826

Registered Aug. 5, 2008

**TRADEMARK
PRINCIPAL REGISTER**

Atlantis Energy

ATLANTIS ENERGY, INC. (CALIFORNIA CORPORATION)
233 SO. AUBURN, STE #110
COLFAX, CA 95713

FOR: APPARATUS FOR CONVERTING ELECTRONIC RADIATION TO ELECTRICAL ENERGY, NAMELY, PHOTOVOLTAIC CLADDING PANELS; APPARATUS FOR CONVERTING ELECTRONIC RADIATION TO ELECTRICAL ENERGY, NAMELY, PHOTOVOLTAIC ROOFING MEMBERS; APPARATUS FOR CONVERTING ELECTRONIC RADIATION TO ELECTRICAL ENERGY, NAMELY, PHOTOVOLTAIC SOLAR MODULES, IN CLASS 9 (U.S. CLS. 21, 23, 26, 36 AND 38).

FIRST USE 12-2-1998; IN COMMERCE 12-2-1998.

THE MARK CONSISTS OF STANDARD CHARACTERS WITHOUT CLAIM TO ANY PARTICULAR FONT, STYLE, SIZE, OR COLOR.

NO CLAIM IS MADE TO THE EXCLUSIVE RIGHT TO USE "ENERGY", APART FROM THE MARK AS SHOWN.

SER. NO. 77-139,628, FILED 3-24-2007.

HENRY S. ZAK, EXAMINING ATTORNEY

Int. Cl.: 36

Prior U.S. Cls.: 100, 101 and 102

United States Patent and Trademark Office

Reg. No. 3,478,827

Registered Aug. 5, 2008

**SERVICE MARK
PRINCIPAL REGISTER**

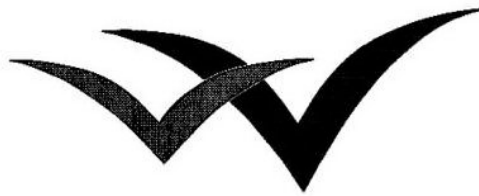

WESTPORT CAPITAL PARTNERS LLC (CON-
NECTICUT LTD LIAB CO)
55 POST ROAD WEST
WESTPORT, CT 06880

FOR: FINANCIAL AND INVESTMENT MAN-
AGEMENT SERVICES, NAMELY, INVESTMENT
OF FUNDS FOR OTHERS; PRIVATE EQUITY IN-
VESTMENT AND PRIVATE EQUITY INVESTMENT
MANAGEMENT; VENTURE CAPITAL SERVICES,
NAMELY, PROVIDING FINANCING TO EMER-
GING START-UP COMPANIES; REAL ESTATE AC-

QUISITION, IN CLASS 36 (U.S. CLS. 100, 101 AND
102).

FIRST USE 2-1-2006; IN COMMERCE 2-1-2006.

THE MARK CONSISTS OF A "W" FORMED
FROM THE DISPOSITION OF TWO SEAGULLS.

SER. NO. 77-140,110, FILED 3-26-2007.

THOMAS MANOR, EXAMINING ATTORNEY

Int. Cl.: 28

Prior U.S. Cls.: 22, 23, 38 and 50

United States Patent and Trademark Office

Reg. No. 3,478,828

Registered Aug. 5, 2008

**TRADEMARK
PRINCIPAL REGISTER**

PENELOPE PITSTOP

HANNA-BARBERA PRODUCTIONS, INC. (DE-
LAWARE CORPORATION)
4000 WARNER BOULEVARD
BURBANK, CA 91522

THE MARK CONSISTS OF STANDARD CHAR-
ACTERS WITHOUT CLAIM TO ANY PARTICULAR
FONT, STYLE, SIZE, OR COLOR.

FOR: TOYS, NAMELY, ACTION FIGURES AND
ACCESSORIES THEREFOR, IN CLASS 28 (U.S. CLS.
22, 23, 38 AND 50).

SER. NO. 77-140,377, FILED 3-26-2007.

FIRST USE 6-0-2006; IN COMMERCE 6-0-2006.

LAURIE KAUFMAN, EXAMINING ATTORNEY

Int. Cl.: 6

Prior U.S. Cls.: 2, 12, 13, 14, 23, 25 and 50

Reg. No. 3,478,829

United States Patent and Trademark Office

Registered Aug. 5, 2008

**TRADEMARK
PRINCIPAL REGISTER**

RIG-RELEASE

THE CALDWELL GROUP, INC. (ILLINOIS CORPORATION)
5055 26TH AVENUE
ROCKFORD, IL 61109

FOR: METAL RIGGING CHAIN, METAL RIGGING ATTACHMENTS, NAMELY, METAL RIGGING WIRE ROPES, METAL RELEASING HOOKS FOR USE ON CRANES, METAL CRANE HOOKS, POWER HOISTS, AND LIFTING SLINGS, IN CLASS 6 (U.S. CLS. 2, 12, 13, 14, 23, 25 AND 50).

FIRST USE 1-31-2005; IN COMMERCE 1-31-2005.

THE MARK CONSISTS OF STANDARD CHARACTERS WITHOUT CLAIM TO ANY PARTICULAR FONT, STYLE, SIZE, OR COLOR.

SER. NO. 77-140,563, FILED 3-26-2007.

JEFF DEFORD, EXAMINING ATTORNEY

Int. Cls.: 1 and 5

Prior U.S. Cls.: 1, 5, 6, 10, 18, 26, 44, 46, 51 and 52

United States Patent and Trademark Office

Reg. No. 3,478,830

Registered Aug. 5, 2008

**TRADEMARK
PRINCIPAL REGISTER**

TRCRtest

TOSOH CORPORATION (JAPAN CORPORATION)

4560, KAISEI-CHO

SHUNAN-SHI, YAMAGUCHI, JAPAN 746-8501

FOR: CHEMICALS, NAMELY, GENE TESTING DIAGNOSTIC REAGENTS FOR RESEARCH USE, IN CLASS 1 (U.S. CLS. 1, 5, 6, 10, 26 AND 46).

FOR: PHARMACEUTICAL PREPARATIONS FOR THE TREATMENT OF INFECTIOUS DISEASES AND CANCER, GENE TESTING REAGENT FOR MEDICAL AND VETERINARY DIAGNOSTIC USE, IN CLASS 5 (U.S. CLS. 6, 18, 44, 46, 51 AND 52).

THE MARK CONSISTS OF STANDARD CHARACTERS WITHOUT CLAIM TO ANY PARTICULAR FONT, STYLE, SIZE, OR COLOR.

PRIORITY CLAIMED UNDER SEC. 44(D) ON JAPAN APPLICATION NO. 2006-118606, FILED 12-22-2006, REG. NO. 5087866, DATED 11-2-2007, EXPIRES 11-1-2017.

OWNER OF U.S. REG. NOS. 3,037,574 AND 3,157,133.

SER. NO. 77-141,101, FILED 3-27-2007.

COLLEEN DOMBROW, EXAMINING ATTORNEY

Int. Cl.: 11

Prior U.S. Cls.: 13, 21, 23, 31 and 34

United States Patent and Trademark Office

Reg. No. 3,478,831

Registered Aug. 5, 2008

**TRADEMARK
PRINCIPAL REGISTER**

CONTROLLED CIRCULATION

ALSTOM POWER INC. (DELAWARE CORPORATION)
2000 DAY HILL ROAD
WINDSOR, CT 06095

FOR: HOT WATER HEATERS, VAPOR GENERATORS, AND HEAT EXCHANGERS WITH THE HEATING FLUID BEING IN THE GAS PHASE AND THE LIQUID TO BE HEATED BEING IN EITHER THE LIQUID OR THE GAS PHASE , IN CLASS 11 (U.S. CLS. 13, 21, 23, 31 AND 34).

FIRST USE 11-0-1952; IN COMMERCE 11-0-1952.

THE MARK CONSISTS OF STANDARD CHARACTERS WITHOUT CLAIM TO ANY PARTICULAR FONT, STYLE, SIZE, OR COLOR.

SEC. 2(F).

SER. NO. 77-142,667, FILED 3-28-2007.

TEJBIR SINGH, EXAMINING ATTORNEY

Int. Cl.: 5

Prior U.S. Cls.: 6, 18, 44, 46, 51 and 52

Reg. No. 3,478,832

United States Patent and Trademark Office

Registered Aug. 5, 2008

**TRADEMARK
PRINCIPAL REGISTER**

DETOX SECRET

CYNTHIA KING (UNITED STATES INDIVIDUAL)
545 EIGHTH AVENUE SUITE 401
545 EIGHTH AVENUE SUITE 401
NEW YORK, NY 10018

FOR: TRANSDERMAL PATCHES CONTAINING NON-MEDICINAL POWDER USED TO EXTRACT BODY OF TOXINS, IN CLASS 5 (U.S. CLS. 6, 18, 44, 46, 51 AND 52).

FIRST USE 4-16-2006; IN COMMERCE 4-16-2006.

THE MARK CONSISTS OF STANDARD CHARACTERS WITHOUT CLAIM TO ANY PARTICULAR FONT, STYLE, SIZE, OR COLOR.

NO CLAIM IS MADE TO THE EXCLUSIVE RIGHT TO USE "DETOX", APART FROM THE MARK AS SHOWN.

SER. NO. 77-142,713, FILED 3-28-2007.

GEORGIA CARTY, EXAMINING ATTORNEY

Int. Cl.: 9

Prior U.S. Cls.: 21, 23, 26, 36 and 38

United States Patent and Trademark Office

Reg. No. 3,478,833

Registered Aug. 5, 2008

**TRADEMARK
PRINCIPAL REGISTER**

KITCHENS.COM

WORLDVIEW TECHNOLOGIES, INC. (ILLINOIS CORPORATION)
420 GRAND, #1B
CHICAGO, IL 60610

FOR: DOWNLOADABLE ELECTRONIC INFORMATIONAL AND INSTRUCTIONAL PUBLICATIONS IN THE NATURE OF NEWSLETTERS, QUIZZES, QUESTIONNAIRES, AND JOURNALS FOR USE BY CONSUMERS IN THE FIELD OF KITCHENS, BATHS, REMODELING, BUILDING AND INTERIOR DESIGN SERVICES, IN CLASS 9 (U.S. CLS. 21, 23, 26, 36 AND 38).

FIRST USE 12-4-2000; IN COMMERCE 12-4-2000.

THE MARK CONSISTS OF STANDARD CHARACTERS WITHOUT CLAIM TO ANY PARTICULAR FONT, STYLE, SIZE, OR COLOR.

OWNER OF U.S. REG. NO. 2,491,760.

SEC. 2(F).

SER. NO. 77-142,921, FILED 3-28-2007.

COLLEEN DOMBROW, EXAMINING ATTORNEY

Int. Cl.: 36

Prior U.S. Cls.: 100, 101 and 102

United States Patent and Trademark Office

Reg. No. 3,478,834

Registered Aug. 5, 2008

**SERVICE MARK
PRINCIPAL REGISTER**

**Charitable Installment
Purchase (ChIP)**

NEW LIFE INTERNATIONAL (TENNESSEE
NON-PROFIT CORPORATION)
103 CONTINENTAL PLACE, SUITE 200
BRENTWOOD, TN 37027

FOR: CHARITABLE FUND RAISING, IN CLASS
36 (U.S. CLS. 100, 101 AND 102).

FIRST USE 1-1-2001; IN COMMERCE 1-1-2001.

THE MARK CONSISTS OF STANDARD CHAR-
ACTERS WITHOUT CLAIM TO ANY PARTICULAR
FONT, STYLE, SIZE, OR COLOR.

NO CLAIM IS MADE TO THE EXCLUSIVE
RIGHT TO USE "CHARITABLE INSTALLMENT
PURCHASE", APART FROM THE MARK AS
SHOWN.

SER. NO. 77-143,016, FILED 3-28-2007.

WILLIAM P. SHANAHAN, EXAMINING ATTOR-
NEY

Int. Cl.: 42

Prior U.S. Cls.: 100 and 101

United States Patent and Trademark Office

Reg. No. 3,478,835

Registered Aug. 5, 2008

**SERVICE MARK
PRINCIPAL REGISTER**



PAPERLESS ENVIRONMENTS, LLC (LOUISIANA
LTD LIAB CO)
SUITE F
7916 WRENWOOD
BATON ROUGE, LA 70809

FOR: DEVELOPMENT, IMPLEMENTATION AND
TECHNICAL SUPPORT OF CUSTOMIZED COMPU-
TER SOFTWARE FOR THE MANAGEMENT OF
INDEXING, STORAGE, ROUTING, AND RETRIE-
VAL OF ELECTRONIC VERSIONS OF DOCU-
MENTS, IN CLASS 42 (U.S. CLS. 100 AND 101).

FIRST USE 2-7-2005; IN COMMERCE 2-7-2005.

NO CLAIM IS MADE TO THE EXCLUSIVE
RIGHT TO USE "PAPERLESS ENVIRONMENTS",
APART FROM THE MARK AS SHOWN.

THE MARK CONSISTS OF THE WORDS "PAPER-
LESS ENVIRONMENTS" BELOW THREE SHEETS
OF STYLIZED PAPER.

SER. NO. 77-144,645, FILED S.R. 3-30-2007 AM. P.R.
2-21-2008.

CARYN GLASSER, EXAMINING ATTORNEY

Int. Cl.: 38

Prior U.S. Cls.: 100, 101 and 104

United States Patent and Trademark Office

Reg. No. 3,478,836

Registered Aug. 5, 2008

SERVICE MARK
PRINCIPAL REGISTER

STAR TELEVISION PRODUCTIONS LIMITED
(BR.VIRGIN ISLANDS LTD LIAB CO)
ROAD TOWN, CRAIGMUIR CHAMBERS
PO BOX 71
TORTOLA, BR.VIRGIN ISLANDS

FOR: PROVIDING ON-LINE CHAT ROOMS, ELECTRONIC BULLETIN BOARDS, AND FORUMS FOR TRANSMISSION OF MESSAGES AMONG COMPUTER USERS CONCERNING TELEVISION, ENTERTAINMENT, ARTS, MUSIC, SPORTS, MOVIES, FASHION, GOSSIP, CULTURE, LIFESTYLE, NEWS AND CELEBRITIES; PROVIDING ON-LINE COMMUNICATIONS LINKS WHICH TRANSFER THE WEBSITE USER TO OTHER LOCAL AND GLOBAL WEB PAGES; COMMUNICATIONS SERVICES, NAMELY, TRANSMITTING STREAMED SOUND AND AUDIO-VISUAL RECORDINGS VIA THE INTERNET; BROADCASTING SERVICES AND PROVISION OF TELECOMMUNICATION ACCESS TO VIDEO AND AUDIO CONTENT PROVIDED VIA A VIDEO-ON-DEMAND SERVICE VIA THE INTER-

NET; COMMUNICATIONS SERVICES, NAMELY, TRANSMITTING STREAMED SOUND AND AUDIO-VISUAL RECORDINGS VIA THE INTERNET; STREAMING OF AUDIO AND VIDEO MATERIAL ON THE INTERNET, IN CLASS 38 (U.S. CLS. 100, 101 AND 104).

FIRST USE 4-0-2000; IN COMMERCE 4-0-2000.

NO CLAIM IS MADE TO THE EXCLUSIVE RIGHT TO USE "INDIA.COM", APART FROM THE MARK AS SHOWN.

THE MARK CONSISTS OF THE WORD "INDYA.-COM" OVER A CIRCLE.

SEC. 2(F).

SER. NO. 77-144,830, FILED 3-30-2007.

MICHELLE DUBOIS, EXAMINING ATTORNEY

Int. Cl.: 41

Prior U.S. Cls.: 100, 101 and 107

United States Patent and Trademark Office

Reg. No. 3,478,837

Registered Aug. 5, 2008

SERVICE MARK
PRINCIPAL REGISTER

The logo for indya.com features the word "indya.com" in a lowercase, handwritten-style font. The letter "y" is particularly stylized, with a long, sweeping tail that loops back under the "a". The "i" has a dot, and the "a" has a dot. The ".com" is in a simpler, sans-serif font. The entire logo is rendered in black.

STAR TELEVISION PRODUCTIONS LIMITED
(BR.VIRGIN ISLANDS LTD LIAB CO)
ROAD TOWN, CRAIGMUIR CHAMBERS
PO BOX 71
TORTOLA, BR.VIRGIN ISLANDS

FOR: PROVIDING INFORMATION ABOUT TELEVISION PROGRAMMING, ENTERTAINMENT, ARTS, MUSIC, SPORTS, AND MOVIES, ENTERTAINMENT GOSSIP, ENTERTAINMENT NEWS AND CELEBRITY ENTERTAINMENT NEWS VIA THE INTERNET, IN CLASS 41 (U.S. CLS. 100, 101 AND 107).

FIRST USE 4-0-2000; IN COMMERCE 4-0-2000.

NO CLAIM IS MADE TO THE EXCLUSIVE RIGHT TO USE "INDIA.COM", APART FROM THE MARK AS SHOWN.

THE MARK CONSISTS OF THE WORD "INDYA.-COM" OVER A CIRCLE.

SEC. 2(F).

SER. NO. 77-144,834, FILED 3-30-2007.

MICHELLE DUBOIS, EXAMINING ATTORNEY

Int. Cl.: 45

Prior U.S. Cls.: 100 and 101

United States Patent and Trademark Office

Reg. No. 3,478,838

Registered Aug. 5, 2008

SERVICE MARK
PRINCIPAL REGISTER



STAR TELEVISION PRODUCTIONS LIMITED
(BR.VIRGIN ISLANDS LTD LIAB CO)
ROAD TOWN, CRAIGMUIR CHAMBERS
PO BOX 71
TORTOLA, BR.VIRGIN ISLANDS

FOR: ONLINE SOCIAL NETWORKING, INTRO-
DUCTION AND DATING SERVICES; PROVIDING
HOROSCOPE INFORMATION VIA THE INTERNET,
IN CLASS 45 (U.S. CLS. 100 AND 101).

FIRST USE 4-0-2000; IN COMMERCE 4-0-2000.

NO CLAIM IS MADE TO THE EXCLUSIVE
RIGHT TO USE "INDIA.COM", APART FROM THE
MARK AS SHOWN.

THE MARK CONSISTS OF THE WORD "INDYA.-
COM" OVER A CIRCLE.

SEC. 2(F).

SER. NO. 77-144,840, FILED 3-30-2007.

MICHELLE DUBOIS, EXAMINING ATTORNEY

Int. Cls.: 35, 41 and 43

Prior U.S. Cls.: 100, 101, 102 and 107

United States Patent and Trademark Office

Reg. No. 3,478,839

Registered Aug. 5, 2008

**SERVICE MARK
PRINCIPAL REGISTER**

ZOOM GROUP

C.G.M. SERVICES, INC. (KENTUCKY CORPORATION)
SUITE 900
410 W. CHESTNUT STREET
LOUISVILLE, KY 40202

FOR: EMPLOYMENT COUNSELING AND RECRUITING; EMPLOYMENT HIRING, RECRUITING, PLACEMENT, STAFFING AND CAREER NETWORKING SERVICES; PUBLIC ADVOCACY TO PROMOTE AWARENESS OF THE PRODUCTIVITY OF APPROPRIATELY TRAINED AND PLACED ADULTS WITH MENTAL RETARDATION IN THE WORKPLACE, IN CLASS 35 (U.S. CLS. 100, 101 AND 102).

FIRST USE 2-8-2007; IN COMMERCE 3-15-2007.

FOR: VOCATIONAL TRAINING FOR ADULTS WITH MENTAL RETARDATION IN THE FIELDS OF LAUNDRY, LIGHT ASSEMBLY AND PACKAGING, JANITORIAL, HORTICULTURE AND LANDSCAPE MAINTENANCE; EDUCATION SERVICES, NAMELY, EMPLOYMENT MENTORING IN THE FIELDS OF LAUNDRY, LIGHT ASSEMBLY AND PACKAGING, JANITORIAL, HORTICULTURE AND LANDSCAPE MAINTENANCE; PROVIDING SUPPORTED EMPLOYMENT JOB COACHING, NAMELY, JOB APPLICATION AND

INTERVIEW COACHING, ASSISTANCE IN SPECIFIC TRAINING, TRANSPORTATION COORDINATION, SKILLS COACHING REGARDING PUNCTUALITY, OFFICE ETIQUETTE, HIERARCHY RECOGNITION AND RESPONSIVENESS, AND SYSTEMS ACCLIMATIZATION, IN CLASS 41 (U.S. CLS. 100, 101 AND 107).

FIRST USE 2-8-2007; IN COMMERCE 3-15-2007.

FOR: DAY CARE CENTERS FOR ADULTS WITH MENTAL RETARDATION, IN CLASS 43 (U.S. CLS. 100 AND 101).

FIRST USE 2-8-2007; IN COMMERCE 3-15-2007.

THE MARK CONSISTS OF STANDARD CHARACTERS WITHOUT CLAIM TO ANY PARTICULAR FONT, STYLE, SIZE, OR COLOR.

NO CLAIM IS MADE TO THE EXCLUSIVE RIGHT TO USE "GROUP", APART FROM THE MARK AS SHOWN.

SER. NO. 77-145,931, FILED 4-2-2007.

AMOS T. MATTHEWS, JR., EXAMINING ATTORNEY

Int. Cl.: 41

Prior U.S. Cls.: 100, 101 and 107

United States Patent and Trademark Office

Reg. No. 3,478,840

Registered Aug. 5, 2008

**SERVICE MARK
PRINCIPAL REGISTER**

PASSPORT APPROVED

PANGAEA ENTERTAINMENT GROUP (CALIFORNIA CORPORATION)
8383 WILSHIRE BOULEVARD, STE. 100
BEVERLY HILLS, CA 90211

FOR: RADIO ENTERTAINMENT SERVICES, NAMELY, RADIO PROGRAMS FEATURING PERFORMANCES BY MUSICAL ARTISTS AND RADIO PERSONALITIES, IN CLASS 41 (U.S. CLS. 100, 101 AND 107).

FIRST USE 4-24-2004; IN COMMERCE 4-24-2004.

THE MARK CONSISTS OF STANDARD CHARACTERS WITHOUT CLAIM TO ANY PARTICULAR FONT, STYLE, SIZE, OR COLOR.

SER. NO. 77-146,421, FILED 4-2-2007.

BENJAMIN ALLEN, EXAMINING ATTORNEY

Int. Cl.: 33

Prior U.S. Cls.: 47 and 49

United States Patent and Trademark Office

Reg. No. 3,478,841

Registered Aug. 5, 2008

**TRADEMARK
PRINCIPAL REGISTER**



LONDON GROUP, LLC (NEW YORK LTD LIAB
CO)
8 PINETREE LANE
OLD WESTBURY, NY 11568

FOR: LIQUEURS, IN CLASS 33 (U.S. CLS. 47 AND
49).

FIRST USE 5-2-2007; IN COMMERCE 5-2-2007.

THE MARK CONSISTS OF THE CONFIGURA-
TION OF A BOTTLE HAVING ELONGATED CON-
VEX SIDES AND A BOTTLECAP HAVING A
SLOPED TOP COMING TO A PEAK AND A FLORAL
DESIGN.

SER. NO. 77-146,629, FILED 4-2-2007.

AISHA SALEM, EXAMINING ATTORNEY

Int. Cl.: 9

Prior U.S. Cls.: 21, 23, 26, 36 and 38

Reg. No. 3,478,842

United States Patent and Trademark Office

Registered Aug. 5, 2008

**TRADEMARK
PRINCIPAL REGISTER**

CENTAURHAULS

CENTAUR TECHNOLOGY (DELAWARE CORPORATION)
7600-C N. CAPITAL OF TEXAS HWY, STE 300
AUSTIN, TX 78731

FOR: MICROPROCESSORS, IN CLASS 9 (U.S. CLS. 21, 23, 26, 36 AND 38).

FIRST USE 9-9-2005; IN COMMERCE 6-1-2006.

THE MARK CONSISTS OF STANDARD CHARACTERS WITHOUT CLAIM TO ANY PARTICULAR FONT, STYLE, SIZE, OR COLOR.

THE WORDING "CENTAURHAULS" HAS NO MEANING IN A FOREIGN LANGUAGE.

SER. NO. 77-146,758, FILED 4-2-2007.

SANI KHOURI, EXAMINING ATTORNEY

Int. Cl.: 32

Prior U.S. Cls.: 45, 46 and 48

United States Patent and Trademark Office

Reg. No. 3,478,843

Registered Aug. 5, 2008

**TRADEMARK
PRINCIPAL REGISTER**

BELLAVODA

MAKHSUDOVA, NORA (UNITED STATES INDIVIDUAL)
9500 GILMAN DRIVE MC 0608
LA JOLLA, CA 92093

FOR: BOTTLED SPRING WATER, BOTTLED TABLE WATER, BOTTLED MINERAL WATER, BOTTLED CARBONATED WATER, AND BOTTLED FLAVORED WATER, IN CLASS 32 (U.S. CLS. 45, 46 AND 48).

FIRST USE 1-1-2007; IN COMMERCE 1-1-2007.

THE MARK CONSISTS OF STANDARD CHARACTERS WITHOUT CLAIM TO ANY PARTICULAR FONT, STYLE, SIZE, OR COLOR.

NO CLAIM IS MADE TO THE EXCLUSIVE RIGHT TO USE "VODA", APART FROM THE MARK AS SHOWN.

THE FOREIGN WORDING IN THE MARK TRANSLATES INTO ENGLISH AS BEAUTIFUL WATER.

SER. NO. 77-146,928, FILED 4-2-2007.

RUSS HERMAN, EXAMINING ATTORNEY

Int. Cl.: 35

Prior U.S. Cls.: 100, 101 and 102

United States Patent and Trademark Office

Reg. No. 3,478,844

Registered Aug. 5, 2008

**SERVICE MARK
PRINCIPAL REGISTER**

ULTIMATE LEASING

WESTERN AMERICA EQUITIES LLC (WA-
SHINGTON LTD LIAB CO)
SUITE 230
11235 SE 6TH STREET
BELLEVUE, WA 98004

FOR: CONDUCTING REAL ESTATE BROKER
INCENTIVE AWARD PROGRAMS TO PROMOTE
ON THE JOB PRODUCTIVITY, IN CLASS 35 (U.S.
CLS. 100, 101 AND 102).

FIRST USE 12-2-2006; IN COMMERCE 12-2-2006.

THE MARK CONSISTS OF STANDARD CHAR-
ACTERS WITHOUT CLAIM TO ANY PARTICULAR
FONT, STYLE, SIZE, OR COLOR.

SER. NO. 77-147,221, FILED 4-3-2007.

RICHARD WHITE, EXAMINING ATTORNEY

Int. Cl.: 41

Prior U.S. Cls.: 100, 101 and 107

United States Patent and Trademark Office

Reg. No. 3,478,845

Registered Aug. 5, 2008

**SERVICE MARK
PRINCIPAL REGISTER**

Haunted History Tours

SMITH, SIDNEY HOFFMAN (UNITED STATES
INDIVIDUAL)

97 FOUNTAINBLEAU DRIVE

NEW ORLEANS, LA 70125

FOR: GUIDED WALKING TOURS THROUGH
VARIOUS HISTORIC AREAS OF NEW ORLEANS,
LOUISIANA, INCLUDING THE FRENCH QUAR-
TER, CEMETERIES AND GARDEN DISTRICT, IN
CLASS 41 (U.S. CLS. 100, 101 AND 107).

FIRST USE 7-1-1995; IN COMMERCE 7-1-1995.

THE MARK CONSISTS OF STANDARD CHAR-
ACTERS WITHOUT CLAIM TO ANY PARTICULAR
FONT, STYLE, SIZE, OR COLOR.

NO CLAIM IS MADE TO THE EXCLUSIVE
RIGHT TO USE "HISTORY TOURS", APART FROM
THE MARK AS SHOWN.

SEC. 2(F).

SER. NO. 77-147,406, FILED S.R. 4-3-2007 AM. P.R.
4-2-2008.

NAAKWAMA ANKRAH, EXAMINING ATTORNEY

Int. Cl.: 9

Prior U.S. Cls.: 21, 23, 26, 36 and 38

Reg. No. 3,478,846

United States Patent and Trademark Office

Registered Aug. 5, 2008

**TRADEMARK
PRINCIPAL REGISTER**



VUZIX CORPORATION (DELAWARE CORPORATION)
2166 BRIGHTON HENRIETTA TOWNLINE ROAD
ROCHESTER, NY 14623

FOR: GOGGLES WITH A DISPLAY MOUNTED TO THE FRAME, MOUNTING HARDWARE FOR MOUNTING A DISPLAY TO GOGGLES, DIGITAL VIDEO EYEWEAR, SOFTWARE AND FIRMWARE FOR VIDEO DRIVERS AND VIDEO PROCESSING, INTERFACE ELECTRONICS, NAMELY, VIDEO DRIVER INTERFACE CIRCUITS FOR DIGITAL VIDEO EYEWEAR, CABLES, NAMELY, ELECTRONIC CABLES AND CONNECTION CABLES, MICRO-DISPLAYS, NAMELY, HEAD-MOUNTED VIDEO DISPLAYS AND NEAR-EYE VIDEO DISPLAYS,

NEAR-EYE DISPLAY OPTICS, IN CLASS 9 (U.S. CLS. 21, 23, 26, 36 AND 38).

FIRST USE 3-30-2007; IN COMMERCE 3-30-2007.

NO CLAIM IS MADE TO THE EXCLUSIVE RIGHT TO USE "GMD", APART FROM THE MARK AS SHOWN.

THE MARK CONSISTS OF A SKULL DESIGN WITH THE LETTERS "GMD" BELOW IT.

SER. NO. 77-147,625, FILED 4-3-2007.

KATHY DE JONGE, EXAMINING ATTORNEY

Int. Cl.: 36

Prior U.S. Cls.: 100, 101 and 102

United States Patent and Trademark Office

Reg. No. 3,478,847

Registered Aug. 5, 2008

**SERVICE MARK
PRINCIPAL REGISTER**

CHASE ULTIMATE FAN REWARDS

JPMORGAN CHASE & CO. (DELAWARE CORPORATION)

270 PARK AVENUE

NEW YORK, NY 10017

FOR: CREDIT CARD SERVICES, IN CLASS 36
(U.S. CLS. 100, 101 AND 102).

FIRST USE 6-1-2005; IN COMMERCE 6-1-2005.

THE MARK CONSISTS OF STANDARD CHARACTERS WITHOUT CLAIM TO ANY PARTICULAR FONT, STYLE, SIZE, OR COLOR.

NO CLAIM IS MADE TO THE EXCLUSIVE RIGHT TO USE "REWARDS", APART FROM THE MARK AS SHOWN.

SER. NO. 77-148,098, FILED 4-4-2007.

MICHAEL LEWIS, EXAMINING ATTORNEY

Int. Cls.: 9 and 42

Prior U.S. Cls.: 21, 23, 26, 36, 38, 100 and 101

United States Patent and Trademark Office

Reg. No. 3,478,848

Registered Aug. 5, 2008

**TRADEMARK
SERVICE MARK
PRINCIPAL REGISTER**

DECIPHER

INNOVATION ASSET GROUP, INC. (OREGON CORPORATION)
SUITE 200
26055 SW CANYON CREEK ROAD
WILSONVILLE, OR 97070

FOR: COMPUTER SOFTWARE FOR MANAGING INTANGIBLE ASSETS SUCH AS INTELLECTUAL PROPERTY AND CONTRACT ASSETS AND OBLIGATIONS BY MAINTAINING SEARCHABLE DATABASES OF INFORMATION AND DATA, AND MANUALS SOLD AS A UNIT, IN CLASS 9 (U.S. CLS. 21, 23, 26, 36 AND 38).

FIRST USE 11-19-2004; IN COMMERCE 11-19-2004.

FOR: COMPUTER SERVICES, NAMELY, ACTING AS AN APPLICATION SERVICE PROVIDER IN THE

FIELD OF KNOWLEDGE MANAGEMENT TO HOST COMPUTER APPLICATION SOFTWARE FOR CREATING SEARCHABLE DATABASES OF INFORMATION AND DATA, IN CLASS 42 (U.S. CLS. 100 AND 101).

FIRST USE 2-1-2006; IN COMMERCE 2-1-2006.

THE MARK CONSISTS OF STANDARD CHARACTERS WITHOUT CLAIM TO ANY PARTICULAR FONT, STYLE, SIZE, OR COLOR.

SER. NO. 77-150,106, FILED 4-5-2007.

PRISCILLA MILTON, EXAMINING ATTORNEY

Int. Cls.: 41 and 42

Prior U.S. Cls.: 100, 101 and 107

United States Patent and Trademark Office

Reg. No. 3,478,849

Registered Aug. 5, 2008

**SERVICE MARK
PRINCIPAL REGISTER**



ANALYTIC SERVICES INC. DBA ANSER (CALIFORNIA CORPORATION)
SUITE 800
2900 SOUTH QUINCY STREET
ARLINGTON, VA 22206

FOR: EDUCATION SERVICES, NAMELY, CONDUCTING CLASSES LEADING TO A MASTER'S DEGREE OR GRADUATE CERTIFICATE IN SYSTEMS ENGINEERING, AND PROFESSIONAL DEVELOPMENT COURSES IN SYSTEMS ENGINEERING, PROGRAM MANAGEMENT AND PROBLEM SOLVING, IN CLASS 41 (U.S. CLS. 100, 101 AND 107).

FIRST USE 3-28-2007; IN COMMERCE 3-28-2007.

FOR: RESEARCH AND DEVELOPMENT IN THE FIELDS OF UNDERSTANDING AND IMPROVING LARGE-SCALE ENTERPRISES, AND INTEGRATION OF RESEARCH IN SYSTEMS THINKING, SYSTEMS ENGINEERING, SYSTEMS ARCHITECTING, ENTERPRISE MANAGEMENT, IN CLASS 42 (U.S. CLS. 100 AND 101).

FIRST USE 3-28-2007; IN COMMERCE 3-28-2007.

NO CLAIM IS MADE TO THE EXCLUSIVE RIGHT TO USE "INSTITUTE", APART FROM THE MARK AS SHOWN.

SER. NO. 77-150,450, FILED 4-6-2007.

ANTHONY RINKER, EXAMINING ATTORNEY

Int. Cls.: 41 and 42

Prior U.S. Cls.: 100, 101 and 107

United States Patent and Trademark Office

Reg. No. 3,478,850

Registered Aug. 5, 2008

**SERVICE MARK
PRINCIPAL REGISTER**

**APPLIED SYSTEMS THINKING
INSTITUTE**

ANALYTIC SERVICES INC. DBA ANSER (CALIFORNIA CORPORATION)
SUITE 800
2900 SOUTH QUINCY STREET
ARLINGTON, VA 22206

FOR: EDUCATION SERVICES, NAMELY, CONDUCTING CLASSES LEADING TO A MASTER'S DEGREE OR GRADUATE CERTIFICATE IN SYSTEMS ENGINEERING, AND PROFESSIONAL DEVELOPMENT COURSES IN SYSTEMS ENGINEERING, PROGRAM MANAGEMENT AND PROBLEM SOLVING, IN CLASS 41 (U.S. CLS. 100, 101 AND 107).

FIRST USE 3-28-2007; IN COMMERCE 3-28-2007.

FOR: RESEARCH AND DEVELOPMENT IN THE FIELDS OF UNDERSTANDING AND IMPROVING LARGE-SCALE ENTERPRISES, AND INTEGRA-

TION OF RESEARCH IN SYSTEMS THINKING, SYSTEMS ENGINEERING, SYSTEMS ARCHITECTING, ENTERPRISE MANAGEMENT, IN CLASS 42 (U.S. CLS. 100 AND 101).

FIRST USE 3-28-2007; IN COMMERCE 3-28-2007.

THE MARK CONSISTS OF STANDARD CHARACTERS WITHOUT CLAIM TO ANY PARTICULAR FONT, STYLE, SIZE, OR COLOR.

NO CLAIM IS MADE TO THE EXCLUSIVE RIGHT TO USE "SYSTEMS" AND "INSTITUTE", APART FROM THE MARK AS SHOWN.

SER. NO. 77-150,454, FILED 4-6-2007.

ANTHONY RINKER, EXAMINING ATTORNEY

Int. Cl.: 5

Prior U.S. Cls.: 6, 18, 44, 46, 51 and 52

Reg. No. 3,478,851

United States Patent and Trademark Office

Registered Aug. 5, 2008

**TRADEMARK
PRINCIPAL REGISTER**



RZN NUTRACEUTICALS, INC. (FLORIDA CORPORATION)
12011 SW 129TH CT., UNIT #1
MIAMI, FL 33186

THE COLOR(S) BLACK AND ORANGE IS/ARE CLAIMED AS A FEATURE OF THE MARK.

FOR: DIETARY SUPPLEMENTS FOR ANIMALS, IN CLASS 5 (U.S. CLS. 6, 18, 44, 46, 51 AND 52).

THE MARK CONSISTS OF THE WORDS "HORSE RELIEF" IN BLACK LETTERS AND AN ORANGE HORSE.

FIRST USE 1-3-2007; IN COMMERCE 1-3-2007.

SER. NO. 77-151,281, FILED 4-7-2007.

NO CLAIM IS MADE TO THE EXCLUSIVE RIGHT TO USE "HORSE", APART FROM THE MARK AS SHOWN.

CHARLES L. JENKINS, EXAMINING ATTORNEY

Int. Cl.: 35

Prior U.S. Cls.: 100, 101 and 102

United States Patent and Trademark Office

Reg. No. 3,478,852

Registered Aug. 5, 2008

**SERVICE MARK
PRINCIPAL REGISTER**



JAZZ PHARMACEUTICALS, INC. (DELAWARE CORPORATION)
3180 PORTER DRIVE
PALO ALTO, CA 94304

THE COLOR(S) PURPLE, GOLD AND WHITE IS/ARE CLAIMED AS A FEATURE OF THE MARK.

FOR: MARKETING CONSULTATION IN THE FIELD OF MEDICAL AND PHARMACEUTICAL PRODUCTS; AND ARRANGING AND CONDUCTING TRADE SHOW EXHIBITIONS IN THE FIELDS OF MEDICINE AND PHARMACEUTICALS, IN CLASS 35 (U.S. CLS. 100, 101 AND 102).

THE MARK CONSISTS OF THE WORDING "JAZZ PHARMACEUTICALS" IN THE COLOR PURPLE POSITIONED TO THE RIGHT OF A CIRCULAR LOGO WITH CONCENTRIC CIRCLES OF PURPLE AND WHITE CONTAINING A STYLIZED DEPICTION OF THE LETTERS "JP" IN THE COLOR WHITE WHICH VERTICALLY SPLITS THE CIRCLE SHOWING GOLD ON THE RIGHT PORTION AND PURPLE ON THE LEFT PORTION OF THE CIRCLE.

FIRST USE 11-0-2005; IN COMMERCE 11-0-2005.

OWNER OF U.S. REG. NO. 3,005,004.

SER. NO. 77-152,441, FILED 4-10-2007.

NO CLAIM IS MADE TO THE EXCLUSIVE RIGHT TO USE "PHARMACEUTICALS", APART FROM THE MARK AS SHOWN.

JOHN DWYER, EXAMINING ATTORNEY

Int. Cl.: 45

Prior U.S. Cls.: 100 and 101

United States Patent and Trademark Office

Reg. No. 3,478,853

Registered Aug. 5, 2008

**SERVICE MARK
PRINCIPAL REGISTER**

20/20 LEGAL VISION

MBV LAW LLP (CALIFORNIA LIMITED LIABILITY PARTNERSHIP)

855 FRONT STREET

SAN FRANCISCO, CA 94111

FOR: LEGAL SERVICES, IN CLASS 45 (U.S. CLS. 100 AND 101).

FIRST USE 4-2-2007; IN COMMERCE 4-2-2007.

THE MARK CONSISTS OF STANDARD CHARACTERS WITHOUT CLAIM TO ANY PARTICULAR FONT, STYLE, SIZE, OR COLOR.

NO CLAIM IS MADE TO THE EXCLUSIVE RIGHT TO USE "LEGAL", APART FROM THE MARK AS SHOWN.

SER. NO. 77-152,871, FILED 4-10-2007.

JIM RINGLE, EXAMINING ATTORNEY

Int. Cls.: 3 and 44

Prior U.S. Cls.: 1, 4, 6, 50, 51, 52, 100 and 101

United States Patent and Trademark Office

Reg. No. 3,478,854

Registered Aug. 5, 2008

TRADEMARK
SERVICE MARK
PRINCIPAL REGISTER



FISH, MEREDITH (UNITED STATES INDIVIDUAL)
195 SPRING STREET
NEW YORK, NY 10012

FOR: COSMETIC SPRAYABLE SUN-TANNING PREPARATIONS, IN CLASS 3 (U.S. CLS. 1, 4, 6, 50, 51 AND 52).

FIRST USE 5-0-2006; IN COMMERCE 5-0-2006.

FOR: SKIN TANNING SERVICE FOR HUMANS FOR COSMETIC PURPOSES, IN CLASS 44 (U.S. CLS. 100 AND 101).

FIRST USE 2-28-2005; IN COMMERCE 2-28-2005.

THE COLOR(S) RED, GREEN AND BROWN IS/ARE CLAIMED AS A FEATURE OF THE MARK.

THE MARK CONSISTS OF THE WORD "BROWN-BERRY" IN THE COLOR BROWN; THE WORD "BROWNBERRY" IS BRACKETED BETWEEN TWO RED RASPBERRIES WITH GREEN LEAVES AND BROWN STEMS.

SER. NO. 77-153,750, FILED 4-11-2007.

B. PARADEWELAI, EXAMINING ATTORNEY

Int. Cls.: 16, 35, 37 and 40

**Prior U.S. Cls.: 2, 5, 22, 23, 29, 37, 38, 50, 100, 101,
102, 103 and 106**

Reg. No. 3,478,855

United States Patent and Trademark Office

Registered Aug. 5, 2008

**TRADEMARK
SERVICE MARK
PRINCIPAL REGISTER**

AVIAT

AVIAT AIRCRAFT, INC. (WYOMING CORPORATION)
672 S. WASHINGTON ST.
AFTON, WY 83110

FOR: PRINTED AIRPLANE MANUALS FOR NAMED GENERAL AVIATION AIRPLANE TYPES, IN CLASS 16 (U.S. CLS. 2, 5, 22, 23, 29, 37, 38 AND 50).

FIRST USE 1-1-1990; IN COMMERCE 1-1-1990.

FOR: RETAIL STORE AND ONLINE RETAIL STORE SERVICES FEATURING PROMOTIONAL ITEMS, NAMELY, FLAGS, PINS, KEY CHAINS, HATS, SHIRTS AND JACKETS, IN CLASS 35 (U.S. CLS. 100, 101 AND 102).

FIRST USE 1-1-1990; IN COMMERCE 1-1-1990.

FOR: MAINTENANCE, REPAIR AND OVERHAUL OF AIRPLANE AND AIRPLANE COMPO-

NENTS AND PARTS, IN CLASS 37 (U.S. CLS. 100, 103 AND 106).

FIRST USE 1-1-1990; IN COMMERCE 1-1-1990.

FOR: CUSTOM MANUFACTURE OF AIRPLANES, AIRPLANE COMPONENTS AND AIRPLANE STRUCTURAL PARTS, IN CLASS 40 (U.S. CLS. 100, 103 AND 106).

FIRST USE 1-1-1990; IN COMMERCE 1-1-1990.

THE MARK CONSISTS OF STANDARD CHARACTERS WITHOUT CLAIM TO ANY PARTICULAR FONT, STYLE, SIZE, OR COLOR.

SER. NO. 77-154,079, FILED 4-11-2007.

ALICE BENMAMAN, EXAMINING ATTORNEY

Int. Cl.: 37

Prior U.S. Cls.: 100, 103 and 106

United States Patent and Trademark Office

Reg. No. 3,478,856

Registered Aug. 5, 2008

**SERVICE MARK
PRINCIPAL REGISTER**

All States Roofing & Construction, Inc

"Gotta Leak? - Gotcha Covered"



ALL STATES ROOFING & CONSTRUCTION, INC
(TEXAS CORPORATION)
13507 KRUEGER RD.
GUY, TX 77444

FOR: ROOFING SERVICES; BUILDING CON-
STRUCTION AND REPAIR; PAINTING, IN CLASS
37 (U.S. CLS. 100, 103 AND 106).

FIRST USE 12-1-2005; IN COMMERCE 2-1-2006.

NO CLAIM IS MADE TO THE EXCLUSIVE
RIGHT TO USE "ROOFING & CONSTRUCTION,
INC" OR THE OUTLINE OF THE UNITED STATES

OF AMERICA, APART FROM THE MARK AS
SHOWN.

THE MARK CONSISTS OF A PICTURE OF THE
UNITED STATES WITH THE FLAG FILLING IN
THE USA SHAPE WITH AN UMBRELLA OVER THE
UNITED STATES AND A RAIN CLOUD OVER THE
UMBRELLA.

SER. NO. 77-154,540, FILED 4-11-2007.

SUSAN LESLIE DUBOIS, EXAMINING ATTORNEY

Int. Cl.: 9

Prior U.S. Cls.: 21, 23, 26, 36 and 38

United States Patent and Trademark Office

Reg. No. 3,478,857

Registered Aug. 5, 2008

**TRADEMARK
PRINCIPAL REGISTER**

Open up your dreams

OKI ELECTRIC INDUSTRY CO., LTD. (JAPAN CORPORATION)
7-12 TORANOMON 1-CHOME
MINATO-KU, TOKYO, JAPAN

FOR: MEASURING APPARATUS, NAMELY, FLOW-METERS FOR USE IN MEASURING WATER FLOWING IN RIVERS; TELEPHONES; TELEPHONE SWITCHBOARDS AND EXCHANGERS; TELEVISION TRANSMITTERS; RADIO TRANSMITTERS; RADAR; FACSIMILE MACHINES; DATA PROCESSORS; COMPUTERS; COMPUTER PRINTERS; COMPUTER PERIPHERALS; COMPUTER PROGRAMS FOR USE IN DATA PROCESSING AND DATA BASE MANAGEMENT FOR GENERAL USE, FOR USE IN INTEGRATING COMPUTER TELEPHONY IN THE FIELD OF COMPUTER NETWORKS, FOR USE IN IDENTIFYING AND AUTHENTICATING USERS OF DIGITAL MONEY IN ELECTRONIC COMMERCE AND FOR USE IN PROCESSING ELECTRONIC PAYMENT FOR SETTLEMENT OF BILLS

IN ELECTRONIC COMMERCE; SEMICONDUCTORS; INTEGRATED CIRCUITS; ELECTROSTATIC COPIERS; PHOTOCOPIERS; FIRE ALARMS; CASH DISPENSERS; CASH REGISTERS; AUTOMATED TELLER MACHINES; ELECTRIC WIRES AND CABLES, IN CLASS 9 (U.S. CLS. 21, 23, 26, 36 AND 38).

THE MARK CONSISTS OF STANDARD CHARACTERS WITHOUT CLAIM TO ANY PARTICULAR FONT, STYLE, SIZE, OR COLOR.

PRIORITY CLAIMED UNDER SEC. 44(D) ON JAPAN APPLICATION NO. 2006-100741, FILED 10-30-2006, REG. NO. 5107667, DATED 1-25-2008, EXPIRES 10-30-2016.

SER. NO. 77-154,786, FILED 4-12-2007.

LINDA ESTRADA, EXAMINING ATTORNEY

Int. Cl.: 28

Prior U.S. Cls.: 22, 23, 38 and 50

United States Patent and Trademark Office

Reg. No. 3,478,858

Registered Aug. 5, 2008

**TRADEMARK
PRINCIPAL REGISTER**



BURRELL, TRAVIS (UNITED STATES INDIVIDUAL)
11693 SAN VINCENTE BLVD., #710
LOS ANGELES, CA 90049 AND
ZUCKERMAN, ROBERT (UNITED STATES INDIVIDUAL)
11693 SAN VINCENTE BLVD., #710
LOS ANGELES, CA 90049

FOR: MANUALLY OPERATED, MULTI-PURPOSE FOLDING EXERCISE APPARATUS THAT CONSISTS OF A SINGULAR UNIT FOR USE IN LIFTING, STRENGTHENING AND STRETCHING EXERCISES, IN CLASS 28 (U.S. CLS. 22, 23, 38 AND 50).

FIRST USE 3-15-2007; IN COMMERCE 3-15-2007.

NO CLAIM IS MADE TO THE EXCLUSIVE RIGHT TO USE "RACK", APART FROM THE MARK AS SHOWN.

THE MARK CONSISTS OF STYLIZED LETTERS "THERACK" WITHIN AN ELLIPSE AND STYLIZED LINES.

SER. NO. 77-154,885, FILED 4-12-2007.

MICHELLE DUBOIS, EXAMINING ATTORNEY

Int. Cls.: 25, 35, 41 and 43

Prior U.S. Cls.: 22, 39, 100, 101, 102 and 107

Reg. No. 3,478,859

United States Patent and Trademark Office

Registered Aug. 5, 2008

**TRADEMARK
SERVICE MARK
PRINCIPAL REGISTER**



KABUSHIKI KAISHA ONWARD HOLDINGS (JAPAN JOINT STOCK COMPANY), TA ONWARD HOLDINGS CO., LTD.
10-5 NIHONBASHI 3-CHOME, CHUO-KU
TOKYO, JAPAN

FOR: CLOTHING, NAMELY, SUITS, COATS, JACKETS, SHIRTS, T-SHIRTS, DRESSES, SKIRTS, BLOUSES, TROUSERS, PANTS, SHORTS, JUMPERS, SWEATERS, CARDIGANS, VESTS, UNDERCLOTHING, PAJAMAS, BATH ROBES, SWIMSUITS, ANORAKS, UNIFORMS, WRISTBANDS; GOLF WEAR, NAMELY, GOLF CLEATS, GOLF TROUSERS, GOLF SHIRTS, GOLF SPIKES, GOLF RAINWEAR, BELTS FOR GOLF CLOTHING, GOLF CAPS AND SUN VISORS FOR GOLF; FOOTWEAR, NAMELY, SHOES, BOOTS, SLIPPERS, SANDALS, RAIN SHOES, SPORT SHOES, GOLF SHOES, SNEAKERS; SOCKS, STOCKINGS; HEADGEAR, NAMELY, CAPS, HATS, VEILS, SUN VISORS; SCARVES, SHAWLS, MUFFLERS, NECKERCHIEFS, GLOVES FOR CLOTHING, NECKTIES, BELTS FOR CLOTHING, APRONS, SUSPENDERS, IN CLASS 25 (U.S. CLS. 22 AND 39).

FIRST USE 11-20-2006; IN COMMERCE 11-20-2006.

FOR: RETAIL STORE SERVICES FEATURING CLOTHING AND GOLF EQUIPMENT AND SUPPLIES, IN CLASS 35 (U.S. CLS. 100, 101 AND 102).

FIRST USE 11-20-2006; IN COMMERCE 11-20-2006.

FOR: PROVIDING GOLF FACILITIES; GOLF INSTRUCTION; PLANNING, ORGANIZATION AND ARRANGEMENT OF PROFESSIONAL OR AMATEUR GOLF TOURNAMENTS OR COMPETITIONS; RENTAL OF GOLF EQUIPMENT; RENTAL OF PARAGLIDERS AND HANG GLIDERS, IN CLASS 41 (U.S. CLS. 100, 101 AND 107).

FIRST USE 11-20-2006; IN COMMERCE 11-20-2006.

FOR: HOTEL, BAR AND RESTAURANT SERVICES; SPA SERVICES, NAMELY, PROVIDING TEMPORARY ACCOMMODATIONS AND MEALS TO CLIENTS OF A HEALTH OR BEAUTY SPA, IN CLASS 43 (U.S. CLS. 100 AND 101).

FIRST USE 11-20-2006; IN COMMERCE 11-20-2006.

OWNER OF U.S. REG. NOS. 2,391,450 AND 3,038,903.

NO CLAIM IS MADE TO THE EXCLUSIVE RIGHT TO USE "TALOFOFO GOLF CLUB", APART FROM THE MARK AS SHOWN.

SER. NO. 77-154,907, FILED 4-12-2007.

CAROLYN CATALDO, EXAMINING ATTORNEY

Int. Cls.: 9 and 37

Prior U.S. Cls.: 21, 23, 26, 36, 38, 100, 103 and 106

United States Patent and Trademark Office

Reg. No. 3,478,860

Registered Aug. 5, 2008

**TRADEMARK
SERVICE MARK
PRINCIPAL REGISTER**

NIVOWAVE

UWT GMBH (FED REP GERMANY CORPORATION)
WESTENDSTRASSE 5
BETZIGAU, FED REP GERMANY D-87488

FOR: ELECTRONIC MEASUREMENT AND CONTROL APPARATUS FOR LEVEL CONTROL, NAMELY, ROTATING PADDLE SWITCHES, LEVEL LIMIT SWITCHES, VIBRATING PROBES FOR LEVEL CONTROL, CAPACITIVE AND CONDUCTIVE MEASURING PROBES AND ULTRASONIC MEASURING DEVICES FOR LEVEL CONTROL, ALL NOT INTENDED FOR MEDICAL PURPOSES, IN CLASS 9 (U.S. CLS. 21, 23, 26, 36 AND 38).

FOR: REPAIR SERVICES FOR ELECTRONIC MEASUREMENT AND CONTROL APPARATUS OF ALL KINDS, ESPECIALLY FOR LEVEL CONTROL, NAMELY, ROTATING PADDLE SWITCHES,

LEVEL LIMIT SWITCHES, VIBRATING PROBES FOR LEVEL CONTROL, CAPACITIVE AND CONDUCTIVE MEASURING PROBES AND ULTRASONIC MEASURING DEVICES FOR LEVEL CONTROL NOT INTENDED FOR MEDICAL PURPOSES, IN CLASS 37 (U.S. CLS. 100, 103 AND 106).

THE MARK CONSISTS OF STANDARD CHARACTERS WITHOUT CLAIM TO ANY PARTICULAR FONT, STYLE, SIZE, OR COLOR.

OWNER OF FED REP GERMANY REG. NO. 30647615, DATED 1-30-2007, EXPIRES 1-30-2017.

SER. NO. 77-154,973, FILED 4-12-2007.

ANGELA GAW, EXAMINING ATTORNEY

Int. Cls.: 11 and 40

Prior U.S. Cls.: 13, 21, 23, 31, 34, 100, 103 and 106

United States Patent and Trademark Office

Reg. No. 3,478,861

Registered Aug. 5, 2008

**TRADEMARK
SERVICE MARK
PRINCIPAL REGISTER**

PowerPure

CHARDON LABORATORIES INC. (OHIO CORPORATION)
7300 TUSSING ROAD
REYNOLDSBURG, OH 43068

FOR: COMPONENTS FOR AIR CONDITIONING AND COOLING SYSTEMS, NAMELY, EVAPORATIVE AIR COOLERS, IN CLASS 11 (U.S. CLS. 13, 21, 23, 31 AND 34).

FIRST USE 8-30-2001; IN COMMERCE 8-30-2001.

FOR: WATER TREATMENT, IN CLASS 40 (U.S. CLS. 100, 103 AND 106).

FIRST USE 8-30-2001; IN COMMERCE 8-30-2001.

THE MARK CONSISTS OF STANDARD CHARACTERS WITHOUT CLAIM TO ANY PARTICULAR FONT, STYLE, SIZE, OR COLOR.

OWNER OF U.S. REG. NO. 3,062,156.

SER. NO. 77-155,338, FILED 4-12-2007.

GEOFFREY FOSDICK, EXAMINING ATTORNEY

Int. Cl.: 42

Prior U.S. Cls.: 100 and 101

United States Patent and Trademark Office

Reg. No. 3,478,862

Registered Aug. 5, 2008

**SERVICE MARK
PRINCIPAL REGISTER**

FRANCHISE ROADMAP

GRANITE TECHNOLOGIES, INC. (COLORADO CORPORATION)
112 N. RUBEY DRIVE, SUITE 135
GOLDEN, CO 804033214

FOR: PROVIDING ONLINE NON-DOWNLOADABLE SOFTWARE FOR BUSINESS ACTIVITY METHODOLOGY AND MANAGEMENT, IN CLASS 42 (U.S. CLS. 100 AND 101).

FIRST USE 1-0-2006; IN COMMERCE 5-1-2006.

THE MARK CONSISTS OF STANDARD CHARACTERS WITHOUT CLAIM TO ANY PARTICULAR FONT, STYLE, SIZE, OR COLOR.

NO CLAIM IS MADE TO THE EXCLUSIVE RIGHT TO USE "FRANCHISE", APART FROM THE MARK AS SHOWN.

SER. NO. 77-156,521, FILED 4-13-2007.

DEZMONA MIZELLE, EXAMINING ATTORNEY

Int. Cls.: 9 and 41

Prior U.S. Cls.: 21, 23, 26, 36, 38, 100, 101 and 107

United States Patent and Trademark Office

Reg. No. 3,478,863

Registered Aug. 5, 2008

**TRADEMARK
SERVICE MARK
PRINCIPAL REGISTER**

FLIGHTCAST

FLIGHTSAFETY DEVELOPMENT CORP. (DELA-
WARE CORPORATION)
2265 B RENAISSANCE DRIVE, SUITE 13
LAS VEGAS, NV 89119

FOR: DOWNLOADABLE PODCASTS IN THE
FIELD OF AVIATION, IN CLASS 9 (U.S. CLS. 21, 23,
26, 36 AND 38).

FIRST USE 3-1-2007; IN COMMERCE 3-1-2007.

FOR: PROVIDING PODCASTS IN THE FIELD OF
AVIATION, IN CLASS 41 (U.S. CLS. 100, 101 AND
107).

FIRST USE 3-1-2007; IN COMMERCE 3-1-2007.

THE MARK CONSISTS OF STANDARD CHAR-
ACTERS WITHOUT CLAIM TO ANY PARTICULAR
FONT, STYLE, SIZE, OR COLOR.

SER. NO. 77-157,360, FILED 4-16-2007.

STEVEN R. FINE, EXAMINING ATTORNEY

Int. Cls.: 25, 28, 35, 37, 41, 42 and 45

**Prior U.S. Cls.: 22, 23, 38, 39, 50, 100, 101, 102, 103,
106 and 107**

Reg. No. 3,478,864

United States Patent and Trademark Office

Registered Aug. 5, 2008

**TRADEMARK
SERVICE MARK
PRINCIPAL REGISTER**

Magic Luck Friendship

FRIENDS & FRIENDS, INC. (FLORIDA CORPORATION)
1891 SW 36TH AVE
MIAMI, FL 33145

FOR: MEN, WOMEN AND CHILDREN'S CLOTHING, NAMELY, T-SHIRTS, IN CLASS 25 (U.S. CLS. 22 AND 39).

FIRST USE 2-1-2003; IN COMMERCE 3-1-2003.

FOR: TOYS, NAMELY, PLUSH DOLLS AND PLASTIC CHARACTER TOYS, IN CLASS 28 (U.S. CLS. 22, 23, 38 AND 50).

FIRST USE 1-12-2007; IN COMMERCE 1-12-2007.

FOR: ARRANGING AND CONDUCTING TRADE SHOWS IN THE FIELD OF ART AND ADVERTISING, IN CLASS 35 (U.S. CLS. 100, 101 AND 102).

FIRST USE 1-1-2004; IN COMMERCE 1-1-2004.

FOR: ART INSTALLATION, IN CLASS 37 (U.S. CLS. 100, 103 AND 106).

FIRST USE 4-1-2003; IN COMMERCE 4-1-2003.

FOR: ART EXHIBITIONS; SPECIAL EFFECTS ANIMATION SERVICES FOR FILM AND VIDEO ADVERTISING, IN CLASS 41 (U.S. CLS. 100, 101 AND 107).

FIRST USE 4-1-2003; IN COMMERCE 4-1-2003.

FOR: INTERIOR DESIGN AND INTERIOR ART DECORATING AND DESIGNING TOYS FOR OTHERS, IN CLASS 42 (U.S. CLS. 100 AND 101).

FIRST USE 4-1-2003; IN COMMERCE 4-1-2003.

FOR: LICENSING OF TOY DESIGNS TO OTHERS, IN CLASS 45 (U.S. CLS. 100 AND 101).

FIRST USE 5-1-2004; IN COMMERCE 5-1-2004.

THE MARK CONSISTS OF STANDARD CHARACTERS WITHOUT CLAIM TO ANY PARTICULAR FONT, STYLE, SIZE, OR COLOR.

SER. NO. 77-157,701, FILED 4-16-2007.

MICHAEL ENGEL, EXAMINING ATTORNEY

Int. Cl.: 41

Prior U.S. Cls.: 100, 101 and 107

United States Patent and Trademark Office

Reg. No. 3,478,865

Registered Aug. 5, 2008

**SERVICE MARK
PRINCIPAL REGISTER**

ASK LORNA

PREFERRED NUTRITION INC. (CANADA CORPORATION)
153 PERTH STREET
ACTON, CANADA L7J1C9

FOR: EDUCATION SERVICES, NAMELY, PROVIDING LIVE AND ON-LINE INTERNET TALK SHOW IN THE FIELD OF HEALTH AND NUTRITION, IN CLASS 41 (U.S. CLS. 100, 101 AND 107).

FIRST USE 9-30-2006; IN COMMERCE 9-30-2006.

THE MARK CONSISTS OF STANDARD CHARACTERS WITHOUT CLAIM TO ANY PARTICULAR FONT, STYLE, SIZE, OR COLOR.

PRIORITY CLAIMED UNDER SEC. 44(D) ON CANADA APPLICATION NO. 1343409, FILED 4-13-2007, REG. NO. TMA708780, DATED 3-4-2008, EXPIRES 3-4-2023.

SER. NO. 77-157,900, FILED 4-16-2007.

TEJBIR SINGH, EXAMINING ATTORNEY

Int. Cl.: 25

Prior U.S. Cls.: 22 and 39

United States Patent and Trademark Office

Reg. No. 3,478,866

Registered Aug. 5, 2008

**TRADEMARK
PRINCIPAL REGISTER**

BALANCE POINT

DELTA GALIL INDUSTRIES LTD. (ISRAEL
CORPORATION)
2 KOYFMAN STREET
TEL AVIV, ISRAEL

FOR: SOCKS; ANKLE SOCKS; ANTI-PERSPIR-
ANT SOCKS; STOCKINGS; HOSIERY; SOLES; SHOE
SOLES; SLIPPER SOLES; INNER SOLES; SOLES FOR
FOOTWEAR, IN CLASS 25 (U.S. CLS. 22 AND 39).

THE MARK CONSISTS OF STANDARD CHAR-
ACTERS WITHOUT CLAIM TO ANY PARTICULAR
FONT, STYLE, SIZE, OR COLOR.

PRIORITY CLAIMED UNDER SEC. 44(D) ON
ISRAEL APPLICATION NO. 194547, FILED 10-18-
2006, REG. NO. 194547, DATED 3-9-2008, EXPIRES 10-
18-2016.

SER. NO. 77-158,113, FILED 4-17-2007.

GIANCARLO CASTRO, EXAMINING ATTORNEY

Int. Cl.: 25

Prior U.S. Cls.: 22 and 39

United States Patent and Trademark Office

Reg. No. 3,478,867

Registered Aug. 5, 2008

**TRADEMARK
PRINCIPAL REGISTER**

The logo for ERGOSTEP features the word "ERGOSTEP" in a bold, black, sans-serif font. The letter "O" is replaced by a stylized graphic of a foot or a step, also in black. The entire logo is centered within a white rectangular box.

DELTA GALIL INDUSTRIES LTD. (ISRAEL
CORPORATION)
2 KOYFMAN STREET
TEL AVIV, ISRAEL

FOR: SOCKS; ANKLE SOCKS; ANTI-PERSPIR-
ANT SOCKS; STOCKINGS; HOSIERY; SOLES; SHOE
SOLES; SLIPPER SOLES; INNER SOLES; SOLES FOR
FOOTWEAR, IN CLASS 25 (U.S. CLS. 22 AND 39).

PRIORITY CLAIMED UNDER SEC. 44(D) ON
ISRAEL APPLICATION NO. 194545, FILED 10-18-
2006, REG. NO. 194545, DATED 3-9-2008, EXPIRES 10-
18-2016.

SER. NO. 77-158,117, FILED 4-17-2007.

GIANCARLO CASTRO, EXAMINING ATTORNEY

Int. Cl.: 35

Prior U.S. Cls.: 100, 101 and 102

United States Patent and Trademark Office

Reg. No. 3,478,868

Registered Aug. 5, 2008

**SERVICE MARK
PRINCIPAL REGISTER**



SANITATION STRATEGIES, LLC (MICHIGAN CORPORATION)
2104 JOLLY ROAD
OKEMOS, MI 488645930

FOR: DISTRIBUTORSHIP SERVICES IN THE FIELD OF CLEANING PRODUCTS AND EQUIPMENT FOR THE ANIMAL LIFE SCIENCES AND FOOD PROCESSING SANITATION INDUSTRIES, IN CLASS 35 (U.S. CLS. 100, 101 AND 102).

FIRST USE 9-0-2003; IN COMMERCE 9-0-2003.

NO CLAIM IS MADE TO THE EXCLUSIVE RIGHT TO USE "SANITATION", APART FROM THE MARK AS SHOWN.

THE MARK CONSISTS OF A BEAKER TO THE RIGHT OF WHICH IS THE LITERAL ELEMENT, "SANITATION STRATEGIES".

SER. NO. 77-158,311, FILED 4-17-2007.

PAM WILLIS, EXAMINING ATTORNEY

Int. Cl.: 28

Prior U.S. Cls.: 22, 23, 38 and 50

Reg. No. 3,478,869

United States Patent and Trademark Office

Registered Aug. 5, 2008

**TRADEMARK
PRINCIPAL REGISTER**

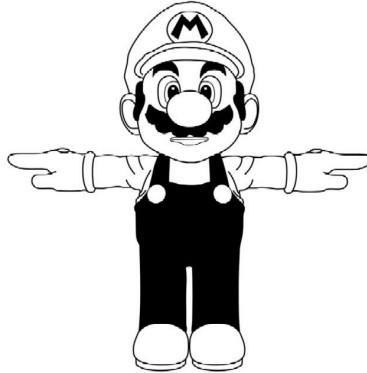

NINTENDO CO., LTD. (JAPAN CORPORATION)
11-1 HOKOTATE-CHO KAMITOKA, MINAMI-KU
KYOTO-SHI, KYOTO, JAPAN 601-8501

FOR: ACTION TYPE TARGET GAMES; ARTICULATED AND NON-ARTICULATED DOLLS; BATH TOYS; BOARD GAMES; CARD GAMES; CARRYING CASES FOR HAND-HELD VIDEO GAME SYSTEMS; CHILDREN'S PLAY COSMETICS; CHRISTMAS TREE ORNAMENTS; COLLECTABLE TOY FIGURES; COSTUME MASKS; ELECTRONIC GAME EQUIPMENT WITH A WATCH FUNCTION; CARD GAMES; FLOATING RECREATIONAL LOUNGE CHAIRS; FLYING DISCS; GOLF BALLS; HAND-HELD GAMES WITH LIQUID CRYSTAL DISPLAYS; INFLATABLE FLOAT CUSHIONS, MATTRESSES AND PADS FOR RECREATIONAL USE; INFLATABLE TOYS; IN-LINE SKATES; JIGSAW PUZZLES; JUMP ROPES; KITES; MANIPULATIVE GAMES; MANIPULATIVE PUZZLES; MUSIC BOX TOYS; MUSICAL TOYS; PAPER DOLLS; PARLOR GAMES; PARTY FAVORS IN THE NATURE OF SMALL TOYS; PLAY FIGURES; PLAYING CARD CASES; PLAYING CARDS; PLUSH DOLLS; PLUSH TOYS; POSITIONABLE TOY FIGURES; PULL TOYS; PUNCHING TOYS; PUPPETS; PUSH TOYS; RIDE-ON TOYS; ROLE PLAYING GAMES; ROLLER SKATES; RUBBER ACTION BALLS; RUBBER CHARACTER TOYS; SKATEBOARDS; SNOWBOARDS; SNOW SKIS; SPINNING TOPS; SPORTS

BALLS; STUFFED TOYS; SWIMMING AIDS, NAME-
LY, POOL RINGS AND ARM FLOATS FOR RE-
CREATIONAL USE; TOY ACTION BALLS; TOY
ACTION FIGURES; TOY BALLOONS; TOY BANKS;
TOY BINOCULARS; TOY BUILDING BLOCKS; TOY
CAP PISTOLS; TOY CLOCKS AND WATCHES; TOY
CONSTRUCTION PLAYSETS; TOY KEY CHAINS
WITH AND WITHOUT SOUND DEVICE; TOY MO-
BILES; TOY MUSICAL INSTRUMENTS; TOY
PUNCHING BAGS; TOY TEA SETS; TOY WHIS-
TLES; TOYS FOR PETS; TRADING CARD GAMES;
WATER SQUIRTING TOYS; WIND-UP TOYS; YO-
YOS, IN CLASS 28 (U.S. CLS. 22, 23, 38 AND 50).

PRIORITY CLAIMED UNDER SEC. 44(D) ON
JAPAN APPLICATION NO. 2006-119736, FILED 12-
26-2006, REG. NO. 508766, DATED 11-2-2007, EX-
PIRES 11-2-2017.

THE MARK CONSISTS OF A FRONT VIEW
DEPICTION OF A MAN STANDING UP WITH
ARMS STRETCHED OUT TO THE SIDES. THE
MAN IS DEPICTED WEARING A HAT, THE HAT
BEARING THE LETTER "M", AND ALSO WEAR-
ING COVERALLS. THE MARK IS BLACK AND
WHITE AND DOES NOT CONTAIN COLOR.

SER. NO. 77-158,353, FILED 4-17-2007.

JILL C. ALT, EXAMINING ATTORNEY

Int. Cl.: 29

Prior U.S. Cl.: 46

United States Patent and Trademark Office

Reg. No. 3,478,870

Registered Aug. 5, 2008

**TRADEMARK
PRINCIPAL REGISTER**

STEAKHOUSE ELITE

KOBE BEEF AMERICA, INC. (OREGON COR-
PORATION)
SUITE B
755 SW 7TH STREET
REDMOND, OR 97756

THE MARK CONSISTS OF STANDARD CHAR-
ACTERS WITHOUT CLAIM TO ANY PARTICULAR
FONT, STYLE, SIZE, OR COLOR.

FOR: BEEF, IN CLASS 29 (U.S. CL. 46).

SER. NO. 77-158,768, FILED 4-17-2007.

FIRST USE 10-12-2007; IN COMMERCE 10-12-2007.

SEAN CROWLEY, EXAMINING ATTORNEY

Int. Cl.: 41

Prior U.S. Cls.: 100, 101 and 107

United States Patent and Trademark Office

Reg. No. 3,478,871

Registered Aug. 5, 2008

**SERVICE MARK
PRINCIPAL REGISTER**



TCS ENTERTAINMENT, INC. (CALIFORNIA CORPORATION)
P.O. BOX 7100
LA VERNE, CA 91750

FOR: ENTERTAINMENT SERVICES, NAMELY, SCRIPT WRITING SERVICES FOR RADIO SHOWS, NAMELY, WRITING ENTERTAINMENT NEWS, OFFBEAT NEWS STORIES AND JOKES; PRODUCTION OF RADIO PROGRAMS AND CONSULTING IN THE FIELD OF PRODUCTION OF RADIO PROGRAMS; ONLINE PRODUCTION COMPANY SERVICES IN THE FIELD OF RADIO SHOW PRODUCTION; PROVIDING NEWS AND INFORMATION IN THE FIELD OF ENTERTAINMENT,

SPORTS AND CURRENT EVENT REPORTING, AND PROVIDING COMEDY SPOTS AND SOUND CLIPS FOR USE IN RADIO SHOWS, IN CLASS 41 (U.S. CLS. 100, 101 AND 107).

FIRST USE 3-0-1996; IN COMMERCE 3-0-1996.

NO CLAIM IS MADE TO THE EXCLUSIVE RIGHT TO USE "YOUR VIRTUAL SHOW PRODUCER", APART FROM THE MARK AS SHOWN.

SER. NO. 77-160,997, FILED 4-19-2007.

CARYN GLASSER, EXAMINING ATTORNEY

Int. Cls.: 9, 41 and 42

Prior U.S. Cls.: 21, 23, 26, 36, 38, 100, 101 and 107

Reg. No. 3,478,872

United States Patent and Trademark Office

Registered Aug. 5, 2008

**TRADEMARK
SERVICE MARK
PRINCIPAL REGISTER**

BENTLEY

BENTLEY SYSTEMS, INCORPORATED (DELAWARE CORPORATION)
685 STOCKTON DRIVE
EXTON, PA 193410678

FOR: COMPUTER SOFTWARE FOR MANAGING, MANIPULATING, AND DISPLAYING DATA AND GRAPHICS FOR USE AS A VISUALIZATION, DRAFTING AND DESIGN AIDS IN THE COMPUTER-AIDED-DESIGN, ENGINEERING, AND GEOGRAPHIC INFORMATION SYSTEMS FIELDS; COMPUTER GRAPHICS SOFTWARE; AND INSTRUCTIONAL MANUALS SOLD AS A UNIT THEREWITH, IN CLASS 9 (U.S. CLS. 21, 23, 26, 36 AND 38).

FIRST USE 10-0-1994; IN COMMERCE 10-0-1994.

FOR: PROVIDING COMPUTER SOFTWARE TRAINING SERVICES VIA SUBSCRIPTION; EDUCATIONAL SERVICES, NAMELY, CONDUCTING TECHNICAL TRAINING SEMINARS, CLASSES AND WORKSHOPS IN THE FIELD OF GEOGRAPHIC INFORMATION SYSTEMS SOFTWARE; EDUCATIONAL SERVICES, NAMELY, CONDUCTING ONLINE TECHNICAL TRAINING SEMINARS, ONLINE CLASSES AND WORKSHOPS IN THE FIELD OF GEOGRAPHIC INFORMATION SYSTEMS SOFTWARE, ONLINE DISTANCE LEARNING; PROVISION OF ONLINE, NON-DOWNLOADABLE SEMINAR VIDEOS VIA A VIDEO-ON-DEMAND SERVICE, WHICH EARN VIEWER LEARNING UNIT CREDITS, IN CLASS 41 (U.S. CLS. 100, 101 AND 107).

FIRST USE 10-0-1997; IN COMMERCE 10-0-1997.

FOR: PROVIDING ON-LINE SUBSCRIPTION BASED ACCESS TO NON-DOWNLOADABLE COMPUTER GRAPHICS SOFTWARE AND COMPUTER SOFTWARE FOR USE AS VISUALIZATION, DRAFTING AND DESIGN AIDS IN THE COMPUTER AIDED DESIGN, ENGINEERING, AND GEOGRAPHIC INFORMATION SYSTEMS FIELDS; TECHNOLOGY CONSULTATION IN THE FIELD OF GEOGRAPHIC INFORMATION SYSTEMS; ON-LINE TECHNICAL SUPPORT SERVICES, NAMELY, TROUBLESHOOTING OF COMPUTER SOFTWARE AND APPLICATION SUPPORT, IN CLASS 42 (U.S. CLS. 100 AND 101).

FIRST USE 3-0-1996; IN COMMERCE 3-0-1996.

THE MARK CONSISTS OF STANDARD CHARACTERS WITHOUT CLAIM TO ANY PARTICULAR FONT, STYLE, SIZE, OR COLOR.

OWNER OF U.S. REG. NOS. 2,059,131, 2,334,086 AND OTHERS.

SEC. 2(F).

SER. NO. 77-161,234, FILED 4-19-2007.

CURTIS FRENCH, EXAMINING ATTORNEY

Int. Cls.: 35 and 36

Prior U.S. Cls.: 100, 101 and 102

United States Patent and Trademark Office

Reg. No. 3,478,873

Registered Aug. 5, 2008

**SERVICE MARK
PRINCIPAL REGISTER**

PURCHASING POWER

PURCHASING POWER, LLC (GEORGIA LTD
LIAB CO)
695 PYLANT STREET N.E.
ATLANTA, GA 30306

FOR: COMPUTERIZED ON-LINE RETAIL STORE SERVICES FEATURING A WIDE VARIETY OF CONSUMER GOODS OF OTHERS; ORGANIZING, ADMINISTERING AND PROVIDING EMPLOYEE AND MEMBER INCENTIVE AND LOYALTY PROGRAMS FOR OTHERS TO IMPROVE EMPLOYEE AND MEMBER ACQUISITION, RETENTION, PERFORMANCE AND LOYALTY BY ALLOWING EMPLOYEES AND MEMBERS TO PURCHASE A WIDE VARIETY OF CONSUMER GOODS OF OTHERS, NAMELY, COMPUTER SYSTEMS, COMPUTER COMPONENTS, COMPUTER SOFTWARE, INTERNET ACCESS PLANS, COMPUTER PERIPHERALS, PRINTERS, TELEVISIONS, VIDEOCASSETTE RECORDERS, DIGITAL VIDEO DISC PLAYERS AND RECORDERS, DIGITAL VIDEO RECORDERS, AUDIO RECEIVERS, AMPLIFIERS, AUDIO SPEAKERS, PORTABLE AUDIO EQUIPMENT, CELLULAR TELEPHONES, PERSONAL DIGITAL ASSISTANTS, DIGITAL CAMERAS, DIGITAL VIDEO CAMCORDERS, HOUSEHOLD APPLIANCES, AND POWER TOOLS THROUGH A PAYROLL DEDUCTION PLAN; PROMOTING THE GOODS AND SERVICES OF OTHERS VIA PAYROLL DEDUCTION PURCHASE PLANS, PAYROLL DISTRIBUTION PUR-

CHASE PROGRAMS AND PAYROLL ALLOTMENT PURCHASE PROGRAMS, IN CLASS 35 (U.S. CLS. 100, 101 AND 102).

FIRST USE 2-17-2000; IN COMMERCE 2-17-2000.

FOR: ORGANIZING, ADMINISTERING AND PROVIDING EMPLOYEE PAYROLL DEDUCTION PLANS, PAYROLL DISTRIBUTION PURCHASE PROGRAMS AND PAYROLL ALLOTMENT PURCHASE PROGRAMS FOR OTHERS THAT PERMIT EMPLOYEES OR ORGANIZATION MEMBERS TO PURCHASE A WIDE VARIETY OF CONSUMER GOODS OF OTHERS VIA EMPLOYEE PAYROLL DEDUCTIONS, PAYROLL DISTRIBUTION AND PAYROLL ALLOTMENT, IN CLASS 36 (U.S. CLS. 100, 101 AND 102).

FIRST USE 2-17-2000; IN COMMERCE 2-17-2000.

THE MARK CONSISTS OF STANDARD CHARACTERS WITHOUT CLAIM TO ANY PARTICULAR FONT, STYLE, SIZE, OR COLOR.

OWNER OF U.S. REG. NO. 2,532,942.

SER. NO. 77-161,815, FILED 4-20-2007.

RONALD AIKENS, EXAMINING ATTORNEY

Int. Cl.: 36

Prior U.S. Cls.: 100, 101 and 102

United States Patent and Trademark Office

Reg. No. 3,478,874

Registered Aug. 5, 2008

**SERVICE MARK
PRINCIPAL REGISTER**

PI FINANCIAL

PI FINANCIAL CORP (CANADA CORPORATION)
19TH FLOOR STE 1900 - 666 BURRARD STREET
VANCOUVER, CANADA V6C3N1

FOR: FINANCIAL SERVICES, NAMELY, BROKERAGE ACCOUNT INVESTMENT AND INVESTMENT MANAGEMENT SERVICES INCLUDING PORTFOLIO MANAGEMENT SERVICES; INVESTMENT, SECURITIES AND MUTUAL FUND INVESTMENT SERVICES; RETAIL AND INSTITUTIONAL SECURITIES INVESTMENT SERVICES; INSTITUTIONAL INVESTMENT AND UNDERWRITING SERVICES, NAMELY, UNDERWRITING NEW SECURITIES ISSUES AND PRIVATE PLACEMENTS OF SECURITIES; WEALTH MANAGEMENT, RETIREMENT, AND ESTATE PLANNING SERVICES; SECURITIES RESEARCH AND ADVISORY SERVICES; AND SECURITIES LENDING AND BORROWING SERVICES; MARKET MAKING SERVICES, NAMELY, ACTING AS MARKET MAKER IN PUBLICLY TRADED SECURITIES; BROKERAGE OF LIFE AND HEALTH INSURANCE POLICIES, ANNUITIES, AND SEGREGATED FUNDS; ESTATE AND TRUST PORTFOLIO MANAGEMENT SERVICES; PENSION SERVICES,

NAMELY, ADMINISTRATION OF EMPLOYEE PENSION PLANS; FINANCIAL CLEARING HOUSE; FUTURES AND DERIVATIVES TRADING SERVICES; AND PROPRIETARY INVESTMENT, NAMELY, INVENTORY TRADING AND MUTUAL FUND INVESTMENT SERVICES, IN CLASS 36 (U.S. CLS. 100, 101 AND 102).

FIRST USE 7-1-2007; IN COMMERCE 7-1-2007.

THE MARK CONSISTS OF STANDARD CHARACTERS WITHOUT CLAIM TO ANY PARTICULAR FONT, STYLE, SIZE, OR COLOR.

PRIORITY CLAIMED UNDER SEC. 44(D) ON CANADA APPLICATION NO. 1343621, FILED 4-17-2007.

NO CLAIM IS MADE TO THE EXCLUSIVE RIGHT TO USE "FINANCIAL", APART FROM THE MARK AS SHOWN.

SER. NO. 77-163,753, FILED 4-24-2007.

ESTHER A. BORSUK, EXAMINING ATTORNEY

Int. Cl.: 3

Prior U.S. Cls.: 1, 4, 6, 50, 51 and 52

United States Patent and Trademark Office

Reg. No. 3,478,875

Registered Aug. 5, 2008

**TRADEMARK
PRINCIPAL REGISTER**

Sun Perféct UV4

BIOACTIVE SKINCARE, LLC (FLORIDA LTD
LIAB CO)
4953 SW 71ST PLACE
4953 SW 71ST PLACE
MIAMI, FL 33155

FOR: AFTER SUN CREAMS; AFTER-SUN LO-
TIONS; COSMETIC SUN-PROTECTING PREPARA-
TIONS; COSMETIC SUN-TANNING
PREPARATIONS; FOAMS CONTAINING COSMET-
ICS AND SUNSCREENS; NON-MEDICATED SUN
CARE PREPARATIONS; PATCHES CONTAINING
SUN SCREEN AND SUN BLOCK FOR USE ON THE
SKIN; SUN BLOCK; SUN BLOCK PREPARATIONS;
SUN CARE LOTIONS; SUN CREAMS; SUN SCREEN;
SUN SCREEN PREPARATIONS; SUN TAN GEL;
SUN TAN LOTION; SUN TAN OIL; SUN-BLOCK
LOTIONS; SUNSCREEN CREAM; SUNSCREEN

CREAMS; COSMETIC SUNTAN LOTIONS, IN
CLASS 3 (U.S. CLS. 1, 4, 6, 50, 51 AND 52).

FIRST USE 12-2-2006; IN COMMERCE 2-4-2007.

THE MARK CONSISTS OF STANDARD CHAR-
ACTERS WITHOUT CLAIM TO ANY PARTICULAR
FONT, STYLE, SIZE, OR COLOR.

NO CLAIM IS MADE TO THE EXCLUSIVE
RIGHT TO USE "SUN" AND "UV4", APART FROM
THE MARK AS SHOWN.

SER. NO. 77-164,969, FILED 4-25-2007.

CHERYL CLAYTON, EXAMINING ATTORNEY

Int. Cl.: 42

Prior U.S. Cls.: 100 and 101

United States Patent and Trademark Office

Reg. No. 3,478,876

Registered Aug. 5, 2008

**SERVICE MARK
PRINCIPAL REGISTER**



PIXEL STREAMS, LLC (OREGON LTD LIAB CO)
SUITE 200
806 SW BROADWAY
PORTLAND, OR 97205

FOR: APPLICATION SERVICE PROVIDER, NAMELY, HOSTING COMPUTER SOFTWARE APPLICATIONS OF OTHERS, EXCLUDING COMPUTER SOFTWARE USED IN THE GRAPHICS ARTS AND PRINTING INDUSTRIES TO HANDLE PRE-PRESS AND PRESS PROCESSES, NAMELY, CONVERTING ELECTRONIC FILES INTO IMAGES FOR PRINT, IN CLASS 42 (U.S. CLS. 100 AND 101).

FIRST USE 1-1-2007; IN COMMERCE 1-1-2007.

NO CLAIM IS MADE TO THE EXCLUSIVE RIGHT TO USE "SECURITY, APPLICATIONS, AC-

CESS, SUPPORT", APART FROM THE MARK AS SHOWN.

THE COLOR(S) BLUE AND GREEN IS/ARE CLAIMED AS A FEATURE OF THE MARK.

THE MARK CONSISTS OF THE TERMS "PIXEL" AND "SECURITY, APPLICATIONS, ACCESS, SUPPORT" IN BLUE, THE TERM "STREAMS" IN GREEN, AND A DEPICTION OF A PATTERN OF PIXELS SHOWN NEXT TO THIS WORDING IN BLUE.

SER. NO. 77-165,094, FILED 4-25-2007.

ELI HELLMAN, EXAMINING ATTORNEY

Int. Cl.: 41

Prior U.S. Cls.: 100, 101 and 107

United States Patent and Trademark Office

Reg. No. 3,478,877

Registered Aug. 5, 2008

**SERVICE MARK
PRINCIPAL REGISTER**

MS. MONSTER

AMY KATHERINE SMITH (UNITED STATES
INDIVIDUAL)
P.O. BOX 170123
SAN FRANCISCO, CA 94117

FOR: ENTERTAINMENT IN THE NATURE OF
AN ON-GOING SPECIAL VARIETY SHOW FEATURING
COMEDIC PERFORMANCES BY MS MONSTER
BROADCAST OVER TELEVISION AND LIVE
COMEDIC PERFORMANCES; ENTERTAINMENT
SERVICES, NAMELY, PROVIDING A WEBSITE
FEATURING, PHOTOGRAPHIC, AUDIO,
GRAPHIC ART, VIDEO, AND PROSE PRESENTA-

TIONS FEATURING MS MONSTER CHARACTER,
IN CLASS 41 (U.S. CLS. 100, 101 AND 107).

FIRST USE 1-1-2004; IN COMMERCE 7-22-2004.

THE MARK CONSISTS OF STANDARD CHARACTERS
WITHOUT CLAIM TO ANY PARTICULAR FONT,
STYLE, SIZE, OR COLOR.

SER. NO. 77-165,104, FILED 4-25-2007.

ANTHONY RINKER, EXAMINING ATTORNEY

Int. Cl.: 11

Prior U.S. Cls.: 13, 21, 23, 31 and 34

United States Patent and Trademark Office

Reg. No. 3,478,878

Registered Aug. 5, 2008

**TRADEMARK
PRINCIPAL REGISTER**

Ecoblue

DESERT U.S.A. CORPORATION (CALIFORNIA CORPORATION)
119 BELVEDERE ST.
SAN FRANCISCO, CA 94117

FOR: WATER AND ENERGY CONSERVATION EQUIPMENT, NAMELY, LOW FLOW SHOWER HEADS, FAUCET AERATORS, PRE RINSE SPRAY VALVES, HIGH EFFICIENCY TOILETS, WATER EFFICIENT URINALS, WATER FILTRATION AND PURIFICATION UNITS, WATER REVITALIZATION TREATMENT UNITS, WATER EFFICIENT IRRIGATION UNITS, WASTEWATER TREATMENT UNITS, RAIN HARVESTING UNITS AND GREY WATER

RECYCLING UNITS, IN CLASS 11 (U.S. CLS. 13, 21, 23, 31 AND 34).

FIRST USE 4-12-2007; IN COMMERCE 4-12-2007.

THE MARK CONSISTS OF STANDARD CHARACTERS WITHOUT CLAIM TO ANY PARTICULAR FONT, STYLE, SIZE, OR COLOR.

SER. NO. 77-165,592, FILED 4-25-2007.

KAREN K. BUSH, EXAMINING ATTORNEY

Int. Cls.: 35, 41 and 42

Prior U.S. Cls.: 100, 101, 102 and 107

Reg. No. 3,478,879

United States Patent and Trademark Office

Registered Aug. 5, 2008

**SERVICE MARK
PRINCIPAL REGISTER**

Talkbean

INTERPARK CORPORATION (REPUBLIC OF KOREA CORPORATION)
1304-3 SEOCHO-DONG, SEOCHO-GU
SEOUL, REPUBLIC OF KOREA

FOR: EMPLOYMENT AGENCIES IN THE FIELD OF ONLINE TUTORS FOR FOREIGN LANGUAGE STUDY WITH NATIVE SPEAKERS; COMPUTERIZED ONLINE RETAIL STORE SERVICES IN THE FIELD OF BOOKS AND EDUCATIONAL MATERIALS; EMPLOYMENT AGENCIES IN THE FIELD OF ONLINE TUTORS; COMPUTERIZED ONLINE RETAIL STORE SERVICES IN THE FIELD OF DIGITAL EDUCATIONAL MATERIALS IN THE NATURE OF SOFTWARE, INSTRUMENTS AND EDUCATIONAL MATERIALS FOR VIRTUAL AND ONLINE LEARNING IN THE NATURE OF SOFTWARE, AND SOFTWARE FOR VIRTUAL/ONLINE LEARNING; ADVERTISING SERVICES IN THE FIELD OF PUBLICATIONS; ADVERTISEMENT PLANNING; ADVERTISING AGENCIES; PUBLICATION OF PUBLICITY TEXTS; ARRANGING OF ADVERTISING; PUBLICITY MATERIAL RENTAL, NAMELY, RENTAL OF PUBLICITY AND MARKETING PRESENTATION MATERIALS, RENTAL OF SIGNS FOR ADVERTISING PURPOSES; UPDATING OF ADVERTISING MATERIAL; RENTAL OF ADVERTISING SPACE; CORPORATE ADVERTISEMENT AND PROMOTION; PRODUCTION AND DISTRIBUTION OF RADIO COMMERCIALS; ORGANIZATION OF EXHIBITIONS FOR COMMERCIAL OR ADVERTISING PURPOSES; ONLINE ADVERTISING ON A COMPUTER NETWORK; PRODUCTION AND DISTRIBUTION OF TELEVISION COMMERCIALS; MARKETING RESEARCH; PROVIDING BUSINESS INFORMATION; BUSINESS RESEARCH SERVICES, NAMELY, PROVIDING ANALYSIS OF RETAIL DATA ON SPECIFIC BUSINESS LOCATIONS; DATA PROCESSING; COMPILATION OF INFORMATION INTO COMPUTER DATABASES; SYSTEMIZATION OF INFORMATION INTO COMPUTER DATABASES; MANAGEMENT OF COMPUTERIZED FILES,

NAMELY, DATA SEARCH IN COMPUTER FILES FOR OTHERS; COMPUTERIZED FILE MANAGEMENT; PROVIDING STATISTICAL INFORMATION; IMPORT-EXPORT AGENCIES FOR SOFTWARE; RETAIL STORE SERVICES FEATURING COMPUTER SOFTWARE; AUCTIONEERING; BUSINESS MANAGEMENT OF GAS STATION; BUSINESS MARKETING SERVICES; EMPLOYMENT AGENCIES, IN CLASS 35 (U.S. CLS. 100, 101 AND 102).

FOR: SERVICES FOR LONG DISTANCE LEARNING, NAMELY, PROVIDING ONLINE CLASSES, SEMINARS, WORKSHOPS IN THE FIELD OF FOREIGN LANGUAGE STUDY AND CONVERSATIONAL FOREIGN LANGUAGE STUDY; PROVIDING SERVICES OF INSTALLATIONS FOR FOREIGN LANGUAGE EDUCATION VIA ONLINE, NAMELY, CONDUCTING ONLINE EXHIBITIONS AND DISPLAYS AND INTERACTIVE EXHIBITS IN THE FIELD OF FOREIGN LANGUAGE STUDY; EDUCATION SERVICES, NAMELY, PROVIDING CLASSES, SEMINARS, WORKSHOPS IN THE FIELD OF FOREIGN LANGUAGE VIA THE INTERNET; EDUCATION SERVICES, NAMELY, PROVIDING ONLINE CLASSES, SEMINARS, WORKSHOPS IN THE FIELD OF COMPANY EDUCATION IN THE NATURE OF BUSINESS AND CORPORATE TRAINING; EDUCATION SERVICES, NAMELY, PROVIDING ONLINE CLASSES, SEMINARS, WORKSHOPS IN THE FIELD OF FINANCE VIA ONLINE; EDUCATION SERVICES, NAMELY, PROVIDING ONLINE CLASSES, SEMINARS, WORKSHOPS IN THE FIELD OF FOREIGN LANGUAGE; EDUCATION SERVICES, NAMELY, PROVIDING ONLINE CLASSES, SEMINARS, WORKSHOPS, IN THE FIELD OF COMPUTER INFORMATION AND TECHNOLOGIES; PROVIDING ONLINE TUTORING IN THE FIELD OF FOREIGN LANGUAGE STUDY; PROVIDING ONLINE INFORMATION ABOUT EDUCATION; ONLINE EDUCATIONAL EXAMINATION SERVICES; CONTENTS PLANNING SERVICES REGARD-

ING EDUCATION, NAMELY, DEVELOPING EDUCATIONAL MANUALS FOR OTHERS IN THE FIELD OF FOREIGN LANGUAGE STUDY; DIGITAL IMAGING SERVICES; PUBLICATION OF ELECTRONIC BOOKS AND JOURNALS ONLINE; PROVIDING ONLINE NON-DOWNLOADABLE ELECTRONIC PUBLICATIONS IN THE NATURE OF MAGAZINES, BOOKS, AND READING MATERIALS IN THE NATURE OF NEWSLETTERS OR PAMPHLETS IN THE FIELD OF LANGUAGE STUDY; BOARDING SCHOOLS; COOKING INSTRUCTIONS; EDUCATION IN THE FIELD OF TELECOMMUNICATIONS RENDERED THROUGH CORRESPONDENCE COURSES; PUBLICATION OF BOOKS; PROVIDING COMMUNITY WEBSITES FOR OTHERS ON THE INTERNET FEATURING INFORMATION RELATING TO GENERAL EDUCATION, IN CLASS 41 (U.S. CLS. 100, 101 AND 107).

FOR: COMPUTER SERVICES, NAMELY, HOSTING AND MAINTAINING AN ONLINE WEBSITE FOR OTHERS TO ALLOW USERS TO STUDY FOREIGN LANGUAGES WITH AN ONLINE TUTOR BASED ON ONE TO ONE PERSON INTERACTIONS; RESEARCH AND DEVELOPMENT AGENCIES FOR OTHER IN THE FIELD OF SOFTWARE FOR USE WITH UPLOADABLE AND DOWNLOADABLE DIGITAL CONTENT; TECHNICAL RESEARCH IN THE FIELD OF ENGINEERING AND SCIENCE; DESIGN OF WEBSITES FOR OTHERS FEATURING DIGITAL CONTENTS AND ELECTRONIC DOCUMENTS; HOSTING COMPUTER SITES AND WEBSITES; CREATING AND MAINTAINING WEBSITES FOR OTHERS; CONVERSION OF DATA OR DOCUMENTS FROM PHYSICAL TO ELECTRONIC MEDIA; INSTALLATION OF COMPUTER SOFTWARE; COMPUTER HARDWARE AND SOFTWARE SYSTEM DESIGN; DATA

CONVERSION OF COMPUTER PROGRAM INFORMATION AND DATA; DUPLICATION OF COMPUTER PROGRAMS; COMPUTER RENTAL; RECOVERY OF COMPUTER DATA; RENTAL OF COMPUTER SOFTWARE; COMPUTER SOFTWARE DESIGN; UPDATING OF COMPUTER SOFTWARE; MAINTENANCE OF COMPUTER SOFTWARE; COMPUTER SYSTEMS ANALYSIS; COMPUTER PROGRAMMING; RENTAL OF COMPUTER PROGRAMS AND TRANSLATION IN THE NATURE OF COMPUTER CODE CONVERSION OF COMPUTER PROGRAMS FOR OTHERS; CONSULTANCY IN THE FIELD OF COMPUTER HARDWARE; ADVISORY SERVICES REGARDING COMPUTERS, IN CLASS 42 (U.S. CLS. 100 AND 101).

THE MARK CONSISTS OF STANDARD CHARACTERS WITHOUT CLAIM TO ANY PARTICULAR FONT, STYLE, SIZE, OR COLOR.

PRIORITY CLAIMED UNDER SEC. 44(D) ON REPUBLIC OF KOREA APPLICATION NO. 2006-0026532, FILED 10-26-2006, REG. NO. 41-0157084, DATED 11-26-2007, EXPIRES 11-26-2017.

PRIORITY CLAIMED UNDER SEC. 44(D) ON REPUBLIC OF KOREA APPLICATION NO. 2006-0026531, FILED 10-26-2006, REG. NO. 41-0157083, DATED 11-26-2007, EXPIRES 11-26-2017.

PRIORITY CLAIMED UNDER SEC. 44(D) ON REPUBLIC OF KOREA APPLICATION NO. 2006-0026528, FILED 10-26-2006, REG. NO. 41-0157082, DATED 11-26-2007, EXPIRES 11-26-2017.

SER. NO. 77-165,995, FILED 4-26-2007.

KRISTINA MORRIS, EXAMINING ATTORNEY

Int. Cl.: 42

Prior U.S. Cls.: 100 and 101

United States Patent and Trademark Office

Reg. No. 3,478,880

Registered Aug. 5, 2008

**SERVICE MARK
PRINCIPAL REGISTER**

BeBorderless

BE BORDERLESS, INC. (ILLINOIS CORPORATION)
913 N HONORE 1F
CHICAGO, IL 60622

FOR: COMPUTER SERVICES IN THE NATURE OF CUSTOMIZED WEB PAGES FEATURING USER-DEFINED INFORMATION, PERSONAL PROFILES AND INFORMATION; COMPUTER SERVICES, NAMELY, HOSTING ON-LINE WEB FACILITIES FOR OTHERS FOR ORGANIZING AND CONDUCTING ONLINE MEETINGS, GATHERINGS, AND

INTERACTIVE DISCUSSIONS, IN CLASS 42 (U.S. CLS. 100 AND 101).

FIRST USE 9-21-2006; IN COMMERCE 9-21-2006.

THE MARK CONSISTS OF STANDARD CHARACTERS WITHOUT CLAIM TO ANY PARTICULAR FONT, STYLE, SIZE, OR COLOR.

SER. NO. 77-166,227, FILED 4-26-2007.

ROBIN MITTLER, EXAMINING ATTORNEY

Int. Cl.: 37

Prior U.S. Cls.: 100, 103 and 106

United States Patent and Trademark Office

Reg. No. 3,478,881

Registered Aug. 5, 2008

**SERVICE MARK
PRINCIPAL REGISTER**



ADVANCED METAL CORP. (NORTH CAROLINA CORPORATION)
SUITE C
5552 CAROLINA BEACH RD.
WILMINGTON, NC 28412

NO CLAIM IS MADE TO THE EXCLUSIVE RIGHT TO USE "METALROOFING.COM", APART FROM THE MARK AS SHOWN.

FOR: ROOFING INSTALLATION, IN CLASS 37 (U.S. CLS. 100, 103 AND 106).

SER. NO. 77-167,162, FILED 4-27-2007.

FIRST USE 12-17-2003; IN COMMERCE 12-17-2003.

TINA BROWN, EXAMINING ATTORNEY

Int. Cl.: 41

Prior U.S. Cls.: 100, 101 and 107

United States Patent and Trademark Office

Reg. No. 3,478,882

Registered Aug. 5, 2008

**SERVICE MARK
PRINCIPAL REGISTER**

HLS

MCCABE FUNERAL HOME (MICHIGAN CORPORATION)
31950 WEST TWELVE MILE ROAD
FARMINGTON HILLS, MI 48334

FOR: MEDIA PRODUCTION SERVICES FOR FUNERALS, NAMELY, MEDIA PRESENTATIONS FOR OTHERS USING PHOTOGRAPHS, AUDIO CLIPS AND VIDEO EXCERPTS FROM A PERSON'S LIFE TO CREATE PERSONALIZED VIDEOS, BROCHURES AND CARDS RELATED TO THAT PERSON, IN CLASS 41 (U.S. CLS. 100, 101 AND 107).

FIRST USE 10-1-2005; IN COMMERCE 10-1-2005.

THE MARK CONSISTS OF STANDARD CHARACTERS WITHOUT CLAIM TO ANY PARTICULAR FONT, STYLE, SIZE, OR COLOR.

SER. NO. 77-167,269, FILED 4-27-2007.

H. M. FISHER, EXAMINING ATTORNEY

Int. Cls.: 19, 37 and 42

Prior U.S. Cls.: 1, 12, 33, 50, 100, 101, 103 and 106

Reg. No. 3,478,883

United States Patent and Trademark Office

Registered Aug. 5, 2008

**TRADEMARK
SERVICE MARK
PRINCIPAL REGISTER**

TAIT TOWERS

TAIT TOWERS, INC. (PENNSYLVANIA CORPORATION)
9 WYNFIELD DRIVE
LITITZ, PA 17543

FOR: PORTABLE STAGES, IN CLASS 19 (U.S. CLS. 1, 12, 33 AND 50).

FIRST USE 0-0-1978; IN COMMERCE 0-0-1978.

FOR: CUSTOM CONSTRUCTION OF STAGES AND SCENERY FOR LIVE PERFORMANCES FOR OTHERS, IN CLASS 37 (U.S. CLS. 100, 103 AND 106).

FIRST USE 0-0-1978; IN COMMERCE 0-0-1978.

FOR: CUSTOM DESIGN OF STAGES AND SCENERY FOR LIVE PERFORMANCES FOR OTHERS, IN CLASS 42 (U.S. CLS. 100 AND 101).

FIRST USE 0-0-1978; IN COMMERCE 0-0-1978.

THE MARK CONSISTS OF STANDARD CHARACTERS WITHOUT CLAIM TO ANY PARTICULAR FONT, STYLE, SIZE, OR COLOR.

SEC. 2(F).

SER. NO. 77-167,661, FILED 4-27-2007.

RONALD MCMORROW, EXAMINING ATTORNEY

Int. Cl.: 1

Prior U.S. Cls.: 1, 5, 6, 10, 26 and 46

Reg. No. 3,478,884

United States Patent and Trademark Office

Registered Aug. 5, 2008

**TRADEMARK
PRINCIPAL REGISTER**

ECCOSHIELD

EASTERN COLOR & CHEMICAL COMPANY
(RHODE ISLAND CORPORATION)
35 LIVINGSTON ST.
PROVIDENCE, RI 02904

THE MARK CONSISTS OF STANDARD CHAR-
ACTERS WITHOUT CLAIM TO ANY PARTICULAR
FONT, STYLE, SIZE, OR COLOR.

FOR: FLAME RESISTANT CHEMICAL FOR USE
IN THE MANUFACTURE OF TEXTILES, PAPER
AND LEATHER, IN CLASS 1 (U.S. CLS. 1, 5, 6, 10, 26
AND 46).

SER. NO. 77-167,769, FILED 4-27-2007.

FIRST USE 5-1-2007; IN COMMERCE 5-1-2007.

JENNY PARK, EXAMINING ATTORNEY

Int. Cl.: 15

Prior U.S. Cls.: 2, 21 and 36

United States Patent and Trademark Office

Reg. No. 3,478,885

Registered Aug. 5, 2008

**TRADEMARK
PRINCIPAL REGISTER**

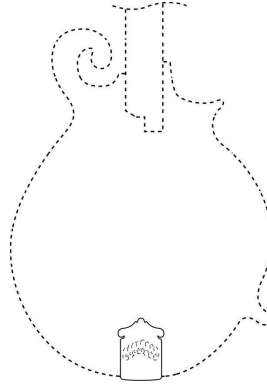

COLLINGS GUITARS, INC. (TEXAS CORPORATION)
11210 WEST HWY 290
AUSTIN, TX 78737

FOR: TAILPIECE FOR STRINGED MUSICAL INSTRUMENTS, NAMELY, MANDOLINS, IN CLASS 15 (U.S. CLS. 2, 21 AND 36).

FIRST USE 10-9-2002; IN COMMERCE 10-9-2002.

THE MARK CONSISTS OF THE FANCIFUL CONFIGURATION OF THE TAILPIECE FOR A MAN-

DOLIN. THE DASHED LINES ARE NOT A FEATURE OF THE MARK BUT SERVE TO INDICATE PLACEMENT OF THE MARK ON AN INSTRUMENT.

SEC. 2(F).

SER. NO. 77-167,960, FILED 4-27-2007.

TINA L. SNAPP, EXAMINING ATTORNEY

Int. Cl.: 1

Prior U.S. Cls.: 1, 5, 6, 10, 26 and 46

United States Patent and Trademark Office

Reg. No. 3,478,886

Registered Aug. 5, 2008

**TRADEMARK
PRINCIPAL REGISTER**

NEUROBASAL

INVITROGEN CORPORATION (DELAWARE
CORPORATION)
1600 FARADAY AVENUE
CARLSBAD, CA 92008

THE MARK CONSISTS OF STANDARD CHAR-
ACTERS WITHOUT CLAIM TO ANY PARTICULAR
FONT, STYLE, SIZE, OR COLOR.

FOR: MEDIA FOR RESEARCH AND SCIENTIFIC
USE OF NEURONAL CELLS, IN CLASS 1 (U.S. CLS.
1, 5, 6, 10, 26 AND 46).

SER. NO. 77-168,069, FILED 4-27-2007.

FIRST USE 1-1-1993; IN COMMERCE 1-1-1993.

DARRYL SPRUILL, EXAMINING ATTORNEY

Int. Cl.: 35

Prior U.S. Cls.: 100, 101 and 102

United States Patent and Trademark Office

Reg. No. 3,478,887

Registered Aug. 5, 2008

**SERVICE MARK
PRINCIPAL REGISTER**

VALUBILL

PRESCIENT WORLDWIDE, LLC (DELAWARE
LTD LIAB CO)
1 BARNES PARK SOUTH
WALLINGFORD, CT 06492

FOR: MANAGEMENT AND BUSINESS CON-
SULTING SERVICES IN THE FIELD OF TELECOM-
MUNICATIONS BILLING; PROVIDING
TELECOMMUNICATIONS BILLING SERVICES
FOR LONG DISTANCE AND LOCAL SERVICE
CARRIERS; BUSINESS MANAGEMENT SERVICES,
NAMELY, BUSINESS TELEPHONE BILL CONSOLI-

DATION FOR OTHERS, IN CLASS 35 (U.S. CLS. 100,
101 AND 102).

FIRST USE 5-15-2000; IN COMMERCE 5-15-2000.

THE MARK CONSISTS OF STANDARD CHAR-
ACTERS WITHOUT CLAIM TO ANY PARTICULAR
FONT, STYLE, SIZE, OR COLOR.

SER. NO. 77-168,690, FILED 4-30-2007.

JAY BESCH, EXAMINING ATTORNEY

Int. Cl.: 16

Prior U.S. Cls.: 2, 5, 22, 23, 29, 37, 38 and 50

Reg. No. 3,478,888

United States Patent and Trademark Office

Registered Aug. 5, 2008

**TRADEMARK
PRINCIPAL REGISTER**

EARLY BIRD BABY

EARLY BIRD BABY, LLC (NEW HAMPSHIRE
LTD LIAB CO)
6 POPE ROAD
BROOKLINE, NH 03033

FOR: PAPER OR CARDBOARD BABY GIFT BOXES SOLD AS A UNIT; PAPER OR CARDBOARD BABY GIFT BOXES SOLD AS A UNIT, NAMELY, KEEPSAKE BOXES; BLANK WRITING JOURNALS; PENS; KITS SOLD AS A UNIT FOR USE FOR BABY AND PARENT COMFORT COMPRISED OF BLANK WRITING JOURNALS AND PENS; KITS SOLD AS A UNIT FOR USE FOR BABY AND PARENT COMFORT COMPRISED OF BLANK WRITING JOURNALS, PENS, AND RECORDABLE PICTURE FRAMES; KITS SOLD AS A UNIT FOR USE FOR BABY AND PARENT COMFORT COMPRISED OF BLANK WRITING JOURNALS, PENS, RECORDABLE PICTURE FRAMES, AND HAND-HELD MIRRORS; KITS SOLD AS A UNIT FOR USE FOR BABY AND PARENT COMFORT COMPRISED OF BLANK WRITING JOURNALS, PENS, RECORDABLE PICTURE FRAMES, HAND-HELD MIRRORS, AND BLANKETS; KITS SOLD AS A UNIT FOR USE FOR BABY AND PARENT COMFORT COMPRISED OF BLANK WRITING JOURNALS, PENS, RECORDABLE PICTURE FRAMES, HAND-HELD MIRRORS,

BLANKETS, AND DISPOSABLE CAMERAS; KITS SOLD AS A UNIT FOR USE FOR BABY AND PARENT COMFORT COMPRISED OF BLANK WRITING JOURNALS, PENS, RECORDABLE PICTURE FRAMES, HAND-HELD MIRRORS, BLANKETS, DISPOSABLE CAMERAS, AND STUFFED TOY ANIMALS; KITS SOLD AS A UNIT COMPRISING BLANK WRITING JOURNALS, PENS, RECORDABLE PICTURE FRAMES, HAND-HELD MIRRORS, BLANKETS, AND DISPOSABLE CAMERAS, IN CLASS 16 (U.S. CLS. 2, 5, 22, 23, 29, 37, 38 AND 50).

FIRST USE 5-6-2007; IN COMMERCE 5-7-2007.

THE MARK CONSISTS OF STANDARD CHARACTERS WITHOUT CLAIM TO ANY PARTICULAR FONT, STYLE, SIZE, OR COLOR.

NO CLAIM IS MADE TO THE EXCLUSIVE RIGHT TO USE "BABY", APART FROM THE MARK AS SHOWN.

SER. NO. 77-168,829, FILED 4-30-2007.

KATHRYN COWARD, EXAMINING ATTORNEY

Int. Cl.: 16

Prior U.S. Cls.: 2, 5, 22, 23, 29, 37, 38 and 50

United States Patent and Trademark Office

Reg. No. 3,478,889

Registered Aug. 5, 2008

TRADEMARK
PRINCIPAL REGISTER



EARLY BIRD BABY, LLC (NEW HAMPSHIRE
LTD LIAB CO)
6 POPE ROAD
BROOKLINE, NH 03033

FOR: PAPER OR CARDBOARD BABY GIFT BOXES SOLD AS A UNIT; PAPER OR CARDBOARD BABY GIFT BOXES SOLD AS A UNIT, NAMELY, KEEPSAKE BOXES; BLANK WRITING JOURNALS; PENS; KITS SOLD AS A UNIT FOR USE FOR BABY AND PARENT COMFORT COMPRISED OF BLANK WRITING JOURNALS AND PENS; KITS SOLD AS A UNIT FOR USE FOR BABY AND PARENT COMFORT COMPRISED OF BLANK WRITING JOURNALS, PENS, AND RECORDABLE PICTURE FRAMES; KITS SOLD AS A UNIT FOR USE FOR BABY AND PARENT COMFORT COMPRISED OF BLANK WRITING JOURNALS, PENS, RECORDABLE PICTURE FRAMES, AND HAND-HELD MIRRORS; KITS SOLD AS A UNIT FOR USE FOR BABY AND PARENT COMFORT COMPRISED OF BLANK WRITING JOURNALS, PENS, RECORDABLE PICTURE FRAMES, HAND-HELD MIRRORS, AND

BLANKETS; KITS SOLD AS A UNIT FOR USE FOR BABY AND PARENT COMFORT COMPRISED OF BLANK WRITING JOURNALS, PENS, RECORDABLE PICTURE FRAMES, HAND-HELD MIRRORS, BLANKETS, AND DISPOSABLE CAMERAS; KITS SOLD AS A UNIT FOR USE FOR BABY AND PARENT COMFORT COMPRISED OF BLANK WRITING JOURNALS, PENS, RECORDABLE PICTURE FRAMES, HAND-HELD MIRRORS, BLANKETS, DISPOSABLE CAMERAS, AND STUFFED TOY ANIMALS; KITS SOLD AS A UNIT COMPRISING BLANK WRITING JOURNALS, PENS, RECORDABLE PICTURE FRAMES, HAND-HELD MIRRORS, BLANKETS, AND DISPOSABLE CAMERAS, IN CLASS 16 (U.S. CLS. 2, 5, 22, 23, 29, 37, 38 AND 50).

FIRST USE 5-6-2007; IN COMMERCE 5-7-2007.

SER. NO. 77-168,846, FILED 4-30-2007.

KATHRYN COWARD, EXAMINING ATTORNEY

Int. Cl.: 44

Prior U.S. Cls.: 100 and 101

United States Patent and Trademark Office

Reg. No. 3,478,890

Registered Aug. 5, 2008

**SERVICE MARK
PRINCIPAL REGISTER**

MULTICARE

MULTICARE HEALTH SYSTEM (WASHINGTON
NON-PROFIT CORPORATION)
P.O. BOX 5299
315 MARTIN LUTHER KING JR. WAY
TACOMA, WA 984150299

FOR: MEDICAL SERVICES; MANAGED
HEALTHCARE SERVICES; INTEGRATED
HEALTHCARE SERVICES, NAMELY, PROVIDING
INFORMATION ABOUT INPATIENT AND OUTPA-
TIENT HEALTHCARE SERVICES AND RELATED
HEALTHCARE SERVICES AND LINKING INPATI-
ENT AND OUTPATIENT HEALTHCARE SERVICES
BY PROVIDING AN INTERNET ACCESSIBLE COM-
PUTERIZED DATABASE FOR USE IN POSTING,
ACCESSING, AND TRANSFERRING INFORMA-

TION ABOUT INPATIENT AND OUTPATIENT
HEALTHCARE SERVICES, IN CLASS 44 (U.S. CLS.
100 AND 101).

FIRST USE 0-0-1983; IN COMMERCE 0-0-1983.

THE MARK CONSISTS OF STANDARD CHAR-
ACTERS WITHOUT CLAIM TO ANY PARTICULAR
FONT, STYLE, SIZE, OR COLOR.

OWNER OF U.S. REG. NO. 3,309,206.

SER. NO. 77-169,195, FILED 4-30-2007.

DAVID YONTEF, EXAMINING ATTORNEY

Int. Cl.: 35

Prior U.S. Cls.: 100, 101 and 102

United States Patent and Trademark Office

Reg. No. 3,478,891

Registered Aug. 5, 2008

**SERVICE MARK
PRINCIPAL REGISTER**

PWC

PROFESSIONAL WOMEN IN CONSTRUCTION
CORP. (NEW YORK NON-PROFIT CORPORATION)
315 EAST 56TH STREET
NEW YORK, NY 10022

FOR: ASSOCIATION SERVICES, NAMELY, PROMOTING THE INTERESTS OF BUSINESS AND PROFESSIONAL WOMEN IN THE CONSTRUCTION INDUSTRY; HOSTING CONSTRUCTION INDUSTRY BUSINESS-TO-BUSINESS NETWORKING EVENTS, IN CLASS 35 (U.S. CLS. 100, 101 AND 102).

FIRST USE 0-0-1983; IN COMMERCE 0-0-1983.

THE MARK CONSISTS OF STANDARD CHARACTERS WITHOUT CLAIM TO ANY PARTICULAR FONT, STYLE, SIZE, OR COLOR.

SER. NO. 77-170,159, FILED 5-1-2007.

LINDA POWELL, EXAMINING ATTORNEY

Int. Cl.: 35

Prior U.S. Cls.: 100, 101 and 102

United States Patent and Trademark Office

Reg. No. 3,478,892

Registered Aug. 5, 2008

**SERVICE MARK
PRINCIPAL REGISTER**



PROFESSIONAL WOMEN IN CONSTRUCTION
CORP. (NEW YORK NON-PROFIT CORPORATION)

315 EAST 56TH STREET
NEW YORK, NY 10022

FOR: ASSOCIATION SERVICES, NAMELY, PROMOTING THE INTERESTS OF BUSINESS AND PROFESSIONAL WOMEN IN THE CONSTRUCTION INDUSTRY; HOSTING CONSTRUCTION INDUSTRY BUSINESS-TO-BUSINESS NETWORKING EVENTS, IN CLASS 35 (U.S. CLS. 100, 101 AND 102).

FIRST USE 0-0-1983; IN COMMERCE 0-0-1983.

THE MARK CONSISTS OF THE LETTERS "PWC" WITH A GEOMETRIC DESIGN CONSISTING OF A TRIANGLE AND LINES TO THE RIGHT.

SER. NO. 77-170,165, FILED 5-1-2007.

LINDA POWELL, EXAMINING ATTORNEY

Int. Cls.: 35, 37 and 42

Prior U.S. Cls.: 100, 101, 102, 103 and 106

United States Patent and Trademark Office

Reg. No. 3,478,893

Registered Aug. 5, 2008

**SERVICE MARK
PRINCIPAL REGISTER**



RENTTECH, INC. (COLORADO CORPORATION)
10877 WILSHIRE BLVD., SUITE 710
LOS ANGELES, CA 90024

FOR: CONSULTATION IN THE FIELD OF BUSINESS OPERATION FOR PROCESS PLANTS FOR CONVERTING NATURAL GAS, REFINERY RESIDUES, COAL AND OTHER CARBON BEARING MATERIALS INTO SYNTHETIC PETROLEUM PRODUCTS, IN CLASS 35 (U.S. CLS. 100, 101 AND 102).

FIRST USE 3-22-2007; IN COMMERCE 3-22-2007.

FOR: CONSULTATION IN THE FIELD OF CONSTRUCTION PLANNING FOR PROCESS PLANTS FOR CONVERTING NATURAL GAS, REFINERY RESIDUES, COAL AND OTHER CARBON BEARING MATERIALS INTO SYNTHETIC PETROLEUM PRODUCTS, IN CLASS 37 (U.S. CLS. 100, 103 AND 106).

FIRST USE 3-22-2007; IN COMMERCE 3-22-2007.

FOR: TECHNOLOGY CONSULTATION AND RESEARCH, PRODUCT DEVELOPMENT, ENGINEERING AND ENGINEERING CONSULTING SERVICES RELATING TO CONSTRUCTION OR OPERATION OF PROCESS PLANTS FOR CONVERTING NATURAL GAS, REFINERY RESIDUES, COAL AND OTHER CARBON BEARING MATERIALS INTO SYNTHETIC PETROLEUM PRODUCTS, IN CLASS 42 (U.S. CLS. 100 AND 101).

FIRST USE 3-22-2007; IN COMMERCE 3-22-2007.

OWNER OF U.S. REG. NO. 2,341,110.

SER. NO. 77-170,198, FILED 5-1-2007.

SAIMA MAKHDOOM, EXAMINING ATTORNEY

Int. Cl.: 41

Prior U.S. Cls.: 100, 101 and 107

United States Patent and Trademark Office

Reg. No. 3,478,894

Registered Aug. 5, 2008

**SERVICE MARK
PRINCIPAL REGISTER**

Seduce A Celeb

GOFISH CORPORATION (NEVADA CORPORATION)
SUITE 260
500 THIRD STREET
SAN FRANCISCO, CA 94107

FOR: ENTERTAINMENT SERVICES, NAMELY, PROVIDING A TELEVISION PROGRAM IN THE FIELD OF NEWS, ENTERTAINMENT AND EDUCATION VIA A GLOBAL COMPUTER NETWORK; PROGRAMMING ON A GLOBAL COMPUTER NETWORK; ENTERTAINMENT SERVICES NAMELY PROVIDING A WEBSITE FEATURING, PHOTOGRAPHIC, AUDIO, VIDEO AND PROSE PRESENTATIONS FEATURING LIVE-ACTION, COMEDY, DRAMA AND REALITY-BASED WEB SERIES; ENTERTAINMENT IN THE NATURE OF ON-GOING TELEVISION PROGRAMS IN THE FIELD OF NEWS, ENTERTAINMENT AND EDUCATION; ENTERTAINMENT IN THE NATURE OF LIVE-ACTION, COMEDY, DRAMA AND REALITY-BASED WEB SERIES; ENTERTAINMENT NAMELY, PRODUCTION OF LIVE-ACTION, COMEDY, DRAMA AND REALITY-BASED WEB SERIES; ENTERTAINMENT

SERVICES, NAMELY, PROVIDING A WEB SITE FEATURING MUSICAL PERFORMANCES, MUSICAL VIDEOS, RELATED FILM CLIPS, PHOTOGRAPHS, AND OTHER MULTIMEDIA MATERIALS; ENTERTAINMENT, NAMELY A CONTINUING LIVE-ACTION, COMEDY, DRAMA AND REALITY-BASED SHOW BROADCAST OVER TELEVISION, SATELLITE, AUDIO, AND VIDEO MEDIA; ENTERTAINMENT IN THE NATURE OF VISUAL AND AUDIO PERFORMANCES, AND MUSICAL, VARIETY, NEWS AND COMEDY SHOWS; TELEVISION SHOW PRODUCTION, IN CLASS 41 (U.S. CLS. 100, 101 AND 107).

FIRST USE 4-5-2007; IN COMMERCE 4-26-2007.

THE MARK CONSISTS OF STANDARD CHARACTERS WITHOUT CLAIM TO ANY PARTICULAR FONT, STYLE, SIZE, OR COLOR.

SER. NO. 77-171,222, FILED 5-2-2007.

KYLE PEETE, EXAMINING ATTORNEY

Int. Cl.: 35

Prior U.S. Cls.: 100, 101 and 102

United States Patent and Trademark Office

Reg. No. 3,478,895

Registered Aug. 5, 2008

SERVICE MARK
PRINCIPAL REGISTER



NATIONAL FAMILY PARTNERSHIP (FLORIDA
CORPORATION)
2490 CORAL WAY
MIAMI, FL 33145

FIRST USE 2-15-2007; IN COMMERCE 2-15-2007.

SER. NO. 77-171,763, FILED 5-3-2007.

FOR: PROMOTING PUBLIC AWARENESS OF
THE NEED FOR DRUG ABUSE PREVENTION, IN
CLASS 35 (U.S. CLS. 100, 101 AND 102).

KARANENDRA S. CHHINA, EXAMINING ATTOR-
NEY

Int. Cl.: 2

Prior U.S. Cls.: 6, 11 and 16

United States Patent and Trademark Office

Reg. No. 3,478,896

Registered Aug. 5, 2008

**TRADEMARK
PRINCIPAL REGISTER**

ENDURO-VAR

DAVID E. EASTERDAY & CO., INC. (OHIO
CORPORATION)
P.O. BOX 332
MT. EATON, OH 44659

FOR: COATINGS IN THE NATURE OF VARN-
ISHES, LACQUERS, WOOD STAINS AND WATER
REPELLANT WOOD FINISHES, IN CLASS 2 (U.S.
CLS. 6, 11 AND 16).

FIRST USE 10-17-2006; IN COMMERCE 10-31-2006.

THE MARK CONSISTS OF STANDARD CHAR-
ACTERS WITHOUT CLAIM TO ANY PARTICULAR
FONT, STYLE, SIZE, OR COLOR.

OWNER OF U.S. REG. NO. 2,543,061.

SER. NO. 77-172,023, FILED 5-3-2007.

PRISCILLA MILTON, EXAMINING ATTORNEY

Int. Cl.: 41

Prior U.S. Cls.: 100, 101 and 107

United States Patent and Trademark Office

Reg. No. 3,478,897

Registered Aug. 5, 2008

**SERVICE MARK
PRINCIPAL REGISTER**

ANCHORAGE PRESS

ANCHORAGE FOUNDATION OF TEXAS
(TEXAS CORPORATION)

10 WAVERLY COURT

HOUSTON, TX 77005

FOR: BOOK PUBLISHING, IN CLASS 41 (U.S. CLS.
100, 101 AND 107).

FIRST USE 10-31-1994; IN COMMERCE 10-31-1994.

THE MARK CONSISTS OF STANDARD CHAR-
ACTERS WITHOUT CLAIM TO ANY PARTICULAR
FONT, STYLE, SIZE, OR COLOR.

NO CLAIM IS MADE TO THE EXCLUSIVE
RIGHT TO USE "PRESS", APART FROM THE
MARK AS SHOWN.

SER. NO. 77-174,194, FILED 5-7-2007.

CHARLES L. JENKINS, EXAMINING ATTORNEY

Int. Cl.: 9

Prior U.S. Cls.: 21, 23, 26, 36 and 38

Reg. No. 3,478,898

United States Patent and Trademark Office

Registered Aug. 5, 2008

**TRADEMARK
PRINCIPAL REGISTER**



Home Continuity Solutions

MURPHY, LINDA M (UNITED STATES INDIVIDUAL)
7372 MONTEVERDE WAY
NAPLES, FL 34119

FOR: SOFTWARE FOR CREATING A HOME CONTINUITY PLAN THAT INCLUDES EMERGENCY RESPONSE AND RECOVERY INFORMATION, IN CLASS 9 (U.S. CLS. 21, 23, 26, 36 AND 38).

FIRST USE 1-19-2007; IN COMMERCE 1-19-2007.

NO CLAIM IS MADE TO THE EXCLUSIVE RIGHT TO USE "HOME CONTINUITY SOLUTIONS", APART FROM THE MARK AS SHOWN.

THE COLOR(S) BLUE,ORANGE,WHITE IS/ARE CLAIMED AS A FEATURE OF THE MARK.

THE MARK CONSISTS OF A BLUE OVAL WITH AN ORANGE BORDER. INSIDE THE OVAL IS A HOUSE ROOF LINE WITH A CHIMNEY AND SMOKE, ALL IN WHITE. THE WHITE LETTERS "HCS" APPEAR BELOW THE ROOF LINE. OUTSIDE AND UNDER THE OVAL APPEAR THE BLUE LETTERS "HOME CONTINUITY SOLUTIONS".

SER. NO. 77-174,530, FILED 5-7-2007.

PRISCILLA MILTON, EXAMINING ATTORNEY

Int. Cls.: 7 and 21

**Prior U.S. Cls.: 2, 13, 19, 21, 23, 29, 30, 31, 33, 34, 35,
40 and 50**

United States Patent and Trademark Office

Reg. No. 3,478,899

Registered Aug. 5, 2008

**TRADEMARK
PRINCIPAL REGISTER**



B&C SRL (ITALY CORPORATION)
VIA A. COSTA, 135/7
BOLOGNA, ITALY 40134

FOR: (BASED ON USE IN COMMERCE) ELECTRIC CARPET CLEANERS, IN CLASS 7 (U.S. CLS. 13, 19, 21, 23, 31, 34 AND 35).

FIRST USE 0-0-1982; IN COMMERCE 0-0-1997.

FOR: (BASED ON USE IN COMMERCE) POTS, SAUCEPANS, NON-ELECTRIC PRESSURE COOKERS, IN CLASS 21 (U.S. CLS. 2, 13, 23, 29, 30, 33, 40 AND 50).

FIRST USE 0-0-1982; IN COMMERCE 0-0-1997.

OWNER OF ITALY REG. NO. 926036, DATED 1-21-2004, EXPIRES 5-2-2013.

THE MARK CONSISTS OF THE WORD FOGACCI AND A STYLIZED LETTER F.

SER. NO. 77-174,626, FILED 5-7-2007.

CAROLINE WOOD, EXAMINING ATTORNEY

Int. Cl.: 27

Prior U.S. Cls.: 19, 20, 37, 42 and 50

United States Patent and Trademark Office

Reg. No. 3,478,900

Registered Aug. 5, 2008

**TRADEMARK
PRINCIPAL REGISTER**

WEATHERED STONE

SEAN HOWARD PRODUCTIONS, INC. (ALABAMA CORPORATION)
355 COMMERCIAL PARK DR.
FAIRHOPE, AL 36532

FOR: FABRIC-BACKED, MODIFIED PLASTER COVERING FOR WALLS, FLOORS, CEILINGS, COUNTERTOPS, AND MOLDINGS, NAMELY, REPLICA COVERINGS AND STONE REPLICA COVERINGS FOR WALLS, FLOORS, CEILINGS, COUNTERTOPS, AND MOLDINGS, IN CLASS 27 (U.S. CLS. 19, 20, 37, 42 AND 50).

FIRST USE 0-0-1997; IN COMMERCE 0-0-1997.

THE MARK CONSISTS OF STANDARD CHARACTERS WITHOUT CLAIM TO ANY PARTICULAR FONT, STYLE, SIZE, OR COLOR.

SEC. 2(F).

SER. NO. 77-175,061, FILED 5-8-2007.

KATHERINE E. HALMEN, EXAMINING ATTORNEY

Int. Cl.: 1

Prior U.S. Cls.: 1, 5, 6, 10, 26 and 46

Reg. No. 3,478,901

United States Patent and Trademark Office

Registered Aug. 5, 2008

**TRADEMARK
PRINCIPAL REGISTER**



ORGANIC SALES & MARKETING, INC. (DELA-
WARE CORPORATION)
114 BROADWAY
RAYNHAM, MA 02767

FOR: FERTILIZER, IN CLASS 1 (U.S. CLS. 1, 5, 6,
10, 26 AND 46).

FIRST USE 4-24-2007; IN COMMERCE 4-24-2007.

THE COLOR(S) GREEN, WHITE, YELLOW,
GRAY, RED, BLUE AND BLACK IS/ARE CLAIMED
AS A FEATURE OF THE MARK.

THE MARK CONSISTS OF THE COLOR GREEN
APPEARING IN THE WORDING "FEED YOUR
LAND FROM MOTHER NATURE", AS OUTLINE

FOR THE WORDING "MOTHER NATURE'S CUI-
SINE" AND IN THE DESIGN OF THE LEAVES; THE
COLOR WHITE IS FOUND IN THE WORDING
"MOTHER NATURE'S CUISINE" AND IN THE
CHECKERBOARD DESIGN; THE COLOR YELLOW
IS FOUND IN THE HANDLE OF THE FORK DE-
SIGN; THE COLOR GRAY IS FOUND IN THE
DESIGN OF THE FORK PRONGS; THE COLOR
RED IS FOUND IN THE CHECKERBOARD DE-
SIGN; THE COLOR BLUE IS FOUND IN THE
CIRCLE DESIGN AND THE COLOR BLACK AP-
PEARS IN THE RECTANGULAR BACKGROUND.

SER. NO. 77-175,088, FILED 5-8-2007.

KAREN BRACEY, EXAMINING ATTORNEY

Int. Cls.: 3, 35 and 44

Prior U.S. Cls.: 1, 4, 6, 50, 51, 52, 100, 101 and 102

United States Patent and Trademark Office

Reg. No. 3,478,902

Registered Aug. 5, 2008

**TRADEMARK
SERVICE MARK
PRINCIPAL REGISTER**

BODY & BOUNCE

DAVIS, JENNIFER P. (UNITED STATES INDIVIDUAL)
7139 HIGHWAY 85, SUITE #286
RIVERDALE, GA 30274

FOR: HAIR CARE PREPARATIONS; HAIR SHINE PREPARATIONS; HAIR RELAXING PREPARATIONS; HAIR CURLING PREPARATIONS; HAIR WAVING PREPARATIONS; HAIR SMOOTHENING PREPARATIONS; AND NON-MEDICATED HAIR CARE PRODUCTS AND TREATMENTS, NAMELY, SHAMPOOS, CONDITIONERS, GELS, MOUSSES, SPRAYS, MOISTURIZERS, DETANGLERS, CREAMS, OILS, POMADES, SMOOTHING GLAZES, SHINING SPRAYS, RELAXING LOTIONS, WAVING LOTIONS, AND CURLING LOTIONS, IN CLASS 3 (U.S. CLS. 1, 4, 6, 50, 51 AND 52).

FIRST USE 0-0-1992; IN COMMERCE 0-0-1992.

FOR: ONLINE RETAIL STORE SERVICES IN THE FIELD OF HAIR CARE PRODUCTS, PREPARA-

TIONS AND TREATMENTS; AND PROVIDING ONLINE INTERACTIVE COMMERCIAL INFORMATION AND ADVICE IN THE FIELD OF HAIR CARE PRODUCTS, PREPARATIONS AND TREATMENTS, IN CLASS 35 (U.S. CLS. 100, 101 AND 102).

FIRST USE 0-0-1998; IN COMMERCE 0-0-1998.

FOR: BEAUTY SALONS, IN CLASS 44 (U.S. CLS. 100 AND 101).

FIRST USE 5-27-1992; IN COMMERCE 5-27-1992.

THE MARK CONSISTS OF STANDARD CHARACTERS WITHOUT CLAIM TO ANY PARTICULAR FONT, STYLE, SIZE, OR COLOR.

SER. NO. 77-175,658, FILED 5-8-2007.

JAMES LOVELACE, EXAMINING ATTORNEY

Int. Cls.: 16, 35 and 41

**Prior U.S. Cls.: 2, 5, 22, 23, 29, 37, 38, 50, 100, 101, 102
and 107**

Reg. No. 3,478,903

United States Patent and Trademark Office

Registered Aug. 5, 2008

**TRADEMARK
SERVICE MARK
PRINCIPAL REGISTER**



GROCERY MANUFACTURERS ASSOCIATION
(DELAWARE CORPORATION)
1350 I (EYE) STREET, NW, SUITE 300
WASHINGTON, DC 20005

FOR: PUBLICATIONS, NAMELY, INDUSTRY REPORTS, GUIDELINES, STUDIES, SURVEYS, BROCHURES AND EDUCATIONAL BOOKLETS RELATING TO ISSUES AND TOPICS OF INTEREST TO THE GROCERY PRODUCTS INDUSTRY, THE MANUFACTURE OF FOOD, AND FOOD PROCESSING, IN CLASS 16 (U.S. CLS. 2, 5, 22, 23, 29, 37, 38 AND 50).

FIRST USE 6-0-2005; IN COMMERCE 6-0-2005.

FOR: ASSOCIATION SERVICES, NAMELY, PROMOTING THE INTERESTS OF MEMBERS OF THE GROCERY MANUFACTURERS INDUSTRY, IN CLASS 35 (U.S. CLS. 100, 101 AND 102).

FIRST USE 6-0-2005; IN COMMERCE 6-0-2005.

FOR: ARRANGING AND CONDUCTING EDUCATIONAL CONFERENCES AND SEMINARS RELATING TO THE GROCERY PRODUCTS INDUSTRY; PROVIDING ON-LINE PUBLICATIONS IN THE NATURE OF INDUSTRY REPORTS, GUIDELINES, STUDIES, SURVEYS, BROCHURES AND EDUCATIONAL BOOKLETS RELATING TO ISSUES AND TOPICS OF INTEREST TO THE GROCERY PRODUCTS INDUSTRY, THE MANUFACTURE OF FOOD, AND FOOD PROCESSING, IN CLASS 41 (U.S. CLS. 100, 101 AND 107).

FIRST USE 6-0-2005; IN COMMERCE 6-0-2005.

THE MARK CONSISTS OF A SQUARE WITH THREE THINNING LINES ABOVE THE TERM "GMA".

SER. NO. 77-175,671, FILED 5-8-2007.

MICHAEL ENGEL, EXAMINING ATTORNEY

Int. Cl.: 41

Prior U.S. Cls.: 100, 101 and 107

United States Patent and Trademark Office

Reg. No. 3,478,904

Registered Aug. 5, 2008

SERVICE MARK
PRINCIPAL REGISTER

SAN FRANCISCO

ROUTZEN, CHRISTIAN (UNITED STATES INDIVIDUAL)
2469 27TH AVE
SAN FRANCISCO, CA 94116

FOR: ENTERTAINMENT, NAMELY, PRODUCTION OF TELEVISION SHOWS, ENTERTAINMENT SERVICES, NAMELY, PERSONAL APPEARANCES BY A SPORTS CELEBRITIES, AND ENTERTAINMENT CELEBRITIES, ENTERTAINMENT SERVICES, NAMELY, CONDUCTING PARTIES; ENTERTAINMENT SERVICES, NAMELY, PARTICIPATION IN SURF COMPETITIONS, POKER COMPETITIONS, SKATE BOARDING COMPETITIONS, MOTORCYCLE RACING COMPETITIONS; ENTERTAINMENT SERVICES, NAMELY, PROVIDING A WEB SITE FEATURING MUSICAL PERFORMANCES, MUSICAL VIDEOS, RELATED FILM CLIPS, PHOTOGRAPHS, AND OTHER MULTIMEDIA MATERIALS, ENTERTAINMENT SERVICES, NAMELY, LIVE, TELEVISED AND MOVIE APPEARANCES BY A PROFESSIONAL ENTERTAINER, ENTERTAINMENT SERVICES, NAMELY, PROVIDING ON-LINE REVIEWS OF MOVIES, BOOKS, MUSIC, MAGAZINES, ENTERTAINMENT SERVICES, NAMELY, PERFORMING AND COMPETING IN MOTOR SPORTS EVENTS, ENTERTAINMENT SERVICES, NAMELY, AN ONLINE ACTIVITY WHERE YOU CREATE YOUR OWN MUSIC VIDEOS; ENTERTAINMENT SERVICES, NAMELY, ARRANGING AND CONDUCTING OF COMPETITIONS FOR SURFING, POKER, SKATE BOARDING, MOTORCYCLE RACING, PHYSICAL ENDURANCE, PARTY PLANNING; ENTERTAIN-

MENT SERVICES, NAMELY, CONDUCTING LIVE BLACKJACK CARD GAME TOURNAMENTS, ENTERTAINMENT SERVICES, NAMELY, PROVIDING A WEBSITE FEATURING, PHOTOGRAPHIC, AUDIO, VIDEO AND PROSE PRESENTATIONS FEATURING SURFING, POKER, PARTYING, ENTERTAINMENT SERVICES, NAMELY, WINE AND FOOD TASTINGS, ENTERTAINMENT SERVICES, NAMELY, NON-DOWNLOADABLE RINGTONES, PRE-RECORDED MUSIC, VIDEO AND GRAPHICS PRESENTED TO MOBILE COMMUNICATIONS DEVICES VIA A GLOBAL COMPUTER NETWORK AND WIRELESS NETWORKS, ENTERTAINMENT, NAMELY, A CONTINUING COMEDY SHOW BROADCAST OVER TELEVISION, SATELLITE, AUDIO, AND VIDEO MEDIA, ENTERTAINMENT, NAMELY, LIVE MUSIC CONCERTS, ENTERTAINMENT, NAMELY, LIVE PERFORMANCES BY MUSICAL BANDS, ENTERTAINMENT, NAMELY, LIVE PERFORMANCES BY ROCK GROUPS, ENTERTAINMENT SERVICES, NAMELY, PLANNING AND CONDUCTING A SERIES OF FILM FESTIVALS, IN CLASS 41 (U.S. CLS. 100, 101 AND 107).

FIRST USE 5-1-2000; IN COMMERCE 5-1-2002.

THE MARK CONSISTS OF THE WORDS IN ALL CAPITALS, SHATTERED, BOLD FONT, REFEREED TO AS BROKEN 74 AT DAFONT.COM.

SER. NO. 77-175,808, FILED 5-8-2007.

MICHAEL SOUDERS, EXAMINING ATTORNEY

Int. Cl.: 9

Prior U.S. Cls.: 21, 23, 26, 36 and 38

Reg. No. 3,478,905

United States Patent and Trademark Office

Registered Aug. 5, 2008

**TRADEMARK
PRINCIPAL REGISTER**

RampMap

KNOWLEDGE BASED SYSTEMS, INC. (TEXAS CORPORATION)
1408 UNIVERSITY DRIVE EAST
COLLEGE STATION, TX 77840

FOR: COMPUTER SOFTWARE AND INSTRUCTIONAL MANUALS SOLD AS A UNIT FOR USE IN CONNECTION WITH PRESENTING A VISUAL PICTURE OF BUSINESS ASSETS IN A GEOGRAPHICAL OR LOGICAL MAP FRAMEWORK FOR THE PURPOSE OF ASSET ALLOCATION AND MANAGEMENT, IN CLASS 9 (U.S. CLS. 21, 23, 26, 36 AND 38).

FIRST USE 9-13-2001; IN COMMERCE 9-13-2001.

THE MARK CONSISTS OF STANDARD CHARACTERS WITHOUT CLAIM TO ANY PARTICULAR FONT, STYLE, SIZE, OR COLOR.

SER. NO. 77-175,868, FILED 5-8-2007.

SANI KHOURI, EXAMINING ATTORNEY

Int. Cls.: 36 and 41

Prior U.S. Cls.: 100, 101, 102 and 107

United States Patent and Trademark Office

Reg. No. 3,478,906

Registered Aug. 5, 2008

**SERVICE MARK
PRINCIPAL REGISTER**



AMERICAN CONCRETE INSTITUTE (MICHIGAN CORPORATION)
P.O. BOX 9094
FARMINGTON HILLS, MI 483339094

FOR: PROVIDING FINANCING FOR ACADEMIC RESEARCH AND SCHOLARSHIPS IN THE FIELD OF CONCRETE, IN CLASS 36 (U.S. CLS. 100, 101 AND 102).

FIRST USE 2-19-2007; IN COMMERCE 2-19-2007.

FOR: PUBLICATION OF MAGAZINES AND OTHER PRINTED MATTER, DEVELOPMENT AND DISSEMINATION OF EDUCATIONAL MATERIALS AND RESEARCH REPORTS OF OTHERS; AND CONDUCTING SEMINARS IN THE FIELD OF CONCRETE, IN CLASS 41 (U.S. CLS. 100, 101 AND 107).

FIRST USE 2-19-2007; IN COMMERCE 2-19-2007.

OWNER OF U.S. REG. NOS. 1,483,364, 1,483,403, AND 1,483,404.

NO CLAIM IS MADE TO THE EXCLUSIVE RIGHT TO USE "FOUNDATION", APART FROM THE MARK AS SHOWN.

THE MARK CONSISTS OF THE WORDS "ACI FOUNDATION" NEXT TO A SERIES OF STRIPES AND ARROWS.

SER. NO. 77-176,428, FILED 5-9-2007.

VIVIAN MICZNIK FIRST, EXAMINING ATTORNEY

Int. Cls.: 6 and 22

Prior U.S. Cls.: 1, 2, 7, 12, 13, 14, 19, 22, 23, 25, 42 and 50

Reg. No. 3,478,907

United States Patent and Trademark Office

Registered Aug. 5, 2008

**TRADEMARK
PRINCIPAL REGISTER**

LIFTEX

LIFTEX CORPORATION (PENNSYLVANIA CORPORATION)
1230 OLD YORK ROAD
WARMINSTER, PA 18974

FOR: CARGO SLINGS OF METAL; METAL SLINGS FOR LOADING; METAL CHAIN SLINGS; WIRE ROPE SLINGS, IN CLASS 6 (U.S. CLS. 2, 12, 13, 14, 23, 25 AND 50).

FIRST USE 10-1-1955; IN COMMERCE 10-1-1955.

FOR: SYNTHETIC SLINGS FOR LOADING, IN CLASS 22 (U.S. CLS. 1, 2, 7, 19, 22, 42 AND 50).

FIRST USE 10-1-1955; IN COMMERCE 10-1-1955.

THE MARK CONSISTS OF STANDARD CHARACTERS WITHOUT CLAIM TO ANY PARTICULAR FONT, STYLE, SIZE, OR COLOR.

OWNER OF U.S. REG. NO. 659,694.

SER. NO. 77-176,584, FILED 5-9-2007.

KALIE KUNG, EXAMINING ATTORNEY

Int. Cls.: 16 and 41

Prior U.S. Cls.: 2, 5, 22, 23, 29, 37, 38, 50, 100, 101 and 107

Reg. No. 3,478,908

United States Patent and Trademark Office

Registered Aug. 5, 2008

**TRADEMARK
SERVICE MARK
PRINCIPAL REGISTER**

JA Careers With A Purpose

JA WORLDWIDE (COLORADO CORPORATION)
1 EDUCATION WAY
COLORADO SPRINGS, CO 80906

FOR: PRINTED EDUCATIONAL MATERIALS AND KITS FOR TEACHING BUSINESS PRINCIPLES TO CHILDREN AND YOUNG ADULTS, NAMELY, TEACHING MANUALS AND GUIDES, STUDENT INSTRUCTIONAL MANUALS, GUIDES AND WORKSHEETS, BROCHURES FOR BUSINESS EDUCATION, BUSINESS FORMS FOR TEACHING AND CERTIFICATES OF ACHIEVEMENT, IN CLASS 16 (U.S. CLS. 2, 5, 22, 23, 29, 37, 38 AND 50).

FIRST USE 1-15-2007; IN COMMERCE 1-15-2007.

FOR: EDUCATIONAL SERVICES, NAMELY, CONDUCTING BUSINESS AND ECONOMIC EDU-

CATION PROGRAMS, SEMINARS, CONFERENCES AND WORKSHOPS FOR TEACHING CHILDREN AND YOUNG ADULTS, IN CLASS 41 (U.S. CLS. 100, 101 AND 107).

FIRST USE 1-15-2007; IN COMMERCE 1-15-2007.

THE MARK CONSISTS OF STANDARD CHARACTERS WITHOUT CLAIM TO ANY PARTICULAR FONT, STYLE, SIZE, OR COLOR.

OWNER OF U.S. REG. NOS. 2,516,563, 3,126,446 AND OTHERS.

SER. NO. 77-176,854, FILED 5-9-2007.

STEPHANIE ALI, EXAMINING ATTORNEY

Int. Cl.: 13

Prior U.S. Cls.: 2 and 9

United States Patent and Trademark Office

Reg. No. 3,478,909

Registered Aug. 5, 2008

**TRADEMARK
PRINCIPAL REGISTER**

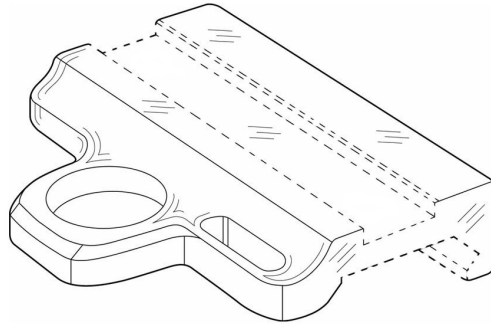

SWAN, RICHARD E. (UNITED STATES INDIVIDUAL)
171 WEST STREET
EAST BRIDGEWATER, MA 02379

FOR: GUN MOUNTS FOR USE IN ATTACHING OPTICAL LENS SIGHTS, HOLOGRAPHIC LENS SIGHTS, LASER SIGHTS, AND NIGHT VISION DEVICES IN THE NATURE OF INFRARED DETECTORS, INVISIBLE LIGHT PROJECTORS AND SCOPES, TO WEAPON PLATFORMS, IN CLASS 13 (U.S. CLS. 2 AND 9).

FIRST USE 6-1-1998; IN COMMERCE 6-1-1998.

THE MARK CONSISTS OF THE CONFIGURATION OF THE BASE PORTION OF A GUN ACCESS-

SORY MOUNT IN THE FORM OF A RECTANGULAR BASE PORTION HAVING A SUBSTANTIALLY SEMI-CIRCULAR ACTUATOR PLATFORM EXTENDING FROM ONE SIDE THEREOF. THE MARK DOES NOT INCLUDE THE PORTIONS OF THE DRAWING SHOWN IN DOTTED LINES. THE REPEATED THREE LINES SHOWN ON THE PRODUCT ARE NOT PART OF THE MARK AND ARE PRESENT TO CONVEY A 3-D EFFECT.

SEC. 2(F).

SER. NO. 77-177,555, FILED 5-10-2007.

JENNIFER HETU, EXAMINING ATTORNEY

Int. Cl.: 13

Prior U.S. Cls.: 2 and 9

United States Patent and Trademark Office

Reg. No. 3,478,910

Registered Aug. 5, 2008

**TRADEMARK
PRINCIPAL REGISTER**

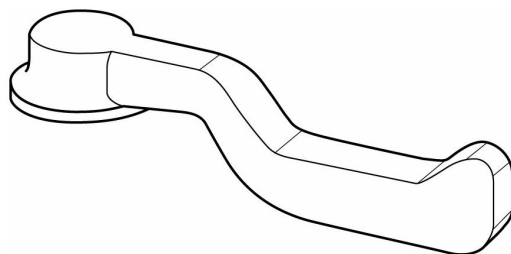

RICHARD E. SWAN (UNITED STATES INDIVIDUAL)
171 WEST STREET
EAST BRIDGEWATER, MA 02379

FOR: GUN MOUNTS FOR USE IN ATTACHING OPTICAL LENS SIGHTS, HOLOGRAPHIC LENS SIGHTS, LASER SIGHTS, AND NIGHT VISION DEVICES IN THE NATURE OF INFRARED DETECTORS, INVISIBLE LIGHT PROJECTORS AND SCOPES, TO WEAPON PLATFORMS, IN CLASS 13 (U.S. CLS. 2 AND 9).

FIRST USE 1-1-1987; IN COMMERCE 1-1-1987.

THE MARK CONSISTS OF THE CONFIGURATION OF AN ACTUATOR ARM FOR A GUN ACCESSORY MOUNT THAT EXTENDS OUTWARDLY AND IN A DOWNWARD FASHION TERMINATING IN A FLARED END.

SEC. 2(F).

SER. NO. 77-177,568, FILED 5-10-2007.

JENNIFER HETU, EXAMINING ATTORNEY

Int. Cl.: 18

Prior U.S. Cls.: 1, 2, 3, 22 and 41

United States Patent and Trademark Office

Reg. No. 3,478,911

Registered Aug. 5, 2008

**TRADEMARK
PRINCIPAL REGISTER**



GOSSAMER GEAR, INC. (TEXAS CORPORATION)
4801 W. FRANCES PLACE
AUSTIN, TX 78731

THE MARK CONSISTS OF A LARGE LOWER CASE "G" IN A LARGE FONT FOLLOWED BY THE LETTERS "OSSAMERGEAR" IN A SMALLER FONT THAT THE "G".

FOR: BACKPACKS, IN CLASS 18 (U.S. CLS. 1, 2, 3, 22 AND 41).

SER. NO. 77-178,069, FILED 5-10-2007.

FIRST USE 4-24-2004; IN COMMERCE 4-24-2004.

REBECCA SMITH, EXAMINING ATTORNEY

Int. Cl.: 11

Prior U.S. Cls.: 13, 21, 23, 31 and 34

Reg. No. 3,478,912

United States Patent and Trademark Office

Registered Aug. 5, 2008

**TRADEMARK
PRINCIPAL REGISTER**

Lovebulbs

HUCUL, LESLIE (UNITED STATES INDIVIDUAL)
1778 SHERWIN LANE
LAS VEGAS, NV 89156

THE MARK CONSISTS OF STANDARD CHARACTERS WITHOUT CLAIM TO ANY PARTICULAR FONT, STYLE, SIZE, OR COLOR.

FOR: LIGHT BULBS, IN CLASS 11 (U.S. CLS. 13, 21, 23, 31 AND 34).

SER. NO. 77-178,167, FILED 5-10-2007.

FIRST USE 8-1-2005; IN COMMERCE 8-1-2005.

ZHALEH DELANEY, EXAMINING ATTORNEY

Int. Cl.: 43

Prior U.S. Cls.: 100 and 101

United States Patent and Trademark Office

Reg. No. 3,478,913

Registered Aug. 5, 2008

**SERVICE MARK
PRINCIPAL REGISTER**

Real life. Real change.

URBAN PEAK DENVER (COLORADO NON-
PROFIT CORPORATION)
730 21ST STREET
DENVER, CO 80205

FOR: EMERGENCY SHELTER SERVICES,
NAMELY, PROVIDING TEMPORARY HOUSING
SERVICES FOR HIGH RISK YOUTH, IN CLASS 43
(U.S. CLS. 100 AND 101).

FIRST USE 5-15-2006; IN COMMERCE 5-15-2006.

THE MARK CONSISTS OF STANDARD CHAR-
ACTERS WITHOUT CLAIM TO ANY PARTICULAR
FONT, STYLE, SIZE, OR COLOR.

SER. NO. 77-179,169, FILED 5-11-2007.

SANI KHOURI, EXAMINING ATTORNEY

Int. Cl.: 43

Prior U.S. Cls.: 100 and 101

United States Patent and Trademark Office

Reg. No. 3,478,914

Registered Aug. 5, 2008

SERVICE MARK
PRINCIPAL REGISTER



U R B A N P E A K

URBAN PEAK DENVER (COLORADO NON-
PROFIT CORPORATION)
730 21ST STREET
DENVER, CO 80205

FOR: EMERGENCY SHELTER SERVICES,
NAMELY, PROVIDING TEMPORARY HOUSING
SERVICES FOR HIGH RISK YOUTH, IN CLASS 43
(U.S. CLS. 100 AND 101).

FIRST USE 5-15-2006; IN COMMERCE 5-15-2006.

THE MARK CONSISTS OF FIVE SHADED FIG-
URES IN DIFFERENT POSITIONS OVER THE
WORDS "URBAN PEAK".

SER. NO. 77-179,188, FILED 5-11-2007.

SANI KHOURI, EXAMINING ATTORNEY

Int. Cl.: 36

Prior U.S. Cls.: 100, 101 and 102

United States Patent and Trademark Office

Reg. No. 3,478,915

Registered Aug. 5, 2008

**SERVICE MARK
PRINCIPAL REGISTER**

**CAPITAL GROWTH WITH PEACE
OF MIND**

TBP ADVISORS, LTD. (NEW YORK CORPORATION)
287 BOWMAN AVENUE
PURCHASE, NY 10577

FOR: INVESTMENT MANAGEMENT; MANAGEMENT OF PORTFOLIOS COMPRISING SECURITIES; FINANCIAL PLANNING, IN CLASS 36 (U.S. CLS. 100, 101 AND 102).

FIRST USE 3-1-2000; IN COMMERCE 3-1-2000.

THE MARK CONSISTS OF STANDARD CHARACTERS WITHOUT CLAIM TO ANY PARTICULAR FONT, STYLE, SIZE, OR COLOR.

NO CLAIM IS MADE TO THE EXCLUSIVE RIGHT TO USE "CAPITAL GROWTH", APART FROM THE MARK AS SHOWN.

SER. NO. 77-179,569, FILED 5-12-2007.

COLLEEN KEARNEY, EXAMINING ATTORNEY

Int. Cl.: 12

Prior U.S. Cls.: 19, 21, 23, 31, 35 and 44

United States Patent and Trademark Office

Reg. No. 3,478,916

Registered Aug. 5, 2008

**TRADEMARK
PRINCIPAL REGISTER**

HISPEC

HISPEC WHEEL & TIRE, INC. (INDIANA CORPORATION)
1655 EAST 12TH STREET
MISHAWAKA, IN 46544

THE MARK CONSISTS OF STANDARD CHARACTERS WITHOUT CLAIM TO ANY PARTICULAR FONT, STYLE, SIZE, OR COLOR.

FOR: WHEEL, TIRES AND PARTS THEREFORE, WHEEL COVERS, VALVE STEMS AND WHEEL SIMULATORS, IN CLASS 12 (U.S. CLS. 19, 21, 23, 31, 35 AND 44).

SER. NO. 77-179,662, FILED 5-13-2007.

FIRST USE 5-0-1995; IN COMMERCE 5-0-1995.

RON FAIRBANKS, EXAMINING ATTORNEY

Int. Cl.: 12

Prior U.S. Cls.: 19, 21, 23, 31, 35 and 44

Reg. No. 3,478,917

United States Patent and Trademark Office

Registered Aug. 5, 2008

**TRADEMARK
PRINCIPAL REGISTER**

HWT

HISPEC WHEEL & TIRE, INC. (INDIANA CORPORATION)
1655 EAST 12TH STREET
MISHAWAKA, IN 46544

THE MARK CONSISTS OF STANDARD CHARACTERS WITHOUT CLAIM TO ANY PARTICULAR FONT, STYLE, SIZE, OR COLOR.

FOR: WHEEL, TIRES AND PARTS THEREFORE, WHEEL COVERS, VALVE STEMS AND WHEEL SIMULATORS, IN CLASS 12 (U.S. CLS. 19, 21, 23, 31, 35 AND 44).

SER. NO. 77-179,666, FILED 5-13-2007.

FIRST USE 1-1-2007; IN COMMERCE 1-1-2007.

RON FAIRBANKS, EXAMINING ATTORNEY

Int. Cl.: 35

Prior U.S. Cls.: 100, 101 and 102

United States Patent and Trademark Office

Reg. No. 3,478,918

Registered Aug. 5, 2008

**SERVICE MARK
PRINCIPAL REGISTER**

**THE HOTTEST OF THE HOT &
THE COOLEST OF THE COOL**

CHINA MIST TEA COMPANY (ARIZONA CORPORATION)
7435 EAST TIERRA BUENA LANE
SCOTTSDALE, AZ 852601608

FOR: RETAIL STORE SERVICES FEATURING HERBAL TEA, ICED TEA, TEA, TEA-BASED BEVERAGES WITH FRUIT FLAVORING, HOT CHOCOLATE, COFFEE AND CLOTHING; WHOLESALE STORES FEATURING HERBAL TEA, ICED TEA, TEA, TEA-BASED BEVERAGES WITH FRUIT FLAVORING, HOT CHOCOLATE, COFFEE AND CLOTHING; WHOLESALE DISTRIBUTORSHIPS FEATURING HERBAL TEA, ICED TEA, TEA, TEA-BASED BEVERAGES WITH FRUIT FLAVORING, HOT CHOCOLATE, COFFEE AND CLOTHING; RE-

TAIL TRADESHOW KIOSK STORE SERVICES FEATURING HERBAL TEA, ICED TEA, TEA, TEA-BASED BEVERAGES WITH FRUIT FLAVORING, HOT CHOCOLATE, COFFEE AND CLOTHING, IN CLASS 35 (U.S. CLS. 100, 101 AND 102).

FIRST USE 5-5-2007; IN COMMERCE 5-5-2007.

THE MARK CONSISTS OF STANDARD CHARACTERS WITHOUT CLAIM TO ANY PARTICULAR FONT, STYLE, SIZE, OR COLOR.

SER. NO. 77-180,752, FILED 5-14-2007.

JENNIFER VASQUEZ, EXAMINING ATTORNEY

Int. Cl.: 35

Prior U.S. Cls.: 100, 101 and 102

United States Patent and Trademark Office

Reg. No. 3,478,919

Registered Aug. 5, 2008

**SERVICE MARK
PRINCIPAL REGISTER**

MRS. GREEN'S NATURAL MARKET

MRS. GREEN'S NATURAL MARKET, INC. (NEW
YORK CORPORATION)

230

7917 104 STREET

EDMONTON, CANADA T6E4E1

FOR: RETAIL STORE SERVICES, NAMELY, THE OPERATION OF NATURAL FOOD MARKETS SPECIALIZING IN ORGANIC PRODUCE, VITAMINS, HOMEOPATHIC REMEDIES, NATURAL COSMETICS AND BODY CARE, ORGANIC BABY FOOD, AND OTHER NATURAL AND ORGANIC FOODS INCLUDING GRAINS, NUTS, HERBAL TEAS, PASTA, FROZEN FOODS, CEREALS, MEAT, POULTRY, DAIRY, AND PREPARED FOOD, AND INCLUDING FRESH JUICE BARS, IN CLASS 35 (U.S. CLS. 100, 101 AND 102).

FIRST USE 8-1-1991; IN COMMERCE 8-1-1991.

THE MARK CONSISTS OF STANDARD CHARACTERS WITHOUT CLAIM TO ANY PARTICULAR FONT, STYLE, SIZE, OR COLOR.

NO CLAIM IS MADE TO THE EXCLUSIVE RIGHT TO USE "NATURAL MARKET", APART FROM THE MARK AS SHOWN.

SER. NO. 77-180,815, FILED 5-14-2007.

SOPHIA S. KIM, EXAMINING ATTORNEY

Int. Cls.: 35, 36 and 41

Prior U.S. Cls.: 100, 101, 102 and 107

United States Patent and Trademark Office

Reg. No. 3,478,920

Registered Aug. 5, 2008

**SERVICE MARK
PRINCIPAL REGISTER**

WHEATLEYPLAZA.COM

WHEATLEY PLAZA ASSOCIATES (NEW YORK
PARTNERSHIP)
2110 NORTHERN BLVD.
MANHASSET, NY 11030

FOR: ONLINE RETAIL STORE SERVICES FEATURING CLOTHING, FASHION, JEWELRY, FURNITURE AND OTHER CONSUMER GOODS; PROMOTING THE GOODS AND SERVICES OF OTHERS VIA A GLOBAL COMPUTER NETWORK; ONLINE AND RETAIL STORE SERVICES FEATURING GIFT CARDS; PROVIDING CONSUMER INFORMATION IN THE FIELD OF ENTERTAINMENT SERVICES FOR PRODUCTS, SERVICES, EVENTS, ACTIVITIES, FACILITIES, AND LOCATIONS, IN CLASS 35 (U.S. CLS. 100, 101 AND 102).

FIRST USE 10-29-2007; IN COMMERCE 10-29-2007.

FOR: SHOPPING CENTER SERVICES, NAMELY, RENTAL, MANAGEMENT, OPERATION, PROMOTION, ADVERTISING, AND MARKETING OF SHOPPING CENTER SPACE; CHARITABLE FUND

RAISING SERVICES, IN CLASS 36 (U.S. CLS. 100, 101 AND 102).

FIRST USE 10-29-2007; IN COMMERCE 10-29-2007.

FOR: ENTERTAINMENT AND RECREATIONAL SERVICES, NAMELY, ARRANGING, ORGANIZING AND PROVIDING FACILITIES FOR COMMUNITY AND HOLIDAY EVENTS, EXHIBITIONS, AND COMMUNITY ACTIVITIES, GATHERINGS AND FESTIVALS, IN CLASS 41 (U.S. CLS. 100, 101 AND 107).

FIRST USE 10-29-2007; IN COMMERCE 10-29-2007.

THE MARK CONSISTS OF STANDARD CHARACTERS WITHOUT CLAIM TO ANY PARTICULAR FONT, STYLE, SIZE, OR COLOR.

SEC. 2(F) AS TO "WHEATLEY PLAZA".

SER. NO. 77-181,078, FILED 5-15-2007.

DORITT L. CARROLL, EXAMINING ATTORNEY

Int. Cl.: 35

Prior U.S. Cls.: 100, 101 and 102

United States Patent and Trademark Office

Reg. No. 3,478,921

Registered Aug. 5, 2008

**SERVICE MARK
PRINCIPAL REGISTER**



SENIOR STAFF LLC (VIRGINIA LTD LIAB CO)
P.O. BOX 1454
ASHBURN, VA 20146

FOR: PROVIDING AN ONLINE SEARCHABLE DATABASE FEATURING EMPLOYMENT OPPORTUNITIES AND CONTENT RELEVANT TO PEOPLE 50 YEARS OF AGE AND OLDER, IN CLASS 35 (U.S. CLS. 100, 101 AND 102).

FIRST USE 4-2-2008; IN COMMERCE 4-2-2008.

NO CLAIM IS MADE TO THE EXCLUSIVE RIGHT TO USE "SENIOR STAFF", APART FROM THE MARK AS SHOWN.

THE MARK CONSISTS OF WORDING "SENIOR STAFF BRINGING EXPERIENCE BACK TO WORK" AND THE DESIGN OF A PAIR OF EYEGASSES THAT FEATURE A STYLIZED "S" IN THE CENTER OF EACH LENS.

SER. NO. 77-181,093, FILED 5-15-2007.

DEIRDRE ROBERTSON, EXAMINING ATTORNEY

Int. Cl.: 1

Prior U.S. Cls.: 1, 5, 6, 10, 26 and 46

Reg. No. 3,478,922

United States Patent and Trademark Office

Registered Aug. 5, 2008

**TRADEMARK
PRINCIPAL REGISTER**

LENANOC

NISSAN CHEMICAL INDUSTRIES, LTD. (JAPAN CORPORATION)
7-1, KANDA-NISHIKI-CHO 3-CHOME
CHIYODA-KU, TOKYO, JAPAN 101-0054

FOR: PLASTIC ADHESIVES NOT FOR STATIONERY OR HOUSEHOLD PURPOSES, NAMELY, EPOXY RESIN ADHESIVES; UNPROCESSED PLASTICS IN PRIMARY FORM; EPOXY RESINS FOR ELECTRONIC DEVICES; AND EPOXY RESINS FOR USE IN THE ENCAPSULATION OF OPTICAL SEMICONDUCTOR DEVICES, IN CLASS 1 (U.S. CLS. 1, 5, 6, 10, 26 AND 46).

THE MARK CONSISTS OF STANDARD CHARACTERS WITHOUT CLAIM TO ANY PARTICULAR FONT, STYLE, SIZE, OR COLOR.

PRIORITY CLAIMED UNDER SEC. 44(D) ON JAPAN APPLICATION NO. 2007-024404, FILED 3-20-2007, REG. NO. 5070914, DATED 8-17-2007, EXPIRES 8-17-2017.

SER. NO. 77-181,481, FILED 5-15-2007.

SAMUEL E. SHARPER JR., EXAMINING ATTORNEY

Int. Cl.: 35

Prior U.S. Cls.: 100, 101 and 102

United States Patent and Trademark Office

Reg. No. 3,478,923

Registered Aug. 5, 2008

**SERVICE MARK
PRINCIPAL REGISTER**

HireOn-Demand

WALLINS, KIMBERLY (UNITED STATES INDIVIDUAL)
2420 FRANKLIN STREET
#31
SAN FRANCISCO, CA 94123

NO CLAIM IS MADE TO THE EXCLUSIVE RIGHT TO USE "HIRE", APART FROM THE MARK AS SHOWN.

FOR: EXECUTIVE SEARCH AND SOFTWARE EMPLOYEE PLACEMENT SERVICES, IN CLASS 35 (U.S. CLS. 100, 101 AND 102).

SER. NO. 77-182,934, FILED 5-16-2007.

FIRST USE 5-14-2007; IN COMMERCE 7-15-2007.

KAELIE KUNG, EXAMINING ATTORNEY

Int. Cl.: 7

Prior U.S. Cls.: 13, 19, 21, 23, 31, 34 and 35

Reg. No. 3,478,924

United States Patent and Trademark Office

Registered Aug. 5, 2008

**TRADEMARK
PRINCIPAL REGISTER**

TORNADO

SHINDAIWA, INC. (OREGON CORPORATION)
11975 SW HERMAN ROAD
TUALATIN, OR 97062

THE MARK CONSISTS OF STANDARD CHAR-
ACTERS WITHOUT CLAIM TO ANY PARTICULAR
FONT, STYLE, SIZE, OR COLOR.

FOR: POWER SAW BLADES, IN CLASS 7 (U.S.
CLS. 13, 19, 21, 23, 31, 34 AND 35).

OWNER OF U.S. REG. NO. 1,756,459.

SER. NO. 77-183,078, FILED 5-16-2007.

FIRST USE 12-20-1990; IN COMMERCE 12-20-1990.

AISHA SALEM, EXAMINING ATTORNEY

Int. Cl.: 44

Prior U.S. Cls.: 100 and 101

United States Patent and Trademark Office

Reg. No. 3,478,925

Registered Aug. 5, 2008

**SERVICE MARK
PRINCIPAL REGISTER**

Split Endz

SPLIT ENDZ HAIRCUTTERS, INC (PENNSYLVANIA CORPORATION)
2105 SPROUL ROAD
BROOMALL, PA 19008 AND
DIGIACOMO, ARTHUR J (UNITED STATES INDIVIDUAL)
1526 ANNE DRIVE
WEST CHESTER, PA 19380

FOR: BEAUTY SALONS; HAIRDRESSING SALONS, IN CLASS 44 (U.S. CLS. 100 AND 101).

FIRST USE 5-10-1982; IN COMMERCE 5-10-1982.

THE MARK CONSISTS OF STANDARD CHARACTERS WITHOUT CLAIM TO ANY PARTICULAR FONT, STYLE, SIZE, OR COLOR.

SER. NO. 77-183,342, FILED 5-17-2007.

ROBERT LAVACHE, EXAMINING ATTORNEY

Int. Cl.: 7

Prior U.S. Cls.: 13, 19, 21, 23, 31, 34 and 35

United States Patent and Trademark Office

Reg. No. 3,478,926

Registered Aug. 5, 2008

**TRADEMARK
PRINCIPAL REGISTER**

RhinoPro

RHINO LININGS USA, INC. (CALIFORNIA CORPORATION)
9151 REHCO ROAD
SAN DIEGO, CA 92121

FOR: HIGH PERFORMANCE PLURAL COMPONENT POWER OPERATED SPRAY EQUIPMENT COMPRISED PRIMARILY OF ELECTRIC MOTORS, WHIP HOSES, POWER OPERATED SPRAY GUNS, AND PATCH GUNS WITH CARTRIDGES CONTAINING PREMEASURED POLYURETHANE/POLYUREA PRIMERS AND CHEMICALS FOR SPOT REPAIRS; COMPLETE POWER-OPERATED SPRAY MACHINES DESIGNED TO SPRAY POLYURETHANE PROTECTIVE LINING COATINGS, PRIMERS AND CHEMICALS ON A WIDE RANGE

OF COMMERCIAL, INDUSTRIAL AND CONSUMER PRODUCTS, IN CLASS 7 (U.S. CLS. 13, 19, 21, 23, 31, 34 AND 35).

FIRST USE 2-6-2006; IN COMMERCE 2-6-2006.

OWNER OF U.S. REG. NOS. 1,612,373, 2,135,280 AND OTHERS.

THE MARK CONSISTS OF STYLIZED TEXT OF THE WORD "RHINOPRO".

SER. NO. 77-183,637, FILED 5-17-2007.

TINA BROWN, EXAMINING ATTORNEY

Int. Cl.: 35

Prior U.S. Cls.: 100, 101 and 102

United States Patent and Trademark Office

Reg. No. 3,478,927

Registered Aug. 5, 2008

**SERVICE MARK
PRINCIPAL REGISTER**

USABILITY BROADCAST NETWORK

HUMAN FACTORS INTERNATIONAL, INC.
(IOWA CORPORATION)
410 WEST LOWE ST.
FAIRFIELD, IA 52556

FOR: PROVIDING BUSINESS MANAGEMENT INFORMATION RELATED TO THE METHOD OF PLANNING AND DESIGNING ERGONOMIC BUSINESS SYSTEMS, PROVIDED VIA A GLOBAL COMPUTER NETWORK OR BY MEANS OF OTHER ELECTRONIC BROADCAST MEDIUMS; BUSINESS MANAGEMENT CONSULTATION RELATED TO THE METHOD OF PLANNING AND DESIGNING ERGONOMIC BUSINESS SYSTEMS, PROVIDED VIA A GLOBAL COMPUTER NETWORK OR BY MEANS OF OTHER ELECTRONIC BROADCAST MEDIUMS, IN CLASS 35 (U.S. CLS. 100, 101 AND 102).

FIRST USE 11-1-2001; IN COMMERCE 11-1-2001.

THE MARK CONSISTS OF STANDARD CHARACTERS WITHOUT CLAIM TO ANY PARTICULAR FONT, STYLE, SIZE, OR COLOR.

NO CLAIM IS MADE TO THE EXCLUSIVE RIGHT TO USE "BROADCAST NETWORK", APART FROM THE MARK AS SHOWN.

SEC. 2(F).

SER. NO. 77-183,717, FILED 5-17-2007.

ANGELA M. MICHELI, EXAMINING ATTORNEY

Int. Cl.: 41

Prior U.S. Cls.: 100, 101 and 107

United States Patent and Trademark Office

Reg. No. 3,478,928

Registered Aug. 5, 2008

**SERVICE MARK
PRINCIPAL REGISTER**

Imagination in Education

PCS EDVENTURES!.COM, INC. (IDAHO CORPORATION)
345 BOBWHITE COURT, SUITE 200
BOISE, ID 83706

FOR: EDUCATIONAL SERVICES, NAMELY, DEVELOPING ON-LINE AND PRINT-BASED CURRICULUM FOR CONDUCTING CLASSES, LESSONS, AND PROJECTS IN THE FIELDS OF SCIENCE, TECHNOLOGY, ROBOTICS, ARCHITECTURE, ENGINEERING, AND MATHEMATICS AND DISTRIBUTION OF COURSE MATERIAL IN CONNECTION THEREWITH; DEVELOPING ON-LINE AND PRINT-BASED CURRICULUM FOR AFTER-SCHOOL EDUCATIONAL PROGRAMS FOR CHILDREN IN PRE-SCHOOL THROUGH HIGH SCHOOL GRADE LEVELS; EDUCATIONAL CONSULTATION IN THE NATURE OF SCHOOL

PARTNERING WITH PRIVATE AND PUBLIC SCHOOLS FOR ENRICHING EDUCATIONAL SERVICES AND IMPROVING STUDENT LEARNING PERFORMANCE FOR PUBLIC AND PRIVATE SCHOOL STUDENTS AT THE PRE-SCHOOL THROUGH HIGH SCHOOL LEVELS, IN CLASS 41 (U.S. CLS. 100, 101 AND 107).

FIRST USE 7-1-2006; IN COMMERCE 7-1-2006.

THE MARK CONSISTS OF STANDARD CHARACTERS WITHOUT CLAIM TO ANY PARTICULAR FONT, STYLE, SIZE, OR COLOR.

SER. NO. 77-184,052, FILED 5-17-2007.

DAVID COLLIER, EXAMINING ATTORNEY

Int. Cl.: 14

Prior U.S. Cls.: 2, 27, 28 and 50

United States Patent and Trademark Office

Reg. No. 3,478,929

Registered Aug. 5, 2008

**TRADEMARK
PRINCIPAL REGISTER**

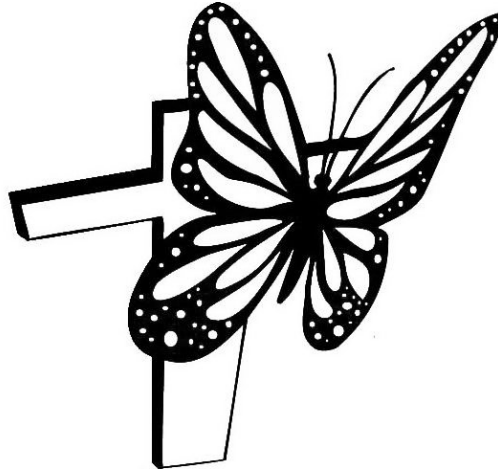

THE UPPER ROOM (TENNESSEE NON-PROFIT
CORPORATION)
P.O. BOX 340004
1908 GRAND AVENUE
NASHVILLE, TN 372030004

FOR: LAPEL PINS; ORNAMENTAL PINS, IN
CLASS 14 (U.S. CLS. 2, 27, 28 AND 50).

FIRST USE 1-1-1996; IN COMMERCE 1-1-1996.

THE MARK CONSISTS OF A BUTTERFLY SU-
PERIMPOSED ON A CROSS.

SER. NO. 77-184,385, FILED 5-18-2007.

DAVID TAYLOR, EXAMINING ATTORNEY

Int. Cl.: 21

Prior U.S. Cls.: 2, 13, 23, 29, 30, 33, 40 and 50

United States Patent and Trademark Office

Reg. No. 3,478,930

Registered Aug. 5, 2008

**TRADEMARK
PRINCIPAL REGISTER**

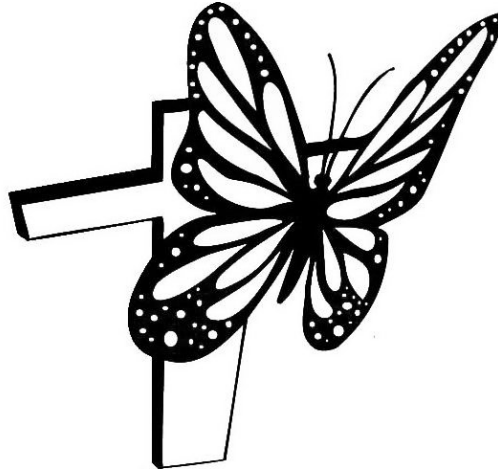

THE UPPER ROOM (TENNESSEE NON-PROFIT
CORPORATION)
P.O. BOX 340004
1908 GRAND AVENUE
NASHVILLE, TN 372030004

THE MARK CONSISTS OF A BUTTERFLY SU-
PERIMPOSED ON A CROSS.

FOR: CUPS; DRINKING CUPS; PLASTIC CUPS,
IN CLASS 21 (U.S. CLS. 2, 13, 23, 29, 30, 33, 40 AND 50).

SER. NO. 77-184,389, FILED 5-18-2007.

FIRST USE 8-0-2000; IN COMMERCE 8-0-2000.

DAVID TAYLOR, EXAMINING ATTORNEY

Int. Cls.: 1, 5 and 42

**Prior U.S. Cls.: 1, 5, 6, 10, 18, 26, 44, 46, 51, 52, 100
and 101**

Reg. No. 3,478,931

United States Patent and Trademark Office

Registered Aug. 5, 2008

**TRADEMARK
SERVICE MARK
PRINCIPAL REGISTER**

EURX

EURX SP.Z.00 (POLAND LTD LIAB CO)
UL. PRZYRODNIKOW 3
GDANSK, POLAND 80-297

FOR: ENZYMES FOR SCIENTIFIC AND RESEARCH PURPOSES; CHEMICAL PREPARATIONS FOR SCIENTIFIC PURPOSES; CHEMICAL REAGENTS FOR NON-MEDICAL PURPOSES; CHEMICAL SOLUTIONS AND PREPARATIONS CONSISTING OF PRE-MIXED REACTANTS AND REAGENTS FOR SCIENTIFIC AND RESEARCH USE IN CONNECTION WITH AMPLIFICATION, ANALYSIS OR LABELING OF NUCLEIC ACID; CHEMICAL TEST KITS FOR DNA PURIFICATION FOR LABORATORY OR RESEARCH USE; CHEMICALS FOR USE IN INDUSTRY AND SCIENCE; CHEMICALS FOR USE IN THE PURIFICATION OF PROTEINS FOR IN VITRO USE; KIT CONTAINING PRE-PACKED COLUMNS, CHEMICALS, PRE-MADE BUFFER CONCENTRATES, SYRINGES AND INSTRUCTIONAL MANUAL FOR THE PURIFICATION OF PROTEINS FOR IN VITRO USE; NUCLEIC ACID SEQUENCES AND CHEMICAL REAGENTS FOR OTHER THAN MEDICAL AND VETERINARY PURPOSES; REAGENT FOR CHEMICAL ANALYSES; REAGENTS AND SUBSTRATES, NAMELY, CHEMICAL COMPOUNDS FOR USE IN PATTERNING AT NANO SCALE OR NEAR NANO SCALE; REAGENTS FOR USE IN SCIENTIFIC APPARATUS FOR CHEMICAL OR BIOLOGICAL ANALYSIS; WATERPROOFING CHEMICAL COMPOSITIONS; WATERPROOFING MEMBRANES IN LIQUID CHEMICAL FORM FOR USE IN CONSTRUCTION, IN CLASS 1 (U.S. CLS. 1, 5, 6, 10, 26 AND 46).

FIRST USE 2-16-1998; IN COMMERCE 2-16-1998.

FOR: BIOLOGICAL AND CHEMICAL PREPARATIONS AND REAGENTS FOR MEDICAL OR VETERINARY USE; NUCLEIC ACID SEQUENCES AND CHEMICAL REAGENTS FOR MEDICAL AND VETERINARY PURPOSES, IN CLASS 5 (U.S. CLS. 6, 18, 44, 46, 51 AND 52).

FIRST USE 2-16-1998; IN COMMERCE 2-16-1998.

FOR: CHEMICAL ANALYSIS; CHEMICAL LABORATORIES; CHEMICAL RESEARCH; CHEMICAL, BIOCHEMICAL, BIOLOGICAL AND BACTERIOLOGICAL RESEARCH AND ANALYSIS; CUSTOM DESIGN AND DEVELOPMENT OF CHEMICAL REAGENTS AND BIOCHEMICAL ASSAYS; DEVELOPMENT AND TEST OF CHEMICAL PRODUCTION METHODS, IN CLASS 42 (U.S. CLS. 100 AND 101).

FIRST USE 2-16-1998; IN COMMERCE 2-16-1998.

THE MARK CONSISTS OF STANDARD CHARACTERS WITHOUT CLAIM TO ANY PARTICULAR FONT, STYLE, SIZE, OR COLOR.

THE WORDING "EURX" IN THE MARK HAS NO MEANING IN FOREIGN LANGUAGE.

SER. NO. 77-184,399, FILED 5-18-2007.

MARK PILARO, EXAMINING ATTORNEY

Int. Cl.: 16

Prior U.S. Cls.: 2, 5, 22, 23, 29, 37, 38 and 50

United States Patent and Trademark Office

Reg. No. 3,478,932

Registered Aug. 5, 2008

TRADEMARK
PRINCIPAL REGISTER

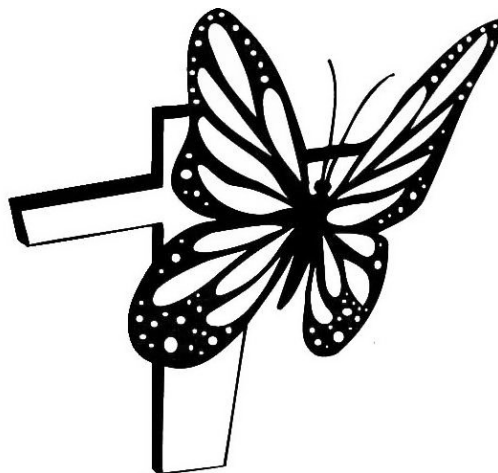

THE UPPER ROOM (TENNESSEE NON-PROFIT CORPORATION)
P.O. BOX 340004
1908 GRAND AVENUE
NASHVILLE, TN 372030004

FOR: PRINTED MATERIALS AND PUBLICATIONS, NAMELY, STATIONERY, BOOKS, BOOKLETS, BROCHURES, NEWSLETTERS, PAMPHLETS, AND TRAINING AND INSTRUCTIONAL MATERIALS, IN THE FIELDS OF CHRISTIANITY, CHRISTIAN, RELIGIOUS AND SPIRITUAL DEVELOPMENT, CHRISTIAN, RELIGIOUS AND SPIRITUAL MINISTRY, CONGREGATIONAL, INSPIRATIONAL AND RELIGIOUS PROGRAMS, DEVOTIONAL TOPICS, PERSONAL DEVELOPMENT,

PERSONAL PIETY, PERSONAL TRANSFORMATION, PRAYER, RELIGION, RELIGIOUS CONGREGATIONS, RELIGIOUS EDUCATION, SPIRITUALITY, AND SPIRITUAL GROWTH, IN CLASS 16 (U.S. CLS. 2, 5, 22, 23, 29, 37, 38 AND 50).

FIRST USE 5-0-1984; IN COMMERCE 5-0-1984.

THE MARK CONSISTS OF A BUTTERFLY SUPERIMPOSED ON A CROSS.

SER. NO. 77-184,401, FILED 5-18-2007.

DAVID TAYLOR, EXAMINING ATTORNEY

Int. Cl.: 35

Prior U.S. Cls.: 100, 101 and 102

United States Patent and Trademark Office

Reg. No. 3,478,933

Registered Aug. 5, 2008

**SERVICE MARK
PRINCIPAL REGISTER**

VAL-U-ADS

SPECIALTY PROMOTIONS & ADVERTISING,
INC. (COLORADO CORPORATION)
SUITE 118
80 GARDEN CENTER
BROOMFIELD, CO 80020

NETWORK, IN CLASS 35 (U.S. CLS. 100, 101 AND
102).

FIRST USE 10-1-1990; IN COMMERCE 10-1-1990.

FOR: PROMOTING THE GOODS AND SERVICES
OF OTHERS BY PREPARING AND PLACING AD-
VERTISEMENTS IN AN ELECTRONIC MAGAZINE
ACCESSED THROUGH A GLOBAL COMPUTER

SER. NO. 77-184,733, FILED 5-18-2007.

LAURIE KAUFMAN, EXAMINING ATTORNEY

Int. Cls.: 40 and 42

Prior U.S. Cls.: 100, 101, 103 and 106

United States Patent and Trademark Office

Reg. No. 3,478,934

Registered Aug. 5, 2008

**SERVICE MARK
PRINCIPAL REGISTER**

GILERO

GILERO, LLC (DELAWARE LTD LIAB CO)
SUITE 107
9310 FOCAL POINT
RALEIGH, NC 27617

FOR: PROTOTYPING, NAMELY, PROTOTYPE
FABRICATION OF NEW BIOMEDICAL, INDUS-
TRIAL AND CONSUMER PRODUCTS FOR OTH-
ERS, IN CLASS 40 (U.S. CLS. 100, 103 AND 106).

FIRST USE 11-20-2002; IN COMMERCE 6-30-2003.

FOR: DESIGN FOR OTHERS IN THE FIELDS OF
BIOMEDICAL AND INDUSTRIAL PRODUCTS; EN-
GINEERING IN THE FIELDS OF BIOMEDICAL,
INDUSTRIAL AND CONSUMER PRODUCTS; DE-
VELOPMENT OF MANUFACTURING PROCESSES
FOR BIOMEDICAL, INDUSTRIAL AND CONSU-

MER PRODUCTS; VALIDATION, NAMELY, ENGI-
NEERING CONSULTING SERVICES IN THE
NATURE OF QUALIFYING MANUFACTURING
PROCESSES FOR COMPLIANCE WITH REGULA-
TORY AUTHORITIES FOR THE FIELDS OF BIO-
MEDICAL, INDUSTRIAL, AND CONSUMER
PRODUCTS , IN CLASS 42 (U.S. CLS. 100 AND 101).

FIRST USE 11-20-2002; IN COMMERCE 6-30-2003.

THE MARK CONSISTS OF STANDARD CHAR-
ACTERS WITHOUT CLAIM TO ANY PARTICULAR
FONT, STYLE, SIZE, OR COLOR.

SER. NO. 77-184,845, FILED 5-18-2007.

COLLEEN DOMBROW, EXAMINING ATTORNEY

Int. Cls.: 40 and 42

Prior U.S. Cls.: 100, 101, 103 and 106

United States Patent and Trademark Office

Reg. No. 3,478,935

Registered Aug. 5, 2008

**SERVICE MARK
PRINCIPAL REGISTER**

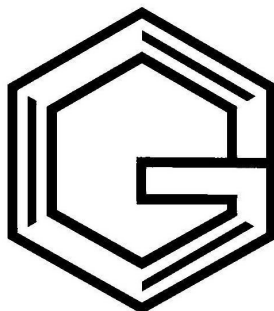

GILERO, LLC (DELAWARE LTD LIAB CO)
SUITE 107
9310 FOCAL POINT
RALEIGH, NC 27617

FOR: PROTOTYPING, NAMELY, PROTOTYPE
FABRICATION OF NEW BIOMEDICAL, INDUS-
TRIAL AND CONSUMER PRODUCTS FOR OTH-
ERS, IN CLASS 40 (U.S. CLS. 100, 103 AND 106).

FIRST USE 11-20-2002; IN COMMERCE 6-30-2003.

FOR: DESIGN FOR OTHERS IN THE FIELDS OF
BIOMEDICAL AND INDUSTRIAL PRODUCTS; EN-
GINEERING IN THE FIELDS OF BIOMEDICAL,
INDUSTRIAL AND CONSUMER PRODUCTS; DE-
VELOPMENT OF MANUFACTURING PROCESSES

FOR BIOMEDICAL, INDUSTRIAL AND CONSU-
MER PRODUCTS; VALIDATION, NAMELY, ENGI-
NEERING CONSULTING SERVICES IN THE
NATURE OF QUALIFYING MANUFACTURING
PROCESSES FOR COMPLIANCE WITH REGULA-
TORY AUTHORITIES FOR THE FIELDS OF BIO-
MEDICAL, INDUSTRIAL, AND CONSUMER
PRODUCTS , IN CLASS 42 (U.S. CLS. 100 AND 101).

FIRST USE 11-20-2002; IN COMMERCE 6-30-2003.

THE MARK CONSISTS OF A STYLIZED CAPITAL
LETTER "G".

SER. NO. 77-184,857, FILED 5-18-2007.

COLLEEN DOMBROW, EXAMINING ATTORNEY

Int. Cl.: 41

Prior U.S. Cls.: 100, 101 and 107

United States Patent and Trademark Office

Reg. No. 3,478,936

Registered Aug. 5, 2008

**SERVICE MARK
PRINCIPAL REGISTER**

THE LEATHER MASKED BALL

BOUND SOUTH, INC. (FLORIDA CORPORATION)
1207 NW 6TH AVE.
FT. LAUDERDALE, FL 33311

FOR: ENTERTAINMENT SERVICES, NAMELY, ORGANIZING AND CONDUCTING DANCE THEME PARTIES AND ENTERTAINMENT IN THE NATURE OF LIVE EVENTS AND SPECIAL EVENTS FEATURING ADULT DANCE PARTIES WITH LIVE PERFORMERS, LASER AND LIGHT SHOWS AT NIGHTCLUBS AND ARENAS, IN CLASS 41 (U.S. CLS. 100, 101 AND 107).

FIRST USE 5-19-2006; IN COMMERCE 10-1-2006.

THE MARK CONSISTS OF STANDARD CHARACTERS WITHOUT CLAIM TO ANY PARTICULAR FONT, STYLE, SIZE, OR COLOR.

NO CLAIM IS MADE TO THE EXCLUSIVE RIGHT TO USE "MASKED BALL", APART FROM THE MARK AS SHOWN.

SER. NO. 77-185,037, FILED 5-18-2007.

LAURIE KAUFMAN, EXAMINING ATTORNEY

Int. Cl.: 33

Prior U.S. Cls.: 47 and 49

United States Patent and Trademark Office

Reg. No. 3,478,937

Registered Aug. 5, 2008

**TRADEMARK
PRINCIPAL REGISTER**

PRAIRIE BERRY

PRAIRIE BERRY, L.L.C. (SOUTH DAKOTA LTD
LIAB CO)
23837 HIGHWAY 385
HILL CITY, SD 57745

THE MARK CONSISTS OF STANDARD CHAR-
ACTERS WITHOUT CLAIM TO ANY PARTICULAR
FONT, STYLE, SIZE, OR COLOR.

FOR: WINES, IN CLASS 33 (U.S. CLS. 47 AND 49).

SER. NO. 77-185,846, FILED 5-21-2007.

FIRST USE 5-26-2001; IN COMMERCE 5-26-2001.

GISELLE AGOSTO, EXAMINING ATTORNEY

Int. Cl.: 16

Prior U.S. Cls.: 2, 5, 22, 23, 29, 37, 38 and 50

Reg. No. 3,478,938

United States Patent and Trademark Office

Registered Aug. 5, 2008

**TRADEMARK
PRINCIPAL REGISTER**

FLATBOARD

GREAT NORTHERN CORP. (WISCONSIN CORPORATION)
395 STROEBE ROAD
APPLETON, WI 54911

FOR: FLAT SHEETS OR DIE-CUT SHAPES OF NON-LAMINATED OR LAMINATED PAPERBOARD SOLD FOR USE AS SEPARATOR PIECES BETWEEN LAYERS OF GOODS, AS PROTECTIVE PACKAGING MATERIAL, AND AS COMPONENTS OF OTHER PRODUCTS, IN CLASS 16 (U.S. CLS. 2, 5, 22, 23, 29, 37, 38 AND 50).

FIRST USE 12-1-1997; IN COMMERCE 12-1-1997.

THE MARK CONSISTS OF STANDARD CHARACTERS WITHOUT CLAIM TO ANY PARTICULAR FONT, STYLE, SIZE, OR COLOR.

SEC. 2(F).

SER. NO. 77-186,014, FILED 5-21-2007.

DAVID TAYLOR, EXAMINING ATTORNEY

Int. Cl.: 3

Prior U.S. Cls.: 1, 4, 6, 50, 51 and 52

United States Patent and Trademark Office

Reg. No. 3,478,939

Registered Aug. 5, 2008

**TRADEMARK
PRINCIPAL REGISTER**



SEXY HAIR CONCEPTS, LLC (CALIFORNIA
LTD LIAB CO)
9232 ETON AVENUE
CHATSWORTH, CA 91311

FOR: HAIR CARE PRODUCTS, NAMELY, HAIR
SHAMPOOS, HAIR COLORS, HAIR CONDITION-
ERS, HAIR MOUSSES, HAIR SPRAYS, HAIR GELS,
HAIR GEL FOAMS, HAIR CREAMS, HAIR STY-
LING FIXATIVE IN THE NATURE OF HAIR
WAXES, HAIR DETANGLING SPRAYS, HAIR
BALMS, HAIR GLOSSES, HAIR POMADES, DRY
SILICON SERUM SPRAYS FOR HAIR AND HAIR
TONICS, IN CLASS 3 (U.S. CLS. 1, 4, 6, 50, 51 AND 52).

FIRST USE 4-30-2002; IN COMMERCE 4-30-2002.

OWNER OF U.S. REG. NOS. 2,403,396, 3,247,540
AND OTHERS.

THE COLOR(S) RED IS/ARE CLAIMED AS A
FEATURE OF THE MARK.

THE MARK CONSISTS OF A STAR FOLLOWED
BY THE WORD "SEXY". THE COLOR RED AP-
PEARS IN THE STAR AND THE WORD "SEXY".

SER. NO. 77-186,183, FILED 5-21-2007.

RAMONA ORTIGA, EXAMINING ATTORNEY

Int. Cl.: 12

Prior U.S. Cls.: 19, 21, 23, 31, 35 and 44

Reg. No. 3,478,940

United States Patent and Trademark Office

Registered Aug. 5, 2008

**TRADEMARK
PRINCIPAL REGISTER**

LSS

KAYABA INDUSTRY CO., LTD. (JAPAN CORPORATION)

WORLD TRADE CENTER BLDG.

4-1, HAMAMATSU-CHO 2 CHOME, MINATO-KU
TOKYO, JAPAN

FOR: SHOCK ABSORBERS FOR AUTOMOBILES;
SHOCK ABSORBERS FOR MOTORCYCLES, IN
CLASS 12 (U.S. CLS. 19, 21, 23, 31, 35 AND 44).

THE MARK CONSISTS OF STANDARD CHARACTERS WITHOUT CLAIM TO ANY PARTICULAR FONT, STYLE, SIZE, OR COLOR.

OWNER OF JAPAN REG. NO. 5098300, DATED 12-14-2007, EXPIRES 12-14-2017.

SER. NO. 77-186,346, FILED 5-21-2007.

DOMINIC J. FERRAIUOLO, EXAMINING ATTORNEY

Int. Cl.: 26

Prior U.S. Cls.: 37, 39, 40, 42 and 50

Reg. No. 3,478,941

United States Patent and Trademark Office

Registered Aug. 5, 2008

**TRADEMARK
PRINCIPAL REGISTER**

RYDER CLIPS

RYDER CLIPS UNLIMITED, INC. (FLORIDA
CORPORATION)
NO. 373
2436 N. FEDERAL HIGHWAY
LIGHTHOUSE POINT, FL 33064

FOR: PANT LEG POSITIONING CLIPS; PANT
LEG RETAINING CLIPS; BOOT CLIPS, LACED
BOOT CLIPS, AND CLIPS ALL FOR MAINTAINING
PANT LEG POSITIONS FOR A RIDER WHILE
TRAVELING ON A MOTORCYCLE AND OTHER
OPEN WHEELED VEHICLES, IN CLASS 26 (U.S.
CLS. 37, 39, 40, 42 AND 50).

FIRST USE 4-1-2007; IN COMMERCE 4-1-2007.

THE MARK CONSISTS OF STANDARD CHAR-
ACTERS WITHOUT CLAIM TO ANY PARTICULAR
FONT, STYLE, SIZE, OR COLOR.

NO CLAIM IS MADE TO THE EXCLUSIVE
RIGHT TO USE "CLIPS", APART FROM THE MARK
AS SHOWN.

SER. NO. 77-186,368, FILED 5-21-2007.

MARY BOAGNI, EXAMINING ATTORNEY

Int. Cl.: 36

Prior U.S. Cls.: 100, 101 and 102

United States Patent and Trademark Office

Reg. No. 3,478,942

Registered Aug. 5, 2008

**SERVICE MARK
PRINCIPAL REGISTER**

Delaware Pooled

DELAWARE MANAGEMENT HOLDINGS, INC.
(DELAWARE CORPORATION)

SUITE 102

1403 FOULK ROAD

WILMINGTON, DE 19803

FOR: FUNDS INVESTMENT, IN CLASS 36 (U.S.
CLS. 100, 101 AND 102).

FIRST USE 12-31-1992; IN COMMERCE 12-31-1992.

THE MARK CONSISTS OF STANDARD CHAR-
ACTERS WITHOUT CLAIM TO ANY PARTICULAR
FONT, STYLE, SIZE, OR COLOR.

OWNER OF U.S. REG. NOS. 1,310,369, 1,332,508,
AND 2,302,698.

SEC. 2(F).

SER. NO. 77-186,410, FILED 5-21-2007.

KRISTINA MORRIS, EXAMINING ATTORNEY

Int. Cls.: 35 and 39

Prior U.S. Cls.: 100, 101, 102 and 105

United States Patent and Trademark Office

Reg. No. 3,478,943

Registered Aug. 5, 2008

**SERVICE MARK
PRINCIPAL REGISTER**



GREENFIELD WORLD TRADE, INC. (FLORIDA CORPORATION)
15712 SW 41 STREET, SUITE 800
FT. LAUDERDALE, FL 33331

FOR: ADVERTISING, PUBLIC RELATIONS AND PROMOTION OF THE SALE, TRANSPORTATION AND DISTRIBUTION OF GOODS AND SERVICES IN THE COMMERCIAL AND RESIDENTIAL EQUIPMENT INDUSTRY, IN ALL MEDIUMS INCLUDING BUT NOT LIMITED TO PRINT ADVERTISING, RADIO, TELEVISION, TRADE SHOWS, SPECIAL EVENTS, INTERNET AND THE WORLD WIDE WEB; DISTRIBUTORSHIP SERVICES IN THE COMMERCIAL AND RESIDENTIAL EQUIPMENT INDUSTRY; IMPORT AND EXPORT AGENCY SERVICES IN THE FIELD OF EQUIPMENT GOODS, IN CLASS 35 (U.S. CLS. 100, 101 AND 102).

FIRST USE 7-30-1999; IN COMMERCE 9-20-1999.

FOR: WAREHOUSING SERVICES, NAMELY, STORAGE, DISTRIBUTION, PICK-UP, PACKING, AND SHIPPING OF EQUIPMENT GOODS; FREIGHT FORWARDING AND SHIPPING OF

EQUIPMENT GOODS, STORAGE AND WAREHOUSING OF EQUIPMENT GOODS, IN CLASS 39 (U.S. CLS. 100 AND 105).

FIRST USE 7-30-1999; IN COMMERCE 9-20-1999.

NO CLAIM IS MADE TO THE EXCLUSIVE RIGHT TO USE "WORLDTRADE", APART FROM THE MARK AS SHOWN.

THE COLOR(S) GREEN AND YELLOW IS/ARE CLAIMED AS A FEATURE OF THE MARK.

THE MARK CONSISTS OF A GREEN OVAL WITHIN WHICH ARE YELLOW STYLIZED BLADES OF GRASS LEANING RIGHT AND APPEARING BELOW WHICH ARE THE WORDS "GREENFIELD WORLD TRADE".

SER. NO. 77-186,529, FILED 5-21-2007.

CHRIS WELLS, EXAMINING ATTORNEY

Int. Cl.: 36

Prior U.S. Cls.: 100, 101 and 102

United States Patent and Trademark Office

Reg. No. 3,478,944

Registered Aug. 5, 2008

**SERVICE MARK
PRINCIPAL REGISTER**

Delaware Trend

DELAWARE MANAGEMENT HOLDINGS, INC.
(DELAWARE CORPORATION)

SUITE 102

1403 FOULK ROAD

WILMINGTON, DE 19803

FOR: FUNDS INVESTMENT, IN CLASS 36 (U.S.
CLS. 100, 101 AND 102).

FIRST USE 8-16-1999; IN COMMERCE 8-16-1999.

THE MARK CONSISTS OF STANDARD CHAR-
ACTERS WITHOUT CLAIM TO ANY PARTICULAR
FONT, STYLE, SIZE, OR COLOR.

OWNER OF U.S. REG. NOS. 1,310,369, 1,332,508,
AND 2,302,698.

SEC. 2(F).

SER. NO. 77-186,734, FILED 5-22-2007.

KRISTINA MORRIS, EXAMINING ATTORNEY

Int. Cl.: 36

Prior U.S. Cls.: 100, 101 and 102

United States Patent and Trademark Office

Reg. No. 3,478,945

Registered Aug. 5, 2008

**SERVICE MARK
PRINCIPAL REGISTER**

Delaware Group

DELAWARE MANAGEMENT HOLDINGS, INC.
(DELAWARE CORPORATION)
SUITE 102
1403 FOULK ROAD
WILMINGTON, DE 19803

FOR: FUNDS INVESTMENT, IN CLASS 36 (U.S.
CLS. 100, 101 AND 102).

FIRST USE 7-31-1975; IN COMMERCE 7-31-1975.

THE MARK CONSISTS OF STANDARD CHAR-
ACTERS WITHOUT CLAIM TO ANY PARTICULAR
FONT, STYLE, SIZE, OR COLOR.

OWNER OF U.S. REG. NOS. 1,310,369, 1,332,508,
AND 2,302,698.

NO CLAIM IS MADE TO THE EXCLUSIVE
RIGHT TO USE "GROUP", APART FROM THE
MARK AS SHOWN.

SEC. 2(F).

SER. NO. 77-186,753, FILED 5-22-2007.

KRISTINA MORRIS, EXAMINING ATTORNEY

Int. Cl.: 28

Prior U.S. Cls.: 22, 23, 38 and 50

Reg. No. 3,478,946

United States Patent and Trademark Office

Registered Aug. 5, 2008

**TRADEMARK
PRINCIPAL REGISTER**



MARK DUNOW (UNITED STATES INDIVIDUAL)
PO BOX 41021
RENO, NV 89504

FOR: GAME EQUIPMENT, NAMELY, BLACKJACK TABLE LAYOUTS AND GAMING TABLES, IN CLASS 28 (U.S. CLS. 22, 23, 38 AND 50).

FIRST USE 1-3-2003; IN COMMERCE 1-3-2003.

OWNER OF U.S. REG. NO. 2,817,848.

NO CLAIM IS MADE TO THE EXCLUSIVE RIGHT TO USE "BLACKJACK", APART FROM THE MARK AS SHOWN.

THE MARK CONSISTS OF DEAD MAN'S HAND BLACKJACK SURROUNDS A CIRCLE CONTAINING A/8 AND A/8.

SER. NO. 77-187,155, FILED 5-22-2007.

MELVIN AXILBUND, EXAMINING ATTORNEY

Int. Cl.: 35

Prior U.S. Cls.: 100, 101 and 102

United States Patent and Trademark Office

Reg. No. 3,478,947

Registered Aug. 5, 2008

**SERVICE MARK
PRINCIPAL REGISTER**

Knowledge Alliance

NATIONAL EDUCATION KNOWLEDGE INDUSTRY ASSOCIATION, INC. (D.C. CORPORATION)
SUITE 700
1718 CONNECTICUT AVENUE, NW
WASHINGTON, DC 200091162

FOR: TRADE ASSOCIATION SERVICES, NAME-
LY, PROMOTING THE INTERESTS OF EDUCA-
TIONAL ORGANIZATIONS AND ENTITIES , IN
CLASS 35 (U.S. CLS. 100, 101 AND 102).

FIRST USE 4-16-2007; IN COMMERCE 4-16-2007.

THE MARK CONSISTS OF STANDARD CHAR-
ACTERS WITHOUT CLAIM TO ANY PARTICULAR
FONT, STYLE, SIZE, OR COLOR.

NO CLAIM IS MADE TO THE EXCLUSIVE
RIGHT TO USE "ALLIANCE", APART FROM THE
MARK AS SHOWN.

SER. NO. 77-187,166, FILED 5-22-2007.

JENNIFER VASQUEZ, EXAMINING ATTORNEY

Int. Cl.: 5

Prior U.S. Cls.: 6, 18, 44, 46, 51 and 52

United States Patent and Trademark Office

Reg. No. 3,478,948

Registered Aug. 5, 2008

**TRADEMARK
PRINCIPAL REGISTER**



BIO-ENGINEERED SUPPLEMENTS & NUTRI-
TION, INC. (DELAWARE CORPORATION)
5901 BROKEN SOUND PARKWAY NW
6TH FLOOR
BOCA RATON, FL 33487

THE MARK CONSISTS OF THE LETTERS "BSN"
WITH EACH LETTER BORDERED BY A POLYGON
WITH A RING AND STAR DEPICTED GOING
AROUND THE POLYGONS.

FOR: DIETARY SUPPLEMENTS, IN CLASS 5 (U.S.
CLS. 6, 18, 44, 46, 51 AND 52).

SER. NO. 77-187,628, FILED 5-22-2007.

FIRST USE 6-1-2005; IN COMMERCE 6-1-2005.

OWNER OF U.S. REG. NO. 3,227,620.

MICHAEL LEWIS, EXAMINING ATTORNEY

Int. Cl.: 39

Prior U.S. Cls.: 100 and 105

United States Patent and Trademark Office

Reg. No. 3,478,949

Registered Aug. 5, 2008

**SERVICE MARK
PRINCIPAL REGISTER**



ISRAIR AIRLINES AND TOURISM LTD. (ISRAEL CORPORATION)
23 BEN YEHUDA ST.
TEL AVIV, ISRAEL 63806

FOR: AIR TRANSPORT; AIR TRANSPORTATION; AIR TRANSPORTATION SERVICES FEATURING A FREQUENT FLYER BONUS PROGRAM; ARRANGING FOR TRAVEL VISAS, PASSPORTS AND TRAVEL DOCUMENTS FOR PERSONS TRAVELING ABROAD; ARRANGING TRAVEL TOURS; ARRANGING TRAVEL TOURS AS A BONUS PROGRAM FOR CREDIT CARDS CUSTOMERS; COORDINATING TRAVEL ARRANGEMENTS FOR INDIVIDUALS AND FOR GROUPS; DELIVERY OF GOODS BY AIR; EXPRESS DELIVERY OF GOODS BY AIR; FREIGHT TRANSPORTATION BY AIR; ORGANISATION OF TRAVEL; ORGANIZATION OF EXCURSIONS, SIGHTSEEING TOURS, HOLIDAYS, TOURS AND TRAVEL; ORGANIZATION OF TRAVEL AND BOAT TRIPS; PROVIDING AN ON-LINE COMPUTER DATABASE IN THE FIELD OF TRAVEL INFORMATION SERVICES; PROVIDING LINKS TO WEB SITES OF OTHERS FEATURING TRAVEL; SUPPLY CHAIN, LOGISTICS AND REVERSE LOGISTICS SERVICES, NAMELY, STORAGE, TRANSPORTATION AND DELIVERY OF DOCUMENTS, PACKAGES, RAW MATERIALS, AND OTHER FREIGHT FOR OTHERS BY AIR, RAIL, SHIP OR TRUCK; TRANSPORT BY AIR; TRANSPORTATION OF PASSENGERS AND/OR GOODS BY AIR; TRAVEL AGENCY SERVICES, NAMELY, MAKING RESERVATIONS AND BOOKINGS FOR TRANSPORTATION; TRAVEL AND TOUR INFORMATION SERVICE; TRAVEL AND TOUR TICKET RESERVATION SERVICE; TRAVEL BOOKING

AGENCIES; TRAVEL CLUBS; TRAVEL GUIDE SERVICES; TRAVEL INFORMATION SERVICES; TRAVEL INFORMATION SERVICES, NAMELY, PROVIDING A WEBSITE THAT NOTIFIES PEOPLE WHEN SOMEONE IS DUE BACK FROM A TRIP BUT HAS NOT YET ARRIVED; TRAVEL, EXCURSION AND CRUISE ARRANGEMENT, IN CLASS 39 (U.S. CLS. 100 AND 105).

FIRST USE 8-0-1998; IN COMMERCE 6-20-2004.

THE COLOR(S) BLUE, DARK BLUE, DARK YELLOW/GOLDENROD AND WHITE IS/ARE CLAIMED AS A FEATURE OF THE MARK.

THE MARK CONSISTS OF TWO WORDS (ONE IN HEBREW LETTERS, ONE IN LATIN LETTERS) WITH A STYLIZED STAR BETWEEN THE TWO WORDS. THE STAR IS DARK YELLOW (GOLDENROD COLOR) AND THE WORDS ARE DARKER SHADE OF THE BLUE COLOR. THE STAR IS CUT THROUGH DIAGONALLY (FROM THE BOTTOM LEFT CORNER UPWARDS TO TOP RIGHT CORNER) WITH A WHITE LINE RESEMBLING A MOVEMENT OF AN ORBIT OR AN AIRPLANE.

THIS TRANSLATES TO "ISRAIR" IN ENGLISH.

THE NON-LATIN CHARACTER(S) IN THE MARK TRANSLITERATE INTO "ISRAIR".

SER. NO. 77-188,187, FILED 5-23-2007.

PAM WILLIS, EXAMINING ATTORNEY

Int. Cl.: 42

Prior U.S. Cls.: 100 and 101

United States Patent and Trademark Office

Reg. No. 3,478,950

Registered Aug. 5, 2008

**SERVICE MARK
PRINCIPAL REGISTER**

The logo for Red Level Networks features the word "RED" in a bold, red, sans-serif font. To its right, the word "LEVEL" is written in a blue, sans-serif font, with the "V" being significantly larger and more stylized than the other letters. Below "LEVEL", the word "NETWORKS" is written in a smaller, red, sans-serif font.

RED LEVEL NETWORKS LLC (MICHIGAN LTD
LIAB CO)
SUITE 223
24371 CATHERINE INDUSTRIAL DRIVE
NOVI, MI 48375

THE COLOR(S) RED, WHITE, AND BLUE IS/ARE
CLAIMED AS A FEATURE OF THE MARK.

FOR: CONSULTING SERVICES IN THE FIELD
OF DESIGN, SELECTION, IMPLEMENTATION
AND USE OF COMPUTER HARDWARE AND
SOFTWARE SYSTEMS FOR OTHERS , IN CLASS
42 (U.S. CLS. 100 AND 101).

THE MARK CONSISTS OF THE WORDING "RED
LEVEL NETWORKS" WITH THE WORD "RED"
APPEARING IN RED LETTERING; THE WORD
"LEVEL" APPEARING IN BLUE LETTERING;
AND THE WORD NETWORKS APPEARING IN
RED LETTERING.

FIRST USE 5-21-2004; IN COMMERCE 5-21-2004.

SER. NO. 77-188,315, FILED 5-23-2007.

NO CLAIM IS MADE TO THE EXCLUSIVE
RIGHT TO USE "NETWORKS", APART FROM
THE MARK AS SHOWN.

ERIN FALK, EXAMINING ATTORNEY

Int. Cl.: 11

Prior U.S. Cls.: 13, 21, 23, 31 and 34

United States Patent and Trademark Office

Reg. No. 3,478,951

Registered Aug. 5, 2008

**TRADEMARK
PRINCIPAL REGISTER**

ECOFAN

CAFRAMO LIMITED (CANADA CORPORATION)
RR2
WIARTON, ONTARIO, CANADA N0H2T0

FOR: ELECTRIC HEATING FAN THAT CREATES ITS OWN ELECTRICITY FOR USE WITH WOOD OR GAS STOVES, IN CLASS 11 (U.S. CLS. 13, 21, 23, 31 AND 34).

FIRST USE 9-0-1994; IN COMMERCE 9-0-1995.

THE MARK CONSISTS OF STANDARD CHARACTERS WITHOUT CLAIM TO ANY PARTICULAR FONT, STYLE, SIZE, OR COLOR.

PRIORITY CLAIMED UNDER SEC. 44(D) ON CANADA APPLICATION NO. 1344408, FILED 4-20-2007.

SER. NO. 77-188,444, FILED 5-23-2007.

COLLEEN DOMBROW, EXAMINING ATTORNEY

Int. Cl.: 10

Prior U.S. Cls.: 26, 39 and 44

United States Patent and Trademark Office

Reg. No. 3,478,952

Registered Aug. 5, 2008

**TRADEMARK
PRINCIPAL REGISTER**

NOVOLINPEN

NOVO NORDISK A/S (DENMARK CORPORATION)
NOVO ALLE
DK-2880, BAGSVAERD, DENMARK

FOR: MEDICAL AND SURGICAL SYRINGES
FOR INJECTION IN THE FORM OF A PENCIL, IN
CLASS 10 (U.S. CLS. 26, 39 AND 44).

THE MARK CONSISTS OF STANDARD CHAR-
ACTERS WITHOUT CLAIM TO ANY PARTICULAR
FONT, STYLE, SIZE, OR COLOR.

OWNER OF DENMARK REG. NO. VR19890128,
DATED 3-17-1989, EXPIRES 3-17-2009.

OWNER OF U.S. REG. NOS. 1,384,926, 1,395,584,
AND 2,430,706.

SER. NO. 77-188,660, FILED 5-23-2007.

KIMBERLY FRYE, EXAMINING ATTORNEY

Int. Cl.: 38

Prior U.S. Cls.: 100, 101 and 104

United States Patent and Trademark Office

Reg. No. 3,478,953

Registered Aug. 5, 2008

**SERVICE MARK
PRINCIPAL REGISTER**



EYE JEWELS, INC. (NEVADA CORPORATION)
1818 OTTAWA DRIVE
LAS VEGAS, NV 891093303

FOR: AUDIO AND VIDEO BROADCASTING SERVICES OVER THE INTERNET; BROADCASTING SERVICES AND PROVISION OF TELECOMMUNICATION ACCESS TO FILMS AND TV PROGRAMMES PROVIDED VIA A VIDEO-ON-DEMAND SERVICE; BROADCASTING SERVICES AND PROVISION OF TELECOMMUNICATION ACCESS TO VIDEO AND AUDIO CONTENT PROVIDED VIA A VIDEO-ON-DEMAND SERVICE VIA THE INTERNET; COMMUNICATIONS SERVICES, NAMELY, TRANSMITTING STREAMED SOUND AND AUDIO-VISUAL RECORDINGS VIA THE INTERNET; ELECTRONIC TRANSMISSION OF VOICE, DATA AND IMAGES BY TELEVISION AND VIDEO BROADCASTING; INTERNET BROADCASTING SERVICES; PROVIDING CO-LOCATION SERVICES FOR VOICE, VIDEO AND DATA COMMUNICATIONS APPLICATIONS; STREAMING OF AUDIO MATERIAL ON THE

INTERNET; STREAMING OF VIDEO MATERIAL ON THE INTERNET; VIDEO-ON-DEMAND TRANSMISSION SERVICES, IN CLASS 38 (U.S. CLS. 100, 101 AND 104).

FIRST USE 3-12-2007; IN COMMERCE 3-12-2007.

NO CLAIM IS MADE TO THE EXCLUSIVE RIGHT TO USE "REAL-VIDEO" AND "TV", APART FROM THE MARK AS SHOWN.

THE MARK CONSISTS OF A STYLIZED CROWN TOPPED BY A MALTESE CROSS; WITHIN THE CROWN IS THE STYLIZED HEAD OF A MALE LION; BENEATH THE CROWN IS A STYLIZED STRIP OF A FILM NEGATIVE; BENEATH THAT ARE THE WORDS "REAL-VIDEO.TV" ALL IN LOWER CASE.

SER. NO. 77-188,917, FILED 5-23-2007.

LESLIE RICHARDS, EXAMINING ATTORNEY

Int. Cl.: 9

Prior U.S. Cls.: 21, 23, 26, 36 and 38

Reg. No. 3,478,954

United States Patent and Trademark Office

Registered Aug. 5, 2008

**TRADEMARK
PRINCIPAL REGISTER**



UBIQ TECHNOLOGIES PTY. LTD. (AUSTRALIA CORPORATION)
54 CURRIE STREET
ADELAIDE, AUSTRALIA 5000

FOR: APPARATUS FOR RECORDING, STORAGE, TRANSMISSION AND REPRODUCTION OF SOUNDS, IMAGES AND DATA, COMPUTERS AND COMPUTER HARDWARE, INCLUDING NOTEBOOK COMPUTERS, HANDHELD COMPUTERS, AND ELECTRONIC NOTEPADS, REPLACEMENT PARTS AND ACCESSORIES FOR THE AFOREMENTIONED GOODS, BLANK SOUND STORAGE MEDIA, NAMELY, CDS, CD-ROMS, SUPER AUDIO CDS, DVDS, DVD-AUDIO, DVD-VIDEO, UNIVERSAL MEDIA DISCS, MEMORY CARDS FOR SOUND RECORDINGS, BLANK IMAGE STORAGE MEDIA, NAMELY, CDS, CD-ROMS, SUPER AUDIO CDS, DVDS, DVD-AUDIO, DVD-VIDEO, UNIVERSAL MEDIA DISCS, MEMORY CARDS FOR IMAGE RECORDINGS, BLANK DATA STORAGE MEDIA, NAMELY, CDS, CD-ROMS, SUPER AUDIO CDS, DVDS, DVD-AUDIO, DVD-VIDEO, UNIVERSAL MEDIA DISCS, MEMORY CARDS FOR DATA RECORDINGS, COMPUTER SOFTWARE FOR VIEWING AUDIOVISUAL AND MULTIMEDIA PROGRAMS, COMPUTER SOFTWARE FOR USE IN COMPUTER GAMES AND ELECTRONIC

GAMES, COMPUTER SOFTWARE FOR CREATING DISPLAYS AND PRESENTATIONS, COMPUTER SOFTWARE FOR USE IN WORD PROCESSING, COMPUTER SOFTWARE FOR USE IN DATABASE MANAGEMENT, COMPUTER SOFTWARE FOR USE AS A SPREAD SHEET, COMPUTER SOFTWARE FOR PRESENTING AND MANIPULATING DATA, COMPUTER SOFTWARE FOR SCREEN SAVERS FOR EDUCATIONAL USE, ELECTRONIC PUBLICATIONS, NAMELY, MULTIMEDIA ELECTRONIC BOOKS AND JOURNALS FEATURING INSTRUCTIONAL, EDUCATIONAL AND TEACHING MATERIALS IN THE FIELD OF LITERATURE, IN CLASS 9 (U.S. CLS. 21, 23, 26, 36 AND 38).

PRIORITY CLAIMED UNDER SEC. 44(D) ON AUSTRALIA APPLICATION NO. 1150369, FILED 12-1-2006, REG. NO. 1150369, DATED 12-1-2006, EXPIRES 12-1-2016.

THE MARK CONSISTS OF THE WORD "QUOKKAPAD" WITH THE "Q" STYLIZED IN THE FORM OF AN ANIMAL.

SER. NO. 77-189,140, FILED 5-24-2007.

ANTHONY RINKER, EXAMINING ATTORNEY

Int. Cl.: 36

Prior U.S. Cls.: 100, 101 and 102

United States Patent and Trademark Office

Reg. No. 3,478,955

Registered Aug. 5, 2008

**SERVICE MARK
PRINCIPAL REGISTER**



FIRST NATIONAL BANK & TRUST CO. (UNITED STATES NATIONAL BANKING ASSOCIATION)
130 EAST MACARTHUR
SHAWNEE, OK 74804

NO CLAIM IS MADE TO THE EXCLUSIVE RIGHT TO USE "FIRST NATIONAL BANK & TRUST CO.", APART FROM THE MARK AS SHOWN.

FOR: BANKING SERVICES, IN CLASS 36 (U.S. CLS. 100, 101 AND 102).

SER. NO. 77-189,284, FILED 5-24-2007.

FIRST USE 2-0-2001; IN COMMERCE 2-0-2001.

KEVON CHISOLM, EXAMINING ATTORNEY

Int. Cls.: 35 and 37

Prior U.S. Cls.: 100, 101, 102, 103 and 106

United States Patent and Trademark Office

Reg. No. 3,478,956

Registered Aug. 5, 2008

**SERVICE MARK
PRINCIPAL REGISTER**

BUYING. SELLING. CARING.

PEACHTREE CITY MARKETING GROUP, L.L.C.
(GEORGIA LTD LIAB CO), DBA THE HOME
SOURCE REALTORS
100 WORLD DRIVE
PEACHTREE CITY, GA 30269

FOR: REAL ESTATE ADVERTISING SERVICES,
IN CLASS 35 (U.S. CLS. 100, 101 AND 102).

FIRST USE 9-28-2006; IN COMMERCE 9-28-2006.

FOR: REAL ESTATE DEVELOPMENT SERVICES,
IN CLASS 37 (U.S. CLS. 100, 103 AND 106).

FIRST USE 9-28-2006; IN COMMERCE 9-28-2006.

THE MARK CONSISTS OF STANDARD CHAR-
ACTERS WITHOUT CLAIM TO ANY PARTICULAR
FONT, STYLE, SIZE, OR COLOR.

SER. NO. 77-189,711, FILED 5-24-2007.

CAROLYN CATALDO, EXAMINING ATTORNEY

Int. Cl.: 36

Prior U.S. Cls.: 100, 101 and 102

United States Patent and Trademark Office

Reg. No. 3,478,957

Registered Aug. 5, 2008

**SERVICE MARK
PRINCIPAL REGISTER**



AMERICAN NATIONAL BANK (UNITED
STATES CHARTERED BANK)
3033 EAST FIRST AVENUE
DENVER, CO 80206

NO CLAIM IS MADE TO THE EXCLUSIVE
RIGHT TO USE "AMERICAN NATIONAL BANK",
APART FROM THE MARK AS SHOWN.

FOR: BANKING AND TRUST SERVICES, IN
CLASS 36 (U.S. CLS. 100, 101 AND 102).

SER. NO. 77-189,917, FILED 5-24-2007.

FIRST USE 5-0-2003; IN COMMERCE 5-0-2003.

KIMBERLY FRYE, EXAMINING ATTORNEY

Int. Cl.: 5

Prior U.S. Cls.: 6, 18, 44, 46, 51 and 52

United States Patent and Trademark Office

Reg. No. 3,478,958

Registered Aug. 5, 2008

**TRADEMARK
PRINCIPAL REGISTER**

EUROZYME

NORDMARK ARZNEIMITTEL GMBH & CO. KG
(FED REP GERMANY "KOMMANDITGE-
SELLSCHAFT" (K.G.))
PINNAUALLEE 4
UETERSEN, FED REP GERMANY 25436

FOR: ENZYMES AND ENZYME PREPARA-
TIONS, NAMELY, DIGESTIVE ENZYMES OF THE
PANCREAS FOR HUMAN AND VETERINARY USE
AS SUBSTITUTE FOR LACK OF ENZYMES DUE TO
PANCREATIC INSUFFICIENCY, IN CLASS 5 (U.S.
CLS. 6, 18, 44, 46, 51 AND 52).

THE MARK CONSISTS OF STANDARD CHAR-
ACTERS WITHOUT CLAIM TO ANY PARTICULAR
FONT, STYLE, SIZE, OR COLOR.

OWNER OF FED REP GERMANY REG. NO.
30210189, DATED 2-28-2002, EXPIRES 2-29-2012.

SER. NO. 77-190,592, FILED 5-25-2007.

TANYA AMOS, EXAMINING ATTORNEY

Int. Cl.: 45

Prior U.S. Cls.: 100 and 101

United States Patent and Trademark Office

Reg. No. 3,478,959

Registered Aug. 5, 2008

**SERVICE MARK
PRINCIPAL REGISTER**



BUCKNER, KRISTOPHER T. (UNITED STATES
INDIVIDUAL)
14979 PRAIRIE AVE.
LAWNDALE, CA 90260

FOR: INTELLECTUAL PROPERTY DETECTIVE
SERVICES; PRIVATE INVESTIGATIVE SERVICES
LIMITED TO THE AREA OF INTELLECTUAL
PROPERTY, IN CLASS 45 (U.S. CLS. 100 AND 101).

FIRST USE 7-1-1994; IN COMMERCE 7-1-1994.

NO CLAIM IS MADE TO THE EXCLUSIVE
RIGHT TO USE "INVESTIGATIVE CONSUL-
TANTS", APART FROM THE MARK AS SHOWN.

THE MARK CONSISTS OF THE PHRASE "INVES-
TIGATIVE CONSULTANTS" WITH "IC" IN THE
CENTER, WITH TWO DIAMOND SHAPES BE-
TWEEN "INVESTIGATIVE" AND "CONSUL-
TANTS", ALL OF WHICH IS SURROUNDED BY A
CIRCLE.

SER. NO. 77-191,233, FILED 5-26-2007.

HOWARD SMIGA, EXAMINING ATTORNEY

Int. Cls.: 9 and 41

Prior U.S. Cls.: 21, 23, 26, 38, 100, 101 and 107

United States Patent and Trademark Office

Reg. No. 3,478,960

Registered Aug. 5, 2008

**TRADEMARK
SERVICE MARK
PRINCIPAL REGISTER**

Another Level Records

STUDIO 4 ENTERPRISES INC. (MINNESOTA CORPORATION)
550 VANDALIA STREET
SAINT PAUL, MN 55114

FOR: AUDIO RECORDINGS FEATURING MUSIC; EDUCATIONAL DOCUMENTARIES IN THE FIELD MUSIC, RECORDED ON PHONOGRAPH RECORDS, AUDIO TAPES, COMPACT DISCS, VIDEOTAPES, VIDEOCASSETTES, DIGITAL AUDIO TAPES, COMPACT DISC VIDEOS, AND LASER DISCS, IN CLASS 9 (U.S. CLS. 21, 23, 26, 36 AND 38).

FIRST USE 0-0-1998; IN COMMERCE 0-0-1998.

FOR: RECORDING STUDIOS, IN CLASS 41 (U.S. CLS. 100, 101 AND 107).

FIRST USE 0-0-1998; IN COMMERCE 0-0-1998.

THE MARK CONSISTS OF STANDARD CHARACTERS WITHOUT CLAIM TO ANY PARTICULAR FONT, STYLE, SIZE, OR COLOR.

NO CLAIM IS MADE TO THE EXCLUSIVE RIGHT TO USE "RECORDS" , APART FROM THE MARK AS SHOWN.

SER. NO. 77-191,557, FILED 5-28-2007.

JEAN IM, EXAMINING ATTORNEY

Int. Cl.: 36

Prior U.S. Cls.: 100, 101 and 102

United States Patent and Trademark Office

Reg. No. 3,478,961

Registered Aug. 5, 2008

**SERVICE MARK
PRINCIPAL REGISTER**

FREEDOM CHOICE

NORTH AMERICAN COMPANY FOR LIFE AND
HEALTH INSURANCE (ILLINOIS CORPORATION)
525 VAN BUREN
CHICAGO, IL 60607

THE MARK CONSISTS OF STANDARD CHAR-
ACTERS WITHOUT CLAIM TO ANY PARTICULAR
FONT, STYLE, SIZE, OR COLOR.

FOR: LIFE INSURANCE AND ANNUITY UN-
DERWRITING SERVICES, IN CLASS 36 (U.S. CLS.
100, 101 AND 102).

SER. NO. 77-191,686, FILED 5-29-2007.

FIRST USE 6-11-2007; IN COMMERCE 6-11-2007.

JENNIFER VASQUEZ, EXAMINING ATTORNEY

Int. Cl.: 36

Prior U.S. Cls.: 100, 101 and 102

United States Patent and Trademark Office

Reg. No. 3,478,962

Registered Aug. 5, 2008

**SERVICE MARK
PRINCIPAL REGISTER**

**"Raleigh's Source for
Insurance"**

DANNY NEWTON FINANCIAL SERVICES INC
(NORTH CAROLINA CORPORATION)
SUITE 109
6021 POYNER VILLAGE PKWY
RALEIGH, NC 27616

THE MARK CONSISTS OF STANDARD CHAR-
ACTERS WITHOUT CLAIM TO ANY PARTICULAR
FONT, STYLE, SIZE, OR COLOR.

FOR: INSURANCE AGENCIES, IN CLASS 36 (U.S.
CLS. 100, 101 AND 102).

SER. NO. 77-191,856, FILED 5-29-2007.

FIRST USE 4-1-2007; IN COMMERCE 4-1-2007.

TINA BROWN, EXAMINING ATTORNEY

Int. Cls.: 16 and 35

Prior U.S. Cls.: 2, 5, 22, 23, 29, 37, 38, 50, 100, 101 and 102

Reg. No. 3,478,963

United States Patent and Trademark Office

Registered Aug. 5, 2008

**TRADEMARK
SERVICE MARK
PRINCIPAL REGISTER**

M.V.P. MARKET VALUE PRICING

LANE AUTOMOTIVE (MICHIGAN CORPORATION)
8300 LANE DRIVE
WATERVLIET, MI 49098

FOR: PRINTED PUBLICATIONS, NAMELY, PRODUCT PRICING, AVAILABILITY, ORDERING AND SHIPPING FORMS, BROCHURES AND BOOKLETS IN THE FIELD OF HIGH PERFORMANCE AND RACING AUTOMOTIVE PARTS AND ACCESSORIES, IN CLASS 16 (U.S. CLS. 2, 5, 22, 23, 29, 37, 38 AND 50).

FIRST USE 7-1-2003; IN COMMERCE 7-1-2003.

FOR: DISTRIBUTORSHIP SERVICES IN THE FIELD OF HIGH PERFORMANCE AND RACING AUTOMOTIVE PARTS AND ACCESSORIES VIA GLOBAL COMPUTER NETWORK FEATURING

PRODUCT PRICING, AVAILABILITY, ORDERING AND SHIPPING, IN CLASS 35 (U.S. CLS. 100, 101 AND 102).

FIRST USE 7-1-2003; IN COMMERCE 7-1-2003.

THE MARK CONSISTS OF STANDARD CHARACTERS WITHOUT CLAIM TO ANY PARTICULAR FONT, STYLE, SIZE, OR COLOR.

NO CLAIM IS MADE TO THE EXCLUSIVE RIGHT TO USE "MARKET VALUE PRICING", APART FROM THE MARK AS SHOWN.

SER. NO. 77-191,883, FILED 5-29-2007.

TAMARA FRAZIER, EXAMINING ATTORNEY

Int. Cls.: 35 and 42

Prior U.S. Cls.: 100, 101 and 102

United States Patent and Trademark Office

Reg. No. 3,478,964

Registered Aug. 5, 2008

**SERVICE MARK
PRINCIPAL REGISTER**

Avenir Associates, Inc.

AVENIR ASSOCIATES INC (NEW JERSEY CORPORATION)
#200
200 CENTENNIAL AVE
PISCATAWAY, NJ 08854

FOR: COMPUTER TECHNICIAN STAFFING SERVICES NOT IN THE FIELD OF TYPE FONTS AND TYPEFACES, IN CLASS 35 (U.S. CLS. 100, 101 AND 102).

FIRST USE 11-25-2005; IN COMMERCE 11-25-2005.

FOR: COMPUTER SOFTWARE DEVELOPMENT AND COMPUTER SOFTWARE CONSULTATION NOT IN THE FIELD OF TYPE FONTS AND TYPEFACES, IN CLASS 42 (U.S. CLS. 100 AND 101).

FIRST USE 11-25-2005; IN COMMERCE 11-25-2005.

THE MARK CONSISTS OF STANDARD CHARACTERS WITHOUT CLAIM TO ANY PARTICULAR FONT, STYLE, SIZE, OR COLOR.

NO CLAIM IS MADE TO THE EXCLUSIVE RIGHT TO USE "ASSOCIATES, INC.", APART FROM THE MARK AS SHOWN.

THE ENGLISH TRANSLATION OF THE WORD "AVENIR" IN THE MARK IS FUTURE.

SER. NO. 77-191,892, FILED 5-29-2007.

SAMUEL E. SHARPER JR., EXAMINING ATTORNEY

Int. Cl.: 2

Prior U.S. Cls.: 6, 11 and 16

United States Patent and Trademark Office

Reg. No. 3,478,965

Registered Aug. 5, 2008

**TRADEMARK
PRINCIPAL REGISTER**

AQUABAR

SUN CHEMICAL CORPORATION (DELAWARE
CORPORATION)
LEGAL DEPT. - TRADEMARKS
35 WATERVIEW BLVD.
PARSIPPANY, NJ 07054

FOR: COATING FOR PAPER, PAPERBOARD
AND FLEXIBLE PACKAGING FILMS WHICH IM-
PARTS MOISTURE RESISTANCE, ALL FOR USE IN
THE CARTON OR PACKAGING INDUSTRY , IN
CLASS 2 (U.S. CLS. 6, 11 AND 16).

FIRST USE 9-12-1984; IN COMMERCE 1-1-1985.

THE MARK CONSISTS OF STANDARD CHAR-
ACTERS WITHOUT CLAIM TO ANY PARTICULAR
FONT, STYLE, SIZE, OR COLOR.

SER. NO. 77-192,087, FILED 5-29-2007.

DAVID MURRAY, EXAMINING ATTORNEY

Int. Cls.: 35 and 36

Prior U.S. Cls.: 100, 101 and 102

United States Patent and Trademark Office

Reg. No. 3,478,966

Registered Aug. 5, 2008

SERVICE MARK
PRINCIPAL REGISTER



BALTIMORE COUNTY EMPLOYEES FEDERAL CREDIT UNION (UNITED STATES FEDERALLY CHARTERED CREDIT UNION)
23 W. SUSQUEHANNA AVENUE
TOWSON, MD 21204

FOR: ADMINISTRATION OF A DISCOUNT PROGRAM FOR ENABLING PARTICIPANTS TO OBTAIN DISCOUNTS ON GOODS AND SERVICES AT VARIOUS MERCHANTS INCLUDING MOVIE THEATERS AND THEME PARKS THROUGH MEMBER PURCHASES THROUGH BRANCH OFFICES, IN CLASS 35 (U.S. CLS. 100, 101 AND 102).

FIRST USE 2-1-2007; IN COMMERCE 2-1-2007.

FOR: CREDIT UNION SERVICES; BANKING SERVICES, NAMELY, PROVIDING DEPOSIT, CHECKING, SAVINGS, IRA, AND MONEY MARKET ACCOUNTS, SAVINGS PROGRAMS FOR YOUTHS, SAVINGS BONDS, SAVINGS ACCOUNTS FOR AUTO, HOLIDAY, PERSONAL, VACATION CLUBS AND HOME, TELEPHONIC AND INTERNET BANKING/ELECTRONIC SERVICES AND ATM SERVICES; LOAN SERVICES, NAMELY, CONSUMER, AUTOMOBILE, EDUCATION, COMPUTER, SHARE SECURED LOANS IN THE NATURE OF LOANS SECURED BY FUNDS ON DEPOSIT, MORTGAGE LOANS, HOME EQUITY, CREDIT

CARD SERVICES AND OVERDRAFT PROTECTION CREDIT LINES; MORTGAGE BANKING; CREDIT CARD AND DEBIT CARD SERVICES; INVESTMENT BANKING SERVICES; INSURANCE SERVICES, NAMELY, UNDERWRITING, ISSUING, ADMINISTRATION OF CREDIT LIFE AND CREDIT DISABILITY INSURANCE; FINANCIAL COUNSELING AND PLANNING, IN CLASS 36 (U.S. CLS. 100, 101 AND 102).

FIRST USE 2-1-2007; IN COMMERCE 2-1-2007.

NO CLAIM IS MADE TO THE EXCLUSIVE RIGHT TO USE "EMPLOYEES FEDERAL CREDIT UNION", APART FROM THE MARK AS SHOWN.

THE MARK CONSISTS OF THE WORDS YOUR FINANCES. OUR PROMISE. BALTIMORE COUNTY EMPLOYEES FEDERAL CREDIT UNION WITH AN ABSTRACT DESIGN BETWEEN COUNTY AND EMPLOYEES.

SEC. 2(F) AS OF "BALTIMORE COUNTY EMPLOYEES FEDERAL CREDIT UNION".

SER. NO. 77-192,219, FILED 5-29-2007.

JANET LEE, EXAMINING ATTORNEY

Int. Cl.: 16

Prior U.S. Cls.: 2, 5, 22, 23, 29, 37, 38 and 50

United States Patent and Trademark Office

Reg. No. 3,478,967

Registered Aug. 5, 2008

**TRADEMARK
PRINCIPAL REGISTER**

**BUSINESS OPPORTUNITIES
JOURNAL**

BUSINESS SERVICE CORPORATION (CALIFORNIA CORPORATION)
868 ROSECRANS
SAN DIEGO, CA 92106

FOR: NEWSPAPER PERIODICAL, IN CLASS 16
(U.S. CLS. 2, 5, 22, 23, 29, 37, 38 AND 50).

FIRST USE 9-15-1973; IN COMMERCE 9-15-1973.

THE MARK CONSISTS OF STANDARD CHARACTERS WITHOUT CLAIM TO ANY PARTICULAR FONT, STYLE, SIZE, OR COLOR.

OWNER OF U.S. REG. NO. 2,122,578.

NO CLAIM IS MADE TO THE EXCLUSIVE RIGHT TO USE "JOURNAL", APART FROM THE MARK AS SHOWN.

SEC. 2(F).

SER. NO. 77-192,362, FILED 5-29-2007.

TARAH HARDY, EXAMINING ATTORNEY

Int. Cls.: 16 and 41

Prior U.S. Cls.: 2, 5, 22, 23, 29, 37, 38, 50, 100, 101 and 107

Reg. No. 3,478,968

United States Patent and Trademark Office

Registered Aug. 5, 2008

**TRADEMARK
SERVICE MARK
PRINCIPAL REGISTER**

WINNING AT WORK

AMERICAN DIABETES ASSOCIATION, INC.
(OHIO CORPORATION)
1701 N. BEAUREGARD STREET
ALEXANDRIA, VA 22311

FOR: KITS CONTAINING PRINTED BROCHURES, FLASH CARDS AND POSTERS FOR DETECTING AND MANAGING DIABETES , IN CLASS 16 (U.S. CLS. 2, 5, 22, 23, 29, 37, 38 AND 50).

FIRST USE 7-1-2006; IN COMMERCE 7-1-2006.

FOR: EDUCATIONAL PROGRAMS FOR PREVENTING AND MANAGING DIABETES AND DISTRIBUTING PROGRAM MATERIALS THEREWITH

IN THE FORM OF A KIT CONTAINING PRINTED BROCHURES FOR DETECTING, PREVENTING AND MANAGING DIABETES, IN CLASS 41 (U.S. CLS. 100, 101 AND 107).

FIRST USE 7-1-2006; IN COMMERCE 7-1-2006.

THE MARK CONSISTS OF STANDARD CHARACTERS WITHOUT CLAIM TO ANY PARTICULAR FONT, STYLE, SIZE, OR COLOR.

SER. NO. 77-192,745, FILED 5-30-2007.

CAROLINE WOOD, EXAMINING ATTORNEY

Int. Cl.: 36

Prior U.S. Cls.: 100, 101 and 102

United States Patent and Trademark Office

Reg. No. 3,478,969

Registered Aug. 5, 2008

**SERVICE MARK
PRINCIPAL REGISTER**

www.mckinley.com
LIVE.WORK.SHOP.PLAY.

MCKINLEY, INC. (MICHIGAN CORPORATION)
SUITE 200
320 MAIN STREET
ANN ARBOR, MI 48104

FOR: REAL ESTATE MANAGEMENT; PROVIDING REAL ESTATE LISTINGS AND REAL ESTATE INFORMATION VIA THE INTERNET; LEASING OF REAL ESTATE; REAL ESTATE CONSULTATION; ASSESSMENT AND MANAGEMENT OF REAL ESTATE; REAL ESTATE BROKERAGE; REAL ESTATE ACQUISITION SERVICES; REAL ESTATE VALUATION SERVICES, IN CLASS 36 (U.S. CLS. 100, 101 AND 102).

FIRST USE 4-19-2006; IN COMMERCE 4-30-2006.

THE MARK CONSISTS OF THE PHRASE "WWW.MCKINLEY.COM" IN STYLIZED LETTERS ABOVE THE WORDS "LIVE. WORK. SHOP. PLAY." ALL IN UPPER CASE LETTERS WITH EACH WORD FOLLOWED BY A PERIOD..

SER. NO. 77-193,108, FILED 5-30-2007.

RONALD AIKENS, EXAMINING ATTORNEY

Int. Cls.: 35 and 42

Prior U.S. Cls.: 100, 101 and 102

United States Patent and Trademark Office

Reg. No. 3,478,970

Registered Aug. 5, 2008

**SERVICE MARK
PRINCIPAL REGISTER**

The logo for PointSource features the word "Point" in a black, sans-serif font, followed by "Source" in a blue, sans-serif font. The letter "i" in "Point" is stylized as a human figure with arms raised, colored blue to match the "Source" text.

POINTSOURCE, LLC (FLORIDA LTD LIAB CO)
5033 47TH STREET WEST
BRADENTON, FL 342102975

FIRST USE 5-31-2004; IN COMMERCE 5-31-2004.

FOR: CONSULTANCY SERVICES IN THE FIELD OF BUSINESS MANAGEMENT; INFORMATION TECHNOLOGY OUTSOURCING SERVICES FOR OTHERS; BUSINESS PROCESSING OUTSOURCING SERVICES FOR OTHERS, IN CLASS 35 (U.S. CLS. 100, 101 AND 102).

THE COLOR(S) BLUE AND BLACK IS/ARE CLAIMED AS A FEATURE OF THE MARK.

FIRST USE 5-31-2004; IN COMMERCE 5-31-2004.

FOR: CONSULTANCY SERVICES IN THE FIELD OF INFORMATION TECHNOLOGY; INFORMATION TECHNOLOGY MANAGEMENT SERVICES; INFORMATION TECHNOLOGY SYSTEMS INTEGRATION SERVICES, IN CLASS 42 (U.S. CLS. 100 AND 101).

THE MARK CONSISTS OF THE WORD "POINT-SOURCE" IN STYLIZED FONT WHEREIN THE LETTERS "I", "S", "O", "U", "R", "C" AND "E" ARE BLUE IN COLOR AND ALL OF THE REMAINING LETTERS ARE BLACK. THE LETTER "I" IS FORMED BY A HUMAN FIGURE.

SER. NO. 77-193,198, FILED 5-30-2007.

ANGELA M. MICHELI, EXAMINING ATTORNEY

Int. Cl.: 9

Prior U.S. Cls.: 21, 23, 26, 36 and 38

Reg. No. 3,478,971

United States Patent and Trademark Office

Registered Aug. 5, 2008

**TRADEMARK
PRINCIPAL REGISTER**

ZEROBURN

IP MINING CORPORATION (CALIFORNIA CORPORATION)
3901 WESTERLY PLACE, SUITE 110
NEWPORT BEACH, CA 92660

THE MARK CONSISTS OF STANDARD CHARACTERS WITHOUT CLAIM TO ANY PARTICULAR FONT, STYLE, SIZE, OR COLOR.

FOR: COMPUTER HARDWARE AND SOFTWARE FOR REDUCING IMAGE RETENTION ON ELECTRONIC DISPLAYS, IN CLASS 9 (U.S. CLS. 21, 23, 26, 36 AND 38).

SER. NO. 77-193,702, FILED 5-30-2007.

FIRST USE 2-11-2004; IN COMMERCE 3-15-2005.

NAAKWAMA ANKRAH, EXAMINING ATTORNEY

Int. Cls.: 29 and 30

Prior U.S. Cl.: 46

United States Patent and Trademark Office

Reg. No. 3,478,972

Registered Aug. 5, 2008

**TRADEMARK
PRINCIPAL REGISTER**

Strawberries-by-the-Sea

CARLSBAD GOURMET (CALIFORNIA CORPORATION)
3640 WOODLAND WAY
CARLSBAD, CA 92008

FOR: FRUIT SPREADS, FRUIT-BASED SPREADS, FRUIT AND NUT-BASED SPREADS, NAMELY, NUT BUTTERS WITH FRUIT; JAMS, JELLIES, FRUIT PRESERVES, MARMALADES, PEANUT BUTTER, MIXTURES OF PEANUT BUTTER AND JELLIES, MIXTURES OF PEANUT BUTTER AND HONEY, IN CLASS 29 (U.S. CL. 46).

FIRST USE 3-12-2004; IN COMMERCE 3-12-2004.

FOR: FRUIT BASED SYRUP, NAMELY, PANCAKE SYRUP; SEASONINGS; HOT SAUCES, BAR-

BEQUE SAUCES, SALSA, FRUIT-BASED SALSAS, SPICY SEASONING MIXES FOR MEAT; CONFECTIONARY, NAMELY, CANDY; SALAD DRESSINGS, VINEGARS, MUSTARDS, IN CLASS 30 (U.S. CL. 46).

FIRST USE 3-12-2004; IN COMMERCE 3-12-2004.

THE MARK CONSISTS OF STANDARD CHARACTERS WITHOUT CLAIM TO ANY PARTICULAR FONT, STYLE, SIZE, OR COLOR.

SER. NO. 77-193,770, FILED 5-30-2007.

KRISTIN DAHLING, EXAMINING ATTORNEY

Int. Cls.: 35, 36 and 44

Prior U.S. Cls.: 100, 101 and 102

United States Patent and Trademark Office

Reg. No. 3,478,973

Registered Aug. 5, 2008

**SERVICE MARK
PRINCIPAL REGISTER**

BROOKDALE SENIOR LIVING

BROOKDALE SENIOR LIVING INC. (DELA-
WARE CORPORATION)
SUITE 1400
330 NORTH WABASH AVENUE
CHICAGO, IL 60611

FOR: BUSINESS MANAGEMENT AND ADMIN-
ISTRATION FOR OTHERS OF SENIOR RESIDEN-
TIAL RETIREMENT, INDEPENDENT LIVING,
ASSISTED LIVING, SKILLED NURSING, NURSING
HOME AND LONG TERM CARE FACILITIES, IN
CLASS 35 (U.S. CLS. 100, 101 AND 102).

FIRST USE 5-7-1997; IN COMMERCE 6-1-1998.

FOR: LEASING, RENTAL AND MANAGEMENT
OF REAL ESTATE IN THE NATURE OF SENIOR
RESIDENTIAL RETIREMENT, INDEPENDENT
LIVING, ASSISTED LIVING, SKILLED NURSING,
NURSING HOME AND LONG TERM CARE FACIL-
ITIES, IN CLASS 36 (U.S. CLS. 100, 101 AND 102).

FIRST USE 5-7-1997; IN COMMERCE 6-1-1998.

FOR: PROVIDING SKILLED NURSING, NUR-
SING HOME AND LONG TERM CARE FACILITIES
, IN CLASS 44 (U.S. CLS. 100 AND 101).

FIRST USE 5-7-1997; IN COMMERCE 6-1-1998.

THE MARK CONSISTS OF STANDARD CHAR-
ACTERS WITHOUT CLAIM TO ANY PARTICULAR
FONT, STYLE, SIZE, OR COLOR.

NO CLAIM IS MADE TO THE EXCLUSIVE
RIGHT TO USE "SENIOR LIVING", APART FROM
THE MARK AS SHOWN.

SER. NO. 77-194,038, FILED 5-31-2007.

STEVEN R. FINE, EXAMINING ATTORNEY

Int. Cls.: 8, 16 and 21

**Prior U.S. Cls.: 2, 5, 13, 22, 23, 28, 29, 30, 33, 37, 38,
40, 44 and 50**

Reg. No. 3,478,974

United States Patent and Trademark Office

Registered Aug. 5, 2008

**TRADEMARK
PRINCIPAL REGISTER**

CAPTIVA

MAT-PAC, INC. (NEW JERSEY CORPORATION)
404 CANDLEWOOD COMMONS
HOWELL, NJ 07731

FOR: PLASTIC CUTLERY, NAMELY, PLASTIC
FORKS, SPOONS, AND KNIVES, IN CLASS 8 (U.S.
CLS. 23, 28 AND 44).

FIRST USE 1-1-2007; IN COMMERCE 1-1-2007.

FOR: DISPOSABLE PAPER GOODS, NAMELY,
TOILET TISSUE, NAPKINS, AND PAPER TOWELS,
IN CLASS 16 (U.S. CLS. 2, 5, 22, 23, 29, 37, 38 AND 50).

FIRST USE 8-1-2005; IN COMMERCE 8-1-2005.

FOR: DISPOSABLE PLASTIC GOODS, NAMELY,
PLASTIC CUPS, PLASTIC PLATES, AND PLASTIC
GLOVES FOR GENERAL USE, IN CLASS 21 (U.S.
CLS. 2, 13, 23, 29, 30, 33, 40 AND 50).

FIRST USE 8-1-2005; IN COMMERCE 8-1-2005.

THE MARK CONSISTS OF STANDARD CHAR-
ACTERS WITHOUT CLAIM TO ANY PARTICULAR
FONT, STYLE, SIZE, OR COLOR.

SER. NO. 77-194,473, FILED 5-31-2007.

BERYL GARDNER, EXAMINING ATTORNEY

Int. Cl.: 4

Prior U.S. Cls.: 1, 6 and 15

United States Patent and Trademark Office

Reg. No. 3,478,975

Registered Aug. 5, 2008

**TRADEMARK
PRINCIPAL REGISTER**

FLEET SUPREME EC

CONOCOPHILLIPS COMPANY (DELAWARE
CORPORATION)
ML 1106
600 NORTH DAIRY ASHFORD
HOUSTON, TX 770791175

FOR: INDUSTRIAL OILS AND GREASES, NAME-
LY, LUBRICANTS FOR LAND VEHICLES, MOTOR
OIL AND ENGINE OIL, IN CLASS 4 (U.S. CLS. 1, 6
AND 15).

FIRST USE 8-23-2006; IN COMMERCE 10-31-2006.

THE MARK CONSISTS OF STANDARD CHAR-
ACTERS WITHOUT CLAIM TO ANY PARTICULAR
FONT, STYLE, SIZE, OR COLOR.

NO CLAIM IS MADE TO THE EXCLUSIVE
RIGHT TO USE "SUPREME", APART FROM THE
MARK AS SHOWN.

SER. NO. 77-194,634, FILED 5-31-2007.

MARY CRAWFORD, EXAMINING ATTORNEY

Int. Cl.: 35

Prior U.S. Cls.: 100, 101 and 102

United States Patent and Trademark Office

Reg. No. 3,478,976

Registered Aug. 5, 2008

**SERVICE MARK
PRINCIPAL REGISTER**

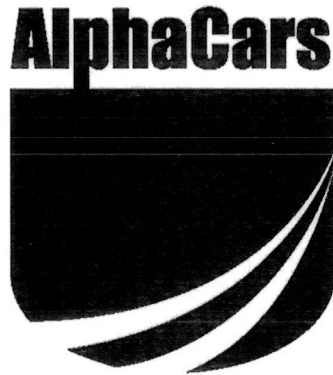

ALPHA TRADING, SERVICES, INC. (MASSACHUSETTS CORPORATION)
649 MASSACHUSETTS AVENUE
BOXBOROUGH, MA 01719

FOR: AUTOMOBILE DISTRIBUTORSHIP SERVICES FEATURING FOREIGN, DOMESTIC, AND USED CARS, IN CLASS 35 (U.S. CLS. 100, 101 AND 102).

FIRST USE 11-1-2003; IN COMMERCE 11-1-2003.

THE MARK CONSISTS OF THE WORD "ALPHACARS" OVER A DARKENED SQUARE ROUNDED AT THE BOTTOM WITH TWO CURVED DIAGONAL LINES.

SER. NO. 77-194,662, FILED 5-31-2007.

JOHN E. MICHOS, EXAMINING ATTORNEY

Int. Cl.: 35

Prior U.S. Cls.: 100, 101 and 102

United States Patent and Trademark Office

Reg. No. 3,478,977

Registered Aug. 5, 2008

**SERVICE MARK
PRINCIPAL REGISTER**

ALPHACARS

ALPHA TRADING, SERVICES, INC. (MASSACHUSETTS CORPORATION)
649 MASSACHUSETTS AVENUE
BOXBOROUGH, MA 01719

THE MARK CONSISTS OF STANDARD CHARACTERS WITHOUT CLAIM TO ANY PARTICULAR FONT, STYLE, SIZE, OR COLOR.

FOR: AUTOMOBILE DISTRIBUTORSHIP SERVICES FEATURING FOREIGN, DOMESTIC, AND USED CARS, IN CLASS 35 (U.S. CLS. 100, 101 AND 102).

SER. NO. 77-194,680, FILED 5-31-2007.

FIRST USE 11-1-2001; IN COMMERCE 11-1-2001.

JOHN E. MICHOS, EXAMINING ATTORNEY

Int. Cl.: 42

Prior U.S. Cls.: 100 and 101

United States Patent and Trademark Office

Reg. No. 3,478,978

Registered Aug. 5, 2008

**SERVICE MARK
PRINCIPAL REGISTER**

RELOCALIZATION NETWORK

METAFOUNDATION DBA POST CARBON INSTITUTE (OREGON NON-PROFIT CORPORATION)
327 MURPHY AVENUE
SEBASTOPOL, CA 95472

FOR: PROVIDING CONSULTATION, RESEARCH, DEMONSTRATIONS AND INFORMATION IN THE FIELDS OF ENERGY, SECURITY AND MAINTENANCE OF CARRYING CAPACITY, IN CLASS 42 (U.S. CLS. 100 AND 101).

FIRST USE 9-0-2002; IN COMMERCE 9-0-2002.

THE MARK CONSISTS OF STANDARD CHARACTERS WITHOUT CLAIM TO ANY PARTICULAR FONT, STYLE, SIZE, OR COLOR.

NO CLAIM IS MADE TO THE EXCLUSIVE RIGHT TO USE "NETWORK", APART FROM THE MARK AS SHOWN.

SER. NO. 77-194,695, FILED 5-31-2007.

WILLIAM P. SHANAHAN, EXAMINING ATTORNEY

Int. Cl.: 4

Prior U.S. Cls.: 1, 6 and 15

United States Patent and Trademark Office

Reg. No. 3,478,979

Registered Aug. 5, 2008

**TRADEMARK
PRINCIPAL REGISTER**

SUPER-D XA

CONOCOPHILLIPS COMPANY (DELAWARE
CORPORATION)

ML 1106

600 NORTH DAIRY ASHFORD

HOUSTON, TX 770791175

FOR: ALL PURPOSE LUBRICANTS; AUTOMO-
TIVE LUBRICANTS, MOTOR OIL, ENGINE OIL, IN
CLASS 4 (U.S. CLS. 1, 6 AND 15).

FIRST USE 8-23-2006; IN COMMERCE 11-30-2006.

THE MARK CONSISTS OF STANDARD CHAR-
ACTERS WITHOUT CLAIM TO ANY PARTICULAR
FONT, STYLE, SIZE, OR COLOR.

OWNER OF U.S. REG. NO. 1,603,340.

NO CLAIM IS MADE TO THE EXCLUSIVE
RIGHT TO USE "XA", APART FROM THE MARK
AS SHOWN.

SER. NO. 77-194,737, FILED 5-31-2007.

MARY CRAWFORD, EXAMINING ATTORNEY

Int. Cl.: 35

Prior U.S. Cls.: 100, 101 and 102

United States Patent and Trademark Office

Reg. No. 3,478,980

Registered Aug. 5, 2008

**SERVICE MARK
PRINCIPAL REGISTER**



EXPECT TO BE IMPRESSED!

ALPHA TRADING, SERVICES, INC. (MASSACHUSETTS CORPORATION)
649 MASSACHUSETTS AVENUE
BOXBOROUGH, MA 01719

FOR: AUTOMOBILE DISTRIBUTORSHIP SERVICES FEATURING FOREIGN, DOMESTIC, AND USED CARS, IN CLASS 35 (U.S. CLS. 100, 101 AND 102).

FIRST USE 11-1-2003; IN COMMERCE 11-1-2003.

THE MARK CONSISTS OF THE WORD "ALPHACARS" OVER A BLACK SQUARE ROUNDED AT THE BOTTOM WITH TWO CURVED DIAGONAL LINES OVER THE WORDS "EXPECT TO BE IMPRESSED!".

SER. NO. 77-194,743, FILED 5-31-2007.

JOHN E. MICHOS, EXAMINING ATTORNEY

Int. Cl.: 11

Prior U.S. Cls.: 13, 21, 23, 31 and 34

United States Patent and Trademark Office

Reg. No. 3,478,981

Registered Aug. 5, 2008

**TRADEMARK
PRINCIPAL REGISTER**

QUICK-MOUNT

ABL IP HOLDING LLC (GEORGIA LTD LIAB
CO)
ONE LITHONIA WAY
CONYERS, GA 30012

FOR: ELECTRIC LIGHTING FIXTURES, IN
CLASS 11 (U.S. CLS. 13, 21, 23, 31 AND 34).

FIRST USE 12-1-1995; IN COMMERCE 12-1-1995.

THE MARK CONSISTS OF STANDARD CHAR-
ACTERS WITHOUT CLAIM TO ANY PARTICULAR
FONT, STYLE, SIZE, OR COLOR.

SEC. 2(F).

SER. NO. 77-195,517, FILED 6-1-2007.

AMOS T. MATTHEWS, JR., EXAMINING ATTOR-
NEY

Int. Cl.: 9

Prior U.S. Cls.: 21, 23, 26, 36 and 38

Reg. No. 3,478,982

United States Patent and Trademark Office

Registered Aug. 5, 2008

**TRADEMARK
PRINCIPAL REGISTER**

MESSAGE STUDIO

STRONGMAIL SYSTEMS, INC. (DELAWARE
CORPORATION)
SUITE 200
1300 ISLAND DRIVE
REDWOOD SHORES, CA 94065

FOR: AN EMAIL MANAGEMENT TOOL, NAME-
LY, COMPUTER HARDWARE AND COMPUTER
SOFTWARE FOR CREATING, SENDING AND
MONITORING EMAIL CAMPAIGNS , IN CLASS 9
(U.S. CLS. 21, 23, 26, 36 AND 38).

FIRST USE 3-29-2006; IN COMMERCE 3-29-2006.

THE MARK CONSISTS OF STANDARD CHAR-
ACTERS WITHOUT CLAIM TO ANY PARTICULAR
FONT, STYLE, SIZE, OR COLOR.

NO CLAIM IS MADE TO THE EXCLUSIVE
RIGHT TO USE "MESSAGE", APART FROM THE
MARK AS SHOWN.

SER. NO. 77-195,537, FILED 6-1-2007.

KATHERINE M. DUBRAY, EXAMINING ATTOR-
NEY

Int. Cls.: 37 and 42

Prior U.S. Cls.: 100, 101, 103 and 106

United States Patent and Trademark Office

Reg. No. 3,478,983

Registered Aug. 5, 2008

**SERVICE MARK
PRINCIPAL REGISTER**

STRONGSTART

STRONGMAIL SYSTEMS, INC. (DELAWARE CORPORATION)
SUITE 200
1300 ISLAND DRIVE
REDWOOD SHORES, CA 94065

FOR: INSTALLATION OF COMPUTER SYSTEMS, IN CLASS 37 (U.S. CLS. 100, 103 AND 106).

FIRST USE 4-0-2005; IN COMMERCE 4-0-2005.

FOR: TECHNICAL SUPPORT, NAMELY, TROUBLESHOOTING OF COMPUTER HARDWARE AND SOFTWARE PROBLEMS; COMPUTER SYSTEMS CONFIGURATION, IN CLASS 42 (U.S. CLS. 100 AND 101).

FIRST USE 4-0-2005; IN COMMERCE 4-0-2005.

THE MARK CONSISTS OF STANDARD CHARACTERS WITHOUT CLAIM TO ANY PARTICULAR FONT, STYLE, SIZE, OR COLOR.

THE WORDING "STRONGSTART" HAS NO MEANING IN A FOREIGN LANGUAGE.

SER. NO. 77-195,544, FILED 6-1-2007.

SIMON TENG, EXAMINING ATTORNEY

Int. Cl.: 43

Prior U.S. Cls.: 100 and 101

United States Patent and Trademark Office

Reg. No. 3,478,984

Registered Aug. 5, 2008

SERVICE MARK
PRINCIPAL REGISTER

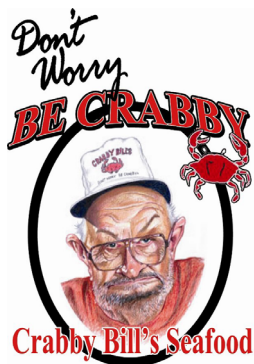

CRABBY BILL'S U.S.A., LLC (FLORIDA LTD
LIAB CO)
404 1ST STREET N., SUITE 5
INDIAN ROCKS BEACH, FL 33785

FOR: RESTAURANT SERVICES; RESTAURANTS;
CATERING, IN CLASS 43 (U.S. CLS. 100 AND 101).

FIRST USE 1-1-2003; IN COMMERCE 1-1-2003.

OWNER OF U.S. REG. NOS. 1,664,569 AND
2,571,669.

NO CLAIM IS MADE TO THE EXCLUSIVE
RIGHT TO USE "SEAFOOD", APART FROM THE
MARK AS SHOWN.

THE NAME(S), PORTRAIT(S), AND/OR SIGNA-
TURE(S) SHOWN IN THE MARK IDENTIFIES
GEORGE LODER, WHOSE CONSENT(S) TO REGIS-
TER IS SUBMITTED.

THE COLOR(S) BLACK, WHITE, RED AND
BEIGE IS/ARE CLAIMED AS A FEATURE OF THE
MARK.

THE MARK CONSISTS OF THE STYLIZED
PHRASE "DON'T WORRY" IN BLACK, "BE CRAB-
BY" WITH A CRAB UNDERNEATH IT IN RED AND
OUTLINED IN WHITE AND BLACK, AN OVAL
OUTLINED IN BLACK WITH A HEADSHOT OF A
MAN INSIDE THE OVAL WITH A BEIGE FACE
AND WEARING A WHITE HAT WITH THE PHRASE
"CRABBY BILL'S" IN RED AND OUTLINED IN
BLACK AND A RED CRAB OUTLINED IN BLACK,
BLACK GLASSES AND A RED SHIRT, AND THE
STYLIZED PHRASE "CRABBY BILL'S SEAFOOD"
IN RED UNDERNEATH.

SER. NO. 77-195,548, FILED 6-1-2007.

LESLEY LAMOTHE, EXAMINING ATTORNEY

Int. Cl.: 30

Prior U.S. Cl.: 46

United States Patent and Trademark Office

Reg. No. 3,478,985

Registered Aug. 5, 2008

**TRADEMARK
PRINCIPAL REGISTER**

FLAXMAX

YZ ENTERPRISES, INC. (OHIO CORPORATION)
1930 INDIAN WOOD CIRCLE
MAUMEE, OH 43537

THE MARK CONSISTS OF STANDARD CHAR-
ACTERS WITHOUT CLAIM TO ANY PARTICULAR
FONT, STYLE, SIZE, OR COLOR.

FOR: COOKIES, IN CLASS 30 (U.S. CL. 46).

SER. NO. 77-195,597, FILED 6-1-2007.

FIRST USE 9-7-2007; IN COMMERCE 9-7-2007.

BARBARA A. GOLD, EXAMINING ATTORNEY

Int. Cl.: 35

Prior U.S. Cls.: 100, 101 and 102

United States Patent and Trademark Office

Reg. No. 3,478,986

Registered Aug. 5, 2008

**SERVICE MARK
PRINCIPAL REGISTER**



DIRECT METALS CO., LLC (GEORGIA LTD
LIAB CO)
NO. 201
1200 CHASTAIN RD.
KENNESAW, GA 30144

FOR: ON-LINE RETAILING AND RETAIL STORE
SERVICES, CATALOG MAIL ORDER SERVICES
AND TELEPHONE ORDER SERVICES, ALL IN
THE FIELD OF FERROUS AND NON-FERROUS
METAL AND FIBERGLASS REINFORCED PLAS-
TIC PRODUCTS, IN CLASS 35 (U.S. CLS. 100, 101
AND 102).

FIRST USE 6-1-1996; IN COMMERCE 6-1-1996.

OWNER OF U.S. REG. NO. 2,077,738.

NO CLAIM IS MADE TO THE EXCLUSIVE
RIGHT TO USE "METALS", APART FROM THE
MARK AS SHOWN.

THE MARK CONSISTS OF THE LETTERS "D"
AND "M" WITH AN ARROW PASSING THROUGH
THE "D" WITH "DIRECT METALS" CONTAINED
IN THE SHAFT OF THE ARROW.

SER. NO. 77-195,876, FILED 6-1-2007.

JULIE WATSON, EXAMINING ATTORNEY

Int. Cl.: 16

Prior U.S. Cls.: 2, 5, 22, 23, 29, 37, 38 and 50

Reg. No. 3,478,987

United States Patent and Trademark Office

Registered Aug. 5, 2008

**TRADEMARK
PRINCIPAL REGISTER**



LG VERWALTUNGS, GMBH (FED REP GERMA-
NY LTD LIAB CO)
KRONPRINZENSTRASSE 53-57
DORTMUND, FED REP GERMANY 44135

FOR: PAPER GOODS, NAMELY, TRANSPARENT, OPAQUE AND TRANSLUCENT FILMS FOR USE WITH INK JET COPIES AND LASER PRINTERS; ADVERTISING BOARDS OF PAPER OR CARDBOARD; ADVERTISING SIGNS OF PAPER OR CARDBOARD; ALUMINUM FOIL LAMINATED PAPER FOR PRINTING PURPOSES; ART PAPER; BABIES' DIAPERS OF PAPER; BOOK-COVER PAPER; COMPUTER PAPER; CONSTRUCTION PAPER; COPY PAPER; DIGITAL PRINTING PAPER; DIRECTORY PAPER; DRAWING PAPER; ENVELOPE PAPER; FACSIMILE TRANSMISSION PAPER; LASER PRINT PAPER; TYPEWRITER PAPER; LETTER PAPER BEING FINISHED PRODUCTS; OFFSET PAPER; PAPER FOR PHOTOCOPIERS; PAPER FOR RECORDING MACHINES; PAPER FOR USE IN THE GRAPHIC ARTS INDUSTRY; PUBLICATION PAPER; REEL PAPER FOR PRINTERS; SEMI-PROCESSED PAPER; SYNTHETIC PAPER; PAPER BOXES; PAPER BAGS; AND PAPER FOR WRAPPING AND PACKAGING; CARDBOARD GOODS, NAMELY, ADVERTISING BOARDS; BOXES, CARTONS, AND CONTAINERS; BACKING FOR BINDING BOOKS; CARRIERS FOR FOODS AND BEVERAGES; FLOOR DISPLAYS FOR MERCHANDISING PRODUCTS; HANG TAGS; MAILING TUBES; PACKAGING; CONTAINERS FOR ICE; LINERBOARD; PICTURE MOUNTS; AND PLA-

CARDS; BOOKBINDING MATERIAL, NAMELY, BOOKBINDINGS; BOOKBINDING TAPE; BOOKBINDING WIRE; AND CLOTH FOR BOOKBINDING; PHOTOGRAPHS; STATIONERY; ADHESIVES FOR STATIONERY FOR HOUSEHOLD PURPOSES; ARTISTS' MATERIALS, NAMELY, BRUSHES; PASTELS; PENCILS; PENS; CANVAS; AND MOLDS FOR MODELING CLAY; ELECTRONIC TYPEWRITERS; TYPEWRITER RIBBONS; PRINTBALLS AND TYPEBALLS; PRINTED INSTRUCTIONAL AND TEACHING MATERIAL IN THE FIELDS OF TELECOMMUNICATIONS AND EDUCATION; OFFICE REQUISITES, NAMELY, STAPLERS; RUBBER BANDS; ENVELOPE SEALING MACHINES; ADHESIVE TAPE DISPENSERS; ADHESIVE APPLYING MACHINES FOR HOME AND OFFICE USE; AUTOMATIC ADHESIVE DISPENSERS FOR OFFICE USE; AUTOMATIC PAPER CLIP DISPENSING MACHINES FOR OFFICE OR STATIONERY USE; BINDERS; CD SHREDDERS; COLLATORS; CORRECTING FLUID FOR TYPE; DOCUMENT BINDING MACHINES FOR OFFICE USE; DOCUMENT LAMINATORS FOR OFFICE USE; ELECTRIC STAPLERS FOR OFFICES; FINGER STALLS; FRANKING MACHINES; GLUE; IMPRINTERS; INK ROLLERS FOR OFFICE MACHINES; LAMINATING MACHINES FOR HOME AND OFFICE USE; LETTER INSERTER MACHINES FOR OFFICE USE; OFFICE CHECK WRITING AND ENGRAVING MACHINES; DECOLLATING MACHINES; HOLE PUNCHERS; LABELING MACHINES; LETTERING MACHINES; OFFICE MACHINE RIBBONS; PAPER

DRILL MACHINES; TYPE COMPOSING MACHINES; EMBOSSERS; PAPER FOLDING MACHINES; PAPER SHREDDERS; PAPER FEEDING MACHINES; PROTRACTORS; PUNCHES; RUBBER BANDS; SEALS; AND SPIRAL BINDING MACHINES; PLASTIC MATERIALS FOR PACKAGING, NAMELY, PLASTIC BAGS AND PLASTIC BUBBLE PACKS; OTHER PACKAGING MATERIAL, NAMELY, ABSORBENT PADS OF PAPER AND CELLULOSE FOR USE IN FOOD PACKAGING; INDUSTRIAL PACKAGING CONTAINERS OF PAPER; PACKAGING AND CONTAINERS COMPRISED OF STARCH-BASED MATERIALS IN THE NATURE OF A PAPER SUBSTITUTE FOR FOOD, BEVERAGES AND CONSUMER PRODUCTS; PAPER CONTAINERS FOR FOOD AND BEVERAGES COMPRISED OF MATERIALS DESIGNED TO LESSEN ADVERSE EFFECTS ON THE ENVIRONMENT; PAPER POUCHES FOR PACKAGING; PAPER ENVELOPES; AND VEGETABLE PARCHMENT FOR USE IN FOOD WRAPPING, PREPARATION, PRO-

CESSING AND PACKAGING, IN CLASS 16 (U.S. CLS. 2, 5, 22, 23, 29, 37, 38 AND 50).

OWNER OF FED REP GERMANY REG. NO. 30674165, DATED 12-12-2006, EXPIRES 12-31-2016.

THE COLOR(S) DARK PURPLE, LIGHT PURPLE, DARK GREY, LIGHT GREY, AND WHITE IS/ARE CLAIMED AS A FEATURE OF THE MARK.

THE MARK CONSISTS OF THE COLOR DARK PURPLE OUTLINED WITH LIGHT PURPLE AND DARK GREY APPEARS IN THE INTERIOR "E" SHAPED DESIGN; THE COLOR LIGHT GRAY OUTLINED WITH DARK GREY AND WHITE APPEARS IN THE EXTERIOR CIRCULAR DESIGN.

SER. NO. 77-195,922, FILED 6-1-2007.

ELLEN PERKINS, EXAMINING ATTORNEY

Int. Cl.: 19

Prior U.S. Cls.: 1, 12, 33 and 50

United States Patent and Trademark Office

Reg. No. 3,478,988

Registered Aug. 5, 2008

**TRADEMARK
PRINCIPAL REGISTER**



LG VERWALTUNGS, GMBH (FED REP GERMA-
NY LTD LIAB CO)
KRONPRINZENSTRASSE 53-57
DORTMUND, FED REP GERMANY 44135

FOR: NON-METAL BUILDING MATERIALS, NAMELY, ADHESIVE MORTAR; ASPHALT; ASPHALT FELT; ASPHALT BASED MASTICS FOR FOUNDATIONS OF BUILDINGS; PLASTIC WEB-BING MATERIAL USED TO REINFORCE BITUMINOUS WATERPROOFING SHEETS; SEMI-WORKED WOODS; HARDWOOD BOARDS; DECKING; WOOD AND PARTICLE BOARDS; PLASTIC PIPE SUPPORTS; CELLULAR PVC TRIM; FLY ASH; BUILDING STONE; COLORED SHEET GLASS; COMMON SHEET GLASS; CONCRETE BLOCKS; BRICKS; POSTS; CONCRETE SLABS AND PANELS; CONCRETE WALLS; GLASS BLOCKS; GLASS PANELS; GLASS POWDER; LAMINATED FLAT GLASS; LOGS; MARBLE; MINERAL PELLETS; MODIFIED SHEET GLASS; NONMETAL CABLE TRAYS; FLASHING; FASCIA; SOFFITS; SHUTTERS; SHINGLES; SIDING; TRIM; CLADDING; DECORATIVE MOLDINGS AND DECORATIVE TRIM; NON-METALLIC MINERALS; NON-METALLIC REINFORCING MATERIALS; NON-METALLIC RIGID PIPES FOR BUILDING; ASPHALT, PITCH AND BITUMEN ASPHALT; BITUMEN SEALANT FOR ROOFING AND DRIVEWAYS; NON-METALLIC

TRANSPORTABLE BUILDINGS; NON-METAL MONUMENTS OF STONE, MARBLE, CONCRETE; SCAFFOLDING, NOT OF METAL; TILES AND PAVING TILES, PAVING STONES, PAVING BLOCKS, NOT OF METAL; ARTIFICIAL STONES; COATINGS, NAMELY, ASPHALT BASED COATINGS AND SEALANTS FOR USE ON ROOFS, WALLS, AND PAVEMENTS, IN CLASS 19 (U.S. CLS. 1, 12, 33 AND 50).

OWNER OF FED REP GERMANY REG. NO. 30674165, DATED 12-12-2006, EXPIRES 12-31-2016.

THE COLOR(S) DARK PURPLE, LIGHT PURPLE, DARK GREY, LIGHT GREY, AND WHITE IS/ARE CLAIMED AS A FEATURE OF THE MARK.

THE MARK CONSISTS OF THE COLOR DARK PURPLE OUTLINED WITH LIGHT PURPLE AND DARK GREY APPEARS IN THE INTERIOR "E" SHAPED DESIGN; THE COLOR LIGHT GRAY OUTLINED WITH DARK GREY AND WHITE APPEARS IN THE EXTERIOR CIRCULAR DESIGN.

SER. NO. 77-195,935, FILED 6-1-2007.

ELLEN PERKINS, EXAMINING ATTORNEY

Int. Cl.: 9

Prior U.S. Cls.: 21, 23, 26, 36 and 38

United States Patent and Trademark Office

Reg. No. 3,478,989

Registered Aug. 5, 2008

**TRADEMARK
PRINCIPAL REGISTER**

AUTOVUE

CIMMETRY SYSTEMS CORP. (CANADA CORPORATION)
400 STE. CROIX AVENUE, SUITE 200 EAST
MONTREAL, QUEBEC, CANADA H4N3L4

FOR: COMPUTER SOFTWARE FOR USE IN DOCUMENT FORMAT SUPPORT, NAMELY, DOCUMENT DISPLAY, DOCUMENT PRINTING, FILE ACCESS, NETWORK FILE ACCESS, LINKING FILES, DOCUMENT MARKUP, ALL IN MULTIPLE FILE FORMATS, CONSOLIDATION OF FILES, VIEWING, DOWNLOADING AND PRINTING FILES FROM A GLOBAL COMPUTER NETWORK, AND VIEWING, COPYING AND PRINTING E-MAIL

ATTACHMENTS TO DOCUMENTS, IN CLASS 9 (U.S. CLS. 21, 23, 26, 36 AND 38).

FIRST USE 4-19-1989; IN COMMERCE 6-1-1989.

THE MARK CONSISTS OF STANDARD CHARACTERS WITHOUT CLAIM TO ANY PARTICULAR FONT, STYLE, SIZE, OR COLOR.

SER. NO. 77-195,955, FILED 6-1-2007.

MICHAEL GAAFAR, EXAMINING ATTORNEY

Int. Cl.: 9

Prior U.S. Cls.: 21, 23, 26, 36 and 38

Reg. No. 3,478,990

United States Patent and Trademark Office

Registered Aug. 5, 2008

**TRADEMARK
PRINCIPAL REGISTER**

AUTOVUE PROFESSIONAL

CIMMETRY SYSTEMS CORP. (CANADA CORPORATION)
400 STE. CROIX AVENUE, SUITE 200 EAST
MONTREAL, QUEBEC, CANADA H4N3L4

FOR: COMPUTER SOFTWARE FOR USE IN DOCUMENT FORMAT SUPPORT, NAMELY, DOCUMENT DISPLAY, DOCUMENT PRINTING, FILE ACCESS, NETWORK FILE ACCESS, LINKING FILES, DOCUMENT MARKUP, ALL IN MULTIPLE FILE FORMATS, CONSOLIDATION OF FILES, VIEWING, DOWNLOADING AND PRINTING FILES FROM A GLOBAL COMPUTER NETWORK, AND VIEWING, COPYING AND PRINTING E-MAIL ATTACHMENTS TO DOCUMENTS, IN CLASS 9 (U.S. CLS. 21, 23, 26, 36 AND 38).

FIRST USE 8-0-1994; IN COMMERCE 8-0-1994.

THE MARK CONSISTS OF STANDARD CHARACTERS WITHOUT CLAIM TO ANY PARTICULAR FONT, STYLE, SIZE, OR COLOR.

NO CLAIM IS MADE TO THE EXCLUSIVE RIGHT TO USE "PROFESSIONAL" , APART FROM THE MARK AS SHOWN.

SER. NO. 77-195,965, FILED 6-1-2007.

MICHAEL GAAFAR, EXAMINING ATTORNEY

Int. Cl.: 35

Prior U.S. Cls.: 100, 101 and 102

United States Patent and Trademark Office

Reg. No. 3,478,991

Registered Aug. 5, 2008

**SERVICE MARK
PRINCIPAL REGISTER**

**TRIADVOCATES^{LLC}**
NAVIGATING GOVERNMENT

TRIADVOCATES LLC (DELAWARE LTD LIAB
CO)
ONE RENAISSANCE SQUARE, SUITE 300
TWO NORTH CENTRAL AVENUE
PHOENIX, AZ 85004

FOR: LOBBYING SERVICES, NAMELY, PROMOTING THE INTERESTS OF COMPANIES, NOT FOR PROFIT ORGANIZATIONS, TRADE ASSOCIATIONS, FOUNDATIONS, GOVERNMENTAL AGENCIES AND INDIVIDUALS IN THE FIELDS OF POLITICS, LEGISLATION AND REGULATIONS; GOVERNMENT AFFAIRS SERVICES, NAMELY, MONITORING AND PROVIDING INFORMATION REGARDING POLITICAL, LEGISLATIVE AND REGULATORY ISSUES AND DEVELOPMENTS; GOVERNMENT RELATIONSHIP MANAGEMENT, NAMELY, BUSINESS CONSULTING FOR ESTABLISHING AND MAINTAINING GOVERNMENT RELATIONSHIPS; GOVERNMENT RELATIONS CONSULTING SERVICES, NAMELY, POLITICAL, LEGISLATIVE AND REGULATORY FORECASTING, AND LOBBYING CONSULTING; PUBLIC AFFAIRS CONSULTING, NAMELY, PUBLIC POLICY RESEARCH AND ADVOCACY SERVICES; MONI-

TORING GOVERNMENT GRANTS AND INCENTIVES, IN CLASS 35 (U.S. CLS. 100, 101 AND 102).

FIRST USE 1-8-2007; IN COMMERCE 1-8-2007.

OWNER OF U.S. REG. NOS. 2,818,306 AND 2,853,363.

NO CLAIM IS MADE TO THE EXCLUSIVE RIGHT TO USE "LLC" AND "GOVERNMENT", APART FROM THE MARK AS SHOWN.

THE MARK CONSISTS OF THE WORD "TRIADVOCATES", WITH THE "A'S" REPRESENTED AS UPSIDE DOWN "V'S", AND WITH THE "V" FEATURING LINES EXTENDING FROM THE LEFT INSIDE OF THE "V" UP AND TO THE RIGHT, ALL OVER THE WORDS "NAVIGATING GOVERNMENT".

SER. NO. 77-196,047, FILED 6-1-2007.

ALEX KEAM, EXAMINING ATTORNEY

Int. Cl.: 41

Prior U.S. Cls.: 100, 101 and 107

United States Patent and Trademark Office

Reg. No. 3,478,992

Registered Aug. 5, 2008

**SERVICE MARK
PRINCIPAL REGISTER**

REWIRING

SEDLAR, JERI (UNITED STATES INDIVIDUAL),
DBA JS ENTERPRISES
1365 YORK AVE.
NEW YORK, NY 10021

FOR: EDUCATIONAL SERVICES, NAMELY,
CONDUCTING CLASSES, SEMINARS, WORK-
SHOPS, CONFERENCES AND SPEECHES REGARD-
ING PRE-RETIREMENT AND RETIREMENT
ISSUES AND PROVIDING COURSE MATERIALS
IN CONNECTION THEREWITH, IN CLASS 41 (U.S.
CLS. 100, 101 AND 107).

FIRST USE 5-8-2007; IN COMMERCE 5-8-2007.

THE MARK CONSISTS OF STANDARD CHAR-
ACTERS WITHOUT CLAIM TO ANY PARTICULAR
FONT, STYLE, SIZE, OR COLOR.

OWNER OF U.S. REG. NOS. 3,043,418 AND
3,270,229.

SER. NO. 77-196,180, FILED 6-2-2007.

LINDA ESTRADA, EXAMINING ATTORNEY

Int. Cl.: 36

Prior U.S. Cls.: 100, 101 and 102

United States Patent and Trademark Office

Reg. No. 3,478,993

Registered Aug. 5, 2008

**SERVICE MARK
PRINCIPAL REGISTER**

SELECTLINK

PERSHING INVESTMENTS LLC (DELAWARE
LTD LIAB CO)
ROUTE 273
WHITE CLAY CENTER ROAD
NEWARK, DE 19711

FOR: FINANCIAL INFORMATION PROCESSING
FOR OTHERS, NAMELY, CONSOLIDATING IN-
VESTORS' BROKERAGE ACCOUNT STATEMENTS
AND SUMMARIZING THE FINANCIAL INFOR-
MATION CONTAINED THEREIN, IN CLASS 36 (U.S.
CLS. 100, 101 AND 102).

FIRST USE 8-28-2000; IN COMMERCE 8-28-2000.

THE MARK CONSISTS OF STANDARD CHAR-
ACTERS WITHOUT CLAIM TO ANY PARTICULAR
FONT, STYLE, SIZE, OR COLOR.

SER. NO. 77-196,471, FILED 6-4-2007.

MICHAEL WIENER, EXAMINING ATTORNEY

Int. Cl.: 36

Prior U.S. Cls.: 100, 101 and 102

United States Patent and Trademark Office

Reg. No. 3,478,994

Registered Aug. 5, 2008

**SERVICE MARK
PRINCIPAL REGISTER**

S·e·l·e·c·tLink

PERSHING INVESTMENTS LLC (DELAWARE
LTD LIAB CO)
ROUTE 273
WHITE CLAY CENTER ROAD
NEWARK, DE 19711

FOR: FINANCIAL INFORMATION PROCESSING
FOR OTHERS, NAMELY, CONSOLIDATING IN-
VESTORS' BROKERAGE ACCOUNT STATEMENTS
AND SUMMARIZING THE FINANCIAL INFOR-

MATION CONTAINED THEREIN, IN CLASS 36 (U.S.
CLS. 100, 101 AND 102).

FIRST USE 8-28-2000; IN COMMERCE 8-28-2000.

SER. NO. 77-196,475, FILED 6-4-2007.

MICHAEL WIENER, EXAMINING ATTORNEY

Int. Cl.: 41

Prior U.S. Cls.: 100, 101 and 107

United States Patent and Trademark Office

Reg. No. 3,478,995

Registered Aug. 5, 2008

**SERVICE MARK
PRINCIPAL REGISTER**

WINNING ONE CUSTOMER AT A
TIME

LEVY FOOD SERVICE LIMITED PARTNERSHIP
(ILLINOIS LIMITED PARTNERSHIP)
SUITE 400
980 N. MICHIGAN AVENUE
CHICAGO, IL 60611

FOR: EDUCATION AND TRAINING PROGRAMS
FOR OTHERS IN THE FIELD OF RESTAURANT
SERVICES AND FOOD SERVICES, IN CLASS 41 (U.S.
CLS. 100, 101 AND 107).

FIRST USE 1-1-1990; IN COMMERCE 1-1-1990.

THE MARK CONSISTS OF STANDARD CHAR-
ACTERS WITHOUT CLAIM TO ANY PARTICULAR
FONT, STYLE, SIZE, OR COLOR.

OWNER OF U.S. REG. NOS. 1,969,233 AND
1,999,242.

SER. NO. 77-196,525, FILED 6-4-2007.

ANNE E. GUSTASON, EXAMINING ATTORNEY

Int. Cl.: 1

Prior U.S. Cls.: 1, 5, 6, 10, 26 and 46

Reg. No. 3,478,996

United States Patent and Trademark Office

Registered Aug. 5, 2008

**TRADEMARK
PRINCIPAL REGISTER**

Aquabind

AQUASOL CORPORATION (NORTH CAROLINA
CORPORATION)
316 COLLEGE ST
PINEVILLE, NC 28134

THE MARK CONSISTS OF STANDARD CHAR-
ACTERS WITHOUT CLAIM TO ANY PARTICULAR
FONT, STYLE, SIZE, OR COLOR.

FOR: ADHESIVES FOR INDUSTRIAL PURPOSES,
IN CLASS 1 (U.S. CLS. 1, 5, 6, 10, 26 AND 46).

SER. NO. 77-196,555, FILED 6-4-2007.

FIRST USE 2-25-2006; IN COMMERCE 2-25-2006.

SETH A. RAPPAPORT, EXAMINING ATTORNEY

Int. Cl.: 25

Prior U.S. Cls.: 22 and 39

United States Patent and Trademark Office

Reg. No. 3,478,997

Registered Aug. 5, 2008

**TRADEMARK
PRINCIPAL REGISTER**

YES ICAN.CC

YESICAN.CC, LLC (TEXAS LTD LIAB CO)
SUITE F-222
16238 HIGHWAY 620
AUSTIN, TX 78717

FOR: T-SHIRTS, IN CLASS 25 (U.S. CLS. 22 AND 39).

FIRST USE 2-26-2007; IN COMMERCE 4-11-2007.

THE MARK CONSISTS OF STANDARD CHARACTERS WITHOUT CLAIM TO ANY PARTICULAR FONT, STYLE, SIZE, OR COLOR.

NO CLAIM IS MADE TO THE EXCLUSIVE RIGHT TO USE "CC", APART FROM THE MARK AS SHOWN.

SER. NO. 77-196,577, FILED 6-4-2007.

RUDY R. SINGLETON, EXAMINING ATTORNEY

Int. Cl.: 25

Prior U.S. Cls.: 22 and 39

United States Patent and Trademark Office

Reg. No. 3,478,998

Registered Aug. 5, 2008

**TRADEMARK
PRINCIPAL REGISTER**



YESICAN.CC, LLC (TEXAS LTD LIAB CO)
SUITE F-222
16238 HIGHWAY 620
AUSTIN, TX 78717

FOR: T-SHIRTS, IN CLASS 25 (U.S. CLS. 22 AND 39).

FIRST USE 2-26-2007; IN COMMERCE 4-11-2007.

NO CLAIM IS MADE TO THE EXCLUSIVE RIGHT TO USE "CC" , APART FROM THE MARK AS SHOWN.

THE MARK CONSISTS OF THE WORDS "BELIEVE FAITH PRODUCE" IN STYLIZED FORMAT ARRANGED IN A CIRCULAR FORMATION AROUND THE MARK "YESICAN.CC" TO GIVE THE IMPRESSION OF AN INKED STAMP.

SER. NO. 77-196,586, FILED 6-4-2007.

RUDY R. SINGLETON, EXAMINING ATTORNEY

Int. Cls.: 35 and 44

Prior U.S. Cls.: 100, 101 and 102

United States Patent and Trademark Office

Reg. No. 3,478,999

Registered Aug. 5, 2008

**SERVICE MARK
PRINCIPAL REGISTER**

CareGivers Galaxy

CGG, LLC (VIRGINIA LTD LIAB CO)
191
2776 SOUTH ARLINGTON MILL DRIVE
ARLINGTON, VA 22206

FOR: PROMOTING THE GOODS AND SERVICES OF OTHERS THAT PROMOTE AND SUPPORT CAREGIVERS BY PROVIDING HYPERTEXT LINKS TO THE WEBSITES OF OTHERS , IN CLASS 35 (U.S. CLS. 100, 101 AND 102).

FIRST USE 6-1-2006; IN COMMERCE 6-15-2006.

FOR: PROVIDING A WEBSITE FEATURING HEALTHCARE INFORMATION AND ADVICE TO

SUPPORT CAREGIVERS, IN CLASS 44 (U.S. CLS. 100 AND 101).

FIRST USE 6-1-2006; IN COMMERCE 6-15-2006.

THE MARK CONSISTS OF STANDARD CHARACTERS WITHOUT CLAIM TO ANY PARTICULAR FONT, STYLE, SIZE, OR COLOR.

NO CLAIM IS MADE TO THE EXCLUSIVE RIGHT TO USE "CAREGIVERS", APART FROM THE MARK AS SHOWN.

SER. NO. 77-196,938, FILED 6-4-2007.

CHRISTINE COOPER, EXAMINING ATTORNEY

Int. Cl.: 9

Prior U.S. Cls.: 21, 23, 26, 36 and 38

Reg. No. 3,479,000

United States Patent and Trademark Office

Registered Aug. 5, 2008

**TRADEMARK
PRINCIPAL REGISTER**

Micro¹²

SEPARATION TECHNOLOGY, INC. (DELA-
WARE CORPORATION)
1096 RAINER DRIVE
ALTAMONTE SPRINGS, FL 32714

FIRST USE 11-13-2003; IN COMMERCE 11-13-2003.

SER. NO. 77-197,006, FILED 6-4-2007.

FOR: LABORATORY APPARATUS, NAMELY,
CENTRIFUGES, IN CLASS 9 (U.S. CLS. 21, 23, 26, 36
AND 38).

KATHRYN COWARD, EXAMINING ATTORNEY

Int. Cl.: 35

Prior U.S. Cls.: 100, 101 and 102

United States Patent and Trademark Office

Reg. No. 3,479,001

Registered Aug. 5, 2008

**SERVICE MARK
PRINCIPAL REGISTER**



THE PEW CHARITABLE TRUSTS (PENNSYLVANIA CORPORATION)
SUITE 1700
2005 MARKET STREET
PHILADELPHIA, PA 19103

FOR: PROMOTING PUBLIC AWARENESS OF THE NEED FOR FEDERAL LEGISLATION MANDATING STRICTER FUEL ECONOMY STANDARDS, IN CLASS 35 (U.S. CLS. 100, 101 AND 102).

FIRST USE 5-23-2007; IN COMMERCE 5-23-2007.

OWNER OF U.S. REG. NOS. 2,931,224, 3,191,067, AND 3,385,322.

NO CLAIM IS MADE TO THE EXCLUSIVE RIGHT TO USE "CAMPAIGN FOR FUEL EFFICIENCY", APART FROM THE MARK AS SHOWN.

THE MARK CONSISTS OF THE LITERAL ELEMENT, "THE PEW CAMPAIGN FOR FUEL EFFICIENCY" AND A FLAME DESIGN.

SER. NO. 77-197,075, FILED 6-4-2007.

MARIAM MAHMOUDI, EXAMINING ATTORNEY

Int. Cl.: 36

Prior U.S. Cls.: 100, 101 and 102

United States Patent and Trademark Office

Reg. No. 3,479,002

Registered Aug. 5, 2008

**SERVICE MARK
PRINCIPAL REGISTER**

**Preferred Professional
Insurance Company**

PREFERRED PROFESSIONAL INSURANCE
COMPANY (NEBRASKA CORPORATION)
SUITE 200
11605 MIRACLE HILLS DRIVE
OMAHA, NE 68154

FOR: INSURANCE UNDERWRITING IN THE
FIELD OF PROPERTY, CASUALTY AND MEDICAL
PROFESSIONAL LIABILITY; INSURANCE ADMIN-
ISTRATION; INSURANCE CLAIMS ADMINISTRA-
TION; INSURANCE CONSULTATION; RISK
MANAGEMENT, IN CLASS 36 (U.S. CLS. 100, 101
AND 102).

FIRST USE 10-1-1998; IN COMMERCE 10-1-1998.

THE MARK CONSISTS OF STANDARD CHAR-
ACTERS WITHOUT CLAIM TO ANY PARTICULAR
FONT, STYLE, SIZE, OR COLOR.

NO CLAIM IS MADE TO THE EXCLUSIVE
RIGHT TO USE "INSURANCE COMPANY", APART
FROM THE MARK AS SHOWN.

SEC. 2(F).

SER. NO. 77-197,118, FILED 6-4-2007.

JAMES A. RAUEN, EXAMINING ATTORNEY

Int. Cl.: 43

Prior U.S. Cls.: 100 and 101

United States Patent and Trademark Office

Reg. No. 3,479,003

Registered Aug. 5, 2008

**SERVICE MARK
PRINCIPAL REGISTER**

STONE HEARTH PIZZA CO.

ASILLEM LLC (MASSACHUSETTS LTD LIAB
CO)

PO BOX 725

SHERBORN, MA 01770

FOR: RESTAURANTS AND RESTAURANT SER-
VICES, IN CLASS 43 (U.S. CLS. 100 AND 101).

FIRST USE 8-5-2005; IN COMMERCE 8-5-2005.

THE MARK CONSISTS OF STANDARD CHAR-
ACTERS WITHOUT CLAIM TO ANY PARTICULAR
FONT, STYLE, SIZE, OR COLOR.

NO CLAIM IS MADE TO THE EXCLUSIVE
RIGHT TO USE "PIZZA CO.", APART FROM THE
MARK AS SHOWN.

SER. NO. 77-197,161, FILED 6-4-2007.

STEVEN JACKSON, EXAMINING ATTORNEY

Prior U.S. Cl.: B

United States Patent and Trademark Office

Reg. No. 3,479,004

Registered Aug. 5, 2008

**CERTIFICATION MARK
PRINCIPAL REGISTER**



PROFESSIONAL RETAIL STORE MAINTENANCE ASSOCIATION (TEXAS UNINC. ASSOCIATION)
14285 MIDWAY ROAD, SUITE 160
ADDISON, TX 75001

FOR: RETAIL FACILITY MAINTENANCE SERVICES, IN CLASS B (U.S. CL. B).

FIRST USE 12-10-2006; IN COMMERCE 12-10-2006.

NO CLAIM IS MADE TO THE EXCLUSIVE RIGHT TO USE "RETAIL FACILITY MAINTENANCE PROFESSIONAL", APART FROM THE MARK AS SHOWN.

THE CERTIFICATION MARK, AS INTENDED TO BE USED BY AUTHORIZED PERSONS, IS INTENDED TO CERTIFY THAT THE PERSON HAS ATTAINED A DEMONSTRATED LEVEL OF SKILL AND COMPETENCY IN THE FIELD OF RETAIL FACILITY MAINTENANCE THROUGH THE SUCCESSFUL COMPLETION OF A COMPREHENSIVE EXAMINATION.

SER. NO. 77-197,171, FILED 6-4-2007.

KAREN K. BUSH, EXAMINING ATTORNEY

Int. Cl.: 35

Prior U.S. Cls.: 100, 101 and 102

United States Patent and Trademark Office

Reg. No. 3,479,005

Registered Aug. 5, 2008

**SERVICE MARK
PRINCIPAL REGISTER**

Clear Sky Burners

CLEAR SKY BURNERS LLC (ARIZONA LTD
LIAB CO)
1101 E. WARNER ROAD
#102
TEMPE, AZ 85284

FOR: ON-LINE RETAIL STORE SERVICES AND
RETAIL STORE SERVICES FEATURING AIR CUR-
TAIN BURNERS, AIR CURTAIN DESTRUCTORS,
AND AIR CURTAIN INCINERATORS, IN CLASS 35
(U.S. CLS. 100, 101 AND 102).

FIRST USE 4-17-2006; IN COMMERCE 5-15-2006.

THE MARK CONSISTS OF STANDARD CHAR-
ACTERS WITHOUT CLAIM TO ANY PARTICULAR
FONT, STYLE, SIZE, OR COLOR.

NO CLAIM IS MADE TO THE EXCLUSIVE
RIGHT TO USE "BURNERS", APART FROM THE
MARK AS SHOWN.

SER. NO. 77-197,399, FILED 6-4-2007.

JEAN IM, EXAMINING ATTORNEY

Int. Cl.: 12

Prior U.S. Cls.: 19, 21, 23, 31, 35 and 44

United States Patent and Trademark Office

Reg. No. 3,479,006

Registered Aug. 5, 2008

**TRADEMARK
PRINCIPAL REGISTER**



GLOBAL PARTS SUPPORT, INC. (FLORIDA CORPORATION)
2830 S. PARK RD
PEMBROKE PINES, FL 33009

THE MARK CONSISTS OF THE LETTERS "GPS" WRAPPED AROUND A GLOBE WITH AN AIRPLANE CIRCLING THE GLOBE THROUGH THE "P".

FOR: AIRPLANE PARTS, NAMELY, FUSELAGES, LANDING GEAR, PROPELLER, AND STRUCTURAL PARTS, IN CLASS 12 (U.S. CLS. 19, 21, 23, 31, 35 AND 44).

SER. NO. 77-197,611, FILED 6-5-2007.

FIRST USE 11-4-2003; IN COMMERCE 11-4-2003.

HEATHER SAPP, EXAMINING ATTORNEY

Int. Cl.: 35

Prior U.S. Cls.: 100, 101 and 102

United States Patent and Trademark Office

Reg. No. 3,479,007

Registered Aug. 5, 2008

**SERVICE MARK
PRINCIPAL REGISTER**



NATIONAL SINGLES ASSOCIATION, INC.
(GEORGIA CORPORATION)
248 THE SOUTH CHASE
ATLANTA, GA 30328

FOR: ASSOCIATION SERVICES, NAMELY, PROMOTING THE INTERESTS OF SINGLE PERSONS, IN CLASS 35 (U.S. CLS. 100, 101 AND 102).

FIRST USE 12-1-2005; IN COMMERCE 12-1-2005.

NO CLAIM IS MADE TO THE EXCLUSIVE RIGHT TO USE "NATIONAL SINGLES ASSOCIATION", APART FROM THE MARK AS SHOWN.

THE COLOR(S) RED AND BLUE IS/ARE CLAIMED AS A FEATURE OF THE MARK.

THE MARK CONSISTS OF THE LETTERS "NSA" IN ALL CAPITAL LETTERS. THE LETTERS "N" AND "A" ARE IN BLUE AND THE LETTER "S" IS IN LARGER SCRIPT IN RED. THE WORDS "NATIONAL SINGLES" ARE UNDERNEATH IT AND THE WORD "ASSOCIATION" ARE UNDERNEATH THAT ALL IN BLUE. THE COLOR WHITE THAT APPEARS IN THE LETTERS "NSA" IS INTENDED TO REPRESENT TRANSPARENCY AND TAKES ON THE COLOR OF THE SURFACE ON WHICH THE MARK IS REPRODUCED.

SER. NO. 77-197,718, FILED 6-5-2007.

KATHERINE CHANG, EXAMINING ATTORNEY

Int. Cl.: 30

Prior U.S. Cl.: 46

United States Patent and Trademark Office

Reg. No. 3,479,008

Registered Aug. 5, 2008

TRADEMARK
PRINCIPAL REGISTER



H & S BAKERY, INC. (MARYLAND CORPORATION)
601 S. CAROLINE STREET
BALTIMORE, MD 21231

FOR: BAKERY PRODUCTS; BREAD, IN CLASS 30
(U.S. CL. 46).

FIRST USE 3-0-2005; IN COMMERCE 3-0-2005.

OWNER OF U.S. REG. NO. 3,061,912.

NO CLAIM IS MADE TO THE EXCLUSIVE RIGHT TO USE "GRAINS," AND THE SHAPE OF THE BAG OR THE BAG FASTENER, APART FROM THE MARK AS SHOWN.

THE MARK CONSISTS OF THE DESIGN USED ON PACKAGING FOR THE GOODS WITH THE DESIGN OF MULTIPLE STALKS OF WHEAT ON THE TOP OF THE BAG, AND A DESIGN OF A

SINGLE STALK OF WHEAT EXTENDING DIAGONALLY ACROSS THE FRONT OF THE PACKAGE. THE PORTION OF THE PACKAGE ABOVE THE SINGLE WHEAT DESIGN IS OPAQUE AND THE PORTION OF THE PACKAGE BELOW THE SINGLE WHEAT DESIGN IS TRANSPARENT. THE WORDS "ULTIMATE GRAINS" WITH A DESIGN OF STALKS OF WHEAT APPEAR IN A BANNER IN THE UPPER OPAQUE PORTION OF THE PACKAGE. THE STIPPLING IN THE LOWER PORTION OF THE DRAWING IS FOR SHADING PURPOSES ONLY TO INDICATE THE TRANSPARENT NATURE OF THIS SECTION OF THE PACKAGING. THE MATTER SHOWN IN THE BROKEN LINES IS NOT PART OF THE MARK.

SER. NO. 77-197,791, FILED 6-5-2007.

KATHERINE CONNOLLY, EXAMINING ATTORNEY

Int. Cl.: 9

Prior U.S. Cls.: 21, 23, 26, 36 and 38

United States Patent and Trademark Office

Reg. No. 3,479,009

Registered Aug. 5, 2008

**TRADEMARK
PRINCIPAL REGISTER**

STREETFINDER WIRELESS

RAND MCNALLY & COMPANY (DELAWARE
CORPORATION)
8255 NORTH CENTRAL PARK AVENUE
SKOKIE, IL 60076

FOR: DOWNLOADABLE NAVIGATION AND
TRAVEL INFORMATION SOFTWARE VIA THE
INTERNET AND WIRELESS DEVICES, IN CLASS 9
(U.S. CLS. 21, 23, 26, 36 AND 38).

FIRST USE 1-0-2007; IN COMMERCE 1-0-2007.

THE MARK CONSISTS OF STANDARD CHAR-
ACTERS WITHOUT CLAIM TO ANY PARTICULAR
FONT, STYLE, SIZE, OR COLOR.

OWNER OF U.S. REG. NOS. 1,248,937 AND
2,088,115.

NO CLAIM IS MADE TO THE EXCLUSIVE
RIGHT TO USE "WIRELESS", APART FROM THE
MARK AS SHOWN.

SEC. 2(F) AS TO "STREETFINDER".

SER. NO. 77-198,026, FILED 6-5-2007.

KARANENDRA S. CHHINA, EXAMINING ATTOR-
NEY

Int. Cl.: 35

Prior U.S. Cls.: 100, 101 and 102

United States Patent and Trademark Office

Reg. No. 3,479,010

Registered Aug. 5, 2008

**SERVICE MARK
PRINCIPAL REGISTER**

ROBINSON LERER & MONTGOMERY

ROBINSON LERER & MONTGOMERY, LLC
(DELAWARE LTD LIAB CO)
4TH FLOOR
1345 AVENUE OF THE AMERICAS
NEW YORK, NY 10105

FOR: BUSINESS CONSULTING SERVICES, NAMELY, STRATEGIC COMMUNICATION SERVICES IN THE AREAS OF CORPORATE COMMUNICATIONS, CRISIS MANAGEMENT, CORPORATE REORGANIZATIONS AND RESTRUCTURINGS, TRANSACTION COMMUNICATIONS, EXECUTIVE TRANSITIONS, GOVERNANCE, EMPLOYEE COMMUNICATIONS, INVESTOR RELATIONS, STRATEGIC POSITIONING AND MARKETING, PHILANTHROPY MARKETING AND CAUSE-RELATED MARKETING; PUBLIC RELATIONS; BUSINESS ADVISORY SERVICES AND BUSINESS

CONSULTANCY AND INFORMATION; CONSULTANCY SERVICES RELATING TO BUSINESS MANAGEMENT, MARKETING, BUSINESS STRATEGIES AND PUBLICITY, NON-LEGAL LITIGATION COMMUNICATIONS SUPPORT SERVICES, IN CLASS 35 (U.S. CLS. 100, 101 AND 102).

FIRST USE 6-1-1996; IN COMMERCE 6-1-1996.

THE MARK CONSISTS OF STANDARD CHARACTERS WITHOUT CLAIM TO ANY PARTICULAR FONT, STYLE, SIZE, OR COLOR.

SER. NO. 77-198,309, FILED 6-5-2007.

CURTIS FRENCH, EXAMINING ATTORNEY

Int. Cl.: 35

Prior U.S. Cls.: 100, 101 and 102

United States Patent and Trademark Office

Reg. No. 3,479,011

Registered Aug. 5, 2008

**SERVICE MARK
PRINCIPAL REGISTER**

RLM

ROBINSON LERER & MONTGOMERY, LLC
(DELAWARE LTD LIAB CO)
4TH FLOOR
1345 AVENUE OF THE AMERICAS
NEW YORK, NY 10105

FOR: BUSINESS CONSULTING SERVICES, NAMELY, STRATEGIC COMMUNICATION SERVICES IN THE AREAS OF CORPORATE COMMUNICATIONS, CRISIS MANAGEMENT, CORPORATE REORGANIZATIONS AND RESTRUCTURINGS, TRANSACTION COMMUNICATIONS, EXECUTIVE TRANSITIONS, GOVERNANCE, EMPLOYEE COMMUNICATIONS, STRATEGIC POSITIONING AND MARKETING, PHILANTHROPY MARKETING AND CAUSE-RELATED MARKETING; PUBLIC RELATIONS; CONSULTANCY SERVICES RELATING

TO BUSINESS MANAGEMENT, MARKETING, BUSINESS STRATEGIES AND PUBLICITY, NON-LEGAL LITIGATION COMMUNICATIONS SUPPORT SERVICES, IN CLASS 35 (U.S. CLS. 100, 101 AND 102).

FIRST USE 6-1-1996; IN COMMERCE 6-1-1996.

THE MARK CONSISTS OF STANDARD CHARACTERS WITHOUT CLAIM TO ANY PARTICULAR FONT, STYLE, SIZE, OR COLOR.

SER. NO. 77-198,331, FILED 6-5-2007.

CURTIS FRENCH, EXAMINING ATTORNEY

Int. Cls.: 35 and 42

Prior U.S. Cls.: 100, 101 and 102

United States Patent and Trademark Office

Reg. No. 3,479,012

Registered Aug. 5, 2008

**SERVICE MARK
PRINCIPAL REGISTER**

IdeaStorm

INNOVATIONS & DEVELOPMENT INC (NEW JERSEY CORPORATION)
115 RIVER ROAD / WHARF 3
EDGEWATER, NJ 07020

FOR: NEW BUSINESS VENTURE DEVELOPMENT AND FORMATION CONSULTING SERVICES; MARKETING PLAN DEVELOPMENT; AND MARKET RESEARCH IN THE FIELDS OF CONSUMER ELECTRONICS, PERSONAL GROOMING PRODUCTS, HOUSE WARE, HARDWARE, FOOD STUFFS, BEVERAGES, MEDICAL DEVICES, TOOLS, DURABLES, PACKAGED GOODS, AND MEDICAL PRODUCTS, IN CLASS 35 (U.S. CLS. 100, 101 AND 102).

FIRST USE 4-25-2003; IN COMMERCE 4-25-2003.

FOR: DESIGN OF NEW PRODUCTS FOR OTHERS; PACKAGING DESIGN; CONCEPTUALIZA-

TION AND DEVELOPMENT SERVICES IN THE FIELDS OF CONSUMER ELECTRONICS, PERSONAL GROOMING PRODUCTS, HOUSE WARE, HARDWARE, FOOD STUFFS, BEVERAGES, MEDICAL DEVICES, TOOLS, DURABLES, PACKAGED GOODS, AND MEDICAL PRODUCTS, IN CLASS 42 (U.S. CLS. 100 AND 101).

FIRST USE 4-25-2003; IN COMMERCE 4-25-2003.

THE MARK CONSISTS OF STANDARD CHARACTERS WITHOUT CLAIM TO ANY PARTICULAR FONT, STYLE, SIZE, OR COLOR.

SER. NO. 77-198,713, FILED 6-6-2007.

TINA L. SNAPP, EXAMINING ATTORNEY

Int. Cl.: 30

Prior U.S. Cl.: 46

United States Patent and Trademark Office

Reg. No. 3,479,013

Registered Aug. 5, 2008

**TRADEMARK
PRINCIPAL REGISTER**

EL VENADO

SJR FOODS, LTD. (TEXAS LIMITED PARTNER-
SHIP)
1370 E. 40TH BUILDING 7, SUITE 3A
HOUSTON, TX 77022

FOR: SPICES; PEPPER; PROCESSED HERBS; DRY
SEASONING MIXES FOR FAJITAS AND CHICKEN,
IN CLASS 30 (U.S. CL. 46).

FIRST USE 9-16-2003; IN COMMERCE 9-16-2003.

THE MARK CONSISTS OF STANDARD CHAR-
ACTERS WITHOUT CLAIM TO ANY PARTICULAR
FONT, STYLE, SIZE, OR COLOR.

THE FOREIGN WORDING IN THE MARK
TRANSLATES INTO ENGLISH AS THE DEER.

SER. NO. 77-198,746, FILED 6-6-2007.

DAWN FELDMAN, EXAMINING ATTORNEY

Int. Cl.: 35

Prior U.S. Cls.: 100, 101 and 102

Reg. No. 3,479,014

United States Patent and Trademark Office

Registered Aug. 5, 2008

**SERVICE MARK
PRINCIPAL REGISTER**

**THE CARBO GROUP ABRASIVE
INTELLIGENCE**

CARBO LUXEMBOURG HOLDING S.A. (LUXEMBOURG CORPORATION)
7, VAL SAINTE CROIX
L-1371 LUXEMBOURG, LUXEMBOURG

FOR: ON-LINE AND REAL-WORLD WHOLESALE ORDERING, WHOLESALE STORE, AND RETAIL STORE SERVICES FEATURING CHEMICALS USED IN INDUSTRY, SCIENCE, PHOTOGRAPHY, AGRICULTURE, HORTICULTURE AND FORESTRY, NAMELY, AUXILIARY FLUIDS FOR USE WITH ABRASIVES, AND SPRAY FOR BELT SANDING; ON-LINE AND REAL-WORLD WHOLESALE ORDERING, WHOLESALE STORE, AND RETAIL STORE SERVICES FEATURING COATED ABRASIVES IN THE FORM OF SHEETS, STRIPS, SELF-ADHESIVE STRIPS, STRIPS ADAPTED FOR USE WITH HOOK AND LOOP FASTENER SYSTEMS, PERFORATED STRIPS, ROLLS, BELTS, WIDE BELTS, CYLINDERS, CONES, DISCS, SELF-ADHESIVE DISCS, DISCS ADAPTED FOR USE WITH HOOK AND LOOP FASTENER SYSTEMS, PERFORATED DISCS, MOUNTED FLAP WHEELS, FLAP WHEELS, AND FLAP DISCS; ON-LINE AND REAL-WORLD WHOLESALE ORDERING, WHOLESALE STORE, AND RETAIL STORE SERVICES FEATURING ABRASIVE PAPER, GRAPHITE CANVAS, CLEANING PREPARATIONS, POLISHING PREPARATIONS, SCOURING PREPARATIONS, ABRASIVE PREPARATIONS, POWER OPERATED GRINDERS, HAND OPERATED GRINDERS, AND GRINDING STONES; ON-LINE AND REAL-WORLD WHOLESALE ORDERING, WHOLESALE STORE, AND RETAIL STORE SERVICES FEATURING GRINDING WHEELS, NAMELY, EXTERNAL CY-

LINDRICAL GRINDING WHEELS, CENTERLESS GRINDING WHEELS, TRANSPORT WHEELS, INTERNAL GRINDING WHEELS, FLAT AND PROFILED GRINDING WHEELS, TOOL GRINDING WHEELS, GEARING GRINDING WHEELS, LAPPING DISCS, HOT PRESSED SNAGGING GRINDING WHEELS, DIAMOND BONDED GRINDING WHEELS, CERAMIC BONDED GRINDING WHEELS, CUT-OFF AND SNAGGING WHEELS, STATIONARY CUT-OFF WHEELS, FETTLING WHEELS, AND FOUNDRY GRINDING WHEELS; AND ON-LINE AND REAL-WORLD WHOLESALE ORDERING, WHOLESALE STORE, AND RETAIL STORE SERVICES FEATURING BONDED ABRASIVES, POLISHING WHEELS, MOUNTED POINTS, GRINDING FILES, SCYTHESTONES, GRINDING DISKS, DRESSING TOOLS, WHETTING STONES, RUBBING BLOCKS, AND GRINDING SEGMENTS, IN CLASS 35 (U.S. CLS. 100, 101 AND 102).

THE MARK CONSISTS OF STANDARD CHARACTERS WITHOUT CLAIM TO ANY PARTICULAR FONT, STYLE, SIZE, OR COLOR.

OWNER OF FED REP GERMANY REG. NO. 30637678, DATED 10-31-2006, EXPIRES 6-17-2016.

NO CLAIM IS MADE TO THE EXCLUSIVE RIGHT TO USE "GROUP" AND "ABRASIVE", APART FROM THE MARK AS SHOWN.

SER. NO. 77-198,795, FILED 6-6-2007.

JASON LOTT, EXAMINING ATTORNEY

Int. Cls.: 9, 16 and 35

**Prior U.S. Cls.: 2, 5, 21, 22, 23, 26, 29, 36, 37, 38, 50,
100, 101 and 102**

Reg. No. 3,479,015

United States Patent and Trademark Office

Registered Aug. 5, 2008

**TRADEMARK
SERVICE MARK
PRINCIPAL REGISTER**

CONVERGENCE AUDIT

CLARITAS INC. (DELAWARE CORPORATION)
5375 MIRA SORRENTO PLACE, SUITE 400
SAN DIEGO, CA 92121

FOR: COMPUTER SOFTWARE, NAMELY, A DATABASE OF SURVEY RESULTS AND ANALYSIS IN THE FIELD OF HOUSEHOLD VOICE, VIDEO, DATA AND ENERGY USAGE RECORDED ON COMPUTER MEDIA, IN CLASS 9 (U.S. CLS. 21, 23, 26, 36 AND 38).

FIRST USE 4-2-1998; IN COMMERCE 4-2-1998.

FOR: PRINTED DOCUMENTS, NAMELY, SURVEY RESULTS AND ANALYSIS IN THE FIELD OF HOUSEHOLD VOICE, VIDEO, DATA AND ENERGY USAGE, IN CLASS 16 (U.S. CLS. 2, 5, 22, 23, 29, 37, 38 AND 50).

FIRST USE 4-2-1998; IN COMMERCE 4-2-1998.

FOR: CONDUCTING HOUSEHOLD SURVEYS OF VOICE, VIDEO, DATA AND ENERGY USAGE FOR

OTHERS VIA QUESTIONNAIRES, TABULATION OF THE INFORMATION AND GENERATION OF DATA THEREFROM, IN CLASS 35 (U.S. CLS. 100, 101 AND 102).

FIRST USE 4-2-1998; IN COMMERCE 4-2-1998.

THE MARK CONSISTS OF STANDARD CHARACTERS WITHOUT CLAIM TO ANY PARTICULAR FONT, STYLE, SIZE, OR COLOR.

OWNER OF U.S. REG. NO. 2,458,712.

NO CLAIM IS MADE TO THE EXCLUSIVE RIGHT TO USE "AUDIT", APART FROM THE MARK AS SHOWN.

SEC. 2(F).

SER. NO. 77-198,890, FILED 6-6-2007.

SANI KHOURI, EXAMINING ATTORNEY

Int. Cls.: 16 and 41

Prior U.S. Cls.: 2, 5, 22, 23, 29, 37, 38, 50, 100, 101 and 107

Reg. No. 3,479,016

United States Patent and Trademark Office

Registered Aug. 5, 2008

**TRADEMARK
SERVICE MARK
PRINCIPAL REGISTER**



STILETTO MAGAZINE (CALIFORNIA LTD LIAB
CO)
8726 S. SEPULVEDA BLVD., SUITE D
C211
LOS ANGELES, CA 90045

FOR: MAGAZINES FEATURING ADULT EN-
TERTAINMENT AND ADULT NIGHT CLUBS, IN
CLASS 16 (U.S. CLS. 2, 5, 22, 23, 29, 37, 38 AND 50).

FIRST USE 5-21-2007; IN COMMERCE 5-21-2007.

FOR: PROVIDING ON-LINE PUBLICATIONS IN
THE NATURE OF A MAGAZINE IN THE FIELD OF
ADULT ENTERTAINMENT AND ADULT NIGHT
CLUBS, IN CLASS 41 (U.S. CLS. 100, 101 AND 107).

FIRST USE 5-21-2007; IN COMMERCE 5-21-2007.

NO CLAIM IS MADE TO THE EXCLUSIVE
RIGHT TO USE "MAGAZINE", APART FROM THE
MARK AS SHOWN.

THE MARK CONSISTS OF THE WORDS "STI-
LETTO MAGAZINE".

SER. NO. 77-198,922, FILED 6-6-2007.

GINA HAYES, EXAMINING ATTORNEY

Int. Cls.: 35 and 42

Prior U.S. Cls.: 100, 101 and 102

United States Patent and Trademark Office

Reg. No. 3,479,017

Registered Aug. 5, 2008

**SERVICE MARK
PRINCIPAL REGISTER**

ASKMOBY

NOWCASTING INTERNATIONAL LIMITED
(IRELAND COMPANY)
BALLYMALEY BUSINESS PARK
ENNIS, COUNTY CLARE, IRELAND

FOR: ADVERTISING SERVICES; PROVISION OF ADVERTISING VIA TELECOMMUNICATIONS NETWORKS AND OVER THE INTERNET; PROVISION OF ADVERTISING SPACE VIA TELECOMMUNICATIONS NETWORKS AND OVER THE INTERNET; PROVISION OF ADVERTISING SPACE SPECIFIC TO LOCATION VIA TELECOMMUNICATIONS NETWORKS AND OVER THE INTERNET; PROVISION OF ADVERTISING SPACE SPECIFIC TO INDUSTRIAL, BUSINESS AND COMMERCIAL SECTORS VIA TELECOMMUNICATIONS NETWORKS AND OVER THE INTERNET; PROVISION OF ADVERTISING SPACE IN CONJUNCTION WITH WEATHER FORECASTS; AND PROVISION OF BUSINESS INFORMATION VIA TELECOMMUNICATIONS NETWORKS AND OVER THE INTERNET, IN CLASS 35 (U.S. CLS. 100, 101 AND 102).

FOR: PROVIDING WEATHER FORECASTS, SEA CONDITION FORECASTS AND AERONAUTICAL CONDITION FORECASTS; PROVISION OF DATA IN CONNECTION WITH WEATHER, SEA AND AIR CONDITIONS, IN CLASS 42 (U.S. CLS. 100 AND 101).

THE MARK CONSISTS OF STANDARD CHARACTERS WITHOUT CLAIM TO ANY PARTICULAR FONT, STYLE, SIZE, OR COLOR.

PRIORITY CLAIMED UNDER SEC. 44(D) ON ERPN CMNTY TM OFC APPLICATION NO. 005677653, FILED 2-9-2007, REG. NO. 005677653, DATED 12-7-2007, EXPIRES 2-9-2017.

SER. NO. 77-199,043, FILED 6-6-2007.

MARY BOAGNI, EXAMINING ATTORNEY

Int. Cl.: 42

Prior U.S. Cls.: 100 and 101

United States Patent and Trademark Office

Reg. No. 3,479,018

Registered Aug. 5, 2008

**SERVICE MARK
PRINCIPAL REGISTER**

WIDGETONE

EMTRACE TECHNOLOGIES, INC. (REPUBLIC
OF KOREA CORPORATION)
5TH FLOOR, SHINSA 2 BUILDING
SEOUL, REPUBLIC OF KOREA 966-5

FOR: PROVIDING TEMPORARY USE OF NON-DOWNLOADABLE COMPUTER PROGRAMS/SOFTWARE TO CONSUMERS VIA THE INTERNET AND GLOBAL COMPUTER NETWORKS THAT ENABLES THEM TO ACCESS AND PROVIDE AUDIO, VIDEO AND DATA CONTENT VIA THE INTERNET AND GLOBAL COMPUTER NETWORKS; HOSTING COMPUTER SITES, NAMELY, WEB SITES OF OTHERS ON A COMPUTER SERVER FOR A GLOBAL COMPUTER NETWORK; CREATING AND MAINTAINING WEB SITES FOR OTHERS; CONVERSION OF DATA OR DOCUMENTS FROM PHYSICAL TO ELECTRONIC MEDIA; INSTALLATION OF COMPUTER SOFTWARE; COMPUTER SYSTEM DESIGN; DATA CONVERSION OF COMPUTER PROGRAM DATA OR INFORMATION; DUPLICATION OF COMPUTER PRO-

GRAMS; COMPUTER RENTAL; RECOVERY OF COMPUTER DATA; RENTAL OF COMPUTER SOFTWARE; COMPUTER SOFTWARE DESIGN FOR OTHERS; UPDATING OF COMPUTER SOFTWARE FOR OTHERS; MAINTENANCE OF COMPUTER SOFTWARE; COMPUTER SYSTEMS ANALYSIS; COMPUTER PROGRAMMING; CONSULTANCY IN THE FIELD OF COMPUTER HARDWARE, IN CLASS 42 (U.S. CLS. 100 AND 101).

THE MARK CONSISTS OF STANDARD CHARACTERS WITHOUT CLAIM TO ANY PARTICULAR FONT, STYLE, SIZE, OR COLOR.

OWNER OF REPUBLIC OF KOREA REG. NO. 0160493, DATED 1-31-2008, EXPIRES 1-31-2018.

SER. NO. 77-199,210, FILED 6-6-2007.

HOWARD SMIGA, EXAMINING ATTORNEY

Int. Cl.: 28

Prior U.S. Cls.: 22, 23, 38 and 50

United States Patent and Trademark Office

Reg. No. 3,479,019

Registered Aug. 5, 2008

**TRADEMARK
PRINCIPAL REGISTER**



9061-4371 QUEBEC INC. (CANADA CORPORATION)
4124 BOUL. INDUSTRIAL
SHERBROOKE, CANADA J1L2S6

THE MARK CONSISTS OF AN OBLONG SHAPED
ELEMENT TO THE LEFT OF THE WORD "POWER-
TEK".

FOR: BASEBALL BATS; HOCKEY STICKS; GOLF
CLUBS, IN CLASS 28 (U.S. CLS. 22, 23, 38 AND 50).

SER. NO. 77-199,329, FILED 6-6-2007.

OWNER OF CANADA REG. NO. TMA674659,
DATED 10-12-2006, EXPIRES 10-12-2021.

WILLIAM BRECKENFELD, EXAMINING ATTOR-
NEY

Int. Cl.: 36

Prior U.S. Cls.: 100, 101 and 102

United States Patent and Trademark Office

Reg. No. 3,479,020

Registered Aug. 5, 2008

**SERVICE MARK
PRINCIPAL REGISTER**

SEG PARTNERS

SELECT EQUITY GROUP, INC. (NEW YORK
CORPORATION)
380 LAFAYETTE STREET
NEW YORK, NY 10003

FOR: ASSET MANAGEMENT, NAMELY, INVESTMENT ADVISORY SERVICES PROVIDED PREDOMINANTLY TO QUALIFIED PURCHASERS AS DEFINED BY THE INVESTMENT COMPANY ACT OF 1940, IN CLASS 36 (U.S. CLS. 100, 101 AND 102).

FIRST USE 8-20-1998; IN COMMERCE 8-20-1998.

THE MARK CONSISTS OF STANDARD CHARACTERS WITHOUT CLAIM TO ANY PARTICULAR FONT, STYLE, SIZE, OR COLOR.

SER. NO. 77-199,450, FILED 6-6-2007.

MICHELLE DUBOIS, EXAMINING ATTORNEY

Int. Cl.: 9

Prior U.S. Cls.: 21, 23, 26, 36 and 38

Reg. No. 3,479,021

United States Patent and Trademark Office

Registered Aug. 5, 2008

**TRADEMARK
PRINCIPAL REGISTER**

MOELLER SMARTWIRE

MOELLER GMBH (FED REP GERMANY CORPORATION)
HEIN-MOELLER-STRASSE 7-11
BONN, FED REP GERMANY D-53115

FOR: ELECTRIC, ELECTRONIC AND OPTO-ELECTRONIC MEASURING APPARATUS, NAMELY, PROXIMITY SWITCHES AND POSITION SWITCHES; SIGNALING APPARATUS, NAMELY, SIGNAL CONDITIONING AND COMMUNICATION DEVICES FOR INDUSTRIAL PROCESS CONTROL AND SIGNAL TOWERS; MONITORING APPARATUS, NAMELY, ELECTRIC LUMINESCENT MULTI-FUNCTION DISPLAY PANELS WITH INTEGRATED INDICATOR LIGHTS; SWITCHING, REGULATING AND ELECTRICAL CONTROL DEVICES, NAMELY, ELECTRICAL RELAYS FOR SENSORS; PROGRAMMABLE APPARATUS FOR SWITCHING, CONTROLLING, AND AUTOMATION SYSTEMS USED TO CONTROL INDUSTRIAL AUTOMATION SYSTEMS, NAMELY, CONTROL TIMING, MEASURING, SAFETY, MONITORING RELAYS, PROGRAMMABLE LOGIC CONTROLLERS; ELECTRONIC MODULES, NAMELY, INTEGRATED CIRCUIT MODULES, VOLTAGE MONITOR MODULES; APPARATUS FOR INDUSTRIAL AND POWER ELECTRONICS, NAMELY, TRIPPING DEVICES; DATA PROCESSORS FOR ELECTRONIC DATA RECORDING, DATA INPUT, DATA PROCESSING, DATA STORAGE, DATA OUTPUT, DATA DISPLAY; APPARATUS FOR ELECTRONIC SIGNAL TRANSMISSION OR DATA TRANSFER, NAMELY, BUS-SYSTEMS COMPOSED OF BUS TERMINALS, BUS CABLES, BUS TERMINATING RESISTORS, BUS SUBSCRIBERS, AND ACCESS PROCEDURES; COMPUTER PROGRAMS FOR INDUSTRIAL AUTOMATION SYSTEMS, OPERATING SYSTEMS AND APPLICATION SOFTWARE FOR INDUSTRIAL AUTOMATION SYSTEMS; SYSTEMS, APPARATUS AND INSTRUMENTS FOR ELECTRIC POWER DISTRIBUTION, CONDUCTING, SWITCHING, TRANSFORMING,

ACCUMULATING, REGULATING OR CONTROLLING ELECTRICITY, NAMELY, EMERGENCY-STOP BUTTONS, EMERGENCY-STOP SWITCHES, DOOR SAFETY SWITCHES, SAFETY RELAYS, CONTACTORS, CONTACTOR RELAYS, SIGNAL TOWERS AND ACOUSTIC INDICATORS, CONTROL CIRCUIT DEVICES, ELECTRONIC AND MECHANICAL POSITION SWITCHES, ELECTRONIC PROXIMITY SWITCHES, PRESSURE SWITCHES, SAFETY POSITION SWITCHES, COMPACT CONTROL SYSTEMS CONSISTING OF ELECTRICAL CONTROL RELAYS, CONTACTORS, MOTOR PROTECTIVE SWITCHES, ELECTRICAL RELAYS AND CIRCUIT BREAKERS, CONNECTED BY BUS SYSTEMS; MULTI-FUNCTION DISPLAYS, MOTOR STARTERS, MOTOR-PROTECTIVE CIRCUIT-BREAKER, CONTACTORS, CONTACTOR RELAYS, MOTOR-PROTECTIVE RELAYS, SOFT STARTERS, NAMELY, A DEVICE WHICH ENABLES A SOFT AND SMOOTH START OF AN ELECTRIC MOTOR, FREQUENCY INVERTERS, CIRCUIT-BREAKERS, CONVENTIONAL WIRED ARC FAULT PROTECTION SYSTEMS CONSISTING OF APPARATUS FOR THE DETECTION OF ELECTRIC ARCS, ARC CONTROLLERS AND QUENCHING APPARATUS, MINIATURE CIRCUIT-BREAKERS, RESIDUAL CURRENT CIRCUIT-BREAKERS, ELECTRIC SWITCHES, SWITCHING DEVICES AND SWITCHGEAR FOR ALL VOLTAGES AND ALL CURRENTS, NAMELY, CIRCUIT-BREAKERS, MINIATURE CIRCUIT-BREAKERS FOR CABLE AND INSTALLATION PROTECTION, MOTOR-PROTECTIVE CIRCUIT-BREAKERS, OVERLOAD PROTECTIVE SWITCHES, ELECTRIC THERMAL OVERLOAD, TIMING AND PROTECTIVE RELAYS; SWITCH-DISCONNECTORS AND ELECTRICAL SWITCHES, PUSHBUTTONS, CONTACTORS, LOW VOLTAGE SWITCHES, ELECTRIC RELAYS, SURGE VOLTAGE PROTECTORS, SURGE VOLTAGE SUPPRESSORS, VOLTAGE REGULATORS, VOLTAGE STABILIZERS, ACTUATORS FOR ELECTRONIC CONTROL CIRCUITS, TIME SWITCHES, POSITION

SWITCHES, SELECTOR SWITCHES, SAFETY SWITCHES; ELECTRIC AND ELECTRONIC APPARATUS FOR PROTECTION OF PERSONNEL AND SYSTEMS AGAINST DAMAGES BY ELECTRIC CURRENTS, VOLTAGES AND ELECTRIC ARCS, NAMELY, CIRCUIT BREAKERS, MINI CIRCUIT BREAKERS, MOLDED CASE CIRCUIT BREAKERS, AIR CIRCUIT BREAKERS, CONTACTORS, MOTOR PROTECTIVE SWITCHES, PUSHBUTTONS, RELAYS, LIMIT SWITCHES, PROXIMITY SWITCHES, EMERGENCY SWITCHES, ELECTRONIC CONTROL RELAYS, RESIDUAL CURRENT CIRCUIT BREAKERS, DOOR-SAFETY SWITCHES, POSITION SWITCHES; ELECTRIC CONNECTION PARTS, NAMELY, ELECTRICAL PLUGS, SOCKETS, ELECTRIC BUS SYSTEMS, ELECTRIC CABLES, BUSBAR SYSTEMS; TERMINALS, NAMELY, THE CONNECTION POINT BETWEEN ELECTRICAL CABLES OR BUSBARS WITH ELECTRICAL SWITCHES; ELECTRICAL PLUGS, ADAPTERS, ELECTRICAL CONNECTION CABLES, ELECTRICAL PLUG DEVICE ENABLING CONNECTION AND DISCONNECTION OF POWER AND/OR CONTROL CABLES; TRANSFORMERS, POWER SUPPLY UNITS; ENCLOSURES, NAMELY, HOUSING FOR ELECTRIC SWITCHES OR DISTRIBUTION BOARDS FOR ELECTRICAL ENERGY; ELECTRIC CONTROL PANEL UNITS,

SWITCHING AND CONTROL APPARATUS FOR ELECTRIC MOTORS; TRANSFORMERS, CHOKES; CURRENT CONVERTERS AND FREQUENCY INVERTERS; SYSTEMS MADE OF COMBINATIONS OF THE BEFORE-MENTIONED GOODS; PARTS OF THE BEFORE-MENTIONED GOODS, IN CLASS 9 (U.S. CLS. 21, 23, 26, 36 AND 38).

THE MARK CONSISTS OF STANDARD CHARACTERS WITHOUT CLAIM TO ANY PARTICULAR FONT, STYLE, SIZE, OR COLOR.

PRIORITY CLAIMED UNDER SEC. 44(D) ON FED REP GERMANY APPLICATION NO. 30675481.9, FILED 12-12-2006, REG. NO. 30675481, DATED 2-12-2007, EXPIRES 12-31-2016.

OWNER OF U.S. REG. NOS. 2,424,180 AND 2,753,354.

THE WORDING "SMARTWIRE" HAS NO MEANING IN A FOREIGN LANGUAGE.

SER. NO. 77-199,455, FILED 6-6-2007.

NORA BUCHANAN WILL, EXAMINING ATTORNEY

Int. Cl.: 9

Prior U.S. Cls.: 21, 23, 26, 36 and 38

Reg. No. 3,479,022

United States Patent and Trademark Office

Registered Aug. 5, 2008

**TRADEMARK
PRINCIPAL REGISTER**

(365) NO OFF SEASON

A-1 ARCHERY (WISCONSIN CORPORATION)
1830 WEBSTER STREET
HUDSON, WI 54016

FIRST USE 2-1-2007; IN COMMERCE 2-1-2007.

FOR: AUDIO AND VISUAL AIDS, NAMELY,
PROMOTIONAL AND INSTRUCTIONAL DVDS
FOR THE HUNTING INDUSTRY FEATURING IN-
STRUCTION IN THE FIELD OF ARCHERY AND
PROMOTION OF THE SPORT OF ARCHERY , IN
CLASS 9 (U.S. CLS. 21, 23, 26, 36 AND 38).

THE MARK CONSISTS OF STANDARD CHAR-
ACTERS WITHOUT CLAIM TO ANY PARTICULAR
FONT, STYLE, SIZE, OR COLOR.

SER. NO. 77-199,456, FILED 6-6-2007.

MICHELLE DUBOIS, EXAMINING ATTORNEY

Int. Cl.: 9

Prior U.S. Cls.: 21, 23, 26, 36 and 38

Reg. No. 3,479,023

United States Patent and Trademark Office

Registered Aug. 5, 2008

**TRADEMARK
PRINCIPAL REGISTER**

Solar Smart

MORETON BAY CORPORATION PTY LTD (AUSTRALIA LTD LIAB CO)
U32, CLEVELAND HOUSE, 120 BLOOMFIELD ST.
CLEVELAND, AUSTRALIA 4163

FOR: DIGITAL SECURITY/SURVEILLANCE CAMERA (WIRED AND WIRELESS) WITH IN-BUILT SOLAR PANEL AND RE-CHARGEABLE BATTERY, IN CLASS 9 (U.S. CLS. 21, 23, 26, 36 AND 38).

THE MARK CONSISTS OF STANDARD CHARACTERS WITHOUT CLAIM TO ANY PARTICULAR FONT, STYLE, SIZE, OR COLOR.

PRIORITY CLAIMED UNDER SEC. 44(D) ON AUSTRALIA APPLICATION NO. 1177375, FILED 5-22-2007, REG. NO. 1177375, DATED 5-22-2007, EXPIRES 5-22-2017.

NO CLAIM IS MADE TO THE EXCLUSIVE RIGHT TO USE "SOLAR", APART FROM THE MARK AS SHOWN.

SER. NO. 77-199,855, FILED 6-7-2007.

JOHN E. MICHOS, EXAMINING ATTORNEY

Int. Cl.: 41

Prior U.S. Cls.: 100, 101 and 107

United States Patent and Trademark Office

Reg. No. 3,479,024

Registered Aug. 5, 2008

**SERVICE MARK
PRINCIPAL REGISTER**

**THE WORLD STANDARD IN
STAGING EDUCATION**

BARB, INC. DBA STAGED HOMES (WASHING-
TON CORPORATION)
4807 CLAYTON RD. SUITE #200
CONCORD, CA 94521

FOR: EDUCATION SERVICES, NAMELY, PRO-
VIDING CONFERENCES, WORKSHOPS, SEMI-
NARS AND TRAINING COURSES AND
DEVELOPING AND DISSEMINATING EDUCA-
TIONAL MATERIALS IN THE FIELD OF HOME
RENOVATION, DESIGN AND DECORATION, IN
CLASS 41 (U.S. CLS. 100, 101 AND 107).

FIRST USE 1-31-2001; IN COMMERCE 1-31-2001.

THE MARK CONSISTS OF STANDARD CHAR-
ACTERS WITHOUT CLAIM TO ANY PARTICULAR
FONT, STYLE, SIZE, OR COLOR.

NO CLAIM IS MADE TO THE EXCLUSIVE
RIGHT TO USE "EDUCATION", APART FROM
THE MARK AS SHOWN.

SEC. 2(F).

SER. NO. 77-199,939, FILED 6-7-2007.

DORITT L. CARROLL, EXAMINING ATTORNEY

Int. Cl.: 9

Prior U.S. Cls.: 21, 23, 26, 36 and 38

United States Patent and Trademark Office

Reg. No. 3,479,025

Registered Aug. 5, 2008

**TRADEMARK
PRINCIPAL REGISTER**

EVMI SYSTEM

HON HAI PRECISION INDUSTRY CO., LTD.
(TAIWAN CORPORATION)
2, TZU YU STREET, TU-CHENG CITY
TAIPEI HSIEN, TAIWAN

FOR: COMPUTER SOFTWARE AND PROGRAMS
FOR USE IN TRACKING DELIVERY, STORAGE,
AND DISTRIBUTION OF GOODS, IN CLASS 9 (U.S.
CLS. 21, 23, 26, 36 AND 38).

FIRST USE 11-1-2002; IN COMMERCE 11-1-2002.

THE MARK CONSISTS OF STANDARD CHAR-
ACTERS WITHOUT CLAIM TO ANY PARTICULAR
FONT, STYLE, SIZE, OR COLOR.

OWNER OF U.S. REG. NO. 2,956,016.

SEC. 2(F).

SER. NO. 77-199,954, FILED 6-7-2007.

NORA BUCHANAN WILL, EXAMINING ATTOR-
NEY

Int. Cl.: 16

Prior U.S. Cls.: 2, 5, 22, 23, 29, 37, 38 and 50

Reg. No. 3,479,026

United States Patent and Trademark Office

Registered Aug. 5, 2008

**TRADEMARK
PRINCIPAL REGISTER**

LA ESTRELLA

MCCLATCHY U.S.A., INC. (DELAWARE CORPORATION)
2100 Q STREET
SACRAMENTO, CA 95816

FOR: NEWSPAPERS FOR GENERAL CIRCULATION, IN CLASS 16 (U.S. CLS. 2, 5, 22, 23, 29, 37, 38 AND 50).

FIRST USE 3-23-2007; IN COMMERCE 3-23-2007.

THE MARK CONSISTS OF STANDARD CHARACTERS WITHOUT CLAIM TO ANY PARTICULAR FONT, STYLE, SIZE, OR COLOR.

THE FOREIGN WORDING IN THE MARK TRANSLATES INTO ENGLISH AS THE STAR.

SER. NO. 77-200,163, FILED 6-7-2007.

JASON TURNER, EXAMINING ATTORNEY

Int. Cl.: 16

Prior U.S. Cls.: 2, 5, 22, 23, 29, 37, 38 and 50

United States Patent and Trademark Office

Reg. No. 3,479,027

Registered Aug. 5, 2008

**TRADEMARK
PRINCIPAL REGISTER**

LA ESTRELLA EN CASA

MCCLATCHY U.S.A., INC. (DELAWARE CORPORATION)
2100 Q STREET
SACRAMENTO, CA 95816

FOR: CIRCULARS IN THE FIELD OF ADVERTISEMENTS OF OTHERS' PRODUCTS AND SERVICES BUNDLED TOGETHER WITH ARTICLES RELATING TO SHOPPING, SPORTS, AND ENTERTAINMENT FOR COMMON DISTRIBUTION, IN CLASS 16 (U.S. CLS. 2, 5, 22, 23, 29, 37, 38 AND 50).

FIRST USE 5-5-2007; IN COMMERCE 5-5-2007.

THE MARK CONSISTS OF STANDARD CHARACTERS WITHOUT CLAIM TO ANY PARTICULAR FONT, STYLE, SIZE, OR COLOR.

OWNER OF U.S. REG. NO. 2,977,603.

THE FOREIGN WORDING IN THE MARK TRANSLATES INTO ENGLISH AS THE STAR IN THE HOUSE.

SER. NO. 77-200,195, FILED 6-7-2007.

JASON TURNER, EXAMINING ATTORNEY

Int. Cl.: 41

Prior U.S. Cls.: 100, 101 and 107

United States Patent and Trademark Office

Reg. No. 3,479,028

Registered Aug. 5, 2008

**SERVICE MARK
PRINCIPAL REGISTER**



DAVE BOWMAN ENTERPRISES, INC. (FLORIDA CORPORATION)

19102 ST. LAURENT DRIVE

LUTZ, FL 33558

FOR: ENTERTAINMENT IN THE NATURE OF A TRANSACTIONAL TELEVISION SHOW OFFERING PRODUCTS FOR PURCHASE, IN CLASS 41 (U.S. CLS. 100, 101 AND 107).

FIRST USE 4-15-2007; IN COMMERCE 5-1-2007.

NO CLAIM IS MADE TO THE EXCLUSIVE RIGHT TO USE TV STORE, APART FROM THE MARK AS SHOWN.

THE MARK CONSISTS OF THE WORDS RODS & RIDES TV STORE WITH FOUR EQUAL HORIZONTAL LINES UNDER THE LETTERS "R" "I" AND PARTIALLY UNDER THE LETTER "D" IN THE WORD RIDES.

SER. NO. 77-200,493, FILED 6-7-2007.

DAVID MURRAY, EXAMINING ATTORNEY

Int. Cl.: 43

Prior U.S. Cls.: 100 and 101

United States Patent and Trademark Office

Reg. No. 3,479,029

Registered Aug. 5, 2008

**SERVICE MARK
PRINCIPAL REGISTER**

FLYING TOMATO

HAWKINS, CHARLES JOSEPH (UNITED STATES
INDIVIDUAL)
1600 WEST 35TH STREET
AUSTIN, TX 78703

FOR: RESTAURANT AND BAR SERVICES; RES-
TAURANTS; TAKE-OUT RESTAURANT SERVICES,
IN CLASS 43 (U.S. CLS. 100 AND 101).

FIRST USE 10-0-2005; IN COMMERCE 10-0-2005.

THE MARK CONSISTS OF STANDARD CHAR-
ACTERS WITHOUT CLAIM TO ANY PARTICULAR
FONT, STYLE, SIZE, OR COLOR.

NO CLAIM IS MADE TO THE EXCLUSIVE
RIGHT TO USE "TOMATO", APART FROM THE
MARK AS SHOWN.

SER. NO. 77-200,580, FILED 6-7-2007.

CHRISTINE COOPER, EXAMINING ATTORNEY

Int. Cl.: 16

Prior U.S. Cls.: 2, 5, 22, 23, 29, 37, 38 and 50

Reg. No. 3,479,030

United States Patent and Trademark Office

Registered Aug. 5, 2008

**TRADEMARK
PRINCIPAL REGISTER**

**CVI CLINICAL AND VACCINE
IMMUNOLOGY**

AMERICAN SOCIETY FOR MICROBIOLOGY
(D.C. CORPORATION)
1752 N STREET, N.W.
WASHINGTON, DC 20036

FOR: PERIODIC SCIENTIFIC JOURNAL IN THE
FIELD OF IMMUNOLOGY, IN CLASS 16 (U.S. CLS.
2, 5, 22, 23, 29, 37, 38 AND 50).

FIRST USE 1-10-2006; IN COMMERCE 1-10-2006.

THE MARK CONSISTS OF STANDARD CHAR-
ACTERS WITHOUT CLAIM TO ANY PARTICULAR
FONT, STYLE, SIZE, OR COLOR.

NO CLAIM IS MADE TO THE EXCLUSIVE
RIGHT TO USE "CLINICAL AND VACCINE IMMUNO-
LOGY", APART FROM THE MARK AS SHOWN.

SER. NO. 77-200,627, FILED 6-7-2007.

TINA BROWN, EXAMINING ATTORNEY

Int. Cl.: 9

Prior U.S. Cls.: 21, 23, 26, 36 and 38

Reg. No. 3,479,031

United States Patent and Trademark Office

Registered Aug. 5, 2008

**TRADEMARK
PRINCIPAL REGISTER**

SIE Super Image Enhancer

NUVICO, LLC (DELAWARE CORPORATION)
ATTENTION: MR. K. LEE
53 SMITH STREET
ENGLEWOOD, NJ 07631

FOR: BUILDING SECURITY SYSTEMS COM-
PRISING SOFTWARE AND HARDWARE FOR PRO-
VIDING PICTURE, VIDEO, ALARM STATUS,
BUILDING PLANS, AND OTHER INFORMATION
TO A REMOTE STATION, IN CLASS 9 (U.S. CLS. 21,
23, 26, 36 AND 38).

FIRST USE 2-20-2007; IN COMMERCE 3-1-2007.

THE MARK CONSISTS OF STANDARD CHAR-
ACTERS WITHOUT CLAIM TO ANY PARTICULAR
FONT, STYLE, SIZE, OR COLOR.

NO CLAIM IS MADE TO THE EXCLUSIVE
RIGHT TO USE "SUPER IMAGE ENHANCER",
APART FROM THE MARK AS SHOWN.

SER. NO. 77-201,412, FILED 6-8-2007.

LESLEY LAMOTHE, EXAMINING ATTORNEY

Int. Cls.: 35 and 43

Prior U.S. Cls.: 100, 101 and 102

United States Patent and Trademark Office

Reg. No. 3,479,032

Registered Aug. 5, 2008

**SERVICE MARK
PRINCIPAL REGISTER**

PRESIDENT'S PICKS

FRESH DIRECT, LLC (DELAWARE CORPORATION)
23-30 BORDEN AVENUE
LONG ISLAND CITY, NY 11101

FOR: PROMOTING THE SALE OF GOODS AND SERVICES OF OTHERS THROUGH THE DISTRIBUTION OF PRINTED MATERIAL, IN CLASS 35 (U.S. CLS. 100, 101 AND 102).

FIRST USE 7-12-2005; IN COMMERCE 7-12-2005.

FOR: INFORMATION SERVICES, NAMELY, PROVIDING INFORMATION ABOUT FOOD, GRO-

CERY ITEMS, BEVERAGES, COOKING TIPS, IN CLASS 43 (U.S. CLS. 100 AND 101).

FIRST USE 7-12-2005; IN COMMERCE 7-12-2005.

THE MARK CONSISTS OF STANDARD CHARACTERS WITHOUT CLAIM TO ANY PARTICULAR FONT, STYLE, SIZE, OR COLOR.

SER. NO. 77-201,505, FILED 6-8-2007.

WILLIAM BRECKENFELD, EXAMINING ATTORNEY

Int. Cl.: 25

Prior U.S. Cls.: 22 and 39

United States Patent and Trademark Office

Reg. No. 3,479,033

Registered Aug. 5, 2008

**TRADEMARK
PRINCIPAL REGISTER**



MC CORPORATION LIMITED (ENGLAND COR-
PORATION)
10 ACTON LANE, CHISWICK
LONDON, ENGLAND W45ED

FOR: CLOTHING, NAMELY, SHIRTS, T-SHIRTS,
SPORTS SHIRTS, AND SWEATERS; BELTS, CAPS,
HATS, AND SUN VISORS, IN CLASS 25 (U.S. CLS. 22
AND 39).

FIRST USE 10-1-2001; IN COMMERCE 10-29-2001.

OWNER OF U.S. REG. NO. 2,899,662.

THE MARK CONSISTS OF MISCELLANEOUS
DESIGN.

SER. NO. 77-201,524, FILED 6-8-2007.

SHAUNIA CARLYLE, EXAMINING ATTORNEY

Int. Cl.: 43

Prior U.S. Cls.: 100 and 101

United States Patent and Trademark Office

Reg. No. 3,479,034

Registered Aug. 5, 2008

**SERVICE MARK
PRINCIPAL REGISTER**

ONCE UPON A TART

ONCE UPON A TART, INC. (NEW YORK CORPORATION)
135 SULLIVAN STREET
NEW YORK, NY 10012

FOR: TAKE-OUT RESTAURANT SERVICES; RESTAURANTS FEATURING HOME DELIVERY; MAIL ORDER BAKERY PRODUCTS SERVICES, IN CLASS 43 (U.S. CLS. 100 AND 101).

FIRST USE 9-15-1992; IN COMMERCE 9-15-1992.

THE MARK CONSISTS OF STANDARD CHARACTERS WITHOUT CLAIM TO ANY PARTICULAR FONT, STYLE, SIZE, OR COLOR.

SER. NO. 77-201,549, FILED 6-8-2007.

JERI J. FICKES, EXAMINING ATTORNEY

Int. Cl.: 41

Prior U.S. Cls.: 100, 101 and 107

United States Patent and Trademark Office

Reg. No. 3,479,035

Registered Aug. 5, 2008

**SERVICE MARK
PRINCIPAL REGISTER**

GolfTards

SMITH, BRENN (UNITED STATES INDIVIDUAL)
3350 SPRING MEADOW COURT
TUCKER, GA 30084

FOR: ENTERTAINMENT SERVICES, NAMELY,
PROVIDING A WEBSITE FEATURING PHOTO-
GRAPHIC, AUDIO, VIDEO AND PROSE PRESEN-
TATIONS FEATURING GOLF, IN CLASS 41 (U.S.
CLS. 100, 101 AND 107).

FIRST USE 2-24-2006; IN COMMERCE 2-24-2006.

THE MARK CONSISTS OF STANDARD CHAR-
ACTERS WITHOUT CLAIM TO ANY PARTICULAR
FONT, STYLE, SIZE, OR COLOR.

SER. NO. 77-201,581, FILED 6-8-2007.

YONG KIM, EXAMINING ATTORNEY

Int. Cl.: 7

Prior U.S. Cls.: 13, 19, 21, 23, 31, 34 and 35

United States Patent and Trademark Office

Reg. No. 3,479,036

Registered Aug. 5, 2008

**TRADEMARK
PRINCIPAL REGISTER**

CIDAN

PETERSEN MACHINERY GROUP A/S (DEN-
MARK CORPORATION)
HEDEVEJ 44, BOGBALLE
ULDUM, DENMARK 7171

FOR: MACHINE AND MACHINE TOOLS FOR
METAL WORKING AND PROCESSING, NAMELY,
MACHINES FOR THE WORKING AND PROCES-
SING OF PLATE MATERIALS IN THE FORM OF
SHEETS AND BANDS; BENDING MACHINES,
POWER-OPERATED PLATE SHEARS, PLATE CON-
VEYOR MACHINES, POWER-OPERATED REELS
FOR THE UNWINDING OF BANDS, STRAIGHTEN-
ING MACHINES FOR THE STRAIGHTENING OF
PLATES AND BANDS, BAND CUTTING MA-
CHINES, SLITTING MACHINES FOR THE CUT-
TING UP OF BANDS INTO STRIPS, MACHINES
FOR SURFACE TREATMENT OF PLATES AND

BANDS, POLISHING MACHINES, TRIMMING MA-
CHINES, MACHINE PARTS FOR ALL THE AFORE-
SAID GOODS, IN CLASS 7 (U.S. CLS. 13, 19, 21, 23, 31,
34 AND 35).

THE MARK CONSISTS OF STANDARD CHAR-
ACTERS WITHOUT CLAIM TO ANY PARTICULAR
FONT, STYLE, SIZE, OR COLOR.

OWNER OF DENMARK REG. NO. VR198903380,
DATED 6-16-1989, RENEWED AS REG. NO.
VR198903380, DATED 6-16-1999, EXPIRES 6-16-2009.

SER. NO. 77-201,634, FILED 6-8-2007.

HEATHER THOMPSON, EXAMINING ATTORNEY

Int. Cl.: 9

Prior U.S. Cls.: 21, 23, 26, 36 and 38

Reg. No. 3,479,037

United States Patent and Trademark Office

Registered Aug. 5, 2008

**TRADEMARK
PRINCIPAL REGISTER**



KOZIO, INC. (COLORADO CORPORATION)
2400 TRADE CENTRE AVE
LONGMONT, CO 80503

FOR: COMPUTER SOFTWARE, COMPUTER HARDWARE, AND UTILITIES, NAMELY, ELECTRONIC DEVICES FOR USE IN COMPUTER HARDWARE VALIDATION AND DIAGNOSTICS, ALL FOR INITIALIZING, BOOTING, TESTING, DIAGNOSING, TROUBLESHOOTING, VALIDATING, TRACKING TEST RESULTS, OPTIMIZING CONFIGURATION, AND MEASURING PERFORMANCE OF ELECTRONIC CIRCUITRY, CIRCUIT BOARDS, BUSES, MEMORIES, PERIPHERALS, CONNECTORS, INTEGRATED CIRCUITS, DISPLAYS, AND ADAPTERS, AND INSTRUCTION MANUALS SOLD AS A UNIT THEREWITH; COMPUTER SOFTWARE, NAMELY, EMBEDDED FUNCTIONALITY TESTING SOFTWARE, COMPUTER HARDWARE, AND UTILITIES ALSO KNOWN AS, GRAPHICAL USER INTERFACES, IN-CIRCUIT PROGRAMMING SOFTWARE, RELATIONAL DATABASE SOFTWARE, TEST EXECUTIVE AND REPORT GENERATOR SOFTWARE, ALL FOR AUTOMATED FUNCTIONAL TESTING, SERIALIZATION, PROCESS CREATION, PROCESS EXECUTION, PROCESS TRACKING, DATABASE INTERACTIONS, NETWORKING, VIEWING, AND MANUFACTURING OF ELECTRONIC CIRCUITRY, CIRCUIT BOARDS, BUSES, MEMORIES, PERIPHERALS, CONNECTORS, INTEGRATED CIRCUITS, DISPLAYS, AND ADAPTERS, AND INSTRUCTION MANUALS SOLD AS A UNIT THEREWITH; COMPUTER SOFTWARE FOR EXECUTING POWER-ON SELF-TEST FOR CUSTOM ELECTRONIC CIRCUITRY, CIRCUIT BOARDS, BUSES, MEMORIES, PERIPHERALS, CONNECTORS, INTEGRATED CIRCUITS, DISPLAYS, AND ADAPTERS, AND INSTRUCTION MANUALS SOLD AS A UNIT THEREWITH; ELECTRONIC PUBLICATIONS, NAMELY, MANUALS FEATURING INFORMATION REGARDING COMPUTER SOFTWARE, COMPUTER HARDWARE, AND UTILITIES, RECORDED ON COMPUTER MEDIA; AND USER MANUALS SOLD AS A UNIT THEREWITH, IN CLASS 9 (U.S. CLS. 21, 23, 26, 36 AND 38).

TRY, CIRCUIT BOARDS, BUSES, MEMORIES, PERIPHERALS, CONNECTORS, INTEGRATED CIRCUITS, DISPLAYS, AND ADAPTERS, AND INSTRUCTION MANUALS SOLD AS A UNIT THEREWITH; COMPUTER SOFTWARE FOR EXECUTING POWER-ON SELF-TEST FOR CUSTOM ELECTRONIC CIRCUITRY, CIRCUIT BOARDS, BUSES, MEMORIES, PERIPHERALS, CONNECTORS, INTEGRATED CIRCUITS, DISPLAYS, AND ADAPTERS, AND INSTRUCTION MANUALS SOLD AS A UNIT THEREWITH; ELECTRONIC PUBLICATIONS, NAMELY, MANUALS FEATURING INFORMATION REGARDING COMPUTER SOFTWARE, COMPUTER HARDWARE, AND UTILITIES, RECORDED ON COMPUTER MEDIA; AND USER MANUALS SOLD AS A UNIT THEREWITH, IN CLASS 9 (U.S. CLS. 21, 23, 26, 36 AND 38).

FIRST USE 5-2-2002; IN COMMERCE 1-8-2003.

THE MARK CONSISTS OF A DIAMOND WITH TWO HORIZONTAL STRIPS REMOVED AND ONE VERTICAL ARCED STRIP REMOVED AS WELL AS A CUTOUT REMOVED WHERE THE LITERAL ELEMENT BEGINS.

SER. NO. 77-201,813, FILED 6-8-2007.

RONALD AIKENS, EXAMINING ATTORNEY

Int. Cl.: 35

Prior U.S. Cls.: 100, 101 and 102

United States Patent and Trademark Office

Reg. No. 3,479,038

Registered Aug. 5, 2008

**SERVICE MARK
PRINCIPAL REGISTER**

VIE IT SnapShot

VIRTUAL INFORMATION EXECUTIVES, LLC
(OREGON LTD LIAB CO)

12639 NW WAKER DRIVE

PORTLAND, OR 97229

FOR: BUSINESS CONSULTING AND BUSINESS
INFORMATION FOR ENTERPRISES; BUSINESS
CONSULTING AND INFORMATION SERVICES,
IN CLASS 35 (U.S. CLS. 100, 101 AND 102).

FIRST USE 3-26-2007; IN COMMERCE 4-7-2007.

THE MARK CONSISTS OF STANDARD CHAR-
ACTERS WITHOUT CLAIM TO ANY PARTICULAR
FONT, STYLE, SIZE, OR COLOR.

OWNER OF U.S. REG. NO. 3,383,738.

NO CLAIM IS MADE TO THE EXCLUSIVE
RIGHT TO USE "IT", APART FROM THE MARK
AS SHOWN.

SER. NO. 77-201,866, FILED 6-8-2007.

DANNEAN HETZEL, EXAMINING ATTORNEY

Int. Cl.: 9

Prior U.S. Cls.: 21, 23, 26, 36 and 38

Reg. No. 3,479,039

United States Patent and Trademark Office

Registered Aug. 5, 2008

TRADEMARK
PRINCIPAL REGISTER

kDiagnostics

KOZIO, INC. (COLORADO CORPORATION)
2400 TRADE CENTRE AVE
LONGMONT, CO 80503

FOR: COMPUTER SOFTWARE, COMPUTER HARDWARE, AND UTILITIES, NAMELY, ELECTRONIC DEVICES FOR USE IN COMPUTER HARDWARE VALIDATION AND DIAGNOSTICS, ALL FOR INITIALIZING, BOOTING, TESTING, DIAGNOSING, TROUBLESHOOTING, VALIDATING, TRACKING TEST RESULTS, OPTIMIZING CONFIGURATION, AND MEASURING PERFORMANCE OF ELECTRONIC CIRCUITRY, CIRCUIT BOARDS, BUSES, MEMORIES, PERIPHERALS, CONNECTORS, INTEGRATED CIRCUITS, DISPLAYS, AND ADAPTERS, AND INSTRUCTION MANUALS SOLD AS A UNIT THEREWITH; COMPUTER SOFTWARE, NAMELY, EMBEDDED FUNCTIONALITY TESTING SOFTWARE, COMPUTER HARDWARE, AND UTILITIES ALSO KNOWN AS, GRAPHICAL USER INTERFACES, IN-CIRCUIT PROGRAMMING SOFTWARE, RELATIONAL DATABASE SOFTWARE, TEST EXECUTIVE AND REPORT GENERATOR SOFTWARE, ALL FOR AUTOMATED FUNCTIONAL TESTING, SERIALIZATION, PROCESS CREATION, PROCESS EXECUTION, PROCESS TRACKING, DATABASE INTERACTIONS, NETWORKING, VIEWING, AND

MANUFACTURING OF ELECTRONIC CIRCUITRY, CIRCUIT BOARDS, BUSES, MEMORIES, PERIPHERALS, CONNECTORS, INTEGRATED CIRCUITS, DISPLAYS, AND ADAPTERS, AND INSTRUCTION MANUALS SOLD AS A UNIT THEREWITH; COMPUTER SOFTWARE FOR EXECUTING POWER-ON SELF-TEST FOR CUSTOM ELECTRONIC CIRCUITRY, CIRCUIT BOARDS, BUSES, MEMORIES, PERIPHERALS, CONNECTORS, INTEGRATED CIRCUITS, DISPLAYS, AND ADAPTERS, AND INSTRUCTION MANUALS SOLD AS A UNIT THEREWITH; ELECTRONIC PUBLICATIONS, NAMELY, MANUALS FEATURING INFORMATION REGARDING COMPUTER SOFTWARE, COMPUTER HARDWARE, AND UTILITIES, RECORDED ON COMPUTER MEDIA; AND USER MANUALS SOLD AS A UNIT THEREWITH, IN CLASS 9 (U.S. CLS. 21, 23, 26, 36 AND 38).

FIRST USE 11-28-2001; IN COMMERCE 6-17-2003.

THE MARK CONSISTS OF STANDARD CHARACTERS WITHOUT CLAIM TO ANY PARTICULAR FONT, STYLE, SIZE, OR COLOR.

SER. NO. 77-201,966, FILED 6-8-2007.

RONALD AIKENS, EXAMINING ATTORNEY

Int. Cl.: 24

Prior U.S. Cls.: 42 and 50

United States Patent and Trademark Office

Reg. No. 3,479,040

Registered Aug. 5, 2008

**TRADEMARK
PRINCIPAL REGISTER**

STARK FABRIC

STARK CARPET CORP. (NEW YORK CORPORATION)
979 THIRD AVENUE
NEW YORK, NY 10022

FOR: TEXTILE FABRICS FOR USE IN CONNECTION WITH HOME AND COMMERCIAL INTERIOR DECORATING SOLD ONLY TO AND THROUGH DESIGN PROFESSIONALS THROUGH AUTHORIZED SHOWROOMS, IN CLASS 24 (U.S. CLS. 42 AND 50).

FIRST USE 6-1-2006; IN COMMERCE 6-1-2006.

THE MARK CONSISTS OF STANDARD CHARACTERS WITHOUT CLAIM TO ANY PARTICULAR FONT, STYLE, SIZE, OR COLOR.

OWNER OF U.S. REG. NOS. 1,133,747, 2,379,891 AND OTHERS.

NO CLAIM IS MADE TO THE EXCLUSIVE RIGHT TO USE "FABRIC", APART FROM THE MARK AS SHOWN.

THE NAME "STARK" DOES NOT IDENTIFY A LIVING INDIVIDUAL.

SER. NO. 77-202,436, FILED 6-11-2007.

MAUREEN DALL, EXAMINING ATTORNEY

Int. Cl.: 5

Prior U.S. Cls.: 6, 18, 44, 46, 51 and 52

United States Patent and Trademark Office

Reg. No. 3,479,041

Registered Aug. 5, 2008

**TRADEMARK
PRINCIPAL REGISTER**

BIO-35

PRO-BIOTIKS LABS, INC. (UTAH CORPORATION)
PO BOX 12608
OGDEN, UT 84111

FOR: VITAMIN AND NUTRITIONAL SUPPLEMENTS, IN CLASS 5 (U.S. CLS. 6, 18, 44, 46, 51 AND 52).

FIRST USE 7-31-1975; IN COMMERCE 7-31-1975.

THE MARK CONSISTS OF STANDARD CHARACTERS WITHOUT CLAIM TO ANY PARTICULAR FONT, STYLE, SIZE, OR COLOR.

SER. NO. 77-203,027, FILED 6-11-2007.

KATHERINE CONNOLLY, EXAMINING ATTORNEY

Int. Cl.: 38

Prior U.S. Cls.: 100, 101 and 104

United States Patent and Trademark Office

Reg. No. 3,479,042

Registered Aug. 5, 2008

**SERVICE MARK
PRINCIPAL REGISTER**

AIX

TECHNOLOGY ADVANCEMENT GROUP, INC.
(VIRGINIA CORPORATION)
22355 TAG WAY
DULLES, VA 20166

THE MARK CONSISTS OF STANDARD CHAR-
ACTERS WITHOUT CLAIM TO ANY PARTICULAR
FONT, STYLE, SIZE, OR COLOR.

FOR: COMMUNICATION SERVICES, NAMELY,
PROVIDING NETWORK ACCESS POINTS TO A
GLOBAL COMPUTER NETWORK, IN CLASS 38
(U.S. CLS. 100, 101 AND 104).

SER. NO. 77-203,632, FILED 6-12-2007.

FIRST USE 0-0-2003; IN COMMERCE 0-0-2003.

SETH A. RAPPAPORT, EXAMINING ATTORNEY

Int. Cl.: 32

Prior U.S. Cls.: 45, 46 and 48

United States Patent and Trademark Office

Reg. No. 3,479,043

Registered Aug. 5, 2008

**TRADEMARK
PRINCIPAL REGISTER**

JUICE UP YOUR GAME!

GAME JUICE, INC. (FLORIDA CORPORATION)
7909 SW 104 STREET
SUITE 213
MIAMI, FL 33156

FOR: NON-ALCOHOLIC DRINKS, NAMELY, EN-
ERGY DRINKS AND SOFT DRINKS, IN CLASS 32
(U.S. CLS. 45, 46 AND 48).

FIRST USE 5-12-2007; IN COMMERCE 8-29-2007.

THE MARK CONSISTS OF STANDARD CHAR-
ACTERS WITHOUT CLAIM TO ANY PARTICULAR
FONT, STYLE, SIZE, OR COLOR.

OWNER OF U.S. REG. NO. 3,382,720.

NO CLAIM IS MADE TO THE EXCLUSIVE
RIGHT TO USE "JUICE", APART FROM THE MARK
AS SHOWN.

SER. NO. 77-203,647, FILED 6-12-2007.

LAURA HAMMEL, EXAMINING ATTORNEY

Int. Cl.: 35

Prior U.S. Cls.: 100, 101 and 102

United States Patent and Trademark Office

Reg. No. 3,479,044

Registered Aug. 5, 2008

**SERVICE MARK
PRINCIPAL REGISTER**

sustainable table

GRACE (DELAWARE CORPORATION)
215 LEXINGTON AVENUE, SUITE 1001
NEW YORK, NY 10016

FOR: OPERATING A WEBSITE FEATURING FREE INFORMATION FOR CONSUMERS ON SUSTAINABLE EATING AND SUSTAINABLE AGRICULTURE, INCLUDING HEALTHY AND HUMANE METHODS OF FARMING AND PRODUCING MEAT, POULTRY, DAIRY AND EGGS THAT CONSERVE AND PRESERVE NATURAL RESOURCES, PROVIDE SAFE AND FAIR WORKING CONDITIONS FOR LABORERS, PROMOTE BIODIVERSITY AND ANIMAL WELFARE, AND SUSTAIN ECONOMIC VIABILITY FOR FARM OP-

ERATIONS, IN CLASS 35 (U.S. CLS. 100, 101 AND 102).

FIRST USE 11-3-2003; IN COMMERCE 11-3-2003.

THE MARK CONSISTS OF STANDARD CHARACTERS WITHOUT CLAIM TO ANY PARTICULAR FONT, STYLE, SIZE, OR COLOR.

NO CLAIM IS MADE TO THE EXCLUSIVE RIGHT TO USE "SUSTAINABLE" , APART FROM THE MARK AS SHOWN.

SER. NO. 77-203,684, FILED 6-12-2007.

ALICE BENMAMAN, EXAMINING ATTORNEY

Int. Cl.: 41

Prior U.S. Cls.: 100, 101 and 107

United States Patent and Trademark Office

Reg. No. 3,479,045

Registered Aug. 5, 2008

**SERVICE MARK
PRINCIPAL REGISTER**

PSDS

DR. ING. H.C. F. PORSCHE AG (FED REP
GERMANY CORPORATION)
PORSCHEPLATZ 1
STUTTGART-ZUFFENHAUSEN, FED REP GER-
MANY 70435

FOR: EDUCATIONAL SERVICES, NAMELY,
CONDUCTING COURSES IN THE FIELDS OF
SPORTS CAR RACING AND HIGH PERFOR-
MANCE DRIVING, IN CLASS 41 (U.S. CLS. 100, 101
AND 107).

FIRST USE 2-29-2008; IN COMMERCE 2-29-2008.

THE MARK CONSISTS OF STANDARD CHAR-
ACTERS WITHOUT CLAIM TO ANY PARTICULAR
FONT, STYLE, SIZE, OR COLOR.

SER. NO. 77-204,065, FILED 6-12-2007.

LAURIE KAUFMAN, EXAMINING ATTORNEY

Int. Cl.: 16

Prior U.S. Cls.: 2, 5, 22, 23, 29, 37, 38 and 50

Reg. No. 3,479,046

United States Patent and Trademark Office

Registered Aug. 5, 2008

**TRADEMARK
PRINCIPAL REGISTER**

PARAMOUNT

GOLDSTEIN, IRA (UNITED STATES INDIVIDUAL)
5325 DEPARTURE DRIVE
RALEIGH, NC 27616 AND
GOLDSTEIN, DAVID (UNITED STATES INDIVIDUAL)
5325 DEPARTURE DRIVE
RALEIGH, NC 27609

FOR: ARTIST'S MATERIALS, NAMELY, ARTIST
CANVAS FOR PAINTING, IN CLASS 16 (U.S. CLS. 2,
5, 22, 23, 29, 37, 38 AND 50).

FIRST USE 5-16-2005; IN COMMERCE 5-16-2005.

THE MARK CONSISTS OF STANDARD CHARACTERS WITHOUT CLAIM TO ANY PARTICULAR FONT, STYLE, SIZE, OR COLOR.

SER. NO. 77-204,211, FILED 6-12-2007.

MICHELLE DUBOIS, EXAMINING ATTORNEY

Int. Cls.: 20 and 22

Prior U.S. Cls.: 1, 2, 7, 13, 19, 22, 25, 32, 42 and 50

United States Patent and Trademark Office

Reg. No. 3,479,047

Registered Aug. 5, 2008

**TRADEMARK
PRINCIPAL REGISTER**



FAIRKEEP PRODUCTS, LLC (ARKANSAS LTD
LIAB CO)
905 SE 21ST STREET
BENTONVILLE, AR 72712

FOR: FURNITURE; FURNITURE FOR HOUSE,
OFFICE AND GARDEN; LAWN FURNITURE; OUT-
DOOR FURNITURE; PLASTIC FURNITURE FOR
GARDENS; SEATING FURNITURE; SEATS; TA-
BLES, IN CLASS 20 (U.S. CLS. 2, 13, 22, 25, 32 AND 50).

FIRST USE 1-8-2007; IN COMMERCE 1-8-2007.

FOR: HAMMOCKS; CANVAS CANOPIES, IN
CLASS 22 (U.S. CLS. 1, 2, 7, 19, 22, 42 AND 50).

FIRST USE 1-8-2007; IN COMMERCE 1-8-2007.

THE MARK CONSISTS OF A CIRCLE WITH A
DOUBLE SIDED "K" INSIDE.

SER. NO. 77-204,242, FILED 6-12-2007.

DAVID TAYLOR, EXAMINING ATTORNEY

Int. Cl.: 30

Prior U.S. Cl.: 46

United States Patent and Trademark Office

Reg. No. 3,479,048

Registered Aug. 5, 2008

TRADEMARK
PRINCIPAL REGISTER



INDIAN S.R.L. (ITALY LTD LIAB CO)
VIA DELL'INDUSTRIA 52
CAVRIAGO, REGGIO EMILIA, ITALY 42025

FOR: ICE CREAMS; THICKENERS FOR ICE CREAMS IN THE NATURE OF CREAM; WAFERS FOR ICE CREAMS; FRUIT ICE CREAMS; YOGURT ICE CREAMS; FROZEN YOGURTS AND ICE CREAMS; PREPARATIONS FOR MAKING ICE CREAMS, NAMELY, CREAM; PRODUCTS AND PREPARATIONS FOR MAKING ICE CREAMS, NAMELY, SUGAR; INSTANT PREPARATIONS FOR MAKING ICE CREAMS, NAMELY, ICE CREAM MIXES; PASTE FOR SWEETS, NAMELY, ALMOND PASTE; FOOD SUPPLY PASTES, NAMELY, SEASONING PASTES; CARAMELS; COFFEE-TEA; CACAO; RICE; TAPIOCA; COFFEE SUBSTITUTES; FLOUR; PREPARATIONS MADE OF CEREALS, NAMELY, ROLLED OATS; BREAD; BISCUITS; CAKES; ARTICLES OF CONFECTIONERY, NAMELY, FROZEN CONFECTIONS; SU-

GARED ALMONDS; HONEY; SYRUP; PEPPER; VINEGAR; SAUCES; SPICES; ICE; DRINKS BASED ON COFFEE IN THE NATURE OF COFFEE BASED BEVERAGES CONTAINING MILK, CACAO OR CHOCOLATE, IN CLASS 30 (U.S. CL. 46).

PRIORITY CLAIMED UNDER SEC. 44(D) ON ITALY APPLICATION NO. MI2007C1028, FILED 1-31-2007, REG. NO. MI2007C1028, DATED 1-31-2008, EXPIRES 1-31-2018.

NO CLAIM IS MADE TO THE EXCLUSIVE RIGHT TO USE "DOLCE & GELATO" AND "MADE IN ITALY", APART FROM THE MARK AS SHOWN.

THE ENGLISH TRANSLATION OF THE WORD "DOLCE" IN THE MARK IS "SWEET".

SER. NO. 77-204,305, FILED 6-12-2007.

TARAH HARDY, EXAMINING ATTORNEY

Int. Cl.: 35

Prior U.S. Cls.: 100, 101 and 102

United States Patent and Trademark Office

Reg. No. 3,479,049

Registered Aug. 5, 2008

**SERVICE MARK
PRINCIPAL REGISTER**



GRACE (DELAWARE CORPORATION)
215 LEXINGTON AVENUE, SUITE 1001
NEW YORK, NY 10016

FOR: OPERATING A WEBSITE FEATURING FREE INFORMATION FOR CONSUMERS ON SUSTAINABLE EATING AND SUSTAINABLE AGRICULTURE, INCLUDING HEALTHY AND HUMANE METHODS OF FARMING AND PRODUCING MEAT, POULTRY, DAIRY AND EGGS THAT CONSERVE AND PRESERVE NATURAL RESOURCES PROVIDE SAFE AND FAIR WORKING CONDITIONS FOR LABORERS, PROMOTE BIODIVERSITY AND ANIMAL WELFARE, AND

SUSTAIN ECONOMIC VIABILITY FOR FARM OPERATIONS, IN CLASS 35 (U.S. CLS. 100, 101 AND 102).

FIRST USE 11-3-2003; IN COMMERCE 11-3-2003.

THE MARK CONSISTS OF STYLIZED PLACE SETTING WHICH INCLUDES A FORK, PLATE AND KNIFE.

SER. NO. 77-204,318, FILED 6-12-2007.

ALICE BENMAMAN, EXAMINING ATTORNEY

Int. Cl.: 41

Prior U.S. Cls.: 100, 101 and 107

United States Patent and Trademark Office

Reg. No. 3,479,050

Registered Aug. 5, 2008

SERVICE MARK
PRINCIPAL REGISTER



SUMMER SCIENCE DAY CAMPS, INC. (GEORGIA CORPORATION)
636 STEELS BRIDGE ROAD
CANTON, GA 30114

FOR: PROVIDING EDUCATIONAL AND RECREATIONAL DAY CAMP SERVICES FOR CHILDREN, IN CLASS 41 (U.S. CLS. 100, 101 AND 107).

FIRST USE 5-1-2007; IN COMMERCE 5-1-2007.

NO CLAIM IS MADE TO THE EXCLUSIVE RIGHT TO USE "CLUB SCIENTIFIC", APART FROM THE MARK AS SHOWN.

THE COLOR(S) ORANGE, GREEN, RED, BLUE, YELLOW, BLACK, BEIGE, BROWN, WHITE AND GRAY IS/ARE CLAIMED AS A FEATURE OF THE MARK.

THE COLOR GREEN APPEARS IN THE WORD "SCIENTIFIC", ON THE SHIRT OF THE MIDDLE PERSON, IN THE VIAL HELD BY THE PERSON ON THE FAR RIGHT, AND IN VARIOUS SHADES IN THE TREES ABOVE THE CANOE; THE COLOR BLUE APPEARS IN THE WORD "CLUB" AND IN THE WATER; THE COLOR RED APPEARS IN THE CANOE, THE BOWTIE ON THE PERSON ON THE FAR LEFT, AND THE HAIR BANDS ON THE

MIDDLE PERSON; THE COLOR BROWN APPEARS IN THE SKIN OF THE MIDDLE PERSON AND THE PADDLE HELD BY THE PERSON ON THE FAR LEFT; THE COLOR YELLOW APPEARS IN THE HAIR OF THE PERSON ON THE FAR RIGHT; THE COLOR ORANGE APPEARS IN THE SHIRT ON THE PERSON ON THE FAR RIGHT AND IN THE VIAL HELD BY THE MIDDLE PERSON; THE COLOR GRAY APPEARS IN THE HAIR OF THE PERSON ON THE FAR LEFT AND THE VIALS HELD BY THE MIDDLE PERSON AND THE PERSON ON THE FAR RIGHT; THE COLOR BLACK APPEARS ON THE SHIRT OF THE PERSON ON THE FAR LEFT, THE HAIR OF THE MIDDLE PERSON, THE INSIDE OUTLINE OF THE CANOE AND THE HAIR OF THE PERSONS ON THE FAR LEFT AND FAR RIGHT, AND THE OUTSIDE OUTLINE OF THE WORDING "CLUB SCIENTIFIC"; THE COLOR WHITE APPEARS IN THE INSIDE OUTLINE OF THE WORDING "CLUB SCIENTIFIC", THE OUTSIDE OUTLINE OF THE PERSONS IN THE CANOE, THE BUBBLES COMING FROM THE VIALS, AND THE REFLECTION ON THE VIALS; AND THE COLOR BEIGE APPEARS IN THE SKIN OF THE PERSON ON THE FAR LEFT AND FAR RIGHT.

SER. NO. 77-204,355, FILED 6-12-2007.

STEVEN JACKSON, EXAMINING ATTORNEY

Int. Cl.: 35

Prior U.S. Cls.: 100, 101 and 102

United States Patent and Trademark Office

Reg. No. 3,479,051

Registered Aug. 5, 2008

**SERVICE MARK
PRINCIPAL REGISTER**



AMERICAN BLINDS AND DRAPERIES, INC.
(CALIFORNIA CORPORATION)
1168 SAN LUIS OBISPO AVENUE
HAYWARD, CA 94544

NO CLAIM IS MADE TO THE EXCLUSIVE
RIGHT TO USE FACTORY AND DRAPES, APART
FROM THE MARK AS SHOWN.

FOR: ONLINE WHOLESALE ORDERING AND
ONLINE RETAIL STORE SERVICES FEATURING
INTERIOR WINDOW COVERINGS, SHEERS,
DRAPES, DRAPERIES, CURTAINS, WINDOW COV-
ERING ACCESSORIES, NAMELY, DRAPERY
HARDWARE, TRAVERSE RODS, VALANCE RODS,
ROD MOUNTING HARDWARE AND PULL
CORDS, IN CLASS 35 (U.S. CLS. 100, 101 AND 102).

THE MARK CONSISTS OF THE STYLIZED
MARK "FACTORY BARGAIN DRAPES" WITH
WINDOW TREATMENT IN BACKGROUND..

SER. NO. 77-204,407, FILED 6-12-2007.

FIRST USE 4-14-2005; IN COMMERCE 4-14-2005.

GIANCARLO CASTRO, EXAMINING ATTORNEY

Int. Cls.: 9 and 41

Prior U.S. Cls.: 21, 23, 26, 36, 38, 100, 101 and 107

Reg. No. 3,479,052

United States Patent and Trademark Office

Registered Aug. 5, 2008

**TRADEMARK
SERVICE MARK
PRINCIPAL REGISTER**

MAXFLIGHT

MAXFLIGHT CORPORATION (NEW JERSEY CORPORATION)

1 EXECUTIVE DRIVE

TOMS RIVER, NJ 08755

FOR: MOTION SIMULATION EQUIPMENT, NAMELY, FLIGHT SIMULATORS AND INTERACTIVE VIDEO GAME PROGRAMS, IN CLASS 9 (U.S. CLS. 21, 23, 26, 36 AND 38).

FIRST USE 11-23-1995; IN COMMERCE 11-23-1995.

FOR: TRAINING SERVICES, NAMELY, AIRPLANE FLIGHT SIMULATION SERVICES, IN CLASS 41 (U.S. CLS. 100, 101 AND 107).

FIRST USE 11-23-1995; IN COMMERCE 11-23-1995.

THE MARK CONSISTS OF STANDARD CHARACTERS WITHOUT CLAIM TO ANY PARTICULAR FONT, STYLE, SIZE, OR COLOR.

SER. NO. 77-204,715, FILED 6-13-2007.

STEVEN JACKSON, EXAMINING ATTORNEY

Int. Cl.: 19

Prior U.S. Cls.: 1, 12, 33 and 50

United States Patent and Trademark Office

Reg. No. 3,479,053

Registered Aug. 5, 2008

**TRADEMARK
PRINCIPAL REGISTER**

DOLOMITE

UNIBOARD CANADA INC. (CANADA CORPORATION)
BUREAU 500
2540 DANIEL-JOHNSON BOULEVARD
LAVAL, CANADA H7T2S3

FOR: MATERIAL FOR CONSTRUCTION AND INTERIOR DECORATING, NAMELY, MELAMINE-COATED PARTICLEBOARD, IN CLASS 19 (U.S. CLS. 1, 12, 33 AND 50).

FIRST USE 5-0-2000; IN COMMERCE 5-0-2000.

THE MARK CONSISTS OF STANDARD CHARACTERS WITHOUT CLAIM TO ANY PARTICULAR FONT, STYLE, SIZE, OR COLOR.

PRIORITY CLAIMED UNDER SEC. 44(D) ON CANADA APPLICATION NO. 1350132, FILED 6-4-2007.

SER. NO. 77-204,937, FILED 6-13-2007.

KYLE PEETE, EXAMINING ATTORNEY

Int. Cl.: 19

Prior U.S. Cls.: 1, 12, 33 and 50

United States Patent and Trademark Office

Reg. No. 3,479,054

Registered Aug. 5, 2008

**TRADEMARK
PRINCIPAL REGISTER**

NOVAWHITE

UNIBOARD CANADA INC. (CANADA CORPORATION)
BUREAU 500
2540 DANIEL-JOHNSON BOULEVARD
LAVAL, CANADA H7T2S3

FOR: MATERIAL FOR CONSTRUCTION AND INTERIOR DECORATING, NAMELY, MELAMINE-COATED PARTICLEBOARD, IN CLASS 19 (U.S. CLS. 1, 12, 33 AND 50).

FIRST USE 5-0-2000; IN COMMERCE 5-0-2000.

THE MARK CONSISTS OF STANDARD CHARACTERS WITHOUT CLAIM TO ANY PARTICULAR FONT, STYLE, SIZE, OR COLOR.

OWNER OF CANADA REG. NO. TMA487350, DATED 12-22-1997, EXPIRES 12-22-2012.

SER. NO. 77-205,109, FILED 6-13-2007.

KYLE PEETE, EXAMINING ATTORNEY

Int. Cl.: 35

Prior U.S. Cls.: 100, 101 and 102

United States Patent and Trademark Office

Reg. No. 3,479,055

Registered Aug. 5, 2008

**SERVICE MARK
PRINCIPAL REGISTER**

HR REMEDY

HR REMEDY, LLC (TEXAS LTD LIAB CO)

P.O. BOX 9526

THE WOODLANDS, TX 77387

FOR: PROVIDING HUMAN RESOURCES MAN-
AGEMENT CONSULTING SERVICES TO BUSINES-
SES, IN CLASS 35 (U.S. CLS. 100, 101 AND 102).

FIRST USE 2-1-2007; IN COMMERCE 2-1-2007.

THE MARK CONSISTS OF STANDARD CHAR-
ACTERS WITHOUT CLAIM TO ANY PARTICULAR
FONT, STYLE, SIZE, OR COLOR.

NO CLAIM IS MADE TO THE EXCLUSIVE
RIGHT TO USE "HR", APART FROM THE MARK
AS SHOWN.

SER. NO. 77-205,643, FILED 6-13-2007.

AMOS T. MATTHEWS, JR., EXAMINING ATTOR-
NEY

Int. Cl.: 30

Prior U.S. Cl.: 46

United States Patent and Trademark Office

Reg. No. 3,479,056

Registered Aug. 5, 2008

TRADEMARK
PRINCIPAL REGISTER



ADL, DESIREE (UNITED STATES INDIVIDUAL)
27881 LA PAZ RD. #G-216
LAGUNA NIGUEL, CA 92677

FOR: CUP CAKES, IN CLASS 30 (U.S. CL. 46).

FIRST USE 5-5-2007; IN COMMERCE 5-5-2007.

NO CLAIM IS MADE TO THE EXCLUSIVE
RIGHT TO USE "FAMOUS CUPCAKES", APART
FROM THE MARK AS SHOWN.

THE MARK CONSISTS OF A CIRCLE WITH THE
WORDS "FAMOUS CUPCAKES ONE IS NEVER
ENOUGH!" IN A STYLIZED TEXT WITH STARS
IN THE BACKGROUND.

SER. NO. 77-205,979, FILED 6-14-2007.

PATRICIA EVANKO, EXAMINING ATTORNEY

Int. Cl.: 42

Prior U.S. Cls.: 100 and 101

United States Patent and Trademark Office

Reg. No. 3,479,057

Registered Aug. 5, 2008

**SERVICE MARK
PRINCIPAL REGISTER**

OCO INTELLIGENT DATA SCHEMA

OCO, INC. (MASSACHUSETTS CORPORATION)
504 TOTTEN POND ROAD
WALTHAM, MA 02451

FOR: DESIGN AND IMPLEMENTATION OF A SOFTWARE SYSTEM THAT FINDS, EXTRACTS, AND IDENTIFIES DATA WITHIN A BUSINESS' ELECTRONIC FILES, AND ORGANIZES THAT DATA INTO A LOGICAL DATA WAREHOUSE , IN CLASS 42 (U.S. CLS. 100 AND 101).

FIRST USE 4-24-2007; IN COMMERCE 4-24-2007.

THE MARK CONSISTS OF STANDARD CHARACTERS WITHOUT CLAIM TO ANY PARTICULAR FONT, STYLE, SIZE, OR COLOR.

OWNER OF U.S. REG. NOS. 2,663,789 AND 3,262,473.

NO CLAIM IS MADE TO THE EXCLUSIVE RIGHT TO USE "INTELLIGENT DATA SCHEMA", APART FROM THE MARK AS SHOWN.

SER. NO. 77-206,135, FILED 6-14-2007.

LINDSEY RUBIN, EXAMINING ATTORNEY

Prior U.S. Cl.: B

United States Patent and Trademark Office

Reg. No. 3,479,058

Registered Aug. 5, 2008

CERTIFICATION MARK
PRINCIPAL REGISTER

COE

AMERICAN SOCIETY OF CATARACT AND RE-
FRACTIVE SURGERY (CALIFORNIA NON-
PROFIT CORPORATION)
4000 LEGATO RD. SUITE 700
FAIRFAX, VA 22033

FOR: OPHTHALMIC ADMINISTRATION SERVI-
CES, IN CLASS B (U.S. CL. B).

FIRST USE 4-1-1999; IN COMMERCE 4-1-1999.

THE MARK CONSISTS OF STANDARD CHAR-
ACTERS WITHOUT CLAIM TO ANY PARTICULAR
FONT, STYLE, SIZE, OR COLOR.

THE CERTIFICATION MARK, AS USED BY
AUTHORIZED PERSONS, CERTIFIES THAT THE
SERVICES ARE PROVIDED BY PROFESSIONALS
WHO HAVE OBTAINED CREDENTIALS BASED ON
A COMBINATION OF WORK EXPERIENCE AND
PERFORMANCE-BASED EXAMS ESTABLISHED
BY THE AMERICAN SOCIETY OF CATARACT
AND REFRACTIVE SURGERY.

SEC. 2(F).

SER. NO. 77-206,394, FILED 6-14-2007.

JASON TURNER, EXAMINING ATTORNEY

Int. Cl.: 41

Prior U.S. Cls.: 100, 101 and 107

United States Patent and Trademark Office

Reg. No. 3,479,059

Registered Aug. 5, 2008

SERVICE MARK
PRINCIPAL REGISTER

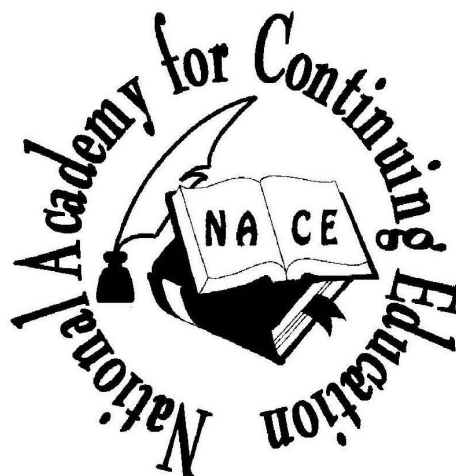

WELCH, RITA, A (UNITED STATES INDIVIDUAL)

5030 CHAMPION BLVD. SUITE G-6, # 256
BOCA RATON, FL 334962473 AND

WELCH, CRAIG, A. (UNITED STATES INDIVIDUAL)

5030 CHAMPION BLVD. G-6, 256
BOCA RATON, FL 334962473

FOR: ELECTRONIC PUBLISHING SERVICES, NAMELY, PUBLICATION OF TEXT AND GRAPHIC WORKS OF OTHERS ON CD, DVD, AND ONLINE, FEATURING MEDICAL CONTINUING EDUCATION COURSES, IN CLASS 41 (U.S. CLS. 100, 101 AND 107).

FIRST USE 3-1-1996; IN COMMERCE 3-1-1996.

NO CLAIM IS MADE TO THE EXCLUSIVE RIGHT TO USE "CONTINUING EDUCATION", APART FROM THE MARK AS SHOWN.

THE MARK CONSISTS OF A CIRCLE WITH "NATIONAL ACADEMY FOR CONTINUING EDUCATION" OUTLINING THE CIRCLE. THE CENTER OF THE CIRCLE CONTAINS AN INK BOTTLE WITH QUILL PEN, CLOSED BOOK & OPEN BOOK INSCRIBED WITH "NACE".

SEC. 2(F) AS TO "NATIONAL ACADEMY FOR CONTINUING EDUCATION".

SER. NO. 77-206,508, FILED 6-14-2007.

HANNO RITTNER, EXAMINING ATTORNEY

Int. Cls.: 35, 36 and 45

Prior U.S. Cls.: 100, 101 and 102

United States Patent and Trademark Office

Reg. No. 3,479,060

Registered Aug. 5, 2008

**SERVICE MARK
PRINCIPAL REGISTER**

CARD COPS

TRILEGIANT CORPORATION (DELAWARE CORPORATION)
100 CONNECTICUT AVENUE
NORWALK, CT 06850

FOR: MONITORING CONSUMER CREDIT REPORTS AND PROVIDING AN ALERT AS TO ANY CHANGES THEREIN; PROVIDING BUSINESS INFORMATION IN THE FIELD OF CREDIT, CREDIT REPORTS AND CREDIT SCORES, IN CLASS 35 (U.S. CLS. 100, 101 AND 102).

FIRST USE 5-1-2001; IN COMMERCE 5-1-2001.

FOR: PAYMENT OF EXPENSES FOLLOWING AN OCCURRENCE OF PERSONAL DATA THEFT THAT RESULTS IN THE OPENING OF FRAUDULENT ACCOUNTS; PROVIDING FINANCIAL INFORMATION IN THE FIELD OF CREDIT, CREDIT REPORTS AND CREDIT SCORES, IN CLASS 36 (U.S. CLS. 100, 101 AND 102).

FIRST USE 5-1-2001; IN COMMERCE 5-1-2001.

FOR: COMPUTER SERVICES, NAMELY, PROVIDING A DATABASE VIA A WEBSITE FEATURING PERSONAL SECURITY INFORMATION FOR MEMBERS REGARDING SOCIAL SECURITY RECORDS, MEDICAL RECORDS AND DRIVING RECORDS OF THEMSELVES AND THEIR FAMILIES, IN CLASS 45 (U.S. CLS. 100 AND 101).

FIRST USE 5-1-2001; IN COMMERCE 5-1-2001.

THE MARK CONSISTS OF STANDARD CHARACTERS WITHOUT CLAIM TO ANY PARTICULAR FONT, STYLE, SIZE, OR COLOR.

SER. NO. 77-206,587, FILED 6-14-2007.

MARY BOAGNI, EXAMINING ATTORNEY

Int. Cl.: 35

Prior U.S. Cls.: 100, 101 and 102

United States Patent and Trademark Office

Reg. No. 3,479,061

Registered Aug. 5, 2008

SERVICE MARK
PRINCIPAL REGISTER

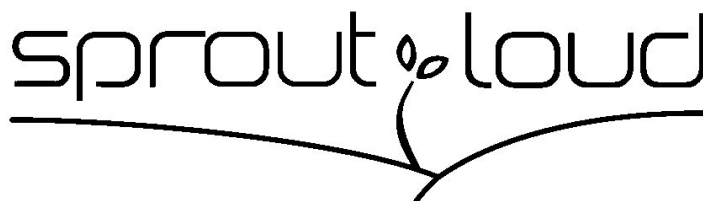

SPROUTLOUD MEDIA NETWORKS, LLC
(FLORIDA LTD LIAB CO)
15431 SW 14TH STREET
SUNRISE, FL 33326

FOR: ADVERTISING AND MARKETING; ADVERTISING AND PUBLICITY SERVICES, NAME-
LY, PROMOTING THE GOODS, SERVICES, BRAND
IDENTITY AND COMMERCIAL INFORMATION
AND NEWS OF THIRD PARTIES THROUGH
PRINT, AUDIO, VIDEO, DIGITAL AND ON-LINE
MEDIUM; CONCEPT AND BRAND DEVELOP-

MENT IN THE PRINT, RADIO, ONLINE MEDIUM,
TELEVISION FIELDS; ADVERTISING SERVICES,
NAME-
LY, CREATING CORPORATE AND BRAND
IDENTITY FOR OTHERS, IN CLASS 35 (U.S. CLS.
100, 101 AND 102).

FIRST USE 2-1-2006; IN COMMERCE 2-1-2006.

SER. NO. 77-206,597, FILED 6-14-2007.

AISHA CLARKE, EXAMINING ATTORNEY

Int. Cl.: 39

Prior U.S. Cls.: 100 and 105

United States Patent and Trademark Office

Reg. No. 3,479,062

Registered Aug. 5, 2008

**SERVICE MARK
PRINCIPAL REGISTER**

GOLDRING GULF DISTRIBUTING

N GOLDRING CORPORATION (ALABAMA
CORPORATION)
809 JEFFERSON HIGHWAY
NEW ORLEANS, LA 70121

FOR: PROVIDING WAREHOUSING AND
TRANSPORT SERVICES BY TRUCK, VANS, MO-
TOR VEHICLES, AUTOMOBILES, AIR, RAIL,
FREIGHT, SHIPS FOR ALCOHOLIC AND NON-
ALCOHOLIC BEVERAGES, IN CLASS 39 (U.S. CLS.
100 AND 105).

FIRST USE 7-14-2001; IN COMMERCE 7-14-2001.

THE MARK CONSISTS OF STANDARD CHAR-
ACTERS WITHOUT CLAIM TO ANY PARTICULAR
FONT, STYLE, SIZE, OR COLOR.

NO CLAIM IS MADE TO THE EXCLUSIVE
RIGHT TO USE "DISTRIBUTING", APART FROM
THE MARK AS SHOWN.

SER. NO. 77-207,071, FILED 6-15-2007.

ROBERT C. CLARK JR., EXAMINING ATTORNEY

Int. Cl.: 41

Prior U.S. Cls.: 100, 101 and 107

United States Patent and Trademark Office

Reg. No. 3,479,063

Registered Aug. 5, 2008

**SERVICE MARK
PRINCIPAL REGISTER**

BLACK MACHISMO

TNA ENTERTAINMENT, LLC (DELAWARE LTD
LIAB CO)

#1001

4100 SPRING VALLEY ROAD
DALLAS, TX 75244

FOR: ENTERTAINMENT SERVICES, NAMELY,
WRESTLING EXHIBITS AND PERFORMANCES BY
A PROFESSIONAL WRESTLER AND ENTERTAI-
NER, IN CLASS 41 (U.S. CLS. 100, 101 AND 107).

FIRST USE 4-5-2007; IN COMMERCE 4-5-2007.

THE MARK CONSISTS OF STANDARD CHAR-
ACTERS WITHOUT CLAIM TO ANY PARTICULAR
FONT, STYLE, SIZE, OR COLOR.

SER. NO. 77-207,486, FILED 6-15-2007.

KAREN K. BUSH, EXAMINING ATTORNEY

Int. Cl.: 25

Prior U.S. Cls.: 22 and 39

United States Patent and Trademark Office

Reg. No. 3,479,064

Registered Aug. 5, 2008

**TRADEMARK
PRINCIPAL REGISTER**

DREAMY

HORSTMAN, CHADLER M (UNITED STATES
INDIVIDUAL)
5520 N 79 PLACE
SCOTTSDALE, AZ 85250

FOR: LINGERIE; CLOTHING, NAMELY, TOPS,
DRESSES, PAJAMAS, BRAS AND PANTIES; SEXY
COSTUMES, NAMELY, BATHING COSTUMES,
DANCE COSTUMES, MASQUERADE COSTUMES,
AND HALLOWEEN COSTUMES, IN CLASS 25 (U.S.
CLS. 22 AND 39).

FIRST USE 6-1-2007; IN COMMERCE 6-1-2007.

THE MARK CONSISTS OF STANDARD CHAR-
ACTERS WITHOUT CLAIM TO ANY PARTICULAR
FONT, STYLE, SIZE, OR COLOR.

SER. NO. 77-207,818, FILED S.R. 6-15-2007 AM. P.R.
9-25-2007.

PAUL F. GAST, EXAMINING ATTORNEY

Int. Cl.: 25

Prior U.S. Cls.: 22 and 39

United States Patent and Trademark Office

Reg. No. 3,479,065

Registered Aug. 5, 2008

**TRADEMARK
PRINCIPAL REGISTER**

ST. TROPEZ

SUPRACOR, INC. (CALIFORNIA CORPORATION)
4050 CORPORATE CT
SAN JOSE, CA 95131

THE MARK CONSISTS OF STANDARD CHARACTERS WITHOUT CLAIM TO ANY PARTICULAR FONT, STYLE, SIZE, OR COLOR.

FOR: FOOTWEAR, NAMELY, SANDALS MADE OF HONEYCOMB THERMOPLASTIC ELASTOMER, IN CLASS 25 (U.S. CLS. 22 AND 39).

SER. NO. 77-207,840, FILED 6-15-2007.

FIRST USE 6-30-2006; IN COMMERCE 6-30-2006.

DAVID YONTEF, EXAMINING ATTORNEY

Int. Cls.: 35 and 40

Prior U.S. Cls.: 100, 101, 102, 103 and 106

United States Patent and Trademark Office

Reg. No. 3,479,066

Registered Aug. 5, 2008

**SERVICE MARK
PRINCIPAL REGISTER**

MONA LISA GALLERY & FRAMING

MONA LISA GALLERY & FRAMING, INC. (NEW
JERSEY CORPORATION)
168 MAPLEWOOD AVE.,
MAPLEWOOD, NJ 07040

FOR: ARRANGING AND CONDUCTING TRADE
SHOWS IN THE FIELD OF ART; ART GALLERIES,
IN CLASS 35 (U.S. CLS. 100, 101 AND 102).

FIRST USE 5-1-2007; IN COMMERCE 5-1-2007.

FOR: FRAMING OF WORKS OF ART, IN CLASS
40 (U.S. CLS. 100, 103 AND 106).

FIRST USE 5-1-2007; IN COMMERCE 5-1-2007.

THE MARK CONSISTS OF STANDARD CHAR-
ACTERS WITHOUT CLAIM TO ANY PARTICULAR
FONT, STYLE, SIZE, OR COLOR.

NO CLAIM IS MADE TO THE EXCLUSIVE
RIGHT TO USE "GALLERY & FRAMING", APART
FROM THE MARK AS SHOWN.

SER. NO. 77-208,148, FILED 6-18-2007.

DOMINICK J. SALEMI, EXAMINING ATTORNEY

Int. Cl.: 18

Prior U.S. Cls.: 1, 2, 3, 22 and 41

United States Patent and Trademark Office

Reg. No. 3,479,067

Registered Aug. 5, 2008

**TRADEMARK
PRINCIPAL REGISTER**

KATE MOSS

MOSS, KATE (UNITED KINGDOM INDIVIDUAL)
C/O STORM MODEL MANAGEMENT LIMITED
5 JUBILEE PLACE
LONDON, UNITED KINGDOM

FOR: HANDBAGS, PURSES, CLUTCH BAGS AND
PURSES; ALL PURPOSE CARRYING BAGS, IN
CLASS 18 (U.S. CLS. 1, 2, 3, 22 AND 41).

FIRST USE 12-20-2007; IN COMMERCE 12-20-2007.

THE MARK CONSISTS OF STANDARD CHARACTERS WITHOUT CLAIM TO ANY PARTICULAR FONT, STYLE, SIZE, OR COLOR.

THE NAME "KATE MOSS" IDENTIFIES A LIVING INDIVIDUAL WHOSE CONSENT IS OF RECORD.

SER. NO. 77-208,156, FILED 6-18-2007.

DOMINICK J. SALEMI, EXAMINING ATTORNEY

Int. Cl.: 11

Prior U.S. Cls.: 13, 21, 23, 31 and 34

Reg. No. 3,479,068

United States Patent and Trademark Office

Registered Aug. 5, 2008

**TRADEMARK
PRINCIPAL REGISTER**

**WORKING TODAY TO PROTECT
TOMORROW'S ENVIRONMENT**

HOOT AEROBIC SYSTEMS, INC. (LOUISIANA
CORPORATION)
2885 HIGHWAY 14 EAST
LAKE CHARLES, LA 70607

THE MARK CONSISTS OF STANDARD CHAR-
ACTERS WITHOUT CLAIM TO ANY PARTICULAR
FONT, STYLE, SIZE, OR COLOR.

FOR: WASTE WATER TREATMENT UNITS AND
STRUCTURAL AND REPLACEMENT PARTS
THEREFOR, IN CLASS 11 (U.S. CLS. 13, 21, 23, 31
AND 34).

SER. NO. 77-208,176, FILED 6-18-2007.

FIRST USE 2-15-2008; IN COMMERCE 2-15-2008.

MICHAEL WEBSTER, EXAMINING ATTORNEY

Int. Cl.: 2

Prior U.S. Cls.: 6, 11 and 16

United States Patent and Trademark Office

Reg. No. 3,479,069

Registered Aug. 5, 2008

**TRADEMARK
PRINCIPAL REGISTER**

FABULOUS FINISHES

SWIMC, INC. (DELAWARE CORPORATION)
300 DELAWARE AVENUE
SUITE 522
WILMINGTON, FED REP GERMANY 198011607

NO CLAIM IS MADE TO THE EXCLUSIVE
RIGHT TO USE "FINISHES", APART FROM THE
MARK AS SHOWN.

FOR: PAINTS, IN CLASS 2 (U.S. CLS. 6, 11 AND 16).

SEC. 2(F).

FIRST USE 3-29-1996; IN COMMERCE 3-29-1996.

SER. NO. 77-208,224, FILED 6-18-2007.

THE MARK CONSISTS OF STANDARD CHAR-
ACTERS WITHOUT CLAIM TO ANY PARTICULAR
FONT, STYLE, SIZE, OR COLOR.

TANYA AMOS, EXAMINING ATTORNEY

Int. Cl.: 16

Prior U.S. Cls.: 2, 5, 22, 23, 29, 37, 38 and 50

Reg. No. 3,479,070

United States Patent and Trademark Office

Registered Aug. 5, 2008

**TRADEMARK
PRINCIPAL REGISTER**

SILATINO

TIME INC. (DELAWARE CORPORATION)
1271 AVENUE OF THE AMERICAS
NEW YORK, NY 10020

FOR: MAGAZINES FEATURING SPORTS AND
TOPICS OF GENERAL INTEREST, IN CLASS 16 (U.S.
CLS. 2, 5, 22, 23, 29, 37, 38 AND 50).

FIRST USE 2-0-2007; IN COMMERCE 2-0-2007.

THE MARK CONSISTS OF STANDARD CHAR-
ACTERS WITHOUT CLAIM TO ANY PARTICULAR
FONT, STYLE, SIZE, OR COLOR.

OWNER OF U.S. REG. NO. 1,863,715.

SER. NO. 77-208,274, FILED 6-18-2007.

FRANK LATTUCA, EXAMINING ATTORNEY

Int. Cl.: 25

Prior U.S. Cls.: 22 and 39

United States Patent and Trademark Office

Reg. No. 3,479,071

Registered Aug. 5, 2008

**TRADEMARK
PRINCIPAL REGISTER**

RED HEAD CWS

BASS PRO TRADEMARKS, L.L.C. (MISSOURI
LTD LIAB CO)
2500 EAST KEARNEY
SPRINGFIELD, MO 65898

FOR: HUNTING CLOTHING, NAMELY, JACK-
ETS, PARKAS, OVERALLS, PANTS, BALACLAVAS,
GLOVES AND MITTENS, IN CLASS 25 (U.S. CLS. 22
AND 39).

FIRST USE 6-0-2003; IN COMMERCE 6-0-2003.

THE MARK CONSISTS OF STANDARD CHAR-
ACTERS WITHOUT CLAIM TO ANY PARTICULAR
FONT, STYLE, SIZE, OR COLOR.

OWNER OF U.S. REG. NOS. 157,633, 1,264,756,
AND 2,207,956.

SER. NO. 77-208,315, FILED 6-18-2007.

KATHY DE JONGE, EXAMINING ATTORNEY

Int. Cl.: 10

Prior U.S. Cls.: 26, 39 and 44

United States Patent and Trademark Office

Reg. No. 3,479,072

Registered Aug. 5, 2008

**TRADEMARK
PRINCIPAL REGISTER**

AQUANOT

COLBY MANUFACTURING CORP. (PENNSYLVANIA CORPORATION)
1016 BRANAGAN DRIVE
TULLYTOWN, PA 19007

FOR: FLOOR SUCTION DEVICE FOR MEDICAL OR SURGICAL USE IN HOSPITALS AND OTHER HEALTHCARE FACILITIES TO COLLECT AND SUCTION WASTE FLUIDS, IN CLASS 10 (U.S. CLS. 26, 39 AND 44).

FIRST USE 10-20-2006; IN COMMERCE 10-20-2006.

THE MARK CONSISTS OF STANDARD CHARACTERS WITHOUT CLAIM TO ANY PARTICULAR FONT, STYLE, SIZE, OR COLOR.

SER. NO. 77-208,320, FILED 6-18-2007.

JOHN DWYER, EXAMINING ATTORNEY

Int. Cl.: 25

Prior U.S. Cls.: 22 and 39

United States Patent and Trademark Office

Reg. No. 3,479,073

Registered Aug. 5, 2008

**TRADEMARK
PRINCIPAL REGISTER**

RED HEAD ENDURASKIN

BASS PRO TRADEMARKS, L.L.C. (MISSOURI
LTD LIAB CO)
2500 EAST KEARNEY
SPRINGFIELD, MO 65898

FOR: HUNTING CLOTHING, NAMELY, PANTS,
SHORTS, SHIRTS, GLOVES, CAPS, AND BALACLA-
VAS, IN CLASS 25 (U.S. CLS. 22 AND 39).

FIRST USE 6-0-2005; IN COMMERCE 6-0-2005.

THE MARK CONSISTS OF STANDARD CHAR-
ACTERS WITHOUT CLAIM TO ANY PARTICULAR
FONT, STYLE, SIZE, OR COLOR.

OWNER OF U.S. REG. NOS. 157,633, 1,264,756,
AND 2,207,956.

SER. NO. 77-208,472, FILED 6-18-2007.

KATHY DE JONGE, EXAMINING ATTORNEY

Int. Cl.: 35

Prior U.S. Cls.: 100, 101 and 102

United States Patent and Trademark Office

Reg. No. 3,479,074

Registered Aug. 5, 2008

SERVICE MARK
PRINCIPAL REGISTER

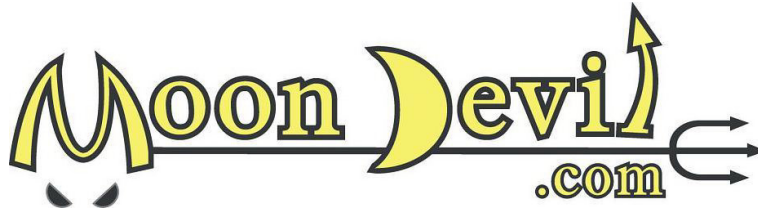

MOON DEVIL (ARIZONA LTD LIAB CO)
P.O. BOX 2847
TEMPE, AZ 85281

FOR: ADVERTISING AND PUBLICITY SERVICES, NAMELY, PROMOTING THE GOODS, SERVICES, BRAND IDENTITY AND COMMERCIAL INFORMATION AND NEWS OF THIRD PARTIES THROUGH PRINT, AUDIO, VIDEO, DIGITAL AND ON-LINE MEDIUM; ADVERTISING BY TRANSMISSION OF ON-LINE PUBLICITY FOR THIRD PARTIES THROUGH ELECTRONIC COMMUNICATIONS NETWORKS; ON-LINE ADVERTISING AND MARKETING SERVICES; ON-LINE BUSINESS DIRECTORIES FEATURING RESTAURANTS AND BARS, IN CLASS 35 (U.S. CLS. 100, 101 AND 102).

FIRST USE 7-1-2006; IN COMMERCE 7-6-2006.

THE COLOR(S) YELLOW AND BLACK IS/ARE CLAIMED AS A FEATURE OF THE MARK.

THE MARK CONSISTS OF THE WORDS "MOON DEVIL" ARE WRITTEN IN YELLOW WRITING, OUTLINED IN BLACK AND UNDERLINED WITH A BLACK TRIDENT, WHICH EXTENDS RIGHTWARD PASSED THE "L" IN THE WORD "DEVIL". BELOW THE TRIDENT, ".COM" IS WRITTEN IN YELLOW WRITING AND IS OUTLINED IN BLACK. EVERY LETTER IN "MOON DEVIL .COM" IS WRITTEN IN BASIC ROMAN LETTERS WITH THE EXCEPTION OF "M," "D" AND "L." THE "M" IS SHAPED TO RESEMBLE THE HORNS OF A DEVIL WITH TWO BLACK, OMINOUS EYES RESTING DIRECTLY BENEATH IT. THE "D" IS SHAPED TO RESEMBLE A CRESCENT MOON, WHICH OVERLAPS THE UNDERLINING TRIDENT. THE "L" IS SHAPED TO RESEMBLE A DEVIL'S TAIL, WHICH HAS A TRIANGULAR POINTED TIP AND BENDS SLIGHTLY TO THE LEFT.

SER. NO. 77-208,489, FILED 6-18-2007.

EDWARD NELSON, EXAMINING ATTORNEY

Int. Cl.: 42

Prior U.S. Cls.: 100 and 101

United States Patent and Trademark Office

Reg. No. 3,479,075

Registered Aug. 5, 2008

**SERVICE MARK
PRINCIPAL REGISTER**

VISUALIZING E-COMMERCE

LIQUIDPIXELS, INCORPORATED (DELAWARE CORPORATION)
9 ROYALE DRIVE, SUITE 103
FAIRPORT, NY 14450

FOR: COMPUTER SERVICES, NAMELY, PROVIDING TEMPORARY USE OF NON-DOWNLOADABLE SOFTWARE TO SUBSCRIBERS FOR USE IN MANIPULATING DIGITAL IMAGES AND CREATING GRAPHICS, PRIMARILY FOR WEBSITES, E-MAIL AND OTHER ON-LINE DIGITAL IMAGE PROCESSING APPLICATIONS, IN CLASS 42 (U.S. CLS. 100 AND 101).

FIRST USE 6-4-2007; IN COMMERCE 6-4-2007.

THE MARK CONSISTS OF STANDARD CHARACTERS WITHOUT CLAIM TO ANY PARTICULAR FONT, STYLE, SIZE, OR COLOR.

NO CLAIM IS MADE TO THE EXCLUSIVE RIGHT TO USE "E-COMMERCE", APART FROM THE MARK AS SHOWN.

SER. NO. 77-208,724, FILED 6-18-2007.

BRENDAN REGAN, EXAMINING ATTORNEY

Int. Cl.: 36

Prior U.S. Cls.: 100, 101 and 102

United States Patent and Trademark Office

Reg. No. 3,479,076

Registered Aug. 5, 2008

**SERVICE MARK
PRINCIPAL REGISTER**

mlsfinder.com

WOLFNET TECHNOLOGIES, LLC (MINNESOTA
LTD LIAB CO)
SUITE 455
211 NORTH FIRST STREET
MINNEAPOLIS, MN 55401

FOR: PROVIDING INFORMATION ON AND VIA
THE INTERNET PERTAINING TO REAL ESTATE
SERVICES, REAL ESTATE LISTINGS, AND REAL
ESTATE TRANSACTIONS , IN CLASS 36 (U.S. CLS.
100, 101 AND 102).

FIRST USE 3-2-2000; IN COMMERCE 3-2-2000.

THE MARK CONSISTS OF STANDARD CHAR-
ACTERS WITHOUT CLAIM TO ANY PARTICULAR
FONT, STYLE, SIZE, OR COLOR.

SEC. 2(F).

SER. NO. 77-208,777, FILED 6-18-2007.

PETER B. BROMAGHIM, EXAMINING ATTORNEY

Int. Cl.: 28

Prior U.S. Cls.: 22, 23, 38 and 50

United States Patent and Trademark Office

Reg. No. 3,479,077

Registered Aug. 5, 2008

**TRADEMARK
PRINCIPAL REGISTER**

TITAN

BASS PRO TRADEMARKS, L.L.C. (MISSOURI
LTD LIAB CO)
2500 EAST KEARNEY
SPRINGFIELD, MO 65898

THE MARK CONSISTS OF STANDARD CHAR-
ACTERS WITHOUT CLAIM TO ANY PARTICULAR
FONT, STYLE, SIZE, OR COLOR.

FOR: INFLATABLE INNER TUBES FOR AQUA-
TIC RECREATIONAL USE, IN CLASS 28 (U.S. CLS.
22, 23, 38 AND 50).

SER. NO. 77-208,835, FILED 6-18-2007.

FIRST USE 5-0-2007; IN COMMERCE 5-0-2007.

COLLEEN DOMBROW, EXAMINING ATTORNEY

Int. Cl.: 42

Prior U.S. Cls.: 100 and 101

United States Patent and Trademark Office

Reg. No. 3,479,078

Registered Aug. 5, 2008

**SERVICE MARK
PRINCIPAL REGISTER**

IPOQA

BEYOND6, LLC (NEW MEXICO LTD LIAB CO)
41-B BISBEE CT.
SANTA FE, NM 87508

FIRST USE 5-1-2000; IN COMMERCE 5-1-2000.

FOR: QUALITY CONTROL AND ASSESSMENT SERVICES FOR OTHERS, NAMELY, FOR MONITORING QUALITY CONTROL OF MANUFACTURING TECHNOLOGY BASED ON AN APPROACH WHICH COLLECTS AND ANALYZES IN-PROCESS, REAL-TIME DATA USING COMPUTER HARDWARE AND SOFTWARE, IN CLASS 42 (U.S. CLS. 100 AND 101).

THE MARK CONSISTS OF STANDARD CHARACTERS WITHOUT CLAIM TO ANY PARTICULAR FONT, STYLE, SIZE, OR COLOR.

SER. NO. 77-209,143, FILED 6-18-2007.

DAVID MURRAY, EXAMINING ATTORNEY

Int. Cl.: 22

Prior U.S. Cls.: 1, 2, 7, 19, 22, 42 and 50

United States Patent and Trademark Office

Reg. No. 3,479,079

Registered Aug. 5, 2008

**TRADEMARK
PRINCIPAL REGISTER**

Cable Clipper

WILLIAM FRICK CORPORATION (ILLINOIS
CORPORATION)
2600 COMMERCE DRIVE
LIBERTYVILLE, IL 60048

FOR: STRAPS FOR SECURING BUNDLES;
BANDS FOR WRAPPING OR BINDING; CABLE
TIES AND STRAPS FOR FASTENING AND SECUR-
ING OBJECTS SUCH AS BUNDLES OF WIRE TO-
GETHER , IN CLASS 22 (U.S. CLS. 1, 2, 7, 19, 22, 42
AND 50).

FIRST USE 1-1-1997; IN COMMERCE 1-1-1997.

THE MARK CONSISTS OF STANDARD CHAR-
ACTERS WITHOUT CLAIM TO ANY PARTICULAR
FONT, STYLE, SIZE, OR COLOR.

NO CLAIM IS MADE TO THE EXCLUSIVE
RIGHT TO USE "CABLE", APART FROM THE
MARK AS SHOWN.

SEC. 2(F).

SER. NO. 77-209,401, FILED 6-19-2007.

JANET LEE, EXAMINING ATTORNEY

Int. Cl.: 9

Prior U.S. Cls.: 21, 23, 26, 36 and 38

Reg. No. 3,479,080

United States Patent and Trademark Office

Registered Aug. 5, 2008

**TRADEMARK
PRINCIPAL REGISTER**

IVM

PHOENIX WORLDWIDE INDUSTRIES, INC.
(FLORIDA CORPORATION)
10780 S.W. 190TH ST.
MIAMI, FL 33157

THE MARK CONSISTS OF STANDARD CHAR-
ACTERS WITHOUT CLAIM TO ANY PARTICULAR
FONT, STYLE, SIZE, OR COLOR.

FOR: ENCODERS, IN CLASS 9 (U.S. CLS. 21, 23, 26,
36 AND 38).

SER. NO. 77-209,736, FILED 6-20-2007.

FIRST USE 8-1-2006; IN COMMERCE 8-1-2006.

ALICIA COLLINS, EXAMINING ATTORNEY

Int. Cl.: 43

Prior U.S. Cls.: 100 and 101

United States Patent and Trademark Office

Reg. No. 3,479,081

Registered Aug. 5, 2008

**SERVICE MARK
PRINCIPAL REGISTER**

SOCIALE
MAKE & TAKE GOURMET

SOCIALE, INC. (MINNESOTA CORPORATION)
3446 DENMARK AVENUE SOUTH
EAGAN, MN 55123

FOR: FOOD PREPARATION SERVICES, NAME-
LY, MEAL PREPARATION ASSISTANCE SERVICES
FOR OTHERS, IN CLASS 43 (U.S. CLS. 100 AND 101).

FIRST USE 6-7-2005; IN COMMERCE 6-7-2005.

OWNER OF U.S. REG. NOS. 3,114,076 AND
3,114,081.

NO CLAIM IS MADE TO THE EXCLUSIVE
RIGHT TO USE "GOURMET", APART FROM THE
MARK AS SHOWN.

THE MARK CONSISTS OF STYLIZED LETTERS
OF THE WORDS "SOCIALE MAKE & TAKE GOUR-
MET".

SER. NO. 77-209,856, FILED 6-19-2007.

ERIN FALK, EXAMINING ATTORNEY

Int. Cl.: 41

Prior U.S. Cls.: 100, 101 and 107

United States Patent and Trademark Office

Reg. No. 3,479,082

Registered Aug. 5, 2008

**SERVICE MARK
PRINCIPAL REGISTER**

MCCLATCHY

THE MCCLATCHY COMPANY (DELAWARE
CORPORATION)
C/O LEGAL DEPARTMENT
2100 Q STREET
SACRAMENTO, CA 95816

FOR: COMPUTER SERVICES, NAMELY, PRO-
VIDING AN ON-LINE NEWSPAPER FEATURING A
WIDE VARIETY OF CURRENT NEWS AND IN-
FORMATION, IN CLASS 41 (U.S. CLS. 100, 101 AND
107).

FIRST USE 12-31-1996; IN COMMERCE 12-31-1996.

THE MARK CONSISTS OF STANDARD CHAR-
ACTERS WITHOUT CLAIM TO ANY PARTICULAR
FONT, STYLE, SIZE, OR COLOR.

OWNER OF U.S. REG. NOS. 2,617,519 AND
3,099,816.

SEC. 2(F).

SER. NO. 77-210,178, FILED 6-19-2007.

ELIZABETH HUGHITT, EXAMINING ATTORNEY

Int. Cl.: 43

Prior U.S. Cls.: 100 and 101

United States Patent and Trademark Office

Reg. No. 3,479,083

Registered Aug. 5, 2008

**SERVICE MARK
PRINCIPAL REGISTER**



FRESHWAY FOOD SYSTEMS, INC. (SOUTH DA-
KOTA CORPORATION)
1105 N. CLIFF AVE., SUITE 101
SIOUX FALLS, SD 57103

FOR: RESTAURANT SERVICES, IN CLASS 43
(U.S. CLS. 100 AND 101).

FIRST USE 7-0-2006; IN COMMERCE 7-0-2006.

OWNER OF U.S. REG. NOS. 1,653,946, 2,802,217
AND OTHERS.

NO CLAIM IS MADE TO THE EXCLUSIVE
RIGHT TO USE "FOOD SYSTEMS", APART FROM
THE MARK AS SHOWN.

THE MARK CONSISTS OF THE WORDS AND
TWO TOMATOS COVERED BY AN ARCH.

SER. NO. 77-210,778, FILED 6-20-2007.

WON TEAK OH, EXAMINING ATTORNEY

Int. Cl.: 36

Prior U.S. Cls.: 100, 101 and 102

United States Patent and Trademark Office

Reg. No. 3,479,084

Registered Aug. 5, 2008

**SERVICE MARK
PRINCIPAL REGISTER**

**PEDIATRIC BRAIN TUMOR
FOUNDATION**

THE PEDIATRIC BRAIN TUMOR FOUNDATION
OF THE UNITED STATES, INC. (GEORGIA
NON-PROFIT CORPORATION)
302 RIDGEFIELD COURT
ASHEVILLE, NC 28806

FOR: CHARITABLE FUND RAISING FOR THE
PURPOSE OF SUPPORTING MEDICAL RESEARCH,
INTERACTION BETWEEN FAMILIES OF CHILD-
REN WITH BRAIN TUMORS AND PROVIDING
SCHOLARSHIPS, ALL IN THE FIELD OF CHILD-
HOOD BRAIN TUMORS, IN CLASS 36 (U.S. CLS. 100,
101 AND 102).

FIRST USE 11-0-1994; IN COMMERCE 1-10-1995.

THE MARK CONSISTS OF STANDARD CHAR-
ACTERS WITHOUT CLAIM TO ANY PARTICULAR
FONT, STYLE, SIZE, OR COLOR.

NO CLAIM IS MADE TO THE EXCLUSIVE
RIGHT TO USE "FOUNDATION", APART FROM
THE MARK AS SHOWN.

SEC. 2(F).

SER. NO. 77-210,783, FILED 6-20-2007.

EVELYN BRADLEY, EXAMINING ATTORNEY

Int. Cls.: 35 and 37

Prior U.S. Cls.: 100, 101, 102, 103 and 106

United States Patent and Trademark Office

Reg. No. 3,479,085

Registered Aug. 5, 2008

**SERVICE MARK
PRINCIPAL REGISTER**



NEXT DAY MOULDING PORTLAND (DELA-
WARE LTD LIAB CO)
BOX 656
4110 SE HAWTHORNE
PORTLAND, OR 97214

FOR: RETAIL STORE SERVICES FEATURING
DECORATIVE MOULDING, IN CLASS 35 (U.S. CLS.
100, 101 AND 102).

FIRST USE 1-6-2007; IN COMMERCE 5-21-2007.

FOR: INSTALLATION OF DECORATIVE
MOULDING, IN CLASS 37 (U.S. CLS. 100, 103 AND
106).

FIRST USE 1-6-2007; IN COMMERCE 5-21-2007.

NO CLAIM IS MADE TO THE EXCLUSIVE
RIGHT TO USE "NEXT DAY MOULDING", APART
FROM THE MARK AS SHOWN.

THE MARK CONSISTS OF THE WORDING
"NEXTDAY" AND THE WORD "MOULDING"
WITHIN A DEPICTION OF DECORATIVE MOULD-
ING.

SER. NO. 77-210,849, FILED 6-20-2007.

EVELYN BRADLEY, EXAMINING ATTORNEY

Int. Cl.: 41

Prior U.S. Cls.: 100, 101 and 107

United States Patent and Trademark Office

Reg. No. 3,479,086

Registered Aug. 5, 2008

**SERVICE MARK
PRINCIPAL REGISTER**

Mountain Craft Days

HISTORICAL & GENEALOGICAL SOCIETY OF
SOMERSET COUNTY (PENNSYLVANIA NON-
PROFIT CORPORATION)
10649 SOMERSET PIKE
SOMERSET, PA 15501

FOR: ORGANIZING COMMUNITY FESTIVALS
FEATURING A VARIETY OF ACTIVITIES, NAME-
LY, ART EXHIBITIONS, HERITAGE MARKETS,
ETHNIC DANCES, AND THE LIKE, IN CLASS 41
(U.S. CLS. 100, 101 AND 107).

FIRST USE 1-1-1971; IN COMMERCE 1-1-1971.

THE MARK CONSISTS OF STANDARD CHAR-
ACTERS WITHOUT CLAIM TO ANY PARTICULAR
FONT, STYLE, SIZE, OR COLOR.

NO CLAIM IS MADE TO THE EXCLUSIVE
RIGHT TO USE "CRAFT DAYS", APART FROM
THE MARK AS SHOWN.

SER. NO. 77-210,887, FILED 6-20-2007.

LESLEY LAMOTHE, EXAMINING ATTORNEY

Int. Cl.: 30

Prior U.S. Cl.: 46

United States Patent and Trademark Office

Reg. No. 3,479,087

Registered Aug. 5, 2008

TRADEMARK
PRINCIPAL REGISTER



UNITED BISCUITS (UK) LIMITED (UNITED KINGDOM CORPORATION)
HAYES PARK, HAYES END ROAD
HAYES, MIDDLESEX, UNITED KINGDOM UB48EE

FOR: BISCUITS, IN CLASS 30 (U.S. CL. 46).

FIRST USE 1-0-2000; IN COMMERCE 1-0-2000.

OWNER OF U.S. REG. NO. 2,814,215.

NO CLAIM IS MADE TO THE EXCLUSIVE RIGHT TO USE "DIGESTIVE", "WHOLE WHEAT", THE DEPICTION OF BISCUITS, AND THE NON-LATIN CHARACTERS WHICH MEAN "DIGESTIVE BISCUITS", APART FROM THE MARK AS SHOWN.

THE COLOR(S) RED, BLUE, YELLOW, GOLD, WHITE, AND BLACK IS/ARE CLAIMED AS A FEATURE OF THE MARK.

THE MARK CONSISTS OF A RECTANGLE IN RED; THE TERMS "MCVITIE'S", "DIGESTIVE", "WHOLE WHEAT", AND THE NON-LATIN CHARACTERS ARE IN WHITE; THE TERM "MCVITIE'S"

APPEARS INSIDE A BLUE BACKGROUND OUTLINED IN YELLOW WITH A DESIGN OF WHEAT IN YELLOW AND BLUE ABOVE; THE WORDS "DIGESTIVE" AND THE NON-LATIN CHARACTERS APPEARING IN THE MARK ARE HIGHLIGHTED IN BLUE; THE DESIGN OF TWO CRACKERS APPEARS IN GOLD; THE TERM "TASTE LIFE'S NATURAL BALANCE" APPEARS IN BLACK; VARYING STRIPES OF YELLOW, RED AND BLUE APPEAR ON THE RIGHT HAND SIDE, WITH ONE OF THE STRIPES CONSISTING OF A WHEAT GRAIN LIKE CHAIN IN GOLD; A DESIGN OF WHEAT APPEARS IN GOLD AGAINST A YELLOW CIRCULAR BACKGROUND DESIGN BEHIND THE TERM "DIGESTIVE".

THE NON-LATIN CHARACTER(S) IN THE MARK TRANSLITERATES INTO "XIAO HUA BING", AND THIS MEANS "DIGESTIVE BISCUITS" IN ENGLISH.

SER. NO. 77-210,997, FILED 6-20-2007.

JIM RINGLE, EXAMINING ATTORNEY

Int. Cl.: 45

Prior U.S. Cls.: 100 and 101

United States Patent and Trademark Office

Reg. No. 3,479,088

Registered Aug. 5, 2008

**SERVICE MARK
PRINCIPAL REGISTER**

CHAKRAnicity

CHAKRANICITY LLC (CONNECTICUT LTD
LIAB CO)
12 ROWLEDGE POND ROAD
SANDY HOOK, CT 06482

FIRST USE 6-8-2007; IN COMMERCE 6-8-2007.

SER. NO. 77-211,148, FILED 6-20-2007.

FOR: PROVIDING ON-LINE INFORMATION IN
THE FIELD OF SPIRITUALITY, SELF-HELP, AND
PERSONAL EMPOWERMENT SUBJECT MATTERS,
IN CLASS 45 (U.S. CLS. 100 AND 101).

KATHERINE M. DUBRAY, EXAMINING ATTOR-
NEY

Int. Cl.: 33

Prior U.S. Cls.: 47 and 49

United States Patent and Trademark Office

Reg. No. 3,479,089

Registered Aug. 5, 2008

**TRADEMARK
PRINCIPAL REGISTER**

KING FISH

DELICATO VINEYARDS, INC. (CALIFORNIA
CORPORATION)
12001 SOUTH HIGHWAY 99
MANTECA, CA 95336

FOR: WINES, IN CLASS 33 (U.S. CLS. 47 AND 49).

FIRST USE 2-1-2004; IN COMMERCE 2-1-2004.

THE MARK CONSISTS OF STANDARD CHAR-
ACTERS WITHOUT CLAIM TO ANY PARTICULAR
FONT, STYLE, SIZE, OR COLOR.

SER. NO. 77-211,251, FILED 6-20-2007.

WILLIAM BRECKENFELD, EXAMINING ATTOR-
NEY

Int. Cl.: 3

Prior U.S. Cls.: 1, 4, 6, 50, 51 and 52

Reg. No. 3,479,090

United States Patent and Trademark Office

Registered Aug. 5, 2008

**TRADEMARK
PRINCIPAL REGISTER**

Restora MD

REID, DUSTIN (UNITED STATES INDIVIDUAL)
1603 PALMA PLAZA
AUSTIN, TX 78703

FOR: BEAUTY CREAMS FOR BODY CARE; BODY AND BEAUTY CARE COSMETICS; CONCEALERS FOR SKIN; CONDITIONERS; COSMETIC CREAMS FOR SKIN CARE; COSMETIC PREPARATIONS FOR BODY CARE; COSMETIC PREPARATIONS FOR SKIN RENEWAL; COSMETIC PREPARATIONS FOR THE CARE OF MOUTH AND TEETH; COSMETIC PRODUCTS IN THE FORM OF AEROSOLS FOR SKIN CARE; COSMETIC PRODUCTS IN THE FORM OF AEROSOLS FOR SKINCARE; DECORATIVE TRANSFERS AND SKIN JEWELS FOR COSMETIC PURPOSES; DEODORANTS FOR BODY CARE; EXFOLIANTS FOR SKIN; LOTIONS FOR FACE AND BODY CARE; LOTIONS FOR SKIN; NON-MEDICATED LIP CARE PREPARATIONS; NON-MEDICATED SKIN CARE PREPARATIONS; NON-MEDICATED SKIN CREAMS; NON-MEDICATED STIMULATING LOTIONS FOR THE SKIN; NON-MEDICATED SUN CARE PREPARATIONS; PATCHES CONTAINING SUN SCREEN AND SUN BLOCK FOR USE ON THE SKIN; SKIN ABRASIVE PREPARATIONS; SKIN AND BODY TOPICAL LOTIONS, CREAMS AND OILS FOR COSMETIC USE; SKIN BRONZER; SKIN BRONZING CREAMS; SKIN CARE PREPARATIONS, NAMELY, CHEMICAL PEELS FOR SKIN; SKIN CARE PREPARATIONS, NAMELY, FRUIT

ACID PEELS FOR SKIN; SKIN CARE PRODUCTS, NAMELY, NON-MEDICATED SKIN SERUM; SKIN CLARIFIERS; SKIN CLEANSERS; SKIN CLEANSING CREAM; SKIN CLEANSING LOTION; SKIN CONDITIONERS; SKIN CREAM; SKIN CREAMS; SKIN CREAMS IN LIQUID AND IN SOLID FORM; SKIN CREAMS IN LIQUID AND SOLID; SKIN CREAMS IN LIQUID AND SOLID FORM; SKIN EMOLLIENTS; SKIN GELS FOR ACCELERATING, ENHANCING OR EXTENDING TANS; SKIN LIGHTENERS; SKIN LIGHTENING CREAMS; SKIN LOTION; SKIN LOTIONS; SKIN MASKS; SKIN MOISTURIZER; SKIN MOISTURIZER MASKS; SKIN POLISHING RICE BRAN (ARAI-NUKA); SKIN SOAP; SKIN TEXTURIZERS; SKIN TONERS; SKIN WHITENING CREAMS; SKIN WHITENING PREPARATIONS; SOAPS FOR BODY CARE; SUN CARE LOTIONS; TOPICAL SKIN SPRAYS FOR COSMETIC PURPOSES; WRINKLE REMOVING SKIN CARE PREPARATIONS, IN CLASS 3 (U.S. CLS. 1, 4, 6, 50, 51 AND 52).

FIRST USE 3-1-2006; IN COMMERCE 9-1-2006.

THE MARK CONSISTS OF STANDARD CHARACTERS WITHOUT CLAIM TO ANY PARTICULAR FONT, STYLE, SIZE, OR COLOR.

SER. NO. 77-211,271, FILED 6-20-2007.

SEAN CROWLEY, EXAMINING ATTORNEY

Int. Cl.: 16

Prior U.S. Cls.: 2, 5, 22, 23, 29, 37, 38 and 50

United States Patent and Trademark Office

Reg. No. 3,479,091

Registered Aug. 5, 2008

TRADEMARK
PRINCIPAL REGISTER

世界周刊

CHINA DAILY NEWS, INC. (CALIFORNIA CORPORATION)
1588 CORPORATE CENTER DRIVE
MONTEREY PARK, CA 91754

FOR: GENERAL FEATURE MAGAZINES; MAGAZINE SUPPLEMENTS TO NEWSPAPERS IN THE FIELD OF GENERAL FEATURES, IN CLASS 16 (U.S. CLS. 2, 5, 22, 23, 29, 37, 38 AND 50).

FIRST USE 3-24-1984; IN COMMERCE 3-24-1984.

NO CLAIM IS MADE TO THE EXCLUSIVE RIGHT TO USE "THE NON-LATIN CHARACTER THAT TRANSLATES TO PUBLICATION", APART FROM THE MARK AS SHOWN.

THE MARK CONSISTS OF FOUR CHINESE CHARACTERS MEANING, FROM LEFT TO RIGHT, "WORLD", "BOUNDARIES", "CIRCLE/WEEKLY" AND "PUBLICATION".

THE NON-LATIN CHARACTERS IN THE MARK TRANSLITERATE INTO "SHI JIE JOU KAN", AND THIS MEANS WORLD WEEKLY PUBLICATION.

SEC. 2(F).

SER. NO. 77-211,375, FILED 6-20-2007.

HEATHER BIDDULPH, EXAMINING ATTORNEY

Int. Cls.: 35, 38 and 41

Prior U.S. Cls.: 100, 101, 102, 104 and 107

United States Patent and Trademark Office

Reg. No. 3,479,092

Registered Aug. 5, 2008

**SERVICE MARK
PRINCIPAL REGISTER**

FREEIQ

FREEIQ, LLC (GEORGIA CORPORATION)
SUITE 145
6420 ATLANTIC BOULEVARD
NORCROSS, GA 30071

FOR: ON-LINE RETAIL STORE SERVICES FEATURING BOOKS, DVDS AND TRAINING MATERIALS IN THE FIELD OF INTERNET MARKETING AND INFORMATION MARKETING; PROVIDING ON-LINE INFORMATION IN THE FIELD OF BUSINESS NETWORKING, NAMELY, REVIEWS OF BUSINESS PRODUCTS AND SERVICES; CAREER DEVELOPMENT CONSULTING; ADVERTISING VIA ELECTRONIC MEDIA AND SPECIFICALLY THE INTERNET, IN CLASS 35 (U.S. CLS. 100, 101 AND 102).

FIRST USE 4-14-2007; IN COMMERCE 4-14-2007.

FOR: STREAMING VIDEO MATERIAL ON THE INTERNET RELATING TO PROFESSIONAL SERVI-

CES OF OTHERS, IN CLASS 38 (U.S. CLS. 100, 101 AND 104).

FIRST USE 4-14-2007; IN COMMERCE 4-14-2007.

FOR: PROVIDING NEWSLETTERS IN THE FIELD OF INTERNET MARKETING AND INFORMATION MARKETING VIA E-MAIL; PROVIDING INFORMATION IN THE FIELD OF HOBBIES FOR ENTERTAINMENT AND RECREATION, IN CLASS 41 (U.S. CLS. 100, 101 AND 107).

FIRST USE 4-14-2007; IN COMMERCE 4-14-2007.

THE MARK CONSISTS OF STANDARD CHARACTERS WITHOUT CLAIM TO ANY PARTICULAR FONT, STYLE, SIZE, OR COLOR.

SER. NO. 77-211,523, FILED 6-21-2007.

ROBIN CHOSID, EXAMINING ATTORNEY

Int. Cl.: 19

Prior U.S. Cls.: 1, 12, 33 and 50

United States Patent and Trademark Office

Reg. No. 3,479,093

Registered Aug. 5, 2008

**TRADEMARK
PRINCIPAL REGISTER**

BUSCH STADIUM

ANHEUSER-BUSCH, INCORPORATED (MIS-
SOURI CORPORATION)

202-6

ONE BUSCH PLACE

ST. LOUIS, MO 63118

FOR: NON-LUMINOUS, NON-MECHANICAL
SIGNS NOT OF METAL, IN CLASS 19 (U.S. CLS. 1,
12, 33 AND 50).

FIRST USE 5-31-2005; IN COMMERCE 5-31-2005.

THE MARK CONSISTS OF STANDARD CHAR-
ACTERS WITHOUT CLAIM TO ANY PARTICULAR
FONT, STYLE, SIZE, OR COLOR.

OWNER OF U.S. REG. NOS. 2,050,640 AND
3,391,391.

SER. NO. 77-211,674, FILED 6-21-2007.

LOURDES AYALA, EXAMINING ATTORNEY

Int. Cl.: 12

Prior U.S. Cls.: 19, 21, 23, 31, 35 and 44

Reg. No. 3,479,094

United States Patent and Trademark Office

Registered Aug. 5, 2008

**TRADEMARK
PRINCIPAL REGISTER**

AGRI-FLEX

TRINITY TRAILER MFG., INC. (IDAHO CORPORATION)
8200 EISENMAN ROAD
BOISE, ID 83716

THE MARK CONSISTS OF STANDARD CHARACTERS WITHOUT CLAIM TO ANY PARTICULAR FONT, STYLE, SIZE, OR COLOR.

FOR: CARGO TRAILERS, IN CLASS 12 (U.S. CLS. 19, 21, 23, 31, 35 AND 44).

SER. NO. 77-211,773, FILED 6-21-2007.

FIRST USE 12-10-2006; IN COMMERCE 2-19-2007.

MELISSA VALLILLO, EXAMINING ATTORNEY

Int. Cl.: 33

Prior U.S. Cls.: 47 and 49

United States Patent and Trademark Office

Reg. No. 3,479,095

Registered Aug. 5, 2008

**TRADEMARK
PRINCIPAL REGISTER**

BUCKELEY'S

KOOKA WINES, INC. (WASHINGTON COR-
PORATION)
315 SECOND AVENUE SOUTH
FLOOR 2
SEATTLE, WA 98104

FOR: WINE, IN CLASS 33 (U.S. CLS. 47 AND 49).

FIRST USE 5-1-2000; IN COMMERCE 5-1-2000.

THE MARK CONSISTS OF STANDARD CHAR-
ACTERS WITHOUT CLAIM TO ANY PARTICULAR
FONT, STYLE, SIZE, OR COLOR.

SEC. 2(F).

SER. NO. 77-211,895, FILED 6-21-2007.

WILLIAM BRECKENFELD, EXAMINING ATTOR-
NEY

Int. Cl.: 3

Prior U.S. Cls.: 1, 4, 6, 50, 51 and 52

United States Patent and Trademark Office

Reg. No. 3,479,096

Registered Aug. 5, 2008

**TRADEMARK
PRINCIPAL REGISTER**

LISS ULTIME

L'OREAL (FRANCE SOCIETE ANONYME)
14 RUE ROYALE
PARIS, FRANCE 75008

FOR: SHAMPOOS; GELS, SPRAYS, MOUSSES
AND BALMS FOR THE HAIR STYLING AND HAIR
CARE; HAIR LACQUERS; HAIR COLOURING AND
HAIR COLOR REMOVERS; PERMANENT HAIR
WAVING AND CURLING LOTIONS; ESSENTIAL
OILS FOR PERSONAL USE, IN CLASS 3 (U.S. CLS. 1,
4, 6, 50, 51 AND 52).

THE MARK CONSISTS OF STANDARD CHAR-
ACTERS WITHOUT CLAIM TO ANY PARTICULAR
FONT, STYLE, SIZE, OR COLOR.

OWNER OF FRANCE REG. NO. 073474052, DA-
TED 1-11-2007, EXPIRES 1-11-2017.

OWNER OF U.S. REG. NOS. 2,453,235, 2,638,481,
AND 3,255,926.

SER. NO. 77-211,996, FILED 6-21-2007.

JASON TURNER, EXAMINING ATTORNEY

Int. Cl.: 16

Prior U.S. Cls.: 2, 5, 22, 23, 29, 37, 38 and 50

United States Patent and Trademark Office

Reg. No. 3,479,097

Registered Aug. 5, 2008

TRADEMARK
PRINCIPAL REGISTER



ALVA & ASSOCIATES (CALIFORNIA CORPORATION)
2060 OTAY LAKES RD
CHULA VISTA, CA 91915

FOR: MAGAZINES FEATURING REAL ESTATE,
IN CLASS 16 (U.S. CLS. 2, 5, 22, 23, 29, 37, 38 AND 50).

FIRST USE 6-1-2007; IN COMMERCE 6-1-2007.

NO CLAIM IS MADE TO THE EXCLUSIVE
RIGHT TO USE "SAN DIEGO FORECLOSURES",
APART FROM THE MARK AS SHOWN.

THE COLOR(S) RED, WHITE, BLUE AND GRAY
IS/ARE CLAIMED AS A FEATURE OF THE MARK.

THE MARK CONSISTS OF THE WORDING "SAN
DIEGO" IN BLUE WHERE THE DESIGN OF A
HOUSE WITH WHITE DOORS, WINDOWS AND
TRIM IS SUBSTITUTED FOR THE LETTER "A"
AND THE DESIGN OF A TALL BUILDING WITH
WHITE WINDOWS IS SUBSTITUTED FOR THE
LETTER "I", ALL ABOVE THE WORD "FORECLO-
SURES" IN RED. THE WORDING FEATURES
GRAY SHADING.

SER. NO. 77-212,209, FILED 6-21-2007.

CHRISTINE COOPER, EXAMINING ATTORNEY

Int. Cl.: 17

Prior U.S. Cls.: 1, 5, 12, 13, 35 and 50

Reg. No. 3,479,098

United States Patent and Trademark Office

Registered Aug. 5, 2008

**TRADEMARK
PRINCIPAL REGISTER**

PICASUS

TORAY KABUSHIKI KAISHA (JAPAN CORPORATION), TA TORAY INDUSTRIES, INC.
1-1, 2-CHOME, NIHONBASHI-MUROMACHI
CHUO-KU, TOKYO, JAPAN

PRIORITY CLAIMED UNDER SEC. 44(D) ON
JAPAN APPLICATION NO. 2007-057960, FILED 6-8-
2007, REG. NO. 5107992, DATED 1-25-2008, EXPIRES
1-25-2018.

FOR: PLASTICS IN THE FORM OF FILMS, IN
CLASS 17 (U.S. CLS. 1, 5, 12, 13, 35 AND 50).

THE WORD "PICASUS" HAS NO MEANING IN A
FOREIGN LANGUAGE.

THE MARK CONSISTS OF STANDARD CHAR-
ACTERS WITHOUT CLAIM TO ANY PARTICULAR
FONT, STYLE, SIZE, OR COLOR.

SER. NO. 77-212,356, FILED 6-21-2007.

ELISSA GARBER KON, EXAMINING ATTORNEY

Int. Cl.: 36

Prior U.S. Cls.: 100, 101 and 102

United States Patent and Trademark Office

Reg. No. 3,479,099

Registered Aug. 5, 2008

**SERVICE MARK
PRINCIPAL REGISTER**

JOHN DAUGHERTY REALTORS

JOHN DAUGHERTY REAL ESTATE, INC.
(TEXAS CORPORATION), DBA JOHN
DAUGHERTY, REALTORS
520 POST OAK BOULEVARD
6TH FLOOR
HOUSTON, TX 77027

FOR: LEASING OF REAL ESTATE; LEASING OF
REAL PROPERTY; PROVIDING INFORMATION IN
THE FIELD OF REAL ESTATE BY MEANS OF
LINKING THE WEB SITE TO OTHER WEB SITES
FEATURING REAL ESTATE INFORMATION; PRO-
VIDING REAL ESTATE LISTINGS AND REAL
ESTATE INFORMATION VIA THE INTERNET;
REAL ESTATE AGENCIES; REAL ESTATE
BROKERAGE; REAL ESTATE LISTING; PROVID-
ING INFORMATION IN THE FIELD OF REAL
ESTATE VIA THE INTERNET, IN CLASS 36 (U.S.
CLS. 100, 101 AND 102).

FIRST USE 3-8-1967; IN COMMERCE 4-15-1967.

THE MARK CONSISTS OF STANDARD CHAR-
ACTERS WITHOUT CLAIM TO ANY PARTICULAR
FONT, STYLE, SIZE, OR COLOR.

NO CLAIM IS MADE TO THE EXCLUSIVE
RIGHT TO USE "REALTORS", APART FROM THE
MARK AS SHOWN.

THE NAME "JOHN DAUGHERTY" IDENTIFIES
A LIVING INDIVIDUAL WHOSE CONSENT IS OF
RECORD.

SER. NO. 77-212,507, FILED 6-21-2007.

HEATHER BIDDULPH, EXAMINING ATTORNEY

Int. Cl.: 42

Prior U.S. Cls.: 100 and 101

United States Patent and Trademark Office

Reg. No. 3,479,100

Registered Aug. 5, 2008

**SERVICE MARK
PRINCIPAL REGISTER**



The Real Estate Tomato

THE REAL ESTATE TOMATO (CALIFORNIA
PARTNERSHIP)
1433 COLDREN RD.
PARADISE, CA 95969

FOR: GRAPHIC DESIGN SERVICES; WEBSITE
DEVELOPMENT FOR OTHERS, IN CLASS 42 (U.S.
CLS. 100 AND 101).

FIRST USE 6-15-2006; IN COMMERCE 9-19-2006.

NO CLAIM IS MADE TO THE EXCLUSIVE
RIGHT TO USE "REAL ESTATE", APART FROM
THE MARK AS SHOWN.

THE MARK CONSISTS IN PART OF THE DESIGN
OF A TOMATO.

SER. NO. 77-212,586, FILED 6-21-2007.

STEVEN R. FOSTER, EXAMINING ATTORNEY

Int. Cl.: 41

Prior U.S. Cls.: 100, 101 and 107

United States Patent and Trademark Office

Reg. No. 3,479,101

Registered Aug. 5, 2008

**SERVICE MARK
PRINCIPAL REGISTER**

**THE WHOLE CHILD LEARNING
COMPANY**

WHOLE CHILD FRANCHISING, LLC (VIRGINIA
LTD LIAB CO)
SUITE 1350
2200 KRAFT DRIVE
BLACKSBURG, VA 24060

FOR: EDUCATIONAL SERVICES IN DAY CARE,
PRESCHOOL AND PRIMARY SCHOOLS, NAMELY,
PROVIDING CLASSES, MATERIALS, INSTRU-
TION AND INTERACTION IN THE FIELDS OF
KINESTHETIC LEARNING, ATHLETICS, ARTS,
CIVICS, MATHEMATICS, LOGIC, CRITICAL
THINKING, PROBLEM SOLVING, SPATIAL RELA-
TIONS, TIME CONCEPTS, MEASUREMENTS, LIN-
GUISTICS, MUSIC, COOPERATION, SOCIAL AND
INTERPERSONAL SKILLS AND ACTIVITIES, MO-
TIVATION, PHONICS, READING, PRE-READING
READINESS, SHAPE AND COLOR RECOGNITION,
SEQUENCING, COMPUTER SKILLS AND THE USE

AND CARE OF COMPUTER EQUIPMENT, IN
CLASS 41 (U.S. CLS. 100, 101 AND 107).

FIRST USE 8-1-1998; IN COMMERCE 8-1-1998.

THE MARK CONSISTS OF STANDARD CHAR-
ACTERS WITHOUT CLAIM TO ANY PARTICULAR
FONT, STYLE, SIZE, OR COLOR.

NO CLAIM IS MADE TO THE EXCLUSIVE
RIGHT TO USE "COMPANY", APART FROM THE
MARK AS SHOWN.

SEC. 2(F).

SER. NO. 77-212,647, FILED 6-21-2007.

ALICE BENMAMAN, EXAMINING ATTORNEY

Int. Cl.: 25

Prior U.S. Cls.: 22 and 39

United States Patent and Trademark Office

Reg. No. 3,479,102

Registered Aug. 5, 2008

**TRADEMARK
PRINCIPAL REGISTER**

A Little Bit Risque

GRANT, MOLLIE HUNTER (UNITED STATES
INDIVIDUAL)
720 BRADBURN DRIVE
MT. PLEASANT, SC 29464

THE MARK CONSISTS OF STANDARD CHAR-
ACTERS WITHOUT CLAIM TO ANY PARTICULAR
FONT, STYLE, SIZE, OR COLOR.

FOR: MATERNITY LINGERIE; MATERNITY
SLEEPWEAR, IN CLASS 25 (U.S. CLS. 22 AND 39).

SER. NO. 77-212,967, FILED 6-22-2007.

FIRST USE 5-31-2007; IN COMMERCE 5-31-2007.

LESLEY LAMOTHE, EXAMINING ATTORNEY

Int. Cl.: 36

Prior U.S. Cls.: 100, 101 and 102

United States Patent and Trademark Office

Reg. No. 3,479,103

Registered Aug. 5, 2008

**SERVICE MARK
PRINCIPAL REGISTER**

DIGITAL DEPOSIT

INDEPENDENT BANKERS' BANK (ILLINOIS
CORPORATION)

#300

3161 WHITE OAKS DRIVE
SPRINGFIELD, IL 62704

FOR: FINANCIAL INFORMATION SERVICES,
NAMELY, THE TRANSMISSION AND PROCES-
SING OF CHECK IMAGES FROM THIRD PARTY
VENDOR FOR THE THIRD-PARTY BANKS , IN
CLASS 36 (U.S. CLS. 100, 101 AND 102).

FIRST USE 9-6-2005; IN COMMERCE 9-6-2005.

THE MARK CONSISTS OF STANDARD CHAR-
ACTERS WITHOUT CLAIM TO ANY PARTICULAR
FONT, STYLE, SIZE, OR COLOR.

OWNER OF U.S. REG. NO. 3,145,026.

SEC. 2(F).

SER. NO. 77-213,077, FILED 6-22-2007.

MICHAEL TANNER, EXAMINING ATTORNEY

Int. Cl.: 5

Prior U.S. Cls.: 6, 18, 44, 46, 51 and 52

Reg. No. 3,479,104

United States Patent and Trademark Office

Registered Aug. 5, 2008

**TRADEMARK
PRINCIPAL REGISTER**

HILO GOLD

STRATICOM INC, T/A THE STRATIS GROUP
(NEW JERSEY CORPORATION)
99 BLOOMFIELD AVE
CALDWELL, NJ 07006

FOR: NON-MEDICAL DIETARY SUPPLEMENTS
IN THE FORM OF A LIQUID, NON-MEDICAL
NUTRITIONAL SUPPLEMENTS IN THE FORM OF
A LIQUID, IN CLASS 5 (U.S. CLS. 6, 18, 44, 46, 51 AND
52).

FIRST USE 3-26-2007; IN COMMERCE 3-26-2007.

THE MARK CONSISTS OF STANDARD CHAR-
ACTERS WITHOUT CLAIM TO ANY PARTICULAR
FONT, STYLE, SIZE, OR COLOR.

NO CLAIM IS MADE TO THE EXCLUSIVE
RIGHT TO USE "HILO", APART FROM THE MARK
AS SHOWN.

SER. NO. 77-213,328, FILED 6-22-2007.

ALICE BENMAMAN, EXAMINING ATTORNEY

Int. Cls.: 35 and 37

Prior U.S. Cls.: 100, 101, 102, 103 and 106

United States Patent and Trademark Office

Reg. No. 3,479,105

Registered Aug. 5, 2008

**SERVICE MARK
PRINCIPAL REGISTER**



THE SOUTHERN CO., INC. (TENNESSEE CORPORATION)
3101 CARRIER STREET
MEMPHIS, TN 38116

FOR: RETAIL STORE SERVICES FEATURING PETROLEUM AND INDUSTRIAL EQUIPMENT; WHOLESALE DISTRIBUTORSHIP FEATURING PETROLEUM AND INDUSTRIAL EQUIPMENT , IN CLASS 35 (U.S. CLS. 100, 101 AND 102).

FIRST USE 4-6-1965; IN COMMERCE 4-6-1965.

FOR: CONSTRUCTION SERVICES, NAMELY, CONSTRUCTION OF RETAIL AND BULK FUELING FACILITIES FOR THE INDUSTRIAL, TRANSPORTATION, AND PETROLEUM INDUSTRIES, IN CLASS 37 (U.S. CLS. 100, 103 AND 106).

FIRST USE 4-6-1965; IN COMMERCE 4-6-1965.

SER. NO. 77-213,616, FILED 6-22-2007.

PAULA MAHONEY, EXAMINING ATTORNEY

Int. Cl.: 9

Prior U.S. Cls.: 21, 23, 26, 36 and 38

Reg. No. 3,479,106

United States Patent and Trademark Office

Registered Aug. 5, 2008

**TRADEMARK
PRINCIPAL REGISTER**

TORQ

ARMOR HOLDINGS PRODUCTS, LLC (DELA-
WARE LTD LIAB CO)
13386 INTERNATIONAL PARKWAY
JACKSONVILLE, FL 32218

THE MARK CONSISTS OF STANDARD CHAR-
ACTERS WITHOUT CLAIM TO ANY PARTICULAR
FONT, STYLE, SIZE, OR COLOR.

FOR: BULLET PROOF AND BULLET RESISTANT
BODY ARMOR AND CLOTHING, IN CLASS 9 (U.S.
CLS. 21, 23, 26, 36 AND 38).

SER. NO. 77-213,644, FILED 6-22-2007.

FIRST USE 12-0-2006; IN COMMERCE 12-0-2006.

JOHN DWYER, EXAMINING ATTORNEY

Int. Cls.: 14, 35, 40 and 42

Prior U.S. Cls.: 2, 27, 28, 50, 100, 101, 102, 103 and 106

United States Patent and Trademark Office

Reg. No. 3,479,107

Registered Aug. 5, 2008

**TRADEMARK
SERVICE MARK
PRINCIPAL REGISTER**



POINT LAKE MARKETING, INC. (CANADA CORPORATION)
1055 DUNSMUIR STREET PO BOX 49023
SUITE 800, FOUR BENTALL CENTRE
VANCOUVER, CANADA V7X1L2

FOR: PRECIOUS GEMS AND GEMSTONES; JEWELRY, IN CLASS 14 (U.S. CLS. 2, 27, 28 AND 50).

FIRST USE 12-31-2004; IN COMMERCE 12-31-2004.

FOR: WHOLESALE AND RETAIL DISTRIBUTORSHIPS FEATURING DIAMONDS, PRECIOUS AND SEMI-PRECIOUS GEMS AND GEMSTONES AND JEWELRY; PROVIDING CONSUMER INFORMATION VIA A WEBSITE IN THE FIELD OF DIAMONDS, JEWELRY, DIAMOND MINING AND DIAMOND PROCESSING, IN CLASS 35 (U.S. CLS. 100, 101 AND 102).

FIRST USE 12-31-2004; IN COMMERCE 12-31-2004.

FOR: LASER SCRIBING SERVICES OF PRECIOUS GEMSTONES AND DIAMONDS, IN CLASS 40 (U.S. CLS. 100, 103 AND 106).

FIRST USE 12-31-2004; IN COMMERCE 12-31-2004.

FOR: PROVIDING INFORMATION VIA A WEBSITE IN THE FIELDS OF DIAMOND MINING AND GEMOLOGICAL SERVICES, NAMELY, GRADING PRECIOUS STONES, IN CLASS 42 (U.S. CLS. 100 AND 101).

FIRST USE 12-31-2004; IN COMMERCE 12-31-2004.

THE MARK CONSISTS OF A SHADED DIAMOND SHAPE AND A SIDE WAYS SHADED TRIANGLE FOLLOWED BY THE WORD "CANADAMARK".

SER. NO. 77-213,664, FILED 6-22-2007.

IRA J. GOODSaid, EXAMINING ATTORNEY

Int. Cl.: 9

Prior U.S. Cls.: 21, 23, 26, 36 and 38

Reg. No. 3,479,108

United States Patent and Trademark Office

Registered Aug. 5, 2008

**TRADEMARK
PRINCIPAL REGISTER**



SYMONS & CO. PTY. LIMITED (AUSTRALIA
CORPORATION)
9/ 12A LOYALTY ROAD
NORTH ROCKS NSW 2151, AUSTRALIA

THE MARK CONSISTS OF A PAIR OF GLASSES,
WITH ONE OF THE LENSES FORMING THE LET-
TER "O" IN "ON THE NOSE"

FOR: READING GLASSES, IN CLASS 9 (U.S. CLS.
21, 23, 26, 36 AND 38).

SER. NO. 77-213,686, FILED 6-22-2007.

OWNER OF AUSTRALIA REG. NO. 1112003,
DATED 5-4-2006, EXPIRES 5-4-2016.

JAMES GRIFFIN, EXAMINING ATTORNEY

Int. Cl.: 10

Prior U.S. Cls.: 26, 39 and 44

United States Patent and Trademark Office

Reg. No. 3,479,109

Registered Aug. 5, 2008

**TRADEMARK
PRINCIPAL REGISTER**

The logo for 'FLESHLIGHT' is rendered in a bold, blocky, sans-serif font. The letters are white with a thick grey outline. The letter 'O' is replaced by a stylized male symbol (♂) with a curved arrow pointing upwards and to the right.

SHUBIN, STEVE (UNITED STATES INDIVIDUAL)
300 TEXAS LONGHORN TRAIL
DRIPPING SPRINGS, TX 78620

FIRST USE 11-1-1998; IN COMMERCE 11-1-1998.

OWNER OF U.S. REG. NO. 2,225,503.

FOR: ADULT SEXUAL AIDS, NAMELY, MASTURBATION SLEEVES THAT ALLOW FOR THE DISCREET COLLECTION OF HUMAN SPERM, IN CLASS 10 (U.S. CLS. 26, 39 AND 44).

SER. NO. 77-213,782, FILED 6-22-2007.

JASON LOTT, EXAMINING ATTORNEY

Int. Cl.: 25

Prior U.S. Cls.: 22 and 39

United States Patent and Trademark Office

Reg. No. 3,479,110

Registered Aug. 5, 2008

**TRADEMARK
PRINCIPAL REGISTER**

Lead Sled

RUUD, ROBERT, D. (UNITED STATES INDIVIDUAL)
7430 MORNINGSID DR.
GRANITE BAY, CA 95746

THE MARK CONSISTS OF STANDARD CHARACTERS WITHOUT CLAIM TO ANY PARTICULAR FONT, STYLE, SIZE, OR COLOR.

FOR: SHORT-SLEEVED OR LONG-SLEEVED T-SHIRTS; BEANIES; HATS; JACKETS; SWEAT SHIRTS, IN CLASS 25 (U.S. CLS. 22 AND 39).

SER. NO. 77-213,950, FILED 6-23-2007.

FIRST USE 10-5-1991; IN COMMERCE 11-3-1992.

DANNEAN HETZEL, EXAMINING ATTORNEY

Int. Cl.: 35

Prior U.S. Cls.: 100, 101 and 102

United States Patent and Trademark Office

Reg. No. 3,479,111

Registered Aug. 5, 2008

**SERVICE MARK
PRINCIPAL REGISTER**

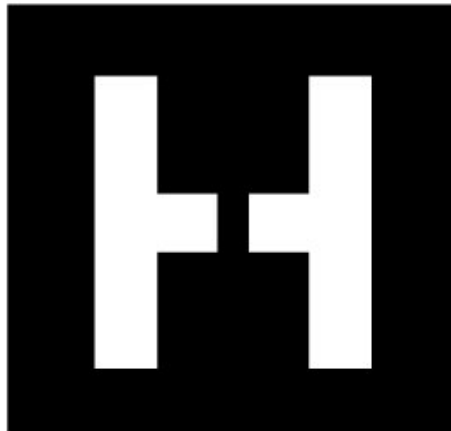

HYDRANT (CALIFORNIA CORPORATION)
642 GATES STREET
SAN FRANCISCO, CA 94110

FOR: INFORMATION, ADVISORY AND CONSULTANCY SERVICES RELATING TO BUSINESS AND MANAGEMENT OR BUSINESS ADMINISTRATION, INCLUDING SUCH SERVICES PROVIDED ON LINE OR VIA THE INTERNET; MARKETING CONSULTING; CONSULTANCY SERVICES REGARDING BUSINESS STRATEGIES; CONSULTING SERVICES IN BUSINESS ORGANIZATION AND MANAGEMENT; BUSINESS MAN-

AGEMENT CONSULTANCY AND ADVISORY SERVICES; BUSINESS MANAGEMENT CONSULTATION; BUSINESS MARKETING CONSULTING SERVICES; BUSINESS ORGANIZATION AND MANAGEMENT CONSULTING SERVICES, IN CLASS 35 (U.S. CLS. 100, 101 AND 102).

FIRST USE 8-22-2005; IN COMMERCE 8-22-2005.

SER. NO. 77-214,518, FILED 6-25-2007.

LESLEY LAMOTHE, EXAMINING ATTORNEY

Int. Cl.: 35

Prior U.S. Cls.: 100, 101 and 102

United States Patent and Trademark Office

Reg. No. 3,479,112

Registered Aug. 5, 2008

**SERVICE MARK
PRINCIPAL REGISTER**

FLORIDA GONE WILD

WEEKS, JASON (UNITED STATES INDIVIDUAL)
16068 74TH AVE. NORTH
PALM BEACH GARDENS, FL 33418

FOR: COMPUTER SERVICES, NAMELY, PROVIDING A WEBSITE FEATURING ONLINE BUSINESS DIRECTORIES OF DINING AND ENTERTAINMENT, NIGHTLIFE, CONCERTS, EVENTS, SPORTS, MUSIC, THEATER, MOVIES AND RECREATION, AMUSEMENT PARKS, ARTS AND HUMANITIES, TRAVEL AND LODGING, INCLUDING ADDRESSES AND PHONE NUMBERS FOR ALL OF THE FOREGOING AND INDICES OF INFORMATION REGARDING OTHER SITES AND OTHER ONLINE RESOURCES; ADVERTISEMENTS FOR THE GOODS AND SERVICES OF OTHERS AND REFERENCE MATERIALS, NAMELY, SCHE-

DULES AND MENUS, IN CLASS 35 (U.S. CLS. 100, 101 AND 102).

FIRST USE 6-22-2007; IN COMMERCE 6-22-2007.

THE MARK CONSISTS OF STANDARD CHARACTERS WITHOUT CLAIM TO ANY PARTICULAR FONT, STYLE, SIZE, OR COLOR.

NO CLAIM IS MADE TO THE EXCLUSIVE RIGHT TO USE "FLORIDA", APART FROM THE MARK AS SHOWN.

SER. NO. 77-214,734, FILED 6-25-2007.

JAMES A. RAUEN, EXAMINING ATTORNEY

Int. Cl.: 44

Prior U.S. Cls.: 100 and 101

United States Patent and Trademark Office

Reg. No. 3,479,113

Registered Aug. 5, 2008

**SERVICE MARK
PRINCIPAL REGISTER**

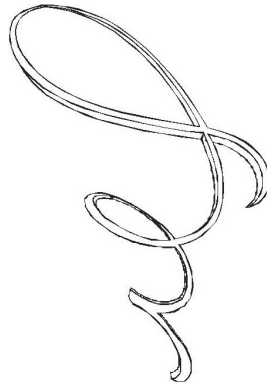

BROWN, SUSAN M. (UNITED STATES INDIVIDUAL)
25W330 GENEVA ROAD
CAROL STREAM, IL 60188

FIRST USE 6-30-1988; IN COMMERCE 6-30-1988.

SER. NO. 77-214,775, FILED 6-25-2007.

FOR: CHIROPRACTIC SERVICES; CHIROPRACTICS, IN CLASS 44 (U.S. CLS. 100 AND 101).

ROBERT LAVACHE, EXAMINING ATTORNEY

Int. Cl.: 35

Prior U.S. Cls.: 100, 101 and 102

United States Patent and Trademark Office

Reg. No. 3,479,114

Registered Aug. 5, 2008

**SERVICE MARK
PRINCIPAL REGISTER**

INTEGRAS

CLARITAS INC. (DELAWARE CORPORATION)
5375 MIRA SORRENTO PLACE, SUITE 400
SAN DIEGO, CA 92121

FIRST USE 1-13-2003; IN COMMERCE 1-13-2003.

FOR: BUSINESS CONSULTING, MARKET RESEARCH AND ANALYSIS, GEOGRAPHIC LOCATION MARKET ANALYSIS AND DEMOGRAPHIC ANALYSIS AND FORECASTING, CONSULTING SERVICES IN THE FIELDS OF GEOGRAPHIC LOCATION MARKET ANALYSIS AND DEMOGRAPHIC MARKETING, MARKET REPORTS AND STUDIES, IN CLASS 35 (U.S. CLS. 100, 101 AND 102).

THE MARK CONSISTS OF STANDARD CHARACTERS WITHOUT CLAIM TO ANY PARTICULAR FONT, STYLE, SIZE, OR COLOR.

SER. NO. 77-215,020, FILED 6-25-2007.

SANI KHOURI, EXAMINING ATTORNEY

Int. Cls.: 3 and 44

Prior U.S. Cls.: 1, 4, 6, 50, 51, 52, 100 and 101

United States Patent and Trademark Office

Reg. No. 3,479,115

Registered Aug. 5, 2008

**TRADEMARK
SERVICE MARK
PRINCIPAL REGISTER**



CANIGLIA, RONALD J. (UNITED STATES INDIVIDUAL)

7102 E. ACOMA DRIVE
SCOTTSDALE, AZ 85254

FOR: SKIN CARE PREPARATIONS, NAMELY CHEMICAL PEELS FOR SKIN; SKIN CARE PRODUCTS, NAMELY, NON-MEDICATED SKIN SERUM; SKIN CREAMS; SKIN LOTIONS; SKIN MOISTURIZER MASKS; SKIN SOAP; SKIN TONERS; FACIAL SCRUBS; FACE AND BODY LOTIONS; BEAUTY CREAMS; BEAUTY MASKS; EXFOLIANTS FOR SKIN, IN CLASS 3 (U.S. CLS. 1, 4, 6, 50, 51 AND 52).

FIRST USE 11-1-1999; IN COMMERCE 11-1-1999.

FOR: COSMETIC AND PLASTIC SURGERY; FACIAL TREATMENT SERVICES, NAMELY, COSMETIC PEELS; HEALTH SPA SERVICES,

NAMELY, COSMETIC BODY CARE SERVICES, IN CLASS 44 (U.S. CLS. 100 AND 101).

FIRST USE 11-1-1999; IN COMMERCE 11-1-1999.

THE COLOR(S) GRAY AND PURPLE IS/ARE CLAIMED AS A FEATURE OF THE MARK.

THE MARK CONSISTS OF A STYLIZED LETTER "C" IN A TWO-DIMENSIONAL SQUARE. THE COLOR GRAY APPEARS IN THE LETTER "C" AND IN THE DESIGN OF THE SQUARE AND THE BACKGROUND OF THE MARK, THE COLOR PURPLE APPEARS IN THE LETTER "C", THE DESIGN OF THE SQUARE AND THE HORIZONTAL LINE.

SER. NO. 77-215,026, FILED 6-25-2007.

SHANNON TWOHIG, EXAMINING ATTORNEY

Int. Cls.: 3 and 5

Prior U.S. Cls.: 1, 4, 6, 18, 44, 46, 50, 51 and 52

United States Patent and Trademark Office

Reg. No. 3,479,116

Registered Aug. 5, 2008

**TRADEMARK
PRINCIPAL REGISTER**

RANDALL INTERNATIONAL

RANDALL INTERNATIONAL, L.P. (DELAWARE
LIMITED PARTNERSHIP)
2885 LOKER AVENUE, EAST
CARLSBAD, CA 92008

FOR: COSMETICS, NON-MEDICATED SKIN
CARE PREPARATIONS, NON-MEDICATED SUN
CARE PREPARATIONS, IN CLASS 3 (U.S. CLS. 1, 4,
6, 50, 51 AND 52).

FIRST USE 7-1-1989; IN COMMERCE 7-1-1989.

FOR: MEDICATED SKIN CARE PREPARATIONS,
MEDICATED SUN CARE PREPARATIONS, IN
CLASS 5 (U.S. CLS. 6, 18, 44, 46, 51 AND 52).

FIRST USE 7-1-1989; IN COMMERCE 7-1-1989.

THE MARK CONSISTS OF STANDARD CHAR-
ACTERS WITHOUT CLAIM TO ANY PARTICULAR
FONT, STYLE, SIZE, OR COLOR.

NO CLAIM IS MADE TO THE EXCLUSIVE
RIGHT TO USE "INTERNATIONAL", APART
FROM THE MARK AS SHOWN.

SER. NO. 77-215,043, FILED 6-25-2007.

LEIGH CAROLINE CASE, EXAMINING ATTOR-
NEY

Int. Cl.: 2

Prior U.S. Cls.: 6, 11 and 16

United States Patent and Trademark Office

Reg. No. 3,479,117

Registered Aug. 5, 2008

**TRADEMARK
PRINCIPAL REGISTER**

SHER-KEM

SWIMC, INC. (DELAWARE CORPORATION)
300 DELAWARE AVENUE
SUITE 522
WILMINGTON, FED REP GERMANY 198011607

THE MARK CONSISTS OF STANDARD CHAR-
ACTERS WITHOUT CLAIM TO ANY PARTICULAR
FONT, STYLE, SIZE, OR COLOR.

FOR: PAINTS, IN CLASS 2 (U.S. CLS. 6, 11 AND 16).

SER. NO. 77-215,797, FILED 6-26-2007.

FIRST USE 2-1-2006; IN COMMERCE 2-1-2006.

TANYA AMOS, EXAMINING ATTORNEY

Int. Cl.: 35

Prior U.S. Cls.: 100, 101 and 102

United States Patent and Trademark Office

Reg. No. 3,479,118

Registered Aug. 5, 2008

**SERVICE MARK
PRINCIPAL REGISTER**

Liberty Media Group

COMMUNITY REDEVELOPMENT AGENCY LLC
(CALIFORNIA LTD LIAB CO)
11693 SAN VICENTE BLVD, #265
LOS ANGELES, CA 90049

FOR: ADVERTISING AND PROMOTION SERVICES; COMMERCIAL INFORMATION AGENCIES; PUBLICITY AGENCIES; MARKETING RESEARCH AND STUDIES; PUBLIC RELATIONS; PUBLICATION OF PUBLICITY TEXTS; BILL-POSTING; PUBLICITY MATERIAL RENTAL; UPDATING OF ADVERTISING MATERIAL; RENTAL AND BROKERING OF ADVERTISING SPACE; ORGANIZATION OF EXHIBITIONS FOR COMMERCIAL OR ADVERTISING PURPOSES; OUTDOOR ADVERTISING, NAMELY, DISSEMINATION OF ADVERTISING FOR OTHERS VIA BILLBOARDS, BUSES, BUS SHELTERS, STREET BENCHES, STREET FURNITURE, STANDS, FLOWER STANDS, LOTTERY STANDS, NEWSPAPER STANDS, TRAINS, TRAIN PLATFORMS, TERMINALS IN COMMUTER RAIL SYSTEMS, POSTERS, DISPLAY SIGNS, DISPLAY CASES AND PHONE BOOTHS, BANNERS, MASTS AND FLAGS, BUILDING FACADES AND WALLS, DIGITAL SIGNS; ADVERTISING BY MAIL ORDER; DIRECT MAIL ADVERTISING; ONLINE ADVERTISING ON A COMPUTER NETWORK; PROVID-

ING ONLINE DATABASES FEATURING INFORMATION AND DATA CONCERNING ADVERTISING SPACE RENTAL AND AVAILABILITY; ADVERTISING OF AUDIO AND VISUAL CONTENT OF OTHERS VIA TELEVISION, CABLE AND SATELLITE, RADIO, INTERNET, MOBILE AND WIRELESS COMMUNICATION DEVICES; RENTAL OF ADVERTISING TIME ON COMMUNICATION MEDIA; AND INTERACTIVE ADVERTISING FOR OTHERS VIA MOBILE PHONES AND OTHER PERSONAL DIGITAL EQUIPMENT, IN CLASS 35 (U.S. CLS. 100, 101 AND 102).

FIRST USE 5-1-2006; IN COMMERCE 5-1-2006.

THE MARK CONSISTS OF STANDARD CHARACTERS WITHOUT CLAIM TO ANY PARTICULAR FONT, STYLE, SIZE, OR COLOR.

NO CLAIM IS MADE TO THE EXCLUSIVE RIGHT TO USE "MEDIA GROUP", APART FROM THE MARK AS SHOWN.

SER. NO. 77-215,815, FILED 6-26-2007.

KELLEY WELLS, EXAMINING ATTORNEY

Int. Cls.: 36 and 37

Prior U.S. Cls.: 100, 101, 102, 103 and 106

United States Patent and Trademark Office

Reg. No. 3,479,119

Registered Aug. 5, 2008

**SERVICE MARK
PRINCIPAL REGISTER**

MONDRIAN

MONDRIAN HOLDINGS, LLC (NEW YORK LTD
LIAB CO)
475 10TH AVENUE
NEW YORK, NY 10018

FOR: REAL ESTATE MANAGEMENT SERVICES,
IN CLASS 36 (U.S. CLS. 100, 101 AND 102).

FIRST USE 6-26-2007; IN COMMERCE 6-26-2007.

FOR: REAL ESTATE DEVELOPMENT SERVICES,
NAMELY, DEVELOPMENT OF RESIDENTIAL
AND COMMERCIAL UNITS IN RESORT PROPER-
TIES, IN CLASS 37 (U.S. CLS. 100, 103 AND 106).

FIRST USE 8-8-2006; IN COMMERCE 8-8-2006.

THE MARK CONSISTS OF STANDARD CHAR-
ACTERS WITHOUT CLAIM TO ANY PARTICULAR
FONT, STYLE, SIZE, OR COLOR.

OWNER OF U.S. REG. NO. 2,219,088.

SER. NO. 77-216,140, FILED 6-26-2007.

JESSICA FATHY, EXAMINING ATTORNEY

Int. Cl.: 3

Prior U.S. Cls.: 1, 4, 6, 50, 51 and 52

Reg. No. 3,479,120

United States Patent and Trademark Office

Registered Aug. 5, 2008

**TRADEMARK
PRINCIPAL REGISTER**

Blissful Home

DOPPELT, JOYCE (UNITED STATES INDIVIDUAL)
1122 HULL TERRACE
EVANSTON, IL 60202 AND
WOLVERTON, WHITNIE CROWN (UNITED STATES INDIVIDUAL)
1104 BRUMMEL ST.
EVANSTON, IL 60202

FOR: GENERAL PURPOSE CLEANING, POLISHING, AND ABRASIVE LIQUIDS AND POWDERS , IN CLASS 3 (U.S. CLS. 1, 4, 6, 50, 51 AND 52).

FIRST USE 4-22-2007; IN COMMERCE 4-22-2007.

THE MARK CONSISTS OF STANDARD CHARACTERS WITHOUT CLAIM TO ANY PARTICULAR FONT, STYLE, SIZE, OR COLOR.

NO CLAIM IS MADE TO THE EXCLUSIVE RIGHT TO USE "HOME", APART FROM THE MARK AS SHOWN.

SER. NO. 77-216,164, FILED 6-26-2007.

MICHAEL GAAFAR, EXAMINING ATTORNEY

Int. Cl.: 16

Prior U.S. Cls.: 2, 5, 22, 23, 29, 37, 38 and 50

United States Patent and Trademark Office

Reg. No. 3,479,121

Registered Aug. 5, 2008

**TRADEMARK
PRINCIPAL REGISTER**

LICENSE QUEST

DOLLAR EMPIRE LLC (CALIFORNIA LTD LIAB
CO)
4423 E. BANDINI BLVD.
VERNON, CA 90023

THE MARK CONSISTS OF STANDARD CHAR-
ACTERS WITHOUT CLAIM TO ANY PARTICULAR
FONT, STYLE, SIZE, OR COLOR.

FOR: COLORING BOOKS, PAPER BANNERS,
STATIONERY, IN CLASS 16 (U.S. CLS. 2, 5, 22, 23,
29, 37, 38 AND 50).

SER. NO. 77-216,336, FILED 6-27-2007.

FIRST USE 11-15-2007; IN COMMERCE 11-15-2007.

SETH A. RAPPAPORT, EXAMINING ATTORNEY

Int. Cl.: 9

Prior U.S. Cls.: 21, 23, 26, 36 and 38

Reg. No. 3,479,122

United States Patent and Trademark Office

Registered Aug. 5, 2008

**TRADEMARK
PRINCIPAL REGISTER**



A-DATA TECHNOLOGY CO., LTD. (TAIWAN CORPORATION)
18 F., NO. 258, LIAN CHENG RD.
CHUNG HO CITY, TAIPEI, TAIWAN

FOR: COMPUTER HARDWARE, NAMELY, COMPUTER MEMORIES AND COMPUTER MEMORY MODULES, MEMORY CARDS, COMPACT DISC READ ONLY MEMORY DRIVES, DISC DRIVES FOR COMPUTERS, MAGNETIC DISK DRIVES, FLASH MEMORIES, USB FLASH MEMORY DRIVES, INTERFACE CARDS FOR COMPUTERS, INTEGRATED CIRCUITS, INTEGRATED CIRCUIT BOARDS, SEMICONDUCTORS, CAMERAS, DIGI-

TAL CAMERAS, VIDEO CAMERAS, IN CLASS 9 (U.S. CLS. 21, 23, 26, 36 AND 38).

FIRST USE 12-0-2006; IN COMMERCE 12-0-2006.

NO CLAIM IS MADE TO THE EXCLUSIVE RIGHT TO USE "FLASH", APART FROM THE MARK AS SHOWN.

SER. NO. 77-216,464, FILED 6-27-2007.

JOHN DALIER, EXAMINING ATTORNEY

Int. Cl.: 10

Prior U.S. Cls.: 26, 39 and 44

United States Patent and Trademark Office

Reg. No. 3,479,123

Registered Aug. 5, 2008

**TRADEMARK
PRINCIPAL REGISTER**

ACUDRIVER

EXACTECH, INC. (FLORIDA CORPORATION)
2320 NORTH WEST 66TH COURT
GAINESVILLE, FL 32653

FIRST USE 5-5-1995; IN COMMERCE 5-5-1995.

FOR: SURGICAL APPARATUS FOR USE IN THE FIELD OF ORTHOPEDIC SURGERY, NAMELY, PNEUMATICALLY POWERED HAND DRIVERS AND PARTS AND ACCESSORIES USED THEREWITH, NAMELY, OSTEOTOMES, GOUGES, PUNCHES AND IMPACTORS, IN CLASS 10 (U.S. CLS. 26, 39 AND 44).

THE MARK CONSISTS OF STANDARD CHARACTERS WITHOUT CLAIM TO ANY PARTICULAR FONT, STYLE, SIZE, OR COLOR.

SER. NO. 77-216,539, FILED 6-27-2007.

MARTHA FROMM, EXAMINING ATTORNEY

Int. Cl.: 10

Prior U.S. Cls.: 26, 39 and 44

Reg. No. 3,479,124

United States Patent and Trademark Office

Registered Aug. 5, 2008

**TRADEMARK
PRINCIPAL REGISTER**

ANCHOR FAST

HOLLISTER INCORPORATED (ILLINOIS CORPORATION)
2000 HOLLISTER DRIVE
LIBERTYVILLE, IL 60048

FOR: PLASTIC MEDICAL CLAMPING DEVICE WITH SKIN BARRIER FEATURE USED FOR SECURING TUBES, DRAINS AND CATHETERS, IN CLASS 10 (U.S. CLS. 26, 39 AND 44).

FIRST USE 12-7-2007; IN COMMERCE 12-7-2007.

THE MARK CONSISTS OF STANDARD CHARACTERS WITHOUT CLAIM TO ANY PARTICULAR FONT, STYLE, SIZE, OR COLOR.

NO CLAIM IS MADE TO THE EXCLUSIVE RIGHT TO USE "ANCHOR", APART FROM THE MARK AS SHOWN.

SER. NO. 77-216,609, FILED 6-27-2007.

ROBERT LAVACHE, EXAMINING ATTORNEY

Int. Cl.: 9

Prior U.S. Cls.: 21, 23, 26, 36 and 38

Reg. No. 3,479,125

United States Patent and Trademark Office

Registered Aug. 5, 2008

**TRADEMARK
PRINCIPAL REGISTER**

SOUNDGATE

STILLWATER DESIGNS AND AUDIO, INC. (OK-
LAHOMA CORPORATION)
5021 N. PERKINS ROAD
STILLWATER, OK 74075

FOR: ELECTRONIC ADAPTERS FOR INTERFA-
CING AUDIO COMPONENTS, EXCLUDING FILM
PROJECTORS, IN CLASS 9 (U.S. CLS. 21, 23, 26, 36
AND 38).

FIRST USE 12-26-1995; IN COMMERCE 4-16-1996.

THE MARK CONSISTS OF STANDARD CHAR-
ACTERS WITHOUT CLAIM TO ANY PARTICULAR
FONT, STYLE, SIZE, OR COLOR.

OWNER OF U.S. REG. NO. 2,955,012.

SEC. 2(F).

SER. NO. 77-216,723, FILED 6-27-2007.

CAROLYN CATALDO, EXAMINING ATTORNEY

Int. Cls.: 35 and 41

Prior U.S. Cls.: 100, 101, 102 and 107

United States Patent and Trademark Office

Reg. No. 3,479,126

Registered Aug. 5, 2008

**SERVICE MARK
PRINCIPAL REGISTER**



IDOC, LLC (NEW JERSEY LTD LIAB CO)
SUITE 315
147 COLUMBIA TURNPIKE
FLORHAM PARK, NJ 07932

FOR: CONSULTING SERVICES IN THE FIELD OF OPTOMETRIC PRACTICE DEVELOPMENT AND MANAGEMENT; AND FACILITATING GROUP PURCHASES BY OPTOMETRISTS AND OPTOMETRIC PRACTICES, IN CLASS 35 (U.S. CLS. 100, 101 AND 102).

FIRST USE 0-0-2000; IN COMMERCE 0-0-2000.

FOR: PROVIDING CONTINUING EDUCATION COURSES FOR OPTOMETRISTS, IN CLASS 41 (U.S. CLS. 100, 101 AND 107).

FIRST USE 0-0-2000; IN COMMERCE 0-0-2000.

NO CLAIM IS MADE TO THE EXCLUSIVE RIGHT TO USE THE REPRESENTATION OF THE CADUCEUS SYMBOL, APART FROM THE MARK AS SHOWN.

THE MARK CONSISTS OF STYLIZED LETTERS "IDOC", THE "O" OF WHICH IS A PUPIL WITHIN A STYLIZED EYE, THE PUPIL CONTAINING A ROD WITH TWO OPPOSING WINGS AND TWO SERPENTS INTERTWINED AROUND THE ROD.

SER. NO. 77-216,727, FILED 6-27-2007.

ELIZABETH HUGHITT, EXAMINING ATTORNEY

Int. Cls.: 30 and 35

Prior U.S. Cls.: 46, 100, 101 and 102

United States Patent and Trademark Office

Reg. No. 3,479,127

Registered Aug. 5, 2008

**TRADEMARK
SERVICE MARK
PRINCIPAL REGISTER**

MORKES

MORKES, INC. (ILLINOIS CORPORATION)
1890 N. RAND RD.
PALATINE, IL 60074

FOR: CONFECTIONS, NAMELY, CANDY, CANDY BARS, CHOCOLATE, CHOCOLATE CANDIES, CHOCOLATE BARS, CHOCOLATE COVERED NUTS, CHOCOLATE COVERED FRUIT, CHOCOLATE TRUFFLES, TOFFEE, CANDY WITH CARAMEL, FUDGE; CANDY COATED APPLES, IN CLASS 30 (U.S. CL. 46).

FIRST USE 7-31-1988; IN COMMERCE 7-31-1988.

FOR: RETAIL CANDY STORES, IN CLASS 35 (U.S. CLS. 100, 101 AND 102).

FIRST USE 7-31-1988; IN COMMERCE 7-31-1988.

THE MARK CONSISTS OF STANDARD CHARACTERS WITHOUT CLAIM TO ANY PARTICULAR FONT, STYLE, SIZE, OR COLOR.

SER. NO. 77-216,884, FILED 6-27-2007.

CHRISTINA SOBRAL, EXAMINING ATTORNEY

Int. Cl.: 41

Prior U.S. Cls.: 100, 101 and 107

United States Patent and Trademark Office

Reg. No. 3,479,128

Registered Aug. 5, 2008

**SERVICE MARK
PRINCIPAL REGISTER**



PROGRESS SOFTWARE CORPORATION (MAS-
SACHUSETTS CORPORATION)
14 OAK PARK
BEDFORD, MA 01730

FOR: EDUCATIONAL SERVICES, NAMELY,
PROVIDING INSTRUCTION IN THE USE OF COM-
PUTER SOFTWARE FOR USE IN DEVELOPING,
DEPLOYING, AND EXECUTING COMPUTER PRO-
GRAMS VIA LOCAL AREA, WIDE AREA, AND
GLOBAL NETWORKS, AND WIRELESS DEVICES,
IN CLASS 41 (U.S. CLS. 100, 101 AND 107).

FIRST USE 9-25-2006; IN COMMERCE 9-25-2006.

OWNER OF U.S. REG. NOS. 1,382,068, 2,752,891
AND OTHERS.

SER. NO. 77-216,915, FILED 6-27-2007.

ROBERT LAVACHE, EXAMINING ATTORNEY

Int. Cl.: 42

Prior U.S. Cls.: 100 and 101

United States Patent and Trademark Office

Reg. No. 3,479,129

Registered Aug. 5, 2008

**SERVICE MARK
PRINCIPAL REGISTER**



PROGRESS SOFTWARE CORPORATION (MAS-
SACHUSETTS CORPORATION)
14 OAK PARK
BEDFORD, MA 01730

FOR: TECHNICAL SUPPORT SERVICES, NAME-
LY, TROUBLESHOOTING OF COMPUTER SOFT-
WARE, MAINTENANCE OF COMPUTER
SOFTWARE, AND CONSULTING SERVICES PER-
TAINING TO COMPUTER SOFTWARE FOR USE IN
DEVELOPING, DEPLOYING, AND EXECUTING
COMPUTER PROGRAMS VIA LOCAL AREA, WIDE
AREA, AND GLOBAL COMPUTER NETWORKS,

AND WIRELESS DEVICES, IN CLASS 42 (U.S. CLS.
100 AND 101).

FIRST USE 9-25-2006; IN COMMERCE 9-25-2006.

OWNER OF U.S. REG. NOS. 1,382,068, 2,752,891
AND OTHERS.

SER. NO. 77-216,924, FILED 6-27-2007.

ROBERT LAVACHE, EXAMINING ATTORNEY

Int. Cl.: 9

Prior U.S. Cls.: 21, 23, 26, 36 and 38

Reg. No. 3,479,130

United States Patent and Trademark Office

Registered Aug. 5, 2008

**TRADEMARK
PRINCIPAL REGISTER**

SONIC

PROGRESS SOFTWARE CORPORATION (MAS-
SACHUSETTS CORPORATION)
14 OAK PARK
BEDFORD, MA 01730

FOR: COMPUTER SOFTWARE FOR USE IN
DEVELOPING, DEPLOYING, AND EXECUTING
COMPUTER PROGRAMS VIA LOCAL AREA, WIDE
AREA, AND GLOBAL COMPUTER NETWORKS,
AND WIRELESS DEVICES, AND INSTRUCTION
MANUALS SOLD THEREWITH, EXCLUDING IN-
TEGRATED CIRCUIT DESIGN AND DEVELOP-
MENT SOFTWARE, AND INSTRUCTION
MANUALS SOLD THEREWITH, IN CLASS 9 (U.S.
CLS. 21, 23, 26, 36 AND 38).

FIRST USE 3-0-2001, THE MARK WAS FIRST
USED ANYWHERE IN A DIFFERENT FORM

OTHER THAN THAT SOUGHT TO BE
REGISTERED ON 09/30/1999.; IN COMMERCE
5-25-2001, THE MARK WAS FIRST USED IN
COMMERCE IN A DIFFERENT FORM OTHER
THAN THAT SOUGHT TO BE REGISTERED ON
12/31/1999..

THE MARK CONSISTS OF STANDARD CHAR-
ACTERS WITHOUT CLAIM TO ANY PARTICULAR
FONT, STYLE, SIZE, OR COLOR.

OWNER OF U.S. REG. NOS. 2,482,552, 2,752,891
AND OTHERS.

SER. NO. 77-216,930, FILED 6-27-2007.

ROBERT LAVACHE, EXAMINING ATTORNEY

Int. Cls.: 30 and 35

Prior U.S. Cls.: 46, 100, 101 and 102

United States Patent and Trademark Office

Reg. No. 3,479,131

Registered Aug. 5, 2008

**TRADEMARK
SERVICE MARK
PRINCIPAL REGISTER**



MORKES, INC. (ILLINOIS CORPORATION)
1890 N. RAND RD.
PALATINE, IL 60074

FOR: CONFECTIONS, NAMELY, CANDY, CANDY BARS, CHOCOLATE, CHOCOLATE CANDIES, CHOCOLATE BARS, CHOCOLATE COVERED NUTS, CHOCOLATE COVERED FRUIT, CHOCOLATE TRUFFLES, TOFFEE, CANDY WITH CARAMEL, FUDGE; CANDY COATED APPLES, IN CLASS 30 (U.S. CL. 46).

FIRST USE 3-31-2007; IN COMMERCE 3-31-2007.

FOR: RETAIL CANDY STORES, IN CLASS 35 (U.S. CLS. 100, 101 AND 102).

FIRST USE 3-31-2007; IN COMMERCE 3-31-2007.

THE MARK CONSISTS OF AN ARTISTIC RENDERING OF A CONFECTION.

SER. NO. 77-216,940, FILED 6-27-2007.

CHRISTINA SOBRAL, EXAMINING ATTORNEY

Int. Cl.: 41

Prior U.S. Cls.: 100, 101 and 107

United States Patent and Trademark Office

Reg. No. 3,479,132

Registered Aug. 5, 2008

**SERVICE MARK
PRINCIPAL REGISTER**

SONIC

PROGRESS SOFTWARE CORPORATION (MAS-
SACHUSETTS CORPORATION)
14 OAK PARK
BEDFORD, MA 01730

FOR: EDUCATIONAL SERVICES, NAMELY,
PROVIDING INSTRUCTION IN THE USE OF COM-
PUTER SOFTWARE FOR USE IN DEVELOPING,
DEPLOYING, AND EXECUTING COMPUTER PRO-
GRAMS VIA LOCAL AREA, WIDE AREA, AND
GLOBAL NETWORKS, AND WIRELESS DEVICES,
IN CLASS 41 (U.S. CLS. 100, 101 AND 107).

FIRST USE 3-0-2001; IN COMMERCE 5-23-2001.

THE MARK CONSISTS OF STANDARD CHAR-
ACTERS WITHOUT CLAIM TO ANY PARTICULAR
FONT, STYLE, SIZE, OR COLOR.

OWNER OF U.S. REG. NOS. 2,482,552, 2,752,891
AND OTHERS.

SER. NO. 77-216,995, FILED 6-27-2007.

ROBERT LAVACHE, EXAMINING ATTORNEY

Int. Cl.: 42

Prior U.S. Cls.: 100 and 101

United States Patent and Trademark Office

Reg. No. 3,479,133

Registered Aug. 5, 2008

**SERVICE MARK
PRINCIPAL REGISTER**

SONIC

PROGRESS SOFTWARE CORPORATION (MAS-
SACHUSETTS CORPORATION)
14 OAK PARK
BEDFORD, MA 01730

FOR: TECHNICAL SUPPORT SERVICES, NAME-
LY, TROUBLESHOOTING OF COMPUTER SOFT-
WARE, MAINTENANCE OF COMPUTER
SOFTWARE, AND CONSULTING SERVICES PER-
TAINING TO COMPUTER SOFTWARE FOR USE IN
DEVELOPING, DEPLOYING, AND EXECUTING
COMPUTER PROGRAMS VIA LOCAL AREA, WIDE
AREA, AND GLOBAL COMPUTER NETWORKS,
AND WIRELESS DEVICES, IN CLASS 42 (U.S. CLS.
100 AND 101).

FIRST USE 3-0-2001; IN COMMERCE 5-23-2001.

THE MARK CONSISTS OF STANDARD CHAR-
ACTERS WITHOUT CLAIM TO ANY PARTICULAR
FONT, STYLE, SIZE, OR COLOR.

OWNER OF U.S. REG. NOS. 2,482,552, 2,752,891
AND OTHERS.

SER. NO. 77-217,000, FILED 6-27-2007.

ROBERT LAVACHE, EXAMINING ATTORNEY

Int. Cl.: 9

Prior U.S. Cls.: 21, 23, 26, 36 and 38

Reg. No. 3,479,134

United States Patent and Trademark Office

Registered Aug. 5, 2008

**TRADEMARK
PRINCIPAL REGISTER**



PROGRESS SOFTWARE CORPORATION (MAS-
SACHUSETTS CORPORATION)
14 OAK PARK
BEDFORD, MA 01826

FOR: COMPUTER SOFTWARE FOR USE IN
DEVELOPING, DEPLOYING, AND EXECUTING
COMPUTER PROGRAMS VIA LOCAL AREA, WIDE
AREA, AND GLOBAL COMPUTER NETWORKS,
AND WIRELESS DEVICES, AND INSTRUCTION
MANUALS SOLD THEREWITH, EXCLUDING IN-
TEGRATED CIRCUIT DESIGN AND DEVELOP-
MENT SOFTWARE, AND INSTRUCTION

MANUALS SOLD THEREWITH, IN CLASS 9 (U.S.
CLS. 21, 23, 26, 36 AND 38).

FIRST USE 4-27-2007; IN COMMERCE 4-27-2007.

OWNER OF U.S. REG. NOS. 1,382,068, 2,752,891
AND OTHERS.

SER. NO. 77-217,028, FILED 6-27-2007.

ROBERT LAVACHE, EXAMINING ATTORNEY

Int. Cl.: 41

Prior U.S. Cls.: 100, 101 and 107

United States Patent and Trademark Office

Reg. No. 3,479,135

Registered Aug. 5, 2008

**SERVICE MARK
PRINCIPAL REGISTER**

WINKY DINK

HARRY W. PRICHETT AND EDWIN BRIT
WYCKOFF PARTNERSHIP, THE (NEW YORK
PARTNERSHIP)
160 CABRINI BOULEVARD
NEW YORK, NY 10033

FOR: ENTERTAINMENT SERVICES IN THE
NATURE OF TELEVISION PROGRAMS IN THE
FIELD OF CHILDREN'S ANIMATED AND LIVE-
ACTION PROGRAMS, IN CLASS 41 (U.S. CLS. 100,
101 AND 107).

FIRST USE 6-25-1996; IN COMMERCE 7-1-1996.

THE MARK CONSISTS OF STANDARD CHAR-
ACTERS WITHOUT CLAIM TO ANY PARTICULAR
FONT, STYLE, SIZE, OR COLOR.

SER. NO. 77-217,058, FILED 6-27-2007.

ANNE E. GUSTASON, EXAMINING ATTORNEY

Int. Cl.: 35

Prior U.S. Cls.: 100, 101 and 102

United States Patent and Trademark Office

Reg. No. 3,479,136

Registered Aug. 5, 2008

**SERVICE MARK
PRINCIPAL REGISTER**

**SALES EFFECTIVENESS
FRAMEWORK**

FORCEMANAGEMENT, LLC (NORTH CAROLI-
NA LTD LIAB CO)
SUITE #325
10700 SIKES PLACE
CHARLOTTE, NC 28277

FOR: BUSINESS CONSULTING, IN CLASS 35 (U.S.
CLS. 100, 101 AND 102).

FIRST USE 10-31-2003; IN COMMERCE 10-31-2003.

THE MARK CONSISTS OF STANDARD CHAR-
ACTERS WITHOUT CLAIM TO ANY PARTICULAR
FONT, STYLE, SIZE, OR COLOR.

NO CLAIM IS MADE TO THE EXCLUSIVE
RIGHT TO USE "SALES EFFECTIVENESS", APART
FROM THE MARK AS SHOWN.

SER. NO. 77-217,095, FILED 6-27-2007.

MICHAEL WEBSTER, EXAMINING ATTORNEY

Int. Cl.: 41

Prior U.S. Cls.: 100, 101 and 107

United States Patent and Trademark Office

Reg. No. 3,479,137

Registered Aug. 5, 2008

**SERVICE MARK
PRINCIPAL REGISTER**

**SMOKY MOUNTAINS
STORYTELLING FESTIVAL**

CITY OF PIGEON FORGE, TENNESSEE (TEN-
NESSEE MUNICIPAL CORPORATION)
P.O. BOX 1390
PIGEON FORGE, TN 37868

FOR: ENTERTAINMENT IN THE NATURE OF A
STORYTELLING FESTIVAL; ENTERTAINMENT
SERVICES, NAMELY, ORGANIZING AND CON-
DUCTING A STORYTELLING FESTIVAL , IN
CLASS 41 (U.S. CLS. 100, 101 AND 107).

FIRST USE 2-0-1994; IN COMMERCE 2-0-1994.

THE MARK CONSISTS OF STANDARD CHAR-
ACTERS WITHOUT CLAIM TO ANY PARTICULAR
FONT, STYLE, SIZE, OR COLOR.

NO CLAIM IS MADE TO THE EXCLUSIVE
RIGHT TO USE "STORYTELLING FESTIVAL",
APART FROM THE MARK AS SHOWN.

SEC. 2(F).

SER. NO. 77-217,193, FILED 6-27-2007.

ELLEN B. AWRICH, EXAMINING ATTORNEY

Int. Cls.: 35, 36 and 44

Prior U.S. Cls.: 100, 101 and 102

United States Patent and Trademark Office

Reg. No. 3,479,138

Registered Aug. 5, 2008

**SERVICE MARK
PRINCIPAL REGISTER**

**THE COMMON SENSE APPROACH
TO MEDICARE**

THE WELLCARE MANAGEMENT GROUP, INC.
(NEW YORK CORPORATION)
8725 HENDERSON ROAD
RENAISSANCE ONE
TAMPA, FL 33634

FOR: INSTITUTIONAL RETAIL PHARMACY SERVICES; MAIL ORDER SERVICES FEATURING PHARMACEUTICALS; PHARMACEUTICAL COST ANALYSIS SERVICES; ADMINISTERING PHARMACY REIMBURSEMENT PROGRAMS AND SERVICES; MAIL ORDER SERVICES FOR GOVERNMENT SPONSORED PRESCRIPTION DRUGS; MANAGED CARE SERVICES IN THE NATURE OF ELECTRONIC PROCESSING OF HEALTH CARE INFORMATION FOR GOVERNMENT-SPONSORED HEALTHCARE PROGRAMS, NAMELY, MEDICAID, TEMPORARY ASSISTANCE TO NEEDY FAMILIES, SUPPLEMENTAL SECURITY INCOME, STATE CHILDREN'S HEALTH INSURANCE PROGRAMS; SALES PROMOTION SERVICES AND BUSINESS MARKETING SERVICES FOR FEDERAL AND STATE GOVERNMENT-SPONSORED HEALTH CARE PLANS; MEDICAL CLAIMS MANAGEMENT SERVICES, NAMELY, RECEIVING, DATA ENTERING, AND RE-PRICING OF TRANSACTIONS THAT ARE ORIGINATED BY PHYSICIANS, HOSPITALS, AND ANCILLARY MEDICAL CARE PROVIDERS FOR FEDERAL AND STATE GOVERNMENT-SPONSORED HEALTH CARE; HEALTH CARE COST CONTAINMENT SERVICES; HEALTH CARE COST REVIEW; HEALTH CARE UTILIZATION AND REVIEW SERVICES; BUSINESS CONSULTING SERVICES, NAMELY, PROVIDING DATA ANALYSIS OF HEALTH CARE DATA FOR BUSINESS PURPOSES; DEMOGRAPHIC CONSULTATION AND STUDIES; CONSUMER RESEARCH; MARKET RESEARCH STUDIES REGARDING CONSUMER BEHAVIOR; PROVIDING BUSINESS MARKETING AND BUSINESS MANAGEMENT INFORMATION; BUSINESS CONSULTING SERVICES, NAMELY, CONSULT-

ING REGARDING OUTCOMES RESEARCH, CONSUMER RESEARCH, CONSUMER BEHAVIOR RESEARCH, AND CONSULTING REGARDING BUSINESS MARKETING AND BUSINESS MANAGEMENT INFORMATION, IN CLASS 35 (U.S. CLS. 100, 101 AND 102).

FIRST USE 1-1-1987; IN COMMERCE 1-1-1987.

FOR: PHARMACY BENEFIT MANAGEMENT SERVICES; ADMINISTRATION OF PRE-PAID FEDERAL AND STATE GOVERNMENT-SPONSORED HEALTH CARE PLANS; ADMINISTRATION OF PREFERRED PROVIDER PLANS IN THE FIELD OF FEDERAL AND STATE GOVERNMENT-SPONSORED HEALTH CARE; INSURANCE CLAIMS PROCESSING, NAMELY, PROCESSING OF HEALTH INSURANCE CLAIMS FOR FEDERAL AND STATE GOVERNMENT-SPONSORED HEALTH CARE; PRESCRIPTION DRUG INSURANCE UNDERWRITING AND ADMINISTRATION, NAMELY, PROVIDING A MEDICARE PART D PRESCRIPTION DRUG PLAN, IN CLASS 36 (U.S. CLS. 100, 101 AND 102).

FIRST USE 1-1-1987; IN COMMERCE 1-1-1987.

FOR: MANAGED HEALTH CARE SERVICES TARGETED TO GOVERNMENT-SPONSORED HEALTHCARE PROGRAMS, NAMELY, MEDICAID, TEMPORARY ASSISTANCE TO NEEDY FAMILIES, SUPPLEMENTAL SECURITY INCOME, STATE CHILDREN'S HEALTH INSURANCE PROGRAMS; PROVIDING FEDERAL AND STATE GOVERNMENT-SPONSORED HEALTH CARE SERVICES; HEALTHCARE SERVICES IN THE NATURE OF HEALTH MAINTENANCE, DENTIST SERVICES, OPTOMETRY SERVICES, DISPENSING OF MEDICATIONS, AND HEALTH MAINTENANCE ORGANIZATIONS FOR BENEFICIARIES OF GOVERNMENT-SPONSORED HEALTHCARE PROGRAMS; HEALTHCARE SERVICES IN THE

NATURE OF HEALTH MAINTENANCE, DENTIST SERVICES, OPTOMETRY SERVICES, WELLNESS PROGRAMS, PROVIDED, IN PART, VIA AN ON-LINE COMPUTER NETWORK OR COMMUNICATIONS MEANS FOR BENEFICIARIES AND PROVIDERS OF GOVERNMENT-SPONSORED HEALTHCARE PROGRAMS; HEALTH MAINTENANCE ORGANIZATION SERVICES IN THE FIELD OF IMMUNIZATION, FAMILY PLANNING, AND PRE-NATAL CARE; HEALTHCARE SERVICES PROVIDED BY A NETWORK OF HEALTHCARE PROFESSIONALS AND SERVICE PROVIDERS FOR BENEFICIARIES OF GOVERNMENT-SPONSORED HEALTHCARE PROGRAMS; DISEASE MANAGEMENT PROGRAM, BEHAVIORAL HEALTH PROGRAM, DISEASE MANAGEMENT PROGRAM, NAMELY, MEDICAL SERVICES IN THE FIELD OF BEHAVIORAL HEALTH DISEASE MANAGEMENT, AND PROVIDING HEALTH CARE SERVICES AND

MEDICAL TESTING SERVICES IN THE FIELD OF MENTAL FITNESS FOR INDIVIDUAL AND BENEFICIARIES OF GOVERNMENT-SPONSORED HEALTHCARE PROGRAMS, IN CLASS 44 (U.S. CLS. 100 AND 101).

FIRST USE 1-1-1987; IN COMMERCE 1-1-1987.

THE MARK CONSISTS OF STANDARD CHARACTERS WITHOUT CLAIM TO ANY PARTICULAR FONT, STYLE, SIZE, OR COLOR.

NO CLAIM IS MADE TO THE EXCLUSIVE RIGHT TO USE "MEDICARE", APART FROM THE MARK AS SHOWN.

SER. NO. 77-217,237, FILED 6-27-2007.

TOBY BULLOFF, EXAMINING ATTORNEY

Int. Cl.: 29

Prior U.S. Cl.: 46

United States Patent and Trademark Office

Reg. No. 3,479,139

Registered Aug. 5, 2008

**TRADEMARK
PRINCIPAL REGISTER**

GLOBAL CHEESE MARKET

ADVANTAGE INTERNATIONAL FOODS CORP.
(NEW JERSEY CORPORATION)
7 PATTON DRIVE
WEST CALDWELL, NJ 07006

NO CLAIM IS MADE TO THE EXCLUSIVE
RIGHT TO USE "CHEESE MARKET", APART
FROM THE MARK AS SHOWN.

FOR: CHEESE, IN CLASS 29 (U.S. CL. 46).

FIRST USE 6-1-2007; IN COMMERCE 6-1-2007.

SER. NO. 77-217,346, FILED 6-27-2007.

THE MARK CONSISTS OF STANDARD CHAR-
ACTERS WITHOUT CLAIM TO ANY PARTICULAR
FONT, STYLE, SIZE, OR COLOR.

ANDREA BUTLER, EXAMINING ATTORNEY

Int. Cl.: 41

Prior U.S. Cls.: 100, 101 and 107

United States Patent and Trademark Office

Reg. No. 3,479,140

Registered Aug. 5, 2008

**SERVICE MARK
PRINCIPAL REGISTER**

HORIZONTAL FUSION

HORIZONTAL FUSION, LLC (NORTH CAROLINA LTD LIAB CO)
455 RAMSEY STREET
FAYETTEVILLE, NC 28301

THE MARK CONSISTS OF STANDARD CHARACTERS WITHOUT CLAIM TO ANY PARTICULAR FONT, STYLE, SIZE, OR COLOR.

FOR: COMPUTER AND WEB-BASED SOFTWARE TRAINING, IN CLASS 41 (U.S. CLS. 100, 101 AND 107).

SER. NO. 77-217,725, FILED 6-28-2007.

FIRST USE 1-1-2007; IN COMMERCE 1-1-2007.

JESSICA FATHY, EXAMINING ATTORNEY

Int. Cls.: 16, 41 and 45

Prior U.S. Cls.: 2, 5, 22, 23, 29, 37, 38, 50, 100, 101 and 107

Reg. No. 3,479,141

United States Patent and Trademark Office

Registered Aug. 5, 2008

**TRADEMARK
SERVICE MARK
PRINCIPAL REGISTER**

Second Billion

BILLION SOULS, INC. (MISSOURI CORPORATION)
P.O. BOX 592880
ORLANDO, FL 32859

FOR: NEWSLETTERS IN THE FIELD OF RELIGION, CHURCH PLANTING AND LEADERSHIP TRAINING; PUBLICATIONS, NAMELY, BROCHURES, BOOKLETS, AND TEACHING MATERIALS IN THE FIELD OF RELIGION, CHURCH PLANTING AND LEADERSHIP TRAINING, IN CLASS 16 (U.S. CLS. 2, 5, 22, 23, 29, 37, 38 AND 50).

FIRST USE 4-1-2007; IN COMMERCE 4-1-2007.

FOR: EDUCATIONAL SERVICES, NAMELY, CONDUCTING CONFERENCES, SEMINARS, WORKSHOPS AND PROGRAMS IN THE FIELD OF RELIGION, CHURCH PLANTING AND LEA-

DERSHIP TRAINING AND DISTRIBUTION OF COURSE MATERIAL IN CONNECTION THEREWITH, IN CLASS 41 (U.S. CLS. 100, 101 AND 107).

FIRST USE 4-1-2007; IN COMMERCE 4-1-2007.

FOR: EVANGELISTIC AND MINISTERIAL SERVICES, IN CLASS 45 (U.S. CLS. 100 AND 101).

FIRST USE 4-1-2007; IN COMMERCE 4-1-2007.

THE MARK CONSISTS OF STANDARD CHARACTERS WITHOUT CLAIM TO ANY PARTICULAR FONT, STYLE, SIZE, OR COLOR.

SER. NO. 77-217,735, FILED 6-28-2007.

BRIAN CALLAGHAN, EXAMINING ATTORNEY

Int. Cl.: 41

Prior U.S. Cls.: 100, 101 and 107

United States Patent and Trademark Office

Reg. No. 3,479,142

Registered Aug. 5, 2008

**SERVICE MARK
PRINCIPAL REGISTER**

**TODAY'S TRAINING BECOMES
TOMORROW'S WEAPON**

HORIZONTAL FUSION, LLC (NORTH CAROLI-
NA LTD LIAB CO)
455 RAMSEY STREET
FAYETTEVILLE, NC 28301

THE MARK CONSISTS OF STANDARD CHAR-
ACTERS WITHOUT CLAIM TO ANY PARTICULAR
FONT, STYLE, SIZE, OR COLOR.

FOR: COMPUTER AND WEB-BASED SOFTWARE
TRAINING, IN CLASS 41 (U.S. CLS. 100, 101 AND
107).

SER. NO. 77-217,860, FILED 6-28-2007.

FIRST USE 1-1-2007; IN COMMERCE 1-1-2007.

JESSICA FATHY, EXAMINING ATTORNEY

Int. Cls.: 16 and 41

Prior U.S. Cls.: 2, 5, 22, 23, 29, 37, 38, 50, 100, 101 and 107

Reg. No. 3,479,143

United States Patent and Trademark Office

Registered Aug. 5, 2008

**TRADEMARK
SERVICE MARK
PRINCIPAL REGISTER**

PowerZone

FRANK DE FINA (UNITED STATES INDIVIDUAL)
5 HILLTOWN COURT
PLAINSBORO, NJ 08536

FOR: PRINTED MATERIAL AND PRINTED PUBLICATIONS, NAMELY, BOOKS, BOOK COVERS, PAMPHLETS, BROCHURES, POSTCARDS, MANUALS, POSTERS, INFORMATIONAL FLYERS, NEWSLETTERS, BOOKS CONTAINING SAMPLE SALES PROPOSALS, REPORTS, STATIONERY, WRITING PAPER, ENVELOPES, WORKBOOKS, SEMINAR AND WORKSHOP MATERIALS IN THE NATURE OF INSTRUCTIONAL AND TEACHING MATERIALS, ALL RELATED TO TECHNIQUES AND PROCESSES FOR CREATING SUCCESSFUL SALES STRATEGIES, IN CLASS 16 (U.S. CLS. 2, 5, 22, 23, 29, 37, 38 AND 50).

FIRST USE 2-28-2005; IN COMMERCE 1-19-2008.

FOR: EDUCATIONAL SERVICES, NAMELY, TRAINING, SEMINARS AND WORKSHOPS, AND DISTRIBUTING COURSE MATERIALS IN CONNECTION THEREWITH IN THE NATURE OF PUBLICATIONS, SEMINAR MATERIALS, WORKBOOKS, NEWSLETTERS, ALL RELATED TO TECHNIQUES AND PROCESSES FOR CREATING SUCCESSFUL SALES STRATEGIES, THE FOREGOING DISTRIBUTED IN PRINT, ONLINE, AND IN MACHINE-READABLE FORMATS, IN CLASS 41 (U.S. CLS. 100, 101 AND 107).

FIRST USE 2-28-2005; IN COMMERCE 1-19-2008.

THE MARK CONSISTS OF STANDARD CHARACTERS WITHOUT CLAIM TO ANY PARTICULAR FONT, STYLE, SIZE, OR COLOR.

SER. NO. 77-217,933, FILED 6-28-2007.

NANCY CLARKE, EXAMINING ATTORNEY

Int. Cl.: 43

Prior U.S. Cls.: 100 and 101

United States Patent and Trademark Office

Reg. No. 3,479,144

Registered Aug. 5, 2008

**SERVICE MARK
PRINCIPAL REGISTER**

SANDWICH QBANO

MARIO ENRICO MAYA (COLOMBIA INDIVIDUAL)

AVENIDA SEXTA #28-35

CALI, COLOMBIA

FOR: RESTAURANT SERVICES, IN CLASS 43
(U.S. CLS. 100 AND 101).

FIRST USE 2-10-2007; IN COMMERCE 2-10-2007.

THE MARK CONSISTS OF STANDARD CHARACTERS WITHOUT CLAIM TO ANY PARTICULAR FONT, STYLE, SIZE, OR COLOR.

NO CLAIM IS MADE TO THE EXCLUSIVE RIGHT TO USE "SANDWICH", APART FROM THE MARK AS SHOWN.

SER. NO. 77-218,040, FILED 6-28-2007.

MARTHA FROMM, EXAMINING ATTORNEY

Int. Cl.: 9

Prior U.S. Cls.: 21, 23, 26, 36 and 38

United States Patent and Trademark Office

Reg. No. 3,479,145

Registered Aug. 5, 2008

**TRADEMARK
PRINCIPAL REGISTER**

GREEN RAY

INNER SIGHT, LLC (HAWAII LTD LIAB CO)
P.O. BOX 2169
KEALAKEKUA, HI 96750

THE MARK CONSISTS OF STANDARD CHAR-
ACTERS WITHOUT CLAIM TO ANY PARTICULAR
FONT, STYLE, SIZE, OR COLOR.

FOR: COMPACT DISCS FEATURING SPOKEN
WORD MOTIVATIONAL, PSYCHOLOGICAL AND
SPIRITUAL TEACHINGS, IN CLASS 9 (U.S. CLS. 21,
23, 26, 36 AND 38).

SER. NO. 77-218,120, FILED 6-28-2007.

FIRST USE 5-10-2007; IN COMMERCE 5-10-2007.

MARK PILARO, EXAMINING ATTORNEY

Int. Cl.: 7

Prior U.S. Cls.: 13, 19, 21, 23, 31, 34 and 35

Reg. No. 3,479,146

United States Patent and Trademark Office

Registered Aug. 5, 2008

**TRADEMARK
PRINCIPAL REGISTER**

VEL-MAX

VELCON FILTERS, INC. (CALIFORNIA CORPORATION)
1210 GARDEN OF THE GODS ROAD
COLORADO SPRINGS, CO 80907

THE MARK CONSISTS OF STANDARD CHARACTERS WITHOUT CLAIM TO ANY PARTICULAR FONT, STYLE, SIZE, OR COLOR.

FOR: COMPONENT PARTS OF FUEL FILTERS, NAMELY FILTER VESSELS FOR REMOVING FINE PARTICLES AND/OR WATER FROM FUELS, IN CLASS 7 (U.S. CLS. 13, 19, 21, 23, 31, 34 AND 35).

SER. NO. 77-218,152, FILED 6-28-2007.

FIRST USE 5-3-2006; IN COMMERCE 5-3-2006.

KAPIL BHANOT, EXAMINING ATTORNEY

Int. Cl.: 36

Prior U.S. Cls.: 100, 101 and 102

United States Patent and Trademark Office

Reg. No. 3,479,147

Registered Aug. 5, 2008

**SERVICE MARK
PRINCIPAL REGISTER**

SUCCESS BUILT ON COMMITMENT

MOUNTAIN WEST REAL ESTATE, INC. (CALI-
FORNIA CORPORATION)
333 H STREET, SUITE 6000
CHULA VISTA, CA 91910

FOR: REAL ESTATE BROKERAGE SERVICES,
LEASING OF REAL ESTATE, AND REAL ESTATE
MANAGEMENT, IN CLASS 36 (U.S. CLS. 100, 101
AND 102).

FIRST USE 2-1-2000; IN COMMERCE 2-1-2000.

THE MARK CONSISTS OF STANDARD CHAR-
ACTERS WITHOUT CLAIM TO ANY PARTICULAR
FONT, STYLE, SIZE, OR COLOR.

SER. NO. 77-218,241, FILED 6-28-2007.

ZHALEH DELANEY, EXAMINING ATTORNEY

Int. Cls.: 3, 5, 8, 10, 11, 12, 14, 18, 20, 21, 24, 27, 29, 30 and 32

Prior U.S. Cls.: 1, 2, 3, 4, 6, 13, 18, 19, 20, 21, 22, 23, 25, 26, 27, 28, 29, 30, 31, 32, 33, 34, 35, 37, 39, 40, 41, 42, 44, 45, 46, 48, 50, 51 and 52

Reg. No. 3,479,148

United States Patent and Trademark Office

Registered Aug. 5, 2008

**TRADEMARK
PRINCIPAL REGISTER**



SESAME WORKSHOP (NEW YORK NON-PROFIT CORPORATION)
ONE LINCOLN PLAZA
NEW YORK, NY 10023

FOR: BABY WIPES, TOOTHPASTE, GUM CLEANER IN THE NATURE OF GUM PASTE, BODY SOAP, BODY WASH, BUBBLE BATH, HAND SOAP, SKIN LOTION, BABY OIL, BABY POWDER, HAIR CARE PREPARATIONS, SHAMPOO, COSMETICS, IN CLASS 3 (U.S. CLS. 1, 4, 6, 50, 51 AND 52).

FIRST USE 10-0-2000; IN COMMERCE 10-0-2000.

FOR: ADHESIVE BANDAGES, VITAMINS, BABY FOOD, BABY FORMULA, IN CLASS 5 (U.S. CLS. 6, 18, 44, 46, 51 AND 52).

FIRST USE 7-0-2000; IN COMMERCE 7-0-2000.

FOR: TABLEWARE AND CUTLERY, NAMELY, KNIVES, FORKS AND SPOONS; SCISSORS, IN CLASS 8 (U.S. CLS. 23, 28 AND 44).

FIRST USE 7-0-2000; IN COMMERCE 7-0-2000.

FOR: BABY BOTTLES, PACIFIERS FOR BABIES, TEETHERS FOR BABIES, THERMOMETERS FOR MEDICAL PURPOSES; DROPPERS FOR ADMINISTERING MEDICINE SOLD EMPTY, IN CLASS 10 (U.S. CLS. 26, 39 AND 44).

FIRST USE 7-0-2000; IN COMMERCE 7-0-2000.

FOR: LAMPS, LAMP SHADES, ELECTRIC NIGHT-LIGHTS, FLASHLIGHTS, CHRISTMAS

TREE LIGHTS, BICYCLE LIGHTS, HUMIDIFIERS, IN CLASS 11 (U.S. CLS. 13, 21, 23, 31 AND 34).

FIRST USE 6-0-2002; IN COMMERCE 6-0-2002.

FOR: AUTOMOTIVE ACCESSORIES, NAMELY, AUTOMOBILE WINDSHIELD SUNSHADES, VEHICLE BEVERAGE HOLDERS, REAR VIEW MIRRORS, VEHICLE SEAT COVERS; BABY STROLLERS, BICYCLES, TRICYCLES, BICYCLE BELLS; CHILDREN'S CAR SEATS; PANNIER BICYCLE BAGS, IN CLASS 12 (U.S. CLS. 19, 21, 23, 31, 35 AND 44).

FIRST USE 7-0-2000; IN COMMERCE 7-0-2000.

FOR: JEWELRY, WATCHES, CLOCKS, IN CLASS 14 (U.S. CLS. 2, 27, 28 AND 50).

FIRST USE 1-0-2000; IN COMMERCE 1-0-2000.

FOR: UMBRELLAS; BAGS, NAMELY, DIAPER BAGS, SPORTS BAGS, GYM BAGS, FANNY PACKS, KNAPSACKS, BACKPACKS, WALLETS, COIN PURSES, WATER AND BABY BOTTLE BAGS, BEACH BAGS, BICYCLE BAGS, BOOK BAGS, SCHOOL BAGS, DIAPER BAGS, DUFFEL BAGS, LUGGAGE, TRAVELING BAGS, BRIEF CASES, LAUNDRY BAGS, PAJAMA BAGS, POCKETBOOKS, HANDBAGS, PURSES, SHOE BAGS FOR TRAVEL, COSMETIC BAGS SOLD EMPTY, TOTE BAGS, CARRY-ALLS; BABY BACKPACKS, INFANT CARRIERS WORN ON THE BODY, BABY CARRIERS WORN ON THE BODY, LEATHER KEY CASES AND NON-METAL KEY CASES, IN CLASS 18 (U.S. CLS. 1, 2, 3, 22 AND 41).

FIRST USE 7-0-2000; IN COMMERCE 7-0-2000.

FOR: FURNITURE FOR BABIES AND CHILDREN, NAMELY, MATTRESSES, CRIBS, BUMPER GUARDS FOR CRIBS, TABLES, CHAIRS, HIGH CHAIRS, BOOSTER SEATS, WORK BENCHES, STEP STOOLS, PLAYPENS; NON-METAL KEY RINGS AND LEATHER KEY RINGS; PICTURE FRAMES; PLAQUES OF PLASTIC AND WOOD; MIRRORS; DRINKING STRAWS; WINDOW SHADES; HAND FANS; SLEEPING BAGS; PILLOWS, IN CLASS 20 (U.S. CLS. 2, 13, 22, 25, 32 AND 50).

FIRST USE 7-0-2000; IN COMMERCE 7-0-2000.

FOR: HOUSEWARES, KITCHENWARE, DINNERWARE AND BEVERAGE WARE OF PAPER, PLASTIC, CERAMIC, GLASS OR EARTHENWARE, NAMELY, DISHES, PLATTERS, PLATES, BOWLS, CUPS, SAUCERS, EGG CUPS, MUGS, TUMBLERS AND DRINKING GLASSES; SERVING PITCHERS; INFANT CUPS; WATER BOTTLES SOLD EMPTY; INSULATED AND NON-INSULATED LUNCH BOXES, INSULATED AND NON-INSULATED LUNCH PAILS, INSULATED BEVERAGE CONTAINERS, INSULATED BOTTLES FOR BEVERAGES; WASTE BASKETS; COOKIE JARS; NAPKIN HOLDERS AND NAPKIN RINGS, BOTH OF NON-PRECIOUS METAL; BOTTLE OPENERS; BED AND SNACK TRAYS, SERVING TRAYS; STATUETTES AND FIGURINES OF CHINA, CRYSTAL, EARTHENWARE, GLASS, PORCELAIN, AND TERRA COTTA; NON-METAL SAVINGS PIGGY BANKS; SUN CATCHERS; BABY BATHTUBS, SOAP DISHES, POTTIES FOR CHILDREN, TOOTHBRUSHES, DENTAL FLOSS, HAIR BRUSHES, HAIR COMBS; BATH SPONGES, IN CLASS 21 (U.S. CLS. 2, 13, 23, 29, 30, 33, 40 AND 50).

FIRST USE 7-0-2000; IN COMMERCE 7-0-2000.

FOR: TEXTILE AND TEXTILE GOODS, NAMELY, SHOWER CURTAINS, WINDOW CURTAINS, FABRIC VALANCES; PLASTIC PLACE MATS; HANDKERCHIEFS; BATH LINENS, NAMELY, BATH TOWELS, HOODED TOWELS, WASH CLOTHS; BED LINENS, NAMELY, BED SHEETS, CRIB SHEETS, BED SKIRTS, PILLOW CASES, PILLOW SHAMS, QUILTS, COVERLETS, BED-

SPREADS, BED BLANKETS, CRIB BLANKETS, RECEIVING BLANKETS, CRIB BUMPERS, COMFORTERS, COMFORTER COVERS, IN CLASS 24 (U.S. CLS. 42 AND 50).

FIRST USE 7-0-2000; IN COMMERCE 7-0-2000.

FOR: RUGS, WALLPAPER, FLOOR MATS , IN CLASS 27 (U.S. CLS. 19, 20, 37, 42 AND 50).

FIRST USE 7-0-2000; IN COMMERCE 7-0-2000.

FOR: SOUPS, DAIRY PRODUCTS EXCLUDING ICE CREAM, ICE MILK, AND FROZEN YOGURT, MEATS, EGGS, MILK, MILK PRODUCTS EXCLUDING ICE CREAM, ICE MILK, AND FROZEN YOGURT, YOGURT, CHEESE, APPLESAUCE, FRUIT-BASED SNACK FOOD, CANNED VEGETABLES, PROCESSED VEGETABLES, CANNED FRUIT, PROCESSED FRUIT, JELLIES, JAMS, POULTRY, FROZEN MEALS CONSISTING PRIMARILY OF MEAT, FISH POULTRY OR VEGETABLES , IN CLASS 29 (U.S. CL. 46).

FIRST USE 7-0-2000; IN COMMERCE 7-0-2000.

FOR: BREAKFAST CEREAL, CAKES, COOKIES, CANDY, COCOA, CRACKERS, READY TO EAT, CEREAL DERIVED BREAKFAST FOOD BARS, PASTA, CEREAL-BASED, RICE-BASED, AND GRANOLA-BASED SNACK BARS, FROZEN MEALS CONSISTING PRIMARILY OF PASTA OR RICE, FRUIT SAUCES EXCLUDING CRANBERRY SAUCE AND APPLESAUCE, PUDDINGS, IN CLASS 30 (U.S. CL. 46).

FIRST USE 7-0-2000; IN COMMERCE 7-0-2000.

FOR: FRUIT JUICES, BOTTLED WATER, IN CLASS 32 (U.S. CLS. 45, 46 AND 48).

FIRST USE 7-0-2000; IN COMMERCE 7-0-2000.

OWNER OF U.S. REG. NOS. 974,206, 2,891,251 AND OTHERS.

SER. NO. 77-218,246, FILED 6-28-2007.

NATALIE POLZER, EXAMINING ATTORNEY

Int. Cl.: 41

Prior U.S. Cls.: 100, 101 and 107

United States Patent and Trademark Office

Reg. No. 3,479,149

Registered Aug. 5, 2008

**SERVICE MARK
PRINCIPAL REGISTER**

BOULDER CREEK FESTIVAL

CITY OF BOULDER, COLORADO (COLORADO
MUNICIPALITY)
CLERK'S OFFICE, MUNICIPAL BUILDING
1777 BROADWAY, 2ND FLOOR
BOULDER, CO 80306

FOR: ORGANIZING COMMUNITY FESTIVALS
FEATURING A VARIETY OF ACTIVITIES, NAME-
LY, ARTS AND CRAFTS EXHIBITIONS, HEALTH
AND TECHNOLOGY EXHIBITIONS, ETHNIC DAN-
CES, MUSICAL AND CULTURAL PERFORMAN-
CES, CARNIVAL RIDES AND GAMES, AND FOOD
AND BEVERAGE MARKETS, AND THE LIKE, IN
CLASS 41 (U.S. CLS. 100, 101 AND 107).

FIRST USE 1-1-1988; IN COMMERCE 1-1-1988.

THE MARK CONSISTS OF STANDARD CHAR-
ACTERS WITHOUT CLAIM TO ANY PARTICULAR
FONT, STYLE, SIZE, OR COLOR.

NO CLAIM IS MADE TO THE EXCLUSIVE
RIGHT TO USE "FESTIVAL", APART FROM THE
MARK AS SHOWN.

SEC. 2(F) AS TO "BOULDER CREEK".

SER. NO. 77-218,280, FILED 6-28-2007.

WILLIAM BRECKENFELD, EXAMINING ATTOR-
NEY

Int. Cls.: 37 and 40

Prior U.S. Cls.: 100, 103 and 106

United States Patent and Trademark Office

Reg. No. 3,479,150

Registered Aug. 5, 2008

**SERVICE MARK
PRINCIPAL REGISTER**

STINGER

STINGER WELLHEAD PROTECTION, INC.
(TEXAS CORPORATION)
4301 WILL ROGERS PARKWAY, SUITE 600-700
OKLAHOMA CITY, OK 73108

FOR: RENTAL OF OIL AND GAS WELL EQUIPMENT, NAMELY, FRACHEADS, COIL TUBING FRACHEADS, FRACSTACKS, WELIHEAD ISOLATION TOOLS, FULL-BORE WELL STIMULATION TOOLS, GATE VALVES, PLUG VALVES, BALL-DROP VALVES, FLANGES, SWEDGES, DRILLING CROSSOVERS, FLOW TEES, SPACER SPOOLS AND SPOOLS, IN CLASS 37 (U.S. CLS. 100, 103 AND 106).

FIRST USE 10-1-1988; IN COMMERCE 10-1-1988.

FOR: OIL AND GAS WELL TREATMENT SERVICES, IN CLASS 40 (U.S. CLS. 100, 103 AND 106).

FIRST USE 10-1-1988; IN COMMERCE 10-1-1988.

THE MARK CONSISTS OF STANDARD CHARACTERS WITHOUT CLAIM TO ANY PARTICULAR FONT, STYLE, SIZE, OR COLOR.

SER. NO. 77-218,337, FILED 6-28-2007.

KAPIL BHANOT, EXAMINING ATTORNEY

Int. Cls.: 17 and 19

Prior U.S. Cls.: 1, 5, 12, 13, 33, 35 and 50

United States Patent and Trademark Office

Reg. No. 3,479,151

Registered Aug. 5, 2008

**TRADEMARK
PRINCIPAL REGISTER**

THE NAME IN MINERAL WOOL

THERMAFIBER, INC. (DELAWARE CORPORATION)
3711 WEST MILL STREET
WABASH, IN 46992

FOR: MINERAL WOOL FOR USE AS A BUILDING INSULATOR, ACOUSTIC AND THERMAL INSULATION FOR USE IN THE AUTOMOTIVE, HVAC, APPLIANCE AND COMMERCIAL INTERIOR INDUSTRIES, ACOUSTICAL INSULATION BARRIER PANELS, FIRE BARRIER SYSTEM COMPRISED OF METAL AND FIBER LAMINATES FOR WRAPPING CONDUITS, CABLE TRAYS, AND STRUCTURAL STEEL, IN CLASS 17 (U.S. CLS. 1, 5, 12, 13, 35 AND 50).

FIRST USE 1-1-2000; IN COMMERCE 1-1-2000.

FOR: NON-METAL FIRE-RESISTANT BOARDS AND PANELS FOR CONSTRUCTION, IN CLASS 19 (U.S. CLS. 1, 12, 33 AND 50).

FIRST USE 1-1-2000; IN COMMERCE 1-1-2000.

THE MARK CONSISTS OF STANDARD CHARACTERS WITHOUT CLAIM TO ANY PARTICULAR FONT, STYLE, SIZE, OR COLOR.

NO CLAIM IS MADE TO THE EXCLUSIVE RIGHT TO USE "MINERAL WOOL", APART FROM THE MARK AS SHOWN.

SER. NO. 77-218,516, FILED S.R. 6-28-2007 AM. P.R. 4-8-2008.

EUGENIA MARTIN, EXAMINING ATTORNEY

Int. Cl.: 5

Prior U.S. Cls.: 6, 18, 44, 46, 51 and 52

Reg. No. 3,479,152

United States Patent and Trademark Office

Registered Aug. 5, 2008

**TRADEMARK
PRINCIPAL REGISTER**

ISO MASS

ULTIMATE NUTRITION, INC. (CONNECTICUT CORPORATION)
21 HYDE ROAD
FARMINGTON, CT 06034

FOR: DIETARY SUPPLEMENTS, NAMELY, WEIGHT GAINERS, IN CLASS 5 (U.S. CLS. 6, 18, 44, 46, 51 AND 52).

FIRST USE 8-13-2007; IN COMMERCE 8-13-2007.

THE MARK CONSISTS OF STANDARD CHARACTERS WITHOUT CLAIM TO ANY PARTICULAR FONT, STYLE, SIZE, OR COLOR.

NO CLAIM IS MADE TO THE EXCLUSIVE RIGHT TO USE "ISO", APART FROM THE MARK AS SHOWN.

SER. NO. 77-218,568, FILED 6-28-2007.

LINDSEY RUBIN, EXAMINING ATTORNEY

Int. Cl.: 45

Prior U.S. Cls.: 100 and 101

United States Patent and Trademark Office

Reg. No. 3,479,153

Registered Aug. 5, 2008

**SERVICE MARK
PRINCIPAL REGISTER**

MotherWoman

MOTHERWOMAN, INC. (MASSACHUSETTS
CORPORATION)
79 SOUTH PLEASANT ST. PO BOX 2635
AMHERST, MA 01004

FOR: ORGANIZING AND CONDUCTING SUP-
PORT GROUPS AND PEER SUPPORT GROUPS FOR
MOTHERS IN THE FIELD OF PARENTING, IN
CLASS 45 (U.S. CLS. 100 AND 101).

FIRST USE 5-1-1999; IN COMMERCE 5-1-1999.

THE MARK CONSISTS OF STANDARD CHAR-
ACTERS WITHOUT CLAIM TO ANY PARTICULAR
FONT, STYLE, SIZE, OR COLOR.

SER. NO. 77-218,575, FILED 6-29-2007.

MARLENE BELL, EXAMINING ATTORNEY

Int. Cls.: 16 and 39

Prior U.S. Cls.: 2, 5, 22, 23, 29, 37, 38, 50, 100 and 105

United States Patent and Trademark Office

Reg. No. 3,479,154

Registered Aug. 5, 2008

**TRADEMARK
SERVICE MARK
PRINCIPAL REGISTER**



SF (IP) LIMITED (HONG KONG LTD LIAB CO)
38-42 KWAI FUNG CRESCENT, KWAI CHUNG,
14TH FLOOR, YOO HOO TOWER,
NEW TERRITORIES, HONG KONG

FOR: PLASTIC WRAP; PAPER BAGS; PAPER BAGS FOR PACKAGING; PLASTIC BAGS FOR PACKAGING; BOXES OF PAPER OR CARDBOARD; PLASTIC BUBBLE PACKS FOR WRAPPING OR PACKAGING; ENVELOPES; PRINTED FORMS; PAPER FOR WRAPPING AND PACKAGING; PACKING PAPER; PRINTED TIMETABLES; SEALING STAMPS; STICKERS; STICKERS; PARAFFINED PAPER; PAPER POUCHES FOR PACKAGING, IN CLASS 16 (U.S. CLS. 2, 5, 22, 23, 29, 37, 38 AND 50).

FOR: AIR TRANSPORT; BARGE TRANSPORT; CAR TRANSPORT; MARINE TRANSPORT; RAILWAY TRANSPORT; RIVER TRANSPORT BY BOAT; COURIER SERVICES; DELIVERY OF GOODS BY AIR, BARGE, RAILWAY, RIVER AND MARINE TRANSPORT; WAREHOUSING SERVICES, NAME-
LY, STORAGE, DISTRIBUTION, PICK-UP, PACK-

ING, AND SHIPPING OF LETTERS, PARCELS, PAPER GOODS, PRINTED MATERIALS AND PACKAGING MATERIALS; TRUCK HAULING; PACKAGING ARTICLES FOR TRANSPORTATION; PARCEL DELIVERY, IN CLASS 39 (U.S. CLS. 100 AND 105).

PRIORITY CLAIMED UNDER SEC. 44(D) ON HONG KONG APPLICATION NO. 300828027, FILED 3-9-2007, REG. NO. 300828027, DATED 3-9-2007, EXPIRES 3-9-2017.

NO CLAIM IS MADE TO THE EXCLUSIVE RIGHT TO USE "EXPRESS", APART FROM THE MARK AS SHOWN.

THE MARK CONSISTS OF THE STYLIZED LETTERS "S" AND "F" ABOVE AN UPWARD BENDING ARCH ABOVE THE WORD "EXPRESS".

SER. NO. 77-218,592, FILED 6-29-2007.

RON FAIRBANKS, EXAMINING ATTORNEY

Int. Cl.: 10

Prior U.S. Cls.: 26, 39 and 44

United States Patent and Trademark Office

Reg. No. 3,479,155

Registered Aug. 5, 2008

**TRADEMARK
PRINCIPAL REGISTER**

DRY PRO

DRY CORP, LLC (NORTH CAROLINA LTD LIAB
CO)
6702 NETHERLANDS DRIVE
WILMINGTON, NC 28405

OWNER OF U.S. REG. NO. 3,262,779.

FOR: CAST COVERS, BANDAGE COVERS, PICC
LINE COVERS, PROSTHETIC COVERS, IN CLASS 10
(U.S. CLS. 26, 39 AND 44).

NO CLAIM IS MADE TO THE EXCLUSIVE
RIGHT TO USE "DRY", APART FROM THE MARK
AS SHOWN.

FIRST USE 6-15-2007; IN COMMERCE 6-15-2007.

SER. NO. 77-218,669, FILED 6-29-2007.

THE MARK CONSISTS OF STANDARD CHAR-
ACTERS WITHOUT CLAIM TO ANY PARTICULAR
FONT, STYLE, SIZE, OR COLOR.

NANCY CLARKE, EXAMINING ATTORNEY

Int. Cl.: 36

Prior U.S. Cls.: 100, 101 and 102

United States Patent and Trademark Office

Reg. No. 3,479,156

Registered Aug. 5, 2008

**SERVICE MARK
PRINCIPAL REGISTER**

**Nellie Mae's Parent
Resources for Education
Preparation (PREP)**

NELLIE MAE CORPORATION (DELAWARE
CORPORATION)
50 BRAINTREE HILL PARK, SUITE 300
BRAINTREE, MA 02184

OWNER OF U.S. REG. NOS. 1,432,277, 2,674,438
AND OTHERS.

FOR: FINANCIAL SERVICES, NAMELY, PRO-
VIDING INFORMATION ON PLANNING AND
PAYING FOR COLLEGE, IN CLASS 36 (U.S. CLS.
100, 101 AND 102).

NO CLAIM IS MADE TO THE EXCLUSIVE
RIGHT TO USE "PARENT RESOURCES FOR EDU-
CATION PREPARATION", APART FROM THE
MARK AS SHOWN.

FIRST USE 9-15-2006; IN COMMERCE 3-15-2007.

SER. NO. 77-218,677, FILED 6-29-2007.

THE MARK CONSISTS OF STANDARD CHAR-
ACTERS WITHOUT CLAIM TO ANY PARTICULAR
FONT, STYLE, SIZE, OR COLOR.

RENEE MCCRAY, EXAMINING ATTORNEY

Int. Cl.: 36

Prior U.S. Cls.: 100, 101 and 102

United States Patent and Trademark Office

Reg. No. 3,479,157

Registered Aug. 5, 2008

**SERVICE MARK
PRINCIPAL REGISTER**

**Nellie Mae's Financial
Success series**

NELLIE MAE CORPORATION (DELAWARE
CORPORATION)
50 BRAINTREE HILL PARK, SUITE 300
BRAINTREE, MA 02184

FOR: DEBT MANAGEMENT CONSULTATION,
IN CLASS 36 (U.S. CLS. 100, 101 AND 102).

FIRST USE 12-1-2006; IN COMMERCE 3-15-2007.

THE MARK CONSISTS OF STANDARD CHAR-
ACTERS WITHOUT CLAIM TO ANY PARTICULAR
FONT, STYLE, SIZE, OR COLOR.

OWNER OF U.S. REG. NOS. 1,432,277, 2,674,438
AND OTHERS.

NO CLAIM IS MADE TO THE EXCLUSIVE
RIGHT TO USE "FINANCIAL SUCCESS SERIES",
APART FROM THE MARK AS SHOWN.

SER. NO. 77-218,710, FILED 6-29-2007.

RENEE MCCRAY, EXAMINING ATTORNEY

Int. Cl.: 35

Prior U.S. Cls.: 100, 101 and 102

United States Patent and Trademark Office

Reg. No. 3,479,158

Registered Aug. 5, 2008

**SERVICE MARK
PRINCIPAL REGISTER**



COLORADO NANOTECHNOLOGY ALLIANCE
(COLORADO CORPORATION)
1625 BROADWAY, SUITE 950
DENVER, CO 80202

FOR: ASSOCIATION SERVICES, NAMELY, PROMOTING THE INTERESTS OF NANOTECHNOLOGY BUSINESSES AND RESEARCH EFFORTS, IN CLASS 35 (U.S. CLS. 100, 101 AND 102).

FIRST USE 4-7-2007; IN COMMERCE 4-7-2007.

NO CLAIM IS MADE TO THE EXCLUSIVE RIGHT TO USE "COLORADO NANOTECHNOLOGY ALLIANCE", APART FROM THE MARK AS SHOWN.

THE MARK CONSISTS OF THREE DIMENSIONAL ANGLED HEXAGONS CIRCLING AN ATOM AT THEIR CENTER.

SER. NO. 77-218,800, FILED 6-29-2007.

MICHAEL W. BAIRD, EXAMINING ATTORNEY

Int. Cl.: 16

Prior U.S. Cls.: 2, 5, 22, 23, 29, 37, 38 and 50

United States Patent and Trademark Office

Reg. No. 3,479,159

Registered Aug. 5, 2008

**TRADEMARK
PRINCIPAL REGISTER**



SANOFI-AVENTIS (FRANCE CORPORATION)
174, AVENUE DE FRANCE
75013 PARIS, FRANCE

FOR: PRINTED MATTER, NAMELY, MAGAZINES IN THE FIELD OF PHARMACEUTICALS, IN CLASS 16 (U.S. CLS. 2, 5, 22, 23, 29, 37, 38 AND 50).

PRIORITY CLAIMED UNDER SEC. 44(D) ON FRANCE APPLICATION NO. 073481136, FILED 2-13-2007, REG. NO. 395030844, DATED 7-20-2007, EXPIRES 7-20-2017.

THE COLOR(S) BLUE AND GREEN IS/ARE CLAIMED AS A FEATURE OF THE MARK.

THE MARK CONSISTS OF THE WORD "ZOOM" IN BLUE WITH A GREEN OVAL CIRCLE SUPERIMPOSED ON THE "M". THERE IS A BLUE SWISH LINE UNDERNEATH THE ENTIRE WORD.

SER. NO. 77-218,934, FILED 6-29-2007.

NANCY CLARKE, EXAMINING ATTORNEY

Int. Cl.: 10

Prior U.S. Cls.: 26, 39 and 44

United States Patent and Trademark Office

Reg. No. 3,479,160

Registered Aug. 5, 2008

**TRADEMARK
PRINCIPAL REGISTER**

AURIPLEX

CHIZARI, ABOLGHASEM (UNITED KINGDOM
INDIVIDUAL)
18 SHERLOCK ROAD
CAMBRIDGE, UNITED KINGDOM CB30HR

FOR: ASSISTIVE LISTENING DEVICE FOR THE
HEARING IMPAIRED; ELECTRIC HEARING AIDS;
ELECTRICAL HEARING AIDS; ELECTRICALLY
OPERATED HEARING AIDS; HEARING AIDS;
HEARING AIDS FOR THE DEAF; MEDICAL HEAR-
ING INSTRUMENTS AND PARTS OF SUCH DEVI-
CES; WIRELESS TRANSMITTERS AND RECEIVERS

FOR USE WITH HEARING AIDS, IN CLASS 10 (U.S.
CLS. 26, 39 AND 44).

FIRST USE 1-1-2005; IN COMMERCE 1-1-2005.

THE MARK CONSISTS OF STANDARD CHAR-
ACTERS WITHOUT CLAIM TO ANY PARTICULAR
FONT, STYLE, SIZE, OR COLOR.

SER. NO. 77-218,979, FILED 6-29-2007.

JENNIFER DIXON, EXAMINING ATTORNEY

Int. Cl.: 9

Prior U.S. Cls.: 21, 23, 26, 36 and 38

Reg. No. 3,479,161

United States Patent and Trademark Office

Registered Aug. 5, 2008

**TRADEMARK
PRINCIPAL REGISTER**



ABREVVITY, INC. (CALIFORNIA CORPORATION)
SUITE 208
21580 STEVENS CREEK BLVD.
CUPERTINO, CA 95014

FOR: COMPUTER HARDWARE AND COMPUTER SOFTWARE PROGRAMS FOR THE INTEGRATION OF TEXT, AUDIO, GRAPHICS, STILL IMAGE AND MOVING PICTURES INTO AN INTERACTIVE DELIVERY FOR MULTIMEDIA APPLICATIONS; COMPUTER SEARCH ENGINE SOFTWARE; COMPUTER SOFTWARE DEVELOPMENT TOOLS; COMPUTER SOFTWARE FOR APPLICATION AND DATABASE INTEGRATION; COMPUTER SOFTWARE FOR CREATING SEARCHABLE DATABASES OF INFORMATION AND DATA, IN CLASS 9 (U.S. CLS. 21, 23, 26, 36 AND 38).

FIRST USE 1-23-2003; IN COMMERCE 3-31-2006.

THE COLOR(S) RED AND BLACK IS/ARE CLAIMED AS A FEATURE OF THE MARK.

THE MARK CONSISTS OF A DESIGN ELEMENT AND A WORD ELEMENT. THE DESIGN ELEMENT APPEARS TO THE LEFT OF THE WORD ELEMENT. THE DESIGN ELEMENT CONSISTS OF THREE IRREGULAR OVALS OF DIFFERENT SIZES, ARRANGED IN A TRIANGULAR-SHAPED PATTERN, WHEREBY EACH OVAL IS CONNECTED TO A THICK LINE THAT EXTENDS TOWARDS THE CENTER OF THE TRIANGULAR-SHAPED PATTERN, AND THOSE LINES CONNECT IN APPROXIMATELY THE CENTER OF THAT PATTERN. THE DESIGN ELEMENT APPEARS IN RED. THE WORD ELEMENT CONSISTS OF THE TEXT "ABREVVITY" IN BLACK.

SER. NO. 77-219,134, FILED 6-29-2007.

PAUL F. GAST, EXAMINING ATTORNEY

Int. Cl.: 10

Prior U.S. Cls.: 26, 39 and 44

United States Patent and Trademark Office

Reg. No. 3,479,162

Registered Aug. 5, 2008

**TRADEMARK
PRINCIPAL REGISTER**

ERECT-CARE

KOZAK, ANDRZEJ W (UNITED STATES INDIVIDUAL)
1218 CRESHILL RD.
EL CAJON, CA 92021

FOR: DEVICE CONSISTING OF TUBING WITH ADJUSTMENT RINGS, BUCKLE CLAMPS AND BACK CLAMPS FOR ASSISTING IN ACQUIRING AND SUSTAINING ERECTION OF THE HUMAN PENIS, IN CLASS 10 (U.S. CLS. 26, 39 AND 44).

FIRST USE 6-22-2007; IN COMMERCE 6-22-2007.

THE MARK CONSISTS OF STANDARD CHARACTERS WITHOUT CLAIM TO ANY PARTICULAR FONT, STYLE, SIZE, OR COLOR.

SER. NO. 77-219,446, FILED 6-29-2007.

JESSICA FATHY, EXAMINING ATTORNEY

Int. Cls.: 35, 42 and 44

Prior U.S. Cls.: 100, 101 and 102

United States Patent and Trademark Office

Reg. No. 3,479,163

Registered Aug. 5, 2008

SERVICE MARK
PRINCIPAL REGISTER



RADY CHILDREN'S HOSPITAL AND HEALTH
CENTER (CALIFORNIA CORPORATION)
3020 CHILDREN'S WAY
SAN DIEGO, CA 92123

FOR: RETAIL PHARMACY SERVICES, IN CLASS
35 (U.S. CLS. 100, 101 AND 102).

FIRST USE 7-29-2006; IN COMMERCE 7-29-2006.

FOR: MEDICAL LABORATORIES; CONDUCT-
ING CLINICAL TRIALS FOR THE PURPOSE OF
MEDICAL RESEARCH; MEDICAL RESEARCH,
NAMELY, BASIC AND CLINICAL BIOMEDICAL
RESEARCH, IN CLASS 42 (U.S. CLS. 100 AND 101).

FIRST USE 7-29-2006; IN COMMERCE 7-29-2006.

FOR: HOSPITAL SERVICES, NAMELY, OUTPA-
TIENT CARE AND INPATIENT CARE; MEDICAL
COUNSELING; CONVALESCENT HOMES; PHYSI-
CAL AND OCCUPATIONAL THERAPY; HOME
HEALTH CARE SERVICES; SPEECH AND HEAR-
ING THERAPY; MEDICAL SERVICES, NAMELY,
PEDIATRIC PRIMARY AND SUBSPECIALTY AM-

BULATORY CARE; PSYCHIATRIC SERVICES; PSY-
CHOLOGICAL COUNSELING; PSYCHOLOGICAL
COUNSELING FOR ABUSED CHILDREN; SURGI-
CAL SERVICES, IN CLASS 44 (U.S. CLS. 100 AND
101).

FIRST USE 7-29-2006; IN COMMERCE 7-29-2006.

OWNER OF U.S. REG. NOS. 1,689,416 AND
2,779,780.

NO CLAIM IS MADE TO THE EXCLUSIVE
RIGHT TO USE "CHILDRENS", APART FROM
THE MARK AS SHOWN.

THE MARK CONSISTS OF THE WORDS "RADY
CHILDRENS" STACKED IN TWO LINES WITH A
KITE DESIGN RUNNING BETWEEN THE "N" AND
"S" OF THE WORD "CHILDRENS".

SER. NO. 77-219,712, FILED 6-29-2007.

EVELYN BRADLEY, EXAMINING ATTORNEY

Int. Cl.: 25

Prior U.S. Cls.: 22 and 39

United States Patent and Trademark Office

Reg. No. 3,479,164

Registered Aug. 5, 2008

**TRADEMARK
PRINCIPAL REGISTER**

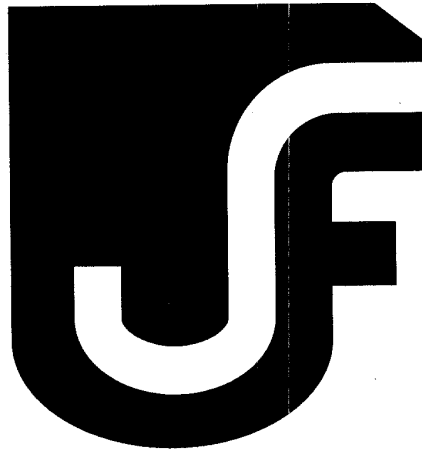

ALLISON, JON P. (UNITED STATES INDIVIDUAL)
408 DELAWARE AVENUE
TOWSON, MD 21286

FOR: CLOTHING, NAMELY, CAPS, T-SHIRTS, BOXER SHORTS, SWEATPANTS AND SWEATSHIRTS, MEN'S AND WOMEN'S JACKETS, IN CLASS 25 (U.S. CLS. 22 AND 39).

FIRST USE 4-30-2006; IN COMMERCE 4-30-2006.

THE MARK CONSISTS OF HIGHLY STYLIZED LETTERS "JF" MELDED INTO EACH OTHER.

SER. NO. 77-219,933, FILED 7-1-2007.

ESTHER BELENKER, EXAMINING ATTORNEY

Int. Cl.: 9

Prior U.S. Cls.: 21, 23, 26, 36 and 38

Reg. No. 3,479,165

United States Patent and Trademark Office

Registered Aug. 5, 2008

**TRADEMARK
PRINCIPAL REGISTER**

The Art of Mushin

ALL WAYS ZEN (TEXAS LTD LIAB CO)
5000 BEE CAVES RD, STE 210
AUSTIN, TX 78746

FOR: HEALTH AND FITNESS EDUCATIONAL
GOODS FOR MIND-BODY FITNESS, NAMELY,
PRE-RECORDED DVDS AND COMPACT DISCS
FEATURING INSTRUCTION IN MEDITATION,
NATURAL HEALING AND STRESS MANAGE-
MENT , IN CLASS 9 (U.S. CLS. 21, 23, 26, 36 AND 38).

FIRST USE 3-15-2007; IN COMMERCE 3-15-2007.

THE MARK CONSISTS OF STANDARD CHAR-
ACTERS WITHOUT CLAIM TO ANY PARTICULAR
FONT, STYLE, SIZE, OR COLOR.

NO CLAIM IS MADE TO THE EXCLUSIVE
RIGHT TO USE "MUSHIN", APART FROM THE
MARK AS SHOWN.

SER. NO. 77-219,980, FILED 7-1-2007.

ELI HELLMAN, EXAMINING ATTORNEY

Int. Cls.: 37 and 42

Prior U.S. Cls.: 100, 101, 103 and 106

United States Patent and Trademark Office

Reg. No. 3,479,166

Registered Aug. 5, 2008

**SERVICE MARK
PRINCIPAL REGISTER**

TECH 2U

TECH SERVICE 2U (CALIFORNIA LTD LIAB CO)
SUITE 9
7144 FAIR OAKS BLVD.
CARMICHAEL, CA 95608

FOR: MAINTENANCE AND REPAIR OF COMPUTERS; MAINTENANCE AND REPAIR OF COMPUTER HARDWARE; MAINTENANCE AND REPAIR OF COMPUTER NETWORKS AND NETWORK EQUIPMENT; MAINTENANCE AND REPAIR OF HOME THEATRE SYSTEMS; INSTALLATION OF COMPUTER NETWORKS AND SYSTEMS; AND INSTALLATION OF HOME THEATRE SYSTEMS, IN CLASS 37 (U.S. CLS. 100, 103 AND 106).

FIRST USE 1-31-2008; IN COMMERCE 1-31-2008.

FOR: COMPUTER SERVICES, NAMELY, VIRUS REMOVAL, SOFTWARE INSTALLATION AND

SOFTWARE REPAIR, IN CLASS 42 (U.S. CLS. 100 AND 101).

FIRST USE 1-31-2008; IN COMMERCE 1-31-2008.

THE MARK CONSISTS OF STANDARD CHARACTERS WITHOUT CLAIM TO ANY PARTICULAR FONT, STYLE, SIZE, OR COLOR.

OWNER OF U.S. REG. NO. 3,317,244.

NO CLAIM IS MADE TO THE EXCLUSIVE RIGHT TO USE "TECH", APART FROM THE MARK AS SHOWN.

SER. NO. 77-220,052, FILED 7-2-2007.

DORITT L. CARROLL, EXAMINING ATTORNEY

Int. Cl.: 28

Prior U.S. Cls.: 22, 23, 38 and 50

United States Patent and Trademark Office

Reg. No. 3,479,167

Registered Aug. 5, 2008

**TRADEMARK
PRINCIPAL REGISTER**

MBX STUNT XT

MATTEL, INC. (DELAWARE CORPORATION)
M1-1518
333 CONTINENTAL BLVD.
EL SEGUNDO, CA 90245

FOR: TOYS, GAMES AND PLAYTHINGS, NAME-
LY, TOY VEHICLES AND ACCESSORIES THERE-
FOR, IN CLASS 28 (U.S. CLS. 22, 23, 38 AND 50).

FIRST USE 3-26-2008; IN COMMERCE 3-26-2008.

THE MARK CONSISTS OF STANDARD CHAR-
ACTERS WITHOUT CLAIM TO ANY PARTICULAR
FONT, STYLE, SIZE, OR COLOR.

OWNER OF U.S. REG. NO. 3,103,395.

SER. NO. 77-220,184, FILED 7-2-2007.

SHANNON TWOHIG, EXAMINING ATTORNEY

Int. Cl.: 9

Prior U.S. Cls.: 21, 23, 26, 36 and 38

Reg. No. 3,479,168

United States Patent and Trademark Office

Registered Aug. 5, 2008

**TRADEMARK
PRINCIPAL REGISTER**

UNI-RUPTER

S&C ELECTRICAL CO. (DELAWARE CORPORATION)
JAMES V. LAPACEK
6601 N. RIDGE BLVD.
CHICAGO, IL 60626

FOR: ELECTRICAL SWITCHES AND CIRCUIT-INTERRUPTING DEVICES, NAMELY, A MANUALLY OPERABLE LOADBREAK DEVICE FOR OPENING ELECTRICAL CIRCUIT DEVICES CARRYING LOAD CURRENTS, IN CLASS 9 (U.S. CLS. 21, 23, 26, 36 AND 38).

FIRST USE 1-1-1978; IN COMMERCE 1-1-1978.

THE MARK CONSISTS OF STANDARD CHARACTERS WITHOUT CLAIM TO ANY PARTICULAR FONT, STYLE, SIZE, OR COLOR.

OWNER OF U.S. REG. NOS. 890,001, 1,500,344 AND OTHERS.

SER. NO. 77-220,252, FILED 7-2-2007.

CHRISTINA SOBRAL, EXAMINING ATTORNEY

Int. Cl.: 35

Prior U.S. Cls.: 100, 101 and 102

United States Patent and Trademark Office

Reg. No. 3,479,169

Registered Aug. 5, 2008

**SERVICE MARK
PRINCIPAL REGISTER**

CORPAMERICA

CORPORATION SERVICE COMPANY (DELA-
WARE CORPORATION)
2711 CENTERVILLE ROAD, SUITE 400
WILMINGTON, DE 19808

FOR: PROVIDING BUSINESS INFORMATION,
CONSULTING AND PLANNING SERVICES IN
THE NATURE OF PROVIDING ASSISTANCE WITH
THE FORMATION AND QUALIFICATION OF COR-
PORATIONS, LIMITED LIABILITY COMPANIES
AND OTHER BUSINESS ENTITIES, IN CLASS 35
(U.S. CLS. 100, 101 AND 102).

FIRST USE 0-0-1989; IN COMMERCE 0-0-1989.

THE MARK CONSISTS OF STANDARD CHAR-
ACTERS WITHOUT CLAIM TO ANY PARTICULAR
FONT, STYLE, SIZE, OR COLOR.

SER. NO. 77-220,492, FILED 7-2-2007.

TEJBIR SINGH, EXAMINING ATTORNEY

Int. Cl.: 9

Prior U.S. Cls.: 21, 23, 26, 36 and 38

Reg. No. 3,479,170

United States Patent and Trademark Office

Registered Aug. 5, 2008

**TRADEMARK
PRINCIPAL REGISTER**

THE INTELLIGENT BODY

WILDMAN, FRANK, PH.D. (UNITED STATES
INDIVIDUAL)
721 THE ALAMEDA
BERKELEY, CA 94707

FOR: AUDIOTAPES, VIDEO TAPES, CD'S, AND
DVD/AUDIO PROGRAMS DOWNLOADABLE
FROM THE INTERNET ON THE SUBJECT OF
THERAPEUTIC MOVEMENT AND SENSORY MO-
TOR LEARNING, IN CLASS 9 (U.S. CLS. 21, 23, 26, 36
AND 38).

FIRST USE 3-31-1984; IN COMMERCE 3-31-1984.

THE MARK CONSISTS OF STANDARD CHAR-
ACTERS WITHOUT CLAIM TO ANY PARTICULAR
FONT, STYLE, SIZE, OR COLOR.

NO CLAIM IS MADE TO THE EXCLUSIVE
RIGHT TO USE "BODY", APART FROM THE
MARK AS SHOWN.

SER. NO. 77-220,497, FILED 7-2-2007.

ANDREA HACK, EXAMINING ATTORNEY

Int. Cl.: 41

Prior U.S. Cls.: 100, 101 and 107

United States Patent and Trademark Office

Reg. No. 3,479,171

Registered Aug. 5, 2008

**SERVICE MARK
PRINCIPAL REGISTER**

Meatballs of Comedy

SORICE, DEMUS JOSEPH (UNITED STATES IN-
DIVIDUAL)
13412 MOORPARK ST. #C
SHERMAN OAKS, CA 91423

FOR: ENTERTAINMENT IN THE NATURE OF
VISUAL AND AUDIO PERFORMANCES, AND MU-
SICAL, VARIETY, NEWS AND COMEDY SHOWS,
IN CLASS 41 (U.S. CLS. 100, 101 AND 107).

FIRST USE 11-30-2006; IN COMMERCE 1-30-2007.

THE MARK CONSISTS OF STANDARD CHAR-
ACTERS WITHOUT CLAIM TO ANY PARTICULAR
FONT, STYLE, SIZE, OR COLOR.

NO CLAIM IS MADE TO THE EXCLUSIVE
RIGHT TO USE "COMEDY", APART FROM THE
MARK AS SHOWN.

SER. NO. 77-220,505, FILED 7-2-2007.

JIM RINGLE, EXAMINING ATTORNEY

Int. Cl.: 5

Prior U.S. Cls.: 6, 18, 44, 46, 51 and 52

Reg. No. 3,479,172

United States Patent and Trademark Office

Registered Aug. 5, 2008

**TRADEMARK
PRINCIPAL REGISTER**



Profarmaco

CAMBREX PROFARMACO MILANO S.R.L. (ITALY SOCIETA A RESPONSABILITA LIMITATA)
VIA CUCCHIARI 17
MILANO, ITALY

FOR: PHARMACEUTICAL COMPOSITIONS HAVING BETA-ADRENERGIC BLOCKING, HYPOGLYCEMIC, TRANQUILIZING, EXPECTORANT, DIURETIC, CORONARY VASODILATOR, ANTIDEPRESSANT, LAXATIVE, HYPNOTIC, ANTI-INFECTIVE, ANTIEPILEPTIC, NEUROLEPTIC, ANTIALLERGIC, ANTIINFLAMMATORY,

BRONCHODILATOR, ANTIARRHYTHMIC AND ANTI-ASTHMATIC PROPERTIES, IN CLASS 5 (U.S. CLS. 6, 18, 44, 46, 51 AND 52).

OWNER OF ITALY REG. NO. 00670630, DATED 2-13-1996, RENEWED AS REG. NO. 00670630, DATED 12-29-2005, EXPIRES 12-29-2015.

SER. NO. 77-220,547, FILED 7-2-2007.

RICHARD A. STRASER, EXAMINING ATTORNEY

Int. Cl.: 35

Prior U.S. Cls.: 100, 101 and 102

United States Patent and Trademark Office

Reg. No. 3,479,173

Registered Aug. 5, 2008

SERVICE MARK
PRINCIPAL REGISTER

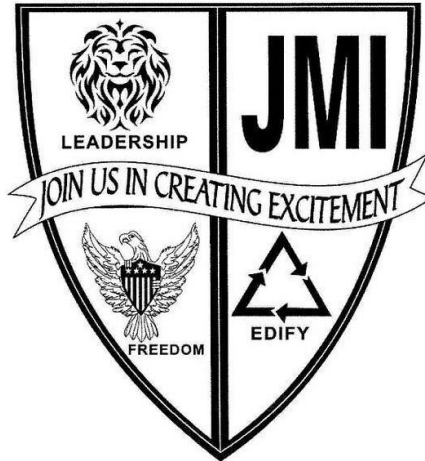

JUICE MARKETING, INC. (NORTH CAROLINA CORPORATION)
6000 FAIRVIEW RD., SUITE 675
CHARLOTTE, NC 28210

FOR: DIRECT MARKETING SERVICES; MULTI-LEVEL MARKETING BUSINESS SERVICES, IN CLASS 35 (U.S. CLS. 100, 101 AND 102).

FIRST USE 5-1-2004; IN COMMERCE 5-1-2004.

THE MARK CONSISTS OF THE SHIELD POINTING DOWN WITH A LINE CROSSING IN THE MIDDLE FROM TOP TO BOTTOM AND A BANNER

CROSSING IN THE MIDDLE FROM SIDE TO SIDE STATING "JOIN US IN CREATING EXCITEMENT" WITH LYON ON THE LEFT UPPER CORNER WITH THE WORD "LEADERSHIP" EAGLE ON THE LEFT LOWER CORNER WITH THE WORD "FREEDOM", THE LETTERS "JMI" ON THE RIGHT UPPER CORNER AND A TRIANGLE WITH ARROWS ON THE RIGHT LOWER CORNER WITH THE WORD "EDIFY".

SER. NO. 77-220,567, FILED 7-2-2007.

JAMES A. RAUEN, EXAMINING ATTORNEY

Int. Cl.: 9

Prior U.S. Cls.: 21, 23, 26, 36 and 38

United States Patent and Trademark Office

Reg. No. 3,479,174

Registered Aug. 5, 2008

**TRADEMARK
PRINCIPAL REGISTER**



GOTTROX LLC (ILLINOIS LTD LIAB CO)
1814 W. HENDERSON
CHICAGO, IL 60657

FOR: ELECTRICAL POWER DISTRIBUTION
UNITS, IN CLASS 9 (U.S. CLS. 21, 23, 26, 36 AND 38).

FIRST USE 6-15-2007; IN COMMERCE 6-15-2007.

OWNER OF U.S. REG. NO. 3,300,364.

NO CLAIM IS MADE TO THE EXCLUSIVE
RIGHT TO USE "ROTATOR", APART FROM THE
MARK AS SHOWN.

THE MARK CONSISTS OF THE WORD "ROTA-
TOR" IN STYLIZED FORM WITH THE LETTER "O"
APPEARING AS AN ELECTRICAL RECEPTICAL.

SER. NO. 77-220,738, FILED 7-2-2007.

TEJBIR SINGH, EXAMINING ATTORNEY

Int. Cl.: 35

Prior U.S. Cls.: 100, 101 and 102

United States Patent and Trademark Office

Reg. No. 3,479,175

Registered Aug. 5, 2008

SERVICE MARK
PRINCIPAL REGISTER



EXPONENT TRADING COMPANY L.L.C. (NE-
VADA LTD LIAB CO)
SUITE 412
108 N. WASHINGTON STREET
SPOKANE, WA 99201

FIRST USE 1-31-2007; IN COMMERCE 1-31-2007.

NO CLAIM IS MADE TO THE EXCLUSIVE
RIGHT TO USE "TRADING COMPANY", APART
FROM THE MARK AS SHOWN.

FOR: ONLINE CONSIGNMENT SERVICES
WHEREBY GOODS ARE RECEIVED ON CONSIGN-
MENT FOR AUCTIONING ON AN ONLINE AU-
CTION SITE; PROVIDING OFFICE SUPPORT STAFF
SERVICES; MANAGING OF TRAINING PRO-
GRAMS FOR OTHERS VIA THE INTERNET; BUSI-
NESS MARKETING SERVICES; DISTRIBUTION
AND DISSEMINATION OF PRINTED ADVERTIS-
ING AND MARKETING MATERIALS; DISTRIBU-
TION AND DISSEMINATION OF ADVERTISING
AND MARKETING MATTER VIA THE INTERNET,
IN CLASS 35 (U.S. CLS. 100, 101 AND 102).

THE MARK CONSISTS OF A FANCIFUL STY-
LIZED "E" ON LEFT SIDE OF MARK, FOLLOWED
BY THE ITALICIZED LETTERS "XPONENT" TO
THE RIGHT OF THE "E" WITH THE LETTER "X" IN
SUPERSCRIPT; THE WORDS "TRADING COMPA-
NY" ITALICIZED UNDER THE LETTERS "XPO-
NENT".

SER. NO. 77-220,895, FILED 7-2-2007.

CORY BOONE, EXAMINING ATTORNEY

Int. Cl.: 35

Prior U.S. Cls.: 100, 101 and 102

United States Patent and Trademark Office

Reg. No. 3,479,176

Registered Aug. 5, 2008

**SERVICE MARK
PRINCIPAL REGISTER**

EXPONENT TRADING COMPANY

EXPONENT TRADING COMPANY L.L.C. (NE-
VADA LTD LIAB CO)
SUITE 412
108 N. WASHINGTON STREET
SPOKANE, WA 99201

FOR: ONLINE CONSIGNMENT SERVICES
WHEREBY GOODS ARE RECEIVED ON CONSIGN-
MENT FOR AUCTIONING ON AN ONLINE AUC-
TION SITE; PROVIDING OFFICE SUPPORT STAFF
SERVICES; MANAGING OF TRAINING PRO-
GRAMS FOR OTHERS VIA THE INTERNET; BUSI-
NESS MARKETING SERVICES; DISTRIBUTION
AND DISSEMINATION OF PRINTED ADVERTIS-
ING AND MARKETING MATERIALS; DISTRIBUTION
AND DISSEMINATION OF ADVERTISING

AND MARKETING MATTER VIA THE INTERNET,
IN CLASS 35 (U.S. CLS. 100, 101 AND 102).

FIRST USE 1-31-2007; IN COMMERCE 1-31-2007.

THE MARK CONSISTS OF STANDARD CHAR-
ACTERS WITHOUT CLAIM TO ANY PARTICULAR
FONT, STYLE, SIZE, OR COLOR.

NO CLAIM IS MADE TO THE EXCLUSIVE
RIGHT TO USE "TRADING COMPANY", APART
FROM THE MARK AS SHOWN.

SER. NO. 77-220,908, FILED 7-2-2007.

CORY BOONE, EXAMINING ATTORNEY

Int. Cl.: 16

Prior U.S. Cls.: 2, 5, 22, 23, 29, 37, 38 and 50

Reg. No. 3,479,177

United States Patent and Trademark Office

Registered Aug. 5, 2008

**TRADEMARK
PRINCIPAL REGISTER**

CLUB VALET

MAVERICK MULTIMEDIA (WASHINGTON CORPORATION), DBA MAVERICK LABEL
120 W. DAYTON AVE.
SUITE A-7
EDMONDS, WA 980204180

OWNER OF U.S. REG. NO. 2,564,547.

FOR: ADHESIVE IDENTIFICATION LABELS, IN CLASS 16 (U.S. CLS. 2, 5, 22, 23, 29, 37, 38 AND 50).

NO CLAIM IS MADE TO THE EXCLUSIVE RIGHT TO USE "CLUB", APART FROM THE MARK AS SHOWN.

FIRST USE 4-0-2007; IN COMMERCE 4-0-2007.

SER. NO. 77-220,929, FILED 7-2-2007.

THE MARK CONSISTS OF STANDARD CHARACTERS WITHOUT CLAIM TO ANY PARTICULAR FONT, STYLE, SIZE, OR COLOR.

CORY BOONE, EXAMINING ATTORNEY

Int. Cl.: 25

Prior U.S. Cls.: 22 and 39

United States Patent and Trademark Office

Reg. No. 3,479,178

Registered Aug. 5, 2008

**TRADEMARK
PRINCIPAL REGISTER**

REVA

RIVER LIGHT V, L.P. (NEW YORK LIMITED
PARTNERSHIP)
99 MADISON AVENUE
NEW YORK, NY 10016

THE MARK CONSISTS OF STANDARD CHAR-
ACTERS WITHOUT CLAIM TO ANY PARTICULAR
FONT, STYLE, SIZE, OR COLOR.

FOR: FOOTWEAR, IN CLASS 25 (U.S. CLS. 22 AND
39).

SER. NO. 77-221,172, FILED 7-3-2007.

FIRST USE 2-28-2006; IN COMMERCE 2-28-2006.

MARK SPARACINO, EXAMINING ATTORNEY

Int. Cl.: 5

Prior U.S. Cls.: 6, 18, 44, 46, 51 and 52

Reg. No. 3,479,179

United States Patent and Trademark Office

Registered Aug. 5, 2008

**TRADEMARK
PRINCIPAL REGISTER**

ALBA-LYBE

TERAL INC. (PUERTO RICO CORPORATION)
4405 GUACAMAYO ST. URB. VILLA DELICIAS
PONCE, PUERTO RICO 007283714

THE MARK CONSISTS OF STANDARD CHAR-
ACTERS WITHOUT CLAIM TO ANY PARTICULAR
FONT, STYLE, SIZE, OR COLOR.

FOR: MULTIVITAMIN NUTRITIONAL SUPPLE-
MENT FOR USE IN STIMULATING THE APPETITE
OF PATIENTS, IN CLASS 5 (U.S. CLS. 6, 18, 44, 46, 51
AND 52).

THE FOREIGN WORDING IN THE MARK,
"ALBA", TRANSLATES INTO ENGLISH AS DAWN.

SER. NO. 77-221,260, FILED 7-3-2007.

FIRST USE 12-1-1964; IN COMMERCE 12-1-1964.

TINA KUAN, EXAMINING ATTORNEY

Int. Cl.: 35

Prior U.S. Cls.: 100, 101 and 102

United States Patent and Trademark Office

Reg. No. 3,479,180

Registered Aug. 5, 2008

**SERVICE MARK
PRINCIPAL REGISTER**

Atomic Holiday Bazaar

TUFF BETTY BAGS (FLORIDA SOLE PROPRIETORSHIP)
2738 SYDELLE STREET
SARASOTA, FL 34237 AND
CRANKY TIKI, INC. (FLORIDA CORPORATION)
255 N JEFFERSON AVE
SARASOTA, FL 34237

FOR: ARRANGING AND CONDUCTING OF FAIRS AND EXHIBITIONS FOR BUSINESS AND ADVERTISING PURPOSES; ARRANGING AND CONDUCTING TRADE SHOW EXHIBITIONS IN THE FIELD OF ARTS AND CRAFTS; ARRANGING AND CONDUCTING TRADE SHOWS IN THE FIELD OF ARTS AND CRAFTS; CONDUCTING TRADE SHOWS IN THE FIELD OF ARTS AND CRAFTS; CONSULTATION RELATING TO TRADE FAIRS; ORGANISATION AND HOLDING OF FAIRS FOR COMMERCIAL OR ADVERTISING PURPOSES; PLANNING AND CONDUCTING OF TRADE

FAIRS, EXHIBITIONS AND PRESENTATIONS FOR ECONOMIC OR ADVERTISING PURPOSES; PROMOTING AND CONDUCTING TRADE SHOWS IN THE FIELD OF ARTS AND CRAFTS, IN CLASS 35 (U.S. CLS. 100, 101 AND 102).

FIRST USE 6-1-2006; IN COMMERCE 6-1-2006.

THE MARK CONSISTS OF STANDARD CHARACTERS WITHOUT CLAIM TO ANY PARTICULAR FONT, STYLE, SIZE, OR COLOR.

NO CLAIM IS MADE TO THE EXCLUSIVE RIGHT TO USE "HOLIDAY BAZAAR", APART FROM THE MARK AS SHOWN.

SER. NO. 77-221,283, FILED 7-3-2007.

DAWN HAN, EXAMINING ATTORNEY

Int. Cl.: 10

Prior U.S. Cls.: 26, 39 and 44

United States Patent and Trademark Office

Reg. No. 3,479,181

Registered Aug. 5, 2008

**TRADEMARK
PRINCIPAL REGISTER**

 **Dry Pro**

DRY CORP LLC (NORTH CAROLINA LTD LIAB
CO)
6702 NETHERLANDS DRIVE
WILMINGTON, NC 28405

FOR: CAST COVERS, BANDAGE COVERS, PICC
LINE COVERS, PROSTHETIC COVERS, IN CLASS 10
(U.S. CLS. 26, 39 AND 44).

FIRST USE 6-15-2007; IN COMMERCE 6-15-2007.

OWNER OF U.S. REG. NO. 3,262,779.

NO CLAIM IS MADE TO THE EXCLUSIVE
RIGHT TO USE "DRY", APART FROM THE MARK
AS SHOWN.

SER. NO. 77-221,548, FILED 7-3-2007.

NANCY CLARKE, EXAMINING ATTORNEY

Int. Cl.: 25

Prior U.S. Cls.: 22 and 39

United States Patent and Trademark Office

Reg. No. 3,479,182

Registered Aug. 5, 2008

**TRADEMARK
PRINCIPAL REGISTER**

YARDIE

COOMBS, STANLENE F (UNITED STATES IN-
DIVIDUAL), DBA PICKNEY ENTERPRISES
PO BOX 390395
SNELLVILLE, GA 30039

FOR: T-SHIRTS; SWEAT SHIRTS; TANK TOPS;
SLEEP SHIRTS; NIGHT GOWNS; PAJAMAS; SWEAT
SUITS; GOLF SHIRTS; KNIT SHIRTS; POLO SHIRTS;
SHIRTS; DRESSES; SKIRTS; BLOUSES; SHORTS;
PANTS; BASEBALL CAPS; HATS; HEADBANDS;
SWEATBANDS, IN CLASS 25 (U.S. CLS. 22 AND 39).

FIRST USE 4-19-2007; IN COMMERCE 4-19-2007.

THE MARK CONSISTS OF STANDARD CHAR-
ACTERS WITHOUT CLAIM TO ANY PARTICULAR
FONT, STYLE, SIZE, OR COLOR.

SER. NO. 77-221,709, FILED 7-3-2007.

KATHLEEN M. VANSTON, EXAMINING ATTOR-
NEY

Int. Cl.: 37

Prior U.S. Cls.: 100, 103 and 106

United States Patent and Trademark Office

Reg. No. 3,479,183

Registered Aug. 5, 2008

**SERVICE MARK
PRINCIPAL REGISTER**

REDNP

REDNP LLC (COLORADO CORPORATION)
P.O. BOX 11997
DENVER, CO 80211

FIRST USE 6-29-2007; IN COMMERCE 6-29-2007.

FOR: PROVIDING AN ONLINE COMPUTER DATABASE IN THE FIELD OF REAL ESTATE DEVELOPMENT AND PROVIDING A WEBSITE FEATURING CONSULTATION SERVICES IN THE FIELD OF REAL ESTATE DEVELOPMENT VIA A GLOBAL COMPUTER NETWORK, IN CLASS 37 (U.S. CLS. 100, 103 AND 106).

THE MARK CONSISTS OF STANDARD CHARACTERS WITHOUT CLAIM TO ANY PARTICULAR FONT, STYLE, SIZE, OR COLOR.

SER. NO. 77-221,745, FILED 7-3-2007.

CHRISTINA SOBRAL, EXAMINING ATTORNEY

Int. Cl.: 35

Prior U.S. Cls.: 100, 101 and 102

United States Patent and Trademark Office

Reg. No. 3,479,184

Registered Aug. 5, 2008

**SERVICE MARK
PRINCIPAL REGISTER**

ASA UMPIRE

AMATEUR SOFTBALL ASSOCIATION OF
AMERICA (OKLAHOMA CORPORATION)
2801 N. E. 50TH
OKLAHOMA CITY, OK 73111

FOR: ASSOCIATION SERVICES, NAMELY, PROMOTING THE INTERESTS OF AMATEUR SOFTBALL, IN CLASS 35 (U.S. CLS. 100, 101 AND 102).

FIRST USE 12-31-1983; IN COMMERCE 12-31-1983.

THE MARK CONSISTS OF STANDARD CHARACTERS WITHOUT CLAIM TO ANY PARTICULAR FONT, STYLE, SIZE, OR COLOR.

OWNER OF U.S. REG. NOS. 1,102,423, 1,446,895 AND OTHERS.

SER. NO. 77-221,848, FILED 7-3-2007.

G. MAYERSCHOFF, EXAMINING ATTORNEY

Int. Cls.: 35 and 45

Prior U.S. Cls.: 100, 101 and 102

United States Patent and Trademark Office

Reg. No. 3,479,185

Registered Aug. 5, 2008

**SERVICE MARK
PRINCIPAL REGISTER**

Project Cuddle

PROJECT CUDDLE, INC. (CALIFORNIA CORPORATION)
2973 HARBOR BLVD. # 326
COSTA MESA, CA 92626

FOR: PROMOTING PUBLIC AWARENESS IN THE NATURE OF PREVENTING INFANT ABANDONMENT, IN CLASS 35 (U.S. CLS. 100, 101 AND 102).

FIRST USE 7-8-1996; IN COMMERCE 7-8-1996.

FOR: TELEPHONE HOT LINE COUNSELING, NAMELY, OFFERING ADVICE REGARDING PREVENTION OF INFANT ABANDONMENT, IN CLASS 45 (U.S. CLS. 100 AND 101).

FIRST USE 7-8-1996; IN COMMERCE 7-8-1996.

THE MARK CONSISTS OF STANDARD CHARACTERS WITHOUT CLAIM TO ANY PARTICULAR FONT, STYLE, SIZE, OR COLOR.

NO CLAIM IS MADE TO THE EXCLUSIVE RIGHT TO USE "PROJECT", APART FROM THE MARK AS SHOWN.

SER. NO. 77-221,914, FILED 7-3-2007.

JAY FLOWERS, EXAMINING ATTORNEY

Int. Cls.: 35 and 45

Prior U.S. Cls.: 100, 101 and 102

United States Patent and Trademark Office

Reg. No. 3,479,186

Registered Aug. 5, 2008

SERVICE MARK
PRINCIPAL REGISTER



PROJECT CUDDLE, INC. (CALIFORNIA CORPORATION)
2973 HARBOR BLVD. # 326
COSTA MESA, CA 92626

FIRST USE 4-15-2004; IN COMMERCE 4-15-2004.

OWNER OF U.S. REG. NO. 2,463,318.

FOR: PROMOTING PUBLIC AWARENESS IN THE NATURE OF PREVENTING INFANT ABANDONMENT, IN CLASS 35 (U.S. CLS. 100, 101 AND 102).

NO CLAIM IS MADE TO THE EXCLUSIVE RIGHT TO USE "PROJECT", APART FROM THE MARK AS SHOWN.

FIRST USE 4-15-2004; IN COMMERCE 4-15-2004.

THE MARK CONSISTS OF A DRAWING OF A SMALL BABY INSIDE A PLANT.

FOR: TELEPHONE HOT LINE COUNSELING, NAMELY, OFFERING ADVICE REGARDING PREVENTION OF INFANT ABANDONMENT, IN CLASS 45 (U.S. CLS. 100 AND 101).

SER. NO. 77-221,921, FILED 7-3-2007.

JAY FLOWERS, EXAMINING ATTORNEY

Int. Cl.: 40

Prior U.S. Cls.: 100, 103 and 106

United States Patent and Trademark Office

Reg. No. 3,479,187

Registered Aug. 5, 2008

**SERVICE MARK
PRINCIPAL REGISTER**

DO IT WITH A CLICK

ARIZONA FAST SHIRTS, LLC (ARIZONA LTD
LIAB CO)

#N

9838 N. 19TH AVE.
PHOENIX, AZ 85021

FOR: CUSTOM IMPRINTING OF CLOTHING,
CLOTHING ACCESSORIES, BANNERS, AND SIGNS
WITH DECORATIVE DESIGNS; CUSTOM IM-
PRINTING OF DECORATIVE DESIGNS ON ITEMS
USED FOR PROMOTIONAL PURPOSES, NAMELY,
TOTE BAGS, CALENDARS, STRESS RELIEF BALLS
FOR HAND EXERCISE, SPORTS BOTTLES, GOLF
ACCESSORIES, PENS, KEY CHAINS, FLASH-
LIGHTS, AND EMERY BOARDS; IMPRINTING

MESSAGES ON T-SHIRTS; IMPRINTING MESSA-
GES ON WEARING APPAREL, ACCESSORIES AND
MUGS; EMBROIDERY SERVICES, IN CLASS 40
(U.S. CLS. 100, 103 AND 106).

FIRST USE 6-29-2007; IN COMMERCE 6-29-2007.

THE MARK CONSISTS OF STANDARD CHAR-
ACTERS WITHOUT CLAIM TO ANY PARTICULAR
FONT, STYLE, SIZE, OR COLOR.

SER. NO. 77-221,996, FILED 7-3-2007.

STEVEN R. FOSTER, EXAMINING ATTORNEY

Int. Cl.: 9

Prior U.S. Cls.: 21, 23, 26, 36 and 38

Reg. No. 3,479,188

United States Patent and Trademark Office

Registered Aug. 5, 2008

**TRADEMARK
PRINCIPAL REGISTER**

SCHLESSINGER MEDIA

LIBRARY VIDEO COMPANY (PENNSYLVANIA CORPORATION)
7 E. WYNNEWOOD RD.
WYNNEWOOD, PA 19096

FOR: PRE-RECORDED AUDIOVISUAL MEDIA, NAMELY, VIDEO CASSETTES, CDS AND DVDS, FEATURING CHILDREN'S EDUCATIONAL SUBJECT MATTER; DIGITAL MEDIA, NAMELY, DOWNLOADABLE DIGITAL AUDIO, VIDEO AND MULTIMEDIA FILES, FEATURING CHILDREN'S EDUCATIONAL SUBJECT MATTER; EDUCATIONAL KITS COMPRISED PRIMARILY OF VIDEO CASSETTES, CDS, DVDS, COMPUTER SOFTWARE, OR DIGITAL MEDIA, AND ALSO INCLUDING ONE OR MORE TEACHER GUIDES, WORK-SHEETS, QUIZZES AND TEACHING AIDS, ALL SOLD TOGETHER AS A UNIT, IN CLASS 9 (U.S. CLS. 21, 23, 26, 36 AND 38).

FIRST USE 9-1-1997; IN COMMERCE 9-1-1997.

THE MARK CONSISTS OF STANDARD CHARACTERS WITHOUT CLAIM TO ANY PARTICULAR FONT, STYLE, SIZE, OR COLOR.

OWNER OF U.S. REG. NOS. 2,254,693, 2,405,018 AND OTHERS.

NO CLAIM IS MADE TO THE EXCLUSIVE RIGHT TO USE "MEDIA", APART FROM THE MARK AS SHOWN.

SEC. 2(F).

SER. NO. 77-222,045, FILED 7-4-2007.

SHANNON TWOHIG, EXAMINING ATTORNEY

Int. Cl.: 32

Prior U.S. Cls.: 45, 46 and 48

United States Patent and Trademark Office

Reg. No. 3,479,189

Registered Aug. 5, 2008

TRADEMARK
PRINCIPAL REGISTER



HIGH FALLS BREWING COMPANY, LLC (NEW YORK LTD LIAB CO)
445 ST. PAUL STREET
ROCHESTER, NY 14605

FOR: BEER, IN CLASS 32 (U.S. CLS. 45, 46 AND 48).

FIRST USE 4-25-2007; IN COMMERCE 4-25-2007.

OWNER OF U.S. REG. NOS. 540,339 AND 1,496,056.

NO CLAIM IS MADE TO THE EXCLUSIVE RIGHT TO USE "LIGHT", "BREWING COMPANY" AND "ROCHESTER, NEW YORK", APART FROM THE MARK AS SHOWN.

THE COLOR(S) RED, WHITE, BLUE, GOLD, AND SILVER IS/ARE CLAIMED AS A FEATURE OF THE MARK.

THE MARK CONSISTS OF THE WORDS "GENNY" IN WHITE WITH A RED AND BLUE BORDER AND LIGHT IN WHITE SUPERIMPOSED ON AN OVAL SHAPED BLUE BACKGROUND WITH A WHITE, GOLD, AND SILVER BORDER, THE WORDS "GENESEE BREWING COMPANY ROCHESTER, NEW YORK" IN GOLD ON A RED ANNULUS WITH BLUE AND GOLD BORDER SURROUNDING A STYLIZED DEPICTION OF TWO ANGELS OVERLYING A RED AND GOLD RIBBON WITH BLUE BORDER AND A LEAF DESIGN. THE DESIGN OF THE ANGELS AND THE CONNECTED DESIGN DETAILS ARE IN GOLD INSIDE A BLUE CIRCLE.

SEC. 2(F) AS TO "GENESEE".

SER. NO. 77-222,047, FILED 7-4-2007.

ELLEN B. AWRICH, EXAMINING ATTORNEY

Int. Cls.: 24 and 25

Prior U.S. Cls.: 22, 39, 42 and 50

United States Patent and Trademark Office

Reg. No. 3,479,190

Registered Aug. 5, 2008

TRADEMARK
PRINCIPAL REGISTER

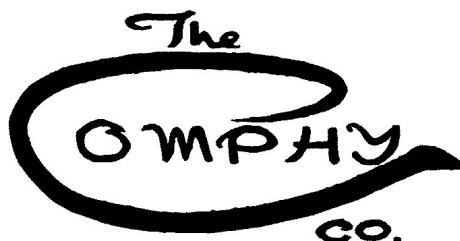

THE COMPHY CO. (CALIFORNIA CORPORATION)
160 W. ANN STREET
LOS ANGELES, CA 90012

FOR: LINENS AND BEDDING FOR HEALTH SPAS, NAMELY, TOWELS, PADS IN THE NATURE OF BED PADS, MATTRESS PADS AND TABLE PADS, SHEETS, DUVETS, COMFORTERS, PILLOW CASES, PILLOW SHAMS, AND TABLE SKIRTS, IN CLASS 24 (U.S. CLS. 42 AND 50).

FIRST USE 11-3-2003; IN COMMERCE 11-3-2003.

FOR: ROBES FOR HEALTH SPAS, IN CLASS 25 (U.S. CLS. 22 AND 39).

FIRST USE 11-3-2003; IN COMMERCE 11-3-2003.

NO CLAIM IS MADE TO THE EXCLUSIVE RIGHT TO USE "CO.", APART FROM THE MARK AS SHOWN.

THE MARK CONSISTS OF AN ENLARGED, STYLIZED "C" THAT ENCOMPASSES THE LETTERS "OMPHY" IN COMPHY, WITH THE WORDS "THE" AND "CO." BEING LOCATED ABOVE AND BELOW THE "C".

SER. NO. 77-222,051, FILED 7-4-2007.

KATHERINE CONNOLLY, EXAMINING ATTORNEY

Int. Cl.: 32

Prior U.S. Cls.: 45, 46 and 48

United States Patent and Trademark Office

Reg. No. 3,479,191

Registered Aug. 5, 2008

TRADEMARK
PRINCIPAL REGISTER



HIGH FALLS BREWING COMPANY, LLC (NEW YORK LTD LIAB CO)
445 ST. PAUL STREET
ROCHESTER, NY 14605

FOR: BEER, IN CLASS 32 (U.S. CLS. 45, 46 AND 48).

FIRST USE 4-25-2007; IN COMMERCE 4-25-2007.

OWNER OF U.S. REG. NO. 540,339.

NO CLAIM IS MADE TO THE EXCLUSIVE RIGHT TO USE "BEER", "SINCE 1878", "BREWING COMPANY" AND "ROCHESTER, NEW YORK", APART FROM THE MARK AS SHOWN.

THE COLOR(S) RED, WHITE, BLUE, AND GOLD IS/ARE CLAIMED AS A FEATURE OF THE MARK.

THE MARK CONSISTS OF THE "GENESEEBREWING COMPANY" IN WHITE WITH A RED BORDER AND GOLD SHADOW AND "BEER" IN GOLD WITH TWO GOLD DIAMONDS SUPERIMPOSED ON AN OVAL SHAPED RED BACKGROUND WITH A BLUE, WHITE, AND GOLD BORDER, THE WORDS "GENESEEBREWING COMPANY ROCHESTER, NEW YORK" IN GOLD ON A RED ANNULUS WITH BLUE AND GOLD BORDER SURROUNDING A STYLIZED DEPICTION OF TWO GOLD ANGELS INSIDE A BLUE CIRCLE WITH A RED AND GOLD BORDER OVERLYING A RED AND GOLD RIBBON WITH BLUE BORDER AND A GOLD AND BLUE LEAF DESIGN.

SEC. 2(F) AS TO "GENESEEBREWING COMPANY".

SER. NO. 77-222,053, FILED 7-4-2007.

ELLEN B. AWRICH, EXAMINING ATTORNEY

Int. Cl.: 32

Prior U.S. Cls.: 45, 46 and 48

United States Patent and Trademark Office

Reg. No. 3,479,192

Registered Aug. 5, 2008

TRADEMARK
PRINCIPAL REGISTER



HIGH FALLS BREWING COMPANY, LLC (NEW YORK LTD LIAB CO)
445 ST. PAUL STREET
ROCHESTER, NY 14605

FOR: BEER; NON-ALCOHOLIC BEER; PALE BEER; LAGER; ALE, IN CLASS 32 (U.S. CLS. 45, 46 AND 48).

FIRST USE 4-25-2007; IN COMMERCE 4-25-2007.

OWNER OF U.S. REG. NO. 540,339.

NO CLAIM IS MADE TO THE EXCLUSIVE RIGHT TO USE "SINCE 1878", "BREWING COMPANY" AND "ROCHESTER, NEW YORK", APART FROM THE MARK AS SHOWN.

THE MARK CONSISTS OF THE WORDS SINCE "1878 GENESEE BREWING COMPANY" WITHIN AN OVAL WITH A DOUBLE LINE BORDER, THE WORDS "GENESEE BREWING CO. ROCHESTER, NEW YORK" WITHIN AN ANNULUS SURROUNDING A STYLIZED DEPICTION OF TWO ANGELS OVERLYING A RIBBON AND A LEAF DESIGN.

SEC. 2(F) AS TO "GENESEE".

SER. NO. 77-222,058, FILED 7-4-2007.

ELLEN B. AWRICH, EXAMINING ATTORNEY

Int. Cl.: 16

Prior U.S. Cls.: 2, 5, 22, 23, 29, 37, 38 and 50

United States Patent and Trademark Office

Reg. No. 3,479,193

Registered Aug. 5, 2008

**TRADEMARK
PRINCIPAL REGISTER**

Boogalaboo

MARVIN, DORIS MOORE (UNITED STATES IN-
DIVIDUAL)
409 MARILU STREET
RICHARDSON, TX 75080

FOR: CHILDREN'S ACTIVITY BOOKS; CHIL-
DREN'S BOOKS; CHILDREN'S INTERACTIVE
EDUCATIONAL BOOKS; CHILDREN'S STORY-
BOOKS, IN CLASS 16 (U.S. CLS. 2, 5, 22, 23, 29, 37, 38
AND 50).

FIRST USE 9-29-2006; IN COMMERCE 10-19-2006.

THE MARK CONSISTS OF STANDARD CHAR-
ACTERS WITHOUT CLAIM TO ANY PARTICULAR
FONT, STYLE, SIZE, OR COLOR.

SER. NO. 77-222,132, FILED 7-5-2007.

ESTHER A. BORSUK, EXAMINING ATTORNEY

Int. Cls.: 2 and 9

Prior U.S. Cls.: 6, 11, 16, 21, 23, 26, 36 and 38

United States Patent and Trademark Office

Reg. No. 3,479,194

Registered Aug. 5, 2008

**TRADEMARK
PRINCIPAL REGISTER**

ECCOLASER

INKJETWAREHOUSE.COM INC. (CONNECTI-
CUT CORPORATION)
106 POWDER MILL ROAD
CANTON, CT 06019

FOR: TONER CARTRIDGES, FILLED INK JET
PRINTER CARTRIDGES, TONER FOR PRINTERS,
PRINTER INK CARTRIDGES, INK JET PRINTER
INK, INK JET PRINTER CLEANING CARTRIDGES,
LASER PRINTER TONER CARTRIDGES, IN CLASS
2 (U.S. CLS. 6, 11 AND 16).

FIRST USE 3-1-2008; IN COMMERCE 3-1-2008.

FOR: UNFILLED PRINTER CARTRIDGES , INK
JET PRINTERS, INK JET COLOR PRINTERS; COL-
OR PRINTERS; COMPUTER PRINTERS; DIGITAL

COLOR PRINTERS; THERMAL PRINTERS; LASER
PRINTERS; COMPUTER CLEANING CARTRID-
GES, INK JET PRINTER CLEANING CARTRIDGES;
COMPONENTS FOR LASER TONER CARTRIDGES,
NAMELY, REPLACEMENT DRUMS AND ROLL-
ERS, IN CLASS 9 (U.S. CLS. 21, 23, 26, 36 AND 38).

FIRST USE 3-1-2008; IN COMMERCE 3-1-2008.

THE MARK CONSISTS OF STANDARD CHAR-
ACTERS WITHOUT CLAIM TO ANY PARTICULAR
FONT, STYLE, SIZE, OR COLOR.

SER. NO. 77-222,228, FILED 7-5-2007.

FLORENTINA BLANDU, EXAMINING ATTORNEY

Int. Cl.: 41

Prior U.S. Cls.: 100, 101 and 107

United States Patent and Trademark Office

Reg. No. 3,479,195

Registered Aug. 5, 2008

**SERVICE MARK
PRINCIPAL REGISTER**



SCHOLASTIC INC. (NEW YORK CORPORATION)
557 BROADWAY
NEW YORK, NY 10012

FOR: EDUCATIONAL SERVICES, NAMELY, PROVIDING AN ONLINE READING PROGRAM FOR CHILDREN WHICH INCORPORATES THE USE OF INTERACTIVE FICTIONAL VIDEO STORYBOOKS WITH RELATED NONFICTION PRINT CONTENT AND DISTRIBUTION OF THE NONFICTION PRINT CONTENT IN CONNECTION THEREWITH, IN CLASS 41 (U.S. CLS. 100, 101 AND 107).

FIRST USE 6-20-2007; IN COMMERCE 6-20-2007.

THE MARK CONSISTS OF THE WORD "BOOK-FLIX", ACCOMPANIED BY THE DESIGN OF A CHILD WEARING EARPHONES WHO IS READING AN INTERACTIVE VIDEO STORYBOOK TO WHICH A COMPUTER MOUSE IS ATTACHED.

SER. NO. 77-222,446, FILED 7-5-2007.

EVELYN BRADLEY, EXAMINING ATTORNEY

Int. Cl.: 9

Prior U.S. Cls.: 21, 23, 26, 36 and 38

United States Patent and Trademark Office

Reg. No. 3,479,196

Registered Aug. 5, 2008

**TRADEMARK
PRINCIPAL REGISTER**

ROSTROPOVICH

ROSTROPOVICH, OLGA (UNITED STATES IN-
DIVIDUAL)
161 WEST 61 STREET, APT. 19FG
NEW YORK, NY 10023

FOR: PHONOGRAPH RECORDS, CDS, AUDIO-
TAPES, VIDEOTAPES AND DVDS FEATURING
MUSICAL SOUND RECORDINGS, IN CLASS 9
(U.S. CLS. 21, 23, 26, 36 AND 38).

FIRST USE 3-1-1950; IN COMMERCE 3-1-1950.

THE MARK CONSISTS OF STANDARD CHAR-
ACTERS WITHOUT CLAIM TO ANY PARTICULAR
FONT, STYLE, SIZE, OR COLOR.

SEC. 2(F).

SER. NO. 77-222,629, FILED 7-5-2007.

MELISSA VALLILLO, EXAMINING ATTORNEY

Int. Cls.: 16 and 35

Prior U.S. Cls.: 2, 5, 22, 23, 29, 37, 38, 50, 100, 101 and 102

Reg. No. 3,479,197

United States Patent and Trademark Office

Registered Aug. 5, 2008

**TRADEMARK
SERVICE MARK
PRINCIPAL REGISTER**

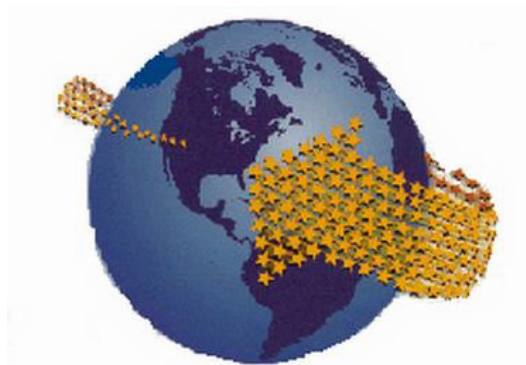

EMERGENCY COMMITTEE FOR AMERICAN
TRADE (D.C. NON-PROFIT ASSOCIATION)
SUITE 1150
900 17TH ST., NW
WASHINGTON, DC 20006

FOR: RESEARCH REPORTS FEATURING INTERNATIONAL TRADE AND INVESTMENT ISSUES PREPARED BY EMERGENCY COMMITTEE FOR AMERICAN TRADE; OFFICE PAPER STATIONERY; OFFICE STATIONERY; PRINTED PAPER SIGNS; PRINTED INSTRUCTIONAL, EDUCATIONAL, AND TEACHING MATERIALS IN THE FIELD OF INTERNATIONAL TRADE AND INVESTMENT; PRINTED INVITATIONS; PRINTED MATERIALS, NAMELY, PRESS RELEASES FEATURING INTERNATIONAL TRADE STATEMENTS BY THE EMERGENCY COMMITTEE FOR AMERICAN TRADE; PRINTED PAPER LABELS; BROCHURES ABOUT INTERNATIONAL TRADE AND INVESTMENT; PUBLICATIONS, NAMELY, BROCHURES, BOOKLETS, AND TEACHING MATERIALS IN THE FIELD OF INTERNATIONAL TRADE AND INVESTMENT, IN CLASS 16 (U.S. CLS. 2, 5, 22, 23, 29, 37, 38 AND 50).

FIRST USE 10-25-1999; IN COMMERCE 10-25-1999.

FOR: ASSOCIATION SERVICES, NAMELY, PROMOTING THE INTERESTS OF MEMBER COMPANIES OF THE EMERGENCY COMMITTEE FOR AMERICAN TRADE IN THE AREA OF TRADE AND INVESTMENT, IN CLASS 35 (U.S. CLS. 100, 101 AND 102).

FIRST USE 10-25-1999; IN COMMERCE 10-25-1999.

THE COLOR(S) BLUE, YELLOW AND GOLD IS/ARE CLAIMED AS A FEATURE OF THE MARK.

THE MARK CONSISTS OF A GLOBE IN SHADES OF BLUE, WITH THE EARTH'S LANDMASSES DEPICTED IN DARK BLUE. AN ARROW MADE OF STARS ENCIRCLES THE GLOBE, WHICH IS IN SHADES OF YELLOW AND GOLD, WITH DARKER GOLD STARS APPEARING IN SHADOW.

SER. NO. 77-222,641, FILED 7-5-2007.

MARK SPARACINO, EXAMINING ATTORNEY

Int. Cl.: 30

Prior U.S. Cl.: 46

United States Patent and Trademark Office

Reg. No. 3,479,198

Registered Aug. 5, 2008

**TRADEMARK
PRINCIPAL REGISTER**

hotwich

SINELLI, JEFFREY (UNITED STATES INDIVIDUAL)
1310 ELM STREET
SUITE 180
DALLAS, TX 75202

THE MARK CONSISTS OF STANDARD CHARACTERS WITHOUT CLAIM TO ANY PARTICULAR FONT, STYLE, SIZE, OR COLOR.

FOR: SANDWICHES, IN CLASS 30 (U.S. CL. 46).

SER. NO. 77-223,018, FILED 7-5-2007.

FIRST USE 12-1-2003; IN COMMERCE 12-1-2003.

BRENDAN REGAN, EXAMINING ATTORNEY

Int. Cl.: 40

Prior U.S. Cls.: 100, 103 and 106

United States Patent and Trademark Office

Reg. No. 3,479,199

Registered Aug. 5, 2008

**SERVICE MARK
PRINCIPAL REGISTER**

ElementShield

ELEMENTSHIELD (CALIFORNIA PARTNER-
SHIP)

304

4169 VIA MARINA

MARINA DEL REY, CA 90292

FOR: IMPRINTING MESSAGES ON WEARING
APPAREL, ACCESSORIES AND MUGS, IN CLASS 40
(U.S. CLS. 100, 103 AND 106).

FIRST USE 7-5-2007; IN COMMERCE 7-5-2007.

THE MARK CONSISTS OF STANDARD CHAR-
ACTERS WITHOUT CLAIM TO ANY PARTICULAR
FONT, STYLE, SIZE, OR COLOR.

SER. NO. 77-223,124, FILED 7-6-2007.

ELLEN BURNS, EXAMINING ATTORNEY

Prior U.S. Cl.: A

United States Patent and Trademark Office

Reg. No. 3,479,200

Registered Aug. 5, 2008

CERTIFICATION MARK
PRINCIPAL REGISTER



KITCHEN CABINET MANUFACTURERS ASSOCIATION (ILLINOIS CORPORATION)
1899 PRESTON WHITE DRIVE
RESTON, VA 20191

FOR: KITCHEN AND VANITY CABINETS, IN CLASS A (U.S. CL. A).

FIRST USE 10-23-2006; IN COMMERCE 10-23-2006.

OWNER OF U.S. REG. NO. 2,873,502.

NO CLAIM IS MADE TO THE EXCLUSIVE RIGHT TO USE "ENVIRONMENTAL STEWARD-

SHIP PROGRAM", APART FROM THE MARK AS SHOWN.

THE CERTIFICATION MARK, AS USED BY AUTHORIZED PERSONS, CERTIFIES THAT THE USER HAS MET THE CERTIFIERS STANDARDS FOR ENVIRONMENTAL SUSTAINABILITY IN THE MANUFACTURE OF KITCHEN AND VANITY CABINETS.

SER. NO. 77-223,459, FILED 7-6-2007.

JENNIFER MARTIN, EXAMINING ATTORNEY

Int. Cl.: 3

Prior U.S. Cls.: 1, 4, 6, 50, 51 and 52

Reg. No. 3,479,201

United States Patent and Trademark Office

Registered Aug. 5, 2008

**TRADEMARK
PRINCIPAL REGISTER**

Le Jardin Naturel

LUTEX COMPANY LIMITED (HONG KONG CORPORATION)
50 GLOUCESTER ROAD
20/F, MALAYSIA BUILDING
WANCHAI, HONG KONG

FOR: BLEACHING PREPARATIONS FOR LAUNDRY USE; CLEANING, POLISHING, SCOURING AND ABRASIVE PREPARATIONS FOR HOUSEHOLD USE; SOAPS; PERFUMERY; ESSENTIAL OILS; BATH TABLETS, BATH PEARLS, BATH SALTS, BATH CRYSTALS, BATH SOAK, NAMELY, BATH OILS, MILK BATH; BODY LOTION, HAND CREAM, NON-MEDICATED FOOT CREAM; BODY SOUFFLE, BODY MIST, BODY POLISHER, NAMELY, EXFOLIANT SCRUB GEL, EXFOLIATING FOOT SCRUB; BATH PREPARATIONS, NAMELY, BATH CREAM; GEL EYE MASKS; INCENSE; SCENTED GOODS, NAMELY, SCENTED ROCKS; SHOWER GEL, BODY WASH, BATH GEL, SHAVING

SOAP; BODY AND FACIAL SCRUBS, NAMELY, SUGAR SCRUB; TALCUM POWDER; HAIR LOTIONS; DENTIFRICES, IN CLASS 3 (U.S. CLS. 1, 4, 6, 50, 51 AND 52).

THE MARK CONSISTS OF STANDARD CHARACTERS WITHOUT CLAIM TO ANY PARTICULAR FONT, STYLE, SIZE, OR COLOR.

OWNER OF HONG KONG REG. NO. 300931950, DATED 8-9-2007, EXPIRES 8-9-2017.

THE FOREIGN WORDING IN THE MARK TRANSLATES INTO ENGLISH AS THE NATURAL GARDEN.

SER. NO. 77-223,666, FILED 7-6-2007.

JAY FLOWERS, EXAMINING ATTORNEY

Int. Cl.: 35

Prior U.S. Cls.: 100, 101 and 102

United States Patent and Trademark Office

Reg. No. 3,479,202

Registered Aug. 5, 2008

**SERVICE MARK
PRINCIPAL REGISTER**

ORIGINALS

THE COUNCIL OF INDEPENDENT RESTAURANTS OF AMERICA, D/B/A DINE ORIGINALS (ILLINOIS NON-PROFIT CORPORATION)

3500 EAST SUNRISE DRIVE
TUCSON, AZ 85718

FOR: ASSOCIATION SERVICES, NAMELY, PROMOTING THE INTERESTS OF THE RESTAURANT INDUSTRY; ADVERTISING AGENCIES, NAMELY, PROMOTING THE RESTAURANT SERVICES OF OTHERS; BUSINESS INFORMATION IN THE FIELD OF RESTAURANTS; LOBBYING SERVICES, NAMELY, PROMOTING THE INTERESTS OF RES-

TAURANTS IN THE FIELDS OF LEGISLATION AND REGULATION, IN CLASS 35 (U.S. CLS. 100, 101 AND 102).

FIRST USE 1-31-2000; IN COMMERCE 1-31-2000.

THE MARK CONSISTS OF STANDARD CHARACTERS WITHOUT CLAIM TO ANY PARTICULAR FONT, STYLE, SIZE, OR COLOR.

SER. NO. 77-223,684, FILED 7-6-2007.

ROBERT C. CLARK JR., EXAMINING ATTORNEY

Int. Cl.: 35

Prior U.S. Cls.: 100, 101 and 102

United States Patent and Trademark Office

Reg. No. 3,479,203

Registered Aug. 5, 2008

**SERVICE MARK
PRINCIPAL REGISTER**

GOTHICSTONE

MANGIA SPECIALTIES INC. (PENNSYLVANIA CORPORATION)
466 WEST VALLEY FORGE ROAD
KING OF PRUSSIA, PA 19406

FOR: WHOLESALE DISTRIBUTORSHIPS FEATURING STONE BUILDING MATERIALS, NAMELY, STONE TILES, PAVERS, PAVING STONES, POOL SURROUNDS MADE OF STONE, PATIO STONE, STONE ROOFING TILES, STONE COLUMNS, STONE BALUSTER, STONE POOL COPING, STONE TREADS, STONE HARDSCAPING MATERIALS, STONE SLABS, AND STONE COUNTERTOPS, ARCHITECTURAL ACCENTS MADE OF LIMESTONE, MARBLE, OR TRAVERTINE, BUILDING MATERIALS MADE OF LIMESTONE, MARBLE OR

TRAVERTINE, IN CLASS 35 (U.S. CLS. 100, 101 AND 102).

FIRST USE 5-1-1996; IN COMMERCE 5-1-1996.

THE MARK CONSISTS OF STANDARD CHARACTERS WITHOUT CLAIM TO ANY PARTICULAR FONT, STYLE, SIZE, OR COLOR.

THE WORDING "GOTHICSTONE" HAS NO MEANING IN A FOREIGN LANGUAGE.

SER. NO. 77-223,723, FILED 7-6-2007.

EVELYN BRADLEY, EXAMINING ATTORNEY

Int. Cl.: 31

Prior U.S. Cls.: 1 and 46

United States Patent and Trademark Office

Reg. No. 3,479,204

Registered Aug. 5, 2008

**TRADEMARK
PRINCIPAL REGISTER**

BONNIE'S GOING GREENER FOR
YOU

ALABAMA FARMERS COOPERATIVE, INC.
(ALABAMA CORPORATION)
POST OFFICE BOX 2227
DECATUR, AL 35609

FOR: LIVE PLANTS, NAMELY, VEGETABLE
PLANTS, FRUIT PLANTS AND HERB PLANTS, IN
CLASS 31 (U.S. CLS. 1 AND 46).

FIRST USE 1-0-2007; IN COMMERCE 1-0-2007.

THE MARK CONSISTS OF STANDARD CHAR-
ACTERS WITHOUT CLAIM TO ANY PARTICULAR
FONT, STYLE, SIZE, OR COLOR.

OWNER OF U.S. REG. NO. 1,097,653.

SER. NO. 77-223,839, FILED 7-6-2007.

BILL DAWE, EXAMINING ATTORNEY

Int. Cl.: 38

Prior U.S. Cls.: 100, 101 and 104

United States Patent and Trademark Office

Reg. No. 3,479,205

Registered Aug. 5, 2008

**SERVICE MARK
PRINCIPAL REGISTER**

BOOZE MAIL

RENKOO, INC. (CALIFORNIA CORPORATION)
386 MAIN STREET, FIRST FLOOR
REDWOOD CITY, CA 94063

FOR: WEB MESSAGING; WIRELESS DIGITAL
MESSAGING SERVICES; INSTANT MESSAGING
SERVICES, IN CLASS 38 (U.S. CLS. 100, 101 AND 104).

FIRST USE 6-29-2007; IN COMMERCE 6-29-2007.

THE MARK CONSISTS OF STANDARD CHAR-
ACTERS WITHOUT CLAIM TO ANY PARTICULAR
FONT, STYLE, SIZE, OR COLOR.

NO CLAIM IS MADE TO THE EXCLUSIVE
RIGHT TO USE "MAIL", APART FROM THE MARK
AS SHOWN.

SER. NO. 77-224,011, FILED 7-6-2007.

JACQUELINE A. LAVINE, EXAMINING ATTOR-
NEY

Int. Cl.: 43

Prior U.S. Cls.: 100 and 101

United States Patent and Trademark Office

Reg. No. 3,479,206

Registered Aug. 5, 2008

**SERVICE MARK
PRINCIPAL REGISTER**



FLOYD, JACK L. (UNITED STATES INDIVIDUAL)
16605 E. PALISADES BLVD. STE. #124,#152
FOUNTAIN HILLS, AZ 85268

NO CLAIM IS MADE TO THE EXCLUSIVE
RIGHT TO USE "CATERED CAMPING", APART
FROM THE MARK AS SHOWN.

FOR: CATERING, IN CLASS 43 (U.S. CLS. 100
AND 101).

SER. NO. 77-224,138, FILED 7-7-2007.

FIRST USE 4-5-2007; IN COMMERCE 6-15-2007.

LINDA ORNDORFF, EXAMINING ATTORNEY

Int. Cl.: 19

Prior U.S. Cls.: 1, 12, 33 and 50

United States Patent and Trademark Office

Reg. No. 3,479,207

Registered Aug. 5, 2008

**TRADEMARK
PRINCIPAL REGISTER**

MAXWALL

NORMENT SECURITY GROUP, INC. (DELA-
WARE CORPORATION)
3224 MOBILE HIGHWAY
MONTGOMERY, AL 36108

THE MARK CONSISTS OF STANDARD CHAR-
ACTERS WITHOUT CLAIM TO ANY PARTICULAR
FONT, STYLE, SIZE, OR COLOR.

FOR: MODULAR MEDIUM AND MAXIMUM
SECURITY CELLS AND JAIL CELLS AND SYS-
TEMS COMPRISED OF WALLS AND PANELS, IN
CLASS 19 (U.S. CLS. 1, 12, 33 AND 50).

SER. NO. 77-224,205, FILED 7-8-2007.

FIRST USE 7-25-1996; IN COMMERCE 7-25-1996.

LINDA ORNDORFF, EXAMINING ATTORNEY

Int. Cl.: 35

Prior U.S. Cls.: 100, 101 and 102

United States Patent and Trademark Office

Reg. No. 3,479,208

Registered Aug. 5, 2008

**SERVICE MARK
PRINCIPAL REGISTER**

**Central States Numismatic
Society**

CENTRAL STATES NUMISMATIC SOCIETY (IL-
LINOIS CORPORATION)

103 POWDER MILL ROAD

BELLEVILLE, IL 62223

FOR: ASSOCIATION SERVICES, NAMELY, PROMOTING THE INTERESTS OF THE NUMISMATIC COMMUNITY, IN CLASS 35 (U.S. CLS. 100, 101 AND 102).

FIRST USE 4-23-1939; IN COMMERCE 4-23-1939.

THE MARK CONSISTS OF STANDARD CHARACTERS WITHOUT CLAIM TO ANY PARTICULAR FONT, STYLE, SIZE, OR COLOR.

NO CLAIM IS MADE TO THE EXCLUSIVE RIGHT TO USE "SOCIETY", APART FROM THE MARK AS SHOWN.

SEC. 2(F).

SER. NO. 77-224,246, FILED 7-8-2007.

MICHAEL KAZAZIAN, EXAMINING ATTORNEY

Int. Cl.: 19

Prior U.S. Cls.: 1, 12, 33 and 50

United States Patent and Trademark Office

Reg. No. 3,479,209

Registered Aug. 5, 2008

**TRADEMARK
PRINCIPAL REGISTER**

GOTHICSTONE

MANGIA SPECIALTIES INC. (PENNSYLVANIA
CORPORATION)
466 WEST VALLEY FORGE ROAD
KING OF PRUSSIA, PA 19406

FOR: STONE BUILDING MATERIALS, NAMELY,
STONE TILES, PAVERS, PAVING STONES, POOL
SURROUNDS MADE OF STONE, PATIO STONE,
STONE ROOFING TILES, STONE COLUMNS,
STONE BALUSTERS, STONE POOL COPING,
STONE STAIR TREADS, STONE SLABS; ARCHI-
TECTURAL ACCENTS MADE OF LIMESTONE,

MARBLE, OR TRAVERTINE, NAMELY, COL-
UMNS, IN CLASS 19 (U.S. CLS. 1, 12, 33 AND 50).

FIRST USE 5-1-1996; IN COMMERCE 5-1-1996.

THE MARK CONSISTS OF STANDARD CHAR-
ACTERS WITHOUT CLAIM TO ANY PARTICULAR
FONT, STYLE, SIZE, OR COLOR.

SER. NO. 77-224,375, FILED 7-9-2007.

EVELYN BRADLEY, EXAMINING ATTORNEY

Int. Cl.: 9

Prior U.S. Cls.: 21, 23, 26, 36 and 38

Reg. No. 3,479,210

United States Patent and Trademark Office

Registered Aug. 5, 2008

**TRADEMARK
PRINCIPAL REGISTER**

JOOMLA!

OPEN SOURCE MATTERS, INC. (NEW YORK
NON-PROFIT CORPORATION)
17TH FLOOR
1995 BROADWAY
NEW YORK, NY 10016

FOR: DOWNLOADABLE SOFTWARE FOR THE
CREATION, INTEGRATION, PUBLICATION, MAN-
AGEMENT, AND MAINTENANCE OF CONTENT,
NAMELY, TEXT, DOCUMENTS, AUDIO, AND VI-
DEO , IN CLASS 9 (U.S. CLS. 21, 23, 26, 36 AND 38).

FIRST USE 9-15-2005; IN COMMERCE 9-15-2005.

THE MARK CONSISTS OF STANDARD CHAR-
ACTERS WITHOUT CLAIM TO ANY PARTICULAR
FONT, STYLE, SIZE, OR COLOR.

SER. NO. 77-224,536, FILED 7-9-2007.

AHSEN KHAN, EXAMINING ATTORNEY

Int. Cl.: 31

Prior U.S. Cls.: 1 and 46

United States Patent and Trademark Office

Reg. No. 3,479,211

Registered Aug. 5, 2008

TRADEMARK
PRINCIPAL REGISTER



HOLLANDIA FLOWERS, INC. (CALIFORNIA CORPORATION)
226 EAST CANON PERDIDO ST., SUITE M
C/O KOENIG & ASSOCIATES
SANTA BARBARA, CA 93101

FOR: UNPROCESSED LETTUCE; FRESH VEGETABLES; RAW VEGETABLES; UNPROCESSED VEGETABLES, IN CLASS 31 (U.S. CLS. 1 AND 46).

FIRST USE 3-7-1997; IN COMMERCE 3-7-1997.

OWNER OF U.S. REG. NOS. 2,212,020, 2,925,412 AND OTHERS.

NO CLAIM IS MADE TO THE EXCLUSIVE RIGHT TO USE "GOURMET", APART FROM THE MARK AS SHOWN.

THE COLOR(S) GREEN, ORANGE, AND BLACK IS/ARE CLAIMED AS A FEATURE OF THE MARK.

THE COLORS GREEN AND ORANGE APPEAR IN A SERIES OF CONCENTRIC OVALS; THE COLOR WHITE IN THE MARK INDICATES A TRANSPARENT AREA AND IS NOT A PART OF THE MARK; THE COLOR BLACK APPEARS IN THE CENTER OF THE MARK, IN THE WORDING "LIVE GOURMET ABSOLUTELY FRESH BECAUSE IT'S STILL ALIVE!"

SER. NO. 77-224,947, FILED 7-9-2007.

JORDAN BAKER, EXAMINING ATTORNEY

Int. Cl.: 29

Prior U.S. Cl.: 46

United States Patent and Trademark Office

Reg. No. 3,479,212

Registered Aug. 5, 2008

**TRADEMARK
PRINCIPAL REGISTER**



HACIENDA QUEILES, S.L. (SPAIN CORPORATION)
PLAZA SANCHO EL FUERTE, 1 BAJO
TUDELA (NAVARRA), SPAIN 31500

FOR: EDIBLE OILS, IN CLASS 29 (U.S. CL. 46).

FIRST USE 6-30-2001; IN COMMERCE 1-10-2002.

"THE NAME(S), PORTRAIT(S), AND/OR SIGNATURE(S) SHOWN IN THE MARK DOES NOT IDENTIFY A PARTICULAR LIVING INDIVIDUAL."

SER. NO. 77-224,956, FILED 7-9-2007.

MICHAEL KEATING, EXAMINING ATTORNEY

Int. Cl.: 35

Prior U.S. Cls.: 100, 101 and 102

United States Patent and Trademark Office

Reg. No. 3,479,213

Registered Aug. 5, 2008

**SERVICE MARK
PRINCIPAL REGISTER**

NYSUT

NEW YORK STATE UNITED TEACHERS (NEW
YORK NON-PROFIT ASSOCIATION)
800 TROY SCHENECTADY ROAD
LATHAM, NY 12110

FOR: PROVIDING LABOR RELATIONS SERVICES, NAMELY, ESTABLISHING COMMITTEES WITH UNIONS TO PROMOTE IMPROVED RELATIONS BETWEEN EMPLOYERS AND UNIONS FOR PUBLIC AND PRIVATE SCHOOL TEACHERS, COLLEGE AND UNIVERSITY FACULTY AND PROFESSIONAL STAFF, SCHOOL BUS DRIVERS, CUSTODIANS, SECRETARIES, CAFETERIA WORKERS, TEACHER ASSISTANTS AND AIDES, NURSES AND HEALTHCARE TECHNICIANS; LOBBYING SERVICES, NAMELY PROMOTING THE INTERESTS OF PUBLIC AND PRIVATE SCHOOL TEACHERS, COLLEGE AND UNIVERSITY FACUL-

TY AND PROFESSIONAL STAFF, SCHOOL BUS DRIVERS, CUSTODIANS, SECRETARIES, CAFETERIA WORKERS, TEACHER ASSISTANTS AND AIDES, NURSES AND HEALTHCARE TECHNICIANS, IN THE FIELDS OF LEGISLATION AND REGULATION, IN CLASS 35 (U.S. CLS. 100, 101 AND 102).

FIRST USE 4-13-1973; IN COMMERCE 3-24-1974.

THE MARK CONSISTS OF STANDARD CHARACTERS WITHOUT CLAIM TO ANY PARTICULAR FONT, STYLE, SIZE, OR COLOR.

SER. NO. 77-225,020, FILED 7-9-2007.

TEJBIR SINGH, EXAMINING ATTORNEY

Int. Cl.: 31

Prior U.S. Cls.: 1 and 46

United States Patent and Trademark Office

Reg. No. 3,479,214

Registered Aug. 5, 2008

**TRADEMARK
PRINCIPAL REGISTER**

Ocean Blue

HEYWARD, MARK (UNITED STATES INDIVIDUAL)
13506 SUMMERPORT VILLAGE PARKWAY
WINDERMERE, FL 34786

THE MARK CONSISTS OF STANDARD CHARACTERS WITHOUT CLAIM TO ANY PARTICULAR FONT, STYLE, SIZE, OR COLOR.

FOR: PET FOOD, IN CLASS 31 (U.S. CLS. 1 AND 46).

SER. NO. 77-225,063, FILED 7-9-2007.

FIRST USE 12-1-2002; IN COMMERCE 12-1-2002.

ELLEN B. AWRICH, EXAMINING ATTORNEY

Int. Cl.: 35

Prior U.S. Cls.: 100, 101 and 102

United States Patent and Trademark Office

Reg. No. 3,479,215

Registered Aug. 5, 2008

**SERVICE MARK
PRINCIPAL REGISTER**



VEGASEL SERVICES U.S.A. (CALIFORNIA CORPORATION)

13914 BORA BORA WAY D224

MARINA DEL REY, CA 90292

FOR: ON-LINE TALENT AGENCY SERVICES IN THE FIELD OF ENTERTAINMENT; PROVIDING AN ON-LINE SEARCHABLE DATABASE FEATURING EMPLOYMENT OPPORTUNITIES IN THE FIELD OF ENTERTAINMENT; EMPLOYMENT HIRING, RECRUITING, PLACEMENT, STAFFING AND CAREER NETWORKING SERVICES IN THE FIELD OF ENTERTAINMENT, IN CLASS 35 (U.S. CLS. 100, 101 AND 102).

FIRST USE 5-25-2007; IN COMMERCE 5-25-2007.

THE COLOR(S) BLUE, DARK BLUE, WHITE AND SILVER IS/ARE CLAIMED AS A FEATURE OF THE MARK.

THE MARK CONSISTS OF THE WORDING "21ST CENTURY ETC" CENTERED ACROSS THREE LINES IN WHITE WITH THE FIRST LETTER OF EACH WORD IN BLUE. THE THREE BALLS ARRANGED IN AN ARC ARE IN BLUE COLOR. THE STYLIZED ARROW WITH TWO CONSECUTIVE ARROWHEADS ARE IN THE COLOR SILVER. THE BACKGROUND OF THE MARK IS DARK BLUE.

SER. NO. 77-225,128, FILED 7-9-2007.

DAWN HAN, EXAMINING ATTORNEY

Int. Cl.: 37

Prior U.S. Cls.: 100, 103 and 106

United States Patent and Trademark Office

Reg. No. 3,479,216

Registered Aug. 5, 2008

**SERVICE MARK
PRINCIPAL REGISTER**



NEATWALL (NEW HAMPSHIRE LTD LIAB CO)
115 TIDEWATER FARM RD.
STRATHAM, NH 03885

FOR: INSTALLATION OF GARAGE CABINETS,
SLATWALL, SLATWALL ACCESSORIES, AND
FLOOR COATINGS, IN CLASS 37 (U.S. CLS. 100,
103 AND 106).

FIRST USE 6-4-2007; IN COMMERCE 6-4-2007.

THE COLOR(S) MAROON AND GRAY IS/ARE
CLAIMED AS A FEATURE OF THE MARK.

THE MARK CONSISTS OF THE OUTLINE OF
THE LEFT SIDE AND ROOF OF A HOUSE IS DARK
GRAY FOLLOWED BY THE WORD NEATWALLS
IN MAROON, UNDERLINED WITH A DARK GRAY
LINE.

SER. NO. 77-225,310, FILED 7-9-2007.

ALEXANDER L. POWERS, EXAMINING ATTOR-
NEY

Int. Cl.: 35

Prior U.S. Cls.: 100, 101 and 102

United States Patent and Trademark Office

Reg. No. 3,479,217

Registered Aug. 5, 2008

**SERVICE MARK
PRINCIPAL REGISTER**

TOMATOMANIA

DAIGRE, COLIN SCOTT (UNITED STATES IN-
DIVIDUAL)
137 N. LARCHMONT BLVD. #510
LOS ANGELES, CA 90004

FOR: RETAIL STORE AND ON-LINE RETAIL
STORE SERVICES FEATURING TOMATO PLANTS,
AND PRODUCTS AND SUPPLIES ASSOCIATED
WITH THE GROWING OF TOMATO PLANTS,
NAMELY, PACKAGED SOIL, CONTAINERS,
STAKES, FERTILIZERS, BOOKS, AND GIFTS, IN
CLASS 35 (U.S. CLS. 100, 101 AND 102).

FIRST USE 3-25-1995; IN COMMERCE 3-25-1995.

THE MARK CONSISTS OF STANDARD CHAR-
ACTERS WITHOUT CLAIM TO ANY PARTICULAR
FONT, STYLE, SIZE, OR COLOR.

SER. NO. 77-225,334, FILED 7-9-2007.

DAVID MURRAY, EXAMINING ATTORNEY

Int. Cl.: 36

Prior U.S. Cls.: 100, 101 and 102

United States Patent and Trademark Office

Reg. No. 3,479,218

Registered Aug. 5, 2008

**SERVICE MARK
PRINCIPAL REGISTER**

UNIVERSITY LANDING

UNIVERSITY LANDING LLC (TENNESSEE LTD
LIAB CO)
SUITE 115
7901 STRICKLAND ROAD
RALEIGH, NC 27615

FOR: APARTMENT HOUSE MANAGEMENT;
LEASING OF APARTMENTS; RENTAL OF APART-
MENTS, IN CLASS 36 (U.S. CLS. 100, 101 AND 102).

FIRST USE 12-31-2005; IN COMMERCE 12-31-2005.

THE MARK CONSISTS OF STANDARD CHAR-
ACTERS WITHOUT CLAIM TO ANY PARTICULAR
FONT, STYLE, SIZE, OR COLOR.

NO CLAIM IS MADE TO THE EXCLUSIVE
RIGHT TO USE "UNIVERSITY", APART FROM
THE MARK AS SHOWN.

SER. NO. 77-225,389, FILED 7-10-2007.

MARY ROSSMAN, EXAMINING ATTORNEY

Int. Cl.: 16

Prior U.S. Cls.: 2, 5, 22, 23, 29, 37, 38 and 50

United States Patent and Trademark Office

Reg. No. 3,479,219

Registered Aug. 5, 2008

TRADEMARK
PRINCIPAL REGISTER



MOMENTA, INC. (NEW HAMPSHIRE CORPORATION)
442 FIRST NH TURNPIKE
NORTHWOOD, NH 03261

FOR: SCRAPBOOKING PRODUCTS, NAMELY, SCRAPBOOK ALBUMS, PHOTO ALBUMS, PAPER AND CARDSTOCK, STICKERS, PRINTED OR COLORED PAPER, PRINTED OR COLORED CARDS, ART PAPER, PAPER RIBBONS, PAPER TAGS, IN CLASS 16 (U.S. CLS. 2, 5, 22, 23, 29, 37, 38 AND 50).

FIRST USE 4-1-2007; IN COMMERCE 4-1-2007.

THE COLOR(S) GREEN, BLUE, TURQUOISE AND WHITE IS/ARE CLAIMED AS A FEATURE OF THE MARK.

THE MARK CONSISTS OF THE PHRASE "IT'S EASY AS 1 2 3" ON A WHITE BACKGROUND SURROUNDED BY A TURQUOISE CIRCLE, WITH THE WORDS "IT'S EASY AS" IN BLUE LETTERS DIRECTLY ABOVE THE NUMBERS 1 2 3 (A WHITE NUMBER 1 INSIDE A SOLID GREEN CIRCLE, A WHITE NUMBER 2 INSIDE A SOLID BLUE CIRCLE, AND A WHITE NUMBER 3 INSIDE A SOLID TURQUOISE CIRCLE).

SER. NO. 77-225,980, FILED 7-10-2007.

LINDA ORNDORFF, EXAMINING ATTORNEY

Prior U.S. Cl.: 200

United States Patent and Trademark Office

Reg. No. 3,479,220

Registered Aug. 5, 2008

COLLECTIVE MEMBERSHIP
PRINCIPAL REGISTER

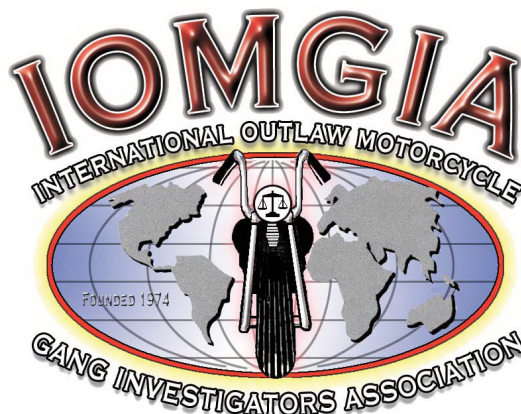

INTERNATIONAL OUTLAW MOTORCYCLE
GANG INVESTIGATORS ASSOCIATION
(NEW HAMPSHIRE CORPORATION)
C/O RATH, YOUNG AND PIGNATELLI, P.C.
ONE CAPITAL PLAZA
CONCORD, NH 033021500

FOR: INDICATING MEMBERSHIP IN AN ORGANIZATION OF LAW ENFORCEMENT PERSONS FROM VARIOUS GOVERNMENTAL ORGANIZATIONS, WHO ARE (1) SWORN LAW ENFORCEMENT PERSONS; (2) INVESTIGATIVE ANALYSTS AT LAW ENFORCEMENT AGENCIES; (3) PAROLE, PROBATION OR CORRECTIONS OFFICERS; OR (4) PROSECUTING ATTORNEYS, WHO ARE INVOLVED IN THE INVESTIGATION OF NON-TRADITIONAL ORGANIZED CRIME GROUPS, PRIMARILY OUTLAW MOTORCYCLE GANGS, IN CLASS 200 (U.S. CL. 200).

FIRST USE 4-17-2007; IN COMMERCE 4-17-2007.

NO CLAIM IS MADE TO THE EXCLUSIVE RIGHT TO USE "INTERNATIONAL OUTLAW MOTORCYCLE GANG INVESTIGATORS ASSOCIATION" AND "FOUNDED 1974", APART FROM THE MARK AS SHOWN.

THE COLOR(S) BLACK, BLUE, GREY, YELLOW, RED IS/ARE CLAIMED AS A FEATURE OF THE MARK.

THE MARK CONSISTS OF AN ELLIPTICAL GREY AND BLUE MAP OF THE GLOBE, WITH A RED AND YELLOW BORDER, WITH A BLACK MOTORCYCLE AND THE COLOR RED SURROUNDING IT SUPERIMPOSED IN THE CENTER OF THE MAP, WITH A CIRCLE CONTAINING BLACK SCALES OF JUSTICE SUPERIMPOSED BETWEEN THE HANDLEBARS OF THE MOTORCYCLE, WITH THE WORDS "INTERNATIONAL OUTLAW MOTORCYCLE" IN BLACK ABOVE THE MAP, WITH THE WORDS "GANG INVESTIGATORS ASSOCIATION" IN BLACK BELOW THE MAP, WITH THE WORDS "FOUNDED 1974" SUPERIMPOSED IN BLACK AND GREY ON THE LOWER LEFT PORTION OF THE MAP, WITH THE ACRONYM "IOMGIA" IN RED ABOVE ALL OTHER ELEMENTS OF THE MARK.

SER. NO. 77-226,033, FILED 7-10-2007.

SIMON TENG, EXAMINING ATTORNEY

Int. Cl.: 25

Prior U.S. Cls.: 22 and 39

United States Patent and Trademark Office

Reg. No. 3,479,221

Registered Aug. 5, 2008

**TRADEMARK
PRINCIPAL REGISTER**



LOVE HEALS, LLC (NEVADA LTD LIAB CO)
PO BOX 205
OJAI, CA 93024

FOR: CLOTHING, NAMELY, SHIRTS, IN CLASS
25 (U.S. CLS. 22 AND 39).

FIRST USE 3-1-2005; IN COMMERCE 12-10-2006.

OWNER OF U.S. REG. NO. 3,179,426.

THE MARK CONSISTS OF THE WORDS "LOVE
AND HEALS," IN BETWEEN THESE WORDS IS A
HEART WITH A PLANT GROWING OUT OF THE
TOP.

SER. NO. 77-226,309, FILED 7-10-2007.

SIMON TENG, EXAMINING ATTORNEY

Int. Cl.: 7

Prior U.S. Cls.: 13, 19, 21, 23, 31, 34 and 35

United States Patent and Trademark Office

Reg. No. 3,479,222

Registered Aug. 5, 2008

**TRADEMARK
PRINCIPAL REGISTER**

METHANE BUSTER

COMVEST CAPITAL, LLC (WEST VIRGINIA LTD
LIAB CO)
P.O. BOX 2025
CLARKSBURG, WV 26302

FOR: SYSTEM FOR EXTRACTION, CAPTURE,
REDUCTION, AND/OR ELIMINATION OF GREEN-
HOUSE GASES, NAMELY, METHANE AND OTHER
HYDROCARBON COMPOUNDS, COMPRISED PRI-
MARILY OF AN INDUSTRIAL ENGINE AND A
POWER OPERATED BLOWER, IN CLASS 7 (U.S.
CLS. 13, 19, 21, 23, 31, 34 AND 35).

FIRST USE 7-1-2000; IN COMMERCE 7-1-2000.

THE MARK CONSISTS OF STANDARD CHAR-
ACTERS WITHOUT CLAIM TO ANY PARTICULAR
FONT, STYLE, SIZE, OR COLOR.

NO CLAIM IS MADE TO THE EXCLUSIVE
RIGHT TO USE "METHANE", APART FROM THE
MARK AS SHOWN.

SER. NO. 77-226,679, FILED 7-11-2007.

BRIAN CALLAGHAN, EXAMINING ATTORNEY

Int. Cls.: 35, 43 and 44

Prior U.S. Cls.: 100, 101 and 102

United States Patent and Trademark Office

Reg. No. 3,479,223

Registered Aug. 5, 2008

**SERVICE MARK
PRINCIPAL REGISTER**



TAYLOR MADE SALES AGENCY, INC. (KENTUCKY CORPORATION)
2765 UNION MILL ROAD
NICHOLASVILLE, KY 40356

FOR: CONSIGNMENT SERVICES, NAMELY, PROMOTING AND MARKETING THE HORSES OF OTHERS BY ARRANGING AND CONDUCTING PUBLIC AUCTIONS, AND THROUGH PRIVATE COMMUNICATION MEANS, IN CLASS 35 (U.S. CLS. 100, 101 AND 102).

FIRST USE 1-31-1980; IN COMMERCE 1-31-1980.

FOR: BOARDING OF ANIMALS, IN CLASS 43 (U.S. CLS. 100 AND 101).

FIRST USE 1-31-1980; IN COMMERCE 1-31-1980.

FOR: HORSE FARM SERVICES; HORSE BREEDING AND STUD SERVICES, IN CLASS 44 (U.S. CLS. 100 AND 101).

FIRST USE 1-31-1980; IN COMMERCE 1-31-1980.

OWNER OF U.S. REG. NOS. 2,393,233, 2,688,928 AND OTHERS.

THE MARK CONSISTS OF A SILHOUETTE OF A RIDING CAP AND CROP AND THE WORDS "TAYLOR MADE" WITHIN A CIRCLE SURROUNDED BY THE WORDS "MAY PROSPERITY LIE IN THIS TRANSACTION" WITHIN AN OUTER CIRCLE.

SER. NO. 77-226,704, FILED 7-11-2007.

JASON BLAIR, EXAMINING ATTORNEY

Int. Cl.: 9

Prior U.S. Cls.: 21, 23, 26, 36 and 38

Reg. No. 3,479,224

United States Patent and Trademark Office

Registered Aug. 5, 2008

**TRADEMARK
PRINCIPAL REGISTER**

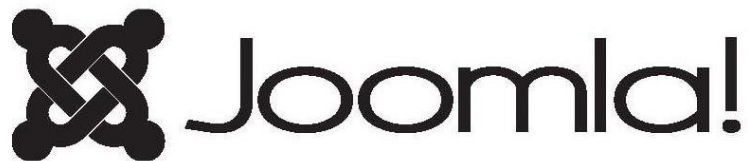

OPEN SOURCE MATTERS, INC. (NEW YORK
NON-PROFIT CORPORATION)
17TH FLOOR
1995 BROADWAY
NEW YORK, NY 10016

FOR: DOWNLOADABLE SOFTWARE FOR THE
CREATION, INTEGRATION, PUBLICATION, MAN-
AGEMENT, AND MAINTENANCE OF CONTENT,
NAMELY, TEXT, DOCUMENTS, AUDIO, AND VI-
DEO , IN CLASS 9 (U.S. CLS. 21, 23, 26, 36 AND 38).

FIRST USE 9-15-2005; IN COMMERCE 9-15-2005.

THE MARK CONSISTS OF A DESIGN CONSIST-
ING OF FOUR "J'S" ROTATED AND LINKED
TOGETHER NEXT TO THE WORD "JOOMLA!".

SER. NO. 77-226,768, FILED 7-11-2007.

AHSEN KHAN, EXAMINING ATTORNEY

Int. Cls.: 29 and 30

Prior U.S. Cl.: 46

United States Patent and Trademark Office

Reg. No. 3,479,225

Registered Aug. 5, 2008

TRADEMARK
PRINCIPAL REGISTER



JEFFERSON, B. RUSSELL, JR. (UNITED STATES
INDIVIDUAL)

426 RAMBLE

HOT SPRINGS, AR 71901

FOR: GUMBO, IN CLASS 29 (U.S. CL. 46).

FIRST USE 10-26-1984; IN COMMERCE 10-26-1984.

FOR: SALSA, IN CLASS 30 (U.S. CL. 46).

FIRST USE 1-1-2006; IN COMMERCE 1-1-2006.

OWNER OF U.S. REG. NO. 1,440,749.

NO CLAIM IS MADE TO THE EXCLUSIVE
RIGHT TO USE "SHRIMP OYSTER", APART FROM
THE MARK AS SHOWN.

THE MARK CONSISTS OF THE DESIGN POR-
TION OF THE MARK COMPRISES A REPRESEN-
TATION OF A MERMAID, THE WORDS "SHRIMP,
OYSTER & BEERHAUS", AND A REPRESENTA-
TION OF A TOP-HATTED MAN.

"THE FOREIGN WORDING IN THE MARK
TRANSLATES INTO ENGLISH AS HOUSE."

SER. NO. 77-226,792, FILED 7-11-2007.

STEVEN JACKSON, EXAMINING ATTORNEY

Int. Cl.: 9

Prior U.S. Cls.: 21, 23, 26, 36 and 38

Reg. No. 3,479,226

United States Patent and Trademark Office

Registered Aug. 5, 2008

**TRADEMARK
PRINCIPAL REGISTER**

POWERHOUSE

EATON CORPORATION (OHIO CORPORATION)
1111 SUPERIOR AVENUE
CLEVELAND, OH 44114

FIRST USE 3-31-1997; IN COMMERCE 3-31-1997.

FOR: ELECTRICAL DISTRIBUTION SYSTEMS
FOR RECREATIONAL VEHICLES CONSISTING
OF POWER DISTRIBUTION PANELS, ELECTRICAL
SWITCHES, TELECOMMUNICATIONS CABLES,
AND ELECTRICAL POWER CONNECTORS , IN
CLASS 9 (U.S. CLS. 21, 23, 26, 36 AND 38).

THE MARK CONSISTS OF STANDARD CHAR-
ACTERS WITHOUT CLAIM TO ANY PARTICULAR
FONT, STYLE, SIZE, OR COLOR.

SER. NO. 77-226,955, FILED 7-11-2007.

TEJBIR SINGH, EXAMINING ATTORNEY

Int. Cl.: 35

Prior U.S. Cls.: 100, 101 and 102

United States Patent and Trademark Office

Reg. No. 3,479,227

Registered Aug. 5, 2008

**SERVICE MARK
PRINCIPAL REGISTER**

SPOTZER

SPOTZER MEDIA GROUP B.V. (NETHERLANDS
LTD LIAB CO)
DE LAIRESSETRAAT 180
1075 HM AMSTERDAM, NETHERLANDS

FOR: ADVERTISING SERVICES, PROMOTIONAL
SERVICES, MARKETING SERVICES, COMMERCIAL
INFORMATION SERVICES, PUBLIC RELATION
SERVICES, NAMELY, PROMOTING AND
MARKETING THE GOODS AND SERVICES OF
OTHERS, AND RELATED CONSULTING SERVICES
FOR ADVERTISING, PROMOTING AND MARKET-
ING; ALL AFORE MENTIONED SERVICES ALSO
BY TRANSMISSION ON-LINE FOR THIRD PART-
IES THROUGH INTERNET AND OTHER ELEC-
TRONIC COMMUNICATIONS NETWORKS;

PROVIDING AND RENTAL OF ADVERTISING
SPACE ON THE INTERNET; PROVIDING SPACE
ON WEB-SITES FOR THE ADVERTISING OF
GOODS AND SERVICES OF OTHERS, IN CLASS 35
(U.S. CLS. 100, 101 AND 102).

FIRST USE 6-1-2006; IN COMMERCE 6-1-2006.

THE MARK CONSISTS OF STANDARD CHAR-
ACTERS WITHOUT CLAIM TO ANY PARTICULAR
FONT, STYLE, SIZE, OR COLOR.

SER. NO. 77-227,179, FILED 7-11-2007.

DAVID COLLIER, EXAMINING ATTORNEY

Int. Cl.: 12

Prior U.S. Cls.: 19, 21, 23, 31, 35 and 44

United States Patent and Trademark Office

Reg. No. 3,479,228

Registered Aug. 5, 2008

**TRADEMARK
PRINCIPAL REGISTER**

TWIN N QUIK

CLUTCH AUTO LIMITED (INDIA COMPANY)
E/14, FIRST FLOOR, JHANDEWALAN EXTENSION
NEW DELHI - 110 055, INDIA

THE MARK CONSISTS OF STANDARD CHAR-
ACTERS WITHOUT CLAIM TO ANY PARTICULAR
FONT, STYLE, SIZE, OR COLOR.

FOR: AUTOMOBILE CLUTCHES AND PARTS
THEREOF, IN CLASS 12 (U.S. CLS. 19, 21, 23, 31, 35
AND 44).

SER. NO. 77-227,349, FILED 7-11-2007.

FIRST USE 6-0-2007; IN COMMERCE 6-0-2007.

RENEE MCCRAY, EXAMINING ATTORNEY

Int. Cl.: 7

Prior U.S. Cls.: 13, 19, 21, 23, 31, 34 and 35

Reg. No. 3,479,229

United States Patent and Trademark Office

Registered Aug. 5, 2008

**TRADEMARK
PRINCIPAL REGISTER**

TOTE-ON-TOTE

SEALED AIR CORPORATION (US) (DELAWARE CORPORATION)
200 RIVERFRONT BOULEVARD
ELMWOOD PARK, NJ 07407

FOR: COMPONENT TRANSFER SYSTEM, NAMELY, A SYSTEM COMPRISED OF A CONTROL PANEL, PUMPS, VALVES, SENSORS AND FILTER, TO AUTOMATICALLY TRANSFER AND DISPENSE POLYURETHANE FOAM PRECURSOR CHEMICALS FROM A REPLACEABLE SUPPLY CONTAINER TO A STATIONARY SUPPLY CONTAINER THROUGH TRANSFER HOSES AND VALVES, FOR USE WITH POLYURETHANE FOAM SPRAY-

ING APPARATUS FOR IN-PLACE PACKAGING OF MERCHANDISE, IN CLASS 7 (U.S. CLS. 13, 19, 21, 23, 31, 34 AND 35).

FIRST USE 3-24-2004; IN COMMERCE 3-24-2004.

THE MARK CONSISTS OF STANDARD CHARACTERS WITHOUT CLAIM TO ANY PARTICULAR FONT, STYLE, SIZE, OR COLOR.

SER. NO. 77-227,400, FILED 7-11-2007.

JOHN DWYER, EXAMINING ATTORNEY

Int. Cl.: 9

Prior U.S. Cls.: 21, 23, 26, 36 and 38

Reg. No. 3,479,230

United States Patent and Trademark Office

Registered Aug. 5, 2008

**TRADEMARK
PRINCIPAL REGISTER**

COPS

DATATRAC CORPORATION (DELAWARE CORPORATION)
SUITE 200
200 HANNOVER PARK ROAD
SANDY SPRINGS, GA 30350

FOR: COMPUTER SOFTWARE, NAMELY, A FULL-FEATURED, CUSTOMIZABLE DELIVERY MANAGEMENT BUSINESS SOFTWARE APPLICATION FOR THE PROFESSIONAL COURIER, DELIVERY AND MESSENGER INDUSTRIES FOR USE IN PROVIDING ORDER ENTRY AND DISPATCHES FOR PACKAGES, CREATING AND SENDING INVOICES, PROCESSING PAYMENTS AND RECORDING ACCOUNTS RECEIVABLE AND ACCOUNTS PAYABLE, AND INTERFACING WITH ALPHANU-

MERIC/NUMERIC PAGING AND WIRELESS DATA COMMUNICATIONS DEVICES, IN CLASS 9 (U.S. CLS. 21, 23, 26, 36 AND 38).

FIRST USE 10-15-1984; IN COMMERCE 10-15-1984.

THE MARK CONSISTS OF STANDARD CHARACTERS WITHOUT CLAIM TO ANY PARTICULAR FONT, STYLE, SIZE, OR COLOR.

OWNER OF U.S. REG. NO. 2,331,603.

SER. NO. 77-227,464, FILED 7-11-2007.

KATHY DE JONGE, EXAMINING ATTORNEY

Int. Cl.: 30

Prior U.S. Cl.: 46

United States Patent and Trademark Office

Reg. No. 3,479,231

Registered Aug. 5, 2008

TRADEMARK
PRINCIPAL REGISTER



BERRY, ALI (UNITED STATES INDIVIDUAL)
21 OAKHURST STREET
DORCHESTER CENTER, MA 02124

FOR: BROWNIES; CAKES; COOKIES; PIES, IN
CLASS 30 (U.S. CL. 46).

FIRST USE 12-1-2004; IN COMMERCE 12-1-2004.

THE LIKENESS (OR, "PORTRAIT") IN THE
MARK IDENTIFIES A LIVING INDIVIDUAL
WHOSE CONSENT IS OF RECORD.

THE MARK CONSISTS OF A PICTURE OR POR-
TRAIT HEAD SHOT OF AN AFRICAN-AMERICAN
WOMAN SMILING. SHE IS WEARING A HEAD
SCARF ON HER HEAD. SHE IS ENCLOSED IN A
CIRCLE OR OVAL. WITHIN THIS OVAL IS A
BACKDROP CONSISTING OF CURTAINS. DIRECT-
LY ABOVE HER HEAD IS A BANNER WITH A
TRIM. ON THIS BANNER ARE THE WORDS:
"SISTER NADINE'S".

SER. NO. 77-227,546, FILED 7-11-2007.

ANDREA BUTLER, EXAMINING ATTORNEY

Int. Cl.: 8

Prior U.S. Cls.: 23, 28 and 44

United States Patent and Trademark Office

Reg. No. 3,479,232

Registered Aug. 5, 2008

**TRADEMARK
PRINCIPAL REGISTER**

The Franklin Bender

FRANKLIN TOOL SYSTEMS, INC. (CALIFORNIA CORPORATION)
10196 CLOVER RANCH DR.
SACRAMENTO, CA 95829

FOR: ADJUSTABLE ARTICULATING JOINT PERMITTING MULTIDIRECTIONAL POSITIONING OF A HAND TOOL, IN CLASS 8 (U.S. CLS. 23, 28 AND 44).

FIRST USE 8-31-2001; IN COMMERCE 10-8-2001.

THE MARK CONSISTS OF STANDARD CHARACTERS WITHOUT CLAIM TO ANY PARTICULAR FONT, STYLE, SIZE, OR COLOR.

NO CLAIM IS MADE TO THE EXCLUSIVE RIGHT TO USE "BENDER", APART FROM THE MARK AS SHOWN.

SER. NO. 77-227,661, FILED 7-12-2007.

ELLEN BURNS, EXAMINING ATTORNEY

Int. Cl.: 3

Prior U.S. Cls.: 1, 4, 6, 50, 51 and 52

Reg. No. 3,479,233

United States Patent and Trademark Office

Registered Aug. 5, 2008

TRADEMARK
PRINCIPAL REGISTER



The logo features the word "Triumph" in a large, bold, serif font. The letter "i" is stylized to resemble a human figure with arms raised in a "V" shape. Below "Triumph" is the word "PHARMACEUTICALS" in a smaller, all-caps, spaced-out serif font.

Triumph
P H A R M A C E U T I C A L S

TRIUMPH PHARMACEUTICALS INC. (COLOR-
ADO CORPORATION)

10403 BAUR BLVD., SUITE A

ST. LOUIS, MO 63132

FOR: NON-MEDICATED MOUTH RINSE,
TOOTHPASTE, BREATH-FRESHENING BREATH
MINTS AND BREATH-FRESHENING GUM, IN
CLASS 3 (U.S. CLS. 1, 4, 6, 50, 51 AND 52).

FIRST USE 1-15-2005; IN COMMERCE 2-15-2005.

NO CLAIM IS MADE TO THE EXCLUSIVE
RIGHT TO USE "PHARMACEUTICALS", APART
FROM THE MARK AS SHOWN.

THE MARK CONSISTS OF THE WORD "TRI-
UMPH" IN STYLIZED FORM WHICH INCLUDES A
STYLIZED HUMAN BODY AS THE "I", AND THE
WORD "PHARMACEUTICALS" IN STANDARD
CHARACTERS.

SER. NO. 77-228,205, FILED 7-12-2007.

DAVID TOOLEY, EXAMINING ATTORNEY

Int. Cl.: 9

Prior U.S. Cls.: 21, 23, 26, 36 and 38

Reg. No. 3,479,234

United States Patent and Trademark Office

Registered Aug. 5, 2008

**TRADEMARK
PRINCIPAL REGISTER**



WOWZATV LLC (CALIFORNIA LTD LIAB CO),
DBA WOWZA MEDIA SYSTEMS
5655 SILVER CREEK VALLEY ROAD, #435
SAN JOSE, CA 95138

FOR: COMPUTER SOFTWARE FOR USE IN
SENDING AND RECEIVING MEDIA OVER THE
INTERNET, INCLUDING VIDEO, AUDIO AND
DATA, IN CLASS 9 (U.S. CLS. 21, 23, 26, 36 AND 38).

FIRST USE 10-31-2006; IN COMMERCE 10-31-2006.

THE COLOR(S) WHITE, COPPER AND GRAY IS/
ARE CLAIMED AS A FEATURE OF THE MARK.

THE MARK CONSISTS OF A CIRCLE CONTAIN-
ING A WHITE LETTER "W", A COPPER TOP POR-
TION AND A GRAY BOTTOM PORTION.

SER. NO. 77-228,211, FILED 7-12-2007.

JANICE L. MCMORROW, EXAMINING ATTOR-
NEY

Int. Cl.: 15

Prior U.S. Cls.: 2, 21 and 36

United States Patent and Trademark Office

Reg. No. 3,479,235

Registered Aug. 5, 2008

**TRADEMARK
PRINCIPAL REGISTER**

GUY LAURENT

SHAR PRODUCTS COMPANY (MICHIGAN CORPORATION)
2465 S. INDUSTRIAL
ANN ARBOR, MI 48104

FOR: BOWS FOR MUSICAL INSTRUMENTS, IN CLASS 15 (U.S. CLS. 2, 21 AND 36).

FIRST USE 3-10-2005; IN COMMERCE 3-31-2005.

THE MARK CONSISTS OF STANDARD CHARACTERS WITHOUT CLAIM TO ANY PARTICULAR FONT, STYLE, SIZE, OR COLOR.

"GUY LAURENT" DOES NOT IDENTIFY A LIVING INDIVIDUAL.

SER. NO. 77-228,302, FILED 7-12-2007.

STEVEN R. FOSTER, EXAMINING ATTORNEY

Int. Cls.: 35, 39 and 40

Prior U.S. Cls.: 100, 101, 102, 103, 105 and 106

United States Patent and Trademark Office

Reg. No. 3,479,236

Registered Aug. 5, 2008

**SERVICE MARK
PRINCIPAL REGISTER**

SUN RUN ELECTRICITY

SUN RUN GENERATION LLC (CALIFORNIA
LTD LIAB CO)
SUITE 1160
180 MONTGOMERY STREET
SAN FRANCISCO, CA 94104

FOR: MANAGEMENT RELATING TO THE
USAGE OF SOLAR ELECTRICITY, NAMELY, PRO-
VIDING RENEWABLE ENERGY SOLUTIONS TO
CUSTOMERS AND ASSISTING IN THE MANAGE-
MENT OF ENERGY PRICES AND SUSTAINABIL-
ITY INITIATIVES FOR THE PURPOSES OF
MANAGING ENERGY USAGE; CONSULTATION
IN THE FIELD OF SOLAR ENERGY USAGE MAN-
AGEMENT, IN CLASS 35 (U.S. CLS. 100, 101 AND
102).

FIRST USE 1-0-2007; IN COMMERCE 1-0-2007.

FOR: DISTRIBUTION AND SUPPLY OF SOLAR
ELECTRICITY; CONSULTATION RELATING TO
THE DISTRIBUTION AND SUPPLY OF SOLAR
ELECTRICITY, IN CLASS 39 (U.S. CLS. 100 AND 105).

FIRST USE 1-0-2007; IN COMMERCE 1-0-2007.

FOR: OPERATING AND MAINTAINING RE-
NEWABLE ENERGY SYSTEMS, NAMELY, GEN-
ERATION OF SOLAR ELECTRICITY;
CONSULTATION IN THE FIELD OF GENERATION
OF SOLAR ELECTRICITY, IN CLASS 40 (U.S. CLS.
100, 103 AND 106).

FIRST USE 1-0-2007; IN COMMERCE 1-0-2007.

THE MARK CONSISTS OF STANDARD CHAR-
ACTERS WITHOUT CLAIM TO ANY PARTICULAR
FONT, STYLE, SIZE, OR COLOR.

NO CLAIM IS MADE TO THE EXCLUSIVE
RIGHT TO USE "ELECTRICITY", APART FROM
THE MARK AS SHOWN.

SER. NO. 77-229,058, FILED 7-13-2007.

MICHAEL KEATING, EXAMINING ATTORNEY

Int. Cl.: 25

Prior U.S. Cls.: 22 and 39

United States Patent and Trademark Office

Reg. No. 3,479,237

Registered Aug. 5, 2008

**TRADEMARK
PRINCIPAL REGISTER**

WEAR

CONSCIOUS CLOTHING



WEAR INCORPORATED (CALIFORNIA CORPORATION)
347 MYRTLE STREET
LAGUNA BEACH, CA 92651

FOR: CLOTHING, NAMELY, T-SHIRTS, POLO SHIRTS, WOVEN SHORT-SLEEVED SHIRTS, KNIT SHORT-SLEEVED SHIRTS, KNIT LONG-SLEEVED T-SHIRTS, HOODED SWEAT SHIRTS, JEANS, TOPS, BOTTOMS, UNDERGARMENTS, BRAS, SOCKS, SCARVES, GLOVES, HATS, HEADWEAR, AND FOOTWEAR, IN CLASS 25 (U.S. CLS. 22 AND 39).

FIRST USE 6-14-2007; IN COMMERCE 6-14-2007.

NO CLAIM IS MADE TO THE EXCLUSIVE RIGHT TO USE "WEAR" AND "CLOTHING", APART FROM THE MARK AS SHOWN.

THE MARK CONSISTS OF THE WORDS "WEAR" CONSCIOUS CLOTHING IN A STYLIZED TEXT.

SER. NO. 77-229,230, FILED 7-13-2007.

CHARLES L. JENKINS, EXAMINING ATTORNEY

Int. Cls.: 7, 9, 37 and 42

**Prior U.S. Cls.: 13, 19, 21, 23, 26, 31, 34, 35, 36, 38,
100, 101, 103 and 106**

Reg. No. 3,479,238

United States Patent and Trademark Office

Registered Aug. 5, 2008

**TRADEMARK
SERVICE MARK
PRINCIPAL REGISTER**

ALKAPPLY

CITIZEN HOLDINGS KABUSHIKI KAISHA (JAPAN CORPORATION), TA CITIZEN HOLDINGS CO., LTD.
1-12, 6-CHOME, TANASHI-CHO
NISHI-TOKYO-SHI, TOKYO, JAPAN

FOR: NUMERICALLY CONTROLLED LATHES, NUMERICALLY CONTROLLED GRINDING MACHINES, NUMERICALLY CONTROLLED MILLING MACHINES, METAL WORKING MACHINES, NAMELY, MACHINING CENTERS AND TURNING CENTERS, IN CLASS 7 (U.S. CLS. 13, 19, 21, 23, 31, 34 AND 35).

FOR: COMPUTER SOFTWARE AND PROVIDING TEMPORARY USE OF DOWNLOADABLE SOFTWARE, FOR USE IN THE MAINTENANCE, DIAGNOSIS, OR REPAIR OF MACHINE TOOLS AND NUMERICALLY CONTROLLED MACHINE TOOLS; COMPUTER SOFTWARE FOR PERFORMING MACHINING BY NUMERICALLY CONTROLLED MACHINE TOOLS; COMPUTER SOFTWARE FOR EDITING MACHINING PROGRAMS OF NUMERICALLY CONTROLLED MACHINE TOOLS, IN CLASS 9 (U.S. CLS. 21, 23, 26, 36 AND 38).

FOR: MAINTENANCE AND REPAIR OF MACHINE TOOLS AND NUMERICALLY CONTROLLED MACHINE TOOLS, IN CLASS 37 (U.S. CLS. 100, 103 AND 106).

FOR: UPDATING OF COMPUTER SOFTWARE; COMPUTER SOFTWARE DESIGN FOR OTHERS; REMOTE MONITORING OF THE COMPUTER SYSTEMS OF OTHERS FOR TECHNICAL PURPOSES AND PROVIDING BACK-UP COMPUTER PROGRAMS AND FACILITIES; REMOTE DIAGNOSIS OF COMPUTER SYSTEMS; RENTAL OF COMPUTER SOFTWARE CONCERNING MACHINING OPERATIONS; COMPUTER SERVICES, NAMELY, PROVIDING INFORMATION CONCERNING DESIGN OR MAINTENANCE OF COMPUTER SOFTWARE FOR USE IN THE MAINTENANCE, DIAGNOSIS OR REPAIR OF MACHINE TOOLS AND NUMERICALLY CONTROLLED MACHINES, IN CLASS 42 (U.S. CLS. 100 AND 101).

THE MARK CONSISTS OF STANDARD CHARACTERS WITHOUT CLAIM TO ANY PARTICULAR FONT, STYLE, SIZE, OR COLOR.

OWNER OF JAPAN REG. NO. 5056406, DATED 6-22-2007, EXPIRES 6-22-2017.

THE TERM "ALKAPPLY" HAS NO MEANING IN A FOREIGN LANGUAGE.

SER. NO. 77-229,302, FILED 7-13-2007.

ELISSA GARBER KON, EXAMINING ATTORNEY

Int. Cls.: 7 and 9

Prior U.S. Cls.: 13, 19, 21, 23, 26, 31, 34, 35, 36 and 38

United States Patent and Trademark Office

Reg. No. 3,479,239

Registered Aug. 5, 2008

**TRADEMARK
PRINCIPAL REGISTER**

ALKARTPRO

CITIZEN HOLDINGS KABUSHIKI KAISHA, (JAPAN CORPORATION), TA CITIZEN HOLDINGS CO., LTD.
1-12, 6-CHOME, TANASHI-CHO
NISHI-TOKYO-SHI, TOKYO, JAPAN

FOR: NUMERICALLY CONTROLLED LATHES; NUMERICALLY CONTROLLED GRINDING MACHINES; NUMERICALLY CONTROLLED MILLING MACHINES, MACHINING CENTERS AND TURNING CENTERS, IN CLASS 7 (U.S. CLS. 13, 19, 21, 23, 31, 34 AND 35).

FOR: COMPUTER SOFTWARE FOR USE IN THE MAINTENANCE, DIAGNOSIS, OR REPAIR OF MACHINE TOOLS AND NUMERICALLY CONTROLLED MACHINE TOOLS; COMPUTER SOFTWARE FOR PERFORMING MACHINING BY NUMERICALLY CONTROLLED MACHINE TOOLS; COMPUTER SOFTWARE FOR EDITING MACHINING PROGRAMS OF NUMERICALLY CONTROLLED

MACHINE TOOLS, IN CLASS 9 (U.S. CLS. 21, 23, 26, 36 AND 38).

THE MARK CONSISTS OF STANDARD CHARACTERS WITHOUT CLAIM TO ANY PARTICULAR FONT, STYLE, SIZE, OR COLOR.

OWNER OF JAPAN REG. NO. 5055153, DATED 6-15-2007, EXPIRES 6-15-2017.

THE TERMS "ALK" OR "ALKART" OR "ALKARTPRO" HAVE NO KNOWN SIGNIFICANCE IN THE RELEVANT TRADE, NO KNOWN GEOGRAPHICAL SIGNIFICANCE, AND NO KNOWN MEANING IN A FOREIGN LANGUAGE.

SER. NO. 77-229,325, FILED 7-13-2007.

ELISSA GARBER KON, EXAMINING ATTORNEY

Int. Cl.: 32

Prior U.S. Cls.: 45, 46 and 48

United States Patent and Trademark Office

Reg. No. 3,479,240

Registered Aug. 5, 2008

**TRADEMARK
PRINCIPAL REGISTER**

JW Dundee's IPA

HIGH FALLS BREWING COMPANY, LLC (NEW
YORK LTD LIAB CO)
445 ST. PAUL STREET
ROCHESTER, NY 14605

FOR: BEER, IN CLASS 32 (U.S. CLS. 45, 46 AND 48).

FIRST USE 8-0-2006; IN COMMERCE 8-0-2006.

THE MARK CONSISTS OF STANDARD CHAR-
ACTERS WITHOUT CLAIM TO ANY PARTICULAR
FONT, STYLE, SIZE, OR COLOR.

OWNER OF U.S. REG. NOS. 3,062,676, 3,167,959
AND OTHERS.

NO CLAIM IS MADE TO THE EXCLUSIVE
RIGHT TO USE "IPA", APART FROM THE MARK
AS SHOWN.

THE NAME(S), PORTRAIT(S), AND/OR SIGNA-
TURE(S) SHOWN IN THE MARK DOES NOT IDENT-
TIFY A PARTICULAR LIVING INDIVIDUAL.

SER. NO. 77-229,442, FILED 7-13-2007.

ELLEN B. AWRICH, EXAMINING ATTORNEY

Int. Cl.: 32

Prior U.S. Cls.: 45, 46 and 48

United States Patent and Trademark Office

Reg. No. 3,479,241

Registered Aug. 5, 2008

**TRADEMARK
PRINCIPAL REGISTER**

JW Dundee's HEFE Weizen

HIGH FALLS BREWING COMPANY, LLC (NEW
YORK LTD LIAB CO)
445 ST. PAUL STREET
ROCHESTER, NY 14605

FOR: BEER, IN CLASS 32 (U.S. CLS. 45, 46 AND 48).

FIRST USE 5-0-2006; IN COMMERCE 5-0-2006.

THE MARK CONSISTS OF STANDARD CHAR-
ACTERS WITHOUT CLAIM TO ANY PARTICULAR
FONT, STYLE, SIZE, OR COLOR.

OWNER OF U.S. REG. NOS. 3,062,676, 3,167,959
AND OTHERS.

NO CLAIM IS MADE TO THE EXCLUSIVE
RIGHT TO USE "HEFE WEIZEN", APART FROM
THE MARK AS SHOWN.

THE NAME(S), PORTRAIT(S), AND/OR SIGNA-
TURE(S) SHOWN IN THE MARK DOES NOT IDENTI-
FY A PARTICULAR LIVING INDIVIDUAL.

THE FOREIGN WORDING IN THE MARK
TRANSLATES INTO ENGLISH AS "YEAST
WHEAT".

SER. NO. 77-229,460, FILED 7-13-2007.

ELLEN B. AWRICH, EXAMINING ATTORNEY

Int. Cl.: 35

Prior U.S. Cls.: 100, 101 and 102

United States Patent and Trademark Office

Reg. No. 3,479,242

Registered Aug. 5, 2008

**SERVICE MARK
PRINCIPAL REGISTER**

FRASER

ISCO INDUSTRIES, LLC (KENTUCKY LTD LIAB
CO)
924 BAXTER AVENUE
LOUISVILLE, KY 40204

FOR: DISTRIBUTORSHIP SERVICES IN THE
FIELD OF MINING EQUIPMENT AND INDUS-
TRIAL EQUIPMENT, NAMELY, LANDFILL, POW-
ER AND UTILITY EQUIPMENT, IN CLASS 35 (U.S.
CLS. 100, 101 AND 102).

FIRST USE 12-31-1983; IN COMMERCE 12-31-1983.

THE MARK CONSISTS OF STANDARD CHAR-
ACTERS WITHOUT CLAIM TO ANY PARTICULAR
FONT, STYLE, SIZE, OR COLOR.

SEC. 2(F).

SER. NO. 77-229,486, FILED 7-13-2007.

CHRISTOPHER BUONGIORNO, EXAMINING AT-
TORNEY

Int. Cl.: 35

Prior U.S. Cls.: 100, 101 and 102

Reg. No. 3,479,243

United States Patent and Trademark Office

Registered Aug. 5, 2008

SERVICE MARK
PRINCIPAL REGISTER



ISCO INDUSTRIES, LLC (KENTUCKY LTD LIAB
CO)
924 BAXTER AVENUE
LOUISVILLE, KY 40202

FOR: DISTRIBUTORSHIP SERVICES IN THE
FIELD OF MINING EQUIPMENT AND INDUS-
TRIAL EQUIPMENT, NAMELY, LANDFILL, POW-
ER AND UTILITY EQUIPMENT, IN CLASS 35 (U.S.
CLS. 100, 101 AND 102).

FIRST USE 12-31-1983; IN COMMERCE 12-31-1983.

NO CLAIM IS MADE TO THE EXCLUSIVE
RIGHT TO USE "MINING & INDUSTRIAL SUP-
PLY", APART FROM THE MARK AS SHOWN.

THE MARK CONSISTS OF THE WORD
"MINING" AND AN AMPERSAND IN STYLIZED
LETTERS, APPEARING OVER THE WORDS "IN-
DUSTRIAL SUPPLY" IN STYLIZED LETTERS,
WHICH APPEAR BETWEEN TWO LINES, AND
ALL APPEARING OVER THE WORD "FRASER"
IN STYLIZED LETTERS OVER A DESIGN FEATU-
RING THE STATE OF TEXAS AND A CROSSED
HAMMER AND SHOVEL.

SER. NO. 77-229,509, FILED 7-13-2007.

CHRISTOPHER BUONGIORNO, EXAMINING AT-
TORNEY

Int. Cl.: 44

Prior U.S. Cls.: 100 and 101

United States Patent and Trademark Office

Reg. No. 3,479,244

Registered Aug. 5, 2008

**SERVICE MARK
PRINCIPAL REGISTER**

QiScan

JACKSON, GLORIA M (UNITED STATES INDIVIDUAL)
508 ARLINGTON DRIVE
RIO VISTA, CA 94571

FOR: PROVIDING WELLNESS SERVICES, NAMELY, PERSONAL ASSESSMENTS, PERSONALIZED ROUTINES, MAINTENANCE SCHEDULES, AND COUNSELING, IN CLASS 44 (U.S. CLS. 100 AND 101).

FIRST USE 10-14-2006; IN COMMERCE 11-1-2006.

THE MARK CONSISTS OF STANDARD CHARACTERS WITHOUT CLAIM TO ANY PARTICULAR FONT, STYLE, SIZE, OR COLOR.

SER. NO. 77-229,721, FILED 7-13-2007.

LINDA LAVACHE, EXAMINING ATTORNEY

Int. Cl.: 32

Prior U.S. Cls.: 45, 46 and 48

United States Patent and Trademark Office

Reg. No. 3,479,245

Registered Aug. 5, 2008

**TRADEMARK
PRINCIPAL REGISTER**

JW Dundee's PALE BOCK

HIGH FALLS BREWING COMPANY, LLC (NEW
YORK LTD LIAB CO)
445 ST. PAUL STREET
ROCHESTER, NY 14605

FOR: BEER, IN CLASS 32 (U.S. CLS. 45, 46 AND 48).

FIRST USE 1-0-2006; IN COMMERCE 1-0-2006.

THE MARK CONSISTS OF STANDARD CHAR-
ACTERS WITHOUT CLAIM TO ANY PARTICULAR
FONT, STYLE, SIZE, OR COLOR.

OWNER OF U.S. REG. NOS. 3,062,676, 3,167,959
AND OTHERS.

NO CLAIM IS MADE TO THE EXCLUSIVE
RIGHT TO USE "PALE BOCK", APART FROM
THE MARK AS SHOWN.

THE NAME(S), PORTRAIT(S), AND/OR SIGNA-
TURE(S) SHOWN IN THE MARK DOES NOT IDEN-
TIFY A PARTICULAR LIVING INDIVIDUAL.

SER. NO. 77-229,806, FILED 7-14-2007.

ELLEN B. AWRICH, EXAMINING ATTORNEY

Int. Cl.: 32

Prior U.S. Cls.: 45, 46 and 48

United States Patent and Trademark Office

Reg. No. 3,479,246

Registered Aug. 5, 2008

**TRADEMARK
PRINCIPAL REGISTER**

JW Dundee's FESTIVE ALE

HIGH FALLS BREWING COMPANY, LLC (NEW
YORK LTD LIAB CO)
445 ST. PAUL STREET
ROCHESTER, NY 14605

FOR: BEER, IN CLASS 32 (U.S. CLS. 45, 46 AND 48).

FIRST USE 10-0-2005; IN COMMERCE 10-0-2005.

THE MARK CONSISTS OF STANDARD CHAR-
ACTERS WITHOUT CLAIM TO ANY PARTICULAR
FONT, STYLE, SIZE, OR COLOR.

OWNER OF U.S. REG. NOS. 3,062,676, 3,167,959
AND OTHERS.

NO CLAIM IS MADE TO THE EXCLUSIVE
RIGHT TO USE "FESTIVE ALE", APART FROM
THE MARK AS SHOWN.

THE NAME(S), PORTRAIT(S), AND/OR SIGNA-
TURE(S) SHOWN IN THE MARK DOES NOT IDENT-
TIFY A PARTICULAR LIVING INDIVIDUAL.

SER. NO. 77-229,808, FILED 7-14-2007.

ELLEN B. AWRICH, EXAMINING ATTORNEY

Int. Cls.: 35 and 44

Prior U.S. Cls.: 100, 101 and 102

United States Patent and Trademark Office

Reg. No. 3,479,247

Registered Aug. 5, 2008

**SERVICE MARK
PRINCIPAL REGISTER**

Warwick Gardens

JENNIFER A WARDELL (NEW YORK PART-
NERSHIP), DBA WARWICK GARDENS
29 FOLEY RD
WARWICK, NY 10990

FOR: RETAIL LAWN, GARDEN AND NURSERY
STORES, IN CLASS 35 (U.S. CLS. 100, 101 AND 102).

FIRST USE 5-1-2005; IN COMMERCE 5-21-2005.

FOR: GARDEN TREE PLANTING; PLANT
BREEDING; PLANT CARE SERVICES; PLANT
NURSERIES; RENTAL OF POTTED PLANTS; GAR-
DEN CARE SERVICES; GARDEN OR FLOWER BED
CARE; GARDENER AND GARDENING SERVICES;
LANDSCAPE GARDENING; LANDSCAPE GAR-
DENING DESIGN FOR OTHERS; HORTICULTUR-

AL SERVICES; TREE NURSERIES, IN CLASS 44 (U.S.
CLS. 100 AND 101).

FIRST USE 5-1-2005; IN COMMERCE 5-21-2005.

THE MARK CONSISTS OF STANDARD CHAR-
ACTERS WITHOUT CLAIM TO ANY PARTICULAR
FONT, STYLE, SIZE, OR COLOR.

NO CLAIM IS MADE TO THE EXCLUSIVE
RIGHT TO USE "GARDENS", APART FROM THE
MARK AS SHOWN.

SER. NO. 77-230,021, FILED 7-15-2007.

KAREN BRACEY, EXAMINING ATTORNEY

Int. Cl.: 40

Prior U.S. Cls.: 100, 103 and 106

United States Patent and Trademark Office

Reg. No. 3,479,248

Registered Aug. 5, 2008

**SERVICE MARK
PRINCIPAL REGISTER**



RIVER METALS RECYCLING LLC (CAYMAN ISLANDS LTD LIAB CO)
2136 CHAMBER CENTER DRIVE
FORT MITCHELL, KY 41017

FOR: TREATMENT OF METAL, IN CLASS 40 (U.S. CLS. 100, 103 AND 106).

FIRST USE 8-1-1998; IN COMMERCE 8-1-1998.

NO CLAIM IS MADE TO THE EXCLUSIVE RIGHT TO USE "METALS RECYCLING LLC", APART FROM THE MARK AS SHOWN.

THE COLOR(S) BLUE, WHITE, TAN AND BLUE-GRAY IS/ARE CLAIMED AS A FEATURE OF THE MARK.

THE MARK CONSISTS OF TWO STYLIZED WHITE "R"'S INSIDE A BLUE "M" WITH "RIVER METALS RECYCLING LLC" TO THE RIGHT IN TAN AND TWO SQUIGGLY LINES REPRESENTING WATER BELOW IN BLUE-GRAY.

SER. NO. 77-230,167, FILED 7-16-2007.

PRISCILLA MILTON, EXAMINING ATTORNEY

Int. Cl.: 36

Prior U.S. Cls.: 100, 101 and 102

United States Patent and Trademark Office

Reg. No. 3,479,249

Registered Aug. 5, 2008

**SERVICE MARK
PRINCIPAL REGISTER**

SELL THAT REAL ESTATE

TAHOE UNITED MANAGEMENT, INC. (NEVADA CORPORATION)
2764 LAKE SAHARA DRIVE
LAS VEGAS, NV 89117

FOR: REAL ESTATE BROKERAGE SERVICES; ACQUISITION SERVICES FOR REAL ESTATE INVESTORS; MORTGAGE INFORMATION SERVICES; PURCHASE AND SALE OF RESIDENTIAL MORTGAGES FOR OTHERS; PURCHASE AND SALE OF RESIDENTIAL REAL ESTATE, NAMELY, REAL ESTATE ACQUISITION, REAL ESTATE AGENCIES SERVICES AND REAL ESTATE BROKERAGE; AND CONSULTING SERVICES IN THE FIELD OF REAL ESTATE INVESTMENT, MORTGAGE LENDING AND IN PREVENTING

REAL ESTATE FORECLOSURE, IN CLASS 36 (U.S. CLS. 100, 101 AND 102).

FIRST USE 12-0-2007; IN COMMERCE 12-0-2007.

THE MARK CONSISTS OF STANDARD CHARACTERS WITHOUT CLAIM TO ANY PARTICULAR FONT, STYLE, SIZE, OR COLOR.

NO CLAIM IS MADE TO THE EXCLUSIVE RIGHT TO USE "REAL ESTATE", APART FROM THE MARK AS SHOWN.

SER. NO. 77-230,354, FILED 7-16-2007.

FRANK LATTUCA, EXAMINING ATTORNEY

Int. Cl.: 9

Prior U.S. Cls.: 21, 23, 26, 36 and 38

United States Patent and Trademark Office

Reg. No. 3,479,250

Registered Aug. 5, 2008

**TRADEMARK
PRINCIPAL REGISTER**

STEERINGWHEELS

AUTODESK, INC. (DELAWARE CORPORATION)
111 MCINNIS PARKWAY
SAN RAFAEL, CA 94903

FOR: GRAPHICAL USER INTERFACE SOFTWARE, IN CLASS 9 (U.S. CLS. 21, 23, 26, 36 AND 38).

FIRST USE 3-25-2008; IN COMMERCE 3-25-2008.

THE MARK CONSISTS OF STANDARD CHARACTERS WITHOUT CLAIM TO ANY PARTICULAR FONT, STYLE, SIZE, OR COLOR.

SER. NO. 77-230,385, FILED 7-16-2007.

THEODORE MCBRIDE, EXAMINING ATTORNEY

Int. Cl.: 30

Prior U.S. Cl.: 46

United States Patent and Trademark Office

Reg. No. 3,479,251

Registered Aug. 5, 2008

**TRADEMARK
PRINCIPAL REGISTER**

BHUTANESE RED RICE

CHHARU TSHONGDEL (BHUTAN CORPORATION)
P. O. BOX 1231
BONDEY, PARO, BHUTAN

NO CLAIM IS MADE TO THE EXCLUSIVE
RIGHT TO USE "RED RICE", APART FROM THE
MARK AS SHOWN.

FOR: WHOLE GRAIN RED RICE, IN CLASS 30
(U.S. CL. 46).

SEC. 2(F).

FIRST USE 11-0-1994; IN COMMERCE 12-0-1994.

SER. NO. 77-230,412, FILED 7-16-2007.

THE MARK CONSISTS OF STANDARD CHARACTERS
WITHOUT CLAIM TO ANY PARTICULAR
FONT, STYLE, SIZE, OR COLOR.

DANNEAN HETZEL, EXAMINING ATTORNEY

Int. Cls.: 9, 16 and 41

**Prior U.S. Cls.: 2, 5, 21, 22, 23, 26, 29, 36, 37, 38, 50,
100, 101 and 107**

Reg. No. 3,479,252

United States Patent and Trademark Office

Registered Aug. 5, 2008

**TRADEMARK
SERVICE MARK
PRINCIPAL REGISTER**

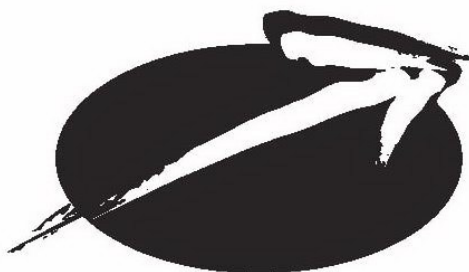

CENTER FOR LEADERSHIP IN SCHOOL RE-
FORM INC. (KENTUCKY CORPORATION),
DBA D/B/A THE SCHLECHTY CENTER
SUITE 200
950 BRECKENRIDGE LANE
LOUISVILLE, KY 40207

FOR: ELECTRONIC PUBLICATIONS RECORDED ON COMPUTER MEDIA AND DOWNLOADABLE ELECTRONIC PUBLICATIONS IN THE NATURE OF BOOKS, HANDBOOKS, WORKBOOKS, TRAINING MANUALS, TRAINING PAMPHLETS AND SEMINAR PAPERS IN THE FIELDS OF EDUCATION, SCHOOL REFORM AND ENGAGEMENT OF STUDENTS, IN CLASS 9 (U.S. CLS. 21, 23, 26, 36 AND 38).

FIRST USE 7-1-2004; IN COMMERCE 7-1-2004.

FOR: BOOKS, HANDBOOKS, WORKBOOKS, TRAINING PAMPHLETS, TRAINING MANUALS, AND PRINTED SEMINAR PAPERS IN THE FIELDS OF EDUCATION, SCHOOL REFORM, AND ENGAGEMENT OF STUDENTS, IN CLASS 16 (U.S. CLS. 2, 5, 22, 23, 29, 37, 38 AND 50).

FIRST USE 7-1-2004; IN COMMERCE 7-1-2004.

FOR: EDUCATIONAL SERVICES, NAMELY, PROVIDING PROFESSIONAL DEVELOPMENT COURSES AND TRAINING SERVICES FOR TEACHERS, EDUCATIONAL LEADERS AND SCHOOL ADMINISTRATORS IN THE FIELD OF EDUCATIONAL AND SCHOOL REFORM; ARRANGING AND CONDUCTING EDUCATIONAL CONFERENCES AND EDUCATIONAL DEMONSTRATIONS; EDUCATIONAL AND ENTERTAINMENT SERVICES, NAMELY, PROVIDING MOTIVATIONAL AND EDUCATIONAL SPEAKERS; EDUCATIONAL RESEARCH; EDUCATIONAL SERVICES, NAMELY, DEVELOPING CURRICULUM FOR OTHERS IN THE FIELDS OF K-12 COURSES, STAFF DEVELOPMENT AND STRUCTURAL SCHOOL REFORM, IN CLASS 41 (U.S. CLS. 100, 101 AND 107).

FIRST USE 7-1-2004; IN COMMERCE 7-1-2004.

THE MARK CONSISTS OF AN ARROW SUPERIMPOSED FROM LEFT TO RIGHT ACROSS AN OVAL.

SER. NO. 77-230,513, FILED 7-16-2007.

IRA J. GOODSaid, EXAMINING ATTORNEY

Int. Cl.: 35

Prior U.S. Cls.: 100, 101 and 102

United States Patent and Trademark Office

Reg. No. 3,479,253

Registered Aug. 5, 2008

**SERVICE MARK
PRINCIPAL REGISTER**

PRACTICEHELP

HEALTH CARE EXCEL, INCORPORATED (DE-
LAWARE CORPORATION)
SUITE 200
2629 WATERFRONT PARKWAY EAST DRIVE
INDIANAPOLIS, IN 46214

FOR: ASSESSMENT OF PHYSICIAN OFFICE
BUSINESS OPERATIONS AND PROCEDURES,
NAMELY, APPOINTMENT SCHEDULING AND
FORMAT AND COMPLETENESS OF PATIENT RE-
CORDS, IN CLASS 35 (U.S. CLS. 100, 101 AND 102).

FIRST USE 11-0-2005; IN COMMERCE 11-0-2005.

THE MARK CONSISTS OF STANDARD CHAR-
ACTERS WITHOUT CLAIM TO ANY PARTICULAR
FONT, STYLE, SIZE, OR COLOR.

SER. NO. 77-230,739, FILED 7-16-2007.

MIDGE BUTLER, EXAMINING ATTORNEY

Int. Cl.: 5

Prior U.S. Cls.: 6, 18, 44, 46, 51 and 52

Reg. No. 3,479,254

United States Patent and Trademark Office

Registered Aug. 5, 2008

**TRADEMARK
PRINCIPAL REGISTER**

ISOSENTIAL

INDOMITUS ASSET MANAGEMENT, L.L.C.
(PENNSYLVANIA LTD LIAB CO)
1579 JACK DRIVE
NORTH HUNTINGDON, PA 15642

THE MARK CONSISTS OF STANDARD CHAR-
ACTERS WITHOUT CLAIM TO ANY PARTICULAR
FONT, STYLE, SIZE, OR COLOR.

FOR: DIETARY SUPPLEMENTS, IN CLASS 5 (U.S.
CLS. 6, 18, 44, 46, 51 AND 52).

SER. NO. 77-230,918, FILED 7-16-2007.

FIRST USE 2-2-2007; IN COMMERCE 6-19-2007.

KAREN SEVERSON, EXAMINING ATTORNEY

Int. Cl.: 5

Prior U.S. Cls.: 6, 18, 44, 46, 51 and 52

United States Patent and Trademark Office

Reg. No. 3,479,255

Registered Aug. 5, 2008

**TRADEMARK
PRINCIPAL REGISTER**

BIFIDOBLEND

AMERICAN LIFELINE, INC (WISCONSIN CORPORATION)
138 1ST ST.
BARABOO, WI 53913

FOR: DIETARY AND NUTRITIONAL SUPPLEMENTS, IN CLASS 5 (U.S. CLS. 6, 18, 44, 46, 51 AND 52).

FIRST USE 2-18-1994; IN COMMERCE 2-18-1994.

THE MARK CONSISTS OF STANDARD CHARACTERS WITHOUT CLAIM TO ANY PARTICULAR FONT, STYLE, SIZE, OR COLOR.

SEC. 2(F).

SER. NO. 77-230,967, FILED 7-16-2007.

MARY MUNSON, EXAMINING ATTORNEY

Int. Cls.: 20, 24 and 35

Prior U.S. Cls.: 2, 13, 22, 25, 32, 42, 50, 100, 101 and 102

Reg. No. 3,479,256

United States Patent and Trademark Office

Registered Aug. 5, 2008

**TRADEMARK
SERVICE MARK
PRINCIPAL REGISTER**

BECAUSE CHILDREN GROW

FLEXA GROUP A/S (DENMARK CORPORATION)
HORNSYLD INDUSTRIVEJ 4
8783 HORNSYLD, DENMARK

FOR: FURNITURE; FURNITURE, NAMELY, CHILDREN'S FURNITURE; MATTRESSES, PILLOWS, BOXES OF WOOD FOR TOYS, COATHOOKS NOT OF METAL, IN CLASS 20 (U.S. CLS. 2, 13, 22, 25, 32 AND 50).

FIRST USE 1-0-1997; IN COMMERCE 7-0-1999.

FOR: TEXTILES AND TEXTILE GOODS, NAMELY, BED LINEN, EIDERDOWNS, TEXTILES IN THE FORM OF CURTAINS AND CANOPIES FOR BEDS, IN CLASS 24 (U.S. CLS. 42 AND 50).

FIRST USE 1-0-1997; IN COMMERCE 7-0-1999.

FOR: WHOLESALE AND RETAIL SERVICES, NAMELY, WHOLESALE DISTRIBUTORSHIPS, WHOLESALE ORDERING SERVICES, WHOLESALE STORES, RETAIL STORES, RETAIL SHOPS, ONLINE RETAIL ORDERING SERVICES, ALL FEATURING FURNITURE AND PARTS THEREFOR; RETAIL STORES AND RETAIL DEPARTMENT STORES FEATURING FURNITURE AND A WIDE VARIETY OF CONSUMER GOODS OF OTHERS, IN CLASS 35 (U.S. CLS. 100, 101 AND 102).

FIRST USE 1-0-1997; IN COMMERCE 7-0-1999.

THE MARK CONSISTS OF STANDARD CHARACTERS WITHOUT CLAIM TO ANY PARTICULAR FONT, STYLE, SIZE, OR COLOR.

SER. NO. 77-231,098, FILED 7-17-2007.

JOHN DALIER, EXAMINING ATTORNEY

Int. Cl.: 29

Prior U.S. Cl.: 46

United States Patent and Trademark Office

Reg. No. 3,479,257

Registered Aug. 5, 2008

**TRADEMARK
PRINCIPAL REGISTER**



AJ & R WORLDWIDE GROUP, INC. (FLORIDA CORPORATION)
901 BRICKELL KEY BOULEVARD, SUITE 2303
MIAMI, FL 33131

FOR: TOMATO PASTE, IN CLASS 29 (U.S. CL. 46).

FIRST USE 2-1-2006; IN COMMERCE 2-1-2006.

NO CLAIM IS MADE TO THE EXCLUSIVE RIGHT TO USE THE REPRESENTATION OF THE TOMATO FRUITS AND "TOMATO PASTE", APART FROM THE MARK AS SHOWN.

THE COLOR(S) RED, GREEN, BLACK, WHITE AND GRAY IS/ARE CLAIMED AS A FEATURE OF THE MARK.

THE MARK CONSISTS OF TWO RED TOMATOES WITH GRAY SHADING AND GREEN STEMS TO THE LEFT OF THE PARTIAL RECTANGLE WITH CURVED CORNERS IN BLACK, WITH A WHITE BACKGROUND, CONTAINING THE WORDING, "TOMA" IN BLACK, WITH THE WORDING "TOMATO PASTE" BELOW IN BLACK.

THE WORDING "TOMA" HAS NO MEANING IN A FOREIGN LANGUAGE.

SER. NO. 77-231,108, FILED 7-17-2007.

ODESSA BIBBINS, EXAMINING ATTORNEY

Int. Cl.: 30

Prior U.S. Cl.: 46

United States Patent and Trademark Office

Reg. No. 3,479,258

Registered Aug. 5, 2008

**TRADEMARK
PRINCIPAL REGISTER**

CinnaYumz

RICHMOND FOODS GROUP, INC. (NEW YORK
CORPORATION)
570 PACKETT'S LANDING
FAIRPORT, NY 14450

THE MARK CONSISTS OF STANDARD CHAR-
ACTERS WITHOUT CLAIM TO ANY PARTICULAR
FONT, STYLE, SIZE, OR COLOR.

FOR: FROZEN DOUGH FOR BREADSTICKS
SOLD IN BULK, IN CLASS 30 (U.S. CL. 46).

SER. NO. 77-231,122, FILED 7-17-2007.

FIRST USE 7-8-2007; IN COMMERCE 7-8-2007.

JOHN WILKE, EXAMINING ATTORNEY

Int. Cl.: 45

Prior U.S. Cls.: 100 and 101

United States Patent and Trademark Office

Reg. No. 3,479,259

Registered Aug. 5, 2008

**SERVICE MARK
PRINCIPAL REGISTER**

Teens For Christ

LIMALAND TEENS FOR CHRIST, INC. (OHIO CORPORATION), DBA TEENS FOR CHRIST
1550 ELIDA ROAD
LIMA, OH 458051509

FOR: RELIGIOUS AND SPIRITUAL SERVICES, NAMELY, PROVIDING GATHERINGS AND RETREATS TO DEVELOP AND ENHANCE THE SPIRITUAL LIVES OF INDIVIDUALS , IN CLASS 45 (U.S. CLS. 100 AND 101).

FIRST USE 11-13-1980; IN COMMERCE 7-10-1989.

THE MARK CONSISTS OF STANDARD CHARACTERS WITHOUT CLAIM TO ANY PARTICULAR FONT, STYLE, SIZE, OR COLOR.

NO CLAIM IS MADE TO THE EXCLUSIVE RIGHT TO USE "TEENS", APART FROM THE MARK AS SHOWN.

SER. NO. 77-231,320, FILED 7-17-2007.

ESTHER A. BORSUK, EXAMINING ATTORNEY

Int. Cl.: 28

Prior U.S. Cls.: 22, 23, 38 and 50

United States Patent and Trademark Office

Reg. No. 3,479,260

Registered Aug. 5, 2008

**TRADEMARK
PRINCIPAL REGISTER**

BIOCONNECT

NAUTILUS, INC. (WASHINGTON CORPORATION)
16400 SE NAUTILUS DRIVE
VANCOUVER, WA 98683

FOR: EXERCISE MACHINES; EXERCISE EQUIPMENT, NAMELY, MANUALLY-OPERATED EXERCISE EQUIPMENT; EXERCISE MACHINES INCORPORATING ELECTRONIC CONSOLES FEATURING ELECTRONIC CONTROLLERS, IN CLASS 28 (U.S. CLS. 22, 23, 38 AND 50).

FIRST USE 12-12-2006; IN COMMERCE 12-12-2006.

THE MARK CONSISTS OF STANDARD CHARACTERS WITHOUT CLAIM TO ANY PARTICULAR FONT, STYLE, SIZE, OR COLOR.

SER. NO. 77-231,536, FILED 7-17-2007.

LESLIE RICHARDS, EXAMINING ATTORNEY

Int. Cl.: 41

Prior U.S. Cls.: 100, 101 and 107

United States Patent and Trademark Office

Reg. No. 3,479,261

Registered Aug. 5, 2008

**SERVICE MARK
PRINCIPAL REGISTER**

CARLOW UNIVERSITY

CARLOW UNIVERSITY (PENNSYLVANIA CORPORATION)
3333 FIFTH AVENUE
PITTSBURGH, PA 15213

FOR: EDUCATIONAL SERVICES, NAMELY, PROVIDING COURSES OF INSTRUCTION AT THE COLLEGE LEVEL AND DISTRIBUTION OF COURSE MATERIAL IN CONNECTION THEREWITH; EDUCATING AT UNIVERSITY OR COLLEGES; EDUCATION SERVICES IN THE NATURE OF COURSES AT THE UNIVERSITY LEVEL, IN CLASS 41 (U.S. CLS. 100, 101 AND 107).

FIRST USE 7-20-2004; IN COMMERCE 7-20-2004.

THE MARK CONSISTS OF STANDARD CHARACTERS WITHOUT CLAIM TO ANY PARTICULAR FONT, STYLE, SIZE, OR COLOR.

OWNER OF U.S. REG. NO. 3,193,799.

NO CLAIM IS MADE TO THE EXCLUSIVE RIGHT TO USE "UNIVERSITY", APART FROM THE MARK AS SHOWN.

SEC. 2(F) AS TO "CARLOW".

SER. NO. 77-231,729, FILED 7-17-2007.

JENNIFER MARTIN, EXAMINING ATTORNEY

Int. Cl.: 41

Prior U.S. Cls.: 100, 101 and 107

United States Patent and Trademark Office

Reg. No. 3,479,262

Registered Aug. 5, 2008

**SERVICE MARK
PRINCIPAL REGISTER**

CARLOW

CARLOW UNIVERSITY (PENNSYLVANIA CORPORATION)
3333 FIFTH AVENUE
PITTSBURGH, PA 15213

FOR: EDUCATIONAL SERVICES, NAMELY, PROVIDING COURSES OF INSTRUCTION AT THE COLLEGE LEVEL; EDUCATING AT UNIVERSITY OR COLLEGES; EDUCATION SERVICES IN THE NATURE OF COURSES AT THE UNIVERSITY LEVEL, IN CLASS 41 (U.S. CLS. 100, 101 AND 107).

FIRST USE 12-31-1969; IN COMMERCE 12-31-1969.

THE MARK CONSISTS OF STANDARD CHARACTERS WITHOUT CLAIM TO ANY PARTICULAR FONT, STYLE, SIZE, OR COLOR.

OWNER OF U.S. REG. NO. 3,193,799.

SEC. 2(F).

SER. NO. 77-231,747, FILED 7-17-2007.

BARBARA GAYNOR, EXAMINING ATTORNEY

Int. Cl.: 41

Prior U.S. Cls.: 100, 101 and 107

Reg. No. 3,479,263

United States Patent and Trademark Office

Registered Aug. 5, 2008

**SERVICE MARK
PRINCIPAL REGISTER**



COUNCIL ON EDUCATION IN MANAGEMENT,
INC. (CALIFORNIA CORPORATION)
OAKHILL BUSINESS PARK
1338 HUNDRED OAKS DRIVE
CHARLOTTE, NC 28217

FOR: EDUCATIONAL SERVICES, NAMELY,
CONDUCTING TRAINING SESSIONS, SEMINARS
AND CONFERENCES IN THE FIELD OF HUMAN
RESOURCES MANAGEMENT AND EMPLOY-
MENT LAW AND DISTRIBUTING COURSE MATE-
RIALS IN CONNECTION THEREWITH, IN CLASS
41 (U.S. CLS. 100, 101 AND 107).

FIRST USE 8-0-2000; IN COMMERCE 8-0-2000.

OWNER OF U.S. REG. NOS. 2,080,411 AND
2,082,633.

NO CLAIM IS MADE TO THE EXCLUSIVE
RIGHT TO USE "EDUCATION IN MANAGEMENT",
APART FROM THE MARK AS SHOWN.

SEC. 2(F).

SER. NO. 77-231,919, FILED 7-17-2007.

AMY HELLA, EXAMINING ATTORNEY

Int. Cl.: 42

Prior U.S. Cls.: 100 and 101

United States Patent and Trademark Office

Reg. No. 3,479,264

Registered Aug. 5, 2008

**SERVICE MARK
PRINCIPAL REGISTER**

**PACE ANALYTICAL LIFE
SCIENCES**

PACE ANALYTICAL SERVICES, INC. (MINNE-
SOTA CORPORATION)
SUITE 200
1700 ELM STREET
MINNEAPOLIS, MN 55414

FOR: PROVIDING LABORATORY ANALYTICAL
CHEMISTRY TESTING AND MICROBIOLOGY
TESTING SERVICES TO THE PHARMACEUTICAL
AND MEDICAL DEVICE INDUSTRIES, TO CHEMI-
CAL COMPANIES AND TO MANUFACTURERS, IN
CLASS 42 (U.S. CLS. 100 AND 101).

FIRST USE 10-0-2006; IN COMMERCE 10-0-2006.

THE MARK CONSISTS OF STANDARD CHAR-
ACTERS WITHOUT CLAIM TO ANY PARTICULAR
FONT, STYLE, SIZE, OR COLOR.

OWNER OF U.S. REG. NOS. 1,517,650, 1,519,396,
AND 2,370,194.

NO CLAIM IS MADE TO THE EXCLUSIVE
RIGHT TO USE "ANALYTICAL LIFE SCIENCES",
APART FROM THE MARK AS SHOWN.

SER. NO. 77-231,935, FILED 7-17-2007.

TARAH HARDY, EXAMINING ATTORNEY

Int. Cl.: 35

Prior U.S. Cls.: 100, 101 and 102

United States Patent and Trademark Office

Reg. No. 3,479,265

Registered Aug. 5, 2008

**SERVICE MARK
PRINCIPAL REGISTER**



BRADLEY-MORRIS, INC. (GEORGIA CORPORATION)
1825 BARRETT LAKES BLVD., SUITE 300
KENNESAW, GA 30144

FOR: JOB AND PERSONNEL PLACEMENT, IN CLASS 35 (U.S. CLS. 100, 101 AND 102).

FIRST USE 8-1-1991; IN COMMERCE 8-1-1991.

NO CLAIM IS MADE TO THE EXCLUSIVE RIGHT TO USE "INC.", APART FROM THE MARK AS SHOWN.

THE COLOR(S) BLUE AND GOLD IS/ARE CLAIMED AS A FEATURE OF THE MARK.

THE MARK CONSISTS OF A BIRD DESIGN AND WORDS ABOVE AND BELOW A LINE TO THE RIGHT OF THE BIRD DESIGN. THE COLOR GOLD APPEARS IN THE BODY OF THE BIRD AND IN THE SECOND HORIZONTAL LINE BETWEEN THE LITERAL ELEMENTS OF THE MARK; THE COLOR BLUE APPEARS AS AN OUTLINE TO THE BIRD DESIGN AND IN THE WORDING "BRADLEY-MORRIS, INC." AND "DELIVERING MILITARY-EXPERIENCED TALENT TO AMERICA'S TOP COMPANIES".

SER. NO. 77-232,344, FILED 7-18-2007.

JORDAN BAKER, EXAMINING ATTORNEY

Int. Cls.: 20 and 25

Prior U.S. Cls.: 2, 13, 22, 25, 32, 39 and 50

United States Patent and Trademark Office

Reg. No. 3,479,266

Registered Aug. 5, 2008

**TRADEMARK
PRINCIPAL REGISTER**

Naked Longboards

NAKED LONGBOARDS, LLC (CALIFORNIA
LTD LIAB CO)
209 SETON HALL AVE
VENTURA, CA 93003

FOR: FURNITURE; FURNITURE CHESTS; FURNITURE FOR DISPLAYING GOODS; FURNITURE FOR HOUSE, OFFICE AND GARDEN; FURNITURE FRAMES; FURNITURE, NAMELY, DISPLAY UNITS; FURNITURE, NAMELY, DRESSERS; FURNITURE, NAMELY, SALES AND DISPLAY COUNTERS; FURNITURE, NAMELY, WALL UNITS; KITCHEN FURNITURE, NAMELY, READY TO ASSEMBLE MOBILE KITCHEN ISLANDS; LIVING ROOM FURNITURE; MIRRORS; OFFICE FURNITURE; SEATING FURNITURE; SEATS; TABLES; TOY BOXES, IN CLASS 20 (U.S. CLS. 2, 13, 22, 25, 32 AND 50).

FIRST USE 7-10-2006; IN COMMERCE 12-3-2006.

FOR: CAPS; CHILDREN'S AND INFANTS' CLOTH BIBS; CHILDREN'S CLOTH EATING BIBS; CLOTH BIBS; HOODS; INFANT AND TODDLER ONE PIECE CLOTHING; JERSEYS; HEAD WEAR; INFANT WEAR; SPORT COATS; SPORT SHIRTS; SPORTS JACKETS; SPORTS JERSEYS; SPORTS SHIRTS; SPORTS SHIRTS WITH SHORT SLEEVES;

SURF WEAR; SWIM WEAR; SWIM WEAR FOR GENTLEMEN AND LADIES; TENNIS WEAR; TOPS; BERMUDA SHORTS; BOARD SHORTS; BOXER SHORTS; FLEECE SHORTS; GYM SHORTS; PANTIES, SHORTS AND BRIEFS; SHORT-SLEEVED OR LONG-SLEEVED T-SHIRTS; SHORT-SLEEVED SHIRTS; SHORTS; SWEAT SHORTS; WALKING SHORTS; CAPRI PANTS; CARGO PANTS; DENIMS; JOGGING PANTS; PANTS; SNOWBOARD PANTS; SWEAT PANTS; WATERPROOF JACKETS AND PANTS; SWIMWEAR; A-SHIRTS; BUTTON-FRONT ALOHA SHIRTS; CAMP SHIRTS; DRESS SHIRTS; GOLF SHIRTS; HEADBANDS AGAINST SWEATING; KNIT SHIRTS; OPEN-NECKED SHIRTS; POLO SHIRTS; SHIRT FRONTS; SHIRTS; T-SHIRTS, IN CLASS 25 (U.S. CLS. 22 AND 39).

FIRST USE 7-10-2006; IN COMMERCE 12-3-2006.

THE MARK CONSISTS OF STANDARD CHARACTERS WITHOUT CLAIM TO ANY PARTICULAR FONT, STYLE, SIZE, OR COLOR.

SER. NO. 77-232,381, FILED 7-18-2007.

LINDA E. BLOHM, EXAMINING ATTORNEY

Int. Cl.: 41

Prior U.S. Cls.: 100, 101 and 107

Reg. No. 3,479,267

United States Patent and Trademark Office

Registered Aug. 5, 2008

SERVICE MARK
PRINCIPAL REGISTER

MMA Today

GOFISH CORPORATION (NEVADA CORPORATION)
500 THIRD STREET SUITE 260
SAN FRANCISCO, CA 94107

FOR: ENTERTAINMENT SERVICES NAMELY PROVIDING A WEBSITE FEATURING, PHOTOGRAPHIC, AUDIO, VIDEO AND PROSE PRESENTATIONS FEATURING INFORMATION, NEWS AND INSTRUCTION IN THE FIELD OF THE SYSTEMIZATION OF FIGHTING TECHNIQUES CONSISTING OF COMBAT SKILLS, FITNESS, SELF-DEFENSE, SPORT, SELF-CULTIVATION/MEDITATION, MENTAL DISCIPLINE, CHARACTER DEVELOPMENT AND BUILDING CONFIDENCE; ENTERTAINMENT NAMELY, PRODUCTION OF LIVE-ACTION, COMEDY, DRAMA AND REALITY-BASED WEB SERIES; ENTERTAINMENT SERVICES, NAMELY, PROVIDING A TELEVISION PROGRAM FEATURING INFORMATION, NEWS AND INSTRUCTION IN THE FIELD OF THE SYSTEMIZATION OF FIGHTING TECHNIQUES CONSISTING OF COMBAT SKILLS, FITNESS, SELF-DEFENSE, SPORT, SELF-CULTIVATION/MEDITATION, MENTAL DISCIPLINE, CHARACTER DEVELOPMENT AND BUILDING CONFIDENCE VIA A GLOBAL COMPUTER NETWORK; ENTERTAINMENT SERVICES, NAMELY, PROVIDING A WEB SITE FEATURING MUSICAL PERFORMANCES, MUSICAL VIDEOS, RELATED FILM CLIPS, PHOTOGRAPHS, AND OTHER MULTIMEDIA MATERIALS; ENTERTAINMENT SERVICES, NAMELY, PROVIDING PODCASTS FEATURING INFORMATION, NEWS AND INSTRUCTION IN THE FIELD OF THE SYSTEMIZATION OF FIGHTING TECHNIQUES CONSISTING OF COMBAT SKILLS, FITNESS, SELF-DEFENSE, SPORT, SELF-CULTIVATION/MEDITATION, MENTAL DISCIPLINE, CHARACTER DEVELOPMENT AND BUILDING CONFIDENCE; ENTERTAINMENT SERVICES, NAMELY, PROVIDING WEBCASTS FEATURING INFORMATION, NEWS AND INSTRUCTION IN THE FIELD

OF THE SYSTEMIZATION OF FIGHTING TECHNIQUES CONSISTING OF COMBAT SKILLS, FITNESS, SELF-DEFENSE, SPORT, SELF-CULTIVATION/MEDITATION, MENTAL DISCIPLINE, CHARACTER DEVELOPMENT AND BUILDING CONFIDENCE; ENTERTAINMENT, NAMELY A CONTINUING LIVE-ACTION, COMEDY, DRAMA AND REALITY-BASED WEB SHOW BROADCAST OVER TELEVISION, SATELLITE, AUDIO, AND VIDEO MEDIA; PROVIDING A WEB SITE WHERE USERS CAN POST RATINGS, REVIEWS AND RECOMMENDATIONS ON EVENTS AND ACTIVITIES IN THE FIELD OF ENTERTAINMENT AND EDUCATION; PROVIDING INFORMATION, NEWS AND COMMENTARY IN THE FIELD OF ENTERTAINMENT; EDUCATIONAL AND ENTERTAINMENT SERVICES, NAMELY, A CONTINUING PROGRAM FEATURING INFORMATION, NEWS AND INSTRUCTION OF SYSTEMIZATION OF FIGHTING TECHNIQUES CONSISTING OF COMBAT SKILLS, FITNESS, SELF-DEFENSE, SPORT, SELF-CULTIVATION/MEDITATION, MENTAL DISCIPLINE, CHARACTER DEVELOPMENT AND BUILDING CONFIDENCE ACCESSIBLE BY RADIO, TELEVISION, SATELLITE, AUDIO, VIDEO AND COMPUTER NETWORKS, IN CLASS 41 (U.S. CLS. 100, 101 AND 107).

FIRST USE 6-6-2007; IN COMMERCE 6-6-2007.

THE MARK CONSISTS OF STANDARD CHARACTERS WITHOUT CLAIM TO ANY PARTICULAR FONT, STYLE, SIZE, OR COLOR.

NO CLAIM IS MADE TO THE EXCLUSIVE RIGHT TO USE "MMA", APART FROM THE MARK AS SHOWN.

SER. NO. 77-232,610, FILED 7-18-2007.

KYLE PEETE, EXAMINING ATTORNEY

Int. Cls.: 41 and 45

Prior U.S. Cls.: 100, 101 and 107

United States Patent and Trademark Office

Reg. No. 3,479,268

Registered Aug. 5, 2008

**SERVICE MARK
PRINCIPAL REGISTER**

BEST FORK FORWARD

YMCA OF METROPOLITAN WASHINGTON
(D.C. CORPORATION)
SEVENTH FLOOR
1112 16TH STREET, N.W.
WASHINGTON, DC 20036

FOR: EDUCATIONAL SERVICES, NAMELY,
PROVIDING INSTRUCTIONAL WORKSHOPS IN
THE FIELD OF HEALTHY EATING, NUTRITION,
PHYSICAL EXERCISE AND PHYSICAL ACTIVITY,
IN CLASS 41 (U.S. CLS. 100, 101 AND 107).

FIRST USE 4-0-2006; IN COMMERCE 4-0-2006.

FOR: COUNSELING IN ETIQUETTE AND SO-
CIAL SKILLS, IN CLASS 45 (U.S. CLS. 100 AND 101).

FIRST USE 4-0-2006; IN COMMERCE 4-0-2006.

THE MARK CONSISTS OF STANDARD CHAR-
ACTERS WITHOUT CLAIM TO ANY PARTICULAR
FONT, STYLE, SIZE, OR COLOR.

SER. NO. 77-232,822, FILED 7-18-2007.

DANNEAN HETZEL, EXAMINING ATTORNEY

Int. Cls.: 9 and 42

Prior U.S. Cls.: 21, 23, 26, 36, 38, 100 and 101

United States Patent and Trademark Office

Reg. No. 3,479,269

Registered Aug. 5, 2008

**TRADEMARK
SERVICE MARK
PRINCIPAL REGISTER**

CustomTutor

BVS, INC. (IOWA CORPORATION)
4060 GLASS ROAD NORTHEAST
CEDAR RAPIDS, IA 52402

FOR: COMPUTER SOFTWARE FOR USE IN INSTRUCTING EMPLOYEES IN SKILLS DEVELOPMENT, NAMELY, BANKING REGULATION COMPLIANCE, IN CLASS 9 (U.S. CLS. 21, 23, 26, 36 AND 38).

FIRST USE 11-1-1999; IN COMMERCE 11-1-1999.

FOR: PROVIDING TEMPORARY USE OF NON-DOWNLOADABLE COMPUTER SOFTWARE FOR USE IN INSTRUCTING EMPLOYEES IN SKILLS DEVELOPMENT, NAMELY, BANKING REGULA-

TION COMPLIANCE, IN CLASS 42 (U.S. CLS. 100 AND 101).

FIRST USE 11-1-1999; IN COMMERCE 11-1-1999.

THE MARK CONSISTS OF STANDARD CHARACTERS WITHOUT CLAIM TO ANY PARTICULAR FONT, STYLE, SIZE, OR COLOR.

OWNER OF U.S. REG. NO. 2,541,847.

SEC. 2(F).

SER. NO. 77-232,854, FILED 7-18-2007.

JORDAN BAKER, EXAMINING ATTORNEY

Int. Cls.: 35, 36, 42, 44 and 45

Prior U.S. Cls.: 100, 101 and 102

United States Patent and Trademark Office

Reg. No. 3,479,270

Registered Aug. 5, 2008

**SERVICE MARK
PRINCIPAL REGISTER**

The logo for 'ikor' is written in a bold, cursive script. The letters are interconnected, with the 'i' and 'k' being particularly prominent. The 'o' is a simple circle, and the 'r' has a long, sweeping tail that curves under the 'o'.

IKOR INCORPORATED (PENNSYLVANIA CORPORATION)
SUITE 6
696 UNIONVILLE ROAD
KENNETT SQUARE, PA 19348

FOR: HUMAN RESOURCES CONSULTING SERVICES; REFERRALS IN THE FIELD OF HEALTH CARE, IN CLASS 35 (U.S. CLS. 100, 101 AND 102).

FIRST USE 12-8-1997; IN COMMERCE 12-8-1997.

FOR: FINANCIAL CONSULTING; FINANCIAL MANAGEMENT, IN CLASS 36 (U.S. CLS. 100, 101 AND 102).

FIRST USE 1-1-2000; IN COMMERCE 1-1-2000.

FOR: PROVIDING QUALITY ASSURANCE SERVICES IN THE FIELDS OF HEALTHCARE FACILITIES, MEDICAL CARE, AND ASSISTED LIVING PROGRAMS, IN CLASS 42 (U.S. CLS. 100 AND 101).

FIRST USE 12-8-1997; IN COMMERCE 12-8-1997.

FOR: CONSULTING SERVICES IN THE FIELD OF HEALTH CARE; MEDICAL EVALUATION SERVICES, NAMELY, REVIEW AND ANALYSIS OF

POTENTIAL MEDICATION INTERACTIONS FOR PATIENTS; MEDICAL EVALUATION, NAMELY, ASSESSMENT FOR OTHERS OF THE MEDICAL CARE OF THE ELDERLY AND DISABLED, IN CLASS 44 (U.S. CLS. 100 AND 101).

FIRST USE 12-8-1997; IN COMMERCE 12-8-1997.

FOR: PROVIDING PATIENT ADVOCATE SERVICES TO HOSPITAL PATIENTS AND PATIENTS IN LONG TERM CARE FACILITIES AND PATIENT ADVOCACY; GUARDIANSHIP SERVICES; CASE MANAGEMENT SERVICES, NAMELY, COORDINATION OF HEALTHCARE, FINANCIAL, AND LIVING NEEDS OF THE ELDERLY AND DISABLED, IN CLASS 45 (U.S. CLS. 100 AND 101).

FIRST USE 12-8-1997; IN COMMERCE 12-8-1997.

OWNER OF U.S. REG. NO. 2,316,953.

THE MARK CONSISTS OF THE MARK CONSISTS OF THE WORD "IKOR" IN LETTERING.

SER. NO. 77-233,313, FILED 7-19-2007.

MICHAEL WEBSTER, EXAMINING ATTORNEY

Int. Cl.: 5

Prior U.S. Cls.: 6, 18, 44, 46, 51 and 52

Reg. No. 3,479,271

United States Patent and Trademark Office

Registered Aug. 5, 2008

**TRADEMARK
PRINCIPAL REGISTER**

NEUROLIFT

NUTRACEUTICAL SCIENCES INSTITUTE, INC.
(DELAWARE CORPORATION)
352 S.W. 12TH AVE
DEERFIELD BEACH, FL 33442

FOR: DIETARY AND NUTRITIONAL SUPPLE-
MENTS, IN CLASS 5 (U.S. CLS. 6, 18, 44, 46, 51 AND
52).

FIRST USE 1-3-2004; IN COMMERCE 1-3-2004.

THE MARK CONSISTS OF STANDARD CHAR-
ACTERS WITHOUT CLAIM TO ANY PARTICULAR
FONT, STYLE, SIZE, OR COLOR.

OWNER OF U.S. REG. NO. 2,195,734.

SER. NO. 77-233,591, FILED 7-19-2007.

MICHAEL GAAFAR, EXAMINING ATTORNEY

Int. Cl.: 28

Prior U.S. Cls.: 22, 23, 38 and 50

Reg. No. 3,479,272

United States Patent and Trademark Office

Registered Aug. 5, 2008

**TRADEMARK
PRINCIPAL REGISTER**

HEALTH BOW

HUPA INTERNATIONAL, INC. (CALIFORNIA CORPORATION)
21717 FERRERO PKWY
WALNUT, CA 91789

FOR: EXERCISE EQUIPMENT, NAMELY, EXERCISE APPARATUS WITH FLEXIBLE RODS TO PROVIDE RESISTANCE, MANUALLY OPERATED MULTI-PURPOSE HOME GYM EXERCISE EQUIPMENT, IN CLASS 28 (U.S. CLS. 22, 23, 38 AND 50).

FIRST USE 1-5-2005; IN COMMERCE 1-5-2005.

THE MARK CONSISTS OF STANDARD CHARACTERS WITHOUT CLAIM TO ANY PARTICULAR FONT, STYLE, SIZE, OR COLOR.

NO CLAIM IS MADE TO THE EXCLUSIVE RIGHT TO USE "BOW", APART FROM THE MARK AS SHOWN.

SER. NO. 77-233,625, FILED 7-19-2007.

KAREN BRACEY, EXAMINING ATTORNEY

Int. Cl.: 37

Prior U.S. Cls.: 100, 103 and 106

United States Patent and Trademark Office

Reg. No. 3,479,273

Registered Aug. 5, 2008

**SERVICE MARK
PRINCIPAL REGISTER**

TUSCAN LAKES

KENWOOD DEVELOPMENT, L.P. (TEXAS LIMITED PARTNERSHIP), DBA TUSCAN LAKES DEVELOPMENT, L.P.
SUITE 500
5005 RIVERWAY
HOUSTON, TX 77056

THE MARK CONSISTS OF STANDARD CHARACTERS WITHOUT CLAIM TO ANY PARTICULAR FONT, STYLE, SIZE, OR COLOR.

FOR: REAL ESTATE DEVELOPMENT, IN CLASS 37 (U.S. CLS. 100, 103 AND 106).

SER. NO. 77-233,836, FILED 7-19-2007.

FIRST USE 2-1-2004; IN COMMERCE 2-1-2004.

TEJBIR SINGH, EXAMINING ATTORNEY

Int. Cl.: 37

Prior U.S. Cls.: 100, 103 and 106

United States Patent and Trademark Office

Reg. No. 3,479,274

Registered Aug. 5, 2008

**SERVICE MARK
PRINCIPAL REGISTER**



KENWOOD DEVELOPMENT, L.P. (TEXAS LIMITED PARTNERSHIP), DBA TUSCAN LAKES DEVELOPMENT, L.P.

SUITE 500
5005 RIVERWAY
HOUSTON, TX 77056

FIRST USE 2-1-2004; IN COMMERCE 2-1-2004.

SER. NO. 77-233,889, FILED 7-19-2007.

FOR: REAL ESTATE DEVELOPMENT, IN CLASS 37 (U.S. CLS. 100, 103 AND 106).

TEJBIR SINGH, EXAMINING ATTORNEY

Int. Cl.: 36

Prior U.S. Cls.: 100, 101 and 102

United States Patent and Trademark Office

Reg. No. 3,479,275

Registered Aug. 5, 2008

**SERVICE MARK
PRINCIPAL REGISTER**

LIQUIDATE THAT REAL ESTATE

TAHOE UNITED MANAGEMENT, INC. (NEVADA CORPORATION)
2764 LAKE SAHARA DRIVE
LAS VEGAS, NV 89117

FOR: REAL ESTATE BROKERAGE SERVICES; ACQUISITION SERVICES FOR REAL ESTATE INVESTORS; MORTGAGE INFORMATION SERVICES; PURCHASE AND SALE OF RESIDENTIAL MORTGAGES FOR OTHERS; PURCHASE AND SALE OF RESIDENTIAL REAL ESTATE, NAMELY, REAL ESTATE ACQUISITION, REAL ESTATE AGENCIES SERVICES AND REAL ESTATE BROKERAGE; AND CONSULTING SERVICES IN THE FIELD OF REAL ESTATE INVESTMENT, MORTGAGE LENDING AND IN PREVENTING

REAL ESTATE FORECLOSURE, IN CLASS 36 (U.S. CLS. 100, 101 AND 102).

FIRST USE 12-0-2007; IN COMMERCE 12-0-2007.

THE MARK CONSISTS OF STANDARD CHARACTERS WITHOUT CLAIM TO ANY PARTICULAR FONT, STYLE, SIZE, OR COLOR.

NO CLAIM IS MADE TO THE EXCLUSIVE RIGHT TO USE "REAL ESTATE", APART FROM THE MARK AS SHOWN.

SER. NO. 77-233,893, FILED 7-19-2007.

FRANK LATTUCA, EXAMINING ATTORNEY

Int. Cls.: 19 and 20

Prior U.S. Cls.: 1, 2, 12, 13, 22, 25, 32, 33 and 50

United States Patent and Trademark Office

Reg. No. 3,479,276

Registered Aug. 5, 2008

**TRADEMARK
PRINCIPAL REGISTER**

PACIFIC ALBUS

UPPER COLUMBIA MILL, LLC (DELAWARE
LTD LIAB CO)
ONE WORLD TRADE CENTER
121 SW SALMON STREET, SUITE 1020
PORTLAND, OR 97204

FOR: WOOD PRODUCTS, NAMELY, LUMBER,
PANELING, DECKING, WINDOWS, DOORS, AND
FENCING, IN CLASS 19 (U.S. CLS. 1, 12, 33 AND 50).

FIRST USE 2-0-2007; IN COMMERCE 2-0-2007.

FOR: SHELVING, IN CLASS 20 (U.S. CLS. 2, 13, 22,
25, 32 AND 50).

FIRST USE 2-0-2007; IN COMMERCE 2-0-2007.

THE MARK CONSISTS OF STANDARD CHAR-
ACTERS WITHOUT CLAIM TO ANY PARTICULAR
FONT, STYLE, SIZE, OR COLOR.

SER. NO. 77-233,958, FILED 7-19-2007.

G. MAYERSCHOFF, EXAMINING ATTORNEY

Int. Cl.: 16

Prior U.S. Cls.: 2, 5, 22, 23, 29, 37, 38 and 50

United States Patent and Trademark Office

Reg. No. 3,479,277

Registered Aug. 5, 2008

TRADEMARK
PRINCIPAL REGISTER



HAPPY HANDS (HK) LIMITED (HONG KONG
LIMITED CORPORATION)
17B, ONE CAPITAL PLACE
18 LUARD ROAD
WANCHAI, HONG KONG

FOR: ADHESIVES, NAMELY, GLUE FOR STA-
TIONERY OR HOUSEHOLD PURPOSES; CREPE
PAPER; CREPE PAPER ARTICLES FOR FABRICA-
TION OF THREE DIMENSIONAL WORKS OF ART;
CREPE PAPER ROLLS FOR FABRICATION OF
ARTICLES OF VARIOUS SHAPES, IN CLASS 16
(U.S. CLS. 2, 5, 22, 23, 29, 37, 38 AND 50).

PRIORITY CLAIMED UNDER SEC. 44(D) ON
HONG KONG APPLICATION NO. 300884007, FILED
6-4-2007, REG. NO. 300884007, DATED 6-4-2007, EX-
PIRES 6-4-2017.

THE COLOR(S) BLUE, YELLOW, GREEN, OR-
ANGE, PURPLE, LAVENDER, RED, WHITE AND
BLACK IS/ARE CLAIMED AS A FEATURE OF THE
MARK.

THE MARK CONSISTS OF A PURPLE SWIRL
EDGED IN THE COLORS WHITE, RED AND
BLACK IN THE BACKGROUND OF THE STYLIZED
TEXT "PAPER'ONI"; THE COLORS IN THE LET-
TERS COMPRISING THE WORD ARE BLUE, YEL-
LOW, GREEN, ORANGE, BLUE, YELLOW, GREEN
AND ORANGE RESPECTIVELY WITH A YELLOW
APOSTROPHE, AND ALL OF THE LETTERS
EDGED IN WHITE, RED AND BLACK.

SER. NO. 77-234,165, FILED 7-19-2007.

LINDA POWELL, EXAMINING ATTORNEY

Int. Cls.: 35, 38 and 41

Prior U.S. Cls.: 100, 101, 102, 104 and 107

United States Patent and Trademark Office

Reg. No. 3,479,278

Registered Aug. 5, 2008

**SERVICE MARK
PRINCIPAL REGISTER**



HEALTHCARE NEWS NETWORK, LLC (FLORIDA LTD LIAB CO)
1625 SE 46TH STREET, UNIT #3
CAPE CORAL, FL 33904

FOR: PRODUCTION AND DISTRIBUTION OF TELEVISION COMMERCIALS AND PUBLIC SERVICE ANNOUNCEMENTS; POST-PRODUCTION EDITING SERVICES FOR VIDEO AND AUDIO COMMERCIALS; PRODUCTION OF ORIGINAL PUBLIC SERVICE ANNOUNCEMENTS AND COMMERCIALS; AND PROVIDING ADVERTISING, MARKETING AND PROMOTIONAL SERVICES FOR THE PHARMACEUTICAL AND MEDICAL INDUSTRY; PRODUCING AUDIO OR VIDEO INFOMERCIALS, IN CLASS 35 (U.S. CLS. 100, 101 AND 102).

FIRST USE 10-16-2006; IN COMMERCE 10-16-2006.

FOR: PROVIDING ACCESS TO A BROADBAND NETWORK FOR USE IN HOSPITAL LOBBIES AND HOSPITAL WAITING ROOMS; BROADCAST OF CABLE TELEVISION PROGRAMS; CABLE TELEVISION BROADCASTING; TELEVISION PROGRAM BROADCASTING VIA CABLE; SUBSCRIPTION TELEVISION BROADCASTING; AND BROADCASTING SERVICES VIA A VARIETY OF DIGITAL, ANALOG, CABLE OR OTHER MEDIA; TELEVISION NARROWCASTING; VIDEO NARROWCASTING SERVICES, IN CLASS 38 (U.S. CLS. 100, 101 AND 104).

FIRST USE 10-16-2006; IN COMMERCE 10-16-2006.

FOR: PRODUCTION OF SPECIALTY TELEVISION PROGRAMMING AND CONTENT TAILORED TO SPECIFIC HOSPITAL AND/OR USER; ENTERTAINMENT IN THE NATURE OF TELEVISION NEWS SHOWS; ENTERTAINMENT IN THE NATURE OF ON-GOING TELEVISION PROGRAMS IN THE FIELD OF HEALTHCARE; ENTERTAINMENT, NAMELY, CONTINUING VARIETY AND NEWS SHOWS VIA TELEVISION; PRODUCTION AND DISTRIBUTION OF TELEVISION PROGRAMS; TELEVISION SCHEDULING; TELEVISION SHOW PRODUCTION; NEWS REPORTING SERVICES; DISTRIBUTION OF TELEVISION PROGRAMMING TO TELEVISION SYSTEMS; PHOTOGRAPHIC AND VIDEO SERVICES, NAMELY, PHOTOGRAPHIC AND VIDEO CAPTURE; AND PRODUCTION OF ORIGINAL TELEVISION PROGRAMS AND DOCUMENTARIES , IN CLASS 41 (U.S. CLS. 100, 101 AND 107).

FIRST USE 10-16-2006; IN COMMERCE 10-16-2006.

THE MARK CONSISTS OF THE LEFT SIDE OF A STYLIZED CADUCEUS.

SER. NO. 77-234,211, FILED 7-19-2007.

JORDAN BAKER, EXAMINING ATTORNEY

Int. Cl.: 36

Prior U.S. Cls.: 100, 101 and 102

United States Patent and Trademark Office

Reg. No. 3,479,279

Registered Aug. 5, 2008

**SERVICE MARK
PRINCIPAL REGISTER**

Hideaway Vacation Homes

TESTA, MICHAEL T (UNITED STATES INDIVIDUAL)
18 ROSEMONT AVENUE
SAN ANSLEMO, CA 94960

FOR: REAL ESTATE SERVICES, NAMELY, RENTAL OF VACATION HOMES, CONDOMINIUMS, CABINS, AND VILLAS USING PAY PER CLICK ADVERTISING ON A GLOBAL COMPUTER NETWORK, IN CLASS 36 (U.S. CLS. 100, 101 AND 102).

FIRST USE 1-1-2006; IN COMMERCE 3-1-2006.

THE MARK CONSISTS OF STANDARD CHARACTERS WITHOUT CLAIM TO ANY PARTICULAR FONT, STYLE, SIZE, OR COLOR.

NO CLAIM IS MADE TO THE EXCLUSIVE RIGHT TO USE "VACATION HOMES", APART FROM THE MARK AS SHOWN.

SER. NO. 77-234,360, FILED 7-20-2007.

DAWN FELDMAN, EXAMINING ATTORNEY

Int. Cl.: 35

Prior U.S. Cls.: 100, 101 and 102

United States Patent and Trademark Office

Reg. No. 3,479,280

Registered Aug. 5, 2008

**SERVICE MARK
PRINCIPAL REGISTER**



CICALESE, TONI (UNITED STATES INDIVIDUAL), DBA ALL4PRINTING GROUP
1929 GREENWICH SEC.4
314 WICKES RD.
BUSHKILL, PA 18324

FOR: ESTIMATING CONTRACTING WORK, IN CLASS 35 (U.S. CLS. 100, 101 AND 102).

FIRST USE 5-10-2006; IN COMMERCE 5-10-2006.

NO CLAIM IS MADE TO THE EXCLUSIVE RIGHT TO USE "PRINTING GROUP", APART FROM THE MARK AS SHOWN.

THE COLOR(S) BLUE & GREEN IS/ARE CLAIMED AS A FEATURE OF THE MARK.

THE MARK CONSISTS OF THE WORD "ALL" IN BLUE SUPERIMPOSED OVER THE NUMBER "4" IN GREEN; THE WORDING "PRINTING GROUP" AND "ALWAYS ONE STEP AHEAD" APPEARS IN BLUE TO THE RIGHT OF THE NUMBER "4"; A BLUE SQUARE APPEARS BELOW THE LETTER "P" IN "PRINTING".

SER. NO. 77-234,729, FILED 7-20-2007.

HEATHER THOMPSON, EXAMINING ATTORNEY

Int. Cl.: 1

Prior U.S. Cls.: 1, 5, 6, 10, 26 and 46

Reg. No. 3,479,281

United States Patent and Trademark Office

Registered Aug. 5, 2008

**TRADEMARK
PRINCIPAL REGISTER**

UNIVERSAL MOLD RELEASE

SMOOTH-ON, INC. (PENNSYLVANIA CORPORATION)
2000 ST. JOHN STREET
EASTON, PA 18042

FOR: SILICONE BASED AGENT APPLIED TO A RUBBER MOLD SURFACE OR PLASTER, CONCRETE, WOOD OR CLAY IN ORDER TO FACILITATE THE DEMOLDING OF A CAST PIECE FROM THE SUBSTRATE, IN CLASS 1 (U.S. CLS. 1, 5, 6, 10, 26 AND 46).

FIRST USE 8-17-1998; IN COMMERCE 4-19-1999.

THE MARK CONSISTS OF STANDARD CHARACTERS WITHOUT CLAIM TO ANY PARTICULAR FONT, STYLE, SIZE, OR COLOR.

NO CLAIM IS MADE TO THE EXCLUSIVE RIGHT TO USE "MOLD RELEASE", APART FROM THE MARK AS SHOWN.

SEC. 2(F).

SER. NO. 77-234,783, FILED 7-20-2007.

KATHRYN COWARD, EXAMINING ATTORNEY

Int. Cl.: 41

Prior U.S. Cls.: 100, 101 and 107

United States Patent and Trademark Office

Reg. No. 3,479,282

Registered Aug. 5, 2008

**SERVICE MARK
PRINCIPAL REGISTER**

TEEN CITY PRODUCTIONS

TEEN CITY PRODUCTIONS, INC. (GEORGIA CORPORATION)
SUITE 03-L
315 W. PONCE DE LEON
DECATUR, GA 30030

FOR: ENTERTAINMENT, NAMELY, A CONTINUING EDUCATIONAL AND ENTERTAINMENT SHOW FOR YOUNG ADULTS BROADCAST OVER TELEVISION, IN CLASS 41 (U.S. CLS. 100, 101 AND 107).

FIRST USE 6-30-2006; IN COMMERCE 8-30-2006.

THE MARK CONSISTS OF STANDARD CHARACTERS WITHOUT CLAIM TO ANY PARTICULAR FONT, STYLE, SIZE, OR COLOR.

NO CLAIM IS MADE TO THE EXCLUSIVE RIGHT TO USE "TEEN" AND "PRODUCTIONS", APART FROM THE MARK AS SHOWN.

SER. NO. 77-234,870, FILED 7-20-2007.

NAAKWAMA ANKRAH, EXAMINING ATTORNEY

Int. Cl.: 5

Prior U.S. Cls.: 6, 18, 44, 46, 51 and 52

Reg. No. 3,479,283

United States Patent and Trademark Office

Registered Aug. 5, 2008

**TRADEMARK
PRINCIPAL REGISTER**

Volcano Oil

MAUI EXCELLENT, LLC (HAWAII LTD LIAB
CO)

197 ALOHI PL

MAKAWAO, HI 96768

FOR: TOPICAL ANALGESICS, IN CLASS 5 (U.S.
CLS. 6, 18, 44, 46, 51 AND 52).

FIRST USE 6-1-2005; IN COMMERCE 1-1-2006.

THE MARK CONSISTS OF STANDARD CHAR-
ACTERS WITHOUT CLAIM TO ANY PARTICULAR
FONT, STYLE, SIZE, OR COLOR.

NO CLAIM IS MADE TO THE EXCLUSIVE
RIGHT TO USE "OIL", APART FROM THE MARK
AS SHOWN.

SER. NO. 77-235,130, FILED 7-20-2007.

RONALD MCMORROW, EXAMINING ATTORNEY

Int. Cl.: 30

Prior U.S. Cl.: 46

United States Patent and Trademark Office

Reg. No. 3,479,284

Registered Aug. 5, 2008

**TRADEMARK
PRINCIPAL REGISTER**

PITACO

WILLIAMS, JOHN D. (UNITED STATES INDIVIDUAL)
1119 2ND AVENUE
FAIRBANKS, AK 99701 AND
WILLIAMS, NANCY D. (UNITED STATES INDIVIDUAL)
1119 2ND AVENUE
FAIRBANKS, AK 99701

FIRST USE 0-0-1978; IN COMMERCE 0-0-1978.

THE MARK CONSISTS OF STANDARD CHARACTERS WITHOUT CLAIM TO ANY PARTICULAR FONT, STYLE, SIZE, OR COLOR.

SER. NO. 77-235,161, FILED 7-20-2007.

FOR: SANDWICHES, IN CLASS 30 (U.S. CL. 46).

EDWARD NELSON, EXAMINING ATTORNEY

Int. Cls.: 41 and 43

Prior U.S. Cls.: 100, 101 and 107

United States Patent and Trademark Office

Reg. No. 3,479,285

Registered Aug. 5, 2008

**SERVICE MARK
PRINCIPAL REGISTER**



SHOOTERS BILLIARDS & SPORTS BAR, LP
(TEXAS LIMITED PARTNERSHIP)
1207 ANDREW COVE
CEDAR PARK, TX 78613

FOR: ENTERTAINMENT SERVICES, NAMELY,
PROVIDING BILLIARD ROOMS, IN CLASS 41 (U.S.
CLS. 100, 101 AND 107).

FIRST USE 1-23-2004; IN COMMERCE 1-23-2004.

FOR: SPORTS BAR AND RESTAURANT SERVI-
CES, IN CLASS 43 (U.S. CLS. 100 AND 101).

FIRST USE 1-23-2004; IN COMMERCE 1-23-2004.

NO CLAIM IS MADE TO THE EXCLUSIVE
RIGHT TO USE "BILLIARDS AND SPORTS BAR",
APART FROM THE MARK AS SHOWN.

THE MARK CONSISTS OF THE WORD "SHOO-
TERS" WITH TWO EIGHT BALLS IN PLACE OF
THE TWO "O"S. THE WORDS "BILLIARDS &
SPORTS BAR" ARE IN A CAPSULE TO THE RIGHT.
A CUE STICK APPEARS HORIZONTALLY BEHIND
THE WORDS.

SER. NO. 77-235,443, FILED 7-21-2007.

REGINA DRUMMOND, EXAMINING ATTORNEY

Int. Cl.: 16

Prior U.S. Cls.: 2, 5, 22, 23, 29, 37, 38 and 50

Reg. No. 3,479,286

United States Patent and Trademark Office

Registered Aug. 5, 2008

**TRADEMARK
PRINCIPAL REGISTER**



AUTO ADVISORY SERVICES, INC. (CALIFORNIA CORPORATION)
14771 PLAZA DRIVE, SUITE A
TUSTIN, CA 92780

FOR: PUBLICATIONS, NAMELY, NEWSLETTERS, BOOKS AND BOOKLETS DESIGNED TO INFORM, GUIDE AND ADVISE MOTOR VEHICLE DEALERS WITH RESPECT TO COMPLYING WITH THE RELEVANT STATE AND FEDERAL LAWS AND PENDING LEGISLATION, IN CLASS 16 (U.S. CLS. 2, 5, 22, 23, 29, 37, 38 AND 50).

FIRST USE 5-0-2006; IN COMMERCE 5-0-2006.

OWNER OF U.S. REG. NO. 3,393,805.

NO CLAIM IS MADE TO THE EXCLUSIVE RIGHT TO USE "ADVISORY SERVICES", APART FROM THE MARK AS SHOWN.

THE MARK CONSISTS OF THE LETTERS "AAS" WITH A NARROW CURVED LINE THROUGH THE MIDDLE WITH "AUTO ADVISORY SERVICES" IN A LONG NARROW BOX UNDERNEATH.

SEC. 2(F) AS TO "AUTO ADVISORY SERVICES" .

SER. NO. 77-236,001, FILED 7-23-2007.

JUSTINE D. PARKER, EXAMINING ATTORNEY

Int. Cl.: 45

Prior U.S. Cls.: 100 and 101

United States Patent and Trademark Office

Reg. No. 3,479,287

Registered Aug. 5, 2008

**SERVICE MARK
PRINCIPAL REGISTER**



AUTO ADVISORY SERVICES, INC. (CALIFORNIA CORPORATION)
14771 PLAZA DRIVE, SUITE A
TUSTIN, CA 92780

FOR: PROVIDING INFORMATION, GUIDANCE AND ADVICE TO MOTOR VEHICLE DEALERS WITH RESPECT TO RELEVANT STATE AND FEDERAL LAW AND PENDING LEGISLATION, IN CLASS 45 (U.S. CLS. 100 AND 101).

FIRST USE 5-0-2006; IN COMMERCE 5-0-2006.

OWNER OF U.S. REG. NO. 3,393,805.

NO CLAIM IS MADE TO THE EXCLUSIVE RIGHT TO USE "ADVISORY SERVICES", APART FROM THE MARK AS SHOWN.

THE MARK CONSISTS OF THE LETTERS "AAS" WITH A NARROW CURVED LINE THROUGH THE MIDDLE WITH "AUTO ADVISORY SERVICES" IN A LONG NARROW BOX UNDERNEATH.

SEC. 2(F) AS TO "AUTO ADVISORY SERVICES".

SER. NO. 77-236,007, FILED 7-23-2007.

JUSTINE D. PARKER, EXAMINING ATTORNEY

Int. Cl.: 28

Prior U.S. Cls.: 22, 23, 38 and 50

United States Patent and Trademark Office

Reg. No. 3,479,288

Registered Aug. 5, 2008

**TRADEMARK
PRINCIPAL REGISTER**



HUPA INTERNATIONAL, INC. (CALIFORNIA CORPORATION)
21717 FERRERO PKWY
WALNUT, CA 91789

FOR: EXERCISE EQUIPMENT, NAMELY, EXERCISE TRAMPOLINES, MANUALLY OPERATED MULTI-PURPOSE HOME GYM EXERCISE EQUIPMENT, IN CLASS 28 (U.S. CLS. 22, 23, 38 AND 50).

FIRST USE 7-29-2003; IN COMMERCE 1-24-2004.

THE MARK CONSISTS OF THE MARK CONSISTS OF AN OVAL MARQUEE WITH THE TEXT "YOG" AND "FLEX" FLANKING AN ABSTRACT SHAPE RESEMBLING A BIRD IN FLIGHT.

SER. NO. 77-236,452, FILED 7-23-2007.

KAREN BRACEY, EXAMINING ATTORNEY

Int. Cl.: 5

Prior U.S. Cls.: 6, 18, 44, 46, 51 and 52

Reg. No. 3,479,289

United States Patent and Trademark Office

Registered Aug. 5, 2008

**TRADEMARK
PRINCIPAL REGISTER**

ISO MASS XTREME GAINER

ULTIMATE NUTRITIONS, INC. (CONNECTICUT CORPORATION)
21 HYDE ROAD
FARMINGTON, CT 06034

FOR: DIETARY SUPPLEMENTS, NAMELY, WEIGHT GAINERS, IN CLASS 5 (U.S. CLS. 6, 18, 44, 46, 51 AND 52).

FIRST USE 8-13-2007; IN COMMERCE 8-13-2007.

THE MARK CONSISTS OF STANDARD CHARACTERS WITHOUT CLAIM TO ANY PARTICULAR FONT, STYLE, SIZE, OR COLOR.

NO CLAIM IS MADE TO THE EXCLUSIVE RIGHT TO USE "ISO" AND "GAINER", APART FROM THE MARK AS SHOWN.

SER. NO. 77-236,734, FILED 7-23-2007.

LINDSEY RUBIN, EXAMINING ATTORNEY

Int. Cl.: 41

Prior U.S. Cls.: 100, 101 and 107

United States Patent and Trademark Office

Reg. No. 3,479,290

Registered Aug. 5, 2008

**SERVICE MARK
PRINCIPAL REGISTER**

WILD SHEEP FOUNDATION

FOUNDATION FOR NORTH AMERICAN WILD
SHEEP (IOWA CORPORATION)
720 ALLEN AVE.
CODY, WY 82414

FOR: EDUCATIONAL SERVICES, NAMELY,
CONDUCTING EDUCATIONAL COMPETITIONS,
CONFERENCES, CONVENTIONS, SEMINARS
AND WORKSHOPS IN THE FIELD OF WILDLIFE
PRESERVATION, ANIMAL WELFARE, WILDLIFE
MANAGEMENT, CONSERVATION, HUNTING,
SPORTSMEN'S RIGHTS AND WILD SHEEP, WILD-
LIFE RESEARCH OPPORTUNITIES, BIOLOGICAL
STUDIES, WILD SHEEP TRANSPLANTS, LAND
ACQUISITION, AND PROVIDING EDUCATIONAL
MATERIALS THEREWITH, IN CLASS 41 (U.S. CLS.
100, 101 AND 107).

FIRST USE 2-0-2008; IN COMMERCE 2-0-2008.

THE MARK CONSISTS OF STANDARD CHAR-
ACTERS WITHOUT CLAIM TO ANY PARTICULAR
FONT, STYLE, SIZE, OR COLOR.

OWNER OF U.S. REG. NOS. 3,183,292 AND
3,198,379.

NO CLAIM IS MADE TO THE EXCLUSIVE
RIGHT TO USE "FOUNDATION", APART FROM
THE MARK AS SHOWN.

SEC. 2(F).

SER. NO. 77-236,882, FILED 7-24-2007.

LINDA M. KING, EXAMINING ATTORNEY

Int. Cls.: 9, 11, 37, 40 and 42

**Prior U.S. Cls.: 13, 21, 23, 26, 31, 34, 36, 38, 100, 101,
103 and 106**

Reg. No. 3,479,291

United States Patent and Trademark Office

Registered Aug. 5, 2008

**TRADEMARK
SERVICE MARK
PRINCIPAL REGISTER**

WIRSOL

WIRSOL GMBH (FED REP GERMANY GMBH)
SCHWETZINGER STRASSE 22-26
WAGHAUSEL-KIRRLACH, FED REP GERMANY
68753

FOR: APPARATUS FOR CONVERTING ELECTRONIC RADIATION TO ELECTRICAL ENERGY, NAMELY, PHOTOVOLTAIC SOLAR MODULES; AUTOMATED PROCESS CONTROL SYSTEMS, NAMELY, MICRO-PROCESSOR BASED HARDWARE AND SOFTWARE USED TO MONITOR THE STATUS OF INDUSTRIAL PROCESSES, NAMELY, POWER GENERATION AND ELECTRICAL DISTRIBUTION FOR THERMAL AND PHOTOVOLTAIC SOLAR PLANTS, IN CLASS 9 (U.S. CLS. 21, 23, 26, 36 AND 38).

FOR: SOLAR COLLECTORS FOR GENERATING WARMTH AND COLDNESS, IN CLASS 11 (U.S. CLS. 13, 21, 23, 31 AND 34).

FOR: CONSTRUCTION OF THERMAL AND PHOTOVOLTAIC SOLAR PLANT FACILITIES, AND INSTALLATION OF SOLAR COLLECTORS FOR GENERATING ENERGY; CONSTRUCTION AND INSTALLATION OF POWER PLANTS, NAMELY, BLOCK-TYPE THERMAL POWER STATIONS AND BIOGAS PLANTS; REPAIR SERVICES, NAMELY, MAINTENANCE OF THERMAL AND PHOTOVOLTAIC SOLAR PLANT FACILITIES, BLOCK-TYPE THERMAL POWER STATIONS AND BIOGAS PLANTS, IN CLASS 37 (U.S. CLS. 100, 103 AND 106).

FOR: PRODUCTION OF ELECTRIC ENERGY AND WARMTH BY OPERATION OF POWER PLANTS, NAMELY, BLOCK-TYPE THERMAL POWER STATIONS AND BIOGAS PLANTS; PRODUCTION OF ENERGY BY OPERATION OF THERMAL AND PHOTOVOLTAIC SOLAR PLANTS; TECHNICAL CONSULTANCY IN RELATION TO THE PRODUCTION AND GENERATION OF ENERGY FROM THERMAL AND PHOTOVOLTAIC SOLAR PLANTS, IN CLASS 40 (U.S. CLS. 100, 103 AND 106).

FOR: ENGINEERING SERVICES, NAMELY, DESIGN OF THERMAL AND PHOTOVOLTAIC SOLAR PLANTS, BLOCK-TYPE THERMAL POWER STATIONS AND BIOGAS PLANTS; ONLINE SYSTEM MANAGEMENT SERVICES THAT ALLOW USERS TO REMOTELY VIEW, MONITOR, PROGRAM, OPERATE AND CONTROL LARGE AND SMALL APPLIANCES AND ELECTRICAL SYSTEMS IN HOMES, OFFICES AND FREE STANDING SOLAR PLANTS, BLOCK-TYPE THERMAL POWER STATIONS AND BIOGAS PLANTS, IN CLASS 42 (U.S. CLS. 100 AND 101).

THE MARK CONSISTS OF STANDARD CHARACTERS WITHOUT CLAIM TO ANY PARTICULAR FONT, STYLE, SIZE, OR COLOR.

OWNER OF FED REP GERMANY REG. NO. 30706945, DATED 3-30-2007, EXPIRES 1-31-2017.

SER. NO. 77-237,065, FILED 7-24-2007.

TEJBIR SINGH, EXAMINING ATTORNEY

Int. Cl.: 25

Prior U.S. Cls.: 22 and 39

United States Patent and Trademark Office

Reg. No. 3,479,292

Registered Aug. 5, 2008

TRADEMARK
PRINCIPAL REGISTER



VIC-VINCENT, VICTOR N (UNITED STATES INDIVIDUAL)

#151

362 GULF BREEZE PKWY.

GULF BREEZE, FL 32561 AND

SMITH, STEVEN J. (UNITED STATES INDIVIDUAL)

#151

362 GULF BREEZE PKWY.

GULF BREEZE, FL 32561

FOR: HEAD WEAR; INFANT WEAR; SURF WEAR; SWIM WEAR; SWIM WEAR FOR GENTLEMEN AND LADIES; TENNIS WEAR; BEACH COVERUPS; BEACH FOOTWEAR; BEACH SHOES; BEACHWEAR; BATHING SUITS; BATHING SUITS FOR MEN; BODY SUITS; GYM SUITS; JOGGING SUITS; PARTS OF CLOTHING, NAMELY, GUSSETS FOR TIGHTS, GUSSETS FOR STOCKINGS, GUSSETS FOR BATHING SUITS, GUSSETS FOR UNDERWEAR, GUSSETS FOR LEOTARDS AND GUSSETS FOR FOOTLETS; RAIN SUITS; SNOW BOARDING SUITS; SNOW SUITS; SWEAT SUITS; TRACK SUITS; TRAINING SUITS; WARM UP SUITS; WET SUIT GLOVES; WET SUITS; WET SUITS FOR WATER-SKIING AND SUB-AQUA; CAPS; CHILDREN'S AND INFANTS' CLOTH BIBS; CHILDREN'S CLOTH EATING BIBS; CLOTH BIBS; CLOTHING, NAMELY, WRAP-AROUNDS; FOOTWEAR NOT FOR SPORTS; HOODS; INFANT AND TODDLER ONE PIECE CLOTHING; JERSEYS; SHORT SETS; SPORT SHIRTS; SPORTS BRA; SPORTS JERSEYS; SPORTS SHIRTS; SPORTS SHIRTS WITH SHORT SLEEVES; SWADDLING CLOTHES; TIES; TOPS; WRAPS; CAP VISORS; CAPS WITH VISORS; SUN VISORS; VISORS; ROBES; SWIMMING CAPS; BATH SLIPPERS; BATHING CAPS; BATHING COSTUMES FOR WOMEN; BATHING TRUNKS; BATHROBES; BIKINIS; BABY TOPS; CROP TOPS; HALTER TOPS; MUSCLE TOPS; RUG-

BY TOPS; TANK TOPS; TANK-TOPS; TUBE TOPS; BRIEFS; LADIES' UNDERWEAR; THONGS; UNDER GARMENTS; UNDERWEAR; UNDERWEAR, NAMELY, BOY SHORTS; WOMEN'S UNDERWEAR; WOVEN OR KNITTED UNDERWEAR; SLEEP SHIRTS; SLEEPING GARMENTS; SLEEPWEAR; HEAD SCARVES; HEAD SWEATBANDS; HEADWEAR; SKULLIES; BERMUDA SHORTS; BOARD SHORTS; BOXER SHORTS; RUGBY SHORTS; SHORT-SLEEVED OR LONG-SLEEVED T-SHIRTS; SHORT-SLEEVED SHIRTS; SHORTS; SWEAT SHORTS; WALKING SHORTS; SANDAL-CLOGS; SANDALS; GOLF SHIRTS; HEADBANDS AGAINST SWEATING; KNIT SHIRTS; NIGHT SHIRTS; OPEN-NECKED SHIRTS; PIQUE SHIRTS; POLO SHIRTS; SHIRT FRONTS; SHIRTS; SWEAT BANDS; SWEAT PANTS; SWEAT SHIRTS; MEN'S SOCKS; SOCKS; SOCKS AND STOCKINGS; THERMAL SOCKS; WATER SOCKS; GOLF CAPS; SKULL CAPS; THONGS; BOARDSHORTS; GYM SHORTS; PANTIES, SHORTS AND BRIEFS, IN CLASS 25 (U.S. CLS. 22 AND 39).

FIRST USE 8-10-2004; IN COMMERCE 8-10-2004.

OWNER OF U.S. REG. NO. 3,116,931.

THE COLOR(S) BLACK AND RED IS/ARE CLAIMED AS A FEATURE OF THE MARK.

THE COLOR BLACK APPEARS IN THE WORD "HURRICANE"; THE COLOR RED APPEARS IN THE WORD "SURVIVOR".

SER. NO. 77-237,248, FILED 7-24-2007.

SUE LAWRENCE, EXAMINING ATTORNEY

Int. Cls.: 35, 42 and 45

Prior U.S. Cls.: 100, 101 and 102

United States Patent and Trademark Office

Reg. No. 3,479,293

Registered Aug. 5, 2008

**SERVICE MARK
PRINCIPAL REGISTER**

MINDS @ WORK

SCOPE E-KNOWLEDGE CENTER PRIVATE LIMITED (INDIA CORPORATION)
672 ANNA SALAI
TEMPLE TOWER 2ND FLOOR
NANDANAM, CHENNAI, INDIA 600035

FOR: BUSINESS RESEARCH, NAMELY, BUSINESS INTELLIGENCE SEARCHES, IN CLASS 35 (U.S. CLS. 100, 101 AND 102).

FIRST USE 1-1-2007; IN COMMERCE 1-1-2007.

FOR: PATENT DRAFTING SERVICES, IN CLASS 42 (U.S. CLS. 100 AND 101).

FIRST USE 1-1-2007; IN COMMERCE 1-1-2007.

FOR: LEGAL RESEARCH SERVICES, NAMELY, PRIOR ART SEARCHES NAMELY, PATENT VA-

LIDITY, INFRINGEMENT, LANDSCAPING, SCIENTIFIC AND TECHNICAL LITERATURE, AND COMPETITIVE INTELLIGENCE SEARCHES; LITIGATION RESEARCH; PATENT FILING SERVICES, IN CLASS 45 (U.S. CLS. 100 AND 101).

FIRST USE 1-1-2007; IN COMMERCE 1-1-2007.

THE MARK CONSISTS OF STANDARD CHARACTERS WITHOUT CLAIM TO ANY PARTICULAR FONT, STYLE, SIZE, OR COLOR.

SER. NO. 77-237,396, FILED 7-24-2007.

JANICE L. MCMORROW, EXAMINING ATTORNEY

Int. Cl.: 9

Prior U.S. Cls.: 21, 23, 26, 36 and 38

Reg. No. 3,479,294

United States Patent and Trademark Office

Registered Aug. 5, 2008

**TRADEMARK
PRINCIPAL REGISTER**

LILTONE

LILTONE, INC. (CALIFORNIA CORPORATION)
908 S. 1ST ST.
ALHAMBRA, CA 91801

THE MARK CONSISTS OF STANDARD CHAR-
ACTERS WITHOUT CLAIM TO ANY PARTICULAR
FONT, STYLE, SIZE, OR COLOR.

FOR: DOWNLOADABLE GRAPHICS, RING
TONES, AND MUSIC VIA THE INTERNET AND
WIRELESS DEVICES, IN CLASS 9 (U.S. CLS. 21, 23,
26, 36 AND 38).

SER. NO. 77-237,455, FILED 7-24-2007.

FIRST USE 2-9-2007; IN COMMERCE 2-9-2007.

JASON TURNER, EXAMINING ATTORNEY

Int. Cls.: 35 and 41

Prior U.S. Cls.: 100, 101, 102 and 107

United States Patent and Trademark Office

Reg. No. 3,479,295

Registered Aug. 5, 2008

SERVICE MARK
PRINCIPAL REGISTER



AMERICAN SOCIETY FOR SURGERY OF THE
HAND (ILLINOIS NON-PROFIT CORPORATION)
6300 NORTH RIVER ROAD, SUITE 600
ROSEMONT, IL 60018

FOR: ASSOCIATION SERVICES, NAMELY, PROMOTING THE INTERESTS OF PROFESSIONALS IN THE FIELD OF HAND SURGERY AND FOSTERING ADVANCES IN SURGERY OF THE HAND, IN CLASS 35 (U.S. CLS. 100, 101 AND 102).

FIRST USE 9-1-2006; IN COMMERCE 9-1-2006.

FOR: EDUCATIONAL SERVICES, NAMELY, CONDUCTING CLASSES AND SEMINARS IN THE

FIELD OF HAND SURGERY, IN CLASS 41 (U.S. CLS. 100, 101 AND 107).

FIRST USE 9-1-2006; IN COMMERCE 9-1-2006.

OWNER OF U.S. REG. NO. 1,743,721.

SEC. 2(F) AS TO "AMERICAN SOCIETY FOR SURGERY OF THE HAND".

SER. NO. 77-237,920, FILED 7-25-2007.

ANDREA SAUNDERS, EXAMINING ATTORNEY

Int. Cl.: 14

Prior U.S. Cls.: 2, 27, 28 and 50

United States Patent and Trademark Office

Reg. No. 3,479,296

Registered Aug. 5, 2008

TRADEMARK
PRINCIPAL REGISTER

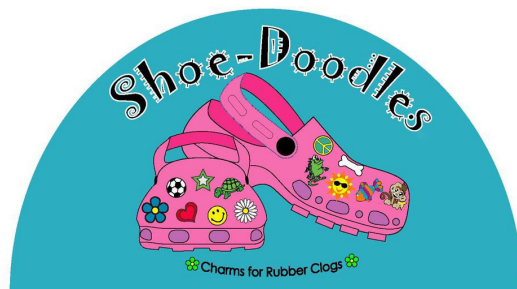

PURE AND SIMPLE SOLUTIONS, LLC (MICHIGAN LTD LIAB CO)
26789 WOODWARD AVENUE
SUITE 104
HUNTINGTON WOODS, MI 48070

FOR: CHARMS, IN CLASS 14 (U.S. CLS. 2, 27, 28 AND 50).

FIRST USE 11-1-2006; IN COMMERCE 11-1-2006.

NO CLAIM IS MADE TO THE EXCLUSIVE RIGHT TO USE "CHARMS FOR RUBBER CLOGS", APART FROM THE MARK AS SHOWN.

THE COLOR(S) BLUE, YELLOW, GREEN, RED, WHITE, BLACK, PINK, PURPLE, ORANGE, BROWN AND TURQUOISE IS/ARE CLAIMED AS A FEATURE OF THE MARK.

THE MARK CONSISTS OF A HALF OVAL INCLUDING THE WORDING "SHOE-DOODLES" AND THE WORDING "CHARMS FOR RUBBER CLOGS" THAT IS SURROUNDED WITH FLOWERS, THE MARK ALSO INCLUDING A PAIR OF SHOES INCLUDING CHARMS CONSISTING OF A FLOWER, A SOCCER BALL, A HEART, A STAR, A SMILEY FACE, A TURTLE, A DAISY, A CREATURE, A PEACE SIGN, A SUN WITH SUNGLASSES, A BONE, A FISH AND A MONKEY WITH A BANANA. THE COLOR TURQUOISE APPEARS IN A HALF OVAL, THE WORDING "SHOE-DOODLES" APPEARS IN BLACK OUTLINED IN WHITE, THE WORDING

"CHARMS FOR RUBBER CLOGS" APPEARS IN BLACK WITH A GREEN AND YELLOW FLOWER AT BOTH ENDS, THE COLORS PINK, PURPLE AND BLACK APPEAR ON THE SHOES, THE COLOR BLUE AND YELLOW APPEAR IN THE FLOWER CHARM, THE COLORS BLACK AND WHITE APPEAR IN THE SOCCER BALL CHARM, THE COLORS RED AND ORANGE APPEAR IN THE HEART CHARM, THE COLORS GREEN AND WHITE APPEAR IN THE STAR CHARM, THE COLORS YELLOW APPEARS ON THE SMILEY FACE CHARM, THE COLOR GREEN APPEARS ON THE TURTLE CHARM, THE COLORS WHITE AND YELLOW APPEAR ON THE DAISY CHARM, THE COLOR GREENS APPEARS ON THE CREATURE CHARM, THE COLORS GREEN AND THE YELLOW APPEAR ON THE PEACE SYMBOL CHARM, THE COLOR WHITE APPEARS ON THE BONE CHARM, THE COLORS YELLOW, ORANGE AND BLACK APPEAR ON THE SUN WITH SUNGLASSES CHARM, THE COLORS ORANGE, PURPLE AND TURQUOISE APPEAR ON THE FISH CHARM AND BROWN AND YELLOW APPEAR ON THE MONKEY WITH BANANA CHARM. THE COLOR WHITE SURROUNDING THE TURQUOISE HALF OVAL IS NOT PART OF THE MARK, BUT RATHER IS AN INDICATION THAT THE MARK APPEARS ON A TRANSPARENT BACKGROUND..

SER. NO. 77-238,148, FILED 7-25-2007.

JAMES A. RAUEN, EXAMINING ATTORNEY

Int. Cl.: 36

Prior U.S. Cls.: 100, 101 and 102

United States Patent and Trademark Office

Reg. No. 3,479,297

Registered Aug. 5, 2008

SERVICE MARK
PRINCIPAL REGISTER



ALL RELO-SERVICES, INC. (TEXAS CORPORATION)
12527 HUNTINGTON FIELD DRIVE
HOUSTON, TX 770993613

FOR: REAL ESTATE BROKERAGE SERVICES, IN
CLASS 36 (U.S. CLS. 100, 101 AND 102).

FIRST USE 5-1-2003; IN COMMERCE 5-1-2003.

OWNER OF U.S. REG. NO. 2,471,191.

NO CLAIM IS MADE TO THE EXCLUSIVE
RIGHT TO USE "MOVING" AND THE DESCRIP-

TIVE DESIGN OF THE GLOBE, APART FROM THE
MARK AS SHOWN.

THE STIPLING IS A FEATURE OF THE MARK.

THE MARK CONSISTS OF THE WORD "ARSI"
STYLIZED WITH THE WORD "MOVING" ON A
WORLD GLOBE.

SER. NO. 77-238,353, FILED 7-25-2007.

RICHARD A. STRASER, EXAMINING ATTORNEY

Int. Cl.: 35

Prior U.S. Cls.: 100, 101 and 102

United States Patent and Trademark Office

Reg. No. 3,479,298

Registered Aug. 5, 2008

**SERVICE MARK
PRINCIPAL REGISTER**

InteliStaf Travel

INTELISTAF HEALTHCARE, INC. (DELAWARE CORPORATION)
SUITE 600
18W140 BUTTERFIELD ROAD
OAKBROOK TERRACE, IL 60181

FOR: RECRUITING HEALTHCARE PROFESSIONALS INCLUDING NURSES AND ALLIED HEALTH PROFESSIONALS FOR LONG-TERM EMPLOYMENT CONTRACTS AT HOSPITALS AND OTHER HEALTHCARE FACILITIES, IN CLASS 35 (U.S. CLS. 100, 101 AND 102).

FIRST USE 1-0-2003; IN COMMERCE 1-0-2003.

THE MARK CONSISTS OF STANDARD CHARACTERS WITHOUT CLAIM TO ANY PARTICULAR FONT, STYLE, SIZE, OR COLOR.

OWNER OF U.S. REG. NO. 2,498,122.

NO CLAIM IS MADE TO THE EXCLUSIVE RIGHT TO USE "TRAVEL", APART FROM THE MARK AS SHOWN.

SER. NO. 77-238,388, FILED 7-25-2007.

DEIRDRE ROBERTSON, EXAMINING ATTORNEY

Int. Cl.: 32

Prior U.S. Cls.: 45, 46 and 48

United States Patent and Trademark Office

Reg. No. 3,479,299

Registered Aug. 5, 2008

**TRADEMARK
PRINCIPAL REGISTER**

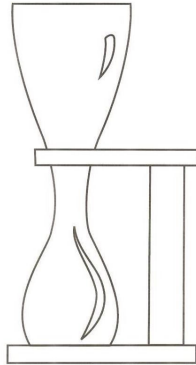

BROUWERIJ BOSTEELS (BELGIUM JOINT
STOCK COMPANY)
KERKSTRAAT 92
BUGGENHOUT, BELGIUM

FOR: BEER; ALE, IN CLASS 32 (U.S. CLS. 45, 46
AND 48).

FIRST USE 0-0-1900; IN COMMERCE 9-30-1983.

THE MARK CONSISTS OF A REPRESENTATION
OF A UNIQUELY SHAPED GLASS WITH A WIDE
MOUTH, A THIN NECK AND A BULBOUS BOT-
TOM IN A HOLDER.

SER. NO. 77-238,467, FILED 7-25-2007.

KATHLEEN M. VANSTON, EXAMINING ATTOR-
NEY

Int. Cl.: 35

Prior U.S. Cls.: 100, 101 and 102

United States Patent and Trademark Office

Reg. No. 3,479,300

Registered Aug. 5, 2008

**SERVICE MARK
PRINCIPAL REGISTER**

**NATIONAL SOCIETY OF
COMPLIANCE PROFESSIONALS**

NATIONAL SOCIETY OF COMPLIANCE PROFESSIONALS (CONNECTICUT CORPORATION)

22 KENT ROAD

CORNWALL BRIDGE, CT 06754

FOR: ASSOCIATION SERVICES, NAMELY, PROMOTING THE INTERESTS OF SECURITIES COMPLIANCE PROFESSIONALS, IN CLASS 35 (U.S. CLS. 100, 101 AND 102).

FIRST USE 0-0-1987; IN COMMERCE 0-0-1987.

THE MARK CONSISTS OF STANDARD CHARACTERS WITHOUT CLAIM TO ANY PARTICULAR FONT, STYLE, SIZE, OR COLOR.

NO CLAIM IS MADE TO THE EXCLUSIVE RIGHT TO USE "SOCIETY", APART FROM THE MARK AS SHOWN.

SEC. 2(F).

SER. NO. 77-238,621, FILED 7-25-2007.

DAVID H. STINE, EXAMINING ATTORNEY

Int. Cls.: 41 and 43

Prior U.S. Cls.: 100, 101 and 107

United States Patent and Trademark Office

Reg. No. 3,479,301

Registered Aug. 5, 2008

**SERVICE MARK
PRINCIPAL REGISTER**

SANCTUM

CONCEPT VENUES LTD (UNITED KINGDOM
CORPORATION)
36 BRIDLE LANE
LONDON W1F 9BZ, UNITED KINGDOM

FOR: NIGHT CLUBS, IN CLASS 41 (U.S. CLS. 100,
101 AND 107).

FOR: HOTEL SERVICES; ARRANGING TEMPOR-
ARY HOUSING ACCOMODATIONS; RENTAL OF
ROOMS; BAR AND RESTAURANT SERVICES, IN
CLASS 43 (U.S. CLS. 100 AND 101).

THE MARK CONSISTS OF STANDARD CHAR-
ACTERS WITHOUT CLAIM TO ANY PARTICULAR
FONT, STYLE, SIZE, OR COLOR.

PRIORITY CLAIMED UNDER SEC. 44(D) ON
ERPNTY TM OFC APPLICATION NO.
005737267, FILED 3-6-2007, REG. NO. 005737267,
DATED 2-28-2008, EXPIRES 3-6-2017.

SER. NO. 77-238,775, FILED 7-25-2007.

JOHN DALIER, EXAMINING ATTORNEY

Int. Cl.: 35

Prior U.S. Cls.: 100, 101 and 102

United States Patent and Trademark Office

Reg. No. 3,479,302

Registered Aug. 5, 2008

**SERVICE MARK
PRINCIPAL REGISTER**



SHEARER, DAVID M (UNITED STATES INDIVIDUAL)
62 MAGNOLIA WAY
NORTH HALEDON, NJ 07508

FOR: PROVIDING ASSISTANCE, FITNESS EVALUATION AND CONSULTATION TO CORPORATE CLIENTS TO HELP THEIR EMPLOYEES MAKE HEALTH, WELLNESS AND NUTRITIONAL CHANGES IN THEIR DAILY LIVING TO INCREASE PRODUCTIVITY AND LOWER HEALTH CARE COSTS, IN CLASS 35 (U.S. CLS. 100, 101 AND 102).

FIRST USE 1-20-1997; IN COMMERCE 1-20-1997.

NO CLAIM IS MADE TO THE EXCLUSIVE RIGHT TO USE CADUCEUS DESIGN, APART FROM THE MARK AS SHOWN.

SER. NO. 77-238,926, FILED 7-25-2007.

ALICE SUE CARRUTHERS, EXAMINING ATTORNEY

Int. Cl.: 35

Prior U.S. Cls.: 100, 101 and 102

United States Patent and Trademark Office

Reg. No. 3,479,303

Registered Aug. 5, 2008

**SERVICE MARK
PRINCIPAL REGISTER**

**FULL SERVICE MOVE AT A DO
IT YOURSELF COST**

U-HAUL INTERNATIONAL, INC (NEVADA
CORPORATION)
2727 NORTH CENTRAL AVENUE
PHOENIX, AZ 85004

FOR: OPERATING AN ON-LINE MARKET-
PLACE FOR SELLERS OF SERVICES RELATED
TO STORAGE, MOVING AND RELOCATING,
NAMELY, PACKING/UNPACKING, LOADING/UN-
LOADING, HOUSECLEANING, LANDSCAPING,
DRIVING, CARPET CLEANING, DISASSEMBLY/
ASSEMBLY, PAINTING, HANDYMAN, CHILD-
CARE, ELECTRONIC/COMPUTER HOOK-UPS,
PET CARE, SNOW REMOVAL, PEST CONTROL,
TRAILER/TRANSPORT HOOK-UPS, AND WARE-
HOUSE SPACE, STORAGE ROOMS, STORAGE
SPACES, AND PARKING SPACES; INTEGRATED

TRACKING AND MANAGEMENT OF COMMER-
CIAL TRANSACTIONS ON A GLOBAL COMPUTER
NETWORK; ADVERTISING SERVICES, NAMELY,
DISSEMINATION OF ADVERTISING FOR OTHERS
VIA THE INTERNET, IN CLASS 35 (U.S. CLS. 100, 101
AND 102).

FIRST USE 7-25-2007; IN COMMERCE 7-25-2007.

THE MARK CONSISTS OF STANDARD CHAR-
ACTERS WITHOUT CLAIM TO ANY PARTICULAR
FONT, STYLE, SIZE, OR COLOR.

SER. NO. 77-239,630, FILED 7-26-2007.

SHANNON TWOHIG, EXAMINING ATTORNEY

Int. Cl.: 44

Prior U.S. Cls.: 100 and 101

United States Patent and Trademark Office

Reg. No. 3,479,304

Registered Aug. 5, 2008

**SERVICE MARK
PRINCIPAL REGISTER**

LASER VAGINAL REJUVENATION

ENTREPRENEURIAL MEDICAL CONSULTING,
LLC (ST.CHRIST-NEVIS LTD LIAB CO)
SUITE 404
9201 SUNSET BLVD.
LOS ANGELES, CA 90069

FOR: MEDICAL SERVICES, NAMELY GYNECO-
LOGIC SURGERY, IN CLASS 44 (U.S. CLS. 100 AND
101).

FIRST USE 1-1-1998; IN COMMERCE 1-1-1998.

THE MARK CONSISTS OF STANDARD CHAR-
ACTERS WITHOUT CLAIM TO ANY PARTICULAR
FONT, STYLE, SIZE, OR COLOR.

OWNER OF U.S. REG. NOS. 2,885,439 AND
2,888,004.

SEC. 2(F).

SER. NO. 77-239,871, FILED 7-26-2007.

DAVID COLLIER, EXAMINING ATTORNEY

Int. Cl.: 43

Prior U.S. Cls.: 100 and 101

United States Patent and Trademark Office

Reg. No. 3,479,305

Registered Aug. 5, 2008

**SERVICE MARK
PRINCIPAL REGISTER**

Moulin D'or

MOULIN D'OR COMPANY SARL (LEBANON
CORPORATION)
ZOUK MOSBEH
KISIRWAN, LEBANON

FOR: SERVING FOOD AND DRINKS; PROVID-
ING TEMPORARY ACCOMMODATION, IN CLASS
43 (U.S. CLS. 100 AND 101).

FIRST USE 1-1-2006; IN COMMERCE 1-1-2006.

THE MARK CONSISTS OF STANDARD CHAR-
ACTERS WITHOUT CLAIM TO ANY PARTICULAR
FONT, STYLE, SIZE, OR COLOR.

THE FOREIGN WORDING IN THE MARK
TRANSLATES INTO ENGLISH AS GOLD MILL.

SER. NO. 77-239,875, FILED 7-26-2007.

JANICE L. MCMORROW, EXAMINING ATTOR-
NEY

Int. Cl.: 6

Prior U.S. Cls.: 2, 12, 13, 14, 23, 25 and 50

Reg. No. 3,479,306

United States Patent and Trademark Office

Registered Aug. 5, 2008

**TRADEMARK
PRINCIPAL REGISTER**

MACFORMET
MOUNTING SOLUTIONS

RODRIGUEZ VILLARREAL, RUBÉN (MEXICO
INDIVIDUAL)
COL. DEL NORTE
AV. LADRÓN DE GUEVARA 1127 OTE
MONTERREY, MEXICO 66290

FIRST USE 11-18-1996; IN COMMERCE 4-1-2007.

NO CLAIM IS MADE TO THE EXCLUSIVE
RIGHT TO USE "MOUNTING SOLUTIONS", APART
FROM THE MARK AS SHOWN.

FOR: METAL STANDS FOR ELECTRONIC DE-
VICES, NAMELY, TV'S, PLASMA SCREENS, LCD
TV'S, HOME THEATERS AND DVD PLAYERS, IN
CLASS 6 (U.S. CLS. 2, 12, 13, 14, 23, 25 AND 50).

SER. NO. 77-240,125, FILED 7-26-2007.

G. MAYERSCHOFF, EXAMINING ATTORNEY

Int. Cl.: 12

Prior U.S. Cls.: 19, 21, 23, 31, 35 and 44

Reg. No. 3,479,307

United States Patent and Trademark Office

Registered Aug. 5, 2008

**TRADEMARK
PRINCIPAL REGISTER**



TRUCKMAR IND. E COM. DE PRODUTOS EM
METAIS LTDA. (BRAZIL LIMITED COMPA-
NY)

RUA MARQUES DE CAXIAS, 277
CENTRO-NITEROI 24030-050, BRAZIL

FOR: HAND PROPELLED VEHICLES MADE OF
ALUMINUM AND IRON USED FOR TRANSPORT-
ING SMALL RECREATIONAL BOATS IN AND OUT

OF THE WATER, IN CLASS 12 (U.S. CLS. 19, 21, 23, 31,
35 AND 44).

OWNER OF BRAZIL REG. NO. 200037811, DATED
9-2-2003, EXPIRES 9-2-2013.

SER. NO. 77-240,165, FILED 7-27-2007.

JOHN HWANG, EXAMINING ATTORNEY

Int. Cl.: 39

Prior U.S. Cls.: 100 and 105

United States Patent and Trademark Office

Reg. No. 3,479,308

Registered Aug. 5, 2008

**SERVICE MARK
PRINCIPAL REGISTER**



ENTERPRISE RENT-A-CAR COMPANY (MISSOURI CORPORATION)
600 CORPORATE PARK DRIVE
ST. LOUIS, MO 63105

FOR: VEHICLE RENTAL AND LEASING SERVICES; AND RESERVATION SERVICES FOR THE RENTAL AND LEASING OF VEHICLES, NAMELY, RENTAL RESERVATIONS FOR AUTOMOBILES, TRUCKS, CARS, LAND VEHICLES, IN CLASS 39 (U.S. CLS. 100 AND 105).

FIRST USE 5-14-2007; IN COMMERCE 5-14-2007.

OWNER OF U.S. REG. NOS. 1,343,167, 2,052,192 AND OTHERS.

THE COLOR(S) GREEN, WHITE AND BLACK IS/ARE CLAIMED AS A FEATURE OF THE MARK.

THE MARK CONSISTS OF A GREEN SQUARE, AND THE LETTER "E" IS IN WHITE AND GREEN IN THE GREEN SQUARE AND THE LITERAL ELEMENT "ENTERPRISE" IN WHITE OUTLINED BY BLACK TO THE RIGHT OF THE GREEN SQUARE.

SER. NO. 77-240,964, FILED 7-27-2007.

KATHY DE JONGE, EXAMINING ATTORNEY

Int. Cls.: 35 and 41

Prior U.S. Cls.: 100, 101, 102 and 107

United States Patent and Trademark Office

Reg. No. 3,479,309

Registered Aug. 5, 2008

**SERVICE MARK
PRINCIPAL REGISTER**

GreenBlue

GREEN BLUE INSTITUTE (DELAWARE TAX EXEMPT CORPORATION), DBA GREENBLUE
600 E. WATER STREET, SUITE C
CHARLOTTESVILLE, VA 22901

FOR: CONSULTING SERVICES IN THE AREA OF SUSTAINABLE BUSINESS SOLUTIONS, AND INFORMATION SERVICES IN THE FIELD OF SUSTAINABLE BUSINESS SOLUTIONS, IN CLASS 35 (U.S. CLS. 100, 101 AND 102).

FIRST USE 4-30-2003; IN COMMERCE 4-30-2003.

FOR: EDUCATION SERVICES, NAMELY, PROVIDING LIVE AND ON-LINE CONFERENCES AND

SEMINARS IN THE FIELD OF SUSTAINABLE BUSINESS SOLUTIONS, AND PRINTED AND PRINTABLE MATERIALS DISTRIBUTED THEREWITH, IN CLASS 41 (U.S. CLS. 100, 101 AND 107).

FIRST USE 4-30-2003; IN COMMERCE 4-30-2003.

THE MARK CONSISTS OF STANDARD CHARACTERS WITHOUT CLAIM TO ANY PARTICULAR FONT, STYLE, SIZE, OR COLOR.

SER. NO. 77-241,079, FILED 7-27-2007.

ANNE E. GUSTASON, EXAMINING ATTORNEY

Int. Cl.: 41

Prior U.S. Cls.: 100, 101 and 107

United States Patent and Trademark Office

Reg. No. 3,479,310

Registered Aug. 5, 2008

**SERVICE MARK
PRINCIPAL REGISTER**



LOCKE, NELSON (UNITED STATES INDIVIDUAL)
15921 SW 14TH STREET
PEMBROKE PINES, FL 33027

FOR: EDUCATIONAL SERVICES, NAMELY, PROVIDING SEMINARS ABOUT REVERSE MORTGAGES FOR BOTH RESIDENTIAL REVERSE MORTGAGE SPECIALISTS AND CONSUMERS IN CLASS 41, IN CLASS 41 (U.S. CLS. 100, 101 AND 107).

FIRST USE 3-31-2006; IN COMMERCE 3-31-2006.

THE STIPPLING IS A FEATURE OF THE MARK.

THE MARK CONSISTS OF A STUDENT'S MORTARBOARD CAP WITH A BACKGROUND GRAPH AND UPWARD ARROW, FOLLOWED BY THE PHRASE "SENIOR MONEY MATTERS!".

SER. NO. 77-241,262, FILED 7-27-2007.

DAVID C. REIHNER, EXAMINING ATTORNEY

Int. Cl.: 10

Prior U.S. Cls.: 26, 39 and 44

United States Patent and Trademark Office

Reg. No. 3,479,311

Registered Aug. 5, 2008

**TRADEMARK
PRINCIPAL REGISTER**

AMS 700 LGX

AMS RESEARCH CORPORATION (DELAWARE CORPORATION)
10700 BREN ROAD WEST
MINNETONKA, MN 55343

FOR: MEDICAL DEVICES FOR THE TREATMENT AND DIAGNOSIS OF ERECTILE DYSFUNCTION (ED) AND ERECTILE RESTORATION, PROSTATE CONDITIONS, URINARY INCONTINENCE, NAMELY, PENILE PROSTHESES, URETHRAL STENTS; PENILE PUMP IMPLANTS, IN CLASS 10 (U.S. CLS. 26, 39 AND 44).

FIRST USE 3-25-2007; IN COMMERCE 3-25-2007.

THE MARK CONSISTS OF STANDARD CHARACTERS WITHOUT CLAIM TO ANY PARTICULAR FONT, STYLE, SIZE, OR COLOR.

OWNER OF U.S. REG. NOS. 1,912,387, 3,219,965, AND 3,236,362.

SER. NO. 77-241,747, FILED 7-30-2007.

KELLEY WELLS, EXAMINING ATTORNEY

Int. Cl.: 35

Prior U.S. Cls.: 100, 101 and 102

United States Patent and Trademark Office

Reg. No. 3,479,312

Registered Aug. 5, 2008

**SERVICE MARK
PRINCIPAL REGISTER**



Catholic
Social Workers
National
Association

CATHOLIC SOCIAL WORKERS NATIONAL ASSOCIATION, INC. (INDIANA NON-PROFIT CORPORATION)

P.O BOX 40124
INDIANAPOLIS, IN 46240

FOR: ASSOCIATION SERVICES, NAMELY, PROMOTING AND SUPPORTING THE INTERESTS OF PROFESSIONAL SOCIAL WORKERS SEEKING DIRECTION WITHIN THEIR PROFESSION BASED ON CHURCH TEACHINGS, AND PROMOTING THE IMPLEMENTATION OF CATHOLIC SOCIAL TEACHINGS, IN CLASS 35 (U.S. CLS. 100, 101 AND 102).

FIRST USE 8-2-2006; IN COMMERCE 8-2-2006.

NO CLAIM IS MADE TO THE EXCLUSIVE RIGHT TO USE "CATHOLIC SOCIAL WORKERS NATIONAL ASSOCIATION", APART FROM THE MARK AS SHOWN.

THE COLOR(S) GREEN, PURPLE, WHITE, BROWN AND FLESH IS/ARE CLAIMED AS A FEATURE OF THE MARK.

THE COLOR GREEN APPEARS IN THE WORDING "CATHOLIC SOCIAL WORKERS NATIONAL ASSOCIATION" AND IN THE DESIGN PORTION AS THE COLOR OF THE PITCHER AND AS THE COLOR OF THE OUTER RIM OF THE WASH BASIN. THE COLOR PURPLE APPEARS AS THE BACKGROUND COLOR OF THE MARK. THE COLOR WHITE APPEARS IN THE MARK AS THE COLOR OF THE CROSS ON THE PITCHER AND AS THE COLOR OF THE CENTER OF THE WASH BASIN. THE COLOR BROWN APPEARS AS THE COLOR OF THE FEET AND LEGS THAT ARE BEING WASHED IN THE BASIN. THE COLOR FLESH APPEARS AS THE COLOR OF THE ARM AND HAND WASHING THE FEET.

SER. NO. 77-241,760, FILED 7-30-2007.

KATINA MISTER, EXAMINING ATTORNEY

Int. Cl.: 41

Prior U.S. Cls.: 100, 101 and 107

United States Patent and Trademark Office

Reg. No. 3,479,313

Registered Aug. 5, 2008

**SERVICE MARK
PRINCIPAL REGISTER**

Magid Media Labs

FRANK N. MAGID ASSOCIATES, INC. (IOWA CORPORATION)
ONE RESEARCH CENTER
MARION, IA 52302

FOR: CONSULTING SERVICES IN THE FIELD OF MULTI-PLATFORM NEWS REPORTING, NAMELY, IN THE MEDIA OF TELEVISION, THE WORLD WIDE WEB, AND WIRELESS DEVICES, IN CLASS 41 (U.S. CLS. 100, 101 AND 107).

FIRST USE 2-1-2007; IN COMMERCE 2-1-2007.

THE MARK CONSISTS OF STANDARD CHARACTERS WITHOUT CLAIM TO ANY PARTICULAR FONT, STYLE, SIZE, OR COLOR.

NO CLAIM IS MADE TO THE EXCLUSIVE RIGHT TO USE "MEDIA LABS", APART FROM THE MARK AS SHOWN.

SER. NO. 77-241,772, FILED 7-30-2007.

BARNEY CHARLON, EXAMINING ATTORNEY

Int. Cl.: 6

Prior U.S. Cls.: 2, 12, 13, 14, 23, 25 and 50

Reg. No. 3,479,314

United States Patent and Trademark Office

Registered Aug. 5, 2008

**TRADEMARK
PRINCIPAL REGISTER**



WAGI

NEWAY VALVE, INC. (TEXAS CORPORATION)
10749 CASH ROAD
STAFFORD, TX 77477

THE MARK CONSISTS OF A STYLIZED LETTER
"WAGI" AND A DESIGNED LOGO .

FOR: MANUALLY OPERATED METAL VALVES,
IN CLASS 6 (U.S. CLS. 2, 12, 13, 14, 23, 25 AND 50).

SER. NO. 77-242,805, FILED 7-31-2007.

FIRST USE 5-1-2007; IN COMMERCE 5-1-2007.

AHSEN KHAN, EXAMINING ATTORNEY

Int. Cl.: 31

Prior U.S. Cls.: 1 and 46

United States Patent and Trademark Office

Reg. No. 3,479,315

Registered Aug. 5, 2008

**TRADEMARK
PRINCIPAL REGISTER**



AMERICAN CONIFER SOCIETY (PENNSYLVANIA CORPORATION)
175 CHARISMA LANE
LEWISVILLE, NC 270239611

FOR: LIVE CONIFER TREES, IN CLASS 31 (U.S. CLS. 1 AND 46).

FIRST USE 3-1-2006; IN COMMERCE 3-1-2006.

NO CLAIM IS MADE TO THE EXCLUSIVE RIGHT TO USE "AMERICAN CONIFER SOCIETY"

AND "CONIFER OF THE YEAR 2007", APART FROM THE MARK AS SHOWN.

THE MARK CONSISTS OF A RING OF PINECONES AND FOLIAGE.

SER. NO. 77-243,348, FILED 7-31-2007.

KATINA MISTER, EXAMINING ATTORNEY

Int. Cl.: 9

Prior U.S. Cls.: 21, 23, 26, 36 and 38

Reg. No. 3,479,316

United States Patent and Trademark Office

Registered Aug. 5, 2008

**TRADEMARK
PRINCIPAL REGISTER**

GENE

ELSEVIER BV (NETHERLANDS CORPORATION)
RADARWEG 29
AMSTERDAM, NETHERLANDS 1043NX

THE MARK CONSISTS OF STANDARD CHAR-
ACTERS WITHOUT CLAIM TO ANY PARTICULAR
FONT, STYLE, SIZE, OR COLOR.

FOR: ELECTRONIC DOWNLOADABLE PUBLI-
CATIONS, NAMELY, JOURNALS IN THE FIELD OF
SCIENCE, IN CLASS 9 (U.S. CLS. 21, 23, 26, 36 AND
38).

SEC. 2(F).

SER. NO. 77-243,665, FILED 7-31-2007.

FIRST USE 12-1-1997; IN COMMERCE 12-1-1997.

MARK SPARACINO, EXAMINING ATTORNEY

Int. Cl.: 41

Prior U.S. Cls.: 100, 101 and 107

United States Patent and Trademark Office

Reg. No. 3,479,317

Registered Aug. 5, 2008

**SERVICE MARK
PRINCIPAL REGISTER**

GENE

ELSEVIER BV (NETHERLANDS CORPORATION)
RADARWEG 29
AMSTERDAM, NETHERLANDS 1043NX

FOR: PROVIDING ON-LINE PUBLICATIONS,
NAMELY, JOURNALS IN THE FIELD OF SCIENCE,
IN CLASS 41 (U.S. CLS. 100, 101 AND 107).

FIRST USE 12-1-1997; IN COMMERCE 12-1-1997.

THE MARK CONSISTS OF STANDARD CHAR-
ACTERS WITHOUT CLAIM TO ANY PARTICULAR
FONT, STYLE, SIZE, OR COLOR.

SEC. 2(F).

SER. NO. 77-243,672, FILED 7-31-2007.

MARK SPARACINO, EXAMINING ATTORNEY

Int. Cl.: 3

Prior U.S. Cls.: 1, 4, 6, 50, 51 and 52

United States Patent and Trademark Office

Reg. No. 3,479,318

Registered Aug. 5, 2008

**TRADEMARK
PRINCIPAL REGISTER**

BEAUTY DROPS

COLONIAL DAMES COMPANY, LTD. (CALI-
FORNIA CORPORATION)
6820 E.WATCHER STREET
COMMERCE, CA 90040

FOR: EYE CREAM, SCAR CARE CREAM AND
SKIN MOISTURIZER, IN CLASS 3 (U.S. CLS. 1, 4, 6,
50, 51 AND 52).

FIRST USE 8-7-2003; IN COMMERCE 8-7-2003.

THE MARK CONSISTS OF STANDARD CHAR-
ACTERS WITHOUT CLAIM TO ANY PARTICULAR
FONT, STYLE, SIZE, OR COLOR.

OWNER OF U.S. REG. NO. 644,546.

SEC. 2(F).

SER. NO. 77-243,981, FILED 8-1-2007.

ADA HAN, EXAMINING ATTORNEY

Int. Cl.: 43

Prior U.S. Cls.: 100 and 101

United States Patent and Trademark Office

Reg. No. 3,479,319

Registered Aug. 5, 2008

**SERVICE MARK
PRINCIPAL REGISTER**

CALIFORNIA VEGAN

NATIVE FOODS, INCORPORATED (CALIFORNIA CORPORATION)
1775 EAST PALM CANYON DRIVE
PALM SPRINGS, CA 92262

FOR: RESTAURANT SERVICES, NAMELY, RESTAURANTS FEATURING ETHNIC FOODS PREPARED USING ORGANIC VEGETARIAN AND VEGAN FOOD ITEMS, IN CLASS 43 (U.S. CLS. 100 AND 101).

FIRST USE 9-21-2002; IN COMMERCE 9-21-2002.

THE MARK CONSISTS OF STANDARD CHARACTERS WITHOUT CLAIM TO ANY PARTICULAR FONT, STYLE, SIZE, OR COLOR.

NO CLAIM IS MADE TO THE EXCLUSIVE RIGHT TO USE "VEGAN", APART FROM THE MARK AS SHOWN.

SEC. 2(F).

SER. NO. 77-244,494, FILED 8-1-2007.

DANIEL BRODY, EXAMINING ATTORNEY

Int. Cl.: 1

Prior U.S. Cls.: 1, 5, 6, 10, 26 and 46

Reg. No. 3,479,320

United States Patent and Trademark Office

Registered Aug. 5, 2008

**TRADEMARK
PRINCIPAL REGISTER**

The logo for SWANCOR features the word "SWANCOR" in a bold, italicized, sans-serif font. The letters "S" and "W" are significantly larger and more stylized than the other letters. The "S" is a thick, curved stroke that starts high and ends low. The "W" is composed of two thick, curved strokes that meet at the bottom. The remaining letters "A", "N", "C", "O", "R" are in a smaller, standard weight of the same font. The entire logo is set against a black rectangular background.

SWANCOR IND. CO., LTD. (TAIWAN CORPORATION)
NO. 9, INDUSTRY SOUTH 6 ROAD
NANTOU CITY, TAIWAN

FOR: CHEMICALS USED IN INDUSTRY AND SCIENCE; PHOTOGRAPHIC CHEMICALS; CHEMICAL PREPARATIONS FOR USE IN AGRICULTURE, HORTICULTURE AND FORESTRY, NAMELY, CHEMICAL PREPARATIONS FOR THE TREATMENT OF SEEDS; UNPROCESSED ARTIFICIAL EPOXY RESINS, UNPROCESSED PLASTICS; MANURES; FIRE EXTINGUISHING COMPOSITIONS; METAL TEMPERING AND SOLDERING PREPARATIONS; CHEMICAL SUBSTANCES FOR PRESERVING FOODSTUFFS; TANNING AGENTS FOR USE IN THE MANUFACTURE OF LEATHER; ADHESIVES FOR GENERAL INDUSTRIAL USE; CHEMICAL VEHICLES USED IN THE MANUFACTURE OF PAINTS; CONCRETE ADDITIVES; EPOXY

GLUE FOR GENERAL BONDING AND REPAIR PURPOSES; MOLD RELEASE COMPOUNDS FOR USE IN A WIDE VARIETY OF INDUSTRIES; PLASTIC MOLDING COMPOUNDS FOR USE IN THE MANUFACTURE OF MOLDED PLASTIC ARTICLES; SILICONE RESINS; SOLDERING CHEMICALS; SOLVENT-TYPE PROCESSING COMPOSITIONS FOR USE IN THE ELECTRONICS INDUSTRY; WATERPROOFING CHEMICAL COMPOSITIONS; WETTING AGENTS FOR USE IN THE MANUFACTURE OF PAINTS, IN CLASS 1 (U.S. CLS. 1, 5, 6, 10, 26 AND 46).

FIRST USE 7-16-2007; IN COMMERCE 7-16-2007.

SER. NO. 77-244,620, FILED 8-1-2007.

MICHAEL SOUDERS, EXAMINING ATTORNEY

Int. Cl.: 35

Prior U.S. Cls.: 100, 101 and 102

United States Patent and Trademark Office

Reg. No. 3,479,321

Registered Aug. 5, 2008

**SERVICE MARK
PRINCIPAL REGISTER**

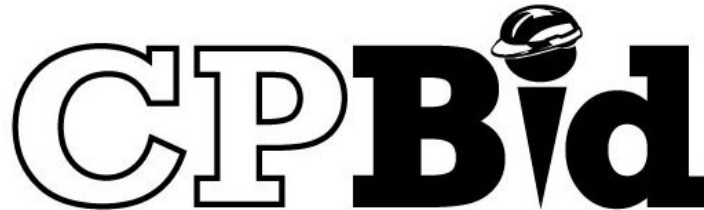

CONTRACTPOWER, LLC (FLORIDA LTD LIAB
CO)
SUITE # 300
100 S. DIXIE HWY
WEST PALM BEACH, FL 33401

OWNER OF U.S. REG. NO. 3,107,378.

FOR: WEB BASED MULTI-STAGE SERVICE FOR
AUCTIONING BIDS ON CONSTRUCTION PRO-
JECTS WITH A VARIETY OF PARTICIPANTS, IN
CLASS 35 (U.S. CLS. 100, 101 AND 102).

THE MARK CONSISTS OF THE TERM "CPBID"
WHERE THE DOT OF THE LETTER "I" IS WEAR-
ING A CONSTRUCTION HELMET.

SER. NO. 77-245,005, FILED 8-2-2007.

FIRST USE 1-29-2007; IN COMMERCE 1-29-2007.

ALYSSA PALADINO, EXAMINING ATTORNEY

Int. Cl.: 44

Prior U.S. Cls.: 100 and 101

United States Patent and Trademark Office

Reg. No. 3,479,322

Registered Aug. 5, 2008

**SERVICE MARK
PRINCIPAL REGISTER**



TEXAS HAND THERAPY CENTER, INC. (TEXAS CORPORATION)
4131 DIRECTORS ROW
HOUSTON, TX 77092

FOR: HAND THERAPY SERVICES, IN CLASS 44 (U.S. CLS. 100 AND 101).

FIRST USE 6-0-2007; IN COMMERCE 6-0-2007.

NO CLAIM IS MADE TO THE EXCLUSIVE RIGHT TO USE "HAND THERAPY CENTER", APART FROM THE MARK AS SHOWN.

THE MARK CONSISTS OF A STYLIZED LETTER ELEMENT H WITH AN OVAL DESIGN ELEMENT, THE LITERAL WORD ELEMENTS "TEXAS HAND THERAPY CENTER" AND A BORDER SURROUNDING ALL OF THE ELEMENTS.

SEC. 2(F) AS TO "TEXAS HAND THERAPY CENTER".

SER. NO. 77-245,429, FILED 8-2-2007.

RENEE SERVANCE, EXAMINING ATTORNEY

Int. Cl.: 9

Prior U.S. Cls.: 21, 23, 26, 36 and 38

Reg. No. 3,479,323

United States Patent and Trademark Office

Registered Aug. 5, 2008

**TRADEMARK
PRINCIPAL REGISTER**

ApparelMagic

MURPHY, JOHN S. (UNITED STATES INDIVIDUAL), DBA MURPHY & ASSOCIATES, INC.
SUITE 116
3715 MARKET ST.
GLENDALE, CA 91208

THE MARK CONSISTS OF STANDARD CHARACTERS WITHOUT CLAIM TO ANY PARTICULAR FONT, STYLE, SIZE, OR COLOR.

FOR: DATABASE MANAGEMENT SOFTWARE FOR USE IN THE FIELD OF APPAREL PRODUCTION, IN CLASS 9 (U.S. CLS. 21, 23, 26, 36 AND 38).

SER. NO. 77-245,911, FILED 8-2-2007.

FIRST USE 7-31-1998; IN COMMERCE 7-31-1998.

JENNIFER VASQUEZ, EXAMINING ATTORNEY

Int. Cl.: 9

Prior U.S. Cls.: 21, 23, 26, 36 and 38

Reg. No. 3,479,324

United States Patent and Trademark Office

Registered Aug. 5, 2008

**TRADEMARK
PRINCIPAL REGISTER**

RPATH

RPATH, INC. (DELAWARE CORPORATION)
701 CORPORATE CENTER DRIVE, SUITE 450
RALEIGH, NC 27607

FIRST USE 4-15-2005; IN COMMERCE 4-15-2005.

FOR: DOWNLOADABLE SOFTWARE OFFERED
OVER THE INTERNET TO ENABLE USERS TO
COMBINE THEIR OWN SOFTWARE WITH OTHER
SOFTWARE COMPONENTS AND APPLIANCE
SOURCES FROM MULTIPLE POINTS OF ORIGIN,
IN CLASS 9 (U.S. CLS. 21, 23, 26, 36 AND 38).

THE MARK CONSISTS OF STANDARD CHAR-
ACTERS WITHOUT CLAIM TO ANY PARTICULAR
FONT, STYLE, SIZE, OR COLOR.

SER. NO. 77-246,145, FILED 8-3-2007.

MARIAM MAHMOUDI, EXAMINING ATTORNEY

Int. Cl.: 41

Prior U.S. Cls.: 100, 101 and 107

United States Patent and Trademark Office

Reg. No. 3,479,325

Registered Aug. 5, 2008

**SERVICE MARK
PRINCIPAL REGISTER**

WALL OF RED

BIO-ENGINEERED SUPPLEMENTS & NUTRI-
TION, INC. (DELAWARE CORPORATION)
6TH FLOOR
5901 BROKEN SOUND PARKWAY NW
BOCA RATON, FL 33487

FOR: PROVIDING RECOGNITION AND INCEN-
TIVES BY THE WAY OF AWARDS TO DEMON-
STRATE EXCELLENCE IN THE FIELD OF
DIETARY SUPPLEMENT SALES AND PROMO-
TION, IN CLASS 41 (U.S. CLS. 100, 101 AND 107).

FIRST USE 12-1-2005; IN COMMERCE 12-1-2005.

THE MARK CONSISTS OF STANDARD CHAR-
ACTERS WITHOUT CLAIM TO ANY PARTICULAR
FONT, STYLE, SIZE, OR COLOR.

SER. NO. 77-246,634, FILED 8-3-2007.

WILLIAM BRECKENFELD, EXAMINING ATTOR-
NEY

Int. Cl.: 41

Prior U.S. Cls.: 100, 101 and 107

United States Patent and Trademark Office

Reg. No. 3,479,326

Registered Aug. 5, 2008

**SERVICE MARK
PRINCIPAL REGISTER**

FURTOGRAPHS

STOLAREK, ANDY (UNITED STATES INDIVIDUAL), DBA ANDREW STOLAREK
966 ARAPAHOE ST.
LOS ANGELES, CA 90006

THE MARK CONSISTS OF STANDARD CHARACTERS WITHOUT CLAIM TO ANY PARTICULAR FONT, STYLE, SIZE, OR COLOR.

FOR: PHOTOGRAPHY SERVICES, IN CLASS 41 (U.S. CLS. 100, 101 AND 107).

SER. NO. 77-247,022, FILED 8-3-2007.

FIRST USE 12-13-2005; IN COMMERCE 12-13-2005.

JANET LEE, EXAMINING ATTORNEY

Int. Cl.: 20

Prior U.S. Cls.: 2, 13, 22, 25, 32 and 50

Reg. No. 3,479,327

United States Patent and Trademark Office

Registered Aug. 5, 2008

**TRADEMARK
PRINCIPAL REGISTER**

QWEST

QWEST COMMUNICATIONS INTERNATIONAL
INC. (DELAWARE CORPORATION)
1801 CALIFORNIA STREET
DENVER, CO 80202

FOR: NON-METAL KEY FOBS, NON-METAL
KEY RINGS, NON-METAL RETRACTABLE BADGE
HOLDERS, NON-METAL PHOTO FRAMES, IN
CLASS 20 (U.S. CLS. 2, 13, 22, 25, 32 AND 50).

FIRST USE 10-31-2000; IN COMMERCE 10-31-2000.

THE MARK CONSISTS OF STANDARD CHAR-
ACTERS WITHOUT CLAIM TO ANY PARTICULAR
FONT, STYLE, SIZE, OR COLOR.

OWNER OF U.S. REG. NO. 3,109,003.

SER. NO. 77-247,029, FILED 8-3-2007.

TRACY WHITTAKER-BROWN, EXAMINING AT-
TORNEY

Int. Cl.: 41

Prior U.S. Cls.: 100, 101 and 107

United States Patent and Trademark Office

Reg. No. 3,479,328

Registered Aug. 5, 2008

**SERVICE MARK
PRINCIPAL REGISTER**



EMPOWERMENT ENTERPRISE

EMPOWERMENT ENTERPRISE, LLC (OKLAHOMA LTD LIAB CO)
4122 SOUTH NEW HAVEN PLACE
TULSA, OK 74135

FOR: EDUCATIONAL SERVICES, NAMELY, CONDUCTING CLASSES, SEMINARS, CONFERENCES, AND WORKSHOPS IN THE FIELD OF ORGANIZATIONAL DEVELOPMENT, PERSONAL GROWTH AND DEVELOPMENT, LEADERSHIP DEVELOPMENT, AND MINISTRY DEVELOPMENT AND DISTRIBUTING COURSE MATERIALS THEREWITH, IN CLASS 41 (U.S. CLS. 100, 101 AND 107).

FIRST USE 6-18-2004; IN COMMERCE 6-18-2004.

NO CLAIM IS MADE TO THE EXCLUSIVE RIGHT TO USE "EMPOWERMENT ENTERPRISE", APART FROM THE MARK AS SHOWN.

THE MARK CONSISTS OF THE WORDING "EMPOWERMENT ENTERPRISE" IN AN ALL-CAPS,

FUTURA CONDENSED TYPEFACE. CENTERED ABOVE THE WORDING IS THE SYMBOL OF A BIRD POINTING SKYWARD, ITS SYMMETRICAL WINGS OUTSTRETCHED TO THE EDGE OF THE WORDING ON EACH SIDE. THE BIRD CONSISTS OF THREE NON-CONTIGUOUS COMPONENTS: A HEAD, A RIGHT HALF AND A LEFT HALF. ITS HEAD IS AN UPSIDE-DOWN "V," POINTING UP. ITS RIGHT HALF IS COMPRISED OF A STYLIZED "E," WHICH FORMS THE WING, BODY AND TAIL OF ITS RIGHT SIDE. ITS LEFT HALF IS A MIRROR IMAGE OF THE RIGHT. THE BOWL OF EACH "E" IS ELONGATED TO FORM THE WING ON EACH SIDE, AND THE TAIL OF EACH "E" IS SHORTENED TO FORM THE LEFT AND RIGHT SIDE OF THE BIRD'S TAIL.

SER. NO. 77-247,066, FILED 8-3-2007.

STEVEN JACKSON, EXAMINING ATTORNEY

Int. Cl.: 45

Prior U.S. Cls.: 100 and 101

United States Patent and Trademark Office

Reg. No. 3,479,329

Registered Aug. 5, 2008

**SERVICE MARK
PRINCIPAL REGISTER**

Ego Impact

WHEELER, ANNEMARIE R. (UNITED STATES
INDIVIDUAL)
1525 E. NOBLE AVE., #160
VISALIA, CA 93292

THE MARK CONSISTS OF STANDARD CHAR-
ACTERS WITHOUT CLAIM TO ANY PARTICULAR
FONT, STYLE, SIZE, OR COLOR.

FOR: PROVIDING HOLISTIC SPIRITUAL COUN-
SELING SERVICES, IN CLASS 45 (U.S. CLS. 100 AND
101).

SER. NO. 77-247,130, FILED 8-3-2007.

FIRST USE 7-14-2007; IN COMMERCE 7-14-2007.

AHSEN KHAN, EXAMINING ATTORNEY

Int. Cl.: 9

Prior U.S. Cls.: 21, 23, 26, 36 and 38

Reg. No. 3,479,330

United States Patent and Trademark Office

Registered Aug. 5, 2008

**TRADEMARK
PRINCIPAL REGISTER**

PortaPeze

SPLAIN, JACQUELINE (UNITED STATES INDIVIDUAL), DBA SPLAIN DEVELOPMENT, LLC
3423 EAST HILLTOP LOOP
HERNANDO, FL 34442

FOR: FALL PROTECTION EQUIPMENT FOR FALL RESTRAINT AND FALL ARREST, NAMELY, BARS, ANCHORS, HARNESES, LINES, LANYARDS, CARABINERS AND ANCHORAGE CONNECTORS, IN CLASS 9 (U.S. CLS. 21, 23, 26, 36 AND 38).

FIRST USE 6-23-2003; IN COMMERCE 8-4-2007.

THE MARK CONSISTS OF STANDARD CHARACTERS WITHOUT CLAIM TO ANY PARTICULAR FONT, STYLE, SIZE, OR COLOR.

SER. NO. 77-247,311, FILED 8-4-2007.

TANYA AMOS, EXAMINING ATTORNEY

Int. Cls.: 14 and 35

Prior U.S. Cls.: 2, 27, 28, 50, 100, 101 and 102

United States Patent and Trademark Office

Reg. No. 3,479,331

Registered Aug. 5, 2008

**TRADEMARK
SERVICE MARK
PRINCIPAL REGISTER**



ANDIN INTERNATIONAL INC. (NEW YORK CORPORATION)
609 GREENWICH STREET
NEW YORK, NY 10014

FOR: JEWELRY; WATCHES; GEMSTONES; DIAMONDS, IN CLASS 14 (U.S. CLS. 2, 27, 28 AND 50).

FIRST USE 10-17-2007; IN COMMERCE 10-17-2007.

FOR: COOPERATIVE ADVERTISING AND MARKETING SERVICES BY WAY OF SOLICITATION, CUSTOMER SERVICE AND PROVIDING MARKETING INFORMATION VIA WEBSITES ON A GLOBAL COMPUTER NETWORK; CREATION OF MARKETING TOOLS DESIGNED TO INCREASE A CLIENT COMPANY'S KNOWLEDGE OF CUSTOMER NEEDS, AND ITS COMPETITORS' PRODUCTS AND SERVICES, PRICING, ADVERTISING STRATEGY AND SALES STRATEGY; ADVERTISING SER-

VICES, FOR THIRD PARTIES, IN CONNECTION WITH THE COMMERCIALIZATION AND SALE OF PERFUMERY AND COSMETIC ARTICLES, PRODUCTS FOR HOUSEHOLD PURPOSES, OPTICAL PRODUCTS, CLOCKS AND TIMEPIECES, JEWELRY, FURNISHING ARTICLES, IN CLASS 35 (U.S. CLS. 100, 101 AND 102).

FIRST USE 10-17-2007; IN COMMERCE 10-17-2007.

NO CLAIM IS MADE TO THE EXCLUSIVE RIGHT TO USE "609 GREENWICH" AND THE PICTORIAL REPRESENTATION OF A DIAMOND, APART FROM THE MARK AS SHOWN.

SER. NO. 77-248,000, FILED 8-6-2007.

WENDY GOODMAN, EXAMINING ATTORNEY

Int. Cl.: 39

Prior U.S. Cls.: 100 and 105

United States Patent and Trademark Office

Reg. No. 3,479,332

Registered Aug. 5, 2008

**SERVICE MARK
PRINCIPAL REGISTER**

CORPSTAR

CORPSTAR LIMOUSINE SERVICES, LLC (CALIFORNIA LTD LIAB CO)
327 ARDEN AVENUE, SUITE 202
GLENDALE, CA 91203

FOR: PROVIDING TRANSPORTATION OF PASSENGERS BY LIMOUSINE AND OTHER MOTOR VEHICLES, NAMELY, BY SEDAN, SUV, BUS, MINI BUS, MOTOR COACH, AND VAN, IN CLASS 39 (U.S. CLS. 100 AND 105).

FIRST USE 2-3-2006; IN COMMERCE 10-28-2006.

THE MARK CONSISTS OF STANDARD CHARACTERS WITHOUT CLAIM TO ANY PARTICULAR FONT, STYLE, SIZE, OR COLOR.

SER. NO. 77-248,467, FILED 8-6-2007.

SONYA STEPHENS, EXAMINING ATTORNEY

Int. Cl.: 6

Prior U.S. Cls.: 2, 12, 13, 14, 23, 25 and 50

Reg. No. 3,479,333

United States Patent and Trademark Office

Registered Aug. 5, 2008

**TRADEMARK
PRINCIPAL REGISTER**

E-ZEE FEED

ITT CORPORATION (INDIANA CORPORATION)
4 WEST RED OAK LANE
WHITE PLAINS, NY 10604

FOR: WELLHEAD FEEDTHRU, NAMELY, METAL HOUSINGS USED TO PERMIT CABLES, CONNECTORS AND TUBING TO PASS THROUGH THE PRESSURE BARRIER OF A WELL, IN CLASS 6 (U.S. CLS. 2, 12, 13, 14, 23, 25 AND 50).

FIRST USE 4-9-1996; IN COMMERCE 4-9-1996.

THE MARK CONSISTS OF STANDARD CHARACTERS WITHOUT CLAIM TO ANY PARTICULAR FONT, STYLE, SIZE, OR COLOR.

NO CLAIM IS MADE TO THE EXCLUSIVE RIGHT TO USE "FEED", APART FROM THE MARK AS SHOWN.

SER. NO. 77-248,602, FILED 8-7-2007.

DAVID MURRAY, EXAMINING ATTORNEY

Int. Cl.: 9

Prior U.S. Cls.: 21, 23, 26, 36 and 38

Reg. No. 3,479,334

United States Patent and Trademark Office

Registered Aug. 5, 2008

**TRADEMARK
PRINCIPAL REGISTER**

Holiday Hang-Ups

HOLIDAY HANG-UPS INC. (MASSACHUSETTS CORPORATION), DBA HOLIDAY HANG-UPS INC.

46 COBB LANE
SCITUATE, MA 02066

FOR: DECORATIVE MAGNETS, IN CLASS 9 (U.S. CLS. 21, 23, 26, 36 AND 38).

FIRST USE 5-1-1991; IN COMMERCE 5-1-1991.

THE MARK CONSISTS OF STANDARD CHARACTERS WITHOUT CLAIM TO ANY PARTICULAR FONT, STYLE, SIZE, OR COLOR.

NO CLAIM IS MADE TO THE EXCLUSIVE RIGHT TO USE "HOLIDAY", APART FROM THE MARK AS SHOWN.

SER. NO. 77-249,072, FILED 8-7-2007.

EVELYN BRADLEY, EXAMINING ATTORNEY

Int. Cl.: 41

Prior U.S. Cls.: 100, 101 and 107

United States Patent and Trademark Office

Reg. No. 3,479,335

Registered Aug. 5, 2008

**SERVICE MARK
PRINCIPAL REGISTER**



EMUSE MEDIA LIMITED (IRELAND COMPAN-
NY)
UNIT 24 ENTERPRISE CENTRE
TRINITY COLLEGE, PEARSE STREET
DUBLIN, IRELAND 2

FOR: ORGANIZING COMMUNITY SPORTING AND CULTURAL EVENTS; EDUCATIONAL SERVICES, NAMELY, CONDUCTING CLASSES AND SEMINARS IN THE FIELD OF HOW TO PROVIDE ELECTRONIC MEDIA OVER THE INTERNET OR OTHER COMMUNICATIONS NETWORKS; PUBLISHING AND ONLINE PUBLISHING SERVICES OF BOOKS, MAGAZINES, MUSIC, IMAGES AND VIDEOS; ON-LINE JOURNALS, NAMELY WEB BLOGS IN THE FIELD OF GENERAL INTEREST; ENTERTAINMENT IN THE NATURE OF COMPETITIONS IN THE FIELD OF VIDEOS, PHOTOGRAPHY, GAMING, GENERAL KNOWLEDGE QUIZZES AND COMPETITIONS BASED PURELY ON CHANCE; PROVIDING ON-LINE COMPUTER GAMES; PRODUCTION AND DISTRIBUTION OF

INTERACTIVE TELEVISION PROGRAMS; PRODUCTION OF VIDEO DISKS AND TAPES; EDITING OF MEDIA OBJECTS AND DIGITAL CONTENT INCLUDING TEXT, DOCUMENTS, PHOTOGRAPHS, IMAGES, VIDEO AND AUDIO; PROVIDING ON-LINE COMPUTER DATABASES AND ON-LINE SEARCHABLE DATABASES REGARDING EDITING OF MEDIA OBJECTS AND DIGITAL CONTENT; PROVIDING ON-LINE COMPUTER DATABASES AND ON-LINE SEARCHABLE DATABASES REGARDING THE EDITING OF VIDEO; PROVISION OF CONSULTATION REGARDING THE FOREGOING, IN CLASS 41 (U.S. CLS. 100, 101 AND 107).

OWNER OF ERPN CMNTY TM OFC REG. NO. 005887013, DATED 2-27-2008, EXPIRES 5-9-2017.

SER. NO. 77-249,177, FILED 8-7-2007.

MARK T. MULLEN, EXAMINING ATTORNEY

Int. Cl.: 42

Prior U.S. Cls.: 100 and 101

United States Patent and Trademark Office

Reg. No. 3,479,336

Registered Aug. 5, 2008

**SERVICE MARK
PRINCIPAL REGISTER**



EMUSE MEDIA LIMITED (IRELAND COMPAN-
NY)
UNIT 24 ENTERPRISE CENTRE
TRINITY COLLEGE, PEARSE STREET
DUBLIN, IRELAND 2

FOR: DESIGN AND DEVELOPMENT OF COM-
PUTER HARDWARE AND SOFTWARE; PROVID-
ING A WEBSITE FEATURING TEMPORARY USE
OF NON-DOWNLOADABLE SOFTWARE ALLOW-
ING WEBSITE USERS TO FACILITATE CREATING,
EDITING, UPLOADING, POSTING, DISPLAYING,
TAGGING, BLOGGING, SHARING, TRADING,
PARSING OR PROVIDING ELECTRONIC MEDIA,
INFORMATION OR DATA INCLUDING IMAGES,
GRAPHICS, SOUND, TEXT, VIDEO OR AUDIO-
VISUAL INFORMATION VIA THE INTERNET OR
OTHER COMMUNICATIONS NETWORKS FOR
EDUCATION AND ENTERTAINMENT PURPOSES;
COMPUTER SERVICES, NAMELY, HOSTING AND
PROVIDING ON-LINE FACILITIES FOR OTHERS
FOR ORGANIZING AND CONDUCTING ON-LINE
MEETINGS, GATHERINGS, INTERACTIVE DIS-
CUSSIONS, THE CREATION OF AND PARTICIPA-
TION IN ON-LINE COMMUNITIES AND SOCIAL
NETWORKS; COMPUTER SERVICES IN THE NAT-

URE OF CUSTOMIZED WEB PAGES FEATURING
USER-DEFINED INFORMATION, PERSONAL IN-
FORMATION AND PROFILES; WEBSITE DESIGN
SERVICES; WEBSITE HOSTING SERVICES FOR
OTHERS; MAINTENANCE OF WEBSITES FOR
OTHERS; PROVIDING ON-LINE NON-DOWN-
LOADABLE SOFTWARE FOR THE CONTEXTUA-
LIZATION AND EDITING OF VIDEO, AUDIO AND
GRAPHICAL DATA; PROVIDING SEARCH EN-
GINE SERVICES FOR OBTAINING DATA ON A
GLOBAL COMPUTER NETWORK; HOSTING DIGI-
TAL CONTENT ON THE INTERNET; PROVIDING A
WEBSITE THAT GIVES COMPUTER USERS THE
ABILITY TO UPLOAD, EXCHANGE AND SHARE
PHOTOS AND VIDEOS; PROVISION OF CONSUL-
TATION REGARDING THE FOREGOING, IN
CLASS 42 (U.S. CLS. 100 AND 101).

OWNER OF ERPN CMNTY TM OFC REG. NO.
005887013, DATED 2-27-2008, EXPIRES 5-9-2017.

SER. NO. 77-249,188, FILED 8-7-2007.

MARK T. MULLEN, EXAMINING ATTORNEY

Int. Cl.: 41

Prior U.S. Cls.: 100, 101 and 107

United States Patent and Trademark Office

Reg. No. 3,479,337

Registered Aug. 5, 2008

SERVICE MARK
PRINCIPAL REGISTER



VERA VICTOR JR. (UNITED STATES INDIVIDUAL)
2727 N GROVE INDUSTRIAL DR.BLDG 155 STEB
FRESNO, CA 93727

FOR: ENTERTAINMENT IN THE NATURE OF MUSICAL GROUP, IN CLASS 41 (U.S. CLS. 100, 101 AND 107).

FIRST USE 12-1-2006; IN COMMERCE 12-23-2006.

THE MARK CONSISTS OF THE WORDING "LOS CAZADORES DEL NORTE" WITH A DEER IN THE BACKGROUND.

THE ENGLISH TRANSLATION OF "LOS CAZADORES DEL NORTE" IN THE MARK IS "THE HUNTERS OF THE NORTH" WITH A DEER IN THE BACKGROUND.

SER. NO. 77-249,591, FILED 8-7-2007.

ALICE BENMAMAN, EXAMINING ATTORNEY

Int. Cls.: 14 and 25

Prior U.S. Cls.: 2, 22, 27, 28, 39 and 50

United States Patent and Trademark Office

Reg. No. 3,479,338

Registered Aug. 5, 2008

TRADEMARK
PRINCIPAL REGISTER



CAIN, MARC A (UNITED STATES INDIVIDUAL)
P.O. BOX 13010
CHICAGO, IL 60613

FOR: JEWELRY, IN CLASS 14 (U.S. CLS. 2, 27, 28
AND 50).

FIRST USE 2-1-1999; IN COMMERCE 2-1-1999.

FOR: POLO SHIRTS; SHIRTS; SHORT-SLEEVED
OR LONG-SLEEVED T-SHIRTS; PANTS; JACKETS;
HATS; BELTS; LEATHER BELTS; SWEAT PANTS;

SWEAT SHIRTS; COATS FOR MEN AND WOMEN,
IN CLASS 25 (U.S. CLS. 22 AND 39).

FIRST USE 2-1-1999; IN COMMERCE 2-1-1999.

THE MARK CONSISTS OF A SHIELD, CREST/
COAT OF ARMS WITH LUCKY PIGGY IN THE TOP
AND A SCROLL LETTERING LP AND PIG/WILD
PIG IN THE CENTER.

SER. NO. 77-249,628, FILED 8-8-2007.

MATTHEW PAPPAS, EXAMINING ATTORNEY

Int. Cl.: 25

Prior U.S. Cls.: 22 and 39

United States Patent and Trademark Office

Reg. No. 3,479,339

Registered Aug. 5, 2008

**TRADEMARK
PRINCIPAL REGISTER**

FAULTLINE

FAULTLINE CORP. (CALIFORNIA CORPORATION), DBA FAULTLINE CLOTHING
542 SAN ANDRES DR.
SOLANA BEACH, CA 92075

FOR: CAPS; FIGURE SKATING CLOTHING, NAMELY, SCARVES, HATS, AND MISCELLANEOUS CLOTHING ACCESSORIES FOR SKATING, NAMELY, GLOVES; HOODS; JERSEYS; TOPS; SKI WEAR; SURF WEAR; SNOW BOARDING SUITS, IN CLASS 25 (U.S. CLS. 22 AND 39).

FIRST USE 2-1-2006; IN COMMERCE 2-27-2006.

THE MARK CONSISTS OF STANDARD CHARACTERS WITHOUT CLAIM TO ANY PARTICULAR FONT, STYLE, SIZE, OR COLOR.

SER. NO. 77-249,632, FILED 8-8-2007.

MATTHEW PAPPAS, EXAMINING ATTORNEY

Int. Cl.: 37

Prior U.S. Cls.: 100, 103 and 106

United States Patent and Trademark Office

Reg. No. 3,479,340

Registered Aug. 5, 2008

**SERVICE MARK
PRINCIPAL REGISTER**

BELFOR ENVIRONMENTAL

BELFOR USA GROUP INC. (COLORADO CORPORATION)
185 OAKLAND, SUITE 300
BIRMINGHAM, MI 48009

FOR: AIR DUCT CLEANING SERVICES; ASBESTOS REMOVAL; CLEANING OF BUILDING EXTERIOR SURFACES; CLEANING OF INDUSTRIAL PREMISES; CLEANING OF RESIDENTIAL HOUSES; EMERGENCY SPILL RESPONSE CONTAINMENT, COLLECTION AND DISPOSAL; ENVIRONMENTAL REMEDIATION SERVICES, NAMELY, WASTE DISPOSAL; EXCAVATION SERVICES; HOUSE AND BUILDING DEMOLITION; LAND RECLAMATION; MEDICAL WASTE, BLOOD AND BODILY FLUID CLEANING AND DISPOSAL SERVICES; MEDICAL WASTE, BLOOD AND BODILY FLUID DISINFECTION SERVICES; REPAIR AND MAINTENANCE OF BUILDINGS IN CASE OF DEMOLITION; REPAIR OR MAINTENANCE OF STORAGE TANKS; SEPTIC TANK CLEANING; STORAGE TANK CLEANING; WASTE DISPOSAL

FOR OTHERS , IN CLASS 37 (U.S. CLS. 100, 103 AND 106).

FIRST USE 5-18-2007; IN COMMERCE 5-18-2007.

THE MARK CONSISTS OF STANDARD CHARACTERS WITHOUT CLAIM TO ANY PARTICULAR FONT, STYLE, SIZE, OR COLOR.

OWNER OF U.S. REG. NO. 2,559,315.

NO CLAIM IS MADE TO THE EXCLUSIVE RIGHT TO USE "ENVIRONMENTAL", APART FROM THE MARK AS SHOWN.

SEC. 2(F) AS TO "BELFOR".

SER. NO. 77-249,808, FILED 8-8-2007.

SUNG IN, EXAMINING ATTORNEY

Int. Cl.: 40

Prior U.S. Cls.: 100, 103 and 106

United States Patent and Trademark Office

Reg. No. 3,479,341

Registered Aug. 5, 2008

**SERVICE MARK
PRINCIPAL REGISTER**

BELFOR ENVIRONMENTAL

BELFOR USA GROUP INC. (COLORADO CORPORATION)
185 OAKLAND, SUITE 300
BIRMINGHAM, MI 48009

FOR: BIOMEDICAL AND BIOHAZARDOUS WASTE MANAGEMENT AND DISPOSAL BY USE OF STERILIZATION DEVICES TO CONVERT WASTE TO SOLID NONINFECTIOUS WASTE; BIOREMEDIATION SERVICES; CHEMICAL ENCAPSULATION AND DISPERSION OF HAZARDOUS CHEMICALS; DECONTAMINATION OF HAZARDOUS MATERIALS; DEMOLITION SERVICES; DESTRUCTION OF WASTE; EMERGENCY RESPONSE SERVICES, NAMELY, PROVIDING DECONTAMINATION, SOIL REMEDIATION, AND WATER TREATMENT; ENVIRONMENTAL REMEDIATION SERVICES, NAMELY, SOIL, WASTE AND/OR WATER TREATMENT SERVICES; HAZARDOUS MATERIALS EMERGENCY RESPONSE REMEDIATION SERVICES; HAZARDOUS WASTE MANAGEMENT; INDUSTRIAL TOXIC WASTE DISPOSAL; MEDICAL WASTE, BLOOD AND BODILY FLUID DECONTAMINATION SERVICES; MOLD

REMEDICATION SERVICES; TREATMENT OF WASTE WATER; WASTE MANAGEMENT; WASTE TREATMENT, IN CLASS 40 (U.S. CLS. 100, 103 AND 106).

FIRST USE 5-18-2007; IN COMMERCE 5-18-2007.

THE MARK CONSISTS OF STANDARD CHARACTERS WITHOUT CLAIM TO ANY PARTICULAR FONT, STYLE, SIZE, OR COLOR.

OWNER OF U.S. REG. NO. 2,559,315.

NO CLAIM IS MADE TO THE EXCLUSIVE RIGHT TO USE "ENVIRONMENTAL", APART FROM THE MARK AS SHOWN.

SEC. 2(F) AS TO "BELFOR".

SER. NO. 77-249,936, FILED 8-8-2007.

SUNG IN, EXAMINING ATTORNEY

Int. Cl.: 25

Prior U.S. Cls.: 22 and 39

United States Patent and Trademark Office

Reg. No. 3,479,342

Registered Aug. 5, 2008

TRADEMARK
PRINCIPAL REGISTER



DBD, INC. (DELAWARE CORPORATION)
C/O DAVID'S BRIDAL, INC.
1001 WASHINGTON ST.
CONSHOHOCKEN, PA 19428

THE COLOR(S) BLACK IS/ARE CLAIMED AS A
FEATURE OF THE MARK.

FOR: SPECIAL OCCASION APPAREL FOR CHILDREN AND YOUNG TEENS, NAMELY, DRESSES, JACKETS, SWEATERS, SHAWLS, WRAPS, SASHES AND BELTS, IN CLASS 25 (U.S. CLS. 22 AND 39).

THE MARK CONSISTS OF "BLUSH" WRITTEN IN LOWER CASE LETTERS WITH A SMALL HALO TYPE OBJECT OVER THE "B" AND THE WORDS "BY US ANGELS" WRITTEN BELOW IS A SMALLER FONT SIZE AND LIGHTER SHADE OF BLACK.

FIRST USE 1-1-2007; IN COMMERCE 6-15-2007.

OWNER OF U.S. REG. NOS. 3,175,879 AND 3,310,038.

SER. NO. 77-250,114, FILED 8-8-2007.

NO CLAIM IS MADE TO THE EXCLUSIVE RIGHT TO USE "BLUSH", APART FROM THE MARK AS SHOWN.

TRACY WHITTAKER-BROWN, EXAMINING ATTORNEY

Int. Cl.: 42

Prior U.S. Cls.: 100 and 101

United States Patent and Trademark Office

Reg. No. 3,479,343

Registered Aug. 5, 2008

**SERVICE MARK
PRINCIPAL REGISTER**

**Connected – Secure –
Available**

LIBERTY LAKE INTERNET EXCHANGE, LLC
(WASHINGTON LTD LIAB CO)
23403 E. MISSION AVE
LIBERTY LAKE, WA 99019

FOR: COMPUTER COLOCATION SERVICES, NAMELY, PROVIDING FACILITIES FOR THE LOCATION OF COMPUTER SERVERS WITH THE EQUIPMENT OF OTHERS; APPLICATION SERVICE PROVIDER (ASP), NAMELY, HOSTING COMPUTER SOFTWARE APPLICATIONS OF OTHERS; COMPUTER SERVICE, NAMELY, ACTING AS AN APPLICATION SERVICE PROVIDER IN THE FIELD OF KNOWLEDGE MANAGEMENT TO HOST COMPUTER APPLICATION SOFTWARE FOR CREATING SEARCHABLE DATABASES OF INFORMATION AND DATA; COMPUTER SERVICE, NAMELY, ACTING AS AN APPLICATION SERVICE PROVIDER IN THE FIELD OF KNOWLEDGE MANAGEMENT TO HOST COMPUTER AP-

PLICATION SOFTWARE FOR THE COLLECTION, EDITING, ORGANIZING, MODIFYING, BOOK MARKING, TRANSMISSION, STORAGE AND SHARING OF DATA AND INFORMATION, IN CLASS 42 (U.S. CLS. 100 AND 101).

FIRST USE 4-1-2007; IN COMMERCE 7-19-2007.

THE MARK CONSISTS OF STANDARD CHARACTERS WITHOUT CLAIM TO ANY PARTICULAR FONT, STYLE, SIZE, OR COLOR.

NO CLAIM IS MADE TO THE EXCLUSIVE RIGHT TO USE "SECURE", APART FROM THE MARK AS SHOWN.

SER. NO. 77-250,130, FILED 8-8-2007.

TEJBIR SINGH, EXAMINING ATTORNEY

Int. Cl.: 41

Prior U.S. Cls.: 100, 101 and 107

United States Patent and Trademark Office

Reg. No. 3,479,344

Registered Aug. 5, 2008

**SERVICE MARK
PRINCIPAL REGISTER**

BRAINSTORM

BRAINSTORM TUTORING, LLC (NEW JERSEY
LTD LIAB CO)
141 WEST OAK STREET
RAMSEY, NJ 07446

FOR: EDUCATIONAL SERVICES, NAMELY, ACADEMIC TUTORING SERVICES MATCHED TO CUSTOMER NEEDS AND DELIVERED BY TRAINED PROFESSIONAL TUTORS IN ONE-ON-ONE SESSIONS BETWEEN TUTOR AND CUSTOMER WITHIN THE CUSTOMER'S HOME OR AT ANOTHER LOCATION OF THE CUSTOMER'S CHOICE, TREATING SUBJECT AREAS OF THE CUSTOMER'S CHOICE AT THE PRE-K THROUGH GRADE 12 LEVELS, AND THE DISTRIBUTION OF TRAINING COURSE MATERIALS PROVIDED IN CONNECTION THEREWITH; EDUCATION SERVICES, NAMELY, PROVIDING TUTORING AND CLASSES TO IMPROVE ACADEMIC PERFORMANCE OF STUDENTS AND FOR PROFESSIONAL

DEVELOPMENT OF TEACHERS; EDUCATIONAL SERVICES, NAMELY, PERSONALIZED IN-HOME AND SMALL GROUP TUTORING IN MATHEMATICS, SCIENCE, READING, WRITING, LANGUAGES, MUSIC, STUDY SKILLS, ORGANIZATION, INTERVIEW SKILLS, APPLICATION PREPARATION, AND STANDARDIZED TEST PREPARATION, IN CLASS 41 (U.S. CLS. 100, 101 AND 107).

FIRST USE 4-0-2006; IN COMMERCE 10-0-2006.

THE MARK CONSISTS OF STANDARD CHARACTERS WITHOUT CLAIM TO ANY PARTICULAR FONT, STYLE, SIZE, OR COLOR.

SER. NO. 77-250,582, FILED 8-8-2007.

SANI KHOURI, EXAMINING ATTORNEY

Int. Cl.: 41

Prior U.S. Cls.: 100, 101 and 107

United States Patent and Trademark Office

Reg. No. 3,479,345

Registered Aug. 5, 2008

**SERVICE MARK
PRINCIPAL REGISTER**

language insurance

FONE-IN LTD. (ANGUILLA LTD LIAB CO)

CARIBBEAN SUITE

THE VALLEY, ANGUILLA

FOR: LANGUAGE INTERPRETATION, IN CLASS
41 (U.S. CLS. 100, 101 AND 107).

FIRST USE 7-23-2007; IN COMMERCE 8-7-2007.

THE MARK CONSISTS OF STANDARD CHAR-
ACTERS WITHOUT CLAIM TO ANY PARTICULAR
FONT, STYLE, SIZE, OR COLOR.

NO CLAIM IS MADE TO THE EXCLUSIVE
RIGHT TO USE "LANGUAGE", APART FROM
THE MARK AS SHOWN.

SER. NO. 77-250,858, FILED 8-9-2007.

GIANCARLO CASTRO, EXAMINING ATTORNEY

Int. Cl.: 25

Prior U.S. Cls.: 22 and 39

United States Patent and Trademark Office

Reg. No. 3,479,346

Registered Aug. 5, 2008

**TRADEMARK
PRINCIPAL REGISTER**

BUGATCHI WOMEN

BUGATCHI UOMO APPAREL, INC. (FLORIDA CORPORATION)
SUITE 200
1377 CLINT MOORE ROAD
BOCA RATON, FL 33487

FOR: WOMEN'S CLOTHING, NAMELY, SHIRTS, KNITS, NAMELY, THREE BUTTON, CREW NECKS, V-NECKS, HALF-ZIP MOCKS, FULL-ZIP, VESTS, SLEEVELESS; SWEATERS, DRESSES, SKITS, JOGGING SUITS, SWEATSHIRTS, GOLF KNITS, VESTS, SKORTS, T-SHIRTS, JEANS, JACKETS, BLAZERS, ACTIVE WEAR, NAMELY, JOGGING PANTS, JOGGING JACKETS, THREE BUTTON SHIRTS, CREW NECKS, V-NECKS, HALF-ZIP MOCKS, FULL-ZIP, VESTS, SLEEVELESS; SHORTS, BELTS, PANTS,

OUTERWEAR, NAMELY, JACKETS, BOMBERS, AND VESTS, IN CLASS 25 (U.S. CLS. 22 AND 39).

FIRST USE 1-1-2005; IN COMMERCE 6-1-2006.

THE MARK CONSISTS OF STANDARD CHARACTERS WITHOUT CLAIM TO ANY PARTICULAR FONT, STYLE, SIZE, OR COLOR.

NO CLAIM IS MADE TO THE EXCLUSIVE RIGHT TO USE "WOMEN", APART FROM THE MARK AS SHOWN.

SER. NO. 77-250,982, FILED 8-9-2007.

DAWN FELDMAN, EXAMINING ATTORNEY

Int. Cl.: 39

Prior U.S. Cls.: 100 and 105

United States Patent and Trademark Office

Reg. No. 3,479,347

Registered Aug. 5, 2008

**SERVICE MARK
PRINCIPAL REGISTER**

ELVIS

ELVIS PRESLEY ENTERPRISES, INC. (TENNESSEE CORPORATION)

3734 ELVIS PRESLEY BLVD.

MEMPHIS, TN 38116

FOR: BOAT CRUISES, IN CLASS 39 (U.S. CLS. 100 AND 105).

FIRST USE 1-0-2007; IN COMMERCE 1-0-2007.

THE MARK CONSISTS OF STANDARD CHARACTERS WITHOUT CLAIM TO ANY PARTICULAR FONT, STYLE, SIZE, OR COLOR.

"THE NAME(S), PORTRAIT(S), AND/OR SIGNATURE(S) SHOWN IN THE MARK DOES NOT IDENTIFY A PARTICULAR LIVING INDIVIDUAL."

SER. NO. 77-251,593, FILED 8-9-2007.

WON TEAK OH, EXAMINING ATTORNEY

Int. Cls.: 35 and 37

Prior U.S. Cls.: 100, 101, 102, 103 and 106

United States Patent and Trademark Office

Reg. No. 3,479,348

Registered Aug. 5, 2008

**SERVICE MARK
PRINCIPAL REGISTER**

**DON LA FORCE ASSOCIATES,
INC.**

BESAM US INC. (CONNECTICUT CORPORATION)
2140 PRIEST BRIDGE COURT, SUITE 7
CROFTON, MD 21114

FOR: ON-LINE RETAIL STORE SERVICES FEATURING MANUAL AND AUTOMATIC DOORS AND DOOR SENSORS, SWITCHES AND ACCESS CONTROLLERS; DISTRIBUTORSHIPS IN THE FIELD OF MANUAL AND AUTOMATIC DOORS AND DOOR SENSORS, SWITCHES AND ACCESS CONTROLLERS, IN CLASS 35 (U.S. CLS. 100, 101 AND 102).

FIRST USE 6-30-1972; IN COMMERCE 6-30-1972.

FOR: INSTALLATION, MAINTENANCE AND REPAIR OF MANUAL AND AUTOMATIC DOORS AND DOOR SENSORS, SWITCHES AND ACCESS CONTROLLERS, IN CLASS 37 (U.S. CLS. 100, 103 AND 106).

FIRST USE 6-30-1972; IN COMMERCE 6-30-1972.

THE MARK CONSISTS OF STANDARD CHARACTERS WITHOUT CLAIM TO ANY PARTICULAR FONT, STYLE, SIZE, OR COLOR.

NO CLAIM IS MADE TO THE EXCLUSIVE RIGHT TO USE "ASSOCIATES, INC.", APART FROM THE MARK AS SHOWN.

THE NAME SHOWN IN THE MARK IDENTIFIES "DONALD J. LA FORCE", WHOSE CONSENT TO REGISTER IS SUBMITTED.

SER. NO. 77-252,439, FILED 8-10-2007.

TINA BROWN, EXAMINING ATTORNEY

Int. Cl.: 6

Prior U.S. Cls.: 2, 12, 13, 14, 23, 25 and 50

Reg. No. 3,479,349

United States Patent and Trademark Office

Registered Aug. 5, 2008

**TRADEMARK
PRINCIPAL REGISTER**

FEENEY

PACIFIC COAST WIRE ROPE & FITTINGS, INC.
(CALIFORNIA CORPORATION), DBA FEE-
NEY WIRE ROPE & FITTINGS, INC.
2603 UNION STREET
OAKLAND, CA 94607

FOR: METAL RIGGING PRODUCTS, NAMELY, BULK WIRE ROPE, CABLE, STRAND, WIRE, CHAIN, RODS, AND RELATED METAL HARDWARE, FITTINGS AND ASSEMBLIES, NAMELY, TURNBUCKLES, FORKS, CLEAVES, SOCKETS, TERMINALS, BOLTS, SCREWS, NUTS, HOOKS, LINKS, RINGS, SLEEVES, CLIPS, THIMBLES, SHACKLES, SWIVELS, FERRULES, THREADED STUDS, BALLS, EYES, ANCHORS, GRIPS, SHEAVES, BLOCKS, PULLEYS, SLINGS, AND TIE-DOWNS ALL FOR USE IN INDUSTRIAL AND CONSTRUCTION FIELDS; METAL BUILDING MATERIAL, NAMELY, SUPPORT FRAMES AND PANELS, CABLE AND ROD ASSEMBLIES, RAILINGS FRAMES, RAILING INFILL MATERIALS, TRELIS SYSTEMS, DOOR, AND WINDOW CANOPIES USED IN RESIDENTIAL, COMMERCIAL, INSTITUTIONAL AND INDUSTRIAL CONSTRUCTION FIELDS; CONSTRUCTION ELEMENTS MADE OF METAL, NAMELY, SUPPORTS; CONSTRUCTION ELE-

MENTS MADE OF METAL, NAMELY, BRACES; METAL BRACKETS FOR USE IN THE CONSTRUCTION AND ASSEMBLY OF DECKING; METAL RAILINGS, METAL RAILING FRAMES, FRAME COMPONENTS, INFILL MATERIALS FOR USE IN FENCES, BRIDGES, BALCONIES, GATES, DECKS, STAIRS, RAMPS, DOCKS, LANDINGS, PORCHES, ROOFS, AND CATWALKS; ATTACHMENT HARDWARE, NAMELY, PLATES, NUTS, SCREWS, BOLTS, LATCHES, WASHERS, RIVETS, AND RELATED ACCESSORIES THEREOF, NAMELY, DECORATIVE CAPS, COVERS, SLEEVES; METAL RAILS, IN CLASS 6 (U.S. CLS. 2, 12, 13, 14, 23, 25 AND 50).

FIRST USE 1-1-1998; IN COMMERCE 1-1-1998.

THE MARK CONSISTS OF STANDARD CHARACTERS WITHOUT CLAIM TO ANY PARTICULAR FONT, STYLE, SIZE, OR COLOR.

SEC. 2(F).

SER. NO. 77-252,452, FILED 8-10-2007.

LINDA POWELL, EXAMINING ATTORNEY

Int. Cl.: 44

Prior U.S. Cls.: 100 and 101

United States Patent and Trademark Office

Reg. No. 3,479,350

Registered Aug. 5, 2008

**SERVICE MARK
PRINCIPAL REGISTER**

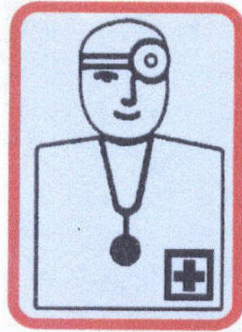

JAVIER R. RIOS MD A PROFESSIONAL CORPORATION (CALIFORNIA CORPORATION), DBA MAGNOLIA CLINICA MEDICA FAMILIAR, CHICAGO CLINICA MEDICA FAMILIAR 9939 MAGNOLIA AVE. RIVERSIDE, CA 92503

FOR: MEDICAL CLINICS, IN CLASS 44 (U.S. CLS. 100 AND 101).

FIRST USE 2-1-2003; IN COMMERCE 2-1-2003.

THE COLOR(S) RED, BLACK & BABY BLUE IS/ ARE CLAIMED AS A FEATURE OF THE MARK.

THE MARK CONSISTS OF PLAIN SINGLE LINE REGTANGLE IN RED COLOR, DOCTOR'S IMAGE IN BLACK BORDERS WITH A LIGHT BAND ON THE HEAD AND STETHOSCOPE AND A CROSS INTHE RIGHT BOTTOM;GREEK CROSS DESIGN IS BLACK COLOR(NOT DISPLAY IN RED COLOR), INSIDE BACKGROUND IN THE REGTANGLE IS BABY BLUE COLOR..

SER. NO. 77-252,465, FILED 8-10-2007.

GRETTA YAO, EXAMINING ATTORNEY

Int. Cl.: 6

Prior U.S. Cls.: 2, 12, 13, 14, 23, 25 and 50

Reg. No. 3,479,351

United States Patent and Trademark Office

Registered Aug. 5, 2008

**TRADEMARK
PRINCIPAL REGISTER**

**FEENEY ARCHITECTURAL
PRODUCTS**

PACIFIC COAST WIRE ROPE & FITTINGS, INC.
(CALIFORNIA CORPORATION), DBA FEENEY WIRE ROPE & FITTINGS, INC.
2603 UNION STREET
OAKLAND, CA 94607

FOR: METAL BUILDING MATERIAL, NAMELY, SUPPORT FRAMES AND PANELS, CABLE AND ROD ASSEMBLIES, RAILINGS FRAMES, RAILING INFILL MATERIALS, TRELLIS SYSTEMS, DOOR, AND WINDOW CANOPIES USED IN RESIDENTIAL, COMMERCIAL, INSTITUTIONAL AND INDUSTRIAL CONSTRUCTION FIELDS; CONSTRUCTION ELEMENTS MADE OF METAL, NAMELY, SUPPORTS; CONSTRUCTION ELEMENTS MADE OF METAL, NAMELY, BRACES; METAL BRACKETS FOR USE IN THE CONSTRUCTION AND ASSEMBLY OF DECKING; METAL RAILINGS, METAL RAILING FRAMES, FRAME COMPONENTS, INFILL MATERIALS FOR USE IN FENCES, BRIDGES, BALCONIES, GATES, DECKS, STAIRS, RAMPS, DOCKS, LANDINGS, PORCHES, ROOFS, AND CATWALKS; ATTACHMENT HARD-

WARE, NAMELY, PLATES, NUTS, SCREWS, BOLTS, LATCHES, WASHERS, RIVETS AND RELATED ACCESSORIES THEREOF, NAMELY, DECORATIVE CAPS, COVERS, SLEEVES; METAL RAILS, IN CLASS 6 (U.S. CLS. 2, 12, 13, 14, 23, 25 AND 50).

FIRST USE 1-1-2007; IN COMMERCE 1-1-2007.

THE MARK CONSISTS OF STANDARD CHARACTERS WITHOUT CLAIM TO ANY PARTICULAR FONT, STYLE, SIZE, OR COLOR.

NO CLAIM IS MADE TO THE EXCLUSIVE RIGHT TO USE "ARCHITECTURAL PRODUCTS", APART FROM THE MARK AS SHOWN.

SEC. 2(F) AS TO "FEENEY".

SER. NO. 77-252,667, FILED 8-10-2007.

LINDA POWELL, EXAMINING ATTORNEY

Int. Cl.: 25

Prior U.S. Cls.: 22 and 39

United States Patent and Trademark Office

Reg. No. 3,479,352

Registered Aug. 5, 2008

**TRADEMARK
PRINCIPAL REGISTER**



MIA BRAZILIA LLC (CALIFORNIA LTD LIAB
CO)
7656 FORMULA PLACE
SAN DIEGO, CA 92121

FOR: WORKOUT WEAR, NAMELY TOPS,
PANTS, BOTTOMS, JACKETS, SHORTS, CAPRIS,
SPORTS BRAS, LEOTARDS, UNITARDS, LEG-
GINGS, SOCKS, LOUNGEWEAR, UNDERGAR-
MENTS; HANGOUT WEAR, NAMELY, TOPS,
PANTS, BOTTOMS, SKIRTS, SHORTS, CAPRIS,
SKORTS, SPORTS, BRAS, JEANS, LOUNGEWEAR,
LOUNGE PANTS, T-SHIRTS, TANK TOPS, SHIRTS,
CAPS, HATS, DRESSES, COATS; ACTIVEWEAR,
NAMELY, TOPS, PANTS, BOTTOMS, JACKETS,
SHORTS, SKORTS, CAPRIS, SPORTS BRAS, JER-
SEYS, SWIMSUITS, COVER-UPS, SWEATSUITS,
SWEAT PANTS, SWEAT SHIRTS, IN CLASS 25 (U.S.
CLS. 22 AND 39).

FIRST USE 3-1-2003; IN COMMERCE 3-1-2003.

NO CLAIM IS MADE TO THE EXCLUSIVE
RIGHT TO USE "BRAZILIAN", APART FROM THE
MARK AS SHOWN.

"THE NAME(S), PORTRAIT(S), AND/OR SIGNA-
TURE(S) SHOWN IN THE MARK DOES NOT IDENT-
IFY A PARTICULAR LIVING INDIVIDUAL."

"THE COLOR(S) BLUE, PINK, GRAY AND
BLACK IS/ARE CLAIMED AS A FEATURE OF
THE MARK."

THE COLOR BLUE APPEARS IN THE WINGS OF
THE BUTTERFLY; THE COLOR PINK APPEARS IN
THE WINGS OF THE BUTTERFLY; THE COLOR
GRAY APPEARS IN THE WINGS AND ANTENNAE
OF THE BUTTERFLY, IN THE WORDING MIA
BRASILIA AND IN AN OUTLINE OF THE BUTTER-
FLY AND WORDING; AND THE COLOR BLACK
APPEARS IN THE RECTANGLE BACKGROUND.

"THE FOREIGN WORDING IN THE MARK
TRANSLATES INTO ENGLISH AS MY BRAZI-
LIAN."

SER. NO. 77-253,134, FILED 8-12-2007.

MARY ROSSMAN, EXAMINING ATTORNEY

Int. Cl.: 41

Prior U.S. Cls.: 100, 101 and 107

United States Patent and Trademark Office

Reg. No. 3,479,353

Registered Aug. 5, 2008

**SERVICE MARK
PRINCIPAL REGISTER**

THE GET REAL GUIDE

KAREN COLLIGAN (UNITED STATES INDIVIDUAL), DBA PEOPLETHINK

1000 GREEN STREET, #602

SAN FRANCISCO, CA 94133

FOR: CAREER COUNSELING, IN CLASS 41 (U.S. CLS. 100, 101 AND 107).

FIRST USE 6-29-2007; IN COMMERCE 6-29-2007.

THE MARK CONSISTS OF STANDARD CHARACTERS WITHOUT CLAIM TO ANY PARTICULAR FONT, STYLE, SIZE, OR COLOR.

NO CLAIM IS MADE TO THE EXCLUSIVE RIGHT TO USE "GUIDE", APART FROM THE MARK AS SHOWN.

SER. NO. 77-253,483, FILED 8-13-2007.

PRISCILLA MILTON, EXAMINING ATTORNEY

Int. Cl.: 25

Prior U.S. Cls.: 22 and 39

United States Patent and Trademark Office

Reg. No. 3,479,354

Registered Aug. 5, 2008

**TRADEMARK
PRINCIPAL REGISTER**

C'est Atelier

BMJ INTERNATIONAL CO. INC. (NEW YORK
CORPORATION)
SUITE 400A
214 WEST 39TH STREET
NEW YORK, NY 10018

FOR: WEARING APPARELS, NAMELY, WOMEN
DRESSES, TROUSERS, SKIRT, OUTERWEAR
JACKET, SPORTSWEAR, NAMELY, JACKET AND
PANTS, IN CLASS 25 (U.S. CLS. 22 AND 39).

FIRST USE 9-7-2007; IN COMMERCE 9-7-2007.

THE MARK CONSISTS OF STANDARD CHAR-
ACTERS WITHOUT CLAIM TO ANY PARTICULAR
FONT, STYLE, SIZE, OR COLOR.

THE ENGLISH TRANSLATION OF THE WORD
"C'EST ATELIER" IN THE MARK IS IT IS STUDIO.

SER. NO. 77-253,593, FILED 8-13-2007.

ALICE BENMAMAN, EXAMINING ATTORNEY

Int. Cl.: 35

Prior U.S. Cls.: 100, 101 and 102

United States Patent and Trademark Office

Reg. No. 3,479,355

Registered Aug. 5, 2008

**SERVICE MARK
PRINCIPAL REGISTER**

CONSUMER STUDIO

CONSUMER STUDIO LLC (NEW YORK LTD
LIAB CO)
9 WASHINGTON AVENUE
PLEASANTVILLE, NY 10570

FOR: BUSINESS MARKETING CONSULTING
SERVICES IN THE FIELD OF BRAND CREATION,
BRAND DEVELOPMENT, BRAND STRATEGY
AND BRAND POSITIONING; MARKET RESEARCH
AND ANALYSIS RELATING TO BRANDS AND
BRAND MARKETING, IN CLASS 35 (U.S. CLS. 100,
101 AND 102).

FIRST USE 9-18-2003; IN COMMERCE 9-18-2003.

THE MARK CONSISTS OF STANDARD CHAR-
ACTERS WITHOUT CLAIM TO ANY PARTICULAR
FONT, STYLE, SIZE, OR COLOR.

NO CLAIM IS MADE TO THE EXCLUSIVE
RIGHT TO USE "CONSUMER", APART FROM
THE MARK AS SHOWN.

SER. NO. 77-253,919, FILED 8-13-2007.

JENNIFER MARTIN, EXAMINING ATTORNEY

Int. Cl.: 5

Prior U.S. Cls.: 6, 18, 44, 46, 51 and 52

United States Patent and Trademark Office

Reg. No. 3,479,356

Registered Aug. 5, 2008

**TRADEMARK
PRINCIPAL REGISTER**

The logo for NITROFUSION features the word "NITRO" in black, bold, italicized capital letters, followed by "FUSION" in red, bold, italicized capital letters. The entire word "NITROFUSION" is outlined in white and grey, giving it a three-dimensional, metallic appearance.

ARIZONA NUTRITIONAL SCIENCES, LLC (ARIZONA LTD LIAB CO)
5012 E. CALLE DEL SOL
CAVE CREEK, AZ 85331

THE COLOR(S) RED, BLACK, WHITE AND GREY IS/ARE CLAIMED AS A FEATURE OF THE MARK.

FOR: AMINO ACIDS FOR NUTRITIONAL PURPOSES; DIETARY AND NUTRITIONAL SUPPLEMENTS; DIETARY FOOD SUPPLEMENTS; DIETARY SUPPLEMENTAL DRINKS; DIETARY SUPPLEMENTS; DIETARY SUPPLEMENTS FOR HUMAN CONSUMPTION; FOOD SUPPLEMENTS; NUTRITIONAL SUPPLEMENTS; POWDERED FRUIT-FLAVORED DIETARY SUPPLEMENT DRINK MIX; POWDERED NUTRITIONAL SUPPLEMENT DRINK MIX, IN CLASS 5 (U.S. CLS. 6, 18, 44, 46, 51 AND 52).

THE MARK CONSISTS OF THE CAPITALIZED WORD "NITROFUSION" WHERE THE LETTERS SPELLING "NITRO" ARE BLACK AND THE LETTERS SPELLING "FUSION" ARE RED. THE WHOLE WORD IS OUTLINED IN WHITE AND GREY AND THE LETTER "F" IS LARGER THAN THE REST OF THE LETTERS.

SER. NO. 77-254,238, FILED 8-13-2007.

FIRST USE 6-15-2007; IN COMMERCE 6-15-2007.

DOMINICK J. SALEMI, EXAMINING ATTORNEY

Int. Cl.: 32

Prior U.S. Cls.: 45, 46 and 48

United States Patent and Trademark Office

Reg. No. 3,479,357

Registered Aug. 5, 2008

**TRADEMARK
PRINCIPAL REGISTER**

**DO ONE THING REALLY,
REALLY WELL**

STEAM WHISTLE BREWING INC. (CANADA
CORPORATION)
255 BREMNER ROAD
THE ROUNDHOUSE
TORONTO, CANADA M5V3M9

FOR: BREWED ALCOHOLIC BEVERAGES,
NAMELY, BEER, IN CLASS 32 (U.S. CLS. 45, 46
AND 48).

THE MARK CONSISTS OF STANDARD CHAR-
ACTERS WITHOUT CLAIM TO ANY PARTICULAR
FONT, STYLE, SIZE, OR COLOR.

OWNER OF CANADA REG. NO. TMA691177,
DATED 6-29-2007, EXPIRES 6-29-2022.

SER. NO. 77-254,560, FILED 8-14-2007.

ALYSSA PALADINO, EXAMINING ATTORNEY

Int. Cl.: 42

Prior U.S. Cls.: 100 and 101

United States Patent and Trademark Office

Reg. No. 3,479,358

Registered Aug. 5, 2008

**SERVICE MARK
PRINCIPAL REGISTER**

Roomspinners

ROOMSPINNERS REDESIGN (WASHINGTON
LTD LIAB CO), DBA ROOMSPINNERS
28118 233RD AVE SE
MAPLE VALLEY, WA 98038 AND
ROOMSPINNERS REDESIGN (WASHINGTON LTD
LIAB CO), DBA ROOMSPINNERS
25867 175TH PL SE
COVINGTON, WA 98042

FOR: INTERIOR DECORATING , IN CLASS 42
(U.S. CLS. 100 AND 101).

FIRST USE 11-1-2005; IN COMMERCE 11-1-2005.

THE MARK CONSISTS OF STANDARD CHAR-
ACTERS WITHOUT CLAIM TO ANY PARTICULAR
FONT, STYLE, SIZE, OR COLOR.

SER. NO. 77-254,995, FILED 8-14-2007.

GENE MACIOL, EXAMINING ATTORNEY

Int. Cl.: 36

Prior U.S. Cls.: 100, 101 and 102

United States Patent and Trademark Office

Reg. No. 3,479,359

Registered Aug. 5, 2008

**SERVICE MARK
PRINCIPAL REGISTER**

ANNUITY RESCUE CENTER

JEFFERSON NATIONAL FINANCIAL CORP.
(DELAWARE CORPORATION)
SUITE 1000
9920 CORPORATE CAMPUS DRIVE
LOUISVILLE, KY 40223

FOR: FINANCIAL SERVICES, NAMELY, PROVIDING ANNUITY COMPARISON SERVICES; INVESTMENT MANAGEMENT OF AND DISTRIBUTION OF ANNUITIES; ISSUANCE AND ADMINISTRATION OF ANNUITIES, IN CLASS 36 (U.S. CLS. 100, 101 AND 102).

FIRST USE 11-16-2006; IN COMMERCE 11-16-2006.

THE MARK CONSISTS OF STANDARD CHARACTERS WITHOUT CLAIM TO ANY PARTICULAR FONT, STYLE, SIZE, OR COLOR.

NO CLAIM IS MADE TO THE EXCLUSIVE RIGHT TO USE "ANNUITY", APART FROM THE MARK AS SHOWN.

SER. NO. 77-255,612, FILED 8-15-2007.

INGRID C. EULIN, EXAMINING ATTORNEY

Int. Cls.: 7 and 16

**Prior U.S. Cls.: 2, 5, 13, 19, 21, 22, 23, 29, 31, 34, 35,
37, 38 and 50**

Reg. No. 3,479,360

United States Patent and Trademark Office

Registered Aug. 5, 2008

**TRADEMARK
PRINCIPAL REGISTER**

CRL

USI, INC. (CONNECTICUT CORPORATION)
98 FORT PATH ROAD, SUITE A
MADISON, CT 064432264

FIRST USE 6-0-1998; IN COMMERCE 9-9-1998.

FOR: LAMINATING MACHINES FOR COMME-
RICAL AND INDUSTRIAL USE, IN CLASS 7 (U.S.
CLS. 13, 19, 21, 23, 31, 34 AND 35).

THE MARK CONSISTS OF STANDARD CHAR-
ACTERS WITHOUT CLAIM TO ANY PARTICULAR
FONT, STYLE, SIZE, OR COLOR.

FIRST USE 6-0-1998; IN COMMERCE 9-9-1998.

SER. NO. 77-256,182, FILED 8-15-2007.

FOR: LAMINATING MACHINES FOR HOME
AND OFFICE USE, IN CLASS 16 (U.S. CLS. 2, 5, 22,
23, 29, 37, 38 AND 50).

KELLEY WELLS, EXAMINING ATTORNEY

Int. Cl.: 35

Prior U.S. Cls.: 100, 101 and 102

United States Patent and Trademark Office

Reg. No. 3,479,361

Registered Aug. 5, 2008

**SERVICE MARK
PRINCIPAL REGISTER**

Jewishsource

HAMAKOR JUDAICA, INC. (ILLINOIS CORPORATION)

7777 MERRIMAC

NILES, IL 60714

FOR: MAIL ORDER CATALOG SERVICES FEATURING JUDAICA, IN CLASS 35 (U.S. CLS. 100, 101 AND 102).

FIRST USE 11-1-1998; IN COMMERCE 11-1-1998.

THE MARK CONSISTS OF STANDARD CHARACTERS WITHOUT CLAIM TO ANY PARTICULAR FONT, STYLE, SIZE, OR COLOR.

OWNER OF U.S. REG. NOS. 2,055,394 AND 3,368,074.

SEC. 2(F).

SER. NO. 77-256,211, FILED 8-15-2007.

KELLEY WELLS, EXAMINING ATTORNEY

Int. Cls.: 29 and 35

Prior U.S. Cls.: 46, 100, 101 and 102

United States Patent and Trademark Office

Reg. No. 3,479,362

Registered Aug. 5, 2008

TRADEMARK
SERVICE MARK
PRINCIPAL REGISTER



PRODUCTORES DEL MAR DE MEXICO, S.A. DE
C.V. (MEXICO CORPORATION)
PUERTO DE TOPOLOBAMPO 1005 LOCAL 2
MAZATLÁN, MEXICO 82050

FOR: SHRIMP, IN CLASS 29 (U.S. CL. 46).

FIRST USE 8-1-2007; IN COMMERCE 8-1-2007.

FOR: WHOLESALE DISTRIBUTORSHIPS FEATURING SHRIMP FOR HUMAN CONSUMPTION, IN CLASS 35 (U.S. CLS. 100, 101 AND 102).

FIRST USE 8-1-2007; IN COMMERCE 8-1-2007.

NO CLAIM IS MADE TO THE EXCLUSIVE RIGHT TO USE "MEXICAN", APART FROM THE MARK AS SHOWN.

THE MARK CONSISTS OF THE WORDING "MEXICAN SHRIMP PARADISE" IN STYLIZED CHARACTERS, A SHRIMP WITH A CROWN TO THE RIGHT OF THE WORDING AND TWO UN-DULATED LINES UNDERNEATH, ALL ENCLOSED IN A RECTANGULAR BORDER.

SER. NO. 77-256,352, FILED 8-15-2007.

ADA HAN, EXAMINING ATTORNEY

Int. Cl.: 41

Prior U.S. Cls.: 100, 101 and 107

United States Patent and Trademark Office

Reg. No. 3,479,363

Registered Aug. 5, 2008

**SERVICE MARK
PRINCIPAL REGISTER**



INDEPENDENT SCHOOL DISTRICT #192 (MINNESOTA INDEPENDENT SCHOOL DISTRICT), DBA FARMINGTON AREA PUBLIC SCHOOLS

421 WALNUT STREET
FARMINGTON, MN 55024

FOR: EDUCATIONAL SERVICES IN THE NATURE OF PRIMARY AND SECONDARY SCHOOLS; EDUCATIONAL SERVICES, NAMELY, PROVIDING COURSES OF INSTRUCTION AT THE PRIMARY AND SECONDARY LEVEL, IN CLASS 41 (U.S. CLS. 100, 101 AND 107).

FIRST USE 1-1-2005; IN COMMERCE 1-1-2005.

NO CLAIM IS MADE TO THE EXCLUSIVE RIGHT TO USE "FARMINGTON AREA PUBLIC SCHOOLS", APART FROM THE MARK AS SHOWN.

THE COLOR(S) ORANGE, BLACK AND WHITE IS/ARE CLAIMED AS A FEATURE OF THE MARK.

THE MARK CONSISTS OF THE WORD "FARMINGTON" IN BLACK CENTERED ABOVE THE WORDS "AREA PUBLIC SCHOOLS" IN BLACK, WITH AN ORANGE CURSIVE STYLIZED "F" BEHIND THE TYPED WORDS, AN ORANGE STAR ABOVE AND TO THE RIGHT OF THE STYLIZED "F" AND A BLACK CIRCLE SURROUNDING ALL OF THE ELEMENTS ON A WHITE BACKGROUND.

SER. NO. 77-256,661, FILED 8-16-2007.

STEVEN JACKSON, EXAMINING ATTORNEY

Int. Cl.: 41

Prior U.S. Cls.: 100, 101 and 107

United States Patent and Trademark Office

Reg. No. 3,479,364

Registered Aug. 5, 2008

**SERVICE MARK
PRINCIPAL REGISTER**



INDEPENDENT SCHOOL DISTRICT #192 (MINNESOTA INDEPENDENT SCHOOL DISTRICT), DBA FARMINGTON SCHOOL DISTRICT

421 WALNUT STREET
FARMINGTON, MN 55024

FOR: EDUCATIONAL SERVICES, NAMELY, PROVIDING COURSES OF INSTRUCTION AT THE EARLY CHILDHOOD, PRIMARY, SECONDARY AND LIFELONG LEARNING LEVEL, IN CLASS 41 (U.S. CLS. 100, 101 AND 107).

FIRST USE 1-1-2005; IN COMMERCE 1-1-2005.

NO CLAIM IS MADE TO THE EXCLUSIVE RIGHT TO USE "FARMINGTON AREA COMMUNITY EDUCATION", APART FROM THE MARK AS SHOWN.

THE COLOR(S) BLUE, RED AND WHITE IS/ARE CLAIMED AS A FEATURE OF THE MARK.

THE MARK CONSISTS OF THE WORDS "FARMINGTON AREA" CENTERED ABOVE THE WORD "COMMUNITY" CENTERED ABOVE THE WORD "EDUCATION"; ALL OF THE WORDS ARE BLUE; THE WORD "EDUCATION" IS UNDERLINED; A RED LINE ARCHES ABOVE THE WORDS "FARMINGTON AREA" FROM THE MIDDLE OF THE LETTER "C" TO THE MIDDLE OF THE LETTER "Y" IN "COMMUNITY"; FOUR REPRESENTATIONS OF HUMAN FIGURES IN INCREASING SIZE FROM LEFT TO RIGHT APPEAR ABOVE THE RED ARCHED LINE; THE FIGURES ARE REPRESENTED BY FIVE-POINTED STARS WITH THE TOP POINT REPLACED BY A FLOATING CIRCLE; ALL OF THE FIGURES ARE BLUE; THE ENTIRE MARK IS ON A WHITE BACKGROUND.

SER. NO. 77-256,989, FILED 8-16-2007.

STEVEN JACKSON, EXAMINING ATTORNEY

Int. Cl.: 44

Prior U.S. Cls.: 100 and 101

United States Patent and Trademark Office

Reg. No. 3,479,365

Registered Aug. 5, 2008

**SERVICE MARK
PRINCIPAL REGISTER**



MED-STAFF, LLC (MISSOURI LTD LIAB CO)
#211
11901 OLIVE BLVD.
ST. LOUIS, MO 63141

NO CLAIM IS MADE TO THE EXCLUSIVE
RIGHT TO USE "MED-STAFF HOME HEALTH,
LLC", APART FROM THE MARK AS SHOWN.

FOR: HOME HEALTH CARE SERVICES, IN
CLASS 44 (U.S. CLS. 100 AND 101).

THE MARK CONSISTS OF, IN PART, A STY-
LIZED HOUSE.

FIRST USE 8-0-2003; IN COMMERCE 8-0-2003.

SER. NO. 77-257,051, FILED 8-16-2007.

OWNER OF U.S. REG. NOS. 1,547,635 AND
2,586,945.

STEVEN JACKSON, EXAMINING ATTORNEY

Int. Cl.: 41

Prior U.S. Cls.: 100, 101 and 107

United States Patent and Trademark Office

Reg. No. 3,479,366

Registered Aug. 5, 2008

**SERVICE MARK
PRINCIPAL REGISTER**

FITNESS TRAINERS TO GO

FITNESS TRAINERS TO GO, INC. (TEXAS CORPORATION)
SUITE 118
3100 CARLISLE STREET
DALLAS, TX 75204

FOR: PERSONAL PHYSICAL FITNESS CONSULTATION, INSTRUCTION, AND TRAINING, IN CLASS 41 (U.S. CLS. 100, 101 AND 107).

FIRST USE 1-20-2004; IN COMMERCE 3-10-2004.

THE MARK CONSISTS OF STANDARD CHARACTERS WITHOUT CLAIM TO ANY PARTICULAR FONT, STYLE, SIZE, OR COLOR.

NO CLAIM IS MADE TO THE EXCLUSIVE RIGHT TO USE "FITNESS TRAINERS", APART FROM THE MARK AS SHOWN.

SER. NO. 77-257,255, FILED 8-16-2007.

SHARON MEIER, EXAMINING ATTORNEY

Int. Cl.: 41

Prior U.S. Cls.: 100, 101 and 107

United States Patent and Trademark Office

Reg. No. 3,479,367

Registered Aug. 5, 2008

**SERVICE MARK
PRINCIPAL REGISTER**

LADY TRAINERS TO GO

FITNESS TRAINERS TO GO, INC. (TEXAS CORPORATION)
SUITE 118
3100 CARLISE STREET
DALLAS, TX 75204

FOR: PERSONAL PHYSICAL FITNESS CONSULTATION, INSTRUCTION, AND TRAINING, IN CLASS 41 (U.S. CLS. 100, 101 AND 107).

FIRST USE 4-4-2005; IN COMMERCE 10-31-2005.

THE MARK CONSISTS OF STANDARD CHARACTERS WITHOUT CLAIM TO ANY PARTICULAR FONT, STYLE, SIZE, OR COLOR.

NO CLAIM IS MADE TO THE EXCLUSIVE RIGHT TO USE "LADY TRAINERS", APART FROM THE MARK AS SHOWN.

SER. NO. 77-257,280, FILED 8-16-2007.

SHARON MEIER, EXAMINING ATTORNEY

Int. Cl.: 36

Prior U.S. Cls.: 100, 101 and 102

United States Patent and Trademark Office

Reg. No. 3,479,368

Registered Aug. 5, 2008

**SERVICE MARK
PRINCIPAL REGISTER**



THE TRAVELERS INDEMNITY COMPANY
(CONNECTICUT CORPORATION)
ONE TOWER SQUARE
HARTFORD, CT 06183

FOR: PROPERTY AND CASUALTY INSURANCE
UNDERWRITING SERVICES IN THE FIELD OF
WIND ENERGY, IN CLASS 36 (U.S. CLS. 100, 101
AND 102).

FIRST USE 9-30-2006; IN COMMERCE 9-30-2006.

OWNER OF U.S. REG. NO. 3,332,643.

NO CLAIM IS MADE TO THE EXCLUSIVE
RIGHT TO USE "WIND POWER INSURANCE",
APART FROM THE MARK AS SHOWN.

THE MARK CONSISTS OF THE WORD "WIND-
PAK" WITH A DESIGN OF FOUR CURVED LINES
BETWEEN THE LETTERS "P" AND "A" TOGETHER
WITH THE SLOGAN "WIND POWER INSURANCE
FOR THE 21ST CENTURY".

SER. NO. 77-257,332, FILED 8-16-2007.

AHSEN KHAN, EXAMINING ATTORNEY

Int. Cl.: 41

Prior U.S. Cls.: 100, 101 and 107

United States Patent and Trademark Office

Reg. No. 3,479,369

Registered Aug. 5, 2008

**SERVICE MARK
PRINCIPAL REGISTER**

Share The Wealth

HARRAH'S LICENSE COMPANY, LLC (NEVADA
LTD LIAB CO)
ONE HARRAH'S COURT
LAS VEGAS, NV 89119

FOR: ENTERTAINMENT SERVICES, NAMELY,
CONDUCTING SPECIAL EVENTS FEATURING CA-
SINO AND GAMING CONTESTS AND TOURNA-
MENTS, IN CLASS 41 (U.S. CLS. 100, 101 AND 107).

FIRST USE 7-21-2006; IN COMMERCE 8-20-2006.

THE MARK CONSISTS OF STANDARD CHAR-
ACTERS WITHOUT CLAIM TO ANY PARTICULAR
FONT, STYLE, SIZE, OR COLOR.

SER. NO. 77-258,237, FILED 8-17-2007.

ANDREW RHIM, EXAMINING ATTORNEY

Int. Cl.: 18

Prior U.S. Cls.: 1, 2, 3, 22 and 41

United States Patent and Trademark Office

Reg. No. 3,479,370

Registered Aug. 5, 2008

**TRADEMARK
PRINCIPAL REGISTER**

GLASS 'N PACK

BASS PRO TRADEMARKS, L.L.C. (MISSOURI
LTD LIAB CO)

2500 EAST KEARNEY

SPRINGFIELD, MO 65898

FOR: SPORTS PACKS AND SPORTS BAGS, IN
CLASS 18 (U.S. CLS. 1, 2, 3, 22 AND 41).

FIRST USE 5-5-2007; IN COMMERCE 5-5-2007.

THE MARK CONSISTS OF STANDARD CHAR-
ACTERS WITHOUT CLAIM TO ANY PARTICULAR
FONT, STYLE, SIZE, OR COLOR.

NO CLAIM IS MADE TO THE EXCLUSIVE
RIGHT TO USE "PACK", APART FROM THE MARK
AS SHOWN.

SER. NO. 77-258,950, FILED 8-20-2007.

DAVID C. REIHNER, EXAMINING ATTORNEY

Int. Cl.: 1

Prior U.S. Cls.: 1, 5, 6, 10, 26 and 46

United States Patent and Trademark Office

Reg. No. 3,479,371

Registered Aug. 5, 2008

**TRADEMARK
PRINCIPAL REGISTER**

MAXIFRUIT

COMPAGNIE FINANCIÈRE ET DE PARTICIPA-
TIONS ROULLIER (FRANCE JOINT STOCK
COMPANY)

27, AVENUE FRANKLIN ROOSEVELT
35400 SAINT MALO, FRANCE

FOR: CHEMICAL PREPARATIONS USED IN
AGRICULTURE, HORTICULTURE AND FOREST-
RY, NAMELY, CHEMICAL PREPARATIONS FOR
THE TREATMENT OF SEEDS; MANURES, IN
CLASS 1 (U.S. CLS. 1, 5, 6, 10, 26 AND 46).

THE MARK CONSISTS OF STANDARD CHAR-
ACTERS WITHOUT CLAIM TO ANY PARTICULAR
FONT, STYLE, SIZE, OR COLOR.

PRIORITY CLAIMED UNDER SEC. 44(D) ON
ERPN CMNTY TM OFC APPLICATION NO.
005699137, FILED 2-19-2007, REG. NO. 005699137,
DATED 2-6-2008, EXPIRES 2-19-2017.

SER. NO. 77-259,053, FILED 8-20-2007.

RUSS HERMAN, EXAMINING ATTORNEY

Int. Cl.: 26

Prior U.S. Cls.: 37, 39, 40, 42 and 50

United States Patent and Trademark Office

Reg. No. 3,479,372

Registered Aug. 5, 2008

**TRADEMARK
PRINCIPAL REGISTER**

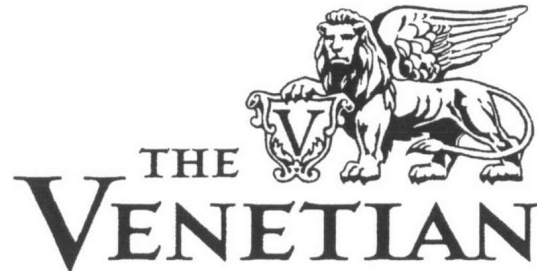

LAS VEGAS SANDS CORP. (NEVADA CORPORATION)

3355 LAS VEGAS BOULEVARD SOUTH
LAS VEGAS, NV 89109

FOR: HAIR CLIPS, IN CLASS 26 (U.S. CLS. 37, 39,
40, 42 AND 50).

FIRST USE 7-16-2007; IN COMMERCE 7-16-2007.

OWNER OF U.S. REG. NOS. 2,411,034, 2,542,999
AND OTHERS.

THE MARK CONSISTS OF WINGED LION WITH
A CREST CONTAINING THE LETTER "V," ACCOMPANIED BY THE TERM "THE VENETIAN".

SER. NO. 77-259,095, FILED 8-20-2007.

LINDA LAVACHE, EXAMINING ATTORNEY

Int. Cl.: 36

Prior U.S. Cls.: 100, 101 and 102

United States Patent and Trademark Office

Reg. No. 3,479,373

Registered Aug. 5, 2008

**SERVICE MARK
PRINCIPAL REGISTER**

SuiteSpot

STAFFME.NET, LLC (TENNESSEE LTD LIAB
CO)
SUITE 203
123 CENTER PARK DR.
KNOXVILLE, TN 37922

FIRST USE 4-0-2006; IN COMMERCE 4-0-2006.

SER. NO. 77-259,621, FILED 8-20-2007.

FOR: LEASING OF OFFICE SPACE, IN CLASS 36
(U.S. CLS. 100, 101 AND 102).

BRIAN CALLAGHAN, EXAMINING ATTORNEY

Int. Cl.: 9

Prior U.S. Cls.: 21, 23, 26, 36 and 38

Reg. No. 3,479,374

United States Patent and Trademark Office

Registered Aug. 5, 2008

**TRADEMARK
PRINCIPAL REGISTER**

FX GOOSE

M25 INVESTMENTS, LLC (TEXAS LTD LIAB CO)
1212 B. BROADHEAD ROAD
WAXAHACHIE, TX 75165

FOR: COMPUTER SOFTWARE PLATFORMS
USED TO CALCULATE FOREIGN CURRENCY
AND PROVIDE FOREIGN CURRENCY RATE IN-
FORMATION FOR INVESTMENT PURPOSES, IN
CLASS 9 (U.S. CLS. 21, 23, 26, 36 AND 38).

FIRST USE 10-1-2006; IN COMMERCE 10-1-2006.

THE MARK CONSISTS OF STANDARD CHAR-
ACTERS WITHOUT CLAIM TO ANY PARTICULAR
FONT, STYLE, SIZE, OR COLOR.

NO CLAIM IS MADE TO THE EXCLUSIVE
RIGHT TO USE "FX", APART FROM THE MARK
AS SHOWN.

SER. NO. 77-261,505, FILED 8-22-2007.

STEPHANIE ALI, EXAMINING ATTORNEY

Int. Cls.: 35, 39 and 40

Prior U.S. Cls.: 100, 101, 102, 103, 105 and 106

United States Patent and Trademark Office

Reg. No. 3,479,375

Registered Aug. 5, 2008

**SERVICE MARK
PRINCIPAL REGISTER**

SUN RUN HOME

SUN RUN GENERATION LLC (CALIFORNIA
LTD LIAB CO)
SUITE 1160
180 MONTGOMERY STREET
SAN FRANCISCO, CA 94104

FOR: MANAGEMENT RELATING TO THE
USAGE OF SOLAR ELECTRICITY, NAMELY, PRO-
VIDING RENEWABLE ENERGY SOLUTIONS TO
CUSTOMERS AND ASSISTING IN THE MANAGE-
MENT OF ENERGY PRICES AND SUSTAINABIL-
ITY INITIATIVES FOR THE PURPOSES OF
MANAGING ENERGY USAGE; CONSULTATION
IN THE FIELD OF SOLAR ENERGY USAGE MAN-
AGEMENT, IN CLASS 35 (U.S. CLS. 100, 101 AND
102).

FIRST USE 8-1-2007; IN COMMERCE 8-15-2007.

FOR: DISTRIBUTION AND SUPPLY OF SOLAR
ELECTRICITY; CONSULTATION RELATING TO
THE DISTRIBUTION AND SUPPLY OF SOLAR
ELECTRICITY, IN CLASS 39 (U.S. CLS. 100 AND 105).

FIRST USE 8-1-2007; IN COMMERCE 8-15-2007.

FOR: OPERATING AND MAINTAINING RE-
NEWABLE ENERGY SYSTEMS, NAMELY, GEN-
ERATION OF SOLAR ELECTRICITY;
CONSULTATION IN THE FIELD OF GENERATION
OF SOLAR ELECTRICITY, IN CLASS 40 (U.S. CLS.
100, 103 AND 106).

FIRST USE 8-1-2007; IN COMMERCE 8-15-2007.

THE MARK CONSISTS OF STANDARD CHAR-
ACTERS WITHOUT CLAIM TO ANY PARTICULAR
FONT, STYLE, SIZE, OR COLOR.

NO CLAIM IS MADE TO THE EXCLUSIVE
RIGHT TO USE "HOME", APART FROM THE
MARK AS SHOWN.

SER. NO. 77-261,542, FILED 8-22-2007.

MICHAEL KEATING, EXAMINING ATTORNEY

Int. Cl.: 9

Prior U.S. Cls.: 21, 23, 26, 36 and 38

United States Patent and Trademark Office

Reg. No. 3,479,376

Registered Aug. 5, 2008

**TRADEMARK
PRINCIPAL REGISTER**

OCTANE

LARCAN INC. (CANADA CORPORATION)
228 AMBASSADOR DRIVE, MISSISSAUGA
ONTARIO, CANADA L5T2J2

FOR: BROADCASTING EQUIPMENT, NAMELY,
ENCODER-MULTIPLEXERS, IN CLASS 9 (U.S. CLS.
21, 23, 26, 36 AND 38).

THE MARK CONSISTS OF STANDARD CHAR-
ACTERS WITHOUT CLAIM TO ANY PARTICULAR
FONT, STYLE, SIZE, OR COLOR.

PRIORITY CLAIMED UNDER SEC. 44(D) ON
CANADA APPLICATION NO. 1336585, FILED 2-22-
2007, REG. NO. TMA706305, DATED 2-1-2008, EX-
PIRES 2-1-2023.

SER. NO. 77-261,666, FILED 8-22-2007.

SHAILA SETTLES, EXAMINING ATTORNEY

Int. Cl.: 38

Prior U.S. Cls.: 100, 101 and 104

United States Patent and Trademark Office

Reg. No. 3,479,377

Registered Aug. 5, 2008

**SERVICE MARK
PRINCIPAL REGISTER**

Holistic Anarchy

WHOLISTIC DIALOGUE, LLC (NEW YORK LTD
LIAB CO)
365 WEST END AVENUE
NEW YORK, NY 10023

FOR: PROVIDING ELECTRONIC BULLETIN
BOARDS FOR TRANSMISSION OF, BLOG, AND
VIDEO BLOG FOR THE POSTING OF HEALTH-
RELATED ARTICLES AND COMMENTS AND
SHARING OF CONTENT AND INFORMATION
RELATED TO HOLISTIC HEALTH AND ALTER-
NATIVE MEDICINE, IN CLASS 38 (U.S. CLS. 100, 101
AND 104).

FIRST USE 7-14-2007; IN COMMERCE 7-14-2007.

THE MARK CONSISTS OF STANDARD CHAR-
ACTERS WITHOUT CLAIM TO ANY PARTICULAR
FONT, STYLE, SIZE, OR COLOR.

NO CLAIM IS MADE TO THE EXCLUSIVE
RIGHT TO USE "HOLISTIC", APART FROM THE
MARK AS SHOWN.

SER. NO. 77-261,847, FILED 8-22-2007.

GRETТА YAO, EXAMINING ATTORNEY

Int. Cl.: 44

Prior U.S. Cls.: 100 and 101

United States Patent and Trademark Office

Reg. No. 3,479,378

Registered Aug. 5, 2008

**SERVICE MARK
PRINCIPAL REGISTER**

Holistic Anarchy

WHOLISTIC DIALOGUE, LLC (NEW YORK LTD
LIAB CO)
365 WEST END AVENUE
NEW YORK, NY 10023

FOR: PROVIDING A WEBSITE FEATURING
HEALTH-RELATED INFORMATION IN THE
FIELDS OF HEALTH, DIETING, HOLISTIC
HEALTH AND HEALING, FEATURING VIDEO
BLOG AND MESSAGE BOARD, IN CLASS 44 (U.S.
CLS. 100 AND 101).

FIRST USE 7-14-2007; IN COMMERCE 7-14-2007.

THE MARK CONSISTS OF STANDARD CHAR-
ACTERS WITHOUT CLAIM TO ANY PARTICULAR
FONT, STYLE, SIZE, OR COLOR.

NO CLAIM IS MADE TO THE EXCLUSIVE
RIGHT TO USE "HOLISTIC", APART FROM THE
MARK AS SHOWN.

SER. NO. 77-261,870, FILED 8-22-2007.

GRETTA YAO, EXAMINING ATTORNEY

Int. Cl.: 36

Prior U.S. Cls.: 100, 101 and 102

United States Patent and Trademark Office

Reg. No. 3,479,379

Registered Aug. 5, 2008

**SERVICE MARK
PRINCIPAL REGISTER**

DRIVE-SURE

KREX, INC. (MICHIGAN CORPORATION)
BUILDING 200
450 SKOKIE BOULEVARD
NORTHBROOK, IL 60062

THE MARK CONSISTS OF STANDARD CHAR-
ACTERS WITHOUT CLAIM TO ANY PARTICULAR
FONT, STYLE, SIZE, OR COLOR.

FOR: PROVIDING AUTOMOTIVE REPAIR WAR-
RANTY SERVICES, IN CLASS 36 (U.S. CLS. 100, 101
AND 102).

SER. NO. 77-261,887, FILED 8-22-2007.

FIRST USE 1-1-2006; IN COMMERCE 1-1-2006.

BRENDAN MCCAULEY, EXAMINING ATTORNEY

Int. Cl.: 35

Prior U.S. Cls.: 100, 101 and 102

United States Patent and Trademark Office

Reg. No. 3,479,380

Registered Aug. 5, 2008

**SERVICE MARK
PRINCIPAL REGISTER**

**BHUNGRY.COM FEEDING THE
HUNGRY**

BHUNGRY INC. (CALIFORNIA CORPORATION)
SUITE 1500
6320 CANOGA AVENUE
WOODLAND HILLS, CA 91367

THE MARK CONSISTS OF STANDARD CHAR-
ACTERS WITHOUT CLAIM TO ANY PARTICULAR
FONT, STYLE, SIZE, OR COLOR.

FOR: ON-LINE ADVERTISING AND MARKET-
ING SERVICES, IN CLASS 35 (U.S. CLS. 100, 101 AND
102).

SER. NO. 77-262,224, FILED 8-22-2007.

FIRST USE 6-4-2007; IN COMMERCE 6-4-2007.

MARY MUNSON, EXAMINING ATTORNEY

Int. Cls.: 5 and 45

Prior U.S. Cls.: 6, 18, 44, 46, 51, 52, 100 and 101

United States Patent and Trademark Office

Reg. No. 3,479,381

Registered Aug. 5, 2008

**TRADEMARK
SERVICE MARK
PRINCIPAL REGISTER**

CYDEX

CYDEX PHARMACEUTICALS, INC. (DELA-
WARE CORPORATION)
10513 W. 84TH TERRACE
CYDEX PHARMACEUTICALS, INC.
LENEXA, KS 66214

FOR: PHARMACEUTICALS FOR THE TREAT-
MENT OF CNS DISEASES AND/OR DISORDERS,
ONCOLOGY, AND PAIN INDICATIONS , IN CLASS
5 (U.S. CLS. 6, 18, 44, 46, 51 AND 52).

FIRST USE 2-8-2006; IN COMMERCE 2-8-2006.

FOR: LICENSING OF EXCIPIENT PHARMACEU-
TICAL PRODUCTS, IN CLASS 45 (U.S. CLS. 100 AND
101).

FIRST USE 6-0-2000; IN COMMERCE 6-0-2000.

THE MARK CONSISTS OF STANDARD CHAR-
ACTERS WITHOUT CLAIM TO ANY PARTICULAR
FONT, STYLE, SIZE, OR COLOR.

SER. NO. 77-262,367, FILED 8-23-2007.

DAVID H. STINE, EXAMINING ATTORNEY

Int. Cl.: 35

Prior U.S. Cls.: 100, 101 and 102

United States Patent and Trademark Office

Reg. No. 3,479,382

Registered Aug. 5, 2008

**SERVICE MARK
PRINCIPAL REGISTER**

FAST OFFICE

FAST OFFICE, INC. (NEW YORK CORPORATION)
1412 BROADWAY
NEW YORK, NY 10018

FOR: DISTRIBUTORSHIP SERVICES IN THE
FIELD OF OFFICE FURNITURE, IN CLASS 35
(U.S. CLS. 100, 101 AND 102).

FIRST USE 6-0-2006; IN COMMERCE 6-0-2006.

THE MARK CONSISTS OF STANDARD CHARACTERS WITHOUT CLAIM TO ANY PARTICULAR FONT, STYLE, SIZE, OR COLOR.

NO CLAIM IS MADE TO THE EXCLUSIVE RIGHT TO USE "OFFICE", APART FROM THE MARK AS SHOWN.

SER. NO. 77-262,433, FILED 8-23-2007.

JOHN DWYER, EXAMINING ATTORNEY

Int. Cl.: 35

Prior U.S. Cls.: 100, 101 and 102

United States Patent and Trademark Office

Reg. No. 3,479,383

Registered Aug. 5, 2008

**SERVICE MARK
PRINCIPAL REGISTER**



fast office

FAST OFFICE, INC. (NEW YORK CORPORATION)
1412 BROADWAY
NEW YORK, NY 10018

FOR: DISTRIBUTORSHIP SERVICES IN THE
FIELD OF OFFICE FURNITURE, IN CLASS 35
(U.S. CLS. 100, 101 AND 102).

FIRST USE 6-0-2006; IN COMMERCE 6-0-2006.

NO CLAIM IS MADE TO THE EXCLUSIVE
RIGHT TO USE "OFFICE", APART FROM THE
MARK AS SHOWN.

THE MARK CONSISTS OF A PICTURE OF A
CHAIR ABOVE THE WORDS "FAST OFFICE".

SER. NO. 77-262,446, FILED 8-23-2007.

JOHN DWYER, EXAMINING ATTORNEY

Int. Cl.: 32

Prior U.S. Cls.: 45, 46 and 48

United States Patent and Trademark Office

Reg. No. 3,479,384

Registered Aug. 5, 2008

**TRADEMARK
PRINCIPAL REGISTER**

**CERVEZA ANCLA NAVAL SUPER
PREMIUM**

BEVERAGES PRIVATE LABEL HOLDING INC
(FLORIDA CORPORATION)
1210 WASHINGTON AVENUE, SUITE 230
MIAMI BEACH, FL 33139

FOR: BREWED MALT-BASED ALCOHOLIC BEVERAGE IN THE NATURE OF A BEER; MALT BEER; NON-ALCOHOLIC BEER; PALE BEER; PORTER, IN CLASS 32 (U.S. CLS. 45, 46 AND 48).

THE MARK CONSISTS OF STANDARD CHARACTERS WITHOUT CLAIM TO ANY PARTICULAR FONT, STYLE, SIZE, OR COLOR.

OWNER OF COLOMBIA REG. NO. 164462, DATED 12-27-1991, EXPIRES 3-15-2014.

NO CLAIM IS MADE TO THE EXCLUSIVE RIGHT TO USE "CERVEZA" AND "SUPER PREMIUM", APART FROM THE MARK AS SHOWN.

THE FOREIGN WORDING IN THE MARK TRANSLATES INTO ENGLISH AS NAVY ANCHOR SUPER PREMIUM BEER.

SER. NO. 77-263,102, FILED 8-23-2007.

JOHN DALIER, EXAMINING ATTORNEY

Int. Cl.: 43

Prior U.S. Cls.: 100 and 101

United States Patent and Trademark Office

Reg. No. 3,479,385

Registered Aug. 5, 2008

**SERVICE MARK
PRINCIPAL REGISTER**



THE SUHANOSKY FAMILY (DELAWARE LTD
LIAB CO)
130 PLEASANT STREET
NANTUCKET, MA 02554

FOR: RESTAURANT SERVICES, IN CLASS 43
(U.S. CLS. 100 AND 101).

FIRST USE 5-30-2006; IN COMMERCE 5-30-2006.

NO CLAIM IS MADE TO THE EXCLUSIVE
RIGHT TO USE "NYC", "FONDATA 2000", "ACK"

AND THE PICTORIAL REPRESENTATION OF PAS-
TA, APART FROM THE MARK AS SHOWN.

THE FOREIGN WORDING IN THE MARK
TRANSLATES INTO ENGLISH AS "UNCUT SHEET
OF PASTA" (SFOGLIA) AND "FOUNDED" (FONDA-
TO).

SEC. 2(F) AS TO "SFOGLIA".

SER. NO. 77-263,170, FILED 8-23-2007.

KATHRYN COWARD, EXAMINING ATTORNEY

Int. Cl.: 29

Prior U.S. Cl.: 46

United States Patent and Trademark Office

Reg. No. 3,479,386

Registered Aug. 5, 2008

**TRADEMARK
PRINCIPAL REGISTER**



GARCIA-HUIDOBRO, RODRIGO (CHILE INDIVIDUAL)
APT. 2
1 ASCAN AVE.
FOREST HILLS, NY 11375

THE MARK CONSISTS OF THE STYLIZED TEXT "ADONIS" WITH AN ABSTRACT DESIGN IN THE FORM OF A FLOWER BETWEEN TWO HORIZONTAL LINES.

FOR: FROZEN SEAFOOD, IN CLASS 29 (U.S. CL. 46).

SER. NO. 77-263,198, FILED 8-23-2007.

FIRST USE 7-0-2006; IN COMMERCE 7-0-2006.

BARNEY CHARLON, EXAMINING ATTORNEY

Int. Cl.: 35

Prior U.S. Cls.: 100, 101 and 102

United States Patent and Trademark Office

Reg. No. 3,479,387

Registered Aug. 5, 2008

**SERVICE MARK
PRINCIPAL REGISTER**

NAME YOUR OWN REWARDS

VIPDESK.COM, INC. (DELAWARE CORPORATION)
324 NORTH FAIRFAX STREET
ALEXANDRIA, VA 22314

THE MARK CONSISTS OF STANDARD CHARACTERS WITHOUT CLAIM TO ANY PARTICULAR FONT, STYLE, SIZE, OR COLOR.

FOR: CONTESTS AND INCENTIVE AWARD PROGRAMS TO PROMOTE THE SALE OF PRODUCTS AND SERVICES OF OTHERS, IN CLASS 35 (U.S. CLS. 100, 101 AND 102).

SER. NO. 77-264,018, FILED 8-24-2007.

FIRST USE 7-1-2005; IN COMMERCE 7-1-2005.

IRA J. GOODSaid, EXAMINING ATTORNEY

Int. Cl.: 42

Prior U.S. Cls.: 100 and 101

United States Patent and Trademark Office

Reg. No. 3,479,388

Registered Aug. 5, 2008

**SERVICE MARK
PRINCIPAL REGISTER**

The logo consists of a yellow rectangular background. The word "Perfect" is written in a gold script font, and the word "POSTAGE" is written in a gold sans-serif font to its right.

ANNE C. SLENTZ (UNITED STATES INDIVIDUAL)
6310 NW CANEY CREEK DRIVE
KANSAS CITY, MO 64151

FOR: GRAPHIC DESIGN SERVICES, IN CLASS 42
(U.S. CLS. 100 AND 101).

FIRST USE 7-1-2007; IN COMMERCE 8-1-2007.

THE COLOR(S) YELLOW AND GOLD IS/ARE
CLAIMED AS A FEATURE OF THE MARK.

THE MARK CONSISTS OF YELLOW RECTANGLE BACKGROUND. THE WORD PERFECT IS IN A GOLD SCRIPT FONT. THE WORD POSTAGE IS ALL CAPS IN A GOLD FONT.

SER. NO. 77-264,267, FILED 8-24-2007.

ESTHER A. BORSUK, EXAMINING ATTORNEY

Int. Cl.: 9

Prior U.S. Cls.: 21, 23, 26, 36 and 38

Reg. No. 3,479,389

United States Patent and Trademark Office

Registered Aug. 5, 2008

**TRADEMARK
PRINCIPAL REGISTER**

DIRTY CHAMBER

DIRTY CHAMBER MUSIC GROUP LLC (FLOR-
IDA LTD LIAB CO)
PO BOX 350261
PALM COAST, FL 32135

FOR: MUSICAL SOUND RECORDINGS AND
MUSICAL AUDIOVISUAL RECORDINGS; SOUND
RECORDINGS AND AUDIO-VIDEO RECORDINGS
FEATURING A MUSIC ARTIST; DOWNLOADABLE
MUSICAL SOUND RECORDINGS; DOWNLOAD-
ABLE SOUND RECORDINGS FEATURING A MU-
SIC ARTIST; DOWNLOADABLE VIDEO
RECORDINGS FEATURING MUSIC; DOWNLOAD-
ABLE VIDEO RECORDINGS FEATURING A MU-
SIC ARTIST; DOWNLOADABLE ELECTRONIC
PUBLICATIONS IN THE NATURE OF BOOKS,

BOOKLETS, MAGAZINES, JOURNALS, MANUALS,
BROCHURES, LEAFLETS, PAMPHLETS AND
NEWSLETTERS, ALL FEATURING A MUSIC AR-
TIST, IN CLASS 9 (U.S. CLS. 21, 23, 26, 36 AND 38).

FIRST USE 8-1-2007; IN COMMERCE 8-17-2007.

THE MARK CONSISTS OF STANDARD CHAR-
ACTERS WITHOUT CLAIM TO ANY PARTICULAR
FONT, STYLE, SIZE, OR COLOR.

SER. NO. 77-264,561, FILED 8-26-2007.

KAREN SEVERSON, EXAMINING ATTORNEY

Int. Cl.: 40

Prior U.S. Cls.: 100, 103 and 106

United States Patent and Trademark Office

Reg. No. 3,479,390

Registered Aug. 5, 2008

**SERVICE MARK
PRINCIPAL REGISTER**



TKO ENTERPRISES, INC. (INDIANA CORPORATION)
2751 STAFFORD ROAD
PLAINFIELD, IN 46168

FOR: CUSTOM MANUFACTURING SERVICES
IN THE FIELD OF FLEET AND VEHICLE GRAPHICS,
COMMERCIAL SIGNAGE AND RETAIL GRAPHICS,
IN CLASS 40 (U.S. CLS. 100, 103 AND 106).

FIRST USE 11-1-1999; IN COMMERCE 11-1-1999.

NO CLAIM IS MADE TO THE EXCLUSIVE
RIGHT TO USE "GRAPHICS", APART FROM THE
MARK AS SHOWN.

SER. NO. 77-264,902, FILED 8-27-2007.

RAUL CORDOVA, EXAMINING ATTORNEY

Int. Cl.: 38

Prior U.S. Cls.: 100, 101 and 104

United States Patent and Trademark Office

Reg. No. 3,479,391

Registered Aug. 5, 2008

**SERVICE MARK
PRINCIPAL REGISTER**

searchles TV

SEARCHLES, INC. (DELAWARE CORPORATION)
SUITE 407
1150 17TH ST. N.W.
WASHINGTON D.C., DC 20036

FOR: STREAMING OF VIDEO MATERIAL ON
THE INTERNET, IN CLASS 38 (U.S. CLS. 100, 101
AND 104).

FIRST USE 2-0-2007; IN COMMERCE 2-0-2007.

THE MARK CONSISTS OF STANDARD CHARACTERS WITHOUT CLAIM TO ANY PARTICULAR FONT, STYLE, SIZE, OR COLOR.

NO CLAIM IS MADE TO THE EXCLUSIVE RIGHT TO USE "TV", APART FROM THE MARK AS SHOWN.

SER. NO. 77-265,015, FILED 8-27-2007.

G. MAYERSCHOFF, EXAMINING ATTORNEY

Int. Cls.: 38, 42 and 45

Prior U.S. Cls.: 100, 101 and 104

United States Patent and Trademark Office

Reg. No. 3,479,392

Registered Aug. 5, 2008

**SERVICE MARK
PRINCIPAL REGISTER**

searchles

SEARCHLES, INC. (DELAWARE CORPORATION)
SUITE 407
1150 17TH ST. N.W.
WASHINGTON D.C., DC 20036

FOR: PROVIDING ON-LINE CHAT ROOMS FOR TRANSMISSION OF MESSAGES AMONG COMPUTER USERS CONCERNING THE SHARING OF WEB CONTENT THROUGH THE USE OF TAGGING AND POSTING SEARCHABLE LINKS OF MUTUAL INTEREST WITH REGISTERED AND NON-REGISTERED USERS, NAMELY, WEB ARTICLES, WEB PAGES, GENERAL CONTENT, VIDEO AND AUDIO, SOCIAL NETWORKING, BUSINESS NETWORKING, GENERAL INTEREST AND VIRTUAL COMMUNITY, IN CLASS 38 (U.S. CLS. 100, 101 AND 104).

FIRST USE 1-0-2006; IN COMMERCE 1-0-2006.

FOR: (BASED ON USE IN COMMERCE) COMPUTER SERVICES, NAMELY, HOSTING AND MAINTAINING AN ONLINE WEBSITE FOR OTHERS TO SEARCH THE INTERNET AND GENERATE MORE ACCURATE SEARCH RESULTS BY SEARCHING THROUGH RELATED CONTENT POSTED, TAGGED AND ORGANIZED BY REGISTERED USERS, TO ALLOW THEM TO REGISTER FOR AN ACCOUNT AND ADD AS FRIENDS THOSE PERSONS

WHOSE CONTENT THEY FOUND TO BE OF INTEREST AND TO ENABLE REGISTERED USERS TO EASILY POST, TAG AND SHARE WEB CONTENT, NAMELY, WEB ARTICLES, WEB PAGES, AUDIO, VIDEO AND GENERAL CONTENT, THROUGH THE USE OF WEB TOOLS IN ORDER TO ATTRACT FRIENDS WITH MUTUAL INTERESTS OR TO CREATE SOCIAL AND BUSINESS NETWORKS BY HAVING THOSE WITH MUTUAL INTERESTS SEARCHING THROUGH THEIR POSTED CONTENT, IN CLASS 42 (U.S. CLS. 100 AND 101).

FIRST USE 1-0-2006; IN COMMERCE 1-0-2006.

FOR: (BASED ON USE IN COMMERCE) ONLINE SOCIAL NETWORKING SERVICES, IN CLASS 45 (U.S. CLS. 100 AND 101).

FIRST USE 1-0-2006; IN COMMERCE 1-0-2006.

THE MARK CONSISTS OF STANDARD CHARACTERS WITHOUT CLAIM TO ANY PARTICULAR FONT, STYLE, SIZE, OR COLOR.

SER. NO. 77-265,241, FILED 8-27-2007.

G. MAYERSCHOFF, EXAMINING ATTORNEY

Int. Cl.: 42

Prior U.S. Cls.: 100 and 101

United States Patent and Trademark Office

Reg. No. 3,479,393

Registered Aug. 5, 2008

**SERVICE MARK
PRINCIPAL REGISTER**

searchles live!

SEARCHLES, INC. (DELAWARE CORPORATION)
SUITE 407
1150 17TH ST. N.W.
WASHINGTON D.C., DC 20036

FOR: HOSTING AN ONLINE COMMUNITY WEBSITE FEATURING A BACKEND PAGE THAT DISPLAYS ALL THE CURRENT ACTIVITY WITHIN A REGISTERED USER'S CIRCLE OF GROUPS AND FRIENDS; NAMELY, THEIR POSTS, RATING, COMMENTING, AND MESSAGING; UPDATES ARE AUTOMATIC AND REAL TIME AS SAID ACTIVITY OCCURS, IN CLASS 42 (U.S. CLS. 100 AND 101).

FIRST USE 6-0-2007; IN COMMERCE 6-0-2007.

THE MARK CONSISTS OF STANDARD CHARACTERS WITHOUT CLAIM TO ANY PARTICULAR FONT, STYLE, SIZE, OR COLOR.

NO CLAIM IS MADE TO THE EXCLUSIVE RIGHT TO USE "LIVE", APART FROM THE MARK AS SHOWN.

SER. NO. 77-265,286, FILED 8-27-2007.

G. MAYERSCHOFF, EXAMINING ATTORNEY

Int. Cl.: 43

Prior U.S. Cls.: 100 and 101

United States Patent and Trademark Office

Reg. No. 3,479,394

Registered Aug. 5, 2008

**SERVICE MARK
PRINCIPAL REGISTER**

INTOWN SUITES
EXTENDED-STAY LIVING

INTOWN SUITES MANAGEMENT, INC. (GEORGIA CORPORATION)
2727 PACES FERRY ROAD, SUITE 2-1200
ATLANTA, GA 30339

FOR: HOTEL SERVICES; EXTENDED-STAY HOTELS, IN CLASS 43 (U.S. CLS. 100 AND 101).

FIRST USE 7-1-2007; IN COMMERCE 7-1-2007.

NO CLAIM IS MADE TO THE EXCLUSIVE RIGHT TO USE "SUITES" AND "EXTENDED-STAY LIVING", APART FROM THE MARK AS SHOWN.

THE MARK CONSISTS OF THE WORDS "INTOWN SUITES" IN A STYLIZED TYPE AND THE WORDS "EXTENDED-STAY LIVING" IN A SECOND STYLIZED TYPE AND SMALLER FONT CENTERED BELOW "INTOWN SUITES".

SER. NO. 77-265,413, FILED 8-27-2007.

KAREN K. BUSH, EXAMINING ATTORNEY

Int. Cl.: 9

Prior U.S. Cls.: 21, 23, 26, 36 and 38

United States Patent and Trademark Office

Reg. No. 3,479,395

Registered Aug. 5, 2008

**TRADEMARK
PRINCIPAL REGISTER**

searchle it!

SEARCHLES, INC. (DELAWARE CORPORATION)
SUITE 407
1150 17TH ST. N.W.
WASHINGTON D.C., DC 20036

FOR: DOWNLOADABLE SOFTWARE FOR EMBEDDING A SOFTWARE TOOL INTO A USER'S BROWSER ENABLING THE USER TO POST LINKS FROM THE INTERNET TO A HOST WEBSITE AND THEIR PERSONAL PAGE ON THE HOST WEBSITE WHILE SIMULTANEOUSLY ALLOWING THE USER TO ADD TAG WORDS, ASSOCIATE THE POST WITH GROUPS, OR SHARE WITH FRIENDS

WITHOUT INTERRUPTING THE USER'S WEB EXPERIENCE, IN CLASS 9 (U.S. CLS. 21, 23, 26, 36 AND 38).

FIRST USE 1-0-2006; IN COMMERCE 1-0-2006.

THE MARK CONSISTS OF STANDARD CHARACTERS WITHOUT CLAIM TO ANY PARTICULAR FONT, STYLE, SIZE, OR COLOR.

SER. NO. 77-265,524, FILED 8-27-2007.

G. MAYERSCHOFF, EXAMINING ATTORNEY

Int. Cl.: 21

Prior U.S. Cls.: 2, 13, 23, 29, 30, 33, 40 and 50

United States Patent and Trademark Office

Reg. No. 3,479,396

Registered Aug. 5, 2008

**TRADEMARK
PRINCIPAL REGISTER**

ICE TUBES

ICE TUBES, INC. (OHIO CORPORATION)
P. O. BOX 334
TALLMADGE, OH 44278

FOR: ICE TRAYS, ICE MOLDS, IN CLASS 21 (U.S.
CLS. 2, 13, 23, 29, 30, 33, 40 AND 50).

FIRST USE 6-1-1998; IN COMMERCE 6-1-1998.

THE MARK CONSISTS OF STANDARD CHAR-
ACTERS WITHOUT CLAIM TO ANY PARTICULAR
FONT, STYLE, SIZE, OR COLOR.

OWNER OF U.S. REG. NO. 2,763,406.

NO CLAIM IS MADE TO THE EXCLUSIVE
RIGHT TO USE "ICE", APART FROM THE MARK
AS SHOWN.

SEC. 2(F).

SER. NO. 77-265,836, FILED 8-28-2007.

AISHA SALEM, EXAMINING ATTORNEY

Int. Cl.: 37

Prior U.S. Cls.: 100, 103 and 106

Reg. No. 3,479,397

United States Patent and Trademark Office

Registered Aug. 5, 2008

**SERVICE MARK
PRINCIPAL REGISTER**



ENGINEERING DESIGN TECHNOLOGIES, INC.
(GEORGIA CORPORATION)
SUITE 200
1705 ENTERPRISE WAY
MARIETTA, GA 30067

FOR: CONSTRUCTION OF OFFICE BUILDINGS,
EDUCATIONAL, GOVERNMENT, HOUSING, IN-
DUSTRIAL, MEDICAL, AND RETAIL FACILITIES,
RESTAURANTS, ROADS, BRIDGES, AND AIR-
PORTS; CONSTRUCTION MANAGEMENT; BUILD-

ING INSPECTION IN THE COURSE OF
CONSTRUCTION; CONSTRUCTION PLANNING;
CONSTRUCTION CONSULTATION, IN CLASS 37
(U.S. CLS. 100, 103 AND 106).

FIRST USE 2-26-1993; IN COMMERCE 2-26-1993.

SER. NO. 77-266,407, FILED 8-28-2007.

SEAN CROWLEY, EXAMINING ATTORNEY

Int. Cl.: 5

Prior U.S. Cls.: 6, 18, 44, 46, 51 and 52

Reg. No. 3,479,398

United States Patent and Trademark Office

Registered Aug. 5, 2008

**TRADEMARK
PRINCIPAL REGISTER**

ANESTENKA

APARICIO, JORGE (EL SALVADOR INDIVIDUAL)
5570 SW 2ND ST
MIAMI, FL 33134

FOR: PAIN RELIEF MEDICATION, IN CLASS 5
(U.S. CLS. 6, 18, 44, 46, 51 AND 52).

FIRST USE 1-1-1967; IN COMMERCE 1-1-1967.

THE MARK CONSISTS OF STANDARD CHARACTERS WITHOUT CLAIM TO ANY PARTICULAR FONT, STYLE, SIZE, OR COLOR.

THE WORDING "ANESTENKA" HAS NO MEANING IN A FOREIGN LANGUAGE.

SER. NO. 77-266,474, FILED 8-28-2007.

ANGELA GAW, EXAMINING ATTORNEY

Int. Cl.: 19

Prior U.S. Cls.: 1, 12, 33 and 50

United States Patent and Trademark Office

Reg. No. 3,479,399

Registered Aug. 5, 2008

**TRADEMARK
PRINCIPAL REGISTER**



EverStrong
P R O F I L E S

EASTERN WHOLESALE FENCE CO., INC. (NEW
YORK CORPORATION)
274 MIDDLE ISLAND ROAD
MEDFORD, NY 11763

NO CLAIM IS MADE TO THE EXCLUSIVE
RIGHT TO USE "PROFILES", APART FROM THE
MARK AS SHOWN.

FOR: VINYL FENCE PROFILES, IN CLASS 19
(U.S. CLS. 1, 12, 33 AND 50).

SER. NO. 77-266,475, FILED 8-28-2007.

FIRST USE 7-0-2006; IN COMMERCE 8-0-2006.

TARAH HARDY, EXAMINING ATTORNEY

Int. Cl.: 6

Prior U.S. Cls.: 2, 12, 13, 14, 23, 25 and 50

United States Patent and Trademark Office

Reg. No. 3,479,400

Registered Aug. 5, 2008

**TRADEMARK
PRINCIPAL REGISTER**

Summit Safe Company

SUMMIT BUSINESS ASSOCIATION, LLC (ALASKA LTD LIAB CO)
2759 E 1520 SOUTH
SPANISH FORK, UT 84660

FOR: METAL FIRE RESISTANT SAFES; METAL SAFES, IN CLASS 6 (U.S. CLS. 2, 12, 13, 14, 23, 25 AND 50).

FIRST USE 6-1-2006; IN COMMERCE 5-1-2007.

THE MARK CONSISTS OF STANDARD CHARACTERS WITHOUT CLAIM TO ANY PARTICULAR FONT, STYLE, SIZE, OR COLOR.

NO CLAIM IS MADE TO THE EXCLUSIVE RIGHT TO USE "SAFE COMPANY", APART FROM THE MARK AS SHOWN.

SER. NO. 77-267,086, FILED 8-29-2007.

COLLEEN DOMBROW, EXAMINING ATTORNEY

Int. Cl.: 11

Prior U.S. Cls.: 13, 21, 23, 31 and 34

United States Patent and Trademark Office

Reg. No. 3,479,401

Registered Aug. 5, 2008

**TRADEMARK
PRINCIPAL REGISTER**



ENTROPY SOLUTIONS, INC. (MISSISSIPPI CORPORATION)
9827 VALLEY VIEW ROAD
EDEN PRAIRIE, MN 55344

FOR: MEDICAL THERMAL MANAGEMENT SYSTEM FOR TRANSPORTING TRANSPLANT ORGANS, MEDICATIONS, BLOOD AND OTHER MEDICAL ITEMS REQUIRING STABLE TEMPERATURES DURING TRANSPORT; MEDICAL CONTAINER FOR STORAGE, TRANSPORTATION AND MAINTENANCE OF STANDARD TEMPERATURE DURING TRANSPORT FOR MEDICATIONS, TRANSPLANT ORGANS, BLOOD AND OTHER MEDICAL ITEMS, IN CLASS 11 (U.S. CLS. 13, 21, 23, 31 AND 34).

FIRST USE 8-23-2007; IN COMMERCE 8-23-2007.

NO CLAIM IS MADE TO THE EXCLUSIVE RIGHT TO USE "THERMAL MANAGEMENT SYSTEM", APART FROM THE MARK AS SHOWN.

THE MARK CONSISTS IN PART OF A HEXAGON CONTAINING THREE ARROWS.

SER. NO. 77-267,485, FILED 8-29-2007.

EDWARD NELSON, EXAMINING ATTORNEY

Int. Cl.: 25

Prior U.S. Cls.: 22 and 39

United States Patent and Trademark Office

Reg. No. 3,479,402

Registered Aug. 5, 2008

**TRADEMARK
PRINCIPAL REGISTER**

CARIBBEAN CARTEL

LIOW, TIAN KONG (MALAYSIA INDIVIDUAL)
20531 BELSHAW AVENUE
CARSON, CA 90746

THE MARK CONSISTS OF STANDARD CHAR-
ACTERS WITHOUT CLAIM TO ANY PARTICULAR
FONT, STYLE, SIZE, OR COLOR.

FOR: SHOES; FOOTWEAR; SANDAL-CLOGS, IN
CLASS 25 (U.S. CLS. 22 AND 39).

SER. NO. 77-267,670, FILED 8-29-2007.

FIRST USE 2-1-2007; IN COMMERCE 6-1-2007.

RAMONA ORTIGA, EXAMINING ATTORNEY

Int. Cl.: 36

Prior U.S. Cls.: 100, 101 and 102

United States Patent and Trademark Office

Reg. No. 3,479,403

Registered Aug. 5, 2008

**SERVICE MARK
PRINCIPAL REGISTER**



LOCKE, NELSON (UNITED STATES INDIVIDUAL)
15921 SW 14TH STREET
PEMBROKE PINES, FL 33027

FOR: FINANCIAL SERVICES, NAMELY, MONEY LENDING; MORTGAGE BROKERAGE; MORTGAGE LENDING, IN CLASS 36 (U.S. CLS. 100, 101 AND 102).

FIRST USE 6-1-2007; IN COMMERCE 6-1-2007.

THE COLOR(S) YELLOW, GRAY, GREEN, AND BLACK IS/ARE CLAIMED AS A FEATURE OF THE MARK.

THE MARK CONSISTS OF AN ANTHROPO-MORPHIC STAR FEATURING A TUXEDO IN THE COLORS GREEN AND GRAY; GRAY MONEY BAGS, GREEN DOLLAR DESIGNS, BLACK FINGERS AND BOW TIE, AND YELLOW SMILEY FACE WITH BLACK LINES.

SER. NO. 77-267,758, FILED 8-29-2007.

DAVID C. REIHNER, EXAMINING ATTORNEY

Int. Cl.: 14

Prior U.S. Cls.: 2, 27, 28 and 50

United States Patent and Trademark Office

Reg. No. 3,479,404

Registered Aug. 5, 2008

**TRADEMARK
PRINCIPAL REGISTER**

WELDER

TIME FACTORY S.R.L. (SAN MARINO LIMITED PARTNERSHIP)
VIA CESARE CANTU, 104
47891 DOGANA, SAN MARINO

FOR: HOROLOGICAL AND CHRONOMETRIC INSTRUMENTS, WRISTWATCHES, POCKET-WATCHES, ELECTRICAL CLOCKS, ELECTRONIC CLOCKS, PENDULUM CLOCKS, CLOCKS CONTAINING ELECTRONIC PLAY, CLOCKS FOR EXTERNAL PLACES, ATOMIC CLOCKS, CLOCKS GENERALLY; WATCH STRAPS; CHRONOMETERS; CLOCKMAKING MECHANISMS AND PARTS, NAMELY, CLOCK MOVEMENTS AND HAIRSPRINGS; WATCHCASES, WATCHBANDS, WATCH-CHAINS, WATCH-GLASSES, CASES, BOXES AND CASKETS FOR CLOCKMAKING; ALARM CLOCKS GENERALLY; CLOCKS, WATCHES AND JEWELRY BOXES OF PRECIOUS METAL; DIAMONDS; DIAMOND RINGS; PRECIOUS STONES; JEWELRY; JEWELS; PLATED ARTICLES OF COSTUME JEWELRY IN PRECIOUS

METALS; JEWELRY BOXES; JEWEL CASES OF PRECIOUS METAL , IN CLASS 14 (U.S. CLS. 2, 27, 28 AND 50).

THE MARK CONSISTS OF STANDARD CHARACTERS WITHOUT CLAIM TO ANY PARTICULAR FONT, STYLE, SIZE, OR COLOR.

PRIORITY CLAIMED UNDER SEC. 44(D) ON SAN MARINO APPLICATION NO. SM-M-2007000, FILED 3-8-2007, REG. NO. 200700036, DATED 7-2-2007, EXPIRES 3-8-2017.

PRIORITY CLAIMED UNDER SEC. 44(D) ON SAN MARINO APPLICATION NO. SM-M-2007000, FILED 3-8-2007.

SER. NO. 77-267,924, FILED 8-30-2007.

LINDA M. KING, EXAMINING ATTORNEY

Int. Cl.: 34

Prior U.S. Cls.: 2, 8, 9 and 17

United States Patent and Trademark Office

Reg. No. 3,479,405

Registered Aug. 5, 2008

**TRADEMARK
PRINCIPAL REGISTER**



SWISHER INTERNATIONAL, INC. (DELAWARE CORPORATION)
459 EAST 16TH STREET
JACKSONVILLE, FL 32206

NO CLAIM IS MADE TO THE EXCLUSIVE RIGHT TO USE "CHEW", APART FROM THE MARK AS SHOWN.

FOR: CHEWING TOBACCO, IN CLASS 34 (U.S. CLS. 2, 8, 9 AND 17).

SEC. 2(F) AS TO "SUPERIOR" AND "QUALITY".

FIRST USE 8-6-2002; IN COMMERCE 8-6-2002.

SER. NO. 77-267,933, FILED 8-30-2007.

OWNER OF U.S. REG. NOS. 1,890,652 AND 2,070,971.

KAELIE KUNG, EXAMINING ATTORNEY

Int. Cl.: 41

Prior U.S. Cls.: 100, 101 and 107

United States Patent and Trademark Office

Reg. No. 3,479,406

Registered Aug. 5, 2008

**SERVICE MARK
PRINCIPAL REGISTER**



CERTIFICATION BOARD OF CARDIOVASCULAR COMPUTED TOMOGRAPHY (MARYLAND CORPORATION)

19562 CLUB HOUSE ROAD
MONTGOMERY VILLAGE, MD 208863002

FOR: STANDARDIZED TESTING SERVICES, NAMELY, DEVELOPING, ADMINISTERING, AND SCORING PRACTICE-RELATED STANDARDIZED EXAMINATIONS IN THE FIELD OF CARDIOVASCULAR COMPUTED TOMOGRAPHY, IN CLASS 41 (U.S. CLS. 100, 101 AND 107).

FIRST USE 7-13-2007; IN COMMERCE 7-13-2007.

NO CLAIM IS MADE TO THE EXCLUSIVE RIGHT TO USE "CERTIFICATION BOARD OF CARDIOVASCULAR COMPUTED TOMOGRAPHY", APART FROM THE MARK AS SHOWN.

THE MARK CONSISTS OF A CIRCLE WITH AN IMAGE OF A HEART ON THE LEFT, THE LETTERS "CBCCT" PROMINENTLY DISPLAYED TO THE RIGHT AND THE WORDS "CERTIFICATION BOARD OF CARDIOVASCULAR COMPUTED TOMOGRAPHY" WRITTEN BELOW.

SER. NO. 77-268,463, FILED 8-30-2007.

NATALIE POLZER, EXAMINING ATTORNEY

Int. Cl.: 1

Prior U.S. Cls.: 1, 5, 6, 10, 26 and 46

Reg. No. 3,479,407

United States Patent and Trademark Office

Registered Aug. 5, 2008

**TRADEMARK
PRINCIPAL REGISTER**

VERMIGREEN

RW ENVIRONMENTS, LLC (CALIFORNIA LTD
LIAB CO)
SUITE 15
100 GALLI DRIVE
NOVATO, CA 94949

THE MARK CONSISTS OF STANDARD CHAR-
ACTERS WITHOUT CLAIM TO ANY PARTICULAR
FONT, STYLE, SIZE, OR COLOR.

FOR: NATURAL FERTILIZERS, IN CLASS 1 (U.S.
CLS. 1, 5, 6, 10, 26 AND 46).

SER. NO. 77-268,821, FILED 8-30-2007.

FIRST USE 7-13-2007; IN COMMERCE 7-13-2007.

LAURIE KAUFMAN, EXAMINING ATTORNEY

Int. Cl.: 35

Prior U.S. Cls.: 100, 101 and 102

United States Patent and Trademark Office

Reg. No. 3,479,408

Registered Aug. 5, 2008

SERVICE MARK
PRINCIPAL REGISTER



XO WINE GLASS INC. (CALIFORNIA CORPORATION)

1000 MANHATTAN AVE.
MANHATTAN BEACH, CA 90266

FOR: ON-LINE RETAIL STORE SERVICES FEATURING CHAMPAGNES AND SPARKLING WINES; RETAIL STORE SERVICES FEATURING CHAMPAGNES AND SPARKLING WINES, IN CLASS 35 (U.S. CLS. 100, 101 AND 102).

FIRST USE 8-4-2007; IN COMMERCE 8-4-2007.

THE MARK CONSISTS OF A DESIGN WITH THE WORDS "BUBBLES THERAPY" ALONG WITH A CHAMPAGNE GLASS ATTACHED TO THE "Y" IN THE WORD "THERAPY". THE CHAMPAGNE GLASS IS APPROXIMATELY HALF FULL AND THREE BUBBLES APPEAR IN THE LIQUID. SIX BUBBLES APPEAR AROUND THE TERM "BUBBLES" AND THREE BUBBLES APPEAR AROUND THE TERM "THERAPY".

SER. NO. 77-268,886, FILED 8-30-2007.

MARLENE BELL, EXAMINING ATTORNEY

Int. Cl.: 20

Prior U.S. Cls.: 2, 13, 22, 25, 32 and 50

United States Patent and Trademark Office

Reg. No. 3,479,409

Registered Aug. 5, 2008

**TRADEMARK
PRINCIPAL REGISTER**

EXO G2

VERSA-GARD, LLC (GEORGIA LTD LIAB CO)
1094 PARKWAY INDUSTRIAL PARK DR.
BUFORD, GA 30518

FOR: MODULAR, CONVERTIBLE, AND ADAP-
TABLE FOOD PROTECTION SYSTEMS CONSIST-
ING OF SNEEZE GUARDS, DISPLAY CASES AND
SHELVING, IN CLASS 20 (U.S. CLS. 2, 13, 22, 25, 32
AND 50).

FIRST USE 6-3-2007; IN COMMERCE 6-28-2007.

THE MARK CONSISTS OF STANDARD CHAR-
ACTERS WITHOUT CLAIM TO ANY PARTICULAR
FONT, STYLE, SIZE, OR COLOR.

SER. NO. 77-269,471, FILED 8-31-2007.

MARY BOAGNI, EXAMINING ATTORNEY

Int. Cl.: 43

Prior U.S. Cls.: 100 and 101

United States Patent and Trademark Office

Reg. No. 3,479,410

Registered Aug. 5, 2008

**SERVICE MARK
PRINCIPAL REGISTER**

**Hot Steaks Hot Music Hot
Italian Cool Place!**

WHALEN, MICHAEL L (UNITED STATES INDIVIDUAL)

1501 RIVER DRIVE

MOLINE, IL 61265

FOR: RESTAURANT AND BAR SERVICES, IN CLASS 43 (U.S. CLS. 100 AND 101).

FIRST USE 4-10-2004; IN COMMERCE 4-10-2004.

THE MARK CONSISTS OF STANDARD CHARACTERS WITHOUT CLAIM TO ANY PARTICULAR FONT, STYLE, SIZE, OR COLOR.

NO CLAIM IS MADE TO THE EXCLUSIVE RIGHT TO USE "HOT STEAKS" AND "HOT ITALIAN", APART FROM THE MARK AS SHOWN.

SER. NO. 77-269,583, FILED 8-31-2007.

SHARON MEIER, EXAMINING ATTORNEY

Int. Cl.: 9

Prior U.S. Cls.: 21, 23, 26, 36 and 38

Reg. No. 3,479,411

United States Patent and Trademark Office

Registered Aug. 5, 2008

**TRADEMARK
PRINCIPAL REGISTER**

ILLUMITEX

ILLUMITEX, INC. (DELAWARE CORPORATION), DBA ILLUMITEX, INC.
4301 W WILLIAM CANNON DR, STE B150 #132
AUSTIN, TX 78749

THE MARK CONSISTS OF STANDARD CHARACTERS WITHOUT CLAIM TO ANY PARTICULAR FONT, STYLE, SIZE, OR COLOR.

FOR: LIGHT EMITTING DIODE (LED) DISPLAYS; LIGHT EMITTING DIODES (LEDS), IN CLASS 9 (U.S. CLS. 21, 23, 26, 36 AND 38).

SER. NO. 77-270,338, FILED 9-3-2007.

FIRST USE 3-24-2005; IN COMMERCE 9-1-2005.

WILLIAM VERHOSEK, EXAMINING ATTORNEY

Int. Cl.: 5

Prior U.S. Cls.: 6, 18, 44, 46, 51 and 52

Reg. No. 3,479,412

United States Patent and Trademark Office

Registered Aug. 5, 2008

**TRADEMARK
PRINCIPAL REGISTER**

TRI-SAN

GENERAL CONVERTERS & ASSEMBLERS, INC.
(WISCONSIN CORPORATION)
1325 16TH STREET
RACINE, WI 53403

THE MARK CONSISTS OF STANDARD CHARACTERS WITHOUT CLAIM TO ANY PARTICULAR FONT, STYLE, SIZE, OR COLOR.

FOR: SANITIZING TABLETS AND SANITIZING POWDERS PACKAGED FOR INDIVIDUALIZED USE FOR SANITIZING COOKING UTENSILS AND EQUIPMENT USED IN CAMPING, IN CLASS 5 (U.S. CLS. 6, 18, 44, 46, 51 AND 52).

SER. NO. 77-271,146, FILED 9-4-2007.

FIRST USE 8-1-1969; IN COMMERCE 8-1-1969.

KATHLEEN M. VANSTON, EXAMINING ATTORNEY

Int. Cl.: 25

Prior U.S. Cls.: 22 and 39

United States Patent and Trademark Office

Reg. No. 3,479,413

Registered Aug. 5, 2008

TRADEMARK
PRINCIPAL REGISTER



WALKER, APRIL (UNITED STATES INDIVIDUAL)
SUITE #1A
420 CLINTON AVENUE
BROOKLYN, NY 11238

FOR: MEN'S AND WOMEN'S SPORTSWEAR CLOTHING, NAMELY, SHIRTS, BLOUSES, VESTS, SWEATSHIRTS, PANTS, OVERALL PANTS, SHORTS, DRESSES, HATS, SWEATERS AND T-SHIRTS, IN CLASS 25 (U.S. CLS. 22 AND 39).

FIRST USE 6-1-1991; IN COMMERCE 2-1-1992.

NO CLAIM IS MADE TO THE EXCLUSIVE RIGHT TO USE "WEAR", APART FROM THE MARK AS SHOWN.

THE MARK CONSISTS OF STYLIZED WORDS "WALKER WEAR".

SER. NO. 77-271,445, FILED 9-4-2007.

CAROLINE WOOD, EXAMINING ATTORNEY

Int. Cl.: 35

Prior U.S. Cls.: 100, 101 and 102

United States Patent and Trademark Office

Reg. No. 3,479,414

Registered Aug. 5, 2008

**SERVICE MARK
PRINCIPAL REGISTER**

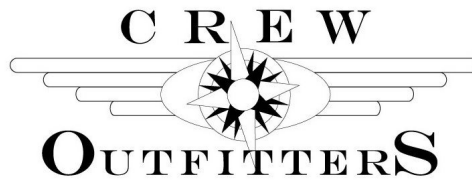

BLACKSTONE INVESTMENT GROUP, INC.
(MISSOURI CORPORATION)
570 W. HIGH STREET
AURORA, MO 65605

FOR: RETAIL STORE SERVICES, ON-LINE RETAIL STORE SERVICES, AND CATALOG ORDERING SERVICES FEATURING LUGGAGE, CLOTHING, FOOTWEAR, HEADGEAR, HEADSETS, SUNGLASSES, SAFETY GLASSES, EAR PROTECTORS, TRAVEL ACCESSORIES AND NOVELTY ITEMS, CARDS, DECALS, POSTERS, BOOKS, MANUALS, SMALL ELECTRICAL APPLIANCES, CLOCKS, AND TOYS, IN CLASS 35 (U.S. CLS. 100, 101 AND 102).

FIRST USE 1-1-2001; IN COMMERCE 1-1-2001.

NO CLAIM IS MADE TO THE EXCLUSIVE RIGHT TO USE "CREW OUTFITTERS", APART FROM THE MARK AS SHOWN.

THE MARK CONSISTS OF THE WORD "CREW" OVER THE DESIGN OF A COMPASS IMPOSED OVER AN OVAL IMPOSED OVER FOUR DECREASING SIZED OVALS ALL OVER THE WORD "OUTFITTERS".

SER. NO. 77-271,812, FILED 9-5-2007.

EVELYN BRADLEY, EXAMINING ATTORNEY

Int. Cls.: 35, 40 and 42

Prior U.S. Cls.: 100, 101, 102, 103 and 106

United States Patent and Trademark Office

Reg. No. 3,479,415

Registered Aug. 5, 2008

**SERVICE MARK
PRINCIPAL REGISTER**



BALDWIN RICHARDS FOODS CO. (ILLINOIS CORPORATION)
20201 S. LAGRANGE ROAD
SUITE 200
FRANKFORT, IL 60423

FOR: CUSTOM PACKAGING OF ARTICLES FOR RETAIL, FOOD SERVICE AND INDUSTRIAL COMPANIES, IN CLASS 35 (U.S. CLS. 100, 101 AND 102).

FIRST USE 12-31-1997; IN COMMERCE 12-31-1997.

FOR: MANUFACTURING SERVICES FOR OTHERS IN THE FIELDS OF FOODS, SAUCES, DESERTS, FILLINGS FOR FOOD, AND CONDIMENTS, IN CLASS 40 (U.S. CLS. 100, 103 AND 106).

FIRST USE 12-31-1997; IN COMMERCE 12-31-1997.

FOR: DESIGN AND TESTING SERVICES FOR NEW AND EXISTING FOOD PRODUCTS; PRODUCT RESEARCH AND DEVELOPMENT; PROVIDING QUALITY ASSURANCE SERVICES IN THE FIELD OF FOOD PRODUCTS; CUSTOM DESIGN SERVICES FOR PRODUCT PACKAGING FOR FOOD PRODUCTS , IN CLASS 42 (U.S. CLS. 100 AND 101).

FIRST USE 12-31-1997; IN COMMERCE 12-31-1997.

OWNER OF U.S. REG. NO. 2,864,341.

THE MARK CONSISTS OF THE LETTERS "B" AND "R" IN A BLOCKED STYLIZED FORM.

SER. NO. 77-272,349, FILED 9-5-2007.

LINDA LAVACHE, EXAMINING ATTORNEY

Int. Cl.: 3

Prior U.S. Cls.: 1, 4, 6, 50, 51 and 52

United States Patent and Trademark Office

Reg. No. 3,479,416

Registered Aug. 5, 2008

TRADEMARK
PRINCIPAL REGISTER



SUNSHINE MAKERS, INC. (CALIFORNIA CORPORATION)
15922 PACIFIC COAST HIGHWAY
HUNTINGTON HARBOUR, CA 92649

FOR: ALL-PURPOSE CLEANING PREPARATIONS FOR COMMERCIAL, INSTITUTIONAL AND INDUSTRIAL USE, INCLUDING BATHROOM CLEANING PREPARATIONS, GLASS CLEANING PREPARATIONS, AND CARPET CLEANING PREPARATIONS, IN CLASS 3 (U.S. CLS. 1, 4, 6, 50, 51 AND 52).

FIRST USE 4-30-2007; IN COMMERCE 4-30-2007.

OWNER OF U.S. REG. NOS. 1,098,481, 1,397,283, AND 2,035,680.

NO CLAIM IS MADE TO THE EXCLUSIVE RIGHT TO USE "CLEAN BUILDING", APART FROM THE MARK AS SHOWN.

THE MARK CONSISTS OF THE TERMS "SIMPLE GREEN CLEAN BUILDING" IN STYLIZED FORM. THE WORD "SIMPLE" APPEARS ON THE FIRST LINE WITH THE WORD "GREEN" IMMEDIATELY BELOW. BOTH WORDS ARE IN LOWERCASE LETTERS. THE WORDS "CLEAN BUILDING" APPEAR BELOW ON A SINGLE LINE IN ALL CAPITAL LETTERS WITH SHADING THEREIN. THE SHADING IS A FEATURE OF THE MARK AND APPLICANT MAKES NO CLAIM OF COLOR.

SEC. 2(F) AS TO "GREEN".

SER. NO. 77-272,491, FILED 9-5-2007.

REBECCA SMITH, EXAMINING ATTORNEY

Int. Cl.: 44

Prior U.S. Cls.: 100 and 101

United States Patent and Trademark Office

Reg. No. 3,479,417

Registered Aug. 5, 2008

**SERVICE MARK
PRINCIPAL REGISTER**

The Rose Lady Wooden Roses

IRVIN, GAYLE (UNITED STATES INDIVIDUAL)
108 ELMCREST COURT
ST. CHARLES, MO 63301

FOR: FLOWER ARRANGING USING FLOWERS
MADE FROM WOOD SHAVINGS FOR WEDDINGS,
HOME DECORATIONS, HOLIDAY DECORATIONS,
AND SPECIAL EVENTS, IN CLASS 44 (U.S. CLS. 100
AND 101).

FIRST USE 9-1-2006; IN COMMERCE 9-1-2006.

THE MARK CONSISTS OF STANDARD CHAR-
ACTERS WITHOUT CLAIM TO ANY PARTICULAR
FONT, STYLE, SIZE, OR COLOR.

NO CLAIM IS MADE TO THE EXCLUSIVE
RIGHT TO USE "ROSE" AND "WOODEN ROSES",
APART FROM THE MARK AS SHOWN.

SER. NO. 77-272,503, FILED 9-5-2007.

SOPHIA S. KIM, EXAMINING ATTORNEY

Int. Cl.: 41

Prior U.S. Cls.: 100, 101 and 107

United States Patent and Trademark Office

Reg. No. 3,479,418

Registered Aug. 5, 2008

**SERVICE MARK
PRINCIPAL REGISTER**

THE UTEACH INSTITUTE

THE BOARD OF REGENTS OF THE UNIVERSITY OF TEXAS SYSTEM (TEXAS STATE AGENCY)
201 WEST 7TH STREET
AUSTIN, TX 78701

FOR: CONSULTATION IN THE FIELD OF TEACHER TRAINING AND PREPARATION; CONSULTATION IN THE FIELD OF TEACHER PREPARATION PROGRAMS; CONSULTATION SERVICES IN THE DEVELOPMENT, IMPLEMENTATION, CONDUCT AND EVALUATION OF TEACHER PREPARATION AND TRAINING PROGRAMS; DEVELOPMENT OF COURSES IN THE FIELD OF TEACHER TRAINING AND PREPARATION; EDUCATIONAL SERVICES, NAMELY, PROVIDING CLASSES AND SEMINARS IN THE FIELD OF TEACHER PREPARATION; EVALUATION AND MONITORING OF TEACHER PREPARATION PROGRAMS; PROVIDING

INFORMATION ONLINE IN THE FIELD OF TEACHING, IN CLASS 41 (U.S. CLS. 100, 101 AND 107).

FIRST USE 3-9-2007; IN COMMERCE 3-9-2007.

THE MARK CONSISTS OF STANDARD CHARACTERS WITHOUT CLAIM TO ANY PARTICULAR FONT, STYLE, SIZE, OR COLOR.

OWNER OF U.S. REG. NO. 2,586,171.

NO CLAIM IS MADE TO THE EXCLUSIVE RIGHT TO USE "INSTITUTE", APART FROM THE MARK AS SHOWN.

SER. NO. 77-272,774, FILED 9-6-2007.

AHSEN KHAN, EXAMINING ATTORNEY

Int. Cls.: 35, 41 and 42

Prior U.S. Cls.: 100, 101, 102 and 107

United States Patent and Trademark Office

Reg. No. 3,479,419

Registered Aug. 5, 2008

**SERVICE MARK
PRINCIPAL REGISTER**

IMCA

INVESTMENT MANAGEMENT CONSULTANTS
ASSN. INC. (COLORADO CORPORATION)
5619 DTC PARKWAY, SUITE 500
GREENWOOD VILLAGE, CO 80111

FOR: ASSOCIATION SERVICES, NAMELY, PROMOTING THE INTERESTS OF INVESTMENT ANALYSTS AND INVESTMENT MANAGEMENT PROFESSIONALS, IN CLASS 35 (U.S. CLS. 100, 101 AND 102).

FIRST USE 11-0-1985; IN COMMERCE 11-0-1985.

FOR: EDUCATIONAL SERVICES, NAMELY, PROVIDING CLASSES, LECTURES, CONFERENCES, WORKSHOPS, AND COURSES OF INSTRUCTION IN THE FIELD OF INVESTMENT COUNSELING, IN CLASS 41 (U.S. CLS. 100, 101 AND 107).

FIRST USE 11-0-1985; IN COMMERCE 11-0-1985.

FOR: TESTING, ANALYSIS AND EVALUATION OF THE SERVICES OF OTHERS FOR THE PURPOSE OF CERTIFICATION, IN CLASS 42 (U.S. CLS. 100 AND 101).

FIRST USE 4-0-1988; IN COMMERCE 4-0-1988.

THE MARK CONSISTS OF STANDARD CHARACTERS WITHOUT CLAIM TO ANY PARTICULAR FONT, STYLE, SIZE, OR COLOR.

OWNER OF U.S. REG. NO. 1,593,513.

SER. NO. 77-272,785, FILED 9-6-2007.

SEAN CROWLEY, EXAMINING ATTORNEY

Int. Cl.: 41

Prior U.S. Cls.: 100, 101 and 107

United States Patent and Trademark Office

Reg. No. 3,479,420

Registered Aug. 5, 2008

**SERVICE MARK
PRINCIPAL REGISTER**

Jeff K

JEFF KOVARSKY (UNITED STATES INDIVIDUAL)
4017 SUN MEADOWS STREET
PLANO, TX 75024

FOR: ENTERTAINMENT, NAMELY, LIVE PERFORMANCES BY EMCEE AND CLUB DISC JOCKEY, IN CLASS 41 (U.S. CLS. 100, 101 AND 107).

FIRST USE 1-1-1984; IN COMMERCE 1-1-1987.

THE MARK CONSISTS OF STANDARD CHARACTERS WITHOUT CLAIM TO ANY PARTICULAR FONT, STYLE, SIZE, OR COLOR.

THE NAME "JEFF K" IDENTIFIES A LIVING INDIVIDUAL WHOSE CONSENT IS OF RECORD.

SER. NO. 77-272,968, FILED 9-6-2007.

B. PARADEWELAI, EXAMINING ATTORNEY

Int. Cl.: 41

Prior U.S. Cls.: 100, 101 and 107

United States Patent and Trademark Office

Reg. No. 3,479,421

Registered Aug. 5, 2008

**SERVICE MARK
PRINCIPAL REGISTER**

**STAY WHERE THE COWBOYS
PLAY!**

BOYD GAMING CORPORATION (NEVADA
CORPORATION)
ATTN: MR. LOU NUNZIATA
6465 SOUTH RAINBOW BOULEVARD, BUILDING
D
LAS VEGAS, NV 89118

FOR: CASINOS; CONDUCTING AND PROVID-
ING FACILITIES FOR SPECIAL EVENTS FEATUR-
ING CASINO AND GAMING CONTESTS AND
TOURNAMENTS; ENTERTAINMENT IN THE NAT-
URE OF LIVE CONCERTS, THEATRICAL AND
MUSICAL FLOOR SHOWS, DANCE HALLS AND
COMEDIANS; NIGHT CLUBS; PROVIDING CASI-
NO FACILITIES; PROVIDING A WEB SITE WHERE
USERS CAN POST RATINGS, REVIEWS AND RE-
COMMENDATIONS ON EVENTS AND ACTIVITIES

IN THE FIELD OF ENTERTAINMENT AND EDU-
CATION; SPECIAL EVENT PLANNING, IN CLASS
41 (U.S. CLS. 100, 101 AND 107).

FIRST USE 8-31-2007; IN COMMERCE 8-31-2007.

THE MARK CONSISTS OF STANDARD CHAR-
ACTERS WITHOUT CLAIM TO ANY PARTICULAR
FONT, STYLE, SIZE, OR COLOR.

OWNER OF U.S. REG. NO. 2,618,020.

SER. NO. 77-273,340, FILED 9-6-2007.

CHERYL CLAYTON, EXAMINING ATTORNEY

Int. Cl.: 43

Prior U.S. Cls.: 100 and 101

United States Patent and Trademark Office

Reg. No. 3,479,422

Registered Aug. 5, 2008

**SERVICE MARK
PRINCIPAL REGISTER**

**STAY WHERE THE COWBOYS
PLAY!**

BOYD GAMING CORPORATION (NEVADA
CORPORATION)
ATTN: MR. LOU NUNZIATA
6465 SOUTH RAINBOW BOULEVARD, BUILDING
D
LAS VEGAS, NV 89118

FOR: COCKTAIL LOUNGES; HOTEL, BAR AND
RESTAURANT SERVICES, IN CLASS 43 (U.S. CLS.
100 AND 101).

FIRST USE 8-31-2007; IN COMMERCE 8-31-2007.

THE MARK CONSISTS OF STANDARD CHAR-
ACTERS WITHOUT CLAIM TO ANY PARTICULAR
FONT, STYLE, SIZE, OR COLOR.

OWNER OF U.S. REG. NO. 2,755,183.

SER. NO. 77-273,513, FILED 9-6-2007.

CHERYL CLAYTON, EXAMINING ATTORNEY

Int. Cl.: 25

Prior U.S. Cls.: 22 and 39

United States Patent and Trademark Office

Reg. No. 3,479,423

Registered Aug. 5, 2008

**TRADEMARK
PRINCIPAL REGISTER**

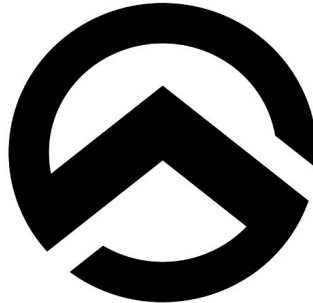

**SUMMIT
SERIES**

THE NORTH FACE APPAREL CORP. (DELA-
WARE CORPORATION)
3411 SILVERSIDE ROAD
WILMINGTON, DE 19810

NO CLAIM IS MADE TO THE EXCLUSIVE
RIGHT TO USE "SERIES" , APART FROM THE
MARK AS SHOWN.

FOR: FOOTWEAR, IN CLASS 25 (U.S. CLS. 22 AND
39).

SER. NO. 77-273,817, FILED 9-7-2007.

FIRST USE 7-0-2002; IN COMMERCE 7-0-2002.

JASON BLAIR, EXAMINING ATTORNEY

Int. Cl.: 25

Prior U.S. Cls.: 22 and 39

United States Patent and Trademark Office

Reg. No. 3,479,424

Registered Aug. 5, 2008

TRADEMARK
PRINCIPAL REGISTER



COLORADO STATE PATROL (COLORADO
STATE AGENCY)
700 KIPLING STREET, SUITE 3000
DENVER, CO 80215

FOR: CLOTHING, NAMELY, SHIRTS, T-SHIRTS,
SWEATSHIRTS, SWEATPANTS, SHORTS AND
HATS, IN CLASS 25 (U.S. CLS. 22 AND 39).

FIRST USE 12-0-1980; IN COMMERCE 12-0-1980.

THE MARK CONSISTS OF WINGS, A SPOKED
MOTORCYCLE WHEEL WITH TREAD DETAIL,

TOP AND BOTTOM BANNERS, SIDE STARS AND
THE WORDS "STATE PATROL" ON THE TOP
BANNER AND THE WORD "COLORADO" ON
THE BOTTOM BANNER.

SEC. 2(F) AS TO "STATE PATROL COLORADO".

SER. NO. 77-274,008, FILED 9-7-2007.

TRICIA SONNEBORN, EXAMINING ATTORNEY

Int. Cl.: 30

Prior U.S. Cl.: 46

United States Patent and Trademark Office

Reg. No. 3,479,425

Registered Aug. 5, 2008

**TRADEMARK
PRINCIPAL REGISTER**

SCHARFFEN BERGER

ARTISAN CONFECTIONS COMPANY (CALI-
FORNIA CORPORATION)
LAW DEPT.
100 CRYSTAL A DRIVE
HERSHEY, PA 17033

FOR: CHOCOLATE GANACHE; CHOCOLATE
SAUCE; CHOCOLATE TOPPING, IN CLASS 30 (U.S.
CL. 46).

FIRST USE 8-30-2002; IN COMMERCE 8-30-2002.

THE MARK CONSISTS OF STANDARD CHAR-
ACTERS WITHOUT CLAIM TO ANY PARTICULAR
FONT, STYLE, SIZE, OR COLOR.

OWNER OF U.S. REG. NOS. 2,215,175 AND
2,259,595.

SER. NO. 77-274,358, FILED 9-7-2007.

G. MAYERSCHOFF, EXAMINING ATTORNEY

Int. Cl.: 30

Prior U.S. Cl.: 46

United States Patent and Trademark Office

Reg. No. 3,479,426

Registered Aug. 5, 2008

**TRADEMARK
PRINCIPAL REGISTER**

SCHARFFEN BERGER

ARTISAN CONFECTIONS COMPANY (CALI-
FORNIA CORPORATION)
LAW DEPT.
100 CRYSTAL A DRIVE
HERSHEY, PA 17033

FOR: BAKING CHOCOLATE, IN CLASS 30 (U.S.
CL. 46).

FIRST USE 9-30-1997; IN COMMERCE 9-30-1997.

THE MARK CONSISTS OF STANDARD CHAR-
ACTERS WITHOUT CLAIM TO ANY PARTICULAR
FONT, STYLE, SIZE, OR COLOR.

OWNER OF U.S. REG. NOS. 2,215,175 AND
2,259,595.

SER. NO. 77-274,360, FILED 9-7-2007.

G. MAYERSCHOFF, EXAMINING ATTORNEY

Int. Cl.: 16

Prior U.S. Cls.: 2, 5, 22, 23, 29, 37, 38 and 50

Reg. No. 3,479,427

United States Patent and Trademark Office

Registered Aug. 5, 2008

**TRADEMARK
PRINCIPAL REGISTER**

MAGIC EYE

MAGIC EYE, INC. (MASSACHUSETTS CORPORATION)
67 SHANK PAINTER ROAD
PROVINCETOWN, MA 02657

FOR: CALENDARS; GREETING CARDS; POSTCARDS; STATIONERY; PRINTED PAPER SIGNS; POSTERS; POSTERS MADE OF PAPER; BOOK COVERS; BOOK-COVER PAPER; BOOKS IN THE FIELD OF THREE DIMENSIONAL OPTICAL ILLUSIONS, IN CLASS 16 (U.S. CLS. 2, 5, 22, 23, 29, 37, 38 AND 50).

FIRST USE 11-1-1993; IN COMMERCE 11-1-1993.

THE MARK CONSISTS OF STANDARD CHARACTERS WITHOUT CLAIM TO ANY PARTICULAR FONT, STYLE, SIZE, OR COLOR.

OWNER OF U.S. REG. NOS. 2,103,765 AND 2,109,412.

SER. NO. 77-274,393, FILED 9-7-2007.

RON FAIRBANKS, EXAMINING ATTORNEY

Int. Cl.: 30

Prior U.S. Cl.: 46

United States Patent and Trademark Office

Reg. No. 3,479,428

Registered Aug. 5, 2008

TRADEMARK
PRINCIPAL REGISTER



WICKED SEASONING, LLC (MONTANA LTD
LIAB CO)
665 WILSON BUTTE ROAD
GREAT FALLS, MT 59405

FOR: SEASONINGS, IN CLASS 30 (U.S. CL. 46).

FIRST USE 4-19-2006; IN COMMERCE 4-19-2006.

NO CLAIM IS MADE TO THE EXCLUSIVE
RIGHT TO USE "SEASONING", APART FROM
THE MARK AS SHOWN.

THE MARK CONSISTS OF AN OVAL WITH
LARGE "WICKED" IN THE MIDDLE, SMALL
"ERIC'S" AT THE TOP, SMALL "SEASONING" AT
THE BOTTOM. THERE ARE FLAMES ABOVE THE
"WICKED" AND CHILI PEPPERS BELOW THE
"WICKED".

SER. NO. 77-274,761, FILED 9-7-2007.

LYDIA BELZER, EXAMINING ATTORNEY

Int. Cl.: 42

Prior U.S. Cls.: 100 and 101

United States Patent and Trademark Office

Reg. No. 3,479,429

Registered Aug. 5, 2008

**SERVICE MARK
PRINCIPAL REGISTER**

Yodle

YODLE, INC. (DELAWARE CORPORATION)
9TH FLOOR
589 8TH AVENUE
NEW YORK, NY 10018

FOR: PROVIDING TEMPORARY USE OF ON-
LINE NON-DOWNLOADABLE SOFTWARE FOR
DISSEMINATION OF INTERNET ADVERTISING
FOR OTHERS, IN CLASS 42 (U.S. CLS. 100 AND 101).

FIRST USE 8-2-2007; IN COMMERCE 8-2-2007.

THE MARK CONSISTS OF STANDARD CHAR-
ACTERS WITHOUT CLAIM TO ANY PARTICULAR
FONT, STYLE, SIZE, OR COLOR.

SER. NO. 77-275,390, FILED 9-10-2007.

JOHN GARTNER, EXAMINING ATTORNEY

Int. Cls.: 35, 40 and 42

Prior U.S. Cls.: 100, 101, 102, 103 and 106

United States Patent and Trademark Office

Reg. No. 3,479,430

Registered Aug. 5, 2008

**SERVICE MARK
PRINCIPAL REGISTER**

WALL PROCESS

MUNRO & ASSOCIATES, INC. (MICHIGAN CORPORATION)
1749 NORTHWOOD DRIVE
TROY, MI 48084

FOR: BUSINESS CONSULTATION SERVICES, NAMELY, PROVIDING PLANNING AND MANAGEMENT TECHNIQUES FOR THE CREATION AND DEVELOPMENT OF COST-EFFECTIVE PRODUCTS, IN CLASS 35 (U.S. CLS. 100, 101 AND 102).

FIRST USE 6-1-2005; IN COMMERCE 6-1-2005.

FOR: CONSULTING SERVICES IN THE FIELDS OF PRODUCT MANUFACTURING AND PRODUCT ASSEMBLY, IN CLASS 40 (U.S. CLS. 100, 103 AND 106).

FIRST USE 6-1-2005; IN COMMERCE 6-1-2005.

FOR: CONSULTING SERVICES IN THE FIELD OF STRATEGIC PRODUCT DESIGN, IN CLASS 42 (U.S. CLS. 100 AND 101).

FIRST USE 6-1-2005; IN COMMERCE 6-1-2005.

THE MARK CONSISTS OF STANDARD CHARACTERS WITHOUT CLAIM TO ANY PARTICULAR FONT, STYLE, SIZE, OR COLOR.

NO CLAIM IS MADE TO THE EXCLUSIVE RIGHT TO USE "PROCESS", APART FROM THE MARK AS SHOWN.

SER. NO. 77-275,773, FILED 9-10-2007.

PRISCILLA MILTON, EXAMINING ATTORNEY

Int. Cls.: 36, 37 and 45

Prior U.S. Cls.: 100, 101, 102, 103 and 106

United States Patent and Trademark Office

Reg. No. 3,479,431

Registered Aug. 5, 2008

**SERVICE MARK
PRINCIPAL REGISTER**



THE RELATED COMPANIES, L.P. (DELAWARE
LIMITED PARTNERSHIP)
625 MADISON AVENUE
NEW YORK, NY 10022

FOR: REAL ESTATE BROKERAGE, LEASING
AND MANAGEMENT, IN CLASS 36 (U.S. CLS. 100,
101 AND 102).

FIRST USE 7-1-2006; IN COMMERCE 7-1-2006.

FOR: REAL ESTATE DEVELOPMENT SERVICES,
IN CLASS 37 (U.S. CLS. 100, 103 AND 106).

FIRST USE 7-1-2006; IN COMMERCE 7-1-2006.

FOR: CONCIERGE SERVICES FOR OTHERS
COMPRISED OF MAKING REQUESTED PERSONAL
ARRANGEMENTS, ERRANDS AND RESER-

VATIONS; AND PROVIDING CUSTOMER-
SPECIFIC INFORMATION TO MEET INDIVIDUAL
NEEDS RENDERED TOGETHER IN AN APART-
MENT COMPLEX, IN CLASS 45 (U.S. CLS. 100 AND
101).

FIRST USE 7-1-2006; IN COMMERCE 7-1-2006.

OWNER OF U.S. REG. NOS. 2,964,804, 2,964,805
AND OTHERS.

THE MARK CONSISTS OF A SQUARE WITHIN A
SQUARE AND THE WORD "RELATED".

SER. NO. 77-275,917, FILED 9-10-2007.

MAUREEN DALL, EXAMINING ATTORNEY

Int. Cl.: 37

Prior U.S. Cls.: 100, 103 and 106

United States Patent and Trademark Office

Reg. No. 3,479,432

Registered Aug. 5, 2008

**SERVICE MARK
PRINCIPAL REGISTER**

PRESSURE WASHING SYSTEMS

MOLOGOUSIS, WILLIAM A. (UNITED STATES
INDIVIDUAL)
1615 S. 55TH AVENUE
CICERO, IL 60804

NO CLAIM IS MADE TO THE EXCLUSIVE
RIGHT TO USE "PRESSURE WASHING", APART
FROM THE MARK AS SHOWN.

FOR: PRESSURE WASHING SERVICES, IN
CLASS 37 (U.S. CLS. 100, 103 AND 106).

SEC. 2(F).

FIRST USE 8-19-1992; IN COMMERCE 8-19-1992.

SER. NO. 77-275,977, FILED 9-10-2007.

THE MARK CONSISTS OF STANDARD CHAR-
ACTERS WITHOUT CLAIM TO ANY PARTICULAR
FONT, STYLE, SIZE, OR COLOR.

TINA BROWN, EXAMINING ATTORNEY

Int. Cl.: 10

Prior U.S. Cls.: 26, 39 and 44

United States Patent and Trademark Office

Reg. No. 3,479,433

Registered Aug. 5, 2008

**TRADEMARK
PRINCIPAL REGISTER**

FLESHLIGHT GIRLS

SHUBIN, STEVE (UNITED STATES INDIVIDUAL)

300 TEXAS LONGHORN TRAIL

DRIPPING SPRINGS, TX 78620

FOR: ADULT SEXUAL AIDS, NAMELY, MASTURBATION SLEEVES THAT ALLOW FOR THE DISCREET COLLECTION OF HUMAN SPERM, IN CLASS 10 (U.S. CLS. 26, 39 AND 44).

FIRST USE 5-21-2007; IN COMMERCE 5-21-2007.

THE MARK CONSISTS OF STANDARD CHARACTERS WITHOUT CLAIM TO ANY PARTICULAR FONT, STYLE, SIZE, OR COLOR.

OWNER OF U.S. REG. NO. 2,225,503.

NO CLAIM IS MADE TO THE EXCLUSIVE RIGHT TO USE "GIRLS", APART FROM THE MARK AS SHOWN.

SER. NO. 77-276,105, FILED 9-11-2007.

JASON LOTT, EXAMINING ATTORNEY

Int. Cl.: 16

Prior U.S. Cls.: 2, 5, 22, 23, 29, 37, 38 and 50

United States Patent and Trademark Office

Reg. No. 3,479,434

Registered Aug. 5, 2008

**TRADEMARK
PRINCIPAL REGISTER**

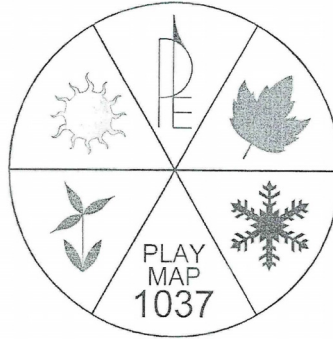

WAYNE SEGER (UNITED STATES INDIVIDUAL)
210 LEWIS STREET
CHARLEVOIX, MI 49720

FOR: CUSTOM MAPS FOR RECREATIONAL PURPOSES, HIGHLIGHTING PARTICULAR DESTINATIONS, IN CLASS 16 (U.S. CLS. 2, 5, 22, 23, 29, 37, 38 AND 50).

FIRST USE 6-1-2007; IN COMMERCE 6-1-2007.

NO CLAIM IS MADE TO THE EXCLUSIVE RIGHT TO USE "MAP", APART FROM THE MARK AS SHOWN.

THE MARK CONSISTS OF A CIRCLE DIVIDED INTO 6 SECTIONS, EACH SEPARATE SECTION CONTAINING, RESPECTIVELY, ONE OF A MAPLE LEAF, A SNOWFLAKE, A FLOWER, A STYLIZED SUN, THE STYLIZED LETTERS "P" AND "E", AND THE WORDS AND NUMERALS "PLAYMAP 1037".

SER. NO. 77-276,205, FILED 9-11-2007.

DEIRDRE ROBERTSON, EXAMINING ATTORNEY

Int. Cls.: 5 and 32

Prior U.S. Cls.: 6, 18, 44, 45, 46, 48, 51 and 52

United States Patent and Trademark Office

Reg. No. 3,479,435

Registered Aug. 5, 2008

**TRADEMARK
PRINCIPAL REGISTER**

Thomas Jefferson Clark

HUB RESEARCH & DEVELOPMENT CO, INC.
(UTAH CORPORATION)
377 WEST 1500 SOUTH
SALT LAKE CITY, UT 84115

FOR: NUTRITIONAL SUPPLEMENTS IN POW-
DER, LIQUID, LOTION, CREAM, SPRAY AND
BALM FORM SOLD AS A COMPONENT OF NU-
TRITIONAL SKIN CARE PRODUCTS; DIETARY
MINERAL SUPPLEMENTS, IN CLASS 5 (U.S. CLS.
6, 18, 44, 46, 51 AND 52).

FIRST USE 1-1-1997; IN COMMERCE 1-1-1997.

FOR: MINERAL WATER, IN CLASS 32 (U.S. CLS.
45, 46 AND 48).

FIRST USE 1-1-1997; IN COMMERCE 1-1-1997.

THE MARK CONSISTS OF STANDARD CHAR-
ACTERS WITHOUT CLAIM TO ANY PARTICULAR
FONT, STYLE, SIZE, OR COLOR.

THE NAME(S), PORTRAIT(S), AND/OR SIGNA-
TURE(S) SHOWN IN THE MARK DOES NOT IDEN-
TIFY A PARTICULAR LIVING INDIVIDUAL.

SER. NO. 77-277,085, FILED 9-11-2007.

LINDSEY RUBIN, EXAMINING ATTORNEY

Int. Cl.: 35

Prior U.S. Cls.: 100, 101 and 102

United States Patent and Trademark Office

Reg. No. 3,479,436

Registered Aug. 5, 2008

SERVICE MARK
PRINCIPAL REGISTER

CLAO

Contact Lens Association of Ophthalmologists
An International Educational Association

CONTACT LENS ASSOCIATION OF OPHTHALMOLOGISTS, INC. (NEW YORK CORPORATION)

2025 WOODLANE DRIVE
WOODBURY, MN 55125

FOR: ASSOCIATION SERVICES, NAMELY, PROMOTING THE INTERESTS OF EDUCATION IN THE FIELD OF OPHTHALMOLOGY AND CONTACT LENS AND RELATED EYE CARE SCIENCE, IN CLASS 35 (U.S. CLS. 100, 101 AND 102).

FIRST USE 0-0-1964; IN COMMERCE 0-0-1964.

NO CLAIM IS MADE TO THE EXCLUSIVE RIGHT TO USE "CONTACT LENS ASSOCIATION OF OPHTHALMOLOGISTS" AND "AN INTERNATIONAL EDUCATIONAL ASSOCIATION", APART FROM THE MARK AS SHOWN.

THE COLOR(S) BLUE AND RED IS/ARE CLAIMED AS A FEATURE OF THE MARK.

THE MARK CONSISTS OF ON THE FIRST LINE THE CAPITALIZED LETTERS "CLAO" APPEAR IN LARGE BLUE COLOR FONT WITH SHADOWING, IMMEDIATELY BELOW THAT ARE THE WORDS "CONTACT LENS ASSOCIATION OF OPHTHALMOLOGISTS" IN SMALLER RED PRINT WITH THE WORD "OPHTHALMOLOGISTS" EXTENDING TO THE RIGHT OF THE END OF THE LETTER "O" IN "CLAO". ON THE THIRD LINE THE PHRASE "AN INTERNATIONAL EDUCATIONAL ASSOCIATION" APPEARS IN RED PRINT WHICH IS A SMALLER FONT SIZE THAN THE PHRASE APPEARING ON THE SECOND LINE.

SER. NO. 77-277,308, FILED 9-12-2007.

LOURDES AYALA, EXAMINING ATTORNEY

Int. Cl.: 36

Prior U.S. Cls.: 100, 101 and 102

United States Patent and Trademark Office

Reg. No. 3,479,437

Registered Aug. 5, 2008

**SERVICE MARK
PRINCIPAL REGISTER**

PATIENT OPTION

PATIENT OPTION, INC. (ILLINOIS CORPORATION)
1440 NORTH DAYTON STREET, SUITE 104
CHICAGO, IL 60622

FOR: FINANCIAL SERVICES, NAMELY, PATIENT LOAN FINANCING FOR ELECTIVE SURGERY AND CONSUMER MEDICAL LOANS, IN CLASS 36 (U.S. CLS. 100, 101 AND 102).

FIRST USE 9-12-2007; IN COMMERCE 9-12-2007.

THE MARK CONSISTS OF STANDARD CHARACTERS WITHOUT CLAIM TO ANY PARTICULAR FONT, STYLE, SIZE, OR COLOR.

NO CLAIM IS MADE TO THE EXCLUSIVE RIGHT TO USE "PATIENT", APART FROM THE MARK AS SHOWN.

SER. NO. 77-277,937, FILED 9-12-2007.

ELLEN PERKINS, EXAMINING ATTORNEY

Int. Cl.: 39

Prior U.S. Cls.: 100 and 105

United States Patent and Trademark Office

Reg. No. 3,479,438

Registered Aug. 5, 2008

**SERVICE MARK
PRINCIPAL REGISTER**

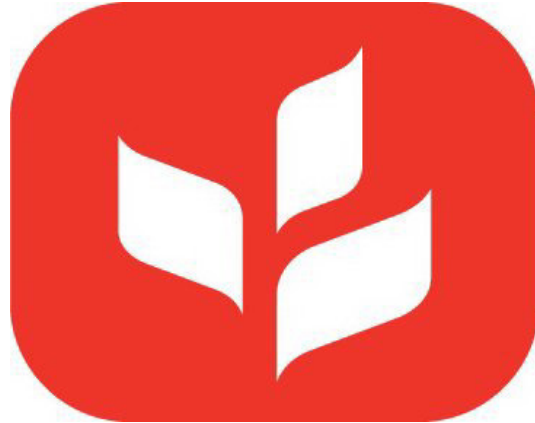

OPTIMAL NUTRITION INC (CALIFORNIA CORPORATION)
9187 CLAIREMONT MESA BLVD, SUITE 6
SAN DIEGO, CA 92123

THE MARK CONSISTS OF RED SQUARE WITH
THREE WHITE LEAVES WITHIN IT.

FOR: ORGANIC MEAL DELIVERY SERVICE, IN
CLASS 39 (U.S. CLS. 100 AND 105).

SER. NO. 77-278,621, FILED 9-13-2007.

FIRST USE 9-1-2006; IN COMMERCE 9-1-2006.

THE COLOR(S) RED IS/ARE CLAIMED AS A
FEATURE OF THE MARK.

NORA BUCHANAN WILL, EXAMINING ATTORNEY

Int. Cl.: 32

Prior U.S. Cls.: 45, 46 and 48

Reg. No. 3,479,439

United States Patent and Trademark Office

Registered Aug. 5, 2008

**TRADEMARK
PRINCIPAL REGISTER**



BEVERAGES UNLIMITED LLC (ST.CHRIST-NEVIS LTD LIAB CO)
PO BOX 636
CHARLESTOWN, ST.CHRIST-NEVIS

FOR: ENERGY DRINKS, IN CLASS 32 (U.S. CLS. 45, 46 AND 48).

FIRST USE 5-30-2007; IN COMMERCE 5-30-2007.

NO CLAIM IS MADE TO THE EXCLUSIVE RIGHT TO USE "ENERGY DRINK", APART FROM THE MARK AS SHOWN.

THE MARK CONSISTS OF THE WORDS "CRAZY HORSE" ABOVE AN IMAGE OF A BUCKING BRONCO, WITH THE WORDS "ENERGY DRINK" BELOW THE IMAGE. THE HORSE IS IN THE MIDDLE OF A LARGE HORSESHOE.

SER. NO. 77-278,726, FILED 9-13-2007.

DEZMONA MIZELLE, EXAMINING ATTORNEY

Int. Cl.: 29

Prior U.S. Cl.: 46

United States Patent and Trademark Office

Reg. No. 3,479,440

Registered Aug. 5, 2008

**TRADEMARK
PRINCIPAL REGISTER**

LINNAEA FARM

LINNAEA FARM (COLORADO LTD LIAB CO)
2914 CR 250
DURANGO, CO 81301

NO CLAIM IS MADE TO THE EXCLUSIVE
RIGHT TO USE "FARM", APART FROM THE
MARK AS SHOWN.

FOR: GOAT CHEESE, IN CLASS 29 (U.S. CL. 46).

FIRST USE 7-0-2007; IN COMMERCE 7-0-2007.

SER. NO. 77-278,882, FILED 9-13-2007.

THE MARK CONSISTS OF STANDARD CHAR-
ACTERS WITHOUT CLAIM TO ANY PARTICULAR
FONT, STYLE, SIZE, OR COLOR.

JACLYN KIDWELL, EXAMINING ATTORNEY

Int. Cl.: 38

Prior U.S. Cls.: 100, 101 and 104

United States Patent and Trademark Office

Reg. No. 3,479,441

Registered Aug. 5, 2008

**SERVICE MARK
PRINCIPAL REGISTER**

E-MARKETINGPLUS

LONG & FOSTER COMPANIES, INC. (VIRGINIA
CORPORATION)
11351 RANDOM HILLS ROAD
FAIRFAX, VA 22030

FOR: PROVIDING AUTOMATED ELECTRONIC
TRANSMISSIONS OF EMAILS CONTAINING CON-
TENT IN THE AREA OF REAL ESTATE, REAL
ESTATE FINANCING AND INSURANCE
THROUGH AN ON-LINE CONTACT MANAGE-
MENT DATABASE VIA A GLOBAL COMPUTER
NETWORK, IN CLASS 38 (U.S. CLS. 100, 101 AND
104).

FIRST USE 9-27-2007; IN COMMERCE 9-27-2007.

THE MARK CONSISTS OF STANDARD CHAR-
ACTERS WITHOUT CLAIM TO ANY PARTICULAR
FONT, STYLE, SIZE, OR COLOR.

SER. NO. 77-279,050, FILED 9-13-2007.

MONIQUE MILLER, EXAMINING ATTORNEY

Int. Cl.: 10

Prior U.S. Cls.: 26, 39 and 44

United States Patent and Trademark Office

Reg. No. 3,479,442

Registered Aug. 5, 2008

**TRADEMARK
PRINCIPAL REGISTER**

ESSENTIAL

MERLYN ASSOCIATES, INC. (CALIFORNIA CORPORATION), DBA MERLYN MEDICAL
1542 EDINGER AVENUE, SUITE A
TUSTIN, CA 92780

FOR: ANESTHETIC MASKS; CPR (CARDIOPULMONARY RESUSCITATION) MASKS; OXYGEN MASKS FOR MEDICAL USE; RESPIRATORY MASKS FOR MEDICAL PURPOSES; SURGICAL MASKS; ENDOTRACHEAL TUBES, IN CLASS 10 (U.S. CLS. 26, 39 AND 44).

FIRST USE 2-1-2006; IN COMMERCE 2-1-2006.

THE MARK CONSISTS OF STANDARD CHARACTERS WITHOUT CLAIM TO ANY PARTICULAR FONT, STYLE, SIZE, OR COLOR.

SER. NO. 77-279,226, FILED 9-13-2007.

G. MAYERSCHOFF, EXAMINING ATTORNEY

Int. Cl.: 41

Prior U.S. Cls.: 100, 101 and 107

United States Patent and Trademark Office

Reg. No. 3,479,443

Registered Aug. 5, 2008

**SERVICE MARK
PRINCIPAL REGISTER**

CAMP SHANE

CAMP SHANE LLC (NEW YORK LTD LIAB CO)
134 TEATOWN ROAD
CROTON ON HUDSON, NY 10520

FOR: RECREATIONAL CAMPS, NAMELY, SUMMER CAMPS, WEIGHT LOSS CAMPS, AND SPORTS CAMPS; RECREATIONAL SERVICES IN THE NATURE OF POOLS, ARTS AND CRAFTS, COMPUTER CENTERS, COMPUTER GAMES, ROCK CLIMBING WALLS, WILDERNESS TRIPS, BOATING, WATER SKIING, TUBING AND PERFORMING ARTS; EDUCATIONAL SERVICES, NAMELY, PROVIDING CLASSES, SEMINARS AND WORKSHOPS IN THE FIELD OF CHILDHOOD OBESITY, WEIGHT LOSS AND NUTRITION EDUCATION AND COUNSELING; EDUCATIONAL SERVICES, NAMELY, PROVIDING CLASSES IN THE FIELD OF COOKING,

EXERCISE AND PHYSICAL FITNESS CONDITIONING AND TRAINING FOR OVERWEIGHT CHILDREN, IN CLASS 41 (U.S. CLS. 100, 101 AND 107).

FIRST USE 6-30-1969; IN COMMERCE 6-30-1969.

THE MARK CONSISTS OF STANDARD CHARACTERS WITHOUT CLAIM TO ANY PARTICULAR FONT, STYLE, SIZE, OR COLOR.

NO CLAIM IS MADE TO THE EXCLUSIVE RIGHT TO USE "CAMP", APART FROM THE MARK AS SHOWN.

SER. NO. 77-279,482, FILED 9-14-2007.

SANJEEV VOHRA, EXAMINING ATTORNEY

Int. Cls.: 35, 38 and 42

Prior U.S. Cls.: 100, 101, 102 and 104

United States Patent and Trademark Office

Reg. No. 3,479,444

Registered Aug. 5, 2008

**SERVICE MARK
PRINCIPAL REGISTER**

BLYK

CVON GROUP LIMITED (UNITED KINGDOM
LTD LIAB CO)
41 CHALTON STREET
LONDON, UNITED KINGDOM NW11JD

FOR: ADVERTISING AGENCIES; ADVERTISING
SERVICES FOR OTHERS; BUSINESS MANAGE-
MENT; BUSINESS ADMINISTRATION CONSUL-
TANCY; PROVIDING OFFICE FUNCTIONS , IN
CLASS 35 (U.S. CLS. 100, 101 AND 102).

FOR: TELECOMMUNICATIONS ACCESS SERVI-
CES; TELECOMMUNICATIONS SERVICES, NAME-
LY, CALL HUNTING; TELECOMMUNICATION
CONSULTATION, IN CLASS 38 (U.S. CLS. 100, 101
AND 104).

FOR: RESEARCH SERVICES IN THE FIELD OF
INFORMATION AND TELECOMMUNICATIONS
TECHNOLOGY; CONSULTING IN THE FIELD OF

TELECOMMUNICATIONS TECHNOLOGY; DE-
SIGN AND DEVELOPMENT OF COMPUTER
HARDWARE AND SOFTWARE, IN CLASS 42 (U.S.
CLS. 100 AND 101).

THE MARK CONSISTS OF STANDARD CHAR-
ACTERS WITHOUT CLAIM TO ANY PARTICULAR
FONT, STYLE, SIZE, OR COLOR.

OWNER OF ERPN CMNTY TM OFC REG. NO.
004905337, DATED 1-16-2007, EXPIRES 2-13-2016.

THE ENGLISH TRANSLATION OF THE WORD
"BLYK" IN THE MARK IS "PEER" OR "SEE".

SER. NO. 77-279,560, FILED 9-14-2007.

FRED CARL, EXAMINING ATTORNEY

Int. Cl.: 35

Prior U.S. Cls.: 100, 101 and 102

United States Patent and Trademark Office

Reg. No. 3,479,445

Registered Aug. 5, 2008

SERVICE MARK
PRINCIPAL REGISTER



PRUKOP, SHANE (UNITED STATES INDIVIDUAL)
4450-A DUPONT COURT
VENTURA, CA 93003

FOR: WHOLESALE DISTRIBUTORSHIPS FEATURING JEWELRY, BOOKMARKS, KEY RINGS AND GARDEN STAKES, IN CLASS 35 (U.S. CLS. 100, 101 AND 102).

FIRST USE 7-21-2007; IN COMMERCE 7-30-2007.

NO CLAIM IS MADE TO THE EXCLUSIVE RIGHT TO USE "CUT" AND "METAL DESIGNS", APART FROM THE MARK AS SHOWN.

SER. NO. 77-279,647, FILED 9-14-2007.

ALICE SUE CARRUTHERS, EXAMINING ATTORNEY

Int. Cl.: 28

Prior U.S. Cls.: 22, 23, 38 and 50

United States Patent and Trademark Office

Reg. No. 3,479,446

Registered Aug. 5, 2008

**TRADEMARK
PRINCIPAL REGISTER**

Voicestream

DEUTSCHE TELEKOM AG (FED REP GERMA-
NY CORPORATION)
FRIEDRICH-EBERT-ALLEE 140
BONN 53113, FED REP GERMANY

FOR: TOYS, NAMELY, BOARD GAMES, PARLOR GAMES, CARD GAMES, TOY ACTION FIGURES, WIND-UP TOYS, STUFFED TOYS, ELECTRICAL AND MECHANICAL ACTION TOYS, GYMNAS TIC APPARATUS AND SPORTING ARTICLES, NAME- LY, CYCLING EQUIPMENT AND ACCESSORIES, NAMELY, STATIONARY CYCLES, FOOTBALL EQUIPMENT AND ACCESSORIES, NAMELY, FOOTBALLS, FOOTBALL SHOULDER PADS, FOOTBALL GIRDLES, FOOTBALL BODY PROTEC- TORS, FOOTBALL KNEE, ELBOW, CHEST AND LEG PADS, SOCCER EQUIPMENT AND ACCES- SORIES, NAMELY, SOCCER BALLS, SOCCER BALL GOAL NETS, SOCCER BALL KNEE PADS, BASE- BALL EQUIPMENT AND ACCESSORIES, NAMELY, BASEBALLS, BASEBALL BATS, BASEBALL BASES,

BASEBALL MITTS, BASEBALL GLOVES, BASKET- BALL EQUIPMENT AND ACCESSORIES, NAMELY, BASKETBALLS, BASKETBALL GOALS, BASKET- BALL NETS, AND ALL PARTS RELATED THERE- TO, IN CLASS 28 (U.S. CLS. 22, 23, 38 AND 50).

THE MARK CONSISTS OF STANDARD CHAR- ACTERS WITHOUT CLAIM TO ANY PARTICULAR FONT, STYLE, SIZE, OR COLOR.

OWNER OF ERPN CMNTY TM OFC REG. NO. 002051951, DATED 2-25-2002, EXPIRES 1-23-2011.

OWNER OF U.S. REG. NOS. 2,060,060, 2,564,564 AND OTHERS.

SER. NO. 77-280,322, FILED 9-14-2007.

JUDITH HELFMAN, EXAMINING ATTORNEY

Int. Cls.: 35 and 41

Prior U.S. Cls.: 100, 101, 102 and 107

United States Patent and Trademark Office

Reg. No. 3,479,447

Registered Aug. 5, 2008

**SERVICE MARK
PRINCIPAL REGISTER**



AMERICAN FEDERATION OF MOTORCYCLISTS, INCORPORATED (CALIFORNIA CORPORATION)

6167 JARVIS AVE., SUITE 333
NEWARK, CA 94560

FOR: PROMOTION OF THE SPORT AND PASTIME OF MOTORCYCLING, IN CLASS 35 (U.S. CLS. 100, 101 AND 102).

FIRST USE 12-1-1978; IN COMMERCE 12-1-1978.

FOR: ORGANIZATION, ARRANGEMENT AND REGULATION OF CLOSED-CIRCUIT ROAD RACING AND OTHER FORMS OF MOTORCYCLE COMPETITION, IN CLASS 41 (U.S. CLS. 100, 101 AND 107).

FIRST USE 12-1-1978; IN COMMERCE 12-1-1978.

NO CLAIM IS MADE TO THE EXCLUSIVE RIGHT TO USE "FEDERATION", APART FROM THE MARK AS SHOWN.

THE MARK CONSISTS OF STYLIZED LETTERS "AFM" IN THE MIDDLE, SURROUNDED BY A DECAGON BORDER, WITH THE WORD, "AMERICAN," ON THE LEFT SIDE, "FEDERATION" ON THE RIGHT SIDE AND "MOTORCYCLISTS" ON THE BOTTOM SIDE.

SEC. 2(F) AS TO "AMERICAN FEDERATION OF MOTORCYCLISTS".

SER. NO. 77-280,345, FILED 9-14-2007.

EMILY CHUO, EXAMINING ATTORNEY

Int. Cl.: 35

Prior U.S. Cls.: 100, 101 and 102

United States Patent and Trademark Office

Reg. No. 3,479,448

Registered Aug. 5, 2008

**SERVICE MARK
PRINCIPAL REGISTER**

More Power Racing

GHUMAN, NEIL (UNITED STATES INDIVIDUAL)
15201 39TH AVE NE
MARYSVILLE, WA 98271

FOR: RETAIL SERVICES, NAMELY, ONLINE RETAIL STORES, RETAIL STORES, IN THE FIELD OF CAR, TRUCK AND MOTORCYCLE ACCESSORIES, IN CLASS 35 (U.S. CLS. 100, 101 AND 102).

FIRST USE 9-14-2007; IN COMMERCE 9-14-2007.

THE MARK CONSISTS OF STANDARD CHARACTERS WITHOUT CLAIM TO ANY PARTICULAR FONT, STYLE, SIZE, OR COLOR.

NO CLAIM IS MADE TO THE EXCLUSIVE RIGHT TO USE "RACING", APART FROM THE MARK AS SHOWN.

SER. NO. 77-280,379, FILED 9-14-2007.

MATTHEW EINSTEIN, EXAMINING ATTORNEY

Int. Cls.: 35 and 39

Prior U.S. Cls.: 100, 101, 102 and 105

United States Patent and Trademark Office

Reg. No. 3,479,449

Registered Aug. 5, 2008

**SERVICE MARK
PRINCIPAL REGISTER**



AMAZON TECHNOLOGIES, INC. (NEVADA CORPORATION)
ATTN: TRADEMARKS
PO BOX 8102
RENO, NV 89507

FOR: COMPUTERIZED ONLINE RETAIL STORE SERVICES IN THE FIELD OF GROCERY, FRESH AND PREPARED FOODS, DRUG STORE AND GENERAL MERCHANDISE; RETAIL GROCERY STORES; AND WHOLESALE DISTRIBUTORSHIP FEATURING FRESH FOODS AND GROCERIES, IN CLASS 35 (U.S. CLS. 100, 101 AND 102).

FIRST USE 6-15-2007; IN COMMERCE 6-15-2007.

FOR: DELIVERY OF GOODS BY CAR, TRUCK OR VAN, IN CLASS 39 (U.S. CLS. 100 AND 105).

FIRST USE 6-15-2007; IN COMMERCE 6-15-2007.

THE MARK CONSISTS OF A STYLIZED LOWER-CASE LETTER "A" WITH A RADISH FORMING THE CENTER OF THE LETTER.

SER. NO. 77-280,852, FILED 9-17-2007.

EVELYN BRADLEY, EXAMINING ATTORNEY

Int. Cl.: 11

Prior U.S. Cls.: 13, 21, 23, 31 and 34

Reg. No. 3,479,450

United States Patent and Trademark Office

Registered Aug. 5, 2008

TRADEMARK
PRINCIPAL REGISTER



SPRINGFIELD WIRE, INC. (MASSACHUSETTS
CORPORATION)
243 COTTAGE STREET
SPRINGFIELD, MA 01104

NO CLAIM IS MADE TO THE EXCLUSIVE
RIGHT TO USE "SPRINGFIELD WIRE, INCORPO-
RATED", APART FROM THE MARK AS SHOWN.

FOR: FLEXIBLE ELECTRICAL HEATING WIRE
AND HEATING ELEMENTS, IN CLASS 11 (U.S. CLS.
13, 21, 23, 31 AND 34).

SER. NO. 77-280,890, FILED 9-17-2007.

FIRST USE 1-26-1965; IN COMMERCE 1-26-1965.

CHERYL CLAYTON, EXAMINING ATTORNEY

Int. Cl.: 41

Prior U.S. Cls.: 100, 101 and 107

United States Patent and Trademark Office

Reg. No. 3,479,451

Registered Aug. 5, 2008

**SERVICE MARK
PRINCIPAL REGISTER**

Ongoing Family Council

THE HERITAGE INSTITUTE (OREGON LTD
LIAB CO)
SUITE 202
7724 SE APEN SUMMIT DR.
PORTLAND, OR 97266

FOR: EDUCATIONAL SERVICES, NAMELY,
CONDUCTING CONTINUING EDUCATION CLAS-
SES, WORKSHOPS AND SEMINARS, IN WRITTEN
AND COMPUTERIZED FORM, IN THE FIELD OF
ESTATE, FINANCIAL, RETIREMENT AND TAX
PLANNING RELATING TO SPECIFIC ISSUES OF
INDIVIDUALS AND FAMILIES, IN CLASS 41 (U.S.
CLS. 100, 101 AND 107).

FIRST USE 6-8-2007; IN COMMERCE 6-8-2007.

THE MARK CONSISTS OF STANDARD CHAR-
ACTERS WITHOUT CLAIM TO ANY PARTICULAR
FONT, STYLE, SIZE, OR COLOR.

SER. NO. 77-281,002, FILED 9-17-2007.

ALICE SUE CARRUTHERS, EXAMINING ATTOR-
NEY

Int. Cl.: 44

Prior U.S. Cls.: 100 and 101

United States Patent and Trademark Office

Reg. No. 3,479,452

Registered Aug. 5, 2008

**SERVICE MARK
PRINCIPAL REGISTER**



SIMONIDES, VERONICA M. (UNITED STATES
INDIVIDUAL)
8851 PROSPECT AVENUE
SANTEE, CA 92071

FOR: HEALTH SPA SERVICES, NAMELY, PRO-
VIDING FACIAL, HAIR, SKIN AND BODY TREAT-
MENTS, MANICURE AND PEDICURE SERVICES,
MASSAGE SERVICES, BODY WAXING SERVICES
AND BEAUTY SALON SERVICES, IN CLASS 44 (U.S.
CLS. 100 AND 101).

FIRST USE 7-15-2007; IN COMMERCE 7-15-2007.

OWNER OF U.S. REG. NO. 3,025,864.

NO CLAIM IS MADE TO THE EXCLUSIVE
RIGHT TO USE "SPA", APART FROM THE MARK
AS SHOWN.

THE COLOR(S) GREEN, BLUE, PURPLE AND
BLACK IS/ARE CLAIMED AS A FEATURE OF THE
MARK.

THE MARK CONSISTS OF FIVE OVERLAPPING
CIRCLES IN THE COLORS GREEN, BLUE AND
PURPLE FOLLOWED BY THE WORDING "ON THE
GO" IN BLUE AND THE WORD "SPA" IN GREEN
WITH THE WORDING "STEP INTO CONVENIENCE
& RELAXATION" IN BLACK BELOW THE WORDS
"ON THE GO SPA".

SER. NO. 77-281,146, FILED 9-17-2007.

FLORENTINA BLANDU, EXAMINING ATTORNEY

Int. Cl.: 41

Prior U.S. Cls.: 100, 101 and 107

United States Patent and Trademark Office

Reg. No. 3,479,453

Registered Aug. 5, 2008

**SERVICE MARK
PRINCIPAL REGISTER**



SUNTEX INTERNATIONAL INC. (PENNSYLVANIA CORPORATION)
3311 FOX HILL ROAD
EASTON, PA 18045

FOR: EDUCATIONAL SERVICES, NAMELY, PROVIDING ON-LINE INSTRUCTIONAL INFORMATION, LESSONS, GAMES AND TOURNAMENTS IN THE AREA OF MATH; PROVIDING ON-LINE MATH GAMES; EDUCATIONAL SERVICES, NAMELY, TOURNAMENTS FEATURING MATH, IN CLASS 41 (U.S. CLS. 100, 101 AND 107).

FIRST USE 2-0-2000; IN COMMERCE 2-0-2000.

OWNER OF U.S. REG. NOS. 1,718,954, 2,104,789 AND OTHERS.

NO CLAIM IS MADE TO THE EXCLUSIVE RIGHT TO USE "MATH PROGRAM", APART FROM THE MARK AS SHOWN.

SEC. 2(F) AS TO "CHALLENGE MATH PROGRAM".

SER. NO. 77-281,209, FILED 9-17-2007.

REBECCA EISINGER, EXAMINING ATTORNEY

Int. Cls.: 9 and 36

Prior U.S. Cls.: 21, 23, 26, 36, 38, 100, 101 and 102

United States Patent and Trademark Office

Reg. No. 3,479,454

Registered Aug. 5, 2008

**TRADEMARK
SERVICE MARK
PRINCIPAL REGISTER**

MYSTAR123.COM

QPAY, INC. (FLORIDA CORPORATION)
SUITE 302
16853 NE 2ND AVENUE
NORTH MIAMI BEACH, FL 33162

FOR: PRE-PAID TELEPHONE CALLING CARDS,
MAGNETICALLY ENCODED, IN CLASS 9 (U.S. CLS.
21, 23, 26, 36 AND 38).

FIRST USE 9-17-2007; IN COMMERCE 9-17-2007.

FOR: TELEPHONE CALLING CARD SERVICES,
IN CLASS 36 (U.S. CLS. 100, 101 AND 102).

FIRST USE 9-17-2007; IN COMMERCE 9-17-2007.

THE MARK CONSISTS OF STANDARD CHAR-
ACTERS WITHOUT CLAIM TO ANY PARTICULAR
FONT, STYLE, SIZE, OR COLOR.

SER. NO. 77-281,221, FILED 9-17-2007.

CURTIS FRENCH, EXAMINING ATTORNEY

Int. Cl.: 35

Prior U.S. Cls.: 100, 101 and 102

United States Patent and Trademark Office

Reg. No. 3,479,455

Registered Aug. 5, 2008

**SERVICE MARK
PRINCIPAL REGISTER**

GINGER  PEACHY

GINGER PEACHY DESIGNS, LLC (CALIFORNIA
LTD LIAB CO)
15233 LA CRUZ DRIVE
PACIFIC PALISADES, CA 90272

FOR: WHOLESALE DISTRIBUTORSHIPS FEATURING JEWELRY, RINGS, BRACELETS, NECKLACES, EARRINGS, ANKLETS, PINS BEING JEWELRY, AND CUFF LINKS, IN CLASS 35 (U.S. CLS. 100, 101 AND 102).

FIRST USE 10-17-2006; IN COMMERCE 10-17-2006.

OWNER OF U.S. REG. NO. 3,141,017.

THE NAME "GINGER PEACHY" DOES NOT IDENTIFY A LIVING INDIVIDUAL.

THE MARK CONSISTS OF THE STYLIZED WORDS "GINGER PEACHY" SEPARATED BY A LATTICE WORK DESIGN IN THE SHAPE OF A DIAMOND.

SER. NO. 77-281,356, FILED 9-17-2007.

DORITT L. CARROLL, EXAMINING ATTORNEY

Int. Cl.: 31

Prior U.S. Cls.: 1 and 46

United States Patent and Trademark Office

Reg. No. 3,479,456

Registered Aug. 5, 2008

TRADEMARK
PRINCIPAL REGISTER



MARS, INCORPORATED (DELAWARE CORPORATION)
6885 ELM STREET
MCLEAN, VA 221013883

FOR: PET FOOD, IN CLASS 31 (U.S. CLS. 1 AND 46).

FIRST USE 12-13-2006; IN COMMERCE 12-13-2006.

NO CLAIM IS MADE TO THE EXCLUSIVE RIGHT TO USE "6 KEY INGREDIENT GROUPS", APART FROM THE MARK AS SHOWN.

THE MARK CONSISTS OF A PYRAMID CONTAINING SIX PET FOOD INGREDIENTS.

SER. NO. 77-281,844, FILED 9-18-2007.

DOMINIC FATHY, EXAMINING ATTORNEY

Int. Cl.: 37

Prior U.S. Cls.: 100, 103 and 106

United States Patent and Trademark Office

Reg. No. 3,479,457

Registered Aug. 5, 2008

**SERVICE MARK
PRINCIPAL REGISTER**

WE SUCK YOUR GUTTERS CLEAN

GUTTERSUCKERS, INC. (WASHINGTON CORPORATION)
800 5TH AVENUE, SUITE 101
SEATTLE, WA 98104

FOR: CLEANING OF BUILDING EXTERIOR SURFACES; CLEANING OF EXTERNAL SURFACES OF BUILDINGS, IN CLASS 37 (U.S. CLS. 100, 103 AND 106).

FIRST USE 4-15-2007; IN COMMERCE 4-15-2007.

THE MARK CONSISTS OF STANDARD CHARACTERS WITHOUT CLAIM TO ANY PARTICULAR FONT, STYLE, SIZE, OR COLOR.

SER. NO. 77-282,499, FILED 9-18-2007.

KATHERINE CONNOLLY, EXAMINING ATTORNEY

Int. Cl.: 27

Prior U.S. Cls.: 19, 20, 37, 42 and 50

United States Patent and Trademark Office

Reg. No. 3,479,458

Registered Aug. 5, 2008

**TRADEMARK
PRINCIPAL REGISTER**

GRIP TOUCH

PYN, S.A. DE C.V. (MEXICO CORPORATION)

CALLE 9 NO. 8 FRACC. ALCE BLANCO

MEXICO D.F., MEXICO 53370

FOR: CARPETS, RUGS, MATS AND MATTING,
LINOLEUM AND OTHER MATERIALS FOR COVERING
EXISTING FLOORS; NON-TEXTILE WALL
HANGINGS, IN CLASS 27 (U.S. CLS. 19, 20, 37, 42
AND 50).

THE MARK CONSISTS OF STANDARD CHARACTERS
WITHOUT CLAIM TO ANY PARTICULAR FONT,
STYLE, SIZE, OR COLOR.

PRIORITY CLAIMED UNDER SEC. 44(D) ON
MEXICO APPLICATION NO. 863305, FILED 6-21-
2007, REG. NO. 1003266, DATED 6-21-2007, EXPIRES
6-21-2017.

SER. NO. 77-282,568, FILED 9-18-2007.

HOWARD B. LEVINE, EXAMINING ATTORNEY

Int. Cl.: 24

Prior U.S. Cls.: 42 and 50

United States Patent and Trademark Office

Reg. No. 3,479,459

Registered Aug. 5, 2008

**TRADEMARK
PRINCIPAL REGISTER**

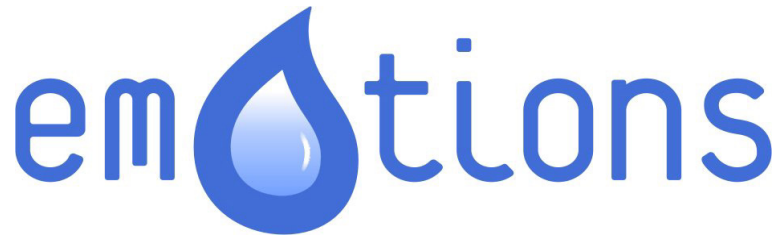

PYN, S.A. DE C.V. (MEXICO CORPORATION)
NAUCALPAN
CALLE 9 NO. 8, FRACC. ALCE BLANCO
MEXICO D.F., MEXICO 53370

FOR: BATH CURTAINS, OF CLOTH OR PLASTIC,
IN CLASS 24 (U.S. CLS. 42 AND 50).

PRIORITY CLAIMED UNDER SEC. 44(D) ON
MEXICO APPLICATION NO. 870940, FILED 7-25-
2007, REG. NO. 1004190, DATED 7-25-2007, EXPIRES
7-25-2017.

THE COLOR(S) BLUE AND WHITE IS/ARE
CLAIMED AS A FEATURE OF THE MARK.

THE MARK CONSISTS OF THE WORD "EMO-
TIONS" IN THE COLOR BLUE WITH THE LETTER
"O" AS A WATER DROP. THE COLOR WHITE
APPEARS IN THE CENTER AND FADED TOP
PORTION OF THE TEAR DESIGN.

SER. NO. 77-282,612, FILED 9-18-2007.

HOWARD B. LEVINE, EXAMINING ATTORNEY

Int. Cl.: 35

Prior U.S. Cls.: 100, 101 and 102

United States Patent and Trademark Office

Reg. No. 3,479,460

Registered Aug. 5, 2008

**SERVICE MARK
PRINCIPAL REGISTER**

bhpremier.com

BETTER HOMES REALTY & AUCTION, LLC
(INDIANA LTD LIAB CO)
1117 N MAIN STREET
HUNTINGBURG, IN 47542

FOR: REAL ESTATE AUCTIONS; REAL ESTATE
MARKETING SERVICES IN THE FIELD OF CON-
DOMINIUMS, APARTMENTS, LUXURY APART-
MENTS, HOMES, IN CLASS 35 (U.S. CLS. 100, 101
AND 102).

FIRST USE 5-1-2007; IN COMMERCE 5-1-2007.

THE MARK CONSISTS OF STANDARD CHAR-
ACTERS WITHOUT CLAIM TO ANY PARTICULAR
FONT, STYLE, SIZE, OR COLOR.

SER. NO. 77-282,736, FILED 9-18-2007.

JAMES A. RAUEN, EXAMINING ATTORNEY

Int. Cl.: 29

Prior U.S. Cl.: 46

United States Patent and Trademark Office

Reg. No. 3,479,461

Registered Aug. 5, 2008

**TRADEMARK
PRINCIPAL REGISTER**



MAR-LEES SEAFOOD, LLC (MASSACHUSETTS
LTD LIAB CO)
110 HERMAN MELLVILLE BLVD.
NEW BEDFORD, MA 02740

OWNER OF U.S. REG. NOS. 781,502, 1,679,545,
AND 2,090,459.

FOR: SEAFOOD, NAMELY, SCALLOPS, IN CLASS
29 (U.S. CL. 46).

SER. NO. 77-283,051, FILED 9-19-2007.

FIRST USE 12-0-2001; IN COMMERCE 12-0-2001.

KATHERINE CHANG, EXAMINING ATTORNEY

Int. Cl.: 3

Prior U.S. Cls.: 1, 4, 6, 50, 51 and 52

Reg. No. 3,479,462

United States Patent and Trademark Office

Registered Aug. 5, 2008

**TRADEMARK
PRINCIPAL REGISTER**

AMORE

AMOREPACIFIC CORPORATION (REPUBLIC OF KOREA CORPORATION)
181, 2-KA, HANGANG-RO
SEOUL, REPUBLIC OF KOREA 140-777

FOR: NON-MEDICATED NOURISHING CREAMS FOR THE SKIN; NAIL POLISH REMOVERS; EYEBROW PENCILS; ROUGE; LIPSTICKS; MASCARAS; FACIAL MASK CONSISTING OF COSMETIC MATERIAL APPLIED TO FACE FOR SOFTENING AND PURIFYING THE SKIN OF THE FACE; BODY GELS FOR MASSAGE USE; MASSAGE OIL; NAIL POLISH; NAIL ENAMELS; HAIR OILS; HAIR CARE PREPARATIONS; HAIR COLOR; HAIR WAVING LOTIONS; HAIR BLEACHES; BATH ADDITIVES IN THE NATURE OF CRYSTALS, GELS AND LIQUIDS, NAMELY, LIQUID BODY MILKS, LIQUID BATH SOAPS AND BUBBLE BATH; VANISHING CREAMS; BATH OIL FOR COSMETIC PURPOSES; BATH POWDER FOR COSMETIC PURPOSES; BAY RUMS; BABY OIL; BABY POWDER; BLUSHERS; PERFUMED POWDER; NON-MEDICATED BATH SALTS; NON-MEDICATED FRAGRANCE, NAMELY, FRAGRANCES FOR PERSONAL USE AND ROOM FRAGRANCES; SUN CARE LOTIONS; SUNSCREEN LOTIONS; SUNSCREEN CREAMS; SUN TAN OIL; SUN-TANNING PREPARATIONS FOR COSMETIC PURPOSES; SHAVING CREAMS; BEAUTY MILK; SKIN MOISTURIZER; EYELINERS; EYE MAKE-UP REMOVERS; EYE SHADOW; AFTER SHAVE LOTIONS; EAU DE COLOGNE; DEODORANTS FOR PERSONAL USE; NON-MEDICATED SKIN CARE PREPARATIONS, NAMELY, SKIN TONERS, SKIN LOTIONS, SKIN EMOLLIENTS AND SKIN CLARIFIERS; LIP POLISHER; NON-MEDICATED LIP CARE PREPARATIONS, NAMELY, LIP NEUTRALIZER AND LIP CONDITIONERS; NON-MEDICATED LIP PROTECTOR; NON-MEDICATED COSMETIC PREPARATIONS FOR BODY SLIMMING PURPOSES, NAMELY, CREAMS FOR CELLULITE REDUCTION, LOTIONS FOR CELLULITE REDUCTION,

GELS FOR CELLULITE REDUCTION AND OILS FOR CELLULITE REDUCTION; COLD CREAMS; COLD WAVING SOLUTIONS; SOLID FACE MAKE-UP POWDER SOLD IN COMPACT; MUSTACHE WAX; SKIN CLEANSING CREAM FOR COSMETIC PURPOSES; DEPILATORY WAX; DEPILATORIES; FOUNDATIONS, NAMELY, LIQUID FOUNDATION, CREAMY FOUNDATION AND MAKE-UP FOUNDATIONS; PERMANENT HAIR WAVING PREPARATIONS; FACE POWDER; POTPOURRI; SKIN WHITENING CREAMS; HAND CREAMS; PERFUMES; HAIR GELS; HAIR LACQUERS; HAIR LOTIONS; HAIR MOUSSE; HAIR SPRAY; HAIR CONDITIONERS; HAIR CREAMS; HAIR TONIC; MAKE-UP POWDER; HYDROGEN PEROXIDE FOR USE ON THE HAIR; ASTRINGENTS FOR COSMETIC PURPOSES; PENCILS FOR COSMETIC PURPOSES; MINERAL SALT IN THE NATURE OF BATH SALTS NOT FOR MEDICAL PURPOSES; SKIN CLEANSING MILK; TALCUM POWDERS; LAVENDER OIL FOR COSMETIC PURPOSES; BERGAMOT OIL FOR COSMETIC PURPOSES; AMBERGRIS; ESSENTIAL OILS, NAMELY, JASMINE OIL FOR COSMETIC PURPOSES; ROSE OIL FOR COSMETIC PURPOSES; SYNTHETIC PERFUMERY; MUSK FOR PERFUMERY; INCENSE STICKS; FUMIGATING INCENSES; ADHESIVES FOR AFFIXING FALSE HAIR; FALSE EYELASHES; ADHESIVES FOR AFFIXING FALSE EYELASHES; FALSE NAILS; PRE-MOISTENED TISSUES IMPREGNATED WITH COSMETIC LOTIONS; COTTON STICKS FOR COSMETIC PURPOSES; BEAUTY MASKS; ADHESIVES FOR COSMETIC USE; COTTON SWABS FOR COSMETIC PURPOSES; SOAP POWDER; DETERGENTS PREPARED FROM PETROLEUM FOR HOUSEHOLD USE; INDUSTRIAL SOAPS; DRY CLEANING FLUIDS; SHAVING SOAP; LIQUID SOAPS; DEODORANT SOAP; CLEANING PREPARATIONS FOR CLEANING WASTE PIPES; SOAP FOR BRIGHTENING TEXTILE; SKIN POLISHING RICE BRAN; NON-MEDICATED DOUCHES; LAUNDRY SOAPS; DISINFECTANT SOAP;

ALMOND SOAP; GLASS CLEANING PREPARATIONS; FABRIC SOFTENERS FOR LAUNDRY USE; WINDSHIELD WASHING FLUID; TOILET BOWL DETERGENTS; BATH SOAPS; SKIN SOAPS; HAIR SHAMPOOS; CREAM SOAPS; HAIR RINSES; COSMETIC SOAPS; NON-MEDICATED MOUTH WASH AND RINSE; NON-MEDICATED DENTAL RINSE; DENTURE CLEANING PREPARATIONS, NAMELY, DENTURE POLISH AND DENTURE CLEANER; TOOTH POWDERS; TOOTH PASTE; COSMETIC MILKS, NAMELY, MOISTURIZING ESSENCE IN THE NATURE OF MILKY LOTION; BODY CREAMS; BODY LOTIONS; FACIAL CLEANSING FOAMS; SKIN CLEANSING LOTION; SKIN CLEANSING OILS; LIP GLOSS; NON-MEDICATED CREAMS FOR MASSAGE USE; LIP LINER; NON-MEDICATED LIP BALM; COLOGNE WATER; EAU DE TOILETTE; SKIN EXFOLIATOR LOTIONS AND CREAMS; PRE-MOISTENED COSMETIC TISSUES HAVING THE HORNY LAYER REMOVAL EFFECT; COSMETIC FACIAL BLOTting PAPERS, NAMELY, OIL BLOTting SHEETS FOR THE SKIN;

SKIN CLEANSERS; TOOTH WHITENING PREPARATIONS, NAMELY, TOOTH WHITENING CREAMS, TOOTH WHITENING GELS AND TOOTH WHITENING PASTES; NON-MEDICATED MOISTURIZING NUTRITIONAL HAIR ESSENCE; SHOE POLISH; COBBLERS' WAX; FURNITURE POLISH; FLOOR POLISH; AUTOMOBILE POLISH; FLOOR WAX, IN CLASS 3 (U.S. CLS. 1, 4, 6, 50, 51 AND 52).

THE MARK CONSISTS OF STANDARD CHARACTERS WITHOUT CLAIM TO ANY PARTICULAR FONT, STYLE, SIZE, OR COLOR.

OWNER OF REPUBLIC OF KOREA REG. NO. 400703774000, DATED 3-23-2007, EXPIRES 3-23-2017.

OWNER OF U.S. REG. NOS. 2,468,046, 3,189,748 AND OTHERS.

SER. NO. 77-283,177, FILED 9-19-2007.

TINA L. SNAPP, EXAMINING ATTORNEY

Int. Cls.: 39 and 43

Prior U.S. Cls.: 100, 101 and 105

United States Patent and Trademark Office

Reg. No. 3,479,463

Registered Aug. 5, 2008

**SERVICE MARK
PRINCIPAL REGISTER**

**ULTIMATE INDIA UNLIMITED
ACCESS**

GREAVES TOURS LLC (ILLINOIS LTD LIAB CO)
205 W. RANDOLPH ST.
CHICAGO, IL 60606

FOR: TRAVEL AGENCY SERVICES, NAMELY,
MAKING RESERVATIONS AND BOOKINGS FOR
TRANSPORTATION; TRAVEL AGENCY SERVICES,
NAMELY, MAKING RESERVATIONS AND BOOK-
INGS FOR SIGHTSEEING TOURS, IN CLASS 39
(U.S. CLS. 100 AND 105).

FIRST USE 7-20-2007; IN COMMERCE 7-20-2007.

FOR: TRAVEL AGENCY SERVICES, NAMELY,
MAKING RESERVATIONS AND BOOKINGS FOR

TEMPORARY LODGING, IN CLASS 43 (U.S. CLS.
100 AND 101).

FIRST USE 7-20-2007; IN COMMERCE 7-20-2007.

THE MARK CONSISTS OF STANDARD CHAR-
ACTERS WITHOUT CLAIM TO ANY PARTICULAR
FONT, STYLE, SIZE, OR COLOR.

NO CLAIM IS MADE TO THE EXCLUSIVE
RIGHT TO USE "INDIA UNLIMITED ACCESS",
APART FROM THE MARK AS SHOWN.

SER. NO. 77-283,622, FILED 9-19-2007.

TINA BROWN, EXAMINING ATTORNEY

Int. Cl.: 41

Prior U.S. Cls.: 100, 101 and 107

United States Patent and Trademark Office

Reg. No. 3,479,464

Registered Aug. 5, 2008

**SERVICE MARK
PRINCIPAL REGISTER**

CONNECTING THE GENERATIONS

WELLPOINT, INC. (INDIANA CORPORATION)
120 MONUMENT CIRCLE
INDIANAPOLIS, IN 46204

FOR: EDUCATIONAL SERVICES, NAMELY,
EDUCATIONAL PROGRAMS DIRECTED TO SE-
NIOR CITIZENS AND THEIR FAMILIES IN THE
FIELD OF LONG-TERM CARE, INDEPENDENT
LIVING, HEALTHY AGING AND FINANCIAL SE-
CURITY, IN CLASS 41 (U.S. CLS. 100, 101 AND 107).

FIRST USE 11-30-2006; IN COMMERCE 11-30-2006.

THE MARK CONSISTS OF STANDARD CHAR-
ACTERS WITHOUT CLAIM TO ANY PARTICULAR
FONT, STYLE, SIZE, OR COLOR.

SER. NO. 77-283,635, FILED 9-19-2007.

SALLY SHIH, EXAMINING ATTORNEY

Int. Cl.: 39

Prior U.S. Cls.: 100 and 105

United States Patent and Trademark Office

Reg. No. 3,479,465

Registered Aug. 5, 2008

**SERVICE MARK
PRINCIPAL REGISTER**

Aaron's American Transportation

RICHARD, CAROL A. (UNITED STATES INDIVIDUAL)
9 NORTH RILEY #203
CLAY COMO, MO 64119

FOR: LIMOUSINE SERVICES; TAXI TRANSPORT; AIRPORT SERVICES, IN CLASS 39 (U.S. CLS. 100 AND 105).

FIRST USE 8-10-2007; IN COMMERCE 8-10-2007.

THE MARK CONSISTS OF STANDARD CHARACTERS WITHOUT CLAIM TO ANY PARTICULAR FONT, STYLE, SIZE, OR COLOR.

NO CLAIM IS MADE TO THE EXCLUSIVE RIGHT TO USE "AMERICAN TRANSPORTATION", APART FROM THE MARK AS SHOWN.

SER. NO. 77-283,939, FILED 9-19-2007.

MONIQUE MILLER, EXAMINING ATTORNEY

Int. Cl.: 8

Prior U.S. Cls.: 23, 28 and 44

Reg. No. 3,479,466

United States Patent and Trademark Office

Registered Aug. 5, 2008

**TRADEMARK
PRINCIPAL REGISTER**

TIGER PAW

SHANGHAI ROBUSTWORKS HARDWARE
TOOLS CO., LTD (CHINA LTD LIAB CO)
MINHANG DISTRICT
NO.151, EAST ZHUANXING ROAD 1421
SHANGHAI, CHINA 201108

FOR: HAND TOOLS, NAMELY, PLIERS NAMELY NEEDLE NOSE PLIERS, LOCKING PLIERS, SLIP JOINT PLIERS, SPANNERS AND WRENCHES, NAMELY, OPEN END WRENCHES, BOX END WRENCHES, COMBINATION WRENCHES, PIPE WRENCHES, ADJUSTABLE WRENCHES, HAMMERS, NAMELY, CLAW HAMMER, FRAMING HAMMER, BALL PEEN HAMMER, SLEDGE HAMMER, CLAMPING TOOLS NAMELY BAR CLAMPS, BAND CLAMPS, C STYLE CLAMPS, TOGGLE CLAMPS, PIPE CLAMPS, WOODEN CLAMPS, CUTTING TOOLS, NAMELY, BLADES FOR HAND SAWS, REAMERS, SCREW DRIVERS NAMELY, SLOTTED, CROSSHEAD, TORX, HEX, SQUARE, VICES NAMELY VICES FOR WOODWORKING, METAL WORKING AND MACHINISTS, DRILL BITS FOR HAND DRILLS, NAMELY, SPADE

DRILLS, TWIST DRILLS, CARBIDE TIPPED DRILLS, BRAD POINT DRILLS, MASONRY DRILLS, MASONRY TOOLS NAMELY, TROWELS, EDGER, GROOVER, CHISEL, WOODWORKING TOOLS, NAMELY, HAND SAWS, CHISELS, DRILL BITS, PLUMBING TOOLS, NAMELY, HAND OPERATED SNAKES, PIPE WRENCHES, PIPE CUTTERS, TUBE CUTTERS AND KNIVES, NAMELY, FOLDING POCKET KNIVES, FIXED BLADE KNIVES, UTILITY KNIVES AND WOODCARVING KNIVES, IN CLASS 8 (U.S. CLS. 23, 28 AND 44).

FIRST USE 8-1-2007; IN COMMERCE 8-1-2007.

THE MARK CONSISTS OF STANDARD CHARACTERS WITHOUT CLAIM TO ANY PARTICULAR FONT, STYLE, SIZE, OR COLOR.

SER. NO. 77-284,285, FILED 9-20-2007.

ROBERT C. CLARK JR., EXAMINING ATTORNEY

Int. Cl.: 41

Prior U.S. Cls.: 100, 101 and 107

United States Patent and Trademark Office

Reg. No. 3,479,467

Registered Aug. 5, 2008

**SERVICE MARK
PRINCIPAL REGISTER**

WelcomeHomeDearborn

CITY OF DEARBORN, MICHIGAN (MICHIGAN CORPORATION)
13615 MICHIGAN AVE., SUITE 8
DEARBORN, MI 48126

FOR: PROVIDING INFORMATION, NEWS AND COMMENTARY IN THE FIELD OF RECREATION AND LEISURE ACTIVITIES IN DEARBORN, IN CLASS 41 (U.S. CLS. 100, 101 AND 107).

FIRST USE 3-1-2007; IN COMMERCE 3-1-2007.

THE MARK CONSISTS OF STANDARD CHARACTERS WITHOUT CLAIM TO ANY PARTICULAR FONT, STYLE, SIZE, OR COLOR.

SER. NO. 77-285,922, FILED 9-21-2007.

ROBIN CHOSID, EXAMINING ATTORNEY

Int. Cl.: 9

Prior U.S. Cls.: 21, 23, 26, 36 and 38

Reg. No. 3,479,468

United States Patent and Trademark Office

Registered Aug. 5, 2008

**TRADEMARK
PRINCIPAL REGISTER**

Advisor Wisdom

USA FINANCIAL MARKETING CORPORATION
(MICHIGAN CORPORATION)
6020 EAST FULTON STREET
ADA, MI 49301

FOR: DOWNLOADABLE PODCASTS IN THE
FIELD OF FINANCIAL NEWS AND INFORMA-
TION, IN CLASS 9 (U.S. CLS. 21, 23, 26, 36 AND 38).

FIRST USE 7-9-2007; IN COMMERCE 7-9-2007.

THE MARK CONSISTS OF STANDARD CHAR-
ACTERS WITHOUT CLAIM TO ANY PARTICULAR
FONT, STYLE, SIZE, OR COLOR.

NO CLAIM IS MADE TO THE EXCLUSIVE
RIGHT TO USE "ADVISOR", APART FROM THE
MARK AS SHOWN.

SER. NO. 77-286,083, FILED 9-21-2007.

KATHRYN COWARD, EXAMINING ATTORNEY

Int. Cl.: 41

Prior U.S. Cls.: 100, 101 and 107

United States Patent and Trademark Office

Reg. No. 3,479,469

Registered Aug. 5, 2008

**SERVICE MARK
PRINCIPAL REGISTER**

Color Accounting

ACCOUNTING COMES ALIVE, INC. (D.C. CORPORATION), DBA LEARNING COMES ALIVE
UNIT B
142 THOMAS ST NW
WASHINGTON, DC 20001

FOR: CONDUCTING WORKSHOPS AND SEMINARS IN BUSINESS; EDUCATION SERVICES, NAMELY, PROVIDING LIVE AND ON-LINE CLASSES IN THE FIELD OF BUSINESS; EDUCATION SERVICES, NAMELY, PROVIDING WORKSHOPS IN THE FIELD OF BUSINESS, IN CLASS 41 (U.S. CLS. 100, 101 AND 107).

FIRST USE 1-1-2004; IN COMMERCE 1-1-2004.

THE MARK CONSISTS OF STANDARD CHARACTERS WITHOUT CLAIM TO ANY PARTICULAR FONT, STYLE, SIZE, OR COLOR.

NO CLAIM IS MADE TO THE EXCLUSIVE RIGHT TO USE "ACCOUNTING", APART FROM THE MARK AS SHOWN.

SER. NO. 77-286,363, FILED 9-21-2007.

MICHAEL WEBSTER, EXAMINING ATTORNEY

Int. Cl.: 35

Prior U.S. Cls.: 100, 101 and 102

United States Patent and Trademark Office

Reg. No. 3,479,470

Registered Aug. 5, 2008

**SERVICE MARK
PRINCIPAL REGISTER**

auditUtopia

PHARMACEUTICAL SERVICES CORPORATION
(CALIFORNIA CORPORATION)
700 CORPORATE CENTER DR, SUITE 201
POMONA, CA 91768 AND
BRANDRETH, EDWARD J. (UNITED STATES IN-
DIVIDUAL)
1773 SWALLOWTAIL RD
ENCINITAS, CA 92024

FOR: MANAGEMENT OF AUDIT ACTIVITIES
BY MEANS OF COMPUTER SOFTWARE WHICH
AUTOMATICALLY CAPTURES, TRACKS, COM-
MUNICATES AND SORTS AUDIT ACTIVITIES IN
THE NATURE OF DUE DILIGENCE DOCUMENT

REQUESTS AND STATE, FEDERAL AND INTER-
NATIONAL REGULATORY AUDIT REQUESTS, IN
CLASS 35 (U.S. CLS. 100, 101 AND 102).

FIRST USE 9-4-2004; IN COMMERCE 9-4-2004.

THE MARK CONSISTS OF STANDARD CHAR-
ACTERS WITHOUT CLAIM TO ANY PARTICULAR
FONT, STYLE, SIZE, OR COLOR.

SER. NO. 77-286,421, FILED 9-22-2007.

MICHAEL WIENER, EXAMINING ATTORNEY

Int. Cl.: 11

Prior U.S. Cls.: 13, 21, 23, 31 and 34

United States Patent and Trademark Office

Reg. No. 3,479,471

Registered Aug. 5, 2008

TRADEMARK
PRINCIPAL REGISTER

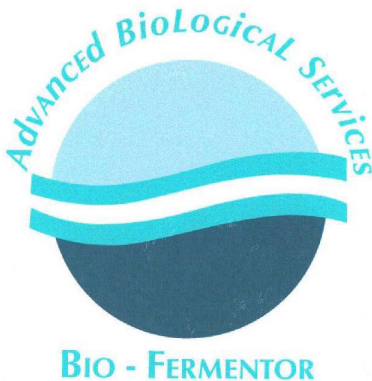

ADVANCED BIOLOGICAL SERVICES, INC.
(FLORIDA CORPORATION)
P.O. BOX 9240
ORANGE PARK, FL 32006

FOR: FERMENTATION SYSTEMS, NAMELY, BIOREACTORS COMPRISED OF A FERMENTATION TANK, ELECTRIC HEATER, AERATOR, AND CIRCULATOR, FOR THE PURPOSES OF HOLDING, HEATING, AERATING AND CIRCULATING THE MIXTURE FOR USE IN THE TREATMENT OF WASTE ON-SITE OR PROXIMATE TO THE CONTAMINATION SITE, IN CLASS 11 (U.S. CLS. 13, 21, 23, 31 AND 34).

FIRST USE 9-1-2006; IN COMMERCE 9-1-2006.

NO CLAIM IS MADE TO THE EXCLUSIVE RIGHT TO USE "ADVANCED BIOLOGICAL SER-

VICES BIO-FERMENTOR", APART FROM THE MARK AS SHOWN.

THE COLOR(S) LIGHT BLUE AND DARK BLUE IS/ARE CLAIMED AS A FEATURE OF THE MARK.

THE MARK CONSISTS OF A CIRCLE WHICH HAS BEEN DIVIDED BY A SET OF CURVY LINES, THE TOP HALF OF THE CIRCLE IS LIGHT BLUE WITH THE PHRASE "ADVANCED BIOLOGICAL SERVICES" PLACED ABOVE IT AND THE WORD "BIO-FERMENTOR" PLACED BELOW THE LOWER HALF OF THE CIRCLE, WHICH IS DARK BLUE.

SER. NO. 77-286,708, FILED 9-24-2007.

BILL DAWE, EXAMINING ATTORNEY

Int. Cl.: 35

Prior U.S. Cls.: 100, 101 and 102

Reg. No. 3,479,472

United States Patent and Trademark Office

Registered Aug. 5, 2008

**SERVICE MARK
PRINCIPAL REGISTER**

FOUR PAWS DESIGN

MIDDLETON, CYNDI M. (UNITED STATES IN-
DIVIDUAL), DBA FOUR PAWS DESIGN
12 WEST STREET
PEPPERELL, MA 01463

THE MARK CONSISTS OF STANDARD CHAR-
ACTERS WITHOUT CLAIM TO ANY PARTICULAR
FONT, STYLE, SIZE, OR COLOR.

FOR: RETAIL PET STORES, IN CLASS 35 (U.S.
CLS. 100, 101 AND 102).

SER. NO. 77-287,644, FILED 9-24-2007.

FIRST USE 12-28-1999; IN COMMERCE 1-1-2000.

KAREN SEVERSON, EXAMINING ATTORNEY

Int. Cl.: 5

Prior U.S. Cls.: 6, 18, 44, 46, 51 and 52

United States Patent and Trademark Office

Reg. No. 3,479,473

Registered Aug. 5, 2008

**TRADEMARK
PRINCIPAL REGISTER**

SUPER 2 DAILY

J.R. CARLSON LABORATORIES, INC. (ILLINOIS
CORPORATION)
15 COLLEGE DR.
ARLINGTON HEIGHTS, IL 600041985

OWNER OF U.S. REG. NOS. 2,148,354 AND
2,760,536.

FOR: VITAMIN SUPPLEMENTS, IN CLASS 5 (U.S.
CLS. 6, 18, 44, 46, 51 AND 52).

NO CLAIM IS MADE TO THE EXCLUSIVE
RIGHT TO USE "2 DAILY", APART FROM THE
MARK AS SHOWN.

FIRST USE 2-13-2004; IN COMMERCE 2-13-2004.

SER. NO. 77-288,114, FILED 9-25-2007.

THE MARK CONSISTS OF STANDARD CHAR-
ACTERS WITHOUT CLAIM TO ANY PARTICULAR
FONT, STYLE, SIZE, OR COLOR.

KATHY DE JONGE, EXAMINING ATTORNEY

Int. Cl.: 43

Prior U.S. Cls.: 100 and 101

United States Patent and Trademark Office

Reg. No. 3,479,474

Registered Aug. 5, 2008

**SERVICE MARK
PRINCIPAL REGISTER**

FLEMING'S 100

OSI/FLEMING'S, LLC (DELAWARE LTD LIAB
CO)
2202 N. WESTSHORE BLVD.
5TH FLOOR
TAMPA, FL 33607

FOR: RESTAURANT AND BAR SERVICES FEATURING WINE BY THE GLASS PROGRAM, IN CLASS 43 (U.S. CLS. 100 AND 101).

FIRST USE 6-30-2003; IN COMMERCE 6-30-2003.

THE MARK CONSISTS OF STANDARD CHARACTERS WITHOUT CLAIM TO ANY PARTICULAR FONT, STYLE, SIZE, OR COLOR.

OWNER OF U.S. REG. NOS. 2,379,146, 3,125,796 AND OTHERS.

NO CLAIM IS MADE TO THE EXCLUSIVE RIGHT TO USE "100", APART FROM THE MARK AS SHOWN.

SER. NO. 77-288,386, FILED 9-25-2007.

BARBARA RUTLAND, EXAMINING ATTORNEY

Int. Cl.: 14

Prior U.S. Cls.: 2, 27, 28 and 50

United States Patent and Trademark Office

Reg. No. 3,479,475

Registered Aug. 5, 2008

**TRADEMARK
PRINCIPAL REGISTER**

CHIC MAGNET

O'CONNELL, MAUREEN (UNITED STATES INDIVIDUAL)
2954 WOODLAND HILLS DRIVE
GRAPEVINE, TX 76051

FOR: JEWELRY AND ACCESSORIES, NAMELY, ANKLE BRACELETS, BRACELETS, CHARMS, JEWELRY CHAINS, CHOKERS, EARRINGS; JEWELRY FOR THE HAIR, IDENTIFICATION BADGE JEWELRY IN THE FORM OF BRACELETS AND NECKLACES; PENDANTS, PINS BEING JEWELRY, RINGS AND WATCHES; ALL OF THE FOREGOING GOODS COMPOSED OF SILVER PIECES, STONES BEING JEWELRY, PRECIOUS STONES, PEARLS,

BEADS, GLASS, CRYSTAL, MAGNETS, PRECIOUS METAL, METAL, OR ANY COMBINATION THEREOF, IN CLASS 14 (U.S. CLS. 2, 27, 28 AND 50).

FIRST USE 12-15-2003; IN COMMERCE 12-15-2003.

THE MARK CONSISTS OF STANDARD CHARACTERS WITHOUT CLAIM TO ANY PARTICULAR FONT, STYLE, SIZE, OR COLOR.

SER. NO. 77-288,694, FILED 9-25-2007.

MICHAEL WIENER, EXAMINING ATTORNEY

Int. Cls.: 35, 41 and 42

Prior U.S. Cls.: 100, 101, 102 and 107

United States Patent and Trademark Office

Reg. No. 3,479,476

Registered Aug. 5, 2008

**SERVICE MARK
PRINCIPAL REGISTER**

1Sky

1 SKY FOUNDATION (D.C. NON-PROFIT CORPORATION)
1522 CERRO GORDO ROAD
SANTE FE, NM 87501

FOR: PROMOTING THE PUBLIC AWARENESS OF THE NEED FOR ENVIRONMENTAL PRESERVATION, NAMELY, USING NON-VIOLENT, CREATIVE CONFRONTATION TO EXPOSE GLOBAL ENVIRONMENTAL ISSUES ESPECIALLY AS RELATED TO ENERGY AND GLOBAL WARMING, IN CLASS 35 (U.S. CLS. 100, 101 AND 102).

FIRST USE 9-5-2007; IN COMMERCE 9-5-2007.

FOR: ONLINE JOURNALS, NAMELY, BLOGS ON THE SUBJECTS OF ENERGY, ENERGY EFFICIENCY, GLOBAL WARMING IMPACTS AND SOLUTIONS, IN CLASS 41 (U.S. CLS. 100, 101 AND 107).

FIRST USE 9-5-2007; IN COMMERCE 9-5-2007.

FOR: PROVIDING A WEBSITE FEATURING INFORMATION ABOUT GLOBAL WARMING AND

ITS EFFECT ON NATURE AND THE ENVIRONMENT; SCIENTIFIC AND NEW PRODUCT RESEARCH AND DEVELOPMENT OF DURABLE USE OF NATURE AND THE ENVIRONMENT; PROVIDING INFORMATION AND ADVICE WITH REGARD TO ENVIRONMENTAL PROTECTION IN THE FIELD OF ENVIRONMENTAL ASSESSMENT, COMPLIANCE AND PLANNING, AS WELL AS CONDUCTING RESEARCH AND DRAWING UP EXPERT REPORTS IN THE AFOREMENTIONED FIELDS, IN CLASS 42 (U.S. CLS. 100 AND 101).

FIRST USE 9-5-2007; IN COMMERCE 9-5-2007.

THE MARK CONSISTS OF STANDARD CHARACTERS WITHOUT CLAIM TO ANY PARTICULAR FONT, STYLE, SIZE, OR COLOR.

SER. NO. 77-289,579, FILED 9-26-2007.

DARRYL SPRUILL, EXAMINING ATTORNEY

Int. Cl.: 16

Prior U.S. Cls.: 2, 5, 22, 23, 29, 37, 38 and 50

United States Patent and Trademark Office

Reg. No. 3,479,477

Registered Aug. 5, 2008

**TRADEMARK
PRINCIPAL REGISTER**

**AN INDEPENDENT REVIEW OF
HIGH YIELD COVENANTS FOR
THE SOPHISTICATED INVESTOR**

COVENANT REVIEW, LLC (NEW YORK LTD
LIAB CO)
6TH FLOOR
708 THIRD AVENUE
NEW YORK, NY 10017

FOR: PRINTED PUBLICATIONS, NAMELY, RE-
PORTS AND NEWSLETTERS PROVIDING WRIT-
TEN COMMENTARY ON BONDS, LOANS, AND
OTHER DOCUMENTS USED IN CONNECTION
WITH FINANCING ACTIVITIES, IN CLASS 16 (U.S.
CLS. 2, 5, 22, 23, 29, 37, 38 AND 50).

FIRST USE 2-9-2006; IN COMMERCE 2-9-2006.

THE MARK CONSISTS OF STANDARD CHAR-
ACTERS WITHOUT CLAIM TO ANY PARTICULAR
FONT, STYLE, SIZE, OR COLOR.

SER. NO. 77-289,778, FILED 9-26-2007.

KIMBERLY FRYE, EXAMINING ATTORNEY

Int. Cl.: 36

Prior U.S. Cls.: 100, 101 and 102

United States Patent and Trademark Office

Reg. No. 3,479,478

Registered Aug. 5, 2008

**SERVICE MARK
PRINCIPAL REGISTER**



CAPITAL PAYMENTS PROCESSING, LLC (DE-
LAWARE LTD LIAB CO)
200 S. BISCAYNE BLVD, STE 1850
MIAMI, FL 33131

FOR: ACCOUNTS RECEIVABLES FINANCING;
CREDIT CARD TRANSACTION PROCESSING SER-
VICES; ELECTRONIC CREDIT CARD TRANSAC-
TIONS, IN CLASS 36 (U.S. CLS. 100, 101 AND 102).

FIRST USE 8-0-2007; IN COMMERCE 8-0-2007.

NO CLAIM IS MADE TO THE EXCLUSIVE
RIGHT TO USE "PAYMENTS PROCESSING LLC."
AND "YOUR MERCHANT SERVICE PROVIDER",
APART FROM THE MARK AS SHOWN.

THE COLOR(S) GREEN, YELLOW, AND BLACK
IS/ARE CLAIMED AS A FEATURE OF THE MARK.

THE MARK CONSISTS OF THE WORDING "CA-
PITAL PAYMENTS PROCESSING LLC." PARTIAL-
LY UNDERLINED IN GREEN WITH "CAPITAL" IN
GREEN, "PAYMENTS" IN YELLOW, "PROCESSING
LLC." IN GREEN, THE WORDING YOUR MER-
CHANT SERVICE PROVIDER IN BLACK, AND A
YELLOW GLOBE TO THE LEFT OF THE WORDING
WITH A CURVED GREEN ARROW GOING
THROUGH THE GLOBE AND GREEN AND YEL-
LOW CRESCENT SHAPES TO THE RIGHT OF THE
GLOBE AND INTERSECTING WITH THE CURVED
ARROW.

SER. NO. 77-289,810, FILED 9-26-2007.

KIMBERLY FRYE, EXAMINING ATTORNEY

Int. Cl.: 1

Prior U.S. Cls.: 1, 5, 6, 10, 26 and 46

United States Patent and Trademark Office

Reg. No. 3,479,479

Registered Aug. 5, 2008

**TRADEMARK
PRINCIPAL REGISTER**

MAKING WATER WORK FOR YOU

CH2O, INC. (WASHINGTON CORPORATION)
8820 OLD HIGHWAY 99 SE
OLYMPIA, WA 98507

THE MARK CONSISTS OF STANDARD CHAR-
ACTERS WITHOUT CLAIM TO ANY PARTICULAR
FONT, STYLE, SIZE, OR COLOR.

FOR: CHEMICALS TO TREAT WATER RELATED
PROBLEMS IN COMMERCIAL AND INDUSTRIAL
WATER SYSTEMS, IN CLASS 1 (U.S. CLS. 1, 5, 6, 10,
26 AND 46).

SER. NO. 77-289,818, FILED 9-26-2007.

FIRST USE 5-15-1990; IN COMMERCE 5-15-1990.

KIMBERLY FRYE, EXAMINING ATTORNEY

Int. Cls.: 35, 41 and 42

Prior U.S. Cls.: 100, 101, 102 and 107

United States Patent and Trademark Office

Reg. No. 3,479,480

Registered Aug. 5, 2008

**SERVICE MARK
PRINCIPAL REGISTER**



VS ENERGY, INC. (PENNSYLVANIA CORPORATION)

VS ENERGY, INC.

85 RYBURN RD.

WASHINGTON, PA 15301

FOR: ENERGY MANAGEMENT SERVICES, NAMELY, ENERGY AUDITING, ENERGY USAGE MANAGEMENT, ENERGY USAGE MANAGEMENT INFORMATION SERVICES, AND INFORMATION IN THE FIELD OF ENERGY EFFICIENCY, IN CLASS 35 (U.S. CLS. 100, 101 AND 102).

FIRST USE 11-7-2003; IN COMMERCE 11-7-2003.

FOR: ENERGY CONSERVATION AND ENERGY EFFICIENCY TRAINING, NAMELY, PROVIDING SEMINARS AND WORKSHOPS IN THE FIELD OF ENERGY CONSERVATION AND ENERGY EFFICIENCY; ENERGY EFFICIENCY TRAINING, NAMELY, PROVIDING TRAINING IN THE FIELD OF ENERGY CONSERVATION AND EFFICIENCY, IN CLASS 41 (U.S. CLS. 100, 101 AND 107).

FIRST USE 11-7-2003; IN COMMERCE 11-7-2003.

FOR: ENGINEERING CONSULTING SERVICES, NAMELY, CONDUCTING ENERGY ASSESSMENT

SURVEYS FOR OTHERS, PROVIDING ENERGY MANAGEMENT AND VERIFICATION SERVICES FOR OTHERS; ENGINEERING SERVICES, NAMELY, ENERGY CONSERVATION PROJECT ENGINEERING, ENERGY AUTOMATION ENGINEERING, AND ENERGY CONTROL SYSTEM INTEGRATION, IN CLASS 42 (U.S. CLS. 100 AND 101).

FIRST USE 11-7-2003; IN COMMERCE 11-7-2003.

NO CLAIM IS MADE TO THE EXCLUSIVE RIGHT TO USE "ENERGY", APART FROM THE MARK AS SHOWN.

THE COLOR(S) BROWN, GREEN AND ORANGE IS/ARE CLAIMED AS A FEATURE OF THE MARK.

THE COLOR BROWN APPEARS IN THE BACKGROUND, THE COLOR ORANGE APPEARS IN THE DESIGN OF THE SUN AND THE COLOR GREEN APPEARS IN THE WORD "ENERGY".

SER. NO. 77-289,820, FILED 9-26-2007.

SAIMA MAKHDOOM, EXAMINING ATTORNEY

Int. Cl.: 35

Prior U.S. Cls.: 100, 101 and 102

United States Patent and Trademark Office

Reg. No. 3,479,481

Registered Aug. 5, 2008

**SERVICE MARK
PRINCIPAL REGISTER**

BIG TURKEY BOWLING

SEATTLE SPORTS LEAGUES, INC. (WASHINGTON CORPORATION)
2013 4TH AVENUE, SUITE 201
SEATTLE, WA 98121

FOR: PROVIDING ON-LINE REGISTRATION SERVICES FOR SPORTS LEAGUES; ADMINISTRATION OF RECREATIONAL SPORTS LEAGUES; COORDINATION OF RECREATIONAL SPORTING OPPORTUNITIES FOR INDIVIDUALS WHO WISH TO PARTICIPATE IN TEAM LEAGUE SPORTS; AND PROVIDING A WEBSITE THAT PROVIDES SPORTS LEAGUE MANAGEMENT, IN CLASS 35 (U.S. CLS. 100, 101 AND 102).

FIRST USE 8-25-2004; IN COMMERCE 8-25-2004.

THE MARK CONSISTS OF STANDARD CHARACTERS WITHOUT CLAIM TO ANY PARTICULAR FONT, STYLE, SIZE, OR COLOR.

NO CLAIM IS MADE TO THE EXCLUSIVE RIGHT TO USE "BOWLING", APART FROM THE MARK AS SHOWN.

SER. NO. 77-290,421, FILED 9-27-2007.

DARRYL SPRUILL, EXAMINING ATTORNEY

Int. Cl.: 28

Prior U.S. Cls.: 22, 23, 38 and 50

United States Patent and Trademark Office

Reg. No. 3,479,482

Registered Aug. 5, 2008

**TRADEMARK
PRINCIPAL REGISTER**



CHEWY TOYS LLC (COLORADO LTD LIAB CO)
1775 MONACO PARKWAY
DENVER, CO 80220

FOR: BABY MULTIPLE ACTIVITY TOYS; CHILDREN'S MULTIPLE ACTIVITY TOYS; INFANT DEVELOPMENT TOYS; INFANT TOYS; STACKING TOYS, IN CLASS 28 (U.S. CLS. 22, 23, 38 AND 50).

FIRST USE 8-24-2007; IN COMMERCE 8-24-2007.

NO CLAIM IS MADE TO THE EXCLUSIVE RIGHT TO USE "CHEWY TOYS", APART FROM THE MARK AS SHOWN.

"THE COLOR(S) LIGHT GREEN, DARK GREEN, BLACK AND WHITE IS/ARE CLAIMED AS A FEATURE OF THE MARK."

THE MARK CONSISTS OF THE WORDING "CHEWY TOYS" IN STYLIZED LIGHT GREEN LETTERS. A DARK GREEN TURTLE HAS ITS MOUTH OPEN AND IS CHEWING ON THE CAPITAL "T" OF THE WORD "TOYS". THE TURTLE IS DARK GREEN WITH LIGHT GREEN HEXAGON DESIGNS ON ITS DARK GREEN SHELL. THE BODY AND SHELL OF THE TURTLE IS OUTLINED IN BLACK. THE MOUTH OF THE TURTLE IS OPEN. THE FACE OF THE TURTLE HAS ONE EYE, WHICH IS WHITE WITH A BLACK DOT.

SER. NO. 77-290,443, FILED 9-27-2007.

DAWN HAN, EXAMINING ATTORNEY

Int. Cl.: 35

Prior U.S. Cls.: 100, 101 and 102

United States Patent and Trademark Office

Reg. No. 3,479,483

Registered Aug. 5, 2008

**SERVICE MARK
PRINCIPAL REGISTER**



SEATTLE SPORTS LEAGUES, INC. (WASHINGTON CORPORATION)
2013 4TH AVENUE, SUITE 201
SEATTLE, WA 98121

FOR: PROVIDING ON-LINE REGISTRATION SERVICES FOR SPORTS LEAGUES; ADMINISTRATION OF RECREATIONAL SPORTS LEAGUES; AND COORDINATION OF RECREATIONAL SPORTING OPPORTUNITIES FOR INDIVIDUALS WHO WISH TO PARTICIPATE IN TEAM LEAGUE SPORTS; PROVIDING A WEBSITE THAT PROVIDES SPORTS LEAGUE MANAGEMENT; AND ON-LINE RETAIL STORE SERVICES FEATURING SPORT-

ING GOODS, IN CLASS 35 (U.S. CLS. 100, 101 AND 102).

FIRST USE 5-18-2004; IN COMMERCE 5-24-2004.

NO CLAIM IS MADE TO THE EXCLUSIVE RIGHT TO USE "KICKBALL", APART FROM THE MARK AS SHOWN.

SER. NO. 77-290,459, FILED 9-27-2007.

DARRYL SPRUILL, EXAMINING ATTORNEY

Int. Cl.: 35

Prior U.S. Cls.: 100, 101 and 102

United States Patent and Trademark Office

Reg. No. 3,479,484

Registered Aug. 5, 2008

**SERVICE MARK
PRINCIPAL REGISTER**

UNDERDOG SPORTS LEAGUES

SEATTLE SPORTS LEAGUES, INC. (WASHINGTON CORPORATION)
2013 4TH AVENUE, SUITE 201
SEATTLE, WA 98121

FOR: PROVIDING ON-LINE REGISTRATION SERVICES FOR SPORTS LEAGUES; ADMINISTRATION OF RECREATIONAL SPORTS LEAGUES; COORDINATION OF RECREATIONAL SPORTING OPPORTUNITIES FOR INDIVIDUALS WHO WISH TO PARTICIPATE IN TEAM LEAGUE SPORTS; AND PROVIDING A WEBSITE THAT PROVIDES SPORTS LEAGUE MANAGEMENT, IN CLASS 35 (U.S. CLS. 100, 101 AND 102).

FIRST USE 2-1-2004; IN COMMERCE 8-25-2004.

THE MARK CONSISTS OF STANDARD CHARACTERS WITHOUT CLAIM TO ANY PARTICULAR FONT, STYLE, SIZE, OR COLOR.

NO CLAIM IS MADE TO THE EXCLUSIVE RIGHT TO USE "SPORTS LEAGUES", APART FROM THE MARK AS SHOWN.

SER. NO. 77-290,465, FILED 9-27-2007.

DARRYL SPRUILL, EXAMINING ATTORNEY

Int. Cl.: 35

Prior U.S. Cls.: 100, 101 and 102

United States Patent and Trademark Office

Reg. No. 3,479,485

Registered Aug. 5, 2008

**SERVICE MARK
PRINCIPAL REGISTER**



SEATTLE SPORTS LEAGUES, INC. (WASHINGTON CORPORATION)
2013 4TH AVENUE, SUITE 201
SEATTLE, WA 98121

FOR: PROVIDING ON-LINE REGISTRATION SERVICES FOR SPORTS LEAGUES; ADMINISTRATION OF RECREATIONAL SPORTS LEAGUES; COORDINATION OF RECREATIONAL SPORTING OPPORTUNITIES FOR INDIVIDUALS WHO WISH TO PARTICIPATE IN TEAM LEAGUE SPORTS; AND PROVIDING A WEBSITE THAT PROVIDES

SPORTS LEAGUE MANAGEMENT, IN CLASS 35 (U.S. CLS. 100, 101 AND 102).

FIRST USE 2-1-2004; IN COMMERCE 8-25-2004.

NO CLAIM IS MADE TO THE EXCLUSIVE RIGHT TO USE "SPORTS LEAGUES", APART FROM THE MARK AS SHOWN.

SER. NO. 77-290,467, FILED 9-27-2007.

DARRYL SPRUILL, EXAMINING ATTORNEY

Int. Cl.: 3

Prior U.S. Cls.: 1, 4, 6, 50, 51 and 52

United States Patent and Trademark Office

Reg. No. 3,479,486

Registered Aug. 5, 2008

**TRADEMARK
PRINCIPAL REGISTER**

SUMMER'S SECRET

SUNFX IP PTY LTD (AUSTRALIA CORPORATION)

UNIT 5

EFKON HOUSE 20/24 TRENERRY STREET

WESTON, AUSTRALIA 2611

FOR: COSMETIC SUN-TANNING PREPARATIONS; COSMETICS; COSMETIC SUN-TANNING PREPARATIONS; COSMETICS, IN CLASS 3 (U.S. CLS. 1, 4, 6, 50, 51 AND 52).

THE MARK CONSISTS OF STANDARD CHARACTERS WITHOUT CLAIM TO ANY PARTICULAR FONT, STYLE, SIZE, OR COLOR.

PRIORITY CLAIMED UNDER SEC. 44(D) ON AUSTRALIA APPLICATION NO. 1189964, FILED 7-27-2007, REG. NO. 1189964, DATED 3-11-2008, EXPIRES 7-27-2017.

SER. NO. 77-291,049, FILED 9-27-2007.

CHERYL CLAYTON, EXAMINING ATTORNEY

Int. Cl.: 3

Prior U.S. Cls.: 1, 4, 6, 50, 51 and 52

United States Patent and Trademark Office

Reg. No. 3,479,487

Registered Aug. 5, 2008

**TRADEMARK
PRINCIPAL REGISTER**



KING ARTHUR'S COURT, L.L.C. (ALABAMA
LTD LIAB CO)
344 COUNTY ROAD 721
CULLMAN, AL 35055

FOR: COSMETIC SOAPS; COSMETICS; FACIAL
CREAM; FACIAL MASKS; FRAGRANCES FOR
PERSONAL USE; HAND SOAPS; LOTIONS FOR
SKIN, FACE AND BODY; MAKE-UP; SKIN MOIST-
URIZER, IN CLASS 3 (U.S. CLS. 1, 4, 6, 50, 51 AND 52).

FIRST USE 7-15-2007; IN COMMERCE 7-15-2007.

THE COLOR(S) GREEN, BROWN, WHITE AND
PINK IS/ARE CLAIMED AS A FEATURE OF THE
MARK.

THE MARK CONSISTS OF A COCONUT, HIBIS-
CUS FLOWER, PALM TREE. THE COLOR GREEN
APPEARS ON THE LEAVES OF THE PALM TREE.
THE COLOR BROWN APPEARS ON THE TRUNK
OF THE PALM TREE AND THE HUSK OF THE
COCONUTS. THE COLOR WHITE APPEARS ON
THE INSIDE OF THE COCONUT. THE COLOR PINK
APPEARS ON THE HIBISCUS FLOWER.

SER. NO. 77-292,107, FILED 9-28-2007.

JANET LEE, EXAMINING ATTORNEY

Int. Cls.: 35 and 41

Prior U.S. Cls.: 100, 101, 102 and 107

United States Patent and Trademark Office

Reg. No. 3,479,488

Registered Aug. 5, 2008

SERVICE MARK
PRINCIPAL REGISTER



CONFERENCE OF
SOUTHWEST FOUNDATIONS

Connecting Grantmakers. Inspiring Excellence.

CONFERENCE OF SOUTHWEST FOUNDATIONS, INC. (TEXAS CORPORATION)
SUITE 100
624 N GOOD-LATIMER EXPRESSWAY
DALLAS, TX 75204

FOR: ASSOCIATION SERVICES, NAMELY, PROMOTING THE INTERESTS OF GRANTMAKING ORGANIZATIONS, IN CLASS 35 (U.S. CLS. 100, 101 AND 102).

FIRST USE 2-0-2007; IN COMMERCE 2-0-2007.

FOR: EDUCATIONAL SERVICES, NAMELY, CONDUCTING EDUCATIONAL CLASSES, SEMINARS AND WORKSHOPS IN THE FIELD OF GRANTMAKING, IN CLASS 41 (U.S. CLS. 100, 101 AND 107).

FIRST USE 7-0-2007; IN COMMERCE 7-0-2007.

THE MARK CONSISTS OF A DESIGN OF SEVERAL STICK FIGURES OF PEOPLE ARRANGED IN A CIRCLE, WITH THE CURVED STICKS FORMING A SPIRAL DESIGN, WITH "CONFERENCE OF SOUTHWEST FOUNDATIONS" ARRANGED IN TWO LINES UNDER THE DESIGN, AND "CONNECTING GRANTMAKERS. INSPIRING EXCELLENCE." UNDERNEATH, WITH A LINE BETWEEN "SOUTHWEST FOUNDATIONS" AND "CONNECTING GRANTMAKERS. INSPIRING EXCELLENCE."

SEC. 2(F) AS TO "CONFERENCE OF SOUTHWEST FOUNDATIONS".

SER. NO. 77-292,532, FILED 10-1-2007.

DOMINIC FATHY, EXAMINING ATTORNEY

Int. Cls.: 35 and 41

Prior U.S. Cls.: 100, 101, 102 and 107

United States Patent and Trademark Office

Reg. No. 3,479,489

Registered Aug. 5, 2008

**SERVICE MARK
PRINCIPAL REGISTER**

**CONFERENCE OF SOUTHWEST
FOUNDATIONS**

CONFERENCE OF SOUTHWEST FOUNDATIONS, INC. (TEXAS CORPORATION)
SUITE 100
624 N GOOD-LATIMER EXPRESSWAY
DALLAS, TX 75204

FOR: ASSOCIATION SERVICES, NAMELY, PROMOTING THE INTERESTS OF GRANTMAKING ORGANIZATIONS, IN CLASS 35 (U.S. CLS. 100, 101 AND 102).

FIRST USE 4-0-1956; IN COMMERCE 4-0-1956.

FOR: EDUCATIONAL SERVICES, NAMELY, CONDUCTING EDUCATIONAL CLASSES, SEMINARS AND WORKSHOPS IN THE FIELD OF

GRANTMAKING, IN CLASS 41 (U.S. CLS. 100, 101 AND 107).

FIRST USE 4-0-1956; IN COMMERCE 4-0-1956.

THE MARK CONSISTS OF STANDARD CHARACTERS WITHOUT CLAIM TO ANY PARTICULAR FONT, STYLE, SIZE, OR COLOR.

SEC. 2(F).

SER. NO. 77-292,535, FILED 10-1-2007.

DOMINIC FATHY, EXAMINING ATTORNEY

Int. Cl.: 10

Prior U.S. Cls.: 26, 39 and 44

United States Patent and Trademark Office

Reg. No. 3,479,490

Registered Aug. 5, 2008

**TRADEMARK
PRINCIPAL REGISTER**

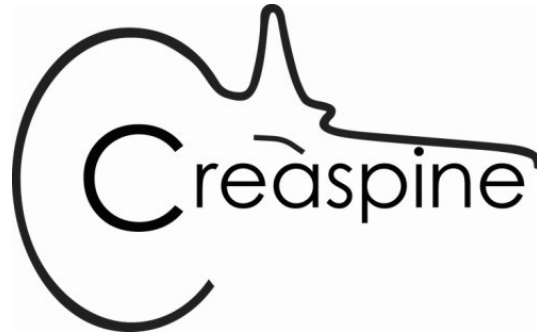

CREASPINE SAS (FRANCE CORPORATION)
PTIB, HOPITAL XAVIER ARNOZAN
AVENUE DU HAUT LEVEQUE
PESSAC, FRANCE 33600

FOR: MEDICAL AND SURGICAL APPARATUS
AND INSTRUMENTS, NAMELY, ORTHOPEDIC
FIXATION DEVICE USED IN ORTHOPEDIC
TRANSPLANT AND/OR IMPLANT SURGERY , IN
CLASS 10 (U.S. CLS. 26, 39 AND 44).

FIRST USE 12-27-2005; IN COMMERCE 5-2-2007.

OWNER OF FRANCE REG. NO. 053400196, DA-
TED 12-27-2005, EXPIRES 12-27-2015.

THE NAME OF THE COMPANY, "CREASPINE",
SURROUNDED BY A CURVED LINE SUGGEST-
ING THE PROFILE A LUMBAR VERTEBRA.

SER. NO. 77-292,566, FILED 10-1-2007.

LINDA MICKLEBURGH, EXAMINING ATTORNEY

Int. Cls.: 16 and 41

Prior U.S. Cls.: 2, 5, 22, 23, 29, 37, 38, 50, 100, 101 and 107

Reg. No. 3,479,491

United States Patent and Trademark Office

Registered Aug. 5, 2008

**TRADEMARK
SERVICE MARK
PRINCIPAL REGISTER**

GLOBE LIFE

CTVGLOBEMEDIA PUBLISHING INC. (CANADA CORPORATION)
9 CHANNEL NINE COURT
SCARBOROUGH, CANADA M1S4B5

FOR: NEWSPAPERS, IN CLASS 16 (U.S. CLS. 2, 5, 22, 23, 29, 37, 38 AND 50).

FOR: PUBLICATION OF AN ELECTRONIC NEWSPAPER ACCESSIBLE VIA A GLOBAL COMPUTER NETWORK, IN CLASS 41 (U.S. CLS. 100, 101 AND 107).

THE MARK CONSISTS OF STANDARD CHARACTERS WITHOUT CLAIM TO ANY PARTICULAR FONT, STYLE, SIZE, OR COLOR.

OWNER OF CANADA REG. NO. TMA708,612, DATED 2-29-2008, EXPIRES 2-28-2023.

SER. NO. 77-292,611, FILED 10-1-2007.

DAVID TAYLOR, EXAMINING ATTORNEY

Int. Cls.: 35 and 45

Prior U.S. Cls.: 100, 101 and 102

United States Patent and Trademark Office

Reg. No. 3,479,492

Registered Aug. 5, 2008

SERVICE MARK
PRINCIPAL REGISTER



US Consumer Protection

Protecting Consumers...Referring Better Business!

U.S. CONSUMER PROTECTION, L.L.C. (NEW JERSEY LTD LIAB CO)
42 SOUTH MAPLE AVENUE
RIDGEWOOD, NJ 07450

FOR: CONSUMER SERVICES, NAMELY, REGISTERING, SCREENING, AND CREDENTIALING THIRD-PARTY VENDORS, SUPPLIERS AND CONTRACTORS FOR BENEFIT OF CONSUMERS , IN CLASS 35 (U.S. CLS. 100, 101 AND 102).

FIRST USE 4-12-2007; IN COMMERCE 8-29-2007.

FOR: PROVIDING GENERAL INFORMATION REGARDING CONSUMER LAWS AND REGULATIONS, IN CLASS 45 (U.S. CLS. 100 AND 101).

FIRST USE 4-12-2007; IN COMMERCE 8-29-2007.

NO CLAIM IS MADE TO THE EXCLUSIVE RIGHT TO USE "US CONSUMER PROTECTION", APART FROM THE MARK AS SHOWN.

THE COLOR(S) BLUE, YELLOW, GRAY AND WHITE IS/ARE CLAIMED AS A FEATURE OF THE MARK.

THE MARK CONSISTS OF A SHIELD OUTLINED IN BLUE ON THE LEFT SIDE OF THE MARK; THE COLOR YELLOW APPEARS IN THE TOP PART OF THE SHIELD, GRADUALLY LIGHTENING TO

PALE YELLOW AND THEN WHITE BY THE MIDDLE OF THE SHIELD, WITH YELLOW VERTICAL LINES APPEARING IN THE CENTER OF THE SHIELD; AT THE TOP OF THE MARK, INSIDE THE SHIELD ARE THE LARGE BLUE LETTERS "U" AND "S" AND BELOW THESE THE WORDS "CONSUMER PROTECTION" IN BLUE; BELOW THIS AND IN FRONT OF THE YELLOW LINES ARE THREE OVERLAPPING BLUE FIGURES REPRESENTING PEOPLE, WITH THEIR SHADOWS IN LIGHTER BLUE SEEN DIRECTLY BELOW THE FIGURES; THERE IS A YELLOW STAR SUPERIMPOSED OVER THE CENTER AND LEFT FIGURE, WITH A WHITE SWOOPING TAIL THAT RUNS FROM THE STAR ACROSS THE CENTER AND RIGHT FIGURES; THE LETTERS "WWW.USCP.ORG" APPEAR IN BLUE AT THE BOTTOM OF THE SHIELD. TO THE RIGHT OF THE SHIELD THE WORDS "US CONSUMER PROTECTION" APPEAR IN BLUE; BENEATH THESE WORDS THERE IS A DASHED LINE IN GREY WITH A YELLOW STAR IN THE CENTER; BENEATH THE DASHED LINE ARE THE WORDS "PROTECTING CONSUMERS...-REFERRING BETTER BUSINESS!" IN DARKER GREY; THE BACKGROUND OF THE OVERALL MARK IS WHITE.

SER. NO. 77-292,633, FILED 10-1-2007.

MICHAEL KAZAZIAN, EXAMINING ATTORNEY

Int. Cl.: 28

Prior U.S. Cls.: 22, 23, 38 and 50

Reg. No. 3,479,493

United States Patent and Trademark Office

Registered Aug. 5, 2008

**TRADEMARK
PRINCIPAL REGISTER**

TURKEY SKINZ

A-WAY HUNTING PRODUCTS, INC. (MICHIGAN CORPORATION)
3230 CALHOUN ROAD
BEAVERTON, MI 486120492

FOR: ANIMAL HUNTING DECOY ACCESSORY, NAMELY, A FULLY FEATHERED CLOTH SKIN/CAPE COVER FOR A DECOY, IN CLASS 28 (U.S. CLS. 22, 23, 38 AND 50).

FIRST USE 10-10-2007; IN COMMERCE 10-10-2007.

THE MARK CONSISTS OF STANDARD CHARACTERS WITHOUT CLAIM TO ANY PARTICULAR FONT, STYLE, SIZE, OR COLOR.

NO CLAIM IS MADE TO THE EXCLUSIVE RIGHT TO USE "SKINS", APART FROM THE MARK AS SHOWN.

SER. NO. 77-292,915, FILED 10-1-2007.

KIMBERLY PERRY, EXAMINING ATTORNEY

Int. Cls.: 8, 9 and 21

**Prior U.S. Cls.: 2, 13, 21, 23, 26, 28, 29, 30, 33, 36, 38,
40, 44 and 50**

Reg. No. 3,479,494

United States Patent and Trademark Office

Registered Aug. 5, 2008

**TRADEMARK
PRINCIPAL REGISTER**

QC

CHAIN DRUG MARKETING ASSOCIATION,
INC. (DELAWARE CORPORATION)
P.O. BOX 995
43157 WEST NINE MILE ROAD
NOVI, MI 483760995

FOR: EYELASH CURLERS; MANICURE IMPLE-
MENTS, NAMELY, NAIL CLIPPERS, TOENAIL
CLIPPERS, NAIL FILES, NAIL BUFFERS, TWEE-
ZERS, NAIL SCISSORS AND CUTICLE SCISSORS,
IN CLASS 8 (U.S. CLS. 23, 28 AND 44).

FIRST USE 1-1-2005; IN COMMERCE 1-1-2005.

FOR: BATTERIES, IN CLASS 9 (U.S. CLS. 21, 23, 26,
36 AND 38).

FIRST USE 1-1-2002; IN COMMERCE 1-1-2002.

FOR: HAIR BRUSHES; NAIL BRUSHES; COMBS,
IN CLASS 21 (U.S. CLS. 2, 13, 23, 29, 30, 33, 40 AND 50).

FIRST USE 1-1-2007; IN COMMERCE 1-1-2007.

THE MARK CONSISTS OF STANDARD CHAR-
ACTERS WITHOUT CLAIM TO ANY PARTICULAR
FONT, STYLE, SIZE, OR COLOR.

OWNER OF U.S. REG. NO. 2,538,741.

SER. NO. 77-293,093, FILED 10-1-2007.

MARY BOAGNI, EXAMINING ATTORNEY

Int. Cl.: 30

Prior U.S. Cl.: 46

United States Patent and Trademark Office

Reg. No. 3,479,495

Registered Aug. 5, 2008

**TRADEMARK
PRINCIPAL REGISTER**

SCHARFFEN BERGER

ARTISAN CONFECTIONS COMPANY (CALI-
FORNIA CORPORATION)
LAW DEPT.
100 CRYSTAL A DRIVE
HERSHEY, PA 17033

FOR: CHOCOLATE DIPPED FRUITS, IN CLASS
30 (U.S. CL. 46).

FIRST USE 8-31-2002; IN COMMERCE 8-31-2002.

THE MARK CONSISTS OF STANDARD CHAR-
ACTERS WITHOUT CLAIM TO ANY PARTICULAR
FONT, STYLE, SIZE, OR COLOR.

OWNER OF U.S. REG. NOS. 2,215,175 AND
2,259,595.

SER. NO. 77-293,234, FILED 10-1-2007.

G. MAYERSCHOFF, EXAMINING ATTORNEY

Int. Cl.: 36

Prior U.S. Cls.: 100, 101 and 102

United States Patent and Trademark Office

Reg. No. 3,479,496

Registered Aug. 5, 2008

SERVICE MARK
PRINCIPAL REGISTER



CHRYSLER, DOUGLAS (UNITED STATES INDIVIDUAL)

20101 SPANGLE CREEK RD. BOX 83

SPANGLE, WA 99031

FOR: RENTAL OF APARTMENTS, IN CLASS 36
(U.S. CLS. 100, 101 AND 102).

FIRST USE 9-28-2007; IN COMMERCE 9-28-2007.

THE MARK CONSISTS OF THE WORDS "DUBH-GLAIS FAICHE" IN STYLIZED TEXT. THERE IS A LAKE IN THE BACKGROUND.

THE ENGLISH TRANSLATION OF THE GAELIC WORDING IN THE MARK IS "DARK WATER MEADOW."

SER. NO. 77-293,712, FILED 10-2-2007.

MELVIN AXILBUND, EXAMINING ATTORNEY

Int. Cl.: 9

Prior U.S. Cls.: 21, 23, 26, 36 and 38

Reg. No. 3,479,497

United States Patent and Trademark Office

Registered Aug. 5, 2008

**TRADEMARK
PRINCIPAL REGISTER**

Z-MAX

CARPENTER ADVANCED CERAMICS, INC. (DE-
LAWARE CORPORATION)
13395 NEW AIRPORT ROAD
AUBURN, CA 95602

THE MARK CONSISTS OF STANDARD CHAR-
ACTERS WITHOUT CLAIM TO ANY PARTICULAR
FONT, STYLE, SIZE, OR COLOR.

FOR: CERAMIC CONTROL VALVES AND
CHOKES FOR REGULATING THE FLOW OF GA-
SES AND LIQUIDS, IN CLASS 9 (U.S. CLS. 21, 23, 26,
36 AND 38).

SER. NO. 77-293,879, FILED 10-2-2007.

FIRST USE 12-0-2004; IN COMMERCE 12-0-2004.

GEOFFREY FOSDICK, EXAMINING ATTORNEY

Int. Cl.: 44

Prior U.S. Cls.: 100 and 101

United States Patent and Trademark Office

Reg. No. 3,479,498

Registered Aug. 5, 2008

**SERVICE MARK
PRINCIPAL REGISTER**

REAL SIMPLE REWARDS

TIME INC. (DELAWARE CORPORATION)
1271 AVENUE OF THE AMERICAS
NEW YORK, NY 10020

FOR: PROVIDING A WEBSITE FEATURING INFORMATION IN THE FIELD OF BEAUTY CARE AND HEALTH CARE, IN CLASS 44 (U.S. CLS. 100 AND 101).

FIRST USE 2-28-2004; IN COMMERCE 2-28-2004.

THE MARK CONSISTS OF STANDARD CHARACTERS WITHOUT CLAIM TO ANY PARTICULAR FONT, STYLE, SIZE, OR COLOR.

OWNER OF U.S. REG. NOS. 2,470,211, 3,098,845 AND OTHERS.

SER. NO. 77-294,022, FILED 10-2-2007.

DOMINIC FATHY, EXAMINING ATTORNEY

Int. Cl.: 42

Prior U.S. Cls.: 100 and 101

United States Patent and Trademark Office

Reg. No. 3,479,499

Registered Aug. 5, 2008

**SERVICE MARK
PRINCIPAL REGISTER**

web2expense

BEYOND PORTALS, INC. (VIRGINIA CORPORATION)
20703 JERSEY MILLS PL.
ASHBURN, VA 20147

FOR: DESIGN AND DEVELOPMENT OF ON-LINE COMPUTER SOFTWARE SYSTEMS; PROVIDING TEMPORARY USE OF ON-LINE NON-DOWNLOADABLE SOFTWARE FOR TRAVEL EXPENSE MANAGEMENT, IN CLASS 42 (U.S. CLS. 100 AND 101).

FIRST USE 8-1-2007; IN COMMERCE 10-1-2007.

THE MARK CONSISTS OF STANDARD CHARACTERS WITHOUT CLAIM TO ANY PARTICULAR FONT, STYLE, SIZE, OR COLOR.

SER. NO. 77-294,373, FILED 10-2-2007.

GIANCARLO CASTRO, EXAMINING ATTORNEY

Int. Cl.: 29

Prior U.S. Cl.: 46

United States Patent and Trademark Office

Reg. No. 3,479,500

Registered Aug. 5, 2008

**TRADEMARK
PRINCIPAL REGISTER**

**BETTER THAN BEEF.
NATURALLY.**

BUFFALO RUN, LLC (FLORIDA LTD LIAB CO)
6555 NORTH POWERLINE ROAD / SUITE 408
FORT LAUDERDALE, FL 33309

FOR: BUFFALO MEAT PRODUCTS, NAMELY,
PROCESSED BUFFALO MEAT, JERKY, IN CLASS
29 (U.S. CL. 46).

FIRST USE 5-30-2007; IN COMMERCE 5-30-2007.

THE MARK CONSISTS OF STANDARD CHAR-
ACTERS WITHOUT CLAIM TO ANY PARTICULAR
FONT, STYLE, SIZE, OR COLOR.

NO CLAIM IS MADE TO THE EXCLUSIVE
RIGHT TO USE "NATURALLY", APART FROM
THE MARK AS SHOWN.

SER. NO. 77-295,858, FILED 10-4-2007.

KEVIN CORWIN, EXAMINING ATTORNEY

Int. Cl.: 19

Prior U.S. Cls.: 1, 12, 33 and 50

United States Patent and Trademark Office

Reg. No. 3,479,501

Registered Aug. 5, 2008

**TRADEMARK
PRINCIPAL REGISTER**

DuraDeck

SIGNATURE FENCING & FLOORING, LLC
(NEW YORK LTD LIAB CO)
50 EAST 42ND STREET, STE 501
NEW YORK, NY 10017

FOR: A MATTING SYSTEM MADE OF MOLDED HIGH DENSITY POLYETHYLENE (HDPE) RECYCLED PLASTIC PANELS DESIGNED TO BE USED ON GROUND SURFACES SUCH AS GRASS, GRAVEL, SOIL, ASPHALT, MUD AND SAND, FOR TURF PROTECTION, GROUND COVER AND PORTABLE ACCESS ROADWAYS, IN CLASS 19 (U.S. CLS. 1, 12, 33 AND 50).

FIRST USE 2-14-2007; IN COMMERCE 2-14-2007.

THE MARK CONSISTS OF STANDARD CHARACTERS WITHOUT CLAIM TO ANY PARTICULAR FONT, STYLE, SIZE, OR COLOR.

SER. NO. 77-296,029, FILED 10-4-2007.

CAROLYN CATALDO, EXAMINING ATTORNEY

Int. Cl.: 16

Prior U.S. Cls.: 2, 5, 22, 23, 29, 37, 38 and 50

United States Patent and Trademark Office

Reg. No. 3,479,502

Registered Aug. 5, 2008

**TRADEMARK
PRINCIPAL REGISTER**

lightworship

CURTIS, VICTOR (UNITED STATES INDIVIDUAL)
6066 HAYES AVENUE, #B
LOS ANGELES, CA 90042

THE MARK CONSISTS OF STANDARD CHARACTERS WITHOUT CLAIM TO ANY PARTICULAR FONT, STYLE, SIZE, OR COLOR.

FOR: PHOTOGRAPHS; PRINTS AND PRINTED MATERIALS IN THE NATURE OF PHOTOGRAPHS, POSTERS, AND DIGITAL PHOTOGRAPHS, IN CLASS 16 (U.S. CLS. 2, 5, 22, 23, 29, 37, 38 AND 50).

SER. NO. 77-296,712, FILED 10-4-2007.

FIRST USE 1-1-1996; IN COMMERCE 6-1-1999.

MICHELLE DUBOIS, EXAMINING ATTORNEY

Int. Cl.: 36

Prior U.S. Cls.: 100, 101 and 102

United States Patent and Trademark Office

Reg. No. 3,479,503

Registered Aug. 5, 2008

**SERVICE MARK
PRINCIPAL REGISTER**

AFRICA LIFE AID

WOYOME FOUNDATION FOR AFRICA (GHANA NON-PROFIT CORPORATION)
PRIVATE MAIL BAG 100
GENERAL POST OFFICE
ACCRA, GHANA

FOR: CHARITABLE FUND RAISING SERVICES
BY MEANS OF MUSICAL CONCERTS, IN CLASS 36
(U.S. CLS. 100, 101 AND 102).

FIRST USE 8-1-2007; IN COMMERCE 8-1-2007.

THE MARK CONSISTS OF STANDARD CHARACTERS WITHOUT CLAIM TO ANY PARTICULAR FONT, STYLE, SIZE, OR COLOR.

NO CLAIM IS MADE TO THE EXCLUSIVE RIGHT TO USE "AFRICA" AND "AID", APART FROM THE MARK AS SHOWN.

SER. NO. 77-297,064, FILED 10-5-2007.

ALEXANDER L. POWERS, EXAMINING ATTORNEY

Int. Cl.: 21

Prior U.S. Cls.: 2, 13, 23, 29, 30, 33, 40 and 50

Reg. No. 3,479,504

United States Patent and Trademark Office

Registered Aug. 5, 2008

**TRADEMARK
PRINCIPAL REGISTER**

STICKYSWAT

MASTERCORE TECHNOLOGIES, INC. (ILLINOIS
CORPORATION)
1916 YUKON DRIVE
BOLINGBROOK, IL 60440

THE MARK CONSISTS OF STANDARD CHAR-
ACTERS WITHOUT CLAIM TO ANY PARTICULAR
FONT, STYLE, SIZE, OR COLOR.

FOR: FLY CATCHERS; INSECT TRAPS, IN CLASS
21 (U.S. CLS. 2, 13, 23, 29, 30, 33, 40 AND 50).

SER. NO. 77-297,749, FILED 10-5-2007.

FIRST USE 7-1-2007; IN COMMERCE 7-1-2007.

JILL C. ALT, EXAMINING ATTORNEY

Int. Cls.: 14, 16, 18, 20, 21, 25, 28 and 35

Prior U.S. Cls.: 1, 2, 3, 5, 13, 22, 23, 25, 27, 28, 29, 30, 32, 33, 37, 38, 39, 40, 41, 50, 100, 101 and 102

Reg. No. 3,479,505

United States Patent and Trademark Office

Registered Aug. 5, 2008

**TRADEMARK
SERVICE MARK
PRINCIPAL REGISTER**

Don't Harsh My Mellow

DON'T HARSH MY MELLOW, LLC (FLORIDA LTD LIAB CO)
2054 ALTA MEADOWS LANE
SUITE 2407
DELRAY BEACH, FL 334441185

FOR: JEWELRY, CLOCKS, WATCHES, IN CLASS 14 (U.S. CLS. 2, 27, 28 AND 50).

FIRST USE 11-13-2007; IN COMMERCE 11-13-2007.

FOR: PAPER GOODS AND PRINTED MATERIAL, NAMELY, BOOKS IN THE FIELD OF PHILOSOPHY, PSYCHOLOGY AND SELF-HELP, POSTERS, GREETING CARDS, STATIONERY AND BUMPER STICKERS; WINDOW SIGNS, WALL SIGNS AND BANNERS MADE OF PAPER, IN CLASS 16 (U.S. CLS. 2, 5, 22, 23, 29, 37, 38 AND 50).

FIRST USE 11-13-2007; IN COMMERCE 11-13-2007.

FOR: TOTE BAGS, SPORTS BAGS, TRAVEL BAGS, GYM BAGS, MESSENGER BAGS, BACKPACKS, TOILETRY CASES SOLD EMPTY, LUGGAGE, BAGS, NAMELY, ALL-PURPOSE CARRY BAGS, CINCH SACKS, DOG COLLARS, CAT COLLARS, DOG LEASHES, CAT LEASHES, IN CLASS 18 (U.S. CLS. 1, 2, 3, 22 AND 41).

FIRST USE 11-13-2007; IN COMMERCE 11-13-2007.

FOR: FURNITURE, DOG BEDS, CAT BEDS, PICTURE FRAMES; NON-METAL, NON-LEATHER AND PLASTIC KEY CHAINS; WINDOW SIGNS AND WALL SIGNS, NAMELY, INFLATABLE PLASTIC WINDOW AND WALL SIGNS; AND BANNERS MADE OF PLASTIC, IN CLASS 20 (U.S. CLS. 2, 13, 22, 25, 32 AND 50).

FIRST USE 11-13-2007; IN COMMERCE 11-13-2007.

FOR: THERMAL INSULATED CONTAINERS FOR FOOD OR BEVERAGES, ALUMINUM WATER BOTTLES SOLD EMPTY, PLASTIC DRINKING BOTTLES SOLD EMPTY, STAINLESS STEEL TRAVEL MUGS, PORTABLE COOLERS, PET BOWLS FOR EATING AND DRINKING, CERAMIC MUGS, THERMAL INSULATED FOAM WRAPS USED TO COVER BOTTLES AND CANS TO KEEP BEVERAGES HOT OR COLD, COFFEE CUPS MADE OF CERAMIC, PAPER, METAL AND OTHER MATERIALS, IN CLASS 21 (U.S. CLS. 2, 13, 23, 29, 30, 33, 40 AND 50).

FIRST USE 11-13-2007; IN COMMERCE 11-13-2007.

FOR: SOCKS, SCARVES, MITTENS, SUNDRESSES, CLOTHING, NAMELY, YOGA WRAPS, BANDANAS, HEADWEAR, FOOTWEAR, GLOVES, UNDERWEAR, PAJAMAS, JACKETS, SPORTSWEAR, NAMELY, T-SHIRTS, SWEATSHIRTS, POLO SHIRTS, HATS, PANTS, SHORTS, CHILDREN'S AND BABY CLOTHING, NAMELY, SHIRTS, PANTS, SHORTS, ROMPERS AND PAJAMAS, IN CLASS 25 (U.S. CLS. 22 AND 39).

FIRST USE 11-13-2007; IN COMMERCE 11-13-2007.

FOR: YOGA RELATED PRODUCTS, NAMELY, YOGA MATS, NYLON FLYING DISCS FOR DOGS, PET TOYS, SURF RELATED PRODUCTS, NAMELY, SURF BOARDS, WATER SPORTS PRODUCTS, NAMELY, WATER SKIS, WAKE BOARDS, WAVE BOARDS, BODY BOARDS, INFLATABLE INNER TUBES FOR AQUATIC RECREATIONAL USE, SNOW SPORTS PRODUCTS, NAMELY, SNOW SKIS, SNOW BOARDS, TOYS, NAMELY, PLASTIC ACTION FIGURES, PLUSH BALLS AND FLYING PLASTIC DISCS, IN CLASS 28 (U.S. CLS. 22, 23, 38 AND 50).

FIRST USE 11-13-2007; IN COMMERCE 11-13-2007.

FOR: RETAIL STORE SERVICES FEATURING CLOTHING AND ACCESSORIES; ON-LINE RETAIL STORE SERVICES FEATURING CLOTHING, ACCESSORIES AND NOVELTY ITEMS, IN CLASS 35 (U.S. CLS. 100, 101 AND 102).

FIRST USE 11-13-2007; IN COMMERCE 11-13-2007.

THE MARK CONSISTS OF STANDARD CHARACTERS WITHOUT CLAIM TO ANY PARTICULAR FONT, STYLE, SIZE, OR COLOR.

SER. NO. 77-297,885, FILED 10-5-2007.

JAMES LOVELACE, EXAMINING ATTORNEY

Int. Cl.: 41

Prior U.S. Cls.: 100, 101 and 107

United States Patent and Trademark Office

Reg. No. 3,479,506

Registered Aug. 5, 2008

**SERVICE MARK
PRINCIPAL REGISTER**

AMBASSADOR CHORUS

BIG APPLE PERFORMING ARTS, INC. (NEW
YORK CORPORATION)

#333

11 BROADWAY
NEW YORK, NY 10004

FOR: ENTERTAINMENT IN THE NATURE OF
LIVE PERFORMANCES BY A MUSICAL GROUP, IN
CLASS 41 (U.S. CLS. 100, 101 AND 107).

FIRST USE 12-0-2001; IN COMMERCE 12-0-2001.

THE MARK CONSISTS OF STANDARD CHAR-
ACTERS WITHOUT CLAIM TO ANY PARTICULAR
FONT, STYLE, SIZE, OR COLOR.

NO CLAIM IS MADE TO THE EXCLUSIVE
RIGHT TO USE "CHORUS", APART FROM THE
MARK AS SHOWN.

SER. NO. 77-298,528, FILED 10-8-2007.

JASON LOTT, EXAMINING ATTORNEY

Int. Cls.: 9 and 42

Prior U.S. Cls.: 21, 23, 26, 36, 38, 100 and 101

United States Patent and Trademark Office

Reg. No. 3,479,507

Registered Aug. 5, 2008

**TRADEMARK
SERVICE MARK
PRINCIPAL REGISTER**

ReceiverNet

ABACA TECHNOLOGY CORPORATION (DELAWARE CORPORATION)
1010 RINCON CIRCLE
SAN JOSE, DE 95131

FOR: DOWNLOADABLE SOFTWARE IN THE FIELD OF COMPUTER SECURITY, NAMELY, UP DATEABLE SOFTWARE USING ONLINE COMMUNICATION FOR IDENTIFICATION AND FILTERING OF SOLICITED AND UNSOLICITED E-MAIL MESSAGES, FOR COLLECTING INFORMATION ABOUT RECEIVED AND TRANSMITTED E-MAIL MESSAGES AND COMPILING STATISTICS ABOUT RECEIVED AND TRANSMITTED E-MAIL MESSAGES AND FOR NOTIFYING A RECIPIENT OF AN E-MAIL MESSAGE WHETHER THE RECEIVED MESSAGE IS SOLICITED OR UNSOLICITED, IN CLASS 9 (U.S. CLS. 21, 23, 26, 36 AND 38).

FIRST USE 11-15-2005; IN COMMERCE 11-15-2006.

FOR: SUBSCRIPTION TO A SERVICE IN THE FIELD OF COMPUTER SECURITY, NAMELY, A

SERVICE FEATURING UP DATEABLE SOFTWARE USING ONLINE COMMUNICATION FOR IDENTIFICATION AND FILTERING OF SOLICITED AND UNSOLICITED E-MAIL MESSAGES, FOR COLLECTING INFORMATION ABOUT RECEIVED AND TRANSMITTED E-MAIL MESSAGES AND COMPILING STATISTICS ABOUT RECEIVED AND TRANSMITTED E-MAIL MESSAGES AND FOR NOTIFYING A RECIPIENT OF AN E-MAIL MESSAGE WHETHER THE RECEIVED MESSAGE IS SOLICITED OR UNSOLICITED, IN CLASS 42 (U.S. CLS. 100 AND 101).

FIRST USE 11-15-2006; IN COMMERCE 11-15-2006.

THE MARK CONSISTS OF STANDARD CHARACTERS WITHOUT CLAIM TO ANY PARTICULAR FONT, STYLE, SIZE, OR COLOR.

SER. NO. 77-298,741, FILED 10-8-2007.

SUSAN LESLIE DUBOIS, EXAMINING ATTORNEY

Int. Cl.: 9

Prior U.S. Cls.: 21, 23, 26, 36 and 38

Reg. No. 3,479,508

United States Patent and Trademark Office

Registered Aug. 5, 2008

**TRADEMARK
PRINCIPAL REGISTER**

THE MAIN STREET ECONOMIST

FEDERAL RESERVE BANK OF KANSAS CITY
(UNITED STATES FEDERALLY CHARTERED
CORPORATION)
925 GRAND BLVD.
KANSAS CITY, MO 64198

FOR: ELECTRONIC DOWNLOADABLE NEW-
LETTERS FEATURING INFORMATION IN THE
FIELD OF ECONOMICS, FINANCE, AND TECH-
NOLOGY, IN CLASS 9 (U.S. CLS. 21, 23, 26, 36 AND
38).

FIRST USE 10-0-1999; IN COMMERCE 10-0-1999.

THE MARK CONSISTS OF STANDARD CHAR-
ACTERS WITHOUT CLAIM TO ANY PARTICULAR
FONT, STYLE, SIZE, OR COLOR.

NO CLAIM IS MADE TO THE EXCLUSIVE
RIGHT TO USE "ECONOMIST", APART FROM
THE MARK AS SHOWN.

SER. NO. 77-298,847, FILED 10-8-2007.

DORITT L. CARROLL, EXAMINING ATTORNEY

Int. Cl.: 35

Prior U.S. Cls.: 100, 101 and 102

United States Patent and Trademark Office

Reg. No. 3,479,509

Registered Aug. 5, 2008

SERVICE MARK
PRINCIPAL REGISTER

Easy Miles

LOYALTY AWARD SERVICES (TEXAS LIMITED
LIABILITY COMPANY)
TWO GALLERIA TOWER CENTER, SUITE 1000
13455 NOEL ROAD
DALLAS, TX 75240

FOR: BUSINESS AND MARKETING MANAGE-
MENT SERVICES, NAMELY, THE REGISTRATION
AND COMPILATION OF STATISTICAL DATA PRO-
MOTING THE SALE OF GOODS AND SERVICES OF
OTHERS BY AWARDED PURCHASE POINTS FOR
THE CUSTOMER'S USE OF SPECIFIED VENDORS
FOR THE FINANCING OR REFINANCING OF A
HOME, PURCHASE OF A HOME, OR THE USE OF A
PARTICULAR MOVING COMPANY, HOME WAR-
RANTY FIRM, FOUNDATION REPAIR COMPANY,
HOME PROTECTION FIRM OR SIMILAR BUSI-

NESS, ENTITY OR SERVICE, IN CLASS 35 (U.S. CLS.
100, 101 AND 102).

FIRST USE 9-11-2006; IN COMMERCE 9-11-2006.

THE MARK CONSISTS OF STANDARD CHAR-
ACTERS WITHOUT CLAIM TO ANY PARTICULAR
FONT, STYLE, SIZE, OR COLOR.

NO CLAIM IS MADE TO THE EXCLUSIVE
RIGHT TO USE "MILES", APART FROM THE
MARK AS SHOWN.

SER. NO. 77-299,308, FILED 10-9-2007.

CAROLYN CATALDO, EXAMINING ATTORNEY

Int. Cl.: 39

Prior U.S. Cls.: 100 and 105

United States Patent and Trademark Office

Reg. No. 3,479,510

Registered Aug. 5, 2008

**SERVICE MARK
PRINCIPAL REGISTER**

WILD CAR

THRIFTY, INC. (OKLAHOMA CORPORATION)
5330 E. 31ST STREET
TULSA, OK 74153

FOR: LEASING OF VEHICLES; RENTAL OF
VEHICLES, IN CLASS 39 (U.S. CLS. 100 AND 105).

FIRST USE 6-15-2007; IN COMMERCE 6-15-2007.

THE MARK CONSISTS OF STANDARD CHAR-
ACTERS WITHOUT CLAIM TO ANY PARTICULAR
FONT, STYLE, SIZE, OR COLOR.

NO CLAIM IS MADE TO THE EXCLUSIVE
RIGHT TO USE "CAR", APART FROM THE MARK
AS SHOWN.

SER. NO. 77-299,333, FILED 10-9-2007.

ELLEN B. AWRICH, EXAMINING ATTORNEY

Int. Cls.: 16 and 41

Prior U.S. Cls.: 2, 5, 22, 23, 29, 37, 38, 50, 100, 101 and 107

Reg. No. 3,479,511

United States Patent and Trademark Office

Registered Aug. 5, 2008

**TRADEMARK
SERVICE MARK
PRINCIPAL REGISTER**

I-4

GETRONICS INTELLECTUAL PROPERTY BV
(NETHERLANDS CORPORATION)
REMBRANDTTOREN, AMSTELPLEIN 1
AMSTERDAM, NETHERLANDS

FOR: PRINTED MATERIALS, NAMELY, REPORTS IN THE FIELD OF INFORMATION SECURITY, IN CLASS 16 (U.S. CLS. 2, 5, 22, 23, 29, 37, 38 AND 50).

FIRST USE 8-10-2007; IN COMMERCE 8-10-2007.

FOR: EDUCATIONAL SERVICES, NAMELY, CONDUCTING CONFERENCES, WORKSHOPS,

SEMINARS AND TRAINING PROGRAMS IN THE FIELD OF INFORMATION SECURITY, IN CLASS 41 (U.S. CLS. 100, 101 AND 107).

FIRST USE 8-10-2007; IN COMMERCE 8-10-2007.

THE MARK CONSISTS OF STANDARD CHARACTERS WITHOUT CLAIM TO ANY PARTICULAR FONT, STYLE, SIZE, OR COLOR.

SER. NO. 77-299,356, FILED 10-9-2007.

LINDA MICKLEBURGH, EXAMINING ATTORNEY

Int. Cl.: 45

Prior U.S. Cls.: 100 and 101

United States Patent and Trademark Office

Reg. No. 3,479,512

Registered Aug. 5, 2008

**SERVICE MARK
PRINCIPAL REGISTER**



JESUS YOUTH (NEW JERSEY CORPORATION)
43 EDWINA CT
DAYTON, NJ 08810

FIRST USE 10-25-1985; IN COMMERCE 10-20-2004.

FOR: MINISTERIAL SERVICES, NAMELY,
HOLDING SPIRITUAL RETREATS TO ASSIST RE-
LIGIOUS LEADERS, BOTH CLERGY AND LAY, TO
DEVELOP AND ENHANCE THEIR SPIRITUAL
LIVES, IN CLASS 45 (U.S. CLS. 100 AND 101).

THE MARK CONSISTS OF THE LOGO OF JESUS
YOUTH WITH THE TWO LETTERS "JY" DEPICTED
AS A PICTURE.

SER. NO. 77-299,404, FILED 10-9-2007.

JANICE KIM, EXAMINING ATTORNEY

Int. Cl.: 35

Prior U.S. Cls.: 100, 101 and 102

United States Patent and Trademark Office

Reg. No. 3,479,513

Registered Aug. 5, 2008

**SERVICE MARK
PRINCIPAL REGISTER**

AGING IN PLACE

COYLE, CECELIA (UNITED STATES INDIVIDUAL)
89 MINEOLA BLVD.
MINEOLA, NY 11501

FOR: BUSINESS CONSULTING SERVICES IN THE FIELD OF MANAGEMENT OF EMPLOYMENT AGENCIES, IN CLASS 35 (U.S. CLS. 100, 101 AND 102).

FIRST USE 1-5-1995; IN COMMERCE 1-5-1995.

THE MARK CONSISTS OF STANDARD CHARACTERS WITHOUT CLAIM TO ANY PARTICULAR FONT, STYLE, SIZE, OR COLOR.

SER. NO. 77-299,555, FILED 10-9-2007.

SOPHIA S. KIM, EXAMINING ATTORNEY

Int. Cl.: 3

Prior U.S. Cls.: 1, 4, 6, 50, 51 and 52

United States Patent and Trademark Office

Reg. No. 3,479,514

Registered Aug. 5, 2008

**TRADEMARK
PRINCIPAL REGISTER**

CAROL COLE COLLECTION

COLE, CAROL (UNITED STATES INDIVIDUAL)
147 BASIL STREET
ENCINITAS, CA 92024

FOR: NON-MEDICATED SKIN CARE PREPARATIONS, NAMELY, SKIN AND FACIAL SERUM, CREAMS, LOTIONS, GELS, TONERS, CLEANSERS AND PEELS, IN CLASS 3 (U.S. CLS. 1, 4, 6, 50, 51 AND 52).

FIRST USE 11-30-2003; IN COMMERCE 1-31-2004.

THE MARK CONSISTS OF STANDARD CHARACTERS WITHOUT CLAIM TO ANY PARTICULAR FONT, STYLE, SIZE, OR COLOR.

NO CLAIM IS MADE TO THE EXCLUSIVE RIGHT TO USE "COLLECTION", APART FROM THE MARK AS SHOWN.

THE NAME(S), PORTRAIT(S), AND/OR SIGNATURE(S) SHOWN IN THE MARK IDENTIFIES "CAROL COLE", WHOSE CONSENT(S) TO REGISTER IS SUBMITTED.

SER. NO. 77-299,770, FILED 10-9-2007.

STEVEN JACKSON, EXAMINING ATTORNEY

Int. Cl.: 9

Prior U.S. Cls.: 21, 23, 26, 36 and 38

United States Patent and Trademark Office

Reg. No. 3,479,515

Registered Aug. 5, 2008

**TRADEMARK
PRINCIPAL REGISTER**

COMMONROOM

THINK COMPUTER CORPORATION (OHIO CORPORATION)
884 COLLEGE AVENUE
PALO ALTO, CA 943061303

FOR: COMMUNICATIONS SOFTWARE FOR CONNECTING ACADEMIC AND PROFESSIONAL USERS; COMPUTER E-COMMERCE SOFTWARE TO ALLOW USERS TO PERFORM ELECTRONIC BUSINESS TRANSACTIONS VIA A GLOBAL COMPUTER NETWORK; COMPUTER SOFTWARE FOR ORGANIZING AND VIEWING DIGITAL IMAGES AND PHOTOGRAPHS; COMPUTER SOFTWARE FOR THE COLLECTION, EDITING, ORGANIZING, MODIFYING, BOOK MARKING, TRANSMISSION, STORAGE AND SHARING OF DATA AND INFORMATION; COMPUTER SOFTWARE FOR USE IN

THE SAFEGUARDING OF DIGITAL FILES, INCLUDING AUDIO, VIDEO, TEXT, BINARY, STILL IMAGES, GRAPHICS AND MULTIMEDIA FILES; DESKTOP PUBLISHING SOFTWARE, IN CLASS 9 (U.S. CLS. 21, 23, 26, 36 AND 38).

FIRST USE 4-1-2006; IN COMMERCE 7-21-2006.

THE MARK CONSISTS OF STANDARD CHARACTERS WITHOUT CLAIM TO ANY PARTICULAR FONT, STYLE, SIZE, OR COLOR.

SER. NO. 77-299,954, FILED 10-9-2007.

HEATHER SAPP, EXAMINING ATTORNEY

Int. Cl.: 12

Prior U.S. Cls.: 19, 21, 23, 31, 35 and 44

Reg. No. 3,479,516

United States Patent and Trademark Office

Registered Aug. 5, 2008

**TRADEMARK
PRINCIPAL REGISTER**

GROUNDKEEPER

BRENTWOOD INDUSTRIES, INC. (PENNSYLVANIA CORPORATION)
621 BRENTWOOD DRIVE
READING, PA 19611

THE MARK CONSISTS OF STANDARD CHARACTERS WITHOUT CLAIM TO ANY PARTICULAR FONT, STYLE, SIZE, OR COLOR.

FOR: WHEELBARROWS, IN CLASS 12 (U.S. CLS. 19, 21, 23, 31, 35 AND 44).

SER. NO. 77-300,218, FILED 10-10-2007.

FIRST USE 9-30-2000; IN COMMERCE 9-30-2000.

AMY MCMENAMIN, EXAMINING ATTORNEY

Int. Cls.: 9 and 41

Prior U.S. Cls.: 21, 23, 26, 36, 38, 100, 101 and 107

Reg. No. 3,479,517

United States Patent and Trademark Office

Registered Aug. 5, 2008

**TRADEMARK
SERVICE MARK
PRINCIPAL REGISTER**

SE7EN

YG ENTERTAINMENT, INC. (REPUBLIC OF
KOREA CORPORATION)
DUKYANG BLDG., 3F
MAPO-GU HAPJUNG-DONG 371-26
SEOUL, REPUBLIC OF KOREA

FOR: CDS AND DVDS FEATURING THE PER-
FORMANCES OF AN INDIVIDUAL, IN CLASS 9
(U.S. CLS. 21, 23, 26, 36 AND 38).

FIRST USE 3-3-2003; IN COMMERCE 4-1-2003.

FOR: LIVE MUSICAL, DANCE AND VOCAL
PERFORMANCES BY AN INDIVIDUAL; PROVID-

ING INFORMATION ON A PERFORMING AND
RECORDING MUSICAL ARTIST VIA A WEBSITE,
IN CLASS 41 (U.S. CLS. 100, 101 AND 107).

FIRST USE 3-6-2003; IN COMMERCE 9-28-2003.

THE MARK CONSISTS OF STANDARD CHAR-
ACTERS WITHOUT CLAIM TO ANY PARTICULAR
FONT, STYLE, SIZE, OR COLOR.

SER. NO. 77-300,425, FILED 10-10-2007.

JERI J. FICKES, EXAMINING ATTORNEY

Int. Cls.: 35 and 41

Prior U.S. Cls.: 100, 101, 102 and 107

United States Patent and Trademark Office

Reg. No. 3,479,518

Registered Aug. 5, 2008

SERVICE MARK
PRINCIPAL REGISTER



THE ANTIQUE BOAT MUSEUM (NEW YORK CORPORATION)
750 MARY STREET
CLAYTON, NY 13624

FOR: ARRANGING AND CONDUCTING OF BOAT AUCTION SALES; PROVIDING A WEB SITE THAT ENABLES USERS TO POST BOATS AND BOAT ENGINES FOR SALE, AND RESIDENTIAL PROPERTY FOR RENT THROUGH ON-LINE CLASSIFIED ADVERTISEMENTS; DISSEMINATION OF CLASSIFIED ADVERTISEMENTS FOR THE SALE OF BOATS AND BOAT ENGINES, AND FOR RENTAL OF RESIDENTIAL PROPERTY; RETAIL STORE SERVICES FEATURING CLOTHING, BOOKS AND DVDS RELATED TO BOATING, POSTERS RELATED TO BOATING, BEVERAGE CUPS, JEWELRY, WRITING IMPLEMENTS, TOTE BAGS, BLANKETS, COASTERS, BOAT CONSTRUCTION PLANS AND NAUTICAL MAPS, IN CLASS 35 (U.S. CLS. 100, 101 AND 102).

FIRST USE 12-31-1991; IN COMMERCE 12-31-1991.

FOR: BOAT MUSEUM SERVICES FEATURING BOATS, BOAT ENGINES AND BOATING-RELATED ARTIFACTS; EDUCATIONAL SERVICES, NAMELY, CONDUCTING CLASSES AND TRAINING ON BOATING, BOAT HANDLING, BOATER SAFETY,

BOAT CONSTRUCTION, BOAT RESTORATION AND BOAT-BUILDING; ENTERTAINMENT SERVICES, NAMELY, ORGANIZING JUDGED COMPETITIONS, PARADES, REGATTAS AND SHOWS OF BOATS; BOAT AND BOATING LIBRARIES, IN CLASS 41 (U.S. CLS. 100, 101 AND 107).

FIRST USE 12-31-1991; IN COMMERCE 12-31-1991.

NO CLAIM IS MADE TO THE EXCLUSIVE RIGHT TO USE "MUSEUM" OR "1000 ISLANDS/CLAYTON, NEW YORK", APART FROM THE MARK AS SHOWN.

THE MARK CONSISTS OF AN OVAL SHAPE WITH THE WORDS "THE ANTIQUE BOAT MUSEUM" AROUND THE TOP OF THE OVAL; THE WORDS "1000 ISLANDS/CLAYTON, NEW YORK" AROUND THE BOTTOM OF THE OVAL; AND A PICTURE OF A BOAT ON THE WATER IN THE CENTER OF THE OVAL.

SEC. 2(F).

SER. NO. 77-300,485, FILED 10-10-2007.

IRA J. GOODSID, EXAMINING ATTORNEY

Int. Cls.: 35 and 41

Prior U.S. Cls.: 100, 101, 102 and 107

United States Patent and Trademark Office

Reg. No. 3,479,519

Registered Aug. 5, 2008

**SERVICE MARK
PRINCIPAL REGISTER**

THE ANTIQUE BOAT MUSEUM

THE ANTIQUE BOAT MUSEUM (NEW YORK CORPORATION)
750 MARY STREET
CLAYTON, NY 13624

FOR: ARRANGING AND CONDUCTING OF BOAT AUCTION SALES; PROVIDING A WEB SITE THAT ENABLES USERS TO POST BOATS AND BOAT ENGINES FOR SALE, AND RESIDENTIAL PROPERTY FOR RENT THROUGH ON-LINE CLASSIFIED ADVERTISEMENTS; DISSEMINATION OF CLASSIFIED ADVERTISEMENTS FOR THE SALE OF BOATS AND BOAT ENGINES, AND FOR RENTAL OF RESIDENTIAL PROPERTY; RETAIL STORE SERVICES FEATURING CLOTHING, BOOKS AND DVDS RELATED TO BOATING, POSTERS RELATED TO BOATING, BEVERAGE CUPS, JEWELRY, WRITING IMPLEMENTS, TOTE BAGS, BLANKETS, COASTERS, BOAT CONSTRUCTION PLANS AND NAUTICAL MAPS, IN CLASS 35 (U.S. CLS. 100, 101 AND 102).

FIRST USE 12-31-1991; IN COMMERCE 12-31-1991.

FOR: BOAT MUSEUM SERVICES FEATURING BOATS, BOAT ENGINES AND BOATING-RELATED

ARTIFACTS; EDUCATIONAL SERVICES, NAME-
LY, CONDUCTING CLASSES AND TRAINING ON
BOATING, BOAT HANDLING, BOATER SAFETY,
BOAT CONSTRUCTION, BOAT RESTORATION
AND BOAT-BUILDING; ENTERTAINMENT SERVI-
CES, NAMELY, ORGANIZING JUDGED COMPETI-
TIONS, PARADES, REGATTAS AND SHOWS OF
BOATS; BOAT AND BOATING LIBRARIES, IN
CLASS 41 (U.S. CLS. 100, 101 AND 107).

FIRST USE 12-31-1991; IN COMMERCE 12-31-1991.

THE MARK CONSISTS OF STANDARD CHAR-
ACTERS WITHOUT CLAIM TO ANY PARTICULAR
FONT, STYLE, SIZE, OR COLOR.

NO CLAIM IS MADE TO THE EXCLUSIVE
RIGHT TO USE "MUSEUM", APART FROM THE
MARK AS SHOWN.

SEC. 2(F).

SER. NO. 77-300,497, FILED 10-10-2007.

IRA J. GOODSaid, EXAMINING ATTORNEY

Int. Cls.: 9 and 38

Prior U.S. Cls.: 21, 23, 26, 36, 38, 100, 101 and 104

Reg. No. 3,479,520

United States Patent and Trademark Office

Registered Aug. 5, 2008

**TRADEMARK
SERVICE MARK
PRINCIPAL REGISTER**

KVH INDUSTRIES
MINI-VSAT
B R O A D B A N D

KVH INDUSTRIES, INC. (DELAWARE CORPORATION)
50 ENTERPRISE CENTER
MIDDLETOWN, RI 02842

FIRST USE 7-12-2007; IN COMMERCE 7-12-2007.

OWNER OF U.S. REG. NO. 2,054,486.

FOR: SATELLITE COMMUNICATIONS EQUIPMENT SYSTEM COMPRISED OF A TRACKING ANTENNA, TRANSMITTER AND RECEIVER, IN CLASS 9 (U.S. CLS. 21, 23, 26, 36 AND 38).

NO CLAIM IS MADE TO THE EXCLUSIVE RIGHT TO USE "MINI-VSAT BROADBAND", APART FROM THE MARK AS SHOWN.

FIRST USE 7-12-2007; IN COMMERCE 7-12-2007.

SEC. 2(F) AS TO "INDUSTRIES".

FOR: PROVIDING OTHERS WITH A TWO-WAY COMMUNICATIONS CONNECTION BETWEEN ONBOARD/MOBILE HARDWARE, SATELLITE AND THE INTERNET, IN CLASS 38 (U.S. CLS. 100, 101 AND 104).

SER. NO. 77-300,605, FILED 10-10-2007.

KATHY DE JONGE, EXAMINING ATTORNEY

Int. Cls.: 16, 35, 41 and 45

**Prior U.S. Cls.: 2, 5, 22, 23, 29, 37, 38, 50, 100, 101, 102
and 107**

Reg. No. 3,479,521

United States Patent and Trademark Office

Registered Aug. 5, 2008

**TRADEMARK
SERVICE MARK
PRINCIPAL REGISTER**

**NATIONAL CONSUMER LAW
CENTER**

NATIONAL CONSUMER LAW CENTER, INC.
(MASSACHUSETTS CORPORATION)
10TH FLOOR
77 SUMMER STREET
BOSTON, MA 02110

FOR: MANUALS IN THE FIELDS OF CONSUMER PROTECTION, CONSUMER CREDIT, AND LENDING PRACTICES; TREATISES IN THE FIELDS OF CONSUMER PROTECTION LAW, CONSUMER CREDIT LAW, AND LENDING PRACTICES LAW; GUIDE BOOKS FEATURING CONSUMER PROTECTION LAW, CONSUMER CREDIT LAW, AND LENDING PRACTICES LAW; PRINTED GUIDES FOR CONSUMERS IN THE FIELDS OF CONSUMER PROTECTION, CONSUMER CREDIT, AND LENDING PRACTICES; PAMPHLETS IN THE FIELDS OF CONSUMER PROTECTION, CONSUMER CREDIT, AND LENDING PRACTICES, IN CLASS 16 (U.S. CLS. 2, 5, 22, 23, 29, 37, 38 AND 50).

FIRST USE 9-1-1970; IN COMMERCE 9-1-1970.

FOR: PROVIDING PUBLIC POLICY INFORMATION IN THE FIELDS OF CONSUMER PROTECTION, CONSUMER CREDIT, AND LENDING PRACTICES, IN CLASS 35 (U.S. CLS. 100, 101 AND 102).

FIRST USE 6-30-1969; IN COMMERCE 6-30-1969.

FOR: EDUCATIONAL SERVICES, NAMELY, CONDUCTING CONFERENCES IN THE FIELDS OF CONSUMER PROTECTION, CONSUMER CREDIT, AND LENDING PRACTICES AND DIS-

TRIBUTING COURSE MATERIALS IN CONNECTION THEREWITH; PROVIDING CONTINUING LEGAL EDUCATION COURSES, IN CLASS 41 (U.S. CLS. 100, 101 AND 107).

FIRST USE 12-31-1974; IN COMMERCE 12-31-1974.

FOR: LEGAL SERVICES; LEGAL CONSULTING SERVICES IN THE FIELDS OF CONSUMER PROTECTION, CONSUMER CREDIT, AND LENDING PRACTICES; EXPERT WITNESS SERVICES IN LEGAL MATTERS IN THE FIELDS OF CONSUMER PROTECTION, CONSUMER CREDIT, AND LENDING PRACTICES; PROVIDING LEGAL INFORMATION IN THE FIELDS OF CONSUMER PROTECTION, CONSUMER CREDIT, AND LENDING PRACTICES, IN CLASS 45 (U.S. CLS. 100 AND 101).

FIRST USE 6-6-1969; IN COMMERCE 6-6-1969.

THE MARK CONSISTS OF STANDARD CHARACTERS WITHOUT CLAIM TO ANY PARTICULAR FONT, STYLE, SIZE, OR COLOR.

NO CLAIM IS MADE TO THE EXCLUSIVE RIGHT TO USE "CONSUMER LAW CENTER", APART FROM THE MARK AS SHOWN.

SEC. 2(F).

SER. NO. 77-300,892, FILED 10-10-2007.

PAUL CROWLEY, EXAMINING ATTORNEY

Int. Cls.: 16, 35, 41 and 45

**Prior U.S. Cls.: 2, 5, 22, 23, 29, 37, 38, 50, 100, 101, 102
and 107**

Reg. No. 3,479,522

United States Patent and Trademark Office

Registered Aug. 5, 2008

**TRADEMARK
SERVICE MARK
PRINCIPAL REGISTER**

NCLC

NATIONAL CONSUMER LAW CENTER, INC.
(MASSACHUSETTS CORPORATION)
10TH FLOOR
77 SUMMER STREET
BOSTON, MA 02110

FOR: MANUALS IN THE FIELDS OF CONSUMER PROTECTION, CONSUMER CREDIT, AND LENDING PRACTICES; TREATISES IN THE FIELDS OF CONSUMER PROTECTION LAW, CONSUMER CREDIT LAW, AND LENDING PRACTICES LAW; GUIDE BOOKS FEATURING CONSUMER PROTECTION LAW, CONSUMER CREDIT LAW, AND LENDING PRACTICES LAW; PRINTED GUIDES FOR CONSUMERS IN THE FIELDS OF CONSUMER PROTECTION, CONSUMER CREDIT, AND LENDING PRACTICES; PAMPHLETS IN THE FIELDS OF CONSUMER PROTECTION, CONSUMER CREDIT, AND LENDING PRACTICES, IN CLASS 16 (U.S. CLS. 2, 5, 22, 23, 29, 37, 38 AND 50).

FIRST USE 9-1-1970; IN COMMERCE 9-1-1970.

FOR: PROVIDING PUBLIC POLICY INFORMATION IN THE FIELDS OF CONSUMER PROTECTION, CONSUMER CREDIT, AND LENDING PRACTICES, IN CLASS 35 (U.S. CLS. 100, 101 AND 102).

FIRST USE 6-30-1969; IN COMMERCE 6-30-1969.

FOR: EDUCATIONAL SERVICES, NAMELY, CONDUCTING CONFERENCES IN THE FIELDS

OF CONSUMER PROTECTION, CONSUMER CREDIT, AND LENDING PRACTICES AND DISTRIBUTING COURSE MATERIALS IN CONNECTION THEREWITH; PROVIDING CONTINUING LEGAL EDUCATION COURSES, IN CLASS 41 (U.S. CLS. 100, 101 AND 107).

FIRST USE 12-31-1974; IN COMMERCE 12-31-1974.

FOR: LEGAL SERVICES; LEGAL CONSULTING SERVICES IN THE FIELDS OF CONSUMER PROTECTION, CONSUMER CREDIT, AND LENDING PRACTICES; EXPERT WITNESS SERVICES IN LEGAL MATTERS IN THE FIELDS OF CONSUMER PROTECTION, CONSUMER CREDIT, AND LENDING PRACTICES; PROVIDING LEGAL INFORMATION IN THE FIELDS OF CONSUMER PROTECTION, CONSUMER CREDIT, AND LENDING PRACTICES, IN CLASS 45 (U.S. CLS. 100 AND 101).

FIRST USE 6-6-1969; IN COMMERCE 6-6-1969.

THE MARK CONSISTS OF STANDARD CHARACTERS WITHOUT CLAIM TO ANY PARTICULAR FONT, STYLE, SIZE, OR COLOR.

SER. NO. 77-300,943, FILED 10-10-2007.

PAUL CROWLEY, EXAMINING ATTORNEY

Int. Cls.: 39 and 44

Prior U.S. Cls.: 100, 101 and 105

United States Patent and Trademark Office

Reg. No. 3,479,523

Registered Aug. 5, 2008

**SERVICE MARK
PRINCIPAL REGISTER**

SLL

STEMLIFELINE INC. (DELAWARE CORPORATION)
1300 INDUSTRIAL ROAD STE. 13
SAN CARLOS, CA 94070

FOR: BIOMEDICAL SERVICES, NAMELY, THE STORAGE OF HUMAN STEM CELLS FOR MEDICAL USE, IN CLASS 39 (U.S. CLS. 100 AND 105).

FIRST USE 7-25-2007; IN COMMERCE 7-25-2007.

FOR: HARVESTING STEM CELLS FROM UNUSED EMBRYOS CREATED THROUGH THE IN

VITRO FERTILIZATION PROCESS FOR MEDICAL TREATMENT, IN CLASS 44 (U.S. CLS. 100 AND 101).

FIRST USE 7-25-2007; IN COMMERCE 7-25-2007.

THE MARK CONSISTS OF STANDARD CHARACTERS WITHOUT CLAIM TO ANY PARTICULAR FONT, STYLE, SIZE, OR COLOR.

SER. NO. 77-301,309, FILED 10-11-2007.

LINDA ORNDORFF, EXAMINING ATTORNEY

Int. Cl.: 11

Prior U.S. Cls.: 13, 21, 23, 31 and 34

United States Patent and Trademark Office

Reg. No. 3,479,524

Registered Aug. 5, 2008

**TRADEMARK
PRINCIPAL REGISTER**

CENTRO DUO

FRANZ KALDEWEI GMBH & CO. KG (FED REP
GERMANY GMBH & CO. KG)
BECKUMER STRASSE 33-35
AHLEN, FED REP GERMANY 59229

OWNER OF ERPN CMNTY TM OFC REG. NO.
004089256, DATED 1-18-2006, EXPIRES 10-26-2014.

FOR: BATHTUBS, SHOWERS AND SHOWER
TRAYS, IN CLASS 11 (U.S. CLS. 13, 21, 23, 31 AND 34).

OWNER OF U.S. REG. NO. 2,537,236.

FIRST USE 1-31-2000; IN COMMERCE 1-31-2000.

SER. NO. 77-301,329, FILED 10-11-2007.

THE MARK CONSISTS OF STANDARD CHAR-
ACTERS WITHOUT CLAIM TO ANY PARTICULAR
FONT, STYLE, SIZE, OR COLOR.

JORDAN BAKER, EXAMINING ATTORNEY

Int. Cls.: 39 and 44

Prior U.S. Cls.: 100, 101 and 105

United States Patent and Trademark Office

Reg. No. 3,479,525

Registered Aug. 5, 2008

**SERVICE MARK
PRINCIPAL REGISTER**

PROTECTING THE FUTURE

STEMLIFELINE INC. (DELAWARE CORPORATION)
1300 INDUSTRIAL ROAD STE. 13
SAN CARLOS, CA 94070

FOR: BIOMEDICAL SERVICES, NAMELY, THE STORAGE OF HUMAN STEM CELLS FOR MEDICAL USE, IN CLASS 39 (U.S. CLS. 100 AND 105).

FIRST USE 7-25-2007; IN COMMERCE 7-25-2007.

FOR: HARVESTING STEM CELLS FROM UNUSED EMBRYOS CREATED THROUGH THE IN

VITRO FERTILIZATION PROCESS FOR MEDICAL TREATMENT, IN CLASS 44 (U.S. CLS. 100 AND 101).

FIRST USE 7-25-2007; IN COMMERCE 7-25-2007.

THE MARK CONSISTS OF STANDARD CHARACTERS WITHOUT CLAIM TO ANY PARTICULAR FONT, STYLE, SIZE, OR COLOR.

SER. NO. 77-301,333, FILED 10-11-2007.

LINDA ORNDORFF, EXAMINING ATTORNEY

Int. Cl.: 11

Prior U.S. Cls.: 13, 21, 23, 31 and 34

United States Patent and Trademark Office

Reg. No. 3,479,526

Registered Aug. 5, 2008

**TRADEMARK
PRINCIPAL REGISTER**

DUSCHPLAN

FRANZ KALDEWEI GMBH & CO. KG (FED REP
GERMANY GMBH & CO. KG)
BECKUMER STRASSE 33-35
AHLEN, FED REP GERMANY 59229

FOR: BATHTUBS, SHOWERS AND SHOWER
TRAYS, IN CLASS 11 (U.S. CLS. 13, 21, 23, 31 AND 34).

FIRST USE 11-30-2000; IN COMMERCE 11-30-2000.

THE MARK CONSISTS OF STANDARD CHAR-
ACTERS WITHOUT CLAIM TO ANY PARTICULAR
FONT, STYLE, SIZE, OR COLOR.

OWNER OF ERPN CMNTY TM OFC REG. NO.
004212932, DATED 3-2-2006, EXPIRES 12-28-2014.

SER. NO. 77-301,347, FILED 10-11-2007.

JORDAN BAKER, EXAMINING ATTORNEY

Int. Cl.: 11

Prior U.S. Cls.: 13, 21, 23, 31 and 34

United States Patent and Trademark Office

Reg. No. 3,479,527

Registered Aug. 5, 2008

**TRADEMARK
PRINCIPAL REGISTER**

SUPERPLAN

FRANZ KALDEWEI GMBH & CO. KG (FED REP
GERMANY GMBH & CO. KG)
BECKUMER STR. 33-35
AHLEN, FED REP GERMANY 59229

FOR: BATHTUBS, SHOWERS AND SHOWER
TRAYS, IN CLASS 11 (U.S. CLS. 13, 21, 23, 31 AND 34).

FIRST USE 5-31-2004; IN COMMERCE 5-31-2004.

THE MARK CONSISTS OF STANDARD CHAR-
ACTERS WITHOUT CLAIM TO ANY PARTICULAR
FONT, STYLE, SIZE, OR COLOR.

OWNER OF ERPN CMNTY TM OFC REG. NO.
004212999, DATED 3-2-2006, EXPIRES 12-28-2014.

SER. NO. 77-301,356, FILED 10-11-2007.

JORDAN BAKER, EXAMINING ATTORNEY

Int. Cls.: 39 and 44

Prior U.S. Cls.: 100, 101 and 105

United States Patent and Trademark Office

Reg. No. 3,479,528

Registered Aug. 5, 2008

**SERVICE MARK
PRINCIPAL REGISTER**

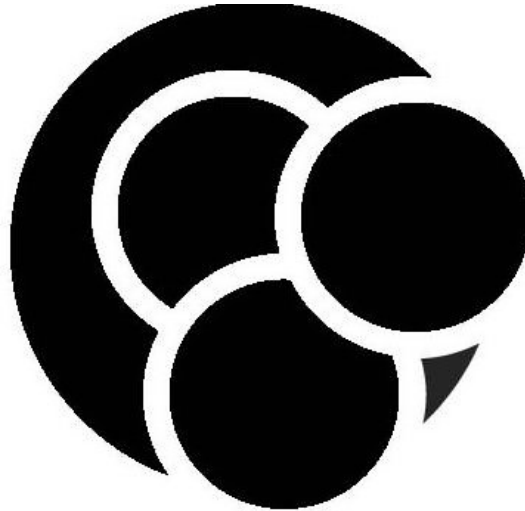

STEMLIFELINE INC. (DELAWARE CORPORATION)
1300 INDUSTRIAL ROAD STE. 13
SAN CARLOS, CA 94070

FOR: BIOMEDICAL SERVICES, NAMELY, THE STORAGE OF HUMAN STEM CELLS FOR MEDICAL USE, IN CLASS 39 (U.S. CLS. 100 AND 105).

FIRST USE 7-25-2007; IN COMMERCE 7-25-2007.

FOR: HARVESTING STEM CELLS FROM UNUSED EMBRYOS CREATED THROUGH THE IN VITRO FERTILIZATION PROCESS FOR MEDICAL TREATMENT, IN CLASS 44 (U.S. CLS. 100 AND 101).

FIRST USE 7-25-2007; IN COMMERCE 7-25-2007.

SER. NO. 77-301,360, FILED 10-11-2007.

LINDA ORNDORFF, EXAMINING ATTORNEY

Int. Cl.: 11

Prior U.S. Cls.: 13, 21, 23, 31 and 34

United States Patent and Trademark Office

Reg. No. 3,479,529

Registered Aug. 5, 2008

**TRADEMARK
PRINCIPAL REGISTER**

MEGAPLAN

FRANZ KALDEWEI GMBH & CO. KG (FED REP
GERMANY GMBH & CO. KG)
BECKUMER STRASSE 33-35
AHLEN, FED REP GERMANY 59229

FOR: BATHTUBS, SHOWERS AND SHOWER
TRAYS, IN CLASS 11 (U.S. CLS. 13, 21, 23, 31 AND 34).

FIRST USE 10-31-2000; IN COMMERCE 10-31-2000.

THE MARK CONSISTS OF STANDARD CHAR-
ACTERS WITHOUT CLAIM TO ANY PARTICULAR
FONT, STYLE, SIZE, OR COLOR.

OWNER OF ERPN CMNTY TM OFC REG. NO.
004212924, DATED 3-2-2006, EXPIRES 12-28-2014.

SER. NO. 77-301,366, FILED 10-11-2007.

JORDAN BAKER, EXAMINING ATTORNEY

Int. Cl.: 11

Prior U.S. Cls.: 13, 21, 23, 31 and 34

United States Patent and Trademark Office

Reg. No. 3,479,530

Registered Aug. 5, 2008

**TRADEMARK
PRINCIPAL REGISTER**

CONODUO

FRANZ KALDEWEI GMBH & CO. KG (FED REP
GERMANY GMBH & CO. KG)
BECKUMER STRASSE 33-35
AHLEN, FED REP GERMANY 59229

OWNER OF FED REP GERMANY REG. NO.
30510137, DATED 5-13-2005, EXPIRES 2-24-2015.

FOR: BATHTUBS, SHOWERS AND SHOWER
TRAYS, IN CLASS 11 (U.S. CLS. 13, 21, 23, 31 AND 34).

OWNER OF U.S. REG. NO. 2,537,236.

FIRST USE 3-31-2006; IN COMMERCE 3-31-2006.

SER. NO. 77-301,377, FILED 10-11-2007.

THE MARK CONSISTS OF STANDARD CHAR-
ACTERS WITHOUT CLAIM TO ANY PARTICULAR
FONT, STYLE, SIZE, OR COLOR.

JORDAN BAKER, EXAMINING ATTORNEY

Int. Cl.: 35

Prior U.S. Cls.: 100, 101 and 102

United States Patent and Trademark Office

Reg. No. 3,479,531

Registered Aug. 5, 2008

**SERVICE MARK
PRINCIPAL REGISTER**

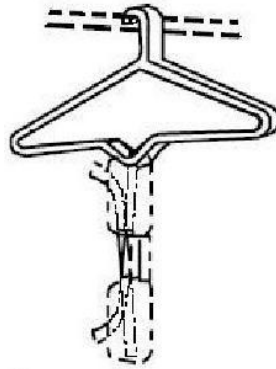

WIS SARL (FRANCE SOCIÉTÉ À RESPONSABILITÉ LIMITÉE (SARL))
30 RUE DE CAMPO FORMIO
PARIS, FRANCE 75009

FOR: RETAIL STORE SERVICES FEATURING EYEGLASSES, SUNGLASSES AND FRAMES THEREFOR, IN CLASS 35 (U.S. CLS. 100, 101 AND 102).

FIRST USE 0-0-1982; IN COMMERCE 0-0-1982.

THE MARK CONSISTS OF A DISPLAY DEVICE FOR EYEGLASS FRAMES IN THE FORM OF A MINIATURE CLOTHES HANGER. AN EYEGLASS FRAME AND SUPPORTING ROD ARE SHOWN IN DOTTED LINE TO SHOW RELATIVE PLACEMENT OF THE DISPLAY DEVICE, AND DO NOT FORM PART OF THE MARK.

SER. NO. 77-301,378, FILED 10-11-2007.

KIMBERLY PERRY, EXAMINING ATTORNEY

Int. Cl.: 11

Prior U.S. Cls.: 13, 21, 23, 31 and 34

United States Patent and Trademark Office

Reg. No. 3,479,532

Registered Aug. 5, 2008

**TRADEMARK
PRINCIPAL REGISTER**

SANILUX

FRANZ KALDEWEI GMBH & CO. KG (FED REP
GERMANY GMBH & CO. KG)
BECKUMER STRASSE 33-35
AHLEN, FED REP GERMANY 59229

FOR: BATHTUBS, SHOWERS AND SHOWER
TRAYS, IN CLASS 11 (U.S. CLS. 13, 21, 23, 31 AND 34).

FIRST USE 10-31-2000; IN COMMERCE 10-31-2000.

THE MARK CONSISTS OF STANDARD CHAR-
ACTERS WITHOUT CLAIM TO ANY PARTICULAR
FONT, STYLE, SIZE, OR COLOR.

OWNER OF FED REP GERMANY REG. NO.
39873487, DATED 1-22-1999, EXPIRES 12-22-2008.

SER. NO. 77-301,383, FILED 10-11-2007.

JORDAN BAKER, EXAMINING ATTORNEY

Int. Cl.: 11

Prior U.S. Cls.: 13, 21, 23, 31 and 34

United States Patent and Trademark Office

Reg. No. 3,479,533

Registered Aug. 5, 2008

**TRADEMARK
PRINCIPAL REGISTER**

SANIFORM

FRANZ KALDEWEI GMBH & CO. KG (FED REP
GERMANY GMBH & CO. KG)
BECKUMER STRASSE 33-35
AHLEN, FED REP GERMANY 59229

FOR: BATHTUBS, SHOWERS AND SHOWER
TRAYS, IN CLASS 11 (U.S. CLS. 13, 21, 23, 31 AND 34).

FIRST USE 3-31-2000; IN COMMERCE 3-31-2000.

THE MARK CONSISTS OF STANDARD CHAR-
ACTERS WITHOUT CLAIM TO ANY PARTICULAR
FONT, STYLE, SIZE, OR COLOR.

OWNER OF FED REP GERMANY REG. NO.
30473472, DATED 3-18-2005, EXPIRES 12-30-2014.

SER. NO. 77-301,395, FILED 10-11-2007.

JORDAN BAKER, EXAMINING ATTORNEY

Int. Cl.: 11

Prior U.S. Cls.: 13, 21, 23, 31 and 34

United States Patent and Trademark Office

Reg. No. 3,479,534

Registered Aug. 5, 2008

**TRADEMARK
PRINCIPAL REGISTER**

MEGA DUO

FRANZ KALDEWEI GMBH & CO. KG (FED REP
GERMANY GMBH & CO. KG)
BECKUMER STRASSE 33-35
AHLEN, FED REP GERMANY 59229

OWNER OF FED REP GERMANY REG. NO.
30473465, DATED 3-24-2005, EXPIRES 12-30-2014.

FOR: BATHTUBS, SHOWERS AND SHOWER
TRAYS, IN CLASS 11 (U.S. CLS. 13, 21, 23, 31 AND 34).

OWNER OF U.S. REG. NO. 2,537,236.

FIRST USE 3-31-2000; IN COMMERCE 3-31-2000.

SER. NO. 77-301,416, FILED 10-11-2007.

THE MARK CONSISTS OF STANDARD CHAR-
ACTERS WITHOUT CLAIM TO ANY PARTICULAR
FONT, STYLE, SIZE, OR COLOR.

JORDAN BAKER, EXAMINING ATTORNEY

Int. Cl.: 11

Prior U.S. Cls.: 13, 21, 23, 31 and 34

United States Patent and Trademark Office

Reg. No. 3,479,535

Registered Aug. 5, 2008

**TRADEMARK
PRINCIPAL REGISTER**

KUSATSU POOL

FRANZ KALDEWEI GMBH & CO. KG (FED REP
GERMANY GMBH & CO. KG)
BECKUMER STRASSE 33-35
AHLEN, FED REP GERMANY 59229

FOR: BATHTUBS, SHOWERS AND SHOWER
TRAYS, IN CLASS 11 (U.S. CLS. 13, 21, 23, 31 AND 34).

FIRST USE 8-31-2000; IN COMMERCE 8-31-2000.

THE MARK CONSISTS OF STANDARD CHAR-
ACTERS WITHOUT CLAIM TO ANY PARTICULAR
FONT, STYLE, SIZE, OR COLOR.

OWNER OF FED REP GERMANY REG. NO.
30473464, DATED 3-24-2005, EXPIRES 12-30-2014.

SER. NO. 77-301,423, FILED 10-11-2007.

JORDAN BAKER, EXAMINING ATTORNEY

Int. Cl.: 41

Prior U.S. Cls.: 100, 101 and 107

United States Patent and Trademark Office

Reg. No. 3,479,536

Registered Aug. 5, 2008

**SERVICE MARK
PRINCIPAL REGISTER**

**MASONRY CONSTRUCTION'S
CHALLENGE**

HANLEY-WOOD, LLC (DELAWARE LTD LIAB
CO)
SUITE 600
ONE THOMAS CIRCLE, N.W.
WASHINGTON, DC 20005

FOR: ARRANGING AND CONDUCTING COM-
PETITIONS IN THE FIELD OF BRICKLAYING, IN
CLASS 41 (U.S. CLS. 100, 101 AND 107).

FIRST USE 8-0-2005; IN COMMERCE 8-0-2005.

THE MARK CONSISTS OF STANDARD CHAR-
ACTERS WITHOUT CLAIM TO ANY PARTICULAR
FONT, STYLE, SIZE, OR COLOR.

OWNER OF U.S. REG. NO. 2,434,409.

NO CLAIM IS MADE TO THE EXCLUSIVE
RIGHT TO USE "CHALLENGE", APART FROM
THE MARK AS SHOWN.

SEC. 2(F) AS TO "MASONRY CONSTRUCTION'S".

SER. NO. 77-301,907, FILED 10-11-2007.

RICHARD WHITE, EXAMINING ATTORNEY

Int. Cl.: 36

Prior U.S. Cls.: 100, 101 and 102

United States Patent and Trademark Office

Reg. No. 3,479,537

Registered Aug. 5, 2008

**SERVICE MARK
PRINCIPAL REGISTER**

**Built By Referral Realty
Group**

BUILT BY REFERRAL REALTY GROUP, LTD.
(ARIZONA CORPORATION)

4204 S ROGER WAY

CHANDLER, AZ 85249

FOR: REAL ESTATE BROKERAGE, IN CLASS 36
(U.S. CLS. 100, 101 AND 102).

FIRST USE 10-1-2007; IN COMMERCE 10-1-2007.

THE MARK CONSISTS OF STANDARD CHAR-
ACTERS WITHOUT CLAIM TO ANY PARTICULAR
FONT, STYLE, SIZE, OR COLOR.

NO CLAIM IS MADE TO THE EXCLUSIVE
RIGHT TO USE "REALTY GROUP", APART FROM
THE MARK AS SHOWN.

SER. NO. 77-302,040, FILED 10-11-2007.

NAKIA HENRY, EXAMINING ATTORNEY

Int. Cl.: 38

Prior U.S. Cls.: 100, 101 and 104

United States Patent and Trademark Office

Reg. No. 3,479,538

Registered Aug. 5, 2008

**SERVICE MARK
PRINCIPAL REGISTER**

WARRIOR FORUM

SAYS JR, CLIFTON A. (UNITED STATES INDIVIDUAL)
1313 OLD RIVER ROAD
STARKS, LA 70661

FOR: PROVIDING ON-LINE FORUMS FOR TRANSMISSION OF MESSAGES AMONG COMPUTER USERS CONCERNING INTERNET MARKETING, IN CLASS 38 (U.S. CLS. 100, 101 AND 104).

FIRST USE 9-10-1997; IN COMMERCE 9-10-1997.

THE MARK CONSISTS OF STANDARD CHARACTERS WITHOUT CLAIM TO ANY PARTICULAR FONT, STYLE, SIZE, OR COLOR.

NO CLAIM IS MADE TO THE EXCLUSIVE RIGHT TO USE "FORUM", APART FROM THE MARK AS SHOWN.

SER. NO. 77-302,153, FILED 10-11-2007.

CARRIE GENOVESE, EXAMINING ATTORNEY

Int. Cl.: 9

Prior U.S. Cls.: 21, 23, 26, 36 and 38

Reg. No. 3,479,539

United States Patent and Trademark Office

Registered Aug. 5, 2008

**TRADEMARK
PRINCIPAL REGISTER**

InPorter

MANAGING EDITOR INC. (DELAWARE CORPORATION), DBA MEI
610 OLD YORK ROAD, SUITE 250
JENKINTOWN, PA 19046

FOR: COMPUTER SOFTWARE FOR IMPORTING AND/OR EXPORTING CROSS-MEDIA CONTENT; COMPUTER HARDWARE AND COMPUTER SOFTWARE PROGRAMS FOR THE INTEGRATION OF TEXT, AUDIO, GRAPHICS, STILL IMAGES AND MOVING PICTURES INTO AN INTERACTIVE DELIVERY FOR MULTIMEDIA APPLICATIONS; COMPUTER SOFTWARE FOR CREATING SEARCHABLE DATABASES OF INFORMATION AND DATA; COMPUTER SOFTWARE FOR ORGANIZING AND VIEWING DIGITAL IMAGES AND PHOTOGRAPHS; COMPUTER SOFTWARE FOR THE COLLECTION, EDITING, ORGANIZING, MODIFYING, BOOK MARKING, TRANSMISSION, STORAGE AND SHARING OF DATA AND INFORMATION; COMPUTER SOFTWARE FOR USE IN THE SAFEGUARDING OF DIGITAL FILES, IN-

CLUDING AUDIO, VIDEO, TEXT, BINARY, STILL IMAGES, GRAPHICS AND MULTIMEDIA FILES; COMPUTER SOFTWARE TO AUTOMATE DATA WAREHOUSING; DESKTOP PUBLISHING SOFTWARE; ENTERPRISE SOFTWARE IN THE NATURE OF A DATABASE FOR NON-TRANSACTIONAL DATA AND A SEARCH ENGINE FOR DATABASE CONTENT; COMPUTER SOFTWARE FOR COMPUTER SYSTEM AND APPLICATION DEVELOPMENT, DEPLOYMENT AND MANAGEMENT, IN CLASS 9 (U.S. CLS. 21, 23, 26, 36 AND 38).

FIRST USE 10-8-2007; IN COMMERCE 10-8-2007.

THE MARK CONSISTS OF STANDARD CHARACTERS WITHOUT CLAIM TO ANY PARTICULAR FONT, STYLE, SIZE, OR COLOR.

SER. NO. 77-302,621, FILED 10-12-2007.

NATALIE POLZER, EXAMINING ATTORNEY

Int. Cl.: 35

Prior U.S. Cls.: 100, 101 and 102

United States Patent and Trademark Office

Reg. No. 3,479,540

Registered Aug. 5, 2008

**SERVICE MARK
PRINCIPAL REGISTER**

BARNETT

INTERLINE BRANDS, INC. (NEW JERSEY CORPORATION)
801 W. BAY STREET
JACKSONVILLE, FL 32204

FOR: CATALOG ORDERING SERVICES VIA MAIL, TELEPHONE AND FACSIMILE FEATURING HARDWARE, PLUMBING, HVAC, ELECTRICAL AND GENERAL HARDWARE ITEMS AND SUPPLIES, IN CLASS 35 (U.S. CLS. 100, 101 AND 102).

FIRST USE 1-31-1975; IN COMMERCE 1-31-1975.

THE MARK CONSISTS OF STANDARD CHARACTERS WITHOUT CLAIM TO ANY PARTICULAR FONT, STYLE, SIZE, OR COLOR.

SEC. 2(F).

SER. NO. 77-302,705, FILED 10-12-2007.

BENJAMIN OKEKE, EXAMINING ATTORNEY

Int. Cl.: 3

Prior U.S. Cls.: 1, 4, 6, 50, 51 and 52

United States Patent and Trademark Office

Reg. No. 3,479,541

Registered Aug. 5, 2008

**TRADEMARK
PRINCIPAL REGISTER**

LIQUA VERSA-GEL

UNITE EUROTHERAPY, INC. (CALIFORNIA
CORPORATION)
SUITE H
9380 ACTIVITY RD
SAN DIEGO, CA 92126

FOR: HAIR CARE AND HAIR STYLING PRE-
PARATIONS, NAMELY, SHAMPOOS, CONDITION-
ERS, SCULPTING LOTIONS, SCULPTING FOAMS,
STYLING GELS AND SPRAYS, AND WAVING AND
SETTING LOTIONS, IN CLASS 3 (U.S. CLS. 1, 4, 6, 50,
51 AND 52).

FIRST USE 3-31-2005; IN COMMERCE 3-31-2005.

THE MARK CONSISTS OF STANDARD CHAR-
ACTERS WITHOUT CLAIM TO ANY PARTICULAR
FONT, STYLE, SIZE, OR COLOR.

SER. NO. 77-302,880, FILED 10-12-2007.

CHRISTOPHER BUONGIORNO, EXAMINING AT-
TORNEY

Int. Cls.: 9 and 41

Prior U.S. Cls.: 21, 23, 26, 36, 38, 100, 101 and 107

Reg. No. 3,479,542

United States Patent and Trademark Office

Registered Aug. 5, 2008

**TRADEMARK
SERVICE MARK
PRINCIPAL REGISTER**

NORTHERN LIGHT

DAVID STUART SANDLER (UNITED STATES
INDIVIDUAL)
4816 QUEEN AVENUE SOUTH
MINNEAPOLIS, MN 55410

FOR: AUDIO RECORDINGS FEATURING MU-
SIC, IN CLASS 9 (U.S. CLS. 21, 23, 26, 36 AND 38).

FIRST USE 3-1-1975; IN COMMERCE 3-1-1975.

FOR: ENTERTAINMENT SERVICES BY A MUSI-
CAL GROUP INCLUDING LIVE MUSICAL PER-

FORMANCES, IN CLASS 41 (U.S. CLS. 100, 101 AND
107).

FIRST USE 3-1-1975; IN COMMERCE 3-1-1975.

THE MARK CONSISTS OF STANDARD CHAR-
ACTERS WITHOUT CLAIM TO ANY PARTICULAR
FONT, STYLE, SIZE, OR COLOR.

SER. NO. 77-303,432, FILED 10-12-2007.

HANNO RITTNER, EXAMINING ATTORNEY

Int. Cl.: 7

Prior U.S. Cls.: 13, 19, 21, 23, 31, 34 and 35

Reg. No. 3,479,543

United States Patent and Trademark Office

Registered Aug. 5, 2008

**TRADEMARK
PRINCIPAL REGISTER**

RETSCO

CONTROL FLOW, INC. (TEXAS CORPORATION)
9201 FAIRBANKS N. HOUSTON RD.
HOUSTON, TX 77064

FOR: MOTION COMPENSATION EQUIPMENT,
NAMELY, RISER TENSIONERS DRILL STRING
COMPENSATORS JACK-UP RIGS FOR USE IN
THE MARITIME INDUSTRY, IN CLASS 7 (U.S.
CLS. 13, 19, 21, 23, 31, 34 AND 35).

FIRST USE 9-27-2007; IN COMMERCE 9-27-2007.

THE MARK CONSISTS OF STANDARD CHAR-
ACTERS WITHOUT CLAIM TO ANY PARTICULAR
FONT, STYLE, SIZE, OR COLOR.

SER. NO. 77-303,482, FILED 10-13-2007.

JENNIFER VASQUEZ, EXAMINING ATTORNEY

Int. Cl.: 31

Prior U.S. Cls.: 1 and 46

United States Patent and Trademark Office

Reg. No. 3,479,544

Registered Aug. 5, 2008

**TRADEMARK
PRINCIPAL REGISTER**

TASTY TWISTS

SVOBODNY, RAY D. (UNITED STATES INDIVIDUAL)

P.O. BOX 390352

EDINA, MN 55439

FOR: EDIBLE DOG TREATS; DOG FOOD, IN CLASS 31 (U.S. CLS. 1 AND 46).

FIRST USE 5-13-2002; IN COMMERCE 5-13-2002.

THE MARK CONSISTS OF STANDARD CHARACTERS WITHOUT CLAIM TO ANY PARTICULAR FONT, STYLE, SIZE, OR COLOR.

OWNER OF U.S. REG. NO. 2,701,571.

SEC. 2(F).

SER. NO. 77-303,713, FILED 10-15-2007.

LINDA ESTRADA, EXAMINING ATTORNEY

Int. Cl.: 28

Prior U.S. Cls.: 22, 23, 38 and 50

United States Patent and Trademark Office

Reg. No. 3,479,545

Registered Aug. 5, 2008

**TRADEMARK
PRINCIPAL REGISTER**

WHOOPS

FUNDEX GAMES, LTD. (NEVADA CORPORATION)
2920 FORTUNE CIRCLE WEST
INDIANAPOLIS, IN 46241

THE MARK CONSISTS OF STANDARD CHARACTERS WITHOUT CLAIM TO ANY PARTICULAR FONT, STYLE, SIZE, OR COLOR.

FOR: ACTIVITY SKILL GAMES, NAMELY, BALANCING STONES AND INSTRUCTIONS SOLD AS A UNIT, IN CLASS 28 (U.S. CLS. 22, 23, 38 AND 50).

SER. NO. 77-304,196, FILED 10-15-2007.

FIRST USE 10-10-2007; IN COMMERCE 10-10-2007.

LYDIA BELZER, EXAMINING ATTORNEY

Int. Cls.: 1, 6, 7 and 8

**Prior U.S. Cls.: 1, 2, 5, 6, 10, 12, 13, 14, 19, 21, 23, 25,
26, 28, 31, 34, 35, 44, 46 and 50**

Reg. No. 3,479,546

United States Patent and Trademark Office

Registered Aug. 5, 2008

**TRADEMARK
PRINCIPAL REGISTER**

CROPCARE

PAULB, LLC (PENNSYLVANIA LTD LIAB CO)
50 WOODCORNER ROAD
LITITZ, PA 17543

FOR: CHEMICALS AS FOAM CONCENTRATE
FOR AGRICULTURAL AND TURF USE, IN CLASS
1 (U.S. CLS. 1, 5, 6, 10, 26 AND 46).

FIRST USE 7-1-1998; IN COMMERCE 7-1-1999.

FOR: HAND-OPERATED METAL GARDEN
HOSE REELS, IN CLASS 6 (U.S. CLS. 2, 12, 13, 14, 23,
25 AND 50).

FIRST USE 7-1-1998; IN COMMERCE 7-1-1999.

FOR: POWER-OPERATED AGRICULTURAL IM-
PLEMENTS, NAMELY, AGRICULTURAL SPRAY-
ERS FOR FIELD, PRODUCE AND ORCHARD,
SHIELDED BOOM SPRAYERS, ATV SPRAYERS,
MULTI-PURPOSE SPOT SPRAYERS, FOAM MAR-
KERS FOR ATTACHMENT TO POWER-OPERATED

SPRAYERS, PLANTERS AND SEED DRILLS, LI-
QUID INOCULANT APPLICATORS, MULTI-PUR-
POSE ENGINE-DRIVEN PRESSURE WASHERS,
PLASTIC MULCH AND DRIP TAPE LIFTER AND
WRAPPER, GAS ENGINE AND ELECTRIC MOTOR
DRIVEN PRESSURE WASHERS, IN CLASS 7 (U.S.
CLS. 13, 19, 21, 23, 31, 34 AND 35).

FIRST USE 7-1-1998; IN COMMERCE 7-1-1999.

FOR: HAND-OPERATED AGRICULTURAL IM-
PLEMENTS, NAMELY, MULTI-PURPOSE SPOT
SPRAYERS, IN CLASS 8 (U.S. CLS. 23, 28 AND 44).

FIRST USE 7-1-1998; IN COMMERCE 7-1-1999.

SEC. 2(F).

SER. NO. 77-304,262, FILED 10-15-2007.

LINDSEY RUBIN, EXAMINING ATTORNEY

Int. Cl.: 35

Prior U.S. Cls.: 100, 101 and 102

United States Patent and Trademark Office

Reg. No. 3,479,547

Registered Aug. 5, 2008

SERVICE MARK
PRINCIPAL REGISTER



PAULB, LLC (PENNSYLVANIA LTD LIAB CO)
50 WOODCORNER ROAD
LITITZ, PA 17543

FOR: RETAIL HARDWARE STORE SERVICES AVAILABLE THROUGH WALK-IN, ON-LINE, TELEPHONE AND MAIL ORDERING, FEATURING A WIDE VARIETY OF HARDWARE SUPPLIES, BUILDING AND CONSTRUCTION SUPPLIES, PAINTING SUPPLIES, PLUMBING SUPPLIES, ELECTRICAL SUPPLIES, AUTOMOTIVE SUPPLIES, HOUSE-WARE SUPPLIES, LAWN AND GARDEN SUPPLIES AND EQUIPMENT, AGRICULTURE AND FARM SUPPLIES AND EQUIPMENT, HAND AND POWER IMPLEMENTS AND TOOLS, GENERATORS, AIR COMPRESSORS, WELDERS AND ACCESSORIES, STORAGE TANKS, SPRAYING DE-

VICES, FASTENERS, IN CLASS 35 (U.S. CLS. 100, 101 AND 102).

FIRST USE 10-1-2006; IN COMMERCE 12-15-2006.

THE NAME PAULB DOES NOT IDENTIFY A LIVING INDIVIDUAL.

THE MARK CONSISTS OF MAN PUSHING WHEELBARROW FILLED WITH HARDWARE ITEMS NEXT TO UNDERLINED LETTERS "PAULB".

SER. NO. 77-304,380, FILED 10-15-2007.

LINDSEY RUBIN, EXAMINING ATTORNEY

Int. Cl.: 41

Prior U.S. Cls.: 100, 101 and 107

United States Patent and Trademark Office

Reg. No. 3,479,548

Registered Aug. 5, 2008

**SERVICE MARK
PRINCIPAL REGISTER**

**American Cash Flow
Institute ACFI**

AMERICAN CASH FLOW CORPORATION
(FLORIDA CORPORATION)
SUITE 600
255 S. ORANGE AVENUE
ORLANDO, FL 32801

FOR: EDUCATIONAL SERVICES IN THE NATURE OF TRAINING THROUGH CLASSROOM AND HOME STUDY PROGRAMS DESIGNED TO EDUCATE OTHERS CONCERNING THE CASH FLOW INDUSTRY AND DISTRIBUTING TRAINING MATERIALS IN CONNECTION THEREWITH, IN CLASS 41 (U.S. CLS. 100, 101 AND 107).

FIRST USE 3-1-1998; IN COMMERCE 3-1-1998.

THE MARK CONSISTS OF STANDARD CHARACTERS WITHOUT CLAIM TO ANY PARTICULAR FONT, STYLE, SIZE, OR COLOR.

OWNER OF U.S. REG. NO. 2,604,618.

NO CLAIM IS MADE TO THE EXCLUSIVE RIGHT TO USE "AMERICAN CASH FLOW INSTITUTE", APART FROM THE MARK AS SHOWN.

SER. NO. 77-304,880, FILED 10-16-2007.

SHAUNIA CARLYLE, EXAMINING ATTORNEY

Int. Cl.: 41

Prior U.S. Cls.: 100, 101 and 107

United States Patent and Trademark Office

Reg. No. 3,479,549

Registered Aug. 5, 2008

**SERVICE MARK
PRINCIPAL REGISTER**

MISS AMERICAN STATES

EFFIE HORNING (UNITED STATES INDIVIDUAL)
3888 CAMEO DR
OCEANSIDSE, CA 92056

OWNER OF U.S. REG. NO. 2,388,769.

FOR: ENTERTAINMENT IN THE NATURE OF BEAUTY AND SCHOLARSHIP PAGEANTS, IN CLASS 41 (U.S. CLS. 100, 101 AND 107).

NO CLAIM IS MADE TO THE EXCLUSIVE RIGHT TO USE "AMERICAN STATES", APART FROM THE MARK AS SHOWN.

FIRST USE 9-1-1999; IN COMMERCE 9-1-1999.

SER. NO. 77-305,085, FILED 10-16-2007.

THE MARK CONSISTS OF STANDARD CHARACTERS WITHOUT CLAIM TO ANY PARTICULAR FONT, STYLE, SIZE, OR COLOR.

INGRID C. EULIN, EXAMINING ATTORNEY

Int. Cl.: 11

Prior U.S. Cls.: 13, 21, 23, 31 and 34

Reg. No. 3,479,550

United States Patent and Trademark Office

Registered Aug. 5, 2008

**TRADEMARK
PRINCIPAL REGISTER**

OCTOPUS

VUE TECHNOLOGY LLC (LOUISIANA LTD
LIAB CO)
38190 COMMERCIAL CT.
SLIDELL, LA 70458

THE MARK CONSISTS OF STANDARD CHAR-
ACTERS WITHOUT CLAIM TO ANY PARTICULAR
FONT, STYLE, SIZE, OR COLOR.

FOR: WATER FILTRATION SYSTEMS FOR
AQUARIUMS, NAMELY, PROTEIN SKIMMERS
AND CALCIUM REACTORS, IN CLASS 11 (U.S.
CLS. 13, 21, 23, 31 AND 34).

SER. NO. 77-305,172, FILED 10-16-2007.

FIRST USE 6-30-2005; IN COMMERCE 6-30-2005.

AHSEN KHAN, EXAMINING ATTORNEY

Int. Cl.: 5

Prior U.S. Cls.: 6, 18, 44, 46, 51 and 52

Reg. No. 3,479,551

United States Patent and Trademark Office

Registered Aug. 5, 2008

**TRADEMARK
PRINCIPAL REGISTER**

NX PAIN FORMULA

PHYSICIAN'S SCIENCE & NATURE, INC. (CALI-
FORNIA CORPORATION)
STE. 634
537 NEWPORT CENTER DRIVE
NEWPORT COAST, CA 92660

FOR: TOPICAL ANALGESIC, IN CLASS 5 (U.S.
CLS. 6, 18, 44, 46, 51 AND 52).

FIRST USE 10-31-2006; IN COMMERCE 1-30-2007.

THE MARK CONSISTS OF STANDARD CHAR-
ACTERS WITHOUT CLAIM TO ANY PARTICULAR
FONT, STYLE, SIZE, OR COLOR.

NO CLAIM IS MADE TO THE EXCLUSIVE
RIGHT TO USE "PAIN FORMULA", APART FROM
THE MARK AS SHOWN.

SER. NO. 77-305,765, FILED 10-17-2007.

NAAKWAMA ANKRAH, EXAMINING ATTORNEY

Int. Cl.: 7

Prior U.S. Cls.: 13, 19, 21, 23, 31, 34 and 35

Reg. No. 3,479,552

United States Patent and Trademark Office

Registered Aug. 5, 2008

**TRADEMARK
PRINCIPAL REGISTER**

MIDWEST INTERNATIONAL

MIDWEST INTERNATIONAL STANDARD PRO-
DUCTS, INC. (DELAWARE CORPORATION)

105 STOVER ROAD

CHARLEVOIX, MI 497200438

FOR: BULK LOADING MACHINES, IN CLASS 7
(U.S. CLS. 13, 19, 21, 23, 31, 34 AND 35).

FIRST USE 4-0-1974; IN COMMERCE 4-0-1974.

THE MARK CONSISTS OF STANDARD CHAR-
ACTERS WITHOUT CLAIM TO ANY PARTICULAR
FONT, STYLE, SIZE, OR COLOR.

NO CLAIM IS MADE TO THE EXCLUSIVE
RIGHT TO USE "MIDWEST", APART FROM THE
MARK AS SHOWN.

SER. NO. 77-305,769, FILED 10-17-2007.

DANIEL CAPSHAW, EXAMINING ATTORNEY

Int. Cl.: 11

Prior U.S. Cls.: 13, 21, 23, 31 and 34

United States Patent and Trademark Office

Reg. No. 3,479,553

Registered Aug. 5, 2008

**TRADEMARK
PRINCIPAL REGISTER**

REEFLUX

VUE TECHNOLOGY LLC (LOUISIANA LTD
LIAB CO)
38190 COMMERCIAL CT
SLIDELL, LA 70458

THE MARK CONSISTS OF STANDARD CHAR-
ACTERS WITHOUT CLAIM TO ANY PARTICULAR
FONT, STYLE, SIZE, OR COLOR.

FOR: AQUARIUM LIGHTS, IN CLASS 11 (U.S.
CLS. 13, 21, 23, 31 AND 34).

SER. NO. 77-305,880, FILED 10-17-2007.

FIRST USE 8-30-2005; IN COMMERCE 8-30-2005.

AHSEN KHAN, EXAMINING ATTORNEY

Int. Cls.: 25 and 41

Prior U.S. Cls.: 22, 39, 100, 101 and 107

Reg. No. 3,479,554

United States Patent and Trademark Office

Registered Aug. 5, 2008

**TRADEMARK
SERVICE MARK
PRINCIPAL REGISTER**



EVANS, TAMIKO (UNITED STATES INDIVIDUAL)
906 CARNEGIE AVENUE
PLAINFIELD, NJ 07060

FOR: BELTS; CAPS; CHILDREN'S AND INFANTS' CLOTH BIBS; CLOTHING, NAMELY, FOLK COSTUMES; CLOTHING, NAMELY, WRAP-AROUNDS; HOODS; INFANT AND TODDLER ONE PIECE CLOTHING; JERSEYS; LEATHER BELTS; PERSPIRATION ABSORBENT UNDERWEAR CLOTHING; SHORT SETS; SWADDLING CLOTHES; TOPS; WRAPS; A-SHIRTS; DRESS SHIRTS; GOLF SHIRTS; KNIT SHIRTS; POLO SHIRTS; RUGBY SHIRTS; SHIRTS; SHIRTS FOR SUITS; BALLOON PANTS; CAPRI PANTS; CARGO PANTS; DENIMS; JOGGING PANTS; LEATHER PANTS; LOUNGE PANTS; PANTS; COATS FOR MEN AND WOMEN; HATS, IN CLASS 25 (U.S. CLS. 22 AND 39).

FIRST USE 10-16-2007; IN COMMERCE 10-16-2007.

FOR: ORGANIZING AND CONDUCTING A RUNNING EVENT THE PROCEEDS OF WHICH ARE DONATED TO CHARITY; COMPUTER EDUCATION TRAINING; COMPUTER EDUCATION TRAINING SERVICES; DEVELOPMENT AND DISSEMINATION OF EDUCATIONAL MATERIALS OF OTHERS IN THE FIELD OF LEADERSHIP; EDUCATING AT SENIOR HIGH SCHOOLS; EDUCATION SERVICES, NAMELY, MENTORING IN THE FIELD OF LEADERSHIP; EDUCATION SERVICES, NAMELY, PROVIDING CLASSES, SEMINARS,

WORKSHOPS, TUTORING, AND MENTORING IN THE FIELD OF MIDDLE AND HIGH SCHOOL REFORM; EDUCATION SERVICES, NAMELY, PROVIDING LIVE AND ON-LINE COURSES AND SEMINARS IN THE FIELD OF LEADERSHIP; EDUCATIONAL PROGRAMS, NAMELY, PRESCHOOLS; INFORMATION IN THE FIELD OF PARENTING CONCERNING EDUCATION OF CHILDREN; PROVIDING ADVICE AND INFORMATION IN THE FIELD OF EDUCATIONAL AND ENTERTAINMENT ACTIVITIES AND EVENTS FOR CHILDREN; PROVIDING AFTER SCHOOL EDUCATIONAL PROGRAMS FOR CHILDREN IN GRADES K-12; PROVIDING CONTINUING BUSINESS EDUCATION COURSES; ARRANGING AND CONDUCTING EDUCATIONAL CONFERENCES; CAREER COUNSELING; CHARITABLE SERVICES, NAMELY, ACADEMIC MENTORING OF SCHOOL AGE CHILDREN; EDUCATION SERVICES, NAMELY, ONE-ON-ONE MENTORING IN THE FIELD OF CAREER AND PERSONAL DEVELOPMENT, IN CLASS 41 (U.S. CLS. 100, 101 AND 107).

FIRST USE 10-16-2007; IN COMMERCE 10-16-2007.

THE MARK CONSISTS OF SILOUETTE OF TWO WOMEN ABOVE AN OPENING FLOWER ABOVE THE WORDS.

SER. NO. 77-306,365, FILED 10-17-2007.

CHRISTINE COOPER, EXAMINING ATTORNEY

Int. Cls.: 35, 36, 37, 41, 42 and 43

Prior U.S. Cls.: 100, 101, 102, 103, 106 and 107

United States Patent and Trademark Office

Reg. No. 3,479,555

Registered Aug. 5, 2008

**SERVICE MARK
PRINCIPAL REGISTER**

READESIGN

THE HEART OF AMERICA FOUNDATION (D.C.
NON-PROFIT CORPORATION)
401 F STREET NW, SUITE 325
WASHINGTON, DC 20001

FOR: PROMOTING PUBLIC AWARENESS OF
THE NEED TO DONATE MONEY, TIME, AND IN-
KIND CONTRIBUTIONS TO SCHOOL LIBRARIES
AND RESOURCE CENTERS THAT SERVE LOW-
INCOME STUDENTS, IN CLASS 35 (U.S. CLS. 100,
101 AND 102).

FIRST USE 2-0-2006; IN COMMERCE 2-0-2006.

FOR: CHARITABLE SERVICES, NAMELY, AC-
CEPTING AND ADMINISTRATING MONETARY
AND IN-KIND CONTRIBUTIONS TO SCHOOLS, IN
CLASS 36 (U.S. CLS. 100, 101 AND 102).

FIRST USE 2-0-2006; IN COMMERCE 2-0-2006.

FOR: CONSTRUCTION AND RENOVATION OF
SCHOOL LIBRARIES AND RESOURCE CENTERS
THAT SERVE LOW-INCOME STUDENTS, IN CLASS
37 (U.S. CLS. 100, 103 AND 106).

FIRST USE 2-0-2006; IN COMMERCE 2-0-2006.

FOR: DONATING BOOKS AND SCHOOL SUP-
PLIES TO SCHOOL LIBRARIES, IN CLASS 41 (U.S.
CLS. 100, 101 AND 107).

FIRST USE 2-0-2006; IN COMMERCE 2-0-2006.

FOR: DONATING COMPUTERS AND COMPU-
TER SOFTWARE TO SCHOOL LIBRARIES; DE-
SIGNING AND DECORATING SCHOOL
LIBRARIES AND RESOURCE CENTERS THAT
SERVE LOW-INCOME STUDENTS, IN CLASS 42
(U.S. CLS. 100 AND 101).

FIRST USE 2-0-2006; IN COMMERCE 2-0-2006.

FOR: DONATING FURNITURE TO SCHOOL
LIBRARIES, IN CLASS 43 (U.S. CLS. 100 AND 101).

FIRST USE 2-0-2006; IN COMMERCE 2-0-2006.

THE MARK CONSISTS OF STANDARD CHAR-
ACTERS WITHOUT CLAIM TO ANY PARTICULAR
FONT, STYLE, SIZE, OR COLOR.

SER. NO. 77-306,533, FILED 10-17-2007.

LAURIE KAUFMAN, EXAMINING ATTORNEY

Int. Cl.: 11

Prior U.S. Cls.: 13, 21, 23, 31 and 34

United States Patent and Trademark Office

Reg. No. 3,479,556

Registered Aug. 5, 2008

**TRADEMARK
PRINCIPAL REGISTER**

CORALVUE

VUE TECHNOLOGY LLC (LOUISIANA LTD
LIAB CO)
38190 COMMERCIAL CT
SLIDELL, LA 70458

THE MARK CONSISTS OF STANDARD CHAR-
ACTERS WITHOUT CLAIM TO ANY PARTICULAR
FONT, STYLE, SIZE, OR COLOR.

FOR: AQUARIUM LIGHTS, IN CLASS 11 (U.S.
CLS. 13, 21, 23, 31 AND 34).

SER. NO. 77-306,785, FILED 10-17-2007.

FIRST USE 5-30-2003; IN COMMERCE 5-30-2003.

AHSEN KHAN, EXAMINING ATTORNEY

Int. Cl.: 37

Prior U.S. Cls.: 100, 103 and 106

Reg. No. 3,479,557

United States Patent and Trademark Office

Registered Aug. 5, 2008

**SERVICE MARK
PRINCIPAL REGISTER**

HERITAGE SOLAR

HERITAGE SOLAR, INC. (CALIFORNIA CORPORATION)
75 MAYFAIR
ALISO VIEJO, CA 92656

FOR: INSTALLATION, MAINTENANCE AND REPAIR OF SOLAR PHOTOVOLTAIC SYSTEMS, SOLAR HOT WATER SYSTEMS, SOLAR POOL SYSTEMS, IN CLASS 37 (U.S. CLS. 100, 103 AND 106).

FIRST USE 12-1-2005; IN COMMERCE 1-6-2006.

THE MARK CONSISTS OF STANDARD CHARACTERS WITHOUT CLAIM TO ANY PARTICULAR FONT, STYLE, SIZE, OR COLOR.

NO CLAIM IS MADE TO THE EXCLUSIVE RIGHT TO USE "SOLAR", APART FROM THE MARK AS SHOWN.

SER. NO. 77-306,824, FILED 10-17-2007.

AMY MCMENAMIN, EXAMINING ATTORNEY

Int. Cl.: 37

Prior U.S. Cls.: 100, 103 and 106

United States Patent and Trademark Office

Reg. No. 3,479,558

Registered Aug. 5, 2008

**SERVICE MARK
PRINCIPAL REGISTER**

Electric Elves

GUTTERSUCKERS, INC. (WASHINGTON CORPORATION)
800 5TH AVENUE, SUITE 101
SEATTLE, WA 98104

FOR: ELECTRICAL REPAIRS AND INSTALLATION OF HOLIDAY LIGHTING, IN CLASS 37 (U.S. CLS. 100, 103 AND 106).

FIRST USE 10-15-2005; IN COMMERCE 10-15-2005.

THE MARK CONSISTS OF STANDARD CHARACTERS WITHOUT CLAIM TO ANY PARTICULAR FONT, STYLE, SIZE, OR COLOR.

SER. NO. 77-306,920, FILED 10-18-2007.

KATHERINE CONNOLLY, EXAMINING ATTORNEY

Int. Cl.: 41

Prior U.S. Cls.: 100, 101 and 107

United States Patent and Trademark Office

Reg. No. 3,479,559

Registered Aug. 5, 2008

**SERVICE MARK
PRINCIPAL REGISTER**



AMERICAN COUNCIL ON EDUCATION (D.C.
CORPORATION)
ONE DUPONT CIRCLE, N.W.
WASHINGTON, DC 20036

FOR: EDUCATIONAL SERVICES, NAMELY,
CONDUCTING PROGRAMS IN THE FIELD OF
INTERNATIONAL DEVELOPMENT, IN CLASS 41
(U.S. CLS. 100, 101 AND 107).

FIRST USE 11-10-2005; IN COMMERCE 11-10-2005.

NO CLAIM IS MADE TO THE EXCLUSIVE
RIGHT TO USE "HIGHER EDUCATION FOR DE-
VELOPMENT", APART FROM THE MARK AS
SHOWN.

THE COLOR(S) GRAY, WHITE, GREEN, AND
BLUE IS/ARE CLAIMED AS A FEATURE OF THE
MARK.

THE MARK CONSISTS OF THE LETTERS "HED"
IN GREEN, THE WORDING "HIGHER EDUCA-
TION FOR DEVELOPMENT" IN BLUE, AND A
WHITE GLOBE DESIGN WITH A GRAY BORDER
AND GRAY CONTINENTS INSIDE THE BORDER.

SER. NO. 77-307,030, FILED 10-18-2007.

ELI HELLMAN, EXAMINING ATTORNEY

Int. Cl.: 43

Prior U.S. Cls.: 100 and 101

United States Patent and Trademark Office

Reg. No. 3,479,560

Registered Aug. 5, 2008

**SERVICE MARK
PRINCIPAL REGISTER**



CHAIR COVERS & LINENS, INC. (MICHIGAN CORPORATION)
25914 JOHN R ROAD
MADISON HEIGHTS, MI 48071

FOR: RENTAL OF CHAIR COVERS, LINENS, CHAIRS AND CHARGER PLATES, IN CLASS 43 (U.S. CLS. 100 AND 101).

FIRST USE 7-1-2007; IN COMMERCE 7-1-2007.

NO CLAIM IS MADE TO THE EXCLUSIVE RIGHT TO USE "CHAIR COVERS & LINENS", APART FROM THE MARK AS SHOWN.

THE MARK CONSISTS OF A GRAPHIC DESIGN OF A CHAIR WITH A SOLID HALF LINE ENCIRCLING TO THE LEFT AND THE WORDS "CHAIR COVERS & LINENS" ARCHED TO THE LEFT OF DESIGN.

SER. NO. 77-307,160, FILED 10-18-2007.

MARTHA FROMM, EXAMINING ATTORNEY

Int. Cl.: 25

Prior U.S. Cls.: 22 and 39

United States Patent and Trademark Office

Reg. No. 3,479,561

Registered Aug. 5, 2008

**TRADEMARK
PRINCIPAL REGISTER**

peace love life

BRAD GREEN (UNITED STATES INDIVIDUAL)
918 21ST #3
SAN DIEGO, CA 92102

FOR: SHORT SLEEVE AND LONG SLEEVE T-SHIRTS, HATS AND HEADGEAR, NAMELY, BASEBALL CAPS, SKULL CAPS AND TOBOGGAN HATS, AND OTHER CLOTHING ITEMS, NAMELY, JACKETS, PANTS, SWEATSHIRTS, HOODED SWEATSHIRTS AND ZIP-FRONT HOODED SWEATSHIRTS, IN CLASS 25 (U.S. CLS. 22 AND 39).

FIRST USE 1-1-2007; IN COMMERCE 8-1-2007.

THE MARK CONSISTS OF STANDARD CHARACTERS WITHOUT CLAIM TO ANY PARTICULAR FONT, STYLE, SIZE, OR COLOR.

OWNER OF U.S. REG. NOS. 3,353,105 AND 3,402,390.

SER. NO. 77-307,345, FILED S.R. 10-18-2007 AM.
P.R. 4-2-2008.

ANNE E. GUSTASON, EXAMINING ATTORNEY

Int. Cl.: 35

Prior U.S. Cls.: 100, 101 and 102

United States Patent and Trademark Office

Reg. No. 3,479,562

Registered Aug. 5, 2008

**SERVICE MARK
PRINCIPAL REGISTER**

JOBOJA

PARKER, II, WILLIAM M. (UNITED STATES
INDIVIDUAL)
9116 S. YATES BLVD.
CHICAGO, IL 60617

FOR: PROVIDING AN ON-LINE COMPUTER
DATABASE VIA THE INTERNET IN THE FIELD
OF CAREER INFORMATION AND PROVIDING A
WEBSITE THAT ENABLES USERS TO POST THEIR
JOB QUALIFICATIONS AND EXPERIENCE USING
A VARIETY OF MEDIA, IN CLASS 35 (U.S. CLS. 100,
101 AND 102).

FIRST USE 10-7-2007; IN COMMERCE 10-7-2007.

THE MARK CONSISTS OF STANDARD CHAR-
ACTERS WITHOUT CLAIM TO ANY PARTICULAR
FONT, STYLE, SIZE, OR COLOR.

SER. NO. 77-307,514, FILED 10-18-2007.

CHRISTINA SOBRAL, EXAMINING ATTORNEY

Int. Cl.: 45

Prior U.S. Cls.: 100 and 101

United States Patent and Trademark Office

Reg. No. 3,479,563

Registered Aug. 5, 2008

**SERVICE MARK
PRINCIPAL REGISTER**

Medi-Law Solutions, LLC

MEDI-LAW SOLUTIONS (NEW JERSEY LTD
LIAB CO)
784 MORRIS TURNPIKE #221
SHORT HILLS, NJ 07078

FOR: CONSULTING SERVICES CONCERNING
LEGAL MATTERS IN THE FIELD OF NURSING
AND MEDICINE, IN CLASS 45 (U.S. CLS. 100 AND
101).

FIRST USE 11-13-2003; IN COMMERCE 11-13-2003.

THE MARK CONSISTS OF STANDARD CHAR-
ACTERS WITHOUT CLAIM TO ANY PARTICULAR
FONT, STYLE, SIZE, OR COLOR.

NO CLAIM IS MADE TO THE EXCLUSIVE
RIGHT TO USE "SOLUTIONS, LLC", APART FROM
THE MARK AS SHOWN.

SER. NO. 77-307,842, FILED 10-18-2007.

REBECCA EISINGER, EXAMINING ATTORNEY

Int. Cl.: 38

Prior U.S. Cls.: 100, 101 and 104

United States Patent and Trademark Office

Reg. No. 3,479,564

Registered Aug. 5, 2008

**SERVICE MARK
PRINCIPAL REGISTER**

NEVER MISS A STORY

SPOKANE TELEVISION, INC. (WASHINGTON
CORPORATION)
500 WEST BOONE AVENUE
SPOKANE, WA 99201

THE MARK CONSISTS OF STANDARD CHAR-
ACTERS WITHOUT CLAIM TO ANY PARTICULAR
FONT, STYLE, SIZE, OR COLOR.

FOR: TELEVISION BROADCASTING, IN CLASS
38 (U.S. CLS. 100, 101 AND 104).

SER. NO. 77-308,159, FILED 10-19-2007.

FIRST USE 6-6-2007; IN COMMERCE 6-6-2007.

BARBARA GAYNOR, EXAMINING ATTORNEY

Int. Cls.: 35 and 45

Prior U.S. Cls.: 100, 101 and 102

United States Patent and Trademark Office

Reg. No. 3,479,565

Registered Aug. 5, 2008

**SERVICE MARK
PRINCIPAL REGISTER**

Gittel on the Go

GITTEL ON THE GO, INC. (CALIFORNIA CORPORATION)

#602

14320 VENTURA BOULEVARD
SHERMAN OAKS, CA 91423

FOR: ADDRESSING OF ENVELOPES, ADMINISTRATION, BILLING AND RECONCILIATION OF ACCOUNTS ON BEHALF OF OTHERS, ADMINISTRATIVE PROCESSING OF PURCHASE ORDERS, APPOINTMENT SCHEDULING SERVICES, ARRANGING AND CONDUCTING BUSINESS CONFERENCES, ARRANGING AND CONDUCTING MARKETING PROMOTIONAL EVENTS FOR OTHERS, ARRANGING AND CONDUCTING OF FAIRS AND EXHIBITIONS FOR BUSINESS AND ADVERTISING PURPOSES, ARRANGING AND CONDUCTION OF AUCTION SALES, ARRANGING FOR OTHERS THE REPAIR AND REPLACEMENT OF RESIDENTIAL APPLIANCES, HOME SECURITY SYSTEMS AND CONSUMER GOODS, ARRANGING FOR PICKUP, DELIVERY, STORAGE AND TRANSPORTATION OF DOCUMENTS, PACKAGES, FREIGHT AND PARCELS VIA GROUND AND AIR CARRIERS, ARRANGING OF CONTRACTUAL SERVICES WITH THIRD PARTIES, ARRANGING OF SUBSCRIPTIONS FOR THE PUBLICATIONS OF OTHERS, ARRANGING PERSONAL APPEARANCES BY PERSONS WORKING IN THE FIELD OF FILM, MUSIC, TELEVISION, ENTERTAINMENT OR SPORT, ARRANGING SUBSCRIPTIONS TO TELECOMMUNICATION SERVICES, ARRANGING THE TRANSPORT OF VEHICLES OF INSURED PARTIES ON BEHALF OF THEIR INSURANCE COMPANIES FOR RESOLUTION OF INSURANCE CLAIMS, ASSISTANCE IN MANAGEMENT OF BUSINESS ACTIVITIES, ASSISTANCE TO INDUSTRIAL OR COMMERCIAL ENTERPRISES IN THE RUNNING OF THEIR BUSINESS, ASSISTANCE WITH BUSINESS MANAGEMENT AND PLANNING, ASSISTANCE, ADVISORY SERVICES AND CONSULTANCY WITH REGARD

TO BUSINESS PLANNING, BUSINESS ANALYSIS, BUSINESS MANAGEMENT, AND BUSINESS ORGANIZATION, BUSINESS ADMINISTRATION AND MANAGEMENT, BUSINESS ADMINISTRATION AND OFFICE WORK, BUSINESS DEVELOPMENT SERVICES, NAMELY, PROVIDING START-UP SUPPORT FOR BUSINESSES OF OTHERS, BUSINESS MANAGEMENT ASSISTANCE AND PARTICULARLY CARRYING OUT TASKS NECESSARY FOR THE SMOOTH CONDUCT OF SALES BY AUCTION, BUSINESS MANAGEMENT ASSISTANCE TO INDUSTRIAL OR COMMERCIAL COMPANIES, BUSINESS MEETING PLANNING, BUSINESS PROCESS OUTSOURCING SERVICES IN THE FIELD OF A WIDE VARIETY OF INDUSTRIES, COMPARISON SHOPPING SERVICES COMPUTERIZED AND CENTRAL FILE MANAGEMENT AND BUSINESS FILE MANAGEMENT, COMPUTERIZED DATABASE MANAGEMENT, COPYING OF DOCUMENTS, COPYING OF DOCUMENTS FOR OTHERS, DATA MANAGEMENT SERVICES FOR USE IN DEBT COLLECTION, NAMELY, ELECTRONIC DATA COLLECTION AND ONLINE CLAIMS MANAGEMENT, DATABASE MANAGEMENT, DESIGN OF ADVERTISING FLYERS FOR OTHERS, DESIGN OF ADVERTISING MATERIALS FOR OTHERS, DEVELOPING AND COORDINATING VOLUNTEER PROJECTS FOR CHARITABLE ORGANIZATIONS, DISTRIBUTION OF PUBLICITY MATERIALS, NAMELY, FLYERS, PROSPECTUSES, BROCHURES, SAMPLES, PARTICULARLY FOR CATALOGUE LONG DISTANCE SALES, DOCUMENT COPYING TASKS, EMPLOYEE RELOCATION AND INFORMATION, EMPLOYMENT AGENCIES, EMPLOYMENT HIRING, RECRUITING, PLACEMENT, STAFFING AND CAREER NETWORKING SERVICES, EMPLOYMENT OUTPLACEMENT SERVICES, EXECUTIVE SEARCH AND PLACEMENT SERVICES, FINANCIAL RECORDS MANAGEMENT, FINANCIAL STATEMENT PREPARATION AND ANALYSIS FOR BUSINESSES, INVENTORY AND SHELF ARRANGEMENT, NAMELY, RE-

PLENISHING AND RESETTING ITEMS FOR SALE, JOB AND PERSONNEL PLACEMENT, JOB PLACEMENT, MAIL SORTING, HANDLING AND RECEIVING, MANAGEMENT AND COMPILATION OF COMPUTERIZED DATABASES, MANAGEMENT AND OPERATION ASSISTANCE TO COMMERCIAL BUSINESSES, MANAGEMENT ASSISTANCE, OFFICE ADMINISTRATION SERVICES, OUTSOURCING IN THE FIELD OF A WIDE VARIETY OF INDUSTRIES, OUTSOURCING SERVICES, FRANCHISING, NAMELY, CONSULTATION AND ASSISTANCE IN BUSINESS MANAGEMENT, ORGANIZATION AND PROMOTION, CORPORATE MANAGEMENT ASSISTANCE, PERSONAL MANAGEMENT SERVICES FOR ENTERTAINERS, PACKAGING ARTICLES TO THE ORDER AND SPECIFICATION OF OTHERS, PAYROLL PREPARATION, PERSONAL MANAGEMENT SERVICES FOR MUSICAL PERFORMERS, PERSONNEL PLACEMENT AND RECRUITMENT, PREPARING FINANCIAL REPORTS FOR OTHERS, PREPARING MAILING LISTS, PREPARING PROMOTIONAL AND MERCHANDISING MATERIAL FOR OTHERS, PROMOTING THE GOODS AND SERVICES OF OTHERS BY PROVIDING A WEBSITE FEATURING COUPONS, REBATES, PRICE-COMPARISON INFORMATION, PRODUCT REVIEWS, LINKS TO THE RETAIL WEBSITES OF OTHERS, AND DISCOUNT INFORMATION, PROVIDING ORGANIZING SERVICES FOR BELONGINGS AND SPACES IN A RESIDENCE OR OFFICE SUCH AS PAPERS AND TIME, PROVIDING ORGANIZING SERVICES FOR INDIVIDUALS AT HOME, IN HOME OFFICES AND IN BUSINESS OFFICES, THAT PROVIDES HELP WITH TIME AND PAPER MANAGEMENT, SALES VOLUME TRACKING FOR OTHERS, SECRETARIAL AND CLERICAL SERVICES, SERVICES COMPRISING THE RECORDING, TRANSCRIPTION, COMPOSITION, COMPILATION AND SYSTEMATIZATION OF WRITTEN COMMUNICATIONS AND RECORDINGS, AS WELL AS THE COMPILATION OF MATHEMATICAL OR STATISTICAL DATA, SERVICES CONSISTING OF THE REGISTRATION, COLLEC-

TION, TRANSCRIPTION, COMPILATION AND SYSTEMIZATION OF WRITTEN COMMUNICATIONS AND DATA, SERVICES WITH REGARD TO PRODUCT PRESENTATION TO THE PUBLIC, SERVING AS A HUMAN RESOURCES DEPARTMENT FOR OTHERS, SHORTHAND SERVICES, TRAVEL MANAGEMENT, WORD PROCESSING, TYPING, TEMPORARY EMPLOYMENT AGENCIES, IN CLASS 35 (U.S. CLS. 100, 101 AND 102).

FIRST USE 2-22-2007; IN COMMERCE 2-22-2007.

FOR: CHAPERONING; CHARITABLE SERVICES, NAMELY, GRANTING WISHES OF DISADVANTAGED CHILDREN; CHARITABLE SERVICES, NAMELY, PROVIDING FLORAL PRODUCTS TO THE ELDERLY AND NEEDY CHILDREN; CHARITABLE SERVICES, NAMELY, PROVIDING CLOTHING TO NEEDY PERSONS; COMPILING INVENTORIES OF PERSONAL ITEMS FOR OTHERS FOR INSURANCE OR SECURITY PURPOSES; HOUSE SITTING; PERSONAL GIFT SELECTION FOR OTHERS; PERSONAL SHOPPING FOR OTHERS; PET SITTING; PREPARATION OF CUSTOMIZED GIFT BASKETS; PREPARATION OF CUSTOMIZED GIFT BASKETS WITH SELECTED ITEMS REGARDING A PARTICULAR OCCASION OR THEME; PROVIDING NON-MEDICAL PERSONAL ASSISTANT SERVICES FOR OTHERS IN THE NATURE OF PLANNING, ORGANIZING, COORDINATING, ARRANGING AND ASSISTING INDIVIDUALS TO PERFORM DAILY TASKS, IN CLASS 45 (U.S. CLS. 100 AND 101).

FIRST USE 2-22-2007; IN COMMERCE 2-22-2007.

THE MARK CONSISTS OF STANDARD CHARACTERS WITHOUT CLAIM TO ANY PARTICULAR FONT, STYLE, SIZE, OR COLOR.

SER. NO. 77-308,530, FILED 10-19-2007.

GIANCARLO CASTRO, EXAMINING ATTORNEY

Int. Cl.: 38

Prior U.S. Cls.: 100, 101 and 104

United States Patent and Trademark Office

Reg. No. 3,479,566

Registered Aug. 5, 2008

SERVICE MARK
PRINCIPAL REGISTER



INDIA BROADCAST LIVE, INC. (DELAWARE CORPORATION)
12327 STANWOOD DRIVE
LOS ANGELES, CA 90066

FOR: INTERNET BROADCASTING SERVICES OF REAL-TIME AUDIO AND AUDIO-VISUAL BROADCASTS RELATING TO INDIA AND INDIAN CULTURE, IN CLASS 38 (U.S. CLS. 100, 101 AND 104).

FIRST USE 3-1-2006; IN COMMERCE 3-1-2006.

OWNER OF U.S. REG. NOS. 3,332,995 AND 3,332,996.

NO CLAIM IS MADE TO THE EXCLUSIVE RIGHT TO USE "INDIA BROADCAST LIVE", APART FROM THE MARK AS SHOWN.

THE COLOR(S) PURPLE, ORANGE, GREEN, BLACK AND WHITE IS/ARE CLAIMED AS A FEATURE OF THE MARK.

THE MARK CONSISTS OF A PURPLE RECTANGLE CONTAINING THE LETTERS "IBL" IN ORANGE, WHITE AND GREEN, RESPECTIVELY, INSIDE WITH THREE LINES OF PURPLE DOTS EMANATING FROM THE TOP AND THE WORDS "INDIA BROADCAST LIVE" IN ORANGE, BLACK AND GREEN, RESPECTIVELY, ARRANGED IN A SEMICIRCLE OVER THE RECTANGLE.

SER. NO. 77-308,994, FILED 10-19-2007.

ADA HAN, EXAMINING ATTORNEY

Int. Cl.: 36

Prior U.S. Cls.: 100, 101 and 102

United States Patent and Trademark Office

Reg. No. 3,479,567

Registered Aug. 5, 2008

**SERVICE MARK
PRINCIPAL REGISTER**



RETIRE D PROFESSIONAL FOOTBALL PLAYERS OF CHICAGO/DOLLARS FOR SCHOLARS, A DIVISION OF SCHOLARSHIP AMERICA, INC. (MINNESOTA CORPORATION)

405 MARVIN WAY
BUFFALO GROVE, IL 60089

FOR: CHARITABLE FUND RAISING, IN CLASS 36 (U.S. CLS. 100, 101 AND 102).

FIRST USE 10-19-2007; IN COMMERCE 10-19-2007.

NO CLAIM IS MADE TO THE EXCLUSIVE RIGHT TO USE "RETIRE D PROFESSIONAL FOOTBALL PLAYERS OF CHICAGO" AND "501C3", APART FROM THE MARK AS SHOWN.

THE COLOR(S) RED, BLUE, BLACK AND GREY IS/ARE CLAIMED AS A FEATURE OF THE MARK.

THE MARK CONSISTS OF AN IMAGE OF THE CHICAGO SKYLINE COMPRISING RED, BLACK AND GREY BUILDINGS AND FOUR RED STARS DISPOSED BETWEEN A PAIR OF ACCRUATE BLUE LINES EXTENDING GENERALLY ABOVE THE CHICAGO SKYLINE, THE CHICAGO SKYLINE BEING GENERALLY CENTERED ABOVE AN IMAGE OF FOOTBALL LACES GENERALLY CENTERED ABOVE THE STYLIZED TERMS "RETIRE D PROFESSIONAL" GENERALLY CENTERED ABOVE STYLIZED TERMS "FOOTBALL PLAYERS" GENERALLY CENTERED ABOVE STYLIZED TERMS "OF CHICAGO" GENERALLY CENTERED ABOVE A RED LINE GENERALLY CENTERED ABOVE STYLIZED TERMS "DOLLARS FOR SCHOLARS 501C3", SAID LACES AND TERMS BEING RED.

SER. NO. 77-309,321, FILED 10-21-2007.

KAPIL BHANOT, EXAMINING ATTORNEY

Int. Cl.: 41

Prior U.S. Cls.: 100, 101 and 107

United States Patent and Trademark Office

Reg. No. 3,479,568

Registered Aug. 5, 2008

**SERVICE MARK
PRINCIPAL REGISTER**

FIND YOURSELF A GOOD MATE

JERKINS JR., FRED (UNITED STATES INDIVIDUAL)
251 ASCHWIND COURT
GALLOWAY, NJ 08205

FOR: ARRANGING OF EXHIBITIONS, SEMINARS AND CONFERENCES; ARRANGING OF SEMINARS; ARRANGING OF SEMINARS AND CONFERENCES; CONDUCTING SEMINARS IN THE FIELD OF ONCOLOGY; CONDUCTING WORKSHOPS AND SEMINARS IN PERSONAL AWARENESS; CONDUCTING WORKSHOPS AND SEMINARS IN SELF AWARENESS; CONDUCTING WORKSHOPS AND SEMINARS IN RELATIONSHIPS AND DATING; EDUCATION SERVICES, NAMELY, PROVIDING CLASSES, SEMINARS, WORKSHOPS, TUTORING, AND MENTORING IN THE FIELD OF MIDDLE AND HIGH SCHOOL REFORM; EDUCATION SERVICES, NAMELY, PROVIDING LIVE AND ON-LINE SEMINARS IN THE FIELD OF RELATIONSHIPS; EDUCATION SERVICES, NAMELY, PROVIDING CONSULTATION IN THE FIELD OF RELATIONSHIPS; EDUCATION

SERVICES, NAMELY, PROVIDING SEMINARS IN THE FIELDS OF RELATIONSHIPS; EDUCATIONAL SERVICES, NAMELY, CONDUCTING SEMINARS IN THE FIELD OF RELATIONSHIPS AND DISTRIBUTION OF COURSE MATERIAL IN CONNECTION THEREWITH; EDUCATIONAL SERVICES, NAMELY, CONDUCTING SEMINARS IN THE FIELD OF RELATIONSHIPS; MEETING AND SEMINAR ARRANGING; WORKSHOPS AND SEMINARS IN THE FIELD OF RELATIONSHIPS, IN CLASS 41 (U.S. CLS. 100, 101 AND 107).

FIRST USE 1-1-2004; IN COMMERCE 1-1-2007.

THE MARK CONSISTS OF STANDARD CHARACTERS WITHOUT CLAIM TO ANY PARTICULAR FONT, STYLE, SIZE, OR COLOR.

SER. NO. 77-309,408, FILED 10-21-2007.

MORGAN WYNNE, EXAMINING ATTORNEY

Int. Cls.: 9, 37 and 42

Prior U.S. Cls.: 21, 23, 26, 36, 38, 100, 101, 103 and 106

Reg. No. 3,479,569

United States Patent and Trademark Office

Registered Aug. 5, 2008

**TRADEMARK
SERVICE MARK
PRINCIPAL REGISTER**

BlueThink

SELVAAG BLUETHINK AS (NORWAY CORPORATION)
POSTBOKS 544 OKERN
0512 OSLO, NORWAY

FOR: COMPUTER SOFTWARE FOR USE IN COMPUTER-AIDED DESIGN IN CONSTRUCTION, BUILDING CONSTRUCTION, AND HOUSE BUILDING AND IN COMPUTER-AIDED DESIGN IN THE INSTALLATION, MAINTENANCE AND REPAIR OF BUILDINGS, HOUSES, SANITARY INSTALLATIONS, ELEVATORS, AND ELECTRIC APPLIANCES, IN CLASS 9 (U.S. CLS. 21, 23, 26, 36 AND 38).

FOR: BUILDING CONSTRUCTION; MAINTENANCE AND REPAIR OF BUILDING CONSTRUCTIONS, HOUSES, AND SANITARY INSTALLATIONS; INSTALLATION, MAINTENANCE AND REPAIR OF ELEVATORS AND ELECTRIC APPLIANCES, IN CLASS 37 (U.S. CLS. 100, 103 AND 106).

FOR: TECHNICAL CONSULTANCY IN THE FIELD OF COMPUTER HARDWARE AND COMPUTER SOFTWARE FOR USE IN CONSTRUCTION, BUILDING CONSTRUCTION, HOUSE BUILDING AND FOR USE IN INSTALLATION, MAINTENANCE AND REPAIR OF BUILDING CONSTRUCTIONS, HOUSES, SANITARY INSTALLATIONS, ELEVATORS AND ELECTRIC APPLIANCES; INSTALLATION, MAINTENANCE AND UPDATING

OF COMPUTER SOFTWARE FOR USE IN CONSTRUCTION, BUILDING CONSTRUCTION, HOUSE BUILDING AND FOR USE IN INSTALLATION, MAINTENANCE AND REPAIR OF BUILDING CONSTRUCTIONS, HOUSES, SANITARY INSTALLATIONS, ELEVATORS AND ELECTRIC APPLIANCES; CREATING AND MAINTAINING WEB SITES FOR OTHERS IN THE FIELD OF CONSTRUCTING, BUILDING CONSTRUCTING AND HOUSE BUILDING; RENTAL OF COMPUTER HARDWARE AND COMPUTER SOFTWARE FOR USE IN CONSTRUCTION, BUILDING CONSTRUCTIONS, HOUSE BUILDING AND FOR USE IN INSTALLATION, MAINTENANCE AND REPAIR OF BUILDING CONSTRUCTIONS, HOUSES, SANITARY INSTALLATIONS, ELEVATORS AND ELECTRIC APPLIANCES, IN CLASS 42 (U.S. CLS. 100 AND 101).

THE MARK CONSISTS OF STANDARD CHARACTERS WITHOUT CLAIM TO ANY PARTICULAR FONT, STYLE, SIZE, OR COLOR.

PRIORITY CLAIMED UNDER SEC. 44(D) ON NORWAY APPLICATION NO. 200711927, FILED 10-5-2007, REG. NO. 244278, DATED 2-14-2008, EXPIRES 2-14-2018.

SER. NO. 77-309,737, FILED 10-22-2007.

KATHLEEN LORENZO, EXAMINING ATTORNEY

Int. Cls.: 16 and 41

Prior U.S. Cls.: 2, 5, 22, 23, 29, 37, 38, 50, 100, 101 and 107

Reg. No. 3,479,570

United States Patent and Trademark Office

Registered Aug. 5, 2008

**TRADEMARK
SERVICE MARK
PRINCIPAL REGISTER**



CONSORTIUM ON READING EXCELLENCE
(CALIFORNIA CORPORATION)
2560 9TH STREET, SUITE 220
BERKELEY, CA 94710

FOR: PRINTED TRAINING AND INSTRUCTIONAL MATERIALS, MANUALS, WORKBOOKS AND HANDBOOKS RELATING TO LITERACY EDUCATION AND MATHEMATICS EDUCATION, IN CLASS 16 (U.S. CLS. 2, 5, 22, 23, 29, 37, 38 AND 50).

FIRST USE 11-17-1997; IN COMMERCE 8-3-1998.

FOR: EDUCATIONAL SERVICES, NAMELY, CONDUCTING CLASSES, WORKSHOPS, INSTITUTES AND SEMINARS IN THE FIELD OF LITERACY EDUCATION AND INSTRUCTION; EDUCATIONAL CONSULTING SERVICES PROVIDED

ON-SITE, IN PERSON, VIA PHONE AND ONLINE RELATING TO LITERACY EDUCATION AND LITERACY INSTRUCTION, IN CLASS 41 (U.S. CLS. 100, 101 AND 107).

FIRST USE 11-19-1997; IN COMMERCE 11-19-1997.

OWNER OF U.S. REG. NOS. 2,292,481, 2,508,906 AND OTHERS.

THE MARK CONSISTS OF THE WORD "CORE", OF WHICH THE LETTER "O" IS IN AN APPLE DESIGN.

SER. NO. 77-309,785, FILED 10-22-2007.

MARY BOAGNI, EXAMINING ATTORNEY

Int. Cl.: 27

Prior U.S. Cls.: 19, 20, 37, 42 and 50

Reg. No. 3,479,571

United States Patent and Trademark Office

Registered Aug. 5, 2008

**TRADEMARK
PRINCIPAL REGISTER**

CLOVER MAT

SUMMIT FLEXIBLE PRODUCTS, LTD. (ORE-
GON CORPORATION)
2425 WEST DOROTHY LANE
DAYTON, OH 45439

FOR: STABLE MATS FOR USE AS ANIMAL
MATTRESSES, IN CLASS 27 (U.S. CLS. 19, 20, 37, 42
AND 50).

FIRST USE 12-31-2004; IN COMMERCE 12-31-2004.

THE MARK CONSISTS OF STANDARD CHAR-
ACTERS WITHOUT CLAIM TO ANY PARTICULAR
FONT, STYLE, SIZE, OR COLOR.

NO CLAIM IS MADE TO THE EXCLUSIVE
RIGHT TO USE "MAT", APART FROM THE MARK
AS SHOWN.

SER. NO. 77-309,797, FILED 10-22-2007.

ANTHONY RINKER, EXAMINING ATTORNEY

Int. Cl.: 35

Prior U.S. Cls.: 100, 101 and 102

United States Patent and Trademark Office

Reg. No. 3,479,572

Registered Aug. 5, 2008

**SERVICE MARK
PRINCIPAL REGISTER**

THUNDER BASH

VARSITY GOLD, INC. (ARIZONA CORPORATION)
SUITE B220
459 NORTH GILBERT ROAD
GILBERT, AZ 85234

FOR: ADMINISTRATION OF A PROGRAM FOR ENABLING PARTICIPANTS TO OBTAIN DISCOUNTS ON GOODS AND RECEIVE IMPROVED SERVICES THROUGH THE ORGANIZATION AND IMPLEMENTATION OF GROUP EVENTS TO PROVIDE FUNDRAISING INCENTIVES; BUSINESS SERVICES FOR ATHLETIC AND ACADEMIC FUNDRAISING PROGRAMS, NAMELY, THE ORGANIZATION AND IMPLEMENTATION OF GROUP

EVENTS TO PROVIDE FUNDRAISING INCENTIVES IN THE DISTRIBUTION OF DISCOUNT CARDS, IN CLASS 35 (U.S. CLS. 100, 101 AND 102).

FIRST USE 0-0-2002; IN COMMERCE 0-0-2002.

THE MARK CONSISTS OF STANDARD CHARACTERS WITHOUT CLAIM TO ANY PARTICULAR FONT, STYLE, SIZE, OR COLOR.

SER. NO. 77-309,806, FILED 10-22-2007.

JUSTINE D. PARKER, EXAMINING ATTORNEY

Int. Cl.: 35

Prior U.S. Cls.: 100, 101 and 102

United States Patent and Trademark Office

Reg. No. 3,479,573

Registered Aug. 5, 2008

**SERVICE MARK
PRINCIPAL REGISTER**



VARSITY GOLD, INC. (ARIZONA CORPORATION)
SUITE B220
459 NORTH GILBERT ROAD
GILBERT, AZ 85234

FOR: BUSINESS SERVICES FOR ATHLETIC AND ACADEMIC FUNDRAISING PROGRAMS, NAMELY, PROMOTING THE GOODS AND SERVICES OF OTHERS THROUGH THE DISTRIBUTION OF DISCOUNT CARDS; ADMINISTRATION OF A DISCOUNT PROGRAM FOR ENABLING PARTICIPANTS TO OBTAIN DISCOUNTS ON GOODS AND RECEIVE IMPROVED SERVICES AS PART OF AN ATHLETIC AND ACADEMIC FUNDRAISING PROGRAM; BUSINESS SERVICES FOR ATHLETIC AND ACADEMIC FUNDRAISING PROGRAMS, NAMELY, PROMOTING THE GOODS AND SERVICES OF OTHERS BY PROVIDING A WEBSITE FEATURING COUPONS, REBATES, PRICE-COMPARISON INFORMATION, PRODUCT REVIEWS, LINKS TO THE RETAIL WEBSITES OF

OTHERS, AND DISCOUNT INFORMATION; BUSINESS SERVICES FOR ATHLETIC AND ACADEMIC FUNDRAISING PROGRAMS, NAMELY, ADMINISTRATION OF A DISCOUNT PROGRAM FOR ENABLING PARTICIPANTS TO OBTAIN DISCOUNTS ON GOODS AND SERVICES THROUGH USE OF A DISCOUNT MEMBERSHIP CARD, IN CLASS 35 (U.S. CLS. 100, 101 AND 102).

FIRST USE 1-1-2002; IN COMMERCE 1-1-2002.

OWNER OF U.S. REG. NOS. 3,362,457 AND 3,368,113.

THE MARK CONSISTS OF THE TERM "VG2" SUBSTANTIALLY WITHIN AN OVAL.

SER. NO. 77-309,844, FILED 10-22-2007.

JUSTINE D. PARKER, EXAMINING ATTORNEY

Int. Cl.: 42

Prior U.S. Cls.: 100 and 101

United States Patent and Trademark Office

Reg. No. 3,479,574

Registered Aug. 5, 2008

**SERVICE MARK
PRINCIPAL REGISTER**

Firebrand Architect

KOSTENKO, CONSTANTIN (UKRAINE INDIVIDUAL)
3000 SPOUT RUN PKWY
ARLINGTON, VA 22201

FOR: CONSULTATION SERVICES IN THE FIELD OF INFORMATION TECHNOLOGY (IT), NAMELY, SOFTWARE ENGINEERING CONSULTING, SOFTWARE DESIGN CONSULTING, SOFTWARE DEVELOPMENT LIFE CYCLE CONSULTING, AND PROVIDING INFORMATION ON SOFTWARE DESIGN; ACCREDITATION SERVICES IN THE FIELD OF INFORMATION TECHNOLOGY (IT), SPECIFICALLY IN THE FIELD OF SOFTWARE DESIGN MATURITY, NAMELY, EVALUATING SOFTWARE TO DETERMINE WHETHER THE SOFTWARE CONFORMS TO AN ESTABLISHED STANDARD

FOR MEETING SPECIFIC BUSINESS PROBLEMS, IN CLASS 42 (U.S. CLS. 100 AND 101).

FIRST USE 9-7-2006; IN COMMERCE 9-7-2006.

THE MARK CONSISTS OF STANDARD CHARACTERS WITHOUT CLAIM TO ANY PARTICULAR FONT, STYLE, SIZE, OR COLOR.

NO CLAIM IS MADE TO THE EXCLUSIVE RIGHT TO USE "ARCHITECT", APART FROM THE MARK AS SHOWN.

SER. NO. 77-309,889, FILED 10-22-2007.

SHAILA SETTLES, EXAMINING ATTORNEY

Int. Cls.: 20 and 24

Prior U.S. Cls.: 2, 13, 22, 25, 32, 42 and 50

United States Patent and Trademark Office

Reg. No. 3,479,575

Registered Aug. 5, 2008

**TRADEMARK
PRINCIPAL REGISTER**

KN LUXURY HOME

KN LTD. (CALIFORNIA CORPORATION)
2505 KERNER BLVD.
SAN RAFAEL, CA 94901

FOR: BED PILLOWS AND DECORATIVE BED
PILLOWS, IN CLASS 20 (U.S. CLS. 2, 13, 22, 25, 32
AND 50).

FIRST USE 7-20-2007; IN COMMERCE 7-20-2007.

FOR: BED SHEETS; BEDDING SETS CONSIST-
ING OF PILLOW SHAMS, COMFORTER AND BED-
SKIRT; WINDOW TREATMENTS, NAMELY,
FABRIC WINDOW PANELS AND FABRIC VALAN-
CES; THROWS; BED BLANKETS; BATH TOWELS;

COMFORTERS; MATTRESS PADS, IN CLASS 24
(U.S. CLS. 42 AND 50).

FIRST USE 1-1-2007; IN COMMERCE 1-1-2007.

THE MARK CONSISTS OF STANDARD CHAR-
ACTERS WITHOUT CLAIM TO ANY PARTICULAR
FONT, STYLE, SIZE, OR COLOR.

OWNER OF U.S. REG. NOS. 3,060,184 AND
3,326,871.

SER. NO. 77-309,977, FILED 10-22-2007.

COLLEEN DOMBROW, EXAMINING ATTORNEY

Int. Cl.: 41

Prior U.S. Cls.: 100, 101 and 107

United States Patent and Trademark Office

Reg. No. 3,479,576

Registered Aug. 5, 2008

**SERVICE MARK
PRINCIPAL REGISTER**

Popular

TOM WHITMAN PRESENTS, INC. (CALIFORNIA
CORPORATION)
SUITE 103
8430 SANTA MONICA BOULEVARD
WEST HOLLYWOOD, CA 90069

THE MARK CONSISTS OF STANDARD CHAR-
ACTERS WITHOUT CLAIM TO ANY PARTICULAR
FONT, STYLE, SIZE, OR COLOR.

FOR: ENTERTAINMENT SERVICES, NAMELY,
ORGANIZING AND HOSTING A WEEKLY PARTY,
IN CLASS 41 (U.S. CLS. 100, 101 AND 107).

SER. NO. 77-310,457, FILED 10-22-2007.

FIRST USE 2-1-2006; IN COMMERCE 2-1-2006.

MICHAEL SOUDERS, EXAMINING ATTORNEY

Int. Cl.: 10

Prior U.S. Cls.: 26, 39 and 44

United States Patent and Trademark Office

Reg. No. 3,479,577

Registered Aug. 5, 2008

**TRADEMARK
PRINCIPAL REGISTER**

КАШТАН

CHESTNUT

KOMKIN, ANDREY V (RUSSIAN FED. INDIVIDUAL)
GEORGIEVA STR 15 - 70
BARNAUL, RUSSIAN FED. 616057

FOR: MASSAGE APPARATUS USING SPHERICAL BALL(S) COVERED WITH POINTED TIPS, IN CLASS 10 (U.S. CLS. 26, 39 AND 44).

OWNER OF RUSSIAN FED. REG. NO. 225277,
DATED 10-21-2002, EXPIRES 10-26-2009.

THE MARK CONSISTS OF A WORD IN CYRILIC CHARACTERS WHICH TRANSLITERATES TO "KASHTAN" AND TRANSLATES TO "CHESTNUT". THE WORD IS TYPED IN A SPECIAL STYLE FONT.

THERE IS A HORIZONTAL LINE UNDER THAT WORD. UNDER THE LINE THERE IS AN ENGLISH WORD "CHESTNUT".

THE FOREIGN WORDING IN THE MARK TRANSLATES INTO ENGLISH AS "CHESTNUT".

THE NON-LATIN CHARACTER(S) IN THE MARK TRANSLITERATE INTO "KASHTAN", AND THIS MEANS "CHESTNUT" IN ENGLISH.

SER. NO. 77-310,538, FILED 10-23-2007.

ALLISON HOLTZ, EXAMINING ATTORNEY

Int. Cls.: 10, 11 and 20

**Prior U.S. Cls.: 2, 13, 21, 22, 23, 25, 26, 31, 32, 34, 39,
44 and 50**

Reg. No. 3,479,578

United States Patent and Trademark Office

Registered Aug. 5, 2008

**TRADEMARK
PRINCIPAL REGISTER**

CHILLOWPLUS

SOOTHSOFT INNOVATIONS WORLDWIDE, INC.
(COLORADO CORPORATION)
SUITE R
2418 N. WEBB RD.
GRAND ISLAND, NE 68803

FOR: PERSONAL COOLING DEVICES FOR THERAPEUTIC USE TO TREAT MENOPAUSAL CONDITIONS HAVING AN OPEN CELL FOAM ENCASED LIQUID CONTAINING COOLING FEATURE, IN CLASS 10 (U.S. CLS. 26, 39 AND 44).

FIRST USE 6-22-2007; IN COMMERCE 6-22-2007.

FOR: PERSONAL COOLING DEVICES FOR NON-MEDICAL PURPOSES IN THE NATURE OF NON-ELECTRIC, OPEN CELL, FOAM ENCASED LIQUID CONTAINING WRAPS AND PADS FOR COMFORT AND SUPPORT, IN CLASS 11 (U.S. CLS. 13, 21, 23, 31 AND 34).

FIRST USE 6-22-2007; IN COMMERCE 6-22-2007.

FOR: PILLOWS AND PILLOW INSERTS HAVING AN OPEN CELL FOAM ENCASED LIQUID CONTAINING COOLING FEATURE, IN CLASS 20 (U.S. CLS. 2, 13, 22, 25, 32 AND 50).

FIRST USE 6-22-2007; IN COMMERCE 6-22-2007.

THE MARK CONSISTS OF STANDARD CHARACTERS WITHOUT CLAIM TO ANY PARTICULAR FONT, STYLE, SIZE, OR COLOR.

OWNER OF U.S. REG. NOS. 2,822,794, 2,993,758 AND OTHERS.

SER. NO. 77-311,048, FILED 10-23-2007.

SUNG IN, EXAMINING ATTORNEY

Int. Cl.: 35

Prior U.S. Cls.: 100, 101 and 102

United States Patent and Trademark Office

Reg. No. 3,479,579

Registered Aug. 5, 2008

**SERVICE MARK
PRINCIPAL REGISTER**

JOHN TV

SCOTT ADAMS (UNITED STATES INDIVIDUAL)
204 N. ROBINSON AVE., 25TH FLOOR
OKLAHOMA CITY, OK 73102

FOR: PROMOTING THE PUBLIC AWARENESS
OF THE NEED FOR CRIME PREVENTION BY
CONDUCTING NATIONWIDE ADVERTISING
CAMPAIGNS WHICH PROMOTE VOLUNTARY CI-
TIZEN ACTIONS PERTAINING TO AND PUBLIC
UNDERSTANDING OF CRIME PREVENTION, IN
CLASS 35 (U.S. CLS. 100, 101 AND 102).

FIRST USE 8-1-1996; IN COMMERCE 8-1-1996.

THE MARK CONSISTS OF STANDARD CHAR-
ACTERS WITHOUT CLAIM TO ANY PARTICULAR
FONT, STYLE, SIZE, OR COLOR.

NO CLAIM IS MADE TO THE EXCLUSIVE
RIGHT TO USE "TV", APART FROM THE MARK
AS SHOWN.

THE NAME(S), PORTRAIT(S), AND/OR SIGNA-
TURE(S) SHOWN IN THE MARK DOES NOT IDEN-
TIFY A PARTICULAR LIVING INDIVIDUAL.

SER. NO. 77-311,054, FILED 10-23-2007.

LINDA ESTRADA, EXAMINING ATTORNEY

Int. Cl.: 35

Prior U.S. Cls.: 100, 101 and 102

United States Patent and Trademark Office

Reg. No. 3,479,580

Registered Aug. 5, 2008

**SERVICE MARK
PRINCIPAL REGISTER**

ADSELF

KANNAX INC. (JAPAN CORPORATION)
5FL., AQUACITY-SHIBAURA,
4-16-23, SHIBAURA, MINATO-KU
TOKYO, JAPAN 1080023

THE MARK CONSISTS OF STANDARD CHAR-
ACTERS WITHOUT CLAIM TO ANY PARTICULAR
FONT, STYLE, SIZE, OR COLOR.

FOR: DISSEMINATION OF ADVERTISING FOR
OTHERS VIA THE INTERNET, IN CLASS 35 (U.S.
CLS. 100, 101 AND 102).

SER. NO. 77-311,065, FILED 10-23-2007.

FIRST USE 11-18-2006; IN COMMERCE 11-18-2006.

LESLIE RICHARDS, EXAMINING ATTORNEY

Int. Cl.: 37

Prior U.S. Cls.: 100, 103 and 106

United States Patent and Trademark Office

Reg. No. 3,479,581

Registered Aug. 5, 2008

**SERVICE MARK
PRINCIPAL REGISTER**



HUSBAND FOR A DAY, INC. (MICHIGAN CORPORATION)
809 WORCHESTER DRIVE
FENTON, MI 48430

FOR: GENERAL HANDYMAN SERVICES, NAMELY, CABINET REFACING, CABINET REPAIR, REPAIR AND MAINTENANCE OF ELECTRIC LIGHTING APPARATUS, PLUMBING, CARPENTRY, PAINTING, PLASTERING, CONSTRUCTING PORCHES, CONSTRUCTING DECKS, INSTALLATION OF CABINETS, ELECTRICAL SYSTEMS, KITCHEN APPLIANCES, KITCHEN CABINETS, CARPET, DRYWALL PANELS, FLOOR TILE, AND WOOD FLOORING, REMODELING OF KITCHENS, BATHROOMS, BEDROOMS, LIVING ROOMS, DINING ROOMS, AND LIVING SPACES; REPAIR, IMPROVEMENT, AND CONSTRUCTION OF RESIDENTIAL REAL PROPERTY; PROVIDING MAINTENANCE AND REPAIRS ON THE HOMES

OF THOSE IN NEED; GENERAL CONTRACTOR SERVICES, NAMELY, CARPENTRY, ELECTRICAL CONTRACTOR SERVICES, GENERAL CONSTRUCTION CONTRACTING, PLUMBING CONTRACTOR SERVICES, DRYWALL CONTRACTOR SERVICES, PAINTING, PLASTERING, INSTALLING FLOOR TILE, AND TILE LAYING, IN CLASS 37 (U.S. CLS. 100, 103 AND 106).

FIRST USE 4-1-2004; IN COMMERCE 4-1-2004.

THE MARK CONSISTS OF THE WORDS "HUSBAND FOR A DAY WE DO WHAT YOU SAY" AND A MAN WITH A TOOL BELT CARRYING A LADDER.

SER. NO. 77-311,091, FILED 10-23-2007.

JULIE WATSON, EXAMINING ATTORNEY

Int. Cl.: 42

Prior U.S. Cls.: 100 and 101

United States Patent and Trademark Office

Reg. No. 3,479,582

Registered Aug. 5, 2008

**SERVICE MARK
PRINCIPAL REGISTER**

PHYSICAL FIRST

OMNIRIM SOLUTIONS, INC. (CANADA CORPORATION)
1066 WEST HASTINGS STREET, SUITE 2400
VANCOUVER, CANADA V6E3X1

FOR: PROVIDING TEMPORARY USE OF NON-DOWNLOADABLE SOFTWARE FOR PHYSICAL BUSINESS AND FINANCIAL RECORDS MANAGEMENT, IN CLASS 42 (U.S. CLS. 100 AND 101).

FIRST USE 10-19-2007; IN COMMERCE 10-19-2007.

THE MARK CONSISTS OF STANDARD CHARACTERS WITHOUT CLAIM TO ANY PARTICULAR FONT, STYLE, SIZE, OR COLOR.

NO CLAIM IS MADE TO THE EXCLUSIVE RIGHT TO USE "PHYSICAL", APART FROM THE MARK AS SHOWN.

SER. NO. 77-311,290, FILED 10-23-2007.

ASMAT KHAN, EXAMINING ATTORNEY

Int. Cl.: 42

Prior U.S. Cls.: 100 and 101

United States Patent and Trademark Office

Reg. No. 3,479,583

Registered Aug. 5, 2008

SERVICE MARK
PRINCIPAL REGISTER



The logo consists of the word "Physical" in a serif font, followed by a vertical line, a paperclip icon, and the word "First" in a cursive font. Dashed lines underline the word "First".

OMNIRIM SOLUTIONS, INC. (CANADA CORPORATION)

1066 WEST HASTINGS STREET, SUITE 2400
VANCOUVER, CANADA V6E3X1

FOR: PROVIDING TEMPORARY USE OF NON-DOWNLOADABLE SOFTWARE FOR PHYSICAL BUSINESS AND FINANCIAL RECORDS MANAGEMENT, IN CLASS 42 (U.S. CLS. 100 AND 101).

FIRST USE 10-19-2007; IN COMMERCE 10-19-2007.

NO CLAIM IS MADE TO THE EXCLUSIVE RIGHT TO USE "PHYSICAL", APART FROM THE MARK AS SHOWN.

THE MARK CONSISTS OF THE WORDS "PHYSICAL FIRST" SEPARATED BY A VERTICAL LINE AND A PAPER CLIP, WITH DASHES UNDERLINING THE WORD "FIRST".

SER. NO. 77-311,440, FILED 10-23-2007.

ASMAT KHAN, EXAMINING ATTORNEY

Int. Cl.: 5

Prior U.S. Cls.: 6, 18, 44, 46, 51 and 52

United States Patent and Trademark Office

Reg. No. 3,479,584

Registered Aug. 5, 2008

**TRADEMARK
PRINCIPAL REGISTER**



HIERRO JOAN CARLES (SPAIN INDIVIDUAL)
TRAVESIA DE LA VIDRIERA 11, 1ºLL
AVILES, SPAIN AND
PEREZ MARIA ESTHER (SPAIN INDIVIDUAL)
TRAVESIA DE LA VIDRIERA 11 1LL
AVILES, SPAIN

FOR: MINERAL NUTRITIONAL SUPPLEMENTS;
MINERAL SUPPLEMENTS; VITAMIN AND MINER-
AL PREPARATIONS FOR MEDICAL USE, IN CLASS
5 (U.S. CLS. 6, 18, 44, 46, 51 AND 52).

FIRST USE 8-1-2006; IN COMMERCE 8-1-2006.

NO CLAIM IS MADE TO THE EXCLUSIVE
RIGHT TO USE "SILICA", APART FROM THE
MARK AS SHOWN.

THE COLOR(S) GREEN IS/ARE CLAIMED AS A
FEATURE OF THE MARK.

THE MARK CONSISTS OF THE WORDING "OR-
GONO LIVING SILICA" AND THE DESIGN FEAT-
URE, CONSISTING OF A CIRCLE CONTAINING
THREE WAVY LINES, ARE IN WHITE. THE COLOR
GREEN APPEARS IN THE BACKGROUND.

THE FOREIGN WORDING IN THE MARK
TRANSLATES INTO ENGLISH AS "NO TRANSLA-
TION".

SEC. 2(F).

SER. NO. 77-311,497, FILED 10-23-2007.

JESSICA FATHY, EXAMINING ATTORNEY

Int. Cl.: 41

Prior U.S. Cls.: 100, 101 and 107

United States Patent and Trademark Office

Reg. No. 3,479,585

Registered Aug. 5, 2008

**SERVICE MARK
PRINCIPAL REGISTER**

SIZE

TOM WHITMAN PRESENTS, INC. (CALIFORNIA
CORPORATION)
SUITE 103
8430 SANTA MONICA BOULEVARD
WEST HOLLYWOOD, CA 90069

THE MARK CONSISTS OF STANDARD CHAR-
ACTERS WITHOUT CLAIM TO ANY PARTICULAR
FONT, STYLE, SIZE, OR COLOR.

FOR: ENTERTAINMENT SERVICES; NAMELY,
ORGANIZING AND HOSTING A WEEKLY PARTY,
IN CLASS 41 (U.S. CLS. 100, 101 AND 107).

SER. NO. 77-311,527, FILED 10-23-2007.

FIRST USE 3-1-2002; IN COMMERCE 3-1-2002.

MICHAEL SOUDERS, EXAMINING ATTORNEY

Int. Cls.: 35 and 41

Prior U.S. Cls.: 100, 101, 102 and 107

United States Patent and Trademark Office

Reg. No. 3,479,586

Registered Aug. 5, 2008

**SERVICE MARK
PRINCIPAL REGISTER**

KOLDWORKS

UPSITE TECHNOLOGIES, INC. (DELAWARE CORPORATION)
BUILDING 150
2904 RODEO PARK DRIVE EAST
SANTA FE, NM 87505

FOR: CONSULTING AND ANALYSIS SERVICES REGARDING THE ENERGY EFFICIENCY AND INFRASTRUCTURE TEMPERATURE AND COOLING EFFICIENCY OF DATA CENTERS, IN CLASS 35 (U.S. CLS. 100, 101 AND 102).

FIRST USE 10-0-2003; IN COMMERCE 10-0-2003.

FOR: EDUCATIONAL SERVICES, NAMELY, TRAINING AND EDUCATIONAL SEMINARS IN

THE AREAS OF DATA CENTER PHYSICAL LAYOUT, TEMPERATURE, AND INFRASTRUCTURE EFFICIENCY, IN CLASS 41 (U.S. CLS. 100, 101 AND 107).

FIRST USE 10-0-2003; IN COMMERCE 10-0-2003.

THE MARK CONSISTS OF STANDARD CHARACTERS WITHOUT CLAIM TO ANY PARTICULAR FONT, STYLE, SIZE, OR COLOR.

SER. NO. 77-311,738, FILED 10-24-2007.

G. MAYERSCHOFF, EXAMINING ATTORNEY

Int. Cl.: 35

Prior U.S. Cls.: 100, 101 and 102

United States Patent and Trademark Office

Reg. No. 3,479,587

Registered Aug. 5, 2008

**SERVICE MARK
PRINCIPAL REGISTER**

KOLDCHECK

UPSITE TECHNOLOGIES, INC. (DELAWARE
CORPORATION)
SUITE 150
2904 RODEO PARK DRIVE EAST
SANTA FE, NM 87505

FOR: CONSULTING AND ANALYSIS SERVICES
REGARDING THE ENERGY EFFICIENCY AND
INFRASTRUCTURE TEMPERATURE AND COOL-
ING EFFICIENCY OF DATA CENTERS , IN CLASS
35 (U.S. CLS. 100, 101 AND 102).

FIRST USE 3-0-2004; IN COMMERCE 3-0-2004.

THE MARK CONSISTS OF STANDARD CHAR-
ACTERS WITHOUT CLAIM TO ANY PARTICULAR
FONT, STYLE, SIZE, OR COLOR.

SER. NO. 77-311,743, FILED 10-24-2007.

G. MAYERSCHOFF, EXAMINING ATTORNEY

Int. Cl.: 17

Prior U.S. Cls.: 1, 5, 12, 13, 35 and 50

Reg. No. 3,479,588

United States Patent and Trademark Office

Registered Aug. 5, 2008

**TRADEMARK
PRINCIPAL REGISTER**

EVD

ILLINOIS TOOL WORKS INC. (DELAWARE
CORPORATION)
3600 WEST LAKE AVENUE
GLENVIEW, IL 60026

THE MARK CONSISTS OF STANDARD CHAR-
ACTERS WITHOUT CLAIM TO ANY PARTICULAR
FONT, STYLE, SIZE, OR COLOR.

FOR: MOISTURE BARRIER, NAMELY, LAMINA-
TED PLASTIC FILM FOR WRAPPING WALLS TO
PREVENT MOISTURE PENETRATION, IN CLASS
17 (U.S. CLS. 1, 5, 12, 13, 35 AND 50).

SER. NO. 77-312,238, FILED 10-24-2007.

FIRST USE 8-1-2004; IN COMMERCE 8-1-2004.

JAY BESCH, EXAMINING ATTORNEY

Int. Cl.: 35

Prior U.S. Cls.: 100, 101 and 102

United States Patent and Trademark Office

Reg. No. 3,479,589

Registered Aug. 5, 2008

**SERVICE MARK
PRINCIPAL REGISTER**

Natural Kids

LEWIS, DONNA DOLEMAN (UNITED STATES
INDIVIDUAL)
8830 LAKEWAY COURT
YPSILANTI TOWNSHIP, MI 48197

FOR: BUSINESS MARKETING SERVICES,
NAMELY, PROVIDING MARKETING CONSULTA-
TION TO SCHOOLS AND BUSINESS ENTITIES
REGARDING THEIR USE OF ECO-FRIENDLY PO-
LICIES, PROCEDURES, CURRICULA, AND PRO-
DUCTS, IN CLASS 35 (U.S. CLS. 100, 101 AND 102).

FIRST USE 10-9-2006; IN COMMERCE 9-9-2007.

THE MARK CONSISTS OF STANDARD CHAR-
ACTERS WITHOUT CLAIM TO ANY PARTICULAR
FONT, STYLE, SIZE, OR COLOR.

NO CLAIM IS MADE TO THE EXCLUSIVE
RIGHT TO USE "KIDS", APART FROM THE MARK
AS SHOWN.

SER. NO. 77-312,300, FILED 10-24-2007.

DORITT L. CARROLL, EXAMINING ATTORNEY

Int. Cl.: 35

Prior U.S. Cls.: 100, 101 and 102

United States Patent and Trademark Office

Reg. No. 3,479,590

Registered Aug. 5, 2008

SERVICE MARK
PRINCIPAL REGISTER



LEWIS, DONNA DOLEMAN (UNITED STATES
INDIVIDUAL)
8830 LAKEWAT COURT
YPSILANTI TOWNSHIP, MI 48197

FOR: BUSINESS MARKETING SERVICES,
NAMELY, PROVIDING MARKETING CONSULTA-
TION TO SCHOOLS AND BUSINESS ENTITIES
REGARDING THEIR USE OF ECO-FRIENDLY PO-
LICIES, PROCEDURES, CURRICULA, AND PRO-
DUCTS, IN CLASS 35 (U.S. CLS. 100, 101 AND 102).

FIRST USE 10-9-2006; IN COMMERCE 9-9-2007.

NO CLAIM IS MADE TO THE EXCLUSIVE
RIGHT TO USE "KIDS", APART FROM THE MARK
AS SHOWN.

THE COLOR(S) FOREST GREEN, LIME GREEN,
BROWN, AND YELLOW IS/ARE CLAIMED AS A
FEATURE OF THE MARK.

THE MARK CONSISTS OF THE STYLIZED
WORDS "NATURAL" AND "KIDS" WITH "NATUR-
AL" IN FOREST GREEN AND "KIDS" IN LIME
GREEN WITH A LEAF AS THE DOT IN THE "I"
SEPARATED BY A FOREST GREEN SAPLING
WITH LIME GREEN LEAVES AND A YELLOW
TOP ROOTED IN A BROWN ARC OF SOIL.

SER. NO. 77-312,344, FILED 10-24-2007.

DORITT L. CARROLL, EXAMINING ATTORNEY

Int. Cl.: 35

Prior U.S. Cls.: 100, 101 and 102

United States Patent and Trademark Office

Reg. No. 3,479,591

Registered Aug. 5, 2008

**SERVICE MARK
PRINCIPAL REGISTER**

FEDCO

FEDCO LLC. (FLORIDA LTD LIAB CO)
5900 NW 97TH AVENUE, C-18
DORAL, FL 331781643

THE MARK CONSISTS OF STANDARD CHAR-
ACTERS WITHOUT CLAIM TO ANY PARTICULAR
FONT, STYLE, SIZE, OR COLOR.

FOR: DISTRIBUTORSHIPS IN THE FIELD OF
MEDICAL AND SURGICAL EQUIPMENT AND
SUPPLIES, IN CLASS 35 (U.S. CLS. 100, 101 AND 102).

SER. NO. 77-312,894, FILED 10-25-2007.

FIRST USE 9-1-2007; IN COMMERCE 9-1-2007.

JAMES STEIN, EXAMINING ATTORNEY

Int. Cls.: 37 and 42

Prior U.S. Cls.: 100, 101, 103 and 106

United States Patent and Trademark Office

Reg. No. 3,479,592

Registered Aug. 5, 2008

**SERVICE MARK
PRINCIPAL REGISTER**

PYLON

PYLON ELECTRONICS, INC. (CANADA CORPORATION)
147 COLONADE ROAD
OTTAWA, CANADA K2E7L9

FOR: REPAIR OF ELECTRICAL, MECHANICAL AND PHYSICAL PROPERTIES INSTRUMENTS, NAMELY, INSTRUMENTS FOR USE IN MEASUREMENT, IN CLASS 37 (U.S. CLS. 100, 103 AND 106).

FIRST USE 6-1-1985; IN COMMERCE 6-1-1985.

FOR: CALIBRATION OF ELECTRICAL, MECHANICAL AND PHYSICAL PROPERTIES INSTRUMENTS, NAMELY, INSTRUMENTS FOR

USE IN MEASUREMENT, IN CLASS 42 (U.S. CLS. 100 AND 101).

FIRST USE 6-1-1985; IN COMMERCE 6-1-1985.

THE MARK CONSISTS OF STANDARD CHARACTERS WITHOUT CLAIM TO ANY PARTICULAR FONT, STYLE, SIZE, OR COLOR.

OWNER OF U.S. REG. NO. 2,140,021.

SER. NO. 77-312,898, FILED 10-25-2007.

DANIEL CAPSHAW, EXAMINING ATTORNEY

Int. Cls.: 9, 16, 25, 28 and 41

Prior U.S. Cls.: 2, 5, 21, 22, 23, 26, 29, 36, 37, 38, 39,
50, 100, 101 and 107

Reg. No. 3,479,593

United States Patent and Trademark Office

Registered Aug. 5, 2008

TRADEMARK
SERVICE MARK
PRINCIPAL REGISTER



MAJOR LEAGUE SOCCER, LLC (DELAWARE
LTD LIAB CO)
420 FIFTH AVENUE
NEW YORK, NY 10018

FOR: MAGNETS; COMPUTER VIDEO GAME
PROGRAMS; PRE-RECORDED DVDS AND PRE-
RECORDED VIDEO TAPES IN THE FIELD OF
SOCCER, IN CLASS 9 (U.S. CLS. 21, 23, 26, 36 AND 38).

FIRST USE 2-9-2007; IN COMMERCE 2-9-2007.

FOR: POSTERS; DECALS; TRADING CARDS;
STICKERS; BUMPER STICKERS; PAPER FLAGS;
PAPER BANNERS; PRINTED PAPER SIGNS; PRIN-
TED MEDIA GUIDES FEATURING SOCCER IN-
FORMATION; SOUVENIR SOCCER PROGRAMS;
YEARBOOKS; PRINTED EVENT ADMISSION TICK-
ETS; PHOTOGRAPHIC PRINTS; MAGAZINES FEAT-
URING SOCCER, IN CLASS 16 (U.S. CLS. 2, 5, 22, 23,
29, 37, 38 AND 50).

FIRST USE 2-9-2007; IN COMMERCE 2-9-2007.

FOR: T-SHIRTS; FLEECE TOPS; JERSEYS; HATS;
CAPS; VISORS; BEANIES; SHORTS; SWEAT SUITS;
JACKETS; HOODED SWEATSHIRTS; SCARVES, IN
CLASS 25 (U.S. CLS. 22 AND 39).

FIRST USE 2-9-2007; IN COMMERCE 2-9-2007.

FOR: BENDABLE TOY FIGURINES; SOCCER
BALL BAGS; SOCCER BALLS; PLUSH TOY ANI-

MALS; HAND-HELD UNIT FOR PLAYING VIDEO
GAMES; DIE CAST SCALE MODEL TRUCKS;
SCALE MODEL TRUCKS, IN CLASS 28 (U.S. CLS.
22, 23, 38 AND 50).

FIRST USE 2-9-2007; IN COMMERCE 2-9-2007.

FOR: ENTERTAINMENT SERVICES, NAMELY,
SOCCER EXHIBITIONS RENDERED LIVE IN A
STADIUM, AND THROUGH THE MEDIA OF TEL-
EVISION AND RADIO AND VIA THE INTERNET;
ENTERTAINMENT SERVICES, NAMELY, NON-
DOWNLOADABLE PRE-RECORDED FILM CLIPS
FROM SOCCER GAMES PRESENTED VIA MOBILE
COMMUNICATION DEVICES; PROVIDING INFOR-
MATION IN THE FIELD OF SOCCER VIA THE
INTERNET AND MOBILE DEVICES, IN CLASS 41
(U.S. CLS. 100, 101 AND 107).

FIRST USE 2-9-2007; IN COMMERCE 2-9-2007.

OWNER OF U.S. REG. NOS. 2,131,002, 2,149,646
AND OTHERS.

NO CLAIM IS MADE TO THE EXCLUSIVE
RIGHT TO USE "COLORADO" AND "96", APART
FROM THE MARK AS SHOWN.

SER. NO. 77-313,333, FILED 10-25-2007.

WILLIAM VERHOSEK, EXAMINING ATTORNEY

Int. Cl.: 30

Prior U.S. Cl.: 46

United States Patent and Trademark Office

Reg. No. 3,479,594

Registered Aug. 5, 2008

TRADEMARK
PRINCIPAL REGISTER

北方餃子館

WALONG MARKETING , INC. (CALIFORNIA CORPORATION)
6281 REGIO AVENUE
BUENA PARK, CA 90620

FOR: FROZEN STUFFED PASTRY WITH FILLING CONSISTING PRIMARILY OF MEATS AND VEGETABLES, IN CLASS 30 (U.S. CL. 46).

FIRST USE 10-1-2007; IN COMMERCE 10-1-2007.

NO CLAIM IS MADE TO THE EXCLUSIVE RIGHT TO USE THE NON-LATIN CHARACTERS

THAT MEAN "DUMPLING", APART FROM THE MARK AS SHOWN.

THE NON-LATIN CHARACTER(S) IN THE MARK TRANSLITERATE INTO BEI FANG JIAO ZI GUAN, AND THIS MEANS NORTHERN DUMPLING HOUSE IN ENGLISH.

SER. NO. 77-313,379, FILED 10-25-2007.

DAVID YONTEF, EXAMINING ATTORNEY

Int. Cls.: 9, 16, 25, 28 and 41

**Prior U.S. Cls.: 2, 5, 21, 22, 23, 26, 29, 36, 37, 38, 39,
50, 100, 101 and 107**

Reg. No. 3,479,595

United States Patent and Trademark Office

Registered Aug. 5, 2008

**TRADEMARK
SERVICE MARK
PRINCIPAL REGISTER**



MAJOR LEAGUE SOCCER, LLC (DELAWARE
LTD LIAB CO)
420 FIFTH AVENUE
NEW YORK, NY 10018

FOR: MAGNETS; COMPUTER VIDEO GAME
PROGRAMS; PRE-RECORDED DVDS AND PRE-
RECORDED VIDEO TAPES IN THE FIELD OF
SOCCER; PORTABLE RADIOS, IN CLASS 9 (U.S.
CLS. 21, 23, 26, 36 AND 38).

FIRST USE 7-13-2007; IN COMMERCE 7-13-2007.

FOR: POSTERS; DECALS; TRADING CARDS;
STICKERS; BUMPER STICKERS; PAPER FLAGS;
PAPER BANNERS; PRINTED PAPER SIGNS; PRINT-
ED MEDIA GUIDES FEATURING SOCCER IN-
FORMATION; SOUVENIR SOCCER PROGRAMS;
YEARBOOKS; PRINTED EVENT ADMISSION TICK-
ETS; PHOTOGRAPHIC PRINTS; MAGAZINES FEAT-
URING SOCCER, IN CLASS 16 (U.S. CLS. 2, 5, 22, 23,
29, 37, 38 AND 50).

FIRST USE 7-13-2007; IN COMMERCE 7-13-2007.

FOR: T-SHIRTS; FLEECE TOPS; JERSEYS; HATS;
CAPS; VISORS; BEANIES; SHORTS; SWEAT SUITS;
JACKETS; HOODED SWEATSHIRTS; SCARVES, IN
CLASS 25 (U.S. CLS. 22 AND 39).

FIRST USE 7-13-2007; IN COMMERCE 7-13-2007.

FOR: BENDABLE TOY FIGURINES; SOCCER
BALL BAGS; SOCCER BALLS; PLUSH TOY ANI-

MALS; HAND-HELD UNIT FOR PLAYING VIDEO
GAMES; DIE CAST SCALE MODEL TRUCKS;
SCALE MODEL TRUCKS; PUZZLES, IN CLASS 28
(U.S. CLS. 22, 23, 38 AND 50).

FIRST USE 7-13-2007; IN COMMERCE 7-13-2007.

FOR: ENTERTAINMENT SERVICES, NAMELY,
SOCCER EXHIBITIONS RENDERED LIVE IN A
STADIUM, AND THROUGH THE MEDIA OF TEL-
EVISION AND RADIO AND VIA THE INTERNET;
ENTERTAINMENT SERVICES, NAMELY, NON-
DOWNLOADABLE PRE-RECORDED FILM CLIPS
FROM SOCCER GAMES PRESENTED VIA MOBILE
COMMUNICATION DEVICES; PROVIDING INFOR-
MATION IN THE FIELD OF SOCCER VIA THE
INTERNET AND MOBILE DEVICES, IN CLASS 41
(U.S. CLS. 100, 101 AND 107).

FIRST USE 7-13-2007; IN COMMERCE 7-13-2007.

OWNER OF U.S. REG. NOS. 2,103,856, 2,127,633
AND OTHERS.

NO CLAIM IS MADE TO THE EXCLUSIVE
RIGHT TO USE "LA", APART FROM THE MARK
AS SHOWN.

SER. NO. 77-313,847, FILED 10-25-2007.

WILLIAM VERHOSEK, EXAMINING ATTORNEY

Int. Cl.: 38

Prior U.S. Cls.: 100, 101 and 104

United States Patent and Trademark Office

Reg. No. 3,479,596

Registered Aug. 5, 2008

**SERVICE MARK
PRINCIPAL REGISTER**

You LIVE in a HotSpot!

FRANK AND STEIN ASSOCIATES, LLC (PENNSYLVANIA LTD LIAB CO)
SUITE 510
5 BAYARD ROAD
PITTSBURGH, PA 15213

FOR: INTERNET CAFE SERVICES, NAMELY, PROVIDING TELECOMMUNICATIONS CONNECTIONS TO THE INTERNET IN A CAFE ENVIRONMENT; INTERNET SERVICE PROVIDER (ISP); PROVIDING REMOTE INTERNET ACCESS; WIRELESS BROADBAND COMMUNICATION SERVICES, IN CLASS 38 (U.S. CLS. 100, 101 AND 104).

FIRST USE 2-1-2005; IN COMMERCE 2-1-2005.

THE MARK CONSISTS OF STANDARD CHARACTERS WITHOUT CLAIM TO ANY PARTICULAR FONT, STYLE, SIZE, OR COLOR.

NO CLAIM IS MADE TO THE EXCLUSIVE RIGHT TO USE "HOTSPOT", APART FROM THE MARK AS SHOWN.

SER. NO. 77-314,006, FILED 10-25-2007.

ALYSSA PALADINO, EXAMINING ATTORNEY

Int. Cl.: 7

Prior U.S. Cls.: 13, 19, 21, 23, 31, 34 and 35

United States Patent and Trademark Office

Reg. No. 3,479,597

Registered Aug. 5, 2008

**TRADEMARK
PRINCIPAL REGISTER**

DYNA

DYNOJET RESEARCH, INC. (DELAWARE CORPORATION)
2191 MENDENHALL DRIVE
NORTH LAS VEGAS, NV 89081

FOR: IGNITION SYSTEMS FOR MOTOR VEHICLES COMPRISING, IGNITION COILS AND PROGRAMMABLE DIGITAL IGNITION MODULES FOR MOTOR VEHICLES; RPM LIMITERS AND RPM CONTROLLED SWITCHES FOR MOTOR VEHICLES, IN CLASS 7 (U.S. CLS. 13, 19, 21, 23, 31, 34 AND 35).

FIRST USE 12-31-1977; IN COMMERCE 12-31-1977.

THE MARK CONSISTS OF STANDARD CHARACTERS WITHOUT CLAIM TO ANY PARTICULAR FONT, STYLE, SIZE, OR COLOR.

SER. NO. 77-314,027, FILED 10-25-2007.

MARK SPARACINO, EXAMINING ATTORNEY

Int. Cl.: 7

Prior U.S. Cls.: 13, 19, 21, 23, 31, 34 and 35

United States Patent and Trademark Office

Reg. No. 3,479,598

Registered Aug. 5, 2008

**TRADEMARK
PRINCIPAL REGISTER**

DYNATEK

DYNOJET RESEARCH, INC. (DELAWARE CORPORATION)
2191 MENDENHALL DRIVE
NORTH LAS VEGAS, NV 89081

FOR: IGNITION SYSTEMS FOR MOTOR VEHICLES COMPRISING, IGNITION COILS AND FUEL INJECTION CONTROLLERS FOR MOTOR VEHICLES; CRANK SENSOR IGNITION TRIGGERS FOR MOTOR VEHICLES, IN CLASS 7 (U.S. CLS. 13, 19, 21, 23, 31, 34 AND 35).

FIRST USE 12-31-1996; IN COMMERCE 12-31-1996.

THE MARK CONSISTS OF STANDARD CHARACTERS WITHOUT CLAIM TO ANY PARTICULAR FONT, STYLE, SIZE, OR COLOR.

SER. NO. 77-314,035, FILED 10-25-2007.

MARK SPARACINO, EXAMINING ATTORNEY

Int. Cl.: 35

Prior U.S. Cls.: 100, 101 and 102

United States Patent and Trademark Office

Reg. No. 3,479,599

Registered Aug. 5, 2008

**SERVICE MARK
PRINCIPAL REGISTER**

PETRONOMICS

PETRONOMICS PARTNERS OF TEXAS, G.P.,
L.L.C. (TEXAS LTD LIAB CO)
7915 SONATA COURT
HOUSTON, TX 77040

THE MARK CONSISTS OF STANDARD CHAR-
ACTERS WITHOUT CLAIM TO ANY PARTICULAR
FONT, STYLE, SIZE, OR COLOR.

FOR: EXPERT EVALUATIONS AND REPORTS
RELATING TO BUSINESS MATTERS IN THE FIELD
OF OIL AND GAS INDUSTRIES, IN CLASS 35 (U.S.
CLS. 100, 101 AND 102).

SER. NO. 77-314,114, FILED 10-26-2007.

FIRST USE 6-30-2004; IN COMMERCE 6-30-2004.

HOWARD SMIGA, EXAMINING ATTORNEY

Int. Cl.: 35

Prior U.S. Cls.: 100, 101 and 102

United States Patent and Trademark Office

Reg. No. 3,479,600

Registered Aug. 5, 2008

SERVICE MARK
PRINCIPAL REGISTER



RIDE4EVER
SPORTS
SNOW - WATER - LAND

ANTIX PARTNERSHIP, LLC (KANSAS LTD LIAB
CO)
11505 PAWNEE CIRCLE
LEAWOOD, KS 66211

FOR: ON-LINE RETAIL STORE SERVICES FEATURING EQUIPMENT, CLOTHING AND PRODUCTS RELATING TO SNOWBOARDING, SKIING, WAKEBOARDING AND SKATEBOARDING; RETAIL STORE SERVICES FEATURING EQUIPMENT, CLOTHING AND PRODUCTS RELATING TO SNOWBOARDING, SKIING, WAKEBOARDING AND SKATEBOARDING, IN CLASS 35 (U.S. CLS. 100, 101 AND 102).

FIRST USE 5-1-2007; IN COMMERCE 9-1-2007.

NO CLAIM IS MADE TO THE EXCLUSIVE RIGHT TO USE "SPORTS", "SNOW", "WATER" AND "LAND", APART FROM THE MARK AS SHOWN.

THE MARK CONSISTS OF THE STYLIZED TEXT "RIDE4EVER SPORTS SNOW - WATER - LAND" IN A CRACKED FONT THAT HAS BEEN ALTERED FOR A PARTICULAR LOOK. "SPORTS" IS STACKED UNDER THE WORD "EVER" AND THE WORDS "SNOW - WATER - LAND" ARE STACKED UNDER THE CONTINUOUS "RIDE4EVER". THE NUMERAL "4" IS LARGER THAN THE REST. "RIDE" AND "EVER" ARE THE NEXT LARGEST. THE WORD "SPORTS" IS SMALLER THAN "RIDE" AND "EVER". AND THE WORDS "SNOW - WATER - LAND" ARE THE SMALLEST OF ALL THE WORDS. ALL THE WORDS ARE UPPER CASE CAPS.

SER. NO. 77-314,300, FILED 10-26-2007.

SOPHIA S. KIM, EXAMINING ATTORNEY

Int. Cl.: 41

Prior U.S. Cls.: 100, 101 and 107

United States Patent and Trademark Office

Reg. No. 3,479,601

Registered Aug. 5, 2008

**SERVICE MARK
PRINCIPAL REGISTER**

be the flow

HALF MOON YOGA, INC. (KENTUCKY COR-
PORATION)
SUITE 201
4414 SHELBYVILLE ROAD
LOUISVILLE, KY 40207

THE MARK CONSISTS OF STANDARD CHAR-
ACTERS WITHOUT CLAIM TO ANY PARTICULAR
FONT, STYLE, SIZE, OR COLOR.

FOR: YOGA INSTRUCTION, IN CLASS 41 (U.S.
CLS. 100, 101 AND 107).

SER. NO. 77-315,150, FILED 10-26-2007.

FIRST USE 9-22-2007; IN COMMERCE 9-22-2007.

HEATHER BIDDULPH, EXAMINING ATTORNEY

Int. Cl.: 3

Prior U.S. Cls.: 1, 4, 6, 50, 51 and 52

United States Patent and Trademark Office

Reg. No. 3,479,602

Registered Aug. 5, 2008

**TRADEMARK
PRINCIPAL REGISTER**

SCIENCE OF YOUTH

ADRIENNE DENESE, M.D., P.C. (NEW YORK CORPORATION)

#211

330 WEST 58TH STREET
NEW YORK, NY 100191822

FOR: SKIN CARE PRODUCTS, NAMELY, NON-MEDICATED SKIN SERUM; EYE CREAM; EYE GELS; COSMETIC ANTI-WRINKLE PREPARATIONS FOR THE SKIN IN GEL FORM; WRINKLE REMOVING SKIN CARE PREPARATIONS; ANTI-WRINKLE CREAM; LIP BALM, IN CLASS 3 (U.S. CLS. 1, 4, 6, 50, 51 AND 52).

FIRST USE 10-1-2007; IN COMMERCE 10-1-2007.

THE MARK CONSISTS OF STANDARD CHARACTERS WITHOUT CLAIM TO ANY PARTICULAR FONT, STYLE, SIZE, OR COLOR.

SER. NO. 77-315,231, FILED 10-27-2007.

ROBERT LAVACHE, EXAMINING ATTORNEY

Int. Cl.: 41

Prior U.S. Cls.: 100, 101 and 107

United States Patent and Trademark Office

Reg. No. 3,479,603

Registered Aug. 5, 2008

SERVICE MARK
PRINCIPAL REGISTER

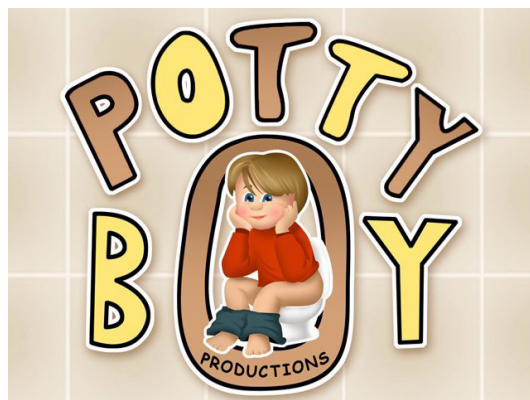

BERNDT, MICHAEL E (UNITED STATES INDIVIDUAL)
APT 20D
301 E 45TH ST
NEW YORK, NY 10017

FOR: ENTERTAINMENT SERVICES, NAMELY, PROVIDING A WEBSITE FEATURING, PHOTOGRAPHIC, AUDIO, VIDEO AND PROSE PRESENTATIONS FEATURING A DAILY UPDATED COLLECTION OF INSTRUCTIONAL, HUMOROUS, AND DOCUMENTARY STYLE VIDEOS, IN CLASS 41 (U.S. CLS. 100, 101 AND 107).

FIRST USE 2-1-2001; IN COMMERCE 10-1-2006.

NO CLAIM IS MADE TO THE EXCLUSIVE RIGHT TO USE "PRODUCTIONS", APART FROM THE MARK AS SHOWN.

THE COLOR(S) BROWN, YELLOW, PEACH, WHITE, BLACK, RED, AND BLUE IS/ARE CLAIMED AS A FEATURE OF THE MARK.

THE MARK CONSISTS OF THE COLOR BROWN APPEARS IN THE LETTERS "P", "T" AND "Y" OF

THE TERM "POTTY", IN THE LETTER "O" OF THE TERM "BOY" AND IN THE DESIGN THE BOY'S HAIR. THE COLOR YELLOW APPEARS IN THE LETTERS "O" AND "T" OF THE TERM "POTTY" AND IN THE LETTERS "B" AND "Y" OF "BOY". THE COLOR PEACH APPEARS IN THE DESIGN OF THE BOY. THE COLOR WHITE APPEARS IN THE DESIGN OF THE TOILET, IN THE BOY'S EYES AND AS THE SECONDARY OUTLINING FOR THE WORDING "POTTY BOY". THE COLOR BLACK APPEARS IN THE LETTERING FOR THE TERM "PRODUCTIONS", AS THE PRIMARY OUTLINING FOR THE WORDING "POTTY BOY" AND IN THE DESIGN OF THE BOY'S EYES. THE COLOR RED APPEARS IN THE DESIGN OF THE BOY'S SHIRT. THE COLOR BLUE APPEARS IN THE DESIGN OF THE BOY'S PANTS AND THE BOY'S EYES. THE COLORS BROWN AND WHITE COMPRISED OF A PATTERN RESEMBLING A TILED WALL APPEAR AS THE BACKGROUND COLOR FOR THE MARK.

SER. NO. 77-315,462, FILED 10-29-2007.

AMY MCMENAMIN, EXAMINING ATTORNEY

Int. Cl.: 11

Prior U.S. Cls.: 13, 21, 23, 31 and 34

United States Patent and Trademark Office

Reg. No. 3,479,604

Registered Aug. 5, 2008

**TRADEMARK
PRINCIPAL REGISTER**

SANI SEAT

T. ELIOT, INC. (NEW YORK CORPORATION)
603 WELLINGTON AVENUE
SEATTLE, WA 98122

FOR: TOILET SEATS HAVING AN AUTOMATIC
SANITARY COVER REPLACEMENT AND STRUC-
TURAL PARTS THEREFOR, IN CLASS 11 (U.S. CLS.
13, 21, 23, 31 AND 34).

FIRST USE 10-15-1986; IN COMMERCE 10-15-1986.

THE MARK CONSISTS OF STANDARD CHAR-
ACTERS WITHOUT CLAIM TO ANY PARTICULAR
FONT, STYLE, SIZE, OR COLOR.

NO CLAIM IS MADE TO THE EXCLUSIVE
RIGHT TO USE "SEAT", APART FROM THE MARK
AS SHOWN.

SER. NO. 77-315,779, FILED 10-29-2007.

MARIA-VICTORIA SUAREZ, EXAMINING ATTOR-
NEY

Int. Cl.: 9

Prior U.S. Cls.: 21, 23, 26, 36 and 38

United States Patent and Trademark Office

Reg. No. 3,479,605

Registered Aug. 5, 2008

**TRADEMARK
PRINCIPAL REGISTER**

LeadPOWER

WARD MEDIA, INC. (NEW YORK CORPORATION)
141 WEST 36TH STREET, 20TH FLOOR
NEW YORK, NY 10018

THE MARK CONSISTS OF STANDARD CHARACTERS WITHOUT CLAIM TO ANY PARTICULAR FONT, STYLE, SIZE, OR COLOR.

FOR: COMPUTER SOFTWARE FOR TRACKING, VERIFYING, SCREENING AND EVALUATING CONSUMER LEADS FOR MARKETING PURPOSES, IN CLASS 9 (U.S. CLS. 21, 23, 26, 36 AND 38).

SER. NO. 77-315,849, FILED 10-29-2007.

FIRST USE 10-3-2007; IN COMMERCE 10-3-2007.

HENRY S. ZAK, EXAMINING ATTORNEY

Int. Cl.: 34

Prior U.S. Cls.: 2, 8, 9 and 17

United States Patent and Trademark Office

Reg. No. 3,479,606

Registered Aug. 5, 2008

**TRADEMARK
PRINCIPAL REGISTER**

**SOUTHERN
SMOKELESS**

MASRI, RODNEY (ISRAEL INDIVIDUAL)
32 JOE KENNEDY BLVD
STATESBORO, GA 30458

FOR: SMOKELESS TOBACCO, IN CLASS 34 (U.S.
CLS. 2, 8, 9 AND 17).

FIRST USE 7-1-2007; IN COMMERCE 7-1-2007.

NO CLAIM IS MADE TO THE EXCLUSIVE
RIGHT TO USE "SMOKELESS" , APART FROM
THE MARK AS SHOWN.

THE MARK CONSISTS OF THE STYLIZED TEXT
OF THE MARK WHERE THE TWO TERMS SHARE
THE INITIAL LETTER "S".

SER. NO. 77-315,963, FILED 10-29-2007.

MARLENE BELL, EXAMINING ATTORNEY

Int. Cl.: 32

Prior U.S. Cls.: 45, 46 and 48

United States Patent and Trademark Office

Reg. No. 3,479,607

Registered Aug. 5, 2008

**TRADEMARK
PRINCIPAL REGISTER**



RED BULL GMBH (AUSTRIA LTD LIAB CO)
AM BRUNNEN 1
FUSCHL AM SEE, AUSTRIA 5330

FOR: NON-ALCOHOLIC BEVERAGES, NAMELY,
SPORTS DRINKS, ENERGY DRINKS AND SOFT
DRINKS, IN CLASS 32 (U.S. CLS. 45, 46 AND 48).

FIRST USE 1-31-1987; IN COMMERCE 5-31-1996.

OWNER OF U.S. REG. NOS. 3,086,964, 3,233,533
AND OTHERS.

NO CLAIM IS MADE TO THE EXCLUSIVE
RIGHT TO USE "ENERGY DRINK", APART FROM
THE MARK AS SHOWN.

THE COLOR(S) RED, BLUE, SILVER AND GOLD
IS/ARE CLAIMED AS A FEATURE OF THE MARK.

THE MARK CONSISTS OF THE WORDS "RED
BULL ENERGY DRINK" AND DOUBLE BULLS
LOGO ON A BLUE AND SILVER TRAPEZOIDAL
GEOMETRIC BACKGROUND. THE COLOR BLUE
APPEARS IN THE UPPER LEFT AND LOWER
RIGHT QUADRILATERALS, AND ON THE BAR
NEAR THE BOTTOM OF THE LOWER LEFT
QUADRILATERAL, THE COLOR SILVER APPEARS
IN THE UPPER RIGHT AND LOWER LEFT QUAD-
RILATERALS AND ON THE BAR NEAR THE
BOTTOM OF THE LOWER RIGHT QUADRILAT-
ERAL, THE COLOR RED APPEARS ON THE LET-
TERING OF "RED BULL ENERGY DRINK" AND
ON THE BULL DESIGNS, AND THE COLOR GOLD
APPEARS ON THE SUN DESIGN IN THE CENTER
OF THE MARK.

SER. NO. 77-316,470, FILED 10-29-2007.

HEATHER SAPP, EXAMINING ATTORNEY

Int. Cl.: 42

Prior U.S. Cls.: 100 and 101

United States Patent and Trademark Office

Reg. No. 3,479,608

Registered Aug. 5, 2008

**SERVICE MARK
PRINCIPAL REGISTER**

1-800-GOT-MOLD?

MYCELIUM HOLDINGS LLC (NEW JERSEY
LTD LIAB CO)
#378
66 WITHERSPOON STREET
PRINCETON, NJ 08542

FOR: INSPECTION, DETECTION AND TESTING
OF INDOOR AIR AND ENVIRONMENT FOR PRE-
SENCE OF MOLD, IN CLASS 42 (U.S. CLS. 100 AND
101).

FIRST USE 3-14-2007; IN COMMERCE 8-1-2007.

THE MARK CONSISTS OF STANDARD CHAR-
ACTERS WITHOUT CLAIM TO ANY PARTICULAR
FONT, STYLE, SIZE, OR COLOR.

OWNER OF U.S. REG. NO. 2,753,002.

SER. NO. 77-316,651, FILED 10-30-2007.

DAWN HAN, EXAMINING ATTORNEY

Int. Cl.: 41

Prior U.S. Cls.: 100, 101 and 107

United States Patent and Trademark Office

Reg. No. 3,479,609

Registered Aug. 5, 2008

**SERVICE MARK
PRINCIPAL REGISTER**



PLAYROOM FOR KIDS, INC., THE (VIRGINIA CORPORATION)
11307 REGALIA DR
CHESTERFIELD, VA 23838

THE COLOR(S) RED IS/ARE CLAIMED AS A FEATURE OF THE MARK.

FOR: CHILDREN'S ENTERTAINMENT AND AMUSEMENT CENTERS, NAMELY, INTERACTIVE PLAY AREAS; AMUSEMENT CENTERS, IN CLASS 41 (U.S. CLS. 100, 101 AND 107).

THE COLOR RED APPEARS IN THE WORDING "THE PLAYROOM" AND IN THE DESIGN OF A CHILD HOLDING A BALLOON WHILE SLIDING DOWN THE "M".

FIRST USE 3-1-2005; IN COMMERCE 3-1-2005.

SER. NO. 77-316,675, FILED 10-30-2007.

NO CLAIM IS MADE TO THE EXCLUSIVE RIGHT TO USE "THE PLAYROOM", APART FROM THE MARK AS SHOWN.

LINDA LAVACHE, EXAMINING ATTORNEY

Int. Cl.: 36

Prior U.S. Cls.: 100, 101 and 102

United States Patent and Trademark Office

Reg. No. 3,479,610

Registered Aug. 5, 2008

SERVICE MARK
PRINCIPAL REGISTER



MEDICAL MUTUAL OF OHIO (OHIO CORPORATION)
2060 EAST NINTH STREET
CLEVELAND, OH 44115

FOR: HEALTH INSURANCE UNDERWRITING;
HEALTH INSURANCE ADMINISTRATION, IN
CLASS 36 (U.S. CLS. 100, 101 AND 102).

FIRST USE 10-31-2001; IN COMMERCE 10-31-2001.

THE MARK CONSISTS OF HEART LOGO.

SEC. 2(F) AS TO "CAROLINA CARE PLAN".

SER. NO. 77-317,030, FILED 10-30-2007.

TEJBIR SINGH, EXAMINING ATTORNEY

Int. Cl.: 41

Prior U.S. Cls.: 100, 101 and 107

United States Patent and Trademark Office

Reg. No. 3,479,611

Registered Aug. 5, 2008

SERVICE MARK
PRINCIPAL REGISTER



D-LINK SYSTEMS, INC. (CALIFORNIA CORPORATION)
17595 MT. HERRMANN STREET
FOUNTAIN VALLEY, CA 92708

FOR: PROVIDING PRACTICAL AND TECHNICAL INFORMATION IN THE FIELD OF THE DESIGN, IMPLEMENTATION, SELECTION AND USE OF COMPUTER HARDWARE AND SOFTWARE TECHNOLOGY VIA A GLOBAL COMPUTER NETWORK; EDUCATIONAL AND ENTERTAINMENT SERVICES, NAMELY, PROVIDING A CONTINUING PROGRAM IN THE FIELD OF THE PRACTICAL AND TECHNICAL INFORMATION ABOUT THE DESIGN, IMPLEMENTATION, SELECTION AND USE OF COMPUTER HARDWARE, SOFTWARE AND TECHNOLOGY PRODUCED AND DISTRIBUTED OVER A TELEVISION, SATELLITE,

AUDIO, VIDEO AND COMPUTER NETWORKS, IN CLASS 41 (U.S. CLS. 100, 101 AND 107).

FIRST USE 7-16-2007; IN COMMERCE 7-16-2007.

NO CLAIM IS MADE TO THE EXCLUSIVE RIGHT TO USE "DIGITAL HOME D.I.Y.", APART FROM THE MARK AS SHOWN.

THE MARK CONSISTS OF THE WORDS "DIGITAL HOME" IN ITALIC SAN-SERIF TYPE WITH THE LETTERS "D.I.Y." IN A STENCIL FONT SURROUNDED BY THE OUTLINE OF A HOUSE.

SER. NO. 77-317,065, FILED 10-30-2007.

AMY MCMENAMIN, EXAMINING ATTORNEY

Int. Cl.: 41

Prior U.S. Cls.: 100, 101 and 107

United States Patent and Trademark Office

Reg. No. 3,479,612

Registered Aug. 5, 2008

**SERVICE MARK
PRINCIPAL REGISTER**

BBI

BBI, INC. (COLORADO CORPORATION), DBA
BARNETT BICYCLE INSTITUTE
2725 ORE MILL ROAD
COLORADO SPRINGS, CO 80904

THE MARK CONSISTS OF STANDARD CHAR-
ACTERS WITHOUT CLAIM TO ANY PARTICULAR
FONT, STYLE, SIZE, OR COLOR.

FOR: VOCATIONAL EDUCATION IN THE FIELD
OF BICYCLE MECHANIC TRAINING, IN CLASS 41
(U.S. CLS. 100, 101 AND 107).

SER. NO. 77-317,122, FILED 10-30-2007.

FIRST USE 1-6-1986; IN COMMERCE 1-6-1986.

JESSICA A. POWERS, EXAMINING ATTORNEY

Int. Cl.: 41

Prior U.S. Cls.: 100, 101 and 107

United States Patent and Trademark Office

Reg. No. 3,479,613

Registered Aug. 5, 2008

**SERVICE MARK
PRINCIPAL REGISTER**

The logo for D-Linktv features the word "D-Link" in a teal, bold, sans-serif font. The "D" is significantly larger than the other letters. The word "tv" is in a black, bold, sans-serif font, with the "t" and "v" being lowercase and slightly slanted. The "t" and "v" are positioned to the right of "D-Link", with the "t" overlapping the "k".

D-LINK SYSTEMS, INC. (CALIFORNIA CORPORATION)
17595 MT. HERRMANN STREET
FOUNTAIN VALLEY, CA 92708

NO CLAIM IS MADE TO THE EXCLUSIVE RIGHT TO USE "TV", APART FROM THE MARK AS SHOWN.

FOR: EDUCATION AND ENTERTAINMENT SERVICES, NAMELY, PROVIDING A WEBSITE VIA THE INTERNET FEATURING INFORMATION IN THE FIELD OF COMPUTER HARDWARE AND SOFTWARE, AUDIO CLIPS, VIDEO CLIPS, MUSICAL PERFORMANCES, INSTRUCTIONAL VIDEOS, FILM CLIPS, PHOTOGRAPHS, AND OTHER MULTIMEDIA MATERIALS, IN CLASS 41 (U.S. CLS. 100, 101 AND 107).

THE COLOR(S) TEAL AND BLACK IS/ARE CLAIMED AS A FEATURE OF THE MARK.

THE MARK CONSISTS OF STYLIZED WORD "D-LINK" IN TEAL WITH THE "D" AND "L" CAPITALIZED, FOLLOWED BY THE LOWERCASE LETTERS "TV" IN BLACK.

FIRST USE 2-12-2007; IN COMMERCE 2-12-2007.

SER. NO. 77-317,298, FILED 10-30-2007.

OWNER OF U.S. REG. NOS. 1,456,290, 2,715,474, AND 2,717,394.

AMY MCMENAMIN, EXAMINING ATTORNEY

Int. Cl.: 36

Prior U.S. Cls.: 100, 101 and 102

United States Patent and Trademark Office

Reg. No. 3,479,614

Registered Aug. 5, 2008

**SERVICE MARK
PRINCIPAL REGISTER**



AMERICA'S CHOICE WARRANTY, LLC
(LOUISIANA LTD LIAB CO)
13144 DORSET AVENUE
BATON ROUGE, LA 70818

FOR: INSURANCE SERVICES, NAMELY, UNDERWRITING EXTENDED WARRANTY CONTRACTS IN THE FIELD OF AUTOMOBILES, IN CLASS 36 (U.S. CLS. 100, 101 AND 102).

FIRST USE 8-1-2007; IN COMMERCE 9-15-2007.

OWNER OF U.S. REG. NO. 7,871,326.

NO CLAIM IS MADE TO THE EXCLUSIVE RIGHT TO USE "AMERICA'S", "WARRANTY, LLC" AND THE DESIGN OF THE UNITED STATES, APART FROM THE MARK AS SHOWN.

THE COLOR(S) LIGHT BLUE, DARK BLUE, RED, WHITE, AND BLACK IS/ARE CLAIMED AS A FEATURE OF THE MARK.

THE MARK CONSISTS OF A LIGHT BLUE AND DARK BLUE MAP OF THE UNITED STATES WITH THE WORDING "AMERICA'S CHOICE" SITUATED ON TOP OF THE MAP. THE "I" IN AMERICA IS DOTTED WITH A RED STAR AND THE WORDS "AMERICA'S CHOICE WARRANTY, LLC" ARE IN WHITE AND OUTLINED IN BLACK.

SER. NO. 77-317,332, FILED 10-30-2007.

NAKIA HENRY, EXAMINING ATTORNEY

Int. Cl.: 41

Prior U.S. Cls.: 100, 101 and 107

United States Patent and Trademark Office

Reg. No. 3,479,615

Registered Aug. 5, 2008

**SERVICE MARK
PRINCIPAL REGISTER**

**EMPOWERED FOR THE 21ST
CENTURY**

GIANT CAMPUS, INC. (WASHINGTON COR-
PORATION)
3101 WESTERN AVENUE, SUITE 100
SEATTLE, WA 98121

FOR: EDUCATIONAL SERVICES IN THE FIELD
OF TECHNOLOGY TRAINING, NAMELY, INFOR-
MATION TECHNOLOGY, COMMUNICATION
TECHNOLOGY, COMPUTER SCIENCE, COMPU-
TER SOFTWARE AND COMPUTER HARDWARE,
IN CLASS 41 (U.S. CLS. 100, 101 AND 107).

FIRST USE 10-2-2007; IN COMMERCE 10-2-2007.

THE MARK CONSISTS OF STANDARD CHAR-
ACTERS WITHOUT CLAIM TO ANY PARTICULAR
FONT, STYLE, SIZE, OR COLOR.

SER. NO. 77-317,417, FILED 10-30-2007.

THOMAS MANOR, EXAMINING ATTORNEY

Int. Cls.: 6, 8, 18, 21 and 30

**Prior U.S. Cls.: 1, 2, 3, 12, 13, 14, 22, 23, 25, 28, 29, 30,
33, 40, 41, 44, 46 and 50**

Reg. No. 3,479,616

United States Patent and Trademark Office

Registered Aug. 5, 2008

**TRADEMARK
PRINCIPAL REGISTER**

FIRST LADY

OLDE MILL COMPANY, INC. (DELAWARE
CORPORATION)
7904 HILL PARK COURT
LORTON, VA 22079

FOR: METAL KEY CHAINS, IN CLASS 6 (U.S.
CLS. 2, 12, 13, 14, 23, 25 AND 50).

FIRST USE 7-27-2004; IN COMMERCE 7-27-2004.

FOR: NAIL FILES, IN CLASS 8 (U.S. CLS. 23, 28
AND 44).

FIRST USE 2-4-2003; IN COMMERCE 2-4-2003.

FOR: TOTE BAGS, IN CLASS 18 (U.S. CLS. 1, 2, 3, 22
AND 41).

FIRST USE 6-11-2007; IN COMMERCE 6-11-2007.

FOR: SHOT GLASSES, IN CLASS 21 (U.S. CLS. 2,
13, 23, 29, 30, 33, 40 AND 50).

FIRST USE 3-22-2007; IN COMMERCE 3-22-2007.

FOR: CANDY MINTS, IN CLASS 30 (U.S. CL. 46).

FIRST USE 6-22-2007; IN COMMERCE 6-22-2007.

THE MARK CONSISTS OF STANDARD CHAR-
ACTERS WITHOUT CLAIM TO ANY PARTICULAR
FONT, STYLE, SIZE, OR COLOR.

OWNER OF U.S. REG. NO. 3,227,319.

SER. NO. 77-317,600, FILED 10-31-2007.

SUNG IN, EXAMINING ATTORNEY

Int. Cl.: 41

Prior U.S. Cls.: 100, 101 and 107

United States Patent and Trademark Office

Reg. No. 3,479,617

Registered Aug. 5, 2008

**SERVICE MARK
PRINCIPAL REGISTER**

**Real People, Real Trades,
Real Profits**

GLOBALTEC SOLUTIONS, L.L.P. (TEXAS PART-
NERSHIP)
5010 ADDISON CIRCLE
ADDISON, TX 75001

FOR: EDUCATIONAL SERVICES, NAMELY,
PROVIDING AN ON-GOING TELEVISION PRO-
GRAM IN THE FIELD OF INVESTMENTS, VIA A
GLOBAL COMPUTER NETWORK, IN CLASS 41
(U.S. CLS. 100, 101 AND 107).

FIRST USE 8-30-2006; IN COMMERCE 8-30-2006.

THE MARK CONSISTS OF STANDARD CHAR-
ACTERS WITHOUT CLAIM TO ANY PARTICULAR
FONT, STYLE, SIZE, OR COLOR.

SER. NO. 77-317,678, FILED 10-31-2007.

ADA HAN, EXAMINING ATTORNEY

Int. Cl.: 5

Prior U.S. Cls.: 6, 18, 44, 46, 51 and 52

Reg. No. 3,479,618

United States Patent and Trademark Office

Registered Aug. 5, 2008

**TRADEMARK
PRINCIPAL REGISTER**

GRATIFY

INDOMITUS ASSET MANAGEMENT LLC
(PENNSYLVANIA LTD LIAB CO)
1579 JACK DRIVE
NORTH HUNTINGDON, PA 15642

FOR: DIETARY AND NUTRITIONAL SUPPLEMENTS; HERBAL SUPPLEMENTS; NUTRITIONAL SUPPLEMENTS; DIETARY SUPPLEMENTS; DIETARY SUPPLEMENTS FOR HUMAN CONSUMPTION, IN CLASS 5 (U.S. CLS. 6, 18, 44, 46, 51 AND 52).

FIRST USE 2-2-2007; IN COMMERCE 10-15-2007.

THE MARK CONSISTS OF STANDARD CHARACTERS WITHOUT CLAIM TO ANY PARTICULAR FONT, STYLE, SIZE, OR COLOR.

SER. NO. 77-317,821, FILED 10-31-2007.

HOWARD SMIGA, EXAMINING ATTORNEY

Int. Cl.: 35

Prior U.S. Cls.: 100, 101 and 102

United States Patent and Trademark Office

Reg. No. 3,479,619

Registered Aug. 5, 2008

**SERVICE MARK
PRINCIPAL REGISTER**



HOTFINDZ INC. (MISSISSIPPI LTD LIAB CO)
VALENCIA
880 ORANGE TERRACE
MACON, GA 31201

FOR: OPERATING ON-LINE MARKETPLACES FOR SELLERS OF GOODS AND/OR SERVICES; ADVERTISING AND ADVERTISEMENT SERVICES; PROVIDING A WEB SITE WHERE USERS CAN POST RATINGS, REVIEWS AND RECOMMENDATIONS ON PRODUCTS AND SERVICES; PROVIDING A WEB SITE AT WHICH USERS CAN OFFER GOODS FOR SALE AND BUY GOODS OFFERED BY OTHERS; ADVERTISING VIA ELECTRONIC MEDIA AND SPECIFICALLY THE INTERNET, IN CLASS 35 (U.S. CLS. 100, 101 AND 102).

FIRST USE 7-10-2007; IN COMMERCE 10-1-2007.

THE COLOR(S) RED, ORANGE, YELLOW, AND BLACK IS/ARE CLAIMED AS A FEATURE OF THE MARK.

THE MARK CONSISTS OF ORANGE FLAME WITH BLACK OUTLINE INSET WITH A SMALLER RED FLAME WITH BLACK OUTLINE. THE FLAMES ARE LOCATED BETWEEN THE WORDS "HOT" AND "FINDZ", WHICH ARE YELLOW TEXT WITH BLACK OUTLINES.

SER. NO. 77-317,904, FILED 10-31-2007.

DARRYL SPRUILL, EXAMINING ATTORNEY

Int. Cls.: 9 and 11

Prior U.S. Cls.: 13, 21, 23, 26, 31, 34, 36 and 38

United States Patent and Trademark Office

Reg. No. 3,479,620

Registered Aug. 5, 2008

**TRADEMARK
PRINCIPAL REGISTER**

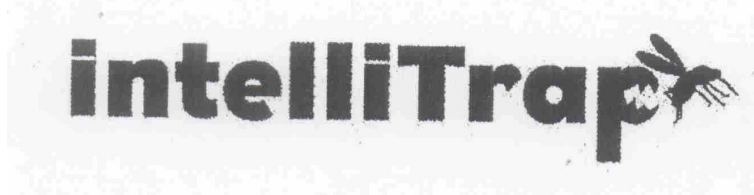

AMCOR, INC. (NEW JERSEY CORPORATION)
685A GOTHAM PARKWAY
CARLSTADT, NJ 07072

FOR: ELECTRICAL AND ELECTRONIC APPARATUS AND INSTRUMENTS FOR ATTRACTING, DESTROYING, KILLING, EXTERMINATING, DETERRING AND REMOVING INSECTS, FLIES AND VERMIN, IN CLASS 9 (U.S. CLS. 21, 23, 26, 36 AND 38).

FIRST USE 1-8-2007; IN COMMERCE 1-8-2007.

FOR: LIGHTING APPARATUS AND INSTRUMENTS FOR USE IN ATTRACTING, DESTROYING, KILLING, EXTERMINATING, DETERRING AND REMOVING INSECTS, FLIES AND VERMIN; HEAT-

ING APPARATUS AND INSTRUMENTS FOR USE IN ATTRACTING, DESTROYING, KILLING, EXTERMINATING, DETERRING AND REMOVING INSECTS, FLIES AND VERMIN, IN CLASS 11 (U.S. CLS. 13, 21, 23, 31 AND 34).

FIRST USE 1-8-2007; IN COMMERCE 1-8-2007.

THE MARK CONSISTS OF THE WORD "INTELLITRAP" IN STYLIZED FORM; THE "P" AT THE END OF "INTELLITRAP" HAS A ZIG-ZAG SHAPE IN THE MIDDLE. THERE IS AN INSECT IN CLOSE PROXIMITY TO THE LETTER "P".

SER. NO. 77-318,119, FILED 10-31-2007.

ZACHARY BELLO, EXAMINING ATTORNEY

Int. Cl.: 35

Prior U.S. Cls.: 100, 101 and 102

United States Patent and Trademark Office

Reg. No. 3,479,621

Registered Aug. 5, 2008

**SERVICE MARK
PRINCIPAL REGISTER**

TAKE A LOAD OFF, TEXAS

ONCOR ELECTRIC DELIVERY COMPANY
(TEXAS CORPORATION)
ENERGY PLAZA
1601 BRYAN STREET
DALLAS, TX 75201

FOR: CONSULTATION IN THE FIELD OF ENERGY EFFICIENCY; EDUCATION SERVICES, NAMELY, INFORMATION IN THE FIELD OF ENERGY EFFICIENCY; CONSULTATION IN THE FIELD OF ENERGY EFFICIENCY, NAMELY, EVALUATION OF ENERGY EFFICIENT EQUIPMENT AND EVALUATION OF CONSTRUCTION OF ENERGY EFFICIENT HOMES TO CONSERVE AND REDUCE ENERGY CONSUMPTION AND MAXIMIZE ENERGY SAVINGS, IN CLASS 35 (U.S. CLS. 100, 101 AND 102).

FIRST USE 9-25-2007; IN COMMERCE 9-25-2007.

THE MARK CONSISTS OF STANDARD CHARACTERS WITHOUT CLAIM TO ANY PARTICULAR FONT, STYLE, SIZE, OR COLOR.

NO CLAIM IS MADE TO THE EXCLUSIVE RIGHT TO USE "TEXAS", APART FROM THE MARK AS SHOWN.

SER. NO. 77-318,224, FILED 10-31-2007.

CHRISTINA SOBRAL, EXAMINING ATTORNEY

Int. Cl.: 35

Prior U.S. Cls.: 100, 101 and 102

United States Patent and Trademark Office

Reg. No. 3,479,622

Registered Aug. 5, 2008

**SERVICE MARK
PRINCIPAL REGISTER**

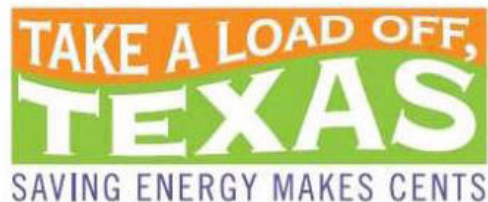

ONCOR ELECTRIC DELIVERY COMPANY
(TEXAS CORPORATION)
ENERGY PLAZA
1601 BRYAN STREET
DALLAS, TX 75201

FOR: CONSULTATION IN THE FIELD OF ENERGY EFFICIENCY; EDUCATION SERVICES, NAMELY, INFORMATION IN THE FIELD OF ENERGY EFFICIENCY; CONSULTATION IN THE FIELD OF ENERGY EFFICIENCY, NAMELY, EVALUATION OF ENERGY EFFICIENT EQUIPMENT AND EVALUATION OF CONSTRUCTION OF ENERGY EFFICIENT HOMES TO CONSERVE AND REDUCE ENERGY CONSUMPTION AND MAXIMIZE ENERGY SAVINGS, IN CLASS 35 (U.S. CLS. 100, 101 AND 102).

FIRST USE 9-25-2007; IN COMMERCE 9-25-2007.

NO CLAIM IS MADE TO THE EXCLUSIVE RIGHT TO USE "TEXAS", APART FROM THE MARK AS SHOWN.

THE COLOR(S) ORANGE, GREEN, WHITE AND BLUE IS/ARE CLAIMED AS A FEATURE OF THE MARK.

THE MARK CONSISTS OF A RECTANGLE DIVIDED INTO TWO BY A CURVED LINE, THE TOP PORTION APPEARS IN ORANGE WITH THE WHITE LETTERING "TAKE A LOAD OFF," THE LOWER PORTION APPEARS IN GREEN WITH THE WHITE LETTERING "TEXAS" BELOW THE RECTANGLE IS THE BLUE LETTERING "SAVING ENERGY MAKES CENTS".

SER. NO. 77-318,276, FILED 10-31-2007.

CHRISTINA SOBRAL, EXAMINING ATTORNEY

Int. Cl.: 35

Prior U.S. Cls.: 100, 101 and 102

United States Patent and Trademark Office

Reg. No. 3,479,623

Registered Aug. 5, 2008

**SERVICE MARK
PRINCIPAL REGISTER**

**TAKE A LOAD OFF, TEXAS
SAVING ENERGY MAKES CENTS**

ONCOR ELECTRIC DELIVERY COMPANY
(TEXAS CORPORATION)
ENERGY PLAZA
1601 BRYAN STREET
DALLAS, TX 75201

FOR: CONSULTATION IN THE FIELD OF ENERGY EFFICIENCY; EDUCATION SERVICES, NAMELY, INFORMATION IN THE FIELD OF ENERGY EFFICIENCY; CONSULTATION IN THE FIELD OF ENERGY EFFICIENCY, NAMELY, EVALUATION OF ENERGY EFFICIENT EQUIPMENT AND EVALUATION OF CONSTRUCTION OF ENERGY EFFICIENT HOMES TO CONSERVE AND REDUCE ENERGY CONSUMPTION AND MAXIMIZE ENERGY SAVINGS, IN CLASS 35 (U.S. CLS. 100, 101 AND 102).

FIRST USE 9-25-2007; IN COMMERCE 9-25-2007.

THE MARK CONSISTS OF STANDARD CHARACTERS WITHOUT CLAIM TO ANY PARTICULAR FONT, STYLE, SIZE, OR COLOR.

NO CLAIM IS MADE TO THE EXCLUSIVE RIGHT TO USE "TEXAS", APART FROM THE MARK AS SHOWN.

SER. NO. 77-318,305, FILED 10-31-2007.

CHRISTINA SOBRAL, EXAMINING ATTORNEY

Int. Cl.: 8

Prior U.S. Cls.: 23, 28 and 44

Reg. No. 3,479,624

United States Patent and Trademark Office

Registered Aug. 5, 2008

**TRADEMARK
PRINCIPAL REGISTER**



PRINCESS CARE, LLC (ARIZONA LTD LIAB CO)
PO BOX 9214
SURPRISE, AZ 85374

FOR: MANICURE SETS; PEDICURE SETS, IN
CLASS 8 (U.S. CLS. 23, 28 AND 44).

FIRST USE 0-0-2005; IN COMMERCE 0-0-2006.

NO CLAIM IS MADE TO THE EXCLUSIVE
RIGHT TO USE "CARE" , APART FROM THE
MARK AS SHOWN.

THE MARK CONSISTS OF THE WORDS "PRIN-
CESS CARE" WITH THE STYLIZED SILHOUETTE
OF A WOMAN IN BETWEEN THE WORDS "PRIN-
CESS CARE".

SER. NO. 77-318,456, FILED 10-31-2007.

JULIE GUTTADAURO, EXAMINING ATTORNEY

Int. Cl.: 25

Prior U.S. Cls.: 22 and 39

United States Patent and Trademark Office

Reg. No. 3,479,625

Registered Aug. 5, 2008

**TRADEMARK
PRINCIPAL REGISTER**



EFCI DESIGNS, LLC (CALIFORNIA LTD LIAB
CO)
1909 40TH STREET
SACRAMENTO, CA 95819

THE MARK CONSISTS OF A LION HEAD.

SER. NO. 77-318,619, FILED 10-31-2007.

FOR: SHIRTS, IN CLASS 25 (U.S. CLS. 22 AND 39).

FIRST USE 11-29-2003; IN COMMERCE 11-29-2003.

TRICIA SONNEBORN, EXAMINING ATTORNEY

Int. Cl.: 9

Prior U.S. Cls.: 21, 23, 26, 36 and 38

United States Patent and Trademark Office

Reg. No. 3,479,626

Registered Aug. 5, 2008

**TRADEMARK
PRINCIPAL REGISTER**

Mongabay

BUTLER, RHETT A (UNITED STATES INDIVIDUAL)
P.O. BOX 291
MENLO PARK, CA 94026

FOR: DOWNLOADABLE MULTIMEDIA FILE CONTAINING ARTWORK, TEXT, AUDIO, VIDEO, GAMES, AND INTERNET WEB LINKS RELATING TO SCIENCE, SOCIAL SCIENCE, TECHNOLOGY, TRAVEL, AND NATURE; DOWNLOADABLE ELECTRONIC PUBLICATIONS IN THE NATURE OF MAGAZINES IN THE FIELD OF SCIENCE, SOCIAL SCIENCE, TECHNOLOGY, TRAVEL, AND NATURE; DIGITAL MATERIALS, NAMELY, DOWNLOADABLE AUDIO FILES, VIDEO FILES, AND

IMAGE FILES FEATURING INFORMATION ON ENVIRONMENTAL SCIENCE, CONSERVATION, TECHNOLOGY, AND TRAVEL, IN CLASS 9 (U.S. CLS. 21, 23, 26, 36 AND 38).

FIRST USE 6-8-1999; IN COMMERCE 6-8-1999.

THE MARK CONSISTS OF STANDARD CHARACTERS WITHOUT CLAIM TO ANY PARTICULAR FONT, STYLE, SIZE, OR COLOR.

SER. NO. 77-318,629, FILED 10-31-2007.

KAREN K. BUSH, EXAMINING ATTORNEY

Int. Cls.: 20, 21 and 27

Prior U.S. Cls.: 2, 13, 19, 20, 22, 23, 25, 29, 30, 32, 33,
37, 40, 42 and 50

Reg. No. 3,479,627

United States Patent and Trademark Office

Registered Aug. 5, 2008

TRADEMARK
PRINCIPAL REGISTER



UPSIDE LIVING, INC. (FLORIDA CORPORATION)
9070 US HWY 1
MICCO, FL 32976

FIRST USE 1-1-2006; IN COMMERCE 6-1-2006.

FOR: STATUES OF WOOD, IN CLASS 20 (U.S. CLS. 2, 13, 22, 25, 32 AND 50).

FIRST USE 1-1-2006; IN COMMERCE 6-1-2006.

FOR: DINNERWARE, IN CLASS 21 (U.S. CLS. 2, 13, 23, 29, 30, 33, 40 AND 50).

FIRST USE 1-1-2006; IN COMMERCE 6-1-2006.

FOR: RUGS, IN CLASS 27 (U.S. CLS. 19, 20, 37, 42 AND 50).

THE MARK CONSISTS OF THE WORD "UPSIDE" AND THE WORD "LIVING". THE WORDS "UPSIDE LIVING" ARE IN A SCRIPT FONT. THE MARK CONTAINS A GRAPHIC ELEMENT BETWEEN THE WORDS "UPSIDE" AND "LIVING". THE GRAPHIC ELEMENT IS MADE UP OF AN OVAL BETWEEN TWO LEAF-LIKE GRAPHIC ELEMENTS. THE LEAF-LIKE GRAPHIC ON THE RIGHT OF THE OVAL IS HIGHER THAN THE LEAF-LIKE GRAPHIC ON THE LEFT.

SER. NO. 77-318,795, FILED 11-1-2007.

STEVEN JACKSON, EXAMINING ATTORNEY

Int. Cls.: 35, 36, 39, 41 and 42

Prior U.S. Cls.: 100, 101, 102, 105 and 107

United States Patent and Trademark Office

Reg. No. 3,479,628

Registered Aug. 5, 2008

**SERVICE MARK
PRINCIPAL REGISTER**

**INTERNATIONAL RHINO
FOUNDATION**

THE INTERNATIONAL RHINO FOUNDATION
(TEXAS CORPORATION)
3823 OWENS ROAD
YULEE, FL 32097

FOR: PROMOTING THE PUBLIC AWARENESS OF THE PROBLEMS AFFECTING THE SURVIVABILITY OF ALL SPECIES OF RHINOCEROS AND CONSERVATION EFFORTS RELATED THERETO, IN CLASS 35 (U.S. CLS. 100, 101 AND 102).

FIRST USE 11-30-1993; IN COMMERCE 11-30-1993.

FOR: CHARITABLE FUNDRAISING SERVICES, NAMELY, FUNDRAISING FOR GROUPS AND PROGRAMS PROMOTING THE PRESERVATION AND CONSERVATION OF RHINOS, IN CLASS 36 (U.S. CLS. 100, 101 AND 102).

FIRST USE 11-30-1993; IN COMMERCE 11-30-1993.

FOR: ANIMAL RESCUE SERVICES IN THE NATURE OF ANIMAL RELOCATION SERVICES, IN CLASS 39 (U.S. CLS. 100 AND 105).

FIRST USE 11-30-1993; IN COMMERCE 11-30-1993.

FOR: EDUCATIONAL SERVICES, NAMELY, CONDUCTING CLASSES IN THE FIELD OF PRE-

SERVATION OF RHINOS AND DISTRIBUTION OF EDUCATIONAL MATERIALS IN CONNECTION THEREWITH, IN CLASS 41 (U.S. CLS. 100, 101 AND 107).

FIRST USE 11-30-1993; IN COMMERCE 11-30-1993.

FOR: ZOOLOGICAL RESEARCH AND CONSULTATION, NAMELY, PROVIDING THE SCIENTIFIC RESOURCES NECESSARY TO FACILITATE THE CONSERVATION OF RHINOS, IN CLASS 42 (U.S. CLS. 100 AND 101).

FIRST USE 11-30-1993; IN COMMERCE 11-30-1993.

THE MARK CONSISTS OF STANDARD CHARACTERS WITHOUT CLAIM TO ANY PARTICULAR FONT, STYLE, SIZE, OR COLOR.

NO CLAIM IS MADE TO THE EXCLUSIVE RIGHT TO USE "FOUNDATION", APART FROM THE MARK AS SHOWN.

SEC. 2(F).

SER. NO. 77-319,182, FILED 11-1-2007.

HOWARD SMIGA, EXAMINING ATTORNEY

Int. Cl.: 20

Prior U.S. Cls.: 2, 13, 22, 25, 32 and 50

United States Patent and Trademark Office

Reg. No. 3,479,629

Registered Aug. 5, 2008

TRADEMARK
PRINCIPAL REGISTER



LANDIS, GARY (UNITED STATES INDIVIDUAL)
5148 ARROWHEAD LANE
PLANO, TX 75093 AND
LANDIS, CHERYL (UNITED STATES INDIVIDUAL)
5148 ARROWHEAD LANE
PLANO, TX 75093

OWNER OF U.S. REG. NO. 3,254,420.

THE MARK CONSISTS OF THE WORDING
"HANGEASE" WHEREIN IN THE DESIGN OF A
COLLAPSED HANGER REPRESENTS THE LETTER
"A" IN THE TERM "HANG".

FOR: CLOTHES HANGERS, IN CLASS 20 (U.S.
CLS. 2, 13, 22, 25, 32 AND 50).

SER. NO. 77-319,843, FILED 11-2-2007.

FIRST USE 4-26-2005; IN COMMERCE 4-26-2005.

ALICIA COLLINS, EXAMINING ATTORNEY

Int. Cl.: 36

Prior U.S. Cls.: 100, 101 and 102

United States Patent and Trademark Office

Reg. No. 3,479,630

Registered Aug. 5, 2008

**SERVICE MARK
PRINCIPAL REGISTER**



METROPOLITAN LIFE INSURANCE COMPANY
(NEW YORK CORPORATION)
1 METLIFE PLAZA, 27-01 QUEENS PLAZA NO.
LONG ISLAND CITY, NY 11101

FOR: PROVIDING INSURANCE AND ADMINISTRATION SERVICES FOR INDIVIDUAL AND GROUP LIFE, HEALTH, HOMEOWNERS, AND AUTOMOBILE INSURANCE, ANNUITIES AND PENSION FUNDS; RESIDENTIAL AND COMMERCIAL MORTGAGE LENDING SERVICES; REAL ESTATE BROKERAGE AND MANAGEMENT SERVICES; MUTUAL FUND BROKERAGE, BANKING

SERVICES AND INVESTMENT ADVISORY SERVICES, IN CLASS 36 (U.S. CLS. 100, 101 AND 102).

FIRST USE 6-1-2006; IN COMMERCE 6-1-2006.

THE MARK CONSISTS OF STANDARD CHARACTERS WITHOUT CLAIM TO ANY PARTICULAR FONT, STYLE, SIZE, OR COLOR.

SER. NO. 77-319,854, FILED 11-2-2007.

LESLEY LAMOTHE, EXAMINING ATTORNEY

Int. Cl.: 33

Prior U.S. Cls.: 47 and 49

United States Patent and Trademark Office

Reg. No. 3,479,631

Registered Aug. 5, 2008

TRADEMARK
PRINCIPAL REGISTER



LA FORTUNA S.A. (CHILE CORPORATION)
CAMINO A LA COSTA, 901
LONTUE, CHILE

FOR: WINES, IN CLASS 33 (U.S. CLS. 47 AND 49).

FIRST USE 3-30-2006; IN COMMERCE 3-30-2006.

OWNER OF U.S. REG. NO. 3,227,378.

THE MARK CONSISTS OF THE WORDS "LOCO MATICO" TO THE LEFT OF A STYLIZED DANCING FIGURE WITHIN AN IRREGULAR QUADRILATERAL.

THE FOREIGN WORDING IN THE MARK TRANSLATES INTO ENGLISH AS "CRAZY WEED".

SER. NO. 77-320,096, FILED 11-2-2007.

STEVEN JACKSON, EXAMINING ATTORNEY

Int. Cl.: 11

Prior U.S. Cls.: 13, 21, 23, 31 and 34

United States Patent and Trademark Office

Reg. No. 3,479,632

Registered Aug. 5, 2008

TRADEMARK
PRINCIPAL REGISTER



HOLIDAY BRIGHT LIGHTS, INC. (NEBRASKA CORPORATION)
10029 SCOTT CIRCLE
OMAHA, NE 68122

NO CLAIM IS MADE TO THE EXCLUSIVE RIGHT TO USE "HOLIDAY BRIGHT LIGHTS", APART FROM THE MARK AS SHOWN.

FOR: ELECTRIC HOLIDAY LIGHTS, IN CLASS 11 (U.S. CLS. 13, 21, 23, 31 AND 34).

SER. NO. 77-320,122, FILED 11-2-2007.

FIRST USE 10-30-2007; IN COMMERCE 10-30-2007.

SIMON TENG, EXAMINING ATTORNEY

Int. Cls.: 35 and 42

Prior U.S. Cls.: 100, 101 and 102

United States Patent and Trademark Office

Reg. No. 3,479,633

Registered Aug. 5, 2008

**SERVICE MARK
PRINCIPAL REGISTER**



BOWMAN DESIGN, INC. (DELAWARE CORPORATION)
12 B HIGHLAND AVENUE
ARLINGTON, MA 02476

FOR: ADVERTISING AND PROMOTION SERVICES AND RELATED CONSULTING; BRAND DEVELOPMENT SERVICES IN THE FIELDS OF ECOMMERCE, MARKETING, PUBLIC RELATIONS, SOFTWARE, AND MOTION PICTURES; CREATING CORPORATE AND BRAND IDENTITY FOR OTHERS; CREATING CORPORATE LOGOS FOR OTHERS, IN CLASS 35 (U.S. CLS. 100, 101 AND 102).

FIRST USE 9-1-1999; IN COMMERCE 9-1-1999.

FOR: COMPUTER SERVICES, NAMELY, DESIGNING AND IMPLEMENTING WEB SITES FOR OTHERS; GRAPHIC AND COMMERCIAL ART DE-

SIGN FOR OTHERS IN PRINT AND ELECTRONIC MEDIA; ECOMMERCE WEBSITE CONSULTATION AND INFORMATION TECHNOLOGY SERVICES, NAMELY, REQUIREMENTS GATHERING, CONTENT ASSESSMENT, DESIGN, DEVELOPMENT, QUALITY ASSURANCE, AND USER ACCEPTANCE TESTING, IN CLASS 42 (U.S. CLS. 100 AND 101).

FIRST USE 9-1-1999; IN COMMERCE 9-1-1999.

OWNER OF U.S. REG. NO. 2,466,843.

THE MARK CONSISTS OF AN ABSTRACT FIGURE OF A MAN HOLDING A BOW.

SER. NO. 77-320,129, FILED 11-2-2007.

MICHAEL KAZAZIAN, EXAMINING ATTORNEY

Int. Cl.: 35

Prior U.S. Cls.: 100, 101 and 102

United States Patent and Trademark Office

Reg. No. 3,479,634

Registered Aug. 5, 2008

**SERVICE MARK
PRINCIPAL REGISTER**

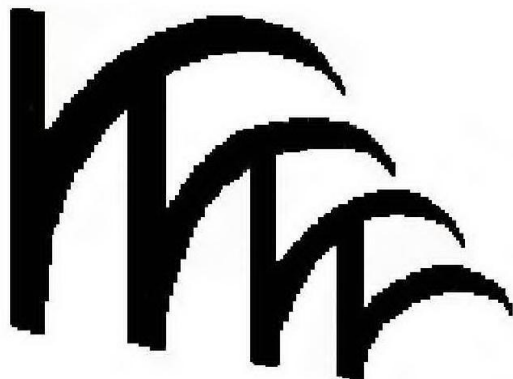

WORLDWIDE PCE LLC (MASSACHUSETTS LTD
LIAB CO)
1170 GULF BOULEVARD, SUITE 102
CLEARWATER, FL 33767

FOR: ADVERTISING AND BUSINESS MANAGEMENT CONSULTANCY; ADVICE IN THE FIELD OF BUSINESS MANAGEMENT AND MARKETING; ADVICE RELATING TO THE ORGANISATION AND MANAGEMENT OF BUSINESS; ADVISORY SERVICES RELATING TO BUSINESS MANAGEMENT AND BUSINESS OPERATIONS; ASSISTANCE TO INDUSTRIAL OR COMMERCIAL ENTERPRISES IN THE RUNNING OF THEIR BUSINESS; ASSISTANCE WITH BUSINESS MANAGEMENT AND PLANNING; ASSISTANCE, ADVISORY SERVICES AND CONSULTANCY WITH REGARD TO BUSINESS PLANNING, BUSINESS ANALYSIS, BUSINESS MANAGEMENT, AND BUSINESS ORGANIZATION; BUSINESS ACQUISITION AND MERGER CONSULTATION; BUSINESS ACQUISITIONS CONSULTATION; BUSINESS ADVISORY SERVICES, CONSULTANCY AND INFORMATION; BUSINESS CONSULTATION; BUSINESS CONSULTATION SERVICES; BUSINESS CONSULTING AND BUSINESS INFORMATION FOR ENTERPRISES;

BUSINESS CONSULTING AND INFORMATION SERVICES; BUSINESS CONSULTING, MANAGEMENT, PLANNING AND SUPERVISION; BUSINESS MANAGEMENT CONSULTANCY AS WELL AS DEVELOPMENT OF PROCESSES FOR THE ANALYSIS AND THE IMPLEMENTATION OF STRATEGY PLANS AND MANAGEMENT PROJECTS; BUSINESS MANAGEMENT CONSULTATION; BUSINESS MANAGEMENT CONSULTING; BUSINESS MANAGEMENT CONSULTING AND ADVISORY SERVICES; BUSINESS ORGANISATION CONSULTING; BUSINESS ORGANIZATION AND MANAGEMENT CONSULTING; BUSINESS PLANNING; BUSINESS SUCCESSION PLANNING, IN CLASS 35 (U.S. CLS. 100, 101 AND 102).

FIRST USE 12-31-2004; IN COMMERCE 12-31-2004.

THE MARK CONSISTS OF TWO CONNECTED LETTER W'S OF DECREASING SIZE IN UNUSUAL FONT.

SER. NO. 77-320,197, FILED 11-2-2007.

KATINA MISTER, EXAMINING ATTORNEY

Int. Cls.: 41 and 44

Prior U.S. Cls.: 100, 101 and 107

United States Patent and Trademark Office

Reg. No. 3,479,635

Registered Aug. 5, 2008

**SERVICE MARK
PRINCIPAL REGISTER**



COLLEGE OF AMERICAN PATHOLOGISTS (ILLINOIS NON-PROFIT CORPORATION)
325 WAUKEGAN ROAD
NORTHFIELD, IL 60093

FOR: EDUCATIONAL SERVICES, NAMELY, PROVIDING LIVE AND ON-LINE CLASSES, SEMINARS, CONFERENCES AND WORKSHOPS IN THE FIELD OF CLINICAL TERMINOLOGY AND HEALTH CARE STANDARDS AND THE USE AND IMPLEMENTATION THEREOF, AND DISTRIBUTING PRINTED AND ELECTRONIC EDUCATIONAL MATERIALS IN CONNECTION THEREWITH, IN CLASS 41 (U.S. CLS. 100, 101 AND 107).

FIRST USE 9-6-2007; IN COMMERCE 9-6-2007.

FOR: CONSULTING SERVICES IN THE FIELD OF HEALTH CARE, NAMELY, CONSULTING SERVICES IN THE FIELD OF CLINICAL TERMINOLOGY AND HEALTH CARE STANDARDS AND THE USE AND IMPLEMENTATION THEREOF, IN CLASS 44 (U.S. CLS. 100 AND 101).

FIRST USE 9-5-2007; IN COMMERCE 9-5-2007.

SER. NO. 77-320,659, FILED 11-2-2007.

KATHERINE E. HALMEN, EXAMINING ATTORNEY

Int. Cl.: 25

Prior U.S. Cls.: 22 and 39

United States Patent and Trademark Office

Reg. No. 3,479,636

Registered Aug. 5, 2008

**TRADEMARK
PRINCIPAL REGISTER**

BOOTIE BELT

TREFFILETTI, LUCI M. (UNITED STATES INDIVIDUAL), DBA BOOTIEBELT BY LOOLOO

178 WINTHROP AVENUE

ALBANY, NY 12206

FOR: BELTS MADE OF LEATHER; BELTS OF TEXTILE; FABRIC BELTS, IN CLASS 25 (U.S. CLS. 22 AND 39).

FIRST USE 11-1-2007; IN COMMERCE 11-1-2007.

THE MARK CONSISTS OF STANDARD CHARACTERS WITHOUT CLAIM TO ANY PARTICULAR FONT, STYLE, SIZE, OR COLOR.

NO CLAIM IS MADE TO THE EXCLUSIVE RIGHT TO USE "BELT", APART FROM THE MARK AS SHOWN.

SER. NO. 77-320,948, FILED S.R. 11-4-2007 AM. P.R. 4-2-2008.

ELLEN BURNS, EXAMINING ATTORNEY

Int. Cl.: 43

Prior U.S. Cls.: 100 and 101

United States Patent and Trademark Office

Reg. No. 3,479,637

Registered Aug. 5, 2008

**SERVICE MARK
PRINCIPAL REGISTER**



PRAXEIS, LLC (MARYLAND LTD LIAB CO)
4250 LAKESIDE DRIVE
JACKSONVILLE, FL 32210

FOR: RETIREMENT HOMES COMMUNITY PROVIDING CONTINUING CARE SERVICES IN THE NATURE OF ELDER CARE, IN CLASS 43 (U.S. CLS. 100 AND 101).

FIRST USE 5-0-2006; IN COMMERCE 5-0-2006.

THE COLOR(S) DARK RED (PMS 7427), GOLD (PMS 873), AND BLUE (PMS 644) IS/ARE CLAIMED AS A FEATURE OF THE MARK.

THE MARK CONSISTS OF THE COLOR BLUE (PMS 644) WHICH APPEARS IN THE WATER DESIGN. THE COLOR GOLD (PMS 873) APPEARS IN THE FOUNTAIN DESIGN, THE OUTLINE ENCLOSING THE FOUNTAIN DESIGN, AND THE WORDING "AT SOUTHWOOD". THE COLOR DARK RED (PMS 7427) APPEARS IN THE WORDING "WESTCOTT LAKES". THE FOREGOING PMS NUMBERS REFER TO THE PANTONE MATCHING SYSTEM.

SER. NO. 77-321,668, FILED 11-5-2007.

DORITT L. CARROLL, EXAMINING ATTORNEY

Int. Cl.: 36

Prior U.S. Cls.: 100, 101 and 102

United States Patent and Trademark Office

Reg. No. 3,479,638

Registered Aug. 5, 2008

**SERVICE MARK
PRINCIPAL REGISTER**



CLYDE COMPANIES, INC. (UTAH CORPORATION)
730 NORTH 1500 WEST
OREM, UT 84057

FOR: INSURANCE AGENCY, NAMELY, UNDERWRITING INSURANCE FOR GENERAL LIABILITY, WORKER'S COMPENSATION, TRUCKING, INLAND MARINE, PROPERTY, AUTOMOBILE, HOMEOWNERS, FLOOD, DIRECTORS AND OFFICERS, BUSINESS OWNERS AND UMBRELLA COVERAGE; SURETY SERVICES, IN CLASS 36 (U.S. CLS. 100, 101 AND 102).

FIRST USE 12-31-2003; IN COMMERCE 12-31-2003.

NO CLAIM IS MADE TO THE EXCLUSIVE RIGHT TO USE "INSURANCE" AND "COMPANY", APART FROM THE MARK AS SHOWN.

SER. NO. 77-321,681, FILED 11-5-2007.

CHRISTINE COOPER, EXAMINING ATTORNEY

Int. Cl.: 16

Prior U.S. Cls.: 2, 5, 22, 23, 29, 37, 38 and 50

United States Patent and Trademark Office

Reg. No. 3,479,639

Registered Aug. 5, 2008

**TRADEMARK
PRINCIPAL REGISTER**

**3-DEEP PHOTOS "MAKING YOUR
PHOTOS COME TO LIFE"**

CONQUET, RUDOLPH A. (UNITED STATES IN-
DIVIDUAL)
P.O. BOX 2041
NEW YORK, NY 10008

FOR: THREE-DIMENSIONAL FRAME MOUN-
TED PHOTOGRAPHS, IN CLASS 16 (U.S. CLS. 2, 5,
22, 23, 29, 37, 38 AND 50).

FIRST USE 8-13-2007; IN COMMERCE 8-13-2007.

THE MARK CONSISTS OF STANDARD CHAR-
ACTERS WITHOUT CLAIM TO ANY PARTICULAR
FONT, STYLE, SIZE, OR COLOR.

NO CLAIM IS MADE TO THE EXCLUSIVE
RIGHT TO USE "PHOTOS", APART FROM THE
MARK AS SHOWN.

SER. NO. 77-322,163, FILED 11-6-2007.

KEVIN DINALLO, EXAMINING ATTORNEY

Int. Cl.: 12

Prior U.S. Cls.: 19, 21, 23, 31, 35 and 44

Reg. No. 3,479,640

United States Patent and Trademark Office

Registered Aug. 5, 2008

**TRADEMARK
PRINCIPAL REGISTER**

TRU-BALANCE

TRU-BALANCE, LLC (COLORADO LTD LIAB
CO)
521 WHITNEY BAY
WINDSOR, CO 80550

FIRST USE 2-5-2004; IN COMMERCE 2-5-2004.

FOR: WHEEL CENTERING DEVICES, NAMELY,
SLEEVES AND PINS MOUNTED ON WHEEL HUB
BOLTS AND DISPOSED IN VEHICLE WHEEL
APERTURES, THE SLEEVES REMAIN AND THE
PINS ARE REMOVED DURING VEHICLE USE, IN
CLASS 12 (U.S. CLS. 19, 21, 23, 31, 35 AND 44).

THE MARK CONSISTS OF STANDARD CHAR-
ACTERS WITHOUT CLAIM TO ANY PARTICULAR
FONT, STYLE, SIZE, OR COLOR.

SER. NO. 77-322,445, FILED 11-6-2007.

LINDA ORNDORFF, EXAMINING ATTORNEY

Int. Cls.: 35 and 42

Prior U.S. Cls.: 100, 101 and 102

United States Patent and Trademark Office

Reg. No. 3,479,641

Registered Aug. 5, 2008

**SERVICE MARK
PRINCIPAL REGISTER**

THINK NOCTURNAL

THINK NOCTURNAL, LLC (NEW HAMPSHIRE
LTD LIAB CO)
8 CONTINENTAL DRIVE, UNIT E
EXETER, NH 03833

FOR: MARKETING CONSULTING SERVICES;
MARKETING RESEARCH; BRANDING CONSUL-
TATION, NAMELY, BRAND PLANNING AND
BRAND DEVELOPMENT FOR OTHERS , IN CLASS
35 (U.S. CLS. 100, 101 AND 102).

FIRST USE 4-30-2006; IN COMMERCE 4-30-2006.

FOR: GRAPHIC DESIGN, ILLUSTRATION AND
WEB SITE DESIGN SERVICES FOR OTHERS; COM-

PUTER SERVICES, NAMELY, DESIGNING CUSTO-
MIZED SOFTWARE APPLICATIONS FOR OTHERS,
IN CLASS 42 (U.S. CLS. 100 AND 101).

FIRST USE 4-30-2006; IN COMMERCE 4-30-2006.

THE MARK CONSISTS OF STANDARD CHAR-
ACTERS WITHOUT CLAIM TO ANY PARTICULAR
FONT, STYLE, SIZE, OR COLOR.

SER. NO. 77-322,516, FILED 11-6-2007.

CURTIS FRENCH, EXAMINING ATTORNEY

Int. Cl.: 44

Prior U.S. Cls.: 100 and 101

United States Patent and Trademark Office

Reg. No. 3,479,642

Registered Aug. 5, 2008

**SERVICE MARK
PRINCIPAL REGISTER**

BIG TREE FARM

BIG TREE FARM, LLC (SOUTH CAROLINA LTD
LIAB CO)
490 BIG TREE ROAD
SALLEY, SC 29137

FOR: HORSE BREEDING SERVICES; HORSE
CARE, NAMELY, FEEDING THE HORSES FOR
ABSENT OWNERS; HORSE FARMS, IN CLASS 44
(U.S. CLS. 100 AND 101).

FIRST USE 3-0-2005; IN COMMERCE 3-0-2005.

THE MARK CONSISTS OF STANDARD CHAR-
ACTERS WITHOUT CLAIM TO ANY PARTICULAR
FONT, STYLE, SIZE, OR COLOR.

NO CLAIM IS MADE TO THE EXCLUSIVE
RIGHT TO USE "FARM", APART FROM THE
MARK AS SHOWN.

SER. NO. 77-322,561, FILED 11-6-2007.

LINDA MICKLEBURGH, EXAMINING ATTORNEY

Int. Cl.: 42

Prior U.S. Cls.: 100 and 101

United States Patent and Trademark Office

Reg. No. 3,479,643

Registered Aug. 5, 2008

**SERVICE MARK
PRINCIPAL REGISTER**

The logo for RedPear features the word "redpear" in a bold, lowercase, sans-serif font. The letters "red" are black, and the letters "pear" are black, except for the letter "e", which is red. The "e" is a simple, rounded shape with a small gap at the top.

WILLEY, BRANDON (UNITED STATES INDIVIDUAL)
SUITE 2
949 EAST GUADALUPE ROAD
TEMPE, AZ 85283

FOR: COMPUTER SERVICES, NAMELY, DESIGNING AND IMPLEMENTING NETWORK WEB PAGES FOR OTHERS; CREATION AND MAINTENANCE OF WEB SITES FOR OTHERS; COMPUTER SERVICES, NAMELY, MANAGING WEB SITES FOR OTHERS; COMPUTER SERVICES, NAMELY, DESIGNING AND IMPLEMENTING WEB SITES FOR OTHERS; CREATING OR MAINTAINING WEB SITES FOR OTHERS; CREATION AND PROVISION OF WEB PAGES TO AND FOR THIRD PARTIES; DESIGN OF HOME PAGES, COMPUTER SOFTWARE AND WEB SITES; DESIGN OF HOMEPAGES AND WEB-SITES; ELABORATION AND MAINTENANCE OF WEB SITES FOR THIRD PARTIES; WEB SITE HOSTING SERVICES; COMPUTER SECURITY SERVICE, NAMELY, RESTRICTING ACCESS TO AND BY COMPUTER NETWORKS TO AND OF UNDESIRE WEB SITES, MEDIA AND INDIVIDUALS AND FACILITIES; COMPUTER SERVICE, NAMELY, ACTING AS AN APPLICATION SERVICE PROVIDER IN THE FIELD OF KNOWLEDGE MANAGEMENT TO HOST COMPUTER APPLICATION SOFTWARE FOR SEARCHING AND RETRIEVING INFORMATION FROM DATABASES AND COMPU-

TER NETWORKS; DESIGN AND DEVELOPMENT OF NETWORKS; INTEGRATION OF COMPUTER SYSTEMS AND NETWORKS; PLANNING, DEVELOPMENT AND TECHNICAL SUPPORT OF ELECTRONIC COMMUNICATIONS NETWORKS; SEARCHING AND RETRIEVING INFORMATION, SITES, AND OTHER RESOURCES AVAILABLE ON COMPUTER NETWORKS FOR OTHERS; TECHNICAL SUPPORT SERVICES, NAMELY, TROUBLESHOOTING OF COMPUTER SOFTWARE PROBLEMS; TECHNICAL SUPPORT, NAMELY, MONITORING OF NETWORK SYSTEMS; TECHNICAL SUPPORT, NAMELY, PROVIDING BACK-UP COMPUTER PROGRAMS AND FACILITIES, IN CLASS 42 (U.S. CLS. 100 AND 101).

FIRST USE 1-5-2007; IN COMMERCE 1-5-2007.

THE COLOR(S) RED AND BLACK IS/ARE CLAIMED AS A FEATURE OF THE MARK.

THE MARK CONSISTS OF THE WORD "RED-PEAR" WITH THE LETTER "E" IN THE COLOR RED AND THE REMAINING LETTERS IN BLACK.

SER. NO. 77-322,567, FILED 11-6-2007.

DANIEL CAPSHAW, EXAMINING ATTORNEY

Int. Cl.: 26

Prior U.S. Cls.: 37, 39, 40, 42 and 50

United States Patent and Trademark Office

Reg. No. 3,479,644

Registered Aug. 5, 2008

**TRADEMARK
PRINCIPAL REGISTER**

HAIR TYES BY CAROLINE

C-LINE, LLC (MISSOURI LTD LIAB CO)
237 WEST MANOR DRIVE
CHESTERFIELD, MO 63017

FOR: HAIR BANDS, IN CLASS 26 (U.S. CLS. 37, 39,
40, 42 AND 50).

FIRST USE 10-22-2007; IN COMMERCE 10-22-2007.

THE MARK CONSISTS OF STANDARD CHAR-
ACTERS WITHOUT CLAIM TO ANY PARTICULAR
FONT, STYLE, SIZE, OR COLOR.

NO CLAIM IS MADE TO THE EXCLUSIVE
RIGHT TO USE "HAIR TYES", APART FROM THE
MARK AS SHOWN.

THE NAME "CAROLINE" IDENTIFIES A LIVING
INDIVIDUAL WHOSE CONSENT IS OF RECORD.

SER. NO. 77-322,659, FILED 11-6-2007.

KIMBERLY PERRY, EXAMINING ATTORNEY

Int. Cl.: 1

Prior U.S. Cls.: 1, 5, 6, 10, 26 and 46

United States Patent and Trademark Office

Reg. No. 3,479,645

Registered Aug. 5, 2008

**TRADEMARK
PRINCIPAL REGISTER**

DYLIGHT

PIERCE BIOTECHNOLOGY, INC. (DELAWARE CORPORATION)
P.O. BOX 117
3747 N. MERIDAN ROAD
ROCKFORD, IL 61105

FOR: REAGENTS FOR SCIENTIFIC AND MEDICAL RESEARCH, NAMELY, FLUORESCENT STAINS, FLUORESCENT DYES AND CONJUGATES OF FLUORESCENT DYES WITH BIOMOLECULES; CHEMICAL SOLUTIONS FOR SCIENTIFIC AND MEDICAL RESEARCH COMPRISED OF CONJUGATES OF FLUORESCENT DYES, A SOLVENT AND ONE OR MORE OF A CO-SOLVENT, PH BUFFER, SALT OR PRESERVATIVE; REAGENT KITS FOR SCIENTIFIC AND MEDICAL RESEARCH COMPRISED OF SOLUTIONS OF CONJUGATES AND A SOLID PHASE FOR SEPARATIONS DURING USE OF THE CONJUGATES; REAGENT KITS

FOR SCIENTIFIC AND MEDICAL RESEARCH COMPRISED OF REACTIVE FLUORESCENT DYES IN SOLID POWDER FORM AND A CHEMICAL SOLUTION CONTAINING AT LEAST ONE CHEMICAL REACTANT FOR ATTACHMENT OF THE FLUORESCENT DYE TO A BIOMOLECULE, IN CLASS 1 (U.S. CLS. 1, 5, 6, 10, 26 AND 46).

FIRST USE 8-0-2004; IN COMMERCE 8-0-2004.

THE MARK CONSISTS OF STANDARD CHARACTERS WITHOUT CLAIM TO ANY PARTICULAR FONT, STYLE, SIZE, OR COLOR.

SER. NO. 77-322,673, FILED 11-6-2007.

LINDA LAVACHE, EXAMINING ATTORNEY

Int. Cl.: 25

Prior U.S. Cls.: 22 and 39

United States Patent and Trademark Office

Reg. No. 3,479,646

Registered Aug. 5, 2008

TRADEMARK
PRINCIPAL REGISTER

St.Pole

JULIE INTERNATIONAL,INC (CALIFORNIA
CORPORATION)
SUITE#200-H
1543 W. OLYMPIC BLVD
LOS ANGELES, CA 90015

FOR: HOODS; CARGO PANTS; PANTS; HEAVY
JACKETS; JACKETS; MEN AND WOMEN JACKETS,
SPORTS JACKETS; WIND-JACKETS; KNIT SHIRTS;
POLO SHIRTS; SHIRTS; SHORT-SLEEVED OR
LONG-SLEEVED T-SHIRTS; SHORT-SLEEVED
SHIRTS; SPORTS SHIRTS; T-SHIRTS; TEE SHIRTS,
IN CLASS 25 (U.S. CLS. 22 AND 39).

FIRST USE 8-26-2007; IN COMMERCE 8-26-2007.

THE MARK CONSISTS OF STANDARD CHAR-
ACTERS WITHOUT CLAIM TO ANY PARTICULAR
FONT, STYLE, SIZE, OR COLOR.

"ST. POLE" HAS NO FOREIGN MEANING.

SER. NO. 77-323,033, FILED S.R. 11-6-2007 AM. P.R.
3-28-2008.

NAKIA HENRY, EXAMINING ATTORNEY

Int. Cl.: 42

Prior U.S. Cls.: 100 and 101

United States Patent and Trademark Office

Reg. No. 3,479,647

Registered Aug. 5, 2008

**SERVICE MARK
PRINCIPAL REGISTER**

Skylon

SKYLON INNOVATIONS, INC. (NORTH CAROLINA CORPORATION)
1304 OAKLAND AVENUE
GREENSBORO, NC 27403

THE MARK CONSISTS OF STANDARD CHARACTERS WITHOUT CLAIM TO ANY PARTICULAR FONT, STYLE, SIZE, OR COLOR.

FOR: TECHNICAL MONITORING SERVICES FOR CONDITIONS OF AIR AND WATER, IN CLASS 42 (U.S. CLS. 100 AND 101).

SER. NO. 77-323,363, FILED 11-7-2007.

FIRST USE 2-28-2005; IN COMMERCE 2-28-2005.

ANTHONY RINKER, EXAMINING ATTORNEY

Int. Cl.: 35

Prior U.S. Cls.: 100, 101 and 102

United States Patent and Trademark Office

Reg. No. 3,479,648

Registered Aug. 5, 2008

SERVICE MARK
PRINCIPAL REGISTER



CYGNUS BUSINESS MEDIA, INC. (DELAWARE CORPORATION)
1233 JANESVILLE AVENUE
FORT ATKINSON, WI 53538

FOR: ARRANGING AND CONDUCTING TRADE SHOWS IN THE FIELD OF LAW ENFORCEMENT, IN CLASS 35 (U.S. CLS. 100, 101 AND 102).

FIRST USE 1-0-2005; IN COMMERCE 1-0-2005.

NO CLAIM IS MADE TO THE EXCLUSIVE RIGHT TO USE "ENFORCEMENT EXPO" AND "FOR LAW ENFORCEMENT", APART FROM THE MARK AS SHOWN.

THE COLOR(S) BLACK AND BLUE IS/ARE CLAIMED AS A FEATURE OF THE MARK.

THE MARK CONSISTS OF THE WORDING "ENFORCEMENT ON THE JOB SOLUTIONS FOR LAW ENFORCEMENT" IN BLACK AND THE WORD EXPO IN BLUE.

SER. NO. 77-323,449, FILED 11-7-2007.

KATHLEEN LORENZO, EXAMINING ATTORNEY

Int. Cl.: 43

Prior U.S. Cls.: 100 and 101

United States Patent and Trademark Office

Reg. No. 3,479,649

Registered Aug. 5, 2008

SERVICE MARK
PRINCIPAL REGISTER



VINAIGRETTE, INC. (NEW MEXICO CORPORATION)
134 S.R. 503
SANTA FE, NM 87506

THE MARK CONSISTS OF A DRAWING OF TWO BOTTLES AND THE WORD "VINAIGRETTE".

FOR: CAFE-RESTAURANTS, IN CLASS 43 (U.S. CLS. 100 AND 101).

SER. NO. 77-323,451, FILED 11-7-2007.

FIRST USE 6-15-2007; IN COMMERCE 10-5-2007.

HENRY S. ZAK, EXAMINING ATTORNEY

Int. Cl.: 42

Prior U.S. Cls.: 100 and 101

United States Patent and Trademark Office

Reg. No. 3,479,650

Registered Aug. 5, 2008

**SERVICE MARK
PRINCIPAL REGISTER**

**Clean Air. Pure Water.
Real Health.**

SKYLON INNOVATIONS, INC. (NORTH CAROLINA CORPORATION)
1304 OAKLAND AVENUE
GREENSBORO, NC 27403

THE MARK CONSISTS OF STANDARD CHARACTERS WITHOUT CLAIM TO ANY PARTICULAR FONT, STYLE, SIZE, OR COLOR.

FOR: TECHNICAL MONITORING SERVICES FOR CONDITIONS OF AIR AND WATER, IN CLASS 42 (U.S. CLS. 100 AND 101).

SER. NO. 77-323,468, FILED 11-7-2007.

FIRST USE 2-28-2005; IN COMMERCE 2-28-2005.

ANTHONY RINKER, EXAMINING ATTORNEY

Int. Cl.: 41

Prior U.S. Cls.: 100, 101 and 107

United States Patent and Trademark Office

Reg. No. 3,479,651

Registered Aug. 5, 2008

**SERVICE MARK
PRINCIPAL REGISTER**

SPECIALIZE FITNESS

SPECIALIZE FITNESS, INC. (NEW YORK CORPORATION)
857 ALBANY AVE
BROOKLYN, NY 11203

FOR: PROVIDING ASSISTANCE, PERSONAL TRAINING AND PHYSICAL FITNESS CONSULTATION TO INDIVIDUALS TO HELP THEM MAKE PHYSICAL FITNESS, STRENGTH, CONDITIONING, AND EXERCISE IMPROVEMENT IN THEIR DAILY LIVING, IN CLASS 41 (U.S. CLS. 100, 101 AND 107).

FIRST USE 10-18-2004; IN COMMERCE 12-18-2004.

THE MARK CONSISTS OF STANDARD CHARACTERS WITHOUT CLAIM TO ANY PARTICULAR FONT, STYLE, SIZE, OR COLOR.

OWNER OF U.S. REG. NO. 3,099,811.

NO CLAIM IS MADE TO THE EXCLUSIVE RIGHT TO USE "FITNESS", APART FROM THE MARK AS SHOWN.

SER. NO. 77-323,550, FILED 11-7-2007.

JULIE WATSON, EXAMINING ATTORNEY

Int. Cl.: 42

Prior U.S. Cls.: 100 and 101

United States Patent and Trademark Office

Reg. No. 3,479,652

Registered Aug. 5, 2008

**SERVICE MARK
PRINCIPAL REGISTER**



SKYLON INNOVATIONS, INC. (NORTH CAROLINA CORPORATION)
1304 OAKLAND AVENUE
GREENSBORO, NC 27403

FIRST USE 2-28-2005; IN COMMERCE 2-28-2005.

SER. NO. 77-323,596, FILED 11-7-2007.

FOR: TECHNICAL MONITORING SERVICES
FOR CONDITIONS OF AIR AND WATER, IN CLASS
42 (U.S. CLS. 100 AND 101).

ANTHONY RINKER, EXAMINING ATTORNEY

Int. Cl.: 38

Prior U.S. Cls.: 100, 101 and 104

United States Patent and Trademark Office

Reg. No. 3,479,653

Registered Aug. 5, 2008

**SERVICE MARK
PRINCIPAL REGISTER**

**ONE COMPANY-CONNECTING
YOUR WORLD**

HARGRAY COMMUNICATIONS GROUP, INC.
(SOUTH CAROLINA CORPORATION)
BLDG C, P.O. BOX 5986
856 WILLIAM HILTON PARKWAY
HILTON HEAD ISLAND, SC 29938

FOR: INTERNET SERVICE PROVIDER; WIRE-
LESS TELEPHONE SERVICES; TELEPHONE COM-
MUNICATIONS SERVICES AND CABLE
TELEVISION BROADCASTING SERVICES, IN
CLASS 38 (U.S. CLS. 100, 101 AND 104).

FIRST USE 10-25-2007; IN COMMERCE 10-25-2007.

THE MARK CONSISTS OF STANDARD CHAR-
ACTERS WITHOUT CLAIM TO ANY PARTICULAR
FONT, STYLE, SIZE, OR COLOR.

SER. NO. 77-323,611, FILED 11-7-2007.

KAREN BRACEY, EXAMINING ATTORNEY

Int. Cl.: 38

Prior U.S. Cls.: 100, 101 and 104

United States Patent and Trademark Office

Reg. No. 3,479,654

Registered Aug. 5, 2008

**SERVICE MARK
PRINCIPAL REGISTER**

Onebox connects the world
to you.

CALL SCIENCES, INC. (DELAWARE CORPORATION)
706 GREEN BAY ROAD, SUITE 7
GLENCOE, IL 60022

FOR: TELECOMMUNICATION SERVICES, NAMELY, THE TRANSMISSION OF VOICE, DATA, IMAGES, VIDEO AND MESSAGES OVER THE INTERNET, IN CLASS 38 (U.S. CLS. 100, 101 AND 104).

FIRST USE 4-11-2007; IN COMMERCE 4-11-2007.

THE MARK CONSISTS OF STANDARD CHARACTERS WITHOUT CLAIM TO ANY PARTICULAR FONT, STYLE, SIZE, OR COLOR.

OWNER OF U.S. REG. NO. 2,836,857.

SER. NO. 77-323,760, FILED 11-7-2007.

LINDA M. KING, EXAMINING ATTORNEY

Int. Cls.: 35 and 41

Prior U.S. Cls.: 100, 101, 102 and 107

United States Patent and Trademark Office

Reg. No. 3,479,655

Registered Aug. 5, 2008

**SERVICE MARK
PRINCIPAL REGISTER**

**SOCIETY OF COMPETITIVE
INTELLIGENCE PROFESSIONALS**

SOCIETY OF COMPETITIVE INTELLIGENCE
PROFESSIONALS (D.C. CORPORATION)
SUITE 600
1700 DIAGONAL ROAD
ALEXANDRIA, VA 22314

FOR: ASSOCIATION SERVICES, NAMELY, PROMOTING THE INTEREST OF COMPETITIVE INTELLIGENCE PROFESSIONALS AND THE COMPETITIVE INTELLIGENCE INDUSTRY, IN CLASS 35 (U.S. CLS. 100, 101 AND 102).

FIRST USE 11-0-1987; IN COMMERCE 11-0-1987.

FOR: EDUCATIONAL SERVICES, NAMELY, ARRANGING AND CONDUCTING COURSES OF INSTRUCTION, EDUCATIONAL CONFERENCES, WORKSHOPS, SEMINARS AND SYMPOSIA IN THE FIELD OF COMPETITIVE INTELLIGENCE, IN CLASS 41 (U.S. CLS. 100, 101 AND 107).

FIRST USE 11-0-1987; IN COMMERCE 11-0-1987.

THE MARK CONSISTS OF STANDARD CHARACTERS WITHOUT CLAIM TO ANY PARTICULAR FONT, STYLE, SIZE, OR COLOR.

OWNER OF U.S. REG. NOS. 1,750,866, 3,339,821 AND OTHERS.

NO CLAIM IS MADE TO THE EXCLUSIVE RIGHT TO USE "SOCIETY", APART FROM THE MARK AS SHOWN.

SEC. 2(F).

SER. NO. 77-323,821, FILED 11-7-2007.

SARA THOMAS, EXAMINING ATTORNEY

Int. Cl.: 3

Prior U.S. Cls.: 1, 4, 6, 50, 51 and 52

United States Patent and Trademark Office

Reg. No. 3,479,656

Registered Aug. 5, 2008

**TRADEMARK
PRINCIPAL REGISTER**



PERSONAL CARE PRODUCTS, INC. (MICHIGAN CORPORATION)
SUITE 202
32500 TELEGRAPH ROAD
BINGHAM FARMS, MI 48025

FOR: HAIR SHAMPOO, CONDITIONERS, GEL AND SPRAY; SHAVING SOAPS AND AFTER SHAVE LOTION; BABY OIL, BABY POWDER, BABY SHAMPOO AND PREMOISTENED BABY WIPES; AROMATHERAPY OILS, BODY LOTION, BODY CREAMS AND BODY WASH; ANTI-AGING AND ANTI-WRINKLE CREAM, DEODORANT SOAP, ANTIBACTERIAL SOAP, PETROLEUM JELLY FOR COSMETIC PURPOSES, BATH FOAM, NON-MEDICATED FOOT POWDER, TOOTHPASTE, PERSONAL DEODORANT, PREMOISTENED COSMETIC WIPES AND NAIL POLISH REMOVER, IN CLASS 3 (U.S. CLS. 1, 4, 6, 50, 51 AND 52).

FIRST USE 10-31-1989; IN COMMERCE 10-31-1989.

OWNER OF U.S. REG. NO. 3,301,688.

NO CLAIM IS MADE TO THE EXCLUSIVE RIGHT TO USE "PERSONAL CARE" , APART FROM THE MARK AS SHOWN.

THE MARK CONSISTS OF WATER DROPS FORMING A STYLIZED DESIGN OF A SEMI-CIRCLE ABOVE THE WORDING "PERSONAL CARE".

SER. NO. 77-324,280, FILED 11-8-2007.

COLLEEN DOMBROW, EXAMINING ATTORNEY

Int. Cl.: 36

Prior U.S. Cls.: 100, 101 and 102

United States Patent and Trademark Office

Reg. No. 3,479,657

Registered Aug. 5, 2008

SERVICE MARK
PRINCIPAL REGISTER



WOYOME FOUNDATION FOR AFRICA (GHANA NON-PROFIT CORPORATION)

PRIVATE MAIL BAG 100
GENERAL POST OFFICE
ACCRA, GHANA

FOR: CHARITABLE FUND RAISING SERVICES BY MEANS OF MUSICAL CONCERTS, IN CLASS 36 (U.S. CLS. 100, 101 AND 102).

FIRST USE 8-1-2007; IN COMMERCE 8-1-2007.

NO CLAIM IS MADE TO THE EXCLUSIVE RIGHT TO USE "AFRICA" AND "AID", APART FROM THE MARK AS SHOWN.

THE COLOR(S) BLACK, BROWN, YELLOW, RED AND WHITE IS/ARE CLAIMED AS A FEATURE OF THE MARK.

THE MARK CONSISTS OF AN OUTLINE OF THE CONTINENT OF AFRICA, IN WHICH AFRICA IS SHOWN IN BROWN, WITH A WHITE BORDER. WITHIN AFRICA, THE NATION OF GHANA IS OUTLINED IN YELLOW. A BLACK RECTANGLE SURROUNDS THE OUTLINE OF AFRICA ON THE TOP AND RIGHT-HAND SIDE. A RED BOW APPEARS ABOVE THE OUTLINE OF AFRICA. THE WORDS "AFRICA LIFE AID" APPEAR TO THE UPPER RIGHT OF THE OUTLINE OF AFRICA, PARTLY WITHIN THE BLACK RECTANGLE AND PARTLY IN THE MARGIN TO THE RIGHT OF THE BLACK RECTANGLE. WHERE THE WORDS OVERLAP THE BLACK RECTANGLE, THE LETTERING IS WHITE; IN THE MARGIN, THE LETTERING IS BLACK.

SER. NO. 77-324,378, FILED 11-8-2007.

ALEXANDER L. POWERS, EXAMINING ATTORNEY

Int. Cl.: 16

Prior U.S. Cls.: 2, 5, 22, 23, 29, 37, 38 and 50

United States Patent and Trademark Office

Reg. No. 3,479,658

Registered Aug. 5, 2008

**TRADEMARK
PRINCIPAL REGISTER**

**the first name in visual
arts entertainment**

THREE J PRODUCTIONS, LLC (CONNECTICUT
LTD LIAB CO)
35 ASHVILLE STREET -P.O. BOX 26811
WEST HAVEN, CT 06516

THE MARK CONSISTS OF STANDARD CHAR-
ACTERS WITHOUT CLAIM TO ANY PARTICULAR
FONT, STYLE, SIZE, OR COLOR.

FOR: PRINTED VISUALS IN THE NATURE OF
GRAPHIC NOVELS, COMIC BOOKS, AND POS-
TERS, IN CLASS 16 (U.S. CLS. 2, 5, 22, 23, 29, 37, 38
AND 50).

SER. NO. 77-324,392, FILED 11-8-2007.

FIRST USE 1-23-2008; IN COMMERCE 1-23-2008.

INGRID C. EULIN, EXAMINING ATTORNEY

Int. Cls.: 31 and 35

Prior U.S. Cls.: 1, 46, 100, 101 and 102

United States Patent and Trademark Office

Reg. No. 3,479,659

Registered Aug. 5, 2008

**TRADEMARK
SERVICE MARK
PRINCIPAL REGISTER**



NATIONAL MANGO BOARD INC. (FLORIDA
NON-PROFIT CORPORATION)
1417 CARDINAL ROAD
ORLANDO, FL 32803

THE COLOR(S) GREEN, WHITE, RED, ORANGE
AND YELLOW IS/ARE CLAIMED AS A FEATURE
OF THE MARK.

FOR: FRESH FRUITS, NAMELY MANGOS, IN
CLASS 31 (U.S. CLS. 1 AND 46).

THE WORDS "NATIONAL" AND "BOARD," THE
LETTERS "M" AND "G" IN THE WORD "MANGO,"
THE OUTLINE OF THE MANGO DESIGN AND
OUTER BORDER OF THE OVAL DESIGN ARE IN
THE COLOR GREEN. THE LETTER "A" IN THE
WORD "MANGO" IS IN THE COLOR RED. THE
LETTER "N" IN THE WORD "MANGO" IS IN THE
COLOR YELLOW. THE MANGO DESIGN IS IN THE
COLORS ORANGE AND YELLOW. THE BACK-
GROUND OF THE OVAL DESIGN IS WHITE.

FIRST USE 4-0-2007; IN COMMERCE 4-0-2007.

FOR: ADVERTISING, MARKETING AND PRO-
MOTION SERVICES, NAMELY, PROMOTING THE
SALE AND CONSUMPTION BY OTHERS OF MAN-
GOS, IN CLASS 35 (U.S. CLS. 100, 101 AND 102).

FIRST USE 1-0-2006; IN COMMERCE 1-0-2006.

NO CLAIM IS MADE TO THE EXCLUSIVE
RIGHT TO USE "NATIONAL MANGO BOARD",
APART FROM THE MARK AS SHOWN.

SER. NO. 77-324,411, FILED 11-8-2007.

BENJAMIN ALLEN, EXAMINING ATTORNEY

Int. Cl.: 42

Prior U.S. Cls.: 100 and 101

United States Patent and Trademark Office

Reg. No. 3,479,660

Registered Aug. 5, 2008

**SERVICE MARK
PRINCIPAL REGISTER**

NEXGEN SOFTWARE SERVICES

NEXGEN SOFTWARE SERVICES, INC. (TEXAS
CORPORATION)
SUITE B9
3400 RESEARCH FOREST DRIVE
THE WOODLANDS, TX 77381

FOR: COMPUTER SOFTWARE DEVELOPMENT,
IN CLASS 42 (U.S. CLS. 100 AND 101).

FIRST USE 8-4-1998; IN COMMERCE 8-4-1998.

THE MARK CONSISTS OF STANDARD CHAR-
ACTERS WITHOUT CLAIM TO ANY PARTICULAR
FONT, STYLE, SIZE, OR COLOR.

NO CLAIM IS MADE TO THE EXCLUSIVE
RIGHT TO USE "SOFTWARE SERVICES", APART
FROM THE MARK AS SHOWN.

SER. NO. 77-324,436, FILED 11-8-2007.

FRANK LATTUCA, EXAMINING ATTORNEY

Int. Cl.: 41

Prior U.S. Cls.: 100, 101 and 107

United States Patent and Trademark Office

Reg. No. 3,479,661

Registered Aug. 5, 2008

**SERVICE MARK
PRINCIPAL REGISTER**



RATHSKELLER PRESS LLC (GEORGIA LTD
LIAB CO)
SUITE B-324
2526 MT VERNON ROAD
ATLANTA, GA 30338

FOR: PUBLICATION OF TEXTS, BOOKS, JOUR-
NALS, IN CLASS 41 (U.S. CLS. 100, 101 AND 107).

FIRST USE 11-2-2007; IN COMMERCE 11-2-2007.

NO CLAIM IS MADE TO THE EXCLUSIVE
RIGHT TO USE "PRESS", APART FROM THE
MARK AS SHOWN.

THE COLOR(S) GREEN, GRAY, BLACK AND
WHITE IS/ARE CLAIMED AS A FEATURE OF THE
MARK.

THE MARK CONSISTS OF A GRAY LIGHT BULB
WITH THE GRAY COLOR SHADING FROM DARK
ON THE LEFT TO A LIGHTER GRAY CENTER
AND THEN BACK TO DARK ON THE RIGHT, IN A
VERTICAL POSITION WITH THE LARGER BULB
PORTION AT THE TOP, SET AGAINST A GREEN
STYLIZED SUNBURST, SHOWING ONLY THE TOP
HALF OF THE SUNBURST, WITH THE WORD
"RATHSKELLER" IN WHITE, HAVING A CAPITAL
"R" AND THE REMAINING LETTERS IN LOWER
CASE, WRAPPED ALONG THE CURVED EDGE OF
THE TOP OF THE SUNBURST, AND THE WORD
"PRESS", IN WHITE IN ALL CAPITAL LETTERS,
CENTERED JUST BELOW THE SUNBURST
AGAINST A BLACK BACKGROUND.

SER. NO. 77-324,451, FILED 11-8-2007.

AMY GEARIN, EXAMINING ATTORNEY

Int. Cl.: 41

Prior U.S. Cls.: 100, 101 and 107

United States Patent and Trademark Office

Reg. No. 3,479,662

Registered Aug. 5, 2008

**SERVICE MARK
PRINCIPAL REGISTER**

CAVALERA CONSPIRACY

CAVALERA, MASSIMILIANO (UNITED STATES
INDIVIDUAL)

C/O OASIS MANAGEMENT
3010 EAST BLOOMFIELD ROAD
PHOENIX, AZ 85032 AND

CAVALERA, IGOR (UNITED STATES INDIVI-
DUAL)

C/O OASIS MANAGEMENT
3010 EAST BLOOMFIELD ROAD
PHOENIX, AZ 85032

FOR: ENTERTAINMENT SERVICES, NAMELY,
LIVE PERFORMANCES BY A MUSICAL GROUP, IN
CLASS 41 (U.S. CLS. 100, 101 AND 107).

FIRST USE 8-31-2007; IN COMMERCE 8-31-2007.

THE MARK CONSISTS OF STANDARD CHAR-
ACTERS WITHOUT CLAIM TO ANY PARTICULAR
FONT, STYLE, SIZE, OR COLOR.

SER. NO. 77-324,619, FILED 11-8-2007.

SETH A. RAPPAPORT, EXAMINING ATTORNEY

Int. Cl.: 35

Prior U.S. Cls.: 100, 101 and 102

United States Patent and Trademark Office

Reg. No. 3,479,663

Registered Aug. 5, 2008

**SERVICE MARK
PRINCIPAL REGISTER**

SAFETYWISE

ROBERT J. WALKER (NEW YORK SOLE PROPRIETORSHIP)
107 E. HAWTHORNE AVE.
VALLEY STREAM, NY 11580

FOR: WHOLESALE DISTRIBUTORSHIP SERVICES AND MAIL ORDER SERVICES, FEATURING WORKPLACE SAFETY PRODUCTS, IN CLASS 35 (U.S. CLS. 100, 101 AND 102).

FIRST USE 11-20-1989; IN COMMERCE 12-30-2006.

THE MARK CONSISTS OF STANDARD CHARACTERS WITHOUT CLAIM TO ANY PARTICULAR FONT, STYLE, SIZE, OR COLOR.

SER. NO. 77-324,702, FILED 11-8-2007.

AMOS T. MATTHEWS, JR., EXAMINING ATTORNEY

Int. Cl.: 20

Prior U.S. Cls.: 2, 13, 22, 25, 32 and 50

United States Patent and Trademark Office

Reg. No. 3,479,664

Registered Aug. 5, 2008

**TRADEMARK
PRINCIPAL REGISTER**

ANIMALS IN MOTION

SAM RABY ENTERPRISES LLC (UTAH LTD
LIAB CO)
15049 S. 3200 W.
BLUFFDALE, UT 84065

FOR: MOUNTS FOR TAXIDERMY COMPOSED
OF WALL MOUNTS, SWING ARMS, MOUNTING
PLATES, AND ATTACHMENT SCREWS; MOUNTS
FOR TAXIDERMY COMPOSED OF PEDESTALS
AND MOUNTING PLATES; COMPONENTS FOR
TAXIDERMY SWING ARM AND PEDESTAL
MOUNTING SYSTEMS, NAMELY, WALL
MOUNTS, SWING ARMS, MOUNTING PLATES,

PEDESTAL MOUNTS, AND MOUNTING POSTS,
IN CLASS 20 (U.S. CLS. 2, 13, 22, 25, 32 AND 50).

FIRST USE 7-21-2007; IN COMMERCE 7-21-2007.

THE MARK CONSISTS OF STANDARD CHAR-
ACTERS WITHOUT CLAIM TO ANY PARTICULAR
FONT, STYLE, SIZE, OR COLOR.

SER. NO. 77-324,744, FILED 11-8-2007.

FRANK LATTUCA, EXAMINING ATTORNEY

Int. Cls.: 16 and 25

Prior U.S. Cls.: 2, 5, 22, 23, 29, 37, 38, 39 and 50

United States Patent and Trademark Office

Reg. No. 3,479,665

Registered Aug. 5, 2008

**TRADEMARK
PRINCIPAL REGISTER**

JUST JIMMY

BENTON, JAMES K. (UNITED STATES INDIVIDUAL)
1080 FOREST LANE
BLOOMFIELD, MI 48301

FOR: PRINTED GOODS, NAMELY, PAPER, PENS, WIRE-BOUND NOTEBOOKS, STICKERS AND ADDRESS BOOKS, IN CLASS 16 (U.S. CLS. 2, 5, 22, 23, 29, 37, 38 AND 50).

FIRST USE 12-31-1999; IN COMMERCE 12-31-1999.

FOR: CLOTHING, NAMELY, T-SHIRTS AND SWEATSHIRTS, IN CLASS 25 (U.S. CLS. 22 AND 39).

FIRST USE 12-31-1999; IN COMMERCE 12-31-1999.

THE MARK CONSISTS OF STANDARD CHARACTERS WITHOUT CLAIM TO ANY PARTICULAR FONT, STYLE, SIZE, OR COLOR.

SER. NO. 77-324,754, FILED 11-8-2007.

MARIA-VICTORIA SUAREZ, EXAMINING ATTORNEY

Int. Cl.: 35

Prior U.S. Cls.: 100, 101 and 102

United States Patent and Trademark Office

Reg. No. 3,479,666

Registered Aug. 5, 2008

**SERVICE MARK
PRINCIPAL REGISTER**

The logo for "Digital Millyard" features the word "digital" in a bold, lowercase, sans-serif font. The letter "i" in "digital" is replaced by a small circle. Below "digital" is the word "millyard" in a similar bold, lowercase, sans-serif font. The letter "i" in "millyard" is also replaced by a small circle. The two circles are positioned such that they appear to be connected by a thin vertical line, creating a design element that links the two words.

HUNTSMAN INTERNATIONAL LLC (DELA-
WARE LTD LIAB CO)
10003 WOODLOCH FOREST DRIVE
THE WOODLANDS, TX 77380

FOR: OPERATION OF SERVICE CENTER FOR
OTHERS IN THE FIELD OF DIGITAL TEXTILE
PRINTING SOLUTIONS, IN CLASS 35 (U.S. CLS. 100,
101 AND 102).

FIRST USE 6-3-2005; IN COMMERCE 10-1-2005.

NO CLAIM IS MADE TO THE EXCLUSIVE
RIGHT TO USE "DIGITAL", APART FROM THE
MARK AS SHOWN.

THE MARK CONSISTS OF "DIGITAL MILL-
YARD" WITH A DESIGN ELEMENT COMPRISED
OF FOUR SHADED CIRCLES REPRESENTING THE
SECOND LETTER "I" IN THE WORD "DIGITAL",
CONNECTING THE LETTER "I" IN THE WORD
"MILLYARD".

SER. NO. 77-324,932, FILED 11-8-2007.

MIDGE BUTLER, EXAMINING ATTORNEY

Int. Cls.: 34 and 35

Prior U.S. Cls.: 2, 8, 9, 17, 100, 101 and 102

United States Patent and Trademark Office

Reg. No. 3,479,667

Registered Aug. 5, 2008

**TRADEMARK
SERVICE MARK
PRINCIPAL REGISTER**



VIPER ROOM DEVELOPMENT, LLC (DELA-
WARE LTD LIAB CO)
510 N. ROBERTSON BLVD.
LOS ANGELES, CA 90048

FOR: MATCHES, IN CLASS 34 (U.S. CLS. 2, 8, 9
AND 17).

FIRST USE 6-6-1994; IN COMMERCE 6-6-1994.

FOR: ONLINE RETAIL CLOTHING STORES, IN
CLASS 35 (U.S. CLS. 100, 101 AND 102).

FIRST USE 3-0-1997; IN COMMERCE 3-0-1997.

THE MARK CONSISTS OF A MERMAID IN TOP
HAT ON DIE.

SER. NO. 77-325,062, FILED 11-8-2007.

WON TEAK OH, EXAMINING ATTORNEY

Int. Cl.: 35

Prior U.S. Cls.: 100, 101 and 102

United States Patent and Trademark Office

Reg. No. 3,479,668

Registered Aug. 5, 2008

SERVICE MARK
PRINCIPAL REGISTER

Member \$en\$e

CLAVERACK RURAL ELECTRIC COOPERATIVE, INC. (PENNSYLVANIA CORPORATION)
RR 2 BOX 17
WYSOX, PA 18854 AND
NORTHWESTERN RURAL ELECTRIC COOPERATIVE ASSOCIATION, INC. (PENNSYLVANIA CORPORATION)
P.O. BOX 207
CAMBRIDGE SPRINGS, PA 16403

FOR: PREPARING ADVERTISING, DEVELOPING PROMOTIONAL CAMPAIGNS AND PROVIDING REFERRALS IN THE FIELD OF RURAL ELECTRIC COOPERATIVES FOR MEMBER BUSINESS, IN CLASS 35 (U.S. CLS. 100, 101 AND 102).

FIRST USE 11-1-1997; IN COMMERCE 11-1-1997.

NO CLAIM IS MADE TO THE EXCLUSIVE RIGHT TO USE "MEMBER", APART FROM THE MARK AS SHOWN.

THE MARK CONSISTS OF THE WORDS "MEMBER" AND "SENSE" WITH "\$" SIGNS FOR THE "S" IN SENSE.

SER. NO. 77-325,588, FILED 11-9-2007.

LINDA E. BLOHM, EXAMINING ATTORNEY

Int. Cl.: 25

Prior U.S. Cls.: 22 and 39

United States Patent and Trademark Office

Reg. No. 3,479,669

Registered Aug. 5, 2008

**TRADEMARK
PRINCIPAL REGISTER**



FRANK 151 MEDIA GROUP LLC (NEW YORK
LTD LIAB CO)
650 BROADWAY, 5TH FLOOR
NEW YORK, NY 10012

FOR: T-SHIRTS AND BASEBALL CAPS, IN CLASS
25 (U.S. CLS. 22 AND 39).

FIRST USE 4-0-2004; IN COMMERCE 4-0-2004.

THE MARK CONSISTS OF A SHADED LETTER
"F" CONTAINING A SILHOUETTE OF BEN
FRANKLIN HOLDING A BOOK, WITH A SHADED
CIRCLE TO THE RIGHT OF THE LETTER "F".

SER. NO. 77-325,601, FILED 11-9-2007.

ODESSA BIBBINS, EXAMINING ATTORNEY

Int. Cl.: 12

Prior U.S. Cls.: 19, 21, 23, 31, 35 and 44

Reg. No. 3,479,670

United States Patent and Trademark Office

Registered Aug. 5, 2008

**TRADEMARK
PRINCIPAL REGISTER**

KWIK KLEAT

HERZOGENRATH, KEITH (UNITED STATES INDIVIDUAL), DBA TEXAS REDHEAD PRODUCTS
800 MARLIN
HITCHCOCK, TX 77563

FOR: MAGNETIC BOAT CLEATS FOR USE WITH OIL CONTAINMENT OR OIL ABSORBENT BOOMS, IN CLASS 12 (U.S. CLS. 19, 21, 23, 31, 35 AND 44).

FIRST USE 11-6-2007; IN COMMERCE 11-6-2007.

THE MARK CONSISTS OF STANDARD CHARACTERS WITHOUT CLAIM TO ANY PARTICULAR FONT, STYLE, SIZE, OR COLOR.

NO CLAIM IS MADE TO THE EXCLUSIVE RIGHT TO USE "CLEAT", APART FROM THE MARK AS SHOWN.

SER. NO. 77-325,621, FILED 11-9-2007.

EVELYN BRADLEY, EXAMINING ATTORNEY

Int. Cl.: 9

Prior U.S. Cls.: 21, 23, 26, 36 and 38

United States Patent and Trademark Office

Reg. No. 3,479,671

Registered Aug. 5, 2008

**TRADEMARK
PRINCIPAL REGISTER**

The Lucky Shop of Xao Fung

ZUCCA VOLANTE LLP (UTAH LIMITED PART-
NERSHIP)
NUMBER 48
735 THREE FOUNTAINS CIRCLE
MURRAY, UT 84107

FOR: DOWNLOADABLE FILMS AND TV PRO-
GRAMS FEATURING MYSTERIES OR DRAMAS
PROVIDED VIA A VIDEO-ON-DEMAND SERVICE,
IN CLASS 9 (U.S. CLS. 21, 23, 26, 36 AND 38).

FIRST USE 3-22-2006; IN COMMERCE 5-23-2007.

THE MARK CONSISTS OF STANDARD CHAR-
ACTERS WITHOUT CLAIM TO ANY PARTICULAR
FONT, STYLE, SIZE, OR COLOR.

THE NAME "XAO FUNG" DOES NOT IDENTIFY
A LIVING INDIVIDUAL.

THE ENGLISH TRANSLATION OF THE CHI-
NESE WORD "XAO" IN THE MARK IS "STIR-
FRY". THE ENGLISH TRANSLATION OF THE
CHINESE SURNAME "FUNG" IS "RICHES".

SER. NO. 77-325,648, FILED 11-9-2007.

MICHELLE DUBOIS, EXAMINING ATTORNEY

Int. Cl.: 35

Prior U.S. Cls.: 100, 101 and 102

United States Patent and Trademark Office

Reg. No. 3,479,672

Registered Aug. 5, 2008

SERVICE MARK
PRINCIPAL REGISTER



INTEGRATED REIMBURSEMENT STRATEGIES,
LLC (MASSACHUSETTS LTD LIAB CO)

715 ROCKY HILL ROAD

PLYMOUTH, MA 02360

FOR: CONSULTING SERVICES IN THE COST AND PAYMENT MANAGEMENT OF HEALTH CARE; MANAGEMENT AND BUSINESS CONSULTING SERVICES IN THE FIELD OF LAUNCHING NEW PRODUCTS BY ANALYZING CURRENT 3RD PARTY HEALTH INSURANCE COMPANY REIMBURSEMENT POLICIES FOR MEDICAL, PHARMACEUTICAL AND BIOTECHNOLOGICAL PRODUCTS IN ORDER TO ASSIST THE GROWTH OF A BUSINESS BY OPTIMIZING THE PROVIDER REIMBURSEMENT OPPORTUNITIES FOR NEW MEDICAL PRODUCTS THROUGH AN IN-DEPTH ANALYSIS OF MEDICAL CODING AND REIMBURSEMENT OPTIONS, IN CLASS 35 (U.S. CLS. 100, 101 AND 102).

FIRST USE 4-2-2007; IN COMMERCE 4-2-2007.

NO CLAIM IS MADE TO THE EXCLUSIVE RIGHT TO USE "PAYMENT COVERAGE CODING" AND "REIMBURSEMENT", APART FROM THE MARK AS SHOWN.

THE COLOR(S) BROWN-RED, BLUE, GREEN, BLACK AND DEEP LILAC IS/ARE CLAIMED AS A FEATURE OF THE MARK.

THE MARK CONSISTS OF A TRIANGLE OUTLINED IN BLACK THAT CONTAINS 6 STACKED SQUARES THAT ARE ALSO OUTLINED IN BLACK: 3 SQUARES ON THE BOTTOM ROW, TWO SQUARES ON THE MIDDLE ROW AND 1 SQUARE ON THE TOP ROW. THE TRIANGLE IS CLEAR AND DOES NOT CONTAIN ANY FILL. THE BOTTOM ROW SQUARES ARE SOLID BROWN-RED. NEXT TO THE BOTTOM ROW SQUARES IS THE WORD "CODING" IN BROWN-RED INK. THE MIDDLE ROW SQUARES ARE SOLID BLUE. NEXT TO THE MIDDLE ROW IS THE WORD "COVERAGE" IN THE SAME BLUE INK. THE TOP SQUARE IS SOLID GREEN. NEXT TO THE TOP SQUARE IS THE WORD "PAYMENT" IN THE SAME GREEN INK. THE WORDS "CODING, COVERAGE" AND "PAYMENT" ARE IN TAHOMA FONT. CENTERED BELOW THE TRIANGLE IS THE PHRASE "BUILDING REIMBURSEMENT" IN MONOTYPE CORSIVA FONT AND DEEP LILAC COLOR.

SER. NO. 77-325,717, FILED S.R. 11-9-2007 AM. P.R. 4-2-2008.

TANYA AMOS, EXAMINING ATTORNEY

Int. Cl.: 9

Prior U.S. Cls.: 21, 23, 26, 36 and 38

Reg. No. 3,479,673

United States Patent and Trademark Office

Registered Aug. 5, 2008

**TRADEMARK
PRINCIPAL REGISTER**

Xi Xu Pao

ZUCCA VOLANTE LLP (UTAH LIMITED PART-
NERSHIP)
NUMBER 48
735 THREE FOUNTAINS CIRCLE
MURRAY, UT 84107

FOR: DOWNLOADABLE FILMS AND TV PRO-
GRAMS FEATURING MYSTERIES OR DRAMAS
PROVIDED VIA A VIDEO-ON-DEMAND SERVICE,
IN CLASS 9 (U.S. CLS. 21, 23, 26, 36 AND 38).

FIRST USE 3-22-2006; IN COMMERCE 5-23-2007.

THE MARK CONSISTS OF STANDARD CHAR-
ACTERS WITHOUT CLAIM TO ANY PARTICULAR
FONT, STYLE, SIZE, OR COLOR.

THE FOREIGN WORDING IN THE MARK
TRANSLATES INTO ENGLISH AS "LETTER HILL
BREAD".

SER. NO. 77-325,766, FILED 11-9-2007.

MICHELLE DUBOIS, EXAMINING ATTORNEY

Int. Cl.: 21

Prior U.S. Cls.: 2, 13, 23, 29, 30, 33, 40 and 50

United States Patent and Trademark Office

Reg. No. 3,479,674

Registered Aug. 5, 2008

**TRADEMARK
PRINCIPAL REGISTER**



KORN, JONATHAN (UNITED STATES INDIVIDUAL)
35 CATHERINE DRIVE
ROCKY HILL, CT 06067 AND
LO, GRACE (CANADA INDIVIDUAL)
35 CATHERINE DRIVE
ROCKY HILL, CT 06067

FOR: ORAL HYGIENE DEVICES, NAMELY, INTERDENTAL CLEANERS SIZED FOR USE WITH INFANTS, IN CLASS 21 (U.S. CLS. 2, 13, 23, 29, 30, 33, 40 AND 50).

FIRST USE 11-1-2007; IN COMMERCE 11-1-2007.

THE COLOR(S) GREEN, BLUE, PINK, GOLD, WHITE AND BLACK IS/ARE CLAIMED AS A FEATURE OF THE MARK.

THE MARK CONSISTS OF A BABY IN WHITE WITH BLACK OUTLINING, BLACK DIMPLE, PINK CHEEKS, BLACK EYES, BLACK MOUTH WITH WHITE TOOTH AND WHITE STARS, AND BLACK HAIR WEARING A WHITE DIAPER WITH BLUE AND GOLD SAFETY PIN. A HAND IN WHITE WITH BLACK OUTLINING IS HOLDING A WHITE CLOTH WITH BLUE OUTLINING. THE BABY AND HAND DESIGNS APPEAR IN A GREEN CIRCLE OUTLINED IN BLACK.

SER. NO. 77-325,902, FILED 11-9-2007.

CHRISTINE COOPER, EXAMINING ATTORNEY

Int. Cl.: 35

Prior U.S. Cls.: 100, 101 and 102

United States Patent and Trademark Office

Reg. No. 3,479,675

Registered Aug. 5, 2008

**SERVICE MARK
PRINCIPAL REGISTER**



DENTAL KALEIDOSCOPE (MASSACHUSETTS
LIMITED PARTNERSHIP)
2184 WASHINGTON STREET
CANTON, MA 02021

FOR: WHOLESALE DISTRIBUTORSHIPS FEATURING DENTAL TREATMENT TOOLS, EQUIPMENT, AND SUPPLIES, DENTAL WHITENING EQUIPMENT AND SUPPLIES, AND DENTAL DIAGNOSTIC EQUIPMENT, IN CLASS 35 (U.S. CLS. 100, 101 AND 102).

FIRST USE 6-1-1997; IN COMMERCE 6-1-1997.

NO CLAIM IS MADE TO THE EXCLUSIVE RIGHT TO USE THE NON-LATIN CHARACTERS THAT MEAN "AESTHETIC DENTISTRY", APART FROM THE MARK AS SHOWN.

THE MARK CONSISTS OF WORDS CONSISTING OF CYRILLIC LETTERS, AND THE DESIGN OF THE MARK CONSISTS OF A SQUARE WITH FOUR

SLIGHTLY CURVED LINES INSIDE WITH THREE CURVED LINES INSIDE THE FOUR CURVED LINES.

THE FOREIGN WORDING IN THE MARK TRANSLATES INTO ENGLISH AS DENTAL KALEIDOSCOPE ART OF MODERN AESTHETIC DENTISTRY.

THE NON-LATIN CHARACTER(S) IN THE MARK TRANSLITERATES INTO "DENTALKALEIDOSCOPE" ISKUSSTVO SOVEREMENNOY ESTETICHESKOY STOMATOLOGII", AND THIS MEANS "DENTAL KALEIDOSCOPE ART OF MODERN AESTHETIC DENTISTRY" IN ENGLISH.

SER. NO. 77-325,927, FILED 11-9-2007.

AMY HELLA, EXAMINING ATTORNEY

Int. Cl.: 36

Prior U.S. Cls.: 100, 101 and 102

United States Patent and Trademark Office

Reg. No. 3,479,676

Registered Aug. 5, 2008

**SERVICE MARK
PRINCIPAL REGISTER**

MAXIMUM REWARDS

FIRST NATIONAL OF NEBRASKA, INC. (NE-
BRASKA CORPORATION)
STOP 3290
1620 DODGE STREET
OMAHA, NE 681973290

FOR: CREDIT CARD SERVICES, IN CLASS 36
(U.S. CLS. 100, 101 AND 102).

FIRST USE 4-29-2007; IN COMMERCE 4-29-2007.

THE MARK CONSISTS OF STANDARD CHAR-
ACTERS WITHOUT CLAIM TO ANY PARTICULAR
FONT, STYLE, SIZE, OR COLOR.

OWNER OF U.S. REG. NO. 3,399,147.

NO CLAIM IS MADE TO THE EXCLUSIVE
RIGHT TO USE "REWARDS", APART FROM THE
MARK AS SHOWN.

SER. NO. 77-325,982, FILED 11-9-2007.

MICHAEL ENGEL, EXAMINING ATTORNEY

Int. Cl.: 36

Prior U.S. Cls.: 100, 101 and 102

United States Patent and Trademark Office

Reg. No. 3,479,677

Registered Aug. 5, 2008

**SERVICE MARK
PRINCIPAL REGISTER**

**INNOVATIVE PRODUCTIVITY
SOLUTIONS**

HARTFORD LIFE INSURANCE COMPANY
(CONNECTICUT CORPORATION)
LAW DEPT.-TECH IP-TRADEMARK UNIT HO1-09
ONE HARTFORD PLAZA
HARTFORD, CT 06155

FOR: INSURANCE ADMINISTRATION AND UNDERWRITING IN THE FIELDS OF ABSENCE MANAGEMENT AND DISABILITY , IN CLASS 36 (U.S. CLS. 100, 101 AND 102).

FIRST USE 11-0-2006; IN COMMERCE 11-0-2006.

THE MARK CONSISTS OF STANDARD CHARACTERS WITHOUT CLAIM TO ANY PARTICULAR FONT, STYLE, SIZE, OR COLOR.

NO CLAIM IS MADE TO THE EXCLUSIVE RIGHT TO USE "PRODUCTIVITY SOLUTIONS", APART FROM THE MARK AS SHOWN.

SER. NO. 77-326,011, FILED 11-9-2007.

MICHAEL LITZAU, EXAMINING ATTORNEY

Int. Cl.: 3

Prior U.S. Cls.: 1, 4, 6, 50, 51 and 52

Reg. No. 3,479,678

United States Patent and Trademark Office

Registered Aug. 5, 2008

**TRADEMARK
PRINCIPAL REGISTER**

BATH ICE CREAM

ME BATH EXPERIENCE INC. (CALIFORNIA
CORPORATION)
4311 WILSHIRE BLVD., SUITE 300
LOS ANGELES, CA 90010

FOR: BATH OILS; BATH SALTS; BATH SOAPS;
BUBBLE BATH; SHOWER AND BATH GEL, IN
CLASS 3 (U.S. CLS. 1, 4, 6, 50, 51 AND 52).

FIRST USE 7-31-2002; IN COMMERCE 7-31-2002.

THE MARK CONSISTS OF STANDARD CHAR-
ACTERS WITHOUT CLAIM TO ANY PARTICULAR
FONT, STYLE, SIZE, OR COLOR.

NO CLAIM IS MADE TO THE EXCLUSIVE
RIGHT TO USE "BATH", APART FROM THE MARK
AS SHOWN.

SER. NO. 77-326,452, FILED 11-9-2007.

FLORENTINA BLANDU, EXAMINING ATTORNEY

Int. Cl.: 41

Prior U.S. Cls.: 100, 101 and 107

United States Patent and Trademark Office

Reg. No. 3,479,679

Registered Aug. 5, 2008

**SERVICE MARK
PRINCIPAL REGISTER**



MAYJUH LLC (WASHINGTON LTD LIAB CO),
DBA JOGO
UNIT 102
122 OHIO STREET
BELLINGHAM, WA 98225

FOR: HEALTH CLUB SERVICES, NAMELY, PROVIDING INSTRUCTION AND EQUIPMENT IN THE FIELD OF PHYSICAL EXERCISE; PROVIDING ASSISTANCE, PERSONAL TRAINING AND PHYSICAL FITNESS CONSULTATION TO INDIVIDUALS TO HELP THEM MAKE PHYSICAL FITNESS, STRENGTH, CONDITIONING, AND EXERCISE IMPROVEMENT IN THEIR DAILY LIVING; PROVIDING INFORMATION IN THE FIELD OF EXERCISE TRAINING; PHYSICAL FITNESS CONDITIONING CLASSES; PHYSICAL FITNESS CONSULTATION;

PHYSICAL FITNESS INSTRUCTION, IN CLASS 41 (U.S. CLS. 100, 101 AND 107).

FIRST USE 8-20-2007; IN COMMERCE 11-5-2007.

THE COLOR(S) WHITE, DARK GREEN IS/ARE CLAIMED AS A FEATURE OF THE MARK.

THE MARK CONSISTS OF THE FONT IS WHITE, THE OUTLINE IS DARK GREEN.

SER. NO. 77-326,480, FILED 11-9-2007.

FLORENTINA BLANDU, EXAMINING ATTORNEY

Int. Cl.: 11

Prior U.S. Cls.: 13, 21, 23, 31 and 34

Reg. No. 3,479,680

United States Patent and Trademark Office

Registered Aug. 5, 2008

**TRADEMARK
PRINCIPAL REGISTER**

Alkaline Balance

NUTRI-STAHl, INC. (CALIFORNIA CORPORATION)
4700 E. AIRPORT DRIVE
ONTARIO, CA 91761

FOR: WATER FILTRATION AND PURIFICATION EQUIPMENT, NAMELY, WATER IONIZERS; WATER PURIFICATION APPARATUS; WATER IONIZERS FOR HOUSEHOLD USE, IN CLASS 11 (U.S. CLS. 13, 21, 23, 31 AND 34).

FIRST USE 8-1-2007; IN COMMERCE 9-6-2007.

THE MARK CONSISTS OF STANDARD CHARACTERS WITHOUT CLAIM TO ANY PARTICULAR FONT, STYLE, SIZE, OR COLOR.

NO CLAIM IS MADE TO THE EXCLUSIVE RIGHT TO USE "ALKALINE", APART FROM THE MARK AS SHOWN.

SER. NO. 77-326,487, FILED 11-9-2007.

AMY GEARIN, EXAMINING ATTORNEY

Int. Cls.: 35 and 41

Prior U.S. Cls.: 100, 101, 102 and 107

Reg. No. 3,479,681

United States Patent and Trademark Office

Registered Aug. 5, 2008

SERVICE MARK
PRINCIPAL REGISTER



COMITÉ INTERNATIONAL OLYMPIQUE (SWITZERLAND ASSOCIATION), DBA INTERNATIONAL OLYMPIC COMMITTEE

CHÂTEAU DE VIDY

1007 LAUSANNE, SWITZERLAND

FOR: ADVERTISING; DISSEMINATION OF ADVERTISING MATTER VIA ALL MEDIA, NAMELY, IN THE FORM OF THEMATIC MESSAGES CENTERED ON HUMAN VALUES; PROMOTION OF PRODUCTS AND SERVICES OF THIRD PARTIES THROUGH SPONSORING ARRANGEMENTS AND LICENSE AGREEMENTS RELATING TO INTERNATIONAL SPORTS' EVENTS; BUSINESS MANAGEMENT; BUSINESS ADMINISTRATION; PROVIDING OFFICE FUNCTIONS; PROMOTING THE GOODS AND SERVICES OF OTHERS BY MEANS OF CONTRACTUAL AGREEMENTS, NAMELY, ARRANGING FOR SPONSORS TO AFFILIATE THEIR GOODS AND SERVICES WITH AN AWARDS PROGRAM, A SPORTS COMPETITION AND SPORTING ACTIVITIES AND LICENSING AGREEMENTS RELATING TO INTERNATIONAL SPORTS' EVENTS TO ENABLE PARTNERS TO GAIN ADDITIONAL NOTORIETY AND/OR IMAGE DERIVED FROM THOSE OF CULTURAL AND SPORTING EVENTS, IN PARTICULAR INTERNATIONAL SPORTING EVENTS; PROMOTING THE GOODS AND SERVICES OF OTHERS BY MEANS OF IMAGE TRANSFER, NAMELY, MAKING THE PARTNERS' PRODUCTS AND SERVICES BENEFIT FROM THE NOTORIETY AND ATTRACTIVENESS OF SPORTING EVENTS AND COMPETITIONS; RENTAL OF ADVERTISING SPACE OF ALL KINDS AND ON ALL CARRIERS, DIGITAL OR NOT; BUSINESS MANAGEMENT SERVICES, NAMELY, ADMINISTRATION OF COMPETITIONS FOR THE PARTICIPATION OF NATIONAL TEAMS TO AN INTERNATIONAL ATHLETIC COMPETITION, AND PROMOTING THE SUPPORT TO SAID TEAMS WITH THE PUBLIC AND THE CONCERNED CIRCLES BY MEANS OF PROMOTIONAL CAMPAIGNS IN THE MEDIA, IN CLASS 35 (U.S. CLS. 100, 101 AND 102).

FOR: EDUCATIONAL RESEARCH; PROVIDING OF TRAINING, NAMELY, TRAINING SERVICES IN THE FIELDS OF BIATHLON, BOBSLEIGH, CURLING, ICE HOCKEY, LUGE, SKATING, SKIING, AQUATICS, ARCHERY, ATHLETICS, BADMINTON, BASEBALL, BASKETBALL, BOXING, CANOEING, KAYAKING, CYCLING, EQUESTRIAN, FENCING, FOOTBALL, GYMNASTICS, HANDBALL, HOCKEY, JUDO, MODERN PENTATHLON, ROWING, SAILING, SHOOTING, SOFTBALL, TABLE TENNIS, TAEKWONDO, TENNIS, TRIATHLON, VOLLEYBALL, WEIGHTLIFTING, AND WRESTLING; ENTERTAINMENT IN THE NATURE OF INTERNATIONAL SPORTING EVENTS, NAMELY, AQUATICS PERFORMANCES, ARCHERY PERFORMANCES, ATHLETICS PERFORMANCES, BADMINTON PERFORMANCES, BASEBALL PERFORMANCES, BASKETBALL PERFORMANCES, BOXING PERFORMANCES, CANOEING AND KAYAKING PERFORMANCES, CYCLING PERFORMANCES, EQUESTRIAN PERFORMANCES, FENCING PERFORMANCES, FOOTBALL PERFORMANCES, GYMNASTICS PERFORMANCES, HANDBALL PERFORMANCES, HOCKEY PERFORMANCES, JUDO PERFORMANCES, MODERN PENTATHLON PERFORMANCES, ROWING PERFORMANCES, SAILING PERFORMANCES, SHOOTING PERFORMANCES, SOFTBALL PERFORMANCES, TABLE TENNIS PERFORMANCES, TAEKWONDO PERFORMANCES, TENNIS PERFORMANCES, TRIATHLON PERFORMANCES, VOLLEYBALL PERFORMANCES, WEIGHTLIFTING PERFORMANCES, AND WRESTLING PERFORMANCES; ORGANIZING INTERNATIONAL COMMUNITY SPORTING AND CULTURAL EVENTS, TELEVISION SHOW PRODUCTION IN THE FIELD OF SPORTING AND CULTURAL ENTERTAINMENT; ORGANIZATION OF CULTURAL AND EDUCATIONAL EXHIBITIONS IN THE FIELD OF SPORTS; ORGANIZATION OF LOTTERIES; BETTING AND GAMBLING SERVICES RELATING TO OR IN CONJUNCTION WITH SPORT; ENTERTAINMENT SERVICES PROVIDED AT OR RELATING TO SPORTS EVENTS, NAMELY, PRESENTATION OF LIVE SHOW PERFORMANCES IN THE NATURE OF OPENING AND CLOSING

CEREMONIES OF INTERNATIONAL SPORTS EVENTS; ORGANIZATION OF INTERNATIONAL COMMUNITY SPORTING AND CULTURAL EVENTS; ORGANIZATION OF SPORTING COMPETITIONS, NAMELY BIATHLON, BOBSLEIGH, CURLING, ICE HOCKEY, LUGE, SKATING AND SKIING, AQUATICS, ARCHERY, ATHLETICS, BADMINTON, BASEBALL, BASKETBALL, BOXING, CANOEING, KAYAKING, CYCLING, EQUESTRIAN, FENCING, FOOTBALL, GYMNASTICS, HANDBALL, HOCKEY, JUDO, MODERN PENTATHLON, ROWING, SAILING, SHOOTING, SOFTBALL, TABLE TENNIS, TAEKWONDO, TENNIS, TRIATHLON, VOLLEYBALL, WEIGHTLIFTING, AND WRESTLING COMPETITIONS; MANAGEMENT OF SPORTING FACILITIES, NAMELY, PROVIDING SPORTS FACILITIES; RENTAL OF AUDIO AND VIDEO EQUIPMENT; PRODUCTION AND DISTRIBUTION OF MOTION PICTURE FILMS; PRODUCTION OF VIDEO TAPES AND AUDIO SOUNDS RECORDINGS; RENTAL OF FILMS AND VIDEO TAPES AND SOUNDS RECORDINGS; PRESENTATION, RENTAL OF INTERACTIVE EDUCATION AND ENTERTAINMENT VIDEOTAPES IN THE FIELD OF SPORTS; PRODUCTION OF RADIO AND TELEVISION PROGRAMS FEATURING COVERAGE OF SPORTS AND SPORTING EVENTS; RADIO AND TELEVISION PROGRAM AND VIDEO TAPE PRODUCTION SERVICES; PRODUCTION OF ANIMATED MOTION PICTURE FILMS; PRODUCTION OF ANIMATED TELEVISION PROGRAMS; SEAT BOOKING SERVICES FOR SHOWS AND SPORTING EVENTS; TIMING OF SPORTS EVENTS; ORGANIZATION OF BEAUTY CONTESTS; ON-LINE GAMBLING SERVICES; PROVIDING OF GAMES OVER THE INTERNET, NAMELY, ON-LINE COMPUTER GAMES; PROVIDING OF RAFFLE SERVICES IN THE NATURE OF A LOTTERY; PROVIDING INFORMATION RELATING TO SPORTS ENTERTAINMENT AND EDUCATION, PROVIDED ON-LINE FROM A COMPUTER DATABASE OR THE INTERNET; ELECTRONIC GAMES SERVICES PROVIDED BY MEANS OF THE INTERNET, NAMELY, PROVIDING ON-LINE COMPUTER GAMES; PROVIDING ON-LINE ELECTRONIC PUBLICATIONS, NAMELY PUBLICATION OF ELEC-

TRONIC MAGAZINES AND NEWSPAPERS; PUBLICATION OF ELECTRONIC BOOKS, REVIEWS, JOURNALS, MAGAZINES, TEXTS OTHER THAN PUBLICITY TEXTS; ON-LINE PUBLICATION OF ELECTRONIC BOOKS, REVIEWS, JOURNALS, MAGAZINES, TEXTS OTHER THAN PUBLICITY TEXTS; PROVIDING NON-DOWNLOADABLE DIGITAL MUSIC ON THE INTERNET VIA A GLOBAL COMPUTER NETWORK; PROVIDING NON-DOWNLOADABLE DIGITAL MUSIC BY MEANS OF MP3 INTERNET WEB SITES ON A GLOBAL COMPUTER NETWORK; PROVIDING SPORT RECORDS AND STATISTICAL INFORMATION IN CONNECTION WITH SPORTS AND SPORTING EVENTS; LEASING OF RECORDED SOUND AND IMAGES, NAMELY, AUDIO, VIDEO AND PHOTOGRAPHIC ARCHIVES RELATING TO SPORT COMPETITIONS AND RELATED EVENTS; AUDIO PRODUCTION SERVICES; PROVIDING INFORMATION IN THE FIELD OF SPORTS, NAMELY, PROVIDING SPORTING RESULTS; PROVIDING INFORMATION RELATED TO SPORTING EVENTS PROVIDED ON-LINE FROM A COMPUTER DATABASE OR FROM THE INTERNET; MUSIC PUBLISHING AND PRODUCTION SERVICES; PROVIDING NON-DOWNLOADABLE DIGITAL MUSIC, NAMELY, MUSIC FROM THE OPENING AND CLOSING CEREMONIES OF INTERNATIONAL SPORTING EVENTS VIA THE INTERNET, IN CLASS 41 (U.S. CLS. 100, 101 AND 107).

PRIORITY CLAIMED UNDER SEC. 44(D) ON SWITZERLAND APPLICATION NO. 55579/2007, FILED 5-25-2007, REG. NO. 564218, DATED 5-25-2007, EXPIRES 5-25-2017.

OWNER OF U.S. REG. NO. 2,999,700.

THE MARK CONSISTS OF THE DESIGN OF FIVE INTERLOCKING RINGS TO THE LEFT OF THE WORDING "MADRID 2016".

SER. NO. 77-326,569, FILED 11-10-2007.

JEFFERY COWARD, EXAMINING ATTORNEY

Int. Cls.: 35 and 41

Prior U.S. Cls.: 100, 101, 102 and 107

United States Patent and Trademark Office

Reg. No. 3,479,682

Registered Aug. 5, 2008

SERVICE MARK
PRINCIPAL REGISTER



COMITÉ INTERNATIONAL OLYMPIQUE (SWITZERLAND ASSOCIATION.), DBA INTERNATIONAL OLYMPIC COMMITTEE
CHÂTEAU DE VIDY
1007 LAUSANNE, SWITZERLAND

FOR: ADVERTISING; DISSEMINATION OF ADVERTISING MATTER VIA ALL MEDIA, NAMELY, IN THE FORM OF THEMATIC MESSAGES CENTERED ON HUMAN VALUES; PROMOTION OF PRODUCTS AND SERVICES OF THIRD PARTIES THROUGH SPONSORING ARRANGEMENTS AND LICENSE AGREEMENTS RELATING TO INTERNATIONAL SPORTS' EVENTS; BUSINESS MANAGEMENT; BUSINESS ADMINISTRATION; PROVIDING OFFICE FUNCTIONS; PROMOTING THE GOODS AND SERVICES OF OTHERS BY MEANS OF CONTRACTUAL AGREEMENTS, NAMELY, ARRANGING FOR SPONSORS TO AFFILIATE THEIR GOODS AND SERVICES WITH AN AWARDS PROGRAM, A SPORTS COMPETITION AND SPORTING ACTIVITIES AND LICENSING AGREEMENTS RELATING TO INTERNATIONAL SPORTS' EVENTS TO ENABLE PARTNERS TO GAIN ADDITIONAL NOTORIETY AND/OR IMAGE DERIVED FROM THOSE OF CULTURAL AND SPORTING EVENTS, IN PARTICULAR INTERNATIONAL SPORTING EVENTS; PROMOTING THE GOODS AND SERVICES OF OTHERS BY MEANS OF IMAGE TRANSFER, NAMELY, MAKING THE PARTNERS' PRODUCTS AND SERVICES BENEFIT FROM THE NOTORIETY AND ATTRACTIVENESS OF SPORTING EVENTS AND COMPETITIONS; RENTAL OF ADVERTISING SPACE OF ALL KINDS AND ON ALL CARRIERS, DIGITAL OR NOT; BUSINESS MANAGEMENT SERVICES, NAMELY, ADMINISTRATION OF COMPETITIONS FOR THE PARTICIPATION OF NATIONAL TEAMS TO AN INTERNATIONAL ATHLETIC COMPETITION, AND PROMOTING THE SUPPORT TO SAID TEAMS WITH THE PUBLIC AND THE CONCERNED CIRCLES BY MEANS OF PROMOTIONAL CAMPAIGNS IN THE MEDIA, IN CLASS 35 (U.S. CLS. 100, 101 AND 102).

FOR: EDUCATIONAL RESEARCH; PROVIDING OF TRAINING, NAMELY, TRAINING SERVICES IN THE FIELDS OF BIATHLON, BOBSLEIGH, CURLING, ICE HOCKEY, LUGE, SKATING, SKIING, AQUATICS, ARCHERY, ATHLETICS, BADMINTON, BASEBALL, BASKETBALL, BOXING, CANOEING, KAYAKING, CYCLING, EQUESTRIAN, FENCING, FOOTBALL, GYMNASTICS, HANDBALL, HOCKEY, JUDO, MODERN PENTATHLON, ROWING, SAILING, SHOOTING, SOFTBALL, TABLE TENNIS, TAEKWONDO, TENNIS, TRIATHLON, VOLLEYBALL, WEIGHTLIFTING, AND WRESTLING; ENTERTAINMENT IN THE NATURE OF INTERNATIONAL SPORTING EVENTS, NAMELY, AQUATICS PERFORMANCES, ARCHERY PERFORMANCES, ATHLETICS PERFORMANCES, BADMINTON PERFORMANCES, BASEBALL PERFORMANCES, BASKETBALL PERFORMANCES, BOXING PERFORMANCES, CANOEING AND KAYAKING PERFORMANCES, CYCLING PERFORMANCES, EQUESTRIAN PERFORMANCES, FENCING PERFORMANCES, FOOTBALL PERFORMANCES, GYMNASTICS PERFORMANCES, HANDBALL PERFORMANCES, HOCKEY PERFORMANCES, JUDO PERFORMANCES, MODERN PENTATHLON PERFORMANCES, ROWING PERFORMANCES, SAILING PERFORMANCES, SHOOTING PERFORMANCES, SOFTBALL PERFORMANCES, TABLE TENNIS PERFORMANCES, TAEKWONDO PERFORMANCES, TENNIS PERFORMANCES, TRIATHLON PERFORMANCES, VOLLEYBALL PERFORMANCES, WEIGHTLIFTING PERFORMANCES, AND WRESTLING PERFORMANCES; ORGANIZING INTERNATIONAL COMMUNITY SPORTING AND CULTURAL EVENTS, TELEVISION SHOW PRODUCTION IN THE FIELD OF SPORTING AND CULTURAL ENTERTAINMENT; ORGANIZATION OF CULTURAL AND EDUCATIONAL EXHIBITIONS IN THE FIELD OF SPORTS; ORGANIZATION OF LOTTERIES; BETTING AND GAMBLING SERVICES RELATING TO OR IN CONJUNCTION WITH SPORT; ENTERTAINMENT SERVICES PROVIDED AT OR RELATING TO SPORTS EVENTS, NAMELY

PRESENTATION OF LIVE SHOW PERFORMANCES IN THE NATURE OF OPENING AND CLOSING CEREMONIES OF INTERNATIONAL SPORTS EVENTS; ORGANIZATION OF INTERNATIONAL COMMUNITY SPORTING AND CULTURAL EVENTS; ORGANIZATION OF SPORTING COMPETITIONS, NAMELY, BIATHLON, BOBSLEIGH, CURLING, ICE HOCKEY, LUGE, SKATING AND SKIING, AQUATICS, ARCHERY, ATHLETICS, BADMINTON, BASEBALL, BASKETBALL, BOXING, CANOEING, KAYAKING, CYCLING, EQUESTRIAN, FENCING, FOOTBALL, GYMNASTICS, HANDBALL, HOCKEY, JUDO, MODERN PENTATHLON, ROWING, SAILING, SHOOTING, SOFTBALL, TABLE TENNIS, TAEKWONDO, TENNIS, TRIATHLON, VOLLEYBALL, WEIGHTLIFTING, AND WRESTLING COMPETITIONS; MANAGEMENT OF SPORTING FACILITIES, NAMELY, PROVIDING SPORTS FACILITIES; RENTAL OF AUDIO AND VIDEO EQUIPMENT; PRODUCTION AND DISTRIBUTION OF MOTION PICTURE FILMS; PRODUCTION OF VIDEO TAPES AND AUDIO SOUNDS RECORDINGS; RENTAL OF FILMS AND VIDEO TAPES AND SOUNDS RECORDINGS; PRESENTATION, RENTAL OF INTERACTIVE EDUCATION AND ENTERTAINMENT VIDEOTAPES IN THE FIELD OF SPORTS; PRODUCTION OF RADIO AND TELEVISION PROGRAMS FEATURING COVERAGE OF SPORTS AND SPORTING EVENTS; RADIO AND TELEVISION PROGRAM AND VIDEO TAPE PRODUCTION SERVICES; PRODUCTION OF ANIMATED MOTION PICTURE FILMS; PRODUCTION OF ANIMATED TELEVISION PROGRAMS; SEAT BOOKING SERVICES FOR SHOWS AND SPORTING EVENTS; TIMING OF SPORTS EVENTS; ORGANIZATION OF BEAUTY CONTESTS; ON-LINE GAMBLING SERVICES; PROVIDING OF GAMES OVER THE INTERNET, NAMELY, ON-LINE COMPUTER GAMES; PROVIDING OF RAFFLE SERVICES IN THE NATURE OF A LOTTERY; PROVIDING INFORMATION RELATING TO SPORTS ENTERTAINMENT AND EDUCATION, PROVIDED ON-LINE FROM A COMPUTER DATABASE OR THE INTERNET; ELECTRONIC GAMES SERVICES PROVIDED BY MEANS OF THE INTERNET, NAMELY, PROVIDING ON-LINE COMPUTER

GAMES; PROVIDING ON-LINE ELECTRONIC PUBLICATIONS, NAMELY, PUBLICATION OF ELECTRONIC MAGAZINES AND NEWSPAPERS; PUBLICATION OF ELECTRONIC BOOKS, REVIEWS, JOURNALS, MAGAZINES, TEXTS OTHER THAN PUBLICITY TEXTS; ON-LINE PUBLICATION OF ELECTRONIC BOOKS, REVIEWS, JOURNALS, MAGAZINES, TEXTS OTHER THAN PUBLICITY TEXTS; PROVIDING NON-DOWNLOADABLE DIGITAL MUSIC ON THE INTERNET VIA A GLOBAL COMPUTER NETWORK; PROVIDING NON-DOWNLOADABLE DIGITAL MUSIC BY MEANS OF MP3 INTERNET WEB SITES ON A GLOBAL COMPUTER NETWORK; PROVIDING SPORT RECORDS AND STATISTICAL INFORMATION IN CONNECTION WITH SPORTS AND SPORTING EVENTS; LEASING OF RECORDED SOUND AND IMAGES, NAMELY, AUDIO, VIDEO AND PHOTOGRAPHIC ARCHIVES RELATING TO SPORT COMPETITIONS AND RELATED EVENTS; AUDIO PRODUCTION SERVICES; PROVIDING INFORMATION IN THE FIELD OF SPORTS, NAMELY, PROVIDING SPORTING RESULTS; PROVIDING INFORMATION RELATED TO SPORTING EVENTS PROVIDED ON-LINE FROM A COMPUTER DATABASE OR FROM THE INTERNET; MUSIC PUBLISHING AND PRODUCTION SERVICES; PROVIDING NON-DOWNLOADABLE DIGITAL MUSIC, NAMELY, MUSIC FROM THE OPENING AND CLOSING CEREMONIES OF INTERNATIONAL SPORTING EVENTS VIA THE INTERNET, IN CLASS 41 (U.S. CLS. 100, 101 AND 107).

PRIORITY CLAIMED UNDER SEC. 44(D) ON SWITZERLAND APPLICATION NO. 55582/2007, FILED 5-25-2007, REG. NO. 564080, DATED 5-25-2007, EXPIRES 5-25-2017.

THE MARK CONSISTS OF THE DESIGN OF FIVE INTERLOCKING RINGS TO THE LEFT OF THE WORDING "RIO 2016".

SER. NO. 77-326,573, FILED 11-10-2007.

JEFFERY COWARD, EXAMINING ATTORNEY

Int. Cls.: 35 and 41

Prior U.S. Cls.: 100, 101, 102 and 107

Reg. No. 3,479,683

United States Patent and Trademark Office

Registered Aug. 5, 2008

**SERVICE MARK
PRINCIPAL REGISTER**

 TOKYO 2016

COMITÉ INTERNATIONAL OLYMPIQUE (SWITZERLAND ASSOCIATION), DBA INTERNATIONAL OLYMPIC COMMITTEE

CHÂTEAU DE VIDY

1007 LAUSANNE, SWITZERLAND

FOR: ADVERTISING; DISSEMINATION OF ADVERTISING MATTER VIA ALL MEDIA, NAMELY, IN THE FORM OF THEMATIC MESSAGES CENTERED ON HUMAN VALUES; PROMOTION OF PRODUCTS AND SERVICES OF THIRD PARTIES THROUGH SPONSORING ARRANGEMENTS AND LICENSE AGREEMENTS RELATING TO INTERNATIONAL SPORTS' EVENTS; BUSINESS MANAGEMENT; BUSINESS ADMINISTRATION; PROVIDING OFFICE FUNCTIONS; PROMOTING THE GOODS AND SERVICES OF OTHERS BY MEANS OF CONTRACTUAL AGREEMENTS, NAMELY, ARRANGING FOR SPONSORS TO AFFILIATE THEIR GOODS AND SERVICES WITH AN AWARDS PROGRAM, A SPORTS COMPETITION AND SPORTING ACTIVITIES AND LICENSING AGREEMENTS RELATING TO INTERNATIONAL SPORTS' EVENTS TO ENABLE PARTNERS TO GAIN ADDITIONAL NOTORIETY AND/OR IMAGE DERIVED FROM THOSE OF CULTURAL AND SPORTING EVENTS, IN PARTICULAR INTERNATIONAL SPORTING EVENTS; PROMOTING THE GOODS AND SERVICES OF OTHERS BY MEANS OF IMAGE TRANSFER, NAMELY, MAKING THE PARTNERS' PRODUCTS AND SERVICES BENEFIT FROM THE NOTORIETY AND ATTRACTIVENESS OF SPORTING EVENTS AND COMPETITIONS; RENTAL OF ADVERTISING SPACE OF ALL KINDS AND ON ALL CARRIERS, DIGITAL OR NOT; BUSINESS MANAGEMENT SERVICES, NAMELY, ADMINISTRATION OF COMPETITIONS FOR THE PARTICIPATION OF NATIONAL TEAMS TO AN INTERNATIONAL ATHLETIC COMPETITION, AND PROMOTING THE SUPPORT TO SAID TEAMS WITH THE PUBLIC AND THE CONCERNED CIRCLES BY MEANS OF PROMOTIONAL CAMPAIGNS IN THE MEDIA, IN CLASS 35 (U.S. CLS. 100, 101 AND 102).

FOR: EDUCATIONAL RESEARCH; PROVIDING OF TRAINING, NAMELY, TRAINING SERVICES IN THE FIELDS OF BIATHLON, BOBSLEIGH, CURLING, ICE HOCKEY, LUGE, SKATING, SKIING, AQUATICS, ARCHERY, ATHLETICS, BADMINTON, BASEBALL, BASKETBALL, BOXING, CANOEING, KAYAKING, CYCLING, EQUESTRIAN, FENCING, FOOTBALL, GYMNASTICS, HANDBALL, HOCKEY, JUDO, MODERN PENTATHLON, ROWING, SAILING, SHOOTING, SOFTBALL, TABLE TENNIS, TAEKWONDO, TENNIS, TRIATHLON, VOLLEYBALL, WEIGHTLIFTING, AND WRESTLING; ENTERTAINMENT IN THE NATURE OF INTERNATIONAL SPORTING EVENTS, NAMELY, AQUATICS PERFORMANCES, ARCHERY PERFORMANCES, ATHLETICS PERFORMANCES, BADMINTON PERFORMANCES, BASEBALL PERFORMANCES, BASKETBALL PERFORMANCES, BOXING PERFORMANCES, CANOEING AND KAYAKING PERFORMANCES, CYCLING PERFORMANCES, EQUESTRIAN PERFORMANCES, FENCING PERFORMANCES, FOOTBALL PERFORMANCES, GYMNASTICS PERFORMANCES, HANDBALL PERFORMANCES, HOCKEY PERFORMANCES, JUDO PERFORMANCES, MODERN PENTATHLON PERFORMANCES, ROWING PERFORMANCES, SAILING PERFORMANCES, SHOOTING PERFORMANCES, SOFTBALL PERFORMANCES, TABLE TENNIS PERFORMANCES, TAEKWONDO PERFORMANCES, TENNIS PERFORMANCES, TRIATHLON PERFORMANCES, VOLLEYBALL PERFORMANCES, WEIGHTLIFTING PERFORMANCES, AND WRESTLING PERFORMANCES; ORGANIZING INTERNATIONAL COMMUNITY SPORTING AND CULTURAL EVENTS, TELEVISION SHOW PRODUCTION IN THE FIELD OF SPORTING AND CULTURAL ENTERTAINMENT; ORGANIZATION OF CULTURAL AND EDUCATIONAL EXHIBITIONS IN THE FIELD OF SPORTS; ORGANIZATION OF LOTTERIES; BETTING AND GAMBLING SERVICES RELATING TO OR IN CONJUNCTION WITH SPORT; ENTERTAINMENT SERVICES PROVIDED AT OR RELATING TO SPORTS EVENTS, NAMELY, PRESENTATION OF LIVE SHOW PERFORMANCES IN THE NATURE OF OPENING AND CLOSING

CEREMONIES OF INTERNATIONAL SPORTS EVENTS; ORGANIZATION OF INTERNATIONAL COMMUNITY SPORTING AND CULTURAL EVENTS; ORGANIZATION OF SPORTING COMPETITIONS, NAMELY, BIATHLON, BOBSLEIGH, CURLING, ICE HOCKEY, LUGE, SKATING AND SKIING, AQUATICS, ARCHERY, ATHLETICS, BADMINTON, BASEBALL, BASKETBALL, BOXING, CANOEING, KAYAKING, CYCLING, EQUESTRIAN, FENCING, FOOTBALL, GYMNASTICS, HANDBALL, HOCKEY, JUDO, MODERN PENTATHLON, ROWING, SAILING, SHOOTING, SOFTBALL, TABLE TENNIS, TAEKWONDO, TENNIS, TRIATHLON, VOLLEYBALL, WEIGHTLIFTING, AND WRESTLING COMPETITIONS; MANAGEMENT OF SPORTING FACILITIES, NAMELY, PROVIDING SPORTS FACILITIES; RENTAL OF AUDIO AND VIDEO EQUIPMENT; PRODUCTION AND DISTRIBUTION OF MOTION PICTURE FILMS; PRODUCTION OF VIDEO TAPES AND AUDIO SOUNDS RECORDINGS; RENTAL OF FILMS AND VIDEO TAPES AND SOUNDS RECORDINGS; PRESENTATION, RENTAL OF INTERACTIVE EDUCATION AND ENTERTAINMENT VIDEOTAPES IN THE FIELD OF SPORTS; PRODUCTION OF RADIO AND TELEVISION PROGRAMS FEATURING COVERAGE OF SPORTS AND SPORTING EVENTS; RADIO AND TELEVISION PROGRAM AND VIDEO TAPE PRODUCTION SERVICES; PRODUCTION OF ANIMATED MOTION PICTURE FILMS; PRODUCTION OF ANIMATED TELEVISION PROGRAMS; SEAT BOOKING SERVICES FOR SHOWS AND SPORTING EVENTS; TIMING OF SPORTS EVENTS; ORGANIZATION OF BEAUTY CONTESTS; ON-LINE GAMBLING SERVICES; PROVIDING OF GAMES OVER THE INTERNET, NAMELY, ON-LINE COMPUTER GAMES; PROVIDING OF RAFFLE SERVICES IN THE NATURE OF A LOTTERY; PROVIDING INFORMATION RELATING TO SPORTS ENTERTAINMENT AND EDUCATION, PROVIDED ON-LINE FROM A COMPUTER DATABASE OR THE INTERNET; ELECTRONIC GAMES SERVICES PROVIDED BY MEANS OF THE INTERNET, NAMELY PROVIDING ON-LINE COMPUTER GAMES; PROVIDING ON-LINE ELECTRONIC PUB-

LICATIONS, NAMELY, PUBLICATION OF ELECTRONIC MAGAZINES AND NEWSPAPERS; PUBLICATION OF ELECTRONIC BOOKS, REVIEWS, JOURNALS, MAGAZINES, TEXTS OTHER THAN PUBLICITY TEXTS; ON-LINE PUBLICATION OF ELECTRONIC BOOKS, REVIEWS, JOURNALS, MAGAZINES, TEXTS OTHER THAN PUBLICITY TEXTS; PROVIDING NON-DOWNLOADABLE DIGITAL MUSIC ON THE INTERNET VIA A GLOBAL COMPUTER NETWORK; PROVIDING NON-DOWNLOADABLE DIGITAL MUSIC BY MEANS OF MP3 INTERNET WEB SITES ON A GLOBAL COMPUTER NETWORK; PROVIDING SPORT RECORDS AND STATISTICAL INFORMATION IN CONNECTION WITH SPORTS AND SPORTING EVENTS; LEASING OF RECORDED SOUND AND IMAGES, NAMELY, AUDIO, VIDEO AND PHOTOGRAPHIC ARCHIVES RELATING TO SPORT COMPETITIONS AND RELATED EVENTS; AUDIO PRODUCTION SERVICES; PROVIDING INFORMATION IN THE FIELD OF SPORTS, NAMELY, PROVIDING SPORTING RESULTS; PROVIDING INFORMATION RELATED TO SPORTING EVENTS PROVIDED ON-LINE FROM A COMPUTER DATABASE OR FROM THE INTERNET; MUSIC PUBLISHING AND PRODUCTION SERVICES; PROVIDING NON-DOWNLOADABLE DIGITAL MUSIC, NAMELY, MUSIC FROM THE OPENING AND CLOSING CEREMONIES OF INTERNATIONAL SPORTING EVENTS VIA THE INTERNET, IN CLASS 41 (U.S. CLS. 100, 101 AND 107).

PRIORITY CLAIMED UNDER SEC. 44(D) ON SWITZERLAND APPLICATION NO. 55576/2007, FILED 5-25-2007, REG. NO. 564079, DATED 5-25-2007, EXPIRES 5-25-2017.

THE MARK CONSISTS OF THE DESIGN OF FIVE INTERLOCKING RINGS TO THE LEFT OF THE WORDING "TOKYO 2016".

SER. NO. 77-326,582, FILED 11-10-2007.

JEFFERY COWARD, EXAMINING ATTORNEY

Int. Cl.: 16

Prior U.S. Cls.: 2, 5, 22, 23, 29, 37, 38 and 50

Reg. No. 3,479,684

United States Patent and Trademark Office

Registered Aug. 5, 2008

TRADEMARK
PRINCIPAL REGISTER

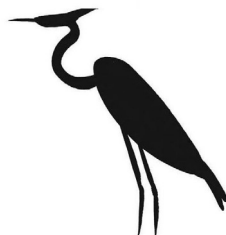

HERON
- ON -
HUDSON
P R E S S

ART IN A BOX, INC. (NEW YORK CORPORATION)
463 WEST STREET, APT. G-122
NEW YORK, NY 10014

FOR: A SERIES OF BOOKS AND WRITTEN ARTICLES IN THE FIELD OF VISUAL ART AND LITERATURE, IN CLASS 16 (U.S. CLS. 2, 5, 22, 23, 29, 37, 38 AND 50).

FIRST USE 11-7-2007; IN COMMERCE 11-7-2007.

NO CLAIM IS MADE TO THE EXCLUSIVE RIGHT TO USE "PRESS", APART FROM THE MARK AS SHOWN.

THE MARK CONSISTS OF A HAND DRAWN IMAGE OF A HERON (BIRD) FACING LEFT AND STANDING ON THE WORDS "HERON-ON-HUDSON PRESS". THE WORDS ARE STACKED ONE UPON THE OTHER AND ARE SET IN ADOBE "COCHIN" TYPEFACE. THE WORDS "HERON" AND "PRESS" ARE TRACKED SO THAT THEY MATCH THE WIDTH OF THE WORD "HUDSON". THE WORD "ON" PRECEDED AND FOLLOWED BY A LONG DASH IS CENTERED.

SER. NO. 77-326,680, FILED 11-11-2007.

CURTIS FRENCH, EXAMINING ATTORNEY

Int. Cl.: 5

Prior U.S. Cls.: 6, 18, 44, 46, 51 and 52

United States Patent and Trademark Office

Reg. No. 3,479,685

Registered Aug. 5, 2008

**TRADEMARK
PRINCIPAL REGISTER**

—NatureNutrition—

GUNLER, INC. (TEXAS CORPORATION)
9595 SIX PINES DR. LVL2 BLDG.8 STE. 8210
THE WOODLANDS, TX 77506

THE MARK CONSISTS OF THE WORDING
"NATURENUTRITION" FLANKED BY HORIZON-
TAL LINES.

FOR: VITAMINS AND NUTRITIONAL SUPPLE-
MENTS, IN CLASS 5 (U.S. CLS. 6, 18, 44, 46, 51 AND
52).

SER. NO. 77-326,852, FILED 11-12-2007.

FIRST USE 10-4-2007; IN COMMERCE 10-4-2007.

ADA HAN, EXAMINING ATTORNEY

Int. Cl.: 17

Prior U.S. Cls.: 1, 5, 12, 13, 35 and 50

United States Patent and Trademark Office

Reg. No. 3,479,686

Registered Aug. 5, 2008

**TRADEMARK
PRINCIPAL REGISTER**



BERGE, HONG XU (UNITED STATES INDIVIDUAL), DBA DIMENSION TRADE COMPANY, LLC
34195 E. COLUMBIA AVENUE
SCAPPOOSE, OR 97056

FOR: PLASTIC TUBES FOR USE IN FORMING A SUPPORT STRUCTURE TO COVER PLANTS, IN CLASS 17 (U.S. CLS. 1, 5, 12, 13, 35 AND 50).

FIRST USE 10-27-2007; IN COMMERCE 10-27-2007.

NO CLAIM IS MADE TO THE EXCLUSIVE RIGHT TO USE "MINI HOOPER", APART FROM THE MARK AS SHOWN.

THE COLOR(S) BLACK AND ORANGE IS/ARE CLAIMED AS A FEATURE OF THE MARK.

THE MARK CONSISTS OF TWO NEAR HALF-CIRCLE ARCHES, WHICH MEET ON THE LEFT SIDE AND CONNECTED WITH A SLANTED LINE ON THE RIGHT TO FORM A PERCEPTION OF A TENT COVER, WITH THE WORDS "MINI HOOPER" APPEAR UNDER THE PERCEPTIVE TENT COVER. THE MARK HAS A BLACK CONTOUR AND THE UPPER PORTION OF THE MARK HAS ORANGE GRADIENT SHADING.

SER. NO. 77-326,950, FILED 11-12-2007.

GILBERT SWIFT, EXAMINING ATTORNEY

Int. Cl.: 44

Prior U.S. Cls.: 100 and 101

United States Patent and Trademark Office

Reg. No. 3,479,687

Registered Aug. 5, 2008

**SERVICE MARK
PRINCIPAL REGISTER**

TSAVO

BOHINC, GARY (UNITED STATES INDIVIDUAL)
12385 NANTUCKET DR.
CHARDON, OH 44024

THE MARK CONSISTS OF STANDARD CHARACTERS WITHOUT CLAIM TO ANY PARTICULAR FONT, STYLE, SIZE, OR COLOR.

FOR: ANIMAL BREEDING SERVICES, IN CLASS 44 (U.S. CLS. 100 AND 101).

SER. NO. 77-326,961, FILED 11-12-2007.

FIRST USE 6-1-2000; IN COMMERCE 1-31-2005.

GILBERT SWIFT, EXAMINING ATTORNEY

Int. Cl.: 36

Prior U.S. Cls.: 100, 101 and 102

United States Patent and Trademark Office

Reg. No. 3,479,688

Registered Aug. 5, 2008

**SERVICE MARK
PRINCIPAL REGISTER**



ELECTRONIC MERCHANT SYSTEMS (OHIO CORPORATION)
5005 ROCKSIDE ROAD PH100
INDEPENDENCE, OH 44131

FOR: PAYMENT PROCESSING SERVICES, NAMELY, CREDIT CARD AND DEBIT CARD TRANSACTION PROCESSING SERVICES, IN CLASS 36 (U.S. CLS. 100, 101 AND 102).

FIRST USE 2-6-1996; IN COMMERCE 2-6-1996.

NO CLAIM IS MADE TO THE EXCLUSIVE RIGHT TO USE "ELECTRONIC MERCHANT SYSTEMS", APART FROM THE MARK AS SHOWN.

THE COLOR(S) BLUE, WHITE AND BLACK IS/ ARE CLAIMED AS A FEATURE OF THE MARK.

THE MARK CONSISTS OF THE COLOR BLACK APPEARS IN THE WORDING "ELECTRONIC MERCHANT SYSTEMS". THE DESIGN ELEMENT CONSISTS OF A BLUE BOX WITH A WHITE SWOOSH INSIDE.

SER. NO. 77-327,134, FILED 11-12-2007.

DOMINICK J. SALEMI, EXAMINING ATTORNEY

Int. Cl.: 39

Prior U.S. Cls.: 100 and 105

United States Patent and Trademark Office

Reg. No. 3,479,689

Registered Aug. 5, 2008

SERVICE MARK
PRINCIPAL REGISTER



THE BONEYARD INC (TENNESSEE CORPORATION)
131 CAMPBELL LANE
CHURCH HILL, TN 37642

FOR: AUTOMOBILE SALVAGE, IN CLASS 39
(U.S. CLS. 100 AND 105).

FIRST USE 1-1-2007; IN COMMERCE 6-15-2007.

NO CLAIM IS MADE TO THE EXCLUSIVE
RIGHT TO USE "INC" , APART FROM THE MARK
AS SHOWN.

THE COLOR(S) BLACK, WHITE, CHARCOAL,
AND BONE IS/ARE CLAIMED AS A FEATURE OF
THE MARK.

THE MARK CONSISTS OF WHITE BACKGROUND. THE LETTERING, "THE BONEYARD INC," IS OUTLINED IN BLACK, AND THE FILL COLOR FOR ALL LETTERING IS A BONE COLOR. A SKULL BETWEEN THE WORD "BONEYARD" AND "INC" IS BONE COLORED WITH CHARCOAL EYES AND NOSE.

SEC. 2(F).

SER. NO. 77-327,147, FILED 11-12-2007.

INGA ERVIN, EXAMINING ATTORNEY

Int. Cl.: 39

Prior U.S. Cls.: 100 and 105

United States Patent and Trademark Office

Reg. No. 3,479,690

Registered Aug. 5, 2008

**SERVICE MARK
PRINCIPAL REGISTER**

AHSTF

LAKELAND FINANCE LLC (DELAWARE LTD
LIAB CO)
SUITE 300
590 JEFFERSON PARKWAY
CHARLOTTESVILLE, VA 22911

FOR: TRAVEL SERVICES, NAMELY, ARRAN-
GING AND CONDUCTING TRAVEL TOURS AND
EDUCATIONAL TRIPS, IN CLASS 39 (U.S. CLS. 100
AND 105).

FIRST USE 9-0-2006; IN COMMERCE 9-0-2006.

THE MARK CONSISTS OF STANDARD CHAR-
ACTERS WITHOUT CLAIM TO ANY PARTICULAR
FONT, STYLE, SIZE, OR COLOR.

SER. NO. 77-327,291, FILED 11-12-2007.

DAVID C. REIHNER, EXAMINING ATTORNEY

Int. Cl.: 19

Prior U.S. Cls.: 1, 12, 33 and 50

United States Patent and Trademark Office

Reg. No. 3,479,691

Registered Aug. 5, 2008

**TRADEMARK
PRINCIPAL REGISTER**

ASSISI

SAROYAN LUMBER COMPANY, INC. (CALI-
FORNIA CORPORATION)
6230 SO. ALAMEDA ST.
HUNTINGTON PARK, CA 90255

THE MARK CONSISTS OF STANDARD CHAR-
ACTERS WITHOUT CLAIM TO ANY PARTICULAR
FONT, STYLE, SIZE, OR COLOR.

FOR: FLOOR BOARDS, WOODEN FLOORING,
HARDWOOD FLOORING; NON-METAL ARCHI-
TECTURAL MOULDINGS AND FINISH TRIM, IN
CLASS 19 (U.S. CLS. 1, 12, 33 AND 50).

SER. NO. 77-327,363, FILED 11-12-2007.

FIRST USE 11-8-2007; IN COMMERCE 11-8-2007.

DEIRDRE ROBERTSON, EXAMINING ATTORNEY

Int. Cl.: 36

Prior U.S. Cls.: 100, 101 and 102

United States Patent and Trademark Office

Reg. No. 3,479,692

Registered Aug. 5, 2008

**SERVICE MARK
PRINCIPAL REGISTER**

**Empowering You with the
Power of Many**

BREAKAWAY PARTNERS (CALIFORNIA LTD
LIAB CO)

#1

1513 9TH STREET
SANTA MONICA, CA 90401

FOR: INVESTMENT ADVISORY SERVICES, IN
CLASS 36 (U.S. CLS. 100, 101 AND 102).

FIRST USE 5-9-2007; IN COMMERCE 5-9-2007.

THE MARK CONSISTS OF STANDARD CHAR-
ACTERS WITHOUT CLAIM TO ANY PARTICULAR
FONT, STYLE, SIZE, OR COLOR.

SER. NO. 77-327,545, FILED 11-12-2007.

INGA ERVIN, EXAMINING ATTORNEY

Int. Cl.: 37

Prior U.S. Cls.: 100, 103 and 106

United States Patent and Trademark Office

Reg. No. 3,479,693

Registered Aug. 5, 2008

**SERVICE MARK
PRINCIPAL REGISTER**

THE RIGHT PRICE!

HALLMARK HOMES, INC. (NEW JERSEY CORPORATION)
6TH FLOOR
90 WOODBRIDGE CENTER DRIVE
WOODBRIDGE, NJ 07095

THE MARK CONSISTS OF STANDARD CHARACTERS WITHOUT CLAIM TO ANY PARTICULAR FONT, STYLE, SIZE, OR COLOR.

FOR: REAL ESTATE DEVELOPMENT, IN CLASS 37 (U.S. CLS. 100, 103 AND 106).

SER. NO. 77-328,023, FILED 11-13-2007.

FIRST USE 11-7-2007; IN COMMERCE 11-7-2007.

PAUL E. FAHRENKOPF, EXAMINING ATTORNEY

Int. Cl.: 41

Prior U.S. Cls.: 100, 101 and 107

United States Patent and Trademark Office

Reg. No. 3,479,694

Registered Aug. 5, 2008

**SERVICE MARK
PRINCIPAL REGISTER**

Howlin Wolf Studio

LEE, HARRY (UNITED STATES INDIVIDUAL)
PO BOX 703
CRESTWOOD, KY 40014

FOR: MOTION PICTURE FILM PRODUCTION;
MULTIMEDIA PUBLISHING OF BOOKS, MAGAZINES,
JOURNALS, SOFTWARE, GAMES, MUSIC,
AND ELECTRONIC PUBLICATIONS; PUBLICA-
TION OF TEXTS, BOOKS, MAGAZINES AND
OTHER PRINTED MATTER, IN CLASS 41 (U.S.
CLS. 100, 101 AND 107).

FIRST USE 8-15-2006; IN COMMERCE 12-15-2006.

THE MARK CONSISTS OF STANDARD CHAR-
ACTERS WITHOUT CLAIM TO ANY PARTICULAR
FONT, STYLE, SIZE, OR COLOR.

NO CLAIM IS MADE TO THE EXCLUSIVE
RIGHT TO USE "STUDIO", APART FROM THE
MARK AS SHOWN.

SER. NO. 77-328,028, FILED 11-13-2007.

JANICE KIM, EXAMINING ATTORNEY

Int. Cl.: 37

Prior U.S. Cls.: 100, 103 and 106

United States Patent and Trademark Office

Reg. No. 3,479,695

Registered Aug. 5, 2008

**SERVICE MARK
PRINCIPAL REGISTER**

**YOUR FAMILY IS GOING TO
LOVE LIVING HERE!**

HALLMARK HOMES, INC. (NEW JERSEY COR-
PORATION)
6TH FLOOR
90 WOODBRIDGE CENTER DRIVE
WOODBRIDGE, NJ 07095

THE MARK CONSISTS OF STANDARD CHAR-
ACTERS WITHOUT CLAIM TO ANY PARTICULAR
FONT, STYLE, SIZE, OR COLOR.

FOR: REAL ESTATE DEVELOPMENT, IN CLASS
37 (U.S. CLS. 100, 103 AND 106).

SER. NO. 77-328,098, FILED 11-13-2007.

FIRST USE 11-7-2007; IN COMMERCE 11-7-2007.

PAUL E. FAHRENKOPF, EXAMINING ATTORNEY

Int. Cl.: 37

Prior U.S. Cls.: 100, 103 and 106

United States Patent and Trademark Office

Reg. No. 3,479,696

Registered Aug. 5, 2008

**SERVICE MARK
PRINCIPAL REGISTER**

**THE RIGHT PRICE IN NEW
JERSEY!**

HALLMARK HOMES, INC. (NEW JERSEY COR-
PORATION)
6TH FLOOR
90 WOODBRIDGE CENTER DRIVE
WOODBIDGE, NJ 07095

THE MARK CONSISTS OF STANDARD CHAR-
ACTERS WITHOUT CLAIM TO ANY PARTICULAR
FONT, STYLE, SIZE, OR COLOR.

FOR: REAL ESTATE DEVELOPMENT, IN CLASS
37 (U.S. CLS. 100, 103 AND 106).

SER. NO. 77-328,140, FILED 11-13-2007.

FIRST USE 11-7-2007; IN COMMERCE 11-7-2007.

PAUL E. FAHRENKOPF, EXAMINING ATTORNEY

Int. Cl.: 41

Prior U.S. Cls.: 100, 101 and 107

United States Patent and Trademark Office

Reg. No. 3,479,697

Registered Aug. 5, 2008

SERVICE MARK
PRINCIPAL REGISTER



ALMA PUBLISHING INC. (OREGON CORPORATION)
5600 VAN WELL ROAD
DALLAS, OR 97338

FOR: LIFE COACHING SERVICES IN THE FIELD OF BUSINESS, SELF HELP, MOTIVATION, HEALTH AND WELLNESS, INTERPERSONAL RELATIONSHIPS, CREATIVITY, SPIRITUALITY, ORGANIZATION, CAREER PLANNING AND GROWTH; PERSONAL COACHING SERVICES IN THE FIELD OF BUSINESS, SELF HELP, MOTIVATION, HEALTH AND WELLNESS, INTERPERSONAL RELATIONSHIPS, CREATIVITY, SPIRITUALITY, ORGANIZATION, CAREER PLANNING AND GROWTH; PROFESSIONAL COACHING SERVICES IN THE FIELD OF BUSINESS, SELF HELP, MOTIVATION, HEALTH AND WELLNESS, INTERPERSONAL RELATIONSHIPS, CREATIVITY, SPIRITUALITY, ORGANIZATION, CAREER PLANNING AND GROWTH; EDUCATION SERVICES, NAMELY, PROVIDING WORKSHOPS, SEMINARS AND RETREATS IN THE FIELD OF BUSINESS, SELF HELP, MOTIVATION, HEALTH AND WELLNESS, INTERPERSONAL RELATIONSHIPS, CREATIVITY, SPIRITUALITY, ORGANIZATION,

CAREER PLANNING AND GROWTH, IN CLASS 41 (U.S. CLS. 100, 101 AND 107).

FIRST USE 0-0-2005; IN COMMERCE 0-0-2005.

THE COLOR(S) GREEN, PURPLE AND WHITE IS/ARE CLAIMED AS A FEATURE OF THE MARK.

THE MARK CONSISTS OF THE WORDS "SUCCESS FOR THE SOUL" IN THE COLOR GREEN WITH A GREENISH HORIZONTAL LINE OVER THE WORDING "FOR" AND UNDER THE WORDING "THE" ALL TO THE RIGHT OF A PYRAMID SHAPE IN THE COLOR GREEN FEATURING A PURPLE CIRCLE ABOVE WITH LIGHT PURPLE AND WHITE RAYS ALL OF THESE DESIGN ELEMENTS ARE SURROUNDED BY A GREEN SQUARE BORDER FEATURING A LIGHT GREENISH COLOR BACKGROUND.

SER. NO. 77-328,146, FILED 11-13-2007.

LINDA ESTRADA, EXAMINING ATTORNEY

Int. Cl.: 35

Prior U.S. Cls.: 100, 101 and 102

United States Patent and Trademark Office

Reg. No. 3,479,698

Registered Aug. 5, 2008

SERVICE MARK
PRINCIPAL REGISTER



CONVERTIBLE CASTLES, INC. (MASSACHUSETTS CORPORATION)
308 EAST MAIN STREET
NORTON, MA 02766

FOR: RETAIL FURNITURE STORES; RETAIL STORE SERVICES FEATURING FURNITURE, RUGS, AND HOME ACCESSORIES, IN CLASS 35 (U.S. CLS. 100, 101 AND 102).

FIRST USE 6-6-2007; IN COMMERCE 6-6-2007.

OWNER OF U.S. REG. NOS. 2,423,282 AND 2,611,313.

NO CLAIM IS MADE TO THE EXCLUSIVE RIGHT TO USE "FURNITURE", APART FROM THE MARK AS SHOWN.

THE COLOR(S) BLACK, GOLD, YELLOW, AND WHITE IS/ARE CLAIMED AS A FEATURE OF THE MARK.

THE MARK CONSISTS OF WHITE RECTANGLE WITH BLACK BORDER AND NARROW YELLOW BORDER CONTAINING WORDS BERNIE&PHYL'S IN BLACK LETTERS, "FURNITURE" IN GOLD LETTERS INSIDE SMALLER GOLD BORDERED WHITE RECTANGLE, TWO HORIZONTAL GOLD LINES FLANKING GOLD RECTANGLE, AND BELOW, ON WHITE BACKGROUND, WORDS "QUALITY, COMFORT & PRICE"... "THAT'S NICE"! WITH "THAT'S NICE"! IN ITALICS .

SER. NO. 77-328,165, FILED 11-13-2007.

JORDAN BAKER, EXAMINING ATTORNEY

Int. Cl.: 37

Prior U.S. Cls.: 100, 103 and 106

United States Patent and Trademark Office

Reg. No. 3,479,699

Registered Aug. 5, 2008

**SERVICE MARK
PRINCIPAL REGISTER**

THE RIGHT PRICE IN NJ!

HALLMARK HOMES, INC. (NEW JERSEY CORPORATION)
6TH FLOOR
90 WOODBRIDGE CENTER DRIVE
WOODBRIDGE, NJ 07095

THE MARK CONSISTS OF STANDARD CHARACTERS WITHOUT CLAIM TO ANY PARTICULAR FONT, STYLE, SIZE, OR COLOR.

FOR: REAL ESTATE DEVELOPMENT, IN CLASS 37 (U.S. CLS. 100, 103 AND 106).

SER. NO. 77-328,190, FILED 11-13-2007.

FIRST USE 11-7-2007; IN COMMERCE 11-7-2007.

PAUL E. FAHRENKOPF, EXAMINING ATTORNEY

Int. Cl.: 41

Prior U.S. Cls.: 100, 101 and 107

United States Patent and Trademark Office

Reg. No. 3,479,700

Registered Aug. 5, 2008

**SERVICE MARK
PRINCIPAL REGISTER**

Taste of the Emerald Coast

WALTON COUNTY CHAMBER OF COMMERCE
(FLORIDA CORPORATION)
63 S. CENTRE TRAIL
SANTA ROSA BEACH, FL 32459

FOR: ENTERTAINMENT SERVICES, NAMELY,
WINE TASTINGS, IN CLASS 41 (U.S. CLS. 100, 101
AND 107).

FIRST USE 9-1-2006; IN COMMERCE 9-1-2006.

THE MARK CONSISTS OF STANDARD CHAR-
ACTERS WITHOUT CLAIM TO ANY PARTICULAR
FONT, STYLE, SIZE, OR COLOR.

NO CLAIM IS MADE TO THE EXCLUSIVE
RIGHT TO USE "EMERALD COAST", APART
FROM THE MARK AS SHOWN.

SER. NO. 77-328,521, FILED 11-13-2007.

THEODORE MCBRIDE, EXAMINING ATTORNEY

Int. Cls.: 35 and 41

Prior U.S. Cls.: 100, 101, 102 and 107

United States Patent and Trademark Office

Reg. No. 3,479,701

Registered Aug. 5, 2008

**SERVICE MARK
PRINCIPAL REGISTER**

VOX Entertainment

VOX ENTERTAINMENT (CALIFORNIA CORPORATION)
115 LOMITA STREET
EL SEGUNDO, CA 90245

FOR: ARRANGING AND CONDUCTING MARKETING PROMOTIONAL EVENTS FOR OTHERS; ADVERTISING AGENCY SPECIALIZING IN THE DESIGN AND EXECUTION OF WORD OF MOUTH, VIRAL, BUZZ AND EXPERIENTIAL MARKETING PROGRAMS, IN CLASS 35 (U.S. CLS. 100, 101 AND 102).

FIRST USE 1-2-2000; IN COMMERCE 1-2-2000.

FOR: SPECIAL EVENT PLANNING, IN CLASS 41 (U.S. CLS. 100, 101 AND 107).

FIRST USE 1-2-1997; IN COMMERCE 1-2-1997.

THE MARK CONSISTS OF STANDARD CHARACTERS WITHOUT CLAIM TO ANY PARTICULAR FONT, STYLE, SIZE, OR COLOR.

NO CLAIM IS MADE TO THE EXCLUSIVE RIGHT TO USE "ENTERTAINMENT", APART FROM THE MARK AS SHOWN.

SER. NO. 77-328,605, FILED 11-13-2007.

STEVEN R. FOSTER, EXAMINING ATTORNEY

Int. Cl.: 39

Prior U.S. Cls.: 100 and 105

United States Patent and Trademark Office

Reg. No. 3,479,702

Registered Aug. 5, 2008

**SERVICE MARK
PRINCIPAL REGISTER**



LAWRY FREIGHT SYSTEM, INC. (MASSACHU-
SETTS CORPORATION)
595 SOUTHAMPTON ROAD
WESTFIELD, MA 01085

FOR: SUPPLY CHAIN LOGISTICS AND RE-
VERSE LOGISTIC SERVICES, NAMELY, STORAGE,
TRANSPORTATION AND DELIVERY OF DOCU-
MENTS, PACKAGES, RAW MATERIALS AND
OTHER FREIGHT FOR OTHERS BY AIR, RAIL,

SHIP OR TRUCK, IN CLASS 39 (U.S. CLS. 100 AND
105).

FIRST USE 1-1-1980; IN COMMERCE 1-1-1980.

SEC. 2(F).

SER. NO. 77-328,873, FILED 11-14-2007.

KRISTIN DAHLING, EXAMINING ATTORNEY

Int. Cl.: 42

Prior U.S. Cls.: 100 and 101

United States Patent and Trademark Office

Reg. No. 3,479,703

Registered Aug. 5, 2008

**SERVICE MARK
PRINCIPAL REGISTER**

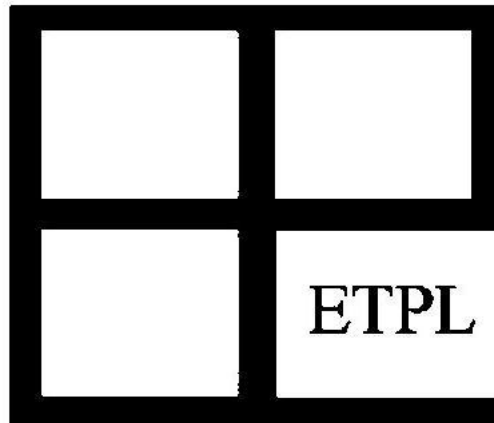

EASTERN TEXAS PATHOLOGY LABORATOR-
IES (TEXAS PROFESSIONAL ASSOCIATION)
134 ROSEDALE
ATHENS, TX 75751

FOR: MEDICAL LABORATORIES, NAMELY,
ANATOMIC AND CLINICAL PATHOLOGY LA-
BORATORY SERVICES; MEDICAL LABORATORY
CONSULTATION SERVICES; MEDICAL LABORA-
TORY SERVICES, NAMELY, COLLECTING ANA-
TOMIC AND CLINICAL PATHOLOGY SPECIMENS
FOR DIAGNOSTIC TESTING, IN CLASS 42 (U.S.
CLS. 100 AND 101).

FIRST USE 6-1-2007; IN COMMERCE 6-1-2007.

THE MARK CONSISTS OF A RECTANGULAR
LOGO WITH THE SYLIZED TEXT "ETPL", USING
OVERLAY OF BLOCKED CAPITAL LETTERS
"ETPL" TO CREATE THE LOGO.

SER. NO. 77-329,103, FILED 11-14-2007.

SEAN CROWLEY, EXAMINING ATTORNEY

Int. Cl.: 41

Prior U.S. Cls.: 100, 101 and 107

United States Patent and Trademark Office

Reg. No. 3,479,704

Registered Aug. 5, 2008

**SERVICE MARK
PRINCIPAL REGISTER**

FROCKS ROCKS & COCKTAILS

MANN, WANDA (UNITED STATES INDIVIDUAL)

#2A

102 EAST 116TH STREET
NEW YORK, NY 10029

FOR: SOCIAL CLUB SERVICES, NAMELY, ARRANGING, ORGANIZING AND HOSTING SOCIAL EVENTS AND PARTIES FOR CLUB MEMBERS ON THE TOPICS OF FASHION, BEAUTY, JEWELRY, LIFESTYLE AND ENTERTAINMENT; EDUCATION SERVICES, NAMELY, PROVIDING CLASSES IN THE FIELDS OF FASHION, BEAUTY, JEWELRY,

LIFESTYLE AND ENTERTAINMENT, IN CLASS 41 (U.S. CLS. 100, 101 AND 107).

FIRST USE 11-2-2007; IN COMMERCE 11-2-2007.

THE MARK CONSISTS OF STANDARD CHARACTERS WITHOUT CLAIM TO ANY PARTICULAR FONT, STYLE, SIZE, OR COLOR.

SER. NO. 77-329,107, FILED 11-14-2007.

SEAN CROWLEY, EXAMINING ATTORNEY

Int. Cl.: 36

Prior U.S. Cls.: 100, 101 and 102

United States Patent and Trademark Office

Reg. No. 3,479,705

Registered Aug. 5, 2008

**SERVICE MARK
PRINCIPAL REGISTER**

SAND CAPITAL

SAND CAPITAL LLC (INDIANA LTD LIAB CO)
SUITE C-195
5725 N. SCOTTSDALE ROAD
SCOTTSDALE, AZ 85250

FOR: FINANCIAL SERVICES, NAMELY, MORTGAGE PROCUREMENT SERVICES TO ASSIST HOMEOWNERS IN AVOIDING FORECLOSURE, IN CLASS 36 (U.S. CLS. 100, 101 AND 102).

FIRST USE 11-13-2007; IN COMMERCE 11-13-2007.

THE MARK CONSISTS OF STANDARD CHARACTERS WITHOUT CLAIM TO ANY PARTICULAR FONT, STYLE, SIZE, OR COLOR.

NO CLAIM IS MADE TO THE EXCLUSIVE RIGHT TO USE "CAPITAL", APART FROM THE MARK AS SHOWN.

SER. NO. 77-329,139, FILED 11-14-2007.

TRACY WHITTAKER-BROWN, EXAMINING ATTORNEY

Int. Cl.: 36

Prior U.S. Cls.: 100, 101 and 102

United States Patent and Trademark Office

Reg. No. 3,479,706

Registered Aug. 5, 2008

**SERVICE MARK
PRINCIPAL REGISTER**

**WE PERFORM WHEN YOUR LOANS
DON'T**

SAND CAPITAL LLC (INDIANA LTD LIAB CO)
SUITE C-195
5725 N. SCOTTSDALE ROAD
SCOTTSDALE, AZ 85250

FOR: FINANCIAL SERVICES, NAMELY, MORT-
GAGE PROCUREMENT SERVICES TO ASSIST
HOMEOWNERS IN AVOIDING FORECLOSURE,
IN CLASS 36 (U.S. CLS. 100, 101 AND 102).

FIRST USE 11-13-2007; IN COMMERCE 11-13-2007.

THE MARK CONSISTS OF STANDARD CHAR-
ACTERS WITHOUT CLAIM TO ANY PARTICULAR
FONT, STYLE, SIZE, OR COLOR.

SER. NO. 77-329,194, FILED 11-14-2007.

TRACY WHITTAKER-BROWN, EXAMINING AT-
TORNEY

Int. Cls.: 35 and 41

Prior U.S. Cls.: 100, 101, 102 and 107

United States Patent and Trademark Office

Reg. No. 3,479,707

Registered Aug. 5, 2008

**SERVICE MARK
PRINCIPAL REGISTER**

**Bringing your brand
identity to life**

VOX ENTERTAINMENT, INC. (CALIFORNIA CORPORATION)
115 LOMITA STREET
EL SEGUNDO, CA 90245

FOR: ARRANGING AND CONDUCTING MARKETING PROMOTIONAL EVENTS FOR OTHERS, ADVERTISING AGENCY SPECIALIZING IN THE DESIGN AND EXECUTION OF WORD OF MOUTH, VIRAL, BUZZ AND EXPERIENTIAL MARKETING PROGRAMS, IN CLASS 35 (U.S. CLS. 100, 101 AND 102).

FIRST USE 10-26-2007; IN COMMERCE 10-26-2007.

FOR: SPECIAL EVENT PLANNING, IN CLASS 41 (U.S. CLS. 100, 101 AND 107).

FIRST USE 10-26-2007; IN COMMERCE 10-26-2007.

THE MARK CONSISTS OF STANDARD CHARACTERS WITHOUT CLAIM TO ANY PARTICULAR FONT, STYLE, SIZE, OR COLOR.

SER. NO. 77-329,287, FILED 11-14-2007.

HOWARD SMIGA, EXAMINING ATTORNEY

Int. Cl.: 7

Prior U.S. Cls.: 13, 19, 21, 23, 31, 34 and 35

Reg. No. 3,479,708

United States Patent and Trademark Office

Registered Aug. 5, 2008

**TRADEMARK
PRINCIPAL REGISTER**

SureFire

HAYNES CORPORATION (FLORIDA CORPORATION)
3581 MERCANTILE AVE.
NAPLES, FL 34104

THE MARK CONSISTS OF STANDARD CHARACTERS WITHOUT CLAIM TO ANY PARTICULAR FONT, STYLE, SIZE, OR COLOR.

FOR: FUEL INJECTORS FOR USE IN THE RAILROAD, MARINE, AND STATIONARY POWER UNIT INDUSTRIES, IN CLASS 7 (U.S. CLS. 13, 19, 21, 23, 31, 34 AND 35).

SER. NO. 77-330,408, FILED 11-15-2007.

FIRST USE 2-0-2004; IN COMMERCE 7-0-2004.

CARRIE GENOVESE, EXAMINING ATTORNEY

Int. Cls.: 3 and 5

Prior U.S. Cls.: 1, 4, 6, 18, 44, 46, 50, 51 and 52

United States Patent and Trademark Office

Reg. No. 3,479,709

Registered Aug. 5, 2008

**TRADEMARK
PRINCIPAL REGISTER**

**HUMPHREYS...IT'S WHAT'S
INSIDE**

HUMPHREYS PHARMACAL, INCORPORATED
(DELAWARE CORPORATION)
31 EAST HIGH STREET
EAST HAMPTON, CT 06424

FOR: FACIAL AND SKIN CLEANSERS, TONERS
AND MOISTURIZERS; AND LOTIONS CONTAIN-
ING WITCH HAZEL USED FOR COSMETIC PUR-
POSES, IN CLASS 3 (U.S. CLS. 1, 4, 6, 50, 51 AND 52).

FIRST USE 5-26-2006; IN COMMERCE 5-26-2006.

FOR: PHARMACEUTICAL PREPARATIONS FOR
RELIEF OF TEETHING AND COLIC, IN CLASS 5
(U.S. CLS. 6, 18, 44, 46, 51 AND 52).

FIRST USE 7-2-2007; IN COMMERCE 7-2-2007.

THE MARK CONSISTS OF STANDARD CHAR-
ACTERS WITHOUT CLAIM TO ANY PARTICULAR
FONT, STYLE, SIZE, OR COLOR.

OWNER OF U.S. REG. NOS. 61,160 AND 649,593.

SER. NO. 77-330,510, FILED 11-15-2007.

AHSEN KHAN, EXAMINING ATTORNEY

Int. Cls.: 35 and 41

Prior U.S. Cls.: 100, 101, 102 and 107

United States Patent and Trademark Office

Reg. No. 3,479,710

Registered Aug. 5, 2008

**SERVICE MARK
PRINCIPAL REGISTER**

NEW MAJORITY LOS ANGELES

NEW MAJORITY CALIFORNIA (CALIFORNIA
NON-PROFIT CORPORATION)
SUITE 600
949 SOUTH COAST DRIVE
COSTA MESA, CA 92626

FOR: ASSOCIATION SERVICES, NAMELY, PROMOTING FISCALLY RESPONSIBLE GOVERNMENT POLICIES; ASSOCIATION SERVICES, NAMELY, PROMOTING THE INTERESTS OF INDIVIDUALS AND GROUPS WHO SUPPORT FISCALLY RESPONSIBLE GOVERNMENT POLICIES, SPECIFICALLY THROUGH SPONSORED POLITICAL ACTION COMMITTEES, IN CLASS 35 (U.S. CLS. 100, 101 AND 102).

FIRST USE 9-15-2004; IN COMMERCE 9-15-2004.

FOR: EDUCATION SERVICES AND OUTREACH, NAMELY, PROVIDING FORUMS, SEMINARS AND SPEAKER WORKSHOPS REGARDING EXISTING AND PROPOSED GOVERNMENT POLICIES; EDUCATIONAL SERVICES, NAMELY, PROVIDING CANDIDATES WITH TRAINING IN THE FIELDS

OF POLITICAL AND GOVERNMENT POLICIES AND FUNCTIONS, PUBLIC COMMUNICATIONS AND FUNDRAISING; EDUCATION SERVICES AND OUTREACH, NAMELY, FORUMS AND SEMINARS TO PROMOTE FISCALLY RESPONSIBLE CANDIDATES AND IDEAS, IN CLASS 41 (U.S. CLS. 100, 101 AND 107).

FIRST USE 9-15-2004; IN COMMERCE 9-15-2004.

THE MARK CONSISTS OF STANDARD CHARACTERS WITHOUT CLAIM TO ANY PARTICULAR FONT, STYLE, SIZE, OR COLOR.

NO CLAIM IS MADE TO THE EXCLUSIVE RIGHT TO USE "LOS ANGELES", APART FROM THE MARK AS SHOWN.

SER. NO. 77-330,738, FILED 11-15-2007.

NORA BUCHANAN WILL, EXAMINING ATTORNEY

Int. Cls.: 35 and 41

Prior U.S. Cls.: 100, 101, 102 and 107

United States Patent and Trademark Office

Reg. No. 3,479,711

Registered Aug. 5, 2008

**SERVICE MARK
PRINCIPAL REGISTER**

NEW MAJORITY CALIFORNIA

NEW MAJORITY CALIFORNIA (CALIFORNIA
NON-PROFIT CORPORATION)
SUITE 600
949 SOUTH COAST DRIVE
COSTA MESA, CA 92626

FOR: ASSOCIATION SERVICES, NAMELY, PROMOTING FISCALLY RESPONSIBLE GOVERNMENT POLICIES; ASSOCIATION SERVICES, NAMELY, PROMOTING THE INTERESTS OF INDIVIDUALS AND GROUPS WHO SUPPORT FISCALLY RESPONSIBLE GOVERNMENT POLICIES, SPECIFICALLY THROUGH SPONSORED POLITICAL ACTION COMMITTEES, IN CLASS 35 (U.S. CLS. 100, 101 AND 102).

FIRST USE 6-30-2005; IN COMMERCE 6-30-2005.

FOR: EDUCATION SERVICES AND OUTREACH, NAMELY, PROVIDING FORUMS, SEMINARS AND SPEAKER WORKSHOPS REGARDING EXISTING AND PROPOSED GOVERNMENT POLICIES; EDUCATIONAL SERVICES, NAMELY, PROVIDING CANDIDATES WITH TRAINING IN THE FIELDS

OF POLITICAL AND GOVERNMENT POLICIES AND FUNCTIONS, PUBLIC COMMUNICATIONS AND FUNDRAISING; EDUCATION SERVICES AND OUTREACH, NAMELY, FORUMS AND SEMINARS TO PROMOTE FISCALLY RESPONSIBLE CANDIDATES AND IDEAS, IN CLASS 41 (U.S. CLS. 100, 101 AND 107).

FIRST USE 6-30-2005; IN COMMERCE 6-30-2005.

THE MARK CONSISTS OF STANDARD CHARACTERS WITHOUT CLAIM TO ANY PARTICULAR FONT, STYLE, SIZE, OR COLOR.

NO CLAIM IS MADE TO THE EXCLUSIVE RIGHT TO USE "CALIFORNIA", APART FROM THE MARK AS SHOWN.

SER. NO. 77-330,740, FILED 11-15-2007.

NORA BUCHANAN WILL, EXAMINING ATTORNEY

Int. Cl.: 43

Prior U.S. Cls.: 100 and 101

United States Patent and Trademark Office

Reg. No. 3,479,712

Registered Aug. 5, 2008

**SERVICE MARK
PRINCIPAL REGISTER**

MARISCOS LA SIRENITA

YBANEZ-GONZALES, INC. (CALIFORNIA CORPORATION)
1421 MARINE WAY
OXNARD, CA 93035

FOR: RESTAURANT SERVICES, IN CLASS 43
(U.S. CLS. 100 AND 101).

FIRST USE 0-0-1994; IN COMMERCE 0-0-1994.

THE MARK CONSISTS OF STANDARD CHARACTERS WITHOUT CLAIM TO ANY PARTICULAR FONT, STYLE, SIZE, OR COLOR.

NO CLAIM IS MADE TO THE EXCLUSIVE RIGHT TO USE "MARISCOS", APART FROM THE MARK AS SHOWN.

THE ENGLISH TRANSLATION OF "MARISCOS LA SIRENITA" IS LITTLE MERMAID SEAFOOD.

SER. NO. 77-330,989, FILED 11-15-2007.

CYNTHIA SLOAN, EXAMINING ATTORNEY

Int. Cl.: 9

Prior U.S. Cls.: 21, 23, 26, 36 and 38

United States Patent and Trademark Office

Reg. No. 3,479,713

Registered Aug. 5, 2008

**TRADEMARK
PRINCIPAL REGISTER**

ONBOARD

ATEK, INC. (CALIFORNIA CORPORATION)
2911 TECH CENTER DR.
SANTA ANA, CA 92705

THE MARK CONSISTS OF STANDARD CHAR-
ACTERS WITHOUT CLAIM TO ANY PARTICULAR
FONT, STYLE, SIZE, OR COLOR.

FOR: COMPUTER KEYBOARDS; KEYBOARDS,
IN CLASS 9 (U.S. CLS. 21, 23, 26, 36 AND 38).

SER. NO. 77-331,051, FILED 11-15-2007.

FIRST USE 9-11-2003; IN COMMERCE 4-6-2005.

SIMON TENG, EXAMINING ATTORNEY

Int. Cl.: 36

Prior U.S. Cls.: 100, 101 and 102

United States Patent and Trademark Office

Reg. No. 3,479,714

Registered Aug. 5, 2008

**SERVICE MARK
PRINCIPAL REGISTER**

RENTAL FINDERS

VASILIOS MANIATIS (UNITED STATES INDIVIDUAL)
5310 CLARENDON ROAD
INDIANAPOLIS, IN 46208

FOR: APARTMENT LEASING SERVICES; ASSISTING PROPERTY OWNERS TO LEASE PROPERTY TO PROSPECTIVE TENANTS; ASSISTING PROSPECTIVE TENANTS TO LOCATE SUITABLE RENTAL PROPERTY PERIOD , IN CLASS 36 (U.S. CLS. 100, 101 AND 102).

FIRST USE 4-1-2001; IN COMMERCE 4-1-2001.

THE MARK CONSISTS OF STANDARD CHARACTERS WITHOUT CLAIM TO ANY PARTICULAR FONT, STYLE, SIZE, OR COLOR.

SEC. 2(F).

SER. NO. 77-331,132, FILED 11-16-2007.

KIMBERLY PERRY, EXAMINING ATTORNEY

Int. Cl.: 42

Prior U.S. Cls.: 100 and 101

United States Patent and Trademark Office

Reg. No. 3,479,715

Registered Aug. 5, 2008

**SERVICE MARK
PRINCIPAL REGISTER**



UTICA COLLEGE (NEW YORK NON-PROFIT CORPORATION)
1600 BURRSTONE ROAD
UTICA, NY 13502

FOR: RESEARCH AND DEVELOPMENT, AND CONSULTATION RELATED THERETO, IN THE FIELDS OF IDENTITY MANAGEMENT, INFORMATION SHARING, AND DATA PROTECTION, IN CLASS 42 (U.S. CLS. 100 AND 101).

FIRST USE 12-7-2007; IN COMMERCE 12-7-2007.

NO CLAIM IS MADE TO THE EXCLUSIVE RIGHT TO USE "CENTER FOR IDENTITY MANAGEMENT AND INFORMATION PROTECTION", APART FROM THE MARK AS SHOWN.

THE COLOR(S) BLUE AND GRAY IS/ARE CLAIMED AS A FEATURE OF THE MARK.

THE MARK CONSISTS OF THE WORDING "CIMP CENTER FOR IDENTITY MANAGEMENT AND INFORMATION PROTECTION" WITH BOTH "I" S IN "CIMP" AND THE WORDING "CENTER FOR IDENTITY MANAGEMENT AND INFORMATION PROTECTION" IN BLUE, AND THE REMAINING LETTERS IN GRAY.

SER. NO. 77-331,201, FILED 11-16-2007.

KIMBERLY PERRY, EXAMINING ATTORNEY

Int. Cl.: 42

Prior U.S. Cls.: 100 and 101

United States Patent and Trademark Office

Reg. No. 3,479,716

Registered Aug. 5, 2008

**SERVICE MARK
PRINCIPAL REGISTER**

USER FIRST DESIGN FORMULA

CUSTOMER EFFECTIVE, INC. (DELAWARE
CORPORATION)
25 E. COURT ST.
GREENVILLE, SC 29601

FOR: COMPUTER SOFTWARE TECHNOLOGY
AND INTEGRATION CONSULTING, IN CLASS 42
(U.S. CLS. 100 AND 101).

FIRST USE 6-1-2005; IN COMMERCE 6-1-2005.

THE MARK CONSISTS OF STANDARD CHAR-
ACTERS WITHOUT CLAIM TO ANY PARTICULAR
FONT, STYLE, SIZE, OR COLOR.

NO CLAIM IS MADE TO THE EXCLUSIVE
RIGHT TO USE "DESIGN FORMULA", APART
FROM THE MARK AS SHOWN.

SER. NO. 77-331,437, FILED 11-16-2007.

RONALD MCMORROW, EXAMINING ATTORNEY

Int. Cl.: 16

Prior U.S. Cls.: 2, 5, 22, 23, 29, 37, 38 and 50

United States Patent and Trademark Office

Reg. No. 3,479,717

Registered Aug. 5, 2008

**TRADEMARK
PRINCIPAL REGISTER**

BILLING & OSS WORLD

VIRGO PUBLISHING, LLC (DELAWARE LTD
LIAB CO)
SUITE 300
3300 NORTH CENTRAL AVENUE
PHOENIX, AZ 85012

FOR: MAGAZINES FEATURING TELECOMMUNICATIONS NEWS AND INFORMATION FOR COMMUNICATION SERVICE PROVIDERS, IN CLASS 16 (U.S. CLS. 2, 5, 22, 23, 29, 37, 38 AND 50).

FIRST USE 10-26-2007; IN COMMERCE 10-26-2007.

THE MARK CONSISTS OF STANDARD CHARACTERS WITHOUT CLAIM TO ANY PARTICULAR FONT, STYLE, SIZE, OR COLOR.

OWNER OF U.S. REG. NOS. 2,563,635, 2,681,214, AND 2,710,178.

NO CLAIM IS MADE TO THE EXCLUSIVE RIGHT TO USE "BILLING & OSS", APART FROM THE MARK AS SHOWN.

SER. NO. 77-331,755, FILED 11-16-2007.

MICHAEL LITZAU, EXAMINING ATTORNEY

Int. Cl.: 12

Prior U.S. Cls.: 19, 21, 23, 31, 35 and 44

United States Patent and Trademark Office

Reg. No. 3,479,718

Registered Aug. 5, 2008

**TRADEMARK
PRINCIPAL REGISTER**

GLOBE POW-R STEER

GLOBE MOTORS, INC. (OHIO CORPORATION)
2275 STANLEY AVENUE
DAYTON, OH 45404

FOR: MOTORS FOR USE IN STEERING EQUIPMENT FOR MOTOR VEHICLES, IN CLASS 12 (U.S. CLS. 19, 21, 23, 31, 35 AND 44).

FIRST USE 11-7-2007; IN COMMERCE 11-7-2007.

THE MARK CONSISTS OF STANDARD CHARACTERS WITHOUT CLAIM TO ANY PARTICULAR FONT, STYLE, SIZE, OR COLOR.

NO CLAIM IS MADE TO THE EXCLUSIVE RIGHT TO USE "POWER STEER", APART FROM THE MARK AS SHOWN.

SER. NO. 77-331,871, FILED 11-16-2007.

ARETHA SOMERVILLE, EXAMINING ATTORNEY

Int. Cls.: 1, 5, 9 and 10

Prior U.S. Cls.: 1, 5, 6, 10, 18, 21, 23, 26, 36, 38, 39, 44, 46, 51 and 52

Reg. No. 3,479,719

United States Patent and Trademark Office

Registered Aug. 5, 2008

**TRADEMARK
PRINCIPAL REGISTER**



THE BINDING SITE, LTD (UNITED KINGDOM CORPORATION)
P.O. BOX 11712
BIRMINGHAM, ENGLAND B144ZB

SCIENTIFIC APPARATUS FOR CHEMICAL OR BIOLOGICAL ANALYSIS; ELECTROPHORESIS GELS OTHER THAN FOR MEDICAL OR VETERINARY PURPOSES, IN CLASS 1 (U.S. CLS. 1, 5, 6, 10, 26 AND 46).

FIRST USE 0-0-1989; IN COMMERCE 0-0-1989.

FOR: DIAGNOSTIC KITS COMPRISED OF DIAGNOSTIC REAGENTS FOR LABORATORY USE, CALIBRATORS, REAGENT PLATES, BUFFERED SOLUTIONS, DILUENT SOLUTIONS, AND SERUM; REAGENTS, DIAGNOSTIC REAGENTS, BIOLOGICAL REAGENTS, HISTOLOGY REAGENTS, ENZYME RADIOIMMUNOASSAY REAGENTS, IMMUNOASSAY REAGENTS, ANTIGEN SUBSTRATES, AND ANTIBODIES FOR SCIENTIFIC RESEARCH USE; AND TEST KITS COMPRISED OF REAGENTS, BUFFERS, CALIBRATORS, DILUENTS, ANTIBODIES, ANTIGEN SUBSTRATES, CONJUGATES, STOPPING SOLUTIONS, ANTISERA AND/OR DROPPER BOTTLES FOR SCIENTIFIC AND RESEARCH USE USING BLOOD, BODY FLUIDS, BODY TISSUES OR EXTRACTS THEREOF; BIOCHEMICALS, NAMELY, MONOCLONAL ANTIBODIES FOR IN VITRO SCIENTIFIC OR RESEARCH USE; CHEMICALS, NAMELY, BUFFER AND STANDARD SOLUTIONS USED IN ANALYTICAL CHEMISTRY; DIAGNOSTIC PREPARATIONS FOR SCIENTIFIC OR RESEARCH USE; DIAGNOSTIC PREPARATIONS FOR SCIENTIFIC USE; DIAGNOSTIC PREPARATIONS USED IN SCIENCE; DIAGNOSTIC REAGENTS FOR IN VITRO USE IN BIOCHEMISTRY, CLINICAL CHEMISTRY AND MICROBIOLOGY; REAGENTS FOR CHEMICAL ANALYSES; REAGENTS FOR RESEARCH PURPOSES; REAGENTS FOR SCIENTIFIC OR MEDICAL RESEARCH USE; REAGENTS FOR USE IN

FOR: CALIBRATING SOLUTIONS, DILUENTS, CONTROL SAMPLES, REAGENTS, ANTIBODIES, ANTIGEN SUBSTRATES, CONJUGATES, STOPPING SOLUTIONS, IMMUNOFLUORESCENCE REAGENTS, HISTOLOGY REAGENTS, ENZYME IMMUNOASSAY REAGENTS AND GENERAL PURPOSE REAGENTS FOR MEDICAL AND VETERINARY DIAGNOSTIC AND CLINICAL USE; AND DIAGNOSTIC AND IMMUNOLOGICAL TEST KITS CONSISTING OF REAGENTS, CONTROLS, BUFFERS, CALIBRATORS, DILUENTS, ANTIBODIES, ANTIGEN SUBSTRATES, CONJUGATES, STOPPING SOLUTIONS, ANTISERA AND/OR DROPPER BOTTLES, ALL FOR USE IN MEASURING THE CONCENTRATION OF PROTEINS, ANTIBODIES, ANTIGENS AND OTHER SUBSTANCES IN BLOOD, OTHER BODY FLUIDS AND BODY TISSUES, OR EXTRACTS THEREOF, FOR USE IN THE DIAGNOSIS, TREATMENT, CURE, PREVENTION OR MITIGATION OF DISEASES AND OTHER CONDITIONS IN HUMANS AND ANIMALS; BIOLOGICAL AND CHEMICAL PREPARATIONS AND REAGENTS FOR MEDICAL OR VETERINARY USE; CLINICAL MEDICAL REAGENTS; DIAGNOSTIC PREPARATIONS FOR CLINICAL OR MEDICAL LABORATORY USE; DIAGNOSTIC PREPARATIONS FOR MEDICAL AND VETERINARY USE;

DIAGNOSTIC REAGENTS FOR MEDICINAL USE; MEDICAL DIAGNOSTIC REAGENTS; MEDICAL DIAGNOSTIC REAGENTS AND ASSAYS FOR TESTING OF BODY FLUIDS; REAGENTS AND MEDIA FOR MEDICAL AND VETERINARY DIAGNOSTIC PURPOSES; REAGENTS FOR MEDICAL USE; MEDICAL DIAGNOSTIC KITS FOR USE IN ELECTROPHORESIS, IMMUNOLOGY AND SEROLOGY, CONSISTING PRIMARILY OF EXTRACTS FROM BLOOD OR BODY FLUIDS; CONTROL SOLUTIONS INDICATIVE OF A POSITIVE RESULT FOR MEDICAL USE; BUFFER SOLUTIONS FOR DILUTING SAMPLES AND/OR REAGENTS FOR MEDICAL USE; REAGENTS, BLOOD REAGENTS; ELECTROPHORETIC GELS FOR MEDICAL PURPOSES; PROTEIN STAIN, FOR VISUALIZING RESULTS, FOR MEDICAL PURPOSES; ANTISERA FOR PRECIPITATING SPECIFIC PROTEINS, FOR MEDICAL PURPOSES; FIXATIVE FOR PRECIPITATING PROTEINS, FOR MEDICAL PURPOSES; TEMPLATES FOR CONTROLLING THE APPLICATION OF SAMPLES AND/OR ANTISERA, FOR MEDICAL PURPOSES; BLOTTING PAPER AND BLOTTING TISSUES FOR REMOVING EXCESS LIQUID FOR GELS, FOR MEDICAL PURPOSES, IN CLASS 5 (U.S. CLS. 6, 18, 44, 46, 51 AND 52).

FIRST USE 0-0-1989; IN COMMERCE 0-0-1989.

FOR: APPARATUS FOR TESTING GAS, LIQUIDS AND SOLIDS; AND ELECTRONIC APPARATUS FOR ELECTROPHYSIOLOGICAL MEASUREMENT AND TESTING OF CELLS; BLANK MAGNETIC DATA CARRIERS; COMPUTER SOFTWARE FOR USE IN DATA MANIPULATION AND INSTRUMENT CONTROL FOR USE IN MEASURING THE CONCENTRATION OF PROTEINS, ANTIBODIES, ANTIGENS AND OTHER SUBSTANCES IN BODY FLUIDS FOR USE IN THE DIAGNOSIS, TREATMENT, PREVENTION, CURE AND MITIGATION OF DISEASES AND OTHER CONDITIONS IN HUMANS; AND NEPHELOMETERS FOR USE IN MEASURING THE CONCENTRATION OF PROTEINS, ANTIBODIES, ANTIGENS AND OTHER SUBSTANCES IN BODY FLUIDS FOR USE IN THE DIAGNOSIS, TREATMENT, PREVENTION, CURE AND MITIGATION OF DISEASES AND OTHER CONDITIONS IN HUMANS; ELECTRONIC AND COMPUTERIZED RADIAL IMMUNODIFFUSION PLATE READERS; ELECTROPHORESIS TANK AND POWER SUPPLY, FOR LABORATORY USE; GEL PRESSES FOR PRESSING AND DRYING GELS;

LABORATORY EQUIPMENT, NAMELY, INCUBATORS, IN CLASS 9 (U.S. CLS. 21, 23, 26, 36 AND 38).

FIRST USE 0-0-1989; IN COMMERCE 0-0-1989.

FOR: MEDICAL DIAGNOSTIC APPARATUS AND INSTRUMENTS FOR THE DIAGNOSIS, TREATMENT AND CURE OF DISEASES IN HUMANS, NAMELY, MULTIPLE MYELOMA, LYMPHOCYTIC NEOPLASMS, WALDENSTROM'S MACROGLOBULINEMIA, AMYLOIDOSIS, LIGHT CHAIN DEPOSITION DISEASES AND CONNECTIVE TISSUES DISEASES, NAMELY, SYSTEMIC LUPUS ERYTHEMATOSUS; APPARATUS FOR BLOOD, URINE AND SERUM ANALYSIS; APPARATUS FOR CLINICAL DIAGNOSIS; APPARATUS USED IN IMPLEMENTING DIAGNOSTIC TESTS DESIGNED TO DETECT ABNORMALITIES IN BLOOD, SERUM AND URINE, NAMELY, AUTOMATED CLINICAL ANALYZERS BASED ON COLORIMETRIC AND TURBIDMETRIC MEASUREMENTS, DILUENTS, REAGENTS, CALIBRATORS, AND CONTROL SERUM; AND MEDICAL DIAGNOSTIC APPARATUS AND ANALYTICAL APPARATUS FOR MEDICAL PURPOSES, IN CLASS 10 (U.S. CLS. 26, 39 AND 44).

FIRST USE 0-0-1989; IN COMMERCE 0-0-1989.

OWNER OF U.S. REG. NOS. 1,508,881, 2,053,840 AND OTHERS.

THE COLOR(S) BLACK, WHITE AND YELLOW IS/ARE CLAIMED AS A FEATURE OF THE MARK.

THE MARK CONSISTS OF TWO HANDS BLACK, HOLDING A YELLOW GLOBE; ENCLOSED IN THE GLOBE IN BLACK ARE STYLIZED MAPS OF THE UNITED KINGDOM AND IRELAND; A RECTANGULAR BASE IS FEATURED BELOW THE HANDS; THE BODY OF THE BASE IS IN YELLOW WITH A BLACK OUTLINE, AND THE BASE FEATURES THE BLACK WORDING "THE BINDING SITE"; THE ENTIRE MARK IS SURROUNDED BY A NARROW WHITE BORDER AND A THIN BLACK LINE.

SER. NO. 77-331,874, FILED 11-16-2007.

JORDAN BAKER, EXAMINING ATTORNEY

Int. Cl.: 40

Prior U.S. Cls.: 100, 103 and 106

United States Patent and Trademark Office

Reg. No. 3,479,720

Registered Aug. 5, 2008

**SERVICE MARK
PRINCIPAL REGISTER**



KTK ASSOCIATES, INC. (TEXAS CORPORATION)
590 FM 1726
GOLIAD, TX 77963

FOR: ENVIRONMENTAL REMEDIATION SERVICES, NAMELY, SOIL, WASTE AND/OR WATER TREATMENT SERVICES, IN CLASS 40 (U.S. CLS. 100, 103 AND 106).

FIRST USE 9-25-2007; IN COMMERCE 9-25-2007.

NO CLAIM IS MADE TO THE EXCLUSIVE RIGHT TO USE "CLEAN LAND", APART FROM THE MARK AS SHOWN.

THE MARK CONSISTS OF AN STYLIZED ISLAND WITH THREE TREES SITUATED IN FRONT OF A SUN, WITH TWO ARCING BANDS FROM THE LEFT OF THE MARK, ONE REACHING THE LAND, THE OTHER REACHING THE TREES AND SUN, A STYLIZED BIRD IS FEATURED IN FRONT OF THE TOP ARC; THE TEXT OF THE MARK "CLEAN LAND PRODUCTS" POSITIONED AT THE BOTTOM OF THE MARK.

SER. NO. 77-331,943, FILED 11-16-2007.

PAULA MAHONEY, EXAMINING ATTORNEY

Int. Cl.: 44

Prior U.S. Cls.: 100 and 101

United States Patent and Trademark Office

Reg. No. 3,479,721

Registered Aug. 5, 2008

**SERVICE MARK
PRINCIPAL REGISTER**

Acne FYI

CAPTAIN, LAURA G. (UNITED STATES INDIVIDUAL)

2067 DISCOVERY CIRCLE EAST

DEERFIELD BEACH, FL 33442

FOR: PROVIDING HEALTH INFORMATION, IN CLASS 44 (U.S. CLS. 100 AND 101).

FIRST USE 9-29-2007; IN COMMERCE 9-29-2007.

THE MARK CONSISTS OF STANDARD CHARACTERS WITHOUT CLAIM TO ANY PARTICULAR FONT, STYLE, SIZE, OR COLOR.

NO CLAIM IS MADE TO THE EXCLUSIVE RIGHT TO USE "ACNE", APART FROM THE MARK AS SHOWN.

SER. NO. 77-332,383, FILED 11-17-2007.

LINDA MICKLEBURGH, EXAMINING ATTORNEY

Int. Cl.: 42

Prior U.S. Cls.: 100 and 101

United States Patent and Trademark Office

Reg. No. 3,479,722

Registered Aug. 5, 2008

**SERVICE MARK
PRINCIPAL REGISTER**

The Truth Seeker

SEGMA LLC (MARYLAND LTD LIAB CO)
15113 WATERGATE ROAD
SILVER SPRING, MD 209055746

FOR: PROVIDING TEMPORARY USE OF ON-LINE NON-DOWNLOADABLE SOFTWARE FOR AUTOMATICALLY GENERATING INDEPENDENT PERFORMANCE RATING INDICES OF THE LEADERSHIP TEAM OF ORGANIZATIONS AND CORPORATIONS RELATING TO CORPORATE GOVERNANCE AND ETHICS, EXECUTIVE COMPENSATION, AUDITING, ACCOUNTING, AND FINANCE, FOR USE BY INDIVIDUAL AND INSTITUTIONAL SHAREOWNERS, ADVISORS, CONSULTANTS, PUBLIC COMPANIES, AND GOV-

ERNMENT AND MARKET REGULATORS, TO MAKE INFORMED INVESTMENT, ASSESSMENT, OR REGULATORY DECISIONS ABOUT PUBLIC COMPANIES, IN CLASS 42 (U.S. CLS. 100 AND 101).

FIRST USE 12-4-2006; IN COMMERCE 1-5-2007.

THE MARK CONSISTS OF STANDARD CHARACTERS WITHOUT CLAIM TO ANY PARTICULAR FONT, STYLE, SIZE, OR COLOR.

SER. NO. 77-332,501, FILED 11-18-2007.

SUE LAWRENCE, EXAMINING ATTORNEY

Int. Cl.: 42

Prior U.S. Cls.: 100 and 101

United States Patent and Trademark Office

Reg. No. 3,479,723

Registered Aug. 5, 2008

**SERVICE MARK
PRINCIPAL REGISTER**



COOK, STEVE C. (UNITED STATES INDIVIDUAL)

8418 ANTERO DR

AUSTIN, TX 78759

FOR: WEBSITE DEVELOPMENT FOR OTHERS; DESIGN, CREATION, HOSTING AND MAINTENANCE OF INTERNET SITES FOR THIRD PARTIES; DESIGN, CREATION, HOSTING, MAINTENANCE OF WEBSITES FOR OTHERS; DESIGN, DEVELOPMENT AND IMPLEMENTATION OF SOFTWARE; DESIGNING WEBSITES FOR ADVERTISING PURPOSES; GRAPHIC ART DESIGN; GRAPHIC DESIGN SERVICES, IN CLASS 42 (U.S. CLS. 100 AND 101).

FIRST USE 1-1-2004; IN COMMERCE 4-16-2007.

NO CLAIM IS MADE TO THE EXCLUSIVE RIGHT TO USE "WEBSITES", APART FROM THE MARK AS SHOWN.

"THE COLOR(S) BURNT ORANGE, BLACK AND WHITE IS/ARE CLAIMED AS A FEATURE OF THE MARK."

"THE MARK CONSISTS OF A BLACK SILHOUETTE OF THE TEXAS CAPITOL BUILDING ON A WHITE BACKGROUND, CENTERED WITHIN A BROAD BURNT-ORANGE CIRCLE, WITH THE WORDS "AUSTEX WEBSITES" IN BLACK CENTERED UNDERNEATH.."

SER. NO. 77-332,661, FILED 11-19-2007.

AHSEN KHAN, EXAMINING ATTORNEY

Int. Cl.: 25

Prior U.S. Cls.: 22 and 39

United States Patent and Trademark Office

Reg. No. 3,479,724

Registered Aug. 5, 2008

**TRADEMARK
PRINCIPAL REGISTER**



APPAMAN INC. (NEW YORK CORPORATION)
SUITE 402B
195 CHRYSTIE STREET
NEW YORK, NY 10002

FOR: CLOTHING, NAMELY, ONE PIECE GAR-
MENT FOR INFANTS AND TODDLERS; SHIRTS;
SWEATSHIRTS; PANTS; SHORTS; OUTERWEAR,
NAMELY, COATS AND JACKETS; SWIMWEAR;
HEADGEAR, NAMELY, HATS , IN CLASS 25 (U.S.
CLS. 22 AND 39).

FIRST USE 5-1-2003; IN COMMERCE 5-1-2003.

THE MARK CONSISTS OF A STYLIZED FACE OF
A MONKEY AND THE WORD "APPAMAN".

SER. NO. 77-333,282, FILED 11-19-2007.

EDWARD NELSON, EXAMINING ATTORNEY

Int. Cls.: 9 and 13

Prior U.S. Cls.: 2, 9, 21, 23, 26, 36 and 38

United States Patent and Trademark Office

Reg. No. 3,479,725

Registered Aug. 5, 2008

**TRADEMARK
PRINCIPAL REGISTER**

ADIRONDACK OPTICS

ADIRONDACK DIGITAL IMAGING SYSTEMS,
INC. (NEW YORK CORPORATION)
1 LEGEND LANE, P.O. BOX 303
KEESEVILLE, NY 12944

FOR: OPTICAL AND TELESCOPIC GUN SIGHTS FOR FIREARMS; OPTICAL AND TELESCOPIC GUN SIGHTS FOR FIREARMS INCORPORATING MOTION PICTURE, PHOTOGRAPHIC, OR VIDEO CAMERA TECHNOLOGY; TELESCOPES AND BINOCULARS; TELESCOPES AND BINOCULARS INCORPORATING MOTION PICTURE, PHOTOGRAPHIC OR VIDEO CAMERA TECHNOLOGY; MOTION PICTURE CAMERAS, PHOTOGRAPHIC CAMERAS, VIDEO CAMERAS; NON-OPTICAL GUN SIGHTS FOR FIREARMS INCORPORATING MOTION PICTURE, PHOTOGRAPHIC OR VIDEO CAMERA TECHNOLOGY, IN CLASS 9 (U.S. CLS. 21, 23, 26, 36 AND 38).

FIRST USE 1-2-2002; IN COMMERCE 1-2-2002.

FOR: FIREARMS; NON-OPTICAL GUN SIGHTS FOR FIREARMS , IN CLASS 13 (U.S. CLS. 2 AND 9).

FIRST USE 1-2-2002; IN COMMERCE 1-2-2002.

THE MARK CONSISTS OF STANDARD CHARACTERS WITHOUT CLAIM TO ANY PARTICULAR FONT, STYLE, SIZE, OR COLOR.

NO CLAIM IS MADE TO THE EXCLUSIVE RIGHT TO USE "OPTICS", APART FROM THE MARK AS SHOWN.

SEC. 2(F).

SER. NO. 77-333,293, FILED 11-19-2007.

ANNE E. GUSTASON, EXAMINING ATTORNEY

Int. Cl.: 35

Prior U.S. Cls.: 100, 101 and 102

United States Patent and Trademark Office

Reg. No. 3,479,726

Registered Aug. 5, 2008

**SERVICE MARK
PRINCIPAL REGISTER**

RAZAVI GLOBAL MEDIA

RAZAVI GLOBAL MEDIA, INC. (CALIFORNIA CORPORATION)
NO. 14
119 COLORADO AVE
SANTA MONICA, CA 90401

FOR: ADVERTISING, MARKETING AND PUBLICITY SERVICES, NAMELY, PROMOTING THE SERVICES OF OTHERS THROUGH THE PLACEMENT OF ONLINE ADVERTISING, ONLINE SWEEPSTAKES AND CONTESTS, POD CASTS, VIRAL CASTS, SECURING CO-BRANDING OPPORTUNITIES, DISTRIBUTION OF PROMOTIONAL PRODUCTS, CREATION OF CUSTOM WEB CONTENT, WEBSITE PUBLISHING, AND ONLINE ADVERTISING CONSULTATION, IN CLASS 35 (U.S. CLS. 100, 101 AND 102).

FIRST USE 11-1-2004; IN COMMERCE 11-15-2004.

THE MARK CONSISTS OF STANDARD CHARACTERS WITHOUT CLAIM TO ANY PARTICULAR FONT, STYLE, SIZE, OR COLOR.

NO CLAIM IS MADE TO THE EXCLUSIVE RIGHT TO USE "GLOBAL MEDIA", APART FROM THE MARK AS SHOWN.

SER. NO. 77-333,419, FILED 11-19-2007.

KELLY MCCOY, EXAMINING ATTORNEY

Int. Cl.: 36

Prior U.S. Cls.: 100, 101 and 102

United States Patent and Trademark Office

Reg. No. 3,479,727

Registered Aug. 5, 2008

**SERVICE MARK
PRINCIPAL REGISTER**



ADVISER INVESTMENT MANAGEMENT, INC.
(DELAWARE CORPORATION)
85 WELLS AVENUE
NEWTON, MA 02459

FOR: INVESTMENT SERVICES IN THE NATURE
OF FINANCIAL INVESTMENT MANAGEMENT, IN
CLASS 36 (U.S. CLS. 100, 101 AND 102).

FIRST USE 11-15-2007; IN COMMERCE 11-15-2007.

OWNER OF U.S. REG. NO. 2,440,480.

NO CLAIM IS MADE TO THE EXCLUSIVE
RIGHT TO USE "ADVISER INVESTMENTS",
APART FROM THE MARK AS SHOWN.

THE MARK CONSISTS OF DOTS IN A TRIAN-
GULAR SHAPE OVER THE WORDS "ADVISER
INVESTMENTS".

SER. NO. 77-333,835, FILED 11-20-2007.

MICHAEL WEBSTER, EXAMINING ATTORNEY

Int. Cl.: 35

Prior U.S. Cls.: 100, 101 and 102

United States Patent and Trademark Office

Reg. No. 3,479,728

Registered Aug. 5, 2008

**SERVICE MARK
PRINCIPAL REGISTER**

PRICE POLICE

COLE CHEVROLET-CADILLAC, INC. (WEST
VIRGINIA CORPORATION), DBA COLE
CHEVROLET-CADILLAC-GMC
P.O. BOX 688
ROUTE 460 EAST AT ROUTE 598
BLUEFIELD, WV 24701

FOR: AUTOMOBILE DEALERSHIPS, IN CLASS 35
(U.S. CLS. 100, 101 AND 102).

FIRST USE 1-6-2006; IN COMMERCE 1-6-2006.

THE MARK CONSISTS OF STANDARD CHAR-
ACTERS WITHOUT CLAIM TO ANY PARTICULAR
FONT, STYLE, SIZE, OR COLOR.

NO CLAIM IS MADE TO THE EXCLUSIVE
RIGHT TO USE "PRICE", APART FROM THE
MARK AS SHOWN.

SER. NO. 77-333,862, FILED 11-20-2007.

ROBERT C. CLARK JR., EXAMINING ATTORNEY

Int. Cl.: 21

Prior U.S. Cls.: 2, 13, 23, 29, 30, 33, 40 and 50

Reg. No. 3,479,729

United States Patent and Trademark Office

Registered Aug. 5, 2008

**TRADEMARK
PRINCIPAL REGISTER**

EARRING ANGEL

WILLIAMS, LYNN (UNITED STATES INDIVIDUAL)

9949 BRADFORD GROVE

FRISCO, TX 75035

FOR: EARRING ORGANIZER BOARD, IN CLASS 21 (U.S. CLS. 2, 13, 23, 29, 30, 33, 40 AND 50).

FIRST USE 2-1-2005; IN COMMERCE 9-5-2007.

THE MARK CONSISTS OF STANDARD CHARACTERS WITHOUT CLAIM TO ANY PARTICULAR FONT, STYLE, SIZE, OR COLOR.

NO CLAIM IS MADE TO THE EXCLUSIVE RIGHT TO USE "EARRING", APART FROM THE MARK AS SHOWN.

SER. NO. 77-334,034, FILED 11-20-2007.

FRED CARL, EXAMINING ATTORNEY

Int. Cls.: 39 and 43

Prior U.S. Cls.: 100, 101 and 105

United States Patent and Trademark Office

Reg. No. 3,479,730

Registered Aug. 5, 2008

**SERVICE MARK
PRINCIPAL REGISTER**

**BRINGING YOU THE BEST OF
INDIA**

GREAVES TOURS, LLC (ILLINOIS LTD LIAB
CO)
304 W RANDOLPH ST.
CHICAGO, IL 60606

FOR: TRAVEL AGENCY SERVICES, NAMELY,
MAKING RESERVATIONS AND BOOKINGS FOR
TRANSPORTATION; TRAVEL AGENCY SERVICES,
NAMELY, MAKING RESERVATIONS AND BOOK-
INGS FOR SIGHTSEEING TOURS, IN CLASS 39
(U.S. CLS. 100 AND 105).

FIRST USE 12-8-1999; IN COMMERCE 12-8-1999.

FOR: TRAVEL AGENCY SERVICES, NAMELY,
MAKING RESERVATIONS AND BOOKINGS FOR
TEMPORARY LODGING, IN CLASS 43 (U.S. CLS.
100 AND 101).

FIRST USE 12-8-1999; IN COMMERCE 12-8-1999.

THE MARK CONSISTS OF STANDARD CHAR-
ACTERS WITHOUT CLAIM TO ANY PARTICULAR
FONT, STYLE, SIZE, OR COLOR.

SER. NO. 77-334,037, FILED 11-20-2007.

TINA BROWN, EXAMINING ATTORNEY

Int. Cl.: 16

Prior U.S. Cls.: 2, 5, 22, 23, 29, 37, 38 and 50

United States Patent and Trademark Office

Reg. No. 3,479,731

Registered Aug. 5, 2008

**TRADEMARK
PRINCIPAL REGISTER**

DESKTOP LABELS

MEYERS PRINTING COMPANY (MINNESOTA
CORPORATION)

7277 BOONE AVENUE NORTH

MINNEAPOLIS, MN 55428

FOR: BLANK AND PARTIALLY PRINTED SELF-
ADHESIVE LABELS FOR LASER AND INKJET
PRINTERS, IN CLASS 16 (U.S. CLS. 2, 5, 22, 23, 29,
37, 38 AND 50).

FIRST USE 5-30-1996; IN COMMERCE 5-30-1996.

THE MARK CONSISTS OF STANDARD CHAR-
ACTERS WITHOUT CLAIM TO ANY PARTICULAR
FONT, STYLE, SIZE, OR COLOR.

NO CLAIM IS MADE TO THE EXCLUSIVE
RIGHT TO USE "LABELS", APART FROM THE
MARK AS SHOWN.

SEC. 2(F).

SER. NO. 77-334,285, FILED 11-20-2007.

JACLYN KIDWELL, EXAMINING ATTORNEY

Int. Cl.: 1

Prior U.S. Cls.: 1, 5, 6, 10, 26 and 46

United States Patent and Trademark Office

Reg. No. 3,479,732

Registered Aug. 5, 2008

**TRADEMARK
PRINCIPAL REGISTER**



T AND N, INC. (MISSOURI CORPORATION)
P.O. BOX 240
815 HWY T
FORISTELL, MO 633480240

FOR: CHEMICAL PREPARATIONS FOR MELT-
ING SNOW AND ICE, IN CLASS 1 (U.S. CLS. 1, 5, 6,
10, 26 AND 46).

FIRST USE 0-0-1995; IN COMMERCE 0-0-1995.

OWNER OF U.S. REG. NOS. 1,365,100, 2,116,251,
AND 2,127,063.

THE MARK CONSISTS OF A DEPICTION OF A
MAN IN A PARKA WITH AN "M+" ON THE
CHEST, MITTENS, SCARF, VISOR, BOOTS AND
PANTS STANDING IN A PUDDLE WHILE HOLD-
ING A SHOVEL.

SER. NO. 77-334,325, FILED 11-20-2007.

FRANK LATTUCA, EXAMINING ATTORNEY

Int. Cl.: 41

Prior U.S. Cls.: 100, 101 and 107

United States Patent and Trademark Office

Reg. No. 3,479,733

Registered Aug. 5, 2008

SERVICE MARK
PRINCIPAL REGISTER



THE WINE ADVOCATE, INC. (MARYLAND CORPORATION)
P.O. BOX 311
MONKTON, MD 21111

FOR: EDUCATIONAL TESTING SERVICES; EDUCATIONAL TESTING SERVICES NAMELY, PREPARING, ADMINISTERING, AND SCORING TESTS RELATED TO WINE; AND EDUCATIONAL SERVICES, NAMELY, THE OFFERING OF WEB BASED AND LIVE TRAINING FOR CERTIFICATION OF OTHERS, IN CLASS 41 (U.S. CLS. 100, 101 AND 107).

FIRST USE 9-17-2007; IN COMMERCE 9-17-2007.

NO CLAIM IS MADE TO THE EXCLUSIVE RIGHT TO USE "WINE CERTIFICATION PROGRAM", APART FROM THE MARK AS SHOWN.

THE NAME(S), PORTRAIT(S), AND/OR SIGNATURE(S) SHOWN IN THE MARK IDENTIFIES ROBERT PARKER JR. AND KEVIN ZRALY, WHOSE CONSENT(S) TO REGISTER IS MADE OF RECORD.

THE MARK CONSISTS OF SIGNATURES SUPERIMPOSED OVER A SEAL WITH THE REMAINDER OF THE LITERAL ELEMENT.

SER. NO. 77-334,371, FILED 11-20-2007.

MICHAEL KEATING, EXAMINING ATTORNEY

Int. Cls.: 35 and 41

Prior U.S. Cls.: 100, 101, 102 and 107

United States Patent and Trademark Office

Reg. No. 3,479,734

Registered Aug. 5, 2008

**SERVICE MARK
PRINCIPAL REGISTER**

APM

ASSOCIATED PRODUCTION MUSIC LLC (CALIFORNIA LTD LIAB CO)
6255 SUNSET BOULEVARD, #820
HOLLYWOOD, CA 90028

FOR: BUSINESS CONSULTATION SERVICES IN THE FIELD OF MUSIC AND MUSIC LICENSING (12/31/1983); ADMINISTRATION AND MANAGEMENT OF MUSIC LICENSING (12/31/1983); PROVIDING AN ON-LINE SEARCHABLE DATABASE FEATURING MUSIC (12/31/2004), IN CLASS 35 (U.S. CLS. 100, 101 AND 102).

FIRST USE 12-31-2004; IN COMMERCE 12-31-2004.

FOR: CONSULTATION SERVICES IN THE FIELD OF MUSIC PUBLISHING SERVICES (12/31/1983); PROVIDING AN ON-LINE WEBSITE FEATURING LIBRARIES OF MUSICAL COMPOSITION AND MUSIC SOUND RECORDINGS (12/31/2001); PROVIDING INFORMATION ON MUSICAL COMPOSITION AND MUSIC SOUND RECORDINGS VIA ELECTRONIC AND OTHER MEANS (12/31/2001); ON-LINE LIBRARY SERVICES, NAMELY, PROVIDING ELECTRONIC LIBRARY SERVICES WHICH FEATURE MUSIC VIA AN ON-LINE COMPUTER

NETWORK (12/31/2001); MUSIC PUBLISHING SERVICES (12/31/1983); ENTERTAINMENT SERVICES, NAMELY, PROVIDING PRERECORDED MUSIC, INFORMATION IN THE FIELD OF MUSIC, AND COMMENTARY AND ARTICLES ABOUT MUSIC, ALL ON-LINE VIA A GLOBAL COMPUTER NETWORK (12/31/2001); PRODUCTION SERVICES OF SOUND RECORDINGS FEATURING MUSIC (12/31/2004); MULTIMEDIA ENTERTAINMENT SERVICES IN THE NATURE OF CREATING, RECORDING, PRODUCTION, AND POST-PRODUCTION SERVICES IN THE FIELDS OF MUSIC, VIDEO AND FILMS (12/31/2004), IN CLASS 41 (U.S. CLS. 100, 101 AND 107).

FIRST USE 12-31-2004; IN COMMERCE 12-31-2004.

THE MARK CONSISTS OF STANDARD CHARACTERS WITHOUT CLAIM TO ANY PARTICULAR FONT, STYLE, SIZE, OR COLOR.

SER. NO. 77-334,695, FILED 11-20-2007.

KELLY MCCOY, EXAMINING ATTORNEY

Int. Cls.: 29 and 30

Prior U.S. Cl.: 46

United States Patent and Trademark Office

Reg. No. 3,479,735

Registered Aug. 5, 2008

**TRADEMARK
PRINCIPAL REGISTER**

MELLO-CUP

FBC FINANCE CO. (CALIFORNIA CORPORATION)
20333 SOUTH NORMANDIE AVENUE
TORRANCE, CA 90502

FOR: STRAWBERRY JAM, CONCORD GRAPE JELLY, BLACKBERRY JELLY, APPLE JELLY, MIXED FRUIT JELLY, IN CLASS 29 (U.S. CL. 46).

FIRST USE 3-1-1969; IN COMMERCE 3-1-1969.

FOR: COFFEE, TEA, COCOA AND SPICES, IN CLASS 30 (U.S. CL. 46).

FIRST USE 3-1-1969; IN COMMERCE 3-1-1969.

THE MARK CONSISTS OF STANDARD CHARACTERS WITHOUT CLAIM TO ANY PARTICULAR FONT, STYLE, SIZE, OR COLOR.

OWNER OF U.S. REG. NO. 3,060,343.

SER. NO. 77-334,774, FILED 11-20-2007.

LINDSEY RUBIN, EXAMINING ATTORNEY

Int. Cl.: 38

Prior U.S. Cls.: 100, 101 and 104

United States Patent and Trademark Office

Reg. No. 3,479,736

Registered Aug. 5, 2008

**SERVICE MARK
PRINCIPAL REGISTER**

EPINOYPINAY

QUIAMBAO, ROMEO BUGAY (UNITED STATES
INDIVIDUAL), DBA PHONE CARD CONNEC-
TION
16801 QUAIL COUNTRY AVENUE
CHINO HILLS, CA 91709

FOR: TELEPHONE TELECOMMUNICATIONS
SERVICES PROVIDED VIA PREPAID TELEPHONE
CALLING CARDS, IN CLASS 38 (U.S. CLS. 100, 101
AND 104).

FIRST USE 8-8-2001; IN COMMERCE 11-11-2001.

THE MARK CONSISTS OF STANDARD CHAR-
ACTERS WITHOUT CLAIM TO ANY PARTICULAR
FONT, STYLE, SIZE, OR COLOR.

THE FOREIGN WORDING IN THE MARK
TRANSLATES INTO ENGLISH AS FILIPINO BOY
AND FILIPINO GIRL.

SER. NO. 77-334,824, FILED 11-21-2007.

LINDA ORNDORFF, EXAMINING ATTORNEY

Int. Cl.: 35

Prior U.S. Cls.: 100, 101 and 102

United States Patent and Trademark Office

Reg. No. 3,479,737

Registered Aug. 5, 2008

**SERVICE MARK
PRINCIPAL REGISTER**

DEVEROES

LAROHN, INC. (OHIO CORPORATION)
1117 VINE STREET
CINCINNATI, OH 45210

THE MARK CONSISTS OF STANDARD CHAR-
ACTERS WITHOUT CLAIM TO ANY PARTICULAR
FONT, STYLE, SIZE, OR COLOR.

FOR: RETAIL CLOTHING STORE SERVICES, IN
CLASS 35 (U.S. CLS. 100, 101 AND 102).

SER. NO. 77-334,941, FILED 11-21-2007.

FIRST USE 10-2-1992; IN COMMERCE 10-2-1992.

ADA HAN, EXAMINING ATTORNEY

Int. Cl.: 41

Prior U.S. Cls.: 100, 101 and 107

United States Patent and Trademark Office

Reg. No. 3,479,738

Registered Aug. 5, 2008

**SERVICE MARK
PRINCIPAL REGISTER**

theatreworksUSA

THEATREWORKS/USA CORP. (NEW YORK CORPORATION)
151 WEST 26TH STREET
NEW YORK, NY 10001

FOR: ENTERTAINMENT SERVICES IN THE NATURE OF PRODUCING AND PERFORMING THEATRICAL PLAYS, IN CLASS 41 (U.S. CLS. 100, 101 AND 107).

FIRST USE 4-1-2007; IN COMMERCE 4-1-2007.

OWNER OF U.S. REG. NOS. 1,364,931 AND 3,095,326.

THE MARK CONSISTS OF THE WORD "THEATREWORKSUSA". THE WORD "THEATREWORKS" APPEARS IN ALL LOWER CASE LETTERS. THE WORD "USA" APPEARS IN UPPER CASE LETTERS. BETWEEN THE LETTER "A" AND "R" IN THE WORD "THEATRE" IS A DRAWING OF A PERSON WITH THEIR ARMS STRETCHED OUT ON EITHER SIDE OF THEIR BODY FORMING THE LETTER "T".

SER. NO. 77-335,046, FILED 11-21-2007.

MICHAEL WIENER, EXAMINING ATTORNEY

Int. Cl.: 5

Prior U.S. Cls.: 6, 18, 44, 46, 51 and 52

United States Patent and Trademark Office

Reg. No. 3,479,739

Registered Aug. 5, 2008

**TRADEMARK
PRINCIPAL REGISTER**

SL FOREMAN

INNOFRESH PRODUCTS, INC. (ARIZONA CORPORATION)
14814 N. 15TH AVENUE
PHOENIX, AZ 85023

FOR: AIR DEODORIZERS, FOR USE IN REFRIGERATORS, FREEZERS, COOLERS, CLOSETS, DRAWERS, NEAR TRASH, UNDER SINKS, STORAGE, FOOTWEAR, GARAGE, LAUNDRY ROOM, PET AREAS, AUTOMOTIVE INTERIORS AND THE LIKE, IN CLASS 5 (U.S. CLS. 6, 18, 44, 46, 51 AND 52).

FIRST USE 10-10-1996; IN COMMERCE 10-10-1996.

THE MARK CONSISTS OF STANDARD CHARACTERS WITHOUT CLAIM TO ANY PARTICULAR FONT, STYLE, SIZE, OR COLOR.

OWNER OF U.S. REG. NO. 2,100,546.

THE NAME "FOREMAN" DOES NOT IDENTIFY A LIVING INDIVIDUAL.

SER. NO. 77-335,084, FILED 11-21-2007.

ROBIN CHOSID, EXAMINING ATTORNEY

Int. Cl.: 36

Prior U.S. Cls.: 100, 101 and 102

United States Patent and Trademark Office

Reg. No. 3,479,740

Registered Aug. 5, 2008

SERVICE MARK
PRINCIPAL REGISTER



TELADVOCATE COMMUNICATIONS, LLC
(FLORIDA LTD LIAB CO)

26852 WINGED ELM DRIVE

WESLEY CHAPEL, FL 33543

FOR: TELECOMMUNICATION AGENCY AND
DEALER SERVICES, NAMELY, BROKERAGE IN
THE FIELD OF TELECOMMUNICATIONS, DATA
COMMUNICATIONS AND INTERNET SERVICES ,
IN CLASS 36 (U.S. CLS. 100, 101 AND 102).

FIRST USE 7-0-2007; IN COMMERCE 7-0-2007.

NO CLAIM IS MADE TO THE EXCLUSIVE
RIGHT TO USE "COMMUNICATIONS", APART
FROM THE MARK AS SHOWN.

THE MARK CONSISTS OF AN IRREGULAR
GEOMETRIC DESIGN CONSISTING OF AN INVER-
TED CRESCENT WITH THREE DESCENDING
DOTS EMERGING OUTWARD FROM THE BASE
WITH THE WORDS "TELADVOCATE COMMUNI-
CATIONS" UNDERNEATH.

SER. NO. 77-335,250, FILED 11-21-2007.

KELLY BOULTON, EXAMINING ATTORNEY

Int. Cl.: 35

Prior U.S. Cls.: 100, 101 and 102

United States Patent and Trademark Office

Reg. No. 3,479,741

Registered Aug. 5, 2008

**SERVICE MARK
PRINCIPAL REGISTER**

BARFLY INTERACTIVE NETWORKS

NATIONAL BROADCAST MEDIA CORPORATION (TEXAS CORPORATION)
2800 INDUSTRIAL TERRACE
AUSTIN, TX 78758

FOR: ADVERTISING, MARKETING AND PROMOTION SERVICES DELIVERED IN BAR AND NIGHTCLUB ENVIRONMENTS, IN CLASS 35 (U.S. CLS. 100, 101 AND 102).

FIRST USE 6-1-2006; IN COMMERCE 6-1-2006.

THE MARK CONSISTS OF STANDARD CHARACTERS WITHOUT CLAIM TO ANY PARTICULAR FONT, STYLE, SIZE, OR COLOR.

NO CLAIM IS MADE TO THE EXCLUSIVE RIGHT TO USE "INTERACTIVE NETWORKS", APART FROM THE MARK AS SHOWN.

SER. NO. 77-335,565, FILED 11-21-2007.

DAVID YONTEF, EXAMINING ATTORNEY

Int. Cl.: 9

Prior U.S. Cls.: 21, 23, 26, 36 and 38

Reg. No. 3,479,742

United States Patent and Trademark Office

Registered Aug. 5, 2008

**TRADEMARK
PRINCIPAL REGISTER**

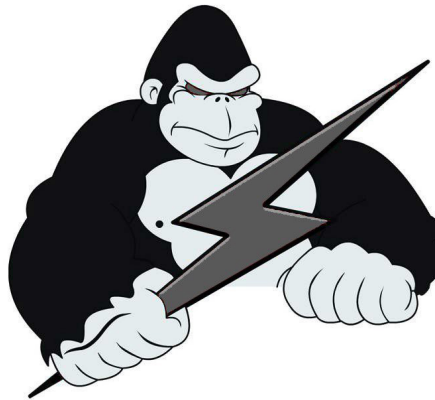

KONGPOWER TECHNOLOGY CO., LTD. (TAI-
WAN CORPORATION)
2F, NO. 501, JHONGSHAN ROAD
FONGYUAN CITY, TAIWAN

FOR: BATTERIES; ELECTRIC WIRES; ELECTRIC
CABLES; ELECTRIC SWITCHES; ELECTRIC
PLUGS; ELECTRIC SOCKETS; VOLTAGE SURGE
PROTECTORS; ELECTRONIC CONTROLS FOR
MOTORS; REMOTE CONTROLS FOR TOY MODEL
CARS, MOTORCYCLES, PLANES, BOATS; BAT-
TERY CHARGERS; ELECTRICAL CONTROLLERS;

ELECTRIC TRANSDUCERS; ANGULAR GAUGES,
IN CLASS 9 (U.S. CLS. 21, 23, 26, 36 AND 38).

FIRST USE 10-1-2007; IN COMMERCE 10-1-2007.

THE MARK CONSISTS OF STYLIZED DEPIC-
TION OF A GORILLA HOLDING A LIGHTENING
BOLT.

SER. NO. 77-335,605, FILED 11-21-2007.

JOHN DALIER, EXAMINING ATTORNEY

Int. Cl.: 43

Prior U.S. Cls.: 100 and 101

United States Patent and Trademark Office

Reg. No. 3,479,743

Registered Aug. 5, 2008

SERVICE MARK
PRINCIPAL REGISTER



CARRIED AWAY, LLC (COLORADO LTD LIAB
CO)
331 GRAPE STREET
DENVER, CO 80220

FOR: FAST FOOD AND NON-STOP RESTAU-
RANT SERVICES; RESTAURANT SERVICES;
TAKE-OUT RESTAURANT SERVICES; MOBILE
CAFE SERVICES FOR PROVIDING FOOD AND
DRINK, IN CLASS 43 (U.S. CLS. 100 AND 101).

FIRST USE 5-20-2004; IN COMMERCE 5-20-2004.

OWNER OF U.S. REG. NO. 3,318,227.

NO CLAIM IS MADE TO THE EXCLUSIVE
RIGHT TO USE "DOGS", APART FROM THE MARK
AS SHOWN.

THE NAME IN THE MARK IDENTIFIES "STE-
VEN BALLAS, JR.", WHOSE CONSENT IS OF RE-
CORD.

THE COLOR(S) RED, BLUE, YELLOW, BROWN
AND GREEN IS/ARE CLAIMED AS A FEATURE OF
THE MARK.

THE MARK CONSISTS OF THE WORD "STEVE'S"
OVERLAYED OVER THE TOP PORTION OF A
DIAMOND ORIENTED SQUARE AND EXTENDS
BEYOND THE BORDERS OF THE DIAMOND ON
BOTH THE RIGHT AND LEFT SIDES. A HOT DOG
IS IN THE MIDDLE OF THE DIAMOND CONSIST-
ING OF A BUN, HOTDOG, WITH TRI-COLORED
CONDIMENTS COVERING THE TOP OF THE HOT-
DOG. THE WORDS "SNAPPIN' DOGS" ARE OVER-
LAYED IN A HORIZONTAL BANNER OVER THE
BOTTOM OF THE HOTDOG BUN AT THE BOTTOM
OF THE DIAMOND ORIENTED SQUARE. THE
BANNER IS ALSO OVERLAID OVER A 3-D RIBBON
EDGE THAT EXTENDS OVER THE CORNERS OF
THE DIAMOND SHAPED SQUARE AND HAS V-
SHAPED CUT-OUT ON THE HORIZONTALLY
EXTENDED EDGES. THE DIAMOND HAS A DARK
MIDDLE WITH A LIGHTER NARROW BORDER
ALONG THE OUTER EDGE.

SER. NO. 77-335,655, FILED 11-21-2007.

HEATHER SAPP, EXAMINING ATTORNEY

Int. Cl.: 19

Prior U.S. Cls.: 1, 12, 33 and 50

United States Patent and Trademark Office

Reg. No. 3,479,744

Registered Aug. 5, 2008

**TRADEMARK
PRINCIPAL REGISTER**

AQUA-LOOP

LOTUFO, ROBERT J (UNITED STATES INDIVIDUAL)
2710 KANASITA DR
HIXSON, TN 37343

THE MARK CONSISTS OF STANDARD CHARACTERS WITHOUT CLAIM TO ANY PARTICULAR FONT, STYLE, SIZE, OR COLOR.

FOR: SYNTHETIC FLOORING MATERIALS OR WALL-CLADDINGS, IN CLASS 19 (U.S. CLS. 1, 12, 33 AND 50).

SER. NO. 77-335,779, FILED 11-22-2007.

FIRST USE 6-1-2007; IN COMMERCE 7-1-2007.

HENRY S. ZAK, EXAMINING ATTORNEY

Int. Cls.: 9 and 41

Prior U.S. Cls.: 21, 23, 26, 36, 38, 100, 101 and 107

Reg. No. 3,479,745

United States Patent and Trademark Office

Registered Aug. 5, 2008

**TRADEMARK
SERVICE MARK
PRINCIPAL REGISTER**

COMPTONPLATING

DAVID ROBERT ZABALZA (UNITED STATES
INDIVIDUAL)

10616 WATERBURY DRIVE
STOCKTON, CA 95209

FOR: MUSICAL SOUND RECORDINGS; PRE-
RECORDED CDS AND SOUND RECORDINGS
FEATURING MUSIC; AUDIO RECORDINGS FEATURING
MUSIC; DOWNLOADABLE MP3 RE-
CORDINGS VIA THE INTERNET AND WIRELESS
DEVICES, IN CLASS 9 (U.S. CLS. 21, 23, 26, 36 AND
38).

FIRST USE 7-3-2007; IN COMMERCE 11-17-2007.

FOR: ENTERTAINMENT IN THE NATURE OF
LIVE MUSICAL PERFORMANCES BY AN INDIVI-
DUAL, GROUP OR BAND; ENTERTAINMENT,
NAMELY, LIVE MUSIC CONCERTS, IN CLASS 41
(U.S. CLS. 100, 101 AND 107).

FIRST USE 7-3-2007; IN COMMERCE 11-17-2007.

THE MARK CONSISTS OF STANDARD CHAR-
ACTERS WITHOUT CLAIM TO ANY PARTICULAR
FONT, STYLE, SIZE, OR COLOR.

SER. NO. 77-335,800, FILED 11-22-2007.

G. MAYERSCHOFF, EXAMINING ATTORNEY

Int. Cl.: 25

Prior U.S. Cls.: 22 and 39

United States Patent and Trademark Office

Reg. No. 3,479,746

Registered Aug. 5, 2008

**TRADEMARK
PRINCIPAL REGISTER**



ELDORA SPEEDWAY, INC. (INDIANA CORPORATION)
13929 STATE ROUTE 118
NEW WESTON, OH 45348

FOR: T-SHIRTS; SWEAT SHIRTS; POLO SHIRTS,
IN CLASS 25 (U.S. CLS. 22 AND 39).

FIRST USE 6-6-2007; IN COMMERCE 6-6-2007.

NO CLAIM IS MADE TO THE EXCLUSIVE
RIGHT TO USE "ROSSBURG, OHIO", APART FROM
THE MARK AS SHOWN.

THE MARK CONSISTS OF A CIRCULAR DESIGN
WITH THE LETTER E SUPERIMPOSED OVER THE
DESIGN; WITHIN THE OUTLINE OF THE CIRCULAR
DESIGN IS THE WORDING "ELDORA SPEEDWAY
ROSSBURG, OHIO".

SER. NO. 77-336,465, FILED 11-26-2007.

CURTIS FRENCH, EXAMINING ATTORNEY

Int. Cl.: 42

Prior U.S. Cls.: 100 and 101

United States Patent and Trademark Office

Reg. No. 3,479,747

Registered Aug. 5, 2008

**SERVICE MARK
PRINCIPAL REGISTER**

citylight

GEOCENTRIC LLC (MARYLAND LTD LIAB CO)
#204
8070 GEORGIA AVE
SILVER SPRING, MD 20910

FOR: PROVIDING NON-DOWNLOADABLE COMPUTER SOFTWARE ONLINE FOR GENERATING DIGITAL MAPS AND RELATED TEXTUAL CONTENT THAT INTEGRATE GEOGRAPHIC, BUSINESS, AND MARKETING INFORMATION; PROVIDING NON-DOWNLOADABLE COMPUTER SOFTWARE ONLINE FOR MANAGING GEOGRAPHICALLY-TAGGED REGIONAL CONTENT, NAMELY, BUSINESS DIRECTORIES, EVENT CALENDARS, AND CONTACT DIRECTORIES; PROVIDING NON-DOWNLOADABLE COMPUTER SOFTWARE ONLINE FOR DISPLAYING DIGITAL

MAPS AND RELATED TEXTUAL CONTENT ON LOCAL AND MOBILE DEVICES OVER NETWORKS, INTRANETS, AND THE INTERNET; PROVIDING NON-DOWNLOADABLE COMPUTER SOFTWARE ONLINE FOR OPTIMIZING REGIONAL CONTENT FOR ONLINE SEARCH ENGINE INDEXING , IN CLASS 42 (U.S. CLS. 100 AND 101).

FIRST USE 11-1-2005; IN COMMERCE 11-1-2005.

THE MARK CONSISTS OF STANDARD CHARACTERS WITHOUT CLAIM TO ANY PARTICULAR FONT, STYLE, SIZE, OR COLOR.

SER. NO. 77-336,468, FILED 11-26-2007.

CORY BOONE, EXAMINING ATTORNEY

Int. Cl.: 41

Prior U.S. Cls.: 100, 101 and 107

United States Patent and Trademark Office

Reg. No. 3,479,748

Registered Aug. 5, 2008

SERVICE MARK
PRINCIPAL REGISTER



ELDORA SPEEDWAY, INC. (INDIANA CORPORATION)
13929 STATE ROUTE 118
NEW WESTON, OH 45348

FOR: ENTERTAINMENT IN THE NATURE OF
AUTOMOBILERACES, IN CLASS 41 (U.S. CLS. 100,
101 AND 107).

FIRST USE 6-0-1954; IN COMMERCE 6-0-1954.

NO CLAIM IS MADE TO THE EXCLUSIVE
RIGHT TO USE "SPEEDWAY" AND "ROSSBURG,
OHIO", APART FROM THE MARK AS SHOWN.

THE MARK CONSISTS OF A CIRCULAR DESIGN
WITH CHECKERED FLAGS COMING OUT FROM
BEHIND THE CIRCULAR DESIGN; WITHIN THE
OUTLINE OF THE CIRCULAR DESIGN IS THE
WORDING "ELDORA SPEEDWAY ROSSBURG,
OHIO"; INSIDE THE CIRCULAR DESIGN IS THE
WORDING "BIG E".

SER. NO. 77-336,477, FILED 11-26-2007.

CURTIS FRENCH, EXAMINING ATTORNEY

Int. Cl.: 41

Prior U.S. Cls.: 100, 101 and 107

United States Patent and Trademark Office

Reg. No. 3,479,749

Registered Aug. 5, 2008

**SERVICE MARK
PRINCIPAL REGISTER**

4-CROWN NATIONALS

ELDORA SPEEDWAY, INC. (INDIANA CORPORATION)
13929 STATE ROUTE 118
NEW WESTON, OH 45348

FOR: ENTERTAINMENT IN THE NATURE OF AUTOMOBILERACES, IN CLASS 41 (U.S. CLS. 100, 101 AND 107).

FIRST USE 7-0-1981; IN COMMERCE 7-0-1981.

THE MARK CONSISTS OF STANDARD CHARACTERS WITHOUT CLAIM TO ANY PARTICULAR FONT, STYLE, SIZE, OR COLOR.

NO CLAIM IS MADE TO THE EXCLUSIVE RIGHT TO USE "NATIONALS", APART FROM THE MARK AS SHOWN.

SER. NO. 77-336,478, FILED 11-26-2007.

CURTIS FRENCH, EXAMINING ATTORNEY

Int. Cls.: 25 and 41

Prior U.S. Cls.: 22, 39, 100, 101 and 107

United States Patent and Trademark Office

Reg. No. 3,479,750

Registered Aug. 5, 2008

**TRADEMARK
SERVICE MARK
PRINCIPAL REGISTER**

ELDORA SPEEDWAY

ELDORA SPEEDWAY, INC. (INDIANA CORPORATION)
13929 STATE ROUTE 118
NEW WESTON, OH 45348

FOR: T-SHIRTS; SWEAT SHIRTS; POLO SHIRTS,
IN CLASS 25 (U.S. CLS. 22 AND 39).

FIRST USE 3-0-2005; IN COMMERCE 3-0-2005.

FOR: ENTERTAINMENT IN THE NATURE OF
AUTOMOBILERACES, IN CLASS 41 (U.S. CLS. 100,
101 AND 107).

FIRST USE 6-0-1954; IN COMMERCE 6-0-1954.

THE MARK CONSISTS OF STANDARD CHARACTERS WITHOUT CLAIM TO ANY PARTICULAR FONT, STYLE, SIZE, OR COLOR.

NO CLAIM IS MADE TO THE EXCLUSIVE RIGHT TO USE "SPEEDWAY", APART FROM THE MARK AS SHOWN.

SER. NO. 77-336,492, FILED 11-26-2007.

CURTIS FRENCH, EXAMINING ATTORNEY

Int. Cl.: 35

Prior U.S. Cls.: 100, 101 and 102

United States Patent and Trademark Office

Reg. No. 3,479,751

Registered Aug. 5, 2008

**SERVICE MARK
PRINCIPAL REGISTER**

WREATHS ACROSS AMERICA

WREATHS ACROSS AMERICA (MAINE CORPORATION)
P.O. BOX 256
HARRINGTON, ME 04643

FOR: CHARITABLE SERVICES NAMELY ORGANIZING AND CONDUCTING VOLUNTEER PROGRAMS AND COMMUNITY SERVICE PROJECTS AIMED AT INCREASING SUPPORT AND MORALE OF MEMBERS OF THE US MILITARY , IN CLASS 35 (U.S. CLS. 100, 101 AND 102).

FIRST USE 1-1-2006; IN COMMERCE 1-1-2006.

THE MARK CONSISTS OF STANDARD CHARACTERS WITHOUT CLAIM TO ANY PARTICULAR FONT, STYLE, SIZE, OR COLOR.

NO CLAIM IS MADE TO THE EXCLUSIVE RIGHT TO USE WREATHS OR AMERICA, APART FROM THE MARK AS SHOWN.

SER. NO. 77-336,880, FILED 11-26-2007.

ESTHER BELENKER, EXAMINING ATTORNEY

Int. Cls.: 41 and 44

Prior U.S. Cls.: 100, 101 and 107

United States Patent and Trademark Office

Reg. No. 3,479,752

Registered Aug. 5, 2008

**SERVICE MARK
PRINCIPAL REGISTER**

KORREKT KRITTERS

KORREKT KRITTERS, LLC (FLORIDA LTD
LIAB CO)
9452 CONSERVATION DRIVE
NEW PORT RICHEY, FL 33655

FOR: PET TRAINING SERVICES, IN CLASS 41
(U.S. CLS. 100, 101 AND 107).

FIRST USE 8-9-2007; IN COMMERCE 8-9-2007.

FOR: CONSULTATION SERVICES IN THE FIELD
OF PET BEHAVIOR, IN CLASS 44 (U.S. CLS. 100 AND
101).

FIRST USE 8-9-2007; IN COMMERCE 8-9-2007.

THE MARK CONSISTS OF STANDARD CHAR-
ACTERS WITHOUT CLAIM TO ANY PARTICULAR
FONT, STYLE, SIZE, OR COLOR.

SER. NO. 77-336,941, FILED 11-26-2007.

ROBIN MITTLER, EXAMINING ATTORNEY

Int. Cl.: 28

Prior U.S. Cls.: 22, 23, 38 and 50

United States Patent and Trademark Office

Reg. No. 3,479,753

Registered Aug. 5, 2008

**TRADEMARK
PRINCIPAL REGISTER**

**THE SCIENCE + ART OF
FISHING**

Z-MAN FISHING PRODUCTS, INC. (SOUTH
CAROLINA CORPORATION)
9801 HIGHWAY 78 EAST
LADSON, SC 29456

THE MARK CONSISTS OF STANDARD CHAR-
ACTERS WITHOUT CLAIM TO ANY PARTICULAR
FONT, STYLE, SIZE, OR COLOR.

FOR: ARTIFICIAL FISHING BAIT; ARTIFICIAL
FISHING LURES; FISHING LURE PARTS; FISHING
LURES; FISHING TACKLE; LURES FOR FISHING,
IN CLASS 28 (U.S. CLS. 22, 23, 38 AND 50).

SER. NO. 77-337,612, FILED 11-27-2007.

FIRST USE 7-31-2005; IN COMMERCE 7-31-2005.

LOURDES AYALA, EXAMINING ATTORNEY

Int. Cl.: 13

Prior U.S. Cls.: 2 and 9

United States Patent and Trademark Office

Reg. No. 3,479,754

Registered Aug. 5, 2008

**TRADEMARK
PRINCIPAL REGISTER**

Pow-R-Entry

IMLCORP LLC (GEORGIA LTD LIAB CO)
SUITE 15
869 PICKENS INDUSTRIAL DRIVE
MARIETTA, GA 30062

FOR: MECHANICAL BREACHING TOOLS WITH
EXPLOSIVE CARTRIDGES FOR USE IN FORCIBLE
ENTRANCE THROUGH LOCKED DOORS, GATES,
SECURITY BARS, FENCES AND PADLOCKS, IN
CLASS 13 (U.S. CLS. 2 AND 9).

FIRST USE 6-1-2007; IN COMMERCE 6-25-2007.

THE MARK CONSISTS OF STANDARD CHAR-
ACTERS WITHOUT CLAIM TO ANY PARTICULAR
FONT, STYLE, SIZE, OR COLOR.

SER. NO. 77-337,788, FILED 11-27-2007.

AMY MCMENAMIN, EXAMINING ATTORNEY

Int. Cl.: 41

Prior U.S. Cls.: 100, 101 and 107

United States Patent and Trademark Office

Reg. No. 3,479,755

Registered Aug. 5, 2008

**SERVICE MARK
PRINCIPAL REGISTER**

Black20

BLACK20, INC. (DELAWARE CORPORATION)
40-17 22ND STREET, UNIT 5
LONG ISLAND CITY, NY 11101

FOR: ENTERTAINMENT IN THE NATURE OF AN ON-GOING SPECIAL VARIETY, NEWS, MUSIC OR COMEDY SHOW FEATURING COMEDY BROADCAST OVER TELEVISION, SATELLITE, AUDIO, AND VIDEO MEDIA; ENTERTAINMENT IN THE NATURE OF VISUAL AND AUDIO PERFORMANCES, AND MUSICAL, VARIETY, NEWS AND COMEDY SHOWS; ENTERTAINMENT, NAMELY A CONTINUING COMEDY SHOW BROADCAST OVER TELEVISION, SATELLITE, AUDIO, AND VIDEO MEDIA; ENTERTAINMENT SERVICES NAMELY PROVIDING A WEBSITE FEATURING PHOTOGRAPHIC, AUDIO, VIDEO AND PROSE PRESENTATIONS FEATURING COMEDY;

ENTERTAINMENT SERVICES, NAMELY, AN ON-GOING SERIES FEATURING COMEDY PROVIDED THROUGH INTERNET; ENTERTAINMENT SERVICES, NAMELY, PROVIDING A WEB SITE FEATURING MUSICAL PERFORMANCES, MUSICAL VIDEOS, RELATED FILM CLIPS, PHOTOGRAPHS, AND OTHER MULTIMEDIA MATERIALS, IN CLASS 41 (U.S. CLS. 100, 101 AND 107).

FIRST USE 4-0-2007; IN COMMERCE 4-0-2007.

THE MARK CONSISTS OF STANDARD CHARACTERS WITHOUT CLAIM TO ANY PARTICULAR FONT, STYLE, SIZE, OR COLOR.

SER. NO. 77-337,929, FILED 11-27-2007.

MARY CRAWFORD, EXAMINING ATTORNEY

Int. Cl.: 41

Prior U.S. Cls.: 100, 101 and 107

United States Patent and Trademark Office

Reg. No. 3,479,756

Registered Aug. 5, 2008

**SERVICE MARK
PRINCIPAL REGISTER**

The Opa Way

DUNDON, ELAINE GM (UNITED STATES INDIVIDUAL)
223 NORTH GUADALUPE STREET # 243
SANTA FE, NM 87501

FOR: EDUCATION SERVICES, NAMELY, PROVIDING CLASSES, SEMINARS, AND WORKSHOPS IN THE FIELD OF PERSONAL IMPROVEMENT AND DEVELOPMENT, IN CLASS 41 (U.S. CLS. 100, 101 AND 107).

FIRST USE 11-27-2007; IN COMMERCE 11-27-2007.

THE MARK CONSISTS OF STANDARD CHARACTERS WITHOUT CLAIM TO ANY PARTICULAR FONT, STYLE, SIZE, OR COLOR.

"THE FOREIGN GREEK WORDING IN THE MARK TRANSLATES INTO ENGLISH AS AN EXPRESSION USED TO EXPRESS JOY, APPROVAL, OR ENCOURAGEMENT."

SER. NO. 77-338,153, FILED 11-27-2007.

WILLIAM ROSSMAN, EXAMINING ATTORNEY

Int. Cl.: 35

Prior U.S. Cls.: 100, 101 and 102

United States Patent and Trademark Office

Reg. No. 3,479,757

Registered Aug. 5, 2008

**SERVICE MARK
PRINCIPAL REGISTER**

Authentic Insights

LEADERSHIP AUTHENTIC INSIGHTS, INC.
(TENNESSEE CORPORATION)
8930 EVENING GROVE COVE
CORDOVA, TN 38018

THE MARK CONSISTS OF STANDARD CHARACTERS WITHOUT CLAIM TO ANY PARTICULAR FONT, STYLE, SIZE, OR COLOR.

FOR: BUSINESS MANAGEMENT CONSULTATION IN THE FIELD OF EXECUTIVE AND LEADERSHIP DEVELOPMENT, IN CLASS 35 (U.S. CLS. 100, 101 AND 102).

SER. NO. 77-338,218, FILED 11-27-2007.

FIRST USE 9-15-2007; IN COMMERCE 9-15-2007.

COLLEEN KEARNEY, EXAMINING ATTORNEY

Int. Cl.: 9

Prior U.S. Cls.: 21, 23, 26, 36 and 38

Reg. No. 3,479,758

United States Patent and Trademark Office

Registered Aug. 5, 2008

**TRADEMARK
PRINCIPAL REGISTER**



E-DESTINACCESS, INC. (NEW HAMPSHIRE CORPORATION)
31881 VIA PATO
COTO DE CAZA, CA 92679

FOR: COMPUTER SOFTWARE FOR THE PLANNING, OPERATING AND BILLING OF GROUP TRAVEL EVENTS, IN CLASS 9 (U.S. CLS. 21, 23, 26, 36 AND 38).

FIRST USE 11-1-2007; IN COMMERCE 11-1-2007.

THE COLOR(S) TEAL, NAVY, BLACK IS/ARE CLAIMED AS A FEATURE OF THE MARK.

THE MARK CONSISTS OF A BLACK LINE OVER THE WORD "DESTIN" WHICH IS TEAL LETTERING AND A NAVY BLUE AIRPLANE WHICH LOOKS ALSO LIKE THE LETTER A.

THE FOREIGN WORDING IN THE MARK TRANSLATES INTO ENGLISH AS DESTINY IN FRENCH.

SER. NO. 77-338,244, FILED 11-27-2007.

WILLIAM ROSSMAN, EXAMINING ATTORNEY

Int. Cl.: 44

Prior U.S. Cls.: 100 and 101

United States Patent and Trademark Office

Reg. No. 3,479,759

Registered Aug. 5, 2008

SERVICE MARK
PRINCIPAL REGISTER



BRIAN THORNBURG, DO, PA (UNITED STATES
INDIVIDUAL)
SUITE 148
6017 PINE RIDGE ROAD
NAPLES, FL 34119

NO CLAIM IS MADE TO THE EXCLUSIVE
RIGHT TO USE "PEDIATRICS", APART FROM
THE MARK AS SHOWN.

FOR: GENERAL PEDIATRIC MEDICAL SERVI-
CES, IN CLASS 44 (U.S. CLS. 100 AND 101).

SER. NO. 77-338,279, FILED 11-27-2007.

FIRST USE 4-17-2006; IN COMMERCE 4-17-2006.

TINA BROWN, EXAMINING ATTORNEY

Int. Cls.: 35 and 43

Prior U.S. Cls.: 100, 101 and 102

United States Patent and Trademark Office

Reg. No. 3,479,760

Registered Aug. 5, 2008

**SERVICE MARK
PRINCIPAL REGISTER**

GRAND HERITAGE

TRADEMARKS HOLDING, LLC (MARYLAND
LTD LIAB CO)
39 BAY DRIVE
ANNAPOLIS, MD 21403

FOR: HOTEL MANAGEMENT AND OPERATION
OF HOTELS FOR OTHERS; BUSINESS MANAGE-
MENT OF HOTELS, IN CLASS 35 (U.S. CLS. 100, 101
AND 102).

FIRST USE 1-1-2004; IN COMMERCE 1-1-2004.

FOR: HOTEL AND RESTAURANT SERVICES;
LUXURY HOTEL SERVICES OFFERED IN DESIG-
NATED ON-SITE HOTEL LOCATIONS; RESORT

HOTEL SERVICES, IN CLASS 43 (U.S. CLS. 100
AND 101).

FIRST USE 1-1-1990; IN COMMERCE 1-1-1990.

THE MARK CONSISTS OF STANDARD CHAR-
ACTERS WITHOUT CLAIM TO ANY PARTICULAR
FONT, STYLE, SIZE, OR COLOR.

OWNER OF U.S. REG. NOS. 1,997,991 AND
3,099,018.

SER. NO. 77-338,431, FILED 11-28-2007.

ANDREA SAUNDERS, EXAMINING ATTORNEY

Int. Cl.: 42

Prior U.S. Cls.: 100 and 101

United States Patent and Trademark Office

Reg. No. 3,479,761

Registered Aug. 5, 2008

**SERVICE MARK
PRINCIPAL REGISTER**

KARDIA HEALTH SYSTEMS

KARDIA HEALTH SYSTEMS, INC. (MINNESOTA CORPORATION)
2900 THOMAS AVE SOUTH, SUITE 300
MINNEAPOLIS, MN 55416

FOR: PROVIDING ONLINE NON-DOWNLOADABLE COMPUTER SOFTWARE FOR ORGANIZING MEDICAL DATA FOR USE IN THE FIELD OF MEDICAL SCHEDULING AND WORKFLOW; PROVIDING ONLINE NON-DOWNLOADABLE COMPUTER SOFTWARE FOR USE IN EVALUATING RESULTS OF AND GENERATING REPORTS BASED UPON MEDICAL DIAGNOSTIC TECHNIQUES; PROVIDING ONLINE NON-DOWNLOADABLE COMPUTER SOFTWARE FOR USE IN MEDICAL BILLING AND CODING; PROVIDING ONLINE NON-DOWNLOADABLE COMPUTER SOFTWARE FOR PRODUCING STRUCTURED PATIENT AND PERSONNEL UTILIZATION REPORTS THAT COMPLY WITH ACCREDITING ORGANIZA-

TIONS' REQUIREMENTS FOR USE IN FACILITATING AND MAINTAINING ACCREDITATION OF INDIVIDUALS AND ORGANIZATIONS IN THE MEDICAL FIELD, IN CLASS 42 (U.S. CLS. 100 AND 101).

FIRST USE 8-3-2007; IN COMMERCE 8-3-2007.

THE MARK CONSISTS OF STANDARD CHARACTERS WITHOUT CLAIM TO ANY PARTICULAR FONT, STYLE, SIZE, OR COLOR.

NO CLAIM IS MADE TO THE EXCLUSIVE RIGHT TO USE "HEALTH SYSTEMS", APART FROM THE MARK AS SHOWN.

SER. NO. 77-338,488, FILED 11-28-2007.

MICHELE SWAIN, EXAMINING ATTORNEY

Int. Cl.: 25

Prior U.S. Cls.: 22 and 39

United States Patent and Trademark Office

Reg. No. 3,479,762

Registered Aug. 5, 2008

**TRADEMARK
PRINCIPAL REGISTER**

APPAMAN

APPAMAN INC. (NEW YORK CORPORATION)
SUITE 402B
195 CHRYSTIE STREET
NEW YORK, NY 10002

FOR: CLOTHING, NAMELY, ONE PIECE GAR-
MENT FOR INFANTS AND TODDLERS; SHIRTS;
SWEATSHIRTS; PANTS; SHORTS; OUTERWEAR,
NAMELY, COATS AND JACKETS; SWIMWEAR;
HEADGEAR, NAMELY, HATS , IN CLASS 25 (U.S.
CLS. 22 AND 39).

FIRST USE 5-1-2003; IN COMMERCE 5-1-2003.

THE MARK CONSISTS OF STANDARD CHAR-
ACTERS WITHOUT CLAIM TO ANY PARTICULAR
FONT, STYLE, SIZE, OR COLOR.

SER. NO. 77-338,673, FILED 11-28-2007.

EDWARD NELSON, EXAMINING ATTORNEY

Int. Cl.: 37

Prior U.S. Cls.: 100, 103 and 106

United States Patent and Trademark Office

Reg. No. 3,479,763

Registered Aug. 5, 2008

**SERVICE MARK
PRINCIPAL REGISTER**

Mister Green Build

CORWIN, THOMAS N (UNITED STATES INDIVIDUAL)
3713 FIVE MILE ROAD
TRAVERSE CITY, MI 49686

FOR: RESIDENTIAL AND COMMERCIAL BUILDING CONSTRUCTION; CUSTOM CONSTRUCTION AND BUILDING RENOVATION; INSTALLATION OF BUILDING INSULATION; RENOVATION AND RESTORATION OF BUILDINGS; BUILDING CONSTRUCTION SERVICES, IN CLASS 37 (U.S. CLS. 100, 103 AND 106).

FIRST USE 10-29-2007; IN COMMERCE 10-29-2007.

THE MARK CONSISTS OF STANDARD CHARACTERS WITHOUT CLAIM TO ANY PARTICULAR FONT, STYLE, SIZE, OR COLOR.

NO CLAIM IS MADE TO THE EXCLUSIVE RIGHT TO USE "GREEN BUILD", APART FROM THE MARK AS SHOWN.

SER. NO. 77-338,725, FILED 11-28-2007.

KAPIL BHANOT, EXAMINING ATTORNEY

Int. Cl.: 35

Prior U.S. Cls.: 100, 101 and 102

United States Patent and Trademark Office

Reg. No. 3,479,764

Registered Aug. 5, 2008

**SERVICE MARK
PRINCIPAL REGISTER**

LEADERS IN LUXURY

PATERNO IMPORTS, LTD. (ILLINOIS CORPORATION), DBA TERLATO WINES INTERNATIONAL
900 ARMOUR DRIVE
LAKE BLUFF, IL 60044

THE MARK CONSISTS OF STANDARD CHARACTERS WITHOUT CLAIM TO ANY PARTICULAR FONT, STYLE, SIZE, OR COLOR.

FOR: ADVERTISING SERVICES, NAMELY, PROMOTING THE WINES OF OTHERS, IN CLASS 35 (U.S. CLS. 100, 101 AND 102).

SER. NO. 77-339,024, FILED 11-28-2007.

FIRST USE 11-25-2007; IN COMMERCE 11-25-2007.

STEPHANIE ALI, EXAMINING ATTORNEY

Int. Cl.: 36

Prior U.S. Cls.: 100, 101 and 102

United States Patent and Trademark Office

Reg. No. 3,479,765

Registered Aug. 5, 2008

**SERVICE MARK
PRINCIPAL REGISTER**



FORECLOSURESDAILY.COM (FLORIDA PART-
NERSHIP)

#104-A

12600 S. BELCHER ROAD
LARGO, FL 33773

FOR: PROVIDING REAL ESTATE LISTINGS AND
REAL ESTATE INFORMATION VIA THE INTER-
NET, IN CLASS 36 (U.S. CLS. 100, 101 AND 102).

FIRST USE 1-1-2004; IN COMMERCE 1-1-2004.

THE STIPPLING IS FOR SHADING PURPOSES
ONLY.

THE MARK CONSISTS OF AN IMAGE OF THE
FRONT OF A COURTHOUSE WITH COLUMNS.
THE STYLIZED WORDS "FORECLOSURESDAILY.-
COM" ARE LOCATED AT THE BOTTOM OF THE
COLUMNS.

SER. NO. 77-339,036, FILED 11-28-2007.

SUSAN LESLIE DUBOIS, EXAMINING ATTORNEY

Int. Cl.: 5

Prior U.S. Cls.: 6, 18, 44, 46, 51 and 52

Reg. No. 3,479,766

United States Patent and Trademark Office

Registered Aug. 5, 2008

**TRADEMARK
PRINCIPAL REGISTER**

GLUCO-FLEX

W.F. YOUNG, INCORPORATED (MASSACHU-
SETTS CORPORATION)
302 BENTON DRIVE
EAST LONGMEADOW, MA 01028

THE MARK CONSISTS OF STANDARD CHAR-
ACTERS WITHOUT CLAIM TO ANY PARTICULAR
FONT, STYLE, SIZE, OR COLOR.

FOR: ANIMAL FEED ADDITIVE FOR LIVE-
STOCK AND HORSES FOR USE AS A NUTRITION-
AL SUPPLEMENT, IN CLASS 5 (U.S. CLS. 6, 18, 44, 46,
51 AND 52).

SER. NO. 77-339,088, FILED 11-28-2007.

FIRST USE 12-0-2000; IN COMMERCE 12-0-2000.

FRED CARL, EXAMINING ATTORNEY

Int. Cl.: 5

Prior U.S. Cls.: 6, 18, 44, 46, 51 and 52

Reg. No. 3,479,767

United States Patent and Trademark Office

Registered Aug. 5, 2008

**TRADEMARK
PRINCIPAL REGISTER**

SKIN RENOVATOR

W.F. YOUNG, INCORPORATED (MASSACHU-
SETTS CORPORATION)
302 BENTON DRIVE
EAST LONGMEADOW, MA 01028

FOR: VETERINARY PREPARATION, NAMELY,
A TOPICAL WOUND DRESSING, IN CLASS 5 (U.S.
CLS. 6, 18, 44, 46, 51 AND 52).

FIRST USE 9-0-2004; IN COMMERCE 9-0-2004.

THE MARK CONSISTS OF STANDARD CHAR-
ACTERS WITHOUT CLAIM TO ANY PARTICULAR
FONT, STYLE, SIZE, OR COLOR.

NO CLAIM IS MADE TO THE EXCLUSIVE
RIGHT TO USE "SKIN", APART FROM THE MARK
AS SHOWN.

SER. NO. 77-339,171, FILED 11-28-2007.

FRED CARL, EXAMINING ATTORNEY

Int. Cl.: 35

Prior U.S. Cls.: 100, 101 and 102

United States Patent and Trademark Office

Reg. No. 3,479,768

Registered Aug. 5, 2008

**SERVICE MARK
PRINCIPAL REGISTER**

SAVORY CHEF

SAVORY CHEF, LLC (OKLAHOMA LTD LIAB
CO)
8283 SOUTH MEMORIAL
TULSA, OK 74133

FOR: RETAIL AND ON-LINE RETAIL STORE
SERVICES FEATURING CULINARY EQUIPMENT,
COOKWARE, BAKEWARE, CUTLERY, KITCHEN
GADGETS, UTENSILS, DINNERWARE, TABLE-
WARE, GLASSWARE, FLATWARE, SERVING
TRAYS, CERAMICS ELECTRIC KITCHEN APPLI-
ANCES, COOKBOOKS, RECIPES, GOURMET
FOODS, MEAT, SAUCES, MIXES, HOUSEWARES,
INDOOR AND OUTDOOR FURNITURE, RUGS,
LAMPS AND LIGHTING FIXTURES, CLOCKS,
CANDLES AND CANDLE HOLDERS, CURTAINS,
TABLE LINENS, KITCHEN TOWELS, BASKETS,
BROOMS, BRUSHES AND DUSTERS FOR CLEAN-

ING, BARBECUES AND BARBECUE ACCESSOR-
IES, PICNIC ACCESSORIES, SOAPS AND HAND
CREAMS, IN CLASS 35 (U.S. CLS. 100, 101 AND 102).

FIRST USE 7-14-2004; IN COMMERCE 7-14-2004.

THE MARK CONSISTS OF STANDARD CHAR-
ACTERS WITHOUT CLAIM TO ANY PARTICULAR
FONT, STYLE, SIZE, OR COLOR.

NO CLAIM IS MADE TO THE EXCLUSIVE
RIGHT TO USE "CHEF", APART FROM THE MARK
AS SHOWN.

SER. NO. 77-339,260, FILED 11-28-2007.

MORGAN WYNNE, EXAMINING ATTORNEY

Int. Cl.: 12

Prior U.S. Cls.: 19, 21, 23, 31, 35 and 44

Reg. No. 3,479,769

United States Patent and Trademark Office

Registered Aug. 5, 2008

**TRADEMARK
PRINCIPAL REGISTER**

XBR

ALCOA INC. (PENNSYLVANIA CORPORATION)
ALCOA CORPORATE CENTER
201 ISABELLA STREET
PITTSBURGH, PA 152125858

FIRST USE 10-31-2006; IN COMMERCE 10-31-2006.

FOR: A STRUCTURAL FEATURE OF WHEELS FOR USE WITH LAND VEHICLES THAT PROTECTS THE WHEELS FROM CHIPPING, CRACKING, SCRATCHING, PEELING, CORROSIONS, DIRT, AND DULLING, SOLD AS AN INTEGRAL PART OF THE WHEELS, IN CLASS 12 (U.S. CLS. 19, 21, 23, 31, 35 AND 44).

THE MARK CONSISTS OF STANDARD CHARACTERS WITHOUT CLAIM TO ANY PARTICULAR FONT, STYLE, SIZE, OR COLOR.

SER. NO. 77-339,359, FILED 11-28-2007.

MATTHEW EINSTEIN, EXAMINING ATTORNEY

Int. Cl.: 33

Prior U.S. Cls.: 47 and 49

United States Patent and Trademark Office

Reg. No. 3,479,770

Registered Aug. 5, 2008

TRADEMARK
PRINCIPAL REGISTER



THE MORLET SELECTION, INCORPORATED
(CALIFORNIA CORPORATION)
818 CHILES AVENUE
ST. HELENA, CA 94574

FOR: WINE, IN CLASS 33 (U.S. CLS. 47 AND 49).

FIRST USE 9-20-2007; IN COMMERCE 9-20-2007.

NO CLAIM IS MADE TO THE EXCLUSIVE
RIGHT TO USE "FAMILY VINEYARDS" , APART
FROM THE MARK AS SHOWN.

THE COLOR(S) BLACK, GRAY, RED AND GOLD
IS/ARE CLAIMED AS A FEATURE OF THE MARK.

THE MARK CONSISTS OF THE WORD "MOR-
LET" IN BLACK CAPITAL LETTERS OUTLINED IN

GRAY ABOVE THE STYLIZED WORDS "FAMILY
VINEYARDS" IN GRAY CENTERED ABOVE THE
WORD "MORLET"; ABOVE THE WORDING ARE
TWO WOMEN IN GOLD HOLDING A GOLD AND
GRAY LYRE WHICH IS RESTING ON TOP OF A
GOLD AND GRAY PEDESTAL WITH A SOLID RED
CIRCLE IN THE CENTER OF WHICH IS A CAPITAL
LETTER "M" IN GOLD SURROUNDED BY TWO
GOLD CIRCLES; BEHIND EACH WOMAN IS A
GRAPE VINE WITH THE VINE, LEAVES AND
GRAPES IN THE COLORS GRAY AND BLACK.

SER. NO. 77-339,368, FILED 11-28-2007.

CHRISTOPHER BUONGIORNO, EXAMINING AT-
TORNEY

Int. Cl.: 36

Prior U.S. Cls.: 100, 101 and 102

United States Patent and Trademark Office

Reg. No. 3,479,771

Registered Aug. 5, 2008

**SERVICE MARK
PRINCIPAL REGISTER**



TICKTOCKSTOCK.COM (CALIFORNIA CORPORATION)
P.O. BOX 20294
BAKERSFIELD, CA 93390

FOR: SECURITIES TRADING AND INVESTING SERVICES, NAMELY, PROVIDING SECURITIES TRADING AND INVESTING INFORMATION FOR OTHERS, VIA THE INTERNET, IN CLASS 36 (U.S. CLS. 100, 101 AND 102).

THE MARK CONSISTS OF THE STYLIZED WORDS "TICKTOCKSTOCK.COM EXPLORING EXPLOSIVE NEW GROWTH OPPORTUNITES". THE LETTER "I" IN "TICK" IS A STICK OF DYNAMITE AND THE LETTER "O" IN "TOCK" IS A CLOCK.

SER. NO. 77-339,901, FILED 11-29-2007.

FIRST USE 6-15-2006; IN COMMERCE 6-15-2006.

REBECCA EISINGER, EXAMINING ATTORNEY

Int. Cl.: 1

Prior U.S. Cls.: 1, 5, 6, 10, 26 and 46

Reg. No. 3,479,772

United States Patent and Trademark Office

Registered Aug. 5, 2008

**TRADEMARK
PRINCIPAL REGISTER**

KEYCOTE

DENTSPLY INTERNATIONAL INC. (DELA-
WARE CORPORATION)
221 WEST PHILADELPHIA STREET
YORK, PA 174050872

FOR: CHEMICALS IN THE NATURE OF RE-
FRACTORY BINDER USED FOR INVESTMENT
CASTING, IN CLASS 1 (U.S. CLS. 1, 5, 6, 10, 26 AND
46).

FIRST USE 6-16-2006; IN COMMERCE 6-16-2006.

THE MARK CONSISTS OF STANDARD CHAR-
ACTERS WITHOUT CLAIM TO ANY PARTICULAR
FONT, STYLE, SIZE, OR COLOR.

OWNER OF U.S. REG. NOS. 1,652,824, 2,425,124
AND OTHERS.

SER. NO. 77-339,956, FILED 11-29-2007.

AMY ALFIERI, EXAMINING ATTORNEY

Int. Cl.: 12

Prior U.S. Cls.: 19, 21, 23, 31, 35 and 44

United States Patent and Trademark Office

Reg. No. 3,479,773

Registered Aug. 5, 2008

**TRADEMARK
PRINCIPAL REGISTER**



COMERCIAL CARDEPORT LTDA. (CHILE LIMITED CORPORATION)

TOCORNAL 673

SANTIAGO, CHILE

FOR: LAND VEHICLE PARTS, NAMELY, FENDER FLARES; LAND VEHICLE PARTS, NAMELY, MUD GUARDS; LAND VEHICLE PARTS, NAMELY, RUNNING BOARDS; LAND VEHICLE PARTS, NAMELY, WHEELS; ROOF RACK STORAGE CONTAINERS FOR LAND VEHICLES; STEERING BOOT KITS FOR USE WITH LAND VEHICLES; STEERING UNITS FOR LAND VEHICLES AND PARTS THEREOF; STEPS FOR ATTACHMENT TO LAND VEHICLES; VEHICLE SEAT COVERS; VEHICLE SEATS, IN CLASS 12 (U.S. CLS. 19, 21, 23, 31, 35 AND 44).

FIRST USE 4-22-2005; IN COMMERCE 10-4-2007.

NO CLAIM IS MADE TO THE EXCLUSIVE RIGHT TO USE "MOTOR", APART FROM THE MARK AS SHOWN.

THE COLOR(S) WHITE, BLACK, GRAY, AND RED IS/ARE CLAIMED AS A FEATURE OF THE MARK.

THE MARK CONSISTS OF A WHITE "Z" NEXT TO A RED "S" ABOVE THE STYLIZED WORD "MOTOR" IN WHITE OVER A BLACK AND GRAY STRIPED BACKGROUND, SURROUNDED BY AN UNEVENLY SHAPED WHITE CIRCLE, ALL OVER A BLACK AND GRAY STRIPED BACKGROUND.

SER. NO. 77-339,980, FILED 11-29-2007.

JACQUELINE A. LAVINE, EXAMINING ATTORNEY

Int. Cl.: 41

Prior U.S. Cls.: 100, 101 and 107

United States Patent and Trademark Office

Reg. No. 3,479,774

Registered Aug. 5, 2008

**SERVICE MARK
PRINCIPAL REGISTER**

FishStock

WORLD PUBLICATIONS, LLC (DELAWARE LTD
LIAB CO)
460 N. ORLANDO AVENUE, SUITE 200
WINTER PARK, FL 32789

FOR: ENTERTAINMENT AND EDUCATIONAL
SERVICE, NAMELY, CONDUCTING INSTRU-
CTION, DEMONSTRATIONS AND CLINICS IN THE
FIELDS OF BOATING AND FISHING, AVAILABLE
TO THE PUBLIC, IN CLASS 41 (U.S. CLS. 100, 101
AND 107).

FIRST USE 1-24-2003; IN COMMERCE 1-24-2003.

THE MARK CONSISTS OF STANDARD CHAR-
ACTERS WITHOUT CLAIM TO ANY PARTICULAR
FONT, STYLE, SIZE, OR COLOR.

OWNER OF U.S. REG. NO. 2,804,923.

SEC. 2(F).

SER. NO. 77-339,982, FILED 11-29-2007.

ROBIN CHOSID, EXAMINING ATTORNEY

Int. Cls.: 7, 8 and 21

**Prior U.S. Cls.: 2, 13, 19, 21, 23, 28, 29, 30, 31, 33, 34,
35, 40, 44 and 50**

Reg. No. 3,479,775

United States Patent and Trademark Office

Registered Aug. 5, 2008

**TRADEMARK
PRINCIPAL REGISTER**

NEOFLAM

CHANG, TAE YOUNG (CALIFORNIA CORPORATION), DBA HIGHEL, INC.
9591 IRVINE CENTER DRIVE
IRVINE, CA 92618

FOR: ELECTRICAL TOOL, NAMELY, ELECTRIC MANDOLINE FOOD SLICERS, IN CLASS 7 (U.S. CLS. 13, 19, 21, 23, 31, 34 AND 35).

FIRST USE 10-1-2007; IN COMMERCE 10-31-2007.

FOR: CUTLERY, NAMELY, KNIVES, IN CLASS 8 (U.S. CLS. 23, 28 AND 44).

FIRST USE 10-1-2007; IN COMMERCE 10-31-2007.

FOR: KITCHEN UTENSILS AND CONTAINERS, NAMELY, PLASTIC FOOD STORAGE CONTAINERS FOR HOUSEHOLD USE, AND CUTTING BOARDS, IN CLASS 21 (U.S. CLS. 2, 13, 23, 29, 30, 33, 40 AND 50).

FIRST USE 10-1-2007; IN COMMERCE 10-31-2007.

THE MARK CONSISTS OF STANDARD CHARACTERS WITHOUT CLAIM TO ANY PARTICULAR FONT, STYLE, SIZE, OR COLOR.

SER. NO. 77-340,056, FILED 11-29-2007.

SANJEEV VOHRA, EXAMINING ATTORNEY

Int. Cl.: 39

Prior U.S. Cls.: 100 and 105

United States Patent and Trademark Office

Reg. No. 3,479,776

Registered Aug. 5, 2008

**SERVICE MARK
PRINCIPAL REGISTER**

The logo for "PIAZZA PRODUCE" features the word "PIAZZA" in a bold, red, sans-serif font with a white outline. Below it, the word "PRODUCE" is written in a white, sans-serif font with a red outline. The background of the text is translucent.

IF&P FOODS, INC. (INDIANA CORPORATION)
5941 WEST 82ND STREET
INDIANAPOLIS, IN 46268

FOR: DISTRIBUTION SERVICES, NAMELY, DELIVERY OF FRESH FRUITS AND FRESH VEGETABLES, IN CLASS 39 (U.S. CLS. 100 AND 105).

FIRST USE 0-0-1985; IN COMMERCE 0-0-1985.

NO CLAIM IS MADE TO THE EXCLUSIVE RIGHT TO USE "PRODUCE", APART FROM THE MARK AS SHOWN.

THE COLOR(S) RED AND WHITE IS/ARE CLAIMED AS A FEATURE OF THE MARK.

THE MARK CONSISTS OF THE TERM "PIAZZA" IN RED BEHIND THE TERM "PRODUCE" IN WHITE AND OUTLINED IN RED. THE BACKGROUND OF THE MARK IS TRANSLUCENT.

SER. NO. 77-340,146, FILED 11-29-2007.

JIM RINGLE, EXAMINING ATTORNEY

Int. Cl.: 41

Prior U.S. Cls.: 100, 101 and 107

United States Patent and Trademark Office

Reg. No. 3,479,777

Registered Aug. 5, 2008

**SERVICE MARK
PRINCIPAL REGISTER**

**WHEN YOU'RE READY TO DO
WHAT YOU CAME HERE FOR.**

SPEISER, AARON (UNITED STATES INDIVIDUAL)
1644 S. LA CIENEGA BOULEVARD
LOS ANGELES, CA 90035

FOR: PROFESSIONAL COACHING SERVICES IN THE FIELDS OF ACTING, LIGHTING PRODUCTION, AUDITIONING FOR MOVIES, TELEVISION, THEATER AND COMMERCIALS, PUBLIC SPEAKING, AND IN THE PRODUCTION OF MOVIES AND TELEVISION SHOWS, IN CLASS 41 (U.S. CLS. 100, 101 AND 107).

FIRST USE 9-1-1995; IN COMMERCE 9-1-1995.

THE MARK CONSISTS OF STANDARD CHARACTERS WITHOUT CLAIM TO ANY PARTICULAR FONT, STYLE, SIZE, OR COLOR.

SER. NO. 77-340,174, FILED 11-29-2007.

JIM RINGLE, EXAMINING ATTORNEY

Int. Cl.: 16

Prior U.S. Cls.: 2, 5, 22, 23, 29, 37, 38 and 50

Reg. No. 3,479,778

United States Patent and Trademark Office

Registered Aug. 5, 2008

**TRADEMARK
PRINCIPAL REGISTER**

LIBRO COLLECTION

BOOKSMART STUDIO, INC. (NEW YORK CORPORATION)
250 NORTH GOODMAN STREET
ROCHESTER, NY 14607

FOR: ART AND PHOTOGRAPH PORTFOLIO CASES, IN CLASS 16 (U.S. CLS. 2, 5, 22, 23, 29, 37, 38 AND 50).

FIRST USE 10-31-2007; IN COMMERCE 10-31-2007.

THE MARK CONSISTS OF STANDARD CHARACTERS WITHOUT CLAIM TO ANY PARTICULAR FONT, STYLE, SIZE, OR COLOR.

NO CLAIM IS MADE TO THE EXCLUSIVE RIGHT TO USE "COLLECTION", APART FROM THE MARK AS SHOWN.

SER. NO. 77-340,304, FILED 11-29-2007.

ANDREA BUTLER, EXAMINING ATTORNEY

Int. Cl.: 37

Prior U.S. Cls.: 100, 103 and 106

United States Patent and Trademark Office

Reg. No. 3,479,779

Registered Aug. 5, 2008

SERVICE MARK
PRINCIPAL REGISTER

Home Sweet Home Improvements

WOTTON, THOMAS H. (VIRGINIA INDIVIDUAL), DBA HOME SWEET HOME IMPROVEMENTS
7211 WOTTON ROAD
BEALETON, VA 22712

FOR: BUILDING CONSTRUCTION AND REPAIR; BUILDING CONSTRUCTION SERVICES; BUILDING CONSTRUCTION SUPERVISION; BUILDING INSPECTION; CONSTRUCTING DECKS; CONSTRUCTING PORCHES; CONSTRUCTING SUNROOMS; CONSTRUCTION AND CONSTRUCTION MANAGEMENT OF TUNNELS AND UNDERGROUND STRUCTURES; CONSTRUCTION AND RENOVATION OF BUILDINGS; CONSTRUCTION AND REPAIR OF BUILDINGS; CONSTRUCTION CONSULTANCY; CONSTRUCTION CONSULTATION; CONSTRUCTION GRADING SERVICES; CONSTRUCTION MANAGEMENT; CONSTRUCTION OF BUILDINGS; CONSTRUCTION PLANNING; CONSTRUCTION SERVICES, NAMELY, PLANNING, LAYING OUT AND CUSTOM CONSTRUCTION OF RESIDENTIAL AND COMMERCIAL COMMUNITIES; CONSTRUCTION SUPERVISION; CONSTRUCTION, MAINTENANCE AND RENOVATION OF PROPERTY; CONSULTATION IN BUILDING CONSTRUCTION SUPERVISION; CONSULTING IN THE FIELD OF BUILDING CONSTRUCTION; CUSTOM CONSTRUCTION AND BUILDING RENOVATION; CUSTOM CONSTRUCTION OF HOMES; GENERAL CONSTRUCTION CONTRACTING; HOUSING SERVICES, NAMELY, DEVELOPMENT OF REAL PROPERTY, NAMELY, REPAIR, IMPROVEMENT, AND NEW CONSTRUCTION; HOUSING SERVICES, NAMELY, REPAIR, IMPROVEMENT, AND CONSTRUCTION OF RESIDENTIAL REAL PROPERTY; RESIDENTIAL AND BUILDING CONSTRUCTION CONSULTING; RESIDENTIAL AND COMMERCIAL BUILDING CONSTRUCTION; CARPENTRY CONTRACTOR SERVICES; DRYWALL CONTRACTOR SERVICES;

ELECTRICAL CONTRACTOR SERVICES; FOUNDATION CONTRACTOR SERVICES; FRAMING CONTRACTOR SERVICES; PAINTING CONTRACTOR SERVICES; PLUMBING CONTRACTOR SERVICES; CARPENTRY; REMODELING OF RESIDENTIAL AND COMMERCIAL DWELLINGS; RENOVATION AND RESTORATION OF BUILDINGS; RENOVATION IN THE FIELD OF HOUSES, COMMERCIAL BUILDINGS, FURNITURE, CUSTOM WOODWORKING; FURNITURE RESTORATION CONSULTATION; FURNITURE RESTORATION, REPAIR AND MAINTENANCE; BUILDING DEMOLITION; BUILDING MAINTENANCE AND REPAIR; BUILDING REINFORCING; BUILDING RESTORATION; CLEANING OF BUILDING EXTERIOR SURFACES; CONSULTATION RELATING TO PAINTING OF BUILDINGS; CONSULTING SERVICES FOR REPAIR AND RESTORATION OF HISTORIC BUILDINGS AND STRUCTURES; HOUSE AND BUILDING DEMOLITION; HOUSE BUILDING AND REPAIR; INSTALLATION OF BUILDING INSULATION; REFURBISHMENT OF BUILDINGS; REPAIR OF BUILDINGS; REPAIR WORK ON BUILDINGS, IN CLASS 37 (U.S. CLS. 100, 103 AND 106).

FIRST USE 1-1-1990; IN COMMERCE 1-1-1990.

THE MARK CONSISTS OF STANDARD CHARACTERS WITHOUT CLAIM TO ANY PARTICULAR FONT, STYLE, SIZE, OR COLOR.

NO CLAIM IS MADE TO THE EXCLUSIVE RIGHT TO USE "IMPROVEMENTS", APART FROM THE MARK AS SHOWN.

SER. NO. 77-340,759, FILED 11-30-2007.

SETH A. RAPPAPORT, EXAMINING ATTORNEY

Int. Cls.: 35, 36, 37, 39, 41, 42 and 45

Prior U.S. Cls.: 100, 101, 102, 103, 105, 106 and 107

United States Patent and Trademark Office

Reg. No. 3,479,780

Registered Aug. 5, 2008

**SERVICE MARK
PRINCIPAL REGISTER**

MESQUITE
T E X A S

THE CITY OF MESQUITE (TEXAS CORPORATION)

P.O. BOX 850137

MESQUITE, TX 751850137

FOR: CHAMBER OF COMMERCE SERVICES, NAMELY, PROMOTING BUSINESS AND TOURISM FOR THE MESQUITE, TEXAS AREA; PROVIDING MUNICIPAL AND GOVERNMENT SERVICES, NAMELY, VOLUNTEER SERVICES IN THE NATURE OF ORGANIZING AND CONDUCTING VOLUNTEER PROGRAMS AND COMMUNITY SERVICE PROJECTS AND PROMOTING THE ECONOMIC DEVELOPMENT IN THE MESQUITE, TEXAS AREA, IN CLASS 35 (U.S. CLS. 100, 101 AND 102).

FIRST USE 1-31-2006; IN COMMERCE 1-31-2006.

FOR: PROVIDING MUNICIPAL AND GOVERNMENT SERVICES, NAMELY, FINANCE SERVICES IN THE NATURE OF FINANCIAL MANAGEMENT OF CITY BUDGET AND TAXES, IN CLASS 36 (U.S. CLS. 100, 101 AND 102).

FIRST USE 1-31-2006; IN COMMERCE 1-31-2006.

FOR: PROVIDING MUNICIPAL AND GOVERNMENT SERVICES, NAMELY, COMMUNITY LAND DEVELOPMENT SERVICES IN THE NATURE OF PLANNING AND LAYING OUT OF RESIDENTIAL AND/OR COMMERCIAL COMMUNITIES, CODE ENFORCEMENT SERVICES IN THE NATURE OF BUILDING INSPECTIONS IN THE COURSE OF BUILDING CONSTRUCTION AND HISTORICAL PRESERVATION SERVICES IN THE NATURE OF

RESTORATION OF BUILDINGS AND WORKS OF ART, IN CLASS 37 (U.S. CLS. 100, 103 AND 106).

FIRST USE 1-31-2006; IN COMMERCE 1-31-2006.

FOR: PROVIDING MUNICIPAL AND GOVERNMENT SERVICES, NAMELY, PUBLIC UTILITIES AND WORKS SERVICES, AND TRANSPORTATION SERVICES IN THE NATURE OF TRANSPORTATION OF PASSENGERS BY BUS, IN CLASS 39 (U.S. CLS. 100 AND 105).

FIRST USE 1-31-2006; IN COMMERCE 1-31-2006.

FOR: PROVIDING MUNICIPAL AND GOVERNMENT SERVICES, NAMELY, RECREATIONAL PARK SERVICES, LIBRARY SERVICES, CITY SPECIAL EVENT PLANNING SERVICES, AND MUSEUM SERVICES, IN CLASS 41 (U.S. CLS. 100, 101 AND 107).

FIRST USE 1-31-2006; IN COMMERCE 1-31-2006.

FOR: PROVIDING MUNICIPAL AND GOVERNMENT SERVICES, NAMELY, CITY PLANNING SERVICES IN THE NATURE OF URBAN PLANNING AND CODE ENFORCEMENT SERVICES IN THE NATURE OF INSPECTING FOOD ESTABLISHMENTS, IN CLASS 42 (U.S. CLS. 100 AND 101).

FIRST USE 1-31-2006; IN COMMERCE 1-31-2006.

FOR: PROVIDING MUNICIPAL AND GOVERNMENT SERVICES, NAMELY, EMERGENCY MANAGEMENT SERVICES IN THE NATURE OF PROVIDING FIRE FIGHTING SERVICES AND PO-

LICE AND CIVIL PROTECTION SERVICES , IN
CLASS 45 (U.S. CLS. 100 AND 101).

FIRST USE 1-31-2006; IN COMMERCE 1-31-2006.

NO CLAIM IS MADE TO THE EXCLUSIVE
RIGHT TO USE "MESQUITE TEXAS", APART
FROM THE MARK AS SHOWN.

THE MARK CONSISTS OF THE WORDS "MES-
QUITE TEXAS". THE DOT ON THE LOWER CASE
"I" IN MESQUITE IS IN THE SHAPE OF A FLAME.

SER. NO. 77-340,914, FILED 11-30-2007.

MARIAM MAHMOUDI, EXAMINING ATTORNEY

Int. Cl.: 30

Prior U.S. Cl.: 46

United States Patent and Trademark Office

Reg. No. 3,479,781

Registered Aug. 5, 2008

**TRADEMARK
PRINCIPAL REGISTER**

PALACE STREET BAKERY

KWIK TRIP, INC. (WISCONSIN CORPORATION)
1626 OAK STREET
LA CROSSE, WI 54603

NO CLAIM IS MADE TO THE EXCLUSIVE
RIGHT TO USE "BAKERY", APART FROM THE
MARK AS SHOWN.

FOR: BREAD; BAKERY PRODUCTS, IN CLASS 30
(U.S. CL. 46).

FIRST USE 6-1-2006; IN COMMERCE 6-1-2006.

SER. NO. 77-341,001, FILED S.R. 11-30-2007 AM.
P.R. 4-10-2008.

THE MARK CONSISTS OF STANDARD CHAR-
ACTERS WITHOUT CLAIM TO ANY PARTICULAR
FONT, STYLE, SIZE, OR COLOR.

LINDA M. KING, EXAMINING ATTORNEY

Int. Cl.: 1

Prior U.S. Cls.: 1, 5, 6, 10, 26 and 46

United States Patent and Trademark Office

Reg. No. 3,479,782

Registered Aug. 5, 2008

**TRADEMARK
PRINCIPAL REGISTER**

TRIGGRR

WESTBRIDGE AGRICULTURAL PRODUCTS
(CALIFORNIA CORPORATION)
1260 AVENIDA CHELSEA
VISTA, CA 92081

FOR: ORGANIC AND INORGANIC SEED TREATMENTS; NAMELY, PLANT GROWTH REGULATING PREPARATIONS; SOIL CONDITIONING PREPARATIONS; PLANT BIOSTIMULANTS; AND PLANT GROWTH ENHANCERS AND REGULATORS; ALL INTENDED FOR USE IN THE AGRICULTURAL, HORTICULTURAL AND GREENHOUSE INDUSTRIES, IN CLASS 1 (U.S. CLS. 1, 5, 6, 10, 26 AND 46).

FIRST USE 4-22-1986; IN COMMERCE 4-22-1986.

OWNER OF U.S. REG. NO. 1,839,153.

THE MARK CONSISTS OF THE WORD "TRIGGRR" IN A STYLIZED FORMAT.

SER. NO. 77-341,049, FILED 11-30-2007.

THEODORE MCBRIDE, EXAMINING ATTORNEY

Int. Cl.: 43

Prior U.S. Cls.: 100 and 101

United States Patent and Trademark Office

Reg. No. 3,479,783

Registered Aug. 5, 2008

**SERVICE MARK
PRINCIPAL REGISTER**



OLGA'S KITCHEN, INC. (MICHIGAN CORPORATION)
1940 NORTHWOOD DRIVE
TROY, MI 48084

FOR: CARRY-OUT RESTAURANTS; RESTAURANT SERVICES, IN CLASS 43 (U.S. CLS. 100 AND 101).

FIRST USE 4-0-2005; IN COMMERCE 4-0-2005.

OWNER OF U.S. REG. NOS. 2,588,094 AND 2,588,145.

NO CLAIM IS MADE TO THE EXCLUSIVE RIGHT TO USE "KITCHEN", APART FROM THE MARK AS SHOWN.

THE MARK CONSISTS OF THE TERMS "OLGA'S KITCHEN" WITHIN TWO CONCENTRIC CIRCLES ENCLOSING A PLATE DESIGN.

SER. NO. 77-341,138, FILED 11-30-2007.

GEORGE LORENZO, EXAMINING ATTORNEY

Int. Cl.: 44

Prior U.S. Cls.: 100 and 101

United States Patent and Trademark Office

Reg. No. 3,479,784

Registered Aug. 5, 2008

**SERVICE MARK
PRINCIPAL REGISTER**

**KIDS. HAIRCUTS. PARTIES.
FUN.**

THE SNIP-ITS CORPORATION (MASSACHU-
SETTS CORPORATION)

1085 WORCESTER ROAD

NATICK, MA 01760

FOR: HAIR SALON SERVICES, IN CLASS 44 (U.S.
CLS. 100 AND 101).

FIRST USE 2-13-2007; IN COMMERCE 2-13-2007.

THE MARK CONSISTS OF STANDARD CHAR-
ACTERS WITHOUT CLAIM TO ANY PARTICULAR
FONT, STYLE, SIZE, OR COLOR.

NO CLAIM IS MADE TO THE EXCLUSIVE
RIGHT TO USE "KIDS" AND "HAIRCUTS", APART
FROM THE MARK AS SHOWN.

SER. NO. 77-341,277, FILED 11-30-2007.

STEVEN JACKSON, EXAMINING ATTORNEY

Int. Cls.: 25 and 35

Prior U.S. Cls.: 22, 39, 100, 101 and 102

Reg. No. 3,479,785

United States Patent and Trademark Office

Registered Aug. 5, 2008

**TRADEMARK
SERVICE MARK
PRINCIPAL REGISTER**

BOXERCRAFT

BOXERCRAFT INCORPORATED (GEORGIA CORPORATION)
P.O. BOX 20016
ATLANTA, GA 30325

FOR: CAPRI PANTS; CARGO PANTS; JOGGING PANTS; LOUNGE PANTS; PANTS; SWEAT PANTS; BOXER BRIEFS; BOXER SHORTS; SHORT-SLEEVED OR LONG-SLEEVED T-SHIRTS; T-SHIRTS; HEADBANDS AGAINST SWEATING; SWEAT BANDS; SWEAT SHIRTS; SWEAT SHORTS; SWEAT SUITS; FLEECE PULLOVERS; FLEECE SHORTS; SCARVES; BOARD SHORTS; GYM SHORTS; SHORTS; MUSCLE TOPS; TANK-TOPS; SCRUBS NOT FOR MEDICAL PURPOSES; FLIP FLOPS; HATS, IN CLASS 25 (U.S. CLS. 22 AND 39).

FIRST USE 10-1-1985; IN COMMERCE 10-1-1985.

FOR: CATALOG ORDERING SERVICE FEATURING AFGHANS, TIE-DYE SHIRTS AND PANTS, CUSTOM LINED HOODED SWEATSHIRTS, PANTS, SHORTS, SHIRTS, FOOTWEAR, BOXER SHORTS, BLANKETS, PILLOW CASES, HATS, AIRBRUSH DESIGNS, TRANSFERS, TWILL DESIGNS, RHINESTONE DESIGNS, FOIL PRINTS, AND PRINT DESIGNS; ELECTRONIC CATALOG SERVICES FEATURING AFGHANS, TIE-DYE SHIRTS AND PANTS, CUSTOM LINED HOODED SWEATSHIRTS, PANTS, SHORTS, SHIRTS, FOOTWEAR, BOXER SHORTS, BLANKETS, PILLOW CASES, HATS, AIRBRUSH DESIGNS, TRANSFERS, TWILL DESIGNS, RHINESTONE DESIGNS, FOIL PRINTS, AND PRINT DESIGNS; MAIL ORDER CATALOG SERVICES FEATURING AFGHANS, TIE-DYE SHIRTS AND PANTS, CUSTOM LINED HOODED SWEATSHIRTS, PANTS, SHORTS, SHIRTS, FOOTWEAR, BOXER SHORTS, BLANKETS, PILLOW CASES, HATS, AIRBRUSH DESIGNS, TRANSFERS, TWILL DESIGNS, RHINESTONE DESIGNS, FOIL PRINTS, AND PRINT DESIGNS; PROMOTING THE GOODS

AND SERVICES OF OTHERS THROUGH ON-LINE ORDERING AND CATALOGING OF THOSE GOODS AND SERVICES; COMPUTERIZED ON-LINE ORDERING SERVICES IN THE FIELD OF AFGHANS, TIE-DYE SHIRTS AND PANTS, CUSTOM LINED HOODED SWEATSHIRTS, PANTS, SHORTS, SHIRTS, FOOTWEAR, BOXER SHORTS, BLANKETS, PILLOW CASES, HATS, AIRBRUSH DESIGNS, TRANSFERS, TWILL DESIGNS, RHINESTONE DESIGNS, FOIL PRINTS, AND PRINT DESIGNS; COMPUTERIZED ON-LINE RETAIL STORE SERVICES IN THE FIELD OF AFGHANS, TIE-DYE SHIRTS AND PANTS, CUSTOM LINED HOODED SWEATSHIRTS, PANTS, SHORTS, SHIRTS, FOOTWEAR, BOXER SHORTS, BLANKETS, PILLOW CASES, HATS, AIRBRUSH DESIGNS, TRANSFERS, TWILL DESIGNS, RHINESTONE DESIGNS, FOIL PRINTS, AND PRINT DESIGNS; ON-LINE ORDERING SERVICES FEATURING AFGHANS, TIE-DYE SHIRTS AND PANTS, CUSTOM LINED HOODED SWEATSHIRTS, PANTS, SHORTS, SHIRTS, FOOTWEAR, BOXER SHORTS, BLANKETS, PILLOW CASES, HATS, AIRBRUSH DESIGNS, TRANSFERS, TWILL DESIGNS, RHINESTONE DESIGNS, FOIL PRINTS, AND PRINT DESIGNS; ON-LINE RETAIL STORE SERVICES FEATURING AFGHANS, TIE-DYE SHIRTS AND PANTS, CUSTOM LINED HOODED SWEATSHIRTS, PANTS, SHORTS, SHIRTS, FOOTWEAR, BOXER SHORTS, BLANKETS, PILLOW CASES, HATS, AIRBRUSH DESIGNS, TRANSFERS, TWILL DESIGNS, RHINESTONE DESIGNS, FOIL PRINTS, AND PRINT DESIGNS, IN CLASS 35 (U.S. CLS. 100, 101 AND 102).

FIRST USE 10-1-1985; IN COMMERCE 10-1-1985.

THE MARK CONSISTS OF STANDARD CHARACTERS WITHOUT CLAIM TO ANY PARTICULAR FONT, STYLE, SIZE, OR COLOR.

SER. NO. 77-341,410, FILED 11-30-2007.

MELISSA VALLILLO, EXAMINING ATTORNEY

Int. Cl.: 35

Prior U.S. Cls.: 100, 101 and 102

United States Patent and Trademark Office

Reg. No. 3,479,786

Registered Aug. 5, 2008

**SERVICE MARK
PRINCIPAL REGISTER**

Creating Capacity

CAVALRY TRANSPORTATION, LLC (TENNESSEE LTD LIAB CO)
808 AIRPARK CENTER DRIVE, SUITE 808
NASHVILLE, TN 37217

FOR: THIRD PARTY TRANSPORTATION LOGISTICS SERVICES, NAMELY, ARRANGING THE TRANSPORTATION OF GOODS FOR OTHERS; THIRD PARTY TRANSPORTATION LOGISTICS SERVICES, NAMELY, PLANNING AND SCHEDULING SHIPMENTS FOR USERS OF TRANSPORTATION SERVICES, IN CLASS 35 (U.S. CLS. 100, 101 AND 102).

FIRST USE 1-15-2007; IN COMMERCE 1-15-2007.

THE MARK CONSISTS OF STANDARD CHARACTERS WITHOUT CLAIM TO ANY PARTICULAR FONT, STYLE, SIZE, OR COLOR.

SER. NO. 77-341,441, FILED 11-30-2007.

JAY FLOWERS, EXAMINING ATTORNEY

Int. Cl.: 26

Prior U.S. Cls.: 37, 39, 40, 42 and 50

United States Patent and Trademark Office

Reg. No. 3,479,787

Registered Aug. 5, 2008

TRADEMARK
PRINCIPAL REGISTER

Ribbies

RIBBIES, INC. (OKLAHOMA CORPORATION)
1612 REDTAIL HAWK
EDMOND, OK 73003

THE MARK CONSISTS OF THE WORD "RIBBIES"
IN STYLIZED LETTERING.

FOR: HAIR CLIPS; HAIR CLIPS AND HOLDERS
THEREFORE SOLD AS A UNIT, IN CLASS 26 (U.S.
CLS. 37, 39, 40, 42 AND 50).

SER. NO. 77-341,496, FILED 11-30-2007.

FIRST USE 11-1-2006; IN COMMERCE 11-1-2006.

WON TEAK OH, EXAMINING ATTORNEY

Int. Cls.: 25 and 35

Prior U.S. Cls.: 22, 39, 100, 101 and 102

Reg. No. 3,479,788

United States Patent and Trademark Office

Registered Aug. 5, 2008

**TRADEMARK
SERVICE MARK
PRINCIPAL REGISTER**

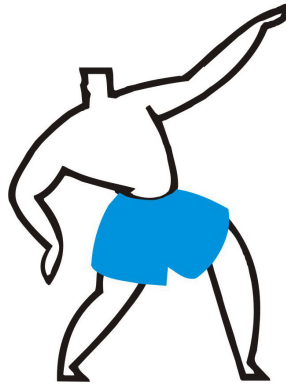

BOXERCRAFT INCORPORATED (GEORGIA CORPORATION)
P.O. BOX 20016
ATLANTA, GA 30325

FOR: CAPRI PANTS; CARGO PANTS; JOGGING PANTS; LOUNGE PANTS; PANTS; SWEAT PANTS; BOXER BRIEFS; BOXER SHORTS; SHIRTS; SHORT-SLEEVED OR LONG-SLEEVED T-SHIRTS; SLEEP SHIRTS; SPORT SHIRTS; T-SHIRTS; TEE SHIRTS; HEADBANDS AGAINST SWEATING; SWEAT BANDS; SWEAT SHIRTS; SWEAT SHORTS; SWEAT SUITS; FLEECE PULLOVERS; FLEECE SHORTS; SCARVES; BOARD SHORTS; GYM SHORTS; SHORTS; MUSCLE TOPS; TANK-TOPS; SCRUBS NOT FOR MEDICAL PURPOSES; FLIP FLOPS; HATS, IN CLASS 25 (U.S. CLS. 22 AND 39).

FIRST USE 10-1-1985; IN COMMERCE 10-1-1985.

FOR: CATALOG ORDERING SERVICE FEATURING AFGHANS, TIE-DYE SHIRTS AND PANTS, CUSTOM LINED HOODED SWEATSHIRTS, PANTS, SHOES, SHIRTS, FOOTWEAR, BOXER SHORTS, BLANKETS, PILLOW CASES, HATS, AIRBRUSH DESIGNS, TRANSFERS, TWILL DESIGNS, RHINESTONE DESIGNS, FOIL PRINTS, AND PRINT DESIGNS; ELECTRONIC CATALOG SERVICES FEATURING AFGHANS, TIE-DYE SHIRTS AND PANTS, CUSTOM LINED HOODED SWEATSHIRTS, PANTS, SHOES, SHIRTS, FOOTWEAR, BOXER SHORTS, BLANKETS, PILLOW CASES, HATS, AIRBRUSH DESIGNS, TRANSFERS, TWILL DESIGNS, RHINESTONE DESIGNS, FOIL PRINTS, AND PRINT DESIGNS; MAIL ORDER CATALOG SERVI-

CES FEATURING AFGHANS, TIE-DYE SHIRTS AND PANTS, CUSTOM LINED HOODED SWEATSHIRTS, PANTS, SHOES, SHIRTS, FOOTWEAR, BOXER SHORTS, BLANKETS, PILLOW CASES, HATS, AIRBRUSH DESIGNS, TRANSFERS, TWILL DESIGNS, RHINESTONE DESIGNS, FOIL PRINTS, AND PRINT DESIGNS; PROMOTING THE GOODS AND SERVICES OF OTHERS THROUGH ON-LINE ORDERING AND CATALOGING OF THOSE GOODS AND SERVICES; COMPUTERIZED ON-LINE ORDERING SERVICES IN THE FIELD OF AFGHANS, TIE-DYE SHIRTS AND PANTS, CUSTOM LINED HOODED SWEATSHIRTS, PANTS, SHOES, SHIRTS, FOOTWEAR, BOXER SHORTS, BLANKETS, PILLOW CASES, HATS, AIRBRUSH DESIGNS, TRANSFERS, TWILL DESIGNS, RHINESTONE DESIGNS, FOIL PRINTS, AND PRINT DESIGNS; COMPUTERIZED ON-LINE RETAIL STORE SERVICES IN THE FIELD OF AFGHANS, TIE-DYE SHIRTS AND PANTS, CUSTOM LINED HOODED SWEATSHIRTS, PANTS, SHOES, SHIRTS, FOOTWEAR, BOXER SHORTS, BLANKETS, PILLOW CASES, HATS, AIRBRUSH DESIGNS, TRANSFERS, TWILL DESIGNS, RHINESTONE DESIGNS, FOIL PRINTS, AND PRINT DESIGNS; ON-LINE ORDERING SERVICES FEATURING AFGHANS, TIE-DYE SHIRTS AND PANTS, CUSTOM LINED HOODED SWEATSHIRTS, PANTS, SHOES, SHIRTS, FOOTWEAR, BOXER SHORTS, BLANKETS, PILLOW CASES, HATS, AIRBRUSH DESIGNS, TRANSFERS, TWILL DESIGNS, RHINESTONE DESIGNS, FOIL PRINTS, AND PRINT DESIGNS, IN CLASS 35 (U.S. CLS. 100, 101 AND 102).

FIRST USE 10-1-1985; IN COMMERCE 10-1-1985.

THE COLOR(S) BLACK AND BLUE IS/ARE CLAIMED AS A FEATURE OF THE MARK.

FEATURE OF THE MARK AND MERELY SHOWS THE TRANSPARENT AREAS IN THE MARK.

THE MARK CONSISTS OF A MAN OUTLINED IN BLACK, WITH OUTSTRETCHED ARMS WEARING BLUE SHORTS. THE COLOR WHITE IS NOT A

SER. NO. 77-341,518, FILED 11-30-2007.

MELISSA VALLILLO, EXAMINING ATTORNEY

Int. Cl.: 26

Prior U.S. Cls.: 37, 39, 40, 42 and 50

United States Patent and Trademark Office

Reg. No. 3,479,789

Registered Aug. 5, 2008

**TRADEMARK
PRINCIPAL REGISTER**

RIBBIES

RIBBIES, INC. (OKLAHOMA CORPORATION)
1612 REDTAIL HAWK
EDMOND, OK 73003

THE MARK CONSISTS OF STANDARD CHAR-
ACTERS WITHOUT CLAIM TO ANY PARTICULAR
FONT, STYLE, SIZE, OR COLOR.

FOR: HAIR CLIPS; HAIR CLIPS AND HOLDERS
THEREFORE SOLD AS A UNIT, IN CLASS 26 (U.S.
CLS. 37, 39, 40, 42 AND 50).

SER. NO. 77-341,581, FILED 11-30-2007.

FIRST USE 11-1-2006; IN COMMERCE 11-1-2006.

WON TEAK OH, EXAMINING ATTORNEY

Int. Cl.: 41

Prior U.S. Cls.: 100, 101 and 107

United States Patent and Trademark Office

Reg. No. 3,479,790

Registered Aug. 5, 2008

**SERVICE MARK
PRINCIPAL REGISTER**



SEAN MCKIRDY (UNITED STATES INDIVIDUAL)
83 NORTHWOOD ROAD
NEWINGTON, CT 06111 AND
ROBERT NUTINI (UNITED STATES INDIVIDUAL)
14 MELROSE LANE
SUFFIELD, CT 06078

FOR: INFORMATION TRACKING SERVICES FOR USE WITH EXERCISE EQUIPMENT AND EXERCISE REGIMES, NAMELY, MONITORING AND TRACKING INFORMATION PERTAINING TO EXERCISE AND FITNESS, IN CLASS 41 (U.S. CLS. 100, 101 AND 107).

FIRST USE 9-1-2007; IN COMMERCE 9-1-2007.

THE COLOR(S) BLUE, GRAY AND BLACK IS/ARE CLAIMED AS A FEATURE OF THE MARK.

THE MARK CONSISTS OF OF A BLUE SHAPE OF A PERSON RUNNING IN A PARTIAL CIRCLE CONSTRUCTED OF A GRAY LINE OF VARYING WIDTH AND THE WORD "FITISTICS" IN BLUE ABOVE A GRAY LINE WHICH ENDS IN A MULTI-PEAK SQUIGGLE RESEMBLING A HEART BEAT SIGNAL AND THE WORDS "FITNESS IN A FLASH" IN BLACK BELOW THE WORD "FITISTICS".

SER. NO. 77-341,589, FILED 11-30-2007.

BARNEY CHARLON, EXAMINING ATTORNEY

Int. Cl.: 37

Prior U.S. Cls.: 100, 103 and 106

United States Patent and Trademark Office

Reg. No. 3,479,791

Registered Aug. 5, 2008

**SERVICE MARK
PRINCIPAL REGISTER**

COMFORTPASS

GRA-TAC, INC. (KENTUCKY CORPORATION)
563 LOVERS LANE
BOWLING GREEN, KY 42101

THE MARK CONSISTS OF STANDARD CHAR-
ACTERS WITHOUT CLAIM TO ANY PARTICULAR
FONT, STYLE, SIZE, OR COLOR.

FOR: HVAC CONTRACTOR SERVICES, IN CLASS
37 (U.S. CLS. 100, 103 AND 106).

SER. NO. 77-341,770, FILED 11-30-2007.

FIRST USE 11-30-2007; IN COMMERCE 11-30-2007.

MICHAEL WEBSTER, EXAMINING ATTORNEY

Int. Cl.: 9

Prior U.S. Cls.: 21, 23, 26, 36 and 38

Reg. No. 3,479,792

United States Patent and Trademark Office

Registered Aug. 5, 2008

**TRADEMARK
PRINCIPAL REGISTER**

AppLoader

NEW RESOURCE GROUP CONSULTING, INC.
(CALIFORNIA CORPORATION)
SUITE 204
456 E ORANGE GROVE.
PASADENA, CA 91104

FOR: COMPUTER SOFTWARE FOR COMPUTER
SYSTEM AND APPLICATION DEVELOPMENT, DE-
PLOYMENT AND MANAGEMENT, IN CLASS 9
(U.S. CLS. 21, 23, 26, 36 AND 38).

FIRST USE 11-11-2005; IN COMMERCE 11-12-2005.

THE MARK CONSISTS OF STANDARD CHAR-
ACTERS WITHOUT CLAIM TO ANY PARTICULAR
FONT, STYLE, SIZE, OR COLOR.

SER. NO. 77-341,797, FILED 12-1-2007.

BRENDAN MCCAULEY, EXAMINING ATTORNEY

Int. Cl.: 28

Prior U.S. Cls.: 22, 23, 38 and 50

United States Patent and Trademark Office

Reg. No. 3,479,793

Registered Aug. 5, 2008

TRADEMARK
PRINCIPAL REGISTER



POZZA, DEBORAH C. (FLORIDA SOLE PROPRIETORSHIP)
1055 WOODYARD ROAD
DEFUNIAK SPRINGS, FL 32435

FOR: PLAYING CARDS AND CARD GAMES, IN CLASS 28 (U.S. CLS. 22, 23, 38 AND 50).

FIRST USE 8-16-2007; IN COMMERCE 9-29-2007.

THE COLOR(S) BLUE, GREEN, RED, ORANGE, AND YELLOW IS/ARE CLAIMED AS A FEATURE OF THE MARK.

THE WORD "FOTO" IS COMPRISED OF SEVERAL COLORS WHICH FADE INTO ONE ANOTHER STARTING WITH GREEN AT THE TOP AND FADING INTO VARIOUS SHADES OF BLUE; THE WORD "FEUD" STARTS WITH YELLOW AND ORANGE AT THE TOP AND FADES INTO DARKER ORANGE AND THEN INTO RED.

SER. NO. 77-341,914, FILED 12-1-2007.

SUE LAWRENCE, EXAMINING ATTORNEY

Int. Cl.: 38

Prior U.S. Cls.: 100, 101 and 104

United States Patent and Trademark Office

Reg. No. 3,479,794

Registered Aug. 5, 2008

**SERVICE MARK
PRINCIPAL REGISTER**

NEW TANG DYNASTY TELEVISION

UNIVERSAL COMMUNICATIONS NETWORK,
INC. (NEW JERSEY CORPORATION), DBA
NEW TANG DYNASTY TELEVISION
SUITE #1200
229 W. 28TH STREET
NEW YORK, NY 10001

FOR: BROADCASTING OF TELEVISION PRO-
GRAMMES; CABLE TELEVISION BROADCAST-
ING; SATELLITE TELEVISION BROADCASTING;
TELEVISION BROADCASTING; TELEVISION PRO-
GRAMME BROADCASTING VIA CABLE; BROAD-
CASTING PROGRAMS VIA A GLOBAL COMPUTER
NETWORK, IN CLASS 38 (U.S. CLS. 100, 101 AND
104).

FIRST USE 2-1-2002; IN COMMERCE 2-1-2002.

THE MARK CONSISTS OF STANDARD CHAR-
ACTERS WITHOUT CLAIM TO ANY PARTICULAR
FONT, STYLE, SIZE, OR COLOR.

NO CLAIM IS MADE TO THE EXCLUSIVE
RIGHT TO USE "TANG DYNASTY" AND "TELEVI-
SION", APART FROM THE MARK AS SHOWN.

SER. NO. 77-341,987, FILED 12-2-2007.

SHAILA SETTLES, EXAMINING ATTORNEY

Int. Cl.: 38

Prior U.S. Cls.: 100, 101 and 104

United States Patent and Trademark Office

Reg. No. 3,479,795

Registered Aug. 5, 2008

SERVICE MARK
PRINCIPAL REGISTER

新唐人電視台
New Tang Dynasty Television

UNIVERSAL COMMUNICATIONS NETWORK,
INC. (NEW JERSEY CORPORATION), DBA
NEW TANG DYNASTY TELEVISION
SUITE #1200
229 W. 28TH STREET
NEW YORK, NY 10001

FOR: BROADCASTING OF TELEVISION PRO-
GRAMMES; CABLE TELEVISION BROADCAST-
ING; SATELLITE TELEVISION BROADCASTING;
TELEVISION BROADCASTING; TELEVISION PRO-
GRAMME BROADCASTING VIA CABLE; BROAD-
CASTING PROGRAMS VIA A GLOBAL COMPUTER
NETWORK, IN CLASS 38 (U.S. CLS. 100, 101 AND
104).

FIRST USE 2-1-2002; IN COMMERCE 2-1-2002.

NO CLAIM IS MADE TO THE EXCLUSIVE
RIGHT TO USE "TANG DYNASTY TELEVISION"
AND THE CHINESE CHARACTERS THAT MEAN
"TANG DYNASTY TELEVISION", APART FROM
THE MARK AS SHOWN.

THE MARK CONSISTS OF THE WORDS "NEW
TANG DYNASTY TELEVISION" IN CHINESE AND
ENGLISH. THE CHINESE CHARACTERS ARE
ABOVE THE ENGLISH WORDS. THE TRANSLA-
TION OF THE CHINESE CHARACTERS IS "NEW
TANG DYNASTY TELEVISION".

THE FOREIGN WORDING IN THE MARK
TRANSLATES INTO ENGLISH AS NEW TANG
DYNASTY TELEVISION.

THE NON-LATIN CHARACTER(S) IN THE
MARK TRANSLITERATE INTO XIN TANG REN
DIAN SHI TAI, AND THIS MEANS NEW TANG
DYNASTY TELEVISION IN ENGLISH.

SER. NO. 77-341,994, FILED 12-2-2007.

SHAILA SETTLES, EXAMINING ATTORNEY

Int. Cl.: 25

Prior U.S. Cls.: 22 and 39

United States Patent and Trademark Office

Reg. No. 3,479,796

Registered Aug. 5, 2008

TRADEMARK
PRINCIPAL REGISTER



MARYED INTERNATIONAL, INC (FLORIDA CORPORATION)
1501 SE DECKER AVE., UNIT 104, BLDG A
STUART, FL 349943964

FOR: PAJAMAS, IN CLASS 25 (U.S. CLS. 22 AND 39).

FIRST USE 11-0-2007; IN COMMERCE 11-0-2007.

NO CLAIM IS MADE TO THE EXCLUSIVE RIGHT TO USE "POST-OP PAJAMAS" , APART FROM THE MARK AS SHOWN.

THE COLOR(S) WHITE, TEAL, TURQUOISE, GREEN, PINK, CORAL AND BRICK IS/ARE CLAIMED AS A FEATURE OF THE MARK.

THE MARK CONSISTS OF A MELTING ICE CUBE AND THE WORD "POPS" DISPLAYED IN

WHITE LETTERS INSIDE THE ICE CUBE. THE COLORS TEAL, TURQUOISE, GREEN, PINK, CORAL AND BRICK ARE DISPLAYED IN THE ICE CUBE FADING FROM TOP TO THE BOTTOM OF THE ICE CUBE. THE WORDING "POST-OP PAJAMAS" ARE DISPLAYED TO THE RIGHT OF THE ICE CUBE AND ARE DISPLAYED IN THE COLORS TEAL, TURQUOISE, GREEN, PINK, CORAL AND BRICK FADING FROM THE TOP OF THE WORDING TO THE BOTTOM OF THE WORDING. THE LETTERS "P" IN "POST," "O" IN "OP", "P" IN "PAJAMAS" AND "S" IN "PAJAMAS" ALL DISPLAY A WHITE MELTING SNOWCAP ON TOP OF THE LETTERS. THE LETTER "S" DISPLAYS AN ADDITIONAL SNOWCAP IN THE MIDDLE OF THE "S".

SER. NO. 77-342,053, FILED 12-2-2007.

RENEE SERVANCE, EXAMINING ATTORNEY

Int. Cl.: 21

Prior U.S. Cls.: 2, 13, 23, 29, 30, 33, 40 and 50

United States Patent and Trademark Office

Reg. No. 3,479,797

Registered Aug. 5, 2008

**TRADEMARK
PRINCIPAL REGISTER**

SANTA ANITA

CINSA, S.A. DE C.V. (MEXICO CORPORATION)
BLVD. ISIDRO LOPE ZERTUCHE 1495
SALTILLO, MEXICO 25000

FOR: HOUSEWARES OF ENAMELED PEWTER,
NAMELY, STRAIGHT SUGAR BOWLS, MIXING
SPOONS, SERVING SPOONS, CREAM PITCHERS,
OATMEAL BOWLS, SOUP DISHES, SAUCERS,
FLAT DISHES, BOWL CUPS, CUPS, BUTTER
DISHES, TAPERED COFFEE POTS, TAPERED
BOWLS, AND DEEP ROUND BOWLS, IN CLASS 21
(U.S. CLS. 2, 13, 23, 29, 30, 33, 40 AND 50).

THE MARK CONSISTS OF STANDARD CHAR-
ACTERS WITHOUT CLAIM TO ANY PARTICULAR
FONT, STYLE, SIZE, OR COLOR.

OWNER OF MEXICO REG. NO. 415380, DATED 4-
16-1991, EXPIRES 4-16-2011.

THE ENGLISH TRANSLATION OF "SANTA" IN
THE MARK IS "SAINT".

SER. NO. 77-342,179, FILED 12-3-2007.

LINDA M. KING, EXAMINING ATTORNEY

Int. Cl.: 44

Prior U.S. Cls.: 100 and 101

United States Patent and Trademark Office

Reg. No. 3,479,798

Registered Aug. 5, 2008

**SERVICE MARK
PRINCIPAL REGISTER**

**LEAVE YOUR TAN LINES AT
THE DOOR...**

BRONZE BAY TANNING, LLC (MICHIGAN LTD
LIAB CO)
109 E. GRAND RIVER AVE
EAST LANSING, MI 48823

THE MARK CONSISTS OF STANDARD CHAR-
ACTERS WITHOUT CLAIM TO ANY PARTICULAR
FONT, STYLE, SIZE, OR COLOR.

FOR: TANNING SALONS FEATURING INDOOR
UV TANNING SERVICES AND UV-LESS TANNING,
IN CLASS 44 (U.S. CLS. 100 AND 101).

SER. NO. 77-342,300, FILED 12-3-2007.

FIRST USE 2-1-2004; IN COMMERCE 2-1-2004.

ROBERT C. CLARK JR., EXAMINING ATTORNEY

Int. Cl.: 20

Prior U.S. Cls.: 2, 13, 22, 25, 32 and 50

United States Patent and Trademark Office

Reg. No. 3,479,799

Registered Aug. 5, 2008

**TRADEMARK
PRINCIPAL REGISTER**

EXACTSLIDE

TCI SUPPLY, INC. (NORTH CAROLINA CORPORATION)
4850 MCWAY COURT
THOMASVILLE, NC 27360

THE MARK CONSISTS OF STANDARD CHARACTERS WITHOUT CLAIM TO ANY PARTICULAR FONT, STYLE, SIZE, OR COLOR.

FOR: FURNITURE HARDWARE, NAMELY, METAL DRAWER SLIDES, IN CLASS 20 (U.S. CLS. 2, 13, 22, 25, 32 AND 50).

SER. NO. 77-342,326, FILED 12-3-2007.

FIRST USE 7-1-2006; IN COMMERCE 7-1-2006.

ROBERT C. CLARK JR., EXAMINING ATTORNEY

Int. Cl.: 9

Prior U.S. Cls.: 21, 23, 26, 36 and 38

Reg. No. 3,479,800

United States Patent and Trademark Office

Registered Aug. 5, 2008

TRADEMARK
PRINCIPAL REGISTER



BELKER, WHITNEY (UNITED STATES INDIVIDUAL)
SUITE 409
1 CENTURY LANE
MIAMI BEACH, FL 33139

FOR: DIGITAL MEDIA, NAMELY, PRE-RECORDED VIDEO CASSETTES, DIGITAL VIDEO DISCS, DIGITAL VERSATILE DISCS, DOWNLOADABLE AUDIO AND VIDEO RECORDINGS, DVDS, AND HIGH DEFINITION DIGITAL DISKS FEATURING AUDIOVISUAL AND MUSICAL RECORDINGS; MUSICAL SOUND RECORDINGS; MUSICAL VIDEO RECORDINGS; PRE-RECORDED CDS, VIDEO TAPES, LASER DISKS AND DVDS FEATURING AUDIOVISUAL AND MUSICAL RECORDINGS; COMPUTER SOFTWARE FOR COMPOSITION, EDITING AND PRODUCTION OF MUSIC, IN CLASS 9 (U.S. CLS. 21, 23, 26, 36 AND 38).

FIRST USE 7-24-2007; IN COMMERCE 7-24-2007.

NO CLAIM IS MADE TO THE EXCLUSIVE RIGHT TO USE "THE MUSIC PRODUCER", APART FROM THE MARK AS SHOWN.

THE COLOR(S) RED AND GRAY IS/ARE CLAIMED AS A FEATURE OF THE MARK.

THE MARK CONSISTS OF THE WORDS "THE MUSIC" IN GRAY WITH A MUSICAL NOTE DESIGN ADJACENT TO THE WORDS ALSO IN GRAY WITH MULTIPLE RED BOXES OF VARYING SIZES DISPOSED ON THE RIGHT SIDE OF SUCH MUSICAL NOTE DESIGN, WITH THE WORD "PRODUCER" ENCLOSED IN A RED BOX BACKGROUND UNDERNEATH THE WORDS "THE MUSIC".

SER. NO. 77-342,404, FILED 12-3-2007.

JULIE WATSON, EXAMINING ATTORNEY

Int. Cl.: 31

Prior U.S. Cls.: 1 and 46

United States Patent and Trademark Office

Reg. No. 3,479,801

Registered Aug. 5, 2008

**TRADEMARK
PRINCIPAL REGISTER**

VERA WANG

V.E.W., LTD. (DELAWARE CORPORATION)
225 WEST 39TH STREET
NEW YORK, NY 10018

OWNER OF U.S. REG. NOS. 2,495,866, 3,234,315
AND OTHERS.

FOR: FLOWERS, NAMELY, LIVE CUT FLOWERS
AND LIVE CUT FLORAL ARRANGEMENTS; LIVE
PLANTS, IN CLASS 31 (U.S. CLS. 1 AND 46).

THE NAME(S), PORTRAIT(S), AND/OR SIGNA-
TURE(S) SHOWN IN THE MARK IDENTIFIES
"VERA WANG", WHOSE CONSENT(S) TO REGIS-
TER IS SUBMITTED.

FIRST USE 1-1-2007; IN COMMERCE 1-1-2007.

SER. NO. 77-342,465, FILED 12-3-2007.

THE MARK CONSISTS OF STANDARD CHAR-
ACTERS WITHOUT CLAIM TO ANY PARTICULAR
FONT, STYLE, SIZE, OR COLOR.

KATHERINE CHANG, EXAMINING ATTORNEY

Int. Cl.: 43

Prior U.S. Cls.: 100 and 101

United States Patent and Trademark Office

Reg. No. 3,479,802

Registered Aug. 5, 2008

**SERVICE MARK
PRINCIPAL REGISTER**

VERA WANG

V.E.W., LTD. (DELAWARE CORPORATION)
225 WEST 39TH STREET
NEW YORK, NY 10018

FOR: HOTEL SERVICES, IN CLASS 43 (U.S. CLS.
100 AND 101).

FIRST USE 5-1-2005; IN COMMERCE 5-1-2005.

THE MARK CONSISTS OF STANDARD CHAR-
ACTERS WITHOUT CLAIM TO ANY PARTICULAR
FONT, STYLE, SIZE, OR COLOR.

OWNER OF U.S. REG. NOS. 2,495,866, 3,234,315
AND OTHERS.

THE NAME(S), PORTRAIT(S), AND/OR SIGNA-
TURE(S) SHOWN IN THE MARK IDENTIFIES
"VERA WANG", WHOSE CONSENT(S) TO REGIS-
TER IS SUBMITTED.

SER. NO. 77-342,471, FILED 12-3-2007.

KATHERINE CHANG, EXAMINING ATTORNEY

Int. Cl.: 5

Prior U.S. Cls.: 6, 18, 44, 46, 51 and 52

Reg. No. 3,479,803

United States Patent and Trademark Office

Registered Aug. 5, 2008

**TRADEMARK
PRINCIPAL REGISTER**

POWER PEARL

W.F. YOUNG, INCORPORATED (MASSACHU-
SETTS CORPORATION)
302 BENTON DRIVE
EAST LONGMEADOW, MA 01028

FOR: ANIMAL FEED SUPPLEMENTS; VETERIN-
ARY PREPARATIONS, NAMELY, RASH OINT-
MENTS, ANTI-ITCH OINTMENTS, LINIMENTS,
PAIN RELIEF MEDICATIONS; ANTI-INSECT
SPRAY AND INSECT REPELLENTS, IN CLASS 5
(U.S. CLS. 6, 18, 44, 46, 51 AND 52).

FIRST USE 10-0-2007; IN COMMERCE 12-1-2007.

THE MARK CONSISTS OF STANDARD CHAR-
ACTERS WITHOUT CLAIM TO ANY PARTICULAR
FONT, STYLE, SIZE, OR COLOR.

SER. NO. 77-342,508, FILED 12-3-2007.

FRED CARL, EXAMINING ATTORNEY

Int. Cl.: 41

Prior U.S. Cls.: 100, 101 and 107

United States Patent and Trademark Office

Reg. No. 3,479,804

Registered Aug. 5, 2008

**SERVICE MARK
PRINCIPAL REGISTER**

**THE MEDICAL COMMUNITY
SPEAKS**

2 UNDER ENTERTAINMENT (OHIO LTD LIAB
CO)
SUITE 100
1404 GOODALE BOULEVARD
COLUMBUS, OH 43212

FOR: ENTERTAINMENT SERVICES, NAMELY,
AN ONGOING MEDICAL DOCUMENTARY SERIES
PROVIDED THROUGH SATELLITE-DELIVERED
TELEVISION, TELEVISION, INTERNET PROTO-
COL TELEVISION, THE INTERNET, AND MOBILE
TELECOMMUNICATION NETWORKS, IN CLASS
41 (U.S. CLS. 100, 101 AND 107).

FIRST USE 11-3-2007; IN COMMERCE 11-3-2007.

THE MARK CONSISTS OF STANDARD CHAR-
ACTERS WITHOUT CLAIM TO ANY PARTICULAR
FONT, STYLE, SIZE, OR COLOR.

SER. NO. 77-342,568, FILED 12-3-2007.

BRIAN PINO, EXAMINING ATTORNEY

Int. Cl.: 42

Prior U.S. Cls.: 100 and 101

United States Patent and Trademark Office

Reg. No. 3,479,805

Registered Aug. 5, 2008

**SERVICE MARK
PRINCIPAL REGISTER**

NUSTART ENERGY

NUSTART ENERGY DEVELOPMENT, LLC (DE-
LAWARE LTD LIAB CO)
200 EXELON WAY, KSA 3-N
KENNETT SQUARE, PA 19348

FOR: DEVELOPING A PROCESS AND CRITERIA
IN THE NATURE OF ENGINEERING REQUIRE-
MENTS FOR LICENSING NUCLEAR POWER
PLANTS FOR OTHERS; DESIGN CONSULTING
FOR NUCLEAR POWER PLANTS, IN CLASS 42
(U.S. CLS. 100 AND 101).

FIRST USE 8-16-2007; IN COMMERCE 8-16-2007.

THE MARK CONSISTS OF STANDARD CHAR-
ACTERS WITHOUT CLAIM TO ANY PARTICULAR
FONT, STYLE, SIZE, OR COLOR.

OWNER OF U.S. REG. NO. 3,385,861.

NO CLAIM IS MADE TO THE EXCLUSIVE
RIGHT TO USE "ENERGY", APART FROM THE
MARK AS SHOWN.

SER. NO. 77-342,585, FILED 12-3-2007.

ADA HAN, EXAMINING ATTORNEY

Int. Cls.: 16 and 41

Prior U.S. Cls.: 2, 5, 22, 23, 29, 37, 38, 50, 100, 101 and 107

Reg. No. 3,479,806

United States Patent and Trademark Office

Registered Aug. 5, 2008

**TRADEMARK
SERVICE MARK
PRINCIPAL REGISTER**

BEST OF NYC

VILLAGE VOICE MEDIA HOLDINGS, LLC (DE-
LAWARE LTD LIAB CO)
1201 EAST JEFFERSON STREET
PHOENIX, AZ 85034

FOR: ANNUAL NEWSPAPER SUPPLEMENTS IN
THE FIELD OF LISTING INDIVIDUALS AND BUSI-
NESSES THAT HAVE ACHIEVED EXCELLENCE IN
AREAS OF INTEREST TO THE GENERAL PUBLIC,
IN CLASS 16 (U.S. CLS. 2, 5, 22, 23, 29, 37, 38 AND 50).

FIRST USE 9-24-1999; IN COMMERCE 9-24-1999.

FOR: CONDUCTING AWARDS PROGRAMS
HONORING INDIVIDUALS AND COMPANIES
THAT HAVE DEMONSTRATED EXCELLENCE IN
THEIR FIELDS, IN THE QUALITY OF THEIR

PRODUCTS AND SERVICES AND IN CUSTOMER
SERVICE, IN CLASS 41 (U.S. CLS. 100, 101 AND 107).

FIRST USE 9-24-1999; IN COMMERCE 9-24-1999.

THE MARK CONSISTS OF STANDARD CHAR-
ACTERS WITHOUT CLAIM TO ANY PARTICULAR
FONT, STYLE, SIZE, OR COLOR.

OWNER OF U.S. REG. NO. 2,652,951.

SEC. 2(F).

SER. NO. 77-342,743, FILED 12-3-2007.

SALLY SHIH, EXAMINING ATTORNEY

Int. Cl.: 35

Prior U.S. Cls.: 100, 101 and 102

United States Patent and Trademark Office

Reg. No. 3,479,807

Registered Aug. 5, 2008

**SERVICE MARK
PRINCIPAL REGISTER**

StudioBaby

MUSICBABY LLC (WYOMING LTD LIAB CO)
2710 THOMES AVE
CHEYENNE, WY 820013029

FIRST USE 3-6-2006; IN COMMERCE 3-6-2006.

FOR: PROVIDING A WEBSITE THAT FEATURES AN ONLINE MARKET FOR USERS TO LIST OFFERED OR WANTED PERSONAL AND BUSINESS ASSETS AND SKILLS FOR HIRE, RENT, SALE OR AUCTION TRANSACTED ON THE BASIS OF PRE-DEFINED PERFORMANCE AND CLOSING TERMS AND CONDITIONS, IN CLASS 35 (U.S. CLS. 100, 101 AND 102).

THE MARK CONSISTS OF STANDARD CHARACTERS WITHOUT CLAIM TO ANY PARTICULAR FONT, STYLE, SIZE, OR COLOR.

SER. NO. 77-342,753, FILED 12-3-2007.

ELIZABETH HUGHITT, EXAMINING ATTORNEY

Int. Cl.: 35

Prior U.S. Cls.: 100, 101 and 102

United States Patent and Trademark Office

Reg. No. 3,479,808

Registered Aug. 5, 2008

**SERVICE MARK
PRINCIPAL REGISTER**

HARDWARE SECRETS

HARDWARE SECRETS, LLC (NEVADA LTD
LIAB CO)
2248 MERIDIAN BLVD., SUITE H
MINDEN, NV 89423

FOR: PROVIDING CONSUMER INFORMATION
FEATURING COMMENTARY, EVALUATIONS
AND PRODUCT DESCRIPTIONS IN THE FIELDS
OF COMPUTERS, COMPUTING, HIGH TECHNOL-
OGY, ELECTRONIC COMMUNICATIONS OR DI-
GITAL TECHNOLOGIES; PROVIDING COMPUTER
DATABASES FEATURING CONSUMER PRODUCT
AND SERVICE INFORMATION IN THE FIELDS OF
COMPUTERS, COMPUTING, HIGH TECHNOLO-
GY, ELECTRONIC COMMUNICATIONS OR DI-
GITAL TECHNOLOGIES, IN CLASS 35 (U.S. CLS. 100,
101 AND 102).

FIRST USE 1-0-2005; IN COMMERCE 1-0-2005.

THE MARK CONSISTS OF STANDARD CHAR-
ACTERS WITHOUT CLAIM TO ANY PARTICULAR
FONT, STYLE, SIZE, OR COLOR.

NO CLAIM IS MADE TO THE EXCLUSIVE
RIGHT TO USE "HARDWARE", APART FROM
THE MARK AS SHOWN.

SER. NO. 77-342,913, FILED 12-3-2007.

DANIEL BRODY, EXAMINING ATTORNEY

Int. Cl.: 41

Prior U.S. Cls.: 100, 101 and 107

United States Patent and Trademark Office

Reg. No. 3,479,809

Registered Aug. 5, 2008

**SERVICE MARK
PRINCIPAL REGISTER**

KINGS & PRIESTS

KINGS & PRIESTS UNLIMITED, INC. (GEORGIA CORPORATION)
3120 THORNBRIDGE TRAIL
DOUGLASVILLE, GA 30135

FOR: EDUCATION SERVICES, NAMELY, PROVIDING SEMINARS, TRAINING, WORKSHOPS, CONFERENCES AND MEETINGS IN THE FIELDS OF BUSINESS, ENTREPRENEURSHIP AND MINISTRY; MEETING AND SEMINAR ARRANGING IN THE FIELDS OF BUSINESS, ENTREPRENEURSHIP AND MINISTRY; ELECTRONIC NEWSLETTERS IN THE FIELDS OF BUSINESS, ENTREPRENEURSHIP

AND MINISTRY, IN CLASS 41 (U.S. CLS. 100, 101 AND 107).

FIRST USE 6-0-1999; IN COMMERCE 6-0-1999.

THE MARK CONSISTS OF STANDARD CHARACTERS WITHOUT CLAIM TO ANY PARTICULAR FONT, STYLE, SIZE, OR COLOR.

SER. NO. 77-342,924, FILED 12-3-2007.

CAROLYN GRAY, EXAMINING ATTORNEY

Int. Cl.: 35

Prior U.S. Cls.: 100, 101 and 102

United States Patent and Trademark Office

Reg. No. 3,479,810

Registered Aug. 5, 2008

**SERVICE MARK
PRINCIPAL REGISTER**



VOX ENTERTAINMENT, INC. (CALIFORNIA CORPORATION)
115 LOMITA STREET
EL SEGUNDO, CA 90245

FOR: ARRANGING AND CONDUCTING MARKETING PROMOTIONAL EVENTS FOR OTHERS, NAMELY, BY PROVIDING STAGE, SOUND, LIGHTING AND DECOR, IN CLASS 35 (U.S. CLS. 100, 101 AND 102).

FIRST USE 9-1-2007; IN COMMERCE 9-1-2007.

NO CLAIM IS MADE TO THE EXCLUSIVE RIGHT TO USE "PRODUCTIONS", APART FROM THE MARK AS SHOWN.

THE COLOR(S) BLACK, WHITE AND RED IS/ ARE CLAIMED AS A FEATURE OF THE MARK.

THE MARK CONSISTS OF A BLACK OUTLINE OF A CIRCLE, A WHITE CIRCLE INSIDE, THEN A BLACK HALF CIRCLE WITH THE WORDS "VOX" PRODUCTIONS INSIDE IN BLACK, WITH A RED THICK LINE STARTING AT THE "V" AND WRAPPING AROUND UNTIL THE END OF THE WORD "PRODUCTIONS".

SER. NO. 77-342,990, FILED 12-3-2007.

HOWARD SMIGA, EXAMINING ATTORNEY

Int. Cl.: 42

Prior U.S. Cls.: 100 and 101

United States Patent and Trademark Office

Reg. No. 3,479,811

Registered Aug. 5, 2008

**SERVICE MARK
PRINCIPAL REGISTER**

KeyMetric

KEYMETRIC, INC. (NEVADA CORPORATION)
SUITE #101-377 800 FIFTH AVENUE
SEATTLE, WA 98104

FOR: COMPUTER SERVICE, NAMELY, ACTING AS AN APPLICATION SERVICE PROVIDER IN THE FIELD OF KNOWLEDGE MANAGEMENT TO HOST COMPUTER APPLICATION SOFTWARE FOR THE COLLECTION, EDITING, ORGANIZING, MODIFYING, BOOK MARKING, TRANSMISSION, STORAGE AND SHARING OF DATA AND INFORMATION; COMPUTER CONSULTATION REGARDING THE USE OF WEBSITES AND INTERNET ADVERTISEMENTS; COMPUTER SERVICES, NAMELY, TRACKING ANALYZING, RECORDING, EVALUATING, REPORTING, REGARDING THE USE OF WEBSITES AND INTERNET ADVERTISEMENTS OF OTHERS; COMPUTER SERVICES, NAMELY, PERFORMANCE MONITORING AND REPORTING USING MATHEMATICAL AND STA-

TISTICAL ANALYSIS OF THE WEBSITES AND INTERNET ADVERTISEMENTS OF OTHERS; COMPUTER SERVICES, NAMELY, MONITORING, COMPILING DATA, AND INTEGRATION OF NETWORK AND TELECOMMUNICATIONS SYSTEMS DATA OF OTHERS TO MEASURE THE USE AND EFFECTIVENESS OF WEBSITES AND INTERNET ADVERTISEMENTS, IN CLASS 42 (U.S. CLS. 100 AND 101).

FIRST USE 12-3-2006; IN COMMERCE 2-6-2007.

THE MARK CONSISTS OF STANDARD CHARACTERS WITHOUT CLAIM TO ANY PARTICULAR FONT, STYLE, SIZE, OR COLOR.

SER. NO. 77-343,010, FILED 12-3-2007.

MICHAEL LITZAU, EXAMINING ATTORNEY

Int. Cls.: 6, 11, 17, 19 and 20

Prior U.S. Cls.: 1, 2, 5, 12, 13, 14, 21, 22, 23, 25, 31, 32, 33, 34, 35 and 50

Reg. No. 3,479,812

United States Patent and Trademark Office

Registered Aug. 5, 2008

**TRADEMARK
PRINCIPAL REGISTER**

RIFENG

FOSHAN RIFENG ENTERPRISES CO., LTD (CHINA LTD LIAB CO)
ZUMIAO ROAD, FOSHAN CITY
8TH/F, RIFENG BUILDING, NO. 16
GUANGDONG, CHINA

FOR: DRAIN PIPES MADE OF METAL; ELBOWS OF METAL FOR PIPES; METAL DRAIN PIPES; METAL GUTTER PIPES; METAL JUNCTIONS FOR PIPES; METAL PIPE CLIPS; METAL PIPE COLLARS; METAL PIPE CONNECTORS; METAL PIPE COUPLINGS AND JOINTS; METAL PIPES AND FITTINGS THEREFOR; TOWEL DISPENSERS OF METAL; TOWEL HOOKS OF METAL; METAL GUTTERS; METAL CONDUIT, IN CLASS 6 (U.S. CLS. 2, 12, 13, 14, 23, 25 AND 50).

FIRST USE 6-6-2001; IN COMMERCE 9-15-2002.

FOR: SPIGOTS; HEATING SYSTEMS COMPOSED PRIMARILY OF TUBES, PIPES AND PRE-ASSEMBLED MANIFOLDS THROUGH WHICH COLD OR LOW TEMPERATURE WATER CIRCULATES; FAUCETS; PIPES BEING PARTS OF SANITARY FACILITIES; MIXER FAUCETS FOR WATER PIPES; HEAT PIPES TO COOL HEAT PRODUCING COMPONENTS; BATH TUBS; SHOWER HEADS; PLUMBING FITTINGS, NAMELY, DRAINS, IN CLASS 11 (U.S. CLS. 13, 21, 23, 31 AND 34).

FIRST USE 6-6-2001; IN COMMERCE 9-15-2002.

FOR: RUBBER TUBES AND PIPES; FLEXIBLE PIPES, NOT OF METAL; FLEXIBLE PLASTIC PIPES FOR PLUMBING PURPOSES; FLEXIBLE PLUMBING PIPES OF PLASTIC; JOINT PACKING FOR PLUMBING PIPES; JUNCTIONS NOT OF METAL FOR PLUMBING PIPES; NON-METAL PIPE COLLARS; NON-METAL PIPE COUPLINGS AND JOINTS; NON-METAL PIPE MUFFS FOR USE WITH PLUMBING PIPES; NON-METAL TUBING AND

TUBING COUPLINGS FOR JOINING AND TERMINATING PIPES; PIPE GASKETS; PIPE JOINT COMPOUND; PIPE JOINT SEALANT; PIPE JOINT TAPE; INSULATION JACKETS FOR INDUSTRIAL PIPES; FIRE HOSES; PLASTIC HOSES FOR PLUMBING USE; WATERING HOSES; ADHESIVE BANDS OTHER THAN FOR STATIONERY AND NOT FOR MEDICAL OR HOUSEHOLD PURPOSES, IN CLASS 17 (U.S. CLS. 1, 5, 12, 13, 35 AND 50).

FIRST USE 6-6-2001; IN COMMERCE 9-15-2002.

FOR: NON-METAL WATER PIPES; RIGID PIPES, NOT OF METAL; NON-METAL GUTTER PIPES; POLYETHYLENE PIPE USED IN GEOTHERMAL HEATING AND COOLING SYSTEMS; FLOOR BOARDS; NON-METAL CLADDING FOR CONSTRUCTION AND BUILDING; BUILDING MATERIALS, NAMELY, COMPOSITE PANELS COMPOSED PRIMARILY OF NONMETAL MATERIALS; NON-METAL DRAINS FOR USE IN CONSTRUCTION OF BASEMENT WATERPROOFING SYSTEM; DRAIN PIPES MADE OF PLASTIC, IN CLASS 19 (U.S. CLS. 1, 12, 33 AND 50).

FIRST USE 6-6-2001; IN COMMERCE 9-15-2002.

FOR: ELBOWS NOT OF METAL FOR PIPES; NON-METAL PIPE CLIPS, IN CLASS 20 (U.S. CLS. 2, 13, 22, 25, 32 AND 50).

FIRST USE 6-6-2001; IN COMMERCE 9-15-2002.

THE MARK CONSISTS OF STANDARD CHARACTERS WITHOUT CLAIM TO ANY PARTICULAR FONT, STYLE, SIZE, OR COLOR.

OWNER OF U.S. REG. NO. 2,910,520.

SER. NO. 77-343,245, FILED 12-4-2007.

ELIZABETH HUGHITT, EXAMINING ATTORNEY

Int. Cl.: 3

Prior U.S. Cls.: 1, 4, 6, 50, 51 and 52

United States Patent and Trademark Office

Reg. No. 3,479,813

Registered Aug. 5, 2008

**TRADEMARK
PRINCIPAL REGISTER**

AMAZÔNIA NUTRIENTS

AMAZONIA NUTRIENTS INC. (CALIFORNIA
CORPORATION)
1042 2ND STREET
MANHATTAN BEACH, CA 90266

FOR: SKIN SOAPS ; BATH SOAPS IN LIQUID,
SOLID OR GEL FORM ; BODY CREAM SOAP ;
COSMETIC SOAPS ; CREAM SOAPS ; DEODORANT
SOAP ; HAND SOAPS ; LIQUID BATH SOAPS ;
LIQUID SOAP USED IN FOOT BATH ; LIQUID
SOAPS ; LIQUID SOAPS FOR HANDS, FACE AND
BODY ; MEDICATED SOAP ; PERFUMED SOAPS ;
SOAPS FOR BODY CARE ; SOAPS FOR PERSONAL
USE ; HAIR TREATMENT PRODUCTS, NAMELY,
HAIR SHAMPOOS, HAIR RINSES, HAIR SHAMPOO
CONDITIONERS AND HAIR COLORING SHAM-
POOS, IN CLASS 3 (U.S. CLS. 1, 4, 6, 50, 51 AND 52).

FIRST USE 1-5-2007; IN COMMERCE 5-16-2007.

THE MARK CONSISTS OF STANDARD CHAR-
ACTERS WITHOUT CLAIM TO ANY PARTICULAR
FONT, STYLE, SIZE, OR COLOR.

NO CLAIM IS MADE TO THE EXCLUSIVE
RIGHT TO USE "NUTRIENTS", APART FROM
THE MARK AS SHOWN.

SER. NO. 77-343,384, FILED 12-4-2007.

RICHARD WHITE, EXAMINING ATTORNEY

Int. Cls.: 6, 11, 17, 19 and 20

Prior U.S. Cls.: 1, 2, 5, 12, 13, 14, 21, 22, 23, 25, 31, 32, 33, 34, 35 and 50

Reg. No. 3,479,814

United States Patent and Trademark Office

Registered Aug. 5, 2008

**TRADEMARK
PRINCIPAL REGISTER**



FOSHAN RIFENG ENTERPRISES CO., LTD (CHINA LTD LIAB CO)
ZUMIAO ROAD, FOSHAN CITY
8TH/F, RIFENG BUILDING, NO. 16
GUANGDONG, CHINA

FOR: DRAIN PIPES MADE OF METAL; ELBOWS OF METAL FOR PIPES; METAL DRAIN PIPES; METAL GUTTER PIPES; METAL JUNCTIONS FOR PIPES; METAL PIPE CLIPS; METAL PIPE COLLARS; METAL PIPE CONNECTORS; METAL PIPE COUPLINGS AND JOINTS; METAL PIPES AND FITTINGS THEREFOR; TOWEL DISPENSERS OF METAL; TOWEL HOOKS OF METAL; METAL GUTTERS; METAL CONDUIT, IN CLASS 6 (U.S. CLS. 2, 12, 13, 14, 23, 25 AND 50).

FIRST USE 6-6-2001; IN COMMERCE 9-15-2002.

FOR: SPIGOTS; HEATING SYSTEMS COMPOSED PRIMARILY OF TUBES, PIPES AND PRE-ASSEMBLED MANIFOLDS THROUGH WHICH COLD OR LOW TEMPERATURE WATER CIRCULATES; FAUCETS; PIPES BEING PARTS OF SANITARY FACILITIES; MIXER FAUCETS FOR WATER PIPES; HEAT PIPES TO COOL HEAT PRODUCING COMPONENTS; BATH TUBS; SHOWER HEADS; PLUMBING FITTINGS, NAMELY, DRAINS, IN CLASS 11 (U.S. CLS. 13, 21, 23, 31 AND 34).

FIRST USE 6-6-2001; IN COMMERCE 9-15-2002.

FOR: RUBBER TUBES AND PIPES; FLEXIBLE PIPES, NOT OF METAL; FLEXIBLE PLASTIC PIPES FOR PLUMBING PURPOSES; FLEXIBLE PLUMB-

ING PIPES OF PLASTIC; JOINT PACKING FOR PLUMBING PIPES; JUNCTIONS NOT OF METAL FOR PLUMBING PIPES; NON-METAL PIPE COLLARS; NON-METAL PIPE COUPLINGS AND JOINTS; NON-METAL PIPE MUFFS FOR USE WITH PLUMBING PIPES; NON-METAL TUBING AND TUBING COUPLINGS FOR JOINING AND TERMINATING PIPES; PIPE GASKETS; PIPE JOINT COMPOUND; PIPE JOINT SEALANT; PIPE JOINT TAPE; INSULATION JACKETS FOR INDUSTRIAL PIPES; FIRE HOSES; PLASTIC HOSES FOR PLUMBING USE; WATERING HOSES; ADHESIVE BANDS OTHER THAN FOR STATIONERY AND NOT FOR MEDICAL OR HOUSEHOLD PURPOSES, IN CLASS 17 (U.S. CLS. 1, 5, 12, 13, 35 AND 50).

FIRST USE 6-6-2001; IN COMMERCE 9-15-2002.

FOR: NON-METAL WATER PIPES; RIGID PIPES, NOT OF METAL; NON-METAL GUTTER PIPES; POLYETHYLENE PIPE USED IN GEOTHERMAL HEATING AND COOLING SYSTEMS; FLOOR BOARDS; NON-METAL CLADDING FOR CONSTRUCTION AND BUILDING; BUILDING MATERIALS, NAMELY, COMPOSITE PANELS COMPOSED PRIMARILY OF NONMETAL MATERIALS; NON-METAL DRAINS FOR USE IN CONSTRUCTION OF BASEMENT WATERPROOFING SYSTEM; DRAIN PIPES MADE OF PLASTIC, IN CLASS 19 (U.S. CLS. 1, 12, 33 AND 50).

FIRST USE 6-6-2001; IN COMMERCE 9-15-2002.

FOR: ELBOWS NOT OF METAL FOR PIPES; NON-METAL PIPE CLIPS, IN CLASS 20 (U.S. CLS. 2, 13, 22, 25, 32 AND 50).

FIRST USE 6-6-2001; IN COMMERCE 9-15-2002.

THE MARK CONSISTS OF TWO BROKEN SEMI-CIRCLES.

SER. NO. 77-343,398, FILED 12-4-2007.

ELIZABETH HUGHITT, EXAMINING ATTORNEY

Int. Cl.: 36

Prior U.S. Cls.: 100, 101 and 102

United States Patent and Trademark Office

Reg. No. 3,479,815

Registered Aug. 5, 2008

**SERVICE MARK
PRINCIPAL REGISTER**

SUCCESSION PROTECTOR

AMERIPRISE FINANCIAL, INC. (DELAWARE CORPORATION)
H27/5226 AMERIPRISE FINANCIAL CENTER
MINNEAPOLIS, MN 55474

OWNER OF U.S. REG. NOS. 2,820,199, 3,336,690 AND OTHERS.

FOR: FINANCIAL SERVICES, NAMELY, UNDERWRITING UNIVERSAL LIFE INSURANCE PRODUCTS, IN CLASS 36 (U.S. CLS. 100, 101 AND 102).

NO CLAIM IS MADE TO THE EXCLUSIVE RIGHT TO USE "SUCCESSION", APART FROM THE MARK AS SHOWN.

FIRST USE 12-3-2007; IN COMMERCE 12-3-2007.

SER. NO. 77-343,445, FILED 12-4-2007.

THE MARK CONSISTS OF STANDARD CHARACTERS WITHOUT CLAIM TO ANY PARTICULAR FONT, STYLE, SIZE, OR COLOR.

LINDA ESTRADA, EXAMINING ATTORNEY

Int. Cl.: 35

Prior U.S. Cls.: 100, 101 and 102

United States Patent and Trademark Office

Reg. No. 3,479,816

Registered Aug. 5, 2008

**SERVICE MARK
PRINCIPAL REGISTER**



**NORTH AMERICAN SPINE SOCIETY (TEXAS
NON-PROFIT CORPORATION)**

7075 VETERANS BOULEVARD

BURR RIDGE, IL 60527

**FOR: ASSOCIATION SERVICES, NAMELY, PRO-
MOTING THE INTERESTS OF SPINE CARE PRO-
VIDERS AND PROFESSIONALS, IN CLASS 35 (U.S.
CLS. 100, 101 AND 102).**

FIRST USE 11-10-2006; IN COMMERCE 1-0-2007.

**NO CLAIM IS MADE TO THE EXCLUSIVE
RIGHT TO USE "NORTH AMERICAN SPINE SO-
CIETY", APART FROM THE MARK AS SHOWN.**

**THE MARK CONSISTS OF RECTANGLE CON-
TAINING A STYLIZED DEPICTION OF A SPINE
WITH THE LETTERS "NASS" TO THE RIGHT, AND
THE WORDS "NORTH AMERICAN SPINE SOCI-
TY" BELOW.**

SER. NO. 77-343,915, FILED 12-4-2007.

ESTHER BELENKER, EXAMINING ATTORNEY

Int. Cl.: 35

Prior U.S. Cls.: 100, 101 and 102

United States Patent and Trademark Office

Reg. No. 3,479,817

Registered Aug. 5, 2008

**SERVICE MARK
PRINCIPAL REGISTER**



KICKS & STICKS, LLC (GEORGIA LTD LIAB CO)
SUITE 2B
4300 BUFORD DRIVE
BUFORD, GA 30518

FOR: RETAIL STORE SERVICES FEATURING
SOCCER SPECIALTY ITEMS, NAMELY, SOCCER
GEAR AND EQUIPMENT, IN CLASS 35 (U.S. CLS.
100, 101 AND 102).

FIRST USE 8-1-2002; IN COMMERCE 11-1-2002.

THE MARK CONSISTS OF THE TEXT "KICKS"
ARCHED OVER A SOCCER BALL, "& STICKS"
ARCHED UNDER THE SOCCER BALL, A HOCKEY
STICK AND LACROSSE STICK CRISS-CROSSED
BEHIND THE SOCCER BALL, AND A STRIPED
SHIELD IN THE BACKGROUND.

SER. NO. 77-344,107, FILED 12-4-2007.

ROBIN MITTLER, EXAMINING ATTORNEY

Int. Cl.: 44

Prior U.S. Cls.: 100 and 101

United States Patent and Trademark Office

Reg. No. 3,479,818

Registered Aug. 5, 2008

**SERVICE MARK
PRINCIPAL REGISTER**

Fruit Tree 101

THE FRUIT TREE PLANTING FOUNDATION
(CALIFORNIA CORPORATION), DBA FTPF
11653 RIVERSIDE DRIVE
LAKESIDE, CA 92040

FOR: CHARITABLE SERVICES, NAMELY, PROVIDING TREES AND PLANTS FOR RECLAMATION, IN CLASS 44 (U.S. CLS. 100 AND 101).

FIRST USE 3-8-2002; IN COMMERCE 3-8-2002.

THE MARK CONSISTS OF STANDARD CHARACTERS WITHOUT CLAIM TO ANY PARTICULAR FONT, STYLE, SIZE, OR COLOR.

NO CLAIM IS MADE TO THE EXCLUSIVE RIGHT TO USE "FRUIT TREE", APART FROM THE MARK AS SHOWN.

SER. NO. 77-344,232, FILED 12-5-2007.

JANET LEE, EXAMINING ATTORNEY

Int. Cls.: 16 and 35

Prior U.S. Cls.: 2, 5, 22, 23, 29, 37, 38, 50, 100, 101 and 102

United States Patent and Trademark Office

Reg. No. 3,479,819

Registered Aug. 5, 2008

**TRADEMARK
SERVICE MARK
PRINCIPAL REGISTER**



AFFIRMATIVE ACTION REGISTER

POTOMAC PUBLISHING, INC. (MISSOURI CORPORATION)
11801 WINTERSET TERRACE
POTOMAC, MD 20854

FOR: NEWSLETTERS IN THE FIELD OF JOB PLACEMENT, IN CLASS 16 (U.S. CLS. 2, 5, 22, 23, 29, 37, 38 AND 50).

FIRST USE 11-23-2007; IN COMMERCE 11-23-2007.

FOR: JOB PLACEMENT SERVICES; AND PROVIDING ONLINE INFORMATION AND NEWS IN THE FIELD OF JOB PLACEMENT, IN CLASS 35 (U.S. CLS. 100, 101 AND 102).

FIRST USE 11-16-2007; IN COMMERCE 11-16-2007.

OWNER OF U.S. REG. NO. 1,029,332.

NO CLAIM IS MADE TO THE EXCLUSIVE RIGHT TO USE "AFFIRMATIVE ACTION REGISTER", APART FROM THE MARK AS SHOWN.

THE MARK CONSISTS OF A GROUP OF SILHOUETTED MEN AND WOMEN WITH THE WORDING "AAR" SUPERIMPOSED THEREON AND THE WORDING "AFFIRMATIVE ACTION REGISTER" UNDERNEATH.

SER. NO. 77-344,240, FILED 12-5-2007.

SONYA STEPHENS, EXAMINING ATTORNEY

Int. Cls.: 35 and 36

Prior U.S. Cls.: 100, 101 and 102

United States Patent and Trademark Office

Reg. No. 3,479,820

Registered Aug. 5, 2008

**SERVICE MARK
PRINCIPAL REGISTER**

JUST EDUCATION LOANS

THE STUDENT LOAN PROCESSORS, INC. (DE-
LAWARE CORPORATION)
910 EAST MAIN STREET
MESA, AZ 85203

FOR: MARKETING THIRD PARTY LOANS FOR
OTHERS, IN CLASS 35 (U.S. CLS. 100, 101 AND 102).

FIRST USE 8-25-2007; IN COMMERCE 8-25-2007.

FOR: PROVIDING ADVICE RELATING TO STU-
DENT LOANS; PROVIDING INFORMATION IN
THE FIELD OF STUDENT LOANS; AND STUDENT
LOAN SERVICES, IN CLASS 36 (U.S. CLS. 100, 101
AND 102).

FIRST USE 8-25-2007; IN COMMERCE 8-25-2007.

THE MARK CONSISTS OF STANDARD CHAR-
ACTERS WITHOUT CLAIM TO ANY PARTICULAR
FONT, STYLE, SIZE, OR COLOR.

NO CLAIM IS MADE TO THE EXCLUSIVE
RIGHT TO USE "EDUCATION LOANS", APART
FROM THE MARK AS SHOWN.

SER. NO. 77-344,247, FILED 12-5-2007.

CAROLYN GRAY, EXAMINING ATTORNEY

Int. Cl.: 9

Prior U.S. Cls.: 21, 23, 26, 36 and 38

Reg. No. 3,479,821

United States Patent and Trademark Office

Registered Aug. 5, 2008

**TRADEMARK
PRINCIPAL REGISTER**

QEAM

THE WILL-BURT COMPANY (OHIO CORPORATION)
169 SOUTH MAIN STREET
ORRVILLE, OH 44667

FOR: TELESCOPING ANTENNA MAST, IN
CLASS 9 (U.S. CLS. 21, 23, 26, 36 AND 38).

FIRST USE 1-0-1997; IN COMMERCE 1-0-1997.

THE MARK CONSISTS OF STANDARD CHARACTERS WITHOUT CLAIM TO ANY PARTICULAR FONT, STYLE, SIZE, OR COLOR.

OWNER OF U.S. REG. NO. 2,982,483.

SER. NO. 77-344,369, FILED 12-5-2007.

ANN E. SAPPENFIELD, EXAMINING ATTORNEY

Int. Cl.: 9

Prior U.S. Cls.: 21, 23, 26, 36 and 38

United States Patent and Trademark Office

Reg. No. 3,479,822

Registered Aug. 5, 2008

**TRADEMARK
PRINCIPAL REGISTER**



RAIA, GABRIEL (UNITED STATES INDIVIDUAL)
1840 QUEENS WAY
VISTA, CA 92084

FOR: COMPUTER SOFTWARE, NAMELY, AN APPLICATION ALLOWING SYSTEM ADMINISTRATORS AND END-USERS TO MANAGE AND RECOVER COMPUTER BASELINE SYSTEMS, NAMELY, OPERATING SYSTEMS, APPLICATIONS AND DATA, WHILE MAINTAINING INFORMATION ASSURANCE VULNERABILITY ASSESSMENT COMPLIANCE REGULATIONS, IN CLASS 9 (U.S. CLS. 21, 23, 26, 36 AND 38).

FIRST USE 3-27-2007; IN COMMERCE 4-20-2007.

NO CLAIM IS MADE TO THE EXCLUSIVE RIGHT TO USE "PROTECTION", APART FROM THE MARK AS SHOWN.

THE STIPPLING IS FOR SHADING PURPOSES ONLY.

THE MARK CONSISTS OF THE STYLIZED WORDS "PLATINUM CS PROTECTION" WITH AN IMAGE OF A CD TO THE RIGHT OF THE WORDS COMING APART IN PUZZLE FORM.

SER. NO. 77-344,485, FILED 12-5-2007.

DAVID MURRAY, EXAMINING ATTORNEY

Int. Cl.: 39

Prior U.S. Cls.: 100 and 105

United States Patent and Trademark Office

Reg. No. 3,479,823

Registered Aug. 5, 2008

**SERVICE MARK
PRINCIPAL REGISTER**



MCS CARGO SYSTEMS, INC. (ILLINOIS CORPORATION)
1147 ELLIS STREET
BENSENVILLE, IL 60106

FOR: DOMESTIC AND INTERNATIONAL FREIGHT TRANSPORTATION SERVICES VIA MOTOR VEHICLES, AUTOMOBILES, TRUCKS, RAILWAYS, SHIPS AND PLANES, IN CLASS 39 (U.S. CLS. 100 AND 105).

FIRST USE 11-28-2007; IN COMMERCE 11-28-2007.

NO CLAIM IS MADE TO THE EXCLUSIVE RIGHT TO USE "DELIVERED", APART FROM THE MARK AS SHOWN.

THE MARK CONSISTS OF A CIRCLE SURROUNDING THE WORDS "DELIVERED GREAN". THE LETTERS "EA" IN GREAN ARE ENLARGED SO THAT THE BOTTOM LINE READS "BY EA LOGISTICS". A BAND OR ARROW UNDERLINES THE WORD "LOGISTICS".

SER. NO. 77-344,997, FILED 12-5-2007.

GIANCARLO CASTRO, EXAMINING ATTORNEY

Int. Cl.: 44

Prior U.S. Cls.: 100 and 101

United States Patent and Trademark Office

Reg. No. 3,479,824

Registered Aug. 5, 2008

**SERVICE MARK
PRINCIPAL REGISTER**

VIP RECOVERY COACHING

WILLIAMS, ROLAND (UNITED STATES INDIVIDUAL)

60 AUGUSTA CIRCLE

PETALUMA, CA 94952

FOR: ADDICTION TREATMENT SERVICES, IN CLASS 44 (U.S. CLS. 100 AND 101).

FIRST USE 11-0-2007; IN COMMERCE 11-0-2007.

THE MARK CONSISTS OF STANDARD CHARACTERS WITHOUT CLAIM TO ANY PARTICULAR FONT, STYLE, SIZE, OR COLOR.

NO CLAIM IS MADE TO THE EXCLUSIVE RIGHT TO USE "RECOVERY COACHING", APART FROM THE MARK AS SHOWN.

SER. NO. 77-345,056, FILED 12-5-2007.

MARIAM MAHMOUDI, EXAMINING ATTORNEY

Int. Cl.: 16

Prior U.S. Cls.: 2, 5, 22, 23, 29, 37, 38 and 50

United States Patent and Trademark Office

Reg. No. 3,479,825

Registered Aug. 5, 2008

**TRADEMARK
PRINCIPAL REGISTER**

PLAYSAM

PLAYSAM I KALMAR AKTIEBOLAG (SWEDEN
LIMITED COMPANY (LTD.))
P.O. BOX 44
KALMAR, SWEDEN SE-39120

OWNER OF U.S. REG. NO. 1,469,877.

FOR: CRAYON PENS AND BALL POINT PENS, IN
CLASS 16 (U.S. CLS. 2, 5, 22, 23, 29, 37, 38 AND 50).

THE MARK "PLAYSAM" (OR PLAY SAM) HAS
NO MEANING IN ANY FOREIGN LANGUAGE.

FIRST USE 12-31-1990; IN COMMERCE 9-30-2006.

SER. NO. 77-345,423, FILED 12-6-2007.

THE MARK CONSISTS OF STANDARD CHAR-
ACTERS WITHOUT CLAIM TO ANY PARTICULAR
FONT, STYLE, SIZE, OR COLOR.

SUE LAWRENCE, EXAMINING ATTORNEY

Int. Cl.: 5

Prior U.S. Cls.: 6, 18, 44, 46, 51 and 52

Reg. No. 3,479,826

United States Patent and Trademark Office

Registered Aug. 5, 2008

**TRADEMARK
PRINCIPAL REGISTER**

JOINT FIX

MEGESTER, INC. (FLORIDA CORPORATION)
2180 CALUMET STREET
CLEARWATER, FL 33765

FOR: DIETARY AND NUTRITIONAL SUPPLEMENTS AND PREPARATONS FOR THE PURPOSE TO AID RELIEF IN SYMPTONS ASSOCIATED WITH ARTHRITIS, IN CLASS 5 (U.S. CLS. 6, 18, 44, 46, 51 AND 52).

FIRST USE 12-6-2007; IN COMMERCE 12-6-2007.

THE MARK CONSISTS OF STANDARD CHARACTERS WITHOUT CLAIM TO ANY PARTICULAR FONT, STYLE, SIZE, OR COLOR.

NO CLAIM IS MADE TO THE EXCLUSIVE RIGHT TO USE "JOINT", APART FROM THE MARK AS SHOWN.

SER. NO. 77-345,577, FILED 12-6-2007.

CHRISTINA SOBRAL, EXAMINING ATTORNEY

Int. Cls.: 7 and 21

**Prior U.S. Cls.: 2, 13, 19, 21, 23, 29, 30, 31, 33, 34, 35,
40 and 50**

Reg. No. 3,479,827

United States Patent and Trademark Office

Registered Aug. 5, 2008

**TRADEMARK
PRINCIPAL REGISTER**



LESSMANN GMBH (FED REP GERMANY COR-
PORATION)
LUCAS-SCHULTES-STRASSE 2
86732 OETTINGEN, FED REP GERMANY

FOR: WIRE BRUSHES AS MACHINE PARTS,
AND MACHINE-OPERATED WIRE BRUSHES, IN
CLASS 7 (U.S. CLS. 13, 19, 21, 23, 31, 34 AND 35).

FIRST USE 6-1-2003; IN COMMERCE 6-1-2003.

FOR: HAND-OPERATED BRUSHES USED AS
TOOLS, NAMELY, STEEL AND/OR BRASS WIRE
BRUSHES FOR USE IN THE METAL INDUSTRY,
CONSTRUCTION INDUSTRY, AUTOMOBILE IN-
DUSTRY, FOOD INDUSTRY, IN CLASS 21 (U.S. CLS.
2, 13, 23, 29, 30, 33, 40 AND 50).

FIRST USE 6-1-2003; IN COMMERCE 6-1-2003.

THE COLOR(S) BLACK AND RED IS/ARE
CLAIMED AS A FEATURE OF THE MARK.

THE MARK CONSISTS OF "LESSMAN" IN
BLACK LETTERING WITH A RED "A" AND A
RED SEMICIRCLE TO THE RIGHT.

SER. NO. 77-345,621, FILED 12-6-2007.

CURTIS FRENCH, EXAMINING ATTORNEY

Int. Cl.: 19

Prior U.S. Cls.: 1, 12, 33 and 50

United States Patent and Trademark Office

Reg. No. 3,479,828

Registered Aug. 5, 2008

**TRADEMARK
PRINCIPAL REGISTER**

Rock-On-A-Roll

AQUATICA, INC. (MINNESOTA CORPORATION), DBA AQUATICA WATER GARDENS
4241 WASHBURN AVENUE SOUTH
MINNEAPOLIS, MN 55410

THE MARK CONSISTS OF STANDARD CHARACTERS WITHOUT CLAIM TO ANY PARTICULAR FONT, STYLE, SIZE, OR COLOR.

FOR: ARTIFICIAL STONE, IN CLASS 19 (U.S. CLS. 1, 12, 33 AND 50).

SER. NO. 77-345,673, FILED 12-6-2007.

FIRST USE 5-1-1998; IN COMMERCE 5-1-1998.

KATHERINE CHANG, EXAMINING ATTORNEY

Int. Cl.: 28

Prior U.S. Cls.: 22, 23, 38 and 50

Reg. No. 3,479,829

United States Patent and Trademark Office

Registered Aug. 5, 2008

**TRADEMARK
PRINCIPAL REGISTER**

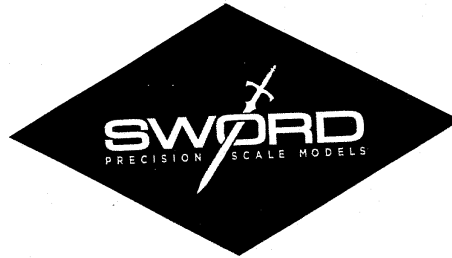

SWORD, CHUCK (UNITED STATES INDIVIDUAL)
107 KARL STREET
BEREA, OH 44017

FOR: SCALE MODEL MINIATURE DIE CAST REPLICAS OF CARS, TRUCKS, AND CONSTRUCTION VEHICLES, IN CLASS 28 (U.S. CLS. 22, 23, 38 AND 50).

FIRST USE 12-1-2006; IN COMMERCE 12-15-2006.

NO CLAIM IS MADE TO THE EXCLUSIVE RIGHT TO USE "PRECISION SCALE MODELS", APART FROM THE MARK AS SHOWN.

THE MARK CONSISTS OF THE WORDS "SWORD PRECISION SCALE MODELS" AND THE DEPICTION OF A SWORD PIERCING THE "O" IN "SWORD" ALL INSIDE A SOLID DIAMOND SHAPE.

SER. NO. 77-345,740, FILED 12-6-2007.

JUSTINE D. PARKER, EXAMINING ATTORNEY

Int. Cl.: 41

Prior U.S. Cls.: 100, 101 and 107

United States Patent and Trademark Office

Reg. No. 3,479,830

Registered Aug. 5, 2008

**SERVICE MARK
PRINCIPAL REGISTER**

RED CARPET TONIGHT

VIPRMEDIA LLC (FLORIDA LTD LIAB CO)
7512 DR. PHILLIPS BLVD. 50-203
ORLANDO, FL 32819

FOR: ENTERTAINMENT IN THE NATURE OF FASHION SHOWS; ENTERTAINMENT IN THE NATURE OF TELEVISION NEWS SHOWS; ENTERTAINMENT SERVICES, NAMELY, WINE AND FOOD TASTINGS; ENTERTAINMENT SERVICES, NAMELY, PLANNING AND CONDUCTING A SERIES OF FILM FESTIVALS, IN CLASS 41 (U.S. CLS. 100, 101 AND 107).

FIRST USE 12-1-2007; IN COMMERCE 12-1-2007.

THE COLOR(S) DARK GRAY, BLACK AND RED IS/ARE CLAIMED AS A FEATURE OF THE MARK.

THE WORDING "RED CARPET" IS DARK GRAY, THE WORD "TONIGHT" IS THE COLOR BLACK ON A RED COLORED IMAGE OF A HALF ROLLED OUT CARPET ROLL WITH A GRAY END BORDER OUTLINED IN BLACK.

SER. NO. 77-345,761, FILED 12-6-2007.

MICHELE SWAIN, EXAMINING ATTORNEY

Int. Cl.: 29

Prior U.S. Cl.: 46

United States Patent and Trademark Office

Reg. No. 3,479,831

Registered Aug. 5, 2008

**TRADEMARK
PRINCIPAL REGISTER**

**THE FINEST ITALIAN CHEESES
MONEY CAN BUY!**

GRANDE CHEESE COMPANY (ILLINOIS CORPORATION)
P.O. BOX 67 DAIRY ROAD
BROWNSVILLE, WI 53006

FOR: CHEESE, IN CLASS 29 (U.S. CL. 46).

FIRST USE 4-27-1993; IN COMMERCE 4-27-1993.

THE MARK CONSISTS OF STANDARD CHARACTERS WITHOUT CLAIM TO ANY PARTICULAR FONT, STYLE, SIZE, OR COLOR.

OWNER OF U.S. REG. NOS. 1,794,519, 2,298,361, AND 2,742,610.

NO CLAIM IS MADE TO THE EXCLUSIVE RIGHT TO USE "ITALIAN CHEESES", APART FROM THE MARK AS SHOWN.

SEC. 2(F).

SER. NO. 77-345,839, FILED 12-6-2007.

STEVEN JACKSON, EXAMINING ATTORNEY

Int. Cls.: 41 and 42

Prior U.S. Cls.: 100, 101 and 107

United States Patent and Trademark Office

Reg. No. 3,479,832

Registered Aug. 5, 2008

**SERVICE MARK
PRINCIPAL REGISTER**

AdvancED

ADVANCE EDUCATION, INC. (GEORGIA CORPORATION)
ATTN: KENNETH BERGMAN
1866 SOUTHERN LANE
DECATUR, GA 300334097

FOR: CONSULTATION IN THE FIELD OF K-12 EDUCATIONAL SYSTEMS; EDUCATION INFORMATION; EDUCATION SERVICES, NAMELY, PROVIDING LIVE AND ON-LINE SEMINARS AND WORKSHOPS IN THE FIELD OF ACCREDITATION OF SCHOOLS AND DISTRICTS; EDUCATIONAL RESEARCH; EDUCATIONAL SERVICES, NAMELY, CONDUCTING PROGRAMS IN THE FIELD OF ACCREDITATION OF SCHOOLS AND DISTRICTS; EDUCATIONAL SERVICES, NAMELY, DEVELOPING, ARRANGING, AND CONDUCTING EDUCATIONAL CONFERENCES AND PROGRAMS AND PROVIDING COURSES OF INSTRUCTION IN THE FIELD OF SCHOOL/DISTRICT ACCREDITATION; PROVIDING INFORMATION AND NEWS IN THE FIELD OF TEACHING METHODOLOGY AND EDUCATION , IN CLASS 41 (U.S. CLS. 100, 101 AND 107).

FIRST USE 8-15-2006; IN COMMERCE 8-15-2006.

FOR: ACCREDITATION SERVICES, NAMELY, EVALUATING ORGANIZATIONS TO DETERMINE WHETHER THE ORGANIZATIONS CONFORM TO AN ESTABLISHED STANDARD; ACCREDITATION SERVICES, NAMELY, SETTING AND PROVIDING STANDARDS FOR PUBLIC AND PRIVATE SCHOOLS AND DISTRICTS FOR THE PURPOSE OF ACCREDITATION; ACCREDITATION SERVICES, NAMELY, DEVELOPING, EVALUATING, AND TESTING STANDARDS FOR PUBLIC AND PRIVATE SCHOOLS AND DISTRICTS FOR THE PURPOSE OF ACCREDITATION, IN CLASS 42 (U.S. CLS. 100 AND 101).

FIRST USE 8-15-2006; IN COMMERCE 8-15-2006.

THE MARK CONSISTS OF STANDARD CHARACTERS WITHOUT CLAIM TO ANY PARTICULAR FONT, STYLE, SIZE, OR COLOR.

SER. NO. 77-345,885, FILED 12-6-2007.

JOHN SCHUYLER YARD, EXAMINING ATTORNEY

Int. Cl.: 42

Prior U.S. Cls.: 100 and 101

United States Patent and Trademark Office

Reg. No. 3,479,833

Registered Aug. 5, 2008

**SERVICE MARK
PRINCIPAL REGISTER**

ACTIVECAMPAIGN

ACTIVECAMPAIGN, INC. (ILLINOIS CORPORATION)
SUITE 1230
150 N. MICHIGAN AVE.
CHICAGO, IL 60601

FOR: COMPUTER SERVICE, ACTING AS AN APPLICATION SERVICE PROVIDER IN THE FIELD OF KNOWLEDGE MANAGEMENT TO HOST COMPUTER APPLICATION SOFTWARE FOR CREATING SEARCHABLE DATABASES OF INFORMATION AND DATA TO ALLOW USERS TO PERFORM, ON-LINE, THE COLLECTING AND ANALYZING OF DIFFERENT TYPES OF OPINION,

INFORMATION AND DATA SURVEYS, IN CLASS 42 (U.S. CLS. 100 AND 101).

FIRST USE 1-10-2003; IN COMMERCE 1-10-2003.

THE MARK CONSISTS OF STANDARD CHARACTERS WITHOUT CLAIM TO ANY PARTICULAR FONT, STYLE, SIZE, OR COLOR.

SER. NO. 77-345,888, FILED 12-6-2007.

ANN E. SAPPENFIELD, EXAMINING ATTORNEY

Int. Cl.: 29

Prior U.S. Cl.: 46

United States Patent and Trademark Office

Reg. No. 3,479,834

Registered Aug. 5, 2008

**TRADEMARK
PRINCIPAL REGISTER**

VEGETOL

NEALANDERS INTERNATIONAL INC. (CANADA CORPORATION)
6980 CREDITVIEW ROAD
MISSISSAUGA, CANADA L5N8E2

OWNER OF CANADA REG. NO. TMA329812,
DATED 7-10-1987, EXPIRES 7-10-2017.

FOR: VEGETABLE OIL AND VEGETABLE OIL
BLENDS, IN CLASS 29 (U.S. CL. 46).

SER. NO. 77-345,897, FILED 12-6-2007.

THE MARK CONSISTS OF STANDARD CHARACTERS WITHOUT CLAIM TO ANY PARTICULAR FONT, STYLE, SIZE, OR COLOR.

KATHERINE E. HALMEN, EXAMINING ATTORNEY

Int. Cl.: 21

Prior U.S. Cls.: 2, 13, 23, 29, 30, 33, 40 and 50

United States Patent and Trademark Office

Reg. No. 3,479,835

Registered Aug. 5, 2008

**TRADEMARK
PRINCIPAL REGISTER**

Pulltex

PULLTEX, S.L. (SPAIN SOCIEDAD DE RESPONSABILIDAD LIMITADA (SL))
MURCIA 33-A, P.I. CAN CALDERON
SANT BOI DE LLOBREGAT, SPAIN 08830

FOR: BOTTLE OPENERS, BOTTLE STANDS, BUCKETS FOR WINE, COOLERS FOR WINE, CORKSCREWS, DECANTERS, DRINKING FLASKS, DRINKING GLASSES, JUGS FOR WINE, COCKTAIL SHAKERS, AND GLASS STOPPERS, IN CLASS 21 (U.S. CLS. 2, 13, 23, 29, 30, 33, 40 AND 50).

FIRST USE 1-31-2003; IN COMMERCE 1-31-2003.

THE MARK CONSISTS OF STYLILIZED WORD "PULLTEX".

SER. NO. 77-346,038, FILED 12-6-2007.

ELLEN PERKINS, EXAMINING ATTORNEY

Int. Cl.: 35

Prior U.S. Cls.: 100, 101 and 102

United States Patent and Trademark Office

Reg. No. 3,479,836

Registered Aug. 5, 2008

**SERVICE MARK
PRINCIPAL REGISTER**

QH EXTEND

MARKETING TECHNOLOGY SOLUTIONS INC.
(DELAWARE CORPORATION)
SUITE 130
510 THORNALL STREET
EDISON, NJ 08837

FOR: ADVERTISING, MARKETING AND PROMOTION SERVICES; ADVERTISING SERVICES, NAMELY, PROVIDING ONLINE MARKETING SERVICES IN THE NATURE OF BANNER ADVERTISING, DISPLAY ADVERTISING, AND LINK EXCHANGES FOR THE MEDICAL, PHARMACEUTICAL AND HEALTHCARE INDUSTRIES; PROVIDING A DATABASE FEATURING CONSUMER RESEARCH DATA AND CONSUMER

PROFILING INFORMATION FOR THE MEDICAL, PHARMACEUTICAL AND HEALTHCARE INDUSTRIES, IN CLASS 35 (U.S. CLS. 100, 101 AND 102).

FIRST USE 5-1-2007; IN COMMERCE 5-1-2007.

THE MARK CONSISTS OF STANDARD CHARACTERS WITHOUT CLAIM TO ANY PARTICULAR FONT, STYLE, SIZE, OR COLOR.

SER. NO. 77-346,160, FILED 12-6-2007.

ANNE MADDEN, EXAMINING ATTORNEY

Int. Cl.: 35

Prior U.S. Cls.: 100, 101 and 102

United States Patent and Trademark Office

Reg. No. 3,479,837

Registered Aug. 5, 2008

**SERVICE MARK
PRINCIPAL REGISTER**

QH CONNECT

MARKETING TECHNOLOGY SOLUTIONS INC.
(DELAWARE CORPORATION)
SUITE 130
510 THORNALL STREET
EDISON, NJ 08837

FOR: BUSINESS MARKETING CONSULTING SERVICES; MARKET RESEARCH AND ANALYSIS SERVICES; CONSUMER RESEARCH; CONSUMER MARKETING RESEARCH SERVICES, NAMELY, CONDUCTING SURVEYS, GATHERING, AND ANALYZING DATA RELATING TO CONSUMER DEMOGRAPHICS, ATTITUDES, OPINIONS AND BEHAVIOR, AND CREATING CONSUMER PROFILES FOR THE MEDICAL, PHARMACEUTICAL AND HEALTHCARE INDUSTRIES; PROVIDING A

DATABASE FEATURING CONSUMER RESEARCH DATA AND CONSUMER PROFILING INFORMATION FOR THE MEDICAL, PHARMACEUTICAL AND HEALTHCARE INDUSTRIES, IN CLASS 35 (U.S. CLS. 100, 101 AND 102).

FIRST USE 5-1-2007; IN COMMERCE 5-1-2007.

THE MARK CONSISTS OF STANDARD CHARACTERS WITHOUT CLAIM TO ANY PARTICULAR FONT, STYLE, SIZE, OR COLOR.

SER. NO. 77-346,165, FILED 12-6-2007.

ANNE MADDEN, EXAMINING ATTORNEY

Int. Cl.: 5

Prior U.S. Cls.: 6, 18, 44, 46, 51 and 52

Reg. No. 3,479,838

United States Patent and Trademark Office

Registered Aug. 5, 2008

**TRADEMARK
PRINCIPAL REGISTER**



MAIQUEZ INVESTMENTS, INC (FLORIDA CORPORATION)

315
351 NW 42ND AVE.
MIAMI, FL 33126

FOR: NUTRITIONAL SUPPLEMENTS, IN CLASS 5 (U.S. CLS. 6, 18, 44, 46, 51 AND 52).

FIRST USE 11-1-2007; IN COMMERCE 12-1-2007.

NO CLAIM IS MADE TO THE EXCLUSIVE RIGHT TO USE "AGE MANAGEMENT SUPPLEMENTS", APART FROM THE MARK AS SHOWN.

THE COLOR(S) GREEN, BLUE IS/ARE CLAIMED AS A FEATURE OF THE MARK.

THE MARK CONSISTS OF THE LABORATORY BOTTLE IS GREEN, THE TRANSVERSE LINES ARE BLUE, AND THE WORDING "AGE MANAGEMENT SUPPLEMENTS" IS IN BLUE.

SER. NO. 77-346,208, FILED 12-6-2007.

BRIAN NEVILLE, EXAMINING ATTORNEY

Int. Cl.: 9

Prior U.S. Cls.: 21, 23, 26, 36 and 38

Reg. No. 3,479,839

United States Patent and Trademark Office

Registered Aug. 5, 2008

**TRADEMARK
PRINCIPAL REGISTER**

STEAM PRO

THERMOFLOW INC. (MASSACHUSETTS CORPORATION)
29 HUDSON ROAD
SUDBURY, MA 01776

FOR: COMPUTER SOFTWARE PROGRAM FOR USE IN DESIGNING STEAM POWER PLANTS, IN CLASS 9 (U.S. CLS. 21, 23, 26, 36 AND 38).

FIRST USE 9-30-1991; IN COMMERCE 9-30-1991.

THE MARK CONSISTS OF STANDARD CHARACTERS WITHOUT CLAIM TO ANY PARTICULAR FONT, STYLE, SIZE, OR COLOR.

NO CLAIM IS MADE TO THE EXCLUSIVE RIGHT TO USE "STEAM", APART FROM THE MARK AS SHOWN.

SER. NO. 77-346,421, FILED 12-7-2007.

MELISSA VALLILLO, EXAMINING ATTORNEY

Int. Cl.: 9

Prior U.S. Cls.: 21, 23, 26, 36 and 38

Reg. No. 3,479,840

United States Patent and Trademark Office

Registered Aug. 5, 2008

**TRADEMARK
PRINCIPAL REGISTER**

STEAM MASTER

THERMOFLOW INC. (MASSACHUSETTS CORPORATION)
29 HUDSON ROAD
SUDBURY, MA 01776

FOR: COMPUTER SOFTWARE PROGRAM USED TO SIMULATE THE PERFORMANCE OF STEAM POWER PLANTS, IN CLASS 9 (U.S. CLS. 21, 23, 26, 36 AND 38).

FIRST USE 2-1-1992; IN COMMERCE 2-1-1992.

THE MARK CONSISTS OF STANDARD CHARACTERS WITHOUT CLAIM TO ANY PARTICULAR FONT, STYLE, SIZE, OR COLOR.

NO CLAIM IS MADE TO THE EXCLUSIVE RIGHT TO USE "STEAM", APART FROM THE MARK AS SHOWN.

SER. NO. 77-346,440, FILED 12-7-2007.

MELISSA VALLILLO, EXAMINING ATTORNEY

Int. Cl.: 41

Prior U.S. Cls.: 100, 101 and 107

United States Patent and Trademark Office

Reg. No. 3,479,841

Registered Aug. 5, 2008

**SERVICE MARK
PRINCIPAL REGISTER**

The Virtual Lecture Hall

MEDICAL DIRECTIONS, INC. (ARIZONA CORPORATION)
5944 E. MIRAMAR DR.
TUCSON, AZ 85715

FOR: EDUCATIONAL SERVICES, NAMELY, CONDUCTING INFORMAL ON-LINE PROGRAMS IN THE FIELDS OF MEDICINE, AND PRINTABLE MATERIALS DISTRIBUTED THEREWITH, IN CLASS 41 (U.S. CLS. 100, 101 AND 107).

FIRST USE 7-1-1997; IN COMMERCE 7-1-1997.

THE MARK CONSISTS OF STANDARD CHARACTERS WITHOUT CLAIM TO ANY PARTICULAR FONT, STYLE, SIZE, OR COLOR.

SEC. 2(F).

SER. NO. 77-346,467, FILED 12-7-2007.

KIMBERLY FRYE, EXAMINING ATTORNEY

Int. Cls.: 35 and 43

Prior U.S. Cls.: 100, 101 and 102

United States Patent and Trademark Office

Reg. No. 3,479,842

Registered Aug. 5, 2008

**SERVICE MARK
PRINCIPAL REGISTER**



JJMD INVESTMENTS, INC. (DELAWARE CORPORATION)
SUITE 203
156 CARLTON RD.
CHARLOTTESVILLE, VA 22902

FOR: RETAIL STORE SERVICES FEATURING BEER AND GROCERIES, IN CLASS 35 (U.S. CLS. 100, 101 AND 102).

FIRST USE 7-20-2007; IN COMMERCE 8-1-2007.

FOR: RESTAURANT SERVICES, IN CLASS 43 (U.S. CLS. 100 AND 101).

FIRST USE 7-20-2007; IN COMMERCE 8-1-2007.

NO CLAIM IS MADE TO THE EXCLUSIVE RIGHT TO USE "BEER", APART FROM THE MARK AS SHOWN.

THE MARK CONSISTS OF WORDS "BEER RUN" IN A SLIGHT ARC, WITH LIGHTNING BOLTS ON THE "B" AND THE "R".

SER. NO. 77-346,830, FILED 12-7-2007.

CURTIS FRENCH, EXAMINING ATTORNEY

Int. Cls.: 9 and 41

Prior U.S. Cls.: 21, 23, 26, 36, 38, 100, 101 and 107

United States Patent and Trademark Office

Reg. No. 3,479,843

Registered Aug. 5, 2008

**TRADEMARK
SERVICE MARK
PRINCIPAL REGISTER**

WHITETAIL FREAKS

A.L.S. ENTERPRISES, INC. (MICHIGAN CORPORATION)
1731 WIERENGO DRIVE
MUSKEGON, MI 49442

FOR: DIGITAL MEDIA, NAMELY, PRERECORDED DIGITAL VIDEO DISKS FEATURING WILD GAME HUNTING, OUTDOOR RECREATION AND SPORTSMAN TOPICS, IN CLASS 9 (U.S. CLS. 21, 23, 26, 36 AND 38).

FIRST USE 8-31-2006; IN COMMERCE 8-31-2006.

FOR: ENTERTAINMENT SERVICES, NAMELY, PRODUCTION AND DISTRIBUTION OF TELEVISION SHOWS AND DVD'S, IN CLASS 41 (U.S. CLS. 100, 101 AND 107).

FIRST USE 8-31-2006; IN COMMERCE 8-31-2006.

THE MARK CONSISTS OF STANDARD CHARACTERS WITHOUT CLAIM TO ANY PARTICULAR FONT, STYLE, SIZE, OR COLOR.

NO CLAIM IS MADE TO THE EXCLUSIVE RIGHT TO USE "WHITETAIL", APART FROM THE MARK AS SHOWN.

SER. NO. 77-346,916, FILED 12-7-2007.

GIANCARLO CASTRO, EXAMINING ATTORNEY

Int. Cl.: 35

Prior U.S. Cls.: 100, 101 and 102

United States Patent and Trademark Office

Reg. No. 3,479,844

Registered Aug. 5, 2008

**SERVICE MARK
PRINCIPAL REGISTER**

Everyday Biographies

EVERYDAY BIOGRAPHIES LTD (UNITED
KINGDOM LTD LIAB CO)
111 HIGH STREET
EDGWARE, UNITED KINGDOM HA87DB

FOR: CUSTOM WRITING SERVICES, NAMELY,
GHOST-WRITING AUTOBIOGRAPHIES FOR OTH-
ERS, IN CLASS 35 (U.S. CLS. 100, 101 AND 102).

FIRST USE 10-26-2006; IN COMMERCE 10-26-2006.

THE MARK CONSISTS OF STANDARD CHAR-
ACTERS WITHOUT CLAIM TO ANY PARTICULAR
FONT, STYLE, SIZE, OR COLOR.

NO CLAIM IS MADE TO THE EXCLUSIVE
RIGHT TO USE "BIOGRAPHIES", APART FROM
THE MARK AS SHOWN.

SER. NO. 77-346,972, FILED 12-7-2007.

FRED CARL, EXAMINING ATTORNEY

Int. Cl.: 44

Prior U.S. Cls.: 100 and 101

United States Patent and Trademark Office

Reg. No. 3,479,845

Registered Aug. 5, 2008

**SERVICE MARK
PRINCIPAL REGISTER**

WEBCNP

THE TRUSTEES OF THE UNIVERSITY OF
PENNSYLVANIA (PENNSYLVANIA COR-
PORATION)
3160 CHESTNUT STREET
PHILADELPHIA, PA 19104

FOR: COMPUTERIZED ON-LINE NEUROCOG-
NITIVE TESTING SERVICES; PROVIDING ON-LINE
DATABASE OF NEUROCOGNITIVE TESTING RE-
SULTS, IN CLASS 44 (U.S. CLS. 100 AND 101).

FIRST USE 4-30-2004; IN COMMERCE 9-15-2004.

THE MARK CONSISTS OF STANDARD CHAR-
ACTERS WITHOUT CLAIM TO ANY PARTICULAR
FONT, STYLE, SIZE, OR COLOR.

SER. NO. 77-347,028, FILED 12-7-2007.

MICHELE SWAIN, EXAMINING ATTORNEY

Int. Cl.: 44

Prior U.S. Cls.: 100 and 101

United States Patent and Trademark Office

Reg. No. 3,479,846

Registered Aug. 5, 2008

**SERVICE MARK
PRINCIPAL REGISTER**



ACTIVE BODY CHIROPRACTIC, LTD (ILLINOIS CORPORATION)
1509 S. STATE ST.
CHICAGO, IL 60605

FOR: CHIROPRACTIC SERVICES, NAMELY, CHIROPRACTIC AND MUSCLE THERAPY, IN CLASS 44 (U.S. CLS. 100 AND 101).

FIRST USE 11-1-2002; IN COMMERCE 11-1-2002.

NO CLAIM IS MADE TO THE EXCLUSIVE RIGHT TO USE "CHIROPRACTIC", APART FROM THE MARK AS SHOWN.

THE MARK CONSISTS OF AN ABSTRACT DESIGN WITH THE STYLIZED WORDS "ACTIVE BODY CHIROPRACTIC" TO THE RIGHT OF IT.

SER. NO. 77-347,134, FILED 12-7-2007.

BENJAMIN OKEKE, EXAMINING ATTORNEY

Int. Cl.: 42

Prior U.S. Cls.: 100 and 101

United States Patent and Trademark Office

Reg. No. 3,479,847

Registered Aug. 5, 2008

**SERVICE MARK
PRINCIPAL REGISTER**

CONCEP

CONCEP GROUP LIMITED (UNITED KINGDOM
CORPORATION)
THE PLAZA, 535 KING'S ROAD
LONDON, UNITED KINGDOM SW100SZ

FOR: DESIGN, CREATION, HOSTING, MAINTENANCE OF WEBSITES FOR OTHERS; PROVIDING TEMPORARY USE OF NON-DOWNLOADABLE ADVERTISING MANAGEMENT SOFTWARE FOR DISTRIBUTING ADVERTISING CAMPAIGNS OF OTHERS AND FOR CREATING ONLINE FEEDBACK SURVEYS AND COMPLEX WEB-BASED FORMS, IN CLASS 42 (U.S. CLS. 100 AND 101).

FIRST USE 4-30-2007; IN COMMERCE 4-30-2007.

THE MARK CONSISTS OF STANDARD CHARACTERS WITHOUT CLAIM TO ANY PARTICULAR FONT, STYLE, SIZE, OR COLOR.

SER. NO. 77-347,859, FILED 12-10-2007.

MARLENE BELL, EXAMINING ATTORNEY

Int. Cl.: 36

Prior U.S. Cls.: 100, 101 and 102

United States Patent and Trademark Office

Reg. No. 3,479,848

Registered Aug. 5, 2008

**SERVICE MARK
PRINCIPAL REGISTER**



ROOF ADVISORY GROUP, INC. (PENNSYLVANIA CORPORATION)
507 N. FRONT STREET
HARRISBURG, PA 17101

FOR: FINANCIAL PLANNING AND INVESTMENT ADVISORY SERVICES, IN CLASS 36 (U.S. CLS. 100, 101 AND 102).

FIRST USE 1-20-1998; IN COMMERCE 1-20-1998.

NO CLAIM IS MADE TO THE EXCLUSIVE RIGHT TO USE "ADVISORY GROUP, INC." AND "INVESTMENT ADVISORY & FINANCIAL PLAN-

NING SERVICES", APART FROM THE MARK AS SHOWN.

THE MARK CONSISTS OF TWO CONCENTRIC CIRCLES WITH A CROSS GOING THROUGH AND THE WORDS ROOF ADVISORY GROUP, INC. INVESTMENT ADVISORY & FINANCIAL PLANNING SERVICES.

SER. NO. 77-347,892, FILED 12-10-2007.

JOHN SCHUYLER YARD, EXAMINING ATTORNEY

Int. Cl.: 41

Prior U.S. Cls.: 100, 101 and 107

United States Patent and Trademark Office

Reg. No. 3,479,849

Registered Aug. 5, 2008

**SERVICE MARK
PRINCIPAL REGISTER**

Untamed Heart Photography

MICHELLE HUESGEN (UNITED STATES INDIVIDUAL), DBA MICHELLE VOLKERDING
334 ANDREWS TRAIL
SAINT PETERS, MO 63376

FOR: PHOTOGRAPHY; PHOTOGRAPHY SERVICES; PORTRAIT PHOTOGRAPHY, IN CLASS 41 (U.S. CLS. 100, 101 AND 107).

FIRST USE 9-18-2007; IN COMMERCE 9-18-2007.

THE MARK CONSISTS OF STANDARD CHARACTERS WITHOUT CLAIM TO ANY PARTICULAR FONT, STYLE, SIZE, OR COLOR.

NO CLAIM IS MADE TO THE EXCLUSIVE RIGHT TO USE "PHOTOGRAPHY", APART FROM THE MARK AS SHOWN.

SER. NO. 77-348,131, FILED 12-10-2007.

DORITT L. CARROLL, EXAMINING ATTORNEY

Int. Cls.: 29 and 30

Prior U.S. Cl.: 46

United States Patent and Trademark Office

Reg. No. 3,479,850

Registered Aug. 5, 2008

**TRADEMARK
PRINCIPAL REGISTER**

MILSTEAD

ASSOCIATED WHOLESALE GROCERS, INC.
(KANSAS CORPORATION)
5000 KANSAS AVE
KANSAS CITY, KS 66106

FOR: POTATO FLAKES, SCALLOP POTATOES,
AND POTATOES AU GRATIN, IN CLASS 29 (U.S.
CL. 46).

FIRST USE 2-5-2001; IN COMMERCE 2-5-2001.

FOR: STUFFING MIXES CONTAINING BREAD,
RICE AND PASTA MIXES COMBINED IN A UNI-
TARY PACKAGE, CHICKEN COATING SEASON-
INGS, ALFREDO SAUCE WITH NOODLES
COMBINED IN A UNITARY PACKAGE, NOODLE
AND SEASONING MIXES COMBINED IN A UNI-
TARY PACKAGE, AND RICE, DEHYDRATED

CHEDDAR, CHEDDAR FLAVORING, AND DEHY-
DRATED BROCCOLI MIXES, COMBINED IN A
UNITARY PACKAGE, IN CLASS 30 (U.S. CL. 46).

FIRST USE 2-5-2001; IN COMMERCE 2-5-2001.

THE MARK CONSISTS OF STANDARD CHAR-
ACTERS WITHOUT CLAIM TO ANY PARTICULAR
FONT, STYLE, SIZE, OR COLOR.

OWNER OF U.S. REG. NO. 2,629,473.

SEC. 2(F).

SER. NO. 77-348,222, FILED 12-10-2007.

JEAN IM, EXAMINING ATTORNEY

Int. Cl.: 9

Prior U.S. Cls.: 21, 23, 26, 36 and 38

Reg. No. 3,479,851

United States Patent and Trademark Office

Registered Aug. 5, 2008

**TRADEMARK
PRINCIPAL REGISTER**

BYTESIZE SCIENCE

AMERICAN CHEMICAL SOCIETY (D.C. CORPORATION)
1155 SIXTEENTH STREET, NW
WASHINGTON, DC 20036

FOR: DOWNLOADABLE PODCASTS IN THE FIELD OF SCIENCE, IN CLASS 9 (U.S. CLS. 21, 23, 26, 36 AND 38).

FIRST USE 10-17-2007; IN COMMERCE 10-17-2007.

THE MARK CONSISTS OF STANDARD CHARACTERS WITHOUT CLAIM TO ANY PARTICULAR FONT, STYLE, SIZE, OR COLOR.

NO CLAIM IS MADE TO THE EXCLUSIVE RIGHT TO USE "SCIENCE", APART FROM THE MARK AS SHOWN.

SER. NO. 77-348,223, FILED 12-10-2007.

LINDA POWELL, EXAMINING ATTORNEY

Int. Cl.: 43

Prior U.S. Cls.: 100 and 101

United States Patent and Trademark Office

Reg. No. 3,479,852

Registered Aug. 5, 2008

**SERVICE MARK
PRINCIPAL REGISTER**

THE CLUB AT TRISTANT

EPIPHANY TELLURIDE, LLC (COLORADO LTD
LIAB CO)
5600 S. QUÉBEC ST., SUITE 325C
GREENWOOD VILLAGE, CO 80111

FOR: PRIVATE RESIDENCE CLUB SERVICES,
NAMELY, PROVISION TO CLUB MEMBERS OF
TEMPORARY ACCOMMODATIONS IN COMPANY
OWNED OR LEASED PRIVATE RESIDENCES , IN
CLASS 43 (U.S. CLS. 100 AND 101).

FIRST USE 11-1-2006; IN COMMERCE 11-1-2006.

THE MARK CONSISTS OF STANDARD CHAR-
ACTERS WITHOUT CLAIM TO ANY PARTICULAR
FONT, STYLE, SIZE, OR COLOR.

NO CLAIM IS MADE TO THE EXCLUSIVE
RIGHT TO USE "CLUB", APART FROM THE MARK
AS SHOWN.

SER. NO. 77-348,291, FILED 12-10-2007.

CIMMERIAN COLEMAN, EXAMINING ATTOR-
NEY

Int. Cl.: 30

Prior U.S. Cl.: 46

United States Patent and Trademark Office

Reg. No. 3,479,853

Registered Aug. 5, 2008

**TRADEMARK
PRINCIPAL REGISTER**

EASY SKILLET

ASSOCIATED WHOLESALE GROCERS, INC.
(KANSAS CORPORATION)
5000 KANSAS AVE
KANSAS CITY, KS 66106

FOR: UNITARY PACKAGED DINNER MIXES
CONSISTING PRIMARILY OF PASTA, NAMELY,
PASTA CHEESEBURGER DINNER MIXES TO BE
COMBINED WITH ADDED HAMBURGER MEAT,
LASAGNA DINNER MIXES TO BE COMBINED
WITH ADDED MEAT, PASTA BEEF DINNER
MIXES TO BE COMBINED WITH ADDED BEEF,
PASTA TUNA DINNER MIXES TO BE COMBINED
WITH ADDED TUNA, PASTA BEEF STROGANOFF
MIXES TO BE COMBINED WITH BEEF, IN CLASS 30
(U.S. CL. 46).

FIRST USE 1-31-2001; IN COMMERCE 1-31-2001.

THE MARK CONSISTS OF STANDARD CHAR-
ACTERS WITHOUT CLAIM TO ANY PARTICULAR
FONT, STYLE, SIZE, OR COLOR.

OWNER OF U.S. REG. NO. 2,526,262.

SEC. 2(F).

SER. NO. 77-348,306, FILED 12-10-2007.

JEAN IM, EXAMINING ATTORNEY

Int. Cl.: 35

Prior U.S. Cls.: 100, 101 and 102

United States Patent and Trademark Office

Reg. No. 3,479,854

Registered Aug. 5, 2008

**SERVICE MARK
PRINCIPAL REGISTER**

**OBAGI P.R.O. SYSTEM
PATIENT REFILLS ONLINE**

OMP, INC. (DELAWARE CORPORATION)
310 GOLDEN SHORE
LONG BEACH, CA 90802

OWNER OF U.S. REG. NOS. 2,203,028, 2,786,594,
AND 2,838,565.

FOR: ONLINE PRESCRIPTION REFILL ORDER-
ING SERVICES, IN CLASS 35 (U.S. CLS. 100, 101 AND
102).

NO CLAIM IS MADE TO THE EXCLUSIVE
RIGHT TO USE "SYSTEM PATIENT REFILLS ON-
LINE", APART FROM THE MARK AS SHOWN.

FIRST USE 11-19-2007; IN COMMERCE 11-19-2007.

SER. NO. 77-348,340, FILED 12-10-2007.

THE MARK CONSISTS OF STANDARD CHAR-
ACTERS WITHOUT CLAIM TO ANY PARTICULAR
FONT, STYLE, SIZE, OR COLOR.

MARY ROSSMAN, EXAMINING ATTORNEY

Int. Cl.: 35

Prior U.S. Cls.: 100, 101 and 102

United States Patent and Trademark Office

Reg. No. 3,479,855

Registered Aug. 5, 2008

**SERVICE MARK
PRINCIPAL REGISTER**



OMP, INC. (DELAWARE CORPORATION)
310 GOLDEN SHORE
LONG BEACH, CA 90802

FOR: ONLINE PRESCRIPTION REFILL ORDER-
ING SERVICES, IN CLASS 35 (U.S. CLS. 100, 101 AND
102).

FIRST USE 11-19-2007; IN COMMERCE 11-19-2007.

OWNER OF U.S. REG. NOS. 2,203,028, 2,786,594,
AND 2,838,565.

NO CLAIM IS MADE TO THE EXCLUSIVE
RIGHT TO USE "SYSTEM PATIENT REFILLS ON-
LINE", APART FROM THE MARK AS SHOWN.

THE MARK CONSISTS OF AN ARROW POINT-
ING TO THE WORD "OBAGI" LOCATED IN A
CIRCLE FOLLOWED BY THE WORDS "P.R.O.
SYSTEM PATIENT REFILLS ONLINE".

SER. NO. 77-348,351, FILED 12-10-2007.

MARY ROSSMAN, EXAMINING ATTORNEY

Int. Cl.: 36

Prior U.S. Cls.: 100, 101 and 102

United States Patent and Trademark Office

Reg. No. 3,479,856

Registered Aug. 5, 2008

**SERVICE MARK
PRINCIPAL REGISTER**

**Academy of Financial
Literacy**

DAY, PHILLIP (UNITED STATES INDIVIDUAL)
2105 E OAKLAND ST.
CHANDLER, AZ 85225

FOR: FINANCIAL CONSULTATION, IN CLASS 36
(U.S. CLS. 100, 101 AND 102).

FIRST USE 6-10-2005; IN COMMERCE 10-10-2006.

THE MARK CONSISTS OF STANDARD CHAR-
ACTERS WITHOUT CLAIM TO ANY PARTICULAR
FONT, STYLE, SIZE, OR COLOR.

NO CLAIM IS MADE TO THE EXCLUSIVE
RIGHT TO USE "FINANCIAL", APART FROM
THE MARK AS SHOWN.

SER. NO. 77-348,363, FILED 12-10-2007.

ALLISON HOLTZ, EXAMINING ATTORNEY

Int. Cl.: 11

Prior U.S. Cls.: 13, 21, 23, 31 and 34

United States Patent and Trademark Office

Reg. No. 3,479,857

Registered Aug. 5, 2008

**TRADEMARK
PRINCIPAL REGISTER**

OVATION

APPLIANCE SCIENTIFIC (TEXAS CORPORATION)
SUITE 114
11601 PLANO ROAD
DALLAS, TX 75243

THE MARK CONSISTS OF STANDARD CHARACTERS WITHOUT CLAIM TO ANY PARTICULAR FONT, STYLE, SIZE, OR COLOR.

FOR: COMMERCIAL COOKING OVENS, IN CLASS 11 (U.S. CLS. 13, 21, 23, 31 AND 34).

SER. NO. 77-348,535, FILED 12-10-2007.

FIRST USE 10-1-2007; IN COMMERCE 10-1-2007.

CAROLYN CATALDO, EXAMINING ATTORNEY

Int. Cl.: 11

Prior U.S. Cls.: 13, 21, 23, 31 and 34

United States Patent and Trademark Office

Reg. No. 3,479,858

Registered Aug. 5, 2008

**TRADEMARK
PRINCIPAL REGISTER**

**OVATION by Appliance
Scientific**

APPLIANCE SCIENTIFIC (TEXAS CORPORATION)
SUITE 114
11601 PLANO ROAD
DALLAS, TX 75243

FOR: COMMERCIAL COOKING OVENS, IN CLASS 11 (U.S. CLS. 13, 21, 23, 31 AND 34).

FIRST USE 10-1-2007; IN COMMERCE 10-1-2007.

THE MARK CONSISTS OF STANDARD CHARACTERS WITHOUT CLAIM TO ANY PARTICULAR FONT, STYLE, SIZE, OR COLOR.

NO CLAIM IS MADE TO THE EXCLUSIVE RIGHT TO USE "BY APPLIANCE SCIENTIFIC", APART FROM THE MARK AS SHOWN.

SER. NO. 77-348,539, FILED 12-10-2007.

CAROLYN CATALDO, EXAMINING ATTORNEY

Int. Cl.: 21

Prior U.S. Cls.: 2, 13, 23, 29, 30, 33, 40 and 50

Reg. No. 3,479,859

United States Patent and Trademark Office

Registered Aug. 5, 2008

**TRADEMARK
PRINCIPAL REGISTER**

CULINARY BUDDY

CULINARY BUDDY CORP. (FLORIDA CORPORATION)
6450 COLLINS AVENUE, PENTHOUSE 1
MIAMI BEACH, FL 33141

FOR: KITCHEN TOOLS AND ACCESSORIES, NAMELY, COOKERY MOLDS, CONDIMENT BOTTLES SOLD EMPTY, FUNNELS, GRATERS, HAND FOOD SPREADERS, HAND OPERATED TAMPERS FOR COFFEE, IN CLASS 21 (U.S. CLS. 2, 13, 23, 29, 30, 33, 40 AND 50).

FIRST USE 7-31-2006; IN COMMERCE 7-31-2006.

THE MARK CONSISTS OF STANDARD CHARACTERS WITHOUT CLAIM TO ANY PARTICULAR FONT, STYLE, SIZE, OR COLOR.

NO CLAIM IS MADE TO THE EXCLUSIVE RIGHT TO USE "CULINARY", APART FROM THE MARK AS SHOWN.

SER. NO. 77-349,029, FILED 12-11-2007.

DANIEL CAPSHAW, EXAMINING ATTORNEY

Int. Cl.: 44

Prior U.S. Cls.: 100 and 101

United States Patent and Trademark Office

Reg. No. 3,479,860

Registered Aug. 5, 2008

**SERVICE MARK
PRINCIPAL REGISTER**

PENN HEART RESCUE

TRUSTEES OF THE UNIVERSITY OF PENNSYLVANIA, THE (PENNSYLVANIA NON-PROFIT CORPORATION)

133 S. 36TH STREET, SUITE 300
OFFICE OF THE GENERAL COUNSEL
PHILADELPHIA, PA 19104

FOR: MEDICAL SERVICES, IN CLASS 44 (U.S. CLS. 100 AND 101).

FIRST USE 2-28-2007; IN COMMERCE 2-28-2007.

THE MARK CONSISTS OF STANDARD CHARACTERS WITHOUT CLAIM TO ANY PARTICULAR FONT, STYLE, SIZE, OR COLOR.

OWNER OF U.S. REG. NOS. 1,773,257, 2,166,447 AND OTHERS.

NO CLAIM IS MADE TO THE EXCLUSIVE RIGHT TO USE "HEART", APART FROM THE MARK AS SHOWN.

SEC. 2(F).

SER. NO. 77-349,039, FILED 12-11-2007.

MICHELE SWAIN, EXAMINING ATTORNEY

Int. Cl.: 44

Prior U.S. Cls.: 100 and 101

United States Patent and Trademark Office

Reg. No. 3,479,861

Registered Aug. 5, 2008

**SERVICE MARK
PRINCIPAL REGISTER**



I SPORT, LLC (CALIFORNIA LTD LIAB CO)
2860 N. SANTIAGO BLVD.
ORANGE, CA 92867

FIRST USE 3-27-2006; IN COMMERCE 3-27-2006.

FOR: MEDICAL CONSULTATION AND ADVISORY SERVICES IN THE FIELD OF VISION CARE AND NUTRITIONAL DRUG SUPPLEMENTATION; PERFORMING DIAGNOSIS OF DISEASES RELATED TO ATHLETIC TRAINING; MEDICAL TESTING SERVICES IN THE FIELD OF VISION CARE AND NUTRITIONAL DRUG SUPPLEMENTATION, IN CLASS 44 (U.S. CLS. 100 AND 101).

THE MARK CONSISTS OF A STYLIZED IMAGE OF AN EYE ON TOP, AND A LOWER CASE STYLIZED "I" FOLLOWED BY THE STYLIZED CAPITAL-CASE WORD "SPORTGAMES" BELOW.

SER. NO. 77-349,215, FILED 12-11-2007.

LAURIE KAUFMAN, EXAMINING ATTORNEY

Int. Cl.: 29

Prior U.S. Cl.: 46

United States Patent and Trademark Office

Reg. No. 3,479,862

Registered Aug. 5, 2008

**TRADEMARK
PRINCIPAL REGISTER**

CORAZON DE RONDA

ANGULO GENERAL QUESERA, S.L. (SPAIN
CORPORATION)
POLIGONO INDUSTRIAL VILLALONQUEJAR
CALLE LOPEZ BRAVO, NUMERO 62
BURGOS, SPAIN 09001

THE ENGLISH TRANSLATION OF "CORAZON
DE RONDA" IN THE MARK IS "HEART OF RON-
DA". THE WORDING "CORAZON DE RONDA"
HAS NO MEANING OTHER THAN TRADEMARK
SIGNIFICANCE.

FOR: CHEESE, IN CLASS 29 (U.S. CL. 46).

FIRST USE 5-22-2007; IN COMMERCE 5-22-2007.

SER. NO. 77-349,249, FILED 12-11-2007.

THE MARK CONSISTS OF STANDARD CHAR-
ACTERS WITHOUT CLAIM TO ANY PARTICULAR
FONT, STYLE, SIZE, OR COLOR.

KALIE KUNG, EXAMINING ATTORNEY

Int. Cl.: 36

Prior U.S. Cls.: 100, 101 and 102

United States Patent and Trademark Office

Reg. No. 3,479,863

Registered Aug. 5, 2008

**SERVICE MARK
PRINCIPAL REGISTER**

PROXY REAL ESTATE

PROXY REAL ESTATE, LLC (WASHINGTON
LTD LIAB CO)

10900 NE 8TH STREET, SUITE 1125

BELLEVUE, WA 98004

FOR: REAL ESTATE BROKERAGE, IN CLASS 36
(U.S. CLS. 100, 101 AND 102).

FIRST USE 2-1-2007; IN COMMERCE 2-1-2007.

THE MARK CONSISTS OF STANDARD CHAR-
ACTERS WITHOUT CLAIM TO ANY PARTICULAR
FONT, STYLE, SIZE, OR COLOR.

NO CLAIM IS MADE TO THE EXCLUSIVE
RIGHT TO USE "REAL ESTATE", APART FROM
THE MARK AS SHOWN.

SER. NO. 77-349,481, FILED 12-11-2007.

DANIEL BRODY, EXAMINING ATTORNEY

Int. Cl.: 38

Prior U.S. Cls.: 100, 101 and 104

United States Patent and Trademark Office

Reg. No. 3,479,864

Registered Aug. 5, 2008

**SERVICE MARK
PRINCIPAL REGISTER**

CONNECT & DELIVER.

PETROCOM, L.L.C. (DELAWARE LTD LIAB CO)
5901 EARHART EXPRESSWAY
HARAHAN, LA 70123

FOR: COMMUNICATIONS SERVICES, NAMELY, CELLULAR TELEPHONE COMMUNICATIONS SERVICES, WIRELESS BROADBAND COMMUNICATION SERVICES; GROUND TO SATELLITE DOMESTIC AND INTERNATIONAL TELECOMMUNICATIONS SERVICES, NAMELY, AUDIO AND VIDEO TRANSMISSION SERVICES VIA SATELLITE; TWO-WAY RADIO COMMUNICATION SERVICES; EMERGENCY RESPONSE COMMUNICATION SERVICES, NAMELY,

TRANSMISSION, RECEPTION AND PROCESSING OF CODED EMERGENCY SIGNALS, IN CLASS 38 (U.S. CLS. 100, 101 AND 104).

FIRST USE 5-0-2007; IN COMMERCE 5-0-2007.

THE MARK CONSISTS OF STANDARD CHARACTERS WITHOUT CLAIM TO ANY PARTICULAR FONT, STYLE, SIZE, OR COLOR.

SER. NO. 77-349,552, FILED 12-11-2007.

ELISSA GARBER KON, EXAMINING ATTORNEY

Int. Cl.: 25

Prior U.S. Cls.: 22 and 39

United States Patent and Trademark Office

Reg. No. 3,479,865

Registered Aug. 5, 2008

**TRADEMARK
PRINCIPAL REGISTER**

REGIUS VESTIO

REGIUS VESTIO, LLC (NEW YORK LTD LIAB
CO)
350 FIFTH AVENUE, SUITE 6617
NEW YORK, NY 10118

FOR: CLOTHING, NAMELY, SHIRTS, VESTS,
SWEATERS, SHOES, CAPS, BANDANNAS, SHORTS,
SWEAT SHIRTS, PANTS, BELTS FOR CLOTHING,
SOCKS, SWIMWEAR, JACKETS, RAINWEAR,
BLOUSES, DRESSES, FOOTWEAR, HOSIERY,
SCARVES, HATS, HEAD BANDS, PAJAMAS, LIN-
GERIE AND SLEEPWEAR, IN CLASS 25 (U.S. CLS. 22
AND 39).

FIRST USE 8-28-2006; IN COMMERCE 8-28-2006.

THE MARK CONSISTS OF STANDARD CHAR-
ACTERS WITHOUT CLAIM TO ANY PARTICULAR
FONT, STYLE, SIZE, OR COLOR.

NO CLAIM IS MADE TO THE EXCLUSIVE
RIGHT TO USE "VESTIO", APART FROM THE
MARK AS SHOWN.

THE FOREIGN WORDING IN THE MARK
TRANSLATES INTO ENGLISH AS ROYAL OR
REGAL CLOTHING.

SER. NO. 77-349,675, FILED 12-12-2007.

ANGELA GAW, EXAMINING ATTORNEY

Int. Cl.: 9

Prior U.S. Cls.: 21, 23, 26, 36 and 38

United States Patent and Trademark Office

Reg. No. 3,479,866

Registered Aug. 5, 2008

**TRADEMARK
PRINCIPAL REGISTER**

CORE CITATION

THE AURI GROUP, LLC (INDIANA LTD LIAB
CO)
8200 HAVERSTICK ROAD, SUITE 245
INDIANAPOLIS, IN 46240

FOR: COMPUTER GRAPHICS SOFTWARE, IN
CLASS 9 (U.S. CLS. 21, 23, 26, 36 AND 38).

FIRST USE 12-11-2007; IN COMMERCE 12-11-2007.

THE MARK CONSISTS OF STANDARD CHAR-
ACTERS WITHOUT CLAIM TO ANY PARTICULAR
FONT, STYLE, SIZE, OR COLOR.

NO CLAIM IS MADE TO THE EXCLUSIVE
RIGHT TO USE "CITATION", APART FROM THE
MARK AS SHOWN.

SER. NO. 77-349,705, FILED 12-12-2007.

KARANENDRA S. CHHINA, EXAMINING ATTOR-
NEY

Int. Cl.: 30

Prior U.S. Cl.: 46

United States Patent and Trademark Office

Reg. No. 3,479,867

Registered Aug. 5, 2008

**TRADEMARK
PRINCIPAL REGISTER**

NUTTY BAR

MCKEE FOODS KINGMAN, INC. (ARIZONA
CORPORATION)
2675 WEST OATMAN ROAD
KINGMAN, AZ 86413

FOR: WAFERS, IN CLASS 30 (U.S. CL. 46).

FIRST USE 4-20-1960; IN COMMERCE 4-20-1960.

THE MARK CONSISTS OF STANDARD CHAR-
ACTERS WITHOUT CLAIM TO ANY PARTICULAR
FONT, STYLE, SIZE, OR COLOR.

OWNER OF U.S. REG. NO. 1,566,205.

NO CLAIM IS MADE TO THE EXCLUSIVE
RIGHT TO USE "BAR", APART FROM THE MARK
AS SHOWN.

SEC. 2(F).

SER. NO. 77-349,859, FILED 12-12-2007.

DAYNA BROWNE, EXAMINING ATTORNEY

Int. Cl.: 29

Prior U.S. Cl.: 46

United States Patent and Trademark Office

Reg. No. 3,479,868

Registered Aug. 5, 2008

**TRADEMARK
PRINCIPAL REGISTER**

WAKEFIELD

HARBOR SEAFOOD, INC. (NEW YORK COR-
PORATION)
969 LAKEVILLE ROAD
NEW HYDE PARK, NY 11040

FOR: FRESH AND FROZEN SHELLFISH AND
IMITATION CRAB MEAT, IN CLASS 29 (U.S. CL. 46).

FIRST USE 6-12-1972; IN COMMERCE 6-12-1972.

THE MARK CONSISTS OF STANDARD CHAR-
ACTERS WITHOUT CLAIM TO ANY PARTICULAR
FONT, STYLE, SIZE, OR COLOR.

SEC. 2(F).

SER. NO. 77-349,876, FILED 12-12-2007.

SUE LAWRENCE, EXAMINING ATTORNEY

Int. Cl.: 10

Prior U.S. Cls.: 26, 39 and 44

United States Patent and Trademark Office

Reg. No. 3,479,869

Registered Aug. 5, 2008

**TRADEMARK
PRINCIPAL REGISTER**

Burton Mobilization Belt

BURTON, M. BENJAMIN (UNITED STATES IN-
DIVIDUAL)
69 GREENWICH STREET
BERGENFIELD, NJ 07621

FOR: ORTHOPEDIC BELTS, IN CLASS 10 (U.S.
CLS. 26, 39 AND 44).

FIRST USE 12-1-2007; IN COMMERCE 12-1-2007.

THE MARK CONSISTS OF STANDARD CHAR-
ACTERS WITHOUT CLAIM TO ANY PARTICULAR
FONT, STYLE, SIZE, OR COLOR.

NO CLAIM IS MADE TO THE EXCLUSIVE
RIGHT TO USE "MOBILIZATION BELT", APART
FROM THE MARK AS SHOWN.

SER. NO. 77-349,893, FILED 12-12-2007.

KATHERINE CONNOLLY, EXAMINING ATTOR-
NEY

Int. Cl.: 7

Prior U.S. Cls.: 13, 19, 21, 23, 31, 34 and 35

Reg. No. 3,479,870

United States Patent and Trademark Office

Registered Aug. 5, 2008

**TRADEMARK
PRINCIPAL REGISTER**

GL 10

BSH BOSCH UND SIEMENS HAUSGERAETE
GMBH (FED REP GERMANY CORPORATION)

CARL-WERY-STRASSE 34
MUNICH, FED REP GERMANY 81739

FOR: HOUSEHOLD AND KITCHEN MACHINES
AND EQUIPMENT, NAMELY, ELECTRIC KITCHEN
MACHINES AND EQUIPMENT, NAMELY, VACUUM
CLEANERS; STRUCTURAL PARTS OF ALL
AFOREMENTIONED GOODS, IN CLASS 7 (U.S. CLS.
13, 19, 21, 23, 31, 34 AND 35).

THE MARK CONSISTS OF STANDARD CHARACTERS
WITHOUT CLAIM TO ANY PARTICULAR
FONT, STYLE, SIZE, OR COLOR.

PRIORITY CLAIMED UNDER SEC. 44(D) ON FED
REP GERMANY APPLICATION NO. 30744379.5/0,
FILED 7-6-2007, REG. NO. 30744379, DATED 10-5-
2007, EXPIRES 7-31-2017.

SER. NO. 77-350,050, FILED 12-12-2007.

JASON BLAIR, EXAMINING ATTORNEY

Int. Cl.: 7

Prior U.S. Cls.: 13, 19, 21, 23, 31, 34 and 35

United States Patent and Trademark Office

Reg. No. 3,479,871

Registered Aug. 5, 2008

**TRADEMARK
PRINCIPAL REGISTER**

GL 20

BSH BOSCH UND SIEMENS HAUSGERAETE
GMBH (FED REP GERMANY CORPORATION)
CARL-WERY-STRASSE 34
MUNICH, FED REP GERMANY 81739

FOR: HOUSEHOLD AND KITCHEN MACHINES
AND EQUIPMENT, NAMELY, ELECTRIC KITCHEN
MACHINES AND EQUIPMENT, NAMELY, VACUUM
CLEANERS; STRUCTURAL PARTS OF ALL
AFOREMENTIONED GOODS, IN CLASS 7 (U.S. CLS.
13, 19, 21, 23, 31, 34 AND 35).

THE MARK CONSISTS OF STANDARD CHARACTERS
WITHOUT CLAIM TO ANY PARTICULAR
FONT, STYLE, SIZE, OR COLOR.

PRIORITY CLAIMED UNDER SEC. 44(D) ON FED
REP GERMANY APPLICATION NO. 30744380.9/0,
FILED 7-6-2007, REG. NO. 30744380, DATED 10-5-
2007, EXPIRES 7-31-2017.

SER. NO. 77-350,066, FILED 12-12-2007.

JASON BLAIR, EXAMINING ATTORNEY

Int. Cls.: 35 and 41

Prior U.S. Cls.: 100, 101, 102 and 107

United States Patent and Trademark Office

Reg. No. 3,479,872

Registered Aug. 5, 2008

**SERVICE MARK
PRINCIPAL REGISTER**

SUGAR

ODDESSE, INC. (NEVADA CORPORATION)
21363 LASSEN, SUITE 101
CHATSWORTH, CA 91311

FOR: ON-LINE RETAIL STORE SERVICES FEATURING ADULT-THEMED TOYS, ADULT-THEMED NOVELTY ITEMS, CLOTHING, LINGERIE, AND ADULT-THEMED DVDS AND VIDEOS; MARKETING CONSULTATION IN THE FIELD OF ONLINE AFFILIATE MARKETING SERVICES; PROMOTING THE GOODS AND SERVICES OF OTHERS BY ARRANGING FOR SPONSORS TO AFFILIATE THEIR GOODS AND SERVICES WITH A WEB SITE AND SPONSORED EVENTS; AFFILIATE MARKETING PROGRAM, NAMELY, PROMOTING THE GOODS AND SERVICES OF OTHERS BY PREPARING AND PLACING PROMOTIONAL ADVERTISEMENTS, BANNERS, AND GRAPHICS ON WEB SITES ACCESSED THROUGH A GLOBAL COMPUTER NETWORK; AND PROVIDING INTEGRATED TRACKING AND MANAGEMENT OF COMMERCIAL TRANSACTIONS ON A

GLOBAL COMPUTER NETWORK, IN CLASS 35 (U.S. CLS. 100, 101 AND 102).

FIRST USE 0-0-2002; IN COMMERCE 0-0-2002.

FOR: RENTAL OF ADULT-THEMED DVDS AND PRE-RECORDED VIDEOS THAT MAY BE DOWNLOADED FROM AN INTERNET WEBSITE; RENTAL OF PRE-RECORDED DVDS AND VIDEO TAPES, IN CLASS 41 (U.S. CLS. 100, 101 AND 107).

FIRST USE 0-0-2002; IN COMMERCE 0-0-2002.

THE MARK CONSISTS OF STANDARD CHARACTERS WITHOUT CLAIM TO ANY PARTICULAR FONT, STYLE, SIZE, OR COLOR.

OWNER OF U.S. REG. NOS. 3,120,566, 3,120,569, AND 3,363,037.

SER. NO. 77-350,093, FILED 12-12-2007.

SANI KHOURI, EXAMINING ATTORNEY

Int. Cl.: 7

Prior U.S. Cls.: 13, 19, 21, 23, 31, 34 and 35

United States Patent and Trademark Office

Reg. No. 3,479,873

Registered Aug. 5, 2008

**TRADEMARK
PRINCIPAL REGISTER**

GL 30

BSH BOSCH UND SIEMENS HAUSGERAETE
GMBH (FED REP GERMANY CORPORATION)

CARL-WERY-STRASSE 34
MUNICH, FED REP GERMANY 81739

FOR: HOUSEHOLD AND KITCHEN MACHINES
AND EQUIPMENT, NAMELY, ELECTRIC KITCHEN
MACHINES AND EQUIPMENT, NAMELY, VACUUM
CLEANERS; STRUCTURAL PARTS OF ALL
AFOREMENTIONED GOODS, IN CLASS 7 (U.S. CLS.
13, 19, 21, 23, 31, 34 AND 35).

THE MARK CONSISTS OF STANDARD CHARACTERS
WITHOUT CLAIM TO ANY PARTICULAR
FONT, STYLE, SIZE, OR COLOR.

PRIORITY CLAIMED UNDER SEC. 44(D) ON FED
REP GERMANY APPLICATION NO. 30744381.7/0,
FILED 7-6-2007, REG. NO. 30744381, DATED 10-5-
2007, EXPIRES 7-31-2017.

SER. NO. 77-350,094, FILED 12-12-2007.

JASON BLAIR, EXAMINING ATTORNEY

Int. Cl.: 7

Prior U.S. Cls.: 13, 19, 21, 23, 31, 34 and 35

United States Patent and Trademark Office

Reg. No. 3,479,874

Registered Aug. 5, 2008

**TRADEMARK
PRINCIPAL REGISTER**

GL 40

BSH BOSCH UND SIEMENS HAUSGERAETE
GMBH (FED REP GERMANY CORPORATION)
CARL-WERY-STRASSE 34
MUNICH, FED REP GERMANY 81739

FOR: HOUSEHOLD AND KITCHEN MACHINES
AND EQUIPMENT, NAMELY, ELECTRIC KITCHEN
MACHINES AND EQUIPMENT, NAMELY, VACUUM
CLEANERS; STRUCTURAL PARTS OF ALL
AFOREMENTIONED GOODS, IN CLASS 7 (U.S. CLS.
13, 19, 21, 23, 31, 34 AND 35).

THE MARK CONSISTS OF STANDARD CHARACTERS
WITHOUT CLAIM TO ANY PARTICULAR
FONT, STYLE, SIZE, OR COLOR.

PRIORITY CLAIMED UNDER SEC. 44(D) ON FED
REP GERMANY APPLICATION NO. 30744382.5/0,
FILED 7-6-2007, REG. NO. 30744382, DATED 10-5-
2007, EXPIRES 7-31-2017.

SER. NO. 77-350,110, FILED 12-12-2007.

JASON BLAIR, EXAMINING ATTORNEY

Int. Cl.: 7

Prior U.S. Cls.: 13, 19, 21, 23, 31, 34 and 35

United States Patent and Trademark Office

Reg. No. 3,479,875

Registered Aug. 5, 2008

**TRADEMARK
PRINCIPAL REGISTER**

GL 50

BSH BOSCH UND SIEMENS HAUSGERAETE
GMBH (FED REP GERMANY CORPORATION)

CARL-WERY-STRASSE 34
MUNICH, FED REP GERMANY 81739

FOR: HOUSEHOLD AND KITCHEN MACHINES
AND EQUIPMENT, NAMELY, ELECTRIC KITCHEN
MACHINES AND EQUIPMENT, NAMELY, VACUUM
CLEANERS; STRUCTURAL PARTS OF ALL
AFOREMENTIONED GOODS, IN CLASS 7 (U.S. CLS.
13, 19, 21, 23, 31, 34 AND 35).

THE MARK CONSISTS OF STANDARD CHARACTERS
WITHOUT CLAIM TO ANY PARTICULAR
FONT, STYLE, SIZE, OR COLOR.

PRIORITY CLAIMED UNDER SEC. 44(D) ON FED
REP GERMANY APPLICATION NO. 30744383.3/0,
FILED 7-6-2007, REG. NO. 30744383, DATED 10-5-
2007, EXPIRES 7-31-2017.

SER. NO. 77-350,133, FILED 12-12-2007.

JASON BLAIR, EXAMINING ATTORNEY

Int. Cl.: 7

Prior U.S. Cls.: 13, 19, 21, 23, 31, 34 and 35

United States Patent and Trademark Office

Reg. No. 3,479,876

Registered Aug. 5, 2008

**TRADEMARK
PRINCIPAL REGISTER**

GL 60

BSH BOSCH UND SIEMENS HAUSGERAETE
GMBH (FED REP GERMANY CORPORATION)

CARL-WERY-STRASSE 34
MUNICH, FED REP GERMANY 81739

FOR: HOUSEHOLD AND KITCHEN MACHINES
AND EQUIPMENT, NAMELY, ELECTRIC KITCHEN
MACHINES AND EQUIPMENT, NAMELY, VACUUM
CLEANERS; STRUCTURAL PARTS OF ALL
AFOREMENTIONED GOODS, IN CLASS 7 (U.S. CLS.
13, 19, 21, 23, 31, 34 AND 35).

THE MARK CONSISTS OF STANDARD CHARACTERS
WITHOUT CLAIM TO ANY PARTICULAR
FONT, STYLE, SIZE, OR COLOR.

PRIORITY CLAIMED UNDER SEC. 44(D) ON FED
REP GERMANY APPLICATION NO. 30744384.1/0,
FILED 7-6-2007, REG. NO. 30744384, DATED 10-5-
2007, EXPIRES 7-31-2017.

SER. NO. 77-350,201, FILED 12-12-2007.

JASON BLAIR, EXAMINING ATTORNEY

Int. Cl.: 7

Prior U.S. Cls.: 13, 19, 21, 23, 31, 34 and 35

United States Patent and Trademark Office

Reg. No. 3,479,877

Registered Aug. 5, 2008

**TRADEMARK
PRINCIPAL REGISTER**

GL 70

BSH BOSCH UND SIEMENS HAUSGERAETE
GMBH (FED REP GERMANY CORPORATION)
CARL-WERY-STRASSE 34
MUNICH, FED REP GERMANY 81739

FOR: HOUSEHOLD AND KITCHEN MACHINES
AND EQUIPMENT, NAMELY, ELECTRIC KITCHEN
MACHINES AND EQUIPMENT, NAMELY, VACUUM
CLEANERS; STRUCTURAL PARTS OF ALL
AFOREMENTIONED GOODS, IN CLASS 7 (U.S. CLS.
13, 19, 21, 23, 31, 34 AND 35).

THE MARK CONSISTS OF STANDARD CHARACTERS
WITHOUT CLAIM TO ANY PARTICULAR
FONT, STYLE, SIZE, OR COLOR.

PRIORITY CLAIMED UNDER SEC. 44(D) ON FED
REP GERMANY APPLICATION NO. 30744386.807,
FILED 7-6-2007, REG. NO. 30744386, DATED 10-5-
2007, EXPIRES 7-31-2017.

SER. NO. 77-350,218, FILED 12-12-2007.

JASON BLAIR, EXAMINING ATTORNEY

Int. Cl.: 7

Prior U.S. Cls.: 13, 19, 21, 23, 31, 34 and 35

United States Patent and Trademark Office

Reg. No. 3,479,878

Registered Aug. 5, 2008

**TRADEMARK
PRINCIPAL REGISTER**

GL 80

BSH BOSCH UND SIEMENS HAUSGERAETE
GMBH (FED REP GERMANY CORPORATION)

CARL-WERY-STRASSE 34

MUNICH, FED REP GERMANY 81739

FOR: HOUSEHOLD AND KITCHEN MACHINES
AND EQUIPMENT, NAMELY, ELECTRIC KITCHEN
MACHINES AND EQUIPMENT, NAMELY, VACUUM
CLEANERS; STRUCTURAL PARTS OF ALL
AFOREMENTIONED GOODS, IN CLASS 7 (U.S. CLS.
13, 19, 21, 23, 31, 34 AND 35).

THE MARK CONSISTS OF STANDARD CHARACTERS
WITHOUT CLAIM TO ANY PARTICULAR
FONT, STYLE, SIZE, OR COLOR.

PRIORITY CLAIMED UNDER SEC. 44(D) ON FED
REP GERMANY APPLICATION NO. 30744387.6/0,
FILED 7-6-2007, REG. NO. 30744387, DATED 10-5-
2007, EXPIRES 7-31-2017.

SER. NO. 77-350,234, FILED 12-12-2007.

JASON BLAIR, EXAMINING ATTORNEY

Int. Cl.: 7

Prior U.S. Cls.: 13, 19, 21, 23, 31, 34 and 35

United States Patent and Trademark Office

Reg. No. 3,479,879

Registered Aug. 5, 2008

**TRADEMARK
PRINCIPAL REGISTER**

GL 90

BSH BOSCH UND SIEMENS HAUSGERAETE
GMBH (FED REP GERMANY CORPORATION)

CARL-WERY-STRASSE 34
MUNICH, FED REP GERMANY 81739

FOR: HOUSEHOLD AND KITCHEN MACHINES
AND EQUIPMENT, NAMELY, ELECTRIC KITCHEN
MACHINES AND EQUIPMENT, NAMELY, VACUUM
CLEANERS; STRUCTURAL PARTS OF ALL
AFOREMENTIONED GOODS, IN CLASS 7 (U.S. CLS.
13, 19, 21, 23, 31, 34 AND 35).

THE MARK CONSISTS OF STANDARD CHARACTERS
WITHOUT CLAIM TO ANY PARTICULAR
FONT, STYLE, SIZE, OR COLOR.

PRIORITY CLAIMED UNDER SEC. 44(D) ON FED
REP GERMANY APPLICATION NO. 30744388.4/0,
FILED 7-6-2007, REG. NO. 30744388, DATED 10-5-
2007, EXPIRES 7-31-2017.

SER. NO. 77-350,248, FILED 12-12-2007.

JASON BLAIR, EXAMINING ATTORNEY

Int. Cl.: 14

Prior U.S. Cls.: 2, 27, 28 and 50

United States Patent and Trademark Office

Reg. No. 3,479,880

Registered Aug. 5, 2008

**TRADEMARK
PRINCIPAL REGISTER**

JENLARI

UNCAS MANUFACTURING COMPANY
(RHODE ISLAND CORPORATION)
150 NIAN TIC AVENUE
PROVIDENCE, RI 02907

FOR: JEWELRY, IN CLASS 14 (U.S. CLS. 2, 27, 28
AND 50).

FIRST USE 2-28-2007; IN COMMERCE 2-28-2007.

THE MARK CONSISTS OF STANDARD CHAR-
ACTERS WITHOUT CLAIM TO ANY PARTICULAR
FONT, STYLE, SIZE, OR COLOR.

THE WORDING "JENLARI" HAS NO MEANING
IN A FOREIGN LANGUAGE.

SER. NO. 77-350,295, FILED 12-12-2007.

MICHAEL TANNER, EXAMINING ATTORNEY

Int. Cl.: 35

Prior U.S. Cls.: 100, 101 and 102

United States Patent and Trademark Office

Reg. No. 3,479,881

Registered Aug. 5, 2008

**SERVICE MARK
PRINCIPAL REGISTER**

**LEADING THE SERVICE
INDUSTRY**

THE DWYER GROUP, INC. (TEXAS CORPORATION)
1010-1020 NORTH UNIVERSITY PARKS DRIVE
WACO, TX 76707

FOR: PROVIDING A WIDE VARIETY OF SUPPORT SERVICES TO FRANCHISE COMPANIES, NAMELY, ACCOUNTING SERVICES, PERSONNEL MANAGEMENT SERVICES AND BUSINESS MANAGEMENT AND BUSINESS CONSULTATION SERVICES, IN CLASS 35 (U.S. CLS. 100, 101 AND 102).

FIRST USE 5-21-2007; IN COMMERCE 5-21-2007.

THE MARK CONSISTS OF STANDARD CHARACTERS WITHOUT CLAIM TO ANY PARTICULAR FONT, STYLE, SIZE, OR COLOR.

SER. NO. 77-350,306, FILED 12-12-2007.

DAVID TOOLEY, EXAMINING ATTORNEY

Int. Cl.: 39

Prior U.S. Cls.: 100 and 105

United States Patent and Trademark Office

Reg. No. 3,479,882

Registered Aug. 5, 2008

SERVICE MARK
PRINCIPAL REGISTER



ASBERRY, DEBRA (ALBANIA INDIVIDUAL)
1642 FAIRHILL DRIVE
EDGEWATER, MD 21140

FOR: ARRANGING TRAVEL TOURS, IN CLASS
39 (U.S. CLS. 100 AND 105).

FIRST USE 10-10-2004; IN COMMERCE 10-10-2004.

NO CLAIM IS MADE TO THE EXCLUSIVE
RIGHT TO USE "WOMEN TRAVELING TOGE-
THER", APART FROM THE MARK AS SHOWN.

"THE MARK CONSISTS OF A GLOBE DESIGN
WITH THE WORDS "WOMEN TRAVELING TOGE-
THER"."

SER. NO. 77-350,467, FILED 12-12-2007.

G. MAYERSCHOFF, EXAMINING ATTORNEY

Int. Cl.: 16

Prior U.S. Cls.: 2, 5, 22, 23, 29, 37, 38 and 50

United States Patent and Trademark Office

Reg. No. 3,479,883

Registered Aug. 5, 2008

TRADEMARK
PRINCIPAL REGISTER

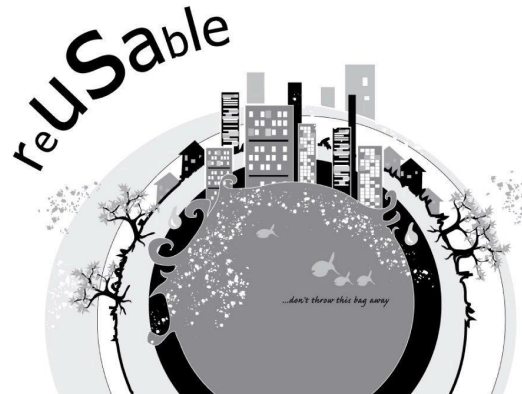

COMMAND PACKAGING (CALIFORNIA CORPORATION)
3840 E 26TH STREET
LOS ANGELES, CA 90023

FOR: MERCHANDISE BAGS, IN CLASS 16 (U.S. CLS. 2, 5, 22, 23, 29, 37, 38 AND 50).

FIRST USE 11-8-2007; IN COMMERCE 11-10-2007.

NO CLAIM IS MADE TO THE EXCLUSIVE RIGHT TO USE "REUSABLE", APART FROM THE MARK AS SHOWN.

THE MARK CONSISTS OF THE WORD REUSABLE AND THE CITYSCAPE.

SER. NO. 77-350,474, FILED 12-12-2007.

ESTHER A. BORSUK, EXAMINING ATTORNEY

Int. Cl.: 35

Prior U.S. Cls.: 100, 101 and 102

United States Patent and Trademark Office

Reg. No. 3,479,884

Registered Aug. 5, 2008

**SERVICE MARK
PRINCIPAL REGISTER**



HEALTH INDUSTRY DISTRIBUTORS ASSOCIATION (VIRGINIA CORPORATION)
310 MONTGOMERY ST.
ALEXANDRIA, VA 22314

FOR: PROVIDING INFORMATION REGARDING SEASONAL FLU VACCINE DISTRIBUTION, LOGISTICS, AND SUPPLY CHAIN, IN CLASS 35 (U.S. CLS. 100, 101 AND 102).

FIRST USE 10-1-2007; IN COMMERCE 10-1-2007.

NO CLAIM IS MADE TO THE EXCLUSIVE RIGHT TO USE "FLU VACCINE" OR "BUSINESS

PRACTICES INITIATIVE", APART FROM THE MARK AS SHOWN.

THE MARK CONSISTS OF A LARGE CHECK MARK WITH A CIRCLE OVERLAYING THE MARK WITH THE WORD "FLU" CONTAINED WITHIN; TO THE RIGHT THE WORD "VACCINE" WITH A LINE BELOW; BELOW THE SAME LINE, THE WORDS "BUSINESS PRACTICES INITIATIVE".

SER. NO. 77-350,565, FILED 12-12-2007.

TINA L. SNAPP, EXAMINING ATTORNEY

Int. Cl.: 43

Prior U.S. Cls.: 100 and 101

United States Patent and Trademark Office

Reg. No. 3,479,885

Registered Aug. 5, 2008

**SERVICE MARK
PRINCIPAL REGISTER**

AZUMA

AZUMA LEASING CT, LP (TEXAS LIMITED
PARTNERSHIP)
2905 SAN GABRIEL, SUITE 218
AUSTIN, TX 78705

FOR: RENTAL OF HOUSEHOLD FURNISHINGS
IN THE NATURE OF APPLIANCES, IN CLASS 43
(U.S. CLS. 100 AND 101).

FIRST USE 10-0-1993; IN COMMERCE 10-0-1993.

THE MARK CONSISTS OF STANDARD CHAR-
ACTERS WITHOUT CLAIM TO ANY PARTICULAR
FONT, STYLE, SIZE, OR COLOR.

THE FOREIGN WORDING IN THE MARK
TRANSLATES INTO ENGLISH AS FROM THE
EAST.

SER. NO. 77-350,889, FILED 12-13-2007.

JENNIFER MARTIN, EXAMINING ATTORNEY

Int. Cl.: 29

Prior U.S. Cl.: 46

United States Patent and Trademark Office

Reg. No. 3,479,886

Registered Aug. 5, 2008

**TRADEMARK
PRINCIPAL REGISTER**

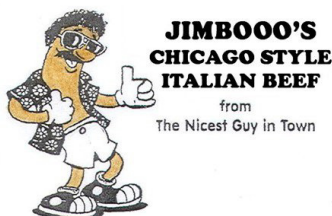

LUNGARO, JIM (UNITED STATES INDIVIDUAL)
429 E. 162ND ST.
SOUTH HOLLAND, IL 60473

FOR: BEEF; BEEF SLICES; PREPARED BEEF;
ROAST BEEF, IN CLASS 29 (U.S. CL. 46).

FIRST USE 12-1-2006; IN COMMERCE 2-1-2007.

NO CLAIM IS MADE TO THE EXCLUSIVE
RIGHT TO USE "CHICAGO STYLE ITALIAN BEEF",
APART FROM THE MARK AS SHOWN.

THE COLOR(S) TAN, WHITE AND BLACK IS/
ARE CLAIMED AS A FEATURE OF THE MARK.

THE MARK CONSISTS OF THE WORDING "JIMBOOO'S CHICAGO STYLE ITALIAN BEEF" AND "FROM THE NICEST GUY IN TOWN" IS BLACK; THE DEPICTION OF A HOT DOG WITH HUMAN LIKE FEATURES IS TAN WITH BLACK OUTLINES; THE HAIR IS BLACK; THE GLASSES ARE BLACK AND WHITE; THE MUSTACHE IS BLACK; THE MOUTH IS BLACK AND WHITE; THE SHIRT IS BLACK WITH WHITE FLORAL DESIGNS; THE HANDS ARE WHITE WITH BLACK OUTLINES; THE PANTS ARE WHITE WITH BLACK OUTLINES; AND THE SHOES ARE BLACK AND WHITE.

SER. NO. 77-350,896, FILED 12-13-2007.

JILL C. ALT, EXAMINING ATTORNEY

Int. Cl.: 16

Prior U.S. Cls.: 2, 5, 22, 23, 29, 37, 38 and 50

United States Patent and Trademark Office

Reg. No. 3,479,887

Registered Aug. 5, 2008

**TRADEMARK
PRINCIPAL REGISTER**

JUBILATION STATION

COOK COMMUNICATIONS MINISTRIES (ILLINOIS CORPORATION)
4050 LEE VANCE VIEW
COLORADO SPRINGS, CO 80918

FOR: STUDY GUIDES; CHILDREN'S INTERACTIVE EDUCATIONAL BOOKS; EDUCATIONAL PUBLICATIONS, NAMELY, EDUCATIONAL LEARNING CARDS, FLASH CARDS, ACTIVITY CARDS, WORKBOOKS, TEXTBOOKS, ACTIVITY BOOKS, STORY BOOKS, PUZZLE BOOKS, PUZZLES, TEACHER GUIDES, MANUALS, POSTERS, EDUCATIONAL CARD GAMES AND EDUCATIONAL BOOKLETS IN THE FIELD OF CHRISTIAN FAITH; PRINTED INSTRUCTIONAL, EDUCATIONAL, AND TEACHING MATERIALS IN THE FIELD

OF CHRISTIAN FAITH, IN CLASS 16 (U.S. CLS. 2, 5, 22, 23, 29, 37, 38 AND 50).

FIRST USE 1-1-1996; IN COMMERCE 1-1-1996.

THE MARK CONSISTS OF STANDARD CHARACTERS WITHOUT CLAIM TO ANY PARTICULAR FONT, STYLE, SIZE, OR COLOR.

OWNER OF U.S. REG. NO. 2,103,358.

SER. NO. 77-350,971, FILED 12-13-2007.

RAUL CORDOVA, EXAMINING ATTORNEY

Int. Cls.: 6, 7, 9, 19 and 20

**Prior U.S. Cls.: 1, 2, 12, 13, 14, 19, 21, 22, 23, 25, 26,
31, 32, 33, 34, 35, 36, 38 and 50**

Reg. No. 3,479,888

United States Patent and Trademark Office

Registered Aug. 5, 2008

**TRADEMARK
PRINCIPAL REGISTER**

STAUFF

STAUFF CORPORATION (NEW JERSEY CORPORATION)
7 WM. DEMAREST PLACE
WALDWICK, NJ 07463

FOR: METAL CLAMPS; METAL HOSE CLAMPS; METAL COUPLINGS FOR USE WITH HYDRAULIC LINES; METAL PIPE COUPLINGS AND JOINTS; MANUALLY OPERATED METAL VALVES; METAL PIPE SUPPORTS; AND HOSE HANGERS OF METAL, IN CLASS 6 (U.S. CLS. 2, 12, 13, 14, 23, 25 AND 50).

FIRST USE 1-1-1984; IN COMMERCE 1-1-1984.

FOR: HYDRAULIC FLUID FILTERS FOR MECHANICAL PURPOSES, IN CLASS 7 (U.S. CLS. 13, 19, 21, 23, 31, 34 AND 35).

FIRST USE 1-1-1984; IN COMMERCE 1-1-1984.

FOR: PRESSURE GAUGES; PRESSURE SENSORS; ELECTRONIC SWITCHES; TEMPERATURE SENSORS; ELECTRONIC FLUID FLOW SENSORS; FLOW METERS; ELECTRONIC TEST INSTRUMENTS AND ASSOCIATED SOFTWARE FOR USE IN LEAK, FLOW AND FUNCTIONAL TESTING; FLOW REGULATORS FOR INDUSTRIAL USE;

AND APPARATUS FOR TESTING GAS, LIQUIDS AND SOLIDS, IN CLASS 9 (U.S. CLS. 21, 23, 26, 36 AND 38).

FIRST USE 1-1-1984; IN COMMERCE 1-1-1984.

FOR: PLASTIC PIPE SUPPORTS, PIPE SUPPORTS MADE OF PLASTIC WITH RUBBER INSERTS, IN CLASS 19 (U.S. CLS. 1, 12, 33 AND 50).

FIRST USE 1-1-1984; IN COMMERCE 1-1-1984.

FOR: NONMETAL CLAMPS; HOSE HANGERS NOT OF METAL, IN CLASS 20 (U.S. CLS. 2, 13, 22, 25, 32 AND 50).

FIRST USE 1-1-1984; IN COMMERCE 1-1-1984.

THE MARK CONSISTS OF STANDARD CHARACTERS WITHOUT CLAIM TO ANY PARTICULAR FONT, STYLE, SIZE, OR COLOR.

SEC. 2(F).

SER. NO. 77-351,140, FILED 12-13-2007.

JUDITH HELFMAN, EXAMINING ATTORNEY

Int. Cl.: 7

Prior U.S. Cls.: 13, 19, 21, 23, 31, 34 and 35

United States Patent and Trademark Office

Reg. No. 3,479,889

Registered Aug. 5, 2008

**TRADEMARK
PRINCIPAL REGISTER**

GS 40

BSH BOSCH UND SIEMENS HAUSGERAETE
GMBH (FED REP GERMANY CORPORATION)

CARL-WERY-STRASSE 34
MUNICH, FED REP GERMANY 81739

FOR: HOUSEHOLD AND KITCHEN MACHINES
AND EQUIPMENT, NAMELY, ELECTRIC KITCHEN
MACHINES AND EQUIPMENT, NAMELY, VACUUM
CLEANERS; STRUCTURAL PARTS OF ALL
AFOREMENTIONED GOODS, IN CLASS 7 (U.S. CLS.
13, 19, 21, 23, 31, 34 AND 35).

THE MARK CONSISTS OF STANDARD CHARACTERS
WITHOUT CLAIM TO ANY PARTICULAR
FONT, STYLE, SIZE, OR COLOR.

PRIORITY CLAIMED UNDER SEC. 44(D) ON FED
REP GERMANY APPLICATION NO. 30744392.2/0,
FILED 7-6-2007, REG. NO. 30744392, DATED 10-5-
2007, EXPIRES 7-31-2017.

SER. NO. 77-351,144, FILED 12-13-2007.

JASON BLAIR, EXAMINING ATTORNEY

Int. Cl.: 45

Prior U.S. Cls.: 100 and 101

United States Patent and Trademark Office

Reg. No. 3,479,890

Registered Aug. 5, 2008

**SERVICE MARK
PRINCIPAL REGISTER**



ADEYEMI, YATO (UNITED STATES INDIVIDUAL)
4972 E. KINGS AVENUE
SCOTTSDALE, AZ 85254 AND
GOSPEL MISSIONS INTERNATIONAL (ARIZONA CORPORATION)
P.O. BOX 54866
PHOENIX, AZ 85078

FOR: CHARITABLE OUTREACH SERVICES, NAMELY, PROVIDING COUNSELING SERVICES IN THE FIELD OF RELIGION TO THE NEEDY, THE IMPRISONED, AND THE SICK; CONDUCTING RELIGIOUS PRAYER SERVICES; EVANGELISTIC AND MINISTERIAL SERVICES; EVANGELISTIC MINISTERIAL SERVICES; MINISTERIAL SERVICES; MINISTERIAL SERVICES, NAMELY, HOLDING SPIRITUAL RETREATS TO ASSIST RELIGIOUS LEADERS, BOTH CLERGY AND LAY, TO DEVELOP AND ENHANCE THEIR SPIRITUAL LIVES; RELIGIOUS AND SPIRITUAL SERVICES, NAMELY, PROVIDING GATHERINGS AND RETREATS TO DEVELOP AND ENHANCE THE SPIRITUAL LIVES OF INDIVIDUALS, IN CLASS 45 (U.S. CLS. 100 AND 101).

FIRST USE 1-1-2000; IN COMMERCE 1-1-2000.

NO CLAIM IS MADE TO THE EXCLUSIVE RIGHT TO USE "GOSPEL MISSIONS INTERNATIONAL", APART FROM THE MARK AS SHOWN.

THE COLOR(S) BLACK, WHITE, GRAY, RED, ORANGE, YELLOW, GOLD, AND BROWN IS/ARE CLAIMED AS A FEATURE OF THE MARK.

THE MARK CONSISTS OF A BROWN EAGLE WITH WHITE HEAD WITH GRAY SHADING, WHITE TAIL WITH GRAY SHADING, YELLOW BEAK AND TALONS, ALL OUTLINED IN BLACK, HOLDING AN ORANGE SCROLL TIED WITH A RED BAND, ALL OUTLINED IN BLACK; BELOW THE EAGLE IS A BIBLE WITH WHITE PAGES WITH GOLD WRITING AND EDGES WITH BLACK MARKS AND BLACK COVER; TO THE RIGHT ARE THE LETTERS "GMI" IN ORANGE, THE WORDING "GOSPEL MISSIONS INTERNATIONAL" IN GRAY AND UNDERLINED WITH A GRAY LINE, AND THE WORDING "TAKING THE GOSPEL TO THE NATIONS!" IN ORANGE.

SER. NO. 77-351,188, FILED 12-13-2007.

CARRIE GENOVESE, EXAMINING ATTORNEY

Int. Cl.: 36

Prior U.S. Cls.: 100, 101 and 102

United States Patent and Trademark Office

Reg. No. 3,479,891

Registered Aug. 5, 2008

**SERVICE MARK
PRINCIPAL REGISTER**

Network  for Good

NETWORK FOR GOOD, INC. (DELAWARE
NON-PROFIT CORPORATION)
7920 NORFOLK AVENUE
BETHESDA, MD 20814

FOR: PHILANTHROPIC SERVICES CONCERN-
ING MONETARY DONATIONS AND CASH CON-
TRIBUTIONS; PROVIDING ONLINE
INFORMATION IN THE FIELD OF CHARITABLE
MONETARY GIVING THROUGH FINANCIAL
AND ESTATE PLANNING, IN CLASS 36 (U.S. CLS.
100, 101 AND 102).

FIRST USE 11-19-2001; IN COMMERCE 11-19-2001.

OWNER OF U.S. REG. NO. 2,691,002.

THE MARK CONSISTS OF THE WORDS "NET-
WORK FOR GOOD" AND DESIGN DEPICTING A
PERSON .

SER. NO. 77-351,190, FILED 12-13-2007.

ANNE MADDEN, EXAMINING ATTORNEY

Int. Cl.: 35

Prior U.S. Cls.: 100, 101 and 102

United States Patent and Trademark Office

Reg. No. 3,479,892

Registered Aug. 5, 2008

**SERVICE MARK
PRINCIPAL REGISTER**

DENEZ

MIMAAPPAREL, INC. (DELAWARE CORPORATION)

#552

73 GREENTREE DRIVE

DOVER, DE 19904

FOR: ON-LINE RETAIL STORE SERVICES FEATURING CLOTHING AND APPAREL; RETAIL CLOTHING STORES, IN CLASS 35 (U.S. CLS. 100, 101 AND 102).

FIRST USE 2-1-2007; IN COMMERCE 2-1-2007.

THE MARK CONSISTS OF STANDARD CHARACTERS WITHOUT CLAIM TO ANY PARTICULAR FONT, STYLE, SIZE, OR COLOR.

THIS TERM HAS NO MEANING IN A FOREIGN LANGUAGE.

SER. NO. 77-351,199, FILED 12-13-2007.

GENE MACIOL, EXAMINING ATTORNEY

Int. Cl.: 7

Prior U.S. Cls.: 13, 19, 21, 23, 31, 34 and 35

United States Patent and Trademark Office

Reg. No. 3,479,893

Registered Aug. 5, 2008

**TRADEMARK
PRINCIPAL REGISTER**

GS 70

BSH BOSCH UND SIEMENS HAUSGERAETE
GMBH (FED REP GERMANY CORPORATION)

CARL-WERY-STRASSE 34
MUNICH, FED REP GERMANY 81739

FOR: HOUSEHOLD AND KITCHEN MACHINES
AND EQUIPMENT, NAMELY, ELECTRIC KITCHEN
MACHINES AND EQUIPMENT, NAMELY, VACUUM
CLEANERS; STRUCTURAL PARTS OF ALL
AFOREMENTIONED GOODS, IN CLASS 7 (U.S. CLS.
13, 19, 21, 23, 31, 34 AND 35).

THE MARK CONSISTS OF STANDARD CHARACTERS
WITHOUT CLAIM TO ANY PARTICULAR
FONT, STYLE, SIZE, OR COLOR.

PRIORITY CLAIMED UNDER SEC. 44(D) ON FED
REP GERMANY APPLICATION NO. 30744395.7/0,
FILED 7-6-2007, REG. NO. 30744395, DATED 10-5-
2007, EXPIRES 7-31-2017.

SER. NO. 77-351,201, FILED 12-13-2007.

JASON BLAIR, EXAMINING ATTORNEY

Int. Cl.: 7

Prior U.S. Cls.: 13, 19, 21, 23, 31, 34 and 35

Reg. No. 3,479,894

United States Patent and Trademark Office

Registered Aug. 5, 2008

**TRADEMARK
PRINCIPAL REGISTER**

GS 80

BSH BOSCH UND SIEMENS HAUSGERAETE
GMBH (FED REP GERMANY CORPORATION)
CARL-WERY-STRASSE 34
MUNICH, FED REP GERMANY 81739

FOR: HOUSEHOLD AND KITCHEN MACHINES
AND EQUIPMENT, NAMELY, ELECTRIC KITCHEN
MACHINES AND EQUIPMENT, NAMELY, VACUUM
CLEANERS; STRUCTURAL PARTS OF ALL
AFOREMENTIONED GOODS, IN CLASS 7 (U.S. CLS.
13, 19, 21, 23, 31, 34 AND 35).

THE MARK CONSISTS OF STANDARD CHARACTERS
WITHOUT CLAIM TO ANY PARTICULAR
FONT, STYLE, SIZE, OR COLOR.

PRIORITY CLAIMED UNDER SEC. 44(D) ON FED
REP GERMANY APPLICATION NO. 30744396.5/0,
FILED 7-6-2007, REG. NO. 30744396, DATED 10-5-
2007, EXPIRES 7-31-2017.

SER. NO. 77-351,212, FILED 12-13-2007.

JASON BLAIR, EXAMINING ATTORNEY

Int. Cl.: 7

Prior U.S. Cls.: 13, 19, 21, 23, 31, 34 and 35

United States Patent and Trademark Office

Reg. No. 3,479,895

Registered Aug. 5, 2008

**TRADEMARK
PRINCIPAL REGISTER**

GS 90

BSH BOSCH UND SIEMENS HAUSGERAETE
GMBH (FED REP GERMANY CORPORATION)

CARL-WERY-STRASSE 34
MUNICH, FED REP GERMANY 81739

FOR: HOUSEHOLD AND KITCHEN MACHINES
AND EQUIPMENT, NAMELY, ELECTRIC KITCHEN
MACHINES AND EQUIPMENT, NAMELY, VACUUM
CLEANERS; STRUCTURAL PARTS OF ALL
AFOREMENTIONED GOODS, IN CLASS 7 (U.S. CLS.
13, 19, 21, 23, 31, 34 AND 35).

THE MARK CONSISTS OF STANDARD CHARACTERS
WITHOUT CLAIM TO ANY PARTICULAR
FONT, STYLE, SIZE, OR COLOR.

PRIORITY CLAIMED UNDER SEC. 44(D) ON FED
REP GERMANY APPLICATION NO. 30744397.3/0,
FILED 7-6-2007, REG. NO. 30744397, DATED 10-5-
2007, EXPIRES 7-31-2017.

SER. NO. 77-351,223, FILED 12-13-2007.

JASON BLAIR, EXAMINING ATTORNEY

Int. Cl.: 35

Prior U.S. Cls.: 100, 101 and 102

United States Patent and Trademark Office

Reg. No. 3,479,896

Registered Aug. 5, 2008

SERVICE MARK
PRINCIPAL REGISTER

BURN RUBBER
Sneaker Boutique

SNEAKER HEADZ, LLC (MICHIGAN LTD LIAB
CO), DBA BURN RUBBER
202 W. FOURTH STREET
ROYAL OAK, MI 48067

FOR: RETAIL STORES FEATURING CLOTHING,
FOOTWEAR, SHOE LACES, HEAD-WEAR, JEWEL-
RY, WATCHES, TOYS, BOOKS AND MAGAZINES,
IN CLASS 35 (U.S. CLS. 100, 101 AND 102).

FIRST USE 3-1-2007; IN COMMERCE 3-1-2007.

NO CLAIM IS MADE TO THE EXCLUSIVE
RIGHT TO USE "SNEAKER BOUTIQUE", APART
FROM THE MARK AS SHOWN.

THE COLOR(S) BLACK AND RED IS/ARE
CLAIMED AS A FEATURE OF THE MARK.

THE MARK CONSISTS OF THE WORDS "BURN
RUBBER" IN BLOCK LETTERS WITH THE WORDS
"SNEAKER BOUTIQUE" IN RED SCRIPT DIRECT-
LY UNDER AND TO THE RIGHT.

SER. NO. 77-351,283, FILED 12-13-2007.

GENE MACIOL, EXAMINING ATTORNEY

Int. Cl.: 42

Prior U.S. Cls.: 100 and 101

United States Patent and Trademark Office

Reg. No. 3,479,897

Registered Aug. 5, 2008

**SERVICE MARK
PRINCIPAL REGISTER**

MYTALENTLINK

MY TALENT LINK, LLC (OHIO LTD LIAB CO)
5915 LANDERBROOK DRIVE, #100
MAYFIELD HEIGHTS, OH 44124

THE MARK CONSISTS OF STANDARD CHAR-
ACTERS WITHOUT CLAIM TO ANY PARTICULAR
FONT, STYLE, SIZE, OR COLOR.

FOR: PROVIDING ON-LINE NON-DOWNLOAD-
ABLE SOFTWARE FOR USE IN THE MANAGE-
MENT OF EMPLOYEE RECRUITMENT AND
HIRING, IN CLASS 42 (U.S. CLS. 100 AND 101).

SER. NO. 77-351,356, FILED 12-13-2007.

FIRST USE 11-12-2007; IN COMMERCE 11-12-2007.

SANJEEV VOHRA, EXAMINING ATTORNEY

Int. Cl.: 42

Prior U.S. Cls.: 100 and 101

United States Patent and Trademark Office

Reg. No. 3,479,898

Registered Aug. 5, 2008

**SERVICE MARK
PRINCIPAL REGISTER**



MY TALENT LINK, LLC (OHIO LTD LIAB CO)
5915 LANDERBROOK DRIVE, #100
MAYFIELD HEIGHTS, OH 44124

FOR: PROVIDING ON-LINE NON-DOWNLOAD-
ABLE SOFTWARE FOR USE IN THE MANAGE-
MENT OF EMPLOYEE RECRUITMENT AND
HIRING, IN CLASS 42 (U.S. CLS. 100 AND 101).

FIRST USE 11-12-2007; IN COMMERCE 11-12-2007.

THE MARK CONSISTS OF THE WORDS "MYTA-
LENTLINK" WITH TWO CHAIN LINKS ABOVE IT.

SER. NO. 77-351,367, FILED 12-13-2007.

SANJEEV VOHRA, EXAMINING ATTORNEY

Int. Cl.: 10

Prior U.S. Cls.: 26, 39 and 44

United States Patent and Trademark Office

Reg. No. 3,479,899

Registered Aug. 5, 2008

**TRADEMARK
PRINCIPAL REGISTER**

Vergenza

VERGENZA INC. (NEW YORK CORPORATION)
26 CLINTON ST. 4A
NEW YORK, NY 10002

FOR: ADULT SEXUAL AIDS, NAMELY, ARTIFICIAL PENISES, IN CLASS 10 (U.S. CLS. 26, 39 AND 44).

FIRST USE 11-1-2007; IN COMMERCE 11-1-2007.

THE MARK CONSISTS OF STANDARD CHARACTERS WITHOUT CLAIM TO ANY PARTICULAR FONT, STYLE, SIZE, OR COLOR.

THE FOREIGN WORDING IN THE MARK TRANSLATES INTO ENGLISH AS "SHAME" OR "DISGRACE".

SER. NO. 77-351,407, FILED 12-13-2007.

JACQUELINE A. LAVINE, EXAMINING ATTORNEY

Int. Cl.: 28

Prior U.S. Cls.: 22, 23, 38 and 50

United States Patent and Trademark Office

Reg. No. 3,479,900

Registered Aug. 5, 2008

**TRADEMARK
PRINCIPAL REGISTER**

ROCK'N ROLL DICE

JOHN BONITO (UNITED STATES INDIVIDUAL)
1847 STABLEGATE AVENUE
HENDERSON, NV 89012

FOR: GAMING TABLES, IN CLASS 28 (U.S. CLS.
22, 23, 38 AND 50).

FIRST USE 10-0-2002; IN COMMERCE 10-0-2002.

THE MARK CONSISTS OF STANDARD CHAR-
ACTERS WITHOUT CLAIM TO ANY PARTICULAR
FONT, STYLE, SIZE, OR COLOR.

NO CLAIM IS MADE TO THE EXCLUSIVE
RIGHT TO USE "DICE", APART FROM THE MARK
AS SHOWN.

SER. NO. 77-351,477, FILED 12-13-2007.

MARY CRAWFORD, EXAMINING ATTORNEY

Int. Cl.: 39

Prior U.S. Cls.: 100 and 105

United States Patent and Trademark Office

Reg. No. 3,479,901

Registered Aug. 5, 2008

**SERVICE MARK
PRINCIPAL REGISTER**

**Best Storage Value in the
West**

OVERTON BOAT & RV STORAGE, LLC (NEVA-
DA LTD LIAB CO)
5485 W. FLAMINGO RD.
LAS VEGAS, NV 89103

FOR: STORAGE OF BOATS AND RECREATION-
AL VEHICLES; STORAGE OF GOODS, IN CLASS 39
(U.S. CLS. 100 AND 105).

FIRST USE 9-11-2007; IN COMMERCE 9-11-2007.

THE MARK CONSISTS OF STANDARD CHAR-
ACTERS WITHOUT CLAIM TO ANY PARTICULAR
FONT, STYLE, SIZE, OR COLOR.

NO CLAIM IS MADE TO THE EXCLUSIVE
RIGHT TO USE "BEST STORAGE VALUE", APART
FROM THE MARK AS SHOWN.

SER. NO. 77-351,503, FILED 12-13-2007.

TARAH HARDY, EXAMINING ATTORNEY

Int. Cl.: 43

Prior U.S. Cls.: 100 and 101

United States Patent and Trademark Office

Reg. No. 3,479,902

Registered Aug. 5, 2008

**SERVICE MARK
PRINCIPAL REGISTER**

Plum V.I.P. Lounge

SEMINOLE TRIBE OF FLORIDA (UNITED STATES FEDERALLY-RECOGNIZED INDIAN TRIBE)

6300 STIRLING ROAD
HOLLYWOOD, FL 33024

FOR: BAR AND RESTAURANT SERVICES, IN CLASS 43 (U.S. CLS. 100 AND 101).

FIRST USE 11-2-2007; IN COMMERCE 11-2-2007.

THE MARK CONSISTS OF STANDARD CHARACTERS WITHOUT CLAIM TO ANY PARTICULAR FONT, STYLE, SIZE, OR COLOR.

NO CLAIM IS MADE TO THE EXCLUSIVE RIGHT TO USE "V.I.P. LOUNGE", APART FROM THE MARK AS SHOWN.

SER. NO. 77-351,522, FILED 12-13-2007.

KATHLEEN M. VANSTON, EXAMINING ATTORNEY

Int. Cl.: 36

Prior U.S. Cls.: 100, 101 and 102

United States Patent and Trademark Office

Reg. No. 3,479,903

Registered Aug. 5, 2008

**SERVICE MARK
PRINCIPAL REGISTER**

Sterling Option III

STERLING LIFE INSURANCE COMPANY (ILLINOIS CORPORATION)

6TH FLOOR

1000 N. MILWAUKEE AVENUE

GLENVIEW, IL 60025

FOR: INSURANCE UNDERWRITING IN THE FIELD OF HEALTH INSURANCE, PRIMARILY FOCUSING ON MEDICARE-RELATED PRODUCTS, IN CLASS 36 (U.S. CLS. 100, 101 AND 102).

FIRST USE 10-31-2007; IN COMMERCE 10-31-2007.

THE MARK CONSISTS OF STANDARD CHARACTERS WITHOUT CLAIM TO ANY PARTICULAR FONT, STYLE, SIZE, OR COLOR.

OWNER OF U.S. REG. NOS. 2,815,962, 2,815,964 AND OTHERS.

NO CLAIM IS MADE TO THE EXCLUSIVE RIGHT TO USE "OPTION III", APART FROM THE MARK AS SHOWN.

SER. NO. 77-351,684, FILED 12-13-2007.

AMY MCMENAMIN, EXAMINING ATTORNEY

Int. Cl.: 36

Prior U.S. Cls.: 100, 101 and 102

United States Patent and Trademark Office

Reg. No. 3,479,904

Registered Aug. 5, 2008

**SERVICE MARK
PRINCIPAL REGISTER**

Sterling Option IV

STERLING LIFE INSURANCE COMPANY (ILLINOIS CORPORATION)

6TH FLOOR

1000 N. MILWAUKEE AVENUE

GLENVIEW, IL 60025

FOR: INSURANCE UNDERWRITING IN THE FIELD OF HEALTH INSURANCE, PRIMARILY FOCUSING ON MEDICARE-RELATED PRODUCTS, IN CLASS 36 (U.S. CLS. 100, 101 AND 102).

FIRST USE 10-31-2007; IN COMMERCE 10-31-2007.

THE MARK CONSISTS OF STANDARD CHARACTERS WITHOUT CLAIM TO ANY PARTICULAR FONT, STYLE, SIZE, OR COLOR.

OWNER OF U.S. REG. NOS. 2,815,962, 2,815,964 AND OTHERS.

NO CLAIM IS MADE TO THE EXCLUSIVE RIGHT TO USE "OPTION IV", APART FROM THE MARK AS SHOWN.

SER. NO. 77-351,691, FILED 12-13-2007.

AMY MCMENAMIN, EXAMINING ATTORNEY

Int. Cl.: 36

Prior U.S. Cls.: 100, 101 and 102

United States Patent and Trademark Office

Reg. No. 3,479,905

Registered Aug. 5, 2008

**SERVICE MARK
PRINCIPAL REGISTER**

Sterling Option II

STERLING LIFE INSURANCE COMPANY (ILLINOIS CORPORATION)

6TH FLOOR

1000 N. MILWAUKEE AVENUE

GLENVIEW, IL 60025

FOR: INSURANCE UNDERWRITING IN THE FIELD OF HEALTH INSURANCE, PRIMARILY FOCUSING ON MEDICARE-RELATED PRODUCTS, IN CLASS 36 (U.S. CLS. 100, 101 AND 102).

FIRST USE 10-31-2005; IN COMMERCE 10-31-2005.

THE MARK CONSISTS OF STANDARD CHARACTERS WITHOUT CLAIM TO ANY PARTICULAR FONT, STYLE, SIZE, OR COLOR.

OWNER OF U.S. REG. NOS. 2,815,962, 2,815,964 AND OTHERS.

NO CLAIM IS MADE TO THE EXCLUSIVE RIGHT TO USE "OPTION II", APART FROM THE MARK AS SHOWN.

SER. NO. 77-351,693, FILED 12-13-2007.

AMY MCMENAMIN, EXAMINING ATTORNEY

Int. Cl.: 36

Prior U.S. Cls.: 100, 101 and 102

United States Patent and Trademark Office

Reg. No. 3,479,906

Registered Aug. 5, 2008

**SERVICE MARK
PRINCIPAL REGISTER**

Sterling Rx Plus

STERLING LIFE INSURANCE COMPANY (ILLINOIS CORPORATION)

6TH FLOOR

1000 N. MILWAUKEE AVENUE

GLENVIEW, IL 60025

FOR: INSURANCE UNDERWRITING IN THE FIELD OF HEALTH INSURANCE, PRIMARILY FOCUSING ON MEDICARE-RELATED PRODUCTS, IN CLASS 36 (U.S. CLS. 100, 101 AND 102).

FIRST USE 10-31-2006; IN COMMERCE 10-31-2006.

THE MARK CONSISTS OF STANDARD CHARACTERS WITHOUT CLAIM TO ANY PARTICULAR FONT, STYLE, SIZE, OR COLOR.

OWNER OF U.S. REG. NOS. 2,815,962, 2,815,964 AND OTHERS.

NO CLAIM IS MADE TO THE EXCLUSIVE RIGHT TO USE "RX PLUS", APART FROM THE MARK AS SHOWN.

SER. NO. 77-351,696, FILED 12-13-2007.

AMY MCMENAMIN, EXAMINING ATTORNEY

Int. Cl.: 36

Prior U.S. Cls.: 100, 101 and 102

United States Patent and Trademark Office

Reg. No. 3,479,907

Registered Aug. 5, 2008

**SERVICE MARK
PRINCIPAL REGISTER**

Sterling Rx

STERLING LIFE INSURANCE COMPANY (ILLINOIS CORPORATION)

6TH FLOOR

1000 N. MILWAUKEE AVENUE

GLENVIEW, IL 60025

FOR: INSURANCE UNDERWRITING IN THE FIELD OF HEALTH INSURANCE, PRIMARILY FOCUSING ON MEDICARE-RELATED PRODUCTS, IN CLASS 36 (U.S. CLS. 100, 101 AND 102).

FIRST USE 10-31-2005; IN COMMERCE 10-31-2005.

THE MARK CONSISTS OF STANDARD CHARACTERS WITHOUT CLAIM TO ANY PARTICULAR FONT, STYLE, SIZE, OR COLOR.

OWNER OF U.S. REG. NOS. 2,815,962, 2,815,964 AND OTHERS.

NO CLAIM IS MADE TO THE EXCLUSIVE RIGHT TO USE "RX", APART FROM THE MARK AS SHOWN.

SER. NO. 77-351,710, FILED 12-13-2007.

AMY MCMENAMIN, EXAMINING ATTORNEY

Int. Cl.: 9

Prior U.S. Cls.: 21, 23, 26, 36 and 38

Reg. No. 3,479,908

United States Patent and Trademark Office

Registered Aug. 5, 2008

**TRADEMARK
PRINCIPAL REGISTER**

MAKE TIME FOR MUSIC

MASTRAN MUSIC GROUP, LLC (TENNESSEE
LTD LIAB CO)
1706 GRAND AVENUE
NASHVILLE, TN 37212

FOR: PRERECORDED AUDIO AND AUDIO-VISUAL MEDIA, NAMELY, PRERECORDED COMPACT DISCS, AUDIO CASSETTES, PRERECORDED VIDEOCASSETTES, DVDS AND PHONOGRAPH RECORDS, ALL FEATURING MUSIC; PRERECORDED AUDIO AND AUDIO-VISUAL MEDIA IN DIGITAL FORMATS, NAMELY, DOWNLOADABLE MUSICAL SOUND RECORDINGS, IN CLASS 9 (U.S. CLS. 21, 23, 26, 36 AND 38).

FIRST USE 10-1-2007; IN COMMERCE 10-1-2007.

THE MARK CONSISTS OF STANDARD CHARACTERS WITHOUT CLAIM TO ANY PARTICULAR FONT, STYLE, SIZE, OR COLOR.

NO CLAIM IS MADE TO THE EXCLUSIVE RIGHT TO USE "MUSIC", APART FROM THE MARK AS SHOWN.

SER. NO. 77-351,790, FILED 12-13-2007.

JIM RINGLE, EXAMINING ATTORNEY

Int. Cl.: 25

Prior U.S. Cls.: 22 and 39

United States Patent and Trademark Office

Reg. No. 3,479,909

Registered Aug. 5, 2008

**TRADEMARK
PRINCIPAL REGISTER**

Hula Baby

GRABLE, ANNA L. (UNITED STATES INDIVIDUAL)
7924 LINEN DRIVE
SANTEE, CA 92071

FOR: CAPS; CHILDREN'S AND INFANTS' CLOTH BIBS; CLOTH DIAPERS; INFANT AND TODDLER ONE PIECE CLOTHING; TOPS; SHORT-SLEEVED OR LONG-SLEEVED T-SHIRTS; SWEAT SHIRTS; T-SHIRTS; TEE SHIRTS; JACKETS; INFANT DIAPER COVERS; INFANT SLEEPERS; INFANT WEAR; ONE PIECE GARMENT FOR INFANTS AND TODDLERS, IN CLASS 25 (U.S. CLS. 22 AND 39).

FIRST USE 5-1-2006; IN COMMERCE 9-16-2006.

THE MARK CONSISTS OF STANDARD CHARACTERS WITHOUT CLAIM TO ANY PARTICULAR FONT, STYLE, SIZE, OR COLOR.

NO CLAIM IS MADE TO THE EXCLUSIVE RIGHT TO USE "BABY", APART FROM THE MARK AS SHOWN.

THE ENGLISH TRANSLATION OF THE WORD "HULA" IN THE MARK IS "DANCE".

SER. NO. 77-351,863, FILED 12-13-2007.

ROBIN CHOSID, EXAMINING ATTORNEY

Int. Cl.: 18

Prior U.S. Cls.: 1, 2, 3, 22 and 41

United States Patent and Trademark Office

Reg. No. 3,479,910

Registered Aug. 5, 2008

**TRADEMARK
PRINCIPAL REGISTER**

NARGEAR

CRONE, GEORGE RANDALL (UNITED STATES
INDIVIDUAL)

#5
303 E.SPRUCE ST.
MISSOULA, MT 59802

FOR: BACKPACKS, BOOK BAGS, SPORTS BAGS,
BUM BAGS, WALLETS AND HANDBAGS, IN
CLASS 18 (U.S. CLS. 1, 2, 3, 22 AND 41).

FIRST USE 12-15-2004; IN COMMERCE 11-1-2005.

THE MARK CONSISTS OF "NARGEAR" IN A
STYLIZED FONT.

SER. NO. 77-351,945, FILED 12-14-2007.

NELSON SNYDER, EXAMINING ATTORNEY

Int. Cl.: 37

Prior U.S. Cls.: 100, 103 and 106

United States Patent and Trademark Office

Reg. No. 3,479,911

Registered Aug. 5, 2008

**SERVICE MARK
PRINCIPAL REGISTER**

GLOBAL CO₂OLING

WANGLER, THOMAS M. (UNITED STATES IN-
DIVIDUAL)
338 MCKEE STREET
BATAVIA, IL 60510

FIRST USE 12-14-2007; IN COMMERCE 12-14-2007.

SER. NO. 77-352,018, FILED 12-14-2007.

FOR: INSTALLATION OF INSULATING MATE-
RIALS; INTERIOR SEALING AND CAULKING
SERVICES; BUILDING SEALING AND CAULKING
SERVICES, IN CLASS 37 (U.S. CLS. 100, 103 AND 106).

JEFFERY COWARD, EXAMINING ATTORNEY

Int. Cls.: 35 and 36

Prior U.S. Cls.: 100, 101 and 102

United States Patent and Trademark Office

Reg. No. 3,479,912

Registered Aug. 5, 2008

**SERVICE MARK
PRINCIPAL REGISTER**

COLLEGES AGAINST CANCER

AMERICAN CANCER SOCIETY, INC. (NEW
YORK CORPORATION)
NATIONAL HOME OFFICE
250 WILLIAMS STREET
ATLANTA, GA 30303

FOR: PROMOTING PUBLIC AWARENESS OF
CANCER RESEARCH, PREVENTION, AND DETEC-
TION, IN CLASS 35 (U.S. CLS. 100, 101 AND 102).

FIRST USE 12-0-2001; IN COMMERCE 12-0-2001.

FOR: CHARITABLE FUNDRAISING SERVICES
TO SUPPORT CANCER RESEARCH, EDUCATION,

ADVOCACY, AND PATIENT AND FAMILY SERVI-
CES, IN CLASS 36 (U.S. CLS. 100, 101 AND 102).

FIRST USE 12-0-2001; IN COMMERCE 12-0-2001.

THE MARK CONSISTS OF STANDARD CHAR-
ACTERS WITHOUT CLAIM TO ANY PARTICULAR
FONT, STYLE, SIZE, OR COLOR.

SEC. 2(F).

SER. NO. 77-352,019, FILED 12-14-2007.

ELLEN B. AWRICH, EXAMINING ATTORNEY

Int. Cl.: 40

Prior U.S. Cls.: 100, 103 and 106

United States Patent and Trademark Office

Reg. No. 3,479,913

Registered Aug. 5, 2008

**SERVICE MARK
PRINCIPAL REGISTER**



J. WESTON WALCH, PUBLISHER (MAINE CORPORATION)
40 WALCH DRIVE
PORTLAND, ME 04103

FOR: PRINTING OF BOOKS AND BOOKLETS, IN CLASS 40 (U.S. CLS. 100, 103 AND 106).

FIRST USE 1-1-2006; IN COMMERCE 1-1-2006.

OWNER OF U.S. REG. NO. 3,088,980.

NO CLAIM IS MADE TO THE EXCLUSIVE RIGHT TO USE "PRINTING", APART FROM THE MARK AS SHOWN.

THE COLOR(S) BLACK, WHITE, DARK BLUE, AND LIGHT BLUE IS/ARE CLAIMED AS A FEATURE OF THE MARK.

THE MARK CONSISTS OF THE WORDS "WALCH PRINTING" IN BLACK LETTERING BORDERED ON THE TOP AND THE BOTTOM BY BLACK PARALLEL LINES AGAINST A WHITE BACKGROUND, WITH A DESIGN OF A BOOK WITH TURNING PAGES IN LIGHT BLUE, DARK BLUE, AND WHITE APPEARING BETWEEN THE WORDS "WALCH" AND "PRINTING".

SER. NO. 77-352,057, FILED 12-14-2007.

TEJBIR SINGH, EXAMINING ATTORNEY

Int. Cls.: 35 and 39

Prior U.S. Cls.: 100, 101, 102 and 105

United States Patent and Trademark Office

Reg. No. 3,479,914

Registered Aug. 5, 2008

**SERVICE MARK
PRINCIPAL REGISTER**

The logo for ParcelPort features the word "ParcelPort" in a bold, italicized, sans-serif font. A thick, black, curved line arches under the word "Port", resembling a swoosh or a stylized underline.

PARCELPORT, LLC (CONNECTICUT LIMITED LIABILITY CORPORATION)
33 STILES LANE
NORTH HAVEN, CT 06473

FOR: BUSINESS CONSULTING SERVICES RELATING TO PRODUCT DISTRIBUTION, OPERATIONS MANAGEMENT SERVICES, LOGISTICS, REVERSE LOGISTICS, SUPPLY CHAIN, AND PRODUCTION SYSTEMS AND DISTRIBUTION SOLUTIONS; BUSINESS MANAGEMENT SERVICES, NAMELY, MANAGING LOGISTICS, REVERSE LOGISTICS, SUPPLY CHAIN SERVICES, SUPPLY CHAIN VISIBILITY AND SYNCHRONIZATION, SUPPLY AND DEMAND FORECASTING AND PRODUCT DISTRIBUTION PROCESSES FOR OTHERS; TRANSPORTATION LOGISTICS SERVICES, NAMELY, ARRANGING THE TRANSPORTATION OF GOODS FOR OTHERS; TRANSPORTATION LOGISTICS SERVICES, NAMELY, PLANNING AND SCHEDULING SHIPMENTS FOR USERS OF TRANSPORTATION SERVICES; COMPUTERIZED TRACKING AND TRACING OF PACKAGES IN TRANSIT; INFORMATION MANAGEMENT SERVICES, NAMELY, SHIPMENT PROCESSING, PREPARING SHIPPING DOCUMENTS AND INVOICES, TRACKING DOCUMENTS, PACKAGES AND FREIGHT OVER COMPUTER NETWORKS, INTRANETS AND INTERNETS; MONITORING AND TRACKING OF PACKAGE SHIPMENTS; PROVIDING ELECTRONIC TRACKING OF FREIGHT INFORMATION TO OTHERS; TRACKING, LOCATING AND MONITORING OF VEHICLES, MARITIME VESSELS AND AIRCRAFT SERVICES FOR COMMERCIAL PURPOSES; CUSTOMS CLEAR-

ANCE SERVICES; ARRANGING FOR PICKUP, DELIVERY, STORAGE AND TRANSPORTATION OF DOCUMENTS, PACKAGES, FREIGHT AND PARCELS VIA GROUND AND AIR CARRIERS; ORDER FULFILLMENT SERVICES, IN CLASS 35 (U.S. CLS. 100, 101 AND 102).

FIRST USE 12-31-2000; IN COMMERCE 12-31-2000.

FOR: DOMESTIC AND INTERNATIONAL COMMON CARRIER FREIGHT TRANSPORTATION BY MEANS OF TRUCK, AIR, OR SEA, AND DOMESTIC AND INTERNATIONAL FREIGHT FORWARDING SERVICES; SUPPLY CHAIN, LOGISTICS AND REVERSE LOGISTICS SERVICES, NAMELY, STORAGE, TRANSPORTATION AND DELIVERY OF DOCUMENTS, PACKAGES, RAW MATERIALS, AND OTHER FREIGHT FOR OTHERS BY AIR, RAIL, SHIP OR TRUCK; WAREHOUSING SERVICES, NAMELY, STORAGE, DISTRIBUTION, PICKUP, AND PACKING FOR SHIPMENT OF DOCUMENTS, PACKAGES, RAW MATERIALS, AND OTHER FREIGHT FOR OTHERS, IN CLASS 39 (U.S. CLS. 100 AND 105).

FIRST USE 12-31-2000; IN COMMERCE 12-31-2000.

THE MARK CONSISTS OF THE WORDS "PARCELPORT" WITH A SWISH UNDER THE WORD "PORT".

SER. NO. 77-352,137, FILED 12-14-2007.

STEPHEN AQUILA, EXAMINING ATTORNEY

Int. Cls.: 35 and 39

Prior U.S. Cls.: 100, 101, 102 and 105

United States Patent and Trademark Office

Reg. No. 3,479,915

Registered Aug. 5, 2008

**SERVICE MARK
PRINCIPAL REGISTER**

JOIN THE EVOLUTION

PARCELPOR, LLC (CONNECTICUT LIMITED LIABILITY CORPORATION)
33 STILES LANE
NORTH HAVEN, CT 06473

FOR: BUSINESS CONSULTING SERVICES RELATING TO PRODUCT DISTRIBUTION, OPERATIONS MANAGEMENT SERVICES, LOGISTICS, REVERSE LOGISTICS, SUPPLY CHAIN, AND PRODUCTION SYSTEMS AND DISTRIBUTION SOLUTIONS; BUSINESS MANAGEMENT SERVICES, NAMELY, MANAGING LOGISTICS, REVERSE LOGISTICS, SUPPLY CHAIN SERVICES, SUPPLY CHAIN VISIBILITY AND SYNCHRONIZATION, SUPPLY AND DEMAND FORECASTING AND PRODUCT DISTRIBUTION PROCESSES FOR OTHERS; TRANSPORTATION LOGISTICS SERVICES, NAMELY, ARRANGING THE TRANSPORTATION OF GOODS FOR OTHERS; TRANSPORTATION LOGISTICS SERVICES, NAMELY, PLANNING AND SCHEDULING SHIPMENTS FOR USERS OF TRANSPORTATION SERVICES; COMPUTERIZED TRACKING AND TRACING OF PACKAGES IN TRANSIT; INFORMATION MANAGEMENT SERVICES, NAMELY, SHIPMENT PROCESSING, PREPARING SHIPPING DOCUMENTS AND INVOICES, TRACKING DOCUMENTS, PACKAGES AND FREIGHT OVER COMPUTER NETWORKS, INTRANETS AND INTERNETS; MONITORING AND TRACKING OF PACKAGE SHIPMENTS; PROVIDING ELECTRONIC TRACKING OF FREIGHT INFORMATION TO OTHERS; TRACKING, LOCATING AND MONITORING OF VEHICLES, MARITIME VESSELS AND AIRCRAFT SERVICES FOR COMMERCIAL PURPOSES; CUSTOMS CLEAR-

ANCE SERVICES; ARRANGING FOR PICKUP, DELIVERY, STORAGE AND TRANSPORTATION OF DOCUMENTS, PACKAGES, FREIGHT AND PARCELS VIA GROUND AND AIR CARRIERS; ORDER FULFILLMENT SERVICES, IN CLASS 35 (U.S. CLS. 100, 101 AND 102).

FIRST USE 11-9-2007; IN COMMERCE 11-9-2007.

FOR: DOMESTIC AND INTERNATIONAL COMMON CARRIER FREIGHT TRANSPORTATION BY MEANS OF TRUCK, AIR, OR SEA, AND DOMESTIC AND INTERNATIONAL FREIGHT FORWARDING SERVICES; SUPPLY CHAIN, LOGISTICS AND REVERSE LOGISTICS SERVICES, NAMELY, STORAGE, TRANSPORTATION AND DELIVERY OF DOCUMENTS, PACKAGES, RAW MATERIALS, AND OTHER FREIGHT FOR OTHERS BY AIR, RAIL, SHIP OR TRUCK; WAREHOUSING SERVICES, NAMELY, STORAGE, DISTRIBUTION, PICKUP, AND PACKING FOR SHIPMENT OF DOCUMENTS, PACKAGES, RAW MATERIALS, AND OTHER FREIGHT FOR OTHERS, IN CLASS 39 (U.S. CLS. 100 AND 105).

FIRST USE 11-9-2007; IN COMMERCE 11-9-2007.

THE MARK CONSISTS OF STANDARD CHARACTERS WITHOUT CLAIM TO ANY PARTICULAR FONT, STYLE, SIZE, OR COLOR.

SER. NO. 77-352,148, FILED 12-14-2007.

STEPHEN AQUILA, EXAMINING ATTORNEY

Int. Cls.: 6, 7, 9, 19 and 20

Prior U.S. Cls.: 1, 2, 12, 13, 14, 19, 21, 22, 23, 25, 26, 31, 32, 33, 34, 35, 36, 38 and 50

Reg. No. 3,479,916

United States Patent and Trademark Office

Registered Aug. 5, 2008

**TRADEMARK
PRINCIPAL REGISTER**



STAUFF CORPORATION (NEW JERSEY CORPORATION)
7 WM. DEMAREST PLACE
WALDWICK, NJ 07463

FOR: METAL CLAMPS; METAL HOSE CLAMPS; METAL COUPLINGS FOR USE WITH HYDRAULIC LINES; METAL PIPE COUPLINGS AND JOINTS; MANUALLY OPERATED METAL VALVES; METAL PIPE SUPPORTS; AND HOSE HANGERS OF METAL, IN CLASS 6 (U.S. CLS. 2, 12, 13, 14, 23, 25 AND 50).

FIRST USE 1-1-1984; IN COMMERCE 1-1-1984.

FOR: HYDRAULIC FLUID FILTERS FOR MECHANICAL PURPOSES, IN CLASS 7 (U.S. CLS. 13, 19, 21, 23, 31, 34 AND 35).

FIRST USE 1-1-1984; IN COMMERCE 1-1-1984.

FOR: PRESSURE GAUGES; PRESSURE SENSORS; ELECTRONIC SWITCHES; TEMPERATURE SENSORS; ELECTRONIC FLUID FLOW SENSORS; FLOW METERS; ELECTRONIC TEST INSTRUMENTS AND ASSOCIATED SOFTWARE FOR USE IN LEAK, FLOW AND FUNCTIONAL TESTING;

FLOW REGULATORS FOR INDUSTRIAL USE; AND APPARATUS FOR TESTING GAS, LIQUIDS AND SOLIDS, IN CLASS 9 (U.S. CLS. 21, 23, 26, 36 AND 38).

FIRST USE 1-1-1984; IN COMMERCE 1-1-1984.

FOR: PLASTIC PIPE SUPPORTS, PIPE SUPPORTS MADE OF PLASTIC WITH RUBBER INSERTS, IN CLASS 19 (U.S. CLS. 1, 12, 33 AND 50).

FIRST USE 1-1-1984; IN COMMERCE 1-1-1984.

FOR: NONMETAL CLAMPS; HOSE HANGERS NOT OF METAL, IN CLASS 20 (U.S. CLS. 2, 13, 22, 25, 32 AND 50).

FIRST USE 1-1-1984; IN COMMERCE 1-1-1984.

THE MARK CONSISTS OF A PHOTOGRAPH OF THE LOGO.

SER. NO. 77-352,151, FILED 12-14-2007.

JUDITH HELFMAN, EXAMINING ATTORNEY

Int. Cls.: 35 and 39

Prior U.S. Cls.: 100, 101, 102 and 105

United States Patent and Trademark Office

Reg. No. 3,479,917

Registered Aug. 5, 2008

**SERVICE MARK
PRINCIPAL REGISTER**

3PL EVOLVED

PARCELPOR, LLC (CONNECTICUT LIMITED LIABILITY CORPORATION)
33 STILES LANE
NORTH HAVEN, CT 06473

FOR: BUSINESS CONSULTING SERVICES RELATING TO PRODUCT DISTRIBUTION, OPERATIONS MANAGEMENT SERVICES, LOGISTICS, REVERSE LOGISTICS, SUPPLY CHAIN, AND PRODUCTION SYSTEMS AND DISTRIBUTION SOLUTIONS; BUSINESS MANAGEMENT SERVICES, NAMELY, MANAGING LOGISTICS, REVERSE LOGISTICS, SUPPLY CHAIN SERVICES, SUPPLY CHAIN VISIBILITY AND SYNCHRONIZATION, SUPPLY AND DEMAND FORECASTING AND PRODUCT DISTRIBUTION PROCESSES FOR OTHERS; TRANSPORTATION LOGISTICS SERVICES, NAMELY, ARRANGING THE TRANSPORTATION OF GOODS FOR OTHERS; TRANSPORTATION LOGISTICS SERVICES, NAMELY, PLANNING AND SCHEDULING SHIPMENTS FOR USERS OF TRANSPORTATION SERVICES; COMPUTERIZED TRACKING AND TRACING OF PACKAGES IN TRANSIT; INFORMATION MANAGEMENT SERVICES, NAMELY, SHIPMENT PROCESSING, PREPARING SHIPPING DOCUMENTS AND INVOICES, TRACKING DOCUMENTS, PACKAGES AND FREIGHT OVER COMPUTER NETWORKS, INTRANETS AND INTERNETS; MONITORING AND TRACKING OF PACKAGE SHIPMENTS; PROVIDING ELECTRONIC TRACKING OF FREIGHT INFORMATION TO OTHERS; TRACKING, LOCATING AND MONITORING OF VEHICLES, MARITIME VESSELS AND AIRCRAFT SERVICES FOR COMMERCIAL PURPOSES; CUSTOMS CLEARANCE SERVICES; ARRANGING FOR PICKUP, DELIVERY, STORAGE AND TRANSPORTATION OF

DOCUMENTS, PACKAGES, FREIGHT AND PARCELS VIA GROUND AND AIR CARRIERS; ORDER FULFILLMENT SERVICES, IN CLASS 35 (U.S. CLS. 100, 101 AND 102).

FIRST USE 11-9-2007; IN COMMERCE 11-9-2007.

FOR: DOMESTIC AND INTERNATIONAL COMMON CARRIER FREIGHT TRANSPORTATION BY MEANS OF TRUCK, AIR, OR SEA, AND DOMESTIC AND INTERNATIONAL FREIGHT FORWARDING SERVICES; SUPPLY CHAIN, LOGISTICS AND REVERSE LOGISTICS SERVICES, NAMELY, STORAGE, TRANSPORTATION AND DELIVERY OF DOCUMENTS, PACKAGES, RAW MATERIALS, AND OTHER FREIGHT FOR OTHERS BY AIR, RAIL, SHIP OR TRUCK; WAREHOUSING SERVICES, NAMELY, STORAGE, DISTRIBUTION, PICKUP, AND PACKING FOR SHIPMENT OF DOCUMENTS, PACKAGES, RAW MATERIALS, AND OTHER FREIGHT FOR OTHERS, IN CLASS 39 (U.S. CLS. 100 AND 105).

FIRST USE 11-9-2007; IN COMMERCE 11-9-2007.

THE MARK CONSISTS OF STANDARD CHARACTERS WITHOUT CLAIM TO ANY PARTICULAR FONT, STYLE, SIZE, OR COLOR.

NO CLAIM IS MADE TO THE EXCLUSIVE RIGHT TO USE "3PL", APART FROM THE MARK AS SHOWN.

SER. NO. 77-352,171, FILED 12-14-2007.

STEPHEN AQUILA, EXAMINING ATTORNEY

Int. Cl.: 17

Prior U.S. Cls.: 1, 5, 12, 13, 35 and 50

Reg. No. 3,479,918

United States Patent and Trademark Office

Registered Aug. 5, 2008

**TRADEMARK
PRINCIPAL REGISTER**

TEMP-TITE

INDUSTRIAL GASKET & SHIM COMPANY, INC.
(PENNSYLVANIA CORPORATION)
200 COUNTRY CLUB ROAD
MEADOW LANDS, PA 15347

FOR: SEALING AND DRESSING COMPOUND
USED IN THE ASSEMBLY AND REPAIR OF TUR-
BINES, ENGINES, PUMPS AND SIMILAR EQUIP-
MENT, NAMELY, ADHESIVE SEALANT AND
CAULKING COMPOUND, ANTI-RUST SEALANTS,
SEALANT COMPOUNDS FOR JOINTS, SEALING
AND INSULATING MATERIALS, SEALING PLUGS
MADE PRIMARILY FROM RUBBER, SILICONE

BASED SEALANTS AND ADHESIVES, IN CLASS 17
(U.S. CLS. 1, 5, 12, 13, 35 AND 50).

FIRST USE 10-1-1971; IN COMMERCE 10-1-1971.

THE MARK CONSISTS OF STANDARD CHAR-
ACTERS WITHOUT CLAIM TO ANY PARTICULAR
FONT, STYLE, SIZE, OR COLOR.

SER. NO. 77-352,183, FILED 12-14-2007.

JAY BESCH, EXAMINING ATTORNEY

Int. Cl.: 28

Prior U.S. Cls.: 22, 23, 38 and 50

United States Patent and Trademark Office

Reg. No. 3,479,919

Registered Aug. 5, 2008

**TRADEMARK
PRINCIPAL REGISTER**



DAIMLER AG (FED REP GERMANY CORPORATION)

MERCEDESSTRASSE 137

D-70327 STUTTGART, FED REP GERMANY

FOR: TOY MODEL VEHICLES, IN CLASS 28 (U.S. CLS. 22, 23, 38 AND 50).

OWNER OF ERPN CMNTY TM OFC REG. NO. 005382916, DATED 8-3-2007, EXPIRES 10-13-2016.

OWNER OF U.S. REG. NO. 2,837,584.

SER. NO. 77-352,193, FILED 12-14-2007.

DAVID MURRAY, EXAMINING ATTORNEY

Int. Cl.: 21

Prior U.S. Cls.: 2, 13, 23, 29, 30, 33, 40 and 50

United States Patent and Trademark Office

Reg. No. 3,479,920

Registered Aug. 5, 2008

**TRADEMARK
PRINCIPAL REGISTER**



DOTPOTS, INC. (FLORIDA CORPORATION)
8780 NW BETHEL FARMS ROAD
ARCADIA, FL 34266

**FOR: ORGANIC CONTAINERS FOR FLOWERS,
STARTER PLANTS AND OTHER VEGETATION, IN
CLASS 21 (U.S. CLS. 2, 13, 23, 29, 30, 33, 40 AND 50).**

FIRST USE 4-17-2007; IN COMMERCE 4-17-2007.

**THE COLOR(S) RED, BROWN AND WHITE IS/
ARE CLAIMED AS A FEATURE OF THE MARK.**

**THE MARK CONSISTS OF THE COLOR RED
APPEARS IN THE CENTER OF THE FIRST LETTER
"O" AND IN THE DESIGN OF THE LADYBUG AND
CIRCLE CARRIER; THE COLOR BROWN APPEARS
IN THE WORDING "DOTPOTS" AND IN THE DE-
SIGN OF THE LEAVES AND VEGETATION AT THE
BOTTOM OF THE CIRCLE; THE COLOR WHITE
APPEARS IN THE DESIGN OF THE LADYBUG
SPOTS, THE CENTER OF THE LEAVES, AND THE
INTERIOR OF THE CIRCLE CARRIER.**

SER. NO. 77-352,226, FILED 12-14-2007.

**JOHN SCHUYLER YARD, EXAMINING ATTOR-
NEY**

Int. Cl.: 35

Prior U.S. Cls.: 100, 101 and 102

United States Patent and Trademark Office

Reg. No. 3,479,921

Registered Aug. 5, 2008

**SERVICE MARK
PRINCIPAL REGISTER**



About Low Vision Inc.

ABOUT LOW VISION, INC. (NEVADA CORPORATION)
747 W. KATELLA AVENUE
ORANGE, CA 92867

FOR: RETAIL SERVICES BY DIRECT SOLICITATION BY SALES AGENTS IN THE FIELD OF VIDEO MAGNIFICATION EQUIPMENT AND COMPUTER SOFTWARE; WHOLESALE DISTRIBUTORSHIPS FEATURING VIDEO MAGNIFICATION EQUIPMENT AND COMPUTER SOFTWARE, IN CLASS 35 (U.S. CLS. 100, 101 AND 102).

FIRST USE 8-1-2004; IN COMMERCE 8-1-2004.

NO CLAIM IS MADE TO THE EXCLUSIVE RIGHT TO USE "LOW VISION INC.", APART FROM THE MARK AS SHOWN.

THE MARK CONSISTS OF A BOLD "O" WITH THE LETTERS "A" "L" "V" ARRANGED VERTICALLY INSIDE THE CIRCLE, WITH STYLIZED TEXT OF "ABOUT LOW VISION INC." AT THE BOTTOM .

SER. NO. 77-352,237, FILED 12-14-2007.

PATRICIA EVANKO, EXAMINING ATTORNEY

Int. Cl.: 29

Prior U.S. Cl.: 46

United States Patent and Trademark Office

Reg. No. 3,479,922

Registered Aug. 5, 2008

**TRADEMARK
PRINCIPAL REGISTER**



HARBOR SEAFOOD, INC. (NEW YORK CORPORATION)
969 LAKEVILLE ROAD
NEW HYDE PARK, NY 11040

FOR: FROZEN SHELLFISH, NAMELY, KING CRAB AND IMITATION CRAB MEAT, IN CLASS 29 (U.S. CL. 46).

FIRST USE 12-31-1988; IN COMMERCE 12-31-1988.

THE MARK CONSISTS OF THE WORD "WAKEFIELD" IN STYLIZED LETTERING.

SEC. 2(F).

SER. NO. 77-352,275, FILED 12-14-2007.

SUE LAWRENCE, EXAMINING ATTORNEY

Int. Cl.: 25

Prior U.S. Cls.: 22 and 39

United States Patent and Trademark Office

Reg. No. 3,479,923

Registered Aug. 5, 2008

**TRADEMARK
PRINCIPAL REGISTER**

HOPSCOTCH

CHILDREN'S APPAREL NETWORK, LTD. (NEW
YORK CORPORATION)
77 SOUTH FIRST STREET
ELIZABETH, NJ 07206

FOR: INFANTS', TODDLERS' AND CHILDREN'S
CLOTHING, NAMELY, JACKETS, SWEATERS,
PANTS, SHORTS, KNIT TOPS, SHIRTS, OVERALLS,
SUNSUITS, IN CLASS 25 (U.S. CLS. 22 AND 39).

FIRST USE 6-29-1981; IN COMMERCE 6-29-1981.

THE MARK CONSISTS OF STANDARD CHAR-
ACTERS WITHOUT CLAIM TO ANY PARTICULAR
FONT, STYLE, SIZE, OR COLOR.

OWNER OF U.S. REG. NO. 1,389,990.

SER. NO. 77-352,591, FILED 12-14-2007.

ANNE FARRELL, EXAMINING ATTORNEY

Int. Cl.: 36

Prior U.S. Cls.: 100, 101 and 102

United States Patent and Trademark Office

Reg. No. 3,479,924

Registered Aug. 5, 2008

**SERVICE MARK
PRINCIPAL REGISTER**

The CFHE HomeStart Solution

CAPITAL FINANCIAL HOME EQUITY LLC
(NORTH CAROLINA LTD LIAB CO)
SUITE 200
870 GREENBRIER CIR.
CHESAPEAKE, VA 23320

THE MARK CONSISTS OF STANDARD CHAR-
ACTERS WITHOUT CLAIM TO ANY PARTICULAR
FONT, STYLE, SIZE, OR COLOR.

FOR: REAL ESTATE CONSULTATION, IN CLASS
36 (U.S. CLS. 100, 101 AND 102).

SER. NO. 77-352,773, FILED 12-14-2007.

FIRST USE 11-1-2006; IN COMMERCE 11-1-2006.

ROBIN MITTLER, EXAMINING ATTORNEY

Int. Cl.: 41

Prior U.S. Cls.: 100, 101 and 107

United States Patent and Trademark Office

Reg. No. 3,479,925

Registered Aug. 5, 2008

**SERVICE MARK
PRINCIPAL REGISTER**

ARTSCIENCE

SILER, TODD (UNITED STATES INDIVIDUAL)
4950 S. YOSEMITE STREET, SUITE F2-325
GREENWOOD VILLAGE, CO 80111

FOR: CONDUCTING WORKSHOPS, PROGRAMS
AND SEMINARS AS WELL AS PROVIDING LEC-
TURE SERVICES IN THE FIELD OF ENRICHING
THE EXPERIENCE OF LEARNING AND IMPROV-
ING THE PROCESS OF COMMUNICATION AND
FOSTERING INNOVATIVE THINKING, IN CLASS
41 (U.S. CLS. 100, 101 AND 107).

FIRST USE 6-1-1990; IN COMMERCE 6-1-1990.

THE MARK CONSISTS OF STANDARD CHAR-
ACTERS WITHOUT CLAIM TO ANY PARTICULAR
FONT, STYLE, SIZE, OR COLOR.

OWNER OF U.S. REG. NO. 2,022,799.

SER. NO. 77-352,847, FILED 12-14-2007.

DOMINIC J. FERRAIUOLO, EXAMINING ATTOR-
NEY

Int. Cl.: 41

Prior U.S. Cls.: 100, 101 and 107

United States Patent and Trademark Office

Reg. No. 3,479,926

Registered Aug. 5, 2008

**SERVICE MARK
PRINCIPAL REGISTER**

NEW HOLLYWOOD AWARDS

ABREU, CARLOS (UNITED STATES INDIVIDUAL)
433 N. CAMDEN DR , ST 600
BEVERLY HILLS, CA 90210

FOR: PROVIDING RECOGNITION AND INCENTIVES BY THE WAY OF AWARDS AND CONTESTS TO DEMONSTRATE EXCELLENCE IN THE FIELDS OF MUSIC, INTERNET, TELEVISION, RADIO AND FILMS, IN CLASS 41 (U.S. CLS. 100, 101 AND 107).

FIRST USE 7-24-2007; IN COMMERCE 12-12-2007.

THE MARK CONSISTS OF STANDARD CHARACTERS WITHOUT CLAIM TO ANY PARTICULAR FONT, STYLE, SIZE, OR COLOR.

OWNER OF U.S. REG. NOS. 2,493,697, 3,150,407 AND OTHERS.

NO CLAIM IS MADE TO THE EXCLUSIVE RIGHT TO USE "NEW" AND "AWARDS", APART FROM THE MARK AS SHOWN.

SEC. 2(F).

SER. NO. 77-353,008, FILED 12-14-2007.

DAYNA BROWNE, EXAMINING ATTORNEY

Int. Cl.: 31

Prior U.S. Cls.: 1 and 46

United States Patent and Trademark Office

Reg. No. 3,479,927

Registered Aug. 5, 2008

**TRADEMARK
PRINCIPAL REGISTER**

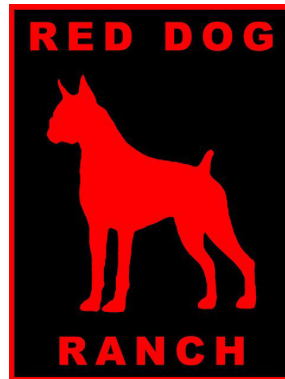

RICHARD WM. FESLER (UNITED STATES IN-
DIVIDUAL)
P.O. BOX 339
GUALALA, CA 954450339

FOR: FRESH VEGETABLES, IN CLASS 31 (U.S.
CLS. 1 AND 46).

FIRST USE 8-29-2004; IN COMMERCE 7-26-2006.

NO CLAIM IS MADE TO THE EXCLUSIVE
RIGHT TO USE "RANCH" , APART FROM THE
MARK AS SHOWN.

THE COLOR(S) RED AND BLACK IS/ARE
CLAIMED AS A FEATURE OF THE MARK.

THE MARK CONSISTS OF A BOX WITH A RED
BORDER AND BLACK BACKGROUND. INSIDE
THE BOX IS THE IMAGE OF A RED DOG WITH
THE TERM "RED DOG" ABOVE AND "RANCH"
BELOW.

SER. NO. 77-353,118, FILED 12-15-2007.

GIANCARLO CASTRO, EXAMINING ATTORNEY

Int. Cl.: 41

Prior U.S. Cls.: 100, 101 and 107

United States Patent and Trademark Office

Reg. No. 3,479,928

Registered Aug. 5, 2008

**SERVICE MARK
PRINCIPAL REGISTER**

STEVENS-HENAGER COLLEGE

STEVENS-HENAGER COLLEGE, INC. (UTAH
CORPORATION)
PO BOX 9428
OGDEN, UT 84409

FOR: EDUCATIONAL SERVICES, NAMELY,
PROVIDING COURSES OF INSTRUCTION AT
THE COLLEGE AND GRADUATE LEVELS, AND
POST-SECONDARY EDUCATIONAL LEVEL; AND
CONDUCTING ONLINE LEARNING INSTRU-
CTION AT THE COLLEGE AND GRADUATE LE-
VELS, IN CLASS 41 (U.S. CLS. 100, 101 AND 107).

FIRST USE 11-0-1999; IN COMMERCE 11-0-1999.

THE MARK CONSISTS OF STANDARD CHAR-
ACTERS WITHOUT CLAIM TO ANY PARTICULAR
FONT, STYLE, SIZE, OR COLOR.

NO CLAIM IS MADE TO THE EXCLUSIVE
RIGHT TO USE "COLLEGE", APART FROM THE
MARK AS SHOWN.

SER. NO. 77-353,145, FILED 12-15-2007.

ALEXANDER L. POWERS, EXAMINING ATTOR-
NEY

Int. Cl.: 10

Prior U.S. Cls.: 26, 39 and 44

United States Patent and Trademark Office

Reg. No. 3,479,929

Registered Aug. 5, 2008

**TRADEMARK
PRINCIPAL REGISTER**



MASSIMO GUERRIERI (ITALY INDIVIDUAL),
DBA VIVINLINEA
221 MIDDLE NECK RD APT. A2
GREAT NECK, NY 11021

THE COLOR(S) RED BURGUNDY COLOR IS/
ARE CLAIMED AS A FEATURE OF THE MARK.

FOR: APPARATUS FOR CELLULITE TREAT-
MENT, REDUCTION AND ELIMINATION; APPA-
RATUS FOR PHYSICAL TRAINING FOR MEDICAL
USE; MEDICAL APPARATUS, NAMELY, ELEC-
TRIC HEATING DEVICES FOR CURATIVE TREAT-
MENT, IN CLASS 10 (U.S. CLS. 26, 39 AND 44).

THE COLOR RED BURGUNDY APPEARS IN
THE THREE OVALS LINK TOGETHER AND THE
WORDING "VIVINLINEA".

SER. NO. 77-353,208, FILED 12-16-2007.

FIRST USE 10-15-2007; IN COMMERCE 10-15-2007.

ANGELA M. MICHELI, EXAMINING ATTORNEY

Int. Cl.: 29

Prior U.S. Cl.: 46

United States Patent and Trademark Office

Reg. No. 3,479,930

Registered Aug. 5, 2008

**TRADEMARK
PRINCIPAL REGISTER**



BRETT STERN (UNITED STATES INDIVIDUAL)
SUITE #531
1221 NW 11TH ST
PORTLAND, OR 97209

FOR: POTATO CHIPS, IN CLASS 29 (U.S. CL. 46).

FIRST USE 12-1-2007; IN COMMERCE 12-1-2007.

OWNER OF U.S. REG. NO. 3,383,400.

THE COLOR(S) GREEN AND BLACK IS/ARE CLAIMED AS A FEATURE OF THE MARK.

THE MARK CONSISTS OF A MARGARITA GLASS WITH A LIME ON THE EDGE IN GREEN. THE WORDS, "CHIP SHOTS" ARE POOKIE TYPE-FACE IN BLACK.

SER. NO. 77-353,225, FILED 12-16-2007.

ROBIN CHOSID, EXAMINING ATTORNEY

Int. Cl.: 29

Prior U.S. Cl.: 46

United States Patent and Trademark Office

Reg. No. 3,479,931

Registered Aug. 5, 2008

**TRADEMARK
PRINCIPAL REGISTER**



BRETT STERN (UNITED STATES INDIVIDUAL)
SUITE #531
1221 NW 11TH ST
PORTLAND, OR 97209

FOR: POTATO CHIPS, IN CLASS 29 (U.S. CL. 46).

FIRST USE 12-1-2007; IN COMMERCE 12-1-2007.

OWNER OF U.S. REG. NO. 3,383,401.

THE COLOR(S) RED AND BLACK IS/ARE CLAIMED AS A FEATURE OF THE MARK.

THE MARK CONSISTS OF BLOODY MARY DRINK WITH CELERY STALK IN GLASS IN RED. THE WORDS, "HOT POTATOES," ARE POOKIE TYPEFACE IN BLACK.

SER. NO. 77-353,237, FILED 12-16-2007.

ROBIN CHOSID, EXAMINING ATTORNEY

Int. Cl.: 21

Prior U.S. Cls.: 2, 13, 23, 29, 30, 33, 40 and 50

Reg. No. 3,479,932

United States Patent and Trademark Office

Registered Aug. 5, 2008

**TRADEMARK
PRINCIPAL REGISTER**

WISE-GLASS

LEFT BRAIN ENTERPRISES, LLC (DELAWARE
LTD LIAB CO)
902 STUART ROAD
WILMINGTON, DE 19807

THE MARK CONSISTS OF STANDARD CHAR-
ACTERS WITHOUT CLAIM TO ANY PARTICULAR
FONT, STYLE, SIZE, OR COLOR.

FOR: BEVERAGE GLASSWARE UPON WHICH
WORDING, MONOGRAMS, LOGOS OR DESIGNS
ARE ETCHED, IN CLASS 21 (U.S. CLS. 2, 13, 23, 29, 30,
33, 40 AND 50).

SER. NO. 77-353,241, FILED 12-16-2007.

FIRST USE 12-0-2007; IN COMMERCE 12-0-2007.

ANGELA M. MICHELI, EXAMINING ATTORNEY

Int. Cl.: 16

Prior U.S. Cls.: 2, 5, 22, 23, 29, 37, 38 and 50

Reg. No. 3,479,933

United States Patent and Trademark Office

Registered Aug. 5, 2008

**TRADEMARK
PRINCIPAL REGISTER**

**PROFILES OF ORGANIZATIONAL
INFLUENCE STRATEGIES (POIS)**

STUART M. SCHMIDT (UNITED STATES INDIVIDUAL)
2200 MT. VERNON STREET
PHILADELPHIA, PA 19130

FOR: EDUCATIONAL PUBLICATIONS, NAME-
LY, TRAINING MANUALS IN THE FIELD OF
MANAGEMENT, IN CLASS 16 (U.S. CLS. 2, 5, 22,
23, 29, 37, 38 AND 50).

FIRST USE 5-21-1982; IN COMMERCE 6-21-2000.

THE MARK CONSISTS OF STANDARD CHAR-
ACTERS WITHOUT CLAIM TO ANY PARTICULAR
FONT, STYLE, SIZE, OR COLOR.

NO CLAIM IS MADE TO THE EXCLUSIVE
RIGHT TO USE "PROFILES OF ORGANIZATIONAL
INFLUENCE STRATEGIES", APART FROM THE
MARK AS SHOWN.

SER. NO. 77-353,271, FILED 12-16-2007.

CHRISIE B. KING, EXAMINING ATTORNEY

Int. Cl.: 9

Prior U.S. Cls.: 21, 23, 26, 36 and 38

Reg. No. 3,479,934

United States Patent and Trademark Office

Registered Aug. 5, 2008

**TRADEMARK
PRINCIPAL REGISTER**

REVEAL

CANFIELD SCIENTIFIC, INC. (NEW JERSEY
CORPORATION)
253 PASSAIC AVENUE
FAIRFIELD, NJ 070042524

FIRST USE 2-2-2008; IN COMMERCE 2-2-2008.

FOR: FACIAL IMAGING SYSTEMS, NAMELY,
IMAGE CAPTURE COMPUTER HARDWARE AND
SOFTWARE FOR USE IN IMAGE CAPTURE, DIS-
PLAY, IMAGE PROCESSING, ANALYSIS, AND
SIMULATION WITHIN THE FIELDS OF MEDI-
CINE, HEALTH CARE, FITNESS, COSMETOLOGY,
FASHION, SOCIAL WORK AND LAW ENFORCE-
MENT, IN CLASS 9 (U.S. CLS. 21, 23, 26, 36 AND 38).

THE MARK CONSISTS OF STANDARD CHAR-
ACTERS WITHOUT CLAIM TO ANY PARTICULAR
FONT, STYLE, SIZE, OR COLOR.

SER. NO. 77-353,342, FILED 12-17-2007.

PAULA MAHONEY, EXAMINING ATTORNEY

Int. Cl.: 41

Prior U.S. Cls.: 100, 101 and 107

United States Patent and Trademark Office

Reg. No. 3,479,935

Registered Aug. 5, 2008

**SERVICE MARK
PRINCIPAL REGISTER**

SPEEDWAY

AVNET, INC. (NEW YORK CORPORATION)
2211 SOUTH 47TH STREET
PHOENIX, AZ 85034

THE MARK CONSISTS OF STANDARD CHAR-
ACTERS WITHOUT CLAIM TO ANY PARTICULAR
FONT, STYLE, SIZE, OR COLOR.

FOR: EDUCATIONAL SERVICES, NAMELY,
PROVIDING WORKSHOPS IN THE FIELDS OF
COMPUTER HARDWARE AND SOFTWARE, IN
CLASS 41 (U.S. CLS. 100, 101 AND 107).

SER. NO. 77-353,561, FILED 12-17-2007.

FIRST USE 5-21-2003; IN COMMERCE 5-21-2003.

DAWN HAN, EXAMINING ATTORNEY

Int. Cl.: 9

Prior U.S. Cls.: 21, 23, 26, 36 and 38

Reg. No. 3,479,936

United States Patent and Trademark Office

Registered Aug. 5, 2008

**TRADEMARK
PRINCIPAL REGISTER**



CAUCHO TECHNOLOGY, INC. (CALIFORNIA CORPORATION)
643 GRAVILLA STREET
LA JOLLA, CA 92037

FOR: COMPUTER SOFTWARE FOR COMPUTER SYSTEM AND APPLICATION DEVELOPMENT, DEPLOYMENT AND MANAGEMENT, IN CLASS 9 (U.S. CLS. 21, 23, 26, 36 AND 38).

FIRST USE 4-15-2002; IN COMMERCE 4-15-2002.

THE COLOR(S) GOLD, NAVY BLUE AND ROYAL BLUE IS/ARE CLAIMED AS A FEATURE OF THE MARK.

THE MARK CONSISTS OF THE WORD "CAUCHO" APPEARING IN GOLD LETTERING WITH THE SILHOUETTE OF A FOUR-LEGGED DRAGONFLY PERCHED ATOP THE BENT "H" IN "CAUCHO". THE DRAGONFLY'S WINGS ARE ROYAL BLUE AND ITS BODY IS NAVY BLUE.

THE FOREIGN WORDING IN THE MARK TRANSLATES INTO ENGLISH AS RUBBER.

SER. NO. 77-353,595, FILED 12-17-2007.

PAM WILLIS, EXAMINING ATTORNEY

Int. Cl.: 35

Prior U.S. Cls.: 100, 101 and 102

United States Patent and Trademark Office

Reg. No. 3,479,937

Registered Aug. 5, 2008

**SERVICE MARK
PRINCIPAL REGISTER**

VIDEOMINING

VIDEOMINING CORPORATION (PENNSYLVANIA CORPORATION)
403 S. ALLEN STREET
STATE COLLEGE, PA 16801

FOR: BUSINESS MANAGEMENT CONSULTING FOR RETAILERS AND MANUFACTURERS IN THE FIELD OF TECHNOLOGY-ENABLED IN-STORE RESEARCH USING AUTOMATED VIDEO ANALYSIS OF SHOPPER BEHAVIOR, IN CLASS 35 (U.S. CLS. 100, 101 AND 102).

FIRST USE 12-21-2004; IN COMMERCE 12-21-2004.

THE MARK CONSISTS OF STANDARD CHARACTERS WITHOUT CLAIM TO ANY PARTICULAR FONT, STYLE, SIZE, OR COLOR.

SER. NO. 77-353,606, FILED 12-17-2007.

SUNG IN, EXAMINING ATTORNEY

Int. Cl.: 28

Prior U.S. Cls.: 22, 23, 38 and 50

United States Patent and Trademark Office

Reg. No. 3,479,938

Registered Aug. 5, 2008

**TRADEMARK
PRINCIPAL REGISTER**



HOSUNG NEW YORK TRADING, INC. (NEW YORK CORPORATION)
300 KINGSLAND AVENUE
BROOKLYN, NY 11222

FOR: INFANT DEVELOPMENT TOYS; INFANT TOYS; PLUSH TOYS, IN CLASS 28 (U.S. CLS. 22, 23, 38 AND 50).

FIRST USE 7-1-2006; IN COMMERCE 3-1-2007.

NO CLAIM IS MADE TO THE EXCLUSIVE RIGHT TO USE "NATURAL", APART FROM THE MARK AS SHOWN.

THE COLOR(S) GREEN, WHITE AND PLUM IS/ ARE CLAIMED AS A FEATURE OF THE MARK.

THE MARK CONSISTS OF THE WORDING "MY NATURAL" APPEARING IN GREEN ABOVE A CIRCULAR DESIGN ELEMENT CONTAINING A DEPICTION OF WHITE COTTON BULBS ON A WHITE BRANCH APPEARING ON A BACKGROUND CONTAINING THE COLORS PLUM AND GREEN. THE CIRCULAR DESIGN ELEMENT HAS A WHITE RING FORMING THE INNER BORDER AND A GREEN SCALLOPED EDGE FORMING THE OUTER BORDER.

SER. NO. 77-353,724, FILED 12-17-2007.

ROBERT LAVACHE, EXAMINING ATTORNEY

Int. Cl.: 37

Prior U.S. Cls.: 100, 103 and 106

United States Patent and Trademark Office

Reg. No. 3,479,939

Registered Aug. 5, 2008

**SERVICE MARK
PRINCIPAL REGISTER**

GEMURGENCY

GEM PLUMBING & HEATING CO., INC.
(RHODE ISLAND CORPORATION)
ONE WELLINGTON ROAD
LINCOLN, RI 02865

THE MARK CONSISTS OF STANDARD CHAR-
ACTERS WITHOUT CLAIM TO ANY PARTICULAR
FONT, STYLE, SIZE, OR COLOR.

FOR: PLUMBING, HEATING, ELECTRICAL AND
AIR CONDITIONING CONTRACTOR SERVICES, IN
CLASS 37 (U.S. CLS. 100, 103 AND 106).

SER. NO. 77-353,793, FILED 12-17-2007.

FIRST USE 1-1-2007; IN COMMERCE 1-1-2007.

ALYSSA PALADINO, EXAMINING ATTORNEY

Int. Cl.: 38

Prior U.S. Cls.: 100, 101 and 104

United States Patent and Trademark Office

Reg. No. 3,479,940

Registered Aug. 5, 2008

**SERVICE MARK
PRINCIPAL REGISTER**

VOIP FOR SMART BUSINESS

ADAPTION TECHNOLOGIES VENTURES, LTD.
(TEXAS PARTNERSHIP)
1029 PRUITT ROAD
THE WOODLANDS, TX 77380

FOR: VOICE OVER INTERNET PROTOCOL
(VOIP) SERVICES, IN CLASS 38 (U.S. CLS. 100, 101
AND 104).

FIRST USE 10-7-2007; IN COMMERCE 10-7-2007.

THE MARK CONSISTS OF STANDARD CHAR-
ACTERS WITHOUT CLAIM TO ANY PARTICULAR
FONT, STYLE, SIZE, OR COLOR.

NO CLAIM IS MADE TO THE EXCLUSIVE
RIGHT TO USE "VOIP", APART FROM THE MARK
AS SHOWN.

SER. NO. 77-354,064, FILED 12-17-2007.

JENNY PARK, EXAMINING ATTORNEY

Int. Cl.: 42

Prior U.S. Cls.: 100 and 101

United States Patent and Trademark Office

Reg. No. 3,479,941

Registered Aug. 5, 2008

**SERVICE MARK
PRINCIPAL REGISTER**

The Tradewinds Group

SAYEN, MICHAEL E (TEXAS SOLE PROPRIETORSHIP), DBA THE TRADEWINDS GROUP
106 S. CHURCH STREET, SUITE 2
MCKINNEY, TX 75069

FOR: GRAPHIC DESIGN; GRAPHIC DESIGN SERVICES; GRAPHIC ILLUSTRATION SERVICES FOR OTHERS, IN CLASS 42 (U.S. CLS. 100 AND 101).

FIRST USE 10-1-2007; IN COMMERCE 12-1-2007.

THE MARK CONSISTS OF STANDARD CHARACTERS WITHOUT CLAIM TO ANY PARTICULAR FONT, STYLE, SIZE, OR COLOR.

NO CLAIM IS MADE TO THE EXCLUSIVE RIGHT TO USE "GROUP", APART FROM THE MARK AS SHOWN.

SER. NO. 77-354,083, FILED 12-17-2007.

SHANNON TWOHIG, EXAMINING ATTORNEY

Int. Cl.: 31

Prior U.S. Cls.: 1 and 46

United States Patent and Trademark Office

Reg. No. 3,479,942

Registered Aug. 5, 2008

**TRADEMARK
PRINCIPAL REGISTER**



Lucky Buck
Antlers

ODYSSEY PETS LLC (TEXAS LTD LIAB CO),
DBA ODYSSEY PETS

17390 PRESTON ROAD SUITE 240

DALLAS, TX 75252

FOR: DOG TREATS; PET TREATS, IN CLASS 31
(U.S. CLS. 1 AND 46).

FIRST USE 12-13-2007; IN COMMERCE 12-13-2007.

NO CLAIM IS MADE TO THE EXCLUSIVE
RIGHT TO USE "ANTLERS", APART FROM THE
MARK AS SHOWN.

THE MARK CONSISTS OF STYLIZED DEER
WITH ANTLERS AND THE WORDS "LUCKY BUCK
ANTLERS".

SER. NO. 77-354,094, FILED 12-17-2007.

DORITT L. CARROLL, EXAMINING ATTORNEY

Int. Cl.: 41

Prior U.S. Cls.: 100, 101 and 107

United States Patent and Trademark Office

Reg. No. 3,479,943

Registered Aug. 5, 2008

**SERVICE MARK
PRINCIPAL REGISTER**

NEWSCHOOLERS

WMG PRODUCTIONS LLC (DELAWARE LTD
LIAB CO)
12100 W. OLYMPIC BLVD., SUITE 400
LOS ANGELES, CA 90064

FOR: ELECTRONIC PUBLISHING SERVICES,
NAMELY, PUBLICATION OF TEXT AND GRAPHIC
WORKS OF OTHERS ON THE WORLD WIDE WEB
FEATURING SKIING AND SNOWBOARDING; EN-
TERTAINMENT SERVICES, NAMELY, PROVIDING
A WEBSITE FEATURING, PHOTOGRAPHIC,
AUDIO, VIDEO AND PROSE PRESENTATIONS
FEATURING SKIING AND SNOWBOARDING;
ON-LINE JOURNALS, NAMELY, BLOGS FEATUR-
ING SKIING AND SNOWBOARDING; PUBLICA-

TION OF THE EDITORIAL CONTENT RELATING
TO SKIING AND SNOWBOARDING OF SITES
ACCESSIBLE VIA A GLOBAL COMPUTER NET-
WORK, IN CLASS 41 (U.S. CLS. 100, 101 AND 107).

FIRST USE 1-1-2007; IN COMMERCE 1-1-2007.

THE MARK CONSISTS OF STANDARD CHAR-
ACTERS WITHOUT CLAIM TO ANY PARTICULAR
FONT, STYLE, SIZE, OR COLOR.

SER. NO. 77-354,095, FILED 12-17-2007.

HOWARD SMIGA, EXAMINING ATTORNEY

Int. Cl.: 41

Prior U.S. Cls.: 100, 101 and 107

United States Patent and Trademark Office

Reg. No. 3,479,944

Registered Aug. 5, 2008

**SERVICE MARK
PRINCIPAL REGISTER**



EMOTIONAL INTELLIGENCE AND DIVERSITY
INSTITUTE, THE (CALIFORNIA PARTNER-
SHIP)

12658 WEST WASHINGTON BLVD., #105
LOS ANGELES, CA 90066

FOR: EDUCATION SERVICES, NAMELY, CON-
DUCTING TRAINING, SEMINARS, WORKSHOPS,
PERSONAL AND GROUP COACHING PROGRAMS
AND RETREATS IN THE FIELD OF DEVELOPING
EMOTIONALLY HEALTHY, PRODUCTIVE ENVIR-

ONMENTS, IN CLASS 41 (U.S. CLS. 100, 101 AND
107).

FIRST USE 11-23-2004; IN COMMERCE 11-23-2004.

THE MARK CONSISTS OF AN OVAL WITH A
TAIL RESEMBLING A TORNADO.

SER. NO. 77-354,134, FILED 12-17-2007.

ALICE BENMAMAN, EXAMINING ATTORNEY

Int. Cl.: 16

Prior U.S. Cls.: 2, 5, 22, 23, 29, 37, 38 and 50

United States Patent and Trademark Office

Reg. No. 3,479,945

Registered Aug. 5, 2008

**TRADEMARK
PRINCIPAL REGISTER**



EMOTIONAL INTELLIGENCE AND DIVERSITY
INSTITUTE, THE (CALIFORNIA PARTNER-
SHIP)

12658 WEST WASHINGTON BLVD., #105
LOS ANGELES, CA 90066

FOR: PRINTED PUBLICATIONS, NAMELY,
WORKBOOKS AND EDUCATIONAL AND TRAIN-
ING MATERIALS IN THE FIELD OF DEVELOPING
EMOTIONALLY HEALTHY, PRODUCTIVE ENVIR-

ONMENTS, IN CLASS 16 (U.S. CLS. 2, 5, 22, 23, 29, 37,
38 AND 50).

FIRST USE 11-23-2004; IN COMMERCE 2-18-2005.

THE MARK CONSISTS OF AN OVAL WITH A
TAIL RESEMBLING A TORNADO.

SER. NO. 77-354,137, FILED 12-17-2007.

ALICE BENMAMAN, EXAMINING ATTORNEY

Int. Cl.: 16

Prior U.S. Cls.: 2, 5, 22, 23, 29, 37, 38 and 50

Reg. No. 3,479,946

United States Patent and Trademark Office

Registered Aug. 5, 2008

**TRADEMARK
PRINCIPAL REGISTER**

e/i/d/i

EMOTIONAL INTELLIGENCE AND DIVERSITY
INSTITUTE, THE (CALIFORNIA PARTNER-
SHIP)
12658 WEST WASHINGTON BLVD., #105
LOS ANGELES, CA 90066

FOR: PRINTED PUBLICATIONS, NAMELY,
WORKBOOKS AND EDUCATIONAL AND TRAIN-
ING MATERIALS IN THE FIELD OF DEVELOPING
EMOTIONALLY HEALTHY, PRODUCTIVE ENVIR-
ONMENTS, IN CLASS 16 (U.S. CLS. 2, 5, 22, 23, 29, 37,
38 AND 50).

FIRST USE 11-9-2004; IN COMMERCE 2-18-2005.

THE MARK CONSISTS OF STANDARD CHAR-
ACTERS WITHOUT CLAIM TO ANY PARTICULAR
FONT, STYLE, SIZE, OR COLOR.

SER. NO. 77-354,139, FILED 12-17-2007.

ALICE BENMAMAN, EXAMINING ATTORNEY

Int. Cl.: 41

Prior U.S. Cls.: 100, 101 and 107

United States Patent and Trademark Office

Reg. No. 3,479,947

Registered Aug. 5, 2008

**SERVICE MARK
PRINCIPAL REGISTER**

e/i/d/i

EMOTIONAL INTELLIGENCE AND DIVERSITY
INSTITUTE, THE (CALIFORNIA PARTNER-
SHIP)
12658 WEST WASHINGTON BLVD., #105
LOS ANGELES, CA 90066

FOR: EDUCATION SERVICES, NAMELY, CON-
DUCTING TRAINING, SEMINARS, WORKSHOPS,
PERSONAL AND GROUP COACHING PROGRAMS
AND RETREATS IN THE FIELD OF DEVELOPING
EMOTIONALLY HEALTHY, PRODUCTIVE ENVIR-
ONMENTS, IN CLASS 41 (U.S. CLS. 100, 101 AND
107).

FIRST USE 11-9-2004; IN COMMERCE 11-23-2004.

THE MARK CONSISTS OF STANDARD CHAR-
ACTERS WITHOUT CLAIM TO ANY PARTICULAR
FONT, STYLE, SIZE, OR COLOR.

SER. NO. 77-354,144, FILED 12-17-2007.

ALICE BENMAMAN, EXAMINING ATTORNEY

Int. Cl.: 35

Prior U.S. Cls.: 100, 101 and 102

United States Patent and Trademark Office

Reg. No. 3,479,948

Registered Aug. 5, 2008

**SERVICE MARK
PRINCIPAL REGISTER**



SOL NÉ COLLECTIONS, INC. (COLORADO CORPORATION)
6500 S. QUEBEC STREET
SUITE 200
CENTENNIAL, CO 80111

FOR: RETAIL STORES FEATURING NEWSLETTERS IN THE FIELDS OF HEALTH, WELLNESS, FOOD AND NUTRITION, HOLISTIC HEALTH CARE, BEAUTY, THE ENVIRONMENT AND ALTERNATIVE MEDICINE AND HEALING; BOOKS, NEWSPAPERS AND PERIODICALS IN THE FIELDS OF HEALTH, NUTRITION AND WELLNESS; COSMETIC GIFTS FOR PERSONAL USE AND CANDLES AND WALL DECORATIONS AS GIFTS FOR THE HOME, IN CLASS 35 (U.S. CLS. 100, 101 AND 102).

FIRST USE 5-0-2005; IN COMMERCE 5-0-2005.

THE COLOR(S) YELLOW, BLUE AND WHITE IS/ARE CLAIMED AS A FEATURE OF THE MARK.

THE COLOR YELLOW APPEARS IN THE GLOBE AND THE RADIATING RAYS OF THE GLOBE, THE COLOR BLUE APPEARS IN THE BACKGROUND AND THE COLOR WHITE APPEARS AROUND THE GLOBE.

SER. NO. 77-354,156, FILED 12-17-2007.

NAAKWAMA ANKRAH, EXAMINING ATTORNEY

Int. Cl.: 9

Prior U.S. Cls.: 21, 23, 26, 36 and 38

United States Patent and Trademark Office

Reg. No. 3,479,949

Registered Aug. 5, 2008

**TRADEMARK
PRINCIPAL REGISTER**



DATAKEY ELECTRONICS, INC. (OHIO CORPORATION)
12730 CREEK VIEW AVENUE
SAVAGE, MN 55378

FOR: BLANK PROGRAMMABLE ELECTRONIC DATA CARRIERS; ELECTRONIC MATING RECEPTACLES USED TO INTERFACE ELECTRONIC DATA CARRIERS WITH MICROPROCESSORS, MICROCONTROLLERS AND PERSONAL COMPUTERS; DATA CARRIER READERS AND WRITERS USED TO INTERFACE WITH MICROPROCESSORS, MICROCONTROLLERS, AND PERSONAL COMPUTERS, IN CLASS 9 (U.S. CLS. 21, 23, 26, 36 AND 38).

FIRST USE 6-30-2002; IN COMMERCE 6-30-2002.

OWNER OF U.S. REG. NOS. 1,455,104 AND 1,457,273.

NO CLAIM IS MADE TO THE EXCLUSIVE RIGHT TO USE "ELECTRONICS", APART FROM THE MARK AS SHOWN.

THE COLOR(S) RED, YELLOW AND BLUE IS/ARE CLAIMED AS A FEATURE OF THE MARK.

THE MARK CONSISTS OF AN IMAGE OF ONE RED AND ONE YELLOW KEY-SHAPED DATA CARRIER TO THE LEFT OF THE BLUE-LETTERED WORDING "DATAKEY ELECTRONICS".

SER. NO. 77-354,179, FILED 12-17-2007.

VERNA BETH RIRIE, EXAMINING ATTORNEY

Int. Cl.: 41

Prior U.S. Cls.: 100, 101 and 107

United States Patent and Trademark Office

Reg. No. 3,479,950

Registered Aug. 5, 2008

**SERVICE MARK
PRINCIPAL REGISTER**



TRIANGLE MARTIAL ARTS ASSOCIATION (CALIFORNIA CORPORATION)
PMB 111
1800 MARKET STREET
SAN FRANCISCO, CA 94102

FOR: EDUCATION SERVICES, NAMELY, PROVIDING CLASSES AND SEMINARS IN THE FIELD OF MARTIAL ARTS; MARTIAL ARTS INSTRUCTION, IN CLASS 41 (U.S. CLS. 100, 101 AND 107).

FIRST USE 11-1-1998; IN COMMERCE 11-8-1998.

NO CLAIM IS MADE TO THE EXCLUSIVE RIGHT TO USE "MARTIAL ARTS ASSOCIATION" AND "ESTABLISHED 1998", APART FROM THE MARK AS SHOWN.

THE STIPPLING IS FOR SHADING PURPOSES ONLY.

SER. NO. 77-354,184, FILED 12-17-2007.

TINA KUAN, EXAMINING ATTORNEY

Int. Cl.: 44

Prior U.S. Cls.: 100 and 101

United States Patent and Trademark Office

Reg. No. 3,479,951

Registered Aug. 5, 2008

**SERVICE MARK
PRINCIPAL REGISTER**



PEDIATRIC DENTAL HEALTHCARE, INC.
(MASSACHUSETTS CORPORATION)
16 WASHINGTON STREET
PLAINVILLE, MA 02762

FOR: DENTIST SERVICES, IN CLASS 44 (U.S. CLS.
100 AND 101).

FIRST USE 1-1-2006; IN COMMERCE 1-1-2006.

NO CLAIM IS MADE TO THE EXCLUSIVE
RIGHT TO USE "PEDIATRIC DENTAL HEALTH-
CARE", APART FROM THE MARK AS SHOWN.

THE COLOR(S) RED, BLUE, YELLOW, WHITE,
GRAY, ORANGE AND BEIGE IS/ARE CLAIMED AS
A FEATURE OF THE MARK.

THE MARK CONSISTS OF AN OUTER ORANGE
CIRCLE AND AN INTERIOR RED CIRCLE. THE
RED CIRCLE CONTAINS THE WORDING "PEDIA-
TRIC DENTAL HEALTHCARE" IN WHITE. THE
CENTER OF THE CIRCLE HAS FOUR JUVENILE
FACES, THREE OF THEM BEIGE AND ONE GRAY.
ONE HAS A BLUE BASEBALL CAP AND ANOTHER
WITH YELLOW HAIR, WITH TWO OF THEM
HAVING RED RIBBONS IN THEIR HAIR. THE
MARK CONTAINS A WHITE BACKGROUND IN
ALL REMAINING AREAS.

SER. NO. 77-354,230, FILED 12-17-2007.

KARANENDRA S. CHHINA, EXAMINING ATTOR-
NEY

Int. Cl.: 18

Prior U.S. Cls.: 1, 2, 3, 22 and 41

United States Patent and Trademark Office

Reg. No. 3,479,952

Registered Aug. 5, 2008

**TRADEMARK
PRINCIPAL REGISTER**

GIRLY GOLFER

DELILA A. HARVEY (UNITED STATES INDIVIDUAL)

1532 REDWING DRIVE

EVANSVILLE, IN 47715

FOR: ALL PURPOSE CARRYING BAGS, IN CLASS 18 (U.S. CLS. 1, 2, 3, 22 AND 41).

FIRST USE 5-8-2007; IN COMMERCE 5-8-2007.

THE MARK CONSISTS OF STANDARD CHARACTERS WITHOUT CLAIM TO ANY PARTICULAR FONT, STYLE, SIZE, OR COLOR.

NO CLAIM IS MADE TO THE EXCLUSIVE RIGHT TO USE "GOLFER", APART FROM THE MARK AS SHOWN.

SER. NO. 77-354,297, FILED 12-18-2007.

EMILY CHUO, EXAMINING ATTORNEY

Int. Cl.: 20

Prior U.S. Cls.: 2, 13, 22, 25, 32 and 50

Reg. No. 3,479,953

United States Patent and Trademark Office

Registered Aug. 5, 2008

**TRADEMARK
PRINCIPAL REGISTER**

REGATTA

SKYLINE DISPLAYS, INC. (MINNESOTA CORPORATION)
3355 DISCOVERY ROAD
EAGAN, MN 55121

THE MARK CONSISTS OF STANDARD CHARACTERS WITHOUT CLAIM TO ANY PARTICULAR FONT, STYLE, SIZE, OR COLOR.

FOR: PORTABLE DISPLAY AND EXHIBITION STANDS FOR USE AT COMMERCIAL TRADE SHOWS AND EXHIBITIONS, IN CLASS 20 (U.S. CLS. 2, 13, 22, 25, 32 AND 50).

SER. NO. 77-354,301, FILED 12-18-2007.

FIRST USE 6-30-2006; IN COMMERCE 6-30-2006.

ANTHONY RINKER, EXAMINING ATTORNEY

Int. Cl.: 6

Prior U.S. Cls.: 2, 12, 13, 14, 23, 25 and 50

Reg. No. 3,479,954

United States Patent and Trademark Office

Registered Aug. 5, 2008

**TRADEMARK
PRINCIPAL REGISTER**

STAKE-LOC

F. BARKOW, INC. (WISCONSIN CORPORATION)
3830 N. FRATNEY STREET
MILWAUKEE, WI 53212

FOR: METAL STAKES AND FASTENERS FOR USE ON RACKS AGAINST WHICH SHEETS OF STONE OR STONE-LIKE PRODUCTS ARE ADAPTED TO REST AND ADAPTED TO BE MOUNTED ON A MOTOR VEHICLE FOR TRANSPORTATION OF SUCH STONE, IN CLASS 6 (U.S. CLS. 2, 12, 13, 14, 23, 25 AND 50).

FIRST USE 12-7-1998; IN COMMERCE 12-7-1998.

THE MARK CONSISTS OF STANDARD CHARACTERS WITHOUT CLAIM TO ANY PARTICULAR FONT, STYLE, SIZE, OR COLOR.

OWNER OF U.S. REG. NO. 2,204,795.

SER. NO. 77-354,308, FILED 12-18-2007.

B. PARADEWELAI, EXAMINING ATTORNEY

Int. Cl.: 16

Prior U.S. Cls.: 2, 5, 22, 23, 29, 37, 38 and 50

Reg. No. 3,479,955

United States Patent and Trademark Office

Registered Aug. 5, 2008

**TRADEMARK
PRINCIPAL REGISTER**



PINCEIS ATLAS S/A (BRAZIL CORPORATION)
RODOVIA BR 116, KM 258, S/N
ESTEIO/RS, BRAZIL

FIRST USE 1-10-1999; IN COMMERCE 1-10-1999.

FOR: PAINT APPLICATOR ROLLERS; PAINT
APPLICATORS; PAINT BOXES AND BRUSHES;
PAINT BRUSHES; PAINT ROLLER COVERS; PAINT
ROLLERS; PAINT TRAYS, ALL FOR USE IN HOME
IMPROVEMENT AND HOME CONSTRUCTION, IN
CLASS 16 (U.S. CLS. 2, 5, 22, 23, 29, 37, 38 AND 50).

THE MARK CONSISTS OF A KIND OF ASTERISK
FOLLOWED BY THE WORD "ATLAS".

SER. NO. 77-354,358, FILED 12-18-2007.

EMILY CHUO, EXAMINING ATTORNEY

Int. Cl.: 41

Prior U.S. Cls.: 100, 101 and 107

United States Patent and Trademark Office

Reg. No. 3,479,956

Registered Aug. 5, 2008

**SERVICE MARK
PRINCIPAL REGISTER**



BACK NINE GOLF
ACADEMY

CARMELCO, LLC (ARKANSAS LTD LIAB CO),
DBA BACK NINE GOLF ACADEMY
502 S.W. 12TH STREET
BENTONVILLE, AR 72712

FOR: GOLF INSTRUCTION, IN CLASS 41 (U.S.
CLS. 100, 101 AND 107).

FIRST USE 8-4-2007; IN COMMERCE 8-4-2007.

NO CLAIM IS MADE TO THE EXCLUSIVE
RIGHT TO USE "GOLF" AND "ACADEMY", APART
FROM THE MARK AS SHOWN.

THE COLOR(S) YELLOW/GOLD, BLACK AND
WHITE IS/ARE CLAIMED AS A FEATURE OF THE
MARK.

THE MARK CONSISTS OF AN INTERTWINED
LOWERCASE "B" AND THE NUMERAL "9" IN
YELLOW/GOLD, OUTLINED IN BLACK, WITH A
WHITE VOID IN THE MIDDLE, CENTERED ABOVE
THE WORDS "BACK NINE GOLF" IN BLACK
LETTERING CENTERED ABOVE A HORIZONTAL
BLACK LINE, WHICH IS CENTERED ABOVE THE
WORD "ACADEMY" IN BLACK LETTERING.

SER. NO. 77-354,365, FILED 12-18-2007.

SHANNON TWOHIG, EXAMINING ATTORNEY

Int. Cls.: 7 and 42

Prior U.S. Cls.: 13, 19, 21, 23, 31, 34, 35, 100 and 101

United States Patent and Trademark Office

Reg. No. 3,479,957

Registered Aug. 5, 2008

**TRADEMARK
SERVICE MARK
PRINCIPAL REGISTER**

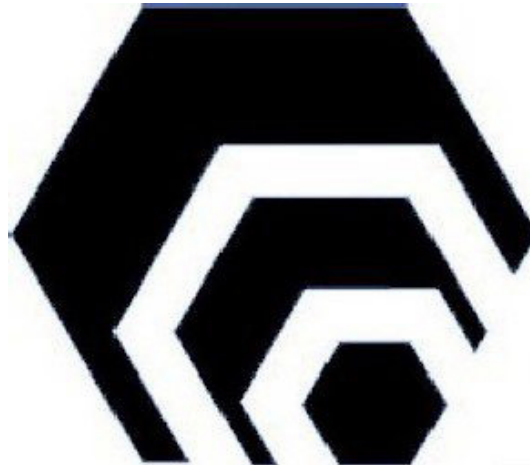

QC AMERICAN (MICHIGAN LTD LIAB CO)
4600 JACKSON ROAD
ANN ARBOR, MI 48103

FOR: MACHINES AND MACHINE TOOLS FOR
THE CUTTING AND FORMING OF MATERIALS,
IN CLASS 7 (U.S. CLS. 13, 19, 21, 23, 31, 34 AND 35).

FIRST USE 10-1-2006; IN COMMERCE 10-1-2006.

FOR: DESIGN AND ENGINEERING SERVICES
OF MACHINE TOOLS, IN CLASS 42 (U.S. CLS. 100
AND 101).

FIRST USE 10-1-2006; IN COMMERCE 10-1-2006.

THE MARK CONSISTS OF TWO HEXAGONS
INSIDE ANOTHER, BIGGER, HEXAGON.

SER. NO. 77-354,430, FILED 12-18-2007.

SUNG IN, EXAMINING ATTORNEY

Int. Cl.: 28

Prior U.S. Cls.: 22, 23, 38 and 50

Reg. No. 3,479,958

United States Patent and Trademark Office

Registered Aug. 5, 2008

**TRADEMARK
PRINCIPAL REGISTER**



EXTREME PAINTBALL DESIGN LLC (MINNE-
SOTA LTD LIAB CO)
9921 TOLEDO DR
BROOKLYN PARK, MN 55443

THE MARK CONSISTS OF THE NUMBER "4"
AND THE LETTER "C". BOTH OF WHICH ARE
PLACED INSIDE A EYE BALL.

FOR: PAINTBALL GUNS, IN CLASS 28 (U.S. CLS.
22, 23, 38 AND 50).

SER. NO. 77-354,431, FILED 12-18-2007.

FIRST USE 7-0-2006; IN COMMERCE 10-0-2006.

SUSAN STIGLITZ, EXAMINING ATTORNEY

Int. Cl.: 41

Prior U.S. Cls.: 100, 101 and 107

United States Patent and Trademark Office

Reg. No. 3,479,959

Registered Aug. 5, 2008

**SERVICE MARK
PRINCIPAL REGISTER**

AIR ZONE

KIRBY ASH ENTERPRISES, INC. (MISSOURI
CORPORATION)
7807 NORTH OAK TRAFFICWAY
KANSAS CITY, MO 64118

THE MARK CONSISTS OF STANDARD CHAR-
ACTERS WITHOUT CLAIM TO ANY PARTICULAR
FONT, STYLE, SIZE, OR COLOR.

FOR: ENTERTAINMENT AND RECREATION
SERVICES, NAMELY, PROVIDING FACILITIES
WITH LARGE INFLATABLE PLAY STRUCTURES,
IN CLASS 41 (U.S. CLS. 100, 101 AND 107).

SER. NO. 77-354,499, FILED 12-18-2007.

FIRST USE 7-31-2007; IN COMMERCE 7-31-2007.

KAREN SEVERSON, EXAMINING ATTORNEY

Int. Cl.: 37

Prior U.S. Cls.: 100, 103 and 106

United States Patent and Trademark Office

Reg. No. 3,479,960

Registered Aug. 5, 2008

**SERVICE MARK
PRINCIPAL REGISTER**

Maxwell The Cleaner

ELLIOTT, RICK (UNITED STATES INDIVIDUAL)
6981 GREYSTONE LANE
FORT MYERS, FL 33912

FOR: DRY CLEANING, IN CLASS 37 (U.S. CLS.
100, 103 AND 106).

FIRST USE 11-1-2007; IN COMMERCE 12-1-2007.

THE MARK CONSISTS OF STANDARD CHAR-
ACTERS WITHOUT CLAIM TO ANY PARTICULAR
FONT, STYLE, SIZE, OR COLOR.

NO CLAIM IS MADE TO THE EXCLUSIVE
RIGHT TO USE "THE CLEANER", APART FROM
THE MARK AS SHOWN.

SER. NO. 77-354,533, FILED 12-18-2007.

IRA J. GOODSaid, EXAMINING ATTORNEY

Int. Cl.: 43

Prior U.S. Cls.: 100 and 101

United States Patent and Trademark Office

Reg. No. 3,479,961

Registered Aug. 5, 2008

**SERVICE MARK
PRINCIPAL REGISTER**

Wineology

NAPOLITANO, LEONARD SEVERIN (UNITED STATES INDIVIDUAL)
1465 ZINFANDEL CT.
TEMPLETON, CA 93465

FOR: PROVIDING INFORMATION ABOUT WINE CHARACTERISTICS, IN CLASS 43 (U.S. CLS. 100 AND 101).

FIRST USE 5-15-2001; IN COMMERCE 5-15-2001.

THE MARK CONSISTS OF STANDARD CHARACTERS WITHOUT CLAIM TO ANY PARTICULAR FONT, STYLE, SIZE, OR COLOR.

OWNER OF U.S. REG. NO. 2,497,103.

SER. NO. 77-354,539, FILED 12-18-2007.

MICHAEL SOUDERS, EXAMINING ATTORNEY

Int. Cl.: 30

Prior U.S. Cl.: 46

United States Patent and Trademark Office

Reg. No. 3,479,962

Registered Aug. 5, 2008

TRADEMARK
PRINCIPAL REGISTER



BRAND NEW PRODUCTS, LLC (DELAWARE
LTD LIAB CO)
SUITE 280
2506 NORTH CLARK STREET
CHICAGO, IL 60614

FOR: CANDY CONTAINING ALCOHOLIC BEV-
ERAGE CONTENT AND FLAVOR; CANDY MINTS;
CANDY WITH CARAMEL; CHOCOLATE; CHOCO-
LATE BARS; CHOCOLATE CANDIES; CHOCOLATE
TRUFFLES; MILK CHOCOLATE; PEPPERMINT
CANDY; SUGARLESS CANDIES; GUMMY CAN-
DIES; BUBBLE GUM; CHEWING GUM; SUGAR-
FREE CHEWING GUM; SUGARFREE CHEWING
GUM; SUGARLESS CHEWING GUM; CANDIES;
CANDY; CANDY BARS; CANDY WITH COCOA,
IN CLASS 30 (U.S. CL. 46).

FIRST USE 9-1-2005; IN COMMERCE 9-1-2005.

NO CLAIM IS MADE TO THE EXCLUSIVE
RIGHT TO USE "SWEETS", APART FROM THE
MARK AS SHOWN.

THE MARK CONSISTS OF THE WORDS "JOLLY
SWEETS" WITHIN A LINED, MODIFIED OVAL
AND A PAIR OF HOLLEY LEAVES ADJACENT TO
THE LITERAL ELEMENT, ALSO WITHIN THE
MODIFIED OVAL.

SER. NO. 77-354,563, FILED 12-18-2007.

KATHLEEN LORENZO, EXAMINING ATTORNEY

Int. Cl.: 35

Prior U.S. Cls.: 100, 101 and 102

United States Patent and Trademark Office

Reg. No. 3,479,963

Registered Aug. 5, 2008

**SERVICE MARK
PRINCIPAL REGISTER**



REP AMERICA (ILLINOIS NON-PROFIT CORPORATION)
3200 CARLISLE BOULEVARD NE, SUITE 114
ALBUQUERQUE, NM 87110

FOR: PROMOTING PUBLIC AWARENESS OF ENVIRONMENTAL AND CONSERVATION ISSUES, IN CLASS 35 (U.S. CLS. 100, 101 AND 102).

FIRST USE 12-1-2007; IN COMMERCE 12-1-2007.

OWNER OF U.S. REG. NOS. 2,192,609 AND 2,192,633.

NO CLAIM IS MADE TO THE EXCLUSIVE RIGHT TO USE "REPUBLICANS FOR ENVIRONMENTAL PROTECTION", APART FROM THE MARK AS SHOWN.

THE COLOR(S) GREEN AND BLUE IS/ARE CLAIMED AS A FEATURE OF THE MARK.

THE MARK CONSISTS OF A DEPICTION OF A GREEN ELEPHANT FACING TO THE RIGHT WITH ITS CHIN RESTING ON THE "R" IN THE ACRONYM "REP" IN ALL BLUE CAPITAL LETTERS, BELOW WHICH IS A LINE IN BLUE, BELOW WHICH ARE THE WORDS "REPUBLICANS FOR" IN GREEN WITH THREE BLUE FIVE-POINTED STARS ON EACH SIDE OF THEM, BELOW WHICH ARE THE WORDS "ENVIRONMENTAL PROTECTION" IN GREEN WITH A BLUE LINE UNDERNEATH THEM.

SER. NO. 77-354,612, FILED 12-18-2007.

MARIA-VICTORIA SUAREZ, EXAMINING ATTORNEY

Int. Cls.: 9 and 42

Prior U.S. Cls.: 21, 23, 26, 36, 38, 100 and 101

United States Patent and Trademark Office

Reg. No. 3,479,964

Registered Aug. 5, 2008

**TRADEMARK
SERVICE MARK
PRINCIPAL REGISTER**

PROXIMITY LAB

KARATZAS, EVAN (UNITED STATES INDIVIDUAL)
85 MELBOURNE STREET
PORTSMOUTH, NH 03801

FOR: INTERFACES AND PERIPHERAL DEVICES FOR COMPUTERS, NAMELY, INTERACTIVE PLATFORMS WITH SENSORS AND DISPLAYS; COMPUTER SOFTWARE FOR CONTROLLING INTERFACES AND PERIPHERAL DEVICES FOR COMPUTERS, NAMELY, INTERACTIVE PLATFORMS WITH SENSORS AND DISPLAYS, IN CLASS 9 (U.S. CLS. 21, 23, 26, 36 AND 38).

FIRST USE 12-1-2004; IN COMMERCE 12-1-2004.

FOR: DESIGN, DEVELOPMENT AND CONSULTING SERVICES IN THE FIELD OF COMPUTER-

BASED ART, USER INTERFACES, WEB SITES AND WEB-BASED APPLICATIONS, COMPUTER HARDWARE AND PERIPHERAL DEVICES FOR USE IN ART EXHIBITS, FOR COMMERCIAL INSTALLATIONS, NAMELY, TRADE SHOWS, AND FOR EDUCATIONAL PURPOSES, IN CLASS 42 (U.S. CLS. 100 AND 101).

FIRST USE 12-1-2004; IN COMMERCE 12-1-2004.

THE MARK CONSISTS OF STANDARD CHARACTERS WITHOUT CLAIM TO ANY PARTICULAR FONT, STYLE, SIZE, OR COLOR.

SER. NO. 77-354,636, FILED 12-18-2007.

MONIQUE MILLER, EXAMINING ATTORNEY

Int. Cl.: 16

Prior U.S. Cls.: 2, 5, 22, 23, 29, 37, 38 and 50

Reg. No. 3,479,965

United States Patent and Trademark Office

Registered Aug. 5, 2008

**TRADEMARK
PRINCIPAL REGISTER**

ACTIVATE

UNIVERSITY OF MARYLAND, BALTIMORE
COUNTY (MARYLAND STATE UNIVERSITY)
1000 HILLTOP CIRCLE
BALTIMORE, MD 21250

FOR: PRINTED INSTRUCTIONAL, EDUCATION-
AL, AND TEACHING MATERIALS IN THE NAT-
URE OF BOOKS, MANUALS, NOTEBOOKS,
BROCHURES, PAMPHLETS, NEWSLETTERS, AR-
TICLES, HANDOUTS, AND TRAINING MATERI-
ALS FOR THE PURPOSE OF TRAINING
ENTREPRENEURS TO CREATE TECHNOLOGY-

BASED START-UP COMPANIES, IN CLASS 16 (U.S.
CLS. 2, 5, 22, 23, 29, 37, 38 AND 50).

FIRST USE 3-3-2005; IN COMMERCE 3-3-2005.

THE MARK CONSISTS OF STANDARD CHAR-
ACTERS WITHOUT CLAIM TO ANY PARTICULAR
FONT, STYLE, SIZE, OR COLOR.

SER. NO. 77-354,667, FILED 12-18-2007.

EMILY CHUO, EXAMINING ATTORNEY

Int. Cl.: 41

Prior U.S. Cls.: 100, 101 and 107

United States Patent and Trademark Office

Reg. No. 3,479,966

Registered Aug. 5, 2008

**SERVICE MARK
PRINCIPAL REGISTER**

ACTIVATE

UNIVERSITY OF MARYLAND, BALTIMORE
COUNTY (MARYLAND STATE UNIVERSITY)
1000 HILLTOP CIRCLE
BALTIMORE, MD 21250

FOR: EDUCATIONAL SERVICES, NAMELY,
PROVIDING COURSES OF INSTRUCTION, SEMI-
NARS, CONFERENCES, TRAINING, WORKSHOPS
AND CONTINUING EDUCATION COURSES TO
TRAIN ENTREPRENEURS TO CREATE TECHNOL-
OGY-BASED START-UP COMPANIES AND DISTRI-
BUTION OF COURSE MATERIALS RELATED
THERE TO, IN CLASS 41 (U.S. CLS. 100, 101 AND 107).

FIRST USE 10-0-2004; IN COMMERCE 10-0-2004.

THE MARK CONSISTS OF STANDARD CHAR-
ACTERS WITHOUT CLAIM TO ANY PARTICULAR
FONT, STYLE, SIZE, OR COLOR.

SER. NO. 77-354,674, FILED 12-18-2007.

EMILY CHUO, EXAMINING ATTORNEY

Int. Cl.: 42

Prior U.S. Cls.: 100 and 101

United States Patent and Trademark Office

Reg. No. 3,479,967

Registered Aug. 5, 2008

**SERVICE MARK
PRINCIPAL REGISTER**

COMMANDGRID

SECURITY WITH ADVANCED TECHNOLOGY,
INC. (COLORADO CORPORATION)
SUITE 1000
10855 DOVER STREET
WESTMINSTER, CO 80021

FOR: ONLINE SYSTEM MANAGEMENT SERVICES THAT PROVIDE REMOTE ACCESS OVER ACCESS CONTROL, ALARMS, VIDEO SURVEILLANCE, AND ENVIRONMENTAL CONDITIONS, NAMELY, LIGHTS, HEATING AND AIR CONDITIONING, IN CLASS 42 (U.S. CLS. 100 AND 101).

FIRST USE 9-20-2007; IN COMMERCE 9-20-2007.

THE MARK CONSISTS OF STANDARD CHARACTERS WITHOUT CLAIM TO ANY PARTICULAR FONT, STYLE, SIZE, OR COLOR.

SER. NO. 77-354,705, FILED 12-18-2007.

MICHELE SWAIN, EXAMINING ATTORNEY

Int. Cl.: 35

Prior U.S. Cls.: 100, 101 and 102

United States Patent and Trademark Office

Reg. No. 3,479,968

Registered Aug. 5, 2008

**SERVICE MARK
PRINCIPAL REGISTER**

CommNexus NextStage

COMMNEXUS SAN DIEGO (CALIFORNIA NON-PROFIT ORGANIZATION), DBA SAN DIEGO TELECOM COUNCIL

SUITE 200
9920 PACIFIC HEIGHTS BOULEVARD
SAN DIEGO, CA 92121

FOR: ASSOCIATION SERVICES, NAMELY, PROMOTING THE INTERESTS OF TELECOMMUNICATIONS COMPANIES, SERVICES PROVIDERS, AND PROFESSIONAL TRADE GROUPS, IN CLASS 35 (U.S. CLS. 100, 101 AND 102).

FIRST USE 10-25-2005; IN COMMERCE 10-25-2005.

THE MARK CONSISTS OF STANDARD CHARACTERS WITHOUT CLAIM TO ANY PARTICULAR FONT, STYLE, SIZE, OR COLOR.

SER. NO. 77-354,753, FILED 12-18-2007.

KIMBERLY PERRY, EXAMINING ATTORNEY

Int. Cl.: 3

Prior U.S. Cls.: 1, 4, 6, 50, 51 and 52

Reg. No. 3,479,969

United States Patent and Trademark Office

Registered Aug. 5, 2008

**TRADEMARK
PRINCIPAL REGISTER**

EXTINGUISHER SPRAY HEAD

KATZ, HAROLD (UNITED STATES INDIVIDUAL)
750 N. HIGHLAND AVENUE
LOS ANGELES, CA 90038

FOR: PLASTIC SPRAY NOZZLES SOLD AS AN INTEGRAL FEATURE OF DISPENSERS FILLED WITH BREATH FRESHENER, IN CLASS 3 (U.S. CLS. 1, 4, 6, 50, 51 AND 52).

FIRST USE 9-30-2002; IN COMMERCE 9-30-2003.

THE MARK CONSISTS OF STANDARD CHARACTERS WITHOUT CLAIM TO ANY PARTICULAR FONT, STYLE, SIZE, OR COLOR.

NO CLAIM IS MADE TO THE EXCLUSIVE RIGHT TO USE "SPRAY HEAD", APART FROM THE MARK AS SHOWN.

SER. NO. 77-354,754, FILED 12-18-2007.

JASON BLAIR, EXAMINING ATTORNEY

Int. Cl.: 45

Prior U.S. Cls.: 100 and 101

United States Patent and Trademark Office

Reg. No. 3,479,970

Registered Aug. 5, 2008

**SERVICE MARK
PRINCIPAL REGISTER**



EMPLOY CHECK, INC. (INDIANA CORPORATION)
1704 S. GREEN RIVER RD.
EVANSVILLE, IN 47715

FOR: PRE-EMPLOYMENT BACKGROUND SCREENING, IN CLASS 45 (U.S. CLS. 100 AND 101).

FIRST USE 4-28-2005; IN COMMERCE 3-17-2006.

THE MARK CONSISTS OF THE DESIGN PORTION OF A DARK CIRCLE CONTAINING: (1) A LOWER CASE LETTER "C" IN A LIGHTER SHADING APPROXIMATELY IN THE CENTER OF THE DARK CIRCLE; (2) APPROXIMATELY THE RIGHT 2/3 OF A LOWER CASE LETTER "E" IN THE SAME SHADING AS ITEM 1 WITHIN THE DARK CIRCLE TO THE LEFT OF AND ADJOINING ITEM 1 ABOVE,

WITH THE REMAINDER OF THE LETTER "E" NOT PRESENT BECAUSE IT WOULD FALL OUTSIDE OF THE DARK CIRCLE; AND (3) A CHECKMARK DEVICE IN A SHADE BETWEEN THOSE OF THE DARK CIRCLE AND ITEMS 1 AND 2 WITH THE LOWER PORTION OF THE CHECKMARK BEGINNING WITHIN ITEM 1 AND WITH ITEM 1 SUPERIMPOSED OVER A PORTION THEREOF THAT EXTENDS AT AN UPWARDS ANGLE CONTINUING OUT OF THE DARK CIRCLE. BENEATH THE DESIGN, THE WORDS "EMPLOY CHECK" APPEAR AS ONE WORD, WITH THE WORD "EMPLOY" IN A DARKER SHADE THAN THE WORD "CHECK".

SER. NO. 77-354,757, FILED 12-18-2007.

KIMBERLY PERRY, EXAMINING ATTORNEY

Int. Cl.: 17

Prior U.S. Cls.: 1, 5, 12, 13, 35 and 50

United States Patent and Trademark Office

Reg. No. 3,479,971

Registered Aug. 5, 2008

TRADEMARK
PRINCIPAL REGISTER

HAMMERHEAD

GRANBERRY SUPPLY CORP. (TEXAS CORPORATION)
SUITE 400
2937 E. BROADWAY
PHOENIX, AZ 85040

FOR: AGRICULTURAL HOSES BOTH RUBBER AND PLASTIC; AIR HOSES; FIRE HOSES; FLEXIBLE PIPES, NOT OF METAL; GARDEN HOSES; HOSES FOR PNEUMATIC TOOLS; RUBBER HYDRAULIC HOSES; PLASTIC HYDRAULIC HOSES; IRRIGATION HOSES; LAWN HOSES; NON-METAL FUEL OIL HOSES; NON-METAL HOSES FOR USE IN MINING; NON-METAL HOSES FOR USE IN CONSTRUCTION; NON-METAL HOSES FOR USE IN MARINE INDUSTRY; NON-METAL HOSES FOR USE IN AGRICULTURE; NON-METAL HOSES FOR USE IN CHEMICAL INDUSTRY; NON-METAL HOSES FOR USE IN PETROLEUM INDUSTRY;

NON-METAL HOSES FOR USE IN VARIOUS MANUFACTURING APPLICATIONS; NON-METAL HOSES FOR USE IN INJECTION MOLDING; NON-METAL HOSES FOR USE IN TRUCK AND CAR PLANTS; PLASTIC HOSES FOR PLUMBING USE; PLASTIC HOSES FOR SWIMMING POOLS; WATERING HOSES, IN CLASS 17 (U.S. CLS. 1, 5, 12, 13, 35 AND 50).

FIRST USE 12-31-1996; IN COMMERCE 12-31-1996.

THE MARK CONSISTS OF STANDARD CHARACTERS WITHOUT CLAIM TO ANY PARTICULAR FONT, STYLE, SIZE, OR COLOR.

SER. NO. 77-354,760, FILED 12-18-2007.

KIMBERLY PERRY, EXAMINING ATTORNEY

Int. Cl.: 19

Prior U.S. Cls.: 1, 12, 33 and 50

United States Patent and Trademark Office

Reg. No. 3,479,972

Registered Aug. 5, 2008

**TRADEMARK
PRINCIPAL REGISTER**

EASY LIFE

EPI 04, INC. (FLORIDA CORPORATION)
270 CROSSWAY ROAD
TALLAHASSEE, FL 32305

THE MARK CONSISTS OF STANDARD CHAR-
ACTERS WITHOUT CLAIM TO ANY PARTICULAR
FONT, STYLE, SIZE, OR COLOR.

FOR: EXTRUDED PLASTIC CEILING AND
WALL PANELS FOR INTERIOR AND EXTERIOR
USE, IN CLASS 19 (U.S. CLS. 1, 12, 33 AND 50).

SER. NO. 77-354,819, FILED 12-18-2007.

FIRST USE 1-31-2005; IN COMMERCE 1-31-2005.

DAWN HAN, EXAMINING ATTORNEY

Int. Cl.: 35

Prior U.S. Cls.: 100, 101 and 102

United States Patent and Trademark Office

Reg. No. 3,479,973

Registered Aug. 5, 2008

**SERVICE MARK
PRINCIPAL REGISTER**

SANDLOTCONNECT

SILVERBACK, LLC (TEXAS LTD LIAB CO)
SUITE 210
1701 RIVER RUN
FORT WORTH, TX 761076547

FOR: PROVIDING AN INTERNET-BASED DATA-BASE OF PATIENT MEDICAL INFORMATION DESIGNED TO FACILITATE PATIENT-AUTHORIZED, HIPAA-COMPLIANT SHARING AND MAINTENANCE OF PATIENT MEDICAL INFORMATION AMONGST A PATIENT'S DOCTORS SUCH THAT THIS INFORMATION CAN BE DIRECTLY INSERTED INTO THE DOCTOR'S MEDICAL REPORTS AS

A MEANS OF INCREASING MEDICAL RECORD GENERATION EFFICIENCY AND ACCURACY, IN CLASS 35 (U.S. CLS. 100, 101 AND 102).

FIRST USE 4-0-2007; IN COMMERCE 4-0-2007.

THE MARK CONSISTS OF STANDARD CHARACTERS WITHOUT CLAIM TO ANY PARTICULAR FONT, STYLE, SIZE, OR COLOR.

SER. NO. 77-354,875, FILED 12-18-2007.

BARBARA RUTLAND, EXAMINING ATTORNEY

Int. Cl.: 42

Prior U.S. Cls.: 100 and 101

United States Patent and Trademark Office

Reg. No. 3,479,974

Registered Aug. 5, 2008

**SERVICE MARK
PRINCIPAL REGISTER**



BUILDING CODE CONSULTING SERVICES,
L.L.P. (TEXAS LTD LIAB CO)
11651 NORTH PLANO ROAD
DALLAS, TX 75243

FOR: TECHNICAL ENGINEERING SERVICES IN PARTICULAR, BUILDING PLAN REVIEWS AND INSPECTIONS FOR CODE COMPLIANCE AND QUALITY CONTROL ISSUES, IN CLASS 42 (U.S. CLS. 100 AND 101).

FIRST USE 5-14-2007; IN COMMERCE 5-14-2007.

OWNER OF U.S. REG. NO. 3,393,710.

NO CLAIM IS MADE TO THE EXCLUSIVE RIGHT TO USE "BUILDING CODE CONSULTING SERVICES", APART FROM THE MARK AS SHOWN.

THE MARK CONSISTS OF THE LOGO CONTAINING THE WORDS "BUILDING CODE CONSULTING SERVICES" WITH THE FIRST LETTER OF EACH WORD CAPITALIZED AND WRITTEN IN A SLOPING MANNER ON A STYLIZED ROOFLINE.

SER. NO. 77-354,917, FILED 12-18-2007.

PAULA MAHONEY, EXAMINING ATTORNEY

Int. Cl.: 37

Prior U.S. Cls.: 100, 103 and 106

United States Patent and Trademark Office

Reg. No. 3,479,975

Registered Aug. 5, 2008

**SERVICE MARK
PRINCIPAL REGISTER**

UNITED SPACE ALLIANCE

UNITED SPACE ALLIANCE, LLC (DELAWARE
LTD LIAB CO)
8550 ASTRONAUT BOULEVARD
CAPE CANAVERAL, FL 32920

FOR: MAINTENANCE OF SPACE FLIGHT AND
SPACE EXPLORATION FACILITIES; REPAIR AND
MAINTENANCE OF VEHICLES AND PLATFORMS
FOR USE IN SPACE FLIGHT AND SPACE EX-
PLORATION; REPAIR, SERVICING AND MAINTEN-
ANCE OF VEHICLES AND APPARATUS FOR
LOCOMOTION BY AIR, IN SPACE AND ON EX-
TRATERRESTRIAL SURFACES, IN CLASS 37 (U.S.
CLS. 100, 103 AND 106).

FIRST USE 1-31-2005; IN COMMERCE 1-31-2005.

THE MARK CONSISTS OF STANDARD CHAR-
ACTERS WITHOUT CLAIM TO ANY PARTICULAR
FONT, STYLE, SIZE, OR COLOR.

OWNER OF U.S. REG. NOS. 2,100,088 AND
2,380,327.

NO CLAIM IS MADE TO THE EXCLUSIVE
RIGHT TO USE "SPACE ALLIANCE", APART
FROM THE MARK AS SHOWN.

SER. NO. 77-354,954, FILED 12-18-2007.

KATINA MISTER, EXAMINING ATTORNEY

Int. Cl.: 41

Prior U.S. Cls.: 100, 101 and 107

United States Patent and Trademark Office

Reg. No. 3,479,976

Registered Aug. 5, 2008

**SERVICE MARK
PRINCIPAL REGISTER**

Self Start

BIRGE, BARBARA (UNITED STATES INDIVIDUAL)
1406 REDCOAT DR.
CHARLOTTE, NC 28211

FOR: EDUCATION SERVICES, NAMELY, PROVIDING LIFE, EXECUTIVE AND PROFESSIONAL COACHING IN THE FIELD OF PERSONAL GROWTH, BUSINESS, CAREERS AND JOB PERFORMANCE, IN CLASS 41 (U.S. CLS. 100, 101 AND 107).

FIRST USE 11-12-2006; IN COMMERCE 4-15-2007.

THE MARK CONSISTS OF STANDARD CHARACTERS WITHOUT CLAIM TO ANY PARTICULAR FONT, STYLE, SIZE, OR COLOR.

SER. NO. 77-355,015, FILED 12-18-2007.

KYLE PEETE, EXAMINING ATTORNEY

Int. Cls.: 16 and 28

Prior U.S. Cls.: 2, 5, 22, 23, 29, 37, 38 and 50

United States Patent and Trademark Office

Reg. No. 3,479,977

Registered Aug. 5, 2008

**TRADEMARK
PRINCIPAL REGISTER**

YEAH! YEAH! OUT LOUD!

YYOL, LLC (WASHINGTON LTD LIAB CO)
10021 NE 81ST AVE.
VANCOUVER, WA 98662

FIRST USE 4-9-2004; IN COMMERCE 3-6-2007.

FOR: STICKERS; CHILDREN'S BOOKS, IN CLASS
16 (U.S. CLS. 2, 5, 22, 23, 29, 37, 38 AND 50).

THE MARK CONSISTS OF STANDARD CHAR-
ACTERS WITHOUT CLAIM TO ANY PARTICULAR
FONT, STYLE, SIZE, OR COLOR.

FIRST USE 4-9-2004; IN COMMERCE 3-6-2007.

SER. NO. 77-355,155, FILED 12-18-2007.

FOR: TOYS, NAMELY, STUFFED FLOWERS
AND PLANTS; TOY FLOWERS AND PLANTS, IN
CLASS 28 (U.S. CLS. 22, 23, 38 AND 50).

JENNIFER VASQUEZ, EXAMINING ATTORNEY

Int. Cl.: 41

Prior U.S. Cls.: 100, 101 and 107

United States Patent and Trademark Office

Reg. No. 3,479,978

Registered Aug. 5, 2008

**SERVICE MARK
PRINCIPAL REGISTER**

SIGLIN, CHRISTOPHER (UNITED STATES INDIVIDUAL)
638 CAMINO DEL LOS MARES
SAN CLEMENTE, CA 92673

THE MARK CONSISTS OF "PICKRSET" IS SPELT USING LOWER CASE ARIAL BOLD FONT. THE LETTER "R" IS CAPITALIZED. THE DOT IS INSET IN THE TOP OF THE LETTER "I".

FOR: PROVIDING A WEB SITE WHERE USERS CAN POST RATINGS, REVIEWS AND RECOMMENDATIONS ON EVENTS AND ACTIVITIES IN THE FIELD OF ENTERTAINMENT, IN CLASS 41 (U.S. CLS. 100, 101 AND 107).

SER. NO. 77-355,181, FILED 12-18-2007.

FIRST USE 4-21-2007; IN COMMERCE 4-21-2007.

KAPIL BHANOT, EXAMINING ATTORNEY

Int. Cl.: 37

Prior U.S. Cls.: 100, 103 and 106

United States Patent and Trademark Office

Reg. No. 3,479,979

Registered Aug. 5, 2008

**SERVICE MARK
PRINCIPAL REGISTER**



LEVITT, DAVID (UNITED STATES INDIVIDUAL)

3310 STORYBOOK LANE

RALEIGH, NC 27614

FOR: WINDOW CLEANING, IN CLASS 37 (U.S. CLS. 100, 103 AND 106).

FIRST USE 6-18-2007; IN COMMERCE 6-18-2007.

NO CLAIM IS MADE TO THE EXCLUSIVE RIGHT TO USE "THE GLASS CLEANERS" , APART FROM THE MARK AS SHOWN.

THE MARK CONSISTS OF A SQUEEGEE SWIPING DOWN OVER THE WORDS "THE GLASS CLEANERS".

SER. NO. 77-355,188, FILED 12-18-2007.

ROBERT LAVACHE, EXAMINING ATTORNEY

Int. Cl.: 36

Prior U.S. Cls.: 100, 101 and 102

United States Patent and Trademark Office

Reg. No. 3,479,980

Registered Aug. 5, 2008

**SERVICE MARK
PRINCIPAL REGISTER**

**JEFFERSON SCHOLARS
FOUNDATION**

JEFFERSON SCHOLARS FOUNDATION (VIRGINIA CORPORATION)
P.O. BOX 400891
CHARLOTTESVILLE, VA 22904

FOR: CHARITABLE FUND-RAISING SERVICES AND THE ADMINISTRATION OF A COLLEGE SCHOLARSHIP PROGRAM, IN CLASS 36 (U.S. CLS. 100, 101 AND 102).

FIRST USE 8-21-1998; IN COMMERCE 8-21-1998.

THE MARK CONSISTS OF STANDARD CHARACTERS WITHOUT CLAIM TO ANY PARTICULAR FONT, STYLE, SIZE, OR COLOR.

NO CLAIM IS MADE TO THE EXCLUSIVE RIGHT TO USE "SCHOLARS FOUNDATION", APART FROM THE MARK AS SHOWN.

SER. NO. 77-355,206, FILED 12-18-2007.

SONYA STEPHENS, EXAMINING ATTORNEY

Int. Cl.: 44

Prior U.S. Cls.: 100 and 101

United States Patent and Trademark Office

Reg. No. 3,479,981

Registered Aug. 5, 2008

SERVICE MARK
PRINCIPAL REGISTER



DOG GONE CLEAN INC. (MICHIGAN CORPORATION)
28900 JEFFERSON AVENUE
SAINT CLAIR SHORES, MI 48081

FOR: PET CARE SERVICES, NAMELY, DOG WALKING, DOG BATHING, NON-MEDICATED PET GROOMING AND IN-HOME MEDICAL CARE, IN CLASS 44 (U.S. CLS. 100 AND 101).

FIRST USE 12-14-2007; IN COMMERCE 12-14-2007.

NO CLAIM IS MADE TO THE EXCLUSIVE RIGHT TO USE "CLEAN", APART FROM THE MARK AS SHOWN.

THE COLOR(S) BLACK, WHITE, LIGHT BROWN, TAN, BLUE, BEIGE, GREY, RED IS/ARE CLAIMED AS A FEATURE OF THE MARK.

THE MARK CONSISTS OF WHITE CAPITAL LETTERS OUTLINED IN BLACK WITH SMALL BLACK PAW PRINTS THAT ARE PLACED SPORADICALLY INSIDE THE WHITE LETTERING. THE WORDS "DOG GONE" ARE LOCATED AT THE TOP OF THE MARK AND THE WORD "CLEAN" IS LOCATED AT THE BOTTOM. IN THE CENTER OF THE WORDING IS A LIGHT BROWN DOG WITH A RED TONGUE HANGING OUT OF HIS MOUTH IN A TAN TUB WITH GRAY WHEELS. THERE ARE BLUE BUBBLES ON THE TUB RIM, THE DOG'S HEAD AND ABOVE THE TUB TO THE LEFT. IN THE BACKGROUND IS A LARGE BEIGE PAW PRINT.

SER. NO. 77-355,267, FILED 12-18-2007.

CIMMERIAN COLEMAN, EXAMINING ATTORNEY

Int. Cl.: 41

Prior U.S. Cls.: 100, 101 and 107

United States Patent and Trademark Office

Reg. No. 3,479,982

Registered Aug. 5, 2008

**SERVICE MARK
PRINCIPAL REGISTER**

MULTI-INTENSO

REGELIN, DAVID A. (UNITED STATES INDIVIDUAL)
314 SOUTH 3RD STREET, APT. 32
BROOKLYN, NY 11211

FOR: EDUCATIONAL SERVICES, NAMELY, CONDUCTING WORKSHOPS, CLASSES AND SEMINARS IN THE FIELD OF YOGA AND DISTRIBUTION OF COURSE MATERIAL IN CONNECTION THEREWITH, IN CLASS 41 (U.S. CLS. 100, 101 AND 107).

FIRST USE 11-1-2006; IN COMMERCE 11-1-2006.

THE MARK CONSISTS OF STANDARD CHARACTERS WITHOUT CLAIM TO ANY PARTICULAR FONT, STYLE, SIZE, OR COLOR.

SER. NO. 77-355,429, FILED 12-19-2007.

RAMONA ORTIGA, EXAMINING ATTORNEY

Int. Cl.: 9

Prior U.S. Cls.: 21, 23, 26, 36 and 38

United States Patent and Trademark Office

Reg. No. 3,479,983

Registered Aug. 5, 2008

**TRADEMARK
PRINCIPAL REGISTER**

THE MEAT HANDLER

CHRISTOPHER M. KUEHNEL (UNITED STATES
INDIVIDUAL)
1030 BEECH STREET
CLEVELAND, WI 53015

NO CLAIM IS MADE TO THE EXCLUSIVE
RIGHT TO USE "MEAT", APART FROM THE
MARK AS SHOWN.

FOR: COMPUTER SOFTWARE FOR DATABASE
MANAGEMENT, IN CLASS 9 (U.S. CLS. 21, 23, 26, 36
AND 38).

SEC. 2(F).

FIRST USE 9-0-1984; IN COMMERCE 7-0-1985.

SER. NO. 77-355,560, FILED 12-19-2007.

THE MARK CONSISTS OF STANDARD CHAR-
ACTERS WITHOUT CLAIM TO ANY PARTICULAR
FONT, STYLE, SIZE, OR COLOR.

LESLEY LAMOTHE, EXAMINING ATTORNEY

Int. Cl.: 41

Prior U.S. Cls.: 100, 101 and 107

United States Patent and Trademark Office

Reg. No. 3,479,984

Registered Aug. 5, 2008

**SERVICE MARK
PRINCIPAL REGISTER**

The Shufflejunkies

MARGOLIS, ANDREW B (UNITED STATES INDIVIDUAL)

1262 BRICKTON DRIVE
ATLANTA, GA 30318 AND

SHEPHEARD, ROGER (UNITED STATES INDIVIDUAL)

339 WINCHESTER WAY
WOODSTOCK, GA 30188 AND

HOLLAND, JONATHAN (UNITED STATES INDIVIDUAL)

2895 EMERALD LANE
ACWORTH, GA 30102

FOR: ENTERTAINMENT, NAMELY, LIVE PERFORMANCES BY A MUSICAL BAND; ENTERTAINMENT, NAMELY, LIVE MUSIC CONCERTS;

ENTERTAINMENT, NAMELY, LIVE PERFORMANCES BY MUSICAL BANDS; ENTERTAINMENT, NAMELY, LIVE PERFORMANCES BY ROCK GROUPS, IN CLASS 41 (U.S. CLS. 100, 101 AND 107).

FIRST USE 12-13-2007; IN COMMERCE 12-13-2007.

THE MARK CONSISTS OF STANDARD CHARACTERS WITHOUT CLAIM TO ANY PARTICULAR FONT, STYLE, SIZE, OR COLOR.

SER. NO. 77-355,612, FILED 12-19-2007.

JUDITH HELFMAN, EXAMINING ATTORNEY

Int. Cl.: 23

Prior U.S. Cl.: 43

United States Patent and Trademark Office

Reg. No. 3,479,985

Registered Aug. 5, 2008

**TRADEMARK
PRINCIPAL REGISTER**



THE GENTLE ART, INC. (OHIO CORPORATION)
P.O. BOX 670
NEW ALBANY, OH 430540670

FOR: WOOL BLENDED THREADS, IN CLASS 23
(U.S. CL. 43).

FIRST USE 0-0-2007; IN COMMERCE 0-0-2007.

NO CLAIM IS MADE TO THE EXCLUSIVE
RIGHT TO USE "WOOL", APART FROM THE
MARK AS SHOWN.

THE MARK CONSISTS OF A DESIGN OF A
SHEEP IN PROFILE FACING RIGHT AND ABOVE
THE TEXT "SIMPLY WOOL".

SER. NO. 77-355,683, FILED S.R. 12-19-2007 AM.
P.R. 4-9-2008.

HOWARD SMIGA, EXAMINING ATTORNEY

Int. Cl.: 17

Prior U.S. Cls.: 1, 5, 12, 13, 35 and 50

Reg. No. 3,479,986

United States Patent and Trademark Office

Registered Aug. 5, 2008

**TRADEMARK
PRINCIPAL REGISTER**



LINDA P. COPELAND (UNITED STATES INDIVIDUAL)
6428 WILKINSON BLVD, STE 204
BELMONT, NC 28012

FOR: BUILDING INSULATION; FOAM INSULATION FOR USE IN BUILDING AND CONSTRUCTION; FOILS OF METAL FOR BUILDING INSULATION; INSULATING BLANKETS FOR HOT WATER HEATERS; INSULATING MATERIALS, NAMELY, POLYURETHANE FOAM AND POLYETHYLENE FOAM; METAL FOIL FOR BUILDING INSULATION; POLYURETHANE FOAM SHEETING FOR USE AS BUILDING INSULATION; SEALING AND INSULATING MATERIALS, IN CLASS 17 (U.S. CLS. 1, 5, 12, 13, 35 AND 50).

FIRST USE 11-19-2007; IN COMMERCE 11-19-2007.

NO CLAIM IS MADE TO THE EXCLUSIVE RIGHT TO USE "ENERGY SHIELD PRODUCTS", APART FROM THE MARK AS SHOWN.

THE COLOR(S) GRADIENT COLORS RED TO YELLOW, GRADIENT COLORS DARK BLUE TO LIGHT BLUE, BLACK FOR TYPED WORDS. IS/ARE CLAIMED AS A FEATURE OF THE MARK.

THE MARK CONSISTS OF FLAMES LOCATED ABOVE THE TYPED LETTERING "ENERGY SHIELD PRODUCTS" AND USE GRADIENT COLORS FROM RED TO YELLOW. TYPED LETTERING "ENERGY SHIELD PRODUCTS" ARE IN BLACK COLOR. ICICLES ARE LOCATED BELOW THE TYPED LETTERING "ENERGY SHIELD PRODUCTS" AND USE GRADIENT COLORS FROM DARK BLUE TO LIGHT BLUE.

SER. NO. 77-355,695, FILED 12-19-2007.

HOWARD SMIGA, EXAMINING ATTORNEY

Int. Cl.: 35

Prior U.S. Cls.: 100, 101 and 102

United States Patent and Trademark Office

Reg. No. 3,479,987

Registered Aug. 5, 2008

**SERVICE MARK
PRINCIPAL REGISTER**



SCORPION PROTECTIVE COATINGS, INC. (IN-
DIANA CORPORATION)
6184 S. US HIGHWAY 231
CLOVERDALE, IN 46120

FOR: WHOLESALE DISTRIBUTORSHIPS FEATURING SPRAY ON POLYURETHANE COATINGS, IN CLASS 35 (U.S. CLS. 100, 101 AND 102).

FIRST USE 0-0-1997; IN COMMERCE 0-0-1997.

THE COLOR(S) PURPLE, BLACK, YELLOW AND BROWN IS/ARE CLAIMED AS A FEATURE OF THE MARK.

THE MARK CONSISTS OF THE WORD "SCORPION" IN THE COLOR PURPLE WITH BLACK OUTLINE LOCATED TO THE LEFT OF A GRAPHICAL DEPICTION OF A SCORPION IN THE COLORS BLACK, BROWN AND YELLOW

SER. NO. 77-355,785, FILED 12-19-2007.

AISHA CLARKE, EXAMINING ATTORNEY

Int. Cl.: 35

Prior U.S. Cls.: 100, 101 and 102

United States Patent and Trademark Office

Reg. No. 3,479,988

Registered Aug. 5, 2008

SERVICE MARK
PRINCIPAL REGISTER



ELEPHANT SANCTUARY IN TENNESSEE, THE
(TENNESSEE CORPORATION)
PO BOX 393
HOHENWALD, TN 38462

FOR: RETAIL STORE SERVICES FEATURING A
VARIETY OF CONSUMER GOODS, IN CLASS 35
(U.S. CLS. 100, 101 AND 102).

FIRST USE 5-31-1996; IN COMMERCE 5-31-1996.

NO CLAIM IS MADE TO THE EXCLUSIVE
RIGHT TO USE "GIFT SHOP", APART FROM THE
MARK AS SHOWN.

THE MARK CONSISTS OF WORDS "OUR GIRLS'
GIFT SHOP" ABOVE A HERD OF ELEPHANTS.

SER. NO. 77-355,843, FILED 12-19-2007.

JENNIFER VASQUEZ, EXAMINING ATTORNEY

Int. Cl.: 20

Prior U.S. Cls.: 2, 13, 22, 25, 32 and 50

Reg. No. 3,479,989

United States Patent and Trademark Office

Registered Aug. 5, 2008

**TRADEMARK
PRINCIPAL REGISTER**



OLSON, STEVEN P. (UNITED STATES INDIVIDUAL)
1166 GOLF VIEW TERRACE
MONROE, GA 30650

NO CLAIM IS MADE TO THE EXCLUSIVE RIGHT TO USE "HANGERS", APART FROM THE MARK AS SHOWN.

FOR: NON-METAL HANGERS, NAMELY, HANGERS FOR PLANTS, BIRDHOUSES, WIND CHIMES, AND SIGNS, IN CLASS 20 (U.S. CLS. 2, 13, 22, 25, 32 AND 50).

SER. NO. 77-355,973, FILED 12-19-2007.

FIRST USE 4-7-2007; IN COMMERCE 4-7-2007.

LINDSEY RUBIN, EXAMINING ATTORNEY

Int. Cl.: 36

Prior U.S. Cls.: 100, 101 and 102

United States Patent and Trademark Office

Reg. No. 3,479,990

Registered Aug. 5, 2008

**SERVICE MARK
PRINCIPAL REGISTER**

**SLEEPSMARTER PROTECTION
HEALTH COMFORT**

FABRICTECH 2000, LLC (NEW JERSEY LTD
LIAB CO)
218 LITTLE FALLS RD, SUITE #2
CEDAR GROVE, NJ 07009

FOR: PROVIDING EXTENDED WARRANTIES
ON MATTRESS COVERS, IN CLASS 36 (U.S. CLS.
100, 101 AND 102).

FIRST USE 2-8-2006; IN COMMERCE 2-8-2006.

THE MARK CONSISTS OF STANDARD CHAR-
ACTERS WITHOUT CLAIM TO ANY PARTICULAR
FONT, STYLE, SIZE, OR COLOR.

NO CLAIM IS MADE TO THE EXCLUSIVE
RIGHT TO USE "PROTECTION", APART FROM
THE MARK AS SHOWN.

SER. NO. 77-356,165, FILED 12-19-2007.

RAUL CORDOVA, EXAMINING ATTORNEY

Int. Cl.: 41

Prior U.S. Cls.: 100, 101 and 107

United States Patent and Trademark Office

Reg. No. 3,479,991

Registered Aug. 5, 2008

**SERVICE MARK
PRINCIPAL REGISTER**

MILAN INSTITUTE

ACR, INC. (CALIFORNIA CORPORATION)
1720 WEST WALNUT AVE.
VISALIA, CA 93277

FOR: EDUCATIONAL SERVICES, NAMELY, PROVIDING COURSES, SEMINARS, AND WORKSHOPS IN THE FIELDS OF ADMINISTRATIVE MEDICAL ASSISTANT, COSMETOLOGY-OPERATOR, DENTAL ASSISTANT, AESTHETICIAN-FACIALIST, FULL CHARGE BOOKKEEPER, HEALTHCARE BILLING AND CODING, HOLISTIC HEALTH PRACTITIONER, INSTRUCTOR OF ALL ASPECTS OF COSMETOLOGY AND BEAUTY SCHOOL OPERATIONS, LEGAL ADMINISTRATIVE ASSISTANT, MANICURIST-MANICURE, MASSAGE THERAPY, MEDICAL ASSISTING, OFFICE ADMINISTRATION, AND PHARMACY-

PHARMACEUTICAL TECHNICIAN, IN CLASS 41 (U.S. CLS. 100, 101 AND 107).

FIRST USE 3-1-2007; IN COMMERCE 3-1-2007.

THE MARK CONSISTS OF STANDARD CHARACTERS WITHOUT CLAIM TO ANY PARTICULAR FONT, STYLE, SIZE, OR COLOR.

NO CLAIM IS MADE TO THE EXCLUSIVE RIGHT TO USE "INSTITUTE", APART FROM THE MARK AS SHOWN.

SER. NO. 77-356,224, FILED 12-19-2007.

JOHN WILKE, EXAMINING ATTORNEY

Int. Cl.: 38

Prior U.S. Cls.: 100, 101 and 104

United States Patent and Trademark Office

Reg. No. 3,479,992

Registered Aug. 5, 2008

**SERVICE MARK
PRINCIPAL REGISTER**

BSTAR

SITELIFE, INC. (ILLINOIS CORPORATION)
1336 S. PULASKI ROAD #202
OAK LAWN, IL 60453

FIRST USE 12-16-2007; IN COMMERCE 12-16-2007.

FOR: PROVIDING ONLINE CHAT ROOMS AND ELECTRONIC BULLETIN BOARDS FOR REGISTERED USERS FOR TRANSMISSION OF MESSAGES CONCERNING COLLEGIATE LIFE, GENERAL INTEREST, CLASSIFIEDS, VIRTUAL COMMUNITY, SOCIAL NETWORKING, PHOTO SHARING, AND TRANSMISSION OF PHOTOGRAPHIC IMAGES, IN CLASS 38 (U.S. CLS. 100, 101 AND 104).

THE MARK CONSISTS OF STANDARD CHARACTERS WITHOUT CLAIM TO ANY PARTICULAR FONT, STYLE, SIZE, OR COLOR.

SER. NO. 77-356,235, FILED 12-19-2007.

KATHLEEN LORENZO, EXAMINING ATTORNEY

Int. Cl.: 9

Prior U.S. Cls.: 21, 23, 26, 36 and 38

United States Patent and Trademark Office

Reg. No. 3,479,993

Registered Aug. 5, 2008

**TRADEMARK
PRINCIPAL REGISTER**



VIDAONE, INC. (CALIFORNIA CORPORATION),
DBA EXPOSE SOFTWARE CORP.

SUITE 203

16776 BERNARDO CENTER DR.
SAN DIEGO, CA 92128

FOR: PERSONAL COMPUTER AND PERSONAL
DIGITAL ASSISTANT SOFTWARE FOR MONITOR-
ING AND TRACKING PERSONAL HEALTH, FIT-
NESS, EXERCISE, ATHLETICS, NUTRITION AND
DIET, IN CLASS 9 (U.S. CLS. 21, 23, 26, 36 AND 38).

FIRST USE 8-19-2005; IN COMMERCE 8-19-2005.

THE COLOR(S) ORANGE AND BLUE IS/ARE
CLAIMED AS A FEATURE OF THE MARK.

THE MARK CONSISTS OF A COMBINATION OF
GEOMETRIC FIGURES REPRESENTING A PER-
SON FOLLOWED BY THE WORD "VIDA" IN OR-
ANGE, COMBINED WITH THE WORD "ONE" IN
BLUE.

SER. NO. 77-356,251, FILED 12-19-2007.

WILLIAM BRECKENFELD, EXAMINING ATTOR-
NEY

Int. Cls.: 35 and 43

Prior U.S. Cls.: 100, 101 and 102

United States Patent and Trademark Office

Reg. No. 3,479,994

Registered Aug. 5, 2008

**SERVICE MARK
PRINCIPAL REGISTER**

SEASIDE MARKET

CARDIFF SEASIDE MARKET, INC. (CALIFORNIA CORPORATION)
2087 SAN ELIJO AVENUE
CARDIFF BY THE SEA, CA 92007

FOR: RETAIL DELICATESSEN SERVICES; RETAIL STORE SERVICES FEATURING GROCERY ITEMS, IN CLASS 35 (U.S. CLS. 100, 101 AND 102).

FIRST USE 6-30-1985; IN COMMERCE 6-30-1985.

FOR: RESTAURANT AND CATERING SERVICES, IN CLASS 43 (U.S. CLS. 100 AND 101).

FIRST USE 6-30-1985; IN COMMERCE 6-30-1985.

THE MARK CONSISTS OF STANDARD CHARACTERS WITHOUT CLAIM TO ANY PARTICULAR FONT, STYLE, SIZE, OR COLOR.

NO CLAIM IS MADE TO THE EXCLUSIVE RIGHT TO USE "MARKET", APART FROM THE MARK AS SHOWN.

SER. NO. 77-356,257, FILED 12-19-2007.

WILLIAM P. SHANAHAN, EXAMINING ATTORNEY

Int. Cl.: 25

Prior U.S. Cls.: 22 and 39

United States Patent and Trademark Office

Reg. No. 3,479,995

Registered Aug. 5, 2008

**TRADEMARK
PRINCIPAL REGISTER**

BOOBIES 2 BOOTIES

HANDS OFF IT'S MINE (CALIFORNIA PART-
NERSHIP)
665 E. FOOTHILL BLVD. SUITE A
CLAREMONT, CA 91711

FOR: JACKETS; JERSEYS; LINGERIE; PANTS;
SHIRTS; SHORTS; TOPS, IN CLASS 25 (U.S. CLS. 22
AND 39).

FIRST USE 7-30-2007; IN COMMERCE 7-30-2007.

THE MARK CONSISTS OF STANDARD CHAR-
ACTERS WITHOUT CLAIM TO ANY PARTICULAR
FONT, STYLE, SIZE, OR COLOR.

SER. NO. 77-356,277, FILED 12-19-2007.

REBECCA EISINGER, EXAMINING ATTORNEY

Int. Cl.: 45

Prior U.S. Cls.: 100 and 101

United States Patent and Trademark Office

Reg. No. 3,479,996

Registered Aug. 5, 2008

**SERVICE MARK
PRINCIPAL REGISTER**

INTELLIGENT DATING

IT'S JUST LUNCH INTERNATIONAL, LLC (NE-
VADA LTD LIAB CO)
SUITE 207
75-430 GERALD FORD DRIVE
PALM DESERT, CA 92211

FOR: DATING SERVICES, IN CLASS 45 (U.S. CLS.
100 AND 101).

FIRST USE 3-0-2006; IN COMMERCE 3-0-2006.

THE MARK CONSISTS OF STANDARD CHAR-
ACTERS WITHOUT CLAIM TO ANY PARTICULAR
FONT, STYLE, SIZE, OR COLOR.

NO CLAIM IS MADE TO THE EXCLUSIVE
RIGHT TO USE "DATING", APART FROM THE
MARK AS SHOWN.

SER. NO. 77-356,300, FILED 12-19-2007.

KATHLEEN LORENZO, EXAMINING ATTORNEY

Int. Cl.: 35

Prior U.S. Cls.: 100, 101 and 102

United States Patent and Trademark Office

Reg. No. 3,479,997

Registered Aug. 5, 2008

**SERVICE MARK
PRINCIPAL REGISTER**



POTOMACWAVE CONSULTING, INC. (WASHINGTON CORPORATION)
704 17TH AVE WEST
KIRKLAND, WA 98033

FOR: BUSINESS CONSULTATION SERVICES, IN CLASS 35 (U.S. CLS. 100, 101 AND 102).

FIRST USE 10-1-2007; IN COMMERCE 10-1-2007.

NO CLAIM IS MADE TO THE EXCLUSIVE RIGHT TO USE "CONSULTING", APART FROM THE MARK AS SHOWN.

THE MARK CONSISTS OF A TOP ROW TEXT "POTOMACWAVE". SECOND ROW TEXT "CONSULTING". SURROUNDING THE WORD "CONSULTING" IS A GRAPHIC OF CONCENTRIC CIRCLES RADIATING FROM THE TEXT

SER. NO. 77-356,401, FILED 12-19-2007.

EUGENIA MARTIN, EXAMINING ATTORNEY

Int. Cl.: 35

Prior U.S. Cls.: 100, 101 and 102

United States Patent and Trademark Office

Reg. No. 3,479,998

Registered Aug. 5, 2008

**SERVICE MARK
PRINCIPAL REGISTER**

POTOMACWAVE CONSULTING

POTOMACWAVE CONSULTING, INC (WA-
SHINGTON CORPORATION)

704 17TH AVE WEST

KIRKLAND, WA 98033

FOR: BUSINESS CONSULTATION SERVICES, IN
CLASS 35 (U.S. CLS. 100, 101 AND 102).

FIRST USE 10-1-2007; IN COMMERCE 10-1-2007.

THE MARK CONSISTS OF STANDARD CHAR-
ACTERS WITHOUT CLAIM TO ANY PARTICULAR
FONT, STYLE, SIZE, OR COLOR.

NO CLAIM IS MADE TO THE EXCLUSIVE
RIGHT TO USE "CONSULTING", APART FROM
THE MARK AS SHOWN.

SER. NO. 77-356,405, FILED 12-19-2007.

LESLIE RICHARDS, EXAMINING ATTORNEY

Int. Cl.: 32

Prior U.S. Cls.: 45, 46 and 48

Reg. No. 3,479,999

United States Patent and Trademark Office

Registered Aug. 5, 2008

**TRADEMARK
PRINCIPAL REGISTER**

Pancho Barnes

PANCHO BARNES ENTERPRISES, INC. (CALI-
FORNIA CORPORATION)
SUITE 106
1137 SECOND STREET
SANTA MONICA, CA 90403

FOR: ENERGY DRINKS, IN CLASS 32 (U.S. CLS.
45, 46 AND 48).

FIRST USE 12-18-2007; IN COMMERCE 12-18-2007.

THE MARK CONSISTS OF STANDARD CHAR-
ACTERS WITHOUT CLAIM TO ANY PARTICULAR
FONT, STYLE, SIZE, OR COLOR.

"THE NAME(S), PORTRAIT(S), AND/OR SIGNA-
TURE(S) SHOWN IN THE MARK DOES NOT IDEN-
TIFY A PARTICULAR LIVING INDIVIDUAL."

SER. NO. 77-356,436, FILED 12-20-2007.

ELLEN PERKINS, EXAMINING ATTORNEY

Int. Cl.: 25

Prior U.S. Cls.: 22 and 39

United States Patent and Trademark Office

Reg. No. 3,480,000

Registered Aug. 5, 2008

**TRADEMARK
PRINCIPAL REGISTER**

(,)

BGB MOTORSPORTS, LLC (FLORIDA LTD LIAB
CO)
6C WEST TOWER CIRCLE #102
ORMOND BEACH, FL 32174

THE MARK CONSISTS OF STANDARD CHAR-
ACTERS WITHOUT CLAIM TO ANY PARTICULAR
FONT, STYLE, SIZE, OR COLOR.

FOR: HATS; POLO SHIRTS; SHIRTS; SHORT-
SLEEVED OR LONG-SLEEVED T-SHIRTS; SHORT-
SLEEVED SHIRTS; T-SHIRTS; TEE SHIRTS; JACK-
ETS, IN CLASS 25 (U.S. CLS. 22 AND 39).

SER. NO. 77-356,531, FILED 12-20-2007.

FIRST USE 1-1-2003; IN COMMERCE 1-1-2003.

ELISSA GARBER KON, EXAMINING ATTORNEY

Int. Cl.: 37

Prior U.S. Cls.: 100, 103 and 106

United States Patent and Trademark Office

Reg. No. 3,480,001

Registered Aug. 5, 2008

SERVICE MARK
PRINCIPAL REGISTER



S&D WINDOW CLEANING LLC (PENNSYLVANIA LTD LIAB CO)
10665 CENTER HIGHWAY
IRWIN, PA 15642

FOR: WINDOW CLEANING, IN CLASS 37 (U.S. CLS. 100, 103 AND 106).

FIRST USE 7-17-2006; IN COMMERCE 7-30-2006.

NO CLAIM IS MADE TO THE EXCLUSIVE RIGHT TO USE "WINDOW CLEANING L.L.C." AND "QUALITY SERVICE AND DEPENDABILITY

SINCE 1977", APART FROM THE MARK AS SHOWN.

THE MARK CONSISTS OF STYLIZED TEXT "SD WINDOW CLEANING L.L.C. QUALITY SERVICE AND DEPENDABILITY SINCE 1977" APPEARS IN GRAPHIC IMAGE OF A WINDOW PANE.

SER. NO. 77-356,631, FILED 12-20-2007.

NELSON SNYDER, EXAMINING ATTORNEY

Int. Cl.: 41

Prior U.S. Cls.: 100, 101 and 107

United States Patent and Trademark Office

Reg. No. 3,480,002

Registered Aug. 5, 2008

**SERVICE MARK
PRINCIPAL REGISTER**

**YOU FILL THE SEATS. WE
FILL THEIR MINDS.**

DIRECT MARKETING ASSOCIATION, INC.
(NEW YORK NON-PROFIT CORPORATION)
1120 AVENUE OF THE AMERICAS
NEW YORK, NY 10036

FOR: EDUCATIONAL SERVICES, NAMELY,
CONDUCTING CONFERENCES, FORUMS AND
SEMINARS IN THE FIELDS OF DIRECT AND
INTERACTIVE MARKETING , IN CLASS 41 (U.S.
CLS. 100, 101 AND 107).

FIRST USE 5-31-2007; IN COMMERCE 5-31-2007.

THE MARK CONSISTS OF STANDARD CHAR-
ACTERS WITHOUT CLAIM TO ANY PARTICULAR
FONT, STYLE, SIZE, OR COLOR.

SER. NO. 77-356,644, FILED 12-20-2007.

CORY BOONE, EXAMINING ATTORNEY

Int. Cl.: 35

Prior U.S. Cls.: 100, 101 and 102

United States Patent and Trademark Office

Reg. No. 3,480,003

Registered Aug. 5, 2008

**SERVICE MARK
PRINCIPAL REGISTER**

INTEREP INTEGRATION

INTEREP NATIONAL RADIO SALES, INC. (DE-
LAWARE CORPORATION)
100 PARK AVENUE, FIFTH FLOOR
NEW YORK, NY 10017

FOR: PROVIDING SALES PROMOTION, MAR-
KETING AND BUSINESS CONSULTING SERVICES
IN THE FIELD OF FACILITATING THE CREA-
TION, PLANNING, BUYING, MARKETING, AND
SALES OF MEDIA, IN CLASS 35 (U.S. CLS. 100, 101
AND 102).

FIRST USE 12-3-2007; IN COMMERCE 12-3-2007.

THE MARK CONSISTS OF STANDARD CHAR-
ACTERS WITHOUT CLAIM TO ANY PARTICULAR
FONT, STYLE, SIZE, OR COLOR.

OWNER OF U.S. REG. NOS. 1,501,570, 2,343,602
AND OTHERS.

NO CLAIM IS MADE TO THE EXCLUSIVE
RIGHT TO USE "INTEGRATION", APART FROM
THE MARK AS SHOWN.

SER. NO. 77-356,661, FILED 12-20-2007.

EMILY CARLSEN, EXAMINING ATTORNEY

Int. Cl.: 41

Prior U.S. Cls.: 100, 101 and 107

United States Patent and Trademark Office

Reg. No. 3,480,004

Registered Aug. 5, 2008

**SERVICE MARK
PRINCIPAL REGISTER**

WHO'S BUILDING YOUR FUTURE

INSTITUTE OF CONSTRUCTION MANAGE-
MENT & TECHNOLOGY (ARIZONA LTD
LIAB CO)
SUITE 195
444 NORTH 44TH STREET
PHOENIX, AZ 85008

FOR: EDUCATION AND ENTERTAINMENT SERVICES, NAMELY, A CONTINUING PROGRAM ABOUT THE CONSTRUCTION AND BUILDING INDUSTRIES ACCESSIBLE BY RADIO AND COMPUTER NETWORKS; ENTERTAINMENT SERVICES, NAMELY, AN ON-GOING SERIES FEATURING INFORMATION ABOUT CONSTRUCTION MANAGEMENT AND TECHNOLOGY PROVIDED THROUGH RADIO BROADCASTS; EDUCATION SERVICES, NAMELY, CONDUCTING AND PROVIDING LIVE AND ON-LINE CLASSES AND SEMINARS IN THE FIELDS OF CONSTRUCTION MANAGEMENT AND CONSTRUCTION TECHNOLOGY, AND DISTRIBUTION OF COURSE MATERIAL IN CONNECTION THEREWITH; ON-

LINE LIBRARY SERVICES, NAMELY, PROVIDING ELECTRONIC LIBRARY SERVICES WHICH FEATURE PUBLICATIONS AND TRAINING MATERIALS AND INFORMATION PERTAINING TO THE CONSTRUCTION AND BUILDING INDUSTRIES VIA AN ON-LINE COMPUTER NETWORK; TRAINING IN THE MANAGEMENT OF CONSTRUCTION PROJECTS, INCLUDING THROUGH CORRESPONDENCE COURSES VIA THE GLOBAL COMPUTER NETWORK AND OTHER MASS MEDIA, IN CLASS 41 (U.S. CLS. 100, 101 AND 107).

FIRST USE 6-15-2007; IN COMMERCE 6-15-2007.

THE MARK CONSISTS OF STANDARD CHARACTERS WITHOUT CLAIM TO ANY PARTICULAR FONT, STYLE, SIZE, OR COLOR.

SER. NO. 77-356,665, FILED 12-20-2007.

CHARISMA HAMPTON, EXAMINING ATTORNEY

Int. Cls.: 9 and 16

Prior U.S. Cls.: 2, 5, 21, 22, 23, 26, 29, 36, 37, 38 and 50

Reg. No. 3,480,005

United States Patent and Trademark Office

Registered Aug. 5, 2008

**TRADEMARK
PRINCIPAL REGISTER**

WHO WILL SPEAK FOR ME?

CENTER FOR CHILDREN'S ADVOCACY, INC.
(CONNECTICUT CORPORATION)
65 ELIZABETH STREET
HARTFORD, CT 06105

FOR: PRERECORDED VIDEO TAPES, CD ROMS, AND DVDS FEATURING INFORMATION IN THE FIELDS OF PROMOTION OF CHILDREN'S RIGHTS, CHILDREN'S WELFARE, CHILDREN'S HEALTH, CHILDREN'S MENTAL HEALTH, CHILDREN'S EDUCATION, CHILDREN'S LEGAL RIGHTS, LEGAL, JUDICIAL AND JUVENILE JUSTICE SYSTEM, IN CLASS 9 (U.S. CLS. 21, 23, 26, 36 AND 38).

FIRST USE 12-31-2001; IN COMMERCE 12-31-2001.

FOR: PRINTED MATTER, NAMELY, PRINTED REPORTS, PRINTED NEWSLETTERS, PRINTED POSTCARDS, PRINTED POSTERS, PRINTED GREETING CARDS, PRINTED TEACHING MATE-

RIALS, PRINTED PAMPHLETS, AND PRINTED BOOKS, ALL IN THE FIELD OF PROMOTION OF CHILDREN'S RIGHTS, CHILDREN'S WELFARE, CHILDREN'S HEALTH, CHILDREN'S MENTAL HEALTH, CHILDREN'S EDUCATION, CHILDREN'S LEGAL RIGHTS, LEGAL, JUDICIAL, EDUCATIONAL AND JUVENILE JUSTICE SYSTEM, IN CLASS 16 (U.S. CLS. 2, 5, 22, 23, 29, 37, 38 AND 50).

FIRST USE 12-31-2001; IN COMMERCE 12-31-2001.

THE MARK CONSISTS OF STANDARD CHARACTERS WITHOUT CLAIM TO ANY PARTICULAR FONT, STYLE, SIZE, OR COLOR.

SER. NO. 77-356,670, FILED 12-20-2007.

WILLIAM BRECKENFELD, EXAMINING ATTORNEY

Int. Cls.: 9 and 16

Prior U.S. Cls.: 2, 5, 21, 22, 23, 26, 29, 36, 37, 38 and 50

Reg. No. 3,480,006

United States Patent and Trademark Office

Registered Aug. 5, 2008

**TRADEMARK
PRINCIPAL REGISTER**

I WILL SPEAK UP FOR MYSELF

CENTER FOR CHILDREN'S ADVOCACY, INC.
(CONNECTICUT CORPORATION)
65 ELIZABETH STREET
HARTFORD, CT 06105

FOR: PRERECORDED VIDEO TAPES, CD ROMS, AND DVDS FEATURING INFORMATION IN THE FIELDS OF PROMOTION OF CHILDREN'S RIGHTS, CHILDREN'S WELFARE, CHILDREN'S HEALTH, CHILDREN'S MENTAL HEALTH, CHILDREN'S EDUCATION, CHILDREN'S LEGAL RIGHTS, LEGAL, JUDICIAL AND JUVENILE JUSTICE SYSTEM, IN CLASS 9 (U.S. CLS. 21, 23, 26, 36 AND 38).

FIRST USE 12-31-2004; IN COMMERCE 12-31-2004.

FOR: PRINTED MATTER, NAMELY, PRINTED REPORTS, PRINTED NEWSLETTERS, PRINTED POSTCARDS, PRINTED POSTERS, PRINTED GREETING CARDS, PRINTED TEACHING MATE-

RIALS, PRINTED PAMPHLETS, AND PRINTED BOOKS, ALL IN THE FIELD OF PROMOTION OF CHILDREN'S RIGHTS, CHILDREN'S WELFARE, CHILDREN'S HEALTH, CHILDREN'S MENTAL HEALTH, CHILDREN'S EDUCATION, CHILDREN'S LEGAL RIGHTS, LEGAL, JUDICIAL, EDUCATIONAL AND JUVENILE JUSTICE SYSTEM, IN CLASS 16 (U.S. CLS. 2, 5, 22, 23, 29, 37, 38 AND 50).

FIRST USE 12-31-2004; IN COMMERCE 12-31-2004.

THE MARK CONSISTS OF STANDARD CHARACTERS WITHOUT CLAIM TO ANY PARTICULAR FONT, STYLE, SIZE, OR COLOR.

SER. NO. 77-356,684, FILED 12-20-2007.

WILLIAM BRECKENFELD, EXAMINING ATTORNEY

Int. Cl.: 41

Prior U.S. Cls.: 100, 101 and 107

United States Patent and Trademark Office

Reg. No. 3,480,007

Registered Aug. 5, 2008

**SERVICE MARK
PRINCIPAL REGISTER**

Sha Sha Ladies

SHA SHA LADIES INTERNATIONAL LLC (WEST
VIRGINIA LTD LIAB CO)
P.O. BOX 232
PETERSBURG, WV 26847

FOR: SOCIAL CLUB SERVICES, NAMELY, AR-
RANGING, ORGANIZING, AND HOSTING SOCIAL
EVENTS, GET-TOGETHERS, AND PARTIES FOR
CLUB MEMBERS, IN CLASS 41 (U.S. CLS. 100, 101
AND 107).

FIRST USE 1-1-2001; IN COMMERCE 2-16-2007.

THE MARK CONSISTS OF STANDARD CHAR-
ACTERS WITHOUT CLAIM TO ANY PARTICULAR
FONT, STYLE, SIZE, OR COLOR.

NO CLAIM IS MADE TO THE EXCLUSIVE
RIGHT TO USE "LADIES", APART FROM THE
MARK AS SHOWN.

SER. NO. 77-356,689, FILED 12-20-2007.

WILLIAM BRECKENFELD, EXAMINING ATTOR-
NEY

Int. Cl.: 44

Prior U.S. Cls.: 100 and 101

United States Patent and Trademark Office

Reg. No. 3,480,008

Registered Aug. 5, 2008

**SERVICE MARK
PRINCIPAL REGISTER**

HEART WIZARD

ADVANCED WELLNESS SOLUTIONS LLC (WA-
SHINGTON LTD LIAB CO)
20270 FRONT ST NE
SUITE 203
POULSBO, WA 98370

FOR: PROVIDING ONLINE WELLNESS ASSES-
MENT SERVICES, NAMELY, PERSONAL ASSES-
MENTS, PERSONALIZED ROUTINES,
MAINTENANCE SCHEDULES AND INFORMA-
TION AND ADVICE RELATING TO TRACKING
OF WELLNESS CHANGES, IN CLASS 44 (U.S. CLS.
100 AND 101).

FIRST USE 7-20-2007; IN COMMERCE 9-20-2007.

THE MARK CONSISTS OF STANDARD CHAR-
ACTERS WITHOUT CLAIM TO ANY PARTICULAR
FONT, STYLE, SIZE, OR COLOR.

NO CLAIM IS MADE TO THE EXCLUSIVE
RIGHT TO USE "HEART", APART FROM THE
MARK AS SHOWN.

SER. NO. 77-356,703, FILED 12-20-2007.

EVELYN BRADLEY, EXAMINING ATTORNEY

Int. Cl.: 9

Prior U.S. Cls.: 21, 23, 26, 36 and 38

United States Patent and Trademark Office

Reg. No. 3,480,009

Registered Aug. 5, 2008

**TRADEMARK
PRINCIPAL REGISTER**

MyVal

MIHAYLOV, STEFAN V. (BULGARIA INDIVIDUAL)
50 CALIFORNIA ST.
SUITE 1500
SAN FRANCISCO, CA 94111

FOR: COMPUTER PROGRAMS AND MANUALS SOLD AS A UNIT FOR USE AS A VALUATION TOOL IN DETERMINING THE COST AND LIABILITIES ASSOCIATED WITH EMPLOYEE BENEFITS, INCLUDING DEFINED CONTRIBUTION, RETIREE MEDICAL AND PENSION PLANS, IN CLASS 9 (U.S. CLS. 21, 23, 26, 36 AND 38).

FIRST USE 8-15-2005; IN COMMERCE 2-3-2006.

THE MARK CONSISTS OF STANDARD CHARACTERS WITHOUT CLAIM TO ANY PARTICULAR FONT, STYLE, SIZE, OR COLOR.

SER. NO. 77-356,715, FILED 12-20-2007.

B. PARADEWELAI, EXAMINING ATTORNEY

Int. Cl.: 42

Prior U.S. Cls.: 100 and 101

United States Patent and Trademark Office

Reg. No. 3,480,010

Registered Aug. 5, 2008

**SERVICE MARK
PRINCIPAL REGISTER**



AEHELPER, LLC (VIRGINIA LTD LIAB CO)
201 ROXBURY INDUSTRIAL CENTER
CHARLES CITY, VA 23030

FOR: COMPUTER SERVICE, NAMELY, ACTING AS AN APPLICATION SERVICE PROVIDER IN THE FIELD OF KNOWLEDGE MANAGEMENT TO HOST COMPUTER APPLICATION SOFTWARE FOR THE COLLECTION, EDITING, ORGANIZING, MODIFYING, BOOK MARKING, TRANSMISSION, STORAGE AND SHARING OF DATA AND INFORMATION; DESIGN AND DEVELOPMENT OF ON-LINE COMPUTER SOFTWARE SYSTEMS, IN CLASS 42 (U.S. CLS. 100 AND 101).

FIRST USE 12-18-2007; IN COMMERCE 12-18-2007.

NO CLAIM IS MADE TO THE EXCLUSIVE RIGHT TO USE "AE", APART FROM THE MARK AS SHOWN.

THE COLOR(S) RED AND GREEN IS/ARE CLAIMED AS A FEATURE OF THE MARK.

THE COLOR RED APPEARS IN THE LETTER "E" AND THE COLOR GREEN APPEARS IN THE LETTER "A" IN THE LETTERING "AE" AT THE TOP OF THE MARK; THE COLOR RED APPEARS IN THE LETTERING "AE" TO THE LEFT OF THE WORD "HELPER" WHICH IS IN THE COLOR GREEN.

SER. NO. 77-356,762, FILED 12-20-2007.

BARNEY CHARLON, EXAMINING ATTORNEY

Int. Cl.: 9

Prior U.S. Cls.: 21, 23, 26, 36 and 38

Reg. No. 3,480,011

United States Patent and Trademark Office

Registered Aug. 5, 2008

**TRADEMARK
PRINCIPAL REGISTER**

MOBILE WORKMATE

OFFICE CLUB, INC., THE (CALIFORNIA CORPORATION)
2200 OLD GERMANTOWN ROAD
DELRAY BEACH, FL 33445

FOR: ROLLING CASES ESPECIALLY ADAPTED FOR HOLDING LAPTOPS AND NOTEBOOK COMPUTERS, OFFICE SUPPLIES AND FILES, IN CLASS 9 (U.S. CLS. 21, 23, 26, 36 AND 38).

FIRST USE 9-6-2007; IN COMMERCE 10-1-2007.

THE MARK CONSISTS OF STANDARD CHARACTERS WITHOUT CLAIM TO ANY PARTICULAR FONT, STYLE, SIZE, OR COLOR.

NO CLAIM IS MADE TO THE EXCLUSIVE RIGHT TO USE "MOBILE", APART FROM THE MARK AS SHOWN.

SER. NO. 77-356,801, FILED 12-20-2007.

DOMINICK J. SALEMI, EXAMINING ATTORNEY

Int. Cl.: 3

Prior U.S. Cls.: 1, 4, 6, 50, 51 and 52

United States Patent and Trademark Office

Reg. No. 3,480,012

Registered Aug. 5, 2008

**TRADEMARK
PRINCIPAL REGISTER**

**FREEZE 24·7 ICECREAM
DOUBLE SCOOP**

FREEZE 24/7 INTERNATIONAL LLC (NEW
YORK LTD LIAB CO)
49 WEST 57TH STREET, 3RD FLOOR
NEW YORK, NY 10019

FOR: FACIAL CREAMS, IN CLASS 3 (U.S. CLS. 1,
4, 6, 50, 51 AND 52).

FIRST USE 3-16-2006; IN COMMERCE 3-16-2006.

THE MARK CONSISTS OF STANDARD CHAR-
ACTERS WITHOUT CLAIM TO ANY PARTICULAR
FONT, STYLE, SIZE, OR COLOR.

OWNER OF U.S. REG. NOS. 3,047,444, 3,122,884,
AND 3,316,134.

SER. NO. 77-356,817, FILED 12-20-2007.

APRIL ROACH, EXAMINING ATTORNEY

Int. Cl.: 37

Prior U.S. Cls.: 100, 103 and 106

United States Patent and Trademark Office

Reg. No. 3,480,013

Registered Aug. 5, 2008

**SERVICE MARK
PRINCIPAL REGISTER**

SERVICE KING

SERVICE KING PAINT & BODY, LLC (TEXAS
LTD LIAB CO)
808 S. CENTRAL EXPRESSWAY
RICHARDSON, TX 75080

FOR: AUTOMOTIVE PAINT AND BODY REPAIR
SHOP, IN CLASS 37 (U.S. CLS. 100, 103 AND 106).

FIRST USE 0-0-1976; IN COMMERCE 0-0-1976.

THE MARK CONSISTS OF STANDARD CHAR-
ACTERS WITHOUT CLAIM TO ANY PARTICULAR
FONT, STYLE, SIZE, OR COLOR.

OWNER OF U.S. REG. NO. 2,101,424.

SER. NO. 77-356,843, FILED 12-20-2007.

HENRY S. ZAK, EXAMINING ATTORNEY

Int. Cl.: 37

Prior U.S. Cls.: 100, 103 and 106

United States Patent and Trademark Office

Reg. No. 3,480,014

Registered Aug. 5, 2008

**SERVICE MARK
PRINCIPAL REGISTER**

**SERVICE KING COLLISION
REPAIR CENTERS**

SERVICE KING PAINT & BODY, LLC (TEXAS
LTD LIAB CO)
808 S. CENTRAL EXPRESSWAY
RICHARDSON, TX 75080

FOR: AUTOMOTIVE PAINT AND BODY REPAIR
SHOP, IN CLASS 37 (U.S. CLS. 100, 103 AND 106).

FIRST USE 0-0-1976; IN COMMERCE 0-0-1976.

THE MARK CONSISTS OF STANDARD CHAR-
ACTERS WITHOUT CLAIM TO ANY PARTICULAR
FONT, STYLE, SIZE, OR COLOR.

OWNER OF U.S. REG. NO. 2,101,424.

NO CLAIM IS MADE TO THE EXCLUSIVE
RIGHT TO USE "COLLISION REPAIR CENTERS",
APART FROM THE MARK AS SHOWN.

SER. NO. 77-356,849, FILED 12-20-2007.

HENRY S. ZAK, EXAMINING ATTORNEY

Int. Cl.: 9

Prior U.S. Cls.: 21, 23, 26, 36 and 38

Reg. No. 3,480,015

United States Patent and Trademark Office

Registered Aug. 5, 2008

**TRADEMARK
PRINCIPAL REGISTER**

FORFILE

LONGWOOD SOFTWARE, INC. (MASSACHU-
SETTS CORPORATION)
107 MAIN STREET
MAYNARD, MA 01754

THE MARK CONSISTS OF STANDARD CHAR-
ACTERS WITHOUT CLAIM TO ANY PARTICULAR
FONT, STYLE, SIZE, OR COLOR.

FOR: COMPUTER SOFTWARE FOR SECURELY
TRANSMITTING LARGE FILES TO ANYONE VIA
GLOBAL COMPUTER NETWORK, IN CLASS 9 (U.S.
CLS. 21, 23, 26, 36 AND 38).

SER. NO. 77-356,915, FILED 12-20-2007.

FIRST USE 6-21-2005; IN COMMERCE 6-21-2005.

THOMAS MANOR, EXAMINING ATTORNEY

Int. Cl.: 9

Prior U.S. Cls.: 21, 23, 26, 36 and 38

Reg. No. 3,480,016

United States Patent and Trademark Office

Registered Aug. 5, 2008

**TRADEMARK
PRINCIPAL REGISTER**

DolpHin

INVENSYS SYSTEMS, INC. (MASSACHUSETTS CORPORATION)
33 COMMERCIAL STREET
FOXBORO, MA 02035 AND
INVENSYS SYSTEMS, INC. (MASSACHUSETTS CORPORATION)
33 COMMERCIAL STREET
FOXBORO, MA 02035

FOR: ELECTROCHEMICAL PH SENSORS FOR USE IN INDUSTRIAL AND ON-LINE PROCESS APPLICATIONS, IN CLASS 9 (U.S. CLS. 21, 23, 26, 36 AND 38).

FIRST USE 7-14-2000; IN COMMERCE 8-20-2002.

OWNER OF U.S. REG. NO. 3,401,805.

THE MARK CONSISTS OF THE WORD "DOLPHIN" WITH A CAPITALIZED "D" AND "H".

SER. NO. 77-356,921, FILED 12-20-2007.

THOMAS MANOR, EXAMINING ATTORNEY

Int. Cl.: 35

Prior U.S. Cls.: 100, 101 and 102

United States Patent and Trademark Office

Reg. No. 3,480,017

Registered Aug. 5, 2008

**SERVICE MARK
PRINCIPAL REGISTER**

We care for and about your
children

NATIONAL ASSOCIATION OF PEDIATRIC
NURSE PRACTITIONERS (OHIO NON-PROF-
IT CORPORATION)
20 BRACE ROAD
SUITE 200
CHERRY HILL, NJ 080342634

FOR: ASSOCIATION SERVICES, NAMELY, PRO-
MOTING THE INTERESTS OF PEDIATRIC NURSE
ASSOCIATES AND PRACTITIONERS, IN CLASS 35
(U.S. CLS. 100, 101 AND 102).

FIRST USE 10-5-2007; IN COMMERCE 10-5-2007.

THE MARK CONSISTS OF STANDARD CHAR-
ACTERS WITHOUT CLAIM TO ANY PARTICULAR
FONT, STYLE, SIZE, OR COLOR.

SER. NO. 77-356,944, FILED 12-20-2007.

JOHN SCHUYLER YARD, EXAMINING ATTOR-
NEY

Int. Cl.: 5

Prior U.S. Cls.: 6, 18, 44, 46, 51 and 52

Reg. No. 3,480,018

United States Patent and Trademark Office

Registered Aug. 5, 2008

**TRADEMARK
PRINCIPAL REGISTER**

SORBOPLEX

W.F. YOUNG, INCORPORATED (MASSACHU-
SETTS CORPORATION)
302 BENTON DRIVE
EAST LONGMEADOW, MA 01028

FOR: A TOPICAL PREPARATION OF A COMBI-
NATION OF AROMATIC TIGHTENERS, NAMELY,
A PROPORTION OF WORMWOOD OIL, PEPPER-
MINT OIL AND CITRIC ACID FOR USE ON ANI-
MALS, NAMELY, AS A POULTICE, IN CLASS 5 (U.S.
CLS. 6, 18, 44, 46, 51 AND 52).

FIRST USE 0-0-2001; IN COMMERCE 0-0-2001.

THE MARK CONSISTS OF STANDARD CHAR-
ACTERS WITHOUT CLAIM TO ANY PARTICULAR
FONT, STYLE, SIZE, OR COLOR.

SER. NO. 77-356,957, FILED 12-20-2007.

FRED CARL, EXAMINING ATTORNEY

Int. Cl.: 6

Prior U.S. Cls.: 2, 12, 13, 14, 23, 25 and 50

Reg. No. 3,480,019

United States Patent and Trademark Office

Registered Aug. 5, 2008

**TRADEMARK
PRINCIPAL REGISTER**

PRIORITY METALS, INC.

MCCARROLL, DON (UNITED STATES INDIVIDUAL)
6032 E. HUMMINGBIRD COURT
ORANGE, CA 92869

FOR: METAL BARS FOR FURTHER MANUFACTURE; METAL PIPES; METAL PIPES AND TUBES; METAL TUBES; METAL TUBING; METALS AND METAL ALLOYS; SHEET METAL, IN CLASS 6 (U.S. CLS. 2, 12, 13, 14, 23, 25 AND 50).

FIRST USE 1-0-1997; IN COMMERCE 1-0-1997.

THE MARK CONSISTS OF STANDARD CHARACTERS WITHOUT CLAIM TO ANY PARTICULAR FONT, STYLE, SIZE, OR COLOR.

NO CLAIM IS MADE TO THE EXCLUSIVE RIGHT TO USE "METALS, INC.", APART FROM THE MARK AS SHOWN.

SER. NO. 77-356,965, FILED 12-20-2007.

AMY ALFIERI, EXAMINING ATTORNEY

Int. Cl.: 19

Prior U.S. Cls.: 1, 12, 33 and 50

United States Patent and Trademark Office

Reg. No. 3,480,020

Registered Aug. 5, 2008

**TRADEMARK
PRINCIPAL REGISTER**

REZIST-IT

MACDONALD, FRANK (UNITED STATES INDIVIDUAL)
20 VALLEY VIEW DRIVE
ORINDA, CA 94563 AND
MACDONALD, SUSANNA (UNITED STATES INDIVIDUAL)
20 VALLEY VIEW DRIVE
ORINDA, CA 94563

FOR: MODULAR BUILDING CONSTRUCTION SYSTEM COMPRISED OF PANELS OF PROPRIETARY INSULATIVE CONCRETE FORMULATIONS CONTAINED IN INTERLOCKING STEEL FRAMES FOR USE IN CONSTRUCTION OF HOUSES, BUILD-

INGS AND OTHER STRUCTURES, IN CLASS 19 (U.S. CLS. 1, 12, 33 AND 50).

FIRST USE 8-0-1996; IN COMMERCE 7-25-2000.

THE MARK CONSISTS OF STANDARD CHARACTERS WITHOUT CLAIM TO ANY PARTICULAR FONT, STYLE, SIZE, OR COLOR.

SER. NO. 77-356,978, FILED 12-20-2007.

ARETHA SOMERVILLE, EXAMINING ATTORNEY

Int. Cl.: 11

Prior U.S. Cls.: 13, 21, 23, 31 and 34

United States Patent and Trademark Office

Reg. No. 3,480,021

Registered Aug. 5, 2008

**TRADEMARK
PRINCIPAL REGISTER**

STINGER DS

STREAMLIGHT, INC. (DELAWARE CORPORATION)
30 EAGLEVILLE ROAD
EAGLEVILLE, PA 19403

FOR: FLASHLIGHTS AND PARTS THEREFOR,
IN CLASS 11 (U.S. CLS. 13, 21, 23, 31 AND 34).

FIRST USE 7-23-2007; IN COMMERCE 7-23-2007.

THE MARK CONSISTS OF STANDARD CHARACTERS WITHOUT CLAIM TO ANY PARTICULAR FONT, STYLE, SIZE, OR COLOR.

OWNER OF U.S. REG. NOS. 1,900,537, 2,490,914,
AND 2,853,207.

SER. NO. 77-356,987, FILED 12-20-2007.

PAUL CROWLEY, EXAMINING ATTORNEY

Int. Cl.: 42

Prior U.S. Cls.: 100 and 101

United States Patent and Trademark Office

Reg. No. 3,480,022

Registered Aug. 5, 2008

**SERVICE MARK
PRINCIPAL REGISTER**

INSITE ARCHITECTURE INC

INSITE ARCHITECTURE, INC. (TEXAS CORPORATION)
11830 TELGE ROAD
HOUSTON, TX 77429

FOR: ARCHITECTURAL AND ENGINEERING SERVICES; ARCHITECTURAL CONSULTANCY; ARCHITECTURAL CONSULTATION; ARCHITECTURAL DESIGN; CONSULTING IN THE FIELDS OF ENGINEERING AND ARCHITECTURE; CONSULTING SERVICES IN THE FIELD OF ARCHITECTURAL DESIGN, IN CLASS 42 (U.S. CLS. 100 AND 101).

FIRST USE 7-10-2001; IN COMMERCE 7-10-2001.

THE MARK CONSISTS OF STANDARD CHARACTERS WITHOUT CLAIM TO ANY PARTICULAR FONT, STYLE, SIZE, OR COLOR.

NO CLAIM IS MADE TO THE EXCLUSIVE RIGHT TO USE "ARCHITECTURE INC", APART FROM THE MARK AS SHOWN.

SER. NO. 77-357,010, FILED 12-20-2007.

HENRY S. ZAK, EXAMINING ATTORNEY

Int. Cls.: 41, 42, 44 and 45

Prior U.S. Cls.: 100, 101 and 107

United States Patent and Trademark Office

Reg. No. 3,480,023

Registered Aug. 5, 2008

**SERVICE MARK
PRINCIPAL REGISTER**

**FOX CHASE
CANCER CENTER**

FOX CHASE CANCER CENTER (PENNSYLVANIA CORPORATION)
333 COTTMAN AVENUE
PHILADELPHIA, PA 19111

FOR: MEDICAL TRAINING AND TEACHING, IN CLASS 41 (U.S. CLS. 100, 101 AND 107).

FIRST USE 1-24-2007; IN COMMERCE 1-24-2007.

FOR: MEDICAL AND SCIENTIFIC RESEARCH, CONDUCTING CLINICAL TRIALS, CANCER AND CANCER PREVENTION RESEARCH, IN CLASS 42 (U.S. CLS. 100 AND 101).

FIRST USE 1-24-2007; IN COMMERCE 1-24-2007.

FOR: HOSPITAL AND MEDICAL SERVICES, COMPREHENSIVE CANCER DETECTION AND TREATMENT SERVICES, MEDICAL EVALUATION SERVICES, MEDICAL TESTING AND SCREENING, MEDICAL COUNSELING, HEALTH RISK ASSESSMENT PROGRAMS FOR PATIENTS, MEDICAL IMAGING SERVICES, MEDICAL INFORMATION SERVICES, AND MEDICAL OUTREACH PROGRAMS, NAMELY, COMMUNITY OUTREACH HEALTH CARE SERVICES IN THE FIELD OF

CANCER PREVENTION AND TREATMENT, IN CLASS 44 (U.S. CLS. 100 AND 101).

FIRST USE 1-24-2007; IN COMMERCE 1-24-2007.

FOR: MEDICAL SUPPORT SERVICES FOR PATIENTS AND FAMILIES OF PATIENTS COPING WITH LIFE THREATENING ILLNESSES, NAMELY, COUNSELING AND EMOTIONAL SUPPORT, ASSISTANCE WITH MEDICAL FORMS AND MEDICAL INSURERS, ASSISTANCE WITH PLANNING, COORDINATING AND MONITORING OF MEDICAL TREATMENT OPTIONS AND DECISIONS, IN CLASS 45 (U.S. CLS. 100 AND 101).

FIRST USE 1-24-2007; IN COMMERCE 1-24-2007.

OWNER OF U.S. REG. NOS. 1,570,101, 3,137,764 AND OTHERS.

NO CLAIM IS MADE TO THE EXCLUSIVE RIGHT TO USE "CANCER CENTER", APART FROM THE MARK AS SHOWN.

SER. NO. 77-357,021, FILED 12-20-2007.

APRIL ROACH, EXAMINING ATTORNEY

Int. Cl.: 37

Prior U.S. Cls.: 100, 103 and 106

United States Patent and Trademark Office

Reg. No. 3,480,024

Registered Aug. 5, 2008

**SERVICE MARK
PRINCIPAL REGISTER**



SERVICE KING PAINT & BODY, LLC (TEXAS
LTD LIAB CO)
808 S. CENTRAL EXPRESSWAY
RICHARDSON, TX 75080

FOR: AUTOMOTIVE PAINT AND BODY REPAIR
SHOP, IN CLASS 37 (U.S. CLS. 100, 103 AND 106).

FIRST USE 0-0-1976; IN COMMERCE 0-0-1976.

OWNER OF U.S. REG. NO. 2,101,424.

THE MARK CONSISTS OF THE LITERAL ELE-
MENTS IN A STYLIZED FONT WITH 3 LINES TO
THE LEFT AND RIGHT OF THE LITERAL ELE-
MENTS.

SER. NO. 77-357,037, FILED 12-20-2007.

HENRY S. ZAK, EXAMINING ATTORNEY

Int. Cl.: 41

Prior U.S. Cls.: 100, 101 and 107

United States Patent and Trademark Office

Reg. No. 3,480,025

Registered Aug. 5, 2008

**SERVICE MARK
PRINCIPAL REGISTER**

**WEB MARKETING SYSTEMS THAT
WORK**

PRO STEP MARKETING, INC. (NORTH CAROLINA CORPORATION)
16419-E NORTHCROSS DRIVE
HUNTERSVILLE, NC 28078

FOR: EDUCATIONAL SERVICES, NAMELY, CONDUCTING CLASSES, SEMINARS, CONFERENCES AND WORKSHOPS IN THE FIELD OF REAL ESTATE MARKETING AND DISTRIBUTION OF COURSE MATERIAL IN CONNECTION THEREWITH, IN CLASS 41 (U.S. CLS. 100, 101 AND 107).

FIRST USE 8-3-2007; IN COMMERCE 8-3-2007.

THE MARK CONSISTS OF STANDARD CHARACTERS WITHOUT CLAIM TO ANY PARTICULAR FONT, STYLE, SIZE, OR COLOR.

NO CLAIM IS MADE TO THE EXCLUSIVE RIGHT TO USE "WEB MARKETING SYSTEMS", APART FROM THE MARK AS SHOWN.

SER. NO. 77-357,041, FILED 12-20-2007.

HENRY S. ZAK, EXAMINING ATTORNEY

Int. Cl.: 24

Prior U.S. Cls.: 42 and 50

United States Patent and Trademark Office

Reg. No. 3,480,026

Registered Aug. 5, 2008

**TRADEMARK
PRINCIPAL REGISTER**

Casa Bini Textiles

MATAS LLC (NEVADA LTD LIAB CO), DBA THE
PEACOCK COLLECTION
SUITE A-1
572 REACTOR WAY
RENO, NV 89502

FOR: TEXTILE FABRICS FOR HOME AND COM-
MERCIAL INTERIORS, IN CLASS 24 (U.S. CLS. 42
AND 50).

FIRST USE 12-1-2007; IN COMMERCE 12-1-2007.

THE MARK CONSISTS OF STANDARD CHAR-
ACTERS WITHOUT CLAIM TO ANY PARTICULAR
FONT, STYLE, SIZE, OR COLOR.

NO CLAIM IS MADE TO THE EXCLUSIVE
RIGHT TO USE "TEXTILES", APART FROM THE
MARK AS SHOWN.

THE ENGLISH TRANSLATION OF THE WORD
"CASA" IN THE MARK IS "HOUSE"

SER. NO. 77-357,061, FILED S.R. 12-20-2007 AM.
P.R. 3-31-2008.

TOBY BULLOFF, EXAMINING ATTORNEY

Int. Cl.: 12

Prior U.S. Cls.: 19, 21, 23, 31, 35 and 44

Reg. No. 3,480,027

United States Patent and Trademark Office

Registered Aug. 5, 2008

**TRADEMARK
PRINCIPAL REGISTER**

Whiskeyjack Paddles

BROWN, DANIEL EDWARD (MINNESOTA LTD
LIAB CO)
31 E. FIRST STREET
DULUTH, MN 55802

FOR: CANOE PADDLES; KAYAK EQUIPMENT,
NAMELY, KAYAK PADDLES AND STAND UP
SURF PADDLES, IN CLASS 12 (U.S. CLS. 19, 21, 23,
31, 35 AND 44).

FIRST USE 12-1-2004; IN COMMERCE 3-11-2005.

THE MARK CONSISTS OF STANDARD CHAR-
ACTERS WITHOUT CLAIM TO ANY PARTICULAR
FONT, STYLE, SIZE, OR COLOR.

NO CLAIM IS MADE TO THE EXCLUSIVE
RIGHT TO USE "PADDLES", APART FROM THE
MARK AS SHOWN.

SER. NO. 77-357,089, FILED 12-20-2007.

MARGERY A. TIERNEY, EXAMINING ATTORNEY

Int. Cl.: 35

Prior U.S. Cls.: 100, 101 and 102

United States Patent and Trademark Office

Reg. No. 3,480,028

Registered Aug. 5, 2008

**SERVICE MARK
PRINCIPAL REGISTER**

CAREER RESCUE

THOMPSON, KIMBERLY (UNITED STATES IN-
DIVIDUAL)

PO BOX 940183

HOUSTON, TX 770947183

FOR: PROVIDING CAREER INFORMATION, IN
CLASS 35 (U.S. CLS. 100, 101 AND 102).

FIRST USE 4-12-2005; IN COMMERCE 12-2-2007.

THE MARK CONSISTS OF STANDARD CHAR-
ACTERS WITHOUT CLAIM TO ANY PARTICULAR
FONT, STYLE, SIZE, OR COLOR.

NO CLAIM IS MADE TO THE EXCLUSIVE
RIGHT TO USE "CAREER", APART FROM THE
MARK AS SHOWN.

SER. NO. 77-357,250, FILED 12-20-2007.

AMY ALFIERI, EXAMINING ATTORNEY

Int. Cl.: 42

Prior U.S. Cls.: 100 and 101

United States Patent and Trademark Office

Reg. No. 3,480,029

Registered Aug. 5, 2008

**SERVICE MARK
PRINCIPAL REGISTER**



SCHIFF PARTNERS, INC (DELAWARE COR-
PORATION)
5 RIVER ROAD
#234
WILTON, CT 06897

THE MARK CONSISTS OF THE WORD "DEVICE-
KEEPER" WHEREIN THE LETTER "I" IS SHAPED
LIKE A PAGER DEVICE AND A CURVED LINE
EXTENDS FROM THE LETTER "I" TO THE FIRST
LETTER "E" IN THE WORD "KEEPER".

FOR: PROVIDING A NON-DOWNLOADABLE
WEB-BASED SOFTWARE APPLICATION FOR
MANAGING MOBILE TECHNOLOGY DEVICE AS-
SETS, IN CLASS 42 (U.S. CLS. 100 AND 101).

SER. NO. 77-357,274, FILED 12-20-2007.

FIRST USE 12-13-2007; IN COMMERCE 1-11-2008.

MARK RADEMACHER, EXAMINING ATTORNEY

Int. Cl.: 35

Prior U.S. Cls.: 100, 101 and 102

United States Patent and Trademark Office

Reg. No. 3,480,030

Registered Aug. 5, 2008

**SERVICE MARK
PRINCIPAL REGISTER**

ChiroSpa

HILL, JOHN (UNITED STATES INDIVIDUAL)
6725 LYNCH
RIVERBANK, CA 95367

THE MARK CONSISTS OF STANDARD CHAR-
ACTERS WITHOUT CLAIM TO ANY PARTICULAR
FONT, STYLE, SIZE, OR COLOR.

FOR: ADVERTISING AND BUSINESS MANAGE-
MENT CONSULTANCY TO LICENSED HEALTH
CARE PROFESSIONAL IN THE FIELD OF AES-
THETICS, IN CLASS 35 (U.S. CLS. 100, 101 AND 102).

SER. NO. 77-357,331, FILED 12-20-2007.

FIRST USE 4-1-2007; IN COMMERCE 4-1-2007.

ROBIN CHOSID, EXAMINING ATTORNEY

Int. Cl.: 25

Prior U.S. Cls.: 22 and 39

United States Patent and Trademark Office

Reg. No. 3,480,031

Registered Aug. 5, 2008

**TRADEMARK
PRINCIPAL REGISTER**

MICROCELL

STUDIO IP HOLDINGS LLC (DELAWARE LTD
LIAB CO)
103 FOULK ROAD
WILMINGTON, DE 10893

THE MARK CONSISTS OF STANDARD CHAR-
ACTERS WITHOUT CLAIM TO ANY PARTICULAR
FONT, STYLE, SIZE, OR COLOR.

FOR: FOOTWEAR; ATHLETIC SHOES, IN CLASS
25 (U.S. CLS. 22 AND 39).

SER. NO. 77-357,341, FILED 12-20-2007.

FIRST USE 1-1-2005; IN COMMERCE 1-1-2005.

KIMBERLY PERRY, EXAMINING ATTORNEY

Int. Cl.: 6

Prior U.S. Cls.: 2, 12, 13, 14, 23, 25 and 50

Reg. No. 3,480,032

United States Patent and Trademark Office

Registered Aug. 5, 2008

TRADEMARK
PRINCIPAL REGISTER



SHELTER ONE, INC. (OREGON CORPORATION)
5887 MONUMENT DRIVE
GRANTS PASS, OR 97526

FOR: METAL SHELTER STRUCTURES, IN
CLASS 6 (U.S. CLS. 2, 12, 13, 14, 23, 25 AND 50).

FIRST USE 9-0-1998; IN COMMERCE 9-0-1998.

NO CLAIM IS MADE TO THE EXCLUSIVE
RIGHT TO USE "SHELTER", APART FROM THE
MARK AS SHOWN.

THE MARK CONSISTS OF A CUBE DESIGN
BETWEEN THE WORDS "SHELTER" AND "ONE"
WHERE THE CUBE HAS SHADOWING HASH
MARKS FROM RIGHT TO LEFT ON THE TOP
AND RIGHT FACING SIDES OF THE CUBE AND
BLANK ON THE LEFT FACING SIDE OF THE
CUBE.

SER. NO. 77-357,363, FILED 12-20-2007.

KAREN BRACEY, EXAMINING ATTORNEY

Int. Cl.: 30

Prior U.S. Cl.: 46

United States Patent and Trademark Office

Reg. No. 3,480,033

Registered Aug. 5, 2008

**TRADEMARK
PRINCIPAL REGISTER**

BACOLINI COFFEE TRADERS

DISPENSER BEVERAGES, INC. (CALIFORNIA CORPORATION)
2090 FARRALON DRIVE
SAN LEANDRO, CA 94577

FOR: BEVERAGES MADE OF COFFEE; CAFFEINE-FREE COFFEE; COFFEE; COFFEE BEANS; COFFEE FLAVORED SYRUP USED IN MAKING FOOD BEVERAGES; COFFEE PODS; COFFEE SUBSTITUTES; COFFEE-BASED BEVERAGE CONTAINING MILK; COFFEE-BASED BEVERAGES; GROUND COFFEE BEANS; INSTANT COFFEE; PREPARED COFFEE AND COFFEE-BASED BEVERAGES; ROASTED COFFEE BEANS; SUGAR-COATED COFFEE BEANS; FLAVORING SYRUP; FLAVORINGS FOR BEVERAGES, IN CLASS 30 (U.S. CL. 46).

FIRST USE 6-30-2005; IN COMMERCE 6-30-2005.

THE MARK CONSISTS OF STANDARD CHARACTERS WITHOUT CLAIM TO ANY PARTICULAR FONT, STYLE, SIZE, OR COLOR.

NO CLAIM IS MADE TO THE EXCLUSIVE RIGHT TO USE "COFFEE TRADERS", APART FROM THE MARK AS SHOWN.

SER. NO. 77-357,377, FILED 12-20-2007.

KEVIN CORWIN, EXAMINING ATTORNEY

Int. Cl.: 1

Prior U.S. Cls.: 1, 5, 6, 10, 26 and 46

Reg. No. 3,480,034

United States Patent and Trademark Office

Registered Aug. 5, 2008

**TRADEMARK
PRINCIPAL REGISTER**

eco-tabs

ECO DISTRIBUTORS, LLC (WYOMING LTD
LIAB CO)
1360 NW 65TH AVE, UNIT N
PLANTATION, FL 333134556

FOR: ODOR ELIMINATING TABLETS COM-
PRISED OF MICROORGANISMS AND ENZYMES
TO BE DISSOLVED IN WATER AND USED TO
DIGEST ORGANIC WASTE, IN CLASS 1 (U.S. CLS. 1,
5, 6, 10, 26 AND 46).

FIRST USE 6-4-2007; IN COMMERCE 11-4-2007.

THE MARK CONSISTS OF STANDARD CHAR-
ACTERS WITHOUT CLAIM TO ANY PARTICULAR
FONT, STYLE, SIZE, OR COLOR.

SER. NO. 77-357,395, FILED 12-20-2007.

ARETHA SOMERVILLE, EXAMINING ATTORNEY

Int. Cl.: 35

Prior U.S. Cls.: 100, 101 and 102

United States Patent and Trademark Office

Reg. No. 3,480,035

Registered Aug. 5, 2008

**SERVICE MARK
PRINCIPAL REGISTER**



ROUNABOUT THEATRE COMPANY, INC.
(NEW YORK NON-PROFIT CORPORATION)
SUITE 1200
231 WEST 39TH STREET
NEW YORK, NY 10018

FOR: MEMBERSHIP CLUB SERVICES THAT PROVIDE A PROMOTIONAL AUDIENCE DEVELOPMENT AND OUTREACH PROGRAM TO ENCOURAGE YOUNG ADULTS TO ATTEND THEATRICAL PERFORMANCES AND ACTIVITIES FOR YOUNG ADULTS TO ATTEND RECEPTIONS AND OTHER SOCIAL ACTIVITIES IN CONNECTION WITH THEATRICAL PERFORMANCES; MEMBERSHIP CLUB SERVICES THAT PROVIDE DISCOUNTED TICKET AGENCY SERVICES FOR YOUNG ADULTS; AND PROVIDING A WEBSITE FEATURING INFORMATION ABOUT AN AUDIENCE DEVELOPMENT AND OUTREACH PRO-

GRAM TO ENCOURAGE YOUNG ADULTS TO ATTEND THEATRICAL PERFORMANCES, IN CLASS 35 (U.S. CLS. 100, 101 AND 102).

FIRST USE 10-1-2000; IN COMMERCE 10-1-2000.

OWNER OF U.S. REG. NO. 3,312,167.

THE MARK CONSISTS OF THE WORD "HIPTIX" IN BLOCK LETTERS, WITH AN OUTLINE. THE FIRST "I" IS LOWERCASE AND THERE IS AN EXCLAMATION POINT IN PLACE OF THE SECOND "I" OF THE WORD.

SER. NO. 77-357,415, FILED 12-20-2007.

HOWARD B. LEVINE, EXAMINING ATTORNEY

Int. Cl.: 41

Prior U.S. Cls.: 100, 101 and 107

United States Patent and Trademark Office

Reg. No. 3,480,036

Registered Aug. 5, 2008

**SERVICE MARK
PRINCIPAL REGISTER**

Telluride

CARTER, JOHN R (UNITED STATES INDIVIDUAL), DBA TELLURIDE
120 WILLOW RIDGE LANE
PELHAM, AL 35124

FOR: ENTERTAINMENT IN THE NATURE OF VISUAL AND AUDIO PERFORMANCES, NAMELY, MUSICAL BAND, ROCK GROUP, GYMNASTIC, DANCE, AND BALLET PERFORMANCES, IN CLASS 41 (U.S. CLS. 100, 101 AND 107).

FIRST USE 2-1-1977; IN COMMERCE 2-1-1977.

THE MARK CONSISTS OF STANDARD CHARACTERS WITHOUT CLAIM TO ANY PARTICULAR FONT, STYLE, SIZE, OR COLOR.

SER. NO. 77-357,458, FILED 12-20-2007.

CHRISTINE COOPER, EXAMINING ATTORNEY

Int. Cl.: 16

Prior U.S. Cls.: 2, 5, 22, 23, 29, 37, 38 and 50

United States Patent and Trademark Office

Reg. No. 3,480,037

Registered Aug. 5, 2008

**TRADEMARK
PRINCIPAL REGISTER**



DAISY D'S PAPER COMPANY (UTAH COR-
PORATION)

#200

375 W 200 S

SALT LAKE CITY, UT 84101

FIRST USE 7-18-2002; IN COMMERCE 7-18-2002.

"DAISY D'S" IS NOT A LIVING INDIVIDUAL.

SER. NO. 77-357,473, FILED 12-20-2007.

FOR: CRAFT PAPER; SCRAPBOOK PAGES, IN
CLASS 16 (U.S. CLS. 2, 5, 22, 23, 29, 37, 38 AND 50).

BARNEY CHARLON, EXAMINING ATTORNEY

Int. Cl.: 36

Prior U.S. Cls.: 100, 101 and 102

United States Patent and Trademark Office

Reg. No. 3,480,038

Registered Aug. 5, 2008

**SERVICE MARK
PRINCIPAL REGISTER**

SUNROCK VENTURES

SUNROCK VENTURES MANAGEMENT, LLC
(DELAWARE LTD LIAB CO)
SUITE 950
201 EAST KENNEDY BLVD
TAMPA, FL 33602

FOR: FINANCIAL SERVICES, NAMELY, INVESTMENT ADVISORY AND INVESTMENT MANAGEMENT SERVICES FOR INVESTMENT FUNDS AND INVESTMENTS, AND FINANCIAL SPONSORSHIP OF THE FORMATION OF INVESTMENT FUNDS; FINANCIAL SERVICES, NAMELY, FINANCIAL PORTFOLIO MANAGEMENT OF INVESTMENT FUNDS FOR OTHERS AND FINANCIAL INVESTMENTS FOR OTHERS IN THE FIELDS OF HEALTH CARE, INFORMATION TECHNOLOGY, AND IN-

FORMATION SERVICES, IN CLASS 36 (U.S. CLS. 100, 101 AND 102).

FIRST USE 10-1-2007; IN COMMERCE 10-1-2007.

THE MARK CONSISTS OF STANDARD CHARACTERS WITHOUT CLAIM TO ANY PARTICULAR FONT, STYLE, SIZE, OR COLOR.

NO CLAIM IS MADE TO THE EXCLUSIVE RIGHT TO USE "VENTURES" , APART FROM THE MARK AS SHOWN.

SER. NO. 77-357,525, FILED 12-20-2007.

TAMARA FRAZIER, EXAMINING ATTORNEY

Int. Cl.: 9

Prior U.S. Cls.: 21, 23, 26, 36 and 38

Reg. No. 3,480,039

United States Patent and Trademark Office

Registered Aug. 5, 2008

**TRADEMARK
PRINCIPAL REGISTER**

HyperVelocity

GLOBAL TECH RESOURCES LLC (NEVADA
LTD LIAB CO)
SUITE 1
3155 EAST PATRICK LANE
LAS VEGAS, NV 891203481

THE MARK CONSISTS OF STANDARD CHAR-
ACTERS WITHOUT CLAIM TO ANY PARTICULAR
FONT, STYLE, SIZE, OR COLOR.

FOR: COMPUTER MEMORIES; COMPUTER
MEMORY HARDWARE, IN CLASS 9 (U.S. CLS. 21,
23, 26, 36 AND 38).

SER. NO. 77-357,566, FILED 12-20-2007.

FIRST USE 8-20-1999; IN COMMERCE 8-20-1999.

PAM WILLIS, EXAMINING ATTORNEY

Int. Cl.: 44

Prior U.S. Cls.: 100 and 101

United States Patent and Trademark Office

Reg. No. 3,480,040

Registered Aug. 5, 2008

**SERVICE MARK
PRINCIPAL REGISTER**

dynemia

GEDDES, DAVID HAMLIN (UNITED STATES
INDIVIDUAL), DBA DYNEMIA.COM
1813 CHANSON WAY
MARIETTA, GA 30062

THE MARK CONSISTS OF STANDARD CHAR-
ACTERS WITHOUT CLAIM TO ANY PARTICULAR
FONT, STYLE, SIZE, OR COLOR.

FOR: HEALTHCARE, IN CLASS 44 (U.S. CLS. 100
AND 101).

SER. NO. 77-357,570, FILED S.R. 12-20-2007 AM.
P.R. 4-3-2008.

FIRST USE 10-25-2007; IN COMMERCE 10-25-2007.

MICHAEL KAZAZIAN, EXAMINING ATTORNEY

Int. Cl.: 10

Prior U.S. Cls.: 26, 39 and 44

Reg. No. 3,480,041

United States Patent and Trademark Office

Registered Aug. 5, 2008

**TRADEMARK
PRINCIPAL REGISTER**

DAAVLIN

THE DAAVLIN DISTRIBUTING COMPANY
(OHIO CORPORATION)

205 W. BEMENT STREET

BRYAN, OH 43506

FOR: ULTRAVIOLET PHOTOTHERAPY MEDICAL EQUIPMENT, IN CLASS 10 (U.S. CLS. 26, 39 AND 44).

FIRST USE 12-31-1981; IN COMMERCE 12-31-1981.

THE MARK CONSISTS OF STANDARD CHARACTERS WITHOUT CLAIM TO ANY PARTICULAR FONT, STYLE, SIZE, OR COLOR.

OWNER OF U.S. REG. NO. 2,524,447.

THE WORDING "DAAVLIN" HAS NO MEANING OTHER THAN TRADEMARK SIGNIFICANCE.

SER. NO. 77-357,627, FILED 12-21-2007.

MARK PILARO, EXAMINING ATTORNEY

Int. Cl.: 7

Prior U.S. Cls.: 13, 19, 21, 23, 31, 34 and 35

United States Patent and Trademark Office

Reg. No. 3,480,042

Registered Aug. 5, 2008

**TRADEMARK
PRINCIPAL REGISTER**

VarioFlex^{Plus}

BSH BOSCH UND SIEMENS HAUSGERAETE
GMBH (FED REP GERMANY CORPORA-
TION)

CARL-WERY-STRASSE 34

MUNICH, FED REP GERMANY 81739

FOR: HOUSEHOLD AND KITCHEN MACHINES
AND EQUIPMENT, NAMELY, ELECTRIC KITCH-
EN MACHINES AND EQUIPMENT, NAMELY,
DISHWASHERS; STRUCTURAL PARTS OF ALL
AFOREMENTIONED GOODS, IN CLASS 7 (U.S.
CLS. 13, 19, 21, 23, 31, 34 AND 35).

PRIORITY CLAIMED UNDER SEC. 44(D) ON FED
REP GERMANY APPLICATION NO. 30746782.1/0,
FILED 7-17-2007, REG. NO. 30746782, DATED 9-7-
2007, EXPIRES 7-31-2017.

THE MARK CONSISTS OF THE WORDS "VAR-
IOFLEX" IMMEDIATELY FOLLOWED BY THE
WORD "PLUS" WHICH APPEARS AS SUPER-
SCRIPT.

SER. NO. 77-357,706, FILED 12-21-2007.

PAM WILLIS, EXAMINING ATTORNEY

Int. Cl.: 41

Prior U.S. Cls.: 100, 101 and 107

United States Patent and Trademark Office

Reg. No. 3,480,043

Registered Aug. 5, 2008

**SERVICE MARK
PRINCIPAL REGISTER**

KETSU-KA

HAMZY, HASSAN A., SR. (UNITED STATES
INDIVIDUAL)
3540 PLEASANT HILL ROAD
KISSIMMEE, FL 34746

THE MARK CONSISTS OF STANDARD CHAR-
ACTERS WITHOUT CLAIM TO ANY PARTICULAR
FONT, STYLE, SIZE, OR COLOR.

FOR: EDUCATIONAL SERVICES, NAMELY,
TEACHING AND INSTRUCTION IN THE FIELD
OF MARTIAL ARTS, IN CLASS 41 (U.S. CLS. 100, 101
AND 107).

SER. NO. 77-357,756, FILED 12-21-2007.

FIRST USE 1-1-1970; IN COMMERCE 1-1-1970.

ALLISON SCHRODY, EXAMINING ATTORNEY

Int. Cls.: 41, 42 and 44

Prior U.S. Cls.: 100, 101 and 107

United States Patent and Trademark Office

Reg. No. 3,480,044

Registered Aug. 5, 2008

**SERVICE MARK
PRINCIPAL REGISTER**

FOX CHASE
C A N C E R C E N T E R
————— **Partners** —————

FOX CHASE CANCER CENTER (PENNSYLVANIA CORPORATION)
333 COTTMAN AVENUE
PHILADELPHIA, PA 191112479

FOR: MEDICAL TRAINING AND TEACHING, IN CLASS 41 (U.S. CLS. 100, 101 AND 107).

FIRST USE 9-7-2006; IN COMMERCE 9-7-2006.

FOR: MEDICAL AND SCIENTIFIC RESEARCH, CONDUCTING CLINICAL TRIALS, CANCER AND CANCER PREVENTION RESEARCH, IN CLASS 42 (U.S. CLS. 100 AND 101).

FIRST USE 9-7-2006; IN COMMERCE 9-7-2006.

FOR: HOSPITAL AND MEDICAL SERVICES, CANCER DETECTION, PREVENTION AND TREATMENT SERVICES, MEDICAL EVALUATION SERVICES, MEDICAL TESTING AND SCREENING,

HEALTH-RISK ASSESSMENT PROGRAMS FOR PATIENTS, MEDICAL INFORMATION SERVICES AND PROVIDING COMMUNITY BASED MEDICAL AND ONCOLOGY SERVICES THROUGH AFFILIATED HOSPITALS, IN CLASS 44 (U.S. CLS. 100 AND 101).

FIRST USE 9-7-2006; IN COMMERCE 9-7-2006.

OWNER OF U.S. REG. NOS. 3,075,307, 3,343,161 AND OTHERS.

NO CLAIM IS MADE TO THE EXCLUSIVE RIGHT TO USE "CANCER CENTER PARTNERS", APART FROM THE MARK AS SHOWN.

SER. NO. 77-357,833, FILED 12-21-2007.

APRIL ROACH, EXAMINING ATTORNEY

Int. Cl.: 41

Prior U.S. Cls.: 100, 101 and 107

United States Patent and Trademark Office

Reg. No. 3,480,045

Registered Aug. 5, 2008

**SERVICE MARK
PRINCIPAL REGISTER**

**NATIONAL CAREGIVER
TRAINING PROGRAM**

HEALTH CARE TRAINING SYSTEMS, INC.
(OREGON CORPORATION)
1911 UNITED WAY
MEDFORD, OR 97504

FOR: EDUCATIONAL SERVICES, NAMELY, CONDUCTING SEMINARS AND LECTURES IN THE FIELD OF HEALTH CARE, AND DISTRIBUTING PRINTED MATERIALS, AUDIOTAPES, VIDEO TAPES, COMPACT DISKS, DIGITAL VIDEO DISKS AND RECORDED PROGRAMS IN CONNECTION THEREWITH; EDUCATIONAL SERVICES, NAMELY, CONDUCTING SEMINARS AND LECTURES IN THE FIELD OF HEALTH CARE VIA A GLOBAL COMPUTER NETWORK, AND DISTRIBUTING PRINTED MATERIALS, AUDIOTAPES, VIDEO TAPES, COMPACT DISKS, DIGITAL VIDEO DISKS AND RECORDED PROGRAMS IN CONNECTION THEREWITH, IN CLASS 41 (U.S. CLS. 100, 101 AND 107).

FIRST USE 8-1-1999; IN COMMERCE 8-1-1999.

THE MARK CONSISTS OF STANDARD CHARACTERS WITHOUT CLAIM TO ANY PARTICULAR FONT, STYLE, SIZE, OR COLOR.

OWNER OF U.S. REG. NO. 2,805,999.

NO CLAIM IS MADE TO THE EXCLUSIVE RIGHT TO USE "TRAINING PROGRAM", APART FROM THE MARK AS SHOWN.

SEC. 2(F) AS TO "NATIONAL CAREGIVER".

SER. NO. 77-357,881, FILED 12-21-2007.

SHAILA SETTLES, EXAMINING ATTORNEY

Int. Cl.: 9

Prior U.S. Cls.: 21, 23, 26, 36 and 38

Reg. No. 3,480,046

United States Patent and Trademark Office

Registered Aug. 5, 2008

**TRADEMARK
PRINCIPAL REGISTER**

KATSTAR

DALEYWARE.COM (NEVADA CORPORATION)
1501 TEN PALMS COURT
LAS VEGAS, NV 89117

CALENDARS, AND MEETINGS, IN CLASS 9 (U.S.
CLS. 21, 23, 26, 36 AND 38).

FIRST USE 6-1-2004; IN COMMERCE 6-1-2004.

FOR: COMPUTER SOFTWARE FOR USE IN
CUSTOMER ACQUISITION, RETENTION, AND RE-
LATIONSHIP MANAGEMENT TO CREATE, SCHE-
DULE, STORE AND TRACK INFORMATION
REGARDING, SALES, MARKETING, CALLS, PRO-
JECTS, COSTS, ACCOUNTING, PLANNING, BILL-
ING, PURCHASING, FORECASTING, REPORTS,

THE MARK CONSISTS OF THE WORD "KAT-
STAR" WITH A STAR IN PLACE OF THE SECOND
"A" IN "KATSTAR".

SER. NO. 77-357,936, FILED 12-21-2007.

PATRICIA EVANKO, EXAMINING ATTORNEY

Int. Cl.: 5

Prior U.S. Cls.: 6, 18, 44, 46, 51 and 52

United States Patent and Trademark Office

Reg. No. 3,480,047

Registered Aug. 5, 2008

**TRADEMARK
PRINCIPAL REGISTER**

STAYIN' ALIVE

NOURICHE NUTRITION LTD (MISSOURI CORPORATION)
21 NORMANDY DRIVE
LAKE ST. LOUIS, MO 63367

FIRST USE 10-1-2007; IN COMMERCE 10-15-2007.

FOR: ELECTROLYTE REPLACEMENT SOLUTIONS; NUTRITIONAL ADDITIVES FOR LIVESTOCK FEED FOR MEDICAL PURPOSES, IN CLASS 5 (U.S. CLS. 6, 18, 44, 46, 51 AND 52).

SER. NO. 77-357,945, FILED 12-21-2007.

JORDAN BAKER, EXAMINING ATTORNEY

Int. Cl.: 41

Prior U.S. Cls.: 100, 101 and 107

United States Patent and Trademark Office

Reg. No. 3,480,048

Registered Aug. 5, 2008

**SERVICE MARK
PRINCIPAL REGISTER**

ReGenesis

REGENESIS, INC. (KANSAS CORPORATION)
5413 FOXRIDGE, #203
MISSION, KS 66202

THE MARK CONSISTS OF STANDARD CHAR-
ACTERS WITHOUT CLAIM TO ANY PARTICULAR
FONT, STYLE, SIZE, OR COLOR.

FOR: LIFE COACHING IN THE FIELD OF PER-
SONAL DEVELOPMENT, IN CLASS 41 (U.S. CLS.
100, 101 AND 107).

SER. NO. 77-357,979, FILED 12-21-2007.

FIRST USE 1-7-2007; IN COMMERCE 1-7-2007.

VERNA BETH RIRIE, EXAMINING ATTORNEY

Int. Cl.: 41

Prior U.S. Cls.: 100, 101 and 107

United States Patent and Trademark Office

Reg. No. 3,480,049

Registered Aug. 5, 2008

**SERVICE MARK
PRINCIPAL REGISTER**

THE FOCUS COACHING SYSTEM

WORTHLEY, BRAD (UNITED STATES INDIVIDUAL)
#375
12819 SE 38TH ST.
BELLEVUE, WA 98006

FOR: PROVIDING AN ON-LINE COMPUTER DATABASE FOR TRAINERS, COACHES, CONSULTANTS, AND OTHERS IN THE FIELD OF PERSONAL AND PROFESSIONAL DEVELOPMENT, IN CLASS 41 (U.S. CLS. 100, 101 AND 107).

FIRST USE 8-0-2006; IN COMMERCE 8-0-2006.

THE MARK CONSISTS OF STANDARD CHARACTERS WITHOUT CLAIM TO ANY PARTICULAR FONT, STYLE, SIZE, OR COLOR.

NO CLAIM IS MADE TO THE EXCLUSIVE RIGHT TO USE "COACHING SYSTEM", APART FROM THE MARK AS SHOWN.

SER. NO. 77-358,023, FILED 12-21-2007.

MATTHEW MCDOWELL, EXAMINING ATTORNEY

Int. Cl.: 30

Prior U.S. Cl.: 46

United States Patent and Trademark Office

Reg. No. 3,480,050

Registered Aug. 5, 2008

TRADEMARK
PRINCIPAL REGISTER

Bubble Blast

BRAND NEW PRODUCTS, LLC (DELAWARE
LTD LIAB CO)
SUITE 280
2506 NORTH CLARK STREET
CHICAGO, IL 60614

FOR: BUBBLE GUM, CHEWING GUM, SUGAR-FREE CHEWING GUM, SUGARLESS CHEWING GUM, SUGAR-FREE BUBBLE GUM, SUGARLESS BUBBLE GUM, CHEWING GUM IN THE FORM OF TAPE, BUBBLE GUM IN THE FORM OF TAPE, SUGAR-FREE GUM IN THE FORM OF TAPE, SUGAR-FREE BUBBLE GUM IN THE FORM OF TAPE, SUGARLESS GUM IN THE FORM OF TAPE, SUGARLESS BUBBLE GUM IN THE FORM OF TAPE, IN CLASS 30 (U.S. CL. 46).

FIRST USE 7-16-2007; IN COMMERCE 7-16-2007.

NO CLAIM IS MADE TO THE EXCLUSIVE RIGHT TO USE "BUBBLE", APART FROM THE MARK AS SHOWN.

THE MARK CONSISTS OF THE WORDS "BUBBLE BLAST" THAT HAVE A FIRST, WHITE LAYER OF SHADOWING BEHIND THE LETTERS OF THE MARK AND A SECOND, BLACK LAYER OF SHADOWING BEHIND THE FIRST LAYER.

SER. NO. 77-358,030, FILED 12-21-2007.

KATHLEEN LORENZO, EXAMINING ATTORNEY

Int. Cl.: 35

Prior U.S. Cls.: 100, 101 and 102

United States Patent and Trademark Office

Reg. No. 3,480,051

Registered Aug. 5, 2008

**SERVICE MARK
PRINCIPAL REGISTER**

CARRIES KIDDIE CLOSET

HUGHES, CARRIE (UNITED STATES INDIVIDUAL)
189 CLUBHOUSE ROAD
BRICK, NJ 08723

FOR: ON-LINE STORE SPECIALIZING IN PERSONALIZED NOTE CARDS, STATIONERY, INVITATIONS, BIRTH ANNOUNCEMENTS, LABELS, PERSONALIZED CHORE CHARTS, CANDY WRAPPERS, GIFT CARDS AND NOTE PADS, IN CLASS 35 (U.S. CLS. 100, 101 AND 102).

FIRST USE 1-1-2002; IN COMMERCE 1-1-2002.

THE MARK CONSISTS OF STANDARD CHARACTERS WITHOUT CLAIM TO ANY PARTICULAR FONT, STYLE, SIZE, OR COLOR.

NO CLAIM IS MADE TO THE EXCLUSIVE RIGHT TO USE "KIDDIE", APART FROM THE MARK AS SHOWN.

SER. NO. 77-358,072, FILED 12-21-2007.

DOMINICK J. SALEMI, EXAMINING ATTORNEY

Int. Cl.: 45

Prior U.S. Cls.: 100 and 101

United States Patent and Trademark Office

Reg. No. 3,480,052

Registered Aug. 5, 2008

**SERVICE MARK
PRINCIPAL REGISTER**

White Paws Pet Sitting

WHITE, MELISSA A. (MINNESOTA SOLE PROPRIETORSHIP), DBA WHITE PAWS PET SITTING

14718 NATCHEZ PLACE
SAVAGE, MN 55378

FOR: PET SITTING, IN CLASS 45 (U.S. CLS. 100 AND 101).

FIRST USE 7-14-2007; IN COMMERCE 8-1-2007.

THE MARK CONSISTS OF STANDARD CHARACTERS WITHOUT CLAIM TO ANY PARTICULAR FONT, STYLE, SIZE, OR COLOR.

NO CLAIM IS MADE TO THE EXCLUSIVE RIGHT TO USE "PET SITTING", APART FROM THE MARK AS SHOWN.

SER. NO. 77-358,120, FILED 12-21-2007.

STEPHEN AQUILA, EXAMINING ATTORNEY

Int. Cl.: 37

Prior U.S. Cls.: 100, 103 and 106

United States Patent and Trademark Office

Reg. No. 3,480,053

Registered Aug. 5, 2008

**SERVICE MARK
PRINCIPAL REGISTER**

RELIABLE ELEVATOR

RELIABLE ELEVATOR, INC. (CALIFORNIA CORPORATION)
8245 RONSON ROAD, SUITE K
SAN DIEGO, CA 92111

FOR: INSTALLATION SERVICES OF ELEVATORS AND LIFTS; REPAIR OR MAINTENANCE OF ELEVATORS, IN CLASS 37 (U.S. CLS. 100, 103 AND 106).

FIRST USE 4-21-2007; IN COMMERCE 4-21-2007.

THE MARK CONSISTS OF STANDARD CHARACTERS WITHOUT CLAIM TO ANY PARTICULAR FONT, STYLE, SIZE, OR COLOR.

NO CLAIM IS MADE TO THE EXCLUSIVE RIGHT TO USE "ELEVATOR", APART FROM THE MARK AS SHOWN.

SER. NO. 77-358,184, FILED 12-21-2007.

KEVIN CORWIN, EXAMINING ATTORNEY

Int. Cl.: 35

Prior U.S. Cls.: 100, 101 and 102

United States Patent and Trademark Office

Reg. No. 3,480,054

Registered Aug. 5, 2008

**SERVICE MARK
PRINCIPAL REGISTER**



POP INTERNATIONAL GALLERIES, INC. (NEW
YORK CORPORATION)
473 WEST BROADWAY
NEW YORK, NY 10012

FOR: ART GALLERY SERVICES, IN CLASS 35
(U.S. CLS. 100, 101 AND 102).

FIRST USE 9-30-1997; IN COMMERCE 9-30-1997.

THE MARK CONSISTS OF THE WORD "POP!"
INSIDE OF A BUBBLE INSIDE OF A RECTANGLE.

SER. NO. 77-358,292, FILED 12-21-2007.

ROBIN MITTLER, EXAMINING ATTORNEY

Int. Cls.: 42 and 45

Prior U.S. Cls.: 100 and 101

United States Patent and Trademark Office

Reg. No. 3,480,055

Registered Aug. 5, 2008

**SERVICE MARK
PRINCIPAL REGISTER**

DEVICECONFIRM

IOVATION INC. (DELAWARE CORPORATION)
SUITE 3200
111 SW FIFTH AVENUE
PORTLAND, OR 97204

FOR: PROVIDING ONLINE NON-DOWNLOADABLE SOFTWARE FOR USE IN THE DETECTION AND PREVENTION OF ONLINE FRAUD, FOR CONTROLLING ONLINE ACCOUNT ACCESS, AND FOR DEVICE IDENTIFICATION AND AUTHENTICATION, IN CLASS 42 (U.S. CLS. 100 AND 101).

FIRST USE 4-1-2007; IN COMMERCE 4-1-2007.

FOR: IDENTIFICATION VERIFICATION SERVICES, NAMELY, PROVIDING AUTHENTICATION

OF ACCOUNT AND DEVICE INFORMATION; PROVIDING USER AND DEVICE AUTHENTICATION SERVICES FOR ONLINE ACCOUNT ACCESS AND E-COMMERCE TRANSACTIONS, IN CLASS 45 (U.S. CLS. 100 AND 101).

FIRST USE 4-1-2007; IN COMMERCE 4-1-2007.

THE MARK CONSISTS OF STANDARD CHARACTERS WITHOUT CLAIM TO ANY PARTICULAR FONT, STYLE, SIZE, OR COLOR.

SER. NO. 77-358,358, FILED 12-21-2007.

PETER B. BROMAGHIM, EXAMINING ATTORNEY

Int. Cl.: 34

Prior U.S. Cls.: 2, 8, 9 and 17

United States Patent and Trademark Office

Reg. No. 3,480,056

Registered Aug. 5, 2008

**TRADEMARK
PRINCIPAL REGISTER**

BLACK & MILD WINE

JMTM LLC (DELAWARE LTD LIAB CO)
1105 N. MARKET
WILMINGTON, DE 19899

FOR: CIGARS; PIPE TOBACCO, IN CLASS 34 (U.S.
CLS. 2, 8, 9 AND 17).

FIRST USE 8-4-2006; IN COMMERCE 8-4-2006.

THE MARK CONSISTS OF STANDARD CHAR-
ACTERS WITHOUT CLAIM TO ANY PARTICULAR
FONT, STYLE, SIZE, OR COLOR.

OWNER OF U.S. REG. NOS. 1,177,552, 3,095,386
AND OTHERS.

NO CLAIM IS MADE TO THE EXCLUSIVE
RIGHT TO USE "WINE", APART FROM THE MARK
AS SHOWN.

SEC. 2(F) AS TO "BLACK & MILD".

SER. NO. 77-358,448, FILED 12-21-2007.

TRACY WHITTAKER-BROWN, EXAMINING AT-
TORNEY

Int. Cls.: 16, 35 and 41

**Prior U.S. Cls.: 2, 5, 22, 23, 29, 37, 38, 50, 100, 101, 102
and 107**

Reg. No. 3,480,057

United States Patent and Trademark Office

Registered Aug. 5, 2008

**TRADEMARK
SERVICE MARK
PRINCIPAL REGISTER**

ASN

AMERICAN SOCIETY FOR NUTRITION (MARY-
LAND CORPORATION)
9650 ROCKVILLE PIKE
BETHESDA, MD 208143990

FOR: PRINTED PUBLICATIONS, NAMELY,
JOURNALS, NEWSLETTERS AND BROCHURES
IN THE FIELD OF NUTRITION, NUTRITION RE-
SEARCH AND SOCIETY AFFAIRS, IN CLASS 16
(U.S. CLS. 2, 5, 22, 23, 29, 37, 38 AND 50).

FIRST USE 10-0-2005; IN COMMERCE 10-0-2005.

FOR: ASSOCIATION SERVICES, NAMELY, PRO-
MOTING THE INTERESTS OF NUTRITION PRO-
FESSIONALS AND THE FIELD OF NUTRITION, IN
CLASS 35 (U.S. CLS. 100, 101 AND 102).

FIRST USE 7-1-2005; IN COMMERCE 7-1-2005.

FOR: EDUCATIONAL SERVICES, NAMELY,
CONDUCTING SYMPOSIA, WORKSHOPS AND
SEMINARS IN THE FIELD OF NUTRITION AND
PROVIDING ONLINE PUBLICATIONS IN THE
NATURE OF JOURNALS, NEWSLETTERS AND
BROCHURES IN THE FIELD OF NUTRITION,
NUTRITION RESEARCH AND SOCIETY AFFAIRS,
IN CLASS 41 (U.S. CLS. 100, 101 AND 107).

FIRST USE 10-0-2005; IN COMMERCE 10-0-2005.

THE MARK CONSISTS OF STANDARD CHAR-
ACTERS WITHOUT CLAIM TO ANY PARTICULAR
FONT, STYLE, SIZE, OR COLOR.

SER. NO. 77-358,449, FILED 12-21-2007.

JAY BESCH, EXAMINING ATTORNEY

Int. Cl.: 41

Prior U.S. Cls.: 100, 101 and 107

United States Patent and Trademark Office

Reg. No. 3,480,058

Registered Aug. 5, 2008

**SERVICE MARK
PRINCIPAL REGISTER**

IMPACT BASEBALL, INC.

IMPACT BASEBALL, INC. (NORTH CAROLINA
CORPORATION)
P.O. BOX 47
SEDALIA, NC 27342

FOR: BASEBALL SCOUTING SERVICE THAT
ARRANGES AND CONDUCTS BASEBALL CAMPS
AND TOURNAMENTS, IN CLASS 41 (U.S. CLS. 100,
101 AND 107).

FIRST USE 9-0-2001; IN COMMERCE 10-0-2001.

THE MARK CONSISTS OF STANDARD CHAR-
ACTERS WITHOUT CLAIM TO ANY PARTICULAR
FONT, STYLE, SIZE, OR COLOR.

NO CLAIM IS MADE TO THE EXCLUSIVE
RIGHT TO USE "BASEBALL, INC.", APART FROM
THE MARK AS SHOWN.

SER. NO. 77-358,545, FILED 12-21-2007.

DANNAN HETZEL, EXAMINING ATTORNEY

Int. Cl.: 9

Prior U.S. Cls.: 21, 23, 26, 36 and 38

Reg. No. 3,480,059

United States Patent and Trademark Office

Registered Aug. 5, 2008

**TRADEMARK
PRINCIPAL REGISTER**

SCS750

MAXWELL TECHNOLOGIES, INC. (DELAWARE
CORPORATION)
9244 BALBOA AVENUE
SAN DIEGO, CA 92123

FOR: COMPUTERS; COMPUTERS, NAMELY,
SINGLE BOARD COMPUTERS FOR EXTREME
ENVIRONMENTS; COMPUTER HARDWARE;
COMPUTER HARDWARE, NAMELY, COMPACT
PERIPHERAL COMPONENT INTERCONNECT
BOARDS; DIGITAL SIGNAL PROCESSORS; SATEL-
LITE PROCESSORS; SYSTEM BOARDS (MOTHER
CARDS) AND PROCESSORS; COMPUTER FIRM-
WARE, NAMELY, BOOT CODE FOR RESYNCHRO-

NIZATION, ERROR DETECTION AND
CORRECTION, AND REDUNDANCY CONTROL,
IN CLASS 9 (U.S. CLS. 21, 23, 26, 36 AND 38).

FIRST USE 9-30-2002; IN COMMERCE 6-4-2004.

THE MARK CONSISTS OF STANDARD CHAR-
ACTERS WITHOUT CLAIM TO ANY PARTICULAR
FONT, STYLE, SIZE, OR COLOR.

SER. NO. 77-358,574, FILED 12-21-2007.

SANJEEV VOHRA, EXAMINING ATTORNEY

Int. Cl.: 42

Prior U.S. Cls.: 100 and 101

United States Patent and Trademark Office

Reg. No. 3,480,060

Registered Aug. 5, 2008

**SERVICE MARK
PRINCIPAL REGISTER**

SAINT JOE

SAINT JOE, INC. (COLORADO CORPORATION)
6790 NORTH FRANKLIN
LOVELAND, CO 80538

FOR: COMPUTER SERVICES, NAMELY, PROVIDING AN ONLINE NON-DOWNLOADABLE TECHNOLOGY FOR USE BY OTHERS TO STORE AND SHARE INFORMATION ABOUT THE DESIGN AND FABRICATION OF STRUCTURAL STEEL BUILDING COMPONENTS, IN CLASS 42 (U.S. CLS. 100 AND 101).

FIRST USE 5-1-2007; IN COMMERCE 5-1-2007.

THE MARK CONSISTS OF STANDARD CHARACTERS WITHOUT CLAIM TO ANY PARTICULAR FONT, STYLE, SIZE, OR COLOR.

SER. NO. 77-358,603, FILED 12-21-2007.

KATHRYN COWARD, EXAMINING ATTORNEY

Int. Cl.: 3

Prior U.S. Cls.: 1, 4, 6, 50, 51 and 52

Reg. No. 3,480,061

United States Patent and Trademark Office

Registered Aug. 5, 2008

**TRADEMARK
PRINCIPAL REGISTER**

Antiox MD

GIANNULLI, THOMAS C. (UNITED STATES IN-
DIVIDUAL)
4838 WESTWOOD ST
SIMI VALLEY, CA 93063

FOR: ANTI-AGING CREAM; COSMETIC
CREAMS FOR SKIN CARE, IN CLASS 3 (U.S. CLS.
1, 4, 6, 50, 51 AND 52).

FIRST USE 11-1-2007; IN COMMERCE 11-1-2007.

THE MARK CONSISTS OF STANDARD CHAR-
ACTERS WITHOUT CLAIM TO ANY PARTICULAR
FONT, STYLE, SIZE, OR COLOR.

NO CLAIM IS MADE TO THE EXCLUSIVE
RIGHT TO USE "MD", APART FROM THE MARK
AS SHOWN.

SER. NO. 77-358,649, FILED 12-21-2007.

SARA THOMAS, EXAMINING ATTORNEY

Int. Cl.: 41

Prior U.S. Cls.: 100, 101 and 107

United States Patent and Trademark Office

Reg. No. 3,480,062

Registered Aug. 5, 2008

**SERVICE MARK
PRINCIPAL REGISTER**

LAS VOCES DEL BAJIO

VASQUEZ, JOSE LUCIO (EL SALVADOR INDIVIDUAL)
P.O. BOX 351734
LOS ANGELES, CA 90035 AND
CRUZ CRUZ, JOSE LUIS (MEXICO INDIVIDUAL)
P.O. BOX 351734
LOS ANGELES, CA 90035

FOR: ENTERTAINMENT IN THE NATURE OF LIVE PERFORMANCES BY MUSICAL GROUP; ENTERTAINMENT, NAMELY, LIVE MUSIC CONCERTS, IN CLASS 41 (U.S. CLS. 100, 101 AND 107).

FIRST USE 1-20-1992; IN COMMERCE 1-20-1992.

THE MARK CONSISTS OF STANDARD CHARACTERS WITHOUT CLAIM TO ANY PARTICULAR FONT, STYLE, SIZE, OR COLOR.

NO CLAIM IS MADE TO THE EXCLUSIVE RIGHT TO USE "VOCES", APART FROM THE MARK AS SHOWN.

THE FOREIGN WORDING IN THE MARK TRANSLATES INTO ENGLISH AS VOICES OF THE LOWLANDS.

SER. NO. 77-358,692, FILED 12-21-2007.

RONALD MCMORROW, EXAMINING ATTORNEY

Int. Cl.: 25

Prior U.S. Cls.: 22 and 39

United States Patent and Trademark Office

Reg. No. 3,480,063

Registered Aug. 5, 2008

**TRADEMARK
PRINCIPAL REGISTER**



**K-CLAW, INC. (TEXAS CORPORATION)
#3310
777 DUNLAVY STREET
HOUSTON, TX 77019**

**THE MARK CONSISTS OF THE LETTERS "K-
CLAW" AND A STYLIZED "K" WITH A CAT'S
HEAD AS A PART OF THE LETTER.**

**FOR: CLOTHING, NAMELY, SHIRTS, T-SHIRTS,
SHORTS, SKIRTS, SKORTS, PANTS, TANK TOPS
AND JACKETS, IN CLASS 25 (U.S. CLS. 22 AND 39).**

SER. NO. 77-358,826, FILED 12-22-2007.

FIRST USE 6-16-2006; IN COMMERCE 6-16-2006.

JEFFERY COWARD, EXAMINING ATTORNEY

Int. Cl.: 41

Prior U.S. Cls.: 100, 101 and 107

United States Patent and Trademark Office

Reg. No. 3,480,064

Registered Aug. 5, 2008

**SERVICE MARK
PRINCIPAL REGISTER**

POWERSHIFT

SUCCESS NRG INC. (FLORIDA CORPORATION)
SUITE 1139 PMB 125
1133 BAL HARBOR BLVD
PUNTA GORDA, FL 33950

THE MARK CONSISTS OF STANDARD CHAR-
ACTERS WITHOUT CLAIM TO ANY PARTICULAR
FONT, STYLE, SIZE, OR COLOR.

FOR: LIFE COACHING SERVICES IN THE FIELD
OF SELF DEVELOPMENT, IN CLASS 41 (U.S. CLS.
100, 101 AND 107).

SER. NO. 77-358,829, FILED 12-22-2007.

FIRST USE 3-1-1998; IN COMMERCE 3-1-1998.

BRIAN PINO, EXAMINING ATTORNEY

Int. Cl.: 42

Prior U.S. Cls.: 100 and 101

United States Patent and Trademark Office

Reg. No. 3,480,065

Registered Aug. 5, 2008

**SERVICE MARK
PRINCIPAL REGISTER**



SCHOOLSYSTEMS, LLC (IOWA LTD LIAB CO)
5823 WELLS LN
CEDAR RAPIDS, IA 52411

FOR: COMPUTER PROGRAMMING AND SOFTWARE DESIGN; COMPUTER SOFTWARE DESIGN; COMPUTER SOFTWARE DEVELOPMENT; DESIGN AND DEVELOPMENT OF ON-LINE COMPUTER SOFTWARE SYSTEMS; DESIGN OF HOME PAGES, COMPUTER SOFTWARE AND WEB SITES; DESIGN, DEVELOPMENT AND IMPLEMENTATION OF SOFTWARE; DEVELOPING COMPUTER SOFTWARE; SOFTWARE DESIGN AND DEVELOPMENT, IN CLASS 42 (U.S. CLS. 100 AND 101).

FIRST USE 11-19-2007; IN COMMERCE 11-25-2007.

NO CLAIM IS MADE TO THE EXCLUSIVE RIGHT TO USE SYSTEMS LLC, APART FROM THE MARK AS SHOWN.

THE COLOR(S) BLACK AND RED IS/ARE CLAIMED AS A FEATURE OF THE MARK.

THE MARK CONSISTS OF SCHOOL SYSTEMS WITH TWO RED APPLES IN PLACE OF THE LETTERS O IN SCHOOL..

SER. NO. 77-358,929, FILED 12-23-2007.

C. DIONNE CLYBURN, EXAMINING ATTORNEY

Int. Cl.: 36

Prior U.S. Cls.: 100, 101 and 102

United States Patent and Trademark Office

Reg. No. 3,480,066

Registered Aug. 5, 2008

**SERVICE MARK
PRINCIPAL REGISTER**

**RETURNING VALUE TO OUR
CREDIT DRIVEN ECONOMY**

ASSET ACCEPTANCE LLC (DELAWARE LTD
LIAB CO)
28405 VAN DYKE
WARREN, MI 48093

THE MARK CONSISTS OF STANDARD CHAR-
ACTERS WITHOUT CLAIM TO ANY PARTICULAR
FONT, STYLE, SIZE, OR COLOR.

FOR: DEBT ACQUISITION, RECOVERY AND
COLLECTION SERVICES, IN CLASS 36 (U.S. CLS.
100, 101 AND 102).

SER. NO. 77-358,938, FILED 12-23-2007.

FIRST USE 6-25-2007; IN COMMERCE 6-25-2007.

JOHN KELLY, EXAMINING ATTORNEY

Int. Cl.: 9

Prior U.S. Cls.: 21, 23, 26, 36 and 38

United States Patent and Trademark Office

Reg. No. 3,480,067

Registered Aug. 5, 2008

TRADEMARK
PRINCIPAL REGISTER

Di Vittore

STEMICK OPTICAL INC. (CALIFORNIA CORPORATION)
5008 COLLIS AVENUE
SOUTH PASADENA, CA 91030

FOR: EYEGLASS CASES; OPTICAL FRAMES, IN CLASS 9 (U.S. CLS. 21, 23, 26, 36 AND 38).

FIRST USE 12-6-2007; IN COMMERCE 12-6-2007.

THE MARK CONSISTS OF THE WORDS "DI VITTORE".

THE FOREIGN WORDING IN THE MARK TRANSLATES INTO ENGLISH AS OF THE VICTOR.

SER. NO. 77-358,947, FILED 12-23-2007.

DAVID I, EXAMINING ATTORNEY

Int. Cls.: 9, 28 and 42

Prior U.S. Cls.: 21, 22, 23, 26, 36, 38, 50, 100 and 101

Reg. No. 3,480,068

United States Patent and Trademark Office

Registered Aug. 5, 2008

**TRADEMARK
SERVICE MARK
PRINCIPAL REGISTER**

Pipeworks

BACKBONE ENTERTAINMENT (CALIFORNIA CORPORATION)
SUITE 100
17600 GILLETTE AVENUE
IRVINE, CA 92614

FOR: HOME VIDEO GAME SOFTWARE AND RELATED PRODUCTS, NAMELY, VIDEO GAME CARTRIDGES, CD-ROM DISCS FEATURING VIDEO GAME PROGRAMS AND VIDEO GAME INSTRUCTION MANUALS ALL SOLD AS A UNIT THEREWITH; ELECTRONIC GAMES AND PLAYTHINGS, NAMELY, VIDEO GAME MACHINES FOR USE WITH EXTERNAL DISPLAY SCREEN OR MONITOR, PORTABLE VIDEO-GAME MACHINES FOR USE WITH EXTERNAL DISPLAY SCREEN OR MONITOR; VIDEO GAME SOFTWARE STORED ON VARIOUS MEDIA FOR USE IN CONNECTION WITH HOME COMPUTERS, CONSOLE GAME MACHINES USED IN CONJUNCTION WITH TELEVISION SETS; COMPUTER SOFTWARE FOR VIDEO GAMES THAT MAY BE DOWNLOADED FROM A GLOBAL COMPUTER NETWORK; AND ELECTRONIC GAME SOFTWARE USED IN CONNECTION WITH CELLULAR OR MOBILE TELEPHONES, IN CLASS 9 (U.S. CLS. 21, 23, 26, 36 AND 38).

FIRST USE 10-27-1999; IN COMMERCE 10-27-1999.

FOR: ELECTRONIC GAMES AND PLAYTHINGS, NAMELY, STAND ALONE VIDEO GAME MACHINES, PORTABLE VIDEO-GAME MACHINES IN THE NATURE OF HAND HELD UNITS FOR PLAYING ELECTRONIC GAMES, IN CLASS 28 (U.S. CLS. 22, 23, 38 AND 50).

FIRST USE 10-27-1999; IN COMMERCE 10-27-1999.

FOR: DESIGN, DEVELOPMENT AND MAINTENANCE OF COMPUTER SOFTWARE FOR OTHERS, NAMELY, DEVELOPMENT OF COMPUTER GAMES SOFTWARE FOR PERSONAL COMPUTERS AND TELEVISION GAME CONSOLES, IN CLASS 42 (U.S. CLS. 100 AND 101).

FIRST USE 10-27-1999; IN COMMERCE 10-27-1999.

THE MARK CONSISTS OF STANDARD CHARACTERS WITHOUT CLAIM TO ANY PARTICULAR FONT, STYLE, SIZE, OR COLOR.

SER. NO. 77-358,953, FILED 12-23-2007.

KAELIE KUNG, EXAMINING ATTORNEY

Int. Cls.: 9, 28 and 42

Prior U.S. Cls.: 21, 22, 23, 26, 36, 38, 50, 100 and 101

United States Patent and Trademark Office

Reg. No. 3,480,069

Registered Aug. 5, 2008

**TRADEMARK
SERVICE MARK
PRINCIPAL REGISTER**



BACKBONE ENTERTAINMENT (CALIFORNIA CORPORATION)
SUITE 100
17600 GILLETTE AVENUE
IRVINE, CA 92614

FOR: HOME VIDEO GAME SOFTWARE AND RELATED PRODUCTS, NAMELY, VIDEO GAME CARTRIDGES, CD-ROM DISCS FEATURING VIDEO GAME PROGRAMS AND VIDEO GAME INSTRUCTION MANUALS ALL SOLD AS A UNIT THEREWITH; ELECTRONIC GAMES AND PLAYTHINGS, NAMELY, VIDEO GAME MACHINES FOR USE WITH EXTERNAL DISPLAY SCREEN OR MONITOR, PORTABLE VIDEO-GAME MACHINES FOR USE WITH EXTERNAL DISPLAY SCREEN OR MONITOR; VIDEO GAME SOFTWARE STORED ON VARIOUS MEDIA FOR USE IN CONNECTION WITH HOME COMPUTERS, CONSOLE GAME MACHINES USED IN CONJUNCTION WITH TELEVISION SETS; COMPUTER SOFTWARE FOR VIDEO GAMES THAT MAY BE DOWNLOADED FROM A GLOBAL COMPUTER NETWORK; AND ELECTRONIC GAME SOFTWARE USED IN CONNECTION WITH CELLULAR OR MOBILE TELEPHONES, IN CLASS 9 (U.S. CLS. 21, 23, 26, 36 AND 38).

FIRST USE 1-15-2007; IN COMMERCE 1-15-2007.

FOR: ELECTRONIC GAMES AND PLAYTHINGS, NAMELY, STAND ALONE VIDEO GAME MA-

CHINES, PORTABLE VIDEO-GAME MACHINES IN THE NATURE OF HAND HELD UNITS FOR PLAYING ELECTRONIC GAMES, IN CLASS 28 (U.S. CLS. 22, 23, 38 AND 50).

FIRST USE 1-15-2007; IN COMMERCE 1-15-2007.

FOR: DESIGN, DEVELOPMENT AND MAINTENANCE OF COMPUTER SOFTWARE FOR OTHERS, NAMELY, DEVELOPMENT OF COMPUTER GAMES SOFTWARE FOR PERSONAL COMPUTERS AND TELEVISION GAME CONSOLES, IN CLASS 42 (U.S. CLS. 100 AND 101).

FIRST USE 1-15-2007; IN COMMERCE 1-15-2007.

THE COLOR(S) BROWN, COPPER, ORANGE, YELLOW AND WHITE IS/ARE CLAIMED AS A FEATURE OF THE MARK.

THE MARK CONSISTS OF THE WORD "PIPEWORKS" AND A COMET TAIL ENCIRCLING THE LETTER "P", UPRIGHT, AND THE LETTER "S", TURNED ON ITS SIDE. THE COLORS BROWN, COPPER, ORANGE, YELLOW AND WHITE APPEAR IN VARIOUS GRADATIONS ON THE WORDING "PIPEWORKS PS" AND THE CURVED DESIGN ELEMENT.

SER. NO. 77-358,954, FILED 12-23-2007.

KAELIE KUNG, EXAMINING ATTORNEY

Int. Cl.: 35

Prior U.S. Cls.: 100, 101 and 102

United States Patent and Trademark Office

Reg. No. 3,480,070

Registered Aug. 5, 2008

**SERVICE MARK
PRINCIPAL REGISTER**

NORTH AMERICAN TUNING

ROMAIN, NICOLAS G (UNITED STATES INDIVIDUAL), DBA NORTH AMERICAN TUNING
7617 NW 25TH ST
MARGATE, FL 33063

FOR: RETAIL STORES, MAIL ORDER AND INTERNET CATALOGS, AND DISTRIBUTORSHIP SERVICES IN THE FIELD OF AUTOMOBILES AND AUTOMOTIVE PRODUCTS, CLOTHING AND ACCESSORIES, IN CLASS 35 (U.S. CLS. 100, 101 AND 102).

FIRST USE 7-1-2006; IN COMMERCE 7-1-2006.

THE MARK CONSISTS OF STANDARD CHARACTERS WITHOUT CLAIM TO ANY PARTICULAR FONT, STYLE, SIZE, OR COLOR.

NO CLAIM IS MADE TO THE EXCLUSIVE RIGHT TO USE "NORTH AMERICAN", APART FROM THE MARK AS SHOWN.

SER. NO. 77-359,034, FILED 12-24-2007.

KARANENDRA S. CHHINA, EXAMINING ATTORNEY

Int. Cl.: 9

Prior U.S. Cls.: 21, 23, 26, 36 and 38

Reg. No. 3,480,071

United States Patent and Trademark Office

Registered Aug. 5, 2008

**TRADEMARK
PRINCIPAL REGISTER**

FARENHEIT

EPSILON ELECTRONICS, INC. (CALIFORNIA
CORPORATION)
1550 SOUTH MAPLE AVENUE
MONTEBELLO, CA 90640

FOR: CAR NAVIGATION COMPUTERS; SATEL-
LITE NAVIGATIONAL SYSTEM, NAMELY, A GLO-
BAL POSITIONING SYSTEM (GPS), IN CLASS 9 (U.S.
CLS. 21, 23, 26, 36 AND 38).

FIRST USE 0-0-2005; IN COMMERCE 0-0-2005.

THE MARK CONSISTS OF STANDARD CHAR-
ACTERS WITHOUT CLAIM TO ANY PARTICULAR
FONT, STYLE, SIZE, OR COLOR.

OWNER OF U.S. REG. NOS. 2,528,491 AND
2,623,662.

SER. NO. 77-359,063, FILED 12-24-2007.

ELLEN BURNS, EXAMINING ATTORNEY

Int. Cl.: 9

Prior U.S. Cls.: 21, 23, 26, 36 and 38

Reg. No. 3,480,072

United States Patent and Trademark Office

Registered Aug. 5, 2008

**TRADEMARK
PRINCIPAL REGISTER**

Power Acoustik

EPSILON ELECTRONICS, INC. (CALIFORNIA CORPORATION)
1550 SOUTH MAPLE AVENUE
MONTEBELLO, CA 90640

FOR: CAR NAVIGATION COMPUTERS; SATELLITE NAVIGATIONAL SYSTEM, NAMELY, A GLOBAL POSITIONING SYSTEM (GPS), IN CLASS 9 (U.S. CLS. 21, 23, 26, 36 AND 38).

FIRST USE 0-0-2005; IN COMMERCE 0-0-2005.

THE MARK CONSISTS OF STANDARD CHARACTERS WITHOUT CLAIM TO ANY PARTICULAR FONT, STYLE, SIZE, OR COLOR.

OWNER OF U.S. REG. NO. 1,706,347.

SER. NO. 77-359,065, FILED 12-24-2007.

ELLEN BURNS, EXAMINING ATTORNEY

Int. Cl.: 35

Prior U.S. Cls.: 100, 101 and 102

United States Patent and Trademark Office

Reg. No. 3,480,073

Registered Aug. 5, 2008

**SERVICE MARK
PRINCIPAL REGISTER**

Trend Agitator

THE SKYLINE STUDIOS, INC. (CALIFORNIA CORPORATION), DBA THE SKYLINE STUDIOS
6709 COLGATE AVENUE
LOS ANGELES, CA 90048

FOR: BUSINESS CONSULTING AND INFORMATION SERVICES, IN CLASS 35 (U.S. CLS. 100, 101 AND 102).

FIRST USE 1-1-2006; IN COMMERCE 1-1-2006.

THE MARK CONSISTS OF STANDARD CHARACTERS WITHOUT CLAIM TO ANY PARTICULAR FONT, STYLE, SIZE, OR COLOR.

NO CLAIM IS MADE TO THE EXCLUSIVE RIGHT TO USE "TREND", APART FROM THE MARK AS SHOWN.

SER. NO. 77-359,069, FILED 12-24-2007.

BARBARA BROWN, EXAMINING ATTORNEY

Int. Cl.: 41

Prior U.S. Cls.: 100, 101 and 107

United States Patent and Trademark Office

Reg. No. 3,480,074

Registered Aug. 5, 2008

**SERVICE MARK
PRINCIPAL REGISTER**

NEON CHEF

LEASE-TECH GROUP, INC (NEVADA CORPORATION)
6840 ELM CREEK DRIVE
SUITE 204
LAS VEGAS, NV 891085042

FOR: ENTERTAINMENT AND EDUCATIONAL SERVICES, NAMELY, AN ONGOING AUDIO AND VISUAL PROGRAM DISTRIBUTED OVER TELEVISION, SATELLITE, WIRELESS, AUDIO AND VIDEO MEDIA, FIBER OPTICS, CABLE, AND A GLOBAL COMPUTER NETWORK IN THE FIELDS OF COOKING AND CULINARY ARTS, IN CLASS 41 (U.S. CLS. 100, 101 AND 107).

FIRST USE 8-31-2004; IN COMMERCE 8-31-2004.

THE MARK CONSISTS OF STANDARD CHARACTERS WITHOUT CLAIM TO ANY PARTICULAR FONT, STYLE, SIZE, OR COLOR.

NO CLAIM IS MADE TO THE EXCLUSIVE RIGHT TO USE "CHEF", APART FROM THE MARK AS SHOWN.

SER. NO. 77-359,145, FILED 12-25-2007.

SUSAN STIGLITZ, EXAMINING ATTORNEY

Int. Cl.: 39

Prior U.S. Cls.: 100 and 105

United States Patent and Trademark Office

Reg. No. 3,480,075

Registered Aug. 5, 2008

**SERVICE MARK
PRINCIPAL REGISTER**

Travelers Digest

TRAVELERS DIGEST (HONG KONG PARTNER-
SHIP)

24F ENTERTAINMENT BLDG. 30 QUEENS ROAD.

CENTRAL, HONG KONG

FOR: PROVIDING AN ON-LINE COMPUTER
DATABASE IN THE FIELD OF TRAVEL INFORMA-
TION SERVICES, IN CLASS 39 (U.S. CLS. 100 AND
105).

FIRST USE 12-6-2000; IN COMMERCE 12-6-2000.

THE MARK CONSISTS OF STANDARD CHAR-
ACTERS WITHOUT CLAIM TO ANY PARTICULAR
FONT, STYLE, SIZE, OR COLOR.

NO CLAIM IS MADE TO THE EXCLUSIVE
RIGHT TO USE "DIGEST", APART FROM THE
MARK AS SHOWN.

SEC. 2(F).

SER. NO. 77-359,207, FILED 12-26-2007.

ELI HELLMAN, EXAMINING ATTORNEY

Int. Cl.: 19

Prior U.S. Cls.: 1, 12, 33 and 50

United States Patent and Trademark Office

Reg. No. 3,480,076

Registered Aug. 5, 2008

**TRADEMARK
PRINCIPAL REGISTER**

UNIQUE

UNIQUE PAVING MATERIALS CORPORATION
(OHIO CORPORATION)
3993 E. 93RD STREET
CLEVELAND, OH 44105

FOR: ASPHALT, IN CLASS 19 (U.S. CLS. 1, 12, 33
AND 50).

FIRST USE 11-30-1971; IN COMMERCE 11-30-1971.

THE MARK CONSISTS OF STANDARD CHAR-
ACTERS WITHOUT CLAIM TO ANY PARTICULAR
FONT, STYLE, SIZE, OR COLOR.

OWNER OF U.S. REG. NO. 1,081,729.

SER. NO. 77-359,239, FILED 12-26-2007.

MATTHEW MCDOWELL, EXAMINING ATTOR-
NEY

Int. Cls.: 35 and 41

Prior U.S. Cls.: 100, 101, 102 and 107

United States Patent and Trademark Office

Reg. No. 3,480,077

Registered Aug. 5, 2008

**SERVICE MARK
PRINCIPAL REGISTER**

CITIZEN RAIN

KING BROADCASTING COMPANY (WASHINGTON CORPORATION)
333 DEXTER AVENUE NORTH
P.O. BOX 24525
SEATTLE, WA 98124

FOR: ADVERTISING, PROMOTING, AND MARKETING THE GOODS AND SERVICES OF OTHERS VIA ELECTRONIC MEDIA, THE INTERNET OR OTHER COMMUNICATIONS NETWORKS, IN CLASS 35 (U.S. CLS. 100, 101 AND 102).

FIRST USE 5-15-2006; IN COMMERCE 5-15-2006.

FOR: ENTERTAINMENT SERVICES, NAMELY, PROVIDING A WEBSITE FEATURING AUDIO,

VIDEO, TEXT, PHOTOGRAPHS, AND OTHER CONTENT AND MATERIALS IN THE FIELDS OF NEWS, SPORTS AND ENTERTAINMENT, IN CLASS 41 (U.S. CLS. 100, 101 AND 107).

FIRST USE 5-15-2006; IN COMMERCE 5-15-2006.

THE MARK CONSISTS OF STANDARD CHARACTERS WITHOUT CLAIM TO ANY PARTICULAR FONT, STYLE, SIZE, OR COLOR.

SER. NO. 77-359,242, FILED 12-26-2007.

DAVID I, EXAMINING ATTORNEY

Int. Cl.: 41

Prior U.S. Cls.: 100, 101 and 107

United States Patent and Trademark Office

Reg. No. 3,480,078

Registered Aug. 5, 2008

**SERVICE MARK
PRINCIPAL REGISTER**

Outlaw Photography

DITTMAN III, WILLIAM (UNITED STATES IN-
DIVIDUAL)

#26

26 STONEHEIGHTS DRIVE
WATERFORD, CT 06385

FOR: PHOTOGRAPHY SERVICES, IN CLASS 41
(U.S. CLS. 100, 101 AND 107).

FIRST USE 11-2-1989; IN COMMERCE 11-2-1989.

THE MARK CONSISTS OF STANDARD CHAR-
ACTERS WITHOUT CLAIM TO ANY PARTICULAR
FONT, STYLE, SIZE, OR COLOR.

NO CLAIM IS MADE TO THE EXCLUSIVE
RIGHT TO USE "PHOTOGRAPHY", APART FROM
THE MARK AS SHOWN.

SER. NO. 77-359,250, FILED 12-26-2007.

JENNIFER VASQUEZ, EXAMINING ATTORNEY

Int. Cl.: 35

Prior U.S. Cls.: 100, 101 and 102

United States Patent and Trademark Office

Reg. No. 3,480,079

Registered Aug. 5, 2008

**SERVICE MARK
PRINCIPAL REGISTER**

Squidbid

APPRECIATING ASSETS, LLC (GEORGIA LTD
LIAB CO)
3960 TIMBERBROOK LANE
MARIETTA, GA 30066

THE MARK CONSISTS OF STANDARD CHAR-
ACTERS WITHOUT CLAIM TO ANY PARTICULAR
FONT, STYLE, SIZE, OR COLOR.

FOR: ONLINE DEMAND DRIVEN MARKET-
PLACE ENGAGING IN FORWARD AND REVERSE
AUCTION FORMATS, IN CLASS 35 (U.S. CLS. 100,
101 AND 102).

SER. NO. 77-359,286, FILED 12-26-2007.

FIRST USE 9-1-2007; IN COMMERCE 9-1-2007.

CAROLINE WOOD, EXAMINING ATTORNEY

Int. Cl.: 41

Prior U.S. Cls.: 100, 101 and 107

United States Patent and Trademark Office

Reg. No. 3,480,080

Registered Aug. 5, 2008

SERVICE MARK
PRINCIPAL REGISTER

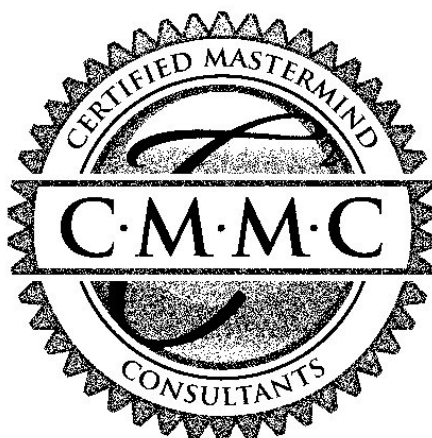

INCREASE GLOBAL NETWORK INC (TENNESSEE CORPORATION)
2400 CRESTMOOR RD #36
NASHVILLE, TN 37215

FOR: EDUCATION SERVICES, NAMELY, PROVIDING LIVE AND ON-LINE CLASSES, SEMINARS AND WORKSHOPS IN THE FIELD OF HUMAN POTENTIAL AND DISTRIBUTION OF COURSE MATERIAL IN CONNECTION THEREWITH, IN CLASS 41 (U.S. CLS. 100, 101 AND 107).

FIRST USE 10-29-2007; IN COMMERCE 11-2-2007.

NO CLAIM IS MADE TO THE EXCLUSIVE RIGHT TO USE "CERTIFIED MASTERMIND CONSULTANTS", APART FROM THE MARK AS SHOWN.

THE STIPPLING IS FOR SHADING PURPOSES ONLY.

THE MARK CONSISTS OF A MEDALLION WITH CONCENTRIC CIRCLES. GEARS APPEAR ON THE OUTER EDGES OF THE OUTSIDE CIRCLE. BETWEEN THE CIRCLES APPEAR THE WORDS "CERTIFIED MASTERMIND" AT THE TOP AND THE WORD "CONSULTANTS" AT THE BOTTOM. INSIDE THE INNER CIRCLE APPEARS THE LETTER "C". ON TOP AND IN THE MIDDLE OF THE MARK FROM ONE SIDE TO THE OTHER APPEARS A RECTANGLE WITH THE LETTERS "CMMC" AND DOTS BETWEEN EACH OF THE LETTERS.

SER. NO. 77-359,304, FILED 12-26-2007.

MICHAEL WIENER, EXAMINING ATTORNEY

Int. Cl.: 41

Prior U.S. Cls.: 100, 101 and 107

United States Patent and Trademark Office

Reg. No. 3,480,081

Registered Aug. 5, 2008

**SERVICE MARK
PRINCIPAL REGISTER**



PLATEMATE.BIZ (FLORIDA CORPORATION),
DBA PLATEMATE STUDIOS, INC.
1396 THE POINTE DRIVE
WEST PALM BEACH, FL 33409

FIRST USE 1-22-2002; IN COMMERCE 1-22-2002.

FOR: EDUCATIONAL SERVICES, NAMELY,
PROVIDING CLASSES, SEMINARS, AND WORK-
SHOPS IN THE FIELD OF DIET; ENTERTAIN-
MENT, NAMELY, PRODUCTION OF TELEVISION
SHOWS; PRODUCTION AND DISTRIBUTION OF
TELEVISION SHOWS AND MOVIES; SPECIAL
EVENT PLANNING, IN CLASS 41 (U.S. CLS. 100,
101 AND 107).

THE MARK CONSISTS OF A FLOWER DESIGN
TO THE LEFT OF THE TERM "PLATEMATE" IN
ALL CAPITAL LETTERS.

SER. NO. 77-359,330, FILED 12-26-2007.

PETER B. BROMAGHIM, EXAMINING ATTORNEY

Int. Cl.: 41

Prior U.S. Cls.: 100, 101 and 107

United States Patent and Trademark Office

Reg. No. 3,480,082

Registered Aug. 5, 2008

**SERVICE MARK
PRINCIPAL REGISTER**

SIX STRING IMPRESSIONS

MOLINA, NESTOR A. (UNITED STATES INDIVIDUAL)

10876 SW 89 ST.

MIAMI, FL 33176

FOR: ENTERTAINMENT, NAMELY, LIVE PERFORMANCES BY A MUSICAL BAND, IN CLASS 41 (U.S. CLS. 100, 101 AND 107).

FIRST USE 11-1-2007; IN COMMERCE 11-1-2007.

THE MARK CONSISTS OF STANDARD CHARACTERS WITHOUT CLAIM TO ANY PARTICULAR FONT, STYLE, SIZE, OR COLOR.

NO CLAIM IS MADE TO THE EXCLUSIVE RIGHT TO USE "SIX STRING", APART FROM THE MARK AS SHOWN.

SER. NO. 77-359,341, FILED 12-26-2007.

KATHERINE E. HALMEN, EXAMINING ATTORNEY

Int. Cl.: 37

Prior U.S. Cls.: 100, 103 and 106

United States Patent and Trademark Office

Reg. No. 3,480,083

Registered Aug. 5, 2008

**SERVICE MARK
PRINCIPAL REGISTER**



H. ROCKER ELECTRIC CO., INC. (LOUISIANA CORPORATION)
47219 CONRAD ANDERSON DRIVE
HAMMOND, LA 70401

FOR: COMMERCIAL AND INDUSTRIAL ELECTRICAL CONTRACTOR SERVICES, IN CLASS 37 (U.S. CLS. 100, 103 AND 106).

FIRST USE 1-1-1989; IN COMMERCE 1-1-1989.

NO CLAIM IS MADE TO THE EXCLUSIVE RIGHT TO USE "ELECTRIC", APART FROM THE MARK AS SHOWN.

THE MARK CONSISTS OF OUR LOGO A CIRCULAR IMAGE, WITH THE NAME "H ROCKER ELECTRIC" INCORPORATED INTO IT.

SER. NO. 77-359,360, FILED 12-26-2007.

JERI J. FICKES, EXAMINING ATTORNEY

Int. Cl.: 25

Prior U.S. Cls.: 22 and 39

United States Patent and Trademark Office

Reg. No. 3,480,084

Registered Aug. 5, 2008

**TRADEMARK
PRINCIPAL REGISTER**

Jillie Willie

GROVER, JILL W. (UNITED STATES INDIVIDUAL), DBA JILLIE WILLIE
860 EAST 700 SOUTH
BRIGHAM CITY, UT 84302

THE MARK CONSISTS OF STANDARD CHARACTERS WITHOUT CLAIM TO ANY PARTICULAR FONT, STYLE, SIZE, OR COLOR.

FOR: APRONS; SLIPPERS; GLOVES, IN CLASS 25 (U.S. CLS. 22 AND 39).

SER. NO. 77-359,385, FILED 12-26-2007.

FIRST USE 10-1-2006; IN COMMERCE 12-8-2006.

DANIEL BRODY, EXAMINING ATTORNEY

Int. Cl.: 41

Prior U.S. Cls.: 100, 101 and 107

United States Patent and Trademark Office

Reg. No. 3,480,085

Registered Aug. 5, 2008

**SERVICE MARK
PRINCIPAL REGISTER**

snowAngel

SNOWANGEL FITNESS, LLC (KENTUCKY LTD
LIAB CO)
SUITE 11
161 ST. MATTHEWS AVENUE
LOUISVILLE, KY 40207

FOR: PHYSICAL EDUCATION SERVICES; PROVIDING ASSISTANCE, PERSONAL TRAINING AND PHYSICAL FITNESS CONSULTATION TO INDIVIDUALS TO HELP THEM MAKE PHYSICAL FITNESS, STRENGTH, CONDITIONING, AND EXERCISE IMPROVEMENT IN THEIR DAILY LIVING; PROVIDING INFORMATION IN THE FIELD OF EXERCISE TRAINING; PRODUCTION OF VIDEO

DISCS AND TAPES; PROVIDING A WEBSITE FEATURING INFORMATION ON EXERCISE AND FITNESS, IN CLASS 41 (U.S. CLS. 100, 101 AND 107).

FIRST USE 11-1-2007; IN COMMERCE 11-1-2007.

THE MARK CONSISTS OF STANDARD CHARACTERS WITHOUT CLAIM TO ANY PARTICULAR FONT, STYLE, SIZE, OR COLOR.

SER. NO. 77-359,423, FILED 12-26-2007.

LINDA MICKLEBURGH, EXAMINING ATTORNEY

Int. Cl.: 5

Prior U.S. Cls.: 6, 18, 44, 46, 51 and 52

Reg. No. 3,480,086

United States Patent and Trademark Office

Registered Aug. 5, 2008

**TRADEMARK
PRINCIPAL REGISTER**

love your life

ARCIERI, STANLEY (UNITED STATES INDIVIDUAL), DBA BIOPHARMACA
335 COUNTYVIEW DR
MILL VALLEY, CA 94941

FOR: DIETARY SUPPLEMENTS FOR HUMAN CONSUMPTION; HERBAL SUPPLEMENTS; NUTRACEUTICALS FOR USE AS A DIETARY SUPPLEMENT; NUTRITIONAL SUPPLEMENTS , IN CLASS 5 (U.S. CLS. 6, 18, 44, 46, 51 AND 52).

FIRST USE 12-3-2007; IN COMMERCE 12-3-2007.

THE MARK CONSISTS OF STANDARD CHARACTERS WITHOUT CLAIM TO ANY PARTICULAR FONT, STYLE, SIZE, OR COLOR.

SER. NO. 77-359,425, FILED 12-26-2007.

EDWARD NELSON, EXAMINING ATTORNEY

Int. Cl.: 3

Prior U.S. Cls.: 1, 4, 6, 50, 51 and 52

United States Patent and Trademark Office

Reg. No. 3,480,087

Registered Aug. 5, 2008

**TRADEMARK
PRINCIPAL REGISTER**

PETITE TREATS

SMART BRANDS INC. (CANADA CORPORATION)
SUITE 130
10800 NO. 5 ROAD
RICHMOND, CANADA V7A4E5

FOR: COSMETICS AND BATH AND BEAUTY PRODUCTS, NAMELY, LIPSTICK, HAND SOAP, HAIR SHAMPOO, PERFUME, EAU DE TOILETTE, EAU DE PARFUM, BATH GEL, MOISTURIZING LOTION, TALC, BODY CREAM, EYE CREAM, BLUSH, HAIR SPRAY, LIP GLOSS, EYE SHADOW, MASCARA, FACE MAKE-UP, NAIL POLISH, NAIL ENAMEL, EYE MAKE-UP, BODY LOTION, SKIN

LIGHTENER, MAKE-UP REMOVER AND BODY SPRAY, IN CLASS 3 (U.S. CLS. 1, 4, 6, 50, 51 AND 52).

FIRST USE 9-14-2007; IN COMMERCE 9-14-2007.

THE MARK CONSISTS OF STANDARD CHARACTERS WITHOUT CLAIM TO ANY PARTICULAR FONT, STYLE, SIZE, OR COLOR.

SER. NO. 77-359,470, FILED 12-26-2007.

ELISSA GARBER KON, EXAMINING ATTORNEY

Int. Cl.: 3

Prior U.S. Cls.: 1, 4, 6, 50, 51 and 52

United States Patent and Trademark Office

Reg. No. 3,480,088

Registered Aug. 5, 2008

**TRADEMARK
PRINCIPAL REGISTER**

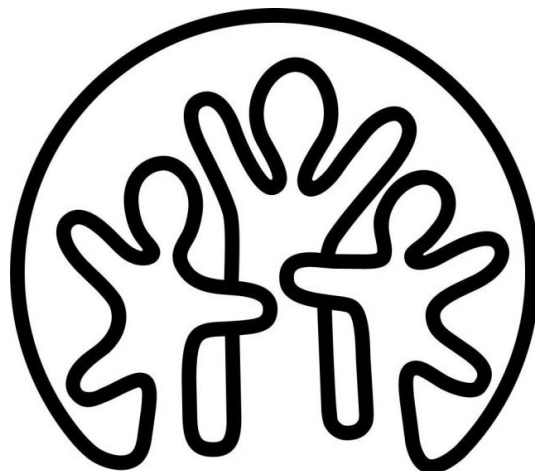

CODDINGTON ENVIRONMENTAL, INC. (NEW YORK CORPORATION)
150 BEEKMAN STREET
NEW YORK, NY 10017

FOR: COMMERCIAL AND HOUSEHOLD CLEANING PRODUCTS, NAMELY, GLASS CLEANERS AND ALL PURPOSE CLEANERS; FLOOR STRIPPING PREPARATIONS; FLOOR SEALING AND FINISHING PREPARATIONS; LAUNDRY DETERGENT; FABRIC SOFTENERS; DISH WASHING SOAP; HAND SOAP, IN CLASS 3 (U.S. CLS. 1, 4, 6, 50, 51 AND 52).

FIRST USE 8-0-2006; IN COMMERCE 8-0-2006.

THE MARK CONSISTS OF A DEPICTION OF THREE HUMAN FIGURES WITHIN A CIRCLE WITH AN OPEN BOTTOM.

SER. NO. 77-359,535, FILED 12-26-2007.

EVELYN BRADLEY, EXAMINING ATTORNEY

Int. Cl.: 21

Prior U.S. Cls.: 2, 13, 23, 29, 30, 33, 40 and 50

United States Patent and Trademark Office

Reg. No. 3,480,089

Registered Aug. 5, 2008

**TRADEMARK
PRINCIPAL REGISTER**

VOODOO

C.S.B. COMMODITIES, INC. (NEW YORK COR-
PORATION)
SUITE 301A
1400 OLD COUNTRY ROAD
WESTBURY, NY 11590

THE MARK CONSISTS OF STANDARD CHAR-
ACTERS WITHOUT CLAIM TO ANY PARTICULAR
FONT, STYLE, SIZE, OR COLOR.

FOR: KNIFE BLOCKS, IN CLASS 21 (U.S. CLS. 2,
13, 23, 29, 30, 33, 40 AND 50).

SER. NO. 77-359,546, FILED 12-26-2007.

FIRST USE 10-1-2007; IN COMMERCE 10-1-2007.

TEJBIR SINGH, EXAMINING ATTORNEY

Int. Cls.: 9 and 16

Prior U.S. Cls.: 2, 5, 21, 22, 23, 26, 29, 36, 37, 38 and 50

United States Patent and Trademark Office

Reg. No. 3,480,090

Registered Aug. 5, 2008

**TRADEMARK
PRINCIPAL REGISTER**



WINNING KIDS, INCORPORATED (FLORIDA CORPORATION)
SUITE 214
4521 PGA BLVD.
PALM BEACH GARDENS, FL 33418

FOR: SERIES OF CD'S AND DVD'S FEATURING CHILDREN'S STORIES, IN CLASS 9 (U.S. CLS. 21, 23, 26, 36 AND 38).

FIRST USE 10-1-2007; IN COMMERCE 10-1-2007.

FOR: SERIES OF CHILDREN'S FICTION BOOKS, IN CLASS 16 (U.S. CLS. 2, 5, 22, 23, 29, 37, 38 AND 50).

FIRST USE 10-1-2007; IN COMMERCE 10-1-2007.

THE COLOR(S) YELLOW, GREEN, ORANGE, BROWN, RED, BLUE, LIGHT BROWN, PURPLE,

PINK, BLACK, WHITE IS/ARE CLAIMED AS A FEATURE OF THE MARK.

THE MARK CONSISTS OF BROWN BEAR WITH YELLOW GLASSES WEARING A GREEN SHIRT WITH ORANGE AND YELLOW STRIPES, HOLDING A BROWN PAPER BAG; BROWN BEAR WITH RED CAP, WEARING A YELLOW SHIRT AND BLUE BACKPACK; LIGHT BROWN BEAR WEARING A PURPLE AND PINK SHIRT. ALL BEARS HAVE BLACK NOSES, EYEBALLS AND EYEBROWS AND EYELASHES LOCATED WITHIN THE WHITE OF THE EYES.

SER. NO. 77-359,556, FILED 12-26-2007.

KATINA MISTER, EXAMINING ATTORNEY

Int. Cl.: 5

Prior U.S. Cls.: 6, 18, 44, 46, 51 and 52

Reg. No. 3,480,091

United States Patent and Trademark Office

Registered Aug. 5, 2008

**TRADEMARK
PRINCIPAL REGISTER**

ARTHRIPHASE

TANGO ADVANCED NUTRITION, INC. (CALI-
FORNIA CORPORATION)
515 EUREKA STREET
SAN FRANCISCO, CA 94114

THE MARK CONSISTS OF STANDARD CHAR-
ACTERS WITHOUT CLAIM TO ANY PARTICULAR
FONT, STYLE, SIZE, OR COLOR.

FOR: DIETARY, HERBAL AND NUTRITIONAL
SUPPLEMENTS, IN CLASS 5 (U.S. CLS. 6, 18, 44, 46, 51
AND 52).

SER. NO. 77-359,568, FILED 12-26-2007.

FIRST USE 11-16-2007; IN COMMERCE 11-18-2007.

EDWARD NELSON, EXAMINING ATTORNEY

Int. Cl.: 28

Prior U.S. Cls.: 22, 23, 38 and 50

United States Patent and Trademark Office

Reg. No. 3,480,092

Registered Aug. 5, 2008

**TRADEMARK
PRINCIPAL REGISTER**

ZeeBeeZ

ZING TOYS, INC (OREGON CORPORATION)
PO BOX 520
BANKS, OR 97106

THE MARK CONSISTS OF STANDARD CHAR-
ACTERS WITHOUT CLAIM TO ANY PARTICULAR
FONT, STYLE, SIZE, OR COLOR.

FOR: POP UP TOYS, IN CLASS 28 (U.S. CLS. 22, 23,
38 AND 50).

SER. NO. 77-359,651, FILED 12-26-2007.

FIRST USE 1-6-2007; IN COMMERCE 1-6-2007.

JUSTINE D. PARKER, EXAMINING ATTORNEY

Int. Cl.: 40

Prior U.S. Cls.: 100, 103 and 106

United States Patent and Trademark Office

Reg. No. 3,480,093

Registered Aug. 5, 2008

**SERVICE MARK
PRINCIPAL REGISTER**

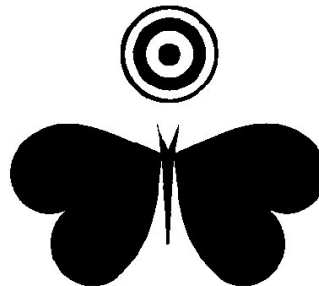

BREENE GRAPHICS, INC. (CALIFORNIA CORPORATION)
9510 VASSAR AVE.
CHATSWORTH, CA 91311

FIRST USE 1-1-1954; IN COMMERCE 1-1-1954.

SER. NO. 77-359,659, FILED 12-26-2007.

FOR: PRINTING, IN CLASS 40 (U.S. CLS. 100, 103 AND 106).

COLLEEN DOMBROW, EXAMINING ATTORNEY

Int. Cl.: 42

Prior U.S. Cls.: 100 and 101

United States Patent and Trademark Office

Reg. No. 3,480,094

Registered Aug. 5, 2008

**SERVICE MARK
PRINCIPAL REGISTER**



**PEOPLE SEARCH
MEDIA**

PEOPLE SEARCH MEDIA, LLC (NEVADA LTD
LIAB CO)
SUITE #320
101 UNIVERSITY AVE.
PALO ALTO, CA 94301

FOR: SEARCHING AND RETRIEVING INFORMATION, SITES, AND OTHER RESOURCES AVAILABLE ON COMPUTER NETWORKS FOR OTHERS, IN CLASS 42 (U.S. CLS. 100 AND 101).

FIRST USE 12-22-2007; IN COMMERCE 12-22-2007.

NO CLAIM IS MADE TO THE EXCLUSIVE RIGHT TO USE "PEOPLE SEARCH", APART FROM THE MARK AS SHOWN.

THE COLOR(S) BLUE, WHITE AND ORANGE IS/ ARE CLAIMED AS A FEATURE OF THE MARK.

THE MARK CONSISTS OF THE COLOR BLUE APPEARS IN ALL THE WORDING IN THE MARK AND IN A BOX ON THE LEFT SIDE OF THE MARK. THE COLOR WHITE APPEARS IN THE LETTER "P" AND A SINGLE LINE RECTANGLE THAT ARE WITHIN THE BOX. THE BOX ALSO CONTAINS A CARICATURE OF A PERSON IN ORANGE.

SER. NO. 77-359,669, FILED 12-26-2007.

MELVIN AXILBUND, EXAMINING ATTORNEY

Int. Cl.: 9

Prior U.S. Cls.: 21, 23, 26, 36 and 38

Reg. No. 3,480,095

United States Patent and Trademark Office

Registered Aug. 5, 2008

**TRADEMARK
PRINCIPAL REGISTER**

Optimum

GLOBAL EDUCATION ONLINE CORPORATION
(CALIFORNIA CORPORATION), DBA GLO-
BAL BUSINESS SERVICE CORPORATION
630 HARDCASTLE COURT
SAN RAMON, CA 94583

THE MARK CONSISTS OF STANDARD CHAR-
ACTERS WITHOUT CLAIM TO ANY PARTICULAR
FONT, STYLE, SIZE, OR COLOR.

FOR: BLANK CD-ROMS FOR SOUND OR VIDEO
RECORDING; CD CASES; CD SLEEVES, IN CLASS 9
(U.S. CLS. 21, 23, 26, 36 AND 38).

SER. NO. 77-359,691, FILED 12-26-2007.

FIRST USE 1-1-2007; IN COMMERCE 1-1-2007.

TEJBIR SINGH, EXAMINING ATTORNEY

Int. Cl.: 39

Prior U.S. Cls.: 100 and 105

United States Patent and Trademark Office

Reg. No. 3,480,096

Registered Aug. 5, 2008

**SERVICE MARK
PRINCIPAL REGISTER**



FISHER HOUSE FOUNDATION (DELAWARE CORPORATION)
SUITE 600
1401 ROCKVILLE PIKE
ROCKVILLE, MD 20852

FOR: CHARITABLE SERVICES, NAMELY, PROVIDING FREE AIRLINE TRANSPORTATION TO MILITARY SERVICE MEMBERS HOSPITALIZED DUE TO THEIR SERVICE IN A COMBAT ZONE AND THEIR FAMILIES OFFERED VIA A WEBSITE, IN CLASS 39 (U.S. CLS. 100 AND 105).

FIRST USE 1-1-2003; IN COMMERCE 1-1-2003.

NO CLAIM IS MADE TO THE EXCLUSIVE RIGHT TO USE "MILES", APART FROM THE MARK AS SHOWN.

THE MARK CONSISTS OF THE STYLIZED WORDS "HERO MILES" WITH AN IMAGE OF A HEART BETWEEN THE WORDS "HERO" AND "MILES". THE HEART HAS THREE CONTRAILS WITH AN AIRPLANE TO THE RIGHT OF THE HEART AND ABOVE THE LETTER "M".

SER. NO. 77-359,705, FILED 12-26-2007.

AHSEN KHAN, EXAMINING ATTORNEY

Int. Cl.: 36

Prior U.S. Cls.: 100, 101 and 102

United States Patent and Trademark Office

Reg. No. 3,480,097

Registered Aug. 5, 2008

**SERVICE MARK
PRINCIPAL REGISTER**

Rent It Today

GLASS, JASON S. (KENTUCKY LTD LIAB CO),
DBA RENT IT TODAY
125 RIFLE RANGE ROAD
ALEXANDRIA, KY 41001

FOR: RENTAL OF HOMES; RENTAL OF OFFICE SPACE; REAL ESTATE RENTAL SERVICES, NAME- LY, RENTAL OF RESIDENTIAL HOUSING; REAL ESTATE SERVICES, NAMELY, RENTAL OF SHORT-TERM FURNISHED APARTMENTS; REAL ESTATE SERVICES, NAMELY, RENTAL OF VACA- TION HOMES, CONDOMINIUMS, CABINS, AND VILLAS USING PAY PER CLICK ADVERTISING ON A GLOBAL COMPUTER NETWORK; RENTAL OF APARTMENTS; RENTAL OF APARTMENTS IN AN

APARTMENT COMMUNITY; RENTAL OF BUILD- INGS FOR PERMANENT OCCUPANCY, IN CLASS 36 (U.S. CLS. 100, 101 AND 102).

FIRST USE 9-1-2007; IN COMMERCE 10-1-2007.

THE MARK CONSISTS OF STANDARD CHAR- ACTERS WITHOUT CLAIM TO ANY PARTICULAR FONT, STYLE, SIZE, OR COLOR.

SER. NO. 77-359,763, FILED 12-26-2007.

TAMARA FRAZIER, EXAMINING ATTORNEY

Int. Cl.: 30

Prior U.S. Cl.: 46

United States Patent and Trademark Office

Reg. No. 3,480,098

Registered Aug. 5, 2008

TRADEMARK
PRINCIPAL REGISTER

Arianna Farms 'Ono Kona
Coffee

ARIANNA FARMS 'ONO KONA COFFEE, LLC
(CALIFORNIA LTD LIAB CO)
STE 375
5235 MISSION OAKS RD.
CAMARILLO, CA 93012

FOR: COFFEE, COFFEE BEANS, WHOLE COFFEE BEANS, ROASTED COFFEE BEANS, UNROASTED PROCESSED COFFEE BEANS, GROUND COFFEE BEANS, GROUND ROASTED COFFEE BEANS, COFFEE (POWDERED, GRANULATED), SOLUBLE COFFEE MIXES; BREWED COFFEE, ESPRESSO, CAPPUCINO; LATTE; BEVERAGE MIXES CONTAINING COFFEE; COFFEE-BASED DRINKS; FROZEN COFFEE CONFECTIONS; COFFEE EXTRACTS; COFFEE FLAVORINGS; COCOA, COCOA POWDER, COCOA-BASED DRINKS; BEVERAGES MADE FROM OR CONTAINING COCOA; POWDERED MIXES CONTAINING COCOA; CHOCOLATE, CHOCOLATE BARS, CHOCOLATES, CONFECTIONARY, CANDY, CHOCOLATE-COVERED COFFEE BEANS; CHOCOLATE-COVERED ESPRESSO BEANS; CHOCOLATE SYRUP; PASTRY, CAKES, BREAD, BAKERY PRODUCTS, BISCUITS, COOKIES, CRACKERS, BROWNIES; CAKE MIXES; BROWNIE MIXES, COOKIE MIXES; PUDDING, PUDDING MIXES; CANDY AND CONFECTION-

ARY; CEREAL; CEREAL-BASED BARS; TEA; TEA-BASED BEVERAGES WITH FRUIT FLAVORING; ICE CREAM; FROZEN CONFECTIONS, GELATO, FROZEN YOGURT; HONEY; SUGAR; POWDERED SUGAR; WHITE SUGAR; CUBE SUGAR; CRYSTAL SUGAR (NOT CONFECTIONERY); CRYSTAL SUGAR PIECES (CONFECTIONERY); BROWN SUGAR, IN CLASS 30 (U.S. CL. 46).

FIRST USE 7-27-2000; IN COMMERCE 7-27-2000.

THE MARK CONSISTS OF STANDARD CHARACTERS WITHOUT CLAIM TO ANY PARTICULAR FONT, STYLE, SIZE, OR COLOR.

NO CLAIM IS MADE TO THE EXCLUSIVE RIGHT TO USE "ONO KONA COFFEE", APART FROM THE MARK AS SHOWN.

THE FOREIGN WORDING IN THE MARK TRANSLATES INTO ENGLISH AS DELICIOUS.

SER. NO. 77-359,771, FILED 12-26-2007.

JACQUELINE A. LAVINE, EXAMINING ATTORNEY

Int. Cl.: 7

Prior U.S. Cls.: 13, 19, 21, 23, 31, 34 and 35

United States Patent and Trademark Office

Reg. No. 3,480,099

Registered Aug. 5, 2008

**TRADEMARK
PRINCIPAL REGISTER**



LIN, CHUN-CHIH (TAIWAN INDIVIDUAL)
CHUNG CHENG RD., CHUNG-HO
TAIPEI, TAIWAN

FIRST USE 6-28-2007; IN COMMERCE 8-28-2007.

FOR: WINDMILLS; AC GENERATORS, NAME-
LY, ALTERNATORS; BICYCLE DYNAMOS; WIND-
POWERED ELECTRICITY GENERATORS; DC
GENERATORS; MOTORS, NAMELY, MOTORS
NOT FOR LAND VEHICLES, BOAT MOTORS,
AND STARTER MOTORS, IN CLASS 7 (U.S. CLS.
13, 19, 21, 23, 31, 34 AND 35).

THE MARK CONSISTS OF WORD "IWIND" THE
DOT ABOVE THE "I" IS A DESIGN DEVICE.

SER. NO. 77-359,849, FILED 12-27-2007.

ROBIN CHOSID, EXAMINING ATTORNEY

Int. Cl.: 42

Prior U.S. Cls.: 100 and 101

United States Patent and Trademark Office

Reg. No. 3,480,100

Registered Aug. 5, 2008

**SERVICE MARK
PRINCIPAL REGISTER**

AUTOWALK

AZIMA, INC. (DELAWARE CORPORATION)
SUITE 2950
400 WEST CUMMINGS PARK
WOBURN, MA 01801

FOR: REMOTE INTERACTIVE MONITORING,
DIAGNOSTIC, AND REPORTING SERVICES IN
THE FIELD OF CONDITION-BASED MAINTENANCE,
PERFORMANCE, AND RELIABILITY OPTIMIZATION
FOR INDUSTRIAL, POWER AND OTHER
CONTINUOUS PROCESS PLANTS; ONLINE
SYSTEM MANAGEMENT SERVICES THAT ALLOW
USERS TO REMOTELY VIEW, MONITOR, AND

ASSESS INDUSTRIAL, POWER AND OTHER
CONTINUOUS PROCESS PLANT OPERATIONS, IN
CLASS 42 (U.S. CLS. 100 AND 101).

FIRST USE 10-12-2007; IN COMMERCE 12-1-2007.

THE MARK CONSISTS OF STANDARD CHARACTERS
WITHOUT CLAIM TO ANY PARTICULAR
FONT, STYLE, SIZE, OR COLOR.

SER. NO. 77-359,982, FILED 12-27-2007.

MARY MUNSON, EXAMINING ATTORNEY

Int. Cl.: 42

Prior U.S. Cls.: 100 and 101

United States Patent and Trademark Office

Reg. No. 3,480,101

Registered Aug. 5, 2008

**SERVICE MARK
PRINCIPAL REGISTER**

ADVANTAGE

AZIMA, INC. (DELAWARE CORPORATION)
SUITE 2950
400 WEST CUMMINGS PARK
WOBURN, MA 01801

FOR: REMOTE INTERACTIVE MONITORING, DIAGNOSTIC, AND REPORTING SERVICES IN THE FIELD OF CONDITION-BASED MAINTENANCE, PERFORMANCE, AND RELIABILITY OPTIMIZATION FOR INDUSTRIAL, POWER AND OTHER CONTINUOUS PROCESS PLANTS; ONLINE SYSTEM MANAGEMENT SERVICES THAT ALLOW USERS TO REMOTELY VIEW, MONITOR, AND

ASSESS INDUSTRIAL, POWER AND OTHER CONTINUOUS PROCESS PLANT OPERATIONS, IN CLASS 42 (U.S. CLS. 100 AND 101).

FIRST USE 10-0-2007; IN COMMERCE 12-1-2007.

THE MARK CONSISTS OF STANDARD CHARACTERS WITHOUT CLAIM TO ANY PARTICULAR FONT, STYLE, SIZE, OR COLOR.

SER. NO. 77-359,986, FILED 12-27-2007.

MARY MUNSON, EXAMINING ATTORNEY

Int. Cl.: 6

Prior U.S. Cls.: 2, 12, 13, 14, 23, 25 and 50

Reg. No. 3,480,102

United States Patent and Trademark Office

Registered Aug. 5, 2008

**TRADEMARK
PRINCIPAL REGISTER**

BOXhaul

ALLTECH MANUFACTURING, LLC (MINNESOTA LTD LIAB CO)
9363 67TH STREET NW
ANNANDALE, MN 55302

THE MARK CONSISTS OF STANDARD CHARACTERS WITHOUT CLAIM TO ANY PARTICULAR FONT, STYLE, SIZE, OR COLOR.

FOR: HOISTABLE METAL CONTAINERS FOR MOVING MATERIALS OR DEBRIS BY CRANE OR HOIST, IN CLASS 6 (U.S. CLS. 2, 12, 13, 14, 23, 25 AND 50).

SER. NO. 77-360,031, FILED 12-27-2007.

FIRST USE 1-15-2005; IN COMMERCE 2-15-2005.

ALEXANDER L. POWERS, EXAMINING ATTORNEY

Int. Cl.: 35

Prior U.S. Cls.: 100, 101 and 102

United States Patent and Trademark Office

Reg. No. 3,480,103

Registered Aug. 5, 2008

SERVICE MARK
PRINCIPAL REGISTER



TAG SPORTS, LLC (MISSOURI LTD LIAB CO),
AKA THE AUBUCHON GROUP, LLC
840 WENNEKER DRIVE
SAINT LOUIS, MO 63124

NO CLAIM IS MADE TO THE EXCLUSIVE
RIGHT TO USE "SPORTS", APART FROM THE
MARK AS SHOWN.

FOR: ARRANGING PERSONAL APPEARANCES
BY PERSONS WORKING IN THE FIELD OF FILM,
MUSIC, TELEVISION, ENTERTAINMENT OR
SPORT; PROMOTING THE GOODS AND SERVICES
OF OTHERS BY ARRANGING FOR SPONSORS TO
AFFILIATE THEIR GOODS AND SERVICES WITH
AN AWARDS PROGRAM, A SPORTS COMPETITION
AND SPORTING ACTIVITIES, IN CLASS 35
(U.S. CLS. 100, 101 AND 102).

THE MARK CONSISTS OF CAPITAL LETTERS
"TAG" UTILIZING THE FONT COLLEGIATE AND
THE WORD "SPORTS" UTILIZING THE FONT
RAGE ITALIC.

SER. NO. 77-360,038, FILED 12-27-2007.

FIRST USE 9-1-2006; IN COMMERCE 9-1-2006.

ANDREA HACK, EXAMINING ATTORNEY

Int. Cl.: 9

Prior U.S. Cls.: 21, 23, 26, 36 and 38

Reg. No. 3,480,104

United States Patent and Trademark Office

Registered Aug. 5, 2008

**TRADEMARK
PRINCIPAL REGISTER**

HOLOVEGA PLUS

HALE, STEVE C. (UNITED STATES INDIVIDUAL)
6050 CRATER LAKE AVENUE
CENTRAL POINT, OR 97502

THE MARK CONSISTS OF STANDARD CHARACTERS WITHOUT CLAIM TO ANY PARTICULAR FONT, STYLE, SIZE, OR COLOR.

FOR: PROJECTION SCREENS; PROJECTION SCREENS FOR MOVIE FILMS; SLIDE OR PHOTOGRAPH PROJECTION APPARATUS; TELEVISION APPARATUS FOR PROJECTION PURPOSES, IN CLASS 9 (U.S. CLS. 21, 23, 26, 36 AND 38).

OWNER OF U.S. REG. NO. 3,045,076.

SER. NO. 77-360,125, FILED 12-27-2007.

FIRST USE 12-1-2007; IN COMMERCE 12-1-2007.

WILLIAM ROSSMAN, EXAMINING ATTORNEY

Int. Cl.: 9

Prior U.S. Cls.: 21, 23, 26, 36 and 38

United States Patent and Trademark Office

Reg. No. 3,480,105

Registered Aug. 5, 2008

**TRADEMARK
PRINCIPAL REGISTER**

HOLOROADSHO PLUS

HALE, STEVE C. (UNITED STATES INDIVIDUAL)
6050 CRATER LAKE AVENUE
CENTRAL POINT, OR 97502

FOR: AMUSEMENT APPARATUS ADAPTED FOR USE WITH AN EXTERNAL DISPLAY SCREEN OR MONITOR; PROJECTION SCREENS; PROJECTION SCREENS FOR MOVIE FILMS; SLIDE OR PHOTOGRAPH PROJECTION APPARATUS; TELEVISION APPARATUS FOR PROJECTION PURPOSES; VIDEO SCREENS, IN CLASS 9 (U.S. CLS. 21, 23, 26, 36 AND 38).

FIRST USE 12-1-2007; IN COMMERCE 12-1-2007.

THE MARK CONSISTS OF STANDARD CHARACTERS WITHOUT CLAIM TO ANY PARTICULAR FONT, STYLE, SIZE, OR COLOR.

SER. NO. 77-360,151, FILED 12-27-2007.

WILLIAM ROSSMAN, EXAMINING ATTORNEY

Int. Cl.: 31

Prior U.S. Cls.: 1 and 46

United States Patent and Trademark Office

Reg. No. 3,480,106

Registered Aug. 5, 2008

TRADEMARK
PRINCIPAL REGISTER



VERITAS V, LLC (CALIFORNIA LTD LIAB CO)
401 MONTEREY STREET, SUITE 201
SALINAS, CA 93901

FOR: ORGANIC FRESH VEGETABLES, IN CLASS
31 (U.S. CLS. 1 AND 46).

FIRST USE 6-0-2007; IN COMMERCE 6-0-2007.

NO CLAIM IS MADE TO THE EXCLUSIVE
RIGHT TO USE "GOOD CLEAN VEGGIES", APART
FROM THE MARK AS SHOWN.

THE COLOR(S) RED, ORANGE, GREEN AND
BLACK IS/ARE CLAIMED AS A FEATURE OF THE
MARK.

THE MARK IS COMPRISED OF THE WORDING
"ORGANICGIRL" AND "GOOD CLEAN VEGGIES"
AND THE DESIGN OF A TOMATO, CARROT AND
LETTUCE LEAF IN A RECTANGULAR BACK-

GROUND CARRIER WITH A SINGLE LINE DIS-
SECTING THE RECTANGLE BELOW THE
WORDING. THE COLOR RED APPEARS IN THE
TOMATO DESIGN AND IN THE WORDING
"GIRL". THE COLOR GREEN APPEARS IN THE
LEAF DESIGN AND ON THE LEAVES SHOWN ON
THE VEGETABLES. THE COLOR ORANGE AP-
PEARS IN THE CARROT DESIGN. THE COLOR
BLACK APPEARS IN THE WORDING "ORGANIC",
IN THE WORDING "GOOD CLEAN VEGGIES", IN
THE OUTLINE OF THE VEGETABLES, IN THE
OUTLINE OF THE RECTANGLE, AND IN THE
DESIGN OF THE LINE. THE COLOR WHITE AP-
PEARS ON THE SHADING PART OF THE TOMATO.
THE WHITE AREA THAT COMPRISES THE BACK-
GROUND AREA OF THE MARK WITHIN THE
RECTANGLE IS INTENDED AS A TRANSPARENT
AREA AND IS NOT PART OF THE MARK.

SER. NO. 77-360,177, FILED 12-27-2007.

SHARON MEIER, EXAMINING ATTORNEY

Int. Cl.: 31

Prior U.S. Cls.: 1 and 46

United States Patent and Trademark Office

Reg. No. 3,480,107

Registered Aug. 5, 2008

TRADEMARK
PRINCIPAL REGISTER



VERITAS V, LLC (CALIFORNIA LTD LIAB CO)
401 MONTEREY STREET, SUITE 201
SALINAS, CA 93901

FOR: ORGANIC FRESH VEGETABLES, IN CLASS
31 (U.S. CLS. 1 AND 46).

FIRST USE 6-0-2007; IN COMMERCE 6-0-2007.

NO CLAIM IS MADE TO THE EXCLUSIVE
RIGHT TO USE "GOOD FRESH GREENS", APART
FROM THE MARK AS SHOWN.

THE COLOR(S) RED, ORANGE, GREEN AND
BLACK IS/ARE CLAIMED AS A FEATURE OF THE
MARK.

THE MARK IS COMPRISED OF THE WORDING
"ORGANICGIRL" AND "GOOD FRESH GREENS"
AND THE DESIGN OF A TOMATO, CARROT AND
LETTUCE LEAF IN A RECTANGULAR BACK-

GROUND CARRIER WITH A SINGLE LINE DIS-
SECTING THE RECTANGLE BELOW THE
WORDING. THE COLOR RED APPEARS IN THE
TOMATO DESIGN AND IN THE WORDING
"GIRL". THE COLOR GREEN APPEARS IN THE
LEAF DESIGN AND ON THE LEAVES SHOWN ON
THE VEGETABLES. THE COLOR ORANGE AP-
PEARS IN THE CARROT DESIGN. THE COLOR
BLACK APPEARS IN THE WORDING "ORGANIC",
IN THE WORDING "GOOD FRESH GREENS", IN
THE OUTLINE OF THE VEGETABLES, IN THE
OUTLINE OF THE RECTANGLE, AND IN THE
DESIGN OF THE LINE. THE COLOR WHITE AP-
PEARS ON THE SHADING PART OF THE TOMATO.
THE WHITE AREA THAT COMPRISES THE BACK-
GROUND AREA OF THE MARK WITHIN THE
RECTANGLE IS INTENDED AS A TRANSPARENT
AREA AND IS NOT PART OF THE MARK.

SER. NO. 77-360,240, FILED 12-27-2007.

SHARON MEIER, EXAMINING ATTORNEY

Int. Cls.: 35, 36 and 42

Prior U.S. Cls.: 100, 101 and 102

United States Patent and Trademark Office

Reg. No. 3,480,108

Registered Aug. 5, 2008

**SERVICE MARK
PRINCIPAL REGISTER**

CASS

CASS INFORMATION SYSTEMS, INC. (MISSOURI CORPORATION)
13001 HOLLENBERG DRIVE
BRIDGETON, MO 63044

FOR: PROVIDING INFORMATION SERVICES RELATING TO BUSINESS EXPENSE MANAGEMENT, IN CLASS 35 (U.S. CLS. 100, 101 AND 102).

FIRST USE 12-31-1956; IN COMMERCE 12-31-1956.

FOR: BANKING; BILL PAYMENT SERVICES, IN CLASS 36 (U.S. CLS. 100, 101 AND 102).

FIRST USE 12-31-1956; IN COMMERCE 12-31-1956.

FOR: APPLICATION SERVICE PROVIDER (ASP) FEATURING ONLINE NONDOWNLOADABLE SOFTWARE FOR ASSEMBLING, ORGANIZING,

AND ANALYZING INFORMATION RELATING TO FREIGHT AND TRANSPORTATION EXPENSE MANAGEMENT, IN CLASS 42 (U.S. CLS. 100 AND 101).

FIRST USE 6-0-2000; IN COMMERCE 6-0-2000.

THE MARK CONSISTS OF STANDARD CHARACTERS WITHOUT CLAIM TO ANY PARTICULAR FONT, STYLE, SIZE, OR COLOR.

OWNER OF U.S. REG. NOS. 1,665,200 AND 2,126,891.

SER. NO. 77-360,346, FILED 12-27-2007.

JOHN SCHUYLER YARD, EXAMINING ATTORNEY

Int. Cl.: 30

Prior U.S. Cl.: 46

United States Patent and Trademark Office

Reg. No. 3,480,109

Registered Aug. 5, 2008

**TRADEMARK
PRINCIPAL REGISTER**

From Our Farm To Your Cup

ARIANNA FARMS 'ONO KONA COFFEE, LLC
(CALIFORNIA LTD LIAB CO)
STE 375
5235 MISSION OAKS RD.
CAMARILLO, CA 93012

FOR: COFFEE, COFFEE BEANS, WHOLE COFFEE BEANS, ROASTED COFFEE BEANS, UNROASTED PROCESSED COFFEE BEANS, GROUND COFFEE BEANS, GROUND ROASTED COFFEE BEANS, COFFEE (POWDERED, GRANULATED), SOLUBLE COFFEE MIXES; BREWED COFFEE, ESPRESSO, CAPPUCINO; LATTE; BEVERAGE MIXES CONTAINING COFFEE; COFFEE-BASED DRINKS; FROZEN COFFEE CONFECTIONS; COFFEE EXTRACTS; COFFEE FLAVORINGS; COCOA, COCOA POWDER, COCOA-BASED DRINKS; BEVERAGES MADE FROM OR CONTAINING COCOA; POWDERED MIXES CONTAINING COCOA; CHOCOLATE, CHOCOLATE BARS, CHOCOLATES, CONFECTIONARY, CANDY, CHOCOLATE-COVERED COFFEE BEANS; CHOCOLATE-COVERED ESPRESSO BEANS; CHOCOLATE SYRUP; PASTRY, CAKES, BREAD, BAKERY PRODUCTS, BISCUITS,

COOKIES, CRACKERS, BROWNIES; CAKE MIXES; BROWNIE MIXES, COOKIE MIXES; PUDDING, PUDDING MIXES; CANDY AND CONFECTIONARY; CEREAL; CEREAL-BASED BARS; TEA; TEA-BASED BEVERAGES WITH FRUIT FLAVORING; ICE CREAM; FROZEN CONFECTIONS, GELATO, FROZEN YOGURT; HONEY; SUGAR; POWDERED SUGAR; WHITE SUGAR; CUBE SUGAR; CRYSTAL SUGAR (NOT CONFECTIONERY); CRYSTAL SUGAR PIECES (CONFECTIONERY); BROWN SUGAR, IN CLASS 30 (U.S. CL. 46).

FIRST USE 9-10-2004; IN COMMERCE 9-10-2004.

THE MARK CONSISTS OF STANDARD CHARACTERS WITHOUT CLAIM TO ANY PARTICULAR FONT, STYLE, SIZE, OR COLOR.

SER. NO. 77-360,381, FILED 12-27-2007.

JACQUELINE A. LAVINE, EXAMINING ATTORNEY

Int. Cl.: 30

Prior U.S. Cl.: 46

United States Patent and Trademark Office

Reg. No. 3,480,110

Registered Aug. 5, 2008

**TRADEMARK
PRINCIPAL REGISTER**

From Farm to Cup

ARIANNA FARMS 'ONO KONA COFFEE, LLC
(CALIFORNIA LTD LIAB CO)
STE 375
5235 MISSION OAKS RD.
CAMARILLO, CA 93012

FOR: COFFEE, COFFEE BEANS, WHOLE COFFEE BEANS, ROASTED COFFEE BEANS, UNROASTED PROCESSED COFFEE BEANS, GROUND COFFEE BEANS, GROUND ROASTED COFFEE BEANS, COFFEE (POWDERED, GRANULATED), SOLUBLE COFFEE MIXES; BREWED COFFEE, ESPRESSO, CAPPUCCINO; LATTE; BEVERAGE MIXES CONTAINING COFFEE; COFFEE-BASED DRINKS; FROZEN COFFEE CONFECTIONS; COFFEE EXTRACTS; COFFEE FLAVORINGS; COCOA, COCOA POWDER, COCOA-BASED DRINKS; BEVERAGES MADE FROM OR CONTAINING COCOA; POWDERED MIXES CONTAINING COCOA; CHOCOLATE, CHOCOLATE BARS, CHOCOLATES, CONFECTIONARY, CANDY, CHOCOLATE-COVERED COFFEE BEANS; CHOCOLATE-COVERED ESPRESSO BEANS; CHOCOLATE SYRUP; PASTRY, CAKES, BREAD, BAKERY PRODUCTS, BISCUITS,

COOKIES, CRACKERS, BROWNIES; CAKE MIXES; BROWNIE MIXES, COOKIE MIXES; PUDDING, PUDDING MIXES; CANDY AND CONFECTIONARY; CEREAL; CEREAL-BASED BARS; TEA; TEA-BASED BEVERAGES WITH FRUIT FLAVORING; ICE CREAM; FROZEN CONFECTIONS, GELATO, FROZEN YOGURT; HONEY; SUGAR; POWDERED SUGAR; WHITE SUGAR; CUBE SUGAR; CRYSTAL SUGAR (NOT CONFECTIONERY); CRYSTAL SUGAR PIECES (CONFECTIONERY); BROWN SUGAR, IN CLASS 30 (U.S. CL. 46).

FIRST USE 9-10-2004; IN COMMERCE 9-10-2004.

THE MARK CONSISTS OF STANDARD CHARACTERS WITHOUT CLAIM TO ANY PARTICULAR FONT, STYLE, SIZE, OR COLOR.

SER. NO. 77-360,399, FILED 12-27-2007.

JACQUELINE A. LAVINE, EXAMINING ATTORNEY

Int. Cl.: 30

Prior U.S. Cl.: 46

United States Patent and Trademark Office

Reg. No. 3,480,111

Registered Aug. 5, 2008

TRADEMARK
PRINCIPAL REGISTER



ARIANNA FARMS 'ONO KONA COFFEE, LLC
(CALIFORNIA LTD LIAB CO)
STE 375
5235 MISSION OAKS RD.
CAMARILLO, CA 93012

FOR: COFFEE, COFFEE BEANS, WHOLE COFFEE BEANS, ROASTED COFFEE BEANS, UNROASTED PROCESSED COFFEE BEANS, GROUND COFFEE BEANS, GROUND ROASTED COFFEE BEANS, COFFEE (POWDERED, GRANULATED), SOLUBLE COFFEE MIXES; BREWED COFFEE, ESPRESSO, CAPPUCCINO; LATTE; BEVERAGE MIXES CONTAINING COFFEE; COFFEE-BASED DRINKS; FROZEN COFFEE CONFECTIONS; COFFEE EXTRACTS; COFFEE FLAVORINGS; COCOA, COCOA POWDER, COCOA-BASED DRINKS; BEVERAGES MADE FROM OR CONTAINING COCOA; POWDERED MIXES CONTAINING COCOA; CHOCOLATE, CHOCOLATE BARS, CHOCOLATES, CONFECTIONERY, CANDY, CHOCOLATE-COVERED COFFEE BEANS; CHOCOLATE-COVERED ESPRESSO BEANS; CHOCOLATE SYRUP; PASTRY, CAKES, BREAD, BAKERY PRODUCTS, BISCUITS, COOKIES, CRACKERS, BROWNIES; CAKE MIXES; BROWNIE MIXES, COOKIE MIXES; PUDDING, PUDDING MIXES; CANDY AND CONFECTIONERY; CEREAL; CEREAL-BASED BARS; TEA; TEA-BASED BEVERAGES WITH FRUIT FLAVORING; ICE CREAM; FROZEN CONFECTIONS, GELATE, FROZEN YOGURT; HONEY; SUGAR; POWDERED

SUGAR; WHITE SUGAR; CUBE SUGAR; CRYSTAL SUGAR (NOT CONFECTIONERY); CRYSTAL SUGAR PIECES (CONFECTIONERY); BROWN SUGAR, IN CLASS 30 (U.S. CL. 46).

FIRST USE 8-2-2006; IN COMMERCE 8-4-2006.

NO CLAIM IS MADE TO THE EXCLUSIVE RIGHT TO USE "ONO KONA COFFEE", APART FROM THE MARK AS SHOWN.

THE STIPLING IS FOR SHADING PURPOSES ONLY.

THE MARK CONSISTS OF A CIRCLE WITH THE STYLIZED WORDS "ARIANNA FARMS" ACROSS THE TOP. IN THE CENTER OF THE CIRCLE ARE MOUNTAINOUS ISLAND AND SHORE LINE WITH A RAINBOW AND CLOUDS. BELOW THE SHORE LINE IS A RIBBON WITH THE STYLIZED WORDS "ONO KONA COFFEE". BELOW THE RIBBON ARE COFFEE BEANS AND A HIBISCUS FLOWER.

THE FOREIGN WORDING IN THE MARK TRANSLATES INTO ENGLISH AS DELICIOUS.

SER. NO. 77-360,422, FILED 12-27-2007.

JACQUELINE A. LAVINE, EXAMINING ATTORNEY

Int. Cl.: 30

Prior U.S. Cl.: 46

United States Patent and Trademark Office

Reg. No. 3,480,112

Registered Aug. 5, 2008

TRADEMARK
PRINCIPAL REGISTER

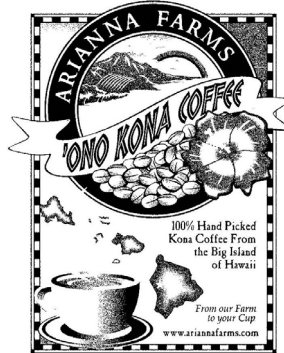

ARIANNA FARMS 'ONO KONA COFFEE, LLC
(CALIFORNIA LTD LIAB CO)

STE 375

5235 MISSION OAKS RD.

CAMARILLO, CA 93012

FIRST USE 8-2-2006; IN COMMERCE 8-4-2006.

NO CLAIM IS MADE TO THE EXCLUSIVE RIGHT TO USE "ONO KONA COFFEE" AND "100% HAND PICKED KONA COFFEE FROM THE BIG ISLAND OF HAWAII", APART FROM THE MARK AS SHOWN.

THE STIPPLING IS FOR SHADING PURPOSES ONLY.

THE MARK CONSISTS OF A RECTANGLE WITH A CHECKERED BORDER. IN THE CENTER OF THE RECTANGLE IS A CIRCLE WITH THE STYLIZED WORDS "ARIANNA FARMS" ACROSS THE TOP. IN THE CENTER OF THE CIRCLE ARE MOUNTAINOUS ISLAND AND SHORE LINE WITH A RAINBOW AND CLOUDS. BELOW THE SHORE LINE IS A RIBBON WITH THE STYLIZED WORDS "ONO KONA COFFEE". BELOW THE RIBBON ARE COFFEE BEANS AND A HIBISCUS FLOWER. BELOW THE CIRCLE AND TO THE RIGHT ARE THE STYLIZED WORDS "100% HAND PICKED KONA COFFEE FROM THE BIG ISLAND OF HAWAII". BELOW THE WORDS "100% HAND PICKED KONA COFFEE FROM THE BIG ISLAND OF HAWAII" AND TO THE LEFT IS AN IMAGE OF A CUP OF COFFEE WITH STEAM COMING UP FROM IT AND THE ISLANDS OF THE STATE OF THE HAWAII ABOVE IT. TO THE RIGHT OF THE CUP ARE THE STYLIZED WORDS "FROM OUR FARM TO YOUR CUP WWW.ARIANNAFARMS.COM".

FOR: COFFEE, COFFEE BEANS, WHOLE COFFEE BEANS, ROASTED COFFEE BEANS, UNROASTED PROCESSED COFFEE BEANS, GROUND COFFEE BEANS, GROUND ROASTED COFFEE BEANS, COFFEE (POWDERED, GRANULATED), SOLUBLE COFFEE MIXES; BREWED COFFEE, ESPRESSO, CAPPUCCINO; LATTE; BEVERAGE MIXES CONTAINING COFFEE; COFFEE-BASED DRINKS; FROZEN COFFEE CONFECTIONS; COFFEE EXTRACTS; COFFEE FLAVORINGS; COCOA, COCOA POWDER, COCOA-BASED DRINKS; BEVERAGES MADE FROM OR CONTAINING COCOA; POWDERED MIXES CONTAINING COCOA; CHOCOLATE, CHOCOLATE BARS, CHOCOLATES, CONFECTIONARY, CANDY, CHOCOLATE-COVERED COFFEE BEANS; CHOCOLATE-COVERED ESPRESSO BEANS; CHOCOLATE SYRUP; PASTRY, CAKES, BREAD, BAKERY PRODUCTS, BISCUITS, COOKIES, CRACKERS, BROWNIES; CAKE MIXES; BROWNIE MIXES, COOKIE MIXES; PUDDING, PUDDING MIXES; CANDY AND CONFECTIONARY; CEREAL; CEREAL-BASED BARS; TEA; TEA-BASED BEVERAGES WITH FRUIT FLAVORING; ICE CREAM; FROZEN CONFECTIONS, GELATO, FROZEN YOGURT; HONEY; SUGAR; POWDERED SUGAR; WHITE SUGAR; CUBE SUGAR; CRYSTAL SUGAR (NOT CONFECTIONERY); CRYSTAL SUGAR PIECES (CONFECTIONERY); BROWN SUGAR, IN CLASS 30 (U.S. CL. 46).

THE FOREIGN WORDING IN THE MARK TRANSLATES INTO ENGLISH AS DELICIOUS.

SER. NO. 77-360,427, FILED 12-27-2007.

JACQUELINE A. LAVINE, EXAMINING ATTOR-
NEY

Int. Cl.: 36

Prior U.S. Cls.: 100, 101 and 102

United States Patent and Trademark Office

Reg. No. 3,480,113

Registered Aug. 5, 2008

**SERVICE MARK
PRINCIPAL REGISTER**

**"The Gateway to Venture
Out!"**

TRISH ROY, PA (FLORIDA CORPORATION)
#278
701 SPANISH MAIN DRIVE
CUDJOE KEY, FL 33042

THE MARK CONSISTS OF STANDARD CHAR-
ACTERS WITHOUT CLAIM TO ANY PARTICULAR
FONT, STYLE, SIZE, OR COLOR.

FOR: RENTAL OF REAL PROPERTY, IN CLASS
36 (U.S. CLS. 100, 101 AND 102).

SER. NO. 77-360,475, FILED 12-27-2007.

FIRST USE 7-1-2007; IN COMMERCE 7-1-2007.

SHARON MEIER, EXAMINING ATTORNEY

Int. Cl.: 41

Prior U.S. Cls.: 100, 101 and 107

United States Patent and Trademark Office

Reg. No. 3,480,114

Registered Aug. 5, 2008

**SERVICE MARK
PRINCIPAL REGISTER**

**ASK A PORN STAR -
Everything you wanted to
ask a porn star but were
afraid to ask.**

LEASE-TECH GROUP, INC (NEVADA COR-
PORATION)
6840 ELM CREEK DRIVE
SUITE 204
LAS VEGAS, NV 891085042

FOR: ENTERTAINMENT AND EDUCATIONAL
SERVICES, NAMELY, AN ONGOING AUDIO AND
VISUAL PROGRAM DISTRIBUTED OVER TELEVI-
SION, SATELLITE, WIRELESS, AUDIO AND VIDEO
MEDIA, FIBER OPTICS, CABLE AND A GLOBAL
COMPUTER NETWORK IN THE FIELDS OF
ADULT ENTERTAINMENT AND SEXUAL EDUCA-
TION, IN CLASS 41 (U.S. CLS. 100, 101 AND 107).

FIRST USE 5-21-1997; IN COMMERCE 5-21-1997.

THE MARK CONSISTS OF STANDARD CHAR-
ACTERS WITHOUT CLAIM TO ANY PARTICULAR
FONT, STYLE, SIZE, OR COLOR.

NO CLAIM IS MADE TO THE EXCLUSIVE
RIGHT TO USE "PORN STAR", APART FROM
THE MARK AS SHOWN.

SER. NO. 77-360,570, FILED 12-27-2007.

SUSAN STIGLITZ, EXAMINING ATTORNEY

Int. Cl.: 41

Prior U.S. Cls.: 100, 101 and 107

United States Patent and Trademark Office

Reg. No. 3,480,115

Registered Aug. 5, 2008

**SERVICE MARK
PRINCIPAL REGISTER**

Qwote

JIMMY J. LEONARD (UNITED STATES INDIVIDUAL)
SUITE 201B
2100 SALZEDO STREET
CORAL GABLES, FL 33134

FOR: ENTERTAINMENT IN THE NATURE OF LIVE PERFORMANCES BY A MUSICAL ARTIST, IN CLASS 41 (U.S. CLS. 100, 101 AND 107).

FIRST USE 6-19-2007; IN COMMERCE 6-19-2007.

THE MARK CONSISTS OF STANDARD CHARACTERS WITHOUT CLAIM TO ANY PARTICULAR FONT, STYLE, SIZE, OR COLOR.

SEC. 2(F).

SER. NO. 77-360,585, FILED 12-27-2007.

PAULA MAHONEY, EXAMINING ATTORNEY

Int. Cl.: 36

Prior U.S. Cls.: 100, 101 and 102

United States Patent and Trademark Office

Reg. No. 3,480,116

Registered Aug. 5, 2008

**SERVICE MARK
PRINCIPAL REGISTER**

SonicCash

SONIC CASH, INC. (IDAHO CORPORATION)
1861 N. WILDWOOD STREET
BOISE, ID 83713

THE MARK CONSISTS OF STANDARD CHAR-
ACTERS WITHOUT CLAIM TO ANY PARTICULAR
FONT, STYLE, SIZE, OR COLOR.

FOR: FINANCIAL SERVICES, NAMELY, PRO-
VIDING SMALL, SHORT-TERM LOANS, EXCLUD-
ING THE SERVICE OF VEHICLE LOANS, IN CLASS
36 (U.S. CLS. 100, 101 AND 102).

SER. NO. 77-360,629, FILED 12-27-2007.

FIRST USE 7-1-2002; IN COMMERCE 7-1-2002.

WILLIAM ROSSMAN, EXAMINING ATTORNEY

Int. Cl.: 36

Prior U.S. Cls.: 100, 101 and 102

United States Patent and Trademark Office

Reg. No. 3,480,117

Registered Aug. 5, 2008

**SERVICE MARK
PRINCIPAL REGISTER**



DEBORAH CHADDOCK BROWN (UNITED STATES INDIVIDUAL), DBA ALLWRITE INK
118 W. STREETSBORO, SUITE 144
HUDSON, OH 44236

FOR: COLLECTING LICENSE FEES ON BEHALF OF INDEPENDENT WRITERS AND PUBLISHERS AND MAKING PAYMENTS TO THE COPYRIGHT OWNERS OF THE MUSIC , IN CLASS 36 (U.S. CLS. 100, 101 AND 102).

FIRST USE 8-7-2004; IN COMMERCE 2-14-2005.

THE COLOR(S) BLUE AND WHITE IS/ARE CLAIMED AS A FEATURE OF THE MARK.

THE MARK CONSISTS OF A BLUE INK BLOT IN WHICH ARE THE WORDS "ALLWRITE INK" IN WHITE INK.

SER. NO. 77-360,631, FILED 12-27-2007.

H. M. FISHER, EXAMINING ATTORNEY

Int. Cl.: 6

Prior U.S. Cls.: 2, 12, 13, 14, 23, 25 and 50

Reg. No. 3,480,118

United States Patent and Trademark Office

Registered Aug. 5, 2008

**TRADEMARK
PRINCIPAL REGISTER**

SecureTip Fastener

55 CONSULTANTS, INC. (CALIFORNIA CORPORATION)

1737 JUNCTION AVENUE

SAN JOSE, CA 95112

FOR: METAL FASTENERS, NAMELY, SCREWS,
IN CLASS 6 (U.S. CLS. 2, 12, 13, 14, 23, 25 AND 50).

FIRST USE 6-1-2007; IN COMMERCE 8-17-2007.

THE MARK CONSISTS OF STANDARD CHARACTERS WITHOUT CLAIM TO ANY PARTICULAR FONT, STYLE, SIZE, OR COLOR.

NO CLAIM IS MADE TO THE EXCLUSIVE RIGHT TO USE "FASTENER", APART FROM THE MARK AS SHOWN.

SER. NO. 77-360,779, FILED 12-28-2007.

RENEE MCCRAY, EXAMINING ATTORNEY

Int. Cl.: 35

Prior U.S. Cls.: 100, 101 and 102

United States Patent and Trademark Office

Reg. No. 3,480,119

Registered Aug. 5, 2008

**SERVICE MARK
PRINCIPAL REGISTER**

INTEGRAL MANAGEMENT

INTEGRAL MANAGEMENT, LLC (FLORIDA
LTD LIAB CO)
910 WEST AVE SUITE 1106
MIAMI BEACH, FL 33139

FOR: BUSINESS MANAGEMENT CONSULTING WITH RELATION TO STRATEGY, MARKETING, PRODUCTION, PERSONNEL AND RETAIL SALE MATTERS; CONSULTING SERVICES IN THE FIELD OF HUMAN RESOURCES DEVELOPMENT, NAMELY, FOR THE PROMOTION OF EMPLOYEE RETENTION, CAREER GROWTH, AND INCREASED PRODUCTIVITY FOR EMPLOYEES AND EMPLOYERS; BUSINESS CONSULTING SERVICES RELATING TO PRODUCT DISTRIBUTION, OPERATIONS MANAGEMENT SERVICES, LOGISTICS, REVERSE LOGISTICS, SUPPLY CHAIN, AND PRODUCTION SYSTEMS AND DISTRIBUTION SOLUTIONS; ADVERTISING AND PROMOTION SERVICES AND RELATED CONSULTING; BUSINESS CONSULTING AND INFORMATION SERVICES; ADVICE AND INFORMATION ABOUT CUSTOMER SERVICES AND PRODUCT MANAGEMENT AND PRICES ON INTERNET SITES IN CONNECTION WITH PURCHASES MADE OVER THE INTERNET; PURCHASING AND PROCUREMENT SERVICES, NAMELY, PROCURING OF CONTRACTS FOR OTHERS FOR THE PURCHASE OF GOODS AND LABOR CONTRACTING SERVICES; NEGOTIATION AND SETTLEMENT OF COMMERCIAL TRANSACTIONS FOR THIRD PARTIES; NEW BUSINESS VENTURE DEVELOPMENT AND FORMATION CONSULTING SERVICES; CONSULTING SERVICES IN THE AREA OF SUSTAINABLE BUSINESS SOLUTIONS; MARKET RESEARCH SERVICES; FINANCIAL STATEMENT PREPARATION AND ANALYSIS FOR BUSINESSES; ACCOUNTANCY SERVICES; FINANCIAL RECORDS MANAGEMENT; PROVIDING AN ON-LINE COMPUTER WEB SITE THAT PROVIDES COMMERCIAL FINANCIAL TRANSACTION DATA, ACCOUNT MANAGEMENT, FINANCIAL REPORTING, AC-

COUNTING FEATURES AND RELATED REFERENCE INFORMATION; PROMOTION OF FINANCIAL AND INSURANCE SERVICES, ON BEHALF OF THIRD PARTIES; HEALTH CARE UTILIZATION AND REVIEW SERVICES; CONSULTING SERVICES IN THE COST AND PAYMENT MANAGEMENT OF HEALTH CARE; PROVIDING ASSISTANCE, FITNESS EVALUATION AND CONSULTATION TO CORPORATE CLIENTS TO HELP THEIR EMPLOYEES MAKE HEALTH, WELLNESS AND NUTRITIONAL CHANGES IN THEIR DAILY LIVING TO INCREASE PRODUCTIVITY AND LOWER HEALTH CARE COSTS; CONSULTING SERVICES IN THE FIELD OF MANAGING INTELLECTUAL PROPERTIES; COMMERCIAL ADMINISTRATION OF THE LICENSING OF THE GOODS AND SERVICES OF OTHERS; TALENT AGENCIES; PERSONAL MANAGEMENT SERVICES FOR ENTERTAINERS; CAREER PLACEMENT; PROVIDING ORGANIZING SERVICES FOR INDIVIDUALS AT HOME, IN HOME OFFICES AND IN BUSINESS OFFICES, THAT PROVIDES HELP WITH TIME AND PAPER MANAGEMENT; ARRANGING FOR OTHERS THE REPAIR AND REPLACEMENT OF RESIDENTIAL APPLIANCES, HOME SECURITY SYSTEMS AND CONSUMER GOODS; PROVIDING INFORMATION ABOUT AND MAKING REFERRALS IN THE FIELD OF CONSUMER PRODUCTS AND SERVICES FOR RETAIL SERVICES CONCERNING PRODUCTS, SERVICES, EVENTS, ACTIVITIES, ATTRACTIONS AND FACILITIES IN PARTICULAR GEOGRAPHIC LOCATIONS, IN CLASS 35 (U.S. CLS. 100, 101 AND 102).

FIRST USE 9-15-2007; IN COMMERCE 9-15-2007.

THE MARK CONSISTS OF STANDARD CHARACTERS WITHOUT CLAIM TO ANY PARTICULAR FONT, STYLE, SIZE, OR COLOR.

NO CLAIM IS MADE TO THE EXCLUSIVE
RIGHT TO USE "MANAGEMENT", APART FROM
THE MARK AS SHOWN.

SER. NO. 77-360,835, FILED 12-28-2007.

MARCIE MILONE, EXAMINING ATTORNEY

Int. Cl.: 42

Prior U.S. Cls.: 100 and 101

United States Patent and Trademark Office

Reg. No. 3,480,120

Registered Aug. 5, 2008

**SERVICE MARK
PRINCIPAL REGISTER**

communication for your
brand

OXBOX DESIGN (NEW YORK CORPORATION)
SUITE 301
368 BROADWAY
NEW YORK, NY 10013

THE MARK CONSISTS OF STANDARD CHAR-
ACTERS WITHOUT CLAIM TO ANY PARTICULAR
FONT, STYLE, SIZE, OR COLOR.

FOR: GRAPHIC DESIGN SERVICES, IN CLASS 42
(U.S. CLS. 100 AND 101).

SER. NO. 77-360,873, FILED 12-28-2007.

FIRST USE 12-1-2007; IN COMMERCE 12-1-2007.

KATHERINE STOIDES, EXAMINING ATTORNEY

Int. Cl.: 44

Prior U.S. Cls.: 100 and 101

United States Patent and Trademark Office

Reg. No. 3,480,121

Registered Aug. 5, 2008

SERVICE MARK
PRINCIPAL REGISTER



the mindful dog, inc.

THE MINDFUL DOG, INC. (NEW YORK CORPORATION)

#1A

410 CENTRAL PARK WEST
NEW YORK, NY 10025

FOR: DOG WALKING SERVICES, IN CLASS 44
(U.S. CLS. 100 AND 101).

FIRST USE 11-1-2007; IN COMMERCE 12-1-2007.

NO CLAIM IS MADE TO THE EXCLUSIVE
RIGHT TO USE "DOG, INC." , APART FROM THE
MARK AS SHOWN.

THE MARK CONSISTS OF A TREE WITH A DOG
AS THE TREE TRUNK, WITH THE STYLIZED TEXT
OF "THE MINDFUL DOG, INC." UNDERNEATH IT.

SER. NO. 77-360,981, FILED 12-28-2007.

SHARON MEIER, EXAMINING ATTORNEY

Int. Cl.: 1

Prior U.S. Cls.: 1, 5, 6, 10, 26 and 46

Reg. No. 3,480,122

United States Patent and Trademark Office

Registered Aug. 5, 2008

**TRADEMARK
PRINCIPAL REGISTER**

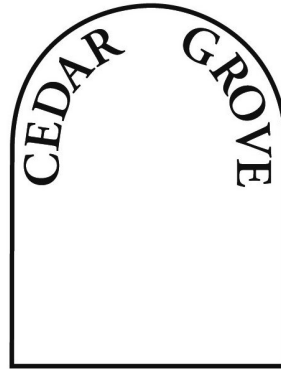

CEDAR GROVE COMPOSTING, INC. (WA-SHINGTON CORPORATION)
7343 E. MARGINAL WAY SOUTH
SEATTLE, WA 98108

THE MARK CONSISTS OF THE WORDS "CEDAR GROVE" WITHIN AN ARCHED-WINDOW SHAPE.

FOR: PLANTING SOIL; POTTING SOIL; SOIL AMENDMENTS; MANURE; COMPOST; LOAM, IN CLASS 1 (U.S. CLS. 1, 5, 6, 10, 26 AND 46).

SER. NO. 77-361,010, FILED 12-28-2007.

FIRST USE 2-1-1991; IN COMMERCE 2-1-1991.

JANET LEE, EXAMINING ATTORNEY

Int. Cl.: 16

Prior U.S. Cls.: 2, 5, 22, 23, 29, 37, 38 and 50

United States Patent and Trademark Office

Reg. No. 3,480,123

Registered Aug. 5, 2008

**TRADEMARK
PRINCIPAL REGISTER**

My password Pad

55 CONSULTANTS, INC. (CALIFORNIA CORPORATION)

1737 JUNCTION AVENUE

SAN JOSE, CA 95112

FOR: NOTE PADS, IN CLASS 16 (U.S. CLS. 2, 5, 22, 23, 29, 37, 38 AND 50).

FIRST USE 6-1-2007; IN COMMERCE 8-17-2007.

THE MARK CONSISTS OF STANDARD CHARACTERS WITHOUT CLAIM TO ANY PARTICULAR FONT, STYLE, SIZE, OR COLOR.

NO CLAIM IS MADE TO THE EXCLUSIVE RIGHT TO USE "PASSWORD PAD", APART FROM THE MARK AS SHOWN.

SER. NO. 77-361,037, FILED 12-28-2007.

RENEE MCCRAY, EXAMINING ATTORNEY

Int. Cl.: 21

Prior U.S. Cls.: 2, 13, 23, 29, 30, 33, 40 and 50

United States Patent and Trademark Office

Reg. No. 3,480,124

Registered Aug. 5, 2008

**TRADEMARK
PRINCIPAL REGISTER**

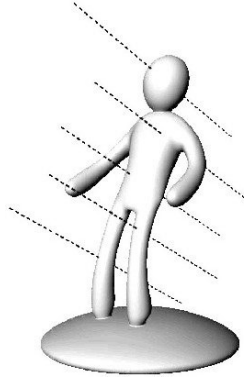

C.S.B. COMMODITIES, INC. (NEW YORK CORPORATION)
SUITE 301A
1400 OLD COUNTRY ROAD
WESTBURY, NY 11590

FOR: KNIFE BLOCKS, IN CLASS 21 (U.S. CLS. 2, 13, 23, 29, 30, 33, 40 AND 50).

FIRST USE 8-31-2005; IN COMMERCE 8-31-2005.

THE MARK CONSISTS OF THE CONFIGURATION OF THE PRODUCT SOLD UNDER THE

MARK. THE CONFIGURATION CONSISTS OF A STYLIZED FIGURE OF A FALLING PERSON. THE DASHED LINES INDICATE THE ENVIRONMENT IN WHICH THE MARK IS USED, NAMELY A STYLIZED REPRESENTATION OF KNIVES HELD IN THE KNIFE HOLDER, AND FORM NO PART OF THE MARK .

SER. NO. 77-361,060, FILED 12-28-2007.

TEJBIR SINGH, EXAMINING ATTORNEY

Int. Cl.: 30

Prior U.S. Cl.: 46

United States Patent and Trademark Office

Reg. No. 3,480,125

Registered Aug. 5, 2008

**TRADEMARK
PRINCIPAL REGISTER**

Chelton Tea Collection

CHELTON USA, INC. (ILLINOIS CORPORATION)
SUITE 110
251 NORTH MILWAUKEE AVENUE
BUFFALO GROVE, IL 60089

FOR: TEA, BEVERAGES MADE OF TEA, BLACK TEA, FLAVOURINGS OF TEA, GREEN TEA, HERB TEA FOR FOOD PURPOSES, ICED TEA, LIME TEA, OOLONG TEA, SAGE TEA AND COFFEE, IN CLASS 30 (U.S. CL. 46).

FIRST USE 9-20-2001; IN COMMERCE 9-20-2001.

THE MARK CONSISTS OF STANDARD CHARACTERS WITHOUT CLAIM TO ANY PARTICULAR FONT, STYLE, SIZE, OR COLOR.

NO CLAIM IS MADE TO THE EXCLUSIVE RIGHT TO USE "TEA COLLECTION", APART FROM THE MARK AS SHOWN.

SEC. 2(F).

SER. NO. 77-361,126, FILED 12-28-2007.

MARY MUNSON, EXAMINING ATTORNEY

Int. Cl.: 20

Prior U.S. Cls.: 2, 13, 22, 25, 32 and 50

Reg. No. 3,480,126

United States Patent and Trademark Office

Registered Aug. 5, 2008

**TRADEMARK
PRINCIPAL REGISTER**

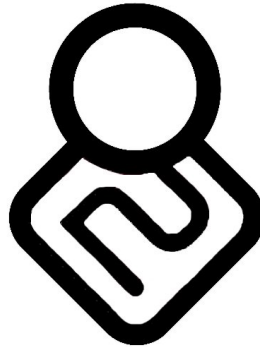

FLEXTANK INC. (GEORGIA CORPORATION)
1200 KNOB CREEK DRIVE
ATHENS, GA 30606

FOR: WINE-MAKING EQUIPMENT, NAMELY,
NON-METAL WINE MATURATION STORAGE
VESSELS, IN CLASS 20 (U.S. CLS. 2, 13, 22, 25, 32
AND 50).

FIRST USE 9-30-2007; IN COMMERCE 9-30-2007.

THE MARK CONSISTS OF A STYLIZED LOCK
DESIGN FEATURING A CIRCLE (LETTER "O")
WITH AN OUTLINED DIAMOND SHAPE AT-
TACHED TO THE BOTTOM OF THE CIRCLE,
AND THE NUMBER "2" FEATURED AT A 45-
DEGREE ANGLE OUTLINED WITHIN THE DIA-
MOND.

SER. NO. 77-361,181, FILED 12-28-2007.

CAROLYN GRAY, EXAMINING ATTORNEY

Int. Cl.: 25

Prior U.S. Cls.: 22 and 39

United States Patent and Trademark Office

Reg. No. 3,480,127

Registered Aug. 5, 2008

**TRADEMARK
PRINCIPAL REGISTER**

**SPACE...IT'S CLOSER THAN
YOU THINK**

DESERT SKY HOLDINGS, LLC (CALIFORNIA
LTD LIAB CO)
19106 BESSEMER STREET
TARZANA, CA 91335

THE MARK CONSISTS OF STANDARD CHAR-
ACTERS WITHOUT CLAIM TO ANY PARTICULAR
FONT, STYLE, SIZE, OR COLOR.

FOR: SHORT-SLEEVED OR LONG-SLEEVED T-
SHIRTS; T-SHIRTS; BASEBALL CAPS; CAP VISORS;
CAPS; GOLF CAPS, IN CLASS 25 (U.S. CLS. 22 AND
39).

SER. NO. 77-361,184, FILED 12-28-2007.

FIRST USE 5-24-2007; IN COMMERCE 5-24-2007.

KELLEY WELLS, EXAMINING ATTORNEY

Int. Cl.: 36

Prior U.S. Cls.: 100, 101 and 102

United States Patent and Trademark Office

Reg. No. 3,480,128

Registered Aug. 5, 2008

**SERVICE MARK
PRINCIPAL REGISTER**

The Prospect Fund

PROSPECT MANAGEMENT, LLC (NEW YORK
LTD LIAB CO)
250 MILL STREET
ROCHESTER, NY 14614

FOR: FINANCIAL SERVICES, NAMELY, INVEST-
MENT MANAGEMENT SERVICES, IN CLASS 36
(U.S. CLS. 100, 101 AND 102).

FIRST USE 12-1-1994; IN COMMERCE 12-1-1994.

THE MARK CONSISTS OF STANDARD CHAR-
ACTERS WITHOUT CLAIM TO ANY PARTICULAR
FONT, STYLE, SIZE, OR COLOR.

NO CLAIM IS MADE TO THE EXCLUSIVE
RIGHT TO USE "FUND", APART FROM THE
MARK AS SHOWN.

SER. NO. 77-361,243, FILED 12-28-2007.

ROBIN CHOSID, EXAMINING ATTORNEY

Int. Cl.: 36

Prior U.S. Cls.: 100, 101 and 102

United States Patent and Trademark Office

Reg. No. 3,480,129

Registered Aug. 5, 2008

**SERVICE MARK
PRINCIPAL REGISTER**

Prospect Fund

PROSPECT MANAGEMENT, LLC (NEW YORK
LTD LIAB CO)
250 MILL STREET
ROCHESTER, NY 14614

FOR: FINANCIAL SERVICES, NAMELY, INVEST-
MENT MANAGEMENT SERVICES, IN CLASS 36
(U.S. CLS. 100, 101 AND 102).

FIRST USE 12-1-1994; IN COMMERCE 12-1-1994.

THE MARK CONSISTS OF STANDARD CHAR-
ACTERS WITHOUT CLAIM TO ANY PARTICULAR
FONT, STYLE, SIZE, OR COLOR.

NO CLAIM IS MADE TO THE EXCLUSIVE
RIGHT TO USE "FUND", APART FROM THE
MARK AS SHOWN.

SER. NO. 77-361,313, FILED 12-28-2007.

ROBIN CHOSID, EXAMINING ATTORNEY

Int. Cls.: 20 and 35

Prior U.S. Cls.: 2, 13, 22, 25, 32, 50, 100, 101 and 102

Reg. No. 3,480,130

United States Patent and Trademark Office

Registered Aug. 5, 2008

**TRADEMARK
SERVICE MARK
PRINCIPAL REGISTER**

ana furniture

ANA GLOBAL INC. (CALIFORNIA CORPORATION)
3011 SOUTH EL CAMINO REAL
SAN MATEO, CA 94403

THE MARK CONSISTS OF STANDARD CHARACTERS WITHOUT CLAIM TO ANY PARTICULAR FONT, STYLE, SIZE, OR COLOR.

FOR: FURNITURE, IN CLASS 20 (U.S. CLS. 2, 13, 22, 25, 32 AND 50).

NO CLAIM IS MADE TO THE EXCLUSIVE RIGHT TO USE "FURNITURE", APART FROM THE MARK AS SHOWN.

FIRST USE 3-1-2007; IN COMMERCE 3-1-2007.

FOR: RETAIL FURNITURE STORES, IN CLASS 35 (U.S. CLS. 100, 101 AND 102).

SER. NO. 77-361,318, FILED 12-28-2007.

FIRST USE 3-1-2007; IN COMMERCE 3-1-2007.

ZHALEH DELANEY, EXAMINING ATTORNEY

Int. Cl.: 43

Prior U.S. Cls.: 100 and 101

United States Patent and Trademark Office

Reg. No. 3,480,131

Registered Aug. 5, 2008

**SERVICE MARK
PRINCIPAL REGISTER**

Cuquita's

VILLAFRANCA, ENRIQUE (UNITED STATES
INDIVIDUAL)
4940 STONY FORD DRIVE
DALLAS, TX 75287

THE MARK CONSISTS OF STANDARD CHAR-
ACTERS WITHOUT CLAIM TO ANY PARTICULAR
FONT, STYLE, SIZE, OR COLOR.

FOR: PROVIDING OF FOOD AND DRINK,
NAMELY, PREPARING, SERVING AND CATER-
ING AUTHENTIC AND TRADITIONAL MEXICAN
FOOD, IN CLASS 43 (U.S. CLS. 100 AND 101).

SER. NO. 77-361,339, FILED 12-28-2007.

FIRST USE 8-28-1997; IN COMMERCE 8-28-1997.

LEIGH LOWRY, EXAMINING ATTORNEY

Int. Cl.: 35

Prior U.S. Cls.: 100, 101 and 102

United States Patent and Trademark Office

Reg. No. 3,480,132

Registered Aug. 5, 2008

**SERVICE MARK
PRINCIPAL REGISTER**



BONZOLIO, INCORPORATED (CALIFORNIA CORPORATION)
402 LA SOLEDAD WAY
OCEANSIDE, CA 92057

FOR: RETAIL AND WHOLESALE ORDERING SERVICES FEATURING RETAIL AND WHOLESALE ADVERTISING SPECIALTY PRODUCTS, PROMOTIONAL PRODUCTS, BUSINESS GIFTS, AND APPAREL TYPICALLY DECORATED WITH BUSINESS NAMES AND LOGOS; WHOLESALE ORDERING OF PROMOTIONAL AND ADVERTISING PREMIUM PRODUCTS; PROCUREMENT SERVICES FOR OTHERS, NAMELY, PURCHASING PROMOTIONAL AND ADVERTISING PREMIUM MERCHANDISE, IN CLASS 35 (U.S. CLS. 100, 101 AND 102).

FIRST USE 7-31-2007; IN COMMERCE 10-31-2007.

OWNER OF U.S. REG. NOS. 3,228,612 AND 3,276,525.

THE MARK CONSISTS OF A STYLIZED LETTER "B" THAT IS ALSO INTENDED TO FORM AN EXCLAMATION POINT HAVING A LIGHTNING BOLT THEREIN.

SER. NO. 77-361,350, FILED 12-28-2007.

SANDRA MANIOS, EXAMINING ATTORNEY

Int. Cl.: 25

Prior U.S. Cls.: 22 and 39

United States Patent and Trademark Office

Reg. No. 3,480,133

Registered Aug. 5, 2008

**TRADEMARK
PRINCIPAL REGISTER**

**Does this skirt make my
butt look fast?**

LANGENDORFER, HEATHER L (CALIFORNIA
SOLE PROPRIETORSHIP), DBA ATALANTA
ATHLETICWEAR
751 LAUREL STREET, SUITE 202
SAN CARLOS, CA 94070

FOR: ATHLETIC APPAREL, NAMELY, SHIRTS,
SHORTS, SKIRTS, SKORTS, TOPS, NAMELY, LONG
SLEEVE SHIRTS, SHORT SLEEVE SHIRTS, WORK-
OUT SKIRTS, RUNNING SKIRTS, BRIEFS, LONG
PANTS, SOCKS, VISORS, CAPS, JACKETS, SWEAT-
SHIRTS AND SWEAT PANTS, AND COVERUPS, IN
CLASS 25 (U.S. CLS. 22 AND 39).

FIRST USE 1-1-2007; IN COMMERCE 4-1-2007.

THE MARK CONSISTS OF STANDARD CHAR-
ACTERS WITHOUT CLAIM TO ANY PARTICULAR
FONT, STYLE, SIZE, OR COLOR.

SER. NO. 77-361,547, FILED 12-29-2007.

HEATHER THOMPSON, EXAMINING ATTORNEY

Int. Cl.: 44

Prior U.S. Cls.: 100 and 101

United States Patent and Trademark Office

Reg. No. 3,480,134

Registered Aug. 5, 2008

**SERVICE MARK
PRINCIPAL REGISTER**

SpaTastic

LINH T. LUU-MURPHY (UNITED STATES IN-
DIVIDUAL)
P.O. BOX 701
CALISTOGA, CA 94515

THE MARK CONSISTS OF STANDARD CHAR-
ACTERS WITHOUT CLAIM TO ANY PARTICULAR
FONT, STYLE, SIZE, OR COLOR.

FOR: MASSAGE AND THERAPEUTIC SHIATSU
MASSAGE, IN CLASS 44 (U.S. CLS. 100 AND 101).

SER. NO. 77-361,587, FILED 12-30-2007.

FIRST USE 12-3-2007; IN COMMERCE 12-3-2007.

JENNIFER DIXON, EXAMINING ATTORNEY

Int. Cl.: 41

Prior U.S. Cls.: 100, 101 and 107

United States Patent and Trademark Office

Reg. No. 3,480,135

Registered Aug. 5, 2008

**SERVICE MARK
PRINCIPAL REGISTER**



BLOM, SALISHA (UNITED STATES INDIVIDUAL)
18 10TH AVE
EDGERTON, MN 56128

FOR: PHOTOGRAPHY SERVICES, IN CLASS 41 (U.S. CLS. 100, 101 AND 107).

FIRST USE 10-19-2007; IN COMMERCE 10-19-2007.

NO CLAIM IS MADE TO THE EXCLUSIVE RIGHT TO USE "PHOTOGRAPHY BY" , APART FROM THE MARK AS SHOWN.

THE COLOR(S) BLACK, WHITE, AND GRAY IS/ARE CLAIMED AS A FEATURE OF THE MARK.

THE MARK CONSISTS OF A BLACK RECTANGULAR SHAPE WITHIN WHICH ARE DEPICTED THE STYLIZED GRAY WORD "CREATIVE" INTENSELY DARKENED WITH BLACK ON ITS TOP LEFT, UNDERLINED BY A WHITE LINE, THE STYLIZED WHITE WORDING "PHOTOGRAPHY BY SALISHA", AND A WHITE ABSTRACT DESIGN OF A FLOWER.

SER. NO. 77-361,653, FILED 12-31-2007.

MARIA-VICTORIA SUAREZ, EXAMINING ATTORNEY

Int. Cl.: 7

Prior U.S. Cls.: 13, 19, 21, 23, 31, 34 and 35

United States Patent and Trademark Office

Reg. No. 3,480,136

Registered Aug. 5, 2008

**TRADEMARK
PRINCIPAL REGISTER**



A.S.V., INC. (MINNESOTA CORPORATION)
840 LILY LANE
P.O. BOX 5160
GRAND RAPIDS, MN 55744

FOR: RUBBER TRACK LOADERS; RUBBER TRACK UTILITY VEHICLES; AND LANDSCAPE, CONSTRUCTION, AND AGRICULTURAL RUBBER TRACK MACHINES, IN CLASS 7 (U.S. CLS. 13, 19, 21, 23, 31, 34 AND 35).

FIRST USE 10-25-2007; IN COMMERCE 10-25-2007.

THE COLOR(S) WHITE, GREEN AND BLACK IS/ ARE CLAIMED AS A FEATURE OF THE MARK.

THE LETTERS IN THE MARK ARE WHITE, THE CURVED LINE IS GREEN, AND THE BACKGROUND IS BLACK.

SER. NO. 77-361,656, FILED 12-31-2007.

ALICE SUE CARRUTHERS, EXAMINING ATTORNEY

Int. Cl.: 7

Prior U.S. Cls.: 13, 19, 21, 23, 31, 34 and 35

Reg. No. 3,480,137

United States Patent and Trademark Office

Registered Aug. 5, 2008

**TRADEMARK
PRINCIPAL REGISTER**

CXRacing

SKYQUEST INC. (CALIFORNIA CORPORATION), DBA CXRACING
WWW.CXRACING.COM
1627 CHICO AVE
S. EL MONTE, CA 91733

FOR: AUTOMOTIVE EXHAUST PIPE; AUTOMOTIVE INTAKE MANIFOLDS; AIR-INTAKE TUBES AND FILTERS FOR AFTER-MARKET INSTALLATION OF AUTOMOTIVE ENGINES; RADIATORS FOR MOTORS AND ENGINES; ENGINE EXHAUST TIPS; EXHAUST MANIFOLD FOR ENGINES; EXHAUST PIPES FOR LAND VEHICLES; EXHAUST SILENCERS FOR ENGINES; HEADERS AS PART OF VEHICLE EXHAUST SYSTEM; INTAKE AND EXHAUST AIR FLOW VANE ASSEMBLY DEVICE FOR USE IN AN INTERNAL COMBUSTION ENGINE; ENGINE PARTS, NAMELY, ELECTRONIC FUEL INJECTION MODULES; FUEL INJECTOR PARTS FOR LAND AND WATER VEHICLE ENGINES; VEHICLE ENGINE PARTS, NAMELY, OIL TANKS; VEHICLE PARTS, NAMELY, ENGINE CAM PROTECTORS; VEHICLE PARTS, NAMELY, ENGINE CASES; VEHICLE PARTS, NAMELY, INTAKE MANIFOLDS; PULLEYS BEING PARTS OF MACHINES; SILENCERS AS PART OF VEHICLE EXHAUST SYSTEMS; VEHICLE BODY AND FRAME ALIGNMENT MACHINES AND STRUCTURAL REPLACEMENT PARTS THEREFOR; VEHICLE ENGINE PARTS, NAMELY, OIL COOLERS; INTERNAL COMBUSTION ENGINES FOR MACHINE OPERA-

TION AND REPLACEMENT PARTS THEREFOR; INTERNAL COMBUSTION ENGINES LAND VEHICLE PARTS, NAMELY, COILS; INTERNAL COMBUSTION ENGINES LAND VEHICLE PARTS, NAMELY, DISTRIBUTOR CAPS; INTERNAL COMBUSTION ENGINES LAND VEHICLE PARTS, NAMELY, DISTRIBUTOR ROTORS; INTERNAL COMBUSTION LAND VEHICLE ENGINE PARTS, NAMELY, CONNECTING RODS; LAND VEHICLE PARTS, NAMELY, SPARK PLUG WIRES; IGNITION PARTS FOR INTERNAL COMBUSTION ENGINES, NAMELY, CONDENSERS; IGNITIONS PARTS FOR INTERNAL COMBUSTION ENGINES, NAMELY, POINTS; INTERNAL COMBUSTION ENGINE PARTS, NAMELY, HEADS; INTERNAL COMBUSTION ENGINE PARTS, NAMELY, PISTON RINGS; INTERNAL COMBUSTION ENGINE PARTS, NAMELY, PISTONS; TURBOCHARGERS FOR CAR, IN CLASS 7 (U.S. CLS. 13, 19, 21, 23, 31, 34 AND 35).

FIRST USE 1-1-2007; IN COMMERCE 1-1-2007.

THE MARK CONSISTS OF STANDARD CHARACTERS WITHOUT CLAIM TO ANY PARTICULAR FONT, STYLE, SIZE, OR COLOR.

SER. NO. 77-361,664, FILED 12-31-2007.

JAMES MACFARLANE, EXAMINING ATTORNEY

Int. Cl.: 35

Prior U.S. Cls.: 100, 101 and 102

United States Patent and Trademark Office

Reg. No. 3,480,138

Registered Aug. 5, 2008

**SERVICE MARK
PRINCIPAL REGISTER**

TranscriptsNow

EMMA HITT MEDICAL WRITING, LLC (GEOR-
GIA LTD LIAB CO)
2386 RIDERWOOD CT
MARIETTA, GA 30062

FOR: MEDICAL TRANSCRIPTION SERVICES, IN
CLASS 35 (U.S. CLS. 100, 101 AND 102).

FIRST USE 12-28-2007; IN COMMERCE 12-28-2007.

THE COLOR(S) NAVY BLUE AND LIME GREEN
IS/ARE CLAIMED AS A FEATURE OF THE MARK.

THE MARK CONSISTS OF "TRANSCRIPTS" IN
NAVY BLUE AND "NOW" IN LIME GREEN.
"TRANSCRIPTSNOW" IS ONE WORD.

SER. NO. 77-361,703, FILED 12-31-2007.

KATHERINE E. HALMEN, EXAMINING ATTOR-
NEY

Int. Cl.: 37

Prior U.S. Cls.: 100, 103 and 106

United States Patent and Trademark Office

Reg. No. 3,480,139

Registered Aug. 5, 2008

**SERVICE MARK
PRINCIPAL REGISTER**

LIFEZONES

GRAND HAVEN HOMES (TEXAS LIMITED
PARTNERSHIP)
1011 NORTH LAMAR BLVD.
AUSTIN, TX 78703

THE MARK CONSISTS OF STANDARD CHAR-
ACTERS WITHOUT CLAIM TO ANY PARTICULAR
FONT, STYLE, SIZE, OR COLOR.

FOR: HOME CONSTRUCTION AND HOME CUS-
TOMIZATION SERVICES, IN CLASS 37 (U.S. CLS.
100, 103 AND 106).

SER. NO. 77-361,762, FILED 12-31-2007.

FIRST USE 1-2-2006; IN COMMERCE 1-2-2006.

KELLY MCCOY, EXAMINING ATTORNEY

Int. Cl.: 42

Prior U.S. Cls.: 100 and 101

United States Patent and Trademark Office

Reg. No. 3,480,140

Registered Aug. 5, 2008

**SERVICE MARK
PRINCIPAL REGISTER**



WAGNON, JOSEPH (UNITED STATES INDIVIDUAL)
200 FRISBIE ST.
OAKLAND, CA 94611

FOR: GRAPHIC DESIGN SERVICES; WEB SITE DESIGN, IN CLASS 42 (U.S. CLS. 100 AND 101).

FIRST USE 11-1-2002; IN COMMERCE 11-1-2002.

NO CLAIM IS MADE TO THE EXCLUSIVE RIGHT TO USE "STUDIO" , APART FROM THE MARK AS SHOWN.

THE MARK CONSISTS OF THE TEXT "PEPE'S STUDIO" IN CENTURY GOTHIC FONTS; ON THE RIGHT OF THE NAME IS A LOGO OF A HAND-SHAPE ICON-LIKE LOGO.

SER. NO. 77-361,786, FILED 12-31-2007.

KELLY MCCOY, EXAMINING ATTORNEY

Int. Cl.: 36

Prior U.S. Cls.: 100, 101 and 102

United States Patent and Trademark Office

Reg. No. 3,480,141

Registered Aug. 5, 2008

**SERVICE MARK
PRINCIPAL REGISTER**

Valley Forge
Financial, LLC 
*Insurance * Investments * Integrity*

VALLEY FORGE FINANCIAL (VIRGINIA LTD
LIAB CO)
SUITE 200
11211 WAPLES MILL RD.
FAIRFAX, VA 22030

FOR: FINANCIAL PLANNING AND INVEST-
MENT ADVISORY SERVICES; INSURANCE AGEN-
CIES; MORTGAGE LENDING, IN CLASS 36 (U.S.
CLS. 100, 101 AND 102).

FIRST USE 12-20-2006; IN COMMERCE 12-20-2006.

NO CLAIM IS MADE TO THE EXCLUSIVE
RIGHT TO USE "FINANCIAL, LLC "AND "INSUR-
ANCE" AND "INVESTMENTS" AND "INTEGRITY",
APART FROM THE MARK AS SHOWN.

THE MARK CONSISTS OF A HOUSE WITH A
STAR, AND THE STYLIZED TEXT "VALLEY
FORGE FINANCIAL, LLC INSURANCE * INVEST-
MENTS * INTEGRITY".

SER. NO. 77-361,804, FILED 12-31-2007.

BRIAN NEVILLE, EXAMINING ATTORNEY

Int. Cl.: 41

Prior U.S. Cls.: 100, 101 and 107

Reg. No. 3,480,142

United States Patent and Trademark Office

Registered Aug. 5, 2008

**SERVICE MARK
PRINCIPAL REGISTER**



IRON HAUS (TEXAS LTD LIAB CO)
541 PRIVATE ROAD 5752
DEVINE, TX 78016

FOR: PROVIDING FITNESS AND EXERCISE FACILITIES, IN CLASS 41 (U.S. CLS. 100, 101 AND 107).

FIRST USE 8-30-2007; IN COMMERCE 8-30-2007.

NO CLAIM IS MADE TO THE EXCLUSIVE RIGHT TO USE "HAUS" AND "FITNESS", APART FROM THE MARK AS SHOWN.

THE MARK CONSISTS OF THE TEXT "IRON HAUS FITNESS" IN STYLIZED LETTERING WITH THE I BEING PART OF A BARBELL. "IRON HAUS" IS ON THE TOP LINE IN THE SHAPE OF A HOUSE WITH THE WORD "FITNESS" BENEATH.

THE ENGLISH TRANSLATION OF THE WORD "HAUS" IN THE MARK IS "HOUSE".

SER. NO. 77-361,822, FILED 12-31-2007.

JAMES MACFARLANE, EXAMINING ATTORNEY

Int. Cl.: 25

Prior U.S. Cls.: 22 and 39

United States Patent and Trademark Office

Reg. No. 3,480,143

Registered Aug. 5, 2008

**TRADEMARK
PRINCIPAL REGISTER**

Gold Crown Dungarees

JAZZMAN SPORTSWEAR CORP. (NEW YORK
CORPORATION)
SUITE 601
463 SEVENTH AVE.
NEW YORK, NY 10018

FOR: BLOUSES; JACKETS; JEANS; SHIRTS;
SHORTS; TOPS; TROUSERS, IN CLASS 25 (U.S.
CLS. 22 AND 39).

FIRST USE 2-0-2007; IN COMMERCE 3-0-2007.

THE MARK CONSISTS OF STANDARD CHAR-
ACTERS WITHOUT CLAIM TO ANY PARTICULAR
FONT, STYLE, SIZE, OR COLOR.

NO CLAIM IS MADE TO THE EXCLUSIVE
RIGHT TO USE "DUNGAREES", APART FROM
THE MARK AS SHOWN.

SER. NO. 77-361,835, FILED 12-31-2007.

LINDA MICKLEBURGH, EXAMINING ATTORNEY

Int. Cl.: 45

Prior U.S. Cls.: 100 and 101

United States Patent and Trademark Office

Reg. No. 3,480,144

Registered Aug. 5, 2008

**SERVICE MARK
PRINCIPAL REGISTER**

Insider Dating

RUMETAGRO LLC (MASSACHUSETTS LTD
LIAB CO)
140 PINE STREET, #9
FLORENCE, MA 01062

FOR: INTERNET BASED SOCIAL NETWORK-
ING, INTRODUCTION, AND DATING SERVICES,
IN CLASS 45 (U.S. CLS. 100 AND 101).

FIRST USE 9-27-2007; IN COMMERCE 11-4-2007.

THE MARK CONSISTS OF STANDARD CHAR-
ACTERS WITHOUT CLAIM TO ANY PARTICULAR
FONT, STYLE, SIZE, OR COLOR.

NO CLAIM IS MADE TO THE EXCLUSIVE
RIGHT TO USE "DATING", APART FROM THE
MARK AS SHOWN.

SER. NO. 77-361,904, FILED 12-31-2007.

AMY ALFIERI, EXAMINING ATTORNEY

Int. Cl.: 45

Prior U.S. Cls.: 100 and 101

United States Patent and Trademark Office

Reg. No. 3,480,145

Registered Aug. 5, 2008

**SERVICE MARK
PRINCIPAL REGISTER**



MYWORLDIS INCORPORATED (DELAWARE CORPORATION)
16041 JOHNSTON ROAD
SUITE G-119
CHARLOTTE, NC 28277

FOR: ONLINE SOCIAL NETWORKING SERVICES, IN CLASS 45 (U.S. CLS. 100 AND 101).

FIRST USE 7-25-2007; IN COMMERCE 7-25-2007.

THE STIPLING IS FOR SHADING PURPOSES ONLY.

THE MARK CONSISTS OF AN ABSTRACT DESIGN WITH THE STYLIZED TEXT "MYWORLDIS.COM BRINGING THE WORLD TOGETHER IN ONE PLACE".

SER. NO. 77-361,907, FILED 12-31-2007.

ALEX KEAM, EXAMINING ATTORNEY

Int. Cl.: 29

Prior U.S. Cl.: 46

United States Patent and Trademark Office

Reg. No. 3,480,146

Registered Aug. 5, 2008

**TRADEMARK
PRINCIPAL REGISTER**

ADAM'S FOOD PRODUCTS

OCEAN DISTRIBUTORS INTERNATIONAL INC.
(FLORIDA CORPORATION)

746 BOCCE COURT

PALM BEACH GARDENS, FL 33410

FOR: SEAFOOD; SEASONED SEAFOOD, IN
CLASS 29 (U.S. CL. 46).

FIRST USE 2-19-2007; IN COMMERCE 2-19-2007.

THE MARK CONSISTS OF STANDARD CHAR-
ACTERS WITHOUT CLAIM TO ANY PARTICULAR
FONT, STYLE, SIZE, OR COLOR.

NO CLAIM IS MADE TO THE EXCLUSIVE
RIGHT TO USE "FOOD PRODUCTS", APART
FROM THE MARK AS SHOWN.

SER. NO. 77-361,946, FILED 12-31-2007.

ALEX KEAM, EXAMINING ATTORNEY

Int. Cl.: 42

Prior U.S. Cls.: 100 and 101

United States Patent and Trademark Office

Reg. No. 3,480,147

Registered Aug. 5, 2008

**SERVICE MARK
PRINCIPAL REGISTER**

JBSERVERS

JBSERVERS.NET (WASHINGTON LTD LIAB CO)
31410 76TH AVE. NW
STANWOOD, WA 98292

FOR: HOSTING THE WEB SITES OF OTHERS ON
A COMPUTER SERVER FOR A GLOBAL COMPU-
TER NETWORK; WEB SITE HOSTING SERVICES,
IN CLASS 42 (U.S. CLS. 100 AND 101).

FIRST USE 3-14-2001; IN COMMERCE 6-5-2004.

THE MARK CONSISTS OF STANDARD CHAR-
ACTERS WITHOUT CLAIM TO ANY PARTICULAR
FONT, STYLE, SIZE, OR COLOR.

SER. NO. 77-361,951, FILED 12-31-2007.

NORA BUCHANAN WILL, EXAMINING ATTOR-
NEY

Int. Cl.: 32

Prior U.S. Cls.: 45, 46 and 48

Reg. No. 3,480,148

United States Patent and Trademark Office

Registered Aug. 5, 2008

**TRADEMARK
PRINCIPAL REGISTER**

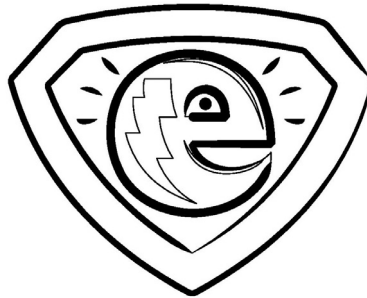

ODWALLA, INC. (CALIFORNIA CORPORATION)
120 STONE PINE ROAD
HALF MOON BAY, CA 94019

THE MARK CONSISTS OF A LOWER CASE "E"
CONTAINING A LIGHTNING BOLT DESIGN IN-
SIDE OF A CONCENTRIC SHIELD DEVICE.

FOR: NON-ALCOHOLIC BEVERAGES, NAMELY,
FRUIT DRINKS AND FRUIT JUICES, IN CLASS 32
(U.S. CLS. 45, 46 AND 48).

SER. NO. 77-361,954, FILED 12-31-2007.

FIRST USE 10-1-2007; IN COMMERCE 10-1-2007.

ALEX KEAM, EXAMINING ATTORNEY

Int. Cl.: 9

Prior U.S. Cls.: 21, 23, 26, 36 and 38

United States Patent and Trademark Office

Reg. No. 3,480,149

Registered Aug. 5, 2008

**TRADEMARK
PRINCIPAL REGISTER**

FLOPHOUSE RECORDS

FLOPHOUSE RECORDS (MAINE CORPORATION)
P.O. BOX 2713
BANGOR, ME 044022713

FOR: PRE-RECORDED CDS, VIDEO TAPES, LASER DISKS AND DVDS FEATURING MUSIC, IN CLASS 9 (U.S. CLS. 21, 23, 26, 36 AND 38).

FIRST USE 1-0-1999; IN COMMERCE 6-8-2006.

THE MARK CONSISTS OF STANDARD CHARACTERS WITHOUT CLAIM TO ANY PARTICULAR FONT, STYLE, SIZE, OR COLOR.

NO CLAIM IS MADE TO THE EXCLUSIVE RIGHT TO USE "RECORDS", APART FROM THE MARK AS SHOWN.

SER. NO. 77-361,960, FILED 12-31-2007.

ALEX KEAM, EXAMINING ATTORNEY

Int. Cl.: 20

Prior U.S. Cls.: 2, 13, 22, 25, 32 and 50

Reg. No. 3,480,150

United States Patent and Trademark Office

Registered Aug. 5, 2008

**TRADEMARK
PRINCIPAL REGISTER**

IE; BLINDS

RAL & ASSOCIATES, INC. (TEXAS CORPORATION)
P.O. BOX 442
BEN WHEELER, TX 757540442

THE MARK CONSISTS OF STANDARD CHARACTERS WITHOUT CLAIM TO ANY PARTICULAR FONT, STYLE, SIZE, OR COLOR.

FOR: WINDOW BLINDS; WINDOW SHADES; FABRIC WINDOW BLINDS; INDOOR WINDOW BLINDS; METAL INDOOR WINDOW BLINDS; BAMBOO BLINDS; BLINDS OF REED, RATTAN OR BAMBOO, SUDARE; INTERNAL VENETIAN BLINDS; SLATTED INDOOR BLINDS; VENETIAN BLINDS, IN CLASS 20 (U.S. CLS. 2, 13, 22, 25, 32 AND 50).

NO CLAIM IS MADE TO THE EXCLUSIVE RIGHT TO USE "BLINDS", APART FROM THE MARK AS SHOWN.

SER. NO. 77-361,972, FILED 12-31-2007.

FIRST USE 9-1-2004; IN COMMERCE 9-1-2005.

ALEX KEAM, EXAMINING ATTORNEY

Int. Cl.: 9

Prior U.S. Cls.: 21, 23, 26, 36 and 38

Reg. No. 3,480,151

United States Patent and Trademark Office

Registered Aug. 5, 2008

**TRADEMARK
PRINCIPAL REGISTER**

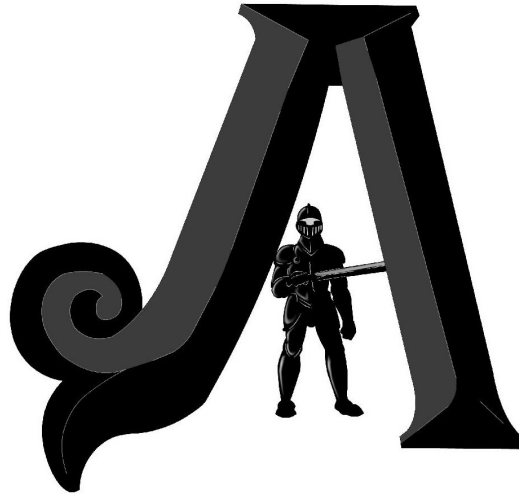

ANDERSON ARMOR & SECURITY LLC (PENN-
SYLVANIA LTD LIAB CO)
1114 WALNUT STREET
COLUMBIA, PA 17512

FOR: BULLET-PROOF VESTS, IN CLASS 9 (U.S.
CLS. 21, 23, 26, 36 AND 38).

FIRST USE 10-30-2007; IN COMMERCE 10-30-2007.

THE MARK IS COMPRISED OF AN UPPER CASE
LETTER "A" WHERE THE HORIZONTAL LINE
ACROSS THE MIDDLE OF THE "A" IS FORMED
BY A KNIGHT IN ARMOR STANDING WITH AN
EXTENDED SWORD.

SER. NO. 77-361,982, FILED 12-31-2007.

ANDREA HACK, EXAMINING ATTORNEY

Int. Cl.: 41

Prior U.S. Cls.: 100, 101 and 107

United States Patent and Trademark Office

Reg. No. 3,480,152

Registered Aug. 5, 2008

**SERVICE MARK
PRINCIPAL REGISTER**

PILATES MUSE

PIERCE, CATHERINE (UNITED STATES INDIVIDUAL)
UNIT A
505 E. MONROE STREET
AUSTIN, TX 78704

FOR: PHYSICAL FITNESS INSTRUCTION, NAMELY, PILATES INSTRUCTION AND DISTRIBUTION OF COURSE MATERIAL IN CONNECTION THEREWITH, IN CLASS 41 (U.S. CLS. 100, 101 AND 107).

FIRST USE 7-1-2007; IN COMMERCE 7-1-2007.

THE MARK CONSISTS OF STANDARD CHARACTERS WITHOUT CLAIM TO ANY PARTICULAR FONT, STYLE, SIZE, OR COLOR.

NO CLAIM IS MADE TO THE EXCLUSIVE RIGHT TO USE "PILATES", APART FROM THE MARK AS SHOWN.

SER. NO. 77-361,989, FILED 12-31-2007.

LEIGH CAROLINE CASE, EXAMINING ATTORNEY

Int. Cl.: 35

Prior U.S. Cls.: 100, 101 and 102

United States Patent and Trademark Office

Reg. No. 3,480,153

Registered Aug. 5, 2008

**SERVICE MARK
PRINCIPAL REGISTER**

T&A Marketing Products

T&A MARKETING PRODUCTS (OKLAHOMA
LTD LIAB CO)
16408 BIG CYPRESS DR.
EDMOND, OK 73013

FOR: ADVERTISING AND PROMOTIONAL SERVICES, NAMELY, PROVISION OF ADVICE AND INFORMATION RELATED TO THE SELECTION, USE AND DISTRIBUTION OF ADVERTISING AND PROMOTIONAL PRODUCTS AND ON-LINE RETAIL STORE SERVICES FEATURING ADVERTISING, MARKETING AND PROMOTIONAL PRODUCTS, NAMELY, PERSONALIZED GOODS BEARING ADVERTISING, MARKETING AND PROMOTIONAL INFORMATION, NAMELY, APPAREL, DRINK WARE, HOUSEWARES, PRINTED PAPER GOODS, WRITING INSTRUMENTS, KEY CHAINS, BAGS, TIMEPIECES, TROPHIES AND

SPORTING GOODS, IN CLASS 35 (U.S. CLS. 100, 101 AND 102).

FIRST USE 10-0-2007; IN COMMERCE 11-0-2007.

THE MARK CONSISTS OF STANDARD CHARACTERS WITHOUT CLAIM TO ANY PARTICULAR FONT, STYLE, SIZE, OR COLOR.

NO CLAIM IS MADE TO THE EXCLUSIVE RIGHT TO USE "MARKETING PRODUCTS", APART FROM THE MARK AS SHOWN.

SER. NO. 77-361,991, FILED 12-31-2007.

MATTHEW MCDOWELL, EXAMINING ATTORNEY

Int. Cl.: 25

Prior U.S. Cls.: 22 and 39

United States Patent and Trademark Office

Reg. No. 3,480,154

Registered Aug. 5, 2008

**TRADEMARK
PRINCIPAL REGISTER**

WHAT'S IN YOUR FLY?

MOORE, AARON (UNITED STATES INDIVIDUAL)
2224 PINE STREET
EVERETT, WA 98201

FOR: ATHLETIC UNIFORMS; BASEBALL CAPS; BATHING SUITS; BEANIES; BELTS; BELTS MADE OF LEATHER; BRIEFS; CAPS; CAPS WITH VISORS; DENIM JACKETS; DENIMS; DRESS SHIRTS; DRESS SUITS; FOOTWEAR; GOLF SHIRTS; HAT BANDS; HATS; HEAD SWEATBANDS; HEADBANDS; HEADBANDS AGAINST SWEATING; HEADGEAR, NAMELY, HATS AND CAPS; HEADWEAR; HOODS; JACKETS; JERSEYS; MEN'S SOCKS; MEN'S SUITS; PANTIES, SHORTS AND BRIEFS; PANTS; SHIRTS; SHIRT FRONTS; SHIRTS FOR SUITS; SHOES; SHORTS; SWEATBANDS; SWEAT PANTS; SWEAT

SHIRTS; SWEAT SHORTS; SWEAT SUITS; SWEATERS; SWEATSOCKS; T-SHIRTS; TURTLENECK SWEATERS; UNDER GARMENTS; UNDERCLOTHES; UNDERPANTS; UNDERSHIRTS; UNDERWEAR, IN CLASS 25 (U.S. CLS. 22 AND 39).

FIRST USE 9-0-2007; IN COMMERCE 9-0-2007.

THE MARK CONSISTS OF STANDARD CHARACTERS WITHOUT CLAIM TO ANY PARTICULAR FONT, STYLE, SIZE, OR COLOR.

SER. NO. 77-362,004, FILED 12-31-2007.

SHAILA SETTLES, EXAMINING ATTORNEY

Int. Cl.: 35

Prior U.S. Cls.: 100, 101 and 102

United States Patent and Trademark Office

Reg. No. 3,480,155

Registered Aug. 5, 2008

**SERVICE MARK
PRINCIPAL REGISTER**

Mimi's Curvy Corner

JMJ ENTERPRISE, INC. (PENNSYLVANIA CORPORATION), DBA MIMI'S CURVY CORNER
P.O. BOX 9106
LANCASTER, PA 17604

FOR: ON-LINE RETAIL STORE SERVICES FEATURING CLOTHING, JEWELRY, BAGS, IN CLASS 35 (U.S. CLS. 100, 101 AND 102).

FIRST USE 5-10-2007; IN COMMERCE 5-10-2007.

THE MARK CONSISTS OF STANDARD CHARACTERS WITHOUT CLAIM TO ANY PARTICULAR FONT, STYLE, SIZE, OR COLOR.

SER. NO. 77-362,071, FILED 12-31-2007.

MARIA-VICTORIA SUAREZ, EXAMINING ATTORNEY

Int. Cl.: 45

Prior U.S. Cls.: 100 and 101

United States Patent and Trademark Office

Reg. No. 3,480,156

Registered Aug. 5, 2008

**SERVICE MARK
PRINCIPAL REGISTER**

**PLACE - PLANNED LEGAL
ADVOCACY CARE FOR EVERYONE**

LABROSSE, LUC R (UNITED STATES INDIVIDUAL), DBA PLANNED LEGAL ADVOCACY CARE FOR EVERYONE
12 BREAKNECK HILL RD
LINCOLN, RI 02865

FOR: CONSULTING SERVICES CONCERNING LEGAL MATTERS IN THE MEDICAL FIELD; PROVIDING PATIENT ADVOCATE SERVICES TO HOSPITAL PATIENTS AND PATIENTS IN LONG TERM CARE FACILITIES; PROVIDING PERSONAL SUPPORT SERVICES FOR FAMILIES OF PATIENTS WITH LIFE THREATENING DISORDERS, NAMELY, COMPANIONSHIP, HELP WITH MEDICAL FORMS, COUNSELING AND EMOTIONAL SUPPORT, IN CLASS 45 (U.S. CLS. 100 AND 101).

FIRST USE 10-15-2007; IN COMMERCE 10-15-2007.

THE MARK CONSISTS OF STANDARD CHARACTERS WITHOUT CLAIM TO ANY PARTICULAR FONT, STYLE, SIZE, OR COLOR.

NO CLAIM IS MADE TO THE EXCLUSIVE RIGHT TO USE "PLANNED LEGAL ADVOCACY", APART FROM THE MARK AS SHOWN.

SER. NO. 77-362,208, FILED 1-1-2008.

LINDA MICKLEBURGH, EXAMINING ATTORNEY

Int. Cl.: 30

Prior U.S. Cl.: 46

United States Patent and Trademark Office

Reg. No. 3,480,157

Registered Aug. 5, 2008

**TRADEMARK
PRINCIPAL REGISTER**

**The Original Buckeye
Gourmet Barbecue Sauce**

BUCKEYE BARBECUE CO. (OHIO CORPORATION)
903 CAMP CREEK RD
WAYNESVILLE, OH 45068

NO CLAIM IS MADE TO THE EXCLUSIVE
RIGHT TO USE "BARBECUE SAUCE", APART
FROM THE MARK AS SHOWN.

FOR: BARBECUE SAUCE, IN CLASS 30 (U.S. CL.
46).

SEC. 2(F).

FIRST USE 10-1-1988; IN COMMERCE 10-1-1988.

SER. NO. 77-362,228, FILED 1-1-2008.

THE MARK CONSISTS OF STANDARD CHAR-
ACTERS WITHOUT CLAIM TO ANY PARTICULAR
FONT, STYLE, SIZE, OR COLOR.

LINDSEY RUBIN, EXAMINING ATTORNEY

Int. Cl.: 18

Prior U.S. Cls.: 1, 2, 3, 22 and 41

United States Patent and Trademark Office

Reg. No. 3,480,158

Registered Aug. 5, 2008

**TRADEMARK
PRINCIPAL REGISTER**

WWW.4RPLANETBAG.COM

HEBEGRACE, INC. (PANAMA CORPORATION)
AP 36
POTRERO, COSTA RICA

FIRST USE 8-15-2007; IN COMMERCE 10-15-2007.

SER. NO. 77-362,235, FILED 1-1-2008.

FOR: ALL-PURPOSE CARRYING BAGS, IN
CLASS 18 (U.S. CLS. 1, 2, 3, 22 AND 41).

MATTHEW EINSTEIN, EXAMINING ATTORNEY

Int. Cl.: 11

Prior U.S. Cls.: 13, 21, 23, 31 and 34

United States Patent and Trademark Office

Reg. No. 3,480,159

Registered Aug. 5, 2008

**TRADEMARK
PRINCIPAL REGISTER**

HATCO

HATCO CORPORATION (WISCONSIN CORPORATION)
635 S. 28TH STREET
MILWAUKEE, WI 53215

FOR: GAS BOOSTER WATER HEATERS, IN CLASS 11 (U.S. CLS. 13, 21, 23, 31 AND 34).

FIRST USE 5-19-1997; IN COMMERCE 5-19-1997.

THE MARK CONSISTS OF STANDARD CHARACTERS WITHOUT CLAIM TO ANY PARTICULAR FONT, STYLE, SIZE, OR COLOR.

OWNER OF U.S. REG. NOS. 655,463, 2,936,162 AND OTHERS.

SER. NO. 77-362,288, FILED 1-2-2008.

BARBARA RUTLAND, EXAMINING ATTORNEY

Int. Cl.: 3

Prior U.S. Cls.: 1, 4, 6, 50, 51 and 52

United States Patent and Trademark Office

Reg. No. 3,480,160

Registered Aug. 5, 2008

**TRADEMARK
PRINCIPAL REGISTER**

MOONMAID BOTANICALS

MOONMAID BOTANICALS (TENNESSEE SOLE
PROPRIETORSHIP)

535 TALL POPLAR WAY

COSBY, TN 37722

FOR: LOTIONS FOR SKIN, FACE AND BODY
CARE, IN CLASS 3 (U.S. CLS. 1, 4, 6, 50, 51 AND 52).

FIRST USE 0-0-1995; IN COMMERCE 0-0-1996.

THE MARK CONSISTS OF STANDARD CHAR-
ACTERS WITHOUT CLAIM TO ANY PARTICULAR
FONT, STYLE, SIZE, OR COLOR.

NO CLAIM IS MADE TO THE EXCLUSIVE
RIGHT TO USE "BOTANICALS", APART FROM
THE MARK AS SHOWN.

SER. NO. 77-362,296, FILED 1-2-2008.

SUSAN STIGLITZ, EXAMINING ATTORNEY

Int. Cl.: 33

Prior U.S. Cls.: 47 and 49

United States Patent and Trademark Office

Reg. No. 3,480,161

Registered Aug. 5, 2008

**TRADEMARK
PRINCIPAL REGISTER**

FENNELLYS

PHILLIPS PRODUCTS COMPANY, LLC (MINNE-
SOTA LTD LIAB CO)
1607 SOUTH 12TH STREET
PRINCETON, MN 55371

THE MARK CONSISTS OF STANDARD CHAR-
ACTERS WITHOUT CLAIM TO ANY PARTICULAR
FONT, STYLE, SIZE, OR COLOR.

FOR: LIQUEURS, IN CLASS 33 (U.S. CLS. 47 AND
49).

SER. NO. 77-362,309, FILED 1-2-2008.

FIRST USE 10-31-2007; IN COMMERCE 12-31-2007.

AMY HELLA, EXAMINING ATTORNEY

Int. Cl.: 5

Prior U.S. Cls.: 6, 18, 44, 46, 51 and 52

Reg. No. 3,480,162

United States Patent and Trademark Office

Registered Aug. 5, 2008

**TRADEMARK
PRINCIPAL REGISTER**

EVERCLEANSE

HINDSIGHT NUTRITIONALS, LLC (INDIANA
LTD LIAB CO)
8605 ALLISONVILLE ROAD, SUITE 277
INDIANAPOLIS, IN 46250

THE MARK CONSISTS OF STANDARD CHAR-
ACTERS WITHOUT CLAIM TO ANY PARTICULAR
FONT, STYLE, SIZE, OR COLOR.

FOR: DIETARY AND NUTRITIONAL SUPPLE-
MENTS, IN CLASS 5 (U.S. CLS. 6, 18, 44, 46, 51 AND
52).

SER. NO. 77-362,354, FILED 1-2-2008.

FIRST USE 2-0-2007; IN COMMERCE 2-0-2007.

CURTIS FRENCH, EXAMINING ATTORNEY

Int. Cl.: 35

Prior U.S. Cls.: 100, 101 and 102

United States Patent and Trademark Office

Reg. No. 3,480,163

Registered Aug. 5, 2008

**SERVICE MARK
PRINCIPAL REGISTER**



SCOOP MANAGEMENT LLC (DELAWARE LTD
LIAB CO)
4TH FLOOR
532 BROADWAY
NEW YORK, NY 10012

FOR: RETAIL STORE SERVICES FEATURING
CLOTHING, FOOTWEAR, JEWELRY, WATCHES,
BAGS, EYEWEAR AND PERFUMES, IN CLASS 35
(U.S. CLS. 100, 101 AND 102).

FIRST USE 11-1-1999; IN COMMERCE 11-1-1999.

OWNER OF U.S. REG. NOS. 2,431,111, 2,755,389
AND OTHERS.

THE MARK CONSISTS OF THE WORDS
"WHAT'S THE SCOOP" IN A DOUBLE OVAL RING.

SER. NO. 77-362,355, FILED 1-2-2008.

SCOTT BIBB, EXAMINING ATTORNEY

Int. Cl.: 35

Prior U.S. Cls.: 100, 101 and 102

United States Patent and Trademark Office

Reg. No. 3,480,164

Registered Aug. 5, 2008

**SERVICE MARK
PRINCIPAL REGISTER**



FP STORES, INC. (CALIFORNIA CORPORATION)
15001 SOUTH FIGUEROA STREET
GARDENA, CA 90248

FOR: RETAIL DISCOUNT STORE SERVICES IN
THE FIELD OF CLOTHING, HOUSEWARES, LUG-
GAGE AND TOYS, IN CLASS 35 (U.S. CLS. 100, 101
AND 102).

FIRST USE 5-0-2005; IN COMMERCE 5-0-2005.

OWNER OF U.S. REG. NO. 1,337,365.

SEC. 2(F) AS TO "FACTORY 2 U".

SER. NO. 77-362,360, FILED 1-2-2008.

VERNA BETH RIRIE, EXAMINING ATTORNEY

Int. Cl.: 34

Prior U.S. Cls.: 2, 8, 9 and 17

United States Patent and Trademark Office

Reg. No. 3,480,165

Registered Aug. 5, 2008

TRADEMARK
PRINCIPAL REGISTER



JMTM, LLC (DELAWARE LTD LIAB CO)
SUITE 1028
1105 N. MARKET STREET
WILMINGTON, DE 19899

FOR: CIGARS; PIPE TOBACCO, IN CLASS 34 (U.S.
CLS. 2, 8, 9 AND 17).

FIRST USE 8-4-2006; IN COMMERCE 8-4-2006.

OWNER OF U.S. REG. NOS. 1,177,552, 3,095,386
AND OTHERS.

NO CLAIM IS MADE TO THE EXCLUSIVE
RIGHT TO USE "WINE", APART FROM THE MARK
AS SHOWN.

THE MARK CONSISTS OF THE WORDS "BLACK
& MILD" WITH "WINE" IN RIBBON.

SEC. 2(F) AS TO "BLACK & MILD".

SER. NO. 77-362,372, FILED 1-2-2008.

TRACY WHITTAKER-BROWN, EXAMINING AT-
TORNEY

Int. Cl.: 35

Prior U.S. Cls.: 100, 101 and 102

United States Patent and Trademark Office

Reg. No. 3,480,166

Registered Aug. 5, 2008

**SERVICE MARK
PRINCIPAL REGISTER**



MALEK PARTNERS LLC (FLORIDA LTD LIAB
CO)
SUITE 900
801 BRICKELL AVENUE
MIAMI, FL 33131

FOR: PROMOTION, MARKETING AND BUSI-
NESS STRATEGY CONSULTING SERVICES FOR
INVESTMENT MANAGEMENT COMPANIES, IN
CLASS 35 (U.S. CLS. 100, 101 AND 102).

FIRST USE 9-7-2007; IN COMMERCE 9-19-2007.

THE MARK CONSISTS OF A SINGLE LINE WITH
TWO BOXES AT LEFT-HAND SIDE, DIVIDED BY A
THIN LINE. THE LEFT-MOST BOX CONTAINS THE
LETTER "M". THE SECOND BOX CONTAINS THE
LETTER "P". THE LINE CONTINUES WITH "MAL-
EKPARTNERS".

SER. NO. 77-362,375, FILED 1-2-2008.

SIMON TENG, EXAMINING ATTORNEY

Int. Cl.: 6

Prior U.S. Cls.: 2, 12, 13, 14, 23, 25 and 50

United States Patent and Trademark Office

Reg. No. 3,480,167

Registered Aug. 5, 2008

**TRADEMARK
PRINCIPAL REGISTER**



SAVANNAH TRIMS, INC. (FLORIDA CORPORATION)
SUITE # 4
3567 91 STREET
LAKE PARK, FL 33403

FIRST USE 1-15-1986; IN COMMERCE 1-15-1986.

SER. NO. 77-362,378, FILED 1-2-2008.

FOR: METAL EXTERIOR BLINDS, IN CLASS 6
(U.S. CLS. 2, 12, 13, 14, 23, 25 AND 50).

JENNY PARK, EXAMINING ATTORNEY

Int. Cl.: 5

Prior U.S. Cls.: 6, 18, 44, 46, 51 and 52

United States Patent and Trademark Office

Reg. No. 3,480,168

Registered Aug. 5, 2008

**TRADEMARK
PRINCIPAL REGISTER**

BAYMEC

BAYER AKTIENGESELLSCHAFT (FED REP
GERMANY AKTIENGESELLSCHAFT)
D-51368
LEVERKUSEN-BAYERWERK, FED REP GERMA-
NY

FOR: VETERINARY PREPARATIONS AND SUB-
STANCES FOR THE CONTROL OF PARASITES IN
DOMESTIC AND FARM ANIMALS, IN CLASS 5
(U.S. CLS. 6, 18, 44, 46, 51 AND 52).

THE MARK CONSISTS OF STANDARD CHAR-
ACTERS WITHOUT CLAIM TO ANY PARTICULAR
FONT, STYLE, SIZE, OR COLOR.

OWNER OF FED REP GERMANY REG. NO.
395027152, DATED 10-5-1995, EXPIRES 1-31-2015.

SER. NO. 77-362,403, FILED 1-2-2008.

KIMBERLY PERRY, EXAMINING ATTORNEY

Int. Cl.: 6

Prior U.S. Cls.: 2, 12, 13, 14, 23, 25 and 50

Reg. No. 3,480,169

United States Patent and Trademark Office

Registered Aug. 5, 2008

**TRADEMARK
PRINCIPAL REGISTER**

**The Beauty of Copper.
The Strength of Steel.**

SOUTHEASTERN METALS MANUFACTURING
COMPANY, INC. (FLORIDA CORPORATION)
3556 LAKESHORE ROAD
BUFFALO, NY 14219

FOR: METAL AND METALLIC COMPOSITE
PRODUCTS, IN PARTICULAR COPPER BONDED
TO STAINLESS STEEL, USED IN BUILDING AND
CONSTRUCTION MATERIALS, NAMELY, ROOF-
ING MATERIALS, ROOF COVERINGS, ROOFING
PANELS, ROOFING TRIMS, EAVE DRIPS, TRIMS,
FLASHING AND VENTILATION PRODUCTS FOR
USE IN RESIDENTIAL AND COMMERCIAL

BUILDINGS, IN CLASS 6 (U.S. CLS. 2, 12, 13, 14, 23,
25 AND 50).

FIRST USE 5-0-2007; IN COMMERCE 6-0-2007.

THE MARK CONSISTS OF STANDARD CHAR-
ACTERS WITHOUT CLAIM TO ANY PARTICULAR
FONT, STYLE, SIZE, OR COLOR.

SER. NO. 77-362,411, FILED 1-2-2008.

JENNY PARK, EXAMINING ATTORNEY

Int. Cl.: 28

Prior U.S. Cls.: 22, 23, 38 and 50

United States Patent and Trademark Office

Reg. No. 3,480,170

Registered Aug. 5, 2008

TRADEMARK
PRINCIPAL REGISTER



FELTON, MARK (UNITED STATES INDIVIDUAL)

#783

15030 VENTURA BLVD.
SHERMAN OAKS, CA 91403

FOR: SOCIAL CARD GAME WHICH IS DESIGNED TO HELP PEOPLE GET TO KNOW EACH OTHER BETTER, IN CLASS 28 (U.S. CLS. 22, 23, 38 AND 50).

FIRST USE 12-1-2007; IN COMMERCE 12-1-2007.

NO CLAIM IS MADE TO THE EXCLUSIVE RIGHT TO USE "FOR THOSE WHO WANT TO GET TO KNOW EACH OTHER BETTER", APART FROM THE MARK AS SHOWN.

THE STIPPLING IS FOR SHADING PURPOSES ONLY.

THE MARK CONSISTS OF A CIRCLE WITH SEVEN CARICATURES (VARIOUS FACES) DRAWN IN THE MIDDLE OF IT WITH THE WORDS (FILL ME IN...?) WRITTEN AT THE BOTTOM OF THE CIRCLE. STRETCHING AROUND THE TOP HALF OF THE CIRCLE ARE THE WORDS (FOR THOSE WHO WANT TO GET TO KNOW EACH OTHER BETTER).

SER. NO. 77-362,429, FILED 1-2-2008.

REBECCA GILBERT, EXAMINING ATTORNEY

Int. Cl.: 5

Prior U.S. Cls.: 6, 18, 44, 46, 51 and 52

Reg. No. 3,480,171

United States Patent and Trademark Office

Registered Aug. 5, 2008

**TRADEMARK
PRINCIPAL REGISTER**

OmegaMagic

CONSTANS, GEORGE (UNITED STATES INDIVIDUAL)
24200 FAIRWOOD LANE
NEVIS, MN 56467

THE MARK CONSISTS OF STANDARD CHARACTERS WITHOUT CLAIM TO ANY PARTICULAR FONT, STYLE, SIZE, OR COLOR.

FOR: NUTRITIONAL SUPPLEMENT OF OMEGA 3, 6, 7 AND 9, IN CLASS 5 (U.S. CLS. 6, 18, 44, 46, 51 AND 52).

SER. NO. 77-362,433, FILED 1-2-2008.

FIRST USE 7-1-2003; IN COMMERCE 7-1-2003.

VERNA BETH RIRIE, EXAMINING ATTORNEY

Int. Cl.: 11

Prior U.S. Cls.: 13, 21, 23, 31 and 34

United States Patent and Trademark Office

Reg. No. 3,480,172

Registered Aug. 5, 2008

**TRADEMARK
PRINCIPAL REGISTER**

GLOWPANEL

SUNSHINE SYSTEMS, LLC. (DELAWARE LTD
LIAB CO)
173 SUNRISE DRIVE
WHEELING, IL 60090

THE MARK CONSISTS OF STANDARD CHAR-
ACTERS WITHOUT CLAIM TO ANY PARTICULAR
FONT, STYLE, SIZE, OR COLOR.

FOR: LED AND HID LIGHT FIXTURES, IN
CLASS 11 (U.S. CLS. 13, 21, 23, 31 AND 34).

SER. NO. 77-362,442, FILED 1-2-2008.

FIRST USE 8-22-2006; IN COMMERCE 7-20-2007.

ESTHER A. BORSUK, EXAMINING ATTORNEY

Int. Cl.: 1

Prior U.S. Cls.: 1, 5, 6, 10, 26 and 46

United States Patent and Trademark Office

Reg. No. 3,480,173

Registered Aug. 5, 2008

**TRADEMARK
PRINCIPAL REGISTER**



TECHNICAL CHEMICAL COMPANY (TEXAS
CORPORATION)
10737 SPANGLER ROAD
DALLAS, TX 75220

FIRST USE 6-10-1991; IN COMMERCE 6-10-1991.

OWNER OF U.S. REG. NO. 3,257,773.

FOR: BRAKE AND CLUTCH FLUIDS; POWER
STEERING FLUID; CHEMICAL ADDITIVES FOR
FUEL TREATMENT; FUEL INJECTION CLEANER
CHEMICAL ADDITIVES; AUTOMOBILE COOLING
SYSTEM LEAK SEALANTS AND RUST INHIBI-
TORS; HYDRAULIC FLUIDS FOR GENERAL USE;
TIRE SEALING COMPOUNDS; AUTOMOBILE TIRE
INFLATOR SEALERS; COOLANTS FOR VEHICLE
ENGINES, IN CLASS 1 (U.S. CLS. 1, 5, 6, 10, 26 AND
46).

THE MARK CONSISTS OF "JOHNSEN'S" AND A
STYLIZED "J" WITH LINES INDICATING MOVE-
MENT.

SER. NO. 77-362,474, FILED 1-2-2008.

SAMUEL E. SHARPER JR., EXAMINING ATTOR-
NEY

Int. Cl.: 35

Prior U.S. Cls.: 100, 101 and 102

United States Patent and Trademark Office

Reg. No. 3,480,174

Registered Aug. 5, 2008

**SERVICE MARK
PRINCIPAL REGISTER**

True Media

TRUE MEDIA, LLC. (ARIZONA LTD LIAB CO)
1841 SOUTH HORNE, SUITE 101
MESA, AZ 85204

THE MARK CONSISTS OF STANDARD CHAR-
ACTERS WITHOUT CLAIM TO ANY PARTICULAR
FONT, STYLE, SIZE, OR COLOR.

FOR: ADVERTISING SERVICES, NAMELY,
CREATING CORPORATE AND BRAND IDENTITY
FOR OTHERS, IN CLASS 35 (U.S. CLS. 100, 101 AND
102).

SER. NO. 77-362,481, FILED 1-2-2008.

FIRST USE 1-30-1998; IN COMMERCE 1-30-1998.

PAUL F. GAST, EXAMINING ATTORNEY

Int. Cl.: 35

Prior U.S. Cls.: 100, 101 and 102

United States Patent and Trademark Office

Reg. No. 3,480,175

Registered Aug. 5, 2008

**SERVICE MARK
PRINCIPAL REGISTER**

The Human Potential Project

CHRISTOPHER DEAN MAJER (UNITED STATES
INDIVIDUAL)
7121 S. BEN BURR ROAD
SPOKANE, WA 99223

FOR: BUSINESS MANAGEMENT CONSULTAN-
CY AS WELL AS DEVELOPMENT OF PROCESSES
FOR THE ANALYSIS AND THE IMPLEMENTA-
TION OF STRATEGY PLANS AND MANAGEMENT
PROJECTS; BUSINESS MANAGEMENT CONSUL-
TATION IN THE FIELD OF EXECUTIVE AND
LEADERSHIP DEVELOPMENT, IN CLASS 35 (U.S.
CLS. 100, 101 AND 102).

FIRST USE 2-1-2002; IN COMMERCE 2-1-2002.

THE MARK CONSISTS OF STANDARD CHAR-
ACTERS WITHOUT CLAIM TO ANY PARTICULAR
FONT, STYLE, SIZE, OR COLOR.

SER. NO. 77-362,490, FILED 1-2-2008.

RUDY R. SINGLETON, EXAMINING ATTORNEY

Int. Cl.: 15

Prior U.S. Cls.: 2, 21 and 36

United States Patent and Trademark Office

Reg. No. 3,480,176

Registered Aug. 5, 2008

**TRADEMARK
PRINCIPAL REGISTER**

Double Trouble

VISUAL SOUND LLC (TENNESSEE LTD LIAB
CO)
4922 PORT ROYAL ROAD, B-11
SPRING HILL, TN 37174

FOR: ELECTRONIC EFFECTS PEDALS FOR USE
WITH MUSICAL INSTRUMENTS; SOUND EFFECT
PEDALS FOR MUSICAL INSTRUMENTS, IN CLASS
15 (U.S. CLS. 2, 21 AND 36).

FIRST USE 8-31-2006; IN COMMERCE 8-31-2006.

THE MARK CONSISTS OF STANDARD CHAR-
ACTERS WITHOUT CLAIM TO ANY PARTICULAR
FONT, STYLE, SIZE, OR COLOR.

SER. NO. 77-362,497, FILED 1-2-2008.

NAAKWAMA ANKRAH, EXAMINING ATTORNEY

Int. Cl.: 9

Prior U.S. Cls.: 21, 23, 26, 36 and 38

United States Patent and Trademark Office

Reg. No. 3,480,177

Registered Aug. 5, 2008

**TRADEMARK
PRINCIPAL REGISTER**

GLASSCALE

JOSHUA D. KESSELMAN (UNITED STATES IN-
DIVIDUAL)
3315 W. BUCKEYE RD., STE. 4
PHOENIX, AZ 85040

THE MARK CONSISTS OF STANDARD CHAR-
ACTERS WITHOUT CLAIM TO ANY PARTICULAR
FONT, STYLE, SIZE, OR COLOR.

FOR: SCALES, IN CLASS 9 (U.S. CLS. 21, 23, 26, 36
AND 38).

SER. NO. 77-362,502, FILED 1-2-2008.

FIRST USE 7-6-2007; IN COMMERCE 10-3-2007.

LINDA E. BLOHM, EXAMINING ATTORNEY

Int. Cl.: 35

Prior U.S. Cls.: 100, 101 and 102

United States Patent and Trademark Office

Reg. No. 3,480,178

Registered Aug. 5, 2008

**SERVICE MARK
PRINCIPAL REGISTER**



INTERNATIONAL TACTICAL OFFICERS
TRAINING ASSOCIATION, LLC (INDIANA
LTD LIAB CO)

PO BOX 3446

TERRE HAUTE, IN 47803

FOR: ASSOCIATION SERVICES, NAMELY, PRO-
MOTING THE INTERESTS AND EDUCATION OF
AND THE EXCHANGE OF INFORMATION BE-
TWEEN MEMBERS OF THE TACTICAL COMMU-
NITY, IN CLASS 35 (U.S. CLS. 100, 101 AND 102).

FIRST USE 11-1-2006; IN COMMERCE 11-1-2006.

NO CLAIM IS MADE TO THE EXCLUSIVE
RIGHT TO USE "INTERNATIONAL TACTICAL

OFFICERS TRAINING ASSOCIATION", APART
FROM THE MARK AS SHOWN.

THE MARK CONSISTS OF A HUMAN EYE
LOOKING THROUGH THE SCOPE OF A RIFLE,
ENCLOSED IN AN OVAL SHAPE, TO THE LEFT OF
THE LETTERS "ITOTA". A GRIDDED GLOBE
FORMS THE "O" IN "ITOTA". THE WORDS "IN-
TERNATIONAL TACTICAL OFFICERS TRAINING
ASSOCIATION" APPEAR BELOW.

SER. NO. 77-362,510, FILED 1-2-2008.

MARK RADEMACHER, EXAMINING ATTORNEY

Int. Cl.: 41

Prior U.S. Cls.: 100, 101 and 107

United States Patent and Trademark Office

Reg. No. 3,480,179

Registered Aug. 5, 2008

**SERVICE MARK
PRINCIPAL REGISTER**

MEREDITH COLLEGE

MEREDITH COLLEGE (NORTH CAROLINA
NON-PROFIT CORPORATION)
3800 HILLSBOROUGH STREET
RALEIGH, NC 276075298

FOR: EDUCATIONAL SERVICES, NAMELY,
PROVIDING COURSES OF INSTRUCTION AT
THE COLLEGE, GRADUATE AND DOCTORAL
LEVELS AND DISTRIBUTING COURSE MATERI-
ALS IN CONNECTION THEREWITH; ENTERTAIN-
MENT SERVICES, NAMELY ATHLETIC
BASKETBALL, BASEBALL, SOCCER, TENNIS AND
VOLLEYBALL EVENTS; AND ORGANIZING AND
CONDUCTING CULTURAL EVENTS, NAMELY,
THEATRE PRODUCTIONS AND ART EXHIBITS,
IN CLASS 41 (U.S. CLS. 100, 101 AND 107).

FIRST USE 11-1-1909; IN COMMERCE 11-1-1909.

THE MARK CONSISTS OF STANDARD CHAR-
ACTERS WITHOUT CLAIM TO ANY PARTICULAR
FONT, STYLE, SIZE, OR COLOR.

NO CLAIM IS MADE TO THE EXCLUSIVE
RIGHT TO USE "COLLEGE", APART FROM THE
MARK AS SHOWN.

SER. NO. 77-362,590, FILED 1-2-2008.

ALEXANDER L. POWERS, EXAMINING ATTOR-
NEY

Int. Cl.: 16

Prior U.S. Cls.: 2, 5, 22, 23, 29, 37, 38 and 50

Reg. No. 3,480,180

United States Patent and Trademark Office

Registered Aug. 5, 2008

**TRADEMARK
PRINCIPAL REGISTER**

MEREDITH COLLEGE

MEREDITH COLLEGE (NORTH CAROLINA
NON-PROFIT CORPORATION)
3800 HILLSBOROUGH STREET
RALEIGH, NC 276075298

FOR: EDUCATIONAL AND TEACHING PUBLI-
CATIONS, NAMELY, REPORTS, MANUALS,
GUIDES, AND PROGRAMS REGARDING UNIVER-
SITY-LEVEL COURSES, UNIVERSITY PROGRAMS,
UNIVERSITY SPORTS, AND UNIVERSITY EVENTS;
NOTEBOOKS, PENS, NOTE PAPER, ENVELOPES,
DECALS, POSTCARDS, STATIONERY, IN CLASS 16
(U.S. CLS. 2, 5, 22, 23, 29, 37, 38 AND 50).

FIRST USE 11-1-1909; IN COMMERCE 11-1-1909.

THE MARK CONSISTS OF STANDARD CHAR-
ACTERS WITHOUT CLAIM TO ANY PARTICULAR
FONT, STYLE, SIZE, OR COLOR.

NO CLAIM IS MADE TO THE EXCLUSIVE
RIGHT TO USE "COLLEGE", APART FROM THE
MARK AS SHOWN.

SER. NO. 77-362,591, FILED 1-2-2008.

ALEXANDER L. POWERS, EXAMINING ATTOR-
NEY

Int. Cl.: 3

Prior U.S. Cls.: 1, 4, 6, 50, 51 and 52

United States Patent and Trademark Office

Reg. No. 3,480,181

Registered Aug. 5, 2008

**TRADEMARK
PRINCIPAL REGISTER**

N CALIFORNIA NORTH

MILLER, JAMES, P (UNITED STATES INDIVIDUAL)
40 TOYON LANE
SAUSALITO, CA 94965

FOR: AFTER-SHAVE LOTIONS; AROMATHERAPY BODY CARE PRODUCTS, NAMELY, BODY LOTION, SHOWER GEL, CUTICLE CREAM, SHAMPOO, CONDITIONER, NON-MEDICATED LIP BALM, SOAP, BODY POLISH, BODY AND FOOT SCRUB AND NON-MEDICATED FOOT CREAM; BODY SPRAY USED AS A PERSONAL DEODORANT AND AS FRAGRANCE; FACE AND BODY LOTIONS, IN CLASS 3 (U.S. CLS. 1, 4, 6, 50, 51 AND 52).

FIRST USE 8-30-1991; IN COMMERCE 8-30-1991.

THE MARK CONSISTS OF STANDARD CHARACTERS WITHOUT CLAIM TO ANY PARTICULAR FONT, STYLE, SIZE, OR COLOR.

OWNER OF U.S. REG. NO. 1,776,975.

NO CLAIM IS MADE TO THE EXCLUSIVE RIGHT TO USE "CALIFORNIA", APART FROM THE MARK AS SHOWN.

SER. NO. 77-362,632, FILED 1-2-2008.

RONALD AIKENS, EXAMINING ATTORNEY

Int. Cls.: 9 and 41

Prior U.S. Cls.: 21, 23, 26, 36, 38, 100, 101 and 107

United States Patent and Trademark Office

Reg. No. 3,480,182

Registered Aug. 5, 2008

**TRADEMARK
SERVICE MARK
PRINCIPAL REGISTER**

ACM Records

COHEN, ALAN (NEW JERSEY CORPORATION),
DBA ACM RECORDS, INC.
PO BOX 195
FAIR LAWN, NJ 07410 AND
EVELYNE COHEN (NEW JERSEY CORPORATION),
DBA ACM RECORDS, INC.
PO BOX 195
FAIR LAWN, NJ 07410

FOR: AUDIO RECORDINGS FEATURING MUSIC; DOWNLOADABLE MP3 FILES, MP3 RECORDINGS, ONLINE DISCUSSION BOARDS, WEBCASTS AND PODCASTS FEATURING MUSIC, AUDIO BOOKS AND NEWS BROADCASTS; DOWNLOADABLE MUSICAL SOUND RECORDINGS; DOWNLOADABLE RING TONES, GRAPHICS AND MUSIC VIA A GLOBAL COMPUTER NETWORK AND WIRELESS DEVICES; DOWNLOADABLE VIDEO RECORDINGS FEATURING MUSIC; MUSICAL VIDEO RECORDINGS; SOUND RECORDINGS FEATURING MUSIC; VIDEO RECORDINGS FEATURING MUSIC; VISUAL RECORDINGS AND AUDIO VISUAL RECORDINGS FEATURING MUSIC AND ANIMATION, IN CLASS 9 (U.S. CLS. 21, 23, 26, 36 AND 38).

FIRST USE 1-1-1991; IN COMMERCE 1-1-1991.

FOR: EDUCATION IN THE FIELD OF MUSIC COMPOSITION, PRODUCTION AND RECORDING RENDERED THROUGH CORRESPONDENCE COURSES; ENTERTAINMENT IN THE NATURE OF AN ON-GOING SPECIAL VARIETY, NEWS, MUSIC OR COMEDY SHOW FEATURING MUSIC BROADCAST OVER TELEVISION, SATELLITE, AUDIO, AND VIDEO MEDIA; ENTERTAINMENT IN THE NATURE OF VISUAL AND AUDIO PERFORMANCES, AND MUSICAL, VARIETY, NEWS AND COMEDY SHOWS; ENTERTAINMENT IN THE NATURE OF VISUAL AND AUDIO PERFORMANCES, NAMELY, MUSICAL BAND, ROCK

GROUP, GYMNASTIC, DANCE, AND BALLET PERFORMANCES; ENTERTAINMENT IN THE NATURE OF MUSICAL GROUPS; ENTERTAINMENT, NAMELY, LIVE PERFORMANCES BY A MUSICAL BAND; ENTERTAINMENT SERVICES, NAMELY, AN ONLINE ACTIVITY WHERE YOU CREATE YOUR OWN MUSIC VIDEOS; ENTERTAINMENT SERVICES, NAMELY, NON-DOWNLOADABLE RINGTONES, PRE-RECORDED MUSIC, VIDEO AND GRAPHICS PRESENTED TO MOBILE COMMUNICATIONS DEVICES VIA A GLOBAL COMPUTER NETWORK AND WIRELESS NETWORKS; ENTERTAINMENT SERVICES, NAMELY, PROVIDING A WEB SITE FEATURING MUSICAL PERFORMANCES, MUSICAL VIDEOS, RELATED FILM CLIPS, PHOTOGRAPHS, AND OTHER MULTIMEDIA MATERIALS; ENTERTAINMENT SERVICES, NAMELY, PROVIDING ON-LINE REVIEWS OF MUSIC; ENTERTAINMENT SERVICES, NAMELY, PROVIDING PRERECORDED MUSIC, INFORMATION IN THE FIELD OF MUSIC, AND COMMENTARY AND ARTICLES ABOUT MUSIC, ALL ONLINE VIA A GLOBAL COMPUTER NETWORK; ENTERTAINMENT, NAMELY, LIVE MUSIC CONCERTS; ENTERTAINMENT, NAMELY, LIVE PERFORMANCES BY MUSICAL BANDS; INSTRUCTION IN THE FIELD OF MUSIC COMPOSITION, PRODUCTION AND RECORDING; MULTIMEDIA ENTERTAINMENT SERVICES IN THE NATURE OF RECORDING, PRODUCTION AND POST-PRODUCTION SERVICES IN THE FIELDS OF MUSIC, VIDEO, AND FILMS; MUSIC COMPOSITION AND TRANSCRIPTION FOR OTHERS; MUSIC COMPOSITION FOR OTHERS; MUSIC PRODUCTION SERVICES; MUSIC SELECTION SERVICES FOR USE IN TV, FILM, RADIO AND VIDEO GAMES; PLANNING ARRANGEMENT OF SHOWING MOVIES, SHOWS, PLAYS OR MUSICAL PERFORMANCES; PRESENTATION OF MUSICAL PERFORMANCE; PRODUCTION OF SOUND AND MUSIC VIDEO RECORDINGS; PROVIDING FACIL-

ITIES FOR MOVIES, SHOWS, PLAYS, MUSIC OR EDUCATIONAL TRAINING; TEACHING IN THE FIELD OF MUSIC COMPOSITION, PRODUCTION AND RECORDING; THEATRICAL AND MUSICAL FLOOR SHOWS PROVIDED AT DISCOTHEQUES AND NIGHTCLUBS, IN CLASS 41 (U.S. CLS. 100, 101 AND 107).

FIRST USE 1-1-1991; IN COMMERCE 1-1-1991.

THE MARK CONSISTS OF STANDARD CHARACTERS WITHOUT CLAIM TO ANY PARTICULAR FONT, STYLE, SIZE, OR COLOR.

NO CLAIM IS MADE TO THE EXCLUSIVE RIGHT TO USE "RECORDS", APART FROM THE MARK AS SHOWN.

SER. NO. 77-362,636, FILED 1-2-2008.

RONALD AIKENS, EXAMINING ATTORNEY

Int. Cl.: 3

Prior U.S. Cls.: 1, 4, 6, 50, 51 and 52

Reg. No. 3,480,183

United States Patent and Trademark Office

Registered Aug. 5, 2008

**TRADEMARK
PRINCIPAL REGISTER**



BRISK SOURCES INC. (CALIFORNIA CORPORATION)
928 CANADA COURT
INDUSTRY, CA 91748

FOR: SKIN MASKING LOTION, IN CLASS 3 (U.S. CLS. 1, 4, 6, 50, 51 AND 52).

FIRST USE 3-22-2007; IN COMMERCE 3-22-2007.

THE MARK CONSISTS OF A FLARE DESIGN, WITH FLARES EXTENDING IN OPPOSITE DIRECTIONS TO THE LEFT AND RIGHT, ALL OF WHICH IS SITUATED DIRECTLY ABOVE THE WORDS "FAM FIAIR".

SER. NO. 77-362,654, FILED 1-2-2008.

MONIQUE MILLER, EXAMINING ATTORNEY

Int. Cl.: 7

Prior U.S. Cls.: 13, 19, 21, 23, 31, 34 and 35

Reg. No. 3,480,184

United States Patent and Trademark Office

Registered Aug. 5, 2008

**TRADEMARK
PRINCIPAL REGISTER**

PIVART

HI-VAC CORPORATION (OHIO CORPORATION)
117 INDUSTRY ROAD
MARIETTA, OH 45750

THE MARK CONSISTS OF STANDARD CHAR-
ACTERS WITHOUT CLAIM TO ANY PARTICULAR
FONT, STYLE, SIZE, OR COLOR.

FOR: POWER METAL HOSE REELS, IN CLASS 7
(U.S. CLS. 13, 19, 21, 23, 31, 34 AND 35).

SER. NO. 77-362,667, FILED 1-2-2008.

FIRST USE 7-0-1997; IN COMMERCE 7-0-1997.

WILLIAM P. SHANAHAN, EXAMINING ATTOR-
NEY

Int. Cl.: 35

Prior U.S. Cls.: 100, 101 and 102

United States Patent and Trademark Office

Reg. No. 3,480,185

Registered Aug. 5, 2008

**SERVICE MARK
PRINCIPAL REGISTER**

No Water No Life

NO WATER NO LIFE LLC (NEW JERSEY LTD
LIAB CO)
330 EAST 79 STREET - #9G
NEW YORK, NY 10075

FOR: PROMOTING PUBLIC AWARENESS OF
THE NEED TO ASSESS AND DOCUMENT WATER-
SHEDS AND PROVOKE PARADIGM SHIFTS IN
WATER CONSERVATION AND CONSUMPTION
BY COMBINING PHOTOGRAPHY, SCIENCE AND
EDUCATION, IN CLASS 35 (U.S. CLS. 100, 101 AND
102).

FIRST USE 9-1-2004; IN COMMERCE 9-1-2004.

THE MARK CONSISTS OF STANDARD CHAR-
ACTERS WITHOUT CLAIM TO ANY PARTICULAR
FONT, STYLE, SIZE, OR COLOR.

SER. NO. 77-362,678, FILED 1-2-2008.

THEODORE MCBRIDE, EXAMINING ATTORNEY

Int. Cl.: 41

Prior U.S. Cls.: 100, 101 and 107

United States Patent and Trademark Office

Reg. No. 3,480,186

Registered Aug. 5, 2008

**SERVICE MARK
PRINCIPAL REGISTER**



RELAY PRODUCTIONS LLC (WISCONSIN LTD
LIAB CO)
7710 BITTERSWEET COURT
MIDDLETON, WI 60304

FOR: ARRANGING AND CONDUCTING ATH-
LETIC EVENTS, NAMELY, RUNNING RACES, IN
CLASS 41 (U.S. CLS. 100, 101 AND 107).

FIRST USE 8-6-2007; IN COMMERCE 9-1-2007.

NO CLAIM IS MADE TO THE EXCLUSIVE
RIGHT TO USE "MADISON CHICAGO" AND "200
RELAY", APART FROM THE MARK AS SHOWN.

THE MARK CONSISTS, IN PART, OF A BOX
CONTAINING HANDS PASSING A BATON WITH
THE WORDS "MC200" IN THE CENTER.

SER. NO. 77-362,701, FILED 1-2-2008.

MARK RADEMACHER, EXAMINING ATTORNEY

Int. Cl.: 43

Prior U.S. Cls.: 100 and 101

United States Patent and Trademark Office

Reg. No. 3,480,187

Registered Aug. 5, 2008

**SERVICE MARK
PRINCIPAL REGISTER**

ELEPHANT HUT

KASEMSANT, PIYASAK (THAILAND INDIVIDUAL)
SUITE 101
2500 30TH ST.
BOULDER, CO 80301

THE MARK CONSISTS OF STANDARD CHARACTERS WITHOUT CLAIM TO ANY PARTICULAR FONT, STYLE, SIZE, OR COLOR.

FOR: RESTAURANT SERVICES, IN CLASS 43 (U.S. CLS. 100 AND 101).

SER. NO. 77-362,722, FILED 1-2-2008.

FIRST USE 10-10-2007; IN COMMERCE 10-10-2007.

TINA BROWN, EXAMINING ATTORNEY

Int. Cl.: 11

Prior U.S. Cls.: 13, 21, 23, 31 and 34

Reg. No. 3,480,188

United States Patent and Trademark Office

Registered Aug. 5, 2008

**TRADEMARK
PRINCIPAL REGISTER**

WINDCHILL

MIST AND COOL LLC (CALIFORNIA LTD LIAB
CO)
SUITE 100
2259 WARD AVE
SIMI VALLEY, CA 93065

FOR: AIR CONDITIONING APPARATUS; AIR-
CONDITIONING APPARATUS; AIR-CONDITION-
ING, AIR COOLING AND VENTILATION APPARA-
TUS AND INSTRUMENTS; CEILING FANS;
CENTRAL AIR-CONDITIONING INSTALLATIONS;
ELECTRONIC GENERATOR FOR USE IN CON-
TROLLING THE AMOUNT OF HUMIDITY IN THE
AIR BY CREATING, REMOVING OR CIRCULAT-
ING SMALL WATER PARTICLES OR WATER VA-
POR IN THE AIR; EVAPORATIVE AIR COOLING

UNITS FOR DOMESTIC USE; HVAC UNITS; HUMI-
DIFIERS; PORTABLE ELECTRIC FANS; VENTILAT-
ING FANS FOR COMMERCIAL AND INDUSTRIAL
USE, IN CLASS 11 (U.S. CLS. 13, 21, 23, 31 AND 34).

FIRST USE 8-1-1997; IN COMMERCE 8-1-1997.

THE MARK CONSISTS OF STANDARD CHAR-
ACTERS WITHOUT CLAIM TO ANY PARTICULAR
FONT, STYLE, SIZE, OR COLOR.

SER. NO. 77-362,729, FILED 1-2-2008.

JANET LEE, EXAMINING ATTORNEY

Int. Cl.: 9

Prior U.S. Cls.: 21, 23, 26, 36 and 38

United States Patent and Trademark Office

Reg. No. 3,480,189

Registered Aug. 5, 2008

**TRADEMARK
PRINCIPAL REGISTER**

CV

CERWIN VEGA, INC. (FLORIDA CORPORATION)
3000 SW 42 STREET
HOLLYWOOD, FL 33312

FOR: ELECTRONIC SOUND REINFORCEMENT PRODUCTS, NAMELY, AUDIO AMPLIFIERS, IN CLASS 9 (U.S. CLS. 21, 23, 26, 36 AND 38).

FIRST USE 1-16-2006; IN COMMERCE 1-16-2006.

OWNER OF U.S. REG. NO. 1,060,670.

SER. NO. 77-362,760, FILED 1-2-2008.

LEIGH LOWRY, EXAMINING ATTORNEY

Int. Cl.: 5

Prior U.S. Cls.: 6, 18, 44, 46, 51 and 52

Reg. No. 3,480,190

United States Patent and Trademark Office

Registered Aug. 5, 2008

**TRADEMARK
PRINCIPAL REGISTER**

PERSEPHONE VITAMINS

PHULI COHAN MD, LLC (MASSACHUSETTS
LTD LIAB CO)
40 SHORNECLIFF ROAD
NEWTON, MA 02458

FOR: VITAMINS, IN CLASS 5 (U.S. CLS. 6, 18, 44,
46, 51 AND 52).

FIRST USE 11-7-2007; IN COMMERCE 11-7-2007.

THE MARK CONSISTS OF STANDARD CHAR-
ACTERS WITHOUT CLAIM TO ANY PARTICULAR
FONT, STYLE, SIZE, OR COLOR.

NO CLAIM IS MADE TO THE EXCLUSIVE
RIGHT TO USE "VITAMINS", APART FROM THE
MARK AS SHOWN.

SER. NO. 77-362,767, FILED 1-2-2008.

JANET LEE, EXAMINING ATTORNEY

Int. Cl.: 41

Prior U.S. Cls.: 100, 101 and 107

United States Patent and Trademark Office

Reg. No. 3,480,191

Registered Aug. 5, 2008

**SERVICE MARK
PRINCIPAL REGISTER**

TOAST OF THE COAST

MCCLATCHY U.S.A., INC. (DELAWARE CORPORATION)
2100 Q STREET
SACRAMENTO, CA 95816

FOR: PROVIDING RECOGNITION AND INCENTIVES BY THE WAY OF AWARDS TO DEMONSTRATE EXCELLENCE IN THE FIELD OF ATHLETICS, IN CLASS 41 (U.S. CLS. 100, 101 AND 107).

FIRST USE 12-1-1987; IN COMMERCE 12-1-1987.

THE MARK CONSISTS OF STANDARD CHARACTERS WITHOUT CLAIM TO ANY PARTICULAR FONT, STYLE, SIZE, OR COLOR.

SER. NO. 77-362,783, FILED 1-2-2008.

RAUL CORDOVA, EXAMINING ATTORNEY

Int. Cl.: 5

Prior U.S. Cls.: 6, 18, 44, 46, 51 and 52

Reg. No. 3,480,192

United States Patent and Trademark Office

Registered Aug. 5, 2008

**TRADEMARK
PRINCIPAL REGISTER**

DRAWING



PHULI COHAN MD, LLC (MASSACHUSETTS
LTD LIAB CO)
40 SHORNECLIFF ROAD
NEWTON, MA 02458

THE MARK CONSISTS OF A FOUR SEASONS
DESIGN IN SHOWING THE SYMBOLS OF THE
SUN, A LEAF, A FLOWER, AND A SNOWFLAKE
THEREIN.

FOR: VITAMINS, IN CLASS 5 (U.S. CLS. 6, 18, 44,
46, 51 AND 52).

SER. NO. 77-362,809, FILED 1-2-2008.

FIRST USE 11-7-2007; IN COMMERCE 11-7-2007.

JANET LEE, EXAMINING ATTORNEY

Int. Cl.: 35

Prior U.S. Cls.: 100, 101 and 102

United States Patent and Trademark Office

Reg. No. 3,480,193

Registered Aug. 5, 2008

**SERVICE MARK
PRINCIPAL REGISTER**



RENT ME FLORIDA, LLC (FLORIDA LTD LIAB
CO)
121 N MCCALL ROAD
ENGLEWOOD, FL 34223

FOR: REAL ESTATE MARKETING SERVICES IN
THE FIELD OF RESIDENTIAL AND COMMERCIAL
PROPERTY RENTAL AND MANAGEMENT, IN
CLASS 35 (U.S. CLS. 100, 101 AND 102).

FIRST USE 6-1-2007; IN COMMERCE 6-1-2007.

THE COLOR(S) BLUE, YELLOW, RED, BLACK,
WHITE, GREEN AND TAN IS/ARE CLAIMED AS A
FEATURE OF THE MARK.

THE MARK CONSISTS OF A HOUSE WITH A
FACE THAT POINTS TO HIMSELF WITH HIS TWO

RED HANDS - THE TWO WINDOWS ARE HIS EYES
- WITH SMALL STEPS LEADING UP TO HIM TO
HIS RIGHT AND A GREEN FLOWER BED WITH
YELLOW FLOWERS TO HIS LEFT. HIS TRIM
COLOR IS BLUE AT THE ROOF AND CHIMNEY,
AS ARE HIS ARMS, HIS EYEBROWS, WINDOW-
SILL EYES, STEPS, FLOWER BED, SMILE, NOSE
AND THE SMALL WINDOW ON HIS FOREHEAD.
THE PUPILS OF HIS EYES ARE BLACK SURROUN-
DED BY YELLOW WITH WINDOW PANES THAT
ARE THIN BLACK LINES. HIS FACE HAS A TAN
FINISH LIKE BLUSH SURROUNDED BY WHITE.
HIS WRISTS ARE ALSO WHITE.

SER. NO. 77-362,822, FILED 1-2-2008.

KYLE PEETE, EXAMINING ATTORNEY

Int. Cl.: 33

Prior U.S. Cls.: 47 and 49

United States Patent and Trademark Office

Reg. No. 3,480,194

Registered Aug. 5, 2008

**TRADEMARK
PRINCIPAL REGISTER**

ANGELO CELLARS

ANGELO CELLARS LLC (COLORADO LTD LIAB
CO)
1050 PIROS DRIVE
COLORADO SPRINGS, CO 80922

NO CLAIM IS MADE TO THE EXCLUSIVE
RIGHT TO USE "CELLARS", APART FROM THE
MARK AS SHOWN.

FOR: WINE, IN CLASS 33 (U.S. CLS. 47 AND 49).

FIRST USE 12-12-2007; IN COMMERCE 12-12-2007.

SER. NO. 77-362,843, FILED 1-2-2008.

THE MARK CONSISTS OF STANDARD CHAR-
ACTERS WITHOUT CLAIM TO ANY PARTICULAR
FONT, STYLE, SIZE, OR COLOR.

MARY CRAWFORD, EXAMINING ATTORNEY

Int. Cls.: 14 and 16

Prior U.S. Cls.: 2, 5, 22, 23, 27, 28, 29, 37, 38 and 50

United States Patent and Trademark Office

Reg. No. 3,480,195

Registered Aug. 5, 2008

**TRADEMARK
PRINCIPAL REGISTER**

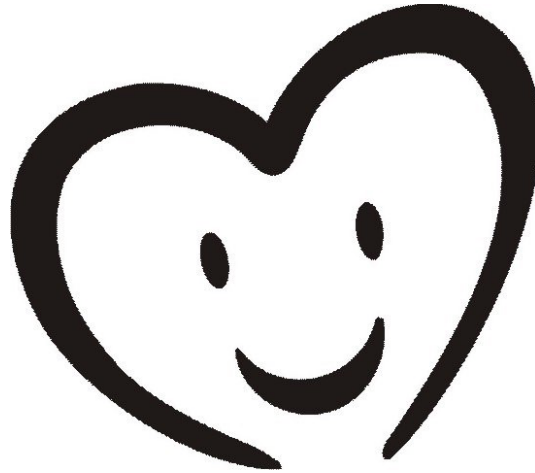

HAPPY HEART, INC. (COLORADO CORPORATION)
5801 MANGROVE CT.
LOVELAND, CO 80538

FOR: JEWELRY, IN CLASS 14 (U.S. CLS. 2, 27, 28 AND 50).

FIRST USE 6-18-1995; IN COMMERCE 12-20-1997.

FOR: PAPER, IN CLASS 16 (U.S. CLS. 2, 5, 22, 23, 29, 37, 38 AND 50).

FIRST USE 6-16-1995; IN COMMERCE 12-20-1997.

THE MARK CONSISTS OF A SHAPE OF A HEART WITH A SMILING FACE INSIDE.

SER. NO. 77-362,847, FILED 1-2-2008.

TEJBIR SINGH, EXAMINING ATTORNEY

Int. Cl.: 29

Prior U.S. Cl.: 46

United States Patent and Trademark Office

Reg. No. 3,480,196

Registered Aug. 5, 2008

**TRADEMARK
PRINCIPAL REGISTER**

**THE TASTE OF ITALY SINCE
1902**

JOHN VOLPI & COMPANY, INC. (MISSOURI
CORPORATION)
5263 NORTHRUP AVE.
ST. LOUIS, MO 63110

OWNER OF U.S. REG. NO. 1,972,600.

FOR: PROCESSED MEATS; CURED MEATS;
DRIED MEATS, IN CLASS 29 (U.S. CL. 46).

NO CLAIM IS MADE TO THE EXCLUSIVE
RIGHT TO USE "ITALY SINCE 1902", APART FROM
THE MARK AS SHOWN.

FIRST USE 0-0-2001; IN COMMERCE 0-0-2001.

SER. NO. 77-362,904, FILED 1-2-2008.

THE MARK CONSISTS OF STANDARD CHAR-
ACTERS WITHOUT CLAIM TO ANY PARTICULAR
FONT, STYLE, SIZE, OR COLOR.

ANDREA K. NADELMAN, EXAMINING ATTOR-
NEY

Int. Cl.: 10

Prior U.S. Cls.: 26, 39 and 44

United States Patent and Trademark Office

Reg. No. 3,480,197

Registered Aug. 5, 2008

**TRADEMARK
PRINCIPAL REGISTER**

EMpulse

EMPROBE, INC. (WASHINGTON CORPORATION)
PO BOX 124
PORT GAMBLE, WA 98364

FOR: MEDICAL APPARATUS, NAMELY, ELECTRIC HEATING DEVICES FOR CURATIVE TREATMENT, IN CLASS 10 (U.S. CLS. 26, 39 AND 44).

FIRST USE 1-2-2002; IN COMMERCE 1-2-2003.

THE MARK CONSISTS OF STANDARD CHARACTERS WITHOUT CLAIM TO ANY PARTICULAR FONT, STYLE, SIZE, OR COLOR.

OWNER OF U.S. REG. NO. 3,034,340.

SER. NO. 77-362,912, FILED 1-2-2008.

TARA PATE, EXAMINING ATTORNEY

Int. Cl.: 5

Prior U.S. Cls.: 6, 18, 44, 46, 51 and 52

United States Patent and Trademark Office

Reg. No. 3,480,198

Registered Aug. 5, 2008

**TRADEMARK
PRINCIPAL REGISTER**

ProDHA Elite

NORDIC NATURALS, INC. (CALIFORNIA CORPORATION)
94 HANGAR WAY
WATSONVILLE, CA 95076

FOR: NUTRITION AND DIETARY SUPPLEMENT CONTAINING PURIFIED FISH OIL AS A PRIMARY INGREDIENT, IN CLASS 5 (U.S. CLS. 6, 18, 44, 46, 51 AND 52).

FIRST USE 2-15-2008; IN COMMERCE 2-15-2008.

THE MARK CONSISTS OF STANDARD CHARACTERS WITHOUT CLAIM TO ANY PARTICULAR FONT, STYLE, SIZE, OR COLOR.

SER. NO. 77-362,927, FILED 1-2-2008.

ANDREA K. NADELMAN, EXAMINING ATTORNEY

Int. Cl.: 41

Prior U.S. Cls.: 100, 101 and 107

United States Patent and Trademark Office

Reg. No. 3,480,199

Registered Aug. 5, 2008

**SERVICE MARK
PRINCIPAL REGISTER**



XIE, HANG (UNITED STATES INDIVIDUAL)
#508
215 NORTH KING STREET
HONOLULU, HI 96817

FIRST USE 11-0-2007; IN COMMERCE 11-0-2007.

THE STIPPLING IS FOR SHADING PURPOSES
ONLY.

FOR: RENTAL AND LEASING OF AQUARIUM
EQUIPMENT AND ACCESSORIES, IN CLASS 41
(U.S. CLS. 100, 101 AND 107).

SER. NO. 77-362,928, FILED 1-2-2008.

STEVEN R. FOSTER, EXAMINING ATTORNEY

Int. Cls.: 38 and 41

Prior U.S. Cls.: 100, 101, 104 and 107

United States Patent and Trademark Office

Reg. No. 3,480,200

Registered Aug. 5, 2008

**SERVICE MARK
PRINCIPAL REGISTER**

FAFARAZZI

EASTLAND MEDIA, INC. (DELAWARE CORPORATION)
29 MILLER ST.
SOMERVILLE, MA 02143

FOR: PROVIDING ON-LINE ELECTRONIC BULLETIN BOARDS FOR TRANSMISSION OF MESSAGES AMONG COMPUTER USERS CONCERNING CURRENT EVENTS, ENTERTAINMENT, CELEBRITIES, AND POPULAR CULTURE, IN CLASS 38 (U.S. CLS. 100, 101 AND 104).

FIRST USE 8-7-2006; IN COMMERCE 8-7-2006.

FOR: ENTERTAINMENT SERVICES, NAMELY, PROVIDING ONLINE COMPUTER GAMES; PROVIDING INFORMATION VIA A GLOBAL COMPUTER NETWORK IN THE FIELDS OF CURRENT

EVENTS, ENTERTAINMENT, CELEBRITIES, AND POPULAR CULTURE; ON-LINE JOURNALS, NAMELY BLOGS, FEATURING CURRENT EVENTS, ENTERTAINMENT, CELEBRITIES, AND POPULAR CULTURE, IN CLASS 41 (U.S. CLS. 100, 101 AND 107).

FIRST USE 8-7-2006; IN COMMERCE 8-7-2006.

THE MARK CONSISTS OF STANDARD CHARACTERS WITHOUT CLAIM TO ANY PARTICULAR FONT, STYLE, SIZE, OR COLOR.

SER. NO. 77-362,977, FILED 1-2-2008.

KATHERINE E. HALMEN, EXAMINING ATTORNEY

Int. Cl.: 43

Prior U.S. Cls.: 100 and 101

United States Patent and Trademark Office

Reg. No. 3,480,201

Registered Aug. 5, 2008

**SERVICE MARK
PRINCIPAL REGISTER**



KASEMSANT, PIYASAK (THAILAND INDIVIDUAL)
SUITE 101
2500 30TH ST.
BOULDER, CO 80301

FOR: RESTAURANT SERVICES, IN CLASS 43
(U.S. CLS. 100 AND 101).

FIRST USE 10-10-2007; IN COMMERCE 10-10-2007.

THE MARK CONSISTS OF AN ELEPHANT WHICH CARRIES AN UMBRELLA AND STANDS ON A STYLISTIC PEDESTAL WITH ITS FRONT RIGHT FOOT STEPPING ON A STAR. THE PHRASE "ELEPHANT HUT" IS INSCRIBED BELOW THE PEDESTAL.

SER. NO. 77-362,985, FILED 1-2-2008.

TINA BROWN, EXAMINING ATTORNEY

Int. Cl.: 25

Prior U.S. Cls.: 22 and 39

United States Patent and Trademark Office

Reg. No. 3,480,202

Registered Aug. 5, 2008

TRADEMARK
PRINCIPAL REGISTER

The logo for "Pureveg" features the word "Pureveg" in a dark green, serif font. The letter "v" is stylized to resemble a leaf with a stem and two smaller leaves branching out. The letter "g" is also stylized, with a leaf-like shape at the top of its vertical stroke.

STEVEN T. GRUBART (UNITED STATES INDIVIDUAL)
2506 WISCONSIN AVE.
DOWNERS GROVE, IL 60515

FOR: BEACH FOOTWEAR; BEACH SHOES; CLOGS; DECK-SHOES; FLIP FLOPS; FOOTWEAR; FOOTWEAR FOR MEN; FOOTWEAR FOR MEN AND WOMEN; FOOTWEAR FOR WOMEN; FOOTWEAR NOT FOR SPORTS; SANDAL-CLOGS; SANDALS; SHOES; WOMEN'S SHOES, IN CLASS 25 (U.S. CLS. 22 AND 39).

FIRST USE 3-24-2004; IN COMMERCE 10-1-2004.

THE COLOR(S) DARK GREEN, LIGHT GREEN IS/ARE CLAIMED AS A FEATURE OF THE MARK.

THE MARK CONSISTS OF THE WORDS "PURE VEG" ARE WRITTEN IN DARK GREEN, WITH THE FIRST LETTER OF EACH WORD CAPITALIZED. THE LETTERS "V" AND "G" ARE STYLIZED TO LOOK LIKE THEY HAVE LEAVES OR A LEAF (RESPECTIVELY) GROWING OUT OF THEM. THESE LEAVES ARE COLORED BOTH DARK AND LIGHT GREEN AND INCLUDE A COLOR FADE EFFECT BETWEEN THE TWO EXTREMES.

SER. NO. 77-363,002, FILED 1-2-2008.

SIMON TENG, EXAMINING ATTORNEY

Int. Cl.: 42

Prior U.S. Cls.: 100 and 101

United States Patent and Trademark Office

Reg. No. 3,480,203

Registered Aug. 5, 2008

**SERVICE MARK
PRINCIPAL REGISTER**



ROGAN, BRANDON T (UNITED STATES INDIVIDUAL), DBA GINKIS
1000 WAUKEGAN RD. A
DEERFIELD, IL 60015

FOR: DESIGN, CREATION, HOSTING, MAINTENANCE OF WEBSITES FOR OTHERS, IN CLASS 42 (U.S. CLS. 100 AND 101).

FIRST USE 12-9-2005; IN COMMERCE 2-8-2006.

THE MARK CONSISTS OF FOUR TRIANGLES ARRANGED SUCH THAT THEY APPEAR TO RE-

SEMBLE A CAPITAL "G" LETTER. EACH TRIANGLE IS EXACTLY THE SAME IN THAT THEY ARE RIGHT TRIANGLES WITH TWO EQUAL LENGTHS MAKING THEM ISOSCELES TRIANGLES ALSO. NEXT TO THE TRIANGLE FORMATION IS THE WORD "GINKIS" IN ALL CAPITAL LETTERS WITH THE "G" BEING SLIGHTLY LARGER.

SER. NO. 77-363,009, FILED 1-2-2008.

TASHIA BUNCH, EXAMINING ATTORNEY

Int. Cl.: 41

Prior U.S. Cls.: 100, 101 and 107

United States Patent and Trademark Office

Reg. No. 3,480,204

Registered Aug. 5, 2008

**SERVICE MARK
PRINCIPAL REGISTER**

Anarchy Club

BUHLER, ADAM M (UNITED STATES INDIVIDUAL)
PO BOX 990992
BOSTON, MA 021990992 AND
SMITH, KEITH D (UNITED STATES INDIVIDUAL)
APT. 15
1999 COMMONWEALTH AVE
BRIGHTON, MA 02135

FOR: ENTERTAINMENT IN THE NATURE OF
VISUAL AND AUDIO PERFORMANCES, NAMELY,
MUSICAL BAND, ROCK GROUP, GYMNASTIC,

DANCE, AND BALLET PERFORMANCES, IN
CLASS 41 (U.S. CLS. 100, 101 AND 107).

FIRST USE 9-1-2005; IN COMMERCE 9-1-2005.

THE MARK CONSISTS OF STANDARD CHARACTERS WITHOUT CLAIM TO ANY PARTICULAR FONT, STYLE, SIZE, OR COLOR.

SER. NO. 77-363,025, FILED 1-3-2008.

LINDA M. KING, EXAMINING ATTORNEY

Int. Cl.: 41

Prior U.S. Cls.: 100, 101 and 107

United States Patent and Trademark Office

Reg. No. 3,480,205

Registered Aug. 5, 2008

SERVICE MARK
PRINCIPAL REGISTER

DaveAwesome

OWSIANY, DAVID, MATTHEW (UNITED STATES INDIVIDUAL), DBA DAVEAWESOME #2
607 E LIVINGSTON ST
ORLANDO, FL 32803

FOR: DISC JOCKEYS FOR PARTIES AND SPECIAL EVENTS; COMPOSITION OF MUSIC FOR OTHERS; MUSIC COMPOSITION AND TRANSCRIPTION FOR OTHERS; MUSIC COMPOSITION FOR OTHERS; ENTERTAINMENT IN THE NATURE OF VISUAL AND AUDIO PERFORMANCES, AND MUSICAL, VARIETY, NEWS AND COMEDY SHOWS; ENTERTAINMENT IN THE NATURE OF VISUAL AND AUDIO PERFORMANCES, NAMELY, MUSICAL BAND, ROCK GROUP, GYMNASTIC, DANCE, AND BALLET PERFORMANCES; ENTERTAINMENT NAMELY, LIVE PERFORMANCES BY A MUSICAL BAND; ENTERTAINMENT IN THE NATURE OF LIVE PERFORMANCES BY DAVEAWESOME; ENTERTAINMENT IN THE NATURE OF PERFORMANCES BY DAVEAWESOME; ENTERTAINMENT, NAMELY, LIVE MUSIC CONCERTS; ENTERTAINMENT, NAMELY, LIVE PERFORMANCES BY MUSICAL BANDS; ENTERTAINMENT, NAMELY, LIVE PERFORMANCES BY ROCK GROUPS; MULTIMEDIA ENTERTAINMENT SERVICES IN THE NATURE OF RECORDING, PRODUCTION AND POST-PRODUCTION SERVICES IN

THE FIELDS OF MUSIC, VIDEO, AND FILMS; ARRANGING AND CONDUCTING NIGHTCLUB ENTERTAINMENT EVENTS; ARRANGING AND CONDUCTING NIGHTCLUB PARTIES; THEATRICAL AND MUSICAL FLOOR SHOWS PROVIDED AT DISCOTHEQUES AND NIGHTCLUBS; PRODUCTION OF VIDEO DISCS AND TAPES; RECORD PRODUCTION; PRODUCTION OF SOUND AND MUSIC VIDEO RECORDINGS; PRODUCTION OF SOUND RECORDINGS; MUSIC PRODUCTION SERVICES; CONSULTATION AND ADVICE REGARDING MUSICAL SELECTIONS AND ARRANGEMENTS FOR SOUND RECORDINGS AND LIVE PERFORMANCES; MULTIMEDIA PUBLISHING OF BOOKS, MAGAZINES, JOURNALS, SOFTWARE, GAMES, MUSIC, AND ELECTRONIC PUBLICATIONS, IN CLASS 41 (U.S. CLS. 100, 101 AND 107).

FIRST USE 10-11-2004; IN COMMERCE 2-12-2005.

THE MARK CONSISTS OF STANDARD CHARACTERS WITHOUT CLAIM TO ANY PARTICULAR FONT, STYLE, SIZE, OR COLOR.

SER. NO. 77-363,029, FILED 1-3-2008.

LINDA M. KING, EXAMINING ATTORNEY

Int. Cl.: 28

Prior U.S. Cls.: 22, 23, 38 and 50

United States Patent and Trademark Office

Reg. No. 3,480,206

Registered Aug. 5, 2008

**TRADEMARK
PRINCIPAL REGISTER**

FOLDFAST

FOLDFAST GOALS, LLC (DELAWARE LTD
LIAB CO)
1211 STONEY RUN DRIVE
WILMINGTON, DE 19803

THE MARK CONSISTS OF STANDARD CHAR-
ACTERS WITHOUT CLAIM TO ANY PARTICULAR
FONT, STYLE, SIZE, OR COLOR.

FOR: SOCCER GOALS, LACROSSE GOALS,
HOCKEY GOALS, IN CLASS 28 (U.S. CLS. 22, 23, 38
AND 50).

SER. NO. 77-363,052, FILED 1-3-2008.

FIRST USE 0-0-2004; IN COMMERCE 0-0-2004.

GEOFFREY FOSDICK, EXAMINING ATTORNEY

Int. Cls.: 35 and 37

Prior U.S. Cls.: 100, 101, 102, 103 and 106

United States Patent and Trademark Office

Reg. No. 3,480,207

Registered Aug. 5, 2008

**SERVICE MARK
PRINCIPAL REGISTER**

MIS

MISSOURI INSULATION & SUPPLY, INC. (MISSOURI CORPORATION)
1348 WEST LIBERTY
OZARK, MO 65721

FOR: DISTRIBUTORSHIP SERVICES IN THE FIELD OF BUILDING INSULATION, FIREPLACES, WINDOWS, WINDOW PANES, DOORS, SIDING AND BUILDING MATERIALS , IN CLASS 35 (U.S. CLS. 100, 101 AND 102).

FIRST USE 12-16-2004; IN COMMERCE 12-16-2004.

FOR: INSTALLATION OF BUILDING INSULATION, FIREPLACES, WINDOWS, WINDOW PANES,

DOORS, SIDING AND BUILDING MATERIALS, IN CLASS 37 (U.S. CLS. 100, 103 AND 106).

FIRST USE 12-16-2004; IN COMMERCE 12-16-2004.

THE MARK CONSISTS OF STANDARD CHARACTERS WITHOUT CLAIM TO ANY PARTICULAR FONT, STYLE, SIZE, OR COLOR.

SER. NO. 77-363,075, FILED 1-3-2008.

RAUL CORDOVA, EXAMINING ATTORNEY

Int. Cl.: 30

Prior U.S. Cl.: 46

United States Patent and Trademark Office

Reg. No. 3,480,208

Registered Aug. 5, 2008

TRADEMARK
PRINCIPAL REGISTER



BOUNTIFUL BERRY, INC. (MAINE CORPORATION)
349 CENTER CONWAY ROAD
BROWNFIELD, ME 04010

FOR: GRANOLA; GRANOLA SNACKS; BREAKFAST CEREALS, IN CLASS 30 (U.S. CL. 46).

FIRST USE 12-31-2001; IN COMMERCE 12-31-2001.

OWNER OF U.S. REG. NO. 2,812,774.

NO CLAIM IS MADE TO THE EXCLUSIVE RIGHT TO USE "HOME MADE, HAND MADE

MAINE MADE", APART FROM THE MARK AS SHOWN.

THE MARK CONSISTS OF FOUR PORTIONS OF CONCENTRIC CIRCLES ABOVE A STYLIZED VERSION OF THE WORDS "GRANDYOATS" WHICH IS ABOVE THE WORDS "HAND MADE, HOME MADE" WHICH IS ABOVE THE WORDS "MAINE MADE".

SER. NO. 77-363,109, FILED 1-3-2008.

ANTHONY RINKER, EXAMINING ATTORNEY

Int. Cl.: 42

Prior U.S. Cls.: 100 and 101

United States Patent and Trademark Office

Reg. No. 3,480,209

Registered Aug. 5, 2008

**SERVICE MARK
PRINCIPAL REGISTER**

NOTSOLDSEPARATELY

NOTSOLDSEPARATELY.COM, LLC (NEW JER-
SEY LTD LIAB CO)
SUITE 503
122 E. KINGSHIGHWAY
MAPLE SHADE, NJ 08052

FOR: CREATION AND DESIGN OF WEBSITES
FOR OTHERS, IN CLASS 42 (U.S. CLS. 100 AND 101).

FIRST USE 1-1-1999; IN COMMERCE 1-1-1999.

THE MARK CONSISTS OF STANDARD CHAR-
ACTERS WITHOUT CLAIM TO ANY PARTICULAR
FONT, STYLE, SIZE, OR COLOR.

SER. NO. 77-363,120, FILED 1-3-2008.

ALYSSA PALADINO, EXAMINING ATTORNEY

Int. Cl.: 18

Prior U.S. Cls.: 1, 2, 3, 22 and 41

United States Patent and Trademark Office

Reg. No. 3,480,210

Registered Aug. 5, 2008

TRADEMARK
PRINCIPAL REGISTER



JUST BASIC SPORTS, INC. (OHIO CORPORATION)
1615 N. GEYERS CHAPEL RD.
WOOSTER, OH 44691

FOR: ALL-PURPOSE CARRYING BAGS, IN CLASS 18 (U.S. CLS. 1, 2, 3, 22 AND 41).

FIRST USE 12-28-2007; IN COMMERCE 12-28-2007.

OWNER OF U.S. REG. NOS. 2,924,015 AND 2,999,839.

THE MARK CONSISTS OF THE WORDING, "PIZZAZZ", IN STYLIZED LETTERING AND A STYLIZED DESIGN OF A HUMAN BEING ADJACENT TO THE WORDING

SER. NO. 77-363,128, FILED 1-3-2008.

PAUL CROWLEY, EXAMINING ATTORNEY

Int. Cl.: 19

Prior U.S. Cls.: 1, 12, 33 and 50

United States Patent and Trademark Office

Reg. No. 3,480,211

Registered Aug. 5, 2008

**TRADEMARK
PRINCIPAL REGISTER**

Vibrance Collection

TAMKO BUILDING PRODUCTS, INC. (MISSOURI CORPORATION)
220 WEST FOURTH STREET
JOPLIN, MO 64801

FOR: COMPOSITE LUMBER MADE FROM A COMBINATION OF POLYMERS AND FILLERS FOR USE IN BUILDING CONSTRUCTION, IN CLASS 19 (U.S. CLS. 1, 12, 33 AND 50).

FIRST USE 1-26-2007; IN COMMERCE 2-18-2007.

THE MARK CONSISTS OF STANDARD CHARACTERS WITHOUT CLAIM TO ANY PARTICULAR FONT, STYLE, SIZE, OR COLOR.

NO CLAIM IS MADE TO THE EXCLUSIVE RIGHT TO USE "COLLECTION", APART FROM THE MARK AS SHOWN.

SER. NO. 77-363,131, FILED 1-3-2008.

PAUL CROWLEY, EXAMINING ATTORNEY

Int. Cl.: 31

Prior U.S. Cls.: 1 and 46

United States Patent and Trademark Office

Reg. No. 3,480,212

Registered Aug. 5, 2008

**TRADEMARK
PRINCIPAL REGISTER**

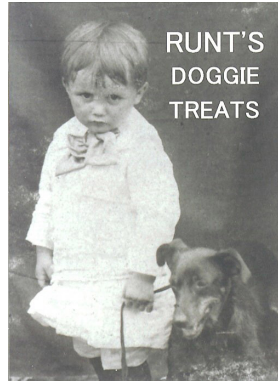

JOHNSON, STACY L. (UNITED STATES INDIVIDUAL)
272 ECKFORD DR.
TROY, MI 48085

FOR: DOG TREATS, IN CLASS 31 (U.S. CLS. 1 AND 46).

FIRST USE 12-10-2007; IN COMMERCE 12-15-2007.

NO CLAIM IS MADE TO THE EXCLUSIVE RIGHT TO USE "DOGGIE TREATS", APART FROM THE MARK AS SHOWN.

THE COLOR(S) WHITE AND GRAY IS/ARE CLAIMED AS A FEATURE OF THE MARK.

THE MARK CONSISTS OF A PHOTOGRAPHIC IMAGE WITH A GRAYSCALE BACKGROUND OF A YOUNG BOY IN WHITE CLOTHING AND GRAYSCALE HAIR COLOR WHO IS STANDING AND HOLDING A LEASH ATTACHED TO A DOG WITH GRAYSCALE COLORING WITH THE WORDS "RUNT'S DOGGIE TREATS" IN WHITE LETTERING PRINTED NEXT TO THE BOY AND ABOVE THE DOG.

SER. NO. 77-363,140, FILED 1-3-2008.

CHRISTOPHER BUONGIORNO, EXAMINING ATTORNEY

Int. Cl.: 43

Prior U.S. Cls.: 100 and 101

United States Patent and Trademark Office

Reg. No. 3,480,213

Registered Aug. 5, 2008

**SERVICE MARK
PRINCIPAL REGISTER**

EVEREST

LETTUCE ENTERTAIN YOU ENTERPRISES, INC
(ILLINOIS CORPORATION)
5419 NORTH SHERIDAN ROAD
CHICAGO, IL 60640

FOR: RESTAURANT SERVICES, IN CLASS 43
(U.S. CLS. 100 AND 101).

FIRST USE 0-0-1986; IN COMMERCE 0-0-1986.

THE MARK CONSISTS OF STANDARD CHAR-
ACTERS WITHOUT CLAIM TO ANY PARTICULAR
FONT, STYLE, SIZE, OR COLOR.

SER. NO. 77-363,142, FILED 1-3-2008.

CHRISTOPHER BUONGIORNO, EXAMINING AT-
TORNEY

Int. Cl.: 41

Prior U.S. Cls.: 100, 101 and 107

United States Patent and Trademark Office

Reg. No. 3,480,214

Registered Aug. 5, 2008

**SERVICE MARK
PRINCIPAL REGISTER**

Chefs At Play

NORTON, KATHLEEN (UNITED STATES INDIVIDUAL), DBA CHEFS AT PLAY
P.O. BOX 709
HINGHAM, MA 02043

THE MARK CONSISTS OF STANDARD CHARACTERS WITHOUT CLAIM TO ANY PARTICULAR FONT, STYLE, SIZE, OR COLOR.

FOR: ENTERTAINMENT SERVICES, NAMELY, CONDUCTING PARTIES, IN CLASS 41 (U.S. CLS. 100, 101 AND 107).

SER. NO. 77-363,194, FILED 1-3-2008.

FIRST USE 4-1-2007; IN COMMERCE 5-24-2007.

CAROLINE WOOD, EXAMINING ATTORNEY

Int. Cls.: 35, 36 and 39

Prior U.S. Cls.: 100, 101, 102 and 105

United States Patent and Trademark Office

Reg. No. 3,480,215

Registered Aug. 5, 2008

**SERVICE MARK
PRINCIPAL REGISTER**



V. ALEXANDER & CO., INC. (TENNESSEE CORPORATION)
SUITE 201
6555 QUINCE ROAD
MEMPHIS, TN 38119

FOR: LOGISTICS MANAGEMENT IN THE FIELD OF TRANSPORTATION; TRANSPORTATION LOGISTICS SERVICES, NAMELY, ARRANGING THE TRANSPORTATION OF GOODS FOR OTHERS; TRANSPORTATION LOGISTICS SERVICES, NAMELY, PLANNING AND SCHEDULING SHIPMENTS FOR USERS OF TRANSPORTATION SERVICES, IN CLASS 35 (U.S. CLS. 100, 101 AND 102).

FIRST USE 3-3-2006; IN COMMERCE 3-3-2006.

FOR: CUSTOMS BROKERAGE, IN CLASS 36 (U.S. CLS. 100, 101 AND 102).

FIRST USE 3-3-2006; IN COMMERCE 3-3-2006.

FOR: FREIGHT FORWARDING; SUPPLY CHAIN, LOGISTICS AND REVERSE LOGISTICS

SERVICES, NAMELY, STORAGE, TRANSPORTATION AND DELIVERY OF DOCUMENTS, PACKAGES, RAW MATERIALS, AND OTHER FREIGHT FOR OTHERS BY AIR, RAIL, SHIP OR TRUCK, IN CLASS 39 (U.S. CLS. 100 AND 105).

FIRST USE 3-3-2006; IN COMMERCE 3-3-2006.

NO CLAIM IS MADE TO THE EXCLUSIVE RIGHT TO USE "COMPANY, INC.", APART FROM THE MARK AS SHOWN.

THE MARK CONSISTS OF ONE LARGE "V" SHAPE WITH A SMALLER "V" SHAPE COMING OUT OF THE MIDDLE OF IT, POSITIONED BETWEEN THE "V" AND "A" IN "V. ALEXANDER" WITH "& COMPANY, INC." BELOW IT.

SER. NO. 77-363,199, FILED 1-3-2008.

CAROLINE WOOD, EXAMINING ATTORNEY

Int. Cl.: 36

Prior U.S. Cls.: 100, 101 and 102

United States Patent and Trademark Office

Reg. No. 3,480,216

Registered Aug. 5, 2008

**SERVICE MARK
PRINCIPAL REGISTER**

Express-Move

EXPRESS CAPITAL MORTGAGE INC. (ARIZONA CORPORATION)
1820 E. RAY ROAD
CHANDLER, AZ 85225

FOR: FINANCING SERVICES; HOUSING SERVICES, NAMELY, REAL PROPERTY ACQUISITION AND CONSUMER FINANCING TO FACILITATE HOME OWNERSHIP; PROVIDING INFORMATION IN THE FIELD OF REAL ESTATE BY MEANS OF LINKING THE WEB SITE TO OTHER WEB SITES FEATURING REAL ESTATE INFORMATION; PROVIDING INFORMATION IN THE FIELD OF REAL

ESTATE VIA THE INTERNET, IN CLASS 36 (U.S. CLS. 100, 101 AND 102).

FIRST USE 11-1-2007; IN COMMERCE 11-1-2007.

THE MARK CONSISTS OF STANDARD CHARACTERS WITHOUT CLAIM TO ANY PARTICULAR FONT, STYLE, SIZE, OR COLOR.

SER. NO. 77-363,206, FILED 1-3-2008.

CAROLINE WOOD, EXAMINING ATTORNEY

Int. Cl.: 41

Prior U.S. Cls.: 100, 101 and 107

United States Patent and Trademark Office

Reg. No. 3,480,217

Registered Aug. 5, 2008

**SERVICE MARK
PRINCIPAL REGISTER**



INCREASE GLOBAL NETWORK INC. (TENNESSEE CORPORATION)

#36

2400 CRESTMOOR RD.
NASHVILLE, TN 37215

FOR: EDUCATION SERVICES, NAMELY, PROVIDING LIVE AND ON-LINE CLASSES, SEMINARS AND WORKSHOPS IN THE FIELD OF HUMAN POTENTIAL AND DISTRIBUTION OF COURSE MATERIAL IN CONNECTION THEREWITH, IN CLASS 41 (U.S. CLS. 100, 101 AND 107).

FIRST USE 10-25-2007; IN COMMERCE 11-2-2007.

NO CLAIM IS MADE TO THE EXCLUSIVE RIGHT TO USE "GLOBAL NETWORK", APART FROM THE MARK AS SHOWN.

THE STIPLING IS FOR SHADING PURPOSES ONLY.

THE MARK CONSISTS OF THE STYLIZED LETTERS "IGN" WITHIN THE DESIGN OF A RECTANGLE, THE STYLIZED WORDING "INCREASE GLOBAL NETWORK" TO THE RIGHT OF THE LETTERS "IGN" WITHIN THE RECTANGLE, AND THE DESIGN OF A GLOBE OF THE EARTH WITH A RING AROUND IT BEHIND ALL OTHER ELEMENTS OF THE MARK.

SER. NO. 77-363,216, FILED 1-3-2008.

JAY BESCH, EXAMINING ATTORNEY

Int. Cl.: 44

Prior U.S. Cls.: 100 and 101

United States Patent and Trademark Office

Reg. No. 3,480,218

Registered Aug. 5, 2008

**SERVICE MARK
PRINCIPAL REGISTER**

Smile Builders

ROBYN LESSER D.M.D., P.A. (FLORIDA CORPORATION)
6415 SHELDON ROAD
TAMPA, FL 33615

THE MARK CONSISTS OF STANDARD CHARACTERS WITHOUT CLAIM TO ANY PARTICULAR FONT, STYLE, SIZE, OR COLOR.

FOR: DENTIST SERVICES, NAMELY, PROVIDING PEDIATRIC DENTISTRY SERVICES, IN CLASS 44 (U.S. CLS. 100 AND 101).

SER. NO. 77-363,230, FILED 1-3-2008.

FIRST USE 12-28-2004; IN COMMERCE 12-28-2004.

JAMES LOVELACE, EXAMINING ATTORNEY

Int. Cl.: 41

Prior U.S. Cls.: 100, 101 and 107

United States Patent and Trademark Office

Reg. No. 3,480,219

Registered Aug. 5, 2008

**SERVICE MARK
PRINCIPAL REGISTER**

SAN FRANCISCO FORTY NINERS

SAN FRANCISCO FORTY NINERS, LIMITED
(CALIFORNIA PARTNERSHIP), DBA SAN
FRANCISCO FORTY NINERS
4949 CENTENNIAL BOULEVARD
SANTA CLARA, CA 95054

FOR: EDUCATIONAL AND ENTERTAINMENT
SERVICES IN THE NATURE OF PROFESSIONAL
FOOTBALL GAMES AND EXHIBITIONS; PROVID-
ING SPORTS AND ENTERTAINMENT INFORMA-
TION VIA A GLOBAL COMPUTER NETWORK OR
A COMMERCIAL ON-LINE SERVICE, IN CLASS 41
(U.S. CLS. 100, 101 AND 107).

FIRST USE 12-31-1946; IN COMMERCE 12-31-1946.

THE MARK CONSISTS OF STANDARD CHAR-
ACTERS WITHOUT CLAIM TO ANY PARTICULAR
FONT, STYLE, SIZE, OR COLOR.

OWNER OF U.S. REG. NOS. 829,949, 1,318,640,
AND 1,810,714.

NO CLAIM IS MADE TO THE EXCLUSIVE
RIGHT TO USE "SAN FRANCISCO", APART FROM
THE MARK AS SHOWN.

SER. NO. 77-363,236, FILED 1-3-2008.

SUSAN STIGLITZ, EXAMINING ATTORNEY

Int. Cl.: 7

Prior U.S. Cls.: 13, 19, 21, 23, 31, 34 and 35

Reg. No. 3,480,220

United States Patent and Trademark Office

Registered Aug. 5, 2008

**TRADEMARK
PRINCIPAL REGISTER**

SAW IT

REED MANUFACTURING (PENNSYLVANIA
CORPORATION)
1425 W. 8TH ST.
ERIE, PA 16514

THE MARK CONSISTS OF STANDARD CHAR-
ACTERS WITHOUT CLAIM TO ANY PARTICULAR
FONT, STYLE, SIZE, OR COLOR.

FOR: AIR POWERED TOOLS, NAMELY, SAWS,
IN CLASS 7 (U.S. CLS. 13, 19, 21, 23, 31, 34 AND 35).

SER. NO. 77-363,250, FILED 1-3-2008.

FIRST USE 5-31-2002; IN COMMERCE 2-28-2003.

ANDREA HACK, EXAMINING ATTORNEY

Int. Cl.: 37

Prior U.S. Cls.: 100, 103 and 106

United States Patent and Trademark Office

Reg. No. 3,480,221

Registered Aug. 5, 2008

**SERVICE MARK
PRINCIPAL REGISTER**



FLORIDA PEST CONTROL & CHEMICAL CO.
(FLORIDA CORPORATION)
116 NW 16TH AVE.
GAINESVILLE, FL 32601

FOR: TERMITE AND PEST CONTROL, IN CLASS
37 (U.S. CLS. 100, 103 AND 106).

FIRST USE 7-24-1994; IN COMMERCE 7-24-1994.

NO CLAIM IS MADE TO THE EXCLUSIVE
RIGHT TO USE "FLORIDA PEST CONTROL &
CHEMICAL CO. SINCE 1949" AND THE PICTORIAL
REPRESENTATION OF THE STATE OF FLORIDA,
APART FROM THE MARK AS SHOWN.

THE MARK CONSISTS OF AN OF THE STATE OF
FLORIDA WITH NUMEROUS STARS ACROSS THE
UPPER PORTION OF THE STATE, TO THE RIGHT
OF THE WORDS "FLORIDA PEST CONTROL",
WITH A HUMAN CARTOON FIGURE AT THE
TOP, HOLDING A SPRAYER DEVICE AND SPRAY-
ING VAPORS OVER THE STATE OUTLINE.

SER. NO. 77-363,257, FILED 1-3-2008.

ANDREA K. NADELMAN, EXAMINING ATTOR-
NEY

Int. Cl.: 43

Prior U.S. Cls.: 100 and 101

United States Patent and Trademark Office

Reg. No. 3,480,222

Registered Aug. 5, 2008

**SERVICE MARK
PRINCIPAL REGISTER**

**SISTERS TEA PARLOR &
BOUTIQUE**

SISTERS, INC. (KENTUCKY CORPORATION)
4765 FOX RUN ROAD
BUCKNER, KY 40010

NO CLAIM IS MADE TO THE EXCLUSIVE
RIGHT TO USE "TEA PARLOR & BOUTIQUE",
APART FROM THE MARK AS SHOWN.

FOR: TEA PARLORS, IN CLASS 43 (U.S. CLS. 100
AND 101).

SER. NO. 77-363,258, FILED 1-3-2008.

FIRST USE 10-31-2006; IN COMMERCE 10-31-2006.

THE MARK CONSISTS OF STANDARD CHAR-
ACTERS WITHOUT CLAIM TO ANY PARTICULAR
FONT, STYLE, SIZE, OR COLOR.

ANDREA K. NADELMAN, EXAMINING ATTOR-
NEY

Int. Cl.: 37

Prior U.S. Cls.: 100, 103 and 106

United States Patent and Trademark Office

Reg. No. 3,480,223

Registered Aug. 5, 2008

**SERVICE MARK
PRINCIPAL REGISTER**

ANYTHING'S POSSIBLE

M & M CONSTRUCTION CONCEPTS & GUT-
TERS, LLC (OHIO LTD LIAB CO)
2249 PICKLE ROAD
OREGON, OH 43616

FOR: BUILDING MAINTENANCE AND REPAIR;
CONSTRUCTION AND RENOVATION OF BUILD-
INGS; ROOFING INSTALLATION; ROOFING RE-
PAIR, IN CLASS 37 (U.S. CLS. 100, 103 AND 106).

FIRST USE 11-1-1997; IN COMMERCE 11-1-1997.

THE MARK CONSISTS OF STANDARD CHAR-
ACTERS WITHOUT CLAIM TO ANY PARTICULAR
FONT, STYLE, SIZE, OR COLOR.

SER. NO. 77-363,279, FILED 1-3-2008.

GEORGE LORENZO, EXAMINING ATTORNEY

Int. Cl.: 14

Prior U.S. Cls.: 2, 27, 28 and 50

United States Patent and Trademark Office

Reg. No. 3,480,224

Registered Aug. 5, 2008

**TRADEMARK
PRINCIPAL REGISTER**

BRIGHTNESS BEYOND COMPARE

M.S. DAFFNER DIAMONDS INTERNATIONAL,
INC (ILLINOIS CORPORATION)
9 HAGALAD STREET APT 17
RAMAT GAN, 52522, ISRAEL

THE MARK CONSISTS OF STANDARD CHAR-
ACTERS WITHOUT CLAIM TO ANY PARTICULAR
FONT, STYLE, SIZE, OR COLOR.

FOR: CUT DIAMONDS; DIAMONDS; PRECIOUS
GEMSTONES; SEMI-PRECIOUS GEMSTONES;
EARRINGS, IN CLASS 14 (U.S. CLS. 2, 27, 28 AND 50).

SER. NO. 77-363,283, FILED 1-3-2008.

FIRST USE 9-1-2005; IN COMMERCE 9-5-2005.

KEVIN DINALLO, EXAMINING ATTORNEY

Int. Cl.: 9

Prior U.S. Cls.: 21, 23, 26, 36 and 38

Reg. No. 3,480,225

United States Patent and Trademark Office

Registered Aug. 5, 2008

**TRADEMARK
PRINCIPAL REGISTER**

BUILDINGCHURCHLEADERS

CHRISTIANITY TODAY INTERNATIONAL (IL-
LINOIS CORPORATION)
465 GUNDERSEN DRIVE
CAROL STREAM, IL 60188

THE COLOR(S) DARK ORANGE, LIGHT GREEN,
AND BLACK IS/ARE CLAIMED AS A FEATURE OF
THE MARK.

FOR: DOWNLOADABLE ELECTRONIC PUBLI-
CATIONS IN THE NATURE OF NEWSLETTERS IN
THE FIELD OF LEADERSHIP TRAINING AND
DEVELOPMENT OF CHURCH AND MINISTRY
LEADERS , IN CLASS 9 (U.S. CLS. 21, 23, 26, 36
AND 38).

THE MARK CONSISTS OF THE WORDS "BUILD-
ING" IN DARK ORANGE, "CHURCH" IN LIGHT
GREEN, AND "LEADERS" IN BLACK.

SER. NO. 77-363,290, FILED 1-3-2008.

FIRST USE 9-0-2007; IN COMMERCE 9-0-2007.

GEOFFREY FOSDICK, EXAMINING ATTORNEY

Int. Cls.: 9 and 11

Prior U.S. Cls.: 13, 21, 23, 26, 31, 34, 36 and 38

United States Patent and Trademark Office

Reg. No. 3,480,226

Registered Aug. 5, 2008

**TRADEMARK
PRINCIPAL REGISTER**



NUHEAT INDUSTRIES LIMITED (CANADA CORPORATION)
1689 CLIVEDEN AVENUE
DELTA, B.C., CANADA V3M6V5

FOR: ELECTRICAL CONTROL FOR ELECTRIC RADIANT HEATERS; THERMOSTATS, IN CLASS 9 (U.S. CLS. 21, 23, 26, 36 AND 38).

FIRST USE 8-0-1999; IN COMMERCE 8-0-1999.

FOR: ELECTRIC RADIANT HEATERS, IN CLASS 11 (U.S. CLS. 13, 21, 23, 31 AND 34).

FIRST USE 8-0-1999; IN COMMERCE 8-0-1999.

OWNER OF U.S. REG. NOS. 2,412,407, 2,523,324, AND 3,284,947.

THE MARK CONSISTS OF A STYLIZED BARE FOOT.

SER. NO. 77-363,307, FILED 1-3-2008.

REBECCA POVARCHUK, EXAMINING ATTORNEY

Int. Cls.: 29 and 30

Prior U.S. Cl.: 46

United States Patent and Trademark Office

Reg. No. 3,480,227

Registered Aug. 5, 2008

**TRADEMARK
PRINCIPAL REGISTER**

GENUINE. CLASSIC. ORIGINAL.

HAWAIIAN HOST, INC. (HAWAII CORPORATION)
500 ALAKAWA STREET, SUITE 111
HONOLULU, HI 96817

FOR: NUTS, NAMELY, SHELLED NUTS, ROASTED NUTS, CANDIED NUTS, PROCESSED NUTS; DRIED FRUITS; JERKY, IN CLASS 29 (U.S. CL. 46).

FIRST USE 12-0-2002; IN COMMERCE 12-0-2002.

FOR: CONFECTIONERY, NAMELY, CHOCOLATE COVERED CANDIES AND NUTS, MINTS, CARAMEL, AND NUT CANDIES, BRITTLES, AND CANDIED OR GLAZED POPCORN; COOKIES; AND COFFEE, IN CLASS 30 (U.S. CL. 46).

FIRST USE 12-0-2002; IN COMMERCE 12-0-2002.

THE MARK CONSISTS OF STANDARD CHARACTERS WITHOUT CLAIM TO ANY PARTICULAR FONT, STYLE, SIZE, OR COLOR.

OWNER OF U.S. REG. NO. 2,718,241.

SEC. 2(F).

SER. NO. 77-363,308, FILED 1-3-2008.

MICHAEL TANNER, EXAMINING ATTORNEY

Int. Cl.: 41

Prior U.S. Cls.: 100, 101 and 107

United States Patent and Trademark Office

Reg. No. 3,480,228

Registered Aug. 5, 2008

**SERVICE MARK
PRINCIPAL REGISTER**

HarlemLIVE

HARLEMLIVE, INC. (NEW YORK CORPORATION)
C/O TEACHRS COLL., 525 W. 120TH ST. #144
NEW YORK, NY 100276670

FOR: ONLINE YOUTH MAGAZINE WITH
AUDIO AND VISUAL CONTENT COVERING THE
PEOPLE PLACES AND EVENTS OF HARLEM AND
OTHER GREATER NEW YORK CITY COMMUNITIES
, IN CLASS 41 (U.S. CLS. 100, 101 AND 107).

FIRST USE 6-30-1996; IN COMMERCE 6-30-1996.

THE MARK CONSISTS OF STANDARD CHARACTERS
WITHOUT CLAIM TO ANY PARTICULAR FONT,
STYLE, SIZE, OR COLOR.

SER. NO. 77-363,315, FILED 1-3-2008.

ELIZABETH HUGHITT, EXAMINING ATTORNEY

Int. Cl.: 41

Prior U.S. Cls.: 100, 101 and 107

United States Patent and Trademark Office

Reg. No. 3,480,229

Registered Aug. 5, 2008

**SERVICE MARK
PRINCIPAL REGISTER**

ONE MOORE CATCH

ONE MOORE CATCH INC. (FLORIDA CORPORATION)
115 W OLYMPIA AVENUE
PUNTA GORDA, FL 33950

THE MARK CONSISTS OF STANDARD CHARACTERS WITHOUT CLAIM TO ANY PARTICULAR FONT, STYLE, SIZE, OR COLOR.

FOR: ENTERTAINMENT SERVICES, NAMELY, AN ON-GOING SERIES FEATURING FISHING PROVIDED THROUGH CABLE TELEVISION, IN CLASS 41 (U.S. CLS. 100, 101 AND 107).

SER. NO. 77-363,322, FILED 1-3-2008.

FIRST USE 9-19-2007; IN COMMERCE 9-19-2007.

ELLEN PERKINS, EXAMINING ATTORNEY

Int. Cl.: 42

Prior U.S. Cls.: 100 and 101

United States Patent and Trademark Office

Reg. No. 3,480,230

Registered Aug. 5, 2008

**SERVICE MARK
PRINCIPAL REGISTER**

Prevention To Recovery

NETSWITCH, INC. (CALIFORNIA CORPORATION), DBA NETSWITCH TECHNOLOGY MANAGEMENT
400 OYSTER POINT BLVD., SUITE 226
SOUTH SAN FRANCISCO, CA 94080

FOR: INTEGRATION OF COMPUTER SYSTEMS AND NETWORKS; DESIGN AND DEVELOPMENT OF NETWORKS, IN CLASS 42 (U.S. CLS. 100 AND 101).

FIRST USE 8-1-2007; IN COMMERCE 10-1-2007.

THE MARK CONSISTS OF STANDARD CHARACTERS WITHOUT CLAIM TO ANY PARTICULAR FONT, STYLE, SIZE, OR COLOR.

SER. NO. 77-363,326, FILED 1-3-2008.

ELIZABETH HUGHITT, EXAMINING ATTORNEY

Int. Cl.: 41

Prior U.S. Cls.: 100, 101 and 107

United States Patent and Trademark Office

Reg. No. 3,480,231

Registered Aug. 5, 2008

**SERVICE MARK
PRINCIPAL REGISTER**



WILSON, JESSICA (UNITED STATES INDIVIDUAL)
SUITE 103
1505 BRIDGEWAY
SAUSALITO, CA 94965

FIRST USE 2-1-1997; IN COMMERCE 2-1-1997.

THE MARK CONSISTS OF AN ABSTRACT DESIGN.

FOR: EDUCATION SERVICES, NAMELY, PROVIDING CLASSES, SEMINARS AND WORKSHOPS IN THE FIELD OF SPIRITUALITY; MEDITATION TRAINING; TRAINING SERVICES IN THE FIELD OF SPIRITUALITY, IN CLASS 41 (U.S. CLS. 100, 101 AND 107).

SER. NO. 77-363,358, FILED 1-3-2008.

CHRISTINE COOPER, EXAMINING ATTORNEY

Int. Cl.: 9

Prior U.S. Cls.: 21, 23, 26, 36 and 38

Reg. No. 3,480,232

United States Patent and Trademark Office

Registered Aug. 5, 2008

**TRADEMARK
PRINCIPAL REGISTER**

MatriMix

MATRICAL, INC. (DELAWARE CORPORATION)
665 N. RIVERPOINT BLVD.
SPOKANE, WA 99202

THE MARK CONSISTS OF STANDARD CHAR-
ACTERS WITHOUT CLAIM TO ANY PARTICULAR
FONT, STYLE, SIZE, OR COLOR.

FOR: FLASKS, IN CLASS 9 (U.S. CLS. 21, 23, 26, 36
AND 38).

SER. NO. 77-363,443, FILED 1-3-2008.

FIRST USE 10-1-2007; IN COMMERCE 11-29-2007.

MATTHEW PAPPAS, EXAMINING ATTORNEY

Int. Cl.: 5

Prior U.S. Cls.: 6, 18, 44, 46, 51 and 52

United States Patent and Trademark Office

Reg. No. 3,480,233

Registered Aug. 5, 2008

TRADEMARK
PRINCIPAL REGISTER

**MALIC
ACID
PLUS**

MMRC, LTD CO (TEXAS LTD LIAB CO)
5426 KING ALBERT
PO BOX 291101
SAN ANTONIO, TX 782291701

NO CLAIM IS MADE TO THE EXCLUSIVE
RIGHT TO USE "MALIC ACID", APART FROM
THE MARK AS SHOWN.

FOR: DIETARY AND NUTRITIONAL SUPPLE-
MENTS, IN CLASS 5 (U.S. CLS. 6, 18, 44, 46, 51 AND
52).

SER. NO. 77-363,468, FILED 1-3-2008.

FIRST USE 9-15-1994; IN COMMERCE 9-15-1994.

LINDSEY RUBIN, EXAMINING ATTORNEY

Int. Cl.: 9

Prior U.S. Cls.: 21, 23, 26, 36 and 38

Reg. No. 3,480,234

United States Patent and Trademark Office

Registered Aug. 5, 2008

**TRADEMARK
PRINCIPAL REGISTER**

CSEP

CALGON CARBON CORPORATION (DELA-
WARE CORPORATION)
500 CALGON CARBON DRIVE
PITTSBURGH, PA 15205

THE MARK CONSISTS OF STANDARD CHAR-
ACTERS WITHOUT CLAIM TO ANY PARTICULAR
FONT, STYLE, SIZE, OR COLOR.

FOR: CHROMATOGRAPHY SEPARATORS, IN
CLASS 9 (U.S. CLS. 21, 23, 26, 36 AND 38).

SER. NO. 77-363,470, FILED 1-3-2008.

FIRST USE 10-0-1994; IN COMMERCE 1-0-1995.

MATTHEW PAPPAS, EXAMINING ATTORNEY

Int. Cls.: 9 and 11

Prior U.S. Cls.: 13, 21, 23, 26, 31, 34, 36 and 38

United States Patent and Trademark Office

Reg. No. 3,480,235

Registered Aug. 5, 2008

**TRADEMARK
PRINCIPAL REGISTER**

NUHEAT

NUHEAT INDUSTRIES LIMITED (CANADA
CORPORATION)
1689 CLIVEDEN AVENUE
DELTA, B.C., CANADA V3M6V5

FOR: ELECTRICAL CONTROL FOR ELECTRIC
RADIANT HEATERS; THERMOSTATS, IN CLASS 9
(U.S. CLS. 21, 23, 26, 36 AND 38).

FIRST USE 1-0-1991; IN COMMERCE 1-0-1991.

FOR: ELECTRIC RADIANT HEATERS, IN CLASS
11 (U.S. CLS. 13, 21, 23, 31 AND 34).

FIRST USE 1-0-1991; IN COMMERCE 1-0-1991.

THE MARK CONSISTS OF STANDARD CHAR-
ACTERS WITHOUT CLAIM TO ANY PARTICULAR
FONT, STYLE, SIZE, OR COLOR.

OWNER OF U.S. REG. NOS. 2,415,672, 2,633,961,
AND 3,284,945.

SER. NO. 77-363,490, FILED 1-3-2008.

REBECCA POVARCHUK, EXAMINING ATTOR-
NEY

Int. Cl.: 35

Prior U.S. Cls.: 100, 101 and 102

United States Patent and Trademark Office

Reg. No. 3,480,236

Registered Aug. 5, 2008

**SERVICE MARK
PRINCIPAL REGISTER**

INETGIANT
ADVERTISE TO THE WORLD

INETGIANT, INC. (NEW YORK CORPORATION)
SUITE 79
1110 SOUTH AVE
STATEN ISLAND, NY 10314

FOR: ADVERTISING AND ADVERTISEMENT
SERVICES, NAMELY, EMAIL ADVERTISING, TAR-
GETED TRAFFIC ADVERTISING, AND WEBSITE

ADVERTISING, IN CLASS 35 (U.S. CLS. 100, 101 AND
102).

FIRST USE 1-1-2001; IN COMMERCE 1-1-2001.

SER. NO. 77-363,499, FILED 1-3-2008.

REBECCA POVARCHUK, EXAMINING ATTOR-
NEY

Int. Cl.: 11

Prior U.S. Cls.: 13, 21, 23, 31 and 34

Reg. No. 3,480,237

United States Patent and Trademark Office

Registered Aug. 5, 2008

**TRADEMARK
PRINCIPAL REGISTER**

Cogent Technologies

COGENT TECHNOLOGIES, INC (MINNESOTA CORPORATION), DBA RESEARCH, INC
MARKETING/LEGAL
7041 BOONE AVE. N.
BROOKLYN PARK, MN 55428

FOR: INDUSTRIAL DRYERS FOR HEATING AND DEHUMIDIFYING, IN CLASS 11 (U.S. CLS. 13, 21, 23, 31 AND 34).

FIRST USE 8-16-2007; IN COMMERCE 9-10-2007.

THE MARK CONSISTS OF STANDARD CHARACTERS WITHOUT CLAIM TO ANY PARTICULAR FONT, STYLE, SIZE, OR COLOR.

NO CLAIM IS MADE TO THE EXCLUSIVE RIGHT TO USE "TECHNOLOGIES", APART FROM THE MARK AS SHOWN.

SER. NO. 77-363,506, FILED 1-3-2008.

KIMBERLY PERRY, EXAMINING ATTORNEY

Int. Cl.: 38

Prior U.S. Cls.: 100, 101 and 104

United States Patent and Trademark Office

Reg. No. 3,480,238

Registered Aug. 5, 2008

**SERVICE MARK
PRINCIPAL REGISTER**

MonyCall

HALL, GARY L. (UNITED STATES INDIVIDUAL)
5709 LYONS VIEW DRIVE #4201
KNOXVILLE, TN 37919

THE MARK CONSISTS OF STANDARD CHARACTERS WITHOUT CLAIM TO ANY PARTICULAR FONT, STYLE, SIZE, OR COLOR.

FOR: TELEPHONE COMMUNICATION SERVICES, IN CLASS 38 (U.S. CLS. 100, 101 AND 104).

SER. NO. 77-363,527, FILED 1-3-2008.

FIRST USE 10-15-2007; IN COMMERCE 10-15-2007.

JORDAN BAKER, EXAMINING ATTORNEY

Int. Cl.: 41

Prior U.S. Cls.: 100, 101 and 107

United States Patent and Trademark Office

Reg. No. 3,480,239

Registered Aug. 5, 2008

**SERVICE MARK
PRINCIPAL REGISTER**

HACP

CURTIS, RICHARD (UNITED STATES INDIVIDUAL)
3101 BRIAR OAK LANE
ROUND ROCK, TX 78681

THE MARK CONSISTS OF STANDARD CHARACTERS WITHOUT CLAIM TO ANY PARTICULAR FONT, STYLE, SIZE, OR COLOR.

FOR: EDUCATION SERVICES, NAMELY, PROVIDING CLASSES IN THE FIELD OF HEALTH-CARE, IN CLASS 41 (U.S. CLS. 100, 101 AND 107).

SER. NO. 77-363,542, FILED 1-3-2008.

FIRST USE 12-1-2007; IN COMMERCE 12-1-2007.

RUSS HERMAN, EXAMINING ATTORNEY

Int. Cl.: 30

Prior U.S. Cl.: 46

United States Patent and Trademark Office

Reg. No. 3,480,240

Registered Aug. 5, 2008

**TRADEMARK
PRINCIPAL REGISTER**

**POLITO'S PIZZA
HOME OF THE BIG SLICE
SIZE DOES MATTER**

POLITO'S PIZZA, LLC. (WISCONSIN LTD LIAB
CO)
4617 NICOLET AVENUE
STEVENS POINT, WI 54481

NO CLAIM IS MADE TO THE EXCLUSIVE
RIGHT TO USE "PIZZA", APART FROM THE
MARK AS SHOWN.

FOR: PIZZA, IN CLASS 30 (U.S. CL. 46).

FIRST USE 7-11-2007; IN COMMERCE 4-10-2008.

SER. NO. 77-363,543, FILED 1-3-2008.

THE MARK CONSISTS OF STANDARD CHAR-
ACTERS WITHOUT CLAIM TO ANY PARTICULAR
FONT, STYLE, SIZE, OR COLOR.

JOHN WILKE, EXAMINING ATTORNEY

Int. Cl.: 25

Prior U.S. Cls.: 22 and 39

United States Patent and Trademark Office

Reg. No. 3,480,241

Registered Aug. 5, 2008

**TRADEMARK
PRINCIPAL REGISTER**

ONE MOORE CATCH

ONE MOORE CATCH INC. (FLORIDA CORPORATION)
115 W OLYMPIA AVENUE
PUNTA GORDA, FL 33950

THE MARK CONSISTS OF STANDARD CHARACTERS WITHOUT CLAIM TO ANY PARTICULAR FONT, STYLE, SIZE, OR COLOR.

FOR: HATS; SHIRTS, IN CLASS 25 (U.S. CLS. 22 AND 39).

SER. NO. 77-363,551, FILED 1-3-2008.

FIRST USE 10-1-2007; IN COMMERCE 10-19-2007.

ELLEN PERKINS, EXAMINING ATTORNEY

Int. Cl.: 42

Prior U.S. Cls.: 100 and 101

United States Patent and Trademark Office

Reg. No. 3,480,242

Registered Aug. 5, 2008

**SERVICE MARK
PRINCIPAL REGISTER**

**CHANGING THE WAY COMPANIES
RUN THEIR DATA CENTERS**

APERTURE TECHNOLOGIES, INC. (DELAWARE
CORPORATION)
9 RIVERBEND DRIVE SOUTH
STAMFORD, CT 06907

THE MARK CONSISTS OF STANDARD CHAR-
ACTERS WITHOUT CLAIM TO ANY PARTICULAR
FONT, STYLE, SIZE, OR COLOR.

FOR: COMPUTER CONSULTATION, IN CLASS 42
(U.S. CLS. 100 AND 101).

SER. NO. 77-363,552, FILED 1-3-2008.

FIRST USE 2-17-2006; IN COMMERCE 2-17-2006.

RUSS HERMAN, EXAMINING ATTORNEY

Int. Cl.: 30

Prior U.S. Cl.: 46

United States Patent and Trademark Office

Reg. No. 3,480,243

Registered Aug. 5, 2008

**TRADEMARK
PRINCIPAL REGISTER**

FHAZANI

RED BRICK PIZZA, INC. (CALIFORNIA COR-
PORATION)
SUITE 2B
40320 NIDO COURT
PALMDALE, CA 93551

THE MARK CONSISTS OF STANDARD CHAR-
ACTERS WITHOUT CLAIM TO ANY PARTICULAR
FONT, STYLE, SIZE, OR COLOR.

FOR: SANDWICHES, IN CLASS 30 (U.S. CL. 46).

SER. NO. 77-363,625, FILED 1-3-2008.

FIRST USE 10-15-2001; IN COMMERCE 10-15-2001.

ALYSSA PALADINO, EXAMINING ATTORNEY

Int. Cl.: 35

Prior U.S. Cls.: 100, 101 and 102

United States Patent and Trademark Office

Reg. No. 3,480,244

Registered Aug. 5, 2008

**SERVICE MARK
PRINCIPAL REGISTER**

ROXFOX

ROXFOX CO. (CALIFORNIA CORPORATION)
555 BROADWAY SUITE 110A
CHULA VISTA, CA 91910

FOR: RETAIL STORE SERVICES FEATURING
CLOTHING, IN CLASS 35 (U.S. CLS. 100, 101 AND
102).

FIRST USE 12-1-2007; IN COMMERCE 12-1-2007.

THE COLOR(S) BLUEISH/WHITE AND BLACK
IS/ARE CLAIMED AS A FEATURE OF THE MARK.

THE MARK CONSISTS OF THE WORD "ROX-
FOX" IN A BLUEISH/WHITE STYLIZED VERSION
OUTLINED IN BLACK.

SER. NO. 77-363,634, FILED 1-3-2008.

LOURDES AYALA, EXAMINING ATTORNEY

Int. Cl.: 44

Prior U.S. Cls.: 100 and 101

United States Patent and Trademark Office

Reg. No. 3,480,245

Registered Aug. 5, 2008

**SERVICE MARK
PRINCIPAL REGISTER**

STEPPING IT UP!

LIFELONG FITNESS ALLIANCE (CALIFORNIA CORPORATION)
658 BAIR ISLAND ROAD, SUITE 200
REDWOOD CITY, CA 94063

FOR: PROVIDING ASSISTANCE, FITNESS EVALUATION AND CONSULTATION TO INDIVIDUALS TO HELP THEM MAKE HEALTH, WELLNESS AND NUTRITIONAL CHANGES IN THEIR DAILY LIVING TO IMPROVE HEALTH; PROVIDING ASSISTANCE, FITNESS EVALUATION AND CONSULTATION TO CORPORATE CLIENTS TO HELP THEIR EMPLOYEES MAKE HEALTH, WELLNESS AND NUTRITIONAL CHANGES IN

THEIR DAILY LIVING TO IMPROVE HEALTH, IN CLASS 44 (U.S. CLS. 100 AND 101).

FIRST USE 1-2-2008; IN COMMERCE 1-2-2008.

THE MARK CONSISTS OF STANDARD CHARACTERS WITHOUT CLAIM TO ANY PARTICULAR FONT, STYLE, SIZE, OR COLOR.

SER. NO. 77-363,643, FILED S.R. 1-3-2008 AM. P.R. 4-2-2008.

NAAKWAMA ANKRAH, EXAMINING ATTORNEY

Int. Cl.: 3

Prior U.S. Cls.: 1, 4, 6, 50, 51 and 52

Reg. No. 3,480,246

United States Patent and Trademark Office

Registered Aug. 5, 2008

**TRADEMARK
PRINCIPAL REGISTER**

STAINLESS BUTLER

ELKAY MANUFACTURING COMPANY (ILLINOIS CORPORATION)

2222 CAMDEN COURT

OAK BROOK, IL 60523

FOR: STAINLESS STEEL CLEANER AND POLISHER, IN CLASS 3 (U.S. CLS. 1, 4, 6, 50, 51 AND 52).

FIRST USE 12-0-2006; IN COMMERCE 12-0-2006.

THE MARK CONSISTS OF STANDARD CHARACTERS WITHOUT CLAIM TO ANY PARTICULAR FONT, STYLE, SIZE, OR COLOR.

NO CLAIM IS MADE TO THE EXCLUSIVE RIGHT TO USE "STAINLESS", APART FROM THE MARK AS SHOWN.

SER. NO. 77-363,667, FILED 1-3-2008.

ZHALEH DELANEY, EXAMINING ATTORNEY

Prior U.S. Cl.: B

United States Patent and Trademark Office

Reg. No. 3,480,247

Registered Aug. 5, 2008

CERTIFICATION MARK
PRINCIPAL REGISTER



SUSTAINABLE TRAVEL INTERNATIONAL
(COLORADO NON-PROFIT ORGANIZATION)
#106
3100 BROADWAY AVE
BOULDER, CO 80304

FOR: TOURISM, HOSPITALITY AND ACCOM-
MODATION SERVICES, IN CLASS B (U.S. CL. B).

FIRST USE 7-0-2006; IN COMMERCE 7-0-2006.

OWNER OF U.S. REG. NO. 3,216,917.

NO CLAIM IS MADE TO THE EXCLUSIVE
RIGHT TO USE "TRAVEL SELF-ASSESSMENT
COMPLETED" AND "EXPIRES", APART FROM
THE MARK AS SHOWN.

THE MARK CONSISTS OF A GLOBE WITHIN A
SINGLE-LINE CIRCULAR BORDER AND SHOW-
ING CONTINENTS WITH AN ARROW WRAPPING

AROUND THEM; THE WORDING "ECO-CERTI-
FIED SUSTAINABLE TRAVEL SELF-ASSESSMENT
COMPLETED" APPEARS BENEATH THE GLOBE
AND ABOVE TWO STARS WHICH ARE ABOVE
THE WORD "EXPIRES". THE DESIGN ELEMENTS
AND WORDING ARE ALL CONTAINED WITHIN A
SINGLE-LINE RECTANGULAR CARRIER.

THE CERTIFICATION MARK, AS USED BY
AUTHORIZED PERSONS, CERTIFIES THAT TRA-
VEL AND TOURISM PROVIDERS IDENTIFY, MEA-
SURE AND MANAGE THEIR ENVIRONMENTAL,
ECONOMIC AND SOCIO- CULTURAL IMPACTS,
ULTIMATELY, WORKING TO ENHANCE THEIR
POSITIVE IMPACTS AND MITIGATE THEIR NE-
GATIVE IMPACTS.

SER. NO. 77-363,677, FILED 1-3-2008.

ELLEN BURNS, EXAMINING ATTORNEY

Int. Cl.: 20

Prior U.S. Cls.: 2, 13, 22, 25, 32 and 50

Reg. No. 3,480,248

United States Patent and Trademark Office

Registered Aug. 5, 2008

**TRADEMARK
PRINCIPAL REGISTER**

DIVERSIBOX

LIBERTY DIVERSIFIED INDUSTRIES, INC.
(MINNESOTA CORPORATION)
5600 NORTH HIGHWAY 169
MINNEAPOLIS, MN 55428

THE MARK CONSISTS OF STANDARD CHAR-
ACTERS WITHOUT CLAIM TO ANY PARTICULAR
FONT, STYLE, SIZE, OR COLOR.

FOR: PACKING CONTAINERS OF PLASTIC MA-
TERIAL; PLASTIC STORAGE CONTAINERS FOR
COMMERCIAL OR INDUSTRIAL USE, IN CLASS 20
(U.S. CLS. 2, 13, 22, 25, 32 AND 50).

SER. NO. 77-363,681, FILED 1-3-2008.

FIRST USE 9-30-2007; IN COMMERCE 9-30-2007.

SIMON TENG, EXAMINING ATTORNEY

Int. Cl.: 5

Prior U.S. Cls.: 6, 18, 44, 46, 51 and 52

Reg. No. 3,480,249

United States Patent and Trademark Office

Registered Aug. 5, 2008

**TRADEMARK
PRINCIPAL REGISTER**

MANALEI

PHARM EAST, INC. (HAWAII CORPORATION)
16-2666 EAST KIPIMANA
P.O. BOX 1458
KEAAU, HI 96749

FOR: DIETARY SUPPLEMENTS; FOOD SUPPLEMENTS; HERBAL SUPPLEMENTS; MINERAL SUPPLEMENTS; NUTRITIONAL SUPPLEMENTS; VITAMIN SUPPLEMENTS, IN CLASS 5 (U.S. CLS. 6, 18, 44, 46, 51 AND 52).

FIRST USE 12-28-2007; IN COMMERCE 12-28-2007.

THE MARK CONSISTS OF STANDARD CHARACTERS WITHOUT CLAIM TO ANY PARTICULAR FONT, STYLE, SIZE, OR COLOR.

THE ENGLISH TRANSLATION OF THE TERMS "MANA" AND "LEI" IN THE MARK ARE POWER [SPIRITUAL] AND FLOWER GARLAND

SER. NO. 77-363,685, FILED 1-3-2008.

THOMAS MANOR, EXAMINING ATTORNEY

Int. Cl.: 36

Prior U.S. Cls.: 100, 101 and 102

United States Patent and Trademark Office

Reg. No. 3,480,250

Registered Aug. 5, 2008

**SERVICE MARK
PRINCIPAL REGISTER**

YOUR DESTINATION FOR MI

AMERICAN INTERNATIONAL GROUP, INC.
(DELAWARE CORPORATION)
70 PINE STREET
NEW YORK, NY 10270

FOR: INSURANCE UNDERWRITING IN THE
FIELD OF MORTGAGE GUARANTY INSURANCE,
IN CLASS 36 (U.S. CLS. 100, 101 AND 102).

FIRST USE 12-27-2007; IN COMMERCE 12-27-2007.

THE MARK CONSISTS OF STANDARD CHAR-
ACTERS WITHOUT CLAIM TO ANY PARTICULAR
FONT, STYLE, SIZE, OR COLOR.

NO CLAIM IS MADE TO THE EXCLUSIVE
RIGHT TO USE "MI", APART FROM THE MARK
AS SHOWN.

SER. NO. 77-363,694, FILED 1-3-2008.

THOMAS MANOR, EXAMINING ATTORNEY

Int. Cl.: 41

Prior U.S. Cls.: 100, 101 and 107

United States Patent and Trademark Office

Reg. No. 3,480,251

Registered Aug. 5, 2008

**SERVICE MARK
PRINCIPAL REGISTER**

Ultimate BootCamp

KANADY, BETH (UNITED STATES INDIVIDUAL)
14245 S. HILLSDALE CT.
PLAINFIELD, IL 60544

FOR: EDUCATIONAL SERVICES, NAMELY, CONDUCTING TRAINING, CLASSES, SEMINARS AND WORKSHOPS IN THE FIELD OF INFORMATION TECHNOLOGY AND DISTRIBUTION OF COURSE MATERIAL IN CONNECTION THEREWITH, IN CLASS 41 (U.S. CLS. 100, 101 AND 107).

FIRST USE 7-25-2007; IN COMMERCE 9-4-2007.

THE MARK CONSISTS OF STANDARD CHARACTERS WITHOUT CLAIM TO ANY PARTICULAR FONT, STYLE, SIZE, OR COLOR.

SER. NO. 77-363,702, FILED 1-3-2008.

DAVID YONTEF, EXAMINING ATTORNEY

Int. Cl.: 35

Prior U.S. Cls.: 100, 101 and 102

United States Patent and Trademark Office

Reg. No. 3,480,252

Registered Aug. 5, 2008

**SERVICE MARK
PRINCIPAL REGISTER**



LATINO TAX, LLC (NEW JERSEY LTD LIAB CO)
4406 VENTNOR AVENUE
ATLANTIC CITY, NJ 08401

FOR: DATA PROCESSING SERVICES; INCOME
TAX PREPARATION, IN CLASS 35 (U.S. CLS. 100, 101
AND 102).

FIRST USE 5-23-2003; IN COMMERCE 5-23-2003.

NO CLAIM IS MADE TO THE EXCLUSIVE
RIGHT TO USE "LATINO TAX" AND "INCOME

TAX EN ESPAÑOL", APART FROM THE MARK AS
SHOWN.

THE MARK CONSISTS OF THE STYLIZED
WORDS "LATINO TAX INCOME TAX EN ESPA-
ÑOL".

THE FOREIGN WORDING IN THE MARK
TRANSLATES INTO ENGLISH AS IN SPANISH.

SER. NO. 77-363,716, FILED 1-3-2008.

LINDA POWELL, EXAMINING ATTORNEY

Int. Cl.: 18

Prior U.S. Cls.: 1, 2, 3, 22 and 41

United States Patent and Trademark Office

Reg. No. 3,480,253

Registered Aug. 5, 2008

**TRADEMARK
PRINCIPAL REGISTER**

FlyBag

FOURHEADS, LLC (CALIFORNIA LTD LIAB CO)
#188
2443 FILLMORE ST.
SAN FRANCISCO, CA 94115

THE MARK CONSISTS OF STANDARD CHAR-
ACTERS WITHOUT CLAIM TO ANY PARTICULAR
FONT, STYLE, SIZE, OR COLOR.

FOR: TRAVEL BAGS; TRAVEL CASES, IN CLASS
18 (U.S. CLS. 1, 2, 3, 22 AND 41).

SER. NO. 77-363,722, FILED 1-3-2008.

FIRST USE 9-1-2007; IN COMMERCE 9-1-2007.

BRIAN PINO, EXAMINING ATTORNEY

Int. Cl.: 32

Prior U.S. Cls.: 45, 46 and 48

United States Patent and Trademark Office

Reg. No. 3,480,254

Registered Aug. 5, 2008

**TRADEMARK
PRINCIPAL REGISTER**

SERIOUS ENERGY

ODWALLA, INC. (CALIFORNIA CORPORATION)

120 STONE PINE ROAD

HALF MOON BAY, CA 94019

FOR: FRUIT BASED JUICES AND DRINKS, IN CLASS 32 (U.S. CLS. 45, 46 AND 48).

FIRST USE 9-0-1999; IN COMMERCE 9-0-1999.

THE MARK CONSISTS OF STANDARD CHARACTERS WITHOUT CLAIM TO ANY PARTICULAR FONT, STYLE, SIZE, OR COLOR.

NO CLAIM IS MADE TO THE EXCLUSIVE RIGHT TO USE "ENERGY", APART FROM THE MARK AS SHOWN.

SER. NO. 77-363,729, FILED 1-3-2008.

ALEX KEAM, EXAMINING ATTORNEY

Int. Cls.: 9 and 42

Prior U.S. Cls.: 21, 23, 26, 36, 38, 100 and 101

United States Patent and Trademark Office

Reg. No. 3,480,255

Registered Aug. 5, 2008

**TRADEMARK
SERVICE MARK
PRINCIPAL REGISTER**

ORGANIC MOTION

ORGANIC MOTION, INC. (DELAWARE CORPORATION)
STUDIO 530
336 WEST 37TH STREET
NEW YORK, NY 10018

FOR: COMPUTER HARDWARE AND SOFTWARE FOR THE CAPTURE, ANALYSIS, EDITING, SYNCHRONIZATION AND GRAPHIC REPRESENTATION OF ANIMATION AND MOTION DATA COLLECTED IN REAL-TIME FOR USE IN THE FIELDS OF MEDICINE, ENTERTAINMENT, EDUCATION, RECREATION, VISUAL EFFECTS, SPORTS INSTRUCTION, SPORTS TRAINING AND REHABILITATION; MOTION CAPTURE SYSTEM COMPRISED OF COMPUTER HARDWARE, SOFTWARE, VIDEO CAMERA AND LIGHTED PERFORMANCE SEMI-PORTABLE STAGE FOR THE CAPTURE, ANALYSIS, EDITING, SYNCHRONIZATION AND GRAPHIC REPRESENTATION OF ANIMATION AND MOTION DATA COLLECTED IN REAL-TIME FOR USE IN THE FIELDS MEDICINE, ENTERTAINMENT, EDUCATION, RECREATION, VISUAL EFFECTS, SPORTS INSTRUCTION, SPORTS TRAINING AND REHABILITATION, IN CLASS 9 (U.S. CLS. 21, 23, 26, 36 AND 38).

FIRST USE 2-7-2007; IN COMMERCE 3-7-2007.

FOR: DEVELOPMENT OF NEW TECHNOLOGY FOR OTHERS IN THE FIELDS OF ANIMATION,

REAL-TIME MARKERLESS MOTION CAPTURE AND OUTPUT AND SPECIAL EFFECTS PRODUCTION; TECHNOLOGY CONSULTATION AND TECHNICAL SUPPORT SERVICES, NAMELY, TROUBLESHOOTING OF COMPUTER HARDWARE AND SOFTWARE PROBLEMS IN THE FIELDS OF ANIMATION, MOTION CAPTURE AND SPECIAL EFFECTS PRODUCTION; CONSULTING SERVICES IN THE DESIGN, SELECTION AND USE OF COMPUTER HARDWARE AND SOFTWARE SYSTEMS FOR OTHERS IN THE FIELDS OF ANIMATION, REAL-TIME MOTION CAPTURE AND OUTPUT AND SPECIAL EFFECTS PRODUCTION, IN CLASS 42 (U.S. CLS. 100 AND 101).

FIRST USE 2-7-2007; IN COMMERCE 3-7-2007.

THE MARK CONSISTS OF STANDARD CHARACTERS WITHOUT CLAIM TO ANY PARTICULAR FONT, STYLE, SIZE, OR COLOR.

NO CLAIM IS MADE TO THE EXCLUSIVE RIGHT TO USE "MOTION" , APART FROM THE MARK AS SHOWN.

SER. NO. 77-363,745, FILED 1-3-2008.

ANDREW RHIM, EXAMINING ATTORNEY

Int. Cl.: 1

Prior U.S. Cls.: 1, 5, 6, 10, 26 and 46

Reg. No. 3,480,256

United States Patent and Trademark Office

Registered Aug. 5, 2008

**TRADEMARK
PRINCIPAL REGISTER**

Agri-Vista

CAL AGRI PRODUCTS, LLC (CALIFORNIA LTD
LIAB CO)
10720 MCCUNE AVENUE
LOS ANGELES, CA 90034

THE MARK CONSISTS OF STANDARD CHAR-
ACTERS WITHOUT CLAIM TO ANY PARTICULAR
FONT, STYLE, SIZE, OR COLOR.

FOR: FERTILIZERS FOR AGRICULTURAL USE;
SOIL AMENDMENTS, IN CLASS 1 (U.S. CLS. 1, 5, 6,
10, 26 AND 46).

SER. NO. 77-363,763, FILED 1-3-2008.

FIRST USE 1-1-2008; IN COMMERCE 1-1-2008.

WILLIAM VERHOSEK, EXAMINING ATTORNEY

Int. Cl.: 37

Prior U.S. Cls.: 100, 103 and 106

United States Patent and Trademark Office

Reg. No. 3,480,257

Registered Aug. 5, 2008

**SERVICE MARK
PRINCIPAL REGISTER**

We fix ugly dents

HOCHSTEDLER, MARK (UNITED STATES IN-
DIVIDUAL)
6127 W LAKESIDE CT.
LITTLETON, CO 80125

THE MARK CONSISTS OF STANDARD CHAR-
ACTERS WITHOUT CLAIM TO ANY PARTICULAR
FONT, STYLE, SIZE, OR COLOR.

FOR: AUTOMOTIVE MAINTENANCE AND RE-
PAIR, IN CLASS 37 (U.S. CLS. 100, 103 AND 106).

SER. NO. 77-363,781, FILED 1-3-2008.

FIRST USE 1-1-2005; IN COMMERCE 5-19-2006.

JAY BESCH, EXAMINING ATTORNEY

Int. Cl.: 43

Prior U.S. Cls.: 100 and 101

United States Patent and Trademark Office

Reg. No. 3,480,258

Registered Aug. 5, 2008

**SERVICE MARK
PRINCIPAL REGISTER**

Mindful Dining for All Seasons

JBT, LLC (MARYLAND LTD LIAB CO)
4917 ELM STREET
BETHESDA, MD 20814

FOR: CAFE AND RESTAURANT SERVICES, IN
CLASS 43 (U.S. CLS. 100 AND 101).

FIRST USE 3-0-2004; IN COMMERCE 3-0-2004.

THE MARK CONSISTS OF THE WORDS "MIND-
FUL DINING FOR ALL SEASONS" WITH A HEART
DESIGN IN PLACE OF THE DOT IN THE LETTER
"I" IN "MINDFUL".

SER. NO. 77-363,797, FILED 1-3-2008.

FRANK LATTUCA, EXAMINING ATTORNEY

Int. Cl.: 43

Prior U.S. Cls.: 100 and 101

United States Patent and Trademark Office

Reg. No. 3,480,259

Registered Aug. 5, 2008

**SERVICE MARK
PRINCIPAL REGISTER**

FEED THE WHOLE GROUP

NOODLES & COMPANY (DELAWARE COR-
PORATION)
520 ZANG STREET, SUITE D
BROOMFIELD, CO 80021

THE MARK CONSISTS OF STANDARD CHAR-
ACTERS WITHOUT CLAIM TO ANY PARTICULAR
FONT, STYLE, SIZE, OR COLOR.

FOR: RESTAURANT SERVICES, IN CLASS 43
(U.S. CLS. 100 AND 101).

SER. NO. 77-363,806, FILED 1-3-2008.

FIRST USE 1-2-2008; IN COMMERCE 1-2-2008.

FRANK LATTUCA, EXAMINING ATTORNEY

Int. Cl.: 43

Prior U.S. Cls.: 100 and 101

United States Patent and Trademark Office

Reg. No. 3,480,260

Registered Aug. 5, 2008

**SERVICE MARK
PRINCIPAL REGISTER**



JBT, LLC (MARYLAND LTD LIAB CO)
4917 ELM STREET
BETHESDA, MD 20814

THE MARK CONSISTS OF A CIRCLE CIRCUM-
SCRIBING THE WORDS "ROCK CREEK" AND A
STYLIZED CREEK.

FOR: CAFE AND RESTAURANT SERVICES, IN
CLASS 43 (U.S. CLS. 100 AND 101).

SER. NO. 77-363,816, FILED 1-3-2008.

FIRST USE 3-0-2004; IN COMMERCE 3-0-2004.

FRANK LATTUCA, EXAMINING ATTORNEY

Int. Cl.: 9

Prior U.S. Cls.: 21, 23, 26, 36 and 38

Reg. No. 3,480,261

United States Patent and Trademark Office

Registered Aug. 5, 2008

**TRADEMARK
PRINCIPAL REGISTER**

LABORATORY LOOT

PROGRESSIVE GAMING INTERNATIONAL
CORP. (NEVADA CORPORATION)
920 PILOT ROAD
LAS VEGAS, NV 89119

FIRST USE 11-13-2007; IN COMMERCE 11-13-2007.

FOR: GAMING EQUIPMENT, NAMELY, ELECTRONIC CONTROLLERS, GAMING MACHINE AND COMPUTER INTERFACE BOARDS, FLAT PANEL DISPLAY SCREENS, ELECTRONIC CIRCUIT BOARDS, AND RELATED SOFTWARE FOR ESTABLISHING, TRACKING, AND GRANTING BONUS AWARDS, IN CLASS 9 (U.S. CLS. 21, 23, 26, 36 AND 38).

THE MARK CONSISTS OF STANDARD CHARACTERS WITHOUT CLAIM TO ANY PARTICULAR FONT, STYLE, SIZE, OR COLOR.

SER. NO. 77-363,842, FILED 1-3-2008.

JORDAN BAKER, EXAMINING ATTORNEY

Int. Cl.: 9

Prior U.S. Cls.: 21, 23, 26, 36 and 38

Reg. No. 3,480,262

United States Patent and Trademark Office

Registered Aug. 5, 2008

**TRADEMARK
PRINCIPAL REGISTER**

Team Backwoods

TEAM BACKWOODS, LLC (OHIO LTD LIAB CO)
6931 WOODWARD CLAYPOOL RD.
MORROW, OH 45152

FIRST USE 3-20-2004; IN COMMERCE 1-10-2005.

FOR: DIGITAL MEDIA, NAMELY, PRE-RECORDED VIDEO CASSETTES, DIGITAL VIDEO DISCS, DIGITAL VERSATILE DISCS, DOWNLOADABLE AUDIO AND VIDEO RECORDINGS, DVDS, AND HIGH DEFINITION DIGITAL DISKS FEATURING BIG GAME ARCHERY AND FIREARM HUNTING AND OUTDOOR SPORTS, IN CLASS 9 (U.S. CLS. 21, 23, 26, 36 AND 38).

THE MARK CONSISTS OF STANDARD CHARACTERS WITHOUT CLAIM TO ANY PARTICULAR FONT, STYLE, SIZE, OR COLOR.

SER. NO. 77-363,851, FILED 1-3-2008.

ANDREA BUTLER, EXAMINING ATTORNEY

Int. Cl.: 36

Prior U.S. Cls.: 100, 101 and 102

United States Patent and Trademark Office

Reg. No. 3,480,263

Registered Aug. 5, 2008

**SERVICE MARK
PRINCIPAL REGISTER**



NATIONAL MORTGAGE COMPLIANCE, LLC
(WASHINGTON LTD LIAB CO)
5063 L COURT
WASHOUGAL, WA 98671

FOR: MORTGAGE COMPLIANCE CONSULTING SERVICES CONCERNING FINANCIAL REQUIREMENTS FOR MORTGAGES FOR MORTGAGE LENDERS AND SERVICERS AND MORTGAGE BROKERS; PROVIDING POST-COMPLIANCE FINANCIAL REVIEWS FOR THE MORTGAGE INDUSTRY, IN CLASS 36 (U.S. CLS. 100, 101 AND 102).

FIRST USE 1-25-2007; IN COMMERCE 1-25-2007.

NO CLAIM IS MADE TO THE EXCLUSIVE RIGHT TO USE "NATIONAL MORTGAGE COMPLIANCE", APART FROM THE MARK AS SHOWN.

THE MARK CONSISTS OF THE TERM "NMC" CONTAINED WITHIN A BOX, WITH THE UNDERLINED TERMS "NATIONAL MORTGAGE COMPLIANCE" LOCATED TO THE RIGHT.

SER. NO. 77-363,868, FILED 1-3-2008.

MARK T. MULLEN, EXAMINING ATTORNEY

Int. Cl.: 42

Prior U.S. Cls.: 100 and 101

United States Patent and Trademark Office

Reg. No. 3,480,264

Registered Aug. 5, 2008

**SERVICE MARK
PRINCIPAL REGISTER**

**We Make the Compaction
Specs Work**

EARTHWORK SOLUTIONS, INC. (TEXAS CORPORATION)
11111 KATY FREEWAY, SUITE 910
HOUSTON, TX 77079

FOR: ENGINEERING SERVICES, NAMELY, ENGINEERING FOR THE COMPACTION OF EARTH, IN CLASS 42 (U.S. CLS. 100 AND 101).

FIRST USE 6-1-2001; IN COMMERCE 5-16-2005.

THE MARK CONSISTS OF STANDARD CHARACTERS WITHOUT CLAIM TO ANY PARTICULAR FONT, STYLE, SIZE, OR COLOR.

SER. NO. 77-363,877, FILED 1-3-2008.

MICHAEL GAAFAR, EXAMINING ATTORNEY

Int. Cl.: 42

Prior U.S. Cls.: 100 and 101

United States Patent and Trademark Office

Reg. No. 3,480,265

Registered Aug. 5, 2008

**SERVICE MARK
PRINCIPAL REGISTER**

**ADVANCING INDUSTRY,
IMPROVING ECONOMY &
BETTERING OUR WORLD**

EARTHWORK SOLUTIONS, INC. (TEXAS CORPORATION)
11111 KATY FREEWAY, SUITE 910
HOUSTON, TX 77079

THE MARK CONSISTS OF STANDARD CHARACTERS WITHOUT CLAIM TO ANY PARTICULAR FONT, STYLE, SIZE, OR COLOR.

FOR: ENGINEERING SERVICES, NAMELY, ENGINEERING FOR THE COMPACTION OF EARTH, IN CLASS 42 (U.S. CLS. 100 AND 101).

SER. NO. 77-363,879, FILED 1-3-2008.

FIRST USE 7-1-2002; IN COMMERCE 5-16-2005.

MICHAEL GAAFAR, EXAMINING ATTORNEY

Int. Cl.: 42

Prior U.S. Cls.: 100 and 101

United States Patent and Trademark Office

Reg. No. 3,480,266

Registered Aug. 5, 2008

**SERVICE MARK
PRINCIPAL REGISTER**

ESOL

EARTHWORK SOLUTIONS, INC. (TEXAS CORPORATION)
11111 KATY FREEWAY, SUITE 910
HOUSTON, TX 77079

FOR: ENGINEERING SERVICES, NAMELY, ENGINEERING FOR THE COMPACTION OF EARTH, IN CLASS 42 (U.S. CLS. 100 AND 101).

FIRST USE 5-1-2003; IN COMMERCE 5-16-2005.

THE MARK CONSISTS OF STANDARD CHARACTERS WITHOUT CLAIM TO ANY PARTICULAR FONT, STYLE, SIZE, OR COLOR.

THE TERM "ESOL" IN THE MARK HAS NO MEANING IN A FOREIGN LANGUAGE

SER. NO. 77-363,881, FILED 1-3-2008.

MICHAEL GAAFAR, EXAMINING ATTORNEY

Int. Cl.: 42

Prior U.S. Cls.: 100 and 101

United States Patent and Trademark Office

Reg. No. 3,480,267

Registered Aug. 5, 2008

**SERVICE MARK
PRINCIPAL REGISTER**

Billy Raygun Design, Inc.

ROOZEE, WILLIAM P. (TEXAS CORPORATION)
4113 LIBERTY CT.
FLOWER MOUND, TX 75028

FOR: CUSTOM DESIGN OF TRADE SHOW EXHIBITS, DISPLAYS, KIOSKS, RETAIL ENVIRONMENTS AND GRAPHIC DESIGNS BASED ON PERSONAL SELECTIONS MADE BY THE CUSTOMER, IN CLASS 42 (U.S. CLS. 100 AND 101).

FIRST USE 12-21-2007; IN COMMERCE 12-21-2007.

THE MARK CONSISTS OF STANDARD CHARACTERS WITHOUT CLAIM TO ANY PARTICULAR FONT, STYLE, SIZE, OR COLOR.

NO CLAIM IS MADE TO THE EXCLUSIVE RIGHT TO USE "DESIGN, INC.", APART FROM THE MARK AS SHOWN.

THE NAME "BILLY RAYGUN" DOES NOT IDENTIFY A LIVING INDIVIDUAL.

SER. NO. 77-363,882, FILED 1-3-2008.

RICHARD WHITE, EXAMINING ATTORNEY

Int. Cl.: 35

Prior U.S. Cls.: 100, 101 and 102

United States Patent and Trademark Office

Reg. No. 3,480,268

Registered Aug. 5, 2008

**SERVICE MARK
PRINCIPAL REGISTER**



Rockhem & Chicstone

LEATHER BOULEVARD (NEW HAMPSHIRE CORPORATION), DBA ROCKHEM & CHICSTONE
555 ROUTE 125
BARRINGTON, NH 03825

FOR: ON-LINE RETAIL STORE SERVICES FEATURING CLOTHING, SHOES, HANDBAGS, FASHION GOODS NAMELY HATS, JEWELRY, ACCESSORIES, GLOVES, SCARVES, AND PURSES, FASHION ACCESSORIES, COSMETICS AND SKINCARE, HOME DECOR AND GIFTS; RETAIL STORE SERVICES FEATURING CLOTHING, SHOES, HANDBAGS, FASHION GOODS NAMELY, HATS, JEWELRY, ACCESSORIES, GLOVES, SCARVES,

AND PURSES, FASHION ACCESSORIES, COSMETICS AND SKINCARE, HOME DECOR AND GIFTS, IN CLASS 35 (U.S. CLS. 100, 101 AND 102).

FIRST USE 1-3-2008; IN COMMERCE 1-3-2008.

THE NAME(S), PORTRAIT(S), AND/OR SIGNATURE(S) SHOWN IN THE MARK DOES NOT IDENTIFY A PARTICULAR LIVING INDIVIDUAL.

SER. NO. 77-363,892, FILED 1-3-2008.

STEVEN R. FINE, EXAMINING ATTORNEY

Int. Cl.: 30

Prior U.S. Cl.: 46

United States Patent and Trademark Office

Reg. No. 3,480,269

Registered Aug. 5, 2008

**TRADEMARK
PRINCIPAL REGISTER**

Mari's

MARI'S NEW YORK, INC (NEW YORK COR-
PORATION)
115 FOURTH AVENUE 8A
NEW YORK, NY 10003

THE MARK CONSISTS OF STANDARD CHAR-
ACTERS WITHOUT CLAIM TO ANY PARTICULAR
FONT, STYLE, SIZE, OR COLOR.

FOR: FOOD PACKAGE COMBINATIONS CON-
SISTING PRIMARILY OF BREAD, CRACKERS
AND/OR COOKIES; BROWNIES, IN CLASS 30 (U.S.
CL. 46).

SER. NO. 77-363,945, FILED 1-4-2008.

FIRST USE 10-26-2006; IN COMMERCE 10-26-2006.

TARAH HARDY, EXAMINING ATTORNEY

Int. Cls.: 9 and 16

Prior U.S. Cls.: 2, 5, 21, 22, 23, 26, 29, 36, 37, 38 and 50

United States Patent and Trademark Office

Reg. No. 3,480,270

Registered Aug. 5, 2008

**TRADEMARK
PRINCIPAL REGISTER**

NFPA 1600

NATIONAL FIRE PROTECTION ASSOCIATION,
INC. (MASSACHUSETTS CORPORATION)
ONE BATTERYMARCH PARK
QUINCY, MA 02169

FOR: DOWNLOADABLE ELECTRONIC PUBLICATIONS IN THE NATURE OF BOOKS AND GUIDES IN THE FIELD OF DISASTER AND EMERGENCY MANAGEMENT AND BUSINESS CONTINUITY PROGRAMS, IN CLASS 9 (U.S. CLS. 21, 23, 26, 36 AND 38).

FIRST USE 3-16-2007; IN COMMERCE 3-16-2007.

FOR: SERIES OF BOOKS AND PRINTED GUIDES IN THE FIELD OF DISASTER AND EMERGENCY MANAGEMENT AND BUSINESS CONTINUITY

PROGRAMS, IN CLASS 16 (U.S. CLS. 2, 5, 22, 23, 29, 37, 38 AND 50).

FIRST USE 9-1-1995; IN COMMERCE 9-1-1995.

THE MARK CONSISTS OF STANDARD CHARACTERS WITHOUT CLAIM TO ANY PARTICULAR FONT, STYLE, SIZE, OR COLOR.

OWNER OF U.S. REG. NOS. 2,796,204, 3,141,884 AND OTHERS.

SER. NO. 77-363,952, FILED 1-4-2008.

SIMON TENG, EXAMINING ATTORNEY

Int. Cl.: 9

Prior U.S. Cls.: 21, 23, 26, 36 and 38

Reg. No. 3,480,271

United States Patent and Trademark Office

Registered Aug. 5, 2008

**TRADEMARK
PRINCIPAL REGISTER**

LEO

EDDY, IAN (UNITED STATES INDIVIDUAL)
12 BARRINGTON DRIVE
ST. PETERS, MO 63376

THE MARK CONSISTS OF STANDARD CHAR-
ACTERS WITHOUT CLAIM TO ANY PARTICULAR
FONT, STYLE, SIZE, OR COLOR.

FOR: MUSICAL SOUND RECORDINGS, IN
CLASS 9 (U.S. CLS. 21, 23, 26, 36 AND 38).

SER. NO. 77-363,994, FILED 1-4-2008.

FIRST USE 10-9-2007; IN COMMERCE 10-9-2007.

BARBARA A. GOLD, EXAMINING ATTORNEY

Int. Cl.: 41

Prior U.S. Cls.: 100, 101 and 107

United States Patent and Trademark Office

Reg. No. 3,480,272

Registered Aug. 5, 2008

**SERVICE MARK
PRINCIPAL REGISTER**

LEO

EDDY, IAN (UNITED STATES INDIVIDUAL)
12 BARRINGTON DRIVE
ST. PETERS, MO 63376

THE MARK CONSISTS OF STANDARD CHAR-
ACTERS WITHOUT CLAIM TO ANY PARTICULAR
FONT, STYLE, SIZE, OR COLOR.

FOR: ENTERTAINMENT, NAMELY, LIVE PER-
FORMANCES BY A MUSICAL BAND, IN CLASS 41
(U.S. CLS. 100, 101 AND 107).

SER. NO. 77-363,998, FILED 1-4-2008.

FIRST USE 9-16-2004; IN COMMERCE 9-16-2004.

BARBARA A. GOLD, EXAMINING ATTORNEY

Int. Cl.: 35

Prior U.S. Cls.: 100, 101 and 102

United States Patent and Trademark Office

Reg. No. 3,480,273

Registered Aug. 5, 2008

SERVICE MARK
PRINCIPAL REGISTER

T H E
EQUIPMENT
SUPERSTORE

THE EQUIPMENT SUPERSTORE, LLC (OHIO
LTD LIAB CO)
600 GILLAM ROAD
WILMINGTON, OH 45177

FOR: RETAIL STORE SERVICES FEATURING
NEW AND USED HEAVY CONSTRUCTION, HOIST-
ING, EXCAVATING, ROAD BUILDING, AGRICUL-
TURAL, AND LAWN AND GARDEN EQUIPMENT,
INCLUDING SPARE AND REPLACEMENT PARTS
FOR THE SAME, IN CLASS 35 (U.S. CLS. 100, 101
AND 102).

FIRST USE 1-6-2000; IN COMMERCE 1-6-2000.

OWNER OF U.S. REG. NO. 2,599,841.

NO CLAIM IS MADE TO THE EXCLUSIVE
RIGHT TO USE "SUPERSTORE", APART FROM
THE MARK AS SHOWN.

THE MARK CONSISTS OF THE WORDS "THE
EQUIPMENT SUPERSTORE" IN A FANCIFUL STY-
LIZATION.

SEC. 2(F).

SER. NO. 77-364,025, FILED 1-4-2008.

JAMES STEIN, EXAMINING ATTORNEY

Int. Cl.: 5

Prior U.S. Cls.: 6, 18, 44, 46, 51 and 52

Reg. No. 3,480,274

United States Patent and Trademark Office

Registered Aug. 5, 2008

**TRADEMARK
PRINCIPAL REGISTER**



CITRA ANTICOAGULANTS, INC. (MASSACHU-
SETTS CORPORATION)
55 MESSINA DRIVE
BRAINTREE, MA 02184

FIRST USE 5-1-1997; IN COMMERCE 5-1-1997.

SER. NO. 77-364,037, FILED 1-4-2008.

FOR: PHARMACEUTICAL PREPARATIONS,
NAMELY, ANTICOAGULANTS, IN CLASS 5 (U.S.
CLS. 6, 18, 44, 46, 51 AND 52).

SIMON TENG, EXAMINING ATTORNEY

Int. Cl.: 16

Prior U.S. Cls.: 2, 5, 22, 23, 29, 37, 38 and 50

Reg. No. 3,480,275

United States Patent and Trademark Office

Registered Aug. 5, 2008

**TRADEMARK
PRINCIPAL REGISTER**

OUTERVERSE

HARDY, PHILLIP (UNITED STATES INDIVIDUAL)
1608 NE 34TH ST
OAKLAND PARK, FL 33334

THE MARK CONSISTS OF STANDARD CHARACTERS WITHOUT CLAIM TO ANY PARTICULAR FONT, STYLE, SIZE, OR COLOR.

FOR: COMIC BOOKS; GRAPHIC NOVELS; MAGAZINES FEATURING ILLUSTRATED STORIES AND EDITORIALS; POSTERS, IN CLASS 16 (U.S. CLS. 2, 5, 22, 23, 29, 37, 38 AND 50).

SER. NO. 77-364,054, FILED 1-4-2008.

FIRST USE 3-1-1994; IN COMMERCE 10-3-1994.

BILL DAWE, EXAMINING ATTORNEY

Int. Cl.: 9

Prior U.S. Cls.: 21, 23, 26, 36 and 38

Reg. No. 3,480,276

United States Patent and Trademark Office

Registered Aug. 5, 2008

**TRADEMARK
PRINCIPAL REGISTER**

Little Dipper

SCIGENE CORPORATION (CALIFORNIA CORPORATION)
306 POTRERO AVENUE
SUNNYVALE, CA 94085

THE MARK CONSISTS OF STANDARD CHARACTERS WITHOUT CLAIM TO ANY PARTICULAR FONT, STYLE, SIZE, OR COLOR.

FOR: LABORATORY ROBOTS, IN CLASS 9 (U.S. CLS. 21, 23, 26, 36 AND 38).

SER. NO. 77-364,079, FILED 1-4-2008.

FIRST USE 6-1-2005; IN COMMERCE 10-14-2005.

RONALD MCMORROW, EXAMINING ATTORNEY

Int. Cl.: 30

Prior U.S. Cl.: 46

United States Patent and Trademark Office

Reg. No. 3,480,277

Registered Aug. 5, 2008

**TRADEMARK
PRINCIPAL REGISTER**

CHI-CHI'S

HORMEL FOODS, LLC (MINNESOTA LTD LIAB
CO)
LAW DEPARTMENT
1 HORMEL PLACE
AUSTIN, MN 55912

THE MARK CONSISTS OF STANDARD CHAR-
ACTERS WITHOUT CLAIM TO ANY PARTICULAR
FONT, STYLE, SIZE, OR COLOR.

OWNER OF U.S. REG. NOS. 1,528,459, 1,594,464,
AND 1,779,107.

FOR: SALSA, IN CLASS 30 (U.S. CL. 46).

SER. NO. 77-364,124, FILED 1-4-2008.

FIRST USE 12-15-1992; IN COMMERCE 12-15-1992.

MELVIN AXILBUND, EXAMINING ATTORNEY

Int. Cl.: 4

Prior U.S. Cls.: 1, 6 and 15

United States Patent and Trademark Office

Reg. No. 3,480,278

Registered Aug. 5, 2008

TRADEMARK
PRINCIPAL REGISTER



GENNARI, LESLIE (UNITED STATES INDIVIDUAL)
14 ARNOLD AVE.
READING, MA 01867

FOR: CANDLES, IN CLASS 4 (U.S. CLS. 1, 6 AND 15).

FIRST USE 5-0-2006; IN COMMERCE 5-0-2006.

NO CLAIM IS MADE TO THE EXCLUSIVE RIGHT TO USE CANDLES, APART FROM THE MARK AS SHOWN.

THE STIPPLING IS FOR SHADING PURPOSES ONLY.

THE MARK CONSISTS OF THE STYLIZED WORDS "SWEET SHOPPE CANDLES LOOK & SMELL SO REAL YOU CAN ALMOST TASTE THEM...". THERE IS AN IMAGE OF A CHEF HOLDING A PIE IN ONE HAND AND A MARTINI GLASS IN THE OTHER HAND TO THE LEFT OF THE WORDS "LOOK & SMELL SO REAL YOU CAN ALMOST TASTE THEM...".

SER. NO. 77-364,131, FILED 1-4-2008.

KIM MONINGHOFF, EXAMINING ATTORNEY

Int. Cls.: 9 and 35

Prior U.S. Cls.: 21, 23, 26, 36, 38, 100, 101 and 102

United States Patent and Trademark Office

Reg. No. 3,480,279

Registered Aug. 5, 2008

**TRADEMARK
SERVICE MARK
PRINCIPAL REGISTER**



STROHL SYSTEMS GROUP, INC. (PENNSYLVANIA CORPORATION)
631 PARK AVENUE
KING OF PRUSSIA, PA 19406

FOR: COMPUTER SOFTWARE IN THE FIELD OF BUSINESS CONTINUITY AND CONTINGENCY PLANNING, NAMELY, COMPUTER SOFTWARE FOR ORGANIZING, COORDINATING, AUTOMATING, MANAGING AND MONITORING A DISASTER RECOVERY PLAN, FOR ANALYZING THE RISKS AND EFFECTS OF AN INTERRUPTION OF BUSINESS, AND FOR DEVELOPING STRATEGIES FOR REDUCING EXPOSURE TO AND RECOVERING FROM AN INTERRUPTION OF BUSINESS, IN CLASS 9 (U.S. CLS. 21, 23, 26, 36 AND 38).

FIRST USE 9-1-2005; IN COMMERCE 9-1-2005.

FOR: BUSINESS PLANNING SERVICES, NAMELY, BUSINESS CONTINGENCY PLANNING SERVICES; BUSINESS PLANNING, NAMELY, DISASTER RECOVERY SERVICES FOR BUSINESSES; AND BUSINESS CONTINUITY PLANNING SERVICES, IN CLASS 35 (U.S. CLS. 100, 101 AND 102).

FIRST USE 9-1-2005; IN COMMERCE 9-1-2005.

THE MARK CONSISTS OF A BROKEN S DESIGN COMPRISED OF INTERLOCKING U DESIGNS WITH ONE DIAMOND DESIGN AT THE TOP AND ONE DIAMOND DESIGN AT THE BOTTOM IN AN OVERALL DIAMOND SHAPE.

SER. NO. 77-364,141, FILED 1-4-2008.

SONYA STEPHENS, EXAMINING ATTORNEY

Int. Cl.: 39

Prior U.S. Cls.: 100 and 105

United States Patent and Trademark Office

Reg. No. 3,480,280

Registered Aug. 5, 2008

**SERVICE MARK
PRINCIPAL REGISTER**

POWER OF RED

ROEHL TRANSPORT, INC. (WISCONSIN CORPORATION)
1916 EAST 29TH STREET
MARSHFIELD, WI 54449

FOR: FREIGHT TRANSPORTATION BY TRUCK;
TRANSPORT BY TRUCK; TRANSPORT OF GOODS;
TRANSPORTATION OF GOODS; TRUCK TRANSPORT,
IN CLASS 39 (U.S. CLS. 100 AND 105).

FIRST USE 12-15-2007; IN COMMERCE 12-15-2007.

THE MARK CONSISTS OF STANDARD CHARACTERS WITHOUT CLAIM TO ANY PARTICULAR FONT, STYLE, SIZE, OR COLOR.

THE WORDING "RED " HAS NO MEANING IN A FOREIGN LANGUAGE.

SER. NO. 77-364,150, FILED 1-4-2008.

WON TEAK OH, EXAMINING ATTORNEY

Int. Cl.: 35

Prior U.S. Cls.: 100, 101 and 102

United States Patent and Trademark Office

Reg. No. 3,480,281

Registered Aug. 5, 2008

**SERVICE MARK
PRINCIPAL REGISTER**

xQ

FRANKLIN COVEY CO. (UTAH CORPORATION)
2200 WEST PARKWAY BLVD.
SALT LAKE CITY, UT 84119

THE MARK CONSISTS OF STANDARD CHAR-
ACTERS WITHOUT CLAIM TO ANY PARTICULAR
FONT, STYLE, SIZE, OR COLOR.

FOR: BUSINESS CONSULTATION SERVICES;
CONDUCTING BUSINESS RESEARCH AND SUR-
VEYS, IN CLASS 35 (U.S. CLS. 100, 101 AND 102).

SER. NO. 77-364,163, FILED 1-4-2008.

FIRST USE 1-0-2003; IN COMMERCE 1-0-2003.

LINDA ESTRADA, EXAMINING ATTORNEY

Int. Cl.: 11

Prior U.S. Cls.: 13, 21, 23, 31 and 34

Reg. No. 3,480,282

United States Patent and Trademark Office

Registered Aug. 5, 2008

**TRADEMARK
PRINCIPAL REGISTER**



POWERED AIRE INC. (PENNSYLVANIA CORPORATION)
109 MORTENSEN ROAD
GREENVILLE, PA 16125

THE MARK CONSISTS OF A SERIES OF SLANTED, THICK AND THIN VERTICAL LINES THAT FORM THE LETTERS "P" AND "A", WITH THE "A" OVERTOP THE LOOP OF THE LETTER "P".

FOR: AN AIR CURTAIN OR AIR DOOR CONSISTING OF A BLOWER FOR DIRECTING A FLOW OF AIR ACROSS AN OPEN DOORWAY, IN CLASS 11 (U.S. CLS. 13, 21, 23, 31 AND 34).

SER. NO. 77-364,204, FILED 1-4-2008.

FIRST USE 11-1-1997; IN COMMERCE 11-1-1997.

MICHAEL SOUDERS, EXAMINING ATTORNEY

Int. Cl.: 5

Prior U.S. Cls.: 6, 18, 44, 46, 51 and 52

Reg. No. 3,480,283

United States Patent and Trademark Office

Registered Aug. 5, 2008

**TRADEMARK
PRINCIPAL REGISTER**

**ROCK N' ROLL HANGOVER
RELIEF**

DINOCO INTERNATIONAL CORPORATION
(NEVADA CORPORATION)
1720 EPPS BRIDGE PARKWAY
ATHENS, GA 30606

FOR: ACETAMINOPHEN; MIXED VITAMIN PREPARATIONS; MULTI-VITAMIN PREPARATIONS; VITAMIN B PREPARATIONS; VITAMIN C PREPARATIONS; VITAMIN D PREPARATIONS; VITAMIN AND MINERAL FORMED AND PACKAGED AS BARS; VITAMIN AND MINERAL PREPARATIONS FOR MEDICAL USE; VITAMIN AND MINERAL PREPARATIONS FOR USE AS INGREDIENTS IN THE FOOD AND PHARMACEUTICAL INDUSTRY; VITAMIN AND MINERAL SUPPLEMENTS; VITAMIN DROPS; VITAMIN ENRICHED WATER; VITAMIN FORTIFIED BEVERAGES; VITAMIN PREPARATIONS; VITAMIN SUPPLEMENT IN TABLET FORM FOR USE IN MAKING AN

EFFERVESCENT BEVERAGE WHEN ADDED TO WATER; VITAMIN SUPPLEMENTS; VITAMIN TABLETS; VITAMINS, IN CLASS 5 (U.S. CLS. 6, 18, 44, 46, 51 AND 52).

FIRST USE 11-11-2006; IN COMMERCE 12-6-2007.

THE MARK CONSISTS OF STANDARD CHARACTERS WITHOUT CLAIM TO ANY PARTICULAR FONT, STYLE, SIZE, OR COLOR.

NO CLAIM IS MADE TO THE EXCLUSIVE RIGHT TO USE "HANGOVER RELIEF", APART FROM THE MARK AS SHOWN.

SER. NO. 77-364,205, FILED 1-4-2008.

ROBERT LAVACHE, EXAMINING ATTORNEY

Int. Cl.: 1

Prior U.S. Cls.: 1, 5, 6, 10, 26 and 46

Reg. No. 3,480,284

United States Patent and Trademark Office

Registered Aug. 5, 2008

**TRADEMARK
PRINCIPAL REGISTER**

PUREMELT

KISSNER MILLING COMPANY LIMITED (CANADA CORPORATION)
32 CHERRY BLOSSOM ROAD
CAMBRIDGE, CANADA N3H4R7

THE MARK CONSISTS OF STANDARD CHARACTERS WITHOUT CLAIM TO ANY PARTICULAR FONT, STYLE, SIZE, OR COLOR.

FOR: DE-ICING AND SNOW MELTING COMPOUNDS FOR EXTERIOR SURFACES, IN CLASS 1 (U.S. CLS. 1, 5, 6, 10, 26 AND 46).

SER. NO. 77-364,206, FILED 1-4-2008.

FIRST USE 10-24-2005; IN COMMERCE 10-24-2005.

ALEX KEAM, EXAMINING ATTORNEY

Int. Cl.: 41

Prior U.S. Cls.: 100, 101 and 107

United States Patent and Trademark Office

Reg. No. 3,480,285

Registered Aug. 5, 2008

**SERVICE MARK
PRINCIPAL REGISTER**

LAKELAND FLYING TIGERS

DETROIT TIGERS, INC. (MICHIGAN CORPORATION)
COMERICA PARK 2100 WOODWARD AVENUE
DETROIT, MI 48201, MI 48201

OWNER OF U.S. REG. NOS. 1,015,996, 1,021,470,
AND 1,480,101.

FOR: ENTERTAINMENT SERVICES IN THE
NATURE OF BASEBALL GAMES, EXHIBITIONS
AND MASCOT APPEARANCES, IN CLASS 41 (U.S.
CLS. 100, 101 AND 107).

NO CLAIM IS MADE TO THE EXCLUSIVE
RIGHT TO USE "LAKELAND", APART FROM
THE MARK AS SHOWN.

FIRST USE 11-11-2006; IN COMMERCE 11-11-2006.

SER. NO. 77-364,279, FILED 1-4-2008.

THE MARK CONSISTS OF STANDARD CHAR-
ACTERS WITHOUT CLAIM TO ANY PARTICULAR
FONT, STYLE, SIZE, OR COLOR.

CURTIS FRENCH, EXAMINING ATTORNEY

Int. Cl.: 35

Prior U.S. Cls.: 100, 101 and 102

United States Patent and Trademark Office

Reg. No. 3,480,286

Registered Aug. 5, 2008

**SERVICE MARK
PRINCIPAL REGISTER**

easyWHEELS

MIAMI UNIVERSITY COMMUNITY FEDERAL
CREDIT UNION (OHIO CORPORATION)
420 WELLS MILL DRIVE
OXFORD, OH 45056

FOR: LOCATING PRE-OWNED VEHICLES
AVAILABLE FOR PURCHASE OR LEASE, IN CLASS
35 (U.S. CLS. 100, 101 AND 102).

FIRST USE 1-1-2003; IN COMMERCE 1-1-2003.

THE MARK CONSISTS OF THE WORD "EASY-
WHEELS". THE "EASY" PORTION IS IN LOWER-
CASE LETTERS AND THE "WHEELS" PORTION IS
IN UPPERCASE LETTERS, EXCEPT FOR THE "EE"
WHICH APPEARS IN LOWERCASE LETTERS AS 2
SPOKED WHEELS.

SER. NO. 77-364,289, FILED 1-4-2008.

SANI KHOURI, EXAMINING ATTORNEY

Int. Cl.: 35

Prior U.S. Cls.: 100, 101 and 102

United States Patent and Trademark Office

Reg. No. 3,480,287

Registered Aug. 5, 2008

**SERVICE MARK
PRINCIPAL REGISTER**

TEXT2EXPRESS

GREENFIELD ONLINE, INC. (DELAWARE CORPORATION)
21 RIVER ROAD
WILTON, CT 06897

FOR: MARKETING RESEARCH SERVICES, NAMELY, PROVIDING A MOBILE PANEL THAT ALLOWS CONSUMERS TO SUBMIT SURVEY FEEDBACK VIA ELECTRONIC AND MOBILE DEVICES; PROVIDING A WEBSITE THAT ALLOWS CONSUMERS TO PARTICIPATE IN MARKETING RESEARCH SURVEYS VIA ELECTRONIC AND

MOBILE DEVICES, IN CLASS 35 (U.S. CLS. 100, 101 AND 102).

FIRST USE 9-30-2007; IN COMMERCE 9-30-2007.

THE MARK CONSISTS OF STANDARD CHARACTERS WITHOUT CLAIM TO ANY PARTICULAR FONT, STYLE, SIZE, OR COLOR.

SER. NO. 77-364,313, FILED 1-4-2008.

CURTIS FRENCH, EXAMINING ATTORNEY

Int. Cl.: 41

Prior U.S. Cls.: 100, 101 and 107

United States Patent and Trademark Office

Reg. No. 3,480,288

Registered Aug. 5, 2008

**SERVICE MARK
PRINCIPAL REGISTER**

DIMENSIONAL

J.P. CORR III (UNITED STATES INDIVIDUAL)
649 OLDE THOMPSON CREEK ROAD
APEX, NC 27523

THE MARK CONSISTS OF STANDARD CHAR-
ACTERS WITHOUT CLAIM TO ANY PARTICULAR
FONT, STYLE, SIZE, OR COLOR.

FOR: PHOTOGRAPHY SERVICES, IN CLASS 41
(U.S. CLS. 100, 101 AND 107).

SER. NO. 77-364,332, FILED 1-4-2008.

FIRST USE 6-1-2007; IN COMMERCE 6-1-2007.

FRED CARL, EXAMINING ATTORNEY

Int. Cl.: 7

Prior U.S. Cls.: 13, 19, 21, 23, 31, 34 and 35

United States Patent and Trademark Office

Reg. No. 3,480,289

Registered Aug. 5, 2008

**TRADEMARK
PRINCIPAL REGISTER**

CREATIVE

VSM GROUP AKTIEBOLAG (SWEDEN JOINT
STOCK COMPANY)
SE-561 84
HUSKVARNA, SWEDEN

FOR: SEWING MACHINES AND PARTS THERE-
FOR, IN CLASS 7 (U.S. CLS. 13, 19, 21, 23, 31, 34 AND
35).

FIRST USE 10-31-1983; IN COMMERCE 10-31-1983.

THE MARK CONSISTS OF STANDARD CHAR-
ACTERS WITHOUT CLAIM TO ANY PARTICULAR
FONT, STYLE, SIZE, OR COLOR.

OWNER OF U.S. REG. NOS. 2,847,233 AND
2,847,234.

SER. NO. 77-364,335, FILED 1-4-2008.

PAUL F. GAST, EXAMINING ATTORNEY

Int. Cl.: 9

Prior U.S. Cls.: 21, 23, 26, 36 and 38

Reg. No. 3,480,290

United States Patent and Trademark Office

Registered Aug. 5, 2008

**TRADEMARK
PRINCIPAL REGISTER**



VIKING LODGE MUSIC

VIKING LODGE MUSIC, LLC (GEORGIA LTD
LIAB CO)
SUITE 100, PMB 360
6175 HICKORY FLAT HIGHWAY
CANTON, GA 30115

FIRST USE 7-1-2007; IN COMMERCE 7-1-2007.

NO CLAIM IS MADE TO THE EXCLUSIVE
RIGHT TO USE "MUSIC", APART FROM THE
MARK AS SHOWN.

FOR: COMPACT DISCS FEATURING PERFOR-
MANCES BY MUSICIANS; DIGITAL MEDIA,
NAMELY, PRE-RECORDED VIDEO CASSETTES,
DIGITAL VIDEO DISCS, DIGITAL VERSATILE
DISCS, DOWNLOADABLE AUDIO AND VIDEO
RECORDINGS, DVDS, AND HIGH DEFINITION
DIGITAL DISKS FEATURING PERFORMANCES
BY MUSICIANS, IN CLASS 9 (U.S. CLS. 21, 23, 26, 36
AND 38).

THE MARK CONSISTS OF A TREBLE CLEF
DESIGN INCORPORATED INTO A CELTIC BUT-
TON WITH THE STYLIZED WORDING "VIKING
LODGE MUSIC".

SER. NO. 77-364,338, FILED 1-4-2008.

JORDAN BAKER, EXAMINING ATTORNEY

Int. Cl.: 41

Prior U.S. Cls.: 100, 101 and 107

United States Patent and Trademark Office

Reg. No. 3,480,291

Registered Aug. 5, 2008

**SERVICE MARK
PRINCIPAL REGISTER**

GYMNOTYPE

J.P. CORR III (UNITED STATES INDIVIDUAL)
649 OLDE THOMPSON CREEK ROAD
APEX, NC 27523

THE MARK CONSISTS OF STANDARD CHAR-
ACTERS WITHOUT CLAIM TO ANY PARTICULAR
FONT, STYLE, SIZE, OR COLOR.

FOR: PHOTOGRAPHY SERVICES, IN CLASS 41
(U.S. CLS. 100, 101 AND 107).

SER. NO. 77-364,339, FILED 1-4-2008.

FIRST USE 6-1-2007; IN COMMERCE 6-1-2007.

FRED CARL, EXAMINING ATTORNEY

Int. Cl.: 5

Prior U.S. Cls.: 6, 18, 44, 46, 51 and 52

Reg. No. 3,480,292

United States Patent and Trademark Office

Registered Aug. 5, 2008

**TRADEMARK
PRINCIPAL REGISTER**

B CONTROL

HEALING POWER, INC. (NEW YORK COR-
PORATION)
5515 CANOGA AVE, #326
WOODLAND HLS, CA 91367

THE MARK CONSISTS OF STANDARD CHAR-
ACTERS WITHOUT CLAIM TO ANY PARTICULAR
FONT, STYLE, SIZE, OR COLOR.

FOR: DIETARY SUPPLEMENTS, IN CLASS 5 (U.S.
CLS. 6, 18, 44, 46, 51 AND 52).

SER. NO. 77-364,340, FILED 1-4-2008.

FIRST USE 2-26-2006; IN COMMERCE 2-26-2006.

TARAH HARDY, EXAMINING ATTORNEY

Int. Cl.: 35

Prior U.S. Cls.: 100, 101 and 102

United States Patent and Trademark Office

Reg. No. 3,480,293

Registered Aug. 5, 2008

SERVICE MARK
PRINCIPAL REGISTER



SHACKELFORD'S FLORIST, INC. (TENNESSEE
CORPORATION)
6106 QUINCE ROAD
MEMPHIS, TN 38119

NO CLAIM IS MADE TO THE EXCLUSIVE
RIGHT TO USE "FLORIST", APART FROM THE
MARK AS SHOWN.

FOR: RETAIL FLORIST SHOPS AND RETAIL
SHOPS FEATURING FLOWERS AND GIFTS, IN
CLASS 35 (U.S. CLS. 100, 101 AND 102).

SER. NO. 77-364,355, FILED 1-4-2008.

FIRST USE 12-31-2002; IN COMMERCE 12-31-2002.

DANIEL BRODY, EXAMINING ATTORNEY

Int. Cl.: 37

Prior U.S. Cls.: 100, 103 and 106

United States Patent and Trademark Office

Reg. No. 3,480,294

Registered Aug. 5, 2008

**SERVICE MARK
PRINCIPAL REGISTER**

BUCKETS & BLADES

BLAYLOCK, WILLIAM (UNITED STATES INDIVIDUAL)
7712 224TH ST. S.W.
EDMONDS, WA 98026

THE MARK CONSISTS OF STANDARD CHARACTERS WITHOUT CLAIM TO ANY PARTICULAR FONT, STYLE, SIZE, OR COLOR.

FOR: EXCAVATION SERVICES; HOUSE AND BUILDING DEMOLITION, IN CLASS 37 (U.S. CLS. 100, 103 AND 106).

SER. NO. 77-364,372, FILED 1-4-2008.

FIRST USE 10-6-2007; IN COMMERCE 10-6-2007.

ESTHER A. BORSUK, EXAMINING ATTORNEY

Int. Cl.: 28

Prior U.S. Cls.: 22, 23, 38 and 50

United States Patent and Trademark Office

Reg. No. 3,480,295

Registered Aug. 5, 2008

**TRADEMARK
PRINCIPAL REGISTER**

PRIMO

CLARENCE J. VENNE, L.L.C. (DELAWARE LTD
LIAB CO)
1425 HANFORD STREET
LEVITTOWN, PA 19057

FOR: BINGO GAME PLAYING EQUIPMENT,
NAMELY, BINGO CALLING CARDS, BINGO
GAME SHEETS, BINGO CHIPS, AND BINGO MAR-
KERS, IN CLASS 28 (U.S. CLS. 22, 23, 38 AND 50).

FIRST USE 0-0-1991; IN COMMERCE 0-0-1991.

THE MARK CONSISTS OF STANDARD CHAR-
ACTERS WITHOUT CLAIM TO ANY PARTICULAR
FONT, STYLE, SIZE, OR COLOR.

SER. NO. 77-364,396, FILED 1-4-2008.

VIVIAN MICZNIK FIRST, EXAMINING ATTOR-
NEY

Int. Cl.: 28

Prior U.S. Cls.: 22, 23, 38 and 50

United States Patent and Trademark Office

Reg. No. 3,480,296

Registered Aug. 5, 2008

**TRADEMARK
PRINCIPAL REGISTER**

PRIMO GOLD

CLARENCE J. VENNE, L.L.C. (DELAWARE LTD
LIAB CO)
1425 HANFORD STREET
LEVITTOWN, PA 19057

FOR: BINGO GAME PLAYING EQUIPMENT,
NAMELY, BINGO MARKERS, IN CLASS 28 (U.S.
CLS. 22, 23, 38 AND 50).

FIRST USE 0-0-1991; IN COMMERCE 0-0-1991.

THE MARK CONSISTS OF STANDARD CHAR-
ACTERS WITHOUT CLAIM TO ANY PARTICULAR
FONT, STYLE, SIZE, OR COLOR.

SER. NO. 77-364,399, FILED 1-4-2008.

VIVIAN MICZNIK FIRST, EXAMINING ATTOR-
NEY

Int. Cl.: 12

Prior U.S. Cls.: 19, 21, 23, 31, 35 and 44

Reg. No. 3,480,297

United States Patent and Trademark Office

Registered Aug. 5, 2008

**TRADEMARK
PRINCIPAL REGISTER**



TEKTRO TECHNOLOGY CORPORATION (TAI-
WAN CORPORATION)
101, SEC 1, KUANGMING ROAD, PUYEN
CHANGHUA, TAIWAN

FOR: BICYCLE BRAKES, BRAKE LEVERS FOR
BICYCLES, DISC BRAKES FOR BICYCLES, AND
HYDRAULIC BRAKES FOR BICYCLES, IN CLASS
12 (U.S. CLS. 19, 21, 23, 31, 35 AND 44).

FIRST USE 12-12-2007; IN COMMERCE 12-12-2007.

NO CLAIM IS MADE TO THE EXCLUSIVE
RIGHT TO USE "CLAMSHELL", APART FROM
THE MARK AS SHOWN.

THE MARK CONSISTS OF A BLACK RECTAN-
GLE WITH A WHITE RECTANGLE IN THE RIGHT
OF THE BLACK RECTANGLE AND THE WORD
"CLAMSHELL" IN THE COLOR BLACK IN THE
WHITE RECTANGLE AND EXTENDING RIGHT-
WARD OUT OF THE BLACK RECTANGLE.

SER. NO. 77-364,438, FILED 1-4-2008.

LINDA M. KING, EXAMINING ATTORNEY

Int. Cl.: 36

Prior U.S. Cls.: 100, 101 and 102

United States Patent and Trademark Office

Reg. No. 3,480,298

Registered Aug. 5, 2008

**SERVICE MARK
PRINCIPAL REGISTER**

TRUSTMARK AFFINITY MARKETS

TRUSTMARK INSURANCE COMPANY (ILLINOIS INSURANCE CORPORATION)
400 FIELD DRIVE
LAKE FOREST, IL 60045

OWNER OF U.S. REG. NOS. 1,427,794, 3,054,133
AND OTHERS.

FOR: INSURANCE SERVICES, NAMELY, ADMINISTRATION OF GROUP HEALTH AND LIFE INSURANCE PRODUCTS, IN CLASS 36 (U.S. CLS. 100, 101 AND 102).

NO CLAIM IS MADE TO THE EXCLUSIVE RIGHT TO USE "AFFINITY MARKETS", APART FROM THE MARK AS SHOWN.

FIRST USE 5-0-2005; IN COMMERCE 5-0-2005.

SER. NO. 77-364,451, FILED 1-4-2008.

THE MARK CONSISTS OF STANDARD CHARACTERS WITHOUT CLAIM TO ANY PARTICULAR FONT, STYLE, SIZE, OR COLOR.

DANIEL BRODY, EXAMINING ATTORNEY

Int. Cl.: 12

Prior U.S. Cls.: 19, 21, 23, 31, 35 and 44

Reg. No. 3,480,299

United States Patent and Trademark Office

Registered Aug. 5, 2008

**TRADEMARK
PRINCIPAL REGISTER**



TEKTRO TECHNOLOGY CORPORATION (TAI-
WAN CORPORATION)
101, SEC 1, KUANGMING ROAD, PUYEN
CHANGHUA, TAIWAN

FOR: BICYCLE BRAKES, BRAKE LEVERS FOR
BICYCLES, DISC BRAKES FOR BICYCLES, AND
HYDRAULIC BRAKES FOR BICYCLES, IN CLASS
12 (U.S. CLS. 19, 21, 23, 31, 35 AND 44).

FIRST USE 12-12-2007; IN COMMERCE 12-12-2007.

THE MARK CONSISTS OF STYLIZED TEXT OF
WORD, "EUROX".

SER. NO. 77-364,479, FILED 1-4-2008.

LINDA M. KING, EXAMINING ATTORNEY

Int. Cl.: 16

Prior U.S. Cls.: 2, 5, 22, 23, 29, 37, 38 and 50

Reg. No. 3,480,300

United States Patent and Trademark Office

Registered Aug. 5, 2008

TRADEMARK
PRINCIPAL REGISTER



DETROIT TIGERS, INC. (MICHIGAN CORPORATION)
COMERICA PARK 2100 WOODWARD AVENUE
DETROIT, MI 48201

FOR: PAPER GOODS AND PRINTED MATTER, NAMELY, AUTOGRAPH BOOKS, BUMPER STICKERS, CALENDARS, DECALS, GAME PROGRAMS, MERCHANDISE BAGS, NOTE PADS, PAPER PENNANTS, PAPER SCHEDULES, POSTCARDS, POSTERS, PRINTED AWARDS, PRINTED GAME TICKETS, PRINTED GUIDES OF INTEREST TO BASEBALL FANS, REFERENCE BOOKS OF INTEREST TO BASEBALL FANS, SCORE CARDS, SCORE SHEETS, STATIONERY, STICKERS, STICKER AL-

BUMS AND TRADING CARDS, IN CLASS 16 (U.S. CLS. 2, 5, 22, 23, 29, 37, 38 AND 50).

FIRST USE 11-11-2006; IN COMMERCE 11-11-2006.

OWNER OF U.S. REG. NO. 1,706,648.

NO CLAIM IS MADE TO THE EXCLUSIVE RIGHT TO USE "LAKELAND", APART FROM THE MARK AS SHOWN.

SER. NO. 77-364,496, FILED 1-4-2008.

CURTIS FRENCH, EXAMINING ATTORNEY

Int. Cl.: 36

Prior U.S. Cls.: 100, 101 and 102

United States Patent and Trademark Office

Reg. No. 3,480,301

Registered Aug. 5, 2008

SERVICE MARK
PRINCIPAL REGISTER



TRUSTMARK INSURANCE COMPANY (ILLINOIS INSURANCE CORPORATION)
400 FIELD DRIVE
LAKE FOREST, IL 60045

FOR: INSURANCE SERVICES, NAMELY, ADMINISTRATION OF GROUP HEALTH AND LIFE INSURANCE PRODUCTS, IN CLASS 36 (U.S. CLS. 100, 101 AND 102).

FIRST USE 5-0-2005; IN COMMERCE 5-0-2005.

OWNER OF U.S. REG. NOS. 1,427,794, 3,054,133 AND OTHERS.

NO CLAIM IS MADE TO THE EXCLUSIVE RIGHT TO USE "AFFINITY MARKETS", APART FROM THE MARK AS SHOWN.

THE MARK CONSISTS OF THE WORDS "TRUSTMARK AFFINITY MARKETS" PLACED TO THE RIGHT OF A TRIANGULAR IMAGE AND ITS SHADOW, ALL PLACED ABOVE THE WORDS "AN AFFINITY FOR EXCELLENCE".

SER. NO. 77-364,498, FILED 1-4-2008.

DANIEL BRODY, EXAMINING ATTORNEY

Int. Cl.: 35

Prior U.S. Cls.: 100, 101 and 102

United States Patent and Trademark Office

Reg. No. 3,480,302

Registered Aug. 5, 2008

**SERVICE MARK
PRINCIPAL REGISTER**

Bonamondo

BONAMONDO, INC. (NEVADA CORPORATION),
FORMERLY AD REWARD NETWORK, INC.,
FORMERLY ADYOURMONEY.COM, INC.
4017 COLBY AVENUE
EVERETT, WA 98201

FOR: ADVERTISING AND COMMERCIAL INFORMATION SERVICES, VIA THE INTERNET; ADVERTISING SERVICES, NAMELY, PROMOTING PROPERTIES FOR SALE BY OWNER VIA THE INTERNET; ADVERTISING VIA ELECTRONIC MEDIA AND SPECIFICALLY THE INTERNET; DESIGN OF INTERNET ADVERTISING; DISSEMINATION OF ADVERTISING FOR OTHERS VIA AN ON-LINE COMMUNICATIONS NETWORK ON THE INTERNET; DISSEMINATION OF ADVERTISING FOR OTHERS VIA THE INTERNET; INTERNET ADVERTISING SERVICES; PROVIDING A

SEARCHABLE ONLINE ADVERTISING GUIDE FEATURING THE GOODS AND SERVICES OF OTHER ON-LINE VENDORS ON THE INTERNET; PROVIDING AND RENTAL OF ADVERTISING SPACE ON THE INTERNET , IN CLASS 35 (U.S. CLS. 100, 101 AND 102).

FIRST USE 5-9-2007; IN COMMERCE 5-9-2007.

THE MARK CONSISTS OF STANDARD CHARACTERS WITHOUT CLAIM TO ANY PARTICULAR FONT, STYLE, SIZE, OR COLOR.

SER. NO. 77-364,505, FILED 1-4-2008.

DANIEL CAPSHAW, EXAMINING ATTORNEY

Int. Cl.: 3

Prior U.S. Cls.: 1, 4, 6, 50, 51 and 52

Reg. No. 3,480,303

United States Patent and Trademark Office

Registered Aug. 5, 2008

**TRADEMARK
PRINCIPAL REGISTER**

CHARLIE'S SOAP

SUTHERLAND PRODUCTS, INC. (NORTH CAROLINA CORPORATION)

203 NORTH FIRST AVENUE

MAYODAN, NC 27027

FOR: ALL-PURPOSE CLEANING SOAP, IN CLASS 3 (U.S. CLS. 1, 4, 6, 50, 51 AND 52).

FIRST USE 1-1-1990; IN COMMERCE 1-1-1990.

THE MARK CONSISTS OF STANDARD CHARACTERS WITHOUT CLAIM TO ANY PARTICULAR FONT, STYLE, SIZE, OR COLOR.

NO CLAIM IS MADE TO THE EXCLUSIVE RIGHT TO USE "SOAP", APART FROM THE MARK AS SHOWN.

SER. NO. 77-364,507, FILED 1-4-2008.

RAUL CORDOVA, EXAMINING ATTORNEY

Int. Cl.: 37

Prior U.S. Cls.: 100, 103 and 106

United States Patent and Trademark Office

Reg. No. 3,480,304

Registered Aug. 5, 2008

**SERVICE MARK
PRINCIPAL REGISTER**

ANV

ANV CONSTRUCTION GROUP, INCORPORATED (VIRGINIA CORPORATION)
SUITE 200
10281 FROSTY COURT
MANASSAS, VA 20109

THE MARK CONSISTS OF STANDARD CHARACTERS WITHOUT CLAIM TO ANY PARTICULAR FONT, STYLE, SIZE, OR COLOR.

FOR: BUILDING CONSTRUCTION SERVICES, IN CLASS 37 (U.S. CLS. 100, 103 AND 106).

SER. NO. 77-364,514, FILED 1-4-2008.

FIRST USE 6-21-2002; IN COMMERCE 4-1-2007.

GEORGE LORENZO, EXAMINING ATTORNEY

Int. Cl.: 42

Prior U.S. Cls.: 100 and 101

United States Patent and Trademark Office

Reg. No. 3,480,305

Registered Aug. 5, 2008

**SERVICE MARK
PRINCIPAL REGISTER**

ETERNALIZE

TERASEM MOVEMENT FOUNDATION, INC.
(DELAWARE CORPORATION)
P.O. BOX 225
BRISTOL, VT 05443

FOR: COMPUTER SERVICES, NAMELY, CREATING, HOSTING AND MAINTAINING AN ON-LINE WEBSITE FEATURING NON-DOWNLOADABLE SOFTWARE FOR THE UPLOADING AND LONG-TERM STORAGE OF DIGITAL FILES , IN CLASS 42 (U.S. CLS. 100 AND 101).

FIRST USE 9-29-2007; IN COMMERCE 9-29-2007.

THE MARK CONSISTS OF STANDARD CHARACTERS WITHOUT CLAIM TO ANY PARTICULAR FONT, STYLE, SIZE, OR COLOR.

SER. NO. 77-364,522, FILED 1-4-2008.

MICHAEL ENGEL, EXAMINING ATTORNEY

Int. Cl.: 16

Prior U.S. Cls.: 2, 5, 22, 23, 29, 37, 38 and 50

United States Patent and Trademark Office

Reg. No. 3,480,306

Registered Aug. 5, 2008

**TRADEMARK
PRINCIPAL REGISTER**



SCHOLASTIC INC. (NEW YORK CORPORATION)
557 BROADWAY
NEW YORK, NY 10012

FOR: EDUCATIONAL MATERIALS FOR EDUCATORS IN THE FORM OF LESSON CARDS TO BE USED IN CONNECTION WITH A SERIES OF BOOKS FOR CHILDREN TO IMPROVE READING

COMPREHENSION, IN CLASS 16 (U.S. CLS. 2, 5, 22, 23, 29, 37, 38 AND 50).

FIRST USE 8-1-2007; IN COMMERCE 8-1-2007.

SER. NO. 77-364,527, FILED 1-4-2008.

EMILY CARLSEN, EXAMINING ATTORNEY

Int. Cl.: 1

Prior U.S. Cls.: 1, 5, 6, 10, 26 and 46

Reg. No. 3,480,307

United States Patent and Trademark Office

Registered Aug. 5, 2008

**TRADEMARK
PRINCIPAL REGISTER**

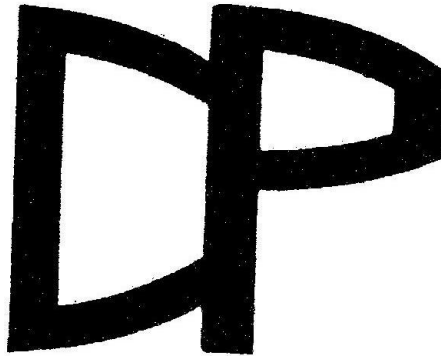

STONER, INCORPORATED (PENNSYLVANIA
CORPORATION)
1070 ROBERT FULTON HIGHWAY
QUARRYVILLE, PA 17566

FOR: CHEMICAL, NAMELY, RELEASE AGENT
FOR USE IN MOLDS TO RELEASE RUBBER,
PLASTIC, AND POLYURETHANE PARTS, IN
CLASS 1 (U.S. CLS. 1, 5, 6, 10, 26 AND 46).

FIRST USE 10-20-1983; IN COMMERCE 10-20-1983.

THE MARK CONSISTS OF THE LETTERS "D"
AND "P" ATTACHED TOGETHER.

SER. NO. 77-364,537, FILED 1-4-2008.

SALLY SHIH, EXAMINING ATTORNEY

Int. Cl.: 35

Prior U.S. Cls.: 100, 101 and 102

United States Patent and Trademark Office

Reg. No. 3,480,308

Registered Aug. 5, 2008

**SERVICE MARK
PRINCIPAL REGISTER**

HONEY'S PLACE

HONEY'S PLACE, INC. (CALIFORNIA CORPORATION)
675 SOUTH GLENWOOD PLACE
BURBANK, CA 91506

THE MARK CONSISTS OF STANDARD CHARACTERS WITHOUT CLAIM TO ANY PARTICULAR FONT, STYLE, SIZE, OR COLOR.

FOR: WHOLESALE DISTRIBUTORSHIPS FEATURING ADULT ENTERTAINMENT PRODUCTS, IN CLASS 35 (U.S. CLS. 100, 101 AND 102).

SER. NO. 77-364,543, FILED 1-4-2008.

FIRST USE 3-14-1994; IN COMMERCE 3-14-1994.

RICHARD WHITE, EXAMINING ATTORNEY

Int. Cl.: 16

Prior U.S. Cls.: 2, 5, 22, 23, 29, 37, 38 and 50

Reg. No. 3,480,309

United States Patent and Trademark Office

Registered Aug. 5, 2008

**TRADEMARK
PRINCIPAL REGISTER**

EZ Comics

SARLA SOFTWARE, L.L.C. (RHODE ISLAND
LTD LIAB CO)

12, PINE TOP ROAD

BARRINGTON, RI 02806

FOR: COMIC BOOKS, IN CLASS 16 (U.S. CLS. 2, 5,
22, 23, 29, 37, 38 AND 50).

FIRST USE 5-1-2007; IN COMMERCE 5-1-2007.

THE MARK CONSISTS OF STANDARD CHAR-
ACTERS WITHOUT CLAIM TO ANY PARTICULAR
FONT, STYLE, SIZE, OR COLOR.

NO CLAIM IS MADE TO THE EXCLUSIVE
RIGHT TO USE "COMICS", APART FROM THE
MARK AS SHOWN.

SER. NO. 77-364,552, FILED 1-4-2008.

DAVID COLLIER, EXAMINING ATTORNEY

Int. Cl.: 34

Prior U.S. Cls.: 2, 8, 9 and 17

United States Patent and Trademark Office

Reg. No. 3,480,310

Registered Aug. 5, 2008

**TRADEMARK
PRINCIPAL REGISTER**

BLACK & MILD CREAM

JMTM, LLC (DELAWARE LTD LIAB CO)
SUITE 1028
1105 N. MARKET STREET
WILMINGTON, DE 19899

FOR: CIGARS, SMOKING TOBACCO, IN CLASS
34 (U.S. CLS. 2, 8, 9 AND 17).

FIRST USE 11-2-2005; IN COMMERCE 11-2-2005.

THE MARK CONSISTS OF STANDARD CHAR-
ACTERS WITHOUT CLAIM TO ANY PARTICULAR
FONT, STYLE, SIZE, OR COLOR.

OWNER OF U.S. REG. NOS. 1,103,566, 2,712,704
AND OTHERS.

NO CLAIM IS MADE TO THE EXCLUSIVE
RIGHT TO USE "CREAM", APART FROM THE
MARK AS SHOWN.

SEC. 2(F) AS TO "BLACK & MILD".

SER. NO. 77-364,556, FILED 1-4-2008.

TRACY WHITTAKER-BROWN, EXAMINING AT-
TORNEY

Int. Cl.: 9

Prior U.S. Cls.: 21, 23, 26, 36 and 38

Reg. No. 3,480,311

United States Patent and Trademark Office

Registered Aug. 5, 2008

**TRADEMARK
PRINCIPAL REGISTER**

The logo features the word "VOLT" in large, bold, black capital letters. Below it, the word "DETECTIVE" is written in white capital letters inside a black rectangular box with a slightly curved bottom edge.

HI-TECH ELECTRONIC PRODUCTS & MFG.,
INC. (ILLINOIS CORPORATION)
25 HI TECH DRIVE
OGLESBY, IL 61348

THE MARK CONSISTS OF THE WORD "VOLT"
IN LARGE BLACK CAPITAL LETTERS ABOVE THE
WORD "DETECTIVE" IN SMALLER WHITE CAP-
ITAL LETTERS ON A BLACK BACKGROUND.

FOR: VOLTAGE TESTERS, IN CLASS 9 (U.S. CLS.
21, 23, 26, 36 AND 38).

FIRST USE 8-30-2007; IN COMMERCE 8-30-2007.

SER. NO. 77-364,558, FILED 1-4-2008.

NO CLAIM IS MADE TO THE EXCLUSIVE
RIGHT TO USE "VOLT", APART FROM THE MARK
AS SHOWN.

DAVID COLLIER, EXAMINING ATTORNEY

Int. Cl.: 36

Prior U.S. Cls.: 100, 101 and 102

United States Patent and Trademark Office

Reg. No. 3,480,312

Registered Aug. 5, 2008

**SERVICE MARK
PRINCIPAL REGISTER**

**AIG IDENTITY THEFT AND
FRAUD GROUP**

AMERICAN INTERNATIONAL GROUP, INC.
(DELAWARE CORPORATION)
70 PINE STREET
NEW YORK, NY 10270

OWNER OF U.S. REG. NOS. 1,151,229, 1,273,845
AND OTHERS.

FOR: INSURANCE UNDERWRITING IN THE
FIELD OF FRAUD AND IDENTITY THEFT, IN
CLASS 36 (U.S. CLS. 100, 101 AND 102).

NO CLAIM IS MADE TO THE EXCLUSIVE
RIGHT TO USE "IDENTITY THEFT AND FRAUD
GROUP", APART FROM THE MARK AS SHOWN.

FIRST USE 12-1-2007; IN COMMERCE 12-7-2007.

SER. NO. 77-364,569, FILED 1-4-2008.

THE MARK CONSISTS OF STANDARD CHAR-
ACTERS WITHOUT CLAIM TO ANY PARTICULAR
FONT, STYLE, SIZE, OR COLOR.

BRIDGETT SMITH, EXAMINING ATTORNEY

Int. Cl.: 2

Prior U.S. Cls.: 6, 11 and 16

United States Patent and Trademark Office

Reg. No. 3,480,313

Registered Aug. 5, 2008

**TRADEMARK
PRINCIPAL REGISTER**

SOUNDGUARD

SISKIN ENTERPRISES, INC. (UTAH CORPORATION)
1635 SOUTH REDWOOD ROAD
SALT LAKE CITY, UT 84104

FOR: CHEMICAL COATING APPLIED TO VEHICLE UNDERCARRIAGES FOR PROTECTION AND TO REDUCE ROAD RELATED NOISE, IN CLASS 2 (U.S. CLS. 6, 11 AND 16).

FIRST USE 8-31-1983; IN COMMERCE 8-31-1983.

THE MARK CONSISTS OF STANDARD CHARACTERS WITHOUT CLAIM TO ANY PARTICULAR FONT, STYLE, SIZE, OR COLOR.

OWNER OF U.S. REG. NO. 2,611,938.

SER. NO. 77-364,579, FILED 1-4-2008.

SANI KHOURI, EXAMINING ATTORNEY

Int. Cl.: 33

Prior U.S. Cls.: 47 and 49

United States Patent and Trademark Office

Reg. No. 3,480,314

Registered Aug. 5, 2008

**TRADEMARK
PRINCIPAL REGISTER**

AIRFIELD ESTATES

AIRPORT RANCH ESTATES, LLC (WASHINGTON LTD LIAB CO), DBA AIRFIELD ESTATES

560 MERLOT DRIVE

PROSSER, WA 99350

FOR: WINE, IN CLASS 33 (U.S. CLS. 47 AND 49).

FIRST USE 3-20-2007; IN COMMERCE 4-15-2007.

THE MARK CONSISTS OF STANDARD CHARACTERS WITHOUT CLAIM TO ANY PARTICULAR FONT, STYLE, SIZE, OR COLOR.

NO CLAIM IS MADE TO THE EXCLUSIVE RIGHT TO USE "ESTATES", APART FROM THE MARK AS SHOWN.

SER. NO. 77-364,582, FILED 1-4-2008.

IRA J. GOODSaid, EXAMINING ATTORNEY

Int. Cl.: 41

Prior U.S. Cls.: 100, 101 and 107

United States Patent and Trademark Office

Reg. No. 3,480,315

Registered Aug. 5, 2008

**SERVICE MARK
PRINCIPAL REGISTER**

VICTORY DAYS

VICTORY DAYS CORPORATION (INDIANA
CORPORATION)
6612 KINGMAN DR
INDIANAPOLIS, IN 46256

FOR: EDUCATION AND ENTERTAINMENT
SERVICES, NAMELY, PROVIDING INFORMATION
AND EVENTS IN THE FIELDS OF MILITARY AND
CIVILIAN HISTORY DURING TIMES OF WAR;
MUSEUMS IN THE FIELDS OF MILITARY AND
CIVILIAN HISTORY DURING TIMES OF WAR, IN
CLASS 41 (U.S. CLS. 100, 101 AND 107).

FIRST USE 12-19-2005; IN COMMERCE 12-19-2005.

THE MARK CONSISTS OF STANDARD CHAR-
ACTERS WITHOUT CLAIM TO ANY PARTICULAR
FONT, STYLE, SIZE, OR COLOR.

SER. NO. 77-364,587, FILED 1-4-2008.

MICHAEL ENGEL, EXAMINING ATTORNEY

Int. Cl.: 33

Prior U.S. Cls.: 47 and 49

United States Patent and Trademark Office

Reg. No. 3,480,316

Registered Aug. 5, 2008

**TRADEMARK
PRINCIPAL REGISTER**

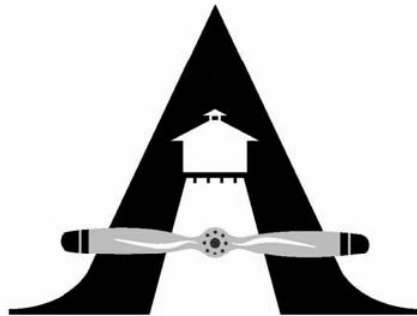

AIRPORT RANCH ESTATES, LLC (WASHINGTON LTD LIAB CO), DBA AIRFIELD ESTATES
560 MERLOT DRIVE
PROSSER, WA 99350

THE MARK CONSISTS OF A TOWER AND PROPELLER DESIGN FORMING THE INSIDE OF A LETTER "A".

FOR: WINE, IN CLASS 33 (U.S. CLS. 47 AND 49).

SER. NO. 77-364,602, FILED 1-4-2008.

FIRST USE 3-20-2007; IN COMMERCE 4-15-2007.

IRA J. GOODSaid, EXAMINING ATTORNEY

Int. Cl.: 2

Prior U.S. Cls.: 6, 11 and 16

United States Patent and Trademark Office

Reg. No. 3,480,317

Registered Aug. 5, 2008

**TRADEMARK
PRINCIPAL REGISTER**

RUSTGUARD

SISKIN ENTERPRISES, INC. (UTAH CORPORATION)
1635 SOUTH REDWOOD ROAD
SALT LAKE CITY, UT 84104

FOR: RUST INHIBITING PREPARATIONS IN THE NATURE OF A COATING FOR USE ON AUTOMOBILE SURFACES, IN CLASS 2 (U.S. CLS. 6, 11 AND 16).

FIRST USE 0-0-1984; IN COMMERCE 0-0-1984.

THE MARK CONSISTS OF STANDARD CHARACTERS WITHOUT CLAIM TO ANY PARTICULAR FONT, STYLE, SIZE, OR COLOR.

OWNER OF U.S. REG. NO. 2,294,347.

SER. NO. 77-364,604, FILED 1-4-2008.

SANI KHOURI, EXAMINING ATTORNEY

Int. Cl.: 28

Prior U.S. Cls.: 22, 23, 38 and 50

United States Patent and Trademark Office

Reg. No. 3,480,318

Registered Aug. 5, 2008

**TRADEMARK
PRINCIPAL REGISTER**

FREE THE HEART

SMALLWOOD JR., JAMES (UNITED STATES
INDIVIDUAL)
1150 SYRACUSE STREET BLDG. 4, APT 61
DENVER, CO 80220

THE MARK CONSISTS OF STANDARD CHAR-
ACTERS WITHOUT CLAIM TO ANY PARTICULAR
FONT, STYLE, SIZE, OR COLOR.

FOR: MANIPULATIVE PUZZLES; PUZZLES, IN
CLASS 28 (U.S. CLS. 22, 23, 38 AND 50).

SER. NO. 77-364,608, FILED 1-4-2008.

FIRST USE 4-23-1992; IN COMMERCE 4-23-1992.

GEORGE LORENZO, EXAMINING ATTORNEY

Int. Cl.: 36

Prior U.S. Cls.: 100, 101 and 102

United States Patent and Trademark Office

Reg. No. 3,480,319

Registered Aug. 5, 2008

**SERVICE MARK
PRINCIPAL REGISTER**

Partners Through Time

SANTA FE TRUST INC. (NEW MEXICO CORPORATION)
BUILDING 1000
4001 OFFICE COURT DRIVE
SANTA FE, NM 87507

THE MARK CONSISTS OF STANDARD CHARACTERS WITHOUT CLAIM TO ANY PARTICULAR FONT, STYLE, SIZE, OR COLOR.

FOR: TRUST SERVICES, NAMELY, INVESTMENT AND TRUST COMPANY SERVICES, IN CLASS 36 (U.S. CLS. 100, 101 AND 102).

SER. NO. 77-364,622, FILED 1-4-2008.

FIRST USE 4-1-1997; IN COMMERCE 4-1-1997.

IRA J. GOODSaid, EXAMINING ATTORNEY

Int. Cl.: 36

Prior U.S. Cls.: 100, 101 and 102

United States Patent and Trademark Office

Reg. No. 3,480,320

Registered Aug. 5, 2008

**SERVICE MARK
PRINCIPAL REGISTER**

SOUTH STREET

SOUTH STREET CAPITAL MANAGEMENT L.P.
(NEW YORK LIMITED PARTNERSHIP)
369 LEXINGTON AVENUE
NEW YORK, NY 10017

THE MARK CONSISTS OF STANDARD CHAR-
ACTERS WITHOUT CLAIM TO ANY PARTICULAR
FONT, STYLE, SIZE, OR COLOR.

FOR: FINANCIAL SERVICES, NAMELY, FINAN-
CIAL FUNDS MANAGEMENT, IN CLASS 36 (U.S.
CLS. 100, 101 AND 102).

SER. NO. 77-364,633, FILED 1-4-2008.

FIRST USE 1-15-2008; IN COMMERCE 1-15-2008.

PAUL E. FAHRENKOPF, EXAMINING ATTORNEY

Int. Cl.: 33

Prior U.S. Cls.: 47 and 49

United States Patent and Trademark Office

Reg. No. 3,480,321

Registered Aug. 5, 2008

**TRADEMARK
PRINCIPAL REGISTER**

GAMBOGI RANCH

C AND C WINE SERVICES, INC. (CALIFORNIA
CORPORATION)
2027 OLIVET ROAD
SANTA ROSA, CA 95401

THE MARK CONSISTS OF STANDARD CHAR-
ACTERS WITHOUT CLAIM TO ANY PARTICULAR
FONT, STYLE, SIZE, OR COLOR.

FOR: WINE, IN CLASS 33 (U.S. CLS. 47 AND 49).

SER. NO. 77-364,642, FILED 1-4-2008.

FIRST USE 9-0-1993; IN COMMERCE 9-0-1993.

JASON ROTH, EXAMINING ATTORNEY

Int. Cl.: 35

Prior U.S. Cls.: 100, 101 and 102

United States Patent and Trademark Office

Reg. No. 3,480,322

Registered Aug. 5, 2008

**SERVICE MARK
PRINCIPAL REGISTER**

NEWCAT

NPI, INC. (MISSOURI CORPORATION)
SUITE 236
ONE WARD PARKWAY
KANSAS CITY, MO 64112

THE MARK CONSISTS OF STANDARD CHAR-
ACTERS WITHOUT CLAIM TO ANY PARTICULAR
FONT, STYLE, SIZE, OR COLOR.

FOR: MARKETING CONSULTING SERVICES IN
THE FIELD OF CATEGORY REDEFINITION, IN
CLASS 35 (U.S. CLS. 100, 101 AND 102).

SER. NO. 77-364,680, FILED 1-4-2008.

FIRST USE 12-31-1990; IN COMMERCE 12-31-1990.

LOURDES AYALA, EXAMINING ATTORNEY

Int. Cl.: 14

Prior U.S. Cls.: 2, 27, 28 and 50

Reg. No. 3,480,323

United States Patent and Trademark Office

Registered Aug. 5, 2008

**TRADEMARK
PRINCIPAL REGISTER**

Comfort Clock

LESSER, KENNETH (UNITED STATES INDIVIDUAL)
1370 TENNYSON STREET
DENVER, CO 80204

FOR: CLOCKS WITH TECHNOLOGICAL MODIFICATIONS FOR ENHANCEMENT OF WELL BEING AND FOR STRESS RELIEF, IN CLASS 14 (U.S. CLS. 2, 27, 28 AND 50).

FIRST USE 11-15-2001; IN COMMERCE 11-15-2001.

THE MARK CONSISTS OF STANDARD CHARACTERS WITHOUT CLAIM TO ANY PARTICULAR FONT, STYLE, SIZE, OR COLOR.

NO CLAIM IS MADE TO THE EXCLUSIVE RIGHT TO USE "CLOCK", APART FROM THE MARK AS SHOWN.

SER. NO. 77-364,695, FILED 1-4-2008.

LOURDES AYALA, EXAMINING ATTORNEY

Int. Cl.: 35

Prior U.S. Cls.: 100, 101 and 102

United States Patent and Trademark Office

Reg. No. 3,480,324

Registered Aug. 5, 2008

**SERVICE MARK
PRINCIPAL REGISTER**



JACK'S COUNTRY STORE, INC. (WASHINGTON CORPORATION)
26006 HIGHWAY 103
P.O. BOX 710
OCEAN PARK, WA 98640

FOR: ONLINE, MAIL ORDER CATALOG, AND RETAIL STORE SERVICES FEATURING GROCERIES, HARDWARE, AND A WIDE VARIETY OF CONSUMER GOODS OF OTHERS , IN CLASS 35 (U.S. CLS. 100, 101 AND 102).

FIRST USE 0-0-1969; IN COMMERCE 0-0-1969.

NO CLAIM IS MADE TO THE EXCLUSIVE RIGHT TO USE "COUNTRY STORE" OR "FOUNDED 1885" OR "GROCERIES, HARDWARE AND GENERAL MERCHANDISE", APART FROM THE MARK AS SHOWN.

SER. NO. 77-364,712, FILED 1-4-2008.

BRENDAN REGAN, EXAMINING ATTORNEY

Int. Cl.: 35

Prior U.S. Cls.: 100, 101 and 102

United States Patent and Trademark Office

Reg. No. 3,480,325

Registered Aug. 5, 2008

**SERVICE MARK
PRINCIPAL REGISTER**

Liquidation Connect

LIQUIDATION CONNECT INC. (CALIFORNIA CORPORATION)
6749 TOP GUN STREET, SUITE 105
SAN DIEGO, CA 92121

FOR: ONLINE RETAIL STORE FEATURING A WIDE VARIETY OF CONSUMER GOODS OF OTHERS, IN CLASS 35 (U.S. CLS. 100, 101 AND 102).

FIRST USE 2-28-2005; IN COMMERCE 2-28-2005.

THE MARK CONSISTS OF STANDARD CHARACTERS WITHOUT CLAIM TO ANY PARTICULAR FONT, STYLE, SIZE, OR COLOR.

NO CLAIM IS MADE TO THE EXCLUSIVE RIGHT TO USE "LIQUIDATION", APART FROM THE MARK AS SHOWN.

SER. NO. 77-364,735, FILED 1-4-2008.

AMY HELLA, EXAMINING ATTORNEY

Int. Cl.: 32

Prior U.S. Cls.: 45, 46 and 48

Reg. No. 3,480,326

United States Patent and Trademark Office

Registered Aug. 5, 2008

**TRADEMARK
PRINCIPAL REGISTER**

PREGGATINIS

BOVIS-NELSEN, NATALIE (UNITED STATES IN-
DIVIDUAL)
333 WASHINGTON BLVD., #215
MARINA DEL REY, CA 90292

THE MARK CONSISTS OF STANDARD CHAR-
ACTERS WITHOUT CLAIM TO ANY PARTICULAR
FONT, STYLE, SIZE, OR COLOR.

FOR: NON-ALCOHOLIC COCKTAILS, IN CLASS
32 (U.S. CLS. 45, 46 AND 48).

SER. NO. 77-364,747, FILED 1-4-2008.

FIRST USE 1-2-2007; IN COMMERCE 1-2-2007.

PAUL F. GAST, EXAMINING ATTORNEY

Int. Cl.: 22

Prior U.S. Cls.: 1, 2, 7, 19, 22, 42 and 50

United States Patent and Trademark Office

Reg. No. 3,480,327

Registered Aug. 5, 2008

**TRADEMARK
PRINCIPAL REGISTER**



SAMPLE, GINA M. (CALIFORNIA SOLE PROPRIETORSHIP), DBA SAMPLE DESIGN
P.O. BOX 235
DEL MAR, CA 92014

FOR: MULTI-PURPOSE CLOTH BAGS, IN CLASS
22 (U.S. CLS. 1, 2, 7, 19, 22, 42 AND 50).

FIRST USE 12-4-2007; IN COMMERCE 1-3-2008.

NO CLAIM IS MADE TO THE EXCLUSIVE
RIGHT TO USE "VERDE BAG", APART FROM
THE MARK AS SHOWN.

THE COLOR(S) DARK GREEN AND PALE
GREEN IS/ARE CLAIMED AS A FEATURE OF
THE MARK.

THE MARK CONSISTS OF A PALE GREEN
DAMASK-STYLE DESIGN WITH THE LETTER "V"
ON TOP IN DARK GREEN ABOVE THE PHRASE
"THE VERDE BAG".

THE ENGLISH TRANSLATION OF THE WORD
"VERDE" IN THE MARK IS GREEN.

SER. NO. 77-364,750, FILED 1-4-2008.

ALYSSA PALADINO, EXAMINING ATTORNEY

Int. Cl.: 25

Prior U.S. Cls.: 22 and 39

United States Patent and Trademark Office

Reg. No. 3,480,328

Registered Aug. 5, 2008

**TRADEMARK
PRINCIPAL REGISTER**

LETHAL CURVES

ROSANNE BELLER, INC. (NEW YORK COR-
PORATION)
P.O. BOX 1041
COMMACK, NY 11725

THE MARK CONSISTS OF STANDARD CHAR-
ACTERS WITHOUT CLAIM TO ANY PARTICULAR
FONT, STYLE, SIZE, OR COLOR.

FOR: SHIRTS; JACKETS; SWEATERS; PANTS;
JEANS; VESTS; UNDERGARMENTS; SOCKS; HATS;
HEADWEAR; BANDANAS; GLOVES; MOTOR-
CYCLE GLOVES, IN CLASS 25 (U.S. CLS. 22 AND 39).

SER. NO. 77-364,767, FILED 1-4-2008.

FIRST USE 11-0-2007; IN COMMERCE 11-0-2007.

JOHN GARTNER, EXAMINING ATTORNEY

Int. Cl.: 41

Prior U.S. Cls.: 100, 101 and 107

United States Patent and Trademark Office

Reg. No. 3,480,329

Registered Aug. 5, 2008

**SERVICE MARK
PRINCIPAL REGISTER**

TAKING CHARGE OF CHANGE

NATIONAL-LOUIS UNIVERSITY (ILLINOIS
NON-PROFIT CORPORATION)
122 S. MICHIGAN AVE.
CHICAGO, IL 60603

FOR: EDUCATIONAL SERVICES, NAMELY, ORGANIZING AND CONDUCTING CLASSES, PROGRAMS AND SEMINARS IN THE FIELD OF EARLY CHILDHOOD EDUCATION; ORGANIZING AND CONDUCTING EDUCATIONAL TRAINING CLASSES, PROGRAMS AND SEMINARS FOR DIRECTORS AND STAFF OF EARLY CHILDHOOD EDUCATION INSTITUTIONS AND DISTRIBUTION OF COURSE MATERIALS IN CONNECTION WITH

ALL OF THE FOREGOING, IN CLASS 41 (U.S. CLS. 100, 101 AND 107).

FIRST USE 1-1-1993; IN COMMERCE 1-1-1993.

THE MARK CONSISTS OF STANDARD CHARACTERS WITHOUT CLAIM TO ANY PARTICULAR FONT, STYLE, SIZE, OR COLOR.

SER. NO. 77-364,884, FILED 1-5-2008.

REBECCA SMITH, EXAMINING ATTORNEY

Int. Cl.: 41

Prior U.S. Cls.: 100, 101 and 107

United States Patent and Trademark Office

Reg. No. 3,480,330

Registered Aug. 5, 2008

**SERVICE MARK
PRINCIPAL REGISTER**

The Armenoids

ROSTOMYAN, EDGAR (ARMENIA INDIVIDUAL)
1615 GUY STREET, # 7
SAN DIEGO, CA 92103

FOR: ENTERTAINMENT IN THE NATURE OF LIVE PERFORMANCES BY MUSIC BAND; ENTERTAINMENT IN THE NATURE OF VISUAL AND AUDIO PERFORMANCES, AND MUSICAL, VARIETY, NEWS AND COMEDY SHOWS; ENTERTAINMENT IN THE NATURE OF VISUAL AND AUDIO PERFORMANCES, NAMELY, MUSICAL BAND, ROCK GROUP, GYMNASTIC, DANCE, AND BALLET PERFORMANCES; ENTERTAINMENT IN THE NATURE OF MUSIC; ENTERTAINMENT, NAMELY, LIVE PERFORMANCES BY A MUSICAL BAND; ENTERTAINMENT, NAMELY, PRODUCTION OF MUSIC; ENTERTAINMENT SERVICES, NAMELY, PROVIDING PRERECORDED MUSIC, INFORMA-

TION IN THE FIELD OF MUSIC, AND COMMENTARY AND ARTICLES ABOUT MUSIC, ALL ONLINE VIA A GLOBAL COMPUTER NETWORK; ENTERTAINMENT, NAMELY, LIVE MUSIC CONCERTS; ENTERTAINMENT, NAMELY, LIVE PERFORMANCES BY MUSICAL BANDS, IN CLASS 41 (U.S. CLS. 100, 101 AND 107).

FIRST USE 1-1-2000; IN COMMERCE 11-1-2007.

THE MARK CONSISTS OF STANDARD CHARACTERS WITHOUT CLAIM TO ANY PARTICULAR FONT, STYLE, SIZE, OR COLOR.

SER. NO. 77-364,889, FILED 1-5-2008.

JOHN E. MICHOS, EXAMINING ATTORNEY

Int. Cl.: 41

Prior U.S. Cls.: 100, 101 and 107

United States Patent and Trademark Office

Reg. No. 3,480,331

Registered Aug. 5, 2008

**SERVICE MARK
PRINCIPAL REGISTER**

Scribbit

MITTON, MICHELLE R. (UNITED STATES IN-
DIVIDUAL)
3015 SEAWIND DRIVE
ANCHORAGE, AK 99516

THE MARK CONSISTS OF STANDARD CHAR-
ACTERS WITHOUT CLAIM TO ANY PARTICULAR
FONT, STYLE, SIZE, OR COLOR.

FOR: ON-LINE JOURNALS, NAMELY, BLOGS
FEATURING PARENTING, HOME, CRAFTS,
FOOD, TRAVEL, FAMILY, HUMOR, IN CLASS 41
(U.S. CLS. 100, 101 AND 107).

SER. NO. 77-364,906, FILED 1-5-2008.

FIRST USE 5-1-2006; IN COMMERCE 5-1-2006.

JOHN E. MICHOS, EXAMINING ATTORNEY

Int. Cls.: 35 and 41

Prior U.S. Cls.: 100, 101, 102 and 107

United States Patent and Trademark Office

Reg. No. 3,480,332

Registered Aug. 5, 2008

**SERVICE MARK
PRINCIPAL REGISTER**

SPASCENE

GROOVY GIRL PUBLISHING, INC (CALIFORNIA CORPORATION)
5666 LA JOLLA BLVD, #137
LA JOLLA, CA 92024

FOR: ONLINE ORDERING SERVICES FEATURING BATH AND BEAUTY PRODUCTS, SPA AND SPA LIFESTYLE PRODUCTS, GIFT CERTIFICATES, PUBLICATIONS, NEWSLETTERS, PRINTED RECIPES AND SPA DIRECTORIES, IN CLASS 35 (U.S. CLS. 100, 101 AND 102).

FIRST USE 6-12-2007; IN COMMERCE 6-12-2007.

FOR: ONLINE PUBLICATION IN THE NATURE OF MAGAZINES, AND ARTICLES IN THE FIELD

OF VACATION TRAVELER, BATH AND BEAUTY, HEALTH AND WELLNESS, SPA REVIEWS, HOME DESIGN, FOOD, RECIPES, FASHIONS, SPA DEALS AND DISCOUNTS, IN CLASS 41 (U.S. CLS. 100, 101 AND 107).

FIRST USE 6-12-2007; IN COMMERCE 6-12-2007.

THE MARK CONSISTS OF STANDARD CHARACTERS WITHOUT CLAIM TO ANY PARTICULAR FONT, STYLE, SIZE, OR COLOR.

SER. NO. 77-364,936, FILED 1-5-2008.

TARAH HARDY, EXAMINING ATTORNEY

Int. Cl.: 7

Prior U.S. Cls.: 13, 19, 21, 23, 31, 34 and 35

United States Patent and Trademark Office

Reg. No. 3,480,333

Registered Aug. 5, 2008

**TRADEMARK
PRINCIPAL REGISTER**

MULTIBAGGER

THE SANDBAGGER CORPORATION (ILLINOIS
CORPORATION)
30846 NORTH HIGHWAY 12
VOLO, IL 60073

FOR: BAGGING MACHINE FOR BAGGING PAR-
TICULATE MATTER, IN CLASS 7 (U.S. CLS. 13, 19,
21, 23, 31, 34 AND 35).

FIRST USE 9-1-1997; IN COMMERCE 9-1-1997.

THE MARK CONSISTS OF STANDARD CHAR-
ACTERS WITHOUT CLAIM TO ANY PARTICULAR
FONT, STYLE, SIZE, OR COLOR.

OWNER OF U.S. REG. NO. 2,526,188.

SEC. 2(F).

SER. NO. 77-364,962, FILED 1-5-2008.

LINDA E. BLOHM, EXAMINING ATTORNEY

Int. Cl.: 42

Prior U.S. Cls.: 100 and 101

United States Patent and Trademark Office

Reg. No. 3,480,334

Registered Aug. 5, 2008

**SERVICE MARK
PRINCIPAL REGISTER**

CRUSHTOWN, LLC (MINNESOTA LTD LIAB CO)
3210 W 45TH STREET
MINNEAPOLIS, MN 55410

FOR: GRAPHIC DESIGN SERVICES, IN CLASS 42
(U.S. CLS. 100 AND 101).

FIRST USE 4-1-2006; IN COMMERCE 8-1-2006.

THE MARK CONSISTS OF A CUSTOM FONT
THAT SPELLS "CRUSHTOWN". THE "T" IN

"CRUSHTOWN" IS RAISED FROM THE BASELINE
OF THE REST OF THE LETTERS AND IS WEDGED
BETWEEN THE "H" AND THE "O". THERE IS A
SQUARE ABOVE THE "T". THE SQUARE SITTING
ON TOP OF THE "T" RESEMBLES A PERSON WITH
THEIR ARMS STRETCHED OUTWARD.

SER. NO. 77-364,984, FILED 1-6-2008.

SANJEEV VOHRA, EXAMINING ATTORNEY

Int. Cl.: 21

Prior U.S. Cls.: 2, 13, 23, 29, 30, 33, 40 and 50

United States Patent and Trademark Office

Reg. No. 3,480,335

Registered Aug. 5, 2008

**TRADEMARK
PRINCIPAL REGISTER**

SKOY

SKOY ENTERPRISES (CALIFORNIA PARTNER-
SHIP)
1166 AVENIDA ESTEBAN
ENCINITAS, CA 92024

THE MARK CONSISTS OF STANDARD CHAR-
ACTERS WITHOUT CLAIM TO ANY PARTICULAR
FONT, STYLE, SIZE, OR COLOR.

FOR: CLEANING CLOTH; CLOTH FOR WIPING
OR DUSTING, IN CLASS 21 (U.S. CLS. 2, 13, 23, 29, 30,
33, 40 AND 50).

SER. NO. 77-364,988, FILED 1-6-2008.

FIRST USE 10-20-2007; IN COMMERCE 10-20-2007.

SANJEEV VOHRA, EXAMINING ATTORNEY

Int. Cl.: 36

Prior U.S. Cls.: 100, 101 and 102

United States Patent and Trademark Office

Reg. No. 3,480,336

Registered Aug. 5, 2008

**SERVICE MARK
PRINCIPAL REGISTER**

Delectable

MENDWELL LLC (IDAHO LTD LIAB CO)
200 TECHNOLOGY DRIVE
IDAHO FALLS, ID 83401

THE MARK CONSISTS OF STANDARD CHAR-
ACTERS WITHOUT CLAIM TO ANY PARTICULAR
FONT, STYLE, SIZE, OR COLOR.

FOR: CHARITABLE FUNDRAISING SERVICES,
IN CLASS 36 (U.S. CLS. 100, 101 AND 102).

SER. NO. 77-364,989, FILED 1-6-2008.

FIRST USE 9-1-2007; IN COMMERCE 12-15-2007.

MICHAEL SOUDERS, EXAMINING ATTORNEY

Int. Cl.: 4

Prior U.S. Cls.: 1, 6 and 15

United States Patent and Trademark Office

Reg. No. 3,480,337

Registered Aug. 5, 2008

**TRADEMARK
PRINCIPAL REGISTER**

Willowberry Candle

SHIELDS, LORETTA (UNITED STATES INDIVIDUAL)

2916 SHANNON DR

PUNTA GORDA, FL 33950

FOR: CANDLES; CANDLES FOR LIGHTING; SCENTED CANDLES, IN CLASS 4 (U.S. CLS. 1, 6 AND 15).

FIRST USE 12-15-2007; IN COMMERCE 12-15-2007.

THE MARK CONSISTS OF STANDARD CHARACTERS WITHOUT CLAIM TO ANY PARTICULAR FONT, STYLE, SIZE, OR COLOR.

NO CLAIM IS MADE TO THE EXCLUSIVE RIGHT TO USE "CANDLE", APART FROM THE MARK AS SHOWN.

SER. NO. 77-365,013, FILED 1-6-2008.

KATHERINE CONNOLLY, EXAMINING ATTORNEY

Int. Cl.: 5

Prior U.S. Cls.: 6, 18, 44, 46, 51 and 52

Reg. No. 3,480,338

United States Patent and Trademark Office

Registered Aug. 5, 2008

**TRADEMARK
PRINCIPAL REGISTER**

CHL-CARE

HEALING POWER, INC. (NEW YORK COR-
PORATION)
5515 CANOGA AVE, #326
WOODLAND HLS, CA 91367

THE MARK CONSISTS OF STANDARD CHAR-
ACTERS WITHOUT CLAIM TO ANY PARTICULAR
FONT, STYLE, SIZE, OR COLOR.

FOR: DIETARY SUPPLEMENTS, IN CLASS 5 (U.S.
CLS. 6, 18, 44, 46, 51 AND 52).

SER. NO. 77-365,057, FILED 1-6-2008.

FIRST USE 2-26-2006; IN COMMERCE 2-26-2006.

TARAH HARDY, EXAMINING ATTORNEY

Int. Cl.: 5

Prior U.S. Cls.: 6, 18, 44, 46, 51 and 52

United States Patent and Trademark Office

Reg. No. 3,480,339

Registered Aug. 5, 2008

**TRADEMARK
PRINCIPAL REGISTER**

RUMO PLUS

HEALING POWER, INC. (NEW YORK COR-
PORATION)
5515 CANOGA AVE, #326
WOODLAND HLS, CA 91367

THE MARK CONSISTS OF STANDARD CHAR-
ACTERS WITHOUT CLAIM TO ANY PARTICULAR
FONT, STYLE, SIZE, OR COLOR.

FOR: DIETARY SUPPLEMENTS, IN CLASS 5 (U.S.
CLS. 6, 18, 44, 46, 51 AND 52).

SER. NO. 77-365,059, FILED 1-6-2008.

FIRST USE 2-26-2006; IN COMMERCE 2-26-2006.

TARAH HARDY, EXAMINING ATTORNEY

Int. Cl.: 11

Prior U.S. Cls.: 13, 21, 23, 31 and 34

United States Patent and Trademark Office

Reg. No. 3,480,340

Registered Aug. 5, 2008

**TRADEMARK
PRINCIPAL REGISTER**

POOL-SAFE

TURBOTEC PRODUCTS, INC. (CONNECTICUT CORPORATION)
651 DAY HILL ROAD
WINDSOR, CT 06095

FOR: HEAT PUMP HEAT EXCHANGERS FOR SWIMMING POOLS, IN CLASS 11 (U.S. CLS. 13, 21, 23, 31 AND 34).

FIRST USE 4-1-2006; IN COMMERCE 4-1-2006.

THE MARK CONSISTS OF STANDARD CHARACTERS WITHOUT CLAIM TO ANY PARTICULAR FONT, STYLE, SIZE, OR COLOR.

OWNER OF U.S. REG. NO. 872,438.

SER. NO. 77-365,087, FILED 1-6-2008.

ALYSSA PALADINO, EXAMINING ATTORNEY

Int. Cl.: 37

Prior U.S. Cls.: 100, 103 and 106

United States Patent and Trademark Office

Reg. No. 3,480,341

Registered Aug. 5, 2008

**SERVICE MARK
PRINCIPAL REGISTER**

Advanced Logic Technologies

ADVANCED LOGIC TECHNOLOGIES, LLC.
(TEXAS LTD LIAB CO)
ST. 307, 5114 BALCONES WOODS DR.
AUSTIN, TX 78759

NO CLAIM IS MADE TO THE EXCLUSIVE
RIGHT TO USE "TECHNOLOGIES", APART FROM
THE MARK AS SHOWN.

FOR: CONSTRUCTION OF BUILDINGS, IN
CLASS 37 (U.S. CLS. 100, 103 AND 106).

SEC. 2(F).

FIRST USE 11-1-1999; IN COMMERCE 11-1-1999.

SER. NO. 77-365,093, FILED 1-6-2008.

THE MARK CONSISTS OF STANDARD CHAR-
ACTERS WITHOUT CLAIM TO ANY PARTICULAR
FONT, STYLE, SIZE, OR COLOR.

IRA J. GOODSID, EXAMINING ATTORNEY

Int. Cl.: 35

Prior U.S. Cls.: 100, 101 and 102

United States Patent and Trademark Office

Reg. No. 3,480,342

Registered Aug. 5, 2008

**SERVICE MARK
PRINCIPAL REGISTER**

WebPT

BRAD JANNENGA (UNITED STATES INDIVIDUAL)
2325 N. 7TH ST.
PHOENIX, AZ 85006

THE MARK CONSISTS OF STANDARD CHARACTERS WITHOUT CLAIM TO ANY PARTICULAR FONT, STYLE, SIZE, OR COLOR.

FOR: RECORDS MANAGEMENT SERVICES, NAMELY, ONLINE DOCUMENTATION MANAGEMENT SERVICES FOR PHYSICAL THERAPISTS, IN CLASS 35 (U.S. CLS. 100, 101 AND 102).

SER. NO. 77-365,097, FILED 1-6-2008.

FIRST USE 10-14-1999; IN COMMERCE 10-14-1999.

CYNTHIA TRIPI, EXAMINING ATTORNEY

Int. Cl.: 30

Prior U.S. Cl.: 46

United States Patent and Trademark Office

Reg. No. 3,480,343

Registered Aug. 5, 2008

**TRADEMARK
PRINCIPAL REGISTER**

Mama's Special Maple

MAMA'S SPECIAL FAMILY, INC. (VERMONT CORPORATION)

P.O. BOX 555

HYDE PARK, VT 05655

FOR: POPPED POPCORN, IN CLASS 30 (U.S. CL. 46).

FIRST USE 8-31-2004; IN COMMERCE 8-31-2004.

THE MARK CONSISTS OF STANDARD CHARACTERS WITHOUT CLAIM TO ANY PARTICULAR FONT, STYLE, SIZE, OR COLOR.

NO CLAIM IS MADE TO THE EXCLUSIVE RIGHT TO USE "SPECIAL MAPLE", APART FROM THE MARK AS SHOWN.

SER. NO. 77-365,129, FILED 1-6-2008.

ADA HAN, EXAMINING ATTORNEY

Int. Cl.: 30

Prior U.S. Cl.: 46

United States Patent and Trademark Office

Reg. No. 3,480,344

Registered Aug. 5, 2008

**TRADEMARK
PRINCIPAL REGISTER**

Mama's Special plain janes

MAMA'S SPECIAL FAMILY, INC. (VERMONT CORPORATION)

P.O. BOX 555

HYDE PARK, VT 05655

FOR: POPPED POPCORN, IN CLASS 30 (U.S. CL. 46).

FIRST USE 8-31-2004; IN COMMERCE 8-31-2004.

THE MARK CONSISTS OF STANDARD CHARACTERS WITHOUT CLAIM TO ANY PARTICULAR FONT, STYLE, SIZE, OR COLOR.

NO CLAIM IS MADE TO THE EXCLUSIVE RIGHT TO USE "SPECIAL PLAIN", APART FROM THE MARK AS SHOWN.

SER. NO. 77-365,130, FILED 1-6-2008.

ADA HAN, EXAMINING ATTORNEY

Int. Cl.: 39

Prior U.S. Cls.: 100 and 105

United States Patent and Trademark Office

Reg. No. 3,480,345

Registered Aug. 5, 2008

**SERVICE MARK
PRINCIPAL REGISTER**

WLG

WLG, INC. (DELAWARE CORPORATION)
SUITE 120
920 EAST ALGONQUIN ROAD
SCHAUMBURG, IL 60173

THE MARK CONSISTS OF STANDARD CHAR-
ACTERS WITHOUT CLAIM TO ANY PARTICULAR
FONT, STYLE, SIZE, OR COLOR.

FOR: FREIGHT FORWARDING SERVICES, IN
CLASS 39 (U.S. CLS. 100 AND 105).

SER. NO. 77-365,197, FILED 1-7-2008.

FIRST USE 3-22-2005; IN COMMERCE 3-22-2005.

AMY HELLA, EXAMINING ATTORNEY

Int. Cl.: 43

Prior U.S. Cls.: 100 and 101

United States Patent and Trademark Office

Reg. No. 3,480,346

Registered Aug. 5, 2008

**SERVICE MARK
PRINCIPAL REGISTER**

MAGNUS JOE

COBB, BOBBY J. (UNITED STATES INDIVIDUAL)
P.O. BOX 3778
GREENVILLE, SC 29608

FOR: RESTAURANT SERVICES, IN CLASS 43
(U.S. CLS. 100 AND 101).

FIRST USE 2-0-2007; IN COMMERCE 2-0-2007.

THE MARK CONSISTS OF STANDARD CHARACTERS WITHOUT CLAIM TO ANY PARTICULAR FONT, STYLE, SIZE, OR COLOR.

MAGNUS JOE DOES NOT IDENTIFY A LIVING INDIVIDUAL.

SER. NO. 77-365,204, FILED 1-7-2008.

EVELYN BRADLEY, EXAMINING ATTORNEY

Int. Cl.: 30

Prior U.S. Cl.: 46

United States Patent and Trademark Office

Reg. No. 3,480,347

Registered Aug. 5, 2008

**TRADEMARK
PRINCIPAL REGISTER**

MAGNUS JOE

COBB, BOBBY J. (UNITED STATES INDIVIDUAL)
P.O. BOX 3778
GREENVILLE, SC 29608

FOR: COFFEE; COFFEE BEANS, IN CLASS 30
(U.S. CL. 46).

FIRST USE 8-0-2007; IN COMMERCE 8-0-2007.

THE MARK CONSISTS OF STANDARD CHARACTERS WITHOUT CLAIM TO ANY PARTICULAR FONT, STYLE, SIZE, OR COLOR.

"MAGNUS JOE" DOES NOT IDENTIFY A LIVING INDIVIDUAL.

SER. NO. 77-365,209, FILED 1-7-2008.

EVELYN BRADLEY, EXAMINING ATTORNEY

Int. Cl.: 35

Prior U.S. Cls.: 100, 101 and 102

United States Patent and Trademark Office

Reg. No. 3,480,348

Registered Aug. 5, 2008

**SERVICE MARK
PRINCIPAL REGISTER**



WESCO, INC. (MICHIGAN CORPORATION)
1460 WHITEHALL ROAD
MUSKEGON, MI 49445

THE COLOR(S) RED, WHITE AND BLUE IS/ARE
CLAIMED AS A FEATURE OF THE MARK.

FOR: RETAIL STORE SERVICES FEATURING
CONVENIENCE STORE ITEMS AND GASOLINE, IN
CLASS 35 (U.S. CLS. 100, 101 AND 102).

THE MARK CONSISTS OF THE NAME "WESCO"
IN BLUE ON A WHITE BACKGROUND WITH RED
TRIANGLES ABOVE AND BELOW THE NAME.

FIRST USE 0-0-1983; IN COMMERCE 0-0-1983.

SER. NO. 77-365,236, FILED 1-7-2008.

OWNER OF U.S. REG. NOS. 1,219,402 AND
1,661,847.

JESSICA FATHY, EXAMINING ATTORNEY

Int. Cl.: 41

Prior U.S. Cls.: 100, 101 and 107

United States Patent and Trademark Office

Reg. No. 3,480,349

Registered Aug. 5, 2008

**SERVICE MARK
PRINCIPAL REGISTER**

**WORKING WITHIN TO BRING
OUT THE BEST**

INNOVATIVE LEARNING STRATEGIES LLC
(WISCONSIN LTD LIAB CO)
SUITE 126A
10 COLLEGE AVENUE
APPLETON, WI 54911

FOR: EDUCATIONAL SERVICES, NAMELY,
CONDUCTING SEMINARS, EDUCATIONAL CON-
FERENCES AND WORKSHOPS, AS WELL AS PRO-
VIDING TRAINING, COACHING, AND
EDUCATIONAL CONSULTING IN CONNECTION
THEREWITH, IN THE FIELDS OF BUSINESS ETI-
QUETTE, FUNDRAISING, PERSONAL COMMUNI-
CATION AND PRESENTATION SKILLS,
LEADERSHIP AND TEAM BUILDING SKILLS, VO-
LUNTEER DEVELOPMENT, HUMAN INTERAC-
TION, PERSONNEL RELATIONSHIPS AND

HUMAN RESOURCE MANAGEMENT IN THE
WORKPLACE, AND DISTRIBUTING PRINTED
COURSE MATERIALS IN CONNECTION THERE-
WITH, IN CLASS 41 (U.S. CLS. 100, 101 AND 107).

FIRST USE 3-1-2000; IN COMMERCE 5-1-2000.

THE MARK CONSISTS OF STANDARD CHAR-
ACTERS WITHOUT CLAIM TO ANY PARTICULAR
FONT, STYLE, SIZE, OR COLOR.

OWNER OF U.S. REG. NO. 2,588,370.

SER. NO. 77-365,245, FILED 1-7-2008.

MARK T. MULLEN, EXAMINING ATTORNEY

Int. Cl.: 18

Prior U.S. Cls.: 1, 2, 3, 22 and 41

United States Patent and Trademark Office

Reg. No. 3,480,350

Registered Aug. 5, 2008

**TRADEMARK
PRINCIPAL REGISTER**

BIG KAHUNA

HIGH SIERRA SPORT COMPANY (ILLINOIS
CORPORATION)
880 CORPORATE WOODS PARKWAY
VERNON HILLS, IL 60061

THE MARK CONSISTS OF STANDARD CHAR-
ACTERS WITHOUT CLAIM TO ANY PARTICULAR
FONT, STYLE, SIZE, OR COLOR.

FOR: BACKPACKS, IN CLASS 18 (U.S. CLS. 1, 2, 3,
22 AND 41).

SER. NO. 77-365,249, FILED 1-7-2008.

FIRST USE 6-1-2005; IN COMMERCE 6-1-2005.

MARK T. MULLEN, EXAMINING ATTORNEY

Int. Cl.: 34

Prior U.S. Cls.: 2, 8, 9 and 17

United States Patent and Trademark Office

Reg. No. 3,480,351

Registered Aug. 5, 2008

TRADEMARK
PRINCIPAL REGISTER



JMTM, INC. (DELAWARE LTD LIAB CO)
SUITE 1028
1105 N. MARKET STREET
WILMINGTON, DE 19899

NO CLAIM IS MADE TO THE EXCLUSIVE
RIGHT TO USE "CREAM", APART FROM THE
MARK AS SHOWN.

FOR: CIGARS; SMOKING TOBACCO, IN CLASS
34 (U.S. CLS. 2, 8, 9 AND 17).

SEC. 2(F) AS TO "BLACK & MILD".

FIRST USE 11-2-2005; IN COMMERCE 11-2-2005.

SER. NO. 77-365,273, FILED 1-7-2008.

OWNER OF U.S. REG. NOS. 1,177,552, 2,712,704,
AND 2,720,516.

TRACY WHITTAKER-BROWN, EXAMINING AT-
TORNEY

Int. Cl.: 25

Prior U.S. Cls.: 22 and 39

United States Patent and Trademark Office

Reg. No. 3,480,352

Registered Aug. 5, 2008

**TRADEMARK
PRINCIPAL REGISTER**



BUCCANEERS LIMITED PARTNERSHIP (DELA-
WARE LIMITED PARTNERSHIP)

ONE BUCCANEER PLACE
TAMPA, FL 33607

FOR: CLOTHING, NAMELY, CAPS AND SWEAT-
SHIRTS, IN CLASS 25 (U.S. CLS. 22 AND 39).

FIRST USE 4-0-1975; IN COMMERCE 4-0-1975.

OWNER OF U.S. REG. NOS. 1,080,614 AND
1,085,720.

THE MARK CONSISTS OF A STYLIZED PIRATE
HEAD WITH A HAT WITH A FEATHER AND
KNIFE IN HIS MOUTH.

SER. NO. 77-365,282, FILED 1-7-2008.

JASON LOTT, EXAMINING ATTORNEY

Int. Cl.: 45

Prior U.S. Cls.: 100 and 101

United States Patent and Trademark Office

Reg. No. 3,480,353

Registered Aug. 5, 2008

**SERVICE MARK
PRINCIPAL REGISTER**

IRETURN

IRETURN INC. (CANADA CORPORATION)
200 - 150 CHIPPEWA ROAD
SHERWOOD PARK AB, CANADA T8A6A2

THE MARK CONSISTS OF STANDARD CHAR-
ACTERS WITHOUT CLAIM TO ANY PARTICULAR
FONT, STYLE, SIZE, OR COLOR.

FOR: LOST AND FOUND SERVICES, IN CLASS 45
(U.S. CLS. 100 AND 101).

SER. NO. 77-365,293, FILED 1-7-2008.

FIRST USE 3-31-2006; IN COMMERCE 3-31-2006.

SHANNON TWOHIG, EXAMINING ATTORNEY

Int. Cl.: 3

Prior U.S. Cls.: 1, 4, 6, 50, 51 and 52

Reg. No. 3,480,354

United States Patent and Trademark Office

Registered Aug. 5, 2008

TRADEMARK
PRINCIPAL REGISTER



WHITNELL, AUDREY L. (UNITED STATES INDIVIDUAL), DBA JOSIE'S ORIGINAL SOAP CO.

RR1 BOX 72
NEWARK, MO 634589732

FOR: ANTIBACTERIAL SKIN SOAPS; AROMATHERAPY BODY CARE PRODUCTS, NAMELY, BODY LOTION, SHOWER GEL, CUTICLE CREAM, SHAMPOO, CONDITIONER, NON-MEDICATED LIP BALM, SOAP, BODY POLISH, BODY AND FOOT SCRUB AND NON-MEDICATED FOOT CREAM; BAR SOAP; BATH SOAPS IN LIQUID, SOLID OR GEL FORM; COSMETIC SOAPS; DEODORANT SOAP; HAND SOAPS; LAUNDRY SOAP; MEDICATED SOAPS; PERFUMED SOAPS; SHAVING SOAPS; SKIN SOAP; SOAPS FOR BODY CARE; SOAPS FOR PERSONAL USE; TOILET SOAPS; BABY OILS; BATH OILS; BODY OILS; ESSENTIAL OILS; ESSENTIAL OILS FOR PERSONAL USE; MASSAGE OILS; NATURAL ESSENTIAL OILS; NUTRITIONAL OILS FOR COSMETIC PURPOSES; OILS FOR COSMETIC PURPOSES; SKIN AND BODY TOPICAL LOTIONS, CREAMS AND OILS FOR COSMETIC USE; AGE RETARDANT LOTION; BABY LOTION; HAND LOTIONS; LOTIONS FOR CELLULITE REDUCTION; LOTIONS FOR COSMETIC PURPOSES; LOTIONS FOR FACE AND BODY CARE; NON-MEDICATED DIAPER RASH OINTMENTS AND LOTIONS; NON-MEDICATED SKIN CARE PREPARATIONS, NAMELY, CREAMS, LOTIONS, GELS, TONERS, CLEANSERS AND PEELS; NON-MEDICATED STIMULATING LOTIONS FOR THE SKIN; SUN-BLOCK LOTIONS; BABY SHAMPOO; HAIR RINSES; HAIR SHAMPOOS AND CONDITIONERS; PET SHAMPOO , IN CLASS 3 (U.S. CLS. 1, 4, 6, 50, 51 AND 52).

FIRST USE 2-27-2007; IN COMMERCE 1-3-2008.

NO CLAIM IS MADE TO THE EXCLUSIVE RIGHT TO USE "ORIGINAL SOAP CO.", APART FROM THE MARK AS SHOWN.

THE MARK IDENTIFIES A LIVING INDIVIDUAL WHOSE CONSENT IS OF RECORD.

THE COLOR(S) BLACK AND GRAY IS/ARE CLAIMED AS A FEATURE OF THE MARK.

THE MARK CONSISTS OF THE WORDING "AUDREY'S ORIGINAL SOAP CO." AND A PLANT LEAF IMAGE OVERLAPPING TWO CONCENTRIC VERTICAL RECTANGLES IN THE UPPER LEFT CORNER OF THE MARK. THE LETTER "A" IN THE WORD "AUDREY'S" AND THE LETTER "O" IN THE WORD "ORIGINAL" SHOW A SHADOW EFFECT BEHIND EACH LETTER. THE COLOR BLACK APPEARS IN THE WORDING "AUDREY'S ORIGINAL SOAP CO.", IN THE SHADOW EFFECT BEHIND THE LETTER "A" IN "AUDREY'S" AND THE LETTER "O" IN "ORIGINAL", AND IN THE OUTLINING OF THE PLANT LEAF IMAGE; AND THE COLOR GRAY APPEARS IN THE PLANT LEAF IMAGE AND THE TWO CONCENTRIC VERTICAL RECTANGLE DESIGNS OF THE MARK.

SER. NO. 77-365,305, FILED 1-7-2008.

ANDREW RHIM, EXAMINING ATTORNEY

Int. Cl.: 41

Prior U.S. Cls.: 100, 101 and 107

United States Patent and Trademark Office

Reg. No. 3,480,355

Registered Aug. 5, 2008

**SERVICE MARK
PRINCIPAL REGISTER**

HIT DOCTOR

HIT DOCTOR INC. (NEW JERSEY CORPORATION)
6 BICENTENNIAL COURT
ERIAL, NJ 08081

FOR: EDUCATION SERVICES, NAMELY, PROVIDING TRAINING CAMPS IN THE FIELDS OF BASEBALL AND SOFTBALL; EDUCATIONAL SERVICES, NAMELY, CONDUCTING PROGRAMS IN THE FIELD OF BASEBALL AND SOFTBALL; EDUCATIONAL SERVICES, NAMELY, PROVIDING TRAINING IN THE FIELDS OF BASEBALL AND SOFTBALL; EDUCATIONAL SERVICES, NAMELY, CONDUCTING TRAINING AND PRACTICE SES-

SIONS IN THE FIELD OF BASEBALL AND SOFTBALL, IN CLASS 41 (U.S. CLS. 100, 101 AND 107).

FIRST USE 5-30-1989; IN COMMERCE 5-30-1989.

THE MARK CONSISTS OF STANDARD CHARACTERS WITHOUT CLAIM TO ANY PARTICULAR FONT, STYLE, SIZE, OR COLOR.

OWNER OF U.S. REG. NO. 2,408,599.

SER. NO. 77-365,337, FILED 1-7-2008.

THEODORE MCBRIDE, EXAMINING ATTORNEY

Int. Cl.: 36

Prior U.S. Cls.: 100, 101 and 102

United States Patent and Trademark Office

Reg. No. 3,480,356

Registered Aug. 5, 2008

**SERVICE MARK
PRINCIPAL REGISTER**

WEDSAFE

WEDSAFE, INC. (CALIFORNIA CORPORATION)
AON CENTER, 8TH FLOOR
200 E. RANDOLPH STREET
CHICAGO, IL 60601

FOR: INSURANCE BROKERAGE, IN CLASS 36
(U.S. CLS. 100, 101 AND 102).

FIRST USE 9-1-2000; IN COMMERCE 9-1-2000.

THE MARK CONSISTS OF STANDARD CHAR-
ACTERS WITHOUT CLAIM TO ANY PARTICULAR
FONT, STYLE, SIZE, OR COLOR.

OWNER OF U.S. REG. NO. 2,492,227.

SER. NO. 77-365,342, FILED 1-7-2008.

KAREN BRACEY, EXAMINING ATTORNEY

Int. Cl.: 31

Prior U.S. Cls.: 1 and 46

United States Patent and Trademark Office

Reg. No. 3,480,357

Registered Aug. 5, 2008

**TRADEMARK
PRINCIPAL REGISTER**

SADDLE KING

CARGILL, INCORPORATED (DELAWARE COR-
PORATION)
15407 MCGINTY ROAD WEST
WAYZATA, MN 55391

THE MARK CONSISTS OF STANDARD CHAR-
ACTERS WITHOUT CLAIM TO ANY PARTICULAR
FONT, STYLE, SIZE, OR COLOR.

FOR: ANIMAL FEED, IN CLASS 31 (U.S. CLS. 1
AND 46).

SER. NO. 77-365,347, FILED 1-7-2008.

FIRST USE 7-31-1969; IN COMMERCE 7-31-1969.

THEODORE MCBRIDE, EXAMINING ATTORNEY

Int. Cl.: 1

Prior U.S. Cls.: 1, 5, 6, 10, 26 and 46

Reg. No. 3,480,358

United States Patent and Trademark Office

Registered Aug. 5, 2008

**TRADEMARK
PRINCIPAL REGISTER**

DEXELAR

CANTOLINO, CHRISTOPHER R. (UNITED STATES INDIVIDUAL)
2614 MANATEE AVENUE WEST
BRADENTON, FL 34205

FIRST USE 5-1-2007; IN COMMERCE 5-1-2007.

FOR: PLASTIC MOLDING COMPOUNDS FOR USE IN PLASTIC EXTRUSION OPERATIONS; PLASTIC MOLDING COMPOUNDS FOR USE IN THE MANUFACTURE OF MOLDED PLASTIC ARTICLES; PLASTIC MOLDING COMPOUNDS FOR USE IN THE MANUFACTURE OF PLASTIC SHEETS AND FILMS; UNPROCESSED PLASTICS IN ALL FORMS, IN CLASS 1 (U.S. CLS. 1, 5, 6, 10, 26 AND 46).

THE MARK CONSISTS OF STANDARD CHARACTERS WITHOUT CLAIM TO ANY PARTICULAR FONT, STYLE, SIZE, OR COLOR.

SER. NO. 77-365,354, FILED 1-7-2008.

SANJEEV VOHRA, EXAMINING ATTORNEY

Int. Cl.: 37

Prior U.S. Cls.: 100, 103 and 106

United States Patent and Trademark Office

Reg. No. 3,480,359

Registered Aug. 5, 2008

**SERVICE MARK
PRINCIPAL REGISTER**

KING CLEANING SERVICE



We mop 'til we drop.

D&B KING, INC. (FLORIDA CORPORATION)

12564 STONEYBROOK W. PKWY.

WINTER GARDEN, FL 34787

FOR: JANITORIAL SERVICES, IN CLASS 37 (U.S.
CLS. 100, 103 AND 106).

FIRST USE 9-1-1988; IN COMMERCE 9-15-1988.

NO CLAIM IS MADE TO THE EXCLUSIVE
RIGHT TO USE "CLEANING SERVICE", APART
FROM THE MARK AS SHOWN.

THE MARK CONSISTS IN PART OF A STYLIZED
KING FIGURE IN ROBE AND SANDALS WHO IS
MOPPING.

SER. NO. 77-365,388, FILED 1-7-2008.

IRA J. GOODSaid, EXAMINING ATTORNEY

Int. Cl.: 39

Prior U.S. Cls.: 100 and 105

United States Patent and Trademark Office

Reg. No. 3,480,360

Registered Aug. 5, 2008

**SERVICE MARK
PRINCIPAL REGISTER**

United Handy Can

SOYKA, STEVE (UNITED STATES INDIVIDUAL)
18645 COMMUNITY ST.
NORTHRIDGE, CA 91324

FOR: RETURNING EMPTIED HOUSEHOLD
TRASH CANS AFTER TRASH PICKUP, IN CLASS
39 (U.S. CLS. 100 AND 105).

FIRST USE 10-31-2007; IN COMMERCE 11-1-2007.

THE MARK CONSISTS OF STANDARD CHAR-
ACTERS WITHOUT CLAIM TO ANY PARTICULAR
FONT, STYLE, SIZE, OR COLOR.

SER. NO. 77-365,425, FILED 1-7-2008.

ALICE SUE CARRUTHERS, EXAMINING ATTOR-
NEY

Int. Cl.: 11

Prior U.S. Cls.: 13, 21, 23, 31 and 34

United States Patent and Trademark Office

Reg. No. 3,480,361

Registered Aug. 5, 2008

**TRADEMARK
PRINCIPAL REGISTER**

WARMTH FOR THE SOLE

NUHEAT INDUSTRIES LIMITED (CANADA
CORPORATION)
1689 CLIVEDEN AVENUE
DELTA, B.C., CANADA V3M6V5

FOR: ELECTRIC RADIANT HEATERS, IN CLASS
11 (U.S. CLS. 13, 21, 23, 31 AND 34).

FIRST USE 9-12-2005; IN COMMERCE 10-14-2005.

THE MARK CONSISTS OF STANDARD CHAR-
ACTERS WITHOUT CLAIM TO ANY PARTICULAR
FONT, STYLE, SIZE, OR COLOR.

SER. NO. 77-365,472, FILED 1-7-2008.

REBECCA POVARCHUK, EXAMINING ATTOR-
NEY

Int. Cl.: 43

Prior U.S. Cls.: 100 and 101

United States Patent and Trademark Office

Reg. No. 3,480,362

Registered Aug. 5, 2008

**SERVICE MARK
PRINCIPAL REGISTER**



FERALON GROUP L.L.C. (TEXAS LTD LIAB CO)
5051 WESTHEIMER ROAD
HOUSTON, TX 77056

THE MARK CONSISTS OF UNIT/SYMBOL OF
MASS.

FOR: RESTAURANT AND BAR SERVICES, IN
CLASS 43 (U.S. CLS. 100 AND 101).

SER. NO. 77-365,476, FILED 1-7-2008.

FIRST USE 11-20-2007; IN COMMERCE 11-20-2007.

LINDA ORNDORFF, EXAMINING ATTORNEY

Int. Cl.: 45

Prior U.S. Cls.: 100 and 101

United States Patent and Trademark Office

Reg. No. 3,480,363

Registered Aug. 5, 2008

SERVICE MARK
PRINCIPAL REGISTER



PENA, JOSE (DOMINICAN REP INDIVIDUAL)
UNIT #2114

3625 S. DECATUR BLVD.
LAS VEGAS, NV 89103

FOR: ONLINE SOCIAL NETWORKING SERVICES, IN CLASS 45 (U.S. CLS. 100 AND 101).

FIRST USE 10-1-2007; IN COMMERCE 10-1-2007.

THE STIPLING IS FOR SHADING PURPOSES ONLY.

THE MARK CONSISTS OF AN IMAGE OF A PERSON INSIDE OF A CIRCLE AND THE TEXT "ME-AND-THE-WORLD.COM" IN FUTURA MD BT FONT.

SER. NO. 77-365,478, FILED 1-7-2008.

LINDA E. BLOHM, EXAMINING ATTORNEY

Int. Cl.: 35

Prior U.S. Cls.: 100, 101 and 102

United States Patent and Trademark Office

Reg. No. 3,480,364

Registered Aug. 5, 2008

**SERVICE MARK
PRINCIPAL REGISTER**

CHAMBAX

CHAMBAX LLC (OHIO LTD LIAB CO)
SUITE 104
6059 FRANTZ ROAD
DUBLIN, OH 43017

FOR: EMPLOYMENT AGENCIES; EMPLOY-
MENT OUTPLACING SERVICES; EMPLOYMENT
RECRUITING CONSULTATION; EMPLOYMENT
HIRING, RECRUITING, PLACEMENT, AND
STAFFING, IN CLASS 35 (U.S. CLS. 100, 101 AND
102).

FIRST USE 1-18-2007; IN COMMERCE 1-18-2007.

THE MARK CONSISTS OF STANDARD CHAR-
ACTERS WITHOUT CLAIM TO ANY PARTICULAR
FONT, STYLE, SIZE, OR COLOR.

SER. NO. 77-365,508, FILED 1-7-2008.

GEORGE LORENZO, EXAMINING ATTORNEY

Int. Cl.: 35

Prior U.S. Cls.: 100, 101 and 102

United States Patent and Trademark Office

Reg. No. 3,480,365

Registered Aug. 5, 2008

**SERVICE MARK
PRINCIPAL REGISTER**



CHAMBAX LLC (OHIO LTD LIAB CO)
SUITE 305
3556 SULLIVANT AVE.
COLUMBUS, OH 43204

FIRST USE 1-18-2007; IN COMMERCE 1-18-2007.

THE MARK CONSISTS OF THE WORD "CHAM-
BAX", WITH A STYLIZED FIGURE OF A HUMAN
BEING FORMING THE LETTER "X".

FOR: EMPLOYMENT AGENCIES; EMPLOY-
MENT OUTPLACING SERVICES; EMPLOYMENT
RECRUITING CONSULTATION; EMPLOYMENT
HIRING, RECRUITING, PLACEMENT, AND
STAFFING, IN CLASS 35 (U.S. CLS. 100, 101 AND
102).

SER. NO. 77-365,518, FILED 1-7-2008.

GEORGE LORENZO, EXAMINING ATTORNEY

Int. Cl.: 10

Prior U.S. Cls.: 26, 39 and 44

United States Patent and Trademark Office

Reg. No. 3,480,366

Registered Aug. 5, 2008

**TRADEMARK
PRINCIPAL REGISTER**

MELROSE

MEDICAL UNIFORM MANUFACTURING INC
(TEXAS CORPORATION)
4951 TERMINAL ST., SUITE G
BELLAIRE, TX 77401

THE MARK CONSISTS OF STANDARD CHAR-
ACTERS WITHOUT CLAIM TO ANY PARTICULAR
FONT, STYLE, SIZE, OR COLOR.

FOR: MEDICAL GARMENTS, NAMELY,
SCRUBS, IN CLASS 10 (U.S. CLS. 26, 39 AND 44).

SER. NO. 77-365,524, FILED 1-7-2008.

FIRST USE 12-31-2005; IN COMMERCE 12-31-2005.

MAYUR VAGHANI, EXAMINING ATTORNEY

Int. Cl.: 42

Prior U.S. Cls.: 100 and 101

United States Patent and Trademark Office

Reg. No. 3,480,367

Registered Aug. 5, 2008

**SERVICE MARK
PRINCIPAL REGISTER**

TAP . . . POTENTIAL REALIZED

TAP PHARMACEUTICAL PRODUCTS, INC. (DE-
LAWARE CORPORATION)
675 NORTH FIELD DRIVE
LAKE FOREST, IL 60045

FOR: PHARMACEUTICAL RESEARCH AND DE-
VELOPMENT; RESEARCH AND DEVELOPMENT
FOR NEW PRODUCTS FOR OTHERS; SCIENTIFIC
RESEARCH, IN CLASS 42 (U.S. CLS. 100 AND 101).

FIRST USE 10-8-2007; IN COMMERCE 10-8-2007.

THE MARK CONSISTS OF STANDARD CHAR-
ACTERS WITHOUT CLAIM TO ANY PARTICULAR
FONT, STYLE, SIZE, OR COLOR.

OWNER OF U.S. REG. NO. 2,772,902.

SER. NO. 77-365,531, FILED 1-7-2008.

KIMBERLY PERRY, EXAMINING ATTORNEY

Int. Cl.: 41

Prior U.S. Cls.: 100, 101 and 107

United States Patent and Trademark Office

Reg. No. 3,480,368

Registered Aug. 5, 2008

**SERVICE MARK
PRINCIPAL REGISTER**

Valencia Surehunter

ARTIX ENTERTAINMENT, LLC (NEVADA LTD
LIAB CO)
P.O. BOX 2005
LAND O' LAKES, CA 34639

FOR: ENTERTAINMENT SERVICES, NAMELY,
PROVIDING AN ON-LINE COMPUTER GAME, IN
CLASS 41 (U.S. CLS. 100, 101 AND 107).

FIRST USE 4-28-2007; IN COMMERCE 4-28-2007.

THE MARK CONSISTS OF STANDARD CHAR-
ACTERS WITHOUT CLAIM TO ANY PARTICULAR
FONT, STYLE, SIZE, OR COLOR.

SER. NO. 77-365,611, FILED 1-7-2008.

CHRISTOPHER BUONGIORNO, EXAMINING AT-
TORNEY

Int. Cl.: 42

Prior U.S. Cls.: 100 and 101

United States Patent and Trademark Office

Reg. No. 3,480,369

Registered Aug. 5, 2008

**SERVICE MARK
PRINCIPAL REGISTER**

SHABOT, EDWARD J (UNITED STATES INDIVIDUAL)

1138 LINCOLN COURT
ELBERON, NJ 07740

FOR: COMPUTER SERVICES, NAMELY, CREATING AN ONLINE COMMUNITY FOR REGISTERED USERS TO PARTICIPATE IN COMPETITIONS, SHOWCASE THEIR SKILLS, GET FEEDBACK FROM THEIR PEERS, FORM VIRTUAL COMMUNITIES, ENGAGE IN SOCIAL NETWORKING AND IMPROVE THEIR TALENT; COMMERCIAL ART

DESIGN; GRAPHIC ART DESIGN, IN CLASS 42 (U.S. CLS. 100 AND 101).

FIRST USE 9-9-2007; IN COMMERCE 9-9-2007.

THE MARK CONSISTS OF GRAFFITI FONT OF THE WORDS DRAW ON TOP OF LOUD AND AN EXCLAMATION POINT AT THE END OF THE WORD LOUD.

SER. NO. 77-365,628, FILED 1-7-2008.

REBECCA EISINGER, EXAMINING ATTORNEY

Int. Cl.: 35

Prior U.S. Cls.: 100, 101 and 102

United States Patent and Trademark Office

Reg. No. 3,480,370

Registered Aug. 5, 2008

**SERVICE MARK
PRINCIPAL REGISTER**

CASH IN A FLASH

JTH TAX, INC. (DELAWARE CORPORATION)
1716 CORPORATE LANDING PARKWAY
VIRGINIA BEACH, VA 23454

FOR: TAX PREPARATION SERVICES; TAX FILING SERVICES, IN CLASS 35 (U.S. CLS. 100, 101 AND 102).

FIRST USE 1-0-2002; IN COMMERCE 1-0-2002.

THE MARK CONSISTS OF STANDARD CHARACTERS WITHOUT CLAIM TO ANY PARTICULAR FONT, STYLE, SIZE, OR COLOR.

NO CLAIM IS MADE TO THE EXCLUSIVE RIGHT TO USE "CASH", APART FROM THE MARK AS SHOWN.

SER. NO. 77-365,636, FILED 1-7-2008.

DORITT L. CARROLL, EXAMINING ATTORNEY

Int. Cl.: 25

Prior U.S. Cls.: 22 and 39

United States Patent and Trademark Office

Reg. No. 3,480,371

Registered Aug. 5, 2008

**TRADEMARK
PRINCIPAL REGISTER**



HAWKS NEST, LLC. (DELAWARE LTD LIAB CO)
45116 VALLEY CENTRAL WAY
LANCASTER, CA 93536

FIRST USE 10-24-2007; IN COMMERCE 10-24-2007.

OWNER OF U.S. REG. NOS. 2,055,350 AND
2,639,772.

FOR: CLOTHING, NAMELY, ATHLETIC UNIFORMS, CAPS, CLOTH BABY BIBS, COATS, GOLF SHIRTS, GYM SHORTS, HATS, JACKETS, JERSEYS, POLO SHIRTS, KNIT SHIRTS, SWEATER VESTS, PULLOVERS, SWEAT PANTS, SWEAT SHIRTS, SPORT SHIRTS, T- SHIRTS, TANK TOPS, VISORS, WIND RESISTANT JACKETS AND WRISTBANDS, IN CLASS 25 (U.S. CLS. 22 AND 39).

NO CLAIM IS MADE TO THE EXCLUSIVE RIGHT TO USE "LANCASTER", APART FROM THE MARK AS SHOWN.

SER. NO. 77-365,660, FILED 1-7-2008.

SIMON TENG, EXAMINING ATTORNEY

Int. Cl.: 40

Prior U.S. Cls.: 100, 103 and 106

United States Patent and Trademark Office

Reg. No. 3,480,372

Registered Aug. 5, 2008

**SERVICE MARK
PRINCIPAL REGISTER**



HOLLINGSWORTH & VOSE COMPANY (MAS-
SACHUSETTS CORPORATION)
112 WASHINGTON STREET
EAST WALPOLE, MA 02032

FOR: MANUFACTURE OF (I) TECHNICAL AND INDUSTRIAL PAPERS AND NONWOVENS MADE OF NATURAL AND/OR SYNTHETIC FIBERS, (II) FILTER MEDIA COMPOSED OF SYNTHETIC FIBERS FOR LIQUID AND AIR FILTRATION, (III) NONWOVENS FOR USE IN BATTERIES AS AN ELECTROLYTE SEPARATORS, (IV) COMPOSITE FILTRATION MEDIA, ALL TO THE ORDER AND SPECIFICATION OF OTHERS, IN CLASS 40 (U.S. CLS. 100, 103 AND 106).

FIRST USE 11-20-2007; IN COMMERCE 11-20-2007.

OWNER OF U.S. REG. NO. 909,122.

THE COLOR(S) RED, BLACK, WHITE, AND GREY IS/ARE CLAIMED AS A FEATURE OF THE MARK.

THE MARK CONSISTS OF A GREY AND WHITE WORLD GLOBE DESIGN. THE WORDS "ONE COMPANY ONE PROCESS" ARE BLACK AND APPEAR AT THE TOP OF THE WORLD GLOBE DESIGN. THE WORDS "ONE TEAM" ARE BLACK AND APPEAR AT THE BOTTOM OF THE WORLD GLOBE DESIGN. THE STYLIZED LETTERS "HV" ARE RED AND APPEAR IN CENTER OF THE WORLD GLOBE DESIGN.

SER. NO. 77-365,681, FILED 1-7-2008.

JAMES STEIN, EXAMINING ATTORNEY

Int. Cl.: 41

Prior U.S. Cls.: 100, 101 and 107

United States Patent and Trademark Office

Reg. No. 3,480,373

Registered Aug. 5, 2008

**SERVICE MARK
PRINCIPAL REGISTER**

VIEWS YOU CAN USE

MORTGAGE MARKET GUIDE, LLC (DELA-
WARE LTD LIAB CO)
24 SOUTH HOLMDEL ROAD
HOLMDEL, NJ 07733

FOR: PROVIDING NEWSLETTER IN THE FIELD
OF CONSUMER TIPS AND CONSUMER AWARE-
NESS VIA E-MAIL, IN CLASS 41 (U.S. CLS. 100, 101
AND 107).

FIRST USE 1-1-2006; IN COMMERCE 1-1-2006.

THE MARK CONSISTS OF STANDARD CHAR-
ACTERS WITHOUT CLAIM TO ANY PARTICULAR
FONT, STYLE, SIZE, OR COLOR.

SER. NO. 77-365,699, FILED 1-7-2008.

BARBARA GAYNOR, EXAMINING ATTORNEY

Int. Cl.: 16

Prior U.S. Cls.: 2, 5, 22, 23, 29, 37, 38 and 50

United States Patent and Trademark Office

Reg. No. 3,480,374

Registered Aug. 5, 2008

TRADEMARK
PRINCIPAL REGISTER



HAWKS NEST, LLC. (DELAWARE LTD LIAB CO)
45116 VALLEY CENTRAL WAY
LANCASTER, CA 93536

STATIONERY, STICKERS, STICKER ALBUMS AND
TRADING CARDS, IN CLASS 16 (U.S. CLS. 2, 5, 22, 23,
29, 37, 38 AND 50).

FOR: PAPER GOODS AND PRINTED MATTER,
NAMELY, AUTOGRAPH BOOKS, BUMPER STICK-
ERS, CALENDARS, DECALS, SPORT GAME PRO-
GRAMS IN A MAGAZINE FORMAT,
MERCHANDISE BAGS, NOTE PADS, PAPER PEN-
NANTS, PAPER SPORT SCHEDULES, POSTCARDS,
POSTERS, PRINTED AWARDS, PRINTED GAME
TICKETS, PRINTED GUIDES IN THE FIELD OF
BASEBALL WHICH ARE OF INTEREST TO BASE-
BALL FANS, REFERENCE BOOKS IN THE FIELD
OF BASEBALL WHICH ARE OF INTEREST TO
BASEBALL FANS, SCORE CARDS, SCORE SHEETS,

FIRST USE 10-24-2007; IN COMMERCE 10-24-2007.

OWNER OF U.S. REG. NOS. 2,055,350 AND
2,639,772.

NO CLAIM IS MADE TO THE EXCLUSIVE
RIGHT TO USE "LANCASTER", APART FROM
THE MARK AS SHOWN.

SER. NO. 77-365,725, FILED 1-7-2008.

SIMON TENG, EXAMINING ATTORNEY

Int. Cl.: 41

Prior U.S. Cls.: 100, 101 and 107

United States Patent and Trademark Office

Reg. No. 3,480,375

Registered Aug. 5, 2008

**SERVICE MARK
PRINCIPAL REGISTER**

Moglin Punter

ARTIX ENTERTAINMENT, LLC (NEVADA LTD
LIAB CO)
P.O. BOX 2005
LAND O' LAKES, FL 34639

FOR: ENTERTAINMENT SERVICES, NAMELY,
PROVIDING AN ON-LINE COMPUTER GAME, IN
CLASS 41 (U.S. CLS. 100, 101 AND 107).

FIRST USE 6-29-2007; IN COMMERCE 6-29-2007.

THE MARK CONSISTS OF STANDARD CHAR-
ACTERS WITHOUT CLAIM TO ANY PARTICULAR
FONT, STYLE, SIZE, OR COLOR.

SER. NO. 77-365,733, FILED 1-7-2008.

CHRISTOPHER BUONGIORNO, EXAMINING AT-
TORNEY

Int. Cl.: 35

Prior U.S. Cls.: 100, 101 and 102

United States Patent and Trademark Office

Reg. No. 3,480,376

Registered Aug. 5, 2008

**SERVICE MARK
PRINCIPAL REGISTER**

THE POWER OF ZERO

SERVICE PAYMENT PLAN, INC. (ILLINOIS
CORPORATION)
SUITE 230
303 EAST WACKER DRIVE
CHICAGO, IL 60601

FOR: THE ADMINISTRATION OF INSTALL-
MENT PAYMENT PLANS FOR AUTOMOTIVE VE-
HICLE SERVICE CONTRACTS, IN CLASS 35 (U.S.
CLS. 100, 101 AND 102).

FIRST USE 11-19-2007; IN COMMERCE 11-19-2007.

THE MARK CONSISTS OF STANDARD CHAR-
ACTERS WITHOUT CLAIM TO ANY PARTICULAR
FONT, STYLE, SIZE, OR COLOR.

SER. NO. 77-365,781, FILED 1-7-2008.

ANTHONY RINKER, EXAMINING ATTORNEY

Int. Cl.: 41

Prior U.S. Cls.: 100, 101 and 107

United States Patent and Trademark Office

Reg. No. 3,480,377

Registered Aug. 5, 2008

**SERVICE MARK
PRINCIPAL REGISTER**

Jimmy The Eye

ARTIX ENTERTAINMENT, LLC (NEVADA LTD
LIAB CO)
P.O. BOX 2005
SAN FRANCISCO, CA 34639

FOR: ENTERTAINMENT SERVICES, NAMELY,
PROVIDING AN ON-LINE COMPUTER GAME, IN
CLASS 41 (U.S. CLS. 100, 101 AND 107).

FIRST USE 5-18-2007; IN COMMERCE 5-18-2007.

THE MARK CONSISTS OF STANDARD CHAR-
ACTERS WITHOUT CLAIM TO ANY PARTICULAR
FONT, STYLE, SIZE, OR COLOR.

SER. NO. 77-365,788, FILED 1-7-2008.

CHRISTOPHER BUONGIORNO, EXAMINING AT-
TORNEY

Int. Cl.: 11

Prior U.S. Cls.: 13, 21, 23, 31 and 34

Reg. No. 3,480,378

United States Patent and Trademark Office

Registered Aug. 5, 2008

**TRADEMARK
PRINCIPAL REGISTER**

THE ROASTBOX

DE LA FUENTE CASTRO, ALEJANDRO (MEX-
ICO INDIVIDUAL)
FRESNO 707 COL. SANTA MONICA
MONCLOVA, MEXICO 25720

THE MARK CONSISTS OF STANDARD CHAR-
ACTERS WITHOUT CLAIM TO ANY PARTICULAR
FONT, STYLE, SIZE, OR COLOR.

FOR: BARBECUES AND GRILLS, IN CLASS 11
(U.S. CLS. 13, 21, 23, 31 AND 34).

SER. NO. 77-365,819, FILED 1-7-2008.

FIRST USE 11-21-2006; IN COMMERCE 11-21-2006.

ELISSA GARBER KON, EXAMINING ATTORNEY

Int. Cl.: 9

Prior U.S. Cls.: 21, 23, 26, 36 and 38

Reg. No. 3,480,379

United States Patent and Trademark Office

Registered Aug. 5, 2008

**TRADEMARK
PRINCIPAL REGISTER**

BIOTRUST

COGENT, INC. (DELAWARE CORPORATION)
209 FAIR OAKS AVENUE
SO. PASADENA, CA 91030

THE MARK CONSISTS OF STANDARD CHAR-
ACTERS WITHOUT CLAIM TO ANY PARTICULAR
FONT, STYLE, SIZE, OR COLOR.

FOR: COMPUTER SOFTWARE FOR BIOMETRIC
IDENTIFICATION AND VERIFICATION, IN CLASS
9 (U.S. CLS. 21, 23, 26, 36 AND 38).

SER. NO. 77-365,943, FILED 1-7-2008.

FIRST USE 9-0-2006; IN COMMERCE 9-0-2006.

JAY FLOWERS, EXAMINING ATTORNEY

Int. Cl.: 43

Prior U.S. Cls.: 100 and 101

United States Patent and Trademark Office

Reg. No. 3,480,380

Registered Aug. 5, 2008

**SERVICE MARK
PRINCIPAL REGISTER**

HOT BOX PIZZA

HOT BOX PIZZA, LLC (INDIANA LTD LIAB CO)
715 BROAD RIPPLE AVENUE
INDIANAPOLIS, IN 46220

FOR: RESTAURANT SERVICES, IN CLASS 43
(U.S. CLS. 100 AND 101).

FIRST USE 5-0-2006; IN COMMERCE 7-0-2006.

THE MARK CONSISTS OF STANDARD CHARACTERS WITHOUT CLAIM TO ANY PARTICULAR FONT, STYLE, SIZE, OR COLOR.

NO CLAIM IS MADE TO THE EXCLUSIVE RIGHT TO USE "PIZZA", APART FROM THE MARK AS SHOWN.

SER. NO. 77-365,962, FILED 1-7-2008.

ALYSSA PALADINO, EXAMINING ATTORNEY

Int. Cl.: 41

Prior U.S. Cls.: 100, 101 and 107

United States Patent and Trademark Office

Reg. No. 3,480,381

Registered Aug. 5, 2008

**SERVICE MARK
PRINCIPAL REGISTER**

SHACKLE

DANIEL J. MASSEY AND SAMUEL L. MASSEY
(ARKANSAS PARTNERSHIP)
P.O. BOX 323
DAMASCUS, AR 72039

THE MARK CONSISTS OF STANDARD CHAR-
ACTERS WITHOUT CLAIM TO ANY PARTICULAR
FONT, STYLE, SIZE, OR COLOR.

FOR: ENTERTAINMENT, NAMELY, LIVE PER-
FORMANCES BY A MUSICAL BAND, IN CLASS 41
(U.S. CLS. 100, 101 AND 107).

SER. NO. 77-365,972, FILED 1-7-2008.

FIRST USE 7-2-2004; IN COMMERCE 7-2-2004.

BRENDAN MCCAULEY, EXAMINING ATTORNEY

Int. Cl.: 43

Prior U.S. Cls.: 100 and 101

United States Patent and Trademark Office

Reg. No. 3,480,382

Registered Aug. 5, 2008

SERVICE MARK
PRINCIPAL REGISTER



HOT BOX PIZZA, LLC (INDIANA LTD LIAB CO)
715 BROAD RIPPLE AVENUE
INDIANAPOLIS, IN 46220

FOR: RESTAURANT SERVICES, IN CLASS 43
(U.S. CLS. 100 AND 101).

FIRST USE 5-0-2006; IN COMMERCE 7-0-2006.

NO CLAIM IS MADE TO THE EXCLUSIVE
RIGHT TO USE "PIZZA" , APART FROM THE
MARK AS SHOWN.

THE MARK CONSISTS OF THE WORDS "HOT
BOX PIZZA" IN LINEAR FORM, SURROUNDED BY
AN IRREGULAR LINE FORMING A RECTANGU-
LAR SHAPE BELOW A STYLIZED FLAME DESIGN.

SER. NO. 77-365,990, FILED 1-7-2008.

ALYSSA PALADINO, EXAMINING ATTORNEY

Int. Cl.: 3

Prior U.S. Cls.: 1, 4, 6, 50, 51 and 52

United States Patent and Trademark Office

Reg. No. 3,480,383

Registered Aug. 5, 2008

TRADEMARK
PRINCIPAL REGISTER



BERRY BUTTER, LLC (MARYLAND LTD LIAB
CO)
5024 EDGAR TERRACE
BALTIMORE, MD 21214

FOR: SKIN CARE PRODUCTS, NAMELY, SHEA BUTTER FOR COSMETIC PURPOSES, BODY CREAM, HAND CREAM, FOOT CREAM, FACIAL CREAM; PERSONAL CARE PRODUCTS, NAMELY, SHEA BUTTER FOR MOISTURIZING PURPOSES, SHEA BUTTER FOR SOOTHING PURPOSES, IN CLASS 3 (U.S. CLS. 1, 4, 6, 50, 51 AND 52).

FIRST USE 12-3-2006; IN COMMERCE 12-3-2006.

NO CLAIM IS MADE TO THE EXCLUSIVE RIGHT TO USE "BERRY BUTTER" AND "SHEA BUTTER", APART FROM THE MARK AS SHOWN.

THE MARK CONSISTS OF THE LITERAL ELEMENT "BERRY BUTTER" IS ADJACENT TO A STANDING TREE WITH A SUN RADIATING FROM BEHIND SAID TREE. THE LITERAL ELEMENT "SHEA BUTTER WITH A TWIST" IS DIRECTLY BENEATH THE LITERAL ELEMENT "BERRY BUTTER" WITH INTERPLAY BETWEEN THE LETTER "Y" IN "BERRY" AND THE WORD "A." IMMEDIATELY FOLLOWING "SHEA BUTTER WITH A TWIST" IS A SINGLE LEAF THAT ANGULARLY DEPENDS FROM A SOLID HORIZONTAL RECTANGULAR LINE.

SER. NO. 77-365,992, FILED 1-7-2008.

KATINA MISTER, EXAMINING ATTORNEY

Int. Cl.: 43

Prior U.S. Cls.: 100 and 101

United States Patent and Trademark Office

Reg. No. 3,480,384

Registered Aug. 5, 2008

**SERVICE MARK
PRINCIPAL REGISTER**

THE DRUNKEN FISH

MUNSOK SO (UNITED STATES INDIVIDUAL)

13217 TAKARA DRIVE

TOWN AND COUNTRY, MO 63131

FOR: RESTAURANT AND BAR SERVICES, IN
CLASS 43 (U.S. CLS. 100 AND 101).

FIRST USE 5-0-2003; IN COMMERCE 5-0-2003.

THE MARK CONSISTS OF STANDARD CHAR-
ACTERS WITHOUT CLAIM TO ANY PARTICULAR
FONT, STYLE, SIZE, OR COLOR.

NO CLAIM IS MADE TO THE EXCLUSIVE
RIGHT TO USE "FISH", APART FROM THE MARK
AS SHOWN.

SER. NO. 77-366,005, FILED 1-7-2008.

DANIEL CAPSHAW, EXAMINING ATTORNEY

Int. Cl.: 43

Prior U.S. Cls.: 100 and 101

United States Patent and Trademark Office

Reg. No. 3,480,385

Registered Aug. 5, 2008

**SERVICE MARK
PRINCIPAL REGISTER**



HOT BOX PIZZA, LLC (INDIANA LTD LIAB CO)
715 BROAD RIPPLE AVENUE
INDIANAPOLIS, IN 46220

FOR: RESTAURANT SERVICES, IN CLASS 43
(U.S. CLS. 100 AND 101).

FIRST USE 5-0-2006; IN COMMERCE 7-0-2006.

NO CLAIM IS MADE TO THE EXCLUSIVE
RIGHT TO USE "PIZZA" , APART FROM THE
MARK AS SHOWN.

THE MARK CONSISTS OF THE WORDS "HOT
BOX PIZZA" IN NONLINEAR FORM, SURROUN-
DED BY AN IRREGULAR LINE FORMING A
SQUARE SHAPE BELOW A STYLIZED FLAME
DESIGN.

SER. NO. 77-366,012, FILED 1-7-2008.

ALYSSA PALADINO, EXAMINING ATTORNEY

Int. Cl.: 25

Prior U.S. Cls.: 22 and 39

United States Patent and Trademark Office

Reg. No. 3,480,386

Registered Aug. 5, 2008

**TRADEMARK
PRINCIPAL REGISTER**

LexieGirl Clothing

LEXIEGIRL CLOTHING, INC. (CALIFORNIA CORPORATION)
18337 CHATHAM LANE
NORTHRIDGE, CA 91326

FOR: CLOTHING, NAMELY, SWEATSHIRTS, SWEATERS, LONG SLEEVE SHIRTS, SHORT SLEEVE SHIRTS, TANK TOPS, PANTS, JACKETS, IN CLASS 25 (U.S. CLS. 22 AND 39).

FIRST USE 10-0-2003; IN COMMERCE 9-0-2005.

THE MARK CONSISTS OF STANDARD CHARACTERS WITHOUT CLAIM TO ANY PARTICULAR FONT, STYLE, SIZE, OR COLOR.

NO CLAIM IS MADE TO THE EXCLUSIVE RIGHT TO USE "CLOTHING", APART FROM THE MARK AS SHOWN.

SER. NO. 77-366,050, FILED 1-7-2008.

MICHAEL KEATING, EXAMINING ATTORNEY

Int. Cl.: 35

Prior U.S. Cls.: 100, 101 and 102

United States Patent and Trademark Office

Reg. No. 3,480,387

Registered Aug. 5, 2008

**SERVICE MARK
PRINCIPAL REGISTER**

Inspire Life, Breathe Free

AMERICAN LUNG ASSOCIATION OF THE
SOUTHEAST, INCORPORATED (FLORIDA
CORPORATION)
5526 ARLINGTON ROAD
JACKSONVILLE, FL 32211

THE MARK CONSISTS OF STANDARD CHAR-
ACTERS WITHOUT CLAIM TO ANY PARTICULAR
FONT, STYLE, SIZE, OR COLOR.

FOR: ASSOCIATION SERVICES, NAMELY, PRO-
MOTING THE INTERESTS OF FIGHTING LUNG
DISEASE, IN CLASS 35 (U.S. CLS. 100, 101 AND 102).

SER. NO. 77-366,085, FILED 1-7-2008.

FIRST USE 10-5-2007; IN COMMERCE 10-5-2007.

SUSAN STIGLITZ, EXAMINING ATTORNEY

Int. Cl.: 3

Prior U.S. Cls.: 1, 4, 6, 50, 51 and 52

United States Patent and Trademark Office

Reg. No. 3,480,388

Registered Aug. 5, 2008

**TRADEMARK
PRINCIPAL REGISTER**

JOLLY RANCHER

HUHTAMAKI FINANCE B.V. (NETHERLANDS
CORPORATION)
JUPITERSTRAAT 102
2132 HE HOOFDDORP, NETHERLANDS

FOR: LIP BALM; LIP GLOSS, IN CLASS 3 (U.S.
CLS. 1, 4, 6, 50, 51 AND 52).

FIRST USE 7-19-2006; IN COMMERCE 7-19-2006.

THE MARK CONSISTS OF STANDARD CHAR-
ACTERS WITHOUT CLAIM TO ANY PARTICULAR
FONT, STYLE, SIZE, OR COLOR.

OWNER OF U.S. REG. NOS. 168,458, 3,289,124 AND
OTHERS.

SER. NO. 77-366,125, FILED 1-8-2008.

DAWN FELDMAN, EXAMINING ATTORNEY

Int. Cl.: 19

Prior U.S. Cls.: 1, 12, 33 and 50

United States Patent and Trademark Office

Reg. No. 3,480,389

Registered Aug. 5, 2008

**TRADEMARK
PRINCIPAL REGISTER**

ECOSHEL

KIRKEY, BRYAN (UNITED STATES INDIVIDUAL)
3111 VERDUN DR. NW
ATLANTA, GA 30305

THE MARK CONSISTS OF STANDARD CHARACTERS WITHOUT CLAIM TO ANY PARTICULAR FONT, STYLE, SIZE, OR COLOR.

FOR: BUILDING MATERIALS, NAMELY, SHINGLES, PREFABRICATED SHINGLE SETS, PREFABRICATED SHINGLE PANELS AND BOARDS, IN CLASS 19 (U.S. CLS. 1, 12, 33 AND 50).

SER. NO. 77-366,126, FILED 1-8-2008.

FIRST USE 10-21-2005; IN COMMERCE 10-21-2005.

JORDAN BAKER, EXAMINING ATTORNEY

Int. Cl.: 3

Prior U.S. Cls.: 1, 4, 6, 50, 51 and 52

United States Patent and Trademark Office

Reg. No. 3,480,390

Registered Aug. 5, 2008

**TRADEMARK
PRINCIPAL REGISTER**

GOOD & PLENTY

HUHTAMAKI FINANCE B.V. (NETHERLANDS
CORPORATION)
JUPITERSTRAAT 102
2132 HE HOOFFDORP, NETHERLANDS

FOR: LIP BALM, IN CLASS 3 (U.S. CLS. 1, 4, 6, 50,
51 AND 52).

FIRST USE 3-31-2007; IN COMMERCE 3-31-2007.

THE MARK CONSISTS OF STANDARD CHAR-
ACTERS WITHOUT CLAIM TO ANY PARTICULAR
FONT, STYLE, SIZE, OR COLOR.

OWNER OF U.S. REG. NOS. 128,924, 132,877, AND
243,197.

SER. NO. 77-366,127, FILED 1-8-2008.

DAWN FELDMAN, EXAMINING ATTORNEY

Int. Cl.: 3

Prior U.S. Cls.: 1, 4, 6, 50, 51 and 52

United States Patent and Trademark Office

Reg. No. 3,480,391

Registered Aug. 5, 2008

**TRADEMARK
PRINCIPAL REGISTER**

WHOPPERS

HUHTAMAKI FINANCE B.V. (NETHERLANDS
CORPORATION)
JUPITERSTRAAT 102
2132 HE HOOFDORP, NETHERLANDS

FOR: LIP BALM, IN CLASS 3 (U.S. CLS. 1, 4, 6, 50,
51 AND 52).

FIRST USE 3-31-2007; IN COMMERCE 3-31-2007.

THE MARK CONSISTS OF STANDARD CHAR-
ACTERS WITHOUT CLAIM TO ANY PARTICULAR
FONT, STYLE, SIZE, OR COLOR.

OWNER OF U.S. REG. NO. 965,678.

SER. NO. 77-366,129, FILED 1-8-2008.

DAWN FELDMAN, EXAMINING ATTORNEY

Int. Cl.: 9

Prior U.S. Cls.: 21, 23, 26, 36 and 38

Reg. No. 3,480,392

United States Patent and Trademark Office

Registered Aug. 5, 2008

**TRADEMARK
PRINCIPAL REGISTER**

ZEUS

KAPRO INDUSTRIES LTD (ISRAEL CORPORATION)
KIBBUTZ KADARIM M. P.
BIKAT BEIT HAKEREM, ISRAEL 12390

THE MARK CONSISTS OF STANDARD CHARACTERS WITHOUT CLAIM TO ANY PARTICULAR FONT, STYLE, SIZE, OR COLOR.

FOR: SPIRIT LEVELS, IN CLASS 9 (U.S. CLS. 21, 23, 26, 36 AND 38).

SER. NO. 77-366,176, FILED 1-8-2008.

FIRST USE 11-4-2007; IN COMMERCE 11-4-2007.

BARBARA BROWN, EXAMINING ATTORNEY

Int. Cl.: 20

Prior U.S. Cls.: 2, 13, 22, 25, 32 and 50

Reg. No. 3,480,393

United States Patent and Trademark Office

Registered Aug. 5, 2008

**TRADEMARK
PRINCIPAL REGISTER**

POW-R-PAX

MANNA MARKETING & DEVELOPMENT
GROUP, INC. (TEXAS CORPORATION)
9140 PREMIERE ROW ROAD
DALLAS, TX 75247

THE MARK CONSISTS OF STANDARD CHAR-
ACTERS WITHOUT CLAIM TO ANY PARTICULAR
FONT, STYLE, SIZE, OR COLOR.

FOR: TABLES USED AS SURFACES FOR CUT-
TING FABRICS IN THE GARMENT INDUSTRY, IN
CLASS 20 (U.S. CLS. 2, 13, 22, 25, 32 AND 50).

SER. NO. 77-366,221, FILED 1-8-2008.

FIRST USE 12-2-1971; IN COMMERCE 12-2-1971.

ALICE BENMAMAN, EXAMINING ATTORNEY

Int. Cls.: 35, 40 and 42

Prior U.S. Cls.: 100, 101, 102, 103 and 106

United States Patent and Trademark Office

Reg. No. 3,480,394

Registered Aug. 5, 2008

**SERVICE MARK
PRINCIPAL REGISTER**

SFC

SFC, LTD. (OHIO LTD LIAB CO)
110 E. WOODRUFF AVENUE
TOLEDO, OH 43604

FOR: PROMOTION AND MARKETING SERVICES AND RELATED CONSULTING, IN CLASS 35 (U.S. CLS. 100, 101 AND 102).

FIRST USE 0-0-1983; IN COMMERCE 0-0-1983.

FOR: DESIGN PRINTING FOR OTHERS; PRINTING OF ADVERTISING MATTER; PRINTING, IN CLASS 40 (U.S. CLS. 100, 103 AND 106).

FIRST USE 0-0-1983; IN COMMERCE 0-0-1983.

FOR: GRAPHIC DESIGN SERVICES, IN CLASS 42 (U.S. CLS. 100 AND 101).

FIRST USE 0-0-1983; IN COMMERCE 0-0-1983.

THE MARK CONSISTS OF STANDARD CHARACTERS WITHOUT CLAIM TO ANY PARTICULAR FONT, STYLE, SIZE, OR COLOR.

SER. NO. 77-366,236, FILED 1-8-2008.

KRISTIN DAHLING, EXAMINING ATTORNEY

Int. Cl.: 16

Prior U.S. Cls.: 2, 5, 22, 23, 29, 37, 38 and 50

United States Patent and Trademark Office

Reg. No. 3,480,395

Registered Aug. 5, 2008

**TRADEMARK
PRINCIPAL REGISTER**

GTtested

FXEXPRESS PUBLICATIONS, INC. (PENNSYLVANIA CORPORATION)
P.O. BOX 508
YARDLEY, PA 190678508

FOR: A COLUMN, FEATURE OR SECTION IN A MAGAZINE IN THE FIELD OF TRAVEL CONSISTING OF REVIEWS OF HOTELS AND AIRLINES, IN CLASS 16 (U.S. CLS. 2, 5, 22, 23, 29, 37, 38 AND 50).

FIRST USE 0-0-2003; IN COMMERCE 0-0-2003.

OWNER OF U.S. REG. NOS. 2,966,810 AND 3,019,821.

THE MARK CONSISTS OF THE STYLIZED WORDS "GTTESTED".

SER. NO. 77-366,246, FILED 1-8-2008.

CHARLOTTE CORWIN, EXAMINING ATTORNEY

Int. Cl.: 25

Prior U.S. Cls.: 22 and 39

United States Patent and Trademark Office

Reg. No. 3,480,396

Registered Aug. 5, 2008

**TRADEMARK
PRINCIPAL REGISTER**

VERTICAL CUT

HESTRA-HANDSKEN AB (SWEDEN CORPORATION)
POST OFFICE BOX 116
S-330 HESTRA, SWEDEN

THE MARK CONSISTS OF STANDARD CHARACTERS WITHOUT CLAIM TO ANY PARTICULAR FONT, STYLE, SIZE, OR COLOR.

FOR: SKI GLOVES, IN CLASS 25 (U.S. CLS. 22 AND 39).

SER. NO. 77-366,266, FILED 1-8-2008.

FIRST USE 1-0-1990; IN COMMERCE 3-0-1996.

ESTHER A. BORSUK, EXAMINING ATTORNEY

Int. Cl.: 37

Prior U.S. Cls.: 100, 103 and 106

United States Patent and Trademark Office

Reg. No. 3,480,397

Registered Aug. 5, 2008

**SERVICE MARK
PRINCIPAL REGISTER**

Pit Stop

PIT STOP RESTORATION LLC (MINNESOTA
LTD LIAB CO)
SUITE E
8616 XYLON AVE N
BROOKLYN PARK, MN 55445

FOR: GROUT RECOLORING SERVICES; RE-
STORATION IN THE FIELD OF TILE AND GROUT
SURFACES; SPECIFICALLY REMOVAL OF EXI-
SITNG CONTAMINANTS, SURFACE PREPARA-
TION, FINISHING, AND SEALING THE ENTIRE
SURFACE, IN CLASS 37 (U.S. CLS. 100, 103 AND 106).

FIRST USE 2-0-2007; IN COMMERCE 2-0-2007.

THE MARK CONSISTS OF STANDARD CHAR-
ACTERS WITHOUT CLAIM TO ANY PARTICULAR
FONT, STYLE, SIZE, OR COLOR.

SER. NO. 77-366,281, FILED 1-8-2008.

ADA HAN, EXAMINING ATTORNEY

Int. Cl.: 38

Prior U.S. Cls.: 100, 101 and 104

United States Patent and Trademark Office

Reg. No. 3,480,398

Registered Aug. 5, 2008

**SERVICE MARK
PRINCIPAL REGISTER**

WMMR

GREATER MEDIA, INC. (DELAWARE COR-
PORATION)
SUITE 300
35 BRAINTREE HILL PARK
BRAINTREE, MA 02184

THE MARK CONSISTS OF STANDARD CHAR-
ACTERS WITHOUT CLAIM TO ANY PARTICULAR
FONT, STYLE, SIZE, OR COLOR.

FOR: RADIO BROADCASTING, IN CLASS 38 (U.S.
CLS. 100, 101 AND 104).

SER. NO. 77-366,295, FILED 1-8-2008.

FIRST USE 1-1-1967; IN COMMERCE 1-1-1967.

JOHN GARTNER, EXAMINING ATTORNEY

Int. Cl.: 29

Prior U.S. Cl.: 46

United States Patent and Trademark Office

Reg. No. 3,480,399

Registered Aug. 5, 2008

**TRADEMARK
PRINCIPAL REGISTER**

DELICIOUS HAS A DARK SIDE

LIFESTYLE EVOLUTION, INC. (PENNSYLVANIA CORPORATION)
817 MAIN STREET
SHARPSBURG, PA 15215

THE MARK CONSISTS OF STANDARD CHARACTERS WITHOUT CLAIM TO ANY PARTICULAR FONT, STYLE, SIZE, OR COLOR.

FOR: PROTEIN BASED, NUTRIENT-DENSE SNACK BARS, IN CLASS 29 (U.S. CL. 46).

SER. NO. 77-366,304, FILED 1-8-2008.

FIRST USE 1-4-2008; IN COMMERCE 1-7-2008.

GINA HAYES, EXAMINING ATTORNEY

Int. Cl.: 38

Prior U.S. Cls.: 100, 101 and 104

United States Patent and Trademark Office

Reg. No. 3,480,400

Registered Aug. 5, 2008

**SERVICE MARK
PRINCIPAL REGISTER**

WRIF

GREATER MEDIA, INC. (DELAWARE COR-
PORATION)
SUITE 300
35 BRAINTREE HILL PARK
BRAINTREE, MA 02184

THE MARK CONSISTS OF STANDARD CHAR-
ACTERS WITHOUT CLAIM TO ANY PARTICULAR
FONT, STYLE, SIZE, OR COLOR.

FOR: RADIO BROADCASTING, IN CLASS 38 (U.S.
CLS. 100, 101 AND 104).

SER. NO. 77-366,331, FILED 1-8-2008.

FIRST USE 3-1-1971; IN COMMERCE 3-1-1971.

JOHN GARTNER, EXAMINING ATTORNEY

Int. Cls.: 9 and 42

Prior U.S. Cls.: 21, 23, 26, 36, 38, 100 and 101

United States Patent and Trademark Office

Reg. No. 3,480,401

Registered Aug. 5, 2008

**TRADEMARK
SERVICE MARK
PRINCIPAL REGISTER**

STOREFRONT 7.0

LAGARDE, INCORPORATED (DELAWARE CORPORATION)
25055 WEST VALLEY PARKWAY
OLATHE, KS 66061

FOR: COMPUTER SOFTWARE USED BY BUSINESSES TO CONDUCT ELECTRONIC COMMERCE OVER A NETWORK, IN CLASS 9 (U.S. CLS. 21, 23, 26, 36 AND 38).

FIRST USE 9-21-2007; IN COMMERCE 9-21-2007.

FOR: PROVIDING TEMPORARY USE OF ON-LINE NON-DOWNLOADABLE SOFTWARE FOR THE CREATION AND MAINTENANCE OF ELEC-

TRONIC COMMERCE WEB SITES, IN CLASS 42 (U.S. CLS. 100 AND 101).

FIRST USE 9-21-2007; IN COMMERCE 9-21-2007.

THE MARK CONSISTS OF STANDARD CHARACTERS WITHOUT CLAIM TO ANY PARTICULAR FONT, STYLE, SIZE, OR COLOR.

OWNER OF U.S. REG. NOS. 2,546,056, 2,790,819 AND OTHERS.

SER. NO. 77-366,393, FILED 1-8-2008.

RICHARD WHITE, EXAMINING ATTORNEY

Int. Cl.: 37

Prior U.S. Cls.: 100, 103 and 106

United States Patent and Trademark Office

Reg. No. 3,480,402

Registered Aug. 5, 2008

**SERVICE MARK
PRINCIPAL REGISTER**

**BUILDING NEIGHBORHOODS -
CREATING NEIGHBORS**

FIEL, PAUL (UNITED STATES INDIVIDUAL)
#196
2160 E. FRY BLVD.
SIERRA VISTA, AZ 85635

THE MARK CONSISTS OF STANDARD CHAR-
ACTERS WITHOUT CLAIM TO ANY PARTICULAR
FONT, STYLE, SIZE, OR COLOR.

FOR: REAL ESTATE DEVELOPMENT, IN CLASS
37 (U.S. CLS. 100, 103 AND 106).

SER. NO. 77-366,432, FILED 1-8-2008.

FIRST USE 1-1-2007; IN COMMERCE 1-1-2007.

KIM MONINGHOFF, EXAMINING ATTORNEY

Int. Cl.: 18

Prior U.S. Cls.: 1, 2, 3, 22 and 41

Reg. No. 3,480,403

United States Patent and Trademark Office

Registered Aug. 5, 2008

**TRADEMARK
PRINCIPAL REGISTER**

GreenCow Rawhide

RUSH DIRECT, INC. (ILLINOIS CORPORATION)
800 DILLON DRIVE
WOOD DALE, IL 60191

FOR: RAWHIDE CHEWS FOR DOGS, IN CLASS
18 (U.S. CLS. 1, 2, 3, 22 AND 41).

FIRST USE 5-1-2004; IN COMMERCE 1-1-2006.

THE MARK CONSISTS OF STANDARD CHARACTERS WITHOUT CLAIM TO ANY PARTICULAR FONT, STYLE, SIZE, OR COLOR.

NO CLAIM IS MADE TO THE EXCLUSIVE RIGHT TO USE "RAWHIDE", APART FROM THE MARK AS SHOWN.

SER. NO. 77-366,485, FILED 1-8-2008.

KRISTIN DAHLING, EXAMINING ATTORNEY

Int. Cl.: 42

Prior U.S. Cls.: 100 and 101

United States Patent and Trademark Office

Reg. No. 3,480,404

Registered Aug. 5, 2008

**SERVICE MARK
PRINCIPAL REGISTER**

ENTEGRION

ENTEGRION, INC. (DELAWARE CORPORATION)
79 TW ALEXANDER DRIVE
4401 RESEARCH COMMONS, SUITE 200
RESEARCH TRIANGLE PARK, NC 27709

FOR: RESEARCH AND DEVELOPMENT SERVICES IN THE LIFE SCIENCES FIELD FOR IDENTIFICATION, INVENTION, DEVELOPMENT AND MANUFACTURING OF MEDICAL DEVICES AND MEDICAL TECHNOLOGIES FOR HEMOSTASIS, WOUND MANAGEMENT, RESUSCITATION AND

TISSUE REPAIR, IN CLASS 42 (U.S. CLS. 100 AND 101).

FIRST USE 9-7-2005; IN COMMERCE 9-7-2005.

THE MARK CONSISTS OF STANDARD CHARACTERS WITHOUT CLAIM TO ANY PARTICULAR FONT, STYLE, SIZE, OR COLOR.

SER. NO. 77-366,509, FILED 1-8-2008.

ERNEST SHOSHO, EXAMINING ATTORNEY

Int. Cl.: 41

Prior U.S. Cls.: 100, 101 and 107

United States Patent and Trademark Office

Reg. No. 3,480,405

Registered Aug. 5, 2008

**SERVICE MARK
PRINCIPAL REGISTER**

PHARMATELEVISION

PHARMA VENTURES LTD (UNITED KINGDOM CORPORATION)
MALDALEN CENTRE, OXFORD SCIENCE PARK
OXFORD, OXFORDSHIRE, UNITED KINGDOM
OX44GA

FOR: PROVIDING NEWS, INFORMATION AND COMMENTARY IN THE FIELDS OF PHARMACEUTICALS AND BIOTECHNOLOGY; PROVIDING NEWS HIGHLIGHTS AND INTERVIEWS WITH INDUSTRY EXPERTS IN THE FIELDS OF PHARMACEUTICALS AND BIOTECHNOLOGY, IN CLASS 41 (U.S. CLS. 100, 101 AND 107).

FIRST USE 8-21-2006; IN COMMERCE 8-21-2006.

THE MARK CONSISTS OF STANDARD CHARACTERS WITHOUT CLAIM TO ANY PARTICULAR FONT, STYLE, SIZE, OR COLOR.

OWNER OF U.S. REG. NOS. 2,676,271 AND 2,774,491.

SER. NO. 77-366,511, FILED 1-8-2008.

JOHN WILKE, EXAMINING ATTORNEY

Int. Cl.: 28

Prior U.S. Cls.: 22, 23, 38 and 50

United States Patent and Trademark Office

Reg. No. 3,480,406

Registered Aug. 5, 2008

**TRADEMARK
PRINCIPAL REGISTER**

TEETER TWIRL

TROXEL PRODUCTS, LLC (DELAWARE LTD
LIAB CO)
100 TUBB AVENUE
WEST POINT, MS 39773

FOR: CHILDREN'S RIDE-ON TOYS, IN CLASS 28
(U.S. CLS. 22, 23, 38 AND 50).

FIRST USE 1-13-2000; IN COMMERCE 1-13-2000.

THE MARK CONSISTS OF STANDARD CHAR-
ACTERS WITHOUT CLAIM TO ANY PARTICULAR
FONT, STYLE, SIZE, OR COLOR.

OWNER OF U.S. REG. NO. 2,411,582.

SER. NO. 77-366,519, FILED 1-8-2008.

COURTNEY MCCORMICK, EXAMINING ATTOR-
NEY

Int. Cl.: 21

Prior U.S. Cls.: 2, 13, 23, 29, 30, 33, 40 and 50

Reg. No. 3,480,407

United States Patent and Trademark Office

Registered Aug. 5, 2008

**TRADEMARK
PRINCIPAL REGISTER**

WILD BIRDS GALORE

BACON PRODUCTS CORPORATION (TENNESSEE CORPORATION)

1605 SHEPHERD ROAD

CHATTANOOGA, TN 37421

FOR: BIRD FEEDERS, IN CLASS 21 (U.S. CLS. 2, 13, 23, 29, 30, 33, 40 AND 50).

FIRST USE 11-5-2007; IN COMMERCE 11-5-2007.

THE MARK CONSISTS OF STANDARD CHARACTERS WITHOUT CLAIM TO ANY PARTICULAR FONT, STYLE, SIZE, OR COLOR.

NO CLAIM IS MADE TO THE EXCLUSIVE RIGHT TO USE "WILD BIRDS", APART FROM THE MARK AS SHOWN.

SER. NO. 77-366,534, FILED 1-8-2008.

DAVID H. STINE, EXAMINING ATTORNEY

Int. Cl.: 21

Prior U.S. Cls.: 2, 13, 23, 29, 30, 33, 40 and 50

United States Patent and Trademark Office

Reg. No. 3,480,408

Registered Aug. 5, 2008

**TRADEMARK
PRINCIPAL REGISTER**



BACON PRODUCTS CORPORATION (TENNESSEE CORPORATION)
1605 SHEPHERD ROAD
CHATTANOOGA, TN 37421

FOR: BIRD FEEDERS, IN CLASS 21 (U.S. CLS. 2, 13, 23, 29, 30, 33, 40 AND 50).

FIRST USE 11-5-2007; IN COMMERCE 11-5-2007.

NO CLAIM IS MADE TO THE EXCLUSIVE RIGHT TO USE "WILD BIRDS" AND THE REPRESENTATION OF A BIRD, APART FROM THE MARK AS SHOWN.

SENTATION OF A BIRD, APART FROM THE MARK AS SHOWN.

THE MARK CONSISTS OF THE WORDS "WILD BIRDS GALORE" IN STYLIZED FONT, AND A CARDINAL BIRD PERCHED ON A BRANCH, ALL SUPERIMPOSED OVER A BIRDSEED WREATH.

SER. NO. 77-366,539, FILED 1-8-2008.

DAVID H. STINE, EXAMINING ATTORNEY

Int. Cl.: 25

Prior U.S. Cls.: 22 and 39

United States Patent and Trademark Office

Reg. No. 3,480,409

Registered Aug. 5, 2008

**TRADEMARK
PRINCIPAL REGISTER**

WHITE'S PACS

WHITE'S BOOTS, INC. (WASHINGTON CORPORATION)
4002 EAST FERRY AVENUE
SPOKANE, WA 99202

FOR: BOOTS, IN CLASS 25 (U.S. CLS. 22 AND 39).

FIRST USE 4-10-2006; IN COMMERCE 4-10-2006.

THE MARK CONSISTS OF STANDARD CHARACTERS WITHOUT CLAIM TO ANY PARTICULAR FONT, STYLE, SIZE, OR COLOR.

OWNER OF U.S. REG. NOS. 1,655,599 AND 2,075,847.

NO CLAIM IS MADE TO THE EXCLUSIVE RIGHT TO USE "PACS", APART FROM THE MARK AS SHOWN.

SER. NO. 77-366,540, FILED 1-8-2008.

VIVIAN MICZNIK FIRST, EXAMINING ATTORNEY

Int. Cl.: 25

Prior U.S. Cls.: 22 and 39

United States Patent and Trademark Office

Reg. No. 3,480,410

Registered Aug. 5, 2008

**TRADEMARK
PRINCIPAL REGISTER**

WHITE'S SNOWCAT

WHITE'S BOOTS, INC. (WASHINGTON CORPORATION)
4002 EAST FERRY AVENUE
SPOKANE, WA 99202

OWNER OF U.S. REG. NOS. 1,655,599 AND 2,075,847.

FOR: BOOTS, IN CLASS 25 (U.S. CLS. 22 AND 39).

SER. NO. 77-366,553, FILED 1-8-2008.

FIRST USE 10-1-2006; IN COMMERCE 10-1-2006.

THE MARK CONSISTS OF STANDARD CHARACTERS WITHOUT CLAIM TO ANY PARTICULAR FONT, STYLE, SIZE, OR COLOR.

VIVIAN MICZNIK FIRST, EXAMINING ATTORNEY

Int. Cl.: 42

Prior U.S. Cls.: 100 and 101

United States Patent and Trademark Office

Reg. No. 3,480,411

Registered Aug. 5, 2008

**SERVICE MARK
PRINCIPAL REGISTER**

VoiceForge

CEPSTRAL, LLC (PENNSYLVANIA LTD LIAB
CO)
1801 CARSON STREET
PITTSBURGH, PA 15203

FOR: PROVIDING AN INTERACTIVE WEBSITE
FOR ALLOWING OTHERS TO BUILD AND PUB-
LISH VOICES, IN CLASS 42 (U.S. CLS. 100 AND 101).

FIRST USE 7-15-2007; IN COMMERCE 8-20-2007.

THE MARK CONSISTS OF STANDARD CHAR-
ACTERS WITHOUT CLAIM TO ANY PARTICULAR
FONT, STYLE, SIZE, OR COLOR.

SER. NO. 77-366,564, FILED 1-8-2008.

CHRISTOPHER BUONGIORNO, EXAMINING AT-
TORNEY

Int. Cl.: 35

Prior U.S. Cls.: 100, 101 and 102

United States Patent and Trademark Office

Reg. No. 3,480,412

Registered Aug. 5, 2008

**SERVICE MARK
PRINCIPAL REGISTER**

PLEXUS RESEARCH

PLEXUS RESEARCH, INC. (MASSACHUSETTS
CORPORATION)
CORPORATE CENTER, WEST WING
550 COCHITUATE ROAD
FRAMINGHAM, MA 017019344

FOR: BUSINESS CONSULTING AND INFORMATION SERVICES FOR UTILITIES AND ENERGY TECHNOLOGY ENTERPRISES, IN CLASS 35 (U.S. CLS. 100, 101 AND 102).

FIRST USE 12-31-1985; IN COMMERCE 12-31-1985.

THE MARK CONSISTS OF STANDARD CHARACTERS WITHOUT CLAIM TO ANY PARTICULAR FONT, STYLE, SIZE, OR COLOR.

NO CLAIM IS MADE TO THE EXCLUSIVE RIGHT TO USE "RESEARCH", APART FROM THE MARK AS SHOWN.

SER. NO. 77-366,576, FILED 1-8-2008.

MARK T. MULLEN, EXAMINING ATTORNEY

Int. Cl.: 44

Prior U.S. Cls.: 100 and 101

United States Patent and Trademark Office

Reg. No. 3,480,413

Registered Aug. 5, 2008

**SERVICE MARK
PRINCIPAL REGISTER**

CITY SMILES

SIMON AND SIMON, P.C. (ILLINOIS CORPORATION)
3800 NORTH PULASKI RD.
CHICAGO, IL 60641

FOR: DENTAL SERVICES; COSMETIC DENTISTRY SERVICES; DENTAL RESTORATION SERVICES; DENTAL HYGIENIST SERVICES; DENTAL ORTHODONTIC SERVICES, IN CLASS 44 (U.S. CLS. 100 AND 101).

FIRST USE 8-0-2004; IN COMMERCE 8-0-2004.

THE MARK CONSISTS OF STANDARD CHARACTERS WITHOUT CLAIM TO ANY PARTICULAR FONT, STYLE, SIZE, OR COLOR.

SER. NO. 77-366,578, FILED 1-8-2008.

JAY FLOWERS, EXAMINING ATTORNEY

Int. Cl.: 25

Prior U.S. Cls.: 22 and 39

United States Patent and Trademark Office

Reg. No. 3,480,414

Registered Aug. 5, 2008

**TRADEMARK
PRINCIPAL REGISTER**

HATHORN HI-LINE

WHITE'S BOOTS, INC. (WASHINGTON COR-
PORATION)

4002 EAST FERRY AVENUE

SPOKANE, WA 99202

FOR: BOOTS, IN CLASS 25 (U.S. CLS. 22 AND 39).

FIRST USE 12-28-2007; IN COMMERCE 12-28-2007.

THE MARK CONSISTS OF STANDARD CHAR-
ACTERS WITHOUT CLAIM TO ANY PARTICULAR
FONT, STYLE, SIZE, OR COLOR.

OWNER OF U.S. REG. NO. 1,410,606.

SER. NO. 77-366,581, FILED 1-8-2008.

VIVIAN MICZNIK FIRST, EXAMINING ATTOR-
NEY

Int. Cl.: 9

Prior U.S. Cls.: 21, 23, 26, 36 and 38

Reg. No. 3,480,415

United States Patent and Trademark Office

Registered Aug. 5, 2008

**TRADEMARK
PRINCIPAL REGISTER**

Mind Stereo

TRANSPARENT CORPORATION (OHIO CORPORATION), DBA TRANSPARENT CORPORATION
WWW.TRANSPARENTCORP.COM
2549 SUMMIT ST
COLUMBUS, OH 43202

FOR: COMPUTER SOFTWARE FOR USE IN ORGANIZING, STREAMING, MANIPULATING, CREATING, OR PLAYING AUDIO AND MULTIMEDIA CONTENT AND OTHER DATA FILES FEATURING LIGHT, SOUND AND/OR MUSIC, IN CLASS 9 (U.S. CLS. 21, 23, 26, 36 AND 38).

FIRST USE 7-15-2006; IN COMMERCE 7-15-2006.

THE MARK CONSISTS OF STANDARD CHARACTERS WITHOUT CLAIM TO ANY PARTICULAR FONT, STYLE, SIZE, OR COLOR.

NO CLAIM IS MADE TO THE EXCLUSIVE RIGHT TO USE "STEREO", APART FROM THE MARK AS SHOWN.

SER. NO. 77-366,587, FILED 1-8-2008.

MARK T. MULLEN, EXAMINING ATTORNEY

Int. Cl.: 25

Prior U.S. Cls.: 22 and 39

United States Patent and Trademark Office

Reg. No. 3,480,416

Registered Aug. 5, 2008

**TRADEMARK
PRINCIPAL REGISTER**

HATHORN EXPLORER

WHITE'S BOOTS, INC. (WASHINGTON CORPORATION)

4002 EAST FERRY AVENUE

SPOKANE, WA 99202

FOR: BOOTS, IN CLASS 25 (U.S. CLS. 22 AND 39).

FIRST USE 12-28-2007; IN COMMERCE 12-28-2007.

THE MARK CONSISTS OF STANDARD CHARACTERS WITHOUT CLAIM TO ANY PARTICULAR FONT, STYLE, SIZE, OR COLOR.

OWNER OF U.S. REG. NO. 1,410,606.

SER. NO. 77-366,594, FILED 1-8-2008.

VIVIAN MICZNIK FIRST, EXAMINING ATTORNEY

Int. Cl.: 41

Prior U.S. Cls.: 100, 101 and 107

United States Patent and Trademark Office

Reg. No. 3,480,417

Registered Aug. 5, 2008

**SERVICE MARK
PRINCIPAL REGISTER**

ESCAPE TO THE WILD

VERSUS, L.P. (DELAWARE LIMITED PARTNER-
SHIP)
ONE COMCAST CENTER
PHILADELPHIA, PA 19103

FOR: ENTERTAINMENT IN THE NATURE OF
ON-GOING TELEVISION PROGRAMS IN THE
FIELD OF OUTDOOR SPORTS; ENTERTAINMENT
SERVICES, NAMELY, AN ON-GOING SERIES FEAT-
URING OUTDOOR SPORTS PROVIDED
THROUGH CABLE TELEVISION, SATELLITE TEL-
EVISION, MOBILE TELEVISION, WEBCASTS, POD-
CASTS; ENTERTAINMENT, NAMELY, A
CONTINUING OUTDOOR SPORTS SHOW BROAD-

CAST OVER TELEVISION, SATELLITE, AUDIO,
AND VIDEO MEDIA, IN CLASS 41 (U.S. CLS. 100,
101 AND 107).

FIRST USE 6-1-2006; IN COMMERCE 6-1-2006.

THE MARK CONSISTS OF STANDARD CHAR-
ACTERS WITHOUT CLAIM TO ANY PARTICULAR
FONT, STYLE, SIZE, OR COLOR.

SER. NO. 77-366,616, FILED 1-8-2008.

KEVIN DINALLO, EXAMINING ATTORNEY

Int. Cl.: 9

Prior U.S. Cls.: 21, 23, 26, 36 and 38

Reg. No. 3,480,418

United States Patent and Trademark Office

Registered Aug. 5, 2008

**TRADEMARK
PRINCIPAL REGISTER**

Neuro Programmer

TRANSPARENT CORPORATION (OHIO CORPORATION), DBA TRANSPARENT CORPORATION
WWW.TRANSPARENTCORP.COM
2549 SUMMIT ST
COLUMBUS, OH 43202

FOR: COMPUTER SOFTWARE FOR MANIPULATING DIGITAL AUDIO INFORMATION FOR USE IN AUDIO MEDIA APPLICATIONS; COMPUTER SOFTWARE FOR PROCESSING DIGITAL MUSIC FILES; DOWNLOADABLE SOFTWARE FOR BRAINWAVE ENTRAINMENT AUDIO PRODUCTION AND THE EMBEDDING OF ENTRAINMENT IN EXISTING AUDIO FILES IN THE FIELD OF SELF HELP; MULTIMEDIA SOFTWARE RECORDED ON CD-ROM FEATURING BRAINWAVE EN-

TRAINMENT AUDIO PRODUCTION AND THE EMBEDDING OF ENTRAINMENT IN EXISTING AUDIO FILES IN THE FIELD OF SELF HELP; MUSIC-COMPOSITION SOFTWARE, IN CLASS 9 (U.S. CLS. 21, 23, 26, 36 AND 38).

FIRST USE 6-1-2003; IN COMMERCE 6-1-2003.

THE MARK CONSISTS OF STANDARD CHARACTERS WITHOUT CLAIM TO ANY PARTICULAR FONT, STYLE, SIZE, OR COLOR.

SER. NO. 77-366,620, FILED 1-8-2008.

MARK T. MULLEN, EXAMINING ATTORNEY

Int. Cl.: 36

Prior U.S. Cls.: 100, 101 and 102

United States Patent and Trademark Office

Reg. No. 3,480,419

Registered Aug. 5, 2008

**SERVICE MARK
PRINCIPAL REGISTER**

AHEAD OF THE CURVE

RLI INSURANCE COMPANY (ILLINOIS CORPORATION)
9025 N. LINDBERGH DRIVE
PEORIA, IL 61615

FOR: INSURANCE SERVICES, NAMELY, UNDERWRITING, ISSUING AND ADMINISTRATION OF INSURANCE IN THE FIELD OF COMMERCIAL TRANSPORTATION, IN CLASS 36 (U.S. CLS. 100, 101 AND 102).

FIRST USE 11-0-1997; IN COMMERCE 11-0-1997.

THE MARK CONSISTS OF STANDARD CHARACTERS WITHOUT CLAIM TO ANY PARTICULAR FONT, STYLE, SIZE, OR COLOR.

SER. NO. 77-366,637, FILED 1-8-2008.

AMY HELLA, EXAMINING ATTORNEY

Int. Cl.: 3

Prior U.S. Cls.: 1, 4, 6, 50, 51 and 52

Reg. No. 3,480,420

United States Patent and Trademark Office

Registered Aug. 5, 2008

**TRADEMARK
PRINCIPAL REGISTER**

SESDERMA

SESDERMA, S.L. (SPAIN CORPORATION)
MASAMAGRELL NO. 3
POLIGONO INDUSTRIAL RAFELBUNYOL
VALENCIA, SPAIN 46138

FOR: SKIN CARE AND BEAUTY PRODUCTS,
NAMELY, COSMETICS, LOTIONS, CREAMS,
CLEANSERS, CLARIFIERS, MASKS, SOAPS FOR
PERSONAL USE, ANTI-WRINKLE CREAMS, SUN
CARE LOTIONS; PERSONAL DEODORANTS AND
ANTIPERSPIRANTS; HAIR CARE PRODUCTS,
NAMELY, SHAMPOOS AND CONDITIONERS, IN
CLASS 3 (U.S. CLS. 1, 4, 6, 50, 51 AND 52).

FIRST USE 1-31-1997; IN COMMERCE 1-31-1997.

THE MARK CONSISTS OF STANDARD CHAR-
ACTERS WITHOUT CLAIM TO ANY PARTICULAR
FONT, STYLE, SIZE, OR COLOR.

OWNER OF U.S. REG. NOS. 2,449,524, 3,076,969
AND OTHERS.

SER. NO. 77-366,696, FILED 1-8-2008.

MATTHEW PAPPAS, EXAMINING ATTORNEY

Int. Cl.: 3

Prior U.S. Cls.: 1, 4, 6, 50, 51 and 52

Reg. No. 3,480,421

United States Patent and Trademark Office

Registered Aug. 5, 2008

**TRADEMARK
PRINCIPAL REGISTER**

SES

SESDERMA, S.L. (SPAIN CORPORATION)
MASAMAGRELL NO. 3
POLIGONO INDUSTRIAL RAFELBUNYOL
VALENCIA, SPAIN 46138

FOR: SKIN CARE AND BEAUTY PRODUCTS,
NAMELY, COSMETICS, LOTIONS, CREAMS,
CLEANSERS, CLARIFIERS, MASKS, SOAPS FOR
PERSONAL USE, ANTI-WRINKLE CREAMS, SUN
CARE LOTIONS; PERSONAL DEODORANTS AND
ANTIPERSPIRANTS; HAIR CARE PRODUCTS,
NAMELY, SHAMPOOS AND CONDITIONERS, IN
CLASS 3 (U.S. CLS. 1, 4, 6, 50, 51 AND 52).

FIRST USE 1-31-1997; IN COMMERCE 1-31-1997.

THE MARK CONSISTS OF STANDARD CHAR-
ACTERS WITHOUT CLAIM TO ANY PARTICULAR
FONT, STYLE, SIZE, OR COLOR.

OWNER OF U.S. REG. NOS. 2,449,524, 3,076,969
AND OTHERS.

SER. NO. 77-366,700, FILED 1-8-2008.

MATTHEW PAPPAS, EXAMINING ATTORNEY

Int. Cl.: 12

Prior U.S. Cls.: 19, 21, 23, 31, 35 and 44

Reg. No. 3,480,422

United States Patent and Trademark Office

Registered Aug. 5, 2008

**TRADEMARK
PRINCIPAL REGISTER**

PURDYBILT

UPSCO, INC. (NEW YORK CORPORATION)
23 CENTRAL STREET
MORAVIA, NY 13118

FIRST USE 12-20-2007; IN COMMERCE 12-20-2007.

FOR: AUTOMOTIVE TRUCK BODIES AND ACCESSORIES BUILT INTO TRUCK BODIES, NAMELY, FIRE TRUCK BODIES, FARRIER TRUCK BODIES, TRUCK DUMP BOXES, UTILITY BOXES, MULTI-DRAWER UNITS, CUSTOM CABINETS, DRAWERS, DRILL PRESS DRAWERS, PROPANE CABINETS, SHELVING, FORGE HOLDERS, PAD RACKS AND SHOE RACKS, IN CLASS 12 (U.S. CLS. 19, 21, 23, 31, 35 AND 44).

THE MARK CONSISTS OF STANDARD CHARACTERS WITHOUT CLAIM TO ANY PARTICULAR FONT, STYLE, SIZE, OR COLOR.

THE WORDING "PURDYBILT" HAS NO MEANING IN A FOREIGN LANGUAGE.

SER. NO. 77-366,737, FILED 1-8-2008.

ANDREA HACK, EXAMINING ATTORNEY

Int. Cl.: 44

Prior U.S. Cls.: 100 and 101

United States Patent and Trademark Office

Reg. No. 3,480,423

Registered Aug. 5, 2008

**SERVICE MARK
PRINCIPAL REGISTER**

OrthoBethesda

BETHESDA-CHEVY CHASE ORTHOPAEDIC ASSOCIATES, LLP (MARYLAND LIMITED LIABILITY PARTNERSHIP)
10215 FERNWOOD ROAD, SUITE 506
BETHESDA, MD 20817

FOR: MEDICAL SERVICES, NAMELY, ORTHOPAEDIC TREATMENT, SURGERY AND THERAPY, IN CLASS 44 (U.S. CLS. 100 AND 101).

FIRST USE 4-30-2006; IN COMMERCE 4-30-2006.

THE MARK CONSISTS OF STANDARD CHARACTERS WITHOUT CLAIM TO ANY PARTICULAR FONT, STYLE, SIZE, OR COLOR.

SER. NO. 77-366,747, FILED 1-8-2008.

SUSAN STIGLITZ, EXAMINING ATTORNEY

Int. Cl.: 14

Prior U.S. Cls.: 2, 27, 28 and 50

United States Patent and Trademark Office

Reg. No. 3,480,424

Registered Aug. 5, 2008

**TRADEMARK
PRINCIPAL REGISTER**

TIME IN A BOTTLE

INTERNATIONAL BULLION & METAL BRO-
KERS (USA) INC. (FLORIDA CORPORATION)
14051 NW 14TH STREET
SUNRISE, FL 33323

THE MARK CONSISTS OF STANDARD CHAR-
ACTERS WITHOUT CLAIM TO ANY PARTICULAR
FONT, STYLE, SIZE, OR COLOR.

FOR: PRECIOUS METALS AND THEIR ALLOYS,
NAMELY, GOLD AND SILVER, IN CLASS 14 (U.S.
CLS. 2, 27, 28 AND 50).

SER. NO. 77-366,751, FILED 1-8-2008.

FIRST USE 10-1-1998; IN COMMERCE 10-1-1998.

SIMON TENG, EXAMINING ATTORNEY

Int. Cl.: 16

Prior U.S. Cls.: 2, 5, 22, 23, 29, 37, 38 and 50

Reg. No. 3,480,425

United States Patent and Trademark Office

Registered Aug. 5, 2008

**TRADEMARK
PRINCIPAL REGISTER**

Mythmatical Battles

4R, INC. (MICHIGAN CORPORATION)
2691 CHAPEL CREEK DRIVE
LAMBERTVILLE, MI 48144

FOR: EDUCATIONAL PUBLICATIONS, NAME-
LY, EDUCATIONAL LEARNING CARDS, FLASH
CARDS, ACTIVITY CARDS, WORKBOOKS, TEXT-
BOOKS, ACTIVITY BOOKS, STORY BOOKS, PUZ-
ZLE BOOKS, PUZZLES, TEACHER GUIDES,
MANUALS, POSTERS, EDUCATIONAL CARD
GAMES AND EDUCATIONAL BOOKLETS IN THE
FIELD OF MYTHOLOGY AND MATH, IN CLASS 16
(U.S. CLS. 2, 5, 22, 23, 29, 37, 38 AND 50).

FIRST USE 9-0-2003; IN COMMERCE 4-0-2004.

THE MARK CONSISTS OF STANDARD CHAR-
ACTERS WITHOUT CLAIM TO ANY PARTICULAR
FONT, STYLE, SIZE, OR COLOR.

NO CLAIM IS MADE TO THE EXCLUSIVE
RIGHT TO USE "BATTLES", APART FROM THE
MARK AS SHOWN.

SER. NO. 77-366,755, FILED 1-8-2008.

JORDAN BAKER, EXAMINING ATTORNEY

Int. Cl.: 7

Prior U.S. Cls.: 13, 19, 21, 23, 31, 34 and 35

United States Patent and Trademark Office

Reg. No. 3,480,426

Registered Aug. 5, 2008

**TRADEMARK
PRINCIPAL REGISTER**

SIDEWINDER

ZEBRA SKIMMERS CORP. (OHIO CORPORATION)
P.O. BOX 833
CHAGRIN FALLS, OH 44022

THE MARK CONSISTS OF STANDARD CHARACTERS WITHOUT CLAIM TO ANY PARTICULAR FONT, STYLE, SIZE, OR COLOR.

FOR: MECHANICAL OIL SKIMMERS, NAMELY, TUBE-TYPE OIL LIFTING DEVICES USED TO REMOVE OIL FROM WATER, IN CLASS 7 (U.S. CLS. 13, 19, 21, 23, 31, 34 AND 35).

SER. NO. 77-366,762, FILED 1-8-2008.

FIRST USE 9-1-1994; IN COMMERCE 9-1-1994.

ADA HAN, EXAMINING ATTORNEY

Int. Cl.: 34

Prior U.S. Cls.: 2, 8, 9 and 17

United States Patent and Trademark Office

Reg. No. 3,480,427

Registered Aug. 5, 2008

**TRADEMARK
PRINCIPAL REGISTER**

HOKAH FREAK

HOKAH HOKAH TOBACCO CO. (GEORGIA
CORPORATION)

32 JOE KENNEDY BLVD.

STATESBORO, GA 30458

FOR: PIPE TOBACCO; TOBACCO, IN CLASS 34
(U.S. CLS. 2, 8, 9 AND 17).

FIRST USE 1-10-2007; IN COMMERCE 1-10-2007.

THE MARK CONSISTS OF STANDARD CHAR-
ACTERS WITHOUT CLAIM TO ANY PARTICULAR
FONT, STYLE, SIZE, OR COLOR.

NO CLAIM IS MADE TO THE EXCLUSIVE
RIGHT TO USE "HOKAH", APART FROM THE
MARK AS SHOWN.

SER. NO. 77-366,766, FILED 1-8-2008.

ADA HAN, EXAMINING ATTORNEY

Int. Cl.: 16

Prior U.S. Cls.: 2, 5, 22, 23, 29, 37, 38 and 50

Reg. No. 3,480,428

United States Patent and Trademark Office

Registered Aug. 5, 2008

**TRADEMARK
PRINCIPAL REGISTER**

I-BALLERS

UNIVERSITY GAMES CORPORATION (CALI-
FORNIA CORPORATION)
2030 HARRISON STREET
SAN FRANCISCO, CA 94110

THE MARK CONSISTS OF STANDARD CHAR-
ACTERS WITHOUT CLAIM TO ANY PARTICULAR
FONT, STYLE, SIZE, OR COLOR.

FOR: CHILDREN'S ACTIVITY BOOKS, IN CLASS
16 (U.S. CLS. 2, 5, 22, 23, 29, 37, 38 AND 50).

SER. NO. 77-366,783, FILED 1-8-2008.

FIRST USE 2-0-2005; IN COMMERCE 2-0-2005.

TINA KUAN, EXAMINING ATTORNEY

Int. Cl.: 42

Prior U.S. Cls.: 100 and 101

United States Patent and Trademark Office

Reg. No. 3,480,429

Registered Aug. 5, 2008

**SERVICE MARK
PRINCIPAL REGISTER**

Elements Of Change

SIMMONS, LEAH D (UNITED STATES INDIVIDUAL)
1909 LOCUST RAVINE
BAKERSFIELD, CA 93306

FOR: DEVELOPING COMPUTER SOFTWARE; COMPUTER PROGRAMMING AND SOFTWARE DESIGN; RESEARCH AND DEVELOPMENT OF ADVANCED LEARNING TECHNOLOGIES AND TEACHING METHODS; COMPUTER PROJECT MANAGEMENT SERVICES; TECHNICAL CONSULTING AND ASSISTANCE WITH COMPUTER-

BASED INFORMATION SYSTEMS AND COMPONENTS, IN CLASS 42 (U.S. CLS. 100 AND 101).

FIRST USE 12-15-1999; IN COMMERCE 5-27-2000.

THE MARK CONSISTS OF STANDARD CHARACTERS WITHOUT CLAIM TO ANY PARTICULAR FONT, STYLE, SIZE, OR COLOR.

SER. NO. 77-366,851, FILED 1-8-2008.

KHANH LE, EXAMINING ATTORNEY

Int. Cls.: 36 and 41

Prior U.S. Cls.: 100, 101, 102 and 107

United States Patent and Trademark Office

Reg. No. 3,480,430

Registered Aug. 5, 2008

**SERVICE MARK
PRINCIPAL REGISTER**

**THANK YOUR VET FOR A
HEALTHY PET**

MORRIS ANIMAL FOUNDATION (COLORADO
CORPORATION)
10200 E. GIRARD AVENUE, #B430
DENVER, CO 80231

FOR: ACCEPTING AND ADMINISTERING
MONETARY CHARITABLE CONTRIBUTIONS, IN
CLASS 36 (U.S. CLS. 100, 101 AND 102).

FIRST USE 1-10-2007; IN COMMERCE 12-31-2007.

FOR: PROVIDING RECOGNITION AND INCEN-
TIVES BY THE WAY OF AWARDS AND CONTESTS
TO DEMONSTRATE EXCELLENCE IN THE FIELD

OF VETERINARY SCIENCE, IN CLASS 41 (U.S. CLS.
100, 101 AND 107).

FIRST USE 1-10-2007; IN COMMERCE 1-12-2007.

THE MARK CONSISTS OF STANDARD CHAR-
ACTERS WITHOUT CLAIM TO ANY PARTICULAR
FONT, STYLE, SIZE, OR COLOR.

SER. NO. 77-366,859, FILED 1-8-2008.

ANDREW RHIM, EXAMINING ATTORNEY

Int. Cl.: 36

Prior U.S. Cls.: 100, 101 and 102

United States Patent and Trademark Office

Reg. No. 3,480,431

Registered Aug. 5, 2008

**SERVICE MARK
PRINCIPAL REGISTER**

**BUILDING NEIGHBORHOODS -
CREATING NEIGHBORS**

FIEL, PAUL (UNITED STATES INDIVIDUAL)
2160 E. FRY BLVD., #196
SIERRA VISTA, AZ 85635

THE MARK CONSISTS OF STANDARD CHAR-
ACTERS WITHOUT CLAIM TO ANY PARTICULAR
FONT, STYLE, SIZE, OR COLOR.

FOR: REAL ESTATE INVESTMENT, IN CLASS 36
(U.S. CLS. 100, 101 AND 102).

SER. NO. 77-366,865, FILED 1-8-2008.

FIRST USE 1-1-2007; IN COMMERCE 1-1-2007.

KIM MONINGHOFF, EXAMINING ATTORNEY

Int. Cl.: 41

Prior U.S. Cls.: 100, 101 and 107

United States Patent and Trademark Office

Reg. No. 3,480,432

Registered Aug. 5, 2008

**SERVICE MARK
PRINCIPAL REGISTER**

GENERATION YES

GENERATION YES CORPORATION (WASHINGTON CORPORATION)
2584 R.W. JOHNSON BLVD. SW
OLYMPIA, WA 98512

FOR: EDUCATIONAL SERVICES, NAMELY, DEVELOPING, ARRANGING, AND CONDUCTING EDUCATIONAL CONFERENCES AND PROGRAMS AND PROVIDING COURSES OF INSTRUCTION IN THE FIELD OF TELECOMMUNICATIONS, GLOBAL COMPUTER NETWORKS, COMPUTER TECHNOLOGY, AND CURRICULUM DEVELOPMENT AND DISTRIBUTION OF COURSE MATERIAL IN CONNECTION THEREWITH; EDUCATIONAL SERVICES, NAMELY, PROVIDING COURSES OF INSTRUCTION AT THE PRIMARY AND SECONDARY LEVEL; EDUCATIONAL SERVICES, NAMELY, CONDUCTING INFORMAL PROGRAMS IN THE FIELDS OF TELECOMMUNICATIONS,

GLOBAL COMPUTER NETWORKS, COMPUTER TECHNOLOGY, AND CURRICULUM DEVELOPMENT, USING ON-LINE ACTIVITIES AND INTERACTIVE EXHIBITS, AND PRINTABLE MATERIALS DISTRIBUTED THEREWITH, IN CLASS 41 (U.S. CLS. 100, 101 AND 107).

FIRST USE 2-15-2000; IN COMMERCE 2-15-2000.

THE MARK CONSISTS OF STANDARD CHARACTERS WITHOUT CLAIM TO ANY PARTICULAR FONT, STYLE, SIZE, OR COLOR.

OWNER OF U.S. REG. NO. 2,903,294.

SER. NO. 77-366,908, FILED 1-8-2008.

DAVID H. STINE, EXAMINING ATTORNEY

Int. Cl.: 35

Prior U.S. Cls.: 100, 101 and 102

United States Patent and Trademark Office

Reg. No. 3,480,433

Registered Aug. 5, 2008

**SERVICE MARK
PRINCIPAL REGISTER**

Farm to Family

CALIFORNIA ASSOCIATION OF FOOD BANKS
(CALIFORNIA CORPORATION)
SUITE 830
1611 TELEGRAPH AVENUE
OAKLAND, CA 94612

FOR: CHARITABLE SERVICES, NAMELY, CO-
ORDINATION OF THE PROCUREMENT AND DIS-
TRIBUTION OF FOOD DONATIONS FROM
MANUFACTURERS, WHOLESALERS, RETAILERS,
AND GOVERNMENT AGENCIES TO ORGANIZA-
TIONS PROVIDING FREE FOOD TO NEEDY PEOP-
LE, IN CLASS 35 (U.S. CLS. 100, 101 AND 102).

FIRST USE 12-0-2005; IN COMMERCE 12-0-2005.

THE MARK CONSISTS OF STANDARD CHAR-
ACTERS WITHOUT CLAIM TO ANY PARTICULAR
FONT, STYLE, SIZE, OR COLOR.

SER. NO. 77-366,929, FILED 1-8-2008.

SIMON TENG, EXAMINING ATTORNEY

Int. Cl.: 35

Prior U.S. Cls.: 100, 101 and 102

United States Patent and Trademark Office

Reg. No. 3,480,434

Registered Aug. 5, 2008

**SERVICE MARK
PRINCIPAL REGISTER**

350AD

BRUNK, KEVIN (UNITED STATES INDIVIDUAL)
P.O. BOX 250
MONTROSE, IA 52639

THE MARK CONSISTS OF STANDARD CHARACTERS WITHOUT CLAIM TO ANY PARTICULAR FONT, STYLE, SIZE, OR COLOR.

FOR: ADVERTISING VIA ELECTRONIC MEDIA AND SPECIFICALLY THE INTERNET, IN CLASS 35 (U.S. CLS. 100, 101 AND 102).

SER. NO. 77-366,951, FILED 1-8-2008.

FIRST USE 2-20-2007; IN COMMERCE 2-20-2007.

DORITT L. CARROLL, EXAMINING ATTORNEY

Int. Cl.: 29

Prior U.S. Cl.: 46

United States Patent and Trademark Office

Reg. No. 3,480,435

Registered Aug. 5, 2008

TRADEMARK
PRINCIPAL REGISTER



VERITAS V, LLC (CALIFORNIA LTD LIAB CO)
401 MONTEREY STREET, SUITE 201
SALINAS, CA 93901

FOR: PRE-WASHED, PRE-CUT AND PACKAGED
FRESH VEGETABLES, IN CLASS 29 (U.S. CL. 46).

FIRST USE 5-4-2007; IN COMMERCE 5-4-2007.

NO CLAIM IS MADE TO THE EXCLUSIVE
RIGHT TO USE "THIS SALAD IS PACKED IN
SUSTAINABLE RENEWABLE PACKAGING",
APART FROM THE MARK AS SHOWN.

THE COLOR(S) GREEN, ORANGE AND RED IS/
ARE CLAIMED AS A FEATURE OF THE MARK.

THE MARK CONSISTS OF THE PHRASE "THIS
SALAD IS PACKED IN SUSTAINABLE RENEW-
ABLE PACKAGING" AND A LINE AND U-SHAPED
DESIGN WHICH RESEMBLES A BOX. THE COLOR
GREEN APPEARS IN THE WORDING "THIS SAL-
AD IS PACKED IN SUSTAINABLE" AND THE
DESIGN ELEMENT. THE COLOR ORANGE AP-
PEARS IN THE WORD "RENEWABLE" AND THE
COLOR RED APPEARS IN THE WORD "PACKA-
GING."

SER. NO. 77-366,961, FILED 1-8-2008.

MATTHEW MCDOWELL, EXAMINING ATTOR-
NEY

Int. Cl.: 31

Prior U.S. Cls.: 1 and 46

United States Patent and Trademark Office

Reg. No. 3,480,436

Registered Aug. 5, 2008

TRADEMARK
PRINCIPAL REGISTER



VERITAS V, LLC (CALIFORNIA LTD LIAB CO)
401 MONTEREY STREET, SUITE 201
SALINAS, CA 93901

FOR: FRESH VEGETABLES, IN CLASS 31 (U.S.
CLS. 1 AND 46).

FIRST USE 5-4-2007; IN COMMERCE 5-4-2007.

NO CLAIM IS MADE TO THE EXCLUSIVE
RIGHT TO USE "THIS SALAD IS PACKED IN
SUSTAINABLE RENEWABLE PACKAGING",
APART FROM THE MARK AS SHOWN.

THE COLOR(S) GREEN, ORANGE AND RED IS/
ARE CLAIMED AS A FEATURE OF THE MARK.

THE MARK CONSISTS OF THE PHRASE "THIS
SALAD IS PACKED IN SUSTAINABLE RENEW-
ABLE PACKAGING" AND A LINE AND U-SHAPED
DESIGN WHICH RESEMBLES A BOX. THE COLOR
GREEN APPEARS IN THE WORDING "THIS SAL-
AD IS PACKED IN SUSTAINABLE" AND THE
DESIGN ELEMENT. THE COLOR ORANGE AP-
PEARS IN THE WORD "RENEWABLE" AND THE
COLOR RED APPEARS IN THE WORD "PACKA-
GING."

SER. NO. 77-366,971, FILED 1-8-2008.

MATTHEW MCDOWELL, EXAMINING ATTOR-
NEY

Int. Cl.: 35

Prior U.S. Cls.: 100, 101 and 102

United States Patent and Trademark Office

Reg. No. 3,480,437

Registered Aug. 5, 2008

**SERVICE MARK
PRINCIPAL REGISTER**

**BURN
RUBBER**

SNEAKER HEADZ, LLC (MICHIGAN LTD LIAB
CO), DBA BURN RUBBER
202 W. FOURTH STREET
ROYAL OAK, MI 48067

FOR: RETAIL STORES FEATURING CLOTHING,
FOOTWEAR, SHOE LACES, HEAD-WEAR, JEWEL-
RY, WATCHES, TOYS, BOOKS AND MAGAZINES,
IN CLASS 35 (U.S. CLS. 100, 101 AND 102).

FIRST USE 3-1-2007; IN COMMERCE 3-1-2007.

THE COLOR(S) BLACK IS/ARE CLAIMED AS A
FEATURE OF THE MARK.

THE MARK CONSISTS OF THE WORD "BURN"
STACKED ON TOP OF THE WORD "RUBBER"
CENTERED ON TOP OF ONE ANOTHER, BOTH
IN THE COLOR BLACK.

SER. NO. 77-367,031, FILED 1-8-2008.

GENE MACIOL, EXAMINING ATTORNEY

Int. Cl.: 25

Prior U.S. Cls.: 22 and 39

United States Patent and Trademark Office

Reg. No. 3,480,438

Registered Aug. 5, 2008

**TRADEMARK
PRINCIPAL REGISTER**



BAYVI LLC (HAWAII LTD LIAB CO)
758 KAPAHULU AVE, A306
HONOLULU, HI 96816

FOR: CLOTHING, NAMELY, T-SHIRTS, SHIRTS,
SWEATSHIRTS, JACKETS, CAPS, BEANIES, PANTS,
SHORTS, BOARDSHORTS, IN CLASS 25 (U.S. CLS. 22
AND 39).

FIRST USE 12-16-2007; IN COMMERCE 12-16-2007.

THE MARK CONSISTS OF A STYLIZED NUM-
BER "6" AND A STYLIZED LETTER "A".

SER. NO. 77-367,106, FILED 1-8-2008.

JASON ROTH, EXAMINING ATTORNEY

Int. Cl.: 36

Prior U.S. Cls.: 100, 101 and 102

United States Patent and Trademark Office

Reg. No. 3,480,439

Registered Aug. 5, 2008

**SERVICE MARK
PRINCIPAL REGISTER**

TIME MEANS MONEY

DIRECT FUTURES, LLC (ILLINOIS LTD LIAB
CO)
141 W JACKSON BLVD, SUITE 2921
CHICAGO, IL 60604

FOR: PROVIDING INFORMATION ON TRADING
OPTIONS AND ON PROFITING FROM THE
TIME DELAY OF OPTIONS; BROKERAGE IN THE
FIELD OF OPTIONS, IN CLASS 36 (U.S. CLS. 100, 101
AND 102).

FIRST USE 12-2-2007; IN COMMERCE 12-2-2007.

THE MARK CONSISTS OF STANDARD CHAR-
ACTERS WITHOUT CLAIM TO ANY PARTICULAR
FONT, STYLE, SIZE, OR COLOR.

SER. NO. 77-367,111, FILED 1-8-2008.

JANICE KIM, EXAMINING ATTORNEY

Int. Cl.: 3

Prior U.S. Cls.: 1, 4, 6, 50, 51 and 52

United States Patent and Trademark Office

Reg. No. 3,480,440

Registered Aug. 5, 2008

**TRADEMARK
PRINCIPAL REGISTER**

JOLLY RANCHER

HUHTAMAKI FINANCE B.V. (NETHERLANDS
CORPORATION)
JUPITERSTRAAT 102
2132 HE HOOFDORP, NETHERLANDS

FOR: NAIL POLISH, IN CLASS 3 (U.S. CLS. 1, 4, 6,
50, 51 AND 52).

FIRST USE 6-30-2007; IN COMMERCE 6-30-2007.

THE MARK CONSISTS OF STANDARD CHAR-
ACTERS WITHOUT CLAIM TO ANY PARTICULAR
FONT, STYLE, SIZE, OR COLOR.

OWNER OF U.S. REG. NOS. 168,458, 3,289,124 AND
OTHERS.

SER. NO. 77-367,162, FILED 1-9-2008.

DAWN FELDMAN, EXAMINING ATTORNEY

Int. Cl.: 35

Prior U.S. Cls.: 100, 101 and 102

United States Patent and Trademark Office

Reg. No. 3,480,441

Registered Aug. 5, 2008

**SERVICE MARK
PRINCIPAL REGISTER**

SANDY TOES FOOTWEAR

VAHOVIUS, CHET J. (UNITED STATES INDIVIDUAL)

SUITE A

805 E. LEE STREET

ENTERPRISE, AL 36330

FOR: RETAIL STORE SERVICES FEATURING SHOES, IN CLASS 35 (U.S. CLS. 100, 101 AND 102).

FIRST USE 7-1-2007; IN COMMERCE 7-1-2007.

THE MARK CONSISTS OF STANDARD CHARACTERS WITHOUT CLAIM TO ANY PARTICULAR FONT, STYLE, SIZE, OR COLOR.

NO CLAIM IS MADE TO THE EXCLUSIVE RIGHT TO USE "FOOTWEAR", APART FROM THE MARK AS SHOWN.

SER. NO. 77-367,189, FILED 1-9-2008.

WARREN L. OLANDRIA, EXAMINING ATTORNEY

Int. Cl.: 25

Prior U.S. Cls.: 22 and 39

United States Patent and Trademark Office

Reg. No. 3,480,442

Registered Aug. 5, 2008

**TRADEMARK
PRINCIPAL REGISTER**

TAIKONHU

URBAN OUTFITTERS (DELAWARE), INC.
(PENNSYLVANIA CORPORATION)
5000 SOUTH BROAD STREET
PHILADELPHIA, PA 191121495

THE MARK CONSISTS OF STANDARD CHAR-
ACTERS WITHOUT CLAIM TO ANY PARTICULAR
FONT, STYLE, SIZE, OR COLOR.

FOR: COATS; JACKETS; PANTS; SHORTS;
SKIRTS; VESTS, IN CLASS 25 (U.S. CLS. 22 AND 39).

SER. NO. 77-367,246, FILED 1-9-2008.

FIRST USE 8-14-2006; IN COMMERCE 8-14-2006.

KIMBERLY FRYE, EXAMINING ATTORNEY

Int. Cl.: 25

Prior U.S. Cls.: 22 and 39

United States Patent and Trademark Office

Reg. No. 3,480,443

Registered Aug. 5, 2008

**TRADEMARK
PRINCIPAL REGISTER**

HAND KNIT BY DOLLIE

URBAN OUTFITTERS (DELAWARE), INC.
(PENNSYLVANIA CORPORATION)

5000 SOUTH BROAD STREET

PHILADELPHIA, PA 191121495

FOR: DRESSES; SKIRTS; SWEATERS; TOPS, IN
CLASS 25 (U.S. CLS. 22 AND 39).

FIRST USE 6-15-2007; IN COMMERCE 6-15-2007.

THE MARK CONSISTS OF STANDARD CHAR-
ACTERS WITHOUT CLAIM TO ANY PARTICULAR
FONT, STYLE, SIZE, OR COLOR.

NO CLAIM IS MADE TO THE EXCLUSIVE
RIGHT TO USE "HAND KNIT", APART FROM
THE MARK AS SHOWN.

SER. NO. 77-367,248, FILED 1-9-2008.

KIMBERLY FRYE, EXAMINING ATTORNEY

Int. Cl.: 35

Prior U.S. Cls.: 100, 101 and 102

United States Patent and Trademark Office

Reg. No. 3,480,444

Registered Aug. 5, 2008

**SERVICE MARK
PRINCIPAL REGISTER**

 **thingamajob**

ALLEGIS GROUP, INC. (MARYLAND CORPORATION)
7301 PARKWAY DRIVE
HANOVER, MD 21076

OWNER OF U.S. REG. NOS. 2,435,800, 2,621,233,
AND 2,643,509.

FOR: PERSONNEL PLACEMENT AND RECRUITMENT; EMPLOYMENT HIRING, RECRUITING, PLACEMENT, STAFFING AND CAREER NETWORKING SERVICES, IN CLASS 35 (U.S. CLS. 100, 101 AND 102).

THE MARK CONSISTS OF A WALKING FIGURE TO THE LEFT OF THE TERM "THINGAMAJOB".

SER. NO. 77-367,262, FILED 1-9-2008.

FIRST USE 5-1-2004; IN COMMERCE 5-1-2004.

KIMBERLY FRYE, EXAMINING ATTORNEY

Int. Cl.: 41

Prior U.S. Cls.: 100, 101 and 107

United States Patent and Trademark Office

Reg. No. 3,480,445

Registered Aug. 5, 2008

**SERVICE MARK
PRINCIPAL REGISTER**

Brooksie Way

COUNT YOUR STEPS (MICHIGAN CORPORATION)
2897 COLONIAL TRAIL
BLOOMFIELD HILLS, MI 48304

FOR: ENTERTAINMENT SERVICES, NAMELY,
PARTICIPATION IN A HALF MARATHON AND 5-
K RUN AND WALK, IN CLASS 41 (U.S. CLS. 100, 101
AND 107).

FIRST USE 1-4-2008; IN COMMERCE 1-4-2008.

THE MARK CONSISTS OF STANDARD CHAR-
ACTERS WITHOUT CLAIM TO ANY PARTICULAR
FONT, STYLE, SIZE, OR COLOR.

SER. NO. 77-367,287, FILED 1-9-2008.

SUNG IN, EXAMINING ATTORNEY

Int. Cl.: 41

Prior U.S. Cls.: 100, 101 and 107

United States Patent and Trademark Office

Reg. No. 3,480,446

Registered Aug. 5, 2008

**SERVICE MARK
PRINCIPAL REGISTER**

**If Nobody Loves You Create
The Demand**

FREEMAN, JOEL A. (UNITED STATES INDIVIDUAL)
1103 BURKHARDT LANE
SEVERN, MD 21144

FOR: CONDUCTING WORKSHOPS AND SEMINARS IN ENTREPRENEURSHIP BUSINESS INTELLIGENCE AND PERSONAL DEVELOPMENT, IN CLASS 41 (U.S. CLS. 100, 101 AND 107).

FIRST USE 3-1-2006; IN COMMERCE 11-5-2006.

THE MARK CONSISTS OF STANDARD CHARACTERS WITHOUT CLAIM TO ANY PARTICULAR FONT, STYLE, SIZE, OR COLOR.

SER. NO. 77-367,305, FILED 1-9-2008.

KIMBERLY FRYE, EXAMINING ATTORNEY

Int. Cl.: 36

Prior U.S. Cls.: 100, 101 and 102

United States Patent and Trademark Office

Reg. No. 3,480,447

Registered Aug. 5, 2008

**SERVICE MARK
PRINCIPAL REGISTER**

ARC CompReport

AMERICAN RESEARCH COMPANY, INC. (VIRGINIA CORPORATION)
10003 ROBINDALE COURT
GREAT FALLS, VA 22066

THE MARK CONSISTS OF STANDARD CHARACTERS WITHOUT CLAIM TO ANY PARTICULAR FONT, STYLE, SIZE, OR COLOR.

FOR: FINANCIAL ANALYSIS AND CONSULTATION, IN CLASS 36 (U.S. CLS. 100, 101 AND 102).

SER. NO. 77-367,310, FILED 1-9-2008.

FIRST USE 1-1-1991; IN COMMERCE 4-1-2006.

JAMES STEIN, EXAMINING ATTORNEY

Int. Cl.: 33

Prior U.S. Cls.: 47 and 49

United States Patent and Trademark Office

Reg. No. 3,480,448

Registered Aug. 5, 2008

**TRADEMARK
PRINCIPAL REGISTER**

Vodka 7000'

HIGH WEST DISTILLERY, LLC (UTAH LTD
LIAB CO)
P.O. BOX 1733
PARK CITY, UT 84060

NO CLAIM IS MADE TO THE EXCLUSIVE
RIGHT TO USE "VODKA", APART FROM THE
MARK AS SHOWN.

FOR: VODKA, IN CLASS 33 (U.S. CLS. 47 AND 49).

FIRST USE 12-21-2007; IN COMMERCE 1-2-2008.

SER. NO. 77-367,365, FILED 1-9-2008.

THE MARK CONSISTS OF STANDARD CHAR-
ACTERS WITHOUT CLAIM TO ANY PARTICULAR
FONT, STYLE, SIZE, OR COLOR.

AMY GEARIN, EXAMINING ATTORNEY

Int. Cl.: 7

Prior U.S. Cls.: 13, 19, 21, 23, 31, 34 and 35

United States Patent and Trademark Office

Reg. No. 3,480,449

Registered Aug. 5, 2008

**TRADEMARK
PRINCIPAL REGISTER**

TORCHMATE

APPLIED ROBOTICS, INC. (MARYLAND CORPORATION)
108 JORDAN TAYLOR LANE
HARWOOD, MD 20776

FOR: CUTTING MACHINES USING PANTOGRAPH OR COORDINATE DRIVE MECHANISMS AND PARTS THEREFOR, IN CLASS 7 (U.S. CLS. 13, 19, 21, 23, 31, 34 AND 35).

FIRST USE 12-26-1979; IN COMMERCE 12-26-1979.

THE MARK CONSISTS OF STANDARD CHARACTERS WITHOUT CLAIM TO ANY PARTICULAR FONT, STYLE, SIZE, OR COLOR.

OWNER OF U.S. REG. NO. 2,083,857.

SER. NO. 77-367,420, FILED 1-9-2008.

JAMES STEIN, EXAMINING ATTORNEY

Int. Cl.: 9

Prior U.S. Cls.: 21, 23, 26, 36 and 38

United States Patent and Trademark Office

Reg. No. 3,480,450

Registered Aug. 5, 2008

**TRADEMARK
PRINCIPAL REGISTER**

TITLEASSIST

ODYSSEY MEDIA, INC. (NEW YORK CORPORATION)
65 MAGNOLIA WAY
NORTH HALEDON, NJ 075083118

FOR: COMPUTER SOFTWARE FOR PROCESSING REAL ESTATE TITLE APPLICATIONS, ORDERING PROPERTY SEARCHES AND SURVEYS, MANAGING ESCROWS, PAYING RECORDING FEES, GENERATING TITLE INSURANCE POLICIES, REPORTS AND OTHER TITLE INSURANCE DOCUMENTS, IN CLASS 9 (U.S. CLS. 21, 23, 26, 36 AND 38).

FIRST USE 1-1-2008; IN COMMERCE 1-1-2008.

THE MARK CONSISTS OF STANDARD CHARACTERS WITHOUT CLAIM TO ANY PARTICULAR FONT, STYLE, SIZE, OR COLOR.

SER. NO. 77-367,439, FILED 1-9-2008.

RICHARD A. STRASER, EXAMINING ATTORNEY

Int. Cl.: 35

Prior U.S. Cls.: 100, 101 and 102

United States Patent and Trademark Office

Reg. No. 3,480,451

Registered Aug. 5, 2008

**SERVICE MARK
PRINCIPAL REGISTER**

JURISTAFF

JURISTAFF, INC. (PENNSYLVANIA CORPORATION)
1600 MARKET STREET, 38TH FLOOR
PHILADELPHIA, PA 19103

FOR: LEGAL PERSONNEL EMPLOYMENT
AGENCY SERVICES, IN CLASS 35 (U.S. CLS. 100,
101 AND 102).

FIRST USE 10-28-1997; IN COMMERCE 11-10-1997.

THE MARK CONSISTS OF STANDARD CHARACTERS WITHOUT CLAIM TO ANY PARTICULAR FONT, STYLE, SIZE, OR COLOR.

OWNER OF U.S. REG. NO. 2,216,292.

SER. NO. 77-367,454, FILED 1-9-2008.

COLLEEN DOMBROW, EXAMINING ATTORNEY

Int. Cl.: 43

Prior U.S. Cls.: 100 and 101

United States Patent and Trademark Office

Reg. No. 3,480,452

Registered Aug. 5, 2008

**SERVICE MARK
PRINCIPAL REGISTER**

KNUCKLEHEADS

SMOKEY'S PEANUTS, INC. (GEORGIA COR-
PORATION)
P.O. BOX 81485
ATHENS, GA 30608

THE MARK CONSISTS OF STANDARD CHAR-
ACTERS WITHOUT CLAIM TO ANY PARTICULAR
FONT, STYLE, SIZE, OR COLOR.

FOR: RESTAURANT AND BAR SERVICES, IN
CLASS 43 (U.S. CLS. 100 AND 101).

SER. NO. 77-367,473, FILED 1-9-2008.

FIRST USE 11-1-2007; IN COMMERCE 11-1-2007.

WON TEAK OH, EXAMINING ATTORNEY

Int. Cl.: 41

Prior U.S. Cls.: 100, 101 and 107

United States Patent and Trademark Office

Reg. No. 3,480,453

Registered Aug. 5, 2008

**SERVICE MARK
PRINCIPAL REGISTER**

ALL ABOUT BEER

CHAUTAUQUA, INC. (NORTH CAROLINA CORPORATION)
501-H WASHINGTON STREET
DURHAM, NC 27701

FOR: PROVIDING AN ON-LINE MAGAZINE AND A WEB SITE CONTAINING INFORMATION IN THE FIELD OF BEER AND BEER CULTURE, IN CLASS 41 (U.S. CLS. 100, 101 AND 107).

FIRST USE 12-0-1996; IN COMMERCE 12-0-1996.

THE MARK CONSISTS OF STANDARD CHARACTERS WITHOUT CLAIM TO ANY PARTICULAR FONT, STYLE, SIZE, OR COLOR.

NO CLAIM IS MADE TO THE EXCLUSIVE RIGHT TO USE "BEER", APART FROM THE MARK AS SHOWN.

SER. NO. 77-367,476, FILED 1-9-2008.

KEVIN DINALLO, EXAMINING ATTORNEY

Int. Cl.: 44

Prior U.S. Cls.: 100 and 101

United States Patent and Trademark Office

Reg. No. 3,480,454

Registered Aug. 5, 2008

**SERVICE MARK
PRINCIPAL REGISTER**

Physio@Work

PHYSIOTHERAPY CORPORATION (DELAWARE
CORPORATION)
STE. 200
855 SPRINGDALE DRIVE
EXTON, PA 19341

FOR: PHYSICAL THERAPY AND HEALTH CARE
SERVICES, NAMELY, INDUSTRIAL REHABILITA-
TION SERVICES, IN CLASS 44 (U.S. CLS. 100 AND
101).

FIRST USE 1-2-2008; IN COMMERCE 1-2-2008.

THE MARK CONSISTS OF STANDARD CHAR-
ACTERS WITHOUT CLAIM TO ANY PARTICULAR
FONT, STYLE, SIZE, OR COLOR.

SER. NO. 77-367,490, FILED 1-9-2008.

KEVIN DINALLO, EXAMINING ATTORNEY

Int. Cl.: 9

Prior U.S. Cls.: 21, 23, 26, 36 and 38

United States Patent and Trademark Office

Reg. No. 3,480,455

Registered Aug. 5, 2008

**TRADEMARK
PRINCIPAL REGISTER**

EMCAT PRO

ALL-TEST PRO, LLC (CONNECTICUT LTD LIAB
CO)
20 SILVER STREET
BRANFORD, CT 06475

FOR: AUTOMATED PROCESS CONTROL SYSTEM, NAMELY, MICRO-PROCESSOR BASED HARDWARE AND SOFTWARE USED TO MONITOR THE STATUS OF INDUSTRIAL MACHINERY, NAMELY, TURBINES, GENERATORS AND COMPRESSORS; COMPUTER SOFTWARE FOR APPLICATION AND DATABASE INTEGRATION; COMPUTER SOFTWARE FOR CREATING SEARCHABLE DATABASES OF INFORMATION AND DATA; COMPUTER SOFTWARE FOR PROVIDING AN ON-LINE DATABASE IN THE FIELD OF TRANSACTION PROCESSING TO UPLOAD TRANSACTIONAL DATA, PROVIDE STATISTICAL ANALYSIS, AND PRODUCE NOTIFICATIONS AND REPORTS; COMPUTER SOFTWARE FOR THE COLLECTION, EDITING, ORGANIZING, MODIFYING, BOOK MARKING, TRANSMISSION, STORAGE

AND SHARING OF DATA AND INFORMATION; DATABASE MANAGEMENT SOFTWARE FOR MOTOR TESTING; ELECTRICAL ENERGY UTILIZATION METERING DEVICES COMPLETE WITH RELATED SOFTWARE, IN CLASS 9 (U.S. CLS. 21, 23, 26, 36 AND 38).

FIRST USE 12-1-2005; IN COMMERCE 12-1-2005.

THE MARK CONSISTS OF STANDARD CHARACTERS WITHOUT CLAIM TO ANY PARTICULAR FONT, STYLE, SIZE, OR COLOR.

NO CLAIM IS MADE TO THE EXCLUSIVE RIGHT TO USE "PRO", APART FROM THE MARK AS SHOWN.

SER. NO. 77-367,580, FILED 1-9-2008.

ELLEN B. AWRICH, EXAMINING ATTORNEY

Int. Cl.: 44

Prior U.S. Cls.: 100 and 101

United States Patent and Trademark Office

Reg. No. 3,480,456

Registered Aug. 5, 2008

**SERVICE MARK
PRINCIPAL REGISTER**

YOU LOSE, YOU GAIN

RODALE INC. (PENNSYLVANIA CORPORATION)
33 EAST MINOR STREET
EMMAUS, PA 180980099

FOR: PROVIDING ONLINE INFORMATION IN THE FIELDS OF HEALTH, DIET AND LIFESTYLE WELLNESS VIA AN INTERNET WEB SITE, IN CLASS 44 (U.S. CLS. 100 AND 101).

FIRST USE 1-1-2008; IN COMMERCE 1-1-2008.

THE MARK CONSISTS OF STANDARD CHARACTERS WITHOUT CLAIM TO ANY PARTICULAR FONT, STYLE, SIZE, OR COLOR.

SER. NO. 77-367,609, FILED 1-9-2008.

MARLENE BELL, EXAMINING ATTORNEY

Int. Cl.: 42

Prior U.S. Cls.: 100 and 101

United States Patent and Trademark Office

Reg. No. 3,480,457

Registered Aug. 5, 2008

**SERVICE MARK
PRINCIPAL REGISTER**

NETSPROUT

NETSPROUT, INC. (CALIFORNIA CORPORATION)
330 TOWNSEND ST. STE. 134
SAN FRANCISCO, CA 94107

THE MARK CONSISTS OF STANDARD CHARACTERS WITHOUT CLAIM TO ANY PARTICULAR FONT, STYLE, SIZE, OR COLOR.

FOR: WEBSITE DEVELOPMENT AND DESIGN AND WEBSITE HOSTING SERVICES, IN CLASS 42 (U.S. CLS. 100 AND 101).

SER. NO. 77-367,621, FILED 1-9-2008.

FIRST USE 11-23-1996; IN COMMERCE 11-23-1996.

IRA J. GOODSaid, EXAMINING ATTORNEY

Int. Cl.: 21

Prior U.S. Cls.: 2, 13, 23, 29, 30, 33, 40 and 50

Reg. No. 3,480,458

United States Patent and Trademark Office

Registered Aug. 5, 2008

**TRADEMARK
PRINCIPAL REGISTER**

Fuel Tank

PETERSON, ANDREW, L (UNITED STATES IN-
DIVIDUAL)
7842 WOODMAN CT
WEST JORDAN, UT 84088

THE MARK CONSISTS OF STANDARD CHAR-
ACTERS WITHOUT CLAIM TO ANY PARTICULAR
FONT, STYLE, SIZE, OR COLOR.

FOR: PERSONAL FLUID HYDRATION SYSTEMS
COMPRISING A FLUID RESERVOIR, A DELIVERY
TUBE, A MOUTHPIECE AND A CARRYING PACK,
IN CLASS 21 (U.S. CLS. 2, 13, 23, 29, 30, 33, 40 AND 50).

SER. NO. 77-367,635, FILED 1-9-2008.

FIRST USE 6-24-2007; IN COMMERCE 9-9-2007.

DANIEL CAPSHAW, EXAMINING ATTORNEY

Int. Cl.: 42

Prior U.S. Cls.: 100 and 101

United States Patent and Trademark Office

Reg. No. 3,480,459

Registered Aug. 5, 2008

**SERVICE MARK
PRINCIPAL REGISTER**

**Staging Turns Cold Into
SOLD!**

ROEMMER, CAROL (UNITED STATES INDIVIDUAL)

#287

32545B GOLDEN LANTERN
DANA POINT, CA 92629

FOR: HOME STAGING CONSULTATION, NAME-
LY, TEMPORARY INTERIOR AND EXTERIOR
HOME DECORATION CONSULTATION FOR THE
PURPOSE OF MAKING HOMES MORE APPEAL-
ING TO PROSPECTIVE BUYERS, IN CLASS 42 (U.S.
CLS. 100 AND 101).

FIRST USE 9-11-2007; IN COMMERCE 9-11-2007.

THE MARK CONSISTS OF STANDARD CHAR-
ACTERS WITHOUT CLAIM TO ANY PARTICULAR
FONT, STYLE, SIZE, OR COLOR.

SER. NO. 77-367,649, FILED 1-9-2008.

JULIE WATSON, EXAMINING ATTORNEY

Int. Cl.: 35

Prior U.S. Cls.: 100, 101 and 102

United States Patent and Trademark Office

Reg. No. 3,480,460

Registered Aug. 5, 2008

**SERVICE MARK
PRINCIPAL REGISTER**

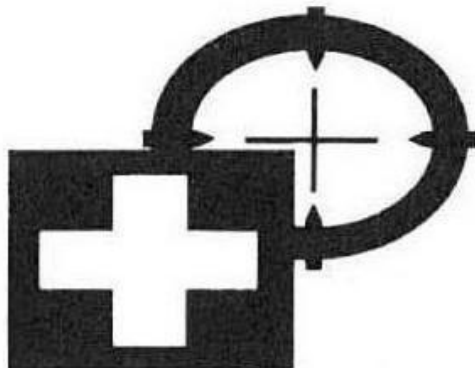

GLOBAL NURSING SOLUTIONS, INC. (PENNSYLVANIA CORPORATION)
209 SIGMA DRIVE
PITTSBURGH, PA 15238

FOR: PERSONNEL RECRUITMENT FOR NURSING PROFESSIONALS, PHYSICAL THERAPISTS, AND OTHER MEDICAL PERSONNEL; PROVIDING TEMPORARY AND PERMANENT JOB PLACEMENT OF NURSING PROFESSIONALS, PHYSICAL THERAPISTS, AND OTHER MEDICAL PERSONNEL TO HOSPITALS AND SKILLED NURSING FACILITIES, IN CLASS 35 (U.S. CLS. 100, 101 AND 102).

THE MARK CONSISTS OF AN OUTLINE OF A GREEK CROSS BORDERED BY A SQUARE BACKGROUND PLUS A CIRCULAR RING ENCLOSING A CROSS HAIR DESIGN, WHEREIN THE TOP RIGHT CORNER OF THE BOX OVERLAPS THE BOTTOM LEFT QUADRANT OF THE RING, AND WHEREIN THE RING COMPRISES FOUR EVENLY SPACED LINES INTERSECTING THE CIRCUMFERENTIAL QUADRANTS OF THE RING.

SER. NO. 77-367,660, FILED 1-9-2008.

FIRST USE 10-31-2003; IN COMMERCE 10-31-2003.

PAUL F. GAST, EXAMINING ATTORNEY

Int. Cl.: 41

Prior U.S. Cls.: 100, 101 and 107

United States Patent and Trademark Office

Reg. No. 3,480,461

Registered Aug. 5, 2008

**SERVICE MARK
PRINCIPAL REGISTER**

LIMA BEAN RIOT

KIELB, FRANK (UNITED STATES INDIVIDUAL)
PO BOX 626
BROOMALL, PA 19008

FOR: ENTERTAINMENT, NAMELY, LIVE PERFORMANCES BY MUSICAL BANDS; ENTERTAINMENT SERVICES, NAMELY, LIVE, TELEVISED AND MOVIE APPEARANCES BY A PROFESSIONAL ENTERTAINER; ENTERTAINMENT, NAMELY, LIVE MUSIC CONCERTS, IN CLASS 41 (U.S. CLS. 100, 101 AND 107).

FIRST USE 10-12-1996; IN COMMERCE 10-12-1996.

THE MARK CONSISTS OF STANDARD CHARACTERS WITHOUT CLAIM TO ANY PARTICULAR FONT, STYLE, SIZE, OR COLOR.

SER. NO. 77-367,669, FILED 1-9-2008.

INGA ERVIN, EXAMINING ATTORNEY

Int. Cl.: 11

Prior U.S. Cls.: 13, 21, 23, 31 and 34

Reg. No. 3,480,462

United States Patent and Trademark Office

Registered Aug. 5, 2008

**TRADEMARK
PRINCIPAL REGISTER**

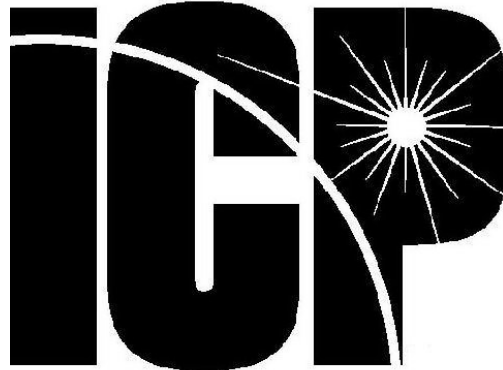

CARRIER CORPORATION (DELAWARE CORPORATION)
ONE CARRIER PLACE
FARMINGTON, CT 06034

FIRST USE 6-0-1997; IN COMMERCE 6-0-1997.

FOR: RESIDENTIAL AND LIGHT COMMERCIAL AIR CONDITIONING, HEATING AND ENVIRONMENTAL CONTROL UNITS, NAMELY, HEATING, DEHUMIDIFYING, VENTILATION, AIR CLEANING AND AIR CONDITIONING APPARATUS AND PARTS THEREFOR, IN CLASS 11 (U.S. CLS. 13, 21, 23, 31 AND 34).

THE MARK CONSISTS OF THE LETTERS ICP IN A STYLIZED FONT.

SER. NO. 77-367,716, FILED 1-9-2008.

SALLY SHIH, EXAMINING ATTORNEY

Int. Cl.: 36

Prior U.S. Cls.: 100, 101 and 102

United States Patent and Trademark Office

Reg. No. 3,480,463

Registered Aug. 5, 2008

**SERVICE MARK
PRINCIPAL REGISTER**



YOUR PARTNERS IN DEBT RESOLUTION

DMB FINANCIAL, LLC (MASSACHUSETTS LTD
LIAB CO)
152 CONANT STREET
BEVERLY, MA 01915

FOR: FINANCIAL SERVICES, NAMELY, DEBT
SETTLEMENT, IN CLASS 36 (U.S. CLS. 100, 101 AND
102).

FIRST USE 4-1-2005; IN COMMERCE 4-1-2005.

NO CLAIM IS MADE TO THE EXCLUSIVE
RIGHT TO USE "FINANCIAL" AND "DEBT RESO-
LUTION", APART FROM THE MARK AS SHOWN.

THE COLOR(S) GREEN AND WHITE IS/ARE
CLAIMED AS A FEATURE OF THE MARK.

THE MARK CONSISTS OF AN UPSIDE DOWN
TRIANGLE-LIKE IMAGE WITH WHITE LETTERS
"DMB" IN THE CENTER. THE TRIANGLE-LIKE
SHAPE IS OUTLINED IN GREEN, HAS A LIGHTER
GREEN OUTLINE INSIDE OF THE DARKER

GREEN AND THE CENTER OF THE TRIANGLE
IS DARKER GREEN, WITH DARKER GREEN
HORIZONTAL LINES THROUGH THE TRIANGLE
STARTS ABOUT THREE QUARTERS DOWN FROM
THE TOP OF THE UPSIDE DOWN TRIANGLE
THAT EXTENDS OUT ON BOTH SIDES OF THE
TRIANGLE. THE RIBBON CONTAINS THE WORD
"FINANCIAL" IN DARK GREEN, THE RIBBON IS
WHITE AND THE RIBBON FOLDS OVER AND IS
GREEN ON THE ENDS WHERE THERE IS NO
LETTERING. ON THE TOP END OF BOTH SIDES
OF THE PART OF THE RIBBON THAT IS WHITE
THERE ARE DECORATIVE LIGHT GREEN LINES
EXTENDING FROM THE RIBBON, BOTH SIDES
ARE MIRROR IMAGES OF EACH OTHER. ON THE
BOTTOM OF THE MARK OUTSIDE OF THE TRI-
ANGLE SHAPE IS THE WORDING "YOUR PART-
NERS IN DEBT RESOLUTION" IN GREEN
LETTERING.

SER. NO. 77-367,725, FILED 1-9-2008.

CYNTHIA SLOAN, EXAMINING ATTORNEY

Int. Cl.: 9

Prior U.S. Cls.: 21, 23, 26, 36 and 38

Reg. No. 3,480,464

United States Patent and Trademark Office

Registered Aug. 5, 2008

**TRADEMARK
PRINCIPAL REGISTER**

LSK Media

ALASKA, INC. (FLORIDA CORPORATION)
10881 NW 122ND STREET
MEDLEY, FL 33178

FOR: BLANK RECORDABLE DVDS; BLANK CD-
ROMS FOR SOUND OR VIDEO RECORDING; CD
CASES, IN CLASS 9 (U.S. CLS. 21, 23, 26, 36 AND 38).

FIRST USE 10-1-2007; IN COMMERCE 10-1-2007.

THE MARK CONSISTS OF STANDARD CHAR-
ACTERS WITHOUT CLAIM TO ANY PARTICULAR
FONT, STYLE, SIZE, OR COLOR.

NO CLAIM IS MADE TO THE EXCLUSIVE
RIGHT TO USE "MEDIA", APART FROM THE
MARK AS SHOWN.

SER. NO. 77-367,726, FILED 1-9-2008.

CYNTHIA SLOAN, EXAMINING ATTORNEY

Int. Cl.: 1

Prior U.S. Cls.: 1, 5, 6, 10, 26 and 46

United States Patent and Trademark Office

Reg. No. 3,480,465

Registered Aug. 5, 2008

**TRADEMARK
PRINCIPAL REGISTER**

ECOPROMOTE

NISSAN CHEMICAL INDUSTRIES, LTD. (JAPAN CORPORATION)

7-1, 3-CHOME, KANDA-NISHIKI-CHO
CHIYODA-KU, TOKYO, JAPAN

FOR: CHEMICALS USED IN INDUSTRY, NAME-
LY, NUCLEATION AGENTS FOR USE IN THE
PLASTICS PROCESSING INDUSTRY, IN CLASS 1
(U.S. CLS. 1, 5, 6, 10, 26 AND 46).

THE MARK CONSISTS OF STANDARD CHAR-
ACTERS WITHOUT CLAIM TO ANY PARTICULAR
FONT, STYLE, SIZE, OR COLOR.

OWNER OF JAPAN REG. NO. 5030937, DATED 3-
9-2007, EXPIRES 3-9-2017.

SER. NO. 77-367,731, FILED 1-9-2008.

HOWARD B. LEVINE, EXAMINING ATTORNEY

Int. Cls.: 39 and 40

Prior U.S. Cls.: 100, 103, 105 and 106

United States Patent and Trademark Office

Reg. No. 3,480,466

Registered Aug. 5, 2008

**SERVICE MARK
PRINCIPAL REGISTER**



MEYER, KARL R. (UNITED STATES INDIVIDUAL)
14217 N. 54TH STREET
SCOTTSDALE, AZ 85254

FOR: TRANSPORT AND STORAGE OF GOODS,
IN CLASS 39 (U.S. CLS. 100 AND 105).

FIRST USE 1-1-2006; IN COMMERCE 6-1-2006.

FOR: CUSTOM MANUFACTURE OF MOLDS
FOR USE IN INDUSTRY, IN CLASS 40 (U.S. CLS.
100, 103 AND 106).

FIRST USE 1-1-2006; IN COMMERCE 6-1-2006.

THE MARK CONSISTS OF A LARGE ALFA "S"
WITH A SMALLER NUMERIC "6" EMBEDDED
WITHIN THE LARGER "S".

SER. NO. 77-367,735, FILED 1-9-2008.

PAM WILLIS, EXAMINING ATTORNEY

Int. Cl.: 31

Prior U.S. Cls.: 1 and 46

United States Patent and Trademark Office

Reg. No. 3,480,467

Registered Aug. 5, 2008

**TRADEMARK
PRINCIPAL REGISTER**

ROYAL GLOBE

FRANK CAPURRO & SON, LLC (CALIFORNIA
LTD LIAB CO)
2250 SALINAS ROAD
MOSS LANDING, CA 95039

THE MARK CONSISTS OF STANDARD CHAR-
ACTERS WITHOUT CLAIM TO ANY PARTICULAR
FONT, STYLE, SIZE, OR COLOR.

FOR: FRESH VEGETABLES; FRESH ARTI-
CHOKES, IN CLASS 31 (U.S. CLS. 1 AND 46).

SER. NO. 77-367,742, FILED 1-9-2008.

FIRST USE 5-31-1999; IN COMMERCE 5-31-1999.

WON TEAK OH, EXAMINING ATTORNEY

Int. Cl.: 38

Prior U.S. Cls.: 100, 101 and 104

United States Patent and Trademark Office

Reg. No. 3,480,468

Registered Aug. 5, 2008

**SERVICE MARK
PRINCIPAL REGISTER**

GUESTLINE

QWEST COMMUNICATIONS INTERNATIONAL
INC. (DELAWARE CORPORATION)
1801 CALIFORNIA STREET
DENVER, CO 80202

THE MARK CONSISTS OF STANDARD CHAR-
ACTERS WITHOUT CLAIM TO ANY PARTICULAR
FONT, STYLE, SIZE, OR COLOR.

FOR: TELEPHONE COMMUNICATION SERVI-
CES, IN CLASS 38 (U.S. CLS. 100, 101 AND 104).

SER. NO. 77-367,764, FILED 1-9-2008.

FIRST USE 12-31-1985; IN COMMERCE 12-31-1985.

WON TEAK OH, EXAMINING ATTORNEY

Int. Cl.: 18

Prior U.S. Cls.: 1, 2, 3, 22 and 41

Reg. No. 3,480,469

United States Patent and Trademark Office

Registered Aug. 5, 2008

**TRADEMARK
PRINCIPAL REGISTER**

WOLFGANG

E-QUEST, INC. (NEW JERSEY CORPORATION),
DBA CUSTOM SADDLERY
205 MEDFORD-MT. HOLLY ROAD
MEDFORD, NJ 08055

THE MARK CONSISTS OF STANDARD CHAR-
ACTERS WITHOUT CLAIM TO ANY PARTICULAR
FONT, STYLE, SIZE, OR COLOR.

FOR: SADDLES, IN CLASS 18 (U.S. CLS. 1, 2, 3, 22
AND 41).

SER. NO. 77-367,851, FILED 1-9-2008.

FIRST USE 1-2-2005; IN COMMERCE 1-2-2005.

ANGELA GAW, EXAMINING ATTORNEY

Int. Cl.: 41

Prior U.S. Cls.: 100, 101 and 107

United States Patent and Trademark Office

Reg. No. 3,480,470

Registered Aug. 5, 2008

**SERVICE MARK
PRINCIPAL REGISTER**



NEW MOTION, INC. (DELAWARE CORPORATION)
42 CORPORATE PARK, 2ND FLOOR
IRVINE, CA 92696

FOR: ENTERTAINMENT SERVICES, NAMELY, CONDUCTING CONTESTS; ENTERTAINMENT SERVICES, NAMELY, PRODUCTION AND DISTRIBUTION OF A GAME SHOW; ENTERTAINMENT SERVICES, NAMELY, PROVIDING ON-LINE COMPUTER GAMES, IN CLASS 41 (U.S. CLS. 100, 101 AND 107).

FIRST USE 11-7-2007; IN COMMERCE 11-7-2007.

THE COLOR(S) GRAY, BLACK, GREEN AND WHITE IS/ARE CLAIMED AS A FEATURE OF THE MARK.

THE COLORS GRAY AND BLACK APPEAR IN THE OUTLINE OF THE LOWER-CASE LETTERS "B" AND "P" AND IN THE SEMI-CIRCULAR ARC THAT CONNECTS THE OUTLINE OF THE LETTERS "B" AND "P". THE COLOR BLACK ALSO APPEARS IN THE SMALL CIRCLE WITHIN THE LETTER "B" AND WITHIN THE LETTER "P". THE NUMBER "4" IS ALSO IN BLACK AND THE COLOR GREEN APPEARS IN THE CIRCLE BEHIND THE NUMBER "4". THE COLOR WHITE APPEARS INSIDE THE OUTLINE OF THE LETTERS "B" AND "P" AND SURROUNDS THE GREEN CIRCLE. THE COLOR WHITE ALSO APPEARS IN THE TRIANGULAR SHAPE WITHIN THE NUMBER "4".

SER. NO. 77-367,872, FILED 1-9-2008.

AMY GEARIN, EXAMINING ATTORNEY

Int. Cl.: 37

Prior U.S. Cls.: 100, 103 and 106

United States Patent and Trademark Office

Reg. No. 3,480,471

Registered Aug. 5, 2008

**SERVICE MARK
PRINCIPAL REGISTER**

ACU-TRU

THE WHEEL WAREHOUSE INC. (OHIO CORPORATION)
4600 GATEWAY CIR.
KETTERING, OH 45440

THE MARK CONSISTS OF STANDARD CHARACTERS WITHOUT CLAIM TO ANY PARTICULAR FONT, STYLE, SIZE, OR COLOR.

FOR: MAINTENANCE AND/OR REPAIR OF ALUMINUM ALLOY OR ALLOY RIMS AND WHEELS, IN CLASS 37 (U.S. CLS. 100, 103 AND 106).

SER. NO. 77-367,911, FILED 1-9-2008.

FIRST USE 10-10-1998; IN COMMERCE 10-10-1998.

BRENDAN MCCAULEY, EXAMINING ATTORNEY

Int. Cl.: 5

Prior U.S. Cls.: 6, 18, 44, 46, 51 and 52

Reg. No. 3,480,472

United States Patent and Trademark Office

Registered Aug. 5, 2008

**TRADEMARK
PRINCIPAL REGISTER**

ISACRUNCH

ISAGENIX WORLDWIDE, LLC (DELAWARE
LTD LIAB CO)
2225 S. PRICE ROAD
CHANDLER, AZ 85286

THE MARK CONSISTS OF STANDARD CHAR-
ACTERS WITHOUT CLAIM TO ANY PARTICULAR
FONT, STYLE, SIZE, OR COLOR.

FOR: NUTRITIONAL SUPPLEMENTS; FOOD
SUPPLEMENTS AND DIETARY SUPPLEMENTS,
IN CLASS 5 (U.S. CLS. 6, 18, 44, 46, 51 AND 52).

SER. NO. 77-367,913, FILED 1-9-2008.

FIRST USE 7-31-2007; IN COMMERCE 7-31-2007.

MATTHEW PAPPAS, EXAMINING ATTORNEY

Int. Cl.: 35

Prior U.S. Cls.: 100, 101 and 102

United States Patent and Trademark Office

Reg. No. 3,480,473

Registered Aug. 5, 2008

**SERVICE MARK
PRINCIPAL REGISTER**

Disruption in the Channel

GRIFFITH, STEPHEN (UNITED STATES INDIVIDUAL)
2353 FIESTA DRIVE
TROY, OH 45373 AND
BENFIELD, SCOTT (UNITED STATES INDIVIDUAL)
423 WARWICK DRIVE
NAPERVILLE, IL 60586

FOR: BUSINESS CONSULTATION SERVICES, IN CLASS 35 (U.S. CLS. 100, 101 AND 102).

FIRST USE 12-1-2007; IN COMMERCE 12-1-2007.

THE MARK CONSISTS OF STANDARD CHARACTERS WITHOUT CLAIM TO ANY PARTICULAR FONT, STYLE, SIZE, OR COLOR.

SER. NO. 77-367,914, FILED 1-9-2008.

KYLE PEETE, EXAMINING ATTORNEY

Int. Cl.: 7

Prior U.S. Cls.: 13, 19, 21, 23, 31, 34 and 35

United States Patent and Trademark Office

Reg. No. 3,480,474

Registered Aug. 5, 2008

**TRADEMARK
PRINCIPAL REGISTER**



AGR STONE & TOOLS USA, INC. (TEXAS CORPORATION)
11526 FM 2854
CONROE, TX 77304

FOR: MACHINES AND MACHINE TOOLS FOR THE CUTTING AND FORMING OF MATERIALS; TOOL BITS FOR MACHINES; GRINDING TOOLS FOR GRINDING MACHINES; BITS FOR POWER DRILLS; CORE DRILLING BITS; POWER DRILL BITS; BLADES FOR POWER SAWS, IN CLASS 7 (U.S. CLS. 13, 19, 21, 23, 31, 34 AND 35).

FIRST USE 1-1-1992; IN COMMERCE 1-1-1992.

THE MARK CONSISTS OF STYLIZED "A", "G" & "R" SET ON THE DIAGONAL WITH A LINE RUNNING CLOCKWISE FROM THE TOP OF "A" TO THE BOTTOM OF THE "R".

SER. NO. 77-367,918, FILED 1-9-2008.

KYLE PEETE, EXAMINING ATTORNEY

Int. Cl.: 39

Prior U.S. Cls.: 100 and 105

United States Patent and Trademark Office

Reg. No. 3,480,475

Registered Aug. 5, 2008

**SERVICE MARK
PRINCIPAL REGISTER**

BAREFOOT EXPEDITIONS

ALTAMIRANO, ANTONIO (UNITED STATES IN-
DIVIDUAL)
2499 ALPINE RD.
MENLO PARK, CA 94025

FOR: ARRANGING TRAVEL TOURS; ORGANI-
SATION OF TRAVEL; PROVIDING AN ON-LINE
COMPUTER DATABASE IN THE FIELD OF TRA-
VEL INFORMATION SERVICES; PROVIDING IN-
FORMATION, NEWS AND COMMENTARY IN THE
FIELD OF TRAVEL; TRAVEL AGENCY SERVICES,
NAMELY, MAKING RESERVATIONS AND BOOK-
INGS FOR TRANSPORTATION; TRAVEL INFOR-
MATION, IN CLASS 39 (U.S. CLS. 100 AND 105).

FIRST USE 9-0-2005; IN COMMERCE 9-0-2005.

THE MARK CONSISTS OF STANDARD CHAR-
ACTERS WITHOUT CLAIM TO ANY PARTICULAR
FONT, STYLE, SIZE, OR COLOR.

NO CLAIM IS MADE TO THE EXCLUSIVE
RIGHT TO USE "EXPEDITIONS", APART FROM
THE MARK AS SHOWN.

SER. NO. 77-367,919, FILED 1-9-2008.

KEVIN DINALLO, EXAMINING ATTORNEY

Int. Cl.: 19

Prior U.S. Cls.: 1, 12, 33 and 50

United States Patent and Trademark Office

Reg. No. 3,480,476

Registered Aug. 5, 2008

**TRADEMARK
PRINCIPAL REGISTER**

EcoMortar

BUILDING MATERIAL IMPORTS, INC. (CALI-
FORNIA CORPORATION)
201 PURRINGTON ROAD
PETALUMA, CA 94952

THE MARK CONSISTS OF STANDARD CHAR-
ACTERS WITHOUT CLAIM TO ANY PARTICULAR
FONT, STYLE, SIZE, OR COLOR.

FOR: LIME MORTAR, IN CLASS 19 (U.S. CLS. 1,
12, 33 AND 50).

SER. NO. 77-367,968, FILED 1-9-2008.

FIRST USE 4-6-2005; IN COMMERCE 4-6-2005.

SALLY SHIH, EXAMINING ATTORNEY

Int. Cl.: 18

Prior U.S. Cls.: 1, 2, 3, 22 and 41

United States Patent and Trademark Office

Reg. No. 3,480,477

Registered Aug. 5, 2008

TRADEMARK
PRINCIPAL REGISTER



CLAUDE AND MONIQUE (OHIO CORPORATION)
307 BEECH ST.
WAUSEON, OH 43567

FOR: HANDBAGS, PURSES, CLUTCHES, DIAPER BAGS, WALLETS, ALL-PURPOSE CARRYING BAGS, IN CLASS 18 (U.S. CLS. 1, 2, 3, 22 AND 41).

FIRST USE 1-25-2006; IN COMMERCE 7-1-2006.

THE MARK CONSISTS OF A STYLIZED MALE STICK FIGURE HOLDING HANDS WITH A STYLIZED FEMALE STICK FIGURE WEARING A

DRESS WITH A HEART IN THE LOWER RIGHT OF THE SKIRT, THERE IS A STYLIZED HEART BETWEEN THEIR HEADS, THE STYLIZED LETTERING "CLAUDE & MONIQUE" ARE BELOW THE FIGURES, THE "L" IN CLAUDE IS A HEART, THE "&" SYMBOL HAS A HEART COMING FROM THE TOP AND BOTTOM, THE "I" IN "MONIQUE" IS DOTTED WITH A HEART.

SER. NO. 77-367,969, FILED 1-9-2008.

SALLY SHIH, EXAMINING ATTORNEY

Int. Cl.: 42

Prior U.S. Cls.: 100 and 101

United States Patent and Trademark Office

Reg. No. 3,480,478

Registered Aug. 5, 2008

**SERVICE MARK
PRINCIPAL REGISTER**

Drawn by Innovation

LAND ARCHITECTURE, INC. (CALIFORNIA
CORPORATION)
231 VERNON STREET
ROSEVILLE, CA 95678

THE MARK CONSISTS OF STANDARD CHAR-
ACTERS WITHOUT CLAIM TO ANY PARTICULAR
FONT, STYLE, SIZE, OR COLOR.

FOR: LANDSCAPE ARCHITECTURAL DESIGN,
IN CLASS 42 (U.S. CLS. 100 AND 101).

SER. NO. 77-368,020, FILED 1-9-2008.

FIRST USE 11-16-2007; IN COMMERCE 11-16-2007.

BRENDAN MCCAULEY, EXAMINING ATTORNEY

Int. Cl.: 35

Prior U.S. Cls.: 100, 101 and 102

United States Patent and Trademark Office

Reg. No. 3,480,479

Registered Aug. 5, 2008

**SERVICE MARK
PRINCIPAL REGISTER**

OFF THE PAGE

HARRY AND DAVID (OREGON CORPORATION)
PO BOX 712
2500 SOUTH PACIFIC HIGHWAY
MEDFORD, OR 97501

FOR: RETAIL STORE SERVICES IN THE FIELD OF GIFTS, HOME DECOR ITEMS, FOODS, AND LIVE PLANTS AND FLOWERS, IN CLASS 35 (U.S. CLS. 100, 101 AND 102).

FIRST USE 10-18-2001; IN COMMERCE 10-18-2001.

THE MARK CONSISTS OF STANDARD CHARACTERS WITHOUT CLAIM TO ANY PARTICULAR FONT, STYLE, SIZE, OR COLOR.

OWNER OF U.S. REG. NO. 2,575,673.

SER. NO. 77-368,052, FILED 1-9-2008.

BARBARA RUTLAND, EXAMINING ATTORNEY

Int. Cl.: 25

Prior U.S. Cls.: 22 and 39

United States Patent and Trademark Office

Reg. No. 3,480,480

Registered Aug. 5, 2008

**TRADEMARK
PRINCIPAL REGISTER**



CHILDREN'S PEDIATRICS CENTERS, LLC
(GEORGIA LTD LIAB CO)
321 E. MAIN STREET
CANTON, GA 30114

FOR: T-SHIRTS; BABY BODYSUITS; CLOTH
BIBS; SWEAT SHIRTS; JERSEYS; CAPS, IN CLASS
25 (U.S. CLS. 22 AND 39).

FIRST USE 12-0-2007; IN COMMERCE 12-0-2007.

OWNER OF U.S. REG. NOS. 3,211,193 AND
3,316,249.

THE MARK CONSISTS OF A CARICATURE OF A
DOCTOR AND A NURSE.

SER. NO. 77-368,110, FILED 1-9-2008.

JIM RINGLE, EXAMINING ATTORNEY

Int. Cl.: 9

Prior U.S. Cls.: 21, 23, 26, 36 and 38

Reg. No. 3,480,481

United States Patent and Trademark Office

Registered Aug. 5, 2008

**TRADEMARK
PRINCIPAL REGISTER**

**THE MOTHER OF ALL
AUTOMATION PROGRAMS**

MANSION PRODUCTIONS, LLC (NEVADA LTD
LIAB CO), DBA MANSION PRODUCTIONS,
INC.
312 FOURTH STREET
CARSON CITY, NV 89703

FOR: COMPUTER SOFTWARE THAT MANAGES
CREDIT CARD BILLING THROUGH MULTIPLE
PROVIDERS FOR AFFILIATE PROGRAMS AND
ADMINISTERS A DATABASE OF AFFILIATE STA-
TISTICS TO PROVIDE TOTAL OVERSIGHT AND
CONTROL OF AN AFFILIATE MARKETING PRO-
GRAM, IN CLASS 9 (U.S. CLS. 21, 23, 26, 36 AND 38).

FIRST USE 8-5-2002; IN COMMERCE 8-5-2002.

THE MARK CONSISTS OF STANDARD CHAR-
ACTERS WITHOUT CLAIM TO ANY PARTICULAR
FONT, STYLE, SIZE, OR COLOR.

SER. NO. 77-368,119, FILED 1-9-2008.

MICHAEL KEATING, EXAMINING ATTORNEY

Int. Cl.: 44

Prior U.S. Cls.: 100 and 101

United States Patent and Trademark Office

Reg. No. 3,480,482

Registered Aug. 5, 2008

**SERVICE MARK
PRINCIPAL REGISTER**

WASHINGTON HEART

WASHINGTON HOSPITAL CENTER CORPORATION
(DELAWARE CORPORATION)
SUITE 2A2
110 IRVING STREET, NW
WASHINGTON, DC 20010

FOR: HEALTHCARE SERVICES, NAMELY, THE
PREVENTION, DIAGNOSIS AND TREATMENT OF
CARDIAC DISEASES AND THE REHABILITATION
OF THOSE WHO HAVE SUFFERED FROM THOSE
DISEASES, IN CLASS 44 (U.S. CLS. 100 AND 101).

FIRST USE 1-15-1986; IN COMMERCE 1-15-1986.

THE MARK CONSISTS OF STANDARD CHAR-
ACTERS WITHOUT CLAIM TO ANY PARTICULAR
FONT, STYLE, SIZE, OR COLOR.

OWNER OF U.S. REG. NOS. 1,426,995 AND
1,475,537.

SEC. 2(F).

SER. NO. 77-368,233, FILED 1-10-2008.

DAVID MILLER, EXAMINING ATTORNEY

Int. Cl.: 36

Prior U.S. Cls.: 100, 101 and 102

United States Patent and Trademark Office

Reg. No. 3,480,483

Registered Aug. 5, 2008

**SERVICE MARK
PRINCIPAL REGISTER**

THE BANK OF INVERNESS

BRANNEN BANKS OF FLORIDA, INC. (FLOR-
IDA CORPORATION)
320 US HIGHWAY 41 SOUTH
INVERNESS, FL 34450

FOR: BANKING SERVICES, IN CLASS 36 (U.S.
CLS. 100, 101 AND 102).

FIRST USE 0-0-1929; IN COMMERCE 0-0-1929.

THE MARK CONSISTS OF STANDARD CHAR-
ACTERS WITHOUT CLAIM TO ANY PARTICULAR
FONT, STYLE, SIZE, OR COLOR.

NO CLAIM IS MADE TO THE EXCLUSIVE
RIGHT TO USE "BANK", APART FROM THE
MARK AS SHOWN.

SEC. 2(F).

SER. NO. 77-368,263, FILED 1-10-2008.

JESSICA A. POWERS, EXAMINING ATTORNEY

Int. Cl.: 14

Prior U.S. Cls.: 2, 27, 28 and 50

United States Patent and Trademark Office

Reg. No. 3,480,484

Registered Aug. 5, 2008

**TRADEMARK
PRINCIPAL REGISTER**

CHRISTIAN BENET

FOSSIL, INC. (DELAWARE CORPORATION)
2280 N. GREENVILLE AVENUE
RICHARDSON, TX 75082

OWNER OF U.S. REG. NO. 2,974,480.

FOR: WATCHES AND JEWELRY, IN CLASS 14
(U.S. CLS. 2, 27, 28 AND 50).

THE NAME(S), PORTRAIT(S), AND/OR SIGNA-
TURE(S) SHOWN IN THE MARK DOES NOT IDEN-
TIFY A PARTICULAR LIVING INDIVIDUAL.

FIRST USE 10-0-2004; IN COMMERCE 10-0-2004.

SER. NO. 77-368,337, FILED 1-10-2008.

THE MARK CONSISTS OF STANDARD CHAR-
ACTERS WITHOUT CLAIM TO ANY PARTICULAR
FONT, STYLE, SIZE, OR COLOR.

STEPHEN AQUILA, EXAMINING ATTORNEY

Int. Cl.: 36

Prior U.S. Cls.: 100, 101 and 102

United States Patent and Trademark Office

Reg. No. 3,480,485

Registered Aug. 5, 2008

**SERVICE MARK
PRINCIPAL REGISTER**



FIRST NATIONAL OF NEBRASKA, INC. (NEBRASKA CORPORATION)
STOP 3290
1620 DODGE STREET
OMAHA, NE 681973290

FOR: RETAIL, COMMERCIAL AND TRUST BANKING SERVICES, IN CLASS 36 (U.S. CLS. 100, 101 AND 102).

FIRST USE 4-1-2003; IN COMMERCE 4-1-2003.

OWNER OF U.S. REG. NO. 2,141,144.

NO CLAIM IS MADE TO THE EXCLUSIVE RIGHT TO USE "BANK", APART FROM THE MARK AS SHOWN.

THE MARK CONSISTS OF A CASTLE, AND A CASTLE FLAG WITH THE WORDING "CASTLE BANK" IN THE CENTER OF THE CASTLE.

SER. NO. 77-368,578, FILED 1-10-2008.

MICHAEL ENGEL, EXAMINING ATTORNEY

Int. Cl.: 28

Prior U.S. Cls.: 22, 23, 38 and 50

United States Patent and Trademark Office

Reg. No. 3,480,486

Registered Aug. 5, 2008

**TRADEMARK
PRINCIPAL REGISTER**

THE L WORD

SHOWTIME NETWORKS INC. (DELAWARE
CORPORATION)
1633 BROADWAY
NEW YORK, NY 10019

FOR: BOARD GAMES, IN CLASS 28 (U.S. CLS. 22,
23, 38 AND 50).

FIRST USE 12-4-2007; IN COMMERCE 12-4-2007.

THE MARK CONSISTS OF STANDARD CHAR-
ACTERS WITHOUT CLAIM TO ANY PARTICULAR
FONT, STYLE, SIZE, OR COLOR.

OWNER OF U.S. REG. NOS. 2,883,277 AND
3,276,350.

SER. NO. 77-368,843, FILED 1-10-2008.

THOMAS MANOR, EXAMINING ATTORNEY

Int. Cl.: 3

Prior U.S. Cls.: 1, 4, 6, 50, 51 and 52

United States Patent and Trademark Office

Reg. No. 3,480,487

Registered Aug. 5, 2008

**TRADEMARK
PRINCIPAL REGISTER**

BEAUTICONTROL MI NOVELA

BC INTERNATIONAL COSMETIC & IMAGE
SERVICES, INC. (DELAWARE CORPORATION)

14901 S. ORANGE BLOSSOM TRAIL
ORLANDO, FL 32837

FOR: PERFUMERY, DEODORANT FOR PERSONAL USE, BODY LOTION AND BODY WASH, IN CLASS 3 (U.S. CLS. 1, 4, 6, 50, 51 AND 52).

FIRST USE 10-15-2007; IN COMMERCE 10-15-2007.

THE MARK CONSISTS OF STANDARD CHARACTERS WITHOUT CLAIM TO ANY PARTICULAR FONT, STYLE, SIZE, OR COLOR.

OWNER OF U.S. REG. NOS. 853,350, 1,856,494, AND 2,084,900.

THE ENGLISH TRANSLATION OF THE WORD "MI NOVELA" IN THE MARK IS "MY STORY".

SER. NO. 77-368,897, FILED 1-10-2008.

MARK SPARACINO, EXAMINING ATTORNEY

Int. Cls.: 20 and 35

Prior U.S. Cls.: 2, 13, 22, 25, 32, 50, 100, 101 and 102

Reg. No. 3,480,488

United States Patent and Trademark Office

Registered Aug. 5, 2008

**TRADEMARK
SERVICE MARK
PRINCIPAL REGISTER**

LANSHACK

ATCOM SERVICES, INC. (NEW JERSEY CORPORATION)
155 MEADOW ROAD
CLARK, NJ 07066

FOR: NON-METAL TOOL BOXES; KITS FOR MARKING ELECTRICAL AND OPTICAL CABLES, ELECTRICAL AND OPTICAL APPARATUS AND INSTRUMENTS AND ELECTRICAL AND OPTICAL INSTALLATIONS, NAMELY, PLASTIC TRANSPARENT SLEEVES, PLASTIC TRANSFER STRIPS, PLASTIC IDENTIFICATION TAGS AND MARKING TOOLS; NON-METAL PIPE AND CABLE CLIPS, IN CLASS 20 (U.S. CLS. 2, 13, 22, 25, 32 AND 50).

FIRST USE 11-3-1997; IN COMMERCE 11-3-1997.

FOR: ON-LINE RETAIL STORE SERVICES FEATURING HAND TOOLS AND KITS CONTAINING HAND TOOLS; FISH TAPE FOR PULLING CABLES; TOOL POUCHES FOR ATTACHMENT TO TOOL BELTS; ROLL-UP FABRIC CONTAINERS FOR HAND TOOLS; TOOL HOLDERS; CABLES FOR ELECTRICAL OR OPTICAL SIGNAL TRANSMISSION; CABLE CONNECTORS; CABLE JUMP LEADS; ELECTRONIC AND OPTICAL COMMUNICATIONS INSTRUMENTS AND COMPONENTS; ELECTRONIC TEST AND MEASUREMENT DEVICES FOR USE IN THE FIELDS OF NETWORKS

AND TELECOMMUNICATIONS; DATA ACCESS PORTS FOR USE WITH ELECTRICAL CONTROL PANELS FOR CONNECTING MULTIPLE DATA AND ELECTRICAL DEVICES; CONVERTERS; COMPUTER NETWORK ADAPTERS, SWITCHES, ROUTERS AND HUBS; MOUNTING RACKS, BRACKETS, AND WALLPLATES FOR TELECOMMUNICATIONS AND DATA TRANSMISSION HARDWARE; NON-METAL TOOL BOXES; KITS FOR MARKING ELECTRICAL AND OPTICAL CABLES, APPARATUS, INSTRUMENTS AND INSTALLATIONS; NON-METAL PIPE AND CABLE CLIPS; CABLE TIES AND STRAPS FOR FASTENING AND SECURING OBJECTS SUCH AS BUNDLES OF WIRE TOGETHER; TOOL BAGS AND POUCHES SOLD EMPTY; DOLLIES AND HAND TRUCKS; AND INDUSTRIAL LUBRICANTS, IN CLASS 35 (U.S. CLS. 100, 101 AND 102).

FIRST USE 11-3-1997; IN COMMERCE 11-3-1997.

THE MARK CONSISTS OF STANDARD CHARACTERS WITHOUT CLAIM TO ANY PARTICULAR FONT, STYLE, SIZE, OR COLOR.

SER. NO. 77-369,227, FILED 1-11-2008.

KAREN BRACEY, EXAMINING ATTORNEY

Int. Cls.: 20 and 35

Prior U.S. Cls.: 2, 13, 22, 25, 32, 50, 100, 101 and 102

United States Patent and Trademark Office

Reg. No. 3,480,489

Registered Aug. 5, 2008

**TRADEMARK
SERVICE MARK
PRINCIPAL REGISTER**



ATCOM SERVICES, INC. (NEW JERSEY CORPORATION)
155 MEADOW ROAD
CLARK, NJ 07066

FOR: NON-METAL TOOL BOXES; KITS FOR MARKING ELECTRICAL AND OPTICAL CABLES, ELECTRICAL AND OPTICAL APPARATUS AND INSTRUMENTS AND ELECTRICAL AND OPTICAL INSTALLATIONS, NAMELY, PLASTIC TRANSPARENT SLEEVES, PLASTIC TRANSFER STRIPS, PLASTIC IDENTIFICATION TAGS AND MARKING TOOLS; NON-METAL PIPE AND CABLE CLIPS, IN CLASS 20 (U.S. CLS. 2, 13, 22, 25, 32 AND 50).

FIRST USE 6-1-1993; IN COMMERCE 6-1-1993.

FOR: ON-LINE RETAIL STORE SERVICES FEATURING HAND TOOLS AND KITS CONTAINING HAND TOOLS; FISH TAPE FOR PULLING CABLES; TOOL POUCHES FOR ATTACHMENT TO TOOL BELTS; ROLL-UP FABRIC CONTAINERS FOR HAND TOOLS; TOOL HOLDERS; CABLES FOR ELECTRICAL OR OPTICAL SIGNAL TRANSMISSION; CABLE CONNECTORS; CABLE JUMP LEADS; ELECTRONIC AND OPTICAL COMMUNICATIONS INSTRUMENTS AND COMPONENTS; ELECTRONIC TEST AND MEASUREMENT DEVICES FOR USE IN THE FIELDS OF NETWORKS AND TELECOMMUNICATIONS; DATA ACCESS PORTS FOR USE WITH ELECTRICAL CONTROL PANELS FOR CONNECTING MULTIPLE DATA

AND ELECTRICAL DEVICES; CONVERTERS; COMPUTER NETWORK ADAPTERS, SWITCHES, ROUTERS AND HUBS; MOUNTING RACKS, BRACKETS, AND WALLPLATES FOR TELECOMMUNICATIONS AND DATA TRANSMISSION HARDWARE; NON-METAL TOOL BOXES; KITS FOR MARKING ELECTRICAL AND OPTICAL CABLES, APPARATUS, INSTRUMENTS AND INSTALLATIONS; NON-METAL PIPE AND CABLE CLIPS; CABLE TIES AND STRAPS FOR FASTENING AND SECURING OBJECTS SUCH AS BUNDLES OF WIRE TOGETHER; TOOL BAGS AND POUCHES SOLD EMPTY; DOLLIES AND HAND TRUCKS; AND INDUSTRIAL LUBRICANTS, IN CLASS 35 (U.S. CLS. 100, 101 AND 102).

FIRST USE 6-1-1993; IN COMMERCE 6-1-1993.

THE COLOR(S) MAROON AND WHITE IS/ARE CLAIMED AS A FEATURE OF THE MARK.

THE MARK CONSISTS OF A MAROON TRIANGLE WITH ROUNDED CORNERS AND A SHALLOW, DOWNWARD-FACING SEMICIRCULAR SECTION REMOVED FROM THE LOWER EDGE; TWO WHITE CRESCENTS FACING EACH OTHER WITH HORNS SLIGHTLY SEPARATED TO OUTLINE A MAROON DISK CENTERED WITHIN THE TRIANGLE; TWO WHITE STARS ORBITING THE EQUATOR OF THE DISK FROM OPPOSITE DIRECTIONS, EACH STAR TRAILING A WHITE ORBITAL

TRACE THAT DISAPPEARS AROUND THE OUTER
EDGE OF A CRESCENT.

SER. NO. 77-369,231, FILED 1-11-2008.

KAREN BRACEY, EXAMINING ATTORNEY

Int. Cl.: 38

Prior U.S. Cls.: 100, 101 and 104

United States Patent and Trademark Office

Reg. No. 3,480,490

Registered Aug. 5, 2008

**SERVICE MARK
PRINCIPAL REGISTER**

SWITCHED

AOL LLC (DELAWARE LTD LIAB CO)
22000 AOL WAY
DULLES, VA 20166

THE MARK CONSISTS OF STANDARD CHAR-
ACTERS WITHOUT CLAIM TO ANY PARTICULAR
FONT, STYLE, SIZE, OR COLOR.

FOR: TELECOMMUNICATIONS SERVICES,
NAMELY, ELECTRONIC MAIL SERVICES, IN
CLASS 38 (U.S. CLS. 100, 101 AND 104).

SER. NO. 77-369,244, FILED 1-11-2008.

FIRST USE 1-3-2008; IN COMMERCE 1-3-2008.

CHERYL CLAYTON, EXAMINING ATTORNEY

Int. Cl.: 42

Prior U.S. Cls.: 100 and 101

United States Patent and Trademark Office

Reg. No. 3,480,491

Registered Aug. 5, 2008

**SERVICE MARK
PRINCIPAL REGISTER**

RentalMan

WYNNE SYSTEMS, INC. (CALIFORNIA CORPORATION)
SUITE 900
19800 MACARTHUR BOULEVARD
IRVINE, CA 926122421

FOR: PROVIDING ON-LINE NON-DOWNLOADABLE SOFTWARE FOR USE IN ACCESSING ACCOUNTING INFORMATION BY EQUIPMENT RENTAL COMPANIES AND FOR PROVIDING SECURE ACCESS TO CUSTOMER INFORMATION, IN CLASS 42 (U.S. CLS. 100 AND 101).

FIRST USE 10-15-2001; IN COMMERCE 10-15-2001.

THE MARK CONSISTS OF STANDARD CHARACTERS WITHOUT CLAIM TO ANY PARTICULAR FONT, STYLE, SIZE, OR COLOR.

SER. NO. 77-369,485, FILED 1-11-2008.

MICHAEL KAZAZIAN, EXAMINING ATTORNEY

Int. Cl.: 16

Prior U.S. Cls.: 2, 5, 22, 23, 29, 37, 38 and 50

United States Patent and Trademark Office

Reg. No. 3,480,492

Registered Aug. 5, 2008

**TRADEMARK
PRINCIPAL REGISTER**

bon appétit

ADVANCE MAGAZINE PUBLISHERS INC. (NEW
YORK CORPORATION)
FOUR TIMES SQUARE
NEW YORK, NY 10036

FOR: MAGAZINES FEATURING FOOD, BEV-
ERAGES, ENTERTAINING, TRAVEL AND RE-
CIPES, IN CLASS 16 (U.S. CLS. 2, 5, 22, 23, 29, 37, 38
AND 50).

FIRST USE 1-1-2008; IN COMMERCE 1-1-2008.

OWNER OF U.S. REG. NOS. 653,791, 1,283,423 AND
OTHERS.

THE ENGLISH TRANSLATION OF THE WORD
"BON APPÉTIT" IN THE MARK IS I WISH YOU A
GOOD APPETITE.

SER. NO. 77-369,555, FILED 1-11-2008.

JENNIFER HETU, EXAMINING ATTORNEY

Int. Cl.: 36

Prior U.S. Cls.: 100, 101 and 102

United States Patent and Trademark Office

Reg. No. 3,480,493

Registered Aug. 5, 2008

**SERVICE MARK
PRINCIPAL REGISTER**

THE REAL ESTATE MAN

SENDER, RANDALL HALL (UNITED STATES
INDIVIDUAL)
8451 UTICA DRIVE
LOS ANGELES, CA 90046

FOR: AGENCIES OR BROKERAGE FOR LEAS-
ING OR RENTING OF LAND; AGENCIES OR
BROKERAGE FOR RENTING LAND; AGENCIES
OR BROKERAGE FOR RENTING OF BUILDINGS;
APPRAISAL OF REAL ESTATE; ASSESSMENT AND
MANAGEMENT OF REAL ESTATE, IN CLASS 36
(U.S. CLS. 100, 101 AND 102).

FIRST USE 1-26-2006; IN COMMERCE 6-1-2006.

THE MARK CONSISTS OF STANDARD CHAR-
ACTERS WITHOUT CLAIM TO ANY PARTICULAR
FONT, STYLE, SIZE, OR COLOR.

NO CLAIM IS MADE TO THE EXCLUSIVE
RIGHT TO USE "REAL ESTATE", APART FROM
THE MARK AS SHOWN.

SER. NO. 77-369,570, FILED 1-11-2008.

TARAH HARDY, EXAMINING ATTORNEY

Int. Cl.: 12

Prior U.S. Cls.: 19, 21, 23, 31, 35 and 44

Reg. No. 3,480,494

United States Patent and Trademark Office

Registered Aug. 5, 2008

**TRADEMARK
PRINCIPAL REGISTER**

EXPLORER

FORD MOTOR COMPANY (DELAWARE CORPORATION)
ONE AMERICAN ROAD
DEARBORN, MI 48126

FOR: SPORT-UTILITY VEHICLES AND MOTOR VEHICLE PARTS AND ACCESSORIES, NAMELY, EXTERIOR INSIGNIA BADGES, HITCH COVERS, SPLASH GUARDS AND LICENSE PLATE FRAMES, IN CLASS 12 (U.S. CLS. 19, 21, 23, 31, 35 AND 44).

FIRST USE 3-15-1990; IN COMMERCE 3-15-1990.

THE MARK CONSISTS OF STANDARD CHARACTERS WITHOUT CLAIM TO ANY PARTICULAR FONT, STYLE, SIZE, OR COLOR.

OWNER OF U.S. REG. NOS. 1,193,137, 2,014,679 AND OTHERS.

SER. NO. 77-369,888, FILED 1-11-2008.

REBECCA GILBERT, EXAMINING ATTORNEY

Int. Cl.: 36

Prior U.S. Cls.: 100, 101 and 102

United States Patent and Trademark Office

Reg. No. 3,480,495

Registered Aug. 5, 2008

**SERVICE MARK
PRINCIPAL REGISTER**

DIRECTSOURCE

AMERICAN INTERNATIONAL GROUP, INC.
(DELAWARE CORPORATION)
70 PINE STREET
NEW YORK, NY 10270

THE MARK CONSISTS OF STANDARD CHAR-
ACTERS WITHOUT CLAIM TO ANY PARTICULAR
FONT, STYLE, SIZE, OR COLOR.

FOR: ANNUITY UNDERWRITING; ISSUANCE
AND ADMINISTRATION OF ANNUITIES, IN
CLASS 36 (U.S. CLS. 100, 101 AND 102).

SER. NO. 77-370,775, FILED 1-14-2008.

FIRST USE 1-1-2008; IN COMMERCE 1-1-2008.

THOMAS MANOR, EXAMINING ATTORNEY

Int. Cl.: 35

Prior U.S. Cls.: 100, 101 and 102

United States Patent and Trademark Office

Reg. No. 3,480,496

Registered Aug. 5, 2008

**SERVICE MARK
PRINCIPAL REGISTER**



THE KILPATRICK COMPANY, INC. (FLORIDA CORPORATION)
7700 HIGH RIDGE ROAD
BOYNTON BEACH, FL 33426

FOR: WHOLESALE DISTRIBUTORSHIPS IN THE FIELDS OF LANDSCAPE AND IRRIGATION SUPPLIES, GOLF COURSE MOWING, AND MAINTENANCE

EQUIPMENT, IN CLASS 35 (U.S. CLS. 100, 101 AND 102).

FIRST USE 1-31-1985; IN COMMERCE 1-31-1985.

SER. NO. 77-370,871, FILED 1-14-2008.

SHANNON TWOHIG, EXAMINING ATTORNEY

Int. Cl.: 27

Prior U.S. Cls.: 19, 20, 37, 42 and 50

United States Patent and Trademark Office

Reg. No. 3,480,497

Registered Aug. 5, 2008

**TRADEMARK
PRINCIPAL REGISTER**

SUPER DUTY

FORD MOTOR COMPANY (DELAWARE CORPORATION)
ONE AMERICAN ROAD
DEARBORN, MI 48126

FOR: FLOOR MATS FOR MOTOR VEHICLES, IN CLASS 27 (U.S. CLS. 19, 20, 37, 42 AND 50).

FIRST USE 1-1-2004; IN COMMERCE 1-1-2004.

THE MARK CONSISTS OF STANDARD CHARACTERS WITHOUT CLAIM TO ANY PARTICULAR FONT, STYLE, SIZE, OR COLOR.

OWNER OF U.S. REG. NOS. 2,332,851, 3,158,613 AND OTHERS.

SER. NO. 77-371,164, FILED 1-14-2008.

REBECCA GILBERT, EXAMINING ATTORNEY

Int. Cl.: 36

Prior U.S. Cls.: 100, 101 and 102

United States Patent and Trademark Office

Reg. No. 3,480,498

Registered Aug. 5, 2008

**SERVICE MARK
PRINCIPAL REGISTER**

PROPRICING

CARGILL, INCORPORATED (DELAWARE CORPORATION)
15407 MCGINTY ROAD WEST
WAYZATA, MN 55391

FOR: FINANCIAL RISK MANAGEMENT SERVICES, NAMELY, PROVIDING CONTRACTS WITH MARKETING AND PRICING ALTERNATIVES TO FARMERS AND PRODUCERS, IN CLASS 36 (U.S. CLS. 100, 101 AND 102).

FIRST USE 11-30-2000; IN COMMERCE 11-30-2000.

THE MARK CONSISTS OF STANDARD CHARACTERS WITHOUT CLAIM TO ANY PARTICULAR FONT, STYLE, SIZE, OR COLOR.

OWNER OF U.S. REG. NO. 2,670,526.

SEC. 2(F).

SER. NO. 77-371,735, FILED 1-15-2008.

THEODORE MCBRIDE, EXAMINING ATTORNEY

Int. Cls.: 9, 35 and 42

Prior U.S. Cls.: 21, 23, 26, 36, 38, 100, 101 and 102

Reg. No. 3,480,499

United States Patent and Trademark Office

Registered Aug. 5, 2008

**TRADEMARK
SERVICE MARK
PRINCIPAL REGISTER**

LUPROLINK

TAP PHARMACEUTICAL PRODUCTS, INC. (DE-
LAWARE CORPORATION)
675 NORTH FIELD DRIVE
LAKE FOREST, IL 60045

FOR: RFID READERS; COMPUTER SOFTWARE
FOR TRACKING AND AUTHENTICATING PHAR-
MACEUTICAL PRODUCTS AND INVENTORY
MANAGEMENT , IN CLASS 9 (U.S. CLS. 21, 23, 26,
36 AND 38).

FIRST USE 11-7-2007; IN COMMERCE 11-7-2007.

FOR: INVENTORY MANAGEMENT IN THE
FIELD OF PHARMACEUTICAL PRODUCTS, IN
CLASS 35 (U.S. CLS. 100, 101 AND 102).

FIRST USE 11-7-2007; IN COMMERCE 11-7-2007.

FOR: PROVIDING ON-LINE NON-DOWNLOAD-
ABLE SOFTWARE FOR TRACKING AND AU-
THENTICATING PHARMACEUTICAL PRODUCTS
AND INVENTORY MANAGEMENT, IN CLASS 42
(U.S. CLS. 100 AND 101).

FIRST USE 11-7-2007; IN COMMERCE 11-7-2007.

THE MARK CONSISTS OF STANDARD CHAR-
ACTERS WITHOUT CLAIM TO ANY PARTICULAR
FONT, STYLE, SIZE, OR COLOR.

OWNER OF U.S. REG. NOS. 1,511,474 AND
2,964,974.

SER. NO. 77-372,724, FILED 1-16-2008.

KIMBERLY PERRY, EXAMINING ATTORNEY

Int. Cls.: 9, 35 and 42

Prior U.S. Cls.: 21, 23, 26, 36, 38, 100, 101 and 102

Reg. No. 3,480,500

United States Patent and Trademark Office

Registered Aug. 5, 2008

**TRADEMARK
SERVICE MARK
PRINCIPAL REGISTER**

LuproLink

TAP PHARMACEUTICAL PRODUCTS, INC. (DE-
LAWARE CORPORATION)
675 NORTH FIELD DRIVE
LAKE FOREST, IL 60045

FOR: RFID READERS; COMPUTER SOFTWARE
FOR TRACKING AND AUTHENTICATING PHAR-
MACEUTICAL PRODUCTS AND INVENTORY
MANAGEMENT , IN CLASS 9 (U.S. CLS. 21, 23, 26,
36 AND 38).

FIRST USE 11-7-2007; IN COMMERCE 11-7-2007.

FOR: INVENTORY MANAGEMENT IN THE
FIELD OF PHARMACEUTICAL PRODUCTS, IN
CLASS 35 (U.S. CLS. 100, 101 AND 102).

FIRST USE 11-7-2007; IN COMMERCE 11-7-2007.

FOR: PROVIDING ON-LINE NON-DOWNLOAD-
ABLE SOFTWARE FOR TRACKING AND AU-
THENTICATING PHARMACEUTICAL PRODUCTS
AND INVENTORY MANAGEMENT, IN CLASS 42
(U.S. CLS. 100 AND 101).

FIRST USE 11-7-2007; IN COMMERCE 11-7-2007.

OWNER OF U.S. REG. NOS. 1,511,474 AND
2,964,974.

THE MARK CONSISTS OF THE LITERAL ELE-
MENT OF THE MARK WITH A STYLIZED CIRCUL-
LAR DESIGN POSITIONED ABOVE THE LITERAL
ELEMENT.

SER. NO. 77-372,727, FILED 1-16-2008.

KIMBERLY PERRY, EXAMINING ATTORNEY

Int. Cl.: 43

Prior U.S. Cls.: 100 and 101

United States Patent and Trademark Office

Reg. No. 3,480,501

Registered Aug. 5, 2008

SERVICE MARK
PRINCIPAL REGISTER



MUNSOK SO (UNITED STATES INDIVIDUAL)
13217 TAKARA DRIVE
TOWN AND COUNTRY, MO 63131

FOR: RESTAURANT AND BAR SERVICES, IN
CLASS 43 (U.S. CLS. 100 AND 101).

FIRST USE 5-0-2003; IN COMMERCE 5-0-2003.

NO CLAIM IS MADE TO THE EXCLUSIVE
RIGHT TO USE "FISH", APART FROM THE MARK
AS SHOWN.

THE MARK CONSISTS OF A RISING OR SET-
TING SUN PARTIALLY OBSTRUCTED BY THE
WORDS "DRUNKEN" AND "FISH".

SER. NO. 77-372,868, FILED 1-16-2008.

DANIEL CAPSHAW, EXAMINING ATTORNEY

Int. Cl.: 41

Prior U.S. Cls.: 100, 101 and 107

United States Patent and Trademark Office

Reg. No. 3,480,502

Registered Aug. 5, 2008

**SERVICE MARK
PRINCIPAL REGISTER**

LEXGO

MCCLATCHY U.S.A., INC. (DELAWARE COR-
PORATION)
2100 Q STREET
SACRAMENTO, CA 95816

THE MARK CONSISTS OF STANDARD CHAR-
ACTERS WITHOUT CLAIM TO ANY PARTICULAR
FONT, STYLE, SIZE, OR COLOR.

FOR: PROVIDING A WEBSITE FEATURING IN-
FORMATION, NEWS AND COMMENTARY IN THE
FIELD OF ENTERTAINMENT, IN CLASS 41 (U.S.
CLS. 100, 101 AND 107).

SER. NO. 77-373,128, FILED 1-16-2008.

FIRST USE 1-11-2008; IN COMMERCE 1-11-2008.

RAUL CORDOVA, EXAMINING ATTORNEY

Int. Cl.: 42

Prior U.S. Cls.: 100 and 101

United States Patent and Trademark Office

Reg. No. 3,480,503

Registered Aug. 5, 2008

**SERVICE MARK
PRINCIPAL REGISTER**

PEAKSAVER

CITY PUBLIC SERVICE (TEXAS CORPORATION)
P.O. BOX 1771
SAN ANTONIO, TX 782961771

THE MARK CONSISTS OF STANDARD CHAR-
ACTERS WITHOUT CLAIM TO ANY PARTICULAR
FONT, STYLE, SIZE, OR COLOR.

FOR: REMOTELY CONTROLLING THE COOL-
ING SYSTEMS OF OTHERS, IN CLASS 42 (U.S. CLS.
100 AND 101).

SER. NO. 77-373,184, FILED 1-16-2008.

FIRST USE 6-11-2003; IN COMMERCE 6-11-2003.

CURTIS FRENCH, EXAMINING ATTORNEY

Int. Cl.: 29

Prior U.S. Cl.: 46

United States Patent and Trademark Office

Reg. No. 3,480,504

Registered Aug. 5, 2008

**TRADEMARK
PRINCIPAL REGISTER**

COASTAL CRAB CAKE

SB PHILLIPS LLC (MARYLAND LTD LIAB CO)
1215 E. FORT AVENUE
BALTIMORE, MD 21230

NO CLAIM IS MADE TO THE EXCLUSIVE
RIGHT TO USE "CRAB CAKE", APART FROM
THE MARK AS SHOWN.

FOR: CRAB CAKES, IN CLASS 29 (U.S. CL. 46).

FIRST USE 6-14-2007; IN COMMERCE 6-14-2007.

SER. NO. 77-373,263, FILED 1-16-2008.

THE MARK CONSISTS OF STANDARD CHAR-
ACTERS WITHOUT CLAIM TO ANY PARTICULAR
FONT, STYLE, SIZE, OR COLOR.

ALEXANDER L. POWERS, EXAMINING ATTOR-
NEY

Int. Cl.: 29

Prior U.S. Cl.: 46

United States Patent and Trademark Office

Reg. No. 3,480,505

Registered Aug. 5, 2008

**TRADEMARK
PRINCIPAL REGISTER**

SILVER T BRAND

CARGILL MEAT SOLUTIONS CORPORATION
(DELAWARE CORPORATION)
151 NORTH MAIN
WICHITA, KS 67202

FOR: MEAT, IN CLASS 29 (U.S. CL. 46).

FIRST USE 12-10-2007; IN COMMERCE 12-10-2007.

THE MARK CONSISTS OF STANDARD CHAR-
ACTERS WITHOUT CLAIM TO ANY PARTICULAR
FONT, STYLE, SIZE, OR COLOR.

OWNER OF U.S. REG. NO. 2,502,555.

NO CLAIM IS MADE TO THE EXCLUSIVE
RIGHT TO USE "BRAND", APART FROM THE
MARK AS SHOWN.

SER. NO. 77-373,435, FILED 1-16-2008.

ALEX KEAM, EXAMINING ATTORNEY

Int. Cl.: 29

Prior U.S. Cl.: 46

United States Patent and Trademark Office

Reg. No. 3,480,506

Registered Aug. 5, 2008

**TRADEMARK
PRINCIPAL REGISTER**



CARGILL MEAT SOLUTIONS CORPORATION
(DELAWARE CORPORATION)
151 NORTH MAIN
WICHITA, KS 67202

FOR: MEAT, IN CLASS 29 (U.S. CL. 46).

FIRST USE 12-10-2007; IN COMMERCE 12-10-2007.

OWNER OF U.S. REG. NOS. 1,258,727 AND
2,502,555.

NO CLAIM IS MADE TO THE EXCLUSIVE
RIGHT TO USE "BRAND", APART FROM THE
MARK AS SHOWN.

THE MARK CONSISTS OF CONCENTRIC CIR-
CLES, THE LETTER "T" AND THE WORDS "SIL-
VER" AND "BRAND".

SER. NO. 77-373,437, FILED 1-16-2008.

ALEX KEAM, EXAMINING ATTORNEY

Int. Cl.: 41

Prior U.S. Cls.: 100, 101 and 107

United States Patent and Trademark Office

Reg. No. 3,480,507

Registered Aug. 5, 2008

**SERVICE MARK
PRINCIPAL REGISTER**

Hollywood Network

ABREU, CARLOS (UNITED STATES INDIVIDUAL)
STE 600
433 N. CAMDEN DR.
BEVERLY HILLS, CA 90210

FOR: PROVIDING INFORMATION AND ARTICLES IN THE FIELDS OF FILM, FILMMAKING, AND ENTERTAINMENT VIA A GLOBAL COMPUTER NETWORK, IN CLASS 41 (U.S. CLS. 100, 101 AND 107).

FIRST USE 2-15-1995; IN COMMERCE 1-15-1996.

THE MARK CONSISTS OF STANDARD CHARACTERS WITHOUT CLAIM TO ANY PARTICULAR FONT, STYLE, SIZE, OR COLOR.

OWNER OF U.S. REG. NOS. 2,539,390, 3,150,407, AND 3,294,675.

NO CLAIM IS MADE TO THE EXCLUSIVE RIGHT TO USE "NETWORK", APART FROM THE MARK AS SHOWN.

SEC. 2(F).

SER. NO. 77-374,800, FILED 1-17-2008.

DAYNA BROWNE, EXAMINING ATTORNEY

Int. Cl.: 36

Prior U.S. Cls.: 100, 101 and 102

United States Patent and Trademark Office

Reg. No. 3,480,508

Registered Aug. 5, 2008

**SERVICE MARK
PRINCIPAL REGISTER**

PREMIERE 7

AMERICAN INTERNATIONAL GROUP, INC.
(DELAWARE CORPORATION)
70 PINE STREET
NEW YORK, NY 10270

FOR: ANNUITY UNDERWRITING; ISSUANCE
AND ADMINISTRATION OF ANNUITIES, IN
CLASS 36 (U.S. CLS. 100, 101 AND 102).

FIRST USE 1-1-2008; IN COMMERCE 1-1-2008.

THE MARK CONSISTS OF STANDARD CHAR-
ACTERS WITHOUT CLAIM TO ANY PARTICULAR
FONT, STYLE, SIZE, OR COLOR.

OWNER OF U.S. REG. NO. 3,362,155.

SER. NO. 77-375,061, FILED 1-18-2008.

THOMAS MANOR, EXAMINING ATTORNEY

Int. Cl.: 36

Prior U.S. Cls.: 100, 101 and 102

United States Patent and Trademark Office

Reg. No. 3,480,509

Registered Aug. 5, 2008

**SERVICE MARK
PRINCIPAL REGISTER**

PREMIERE 5

AMERICAN INTERNATIONAL GROUP, INC.
(DELAWARE CORPORATION)
70 PINE STREET
NEW YORK, NY 10270

FOR: ANNUITY UNDERWRITING; ISSUANCE
AND ADMINISTRATION OF ANNUITIES, IN
CLASS 36 (U.S. CLS. 100, 101 AND 102).

FIRST USE 1-1-2008; IN COMMERCE 1-1-2008.

THE MARK CONSISTS OF STANDARD CHAR-
ACTERS WITHOUT CLAIM TO ANY PARTICULAR
FONT, STYLE, SIZE, OR COLOR.

OWNER OF U.S. REG. NO. 3,362,154.

SER. NO. 77-375,079, FILED 1-18-2008.

THOMAS MANOR, EXAMINING ATTORNEY

Int. Cl.: 41

Prior U.S. Cls.: 100, 101 and 107

United States Patent and Trademark Office

Reg. No. 3,480,510

Registered Aug. 5, 2008

**SERVICE MARK
PRINCIPAL REGISTER**

GENYES

GENERATION YES CORPORATION (WASHINGTON CORPORATION)
2584 R.W. JOHNSON BLVD. SW
OLYMPIA, WA 98512

FOR: EDUCATIONAL SERVICES, NAMELY, DEVELOPING, ARRANGING, AND CONDUCTING EDUCATIONAL CONFERENCES AND PROGRAMS AND PROVIDING COURSES OF INSTRUCTION IN THE FIELD OF TELECOMMUNICATIONS, GLOBAL COMPUTER NETWORKS, COMPUTER TECHNOLOGY, AND CURRICULUM DEVELOPMENT AND DISTRIBUTION OF COURSE MATERIAL IN CONNECTION THEREWITH; EDUCATIONAL SERVICES, NAMELY, PROVIDING COURSES OF INSTRUCTION AT THE PRIMARY AND SECONDARY LEVEL; EDUCATIONAL SERVICES, NAMELY, CONDUCTING INFORMAL PROGRAMS

IN THE FIELDS OF TELECOMMUNICATIONS, GLOBAL COMPUTER NETWORKS, COMPUTER TECHNOLOGY, AND CURRICULUM DEVELOPMENT, USING ON-LINE ACTIVITIES AND INTERACTIVE EXHIBITS, AND PRINTABLE MATERIALS DISTRIBUTED THEREWITH, IN CLASS 41 (U.S. CLS. 100, 101 AND 107).

FIRST USE 8-19-1996; IN COMMERCE 8-19-1996.

THE MARK CONSISTS OF STANDARD CHARACTERS WITHOUT CLAIM TO ANY PARTICULAR FONT, STYLE, SIZE, OR COLOR.

SER. NO. 77-375,431, FILED 1-18-2008.

DAVID H. STINE, EXAMINING ATTORNEY

Int. Cl.: 25

Prior U.S. Cls.: 22 and 39

United States Patent and Trademark Office

Reg. No. 3,480,511

Registered Aug. 5, 2008

**TRADEMARK
PRINCIPAL REGISTER**

FOSSIL

FOSSIL, INC. (DELAWARE CORPORATION)
2280 N. GREENVILLE AVENUE
RICHARDSON, TX 75225

FOR: CLOTHING, NAMELY, SHIRTS, PANTS,
JACKETS, COATS, SWEATSHIRTS, SKIRTS;
CLOTHING, NAMELY, MEN'S TIES; CLOTHING,
NAMELY, SCARVES, GLOVES AND MITTENS, IN
CLASS 25 (U.S. CLS. 22 AND 39).

FIRST USE 7-31-2000; IN COMMERCE 7-31-2000.

THE MARK CONSISTS OF STANDARD CHAR-
ACTERS WITHOUT CLAIM TO ANY PARTICULAR
FONT, STYLE, SIZE, OR COLOR.

OWNER OF U.S. REG. NOS. 1,559,950, 1,766,792
AND OTHERS.

SER. NO. 77-375,645, FILED 1-18-2008.

STEPHEN AQUILA, EXAMINING ATTORNEY

Int. Cl.: 9

Prior U.S. Cls.: 21, 23, 26, 36 and 38

Reg. No. 3,480,512

United States Patent and Trademark Office

Registered Aug. 5, 2008

**TRADEMARK
PRINCIPAL REGISTER**

HIPPIE

TECHGUARD SECURITY, LLC (MISSOURI LTD
LIAB CO)
SUITE 206
743 SPIRIT 40 PARK DR.
CHESTERFIELD, MO 63005

FOR: COMPUTER SECURITY HARDWARE AND
SOFTWARE FOR THE CREATION OF FIREWALL
FILTERS USED TO IDENTIFY AND DETERMINE
THE GEOGRAPHIC ORIGIN FOR SOURCE IP AD-
DRESSES AND FILTER INCOMING INFORMA-
TION ACCORDING TO USER-DEFINED

SETTINGS, IN CLASS 9 (U.S. CLS. 21, 23, 26, 36
AND 38).

FIRST USE 11-24-2006; IN COMMERCE 11-24-2006.

THE MARK CONSISTS OF STANDARD CHAR-
ACTERS WITHOUT CLAIM TO ANY PARTICULAR
FONT, STYLE, SIZE, OR COLOR.

SER. NO. 77-376,523, FILED 1-21-2008.

KIMBERLY PERRY, EXAMINING ATTORNEY

Int. Cls.: 36 and 37

Prior U.S. Cls.: 100, 101, 102, 103 and 106

United States Patent and Trademark Office

Reg. No. 3,480,513

Registered Aug. 5, 2008

**SERVICE MARK
PRINCIPAL REGISTER**

DOING IT RIGHT. RIGHT NOW.

CALDWELL WATSON REAL ESTATE GROUP,
INC. (TEXAS CORPORATION)
4TH FLOOR
7904 N. SAM HOUSTON PARKWAY WEST
HOUSTON, TX 77064

FOR: COMMERCIAL AND RESIDENTIAL REAL
ESTATE BROKERAGE SERVICES; COMMERCIAL
AND RESIDENTIAL REAL ESTATE MANAGE-
MENT SERVICES, IN CLASS 36 (U.S. CLS. 100, 101
AND 102).

FIRST USE 1-15-1999; IN COMMERCE 1-15-1999.

FOR: COMMERCIAL AND RESIDENTIAL REAL
ESTATE DEVELOPMENT SERVICES, IN CLASS 37
(U.S. CLS. 100, 103 AND 106).

FIRST USE 1-15-1999; IN COMMERCE 1-15-1999.

THE MARK CONSISTS OF STANDARD CHAR-
ACTERS WITHOUT CLAIM TO ANY PARTICULAR
FONT, STYLE, SIZE, OR COLOR.

SER. NO. 77-376,612, FILED 1-21-2008.

BARBARA GAYNOR, EXAMINING ATTORNEY

Int. Cl.: 44

Prior U.S. Cls.: 100 and 101

United States Patent and Trademark Office

Reg. No. 3,480,514

Registered Aug. 5, 2008

**SERVICE MARK
PRINCIPAL REGISTER**

PHYSIOKIDS

PHYSIOTHERAPY CORPORATION (DELAWARE
CORPORATION)
SUITE 200
855 SPRINGDALE DRIVE
EXTON, PA 19341

FOR: PHYSICAL THERAPY SERVICES; PEDIA-
TRIC PHYSICAL THERAPY SERVICES INCLUD-
ING OCCUPATIONAL THERAPY AND SPEECH-
LANGUAGE THERAPY, IN CLASS 44 (U.S. CLS. 100
AND 101).

FIRST USE 6-15-2007; IN COMMERCE 6-15-2007.

THE MARK CONSISTS OF STANDARD CHAR-
ACTERS WITHOUT CLAIM TO ANY PARTICULAR
FONT, STYLE, SIZE, OR COLOR.

SER. NO. 77-377,028, FILED 1-22-2008.

KEVIN DINALLO, EXAMINING ATTORNEY

Int. Cls.: 38 and 41

Prior U.S. Cls.: 100, 101, 104 and 107

United States Patent and Trademark Office

Reg. No. 3,480,515

Registered Aug. 5, 2008

**SERVICE MARK
PRINCIPAL REGISTER**



SHERIDAN BROADCASTING CORPORATION
(DELAWARE CORPORATION)
SUITE 200
960 PENN AVENUE
PITTSBURGH, PA 15222

FOR: RADIO BROADCASTING SERVICES, IN
CLASS 38 (U.S. CLS. 100, 101 AND 104).

FIRST USE 10-1-2007; IN COMMERCE 10-1-2007.

FOR: ENTERTAINMENT SERVICES IN THE
NATURE OF RADIO PROGRAMS IN THE FIELD
OF GOSPEL MUSIC, NEWS, BUSINESS, ENTER-
TAINMENT AND PUBLIC AFFAIRS, IN CLASS 41
(U.S. CLS. 100, 101 AND 107).

FIRST USE 10-1-2007; IN COMMERCE 10-1-2007.

OWNER OF U.S. REG. NOS. 3,073,352 AND
3,368,765.

NO CLAIM IS MADE TO THE EXCLUSIVE
RIGHT TO USE "AM 1570", APART FROM THE
MARK AS SHOWN.

SER. NO. 77-377,168, FILED 1-22-2008.

DAVID TAYLOR, EXAMINING ATTORNEY

Int. Cls.: 38 and 41

Prior U.S. Cls.: 100, 101, 104 and 107

United States Patent and Trademark Office

Reg. No. 3,480,516

Registered Aug. 5, 2008

**SERVICE MARK
PRINCIPAL REGISTER**



SHERIDAN BROADCASTING CORPORATION
(DELAWARE CORPORATION)
SUITE 200
960 PENN AVENUE
PITTSBURGH, PA 15222

FOR: RADIO BROADCASTING SERVICES, IN
CLASS 38 (U.S. CLS. 100, 101 AND 104).

FIRST USE 5-1-1997; IN COMMERCE 5-1-1997.

FOR: ENTERTAINMENT SERVICES IN THE
NATURE OF RADIO PROGRAMS IN THE FIELD

OF GOSPEL MUSIC, NEWS, BUSINESS, ENTER-
TAINMENT AND PUBLIC AFFAIRS, IN CLASS 41
(U.S. CLS. 100, 101 AND 107).

FIRST USE 5-1-1997; IN COMMERCE 5-1-1997.

OWNER OF U.S. REG. NOS. 2,250,840 AND
2,834,713.

SER. NO. 77-377,185, FILED 1-22-2008.

DAVID TAYLOR, EXAMINING ATTORNEY

Int. Cl.: 25

Prior U.S. Cls.: 22 and 39

United States Patent and Trademark Office

Reg. No. 3,480,517

Registered Aug. 5, 2008

**TRADEMARK
PRINCIPAL REGISTER**

SEXY LITTLE BRIDE

VICTORIA'S SECRET STORES BRAND MAN-
AGEMENT, INC. (DELAWARE CORPORA-
TION)
FOUR LIMITED PARKWAY
REYNOLDSBURG, OH 43068

FOR: PANTIES; TANK TOPS; JACKETS; GAR-
TERS; GLOVES, IN CLASS 25 (U.S. CLS. 22 AND 39).

FIRST USE 4-4-2006; IN COMMERCE 4-4-2006.

THE MARK CONSISTS OF STANDARD CHAR-
ACTERS WITHOUT CLAIM TO ANY PARTICULAR
FONT, STYLE, SIZE, OR COLOR.

OWNER OF U.S. REG. NOS. 3,161,607 AND
3,357,655.

SER. NO. 77-377,499, FILED 1-22-2008.

BRIDGETT SMITH, EXAMINING ATTORNEY

Int. Cl.: 41

Prior U.S. Cls.: 100, 101 and 107

United States Patent and Trademark Office

Reg. No. 3,480,518

Registered Aug. 5, 2008

**SERVICE MARK
PRINCIPAL REGISTER**



APERTURE TECHNOLOGIES, INC. (DELAWARE CORPORATION)
9 RIVERBEND DRIVE SOUTH
STAMFORD, CT 06907

FOR: EDUCATIONAL SERVICES, NAMELY, CONDUCTING CLASSES, SEMINARS, CONFERENCES, AND WORKSHOPS IN THE FIELD OF FACILITY, SPACE, PERSONNEL AND TECHNOLOGY MANAGEMENT AND IN THE FIELD OF COMPUTER SOFTWARE PROGRAMMING AND IMPLEMENTATION TO ASSIST FACILITY AND TECHNOLOGY PERSONNEL MANAGEMENT AND DISTRIBUTION OF COURSE MATERIALS IN CONNECTION THEREWITH, IN CLASS 41 (U.S. CLS. 100, 101 AND 107).

FIRST USE 12-16-2002; IN COMMERCE 12-16-2002.

OWNER OF U.S. REG. NOS. 1,778,785, 2,731,927 AND OTHERS.

THE COLOR(S) RED AND BLACK IS/ARE CLAIMED AS A FEATURE OF THE MARK.

THE MARK CONSISTS OF A RED BROKEN CIRCLE DESIGN COMPRISED OF FOUR CRESCENT-SHAPED SECTIONS TO THE LEFT OF THE WORD "APERTURE" IN BLACK.

SER. NO. 77-377,513, FILED 1-22-2008.

RUSS HERMAN, EXAMINING ATTORNEY

Int. Cl.: 42

Prior U.S. Cls.: 100 and 101

United States Patent and Trademark Office

Reg. No. 3,480,519

Registered Aug. 5, 2008

**SERVICE MARK
PRINCIPAL REGISTER**



APERTURE TECHNOLOGIES, INC. (DELAWARE CORPORATION)
9 RIVERBEND DRIVE SOUTH
STAMFORD, CT 06907

FOR: COMPUTER CONSULTATION, IN CLASS 42 (U.S. CLS. 100 AND 101).

FIRST USE 12-16-2002; IN COMMERCE 12-16-2002.

OWNER OF U.S. REG. NOS. 1,778,785, 2,731,927 AND OTHERS.

THE COLOR(S) RED AND BLACK IS/ARE CLAIMED AS A FEATURE OF THE MARK.

THE MARK CONSISTS OF A RED BROKEN CIRCLE DESIGN COMPRISED OF FOUR CRES-CENT-SHAPED SECTIONS TO THE LEFT OF THE WORD "APERTURE" IN BLACK.

SER. NO. 77-377,528, FILED 1-22-2008.

RUSS HERMAN, EXAMINING ATTORNEY

Int. Cl.: 25

Prior U.S. Cls.: 22 and 39

United States Patent and Trademark Office

Reg. No. 3,480,520

Registered Aug. 5, 2008

**TRADEMARK
PRINCIPAL REGISTER**

SEXY LITTLE THINGS

VICTORIA'S SECRET STORES BRAND MAN-
AGEMENT, INC. (DELAWARE CORPORA-
TION)
FOUR LIMITED PARKWAY
REYNOLDSBURG, OH 43068

FOR: SKIRTS; HATS; GLOVES; JACKETS; TANK
TOPS; HOSIERY, IN CLASS 25 (U.S. CLS. 22 AND 39).

FIRST USE 10-18-2005; IN COMMERCE 10-18-2005.

THE MARK CONSISTS OF STANDARD CHAR-
ACTERS WITHOUT CLAIM TO ANY PARTICULAR
FONT, STYLE, SIZE, OR COLOR.

OWNER OF U.S. REG. NOS. 3,161,607 AND
3,357,655.

SER. NO. 77-377,615, FILED 1-22-2008.

BRIDGETT SMITH, EXAMINING ATTORNEY

Int. Cl.: 9

Prior U.S. Cls.: 21, 23, 26, 36 and 38

Reg. No. 3,480,521

United States Patent and Trademark Office

Registered Aug. 5, 2008

**TRADEMARK
PRINCIPAL REGISTER**

The Future is Bright

SUNSHINE SYSTEMS, LLC. (DELAWARE LTD
LIAB CO)
173 SUNRISE DRIVE
WHEELING, IL 60090

FOR: FLUORESCENT LAMP BALLAST FOR
ELECTRIC LIGHTS; LED AND HID LIGHT CON-
TROLS; LIGHT EMITTING DIODE (LED) DIS-
PLAYS; LIGHT EMITTING DIODES (LEDS), IN
CLASS 9 (U.S. CLS. 21, 23, 26, 36 AND 38).

FIRST USE 2-26-2002; IN COMMERCE 3-4-2003.

THE MARK CONSISTS OF STANDARD CHAR-
ACTERS WITHOUT CLAIM TO ANY PARTICULAR
FONT, STYLE, SIZE, OR COLOR.

SER. NO. 77-378,058, FILED 1-23-2008.

ESTHER A. BORSUK, EXAMINING ATTORNEY

Int. Cl.: 38

Prior U.S. Cls.: 100, 101 and 104

United States Patent and Trademark Office

Reg. No. 3,480,522

Registered Aug. 5, 2008

**SERVICE MARK
PRINCIPAL REGISTER**

SIP ADVANTAGE OFFICETRUNK

ADAPTION TECHNOLOGIES VENTURES, LTD.
(TEXAS PARTNERSHIP)
1009 PRUITT ROAD
THE WOODLANDS, TX 77380

FOR: SERVICE THAT ENABLES A PRIVATE
BRANCH EXCHANGE TO CONNECT TO THE
PUBLIC SWITCHED TELEPHONE NETWORK
USING VOICE OVER INTERNET PROTOCOL , IN
CLASS 38 (U.S. CLS. 100, 101 AND 104).

FIRST USE 1-3-2008; IN COMMERCE 1-3-2008.

THE MARK CONSISTS OF STANDARD CHAR-
ACTERS WITHOUT CLAIM TO ANY PARTICULAR
FONT, STYLE, SIZE, OR COLOR.

NO CLAIM IS MADE TO THE EXCLUSIVE
RIGHT TO USE "SIP" AND "OFFICETRUNK",
APART FROM THE MARK AS SHOWN.

SER. NO. 77-378,168, FILED 1-23-2008.

JENNY PARK, EXAMINING ATTORNEY

Int. Cl.: 20

Prior U.S. Cls.: 2, 13, 22, 25, 32 and 50

United States Patent and Trademark Office

Reg. No. 3,480,523

Registered Aug. 5, 2008

**TRADEMARK
PRINCIPAL REGISTER**

TRADEWINDS

SKYLINE DISPLAYS, INC. (MINNESOTA CORPORATION)
3355 DISCOVERY ROAD
EAGAN, MN 55121

THE MARK CONSISTS OF STANDARD CHARACTERS WITHOUT CLAIM TO ANY PARTICULAR FONT, STYLE, SIZE, OR COLOR.

FOR: PORTABLE DISPLAY AND EXHIBITION STANDS FOR USE AT COMMERCIAL TRADE SHOWS AND EXHIBITIONS, IN CLASS 20 (U.S. CLS. 2, 13, 22, 25, 32 AND 50).

SER. NO. 77-378,472, FILED 1-23-2008.

FIRST USE 6-0-2005; IN COMMERCE 6-0-2005.

B. PARADEWELAI, EXAMINING ATTORNEY

Int. Cl.: 25

Prior U.S. Cls.: 22 and 39

United States Patent and Trademark Office

Reg. No. 3,480,524

Registered Aug. 5, 2008

**TRADEMARK
PRINCIPAL REGISTER**

SPLENDID MILLS

MO INDUSTRIES, LLC (DELAWARE LTD LIAB
CO)
3751 SOUTH HILL STREET
LOS ANGELES, CA 90007

FOR: T-SHIRTS; SWEATERS; SHIRTS; PANTS;
SHORTS; TANK TOPS; TOPS; SWEAT PANTS;
SWEAT SHIRTS; UNDERGARMENTS, IN CLASS
25 (U.S. CLS. 22 AND 39).

FIRST USE 4-15-2005; IN COMMERCE 4-15-2005.

THE MARK CONSISTS OF STANDARD CHAR-
ACTERS WITHOUT CLAIM TO ANY PARTICULAR
FONT, STYLE, SIZE, OR COLOR.

OWNER OF U.S. REG. NO. 2,806,521.

SER. NO. 77-379,528, FILED 1-24-2008.

BARBARA BROWN, EXAMINING ATTORNEY

Int. Cl.: 3

Prior U.S. Cls.: 1, 4, 6, 50, 51 and 52

Reg. No. 3,480,525

United States Patent and Trademark Office

Registered Aug. 5, 2008

**TRADEMARK
PRINCIPAL REGISTER**



IDEASONE, INC. (CALIFORNIA CORPORATION)
59-1526 KOHALA RANCH ROAD
KAMUELA, HI 96743

THE MARK CONSISTS OF AN ARTISTIC REPRESENTATION OF A SCARAB.

FOR: SKIN AND BODY PREPARATIONS, NAMELY, LOTIONS, CREAMS, OILS AND GELS, IN CLASS 3 (U.S. CLS. 1, 4, 6, 50, 51 AND 52).

SER. NO. 77-379,782, FILED 1-24-2008.

FIRST USE 1-18-2008; IN COMMERCE 1-18-2008.

MATTHEW PAPPAS, EXAMINING ATTORNEY

Int. Cl.: 35

Prior U.S. Cls.: 100, 101 and 102

United States Patent and Trademark Office

Reg. No. 3,480,526

Registered Aug. 5, 2008

**SERVICE MARK
PRINCIPAL REGISTER**

Mother Om Media

WISE EARTH SCHOOL OF AYURVEDA, LTD.
(NORTH CAROLINA NON-PROFIT ORGANI-
ZATION)
PO BOX 160
CANDLER, NC 28715

FOR: ON-LINE RETAIL STORE SERVICES FEA-
TURING BOOKS, PRINTED PUBLICATIONS, CDS,
DVDS, AND OTHER ELECTRONIC MEDIA, IN
CLASS 35 (U.S. CLS. 100, 101 AND 102).

FIRST USE 8-20-2007; IN COMMERCE 8-20-2007.

THE MARK CONSISTS OF STANDARD CHAR-
ACTERS WITHOUT CLAIM TO ANY PARTICULAR
FONT, STYLE, SIZE, OR COLOR.

NO CLAIM IS MADE TO THE EXCLUSIVE
RIGHT TO USE "MEDIA", APART FROM THE
MARK AS SHOWN.

SER. NO. 77-381,509, FILED 1-27-2008.

KIMBERLY FRYE, EXAMINING ATTORNEY

Int. Cl.: 16

Prior U.S. Cls.: 2, 5, 22, 23, 29, 37, 38 and 50

United States Patent and Trademark Office

Reg. No. 3,480,527

Registered Aug. 5, 2008

**TRADEMARK
PRINCIPAL REGISTER**

BU2

SOCIETE BIC (FRANCE SOCIÉTÉ ANONYME
(SA))
14, RUE JEANNE D'ASNIERES
CLICHY, FRANCE 92110

THE MARK CONSISTS OF STANDARD CHAR-
ACTERS WITHOUT CLAIM TO ANY PARTICULAR
FONT, STYLE, SIZE, OR COLOR.

FOR: WRITING INSTRUMENTS, NAMELY,
PENS, PENCILS, MARKERS AND HIGHLIGHTING
MARKERS, IN CLASS 16 (U.S. CLS. 2, 5, 22, 23, 29, 37,
38 AND 50).

SER. NO. 77-381,743, FILED 1-28-2008.

FIRST USE 2-5-2004; IN COMMERCE 2-5-2004.

MELISSA VALLILLO, EXAMINING ATTORNEY

Int. Cl.: 10

Prior U.S. Cls.: 26, 39 and 44

United States Patent and Trademark Office

Reg. No. 3,480,528

Registered Aug. 5, 2008

**TRADEMARK
PRINCIPAL REGISTER**

bT-Vision

SUZUKI, DAVID S. (UNITED STATES INDIVIDUAL)
2244 1ST AVENUE SOUTH
SEATTLE, WA 98134

THE MARK CONSISTS OF STANDARD CHARACTERS WITHOUT CLAIM TO ANY PARTICULAR FONT, STYLE, SIZE, OR COLOR.

FOR: LIGHT EMITTING DEVICES, NAMELY, LAMPS AND LED DEVICES FOR TREATMENT OF A VARIETY OF SKIN CONDITIONS, IN CLASS 10 (U.S. CLS. 26, 39 AND 44).

SER. NO. 77-382,632, FILED 1-28-2008.

FIRST USE 1-26-2008; IN COMMERCE 1-26-2008.

KELLY MCCOY, EXAMINING ATTORNEY

Int. Cl.: 35

Prior U.S. Cls.: 100, 101 and 102

United States Patent and Trademark Office

Reg. No. 3,480,529

Registered Aug. 5, 2008

**SERVICE MARK
PRINCIPAL REGISTER**



HONEY'S PLACE, INC. (CALIFORNIA CORPORATION)
675 SOUTH GLENWOOD PLACE
BURBANK, CA 91506

FOR: WHOLESALE DISTRIBUTORSHIPS FEATURING ADULT ENTERTAINMENT PRODUCTS, IN CLASS 35 (U.S. CLS. 100, 101 AND 102).

FIRST USE 3-14-1994; IN COMMERCE 3-14-1994.

THE MARK CONSISTS OF A COUCH WITH A FEMALE FLAPPER-TYPE FIGURE, SMOKING A CIGARETTE, WITH FEET RESTING ON ONE ARM OF THE COUCH, AND RECLINING ON THE PILLOWS ON THE COUCH.

SER. NO. 77-383,632, FILED 1-29-2008.

RICHARD WHITE, EXAMINING ATTORNEY

Int. Cl.: 28

Prior U.S. Cls.: 22, 23, 38 and 50

United States Patent and Trademark Office

Reg. No. 3,480,530

Registered Aug. 5, 2008

**TRADEMARK
PRINCIPAL REGISTER**

BARBERSHOP BOYS

ARISTOCRAT TECHNOLOGIES AUSTRALIA
PTY LTD (AUSTRALIA CORPORATION)
71 LONGUEVILLE ROAD
LANE COVE, NSW, AUSTRALIA 2066

FOR: GAMING MACHINES; GAMING MACHINES COMPRISING OF SOFTWARE MODULES AND COMPONENTS FEATURING GAME SYMBOLS, MATHEMATICS, SOUND EFFECTS AND OTHER CONFIGURABLE ITEMS EMBEDDED IN ERASABLE PROGRAMMABLE READ-ONLY MEMORY (EPROM) CHIPS OR OTHER STORAGE MEDIA; GAMING MACHINES, NAMELY, POKER

MACHINES, IN CLASS 28 (U.S. CLS. 22, 23, 38 AND 50).

THE MARK CONSISTS OF STANDARD CHARACTERS WITHOUT CLAIM TO ANY PARTICULAR FONT, STYLE, SIZE, OR COLOR.

OWNER OF AUSTRALIA REG. NO. 1141908, DATED 10-19-2006, EXPIRES 10-19-2016.

SER. NO. 77-384,255, FILED 1-30-2008.

NAAKWAMA ANKRAH, EXAMINING ATTORNEY

Int. Cl.: 9

Prior U.S. Cls.: 21, 23, 26, 36 and 38

United States Patent and Trademark Office

Reg. No. 3,480,531

Registered Aug. 5, 2008

**TRADEMARK
PRINCIPAL REGISTER**

GAMESHIELD

SOFTWARESHIELD TECHNOLOGIES, INC. (CANADA CORPORATION)
SUITE 240
375 WATER STREET
VANCOUVER, CANADA V6B5C6

THE MARK CONSISTS OF STANDARD CHARACTERS WITHOUT CLAIM TO ANY PARTICULAR FONT, STYLE, SIZE, OR COLOR.

FOR: DIGITAL RIGHTS MANAGEMENT SOFTWARE AND LICENSE ENFORCEMENT SOFTWARE, IN CLASS 9 (U.S. CLS. 21, 23, 26, 36 AND 38).

SER. NO. 77-384,494, FILED 1-30-2008.

FIRST USE 12-21-2007; IN COMMERCE 12-21-2007.

JILL PRATER, EXAMINING ATTORNEY

Int. Cl.: 16

Prior U.S. Cls.: 2, 5, 22, 23, 29, 37, 38 and 50

United States Patent and Trademark Office

Reg. No. 3,480,532

Registered Aug. 5, 2008

**TRADEMARK
PRINCIPAL REGISTER**

CASTLE TO THE ROCK

MCCLATCHY U.S.A., INC. (DELAWARE CORPORATION)
2100 Q STREET
SACRAMENTO, CA 95816

THE MARK CONSISTS OF STANDARD CHARACTERS WITHOUT CLAIM TO ANY PARTICULAR FONT, STYLE, SIZE, OR COLOR.

FOR: ANNUAL VISITORS GUIDE CONTAINING FEATURE ARTICLES ABOUT CALIFORNIA'S CENTRAL COAST REGION, IN CLASS 16 (U.S. CLS. 2, 5, 22, 23, 29, 37, 38 AND 50).

SER. NO. 77-384,691, FILED 1-30-2008.

FIRST USE 8-31-2007; IN COMMERCE 8-31-2007.

RAUL CORDOVA, EXAMINING ATTORNEY

Int. Cl.: 18

Prior U.S. Cls.: 1, 2, 3, 22 and 41

Reg. No. 3,480,533

United States Patent and Trademark Office

Registered Aug. 5, 2008

**TRADEMARK
PRINCIPAL REGISTER**

VICTORIA'S SECRET

VICTORIA'S SECRET STORES BRAND MAN-
AGEMENT, INC. (DELAWARE CORPORA-
TION)
FOUR LIMITED PARKWAY
REYNOLDSBURG, OH 43068

FOR: LUGGAGE; LUGGAGE TAGS; HAND-
BAGS; PURSES; TOTE BAGS; WHEELED TOTE
BAGS; LEATHER BAGS, SUITCASES AND WAL-
LETS; PURSES AND WALLETS; WALLETS; SATCH-
ELS; BACKPACKS; GYM BAGS, IN CLASS 18 (U.S.
CLS. 1, 2, 3, 22 AND 41).

FIRST USE 7-0-1996; IN COMMERCE 7-0-1996.

THE MARK CONSISTS OF STANDARD CHAR-
ACTERS WITHOUT CLAIM TO ANY PARTICULAR
FONT, STYLE, SIZE, OR COLOR.

OWNER OF U.S. REG. NOS. 1,146,199, 2,455,260
AND OTHERS.

SER. NO. 77-387,829, FILED 2-4-2008.

BRIDGETT SMITH, EXAMINING ATTORNEY

Int. Cl.: 16

Prior U.S. Cls.: 2, 5, 22, 23, 29, 37, 38 and 50

Reg. No. 3,480,534

United States Patent and Trademark Office

Registered Aug. 5, 2008

**TRADEMARK
PRINCIPAL REGISTER**

EVERY SHOT COUNTS

WYETH (DELAWARE CORPORATION)
FIVE GIRALDA FARMS
MADISON, NJ 07940

FOR: PRINTED MATERIALS, NAMELY, TRAINING MANUALS, INFORMATIONAL BOOKLETS, NEWSLETTERS, LEAFLETS, BROCHURES, CHARTS, PRODUCT INFORMATIONAL SHEETS, MAGAZINES, CATALOGS, DISPLAYS, NAMELY PAPER DISPLAY BOXES, CARDBOARD FLOOR DISPLAY UNITS FOR MERCHANDISING PRODUCTS, PRINTED EDUCATIONAL MANUALS AND POSTERS ALL RELATED TO ANIMAL

HEALTH AND VETERINARY MEDICINE, IN CLASS 16 (U.S. CLS. 2, 5, 22, 23, 29, 37, 38 AND 50).

FIRST USE 7-0-2007; IN COMMERCE 7-0-2007.

THE MARK CONSISTS OF STANDARD CHARACTERS WITHOUT CLAIM TO ANY PARTICULAR FONT, STYLE, SIZE, OR COLOR.

SER. NO. 77-388,098, FILED 2-4-2008.

VERNA BETH RIRIE, EXAMINING ATTORNEY

Int. Cl.: 35

Prior U.S. Cls.: 100, 101 and 102

United States Patent and Trademark Office

Reg. No. 3,480,535

Registered Aug. 5, 2008

**SERVICE MARK
PRINCIPAL REGISTER**

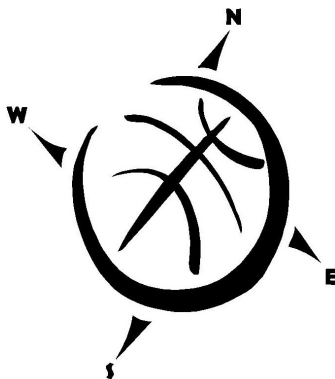

BILL A. DUFFY, INC. (CALIFORNIA CORPORATION), DBA BDA SPORTS MANAGEMENT STE. A
822 ASHLEY LANE
WALNUT CREEK, CA 94596

FOR: MANAGEMENT OF PROFESSIONAL ATHLETES, IN CLASS 35 (U.S. CLS. 100, 101 AND 102).

FIRST USE 2-22-1999; IN COMMERCE 2-22-1999.

THE MARK CONSISTS OF A NON-CLOSED CIRCLE IN THE SHAPE OF A BASKETBALL WITH COMPASS POINTS INDICATING THE FOUR DIRECTIONS OF THE GLOBE - "N", "E", "S" AND "W". THE DESIGN IS COMPRISED AS FOLLOWS: INSIDE THE NON-CLOSED CIRCLE IS A DIAGONAL LINE FROM TOP RIGHT TO BOTTOM LEFT. CROSSING THE LINE ARE THREE (3) ARCHED

LINES; TWO (2) WITH LEFTWARD CURVATURE AND ONE (1) WITH RIGHTWARD CURVATURE REPRESENTING THE SEAMS OF THE BASKETBALL. OUTSIDE OF THE NON-CLOSED CIRCLE ARE FOUR (4) SOLID TRIANGULAR-SHAPED POINTS, WITH THE LETTERS "N" ON THE NORTHERN-MOST POINT, "E" ON THE EASTERN-MOST POINT, "S" ON THE SOUTHERN-MOST POINT, AND "W" ON THE WESTERN-MOST POINT. IN CONJUNCTION, THE BASKETBALL-SHAPED CIRCLE AND THE COMPASS POINTS REPRESENT THE GLOBE.

SER. NO. 77-389,396, FILED 2-5-2008.

LEIGH CAROLINE CASE, EXAMINING ATTORNEY

Int. Cl.: 36

Prior U.S. Cls.: 100, 101 and 102

United States Patent and Trademark Office

Reg. No. 3,480,536

Registered Aug. 5, 2008

**SERVICE MARK
PRINCIPAL REGISTER**

HAVE IT ALL

WINTRUST FINANCIAL CORPORATION (ILLI-
NOIS CORPORATION)
727 NORTH BANK LANE
LAKE FOREST, IL 60045

THE MARK CONSISTS OF STANDARD CHAR-
ACTERS WITHOUT CLAIM TO ANY PARTICULAR
FONT, STYLE, SIZE, OR COLOR.

FOR: BANKING SERVICES, IN CLASS 36 (U.S.
CLS. 100, 101 AND 102).

SER. NO. 77-389,893, FILED 2-6-2008.

FIRST USE 2-4-2008; IN COMMERCE 2-4-2008.

MICHAEL ENGEL, EXAMINING ATTORNEY

Int. Cl.: 16

Prior U.S. Cls.: 2, 5, 22, 23, 29, 37, 38 and 50

United States Patent and Trademark Office

Reg. No. 3,480,537

Registered Aug. 5, 2008

**TRADEMARK
PRINCIPAL REGISTER**

The word "Point" is written in a large, bold, black cursive font. The letters are thick and connected, with a prominent dot on the 'i' and a sharp point on the 't'.

SCHOLASTIC INC. (NEW YORK CORPORATION)
557 BROADWAY
NEW YORK, NY 10012

FOR: FICTION AND NON-FICTION BOOKS ON A VARIETY OF SUBJECTS FOR CHILDREN, IN CLASS 16 (U.S. CLS. 2, 5, 22, 23, 29, 37, 38 AND 50).

FIRST USE 3-1-2005; IN COMMERCE 3-1-2005.

OWNER OF U.S. REG. NO. 1,413,360.

THE MARK CONSISTS OF STYLIZED LETTERS OF THE WORD "POINT".

SER. NO. 77-391,029, FILED 2-7-2008.

ANNE E. GUSTASON, EXAMINING ATTORNEY

Int. Cl.: 6

Prior U.S. Cls.: 2, 12, 13, 14, 23, 25 and 50

Reg. No. 3,480,538

United States Patent and Trademark Office

Registered Aug. 5, 2008

**TRADEMARK
PRINCIPAL REGISTER**

OAK SUMMIT

AMARR COMPANY (NORTH CAROLINA COR-
PORATION)
165 CARRIAGE COURT
WINSTON-SALEM, NC 27105

THE MARK CONSISTS OF STANDARD CHAR-
ACTERS WITHOUT CLAIM TO ANY PARTICULAR
FONT, STYLE, SIZE, OR COLOR.

FOR: METAL GARAGE DOORS AND REPLACE-
MENT PARTS THEREOF, IN CLASS 6 (U.S. CLS. 2,
12, 13, 14, 23, 25 AND 50).

SER. NO. 77-392,059, FILED 2-8-2008.

FIRST USE 3-1-2006; IN COMMERCE 3-1-2006.

REBECCA SMITH, EXAMINING ATTORNEY

Int. Cl.: 12

Prior U.S. Cls.: 19, 21, 23, 31, 35 and 44

United States Patent and Trademark Office

Reg. No. 3,480,539

Registered Aug. 5, 2008

**TRADEMARK
PRINCIPAL REGISTER**

VICTRA ASYMMET

CHENG SHIN RUBBER USA, INC. (GEORGIA
CORPORATION)
545 OLD PEACHTREE ROAD
SUWANEE, GA 30024

FOR: TIRES, IN CLASS 12 (U.S. CLS. 19, 21, 23, 31,
35 AND 44).

FIRST USE 7-27-2006; IN COMMERCE 7-27-2006.

THE MARK CONSISTS OF STANDARD CHAR-
ACTERS WITHOUT CLAIM TO ANY PARTICULAR
FONT, STYLE, SIZE, OR COLOR.

OWNER OF U.S. REG. NO. 2,993,037.

SER. NO. 77-392,463, FILED 2-8-2008.

KEVIN DINALLO, EXAMINING ATTORNEY

Int. Cl.: 5

Prior U.S. Cls.: 6, 18, 44, 46, 51 and 52

United States Patent and Trademark Office

Reg. No. 3,480,540

Registered Aug. 5, 2008

**TRADEMARK
PRINCIPAL REGISTER**

BETADRENE-SR

WHEAT, JARED R. (UNITED STATES INDIVIDUAL)
6015-B UNITY DRIVE
NORCROSS, GA 30071

THE MARK CONSISTS OF STANDARD CHARACTERS WITHOUT CLAIM TO ANY PARTICULAR FONT, STYLE, SIZE, OR COLOR.

FOR: DIETARY SUPPLEMENTS, IN CLASS 5 (U.S. CLS. 6, 18, 44, 46, 51 AND 52).

SER. NO. 77-392,826, FILED 2-8-2008.

FIRST USE 4-1-1999; IN COMMERCE 4-1-1999.

KELLY MCCOY, EXAMINING ATTORNEY

Int. Cl.: 32

Prior U.S. Cls.: 45, 46 and 48

United States Patent and Trademark Office

Reg. No. 3,480,541

Registered Aug. 5, 2008

**TRADEMARK
PRINCIPAL REGISTER**

OK! ORGANICS

MEGESTER, INC. (FLORIDA CORPORATION)
2180 CALUMET STREET
CLEARWATER, FL 33765

FOR: NATURAL NON-ALCOHOLIC BEVERAGES
CONTAINING FRUIT JUICES, IN CLASS 32 (U.S.
CLS. 45, 46 AND 48).

FIRST USE 2-6-2008; IN COMMERCE 2-6-2008.

THE MARK CONSISTS OF STANDARD CHAR-
ACTERS WITHOUT CLAIM TO ANY PARTICULAR
FONT, STYLE, SIZE, OR COLOR.

NO CLAIM IS MADE TO THE EXCLUSIVE
RIGHT TO USE "ORGANICS", APART FROM THE
MARK AS SHOWN.

SER. NO. 77-393,783, FILED 2-11-2008.

CHRISTINA SOBRAL, EXAMINING ATTORNEY

Int. Cl.: 41

Prior U.S. Cls.: 100, 101 and 107

United States Patent and Trademark Office

Reg. No. 3,480,542

Registered Aug. 5, 2008

**SERVICE MARK
PRINCIPAL REGISTER**

FOCUS

NORTHWESTERN COLLEGE (MINNESOTA
NON-PROFIT CORPORATION)
3003 SNELLING AVENUE NORTH
ST. PAUL, MN 551131598

FOR: EDUCATIONAL SERVICES, NAMELY,
PROVIDING COURSES OF INSTRUCTION AT
THE COLLEGE LEVEL, IN CLASS 41 (U.S. CLS. 100,
101 AND 107).

FIRST USE 5-31-1999; IN COMMERCE 5-31-1999.

THE MARK CONSISTS OF STANDARD CHAR-
ACTERS WITHOUT CLAIM TO ANY PARTICULAR
FONT, STYLE, SIZE, OR COLOR.

OWNER OF U.S. REG. NO. 2,518,137.

SER. NO. 77-395,105, FILED 2-12-2008.

JOHN WILKE, EXAMINING ATTORNEY

Int. Cls.: 1 and 35

Prior U.S. Cls.: 1, 5, 6, 10, 26, 46, 100, 101 and 102

Reg. No. 3,480,543

United States Patent and Trademark Office

Registered Aug. 5, 2008

**TRADEMARK
SERVICE MARK
PRINCIPAL REGISTER**

**PROVEN PROFESSIONALS -
PROVEN PRODUCTS - PROVEN
RESULTS**

THE MUD MASTER GROUP, LLC (MISSISSIPPI
LTD LIAB CO)
740 JOLIMAR TRAIL SE
SUMMIT, MS 39666

FOR: ADDITIVES FOR OIL AND GAS WELL
DRILLING FLUIDS, IN CLASS 1 (U.S. CLS. 1, 5, 6, 10,
26 AND 46).

FIRST USE 6-1-2007; IN COMMERCE 6-1-2007.

FOR: RETAIL SERVICES BY DIRECT SOLICITA-
TION BY SALES AGENTS IN THE FIELD OF
ADDITIVES FOR OIL AND GAS WELL DRILLING
FLUIDS, IN CLASS 35 (U.S. CLS. 100, 101 AND 102).

FIRST USE 6-1-2007; IN COMMERCE 6-1-2007.

THE MARK CONSISTS OF STANDARD CHAR-
ACTERS WITHOUT CLAIM TO ANY PARTICULAR
FONT, STYLE, SIZE, OR COLOR.

NO CLAIM IS MADE TO THE EXCLUSIVE
RIGHT TO USE "PROFESSIONALS" AND "PRO-
DUCTS", APART FROM THE MARK AS SHOWN.

SER. NO. 77-395,646, FILED 2-13-2008.

LOURDES AYALA, EXAMINING ATTORNEY

Int. Cl.: 32

Prior U.S. Cls.: 45, 46 and 48

United States Patent and Trademark Office

Reg. No. 3,480,544

Registered Aug. 5, 2008

**TRADEMARK
PRINCIPAL REGISTER**

BRETAÑA

GASEOSAS POSADA TOBON S.A. (COLOMBIA
CORPORATION)
CALLE 52 NO. 47-42
MEDELLIN, COLOMBIA

FOR: CLUB SODA, IN CLASS 32 (U.S. CLS. 45, 46
AND 48).

FIRST USE 3-24-1939; IN COMMERCE 0-0-1982.

THE MARK CONSISTS OF STANDARD CHAR-
ACTERS WITHOUT CLAIM TO ANY PARTICULAR
FONT, STYLE, SIZE, OR COLOR.

OWNER OF U.S. REG. NO. 1,490,415.

THE FOREIGN WORDING IN THE MARK
TRANSLATES INTO ENGLISH AS 'HYACINTH'
OR 'BRITTANY'.

SER. NO. 77-395,955, FILED 2-13-2008.

DAVID MILLER, EXAMINING ATTORNEY

Int. Cl.: 9

Prior U.S. Cls.: 21, 23, 26, 36 and 38

United States Patent and Trademark Office

Reg. No. 3,480,545

Registered Aug. 5, 2008

**TRADEMARK
PRINCIPAL REGISTER**

ChemGard

THE BAKER COMPANY (MAINE CORPORATION)
PO DRAWER E
161 GATEHOUSE ROAD
SANFORD, ME 04073

FOR: HIGH PERFORMANCE FUME HOODS FOR
REMOVAL OF CONTAMINATED AIR IN LABORATORY
AND RESEARCH FACILITIES, IN CLASS 9
(U.S. CLS. 21, 23, 26, 36 AND 38).

FIRST USE 6-1-1985; IN COMMERCE 6-1-1985.

THE MARK CONSISTS OF STANDARD CHARACTERS
WITHOUT CLAIM TO ANY PARTICULAR FONT,
STYLE, SIZE, OR COLOR.

SER. NO. 77-397,224, FILED 2-14-2008.

KIMBERLY PERRY, EXAMINING ATTORNEY

Int. Cl.: 16

Prior U.S. Cls.: 2, 5, 22, 23, 29, 37, 38 and 50

Reg. No. 3,480,546

United States Patent and Trademark Office

Registered Aug. 5, 2008

**TRADEMARK
PRINCIPAL REGISTER**

7 LEGUAS

UNION TELECOM, INC. (ILLINOIS CORPORATION)
5420 NORTH HARLEM AVE
CHICAGO, IL 60656

FOR: PRE-PAID TELEPHONE CALLING CARDS,
NOT MAGNETICALLY ENCODED, IN CLASS 16
(U.S. CLS. 2, 5, 22, 23, 29, 37, 38 AND 50).

FIRST USE 1-1-2008; IN COMMERCE 1-1-2008.

THE MARK CONSISTS OF STANDARD CHARACTERS WITHOUT CLAIM TO ANY PARTICULAR FONT, STYLE, SIZE, OR COLOR.

THE FOREIGN WORDING IN THE MARK TRANSLATES INTO ENGLISH AS LEAGUES.

SER. NO. 77-398,037, FILED 2-15-2008.

JORDAN BAKER, EXAMINING ATTORNEY

Int. Cls.: 1 and 17

Prior U.S. Cls.: 1, 5, 6, 10, 12, 13, 26, 35, 46 and 50

United States Patent and Trademark Office

Reg. No. 3,480,547

Registered Aug. 5, 2008

**TRADEMARK
PRINCIPAL REGISTER**

MEGACEL

BAYER AKTIENGESELLSCHAFT (FED REP
GERMANY AKTIENGESELLSCHAFT)
D-51368
LEVERKUSEN-BAYERWERK, FED REP GERMA-
NY

FOR: CHEMICALS USED IN THE MANUFAC-
TURE OF POLYURETHANE FOAM, IN CLASS 1
(U.S. CLS. 1, 5, 6, 10, 26 AND 46).

FOR: POLYURETHANE FOAM FOR MATTRES-
SES AND UPHOLSTERED FURNITURE, IN CLASS
17 (U.S. CLS. 1, 5, 12, 13, 35 AND 50).

THE MARK CONSISTS OF STANDARD CHAR-
ACTERS WITHOUT CLAIM TO ANY PARTICULAR
FONT, STYLE, SIZE, OR COLOR.

OWNER OF FED REP GERMANY REG. NO.
30740957, DATED 9-5-2007, EXPIRES 6-30-2017.

OWNER OF U.S. REG. NOS. 1,825,692 AND
1,987,420.

SER. NO. 77-399,557, FILED 2-18-2008.

KIMBERLY PERRY, EXAMINING ATTORNEY

Int. Cl.: 41

Prior U.S. Cls.: 100, 101 and 107

United States Patent and Trademark Office

Reg. No. 3,480,548

Registered Aug. 5, 2008

**SERVICE MARK
PRINCIPAL REGISTER**

CHIC REPORT

INTERNATIONAL MERCHANDISING COR-
PORATION (OHIO CORPORATION)
IMG CENTER
1360 EAST NINTH STREET
CLEVELAND, OH 44114

FOR: PROVIDING A WEB SITE FEATURING
ONLINE PUBLICATIONS IN THE FIELD OF FASH-
ION, IN CLASS 41 (U.S. CLS. 100, 101 AND 107).

FIRST USE 8-0-2007; IN COMMERCE 8-0-2007.

THE MARK CONSISTS OF STANDARD CHAR-
ACTERS WITHOUT CLAIM TO ANY PARTICULAR
FONT, STYLE, SIZE, OR COLOR.

NO CLAIM IS MADE TO THE EXCLUSIVE
RIGHT TO USE "REPORT", APART FROM THE
MARK AS SHOWN.

SER. NO. 77-400,742, FILED 2-19-2008.

JENNIFER HETU, EXAMINING ATTORNEY

Int. Cl.: 3

Prior U.S. Cls.: 1, 4, 6, 50, 51 and 52

United States Patent and Trademark Office

Reg. No. 3,480,549

Registered Aug. 5, 2008

**TRADEMARK
PRINCIPAL REGISTER**

VERY SEXY ATTRACTION

VICTORIA'S SECRET STORES BRAND MAN-
AGEMENT, INC. (DELAWARE CORPORA-
TION)
FOUR LIMITED PARKWAY
REYNOLDSBURG, OH 43068

FOR: PERFUMED POWDER; PERFUMES; BODY
CREAMS; BODY LOTIONS; BODY SCRUB; BODY
SPRAYS; BODY WASHES, IN CLASS 3 (U.S. CLS. 1, 4,
6, 50, 51 AND 52).

FIRST USE 9-25-2007; IN COMMERCE 9-25-2007.

THE MARK CONSISTS OF STANDARD CHAR-
ACTERS WITHOUT CLAIM TO ANY PARTICULAR
FONT, STYLE, SIZE, OR COLOR.

OWNER OF U.S. REG. NOS. 2,725,765, 2,849,071,
AND 2,946,353.

SER. NO. 77-402,467, FILED 2-21-2008.

BRIDGETT SMITH, EXAMINING ATTORNEY

Int. Cl.: 36

Prior U.S. Cls.: 100, 101 and 102

United States Patent and Trademark Office

Reg. No. 3,480,550

Registered Aug. 5, 2008

**SERVICE MARK
PRINCIPAL REGISTER**



HOME LOAN INVESTMENT BANK, FSB (UNITED STATES A FEDERALLY CHARTERED SAVINGS BANK)
2 ALTIERI WAY
WARWICK, RI 02886

FOR: BANKING, HOME EQUITY LOANS, MORTGAGE BANKING, MORTGAGE BROKERAGE, MORTGAGE LENDING, SAVINGS AND LOAN ASSOCIATIONS, SAVINGS AND LOAN SERVICES, SAVINGS BANK SERVICES, INVESTMENT BANK-

ING SERVICES, REAL ESTATE ACQUISITION, REAL ESTATE INVESTMENT, REAL ESTATE MANAGEMENT, INSURANCE ADMINISTRATION, IN CLASS 36 (U.S. CLS. 100, 101 AND 102).

FIRST USE 5-6-1985; IN COMMERCE 5-6-1985.

SER. NO. 77-402,522, FILED 2-21-2008.

CHRISTINE COOPER, EXAMINING ATTORNEY

Int. Cl.: 35

Prior U.S. Cls.: 100, 101 and 102

United States Patent and Trademark Office

Reg. No. 3,480,551

Registered Aug. 5, 2008

**SERVICE MARK
PRINCIPAL REGISTER**

**IT'S (YOUR) PRACTICE. MADE
PERFECT.**

AMERICAN COLLEGE OF CARDIOLOGY
FOUNDATION (D.C. NON-PROFIT COR-
PORATION)
2400 N STREET, NW
WASHINGTON, DC 20037

FOR: PROVIDING AN ONLINE REGISTRY FEATURING QUALITY ASSURANCE MEASUREMENT FOR ACUTE CORONARY SYNDROMES FOR DOCTORS IN AN OFFICE BASED SETTING IN THE FIELD OF CARDIOLOGY, CARDIOVASCULAR MEDICINE AND HEALTH, IN CLASS 35 (U.S. CLS. 100, 101 AND 102).

FIRST USE 10-1-2007; IN COMMERCE 10-17-2007.

THE MARK CONSISTS OF STANDARD CHARACTERS WITHOUT CLAIM TO ANY PARTICULAR FONT, STYLE, SIZE, OR COLOR.

SER. NO. 77-403,571, FILED 2-22-2008.

MARGERY A. TIERNEY, EXAMINING ATTORNEY

Int. Cl.: 43

Prior U.S. Cls.: 100 and 101

United States Patent and Trademark Office

Reg. No. 3,480,552

Registered Aug. 5, 2008

**SERVICE MARK
PRINCIPAL REGISTER**

LITTLE SIX

SHAKOPEE MDEWAKANTON SIOUX COMMUNITY (UNITED STATES FEDERALLY-RECOGNIZED INDIAN TRIBE)

2400 MYSTIC LAKE BLVD.

PRIOR LAKE, MN 55372

FOR: RESTAURANT SERVICES, IN CLASS 43 (U.S. CLS. 100 AND 101).

FIRST USE 12-13-2007; IN COMMERCE 12-13-2007.

THE MARK CONSISTS OF STANDARD CHARACTERS WITHOUT CLAIM TO ANY PARTICULAR FONT, STYLE, SIZE, OR COLOR.

OWNER OF U.S. REG. NOS. 1,816,202, 2,369,002 AND OTHERS.

SER. NO. 77-406,190, FILED 2-26-2008.

KATHY DE JONGE, EXAMINING ATTORNEY

Int. Cl.: 43

Prior U.S. Cls.: 100 and 101

United States Patent and Trademark Office

Reg. No. 3,480,553

Registered Aug. 5, 2008

**SERVICE MARK
PRINCIPAL REGISTER**



SHAKOPEE MDEWAKANTON SIOUX COMMUNITY (UNITED STATES FEDERALLY-RECOGNIZED INDIAN TRIBE)
2400 MYSTIC LAKE BLVD
PRIOR LAKE, MN 55372

FOR: RESTAURANT SERVICES, IN CLASS 43 (U.S. CLS. 100 AND 101).

FIRST USE 12-13-2007; IN COMMERCE 12-13-2007.

OWNER OF U.S. REG. NOS. 1,816,202, 2,369,002 AND OTHERS.

THE MARK CONSISTS OF THE WORDS "LITTLE SIX", IN WHICH A TEEPEE FORMS THE LETTER "X", FOLLOWED BY CATTAILS.

SER. NO. 77-406,201, FILED 2-26-2008.

KATHY DE JONGE, EXAMINING ATTORNEY

Int. Cl.: 41

Prior U.S. Cls.: 100, 101 and 107

United States Patent and Trademark Office

Reg. No. 3,480,554

Registered Aug. 5, 2008

**SERVICE MARK
PRINCIPAL REGISTER**

**PHANTOM GOURMET BBQ
BEACH PARTY**

PHANTOM GOURMET, INC. (MASSACHUSETTS
CORPORATION)
P.O. BOX 269, 47 HARVARD AVENUE
BOSTON, MA 02134

OWNER OF U.S. REG. NOS. 2,051,042, 2,859,952
AND OTHERS.

FOR: ENTERTAINMENT SERVICES IN THE
NATURE OF FOOD AND MUSIC FESTIVALS, IN
CLASS 41 (U.S. CLS. 100, 101 AND 107).

NO CLAIM IS MADE TO THE EXCLUSIVE
RIGHT TO USE "GOURMET BARBECUE BEACH
PARTY", APART FROM THE MARK AS SHOWN.

FIRST USE 6-22-2007; IN COMMERCE 6-22-2007.

SER. NO. 77-406,238, FILED 2-26-2008.

THE MARK CONSISTS OF STANDARD CHAR-
ACTERS WITHOUT CLAIM TO ANY PARTICULAR
FONT, STYLE, SIZE, OR COLOR.

ALYSSA PALADINO, EXAMINING ATTORNEY

Int. Cl.: 41

Prior U.S. Cls.: 100, 101 and 107

United States Patent and Trademark Office

Reg. No. 3,480,555

Registered Aug. 5, 2008

**SERVICE MARK
PRINCIPAL REGISTER**

Pawn Kings

FUJISANKEI COMMUNICATIONS INTERNA-
TIONAL, INC. (NEW YORK CORPORATION)
150 E. 52ND ST., 34TH FL.
NEW YORK, NY 10022

FOR: ENTERTAINMENT IN THE NATURE OF
ON-GOING TELEVISION PROGRAMS IN THE
FIELD OF REALITY-BASED ATHLETIC COMPETI-
TIONS, IN CLASS 41 (U.S. CLS. 100, 101 AND 107).

FIRST USE 11-1-2007; IN COMMERCE 11-1-2007.

THE MARK CONSISTS OF STANDARD CHAR-
ACTERS WITHOUT CLAIM TO ANY PARTICULAR
FONT, STYLE, SIZE, OR COLOR.

SER. NO. 77-406,471, FILED 2-26-2008.

BARBARA GAYNOR, EXAMINING ATTORNEY

Int. Cl.: 25

Prior U.S. Cls.: 22 and 39

United States Patent and Trademark Office

Reg. No. 3,480,556

Registered Aug. 5, 2008

**TRADEMARK
PRINCIPAL REGISTER**



HAWKS NEST, LLC. (CALIFORNIA LTD LIAB
CO)
45116 VALLEY CENTRAL WAY
LANCASTER, CA 93536

FOR: CLOTHING, NAMELY, ATHLETIC UNI-
FORMS, CAPS, CLOTH BABY BIBS, COATS, GOLF
SHIRTS, GYM SHORTS, GYM SUITS, HATS, JACK-
ETS, JERSEYS, KNIT SHIRTS, PAJAMAS, POLO
SHIRTS, PONCHOS, PULLOVERS, RAIN COATS,
SWEATERS, SWEAT PANTS, SWEAT SHIRTS,

SWEAT SUITS, SOCKS, SPORT SHIRTS, T- SHIRTS,
TANK TOPS, VISORS, WIND RESISTANT JACKETS
AND WRISTBANDS, IN CLASS 25 (U.S. CLS. 22 AND
39).

FIRST USE 10-24-2007; IN COMMERCE 10-24-2007.

SER. NO. 77-407,428, FILED 2-27-2008.

SIMON TENG, EXAMINING ATTORNEY

Int. Cl.: 11

Prior U.S. Cls.: 13, 21, 23, 31 and 34

United States Patent and Trademark Office

Reg. No. 3,480,557

Registered Aug. 5, 2008

**TRADEMARK
PRINCIPAL REGISTER**

ATTUNE

GENLYTE THOMAS GROUP LLC (DELAWARE
LTD LIAB CO)
SUITE 601
10350 ORMSBY PARK PLACE
LOUISVILLE, KY 40223

THE MARK CONSISTS OF STANDARD CHAR-
ACTERS WITHOUT CLAIM TO ANY PARTICULAR
FONT, STYLE, SIZE, OR COLOR.

FOR: ELECTRIC LIGHTING FIXTURES, IN
CLASS 11 (U.S. CLS. 13, 21, 23, 31 AND 34).

SER. NO. 77-408,760, FILED 2-28-2008.

FIRST USE 1-23-2007; IN COMMERCE 1-23-2007.

TARAH HARDY, EXAMINING ATTORNEY

Int. Cl.: 41

Prior U.S. Cls.: 100, 101 and 107

United States Patent and Trademark Office

Reg. No. 3,480,558

Registered Aug. 5, 2008

**SERVICE MARK
PRINCIPAL REGISTER**



FULL SAIL, INC. (FLORIDA CORPORATION)
SUITE 160
3300 UNIVERSITY BLVD
WINTER PARK, FL 32792

FOR: EDUCATIONAL SERVICES, NAMELY, OFFERING COURSES OF INSTRUCTION AT THE HIGH SCHOOL, COLLEGE AND POST-GRADUATE LEVEL IN ART, MUSIC, AUDIO, FILM, VIDEO, TELEVISION, DIGITAL MEDIA, WEB DESIGN, COMPUTER ANIMATION, GAME DESIGN, LIVE EVENT PRODUCTION AND THE ENTERTAINMENT BUSINESS, IN CLASS 41 (U.S. CLS. 100, 101 AND 107).

FIRST USE 3-23-2008; IN COMMERCE 3-23-2008.

OWNER OF U.S. REG. NOS. 2,020,654, 3,199,171 AND OTHERS.

THE MARK CONSISTS OF A DESIGN OF AN AIRPLANE WITHIN A CIRCLE.

SER. NO. 77-408,805, FILED 2-28-2008.

STEVEN JACKSON, EXAMINING ATTORNEY

Int. Cl.: 5

Prior U.S. Cls.: 6, 18, 44, 46, 51 and 52

United States Patent and Trademark Office

Reg. No. 3,480,559

Registered Aug. 5, 2008

**TRADEMARK
PRINCIPAL REGISTER**



WYETH (DELAWARE CORPORATION)
FIVE GIRALDA FARMS
MADISON, NJ 07940

FOR: PHARMACEUTICAL PREPARATIONS,
NAMELY, ORAL CONTRACEPTIVES, IN CLASS 5
(U.S. CLS. 6, 18, 44, 46, 51 AND 52).

FIRST USE 7-9-2007; IN COMMERCE 7-9-2007.

OWNER OF U.S. REG. NO. 3,349,850.

THE MARK CONSISTS OF A FANCIFUL BIRD
DESIGN.

SER. NO. 77-409,384, FILED 2-29-2008.

VERNA BETH RIRIE, EXAMINING ATTORNEY

Int. Cl.: 41

Prior U.S. Cls.: 100, 101 and 107

United States Patent and Trademark Office

Reg. No. 3,480,560

Registered Aug. 5, 2008

**SERVICE MARK
PRINCIPAL REGISTER**

FIRST COUNCIL CASINO

OTOE-MISSOURIA TRIBE OF OKLAHOMA
(UNITED STATES FEDERALLY-RECOGNIZED INDIAN TRIBE)

8151 HIGHWAY 177
RED ROCK, OK 74651

FOR: CASINOS, IN CLASS 41 (U.S. CLS. 100, 101 AND 107).

FIRST USE 6-18-2007; IN COMMERCE 2-28-2008.

THE MARK CONSISTS OF STANDARD CHARACTERS WITHOUT CLAIM TO ANY PARTICULAR FONT, STYLE, SIZE, OR COLOR.

NO CLAIM IS MADE TO THE EXCLUSIVE RIGHT TO USE "CASINO", APART FROM THE MARK AS SHOWN.

SER. NO. 77-411,264, FILED 3-3-2008.

KATHLEEN M. VANSTON, EXAMINING ATTORNEY

Int. Cl.: 41

Prior U.S. Cls.: 100, 101 and 107

United States Patent and Trademark Office

Reg. No. 3,480,561

Registered Aug. 5, 2008

**SERVICE MARK
PRINCIPAL REGISTER**

Crazy Sexy

RED HOUSE PICTURES, LLC (NEW YORK LTD
LIAB CO)
P.O. BOX 207
WOODSTOCK, NY 12498

FOR: PRODUCTION AND DISTRIBUTION OF
MOTION PICTURES; PRODUCTION OF FILMS;
ON-LINE JOURNALS, NAMELY, BLOGS FEATUR-
ING INFORMATION ON HEALTH AND OVERALL
WELLNESS; EDUCATION SERVICES, NAMELY,
PROVIDING LIVE AND ON-LINE EDUCATIONAL
AND INFORMATIONAL ACTIVITIES IN THE
FORM OF CLASSES, SEMINARS, AND WORK-
SHOPS IN THE FIELD OF HEALTH, OVERALL
WELLNESS, ECOLOGY, AND ENVIRONMENTAL

ISSUES; ENTERTAINMENT SERVICES, NAMELY,
PERSONAL APPEARANCES BY A MOTIVATIONAL
AND INFORMATIONAL SPEAKER, IN CLASS 41
(U.S. CLS. 100, 101 AND 107).

FIRST USE 3-1-2007; IN COMMERCE 3-1-2007.

THE MARK CONSISTS OF STANDARD CHAR-
ACTERS WITHOUT CLAIM TO ANY PARTICULAR
FONT, STYLE, SIZE, OR COLOR.

SER. NO. 77-414,146, FILED 3-5-2008.

DAWN HAN, EXAMINING ATTORNEY

Int. Cl.: 28

Prior U.S. Cls.: 22, 23, 38 and 50

United States Patent and Trademark Office

Reg. No. 3,480,562

Registered Aug. 5, 2008

**TRADEMARK
PRINCIPAL REGISTER**

AdventureQuest

ARTIX ENTERTAINMENT, LLC (NEVADA LTD
LIAB CO)
P.O. BOX 2005
LAND O' LAKES, CA 34639

FOR: TOYS, NAMELY, TOY FIGURES, DOLLS,
STUFFED PLUSH TOYS, BOARD GAMES AND
PUZZLES, IN CLASS 28 (U.S. CLS. 22, 23, 38 AND 50).

FIRST USE 1-18-2006; IN COMMERCE 1-18-2006.

THE MARK CONSISTS OF STANDARD CHAR-
ACTERS WITHOUT CLAIM TO ANY PARTICULAR
FONT, STYLE, SIZE, OR COLOR.

OWNER OF U.S. REG. NO. 3,186,959.

SER. NO. 77-414,283, FILED 3-5-2008.

CHRISTOPHER BUONGIORNO, EXAMINING AT-
TORNEY

Int. Cl.: 40

Prior U.S. Cls.: 100, 103 and 106

United States Patent and Trademark Office

Reg. No. 3,480,563

Registered Aug. 5, 2008

**SERVICE MARK
PRINCIPAL REGISTER**

Rezenate!

STRATEGIC PARTNERS, INC. (CALIFORNIA
CORPORATION)
9800 DE SOTO AVE.
CHATSWORTH, CA 91331

THE MARK CONSISTS OF STANDARD CHAR-
ACTERS WITHOUT CLAIM TO ANY PARTICULAR
FONT, STYLE, SIZE, OR COLOR.

FOR: CUSTOM MANUFACTURE OF EMPLOYEE
UNIFORMS, IN CLASS 40 (U.S. CLS. 100, 103 AND
106).

SER. NO. 77-416,031, FILED 3-7-2008.

FIRST USE 2-16-2007; IN COMMERCE 2-16-2007.

DANIEL CAPSHAW, EXAMINING ATTORNEY

Int. Cl.: 5

Prior U.S. Cls.: 6, 18, 44, 46, 51 and 52

Reg. No. 3,480,564

United States Patent and Trademark Office

Registered Aug. 5, 2008

**TRADEMARK
PRINCIPAL REGISTER**

ALLERTHERAPY

PROACTIVE REMEDIES, LLC (VIRGINIA LTD
LIAB CO)
#124
673 POTOMAC STATION DRIVE
LEESBURG, VA 20176

THE MARK CONSISTS OF STANDARD CHAR-
ACTERS WITHOUT CLAIM TO ANY PARTICULAR
FONT, STYLE, SIZE, OR COLOR.

FOR: ALLERGY RELIEF MEDICATION, IN
CLASS 5 (U.S. CLS. 6, 18, 44, 46, 51 AND 52).

SER. NO. 77-425,989, FILED 3-19-2008.

FIRST USE 8-9-2007; IN COMMERCE 2-0-2008.

CYNTHIA SLOAN, EXAMINING ATTORNEY

Int. Cl.: 25

Prior U.S. Cls.: 22 and 39

United States Patent and Trademark Office

Reg. No. 3,480,565

Registered Aug. 5, 2008

**TRADEMARK
PRINCIPAL REGISTER**

RĒBAR

KINNDER INDUSTRIES, LLC (WASHINGTON
LTD LIAB CO)
P.O. BOX 55460
PORTLAND, OR, OR 972205460

FOR: OUTERWEAR, NAMELY, COATS, WIND
AND WATER RESISTANT JACKETS FOR SNOW
BOARDING, SKIING, HUNTING, FISHING, WA-
TER SPORTS, HIKING, RUNNING, CLIMBING
AND FOR MILITARY USE; JACKETS, COATS,
ANORAKS, PARKAS, PULLOVERS, WIND AND
WATER RESISTANT JACKETS, WIND AND WA-

TER PROOF JACKETS, RAINWEAR, TRENCH
COATS, IN CLASS 25 (U.S. CLS. 22 AND 39).

FIRST USE 2-0-2007; IN COMMERCE 2-0-2007.

THE MARK CONSISTS OF STANDARD CHAR-
ACTERS WITHOUT CLAIM TO ANY PARTICULAR
FONT, STYLE, SIZE, OR COLOR.

SER. NO. 77-975,072, FILED 9-26-2006.

LAURA HAMMEL, EXAMINING ATTORNEY

Int. Cl.: 21

Prior U.S. Cls.: 2, 13, 23, 29, 30, 33, 40 and 50

Reg. No. 3,480,566

United States Patent and Trademark Office

Registered Aug. 5, 2008

**TRADEMARK
PRINCIPAL REGISTER**

POO PEE

FOUR PAWS PRODUCTS, LTD. (NEW YORK
CORPORATION)
50 WIRELESS BLVD.
HAUPPAUGE, NY 11788

FOR: MANUALLY OPERATED SCOOP FOR
PICKING UP AND DISPOSING OF PET WASTE;
RAKE AND PAN SOLD AS A UNIT FOR PICKING
UP AND DISPOSING OF PET WASTE , IN CLASS 21
(U.S. CLS. 2, 13, 23, 29, 30, 33, 40 AND 50).

FIRST USE 1-14-2008; IN COMMERCE 1-14-2008.

THE MARK CONSISTS OF STANDARD CHAR-
ACTERS WITHOUT CLAIM TO ANY PARTICULAR
FONT, STYLE, SIZE, OR COLOR.

SER. NO. 77-975,361, FILED 8-24-2007.

BRIAN NEVILLE, EXAMINING ATTORNEY

Int. Cl.: 42

Prior U.S. Cls.: 100 and 101

United States Patent and Trademark Office

Reg. No. 3,480,567

Registered Aug. 5, 2008

**SERVICE MARK
PRINCIPAL REGISTER**

EFUEL

COLT INTERNATIONAL, INC. (TEXAS CORPORATION)
300 FLINT RIDGE ROAD
WEBSTER, TX 77598

FOR: PROVIDING TEMPORARY USE OF ON-LINE NON-DOWNLOADABLE SOFTWARE FOR AIRCRAFT SCHEDULING, FLIGHT PLANNING AND SCHEDULING AND OBTAINING TRANSPORTATION INFORMATION, IN CLASS 42 (U.S. CLS. 100 AND 101).

FIRST USE 9-20-2007; IN COMMERCE 9-20-2007.

THE MARK CONSISTS OF STANDARD CHARACTERS WITHOUT CLAIM TO ANY PARTICULAR FONT, STYLE, SIZE, OR COLOR.

SER. NO. 77-975,404, FILED 6-27-2007.

DEIRDRE ROBERTSON, EXAMINING ATTORNEY

Int. Cl.: 25

Prior U.S. Cls.: 22 and 39

United States Patent and Trademark Office

Reg. No. 3,480,568

Registered Aug. 5, 2008

**TRADEMARK
PRINCIPAL REGISTER**

PARISH

BRAND X, L.L.C. (NEW YORK LTD LIAB CO)
31 W. 34TH STREET
NEW YORK, NY 10001

FOR: CLOTHING AND APPAREL FOR MEN, WOMEN, YOUNG ADULTS, CHILDREN AND INFANTS, NAMELY, SHIRTS, EMBROIDERED SHIRTS, TEE-SHIRTS, SPORT SHIRTS, JERSEYS, TANK TOPS, PANTS, JEANS, SHORTS, SWEAT-SHIRTS, SWEATPANTS, WARM-UP SUITS, SOCKS, VESTS, BELTS, LOUNGEWEAR, SLEEPWEAR, NIGHT SHIRTS, UNDERGARMENTS, UNDER-PANTS, UNDERSHIRTS, FOOTWEAR, SHOES, BOOTS, SNEAKERS, SWIMSUITS, BEACH COVER-UPS, SWEATERS, SUITS, SPORT COATS, JACKETS, PARKAS, COATS, OVERCOATS, RAINCOATS, TOP COATS, SCARVES, GLOVES, HEADWEAR, HEAD

BANDS, BANDANNAS, HATS, BASEBALL CAPS, EMBROIDERED CAPS, KNITTED HATS, JUMP-SUITS ; CLOTHING FOR WOMEN AND YOUNG ADULTS, NAMELY, BLOUSES, DRESSES, SKIRTS, TOPS, SCARVES, SARONGS, JUMPERS, SHAWLS , IN CLASS 25 (U.S. CLS. 22 AND 39).

FIRST USE 9-15-2006; IN COMMERCE 9-15-2006.

THE MARK CONSISTS OF STANDARD CHAR-
ACTERS WITHOUT CLAIM TO ANY PARTICULAR
FONT, STYLE, SIZE, OR COLOR.

SER. NO. 77-975,635, FILED 10-6-2006.

WILLIAM ROSSMAN, EXAMINING ATTORNEY

Int. Cl.: 3

Prior U.S. Cls.: 1, 4, 6, 50, 51 and 52

United States Patent and Trademark Office

Reg. No. 3,480,569

Registered Aug. 5, 2008

**TRADEMARK
PRINCIPAL REGISTER**

ADRENALINE

COTY B.V. (BENELUX CORPORATION)
OUDEWEG 147
HAARLEM, BENELUX 2031

FOR: SOAPS; PERFUMERY; ESSENTIAL OILS
FOR PERSONAL USE; COSMETICS; HAIR LO-
TIONS, IN CLASS 3 (U.S. CLS. 1, 4, 6, 50, 51 AND 52).

FIRST USE 1-31-2003; IN COMMERCE 1-31-2003.

PRIORITY CLAIMED UNDER SEC. 44(D) ON
BENELUX APPLICATION NO. 1008533, FILED 4-2-
2002, REG. NO. 0705143, DATED 4-2-2002, EXPIRES 4-
2-2012.

SER. NO. 78-129,455, FILED 5-17-2002.

MARY CRAWFORD, EXAMINING ATTORNEY

Int. Cl.: 25

Prior U.S. Cls.: 22 and 39

United States Patent and Trademark Office

Reg. No. 3,480,570

Registered Aug. 5, 2008

**TRADEMARK
PRINCIPAL REGISTER**

SP

WICKED FASHIONS, INC. (NEW YORK COR-
PORATION)
222 BRIDGE PLAZA SOUTH
FORT LEE, NJ 07024

FIRST USE 12-1-1995; IN COMMERCE 12-1-1995.

SER. NO. 78-204,707, FILED 1-17-2003.

FOR: WEARING APPAREL, NAMELY, JEANS,
TROUSERS, SHORTS, COATS, JACKETS, VESTS,
SHIRTS, AND FOOTWEAR, IN CLASS 25 (U.S. CLS.
22 AND 39).

AMY HELLA, EXAMINING ATTORNEY

Int. Cl.: 15

Prior U.S. Cls.: 2, 21 and 36

United States Patent and Trademark Office

Reg. No. 3,480,571

Registered Aug. 5, 2008

**TRADEMARK
PRINCIPAL REGISTER**

SAN DIMAS

JACKSON/CHARVEL MANUFACTURING, INC.
(DELAWARE CORPORATION)
SUITE 100
8860 E. CHAPARRAL ROAD
SCOTTSDALE, AZ 85250

FOR: ELECTRIC GUITARS, IN CLASS 15 (U.S.
CLS. 2, 21 AND 36).

FIRST USE 6-22-1993; IN COMMERCE 6-22-1993.

THE MARK CONSISTS OF STANDARD CHAR-
ACTERS WITHOUT CLAIM TO ANY PARTICULAR
FONT, STYLE, SIZE, OR COLOR.

SEC. 2(F).

SER. NO. 78-312,464, FILED 10-11-2003.

JANICE L. MCMORROW, EXAMINING ATTOR-
NEY

Int. Cl.: 36

Prior U.S. Cls.: 100, 101 and 102

United States Patent and Trademark Office

Reg. No. 3,480,572

Registered Aug. 5, 2008

**SERVICE MARK
PRINCIPAL REGISTER**

Abacus Federal Savings Bank

國寶銀行



ABACUS FEDERAL SAVINGS BANK (UNITED STATES CORPORATION)
6 BOWERY STREET
NEW YORK, NY 10013

FOR: BANKING SERVICES AND LOAN SERVICES, NAMELY, RESIDENTIAL AND COMMERCIAL MORTGAGE LENDING SERVICES, LINE OF CREDIT LOANS, HOME EQUITY LOANS, INSTALLMENT LOANS, STUDENT LOANS, MORTGAGE LOANS, AND VEHICLE LOANS; CONSUMER AND COMMERCIAL LENDING SERVICES, SAVINGS ACCOUNT SERVICES, FINANCING SERVICES, CHECKING SERVICES; FINANCIAL SERVICES, NAMELY, FINANCIAL MANAGEMENT, FINANCIAL FINANCING SERVICES AND FINANCIAL PLANNING AND ALL OTHER RELATED BANKING SERVICES, IN CLASS 36 (U.S. CLS. 100, 101 AND 102).

FIRST USE 12-0-1984; IN COMMERCE 12-0-1984.

NO CLAIM IS MADE TO THE EXCLUSIVE RIGHT TO USE "FEDERAL SAVINGS BANK", APART FROM THE MARK AS SHOWN.

THE FOREIGN WORDING IN THE MARK TRANSLATES INTO ENGLISH AS "ABACUS FEDERAL SAVINGS BANK".

THE NON-LATIN CHARACTERS IN THE MARK TRANSLITERATE TO GUO BAO YIN HANG.

SER. NO. 78-332,506, FILED 11-24-2003.

ROBIN CHOSID, EXAMINING ATTORNEY

Int. Cl.: 9

Prior U.S. Cls.: 21, 23, 26, 36 and 38

Reg. No. 3,480,573

United States Patent and Trademark Office

Registered Aug. 5, 2008

TRADEMARK
PRINCIPAL REGISTER



EMI (IP) LIMITED (UNITED KINGDOM CORPORATION)
27 WRIGHTS LANE
LONDON, W8 5SW, ENGLAND

FOR: MUSICAL SOUND RECORDINGS, IN CLASS 9 (U.S. CLS. 21, 23, 26, 36 AND 38).

FIRST USE 5-0-1996; IN COMMERCE 5-0-1996.

OWNER OF U.S. REG. NOS. 1,850,213, 2,718,483 AND OTHERS.

NO CLAIM IS MADE TO THE EXCLUSIVE RIGHT TO USE THE REPRESENTATION OF ARABIC CHARACTERS THAT TRANSLATE TO ARABIC MUSIC, APART FROM THE MARK AS SHOWN.

THE MARK CONSISTS OF A BLACK BOX WITH THE FOLLOWING INSIDE: THE LETTERS EMI AND ARABIC CHARACTERS WHICH TRANSLITERATE TO MUSICA AL-ARABIYA WHICH MEAN "MUSIC ARABIA" IN ENGLISH.

THE NON-LATIN CHARACTERS IN THE MARK TRANSLITERATE TO MUSICA AL-ARABIYA AND THIS MEANS ARABIC MUSIC IN ENGLISH.

SER. NO. 78-333,105, FILED 11-25-2003.

DOMINICK J. SALEMI, EXAMINING ATTORNEY

Int. Cls.: 20, 24 and 25

Prior U.S. Cls.: 2, 13, 22, 25, 32, 39, 42 and 50

United States Patent and Trademark Office

Reg. No. 3,480,574

Registered Aug. 5, 2008

**TRADEMARK
PRINCIPAL REGISTER**

CLINICA

EFFIGI INC. (CANADA CORPORATION)
1155 AUTOROUTE 13
LAVAL, QUEBEC, CANADA H7W 5J8

FOR: PILLOWS, BABY BOLSTERS, MATTRESSES,
BED BASES IN THE NATURE OF BOX SPRINGS,
BED FRAMES, IN CLASS 20 (U.S. CLS. 2, 13, 22, 25, 32
AND 50).

FOR: BEDDING ARTICLES, NAMELY PILLOW-
CASES AND BOLSTER CASES, BED SHEETS, DU-
VETS, DUVET COVER; UNDER SHEETS IN THE
NATURE OF BED SHEETS, EIDERDOWNS; BATH
LINEN, NAMELY BATH SHEETS, BATH TOWELS,
TOWELS, HAND TOWELS, WASH CLOTHS, FACE
CLOTHS; TABLE LINEN, NAMELY TABLE-
CLOTHS, TEXTILE TABLE MATS, OVERCLOTHS,
TRAY-CLOTHS, NAPKINS, DISH TOWELS, IN
CLASS 24 (U.S. CLS. 42 AND 50).

FOR: UNDERWEAR, SOCKS, STOCKINGS, IN
CLASS 25 (U.S. CLS. 22 AND 39).

THE MARK CONSISTS OF STANDARD CHAR-
ACTERS WITHOUT CLAIM TO ANY PARTICULAR
FONT, STYLE, SIZE, OR COLOR.

OWNER OF CANADA REG. NO. TMA642,190,
DATED 6-16-2005, EXPIRES 6-16-2020.

THE ENGLISH TRANSLATION OF THE WORD
CLINICA IN THE MARK IS CLINIC.

SER. NO. 78-344,385, FILED 12-22-2003.

ADA HAN, EXAMINING ATTORNEY

Int. Cls.: 8, 13 and 25

Prior U.S. Cls.: 2, 9, 22, 23, 28, 39 and 44

United States Patent and Trademark Office

Reg. No. 3,480,575

Registered Aug. 5, 2008

**TRADEMARK
PRINCIPAL REGISTER**

M45

HECKLER & KOCH GMBH (FED REP GERMA-
NY GMBH)

HECKLER & KOCH STR.1

OBERNDORF/NECKAR, FED REP GERMANY D-
78727

FOR: CUTLERY AND SIDE ARMS, NAMELY,
BAYONETS, FISHING KNIVES, HUNTING KNIVES,
SIDE ARMS, NAMELY, SWORDS, MANUALLY
OPERATED JACKS AND STANDS FOR HAND
JACKS, POCKET KNIVES, SPORT KNIVES, FOLD-
ING KNIVES, CHEF'S KNIVES, KITCHEN KNIVES,
BUTCHER KNIVES, PARING KNIVES, KNIVES OF
PRECIOUS METAL, UTILITY KNIVES, IN CLASS 8
(U.S. CLS. 23, 28 AND 44).

FOR: FIREARMS, NAMELY, SIDE ARMS, AM-
MUNITION AND PROJECTILES, EXPLOSIVES,
FIREWORKS AND COVERS FOR FIREARMS, IN
CLASS 13 (U.S. CLS. 2 AND 9).

FOR: CLOTHING, FOOTWEAR AND HEAD-
GEAR, NAMELY, ANORACKS, BELTS FOR
CLOTHING, BLAZERS, BOOTS, CAPS AS HEAD-
WEAR, FLIGHT SUITS, GOLF SHIRTS, JACKETS,
NECKTIES, OVERALLS, PARKAS, POLO SHIRTS,
PULLOVERS, RAIN COATS, DRESS SHIRTS,
STOCKINGS, T-SHIRTS AND SWEATERS, IN CLASS
25 (U.S. CLS. 22 AND 39).

THE MARK CONSISTS OF STANDARD CHAR-
ACTERS WITHOUT CLAIM TO ANY PARTICULAR
FONT, STYLE, SIZE, OR COLOR.

PRIORITY CLAIMED UNDER SEC. 44(D) ON FED
REP GERMANY APPLICATION NO. 30426705.8/1,
FILED 5-10-2004, REG. NO. 304267051, DATED 11-19-
2004, EXPIRES 5-31-2014.

SER. NO. 78-440,944, FILED 6-24-2004.

JOHN DWYER, EXAMINING ATTORNEY

Int. Cl.: 11

Prior U.S. Cls.: 13, 21, 23, 31 and 34

United States Patent and Trademark Office

Reg. No. 3,480,576

Registered Aug. 5, 2008

**TRADEMARK
PRINCIPAL REGISTER**

INSTALLER'S CHOICE

HUNTER FAN COMPANY (DELAWARE COR-
PORATION)
2500 FRISCO AVENUE
MEMPHIS, TN 38114

FOR: CEILING FANS, IN CLASS 11 (U.S. CLS. 13,
21, 23, 31 AND 34).

FIRST USE 4-1-2000; IN COMMERCE 4-1-2000.

THE MARK CONSISTS OF STANDARD CHAR-
ACTERS WITHOUT CLAIM TO ANY PARTICULAR
FONT, STYLE, SIZE, OR COLOR.

OWNER OF U.S. REG. NO. 1,560,731.

SER. NO. 78-446,318, FILED 7-6-2004.

ZHALEH DELANEY, EXAMINING ATTORNEY

Int. Cls.: 9 and 41

Prior U.S. Cls.: 21, 23, 26, 36, 38, 100, 101 and 107

United States Patent and Trademark Office

Reg. No. 3,480,577

Registered Aug. 5, 2008

**TRADEMARK
SERVICE MARK
PRINCIPAL REGISTER**

FOREVER-KIDS

SEARLES, LINDA (UNITED STATES INDIVIDUAL)
18 SHACKAMAXON TERRACE
ANNADALE, NJ 08801

FOR: AUDIO CASSETTE TAPES FEATURING CHILDREN'S STORIES AND MUSIC, GYMNASTICS INSTRUCTION AND SENSORY MOTOR PLAY, IN CLASS 9 (U.S. CLS. 21, 23, 26, 36 AND 38).

FIRST USE 1-0-2004; IN COMMERCE 1-0-2004.

FOR: GYMNASTICS INSTRUCTION CLASSES, IN CLASS 41 (U.S. CLS. 100, 101 AND 107).

FIRST USE 1-0-2004; IN COMMERCE 1-0-2004.

THE MARK CONSISTS OF STANDARD CHARACTERS WITHOUT CLAIM TO ANY PARTICULAR FONT, STYLE, SIZE, OR COLOR.

SER. NO. 78-455,825, FILED 7-23-2004.

RONALD MCMORROW, EXAMINING ATTORNEY

Int. Cl.: 41

Prior U.S. Cls.: 100, 101 and 107

United States Patent and Trademark Office

Reg. No. 3,480,578

Registered Aug. 5, 2008

**SERVICE MARK
PRINCIPAL REGISTER**

POWER NAPPING

DELUCA, TOM (UNITED STATES INDIVIDUAL)
1464 WINDSONG RD
ORLANDO, FL 32809

FOR: EDUCATIONAL SERVICES, NAMELY,
CONDUCTING SEMINARS IN THE FIELD OF
FOCUSED RELAXATION, DISTRIBUTING
COURSE MATERIALS IN CONNECTION THERE-
WITH, IN CLASS 41 (U.S. CLS. 100, 101 AND 107).

FIRST USE 11-1-1989; IN COMMERCE 3-1-1991.

THE MARK CONSISTS OF STANDARD CHAR-
ACTERS WITHOUT CLAIM TO ANY PARTICULAR
FONT, STYLE, SIZE, OR COLOR.

SER. NO. 78-465,403, FILED 8-11-2004.

GENE MACIOL, EXAMINING ATTORNEY

Int. Cl.: 27

Prior U.S. Cls.: 19, 20, 37, 42 and 50

Reg. No. 3,480,579

United States Patent and Trademark Office

Registered Aug. 5, 2008

**TRADEMARK
PRINCIPAL REGISTER**

CROSSPOINT FABRICS

COLUMBIA INSURANCE COMPANY (NEBRASKA CORPORATION)
3024 HARNEY STREET
OMAHA, NE 681313580

FOR: TEXTILE WALLCOVERINGS NOT SOLD THROUGH RETAIL OUTLETS, IN CLASS 27 (U.S. CLS. 19, 20, 37, 42 AND 50).

FIRST USE 10-31-2000; IN COMMERCE 10-31-2000.

THE MARK CONSISTS OF STANDARD CHARACTERS WITHOUT CLAIM TO ANY PARTICULAR FONT, STYLE, SIZE, OR COLOR.

NO CLAIM IS MADE TO THE EXCLUSIVE RIGHT TO USE "FABRICS", APART FROM THE MARK AS SHOWN.

SER. NO. 78-472,460, FILED 8-24-2004.

ADA HAN, EXAMINING ATTORNEY

Int. Cl.: 35

Prior U.S. Cls.: 100, 101 and 102

United States Patent and Trademark Office

Reg. No. 3,480,580

Registered Aug. 5, 2008

**SERVICE MARK
PRINCIPAL REGISTER**

PHILANTHROPIA

MECENA FINANCE LTD. (SWITZERLAND LTD
LIAB JT ST CO)

C/O JURIS TREUHAND AG, INDUSTRIESTRASSE
47

ZUG, SWITZERLAND CH-6304

FOR: ASSISTING CULTURAL ORGANIZATIONS,
SUCH AS MUSEUMS, ASSOCIATIONS, FOUNDA-
TIONS, UNIVERSITIES AND COLLEGES TO AT-
TAIN THEIR FINANCIAL AND FUND RAISING
OBJECTIVES, NAMELY, BUSINESS MANAGE-
MENT OF FUND RAISING CAMPAIGNS, CON-
DUCTING MARKET STUDIES AND
OUTSOURCING OF HUMAN RESOURCES IN THE
FIELD OF FUND RAISING, IN CLASS 35 (U.S. CLS.
100, 101 AND 102).

PRIORITY CLAIMED UNDER SEC. 44(D) ON
ERPNTY TM OFC APPLICATION NO.
003908647, FILED 7-4-2004, REG. NO. 003908647,
DATED 9-5-2006, EXPIRES 7-4-2014.

THE COLOR(S) OLIVE GREEN AND BLACK IS/
ARE CLAIMED AS A FEATURE OF THE MARK.

THE MARK CONSISTS OF "PHILANTHROPIA"
WHERE THE FANCIFUL LETTER "I" IS OLIVE
GREEN AND THE REMAINING LETTERS OF THE
MARK ARE BLACK.

SER. NO. 78-475,547, FILED 8-30-2004.

JENNIFER DIXON, EXAMINING ATTORNEY

Int. Cl.: 35

Prior U.S. Cls.: 100, 101 and 102

United States Patent and Trademark Office

Reg. No. 3,480,581

Registered Aug. 5, 2008

**SERVICE MARK
PRINCIPAL REGISTER**

1-WORLD

DAVIA BAILEY (UNITED STATES INDIVIDUAL)
8312 GREENWOOD AVE S.
SEATTLE, WA 98121

THE MARK CONSISTS OF STANDARD CHARACTERS WITHOUT CLAIM TO ANY PARTICULAR FONT, STYLE, SIZE, OR COLOR.

FOR: ON-LINE RETAIL STORE SERVICES FEATURING GLOBES, MAPS, AND ACCESSORIES FOR GLOBES AND MAPS, IN CLASS 35 (U.S. CLS. 100, 101 AND 102).

SER. NO. 78-477,474, FILED 9-1-2004.

FIRST USE 12-31-1996; IN COMMERCE 12-31-1996.

BRIAN PINO, EXAMINING ATTORNEY

Int. Cl.: 5

Prior U.S. Cls.: 6, 18, 44, 46, 51 and 52

Reg. No. 3,480,582

United States Patent and Trademark Office

Registered Aug. 5, 2008

**TRADEMARK
PRINCIPAL REGISTER**

NUTRAMIN

CALIFORNIA EARTH MINERALS, INC. (CALI-
FORNIA CORPORATION)
P.O. BOX 3113
CULVER CITY, CA 90231

THE MARK CONSISTS OF STANDARD CHAR-
ACTERS WITHOUT CLAIM TO ANY PARTICULAR
FONT, STYLE, SIZE, OR COLOR.

FOR: NATURAL MINERAL SUPPLEMENT FOR
ANIMALS; NATURAL NUTRIENT SUPPLEMENT
FOR ANIMALS, IN CLASS 5 (U.S. CLS. 6, 18, 44, 46, 51
AND 52).

SER. NO. 78-508,337, FILED 10-29-2004.

FIRST USE 4-27-2001; IN COMMERCE 4-27-2001.

RON FAIRBANKS, EXAMINING ATTORNEY

Int. Cl.: 9

Prior U.S. Cls.: 21, 23, 26, 36 and 38

Reg. No. 3,480,583

United States Patent and Trademark Office

Registered Aug. 5, 2008

**TRADEMARK
PRINCIPAL REGISTER**

SIGNATURE SERIES

MONSTER, LLC (NEVADA LTD LIAB CO)
7251 LAKE MEAD BLVD. WEST, 3RD FLOOR
LAS VEGAS, NV 89128

FOR: POWER CONTROLLERS FOR USE WITH LOUDSPEAKERS AND STEREO AMPLIFIERS; AUDIO EQUIPMENT AND ACCESSORIES, NAME- LY, HOME THEATER AMPLIFIERS AND PRE- AMPLIFIERS; VIDEO EQUIPMENT AND ACCE- SORIES, NAMELY, HOME THEATER VIDEO POW- ER SUPPLIES AND ELECTRONIC GAME EQUIPMENT AND ACCESSORIES, NAMELY, ELECTRONIC GAME EQUIPMENT POWER SUP- PLIES; ELECTRICAL POWER CONTROL COMPO- NENTS AND ACCESSORIES, NAMELY, POWER CONTROLLERS, VOLTAGE REGULATORS FOR ELECTRIC POWER; ENERGY CONDITIONING DE-

VICES, NAMELY, AUTOMATIC VOLTAGE STABI- LIZERS, POWER CONDITIONERS, IN CLASS 9 (U.S. CLS. 21, 23, 26, 36 AND 38).

FIRST USE 11-18-2002; IN COMMERCE 11-18-2002.

THE MARK CONSISTS OF STANDARD CHAR- ACTERS WITHOUT CLAIM TO ANY PARTICULAR FONT, STYLE, SIZE, OR COLOR.

NO CLAIM IS MADE TO THE EXCLUSIVE RIGHT TO USE "SERIES", APART FROM THE MARK AS SHOWN.

SER. NO. 78-509,886, FILED 11-2-2004.

KRISTINA MORRIS, EXAMINING ATTORNEY

Int. Cls.: 9, 16, 25, 35, 38 and 41

**Prior U.S. Cls.: 2, 5, 21, 22, 23, 26, 29, 36, 37, 38, 39,
50, 100, 101, 102, 104 and 107**

Reg. No. 3,480,584

United States Patent and Trademark Office

Registered Aug. 5, 2008

**TRADEMARK
SERVICE MARK
PRINCIPAL REGISTER**

TELCEL DIRECTO

ADMINISTRADORA DE MARCAS RD, S. DE
R.L. DE C.V. (MEXICO CORPORATION)
LAGO ALBERTO NO. 366, COL. ANAHUAC
DELEGACION MIGUEL HIDALGO
C.P. 11320, MEXICO, D.F., MEXICO

FOR: TELECOMMUNICATION PRODUCTS, NAMELY, TELEPHONES, CELLULAR TELEPHONES AND TELEPHONE ANSWERING MACHINES; APPARATUS FOR RECORDING, TRANSMISSION, REPRODUCTION OF SOUND OR IMAGES, NAMELY, PHONOGRAPH RECORDS, CD AND DVD PLAYERS, AUDIO AND VIDEO TAPE RECORDERS; BLANK AUDIO AND VIDEO TAPES AND CDS; STEREO RECEIVERS, AMPLIFIERS, AND TUNERS; BLANK MAGNETIC DATA CARRIERS, DATA PROCESSORS AND COMPUTERS; COMPUTER HARDWARE, NAMELY, MEMORY CARDS, MODEMS, COMPUTER INTERFACE BOARDS, BLANK MAGNETIC COMPUTER TAPES, FAX MACHINES, FIBER OPTIC CABLES, COMPUTER AND ELECTRIC CABLES, OPTICAL CHARACTER RECOGNITION APPARATUS, BLANK OPTICAL DISCS, OPTICAL SCANNERS AND MAGNETIC CODED CARDS FOR PREPAID TELECOMMUNICATIONS SERVICES; SATELLITES, BLANK DIGITAL OPTICAL DISKS, COMPUTER KEYBOARDS, PROCESS COMPUTERS, COMPUTERS FOR DATA AND WORD PROCESSING, COMPUTER TERMINALS, COMPUTER PRINTERS, COMPUTER MONITORS, INTEGRATED CIRCUITS AND COMPONENTS, NAMELY, COMPUTER CHIPS; ELECTRONIC CIRCUIT BOARDS, ELECTRONIC NOTICE BOARDS, INTEGRATED CIRCUIT CARDS; DOWNLOADABLE RING TONES AND MASTER TONES, NAMELY, A CLIP OF A SONG IN ITS

ORIGINAL FORMAT; DOWNLOADABLE TEXT FILES FEATURING NEWS IN THE FIELD OF ENTERTAINMENT; DOWNLOADABLE WALLPAPER GRAPHICS, IMAGES AND PHOTOGRAPHS, ALL OF THE FOREGOING DOWNLOADABLE VIA THE INTERNET AND WIRELESS DEVICES, IN CLASS 9 (U.S. CLS. 21, 23, 26, 36 AND 38).

FOR: ADVERTISEMENT BOARDS OF PAPER OR CARDBOARD; BINDERS; BOOK BINDINGS; BOOKLETS IN THE FIELD OF TELECOMMUNICATIONS SERVICES; BOOKMARKERS; BOOKS IN THE FIELD OF TELECOMMUNICATIONS SERVICES; BOXES OF CARDBOARD OR PAPER; CALENDARS; CATALOGUES IN THE FIELD OF TELECOMMUNICATIONS PRODUCTS AND SERVICES; COASTERS OF PAPER; DECALCOMANIA; ENVELOPES; FOUNTAIN PENS; GREETING CARDS; HANDBOOKS IN THE FIELD OF TELECOMMUNICATIONS PRODUCTS AND SERVICES; MANUALS IN THE FIELD OF TELECOMMUNICATIONS PRODUCTS; NEWSPAPERS FOR GENERAL CIRCULATION; OFFICE SUPPLIES, NAMELY, ENVELOPES AND FOLDERS, PACKING PAPER, BOND PAPER, PAPER SHEETS, PEN CASES, PENS, PENCILS, POSTCARDS, POSTERS, PRINTING BLOCKS; PRINTED PUBLICATIONS, NAMELY, BOOKS, MAGAZINES, PAMPHLETS AND INSTRUCTIONAL MANUALS IN THE FIELD OF TELECOMMUNICATIONS; FLYERS, POSTERS, AND PRINTED MENU BOARDS OF PAPER OR CARDBOARD IN THE FIELD OF TELECOMMUNICATIONS PRODUCTS AND SERVICES; STATIONERY, STICKERS, WRITING PADS, WRITING PAPER, IN CLASS 16 (U.S. CLS. 2, 5, 22, 23, 29, 37, 38 AND 50).

FOR: CLOTHING, NAMELY, SHIRTS, TROUSERS, BLOUSES, SKIRTS, PANTS, COATS AND JACKETS; FOOTWEAR; HEADGEAR, NAMELY, HATS, CAPS AND VISORS, IN CLASS 25 (U.S. CLS. 22 AND 39).

FOR: ADVERTISING SERVICES; ADVERTISING BY MAIL ORDER; DISSEMINATION OF ADVERTISING MATTER; BUSINESS MANAGEMENT PLANNING, SUPERVISION AND IMPLEMENTATION; DEMONSTRATION OF PRODUCTS; ORGANIZING EXHIBITIONS FOR BUSINESS AND ADVERTISING PURPOSES, NAMELY, IN THE FIELD OF TELECOMMUNICATIONS PRODUCTS AND SERVICES, IN CLASS 35 (U.S. CLS. 100, 101 AND 102).

FOR: TELECOMMUNICATION SERVICES, NAMELY, PERSONAL COMMUNICATION SERVICES; TELEMATIC SERVICES, NAMELY, TELECOMMUNICATION SERVICES, NAMELY, PROVISION OF MOBILE TELECOMMUNICATIONS SERVICES, NAMELY, VOICE AND DATA TRANSMISSIONS, ACCESSIBLE BY ACCESS CODE OR TERMINALS, TELEPHONE, TELEVISION, RADIO AND DATA TRANSMISSIONS ACCESSIBLE BY ACCESS CODE OR TERMINALS, TELEPHONE, TELEVISION, RADIO AND TELEPRINTER; ELECTRONIC TRANSMISSION OF MESSAGES AND CODED IMAGES; ELECTRONIC TRANSMISSION OF MESSAGES AND DATA; WIRELESS DIGITAL MESSAGING SERVICES, ELECTRONIC STORE-AND-FORWARD MESSAGING, ELECTRONIC TRANSMISSION OF DATA AND DOCUMENTS VIA COMPUTER TERMINALS, COMPUTER TELECOMMUNICATIONS, NAMELY, PROVIDING MULTIPLE USER ACCESS TO THE INTERNET; FACSIMILE TRANSMISSION, ELECTRONIC MAIL SERVICES, TELEPHONE COMMUNICATION SERVICES, IN CLASS 38 (U.S. CLS. 100, 101 AND 104).

FOR: EDUCATIONAL SERVICES, NAMELY, CONDUCTING SEMINARS, CONFERENCES, AND WORKSHOPS IN THE FIELD OF TELECOMMUNICATIONS SERVICES; ENTERTAINMENT, NAMELY, CONDUCTING CONTEST RAFFLES AND COMPETITIONS IN THE FIELD OF CULTURE, SPORTS AND SOCIAL FUNCTIONS; ENTERTAINMENT SERVICES, NAMELY, NON-DOWNLOADABLE RING TONES, WALLPAPER GRAPHICS, IMAGES AND PHOTOGRAPHS PRESENTED TO

MOBILE COMMUNICATIONS DEVICES VIA A GLOBAL COMPUTER NETWORK AND WIRELESS NETWORKS; PROVIDING NEWS IN THE FIELD OF ENTERTAINMENT, IN CLASS 41 (U.S. CLS. 100, 101 AND 107).

THE MARK CONSISTS OF STANDARD CHARACTERS WITHOUT CLAIM TO ANY PARTICULAR FONT, STYLE, SIZE, OR COLOR.

PRIORITY CLAIMED UNDER SEC. 44(D) ON MEXICO APPLICATION NO. 685020, FILED 10-28-2004, REG. NO. 861858, DATED 10-28-2004, EXPIRES 10-28-2014.

PRIORITY CLAIMED UNDER SEC. 44(D) ON MEXICO APPLICATION NO. 685021, FILED 10-28-2004, REG. NO. 861859, DATED 10-28-2004, EXPIRES 10-28-2014.

PRIORITY CLAIMED UNDER SEC. 44(D) ON MEXICO APPLICATION NO. 685022, FILED 10-28-2004, REG. NO. 861860, DATED 10-28-2004, EXPIRES 10-28-2014.

PRIORITY CLAIMED UNDER SEC. 44(D) ON MEXICO APPLICATION NO. 685023, FILED 10-28-2004, REG. NO. 861861, DATED 10-28-2004, EXPIRES 10-28-2014.

PRIORITY CLAIMED UNDER SEC. 44(D) ON MEXICO APPLICATION NO. 685025, FILED 10-28-2004, REG. NO. 861863, DATED 10-28-2004, EXPIRES 10-28-2014.

PRIORITY CLAIMED UNDER SEC. 44(D) ON MEXICO APPLICATION NO. 685024, FILED 10-28-2004, REG. NO. 861862, DATED 10-28-2004, EXPIRES 10-28-2014.

NO CLAIM IS MADE TO THE EXCLUSIVE RIGHT TO USE "DIRECTO", APART FROM THE MARK AS SHOWN.

THE ENGLISH TRANSLATION OF THE WORD "DIRECTO" IN THE MARK IS DIRECT.

SER. NO. 78-518,845, FILED 11-17-2004.

JOHN GARTNER, EXAMINING ATTORNEY

Int. Cls.: 35, 41, 42, 44 and 45

Prior U.S. Cls.: 100, 101, 102 and 107

United States Patent and Trademark Office

Reg. No. 3,480,585

Registered Aug. 5, 2008

**SERVICE MARK
PRINCIPAL REGISTER**

AMMAS

AMMAS.COM LIMITED (NEW ZEALAND COMPANY)
47 KILLARNEY STREET
TAKAPUNA, AUCKLAND, NEW ZEALAND

FOR: PROVIDING AN ON-LINE COMPUTER DATABASE OF PROPRIETARY COLLECTIONS OF INFORMATION IN THE FIELDS OF BUSINESS AND ECONOMY AND CAREER , IN CLASS 35 (U.S. CLS. 100, 101 AND 102).

FOR: PROVIDING AN ON-LINE COMPUTER DATABASE OF PROPRIETARY COLLECTIONS OF INFORMATION IN THE FIELDS OF THE ARTS AND HUMANITIES, ENTERTAINMENT AND THE NEWS MEDIA, AND ABOUT EDUCATION, RE-CREATION AND SPORTS, IN CLASS 41 (U.S. CLS. 100, 101 AND 107).

FOR: COMPUTER SERVICES, NAMELY, PROVIDING SEARCH ENGINES FOR USERS OF A COMPUTER NETWORK TO CONDUCT SEARCHES FOR INFORMATION; COMPUTER SERVICES, NAMELY, CREATING INDEXES OF RANKINGS OF HUMAN EXPERTISE, WEB SITES AND OTHER RESOURCES AVAILABLE ON A COMPUTER NETWORK; DATA MINING IN THE NATURE OF EXTRACTING INFORMATION FOR COMPARATIVE ANALYSIS; HOSTING AND CUSTOM DESIGN OF WEBSITES FOR OTHERS; PROVIDING AN ON-LINE COMPUTER DATABASE OF PROPRIETARY COLLECTIONS OF INFORMATION IN THE FIELDS OF COMPUTERS AND THE INTERNET, SCIENCE AND ELECTRONIC TECHNOLOGY, IN CLASS 42 (U.S. CLS. 100 AND 101).

FOR: PROVIDING AN ON-LINE COMPUTER DATABASE OF PROPRIETARY COLLECTIONS OF INFORMATION IN THE FIELDS OF FAMILY HEALTH, IN CLASS 44 (U.S. CLS. 100 AND 101).

FOR: PROVIDING AN ON-LINE COMPUTER DATABASE OF PROPRIETARY COLLECTIONS OF INFORMATION IN THE FIELDS OF DATING AND DATING SERVICES, HOROSCOPE CASTINGS AND MARRIAGE BUREAUS, IN CLASS 45 (U.S. CLS. 100 AND 101).

THE MARK CONSISTS OF STANDARD CHARACTERS WITHOUT CLAIM TO ANY PARTICULAR FONT, STYLE, SIZE, OR COLOR.

PRIORITY CLAIMED UNDER SEC. 44(D) ON NEW ZEALAND APPLICATION NO. 714371, FILED 6-25-2004, REG. NO. 714371, DATED 3-10-2005, EXPIRES 6-25-2014.

THE NAME(S), PORTRAIT(S), AND/OR SIGNATURE(S) SHOWN IN THE MARK DOES NOT IDENTIFY A PARTICULAR LIVING INDIVIDUAL.

"THE FOREIGN WORDING IN THE MARK TRANSLATES INTO ENGLISH AS MOTHERS."

SER. NO. 78-530,521, FILED 12-10-2004.

CHARLOTTE CORWIN, EXAMINING ATTORNEY

Int. Cls.: 9, 16, 37 and 42

**Prior U.S. Cls.: 2, 5, 21, 22, 23, 26, 29, 36, 37, 38, 50,
100, 101, 103 and 106**

Reg. No. 3,480,586

United States Patent and Trademark Office

Registered Aug. 5, 2008

**TRADEMARK
SERVICE MARK
PRINCIPAL REGISTER**

MyCollection

ESPRO INFORMATION TECHNOLOGIES LTD.
(ISRAEL CORPORATION)
17 ATIR YEDA ST. NEW INDUSTRIAL PARK
KFAR SABA, ISRAEL 44643

FOR: COMPUTER HARDWARE AND SOFTWARE FOR SELECTING AND MARKING ITEMS THROUGH PORTABLE GUIDING SYSTEMS FOR TAILORING MULTIMEDIA PRODUCTS TO BE EITHER PRODUCED ON THE SPOT OR DELIVERED VIA E-MAIL OR POST, IN CLASS 9 (U.S. CLS. 21, 23, 26, 36 AND 38).

FOR: PRINTED MATTER, NAMELY POSTERS, CATALOGUES, CUSTOMIZED CATALOGUES, TEXT AND IMAGES, BASED ON PERSONAL SELECTIONS, PRINTED AND BOUND ON DEMAND, IN CLASS 16 (U.S. CLS. 2, 5, 22, 23, 29, 37, 38 AND 50).

FOR: INSTALLATION, MAINTENANCE, AND REPAIR OF COMPUTER HARDWARE FOR PORTABLE GUIDING SYSTEMS, IN CLASS 37 (U.S. CLS. 100, 103 AND 106).

FOR: INSTALLATION, MAINTENANCE, AND REPAIR OF COMPUTER SOFTWARE FOR PORTA-

BLE GUIDING SYSTEMS; TECHNICAL SUPPORT, NAMELY, TROUBLESHOOTING OF COMPUTER HARDWARE AND SOFTWARE PROBLEMS, IN CLASS 42 (U.S. CLS. 100 AND 101).

THE MARK CONSISTS OF STANDARD CHARACTERS WITHOUT CLAIM TO ANY PARTICULAR FONT, STYLE, SIZE, OR COLOR.

PRIORITY CLAIMED UNDER SEC. 44(D) ON ISRAEL APPLICATION NO. 3944733, FILED 7-17-2004, REG. NO. 177372, DATED 12-10-2006, EXPIRES 1-2-2015.

OWNER OF ISRAEL REG. NO. 177374, DATED 12-10-2006, EXPIRES 1-2-2015.

OWNER OF ISRAEL REG. NO. 177373, DATED 12-10-2006, EXPIRES 1-2-2015.

SER. NO. 78-540,803, FILED 1-2-2005.

ROBIN CHOSID, EXAMINING ATTORNEY

Int. Cl.: 3

Prior U.S. Cls.: 1, 4, 6, 50, 51 and 52

Reg. No. 3,480,587

United States Patent and Trademark Office

Registered Aug. 5, 2008

**TRADEMARK
PRINCIPAL REGISTER**

MyChelle

MYCHELLE DERMACEUTICALS LLC (COLOR-
ADO LTD LIAB CO)
310 MAIN STREET
P.O. BOX 1
FRISCO, CO 80443

FOR: SKIN PRODUCTS NAMELY, FACIAL
CREAMS, FACIAL CLEANSERS, FACIAL TONERS,
FACIAL MASKS, FACIAL PEELS, FACIAL SCRUB,
SERUMS, BODY SCRUB, BODY CREAMS, LO-
TIONS, MOISTURIZERS, LIP CREAM AND MAKE
UP, IN CLASS 3 (U.S. CLS. 1, 4, 6, 50, 51 AND 52).

FIRST USE 11-1-2000; IN COMMERCE 11-1-2000.

THE MARK CONSISTS OF STANDARD CHAR-
ACTERS WITHOUT CLAIM TO ANY PARTICULAR
FONT, STYLE, SIZE, OR COLOR.

SER. NO. 78-545,374, FILED 1-11-2005.

DAVID C. REIHNER, EXAMINING ATTORNEY

Int. Cl.: 8

Prior U.S. Cls.: 23, 28 and 44

United States Patent and Trademark Office

Reg. No. 3,480,588

Registered Aug. 5, 2008

**TRADEMARK
PRINCIPAL REGISTER**

SHORTCUT

FISKARS BRANDS, INC. (WISCONSIN CORPORATION)
2537 DANIELS STREET
MADISON, WI 537186772

FOR: MULTI-FUNCTION POCKET HAND TOOLS FOR OUTDOOR RECREATIONAL USE COMPRISING ALL OR A COMBINATION OF THE FOLLOWING SCREWDRIVERS, BOTTLE OPENERS, KNIFE BLADE, FILE, AND TWEEZERS , IN CLASS 8 (U.S. CLS. 23, 28 AND 44).

FIRST USE 1-1-2006; IN COMMERCE 1-1-2006.

THE MARK CONSISTS OF STANDARD CHARACTERS WITHOUT CLAIM TO ANY PARTICULAR FONT, STYLE, SIZE, OR COLOR.

SER. NO. 78-554,096, FILED 1-26-2005.

SIMON TENG, EXAMINING ATTORNEY

Int. Cls.: 30, 35 and 43

Prior U.S. Cls.: 46, 100, 101 and 102

United States Patent and Trademark Office

Reg. No. 3,480,589

Registered Aug. 5, 2008

**TRADEMARK
SERVICE MARK
PRINCIPAL REGISTER**

City Brew

J & B INC. (MONTANA CORPORATION)
P.O. BOX 22209
BILLINGS, MT 59104

FOR: GROUND AND WHOLE BEAN COFFEE;
COFFEE, TEA, HERBAL TEA, COCOA AND
ESPRESSO BEVERAGES, AND BEVERAGES MADE
WITH A BASE OF COFFEE, TEA, HERBAL TEA,
COCOA AND ESPRESSO; BAKED GOODS, NAME-
LY BISCOTTI, BREAD, BROWNIES, CAKES, COOK-
IES, MUFFINS, PASTRIES, SCONES, BAGELS AND
GRANOLA BARS; CHOCOLATE; CANDY, IN
CLASS 30 (U.S. CL. 46).

FIRST USE 12-21-1998; IN COMMERCE 12-31-1998.

FOR: COFFEE KIOSK SERVICES, IN CLASS 35
(U.S. CLS. 100, 101 AND 102).

FIRST USE 12-20-2004; IN COMMERCE 12-20-2004.

FOR: COFFEE HOUSE SERVICES, IN CLASS 43
(U.S. CLS. 100 AND 101).

FIRST USE 12-1-1998; IN COMMERCE 12-1-1998.

THE MARK CONSISTS OF STANDARD CHAR-
ACTERS WITHOUT CLAIM TO ANY PARTICULAR
FONT, STYLE, SIZE, OR COLOR.

NO CLAIM IS MADE TO THE EXCLUSIVE
RIGHT TO USE "BREW", APART FROM THE
MARK AS SHOWN.

SER. NO. 78-555,821, FILED 1-28-2005.

KYLE PEETE, EXAMINING ATTORNEY

Int. Cls.: 16 and 35

Prior U.S. Cls.: 2, 5, 22, 23, 29, 37, 38, 50, 100, 101 and 102

Reg. No. 3,480,590

United States Patent and Trademark Office

Registered Aug. 5, 2008

**TRADEMARK
SERVICE MARK
PRINCIPAL REGISTER**



OREGON SCIENTIFIC INTERNATIONAL LIM-
ITED (BERMUDA LTD LIAB CO)

2 CHURCH STREET

CLARENDON HOUSE

HAMILTON HM11, BERMUDA

FOR: ANNOUNCEMENT CARDS; BAGS OF PAPER OR PLASTICS FOR PACKAGING; PRINTED MATTER, NAMELY, GREETING CARDS, PRINTED GREETING CARDS FOR ELECTRONIC INFORMATION STORED THEREIN; LEAFLETS AND BROCHURES IN THE FIELDS OF LIFESTYLE CONSUMER ELECTRONIC, DIGITAL AND COMMUNICATIONS PRODUCTS AND ACCESSORIES AND RELATED TOPICS; PRINTED MATERIALS, NAMELY, POSTERS, POSTERS MADE OF PAPER; PRINTED PUBLICATIONS, NAMELY, PRINTED VISUALS IN THE NATURE OF PROMOTIONAL MATERIALS, BOOKS, BOOKLETS, MAGAZINES, PERIODICALS, CATALOGUES, NEWSLETTERS, PAMPHLETS, PRESS RELEASES, PRINTED INSTRUCTIONAL, EDUCATIONAL AND TEACHING MATERIALS, ALL IN THE FIELDS OF LIFESTYLE CONSUMER ELECTRONIC, DIGITAL AND COMMUNICATIONS PRODUCTS AND ACCESSORIES AND RELATED TOPICS; CALENDARS; CARDBOARD FOR PACKAGING; BUSINESS CARDS; ENVELOPES; PAPER HAND TOWELS; NEWSPAPERS; NOTE BOOKS; OFFICE STATIONERY; PAPER; PHOTOGRAPHS; PICTURES; POSTCARDS; POSTERS MADE OF PAPER; SIGNBOARDS OF PAPER OR CARDBOARD; SEALS AND RUBBER STAMPS FOR THE OFFICE; STATIONERY; STICKERS; WRAPPING PAPER; WRITING INSTRUMENTS, INCLUDING PENS, PENCILS, CRAYONS, MARKERS; GLOBES, IN CLASS 16 (U.S. CLS. 2, 5, 22, 23, 29, 37, 38 AND 50).

FOR: ACCOUNTING SERVICES; ADVERTISING AND ADVERTISEMENT SERVICES; ADVERTISING AGENCIES; BUSINESS MANAGEMENT ASSISTANCE TO COMMERCIAL AND INDUSTRIAL COMPANIES AND CONCERNS; AUDITING SERVICES, NAMELY, BUSINESS AUDITING, ACCOUNT AUDITING; BUSINESS INFORMATION AND INQUIRIES; BUSINESS MANAGEMENT AND ORGANIZATION CONSULTANCY; COMPILATION AND SYSTEMIZATION OF INFORMATION IN DATABASES; DIRECT MAIL ADVERTISING; DISSEMINATION OF ADVERTISING MATTER; DISTRIBUTION OF SAMPLES FOR PUBLICITY PURPOSES; ORGANIZATION OF EXHIBITIONS AND TRADE FAIRS FOR COMMERCIAL OR ADVERTISING PURPOSES; IMPORT-EXPORT AGENCIES; ADVERTISING, INCLUDING PROMOTION RELATING TO THE SALE OF ARTICLES AND SERVICES FOR THIRD PARTIES BY THE TRANSMISSION OF ADVERTISING MATERIAL AND THE DISSEMINATION OF ADVERTISING MESSAGES ON COMPUTER NETWORKS; PERSONNEL CONSULTANCY; MARKETING RESEARCH STUDIES; NEWS CLIPPING SERVICES; ON-LINE ADVERTISING ON COMPUTER COMMUNICATIONS NETWORKS; OUTDOOR ADVERTISING, NAMELY, PREPARING AND PLACING OUTDOOR ADVERTISEMENTS FOR OTHERS; PUBLIC RELATIONS; PUBLICATION OF PUBLICITY TEXTS; PUBLICITY AND SALES PROMOTION RELATING TO GOODS AND SERVICES OFFERED AND ORDERED BY TELECOMMUNICATIONS OR ELECTRONIC MEANS; PREPARATION AND PLACEMENT OF CUSTOM ADVERTISEMENTS AND COMMERCIALS FOR OTHERS; SALES PROMOTION; SECRETARIAL AND CLERICAL SERVICES; SHOP WINDOW DISPLAY ARRANGEMENT SERVICES; TELEVISION ADVERTISING, NAMELY, PROVID-

ING TELEVISION ADVERTISING FOR OTHERS;
WORD PROCESSING AND TYPING SERVICES, IN
CLASS 35 (U.S. CLS. 100, 101 AND 102).

OWNER OF HONG KONG REG. NO. 300352269,
DATED 11-1-2005, EXPIRES 10-1-2015.

NO CLAIM IS MADE TO THE EXCLUSIVE
RIGHT TO USE "SCIENTIFIC", APART FROM THE
MARK AS SHOWN.

SER. NO. 78-561,672, FILED 2-7-2005.

SANDRA MANIOS, EXAMINING ATTORNEY

Int. Cl.: 35

Prior U.S. Cls.: 100, 101 and 102

United States Patent and Trademark Office

Reg. No. 3,480,591

Registered Aug. 5, 2008

**SERVICE MARK
PRINCIPAL REGISTER**

MAXPARTNER

NUVO NETWORK MANAGEMENT INC. (CANADA CORPORATION)
2650 QUEENSVIEW DRIVE
OTTAWA, CANADA K2B 8H6

FOR: BUSINESS CONSULTING SERVICES, NAMELY, CREATING SALES AND MARKETING PROGRAMS FOR COMPANIES THAT ARE VALUE-ADDED RESELLERS OF INFORMATION TECHNOLOGY MANAGEMENT SECURITY AND SERVICES, IN CLASS 35 (U.S. CLS. 100, 101 AND 102).

THE MARK CONSISTS OF STANDARD CHARACTERS WITHOUT CLAIM TO ANY PARTICULAR FONT, STYLE, SIZE, OR COLOR.

OWNER OF CANADA REG. NO. TMA701,182, DATED 11-20-2007, EXPIRES 11-22-2022.

SER. NO. 78-564,390, FILED 2-10-2005.

PAM WILLIS, EXAMINING ATTORNEY

Int. Cl.: 14

Prior U.S. Cls.: 2, 27, 28 and 50

United States Patent and Trademark Office

Reg. No. 3,480,592

Registered Aug. 5, 2008

**TRADEMARK
PRINCIPAL REGISTER**

NEWD

ALESSANDRO MASINI (ITALY INDIVIDUAL)
VIA GIACOMO ZANELLA 44
FLORENCE, ITALY 50124

THE MARK CONSISTS OF THE WORD "NEWD"
IN A SPECIALIZED FONT.

FOR: JEWELRY, IN CLASS 14 (U.S. CLS. 2, 27, 28
AND 50).

SER. NO. 78-565,680, FILED 2-11-2005.

FIRST USE 7-15-2005; IN COMMERCE 10-15-2005.

NANCY CLARKE, EXAMINING ATTORNEY

Int. Cl.: 16

Prior U.S. Cls.: 2, 5, 22, 23, 29, 37, 38 and 50

Reg. No. 3,480,593

United States Patent and Trademark Office

Registered Aug. 5, 2008

**TRADEMARK
PRINCIPAL REGISTER**

SILENT BAGS

COMPLETE PROPS (CALIFORNIA SOLE PROPRIETORSHIP)
5312 WILLOW OAK ST.
SIMI VALLEY, CA 93063

FOR: STAGE PROPS, NAMELY, PAPER AND PLASTIC SHOPPING BAGS, IN CLASS 16 (U.S. CLS. 2, 5, 22, 23, 29, 37, 38 AND 50).

FIRST USE 1-1-1995; IN COMMERCE 1-1-1995.

THE MARK CONSISTS OF STANDARD CHARACTERS WITHOUT CLAIM TO ANY PARTICULAR FONT, STYLE, SIZE, OR COLOR.

NO CLAIM IS MADE TO THE EXCLUSIVE RIGHT TO USE "BAGS", APART FROM THE MARK AS SHOWN.

SEC. 2(F).

SER. NO. 78-566,217, FILED 2-12-2005.

ELLEN B. AWRICH, EXAMINING ATTORNEY

Int. Cl.: 28

Prior U.S. Cls.: 22, 23, 38 and 50

Reg. No. 3,480,594

United States Patent and Trademark Office

Registered Aug. 5, 2008

**TRADEMARK
PRINCIPAL REGISTER**

BATTLE KINGS

MATTEL, INC. (DELAWARE CORPORATION)
M1-1518
333 CONTINENTAL BLVD.
EL SEGUNDO, CA 902455012

FOR: TOYS, GAMES AND PLAYTHINGS, NAME-
LY, TOY MILITARY VEHICLES AND ACCESSOR-
IES THEREFOR, IN CLASS 28 (U.S. CLS. 22, 23, 38
AND 50).

FIRST USE 3-6-2008; IN COMMERCE 3-6-2008.

THE MARK CONSISTS OF STANDARD CHAR-
ACTERS WITHOUT CLAIM TO ANY PARTICULAR
FONT, STYLE, SIZE, OR COLOR.

SER. NO. 78-571,963, FILED 2-22-2005.

MAUREEN DALL, EXAMINING ATTORNEY

Int. Cls.: 9, 16, 25, 35, 38 and 41

Prior U.S. Cls.: 2, 5, 21, 22, 23, 26, 29, 36, 37, 38, 39, 50, 100, 101, 102, 104 and 107

Reg. No. 3,480,595

United States Patent and Trademark Office

Registered Aug. 5, 2008

**TRADEMARK
SERVICE MARK
PRINCIPAL REGISTER**



ADMINISTRADORA DE MARCAS RD, S. DE
R.L. DE C.V. (MEXICO CORPORATION)
INDUSTRIESTRASSE 7, CH-6301
ZUG, SWITZERLAND

FOR: TELECOMMUNICATION PRODUCTS, NAMELY, TELEPHONES, CELLULAR TELEPHONES AND TELEPHONE ANSWERING MACHINES; APPARATUS FOR RECORDING, TRANSMISSION, REPRODUCTION OF SOUND OR IMAGES, NAMELY, PHONOGRAPH RECORDS, CD AND DVD PLAYERS, AUDIO AND VIDEO TAPE RECORDERS; BLANK AUDIO AND VIDEO TAPES AND CDS; STEREO RECEIVERS, AMPLIFIERS, AND TUNERS; BLANK MAGNETIC DATA CARRIERS, DATA PROCESSORS AND COMPUTERS; COMPUTER HARDWARE, NAMELY, MEMORY CARDS, MODEMS, COMPUTER INTERFACE BOARDS, BLANK MAGNETIC COMPUTER TAPES, FAX MACHINES, FIBER OPTIC CABLES, COMPUTER AND ELECTRIC CABLES, OPTICAL CHARACTER RECOGNITION APPARATUS, BLANK OPTICAL DISCS, OPTICAL SCANNERS AND MAGNETIC CODED CARDS FOR PREPAID TELECOMMUNICATIONS SERVICES; SATELLITES, BLANK DIGITAL OPTICAL DISKS, COMPUTER KEYBOARDS, PROCESS COMPUTERS, COMPUTERS FOR DATA AND WORD PROCESSING, COMPUTER TERMINALS, COMPUTER PRINTERS, COMPUTER MONITORS, INTEGRATED CIRCUITS AND COMPONENTS, NAMELY, COMPUTER CHIPS; ELECTRONIC CIRCUIT BOARDS, ELECTRONIC NOTICE BOARDS, INTEGRATED CIRCUIT CARDS; DOWNLOADABLE RING TONES AND MASTER TONES, NAMELY, A CLIP OF A SONG IN ITS ORIGINAL FORMAT; DOWNLOADABLE TEXT FILES FEATURING NEWS IN THE FIELD OF

ENTERTAINMENT; DOWNLOADABLE WALLPAPER GRAPHICS, IMAGES AND PHOTOGRAPHS, ALL OF THE FOREGOING DOWNLOADABLE VIA THE INTERNET AND WIRELESS DEVICES, IN CLASS 9 (U.S. CLS. 21, 23, 26, 36 AND 38).

FOR: ADVERTISEMENT BOARDS OF PAPER OR CARDBOARD; BINDERS; BOOK BINDINGS; BOOKLETS IN THE FIELD OF TELECOMMUNICATIONS SERVICES; BOOKMARKERS; BOOKS IN THE FIELD OF TELECOMMUNICATIONS SERVICES; BOXES OF CARDBOARD OR PAPER; CALENDARS; CATALOGUES IN THE FIELD OF TELECOMMUNICATIONS PRODUCTS AND SERVICES; COASTERS OF PAPER; DECALCOMANIA; ENVELOPES; FOUNTAIN PENS; GREETING CARDS; HANDBOOKS IN THE FIELD OF TELECOMMUNICATIONS PRODUCTS AND SERVICES; MANUALS IN THE FIELD OF TELECOMMUNICATIONS PRODUCTS; NEWSPAPERS FOR GENERAL CIRCULATION; OFFICE SUPPLIES, NAMELY, ENVELOPES AND FOLDERS, PACKING PAPER, BOND PAPER, PAPER SHEETS, PEN CASES, PENS, PENCILS, POSTCARDS, POSTERS, PRINTING BLOCKS; PRINTED PUBLICATIONS, NAMELY, BOOKS, MAGAZINES, PAMPHLETS AND INSTRUCTIONAL MANUALS IN THE FIELD OF TELECOMMUNICATIONS; FLYERS, POSTERS, AND PRINTED MENU BOARDS OF PAPER OR CARDBOARD IN THE FIELD OF TELECOMMUNICATIONS PRODUCTS AND SERVICES; STATIONERY, STICKERS, WRITING PADS, WRITING PAPER, IN CLASS 16 (U.S. CLS. 2, 5, 22, 23, 29, 37, 38 AND 50).

FOR: CLOTHING, NAMELY, SHIRTS, TROUSERS, BLOUSES, SKIRTS, PANTS, COATS AND JACKETS; FOOTWEAR; HEADGEAR, NAMELY,

HATS, CAPS AND VISORS , IN CLASS 25 (U.S. CLS. 22 AND 39).

FOR: ADVERTISING SERVICES; ADVERTISING BY MAIL ORDER; DISSEMINATION OF ADVERTISING MATTER; BUSINESS MANAGEMENT PLANNING, SUPERVISION AND IMPLEMENTATION; DEMONSTRATION OF PRODUCTS; ORGANIZING EXHIBITIONS FOR BUSINESS AND ADVERTISING PURPOSES, NAMELY, IN THE FIELD OF TELECOMMUNICATIONS PRODUCTS AND SERVICES, IN CLASS 35 (U.S. CLS. 100, 101 AND 102).

FOR: TELECOMMUNICATION SERVICES, NAMELY, PERSONAL COMMUNICATION SERVICES; TELEMATIC SERVICES, NAMELY, TELECOMMUNICATION SERVICES, NAMELY, PROVISION OF MOBILE TELECOMMUNICATIONS SERVICES, NAMELY, VOICE AND DATA TRANSMISSIONS, ACCESSIBLE BY ACCESS CODE OR TERMINALS, TELEPHONE, TELEVISION, RADIO AND DATA TRANSMISSIONS ACCESSIBLE BY ACCESS CODE OR TERMINALS, TELEPHONE, TELEVISION, RADIO AND TELEPRINTER; ELECTRONIC TRANSMISSION OF MESSAGES AND CODED IMAGES; ELECTRONIC TRANSMISSION OF MESSAGES AND DATA; WIRELESS DIGITAL MESSAGING SERVICES, ELECTRONIC STORE-AND-FORWARD MESSAGING, ELECTRONIC TRANSMISSION OF DATA AND DOCUMENTS VIA COMPUTER TERMINALS, COMPUTER TELECOMMUNICATIONS, NAMELY, PROVIDING MULTIPLE USER ACCESS TO THE INTERNET; FACSIMILE TRANSMISSION, ELECTRONIC MAIL SERVICES, TELEPHONE COMMUNICATION SERVICES, IN CLASS 38 (U.S. CLS. 100, 101 AND 104).

FOR: EDUCATIONAL SERVICES, NAMELY, CONDUCTING SEMINARS, CONFERENCES, AND WORKSHOPS IN THE FIELD OF TELECOMMUNICATIONS SERVICES; ENTERTAINMENT, NAMELY, CONDUCTING CONTEST RAFFLES AND COMPETITIONS IN THE FIELD OF CULTURE, SPORTS AND SOCIAL FUNCTIONS; ENTERTAINMENT SERVICES, NAMELY, NON-DOWNLOADABLE RING TONES, WALLPAPER GRAPHICS, IMAGES AND PHOTOGRAPHS PRESENTED TO MOBILE COMMUNICATIONS DEVICES VIA A GLOBAL COMPUTER NETWORK AND WIRELESS NETWORKS; PROVIDING NEWS IN THE FIELD OF ENTERTAINMENT, IN CLASS 41 (U.S. CLS. 100, 101 AND 107).

PRIORITY CLAIMED UNDER SEC. 44(D) ON MEXICO APPLICATION NO. 703177, FILED 2-21-2005, REG. NO. 883152, DATED 2-21-2005, EXPIRES 2-21-2015.

PRIORITY CLAIMED UNDER SEC. 44(D) ON MEXICO APPLICATION NO. 703178, FILED 2-21-2005, REG. NO. 879059, DATED 2-21-2005, EXPIRES 2-21-2015.

PRIORITY CLAIMED UNDER SEC. 44(D) ON MEXICO APPLICATION NO. 703179, FILED 2-21-2005, REG. NO. 884873, DATED 2-21-2005, EXPIRES 2-21-2015.

PRIORITY CLAIMED UNDER SEC. 44(D) ON MEXICO APPLICATION NO. 703180, FILED 2-21-2005, REG. NO. 878434, DATED 2-21-2005, EXPIRES 2-21-2015.

PRIORITY CLAIMED UNDER SEC. 44(D) ON MEXICO APPLICATION NO. 703181, FILED 2-21-2005, REG. NO. 880822, DATED 2-21-2005, EXPIRES 2-21-2015.

PRIORITY CLAIMED UNDER SEC. 44(D) ON MEXICO APPLICATION NO. 703182, FILED 2-21-2005, REG. NO. 879654, DATED 2-21-2005, EXPIRES 2-21-2015.

NO CLAIM IS MADE TO THE EXCLUSIVE RIGHT TO USE "DIRECTO", APART FROM THE MARK AS SHOWN.

THE COLOR(S) BLUE IS/ARE CLAIMED AS A FEATURE OF THE MARK.

THE ENTIRE MARK IS RENDERED IN THE COLOR BLUE

THE MARK CONSISTS, IN PART, OF A STYLIZED DEPICTION OF A CELLULAR TELEPHONE.

THE ENGLISH TRANSLATION OF THE WORD "DIRECTO" IN THE MARK IS "DIRECT".

SER. NO. 78-589,788, FILED 3-17-2005.

JOHN GARTNER, EXAMINING ATTORNEY

Int. Cls.: 9, 16, 25, 35, 38 and 41

**Prior U.S. Cls.: 2, 5, 21, 22, 23, 26, 29, 36, 37, 38, 39,
50, 100, 101, 102, 104 and 107**

Reg. No. 3,480,596

United States Patent and Trademark Office

Registered Aug. 5, 2008

**TRADEMARK
SERVICE MARK
PRINCIPAL REGISTER**



ADMINISTRADORA DE MARCAS RD. S. DE
R.L. DE C.V. (MEXICO CORPORATION)
INDUSTRIESTRASSE 7, CH-6301
ZUG, SWITZERLAND

FOR: TELECOMMUNICATION PRODUCTS, NAMELY, TELEPHONES, CELLULAR TELEPHONES AND TELEPHONE ANSWERING MACHINES; APPARATUS FOR RECORDING, TRANSMISSION, REPRODUCTION OF SOUND OR IMAGES, NAMELY, PHONOGRAPH RECORDS, CD AND DVD PLAYERS, AUDIO AND VIDEO TAPE RECORDERS; BLANK AUDIO AND VIDEO TAPES AND CDS; STEREO RECEIVERS, AMPLIFIERS, AND TUNERS; BLANK MAGNETIC DATA CARRIERS, DATA PROCESSORS AND COMPUTERS; COMPUTER HARDWARE, NAMELY, MEMORY CARDS, MODEMS, COMPUTER INTERFACE BOARDS, BLANK MAGNETIC COMPUTER TAPES, FAX MACHINES, FIBER OPTIC CABLES, COMPUTER AND ELECTRIC CABLES, OPTICAL CHARACTER RECOGNITION APPARATUS, BLANK OPTICAL DISCS, OPTICAL SCANNERS AND MAGNETIC CODED CARDS FOR PREPAID TELECOMMUNICATIONS SERVICES; SATELLITES, BLANK DIGITAL OPTICAL DISKS, COMPUTER KEYBOARDS, PROCESS COMPUTERS, COMPUTERS FOR DATA AND WORD PROCESSING, COMPUTER TERMINALS, COMPUTER PRINTERS, COMPUTER MONITORS, INTEGRATED CIRCUITS AND COMPONENTS, NAMELY, COMPUTER CHIPS; ELECTRONIC CIRCUIT BOARDS, ELECTRONIC NOTICE BOARDS, INTEGRATED CIRCUIT CARDS; DOWNLOADABLE RING TONES AND MASTER TONES, NAMELY, A CLIP OF A SONG IN ITS ORIGINAL FORMAT; DOWNLOADABLE TEXT FILES FEATURING NEWS IN THE FIELD OF

ENTERTAINMENT; DOWNLOADABLE WALLPAPER GRAPHICS, IMAGES AND PHOTOGRAPHS, ALL OF THE FOREGOING DOWNLOADABLE VIA THE INTERNET AND WIRELESS DEVICES, IN CLASS 9 (U.S. CLS. 21, 23, 26, 36 AND 38).

FOR: ADVERTISEMENT BOARDS OF PAPER OR CARDBOARD; BINDERS; BOOK BINDINGS; BOOKLETS IN THE FIELD OF TELECOMMUNICATIONS SERVICES; BOOKMARKERS; BOOKS IN THE FIELD OF TELECOMMUNICATIONS SERVICES; BOXES OF CARDBOARD OR PAPER; CALENDARS; CATALOGUES IN THE FIELD OF TELECOMMUNICATIONS PRODUCTS AND SERVICES; COASTERS OF PAPER; DECALCOMANIA; ENVELOPES; FOUNTAIN PENS; GREETING CARDS; HANDBOOKS IN THE FIELD OF TELECOMMUNICATIONS PRODUCTS AND SERVICES; MANUALS IN THE FIELD OF TELECOMMUNICATIONS PRODUCTS; NEWSPAPERS FOR GENERAL CIRCULATION; OFFICE SUPPLIES, NAMELY, ENVELOPES AND FOLDERS, PACKING PAPER, BOND PAPER, PAPER SHEETS, PEN CASES, PENS, PENCILS, POSTCARDS, POSTERS, PRINTING BLOCKS; PRINTED PUBLICATIONS, NAMELY, BOOKS, MAGAZINES, PAMPHLETS AND INSTRUCTIONAL MANUALS IN THE FIELD OF TELECOMMUNICATIONS; FLYERS, POSTERS, AND PRINTED MENU BOARDS OF PAPER OR CARDBOARD IN THE FIELD OF TELECOMMUNICATIONS PRODUCTS AND SERVICES; STATIONERY, STICKERS, WRITING PADS, WRITING PAPER, IN CLASS 16 (U.S. CLS. 2, 5, 22, 23, 29, 37, 38 AND 50).

FOR: CLOTHING, NAMELY, SHIRTS, TROUSERS, BLOUSES, SKIRTS, PANTS, COATS AND JACKETS; FOOTWEAR; HEADGEAR, NAMELY,

HATS, CAPS AND VISORS , IN CLASS 25 (U.S. CLS. 22 AND 39).

FOR: ADVERTISING SERVICES; ADVERTISING BY MAIL ORDER; DISSEMINATION OF ADVERTISING MATTER; BUSINESS MANAGEMENT PLANNING, SUPERVISION AND IMPLEMENTATION; DEMONSTRATION OF PRODUCTS; ORGANIZING EXHIBITIONS FOR BUSINESS AND ADVERTISING PURPOSES, NAMELY, IN THE FIELD OF TELECOMMUNICATIONS PRODUCTS AND SERVICES, IN CLASS 35 (U.S. CLS. 100, 101 AND 102).

FOR: TELECOMMUNICATION SERVICES, NAMELY, PERSONAL COMMUNICATION SERVICES; TELEMATIC SERVICES, NAMELY, TELECOMMUNICATION SERVICES, NAMELY, PROVISION OF MOBILE TELECOMMUNICATIONS SERVICES, NAMELY, VOICE AND DATA TRANSMISSIONS, ACCESSIBLE BY ACCESS CODE OR TERMINALS, TELEPHONE, TELEVISION, RADIO AND DATA TRANSMISSIONS ACCESSIBLE BY ACCESS CODE OR TERMINALS, TELEPHONE, TELEVISION, RADIO AND TELEPRINTER; ELECTRONIC TRANSMISSION OF MESSAGES AND CODED IMAGES; ELECTRONIC TRANSMISSION OF MESSAGES AND DATA; WIRELESS DIGITAL MESSAGING SERVICES, ELECTRONIC STORE-AND-FORWARD MESSAGING, ELECTRONIC TRANSMISSION OF DATA AND DOCUMENTS VIA COMPUTER TERMINALS, COMPUTER TELECOMMUNICATIONS, NAMELY, PROVIDING MULTIPLE USER ACCESS TO THE INTERNET; FACSIMILE TRANSMISSION, ELECTRONIC MAIL SERVICES, TELEPHONE COMMUNICATION SERVICES, IN CLASS 38 (U.S. CLS. 100, 101 AND 104).

FOR: EDUCATIONAL SERVICES, NAMELY, CONDUCTING SEMINARS, CONFERENCES, AND WORKSHOPS IN THE FIELD OF TELECOMMUNICATIONS SERVICES; ENTERTAINMENT, NAMELY, CONDUCTING CONTEST RAFFLES AND COMPETITIONS IN THE FIELD OF CULTURE, SPORTS AND SOCIAL FUNCTIONS; ENTERTAINMENT SERVICES, NAMELY, NON-DOWNLOADABLE RING TONES, WALLPAPER GRAPHICS, IMAGES AND PHOTOGRAPHS PRESENTED TO MOBILE COMMUNICATIONS DEVICES VIA A

GLOBAL COMPUTER NETWORK AND WIRELESS NETWORKS; PROVIDING NEWS IN THE FIELD OF ENTERTAINMENT, IN CLASS 41 (U.S. CLS. 100, 101 AND 107).

PRIORITY CLAIMED UNDER SEC. 44(D) ON MEXICO APPLICATION NO. 703171, FILED 2-21-2005, REG. NO. 883151, DATED 2-21-2005, EXPIRES 2-21-2015.

PRIORITY CLAIMED UNDER SEC. 44(D) ON MEXICO APPLICATION NO. 703172, FILED 2-21-2005, REG. NO. 878432, DATED 2-21-2005, EXPIRES 2-21-2015.

PRIORITY CLAIMED UNDER SEC. 44(D) ON MEXICO APPLICATION NO. 703173, FILED 2-21-2005, REG. NO. 884872, DATED 2-21-2005, EXPIRES 2-21-2015.

PRIORITY CLAIMED UNDER SEC. 44(D) ON MEXICO APPLICATION NO. 703174, FILED 2-21-2005, REG. NO. 878433, DATED 2-21-2005, EXPIRES 2-21-2015.

PRIORITY CLAIMED UNDER SEC. 44(D) ON MEXICO APPLICATION NO. 703176, FILED 2-21-2005, REG. NO. 879653, DATED 2-21-2005, EXPIRES 2-21-2015.

PRIORITY CLAIMED UNDER SEC. 44(D) ON MEXICO APPLICATION NO. 703175, FILED 2-21-2005, REG. NO. 879652, DATED 2-21-2005, EXPIRES 2-21-2015.

NO CLAIM IS MADE TO THE EXCLUSIVE RIGHT TO USE "DIRECTO", APART FROM THE MARK AS SHOWN.

THE MARK CONSISTS, IN PART, OF A STYLIZED DEPICTION OF A CELLULAR TELEPHONE.

THE ENGLISH TRANSLATION OF THE WORD DIRECTO IN THE MARK IS "DIRECT".

SER. NO. 78-589,855, FILED 3-17-2005.

JOHN GARTNER, EXAMINING ATTORNEY

Int. Cls.: 9, 16, 25, 35, 38 and 41

**Prior U.S. Cls.: 2, 5, 21, 22, 23, 26, 29, 36, 37, 38, 39,
50, 100, 101, 102, 104 and 107**

Reg. No. 3,480,597

United States Patent and Trademark Office

Registered Aug. 5, 2008

**TRADEMARK
SERVICE MARK
PRINCIPAL REGISTER**



ADMINISTRADORA DE MARCAS RD, S. DE
R.L. DE C.V. (MEXICO CORPORATION)
INDUSTRIESTRASSE 7, CH-6301
ZUG, SWITZERLAND

FOR: TELECOMMUNICATION PRODUCTS, NAMELY, TELEPHONES, CELLULAR TELEPHONES AND TELEPHONE ANSWERING MACHINES; APPARATUS FOR RECORDING, TRANSMISSION, REPRODUCTION OF SOUND OR IMAGES, NAMELY, PHONOGRAPH RECORDS, CD AND DVD PLAYERS, AUDIO AND VIDEO TAPE RECORDERS; BLANK AUDIO AND VIDEO TAPES AND CDS; STEREO RECEIVERS, AMPLIFIERS, AND TUNERS; BLANK MAGNETIC DATA CARRIERS, DATA PROCESSORS AND COMPUTERS; COMPUTER HARDWARE, NAMELY, MEMORY CARDS, MODEMS, COMPUTER INTERFACE BOARDS, BLANK MAGNETIC COMPUTER TAPES, FAX MACHINES, FIBER OPTIC CABLES, COMPUTER AND ELECTRIC CABLES, OPTICAL CHARACTER RECOGNITION APPARATUS, BLANK OPTICAL DISCS, OPTICAL SCANNERS AND MAGNETIC CODED CARDS FOR PREPAID TELECOMMUNICATIONS SERVICES; SATELLITES, BLANK DIGITAL OPTICAL DISKS, COMPUTER KEYBOARDS, PROCESS COMPUTERS, COMPUTERS FOR DATA AND WORD PROCESSING, COMPUTER TERMINALS, COMPUTER PRINTERS, COMPUTER MONITORS, INTEGRATED CIRCUITS AND COMPONENTS, NAMELY, COMPUTER CHIPS; ELECTRONIC CIRCUIT BOARDS, ELECTRONIC NOTICE BOARDS, INTEGRATED CIRCUIT CARDS; DOWNLOADABLE RING TONES AND MASTER TONES, NAMELY, A CLIP OF A SONG IN ITS ORIGINAL FORMAT; DOWNLOADABLE TEXT FILES FEATURING NEWS IN THE FIELD OF ENTERTAINMENT; DOWNLOADABLE WALLPAPER GRAPHICS, IMAGES AND PHOTOGRAPHS, ALL OF THE FOREGOING DOWNLOADABLE VIA

THE INTERNET AND WIRELESS DEVICES, IN CLASS 9 (U.S. CLS. 21, 23, 26, 36 AND 38).

FOR: ADVERTISEMENT BOARDS OF PAPER OR CARDBOARD; BINDERS; BOOK BINDINGS; BOOKLETS IN THE FIELD OF TELECOMMUNICATIONS SERVICES; BOOKMARKERS; BOOKS IN THE FIELD OF TELECOMMUNICATIONS SERVICES; BOXES OF CARDBOARD OR PAPER; CALENDARS; CATALOGUES IN THE FIELD OF TELECOMMUNICATIONS PRODUCTS AND SERVICES; COASTERS OF PAPER; DECALCOMANIA; ENVELOPES; FOUNTAIN PENS; GREETING CARDS; HANDBOOKS IN THE FIELD OF TELECOMMUNICATIONS PRODUCTS AND SERVICES; MANUALS IN THE FIELD OF TELECOMMUNICATIONS PRODUCTS; NEWSPAPERS FOR GENERAL CIRCULATION; OFFICE SUPPLIES, NAMELY, ENVELOPES AND FOLDERS, PACKING PAPER, BOND PAPER, PAPER SHEETS, PEN CASES, PENS, PENCILS, POSTCARDS, POSTERS, PRINTING BLOCKS; PRINTED PUBLICATIONS, NAMELY, BOOKS, MAGAZINES, PAMPHLETS AND INSTRUCTIONAL MANUALS IN THE FIELD OF TELECOMMUNICATIONS; FLYERS, POSTERS, AND PRINTED MENU BOARDS OF PAPER OR CARDBOARD IN THE FIELD OF TELECOMMUNICATIONS PRODUCTS AND SERVICES; STATIONERY, STICKERS, WRITING PADS, WRITING PAPER, IN CLASS 16 (U.S. CLS. 2, 5, 22, 23, 29, 37, 38 AND 50).

FOR: CLOTHING, NAMELY, SHIRTS, TROUSERS, BLOUSES, SKIRTS, PANTS, COATS AND JACKETS; FOOTWEAR; HEADGEAR, NAMELY, HATS, CAPS AND VISORS, IN CLASS 25 (U.S. CLS. 22 AND 39).

FOR: ADVERTISING SERVICES; ADVERTISING BY MAIL ORDER; DISSEMINATION OF ADVERTISING MATTER; BUSINESS MANAGEMENT

PLANNING, SUPERVISION AND IMPLEMENTATION; DEMONSTRATION OF PRODUCTS; ORGANIZING EXHIBITIONS FOR BUSINESS AND ADVERTISING PURPOSES, NAMELY, IN THE FIELD OF TELECOMMUNICATIONS PRODUCTS AND SERVICES, IN CLASS 35 (U.S. CLS. 100, 101 AND 102).

FOR: TELECOMMUNICATION SERVICES, NAMELY, PERSONAL COMMUNICATION SERVICES; TELEMATIC SERVICES, NAMELY, TELECOMMUNICATION SERVICES, NAMELY, PROVISION OF MOBILE TELECOMMUNICATIONS SERVICES, NAMELY, VOICE AND DATA TRANSMISSIONS, ACCESSIBLE BY ACCESS CODE OR TERMINALS, TELEPHONE, TELEVISION, RADIO AND DATA TRANSMISSIONS ACCESSIBLE BY ACCESS CODE OR TERMINALS, TELEPHONE, TELEVISION, RADIO AND TELEPRINTER; ELECTRONIC TRANSMISSION OF MESSAGES AND CODED IMAGES; ELECTRONIC TRANSMISSION OF MESSAGES AND DATA; WIRELESS DIGITAL MESSAGING SERVICES, ELECTRONIC STORE-AND-FORWARD MESSAGING, ELECTRONIC TRANSMISSION OF DATA AND DOCUMENTS VIA COMPUTER TERMINALS, COMPUTER TELECOMMUNICATIONS, NAMELY, PROVIDING MULTIPLE USER ACCESS TO THE INTERNET; FACSIMILE TRANSMISSION, ELECTRONIC MAIL SERVICES, TELEPHONE COMMUNICATION SERVICES, IN CLASS 38 (U.S. CLS. 100, 101 AND 104).

FOR: EDUCATIONAL SERVICES, NAMELY, CONDUCTING SEMINARS, CONFERENCES, AND WORKSHOPS IN THE FIELD OF TELECOMMUNICATIONS SERVICES; ENTERTAINMENT, NAMELY, CONDUCTING CONTEST RAFFLES AND COMPETITIONS IN THE FIELD OF CULTURE, SPORTS AND SOCIAL FUNCTIONS; ENTERTAINMENT SERVICES, NAMELY, NON-DOWNLOADABLE RING TONES, WALLPAPER GRAPHICS, IMAGES AND PHOTOGRAPHS PRESENTED TO MOBILE COMMUNICATIONS DEVICES VIA A GLOBAL COMPUTER NETWORK AND WIRELESS NETWORKS; PROVIDING NEWS IN THE FIELD OF

ENTERTAINMENT, IN CLASS 41 (U.S. CLS. 100, 101 AND 107).

PRIORITY CLAIMED UNDER SEC. 44(D) ON MEXICO APPLICATION NO. 703160, FILED 2-21-2005, REG. NO. 878428, DATED 2-21-2005, EXPIRES 2-21-2015.

PRIORITY CLAIMED UNDER SEC. 44(D) ON MEXICO APPLICATION NO. 703159, FILED 2-21-2005, REG. NO. 883149, DATED 2-21-2005, EXPIRES 2-21-2015.

PRIORITY CLAIMED UNDER SEC. 44(D) ON MEXICO APPLICATION NO. 703161, FILED 2-21-2005, REG. NO. 883839, DATED 2-21-2005, EXPIRES 2-21-2015.

PRIORITY CLAIMED UNDER SEC. 44(D) ON MEXICO APPLICATION NO. 703162, FILED 2-21-2005, REG. NO. 878429, DATED 2-21-2005, EXPIRES 2-21-2015.

PRIORITY CLAIMED UNDER SEC. 44(D) ON MEXICO APPLICATION NO. 703164, FILED 2-21-2005, REG. NO. 879649, DATED 2-21-2005, EXPIRES 2-21-2015.

PRIORITY CLAIMED UNDER SEC. 44(D) ON MEXICO APPLICATION NO. 703163, FILED 2-21-2005, REG. NO. 879648, DATED 2-21-2005, EXPIRES 2-21-2015.

NO CLAIM IS MADE TO THE EXCLUSIVE RIGHT TO USE "DIRECTO", APART FROM THE MARK AS SHOWN.

THE MARK CONSISTS, IN PART, OF A STYLIZED DEPICTION OF A CELLULAR TELEPHONE.

THE ENGLISH TRANSLATION OF THE WORD DIRECTO IN THE MARK IS "DIRECT".

SER. NO. 78-589,926, FILED 3-17-2005.

JOHN GARTNER, EXAMINING ATTORNEY

Int. Cls.: 16, 35, 41, 42 and 44

**Prior U.S. Cls.: 2, 5, 22, 23, 29, 37, 38, 50, 100, 101, 102
and 107**

Reg. No. 3,480,598

United States Patent and Trademark Office

Registered Aug. 5, 2008

**TRADEMARK
SERVICE MARK
PRINCIPAL REGISTER**



AMERICAN SOCIETY FOR THERAPEUTIC
RADIOLOGY AND ONCOLOGY, THE (ILLI-
NOIS CORPORATION)
8280 WILLOW OAKS CORPORATE DRIVE
SUITE 500
FAIRFAX, VA 22031

FOR: PRINTED EDUCATIONAL MATERIALS IN
THE FIELDS OF RADIOLOGY AND ONCOLOGY,
IN CLASS 16 (U.S. CLS. 2, 5, 22, 23, 29, 37, 38 AND 50).

FIRST USE 2-8-2005; IN COMMERCE 3-22-2005.

FOR: ASSOCIATION SERVICES, NAMELY, PRO-
MOTING THE INTERESTS OF PERSONS IN THE
FIELDS OF RADIOLOGY AND ONCOLOGY, IN
CLASS 35 (U.S. CLS. 100, 101 AND 102).

FIRST USE 2-8-2005; IN COMMERCE 2-8-2005.

FOR: EDUCATIONAL SERVICES, NAMELY,
CONDUCTING EDUCATIONAL CONFERENCES,
LECTURES, SYMPOSIUMS, AND SEMINARS IN
THE FIELDS OF RADIOLOGY AND ONCOLOGY ,
IN CLASS 41 (U.S. CLS. 100, 101 AND 107).

FIRST USE 2-8-2005; IN COMMERCE 2-8-2005.

FOR: PROVIDING INFORMATION REGARDING
RADIOLOGY AND ONCOLOGY RESEARCH, IN
CLASS 42 (U.S. CLS. 100 AND 101).

FIRST USE 2-8-2005; IN COMMERCE 2-8-2005.

FOR: DISSEMINATING MEDICAL INFORMA-
TION IN THE FIELDS OF RADIOLOGY AND
ONCOLOGY, IN CLASS 44 (U.S. CLS. 100 AND 101).

FIRST USE 2-8-2005; IN COMMERCE 2-8-2005.

OWNER OF U.S. REG. NO. 1,878,633.

NO CLAIM IS MADE TO THE EXCLUSIVE
RIGHT TO USE "AMERICAN SOCIETY FOR THER-
APEUTIC RADIOLOGY AND ONCOLOGY", APART
FROM THE MARK AS SHOWN.

SER. NO. 78-592,706, FILED 3-22-2005.

SALLY SHIH, EXAMINING ATTORNEY

Int. Cl.: 25

Prior U.S. Cls.: 22 and 39

United States Patent and Trademark Office

Reg. No. 3,480,599

Registered Aug. 5, 2008

TRADEMARK
PRINCIPAL REGISTER

T.O.N.Y.

NILES, HASSAN M. (UNITED STATES INDIVIDUAL)
12003 HEATHERVIEW DR. APT. 307
RALEIGH, NC 27614

FOR: CLOTHING, NAMELY, SWEATSHIRTS, SHIRTS, JEANS, JACKETS, COATS, SWEATPANTS, SLACKS, SUITS, HATS, HEADBANDS, VISORS, CAPS, DRESSES, SHOES, SNEAKERS, BOOTS, WRISTBANDS, SOCKS, T-SHIRTS, BELTS, UNDERGARMENTS, NECKTIES, DRESS SHIRTS, COLLARED SHIRTS, RUGBY SHIRTS, KNIT SHIRTS, SHORTS, AND SANDALS, IN CLASS 25 (U.S. CLS. 22 AND 39).

FIRST USE 1-15-2005; IN COMMERCE 1-15-2005.

THE MARK CONSISTS OF STANDARD CHARACTERS WITHOUT CLAIM TO ANY PARTICULAR FONT, STYLE, SIZE, OR COLOR.

SER. NO. 78-596,729, FILED 3-29-2005.

MARIA-VICTORIA SUAREZ, EXAMINING ATTORNEY

Int. Cl.: 36

Prior U.S. Cls.: 100, 101 and 102

United States Patent and Trademark Office

Reg. No. 3,480,600

Registered Aug. 5, 2008

**SERVICE MARK
PRINCIPAL REGISTER**

The Legend Group

LEGEND GROUP HOLDINGS, LLC (DELAWARE
LIMITED LIABILITY CORPORATION)
SUITE 300
4600 EAST PARK DRIVE
PALM BEACH GARDENS, FL 33410

FOR: A FULL LINE OF INVESTMENT SERVICES
AND FINANCIAL PRODUCTS, NAMELY, INVEST-
MENT ADVISORY SERVICES; GENERAL INVEST-
MENT AND RETIREMENT ACCOUNT
MANAGEMENT AND ADMINISTRATION; GEN-
ERAL FINANCIAL PLANNING SERVICES; FINAN-
CIAL PLANNING SERVICES TARGETED FOR
RETIREMENT; COMPUTERIZED FINANCIAL
ANALYSIS, TRACKING, AND REPORTING OF
PENSION AND RETIREMENT BENEFITS AND

ACCOUNT RETURNS, IN CLASS 36 (U.S. CLS. 100,
101 AND 102).

FIRST USE 12-29-1988; IN COMMERCE 12-29-1988.

THE MARK CONSISTS OF STANDARD CHAR-
ACTERS WITHOUT CLAIM TO ANY PARTICULAR
FONT, STYLE, SIZE, OR COLOR.

NO CLAIM IS MADE TO THE EXCLUSIVE
RIGHT TO USE "GROUP", APART FROM THE
MARK AS SHOWN.

SER. NO. 78-607,443, FILED 4-12-2005.

BARBARA RUTLAND, EXAMINING ATTORNEY

Int. Cl.: 36

Prior U.S. Cls.: 100, 101 and 102

United States Patent and Trademark Office

Reg. No. 3,480,601

Registered Aug. 5, 2008

SERVICE MARK
PRINCIPAL REGISTER



THE GOVERNOR AND COMPANY OF THE
BANK OF IRELAND (IRELAND LTD LIAB
CO), DBA BANK OF IRELAND GROUP
LOWER BAGGOT STREET
DUBLIN, IRELAND 2

FOR: ELECTRONIC FINANCIAL PLANNING
AND INVESTMENT SERVICES; ELECTRONIC
BANKING SERVICES, IN CLASS 36 (U.S. CLS. 100,
101 AND 102).

PRIORITY CLAIMED UNDER SEC. 44(D) ON
IRELAND APPLICATION NO. 2317728, FILED 3-31-
2005, REG. NO. 231728, DATED 3-31-2005, EXPIRES 3-
31-2012.

OWNER OF U.S. REG. NOS. 2,144,407, 2,397,092
AND OTHERS.

NO CLAIM IS MADE TO THE EXCLUSIVE
RIGHT TO USE "BUSINESS ON LINE", APART
FROM THE MARK AS SHOWN.

THE COLOR(S) RED, WHITE, BLUE AND GREEN
IS/ARE CLAIMED AS A FEATURE OF THE MARK.

THE MARK CONSISTS OF THE WORD BUSINESS
IN RED, THE WORD LINE IN GREEN, AND THE
WORDS BANK OF IRELAND AND ON IN WHITE,
ALL ON A BLUE BACKGROUND WITH A WHITE
CHEVRON-LIKE DESIGN IN A WHITE OVAL.

SEC. 2(F) "BANK OF IRELAND".

SER. NO. 78-607,917, FILED 4-13-2005.

KIMBERLY FRYE, EXAMINING ATTORNEY

Int. Cl.: 36

Prior U.S. Cls.: 100, 101 and 102

United States Patent and Trademark Office

Reg. No. 3,480,602

Registered Aug. 5, 2008

SERVICE MARK
PRINCIPAL REGISTER



THE GOVERNOR AND COMPANY OF THE
BANK OF IRELAND (IRELAND LTD LIAB
CO), DBA BANK OF IRELAND GROUP
LOWER BAGGOT STREET
DUBLIN, IRELAND 2

FOR: ELECTRONIC FINANCIAL PLANNING
AND INVESTMENT SERVICES; ELECTRONIC
BANKING SERVICES, IN CLASS 36 (U.S. CLS. 100,
101 AND 102).

PRIORITY CLAIMED UNDER SEC. 44(D) ON
IRELAND APPLICATION NO. 231728, FILED 3-31-
2005, REG. NO. 231728, DATED 3-31-2005, EXPIRES 3-
31-2012.

OWNER OF U.S. REG. NOS. 2,144,407, 2,397,092
AND OTHERS.

NO CLAIM IS MADE TO THE EXCLUSIVE
RIGHT TO USE "BUSINESS ON LINE" OR "BANK",
APART FROM THE MARK AS SHOWN.

THE COLOR(S) WHITE, RED, BLUE AND GREEN
IS/ARE CLAIMED AS A FEATURE OF THE MARK.

THE MARK CONSISTS OF RED, BLUE, AND
GREEN LETTERING WITH A BLUE CHEVRON-
LIKE DESIGN IN AN OVAL ON A WHITE BACK-
GROUND.

SEC. 2(F) AS TO "BANK OF IRELAND".

SER. NO. 78-607,965, FILED 4-13-2005.

TINA L. SNAPP, EXAMINING ATTORNEY

Int. Cl.: 36

Prior U.S. Cls.: 100, 101 and 102

United States Patent and Trademark Office

Reg. No. 3,480,603

Registered Aug. 5, 2008

**SERVICE MARK
PRINCIPAL REGISTER**

CONNEXIS

BNP PARIBAS (FRANCE CORPORATION)
16 BOULEVARD DES ITALIENS
PARIS, FRANCE 75009

FIRST USE 12-11-2003; IN COMMERCE 12-11-2003.

FOR: GLOBAL FINANCIAL TRANSACTION
MANAGEMENT SERVICES, NAMELY, OFFERING
CASH MANAGEMENT, ISSUING LETTERS OF
CREDIT, ACCOUNTS RECEIVABLE FINANCING,
ACCOUNTS PAYABLE DEBITING SERVICES, FOR
CORPORATE CLIENTS THROUGH A SECURE, ON-
LINE TRANSACTIONAL PLATFORM, IN CLASS 36
(U.S. CLS. 100, 101 AND 102).

THE MARK CONSISTS OF STANDARD CHAR-
ACTERS WITHOUT CLAIM TO ANY PARTICULAR
FONT, STYLE, SIZE, OR COLOR.

SER. NO. 78-611,959, FILED 4-19-2005.

MICHAEL GAAFAR, EXAMINING ATTORNEY

Int. Cl.: 9

Prior U.S. Cls.: 21, 23, 26, 36 and 38

United States Patent and Trademark Office

Reg. No. 3,480,604

Registered Aug. 5, 2008

**TRADEMARK
PRINCIPAL REGISTER**

SHAREWORKS

SOLIUM CAPITAL INC. (CANADA CORPORATION)

#710 805 8TH AVENUE SW

CALGARY, ALBERTA, CANADA T2P 1H7

FOR: COMPUTER SOFTWARE PROGRAMS; NAMELY SOFTWARE PROGRAMS FOR MANAGING EQUITY COMPENSATION PLANS; NAMELY STOCK OPTION AND SHARE PURCHASE PLANS AND RELATED TRANSACTIONS, IN CLASS 9 (U.S. CLS. 21, 23, 26, 36 AND 38).

THE MARK CONSISTS OF STANDARD CHARACTERS WITHOUT CLAIM TO ANY PARTICULAR FONT, STYLE, SIZE, OR COLOR.

PRIORITY CLAIMED UNDER SEC. 44(D) ON CANADA APPLICATION NO. 1253376, FILED 4-7-2005, REG. NO. TMA693,254, DATED 8-2-2007, EXPIRES 8-2-2022.

SER. NO. 78-618,942, FILED 4-28-2005.

PATRICIA EVANKO, EXAMINING ATTORNEY

Int. Cl.: 9

Prior U.S. Cls.: 21, 23, 26, 36 and 38

United States Patent and Trademark Office

Reg. No. 3,480,605

Registered Aug. 5, 2008

**TRADEMARK
PRINCIPAL REGISTER**

SOLIUM SHAREWORKS

SOLIUM CAPITAL INC. (CANADA CORPORATION)

#710 805 8TH AVENUE SW

CALGARY, ALBERTA, CANADA T2P 1H7

FOR: COMPUTER SOFTWARE PROGRAMS; NAMELY SOFTWARE PROGRAMS FOR MANAGING EQUITY COMPENSATION PLANS; NAMELY STOCK OPTIONS AND SHARE PURCHASE PLANS AND RELATED TRANSACTIONS, IN CLASS 9 (U.S. CLS. 21, 23, 26, 36 AND 38).

THE MARK CONSISTS OF STANDARD CHARACTERS WITHOUT CLAIM TO ANY PARTICULAR FONT, STYLE, SIZE, OR COLOR.

PRIORITY CLAIMED UNDER SEC. 44(D) ON CANADA APPLICATION NO. 1253377, FILED 4-7-2005, REG. NO. TMA693253, DATED 8-2-2007, EXPIRES 8-2-2022.

SER. NO. 78-618,960, FILED 4-28-2005.

PATRICIA EVANKO, EXAMINING ATTORNEY

Int. Cl.: 42

Prior U.S. Cls.: 100 and 101

United States Patent and Trademark Office

Reg. No. 3,480,606

Registered Aug. 5, 2008

**SERVICE MARK
PRINCIPAL REGISTER**

**THE COMMUNITY OF PRACTICE
COMPANY**

TOMOYE CORPORATION (CANADA CORPORATION)
86 PROMENADE DU PORTAGE
GATINEAU, CANADA J8X 2K1

FOR: COMPUTER SERVICES, NAMELY, DESIGNING, MAINTAINING, AND HOSTING ONLINE COMMUNITY WEBSITES FOR OTHERS; PROVIDING ONLINE NONDOWNLOADABLE SOFTWARE THAT ALLOWS USERS TO COLLABORATE ON PROJECTS, COMMUNICATE, AND EXCHANGE INFORMATION WITH OTHER COMMUNITY MEMBERS VIA COMPUTER NETWORKS AND GLOBAL COMMUNICATION NETWORKS; COMPUTER CONSULTATION, NAMELY, PROVIDING CONSULTATIONS WITH USERS AND OFFERING ADVICE TO BUSINESS ON THE DEVELOPMENT OF ONLINE COMMUNITY WEBSITES, IN CLASS 42 (U.S. CLS. 100 AND 101).

THE MARK CONSISTS OF STANDARD CHARACTERS WITHOUT CLAIM TO ANY PARTICULAR FONT, STYLE, SIZE, OR COLOR.

PRIORITY CLAIMED UNDER SEC. 44(D) ON CANADA APPLICATION NO. 1235404, FILED 10-28-2004, REG. NO. TMA688385, DATED 5-28-2007, EXPIRES 5-28-2022.

NO CLAIM IS MADE TO THE EXCLUSIVE RIGHT TO USE "COMPANY", APART FROM THE MARK AS SHOWN.

SER. NO. 78-618,980, FILED 4-28-2005.

TARAH HARDY, EXAMINING ATTORNEY

Int. Cl.: 43

Prior U.S. Cls.: 100 and 101

United States Patent and Trademark Office

Reg. No. 3,480,607

Registered Aug. 5, 2008

**SERVICE MARK
PRINCIPAL REGISTER**

PASTAGINA

PASTARIA, LLC (CALIFORNIA LTD LIAB CO)
748 MONTEREY PASS ROAD
MONTEREY PARK, CA 91754

FOR: RESTAURANT AND BAR SERVICES,
TAKE-OUT RESTAURANT SERVICES, AND FOOD
CATERING SERVICES, IN CLASS 43 (U.S. CLS. 100
AND 101).

FIRST USE 7-3-2007; IN COMMERCE 7-3-2007.

THE MARK CONSISTS OF STANDARD CHAR-
ACTERS WITHOUT CLAIM TO ANY PARTICULAR
FONT, STYLE, SIZE, OR COLOR.

OWNER OF U.S. REG. NO. 3,381,805.

THE WORDING "PASTAGINA" HAS NO MEAN-
ING IN A FOREIGN LANGUAGE.

SER. NO. 78-621,436, FILED 5-2-2005.

JACQUELINE A. LAVINE, EXAMINING ATTOR-
NEY

Int. Cl.: 30

Prior U.S. Cl.: 46

United States Patent and Trademark Office

Reg. No. 3,480,608

Registered Aug. 5, 2008

**TRADEMARK
PRINCIPAL REGISTER**



ACECOOK VIETNAM COMPANY LIMITED
(VIETNAM PRIVATE LIMITED COMPANY)
BLOCK II-3, ROAD NO. 11
TAN BINH INDUSTRIAL PARKTAY THANH
WARD, TAN PHU DISTRICT
HO CHI MINH CITY, VIETNAM

OWNER OF VIETNAM REG. NO. 94556, DATED 1-
14-2008, EXPIRES 12-11-2016.

SER. NO. 78-626,330, FILED 5-10-2005.

FOR: INSTANT NOODLES, VERMICELLI, AND
RICE NOODLES, IN CLASS 30 (U.S. CL. 46).

JORDAN BAKER, EXAMINING ATTORNEY

Int. Cl.: 25

Prior U.S. Cls.: 22 and 39

United States Patent and Trademark Office

Reg. No. 3,480,609

Registered Aug. 5, 2008

TRADEMARK
PRINCIPAL REGISTER

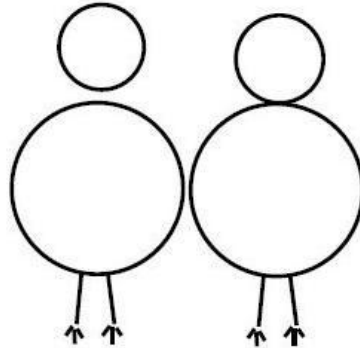

2 chix.

2 CHIX (CALIFORNIA PARTNERSHIP)
SUITE 715 EAST
11835 WEST OLYMPIC BOULEVARD
LOS ANGELES, CA 90064

FIRST USE 7-10-2004; IN COMMERCE 7-10-2004.

SER. NO. 78-638,592, FILED 5-26-2005.

FOR: CLOTHING, NAMELY, TEE SHIRTS AND
TANK TOPS, IN CLASS 25 (U.S. CLS. 22 AND 39).

APRIL ROACH, EXAMINING ATTORNEY

Int. Cl.: 28

Prior U.S. Cls.: 22, 23, 38 and 50

United States Patent and Trademark Office

Reg. No. 3,480,610

Registered Aug. 5, 2008

**TRADEMARK
PRINCIPAL REGISTER**

LITTLE ROCKERS

MATTEL, INC. (DELAWARE CORPORATION)
M1-1518
333 CONTINENTAL BLVD.
EL SEGUNDO, CA 902455012

FOR: TOYS, GAMES AND PLAYTHINGS, DOLLS,
DOLL CLOTHING AND DOLL ACCESSORIES, TOY
FIGURES AND ACCESSORIES THEREFOR, IN
CLASS 28 (U.S. CLS. 22, 23, 38 AND 50).

FIRST USE 1-23-2006; IN COMMERCE 1-23-2006.

THE MARK CONSISTS OF STANDARD CHAR-
ACTERS WITHOUT CLAIM TO ANY PARTICULAR
FONT, STYLE, SIZE, OR COLOR.

SER. NO. 78-645,711, FILED 6-7-2005.

DAVID TAYLOR, EXAMINING ATTORNEY

Int. Cls.: 38 and 42

Prior U.S. Cls.: 100, 101 and 104

United States Patent and Trademark Office

Reg. No. 3,480,611

Registered Aug. 5, 2008

**SERVICE MARK
PRINCIPAL REGISTER**

LIPMAN

VERIFONE ISRAEL LTD. (ISRAEL COMPANY)
PARK AFEK 11 HA'AMAL STREET
ROSH HA'AIN, ISRAEL 48902

FOR: TELECOMMUNICATION SERVICES, NAMELY, PROVIDING MULTIPLE USER ACCESS TO TELEPHONE NETWORKS AND TO INTERNET AND COMPUTER NETWORKS FOR USE IN TRANSMITTING DATA AND INFORMATION IN THE FIELDS OF ELECTRONIC COMMERCE AND FINANCIAL TRANSACTIONS, IN CLASS 38 (U.S. CLS. 100, 101 AND 104).

FOR: CUSTOM DESIGN, ENGINEERING AND CONSULTING RELATING TO HARDWARE AND SOFTWARE USED IN ELECTRONIC COMMERCE AND FINANCIAL TRANSACTIONS; COMPUTER SERVICES, NAMELY, PROVIDING TEMPORARY USE OF ONLINE NON-DOWNLOADABLE COMPUTER SOFTWARE FOR INFORMATION MANAGEMENT AND TRANSACTION MANAGEMENT IN THE FIELD OF ELECTRONIC COMMERCE, IN CLASS 42 (U.S. CLS. 100 AND 101).

THE MARK CONSISTS OF STANDARD CHARACTERS WITHOUT CLAIM TO ANY PARTICULAR FONT, STYLE, SIZE, OR COLOR.

PRIORITY CLAIMED UNDER SEC. 44(D) ON ISRAEL APPLICATION NO. 181141, FILED 6-7-2005, REG. NO. 181141, DATED 4-15-2007, EXPIRES 6-7-2015.

PRIORITY CLAIMED UNDER SEC. 44(D) ON ISRAEL APPLICATION NO. 181140, FILED 6-7-2005, REG. NO. 181140, DATED 5-2-2007, EXPIRES 6-7-2015.

OWNER OF U.S. REG. NO. 2,839,592.

SEC. 2(F).

SER. NO. 78-656,945, FILED 6-23-2005.

ARETHA SOMERVILLE, EXAMINING ATTORNEY

Int. Cls.: 29, 31 and 40

Prior U.S. Cls.: 1, 46, 100, 103 and 106

United States Patent and Trademark Office

Reg. No. 3,480,612

Registered Aug. 5, 2008

**TRADEMARK
SERVICE MARK
PRINCIPAL REGISTER**



OBSCHESTVO S OGRANICHENNOY OTVETSTVENNOSTYU KOMPANIA "TUNAYCHA" (RUSSIAN FED. LTD LIAB CO)
P. OKHOTSKOE, KORSAKOVSKY R-N
SAKHALIN, RUSSIAN FED. RU-694007

FOR: CAVIAR; ISINGLASS FOR USE AS UNFLAVORED AND UNSWEETENED GELATINS; PRESERVED FISH; SHRIMP, NOT LIVE; PRAWNS, NOT LIVE; SPINY LOBSTERS, NOT LIVE; SALMON; MUSSELS, NOT LIVE; CLAMS, NOT LIVE; LOBSTERS, NOT LIVE; LIVER PASTES; FROZEN, PREPARED, AND PACKAGED MEALS CONSISTING PRIMARILY OF FISH; SALTED FISH; CRUSTACEANS, NOT LIVE; CRAYFISH, NOT LIVE; SHELLFISH, NOT LIVE; FISH, NOT LIVE; SARDINES; HERRING; TUNA FISH; OYSTERS, NOT LIVE; FISH FILLETS, IN CLASS 29 (U.S. CL. 46).

FOR: LIVE FISH SPAWN; SPINY LOBSTERS, LIVE; LOBSTERS, LIVE; MUSSELS, LIVE; CRUSTACEANS, LIVE; CRAYFISH, LIVE; FISH, LIVE; OYSTERS, LIVE, IN CLASS 31 (U.S. CLS. 1 AND 46).

FOR: SEAFOOD PROCESSING; SEAFOOD SMOKING; FOOD PROCESSING, NAMELY, PROCESSING OF OIL, IN CLASS 40 (U.S. CLS. 100, 103 AND 106).

OWNER OF RUSSIAN FED. REG. NO. 162430, DATED 3-31-1998, RENEWED AS REG. NO. 162430, DATED 6-14-2007, EXPIRES 11-12-2017.

THE COLORS DARK BLUE AND SKY BLUE ARE CLAIMED AS A FEATURE OF THE MARK.

THE COLOR DARK BLUE APPEARS IN THE STYLIZED T DESIGN AND THE BOTTOM HALF OF THE WORD TUNAYCHA, AND THE COLOR SKY BLUE APPEARS IN THE TWO VERTICAL LINES ON EITHER SIDE OF THE T DESIGN AND THE TOP HALF OF THE WORD TUNAYCHA.

SER. NO. 78-661,979, FILED 6-30-2005.

JOHN GARTNER, EXAMINING ATTORNEY

Int. Cl.: 25

Prior U.S. Cls.: 22 and 39

United States Patent and Trademark Office

Reg. No. 3,480,613

Registered Aug. 5, 2008

**TRADEMARK
PRINCIPAL REGISTER**



GLOBAL COLLECTIVE DESIGN INCORPORATED (CANADA CORPORATION)
130 11300 NO. FIVE ROAD
RICHMOND, CANADA V7A 5J7

FOR: CLOTHING, NAMELY, T SHIRTS, SHIRTS, SWEATSHIRTS, PULLOVERS, SWEATPANTS, PANTS, SHORTS, JACKETS, VESTS, BELTS; HEADWEAR, NAMELY, HATS, CAPS, TOQUES, HEADBANDS; FOOTWEAR, NAMELY, SHOES, SPORTS SHOES, BOOTS, SANDALS, IN CLASS 25 (U.S. CLS. 22 AND 39).

FIRST USE 0-0-1999; IN COMMERCE 0-0-1999.

PRIORITY CLAIMED UNDER SEC. 44(D) ON CANADA APPLICATION NO. 1263126, FILED 6-22-2005.

THE MARK CONSISTS OF O AND LOOPS DESIGN.

SER. NO. 78-666,159, FILED 7-8-2005.

MARTHA FROMM, EXAMINING ATTORNEY

Int. Cls.: 16, 35, 36 and 38

**Prior U.S. Cls.: 2, 5, 22, 23, 29, 37, 38, 50, 100, 101, 102
and 104**

Reg. No. 3,480,614

United States Patent and Trademark Office

Registered Aug. 5, 2008

**TRADEMARK
SERVICE MARK
PRINCIPAL REGISTER**

BORSA ITALIANA

BORSA ITALIANA S.P.A. (ITALY CORPORATION)
PIAZZA DEGLI AFFARI, 6
MILANO, ITALY 20123

FOR: PRINTED PAPER AND CARDBOARD LEAFLETS, PAMPHLETS AND INFORMATIONAL SHEETS CONCERNING BUSINESS INFORMATION, STOCK EXCHANGE SERVICES, SHARE PRICES, FINANCIAL SERVICES IN GENERAL, AND ANALYSIS AND INFORMATION RELATING TO BONDS, GOVERNMENT BONDS, STOCKS, GENERAL FINANCIAL SERVICES, STOCK MARKET, FINANCIAL MARKETS IN GENERAL, ADVICE ON INVESTMENTS, AND FINANCIAL INFORMATION RELATING TO COMPANIES OF OTHER ORGANIZATIONS; PRINTED INSTRUCTIONAL MAGAZINES, NEWSLETTERS, BROCHURES AND BOOKS, ALL RELATING TO INVESTMENTS, GENERAL FINANCE, INFORMATION AND ANALYSIS OF INFORMATION RELATING TO BONDS, GOVERNMENT BONDS, STOCKS, GENERAL FINANCIAL SERVICES, STOCK MARKET, FINANCIAL MARKETS IN GENERAL, ADVICE ON INVESTMENTS, AND FINANCIAL INFORMATION RELATING TO COMPANIES AND OTHER ORGANIZATIONS; PRINTED MATERIALS, NAMELY, PRESS RELEASES FEATURING BUSINESS INFORMATION, STOCK EXCHANGE SERVICES, SHARE PRICES AND FINANCIAL SERVICES IN GENERAL, ANALYSIS AND INFORMATION RELATING TO BONDS, GOVERNMENT BONDS, STOCKS, GENERAL FINANCIAL SERVICES, STOCK MARKET, FINANCIAL MARKETS IN GENERAL, ADVICE ON INVESTMENTS, AND FINANCIAL INFORMATION RELATING TO COMPANIES OF OTHER ORGANIZATIONS; PRINTED TEACHING MATERIALS FOR EDUCATION AND INSTRUCTION CONCERNING MARKET DATA IN THE FINANCIAL FIELD; PRINTED PUBLICA-

TIONS, NAMELY, MAGAZINES, BOOKS, NEWSLETTERS RELATING TO FINANCIAL SERVICES; PRINTED BOOKS AND MANUALS REGARDING THE TREATMENT OF DATA PROCESSING AND ESTIMATE OF FINANCIAL INSTRUMENTS, IN CLASS 16 (U.S. CLS. 2, 5, 22, 23, 29, 37, 38 AND 50).

FIRST USE 0-0-1998; IN COMMERCE 0-0-1998.

FOR: ADVERTISING SERVICES IN THE NATURE OF THE STUDY, PLANNING AND DEVELOPMENT OF PRINTED ADVERTISING MATERIALS AND ADVERTISING CAMPAIGNS BY MALL, RADIO, TELEVISION, INTERNET PROMOTION OF FINANCIAL AND NEGOTIATION SERVICES; BUSINESS INFORMATION; BUSINESS MANAGEMENT; BUSINESS ADMINISTRATION AND BUSINESS APPRAISALS; PROVIDING A DATABASE IN THE FIELD OF BUSINESS INFORMATION, BUSINESS REPORTS AND BUSINESS RESEARCH; ON-LINE ADVERTISING SERVICES FOR FINANCIAL PRODUCTS AND SERVICES; PROVIDING ON-LINE COMPUTER DATA BASES FEATURING TRADE INFORMATION IN THE FIELD OF FINANCIAL PRODUCTS AND SERVICES; PROVIDING CONSUMER INFORMATION IN THE NATURE OF A REVIEW AND RANKING OF FINANCIAL PRODUCTS; PROVIDING ON-LINE RETAIL STORE SERVICES VIA WEB SITE FEATURING FINANCIAL PRODUCTS; COST ANALYSIS SERVICES; BUSINESS MARKETING SERVICES; CONSULTATION REGARDING BUSINESS MANAGEMENT, STATISTIC INFORMATION, AND BUSINESS DATA GATHERING SERVICES; EXHIBITION AND TRADE FAIR ORGANIZATION FOR BUSINESS AND ADVERTISING PURPOSES; BUSINESS INVESTIGATION; MARKET RESEARCH AND MARKETING; MANAGEMENT OF COMPUTERIZED RECORDS, NAMELY, DOCUMENT INDEXING FOR OTHERS;

PROVIDING BUSINESS INFORMATION ON COMPANIES; PUBLIC OPINION SURVEY SERVICES; CALCULATION, RECORDING, ARRANGEMENT, COMPILATION AND SYSTEMIZATION OF STATISTICAL DATA AND INDEX FIGURES CONCERNING STOCK EXCHANGE QUOTES, INVESTMENT FUNDS, SECURITIES, INTEREST RATES, PRICES, EXCHANGE RATES AND OTHER ECONOMIC DATA, IN CLASS 35 (U.S. CLS. 100, 101 AND 102).

FIRST USE 0-0-1998; IN COMMERCE 0-0-1998.

FOR: FINANCIAL SERVICES, NAMELY, LISTING OF FINANCIAL INSTRUMENTS, NAMELY, SHARES, BONDS, WARRANTS, DERIVATIVES PRODUCTS, EXCHANGE TRADE FUNDS, GOVERNMENT BONDS, ASSETS BACKED SECURITIES, NAMELY, THE ADMISSION ON THE TRADING PLATFORM FOR THE NEGOTIATION OF ALL THE ABOVE SECURITIES, INCLUDING DEBT, EQUITY AND DERIVATIVES; OPERATING A STOCK EXCHANGE, NAMELY, PROVIDING A FINANCIAL MARKET FOR THE TRADING AND AUCTIONING OF COMMODITIES, FUTURES, OPTIONS, SECURITIES INCLUDING DERIVATIVES; PROVIDING STOCK EXCHANGE PRICE QUOTATIONS AND RELATED INFORMATION; PROVIDING FULLY AUTOMATED SECURITIES INCLUDING DERIVATIVES BROKERAGE SERVICES; FINANCIAL SERVICES, NAMELY, SECURITIES INCLUDING DERIVATIVES TRADING SERVICES FEATURING COMPUTERIZED TRADING AND ORDER EXECUTION; ON-LINE FINANCIAL SERVICES, NAMELY, SECURITIES AND DERIVATIVES TRADING SERVICES FEATURING ON-LINE COMPUTERIZED TRADING AND ORDER EXECUTION; PROVIDING AN ON-LINE COMPUTER DATABASE IN THE FIELD OF COMMERCIAL TRANSACTIONS INVOLVING FINANCIAL MARKETS; OPERATING A STOCK EXCHANGE FOR THE BROKERAGE OF SECURITIES INCLUDING DERIVATIVES; PROVIDING STOCK EXCHANGE PRICE QUOTATIONS, LISTINGS OF COMPANIES AND THEIR PRODUCTS TRADED AND RELATED FINANCIAL INFORMATION; ISSUING, MANAGING AND ADMINISTERING INITIAL PUBLIC OFFERINGS OF STOCK; FINANCIAL CLEARINGHOUSE SERVICES; MANAGING FOREIGN EXCHANGE RISK FOR OTHERS; PORTFOLIO AND FUNDS MANAGEMENT SERVICES; FINANCIAL RESEARCH, ANALYSIS AND CONSULTING SERVICES; RISK MANAGEMENT SERVICES; COMPILING AND DISSEMINATING INDICES OF STOCK MARKET PERFORMANCE; MONETARY EXCHANGE SERVICES; DISSEMINATION OF INFORMATION ON PRICES, NAMELY, LAST PRICES, CLOSING PRICES, REFERENCE PRICES, CHANGES FROM PREVIOUS PRICES AND PERIOD AVERAGES, OF LISTED FINANCIAL INSTRUMENTS TO FINANCIAL INTERMEDIARIES, INVESTORS AND TO THE PUBLIC IN GENERAL; ANALYSIS OF INFORMATION RELATING TO BONDS, STOCKS, GENERAL FINANCIAL SERVICES, STOCK MARKET, FINANCIAL MARKETS IN GENERAL, ADVICE ON INVESTMENTS, AND FINANCIAL INFORMATION SERVICES, NAMELY, QUOTATION OF STOCK EXCHANGE PRICES; FINANCIAL INFORMATION

PROVIDED BY ELECTRONIC MEANS; FINANCIAL INFORMATION SERVICES IN THE NATURE OF INVESTMENT FORECASTING, FINANCIAL FORECASTING, ECONOMIC FORECASTING, ECONOMIC ANALYSIS, EXCHANGE RATE OR STOCK EXCHANGE INFORMATION; PROVIDING FINANCIAL INFORMATION RELATED TO THE VALUE AND NATURE OF FINANCIAL INSTRUMENTS VIA ELECTRONIC MEANS; PROVIDING AN ON-LINE DATABASE CONTAINING REAL TIME FINANCIAL INVESTMENT INFORMATION; FINANCIAL LOAN SERVICES; SHARES AND SECURITIES BROKERAGE SERVICES IN THE NATURE OF ACCEPTANCE, EXCHANGE AND PLACEMENT OF PUBLIC AND PRIVATE SECURITIES, SHARES AND BOND SECURITIES; INVESTMENT MANAGEMENT AND BROKERAGE SERVICES; FINANCIAL ANALYSIS SERVICES; INVESTMENT FUND TRANSFER AND TRANSACTION SERVICES VIA THE INTERNET AND WIRELESS COMMUNICATION NETWORKS; PROVIDING FINANCIAL INFORMATION RELATED TO THE VALUE AND NATURE OF FINANCIAL INSTRUMENTS VIA RADIO AND TELEVISION; CAPITAL AND FUNDS INVESTMENT; PROVIDING FINANCIAL INFORMATION RELATING TO FINANCIAL INSTRUMENTS VIA ELECTRONIC MEANS; REAL ESTATE APPRAISAL; ORGANIZATION AND OPERATION OF TRADING MARKETS FOR FINANCIAL SERVICES OR FINANCIAL INSTRUMENTS, NAMELY, CONDUCTING A SECURITIES OR FINANCIAL INSTRUMENTS EXCHANGE AND RELATED STOCK MARKET SERVICES; PROVIDING A BROAD RANGE OF FINANCIAL AND INVESTING INFORMATION BY MEANS OF ELECTRONIC COMMUNICATIONS NETWORK; REAL ESTATE MANAGEMENT; REAL ESTATE RENTAL; PROVIDING COMPUTERIZED FINANCIAL INFORMATION RELATING COMPANY APPRAISAL, SHARES PRICES AND FINANCIAL INFORMATION FOR INVESTORS; PROVIDING A DATABASE IN THE FIELD OF FINANCIAL INFORMATION; PROVIDING FINANCIAL INFORMATION IN THE NATURE OF A WEB SITE FEATURING INFORMATION REGARDING FINANCIAL EVENTS, IN CLASS 36 (U.S. CLS. 100, 101 AND 102).

FIRST USE 0-0-1998; IN COMMERCE 0-0-1998.

FOR: SERVICES OF INFORMATION AGENCIES, NAMELY, TRANSMISSION OF NEWS; ELECTRONIC TRANSMISSION OF FINANCIAL INSTRUMENTS MARKET INFORMATION, QUOTATIONS AND ORDERS; PROVIDING ACCESS TO TELECOMMUNICATIONS NETWORKS, NAMELY, DDM, DDM-PLUS, MARKET CONNECT, WHICH ARE DISTRIBUTED VIA WEB OR VIA DEDICATED FEED, FOR COLLECTION, PROCESSING, DISTRIBUTION AND TRANSMISSION OF FINANCIAL INSTRUMENTS AND MARKET INFORMATION; TRANSFER OF DATA BY TELECOMMUNICATIONS; PROVIDING ACCESS TO COMPUTER NETWORKS FOR THE ELECTRONIC TRANSMISSION OF DATA, COMMUNICATIONS, DOCUMENTS, PERSONAL AND PROFESSIONAL INFORMATION IN THE FIELD OF FINANCE, IN CLASS 38 (U.S. CLS. 100, 101 AND 104).

FIRST USE 0-0-1998; IN COMMERCE 0-0-1998.

SEC. 2(F).

THE MARK CONSISTS OF STANDARD CHARACTERS WITHOUT CLAIM TO ANY PARTICULAR FONT, STYLE, SIZE, OR COLOR.

SER. NO. 78-668,479, FILED 7-12-2005.

THE FOREIGN WORDING IN THE MARK TRANSLATES INTO ENGLISH AS ITALIAN STOCK EXCHANGE.

ESTHER A. BORSUK, EXAMINING ATTORNEY

Int. Cls.: 29 and 30

Prior U.S. Cl.: 46

United States Patent and Trademark Office

Reg. No. 3,480,615

Registered Aug. 5, 2008

**TRADEMARK
PRINCIPAL REGISTER**



ELLENHANNELL INC. (CANADA CORPORATION)
110 TIMBER VALLEY AVENUE
RICHMOND HILL, ONTARIO, CANADA L4E 4Z9

FOR: FOIE GRAS, IN CLASS 29 (U.S. CL. 46).

FOR: CHOCOLATE; PRALINE; CONFECTIONARY, NAMELY, BISCUITS, COOKIES, CHOCOLATE TRUFFLES, CANDY, LOLLIPOPS, CARAMEL AND TOFFEE, IN CLASS 30 (U.S. CL. 46).

PRIORITY CLAIMED UNDER SEC. 44(D) ON CANADA APPLICATION NO. 1264900, FILED 7-14-2005, REG. NO. TMA688,932, DATED 6-1-2007, EXPIRES 6-1-2022.

SER. NO. 78-673,864, FILED 7-19-2005.

DAVID MURRAY, EXAMINING ATTORNEY

Int. Cl.: 21

Prior U.S. Cls.: 2, 13, 23, 29, 30, 33, 40 and 50

Reg. No. 3,480,616

United States Patent and Trademark Office

Registered Aug. 5, 2008

**TRADEMARK
PRINCIPAL REGISTER**

EXCALIBUR

MAYBRUN, INC. (CALIFORNIA CORPORATION)
2205 SOUTH WRIGHT STREET
SANTA ANA, CA 92705

THE MARK CONSISTS OF STANDARD CHARACTERS WITHOUT CLAIM TO ANY PARTICULAR FONT, STYLE, SIZE, OR COLOR.

FOR: COOKING EQUIPMENT AND KITCHEN EQUIPMENT, NAMELY, COOKING UTENSILS FOR BBQ'S, NAMELY, FORKS, TONGS, TURNERS AND SPATULAS, IN CLASS 21 (U.S. CLS. 2, 13, 23, 29, 30, 33, 40 AND 50).

OWNER OF U.S. REG. NO. 3,242,562.

SER. NO. 78-679,522, FILED 7-27-2005.

FIRST USE 11-8-2005; IN COMMERCE 11-8-2005.

HEATHER SAPP, EXAMINING ATTORNEY

Int. Cls.: 35 and 41

Prior U.S. Cls.: 100, 101, 102 and 107

United States Patent and Trademark Office

Reg. No. 3,480,617

Registered Aug. 5, 2008

**SERVICE MARK
PRINCIPAL REGISTER**

NEW MAJORITY

NEW MAJORITY CALIFORNIA (CALIFORNIA CORPORATION)
SUITE 600
949 SOUTH COAST DRIVE
COSTA MESA, CA 92626

FOR: ASSOCIATION SERVICES, NAMELY, PROMOTING FISCALLY RESPONSIBLE GOVERNMENT POLICIES; ASSOCIATION SERVICES, NAMELY, PROMOTING THE INTERESTS OF INDIVIDUALS AND GROUPS WHO SUPPORT FISCALLY RESPONSIBLE GOVERNMENT POLICIES, SPECIFICALLY THROUGH SPONSORED POLITICAL ACTION COMMITTEES, IN CLASS 35 (U.S. CLS. 100, 101 AND 102).

FIRST USE 12-31-1999; IN COMMERCE 12-31-1999.

FOR: EDUCATION SERVICES AND OUTREACH, NAMELY, PROVIDING FORUMS, SEMINARS AND SPEAKER WORKSHOPS REGARDING EXISTING

AND PROPOSED GOVERNMENT POLICIES; EDUCATIONAL SERVICES, NAMELY, PROVIDING TRAINING TO CANDIDATES IN THE FIELDS OF POLITICAL AND GOVERNMENT POLICIES AND FUNCTIONS, PUBLIC COMMUNICATIONS AND FUNDRAISING; EDUCATION SERVICES AND OUTREACH, NAMELY, FORUMS AND SEMINARS TO PROMOTE FISCALLY RESPONSIBLE CANDIDATES AND IDEAS, IN CLASS 41 (U.S. CLS. 100, 101 AND 107).

FIRST USE 12-31-1999; IN COMMERCE 12-31-1999.

THE MARK CONSISTS OF STANDARD CHARACTERS WITHOUT CLAIM TO ANY PARTICULAR FONT, STYLE, SIZE, OR COLOR.

SER. NO. 78-682,257, FILED 7-31-2005.

CURTIS FRENCH, EXAMINING ATTORNEY

Int. Cls.: 4 and 37

Prior U.S. Cls.: 1, 6, 15, 100, 103 and 106

United States Patent and Trademark Office

Reg. No. 3,480,618

Registered Aug. 5, 2008

**TRADEMARK
SERVICE MARK
PRINCIPAL REGISTER**

FUELING THE FUTURE

SHELL TRADEMARK MANAGEMENT B.V.
(NETHERLANDS CORPORATION)
CAREL VAN BYLANDTLAAN 30, 2596 HR
THE HAGUE, NETHERLANDS

FOR: FUEL FOR MOTOR VEHICLES, NAMELY,
HYDROGEN, IN CLASS 4 (U.S. CLS. 1, 6 AND 15).

FIRST USE 1-1-2002; IN COMMERCE 1-1-2002.

FOR: AUTOMOBILE SERVICE STATION SERVI-
CES, IN CLASS 37 (U.S. CLS. 100, 103 AND 106).

FIRST USE 1-1-2002; IN COMMERCE 1-1-2002.

THE MARK CONSISTS OF STANDARD CHAR-
ACTERS WITHOUT CLAIM TO ANY PARTICULAR
FONT, STYLE, SIZE, OR COLOR.

SER. NO. 78-688,263, FILED 8-9-2005.

PAUL E. FAHRENKOPF, EXAMINING ATTORNEY

Int. Cl.: 25

Prior U.S. Cls.: 22 and 39

United States Patent and Trademark Office

Reg. No. 3,480,619

Registered Aug. 5, 2008

**TRADEMARK
PRINCIPAL REGISTER**

DIRTY SHIRT

SHULHAFFER, ALEXANDRIA M. (UNITED STATES INDIVIDUAL)

2561 WOODBOURNE AVENUE

LOUISVILLE, KY 40205

FOR: T-SHIRTS, IN CLASS 25 (U.S. CLS. 22 AND 39).

FIRST USE 5-30-2005; IN COMMERCE 5-30-2005.

THE MARK CONSISTS OF STANDARD CHARACTERS WITHOUT CLAIM TO ANY PARTICULAR FONT, STYLE, SIZE, OR COLOR.

NO CLAIM IS MADE TO THE EXCLUSIVE RIGHT TO USE "SHIRT", APART FROM THE MARK AS SHOWN.

SER. NO. 78-690,673, FILED 8-11-2005.

DAVID HOFFMAN, EXAMINING ATTORNEY

Int. Cl.: 9

Prior U.S. Cls.: 21, 23, 26, 36 and 38

Reg. No. 3,480,620

United States Patent and Trademark Office

Registered Aug. 5, 2008

**TRADEMARK
PRINCIPAL REGISTER**

Q5

QWIZDOM, INC. (WASHINGTON CORPORATION)
12617 MERIDIAN E.
PUYALLUP, WA 98373

FIRST USE 4-0-2005; IN COMMERCE 4-0-2005.

FOR: HANDHELD RESPONSE UNITS FOR WIRELESS AUDIENCE RESPONSE SYSTEMS, NAMELY, HANDHELD TRANSMITTER AND RECEIVER DEVICES WITH KEYPADS FOR USE IN ENTERING, STORING AND TRANSMITTING INFORMATION PROVIDED BY USERS, IN CLASS 9 (U.S. CLS. 21, 23, 26, 36 AND 38).

THE MARK CONSISTS OF STANDARD CHARACTERS WITHOUT CLAIM TO ANY PARTICULAR FONT, STYLE, SIZE, OR COLOR.

SER. NO. 78-695,326, FILED 8-18-2005.

RAUL CORDOVA, EXAMINING ATTORNEY

Int. Cl.: 41

Prior U.S. Cls.: 100, 101 and 107

United States Patent and Trademark Office

Reg. No. 3,480,621

Registered Aug. 5, 2008

**SERVICE MARK
PRINCIPAL REGISTER**

**AMERICA'S LEADER IN
CREATIVE EDUCATION**

EDUCATION MANAGEMENT LLC (DELAWARE
LTD LIAB CO)
210 SIXTH AVENUE
PITTSBURGH, PA 15222

FOR: EDUCATIONAL SERVICES, NAMELY,
PROVIDING COURSES OF INSTRUCTION AT
THE POSTSECONDARY LEVEL, IN CLASS 41 (U.S.
CLS. 100, 101 AND 107).

FIRST USE 8-0-1999; IN COMMERCE 8-0-1999.

THE MARK CONSISTS OF STANDARD CHAR-
ACTERS WITHOUT CLAIM TO ANY PARTICULAR
FONT, STYLE, SIZE, OR COLOR.

OWNER OF U.S. REG. NO. 2,495,162.

SEC. 2(F).

SER. NO. 78-703,333, FILED 8-30-2005.

DAWN FELDMAN, EXAMINING ATTORNEY

Int. Cls.: 9, 11 and 37

**Prior U.S. Cls.: 13, 21, 23, 26, 31, 34, 36, 38, 100, 103
and 106**

Reg. No. 3,480,622

United States Patent and Trademark Office

Registered Aug. 5, 2008

**TRADEMARK
SERVICE MARK
PRINCIPAL REGISTER**

THE FORCE IN AIR

DANTHERM FILTRATION HOLDING A/S (DEN-
MARK CORPORATION)
INDUSTRIVEJ 13
MARIAGER, DENMARK 9550

FOR: ELECTRONIC APPARATUS FOR THE CON-
TROL AND MONITORING OF VENTILATION SYS-
TEMS, FILTER SYSTEMS AND EXHAUST SYS-
TEMS IN THE FORM OF ELECTRIC PANELS
AND MONITORING PANELS, SOFTWARE AND
PARTS AND FITTINGS FOR THE AFORESAID
GOODS, IN CLASS 9 (U.S. CLS. 21, 23, 26, 36 AND 38).

FIRST USE 8-15-2005; IN COMMERCE 8-15-2005.

FOR: APPARATUS FOR VENTILATION SYS-
TEMS, FILTER SYSTEMS AND EXHAUST SYS-
TEMS, NAMELY, VENTILATING EXHAUST FANS
FOR VENTILATION SYSTEMS, EXHAUST SYS-
TEMS, EXTRACTION, PARTICLE AND BELT SUC-
TION SYSTEMS AND CONVEYANCE SYSTEMS;
AIR FILTERS USED IN COMMERCIAL AND IN-
DUSTRIAL INSTALLATIONS IN THE NATURE OF
EQUIPMENT FOR AIR CLEANING AND FILTRA-
TION SYSTEMS FOR THE REMOVAL OF DUST,
FUMES AND MIST AND STRUCTURAL PARTS
THEREFOR; PARTS AND ACCESSORIES FOR THE
OPERATION OF VENTILATION SYSTEMS, FILTER
SYSTEMS AND EXHAUST SYSTEMS, NAMELY,

FILTRATION ENCLOSURES, CARTRIDGE FIL-
TERS, BELTS AND HOSES, IN CLASS 11 (U.S. CLS.
13, 21, 23, 31 AND 34).

FIRST USE 8-15-2005; IN COMMERCE 8-15-2005.

FOR: INSTALLATION, REPAIR AND MAINTEN-
ANCE OF EQUIPMENT FOR VENTILATION,
HEATING, DRYING AND AIR CONDITIONING
SYSTEMS, AND AIR FILTERS USED IN COMMER-
CIAL AND INDUSTRIAL INSTALLATIONS, IN
CLASS 37 (U.S. CLS. 100, 103 AND 106).

FIRST USE 8-15-2005; IN COMMERCE 8-15-2005.

THE MARK CONSISTS OF STANDARD CHAR-
ACTERS WITHOUT CLAIM TO ANY PARTICULAR
FONT, STYLE, SIZE, OR COLOR.

PRIORITY CLAIMED UNDER SEC. 44(D) ON
DENMARK APPLICATION NO. 004486965, FILED
7-11-2005, REG. NO. 004486965, DATED 11-14-2006,
EXPIRES 7-11-2015.

SER. NO. 78-704,275, FILED 8-31-2005.

MELISSA VALLILLO, EXAMINING ATTORNEY

Int. Cl.: 35

Prior U.S. Cls.: 100, 101 and 102

United States Patent and Trademark Office

Reg. No. 3,480,623

Registered Aug. 5, 2008

**SERVICE MARK
PRINCIPAL REGISTER**

INDURADEX

REFRIGIWEAR, INC. (GEORGIA CORPORATION)
54 BREAKSTONE DRIVE
DAHLONEGA, GA 30533

FOR: PROVIDING A RATING SYSTEM FOR HANDWEAR, NAMELY, PROVIDING RATINGS OF THE INSULATION, DURABILITY AND DEXTERITY OF CONSUMER GOODS IN THE NATURE OF HANDWEAR VIA A RETAIL CATALOG , IN CLASS 35 (U.S. CLS. 100, 101 AND 102).

FIRST USE 9-1-2005; IN COMMERCE 9-1-2005.

THE MARK CONSISTS OF STANDARD CHARACTERS WITHOUT CLAIM TO ANY PARTICULAR FONT, STYLE, SIZE, OR COLOR.

SER. NO. 78-707,002, FILED 9-6-2005.

TINA BROWN, EXAMINING ATTORNEY

Int. Cl.: 35

Prior U.S. Cls.: 100, 101 and 102

United States Patent and Trademark Office

Reg. No. 3,480,624

Registered Aug. 5, 2008

**SERVICE MARK
PRINCIPAL REGISTER**

INDURASAFE

REFRIGIWEAR, INC. (GEORGIA CORPORATION)
54 BREAKSTONE DRIVE
DAHLONEGA, GA 30533

FOR: PROVIDING A RATING SYSTEM FOR FOOTWEAR, NAMELY, PROVIDING RATINGS OF THE INSULATION, DURABILITY AND SAFETY OF CONSUMER GOODS IN THE NATURE OF FOOTWEAR VIA A RETAIL CATALOG, IN CLASS 35 (U.S. CLS. 100, 101 AND 102).

FIRST USE 9-1-2005; IN COMMERCE 9-1-2005.

THE MARK CONSISTS OF STANDARD CHARACTERS WITHOUT CLAIM TO ANY PARTICULAR FONT, STYLE, SIZE, OR COLOR.

SER. NO. 78-707,005, FILED 9-6-2005.

TINA BROWN, EXAMINING ATTORNEY

Int. Cl.: 9

Prior U.S. Cls.: 21, 23, 26, 36 and 38

Reg. No. 3,480,625

United States Patent and Trademark Office

Registered Aug. 5, 2008

**TRADEMARK
PRINCIPAL REGISTER**

**B.R.A.T. BRUSH RAPID
ATTACK TRUCK**

FIREMATIC MANUFACTURING INC. (NEW
YORK CORPORATION)

10 RAMSAY ROAD

EAST YAPHANK, NY 11967

FOR: FIRE TRUCKS, IN CLASS 9 (U.S. CLS. 21, 23,
26, 36 AND 38).

FIRST USE 1-31-2002; IN COMMERCE 1-31-2002.

THE MARK CONSISTS OF STANDARD CHAR-
ACTERS WITHOUT CLAIM TO ANY PARTICULAR
FONT, STYLE, SIZE, OR COLOR.

NO CLAIM IS MADE TO THE EXCLUSIVE
RIGHT TO USE "BRUSH RAPID ATTACK TRUCK",
APART FROM THE MARK AS SHOWN.

SER. NO. 78-708,723, FILED 9-8-2005.

TINA L. SNAPP, EXAMINING ATTORNEY

Int. Cl.: 19

Prior U.S. Cls.: 1, 12, 33 and 50

United States Patent and Trademark Office

Reg. No. 3,480,626

Registered Aug. 5, 2008

**TRADEMARK
PRINCIPAL REGISTER**

J.J. Haines & Company, Inc.

J.J. HAINES & COMPANY, INC. (MARYLAND CORPORATION)
6950 AVIATION BOULEVARD
GLEN BURNIE, MD 21061

FOR: NONMETALLIC BUILDING MATERIALS, NAMELY, SEMI-WORKED WOODS, SUCH AS BEAMS, PLANKS AND PANELS, AND VENEERS; HARDWOOD FLOORING, IN CLASS 19 (U.S. CLS. 1, 12, 33 AND 50).

FIRST USE 1-1-1875; IN COMMERCE 1-1-1875.

THE MARK CONSISTS OF STANDARD CHARACTERS WITHOUT CLAIM TO ANY PARTICULAR FONT, STYLE, SIZE, OR COLOR.

OWNER OF U.S. REG. NO. 1,684,734.

NO CLAIM IS MADE TO THE EXCLUSIVE RIGHT TO USE "COMPANY, INC.", APART FROM THE MARK AS SHOWN.

SEC. 2(F).

SER. NO. 78-711,250, FILED 9-12-2005.

JAMES GRIFFIN, EXAMINING ATTORNEY

Int. Cl.: 20

Prior U.S. Cls.: 2, 13, 22, 25, 32 and 50

Reg. No. 3,480,627

United States Patent and Trademark Office

Registered Aug. 5, 2008

**TRADEMARK
PRINCIPAL REGISTER**

ANSWER

STEELCASE INC. (MICHIGAN CORPORATION)
901 44TH STREET SE
PO BOX 1967
GRAND RAPIDS, MI 49501

THE MARK CONSISTS OF STANDARD CHAR-
ACTERS WITHOUT CLAIM TO ANY PARTICULAR
FONT, STYLE, SIZE, OR COLOR.

FOR: OFFICE FURNITURE, IN CLASS 20 (U.S.
CLS. 2, 13, 22, 25, 32 AND 50).

SER. NO. 78-730,651, FILED 10-11-2005.

FIRST USE 4-20-1998; IN COMMERCE 4-20-1998.

ANDREW LAWRENCE, EXAMINING ATTORNEY

Int. Cls.: 9, 11 and 38

**Prior U.S. Cls.: 13, 21, 23, 26, 31, 34, 36, 38, 100, 101
and 104**

Reg. No. 3,480,628

United States Patent and Trademark Office

Registered Aug. 5, 2008

**TRADEMARK
SERVICE MARK
PRINCIPAL REGISTER**

SAVIORLITE

YUEN, SE KIT (HONG KONG INDIVIDUAL)
6/F., YAU LEE CENTRE, 45 HOI YUEN ROAD
KWUN TONG, KOWLOON, HONG KONG

FOR: SCIENTIFIC MEASURING INSTRUMENTS, NAMELY CONDUCTIVITY METERS; NAUTICAL APPARATUS AND INSTRUMENTS, NAMELY, WATER METERS; SURVEYING APPARATUS AND INSTRUMENTS, NAMELY, SURVEYORS' LEVELS; PHOTOGRAPHIC APPARATUS AND INSTRUMENTS, NAMELY, CAMERAS; CINEMATOGRAPHIC APPARATUS AND INSTRUMENTS, NAMELY, CAMERAS; OPTICAL CHARACTER RECOGNITION APPARATUS; WEIGHING EQUIPMENT, NAMELY, SCALES AND BALANCES; INSTRUMENTS FOR MEASURING LENGTH; SIGNALING APPARATUS AND INSTRUMENTS, NAMELY, SIGNALING BUOYS; CHECKING APPARATUS FOR CHECKING FLIGHT PARAMETERS; LIFE-SAVING APPARATUS AND INSTRUMENTS, NAMELY, LIFE JACKETS; TEACHING APPARATUS AND INSTRUMENTS, NAMELY, MEDICAL TEACHING MANNEQUINS; ELECTRICAL CONDUCTORS; ELECTRIC CURRENT SWITCHES; ELECTRIC TRANSFORMERS; ELECTRIC ACCUMULATORS; ELECTRIC OXYGEN REGULATORS; ELECTRICAL CONTROLLERS; APPARATUS FOR RECORDING, TRANSMISSION OR REPRODUCTION OF SOUND OR IMAGES; BLANK MAGNETIC DATA CARRIERS; BLANK CASSETTES AND BLANK COMPACT DISCS; AUTOMATIC VENDING MACHINES; CASH REGISTERS; CALCULATING MACHINES, NAMELY, CALCULATING SCALES; DATA PROCESSING EQUIPMENT AND COMPU-

TERS; FIRE-EXTINGUISHING APPARATUS; TELECOMMUNICATION CABLES; PORTABLE MEDIA PLAYERS AND GLOBAL POSITIONING SYSTEMS, IN CLASS 9 (U.S. CLS. 21, 23, 26, 36 AND 38).

FOR: ELECTRIC LIGHTING FIXTURES; HEAT PUMPS; STEAM GENERATORS; COOKING RANGES; REFRIGERATORS; CLOTHES DRYERS; VENTILATING EXHAUST FANS; REGULATING ACCESSORIES FOR WATER SUPPLY, NAMELY METERED VALVES; PIPES BEING PARTS OF SANITARY FACILITIES, IN CLASS 11 (U.S. CLS. 13, 21, 23, 31 AND 34).

FOR: LEASING OF TELECOMMUNICATION EQUIPMENT, NAMELY, MOBILE PHONES AND WALKIE-TALKIES; MOBILE MEDIA AND ENTERTAINMENT SERVICES IN THE NATURE OF ELECTRONIC TRANSMISSION OF ENTERTAINMENT MEDIA CONTENT, IN CLASS 38 (U.S. CLS. 100, 101 AND 104).

THE MARK CONSISTS OF STANDARD CHARACTERS WITHOUT CLAIM TO ANY PARTICULAR FONT, STYLE, SIZE, OR COLOR.

PRIORITY CLAIMED UNDER SEC. 44(D) ON HONG KONG APPLICATION NO. 300496882, FILED 9-17-2005, REG. NO. 300496882, DATED 9-17-2005, EXPIRES 9-16-2015.

SER. NO. 78-737,203, FILED 10-20-2005.

JENNIFER VASQUEZ, EXAMINING ATTORNEY

Int. Cls.: 29, 30 and 43

Prior U.S. Cls.: 46, 100 and 101

United States Patent and Trademark Office

Reg. No. 3,480,629

Registered Aug. 5, 2008

**TRADEMARK
SERVICE MARK
PRINCIPAL REGISTER**

GORDON RAMSAY

GORDON RAMSAY RESTAURANT HOLDING
US LP (DELAWARE LIMITED PARTNERSHIP)
ATTN: FREDERICK R. CUMMINGS, JR.
C/O WARSHAW, BURSTEIN, COHENSCHLE-
SINGER & KUH, LLP, 555 FIFTH AVENUE
NEW YORK, NY 10017

FOR: PREPARED MEALS AND DISHES CON-
SISTING PRIMARILY OF MEAT, FISH, POULTRY
OR VEGETABLES, IN CLASS 29 (U.S. CL. 46).

FOR: COFFEE AND TEA; PASTRIES, CONFEC-
TIONERY, NAMELY, CANDIES AND CHOCO-
LATES, IN CLASS 30 (U.S. CL. 46).

FOR: RESTAURANT, CAFÉ, BAR AND CATER-
ING SERVICES; HOTEL SERVICES; ADVISORY
SERVICES RELATING TO CAFÉ, RESTAURANT,
BAR, CATERING AND HOTEL SERVICES; CON-
SULTATION IN THE FIELD OF THE SELECTION,

PREPARATION AND SERVING OF FOOD AND
BEVERAGES AND RESTAURANT, CAFÉ, BAR,
CATERING, IN CLASS 43 (U.S. CLS. 100 AND 101).

THE MARK CONSISTS OF STANDARD CHAR-
ACTERS WITHOUT CLAIM TO ANY PARTICULAR
FONT, STYLE, SIZE, OR COLOR.

OWNER OF ERPN CMNTY TM OFC REG. NO.
003744208, DATED 8-24-2005, EXPIRES 4-1-2014.

THE NAME "GORDON RAMSAY" IDENTIFIES A
LIVING INDIVIDUAL WHOSE CONSENT IS OF
RECORD.

SER. NO. 78-742,530, FILED 10-28-2005.

BILL DAWE, EXAMINING ATTORNEY

Int. Cl.: 5

Prior U.S. Cls.: 6, 18, 44, 46, 51 and 52

Reg. No. 3,480,630

United States Patent and Trademark Office

Registered Aug. 5, 2008

**TRADEMARK
PRINCIPAL REGISTER**

CAL MELTS

HOLISTA HEALTH (CANADA) INC. (CANADA CORPORATION)
101-3680 BONNEVILLE PLACE
BURNABY, BRITISH COLUMBIA V3N 4T5

FOR: DIETARY AND NUTRITIONAL SUPPLEMENTS IN TABLET FORM FOR MAINTAINING BONE HEALTH AND PREVENTING OSTEOPOROSIS, IN CLASS 5 (U.S. CLS. 6, 18, 44, 46, 51 AND 52).

THE MARK CONSISTS OF STANDARD CHARACTERS WITHOUT CLAIM TO ANY PARTICULAR FONT, STYLE, SIZE, OR COLOR.

PRIORITY CLAIMED UNDER SEC. 44(D) ON CANADA APPLICATION NO. 1279054, FILED 11-9-2005, REG. NO. TMA687397, DATED 5-9-2007, EXPIRES 5-9-2022.

NO CLAIM IS MADE TO THE EXCLUSIVE RIGHT TO USE "CAL", APART FROM THE MARK AS SHOWN.

SER. NO. 78-751,590, FILED 11-10-2005.

KATHRYN COWARD, EXAMINING ATTORNEY

Int. Cls.: 40 and 42

Prior U.S. Cls.: 100, 101, 103 and 106

United States Patent and Trademark Office

Reg. No. 3,480,631

Registered Aug. 5, 2008

**SERVICE MARK
PRINCIPAL REGISTER**

COMMAND NUTRITIONALS

COMMAND NUTRITIONALS, LLC (NEW JERSEY LTD LIAB CO)
4 MADISON ROAD
FAIRFIELD, NJ 07004

FOR: MANUFACTURE AND CUSTOM FORMULATION OF VITAMIN PREPARATIONS, DIETARY SUPPLEMENTS, PHARMACEUTICAL TABLETS, PILLS AND CAPSULES, ENERGY BARS, MEAL REPLACEMENT BARS, ENERGY DRINKS, SHAKES, POWDERS AND FORMULAS, FOOD SUBSTITUTES AND MEAL REPLACEMENTS, TEAS, AND HEALTH PRODUCTS TO THE ORDER AND SPECIFICATION OF OTHERS, IN CLASS 40 (U.S. CLS. 100, 103 AND 106).

FIRST USE 6-1-2004; IN COMMERCE 1-1-2005.

FOR: PRODUCT RESEARCH AND DEVELOPMENT, PRODUCT DEVELOPMENT CONSULTATION, AND TESTING FOR NEW PRODUCT DEVELOPMENT IN THE FIELD OF VITAMIN PREPARATIONS, DIETARY SUPPLEMENTS, PHARMA-

CEUTICAL TABLETS, PILLS AND CAPSULES, ENERGY BARS, MEAL REPLACEMENT BARS, ENERGY DRINKS, SHAKES, POWDERS AND FORMULAS, FOOD SUBSTITUTES AND MEAL REPLACEMENTS, TEAS, AND HEALTH PRODUCTS FOR OTHERS, IN CLASS 42 (U.S. CLS. 100 AND 101).

FIRST USE 6-1-2004; IN COMMERCE 1-1-2005.

THE MARK CONSISTS OF STANDARD CHARACTERS WITHOUT CLAIM TO ANY PARTICULAR FONT, STYLE, SIZE, OR COLOR.

NO CLAIM IS MADE TO THE EXCLUSIVE RIGHT TO USE "NUTRITIONALS", APART FROM THE MARK AS SHOWN.

SER. NO. 78-760,161, FILED 11-23-2005.

KAREN BRACEY, EXAMINING ATTORNEY

Int. Cls.: 16, 36, 41, 44 and 45

**Prior U.S. Cls.: 2, 5, 22, 23, 29, 37, 38, 50, 100, 101, 102
and 107**

Reg. No. 3,480,632

United States Patent and Trademark Office

Registered Aug. 5, 2008

**TRADEMARK
SERVICE MARK
PRINCIPAL REGISTER**



AUTISM SOCIETY OF AMERICA, INC. (D.C.
NON-PROFIT CORPORATION)
SUITE 300
7910 WOODMONT AVENUE
BETHESDA, MD 20814

FOR: PUBLICATIONS, NAMELY, NEWSLETTERS, MANUALS, BOOKLETS, BROCHURES AND PAMPHLETS, ALL CONCERNING AUTISTIC CHILDREN AND ADULTS; MEETING REPORTS, ANNUAL REPORTS, AND MEETING PROGRAMS CONCERNING AUTISTIC CHILDREN AND ADULTS DISTRIBUTED TO PERSONS OUTSIDE THE ORGANIZATION; POSTERS, MEMORANDUM PADS, AND CARDBOARD OR PAPER COVERS FOR COLLECTION CANS SOLD SEPARATELY, IN CLASS 16 (U.S. CLS. 2, 5, 22, 23, 29, 37, 38 AND 50).

FIRST USE 8-1-2005; IN COMMERCE 8-1-2005.

FOR: CHARITABLE FUNDRAISING, IN CLASS 36 (U.S. CLS. 100, 101 AND 102).

FIRST USE 8-1-2005; IN COMMERCE 8-1-2005.

FOR: EDUCATION SERVICES, NAMELY, CONDUCTING CONFERENCES, CLASSES, SEMINARS, WORKSHOPS AND MEETINGS CONCERNING AUTISTIC CHILDREN AND ADULTS, AND AUTISM AWARENESS; PROVIDING A WEBSITE WITH EDUCATIONAL INFORMATION ON AUTISM REGARDING WORKSHOPS, CONFERENCES, CLASSES, SEMINARS AND MEETINGS AND INFORMATION ABOUT EDUCATIONAL RESOURCES AVAILABLE FOR INDIVIDUALS WITH AUTISM IN THE NATURE OF SCHOOLS, WORKSHOPS, CONFERENCES, CLASSES, SEMINARS AND MEETINGS, IN CLASS 41 (U.S. CLS. 100, 101 AND 107).

FIRST USE 8-1-2005; IN COMMERCE 8-1-2005.

FOR: PROVIDING A WEBSITE WITH INFORMATION ABOUT HEALTH RESOURCES AVAILABLE FOR INDIVIDUALS WITH AUTISM, IN CLASS 44 (U.S. CLS. 100 AND 101).

FIRST USE 8-1-2005; IN COMMERCE 8-1-2005.

FOR: PROVIDING CONSULTATION AND INFORMATION IN THE FIELD OF EMERGENCY RESPONSE FOR ASSISTANCE TO DEVELOPMENTALLY DISABLED INDIVIDUALS, IN CLASS 45 (U.S. CLS. 100 AND 101).

FIRST USE 10-18-2005; IN COMMERCE 10-18-2005.

OWNER OF U.S. REG. NOS. 2,094,267, 3,120,312 AND OTHERS.

NO CLAIM IS MADE TO THE EXCLUSIVE RIGHT TO USE "AUTISM", APART FROM THE MARK AS SHOWN.

THE COLOR(S) RED, WHITE AND BLUE IS/ARE CLAIMED AS A FEATURE OF THE MARK.

THE COLOR RED APPEARS IN THE LITERAL PORTION "ASA AUTISM SOCIETY OF AMERICA;" THE COLOR BLUE APPEARS IN THE SQUARE DESIGN CONTAINING WHITE STARS; THE COLOR WHITE ALSO APPEARS AS THE BACKGROUND OF THE ENTIRE MARK.

SEC. 2(F) AS TO "AUTISM SOCIETY OF AMERICA".

SER. NO. 78-779,923, FILED 12-22-2005.

BENJAMIN OKEKE, EXAMINING ATTORNEY

Int. Cl.: 35

Prior U.S. Cls.: 100, 101 and 102

United States Patent and Trademark Office

Reg. No. 3,480,633

Registered Aug. 5, 2008

**SERVICE MARK
PRINCIPAL REGISTER**



TOWN OF MIAMI LAKES (FLORIDA MUNICIPAL CORPORATION)
6853 MAIN STREET
MIAMI LAKES, FL 33014

FOR: PROMOTING THE ADVANCEMENT OF ECONOMIC AND BUSINESS DEVELOPMENT, AND COMMUNITY, EDUCATIONAL, RECREATIONAL, CULTURAL, HISTORICAL AND MUNICIPAL INTERESTS OF THE TOWN OF MIAMI LAKES, FLORIDA, IN CLASS 35 (U.S. CLS. 100, 101 AND 102).

FIRST USE 6-12-2001; IN COMMERCE 8-10-2001.

NO CLAIM IS MADE TO THE EXCLUSIVE RIGHT TO USE "TOWN OF MIAMI LAKES", "FLORIDA" AND "INCORPORATED 2001", APART FROM THE MARK AS SHOWN.

THE COLOR(S) BLUE, WHITE, BLACK, GREY, GREEN, YELLOW, ORANGE, BROWN AND TAN IS/ARE CLAIMED AS A FEATURE OF THE MARK.

THE COLOR BLUE APPEARS IN THE OVAL CARRIER, IN THE OUTLINING ON THE CLOUD AND IN THE DEPICTION OF WATER; THE COLOR

WHITE APPEARS IN THE BODY OF THE EGRET, IN THE BODY OF THE CLOUD AND ON THE COWS, IN THE DIAMOND DESIGNS AS WELL AS IN THE WORDING "TOWN OF MIAMI LAKES FLORIDA"; THE COLOR BLACK APPEARS IN THE COWS, IN THE LINING ON THE EGRET, IN THE LINING ON THE OVAL CARRIER, IN THE DESIGN OF THE HOUSES, IN THE LETTERING "INCORPORATED 2001" AND IN THE FINE LINES DEPICTING THE OUTLINES OF GRASS AND TREES; THE COLOR GRAY APPEARS IN THE INNER LINING OF THE OVAL CARRIER; THE COLOR GREEN APPEARS IN THE DESIGN OF BOTH THE GRASS AND TREES; THE COLOR YELLOW APPEARS ON THE BOAT SAIL AND IN THE TOP PORTION OF THE SUN DESIGN; THE COLOR ORANGE APPEARS ON THE BOAT HULL AND IN THE BOTTOM PORTION OF THE SUN DESIGN; THE MUD IS DEPICTED IN BROWN AND GREEN; THE BANNER IS DISPLAYED IN TAN AND THE SKY SHADES FROM BLUE TO ORANGE.

SER. NO. 78-785,509, FILED 1-5-2006.

SIMON TENG, EXAMINING ATTORNEY

Int. Cl.: 28

Prior U.S. Cls.: 22, 23, 38 and 50

United States Patent and Trademark Office

Reg. No. 3,480,634

Registered Aug. 5, 2008

**TRADEMARK
PRINCIPAL REGISTER**

GROOVY-GLAM

MATTEL, INC. (DELAWARE CORPORATION)
M1-1518
333 CONTINENTAL BLVD.
EL SEGUNDO, CA 902455012

FOR: TOYS, GAMES AND PLAYTHINGS, NAME-
LY, DOLLS, DOLL CLOTHING AND DOLL ACCES-
SORIES, TOY FIGURES, TOY ANIMALS, AND
ACCESSORIES FOR ALL OF THE FOREGOING, IN
CLASS 28 (U.S. CLS. 22, 23, 38 AND 50).

FIRST USE 10-23-2006; IN COMMERCE 10-23-2006.

THE MARK CONSISTS OF STANDARD CHAR-
ACTERS WITHOUT CLAIM TO ANY PARTICULAR
FONT, STYLE, SIZE, OR COLOR.

SER. NO. 78-788,232, FILED 1-10-2006.

JOHN GARTNER, EXAMINING ATTORNEY

Int. Cls.: 37, 39 and 45

Prior U.S. Cls.: 100, 101, 103, 105 and 106

United States Patent and Trademark Office

Reg. No. 3,480,635

Registered Aug. 5, 2008

**SERVICE MARK
PRINCIPAL REGISTER**



AIR SERV CORPORATION (GEORGIA CORPORATION)
SUITE 1800
3399 PEACHTREE ROAD, NE
ATLANTA, GA 30326

FOR: AIRCRAFT MAINTENANCE AND REPAIR SERVICES; OUTER AND INNER CLEANING OF AIRCRAFT, AND AIRPLANE DEICING SERVICES, IN CLASS 37 (U.S. CLS. 100, 103 AND 106).

FIRST USE 1-31-2003; IN COMMERCE 1-31-2003.

FOR: TRANSPORTATION AND AVIATION SUPPORT SERVICES, NAMELY, CARGO HANDLING, PASSENGER ASSISTANCE, NAMELY, AIRPORT PASSENGER CHECK-IN SERVICES, BAGGAGE HANDLING, NAMELY, AIRPORT BAGGAGE CHECK-IN SERVICES; AIRPLANE PUSHBACK; PROVIDING GROUND TRANSPORTATION FOR PASSENGERS BETWEEN AIRPORT PARKING LOTS AND TERMINALS, IN CLASS 39 (U.S. CLS. 100 AND 105).

FIRST USE 1-31-2003; IN COMMERCE 1-31-2003.

FOR: SECURITY CONTROL OF PERSONS AND LUGGAGE IN AIRPORTS; BAGGAGE HANDLING INSPECTIONS FOR AIRLINES; AND BAGGAGE INSPECTION FOR SECURITY PURPOSES, IN CLASS 45 (U.S. CLS. 100 AND 101).

FIRST USE 1-31-2003; IN COMMERCE 1-31-2003.

THE MARK CONSISTS OF FOUR LAYERS OF DESIGN ELEMENTS. FIRST, THE MARK CONSISTS OF A FIVE POINT STAR SUPERIMPOSED OVER A LARGER CIRCLE. THIS CIRCLE IS SUPERIMPOSED OVER A SECOND LARGER CIRCLE. THE LARGER CIRCLE IS SUPERIMPOSED OVER A LARGER SHIELD DESIGN.

SER. NO. 78-790,393, FILED 1-12-2006.

STEPHANIE ALI, EXAMINING ATTORNEY

Int. Cl.: 42

Prior U.S. Cls.: 100 and 101

United States Patent and Trademark Office

Reg. No. 3,480,636

Registered Aug. 5, 2008

**SERVICE MARK
PRINCIPAL REGISTER**

INTERTEK

INTERTEK GROUP PLC. (UNITED KINGDOM
PUBLIC LIMITED COMPANY (PLC))
25 SAVILE ROW
LONDON, UNITED KINGDOM W1S 2ES

FOR: TESTING, INSPECTION AND MEASUREMENT EVALUATION SERVICES OF THE GOODS AND SERVICES OF OTHERS IN THE FIELDS OF MATERIALS, CONSUMER PRODUCTS, VEHICLES, COMMODITIES, MINERALS, FOODS, BEVERAGES, MEDICAL PRODUCTS, PHARMACEUTICALS, BUSINESS SYSTEMS, MANAGEMENT SYSTEMS, QUALITY MANAGEMENT SYSTEMS, ENVIRONMENTAL MANAGEMENT SYSTEMS AND MANUFACTURING SYSTEMS; ELECTRICAL, PHYSICAL, CHEMICAL, MECHANICAL AND OPTICAL TESTING, INSPECTION AND MEASUREMENT EVALUATION SERVICES FOR THE GOODS AND SERVICES OF OTHERS; PRE-SHIPMENT AND POST-SHIPMENT INSPECTION SERVICES IN THE FIELDS OF MATERIALS, CONSUMER PRODUCTS, VEHICLES, COMMODITIES, MINERALS, FOODS, BEVERAGES, MEDICAL PRODUCTS, PHARMACEUTICALS, CHEMICALS, OIL, AND GAS; ALL FOR COMPLIANCE WITH REGULATORY, QUALITY, QUANTITY, PERFORMANCE AND SAFETY STANDARDS; QUALITY CONTROL SERVICES FOR OTHERS; CONSULTATION SERVICES IN THE FIELD OF SAFETY NEEDS FOR COMMERCIAL, INDUSTRIAL, AGRICULTURAL, ENERGY, CHEMICAL, AND CONSUMER GOODS COMPANIES; CALIBRATION SERVICES; LABORATORY SERVICES, NAMELY, ENGINEERING LABORATORY SERVICES, ELECTRICAL LABORATORY SERVICES AND MEDICAL LABORATORY SERVICES; MEDICAL LABORATORY SERVICES, NAMELY, BLOOD TESTING SERVICES AND BODY FLUID TESTING SERVICES; INDUSTRIAL ANALYSIS SERVICES IN THE FIELDS OF MATERIALS, CONSUMER PRODUCTS, VEHICLES, COMMODITIES, MINERALS, FOODS, BEVERAGES, MEDICAL PRODUCTS, PHARMACEUTICALS, BUSINESS

SYSTEMS, MANAGEMENT SYSTEMS, QUALITY MANAGEMENT SYSTEMS, ENVIRONMENTAL MANAGEMENT SYSTEMS AND MANUFACTURING SYSTEMS; INDUSTRIAL AND SCIENTIFIC RESEARCH SERVICES IN THE FIELDS OF MATERIALS, CONSUMER PRODUCTS, VEHICLES, COMMODITIES, MINERALS, FOODS, BEVERAGES, MEDICAL PRODUCTS, PHARMACEUTICALS, BUSINESS SYSTEMS, MANAGEMENT SYSTEMS, QUALITY MANAGEMENT SYSTEMS, ENVIRONMENTAL MANAGEMENT SYSTEMS AND MANUFACTURING SYSTEMS; CERTIFICATION SERVICES, NAMELY, TESTING, ANALYSIS AND EVALUATION OF THE GOODS AND SERVICES OF OTHERS FOR THE PURPOSE OF CERTIFICATION; SAFETY PRODUCT DESIGN SERVICES, NAMELY, DESIGN OF SAFETY MEASURES AND GUIDELINES IN THE FIELDS OF MATERIALS, CONSUMER PRODUCTS, VEHICLES, COMMODITIES, MINERALS, FOODS, BEVERAGES, MEDICAL PRODUCTS, PHARMACEUTICALS, BUSINESS SYSTEMS, MANAGEMENT SYSTEMS, QUALITY MANAGEMENT SYSTEMS, ENVIRONMENTAL MANAGEMENT SYSTEMS AND MANUFACTURING SYSTEMS; ENGINEERING SERVICES, EXCLUDING THOSE IN THE AREA OF PROCESS CONTROL OF LIQUID METALS; PREPARING ENGINEERING ANALYSES AND REPORTS, EXCLUDING THOSE IN THE AREA OF PROCESS CONTROL OF LIQUID METALS; COMPUTER PROGRAMMING FOR OTHERS, IN CLASS 42 (U.S. CLS. 100 AND 101).

THE MARK CONSISTS OF STANDARD CHARACTERS WITHOUT CLAIM TO ANY PARTICULAR FONT, STYLE, SIZE, OR COLOR.

OWNER OF UNITED KINGDOM REG. NO. 2322201, DATED 2-27-2004, EXPIRES 1-29-2013.

OWNER OF U.S. REG. NO. 3,010,514.

SER. NO. 78-795,876, FILED 1-20-2006.

REBECCA POVARCHUK, EXAMINING ATTOR-
NEY

Int. Cl.: 41

Prior U.S. Cls.: 100, 101 and 107

United States Patent and Trademark Office

Reg. No. 3,480,637

Registered Aug. 5, 2008

**SERVICE MARK
PRINCIPAL REGISTER**

WILD ADVENTURES

WILD ADVENTURES VALDOSTA, LLC (GEOR-
GIA LTD LIAB CO)
3766 OLD CLYATTVILLE ROAD
VALDOSTA, GA 31601

THE MARK CONSISTS OF STANDARD CHAR-
ACTERS WITHOUT CLAIM TO ANY PARTICULAR
FONT, STYLE, SIZE, OR COLOR.

FOR: AMUSEMENT PARKS, IN CLASS 41 (U.S.
CLS. 100, 101 AND 107).

SER. NO. 78-797,176, FILED 1-23-2006.

FIRST USE 3-15-1997; IN COMMERCE 3-15-1997.

LINDA ESTRADA, EXAMINING ATTORNEY

Int. Cl.: 43

Prior U.S. Cls.: 100 and 101

United States Patent and Trademark Office

Reg. No. 3,480,638

Registered Aug. 5, 2008

**SERVICE MARK
PRINCIPAL REGISTER**



BONE'S STEAKHOUSE, INC. (FLORIDA CORPORATION)
8214 STATE ROAD 52
HUDSON, FL 34667

FOR: RESTAURANT SERVICES, IN CLASS 43
(U.S. CLS. 100 AND 101).

FIRST USE 1-10-2006; IN COMMERCE 1-10-2006.

NO CLAIM IS MADE TO THE EXCLUSIVE
RIGHT TO USE "TEXAS STEAKHOUSE" AND THE

OUTLINE OF THE STATE OF TEXAS, APART
FROM THE MARK AS SHOWN.

THE NAME(S), PORTRAIT(S), AND/OR SIGNATURE(S) SHOWN IN THE MARK DOES NOT IDENTIFY A PARTICULAR LIVING INDIVIDUAL.

SER. NO. 78-799,707, FILED 1-26-2006.

SEAN CROWLEY, EXAMINING ATTORNEY

Int. Cl.: 40

Prior U.S. Cls.: 100, 103 and 106

United States Patent and Trademark Office

Reg. No. 3,480,639

Registered Aug. 5, 2008

**SERVICE MARK
PRINCIPAL REGISTER**



ANDROID INDUSTRIES, L.L.C. (MICHIGAN
LTD LIAB CO)
2155 EXECUTIVE HILLS BLVD.
AUBURN HILLS, MI 48326

FOR: ASSEMBLY OF PRODUCTS FOR OTHERS,
NAMELY, DRESS AND SEQUENCING OF PRO-
DUCTS FOR THE AUTOMOTIVE INDUSTRY, IN
CLASS 40 (U.S. CLS. 100, 103 AND 106).

FIRST USE 0-0-1989; IN COMMERCE 0-0-1989.

OWNER OF U.S. REG. NO. 3,026,699.

THE MARK CONSISTS OF STYLIZED LETTERS
"A" AND "I".

SER. NO. 78-802,583, FILED 1-30-2006.

TIMOTHY FINNEGAN, EXAMINING ATTORNEY

Int. Cl.: 44

Prior U.S. Cls.: 100 and 101

United States Patent and Trademark Office

Reg. No. 3,480,640

Registered Aug. 5, 2008

**SERVICE MARK
PRINCIPAL REGISTER**

WEEDPRO

WEEDPRO, INC. (GEORGIA CORPORATION)
SUITE 100
11120 INDIAN VILLAGE
ALPHARETTA, GA 30022

THE MARK CONSISTS OF STANDARD CHAR-
ACTERS WITHOUT CLAIM TO ANY PARTICULAR
FONT, STYLE, SIZE, OR COLOR.

FOR: LAWN CARE; LAWN MOWING SERVICES,
IN CLASS 44 (U.S. CLS. 100 AND 101).

SER. NO. 78-807,606, FILED 2-6-2006.

FIRST USE 3-11-2005; IN COMMERCE 5-22-2005.

HOWARD FRIEDMAN, EXAMINING ATTORNEY

Int. Cl.: 12

Prior U.S. Cls.: 19, 21, 23, 31, 35 and 44

Reg. No. 3,480,641

United States Patent and Trademark Office

Registered Aug. 5, 2008

**TRADEMARK
PRINCIPAL REGISTER**

Mirra

MIRRA, DAVID (UNITED STATES INDIVIDUAL)
2008 FERN DRIVE
GREENVILLE, NC 27858

THE MARK CONSISTS OF STANDARD CHAR-
ACTERS WITHOUT CLAIM TO ANY PARTICULAR
FONT, STYLE, SIZE, OR COLOR.

FOR: BICYCLES, BICYCLE PARTS, NAMELY,
PEDALS, HANDLE BAR STEMS, BICYCLE
FRAMES, SADDLES, HANDLE BARS, FORKS,
FRONT FORK JOINTS, FORK CROWN COVERS,
HANDLE BAR GRIPS, WHEEL HUBS, CRANK SET,
BICYCLE RIMS, BICYCLE CHAIRS, SEAT POST
AND SEAT STEM, IN CLASS 12 (U.S. CLS. 19, 21, 23,
31, 35 AND 44).

PRIORITY CLAIMED UNDER SEC. 44(D) ON
TAIWAN APPLICATION NO. 094053252, FILED 11-
4-2005.

SER. NO. 78-812,968, FILED 2-12-2006.

FIRST USE 7-0-1998; IN COMMERCE 7-0-1998.

JORDAN BAKER, EXAMINING ATTORNEY

Int. Cl.: 17

Prior U.S. Cls.: 1, 5, 12, 13, 35 and 50

Reg. No. 3,480,642

United States Patent and Trademark Office

Registered Aug. 5, 2008

**TRADEMARK
PRINCIPAL REGISTER**

HOTTAPE

HOTTAPE ACQUISITION, LLC (NORTH CAROLINA CORPORATION)
115 TODD COURT
THOMASVILLE, NC 27360

THE MARK CONSISTS OF STANDARD CHARACTERS WITHOUT CLAIM TO ANY PARTICULAR FONT, STYLE, SIZE, OR COLOR.

FOR: THERMOPLASTIC ROAD, PAVEMENT, ASPHALT, CONCRETE, AND BRICK MARKING TAPE, IN CLASS 17 (U.S. CLS. 1, 5, 12, 13, 35 AND 50).

SER. NO. 78-824,453, FILED 2-27-2006.

FIRST USE 4-1-1991; IN COMMERCE 4-1-1991.

ALICE BENMAMAN, EXAMINING ATTORNEY

Int. Cl.: 3

Prior U.S. Cls.: 1, 4, 6, 50, 51 and 52

United States Patent and Trademark Office

Reg. No. 3,480,643

Registered Aug. 5, 2008

TRADEMARK
PRINCIPAL REGISTER



COURREGES PARFUMS (FRANCE JOINT
STOCK COMPANY)
40 RUE FRANCOIS 1ER
PARIS, FRANCE 75008

FOR: TOILET SOAPS, PERFUMES, COLOGNE,
TOILET WATERS, ESSENTIAL OILS FOR PERSONAL
USE, SKIN CARE PRODUCTS IN THE FORM
OF MILKS, LOTIONS, CREAMS, EMULSIONS,
GELS FOR FACE AND BODY; LIPSTICKS, LIP-
GLOSS, NAIL VARNISH, MAKE-UP FOUNDATION,
COLORED CREAMS, MASCARAS, EYE SHADOW,
BLUSH, COSMETIC PENCILS, MAKE-UP POWDER,
MAKE-UP REMOVING PREPARATIONS IN THE
FORM OF LOTIONS, MILKS, CREAMS AND GELS;
COSMETIC PREPARATIONS FOR BATH IN THE
FORM OF CREAMS, GELS, OILS, BATH SALTS;
TALCUM POWDER FOR TOILET USE, PERFUMED

POWDER, DEODORANTS FOR PERSONAL USE,
PRE-SHAVE LOTIONS, AFTER-SHAVE LOTIONS,
SHAVING CREAMS, GELS, FOAMS, PRODUCTS
FOR THE HAIR, NAMELY, LACQUER, GELS,
CREAMS, BALMS, FOAMS AND SHAMPOOS, IN
CLASS 3 (U.S. CLS. 1, 4, 6, 50, 51 AND 52).

OWNER OF FRANCE REG. NO. 97667744, DATED
3-10-1997, RENEWED AS REG. NO. 97667744, DATED
1-30-2007, EXPIRES 1-30-2017.

OWNER OF U.S. REG. NOS. 842,656 AND 3,019,860.

SER. NO. 78-829,962, FILED 3-6-2006.

REBECCA SMITH, EXAMINING ATTORNEY

Int. Cl.: 9

Prior U.S. Cls.: 21, 23, 26, 36 and 38

Reg. No. 3,480,644

United States Patent and Trademark Office

Registered Aug. 5, 2008

**TRADEMARK
PRINCIPAL REGISTER**

ILLUMIPRO

MECCA WAREHOUSE LIMITED (NEW ZEALAND COMPANY)
64 DELAMERE RD
HAMILTON, NEW ZEALAND 2015

FOR: PHOTOCOPIERS AND PARTS AND ACCESSORIES THEREFOR, NAMELY, DOCUMENT FEEDERS, DUPLEXING UNITS, DOCUMENT SORTERS, DOCUMENT STAPLING UNITS, AND DOCUMENT FOLDING UNITS; APPARATUS FOR RECORDING, TRANSMISSION OR REPRODUCTION OF DOCUMENTS AND IMAGES; FACSIMILE MACHINES; COMPUTER AND NETWORK PERIPHERALS, NAMELY, SCANNERS, MONITORS, PRINTERS AND MULTIFUNCTIONAL DEVICES COMPOSED OF PRINTER, PHOTOCOPIER, SCANNER AND FACSIMILE MACHINES; REPLACEMENT PARTS FOR ALL OF THE AFORESAID GOODS; COMPUTER SOFTWARE FOR PRINT MANAGEMENT; COMPUTER SOFTWARE FOR THE DISPLAY, MANAGEMENT, EDITING, PRINTING AND SHARING OF DIGITAL IMAGES; COMPUTER HARDWARE, SOFTWARE, AND DEVICES, USED ALONE OR IN COMBINATION, FOR ROUTING, SWITCHING, TRANSMITTING, PROCESSING, FILTERING, ANALYZING, SECURING, AND STORING VIDEO OR VOICE TRAFFIC; TELEPHONES; TELEPHONE HEADSETS; TELEPHONE HANDPIECES, NAMELY, CORDLESS TELEPHONE HANDSETS, WIRED TELEPHONE HANDSETS AND CORDLESS TELEPHONES FOR CONNECTION TO A CELLULAR NETWORK; CORDLESS TELEPHONES; PRIVATE BRANCH EXCHANGE (PBX) AND PRIVATE AUTOMATIC BRANCH EXCHANGE (PABX) SYSTEMS COMPRISED OF TELEPHONES, IP TELEPHONES, COMPUTER SERVERS, AND TELEPHONE SWITCHBOARDS AND EXCHANGERS; WIRELESS PBX AND PABX HARDWARE; COMPUTER HARDWARE AND SOFTWARE FOR MANAGING AND/OR CONTROLLING TELEPHONE COMMUNICATIONS SYSTEMS; SOFTWARE FOR MANAGING AND/OR

CONTROLLING TELEPHONE COMMUNICATIONS TO A CALL CENTER ENVIRONMENT; COMPUTER SOFTWARE FOR MANAGING THE COMMUNICATION FLOWS AND INTERACTIONS BETWEEN TERMINALS AND USERS OVER TELECOMMUNICATIONS NETWORKS; COMPUTER SOFTWARE FOR TRANSMITTING AND RECEIVING VOICE AND/OR DATA OVER TELECOMMUNICATIONS NETWORKS; COMPUTER SOFTWARE FOR ACCESSING, MANAGING, SECURING, OPERATING AND/OR MONITORING TELECOMMUNICATIONS NETWORKS AND TELEPHONY SYSTEMS; COMPUTER SOFTWARE FOR QUALITY CONTROL AND DETECTION OF DEFAULTS AND INCIDENTS IN TELECOMMUNICATIONS NETWORKS; COMPUTER SOFTWARE FOR MANAGING TELEPHONE DIRECTORIES; COMPUTER SOFTWARE FOR CONFIDENTIALITY OF COMMUNICATIONS BY IDENTIFICATION OF THE USERS, BY ACCESS CONTROL, AND BY ENCRYPTING; REMOTE CONTROLS, NAMELY, TELEVISION REMOTE CONTROLS, VCR REMOTE CONTROLS, STEREO REMOTE CONTROLS, AND REMOTE CONTROLS FOR CONTROLLING COMPUTER SOFTWARE RUNNING ON A COMPUTER; TELEVISIONS AND MONITORS; FLAT PANEL TELEVISION AND DISPLAY MONITORS; LCD AND PLASMA TELEVISIONS AND MONITORS; VIDEO PROJECTORS; DIGITAL CAMERAS; TELEVISION TUNERS; SECURITY CAMERAS; VIDEO RECORDERS FOR SECURITY CAMERAS; ALARM SENSORS AND MOTION DETECTORS; VIDEO CONFERENCING EQUIPMENT, NAMELY, VIDEO CAMERAS, VIDEO TRANSCODERS, MICROPHONES AND VIDEO MONITORS, ALL FOR THE PURPOSE OF ALLOWING TWO-WAY AUDIO AND VIDEO COMMUNICATIONS BETWEEN DIFFERENT LOCATION SITES; CAMERAS AND IMAGE CAPTURE DEVICES CONNECTABLE TO A COMPUTER, TELECOMMUNICATIONS NETWORK, OR DATA NETWORK; DIGITAL VIDEO CAMERAS; MICROPHONES; HEADPHONES; VIDEO AMPLIFIERS; VIDEO TU-

NERS; SOFTWARE FOR CONTROLLING CAMERAS OR IMAGE CAPTURING DEVICES FOR SECURITY AND MONITORING, IN CLASS 9 (U.S. CLS. 21, 23, 26, 36 AND 38).

THE MARK CONSISTS OF STANDARD CHARACTERS WITHOUT CLAIM TO ANY PARTICULAR FONT, STYLE, SIZE, OR COLOR.

PRIORITY CLAIMED UNDER SEC. 44(D) ON NEW ZEALAND APPLICATION NO. NZ743248, FILED 2-21-2006, REG. NO. 743248, DATED 2-21-2006, EXPIRES 2-21-2016.

SER. NO. 78-830,183, FILED 3-6-2006.

ESTHER BELENKER, EXAMINING ATTORNEY

Int. Cls.: 5, 29 and 30

Prior U.S. Cls.: 6, 18, 44, 46, 51 and 52

United States Patent and Trademark Office

Reg. No. 3,480,645

Registered Aug. 5, 2008

TRADEMARK
PRINCIPAL REGISTER



TRIALIA FOODS AUSTRALIA PTY LTD (AUSTRALIA CORPORATION)
424-426 PRINCES HIGHWAY
NOBLE PARK NORTH, AUSTRALIA 3174

FOR: BISCUITS, BREAD, BREAD ROLLS, CAKES, CEREAL PRODUCTS, CONFECTIONERY, CRACKERS, NOODLES, FISH SAUCE, RELISH, SAUCES, CEREAL-BASED SNACK-FOODS AND PREPARED DIETARY ITEMS THAT ARE GLUTEN-FREE TO ACCOMMODATE SPECIAL MEDICAL AND HEALTH CONDITIONS, IN CLASS 5 (U.S. CLS. 6, 18, 44, 46, 51 AND 52).

FIRST USE 7-1-1978; IN COMMERCE 10-1-2005.

FOR: PICKLED FISH; PICKLES, IN CLASS 29 (U.S. CL. 46).

FIRST USE 7-1-1978; IN COMMERCE 10-1-2005.

FOR: BISCUITS; BREAD ROLLS; CAKES; CEREAL BASED SNACK FOOD; CRACKERS; NOODLES; RELISH, IN CLASS 30 (U.S. CL. 46).

FIRST USE 7-1-1978; IN COMMERCE 10-1-2005.

THE MARK CONSISTS OF THE WORD "ESKAL" IN A SCRIPT-LIKE FONT INSIDE A DARKER OVAL

SER. NO. 78-830,207, FILED 3-6-2006.

KELLY BOULTON, EXAMINING ATTORNEY

Int. Cl.: 41

Prior U.S. Cls.: 100, 101 and 107

United States Patent and Trademark Office

Reg. No. 3,480,646

Registered Aug. 5, 2008

**SERVICE MARK
PRINCIPAL REGISTER**

MUSIC RHAPSODY

LYNN KLEINER'S MUSIC RHAPSODY (CALI-
FORNIA CORPORATION)
1603 AVIATION BLVD.
SUITE 1
REDONDO BEACH, CA 90278

FOR: EDUCATIONAL SERVICES, NAMELY, IN-
STRUCTION IN THE FIELDS OF MUSIC AND
MUSIC APPRECIATION, IN CLASS 41 (U.S. CLS.
100, 101 AND 107).

FIRST USE 0-0-1983; IN COMMERCE 0-0-1998.

THE MARK CONSISTS OF STANDARD CHAR-
ACTERS WITHOUT CLAIM TO ANY PARTICULAR
FONT, STYLE, SIZE, OR COLOR.

NO CLAIM IS MADE TO THE EXCLUSIVE
RIGHT TO USE "MUSIC", APART FROM THE
MARK AS SHOWN.

SER. NO. 78-834,783, FILED 3-10-2006.

MARIAM MAHMOUDI, EXAMINING ATTORNEY

Int. Cls.: 35 and 39

Prior U.S. Cls.: 100, 101, 102 and 105

United States Patent and Trademark Office

Reg. No. 3,480,647

Registered Aug. 5, 2008

**SERVICE MARK
PRINCIPAL REGISTER**

**TEMPERATURE-CRITICAL
DELIVERY EXPERTS**

MARITIME-ONTARIO FREIGHT LINES LIM-
ITED (CANADA CORPORATION)
1 MARITIME-ONTARIO BLVD.
BRAMPTON, ONTARIO L6S 6G4

FOR: ARRANGING FOR PICK UP, DELIVERY,
STORAGE AND TRANSPORTATION OF TEM-
PERATURE SENSITIVE GOODS VIA DEDICATED
CONTRACT GROUND AND AIR CARRIERS;
MANAGING A FLEET OF CUSTOMIZED VEHIC-
LES OF AND FOR OTHERS THAT PROVIDE A
FULL RANGE OF CLIMATE CONTROL DESIGNED
TO PROVIDE TEMPERATURE CONTROLLED DE-
LIVERIES, IN CLASS 35 (U.S. CLS. 100, 101 AND 102).

FOR: FORWARDING, TRANSPORTATION AND
DISTRIBUTION OF TEMPERATURE CONTROL
SHIPMENTS BY TRUCK, TRAIN, BOAT AND AIR,
IN CLASS 39 (U.S. CLS. 100 AND 105).

THE MARK CONSISTS OF STANDARD CHAR-
ACTERS WITHOUT CLAIM TO ANY PARTICULAR
FONT, STYLE, SIZE, OR COLOR.

PRIORITY CLAIMED UNDER SEC. 44(D) ON
CANADA APPLICATION NO. 1291466, FILED 2-24-
2006, REG. NO. TMA695956, DATED 9-7-2007, EX-
PIRES 9-7-2022.

NO CLAIM IS MADE TO THE EXCLUSIVE
RIGHT TO USE "DELIVERY EXPERTS", APART
FROM THE MARK AS SHOWN.

SER. NO. 78-837,825, FILED 3-15-2006.

WILLIAM P. SHANAHAN, EXAMINING ATTOR-
NEY

Int. Cl.: 9

Prior U.S. Cls.: 21, 23, 26, 36 and 38

Reg. No. 3,480,648

United States Patent and Trademark Office

Registered Aug. 5, 2008

**TRADEMARK
PRINCIPAL REGISTER**

POWER BLOCKER

PHILIPS ELECTRONICS NORTH AMERICA
CORPORATION (DELAWARE CORPORATION)

1251 AVENUE OF THE AMERICAS
NEW YORK, NY 100201104

FOR: MULTI-OUTLET SOCKET BLOCKS; VOLTAGE SURGE SUPPRESSORS, IN CLASS 9 (U.S. CLS. 21, 23, 26, 36 AND 38).

FIRST USE 1-30-1995; IN COMMERCE 1-30-1995.

THE MARK CONSISTS OF STANDARD CHARACTERS WITHOUT CLAIM TO ANY PARTICULAR FONT, STYLE, SIZE, OR COLOR.

OWNER OF U.S. REG. NO. 1,980,837.

NO CLAIM IS MADE TO THE EXCLUSIVE RIGHT TO USE "POWER", APART FROM THE MARK AS SHOWN.

SER. NO. 78-837,955, FILED 3-15-2006.

DORITT L. CARROLL, EXAMINING ATTORNEY

Int. Cls.: 16, 31, 35 and 41

**Prior U.S. Cls.: 1, 2, 5, 22, 23, 29, 37, 38, 46, 50, 100,
101, 102 and 107**

Reg. No. 3,480,649

United States Patent and Trademark Office

Registered Aug. 5, 2008

**TRADEMARK
SERVICE MARK
PRINCIPAL REGISTER**

ALL-AMERICA ROSE SELECTIONS

ALL-AMERICA ROSE SELECTIONS, INC. (PENN-
SYLVANIA NON-PROFIT CORPORATION)
SUITE 1400
388 MARKET STREET
SAN FRANCISCO, CA 94111

FOR: PRINTED PUBLICATIONS, NAMELY,
NEWSLETTERS PROMOTING INTEREST IN THE
INTRODUCTION, SALE, AND GROWING OF RO-
SES, IN CLASS 16 (U.S. CLS. 2, 5, 22, 23, 29, 37, 38 AND
50).

FIRST USE 5-5-1938; IN COMMERCE 5-5-1938.

FOR: LIVE PLANTS, IN CLASS 31 (U.S. CLS. 1
AND 46).

FIRST USE 5-5-1938; IN COMMERCE 5-5-1938.

FOR: ASSOCIATION SERVICES, NAMELY, PRO-
MOTING INTEREST IN THE INTRODUCTION,
SALE AND GROWING OF ROSES THROUGH THE
DISSEMINATION OF ON-LINE NEWSLETTERS,
CONDUCTING CONTESTS, AND ACCREDITING

PUBLIC GARDENS, IN CLASS 35 (U.S. CLS. 100, 101
AND 102).

FIRST USE 5-5-1938; IN COMMERCE 5-5-1938.

FOR: ARRANGING AND CONDUCTING CON-
TESTS IN THE FIELD OF HORTICULTURE, IN
CLASS 41 (U.S. CLS. 100, 101 AND 107).

FIRST USE 5-5-1938; IN COMMERCE 5-5-1938.

THE MARK CONSISTS OF STANDARD CHAR-
ACTERS WITHOUT CLAIM TO ANY PARTICULAR
FONT, STYLE, SIZE, OR COLOR.

NO CLAIM IS MADE TO THE EXCLUSIVE
RIGHT TO USE "ROSE SELECTIONS", APART
FROM THE MARK AS SHOWN.

SER. NO. 78-838,257, FILED 3-15-2006.

ZACHARY BELLO, EXAMINING ATTORNEY

Int. Cl.: 44

Prior U.S. Cls.: 100 and 101

United States Patent and Trademark Office

Reg. No. 3,480,650

Registered Aug. 5, 2008

**SERVICE MARK
PRINCIPAL REGISTER**

MONKEY DIET TYPE

HAUSER, MARION A. (UNITED STATES INDIVIDUAL)
715 LAKE STREET, SUITE 600
OAK PARK, IL 60301 AND
HAUSER, ROSS A. (UNITED STATES INDIVIDUAL)
715 LAKE STREET, SUITE 600
OAK PARK, IL 60301

FOR: HEALTH AND NUTRITION CONSULTING
SERVICES, IN CLASS 44 (U.S. CLS. 100 AND 101).

FIRST USE 1-31-2003; IN COMMERCE 1-31-2003.

THE MARK CONSISTS OF STANDARD CHARACTERS WITHOUT CLAIM TO ANY PARTICULAR FONT, STYLE, SIZE, OR COLOR.

NO CLAIM IS MADE TO THE EXCLUSIVE RIGHT TO USE "DIET TYPE", APART FROM THE MARK AS SHOWN.

SER. NO. 78-840,199, FILED 3-17-2006.

RAMONA ORTIGA, EXAMINING ATTORNEY

Int. Cl.: 30

Prior U.S. Cl.: 46

United States Patent and Trademark Office

Reg. No. 3,480,651

Registered Aug. 5, 2008

TRADEMARK
PRINCIPAL REGISTER



RUM CAKE FAIRY DESSERT COMPANY LLC
(NEW JERSEY LTD LIAB CO)
390 AMWELL ROAD
BUILDING 3, SUITE 312
HILLSBOROUGH, NJ 08844

FOR: BAKERY DESSERTS; BAKERY GOODS;
BAKERY PRODUCTS, IN CLASS 30 (U.S. CL. 46).

FIRST USE 1-27-2006; IN COMMERCE 2-2-2006.

NO CLAIM IS MADE TO THE EXCLUSIVE
RIGHT TO USE "RUM CAKE" "DELICATELY FLA-
VORED" "DELICIOUSLY MOIST" AND "DESSERT
COMPANY LLC", APART FROM THE MARK AS
SHOWN.

THE COLOR(S) GREEN, PINK, ORANGE AND
BROWN IS/ARE CLAIMED AS A FEATURE OF THE
MARK.

THE MARK CONSISTS OF AN ORANGE FAIRY
FLOATING WITH A BROWN RUM CAKE TO THE
RIGHT OF THE WORDS "RUM CAKE" IN GREEN,
ALL OVER THE WORD "FAIRY" AND "DESSERT
COMPANY LLC" IN PINK BELOW AND RIGHT
WITH THE WORDS "DELICATELY FLAVORED"
AND "DELICIOUSLY MOIST" IN GREEN ABOVE
AND RIGHT.

SER. NO. 78-842,190, FILED 3-21-2006.

JAMES STEIN, EXAMINING ATTORNEY

Int. Cl.: 5

Prior U.S. Cls.: 6, 18, 44, 46, 51 and 52

United States Patent and Trademark Office

Reg. No. 3,480,652

Registered Aug. 5, 2008

**TRADEMARK
PRINCIPAL REGISTER**

ECHINAMAX

WN PHARMACEUTICALS LTD. (CANADA CORPORATION)

2000 BRIGANTINE DRIVE

COQUITLAM, CANADA V3K 7B5

FOR: DIETARY AND NUTRITIONAL SUPPLEMENTS; HERBAL SUPPLEMENTS, IN CLASS 5 (U.S. CLS. 6, 18, 44, 46, 51 AND 52).

THE MARK CONSISTS OF STANDARD CHARACTERS WITHOUT CLAIM TO ANY PARTICULAR FONT, STYLE, SIZE, OR COLOR.

OWNER OF CANADA REG. NO. TMA558926, DATED 3-7-2002, EXPIRES 3-7-2017.

SER. NO. 78-842,226, FILED 3-21-2006.

CAROLYN GRAY, EXAMINING ATTORNEY

Int. Cls.: 35, 41 and 44

Prior U.S. Cls.: 100, 101, 102 and 107

United States Patent and Trademark Office

Reg. No. 3,480,653

Registered Aug. 5, 2008

**SERVICE MARK
PRINCIPAL REGISTER**

RECESS

RECESS FITNESS, HEALTH AND PLAY LLC
(OREGON LTD LIAB CO)
3905 NE RODNEY AV.
PORTLAND, OR 972121047

FOR: ADVERTISING AND PROMOTION SERVICES AND RELATED CONSULTING IN CONNECTION WITH HEALTH, NUTRITION, LIFESTYLE, SPORTS, AND WELLNESS FOR ADULTS; CONDUCTING BUSINESS AND MARKET RESEARCH SURVEYS IN CONNECTION WITH HEALTH, NUTRITION, LIFESTYLE, SPORTS, AND WELLNESS FOR ADULTS; CONDUCTING EMPLOYEE INCENTIVE AWARD PROGRAMS TO PROMOTE HEALTH, NUTRITION, LIFESTYLE, SPORTS AND WELLNESS FOR ADULTS; HEALTH CARE COST CONTAINMENT FOR ADULTS; HUMAN RESOURCES CONSULTATION FOR ADULTS; MANAGEMENT AND BUSINESS CONSULTING SERVICES IN THE FIELD OF HEALTH, NUTRITION, LIFESTYLE, SPORTS AND WELLNESS FOR ADULTS; MARKET RESEARCH AND ANALYSIS REGARDING HEALTH, NUTRITION, LIFESTYLE, SPORTS, AND WELLNESS FOR ADULTS; PROMOTING PUBLIC AWARENESS OF HEALTH, NUTRITION, LIFESTYLE, SPORTS AND WELLNESS FOR ADULTS, IN CLASS 35 (U.S. CLS. 100, 101 AND 102).

FIRST USE 11-11-2005; IN COMMERCE 11-23-2005.

FOR: EDUCATION SERVICES, NAMELY, PROVIDING CLASSES, TUTORING, INSTRUCTION,

COACHING, AND SEMINARS IN THE FIELD OF HEALTH, NUTRITION, LIFESTYLE, SPORTS AND WELLNESS FOR ADULTS, EXCLUDING HOSPITAL PATIENTS; EDUCATIONAL SERVICES, NAMELY, CONDUCTING ON-LINE EXHIBITIONS AND DISPLAYS AND INTERACTIVE EXHIBITS IN THE FIELD OF HEALTH, NUTRITION, LIFESTYLE, SPORTS AND WELLNESS FOR ADULTS, EXCLUDING HOSPITAL PATIENTS; PHYSICAL FITNESS CONSULTATION FOR ADULTS, IN CLASS 41 (U.S. CLS. 100, 101 AND 107).

FIRST USE 11-11-2005; IN COMMERCE 11-23-2005.

FOR: CONSULTING SERVICES IN THE FIELD OF MENTAL FITNESS FOR ADULTS; FOOD NUTRITION CONSULTATION FOR ADULTS; NUTRITION COUNSELING FOR ADULTS, IN CLASS 44 (U.S. CLS. 100 AND 101).

FIRST USE 11-11-2005; IN COMMERCE 11-23-2005.

THE MARK CONSISTS OF STANDARD CHARACTERS WITHOUT CLAIM TO ANY PARTICULAR FONT, STYLE, SIZE, OR COLOR.

SER. NO. 78-845,045, FILED 3-24-2006.

CARRIE GENOVESE, EXAMINING ATTORNEY

Int. Cl.: 25

Prior U.S. Cls.: 22 and 39

United States Patent and Trademark Office

Reg. No. 3,480,654

Registered Aug. 5, 2008

**TRADEMARK
PRINCIPAL REGISTER**

TONY BENNETT

BENEDETTO ARTS GMBH (FED REP GERMA-
NY GMBH)
GRUENEWALDER STR. 30
SOLINGEN, FED REP GERMANY 42657

FOR: CLOTHING, NAMELY, SWEATERS, T-
SHIRTS, SUITS, TIES, SHIRTS, DRESS SHIRTS,
OVERCOATS, RAIN COATS, DOWN JACKETS,
EAR MUFFS, FUR JACKETS, TUXEDOS, SPORTS
JACKETS, LEATHER JACKETS, SWIMMING
TRUNKS, TIES, BOW TIES, BRIEFS, GLOVES,
SOCKS AND BELTS; FOOTWEAR, NAMELY,
SHOES, ATHLETIC SHOES, SNEAKERS, SANDALS,
SLIPPERS AND BOOTS; HEADGEAR, NAMELY,
HATS, CAPS, GOLF CAPS AND BASEBALL CAPS,
IN CLASS 25 (U.S. CLS. 22 AND 39).

THE MARK CONSISTS OF STANDARD CHAR-
ACTERS WITHOUT CLAIM TO ANY PARTICULAR
FONT, STYLE, SIZE, OR COLOR.

PRIORITY CLAIMED UNDER SEC. 44(D) ON FED
REP GERMANY APPLICATION NO. 305569139,
FILED 9-27-2005, REG. NO. 30556913, DATED 12-1-
2005, EXPIRES 9-30-2015.

THE NAME(S), PORTRAIT(S), AND/OR SIGNA-
TURE(S) SHOWN IN THE MARK IDENTIFIES
"TONY BENNETT" , WHOSE CONSENT(S) TO REG-
ISTER IS SUBMITTED.

SER. NO. 78-845,790, FILED 3-24-2006.

JOHN WILKE, EXAMINING ATTORNEY

Int. Cl.: 5

Prior U.S. Cls.: 6, 18, 44, 46, 51 and 52

United States Patent and Trademark Office

Reg. No. 3,480,655

Registered Aug. 5, 2008

**TRADEMARK
PRINCIPAL REGISTER**

CHOLESTEROL ESSENTIALS

HEALTHY DIRECTIONS, LLC (DELAWARE LTD
LIAB CO)

7811 MONTROSE ROAD

POTOMAC, MD 20854

FOR: NUTRITIONAL SUPPLEMENTS, IN CLASS
5 (U.S. CLS. 6, 18, 44, 46, 51 AND 52).

FIRST USE 5-0-2002; IN COMMERCE 5-0-2002.

THE MARK CONSISTS OF STANDARD CHAR-
ACTERS WITHOUT CLAIM TO ANY PARTICULAR
FONT, STYLE, SIZE, OR COLOR.

NO CLAIM IS MADE TO THE EXCLUSIVE
RIGHT TO USE "CHOLESTEROL", APART FROM
THE MARK AS SHOWN.

SER. NO. 78-848,668, FILED 3-29-2006.

MARY CRAWFORD, EXAMINING ATTORNEY

Int. Cl.: 30

Prior U.S. Cl.: 46

United States Patent and Trademark Office

Reg. No. 3,480,656

Registered Aug. 5, 2008

**TRADEMARK
PRINCIPAL REGISTER**

GUSTO ITALIA

PIAZZA TOMASSO INTERNATIONAL INC. (CANADA CORPORATION)
SUITE 2120
300, LEO-PARISEAU
MONTREAL (QUEBEC), CANADA H2X 4B3

FOR: FROZEN ENTREES AND MEALS, NAMELY, LASAGNA WITH MEAT, VEGETARIAN LASAGNA, FIORENTINA CANNELLONI, CANNELLONI WITH MEAT, MACARONI WITH CHEESE, MACARONI WITH BEEF, IN CLASS 30 (U.S. CL. 46).

THE MARK CONSISTS OF STANDARD CHARACTERS WITHOUT CLAIM TO ANY PARTICULAR FONT, STYLE, SIZE, OR COLOR.

PRIORITY CLAIMED UNDER SEC. 44(D) ON CANADA APPLICATION NO. 1286984, FILED 1-13-2006, REG. NO. TMA678,049, DATED 12-1-2006, EXPIRES 12-1-2021.

NO CLAIM IS MADE TO THE EXCLUSIVE RIGHT TO USE "ITALIA", APART FROM THE MARK AS SHOWN.

THE FOREIGN WORDING IN THE MARK TRANSLATES INTO ENGLISH AS TASTE ITALY, RELISH ITALY, OR ZEST ITALY.

SER. NO. 78-848,964, FILED 3-29-2006.

JAMES STEIN, EXAMINING ATTORNEY

Int. Cl.: 30

Prior U.S. Cl.: 46

United States Patent and Trademark Office

Reg. No. 3,480,657

Registered Aug. 5, 2008

**TRADEMARK
PRINCIPAL REGISTER**

GUSTO ITALIA

PIAZZA TOMASSO INTERNATIONAL INC. (CANADA CORPORATION)
SUITE 2120
300, LEO-PARISEAU
MONTREAL (QUEBEC), CANADA H2X 4B3

FOR: FROZEN ENTREES AND MEALS, NAME-
LY, LASAGNA WITH MEAT, VEGETARIAN LA-
SAGNA, FIORENTINA CANNELLONI,
CANNELLONI WITH MEAT, MACARONI WITH
CHEESE, MACARONI WITH BEEF, IN CLASS 30
(U.S. CL. 46).

PRIORITY CLAIMED UNDER SEC. 44(D) ON
CANADA APPLICATION NO. 1294842, FILED 3-23-

2006, REG. NO. TMA677,945, DATED 11-30-2006,
EXPIRES 11-30-2021.

NO CLAIM IS MADE TO THE EXCLUSIVE
RIGHT TO USE "ITALIA", APART FROM THE
MARK AS SHOWN.

THE FOREIGN WORDING IN THE MARK
TRANSLATES INTO ENGLISH AS TASTE ITALY,
RELISH ITALY, OR ZEST ITALY.

SER. NO. 78-849,004, FILED 3-29-2006.

JAMES STEIN, EXAMINING ATTORNEY

Int. Cls.: 35 and 42

Prior U.S. Cls.: 100, 101 and 102

United States Patent and Trademark Office

Reg. No. 3,480,658

Registered Aug. 5, 2008

**SERVICE MARK
PRINCIPAL REGISTER**

ARESCO

AURELIO, JULIO FRANCISCO ANTONIO (ARGENTINA INDIVIDUAL)
AV. SANTA FE 936, 3RD FLOOR
BUENOS AIRES, ARGENTINA 1059

FOR: CONSULTING SERVICES COMPRISING THE PROVISION OF STATISTIC INFORMATION OF PUBLIC OPINION IN THE FIELD OF POLITICS AND SOCIO-POLITICAL STUDIES; PROFESSIONAL CONSULTATION COMPRISING THE PROVISION OF EVALUATIONS, ESTIMATIONS, RESEARCHES AND REPORTS OF REALITY DATA IN THE FIELDS OF: MARKET INVESTIGATION, ECONOMIC, BUSINESS AND STATISTICAL STUDIES, MARKETING, ADVERTISING, RATING MEASUREMENT ON TV, IMAGE CAMPAIGNS, IN CLASS 35 (U.S. CLS. 100, 101 AND 102).

FIRST USE 3-0-2006; IN COMMERCE 3-0-2006.

FOR: PROFESSIONAL CONSULTATION COMPRISING THE PROVISION OF EVALUATIONS, ES-

TIMATIONS, RESEARCHES AND REPORTS OF REALITY DATA IN THE FIELDS OF: COMPUTER AND TECHNOLOGICAL ADVICE SERVICES, COMPUTERS AND SOFTWARE DESIGN AND DEVELOPMENT, AND LEGAL SERVICES, IN CLASS 42 (U.S. CLS. 100 AND 101).

FIRST USE 3-0-2006; IN COMMERCE 3-0-2006.

THE MARK CONSISTS OF STANDARD CHARACTERS WITHOUT CLAIM TO ANY PARTICULAR FONT, STYLE, SIZE, OR COLOR.

OWNER OF ARGENTINA REG. NO. 1767375, DATED 4-16-2001, EXPIRES 4-16-2011.

SER. NO. 78-850,282, FILED 3-30-2006.

MARK PILARO, EXAMINING ATTORNEY

Int. Cls.: 39, 41 and 43

Prior U.S. Cls.: 100, 101, 105 and 107

United States Patent and Trademark Office

Reg. No. 3,480,659

Registered Aug. 5, 2008

**SERVICE MARK
PRINCIPAL REGISTER**

P&O CRUISES

THE PENINSULAR AND ORIENTAL STEAM
NAVIGATION COMPANY (UNITED KING-
DOM CORPORATION)
79 PALL MALL
LONDON, UNITED KINGDOM SW1Y 5EJ

FOR: CRUISE SHIP SERVICES; TRAVEL AGEN-
CY SERVICES, NAMELY, MAKING RESERVA-
TIONS AND BOOKINGS FOR TRANSPORTATION
, IN CLASS 39 (U.S. CLS. 100 AND 105).

FIRST USE 0-0-1932; IN COMMERCE 0-0-1969.

FOR: RECREATIONAL SERVICES IN THE NAT-
URE OF SWIMMING POOLS, PROVIDING SPORTS
HALL FACILITIES, RENTAL OF GOLF, SHUFFLE-
BOARD, VOLLEYBALL, TENNIS AND TABLE TEN-
NIS EQUIPMENT FOR SPORTS ACTIVITIES,
GYMNASIUMS, EDUCATION SERVICES, NAME-
LY, PROVIDING CLASSES, SEMINARS AND
WORKSHOPS IN CULTURAL ACTIVITIES IN THE
FIELDS OF ARTS, LITERATURE AND GEOGRA-
PHY; ENTERTAINMENT IN THE NATURE OF
VISUAL AND AUDIO PERFORMANCES, AND MU-
SICAL, VARIETY, DANCE AND COMEDY SHOWS;
PRESENTATION OF LIVE SHOW PERFORMAN-
CES; PROVIDING FACILITIES FOR MOVIES,
SHOWS, PLAYS, MUSIC OR EDUCATIONAL
TRAINING; PLANNING ARRANGEMENT OF
SHOWING MOVIES, SHOWS, PLAYS OR MUSICAL
PERFORMANCES; DANCE EVENTS; DANCE IN-

STRUCTION; DISCOTHEQUES; NIGHT CLUBS; OR-
GANIZING AND CONDUCTING SWIMMING POOL
AND POOLSIDE RECREATIONAL GAMES AND
CONTESTS, IN CLASS 41 (U.S. CLS. 100, 101 AND
107).

FIRST USE 0-0-1932; IN COMMERCE 0-0-1969.

FOR: RESTAURANT AND BAR SERVICES; PRO-
VISION OF TEMPORARY ACCOMMODATION, IN
CLASS 43 (U.S. CLS. 100 AND 101).

FIRST USE 0-0-1932; IN COMMERCE 0-0-1969.

THE MARK CONSISTS OF STANDARD CHAR-
ACTERS WITHOUT CLAIM TO ANY PARTICULAR
FONT, STYLE, SIZE, OR COLOR.

PRIORITY CLAIMED UNDER SEC. 44(D) ON
ERPN CMNTY TM OFC APPLICATION NO.
004840302, FILED 1-17-2006.

NO CLAIM IS MADE TO THE EXCLUSIVE
RIGHT TO USE "CRUISES", APART FROM THE
MARK AS SHOWN.

SER. NO. 78-854,499, FILED 4-5-2006.

LAURA HAMMEL, EXAMINING ATTORNEY

Int. Cl.: 35

Prior U.S. Cls.: 100, 101 and 102

United States Patent and Trademark Office

Reg. No. 3,480,660

Registered Aug. 5, 2008

**SERVICE MARK
PRINCIPAL REGISTER**

BRIDGE LIGHTING

INTERLINE BRANDS, INC. (NEW JERSEY CORPORATION)
801 BAY STREET
JACKSONVILLE, FL 32204

FOR: RETAIL CATALOG SERVICES IN THE FIELD OF LIGHTING PRODUCTS, LIGHTING FIXTURES, LIGHT BULBS, LAMPS, CLOCKS, AND CEILING FANS, IN CLASS 35 (U.S. CLS. 100, 101 AND 102).

FIRST USE 3-27-2006; IN COMMERCE 3-27-2006.

THE MARK CONSISTS OF STANDARD CHARACTERS WITHOUT CLAIM TO ANY PARTICULAR FONT, STYLE, SIZE, OR COLOR.

NO CLAIM IS MADE TO THE EXCLUSIVE RIGHT TO USE "LIGHTING", APART FROM THE MARK AS SHOWN.

SER. NO. 78-857,731, FILED 4-10-2006.

JUSTINE D. PARKER, EXAMINING ATTORNEY

Int. Cl.: 12

Prior U.S. Cls.: 19, 21, 23, 31, 35 and 44

United States Patent and Trademark Office

Reg. No. 3,480,661

Registered Aug. 5, 2008

TRADEMARK
PRINCIPAL REGISTER

Honda Lock

HONDA LOCK MFG. CO., LTD. (JAPAN CORPORATION)

3700, AZA-WADAYAMA, OAZA-SHIMONAKA

SADOWARA-CHO

MIYAZAKI-CITY, MIYAZAKI, JAPAN 880-0293

FOR: SENSORS FOR LAND VEHICLES, NAME-
LY, WHEEL SENSORS FOR ANTI-LOCK BRAKE
SYSTEMS, AND ELECTRIC POWER STEERING
TORQUE SENSORS, ALL SOLD AS COMPONENTS
OF THE ANTI-LOCK BRAKE SYSTEMS AND POW-
ER STEERING SYSTEMS; MIRROR SYSTEMS FOR
LAND VEHICLES, NAMELY, DOOR MIRRORS,
SIDE UNDER MIRRORS, REAR VIEW MIRRORS,
REAR UNDER MIRRORS; ENTRY SYSTEMS FOR
LAND VEHICLES, NAMELY, SMART ENTRY DE-
VICES COMPRISING KEYLESS DOOR LATCHES,
OUTSIDE DOOR HANDLES, INSIDE DOOR HAN-
DLES, POWER SLIDE DOOR LOCKS; SECURITY
SYSTEMS FOR LAND VEHICLES, NAMELY, IM-
MOBILIZER SYSTEMS, FOR VEHICLES COM-
PRISED OF REMOTE CONTROLLER AND
RECEIVER WITH BUILT-IN ELECTRIC CIRCUIT
TO OPEN AND SHUT DOORS, AND TO START
AND HALT ENGINES FOR SECURITY SYSTEMS

FOR VEHICLES; STEERING WHEEL LOCKS COM-
PRISING SWITCHES, LOCK CYLINDERS, AND
KEYS; GAS CAPS FOR LAND VEHICLES; HELMET
HOLDERS AND SEAT LOCKS FOR MOTOR-
CYCLES, IN CLASS 12 (U.S. CLS. 19, 21, 23, 31, 35
AND 44).

FIRST USE 5-1-2005; IN COMMERCE 5-1-2005.

NO CLAIM IS MADE TO THE EXCLUSIVE
RIGHT TO USE "LOCK", APART FROM THE MARK
AS SHOWN.

THE COLOR(S) RED IS/ARE CLAIMED AS A
FEATURE OF THE MARK.

THE MARK CONSISTS OF THE WORDS "HON-
DA LOCK" IN RED.

SER. NO. 78-861,276, FILED S.R. 4-13-2006 AM. P.R.
2-11-2008.

ESTHER BELENKER, EXAMINING ATTORNEY

Int. Cl.: 5

Prior U.S. Cls.: 6, 18, 44, 46, 51 and 52

United States Patent and Trademark Office

Reg. No. 3,480,662

Registered Aug. 5, 2008

TRADEMARK
PRINCIPAL REGISTER



REDOBLE, VICTORIA (UNITED STATES INDIVIDUAL)
13518 HIKE LANE
SAN DIEGO, CA 92129

FOR: NUTRITIONALLY FORTIFIED BEVERAGES USED TO ASSIST WOMEN WITH MENOPAUSE AND HOT FLASH SYMPTOMS, IN CLASS 5 (U.S. CLS. 6, 18, 44, 46, 51 AND 52).

FIRST USE 3-1-2005; IN COMMERCE 3-1-2005.

NO CLAIM IS MADE TO THE EXCLUSIVE RIGHT TO USE "COOLS HOT FLASHES FAST", APART FROM THE MARK AS SHOWN.

THE COLOR(S) RED, BLUE, MAGENTA, YELLOW, ORANGE, GREEN, GRAY, BROWN, TAN AND WHITE IS/ARE CLAIMED AS A FEATURE OF THE MARK.

THE COLOR RED IS LOCATED IN THE HEARTS, STRAWBERRIES AND MANGOES. THE COLOR

BLUE IS LOCATED IN THE DRESS, WATER DROPS, WATER PUDDLE, LIQUID IN THE BOTTLE, SHOES, WORDING "VICKI'S FLASH POPS", THE BLUEBERRIES AND THE BANNER. THE COLOR YELLOW IS LOCATED IN THE HAIR, PINEAPPLES, BANANA, MANGO, THE OUTLINES OF "VICKI'S FLASH POPS" AND THE BANNER. THE COLOR ORANGE IS IN THE PINEAPPLE, ORANGES, AND MANGOES. THE COLOR GREEN IS LOCATED IN THE PINEAPPLE STEM. THE COLOR BROWN IS LOCATED IN THE MANGO SEEDS. THE COLOR TAN IS LOCATED IN THE WOMAN'S SKIN. THE COLOR GREY IS LOCATED IN THE CLOTH HELD BY THE WOMAN. THE COLOR WHITE IS LOCATED IN THE WOMAN'S SLEEVE, THE ORANGES AND THE WORDING "COOLS HOT FLASHES FAST!".

SER. NO. 78-867,819, FILED 4-24-2006.

TRACY WHITTAKER-BROWN, EXAMINING ATTORNEY

Int. Cl.: 16

Prior U.S. Cls.: 2, 5, 22, 23, 29, 37, 38 and 50

United States Patent and Trademark Office

Reg. No. 3,480,663

Registered Aug. 5, 2008

**TRADEMARK
PRINCIPAL REGISTER**



HENKEL KGAA (FED REP GERMANY PART-
NERSHIP LIMITED BY SHARES)
HENKELSTRASSE 67
DUESSELDORF, FED REP GERMANY D-40191

FOR: GLUE STICKS FOR STATIONERY OR
HOUSEHOLD USE, NAMELY, ADHESIVE STICKS
AND ADHESIVE ROLLERS; CORRECTION PRO-
DUCTS, NAMELY, CORRECTION TAPES, COR-
RECTION PENS AND CORRECTION FLUIDS FOR
DOCUMENTS; ADHESIVE TAPES FOR HOUSE-
HOLD AND STATIONERY PURPOSES, IN CLASS
16 (U.S. CLS. 2, 5, 22, 23, 29, 37, 38 AND 50).

PRIORITY CLAIMED UNDER SEC. 44(D) ON FED
REP GERMANY APPLICATION NO. 305628976,
FILED 11-18-2005, REG. NO. 30562897, DATED 12-6-
2005, EXPIRES 11-30-2015.

THE COLOR(S) BLACK AND ORANGE IS/ARE
CLAIMED AS A FEATURE OF THE MARK.

THE MARK CONSISTS OF THE WORDING
"EPIX" WITH CIRCLE AND HORIZONTAL LINES.
THE COLOR BLACK APPEARS AS THE WORDING
"EPIX" AND THE COLOR ORANGE APPEARS AS
THE CIRCLE AND HORIZONTAL LINES. THE
BACKGROUND IS TRANSLUCENT, INCLUDING
THE SPACE BETWEEN THE "E" AND THE "P".

SER. NO. 78-869,292, FILED 4-25-2006.

ROBERT STRUCK, EXAMINING ATTORNEY

Int. Cl.: 16

Prior U.S. Cls.: 2, 5, 22, 23, 29, 37, 38 and 50

Reg. No. 3,480,664

United States Patent and Trademark Office

Registered Aug. 5, 2008

**TRADEMARK
PRINCIPAL REGISTER**



DIPIETRO, JOSEPH (UNITED STATES INDIVIDUAL)
85 THISTLE ROAD
NORTH ANDOVER, MA 01845

FIRST USE 7-28-2000; IN COMMERCE 7-28-2000.

THE MARK CONSISTS OF WORDS "TOBACCO
BAD KIDS" ON A BANNER.

FOR: PAPER GOODS AND PRINTED MATTER,
NAMELY, DECALS, TEMPORARY TATTOOS; POS-
TERS, STICKERS, AND TRADING CARDS, IN
CLASS 16 (U.S. CLS. 2, 5, 22, 23, 29, 37, 38 AND 50).

SER. NO. 78-869,300, FILED 4-25-2006.

BRENDAN REGAN, EXAMINING ATTORNEY

Prior U.S. Cl.: B

United States Patent and Trademark Office

Reg. No. 3,480,665

Registered Aug. 5, 2008

**CERTIFICATION MARK
PRINCIPAL REGISTER**

PRO CIRCLE

EMERSON ELECTRIC CO. (MISSOURI CORPORATION)
8000 WEST FLORISSANT AVE.
ST. LOUIS, MO 63136

FOR: REPAIR AND INSTALLATION OF IN-SINK FOOD WASTE DISPOSERS AND GARBAGE DISPOSALS AND HOT WATER DISPENSERS, IN CLASS B (U.S. CL. B).

FIRST USE 8-0-1998; IN COMMERCE 11-0-1999.

THE MARK CONSISTS OF STANDARD CHARACTERS WITHOUT CLAIM TO ANY PARTICULAR FONT, STYLE, SIZE, OR COLOR.

NO CLAIM IS MADE TO THE EXCLUSIVE RIGHT TO USE "PRO", APART FROM THE MARK AS SHOWN.

THE CERTIFICATION MARK, AS USED BY AUTHORIZED PERSONS, CERTIFIES THAT THE PERSON USING THE MARK HAS MET CERTAIN EDUCATIONAL AND EXPERIENTIAL CRITERIA, HAS PASSED THE CORE AND SPECIALTY EXAMINATIONS IN THE FIELD OF REPAIR AND INSTALLATION OF IN-SINK FOOD WASTE DISPOSERS AND GARBAGE DISPOSALS AND HOT WATER DISPENSERS, AND ADHERES TO ETHICAL STANDARDS ESTABLISHED BY CERTIFIER

SER. NO. 78-878,533, FILED 5-8-2006.

JOHN DWYER, EXAMINING ATTORNEY

Int. Cl.: 6

Prior U.S. Cls.: 2, 12, 13, 14, 23, 25 and 50

United States Patent and Trademark Office

Reg. No. 3,480,666

Registered Aug. 5, 2008

**TRADEMARK
PRINCIPAL REGISTER**

BULLET BOND 1000

THOMAS & BETTS INTERNATIONAL, INC. (DE-
LAWARE CORPORATION)
501 SILVERSIDE ROAD
SUITE 67
WILMINGTON, DE 19809

THE MARK CONSISTS OF STANDARD CHAR-
ACTERS WITHOUT CLAIM TO ANY PARTICULAR
FONT, STYLE, SIZE, OR COLOR.

FOR: METAL CABLE CLIPS, IN CLASS 6 (U.S.
CLS. 2, 12, 13, 14, 23, 25 AND 50).

SER. NO. 78-880,225, FILED 5-10-2006.

FIRST USE 4-3-2003; IN COMMERCE 4-3-2003.

JANICE KIM, EXAMINING ATTORNEY

Int. Cls.: 19 and 42

Prior U.S. Cls.: 1, 12, 33, 50, 100 and 101

United States Patent and Trademark Office

Reg. No. 3,480,667

Registered Aug. 5, 2008

**TRADEMARK
SERVICE MARK
PRINCIPAL REGISTER**



**WOOD COMPOSITE
TECHNOLOGIES INC.**

WOOD COMPOSITE TECHNOLOGIES INC. (CANADA CORPORATION)
1408 - 7TH STREET
NISKU, CANADA T9E 7P9

FOR: WOOD COMPOSITE BUILDING MATERIALS, NAMELY, BOARDS, TRIMS AND FASCIA, IN CLASS 19 (U.S. CLS. 1, 12, 33 AND 50).

FOR: PRODUCT RESEARCH AND DEVELOPMENT, NAMELY, RESEARCH AND DEVELOPMENT IN THE AREA OF WOOD COMPOSITE BUILDING MATERIALS, IN CLASS 42 (U.S. CLS. 100 AND 101).

OWNER OF CANADA REG. NO. TMA705,231, DATED 1-22-2008, EXPIRES 1-22-2023.

NO CLAIM IS MADE TO THE EXCLUSIVE RIGHT TO USE "WOOD COMPOSITE TECHNOLOGIES INC.", APART FROM THE MARK AS SHOWN.

SER. NO. 78-880,252, FILED 5-10-2006.

DORITT L. CARROLL, EXAMINING ATTORNEY

Int. Cl.: 29

Prior U.S. Cl.: 46

United States Patent and Trademark Office

Reg. No. 3,480,668

Registered Aug. 5, 2008

**TRADEMARK
PRINCIPAL REGISTER**

SEASON SENSATIONS

DAIRY FARMERS OF AMERICA, INC. (KANSAS
CORPORATION)
10220 N. AMBASSADOR DRIVE
KANSAS CITY, MO 64153

FOR: DRY-MIX SEASONING PACKET SOLD AS
A COMPONENT OF A SHREDDED CHEESE PACK-
AGE, IN CLASS 29 (U.S. CL. 46).

FIRST USE 9-1-2006; IN COMMERCE 9-1-2006.

THE MARK CONSISTS OF STANDARD CHAR-
ACTERS WITHOUT CLAIM TO ANY PARTICULAR
FONT, STYLE, SIZE, OR COLOR.

NO CLAIM IS MADE TO THE EXCLUSIVE
RIGHT TO USE "SEASON", APART FROM THE
MARK AS SHOWN.

SER. NO. 78-884,445, FILED 5-16-2006.

JILL C. ALT, EXAMINING ATTORNEY

Int. Cl.: 25

Prior U.S. Cls.: 22 and 39

United States Patent and Trademark Office

Reg. No. 3,480,669

Registered Aug. 5, 2008

**TRADEMARK
PRINCIPAL REGISTER**

**REAL DEAL
TRACK CLUB
19 EST. 91**

GREEN, JR. WALTER H (UNITED STATES IN-
DIVIDUAL)
P.O. BOX 1893
NORFOLK, VA 235011893

THE MARK CONSISTS OF THE WORDING
"REAL DEAL TRACK CLUB 19 EST. 91" IN STY-
LIZED FORM MEANING REAL DEAL TRACK
CLUB ESTABLISHED 1991.

FOR: SHORT-SLEEVED OR LONG-SLEEVED T-
SHIRTS, IN CLASS 25 (U.S. CLS. 22 AND 39).

FIRST USE 9-1-1991; IN COMMERCE 9-1-1991.

SER. NO. 78-888,337, FILED 5-19-2006.

NO CLAIM IS MADE TO THE EXCLUSIVE
RIGHT TO USE "TRACK CLUB EST. 1991", APART
FROM THE MARK AS SHOWN.

ZHALEH DELANEY, EXAMINING ATTORNEY

Int. Cl.: 42

Prior U.S. Cls.: 100 and 101

United States Patent and Trademark Office

Reg. No. 3,480,670

Registered Aug. 5, 2008

**SERVICE MARK
PRINCIPAL REGISTER**

stylehive

STYLEHIVE, INC. (DELAWARE CORPORATION)
685 MARKET STREET
SUITE 590
SAN FRANCISCO, CA 94105

FOR: COMPUTER SERVICES, NAMELY, HOSTING ON-LINE WEB FACILITIES FOR OTHERS FOR ORGANIZING AND CONDUCTING ONLINE INTERACTIVE DISCUSSIONS IN THE FIELDS OF TRENDS IN FASHION, APPAREL, BRANDS, DESIGNERS, HOME FURNISHINGS, LIFESTYLE, AND BEAUTY; COMPUTER SERVICE, NAMELY, ACTING AS AN APPLICATION SERVICE PROVIDER

IN THE FIELD OF KNOWLEDGE MANAGEMENT TO HOST COMPUTER APPLICATION SOFTWARE FOR THE BOOK MARKING OF DATA AND INFORMATION IN THE FIELDS OF TRENDS IN FASHION, APPAREL, BRANDS, DESIGNERS, HOME FURNISHINGS, LIFESTYLE, AND BEAUTY, IN CLASS 42 (U.S. CLS. 100 AND 101).

FIRST USE 5-0-2005; IN COMMERCE 5-0-2005.

SER. NO. 78-890,653, FILED 5-23-2006.

DAVID YONTEF, EXAMINING ATTORNEY

Int. Cl.: 35

Prior U.S. Cls.: 100, 101 and 102

United States Patent and Trademark Office

Reg. No. 3,480,671

Registered Aug. 5, 2008

**SERVICE MARK
PRINCIPAL REGISTER**

TALKABILITY

FRANK PUBLIC RELATIONS, LTD (UNITED
KINGDOM COMPANY)
2ND FLOOR, THE FORUM
74-80 CAMDEN STREET
LONDON, UNITED KINGDOM NW1 0EG

FOR: PUBLIC RELATIONS; ADVERTISING AND
MARKETING SERVICES; ADVISORY AND CON-
SULTANCY SERVICES AND INFORMATION SER-
VICES RELATING TO PUBLIC RELATIONS,
MARKETING, AND ADVERTISING; MARKET
ANALYSIS; MARKET REPORTS AND STUDIES,
IN CLASS 35 (U.S. CLS. 100, 101 AND 102).

THE MARK CONSISTS OF STANDARD CHAR-
ACTERS WITHOUT CLAIM TO ANY PARTICULAR
FONT, STYLE, SIZE, OR COLOR.

OWNER OF ERPN CMNTY TM OFC REG. NO.
E2418259, DATED 6-12-2003, EXPIRES 10-22-2011.

SER. NO. 78-891,380, FILED 5-24-2006.

ROBERT LAVACHE, EXAMINING ATTORNEY

Int. Cl.: 3

Prior U.S. Cls.: 1, 4, 6, 50, 51 and 52

United States Patent and Trademark Office

Reg. No. 3,480,672

Registered Aug. 5, 2008

**TRADEMARK
PRINCIPAL REGISTER**

**THE SCIENCE OF LOOKING
YOUNG**

PRODUCT EXCELLENCE INC. (CANADA CORPORATION)
156 ROMINA DRIVE
CONCORD, CANADA L4K 4Z7

FOR: NON-MEDICATED SKIN CARE PREPARATIONS; SKIN CREAMS AND LIP CARE PRODUCTS, NAMELY, LIP PLUMPERS, IN CLASS 3 (U.S. CLS. 1, 4, 6, 50, 51 AND 52).

THE MARK CONSISTS OF STANDARD CHARACTERS WITHOUT CLAIM TO ANY PARTICULAR FONT, STYLE, SIZE, OR COLOR.

PRIORITY CLAIMED UNDER SEC. 44(D) ON CANADA APPLICATION NO. 1,290,740, FILED 2-21-2006, REG. NO. TMA688896, DATED 6-1-2007, EXPIRES 6-1-2022.

SER. NO. 78-892,446, FILED 5-25-2006.

ESTHER A. BORSUK, EXAMINING ATTORNEY

Int. Cl.: 33

Prior U.S. Cls.: 47 and 49

United States Patent and Trademark Office

Reg. No. 3,480,673

Registered Aug. 5, 2008

**TRADEMARK
PRINCIPAL REGISTER**

WATER COLOR

JOHNSON-MILLER & ASSOCIATES, LTD. (ILLINOIS CORPORATION), DBA I & B IMPORTS
SUITE 409
213 WEST INSTITUTE PLACE
CHICAGO, IL 60610

FOR: WINES, IN CLASS 33 (U.S. CLS. 47 AND 49).

FIRST USE 9-22-2005; IN COMMERCE 9-22-2005.

THE MARK CONSISTS OF STANDARD CHARACTERS WITHOUT CLAIM TO ANY PARTICULAR FONT, STYLE, SIZE, OR COLOR.

NO CLAIM IS MADE TO THE EXCLUSIVE RIGHT TO USE "WATER", APART FROM THE MARK AS SHOWN.

SER. NO. 78-893,324, FILED 5-25-2006.

LINDA MICKLEBURGH, EXAMINING ATTORNEY

Int. Cl.: 41

Prior U.S. Cls.: 100, 101 and 107

United States Patent and Trademark Office

Reg. No. 3,480,674

Registered Aug. 5, 2008

**SERVICE MARK
PRINCIPAL REGISTER**

RED HOT DATELINE

TELIGENCE (US), INC. (NEVADA CORPORATION)
1045 HOWE STREET STE. 700
VANCOUVER, CANADA V6Z 2A9

FOR: ENTERTAINMENT SERVICES, NAMELY, PROVIDING ONLINE COMPUTER GAMES, A WEBSITE FEATURING MUSIC, GAMES, AND AUDIO, VIDEO, MUSIC, GAMES AND OTHER MULTIMEDIA MATERIALS AND ENTERTAINMENT INFORMATION PROVIDED ONLINE, AND THROUGH WIRELESS, TELEPHONIC, MOBILE, AND DIGITAL DEVICES, IN CLASS 41 (U.S. CLS. 100, 101 AND 107).

FIRST USE 12-1-2004; IN COMMERCE 12-1-2004.

THE MARK CONSISTS OF STANDARD CHARACTERS WITHOUT CLAIM TO ANY PARTICULAR FONT, STYLE, SIZE, OR COLOR.

OWNER OF U.S. REG. NOS. 3,044,588 AND 3,048,836.

NO CLAIM IS MADE TO THE EXCLUSIVE RIGHT TO USE "DATELINE", APART FROM THE MARK AS SHOWN.

SER. NO. 78-896,144, FILED 5-30-2006.

JEFF DEFORD, EXAMINING ATTORNEY

Int. Cl.: 11

Prior U.S. Cls.: 13, 21, 23, 31 and 34

United States Patent and Trademark Office

Reg. No. 3,480,675

Registered Aug. 5, 2008

**TRADEMARK
PRINCIPAL REGISTER**

TRAKKABEAM

VECTORBEAM TECHNOLOGIES PTY LTD (AUSTRALIA PRIVATE LIMITED COMPANY)
76 HERALD STREET
CHELTENHAM, VICTORIA, AUSTRALIA 3192

FOR: ELECTRIC LIGHT BULBS; ELECTRIC NIGHT LIGHTS; HALOGEN LIGHT BULBS; HIGH INTENSITY SEARCH LIGHTS; LAMPS; LED LIGHT BULBS; SOCKETS FOR ELECTRIC LIGHTS; SPOT LIGHTS; SPOT LIGHTS AND SEARCH LIGHTS OF VARYING BEAM WIDTH AND INTENSITY; COLOR FILTERS FOR USE IN LIGHTING INSTRUMENTS, LIGHT DIFFUSERS; FILTERS FOR USE IN RELATION TO SEARCH LIGHTS AND SPOT LIGHTS, NAMELY, INFRARED FILTERS, UV FIL-

TERS, COLOR FILTERS, IN CLASS 11 (U.S. CLS. 13, 21, 23, 31 AND 34).

THE MARK CONSISTS OF STANDARD CHARACTERS WITHOUT CLAIM TO ANY PARTICULAR FONT, STYLE, SIZE, OR COLOR.

PRIORITY CLAIMED UNDER SEC. 44(D) ON AUSTRALIA APPLICATION NO. 1089724, FILED 12-7-2005, REG. NO. 1089724, DATED 12-7-2005, EXPIRES 12-7-2015.

SER. NO. 78-901,830, FILED 6-6-2006.

MONIQUE MILLER, EXAMINING ATTORNEY

Int. Cl.: 11

Prior U.S. Cls.: 13, 21, 23, 31 and 34

United States Patent and Trademark Office

Reg. No. 3,480,676

Registered Aug. 5, 2008

**TRADEMARK
PRINCIPAL REGISTER**

TRAKKA

VECTORBEAM TECHNOLOGIES PTY LTD (AUSTRALIA PRIVATE LIMITED COMPANY)
76 HERALD STREET
CHELTENHAM, VICTORIA, AUSTRALIA 3192

FOR: ELECTRIC LIGHT BULBS; ELECTRIC NIGHT LIGHTS; HALOGEN LIGHT BULBS; HIGH INTENSITY SEARCH LIGHTS; LAMPS; LED LIGHT BULBS; SOCKETS FOR ELECTRIC LIGHTS; SPOT LIGHTS; SPOT LIGHTS AND SEARCH LIGHTS OF VARYING BEAM WIDTH AND INTENSITY; COLOR FILTERS FOR USE IN LIGHTING INSTRUMENTS, LIGHT DIFFUSERS; FILTERS FOR USE IN RELATION TO SEARCH LIGHTS AND SPOT LIGHTS, NAMELY, INFRARED FILTERS, UV FIL-

TERS, COLOR FILTERS, IN CLASS 11 (U.S. CLS. 13, 21, 23, 31 AND 34).

THE MARK CONSISTS OF STANDARD CHARACTERS WITHOUT CLAIM TO ANY PARTICULAR FONT, STYLE, SIZE, OR COLOR.

PRIORITY CLAIMED UNDER SEC. 44(D) ON AUSTRALIA APPLICATION NO. 1103443, FILED 3-14-2006, REG. NO. 1103443, DATED 3-14-2006, EXPIRES 3-14-2016.

SER. NO. 78-901,873, FILED 6-6-2006.

MONIQUE MILLER, EXAMINING ATTORNEY

Int. Cl.: 20

Prior U.S. Cls.: 2, 13, 22, 25, 32 and 50

United States Patent and Trademark Office

Reg. No. 3,480,677

Registered Aug. 5, 2008

**TRADEMARK
PRINCIPAL REGISTER**



UTILITY COMPOSITES INTL LTD (TEXAS LIMITED PARTNERSHIP)
2704A MEISTER PLACE
ROUND ROCK, TX 78664

FOR: NON-METAL FASTENERS, NAMELY, PLASTIC COMPOSITE NAILS AND STAPLES, IN CLASS 20 (U.S. CLS. 2, 13, 22, 25, 32 AND 50).

FIRST USE 1-7-1997; IN COMMERCE 2-7-1997.

OWNER OF U.S. REG. NO. 1,958,305.

THE MARK CONSISTS OF A STYLIZED REPRESENTATION OF A BIRD'S CLAW AGAINST A CIRCULAR BORDER, AND THE TERM "RAPTOR"

SER. NO. 78-901,940, FILED 6-6-2006.

AMY ALFIERI, EXAMINING ATTORNEY

Int. Cl.: 28

Prior U.S. Cls.: 22, 23, 38 and 50

Reg. No. 3,480,678

United States Patent and Trademark Office

Registered Aug. 5, 2008

**TRADEMARK
PRINCIPAL REGISTER**

BULL RIDE

MATTEL, INC. (DELAWARE CORPORATION)
MAIL STOP M1-1518
333 CONTINENTAL BOULEVARD
EL SEGUNDO, CA 90245

FOR: TOYS, GAMES AND PLAYTHINGS, NAME-
LY, TOY VEHICLES, TOY VEHICLE PLAYSETS,
AND ACCESSORIES FOR ALL OF THE FOREGO-
ING, IN CLASS 28 (U.S. CLS. 22, 23, 38 AND 50).

FIRST USE 3-19-2007; IN COMMERCE 3-19-2007.

THE MARK CONSISTS OF STANDARD CHAR-
ACTERS WITHOUT CLAIM TO ANY PARTICULAR
FONT, STYLE, SIZE, OR COLOR.

NO CLAIM IS MADE TO THE EXCLUSIVE
RIGHT TO USE "BULL", APART FROM THE MARK
AS SHOWN.

SER. NO. 78-902,057, FILED 6-6-2006.

CHARLES L. JENKINS, EXAMINING ATTORNEY

Int. Cl.: 43

Prior U.S. Cls.: 100 and 101

United States Patent and Trademark Office

Reg. No. 3,480,679

Registered Aug. 5, 2008

**SERVICE MARK
PRINCIPAL REGISTER**

THE GARAGE

LUCKY 13, INC. (IDAHO CORPORATION)
P.O. BOX 2584
BOISE, ID 837012584

THE MARK CONSISTS OF STANDARD CHAR-
ACTERS WITHOUT CLAIM TO ANY PARTICULAR
FONT, STYLE, SIZE, OR COLOR.

FOR: RESTAURANT AND BAR SERVICES, IN
CLASS 43 (U.S. CLS. 100 AND 101).

SER. NO. 78-902,644, FILED 6-7-2006.

FIRST USE 8-0-2004; IN COMMERCE 8-0-2004.

AMY GEARIN, EXAMINING ATTORNEY

Int. Cl.: 3

Prior U.S. Cls.: 1, 4, 6, 50, 51 and 52

United States Patent and Trademark Office

Reg. No. 3,480,680

Registered Aug. 5, 2008

**TRADEMARK
PRINCIPAL REGISTER**

SECRET TOUCH

GUERLAIN S.A (FRANCE CORPORATION)
68, AVENUE DES CHAMPS-ELYSEES
PARIS, FRANCE 75008

FOR: PERFUMES, PERFUMERY, EAU DE COLOGNE, TOILET WATERS, PERFUMED BODY MILKS, BODY LOTIONS, AND PERFUMED SOAP, IN CLASS 3 (U.S. CLS. 1, 4, 6, 50, 51 AND 52).

THE MARK CONSISTS OF STANDARD CHARACTERS WITHOUT CLAIM TO ANY PARTICULAR FONT, STYLE, SIZE, OR COLOR.

OWNER OF FRANCE REG. NO. 063434052, DATED 6-9-2006, EXPIRES 6-9-2016.

SER. NO. 78-905,099, FILED 6-9-2006.

GRETTA YAO, EXAMINING ATTORNEY

Int. Cl.: 9

Prior U.S. Cls.: 21, 23, 26, 36 and 38

Reg. No. 3,480,681

United States Patent and Trademark Office

Registered Aug. 5, 2008

**TRADEMARK
PRINCIPAL REGISTER**

MISTAMEANA

MARIN, JAIME S. (UNITED STATES INDIVIDUAL)
12259 FOX HOUND LANE
ORLANDO, FL 32826

THE MARK CONSISTS OF STANDARD CHARACTERS WITHOUT CLAIM TO ANY PARTICULAR FONT, STYLE, SIZE, OR COLOR.

FOR: PHONO RECORDS FEATURING MUSIC, NAMELY, COMPACT DISCS FEATURING MUSIC, AND CASSETTE TAPES FEATURING MUSIC, IN CLASS 9 (U.S. CLS. 21, 23, 26, 36 AND 38).

SER. NO. 78-906,479, FILED 6-12-2006.

FIRST USE 4-20-1993; IN COMMERCE 5-0-1993.

BARBARA BROWN, EXAMINING ATTORNEY

Int. Cl.: 35

Prior U.S. Cls.: 100, 101 and 102

United States Patent and Trademark Office

Reg. No. 3,480,682

Registered Aug. 5, 2008

**SERVICE MARK
PRINCIPAL REGISTER**

The logo for Importek features the word "importek" in a bold, italicized, lowercase sans-serif font. A stylized, curved line starts above the 'i', loops around the top of the 'm', and ends above the 'k', resembling a swoosh or a stylized 'i'.

INVENTEC MULTIMEDIA & TELECOM COR-
PORATION (TAIWAN CORPORATION)
5F., NO. 396, SEC. 1, NEIHU RD.
TAIPEI CITY, TAIWAN

FOR: PROVIDING BUSINESS ADVICE VIA A
GLOBAL COMPUTER NETWORK; RENTAL OF
ADVERTISING SPACE ON WEB SITES; PROMOT-
ING THE GOODS AND SERVICES OF OTHERS BY
MEANS OF OPERATING AN ON-LINE SHOPPING
MALL WITH LINKS TO THE RETAIL WEB SITES
OF OTHERS; MANAGEMENT OF COMPUTERIZED
FILES; MANAGEMENT AND COMPILATION OF
COMPUTERIZED DATABASES; RENTAL OF OF-
FICE MACHINERY AND EQUIPMENT; RETAIL
STORE SERVICES IN THE FIELD OF COMPUTER

HARDWARE AND SOFTWARE, ELECTRONIC AP-
PARATUS AND APPLIANCES, PHOTOGRAPHIC
EQUIPMENT, BEAUTY PRODUCTS AND APPARA-
TUS, MEDICAL APPARATUS, AND VITAMINS,
SUPPLEMENTS AND OTHER NUTRITION RELA-
TED PRODUCTS, IN CLASS 35 (U.S. CLS. 100, 101
AND 102).

OWNER OF TAIWAN REG. NO. 01242354, DATED
12-16-2006, EXPIRES 12-15-2016.

SER. NO. 78-909,223, FILED 6-15-2006.

INGA ERVIN, EXAMINING ATTORNEY

Int. Cl.: 9

Prior U.S. Cls.: 21, 23, 26, 36 and 38

Reg. No. 3,480,683

United States Patent and Trademark Office

Registered Aug. 5, 2008

**TRADEMARK
PRINCIPAL REGISTER**

IMPORTTEK

INVENTEC MULTIMEDIA & TELECOM CORPORATION (TAIWAN CORPORATION)
5F., NO. 396, SEC. 1, NEIHU RD.
TAIPEI CITY, TAIWAN

FOR: COMPUTER HARDWARE; COMPUTER SOFTWARE FOR USE IN DATABASE MANAGEMENT, USE AS A SPREADSHEET, AND WORD PROCESSING; CABLE MODEMS; COMPUTER SERVERS; SET-TOP BOXES; NETWORK CARDS; COMPUTER NETWORK HUBS, SWITCHES AND ROUTERS; SIGNAL TRANSCIVERS; ELECTRONIC DEVICE USED TO PROVIDE SIGNAL CONVERSIONS FOR COMPUTER VIDEO AND AUDIO TELECONFERENCING; GATEWAY ROUTERS IN THE NATURE OF COMPUTER CONTROL HARDWARE; COMPUTER PERIPHERAL APPLICATION CARDS; SATELLITE RECEIVERS; INTERFACE CARDS FOR DATA PROCESSING EQUIPMENT IN THE FORM OF PRINTED CIRCUITS; COMPUTER MOTHERBOARDS; DVD PLAYERS AND RECORDERS; DIGITAL VIDEO CAMERAS; PERSONAL DIGITAL ASSISTANTS; ACCESS CONTROL AND ALARM MONITORING SYSTEMS; DIGITAL TELEVISIONS; LCD TELEVISIONS; TELEVISION GAME MACHINES; REMOTE CONTROLS FOR TELEVISIONS, RADIOS, AND STEREO; AUDIO SYSTEMS COMPRISED OF STEREO TUNERS AND AMPLIFIERS; MD PLAYERS; MEMORY CARDS; AMPLIFIERS; HEADPHONES; MICROPHONES; DIGITAL CAMERAS; CAMERA MODULES; MP3 PLAYERS; CABLE BROADCAST TRANSMISSION MACHINES AND APPARATUS; PORTABLE MEDIA PLAYERS; INTERNET PHONES; VIDEO PHONES; CELL PHONES; COMPUTER WEB CAMERAS; LCD OVER-HEAD PROJECTORS; LCD MONITORS; USB HARD-

WARE AND USB OPERATING SOFTWARE; PRERECORDED CDS FEATURING COMPUTER DATA AND COMPUTER GAMES; COMPUTER TELEPHONY HARDWARE THAT CONNECTS TO THE USERS' PRIVATE BRANCH EXCHANGE (PBX); HDTV TUNERS; ELECTRONIC COMPUTER BASED SYSTEM COMPRISING AN OPTICAL TEST MODULE; SOFTWARE FOR ANALYZING, REPORTING AND PRINTING OPTICAL SPECTRUM ANALYZER DATA; FIBER OPTIC COMPONENTS, NAMELY, SIGNAL MONITORS; AMPLIFIERS; OPTICAL SWITCHES; OPTICAL AUTO SWITCHES; OPTICAL TRANSMITTERS; FIBER OPTIC TRANSCIVERS; FIBER OPTIC COMMUNICATION SIGNAL TRANSMITTERS; FIBER OPTIC COUPLING APPARATUS; FIBER OPTIC COMMUNICATION WAVELENGTH DIVISION MULTIPLEXER; OSCILLATE LASER DIODE MODULE FOR FIBER OPTIC AMPLIFIER; LASER MACHINING POSITIONING SYSTEM COMPRISED OF LASER GENERATORS; FIBER OPTICS; FIBER CHANNEL SWITCHES; CABLES FOR OPTICAL SIGNAL TRANSMISSION AND FIBER OPTIC COUPLING APPARATUS, IN CLASS 9 (U.S. CLS. 21, 23, 26, 36 AND 38).

THE MARK CONSISTS OF STANDARD CHARACTERS WITHOUT CLAIM TO ANY PARTICULAR FONT, STYLE, SIZE, OR COLOR.

OWNER OF TAIWAN REG. NO. 01299415, DATED 2-1-2008, EXPIRES 1-31-2018.

SER. NO. 78-909,257, FILED 6-15-2006.

INGA ERVIN, EXAMINING ATTORNEY

Int. Cl.: 36

Prior U.S. Cls.: 100, 101 and 102

United States Patent and Trademark Office

Reg. No. 3,480,684

Registered Aug. 5, 2008

**SERVICE MARK
PRINCIPAL REGISTER**

The logo for 'Importek' features the word 'Importek' in a bold, italicized, sans-serif font. A stylized, curved line starts under the 'i', loops around the 'm', and ends under the 'k', resembling a signal or a stylized 'i'.

INVENTEC MULTIMEDIA & TELECOM COR-
PORATION (TAIWAN CORPORATION)
5F., NO. 396, SEC. 1, NEIHU RD.
TAIPEI CITY, TAIWAN

OWNER OF TAIWAN REG. NO. 01242382, DATED
12-16-2006, EXPIRES 12-15-2016.

FOR: PROVIDING FINANCIAL MARKET IN-
FORMATION; PROVIDING FINANCIAL INFOR-
MATION IN THE FIELD OF FINANCIAL
INVESTMENTS PROVIDED BY ELECTRONIC
MEANS, IN CLASS 36 (U.S. CLS. 100, 101 AND 102).

SER. NO. 78-909,273, FILED 6-15-2006.

INGA ERVIN, EXAMINING ATTORNEY

Int. Cl.: 37

Prior U.S. Cls.: 100, 103 and 106

United States Patent and Trademark Office

Reg. No. 3,480,685

Registered Aug. 5, 2008

**SERVICE MARK
PRINCIPAL REGISTER**

The logo for Importek features the word "Importek" in a bold, italicized, sans-serif font. A stylized, curved line starts above the 'i', loops around the top of the 'i', and then extends to the right, ending above the 'k'.

INVENTEC MULTIMEDIA & TELECOM COR-
PORATION (TAIWAN CORPORATION)
5F., NO. 396, SEC. 1, NEIHU RD.
TAIPEI CITY, TAIWAN

FOR: INSTALLATION, REPAIR AND MAINTENANCE OF TELEPHONES AND COMMUNICATION EQUIPMENT; MAINTENANCE AND REPAIR OF COMPUTERS; INSTALLATION, REPAIR AND MAINTENANCE OF HOUSEHOLD APPLIANCES; MAINTENANCE AND REPAIR OF DIGITAL CAMERAS, VIDEO CAMERAS, VIDEO SCAN MACHINES AND OVERHEAD PROJECTORS;

INSTALLATION OF COMPUTER SYSTEMS; INSTALLATION AND REPAIR OF SAFETY EQUIPMENTS AND ALARMS, IN CLASS 37 (U.S. CLS. 100, 103 AND 106).

OWNER OF TAIWAN REG. NO. 01242415, DATED 12-16-2006, EXPIRES 12-15-2016.

SER. NO. 78-909,299, FILED 6-15-2006.

INGA ERVIN, EXAMINING ATTORNEY

Int. Cl.: 38

Prior U.S. Cls.: 100, 101 and 104

United States Patent and Trademark Office

Reg. No. 3,480,686

Registered Aug. 5, 2008

**SERVICE MARK
PRINCIPAL REGISTER**



INVENTEC MULTIMEDIA & TELECOM COR-
PORATION (TAIWAN CORPORATION)
5F., NO. 396, SEC. 1, NEIHU RD.
TAIPEI CITY, TAIWAN

FOR: DELIVERY OF MESSAGES BY ELECTRO-
NIC TRANSMISSION; ELECTRONIC TRANSMIS-
SIONS OF DATA AND DOCUMENTS VIA
COMPUTER TERMINALS; ELECTRONIC, ELEC-
TRIC AND DIGITAL TRANSMISSION OF VOICE,
DATA, IMAGES, SIGNALS AND MESSAGES; PRO-
VIDING VOICE COMMUNICATION SERVICES VIA
THE INTERNET; TELEPHONE VOICE MESSAGING
SERVICES; ELECTRONIC MAIL SERVICES; DATA
COMMUNICATION BY ELECTRONIC MAIL; REN-
TAL OF COMMUNICATION APPARATUS AND
IMPLEMENTS; PROVIDING ON-LINE ELECTRO-
NIC BULLETIN BOARDS FOR TRANSMISSION OF

MESSAGES AMONG COMPUTER USERS CON-
CERNING MUSIC, NEWS, CURRENT EVENTS,
POLITICS, ENTERTAINMENT AND ARTS AND
LEISURE; COMPUTER AIDED TRANSMISSION
OF INFORMATION AND IMAGES; SATELLITE
TRANSMISSION SERVICES; TELEPHONE COM-
MUNICATION SERVICES; INFORMATION TRANS-
MISSION VIA ELECTRONIC COMMUNICATIONS
NETWORKS., IN CLASS 38 (U.S. CLS. 100, 101 AND
104).

OWNER OF TAIWAN REG. NO. 01242424, DATED
12-16-2006, EXPIRES 12-15-2016.

SER. NO. 78-909,314, FILED 6-15-2006.

INGA ERVIN, EXAMINING ATTORNEY

Int. Cl.: 41

Prior U.S. Cls.: 100, 101 and 107

United States Patent and Trademark Office

Reg. No. 3,480,687

Registered Aug. 5, 2008

**SERVICE MARK
PRINCIPAL REGISTER**

The logo for Importek features the word "importek" in a bold, lowercase, sans-serif font. The letter "i" is stylized with a curved line that loops around the top and left side of the letter, resembling a signal or a stylized "i".

INVENTEC MULTIMEDIA & TELECOM COR-
PORATION (TAIWAN CORPORATION)
5F., NO. 396, SEC. 1, NEIHU RD.
TAIPEI CITY, TAIWAN

FOR: ENTERTAINMENT SERVICES, NAMELY, PROVIDING INFORMATION IN THE FIELD OF TELEVISION PROGRAMS, RADIO PROGRAMS, ENTERTAINMENT, MUSIC, SPORTS AND LEISURE; ENTERTAINMENT SERVICES, NAMELY, PROVIDING ELECTRONIC GAME SERVICES; COMPUTER EDUCATION TRAINING; PRESENTATION OF LIVE SHOW PERFORMANCES; EDITING AND RECORDING OF SOUNDS AND IMAGES VIA A GLOBAL COMPUTER NETWORK; PRODUCTION OF VIDEO PROGRAMS VIA A GLOBAL COMPUTER NETWORK; PROVIDING ELECTRONIC PUBLICATIONS, NAMELY, PROVIDING ONLINE BOOKS IN THE FIELD OF ART, HUMANITIES, SCIENCE, HISTORY, POLITICS, ECONOMY,

SOCIETY, BUSINESS, AMUSEMENT, EDUCATION, LIFE, HEALTH, SPORTS, TRAVEL, AND INFORMATION TECHNOLOGY; PUBLICATION OF BOOKS, MAGAZINES AND ARTICLES ABOUT ART, HUMANITIES, SCIENCE, HISTORY, POLITICS, ECONOMY, SOCIETY, BUSINESS, AMUSEMENT, EDUCATION, LIFE, HEALTH, SPORTS, TRAVEL, AND INFORMATION TECHNOLOGY; PRODUCTION OF RADIO AND TV PROGRAMS; ARRANGING FOR TICKET RESERVATIONS FOR SHOWS AND OTHER ENTERTAINMENT EVENTS., IN CLASS 41 (U.S. CLS. 100, 101 AND 107).

OWNER OF TAIWAN REG. NO. 01245544., DATED 1-1-2007, EXPIRES 12-31-2016.

SER. NO. 78-909,336, FILED 6-15-2006.

INGA ERVIN, EXAMINING ATTORNEY

Int. Cl.: 42

Prior U.S. Cls.: 100 and 101

United States Patent and Trademark Office

Reg. No. 3,480,688

Registered Aug. 5, 2008

**SERVICE MARK
PRINCIPAL REGISTER**



INVENTEC MULTIMEDIA & TELECOM CORPORATION (TAIWAN CORPORATION)
5F., NO. 396, SEC. 1, NEIHU RD.
TAIPEI CITY, TAIWAN

FOR: COMPUTER SOFTWARE CONSULTATION; COMPUTER SOFTWARE DESIGN FOR OTHERS AND COMPUTER SOFTWARE DEVELOPMENT; RENTAL OF COMPUTER HARDWARE; COMPUTER DATA RESTORATION; CROSS-PLATFORM CONVERSION OF DIGITAL CONTENT INTO OTHER FORMS OF DIGITAL CONTENT; DATA CONVERSION OF COMPUTER PROGRAM DATA OR INFORMATION; DESIGN OF SPECIALTY INTERIOR AND EXTERIOR ENVIRONMENT SETTINGS; REGISTRATION OF DOMAIN NAMES FOR IDENTIFICATION OF USERS ON A GLOBAL COMPUTER NETWORK; PRODUCT DEVELOPMENT AND PRODUCT DEVELOPMENT CONSULTATION; DESIGN OF OTHERS OF INTEGRATED CIRCUITS AND INTEGRATED CIRCUIT CORES FOR USE IN WIRELESS COMMUNICATIONS AND WIRELESS COMMUNICATION EQUIPMENT AND APPARATUS AND DIGITAL SIGNAL PROCESSORS

(DSP) ; DESIGN OF SEMICONDUCTOR CHIPS; DESIGN OF COMPUTER HARDWARE, INTEGRATED CIRCUITS, COMMUNICATIONS HARDWARE AND SOFTWARE AND COMPUTER NETWORKS FOR OTHERS; INFORMATION TECHNOLOGY CONSULTATION; ENVIRONMENTAL SERVICES, NAMELY, TECHNICAL CONSULTATION IN THE FIELD OF ENVIRONMENTAL SCIENCE, ENGINEERING SERVICES, DESIGN FOR OTHERS IN THE FIELD OF ENVIRONMENTAL ENGINEERING, DESIGNING AND TESTING OF NEW ENVIRONMENTALLY FRIENDLY PRODUCTS FOR OTHERS; TECHNICAL SUPPORT, NAMELY, MONITORING OF NETWORK SYSTEMS IN THE FIELD OF FIBER OPTIC COMMUNICATION., IN CLASS 42 (U.S. CLS. 100 AND 101).

OWNER OF TAIWAN REG. NO. 01242567, DATED 12-16-2006, EXPIRES 12-15-2016.

SER. NO. 78-909,354, FILED 6-15-2006.

INGA ERVIN, EXAMINING ATTORNEY

Int. Cl.: 35

Prior U.S. Cls.: 100, 101 and 102

United States Patent and Trademark Office

Reg. No. 3,480,689

Registered Aug. 5, 2008

**SERVICE MARK
PRINCIPAL REGISTER**

IMPORTEK

INVENTEC MULTIMEDIA & TELECOM CORPORATION (TAIWAN CORPORATION)
5F., NO. 396, SEC. 1, NEIHU RD.
TAIPEI CITY, TAIWAN

FOR: PROVISION OF BUSINESS INFORMATION AND INTEGRATED COMPUTER DATABASE IN THE FIELD OF BUSINESS MANAGEMENT CONSULTING VIA COMPUTER OR INTERNET; RENTAL OF ADVERTISING SPACE ON THE INTERNET; COMPUTERIZED ON-LINED ORDERING SERVICES FEATURING COMPUTER HARDWARE; MANAGEMENT OF COMPUTERIZED FILES; DATABASE MANAGEMENT; RENTAL OF OFFICE MACHINERY AND EQUIPMENT; RETAIL STORE SERVICES FEATURING COMPUTER HARDWARE AND SOFTWARE, ELECTRONIC APPLIANCES, AND PHOTOGRAPHIC EQUIPMENT; ORGANIZATION OF INTERNET AUCTIONS; PROVIDING PRODUCT INFORMATION; DISSEMINATION OF ADVERTISING MATTER FOR OTHERS VIA THE INTERNET; PUBLICATION OF ADVERTISING TESTS; HOSPITAL MANAGEMENT, NAMELY, PROVIDING MANAGEMENT SERVICE VIA

INTERNET; HOSPITAL AND HEALTH CARE FACILITIES MANAGEMENT; CONSULTATION IN THE FIELD OF MANAGING HOSPITAL AND HEALTH CARE FACILITIES; RETAIL STORE SERVICES FEATURING BEAUTY PRODUCTS AND BEAUTY APPARATUS; RETAIL STORE SERVICES FEATURING MEDICAL APPARATUS; RETAIL STORE SERVICES FEATURING VITAMINS, SUPPLEMENTS AND OTHER NUTRITION RELATED PRODUCTS., IN CLASS 35 (U.S. CLS. 100, 101 AND 102).

THE MARK CONSISTS OF STANDARD CHARACTERS WITHOUT CLAIM TO ANY PARTICULAR FONT, STYLE, SIZE, OR COLOR.

OWNER OF TAIWAN REG. NO. 01242355, DATED 12-16-2006, EXPIRES 12-15-2016.

SER. NO. 78-909,411, FILED 6-15-2006.

MIDGE BUTLER, EXAMINING ATTORNEY

Int. Cl.: 42

Prior U.S. Cls.: 100 and 101

United States Patent and Trademark Office

Reg. No. 3,480,690

Registered Aug. 5, 2008

**SERVICE MARK
PRINCIPAL REGISTER**

IMPORTEK

INVENTEC MULTIMEDIA & TELECOM CORPORATION (TAIWAN CORPORATION)
5F., NO. 396, SEC. 1, NEIHU RD.
TAIPEI CITY, TAIWAN

FOR: COMPUTER SOFTWARE CONSULTATION; COMPUTER SOFTWARE DESIGN FOR OTHERS AND COMPUTER SOFTWARE DEVELOPMENT; RENTAL OF COMPUTER HARDWARE; COMPUTER DATA RESTORATION; CROSS-PLATFORM CONVERSION OF DIGITAL CONTENT INTO OTHER FORMS OF DIGITAL CONTENT; DATA CONVERSION OF COMPUTER PROGRAM DATA OR INFORMATION; DESIGN OF SPECIALTY INTERIOR AND EXTERIOR ENVIRONMENT SETTINGS; REGISTRATION OF DOMAIN NAMES FOR IDENTIFICATION OF USERS ON A GLOBAL COMPUTER NETWORK; PRODUCT DEVELOPMENT AND PRODUCT DEVELOPMENT CONSULTATION; DESIGN OF OTHERS OF INTEGRATED CIRCUITS AND INTEGRATED CIRCUIT CORES FOR USE IN WIRELESS COMMUNICATIONS AND WIRELESS COMMUNICATION EQUIPMENT AND APPARATUS AND DIGITAL SIGNAL PROCESSORS (DSP) ; DESIGN OF SEMICONDUCTOR CHIPS; DESIGN OF COMPUTER HARDWARE, INTEGRA-

TED CIRCUITS, COMMUNICATIONS HARDWARE AND SOFTWARE AND COMPUTER NETWORKS FOR OTHERS; INFORMATION TECHNOLOGY CONSULTATION; ENVIRONMENTAL SERVICES, NAMELY, TECHNICAL CONSULTATION IN THE FIELD OF ENVIRONMENTAL SCIENCE, ENGINEERING SERVICES, DESIGN FOR OTHERS IN THE FIELD OF ENVIRONMENTAL ENGINEERING, DESIGNING AND TESTING OF NEW ENVIRONMENTALLY FRIENDLY PRODUCTS FOR OTHERS; TECHNICAL SUPPORT, NAMELY, MONITORING OF NETWORK SYSTEMS IN THE FIELD OF FIBER OPTIC COMMUNICATION., IN CLASS 42 (U.S. CLS. 100 AND 101).

THE MARK CONSISTS OF STANDARD CHARACTERS WITHOUT CLAIM TO ANY PARTICULAR FONT, STYLE, SIZE, OR COLOR.

OWNER OF TAIWAN REG. NO. 01242568, DATED 12-16-2006, EXPIRES 12-15-2016.

SER. NO. 78-909,413, FILED 6-15-2006.

MIDGE BUTLER, EXAMINING ATTORNEY

Int. Cl.: 41

Prior U.S. Cls.: 100, 101 and 107

United States Patent and Trademark Office

Reg. No. 3,480,691

Registered Aug. 5, 2008

**SERVICE MARK
PRINCIPAL REGISTER**

IMPORTEK

INVENTEC MULTIMEDIA & TELECOM COR-
PORATION (TAIWAN CORPORATION)
5F., NO. 396, SEC. 1, NEIHU RD.
TAIPEI CITY, TAIWAN

FOR: PROVIDING INFORMATION IN THE
FIELD OF TELEVISION, RADIO PROGRAMS, EN-
TERTAINMENT, MUSIC, SPORTS AND LEISURE
ACTIVITIES; PROVIDING TELEVISION PRO-
GRAMS IN THE FIELD OF NEWS AND COMEDY
AND MOTION PICTURE FILMS VIA COMPUTER
TO CONNECT INTERNET; PROVIDING ON-LINE
COMPUTER GAMES VIA A GLOBAL COMPUTER
NETWORK; PROVIDING ENTERTAINMENT SER-
VICES IN THE NATURE OF THEATRICAL PER-
FORMANCES; PROVIDING ON-LINE
EDUCATIONAL COURSES IN THE FIELD OF
ART, HUMANITIES, SCIENCE, HISTORY, POLI-
TICS, ECONOMY, SOCIETY, BUSINESS, AMUSE-
MENT, EDUCATION, LIFE, HEALTH, SPORTS,
TRAVEL, AND INFORMATION TECHNOLOGY;
PRODUCTION OF RECORDS AND VIDEOTAPES;
PROVIDING ON-LINE PUBLICATIONS IN THE

NATURE OF BOOKS IN THE FIELD OF FICTION,
MAGAZINES AND ARTICLES; PUBLICATION OF
BOOKS, MAGAZINES AND ARTICLES; PRODUC-
TION OF RADIO AND TELEVISION PROGRAMS;
PROVIDING WILL-CALL TICKET SERVICES FOR
VARIOUS ACTIVITIES INCLUDING DISPLAYS
AND COMPETITIONS; RENTAL OF SOUND RE-
CORDINGS, VIDEO TAPES AND MOTION PIC-
TURE FILMS; PRODUCTION OF MOTION
PICTURE FILMS, DIGITAL IMAGING SERVICES.,
IN CLASS 41 (U.S. CLS. 100, 101 AND 107).

THE MARK CONSISTS OF STANDARD CHAR-
ACTERS WITHOUT CLAIM TO ANY PARTICULAR
FONT, STYLE, SIZE, OR COLOR.

OWNER OF TAIWAN REG. NO. 01245545, DATED
1-1-2007, EXPIRES 12-31-2016.

SER. NO. 78-909,433, FILED 6-15-2006.

MIDGE BUTLER, EXAMINING ATTORNEY

Int. Cl.: 38

Prior U.S. Cls.: 100, 101 and 104

United States Patent and Trademark Office

Reg. No. 3,480,692

Registered Aug. 5, 2008

**SERVICE MARK
PRINCIPAL REGISTER**

IMPORTEK

INVENTEC MULTIMEDIA & TELECOM CORPORATION (TAIWAN CORPORATION)
5F., NO. 396, SEC. 1, NEIHU RD.
TAIPEI CITY, TAIWAN

FOR: DELIVERY OF MESSAGES BY ELECTRONIC TRANSMISSION; ELECTRONIC TRANSMISSIONS OF DATA AND DOCUMENTS VIA COMPUTER TERMINALS; ELECTRONIC, ELECTRIC AND DIGITAL TRANSMISSION OF VOICE, DATA, IMAGES, SIGNALS AND MESSAGES; PROVIDING VOICE COMMUNICATION SERVICES VIA THE INTERNET; TELEPHONE VOICE MESSAGING SERVICES; ELECTRONIC MAIL SERVICES; DATA COMMUNICATION BY ELECTRONIC MAIL; RENTAL OF COMMUNICATION APPARATUS AND IMPLEMENTS; PROVIDING ON-LINE ELECTRONIC BULLETIN BOARDS FOR TRANSMISSION OF MESSAGES AMONG COMPUTER USERS CONCERNING MUSIC, NEWS, CURRENT EVENTS, POLITICS, ENTERTAINMENT AND ARTS AND LEISURE; COMPUTER AIDED TRANSMISSION OF INFORMATION AND IMAGES; SATELLITE

TRANSMISSION SERVICES; TELEPHONE COMMUNICATION SERVICES; INFORMATION TRANSMISSION VIA ELECTRONIC COMMUNICATIONS NETWORKS; RENTAL OF EMAIL BOXES; RENTAL OF EQUIPMENT FOR TELECOMMUNICATIONS; TRANSMISSION OF INFORMATION BY ELECTRONIC COMMUNICATIONS NETWORKS; TELECOMMUNICATIONS SERVICES, NAMELY PROVIDING FIBER OPTIC NETWORK SERVICES., IN CLASS 38 (U.S. CLS. 100, 101 AND 104).

THE MARK CONSISTS OF STANDARD CHARACTERS WITHOUT CLAIM TO ANY PARTICULAR FONT, STYLE, SIZE, OR COLOR.

OWNER OF TAIWAN REG. NO. 01242425, DATED 12-16-2006, EXPIRES 12-16-2016.

SER. NO. 78-909,443, FILED 6-15-2006.

MIDGE BUTLER, EXAMINING ATTORNEY

Int. Cl.: 36

Prior U.S. Cls.: 100, 101 and 102

United States Patent and Trademark Office

Reg. No. 3,480,693

Registered Aug. 5, 2008

**SERVICE MARK
PRINCIPAL REGISTER**

IMPORTEK

INVENTEC MULTIMEDIA & TELECOM COR-
PORATION (TAIWAN CORPORATION)

5F., NO. 396, SEC. 1, NEIHU RD.

TAIPEI CITY, TAIWAN

FOR: PROVIDING INFORMATION IN THE
FIELD OF FINANCE INVESTMENT., IN CLASS 36
(U.S. CLS. 100, 101 AND 102).

THE MARK CONSISTS OF STANDARD CHAR-
ACTERS WITHOUT CLAIM TO ANY PARTICULAR
FONT, STYLE, SIZE, OR COLOR.

OWNER OF TAIWAN REG. NO. 01242383, DATED
12-16-2006, EXPIRES 12-15-2016.

SER. NO. 78-909,455, FILED 6-15-2006.

MIDGE BUTLER, EXAMINING ATTORNEY

Int. Cl.: 37

Prior U.S. Cls.: 100, 103 and 106

United States Patent and Trademark Office

Reg. No. 3,480,694

Registered Aug. 5, 2008

**SERVICE MARK
PRINCIPAL REGISTER**

IMPORTEK

INVENTEC MULTIMEDIA & TELECOM COR-
PORATION (TAIWAN CORPORATION)
5F., NO. 396, SEC. 1, NEIHU RD.
TAIPEI CITY, TAIWAN

FOR: INSTALLATION, REPAIR AND MAINTENANCE OF TELEPHONES AND COMMUNICATION EQUIPMENT; MAINTENANCE AND REPAIR OF COMPUTERS; INSTALLATION, REPAIR AND MAINTENANCE OF HOUSEHOLD APPLIANCES; MAINTENANCE AND REPAIR OF DIGITAL CAMERAS, VIDEO CAMERAS, VIDEO SCAN MACHINES AND OVERHEAD PROJECTORS; INSTALLATION OF COMPUTER SYSTEMS; INSTALLATION AND REPAIR OF SAFETY EQUIP-

MENT AND ALARMS, IN CLASS 37 (U.S. CLS. 100, 103 AND 106).

THE MARK CONSISTS OF STANDARD CHARACTERS WITHOUT CLAIM TO ANY PARTICULAR FONT, STYLE, SIZE, OR COLOR.

OWNER OF TAIWAN REG. NO. 01242416, DATED 12-16-2006, EXPIRES 12-15-2016.

SER. NO. 78-909,458, FILED 6-15-2006.

INGA ERVIN, EXAMINING ATTORNEY

Int. Cl.: 30

Prior U.S. Cl.: 46

United States Patent and Trademark Office

Reg. No. 3,480,695

Registered Aug. 5, 2008

**TRADEMARK
PRINCIPAL REGISTER**

VIJAYA FOODS

VIJAYA FOODS INC. (ILLINOIS CORPORATION)
1900 NORTH AUSTIN AVENUE
CHICAGO, IL 60639

FOR: BREADS, CEREAL-BASED SNACK FOODS,
IN CLASS 30 (U.S. CL. 46).

FIRST USE 0-0-1988; IN COMMERCE 0-0-1988.

THE MARK CONSISTS OF STANDARD CHAR-
ACTERS WITHOUT CLAIM TO ANY PARTICULAR
FONT, STYLE, SIZE, OR COLOR.

NO CLAIM IS MADE TO THE EXCLUSIVE
RIGHT TO USE "FOODS", APART FROM THE
MARK AS SHOWN.

SER. NO. 78-911,973, FILED 6-20-2006.

MARY BOAGNI, EXAMINING ATTORNEY

Int. Cl.: 42

Prior U.S. Cls.: 100 and 101

United States Patent and Trademark Office

Reg. No. 3,480,696

Registered Aug. 5, 2008

**SERVICE MARK
PRINCIPAL REGISTER**

Cheap Geek

FALTSKOG, MARGARET C (UNITED STATES
INDIVIDUAL)
699 SARATOGA RD
BURNT HILLS, NY 12027

FOR: TECHNICAL SUPPORT SERVICES, NAME-
LY, TROUBLESHOOTING OF COMPUTER HARD-
WARE, SOFTWARE AND INTERNET NETWORK
PROBLEMS, IN CLASS 42 (U.S. CLS. 100 AND 101).

FIRST USE 5-1-2005; IN COMMERCE 5-1-2005.

THE MARK CONSISTS OF STANDARD CHAR-
ACTERS WITHOUT CLAIM TO ANY PARTICULAR
FONT, STYLE, SIZE, OR COLOR.

SER. NO. 78-912,138, FILED 6-20-2006.

ALYSSA PALADINO, EXAMINING ATTORNEY

Int. Cl.: 38

Prior U.S. Cls.: 100, 101 and 104

United States Patent and Trademark Office

Reg. No. 3,480,697

Registered Aug. 5, 2008

**SERVICE MARK
PRINCIPAL REGISTER**

IMMEDIA

IMMEDIA, LLC (ARIZONA LTD LIAB CO)
SUITE 4
8260 E. RAINTREE ROAD
SCOTTSDALE, AZ 85260

FOR: ELECTRONIC, ELECTRIC, DIGITAL AND WIRELESS TRANSMISSION OF VOICE, DATA, IMAGES, SIGNALS AND MESSAGES VIA TELEPHONE, TELEVISION AND COMPUTER COMMUNICATION SYSTEMS; VIDEOCONFERENCING SERVICES; VIDEO TELEPHONE COMMUNICATION SERVICES; AUDIO CONFERENCING SERVICES; TELECOMMUNICATIONS CONSULTATION IN THE NATURE OF TECHNICAL CONSULTING IN THE FIELD OF AUDIO, TEXT AND VISUAL

DATA TRANSMISSION AND COMMUNICATION, IN CLASS 38 (U.S. CLS. 100, 101 AND 104).

FIRST USE 10-1-2004; IN COMMERCE 10-1-2004.

THE MARK CONSISTS OF STANDARD CHARACTERS WITHOUT CLAIM TO ANY PARTICULAR FONT, STYLE, SIZE, OR COLOR.

"IMMEDIA" AND "IM" APPEARING IN THE MARK HAS NO MEANING IN A FOREIGN LANGUAGE.

SER. NO. 78-912,736, FILED 6-20-2006.

TANYA AMOS, EXAMINING ATTORNEY

Int. Cl.: 12

Prior U.S. Cls.: 19, 21, 23, 31, 35 and 44

United States Patent and Trademark Office

Reg. No. 3,480,698

Registered Aug. 5, 2008

**TRADEMARK
PRINCIPAL REGISTER**

HI-LEX CORPORATION

HI-LEX CORPORATION (JAPAN CORPORATION)
12-28 SAKAE-MACHI 1CHOME, TAKARAZUKA-SHI
HYOGO-KEN, JAPAN

FOR: ROPEWAYS FOR CARGO OR FREIGHT HANDLING; UNLOADING TIPLER FOR TILTING RAILWAY FREIGHT CARS IN THE NATURE OF FORK LIFT TRUCKS; MINE-CAR PUSHERS; MINE-CAR PULLERS; TRACTORS; NON-ELECTRIC PRIME MOVERS FOR LAND VEHICLES AND NOT INCLUDING PARTS FOR THE AFORESAID; PARACHUTES; ANTI-THEFT ALARMS FOR VEHICLES; WHEELCHAIRS; AC MOTORS OR DC MOTORS FOR LAND VEHICLES NOT INCLUDING PARTS FOR THE AFORESAID; VESSELS AND STRUCTURAL PARTS THEREFOR; AIRCRAFT AND STRUCTURAL PARTS THEREFOR; RAILWAY ROLLING STOCK AND STRUCTURAL PARTS THEREFOR; AUTOMOBILES AND STRUCTURAL PARTS THEREFOR; TWO-WHEELED MO-

TOR VEHICLES, BICYCLES AND THEIR PARTS AND FITTINGS; BABY CARRIAGES; RICKSHAWS; SLEIGHS; WHEELBARROWS; CARTS; HORSE DRAWN CARRIAGES; BICYCLE TRAILERS; ADHESIVE RUBBER PATCHES FOR REPAIRING TUBES OR TIRES, IN CLASS 12 (U.S. CLS. 19, 21, 23, 31, 35 AND 44).

PRIORITY CLAIMED UNDER SEC. 44(D) ON JAPAN APPLICATION NO. 2005122505, FILED 12-28-2005, REG. NO. 4989435, DATED 9-22-2006, EXPIRES 9-22-2016.

NO CLAIM IS MADE TO THE EXCLUSIVE RIGHT TO USE "CORPORATION", APART FROM THE MARK AS SHOWN.

SER. NO. 78-913,191, FILED 6-21-2006.

LINDA POWELL, EXAMINING ATTORNEY

Int. Cl.: 6

Prior U.S. Cls.: 2, 12, 13, 14, 23, 25 and 50

Reg. No. 3,480,699

United States Patent and Trademark Office

Registered Aug. 5, 2008

TRADEMARK
PRINCIPAL REGISTER

HI-LEX CORPORATION

HI-LEX CORPORATION (JAPAN CORPORATION)
12-28 SAKAE-MACHI 1CHOME, TAKARAZUKA-SHI
HYOGO-KEN, JAPAN

FOR: IRONS AND STEELS; NON-PRECIOUS AND NONFERROUS METALS AND THEIR ALLOYS; ORES OF METAL, NAMELY, LEAD, TIN, ZINC, CHROME IRON, COBALT, COPPER, MANGANESE, MOLYBDENUM, TUNGSTEN AND NICKEL; METAL MATERIALS FOR BUILDING AND CONSTRUCTION, NAMELY, METAL CLADDING AND REINFORCING MATERIALS OF METAL FOR BUILDING PURPOSES; PREFABRICATED BUILDING ASSEMBLY KITS OF METAL; LOADING AND UNLOADING PALLETS OF METAL; METAL TURN-TABLES FOR LOAD HANDLING; METAL TRAVERSERS FOR LOAD HANDLING; ARTIFICIAL FISH REEFS OF METAL; POULTRY CAGES OF METAL; PAINT SPRAYING BOOTHS OF METAL; METAL MOULDS FOR FORMING CEMENT PRODUCTS; METAL PULLEYS, SPRINGS AND VALVES NOT INCLUDING MACHINE ELEMENTS; METAL JUNCTIONS FOR PIPES; METAL FLANGES; METAL KEYS BEING MECHANICAL ELEMENTS; COTTER PINS; METAL RAILWAY POINTS; NON-LUMINOUS AND NON-MECHANICAL ROAD SIGNS OF METAL; NON-LUMINOUS BEACONS OF METAL; RESERVOIRS OF METAL; ANCHORS; MOORING BITS OF METAL; MOORING BOLLARDS OF METAL; CONTAINERS OF METAL FOR TRANSPORT; ANVILS; METAL SWAGE BLOCKS; METAL HARDWARE, NAMELY, PULLEYS, SPRINGS, NUTS AND WASHERS; WIRE

ROPES; WIRE NETS AND GAUZES; INDUSTRIAL PACKAGING CONTAINERS OF METAL; METAL NAMEPLATES AND DOOR NAMEPLATES; METAL CHAINS FOR DOGS; METAL STEPLADDERS AND LADDERS; LETTER BOXES OF METAL; HATHANGING HOOKS OF METAL; MONEY BOXES OF METAL; WATER TANKS OF METAL FOR HOUSEHOLD PURPOSES; TOOL BOXES OF METAL; TOWEL DISPENSERS OF METAL; METAL JOINERY FITTINGS; METAL SAFES; UPRIGHT SIGNBOARDS OF METAL; TRANSPORTABLE GREENHOUSES OF METAL FOR HOUSEHOLD USE; METAL TOMBS AND METAL TOMB PLAQUES; BUCKLES OF METAL FOR INDUSTRIAL USE; FERRULES OF METAL FOR CANES AND WALKING-STICKS; CRAMPONS BEING CLIMBING IRONS; MOUNTAINEERING EQUIPMENT, NAMELY, ROCK PITONS OF METAL; DIVING PLATFORMS OF METAL; STIRRUPS OF METAL; SPURS; SCULPTURES OF METAL, IN CLASS 6 (U.S. CLS. 2, 12, 13, 14, 23, 25 AND 50).

PRIORITY CLAIMED UNDER SEC. 44(D) ON JAPAN APPLICATION NO. 2005122508, FILED 12-28-2005, REG. NO. 4989438, DATED 9-22-2006, EXPIRES 9-22-2016.

NO CLAIM IS MADE TO THE EXCLUSIVE RIGHT TO USE "CORPORATION", APART FROM THE MARK AS SHOWN.

SER. NO. 78-913,258, FILED 6-21-2006.

LINDA POWELL, EXAMINING ATTORNEY

Int. Cl.: 16

Prior U.S. Cls.: 2, 5, 22, 23, 29, 37, 38 and 50

United States Patent and Trademark Office

Reg. No. 3,480,700

Registered Aug. 5, 2008

**TRADEMARK
PRINCIPAL REGISTER**

**Miss Spider's Sunny Patch
Friends**

CALLAWAY & KIRK COMPANY LLC (DELA-
WARE LTD LIAB CO)
19 FULTON STREET
NEW YORK, NY 10038

FOR: CHILDREN'S BOOKS, IN CLASS 16 (U.S.
CLS. 2, 5, 22, 23, 29, 37, 38 AND 50).

FIRST USE 7-7-2005; IN COMMERCE 7-7-2005.

THE MARK CONSISTS OF STANDARD CHAR-
ACTERS WITHOUT CLAIM TO ANY PARTICULAR
FONT, STYLE, SIZE, OR COLOR.

OWNER OF U.S. REG. NOS. 2,041,646, 3,317,966
AND OTHERS.

SER. NO. 78-913,761, FILED 6-21-2006.

ESTHER BELENKER, EXAMINING ATTORNEY

Int. Cl.: 38

Prior U.S. Cls.: 100, 101 and 104

United States Patent and Trademark Office

Reg. No. 3,480,701

Registered Aug. 5, 2008

**SERVICE MARK
PRINCIPAL REGISTER**

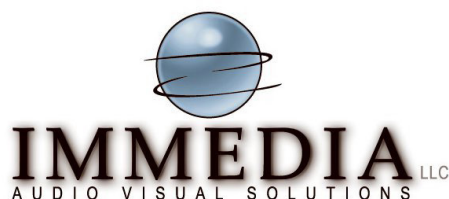

IMMEDIA, LLC (ARIZONA LTD LIAB CO)
SUITE 4
8260 E. RAINTREE ROAD
SCOTTSDALE, AZ 85260

FOR: ELECTRONIC, ELECTRIC, DIGITAL AND WIRELESS TRANSMISSION OF VOICE, DATA, IMAGES, SIGNALS AND MESSAGES VIA TELEPHONE, TELEVISION AND COMPUTER COMMUNICATION SYSTEMS; VIDEOCONFERENCING SERVICES; VIDEO TELEPHONE COMMUNICATION SERVICES; AUDIO CONFERENCING SERVICES; TELECOMMUNICATIONS CONSULTATION IN THE NATURE OF TECHNICAL CONSULTING IN THE FIELD OF AUDIO, TEXT AND VISUAL DATA TRANSMISSION AND COMMUNICATION, IN CLASS 38 (U.S. CLS. 100, 101 AND 104).

FIRST USE 10-1-2004; IN COMMERCE 10-1-2004.

NO CLAIM IS MADE TO THE EXCLUSIVE RIGHT TO USE "AUDIO VISUAL SOLUTIONS"

AND "LLC", APART FROM THE MARK AS SHOWN.

THE COLOR(S) BLUE, BLACK, WHITE AND GRAY IS/ARE CLAIMED AS A FEATURE OF THE MARK.

THE MARK CONSISTS OF A BLUE SHADED CIRCLE OUTLINED IN BLACK AND CONTAINING TWO CURVED BLACK LINES. THE BLUE SHADED CIRCLE ALSO CONTAINS AREAS OF WHITE. THE MARK ALSO CONTAINS THE WORD "IMMEDIA" IN BLACK WITH GRAY SHADING, THE TERM "LLC" IN GRAY, AND THE WORDS "AUDIO VISUAL SOLUTIONS" IN BLACK.

SER. NO. 78-914,849, FILED 6-22-2006.

TANYA AMOS, EXAMINING ATTORNEY

Int. Cl.: 44

Prior U.S. Cls.: 100 and 101

United States Patent and Trademark Office

Reg. No. 3,480,702

Registered Aug. 5, 2008

**SERVICE MARK
PRINCIPAL REGISTER**



HEANEY, PATRICK D (VIRGINIA CORPORATION)
5501 DEVONSHIRE COURT
RICHMOND, VA 23225

FOR: AROMATHERAPY SERVICES; BEAUTY SALONS; COSMETICIAN SERVICES; COSMETOLOGY SERVICES; HAIR CUTTING; HAIR IMPLANTATION; HAIR REPLACEMENT; HAIR SALON SERVICES, NAMELY, TREATMENTS TO PROTECT HAIR FROM AFFECTS OF EXPOSURE TO SUNLIGHT, HEAT, HUMIDITY AND CHLORINATED WATER; HAIR STYLING; HAIRDRESSING SALONS; HAIRDRESSING SERVICES; HEALTH SPA SERVICES FOR HEALTH AND WELLNESS OF THE BODY AND SPIRIT OFFERED AT A HEALTH RESORT; HEALTH SPA SERVICES, NAMELY, COSMETIC BODY CARE SERVICES, IN CLASS 44 (U.S. CLS. 100 AND 101).

FIRST USE 8-15-2003; IN COMMERCE 8-15-2003.

NO CLAIM IS MADE TO THE EXCLUSIVE RIGHT TO USE "SALON", APART FROM THE MARK AS SHOWN.

"THE COLOR(S) ORANGE, BLACK AND WHITE IS/ARE CLAIMED AS A FEATURE OF THE MARK."

THE MARK CONSISTS OF THE COLOR ORANGE APPEARS IN THE DESIGN, IN THE WORD SALON, AND IN THE BORDER OF THE RECTANGLE THAT ENCLOSSES THE MARK. THE COLOR WHITE APPEARS IN THE WORD MANGO. THE COLOR BLACK APPEARS IN THE BACKGROUND".

SER. NO. 78-920,989, FILED 6-30-2006.

DORITT L. CARROLL, EXAMINING ATTORNEY

Int. Cl.: 41

Prior U.S. Cls.: 100, 101 and 107

United States Patent and Trademark Office

Reg. No. 3,480,703

Registered Aug. 5, 2008

**SERVICE MARK
PRINCIPAL REGISTER**

STARSIAN

CJ MEDIA, INC. (REPUBLIC OF KOREA CORPORATION)
KANGNAM-GU
97-1, CHONGDAM-DONG
SEOUL, REPUBLIC OF KOREA

FOR: CINEMA THEATERS; DIGITAL IMAGING SERVICES; PRODUCTION OF RADIO AND TELEVISION PROGRAMS; PRESENTATION OF LIVE SHOW PERFORMANCES; PRODUCTION OF VIDEO FILMS; PRODUCTION OF TELEVISION, FILM AND THEATRE SHOWS; ORGANIZATION OF TELEVISION, FILM AND THEATRE SHOWS; ORGANIZATION OF MUSICAL GROUPS; ENTERTAINMENT SERVICES, NAMELY, LIVE, TELEVISED AND MOVIE APPEARANCES BY A PROFESSIONAL ENTERTAINER; PROVIDING INFORMATION ABOUT MUSIC, MOVIES AND THEATRES; FILM DISTRIBUTION; EXHIBITION OF CINE FILMS FOR CULTURAL OR ENTERTAINMENT PURPOSES; MOTION PICTURE FILM PRODUCTION; PRESENTATION OF MUSICAL PERFORMANCES; TELEVISION NEWS SHOWS, TELEVISION SHOWS; TEACHING; INFORMATION ON EDUCATION; EDUCATIONAL EXAMINATION SERVICES; ORGANIZATION AND MANAGEMENT OF EXHIBITIONS FOR CULTURAL OR ENTERTAINMENT PURPOSES; EDUCATION IN THE FIELD OF COMPUTERS, MUSIC AND ART REN-

DERED THROUGH CORRESPONDENCE COURSES; SPONSORING AND PROMOTING FOOTBALL GAMES, SPONSORING AND PROMOTING BASKETBALL GAMES, SPONSORING AND PROMOTING COMPUTER GAMES; PROVIDING FACILITIES FOR RECREATION ACTIVITIES; PROVIDING RECREATION INFORMATION; ENTERTAINMENT SERVICES, NAMELY, PROVIDING ON-LINE COMPUTER GAMES; VIDEO FILMING; PHOTOGRAPHY SERVICES; ENTERTAINMENT IN THE NATURE OF BEAUTY PAGEANTS; ORGANIZATION OF DANCING EVENTS, ORGANIZATION OF SPORTS EVENTS IN THE FIELD OF FOOTBALL., IN CLASS 41 (U.S. CLS. 100, 101 AND 107).

THE MARK CONSISTS OF STANDARD CHARACTERS WITHOUT CLAIM TO ANY PARTICULAR FONT, STYLE, SIZE, OR COLOR.

PRIORITY CLAIMED UNDER SEC. 44(D) ON REPUBLIC OF KOREA APPLICATION NO. 2006-0016197, FILED 6-26-2006, REG. NO. 0150686, DATED 6-29-2007, EXPIRES 6-29-2017.

SER. NO. 78-923,610, FILED 7-6-2006.

GISSELLE AGOSTO, EXAMINING ATTORNEY

Int. Cl.: 35

Prior U.S. Cls.: 100, 101 and 102

United States Patent and Trademark Office

Reg. No. 3,480,704

Registered Aug. 5, 2008

**SERVICE MARK
PRINCIPAL REGISTER**

Airlift Ideas

AIRLIFT IDEAS, INC. (ILLINOIS CORPORATION)
1923 W. RACE
CHICAGO, IL 60622

FOR: ADVERTISING AGENCY SERVICES, NAMELY, CREATING BRAND IDENTITY, AND SERVICE AND BRAND NAMES FOR OTHERS; PROVIDING BUSINESS EVALUATIONS AND ANALYSIS OF BRAND IDENTITY; DEVELOPMENT AND IMPLEMENTATION OF BRAND STRATEGIES FOR OTHERS; AND PROVIDING PROMOTION, MARKETING AND RELATED CONSULTING SERVICES, IN CLASS 35 (U.S. CLS. 100, 101 AND 102).

FIRST USE 8-1-2005; IN COMMERCE 6-15-2006.

THE MARK CONSISTS OF STANDARD CHARACTERS WITHOUT CLAIM TO ANY PARTICULAR FONT, STYLE, SIZE, OR COLOR.

NO CLAIM IS MADE TO THE EXCLUSIVE RIGHT TO USE "IDEAS", APART FROM THE MARK AS SHOWN.

SER. NO. 78-925,993, FILED 7-10-2006.

WANDA KAY PRICE, EXAMINING ATTORNEY

Int. Cl.: 42

Prior U.S. Cls.: 100 and 101

United States Patent and Trademark Office

Reg. No. 3,480,705

Registered Aug. 5, 2008

**SERVICE MARK
PRINCIPAL REGISTER**

FACES OF EARTH

AMERICAN GEOLOGICAL INSTITUTE (D.C.
CORPORATION)
4220 KING STREET
ALEXANDRIA, VA 223021502

FOR: PROVIDING A WEB SITE CONTAINING
EDUCATIONAL INFORMATION IN THE FIELD OF
THE EARTH SCIENCES, IN CLASS 42 (U.S. CLS. 100
AND 101).

FIRST USE 6-29-2006; IN COMMERCE 6-29-2006.

THE MARK CONSISTS OF STANDARD CHAR-
ACTERS WITHOUT CLAIM TO ANY PARTICULAR
FONT, STYLE, SIZE, OR COLOR.

NO CLAIM IS MADE TO THE EXCLUSIVE
RIGHT TO USE "EARTH", APART FROM THE
MARK AS SHOWN.

SER. NO. 78-928,902, FILED 7-13-2006.

FRED CARL, EXAMINING ATTORNEY

Int. Cls.: 9, 41 and 42

Prior U.S. Cls.: 21, 23, 26, 36, 38, 100, 101 and 107

United States Patent and Trademark Office

Reg. No. 3,480,706

Registered Aug. 5, 2008

**TRADEMARK
SERVICE MARK
PRINCIPAL REGISTER**

STRATA

STRATA MARKETING, INC. (DELAWARE CORPORATION)
SUITE 1900
30 WEST MONROE STREET
CHICAGO, IL 60603

FOR: COMPUTER SOFTWARE FOR USE IN DATABASE MANAGEMENT AND AS A SPREADSHEET IN THE FIELD OF QUANTITATIVE AND QUALITATIVE ANALYSIS, PLANNING, SCHEDULING, MEDIA-BUYING, INVOICING AND POST-BUY ANALYSIS OF ADVERTISING SERVICES IN ALL FORMS OF MEDIA COMMUNICATIONS, STATIONS, SYSTEM, NETWORKS, AND SERVICES, IN CLASS 9 (U.S. CLS. 21, 23, 26, 36 AND 38).

FIRST USE 11-30-1984; IN COMMERCE 11-30-1984.

FOR: TRAINING IN THE USE OF COMPUTER SOFTWARE IN THE FIELD OF QUANTITATIVE AND QUALITATIVE ANALYSIS, PLANNING, SCHEDULING, MEDIA-BUYING, INVOICING AND POST-BUY ANALYSIS OF ADVERTISING SERVICES IN ALL FORMS OF MEDIA COMMUNICATIONS, STATIONS, SYSTEMS, NETWORKS AND SERVICES, IN CLASS 41 (U.S. CLS. 100, 101 AND 107).

FIRST USE 11-30-1984; IN COMMERCE 11-30-1984.

FOR: APPLICATION SERVICE PROVIDER FEATURING SOFTWARE FOR USE IN DATABASE MANAGEMENT AND AS A SPREADSHEET IN THE FIELD OF QUANTITATIVE AND QUALITATIVE ANALYSIS, PLANNING, SCHEDULING, MEDIA-BUYING, INVOICING AND POST-BUY ANALYSIS OF ADVERTISING SERVICES IN ALL FORMS OF MEDIA COMMUNICATIONS, STATIONS, SYSTEMS, NETWORKS AND SERVICES , IN CLASS 42 (U.S. CLS. 100 AND 101).

FIRST USE 11-30-1984; IN COMMERCE 11-30-1984.

THE MARK CONSISTS OF STANDARD CHARACTERS WITHOUT CLAIM TO ANY PARTICULAR FONT, STYLE, SIZE, OR COLOR.

SER. NO. 78-933,260, FILED 7-19-2006.

MICHAEL WIENER, EXAMINING ATTORNEY

Int. Cls.: 35 and 45

Prior U.S. Cls.: 100, 101 and 102

United States Patent and Trademark Office

Reg. No. 3,480,707

Registered Aug. 5, 2008

**SERVICE MARK
PRINCIPAL REGISTER**

GMS

GUARDIAN MORTGAGE DOCUMENTS, INC.
(COLORADO CORPORATION)
SUITE 200
225 UNION BLVD.
LAKEWOOD, CO 80228

FOR: DATA PROCESSING, BUSINESS MANAGEMENT IN THE NATURE OF VENDOR MANAGEMENT ALL FOR THE MORTGAGE BANKING INDUSTRY, IN CLASS 35 (U.S. CLS. 100, 101 AND 102).

FIRST USE 7-31-1997; IN COMMERCE 7-31-1997.

FOR: MORTGAGE LOAN CLOSING AND POST-CLOSING COORDINATION SERVICES FOR THE MORTGAGE BANKING INDUSTRY, IN CLASS 45 (U.S. CLS. 100 AND 101).

FIRST USE 7-31-1997; IN COMMERCE 7-31-1997.

THE MARK CONSISTS OF STANDARD CHARACTERS WITHOUT CLAIM TO ANY PARTICULAR FONT, STYLE, SIZE, OR COLOR.

SER. NO. 78-934,180, FILED 7-20-2006.

FRANK LATTUCA, EXAMINING ATTORNEY

Int. Cls.: 39 and 40

Prior U.S. Cls.: 100, 103, 105 and 106

United States Patent and Trademark Office

Reg. No. 3,480,708

Registered Aug. 5, 2008

**SERVICE MARK
PRINCIPAL REGISTER**

QUESTAR GAS MANAGEMENT

QUESTAR CORPORATION (UTAH CORPORATION)
180 EAST 100 SOUTH
SALT LAKE CITY, UT 841391500

FOR: NATURAL GAS GATHERING, TRANSPORTATION AND STORAGE, IN CLASS 39 (U.S. CLS. 100 AND 105).

FIRST USE 12-31-1996; IN COMMERCE 12-31-1996.

FOR: OIL AND GAS TREATMENT AND PROCESSING, IN CLASS 40 (U.S. CLS. 100, 103 AND 106).

FIRST USE 12-31-1996; IN COMMERCE 12-31-1996.

THE MARK CONSISTS OF STANDARD CHARACTERS WITHOUT CLAIM TO ANY PARTICULAR FONT, STYLE, SIZE, OR COLOR.

OWNER OF U.S. REG. NOS. 2,300,595, 2,300,600 AND OTHERS.

NO CLAIM IS MADE TO THE EXCLUSIVE RIGHT TO USE "GAS MANAGEMENT", APART FROM THE MARK AS SHOWN.

SER. NO. 78-935,743, FILED 7-24-2006.

AMEETA JORDAN, EXAMINING ATTORNEY

Int. Cls.: 9, 36, 37 and 42

**Prior U.S. Cls.: 21, 23, 26, 36, 38, 100, 101, 102, 103
and 106**

Reg. No. 3,480,709

United States Patent and Trademark Office

Registered Aug. 5, 2008

**TRADEMARK
SERVICE MARK
PRINCIPAL REGISTER**

SERVIDYNE

SERVIDYNE, INC. (GEORGIA CORPORATION)
SUITE 325
1945 THE EXCHANGE
ATLANTA, GA 30339

FOR: COMPUTER SOFTWARE FOR USE IN
MANAGING EMPLOYEES WHO SERVE BUILDING
RESIDENTS IN COMMERCIAL INSTITUTIONAL
FACILITIES, IN CLASS 9 (U.S. CLS. 21, 23, 26, 36
AND 38).

FIRST USE 2-0-2000; IN COMMERCE 2-0-2000.

FOR: WEB-BASED PROPERTY MANAGEMENT
AND SERVICES SOLUTIONS FEATURING FULLY
AUTOMATED MAINTENANCE MANAGEMENT
USING THE INTERNET AND WIRELESS HAND-
HELD DEVICES, NAMELY, REAL PROPERTY
MANAGEMENT, INCLUDING COMMERCIAL, IN-
STITUTIONAL, INDUSTRIAL, RETAIL AND HOS-
PITALITY PROPERTIES, IN CLASS 36 (U.S. CLS. 100,
101 AND 102).

FIRST USE 4-0-2004; IN COMMERCE 4-0-2004.

FOR: PROVIDING MAINTENANCE AND SER-
VICE REQUEST SOLUTIONS, NAMELY, PROVID-
ING MAINTENANCE OF ENERGY FACILITIES TO
AID IN THE REDUCTION OF BUILDING OPERAT-
ING AND OWNERSHIP COSTS; BUILDING COM-
MISSIONING, NAMELY, PROVIDING
CONSTRUCTION CONSULTATION; INSTALLA-
TION OF ENERGY SAVING SYSTEMS THAT RE-
DUCE ENERGY CONSUMPTION AND
OPERATING COSTS TO COMMERCIAL, INDUS-
TRIAL AND INSTITUTIONAL FACILITIES; LIGHT-
ING SERVICES, NAMELY, INSTALLATION AND
MAINTENANCE OF ENERGY-EFFICIENT LIGHT-
ING SYSTEMS; GROUP RELAMP SERVICES,

NAMELY, INSTALLATION AND REPLACEMENT
OF ENTIRE LIGHTING SYSTEMS AT A PREDE-
TERMINED TIME; INSTALLATION AND RETRO-
FITTING OF HVAC ENERGY EFFICIENCY
SYSTEMS, IN CLASS 37 (U.S. CLS. 100, 103 AND 106).

FIRST USE 4-0-2001; IN COMMERCE 4-0-2001.

FOR: ENGINEERING SERVICES, NAMELY,
ANALYSIS OF ENVIRONMENTAL CONTROL SYS-
TEMS TO DETERMINE THE MINIMUM ATTAIN-
ABLE ENERGY CONSUMPTION LEVELS OF THE
SYSTEMS; ENGINEERING IN THE FIELD OF OP-
TIMAL FACILITY PERFORMANCE TO AID IN THE
REDUCTION OF BUILDING AND OWNERSHIP
COSTS; ENGINEERING DESIGN SERVICES; MON-
ITORING ELECTRIC POWER CONSUMPTION AND
PROVIDING ANALYSIS; TESTING, ANALYSIS
AND EVALUATION OF THE GOODS AND SERVIC-
ES OF OTHERS FOR THE PURPOSE OF CERTIFI-
CATION FOR GOVERNMENT AND PRIVATE
ENERGY CERTIFICATION PROGRAMS; ENERGY
MODELING, NAMELY, ENGINEERING IN THE
FIELD OF ENERGY; MECHANICAL ELECTRICAL
AND PLUMBING SURVEYS, NAMELY, CONDUCT-
ING ENGINEERING SURVEYS; DESIGNING, IN-
STALLING AND SUPPORTING COMPUTERIZED
MAINTENANCE AND SERVICE REQUEST SYS-
TEMS; DESIGNING, INSTALLING AND SUPPORT-
ING FACILITY MANAGEMENT SOFTWARE
APPLICATIONS; LIGHTING SERVICES, NAMELY,
DESIGN OF ENERGY-EFFICIENT LIGHTING SYS-
TEMS; POWER TECHNOLOGY SERVICES, NAME-
LY, PROVIDING ENGINEERING SERVICES FOR
THE DEVELOPMENT OF PROJECTS FOR ONSITE
POWER PLANTS AND DISTRIBUTED RESOUR-
CES; CONDUCTING PREVENTATIVE MAINTEN-
ANCE ENGINEERING SURVEYS, IN CLASS 42
(U.S. CLS. 100 AND 101).

FIRST USE 0-0-1994; IN COMMERCE 0-0-1994.

THE MARK CONSISTS OF STANDARD CHARACTERS WITHOUT CLAIM TO ANY PARTICULAR FONT, STYLE, SIZE, OR COLOR.

OWNER OF U.S. REG. NOS. 2,495,940 AND 2,598,920.

THE WORDING "SERVIDYNE" HAS NO MEANING IN A FOREIGN LANGUAGE.

SER. NO. 78-936,401, FILED 7-24-2006.

SEAN CROWLEY, EXAMINING ATTORNEY

Int. Cls.: 41, 42 and 44

Prior U.S. Cls.: 100, 101 and 107

United States Patent and Trademark Office

Reg. No. 3,480,710

Registered Aug. 5, 2008

**SERVICE MARK
PRINCIPAL REGISTER**



SANSUM-SANTA BARBARA MEDICAL FOUNDATION CLINIC (CALIFORNIA NON-PROFIT CORPORATION)
470 SOUTH PATTERSON AVENUE
SANTA BARBARA, CA 93111

FOR: EDUCATIONAL SERVICES, NAMELY, PROVIDING CLASSES, WORKSHOPS AND SEMINARS IN THE FIELDS OF MEDICINE AND HEALTH, IN CLASS 41 (U.S. CLS. 100, 101 AND 107).

FIRST USE 5-13-2006; IN COMMERCE 5-13-2006.

FOR: MEDICAL AND SCIENTIFIC HEALTH RESEARCH, IN CLASS 42 (U.S. CLS. 100 AND 101).

FIRST USE 5-13-2006; IN COMMERCE 5-13-2006.

FOR: PROVIDING MEDICAL SERVICES BY PHYSICIANS AND NON-PHYSICIAN HEALTHCARE PROFESSIONALS; RESOURCE CENTER FOR PROVIDING INFORMATION IN THE FIELDS OF MEDICINE AND HEALTH, IN CLASS 44 (U.S. CLS. 100 AND 101).

FIRST USE 5-13-2006; IN COMMERCE 5-13-2006.

NO CLAIM IS MADE TO THE EXCLUSIVE RIGHT TO USE "CLINIC", APART FROM THE MARK AS SHOWN.

SER. NO. 78-937,427, FILED 7-25-2006.

SEAN CROWLEY, EXAMINING ATTORNEY

Int. Cls.: 41, 42 and 44

Prior U.S. Cls.: 100, 101 and 107

United States Patent and Trademark Office

Reg. No. 3,480,711

Registered Aug. 5, 2008

**SERVICE MARK
PRINCIPAL REGISTER**

SANSUM CLINIC

SANSUM-SANTA BARBARA MEDICAL FOUNDATION CLINIC (CALIFORNIA NON-PROFIT CORPORATION)
470 SOUTH PATTERSON AVENUE
SANTA BARBARA, CA 93111

FOR: EDUCATIONAL SERVICES, NAMELY, PROVIDING CLASSES, WORKSHOPS AND SEMINARS IN THE FIELDS OF MEDICINE AND HEALTH, IN CLASS 41 (U.S. CLS. 100, 101 AND 107).

FIRST USE 5-13-2006; IN COMMERCE 5-13-2006.

FOR: MEDICAL AND SCIENTIFIC HEALTH RESEARCH, IN CLASS 42 (U.S. CLS. 100 AND 101).

FIRST USE 5-13-2006; IN COMMERCE 5-13-2006.

FOR: PROVIDING MEDICAL SERVICES BY PHYSICIANS AND NON-PHYSICIAN HEALTHCARE

PROFESSIONALS; RESOURCE CENTER FOR PROVIDING INFORMATION IN THE FIELDS OF MEDICINE AND HEALTH, IN CLASS 44 (U.S. CLS. 100 AND 101).

FIRST USE 5-13-2006; IN COMMERCE 5-13-2006.

THE MARK CONSISTS OF STANDARD CHARACTERS WITHOUT CLAIM TO ANY PARTICULAR FONT, STYLE, SIZE, OR COLOR.

NO CLAIM IS MADE TO THE EXCLUSIVE RIGHT TO USE "CLINIC", APART FROM THE MARK AS SHOWN.

SER. NO. 78-937,428, FILED 7-25-2006.

SEAN CROWLEY, EXAMINING ATTORNEY

Int. Cls.: 16, 35 and 41

**Prior U.S. Cls.: 2, 5, 22, 23, 29, 37, 38, 50, 100, 101, 102
and 107**

Reg. No. 3,480,712

United States Patent and Trademark Office

Registered Aug. 5, 2008

**TRADEMARK
SERVICE MARK
PRINCIPAL REGISTER**

DCWV

DCWV ACQUISITION CORPORATION (DELA-
WARE CORPORATION)
C/O H.I.G. CAPITAL, LLC
ONE MARKET – SPEAR TOWER
SAN FRANCISCO, CA 94105

FOR: SCRAPBOOK, MEMORY, STATIONERY
AND CRAFT PRODUCTS, NAMELY, SCRAP-
BOOKS, SCRAPBOOK PAGES, CRAFT PAPER,
STICKERS, DRAWING TEMPLATES, MEMORY
BOOKS AND ALBUMS, IN CLASS 16 (U.S. CLS. 2, 5,
22, 23, 29, 37, 38 AND 50).

FIRST USE 0-0-1993; IN COMMERCE 0-0-1993.

FOR: RETAIL STORE SERVICES FEATURING
SCRAPBOOK, MEMORY, STATIONERY AND
CRAFT PRODUCTS, NAMELY, SCRAPBOOKS,
SCRAPBOOKING PAPER, CRAFT PAPER, STICK-
ERS, DRAWING TEMPLATES, MEMORY BOOKS
AND ALBUMS; ON-LINE RETAIL STORE SERVI-
CES FEATURING SCRAPBOOK, MEMORY, STA-

TIONERY AND CRAFT PRODUCTS, NAMELY,
SCRAPBOOKS, SCRAPBOOKING PAPER, CRAFT
PAPER, STICKERS, DRAWING TEMPLATES, MEM-
ORY BOOKS AND ALBUMS, IN CLASS 35 (U.S. CLS.
100, 101 AND 102).

FIRST USE 0-0-1993; IN COMMERCE 0-0-1993.

FOR: CONSULTATION SERVICES IN THE FIELD
OF CREATING SCRAPBOOKS, IN CLASS 41 (U.S.
CLS. 100, 101 AND 107).

FIRST USE 0-0-1993; IN COMMERCE 0-0-1993.

THE MARK CONSISTS OF STANDARD CHAR-
ACTERS WITHOUT CLAIM TO ANY PARTICULAR
FONT, STYLE, SIZE, OR COLOR.

SER. NO. 78-943,527, FILED 8-2-2006.

BILL DAWE, EXAMINING ATTORNEY

Int. Cl.: 35

Prior U.S. Cls.: 100, 101 and 102

United States Patent and Trademark Office

Reg. No. 3,480,713

Registered Aug. 5, 2008

**SERVICE MARK
PRINCIPAL REGISTER**

3WISHES.COM

3WISHES.COM, INC. (NORTH CAROLINA CORPORATION)
2144 EAST LYON STATION ROAD
CREEDMOOR, NC 27522

FOR: ONLINE RETAIL STORE FEATURING WOMEN'S CLOTHING AND ACCESSORIES, NAMELY, LINGERIE, UNDERWEAR, BRAS, PANTIES, DRESSES, COSTUMES, SHOES, AND WIGS, IN CLASS 35 (U.S. CLS. 100, 101 AND 102).

FIRST USE 8-1-1998; IN COMMERCE 8-1-1998.

THE MARK CONSISTS OF STANDARD CHARACTERS WITHOUT CLAIM TO ANY PARTICULAR FONT, STYLE, SIZE, OR COLOR.

SER. NO. 78-945,599, FILED 8-4-2006.

JOHN SCHUYLER YARD, EXAMINING ATTORNEY

Int. Cl.: 20

Prior U.S. Cls.: 2, 13, 22, 25, 32 and 50

United States Patent and Trademark Office

Reg. No. 3,480,714

Registered Aug. 5, 2008

**TRADEMARK
PRINCIPAL REGISTER**

RAPTOR

UTILITY COMPOSITES INTERNATIONAL, L.P.
(TEXAS LIMITED PARTNERSHIP)
2704A MEISTER PLACE
ROUND ROCK, TX 78664

THE MARK CONSISTS OF STANDARD CHAR-
ACTERS WITHOUT CLAIM TO ANY PARTICULAR
FONT, STYLE, SIZE, OR COLOR.

FOR: NON-METAL FASTENERS, NAMELY,
NAILS AND STAPLES FOR CONSTRUCTION OR
INDUSTRIAL USE, IN CLASS 20 (U.S. CLS. 2, 13, 22,
25, 32 AND 50).

SER. NO. 78-949,797, FILED 8-10-2006.

FIRST USE 2-18-1994; IN COMMERCE 2-18-1994.

AMY ALFIERI, EXAMINING ATTORNEY

Int. Cls.: 10 and 28

Prior U.S. Cls.: 22, 23, 26, 38, 39, 44 and 50

United States Patent and Trademark Office

Reg. No. 3,480,715

Registered Aug. 5, 2008

**TRADEMARK
PRINCIPAL REGISTER**

SLENDERTONE FLEX MAX

BIO-MEDICAL RESEARCH LIMITED (IRELAND
CORPORATION)
BMR HOUSE
PARKMORE BUSINESS PARK WEST
GALWAY, IRELAND

FOR: ELECTRIC MASSAGE APPARATUS FEATURING BODY BELTS AND PADS FOR HOUSEHOLD USE; ELECTRICAL APPARATUS AND INSTRUMENTS, NAMELY, VIBRATING APPARATUS FEATURING BODY BELTS AND PADS USED TO STIMULATE MUSCLES AND INCREASE TONE, STRENGTH AND PHYSICAL PERFORMANCE FOR HEALTH AND MEDICAL PURPOSES, IN CLASS 10 (U.S. CLS. 26, 39 AND 44).

FOR: BODY TRAINING APPARATUS, NAMELY, APPARATUS FOR THE STRENGTHENING AND

TONING OF MUSCLES INCLUDING ABDOMINAL MUSCLES, IN CLASS 28 (U.S. CLS. 22, 23, 38 AND 50).

THE MARK CONSISTS OF STANDARD CHARACTERS WITHOUT CLAIM TO ANY PARTICULAR FONT, STYLE, SIZE, OR COLOR.

PRIORITY CLAIMED UNDER SEC. 44(D) ON ERPN CMNTY TM OFC APPLICATION NO. 004898094, FILED 2-13-2006, REG. NO. 004898094, DATED 11-30-2007, EXPIRES 11-30-2017.

OWNER OF U.S. REG. NOS. 1,180,968, 2,813,471, AND 3,032,699.

SER. NO. 78-950,027, FILED 8-11-2006.

REBECCA GILBERT, EXAMINING ATTORNEY

Int. Cl.: 41

Prior U.S. Cls.: 100, 101 and 107

United States Patent and Trademark Office

Reg. No. 3,480,716

Registered Aug. 5, 2008

**SERVICE MARK
PRINCIPAL REGISTER**

GRAND CIRCUIT

GRAND CIRCUIT, INC. (OHIO CORPORATION)
750 MICHIGAN AVENUE
COLUMBUS, OH 73215

FOR: ENTERTAINMENT, NAMELY, CONDUCT-
ING HORSE RACES, IN CLASS 41 (U.S. CLS. 100, 101
AND 107).

FIRST USE 1-1-1887; IN COMMERCE 1-1-1887.

THE MARK CONSISTS OF STANDARD CHAR-
ACTERS WITHOUT CLAIM TO ANY PARTICULAR
FONT, STYLE, SIZE, OR COLOR.

SEC. 2(F).

SER. NO. 78-951,451, FILED 8-14-2006.

JOHN E. MICHOS, EXAMINING ATTORNEY

Int. Cl.: 41

Prior U.S. Cls.: 100, 101 and 107

United States Patent and Trademark Office

Reg. No. 3,480,717

Registered Aug. 5, 2008

**SERVICE MARK
PRINCIPAL REGISTER**

Old School Omega By The Sea

SPORTS PERSPECTIVES INTERNATIONAL, INC.
(D.C. CORPORATION)
1130 SHEPHERD ROAD, N.W.
WASHINGTON, DC 20012

THE MARK CONSISTS OF STANDARD CHARACTERS WITHOUT CLAIM TO ANY PARTICULAR FONT, STYLE, SIZE, OR COLOR.

FOR: SPECIAL EVENT PLANNING CONSULTATION, IN CLASS 41 (U.S. CLS. 100, 101 AND 107).

SER. NO. 78-953,215, FILED 8-16-2006.

FIRST USE 8-16-2006; IN COMMERCE 8-6-2006.

RICHARD A. STRASER, EXAMINING ATTORNEY

Int. Cls.: 9, 11, 37 and 41

Prior U.S. Cls.: 13, 21, 23, 26, 31, 34, 36, 38, 100, 101, 103, 106 and 107

Reg. No. 3,480,718

United States Patent and Trademark Office

Registered Aug. 5, 2008

**TRADEMARK
SERVICE MARK
PRINCIPAL REGISTER**

climate of innovation

VISSMANN WERKE GMBH & CO KG (FED REP GERMANY LTD LIAB CO)
VISSMANNSTR. 1
ALLENDORF, FED REP GERMANY D-35107

FOR: ELECTRIC CONTROL DEVICES FOR HEATING AND SOLAR ENERGY MANAGEMENT; REMOTE CONTROLS FOR HEATING AND SOLAR INSTALLATIONS, IN CLASS 9 (U.S. CLS. 21, 23, 26, 36 AND 38).

FOR: OIL, GAS AND SOLID FUEL BOILERS, IN PARTICULAR LOW TEMPERATURE OIL-POWERED BOILERS, GAS CONDENSER APPARATUS, NAMELY, GAS FIRED CONDENSING BOILERS, OIL AND GAS-POWERED WALL-HUNG BOILERS, LOW TEMPERATURE GAS-POWERED BOILERS, CAST BOILERS; HEATING CIRCUIT PUMPS; OIL AND GAS BURNERS FOR BOILERS, IN PARTICULAR OIL AND GAS BLOWER BURNERS; SOLAR INSTALLATIONS, IN PARTICULAR SOLAR COLLECTORS, STORAGE WATER HEATERS; ELECTRIC WATER HEATERS; INSTANTANEOUS WATER HEATERS; HEAT PUMPS; HEAT EXCHANGERS; VENTILATING APPARATUS, NAMELY, EXHAUST FANS, DUCTS, LOUVERS, AND AIR

CONDITIONING UNITS; STEAM GENERATORS, IN CLASS 11 (U.S. CLS. 13, 21, 23, 31 AND 34).

FOR: REPAIR, MAINTENANCE AND INSTALLATION OF BOILER SYSTEMS AND SOLAR INSTALLATIONS, IN CLASS 37 (U.S. CLS. 100, 103 AND 106).

FOR: ORGANIZING, SPONSORING AND PROVIDING SPORTING EVENTS, NAMELY, WINTER SPORT COMPETITIONS, IN CLASS 41 (U.S. CLS. 100, 101 AND 107).

THE MARK CONSISTS OF STANDARD CHARACTERS WITHOUT CLAIM TO ANY PARTICULAR FONT, STYLE, SIZE, OR COLOR.

PRIORITY CLAIMED UNDER SEC. 44(D) ON ERPN CMNTY TM OFC APPLICATION NO. 4912044, FILED 2-20-2006, REG. NO. 4912044, DATED 2-6-2007, EXPIRES 2-20-2016.

SER. NO. 78-954,095, FILED 8-17-2006.

ROSELLE HERRERA, EXAMINING ATTORNEY

Int. Cl.: 25

Prior U.S. Cls.: 22 and 39

United States Patent and Trademark Office

Reg. No. 3,480,719

Registered Aug. 5, 2008

**TRADEMARK
PRINCIPAL REGISTER**

LUXURY KICKS

IGUASU TRADING, USA, INC. (CALIFORNIA
CORPORATION)
608 S. MAPLE AVE, UNIT #6
LOS ANGELES, CA 90014

FOR: CLOTHING, NAMELY, FOOTWEAR, HATS,
SHIRTS, PANTS, JACKETS AND SWEATERS, IN
CLASS 25 (U.S. CLS. 22 AND 39).

FIRST USE 1-1-2002; IN COMMERCE 1-1-2002.

THE MARK CONSISTS OF STANDARD CHAR-
ACTERS WITHOUT CLAIM TO ANY PARTICULAR
FONT, STYLE, SIZE, OR COLOR.

SEC. 2(F).

SER. NO. 78-957,096, FILED 8-21-2006.

SUSAN LESLIE DUBOIS, EXAMINING ATTORNEY

Int. Cl.: 25

Prior U.S. Cls.: 22 and 39

United States Patent and Trademark Office

Reg. No. 3,480,720

Registered Aug. 5, 2008

**TRADEMARK
PRINCIPAL REGISTER**



IGUASU TRADING, USA, INC. (CALIFORNIA CORPORATION)
608 S. MAPLE AVE., UNIT #6
LOS ANGELES, CA 90014

FIRST USE 1-1-2005; IN COMMERCE 1-1-2005.

SEC. 2(F).

FOR: CLOTHING, NAMELY, FOOTWEAR, HATS, SHIRTS, PANTS, JACKETS, AND SWEATERS, IN CLASS 25 (U.S. CLS. 22 AND 39).

SER. NO. 78-957,107, FILED 8-21-2006.

SUSAN LESLIE DUBOIS, EXAMINING ATTORNEY

Int. Cl.: 35

Prior U.S. Cls.: 100, 101 and 102

United States Patent and Trademark Office

Reg. No. 3,480,721

Registered Aug. 5, 2008

**SERVICE MARK
PRINCIPAL REGISTER**

METAPHOR STUDY

D. P. BOSTWICK AND ASSOCIATES, INC. (MI-
CHIGAN CORPORATION)
394 BRYN MAWR STREET
BIRMINGHAM, MI 48009

FOR: MARKET ANALYSIS; MARKET REPORTS
AND STUDIES; MARKET RESEARCH; MARKET
RESEARCH CONSULTATION; MARKET RE-
SEARCH SERVICES, IN CLASS 35 (U.S. CLS. 100,
101 AND 102).

FIRST USE 12-6-2005; IN COMMERCE 12-6-2005.

THE MARK CONSISTS OF STANDARD CHAR-
ACTERS WITHOUT CLAIM TO ANY PARTICULAR
FONT, STYLE, SIZE, OR COLOR.

NO CLAIM IS MADE TO THE EXCLUSIVE
RIGHT TO USE "STUDY", APART FROM THE
MARK AS SHOWN.

SER. NO. 78-958,736, FILED 8-23-2006.

MARY CRAWFORD, EXAMINING ATTORNEY

Int. Cl.: 35

Prior U.S. Cls.: 100, 101 and 102

United States Patent and Trademark Office

Reg. No. 3,480,722

Registered Aug. 5, 2008

**SERVICE MARK
PRINCIPAL REGISTER**

eSnipe

ESNIPE, INC. (WASHINGTON CORPORATION)
12819 S.E. 38TH STREET PMB 293
BELLEVUE, WA 98006

FOR: PLACING BIDS FOR OTHERS ON ONLINE
AUCTIONS, IN CLASS 35 (U.S. CLS. 100, 101 AND
102).

FIRST USE 1-18-2000; IN COMMERCE 1-18-2000.

THE MARK CONSISTS OF STANDARD CHAR-
ACTERS WITHOUT CLAIM TO ANY PARTICULAR
FONT, STYLE, SIZE, OR COLOR.

SEC. 2(F).

SER. NO. 78-958,752, FILED 8-23-2006.

CHRISIE B. KING, EXAMINING ATTORNEY

Int. Cl.: 16

Prior U.S. Cls.: 2, 5, 22, 23, 29, 37, 38 and 50

Reg. No. 3,480,723

United States Patent and Trademark Office

Registered Aug. 5, 2008

**TRADEMARK
PRINCIPAL REGISTER**

EKS

EXPERT KNOWLEDGE SYSTEMS, LLC (NEW
HAMPSHIRE LTD LIAB CO)
21 BLOOMINGDALE ROAD
WHITE PLAINS, NY 10605

FOR: PRINTED INSTRUCTIONAL, EDUCATION-
AL, AND TEACHING MATERIALS IN THE FIELD
OF MEDICINE, HEALTH, CLINICAL RESEARCH
AND PHARMACEUTICAL PREPARATIONS , IN
CLASS 16 (U.S. CLS. 2, 5, 22, 23, 29, 37, 38 AND 50).

FIRST USE 7-0-1996; IN COMMERCE 7-0-1996.

THE MARK CONSISTS OF STANDARD CHAR-
ACTERS WITHOUT CLAIM TO ANY PARTICULAR
FONT, STYLE, SIZE, OR COLOR.

SER. NO. 78-959,006, FILED 8-23-2006.

BONNIE LUKEN, EXAMINING ATTORNEY

Int. Cl.: 3

Prior U.S. Cls.: 1, 4, 6, 50, 51 and 52

United States Patent and Trademark Office

Reg. No. 3,480,724

Registered Aug. 5, 2008

**TRADEMARK
PRINCIPAL REGISTER**

COLOR RESCUE

LA COUPE PRODUCTS INC. (CANADA CORPORATION)
1200 AEROWOOD DRIVE, UNIT 50
MISSISSAUGA, ONTARIO, CANADA L4W2S7

FOR: HAIR CARE PREPARATIONS, IN CLASS 3
(U.S. CLS. 1, 4, 6, 50, 51 AND 52).

THE MARK CONSISTS OF STANDARD CHARACTERS WITHOUT CLAIM TO ANY PARTICULAR FONT, STYLE, SIZE, OR COLOR.

PRIORITY CLAIMED UNDER SEC. 44(D) ON CANADA APPLICATION NO. 1292214, FILED 3-2-2006, REG. NO. TMA706220, DATED 1-31-2008, EXPIRES 1-31-2023.

NO CLAIM IS MADE TO THE EXCLUSIVE RIGHT TO USE "COLOR", APART FROM THE MARK AS SHOWN.

SER. NO. 78-960,392, FILED 8-25-2006.

JASON TURNER, EXAMINING ATTORNEY

Int. Cl.: 41

Prior U.S. Cls.: 100, 101 and 107

United States Patent and Trademark Office

Reg. No. 3,480,725

Registered Aug. 5, 2008

**SERVICE MARK
PRINCIPAL REGISTER**

POJACK

PO-JACK L.L.C. (NEW YORK LTD LIAB CO)
107 LAW ROAD
BRIARCLIFF MANOR, NY 10510

FIRST USE 12-31-2003; IN COMMERCE 12-31-2003.

FOR: EDUCATIONAL SERVICES, NAMELY PROVIDING INSTRUCTION IN THE FIELD OF CARD GAMES; EDUCATIONAL DEMONSTRATIONS IN THE FIELD OF CARD GAMES; ENTERTAINMENT SERVICES, NAMELY CONDUCTING CARD GAMES; CASINO SERVICES, IN CLASS 41 (U.S. CLS. 100, 101 AND 107).

THE MARK CONSISTS OF STANDARD CHARACTERS WITHOUT CLAIM TO ANY PARTICULAR FONT, STYLE, SIZE, OR COLOR.

SER. NO. 78-960,977, FILED 8-25-2006.

RAMONA ORTIGA, EXAMINING ATTORNEY

Int. Cls.: 30 and 43

Prior U.S. Cls.: 46, 100 and 101

United States Patent and Trademark Office

Reg. No. 3,480,726

Registered Aug. 5, 2008

**TRADEMARK
SERVICE MARK
PRINCIPAL REGISTER**

Veraci Pizza

VERACI PIZZA (WASHINGTON PARTNERSHIP)
1512 NW 64TH STREET
SEATTLE, WA 98107

FOR: FRESH PIZZA, IN CLASS 30 (U.S. CL. 46).

FIRST USE 5-2-2004; IN COMMERCE 5-2-2004.

FOR: CATERING, IN CLASS 43 (U.S. CLS. 100
AND 101).

FIRST USE 5-2-2004; IN COMMERCE 5-2-2004.

THE MARK CONSISTS OF STANDARD CHARACTERS WITHOUT CLAIM TO ANY PARTICULAR FONT, STYLE, SIZE, OR COLOR.

NO CLAIM IS MADE TO THE EXCLUSIVE RIGHT TO USE "PIZZA", APART FROM THE MARK AS SHOWN.

THE WORDING "VERACI" HAS NO MEANING IN A FOREIGN LANGUAGE.

SER. NO. 78-963,264, FILED 8-29-2006.

STEVEN R. FOSTER, EXAMINING ATTORNEY

Int. Cl.: 9

Prior U.S. Cls.: 21, 23, 26, 36 and 38

United States Patent and Trademark Office

Reg. No. 3,480,727

Registered Aug. 5, 2008

**TRADEMARK
PRINCIPAL REGISTER**

COUGAR

CONTEX A/S (DENMARK CORPORATION)
SVANEVANG 2
ALLEROED, DENMARK 3450

FOR: APPARATUS FOR RECORDING, TRANSMISSION, PROCESSING OR REPRODUCTION OF DATA, NAMELY, SCANNERS, 2D-PRINTERS OR 3D-PRINTERS; OPERATING SOFTWARE FOR USE INSIDE SCANNERS, 2D-PRINTERS OR 3D-PRINTERS; COMPUTER SOFTWARE FOR TRANSMISSION, PROCESSING, REPRODUCTION, ENHANCEMENT AND REFINEMENT OF IMAGES, FOR USE IN CONNECTION WITH SCANNERS, 2D-

PRINTERS OR 3D-PRINTERS, IN CLASS 9 (U.S. CLS. 21, 23, 26, 36 AND 38).

FIRST USE 3-3-2003; IN COMMERCE 3-3-2003.

THE MARK CONSISTS OF STANDARD CHARACTERS WITHOUT CLAIM TO ANY PARTICULAR FONT, STYLE, SIZE, OR COLOR.

SER. NO. 78-964,581, FILED 8-31-2006.

ANGELA M. MICHELI, EXAMINING ATTORNEY

Int. Cl.: 5

Prior U.S. Cls.: 6, 18, 44, 46, 51 and 52

Reg. No. 3,480,728

United States Patent and Trademark Office

Registered Aug. 5, 2008

**TRADEMARK
PRINCIPAL REGISTER**

Eco-Jet

ECO-SAFE USA, INC. (CALIFORNIA CORPORATION)
19528 VENTURA BLVD.
#159
TARZANA, CA 91356

THE MARK CONSISTS OF STANDARD CHARACTERS WITHOUT CLAIM TO ANY PARTICULAR FONT, STYLE, SIZE, OR COLOR.

FOR: ALL PURPOSE DISINFECTING AND DEODORIZING PREPARATIONS, IN CLASS 5 (U.S. CLS. 6, 18, 44, 46, 51 AND 52).

SER. NO. 78-965,428, FILED 8-31-2006.

FIRST USE 8-15-2006; IN COMMERCE 8-15-2006.

ALLISON SCHRODY, EXAMINING ATTORNEY

Int. Cls.: 35 and 41

Prior U.S. Cls.: 100, 101, 102 and 107

United States Patent and Trademark Office

Reg. No. 3,480,729

Registered Aug. 5, 2008

**SERVICE MARK
PRINCIPAL REGISTER**

**SPECTACULAR EVENTS DON'T
JUST HAPPEN**

WUNDERMAN, HUGH (UNITED STATES INDIVIDUAL)
2195 REDMOND ROAD
MERRICK, NY 11566

FOR: PUBLIC RELATIONS AND BUSINESS MARKETING SERVICES; RETAIL STORE AND ONLINE RETAIL SERVICES FEATURING CLOTHING, HATS, VISORS, CAPS, T-SHIRTS, SWEAT SHIRTS AND SUITS, SOCKS, UNDERWEAR, JACKETS, COATS, UMBRELLAS, BANDANNAS, DU RAGS, BELTS, BACKPACKS, POCKETBOOKS, BATH TOWELS, AND SHEETS, BEDDING, AND PILLOWS, SLEEPING EYE MASKS, CARRYING BAGS, BAGS, BOXES, ACRYLIC AND PLASTIC ITEMS, WOOD, CARDBOARD, PAPER GOODS AND PLASTIC WARE, PENS, STICKY NOTES, PRINTED NOTE PADS, COMPUTER MOUSE PADS, FLYING DISCS, YO-YOS, JEWELRY, KEY CHAINS, BELT BUCKLES, BRACELETS, LIGHTERS, RINGS, TOE RINGS, NECKLACES, PENDANTS, EARRINGS, BOOKS, SCRIPTS, SHOWS, TREATMENTS, POSTERS, PICTURES, PHOTOGRAPHS, SNOW GLOBES, PICTURE FRAMES, CASES, LICENSE PLATE FRAMES, PRE-RECORDED CDS, VIDEO TAPES, LASER DISKS AND DVDS, PHONOGRAPH RECORDS, VINYL RECORDS, VIDEO CASSETTE TAPES, AUDIO CASSETTE TAPES, REEL-TO-REEL TAPES, MOTION PICTURE FILM; SPECIAL EVENT MANAGEMENT SERVICES FOR MEETINGS, CONVENTIONS, WEDDINGS, AND PARTIES; BUSINESS MEETING PLANNING, IN CLASS 35 (U.S. CLS. 100, 101 AND 102).

FIRST USE 1-1-2002; IN COMMERCE 1-1-2002.

FOR: SPECIAL EVENT PLANNING; SPECIAL EVENT PLANNING CONSULTATION SERVICES FOR MEETINGS, CONVENTIONS, WEDDINGS AND PARTIES; MULTIMEDIA ENTERTAINMENT SOFTWARE PRODUCTION SERVICES; PRODUCTION OF VIDEO ONTO DVDS, VIDEO CASSETTES, VIDEO TAPES, AND THE INTERNET, FOR OTHERS; PHOTOGRAPHY SERVICES; ENTERTAINMENT SERVICES, NAMELY, LIGHTING PRODUCTION, AND PRODUCTION OF VARIETY SHOWS; RENTAL OF AUDIO-VISUAL EQUIPMENT; RENTAL OF PORTABLE STAGES; ENTERTAINMENT SERVICES, NAMELY, PERSONAL APPEARANCES BY IMPERSONATORS, BANDS, CLOWNS, JUGGLERS, MAGICIANS, MIMES, MODELS, COMICS, AND MUSICIANS AND NOVELTY AND VARIETY ACTS AND SPECIALTY ACTS BY PERFORMERS, IN CLASS 41 (U.S. CLS. 100, 101 AND 107).

FIRST USE 1-1-2002; IN COMMERCE 1-1-2002.

THE MARK CONSISTS OF STANDARD CHARACTERS WITHOUT CLAIM TO ANY PARTICULAR FONT, STYLE, SIZE, OR COLOR.

SER. NO. 78-965,684, FILED 9-1-2006.

HOWARD SMIGA, EXAMINING ATTORNEY

Int. Cl.: 17

Prior U.S. Cls.: 1, 5, 12, 13, 35 and 50

United States Patent and Trademark Office

Reg. No. 3,480,730

Registered Aug. 5, 2008

**TRADEMARK
PRINCIPAL REGISTER**

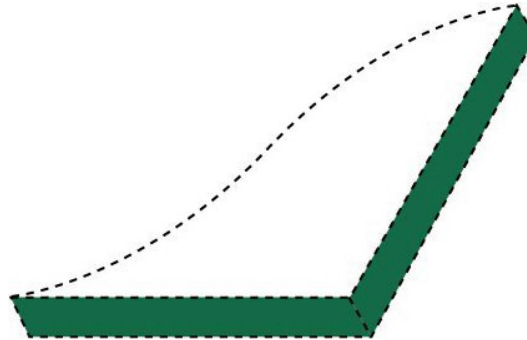

WEYERHAEUSER COMPANY (WASHINGTON CORPORATION)
33663 WEYERHAEUSER WAY SOUTH
FEDERAL WAY, WA 98003

FOR: STRUCTURAL BUILDING INSULATION PANELS, IN CLASS 17 (U.S. CLS. 1, 5, 12, 13, 35 AND 50).

FIRST USE 6-1-2003; IN COMMERCE 6-1-2003.

THE COLOR(S) GREEN IS/ARE CLAIMED AS A FEATURE OF THE MARK.

THE MARK CONSISTS OF THE COLOR GREEN AS APPLIED TO THE EDGES OF THE STRUCTURAL BUILDING INSULATION PANELS. THE DOTTED OUTLINE OF THE GOODS IS INTENDED TO SHOW THE POSITION OF THE MARK ON THE GOODS AND IS NOT A PART OF THE MARK.

SEC. 2(F).

SER. NO. 78-965,802, FILED 9-1-2006.

JOHN LINCOSKI, EXAMINING ATTORNEY

Int. Cl.: 43

Prior U.S. Cls.: 100 and 101

United States Patent and Trademark Office

Reg. No. 3,480,731

Registered Aug. 5, 2008

**SERVICE MARK
PRINCIPAL REGISTER**

eOakwood

R & B REALTY GROUP DBA OAKWOOD
WORLDWIDE (CALIFORNIA LIMITED LIABILITY PARTNERSHIP)
2222 CORINTH AVENUE
LOS ANGELES, CA 90064

FOR: ARRANGING TEMPORARY HOUSING ACCOMMODATIONS; PROVIDING INFORMATION IN THE FIELD OF REAL ESTATE PERTAINING TO RESERVATIONS, RENTAL OR LEASING OF TEMPORARY HOUSING ACCOMMODATIONS VIA THE INTERNET, IN CLASS 43 (U.S. CLS. 100 AND 101).

FIRST USE 8-31-2004; IN COMMERCE 8-31-2004.

THE MARK CONSISTS OF STANDARD CHARACTERS WITHOUT CLAIM TO ANY PARTICULAR FONT, STYLE, SIZE, OR COLOR.

SER. NO. 78-966,009, FILED 9-1-2006.

STEPHEN AQUILA, EXAMINING ATTORNEY

Int. Cl.: 35

Prior U.S. Cls.: 100, 101 and 102

United States Patent and Trademark Office

Reg. No. 3,480,732

Registered Aug. 5, 2008

**SERVICE MARK
PRINCIPAL REGISTER**

TREES FOR TROOPS

CHRISTMAS SPIRIT FOUNDATION (MISSOURI
NON-PROFIT CORPORATION)
16020 SWINGLEY RIDGE RD., SUITE 300
CHESTERFIELD, MO 63017

FOR: CHARITABLE SERVICES, NAMELY, PRO-
VIDING CHRISTMAS TREES TO MILITARY PER-
SONNEL AND THEIR FAMILIES, IN CLASS 35 (U.S.
CLS. 100, 101 AND 102).

FIRST USE 12-0-2004; IN COMMERCE 12-0-2004.

THE MARK CONSISTS OF STANDARD CHAR-
ACTERS WITHOUT CLAIM TO ANY PARTICULAR
FONT, STYLE, SIZE, OR COLOR.

SEC. 2(F).

SER. NO. 78-967,502, FILED 9-5-2006.

KEVIN CORWIN, EXAMINING ATTORNEY

Int. Cl.: 35

Prior U.S. Cls.: 100, 101 and 102

United States Patent and Trademark Office

Reg. No. 3,480,733

Registered Aug. 5, 2008

**SERVICE MARK
PRINCIPAL REGISTER**

END OF THE ROLL

ALARIS INCOME GROWTH FUND L.P. (CANADA LIMITED PARTNERSHIP)
125, 101-6TH STREET S.W.
CALGARY, CANADA T2P 5K7

FOR: RETAIL STORE SERVICES IN THE FIELD OF CARPETING AND FLOOR COVERINGS, IN CLASS 35 (U.S. CLS. 100, 101 AND 102).

THE MARK CONSISTS OF STANDARD CHARACTERS WITHOUT CLAIM TO ANY PARTICULAR FONT, STYLE, SIZE, OR COLOR.

OWNER OF CANADA REG. NO. TMA367096, DATED 3-23-1990, RENEWED AS REG. NO. TMA367096, DATED 3-23-2005, EXPIRES 3-23-2020.

OWNER OF U.S. REG. NO. 2,504,822.

SEC. 2(F).

SER. NO. 78-968,753, FILED 9-7-2006.

MICHAEL WEBSTER, EXAMINING ATTORNEY

Int. Cl.: 1

Prior U.S. Cls.: 1, 5, 6, 10, 26 and 46

Reg. No. 3,480,734

United States Patent and Trademark Office

Registered Aug. 5, 2008

**TRADEMARK
PRINCIPAL REGISTER**

AMERICAN AGRITECH

AMERICAN AGRITECH, L.L.C (ARIZONA LTD
LIAB CO)
6858 WEST CHICAGO STREET #3
CHANDLER, AZ 85226

FOR: PLANT NUTRIENTS AND PLANT SUPPLE-
MENTS IN THE NATURE OF PLANT FOOD,
GROWING MEDIA FOR PLANTS, AND PLANT
FOOD FOR THE HORTICULTURAL INDUSTRY;
PLANT GROW MEDIA, SUBSTRATES, AND FER-
TILIZERS, AND SALT LEACHING SOLUTIONS
FOR PLANTS; ORGANIC PLANT GROW MEDIA,
IN CLASS 1 (U.S. CLS. 1, 5, 6, 10, 26 AND 46).

FIRST USE 6-10-1996; IN COMMERCE 6-10-1996.

THE MARK CONSISTS OF STANDARD CHAR-
ACTERS WITHOUT CLAIM TO ANY PARTICULAR
FONT, STYLE, SIZE, OR COLOR.

NO CLAIM IS MADE TO THE EXCLUSIVE
RIGHT TO USE "AMERICAN", APART FROM THE
MARK AS SHOWN.

SER. NO. 78-968,918, FILED 9-7-2006.

SUSAN STIGLITZ, EXAMINING ATTORNEY

Int. Cls.: 9, 16 and 42

**Prior U.S. Cls.: 2, 5, 21, 22, 23, 26, 29, 36, 37, 38, 50,
100 and 101**

Reg. No. 3,480,735

United States Patent and Trademark Office

Registered Aug. 5, 2008

**TRADEMARK
SERVICE MARK
PRINCIPAL REGISTER**

CHEMBOOK

ID BUSINESS SOLUTION LIMITED (ENGLAND CORPORATION)
THE SURREY BUSINESS RESEARCH PARK
2 OCCAM COURT
GUILFORD, UNITED KINGDOM GU2 5QB

FOR: COMPUTER SOFTWARE FOR USE IN THE DRUG CREATION, PHARMACEUTICAL RESEARCH AND BIOLOGICAL RESEARCH INDUSTRIES; COMPUTER HARDWARE; ELECTRONIC NOTEBOOKS, NAMELY, NOTEBOOK COMPUTERS, IN CLASS 9 (U.S. CLS. 21, 23, 26, 36 AND 38).

FOR: PRINTED MATERIALS AND PUBLICATIONS, NAMELY, BOOKS IN THE FIELD OF DRUG CREATION, PHARMACEUTICAL RESEARCH AND BIOLOGICAL RESEARCH INDUSTRIES; PRINTED NOTEBOOKS; MANUALS FOR COMPUTER SOFTWARE FOR USE IN THE DRUG, CREATION, PHARMACEUTICAL RESEARCH AND BIOLOGICAL RESEARCH INDUSTRIES, IN CLASS 16 (U.S. CLS. 2, 5, 22, 23, 29, 37, 38 AND 50).

FOR: COMPUTER PROGRAMMING; COMPUTER SOFTWARE DESIGN FOR OTHERS; PHARMACEUTICAL AND SCIENTIFIC RESEARCH; COMPUTER CONSULTANCY SERVICES, IN CLASS 42 (U.S. CLS. 100 AND 101).

THE MARK CONSISTS OF STANDARD CHARACTERS WITHOUT CLAIM TO ANY PARTICULAR FONT, STYLE, SIZE, OR COLOR.

PRIORITY CLAIMED UNDER SEC. 44(D) ON ERPN CMNTY TM OFC APPLICATION NO. 005295845, FILED 8-16-2006, REG. NO. 005295845, DATED 1-8-2008, EXPIRES 1-8-2018.

SER. NO. 78-971,633, FILED 9-11-2006.

SHANNON TWOHIG, EXAMINING ATTORNEY

Int. Cls.: 9 and 16

Prior U.S. Cls.: 2, 5, 21, 22, 23, 26, 29, 36, 37, 38 and 50

United States Patent and Trademark Office

Reg. No. 3,480,736

Registered Aug. 5, 2008

**TRADEMARK
PRINCIPAL REGISTER**

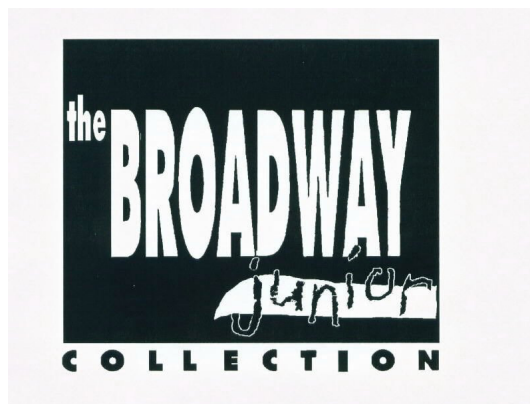

MTI ENTERPRISES, INC. (NEW YORK CORPORATION), DBA MUSIC THEATRE INTERNATIONAL
421 WEST 54TH STREET
NEW YORK, NY 10019

FOR: AUDIO AND VISUAL PRERECORDED DISCS, IN THE FIELD OF MUSICAL THEATRICAL PRODUCTIONS, CONTAINING CHOREOGRAPHIC MATERIALS, MUSICAL PERFORMANCES, REHEARSAL MATERIALS, AND EDUCATIONAL GUIDES FOR CHILDREN, IN CLASS 9 (U.S. CLS. 21, 23, 26, 36 AND 38).

FIRST USE 9-0-1997; IN COMMERCE 9-0-1997.

FOR: PRINTED MATTER IN THE FIELD OF MUSICAL THEATRICAL PRODUCTIONS, NAMELY, MUSICAL SCORES AND SHEET MUSIC, BOOKS, GUIDES, PRINTED EDUCATIONAL MA-

TERIALS AND KITS COMBINING SUCH PRINTED MATTER WITH AUDIO AND VISUAL RECORDINGS, IN CLASS 16 (U.S. CLS. 2, 5, 22, 23, 29, 37, 38 AND 50).

FIRST USE 9-0-1997; IN COMMERCE 9-0-1997.

OWNER OF U.S. REG. NO. 2,526,305.

NO CLAIM IS MADE TO THE EXCLUSIVE RIGHT TO USE "COLLECTION", APART FROM THE MARK AS SHOWN.

SEC. 2(F).

SER. NO. 78-972,503, FILED 9-12-2006.

TINA BROWN, EXAMINING ATTORNEY

Int. Cls.: 35 and 42

Prior U.S. Cls.: 100, 101 and 102

United States Patent and Trademark Office

Reg. No. 3,480,737

Registered Aug. 5, 2008

SERVICE MARK
PRINCIPAL REGISTER



INTEGRASCREEN SINGAPORE PTE LTD (SINGAPORE CORPORATION)
LEVEL 14,
30 CECIL ST, PRUDENTIAL TOWER
SINGAPORE, SINGAPORE 049712

FOR: BUSINESS ACQUISITION AND MERGER CONSULTATION; BUSINESS ACQUISITIONS CONSULTATION; BUSINESS CONSULTING AND BUSINESS INFORMATION FOR ENTERPRISES; BUSINESS ENQUIRIES AND INVESTIGATIONS; BUSINESS INVESTIGATIONS; BUSINESS INVESTIGATIONS, EVALUATIONS, EXPERT APPRAISALS, INFORMATION AND RESEARCH; BUSINESS MERGER CONSULTATION; BUSINESS RESEARCH; BUSINESS SERVICES, NAMELY, REGISTERING, SCREENING, CREDENTIALING, AND ORGANIZING THIRD-PARTY VENDORS, SUPPLIERS, AND CONTRACTORS, AND DOCUMENTATION AND INFORMATION ON BEHALF OF OTHERS; COMPUTERIZED DATABASE MANAGEMENT; INFORMATION AND EXPERT OPINIONS RELATING TO COMPANIES AND BUSINESS; VERIFYING AND MONITORING THE CREDENTIALS OF DOCTORS AND OTHER MEDICAL PROFESSIONALS, IN CLASS 35 (U.S. CLS. 100, 101 AND 102).

FIRST USE 7-1-2000; IN COMMERCE 7-1-2000.

FOR: CONSULTING AND LEGAL SERVICES IN THE FIELD OF PRIVACY AND SECURITY LAWS, REGULATIONS, AND REQUIREMENTS; DATA MINING; DATA WAREHOUSING; DATABASE DEVELOPMENT SERVICES; LEGAL DOCUMENT PREPARATION AND RESEARCH SERVICES FOR

ATTORNEYS; LEGAL RESEARCH; PROVIDING INFORMATION RELATING TO LEGAL AFFAIRS; PUBLIC DOCUMENT RETRIEVAL; RESEARCH IN THE FIELD OF INTELLIGENCE AND SECURITY; RETRIEVING PUBLIC DOCUMENTS, IN CLASS 42 (U.S. CLS. 100 AND 101).

FIRST USE 7-1-2000; IN COMMERCE 7-1-2000.

OWNER OF U.S. REG. NO. 3,268,433.

NO CLAIM IS MADE TO THE EXCLUSIVE RIGHT TO USE "SCREEN" AND "ENHANCED DUE DILIGENCE", APART FROM THE MARK AS SHOWN.

THE COLOR(S) GREEN AND BLUE IS/ARE CLAIMED AS A FEATURE OF THE MARK.

THE MARK CONSISTS OF 2 RECTANGULAR BOXES, PLACED ONE BELOW THE OTHER. THE GREEN RECTANGLE ON TOP CONTAINS A FINGERPRINT DESIGN AND THE BLUE RECTANGLE AT THE BOTTOM CONTAINS THE WORDS "INTEGRASCREEN". THE WORDING "ENHANCED DUE DILIGENCE" IN BLUE IS PLACED BETWEEN TWO STRAIGHT BLUE LINES AND WRAPS AROUND THE BOTTOM RIGHT CORNER OF THE STACKED RECTANGLES.

SER. NO. 78-973,936, FILED 9-13-2006.

ELLEN BURNS, EXAMINING ATTORNEY

Int. Cls.: 35 and 42

Prior U.S. Cls.: 100, 101 and 102

United States Patent and Trademark Office

Reg. No. 3,480,738

Registered Aug. 5, 2008

**SERVICE MARK
PRINCIPAL REGISTER**



INTEGRASCREEN SINGAPORE PTE LTD (SINGAPORE CORPORATION)
LEVEL 14,
30 CECIL ST, PRUDENTIAL TOWER
SINGAPORE, SINGAPORE 049712

FOR: BUSINESS ACQUISITION AND MERGER CONSULTATION; BUSINESS ACQUISITIONS CONSULTATION; BUSINESS CONSULTING AND BUSINESS INFORMATION FOR ENTERPRISES; BUSINESS ENQUIRIES AND INVESTIGATIONS; BUSINESS INVESTIGATIONS; BUSINESS INVESTIGATIONS, EVALUATIONS, EXPERT APPRAISALS, INFORMATION AND RESEARCH; BUSINESS MERGER CONSULTATION; BUSINESS RESEARCH; BUSINESS SERVICES, NAMELY, REGISTERING, SCREENING, CREDENTIALING, AND ORGANIZING THIRD-PARTY VENDORS, SUPPLIERS, AND CONTRACTORS, AND DOCUMENTATION AND INFORMATION ON BEHALF OF OTHERS; COMPUTERIZED DATABASE MANAGEMENT; INFORMATION AND EXPERT OPINIONS RELATING TO COMPANIES AND BUSINESS; VERIFYING AND MONITORING THE CREDENTIALS OF DOCTORS AND OTHER MEDICAL PROFESSIONALS, IN CLASS 35 (U.S. CLS. 100, 101 AND 102).

FIRST USE 7-1-2000; IN COMMERCE 7-1-2000.

FOR: CONSULTING AND LEGAL SERVICES IN THE FIELD OF PRIVACY AND SECURITY LAWS, REGULATIONS, AND REQUIREMENTS; DATA MINING; DATA WAREHOUSING; DATABASE DEVELOPMENT SERVICES; LEGAL DOCUMENT

PREPARATION AND RESEARCH SERVICES FOR ATTORNEYS; LEGAL RESEARCH; PROVIDING INFORMATION RELATING TO LEGAL AFFAIRS; PUBLIC DOCUMENT RETRIEVAL; RESEARCH IN THE FIELD OF INTELLIGENCE AND SECURITY; RETRIEVING PUBLIC DOCUMENTS, IN CLASS 42 (U.S. CLS. 100 AND 101).

FIRST USE 7-1-2000; IN COMMERCE 7-1-2000.

NO CLAIM IS MADE TO THE EXCLUSIVE RIGHT TO USE "GLOBAL PARTNER ASSURANCE SCREENING SYSTEM", APART FROM THE MARK AS SHOWN.

THE COLOR(S) GREEN AND BLUE IS/ARE CLAIMED AS A FEATURE OF THE MARK.

ALPHABET "G" OF THE "GPASS" LOGO IS GREEN IN COLOR AND THE REMAINING ALPHABETS - "PASS" ARE BLUE IN COLOR. GREEN TICK MARK IS PLACED IN FRONT OF THE ALPHABET "A". THE FULL FORM -"GLOBAL PARTNER ASSURANCE SCREENING SYSTEM" OF THE ACRONYM "GPASS" IS WRITTEN BELOW THE LOGO SUCH THAT THE WHOLE PHRASE FITS EXACTLY AS PER THE WIDTH OF THE LOGO, THE COLOR OF THE TEXT IS BLUE.

SER. NO. 78-974,005, FILED 9-14-2006.

ELLEN BURNS, EXAMINING ATTORNEY

Int. Cl.: 43

Prior U.S. Cls.: 100 and 101

United States Patent and Trademark Office

Reg. No. 3,480,739

Registered Aug. 5, 2008

**SERVICE MARK
PRINCIPAL REGISTER**

CASANOVA GRILL

OPPKNOX, LLC (NEW JERSEY LTD LIAB CO)
47 BON AIR DRIVE
MARLTON, NJ 08053

FOR: RESTAURANT SERVICES, IN CLASS 43
(U.S. CLS. 100 AND 101).

FIRST USE 9-13-2003; IN COMMERCE 9-13-2003.

THE MARK CONSISTS OF STANDARD CHARACTERS WITHOUT CLAIM TO ANY PARTICULAR FONT, STYLE, SIZE, OR COLOR.

NO CLAIM IS MADE TO THE EXCLUSIVE RIGHT TO USE "GRILL", APART FROM THE MARK AS SHOWN.

SER. NO. 78-974,447, FILED 9-14-2006.

KEVIN CORWIN, EXAMINING ATTORNEY

Int. Cl.: 1

Prior U.S. Cls.: 1, 5, 6, 10, 26 and 46

Reg. No. 3,480,740

United States Patent and Trademark Office

Registered Aug. 5, 2008

**TRADEMARK
PRINCIPAL REGISTER**

CANFLEX-ACR

ATOMIC ENERGY OF CANADA LIMITED (CANADA CORPORATION)
2251 SPEAKMAN DRIVE
MISSISSAUGA
ONTARIO, CANADA L5K 1B2

FOR: NUCLEAR FUEL, IN CLASS 1 (U.S. CLS. 1, 5, 6, 10, 26 AND 46).

THE MARK CONSISTS OF STANDARD CHARACTERS WITHOUT CLAIM TO ANY PARTICULAR FONT, STYLE, SIZE, OR COLOR.

PRIORITY CLAIMED UNDER SEC. 44(D) ON CANADA APPLICATION NO. 1314181, FILED 8-24-2006, REG. NO. TMA700,770, DATED 11-14-2007, EXPIRES 11-14-2022.

OWNER OF U.S. REG. NOS. 2,814,491 AND 3,122,539.

SER. NO. 78-974,659, FILED 9-14-2006.

WILLIAM P. SHANAHAN, EXAMINING ATTORNEY

Int. Cl.: 41

Prior U.S. Cls.: 100, 101 and 107

United States Patent and Trademark Office

Reg. No. 3,480,741

Registered Aug. 5, 2008

**SERVICE MARK
PRINCIPAL REGISTER**

WAHINE

QUIKSILVER, INC. (DELAWARE CORPORATION)
15202 GRAHAM STREET
HUNTINGTON BEACH, CA 92649

FOR: ENTERTAINMENT IN THE NATURE OF SPORTING EVENTS AND COMPETITIONS; ORGANIZATION AND CONDUCTING OF SPORTS COMPETITIONS, NAMELY, SURFING, IN CLASS 41 (U.S. CLS. 100, 101 AND 107).

FIRST USE 10-4-1997; IN COMMERCE 10-4-1997.

THE MARK CONSISTS OF STANDARD CHARACTERS WITHOUT CLAIM TO ANY PARTICULAR FONT, STYLE, SIZE, OR COLOR.

THE FOREIGN WORDING IN THE MARK TRANSLATES INTO ENGLISH AS GIRL.

SER. NO. 78-979,966, FILED 8-10-2006.

JULIE GUTTADAURO, EXAMINING ATTORNEY

Int. Cls.: 35 and 42

Prior U.S. Cls.: 100, 101 and 102

United States Patent and Trademark Office

Reg. No. 3,480,742

Registered Aug. 5, 2008

**SERVICE MARK
PRINCIPAL REGISTER**

نخيل

NAKHEEL CO LLC (UNITED ARAB EMIR. LTD
LIAB CO)
P.O. BOX 17777
DUBAI, UNITED ARAB EMIR.

FOR: ADVERTISING, MARKETING AND PROMOTING REAL ESTATE DEVELOPMENTS INCLUDING COMMERCIAL AND RESIDENTIAL PROPERTIES; BUSINESS MANAGEMENT OF REAL ESTATE DEVELOPMENT PROJECTS; ORGANIZING OF EXHIBITIONS FOR COMMERCIAL AND ADVERTISING PURPOSES IN THE FIELD OF REAL ESTATE; ADVISORY, CONSULTANCY AND INFORMATION SERVICES RELATING TO ALL OF THE AFORESAID SERVICES, IN CLASS 35 (U.S. CLS. 100, 101 AND 102).

FOR: ARCHITECTURAL DESIGN; DESIGN OF SPECIALTY INTERIOR ENVIRONMENT SETTINGS; ENGINEERING; LAND SURVEYING; GEOLOGICAL PROSPECTING; URBAN PLANNING; CONSTRUCTION DRAFTING; ADVISORY AND CONSULTANCY SERVICES AND PROVIDING INFORMATION ON ARCHITECTURAL DESIGN, DESIGN OF SPECIALTY INTERIOR ENVIRONMENT SETTING, ENGINEERING, LAND SURVEYING, GEOLOGICAL PROSPECTING, URBAN PLAN-

NING AND CONSTRUCTION DRAFTING, IN CLASS 42 (U.S. CLS. 100 AND 101).

PRIORITY CLAIMED UNDER SEC. 44(D) ON UNITED ARAB EMIR. APPLICATION NO. 82831, FILED 7-12-2006, REG. NO. 80934, DATED 4-4-2007, EXPIRES 7-12-2016.

PRIORITY CLAIMED UNDER SEC. 44(D) ON UNITED ARAB EMIR. APPLICATION NO. 82832, FILED 7-12-2006, REG. NO. 80933, DATED 4-4-2007, EXPIRES 7-12-2016.

THE MARK CONSISTS OF "NAKHEEL" IN ARABIC.

THE ENGLISH TRANSLATION OF THE NON-LATIN CHARACTERS IN THE MARK IS "PALMS."

THE NON-LATIN CHARACTERS IN THE MARK TRANSLITERATE INTO "NAKHEEL."

SER. NO. 78-979,992, FILED 7-20-2006.

YAT SYE, LEE, EXAMINING ATTORNEY

Int. Cl.: 14

Prior U.S. Cls.: 2, 27, 28 and 50

United States Patent and Trademark Office

Reg. No. 3,480,743

Registered Aug. 5, 2008

TRADEMARK
PRINCIPAL REGISTER



BULGARI SPA (ITALY JOINT STOCK COMPAN-
NY)
VIA LUNGOTEVERE MARZIO, 11
I-00186 ROMA, ITALY

PRIORITY DATE OF 12-21-2004 IS CLAIMED.

FOR: PRECIOUS METALS AND THEIR ALLOYS;
GOODS IN PRECIOUS METALS OR COATED
THEREWITH, NAMELY, JEWELLERY BOXES
AND BUCKLES OF PRECIOUS METAL OR
COATED THEREWITH FOR WATCHES; JEWEL-
LERY, PRECIOUS STONES; HOROLOGICAL AND
CHRONOMETRIC INSTRUMENTS, ALL FOR SALE
IN SPECIALTY JEWELRY RETAIL STORES, IN
CLASS 14 (U.S. CLS. 2, 27, 28 AND 50).

OWNER OF INTERNATIONAL REGISTRATION
0843711 DATED 1-19-2005, EXPIRES 1-19-2015.

SER. NO. 79-009,026, FILED 1-19-2005.

DAVID HOFFMAN, EXAMINING ATTORNEY

Int. Cl.: 33

Prior U.S. Cls.: 47 and 49

United States Patent and Trademark Office

Reg. No. 3,480,744

Registered Aug. 5, 2008

**TRADEMARK
PRINCIPAL REGISTER**

OUTLAWED

KANGAROO RIDGE WINE COMPANY PTY LIM-
ITED (AUSTRALIA COMPANY)
BASEDOW ROAD
TANUNDA SA 5352
AUSTRALIA

FOR: TABLE WINES, IN CLASS 33 (U.S. CLS. 47
AND 49).

THE MARK CONSISTS OF STANDARD CHAR-
ACTERS WITHOUT CLAIM TO ANY PARTICULAR
FONT, STYLE, SIZE, OR COLOR.

PRIORITY DATE OF 4-28-2004 IS CLAIMED.

OWNER OF INTERNATIONAL REGISTRATION
0845013 DATED 10-27-2004, EXPIRES 10-27-2014.

SER. NO. 79-009,428, FILED 10-27-2004.

KRISTINA MORRIS, EXAMINING ATTORNEY

Int. Cls.: 9, 18 and 25

Prior U.S. Cls.: 1, 2, 3, 21, 22, 23, 26, 36, 38, 39 and 41

Reg. No. 3,480,745

United States Patent and Trademark Office

Registered Aug. 5, 2008

**TRADEMARK
PRINCIPAL REGISTER**

GURU

JAM SESSION S.R.L. (ITALY SOCIÉTÉ À RE-
SPONSABILITE LIMITEE)
VIA MERCALLI, 8/A
I-43100 PARMA
ITALY

FOR: SPECTACLES, SPECTACLE CASES AND
FRAMES, SUNGLASSES, IN CLASS 9 (U.S. CLS. 21,
23, 26, 36 AND 38).

FOR: ALL PURPOSE SPORT BAGS; ALL PUR-
POSE CARRYING BAGS, DUFFEL BAGS, HAND-
BAGS; KEY BAGS; LEATHER AND IMITATION OF
LEATHER BAGS; BABY CARRYING BAGS; BEACH
BAGS, BELT BAGS, COSMETIC BAGS SOLD EMP-
TY, SCHOOL BAGS; TOTE BAGS; GYM BAGS;
SCHOOL KNAPSACKS, DRAWSTRING POUCHES;
LEATHER POUCHES; TRUNKS, VALISES AND
RUCKSACKS, UMBRELLAS, WALKING STICKS,
LEATHERWARE NAMELY, BRIEFCASE TYPE
PORTFOLIOS AND DOCUMENTS WALLETS, BABY
CARRIERS WORN ON THE BODY; BEACH UM-
BRELLAS; BRIEFCASES, BUSINESS CARDS CASES;
CELLULOSE FOOD CASING; COIN PURSES, NOT
OF PRECIOUS METALS; GOLF UMBRELLAS; SUIT-
CASES AND WALLETS; MULTIPURPOSE PURSES,
IN CLASS 18 (U.S. CLS. 1, 2, 3, 22 AND 41).

FOR: BELTS, SHOES, FOOTWEAR, SLIPPERS,
HEADWEAR, NAMELY, HATS AND CAPS, GOLF
CAPS, BASEBALL CAPS, CLOTHING FOR MEN,
WOMEN, CHILDREN AND BOYS, NAMELY,
APRONS, BANDANAS, SUITS, BATHING SUITS,
BATHING TRUNKS, BATHROBES, BATH-WRAPPS,
SASHES FOR WEAR, JUMPERS, BERMUDA
SHORTS, BRAS, COATS, CRAVATS, DRESSES, EAR-
BANDS, GLOVES, JACKETS, JEANS, JERSEYS, LIN-
GERIE, TROUSERS, VESTS, BRIEFS AND PANTS,
POLO SHIRTS, PULLOVERS, RAINWEAR, SHIRTS,
SCARVES, SILK SCARVES, SKIRTS, SLEEPWEAR,
SLIPS, T-SHIRTS, UNDERWEAR, HOSIERY, SOCKS,
INFANTWEAR, SEA CLOTHING, NAMELY, SWIM-
MING SUITS AND SWIMMING TRUNKS, IN CLASS
25 (U.S. CLS. 22 AND 39).

PRIORITY DATE OF 3-10-2005 IS CLAIMED.

OWNER OF INTERNATIONAL REGISTRATION
0858203 DATED 5-3-2005, EXPIRES 5-3-2015.

SER. NO. 79-013,972, FILED 5-3-2005.

SHANNON TWOHIG, EXAMINING ATTORNEY

Int. Cl.: 30

Prior U.S. Cl.: 46

United States Patent and Trademark Office

Reg. No. 3,480,746

Registered Aug. 5, 2008

**TRADEMARK
PRINCIPAL REGISTER**

UDARNITSA

OTKRYTOE AKTSIONERNOE OBSHCHESTVO;
"KONDITERSKAYA FABRIKA "UDARNITSA"
(RUSSIAN FED. JOINT STOCK COMPANY)
13, UL. SHABOLOVKA
RU-119049 MOSKVA, RUSSIAN FED.

FOR: PASTRY AND CONFECTIONERY, NAME-
LY, DESSERT SOUFFLE SWEETMEAT, DESSERT
SOUFFLE SWEETMEAT COVERED WITH CHOCO-
LATE, PASTILLES, FRUIT JELLIES, FRUIT JELLIES
COVERED WITH CHOCOLATE, CHEWING FRUIT
JELLIES, CANDIES, MARMALADE STUFFED CAN-
DIES, SOUFFLE SWEETMEAT STUFFED CANDIES;
CHOCOLATE, CHOCOLATE SWEETS, INCLUDING
MARMALADE STUFFED CHOCOLATES, SOUF-
FLE SWEETMEAT STUFFED CHOCOLATES, CAN-
DIES OF MARMALADE, SWEETMEATS IN THE
FORM OF DROPS COVERED WITH SUGAR OR
SUGAR POWDER AND HAVING FRUIT STUFF,
INCLUDING CRANBERRY; CHOCOLATE COV-
ERED NUTS, DESSERT SOUFFLE, CARAMELS,

LOLLIPOPS, PASTILLES, FONDANTS, PRALINES,
HALVAH, CAKES, MARZIPAN, IN CLASS 30 (U.S.
CL. 46).

THE MARK CONSISTS OF STANDARD CHAR-
ACTERS WITHOUT CLAIM TO ANY PARTICULAR
FONT, STYLE, SIZE, OR COLOR.

OWNER OF INTERNATIONAL REGISTRATION
0890384 DATED 4-20-2006, EXPIRES 4-20-2016.

THE FOREIGN WORDING IN THE MARK
TRANSLATES INTO ENGLISH AS A TYPE OF
LEADING WOMAN WORKER.

SER. NO. 79-025,867, FILED 4-20-2006.

BARNEY CHARLON, EXAMINING ATTORNEY

Int. Cl.: 30

Prior U.S. Cl.: 46

United States Patent and Trademark Office

Reg. No. 3,480,747

Registered Aug. 5, 2008

**TRADEMARK
PRINCIPAL REGISTER**

SHARMEL

OTKRYTOE AKTSIONERNOE OBSHCHESTVO;
"KONDITERSKAYA FABRIKA "UDARNITSA"
(RUSSIAN FED. JOINT STOCK COMPANY)
13, UL. SHABOLOVKA
RU-119049 MOSKVA, RUSSIAN FED.

FOR: PASTRY AND CONFECTIONERY, NAME-
LY, DESSERT SOUFFLE SWEETMEAT, DESSERT
SOUFFLE SWEETMEAT COVERED WITH CHOCO-
LATE, PASTILLES, FRUIT JELLIES, FRUIT JELLIES
COVERED WITH CHOCOLATE, CHEWING FRUIT
JELLIES, CANDIES, MARMALADE STUFFED CAN-
DIES, SOUFFLE SWEETMEAT STUFFED CANDIES;
CHOCOLATE, CHOCOLATE SWEETS, INCLUDING
MARMALADE STUFFED CHOCOLATES, SOUF-
FLE SWEETMEAT STUFFED CHOCOLATES, CAN-
DIES OF MARMALADE, SWEETMEATS IN THE
FORM OF DROPS COVERED WITH SUGAR OR
SUGAR POWDER AND HAVING FRUIT STUFF,
INCLUDING CRANBERRY; CHOCOLATE COV-

ERED NUTS, DESSERT SOUFFLE, CARMELS,
LOLLIPOPS, PASTILLES, FONDANTS, PRALINES,
HALVAH, CAKES, MARZIPAN, IN CLASS 30 (U.S.
CL. 46).

THE MARK CONSISTS OF STANDARD CHAR-
ACTERS WITHOUT CLAIM TO ANY PARTICULAR
FONT, STYLE, SIZE, OR COLOR.

OWNER OF INTERNATIONAL REGISTRATION
0890386 DATED 4-20-2006, EXPIRES 4-20-2016.

THE WORD "SHARMEL" IS AN INVENTED
WORD AND HAS NO MEANING IN ENGLISH.

SER. NO. 79-025,869, FILED 4-20-2006.

BARNEY CHARLON, EXAMINING ATTORNEY

Int. Cls.: 29 and 30

Prior U.S. Cl.: 46

United States Patent and Trademark Office

Reg. No. 3,480,748

Registered Aug. 5, 2008

TRADEMARK
PRINCIPAL REGISTER

МАРМЕЛАНДИЯ

OTKRYTOE AKTSIONERNOE OBSHCHESTVO;
"KONDITERSKAYA FABRIKA "UDARNITSA"
(RUSSIAN FED. JOINT STOCK COMPANY)
13, UL. SHABOLOVKA
RU-119049 MOSKVA, RUSSIAN FED.

FOR: FRUIT, NAMELY, APPLES, PEARS, APRICOTS, PEACHES, PRESERVED, STEWED AND DRIED, IN CLASS 29 (U.S. CL. 46).

FOR: PASTRY AND CONFECTIONERY, NAMELY, DESSERT SOUFFLE SWEETMEAT, DESSERT SOUFFLE SWEETMEAT COVERED WITH CHOCOLATE, PASTILLES, FRUIT JELLIES, FRUIT JELLIES COVERED WITH CHOCOLATE, CHEWING FRUIT JELLIES, CANDIES, MARMALADE STUFFED CANDIES, SOUFFLE SWEETMEAT STUFFED CANDIES; CHOCOLATE, CHOCOLATE SWEETS, INCLUDING MARMALADE STUFFED CHOCOLATES, SOUFFLE SWEETMEAT STUFFED CHOCOLATES, CANDIES OF MARMALADE, SWEETMEATS IN THE FORM OF DROPS COVERED WITH SUGAR OR SUGAR POWDER AND HAVING FRUIT STUFF,

INCLUDING CRANBERRY; CHOCOLATE COVERED NUTS, DESSERT SOUFFLE, CARAMELS, LOLLIPOPS, PASTILLES, FONDANTS, PRALINES, HALVAH, CAKES, MARZIPAN, IN CLASS 30 (U.S. CL. 46).

OWNER OF INTERNATIONAL REGISTRATION
0890581 DATED 4-26-2006, EXPIRES 4-26-2016.

THE WORD "MARMELANDIA" IS AN INVENTED WORD AND HAS NO MEANING IN ENGLISH

THE TRANSLITERATION OF THE NON-LATIN CHARACTERS IN THE MARK IS: MARMELANDIA.

SER. NO. 79-025,957, FILED 4-26-2006.

BARNEY CHARLON, EXAMINING ATTORNEY

Int. Cl.: 30

Prior U.S. Cl.: 46

United States Patent and Trademark Office

Reg. No. 3,480,749

Registered Aug. 5, 2008

TRADEMARK
PRINCIPAL REGISTER



OTKRYTOE AKTSIONERNOE OBSHCHESTVO;
"KONDITERSKAYA FABRIKA "UDARNITSA"
(RUSSIAN FED. JOINT STOCK COMPANY)
13, UL. SHABOLOVKA
RU-119049 MOSKVA, RUSSIAN FED.

FOR: PASTRY AND CONFECTIONERY, NAME-
LY, DESSERT SOUFFLE SWEETMEAT, DESSERT
SOUFFLE SWEETMEAT COVERED WITH CHOCO-
LATE, PASTILLES, FRUIT JELLIES, FRUIT JELLIES
COVERED WITH CHOCOLATE, CHEWING FRUIT
JELLIES, CANDIES, MARMALADE STUFFED CAN-
DIES, SOUFFLE SWEETMEAT STUFFED CANDIES;
CHOCOLATE, CHOCOLATE SWEETS, INCLUDING
MARMALADE STUFFED CHOCOLATES, SOUF-
FLE SWEETMEAT STUFFED CHOCOLATES, CAN-
DIES OF MARMALADE, SWEETMEATS IN THE
FORM OF DROPS COVERED WITH SUGAR OR
SUGAR POWDER AND HAVING FRUIT STUFF,
INCLUDING CRANBERRY; CHOCOLATE COV-

ERED NUTS, DESSERT SOUFFLE, CARAMELS,
LOLLIPOPS, PASTILLES, FONDANTS, PRALINES,
HALVAH, CAKES, MARZIPAN, IN CLASS 30 (U.S.
CL. 46).

OWNER OF INTERNATIONAL REGISTRATION
0890584 DATED 4-25-2006, EXPIRES 4-25-2016.

THE WORD "SHARMEL" IS AN INVENTED
WORD AND HAS NO MEANING IN ENGLISH.

THE TRANSLITERATION OF THE NON-LATIN
CHARACTERS IN THE MARK IS: SHARMEL.

SER. NO. 79-025,958, FILED 4-25-2006.

BARNEY CHARLON, EXAMINING ATTORNEY

Int. Cl.: 8

Prior U.S. Cls.: 23, 28 and 44

United States Patent and Trademark Office

Reg. No. 3,480,750

Registered Aug. 5, 2008

**TRADEMARK
PRINCIPAL REGISTER**

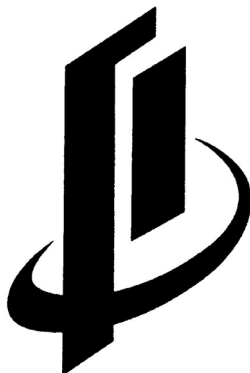

FENGHUA NANFANG MACHINUFACTURE
CO., LTD. (CHINA CORPORATION)
SHANGTIAN TOWN FENGHUA
CITY ZHEJIANG 315511
CHINA

FOR: LIFTING JACKS, HAND-OPERATED;
HAND TOOLS, NAMELY, HANDPRESSES; HAND
TOOLS, NAMELY, DRILLS, PLANES, WRENCHES;
HAND TOOLS, NAMELY, SCRAPERS; HANDHELD
CUTTING TOOLS; HAND TOOLS, NAMELY,
PUNCHES; VICES; TUBE CUTTING INSTRUMENTS,
NAMELY, SCISSORS; CLAMPS FOR CARPENTERS
AND COOPERS; HAND-OPERATED SHEARERS, IN
CLASS 8 (U.S. CLS. 23, 28 AND 44).

OWNER OF INTERNATIONAL REGISTRATION
0892706 DATED 3-8-2006, EXPIRES 3-8-2016.

THE MARK HAS NO GEOGRAPHICAL MEAN-
ING AND HAS NO MEANING IN THE RELATION-
AL GOODS AND INDUSTRY.

SER. NO. 79-026,670, FILED 3-8-2006.

ALICE BENMAMAN, EXAMINING ATTORNEY

Int. Cl.: 39

Prior U.S. Cls.: 100 and 105

United States Patent and Trademark Office

Reg. No. 3,480,751

Registered Aug. 5, 2008

**SERVICE MARK
PRINCIPAL REGISTER**



PULLMANTUR, S.A. (SPAIN CORPORATION)
C/MAHONIA, 2

EDIFICIO PÓRTICO.; PLANTA 5ª; AVENIDA DE LOS
ANDES-CAMPO DE LAS NACIONES; E-28043
MADRID
SPAIN

FOR: TRAVEL ARRANGEMENTS, NAMELY,
ARRANGING CRUISES, IN CLASS 39 (U.S. CLS.
100 AND 105).

OWNER OF INTERNATIONAL REGISTRATION
0893462 DATED 2-27-2006, EXPIRES 2-27-2016.

NO CLAIM IS MADE TO THE EXCLUSIVE
RIGHT TO USE "CRUISES", APART FROM THE
MARK AS SHOWN.

SER. NO. 79-026,943, FILED 2-27-2006.

TRACY WHITTAKER-BROWN, EXAMINING AT-
TORNEY

Int. Cl.: 18

Prior U.S. Cls.: 1, 2, 3, 22 and 41

United States Patent and Trademark Office

Reg. No. 3,480,752

Registered Aug. 5, 2008

**TRADEMARK
PRINCIPAL REGISTER**

PUPPYANGEL

PA TREND INC. (REPUBLIC OF KOREA LIMITED COMPANY)
76-24, SAMSUNG-DONG,
KANGNAM-GU; SEOUL
REPUBLIC OF KOREA

LEATHER STRAPS FOR PETS, LEADS FOR PETS,
IN CLASS 18 (U.S. CLS. 1, 2, 3, 22 AND 41).

OWNER OF INTERNATIONAL REGISTRATION
0897956 DATED 8-25-2006, EXPIRES 8-25-2016.

FOR: CLOTHING FOR PETS, NOSE BAGS IN THE
NATURE OF FEED BAGS FOR ANIMALS, DOG
COLLARS, PET COLLARS, PET CARRYING BOXES,
BACKPACKS FOR PETS, PET CARRYING BAGS,

SER. NO. 79-028,645, FILED 8-25-2006.

ADA HAN, EXAMINING ATTORNEY

Int. Cls.: 3, 9, 16, 35, 38, 39 and 41

Prior U.S. Cls.: 1, 2, 4, 5, 6, 21, 22, 23, 26, 29, 36, 37, 38, 50, 51, 52, 100, 101, 102, 104, 105 and 107

Reg. No. 3,480,753

United States Patent and Trademark Office

Registered Aug. 5, 2008

TRADEMARK
SERVICE MARK
PRINCIPAL REGISTER

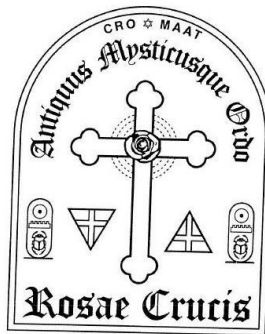

ORDRE DE LA ROSE-CROIX A.M.O.R.C.

ANCIEN ET MYSTIQUE ORDRE DE LA ROSE CROIX, EN ABRÉGÉ A.M.O.R.C., ÉGALEMENT CONNU SOUS LE NOM DE ORDRE DE LA ROSE-CROIX (FRANCE NON-PROFIT ORGANIZATION)

CHÂTEAU D'OMONVILLE
F-27110 LE TREMBLAY
FRANCE

FOR: INCENSE, ESSENTIAL OILS, PERFUMES, COSMETICS, SOAP FOR PERSONAL USE, DENTIFRICES, IN CLASS 3 (U.S. CLS. 1, 4, 6, 50, 51 AND 52).

FOR: AUDIOVISUAL RECEIVERS; MAGNETIC DATA CARRIERS FEATURING MUSIC, DISCOURSES, PRESENTATIONS, STUDIES IN THE FIELD OF PHILOSOPHY, CULTURE, SCIENCES, KNOWLEDGE, METAPHYSICS, MYSTICISM, TRADITIONS, RELIGIONS, SELF-DEVELOPMENT, PSYCHOLOGY, ART, AND HISTORY; VIDEO CASSETTES FEATURING MUSIC, DISCOURSES, PRESENTATIONS, STUDIES IN THE FIELD OF PHILOSOPHY, CULTURE, SCIENCES, KNOWLEDGE, METAPHYSICS, MYSTICISM, TRADITIONS, RELIGIONS, SELF-DEVELOPMENT, PSYCHOLOGY, ART, AND HISTORY; RECORD DISKS FEATURING MUSIC, DISCOURSES, PRESENTATIONS, STUDIES IN THE FIELD OF PHILOSOPHY, CULTURE, SCIENCES, KNOWLEDGE, METAPHYSICS, MYSTICISM, TRADITIONS, RELIGIONS, SELF-DEVELOPMENT, PSYCHOLOGY, ART, AND HISTORY; AND COMPACT DISCS FEATURING MUSIC, DISCOURSES, PRESENTATIONS, STUDIES IN THE FIELD OF PHILOSOPHY, CULTURE, SCIENCES, KNOWLEDGE,

METAPHYSICS, MYSTICISM, TRADITIONS, RELIGIONS, SELF-DEVELOPMENT, PSYCHOLOGY, ART, AND HISTORY; EXPOSED CINEMATOGRAPHIC FILM; PHOTOGRAPHIC SLIDE TRANSPARENCIES, IN CLASS 9 (U.S. CLS. 21, 23, 26, 36 AND 38).

FOR: PUBLICATIONS ON PAPER, NAMELY, NEWSLETTERS, BROCHURES, AND BOOKS, MAGAZINES, REVIEWS, PERIODICALS, MANUALS, HANDBOOKS, LEAFLETS, OPUSCULES, PAMPHLETS, JOURNALS, AND MONOGRAPHS IN THE FIELDS OF PHILOSOPHY, CULTURE, SCIENCE, KNOWLEDGE, TRADITIONS, RELIGIONS, SELF-DEVELOPMENT, PSYCHOLOGY, ART, AND HISTORY; PHOTOGRAPHS, STATIONERY, GREETING CARDS, WRITING IMPLEMENTS, EDUCATIONAL PUBLICATIONS, NAMELY, TRAINING MONOGRAPHS IN THE FIELDS OF PHILOSOPHY, CULTURE, SCIENCE, KNOWLEDGE, TRADITIONS, RELIGIONS, SELF-DEVELOPMENT, PSYCHOLOGY, ART, AND HISTORY; PRINTED PAPER SIGNS, POSTERS, IN CLASS 16 (U.S. CLS. 2, 5, 22, 23, 29, 37, 38 AND 50).

FOR: PUBLIC RELATIONS ; BUSINESS ORGANIZATION ADVICE; ADVERTISING AND ADVERTISEMENT SERVICES, IN CLASS 35 (U.S. CLS. 100, 101 AND 102).

FOR: RADIO COMMUNICATIONS AND BROADCASTING OF RADIO AND TELEVISION PROGRAMS ; TELEMATIC SENDING OF

INFORMATION, IN CLASS 38 (U.S. CLS. 100, 101 AND 104).

FOR: ORGANIZATION OF TRAVEL, IN CLASS 39 (U.S. CLS. 100 AND 105).

FOR: EDUCATION SERVICES, NAMELY, PROVIDING CLASSES, SEMINARS, WORKSHOPS, TUTORING AND MENTORING IN THE FIELDS OF PHILOSOPHY, CULTURE, SCIENCE, KNOWLEDGE, TRADITIONS, RELIGIONS, SELF-DEVELOPMENT, PSYCHOLOGY, ART, AND HISTORY; TRAINING IN THE FIELD OF PHILOSOPHY, CULTURE, SCIENCE, KNOWLEDGE, TRADITIONS, RELIGIONS, SELF-DEVELOPMENT, PSYCHOLOGY, ART, AND HISTORY; ENTERTAINMENT SERVICES, NAMELY, PROVIDING A WEB SITE FEATURING PHOTOGRAPHIC, AUDIO, VIDEO, AND PROSE PRESENTATIONS FEATURING PHILOSOPHY, CULTURE, SCIENCE, KNOWLEDGE, METAPHYSICS, MYSTICISM, TRADITIONS, RELIGIONS, SELF-DEVELOPMENT, PSYCHOLOGY, ART, AND HISTORY; ENTERTAINMENT IN THE NATURE OF THEATRE PRODUCTIONS, DANCE PERFORMANCES, AND MUSIC PERFORMANCES FEATURING PHILOSOPHY, CULTURE, SCIENCE, KNOWLEDGE, METAPHYSICS, MYSTICISM, TRADITIONS, RELIGIONS, SELF-DEVELOPMENT, PSYCHOLOGY, ART, AND HISTORY; ORGANIZING COMMUNITY CULTURAL EVENTS; TEACHING IN THE FIELD OF PHILOSOPHY, CULTURE, SCIENCE, KNOWLEDGE, TRADITIONS, RELIGIONS, SELF-DEVELOPMENT, PSYCHOLOGY, ART, AND HISTORY; EDUCATIONAL SERVICES, NAMELY, CONDUCTING CONVENTIONS, CONFERENCES, PUBLIC LECTURES AND SEMINARS IN THE FIELD OF PHILOSOPHY, CULTURE, SCIENCE, KNOWLEDGE, TRADITIONS, RELIGIONS, SELF-

DEVELOPMENT, PSYCHOLOGY, ART, AND HISTORY; PUBLISHING OF BOOKS, REVIEWS, NEWSPAPERS, MAGAZINES; ELECTRONIC PUBLISHING SERVICES, NAMELY, PUBLISHING OF TEXT AND GRAPHIC WORKS OF OTHERS ON CDS, DVDS, AND ONLINE, FEATURING PHILOSOPHY, CULTURE, SCIENCE, KNOWLEDGE, TRADITIONS, RELIGIONS, SELF-DEVELOPMENT, PSYCHOLOGY, ART, AND HISTORY; ORGANIZING EXHIBITIONS FOR CULTURAL OR EDUCATIONAL PURPOSES IN THE FIELD OF PHILOSOPHY, CULTURE, SCIENCE, KNOWLEDGE, METAPHYSICS, MYSTICISM, TRADITIONS, RELIGIONS, SELF-DEVELOPMENT, PSYCHOLOGY, ART, AND HISTORY; EDUCATION IN THE FIELDS OF PHILOSOPHY, CULTURE, KNOWLEDGE, TRADITIONS, RELIGIONS, SELF-DEVELOPMENT RENDERED THROUGH CORRESPONDENCE COURSES; MOTION PICTURE FILM PRODUCTION, IN CLASS 41 (U.S. CLS. 100, 101 AND 107).

OWNER OF INTERNATIONAL REGISTRATION 0653324 DATED 4-11-1996, EXPIRES 4-11-2016.

OWNER OF U.S. REG. NOS. 1,748,401, 2,000,628 AND OTHERS.

"THE FOREIGN WORDING IN THE MARK TRANSLATES INTO ENGLISH AS "THE TRUTH SHALL BE"; "THE ANCIENT AND MYSTICAL ORDER OF THE ROSE CROSS"; "ORDER OF THE ROSE CROSS"."

SER. NO. 79-028,705, FILED 9-6-2006.

LINDA M. KING, EXAMINING ATTORNEY

Int. Cl.: 2

Prior U.S. Cls.: 6, 11 and 16

United States Patent and Trademark Office

Reg. No. 3,480,754

Registered Aug. 5, 2008

**TRADEMARK
PRINCIPAL REGISTER**

HEMPEL'S

HEMPEL A/S (DENMARK LIMITED COMPANY)
LUNDTOFTEVEJ 150
DK-2800 KONGENS LYNGBY
DENMARK

FOR: DYES, NAMELY, PAINT DYES, NATURAL
DYES, SYNTHETIC DYES AND MORDANT DYES;
AND LACQUERS, IN CLASS 2 (U.S. CLS. 6, 11 AND
16).

THE MARK CONSISTS OF STANDARD CHAR-
ACTERS WITHOUT CLAIM TO ANY PARTICULAR
FONT, STYLE, SIZE, OR COLOR.

OWNER OF INTERNATIONAL REGISTRATION
0900730 DATED 9-22-2006, EXPIRES 9-22-2016.

OWNER OF U.S. REG. NOS. 582,760, 2,439,543 AND
OTHERS.

SEC. 2(F).

SER. NO. 79-029,634, FILED 9-22-2006.

MICHELLE DUBOIS, EXAMINING ATTORNEY

Int. Cl.: 3

Prior U.S. Cls.: 1, 4, 6, 50, 51 and 52

United States Patent and Trademark Office

Reg. No. 3,480,755

Registered Aug. 5, 2008

TRADEMARK
PRINCIPAL REGISTER

BES BEAUTY EXPRESS SERVICE; THOMAS
BERNECKER (FED REP GERMANY SOLE
PROPRIETORSHIP)

IN DER SALZHECK 7

56332 DIEBLICH

FED REP GERMANY

FOR: COSMETICS, IN CLASS 3 (U.S. CLS. 1, 4, 6, 50,
51 AND 52).

OWNER OF INTERNATIONAL REGISTRATION
0900644 DATED 8-11-2006, EXPIRES 8-11-2016.

NO CLAIM IS MADE TO THE EXCLUSIVE
RIGHT TO USE "TEN NAILS", APART FROM THE
MARK AS SHOWN.

THE COLOR(S) BLACK, GREY AND RED IS/ARE
CLAIMED AS A FEATURE OF THE MARK.

THE MARK CONSISTS OF THE COLOR BLACK
APPEARS IN THE WORD "TEN", THE COLOR
GREY APPEARS IN THE WORD "NAILS", THE
COLOR RED APPEARS IN A FINGERNAIL FORM-
ING THE TOP OF THE LETTER "I" IN THE WORD
"NAILS".

SER. NO. 79-029,718, FILED 8-11-2006.

DAYNA BROWNE, EXAMINING ATTORNEY

Int. Cl.: 9

Prior U.S. Cls.: 21, 23, 26, 36 and 38

United States Patent and Trademark Office

Reg. No. 3,480,756

Registered Aug. 5, 2008

**TRADEMARK
PRINCIPAL REGISTER**

VIPexperience

VIP EXPERIENCE LIMITED (UNITED KING-
DOM LIMITED COMPANY)

10 ATHERTON STREET

LONDON SW11 2JE

UNITED KINGDOM

FOR: COMPUTERS; COMPUTER PROGRAMS WHICH ASSIST WITH THE BOOKING OF HOTEL RESERVATIONS AND PLANE, BOAT, BUS AND AUTO RESERVATIONS AND ALLOCATION OF SPORT AND ENTERTAINMENT TICKETS; COMPUTER HARDWARE AND COMPUTER SOFTWARE FOR DATABASE MANAGEMENT FOR GENERAL USE; MOBILE TELEPHONES; COMPUTER SCREENSAVER SOFTWARE; SUNGLASSES; COMPUTER GAME SOFTWARE; COMPUTER GAME CONSOLES; SPEEDOMETERS; CALCULA-

TORS; ELECTRONIC SCOREBOARD APPARATUS; RADIOS; ENCODED AND MAGNETIC CREDIT AND DEBIT CARDS; TELEVISIONS, IN CLASS 9 (U.S. CLS. 21, 23, 26, 36 AND 38).

PRIORITY DATE OF 8-31-2006 IS CLAIMED.

OWNER OF INTERNATIONAL REGISTRATION 0901944 DATED 9-6-2006, EXPIRES 9-6-2016.

SER. NO. 79-030,309, FILED 9-6-2006.

CHRISTOPHER BUONGIORNO, EXAMINING ATTORNEY

Int. Cls.: 9, 38 and 42

Prior U.S. Cls.: 21, 23, 26, 36, 38, 100, 101 and 104

United States Patent and Trademark Office

Reg. No. 3,480,757

Registered Aug. 5, 2008

**TRADEMARK
SERVICE MARK
PRINCIPAL REGISTER**

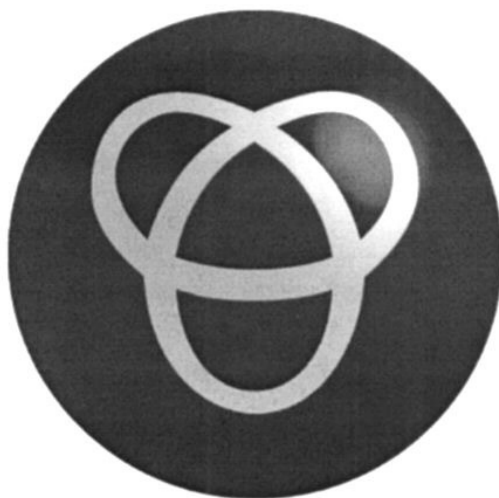

TELEPO AB (SWEDEN AB)
BOX 3135
SE-103 62 STOCKHOLM
SWEDEN

FOR: INTEGRATED CIRCUITS; COMPUTER SOFTWARE FOR USE IN THE CONVERGENCE AND INTEROPERABILITY OF TELECOMMUNICATION NETWORKS, IN CLASS 9 (U.S. CLS. 21, 23, 26, 36 AND 38).

FOR: TELECOMMUNICATIONS SERVICES, NAMELY, ELECTRONIC TRANSMISSION OF VOICE SIGNALS, MUSIC, AUDIO, DATA, FACSIMILES, IMAGES, INFORMATION, NUMERIC MESSAGES, TEXT MESSAGES, MULTIMEDIA MESSAGES, INSTANT MESSAGES AND VIDEO-BASED MESSAGING VIA A GLOBAL COMPUTER NETWORK AND WIRED AND WIRELESS DEVICES; COMMUNICATIONS BY TELEPHONE; CELLULAR TELEPHONE COMMUNICATION; COMMUNICATIONS BY COMPUTER TERMINALS; COMPUTER-AIDED TRANSMISSION OF MESSAGES AND IMAGES; ELECTRONIC MAIL; INFORMATION ABOUT TELECOMMUNICATION; COMMUNICATIONS BY FIBER OPTIC NETWORKS; PROVIDING TELECOMMUNICATIONS CONNECTIONS TO A GLOBAL COMPUTER NETWORK; TELECOMMUNICATIONS ROUTING AND JUNCTION SERVICES; TELECOMMUNICATIONS, NAMELY, MOBILE INTERACTIVE SERVICES FOR

THE TRANSMISSION OF SOUND, DATA AND VISUAL IMAGES VIA INTERACTIVE MULTIMEDIA NETWORKS; LOCAL AND LONG DISTANCE TELEPHONE SERVICES, IN CLASS 38 (U.S. CLS. 100, 101 AND 104).

FOR: COMPUTER SERVICES IN THE FIELD OF THE CONVERGENCE AND INTEROPERABILITY OF COMMUNICATIONS NETWORKS, NAMELY, COMPUTER PROGRAMMING, UPDATING OF COMPUTER SOFTWARE FOR OTHERS, MAINTENANCE OF COMPUTER SOFTWARE, COMPUTER SYSTEM DESIGN, INSTALLATION OF COMPUTER SOFTWARE, DESIGN OF COMPUTER HARDWARE, PROVIDING INFORMATION SERVICES IN THE FIELD OF COMPUTER SYSTEMS APPLICATIONS, ENGINEERING SERVICES RELATED TO COMPUTER PROGRAMMING, QUALITY CONTROL OF COMPUTER SOFTWARE FOR OTHERS, LICENSING OF COMPUTER SOFTWARE, CREATION OF COMPUTER SOFTWARE FOR OTHERS FOR DATA PROCESSES, TECHNICAL SUPPORT REGARDING COMPUTER SOFTWARE AND COMPUTER HARDWARE, NAMELY, TROUBLESHOOTING OF COMPUTER SOFTWARE AND COMPUTER HARDWARE PROBLEMS, DEVELOPMENT OF COMPUTER SYSTEMS, DESIGN OF COMPUTER HARDWARE AND SOFTWARE FOR OTHERS, DEVELOPMENT OF COMPUTER HARDWARE AND SOFTWARE, IN CLASS 42 (U.S. CLS. 100 AND 101).

PRIORITY DATE OF 4-21-2006 IS CLAIMED.

SER. NO. 79-030,566, FILED 10-5-2006.

OWNER OF INTERNATIONAL REGISTRATION
0902639 DATED 10-5-2006, EXPIRES 10-5-2016.

DANIEL BRODY, EXAMINING ATTORNEY

Int. Cls.: 9, 35, 36, 38, 39 and 42

Prior U.S. Cls.: 21, 23, 26, 36, 38, 100, 101, 102, 104 and 105

Reg. No. 3,480,758

United States Patent and Trademark Office

Registered Aug. 5, 2008

**TRADEMARK
SERVICE MARK
PRINCIPAL REGISTER**



AKCIONERNO DRUJESTVO; "DATAMAX SYSTEM HOLDING" (BULGARIA PUBLIC LIMITED COMPANY)

IVAN VAZOV STR. 16

BG-1000 SOFIA

BULGARIA

FOR: SCIENTIFIC, NAUTICAL, SURVEYING, PHOTOGRAPHIC, CINEMATOGRAPHIC, OPTICAL, WEIGHING, MEASURING, SIGNALING, CHECKING, LIFE-SAVING, AND TEACHING APPARATUS AND INSTRUMENTS, NAMELY, MICROSCOPES, DIRECTIONAL COMPASSES, PROTRACTORS, CAMERAS, MAGNIFYING GLASSES, TELESCOPES, GRADUATED RULERS, EMERGENCY FLARES, VOLT-OHM METERS, PHOTOGRAPHIC CAMERAS, CINEMATOGRAPHIC CAMERAS, OPTICAL LENSES, SCALES, MEASURING TAPES, SIGNALING BUOYS, LIFE-SAVING RAFTS; APPARATUS FOR RECORDING, TRANSMISSION OR REPRODUCTION OF SOUND OR IMAGES; APPARATUS AND INSTRUMENTS FOR CONDUCTING, SWITCHING, TRANSFORMING, ACCUMULATING, REGULATING OR CONTROLLING ELECTRICITY, NAMELY, ELECTRIC ACCUMULATORS, ELECTRIC TRANSFORMERS, ELECTRIC CURRENT SWITCHES, ELECTRICAL CONDUCTORS, VOLTAGE REGULATORS; AUTOMATIC VENDING MACHINES AND MECHANISMS FOR COIN-OPERATED APPARATUS, NAMELY, COIN COUNTING AND SORTING MACHINES; CASH REGISTERS, CALCULATORS, DATA PROCESSING AND COMPUTER EQUIPMENT, NAMELY, DATA PROCESSORS, COMPUTERS, NOTEBOOK COMPUTERS, PERSONAL DIGITAL ASSISTANTS (PDA), ELECTRONIC PERSONAL ORGANIZERS, HAND-HELD COMPUTERS; FIRE EXTINGUISHERS, IN CLASS 9 (U.S. CLS. 21, 23, 26, 36 AND 38).

FOR: ADVERTISING; BUSINESS MANAGEMENT; BUSINESS ADMINISTRATION; OFFICE FUNCTIONS, IN CLASS 35 (U.S. CLS. 100, 101 AND 102).

FOR: INSURANCE, NAMELY, INSURANCE UNDERWRITING IN THE FIELD OF LIFE, HEALTH, ACCIDENT, FIRE AND EMPLOYEES' PENSIONS; FINANCIAL AFFAIRS, NAMELY, FINANCIAL PLANNING, FINANCIAL RESEARCH, FINANCIAL RISK MANAGEMENT, CREDIT CARD SERVICES, BANKING, LOAN FINANCING, INSTALLMENT LOANS, CREDIT BUREAUS, FINANCIAL CONSULTATION, HIRE-PURCHASE FINANCING, SAVING BANKS; MONETARY AFFAIRS, NAMELY, ACQUISITION AND TRANSFER OF MONETARY CLAIMS, MONEY ORDER SERVICES; REAL ESTATE AFFAIRS, NAMELY, REAL ESTATE FACILITY MANAGEMENT, REAL ESTATE AGENCIES, REAL ESTATE APPRAISAL, REAL ESTATE ACQUISITION SERVICES, REAL ESTATE BROKERAGE, REAL ESTATE INVESTMENT, REAL ESTATE MANAGEMENT, REAL ESTATE PROCUREMENT FOR OTHERS, REAL ESTATE SYNDICATION, REAL ESTATE TRUSTEE SERVICES, REAL ESTATE LEASING SERVICES, IN CLASS 36 (U.S. CLS. 100, 101 AND 102).

FOR: TELECOMMUNICATIONS, NAMELY, ELECTRIC, DIGITAL, CELLULAR AND WIRELESS TRANSMISSION OF VOICE, DATA, INFORMATION IMAGES, SIGNALS AND MESSAGES AND TRANSMISSION OF VOICE, DATA, IMAGES, AUDIO, VIDEO AND INFORMATION VIA TELEPHONE, TELEVISION AND GLOBAL COMMUNICATION NETWORKS, IN CLASS 38 (U.S. CLS. 100, 101 AND 104).

FOR: STORAGE OF ELECTRONICALLY-STORED DATA OR DOCUMENTS, IN CLASS 39 (U.S. CLS. 100 AND 105).

FOR: SCIENTIFIC RESEARCH AND DEVELOPMENT; INDUSTRIAL ANALYSIS AND RESEARCH SERVICES, NAMELY, MECHANICAL RESEARCH, TECHNICAL RESEARCH, PRODUCT RESEARCH AND DEVELOPMENT FOR OTHERS, INDUSTRIAL DESIGN, DRESS DESIGNING, PACKAGING DESIGN; DESIGN AND DEVELOPMENT OF COMPUTER HARDWARE AND SOFTWARE; LEGAL SERVICES, IN CLASS 42 (U.S. CLS. 100 AND 101).

PRIORITY DATE OF 5-9-2006 IS CLAIMED.

OWNER OF INTERNATIONAL REGISTRATION 0902705 DATED 9-25-2006, EXPIRES 9-25-2016.

NO CLAIM IS MADE TO THE EXCLUSIVE RIGHT TO USE "EASY PAY" , APART FROM THE MARK AS SHOWN.

THE COLOR(S) RED, BLUE AND WHITE IS/ARE CLAIMED AS A FEATURE OF THE MARK.

THE MARK CONSISTS OF THE WORDING "EASYPAY" WITH "EASY" IN RED AND "PAY" IN DARK BLUE TO THE RIGHT OF A STYLIZED BLUE ENVELOPE INTERSECTING WITH A RED AND WHITE STYLIZED ARROW WITH THE ENVELOPE SURROUNDED BY A BLUE AND WHITE STYLIZED CIRCLE.

SER. NO. 79-030,593, FILED 9-25-2006.

ALICE BENMAMAN, EXAMINING ATTORNEY

Int. Cls.: 7, 8, 9 and 20

**Prior U.S. Cls.: 2, 13, 19, 21, 22, 23, 25, 26, 28, 31, 32,
34, 35, 36, 38, 44 and 50**

Reg. No. 3,480,759

United States Patent and Trademark Office

Registered Aug. 5, 2008

**TRADEMARK
PRINCIPAL REGISTER**



HOFFMANN GMBH QUALITÄTSWERKZEUGE
(FED REP GERMANY LTD LIAB CO)
HABERLANDSTRASSE 55
81241 MÜNCHEN
FED REP GERMANY

FOR: MECHANICALLY OPERATED POWER TOOLS FOR MATERIALS OF ALL TYPES IN THE NATURE OF POWER MACHINE OPERATED TOOLS FOR ALL KINDS OF MATERIALS, NAMELY, POWER OPERATED TWIST DRILLS, POWER OPERATED CENTER DRILLS, POWER OPERATED STEP DRILLS, POWER OPERATED HOLE CUTTERS, POWER OPERATED SOLID CARBIDE DRILLS, POWER OPERATED STONE DRILLS, POWER OPERATED TAPS, DIES FOR USE WITH MACHINE TOOLS, HOLDERS FOR USE WITH DIES, BORING MACHINES IN THE NATURE OF COUNTERBORERS, COUNTERSINKS, REAMERS, SAW BLADES FOR POWER TOOLS, SHELL ENDMILLS, ROUGHING ENDMILLS AND ENDMILLS WITH SHANKS; POWER OPERATED MILLING TOOLS AND PARTS THEREFOR, NAMELY, MILLING CUTTERS, MILLING CUTTER HEADS AND MILLING THREAD MILL CUTTERS; POWER OPERATED CLAMPING TOOLS AND PARTS THEREFOR, NAMELY, FASTENER COLLETS, LATHE CHUCKS; DRIVING CENTERS IN THE NATURE OF MACHINING CENTERS FOR METAL WORKING MACHINES, AND POWER OPERATED LATHE CHUCKS FOR TURNING AND DRIVING STOCK; SPINDLES FOR POWER BORING HEADS FOR MACHINING WORK PIECES, POWER OPERATED METAL VICE JAWS FOR HOLDING MACHINING WORK PIECES, COLLET CHUCKS FOR HOLDING MACHINE TOOLS, MACHINE POWER OPERATED VISES, DRILL CHUCKS FOR POWER OPERATED DRILLS, MILLING CHUCKS FOR POWER OPERATED DRILLS, MAGNETIC CHUCKS FOR POWER OPERATED DRILLS, PARALLELS FOR POWER OPERATED TOOLS, ARBORS IN THE NATURE

OF AN AXIS OR SHAFT SUPPORTING A ROTATING PART ON A POWER OPERATED LATHE, METAL CLAMPS USED FOR HOLDING PIECE PARTS ON MACHINE TOOL TABLES, V-BLOCKS FOR POWER OPERATED TOOLS; POWER OPERATED TOOL PRESETTERS FOR POSITIONING WORK PIECES ON MACHINE TOOL TABLES, NAMELY, POWER OPERATED VICES; POWER OPERATED FILING, GRINDING AND SAWING TOOLS AND PARTS THEREFOR, NAMELY, HIGH SPEED STEEL ENGRAVING MACHINES, MILLING CUTTERS, GRINDERS, ABRASIVE DISCS FOR POWER OPERATED SANDERS AND GRINDERS, POWER SAW BLADES AND POWER OPERATED SAWS; ABRASIVES CUP WIRE BRUSHES FOR USE IN MACHINES; WHEEL BRUSHES, NAMELY, ROTARY BRUSHES FOR MACHINES; POWER OPERATED HAND TOOLS, NAMELY, SCREW DRIVERS, WRENCHES, POWER SOCKETS AND BITS FOR POWER DRILLING AND DRIVING TOOLS; TOOL BITS FOR MACHINES, IN CLASS 7 (U.S. CLS. 13, 19, 21, 23, 31, 34 AND 35).

FOR: MANUALLY OPERATED TOOLS FOR MATERIALS OF ALL TYPES, NAMELY, MANUAL TWIST DRILLS, MANUAL CENTER DRILLS, MANUAL HOLE CUTTERS, REAMERS; HAND OPERATED CLAMPING TOOLS AND PARTS THEREFOR, NAMELY, FASTENER COLLETS, LATHE CHUCKS, AND COLLET CHUCKS FOR HOLDING MANUALLY OPERATED TOOLS; MANUALLY OPERATED METAL VISES, MANUALLY OPERATED DRILL CHUCKS, MILLING CHUCKS FOR MANUALLY OPERATED DRILLS, MAGNETIC CHUCKS FOR MANUALLY OPERATED DRILLS, MANUALLY OPERATED PARALLELS, ARBORS IN THE NATURE OF AN AXIS OR SHAFT SUPPORTING A ROTATING PART ON A MANUALLY OPERATED LATHE; HAND TOOLS, NAMELY, CLAMPS, MANUALLY OPERATED V-

BLOCKS; MANUALLY OPERATED PRESETTERS AND PARALLELS FOR MANUALLY OPERATED POSITIONING OF WORK PIECES ON MACHINE TOOL TABLES, NAMELY, METAL VISES AND HAND OPERATED CLAMPS; MANUALLY OPERATED FILING, GRINDING AND SAWING HAND TOOLS AND PARTS THEREFOR, NAMELY, FILES, WOOD RASPS, ENGRAVING NEEDLES, CUP BRUSHES, HAND SCRATCH WIRE BRUSHES, ABRASIVE DISCS FOR MANUALLY OPERATED SANDERS AND GRINDERS, SAW BLADES; MANUALLY OPERATED HAND TOOLS, NAMELY, WRENCHES, TORQUE SOCKET SETS, TORQUE SOCKET WRENCHES AND RATCHET WRENCH SETS, EXTENSIONS FOR HAND TOOLS, SCREWDRIVERS, BITS FOR HAND DRILLS, AND PLIERS, CUTTING PLIERS, WIRE STRIPPERS, ELECTRICIAN PLIERS, BOLT AND CABLE CUTTERS, CHISELS, HAMMERS, SCISSORS, RIVETING PLIERS; WOOD WORKING HAND TOOLS AND PARTS THEREFOR, NAMELY, WOOD PLANERS, WOODBORING BITS FOR HAND DRILLS, WOODEN HAMMERS, WOOD MARKING GAGES, RIPPING CHISELS; WATER INSTALLATION HAND TOOLS, NAMELY, PIPE CUTTERS AND PIPE BENDING DEVICES; ELECTRICIAN KNIVES, KNIVES; HAND TOOLS, NAMELY, SHEET METAL PUNCHES; HAND TOOLS, NAMELY, ADJUSTABLE CLAMPS; METAL VISES; SHEET METAL CUTTERS, NAMELY, METAL CUTTING SAWS AND METAL CUTTING SCISSORS; ANGLE BENDING HAND TOOLS, NAMELY, SHEET BENDING BRAKES AND COMPONENTS THEREOF, IN CLASS 8 (U.S. CLS. 23, 28 AND 44).

FOR: HAND-HELD MEASURING APPARATUS AND MEASURING DEVICES, NAMELY, ELECTRONIC NON-LASER GAUGES FOR MEASURING PRODUCTION PARAMETERS IN THE NATURE OF WEIGHT, PRESSURE AND LENGTH; HAND-HELD MEASURING APPARATUS AND MEASURING DEVICES, NAMELY, CALIPERS FOR MEASURING, MICROMETERS, DIAL INDICATORS, AND PLUMB LEVELS; INSTRUMENTS FOR MEASURING ANGLES, NAMELY, GAUGE BLOCKS, AND INSTRUMENTS FOR MEASURING LENGTHS AT RIGHT

ANGLES; INSTRUMENTS FOR MEASURING LENGTH, MEASURING TAPES, TAPE RULERS, GRADUATED RULERS, FOLDING RULERS, HEIGHT MEASURING GAUGES AND CROSS BEAM DEPTH GAUGES, WAVEMETER; TORQUE GAUGES AND TEMPERATURE SENSORS AND TEMPERATURE INDICATORS; APPARATUS FOR OPTICAL INSPECTION FOR INDUSTRIAL USE AND SURVEYING MEASUREMENT, NAMELY, TESTING EQUIPMENT FOR MEASURING THE TEMPERATURE, PRESSURE, POSITION OR FORM OF WORKPIECES IN A MACHINE TOOL, INSTRUMENTS FOR MEASURING THICKNESS; TOOL MEASURING INSTRUMENTS IN THE NATURE OF SURFACE COMPARISON PLATES FOR COMPARATIVE CHECKING OF SURFACE FINISHES USING VISUAL AND TACTILE METHODS, MICROSCOPES; SURFACE ROUGHNESS TESTING MACHINES AND INSTRUMENTS, AND PROFILOMETER, IN CLASS 9 (U.S. CLS. 21, 23, 26, 36 AND 38).

FOR: WOODEN AND METAL WORKBENCHES; METAL CABINETS WITH DRAWERS FOR STORING TOOLS AND TECHNICAL EQUIPMENT, IN CLASS 20 (U.S. CLS. 2, 13, 22, 25, 32 AND 50).

OWNER OF INTERNATIONAL REGISTRATION 0662607 DATED 9-30-1996, EXPIRES 9-30-2016.

"THE MARK CONSISTS OF THE STYLIZED WORDING "GARANT" AND THE DESIGN OF A MAN AND A CIRCLE WITH A STAR IN THE CENTER. THE MAN IS HOLDING A TOOL THAT EXTENDS TO THE CENTER OF THE CIRCLE AND STAR. THE DESIGN IS TO THE LEFT OF THE WORDING."

"THE FOREIGN WORDING IN THE MARK TRANSLATES INTO ENGLISH AS GUARANTOR."

SER. NO. 79-030,733, FILED 10-2-2006.

JAY BESCH, EXAMINING ATTORNEY

Int. Cls.: 9 and 42

Prior U.S. Cls.: 21, 23, 26, 36, 38, 100 and 101

United States Patent and Trademark Office

Reg. No. 3,480,760

Registered Aug. 5, 2008

**TRADEMARK
SERVICE MARK
PRINCIPAL REGISTER**



WALL STREET SYSTEMS DELAWARE, INC.
(DELAWARE CORPORATION)
30 BROAD STREET
NEW YORK, NEW YORK 10004
UNITED STATES

FOR: COMPUTER SOFTWARE FOR CASH MONITORING AND MANAGEMENT; COMPUTER SOFTWARE FOR DEBT MONITORING AND MANAGEMENT; COMPUTER SOFTWARE FOR TREASURY MANAGEMENT; COMPUTER SOFTWARE FOR CURRENCY EXCHANGE MONITORING, PROCESSING AND MANAGEMENT; COMPUTER SOFTWARE FOR TRADE SETTLEMENT, CUSTODY MANAGEMENT, AND FINANCIAL REPORTING; COMPUTER SOFTWARE FOR PROCESSING FINANCIAL TRANSACTIONS; DOWNLOADABLE COMPUTER SOFTWARE FOR USE IN FINANCIAL TRADING, FINANCIAL ANALYSIS, FINANCIAL RISK MANAGEMENT AND FINANCIAL TRANSACTIONS; COMPUTER SOFTWARE FOR ACCOUNTING AND FINANCIAL RISK MANAGEMENT, IN CLASS 9 (U.S. CLS. 21, 23, 26, 36 AND 38).

FOR: COMPUTER PROGRAMMING, COMPUTER SOFTWARE DESIGN AND CONSULTANCY SERVICES AND CUSTOM DESIGN OF COMPUTER SOFTWARE IN THE FIELD OF PROCESSING FINANCIAL TRANSACTIONS; INSTALLATION, MAINTENANCE AND UPDATING OF COMPUTER SOFTWARE FOR PROCESSING FINANCIAL TRANSACTIONS; PROVIDING TEMPORARY USE OF NON-DOWNLOADABLE SOFTWARE FOR PROCESSING FINANCIAL TRANSACTIONS; PROVISION OF INFORMATION AND ADVICE ON THE FOREGOING, IN CLASS 42 (U.S. CLS. 100 AND 101).

OWNER OF INTERNATIONAL REGISTRATION
0903752 DATED 10-2-2006, EXPIRES 10-2-2016.

SER. NO. 79-031,006, FILED 10-2-2006.

JAMES STEIN, EXAMINING ATTORNEY

Int. Cls.: 16, 19, 20 and 21

**Prior U.S. Cls.: 1, 2, 5, 12, 13, 22, 23, 25, 29, 30, 32, 33,
37, 38, 40 and 50**

Reg. No. 3,480,761

United States Patent and Trademark Office

Registered Aug. 5, 2008

**TRADEMARK
PRINCIPAL REGISTER**

SMANIA

SMANIA SPA (ITALY JOINT STOCK COMPANY)
VIA JULIA, 61
I-35010 VIGONZA (PD)
ITALY

FOR: DECORATIVE PAINTINGS; PAPER RIBBONS, PARCHMENT PAPER, TRACING PAPER, CARBON PAPER, TABLE CLOTHS OF PAPER, TABLE LINEN OF PAPER, TABLE MATS OF PAPER, FLOWER-POT COVERS OF PAPER, CALENDARS, FIGURINES AND STATUETTES OF PAPIER MACHÉ, POSTERS, GEOGRAPHICAL MAPS, PORTRAITS, PHOTOGRAPHS, DECALCOMANIAS, PICTURES, PAPER CUTTERS, PAPER KNIVES, DESKTOP STATIONERY CABINETS, DOCUMENT FILES, DESK STANDS AND HOLDERS FOR PENS, PENCILS AND INK, INKING PADS, STAMP STANDS, WRITING INSTRUMENTS, GLUE FOR STATIONERY OR HOUSEHOLD PURPOSES, DRAWING INSTRUMENTS BEING COMPASSES, CURVES AND SQUARES, CANVAS FOR PAINTING, STENCILS, BLACKBOARDS, INDOOR AQUARIA, CHAPLETS, IN CLASS 16 (U.S. CLS. 2, 5, 22, 23, 29, 37, 38 AND 50).

FOR: FIGURINES AND STATUETTES IN STONE; SEMI-WORKED WOOD, CONCRETE, MARBLE, ALABASTER, MAGNESIA CEMENT, CONCRETE BUILDING MATERIALS IN THE FORM OF BLOCKS, BRICKS AND PANELS; TILES NOT OF METAL FOR BUILDING; FIRECLAY, ASPHALT, PITCH, DOORS AND WINDOWS NOT OF METAL; DOOR AND WINDOW FRAMES NOT OF METAL; NON-METAL STAIRCASES, LETTER BOXES OF MASONRY, WINDOW GLASS EXCEPT GLASS FOR VEHICLE WINDOWS; SAFETY GLASS FOR BUILDING PURPOSES, FRAMEWORKS FOR BUILDING NOT OF METAL; TOMBSTONES OF STONE, CONCRETE OR MARBLE, IN CLASS 19 (U.S. CLS. 1, 12, 33 AND 50).

FOR: BEDSIDE TABLES, COLD CAST RESIN FIGURINES, PLASTIC FIGURINES, ROOM DIVIDERS, SCREENS BEING FURNITURE, COUNTER-

TOPS FOR BARS, BAR-STOOLS; CHAIRS, TABLES, BENCHES, DECK CHAIRS, ARMCHAIRS, WARDROBES, CUPBOARDS, BEDS, SHELVES, CHESTS OF DRAWERS, FILE CABINETS, TABLES FOR MEETING ROOMS, DESKS, TYPING DESKS, DRAWERS, SOFAS, DIVANS, WRITING DESKS; UMBRELLA STANDS, TEA CARTS BEING FURNITURE, FOOTSTOOLS BEING FURNITURE, SEATS BEING FURNITURE, MIRROR STANDS, BOOKCASES, CLOTHES HANGERS; OUTDOOR AND INDOOR FURNITURE; FURNITURE PARTITIONS; DOORS FOR FURNITURE, FURNITURE FRAMES, CHAIR LEGS, TABLE LEAVES, ARM RESTS; MIRRORS, PLASTIC BOTTLE STOPPERS AND PLASTIC LIDS, CUSHIONS, PILLOWS, MATTRESSES, BEDS FOR HOUSEHOLD PETS, DOG KENNELS, HAND FANS; PICTURE FRAMES, INTERIOR BLINDS FOR WINDOWS, WINDOW SHADES, BEAD CURTAINS FOR DECORATION, CLOTHES HOOKS NOT OF METAL, MANNEQUINS, CRADLES, PLASTIC AND WOODEN SCULPTURES; NON-METAL DOOR HANDLES AND KNOBS, NON-METAL WINDOW HANDLES, NON-METAL KEY HOLDERS, NON-METAL LADDERS; DECORATIVE WALL PLAQUES NOT OF TEXTILE; HINGES NOT OF METAL, LETTER BOXES NOT OF METAL OR OF MASONRY, FLAGPOLES, DRINKING STRAWS, PLASTIC AND WOOD CRATES, NON-METALLIC NUMBER PLATES AND DOOR NAMEPLATES, RATTAN, WICKER, NAMELY, HOME FURNITURE OF WICKER; BAMBOO, NAMELY, HOME FURNITURE OF BAMBOO, IN CLASS 20 (U.S. CLS. 2, 13, 22, 25, 32 AND 50).

FOR: SCULPTURES AND STATUETTES IN CERAMICS AND EARTHENWARE; CANDLE HOLDERS NOT OF PRECIOUS METALS, HAND BASINS, FLOWER POT HOLDERS AND COVERS; SOAP BOXES, DECORATIVE BOXES OF PORCELAIN, TERRACOTTA OR GLASS; AND PLATES, DECORATIVE CRYSTAL PRISMS, STAINED GLASS, WASTEPAPER BASKETS, BASINS BEING BOWLS, POTS, GLASS BOWLS, DRINKING GLASSES, TRAYS, NOT OF PRECIOUS METAL, FLOWER

POTS, CANDLE EXTINGUISHERS AND CANDLE-STICKS, NOT OF PRECIOUS METAL, CANDLE RINGS, NOT OF PRECIOUS METAL, PITCHERS, NOT OF PRECIOUS METAL, LAMP GLASS BRUSHES, DISHWASHING BRUSHES, TOOTHBRUSHES, TOOTHPICKS, TOOTHPICK HOLDERS, NOT OF PRECIOUS METAL, PERFUME SPRAYERS SOLD EMPTY, THERMAL INSULATED CONTAINERS FOR FOOD AND BEVERAGE, CLOTHS FOR CLEANING, UNWORKED OR SEMI-WORKED GLASS, NOT FOR BUILDING, BIRD CAGES FOR DOMESTIC BIRDS, INSECT TRAPS, IN CLASS 21 (U.S. CLS. 2, 13, 23, 29, 30, 33, 40 AND 50).

THE MARK CONSISTS OF STANDARD CHARACTERS WITHOUT CLAIM TO ANY PARTICULAR FONT, STYLE, SIZE, OR COLOR.

PRIORITY DATE OF 3-10-2006 IS CLAIMED.

OWNER OF INTERNATIONAL REGISTRATION 0904905 DATED 6-1-2006, EXPIRES 6-1-2016.

THE ENGLISH TRANSLATION OF THE WORD "SMANIA" IN THE MARK IS "CRAVING".

SER. NO. 79-031,461, FILED 6-1-2006.

DEBRA LEE, EXAMINING ATTORNEY

Int. Cl.: 20

Prior U.S. Cls.: 2, 13, 22, 25, 32 and 50

United States Patent and Trademark Office

Reg. No. 3,480,762

Registered Aug. 5, 2008

**TRADEMARK
PRINCIPAL REGISTER**

TEKHNE

TEKHNE SRL (ITALY LIMITED COMPANY)
VIA MALIGNANI, 9
I-34071 CORMONS (GO)
ITALY

FOR: ARMCHAIRS; BED FRAMES; BEDS;
BENCHES; BOOKCASES; CHAIR PADS; CHAIRS;
DECK CHAIRS; DIVANS; DOORS FOR FURNI-
TURE; FURNITURE FRAMES; FURNITURE
PARTS, NAMELY, CHAIR LEGS, TABLE LEGS,
TABLE LEAVES, ARM RESTS, FOOT RESTS; HIGH-
CHAIRS; FURNITURE MIRRORS; OTTOMANS;
PILLOWS; SHELVES; SOFAS; STOOLS; TRESTLE
TABLES; FURNITURE TABLES; WORK BENCHES;
INDUSTRIAL WORK TABLES, IN CLASS 20 (U.S.
CLS. 2, 13, 22, 25, 32 AND 50).

THE MARK CONSISTS OF STANDARD CHAR-
ACTERS WITHOUT CLAIM TO ANY PARTICULAR
FONT, STYLE, SIZE, OR COLOR.

PRIORITY DATE OF 7-10-2006 IS CLAIMED.

OWNER OF INTERNATIONAL REGISTRATION
0905929 DATED 9-18-2006, EXPIRES 9-18-2016.

THE ENGLISH TRANSLATION OF THE WORD
"TEKHNE" IN THE MARK IS TECHNOLOGY.

SER. NO. 79-031,861, FILED 9-18-2006.

SUNG IN, EXAMINING ATTORNEY

Int. Cls.: 18 and 25

Prior U.S. Cls.: 1, 2, 3, 22, 39 and 41

United States Patent and Trademark Office

Reg. No. 3,480,763

Registered Aug. 5, 2008

**TRADEMARK
PRINCIPAL REGISTER**

ONE OF 2

AUDLEY SHOES GMBH (FED REP GERMANY
GMBH)
HEYENFELDWEG 53
47802 KREFELD
FED REP GERMANY

FOR: LEATHER AND IMITATIONS OF LEATHER, AND GOODS MADE OF THESE MATERIALS AND NOT INCLUDED IN OTHER CLASSES, NAMELY, LEATHER HANDBAGS, LEATHER PURSES, LEATHER SUITCASES, LEATHER KEY CASES, LEATHER WALLETS, LEATHER SOLD IN BULK, LEATHER AND IMITATION LEATHER BAGS; ANIMAL SKINS; LUGGAGE TRUNKS AND TRAVELING BAGS; UMBRELLAS, PARASOLS AND WALKING STICKS; WHIPS, HARNESSSES AND SADDLERY, IN CLASS 18 (U.S. CLS. 1, 2, 3, 22 AND 41).

FOR: ARTICLES OF CLOTHING, NAMELY, SHIRTS, SHORTS, PANTS, SKIRTS, SOCKS, JACKETS, BLOUSES, TIES, UNDERWEAR, PAJAMAS; HEADGEAR, NAMELY, BANDANNAS, CAPS, HEAD-SCARVES, SUN-VISORS, BEANIES; ACCESSORIES, NAMELY HEAD SCARVES, SCARVES, DRESS HANDKERCHIEFS, NAMELY POCKET SQUARES, POCKET KERCHIEFS; TIES; GLOVES; FOOTWEAR, IN CLASS 25 (U.S. CLS. 22 AND 39).

OWNER OF INTERNATIONAL REGISTRATION
0906117 DATED 11-16-2006, EXPIRES 11-16-2016.

SER. NO. 79-031,966, FILED 11-16-2006.

MICHAEL TANNER, EXAMINING ATTORNEY

Int. Cl.: 43

Prior U.S. Cls.: 100 and 101

United States Patent and Trademark Office

Reg. No. 3,480,764

Registered Aug. 5, 2008

**SERVICE MARK
PRINCIPAL REGISTER**

KJC Café

CHOI, HAK LAK (REPUBLIC OF KOREA INDIVIDUAL)
116-1, CHUNGDAM-DONG
KANGNAM-GU; SEOUL
REPUBLIC OF KOREA

OWNER OF INTERNATIONAL REGISTRATION
0906359 DATED 10-16-2006, EXPIRES 10-16-2016.

FOR: CAFES, CAFETERIAS, COCKTAIL LOUNGE SERVICES, KOREAN BAR SERVICES, RESTAURANTS, SELF-SERVICE RESTAURANTS, SNACK-BARS, GENERAL BAR SERVICES , IN CLASS 43 (U.S. CLS. 100 AND 101).

NO CLAIM IS MADE TO THE EXCLUSIVE RIGHT TO USE "CAFE", APART FROM THE MARK AS SHOWN.

THE MARK CONSISTS OF STANDARD CHARACTERS WITHOUT CLAIM TO ANY PARTICULAR FONT, STYLE, SIZE, OR COLOR.

SER. NO. 79-032,050, FILED 10-16-2006.

PRIORITY DATE OF 7-24-2006 IS CLAIMED.

JANICE L. MCMORROW, EXAMINING ATTORNEY

Int. Cl.: 7

Prior U.S. Cls.: 13, 19, 21, 23, 31, 34 and 35

Reg. No. 3,480,765

United States Patent and Trademark Office

Registered Aug. 5, 2008

**TRADEMARK
PRINCIPAL REGISTER**



HEBEI HUABEI OILFIELD RONGSHENG; MA-
CHINERY MANUFACTURE CO., LTD. (CHI-
NA CORPORATION)
EAST OF HUIZHAN ROAD
RENQIU, HEBEI PROVINCE 062252
CHINA

FOR: MACHINERY FOR THE PETROCHEMICAL
INDUSTRY, NAMELY, OIL-WELL PUMPING MA-
CHINES, OIL FILTERS, AND OIL TANKS; APPA-
RATUS AND MACHINES FOR PETROLEUM
EXPLOITATION AND REFINEMENT, NAMELY,
MUD PUMPS AND MUD PUMP ASSEMBLIES WITH
DRIVES, TOOL JOINTS, HYDRAULIC POWER
TONGS, OIL WELL PUMPING UNITS, OIL WELL
PUMPS, OIL WELL PUMPING RODS; PETROLEUM

SUCTION PUMPS; PETROLEUM SLURRY PUMPS;
OIL REFINING MACHINES, NAMELY, OIL SE-
PARATORS; FLUSHING MACHINES, NAMELY,
BRAKE FLUSHING MACHINES; OIL WELL DRILL;
FLOATING OR NON-FLOATING DRILLING RIGS,
IN CLASS 7 (U.S. CLS. 13, 19, 21, 23, 31, 34 AND 35).

OWNER OF INTERNATIONAL REGISTRATION
0906538 DATED 9-26-2006, EXPIRES 9-26-2016.

SER. NO. 79-032,117, FILED 9-26-2006.

KAPIL BHANOT, EXAMINING ATTORNEY

Int. Cl.: 36

Prior U.S. Cls.: 100, 101 and 102

United States Patent and Trademark Office

Reg. No. 3,480,766

Registered Aug. 5, 2008

SERVICE MARK
PRINCIPAL REGISTER



COMPAGNIE INDUSTRIELLE ET; FINANCIERE
D'INGENIERIE - INGENICO (FRANCE SOCI-
ETE ANONYME)
192, AVENUE CHARLES DE GAULLE
F-92200 NEUILLY S/SEINE, FRANCE

FOR: FINANCIAL AFFAIRS, NAMELY, CREDIT AND FINANCIAL CONSULTATION, FINANCIAL FORECASTING, FINANCIAL PLANNING, FINANCIAL INFORMATION IN THE NATURE OF RATES OF EXCHANGE, FINANCIAL INFORMATION PROCESSING; MONETARY AFFAIRS, NAMELY, MONETARY EXCHANGE, MONEY ORDER SERVICES, MONEY TRANSFER SERVICES, MONEY ORDER PAYMENT GUARANTEE SERVICES, WARRANTY CLAIMS ADMINISTRATION SERVICES IN THE NATURE OF PROCESSING WARRANTY CLAIMS IN THE FIELD OF INVESTMENTS; BANKING AFFAIRS, BANKING SERVICES AND BANKING CONSULTATION; CREDIT AGENCIES AND DEBT RECOVERY AGENCIES; FINANCIAL ANALYSIS; CREDIT FINANCING SERVICES AND LEASE-PURCHASE FINANCING; STOCK EXCHANGE PRICE QUOTATIONS; RAISING AND INVESTMENT OF CAPITAL, NAMELY, CAPITAL INVESTMENT CONSULTATION, EQUITY CAPITAL INVESTMENT, MANAGEMENT OF CAPITAL INVESTMENT FUND, PROVIDING WORKING CAPITAL; DEBIT AND CREDIT CARD SERVICES; CURRENCY EXCHANGE OPERATIONS, NAMELY, CURRENCY EXCHANGE AND ADVICE; CHECK VERIFICATION; FINANCIAL CONSULTATION; DEPOSIT OF VALUABLES, NAMELY, SAFETY DEPOSIT BOX SERVICES; ISSUING OF TOKENS OF VALUE; ISSUANCE OF CREDIT CARDS; SAVINGS ACCOUNT SERVICES, SAVINGS BANK SERVICES; FIDUCIARY SERVICES, NAMELY, FIDUCIARY REPRESENTATIVE, FIDUCIARY TAX PAYMENT PROCESSING SERVICES; FINANCING SERVICES; FINANCIAL INFORMATION SERVICES, NAMELY, PROVIDING INFORMATION IN THE FIELD OF FINANCE, FINANCIAL INFORMATION PROCESSING, FINANCIAL INFORMATION PROVIDED BY ELECTRONIC MEANS, FINANCIAL INFORMATION IN THE NATURE OF RATES OF EXCHANGE;

FUND TRANSFER SERVICES BY MEANS OF ELECTRONIC CREDIT AND DEBIT CARDS AND PAYMENT TERMINALS; ELECTRONIC TRANSFER OF FUNDS; ISSUANCE OF CREDIT CARDS AND DEBIT CARDS; FUND INVESTMENT SERVICES; FINANCIAL TRANSACTION AND STOCK EXCHANGE TRANSACTION SERVICES AND PLACING OF ORDERS ON FINANCIAL MARKETS, NAMELY, ASSISTING OTHERS WITH THE COMPLETION OF FINANCIAL TRANSACTIONS FOR STOCKS, BONDS, SECURITIES AND EQUITIES BY ALL MEANS AND ESPECIALLY BY MEANS OF ELECTRONIC DEBIT OR CREDIT CARDS; FINANCIAL AND MONETARY SERVICES, NAMELY, BANKING, FINANCING SERVICES, CREDIT AND DEBIT CARD SERVICES, MONETARY EXCHANGE, ALL CARRIED OUT BY ALL ELECTRONIC TRANSMISSION MEANS AND ESPECIALLY VIA MOBILE OR FIXED TELEPHONY, PERSONAL DATA ASSISTANTS, COMPUTERS, AND ON LINE VIA THE INTERNET, IN CLASS 36 (U.S. CLS. 100, 101 AND 102).

PRIORITY DATE OF 5-22-2006 IS CLAIMED.

OWNER OF INTERNATIONAL REGISTRATION
0906540 DATED 10-27-2006, EXPIRES 10-27-2016.

OWNER OF U.S. REG. NO. 2,212,216.

THE MARK CONSISTS OF THE STYLIZED WORDING "INGENICO" HAVING THE LETTER "E" WITH A SEMI-CIRCLE EXTENDING FROM THE BOTTOM OF THE LETTER AROUND THE LETTER, AND HAVING THE GENERALLY TRIANGULAR DESIGN TO THE LEFT OF THE WORDING.

SER. NO. 79-032,118, FILED 10-27-2006.

JAY BESCH, EXAMINING ATTORNEY

Int. Cl.: 3

Prior U.S. Cls.: 1, 4, 6, 50, 51 and 52

United States Patent and Trademark Office

Reg. No. 3,480,767

Registered Aug. 5, 2008

**TRADEMARK
PRINCIPAL REGISTER**

NANO WEAR

COTY DEUTSCHLAND GMBH (FED REP GER-
MANY GMBH & CO. KG)
FORT MALAKOFF PARK
RHEINSTRASSE 4E55116 MAINZ
FED REP GERMANY

OWNER OF INTERNATIONAL REGISTRATION
0907190A DATED 11-9-2006, EXPIRES 11-9-2016.

FOR: SOAPS; PERFUMERY; ESSENTIAL OILS;
COSMETICS; NAIL POLISH; COSMETIC HAIR LO-
TIONS, IN CLASS 3 (U.S. CLS. 1, 4, 6, 50, 51 AND 52).

NO CLAIM IS MADE TO THE EXCLUSIVE
RIGHT TO USE "NANO", APART FROM THE
MARK AS SHOWN.

THE MARK CONSISTS OF STANDARD CHAR-
ACTERS WITHOUT CLAIM TO ANY PARTICULAR
FONT, STYLE, SIZE, OR COLOR.

SER. NO. 79-032,405, FILED 11-9-2006.

PRIORITY DATE OF 5-9-2006 IS CLAIMED.

SIMON TENG, EXAMINING ATTORNEY

Int. Cl.: 7

Prior U.S. Cls.: 13, 19, 21, 23, 31, 34 and 35

United States Patent and Trademark Office

Reg. No. 3,480,768

Registered Aug. 5, 2008

**TRADEMARK
PRINCIPAL REGISTER**

HANSEN

SA HANSEN TRANSMISSIONS - INTERNATIONAL NV.; NAAMLOZE VENNOOTSCHAP (BELGIUM NAAMLOZE VENNOOTSCHAP)
LEONARDO DA VINCILAAN 1
B-2650 EDEGEM
BELGIUM

FOR: MOTORS, OTHER THAN FOR LAND VEHICLES, NAMELY, ELECTRIC MOTORS FOR MACHINES; ENGINES FOR MACHINE OPERATION; TRANSMISSION COUPLINGS OTHER THAN FOR LAND VEHICLES, NAMELY, TRANSMISSION COUPLINGS FOR MACHINES; TRANSMISSION BELTS OTHER THAN FOR LAND VEHICLES, NAMELY, POWER TRANSMISSION BELTS FOR MACHINES; AERODYNAMIC WIND TURBINES AND STRUCTURAL PARTS THEREFOR; PLANETARY GEAR-MOTORS; VARIABLE SPEED POWER TRANSMISSIONS; DISK BRAKES FOR MACHINES; DRUM BRAKES FOR MACHINES, IN CLASS 7 (U.S. CLS. 13, 19, 21, 23, 31, 34 AND 35).

THE MARK CONSISTS OF STANDARD CHARACTERS WITHOUT CLAIM TO ANY PARTICULAR FONT, STYLE, SIZE, OR COLOR.

PRIORITY DATE OF 3-1-2006 IS CLAIMED.

OWNER OF INTERNATIONAL REGISTRATION 0908236 DATED 9-1-2006, EXPIRES 9-1-2016.

OWNER OF U.S. REG. NO. 1,526,522.

SEC. 2(F).

SER. NO. 79-032,774, FILED 9-1-2006.

CARRIE GENOVESE, EXAMINING ATTORNEY

Int. Cls.: 9 and 11

Prior U.S. Cls.: 13, 21, 23, 26, 31, 34, 36 and 38

Reg. No. 3,480,769

United States Patent and Trademark Office

Registered Aug. 5, 2008

**TRADEMARK
PRINCIPAL REGISTER**

HOVAL

HOVALWERK AKTIENGESELLSCHAFT (LIECHTENSTEIN JOINT STOCK COMPANY)
AUSTRASSE 70,
FL-9490 VADUZ
LIECHTENSTEIN

FOR: MEASURING APPARATUS AND INSTRUMENTS FOR HEATING, DRYING, VENTILATING AND AIR CONDITIONING SYSTEMS; SIGNALING APPARATUS AND INSTRUMENTS FOR HEATING, DRYING, VENTILATING AND AIR CONDITIONING SYSTEMS, NAMELY, EMERGENCY WARNING LIGHTS, SIGNAL TRANSMITTERS, EMERGENCY SIGNAL TRANSMITTERS; ELECTRIC AND ELECTRONIC CONTROLLING AND REGULATING APPARATUS FOR HEATING, DRYING, VENTILATING AND AIR CONDITIONING SYSTEMS; AND AUTOMATIC CONTROL APPARATUS FOR HEATING, DRYING, VENTILATING AND AIR CONDITIONING SYSTEMS, IN CLASS 9 (U.S. CLS. 21, 23, 26, 36 AND 38).

FOR: INDUSTRIAL AND FURNACE BOILERS FOR LIQUID, GASEOUS AND SOLID FUELS; STEAM PRODUCING INDUSTRIAL AND FUR-

NACE BOILERS, FUEL CENTRAL HEATING BOILERS, COMBINATION FUEL HEATING BOILERS FOR CENTRAL HEATING AND HOT WATER PREPARATION; WATER HEATERS FOR HOT WATER SUPPLY SYSTEMS AND PARTS THEREOF; HEAT EXCHANGERS FOR HEATING SYSTEMS AND PARTS THEREOF; SOLID FUEL BURNERS FOR INDUSTRIAL AND DOMESTIC USE; SOLID FUEL, OIL AND GAS BURNERS FOR INDUSTRIAL AND DOMESTIC USE AND PARTS THEREOF VENTILATING AND AIR-CONDITION INSTALLATIONS AND PARTS THEREOF, NAMELY, AIR HEATERS, AIR COOLERS, AIR FILTERS, SOUND INSULATORS THE NATURE OF MUFFLERS, HEAT RECOVERY HEAT EXCHANGERS FOR VENTILATING AND AIR CONDITIONING SYSTEMS, IN CLASS 11 (U.S. CLS. 13, 21, 23, 31 AND 34).

OWNER OF INTERNATIONAL REGISTRATION
0652248 DATED 1-29-1996, EXPIRES 1-29-2016.

SER. NO. 79-032,788, FILED 10-17-2006.

MARTHA FROMM, EXAMINING ATTORNEY

Int. Cl.: 35

Prior U.S. Cls.: 100, 101 and 102

United States Patent and Trademark Office

Reg. No. 3,480,770

Registered Aug. 5, 2008

**SERVICE MARK
PRINCIPAL REGISTER**

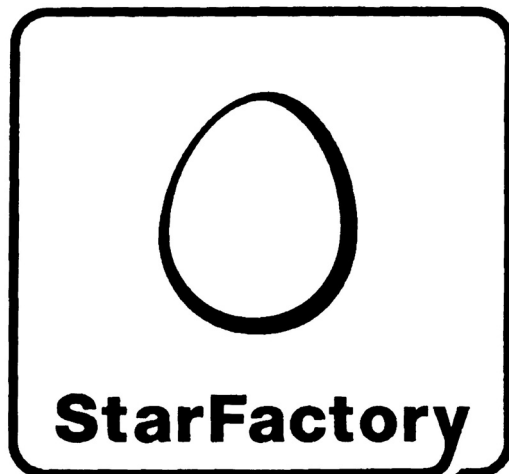

STARFACTORY INTERNATIONAL FOOTBALL
MANAGEMENT AKTIENGESELLSCHAFT
(LIECHTENSTEIN CORPORATION)
BAHNHOFSTRASSE 16
FL-9494 SCHAAN, LIECHTENSTEIN

FOR: ADVERTISING; BUSINESS MANAGE-
MENT; BUSINESS ADMINISTRATION; BUSINESS
MANAGEMENT CONSULTATION FOR ASSOCIA-
TIONS, FEDERATIONS, ATHLETES, SPONSORS
AND THE MEDIA REGARDING BUSINESS MAN-
AGEMENT ISSUES; MARKETING CONSULTA-
TION FOR ATHLETES REGARDING
MARKETING ISSUES AND MARKETING SERVI-
CES CONNECTED THEREWITH; MARKETING

CONSULTATION REGARDING PLACEMENT OF
ATHLETES FOR ENDORSEMENTS; ADVERTISING
SERVICES, NAMELY, PURCHASE AND PROVI-
SION OF ADVERTISING SPACE AND MARKETING
RIGHTS; RENTAL AND PROVISION OF ADVER-
TISING SPACES AND ADVERTISING SIGNS, IN
CLASS 35 (U.S. CLS. 100, 101 AND 102).

OWNER OF INTERNATIONAL REGISTRATION
0908570 DATED 3-27-2006, EXPIRES 3-27-2016.

SER. NO. 79-032,922, FILED 3-27-2006.

DAYNA BROWNE, EXAMINING ATTORNEY

Int. Cls.: 8 and 14

Prior U.S. Cls.: 2, 23, 27, 28, 44 and 50

Reg. No. 3,480,771

United States Patent and Trademark Office

Registered Aug. 5, 2008

**TRADEMARK
PRINCIPAL REGISTER**

ELEMENTAIRE

ORFEVRENERIE CHRISTOFLE (FRANCE SOCIÉTÉ
PAR ACTIONS SIMPLIFIÉE (SAS))

9, RUE ROYALE
F-75008 PARIS, FRANCE

FOR: HAND TOOLS AND HAND-OPERATED IMPLEMENTS, NAMELY, CUTLERY, FORKS, AND SPOONS; SIDE ARMS, NOT INCLUDING FIRE ARMS, NAMELY, HUNTING KNIVES AND SWORDS; RAZORS; SILVERWARE AND TABLEWARE, NAMELY, CUTLERY, FORKS AND SPOONS; SCISSORS; HAND TOOLS, NAMELY, TONGS; CHOPSTICKS, IN CLASS 8 (U.S. CLS. 23, 28 AND 44).

FOR: GOODS, UTENSILS, AND CONTAINERS MADE OF PRECIOUS METALS, NAMELY, SILVER AND GOLD, AND ALLOYS THEREOF OR PLATED THEREWITH, NAMELY, WORKS OF ART, PLATES, CANDLESTICKS, TEA BOXES AND BALLS, COFFEE SERVICES, CANDELABRAS, CANDLESTICKS, FANCY KEY RINGS, TOOTHPICK HOLDERS, BASKETS FOR HOUSEHOLD USE, TIE PINS, TIE CLIPS, PITCHERS, CANDLE EXTINGUISHERS, FIGURINES, STATUETTES, FLASKS, BEAKERS, WATERING CANS, FLOWERPOT HOLDERS, TANKARDS, CLOCKS, OIL CRUETS, INSIGNIA, CHANGE PURSES, SERVING TRAYS, EGGCUPS, BOOKMARKS, PAPERWEIGHTS, LETTER OPENER, TEA STRAI-

NERS, SIEVES, PENDULUM CLOCKS, TIMEPIECES, TRAYS FOR DOMESTIC PURPOSES, DISHES, PEPPER POTS, TOWEL RAILS, POWDER COMPACTS, ALARM CLOCKS, NAPKIN RINGS, SALAD DISHES, SALT CELLARS, SAUCERS, SOUP BOWLS, STATUES, STATUETTES, SUGAR BOWLS, TABLE CENTERPIECES, CUPS, TEA SERVICES, TEAPOTS, TUMBLERS, BABY RATTLES, VASES, AND JEWELRY CASES, IN CLASS 14 (U.S. CLS. 2, 27, 28 AND 50).

THE MARK CONSISTS OF STANDARD CHARACTERS WITHOUT CLAIM TO ANY PARTICULAR FONT, STYLE, SIZE, OR COLOR.

PRIORITY DATE OF 5-31-2006 IS CLAIMED.

OWNER OF INTERNATIONAL REGISTRATION 0909488 DATED 10-17-2006, EXPIRES 10-17-2016.

THE FOREIGN WORDING IN THE MARK TRANSLATES INTO ENGLISH AS ELEMENTARY.

SER. NO. 79-033,268, FILED 10-17-2006.

MARILYN IZZI, EXAMINING ATTORNEY

Int. Cl.: 33

Prior U.S. Cls.: 47 and 49

United States Patent and Trademark Office

Reg. No. 3,480,772

Registered Aug. 5, 2008

**TRADEMARK
PRINCIPAL REGISTER**

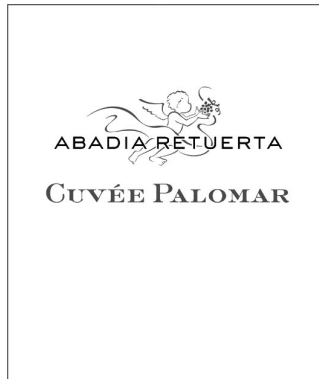

ABADIA RETUERTA S.A. (SPAIN SOCIEDAD ANONIMA)
ABADÍA STA. MARÍA DE RETUERTA
CTRA. N-122, KM.332; E-47340 SARDÓN DEL-
DUERO (VALLADOLID)
SPAIN

OWNER OF U.S. REG. NO. 2,238,802.

NO CLAIM IS MADE TO THE EXCLUSIVE
RIGHT TO USE "CUVÉE", APART FROM THE
MARK AS SHOWN.

FOR: WINE, IN CLASS 33 (U.S. CLS. 47 AND 49).

SER. NO. 79-033,374, FILED 12-1-2006.

OWNER OF INTERNATIONAL REGISTRATION
0909737 DATED 12-1-2006, EXPIRES 12-1-2016.

CYNTHIA SLOAN, EXAMINING ATTORNEY

Int. Cl.: 33

Prior U.S. Cls.: 47 and 49

United States Patent and Trademark Office

Reg. No. 3,480,773

Registered Aug. 5, 2008

**TRADEMARK
PRINCIPAL REGISTER**

CUVÉE PALOMAR

ABADIA RETUERTA S.A. (SPAIN SOCIEDAD ANONIMA)
ABADÍA STA. MARÍA DE RETUERTA
CTRA. N-122, KM.332; E-47340 SARDÓN DEL-
DUERO (VALLADOLID)
SPAIN

NO CLAIM IS MADE TO THE EXCLUSIVE RIGHT TO USE "CUVÉE", APART FROM THE MARK AS SHOWN.

FOR: WINE, IN CLASS 33 (U.S. CLS. 47 AND 49).

SER. NO. 79-033,460, FILED 12-1-2006.

OWNER OF INTERNATIONAL REGISTRATION
0909736 DATED 12-1-2006, EXPIRES 12-1-2016.

CYNTHIA SLOAN, EXAMINING ATTORNEY

Int. Cl.: 25

Prior U.S. Cls.: 22 and 39

United States Patent and Trademark Office

Reg. No. 3,480,774

Registered Aug. 5, 2008

**TRADEMARK
PRINCIPAL REGISTER**

POLISTAS

POLO RELATIONS LTD (UNITED KINGDOM
LIMITED COMPANY)
CEDAR TREE BARN,
FOSSE WAY; RADFORD SEMELE, WARWICK-
SHIRE, CV31 1XQ
UNITED KINGDOM

FOR: CLOTHING, NAMELY, TROUSERS, JEANS,
UNDERWEAR, SWIMWEAR, SHIRTS, DRESSES,
TIES, JACKETS, SUITS AND SOCKS; FOOTWEAR
SUCH AS SHOES AND BOOTS; HEADGEAR,
NAMELY, BASEBALL CAPS AND HATS; NONE
OF THE AFOREMENTIONED GOODS INTENDED
FOR USE IN THE SPORT OF POLO, IN CLASS 25
(U.S. CLS. 22 AND 39).

THE MARK CONSISTS OF STANDARD CHAR-
ACTERS WITHOUT CLAIM TO ANY PARTICULAR
FONT, STYLE, SIZE, OR COLOR.

OWNER OF INTERNATIONAL REGISTRATION
0910207 DATED 5-22-2006, EXPIRES 5-22-2016.

THE ENGLISH TRANSLATION OF THE MARK IS
POLO PLAYERS.

SER. NO. 79-033,541, FILED 5-22-2006.

DAYNA BROWNE, EXAMINING ATTORNEY

Int. Cl.: 22

Prior U.S. Cls.: 1, 2, 7, 19, 22, 42 and 50

Reg. No. 3,480,775

United States Patent and Trademark Office

Registered Aug. 5, 2008

**TRADEMARK
PRINCIPAL REGISTER**



SOYANG TECHNOLOGIES CO., LTD. (CHINA CORPORATION LIMITED)
MINZHENG, YONGCHANG,
FUYANG CITY; ZHEJIANG PROVINCE 311400
CHINA

FOR: AWNINGS; CANVAS SACKS FOR STORAGE OF MATERIALS IN BULK, NOT LUGGAGE OR TRAVEL BAGS; CANVAS TARPAULINS; CHEMICAL FIBER NETTINGS; COMMERCIAL NETS; DISPOSABLE BULK CONTAINER LINERS, USED AS DISPOSABLE COVERS FOR BULK CONTAINERS; FABRIC AND POLYESTER MESH NET USED FOR STORING TOYS AND OTHER HOUSEHOLD ITEMS; TARPAULINS, NOT FOR SHIPS; TENTS, NOT FOR CAMPING; UNFITTED LINERS OF FLEXIBLE VINYL FOR HOT TUBS, SWIMMING

POOLS, PONDS, SPAS AND INDUSTRIAL TANKS; UNFITTED SWIMMING POOL COVERS; UNFITTED VEHICLE COVERS, IN CLASS 22 (U.S. CLS. 1, 2, 7, 19, 22, 42 AND 50).

OWNER OF INTERNATIONAL REGISTRATION
0910871 DATED 3-13-2006, EXPIRES 3-13-2016.

NO CLAIM IS MADE TO THE EXCLUSIVE RIGHT TO USE "FLEX", APART FROM THE MARK AS SHOWN.

SER. NO. 79-033,622, FILED 3-13-2006.

DAVID HOFFMAN, EXAMINING ATTORNEY

Int. Cl.: 3

Prior U.S. Cls.: 1, 4, 6, 50, 51 and 52

United States Patent and Trademark Office

Reg. No. 3,480,776

Registered Aug. 5, 2008

**TRADEMARK
PRINCIPAL REGISTER**

BONJOUR L'AMOUR

MÜLHENS GMBH & CO. KG (FED REP GER-
MANY KOMMANDITGESELLSCHAFT)
VENLOER STRAßE 241-245
50823 KÖLN, FED REP GERMANY

FOR: PERFUMERIES, ESSENTIAL OILS FOR
PERSONAL USE, COSMETICS, NAMELY, EYE
MAKE-UP AND FACIAL MAKE-UP, NON-MEDI-
CATED SKIN CARE PREPARATIONS, NAMELY,
CREAMS, LOTIONS, MOISTURIZERS, TEXTURI-
ZERS AND TONERS; BATH GEL, SHOWER GEL,
FOAM BATH AND PERSONAL DEODORANTS;
HAIR LOTIONS, DENTIFRICES, TOILET SOAPS,
IN CLASS 3 (U.S. CLS. 1, 4, 6, 50, 51 AND 52).

THE MARK CONSISTS OF STANDARD CHAR-
ACTERS WITHOUT CLAIM TO ANY PARTICULAR
FONT, STYLE, SIZE, OR COLOR.

PRIORITY DATE OF 7-5-2006 IS CLAIMED.

OWNER OF INTERNATIONAL REGISTRATION
0910879 DATED 11-27-2006, EXPIRES 11-27-2016.

THE FOREIGN WORDING IN THE MARK
TRANSLATES INTO ENGLISH AS HELLO LOVE.

SER. NO. 79-033,680, FILED 11-27-2006.

WILLIAM BRECKENFELD, EXAMINING ATTOR-
NEY

Int. Cls.: 14, 18, 24 and 25

Prior U.S. Cls.: 1, 2, 3, 22, 27, 28, 39, 41, 42 and 50

United States Patent and Trademark Office

Reg. No. 3,480,777

Registered Aug. 5, 2008

**TRADEMARK
PRINCIPAL REGISTER**



RIANI BUCKI MODE GMBH (FED REP GERMA-
NY LTD LIAB CO)
GMÜNDER STRASSE 72
73614 SCHORNDORF
FED REP GERMANY

FOR: JEWELRY, PRECIOUS STONES, CLOCKS
AND CHRONOMETRICAL INSTRUMENTS, PRE-
CIOUS METALS AND THEIR ALLOYS; GOODS IN
PRECIOUS METALS OR COATED THEREWITH,
NAMESLY BADGES, BRACELETS, CASES FOR
WATCHES AND CLOCKS, EARRINGS AND EAR
CLIPS, KEY RINGS AND KEY HOLDERS, MEDAL-
LIONS AND MEDALS, STATUETTES AND SCULP-
TURES, WATCH BOXES, WATCH CASES AND
BANDS; BROOCHES; JEWELRY CHAINS, IN CLASS
14 (U.S. CLS. 2, 27, 28 AND 50).

FOR: LEATHER AND IMITATIONS OF LEA-
THER, NAMESLY, FOR SHOES AND HATS; UM-
BRELLAS, PARASOLS AND WALKING STICKS;
TRIMMINGS OF LEATHER FOR FURNITURE;
BELTED BANDS OF LEATHER; IMITATION LEA-
THER; COSMETIC BAGS OF LEATHER, IN CLASS
18 (U.S. CLS. 1, 2, 3, 22 AND 41).

FOR: TEXTILES, NAMESLY, TEXTILE FABRICS
FOR THE MANUFACTURE OF CLOTHING AND
SHOES; TEXTILE GOODS, NAMESLY, BATH
SHEETS, BATH TOWELS, BEACH TOWELS, BED
BLANKETS, BED SHEETS, BED SPREADS, COVERS
FOR CUSHIONS, CURTAINS, HAND TOWELS,
HANDKERCHIEFS, PILLOWCASES AND COVERS,
SERVIETTES; UNFITTED FABRIC FURNITURE
COVERS, NAMESLY, BED AND TABLE COVERS;
TISSUES OF TEXTILE FOR REMOVING MAKE-UP;

BATH LINEN EXCEPT CLOTHING; BED LINEN , IN
CLASS 24 (U.S. CLS. 42 AND 50).

FOR: CLOTHING, NAMESLY, MEN'S AND WO-
MEN'S SUITS, WEDDING DRESSES, EVENING
DRESSES, LOUNGE WEAR, GOLF SHOES, SKI
WEAR, RAIN WEAR, SWIM WEAR, MATERNITY
LINGERIE, BATHING COSTUMES, BATHING
SUITS, BATHING TRUNKS, BEACH WEAR, BELTS
MADE OF LEATHER AND BELTS MADE OF
TEXTILE, BIKINIS, BLAZERS, BLOUSES, VESTS,
BOLEROS, CAPES, CARDIGANS, BOAS, BODY
SUITS, BODY SHAPERS, BOW TIES, BOXER
SHORTS, BRAS, BUSTIERS, SOCKS, CAFTANS,
CHEMISES, CHILDREN'S AND INFANTS' CLOTH
BIBS, COATS, COLLARS, CORSETS, CORSELETS,
CRAVATS, CULOTTES, DANCE COSTUMES, IN-
FANT WEAR, JACKETS, JEANS, JERSEYS, JUM-
PERS, JOGGING OUTFITS, JOGGING SUITS,
LEGGINGS, LINGERIE, MINI SKIRTS, NECK TIES,
NEGLIGEEES, OVERALLS, PAJAMAS, PANTIES,
PANTSUITS, PANTY HOSE, PARKAS, PULLOVERS,
SCARVES, GLOVES, TUNICS, SHIRTS AND SHIRTS
FOR SUITS, SHORT TROUSERS, SLEEP WEAR,
SLIPS, SOCKS AND STOCKINGS, T-SHIRTS,
TIGHTS, TROUSERS, UNDERGARMENTS, UN-
DERWEAR, FOOTWEAR, LADIES' BOOTS, JACK-
BOOTS, SANDALS, SNEAKERS, HEADGEAR,
NAMESLY, HATS, CAPS, BASEBALL CAPS, TOQUES,
IN CLASS 25 (U.S. CLS. 22 AND 39).

OWNER OF INTERNATIONAL REGISTRATION
0910452 DATED 3-2-2006, EXPIRES 3-2-2016.

SER. NO. 79-033,764, FILED 3-2-2006.

DOMINIC FATHY, EXAMINING ATTORNEY

Int. Cl.: 5

Prior U.S. Cls.: 6, 18, 44, 46, 51 and 52

United States Patent and Trademark Office

Reg. No. 3,480,778

Registered Aug. 5, 2008

**TRADEMARK
PRINCIPAL REGISTER**

ENTRYBODY

OÜ INBIO (ESTONIA CORPORATION)
AKADEEMIA TEE 15
EE-12618 TALLINN
ESTONIA

FOR: PHARMACEUTICAL AND VETERINARY PREPARATIONS BASED ON ANTIGEN-ANTIBODY TECHNOLOGY, NAMELY, MONOCLONAL ANTIBODIES, POLYPEPTIDES FOR MEDICAL AND VETERINARY PURPOSES, ENZYME PREPARATIONS, CHEMICAL PREPARATIONS, ALL FOR IMMUNOGLOBULIN THERAPY, STRENGTHENING IMMUNE SYSTEM, TREATING DISEASES AND DISORDERS OF THE IMMUNE SYSTEM, TREATING INFLAMMATORY DISEASES, DISEASES AND LESIONS OF THE MUSCULOSKELETAL AND NERVOUS SYSTEM, CARDIOVASCULAR DISEASES, GASTROINTESTINAL DISEASES AND CANCER DISEASES, SANITARY PREPARATIONS FOR MEDICAL PURPOSES, DIETETIC FOODS ADAPTED FOR MEDICAL USE, FOOD FOR BABIES; MEDICAL PLASTERS, MATERIALS FOR DRESSINGS,

NAMELY, BANDAGES FOR DRESSING, GAUZE FOR DRESSING, SURGICAL DRESSINGS, WOUND DRESSINGS; MATERIAL FOR STOPPING TEETH, DENTAL WAX; ALL-PURPOSED DISINFECTANTS; PREPARATIONS FOR DESTROYING VERMIN; FUNGICIDES, HERBICIDES, IN CLASS 5 (U.S. CLS. 6, 18, 44, 46, 51 AND 52).

THE MARK CONSISTS OF STANDARD CHARACTERS WITHOUT CLAIM TO ANY PARTICULAR FONT, STYLE, SIZE, OR COLOR.

PRIORITY DATE OF 6-27-2006 IS CLAIMED.

OWNER OF INTERNATIONAL REGISTRATION
0911570 DATED 12-20-2006, EXPIRES 12-20-2016.

SER. NO. 79-033,945, FILED 12-20-2006.

ALICE BENMAMAN, EXAMINING ATTORNEY

Int. Cls.: 3, 4, 9, 18, 20, 25 and 28

Prior U.S. Cls.: 1, 2, 3, 4, 6, 13, 15, 21, 22, 23, 25, 26, 32, 36, 38, 39, 41, 50, 51 and 52

Reg. No. 3,480,779

United States Patent and Trademark Office

Registered Aug. 5, 2008

**TRADEMARK
PRINCIPAL REGISTER**

ZETT KABUSHIKI KAISHA (JAPAN CORPORATION)
1-2-16, KARASUGATSUJI
TENNOJI-KU, OSAKA-SHI; OSAKA-FU 543-8601
JAPAN

FOR: SHOE AND BOOT CREAM; SHOE BLACK, NAMELY, SHOE POLISH; POLISHING PREPARATIONS; POLISHING CREAMS FOR LEATHER; POLISHING OIL FOR LEATHERS; LEATHER LOTIONS; SHOE CREAM; SHOE POLISH; CLEANING PREPARATIONS FOR SHOES; DEODORANT SPRAYS FOR PERSONAL USE; CLEANING PREPARATIONS FOR BASEBALL AND SOFTBALL GLOVES AND SHOES, IN CLASS 3 (U.S. CLS. 1, 4, 6, 50, 51 AND 52).

FOR: GREASE FOR SHOES AND BOOTS; LEATHER PRESERVING OIL AND GREASE; OIL FOR THE PRESERVATION OF LEATHER; GREASE FOR THE PRESERVATION OF LEATHER; GREASE FOR LUBRICATING AND PRESERVING LEATHER; GREASE FOR SHOES, IN CLASS 4 (U.S. CLS. 1, 6 AND 15).

FOR: SPORTS TRAINING SIMULATORS; MEASURING OR TESTING MACHINES AND INSTRUMENTS, NAMELY, RADAR GUNS FOR MEASURING BASEBALL SPEED, SOFTBALL SPEED, AND BATTING SPEED; SPECTACLES, EYEGLASSES AND SAFETY AND SWIMMING GOGGLES; PROTECTIVE HELMETS FOR SPORTS; HELMETS FOR PROTECTIVE USE; GLASSES FOR SPORTS USE; SUNGLASSES; CASES FOR GLASSES SOLD EMPTY; SPEED GUNS, NAMELY, RADAR GUNS FOR POLICE WORK AND SPORTING EVENTS; HELMET CASES FOR PROTECTIVE HELMETS SOLD EMPTY; ELECTRONIC SCOREBOARDS FOR GAMES, IN CLASS 9 (U.S. CLS. 21, 23, 26, 36 AND 38).

FOR: INDUSTRIAL PACKAGING CONTAINERS OF LEATHER; ALL-PURPOSE SPORTS BAGS; ATHLETIC BAGS; SHOULDER BAGS; TRAVELING BAGS; BOSTON BAGS; PROTECTOR CASES; CATCHER MASK CASES; POUCHES, NAMELY, LEATHER POUCHES AND DRAWSTRING POUCHES; VANITY CASES SOLD EMPTY; LEATHER THAT IS UN-WORKED OR SEMI-WORKED; SPORTS BAGS SOLD EMPTY; HANDBAGS SOLD EMPTY; PACK SACKS SOLD EMPTY, NAMELY, SPORTS PACKS; SHOE BAGS FOR TRAVEL; DRAWSTRING POUCHES SOLD EMPTY; LEATHER STRAPS, IN CLASS 18 (U.S. CLS. 1, 2, 3, 22 AND 41).

FOR: NON-ELECTRIC SPORTS SCOREBOARDS FOR BASEBALL AND SOFTBALL GAMES, IN CLASS 20 (U.S. CLS. 2, 13, 22, 25, 32 AND 50).

FOR: CLOTHING, NAMELY, WRISTBANDS, WIND-RESISTANT JACKETS, SPORT SHORTS, T-SHIRTS, COATS, UNDERSHIRTS, UNDERPANTS, SWEATSHIRTS, SWEATPANTS, WARM-UP SHIRTS, WARM-UP PANTS, UNIFORMS; SOCK SUSPENDERS; WAISTBANDS; BELTS FOR CLOTHING; BOOTS FOR SPORTS; SWEATERS; SPECIAL SPORTSWEAR FOR BALL SPORTS, NAMELY, SPORTS BRAS, BASEBALL UNIFORMS, SOFTBALL UNIFORMS, SLIDING PANTS THAT ARE WORN UNDER UNIFORMS FOR THE PROTECTION OF SCRATCHES FROM SLIDES TO THE UPPER LEGS, JACKETS DESIGNED FOR BASEBALL OR SOFTBALL GAMES; SOCKS; SPORTS STOCKINGS; GARTERS FOR SPORTS STOCKINGS; BELTS; CLOTHING, NAMELY, WRIST BANDS; CAPS; SUN VISORS AND HEAD GEAR; SHOES; SPORTS SHOES AND SPIKE SHOES, NAMELY, BASEBALL SPIKE SHOES, SOFTBALL SPIKE SHOES, BASEBALL SHOES, SOFTBALL SHOES; NON-ORTHOPEDIC

SHOE INSOLES; PROTECTIVE METAL MEMBERS FOR SHOES; TOE COVERS FOR THE PROTECTION OF SHOE TOES, NAMELY, TOE CAPS, IN CLASS 25 (U.S. CLS. 22 AND 39).

FOR: NETS FOR SPORTS USE, NAMELY, BASEBALL OR SOFTBALL GAMES AND PRACTICES; ROSIN FOR USE BY ATHLETES; ELECTRIC HAND-HELD BALL AND STRIKE SWING COUNT INDICATORS FOR UMPIRE USE DURING BASEBALL AND SOFTBALL GAMES; GLOVES FOR SPORTS USE, NAMELY, BASEBALL AND SOFTBALL GLOVES, BASEBALL AND SOFTBALL GLOVE REPLACEMENT WEBBING, AND REPLACEMENT FINGERS FOR BASEBALL AND SOFTBALL GLOVES THAT PROTECT THE WEARER'S FINGERS AGAINST IMPACT WHEN CATCHING A BASEBALL OR A SOFTBALL; BASEBALL BATS AND SOFTBALL BATS; GRIP TAPES FOR BASEBALL BATS AND SOFTBALL BATS; EXERCISE WEIGHTS FOR ADDING BAT WEIGHT TO BASEBALL BATS AND SOFTBALL BATS; BASEBALL BAT STANDS AND SOFTBALL BAT STANDS; BASEBALLS AND SOFTBALLS; BATTING GLOVES; BASEBALL, SOFTBALL, AND FOOTBALL MASKS FOR PROTECTING THE FACE; SUN SHIELDS OR RAIN SHIELDS IN THE FORM OF MASKS FOR PROTECTING THE FACE, NAMELY, CATCHERS MASKS AND FENCING MASKS; LEG GUARDS FOR ATHLETIC USE; ARM GUARDS FOR SPORTS; FOOT GUARDS FOR SPORTS; THROAT PROTECTORS FOR SPORTS; CHEST PROTECTORS FOR

SPORTS; ANKLE SUPPORTERS FOR SPORTS; KNEE SUPPORTERS FOR SPORTS; WAIST SUPPORTERS FOR SPORTS; BODY EXERCISING APPARATUS, NAMELY, MANUALLY-OPERATED MUSCLE STRETCHING EQUIPMENT, WEIGHT AND STRENGTH TRAINING EQUIPMENT, QUICKNESS AND DEXTERITY TRAINING EQUIPMENT; BASEBALL AND SOFTBALL CASES SOLD EMPTY; BASEBALL AND SOFTBALL BAT CASES SOLD EMPTY; BASEBALL BASES; SOFTBALL BASES; PITCHERS PLATES; LINE MARKERS FOR SPORTS FIELDS; UMPIRE BASEBALL AND SOFTBALL CASES SOLD EMPTY; SPECIALLY DESIGNED BAGS FOR UMPIRE BASEBALLS AND SOFTBALLS; BALL PITCHING MACHINES AND REPLACEMENT PARTS AND REPLACEMENT FITTINGS THEREFORE; BALL TOSsing MACHINES AND REPLACEMENT PARTS AND REPLACEMENT FITTINGS THEREFORE; WRIST SUPPORTS FOR USE IN PLAYING SPORTS, IN CLASS 28 (U.S. CLS. 22, 23, 38 AND 50).

PRIORITY DATE OF 6-29-2005 IS CLAIMED.

OWNER OF INTERNATIONAL REGISTRATION 0911577 DATED 11-4-2005, EXPIRES 11-4-2015.

SER. NO. 79-033,948, FILED 11-4-2005.

SEAN CROWLEY, EXAMINING ATTORNEY

Int. Cls.: 29 and 33

Prior U.S. Cls.: 46, 47 and 49

United States Patent and Trademark Office

Reg. No. 3,480,780

Registered Aug. 5, 2008

**TRADEMARK
PRINCIPAL REGISTER**



SPINELLI S.R.L. (ITALY LTD LIAB CO)
VIA CONTRADA PIANA LA FARA, 90
I-66040 ATESSA (CH)
ITALY

FOR: EDIBLE OILS, IN CLASS 29 (U.S. CL. 46).

FOR: ALCOHOLIC BEVERAGES NAMELY
WINES, SPARKLING WINES, DISTILLED SPIRITS,
IN CLASS 33 (U.S. CLS. 47 AND 49).

PRIORITY DATE OF 10-19-2006 IS CLAIMED.

OWNER OF INTERNATIONAL REGISTRATION
0912003 DATED 11-27-2006, EXPIRES 11-27-2016.

THE MARK IS COMPOSED OF THE WORDING
"TERRA D'ALIGI" WITHIN A STYLIZED FRAME,
ABOVE WHICH THERE IS A STYLIZED PICTURE
OF AN OLD FARMHOUSE.

SER. NO. 79-034,089, FILED 11-27-2006.

MICHAEL TANNER, EXAMINING ATTORNEY

Int. Cls.: 4, 7, 17, 37 and 42

**Prior U.S. Cls.: 1, 5, 6, 12, 13, 15, 19, 21, 23, 31, 34, 35,
50, 100, 101, 103 and 106**

Reg. No. 3,480,781

United States Patent and Trademark Office

Registered Aug. 5, 2008

**TRADEMARK
SERVICE MARK
PRINCIPAL REGISTER**

THERMAMAX

THERMAMAX; HOCHTEMPERATURDÄMMUN-
GEN GMBH (FED REP GERMANY GMBH)
ÖLHAFENSTR. 28
68169 MANNHEIM
FED REP GERMANY

FOR: INDUSTRIAL OILS AND GREASES; IN-
DUSTRIAL LUBRICANTS , IN CLASS 4 (U.S. CLS. 1,
6 AND 15).

FOR: MOTORS FOR USE IN HIGH TEMPERA-
TURE INDUSTRIAL MACHINES FOR THE HIGH
TEMPERATURE SECTOR; AND HEAT ENGINES
FOR MACHINES, NAMELY, ENGINES POWERED
BY THERMAL ENERGY FOR THE HIGH TEM-
PERATURE SECTOR, IN CLASS 7 (U.S. CLS. 13, 19,
21, 23, 31, 34 AND 35).

FOR: INSULATING MATERIALS FOR MOTORS
AND HEAT ENGINES FOR THE HIGH TEMPERA-
TURE SECTOR, NAMELY, INSULATION PANELS,
PIPE WRAPPINGS, TUBES AND SLEEVES OF FI-
BERGLASS, CERAMIC FIBER, DRY CHEMICAL
FIBER, ALUMINUM, STEEL AND STAINLESS
STEEL FOR HIGH TEMPERATURE INDUSTRIAL
MACHINES, ENGINES, TURBINES, AUTOMOTIVE
VEHICLES, AIRCRAFT, SPACECRAFT AND IN-
DUSTRIAL PLANTS OPERATED AT HIGH TEM-
PERATURES; AND INSULATING AND STOPPING

MATERIALS, NAMELY, INSULATION MATERI-
ALS COMPOSED OF FIBERGLASS, CERAMIC FI-
BER, DRY CHEMICAL POWDER, ALUMINUM,
STEEL AND STAINLESS STEEL, IN CLASS 17 (U.S.
CLS. 1, 5, 12, 13, 35 AND 50).

FOR: INSTALLATION OF INSULATING MATE-
RIALS, NAMELY, INSULATION OF MOTORS AND
HEAT ENGINES FOR THE HIGH TEMPERATURE
SECTOR, IN CLASS 37 (U.S. CLS. 100, 103 AND 106).

FOR: DEVELOPMENT OF NEW PROCESSES FOR
OTHERS IN THE FIELD OF INDUSTRIAL PROCES-
SES IN THE HIGH TEMPERATURE SECTOR, IN
CLASS 42 (U.S. CLS. 100 AND 101).

THE MARK CONSISTS OF STANDARD CHAR-
ACTERS WITHOUT CLAIM TO ANY PARTICULAR
FONT, STYLE, SIZE, OR COLOR.

OWNER OF INTERNATIONAL REGISTRATION
0912252 DATED 10-9-2006, EXPIRES 10-9-2016.

SER. NO. 79-034,167, FILED 10-9-2006.

BENJAMIN OKEKE, EXAMINING ATTORNEY

Int. Cls.: 9 and 41

Prior U.S. Cls.: 21, 23, 26, 36, 38, 100, 101 and 107

Reg. No. 3,480,782

United States Patent and Trademark Office

Registered Aug. 5, 2008

**TRADEMARK
SERVICE MARK
PRINCIPAL REGISTER**

ACE INTERACTIVE

ARISTOCRAT TECHNOLOGIES AUSTRALIA
PTY LTD (AUSTRALIA AUSTRALIAN PRO-
PRIETARY COMPANY, LIMITED BY
SHARES)
71 LONGUEVILLE ROAD
LANE COVE NSW 2066
AUSTRALIA

FOR: COMPUTER HARDWARE; TERMINALS,
NAMELY, CENTRAL PROCESSING UNITS FOR
DATA COLLECTION, PROCESSING, DISPLAY
AND/OR THE PLAYING OF INTERACTIVE
GAMES; COMPUTER SOFTWARE, NAMELY, COM-
PUTER SOFTWARE FOR GAMING PURPOSES
AND ON-LINE GAMING, ELECTRONIC GAMING
SYSTEM APPARATUS, NAMELY, GAMING MA-
CHINES; GAMING MACHINES AND PARTS AND
ACCESSORIES, NAMELY, SOFTWARE MODULES
AND PRE-RECORDED COMPUTER GAME PRO-
GRAMS; STORAGE MEDIA AND COMPONENTS,
NAMELY, FLASH DRIVES, ERASABLE PROGRAM-
MABLE READ-ONLY MEMORY (EPROM) CHIPS;
RECORDING DISCS, NAMELY, BLANK CD-ROMS
FOR SOUND OR VIDEO RECORDING; APPARA-
TUS FOR RECORDING, TRANSMISSION, REPRO-
DUCTION OR DISPLAY OF SOUND OR IMAGES;
STORAGE MEDIA, NAMELY, COMPACT DISCS,
PRE-RECORDED DIGITAL VERSATILE DISCS
FEATURING GAME PROGRAMS; DATA PROCES-
SING EQUIPMENT, NAMELY, CENTRAL PROCES-
SING UNITS; ELECTRONIC SYSTEMS, NAMELY,
CENTRAL PROCESSING UNITS FOR LINKING
GAMING AND POKER MACHINES, IN CLASS 9
(U.S. CLS. 21, 23, 26, 36 AND 38).

FOR: GAMING SERVICES, NAMELY, GAMING
SERVICES PROVIDED ON-LINE IN THE NATURE
OF ONLINE CARD AND POKER GAMES AND
GAMES OF CHANCE; PROVIDING ON-LINE COM-
PUTER GAMES; OPERATION, ORGANIZATION
AND PROVISION OF GAMING MACHINES THAT
PROVIDE BONUS-PAYOUT SYSTEMS VIA A GLO-
BAL COMPUTER NETWORK; PROVIDING TRAIN-
ING IN RELATION TO THE USE OF,
INSTALLATION, MAINTENANCE AND REPAIR
OF ON-LINE GAMING SYSTEMS, GAMES AND
APPARATUS; PROVIDING ADVISORY, INFORMA-
TION AND CONSULTANCY SERVICES IN RELA-
TION TO THE AFOREMENTIONED SERVICES, IN
CLASS 41 (U.S. CLS. 100, 101 AND 107).

THE MARK CONSISTS OF STANDARD CHAR-
ACTERS WITHOUT CLAIM TO ANY PARTICULAR
FONT, STYLE, SIZE, OR COLOR.

PRIORITY DATE OF 5-1-2006 IS CLAIMED.

OWNER OF INTERNATIONAL REGISTRATION
0912471 DATED 11-1-2006, EXPIRES 11-1-2016.

NO CLAIM IS MADE TO THE EXCLUSIVE
RIGHT TO USE "INTERACTIVE", APART FROM
THE MARK AS SHOWN.

SER. NO. 79-034,247, FILED 11-1-2006.

JESSICA A. POWERS, EXAMINING ATTORNEY

Int. Cl.: 11

Prior U.S. Cls.: 13, 21, 23, 31 and 34

United States Patent and Trademark Office

Reg. No. 3,480,783

Registered Aug. 5, 2008

**TRADEMARK
PRINCIPAL REGISTER**

ACTIDISK

OTV SA (FRANCE SOCIÉTÉ ANONYME)
IMMEUBLE L'AQUARÈNE -
1, PLACE MONTGOLFIER; F-94410 SAINT MAUR-
ICE
FRANCE

FOR: WATER AND WASTE WATER PURIFYING
UNITS; WATER AND WASTE WATER FILTERING
UNITS FOR INDUSTRIAL USE; FIXED OR MOVA-
BLE APPARATUS, DEVICES AND INSTALLATIONS
FOR WASTE WATER PURIFICATION, NAMELY,
WATER PURIFICATION UNITS; FIXED OR MO-
BILE WATER PURIFICATION UNITS AND INSTAL-
LATIONS USING CLARIFICATION,
FLOCCULATION, AND DECANTATION; BIOLOGI-
CAL DISCS USED FOR WATER, WASTE WATER
AND SLUDGE TREATMENT, NAMELY, WATER
FILTERS, IN CLASS 11 (U.S. CLS. 13, 21, 23, 31 AND
34).

THE MARK CONSISTS OF STANDARD CHAR-
ACTERS WITHOUT CLAIM TO ANY PARTICULAR
FONT, STYLE, SIZE, OR COLOR.

PRIORITY DATE OF 1-12-2006 IS CLAIMED.

OWNER OF INTERNATIONAL REGISTRATION
0912761 DATED 7-11-2006, EXPIRES 7-11-2016.

OWNER OF U.S. REG. NOS. 2,129,707 AND
3,038,316.

SER. NO. 79-034,340, FILED 7-11-2006.

ROBERT STRUCK, EXAMINING ATTORNEY

Int. Cls.: 9 and 35

Prior U.S. Cls.: 21, 23, 26, 36, 38, 100, 101 and 102

United States Patent and Trademark Office

Reg. No. 3,480,784

Registered Aug. 5, 2008

**TRADEMARK
SERVICE MARK
PRINCIPAL REGISTER**

WOSBEE

SMILEHOUSE OY (FINLAND COMPANY)
ITÄLAHDENKATU 22A
FI-00210 HELSINKI
FINLAND

FOR: COMPUTER SOFTWARE FOR ALLOWING
USERS TO SELL GOODS AND SERVICES ONLINE
VIA A GLOBAL COMPUTER NETWORK, IN CLASS
9 (U.S. CLS. 21, 23, 26, 36 AND 38).

FOR: COMPUTERIZED ON-LINE RETAIL STORE
SERVICES IN THE FIELD OF COMPUTER SOFT-
WARE TO BE USED WITH THE ONLINE RETAIL
INDUSTRY, IN CLASS 35 (U.S. CLS. 100, 101 AND
102).

THE MARK CONSISTS OF STANDARD CHAR-
ACTERS WITHOUT CLAIM TO ANY PARTICULAR
FONT, STYLE, SIZE, OR COLOR.

PRIORITY DATE OF 12-15-2006 IS CLAIMED.

OWNER OF INTERNATIONAL REGISTRATION
0912813 DATED 12-19-2006, EXPIRES 12-19-2016.

THE WORDING "WOSBEE" HAS NO MEANING
IN A FOREIGN LANGUAGE.

SER. NO. 79-034,361, FILED 12-19-2006.

LOURDES AYALA, EXAMINING ATTORNEY

Int. Cls.: 35 and 42

Prior U.S. Cls.: 100, 101 and 102

United States Patent and Trademark Office

Reg. No. 3,480,785

Registered Aug. 5, 2008

**SERVICE MARK
PRINCIPAL REGISTER**



TERO LTD (GREECE CORPORATION)
ANTONI TRITSI ST 21
THESSALONIKI, GREECE GR570 01

OWNER OF INTERNATIONAL REGISTRATION
0913054 DATED 11-8-2006, EXPIRES 11-8-2016.

FOR: LOCATION-BASED ADVERTISING AND
MARKETING SERVICES, IN CLASS 35 (U.S. CLS.
100, 101 AND 102).

THE COLOR(S) ORANGE AND BLUE IS/ARE
CLAIMED AS A FEATURE OF THE MARK.

FOR: TECHNOLOGICAL RESEARCH SERVICES
AND DESIGN RELATING THERETO IN THE FIELD
OF LOCATION-BASED DISTRIBUTION OF ON-
LINE CONTENT; DESIGN AND DEVELOPMENT
OF COMPUTER HARDWARE AND SOFTWARE IN
THE FIELD OF LOCATION-BASED DISTRIBUTION
OF ONLINE CONTENT, IN CLASS 42 (U.S. CLS. 100
AND 101).

THE COLOR ORANGE APPEARS IN THE DE-
SIGN OF THE MAN AND THE COLOR BLUE
APPEARS IN THE WORDING "ORTELIO" AND
THE HALF-GLOBE DESIGN.

SER. NO. 79-034,449, FILED 11-8-2006.

HEATHER SAPP, EXAMINING ATTORNEY

Int. Cls.: 6 and 40

Prior U.S. Cls.: 2, 12, 13, 14, 23, 25, 50, 100, 103 and 106

United States Patent and Trademark Office

Reg. No. 3,480,786

Registered Aug. 5, 2008

**TRADEMARK
SERVICE MARK
PRINCIPAL REGISTER**

KHP

GEBR. KEMPER GMBH + CO. KG METALL-
WERKE (FED REP GERMANY LIMITED
PARTNERSHIP)
HARKORTSTR. 5
57462 OLPE
FED REP GERMANY

FOR: LOW-ALLOY COPPER PLATE METAL,
SHEET METAL, STRIP METAL, AND ROLLED
SHEET METAL FOR THE ELECTRICAL INDUSTRY
AND THE ELECTRONIC INDUSTRY; LOW-ALLOY
COPPER METAL STRIPS AND ROLLED SHEET
METAL USED ON PACKAGING FOR THE ELEC-
TRICAL INDUSTRY AND THE ELECTRONIC IN-
DUSTRY, IN CLASS 6 (U.S. CLS. 2, 12, 13, 14, 23, 25
AND 50).

FOR: METAL TREATMENT, NAMELY, THE
ROLLING OF METAL AND METAL COATING, IN
CLASS 40 (U.S. CLS. 100, 103 AND 106).

PRIORITY DATE OF 9-20-2006 IS CLAIMED.

OWNER OF INTERNATIONAL REGISTRATION
0913313 DATED 12-12-2006, EXPIRES 12-12-2016.

SER. NO. 79-034,525, FILED 12-12-2006.

GILBERT SWIFT, EXAMINING ATTORNEY

Int. Cls.: 9 and 16

Prior U.S. Cls.: 2, 5, 21, 22, 23, 26, 29, 36, 37, 38 and 50

Reg. No. 3,480,787

United States Patent and Trademark Office

Registered Aug. 5, 2008

**TRADEMARK
PRINCIPAL REGISTER**

Novacard

NOVACARD INFORMATIONSSYSTEME GMBH
(FED REP GERMANY GMBH (LIMITED LIABILITY COMPANY))
SCHMIEDEWEG 2
26135 OLDENBURG
FED REP GERMANY

FOR: CARDS WITH INTEGRATED CIRCUITS IN THE NATURE OF BLANK SMARTCARDS; MAGNETIC CODED PLASTIC CARDS FOR IDENTIFICATION FUNCTIONS; MAGNETIC IDENTIFICATION CARDS; MAGNETIC CARDS, IN PARTICULAR MEMORY CARDS; PROCESSOR CARDS AND CONTACTLESS CARDS, NAMELY, ELECTRONIC CIRCUIT CARDS; MAGNETIC BIOMETRIC IDENTIFYING CARDS, IN CLASS 9 (U.S. CLS. 21, 23, 26, 36 AND 38).

FOR: PLASTIC CREDIT CARDS AND DEBIT CARDS WITHOUT MAGNETIC CODING; MEDI-

CAL IDENTIFICATION CARDS, NOT MAGNETICALLY ENCODED, IN CLASS 16 (U.S. CLS. 2, 5, 22, 23, 29, 37, 38 AND 50).

THE MARK CONSISTS OF STANDARD CHARACTERS WITHOUT CLAIM TO ANY PARTICULAR FONT, STYLE, SIZE, OR COLOR.

PRIORITY DATE OF 6-12-2006 IS CLAIMED.

OWNER OF INTERNATIONAL REGISTRATION 0913526 DATED 11-30-2006, EXPIRES 11-30-2016.

SER. NO. 79-034,584, FILED 11-30-2006.

NELSON SNYDER, EXAMINING ATTORNEY

Int. Cl.: 42

Prior U.S. Cls.: 100 and 101

United States Patent and Trademark Office

Reg. No. 3,480,788

Registered Aug. 5, 2008

**SERVICE MARK
PRINCIPAL REGISTER**

ADOsox

BOC ASSET MANAGEMENT GMBH (AUSTRIA
GMBH)
BÄCKERSTR. 5
A-1010 WIEN, AUSTRIA

OWNER OF INTERNATIONAL REGISTRATION
0914342 DATED 1-22-2007, EXPIRES 1-22-2017.

FOR: CREATION, MAINTENANCE, DESIGN
AND RENTAL OF COMPUTER SOFTWARE RE-
LATING TO THE SARBANES-OXLEY ACT OR
OTHER SIMILAR REGULATORY STATUTES, IN
CLASS 42 (U.S. CLS. 100 AND 101).

OWNER OF U.S. REG. NOS. 3,100,925 AND
3,135,968.

SER. NO. 79-034,820, FILED 1-22-2007.

PRIORITY DATE OF 7-24-2006 IS CLAIMED.

MARY MUNSON, EXAMINING ATTORNEY

Int. Cl.: 5

Prior U.S. Cls.: 6, 18, 44, 46, 51 and 52

Reg. No. 3,480,789

United States Patent and Trademark Office

Registered Aug. 5, 2008

**TRADEMARK
PRINCIPAL REGISTER**



QINGDAO YEBIO BIOENGINEERING; CO., LTD.
(CHINA CORPORATION)
J.10TH FLOOR
TIANZHI INTERNATIONAL HOUSE
QINGDAO BONDED ZONE, CHINA

OWNER OF INTERNATIONAL REGISTRATION
0914352 DATED 1-22-2007, EXPIRES 1-22-2017.

FOR: MEDICINES FOR VETERINARY PURPOSES, NAMELY, DIAGNOSTIC PREPARATIONS FOR VETERINARY USE; BIOLOGICAL ENZYMES USED AS A VETERINARY PREPARATION FOR THE TREATMENT OF INTESTINAL AND DIGESTIVE DISORDERS; AND AMINO ACIDS FOR VETERINARY PURPOSES, IN CLASS 5 (U.S. CLS. 6, 18, 44, 46, 51 AND 52).

THE WORDING "YEBIO" HAS NO MEANING IN A FOREIGN LANGUAGE.

SER. NO. 79-034,827, FILED 1-22-2007.

VERNA BETH RIRIE, EXAMINING ATTORNEY

Int. Cls.: 9 and 13

Prior U.S. Cls.: 2, 9, 21, 23, 26, 36 and 38

United States Patent and Trademark Office

Reg. No. 3,480,790

Registered Aug. 5, 2008

**TRADEMARK
PRINCIPAL REGISTER**

Fieldguard

OERLIKON CONTRAVES AG (SWITZERLAND
SOCIÉTÉ ANONYME)
BIRCHSTRASSE 155
CH-8050 ZÜRICH
SWITZERLAND

FOR: APPARATUS FOR ELECTRONIC CONTROL OF FIRING PARAMETERS FOR ARMAMENTS, NAMELY, AN APPARATUS FOR TRACKING TARGETS TO BE FIRED AT, FOR USE IN MILITARY OPERATIONS AND APPLICATIONS, IN CLASS 9 (U.S. CLS. 21, 23, 26, 36 AND 38).

FOR: CANNONS, ROCKETS, IN CLASS 13 (U.S. CLS. 2 AND 9).

THE MARK CONSISTS OF STANDARD CHARACTERS WITHOUT CLAIM TO ANY PARTICULAR FONT, STYLE, SIZE, OR COLOR.

PRIORITY DATE OF 7-24-2006 IS CLAIMED.

OWNER OF INTERNATIONAL REGISTRATION 0914693 DATED 12-11-2006, EXPIRES 12-11-2016.

SER. NO. 79-034,944, FILED 12-11-2006.

LYDIA BELZER, EXAMINING ATTORNEY

Int. Cls.: 9 and 13

Prior U.S. Cls.: 2, 9, 21, 23, 26, 36 and 38

United States Patent and Trademark Office

Reg. No. 3,480,791

Registered Aug. 5, 2008

**TRADEMARK
PRINCIPAL REGISTER**

Seaguard

OERLIKON CONTRAVES AG (SWITZERLAND
SOCIÉTÉ ANONYME)
BIRCHSTRASSE 155
CH-8050 ZÜRICH
SWITZERLAND

FOR: ELECTRONIC FIRING CONTROL APPARATUS FOR ARMAMENTS, NAMELY, AN APPARATUS FOR TRACKING TARGETS TO BE FIRED AT, FOR USE IN MILITARY OPERATIONS AND APPLICATIONS, IN CLASS 9 (U.S. CLS. 21, 23, 26, 36 AND 38).

FOR: CANNONS, ROCKETS, IN CLASS 13 (U.S. CLS. 2 AND 9).

THE MARK CONSISTS OF STANDARD CHARACTERS WITHOUT CLAIM TO ANY PARTICULAR FONT, STYLE, SIZE, OR COLOR.

PRIORITY DATE OF 7-24-2006 IS CLAIMED.

OWNER OF INTERNATIONAL REGISTRATION
0914695 DATED 12-11-2006, EXPIRES 12-11-2016.

SER. NO. 79-034,946, FILED 12-11-2006.

LYDIA BELZER, EXAMINING ATTORNEY

Int. Cls.: 9 and 13

Prior U.S. Cls.: 2, 9, 21, 23, 26, 36 and 38

United States Patent and Trademark Office

Reg. No. 3,480,792

Registered Aug. 5, 2008

**TRADEMARK
PRINCIPAL REGISTER**

Skysshield

OERLIKON CONTRAVES AG (SWITZERLAND
SOCIÉTÉ ANONYME)
BIRCHSTRASSE 155
CH-8050 ZÜRICH
SWITZERLAND

FOR: ELECTRONIC FIRING CONTROL APPARATUS FOR ARMAMENTS, NAMELY, AN APPARATUS FOR TRACKING TARGETS TO BE FIRED AT, FOR USE IN MILITARY OPERATIONS AND APPLICATIONS, IN CLASS 9 (U.S. CLS. 21, 23, 26, 36 AND 38).

FOR: CANNONS, ROCKETS, IN CLASS 13 (U.S. CLS. 2 AND 9).

THE MARK CONSISTS OF STANDARD CHARACTERS WITHOUT CLAIM TO ANY PARTICULAR FONT, STYLE, SIZE, OR COLOR.

PRIORITY DATE OF 7-24-2006 IS CLAIMED.

OWNER OF INTERNATIONAL REGISTRATION 0914696 DATED 12-11-2006, EXPIRES 12-11-2016.

OWNER OF U.S. REG. NO. 3,040,122.

SER. NO. 79-034,947, FILED 12-11-2006.

LYDIA BELZER, EXAMINING ATTORNEY

Int. Cls.: 12, 26 and 28

Prior U.S. Cls.: 19, 21, 22, 23, 31, 35, 37, 38, 39, 40, 42, 44 and 50

Reg. No. 3,480,793

United States Patent and Trademark Office

Registered Aug. 5, 2008

**TRADEMARK
PRINCIPAL REGISTER**



VIBRAM S.P.A. (ITALY CORPORATION)
VIA CRISTOFORO COLOMBO, 5
I-21041 ALBIZZATE (VA)
ITALY

FOR: PARTS OF BICYCLE AND MOTORCYCLES,
NAMELY, HAND BAR GRIPS, AND SADDLES, IN
CLASS 12 (U.S. CLS. 19, 21, 23, 31, 35 AND 44).

FOR: CLOTH PATCHES FOR CLOTHING; EM-
BROIDERED PATCHES FOR CLOTHING; ORNA-
MENTAL PATCHES FOR CLOTHING; PATCHES
FOR CLOTHING MADE OF RUBBER, PLASTIC
AND VINYL; PATCHES FOR REPAIRING TEXTILE
ARTICLES; BUTTONS FOR CLOTHING; ORNA-
MENTAL NOVELTY BUTTONS, PRESS BUTTONS;
RIVET BUTTONS; SHIRT BUTTONS; ZIPPER FAS-
TENERS; ZIPPER PULLS; ZIPPERS; SLIDE FASTEN-
ERS, IN CLASS 26 (U.S. CLS. 37, 39, 40, 42 AND 50).

FOR: RUBBER BALLS; TOYS FOR ANIMALS, IN
CLASS 28 (U.S. CLS. 22, 23, 38 AND 50).

PRIORITY DATE OF 11-15-2006 IS CLAIMED.

OWNER OF INTERNATIONAL REGISTRATION
0915254 DATED 1-30-2007, EXPIRES 1-30-2017.

OWNER OF U.S. REG. NOS. 822,309, 3,194,572 AND
OTHERS.

THE MARK CONSISTS OF THE WORD "VI-
BRAM" IN SPECIAL SCRIPT.

SER. NO. 79-035,149, FILED 1-30-2007.

STEPHEN AQUILA, EXAMINING ATTORNEY

Int. Cls.: 12, 26 and 28

**Prior U.S. Cls.: 19, 21, 22, 23, 31, 35, 37, 38, 39, 40, 42,
44 and 50**

Reg. No. 3,480,794

United States Patent and Trademark Office

Registered Aug. 5, 2008

**TRADEMARK
PRINCIPAL REGISTER**

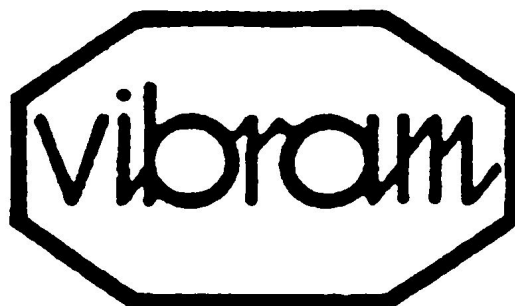

VIBRAM S.P.A. (ITALY CORPORATION)
VIA CRISTOFORO COLOMBO, 5
I-21041 ALBIZZATE (VA)
ITALY

FOR: PARTS OF BICYCLE AND MOTORCYCLES,
NAMELY, HAND BAR GRIPS, AND SADDLES, IN
CLASS 12 (U.S. CLS. 19, 21, 23, 31, 35 AND 44).

FOR: CLOTH PATCHES FOR CLOTHING; EM-
BROIDERED PATCHES FOR CLOTHING; ORNA-
MENTAL PATCHES FOR CLOTHING; PATCHES
FOR CLOTHING MADE OF RUBBER, PLASTIC
AND VINYL; PATCHES FOR REPAIRING TEXTILE
ARTICLES; BUTTONS FOR CLOTHING; ORNA-
MENTAL NOVELTY BUTTONS, PRESS BUTTONS;
RIVET BUTTONS; SHIRT BUTTONS; ZIPPER FAS-
TENERS; ZIPPER PULLS; ZIPPERS; SLIDE FASTEN-
ERS, IN CLASS 26 (U.S. CLS. 37, 39, 40, 42 AND 50).

FOR: RUBBER BALLS; TOYS FOR ANIMALS, IN
CLASS 28 (U.S. CLS. 22, 23, 38 AND 50).

PRIORITY DATE OF 11-15-2006 IS CLAIMED.

OWNER OF INTERNATIONAL REGISTRATION
0915272 DATED 1-30-2007, EXPIRES 1-30-2017.

OWNER OF U.S. REG. NOS. 822,309, 3,194,572 AND
OTHERS.

THE MARK CONSISTS OF THE WORD "VI-
BRAM" IN SPECIAL SCRIPT POSITIONED INTO
AN OCTAGONAL FIGURE.

SER. NO. 79-035,155, FILED 1-30-2007.

STEPHEN AQUILA, EXAMINING ATTORNEY

Int. Cls.: 9 and 13

Prior U.S. Cls.: 2, 9, 21, 23, 26, 36 and 38

United States Patent and Trademark Office

Reg. No. 3,480,795

Registered Aug. 5, 2008

**TRADEMARK
PRINCIPAL REGISTER**

Skyguard

OERLIKON CONTRAVES AG (SWITZERLAND
SOCIÉTÉ ANONYME (SA))
BIRCHSTRASSE 155
CH-8050 ZÜRICH
SWITZERLAND

FOR: ELECTRONIC FIRE-CONTROL APPARATUS FOR ARMAMENTS, NAMELY, AN APPARATUS FOR TRACKING TARGETS TO BE FIRED AT, FOR USE IN MILITARY OPERATIONS AND APPLICATIONS, IN CLASS 9 (U.S. CLS. 21, 23, 26, 36 AND 38).

FOR: CANNONS, ROCKETS, IN CLASS 13 (U.S. CLS. 2 AND 9).

THE MARK CONSISTS OF STANDARD CHARACTERS WITHOUT CLAIM TO ANY PARTICULAR FONT, STYLE, SIZE, OR COLOR.

PRIORITY DATE OF 7-24-2006 IS CLAIMED.

OWNER OF INTERNATIONAL REGISTRATION 0915781 DATED 11-14-2006, EXPIRES 11-14-2016.

SER. NO. 79-035,347, FILED 11-14-2006.

LYDIA BELZER, EXAMINING ATTORNEY

Int. Cls.: 10, 20 and 37

Prior U.S. Cls.: 2, 13, 22, 25, 26, 32, 39, 44, 50, 100, 103
and 106

Reg. No. 3,480,796

United States Patent and Trademark Office

Registered Aug. 5, 2008

TRADEMARK
SERVICE MARK
PRINCIPAL REGISTER



LINET SPOL. S R.O. (CZECH REPUBLIC COR-
PORATION)
ELEVCICE 5

CZ-274 01 SLANY
CZECH REPUBLIC

FOR: SPECIAL FURNITURE FOR MEDICAL PURPOSES, NAMELY, HOSPITAL AND NURSING CARE BEDS IN THE NATURE OF MECHANICAL BEDS FOR PATIENT TREATMENT AND FOR TRANSPORT FOR EXAMINATION IN HOSPITAL PREMISES; ELECTRICAL BEDS, WHICH ARE ELECTRICALLY ADJUSTABLE FOR PATIENT USE IN HOSPITAL DEPARTMENTS SPECIALIZING IN PATIENT DIAGNOSIS, FOR PATIENTS WITH RESPIRATORY PROBLEMS AND CARDIAC PROBLEMS AND TO PREVENT AND HELP TREATMENT OF PRESSURE SORES; INTENSIVE CARE BEDS FOR PATIENT RESUSCITATION FOR PATIENTS IN CRITICAL CONDITION AND FOR PATIENT TREATMENT; CHILDREN'S AND INFANTS' BEDS FOR PATIENT TREATMENT AND TRANSPORT FOR EXAMINATION IN HOSPITAL PREMISES; MATERNITY BEDS FOR TREATMENT OF MATERNITY PATIENTS AND FACILITATING INFANT DELIVERY; ACCESSORIES FOR USE WITH SUCH BEDS, NAMELY, INFUSION STANDS, LIFTING POLES AND ORTHOPEDIC EXTENSION SYSTEMS FOR PATIENT TREATMENT; OTHER FURNITURE FOR USE IN MEDICAL AND NURSING FACILITIES, NAMELY, ANTI-DECUBITUS SYSTEMS COMPRISED OF AN ACTIVE ANTI-DECUBITUS MATTRESS SYSTEM FOR THE PREVENTION AND TREATMENT OF BED SORES FOR

PATIENT'S TREATMENT; PASSIVE ANTI-DECUBITUS MATTRESSES FOR PREVENTION AND TREATMENT OF PRESSURE SORES; COUCHES FOR PATIENT TREATMENT AND FOR TRANSPORT FOR EXAMINATIONS IN HOSPITAL PREMISES; STRETCHERS AND MATTRESSES FOR PATIENT TREATMENT AND TRANSPORT FOR EXAMINATION IN HOSPITAL PREMISES; SEATS FOR PATIENT TREATMENT AND TRANSPORT IN HOSPITAL FORENSIC, IN CLASS 10 (U.S. CLS. 26, 39 AND 44).

FOR: FURNITURE, MATTRESSES, IN CLASS 20 (U.S. CLS. 2, 13, 22, 25, 32 AND 50).

FOR: REPAIR AND SERVICING OF SPECIAL FURNITURE FOR MEDICAL PURPOSES , IN CLASS 37 (U.S. CLS. 100, 103 AND 106).

OWNER OF INTERNATIONAL REGISTRATION
0915991 DATED 10-29-2006, EXPIRES 10-29-2016.

THE STIPPLING IN THE DRAWING IS FOR SHADING PURPOSES ONLY

THE ENGLISH TRANSLATION OF THE WORD "ELEGANZA" IN THE MARK IS ELEGANCE.

SER. NO. 79-035,404, FILED 10-29-2006.

KAELIE KUNG, EXAMINING ATTORNEY

Int. Cl.: 21

Prior U.S. Cls.: 2, 13, 23, 29, 30, 33, 40 and 50

Reg. No. 3,480,797

United States Patent and Trademark Office

Registered Aug. 5, 2008

**TRADEMARK
PRINCIPAL REGISTER**

Medido

INNOSPENSE CAPITAL BV (NETHERLANDS
CORPORATION)
VAN DER DUYNSTRAAT 54
NL-2515 NK THE HAGUE
NETHERLANDS

OWNER OF INTERNATIONAL REGISTRATION
0916599 DATED 1-23-2007, EXPIRES 1-23-2017.

FOR: CONTAINERS FOR HOUSEHOLD OR
KITCHEN USE NOT OF PRECIOUS METAL, IN
CLASS 21 (U.S. CLS. 2, 13, 23, 29, 30, 33, 40 AND 50).

THE FOREIGN WORDING IN THE MARK
TRANSLATES INTO ENGLISH AS MEASURED.

SER. NO. 79-035,614, FILED 1-23-2007.

THE MARK CONSISTS OF STANDARD CHAR-
ACTERS WITHOUT CLAIM TO ANY PARTICULAR
FONT, STYLE, SIZE, OR COLOR.

ANNE E. GUSTASON, EXAMINING ATTORNEY

Int. Cls.: 29, 30 and 32

Prior U.S. Cls.: 45, 46 and 48

United States Patent and Trademark Office

Reg. No. 3,480,798

Registered Aug. 5, 2008

TRADEMARK
PRINCIPAL REGISTER



FERRERO S.P.A. (ITALY SOCIÉTÉ PAR AC-
TIONS)
PIAZZA PIETRO FERRERO, 1
I-12051 ALBA (CN)
ITALY

FOR: MILK AND MILK PRODUCTS EXCLUD-
ING ICE CREAM, ICE MILK AND FROZEN YO-
GURT, IN CLASS 29 (U.S. CL. 46).

FOR: BEVERAGES MADE OF COFFEE, CACAO
OR CHOCOLATE, COFFEE FLAVORED PASTRY
AND CANDY, COFFEE FLAVORED ICE CREAM,
IN CLASS 30 (U.S. CL. 46).

FOR: SYRUPS AND OTHER PREPARATIONS
FOR MAKING SOFT-DRINKS FLAVORED WITH
COFFEE, IN CLASS 32 (U.S. CLS. 45, 46 AND 48).

PRIORITY DATE OF 12-18-2006 IS CLAIMED.

OWNER OF INTERNATIONAL REGISTRATION
0917050 DATED 1-10-2007, EXPIRES 1-10-2017.

NO CLAIM IS MADE TO THE EXCLUSIVE
RIGHT TO USE "ESPRESSO", APART FROM THE
MARK AS SHOWN.

THE COLOR(S) BROWN, WHITE, RED AND
YELLOW GOLD IS/ARE CLAIMED AS A FEATURE
OF THE MARK.

THE MARK CONSISTS OF THE WORDS "POCK-
ET ESPRESSO TO GO" AND A RECTANGLE ABOVE
THE WORDING "POCKET" ALL ON A BROWN
BACKGROUND. THE COLOR YELLOW APPEARS
IN THE RECTANGLE, THE COLOR WHITE AP-
PEARS IN "POCKET ESPRESSO". THE COLORS
RED AND WHITE APPEAR IN THE WORDS "TO"
AND "GO".

SER. NO. 79-035,807, FILED 1-10-2007.

FLORENTINA BLANDU, EXAMINING ATTORNEY

Int. Cl.: 32

Prior U.S. Cls.: 45, 46 and 48

United States Patent and Trademark Office

Reg. No. 3,480,799

Registered Aug. 5, 2008

**TRADEMARK
PRINCIPAL REGISTER**



ZAGO S.R.L. (ITALY CORPORATION)
VIA EINAUDI, 18
I-33080 PRATA DI PORDENONE (PN)
ITALY

OWNER OF INTERNATIONAL REGISTRATION
0917057 DATED 12-12-2006, EXPIRES 12-12-2016.

FOR: BEERS; MINERAL AND AERATED WATERS; NON-ALCOHOLIC DRINKS, NAMELY, SODA POPS, MALT BEVERAGES, MALT COOLERS, CARBONATED BEVERAGES; FRUIT DRINKS AND FRUIT JUICES; SYRUPS, CONCENTRATES AND POWDERS FOR MAKING SOFT DRINKS AND FRUIT DRINKS, IN CLASS 32 (U.S. CLS. 45, 46 AND 48).

THE MARK CONSISTS OF "HY". THE CHARACTER THAT RESEMBLES A GREEK CHARACTER "PSI" IS REALLY A STYLIZED "Y".

SER. NO. 79-035,810, FILED 12-12-2006.

PRIORITY DATE OF 11-20-2006 IS CLAIMED.

KATHERINE E. HALMEN, EXAMINING ATTORNEY

Int. Cls.: 3, 11, 12, 14, 16, 18, 20, 24, 25, 28, 30, 32 and 33

Prior U.S. Cls.: 1, 2, 3, 4, 5, 6, 13, 19, 21, 22, 23, 25, 27, 28, 29, 31, 32, 34, 35, 37, 38, 39, 41, 42, 44, 45, 46, 47, 48, 49, 50, 51 and 52

Reg. No. 3,480,800

United States Patent and Trademark Office

Registered Aug. 5, 2008

**TRADEMARK
PRINCIPAL REGISTER**



FIAT AUTO S.P.A. (ITALY SOCIÉTÉ PAR ACTIONS)
CORSO GIOVANNI AGNELLI, 200
I-10135 TORINO
ITALY

FOR: BLEACHING PREPARATIONS FOR LAUNDRY USE; OTHER SUBSTANCES FOR LAUNDRY USE, NAMELY, LAUNDRY BLUEING; CLEANING, POLISHING, SCOURING AND ABRASIVE PREPARATIONS, NAMELY, GENERAL PURPOSE CLEANING, POLISHING AND ABRASIVE LIQUIDS AND POWDERS; SOAPS; PERFUMERY, ESSENTIAL OILS, COSMETICS, HAIR LOTIONS; DENTIFRICES, IN CLASS 3 (U.S. CLS. 1, 4, 6, 50, 51 AND 52).

FOR: APPARATUS FOR LIGHTING, HEATING, STEAM GENERATING, COOKING, REFRIGERATING, DRYING, VENTILATING, WATER SUPPLY AND SANITARY PURPOSES, NAMELY, HEADLIGHTS FOR VEHICLES, IN CLASS 11 (U.S. CLS. 13, 21, 23, 31 AND 34).

FOR: VEHICLES, NAMELY, LAND VEHICLES, AUTOMOBILES, SPORTS CARS, MOTOR BUSES, TRUCKS, TRAILERS, TRACTORS; APPARATUS FOR LOCOMOTION BY LAND, AIR OR WATER, NAMELY, AIRPLANES; HYDROPLANES, AIRCRAFT, HELICOPTERS, ELECTRIC LOCOMOTIVES, BICYCLES, MOTORCYCLES, MOTORBOATS, SAILING SHIPS, YACHTS, IN CLASS 12 (U.S. CLS. 19, 21, 23, 31, 35 AND 44).

FOR: GOODS MADE OF PRECIOUS METAL AND THEIR ALLOYS OR COATED WITH THESE MATERIALS NOT INCLUDED IN OTHER CLASSES, NAMELY, STATUES OF PRECIOUS METAL; JEWELRY; PRECIOUS STONES; TIMEPIECES AND CHRONOMETRIC INSTRUMENTS, IN CLASS 14 (U.S. CLS. 2, 27, 28 AND 50).

FOR: PAPER, CARDBOARD, GOODS MADE FROM PAPER AND CARDBOARD, NAMELY, CARD BOARD BOXES; BOOKBINDING MATERIALS, NAMELY, BOOKBINDINGS, BOOKBINDING TAPE; PHOTOGRAPHS; STATIONERY; ADHESIVES FOR STATIONERY OR HOUSEHOLD PURPOSES; ARTISTS' MATERIALS, NAMELY, ARTISTS' BRUSHES; PAINT BRUSHES; TYPEWRITERS; OFFICE REQUISITES, EXCEPT FURNITURE, NAMELY, STAPLERS; PRINTED INSTRUCTIONAL AND TEACHING MATERIALS IN THE FIELD OF HISTORY; PLASTIC MATERIAL FOR PACKAGING, NAMELY, PLASTIC BAGS FOR PACKING; PRINTERS' TYPE; PRINTING BLOCKS, IN CLASS 16 (U.S. CLS. 2, 5, 22, 23, 29, 37, 38 AND 50).

FOR: LEATHER; IMITATION LEATHER; GOODS MADE OF LEATHER AND IMITATION OF LEATHER NOT INCLUDED IN OTHER CLASSES, NAMELY, WALLETS, KEY CASES, ATTACHÉ CASES, BRIEFCASES, SUIT BAGS, HANDBAGS, TRAVELING BAGS, ATHLETIC BAGS, VANITY CASES SOLD EMPTY, PURSES, DOCUMENT CASES; ANIMAL SKINS AND HIDES; TRUNKS AND SUITCASES; UMBRELLAS, PARASOLS AND

WALKING STICKS; WHIPS AND SADDLERY, IN CLASS 18 (U.S. CLS. 1, 2, 3, 22 AND 41).

FOR: FURNITURE; MIRRORS; PICTURE FRAMES; GOODS NOT INCLUDED IN OTHER CLASSES OF WOOD, CORK, REED, CANE, WICKER, HORN, BONE, IVORY, WHALEBONE, SHELL, AMBER, MOTHER-OF-PEARL, MEERSCHAUM, SUBSTITUTES FOR ALL THESE MATERIALS OR OF PLASTICS, NAMELY, SCULPTURES OF IVORY, IN CLASS 20 (U.S. CLS. 2, 13, 22, 25, 32 AND 50).

FOR: FABRICS AND TEXTILE GOODS NOT INCLUDED IN OTHER CLASSES, NAMELY, FABRICS FOR THE MANUFACTURE OF CLOTHING; BED COVERS, NAMELY, COMFORTERS; TABLE COVERS, NAMELY, TABLE CLOTHS NOT OF PAPER, IN CLASS 24 (U.S. CLS. 42 AND 50).

FOR: CLOTHING, NAMELY, PANTS, T-SHIRTS, SWEATSHIRTS, POLO-SHIRTS, TIES, OVERALLS, WIND RESISTANT JACKETS, WATERPROOF JACKETS, BLAZERS, PULLOVERS, COATS, ROBES, SCARVES, SWEATERS, SHIRTS, TROUSERS, BELTS, RAINCOATS, TRACKSUITS, SHORTS, GLOVES, PAJAMAS, SLIPPERS, SWIM-WEAR, OVERALL COATS, FOULARDS; FOOTWEAR; HEADGEAR, NAMELY HEADWEAR, IN CLASS 25 (U.S. CLS. 22 AND 39).

FOR: GAMES, NAMELY, BOARD GAMES, PUZZLES; TOYS, NAMELY, TOY MODEL VEHICLES; TOY COLLECTABLE REPRODUCTIONS OF AUTOMOBILES AND OTHER VEHICLES; TOY BUILDING STRUCTURES, NAMELY, BUILDING BLOCKS; TOY VEHICLE TRAIN TRACKS; TOY AUTOMOBILES; GYMNAS TIC AND SPORTING ARTICLES NOT INCLUDED IN OTHER CLASSES, NAMELY, BASEBALL BATS; DECORATIONS FOR CHRIST-

MAS TREES, IN CLASS 28 (U.S. CLS. 22, 23, 38 AND 50).

FOR: COFFEE, TEA, COCOA, SUGAR, RICE, TAPIOCA, SAGO, ARTIFICIAL COFFEE; FLOURS; PREPARATIONS MADE FROM CEREALS, NAMELY BREAKFAST CEREALS; CONFECTIONERY, NAMELY PASTILLES, CANDY, FRUIT JELLIES, EDIBLE ICES; HONEY; TREACLE; SYRUP, NAMELY CORN SYRUP, MAPLE SYRUP; YEAST; BAKING-POWDER; SALT, MUSTARD; VINEGAR, CONDIMENTS, NAMELY SAUCES; SPICES, ICE FOR REFRESHMENT, IN CLASS 30 (U.S. CL. 46).

FOR: BEERS; MINERAL AND AERATED WATERS; NON-ALCOHOLIC DRINKS, NAMELY, CARBONATED BEVERAGES, HONEY-BASED BEVERAGES WITH TEA FLAVOR; FRUIT DRINKS AND FRUIT JUICES; SYRUPS AND OTHER PREPARATIONS FOR MAKING BEVERAGES, NAMELY, FRUIT DRINKS, IN CLASS 32 (U.S. CLS. 45, 46 AND 48).

FOR: ALCOHOLIC BEVERAGES, EXCEPT BEERS, NAMELY, WHISKEY, IN CLASS 33 (U.S. CLS. 47 AND 49).

PRIORITY DATE OF 10-16-2006 IS CLAIMED.

OWNER OF INTERNATIONAL REGISTRATION 0917107 DATED 11-27-2006, EXPIRES 11-27-2016.

OWNER OF U.S. REG. NO. 2,899,069.

SER. NO. 79-035,827, FILED 11-27-2006.

DAYNA BROWNE, EXAMINING ATTORNEY

Int. Cl.: 11

Prior U.S. Cls.: 13, 21, 23, 31 and 34

United States Patent and Trademark Office

Reg. No. 3,480,801

Registered Aug. 5, 2008

TRADEMARK
PRINCIPAL REGISTER

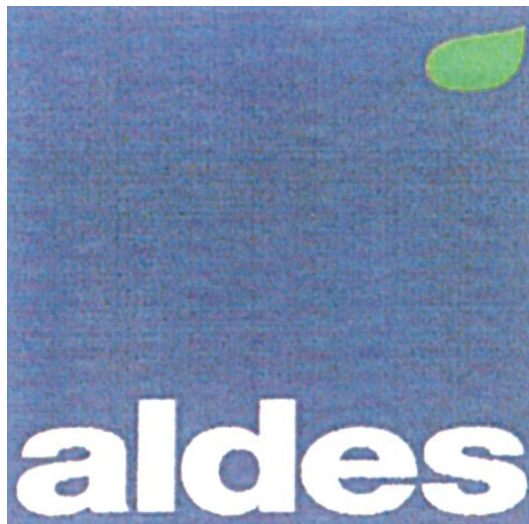

ALDES AERAULIQUE (FRANCE SOCIÉTÉ ANONYME)
20, BOULEVARD JOLIOT-CURIE
F-69200 VENISSIEUX
FRANCE

FOR: EQUIPMENT AND INSTALLATIONS FOR VENTILATION, AERATION AND AIR CONDITIONING, NAMELY, DAMPERS, NAMELY, CONTROL DEVICES USED IN AIR DUCTS TO REGULATE THE FLOW OF AIR, AIR CONDITIONING UNITS, AIR PURIFICATION UNITS, DRYERS USED FOR THE REMOVAL OF WATER VAPOR FROM COMPRESSED AIR AND GASES, DEHUMIDIFIERS, HEAT ACCUMULATOR FOR VENTILATORS FOR RECOVERY OF HEAT; EXHAUST AND BLOWER FANS, NAMELY, VENTILATION EXHAUST FANS, EXTERIOR MOUNT VENTILATING EXHAUST FANS, AND DUCT FANS, NAMELY, ELECTRIC DUCT FANS, AND DUCT FANS FOR VENTILATING; EXHAUST AND AIR SUPPLY OUTLETS, NAMELY, CENTRAL EXHAUST SYSTEMS COMPRISED OF VENTILATING EXHAUST FANS; AIR INLETS FOR RECOVERING AIR AS AN INTEGRAL COMPONENTS OF AIR CONDITIONER UNITS

AND AIR PURIFICATION AND AIR VENTILATION UNITS; EXHAUST HOODS FOR KITCHEN, IN CLASS 11 (U.S. CLS. 13, 21, 23, 31 AND 34).

PRIORITY DATE OF 5-16-2006 IS CLAIMED.

OWNER OF INTERNATIONAL REGISTRATION 0917326 DATED 11-3-2006, EXPIRES 11-3-2016.

OWNER OF U.S. REG. NOS. 1,238,180 AND 2,590,610.

THE COLOR(S) WHITE, BLUE AND GREEN IS/ ARE CLAIMED AS A FEATURE OF THE MARK.

THE NAME "ALDES" IS DEPICTED IN WHITE ON A BLUE SQUARE FEATURING, AT ITS UPPER PART, A GREEN LEAF.

SER. NO. 79-035,908, FILED 11-3-2006.

MYRIAH HABEEB, EXAMINING ATTORNEY

Int. Cls.: 9 and 42

Prior U.S. Cls.: 21, 23, 26, 36, 38, 100 and 101

Reg. No. 3,480,802

United States Patent and Trademark Office

Registered Aug. 5, 2008

**TRADEMARK
SERVICE MARK
PRINCIPAL REGISTER**

MICROPASS

INSIDE CONTACTLESS (FRANCE CORPORATION)
BÂT. 11 A DU CLUB DU GOLF
F-13856 AIX EN PROVENCE CEDEX 03
FRANCE

FOR: PROGRAMS FOR COMPUTERS AND MICROPROCESSORS FOR READING OF CHIPS AND THE MODIFICATION AND EXCHANGE OF DATA AND FOR SAFETY OF DATA IN THE FIELD OF PAYMENTS, FINANCE, TELEPHONY, TRANSPORT, ACCESS CONTROL, ELECTRONIC IDENTIFICATION, RETAIL AND GIFT CARD, ALL TO FACILITATE COMMUNICATION BETWEEN HAND-HELD ELECTRONIC DEVICES; ENCRYPTION AND DECRYPTION PROGRAMS FOR COMPUTER DATA, ELECTRONIC LIAISON BETWEEN A COMPUTER AND A COMMUNICATION NETWORK, NAMELY READERS, SOFTWARE FOR THE MANAGEMENT OF DATABASE, INTERFACE CARDS FOR COMMUNICATION, INTERFACE MODULES FOR COMMUNICATION, NAMELY FOR THE EXCHANGE OF DATA, DATA CONVERTERS, CHIPS, NAMELY INTEGRATED CIRCUITS, COMPUTER CHIPS, NAMELY CONTACTLESS INTERFACE CHIPS, SEMICONDUCTOR CHIPS, SILICON CHIPS, MICROCIRCUITS FOR CODING AND DECODING DATA, PRINTED CIRCUITS, SEMICONDUCTORS, CENTRAL PROCESSING UNITS, MICROPROCESSORS, MICROCONTROLLERS, ELECTRONIC TAGS, NAMELY TAGS FOR CONTROLLING ACCESS, MANAGEMENT OF STOCK, TRACEABILITY OF GOODS, PROTECTION AGAINST THEFT, CHIP CARDS, NAMELY BLANK ELECTRONIC CHIP CARDS, ENCODED ELECTRONIC CHIP CARDS CONTAINING PROGRAMMING FOR READING, WRITING, CONTROLLING, EXCHANGING AND MODIFICATION OF DATA FOR USE IN THE FIELD OF PAYMENT, FINANCE, ACCESS, CONTROL, TRANSPORT, TICKETING, ELECTRONIC IDENTIFICATION, RETAIL AND

GIFT CARD AND MOBILE COMMUNICATION FIELDS FOR USE WITH SMART CARDS, KEY FOBS, MOBILE PHONES, HANDHELD CONSUMER ELECTRONIC DEVICES, POINT OF SALE DISPLAYS AND PC PERIPHERALS, MEMORY CARDS, ELECTRIC AND ELECTRONIC LOCKS, IN INTERNATIONAL CLASS 9, IN CLASS 9 (U.S. CLS. 21, 23, 26, 36 AND 38).

FOR: DESIGN OF PROGRAMS FOR COMPUTERS AND MICROPROCESSORS FOR OTHERS, COMPUTER SYSTEM DESIGN AND DEVELOPMENT, TECHNICAL DEVELOPMENT AND STUDY SERVICES FOR DATA EXCHANGE SYSTEMS AND DEVICES, NAMELY CONDUCTING SCIENTIFIC RESEARCH, CONDUCTING TECHNICAL FEASIBILITY STUDIES AND NEW PRODUCT DEVELOPMENT FOR OTHERS, PERSONALIZED STUDY AND PROGRAMMING SERVICE FOR CHIP CARDS AND ELECTRONIC CARDS, NAMELY CUSTOMIZATION OF COMPUTER CHIPS CARDS AND ELECTRONIC CARDS WITH INTEGRATED CIRCUITS FOR OTHERS, IN INTERNATIONAL CLASS 42, IN CLASS 42 (U.S. CLS. 100 AND 101).

THE MARK CONSISTS OF STANDARD CHARACTERS WITHOUT CLAIM TO ANY PARTICULAR FONT, STYLE, SIZE, OR COLOR.

PRIORITY DATE OF 7-26-2006 IS CLAIMED.

OWNER OF INTERNATIONAL REGISTRATION 0917800 DATED 1-2-2007, EXPIRES 1-2-2017.

SER. NO. 79-036,137, FILED 1-2-2007.

RONALD AIKENS, EXAMINING ATTORNEY

Int. Cl.: 38

Prior U.S. Cls.: 100, 101 and 104

United States Patent and Trademark Office

Reg. No. 3,480,803

Registered Aug. 5, 2008

**SERVICE MARK
PRINCIPAL REGISTER**

Blue Zone

AD COMMUNICATIONS PTY LTD (AUSTRALIA
LTD LIAB CO)
C/- HAYAS
SUITE 45; 47 NERIDAH STREET
CHATSWOOD, AUSTRALIA NSW 2067

PRIORITY DATE OF 10-18-2006 IS CLAIMED.

FOR: TRANSMISSION OF VOICE AND DATA
SERVICES TO MOBILE DEVICES AND PERSONAL
COMPUTERS VIA SHORT RANGE WIRELESS AND
LONG RANGE WIRELESS TECHNOLOGIES AND
SPECTRUMS, IN CLASS 38 (U.S. CLS. 100, 101 AND
104).

OWNER OF INTERNATIONAL REGISTRATION
0917841 DATED 12-7-2006, EXPIRES 12-7-2016.

SER. NO. 79-036,143, FILED 12-7-2006.

THE MARK CONSISTS OF STANDARD CHAR-
ACTERS WITHOUT CLAIM TO ANY PARTICULAR
FONT, STYLE, SIZE, OR COLOR.

WILLIAM P. SHANAHAN, EXAMINING ATTOR-
NEY

Int. Cls.: 1, 5, 21, 29 and 30

**Prior U.S. Cls.: 1, 2, 5, 6, 10, 13, 18, 23, 26, 29, 30, 33,
40, 44, 46, 50, 51 and 52**

Reg. No. 3,480,804

United States Patent and Trademark Office

Registered Aug. 5, 2008

**TRADEMARK
PRINCIPAL REGISTER**

FUCHS

DF WORLD OF SPICES GMBH (FED REP GER-
MANY LIMITED LIABILITY COMPANY)
WESTRING 15-17
49201 DISSEN
FED REP GERMANY

FOR: CHEMICAL PREPARATIONS, NAME-
LY, CHEMICAL ADDITIVES FOR USE IN THE MANU-
FACTURE OF FOOD AS A BAKERY AND COOK-
ING IMPROVER; CHEMICAL PRODUCTS FOR THE
FRESH-KEEPING AND PRESERVING OF FOOD;
IODIZED SALT; PREPARATIONS OF BACTERIA,
NAMELY, BACTERIA FOR USE IN FOOD MANU-
FACTURE; CHEMICAL PREPARATIONS, NAME-
LY, MEAT PICKLING PREPARATIONS FOR THE
FRESH-KEEPING AND PRESERVING OF FOOD;
GELATIN GLUE USED IN INDUSTRY; CHEMICAL
PREPARATIONS, NAMELY, TASTE CONDITION-
ERS IN THE NATURE OF DOUGH CONDITIONERS
USED IN INDUSTRY FOR FOODSTUFFS; COLOR
STABILIZERS BEING CHEMICAL PREPARATIONS;
EMULSIFYING AGENTS FOR THE FOOD INDUS-
TRY; AGAR; ENZYMES AND ENZYME PREPARA-
TIONS FOR USE IN THE FOOD INDUSTRY;
CHEMICAL PRESERVATIVES FOR FOODSTUFFS;
OILS FOR PRESERVING FOODSTUFFS; MICRO-
ORGANISM CULTURES USED IN INDUSTRY NOT
FOR MEDICAL OR VETERINARY USE; CHEMICAL
SUBSTANCES FOR PRESERVING FOODSTUFFS;
EDIBLE COATING AGENTS BEING CHEMICAL
PREPARATIONS FOR PRESERVING AND FRESH-
ENING FOODSTUFFS FOR USE IN THE MANU-
FACTURE OF FOODSTUFFS, IN CLASS 1 (U.S. CLS.
1, 5, 6, 10, 26 AND 46).

FOR: FOOD SUPPLEMENTS FOR MEDICAL
PURPOSES; DIETETIC FOODSTUFFS ADAPTED
FOR MEDICAL USE; MEDICINAL HERBS AND
SPICES ADAPTED FOR MEDICAL USE; MEDICIN-
AL HERBS IN DRIED OR PRESERVED FORM;
HERBAL TEAS FOR MEDICINAL PURPOSES;

FOOD SUPPLEMENTS NOT FOR MEDICAL USE
WITH A BASIS OF VITAMINS, MINERALS, TRACE
ELEMENTS AND STEROLS; HERB TEAS FOR
DIETETIC PURPOSES ADAPTED FOR MEDICAL
USE, IN CLASS 5 (U.S. CLS. 6, 18, 44, 46, 51 AND 52).

FOR: HAND-OPERATED SPICE MILLS FOR
HOUSEHOLD PURPOSES, HOUSEHOLD UTEN-
SILS, NAMELY, GRATERS; SPICE SHAKERS AND
CONTAINERS AND LIDS FOR SPICE SHAKERS
AND CONTAINERS, SOLD AS A UNIT; SPICE SETS,
NAMELY, SALT AND PEPPER SHAKERS; CRUET
STANDS FOR TABLES NOT MADE FROM PRE-
CIOUS METAL OR PLATED THEREWITH; BOXES
AND CONTAINERS FOR HOUSEHOLD OR KITCH-
EN USE NOT MADE FROM PRECIOUS METAL,
NAMELY RECIPE BOXES; VINEGAR AND OIL
CRUETS NOT MADE FROM PRECIOUS METAL;
SALT AND PEPPER SHAKERS NOT MADE FROM
PRECIOUS METAL OR PLATED THEREWITH, IN
CLASS 21 (U.S. CLS. 2, 13, 23, 29, 30, 33, 40 AND 50).

FOR: DRIED PROCESSED MUSHROOMS; UN-
FLAVORED AND UNSWEETENED GELATINS; AL-
GAE EXTRACTS FOR FOOD; PREPARED AND
SEMI-PREPARED MEALS, DRY MIXTURES FOR
PREPARED MEALS, SOUPS, FILLINGS AND MIX-
TURES, MAINLY CONSISTING OF MEAT, FISH,
POULTRY, GAME, MEAT EXTRACTS, MILK PRO-
DUCTS, PRESERVED, DRIED AND COOKED
FRUITS AND VEGETABLES; MEAT EXTRACTS;
MEAT, FISH AND VEGETABLE JELLIES AND
PASTES; MEAT, FISH, FRUIT AND VEGETABLE
PRESERVES; PICKLES; PRESERVED, DRIED, FRO-
ZEN AND COOKED FRUIT AND VEGETABLES;
PROCESSED CHILI PEPPERS; PIRI PIRI BEING
CHILI IN BRINE; PREPARATIONS FOR MAKING
BOUILLON, SOUPS, MEAT BROTH AND BEEF
STOCKS; MEAT BROTH AND BOUILLON CON-
CENTRATES; BEEF STOCKS, SOUPS; PREPARA-
TIONS FOR MAKING SOUPS; VEGETABLE JUICES

FOR COOKING, OIL FOR FOOD; DIPS, MAINLY ON THE BASIS OF MILK PRODUCTS, PROCESSED FRUIT, PROCESSED VEGETABLE AND PLANT JUICES FOR COOKING, PREPARATIONS FOR MAKING DIPS, MAINLY ON THE BASIS OF MILK, PROCESSED FRUIT, PROCESSED VEGETABLES OR PLANT JUICES FOR COOKING; PICKLED GHERKINS; CHICKPEA PASTE, NAMELY HUMMUS; EDIBLE COATINGS FOR FOODSTUFFS MAINLY CONSISTING OF FATS, OILS AND GELATIN; PRESERVED MUSHROOMS, IN CLASS 29 (U.S. CL. 46).

FOR: SPICES, SPICE FLAVORINGS, SPICE FLAVORED SALTS, SPICE ESSENCES, SPICE EXTRACTS, SPICE MIXTURES, SPICED OIL FOR USE AS A SEASONING, SPICE PASTES, SPICE PREPARATIONS, SEASONED SALTS, AND CONDIMENTS, NAMELY, KETCHUP; FLAVORINGS AND SEASONINGS FOR FOODSTUFFS; SOUP SEASONING AND FLAVORINGS; VEGETABLE FLAVORINGS FOR FOODSTUFFS, FLAVORINGS AND BAKING FLAVORINGS EXCLUDING ETHEREAL OILS; ESSENCES FOR NUTRITIONAL PURPOSES, NAMELY PROCESSED HERBS; SALSA BEING A SAUCE CONTAINING CHILIES AND TOMATOES; SAUCES; STARCH-BASED BINDING AGENTS FOR COOKING PURPOSES; STARCH-BASED BINDING AGENTS FOR SAUSAGES; VINEGAR; MUSTARD; COOKING SALT; SALT; MAYONNAISE; CAPERS; KETCHUP; BINDING AGENTS BASED ON FLOUR;

PRESERVING SALTS FOR FOODSTUFFS; FLOUR; BREADCRUMBS; FLOUR COATINGS; MUSTARD FLOUR; SOY FLOUR; TACOS; TORTILLAS; TAPIOCA FLOUR FOR FOOD; SUGAR; EXTRUDED WHEAT SNACKS, TORTILLA CHIPS; DIPS BEING SAUCES FOR USE AS CONDIMENTS; PREPARATIONS FOR MAKING DIPS, NAMELY SEASONINGS, SAUCES AND SPICES; CROUTONS; BAKING MIXTURES, NAMELY, BAKING MIXTURES WITH SPICES AND FLAVORINGS; EDIBLE COATING AGENTS FOR FOODSTUFFS, NAMELY, MARZIPAN AND ICING, IN CLASS 30 (U.S. CL. 46).

THE MARK CONSISTS OF STANDARD CHARACTERS WITHOUT CLAIM TO ANY PARTICULAR FONT, STYLE, SIZE, OR COLOR.

PRIORITY DATE OF 1-16-2006 IS CLAIMED.

OWNER OF INTERNATIONAL REGISTRATION 0918425 DATED 6-15-2006, EXPIRES 6-15-2016.

THE FOREIGN WORDING IN THE MARK TRANSLATES INTO ENGLISH AS FOX.

SER. NO. 79-036,362, FILED 6-15-2006.

GILBERT SWIFT, EXAMINING ATTORNEY

Int. Cls.: 7, 9, 12 and 42

**Prior U.S. Cls.: 13, 19, 21, 23, 26, 31, 34, 35, 36, 38, 44,
100 and 101**

Reg. No. 3,480,805

United States Patent and Trademark Office

Registered Aug. 5, 2008

**TRADEMARK
SERVICE MARK
PRINCIPAL REGISTER**



SCHWING GMBH (FED REP GERMANY CORPORATION)
HEERSTRASSE 11
44653 HERNE, FED REP GERMANY

FOR: MACHINES FOR THE MANUFACTURE, TRANSPORT AND CONVEYING OF CONCRETE AND MORTAR, NAMELY, MACHINES FOR THE MIXING AND PLACING OF CONCRETE AND MORTAR; CONVEYING PUMPS FOR SLURRIES, DUAL-CYLINDER PUMPS FOR SLURRIES AND SWIVEL SWITCHES FOR REDIRECTING FLOW AND PARTS OF AFOREMENTIONED PUMPS, NAMELY, PIPES AND WEAR RINGS; MIXING MACHINES FOR CONCRETE AND MORTAR; MACHINE PARTS, NAMELY, DISTRIBUTION MASTS FOR CONCRETE AND MORTAR; HYDRAULIC CONTROLS FOR CONCRETE AND MORTAR PROCESSING AND CONVEYING MACHINES, IN CLASS 7 (U.S. CLS. 13, 19, 21, 23, 31, 34 AND 35).

FOR: ELECTRONIC CONTROLS FOR MACHINES AND DEVICES THAT PROCESS, MEASURE AND CONVEY CONCRETE AND MORTAR, IN CLASS 9 (U.S. CLS. 21, 23, 26, 36 AND 38).

FOR: CONCRETE AND MORTAR MIXING TRUCKS, IN CLASS 12 (U.S. CLS. 19, 21, 23, 31, 35 AND 44).

FOR: ENGINEERING SERVICES, IN CLASS 42 (U.S. CLS. 100 AND 101).

PRIORITY DATE OF 5-22-2006 IS CLAIMED.

OWNER OF INTERNATIONAL REGISTRATION 0918445 DATED 11-22-2006, EXPIRES 11-22-2016.

OWNER OF U.S. REG. NOS. 1,238,037, 1,517,014 AND OTHERS.

THE COLOR(S) BLACK, WHITE, LIGHT GREEN AND DARK GREEN IS/ARE CLAIMED AS A FEATURE OF THE MARK.

THE TERMS "SCHWING STETTER" APPEAR IN THE COLOR BLACK. THE DESIGN ELEMENT TO THE LEFT OF THE LETTERING IS A BLACK OUTLINE OF A SQUARE, WHICH CONTAINS A THIN LIGHT GREEN STRIPE AND A THICKER DARK GREEN STRIP EXTENDING DIAGONALLY ACROSS THE INNER PORTION OF THE SQUARE. THE BACKGROUND OF THE MARK IS WHITE.

SEC. 2(F) AS TO "SCHWING".

SER. NO. 79-036,372, FILED 11-22-2006.

PAULA MAHONEY, EXAMINING ATTORNEY

Int. Cl.: 41

Prior U.S. Cls.: 100, 101 and 107

United States Patent and Trademark Office

Reg. No. 3,480,806

Registered Aug. 5, 2008

SERVICE MARK
PRINCIPAL REGISTER



PLZENSKY PRAZDROJ, A.S. (CZECH REPUBLIC CORPORATION)
U PRAZDROJE 7
CZ-304 97 PLZEN
CZECH REPUBLIC

FOR: EDUCATION SERVICES, NAMELY, PROVIDING CLASSES, SEMINARS, WORKSHOPS AND CONTESTS IN THE FIELD OF PHOTOGRAPHY, ARTS AND ADVERTISING; ENTERTAINMENT IN THE NATURE OF PHOTOGRAPHY AND PROVIDING RECOGNITION AND INCENTIVES BY THE WAY OF AWARDS AND CONTESTS TO DEMONSTRATE EXCELLENCE IN THE FIELD OF PHOTOGRAPHY; ORGANIZING COMMUNITY SPORTING AND CULTURAL EVENTS; ORGANIZATION OF EDUCATION, CULTURAL AND ENTERTAINMENT COMPETITIONS AND INCENTIVE AWARDS PROGRAMS IN THE FIELD OF PHOTOGRAPHY, ARTS AND ADVERTISING; ORGANIZATION OF EXHIBITIONS FOR CULTURAL OR EDUCATIONAL PURPOSES IN THE NATURE OF PHOTOGRAPHY, ARTS AND ADVERTISING, IN CLASS 41 (U.S. CLS. 100, 101 AND 107).

PRIORITY DATE OF 7-20-2006 IS CLAIMED.

OWNER OF INTERNATIONAL REGISTRATION 0919086 DATED 12-21-2006, EXPIRES 12-21-2016.

OWNER OF U.S. REG. NOS. 75,301, 1,806,323 AND OTHERS.

NO CLAIM IS MADE TO THE EXCLUSIVE RIGHT TO USE "INTERNATIONAL PHOTOGRAPHY AWARDS" AND "OD ROKU 1842", APART FROM THE MARK AS SHOWN.

THE ENGLISH TRANSLATION OF "PLZENSKY PRAZDROJ" IS ANCIENT SOURCE OR SPRING OF PILSEN. THE ENGLISH TRANSLATION OF "OD ROKU 1842" IS FROM THE YEAR 1842. THE ENGLISH TRANSLATION OF "URQUELL" IS ANCIENT SOURCE OR PRIMARY SOURCE.

SER. NO. 79-036,579, FILED 12-21-2006.

ROBERT STRUCK, EXAMINING ATTORNEY

Int. Cls.: 9, 42 and 45

Prior U.S. Cls.: 21, 23, 26, 36, 38, 100 and 101

United States Patent and Trademark Office

Reg. No. 3,480,807

Registered Aug. 5, 2008

**TRADEMARK
SERVICE MARK
PRINCIPAL REGISTER**



MW SECURITY AB (SWEDEN JOINT-STOCK
COMPANY)
STURKÖGATAN 9
SE-211 24 MALMÖ
SWEDEN

FOR: CHECKING AND SUPERVISION APPARATUS AND INSTRUMENTS IN THE NATURE OF PROPERTY SUPERVISION DEVICES AND OTHER APPARATUS FOR PROTECTION AGAINST SHOP LIFTING AND SIMILAR THEFT, NAMELY, THEFT ALARMS, ELECTRICAL, MECHANICAL AND ELECTRONIC DETECTORS AND ALARMS; MINIATURIZED THEFT DETECTORS AND ALARMS; BURGLAR AND INTRUDER DETECTORS AND ALARMS FOR RESIDENTIAL AND BUSINESS PREMISES; APPARATUS FOR IDENTIFICATION CONTROL AND IDENTIFICATION PURPOSES, NAMELY, MAGNETIC IDENTIFYING CARDS, MAGNETICALLY ENCODED IDENTIFICATION BRACELETS, MOTION DETECTORS AND ALARMS; VIBRATION DETECTORS AND ALARMS FOR PROTECTION AGAINST SHOP LIFTING AND SIMILAR THEFT; NOISE DETECTORS AND ALARMS FOR PROTECTION AGAINST SHOP LIFTING AND SIMILAR THEFT; SURVEILLANCE TELEVISION CAMERAS AND PHOTOGRAPHIC CAMERAS FOR PROTECTION AGAINST SHOP LIFTING AND SIMILAR THEFT; OPEN AND CLOSED VIDEO CIRCUIT MONITORS FOR PROTECTION AGAINST SHOP LIFTING AND SIMILAR THEFT; OPTIC SENSORS AND OPTICAL SCAN-

NERS FOR IDENTIFICATION CONTROL AND IDENTIFICATION PURPOSES; ELECTRONIC LOCKS FOR RESIDENTIAL AND BUSINESS PREMISES; PHOTO ELECTRONIC BEAMS IN THE NATURE OF PROPERTY SUPERVISION DEVICES AND OTHER APPARATUS FOR PROTECTION AGAINST SHOP LIFTING AND SIMILAR THEFT, NAMELY, BURGLAR AND INTRUDER DETECTORS AND ALARMS FOR RESIDENTIAL AND BUSINESS PREMISES; PASSIVE INFRARED REFLECTORS IN THE NATURE OF PROPERTY SUPERVISION DEVICES AND OTHER APPARATUS FOR PROTECTION AGAINST SHOP LIFTING AND SIMILAR THEFT, NAMELY, BURGLAR AND INTRUDER DETECTORS AND ALARMS FOR RESIDENTIAL AND BUSINESS PREMISES; INFRARED BODY HEAT SENSORS FOR PROTECTION AGAINST SHOP LIFTING AND SIMILAR THEFT; GLASS BREAKAGE DETECTORS AND ALARMS FOR PROTECTION AGAINST SHOP LIFTING AND SIMILAR THEFT; CARD READERS FOR ELECTRONICALLY CONTROLLING ACCESS FOR PROTECTION AGAINST SHOP LIFTING AND SIMILAR THEFT; PLASTIC CASES SPECIALLY ADAPTED FOR PHONOGRAPHS, VIDEOTAPES, COMPACT DISCS, TELEVISION GAME CARTRIDGES AND COMPUTER PROGRAMS DISCS; ANTI-THEFT ALARMS FOR TIES, SHOES, AND SPECTACLES AND OTHER GOODS, NAMELY RADIO FREQUENCY IDENTIFICATION TAGS, MINIATURIZED DETECTORS, ALARMS AND NOISE DETECTORS; RECORDED COMPUTER PRO-

GRAMMES FOR ORDER PROCESSING, IN CLASS 9 (U.S. CLS. 21, 23, 26, 36 AND 38).

FOR: COMPUTER RENTAL; CONSULTANCY IN THE FIELD OF COMPUTER HARDWARE; COMPUTER PROGRAMMING, UPDATING OF COMPUTER SOFTWARE FOR OTHERS, COMPUTER SOFTWARE DESIGN FOR OTHERS, DESIGN FOR OTHERS IN THE FIELD OF WRAPPING DESIGN, PACKAGING DESIGN, GRAPHIC ARTS DESIGN AND INDUSTRIAL DESIGN, RESEARCH AND DEVELOPMENT FOR NEW PRODUCTS FOR OTHERS; LICENSING OF INTELLECTUAL PROPERTY, ENGINEERING SERVICES; QUALITY CONTROL FOR OTHERS; PATENT EXPLOITATION, NAMELY, PATENT LICENSING; TECHNICAL PROJECT STUDIES, NAMELY, CONDUCTING FEASIBILITY STUDIES AND PRODUCT RESEARCH IN THE FIELD

OF PERSONAL, RESIDENTIAL AND COMMERCIAL SECURITY, IN CLASS 42 (U.S. CLS. 100 AND 101).

FOR: CONSULTANCY IN SECURITY MATTERS, NAMELY, IN SECURITY AND SURVIVABILITY OF COMMERCIAL, INDUSTRIAL, AND PUBLIC FACILITIES; LOCKSMITHING, NAMELY, OPENING OF SECURITY LOCKS; NIGHT GUARDS, IN CLASS 45 (U.S. CLS. 100 AND 101).

OWNER OF INTERNATIONAL REGISTRATION 0919124 DATED 10-25-2006, EXPIRES 10-25-2016.

SER. NO. 79-036,592, FILED 10-25-2006.

KRISTINA MORRIS, EXAMINING ATTORNEY

Int. Cls.: 9, 18 and 25

Prior U.S. Cls.: 1, 2, 3, 21, 22, 23, 26, 36, 38, 39 and 41

Reg. No. 3,480,808

United States Patent and Trademark Office

Registered Aug. 5, 2008

**TRADEMARK
PRINCIPAL REGISTER**

WEISE

FWLERS OF BRISTOL LTD (UNITED KING-
DOM LIMITED COMPANY (LTD.))
2-12 BATH ROAD, PYLLE HILL
BRISTOL, BS4 3DR
UNITED KINGDOM

FOR: PROTECTIVE CLOTHING; PROTECTIVE
CLOTHING FOR USE IN MOTOR SPORTS, NAME-
LY, HELMETS, PROTECTIVE VISORS, BACK PADS,
WRIST PADS, ELBOW PADS, KNEE PADS,
SHOULDER PADS, FULL UPPER BODY PROTEC-
TORS, LUMBAR PROTECTORS, PROTECTIVE
JACKETS, PROTECTIVE TROUSERS, PROTECTIVE
GLOVES, PROTECTIVE BOOTS; BAGS AND CASES
FOR HELMETS AND VISORS, IN CLASS 9 (U.S. CLS.
21, 23, 26, 36 AND 38).

FOR: LEATHER AND IMITATIONS OF LEA-
THER, AND GOODS MADE OF THESE MATERI-
ALS AND NOT INCLUDED IN OTHER CLASSES,
NAMELY, BAGS, BRIEFCASES, CASES; CASES FOR
USE ON A MOTORCYCLE; BAGS, NAMELY, SAD-
DLER BAGS, RUCK SACKS, DAY SACKS, BODY
BELTS, ATHLETIC BAGS, BEACH BAGS, COVERS
FOR ALL THE AFORESAID BAGS; SPORTS BAGS
AND HOLDALLS, BAGS AND CASES ADAPTED
FOR USE ON A MOTORCYCLE; ARTICLES OF
LUGGAGE; UMBRELLAS, IN CLASS 18 (U.S. CLS. 1,
2, 3, 22 AND 41).

FOR: CLOTHING, NAMELY, JACKETS, COATS,
JEANS, TROUSERS, PANTS, SKIRTS, DRESSES,

SWEATERS, T-SHIRTS, SHIRTS, WAISTCOATS,
GLOVES, MUFFS, FACE MASKS, BALACLAVAS,
SCARVES, SNOODS, NECK-WARMERS; WATER-
PROOF CLOTHING, NAMELY, WATERPROOF
OVER-SUITS, WATERPROOF OVER-BOOTS AND
WATERPROOF OVER-GLOVES; SUITS AND RACE
SUITS FOR USE IN MOTOR SPORTS; FOOTWEAR,
NAMELY, SHOES, BOOTS, SANDALS, FLIP-FLOPS,
SLIPPERS, SOCKS, TRAINING SHOES; MOTOR-
CYCLE BOOTS; HEADGEAR, NAMELY, CAPS,
HATS, IN CLASS 25 (U.S. CLS. 22 AND 39).

THE MARK CONSISTS OF STANDARD CHAR-
ACTERS WITHOUT CLAIM TO ANY PARTICULAR
FONT, STYLE, SIZE, OR COLOR.

PRIORITY DATE OF 11-15-2006 IS CLAIMED.

OWNER OF INTERNATIONAL REGISTRATION
0920348 DATED 1-29-2007, EXPIRES 1-29-2017.

THE FOREIGN WORDING IN THE MARK
TRANSLATES INTO ENGLISH AS "WISE".

SER. NO. 79-037,034, FILED 1-29-2007.

LINDA ESTRADA, EXAMINING ATTORNEY

Int. Cls.: 4, 20, 21 and 28

Prior U.S. Cls.: 1, 2, 6, 13, 15, 22, 23, 25, 29, 30, 32, 33, 38, 40 and 50

Reg. No. 3,480,809

United States Patent and Trademark Office

Registered Aug. 5, 2008

**TRADEMARK
PRINCIPAL REGISTER**

PTMD

POT EN MAND B.V. (NETHERLANDS BESLO-
TEN VENNOOTSCHAP)
PIETSEWEG 13 A
NL-4751 RT OUD GASTEL
NETHERLANDS

FOR: CANDLES AND LAMP WICKS; LAMP OIL,
IN CLASS 4 (U.S. CLS. 1, 6 AND 15).

FOR: FURNITURE, MIRRORS AND PICTURE
FRAMES, IN CLASS 20 (U.S. CLS. 2, 13, 22, 25, 32 AND
50).

FOR: FLOWER POTS, POTS, VASES, BOWLS,
TRAYS, ALL AFORESAID PRODUCTS OF PRE-
CIOUS METAL; NON-ELECTRIC CANDELABRAS
NOT OF PRECIOUS METAL; TABLEWARE FOR
HOUSEHOLD OR KITCHEN USE, NOT OF PRE-
CIOUS METAL, NOT GILDED OR SILVER PLATED,
NAMELY, PLATES, DISHES, BOWLS, MUGS, CUPS,
SAUCERS; UTENSILS, FOR HOUSEHOLD OR
KITCHEN USE, NOT OF PRECIOUS METAL, NOT
GILDED OR SILVER PLATED, NAMELY,
GRATERS, SIEVES, SPATULAS, STRAINERS AND
TURNERS; GLASSWARE, NAMELY, BEVERAGE
GLASSWARE, FIGURES OF GLASSWARE, GLASS
PLATES, GLASS DISHES, GLASS BOWLS, GLASS
MUGS, GLASS CUPS, GLASS SAUCERS; PORCE-
LAIN WARE, NAMELY, PORCELAIN PLATES,
PORCELAIN DISHES, PORCELAIN BOWLS, POR-
CELAIN MUGS, PORCELAIN CUPS, PORCELAIN

SAUCERS, SCULPTURES OF PORCELAIN, FIG-
URES OF PORCELAIN; EARTHENWARE, NAME-
LY, EARTHENWARE PLATES, EARTHENWARE
DISHES, EARTHENWARE BOWLS, EARTHEN-
WARE MUGS, EARTHENWARE CUPS, EARTHEN-
WARE SAUCERS, SCULPTURES OF
EARTHENWARE AND FIGURES OF EARTHEN-
WARE; FLOWER POTS, POTS, VASES, BOWLS, AND
TRAYS; CANDLE HOLDERS, NAMELY, A HOLDER
FITTED WITH A BELL JAR MADE OF GLASS OR
CRYSTAL TO PROTECT THE CANDLE AGAINST
WIND, RAIN OR STORM, IN CLASS 21 (U.S. CLS. 2,
13, 23, 29, 30, 33, 40 AND 50).

FOR: CHRISTMAS TREE ORNAMENTS EXCEPT
LIGHTING APPARATUS AND CONFECTIONERY,
IN CLASS 28 (U.S. CLS. 22, 23, 38 AND 50).

THE MARK CONSISTS OF STANDARD CHAR-
ACTERS WITHOUT CLAIM TO ANY PARTICULAR
FONT, STYLE, SIZE, OR COLOR.

OWNER OF INTERNATIONAL REGISTRATION
0920525 DATED 2-1-2007, EXPIRES 2-1-2017.

SER. NO. 79-037,128, FILED 2-1-2007.

TANYA AMOS, EXAMINING ATTORNEY

Int. Cls.: 7 and 9

Prior U.S. Cls.: 13, 19, 21, 23, 26, 31, 34, 35, 36 and 38

Reg. No. 3,480,810

United States Patent and Trademark Office

Registered Aug. 5, 2008

**TRADEMARK
PRINCIPAL REGISTER**

EIRICH MOLARIS

MASCHINENFABRIK GUSTAV EIRICH GMBH &
CO. KG (FED REP GERMANY GMBH & CO.
KG)

WALLDÜRNER STR. 50
74736 HARDHEIM, FED REP GERMANY

FOR: MIXING MACHINES FOR THE CHEMICAL, CERAMIC AND METALLURGIC INDUSTRIES AS WELL AS FOR THE BUILDING MATERIALS INDUSTRY, IN PARTICULAR MIXING MACHINES FOR THE CARBON INDUSTRY AND FOR THE ALUMINUM INDUSTRY; STIRRING MACHINES AND KNEADING MACHINES FOR THE CHEMICAL, CERAMIC AND METALLURGIC INDUSTRIES AS WELL AS FOR THE BUILDING MATERIALS INDUSTRY; MILLING AND CHIPPING MACHINES FOR THE CHEMICAL, CERAMIC AND METALLURGIC INDUSTRIES AS WELL AS FOR THE BUILDING MATERIALS INDUSTRY; MILLS FOR THE CHEMICAL, CERAMIC AND METALLURGIC INDUSTRIES AS WELL AS FOR THE BUILDING MATERIALS INDUSTRY, IN PARTICULAR DISC MILLS, MILLS FOR HARD MILLING, WET MILLS AND POWDER MILLS; PAN MILLS; CUT-OFF MACHINES, PRESSING MACHINES, GRANULATING MACHINES, REACTION MACHINES, EMULSIFYING MACHINES AND DISINTEGRATION MACHINES FOR THE CHEMICAL, CERAMIC AND METALLURGIC INDUSTRIES AS WELL AS FOR THE BUILDING MATERIALS INDUSTRY; CONDITIONING MACHINES FOR THE CHEMICAL, CERAMIC AND METALLURGIC INDUSTRIES AS WELL AS FOR THE BUILDING MATERIALS INDUSTRY; PARTS OF THE AFOREMENTIONED MACHINES; ELECTRICALLY OR PNEUMATICALLY DRIVEN MECHANICAL CONVEYORS; PARTS OF THE AFOREMENTIONED GOODS, INCLUDED IN THIS CLASS, IN CLASS 7 (U.S. CLS. 13, 19, 21, 23, 31, 34 AND 35).

FOR: DOSING APPARATUS FOR BULK GOODS;
ELECTRIC OR ELECTRONIC CONTROLS FOR

MIXING MACHINES FOR THE CHEMICAL, CERAMIC AND METALLURGICAL INDUSTRIES, AND FOR THE BUILDING MATERIAL INDUSTRY, IN PARTICULAR MIXING MACHINES FOR THE CARBON INDUSTRY AND FOR THE ALUMINUM INDUSTRY, FOR AGITATING MACHINES AND KNEADING MACHINES FOR THE CHEMICAL, CERAMIC AND METALLURGICAL INDUSTRIES, AND FOR THE BUILDING MATERIAL INDUSTRY, FOR SEPARATING, PRESSING, GRANULATING, REACTION, EMULSIFYING AND DISINTEGRATING MACHINES FOR THE CHEMICAL, CERAMIC AND METALLURGICAL INDUSTRIES, AND FOR THE BUILDING MATERIAL INDUSTRY, FOR PROCESSING MACHINES FOR THE CHEMICAL, CERAMIC AND METALLURGICAL INDUSTRIES, AND FOR THE BUILDING MATERIAL INDUSTRY, FOR DOSING MACHINES FOR BULK GOODS, FOR HOMOGENIZING MACHINES AND AUTOCLAVES (STERILIZING MACHINES) FOR THE CHEMICAL, CERAMIC AND METALLURGICAL INDUSTRIES, AND FOR THE BUILDING MATERIAL INDUSTRY; PARTS FOR THE AFORESAID GOODS, IN CLASS 9 (U.S. CLS. 21, 23, 26, 36 AND 38).

PRIORITY DATE OF 8-30-2006 IS CLAIMED.

OWNER OF INTERNATIONAL REGISTRATION
0920567 DATED 2-8-2007, EXPIRES 2-8-2017.

THE NAME(S), PORTRAIT(S), AND/OR SIGNATURE(S) SHOWN IN THE MARK DOES NOT IDENTIFY A PARTICULAR LIVING INDIVIDUAL.

SER. NO. 79-037,140, FILED 2-8-2007.

FRED CARL, EXAMINING ATTORNEY

Int. Cls.: 9, 38 and 41

Prior U.S. Cls.: 21, 23, 26, 36, 38, 100, 101, 104 and 107

Reg. No. 3,480,811

United States Patent and Trademark Office

Registered Aug. 5, 2008

**TRADEMARK
SERVICE MARK
PRINCIPAL REGISTER**

IATE

LA COMMUNAUTÉ EUROPÉENNE; REPRESENTÉE PAR LA COMMISSION DES COMMUNAUTÉS EUROPÉENNES (BELGIUM ORGANISATION DE DROIT INTERNATIONAL PRIVE)

RUE DE LA LOI 200
B-1049 BRUXELLES
BELGIUM

FOR: SCIENTIFIC, ELECTRIC, PHOTOGRAPHIC, CINEMATOGRAPHIC AND TEACHING APPARATUS AND INSTRUMENTS, NAMELY, VIDEO CAMERAS, DVD RECORDING APPARATUS; APPARATUS FOR RECORDING, TRANSMITTING AND REPRODUCTION OF SOUND OR IMAGES, APPARATUS FOR SPEECH RECORDING AND REPLAYING, APPARATUS FOR TRANSMISSION OF COMMUNICATION; PRE-RECORDED MAGNETIC DATA CARRIERS, PRE-RECORDED DISCS IN THE FIELD OF LINGUISTICS, TRANSLATION AND TERMINOLOGY; CALCULATING MACHINES, DATA PROCESSING AND COMPUTER EQUIPMENT, NAMELY, CALCULATORS AND COMPUTERS; AUDIOVISUAL RECEIVERS FOR USE IN TEACHING; PRE-RECORDED VIDEO TAPES IN THE FIELD OF LINGUISTICS, TRANSLATION AND TERMINOLOGY; VIDEO SCREENS; COMPUTER MONITORS; COMPUTER PERIPHERALS; DATA PROCESSING EQUIPMENT, NAMELY, COMPUTER MICE; ELECTRONIC LIGHT PENS FOR VISUAL DISPLAY UNITS; PRE-RECORDED AUDIO-VIDEO COMPACT DISCS IN THE FIELD OF LINGUISTICS, TRANSLATION AND TERMINOLOGY; PRE-RECORDED MAGNETIC AND OPTICAL DATA MEDIA RELATING TO LINGUISTICS, TRANSLATION AND TERMINOLOGY; PRE-RECORDED MAGNETIC DISCS RELATING TO LINGUISTICS, TRANSLATION AND TERMINOLOGY; PRE-RECORDED OPTICAL DISCS RELATING TO

LINGUISTICS, TRANSLATION AND TERMINOLOGY; PRE-RECORDED OPTICAL COMPACT DISCS RELATING TO LINGUISTICS, TRANSLATION AND TERMINOLOGY; BLANK MAGNETIC COMPUTER TAPES; PRE-RECORDED CDS, CD-ROMS RELATING TO LINGUISTICS, TRANSLATION AND TERMINOLOGY; COMPUTER DISKETTES WITH RECORDED TEXTS AND PICTURES RELATING TO LINGUISTICS, TRANSLATION AND TERMINOLOGY; COMPUTER SOFTWARE TRANSLATION PROGRAMS FOR USE IN LANGUAGE TRANSLATION; RECORDED COMPUTER OPERATING PROGRAMS, IN CLASS 9 (U.S. CLS. 21, 23, 26, 36 AND 38).

FOR: TELECOMMUNICATIONS ACCESS SERVICES; TRANSFER OF DATA BY TELECOMMUNICATIONS; TELECOMMUNICATIONS SERVICES, NAMELY, ELECTRONIC MAIL SERVICES; ELECTRONIC TRANSMISSION OF MESSAGES AND DATA VIA THE INTERNET AND BY EMAIL; TELECOMMUNICATIONS ACCESS SERVICES TO DATA IN ELECTRONIC FORMAT; PROVIDING MULTIPLE USER ACCESS TO A GLOBAL COMPUTER INFORMATION NETWORK FOR PRESS AND INFORMATION AGENCIES; ELECTRONIC TRANSMISSION OF DATA AND INFORMATION; PROVIDING MULTIPLE USER ACCESS TO A GLOBAL COMPUTER INFORMATION NETWORK FOR ACCESS TO DATABASES; COMMUNICATIONS BY COMPUTER TERMINALS; PROVIDING ACCESS TO A GLOBAL COMPUTER NETWORK; ELECTRONIC TRANSMISSION OF MESSAGES AND IMAGES BY COMPUTERS; TELECOMMUNICATIONS SERVICES, NAMELY, THE ELECTRONIC TRANSMISSION OF THE IMAGES AND MESSAGES FOR DISPLAY OF THE IMAGES AND MESSAGES, IN CLASS 38 (U.S. CLS. 100, 101 AND 104).

FOR: EDUCATION IN THE FIELD OF LINGUISTICS, TRANSLATION AND TERMINOLOGY RENDERED THROUGH INTERNET WEBSITES, CORRESPONDENCE COURSES AND VIDEO CONFERENCES AND SEMINARS; TEACHING SERVICES IN THE FIELD OF LINGUISTICS, TRANSLATION AND TERMINOLOGY; TRAINING SERVICES IN THE FIELD OF LINGUISTICS, TRANSLATION AND TERMINOLOGY; EDUCATIONAL AND ENTERTAINMENT SERVICES, NAMELY, A CONTINUING PROGRAM ABOUT LINGUISTICS, TRANSLATION AND TERMINOLOGY ACCESSIBLE BY RADIO, TELEVISION, SATELLITE, AUDIO, VIDEO AND COMPUTER NETWORKS; ORGANIZING COMMUNITY CULTURAL EVENTS; INSTRUCTION IN THE FIELD OF LINGUISTICS, TRANSLATION AND TERMINOLOGY; PROVIDING PRACTICAL EDUCATIONAL TRAINING DEMONSTRATIONS; PROVIDING INFORMATION ON EDUCATION; PROVIDING ONLINE NON-DOWNLOADABLE PUBLICATIONS IN THE NATURE OF NEWSLETTERS, ELECTRONIC MAGAZINES IN THE FIELD OF LINGUISTICS, TRANSLATION AND TERMINOLOGY; PROVIDING ONLINE CARD GAMES, PROVIDING ONLINE COMPUTER GAMES; ORGANIZATION OF EXHIBITIONS FOR CULTURAL AND EDUCATIONAL PURPOSES, IN PARTICULAR FOR THE PURPOSE OF EDUCATING THE PUBLIC ON LINGUISTICS, TRANSLATIONS AND ISSUES RELATING TO TERMINOLOGY; PUBLICATION OF BOOKS; ARRANGING AND CONDUCTING TRAINING WORKSHOPS, COLLOQUIUMS, CONFERENCES,

CONVENTIONS, SEMINARS AND SYMPOSIUMS IN THE FIELD OF LINGUISTICS, TRANSLATION AND TERMINOLOGY; ELECTRONIC PUBLISHING SERVICES OTHER THAN ADVERTISING, NAMELY, PUBLICATION OF TEXTS OF OTHERS ONLINE FEATURING INFORMATION ON LINGUISTICS, TRANSLATION AND TERMINOLOGY; PUBLISHING OF ELECTRONIC PUBLICATIONS, NAMELY, ELECTRONIC PUBLISHING OF ONLINE BOOKS AND PERIODICALS; MULTIMEDIA PUBLISHING OF SOFTWARE AND DOCUMENTS IN THE NATURE OF NEWSLETTERS RELATING TO LINGUISTICS, TRANSLATION AND TERMINOLOGY; TRANSLATION SERVICES, IN CLASS 41 (U.S. CLS. 100, 101 AND 107).

THE MARK CONSISTS OF STANDARD CHARACTERS WITHOUT CLAIM TO ANY PARTICULAR FONT, STYLE, SIZE, OR COLOR.

PRIORITY DATE OF 10-20-2006 IS CLAIMED.

OWNER OF INTERNATIONAL REGISTRATION 0920749 DATED 2-7-2007, EXPIRES 2-7-2017.

IATE HAS NO MEANING IN A FOREIGN LANGUAGE.

SER. NO. 79-037,207, FILED 2-7-2007.

TANYA AMOS, EXAMINING ATTORNEY

Int. Cl.: 28

Prior U.S. Cls.: 22, 23, 38 and 50

United States Patent and Trademark Office

Reg. No. 3,480,812

Registered Aug. 5, 2008

**TRADEMARK
PRINCIPAL REGISTER**



PEDRO HENRIQUE VIEIRA XAVIER; CARRA-
DINHA (PORTUGAL INDIVIDUAL)
AV^a 5 DE OUTUBRO, N^o 198, 6^o ESQ.
P-1050-064 LISBOA, PORTUGAL

OWNER OF INTERNATIONAL REGISTRATION
0920964 DATED 2-1-2007, EXPIRES 2-1-2017.

FOR: MOUNTAINEERING EQUIPMENT, NAME-
LY, BINDING STRAPS, HOOK AND RING COMBI-
NATIONS, HOOKS; TREKKING POLES;
ARTIFICIAL CLIMBING WALLS; BAGS SPECIAL-
LY ADAPTED FOR SPORTS EQUIPMENT; CASES
SPECIALLY ADAPTED FOR SPORTS EQUIPMENT;
AND NORDIC WALKING POLES, IN CLASS 28 (U.S.
CLS. 22, 23, 38 AND 50).

THE WORDING "ORTIK" HAS NO MEANING IN
A FOREIGN LANGUAGE.

SER. NO. 79-037,275, FILED 2-1-2007.

PRIORITY DATE OF 8-1-2006 IS CLAIMED.

TANYA AMOS, EXAMINING ATTORNEY

Int. Cl.: 10

Prior U.S. Cls.: 26, 39 and 44

United States Patent and Trademark Office

Reg. No. 3,480,813

Registered Aug. 5, 2008

**TRADEMARK
PRINCIPAL REGISTER**

BELLAVISTA

IMTMEDICAL AG (SWITZERLAND SOCIÉTÉ
ANONYME (SA); INCORPORATED COMPAN-
NY)
GEWERBESTRASSE 8
BUCHS SG, SWITZERLAND CH9470

FOR: MEDICAL INSTRUMENTS AND APPARA-
TUSES, NAMELY, PATIENT MONITORING SEN-
SORS AND ALARMS FOR USE IN INTENSIVE
CARE TREATMENT AND VENTILATORS FOR
USE IN INTENSIVE HOME AND HOSPITAL PA-
TIENT CARE, IN CLASS 10 (U.S. CLS. 26, 39 AND 44).

THE MARK CONSISTS OF STANDARD CHAR-
ACTERS WITHOUT CLAIM TO ANY PARTICULAR
FONT, STYLE, SIZE, OR COLOR.

PRIORITY DATE OF 9-4-2006 IS CLAIMED.

OWNER OF INTERNATIONAL REGISTRATION
0920970 DATED 3-1-2007, EXPIRES 3-1-2017.

THE ENGLISH TRANSLATION OF "BELLA VIS-
TA" IS "BEAUTIFUL VIEW".

SER. NO. 79-037,276, FILED 3-1-2007.

AMY MCMENAMIN, EXAMINING ATTORNEY

Int. Cl.: 31

Prior U.S. Cls.: 1 and 46

United States Patent and Trademark Office

Reg. No. 3,480,814

Registered Aug. 5, 2008

TRADEMARK
PRINCIPAL REGISTER

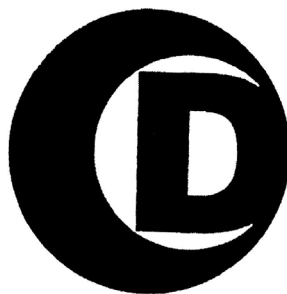

金康达

HUAIAN CITY KANGDA FEED CO., LTD. (CHINA CORPORATION)
TIEYINGCUN
BAOJIZHEN, XUYIXIAN
JIANGSU, CHINA

FOR: ADDITIVES TO FODDER, NOT FOR MEDICAL PURPOSES; FODDER; ANIMAL FOODSTUFFS; BEVERAGES FOR PETS; STALL FOOD FOR ANIMALS, NAMELY, NUTRITIONAL ADDITIVES FOR ANIMAL FOODSTUFFS, NOT FOR MEDICAL PURPOSES; PROTEIN FOR ANIMAL CONSUMPTION, NAMELY, SOY BEAN MEAL; BIRD FOOD, NAMELY, BIRD SEED; ANIMAL FATTENING PREPARATIONS, NAMELY, ANIMAL FEED ADDITIVES FOR NON-NUTRITIONAL PURPOSES FOR USE AS INGREDIENT OR FILLER, IN CLASS 31 (U.S. CLS. 1 AND 46).

OWNER OF INTERNATIONAL REGISTRATION
0921059 DATED 4-3-2007, EXPIRES 4-3-2017.

THE TRANSLITERATION, "JIN KANG DA," DOES NOT HAVE A MEANING IN ENGLISH.

THE NON-LATIN CHARACTERS IN THE MARK TRANSLITERATE TO "JIN KANG DA," AND THIS IS MEANINGLESS IN ENGLISH.

SER. NO. 79-037,307, FILED 4-3-2007.

MARLENE BELL, EXAMINING ATTORNEY

Int. Cls.: 9 and 42

Prior U.S. Cls.: 21, 23, 26, 36, 38, 100 and 101

United States Patent and Trademark Office

Reg. No. 3,480,815

Registered Aug. 5, 2008

**TRADEMARK
SERVICE MARK
PRINCIPAL REGISTER**

AD - O R I O N

A&D COMPANY, LTD. (JAPAN CORPORATION)
23-14, HIGASHI IKEBUKURO 3-CHOME
TOSHIMA-KU; TOKYO 170-0013
JAPAN

FOR: COMPUTER HARDWARE, SOFTWARE,
AND PERIPHERALS, SOLD AS A UNIT, FOR MEASURING, TESTING AND CALIBRATING AUTOMOBILE ENGINE TORQUE AND AUTOMOBILE ENGINE REVOLUTIONS; COMPUTER SOFTWARE FOR MEASURING, TESTING AND CALIBRATING AUTOMOBILE ENGINE TORQUE AND AUTOMOBILE ENGINE REVOLUTIONS; ENCODED ELECTRONIC CIRCUIT CARDS CONTAINING PROGRAMMING FOR MEASURING, TESTING AND CALIBRATING AUTOMOBILE ENGINE TORQUE AND AUTOMOBILE ENGINE REVOLUTIONS, IN CLASS 9 (U.S. CLS. 21, 23, 26, 36 AND 38).

FOR: PROVIDING ON-LINE NON-DOWNLOADABLE SOFTWARE FOR MEASURING, TESTING AND CALIBRATING AUTOMOBILE ENGINE TORQUE AND AUTOMOBILE ENGINE REVOLUTIONS, IN CLASS 42 (U.S. CLS. 100 AND 101).

PRIORITY DATE OF 10-5-2006 IS CLAIMED.

OWNER OF INTERNATIONAL REGISTRATION
0921509 DATED 3-5-2007, EXPIRES 3-5-2017.

SER. NO. 79-037,506, FILED 3-5-2007.

TANYA AMOS, EXAMINING ATTORNEY

Int. Cls.: 5, 16, 24 and 25

**Prior U.S. Cls.: 2, 5, 6, 18, 22, 23, 29, 37, 38, 39, 42, 44,
46, 50, 51 and 52**

Reg. No. 3,480,816

United States Patent and Trademark Office

Registered Aug. 5, 2008

**TRADEMARK
PRINCIPAL REGISTER**

Nanosan

SCHILL + SEILACHER AKTIENGESELL-
SCHAFT (FED REP GERMANY AG)
SCHÖNAICHER STR. 205
71032 BÖBLINGEN
FED REP GERMANY

FOR: SURGICAL DRESSINGS, SURGICAL BANDAGES; COMPRESSES; SURGICAL WOVEN FABRICS AND SURGICAL NON-WOVEN FABRICS; HEMOSTATIC PENCILS, HEMOSTATIC SPONGES AND HEMOSTATIC PADS; SANITARY TOWELS, MENSTRUATION PADS AND SANITARY PANTIES, HYGIENIC BANDAGES AND BANDAGES FOR DRESSINGS; NON-WOVEN FABRICS FOR INTERNAL AND TOPOLOGIC HEMOSTASIS AND FOR USE IN HERNIORRHAPHY AND HERNIOPLASTY; NAPKINS AND ABSORBENT PANTS FOR INCONTINENTS, IN CLASS 5 (U.S. CLS. 6, 18, 44, 46, 51 AND 52).

FOR: BABIES' NAPKINS MADE OF CELLULOSE OR PAPER, IN CLASS 16 (U.S. CLS. 2, 5, 22, 23, 29, 37, 38 AND 50).

FOR: NON-WOVEN TEXTILE FABRICS; TEXTILE GOODS, NAMELY, QUILTS, TAPESTRIES, NAPKINS, PLACEMATS, TOWELS, TABLECLOTHS, SHEETS; FILTERING MATERIALS OF NON-WOVEN TEXTILE FABRIC; ABSORBENT PADS IN THE NATURE OF BED PADS AND MATTRESS PADS; BED CLOTHES, NAMELY, BED SHEETS, BED SPREADS, BED BLANKETS, MATTRESS COVERS, PILLOW CASES; UPHOLSTERY FABRICS, IN CLASS 24 (U.S. CLS. 42 AND 50).

FOR: BABIES' DIAPERS OF TEXTILE; BABIES' PANTS, IN CLASS 25 (U.S. CLS. 22 AND 39).

OWNER OF INTERNATIONAL REGISTRATION
0922104 DATED 3-26-2007, EXPIRES 3-26-2017.

SER. NO. 79-037,742, FILED 3-26-2007.

KATHERINE CONNOLLY, EXAMINING ATTORNEY

Int. Cl.: 33

Prior U.S. Cls.: 47 and 49

United States Patent and Trademark Office

Reg. No. 3,480,817

Registered Aug. 5, 2008

**TRADEMARK
PRINCIPAL REGISTER**

CHAT ROUGE

SOCIETE ANONYME; GRANDS TERROIRS ET
SIGNATURES (FRANCE SOCIÉTÉ ANON-
YME)

LE RIBOUILLON
F-69430 QUINCIE EN BEAUJOLAIS
FRANCE

FOR: WINES, IN CLASS 33 (U.S. CLS. 47 AND 49).

THE MARK CONSISTS OF STANDARD CHAR-
ACTERS WITHOUT CLAIM TO ANY PARTICULAR
FONT, STYLE, SIZE, OR COLOR.

OWNER OF INTERNATIONAL REGISTRATION
0923455 DATED 4-10-2007, EXPIRES 4-10-2017.

THE FOREIGN WORDING IN THE MARK
TRANSLATES INTO ENGLISH AS RED CAT.

SER. NO. 79-038,235, FILED 4-10-2007.

NORA BUCHANAN WILL, EXAMINING ATTOR-
NEY

Int. Cls.: 5 and 11

Prior U.S. Cls.: 6, 13, 18, 21, 23, 31, 34, 44, 46, 51 and 52

United States Patent and Trademark Office

Reg. No. 3,480,818

Registered Aug. 5, 2008

**TRADEMARK
PRINCIPAL REGISTER**

DESERT

DESERT ECO SYSTEMS PTY LTD (AUSTRALIA
PROPRIETARY LIMITED COMPANY (PTY
LTD))
R/OFF 4 BELINDA STREET
EVANDALE SA, AUSTRALIA 5069

FOR: SANITARY PREPARATIONS, NAMELY,
DISINFECTANTS IN THE NATURE OF URINAL
BLOCKS AND MICROBIAL WATERLESS URINAL
COMPOSITIONS, IN CLASS 5 (U.S. CLS. 6, 18, 44, 46,
51 AND 52).

FOR: REGULATING ACCESSORIES FOR WATER
SUPPLY, NAMELY, METERED VALVES; DISIN-
FECTANT DISPENSERS FOR TOILETS, IN CLASS
11 (U.S. CLS. 13, 21, 23, 31 AND 34).

THE MARK CONSISTS OF STANDARD CHAR-
ACTERS WITHOUT CLAIM TO ANY PARTICULAR
FONT, STYLE, SIZE, OR COLOR.

PRIORITY DATE OF 9-27-2006 IS CLAIMED.

OWNER OF INTERNATIONAL REGISTRATION
0923716 DATED 3-26-2007, EXPIRES 3-26-2017.

OWNER OF U.S. REG. NO. 3,256,604.

SER. NO. 79-038,327, FILED 3-26-2007.

DAVID MILLER, EXAMINING ATTORNEY

Int. Cl.: 9

Prior U.S. Cls.: 21, 23, 26, 36 and 38

Reg. No. 3,480,819

United States Patent and Trademark Office

Registered Aug. 5, 2008

**TRADEMARK
PRINCIPAL REGISTER**



NOKIA CORPORATION (FINLAND CORPORATION)
KEILALAHDENTIE 4
FI-02150 ESPOO
FINLAND

FOR: MOBILE TELEPHONE ACCESSORIES, NAMELY, ANTENNAS, AUDIO ADAPTERS, BATTERIES, BATTERY CHARGERS, CARRYING CASES FOR MOBILE TELEPHONES, CHARGER ADAPTERS, CLIPS FOR MOBILE TELEPHONES, DATA CABLES, DESKTOP STANDS AND HOLDERS FOR MOBILE TELEPHONES, DEVICES FOR HANDS-FREE USE OF MOBILE TELEPHONES IN VEHICLES, DIGITAL PENS, NAMELY, COMPUTER CURSOR CONTROL DEVICES IN THE NATURE OF LIGHT PENS, EARPHONES, ELECTRIC CABLES, HEADPHONES, KEYBOARDS, LOUDSPEAKERS, MEMORY CARDS, MICROPHONES, POWER SUP-

PLIES, RADIO TRANSMITTERS, TRIPODS FOR CAMERAS, AND WIRELESS GPS NAVIGATION MODULES; DVDS AND CD-ROMS FEATURING GUIDES AND INSTRUCTION MANUALS FOR MOBILE TELEPHONES, IN CLASS 9 (U.S. CLS. 21, 23, 26, 36 AND 38).

OWNER OF INTERNATIONAL REGISTRATION
0924169 DATED 4-13-2007, EXPIRES 4-13-2017.

NO CLAIM IS MADE TO THE EXCLUSIVE RIGHT TO USE "ORIGINAL ACCESSORIES", APART FROM THE MARK AS SHOWN.

SER. NO. 79-038,477, FILED 4-13-2007.

TANYA AMOS, EXAMINING ATTORNEY

Int. Cls.: 22, 24 and 27

Prior U.S. Cls.: 1, 2, 7, 19, 20, 22, 37, 42 and 50

Reg. No. 3,480,820

United States Patent and Trademark Office

Registered Aug. 5, 2008

**TRADEMARK
PRINCIPAL REGISTER**

CGEAR

CGEAR AUSTRALIA PTY LTD (AUSTRALIA CORPORATION)
BUILDING D1-1
85 TURNER STREET
PORT MELBOURNE VIC 3207, AUSTRALIA

FOR: MARQUEES IN THE NATURE OF WOVEN, NON-WOVEN AND KNITTED MESH FABRIC CANOPIES AND AWNINGS FOR SHADE, SHELTERING AND PROTECTION; PERMANENT, PORTABLE AND DEMOUNTABLE MARQUEES IN THE NATURE OF WOVEN, NON-WOVEN, AND KNITTED MESH FABRIC CANOPIES AND AWNINGS FOR SHADE, SHELTERING AND PROTECTION; MARQUEES FOR OUTDOOR SHADE, SHELTERING AND PROTECTION, NAMELY, WOVEN, NON-WOVEN AND KNITTED MESH FABRIC AWNINGS AND CANOPIES; AWNINGS AND CANOPIES MADE OF WOVEN, NON-WOVEN AND KNITTED MESH SHEET MATERIAL, PLASTIC WOVEN, NON-WOVEN AND KNITTED MESH FABRIC, FABRICS AND MATERIALS; AWNINGS MADE OF PLASTIC CLOTH; SHADE SAILS; TARPAULINS; TENTS; RETRACTABLE COVERS FOR TENTS; BEACH AWNINGS AND CANOPIES MADE OF WOVEN, NON-WOVEN AND KNITTED MESH, FABRIC, FABRICS AND MATERIALS; CARAVAN AWNINGS; MARKET AWNINGS AND CANOPIES MADE OF WOVEN, NON-WOVEN AND KNITTED MESH FABRIC, FABRICS AND MATERIALS; PLASTIC INSECT PROTECTION NETS AND NETTING; AWNINGS OF TEXTILE; SHADE AWNINGS AND CANOPIES MADE OF WOVEN, NON-WOVEN AND KNITTED MESH FABRIC, FABRICS AND MATERIALS; GROUNDSHEETS MADE FROM WOVEN, NON-WOVEN AND KNITTED MESH FABRIC, FABRICS AND MATERIALS, IN CLASS 22 (U.S. CLS. 1, 2, 7, 19, 22, 42 AND 50).

FOR: TEXTILE FABRICS AND CLOTHS FOR USE IN THE MANUFACTURE OF GROUND COVERINGS, CANOPIES, AWNINGS, SHADES, TARPAULINS AND TENTS; SYNTHETIC TEXTILE FABRICS AND CLOTHS FOR USE IN THE MANUFACTURE

OF GROUND COVERINGS, CANOPIES, AWNINGS, SHADES, TARPAULINS AND TENTS; WOVEN, NON-WOVEN AND KNITTED TEXTILE FABRICS AND CLOTHS FOR USE IN THE MANUFACTURE OF GROUND COVERINGS, CANOPIES, AWNINGS, SHADES, TARPAULINS AND TENTS; PLASTIC COATED TEXTILE FABRICS AND CLOTHS FOR USE IN THE MANUFACTURE OF GROUND COVERINGS, CANOPIES, AWNINGS, SHADES, TARPAULINS AND TENTS; PLASTIC FABRIC AND CLOTH TEXTILES FOR USE IN THE MANUFACTURE OF GROUND COVERINGS, CANOPIES, AWNINGS, SHADES, TARPAULINS AND TENTS; PLASTIC COATED FABRICS AND CLOTHS FOR USE IN THE MANUFACTURE OF GROUND COVERINGS, CANOPIES, AWNINGS, SHADES, TARPAULINS AND TENTS; WOVEN, NON-WOVEN AND KNITTED FABRICS AND CLOTHS FOR USE IN THE MANUFACTURE OF GROUND COVERINGS, CANOPIES, AWNINGS, SHADES, TARPAULINS AND TENTS; PLASTIC COATED FABRICS AND CLOTHS FOR USE IN THE MANUFACTURE OF GROUND COVERINGS, CANOPIES, AWNINGS, SHADES, TARPAULINS AND TENTS; WOVEN, NON-WOVEN AND KNITTED MESH FABRICS AND CLOTHS FOR USE IN THE MANUFACTURE OF GROUND COVERINGS, CANOPIES, AWNINGS, SHADES, TARPAULINS AND TENTS; TEXTILE FABRICS AND CLOTHS FOR USE IN THE MANUFACTURE OF SCREENS, SHELTERS, SHADES AND WINDSCREENS; SWAGS, IN CLASS 24 (U.S. CLS. 42 AND 50).

FOR: MATS AND MATTING, NAMELY, POLYETHYLENE KNITTED MATS AND MATTING FOR COVERING OUTDOOR GROUND SURFACES, PLASTIC PERSONAL SITTING MATTING FOR OUTDOOR USE; PLASTIC OUTDOOR GROUND SURFACE MATTING HAVING MILITARY USE; POLYETHYLENE KNITTED OUTDOOR GROUND SURFACE MATS AND MATTING HAVING MILITARY USE; PLASTIC OUTDOOR GROUND SURFACE MATS AND MATTING FOR RECREATIONAL USE; POLYETHYLENE KNITTED OUTDOOR GROUND SURFACE MATS AND MATTING FOR RECREATIONAL USE, IN CLASS 27 (U.S. CLS. 19, 20, 37, 42 AND 50).

THE MARK CONSISTS OF STANDARD CHARACTERS WITHOUT CLAIM TO ANY PARTICULAR FONT, STYLE, SIZE, OR COLOR.

OWNER OF INTERNATIONAL REGISTRATION 0924347 DATED 2-28-2007, EXPIRES 2-28-2017.

SER. NO. 79-038,542, FILED 2-28-2007.

PRIORITY DATE OF 1-24-2007 IS CLAIMED.

CHARLOTTE CORWIN, EXAMINING ATTORNEY

Int. Cls.: 18 and 25

Prior U.S. Cls.: 1, 2, 3, 22, 39 and 41

Reg. No. 3,480,821

United States Patent and Trademark Office

Registered Aug. 5, 2008

**TRADEMARK
PRINCIPAL REGISTER**

EnviroSax

MARK DAVID-TOOZE (AUSTRALIA INDIVIDUAL)

UNIT 11

2 HAWKER STREET; CURRUMBIN QLD 4223

AUSTRALIA AND

BELINDA DAVID-TOOZE (AUSTRALIA INDIVIDUAL)

UNIT 11

2 HAWKER STREET; CURRUMBIN QLD 4223

AUSTRALIA

FOR: IMITATION LEATHER BAGS, HANDBAGS, PURSES, LUGGAGE AND GARMENT BAGS FOR TRAVEL; CANVAS SHOPPING BAGS, MESH SHOPPING BAGS, LEATHER SHOPPING BAGS, TEXTILE SHOPPING BAGS, AND SHOPPING BAGS MADE FROM SYNTHETIC FABRICS; AND SHOULDER BAGS, BACKPACKS, CARRY-ALL BAGS, AND CARRY-ON BAGS MADE FROM TEXTILE AND SYNTHETIC FABRICS, IN CLASS 18 (U.S. CLS. 1, 2, 3, 22 AND 41).

FOR: FOOTWEAR, HATS, CAPS, TROUSERS, PANTS, SHIRTS, VESTS, T-SHIRTS, SWEAT SHIRTS, SWEAT PANTS, SWEAT BANDS, SWEAT SHORTS, SWEAT SUITS, SWEATERS, SWIM WEAR, SWIM SUITS, SPORT SHIRTS, SHORTS, SCARVES, COATS, JACKETS, SUITS, RAINWEAR, POLO SHIRTS, PONCHOS, NECKERCHIEFS, NECKTIES, NECKWEAR, KNIT SHIRTS, GYM SHORTS, GYM SHIRTS, AND GYM SUITS, IN CLASS 25 (U.S. CLS. 22 AND 39).

THE MARK CONSISTS OF STANDARD CHARACTERS WITHOUT CLAIM TO ANY PARTICULAR FONT, STYLE, SIZE, OR COLOR.

OWNER OF INTERNATIONAL REGISTRATION 0924379 DATED 4-13-2007, EXPIRES 4-13-2017.

SER. NO. 79-038,555, FILED 4-13-2007.

TANYA AMOS, EXAMINING ATTORNEY

Int. Cls.: 6, 19 and 24

Prior U.S. Cls.: 1, 2, 12, 13, 14, 23, 25, 33, 42 and 50

United States Patent and Trademark Office

Reg. No. 3,480,822

Registered Aug. 5, 2008

**TRADEMARK
PRINCIPAL REGISTER**



CHARLES LAUZIER (FRANCE SOCIÉTÉ PAR
ACTIONS SIMPLIFIÉE)

Z.A. LAFAYETTE

F-38790 SAINT GEORGES D'ESPERANCHE

FRANCE

FOR: TRANSPORTABLE METAL CONSTRUCTIONS, FRAMEWORKS OF METAL, METAL WINDOW CASEMENTS AND METAL WINDOW AND DOOR FITTINGS, NAMELY, DOOR CASINGS, DOOR FRAMES, DOOR JAMB; METAL FURNITURE CASTORS AND FITTINGS, NAMELY, CASTORS, HANDLES, HINGES; METALLIC PARTITIONS AND FENCES; METAL BUILDING PANELS; METAL EXTERIOR BLINDS, METAL WINDOW SHUTTERS AND METAL ROLLER SHUTTERS; METAL MOULDINGS, METAL CORNICES AND ANGLE BEAMS; METAL STAIRCASES, METAL LOCKS, METAL BUILDING FLASHINGS, METAL CHIMNEY WIND VANES, METAL RAILINGS FOR FENCES, BALCONIES, STAIRS, METAL GRAB RAILS, METAL GUARD RAILS, METAL HAND RAILS, INTERIOR METAL SHUTTERS, METAL ROLL SHUTTERS, METAL LOUVRES, METAL WINDOW SILLS, METAL LINTELS, METAL STRIPS, METAL FENCES, METAL FLOORS, METAL CUPBOARDS, METAL STORAGE BOXES, METAL FACINGS, METAL DOOR CASES, METAL DOORS AND WINDOWS; METAL ARMATURES, METAL FITTINGS, NAMELY, HINGES, METAL GUIDES AND DOOR PANELS FOR SECTIONS OF GATES; METAL MANTELPieces, METAL CHIMNEY EXTENSIONS, IN CLASS 6 (U.S. CLS. 2, 12, 13, 14, 23, 25 AND 50).

FOR: SEMI-WORKED WOOD, BEAMS NOT OF METAL, PLANKS, CONCRETE PANELS, PLYWOOD, SHAPED WOOD, TIMBER, BUILDING TIMBER, WOOD PANELING, WOOD VENEERS, VENEER WOOD; NON-METALLIC REINFORCEMENTS FOR CONCRETE AND WOOD BUILDING CONSTRUCTION, NAMELY, PLATES, RODS AND BARS, NON-METAL WINDOW CASEMENTS, NON-METAL BUILDING PANELS, NON-METAL WINDOW AND DOOR FRAMES; NON-METALLIC MANTELPieces, NON-METALLIC LENGTHENING PIECES FOR CHIMNEYS, NAMELY, CHIMNEY PIPE EXTENSIONS; NON-METALLIC WAINSCOTING AND LATHS; WOOD STRIPS FOR PANELING, NAMELY, WOOD MOLDINGS, PARQUET FLOOR BOARDS, NON-METALLIC PALINGS, PARQUET WOOD FLOORING, NON-METALLIC FLOORS; NON-METAL STAIRS, NON-METAL PALINGS, NON-METAL EXTERIOR BLINDS, NON-METAL WINDOW SHUTTERS, NON-METAL ROLLING SHUTTERS, NON-METAL LOUVRES, NON-METAL WINDOW SILLS, NON-METAL LINTELS, NON-METAL RAILINGS FOR FENCES, BALCONIES, STAIRS, NON-METAL GRAB RAILS, NON-METAL GUARD RAILS, NON-METAL HAND RAILS, DOOR CASINGS, NOT OF METAL, NONMETALLIC DOORS AND WINDOWS; NON-METALLIC PARTITIONS; NON-METALLIC FENCES; CORNICES, ANGLE BEAMS, NOT OF METAL, NON-METALLIC MOULDINGS; NON-METAL CUPBOARDS, NON-METALLIC STORAGE BOXES AND FACINGS, IN CLASS 19 (U.S. CLS. 1, 12, 33 AND 50).

FOR: TEXTILE OR PLASTIC CURTAINS; DOOR
CURTAINS, IN CLASS 24 (U.S. CLS. 42 AND 50).

SER. NO. 79-038,569, FILED 4-24-2007.

OWNER OF INTERNATIONAL REGISTRATION
0880841 DATED 9-20-2005, EXPIRES 9-20-2015.

ALICE BENMAMAN, EXAMINING ATTORNEY

Int. Cls.: 29, 30, 31, 32, 33, 35 and 43

Prior U.S. Cls.: 1, 45, 46, 47, 48, 49, 100, 101 and 102

United States Patent and Trademark Office

Reg. No. 3,480,823

Registered Aug. 5, 2008

**TRADEMARK
SERVICE MARK
PRINCIPAL REGISTER**



FAMIGLIA CHIARI S.R.L. (ITALY LIMITED LIABILITY COMPANY)
VIA ROMA, 55/A
I-40069 ZOLA PREDOSA (BO)
ITALY

FOR: MEAT, FISH, POULTRY AND GAME; MEAT EXTRACTS; PRESERVED, DRIED AND COOKED FRUITS AND VEGETABLES; JELLIES, JAMS, COMPOTES; EGGS, MILK, CREAM, BUTTER, CHEESE, YOGURT; MILK-BASED PRODUCTS EXCLUDING ICE CREAM AND ICE MILK AND FROZEN YOGURT; YOGURT CREAMS, MILK CREAMS; SOYA MILK AND OTHER MILK-BASED PRODUCTS, NAMELY, CREAM, FRESH CHEESE, SOUR CREAM; GASTRONOMIC CHEESE-BASED PREPARATIONS, NAMELY, CHEESE FOOD; EDIBLE OILS AND FATS, IN CLASS 29 (U.S. CL. 46).

FOR: COFFEE, TEA, COCOA, SUGAR, RICE, SUBSTITUTES OF COFFEE; CHOCOLATE, CHOCOLATE PRODUCTS, NAMELY, FILLED CHOCOLATE BARS AND NON-FILLED CHOCOLATE BARS, FROZEN CHOCOLATE CONFECTIONERY, PRALINES, FILLED CHOCOLATE, CHOCOLATE TRUFFLES, HOLLOW CHOCOLATE FIGURES AND SOLID CHOCOLATE FIGURES; CONFECTIONERY, NAMELY, PETIT FOURS, SWEET CAKES, TARTS, CHOCOLATE PASTES; PASTRY, SWEETS, FLOURS AND CEREAL-MADE PRODUCTS, NAMELY, PROCESSED CEREAL FOR USE AS A BREAKFAST FOOD, SNACK FOOD OR INGREDIENT FOR MAKING FOOD, CEREAL BASED SNACK FOODS AND STUFFING MIXES

CONTAINING FLOUR OR CEREALS, MUESLI; BREAD PRODUCTS, NAMELY, RUSKS, TOAST, BREAD-STICKS, BISCUITS, WAFERS; DESSERTS, NAMELY, DESSERT SOUFFLÉS, DESSERT MOUSSES, PUDDINGS; SORBETS, PASTA; RICE-BASED, FLOUR-BASED AND CEREAL-BASED PRODUCTS, EVEN AS READY-COOKED DISHES, NAMELY, PREPARED AND PACKAGED MEALS CONSISTING PRIMARILY OF PASTA AND CEREALS; SALAD CONDIMENTS, NAMELY, FRENCH DRESSINGS, MUSTARD, VINEGAR, SAUCES; FLAVORING SYRUPS, INCLUDING, COFFEE FLAVORED SYRUP USED IN MAKING READY-TO-DRINK COFFEE AND READY-TO-DRINK COFFEE BASED BEVERAGES, IN CLASS 30 (U.S. CL. 46).

FOR: FRESH FRUITS AND VEGETABLES; LIVE NATURAL PLANTS AND FLOWERS, IN CLASS 31 (U.S. CLS. 1 AND 46).

FOR: BEERS; MINERAL AND AERATED WATERS, NON ALCOHOLIC DRINKS, NAMELY, DRINKING WATERS; FLAVORED WATERS; MINERAL AND AERATED WATERS; SOFT DRINKS; ENERGY DRINKS AND SPORTS DRINKS; FRUIT DRINKS AND FRUIT JUICES; SYRUPS, CONCENTRATES AND POWDERS FOR MAKING BEVERAGES, NAMELY, FLAVORED WATERS, MINERAL AND AERATED WATERS, SOFT DRINKS, ENERGY DRINKS AND SPORTS DRINKS, FRUIT DRINKS AND JUICES; FRUIT DRINKS AND JUICES; SYRUPS FOR MAKING BEVERAGES, NAMELY, FOR MAKING FRUIT FLAVORED DRINKS, COFFEE FLAVORED SOFT DRINKS; FRUIT NECTARS,

LEMONADES, IN CLASS 32 (U.S. CLS. 45, 46 AND 48).

FOR: ALCOHOLIC BEVERAGES NAMELY, WINE, LIQUORS, ALCOHOLIC PUNCH, ALCOHOLIC BITTERS, IN CLASS 33 (U.S. CLS. 47 AND 49).

FOR: ONLINE RETAIL STORES FEATURING FOOD PRODUCTS; RETAIL STORE SERVICES FEATURING FOOD PRODUCTS; MAIL ORDER CATALOGUE SERVICES FEATURING FOOD PRODUCTS; MANAGEMENT OF RETAIL STORES; WHOLESALE OUTLETS FEATURING FOOD PRODUCTS; ADVERTISING; BUSINESS MANAGEMENT, IN CLASS 35 (U.S. CLS. 100, 101 AND 102).

FOR: SERVICES FOR PROVIDING FOOD AND DRINK, NAMELY, RESTAURANTS, CATERING OF FOOD AND DRINKS, SERVING FOOD AND DRINKS; PROVIDING TEMPORARY ACCOMMODATION, IN CLASS 43 (U.S. CLS. 100 AND 101).

PRIORITY DATE OF 2-23-2007 IS CLAIMED.

OWNER OF INTERNATIONAL REGISTRATION 0924467 DATED 4-5-2007, EXPIRES 4-5-2017.

THE TRADEMARK IS CONSTITUTED BY THE WORDS "VECCHIA MALGA" IN FANCY CURSIVE CHARACTERS. THE STYLIZED LETTER "V" IS MADE OF TWO CURVILINEAR STROKES, PARTIALLY SUPERIMPOSED AND IT DOMINATES THE OTHER LETTERS OF THE WORD "VECCHIA". THE WORDS "VECCHIA MALGA" ARE UNDERLINED BY A CURVED STROKE.

THE ENGLISH TRANSLATION OF THE FOREIGN WORD(S) IN THE MARK IS ANCIENT ALPINE HUT.

SER. NO. 79-038,589, FILED 4-5-2007.

ELI HELLMAN, EXAMINING ATTORNEY

Int. Cl.: 12

Prior U.S. Cls.: 19, 21, 23, 31, 35 and 44

Reg. No. 3,480,824

United States Patent and Trademark Office

Registered Aug. 5, 2008

**TRADEMARK
PRINCIPAL REGISTER**

ARZANÁ

ARZANA' SPA (ITALY JOINT STOCK COMPANY)
PIAZZA ADELAIDE LONIGO, 8
I-35030 RUBANO (PADOVA)
ITALY

FOR: APPARATUS FOR LOCOMOTION BY WATER, NAMELY, SAILBOATS, CRUISING SAILBOATS, CRUISING SAIL YACHTS, RACING SAILBOATS, CRUISER-RACER SAILBOATS, CATALANANS, TRIMARANS, MOTORBOATS, MOTOR YACHTS, INFLATABLE BOATS, DINGHIES AND STRUCTURAL PARTS THEREOF, IN CLASS 12 (U.S. CLS. 19, 21, 23, 31, 35 AND 44).

THE MARK CONSISTS OF STANDARD CHARACTERS WITHOUT CLAIM TO ANY PARTICULAR FONT, STYLE, SIZE, OR COLOR.

PRIORITY DATE OF 11-23-2006 IS CLAIMED.

OWNER OF INTERNATIONAL REGISTRATION
0924637 DATED 5-4-2007, EXPIRES 5-4-2017.

SER. NO. 79-038,642, FILED 5-4-2007.

GEORGIA CARTY, EXAMINING ATTORNEY

Int. Cl.: 18

Prior U.S. Cls.: 1, 2, 3, 22 and 41

United States Patent and Trademark Office

Reg. No. 3,480,825

Registered Aug. 5, 2008

**TRADEMARK
PRINCIPAL REGISTER**

LINDY

HERMES INTERNATIONAL (FRANCE SOCIÉTÉ
EN COMMANDITE PAR ACTIONS)
24 RUE DU FAUBOURG SAINT HONORÉ
F-75008 PARIS
FRANCE

FOR: LEATHER HANDBAGS FOR WOMEN
SOLD ONLY THROUGH STORES OWNED BY
APPLICANT, IN CLASS 18 (U.S. CLS. 1, 2, 3, 22 AND
41).

THE MARK CONSISTS OF STANDARD CHAR-
ACTERS WITHOUT CLAIM TO ANY PARTICULAR
FONT, STYLE, SIZE, OR COLOR.

PRIORITY DATE OF 10-19-2006 IS CLAIMED.

OWNER OF INTERNATIONAL REGISTRATION
0924725 DATED 4-10-2007, EXPIRES 4-10-2017.

SER. NO. 79-038,680, FILED 4-10-2007.

SEAN CROWLEY, EXAMINING ATTORNEY

Int. Cl.: 14

Prior U.S. Cls.: 2, 27, 28 and 50

Reg. No. 3,480,826

United States Patent and Trademark Office

Registered Aug. 5, 2008

**TRADEMARK
PRINCIPAL REGISTER**

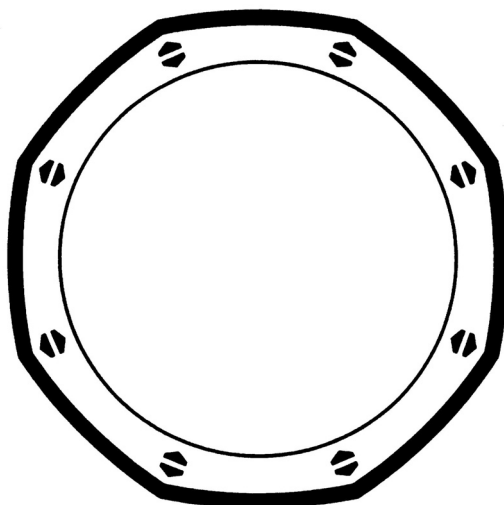

SOCIETE ANONYME DE LA MANUFACTURE;
D'HORLOGERIE AUDEMARS PIGUET & CIE
(SWITZERLAND SOCIÉTÉ ANONYME (SA))
16, ROUTE DE FRANCE
CH-1348 LE BRASSUS
SWITZERLAND

FOR: PRECIOUS METALS AND THEIR ALLOYS
AND OBJECTS MADE OF PRECIOUS METALS,
THEIR ALLOYS OR COATED THEREWITH, NAME-
LY, CRAFT WORK OBJECTS, ORNAMENTAL OB-
JECTS, TIE PINS, CUFF LINKS, PENDANTS;
JEWELRY, BIJOUTERIE, PRECIOUS AND SEMI-
PRECIOUS STONES; TIMEPIECES, NAMELY,
WATCHES, WATCH MAKING MATERIALS,
NAMELY, WATCH PARTS, PENDULUM CLOCKS,
PENDULETTES, ALARM CLOCKS AND CHRONO-

METRIC INSTRUMENTS, CHRONOGRAPHS FOR
USE AS TIMEPIECES AND WATCHES, APPARATUS
FOR TIMING SPORTS EVENTS, CHRONOMETERS,
WATCH STRAPS, DIALS FOR CLOCK-AND-
WATCH MAKING, BOXES, CHESTS IN THE NAT-
URE OF OVERSIZE JEWELRY BOXES, CASKETS
AND CASES FOR TIMEPIECES AND JEWELRY;
KEY RINGS OF PRECIOUS METAL, IN CLASS 14
(U.S. CLS. 2, 27, 28 AND 50).

OWNER OF INTERNATIONAL REGISTRATION
0594072 DATED 10-16-1992, EXPIRES 10-16-2012.

SER. NO. 79-038,879, FILED 12-18-2006.

NAKWAMA ANKRAH, EXAMINING ATTORNEY

Int. Cl.: 3

Prior U.S. Cls.: 1, 4, 6, 50, 51 and 52

United States Patent and Trademark Office

Reg. No. 3,480,827

Registered Aug. 5, 2008

**TRADEMARK
PRINCIPAL REGISTER**

L I C H T E N A

LABORATORI FITOCOSMESI; & FARMACEUTICI S.R.L. (ITALY LIMITED COMPANY)
VIALE BIANCA MARIA, 25
I-20129 MILANO
ITALY

FOR: COSMETIC PRODUCTS, NAMELY, DEODORANTS FOR PERSONAL USE; CREAMS, LOTIONS AND OILS FOR THE FACE AND THE BODY; CLEANSING MILKS, CREAMS AND OILS; MAKE-UP CREAMS; BEAUTY MASKS; MAKE-UP REMOVERS; EYE SHADOWS; LIPSTICKS; MASCARA; ROUGE; CRAYONS FOR THE EYES AND THE LIPS; POWDERS, CREAMS, OILS AND LOTIONS FOR SUN TANNING AND AFTER SUN EXPOSURE; PRE- AND AFTER SHAVE CREAMS AND LOTIONS;

TALCUM POWDERS; BATH SALTS, BATH FOAMS AND OILS; AFTER-BATH CREAMS AND LOTIONS, IN CLASS 3 (U.S. CLS. 1, 4, 6, 50, 51 AND 52).

OWNER OF INTERNATIONAL REGISTRATION 0653866 DATED 3-14-1996, EXPIRES 3-14-2016.

THE WORDING "LICHTENA" HAS NO MEANING IN A FOREIGN LANGUAGE.

SER. NO. 79-038,881, FILED 11-24-2006.

RENEE SERVANCE, EXAMINING ATTORNEY

Int. Cl.: 25

Prior U.S. Cls.: 22 and 39

United States Patent and Trademark Office

Reg. No. 3,480,828

Registered Aug. 5, 2008

TRADEMARK
PRINCIPAL REGISTER

The logo for Marie Jo Stolling features the name "MARIE JO" in a simple, sans-serif font above the word "STOLLING". The letter "O" in "STOLLING" is replaced by a stylized, grey leaf-like shape with a central vein.

VAN DE VELDE N.V. (BELGIUM NAAMLOZE
VENNOOTSCHAP)
LAGEWEG 4
B-9260 SCHELLEBELLE
BELGIUM

FOR: CORSETS, BRASSIERES, LINGERIE, WO-
MEN'S UNDERWEAR, GIRLS UNDERWEAR;
BATH ROBES FOR LADIES, BATHING SUITS
AND BIKINIS, IN CLASS 25 (U.S. CLS. 22 AND 39).

PRIORITY DATE OF 12-11-2006 IS CLAIMED.

OWNER OF INTERNATIONAL REGISTRATION
0925341 DATED 4-10-2007, EXPIRES 4-10-2017.

OWNER OF U.S. REG. NOS. 1,446,490, 2,163,719,
AND 2,600,894.

SER. NO. 79-038,946, FILED 4-10-2007.

WILLIAM P. SHANAHAN, EXAMINING ATTOR-
NEY

Int. Cl.: 6

Prior U.S. Cls.: 2, 12, 13, 14, 23, 25 and 50

Reg. No. 3,480,829

United States Patent and Trademark Office

Registered Aug. 5, 2008

**TRADEMARK
PRINCIPAL REGISTER**

JASON

ZHEJIANG PUJIANG ZHONGXING CO., LTD.
(CHINA CORPORATION)
NO. 18, BAN BAN ROAD
PUJIANG; ZHEJIANG PROVINCE
CHINA

OWNER OF INTERNATIONAL REGISTRATION
0925617 DATED 5-8-2007, EXPIRES 5-8-2017.

SER. NO. 79-039,061, FILED 5-8-2007.

FOR: METAL PADLOCKS; METAL KEYS FOR
LOCKS; LOCKS OF METAL FOR BAGS; METAL
HINGES; METAL CHAINS, IN CLASS 6 (U.S. CLS. 2,
12, 13, 14, 23, 25 AND 50).

ANDREA K. NADELMAN, EXAMINING ATTOR-
NEY

Int. Cl.: 36

Prior U.S. Cls.: 100, 101 and 102

United States Patent and Trademark Office

Reg. No. 3,480,830

Registered Aug. 5, 2008

**SERVICE MARK
PRINCIPAL REGISTER**

SSEINDEX

SHANGHAI STOCK EXCHANGE (CHINA NON-
PROFIT ORGANIZATION)
528 PUDONG ROAD SOUTH
200120 SHANGHAI
CHINA

FOR: PROVIDING STOCK EXCHANGE QUOTA-
TIONS; FINANCIAL ANALYSIS; FINANCIAL MAN-
AGEMENT, NAMELY, CONDUCTING A
SECURITIES EXCHANGE AND RELATED STOCK
MARKET SERVICES, NAMELY, PROVIDING FI-
NANCIAL AND SECURITIES INFORMATION,
COMPILING AND DISSEMINATING TRADE
QUOTES, ORDER, EXECUTION, INDEX VALUE

AND OTHER RELATED STOCK MARKET INFOR-
MATION; PROVIDING FINANCING SERVICES,
NAMELY, PROVIDING SECURITIES MARKET IN-
FORMATION, IN CLASS 36 (U.S. CLS. 100, 101 AND
102).

OWNER OF INTERNATIONAL REGISTRATION
0925737 DATED 5-30-2007, EXPIRES 5-30-2017.

SER. NO. 79-039,119, FILED 5-30-2007.

LINDA ESTRADA, EXAMINING ATTORNEY

Int. Cl.: 9

Prior U.S. Cls.: 21, 23, 26, 36 and 38

Reg. No. 3,480,831

United States Patent and Trademark Office

Registered Aug. 5, 2008

**TRADEMARK
PRINCIPAL REGISTER**

Silan

HANGZHOU SILAN MICROELECTRONICS CO.,
LTD. (CHINA CORPORATION)
NO. 4 HUANG GU SHAN ROAD
HANGZHOU; 310012 ZHEJIANG PROVINCE
CHINA

FOR: ELECTRONIC TAGS COMPRISING ENCO-
DED SMART CARDS CONTAINING PROGRAM-
MING USED TO DISTINGUISH ORIGIN OR
QUALITY OF THE GOODS FOR COMMERCIAL
USE; CHRONOGRAPHS FOR USE AS SPECIALIZED
TIME RECORDING APPARATUSES; THEFT PRE-
VENTION INSTALLATIONS, NAMELY, ELECTRIC
THEFT ALARMS; INTEGRATED CIRCUITS; SEMI-
CONDUCTOR POWER ELEMENTS, IN CLASS 9
(U.S. CLS. 21, 23, 26, 36 AND 38).

THE MARK CONSISTS OF STANDARD CHAR-
ACTERS WITHOUT CLAIM TO ANY PARTICULAR
FONT, STYLE, SIZE, OR COLOR.

OWNER OF INTERNATIONAL REGISTRATION
0925898 DATED 5-21-2007, EXPIRES 5-21-2017.

THE WORDING "SILAN" HAS NO MEANING IN
A FOREIGN LANGUAGE.

SER. NO. 79-039,181, FILED 5-21-2007.

TRACY WHITTAKER-BROWN, EXAMINING AT-
TORNEY

Int. Cl.: 31

Prior U.S. Cls.: 1 and 46

United States Patent and Trademark Office

Reg. No. 3,480,832

Registered Aug. 5, 2008

**TRADEMARK
PRINCIPAL REGISTER**



FRUTA DEL PACÍFICO S.A. (SPAIN SOCIEDAD ANONIMA)
GRAN VIA CARLES III, 158 ESC. A 2^º 1^ª
E-08034 BARCELONA
SPAIN

FOR: FRESH FRUITS AND VEGETABLES, IN CLASS 31 (U.S. CLS. 1 AND 46).

OWNER OF INTERNATIONAL REGISTRATION 0926040 DATED 5-31-2007, EXPIRES 5-31-2017.

OWNER OF U.S. REG. NO. 3,220,287.

NO CLAIM IS MADE TO THE EXCLUSIVE RIGHT TO USE "VERDE", APART FROM THE MARK AS SHOWN.

THE COLOR(S) LIGHT GREEN, DARK GREEN AND WHITE IS/ARE CLAIMED AS A FEATURE OF THE MARK.

THE WORDS VIDA VERDE APPEAR IN WHITE WITH DARK-GREEN SHADING AGAINST A MAINLY OVAL BACKGROUND IN LIGHT GREEN, WHICH APPEARS WITH AN INCOMPLETE DOUBLE BORDER IN WHITE AND DARK GREEN; THE LEAVES ARE IN DARK AND LIGHT GREEN WITH WHITE VEINS; ALL AGAINST A WHITE BACKGROUND.

THE ENGLISH TRANSLATION OF THE FOREIGN WORD(S) IN THE MARK IS: GREEN LIFE.

SER. NO. 79-039,258, FILED 5-31-2007.

ROBERT STRUCK, EXAMINING ATTORNEY

Int. Cls.: 12 and 37

Prior U.S. Cls.: 19, 21, 23, 31, 35, 44, 100, 103 and 106

United States Patent and Trademark Office

Reg. No. 3,480,833

Registered Aug. 5, 2008

**TRADEMARK
SERVICE MARK
PRINCIPAL REGISTER**



RFP SRL RICOSTRUZIONE; FASCIA PRESTAMPATA (ITALY LTD LIAB CO)
S.S. 96, KM. 119
I-70026 MODUGNO (BA)
ITALY

FOR: ADHESIVE RUBBER PATCHES FOR REPAIRING TUBES OR TIRES; TREADS USED TO RETREAD TIRES; TIRE AND TIRE INNER TUBE REPAIR AND RETREAD KITS COMPRISED OF PLASTERS, NAMELY, TIRE PATCHES, RETREADING BANDS, CUSHION GUM, RUBBER STRIPS AND ADHESIVE FILMS FOR USE AS TIRE PATCHES, TIRE PATCH INLAYS, ADHESIVE SLEEVES AND RUBBER SEALING PLUGS, IN CLASS 12 (U.S. CLS. 19, 21, 23, 31, 35 AND 44).

FOR: TYRES AND INNER TUBES REPAIR, MAINTENANCE AND RETREADING SERVICES, IN CLASS 37 (U.S. CLS. 100, 103 AND 106).

PRIORITY DATE OF 12-23-2005 IS CLAIMED.

OWNER OF INTERNATIONAL REGISTRATION 0926094 DATED 5-17-2006, EXPIRES 5-17-2016.

NO CLAIM IS MADE TO THE EXCLUSIVE RIGHT TO USE "TIRE REPAIRING SYSTEM", APART FROM THE MARK AS SHOWN.

THE COLOR(S) YELLOW AND BLACK IS/ARE CLAIMED AS A FEATURE OF THE MARK.

THE MARK CONSISTS OF THE BLACK WORDING TYRE REPAIRING SYSTEM, THE WORDING TAP RAP WITH THE LETTERS T AND R IN YELLOW AND AP AND A IN BLACK. TWO TIRE TREAD DESIGNS APPEAR IN BLACK AND YELLOW, ONE ABOVE THE WORD REPAIRING AND THE OTHER BELOW THE WORD REPAIRING.

SER. NO. 79-039,281, FILED 5-17-2006.

AMY MCMENAMIN, EXAMINING ATTORNEY

Int. Cls.: 9, 25, 28 and 41

**Prior U.S. Cls.: 21, 22, 23, 26, 36, 38, 39, 50, 100, 101
and 107**

Reg. No. 3,480,834

United States Patent and Trademark Office

Registered Aug. 5, 2008

**TRADEMARK
SERVICE MARK
PRINCIPAL REGISTER**

THE SEVEN OF DARAN

LOURENS FISHER; DESIGN & INVESTMENTS
N.V. (NETHERLD ANTILLES LTD LIAB CO)
BERG ARRARAT 1
CURACAO
NETHERLD ANTILLES

FOR: GAME COMPUTERS; COMPUTER GAMES, NAMELY, COMPUTER GAME SOFTWARE; GAMES APPARATUS FOR USE WITH TELEVISION APPARATUS ONLY, NAMELY, VIDEO GAME MACHINES FOR USE WITH TELEVISIONS; VIDEO GAME SOFTWARE; VIDEO GAME PROGRAMS; INTERACTIVE VIDEO GAME DEVICES COMPRISED OF COMPUTER HARDWARE AND SOFTWARE AND ACCESSORIES, NAMELY, GAME CONSOLES, GAME CONTROLLERS, AND SOFTWARE FOR OPERATING GAME CONTROLLERS; ELECTRONIC GAME PROGRAMS; ELECTRONIC GAME SOFTWARE; ELECTRONIC VIDEO AND COMPUTER GAME DISCS; ELECTRONIC VIDEO GAME MACHINES FOR USE WITH EXTERNAL DISPLAY SCREEN OR MONITOR; INTERACTIVE VIDEO AND COMPUTER GAME SOFTWARE; INTERACTIVE VIDEO AND COMPUTER GAME PROGRAMS; MOTION PICTURE FILMS FEATURING COMEDY, DRAMA, ACTION, ADVENTURE AND/OR ANIMATION; PRERECORDED DVDS, CDS, VIDEOS FEATURING MUSIC, COMEDY, DRAMA, ACTION, ADVENTURE, AND/OR ANIMATION, IN CLASS 9 (U.S. CLS. 21, 23, 26, 36 AND 38).

FOR: CLOTHING, NAMELY, TROUSERS, SKIRTS, SHORTS, JUMPERS, SWEATERS, T-SHIRTS, LONG SLEEVES, BLOUSES, JACKETS, COATS, BODYWARMERS, CAPS, HOODS, AND MASQUERADE AND HALLOWEEN COSTUMES AND MASKS SOLD IN CONNECTION THEREWITH, IN CLASS 25 (U.S. CLS. 22 AND 39).

FOR: GAMES AND PLAYTHINGS, NAMELY, BOARD GAMES, CARD GAMES, PLAYING CARDS, PUZZLES, DOLLS, PLUSH TOYS, AND ELECTRONIC GAME APPARATUS OTHER THAN THOSE FOR USE WITH TELEVISION APPARATUS, IN CLASS 28 (U.S. CLS. 22, 23, 38 AND 50).

FOR: ENTERTAINMENT SERVICES IN THE NATURE OF THE DISTRIBUTION AND DISPLAY OF LIVE-ACTION, COMEDY, DRAMA AND ANIMATED MOTION PICTURE THEATRICAL FILMS; PRODUCTION OF LIVE-ACTION, COMEDY, DRAMA AND ANIMATED MOTION PICTURE THEATRICAL FILMS; ENTERTAINMENT SERVICES IN THE NATURE OF LIVE-ACTION, COMEDY, DRAMA AND ANIMATED TELEVISION SERIES; PRODUCTION OF LIVE-ACTION, COMEDY, DRAMA AND ANIMATED TELEVISION SERIES; THEATRICAL PERFORMANCES BOTH ANIMATED AND LIVE ACTION; PRODUCTION OF MOVIES RECORDED ON VIDEOTAPES, DVDS AND OTHER DATA CARRIERS; PROVIDING INFORMATION FOR AND ACTUAL ENTERTAINMENT VIA ELECTRONIC GLOBAL COMMUNICATIONS NETWORK IN THE NATURE OF LIVE-ACTION, COMEDY, DRAMA AND ANIMATED PROGRAMS AND PRODUCTION OF LIVE-ACTION COMEDY, ACTION AND ANIMATED MOTION FILMS FOR DISTRIBUTION VIA A GLOBAL COMPUTER NETWORK, IN CLASS 41 (U.S. CLS. 100, 101 AND 107).

THE MARK CONSISTS OF STANDARD CHARACTERS WITHOUT CLAIM TO ANY PARTICULAR FONT, STYLE, SIZE, OR COLOR.

PRIORITY DATE OF 8-22-2006 IS CLAIMED.

OWNER OF INTERNATIONAL REGISTRATION 0926689 DATED 2-22-2007, EXPIRES 2-22-2017.

THE WORDING "DARAN" HAS NO MEANING IN A FOREIGN LANGUAGE.

SER. NO. 79-039,501, FILED 2-22-2007.

KRISTIN DAHLING, EXAMINING ATTORNEY

Int. Cl.: 6

Prior U.S. Cls.: 2, 12, 13, 14, 23, 25 and 50

Reg. No. 3,480,835

United States Patent and Trademark Office

Registered Aug. 5, 2008

TRADEMARK
PRINCIPAL REGISTER

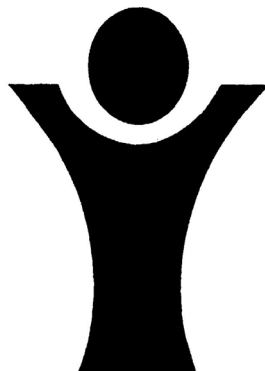

NORINCO (FRANCE SOCIÉTÉ PAR ACTIONS
SIMPLIFIÉE)
ZONE INDUSTRIELLE DE MARIVAUX
F-60149 SAINT-CREPIN IBOUVILLERS
FRANCE

FOR: METAL PIPES AND METAL TUBES; CAST
IRON, CAST IRON FOR USE IN HYDRAULICS,
SANITATION, ROAD SYSTEMS AND BUILDINGS;
METAL MANHOLE COVERS WITH VIEWING POR-
TAL; CAST-IRON MANHOLE COVERS WITH VIEW-
ING PORTAL; GRATINGS OF CAST-IRON AND
GRATINGS OF METAL; CAST-IRON GULLIES;
TELECOMMUNICATIONS CHAMBER COVERS OF
CAST IRON; CAST IRON FOR ORNAMENTS AND
DECORATION; STREET FURNITURE, NAMELY,
BENCH LEGS OF CAST-IRON AND BENCH LEGS
OF METAL SOLD SEPARATELY FROM BENCHES,

AND METAL BOLLARDS, CAST-IRON BOLLARDS,
EQUIPMENT FOR FURNISHING SPECIAL ROOMS,
NAMELY, TRASH CANS OF DUCTILE CAST IRON,
STEEL, STAINLESS STEEL, GALVANIZED STEEL
AND ALUMINUM, AND CHIMNEY PLATES OF
CAST IRON; MODULAR COVERING OF CAST
IRON FOR GUTTERS AND HOPPERS, IN CLASS 6
(U.S. CLS. 2, 12, 13, 14, 23, 25 AND 50).

OWNER OF INTERNATIONAL REGISTRATION
0926850 DATED 4-11-2007, EXPIRES 4-11-2017.

SER. NO. 79-039,569, FILED 4-11-2007.

CARYN GLASSER, EXAMINING ATTORNEY

Int. Cl.: 23

Prior U.S. Cl.: 43

United States Patent and Trademark Office

Reg. No. 3,480,836

Registered Aug. 5, 2008

**TRADEMARK
PRINCIPAL REGISTER**



NEXIS FIBERS AG (SWITZERLAND SOCIÉTÉ
ANONYME (SA))
GERLISWILSTRASSE 17
CH-6021 EMMENBRÜCKE
SWITZERLAND

FOR: YARNS AND THREADS FOR TEXTILE
USE, IN CLASS 23 (U.S. CL. 43).

PRIORITY DATE OF 12-22-2006 IS CLAIMED.

OWNER OF INTERNATIONAL REGISTRATION
0926900 DATED 5-21-2007, EXPIRES 5-21-2017.

NO CLAIM IS MADE TO THE EXCLUSIVE
RIGHT TO USE "FIBERS", APART FROM THE
MARK AS SHOWN.

SER. NO. 79-039,594, FILED 5-21-2007.

SEAN CROWLEY, EXAMINING ATTORNEY

Int. Cl.: 25

Prior U.S. Cls.: 22 and 39

United States Patent and Trademark Office

Reg. No. 3,480,837

Registered Aug. 5, 2008

TRADEMARK
PRINCIPAL REGISTER

宾宝
BIN BAO

SHANTOU JINXINXING; TRADING DEVELOPMENT CO., LTD. (CHINA CORPORATION)
DOWNSTAIRS, NO. 31
CHANGPING ROAD, SHANTOU CITY; GUANGDONG PROVINCE
CHINA

FOR: DRESSES, NAMELY, DRESS SHIRTS, DRESS SUITS, SKIRTS; BATHING SUITS, NAMELY, BATHING SUITS FOR MEN; HATS, NAMELY, WOOLY HATS; HEADGEAR, NAMELY, HATS, CAPS; SCARVES, NAMELY, HEAD SCARVES, SHOULDER SCARVES, SILK SCARVES; BELTS, NAMELY, SUSPENDER BELTS FOR MEN, SUSPENDER BELTS FOR WOMEN; WAIST BELTS; UNDERWEAR, NAMELY, WOMEN'S UNDERWEAR, KNITTED UNDERWEAR, LADIES' UNDERWEAR, IN CLASS 25 (U.S. CLS. 22 AND 39).

OWNER OF INTERNATIONAL REGISTRATION
0926959 DATED 5-21-2007, EXPIRES 5-21-2017.

THE MARK CONSISTS OF CHINESE CHARACTERS AND THE WORD "BIN BAO" (PINYIN).

THE ENGLISH TRANSLATION OF THE FOREIGN WORD(S) IN THE MARK IS: GUEST TREASURE.

THE TRANSLITERATION OF THE NON-LATIN CHARACTERS IN THE MARK IS: BIN BAO.

SER. NO. 79-039,619, FILED 5-21-2007.

SEAN CROWLEY, EXAMINING ATTORNEY

Int. Cl.: 25

Prior U.S. Cls.: 22 and 39

United States Patent and Trademark Office

Reg. No. 3,480,838

Registered Aug. 5, 2008

**TRADEMARK
PRINCIPAL REGISTER**



GABOR SHOES AG (FED REP GERMANY JOINT
STOCK COMPANY)
MARIENBERGER STRASSE 31
ROSENHEIM, FED REP GERMANY 83024

FOR: CLOTHING, NAMELY, COATS, JACKETS,
MANTLES, OVERCOATS, PULLOVERS, SWEAT-
SHIRTS, T-SHIRTS, BLOUSES; OUTDOOR CLOTH-
ING, NAMELY, JACKETS, SKI JACKETS, PARKAS,
ANORAKS, VESTS, SKI WEAR, RAINWEAR, LONG
UNDERWEAR, LEGGINGS, LEG WARMERS,
SWEATERS, TURTLENECKS, PANTS, TROUSERS,
SWEATPANTS, SWEATSHIRTS, OVERALLS, BIB
OVERALLS, INSULATED PANTS, EAR MUFFS,
EARBANDS, MUFFLERS, SOCKS, GLOVES, MIT-

TENS; FOOTWEAR; HEADGEAR, NAMELY, HATS,
CAPS, SCARVES, IN CLASS 25 (U.S. CLS. 22 AND 39).

OWNER OF INTERNATIONAL REGISTRATION
0927080 DATED 5-10-2007, EXPIRES 5-10-2017.

OWNER OF U.S. REG. NOS. 1,170,769, 2,194,999,
AND 2,970,787.

SER. NO. 79-039,664, FILED 5-10-2007.

KATHERINE E. HALMEN, EXAMINING ATTOR-
NEY

Int. Cls.: 3, 9, 14, 18 and 25

Prior U.S. Cls.: 1, 2, 3, 4, 6, 21, 22, 23, 26, 27, 28, 36,
38, 39, 41, 50, 51 and 52

Reg. No. 3,480,839

United States Patent and Trademark Office

Registered Aug. 5, 2008

TRADEMARK
PRINCIPAL REGISTER

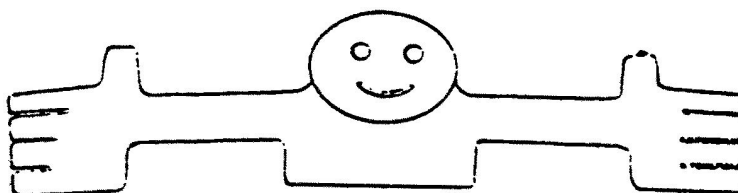

TEORA VINCENZO (ITALY INDIVIDUAL)
VIA BENVENUTO CELLINI, 1
I-20129 MILANO
ITALY

FOR: PERFUMES, DEODORANTS FOR PERSONAL USE, LIQUID SOAPS, TOILET SOAPS, BATH FOAM, DENTIFRICES, SHAMPOOS, ESSENTIAL OILS FOR PERSONAL USE, HAIR LOTIONS, AFTERSHAVE, EAU DE COLOGNE, HAIR GEL, HAIR DYE CREAMS, SKIN CREAMS, BODY CREAMS, MASCARA, EYELINERS, EYESHADOWS, EYE PENCILS, LIPSTICKS, NAIL HARDENERS, NAIL VARNISH REMOVERS, SUN-TANNING OILS AND CREAMS MS, IN CLASS 3 (U.S. CLS. 1, 4, 6, 50, 51 AND 52).

FOR: EYEGLASSES AND SUNGLASSES; RADIOS; DIRECTIONAL COMPASSES; MAGNIFYING GLASSES; CREDIT CARD HOLDERS MADE OF LEATHER OR IMITATION OF LEATHER, IN CLASS 9 (U.S. CLS. 21, 23, 26, 36 AND 38).

FOR: JEWELRY; WRIST WATCHES; CLOCKS; WATCHES; CHRONOMETERS; COSTUME JEWELRY COATED WITH PRECIOUS METALS; PRECIOUS METALS AND THEIR ALLOYS; DIAMONDS; PRECIOUS STONES; BRACELETS, NECKLACES, EARRINGS, PENDANTS AND BROOCHES MADE OF LEATHER OR IMITATION OF LEATHER, IN CLASS 14 (U.S. CLS. 2, 27, 28 AND 50).

FOR: VALISES; HANDBAGS; RUCKSACKS FOR SPORTS AND LEISURE PURPOSES; SMALL

SCHOOL RUCKSACKS, SACHELS, PURSES; TRUNKS; ANIMAL SKINS; WALLETS, KEY BOXES AND CASES, ATTACHÉ CASES; UMBRELLAS, PARASOLS; WALKING STICKS; HARNESS; WORKS OF ART MADE OF LEATHER OR IMITATION OF LEATHER; CLOTHING FOR PETS; COLLARS AND LEASHES FOR ANIMALS, IN CLASS 18 (U.S. CLS. 1, 2, 3, 22 AND 41).

FOR: SHIRTS, VESTS, BLOUSES, SKIRTS, SUITS, JACKETS, WAISTCOATS, TROUSERS, T-SHIRTS, SPORT JERSEY AND UNDERWEAR, JUMPERS, PAJAMAS, STOCKINGS, CORSETS, GARTERS, SHORTS, SLIPS, PETTICOATS, HATS, HEAD-SCARVES, NECKTIES, OVERCOATS, COATS, BELTS, SWIMSUITS, BATHING TRUNKS, SWIMMING CAPS, SMOCKS, TRACKSUITS FOR SPORTING OR LEISURE PURPOSES, WATERPROOF JACKETS, WINDCHEATERS, SKIWEAR, PELISSES AND FUR JACKETS, SCARVES, GLOVES, DRESSING GOWNS, FOOTWEAR, SLIPPERS, SHOES AND LEISURE SHOES, SANDALS, BOOTS, IN CLASS 25 (U.S. CLS. 22 AND 39).

PRIORITY DATE OF 9-22-2006 IS CLAIMED.

OWNER OF INTERNATIONAL REGISTRATION
0927163 DATED 1-8-2007, EXPIRES 1-8-2017.

SER. NO. 79-039,695, FILED 1-8-2007.

JAMES MACFARLANE, EXAMINING ATTORNEY

Int. Cl.: 36

Prior U.S. Cls.: 100, 101 and 102

United States Patent and Trademark Office

Reg. No. 3,480,840

Registered Aug. 5, 2008

**SERVICE MARK
PRINCIPAL REGISTER**



SOCIETE GENERALE (FRANCE SOCIETE ANONYME)
29 BOULEVARD HAUSSMANN
F-75009 PARIS
FRANCE

FOR: BANKING; FINANCIAL SERVICES, NAME-
LY, MONEY LENDING; FINANCIAL INVESTMENT
SERVICES, NAMELY, ASSET ACQUISITION, CON-
SULTATION, DEVELOPMENT AND MANAGE-
MENT SERVICES; FINANCIAL PLANNING;
FINANCIAL FORECASTING; FINANCIAL SERVI-
CES, NAMELY, CASH MANAGEMENT, FINAN-
CIAL CLEARING HOUSES, INVESTMENT
MANAGEMENT; FINANCIAL GUARANTEE AND
SURETY; FINANCIAL INFORMATION PROCES-
SING; FINANCIAL RESEARCH; FINANCIAL RISK
MANAGEMENT; REAL ESTATE MANAGEMENT;
REAL ESTATE VALUATION SERVICES; REAL ES-
TATE CONSULTATION; REAL ESTATE AGENCIES
FEATURING THE BROKERAGE AND RENTAL OF
BUSINESS ASSETS IN THE NATURE OF REAL
PROPERTY AND BUILDINGS; REAL ESTATE AP-
PRaisal; APARTMENT HOUSE MANAGEMENT;
CREDIT AGENCIES; DEBT RECOVERY AND COL-
LECTION AGENCIES; FINANCIAL ANALYSIS; IN-
SURANCE AGENCIES; INSURANCE
UNDERWRITING FOR ALL TYPES OF INSUR-
ANCE; INSURANCE UNDERWRITING CONSU-
LTATION; LIFE INSURANCE BROKERAGE; LIFE
INSURANCE UNDERWRITING; INSURANCE
CONSULTATION; SAVINGS BANK SERVICES;
CREDIT CARD SERVICES; DEBIT CARD SERVI-
CES; ESTABLISHING MUTUAL FUNDS FOR OTH-
ERS; MUTUAL FUND BROKERAGE; MUTUAL
FUND DISTRIBUTION; FINANCIAL CONSULTA-
TION; REAL ESTATE APPRAISAL; MANAGEMENT
OF BUILDINGS; STOCK EXCHANGE PRICE QUO-
TATIONS; SECURITIES BROKERAGE; INSUR-

ANCE BROKERAGE; CREDIT BUREAUS;
BROKERAGE FOR HIRE-PURCHASE FINANCING;
FINANCING SERVICES, NAMELY, HIRE-PUR-
CHASE FINANCING; SAFETY DEPOSIT BOX SER-
VICES; MANAGEMENT OF PORTFOLIOS
COMPRISING SECURITIES; ISSUING OF TRAVE-
LERS' CHECKS; SAVINGS AND LOAN SERVICES;
SAVINGS BANK SERVICES; ADMINISTRATION OF
SAVINGS ACCOUNTS; FINANCIAL EVALUA-
TIONS FOR INSURANCE, BANKING, REAL ES-
TATE; FINANCING SERVICES; RAISING FUNDS
FOR CHARITABLE PURPOSES; PROVIDING FUND
RAISING SERVICES FOR OTHERS VIA A GLOBAL
COMPUTER NETWORK; VENTURE CAPITAL
FUNDING SERVICES TO EMERGING AND
START-UP COMPANIES; FINANCIAL INFORMATI-
ON PROCESSING; FINANCIAL INFORMATION
PROVIDED BY ELECTRONIC MEANS; PROVIDING
INFORMATION IN INSURANCE MATTERS; HOME
EQUITY LOANS; EQUITY CAPITAL INVEST-
MENTS; MANAGEMENT OF A CAPITAL INVEST-
MENT FUND; CAPITAL INVESTMENT
CONSULTATION; CASH AND FOREIGN EX-
CHANGE TRANSACTIONS. FOREIGN EXCHANGE
INFORMATION SERVICES; FINANCIAL TRUST
OPERATIONS; MONETARY EXCHANGE; IN-
STALLMENT LOANS; BILL PAYMENT SERVICES;
ELECTRONIC PAYMENT, NAMELY, ELECTRONIC
PROCESSING AND TRANSMISSION OF BILL PAY-
MENT DATA; LOAN FINANCING; SECURITY SER-
VICES, NAMELY, GUARANTEEING LOANS;
FINANCIAL SERVICES, NAMELY ASSISTING OTH-
ERS WITH THE COMPLETION OF FINANCIAL
TRANSACTIONS FOR STOCKS, BONDS, SECURI-
TIES AND EQUITIES; ELECTRONIC FUNDS
TRANSFER; CHECK VERIFICATION; FINANCIAL
AND BANKING MANAGEMENT; ANALYZING
AND COMPILING DATA FOR MEASURING THE
PERFORMANCE OF FINANCIAL MARKETS;

MANAGEMENT OF PORTFOLIOS COMPRISING SECURITIES, ALL OF THE ABOVE SERVICES CAPABLE OF BEING PROVIDED VIA THE INTERNET, IN CLASS 36 (U.S. CLS. 100, 101 AND 102).

PRIORITY DATE OF 10-23-2006 IS CLAIMED.

OWNER OF INTERNATIONAL REGISTRATION 0927182 DATED 4-10-2007, EXPIRES 4-10-2017.

OWNER OF U.S. REG. NOS. 2,450,412, 2,859,223 AND OTHERS.

THE COLOR(S) RED, BLACK AND WHITE IS/ ARE CLAIMED AS A FEATURE OF THE MARK.

THE MARK CONSISTS OF A SQUARE SHADED RED TO THE TOP AND BLACK TO THE BOTTOM WITH A WHITE BAND AT THE CENTER TO THE LEFT OF THE LETTERS "SG" IN BLACK WHICH ARE ABOVE A RED CHEVRON.

SER. NO. 79-039,700, FILED 4-10-2007.

NORA BUCHANAN WILL, EXAMINING ATTORNEY

Int. Cl.: 8

Prior U.S. Cls.: 23, 28 and 44

Reg. No. 3,480,841

United States Patent and Trademark Office

Registered Aug. 5, 2008

**TRADEMARK
PRINCIPAL REGISTER**

SeeSa

LI GUANJUN (CHINA INDIVIDUAL)
YUXIN VILLAGE, XINQIAN TOWN,
HUANGYAN, TAIZHOU; ZHEJIANG
CHINA

FOR: ABRADING INSTRUMENTS, NAMELY,
HAND OPERATED ABRADING TOOLS; HAND-
OPERATED AGRICULTURAL IMPLEMENTS,
NAMELY, SHOVELS; INSECTICIDE ATOMIZERS,
NAMELY, HAND-OPERATED SPRAYERS FOR IN-
SECTICIDE; APPLIANCES AND INSTRUMENTS
FOR SLAUGHTERING BUTCHERS' ANIMALS,
NAMELY, BUTCHERS KNIVES; OYSTER OPEN-
ERS; ELECTRIC OR NON-ELECTRIC FINGERNAIL

POLISHERS, NAMELY, NAIL BUFFERS; HAND-
OPERATED HAND TOOLS, NAMELY, HAND
PUMPS, MASONS' HAMMERS, PRUNING SCIS-
SORS, CHISELS AND DAGGERS; TABLE CUT-
LERY, NAMELY, KNIVES, FORKS AND SPOONS,
IN CLASS 8 (U.S. CLS. 23, 28 AND 44).

OWNER OF INTERNATIONAL REGISTRATION
0927253 DATED 5-21-2007, EXPIRES 5-21-2017.

SER. NO. 79-039,721, FILED 5-21-2007.

SEAN CROWLEY, EXAMINING ATTORNEY

Int. Cls.: 16 and 41

Prior U.S. Cls.: 2, 5, 22, 23, 29, 37, 38, 50, 100, 101 and 107

Reg. No. 3,480,842

United States Patent and Trademark Office

Registered Aug. 5, 2008

**TRADEMARK
SERVICE MARK
PRINCIPAL REGISTER**



FREGATE (FRANCE SOCIÉTÉ PAR ACTIONS
SIMPLIFIÉE UNIPERSONNELLE)
74 RUE DE PARIS
F-35000 RENNES
FRANCE

FOR: NEWSPAPERS; POSTERS; BOOKS, BOOK-
LETS, CATALOGS, MAGAZINES, PERIODICALS,
LEAFLETS, NEWSLETTERS AND PAMPHLETS IN
THE FIELDS OF HUMAN RESOURCES, STAFF
TRAINING, COMPANY INTERNAL COMMUNICA-
TIONS, COMPANY IMAGE PROMOTION, COMPA-
NY KNOWLEDGE, AND COMPANY
ORGANIZATIONAL AND WORKING SYSTEMS,
IN CLASS 16 (U.S. CLS. 2, 5, 22, 23, 29, 37, 38 AND 50).

FOR: PROVIDING OF TRAINING IN THE
FIELDS OF HUMAN RESOURCES, STAFF TRAIN-
ING, COMPANY INTERNAL COMMUNICATIONS,
COMPANY IMAGE PROMOTION, COMPANY
KNOWLEDGE, AND COMPANY ORGANIZATION-

AL AND WORKING SYSTEMS; ARRANGING AND
CONDUCTING MEETINGS, LECTURES, SEMI-
NARS AND TRAINING WORKSHOPS IN THE
FIELD OF HUMAN RESOURCES, STAFF TRAIN-
ING, COMPANY INTERNAL COMMUNICATIONS,
COMPANY IMAGE PROMOTION, COMPANY
KNOWLEDGE, AND COMPANY ORGANIZATION-
AL AND WORKING SYSTEMS; PUBLISHING OF
ELECTRONIC PUBLICATION OF ONLINE PAMPH-
LETS AND PERIODICALS, IN CLASS 41 (U.S. CLS.
100, 101 AND 107).

OWNER OF INTERNATIONAL REGISTRATION
0927255 DATED 3-23-2007, EXPIRES 3-23-2017.

SER. NO. 79-039,723, FILED 3-23-2007.

JOSETTE BEVERLY, EXAMINING ATTORNEY

Int. Cls.: 6 and 12

**Prior U.S. Cls.: 2, 12, 13, 14, 19, 21, 23, 25, 31, 35, 44
and 50**

Reg. No. 3,480,843

United States Patent and Trademark Office

Registered Aug. 5, 2008

**TRADEMARK
PRINCIPAL REGISTER**

DUCTIBOR

ARCELORMITTAL FLAT CARBON EUROPE SA
19, AVENUE DE LA LIBERTÉ
L-2930 LUXEMBOURG
LUXEMBOURG

FOR: COMMON METALS AND THEIR ALLOYS, NAMELY, UNPROCESSED OR SEMI-PROCESSED METAL, UNPROCESSED OR SEMI-PROCESSED STEEL, STEEL, STAINLESS STEEL, COATED STEEL, CARBON STEEL, CLAD STEEL, CHROMIUM STEEL, GALVANIZED STEEL, ELECTRO-GALVANIZED STEEL, IRON UNPROCESSED OR SEMI-PROCESSED IRON, IN THE FORM OF SHEETS, SLABS, BARS, CROSS PIECES, SIDES, THESE PRODUCTS BEING MADE OF METAL, IN CLASS 6 (U.S. CLS. 2, 12, 13, 14, 23, 25 AND 50).

FOR: METAL PARTS IN THE NATURE OF CAR BODY COMPONENTS FOR MOTOR VEHICLES THAT PROVIDE STRUCTURAL REINFORCEMENT AND SAFETY FOR MOTOR VEHICLES, NAMELY, AUTOMOBILE BUMPERS AND VEHI-

CLE CROSSMEMBERS IN THE NATURE OF AUTOMOBILE BODIES; CHASSIS, NAMELY, AUTOMOBILE CHASSIS; WELDED SIDES, NAMELY, SIDES SHIELDS AS STRUCTURAL PARTS OF VEHICLES; WHEEL ARMS, NAMELY, AUTOMOBILE SPARE WHEEL HOLDERS, IN CLASS 12 (U.S. CLS. 19, 21, 23, 31, 35 AND 44).

THE MARK CONSISTS OF STANDARD CHARACTERS WITHOUT CLAIM TO ANY PARTICULAR FONT, STYLE, SIZE, OR COLOR.

PRIORITY DATE OF 12-8-2006 IS CLAIMED.

OWNER OF INTERNATIONAL REGISTRATION 0927277 DATED 5-21-2007, EXPIRES 5-21-2017.

SER. NO. 79-039,731, FILED 5-21-2007.

SEAN CROWLEY, EXAMINING ATTORNEY

Int. Cls.: 3, 18, 24 and 25

Prior U.S. Cls.: 1, 2, 3, 4, 6, 22, 39, 41, 42, 50, 51 and 52

United States Patent and Trademark Office

Reg. No. 3,480,844

Registered Aug. 5, 2008

**TRADEMARK
PRINCIPAL REGISTER**

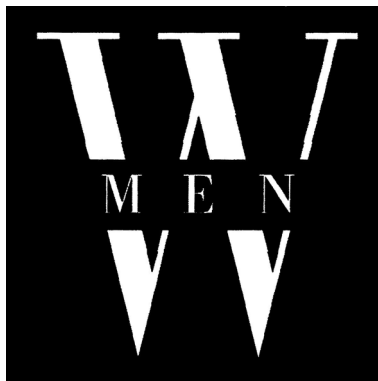

VAKKO HOLDING A.S. (TURKEY CORPORATION)

ALI RIZA GÜRCAN

CAD. NO: 27 MERTER; TR-34173 ISTANBUL

TURKEY

FOR: SOAPS, PERFUMES, ESSENTIAL OILS, COSMETICS, HAIR LOTIONS, DENTIFRICES, DEPILATORIES, MAKE-UP REMOVING PREPARATIONS, LIPSTICK, BEAUTY MASKS, SHAVING PRODUCTS, NAMELY, AFTER SHAVE, AFTER SHAVE BALMS, AFTER SHAVE CREAMS, AFTER SHAVE EMULSIONS, AFTER SHAVE GEL, AFTER SHAVE LOTIONS, PRE-SHAVE CREAMS, SHAVING BALM, SHAVING CREAMS, SHAVING FOAM, SHAVING GELS, SHAVING LOTIONS, SHAVING MOUSSE, SHAVING PREPARATIONS, SHAVING SOAP, SHAVING SPRITZ IN THE NATURE OF A MOISTURIZING SOLUTION FOR SHAVING, LEATHER POLISHES, CREAMS FOR LEATHER, IN CLASS 3 (U.S. CLS. 1, 4, 6, 50, 51 AND 52).

FOR: LEATHER AND IMITATIONS OF LEATHER, AND GOODS MADE OF THESE MATERIALS, NAMELY, BRIEFCASES, KEY CHAINS, KEY CASES, BAGS, LEATHER BAGS FOR MERCHANDISE PACKAGING SUCH AS ENVELOPES AND POUCHES, SHOULDER BAGS, SUITCASES, WALLET, LEATHER BOXES FOR STORING GREETING CARDS, CASES, HAND BAGS, PURSES, SHOPPING BAGS, TRAVELLING CASES, ANIMAL SKINS AND HIDES, TRUNKS AND TRAVELLING BAGS, UMBRELLAS, PARASOLS AND WALKING STICKS, IN CLASS 18 (U.S. CLS. 1, 2, 3, 22 AND 41).

FOR: TEXTILES, NAMELY, CURTAIN LOOPS OF TEXTILE MATERIAL, CURTAINS MADE OF TEXTILE FABRICS, FACE TOWELS MADE OF TEXTILE MATERIALS, GIFT WRAP OF TEXTILE, HAND TOWELS OF TEXTILE, PRINTED TEXTILE LABELS, QUILTS OF TEXTILE, TAPESTRIES OF TEXTILE, TEXTILE FABRIC OF ANIMAL SKINS IMITATIONS, TEXTILE FABRICS FOR HOME AND COMMERCIAL INTERIORS, TEXTILE FABRICS FOR LINGERIE, TEXTILE FABRICS FOR THE MANUFACTURE OF CLOTHING, TEXTILE HANG TAGS, TEXTILE LABELS, TEXTILE NAPKINS, TEXTILE NAPKINS FOR REMOVING MAKE-UP, TEXTILE TISSUES FOR REMOVING MAKE-UP, TEXTILE SUBSTITUTE MATERIALS MADE FROM SYNTHETIC MATERIALS, TEXTILE USED AS LINING FOR CLOTHING, BED AND TABLE COVERS, NAMELY, PLACE MATS OF TEXTILE MATERIAL, TABLE LINEN OF TEXTILE, TABLECLOTHS OF TEXTILE, TEXTILE PLACE MATS, TEXTILE PRINTERS' BLANKETS, TEXTILE SERVIETTES, FABRICS FOR TEXTILE USE, NAMELY, FELT AND NON-WOVEN TEXTILE FABRICS, FIBERGLASS FABRICS FOR TEXTILE USE, COVERED RUBBER YARN FABRICS FOR TEXTILE USE, WAVY FIBER TEXTILE, VELVET, BED LINEN, HOUSEHOLD LINEN, BATH LINEN, EXCEPT CLOTHING, IN CLASS 24 (U.S. CLS. 42 AND 50).

FOR: ARTICLES OF CLOTHING FOR MEN, WOMEN AND CHILDREN, NAMELY, PANTS, SHORTS, SKIRTS, JACKETS, BLOUSES, SHIRTS, TOP, T-SHIRTS AND SWEAT SUITS, HEADGEAR, NAMELY, HATS, CAPS, AND FOOTWEAR, IN CLASS 25 (U.S. CLS. 22 AND 39).

PRIORITY DATE OF 4-16-2007 IS CLAIMED.

NO CLAIM IS MADE TO THE EXCLUSIVE
RIGHT TO USE "MEN", APART FROM THE MARK
AS SHOWN.

SER. NO. 79-039,744, FILED 4-26-2007.

OWNER OF INTERNATIONAL REGISTRATION
0927317 DATED 4-26-2007, EXPIRES 4-26-2017.

KATHERINE M. DUBRAY, EXAMINING ATTOR-
NEY

Int. Cls.: 1, 5 and 29

Prior U.S. Cls.: 1, 5, 6, 10, 18, 26, 44, 46, 51 and 52

United States Patent and Trademark Office

Reg. No. 3,480,845

Registered Aug. 5, 2008

**TRADEMARK
PRINCIPAL REGISTER**



EPAX AS (NORWAY LTD LIAB CO)
VOLLSSVEIEN 6
N-1366 LYSAKER
NORWAY

FOR: FATTY ACIDS, NAMELY, OMEGA-3 FATTY ACIDS FOR USE IN THE MANUFACTURE OF HUMAN AND ANIMAL FOODS AND DIETARY SUPPLEMENTS, IN CLASS 1 (U.S. CLS. 1, 5, 6, 10, 26 AND 46).

FOR: ESTERS FOR PHARMACEUTICAL PURPOSES, COD LIVER OIL, NUTRITIONAL ADDITIVES FOR MEDICAL AND VETERINARY PURPOSES, DIETETIC FOODS ADAPTED FOR MEDICAL AND VETERINARY PURPOSES, DIETETIC SUBSTANCES ADAPTED FOR MEDICAL AND VETERINARY USE, MEDICAL AND VETERINARY PREPARATIONS MAINLY COMPRISING FATTY ACIDS AND/OR OMEGA-3, FOR THE PREVENTION AND TREATMENT OF PSYCHOLOGICAL DISEASES, PSYCHOLOGICAL DISORDERS, CEREBRAL DISEASES, CEREBRAL DISORDERS, DEMENTIA, ALZHEIMER'S DISEASE, EYE DISEASES, EYE DISORDERS, HEART DISEASES, HEART DISORDERS, CARDIO-VASCULAR DISEASES, CARDIO-VASCULAR DISORDERS, CHRONIC INFLAMMATORY DISEASES, CHRONIC INFLAM-

MATORY DISORDERS, AND ARTHRITIS; FOOD AND DIETARY SUPPLEMENTS FOR MEDICAL AND VETERINARY PURPOSES, HUMAN AND ANIMAL FOOD AND DIETARY SUPPLEMENTS DERIVED FROM EDIBLE FISH OILS AND FATS, IN CLASS 5 (U.S. CLS. 6, 18, 44, 46, 51 AND 52).

FOR: EDIBLE FATS, EDIBLE OILS, FATTY SUBSTANCES FOR THE MANUFACTURE OF EDIBLE FATS, FOOD AND DIETARY SUPPLEMENTS FOR NUTRITIONAL PURPOSES, HUMAN AND ANIMAL FOOD ADDITIVES DERIVED FROM EDIBLE FISH OILS AND FATS, IN CLASS 29 (U.S. CL. 46).

OWNER OF INTERNATIONAL REGISTRATION 0927575 DATED 4-13-2007, EXPIRES 4-13-2017.

OWNER OF U.S. REG. NOS. 1,752,168 AND 2,699,140.

NO CLAIM IS MADE TO THE EXCLUSIVE RIGHT TO USE "MARINE OMEGA-3 FORMULA", APART FROM THE MARK AS SHOWN.

SER. NO. 79-039,834, FILED 4-13-2007.

LINDA E. BLOHM, EXAMINING ATTORNEY

Int. Cls.: 11 and 21

Prior U.S. Cls.: 2, 13, 21, 23, 29, 30, 31, 33, 34, 40 and 50

United States Patent and Trademark Office

Reg. No. 3,480,846

Registered Aug. 5, 2008

**TRADEMARK
PRINCIPAL REGISTER**

BESTMINERAL

BWT AKTIENGESELLSCHAFT (AUSTRIA SOCI-
ÉTÉ ANONYME)
WALTER-SIMMER-STRASSE 4
A-5310 MONDSEE
AUSTRIA

FOR: WATER TREATMENT APPARATUS,
NAMELY, REVERSE OSMOSIS FILTRATION
UNITS; WATER SOFTENING APPARATUS AND
INSTALLATIONS; WATER FILTERING APPARA-
TUS, NAMELY, WATER FILTERING UNITS FOR
DOMESTIC USE; WATER FILTERS; WATER
TREATMENT EQUIPMENT, NAMELY, CAR-
TRIDGE FILTRATION UNITS, IN CLASS 11 (U.S.
CLS. 13, 21, 23, 31 AND 34).

FOR: CONTAINERS FOR HOUSEHOLD OR
KITCHEN USE; FILTERS FOR HOUSEHOLD PUR-
POSES, NAMELY, COFFEE FILTERS NOT OF PA-

PER BEING PART OF NON-ELECTRIC COFFEE
MAKERS, IN CLASS 21 (U.S. CLS. 2, 13, 23, 29, 30, 33,
40 AND 50).

THE MARK CONSISTS OF STANDARD CHAR-
ACTERS WITHOUT CLAIM TO ANY PARTICULAR
FONT, STYLE, SIZE, OR COLOR.

PRIORITY DATE OF 4-13-2007 IS CLAIMED.

OWNER OF INTERNATIONAL REGISTRATION
0927660 DATED 5-14-2007, EXPIRES 5-14-2017.

SER. NO. 79-039,855, FILED 5-14-2007.

SUE LAWRENCE, EXAMINING ATTORNEY

Int. Cl.: 33

Prior U.S. Cls.: 47 and 49

United States Patent and Trademark Office

Reg. No. 3,480,847

Registered Aug. 5, 2008

**TRADEMARK
PRINCIPAL REGISTER**

TERRE SOVRANE

BATASIOLO SPA (ITALY SOCIETÀ PER AZIONI
(SPA))
FRAZ. ANNUNZIATA 87
I-12064 LA MORRA, CN
ITALY

OWNER OF U.S. REG. NO. 3,240,146.

FOR: WINES, IN CLASS 33 (U.S. CLS. 47 AND 49).

THE ENGLISH TRANSLATION OF THE FOREIGN WORD(S) IN THE MARK IS: "TERRE SOVRANE" MAY BE TRANSLATED AS "SOVEREIGN LANDS".

THE MARK CONSISTS OF STANDARD CHARACTERS WITHOUT CLAIM TO ANY PARTICULAR FONT, STYLE, SIZE, OR COLOR.

SER. NO. 79-039,988, FILED 5-15-2007.

OWNER OF INTERNATIONAL REGISTRATION
0928125 DATED 5-15-2007, EXPIRES 5-15-2017.

CORY BOONE, EXAMINING ATTORNEY

Int. Cl.: 20

Prior U.S. Cls.: 2, 13, 22, 25, 32 and 50

Reg. No. 3,480,848

United States Patent and Trademark Office

Registered Aug. 5, 2008

**TRADEMARK
PRINCIPAL REGISTER**

LUXOS

OKAMURA CORPORATION (JAPAN CORPORATION)
7-18, KITASAIWAI 2-CHOME
NISHI-KU, YOKOHAMA-SHI; KANAGAWA-KEN
220-0004
JAPAN

FOR: CHAIRS, ARMCHAIRS, DESKS, TABLES,
LOCKERS, INDEX CABINETS, FILING CABINETS,
SHELVES FOR FILING-CABINETS, RACKS, NAME-
LY COAT RACKS, HAT RACKS, MAGAZINE
RACKS, SHOE RACKS, STORAGE RACKS, DIS-
PLAY RACKS, SCREENS, SHELVES FOR STORAGE,
STOOLS, SOFAS, SEATS, BENCHES, SIDEBARDS,
CHESTS OF DRAWERS, FURNITURE PARTITIONS,
FURNITURE OF METAL, ALL FOR OFFICE USE;

OFFICE FURNITURE; SCHOOL FURNITURE; FUR-
NITURE FOR HOUSE, IN CLASS 20 (U.S. CLS. 2, 13,
22, 25, 32 AND 50).

THE MARK CONSISTS OF STANDARD CHAR-
ACTERS WITHOUT CLAIM TO ANY PARTICULAR
FONT, STYLE, SIZE, OR COLOR.

OWNER OF INTERNATIONAL REGISTRATION
0928203 DATED 5-23-2007, EXPIRES 5-23-2017.

SER. NO. 79-040,013, FILED 5-23-2007.

DAWN HAN, EXAMINING ATTORNEY

Int. Cl.: 25

Prior U.S. Cls.: 22 and 39

United States Patent and Trademark Office

Reg. No. 3,480,849

Registered Aug. 5, 2008

**TRADEMARK
PRINCIPAL REGISTER**



ALBERTO INCANUTI S.R.L. (ITALY CORPORATION)

VIA PUBLIO RUTILIO RUFO, 22

I-20161 MILANO

ITALY

FOR: CLOTHING, NAMELY DRESSES, SUITS, SHIRTS, BLOUSES, SKIRTS, JACKETS, OVERCOATS, T-SHIRTS, PULLOVERS, SCARVES, FOU-LARDS, STOCKINGS, SOCKS, GLOVES, TIES, BELTS, SWIMSUITS, TRUNKS, BEACH WEAR, BEACH ROBES, UNDERSHIRTS, BRAS, UNDER-PANTS, SUSPENDER BELTS, PETTICOATS, DRES-SING GOWNS, NIGHTDRESSES, PYJAMAS, SHAWLS, SHOES AND HATS, IN CLASS 25 (U.S. CLS. 22 AND 39).

OWNER OF INTERNATIONAL REGISTRATION
0928344 DATED 5-16-2007, EXPIRES 5-16-2017.

THE NAME "ALBERTO INCANUTI" IDENTIFIES
A LIVING INDIVIDUAL WHOSE CONSENT IS OF
RECORD.

THE MARK CONSISTS OF THE WORDING "AL-
BERTO INCANUTI" WRITTEN IN FANCY CHAR-
ACTERS AND PROCEDED BY A CAPITAL
APOSTROPHIZED "I".

SER. NO. 79-040,058, FILED 5-16-2007.

NORA BUCHANAN WILL, EXAMINING ATTOR-
NEY

Int. Cl.: 2

Prior U.S. Cls.: 6, 11 and 16

United States Patent and Trademark Office

Reg. No. 3,480,850

Registered Aug. 5, 2008

TRADEMARK
PRINCIPAL REGISTER



HEMPEL A/S
LUNDTOFTEVEJ 150
DK-2800 KONGENS LYNGBY
DENMARK

FOR: PAINTS, INCLUDING PAINTS WITH ANTI-FOULING PROPERTIES, VARNISHES, LACQUERS; RUST PRESERVATIVES IN THE NATURE OF A COATING AND WOOD PRESERVATIVES AGAINST DETERIORATION; COLORANTS FOR USE IN THE MANUFACTURE OF PAINTS; DYESTUFFS; MORDANT DYES; RAW NATURAL RESINS FOR USE IN THE MANUFACTURE OF RESINS AND FOR GENERAL INDUSTRIAL USE; AND METALS IN FOIL AND POWDER FORM FOR PAINTERS, DECORATORS, PRINTERS AND ARTISTS, IN CLASS 2 (U.S. CLS. 6, 11 AND 16).

OWNER OF INTERNATIONAL REGISTRATION 0675286 DATED 6-17-1997, EXPIRES 6-17-2017.

OWNER OF U.S. REG. NOS. 58,760, 2,539,543 AND OTHERS.

NO CLAIM IS MADE TO THE EXCLUSIVE RIGHT TO USE "ESTD 1915", APART FROM THE MARK AS SHOWN.

THE MARK CONSISTS OF THE WORDING "HEMPEL ESTD 1915" AROUND THE WATER SAFETY RING AND THE DESIGN OF A SAILOR HOLDING UP A MODEL SHIP FEATURING THE LETTERS "J.C.H."

SER. NO. 79-040,074, FILED 6-19-2007.

WARREN L. OLANDRIA, EXAMINING ATTORNEY

Int. Cl.: 1

Prior U.S. Cls.: 1, 5, 6, 10, 26 and 46

Reg. No. 3,480,851

United States Patent and Trademark Office

Registered Aug. 5, 2008

**TRADEMARK
PRINCIPAL REGISTER**

Wisesorb

WISEPAC ACTIVE PACKAGING; COMPONENTS
CORPORATION (CHINA CORPORATION)
128 LUOJIN ROAD MINHANG DISTRICT
SHANGHAI
CHINA

OWNER OF INTERNATIONAL REGISTRATION
0928498 DATED 5-30-2007, EXPIRES 5-30-2017.

FOR: DESSICANT, IN CLASS 1 (U.S. CLS. 1, 5, 6, 10,
26 AND 46).

SER. NO. 79-040,124, FILED 5-30-2007.

THE MARK CONSISTS OF STANDARD CHAR-
ACTERS WITHOUT CLAIM TO ANY PARTICULAR
FONT, STYLE, SIZE, OR COLOR.

TARAH HARDY, EXAMINING ATTORNEY

Int. Cl.: 33

Prior U.S. Cls.: 47 and 49

United States Patent and Trademark Office

Reg. No. 3,480,852

Registered Aug. 5, 2008

**TRADEMARK
PRINCIPAL REGISTER**

NATUREO

MIGUEL TORRES S.A. (SPAIN SOCIEDAD ANÓNIMA)
MIQUEL TORRES I CARBÓ, 6
E-08720 VILAFRANCA DEL PENEDES (BARCELONA)
SPAIN

OWNER OF INTERNATIONAL REGISTRATION
0928721 DATED 5-16-2007, EXPIRES 5-16-2017.

FOR: WINES, IN CLASS 33 (U.S. CLS. 47 AND 49).

SER. NO. 79-040,212, FILED 5-16-2007.

THE MARK CONSISTS OF STANDARD CHARACTERS WITHOUT CLAIM TO ANY PARTICULAR FONT, STYLE, SIZE, OR COLOR.

AMEETA JORDAN, EXAMINING ATTORNEY

Int. Cl.: 33

Prior U.S. Cls.: 47 and 49

United States Patent and Trademark Office

Reg. No. 3,480,853

Registered Aug. 5, 2008

**TRADEMARK
PRINCIPAL REGISTER**

POLIAKOV

SOCIÉTÉ DES VINS ET SPIRITUEUX; LA MARTINIQUE (SOCIÉTÉ ANONYME) (FRANCE)
SOCIÉTÉ ANONYME (SA)

18 RUE DE L'ENTREPÔT,
F-94220 CHARENTON-LE-PONT
FRANCE

FOR: WINES, DISTILLED SPIRITS AND LIQUEURS, IN CLASS 33 (U.S. CLS. 47 AND 49).

THE MARK CONSISTS OF STANDARD CHARACTERS WITHOUT CLAIM TO ANY PARTICULAR FONT, STYLE, SIZE, OR COLOR.

OWNER OF INTERNATIONAL REGISTRATION
0682542 DATED 11-7-1997, EXPIRES 11-7-2017.

SER. NO. 79-040,304, FILED 5-31-2007.

ROBERT STRUCK, EXAMINING ATTORNEY

Int. Cls.: 9, 11, 20 and 40

**Prior U.S. Cls.: 2, 13, 21, 22, 23, 25, 26, 31, 32, 34, 36,
38, 50, 100, 103 and 106**

Reg. No. 3,480,854

United States Patent and Trademark Office

Registered Aug. 5, 2008

**TRADEMARK
SERVICE MARK
PRINCIPAL REGISTER**

CoolDesk

KNÜRR AG (FED REP GERMANY AG)
MARIAKIRCHENER STR. 38
94424 ARNSTORF
FED REP GERMANY

FOR: ELECTRICAL AND ELECTRONIC APPARATUS AND INSTRUMENTS, NAMELY, BACKPLANES, PRINTED CIRCUIT BOARDS, DATA PROCESSORS, COMPUTER SERVERS, COMPUTERS, COMPUTER DISC DRIVES, COMPUTER MONITORS; MONITORING AND CONTROL INSTRUMENTS, NAMELY, SENSORS, THERMOMETERS, THERMOSTATS, AND TEMPERATURE PRESSURE GAUGES, ALL FOR MONITORING AND CONTROLLING THE TEMPERATURE, HUMIDITY, ACCESS, SMOKE, PRESSURE, AND SPEED OF ELECTRICAL FANS, COMPUTER CHASSIS'S AND ENCLOSURES FOR THE AFORESAID GOODS, AND PARTS THEREFOR, NAMELY, BLANKING PLATES FOR ENCLOSING OPEN FRONT AREAS IN COMPUTER CHASSIS'S AND ENCLOSURES; MOUNTING RACKS FOR COMPUTER HARDWARE, NAMELY, ELECTRONIC DATA PROCESSING RACKS, 19-INCH RACKS AND SERVER RACKS; ELECTRONIC DATA PROCESSING WORKPLACES, NAMELY, COMPUTER WORKSTATIONS COMPRISING COMPUTER HARDWARE IN THE NATURE OF HARD DRIVES AND MONITORS, COOLING UNITS FOR CPUS, AND ELECTRICAL FANS, IN CLASS 9 (U.S. CLS. 21, 23, 26, 36 AND 38).

FOR: REFRIGERATING DISPLAY CABINETS; REFRIGERATING OR REFRIGERATED TABLES; MOUNTING RACKS FOR ELECTRIC FANS, FOR FAN UNITS IN THE NATURE OF PORTABLE ELECTRIC FANS, FOR COOLING UNITS IN THE NATURE OF AIR CONDITIONERS AND FOR HEAT EXCHANGERS NOT BEING PARTS OF MACHINES; ELECTRICAL FANS; FAN UNITS IN THE NATURE OF PORTABLE ELECTRIC FANS; HEAT EXCHANGERS NOT BEING PART OF MACHINES; COOLING DEVICES IN THE NATURE OF AIR CONDITION-

ERS; COOLING ASSEMBLIES IN THE NATURE OF EVAPORATIVE AIR COOLING UNITS FOR DOMESTIC USE; COOLING ELEMENTS IN THE NATURE OF WATER COOLING TOWERS; AND SUBASSEMBLIES AND PARTS OF THE AFOREMENTIONED GOODS, IN CLASS 11 (U.S. CLS. 13, 21, 23, 31 AND 34).

FOR: WORK TABLES, NAMELY, BANK TABLES, STOCK-MARKET TABLES AND MERCHANT TABLES, IN CLASS 20 (U.S. CLS. 2, 13, 22, 25, 32 AND 50).

FOR: ASSEMBLY OF THE FOLLOWING GOODS FOR THIRD PARTY COSTUMERS: ELECTRICAL AND ELECTRONIC APPARATUS AND INSTRUMENTS, NAMELY, BACKPLANES, PRINTED CIRCUIT BOARDS, DATA PROCESSORS, COMPUTER SERVERS, COMPUTERS, COMPUTER DISC DRIVES, COMPUTER MONITORS; MONITORING AND CONTROL INSTRUMENTS, NAMELY, SENSORS FOR MONITORING AND CONTROLLING TEMPERATURE, HUMIDITY, ACCESS, SMOKE, PRESSURE, SPEED; THERMOMETERS, THERMOSTATS, TEMPERATURE PRESSURE GAUGES FOR MONITORING AND CONTROLLING THE TEMPERATURE, PRESSURE, SPEED AND FOR CONTROLLING THE TEMPERATURE, PRESSURE, SPEED OF ELECTRICAL FANS; CHASSIS AND ENCLOSURES FOR THE AFORESAID GOODS AND PARTS THEREFOR, NAMELY, BLANKING PLATES FOR ENCLOSING OPEN FRONT AREAS IN CHASSIS AND ENCLOSURES; MOUNTING RACKS FOR COMPUTER HARDWARE, NAMELY, ELECTRONIC DATA PROCESSING RACKS, 19-INCH RACKS AND SERVER RACKS; ELECTRONIC DATA PROCESSING TABLES, NAMELY, TABLES FOR ARRANGEMENT OF COMPUTER HARDWARE, COOLING UNITS AND ELECTRICAL FANS; ELECTRONIC DATA PROCESSING WORKPLACES, NAMELY, WORKPLACES FOR ARRANGEMENT AND RECEIVING OF COMPUTER HARDWARE, COOLING UNITS AND ELECTRICAL FANS; RE-

FRIGERATING DISPLAY CABINETS; REFRIGERATING OR REFRIGERATED TABLES; MOUNTING RACKS FOR ELECTRIC FANS, FOR FAN UNITS IN THE NATURE OF PORTABLE ELECTRIC FANS, FOR COOLING UNITS IN THE NATURE OF AIR CONDITIONERS AND FOR HEAT EXCHANGERS NOT BEING PARTS OF MACHINES; ELECTRICAL FANS, FAN UNITS IN THE NATURE OF PORTABLE ELECTRIC FANS, HEAT EXCHANGERS NOT BEING PART OF MACHINES, COOLING DEVICES IN THE NATURE OF AIR CONDITIONERS, COOLING ASSEMBLIES IN THE NATURE OF EVAPORATIVE AIR COOLING UNITS FOR DOMESTIC USE, COOLING ELEMENTS IN THE NATURE OF WA-

TER COOLING TOWERS; SUBASSEMBLIES AND PARTS OF THE AFOREMENTIONED GOODS, IN CLASS 40 (U.S. CLS. 100, 103 AND 106).

PRIORITY DATE OF 10-6-2006 IS CLAIMED.

OWNER OF INTERNATIONAL REGISTRATION 0929458 DATED 2-13-2007, EXPIRES 2-13-2017.

SER. NO. 79-040,522, FILED 2-13-2007.

ATTIYA MALIK, EXAMINING ATTORNEY

Int. Cls.: 35, 36 and 39

Prior U.S. Cls.: 100, 101, 102 and 105

United States Patent and Trademark Office

Reg. No. 3,480,855

Registered Aug. 5, 2008

**SERVICE MARK
PRINCIPAL REGISTER**



ITALSEMPIONE -; SPEDIZIONI INTERNAZIONALI S.P.A. (ITALY JOINT STOCK COMPANY)
PIAZZA MATTEOTTI, 15
I-28845 DOMODOSSOLA (VERBANIA)
ITALY

FOR: TRANSPORT BY FERRY, BOAT, RAIL AND AIR, TRUCK TRANSPORT; PACKAGING OF GOODS FOR TRANSPORTATION AND STORAGE OF GOODS; TRAVEL ARRANGEMENT, IN CLASS 39 (U.S. CLS. 100 AND 105).

FOR: ADVERTISING; BUSINESS MANAGEMENT; BUSINESS ADMINISTRATION; OFFICE FUNCTIONS, IN CLASS 35 (U.S. CLS. 100, 101 AND 102).

PRIORITY DATE OF 1-26-2007 IS CLAIMED.

FOR: SERVICES FOR CUSTOMS FORMALITIES, NAMELY, CUSTOMS BROKERAGE; INSURANCE AGENCIES; FINANCIAL AFFAIRS, NAMELY, FINANCIAL CONSULTATION; MONETARY AFFAIRS, NAMELY, MONETARY EXCHANGE; REAL ESTATE AFFAIRS, NAMELY, REAL ESTATE BROKERAGE, IN CLASS 36 (U.S. CLS. 100, 101 AND 102).

OWNER OF INTERNATIONAL REGISTRATION 0929590 DATED 5-22-2007, EXPIRES 5-22-2017.

SER. NO. 79-040,556, FILED 5-22-2007.

KRISTINA MORRIS, EXAMINING ATTORNEY

Int. Cls.: 3, 9, 16, 18, 25, 28, 30, 32 and 41

Prior U.S. Cls.: 1, 2, 3, 4, 5, 6, 21, 22, 23, 26, 29, 36, 37, 38, 39, 41, 45, 46, 48, 50, 51, 52, 100, 101 and 107

Reg. No. 3,480,856

United States Patent and Trademark Office

Registered Aug. 5, 2008

**TRADEMARK
SERVICE MARK
PRINCIPAL REGISTER**

WISHINGTOOTH

DAVID JACK EVERETT (UNITED KINGDOM INDIVIDUAL)
39 MATTHEWS CHASE
BINFIELD
BRACKNELL, BERKSHIRE RG42 4UR, UNITED KINGDOM

FOR: DENTAL CARE PRODUCTS AND PREPARATIONS, NAMELY, DENTAL BLEACHING GEL, TOOTHPASTE, NON-MEDICATED DENTAL RINSE; PRODUCTS FOR USE IN RELATION TO DENTAL HYGIENE, NAMELY, DENTURE CLEANERS; COSMETICS; BODY POWDER; HAIR AND BODY LOTION; HAIR AND BODY OIL; SKIN CREAM; HAIR AND BODY SHAMPOO; HAIR CONDITIONER; SOAP IN ALL FORMS FOR USE ON THE HUMAN BODY; BATH PRODUCTS, NAMELY, ESSENTIAL OILS; SUN-SCREEN; SUN BLOCK AND AFTER-SUN LOTION; ALL FOR PERSONAL USE, IN CLASS 3 (U.S. CLS. 1, 4, 6, 50, 51 AND 52).

FOR: SOUND, VIDEO AND DATA RECORDING AND REPRODUCING APPARATUS FOR STORING, RECORDING, TRANSMITTING AND REPRODUCING SOUND AND IMAGES, NAMELY, COMPUTERS, TELEVISIONS, MP3 AND MP4 PLAYERS, DVD PLAYERS AND PARTS AND FITTINGS FOR THE AFORESAID GOODS; AMUSEMENT APPARATUS FOR GAMES FOR USE WITH A TELEVISION SCREEN OR VIDEO MONITOR, NAMELY, VIDEO GAME DISCS AND VIDEO GAME CARTRIDGES AND PARTS AND FITTINGS FOR THE AFORESAID GOODS; COMPUTERIZED OR ELECTRONIC AMUSEMENT APPARATUS, NAMELY, VIDEO GAME PLAYERS AND HAND-HELD VIDEO GAME PLAYERS AND PDA'S AND PARTS AND FITTINGS FOR THE AFORESAID GOODS; COIN OR TOKEN OPERATED ELECTRICAL OR ELECTRONIC AMUSEMENT APPARATUS, NAMELY, HELMETS, HEADSETS, VISORS, SCREENS AND BOOTHS FOR DISPLAYING CARTOONS, ANIMATION OR VIRTUAL REALITY IMAGES, OR FOR PLAYING MUSIC, AND PARTS AND FITTINGS FOR THE AFORESAID GOODS; COMPUTER SOFTWARE FOR USE IN DATABASE MANAGEMENT, USE AS

A SPREADSHEET, AND IN WORD PROCESSING; COMPUTER GAME SOFTWARE; COMPUTER GAME DISCS, CARTRIDGES AND TAPES; ELECTRONIC GAME PROGRAMS; VIDEO GAME DISCS AND CARTRIDGES; MULTIMEDIA SOFTWARE RECORDED ON CD-ROM FEATURING GAMES; SOUND AND VIDEO RECORDINGS FEATURING SONGS, STORIES, DANCE ROUTINES, PARTY GAMES, THEMED PARTY FORMATS; COMPUTER BAGS; PHONOGRAPH RECORDINGS FEATURING SONGS, STORIES; PRERECORDED CDS AND DVDS FEATURING SONGS, STORIES, ANIMATED CARTOONS, THEMED PARTY FORMATS, LIVE ACTION, MIXED LIVE ACTION AND ANIMATION; CINEMATOGRAPHIC FILMS FEATURING LIVE ACTION, STOP-MOTION, ANIMATION, MIXED LIVE ACTION AND ANIMATION; MOTION PICTURE FILMS, VIDEOTAPES AND VIDEO DISCS ALL FEATURING LIVE ACTION, STOP-MOTION, ANIMATION, MIXED LIVE ACTION AND ANIMATION; PRERECORDED MAGNETIC DATA CARRIERS CONTAINING IMAGES OR SOUND FEATURING SONGS AND STORIES; LASER DISCS FEATURING LIVE ACTION, STOP-MOTION, ANIMATION, MIXED LIVE ACTION AND ANIMATION; COMPUTER MOUSE PADS; DOWNLOADABLE COMPUTER PROGRAMS USE IN DATABASE MANAGEMENT, USE AS A SPREADSHEET, AND IN WORD PROCESSING; COMPUTER GAME PROGRAMS; DOWNLOADABLE TELEPHONE RING TONES VIA A GLOBAL COMPUTER NETWORK AND WIRELESS DEVICES; DOWNLOADABLE ELECTRONIC PUBLICATIONS IN THE NATURE OF BOOKS AND PAMPHLETS AND COMICS AND COMIC STRIPS IN THE FIELD OF CHILDREN'S AND FAMILY EVENTS, FAIRY STORIES, ADVENTURE STORIES AND MULTICULTURAL UNITY; DECORATIVE MAGNETS; DOWNLOADABLE FILMS AND VIDEOS IN THE FIELD OF CHILDREN'S AND FAMILY EVENTS, FAIRY STORIES, ADVENTURE STORIES AND MULTICULTURAL UNITY; DOWNLOADABLE MUSICAL SOUND RECORDINGS, IN CLASS 9 (U.S. CLS. 21, 23, 26, 36 AND 38).

FOR: PAPER, CARDBOARD; CARDBOARD AND PAPER GOODS, NAMELY, BOXES, CARTONS AND CONTAINERS; PRINTED MATTER, NAMELY, PERIODICALS, BOOKS, MAGAZINES, NEWSLETTERS ALL IN THE FIELD OF CHILDREN'S AND FAMILY EVENTS, FAIRY STORIES, ADVENTURE STORIES AND MULTI-CULTURAL UNITY; CALENDARS; POSTERS; CARTOON STRIPS; CARTOON PRINTS; PAMPHLETS IN THE FIELD OF CHILDREN'S AND FAMILY EVENTS, FAIRY STORIES, ADVENTURE STORIES AND MULTI-CULTURAL UNITY; STAND-UP CARDBOARD CARTOON CUT-OUTS; GREETING CARDS; POSTCARDS; TRADING CARDS; PERSONAL ORGANIZERS; MEMO CUBES; ADDRESS BOOKS; APPOINTMENT BOOKS; DIARIES, GIFT WRAP PAPER; PAPER GIFT TAGS; STICKERS; BUMPER STICKERS; BOOK MARKS; BOOK COVERS; PAPER AND CARDBOARD PLACEMATS; PAPER COASTERS; PAPER TABLE CLOTHS; PENS AND PENCIL HOLDERS; PAPER STATIONERY; PRINTED INSTRUCTIONAL AND TEACHING MATERIALS IN THE FIELD OF CHILDREN'S AND FAMILY EVENTS, FAIRY STORIES, ADVENTURE STORIES AND MULTI-CULTURAL UNITY; ADHESIVES FOR STATIONERY OR HOUSEHOLD PURPOSES; ARTISTS' MATERIAL, NAMELY, BRUSHES, PASTELS AND PENCILS; OFFICE REQUISITES, NAMELY, RUBBER BANDS, PUNCHES AND PAPER EMBOSSERS, IN CLASS 16 (U.S. CLS. 2, 5, 22, 23, 29, 37, 38 AND 50).

FOR: LUGGAGE; BAGS, NAMELY, BOOK BAGS AND CARRY-ALL BAGS; TRAVELING BAGS AND CASES OF LEATHER; SPORTS BAGS; OVERNIGHT BAGS; BEACH BAGS; KNAPSACKS; HANDBAGS; DUFFLE BAGS; RUCKSACKS; BACKPACKS; DAY PACKS; BRIEFCASES; ATTACHÉ CASES; BAGS FOR TOILETRIES, SOLD EMPTY; MAKE-UP BAGS, SOLD EMPTY; PURSES AND WALLETS; UMBRELLAS; KEY CASES; ARTICLES AND BAGS MADE OF LEATHER AND/OR IMITATION LEATHER, NAMELY, BOOK BAGS, SCHOOL BAGS AND CLUTCH BAGS; PARTS AND FITTINGS FOR THE ABOVE MENTIONED, NAMELY, DECORATIVE STRAPS, IN CLASS 18 (U.S. CLS. 1, 2, 3, 22 AND 41).

FOR: CLOTHING, NAMELY, SCARVES, UNDERWEAR, SLEEPWEAR, SHIRTS, PANTS, DRESSES; FOOTWEAR; HEADGEAR, NAMELY, HATS AND CAPS, IN CLASS 25 (U.S. CLS. 22 AND 39).

FOR: TOYS, NAMELY, BATH TOYS, FANTASY CHARACTER TOYS; GAMES, NAMELY, ARCADE GAMES AND PADDLEBALL GAMES; NOVELTY PLAYTHINGS, NAMELY, FAKE TEETH; HANDHELD UNITS FOR PLAYING ELECTRONIC GAMES; FULL-SIZE STAND-ALONE ARCADE GAMES; JIGSAW AND MANIPULATIVE PUZZLES; TOY ACTION FIGURES AND ACCESSORIES; WIND-UP TOYS, MUSICAL TOYS; PUPPETS; ACTION SKILL GAMES; BOARD GAMES; ELECTRONIC BOARD GAMES; CARD GAMES; PLAYING CARDS; FLYING DISCS; BALLOONS; PLUSH TOYS; PLUSH STUFFED TOYS; SPORT BALLS; CHRISTMAS TREE ORNAMENTS; BATH TOYS; DOLLS AND DOLL CLOTHING; SPORTING GOODS, EQUIPMENT AND ARTICLES, NAMELY, CHIL-

DREN'S SWINGS, SKIS AND SNOWBOARDS; TOY SCOOTERS; PAPER STREAMERS; COSTUME MASKS; TOY MODEL CARS AND TRAIN SETS; MODELED PLASTIC TOY FIGURINES; MARBLES; YO-YOS; INFLATABLE AND KICKBOARD FLOTATION DEVICES FOR RECREATIONAL USE; TOY BUCKET AND SHOVEL SETS; PARTS AND FITTINGS FOR THE AFORESAID GOODS, IN CLASS 28 (U.S. CLS. 22, 23, 38 AND 50).

FOR: COFFEE; TEA; COCOA; SUGAR; RICE; TAPIOCA; SAGO; COFFEE SUBSTITUTES, NAMELY, ARTIFICIAL COFFEE; BREAD, PASTRY AND CONFECTIONERY, NAMELY, PIES; FRUIT ICES; HONEY, TREACLE; YEAST, BAKING-POWDER; SALT, MUSTARD; VINEGAR, SAUCES; SPICES; ICE, IN CLASS 30 (U.S. CL. 46).

FOR: NON-ALCOHOLIC DRINKS, NAMELY, FRUIT DRINKS, FRUIT JUICES, MINERAL WATER AND AERATED WATER; SYRUPS AND OTHER PREPARATIONS FOR MAKING BEVERAGES, NAMELY, FRUIT JUICE CONCENTRATES, VEGETABLE JUICE CONCENTRATES AND NON-ALCOHOLIC COCKTAIL MIXES, IN CLASS 32 (U.S. CLS. 45, 46 AND 48).

FOR: ENTERTAINMENT SERVICES, NAMELY, PROVIDING A TELEVISION PROGRAM IN THE FIELD OF A MAGAZINE FORMAT DAILY FAMILY SHOW AND A BEHIND THE SCENES SHOW AND A TALENT SHOW VIA A GLOBAL COMPUTER NETWORK; ENTERTAINMENT SERVICES, NAMELY, PRODUCTION OF ANIMATED FILMS AND MUSICAL VIDEOS; ENTERTAINMENT IN THE NATURE OF A TELEVISION COMEDY SERIES; PRODUCTION OF RADIO AND TELEVISION PROGRAMS; PRODUCTION OF MOTION PICTURE FILMS; PRODUCTION OF LIVE ENTERTAINMENT FEATURES, NAMELY, LIVE PERFORMANCE BY A BAND, CONCERTS, TELEVISION PROGRAM; PRODUCTION OF ANIMATED MOTION PICTURES AND TELEVISION FEATURES; CINEMA AND TELEVISION STUDIOS; MOTION PICTURE ENTERTAINMENT, NAMELY, MOTION PICTURE PRODUCTION AND DISTRIBUTION; LIVE ENTERTAINMENT PERFORMANCES AND SHOWS, NAMELY, LIVE MUSICAL CONCERTS, PERFORMANCES BY A MUSICAL BAND, LIVE PERFORMANCES BY A PROFESSIONAL ENTERTAINER; EDUCATION AND INSTRUCTION SERVICES, NAMELY, CONDUCTING COURSES OF INSTRUCTION IN THE FIELD OF DENTAL CARE; RECORDING SERVICES IN THE NATURE OF RECORDING STUDIOS; PRODUCTION OF PRE-RECORDED AUDIO AND VIDEO TAPES, AUDIO AND VIDEO CASSETTES, AUDIO AND VIDEO DISCS, CD-ROMS AND DVDS ALL IN THE FIELD OF MUSIC; PUBLICATION OF BOOKS, MAGAZINES, PRINTED MATTER AND PERIODICALS; PRODUCTION OF SPECIAL EFFECTS FOR RADIO, TELEVISION OR FILMS; ENTERTAINMENT IN THE NATURE OF THEATRE PRODUCTION; ENTERTAINMENT SERVICES, NAMELY, PROVIDING A WEBSITE FEATURING TELEVISION PROGRAM, AUDIO, VIDEO AND MOTION PICTURE FILM ALL IN THE FIELD OF A MAGAZINE FORMAT DAILY FAMILY SHOW

AND A BEHIND THE SCENES SHOW AND A TALENT SHOW VIA A GLOBAL COMMUNICATIONS NETWORK; ENTERTAINMENT INFORMATION; PROVIDING ADVICE IN THE FIELD OF ENTERTAINMENT ACTIVITIES AND EVENTS FOR CHILDREN, IN CLASS 41 (U.S. CLS. 100, 101 AND 107).

PRIORITY DATE OF 8-10-2006 IS CLAIMED.

OWNER OF INTERNATIONAL REGISTRATION 0929630 DATED 2-8-2007, EXPIRES 2-8-2017.

SER. NO. 79-040,570, FILED 2-8-2007.

NICHOLAS ALTREE, EXAMINING ATTORNEY

Int. Cls.: 18 and 25

Prior U.S. Cls.: 1, 2, 3, 22, 39 and 41

Reg. No. 3,480,857

United States Patent and Trademark Office

Registered Aug. 5, 2008

**TRADEMARK
PRINCIPAL REGISTER**



BOO FOO WOO CO., LTD. (JAPAN CORPORATION)
1728-1, OGAWA
MACHIDA-SHI; TOKYO 194-0003
JAPAN

FOR: SPORTS BAGS, BAGS FOR SPORTS, ALL PURPOSE SPORT BAGS, BAGS AND HOLDALLS FOR SPORTS CLOTHING, ATHLETIC BAGS, ALL-PURPOSE ATHLETIC BAGS, ALL-PURPOSE CARRYING BAGS, SHOULDER BAGS, BOSTON BAGS, TOTE BAGS, SLING BAGS, WAIST BAGS, BEACH BAGS, BOOK BAGS, BAGS FOR UMBRELLAS, BELT BAGS, DIAPER BAGS, MESSENGER BAGS, CHARM BAGS, COSMETIC BAGS SOLD EMPTY, MAKE-UP BAGS SOLD EMPTY, TRAVEL BAGS, GARMENT BAGS FOR TRAVEL, GARMENTS FOR PETS, GLADSTONE BAGS, GYM BAGS, HANDBAGS, HIKING BAGS, KEY BAGS, KIT BAGS, LEATHER BAGS, LEATHER HANDBAGS, MESH SHOPPING BAGS, HAT BOXES OF LEATHER FOR TRAVEL, ANIMAL CARRIERS, ATTACHÉ CASES, BRIEFCASES, WALLETS FOR CREDIT CARDS, WALLETS FOR NAME CARDS, DOCUMENT CASES, POCKETBOOKS, KEY CASES, LEATHER CASES, LEATHER CASES FOR KEYS, WALLETS, LEATHER SUITCASES AND WALLETS, KEY WALLETS, POCKET WALLETS, PURSES, CHANGE PURSES, COIN PURSES, MULTI-PURPOSE PURSES, PURSES NOT OF PRECIOUS METAL, BANKNOTE HOLDERS, BILLFOLDS, BACKPACKS, BABY BACKPACKS, SCHOOLCHILDREN'S BACKPACKS, SMALL BACKPACKS, WAIST PACKS, DAYPACKS,

RUCKSACKS, SMALL RUCKSACKS, HIKING RUCKSACKS, HIPSACKS, KNAPSACKS, SCHOOL KNAPSACKS, CLOTHING FOR ANIMALS, PET CLOTHING, COLLARS FOR PETS, ANIMAL LEASHES, DOG SHOES, FUR, ANIMAL HIDES, ANIMAL SKINS, PARASOLS, BEACH PARASOLS, UMBRELLAS, BEACH UMBRELLAS, SUN UMBRELLAS, IN CLASS 18 (U.S. CLS. 1, 2, 3, 22 AND 41).

FOR: CLOTHING, NAMELY, COATS, COATS MADE OF COTTON, COATS OF DENIM, RAIN COATS, WIND COATS, JACKETS, DOWN JACKETS, DENIM JACKETS, RAIN JACKETS, WIND-JACKETS, SWEATERS, V-NECK SWEATERS, TURTLENECK SWEATERS, TURTLENECKS, CARDIGANS, PANTS, SWEAT PANTS, JOGGING PANTS, DENIM PANTS, CAPRI PANTS, TROUSERS, INFANTS' TROUSERS, JEANS, DUNGAREES, PANTALOONS, SKIRTS, T-SHIRTS, POLO SHIRTS, SWEAT SHIRTS, WIND SHIRTS, DRESS SHIRTS, UNDERSHIRTS, GYM SUITS, JOGGING SUITS, WARM UP SUITS, RAIN SUITS, LADIES' SUITS, SWEATSUITS, TANK TOPS, JERSEYS, VESTS, OVERALLS, BIB OVERALLS, PAJAMAS, BABY DOLL PYJAMAS, SHORTS, WALKING SHORTS, SWEAT SHORTS, BERMUDA SHORTS, BOARDSHORTS, GYM SHORTS, FLEECE SHORTS, TRUNKS, BREECHES, CASUAL PANTS, CLAM DIGGERS, INFANT WEAR, INFANT AND TODDLER ONE PIECE CLOTHING, UNDERWEAR, WOMEN'S UNDERWEAR, WOVEN OR KNITTED UNDERWEAR, BRAS, BRASSIERES, PANTIES, SHORTS AND BRIEFS, UNDERCLOTHES, CAMI-

SOLES, CHEMISES, UNDERGARMENTS, TIGHTS, SOCKS, WOOLEN SOCKS, ANKLE SOCKS, ANKLETS, WINDCHEATERS, ANORAKS, PARKAS, PONCHOS, PULLOVERS, FLEECE PULLOVERS, ATHLETIC UNIFORMS, JOGGING OUTFITS, SWIMMING COSTUMES, SWIMMING TRUNKS, SWIMSUITS, TANKINIS, BEACHWEAR, BATHING COSTUMES, BATHING SUITS, BATHING TRUNKS, HEADWEAR, CHILDREN'S HEADWEAR, HATS, WOOLLY HATS, KNITTED CAPS, BASEBALL CAPS, SWIMMING CAPS, BATHING CAPS, CAPS WITH VISORS, VISORS, SUN VISORS, BEANIES, BERETS, TURBANS, BANDANAS, FOOTWEAR, FOOTWEAR FOR MEN AND WOMEN, ATHLETIC FOOTWEAR, BEACH FOOTWEAR, SHOES, BOOTS, WOMEN'S SHOES AND BOOTS, INFANTS' SHOES AND BOOTS, WORK SHOES AND BOOTS, ATHLETIC SHOES, BEACH SHOES, WINTER BOOTS, RAIN BOOTS, LADIES' BOOTS, ANKLE BOOTS, MOCCASINS, GALOSHES, MUKLUKS, SNEAKERS, BASKETBALL SNEAKERS, THONGS FOR FOOTWEAR, THONGS FOR UNDERWEAR, INSOLES, INSOLES FOR SHOES AND BOOTS, BELTS, BELTS MADE OF LEATHER, BELTS OF TEXTILE, SUSPENDERS, APRONS, LAYETTES, CHILDREN'S AND INFANTS' CLOTH BIBS, BABY BIBS NOT OF PAPER, CLOTH BIBS, CRAVATS, DICKIES, INFANT CLOTH DIAPERS, INFANT DIAPER COVERS, INFANT

SLEEPERS, JACKET LINERS, JODHPURS, KERICHEFS, BABUSHKAS, MUFFLERS, MUFFS, GLOVES, LEG WARMERS, VEILS, WRIST BAND, IN CLASS 25 (U.S. CLS. 22 AND 39).

PRIORITY DATE OF 12-18-2006 IS CLAIMED.

OWNER OF INTERNATIONAL REGISTRATION 0929661 DATED 3-9-2007, EXPIRES 3-9-2017.

OWNER OF U.S. REG. NO. 2,453,601.

THE COLOR(S) BLUE AND WHITE IS/ARE CLAIMED AS A FEATURE OF THE MARK.

THE COLOR BLUE APPEARS ON THE ELEMENTS IN THE CENTER OF THE MARK WITH THE COLOR WHITE AROUND THE ELEMENTS. THE BORDER DESIGN IS IN BLUE, THEN WHITE, THEN BLUE.

SER. NO. 79-040,588, FILED 3-9-2007.

ALICIA COLLINS, EXAMINING ATTORNEY

Int. Cls.: 16 and 20

Prior U.S. Cls.: 2, 5, 13, 22, 23, 25, 29, 32, 37, 38 and 50

Reg. No. 3,480,858

United States Patent and Trademark Office

Registered Aug. 5, 2008

**TRADEMARK
PRINCIPAL REGISTER**



COLEBROOK BOSSON SAUNDERS PRODUCTS
LTD. (UNITED KINGDOM LIMITED COMPA-
NY)
18 BOWDEN STREET
LONDON SE11 4DS
UNITED KINGDOM

FOR: PAPER TRAYS, NAMELY, HOLDERS FOR
STATIONERY AND FOR PAPER THAT IS USED IN
PRINTERS AND COPIERS, NOT BEING PART OF
PRINTERS OR COPIERS; LETTER TRAYS; FILE
HOLDERS, NAMELY, DOCUMENT FILE HOLDER
RACKS AND TRAYS; MEMO BOARDS; ALL BEING
FOR OFFICE USE, IN CLASS 16 (U.S. CLS. 2, 5, 22, 23,
29, 37, 38 AND 50).

FOR: OFFICE FURNITURE; OFFICE FURNI-
TURE IN THE NATURE OF STORAGE AND OR-
GANIZATION SYSTEMS COMPRISING SHELVES,
STORAGE RACKS AND FURNITURE PARTS,
SOLD AS A UNIT; SHELVING; STORAGE RACKS;

FURNITURE FOR HOLDING CDS, NAMELY,
SHELVES FOR CDS WHICH ATTACH TO FURNI-
TURE; FURNITURE FOR HOLDING TELE-
PHONES, NAMELY, SHELVES FOR TELEPHONES
WHICH ATTACH TO FURNITURE; NON-METAL
PEGS; DESKS; BENCHES; FURNITURE PARTS;
NON-METAL FURNITURE FITTINGS, IN CLASS
20 (U.S. CLS. 2, 13, 22, 25, 32 AND 50).

OWNER OF INTERNATIONAL REGISTRATION
0810906 DATED 7-2-2003, EXPIRES 7-2-2013.

NO CLAIM IS MADE TO THE EXCLUSIVE
RIGHT TO USE "FOLDER", APART FROM THE
MARK AS SHOWN.

SER. NO. 79-040,614, FILED 6-1-2007.

MARY CRAWFORD, EXAMINING ATTORNEY

Int. Cl.: 25

Prior U.S. Cls.: 22 and 39

United States Patent and Trademark Office

Reg. No. 3,480,859

Registered Aug. 5, 2008

TRADEMARK
PRINCIPAL REGISTER

AMBRÉ

SANITA A/S (DENMARK AKTIESELSKAP (A/S))
LA COURS VEJ 6
DK-7430 IKAST
DENMARK

OWNER OF INTERNATIONAL REGISTRATION
0851954 DATED 6-1-2005, EXPIRES 6-1-2015.

FOR: FOOTWEAR, IN CLASS 25 (U.S. CLS. 22 AND
39).

THE ENGLISH TRANSLATION OF THE WORD
"AMBRÉ" IN THE MARK IS "AMBER".

THE MARK CONSISTS OF STANDARD CHAR-
ACTERS WITHOUT CLAIM TO ANY PARTICULAR
FONT, STYLE, SIZE, OR COLOR.

SER. NO. 79-040,622, FILED 7-6-2007.

JOHN GARTNER, EXAMINING ATTORNEY

Int. Cl.: 7

Prior U.S. Cls.: 13, 19, 21, 23, 31, 34 and 35

United States Patent and Trademark Office

Reg. No. 3,480,860

Registered Aug. 5, 2008

TRADEMARK
PRINCIPAL REGISTER



DIATEX S.P.A. (ITALY JOINT STOCK COMPANY)

VIA FIRENZE, 4

I-36030 VILLAVERLA (VI)

ITALY

FOR: MACHINE TOOLS FOR GRINDING, CUTTING, PERFORATING, MILLING, SAWING AND POLISHING CERAMICS, STONES AND GLASS USING NATURAL OR ARTIFICIALLY PRODUCED ABRASIVE GRAINS, IN CLASS 7 (U.S. CLS. 13, 19, 21, 23, 31, 34 AND 35).

PRIORITY DATE OF 4-5-2007 IS CLAIMED.

OWNER OF INTERNATIONAL REGISTRATION
0930076 DATED 5-15-2007, EXPIRES 5-15-2017.

THE TRADEMARK CONSISTS IN THE WORDING "DIATEX", WITH THE WORD "DIA" WRITTEN INTO A RECTANGLE IN CAPITAL LETTER IN LIGHT SHADE ON A DARKER BACKGROUND, UNDER WHICH APPEARS THE WORD "TEX" WRITTEN INTO A RECTANGLE IN CAPITAL LETTER IN DARK SHADE ON A LIGHTER BACKGROUND.

SER. NO. 79-040,780, FILED 5-15-2007.

GISELLE AGOSTO, EXAMINING ATTORNEY

Int. Cl.: 1

Prior U.S. Cls.: 1, 5, 6, 10, 26 and 46

Reg. No. 3,480,861

United States Patent and Trademark Office

Registered Aug. 5, 2008

**TRADEMARK
PRINCIPAL REGISTER**

OMYA SYNCARB

OMYA AG (SWITZERLAND CORPORATION)
BASLERSTRABE 42
CH-4665 OFTRINGEN, ARGAU
SWITZERLAND

OWNER OF INTERNATIONAL REGISTRATION
0721572 DATED 9-14-1999, EXPIRES 9-14-2009.

FOR: CALCIUM CARBONATE SUSPENSION
FOR USE IN THE MANUFACTURE OF PAPER, IN
CLASS 1 (U.S. CLS. 1, 5, 6, 10, 26 AND 46).

OWNER OF U.S. REG. NOS. 983,598, 2,063,863,
AND 2,502,000.

THE MARK CONSISTS OF STANDARD CHAR-
ACTERS WITHOUT CLAIM TO ANY PARTICULAR
FONT, STYLE, SIZE, OR COLOR.

SER. NO. 79-040,916, FILED 4-11-2007.

LEIGH LOWRY, EXAMINING ATTORNEY

Int. Cl.: 12

Prior U.S. Cls.: 19, 21, 23, 31, 35 and 44

Reg. No. 3,480,862

United States Patent and Trademark Office

Registered Aug. 5, 2008

**TRADEMARK
PRINCIPAL REGISTER**

V-MAXX AUTOSPORT

HILTRAC B.V. (NETHERLANDS LTD LIAB CO)
ZANDSTRAAT 11
NL-5712 XX SOMEREN
NETHERLANDS

THE MARK CONSISTS OF STANDARD CHARACTERS WITHOUT CLAIM TO ANY PARTICULAR FONT, STYLE, SIZE, OR COLOR.

FOR: APPARATUS FOR LOCOMOTION BY LAND, NAMELY, AUTOMOBILES AND TRUCKS, AND PARTS THEREFORE, NAMELY, SHOCK ABSORBERS, LAND VEHICLE SUSPENSION PARTS, NAMELY, COIL SPRINGS; LAND VEHICLE SUSPENSION PARTS FOR AUTOMOBILES AND TRUCKS, NAMELY, LEAF SPRINGS, SHOCK ABSORBING SPRINGS FOR MOTOR CARS, SUSPENSION SPRINGS FOR MOTOR CARS; SPECIFICALLY EXCLUDING MOTORCYCLES AND ANY PARTS THEREFORE, IN CLASS 12 (U.S. CLS. 19, 21, 23, 31, 35 AND 44).

OWNER OF INTERNATIONAL REGISTRATION
0811929 DATED 9-23-2003, EXPIRES 9-23-2013.

NO CLAIM IS MADE TO THE EXCLUSIVE RIGHT TO USE "AUTOSPORT", APART FROM THE MARK AS SHOWN.

SER. NO. 79-040,941, FILED 12-12-2006.

KRISTINA MORRIS, EXAMINING ATTORNEY

Int. Cl.: 3

Prior U.S. Cls.: 1, 4, 6, 50, 51 and 52

United States Patent and Trademark Office

Reg. No. 3,480,863

Registered Aug. 5, 2008

**TRADEMARK
PRINCIPAL REGISTER**

EYE · OLOGY

LA COLLINE INTERNATIONAL (FRANCE SOCI-
ÉTÉ A RESPONSABILITÉ LIMITÉE)
7, RUE AUBER
F-75009 PARIS
FRANCE

OWNER OF INTERNATIONAL REGISTRATION
0837158 DATED 10-1-2004, EXPIRES 10-1-2014.

SER. NO. 79-040,947, FILED 11-14-2006.

FOR: SOAPS, PERFUMES, COSMETICS, HAIR
LOTIONS, BEAUTY MASKS, LIPSTICKS, IN CLASS
3 (U.S. CLS. 1, 4, 6, 50, 51 AND 52).

DEBRA LEE, EXAMINING ATTORNEY

Int. Cl.: 35

Prior U.S. Cls.: 100, 101 and 102

United States Patent and Trademark Office

Reg. No. 3,480,864

Registered Aug. 5, 2008

**SERVICE MARK
PRINCIPAL REGISTER**

GOME

BEIJING GOME APPLIANCE CO., LTD (CHINA CORPORATION)
NO. 8 XINCHENG INDUSTRIAL PARK,
1, LUCHENG TOWN.; TONGZHOU DISTRICT; BEIJING
CHINA

FOR: ADVERTISING; ADVERTISING AGENCIES; IMPORT-EXPORT AGENCIES; ORGANIZATION OF EXHIBITION FOR COMMERCIAL OR ADVERTISING PURPOSE; SALES PROMOTION FOR OTHERS; PERSONNEL MANAGEMENT CONSULTANCY; RELOCATION SERVICES FOR BUSI-

NESS; OFFICE MACHINES AND EQUIPMENT RENTAL; ACCOUNTING; RENTAL OF VENDING MACHINES, IN CLASS 35 (U.S. CLS. 100, 101 AND 102).

OWNER OF INTERNATIONAL REGISTRATION
0930415 DATED 7-6-2007, EXPIRES 7-6-2017.

SER. NO. 79-040,972, FILED 7-6-2007.

DORITT L. CARROLL, EXAMINING ATTORNEY

Int. Cl.: 10

Prior U.S. Cls.: 26, 39 and 44

United States Patent and Trademark Office

Reg. No. 3,480,865

Registered Aug. 5, 2008

**TRADEMARK
PRINCIPAL REGISTER**

KRENKEL

PROF. DR. MED. CHRISTIAN KRENKEL (AUSTRIA INDIVIDUAL)
MOOSSTRABE 80A
A-5020 SALZBURG, AUSTRIA

FOR: DISTRACTION AND FIXATION ELEMENTS FOR MEDICAL USE, NAMELY, ENDO-DISTRATORS IN THE NATURE OF BONE SCREWS AND DISTRACTION SLEEVES, IN CLASS 10 (U.S. CLS. 26, 39 AND 44).

THE MARK CONSISTS OF STANDARD CHARACTERS WITHOUT CLAIM TO ANY PARTICULAR FONT, STYLE, SIZE, OR COLOR.

PRIORITY DATE OF 6-27-2006 IS CLAIMED.

OWNER OF INTERNATIONAL REGISTRATION 0930454 DATED 12-21-2006, EXPIRES 12-21-2016.

SER. NO. 79-040,987, FILED 12-21-2006.

KRISTINA MORRIS, EXAMINING ATTORNEY

Int. Cl.: 33

Prior U.S. Cls.: 47 and 49

United States Patent and Trademark Office

Reg. No. 3,480,866

Registered Aug. 5, 2008

**TRADEMARK
PRINCIPAL REGISTER**

QUERCIOLO

AZIENDA GOMBA SOCIETA' SEMPLICE AGRICOLA (ITALY SOCIETE CIVILE)
VIA BOSCHETTI, 2
I-12060 BAROLO (CN)
ITALY

FOR: WINES, IN CLASS 33 (U.S. CLS. 47 AND 49).

THE MARK CONSISTS OF STANDARD CHARACTERS WITHOUT CLAIM TO ANY PARTICULAR FONT, STYLE, SIZE, OR COLOR.

PRIORITY DATE OF 5-31-2007 IS CLAIMED.

OWNER OF INTERNATIONAL REGISTRATION
0930592 DATED 6-20-2007, EXPIRES 6-20-2017.

SER. NO. 79-041,031, FILED 6-20-2007.

MICHAEL TANNER, EXAMINING ATTORNEY

Int. Cl.: 14

Prior U.S. Cls.: 2, 27, 28 and 50

United States Patent and Trademark Office

Reg. No. 3,480,867

Registered Aug. 5, 2008

**TRADEMARK
PRINCIPAL REGISTER**

FANTASME

JACRI SA (SWITZERLAND SOCIÉTÉ ANON-
YME)
ROUTE DES FALAISES 7
CH-2000 NEUCHÂTEL
SWITZERLAND

FOR: JEWELRY, NAMELY, RINGS, BRACELETS,
CHAINS, NECKLACES, PENDANTS, EARRINGS,
BROOCHES; CUFFLINKS, TIE PINS; GOODS IN
PRECIOUS METALS, THEIR ALLOYS OR PLATED
THEREWITH, NAMELY, KEY RINGS; TIMEPIECES
AND CHRONOMETRIC INSTRUMENTS, NAMELY,
WATCHES, CHRONOGRAPH WATCHES, STOP-
WATCHES, ALARM CLOCKS AND PARTS THERE-
OF INCLUDED IN THIS CLASS, NAMELY, WATCH
CASES, WATCH BANDS, WATCH DIALS, WATCH
MOVEMENTS, WATCH GLASSES, IN CLASS 14 (U.S.
CLS. 2, 27, 28 AND 50).

THE MARK CONSISTS OF STANDARD CHAR-
ACTERS WITHOUT CLAIM TO ANY PARTICULAR
FONT, STYLE, SIZE, OR COLOR.

PRIORITY DATE OF 2-9-2007 IS CLAIMED.

OWNER OF INTERNATIONAL REGISTRATION
0930626 DATED 7-2-2007, EXPIRES 7-2-2017.

THE FOREIGN WORDING IN THE MARK
TRANSLATES INTO ENGLISH AS "PHANTASM".

SER. NO. 79-041,049, FILED 7-2-2007.

TARAH HARDY, EXAMINING ATTORNEY

Int. Cl.: 35

Prior U.S. Cls.: 100, 101 and 102

United States Patent and Trademark Office

Reg. No. 3,480,868

Registered Aug. 5, 2008

**SERVICE MARK
PRINCIPAL REGISTER**

TØREAD

DREAMSCO CO., LTD.
11F. CHANG GYEONG BLDG,
28-7, WONNAM-DONGJONGNO-GU, SEOUL
REPUBLIC OF KOREA

FOR: ADVERTISING OF PUBLISHED TEXTS; MODELLING FOR ADVERTISING OR SALES PROMOTION; ADVERTISEMENT PLANNING; ADVERTISING AGENCIES; PUBLICATION OF PUBLICITY TEXTS; ARRANGING OF ADVERTISING; PUBLICITY MATERIAL RENTAL; RENTAL OF ADVERTISING SPACE; RENTAL OF COMMERCIAL BOARDS; CORPORATE ADVERTISEMENT AND PROMOTION; RADIO ADVERTISING; FILM ADVERTISING; OUTDOOR ADVERTISING; ON-LINE ADVERTISING ON A COMPUTER NETWORK; TELEVISION ADVERTISING; SALES PROMOTION FOR OTHERS; MARKETING RESEARCH; OPINION POLLING; PERSONNEL MANAGEMENT CONSULTANCY; BUSINESS DATA RESEARCH; COMPILATION OF INFORMATION INTO COMPUTER DATABASES; SYSTEMIZATION OF INFORMATION INTO COMPUTER DATABASES; PROVIDING AN ONLINE SEARCHABLE DATABASE IN THE FIELD OF LOCATING PRODUCTS, DESCRIBING PRODUCTS, RATING PRODUCTS, PRICING PRODUCTS AND COMPARING PRICES OF PRODUCTS; COMPUTERIZED FILE MANAGEMENT; STATISTICAL INFORMATION; BUSINESS MANAGEMENT OF HOTELS; AUCTIONEERING; IMPORT-EXPORT AGENCIES; BUSINESS MANAGEMENT OF GAS STATIONS; PROCUREMENT SERVICES, NAMELY, PURCHASING CLOTHING FOR OTHERS; INTERMEDIARY SERVICES RELATING TO THE SALE OF CLOTHING; INTERMEDIARY SERVICES RELATING TO THE SALE OF BAGS; INTERMEDIARY

SERVICES RELATING TO THE SALE OF SHOES; INTERMEDIARY SERVICES RELATING TO THE SALE OF FASHION ACCESSORIES OF PRECIOUS METAL; INTERMEDIARY SERVICES RELATING TO THE SALE OF FASHION ACCESSORIES NOT OF METAL; INTERMEDIARY SERVICES RELATING TO THE SALE OF WATCHES; INTERMEDIARY SERVICES RELATING TO THE SALE OF SPORTSWEAR; INTERMEDIARY SERVICES RELATING TO THE SALE OF ELECTRONIC PRODUCTS FOR HOUSEHOLD PURPOSES; INTERMEDIARY SERVICES RELATING TO THE SALE OF HOME ELECTRONIC APPLIANCES; INTERMEDIARY SERVICES RELATING TO THE SALE OF COMPUTERS; INTERMEDIARY SERVICES RELATING TO THE SALE OF PERIPHERAL DEVICES FOR COMPUTERS; INTERMEDIARY SERVICES RELATING TO THE SALE OF SOUNDERS; INTERMEDIARY SERVICES RELATING TO THE SALE OF COMPUTER SOFTWARE; INTERMEDIARY SERVICES RELATING TO THE SALE OF FASHION GOODS; INTERMEDIARY SERVICES RELATING TO THE SALE OF CLOTHING ACCESSORIES; INTERMEDIARY SERVICES RELATING TO THE SALE OF SPORTS GOODS; INTERMEDIARY SERVICES RELATING TO THE SALE OF SODA WATER; PHOTOCOPYING; BUSINESS MANAGEMENT OF PERFORMING ARTISTS; MARKETING SERVICES; OFFICE MACHINES AND EQUIPMENT RENTAL; DEMONSTRATION OF GOODS; SHOP WINDOW DRESSING; PERSONNEL RECRUITMENT; PROVISION OF INFORMATION RELATING TO JOBS AND PART-TIME JOBS; RENTAL OF VENDING MACHINES, IN CLASS 35 (U.S. CLS. 100, 101 AND 102).

OWNER OF INTERNATIONAL REGISTRATION
0930687 DATED 1-31-2007, EXPIRES 1-31-2017.

SER. NO. 79-041,074, FILED 1-31-2007.
SEAN CROWLEY, EXAMINING ATTORNEY

Int. Cl.: 3

Prior U.S. Cls.: 1, 4, 6, 50, 51 and 52

United States Patent and Trademark Office

Reg. No. 3,480,869

Registered Aug. 5, 2008

TRADEMARK
PRINCIPAL REGISTER

CURLYSUE

DREAMSCO CO., LTD.
11F. CHANG GYEONG BLDG,
28-7. WONNAM-DONGJONGNO-GU, SEOUL
REPUBLIC OF KOREA

FOR: NOURISHING CREAMS BEING COSMETICS; NAIL ENAMEL REMOVERS; EYEBROW PENCILS; HAIR CARE PREPARATIONS, NAMELY, HAIR-WASHING POWDER; LAVENDER WATER, NAMELY, TOILET WATER, SCENTED LINEN WATER; LIQUID ROUGE; SACHETS FOR PERFUMING LINEN; LIPSTICKS; MASCARA; FACE MASK PACK FOR COSMETIC USE; MASSAGE GEL; MASSAGE OIL; NAIL POLISH; ENAMEL FOR MANICURES; VARNISH-REMOVING PREPARATIONS; HAIR COLORANTS; HAIR WAVING PREPARATIONS; COLOR-REMOVING PREPARATIONS FOR HAIR; ESSENTIAL OILS, NAMELY, BADIAN ESSENCE; VANISHING CREAMS; BATH OIL; BATH POWDER; BABY OIL; BABY POWDER; BLUSHER; PERFUMED TALCUM POWDER FOR COSMETIC USE; DANDRUFF LOTIONS NOT FOR MEDICAL TREATMENT; DANDRUFF CREAMS NOT FOR MEDICAL TREATMENT; BATH SALTS, NOT FOR MEDICAL PURPOSES; AROMATICS OTHER THAN FOR MEDICAL PURPOSES, NAMELY, AROMATHERAPY CREAMS, AROMATHERAPY OILS, INCENSE, ROOM FRAGRANCES; ESSENTIAL OILS, NAMELY, SAFROL; AFTER-SUN MILK; SUNSCREEN CREAMS; SUNTAN OILS FOR COSMETIC PURPOSES; SUN-TANNING PREPARATIONS; SHAVING CREAMS; NAIL POLISHING POWDER; NAIL COLORANTS; LOTIONS FOR SKIN CARE; COSMETIC SKIN FRESHENERS, NAMELY, BODY SPRAY, SCENTED BODY SPRAY; ESSENTIAL OILS OF CITRON; EYELINERS; EYE MAKE-UP REMOVERS; EYE SHADOW; AFTER SHAVE LOTIONS; ESSENTIAL OILS; EAU DE COLOGNE; DEODORANTS FOR PERSONAL USE; COSMETIC LOTIONS; LIP GLOSS; LIP COATINGS, NAMELY, NON-MEDICATED LIP CARE PREPARATIONS; LIP CONDITIONERS; NON-MEDICATED PROTECTIVE PREPARATIONS FOR LIPS; COSMETIC PREPARATIONS FOR SLIMMING PURPOSES; COLD CREAMS; COLD WAVING SOLUTIONS; SOLID POWDER FOR COMPACTS; MOUSTACHE WAX;

SKIN CLEANSING CREAM; DEPILATORY WAX; DEPILATORY PREPARATIONS; BEARD DYES; PERMANENT WAVE PREPARATIONS; NEUTRALIZERS FOR PERMANENT WAVING; FOUNDATION CREAMS; PERMANENT WAVING LOTIONS; FACE POWDER; POTPOURRI PERFUMES; SKIN WHITENING CREAMS; HAND CREAMS FOR COSMETIC PURPOSES; PERFUMES; LIP BALMS; HAIR GEL; HAIR GLAZE; HAIR STYLING PREPARATIONS; HAIR LACQUERS; HAIR LOTIONS; HAIR MOISTURIZERS; HAIR MOUSSE; HAIR SPRAY; HAIR CONDITIONERS; HAIR CREAMS; HAIR TONIC; PERFUME OILS, NAMELY, HELIOTROPINE; HYDROGEN PEROXIDE FOR COSMETIC PURPOSES; GREASES FOR COSMETIC PURPOSES; PETROLEUM JELLY FOR COSMETIC PURPOSES; ASTRINGENTS FOR COSMETIC PURPOSES; COSMETIC PENCILS; COSMETIC DYES; COSMETIC BATH SALTS; HAIR COLORANTS; CLEANSING MILK FOR TOILET PURPOSES; POMADES FOR COSMETIC PURPOSES; COSMETIC ADDITIVES FOR BATHS, NAMELY, BATH BEADS; AFTER-SHAVE COLOGNE; MAKE-UP POWDER; SOAP POWDER; SHAVING SOAP; BATH SOAPS; LIQUID SOAPS; COSMETIC SOAPS; SOAPS FOR FOOT PERSPIRATION; DEODORANT SOAP; SHAMPOOS; SOAP FOR BRIGHTENING TEXTILE; EXFOLIANTS FOR THE CARE OF THE SKIN; ALL PURPOSE CLEANING PREPARATIONS; OILS FOR CLEANING PURPOSES; MEDICATED SOAP; GLASS CLEANING PREPARATIONS; RINSE AGENTS FOR LAUNDRY; WINDSCREEN CLEANING LIQUIDS; CREAM SOAPS; TOILET BOWL DETERGENTS; HAIR RINSES FOR COSMETIC USE; GENERAL PURPOSE ABRASIVE POWDERS; DENTIFRICES; TALCUM POWDER FOR TOILET USE, IN CLASS 3 (U.S. CLS. 1, 4, 6, 50, 51 AND 52).

OWNER OF INTERNATIONAL REGISTRATION
0930688 DATED 1-31-2007, EXPIRES 1-31-2017.

SER. NO. 79-041,075, FILED 1-31-2007.

WILLIAM P. SHANAHAN, EXAMINING ATTORNEY

Int. Cl.: 7

Prior U.S. Cls.: 13, 19, 21, 23, 31, 34 and 35

United States Patent and Trademark Office

Reg. No. 3,480,870

Registered Aug. 5, 2008

**TRADEMARK
PRINCIPAL REGISTER**

PLATINO

PRIMA INDUSTRIE SPA (ITALY CORPORATION)
VIA ANTONELLI, 32
I-10097 COLLEGNO (TO)
ITALY

OWNER OF INTERNATIONAL REGISTRATION
0930733 DATED 4-6-2007, EXPIRES 4-6-2017.

FOR: ELECTRONICALLY CONTROLLED CUTTING AND WELDING LASER MACHINES, FOR THE AUTOMOTIVE, AEROSPACE AND SHEET METAL INDUSTRY, IN CLASS 7 (U.S. CLS. 13, 19, 21, 23, 31, 34 AND 35).

THE ENGLISH TRANSLATION OF THE WORD "PLATINO" IN THE MARK IS "PLATINUM".

SER. NO. 79-041,093, FILED 4-6-2007.

THE MARK CONSISTS OF STANDARD CHARACTERS WITHOUT CLAIM TO ANY PARTICULAR FONT, STYLE, SIZE, OR COLOR.

DAVID HOFFMAN, EXAMINING ATTORNEY

Int. Cl.: 3

Prior U.S. Cls.: 1, 4, 6, 50, 51 and 52

United States Patent and Trademark Office

Reg. No. 3,480,871

Registered Aug. 5, 2008

**TRADEMARK
PRINCIPAL REGISTER**

Qai

BHL S.A. (LUXEMBOURG SOCIÉTÉ ANONYME)
10, RUE NICOLAS ADAMES
L-1114 LUXEMBOURG, LUXEMBOURG

FOR: COSMETICS FOR MEN AN WOMEN, NAMELY, DAY AND NIGHT CREAMS, CLEANSING PREPARATIONS FOR THE FACE AND BODY, BEAUTY MASKS, BUBBLE BATH, SHAVING CREAM, AFTER-SHAVE LOTION, MAKE-UP FOUNDATION, NAIL POLISH, BODY DEODORANTS, HAND AND BODY SOAPS, SHAMPOOS AND RINSING AGENTS FOR THE HAIR, DENTIFRICES, PERFUMES, EAUX DE TOILETTE, AND ESSENTIAL OILS FOR PERSONAL USE, IN CLASS 3 (U.S. CLS. 1, 4, 6, 50, 51 AND 52).

PRIORITY DATE OF 6-8-2007 IS CLAIMED.

OWNER OF INTERNATIONAL REGISTRATION
0930804 DATED 6-19-2007, EXPIRES 6-19-2017.

THE WORDING "QAI" HAS NO MEANING IN A FOREIGN LANGUAGE.

SER. NO. 79-041,116, FILED 6-19-2007.

WARREN L. OLANDRIA, EXAMINING ATTORNEY

Int. Cl.: 30

Prior U.S. Cl.: 46

United States Patent and Trademark Office

Reg. No. 3,480,872

Registered Aug. 5, 2008

**TRADEMARK
PRINCIPAL REGISTER**

POCKET ESPRESSO

FERRERO S.P.A. (ITALY SOCIÉTÉ PAR ACTION)
PIAZZALE PIETRO FERRERO
I-12051 ALBA (CN)
ITALY

OWNER OF U.S. REG. NOS. 884,227 AND 894,699.

FOR: COFFEE-FLAVORED PASTRIES, CANDIES,
AND CHOCOLATES; COFFEE-FLAVORED PRA-
LINES AND SWEETS; COFFEE-FLAVORED OR
FILLED PRALINES AND SWEETS, IN CLASS 30
(U.S. CL. 46).

NO CLAIM IS MADE TO THE EXCLUSIVE
RIGHT TO USE "ESPRESSO", APART FROM THE
MARK AS SHOWN.

SER. NO. 79-041,251, FILED 2-14-2007.

OWNER OF INTERNATIONAL REGISTRATION
0510218 DATED 2-13-1987, EXPIRES 2-13-2017.

SEAN CROWLEY, EXAMINING ATTORNEY

Int. Cl.: 12

Prior U.S. Cls.: 19, 21, 23, 31, 35 and 44

Reg. No. 3,480,873

United States Patent and Trademark Office

Registered Aug. 5, 2008

**TRADEMARK
PRINCIPAL REGISTER**

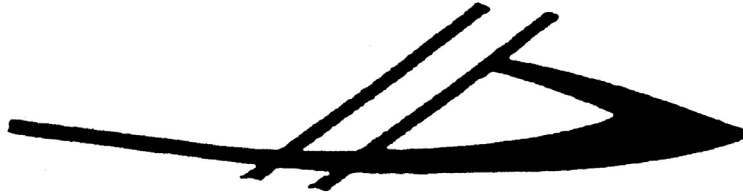

EMPACHER VERWALTUNGS GMBH & CO. KG
ROCKENAUER STRASSE 7
69412 EBERBACH A. N.
FED REP GERMANY

OWNER OF INTERNATIONAL REGISTRATION
0545508 DATED 11-6-1989, EXPIRES 11-6-2009.

SER. NO. 79-041,253, FILED 1-9-2007.

FOR: BOATS, IN CLASS 12 (U.S. CLS. 19, 21, 23, 31,
35 AND 44).

SHAILA SETTLES, EXAMINING ATTORNEY

Int. Cl.: 25

Prior U.S. Cls.: 22 and 39

United States Patent and Trademark Office

Reg. No. 3,480,874

Registered Aug. 5, 2008

**TRADEMARK
PRINCIPAL REGISTER**

SOLOLA

SOLOLA.; SOCIÉTÉ PAR ACTIONS SIMPLIFIÉE
(FRANCE SOCIÉTÉ PAR ACTIONS SIMPLIFIÉE)
57, AVENUE MICHELET
F-93400 SAINT-OUEN
FRANCE

FOR: CLOTHING, NAMELY, HOSIERY, DRESSES, SKIRTS, TROUSERS, SHIRTS, TEE-SHIRTS, SUITS, JACKETS, COATS; UNDERWEAR, PAJAMAS, DRESSING GOWNS; NECKTIES, SASHES FOR WEAR, SCARVES, BELTS, GLOVES, SOCKS, STOCKINGS, TIGHTS; READY-MADE CLOTHING, NAMELY, SHIRTS, PANTS, DRESSES, COATS, JACKETS, SUITS, SKIRTS, RAINCOATS, JUMPERS,

ANORAKS, CAPES, JEANS, PARKAS, SHORTS, BLOUSES, SWEATERS, VESTS; KNITWEAR, NAMELY, DRESSES, COATS, JACKETS, SUITS, CAPES, SWEATERS, VESTS, PULLOVERS, SOCKS; FOOTWEAR; HEADWEAR; HEADGEAR, NAMELY HATS, IN CLASS 25 (U.S. CLS. 22 AND 39).

OWNER OF INTERNATIONAL REGISTRATION
0569862 DATED 5-10-1991, EXPIRES 5-10-2011.

SER. NO. 79-041,254, FILED 1-15-2007.

JAMES A. RAUEN, EXAMINING ATTORNEY

Int. Cl.: 41

Prior U.S. Cls.: 100, 101 and 107

United States Patent and Trademark Office

Reg. No. 3,480,875

Registered Aug. 5, 2008

**SERVICE MARK
PRINCIPAL REGISTER**

WHY NOT

EDYMA RESTAURADORES, S.L.; SOCIEDAD UNIPERSONAL (SPAIN SOCIEDAD LIMITADA SOCIEDAD UNIPERSONALE)
LIBERTAD, 23
E-28004 MADRID
SPAIN

FOR: ENTERTAINMENT, NAMELY, ARRANGING AND CONDUCTING NIGHTCLUB EVENTS; ENTERTAINMENT IN THE NATURE OF AIR SHOWS; ENTERTAINMENT IN THE NATURE OF RECORD PRODUCTION; PROVIDING A WEB SITE FEATURING MUSICAL PERFORMANCES, MUSICAL VIDEOS, RELATED FILM CLIPS, PHOTOGRAPHS, AND OTHER MULTIMEDIA MATERIALS; PROVIDING PRE-RECORDED MUSIC, INFORMATION IN THE FIELD OF MUSIC, AND COMMENTARY AND ARTICLES ABOUT

MUSIC, ALL ON-LINE VIA A GLOBAL COMPUTER NETWORK; ENTERTAINMENT SERVICES IN THE NATURE OF LIVE MUSICAL PERFORMANCES AND LIVE MUSIC CONCERTS; DISCOTHEQUES, IN CLASS 41 (U.S. CLS. 100, 101 AND 107).

THE MARK CONSISTS OF STANDARD CHARACTERS WITHOUT CLAIM TO ANY PARTICULAR FONT, STYLE, SIZE, OR COLOR.

OWNER OF INTERNATIONAL REGISTRATION 0743371 DATED 9-21-2000, EXPIRES 9-21-2010.

SER. NO. 79-041,262, FILED 2-6-2007.

SUE LAWRENCE, EXAMINING ATTORNEY

Int. Cl.: 24

Prior U.S. Cls.: 42 and 50

United States Patent and Trademark Office

Reg. No. 3,480,876

Registered Aug. 5, 2008

**TRADEMARK
PRINCIPAL REGISTER**

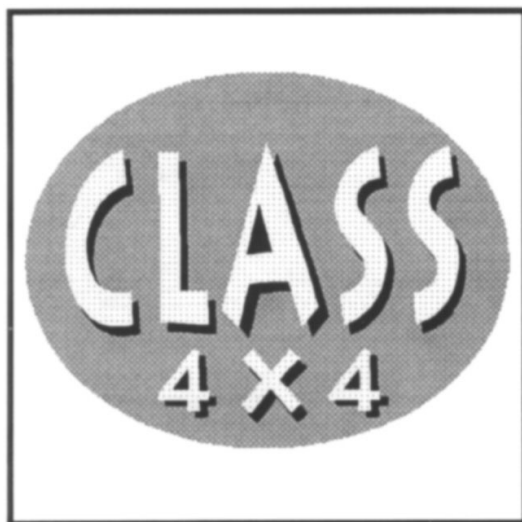

TELASIS TEKSTIL URUNLERI; SANAYI VE TICARET ANONIM SIRKETI (TURKEY JOINT STOCK COMPANY)

HADIMKOY YOLU

SANBIR BULVARI, 4.BOLGE.; 9.CADDE, NO:58/A;
BUYUKCEKMECE - ISTANBUL
TURKEY

FOR: NONWOVEN TEXTILE PRODUCTS, NAMELY, INTERLININGS IN THE NATURE OF TEXTILE USED AS LININGS FOR CLOTHING, ADHESIVE FABRIC FOR APPLICATION BY HEAT, CHEMICAL FIBER FABRICS, CLOTHS USED FOR WRAPPING GOODS, CONTOURED MATTRESS COVERS, COVERLETS, DIAPER CHANGING PADS NOT OF PAPER, DIAPER CHANGING MATS, FABRIC FOR BOOTS AND SHOES, FABRIC TABLE TOPPERS, FABRICS FOR TEXTILE USE, FELT AND NON-WOVEN TEXTILE FABRICS, FELT CLOTH, FIBERGLASS FABRIC FOR TEXTILE USE, FIBERGLASS FABRICS FOR TEXTILE USE, FIBERGLASS REINFORCEMENT FABRIC FOR USE IN LAND, SEA AND AEROSPACE APPLICATIONS, FLAX FABRICS, HAND TOWELS, HOUSEHOLD LINEN, JERSEY FABRICS FOR CLOTHING, JERSEY MATERIAL FABRIC, KNITTED FABRIC, KNITTED FABRICS, KNITTED FABRICS OF CHEMICAL-FIBER YARN, KNITTED FABRICS OF COTTON YARN, KNITTED FABRICS OF WOOL YARN, LINEN FABRIC, LINEN CLOTH, LINEN LINING FABRIC FOR SHOES, MATTRESS COVERS, MAT-

TRESS PADS, MIXED FIBER FABRICS, NON-WOVEN FABRICS AND FELTS, NON-WOVEN TEXTILE FABRICS, OIL CLOTHS, PILLOW COVERS, POLYESTER FABRIC, PRESS FELT, QUILTS, QUILTS OF TEXTILE, SILK-COTTON MIXED FABRICS, SILK-WOOL MIXED FABRICS, TABLE AND BED LINEN, TABLE CLOTHS NOT OF PAPER, TABLECLOTHS, NOT OF PAPER, TABLE LINEN, TABLE LINEN OF TEXTILE, TABLE MATS NOT OF PAPER, TABLE NAPKINS OF TEXTILE, TEXTILE FABRICS FOR THE MANUFACTURE OF CLOTHING, TEXTILE FABRICS FOR HOME AND COMMERCIAL INTERIORS, TEXTILE GOODS, NAMELY, A SYNTHETIC SHEET WITH FRAGRANCE FOR THE PURPOSE OF INSERTING INTO PILLOW SLIP AND UNDER FITTED SHEET TO EMIT FRAGRANCE, TEXTILE TABLECLOTHS, UPHOLSTERY FABRICS, VINYL AND CLOTH TEXTILES FOR USE IN THE MANUFACTURE OF TEXTILE TABLECLOTHS, WASH CLOTHS, WOOLEN FABRIC, WOOLEN BLANKETS, AND WRAPPING CLOTH FOR GENERAL PURPOSES, IN CLASS 24 (U.S. CLS. 42 AND 50).

OWNER OF INTERNATIONAL REGISTRATION
0767759 DATED 10-29-2001, EXPIRES 10-29-2011.

SER. NO. 79-041,265, FILED 1-11-2007.

SHAILA SETTLES, EXAMINING ATTORNEY

Int. Cls.: 38, 41, 42 and 45

Prior U.S. Cls.: 100, 101, 104 and 107

United States Patent and Trademark Office

Reg. No. 3,480,877

Registered Aug. 5, 2008

**SERVICE MARK
PRINCIPAL REGISTER**

LAST POST

LAST POST LIMITED (UNITED KINGDOM PRIVATE LIMITED COMPANY)
145-157 ST JOHN STREET
LONDON EC1V 4PY
UNITED KINGDOM

FOR: COMMUNICATION BY ELECTRONIC MAIL SYSTEMS; ELECTRONIC MAIL SERVICES; ELECTRONIC MAILING SERVICES; ELECTRONIC MAIL FORWARDING SERVICES, IN CLASS 38 (U.S. CLS. 100, 101 AND 104).

FOR: ELECTRONIC PUBLISHING SERVICES, NAMELY, PUBLICATION OF TEXT, AUDIO, VIDEO AND GRAPHIC WORKS ONLINE, FEATURING DIARIES, COMMENTARY, PHOTOS, POETRY, OBITUARIES, MEMOIRS, MINI-ESSAYS, NON-FICTION AND FICTION, IN CLASS 41 (U.S. CLS. 100, 101 AND 107).

FOR: INDUSTRIAL ANALYSIS AND RESEARCH SERVICES; DESIGN AND DEVELOPMENT OF COMPUTER HARDWARE AND SOFTWARE, IN CLASS 42 (U.S. CLS. 100 AND 101).

FOR: LEGAL SERVICES; LEGAL SERVICES RENDERED ON-LINE; LEGAL SERVICES RELATING TO WILLS, IN CLASS 45 (U.S. CLS. 100 AND 101).

OWNER OF INTERNATIONAL REGISTRATION 0931493 DATED 3-29-2007, EXPIRES 3-29-2017.

SER. NO. 79-041,329, FILED 3-29-2007.

KRISTIN DAHLING, EXAMINING ATTORNEY

Int. Cls.: 29, 31 and 44

Prior U.S. Cls.: 1, 46, 100 and 101

United States Patent and Trademark Office

Reg. No. 3,480,878

Registered Aug. 5, 2008

**TRADEMARK
SERVICE MARK
PRINCIPAL REGISTER**

YELLOW MOON

NUNHEMS B.V. (NETHERLANDS LTD LIAB CO)
VOORT 6
NL-6083 AC NUNHEM
NETHERLANDS

FOR: PRESERVED, DRIED AND COOKED VEGETABLES; PRESERVED FRUITS; DRIED FRUITS; AND PROCESSED FRUITS, NAMELY, COOKED FRUITS, IN CLASS 29 (U.S. CL. 46).

FOR: AGRICULTURAL SEEDS, NAMELY, VEGETABLE SEEDS; FRUIT SEEDS; FRUIT SEEDS, NAMELY, MELON SEEDS; FRUIT SEEDS, NAMELY, WATERMELON SEEDS; LIVING FRUIT PLANTS AND LIVING PLANTS AND ASSOCIATED PROPAGATION MATERIALS TAKEN THEREFROM, NAMELY, PLANT CUTTINGS, YOUNG LIVING PLANTS AND PLANT TISSUE CULTURES FOR AGRICULTURAL AND HORTICULTURAL PURPOSES, IN CLASS 31 (U.S. CLS. 1 AND 46).

FOR: ADVISE AND RECOMMENDATIONS RELATED TO THE CULTIVATION OF PROPAGATION MATERIAL, NAMELY, PLANT CUTTINGS, YOUNG LIVING PLANTS AND PLANT TISSUE CULTURES FOR AGRICULTURAL AND HORTICULTURAL PURPOSES, IN CLASS 44 (U.S. CLS. 100 AND 101).

PRIORITY DATE OF 1-4-2007 IS CLAIMED.

OWNER OF INTERNATIONAL REGISTRATION
0931508 DATED 6-29-2007, EXPIRES 6-29-2017.

SER. NO. 79-041,336, FILED 6-29-2007.

JOHN SCHUYLER YARD, EXAMINING ATTORNEY

Int. Cls.: 9, 18, 20, 22 and 25

Prior U.S. Cls.: 1, 2, 3, 7, 13, 19, 21, 22, 23, 25, 26, 32, 36, 38, 39, 41, 42 and 50

Reg. No. 3,480,879

United States Patent and Trademark Office

Registered Aug. 5, 2008

**TRADEMARK
PRINCIPAL REGISTER**



COMEFLY OUTDOOR CO., LTD. (CHINA CORPORATION)
YINGJIASHAN, QUZHOU CITY
ZHEJIANG PROVINCE
CHINA

FOR: EYEGASSES; SPECTACLE FRAMES; SUNGLASSES; CONTACT LENSES; EYEGASS CHAINS; TELESCOPES; GOGGLES FOR SPORTS, IN CLASS 9 (U.S. CLS. 21, 23, 26, 36 AND 38).

FOR: BACKPACKS; VALISES; HANDBAGS; UMBRELLAS; ALPENSTOCKS; LEATHER, UNWORKED OR SEMI-WORKED, IN CLASS 18 (U.S. CLS. 1, 2, 3, 22 AND 41).

FOR: SLEEPING BAGS; FURNITURE; MATTRESSES; FURNITURE OF METAL; CLOSURES, NOT OF METAL, FOR CONTAINERS; TENT PEGS, NOT OF

METAL; BAMBOO ARTWORK; MIRRORS, IN CLASS 20 (U.S. CLS. 2, 13, 22, 25, 32 AND 50).

FOR: TENTS; HAMMOCKS; ROPES; TEXTILE FIBERS; SAILS FOR SKI SAILING, IN CLASS 22 (U.S. CLS. 1, 2, 7, 19, 22, 42 AND 50).

FOR: WET SUITS FOR WATER-SKIING; FOOTWEAR; MOUNTAIN CLIMBING SHOES; HOSIERY; HATS; GLOVES; SCARVES; LEATHER BELTS, IN CLASS 25 (U.S. CLS. 22 AND 39).

OWNER OF INTERNATIONAL REGISTRATION 0931572 DATED 4-23-2007, EXPIRES 4-23-2017.

SER. NO. 79-041,367, FILED 4-23-2007.

MARK PILARO, EXAMINING ATTORNEY

Int. Cl.: 30

Prior U.S. Cl.: 46

United States Patent and Trademark Office

Reg. No. 3,480,880

Registered Aug. 5, 2008

**TRADEMARK
PRINCIPAL REGISTER**

RIBLOT

RELANGHE S.R.L. (ITALY LTD LIAB CO)
CORSO BRA, 105
I-12051 ALBA (CUNEO)
ITALY

FOR: COFFEE, TEA, COCOA, SUGAR, RICE, TAPIOCA, SAGO, ARTIFICIAL COFFEE; FLOUR, BREAD, PASTRY, CONFECTIONERY, NAMELY, CHOCOLATE AND CHOCOLATES, CHOCOLATE COVERED NUTS, CHOCOLATE TRUFFLES, SWEET TRUFFLES, MILK CHOCOLATE, DARK CHOCOLATE, PRALINES, GIANDUIA CHOCOLATE, CANDY, PASTILLES, CRYSTAL SUGAR PIECES, FONDANTS, FROZEN CONFECTIONERY, FROZEN YOGURT, FRUIT JELLIES, PEPPERMINT FOR CONFECTIONERY, FLAVORED ICES; HONEY, TREACLE; YEAST, BAKING-POWDER; SALT,

MUSTARD; VINEGAR, SAUCES, SPICES, ICE, IN CLASS 30 (U.S. CL. 46).

THE MARK CONSISTS OF STANDARD CHARACTERS WITHOUT CLAIM TO ANY PARTICULAR FONT, STYLE, SIZE, OR COLOR.

OWNER OF INTERNATIONAL REGISTRATION 0931635 DATED 6-26-2007, EXPIRES 6-26-2017.

"RIBLOT" HAS NO MEANING IN A FOREIGN LANGUAGE.

SER. NO. 79-041,390, FILED 6-26-2007.

MELISSA VALLILLO, EXAMINING ATTORNEY

Int. Cl.: 30

Prior U.S. Cl.: 46

United States Patent and Trademark Office

Reg. No. 3,480,881

Registered Aug. 5, 2008

TRADEMARK
PRINCIPAL REGISTER

REIROT

RELANGHE S.R.L. (ITALY LTD LIAB CO)
CORSO BRA, 105
I-12051 ALBA (CUNEO)
ITALY

FOR: COFFEE, TEA, COCOA, SUGAR, RICE, TAPIOCA, SAGO, ARTIFICIAL COFFEE; FLOUR, BREAD, PASTRY, CONFECTIONERY, NAMELY, CHOCOLATES, CHOCOLATE COVERED NUTS, PRALINES, GIANDUIA CHOCOLATE, CANDY, PASTILLES, CRYSTAL SUGAR PIECES, FONDANTS, FROZEN CONFECTIONERY, FROZEN YOGURT, FRUIT JELLIES, PEPPERMINT FOR CONFECTIONERY, FLAVORED ICES; HONEY, TREACLE; YEAST, BAKING-POWDER; SALT, MUSTARD; VINEGAR, SAUCES, SPICES, ICE, IN CLASS 30 (U.S. CL. 46).

THE MARK CONSISTS OF STANDARD CHARACTERS WITHOUT CLAIM TO ANY PARTICULAR FONT, STYLE, SIZE, OR COLOR.

OWNER OF INTERNATIONAL REGISTRATION
0931636 DATED 5-31-2007, EXPIRES 5-31-2017.

"REIROT" HAS NO MEANING IN A FOREIGN LANGUAGE.

SER. NO. 79-041,391, FILED 5-31-2007.

MELISSA VALLILLO, EXAMINING ATTORNEY

Int. Cls.: 9, 16 and 41

**Prior U.S. Cls.: 2, 5, 21, 22, 23, 26, 29, 36, 37, 38, 50,
100, 101 and 107**

Reg. No. 3,480,882

United States Patent and Trademark Office

Registered Aug. 5, 2008

**TRADEMARK
SERVICE MARK
PRINCIPAL REGISTER**

MELODY BEAR

JILL EWING (UNITED KINGDOM INDIVIDUAL)
"DARWOOD", DARWOOD PLACE,
ST IVES, HUNTINGDON; CAMBRIDGESHIRE
PE275PF
UNITED KINGDOM

FOR: SOUND AND VIDEO RECORDINGS,
SOUND RECORDINGS, CD-ROMS, DVDS, FEATURING
MUSIC AND INSTRUCTION, ALL FOR USE IN
DANCE CLASSES; DOWNLOADABLE ELECTRONIC
PUBLICATIONS IN THE NATURE OF STORYBOOKS,
INSTRUCTION MANUALS, SYLLABUS, AND LESSON
PLANS, IN THE FIELD OF INSTRUCTION AND
TRAINING IN DANCE AND MOVEMENT, IN CLASS 9
(U.S. CLS. 21, 23, 26, 36 AND 38).

FOR: PUBLICATIONS, NAMELY, STORYBOOKS,
INSTRUCTION MANUALS, SYLLABUS, LESSON
PLANS, AND BOOKS, ALL FEATURING INSTRUCTION
AND INFORMATION FOR USE IN DANCE CLASSES;
STORY BOOKS FOR CHILDREN; IN-

STRUCTIONAL AND TEACHING MATERIAL FOR
USE IN DANCE CLASSES, IN CLASS 16 (U.S. CLS. 2,
5, 22, 23, 29, 37, 38 AND 50).

FOR: PROVISION OF INSTRUCTION AND
TRAINING IN DANCE OR MOVEMENT; DANCE
CLASSES FOR CHILDREN, IN CLASS 41 (U.S. CLS.
100, 101 AND 107).

THE MARK CONSISTS OF STANDARD CHARACTERS
WITHOUT CLAIM TO ANY PARTICULAR FONT,
STYLE, SIZE, OR COLOR.

OWNER OF INTERNATIONAL REGISTRATION
0931680 DATED 6-29-2007, EXPIRES 6-29-2017.

SER. NO. 79-041,413, FILED 6-29-2007.

JOHN SCHUYLER YARD, EXAMINING ATTORNEY

Int. Cl.: 10

Prior U.S. Cls.: 26, 39 and 44

United States Patent and Trademark Office

Reg. No. 3,480,883

Registered Aug. 5, 2008

**TRADEMARK
PRINCIPAL REGISTER**

SIROLaser

SIRONA DENTAL SYSTEMS GMBH (FED REP
GERMANY PUBLIC LIMITED COMPANY)

FABRIKSTRASSE 31

64625 BENSHEIM

FED REP GERMANY

THE MARK CONSISTS OF STANDARD CHAR-
ACTERS WITHOUT CLAIM TO ANY PARTICULAR
FONT, STYLE, SIZE, OR COLOR.

PRIORITY DATE OF 10-6-2006 IS CLAIMED.

FOR: DENTAL LASER HANDPIECES; DENTAL
APPARATUSES, NAMELY, INTRA-ORAL LIGHT
SYSTEMS, WITH LASER UNITS, LIGHT GUIDE
AND HANDPIECE; PARTS OF DENTAL INSTRU-
MENTS, NAMELY, TIPS FOR LASER HANDPIECES,
LASER FIBRES FOR LASER HANDPIEEES, IN
CLASS 10 (U.S. CLS. 26, 39 AND 44).

OWNER OF INTERNATIONAL REGISTRATION
0931685 DATED 3-22-2007, EXPIRES 3-22-2017.

SER. NO. 79-041,416, FILED 3-22-2007.

KRISTIN DAHLING, EXAMINING ATTORNEY

Int. Cls.: 6, 20 and 21

Prior U.S. Cls.: 2, 12, 13, 14, 22, 23, 25, 29, 30, 32, 33,
40 and 50

Reg. No. 3,480,884

United States Patent and Trademark Office

Registered Aug. 5, 2008

TRADEMARK
PRINCIPAL REGISTER



PONT EMBALLAGE (FRANCE SOCIÉTÉ PAR
ACTIONS SIMPLIFIÉE)
23 RUE DE CHEVILLY,
ZI LA CERISAIE NORD; F-94260 FRESNES
FRANCE

FOR: INDUSTRIAL PACKAGING CONTAINERS
OF METAL, IN CLASS 6 (U.S. CLS. 2, 12, 13, 14, 23, 25
AND 50).

FOR: PACKAGING CONTAINERS OF PLASTIC,
IN CLASS 20 (U.S. CLS. 2, 13, 22, 25, 32 AND 50).

FOR: PACKAGING CONTAINERS OF GLASS,
NAMESLY, CONTAINERS FOR INDUSTRIAL OR
HOUSEHOLD USE, NAMESLY, GLASS JARS, IN
CLASS 21 (U.S. CLS. 2, 13, 23, 29, 30, 33, 40 AND 50).

PRIORITY DATE OF 2-13-2007 IS CLAIMED.

OWNER OF INTERNATIONAL REGISTRATION
0931773 DATED 6-15-2007, EXPIRES 6-15-2017.

"PE" AND "EXCELLENS" HAS NO FOREIGN
MEANING.

SER. NO. 79-041,460, FILED 6-15-2007.

SIMON TENG, EXAMINING ATTORNEY

Int. Cl.: 9

Prior U.S. Cls.: 21, 23, 26, 36 and 38

Reg. No. 3,480,885

United States Patent and Trademark Office

Registered Aug. 5, 2008

**TRADEMARK
PRINCIPAL REGISTER**

YOUR MOBILE CUPPA MUSIC

KONINKLIJKE PHILIPS ELECTRONICS N.V.
(NETHERLANDS LTD LIAB CO)
GROENEWOUDSEWEG 1
NL-5621 BA EINDHOVEN
NETHERLANDS

OWNER OF INTERNATIONAL REGISTRATION
0931820 DATED 7-9-2007, EXPIRES 7-9-2017.

FOR: APPARATUS FOR RECORDING, TRANSMITTING, REPRODUCING SOUND OR IMAGES; SOFTWARE USED IN CONNECTION WITH AUDIO CODING TECHNOLOGY, MUSIC CLASSIFICATION AND MANAGEMENT TECHNOLOGY AND TECHNOLOGY FOR MOBILE DEVICES, IN CLASS 9 (U.S. CLS. 21, 23, 26, 36 AND 38).

NO CLAIM IS MADE TO THE EXCLUSIVE RIGHT TO USE "MOBILE" AND "MUSIC", APART FROM THE MARK AS SHOWN.

THE WORDING "CUPPA" HAS NO MEANING IN A FOREIGN LANGUAGE.

THE MARK CONSISTS OF STANDARD CHARACTERS WITHOUT CLAIM TO ANY PARTICULAR FONT, STYLE, SIZE, OR COLOR.

SER. NO. 79-041,484, FILED 7-9-2007.

PRIORITY DATE OF 2-9-2007 IS CLAIMED.

NAKIA HENRY, EXAMINING ATTORNEY

Int. Cls.: 35 and 36

Prior U.S. Cls.: 100, 101 and 102

United States Patent and Trademark Office

Reg. No. 3,480,886

Registered Aug. 5, 2008

**SERVICE MARK
PRINCIPAL REGISTER**

SCOR Global Life

SCOR (FRANCE SOCIETE ANONYME)
1 AVENUE DU GÉNÉRAL DE GAULLE
F-92800 PUTEAUX
FRANCE

FOR: COMMERCIAL CONSULTANCY WITH RESPECT TO ANALYSIS, ORGANIZATION AND PREVENTION OF BUSINESS RISKS OR THE COMBINATION THEREOF; MANAGEMENT OF COMPUTERIZED FILES; BUSINESS ADVICE ON THE ORGANIZATION AND MANAGEMENT OF INDUSTRIAL AND COMMERCIAL COMPANIES; BUSINESS MANAGEMENT ASSISTANCE; ACCOUNTANCY CONSULTANCY AND BUSINESS EXPERT APPRAISAL; BUSINESS ADVICE AND EXPERT OPINIONS REGARDING ACCOUNTING EVALUATION OF TANGIBLE OR INTANGIBLE CORPORATE ASSETS; ORGANIZATION OF EXHIBITIONS IN THE FORM OF SEMINARS AND COLLOQUIUMS FOR COMMERCIAL PURPOSES RELATING TO CORPORATE AND SOCIAL RISK ANALYSIS, MANAGEMENT AND PREVENTION; COMMERCIAL MANAGEMENT AND ON-LINE COMMERCIAL MANAGEMENT SERVICES FOR THIRD PARTIES OF TELECOMMUNICATIONS NETWORKS AND TELECOMMUNICATIONS SITES FOR ELECTRONIC COMMERCE; ALL OF THE FOREGOING SERVICES RELATE TO INSURANCE AND REINSURANCE, IN CLASS 35 (U.S. CLS. 100, 101 AND 102).

FOR: INSURANCE AND REINSURANCE SERVICES, NAMELY ADVICE, CONSULTING AND INFORMATION ON INSURANCE AND REINSURANCE; FINANCIAL INTERMEDIATION IN THE NATURE OF INVESTMENT ADVICE; INSURANCE AND REINSURANCE BROKERAGE; ACTUARIAL SERVICES; FINANCIAL ADVICE AND INFORMATION, NAMELY, FINANCIAL ANALYSIS AND CONSULTATION, FINANCIAL

INFORMATION PROCESSING, FINANCIAL FORECASTING, FINANCIAL INFORMATION AND EVALUATIONS, FINANCIAL RISK MANAGEMENT CONSULTATIONS; FINANCIAL MANAGEMENT IN THE NATURE OF ADVICE ON LIQUIDITY MANAGEMENT; INVESTMENT SERVICES, NAMELY ASSET ACQUISITION AND ACQUISITION AND TRANSFER OF MONETARY CLAIMS OF ENTERPRISES AND INTERESTS IN ENTERPRISES; INVESTMENT SERVICES, NAMELY FINANCIAL ADVICE AND EXPERT OPINIONS REGARDING ACCOUNTING EVALUATION OF TANGIBLE OR INTANGIBLE CORPORATE ASSETS; FINANCIAL RISK MANAGEMENT IN THE NATURE OF ADVICE AND EXPERT OPINIONS REGARDING FINANCIAL EVALUATION OF CORPORATE AND SOCIAL RISKS; FISCAL ASSESSMENT AND EVALUATION IN THE NATURE OF ADVICE AND EXPERT OPINIONS REGARDING FINANCIAL ASSESSMENT OF DAMAGES IN CONNECTION WITH INSURANCE OR REINSURANCE UNDERWRITING, IN CLASS 36 (U.S. CLS. 100, 101 AND 102).

PRIORITY DATE OF 12-6-2006 IS CLAIMED.

OWNER OF INTERNATIONAL REGISTRATION 0932000 DATED 5-29-2007, EXPIRES 5-29-2017.

OWNER OF U.S. REG. NOS. 1,589,312, 2,779,080 AND OTHERS.

NO CLAIM IS MADE TO THE EXCLUSIVE RIGHT TO USE "GLOBAL LIFE", APART FROM THE MARK AS SHOWN.

SER. NO. 79-041,558, FILED 5-29-2007.

NATALIE POLZER, EXAMINING ATTORNEY

Int. Cls.: 1, 5, 10 and 42

**Prior U.S. Cls.: 1, 5, 6, 10, 18, 26, 39, 44, 46, 51, 52, 100
and 101**

Reg. No. 3,480,887

United States Patent and Trademark Office

Registered Aug. 5, 2008

**TRADEMARK
SERVICE MARK
PRINCIPAL REGISTER**



CIS BIO INTERNATIONAL, SOCIÉTÉ ANONYME
(FRANCE SOCIÉTÉ ANONYME)
RN 306 SACLAY - BP 32
F-91192 GIF-SUR-YVETTE CEDEX
FRANCE

FOR: CHEMICAL PREPARATIONS FOR USE IN SCIENTIFIC RESEARCH, NAMELY FLUORESCENT REAGENTS FOR IN-VITRO MEASUREMENT OF BIOMOLECULAR INTERACTIONS AND FOR IN-VITRO DRUG SCREENING RESEARCH AND ANTIBODY REAGENTS USED FOR IN-VITRO DETECTION OF ANTIGENS IN CELL AND TISSUE, IN CLASS 1 (U.S. CLS. 1, 5, 6, 10, 26 AND 46).

FOR: PRODUCTS INTENDED FOR THE IMPLEMENTATION OF BIOLOGICAL/BIOCHEMICAL ASSAYS FOR IN VITRO DIAGNOSIS, NAMELY IMMUNOASSAY KITS FOR USE BY CLINICAL LABORATORIES, CONTAINING LABELLED ANTIBODIES OR ANTIGEN FOR IN VITRO DIAGNOSIS OF CANCER, INFECTION, INFLAMMATION, AUTO-IMMUNE, CARDIOVASCULAR AND NERVOUS SYSTEM DISEASES, IN CLASS 5 (U.S. CLS. 6, 18, 44, 46, 51 AND 52).

FOR: ELUTION AND HANDLING BOXES FOR RADIO-ISOTOPE GENERATORS, NAMELY APPA-

RATUS FOR PRODUCTION AND ELUTION OF STERILE 99M TECHNETIUM SOLUTION TO BE USED IN HOSPITALS AND RADIOPHARMACIES AND CONTAINERS SPECIFICALLY DESIGNED FOR TRANSPORTING AND HOLDING RADIO-ISOTOPE GENERATORS, IN CLASS 10 (U.S. CLS. 26, 39 AND 44).

FOR: SCIENTIFIC SERVICES FOR THE PHARMACEUTICAL INDUSTRY AND RESEARCH AND DESIGN RELATING THERETO, NAMELY SCIENTIFIC AND TECHNICAL CONSULTING AND RESEARCH SERVICES RELATING TO THE DEVELOPMENT OF DRUG SCREENING BIOASSAYS FOR USE BY RESEARCH LABORATORIES, IN CLASS 42 (U.S. CLS. 100 AND 101).

OWNER OF INTERNATIONAL REGISTRATION 0932036 DATED 6-28-2007, EXPIRES 6-28-2017.

OWNER OF U.S. REG. NOS. 1,085,173, 2,619,411 AND OTHERS.

SER. NO. 79-041,578, FILED 6-28-2007.

MARY ROSSMAN, EXAMINING ATTORNEY

Int. Cls.: 12, 22 and 25

Prior U.S. Cls.: 1, 2, 7, 19, 21, 22, 23, 31, 35, 39, 42, 44
and 50

Reg. No. 3,480,888

United States Patent and Trademark Office

Registered Aug. 5, 2008

TRADEMARK
PRINCIPAL REGISTER



FOUNTAINE PAJOT (FRANCE SOCIÉTÉ ANON-
YME)
ZONE INDUSTRIELLE
F-17290 AIGREFEUILLE D'AUNIS
FRANCE

FOR: BOATS; SHIPS; PLEASURE BOATS; MASTS
FOR BOATS, SHIPS AND PLEASURE BOATS; UP-
PERWORKS, NAMELY, BOAT FITTINGS, TRAIL-
ERS, IN CLASS 12 (U.S. CLS. 19, 21, 23, 31, 35 AND
44).

FOR: SAILS, NON-METAL RIGGING FOR
BOATS, SHIPS AND PLEASURE BOATS, IN CLASS
22 (U.S. CLS. 1, 2, 7, 19, 22, 42 AND 50).

FOR: CLOTHING, NAMELY, SHIRTS, PANTS,
JACKETS, FOOTWEAR; HEADGEAR, NAMELY,

HATS, VISORS, CAPS, IN CLASS 25 (U.S. CLS. 22
AND 39).

PRIORITY DATE OF 2-20-2007 IS CLAIMED.

OWNER OF INTERNATIONAL REGISTRATION
0932042 DATED 6-11-2007, EXPIRES 6-11-2017.

NO CLAIM IS MADE TO THE EXCLUSIVE
RIGHT TO USE "CATAMARANS", APART FROM
THE MARK AS SHOWN.

SER. NO. 79-041,583, FILED 6-11-2007.

CAROLINE WOOD, EXAMINING ATTORNEY

Int. Cl.: 14

Prior U.S. Cls.: 2, 27, 28 and 50

United States Patent and Trademark Office

Reg. No. 3,480,889

Registered Aug. 5, 2008

**TRADEMARK
PRINCIPAL REGISTER**

MEREA

MILUS INTERNATIONAL S.A. (SWITZERLAND
SOCIÉTÉ ANONYME (SA))
REUCHENNETTESTRASSE 19
CH-2502 BIEL/BIENNE
SWITZERLAND

FOR: JEWELLERY, PRECIOUS STONES; HOROLOGICAL AND CHRONOMETRIC INSTRUMENTS AND THEIR PARTS, IN CLASS 14 (U.S. CLS. 2, 27, 28 AND 50).

THE MARK CONSISTS OF STANDARD CHARACTERS WITHOUT CLAIM TO ANY PARTICULAR FONT, STYLE, SIZE, OR COLOR.

PRIORITY DATE OF 2-20-2007 IS CLAIMED.

OWNER OF INTERNATIONAL REGISTRATION
0932076 DATED 7-3-2007, EXPIRES 7-3-2017.

SER. NO. 79-041,600, FILED 7-3-2007.

ALLISON HOLTZ, EXAMINING ATTORNEY

Int. Cl.: 2

Prior U.S. Cls.: 6, 11 and 16

United States Patent and Trademark Office

Reg. No. 3,480,890

Registered Aug. 5, 2008

**TRADEMARK
PRINCIPAL REGISTER**

INTERSHEEN

AKZO NOBEL COATINGS INTERNATIONAL
B.V. (NETHERLANDS B.V.)
VELPERWEG 76
NL-6824 BM ARNHEM
NETHERLANDS

FOR: PAINTS; COATINGS IN THE NATURE OF PAINTS; ENAMEL PAINTS; VARNISHES; COLORANTS USED IN THE MANUFACTURE OF COATINGS; DISTEMPERS; LACQUERS; SICCATIVES, NAMELY, DRYING AGENTS FOR PAINTS AND VARNISHES; WOOD PRESERVATIVES; MORDANTS USED IN THE MANUFACTURE OF COATINGS; ANTI-CORROSIVE COATINGS; ANTI-FOULING PAINTS; ANTI-FOULING COATINGS IN THE NATURE OF PAINTS; THINNERS FOR AFORESAID GOODS; AND PRIMERS, IN CLASS 2 (U.S. CLS. 6, 11 AND 16).

THE MARK CONSISTS OF STANDARD CHARACTERS WITHOUT CLAIM TO ANY PARTICULAR FONT, STYLE, SIZE, OR COLOR.

PRIORITY DATE OF 6-12-2007 IS CLAIMED.

OWNER OF INTERNATIONAL REGISTRATION
0932079 DATED 6-22-2007, EXPIRES 6-22-2017.

SER. NO. 79-041,602, FILED 6-22-2007.

PAM WILLIS, EXAMINING ATTORNEY

Int. Cls.: 9 and 11

Prior U.S. Cls.: 13, 21, 23, 26, 31, 34, 36 and 38

Reg. No. 3,480,891

United States Patent and Trademark Office

Registered Aug. 5, 2008

**TRADEMARK
PRINCIPAL REGISTER**

ARRI 

ARNOLD & RICHTER CINE TECHNIK GMBH &
CO. BETRIEBS KG (FED REP GERMANY
LIMITED LIABILITY PARTNERSHIP UNDER
GERMAN LAW)

TÜRKENSTRASSE 89
80799 MÜNCHEN
FED REP GERMANY

FOR: FILM AND VIDEO RECORDING, PLAYBACK AND PROJECTION EQUIPMENT, NAMELY, FILM CAMERAS, VIDEO CAMERAS, VIDEO RECORDERS, MONITORS, VIDEO DISPLAY TERMINALS, VIDEO ASSISTS ENABLING PLAYBACK OF IMAGES BY THE VIEW FINDER OF CAMERAS; FILM AND VIDEO PROCESSING AND VIEWING APPARATUS, NAMELY, COPY MACHINES, PICTURE EDITORS, DATA CONVERTER, POST PRODUCTION MACHINES FOR RECORDING AND CONVERTING ANALOGUE INFORMATION STORED ON FILM STRIPS TO DIGITAL DATA AND DIGITAL DATA TO ANALOGUE FILM STRIPS, AND COLOUR DETERMINATION MACHINES; TEST EQUIPMENT FOR THE ANALYSIS OF THE PICTURE QUALITY, NAMELY, COMPUTER SOFTWARE TO IMPROVE PICTURE QUALITY; ACCESSORIES FOR ALL THE AFOREMENTIONED GOODS, NAMELY, TRIPODS, TRIPOD HEADS AND HANGING FIXTURES, MULTIFUNCTIONAL REMOTE CONTROL EQUIPMENT, NAMELY, RADIO TRANSRECEIVERS FOR THE EXCHANGE OF CONTROL SIGNALS, HANDHELD REMOTE CONTROL UNITS FOR CAMERAS, WIRELESS REMOTE CONTROL ADAPTERS; CAMERA LENSES, FILM CASSETTES AND VIDEO CASSETTES, LENS HOODS NAMELY, SHADES FOR CAMERA LENSES WITH FILTER RINGS, OPTICAL FILTERS AND FILTER HOLDERS, METAL FRAMES FOR ADJUSTING OPTICAL FILTERS; ADAPTORS, NAMELY, CONNECTORS FOR BETWEEN CAMERAS, TRIPODS AND OTHER CAMERA ACCESSORIES, MARKER DISCS PROVIDING MEANS FOR THE SETTING OF CAMERA LENSES

WITH RESPECT TO THE FIXATION OF SET VALUES, COUNTERS, MOUNTED ACCUMULATORS, SOUND PROOF CAMERA CASES, ANAMORPHIC LENSES, MOTOR HANDLES FOR OPERATING CAMERAS, ELECTRIC TIME CODING UNITS FOR MARKING FILMS; MEMORY CHIPS; APPARATUS FOR DIGITAL PICTURE PROCESSING, NAMELY, POST PRODUCTION MACHINES FOR ADAPTATION, EDITING AND TRANSFORMATION OF PICTURE DATA; APPARATUS FOR RECORDING AND CONVERSION OF INFORMATION STORED ON FILM STRIPS TO DIGITAL DATA CARRIER; COMPUTERS, COMPUTER SOFTWARE FOR DATA PROCESSING SCANNERS; DATA PROCESSING SCANNERS; APPARATUS FOR RECORDING AND EXPOSURE OF INFORMATION STORED ON DATA DIGITAL CARRIER TO FILM STRIPS, IN PARTICULAR LASER EXPOSURES; BATTERIES, RECHARGEABLE ELECTRIC BATTERIES, POWER SUPPLIES, VOLTAGE CONVERTERS AND ELECTRONIC DEVICES FOR CONTROLLING OF THE BRIGHTNESS, COLOUR BEAM CHARACTERISTICS AND OPERATING CONDITIONS OF LAMPS, SPOTLIGHTS, SEARCHLIGHTS AND OTHER LIGHTING; ELECTRICAL BALLASTS FOR LAMPS, SPOTLIGHTS, SEARCH LIGHTS AND OTHER LIGHTING, NOT AS PARTS OF THE AFOREMENTIONED GOODS; ELECTRICAL SIGNALLING APPARATUS FLASHES AND FLASH LIGHTS FOR PHOTOGRAPHY; OPTICAL FIBERS, NAMELY, APPARATUS FOR SENDING, RECEIVING AND CONVERSION OF CONTROL SIGNALS FOR LAMPS AND LIGHTING, IN CLASS 9 (U.S. CLS. 21, 23, 26, 36 AND 38).

FOR: FILM LIGHTING, VIDEO LIGHTING AND STAGE LIGHTING APPARATUS AND INSTALLATIONS THEREOF, NAMELY, ELECTRICAL LAMP FIXTURES, REFLECTORS, RETRACTORS, PANELS, SCREENS, GLOBES AND FIXTURES; ACCESSORIES FOR THE AFOREMENTIONED GOODS, NAMELY APPARATUS DEVICES FOR

INFLUENCING COLOUR, BRIGHTNESS AND REFLECTIVE FEATURES, NAMELY, BARN DOORS, COLOUR CHANGERS, PROJECTORS, FOLLOW SPOTS, DIMMERS, DOUSERS, INCLUDED IN THIS CLASS; ADAPTED FIXED, MANUAL AND/OR POWERED MOUNTING PARTS FOR LIGHTING AND LAMPS; ADAPTED CONTROL FACILITIES AND BEARINGS FOR LIGHTING AND LAMPS, IN PARTICULAR SUSPENSIONS AND ADAPTORS, INCLUDED IN THIS CLASS; TRANSPORT CASES WHICH ARE ADAPTED TO THE AFOREMENTIONED GOODS, IN CLASS 11 (U.S. CLS. 13, 21, 23, 31 AND 34).

PRIORITY DATE OF 12-5-2006 IS CLAIMED.

OWNER OF INTERNATIONAL REGISTRATION
0932084 DATED 6-4-2007, EXPIRES 6-4-2017.

SER. NO. 79-041,604, FILED 6-4-2007.

PAUL E. FAHRENKOPF, EXAMINING ATTORNEY

Int. Cls.: 9 and 11

Prior U.S. Cls.: 13, 21, 23, 26, 31, 34, 36 and 38

Reg. No. 3,480,892

United States Patent and Trademark Office

Registered Aug. 5, 2008

**TRADEMARK
PRINCIPAL REGISTER**

ARRI

ARNOLD & RICHTER CINE TECHNIK GMBH &
CO. BETRIEBS KG (FED REP GERMANY
LIMITED LIABILITY PARTNERSHIP UNDER
GERMAN LAW)

TÜRKENSTRASSE 89
80799 MÜNCHEN
FED REP GERMANY

FOR: FILM AND VIDEO RECORDING, PLAY BACK AND PROJECTION EQUIPMENT, NAMELY, FILM CAMERAS, VIDEO CAMERAS, VIDEO RECORDERS, MONITORS, VIDEO DISPLAY TERMINALS, VIDEO ASSISTS ENABLING PLAYBACK OF IMAGES BY THE VIEW FINDER OF CAMERAS; FILM AND VIDEO PROCESSING AND VIEWING APPARATUS, NAMELY, COPY MACHINES, PICTURE EDITORS, DATA CONVERTER, POST PRODUCTION MACHINES FOR RECORDING AND CONVERTING ANALOGUE INFORMATION STORED ON FILM STRIPS TO DIGITAL DATA AND DIGITAL DATA TO ANALOGUE FILM STRIPS, AND COLOUR DETERMINATION MACHINES; TEST EQUIPMENT FOR THE ANALYSIS OF THE PICTURE QUALITY, NAMELY, COMPUTER SOFTWARE TO IMPROVE PICTURE QUALITY; ACCESSORIES FOR ALL THE AFOREMENTIONED GOODS, NAMELY, TRIPODS, TRIPOD HEADS AND HANGING FIXTURES, MULTIFUNCTIONAL REMOTE CONTROL EQUIPMENT, NAMELY, RADIO TRANS RECEIVERS FOR THE EXCHANGE OF CONTROL SIGNALS, HAND-HELD REMOTE CONTROL UNITS FOR CAMERAS, WIRELESS REMOTE CONTROL ADAPTERS; CAMERA LENSES, FILM CASSETTES AND VIDEO CASSETTES, LENS HOODS NAMELY, SHADES FOR CAMERA LENSES WITH FILTER RINGS, OPTICAL FILTERS AND FILTER HOLDERS, METAL FRAMES FOR ADJUSTING OPTICAL FILTERS; ADAPTORS, NAMELY, CONNECTORS FOR BETWEEN CAMERAS, TRIPODS AND OTHER CAMERA ACCESSORIES, MARKER DISCS PROVIDING MEANS FOR THE SETTING OF CAMERA

LENSES WITH RESPECT TO THE FIXATION OF SET VALUES, COUNTERS, MOUNTED ACCUMULATORS, SOUND PROOF CAMERA CASES, ANAMORPHIC LENSES, MOTOR HANDLES FOR OPERATING CAMERAS, ELECTRIC TIME CODING UNITS FOR MARKING FILMS; MEMORY CHIPS; APPARATUS FOR DIGITAL PICTURE PROCESSING, NAMELY, POST PRODUCTION MACHINES FOR ADAPTATION, EDITING AND TRANSFORMATION OF PICTURE DATA; APPARATUS FOR RECORDING AND CONVERSION OF INFORMATION STORED ON FILM STRIPS TO DIGITAL DATA CARRIER; COMPUTERS, COMPUTER SOFTWARE FOR DATA PROCESSING SCANNERS; DATA PROCESSING SCANNERS; APPARATUS FOR RECORDING AND EXPOSURE OF INFORMATION STORED ON DATA DIGITAL CARRIER TO FILM STRIPS, IN PARTICULAR LASER EXPOSURES; BATTERIES, RECHARGEABLE ELECTRIC BATTERIES POWER SUPPLIES, VOLTAGE CONVERTERS AND ELECTRONIC DEVICES FOR CONTROLLING OF THE BRIGHTNESS, COLOUR BEAM CHARACTERISTICS AND OPERATING CONDITIONS OF LAMPS, SPOTLIGHTS, SEARCHLIGHTS AND OTHER LIGHTING; ELECTRICAL BALLASTS FOR LAMPS, SPOTLIGHTS, SEARCHLIGHTS AND OTHER LIGHTING, NOT AS PARTS OF THE AFOREMENTIONED GOODS; ELECTRICAL SIGNALLING APPARATUS FLASHES AND FLASH LIGHTS FOR PHOTOGRAPHY; OPTICAL FIBERS, NAMELY, APPARATUS FOR SENDING, RECEIVING AND CONVERSION OF CONTROL SIGNALS FOR LAMPS AND LIGHTING, IN CLASS 9 (U.S. CLS. 21, 23, 26, 36 AND 38).

FOR: FILM LIGHTING, VIDEO LIGHTING AND STAGE LIGHTING APPARATUS AND INSTALLATIONS THEREOF, NAMELY, ELECTRICAL LAMP FIXTURES, REFLECTORS, RETRACTORS, PANELS, SCREENS, GLOBES AND FIXTURES; ACCESSORIES FOR THE AFOREMENTIONED GOODS, NAMELY, APPARATUS DEVICES FOR INFLUEN-

CING COLOUR, BRIGHTNESS AND REFLECTIVE FEATURES, NAMELY, BARN DOORS, COLOUR CHANGERS, PROJECTORS, FOLLOW SPOTS, DIMMERS, DOUSERS, INCLUDED IN THIS CLASS; ADAPTED FIXED, MANUAL AND/OR POWERED MOUNTING PARTS FOR LIGHTING AND LAMPS; ADAPTED CONTROL FACILITIES AND BEARINGS FOR LIGHTING AND LAMPS, IN PARTICULAR SUSPENSIONS AND ADAPTORS, INCLUDED IN THIS CLASS; TRANSPORT CASES WHICH ARE ADAPTED TO THE AFOREMENTIONED GOODS, IN CLASS 11 (U.S. CLS. 13, 21, 23, 31 AND 34).

THE MARK CONSISTS OF STANDARD CHARACTERS WITHOUT CLAIM TO ANY PARTICULAR FONT, STYLE, SIZE, OR COLOR.

PRIORITY DATE OF 12-5-2006 IS CLAIMED.

OWNER OF INTERNATIONAL REGISTRATION 0932085 DATED 6-4-2007, EXPIRES 6-4-2017.

SER. NO. 79-041,605, FILED 6-4-2007.

PAUL E. FAHRENKOPF, EXAMINING ATTORNEY

Int. Cl.: 9

Prior U.S. Cls.: 21, 23, 26, 36 and 38

United States Patent and Trademark Office

Reg. No. 3,480,893

Registered Aug. 5, 2008

TRADEMARK
PRINCIPAL REGISTER

snowpulse

SNOWPULSE SA (SWITZERLAND SOCIÉTÉ ANONYME (SA))
PLACE DE SAVOLEYRES, CASE POSTALE 373
CH-1936 VERBIER
SWITZERLAND

FOR: SCIENTIFIC, NAUTICAL, SURVEYING, PHOTOGRAPHIC, CINEMATOGRAPHIC, OPTICAL, WEIGHING, MEASURING, SIGNALING, CHECKING, LIFE SAVING AND TEACHING APPARATUS AND INSTRUMENTS, NAMELY, INSTRUMENTS AND APPARATUS FOR CONTROLLING, MONITORING, ANALYZING AVALANCHES; APPARATUS AND INSTRUMENTS FOR CONDUCTING, SWITCHING, TRANSFORMING, ACCUMULATING, REGULATING OR CONTROLLING ELECTRICITY, NAMELY, APPARATUS AND INSTRUMENTS FOR CONVEYING, DISTRIBUTING, TRANSFORMING, STORING, REGULATING, CONTROLLING, MEASURING, MONITORING ELECTRIC CURRENT; APPARATUS FOR RECORDING, TRANSMITTING AND REPRODUCING SOUND OR IMAGES, NAMELY, IMAGE AND

SOUND RECORDERS, VIDEO RECORDERS, DIGITAL RECORDERS, PRE-RECORDED MAGNETIC, OPTICAL AND DIGITAL DATA CARRIERS FEATURING AVALANCHE-RELATED SUBJECTS; AUTOMATIC VENDING MACHINES AND MECHANISMS FOR COIN-OPERATED APPARATUS, NAMELY, COIN-OPERATED MACHINES; CASH REGISTERS, CALCULATORS, DATA PROCESSORS AND COMPUTERS; FIRE EXTINGUISHERS, IN CLASS 9 (U.S. CLS. 21, 23, 26, 36 AND 38).

THE MARK CONSISTS OF STANDARD CHARACTERS WITHOUT CLAIM TO ANY PARTICULAR FONT, STYLE, SIZE, OR COLOR.

OWNER OF INTERNATIONAL REGISTRATION 0932250 DATED 6-18-2007, EXPIRES 6-18-2017.

SER. NO. 79-041,702, FILED 6-18-2007.

TINA KUAN, EXAMINING ATTORNEY

Int. Cls.: 35, 36 and 45

Prior U.S. Cls.: 100, 101 and 102

United States Patent and Trademark Office

Reg. No. 3,480,894

Registered Aug. 5, 2008

**SERVICE MARK
PRINCIPAL REGISTER**



FRANCISCO JAVIER LOPEZ PEREZ (SPAIN IN-
DIVIDUAL)
AVDA. MERIDIANA, 354-1°
E-08027 BARCELONA, SPAIN

FOR: ADVERTISING SERVICES; BUSINESS OP-
ERATION, BUSINESS ADMINISTRATION AND OF-
FICE FUNCTIONS, IN CLASS 35 (U.S. CLS. 100, 101
AND 102).

FOR: INSURANCE CONSULTANCY; FINAN-
CIAL CONSULTANCY; MONETARY EXCHANGE;
REAL ESTATE CONSULTANCY, IN CLASS 36 (U.S.
CLS. 100, 101 AND 102).

FOR: LEGAL SERVICES, IN CLASS 45 (U.S. CLS.
100 AND 101).

OWNER OF INTERNATIONAL REGISTRATION
0932327 DATED 5-28-2007, EXPIRES 5-28-2017.

SER. NO. 79-041,735, FILED 5-28-2007.

CARYN GLASSER, EXAMINING ATTORNEY

Int. Cls.: 18, 24 and 25

Prior U.S. Cls.: 1, 2, 3, 22, 39, 41, 42 and 50

Reg. No. 3,480,895

United States Patent and Trademark Office

Registered Aug. 5, 2008

**TRADEMARK
PRINCIPAL REGISTER**

EINSVONSIEBEN

DITTMAR GMBH & CO. KG (FED REP GERMA-
NY LIMITED PARTNERSHIP)
GROTRIAN-STEINWEG-STRASSE 4B
38112 BRAUNSCHWEIG, FED REP GERMANY

FOR: LEATHER AND IMITATIONS OF LEA-
THER; GOODS MADE OF THESE MATERIALS,
NAMELY, SUITCASES, HAND-BAGS, LUGGAGE,
BRIEFCASES, WALLETS, CARRYING BAGS FOR
MONEY; SMALL ARTICLES OUT OF LEATHER,
NAMELY, BUSINESS CARD HOLDERS, CHANGE
PURSES AND KEY CHAINS; DRESSING-CASES,
NAMELY, SUIT BAGS; TOILETRY BAGS; UMBREL-
LAS; WALKING STICKS; SADDLERY, IN CLASS 18
(U.S. CLS. 1, 2, 3, 22 AND 41).

FOR: BEDDING, NAMELY, COMFORTERS, BED
BLANKETS AND PILLOW CASES; BEDSPREADS;
TABLE COVERS, NAMELY, TABLE CLOTHS NOT
MADE OF PAPER, FABRIC TABLE RUNNERS AND
TABLE LINEN; TEXTILE PLACE MATS; LININGS,
NAMELY, TEXTILE USED AS LINING FOR
CLOTHING; TEXTILE DRAPERIES AND CUR-
TAINS; CLOTHS, NAMELY, WASH CLOTHS, DISH
CLOTHS AND OIL CLOTHS; SHEETS, NAMELY,
BED SHEETS AND BATH SHEETS; UNFITTED
TEXTILE FURNITURE COVERS; TEXTILE COV-
ERS, NAMELY, DUVET COVERS, PILLOW COVERS
AND MATTRESS COVERS; QUILTS; LINEN; VEL-
VET; WOVEN FABRICS FOR TEXTILE USE, IN
CLASS 24 (U.S. CLS. 42 AND 50).

FOR: CLOTHES, NAMELY, SHIRTS, BLOUSES,
WAISTCOATS, PULLOVERS, SWEATSHIRT, JACK-
ETS, TROUSERS, SPORTS JACKET, SUITS, COATS,
UNDERWEAR, SOCKS, SHOES, TIES, SCARVES
AND BELTS; DRESSING CLOTHS, NAMELY, SARIS
AND HEAD SCARVES; HEADGEAR, NAMELY,
CAPS, BONNETS, HATS, IN CLASS 25 (U.S. CLS. 22
AND 39).

THE MARK CONSISTS OF STANDARD CHAR-
ACTERS WITHOUT CLAIM TO ANY PARTICULAR
FONT, STYLE, SIZE, OR COLOR.

PRIORITY DATE OF 11-24-2006 IS CLAIMED.

OWNER OF INTERNATIONAL REGISTRATION
0932385 DATED 5-23-2007, EXPIRES 5-23-2017.

THE ENGLISH TRANSLATION OF THE WORD
"EINSVONSIEBEN" IN THE MARK IS ONEOUTOF-
SEVEN.

SER. NO. 79-041,758, FILED 5-23-2007.

AMY MCMENAMIN, EXAMINING ATTORNEY

Int. Cls.: 29, 30 and 44

Prior U.S. Cls.: 46, 100 and 101

United States Patent and Trademark Office

Reg. No. 3,480,896

Registered Aug. 5, 2008

**TRADEMARK
SERVICE MARK
PRINCIPAL REGISTER**

FLINNDAL

NATUFIT NEDERLAND B.V. (NETHERLANDS
LTD LIAB CO)
FLORAPARK 10
NL-2012 HK HAARLEM
NETHERLANDS

FOR: NUTRITIONAL SUPPLEMENTS CONTAINING INGREDIENTS OF ANIMAL ORIGIN, DAIRY INGREDIENTS, AND EDIBLE OILS AND FATS, NOT ADOPTED FOR MEDICAL USE, IN CLASS 29 (U.S. CL. 46).

FOR: NUTRITIONAL SUPPLEMENTS CONTAINING INGREDIENTS OF VEGETABLE ORIGIN NOT ADAPTED FOR MEDICAL USE, IN CLASS 30 (U.S. CL. 46).

FOR: PROVIDING NUTRITIONAL ADVICE TO OTHERS, NAMELY, NUTRITIONAL COUNSELING, PROVIDING INFORMATION ABOUT DIETARY SUPPLEMENTS AND NUTRITION,

PROVIDING A WEBSITE THAT FEATURES INFORMATION ABOUT NUTRITION, NUTRITIONAL SUPPLEMENTS, AND DIETARY AND NUTRITIONAL GUIDANCE, IN CLASS 44 (U.S. CLS. 100 AND 101).

THE MARK CONSISTS OF STANDARD CHARACTERS WITHOUT CLAIM TO ANY PARTICULAR FONT, STYLE, SIZE, OR COLOR.

PRIORITY DATE OF 6-26-2007 IS CLAIMED.

OWNER OF INTERNATIONAL REGISTRATION 0932400 DATED 7-11-2007, EXPIRES 7-11-2017.

SER. NO. 79-041,765, FILED 7-11-2007.

GEOFFREY FOSDICK, EXAMINING ATTORNEY

Int. Cls.: 6 and 9

Prior U.S. Cls.: 2, 12, 13, 14, 21, 23, 25, 26, 36, 38 and 50

Reg. No. 3,480,897

United States Patent and Trademark Office

Registered Aug. 5, 2008

**TRADEMARK
PRINCIPAL REGISTER**

BODYKEY

KABA AG (SWITZERLAND SOCIÉTÉ ANONYME
(JOINT STOCK COMPANY))
MÜHLEBÜHLSTRASSE,
KEMPTEN; CH-8023 WETZIKON
SWITZERLAND

FOR: NON-ELECTRIC LOCKS OF METAL AND KEYS THEREFORE; CASH BOXES OF METAL AND METAL SAFES; SMALL ITEMS OF METAL HARDWARE, NAMELY, METAL FITTINGS FOR VEHICLES, WINDOWS, SUITCASES AND FURNITURE, NAMELY, LATCHES, KNOBS, HINGES, NUTS, WASHERS AND BUCKLES OF COMMON METAL; DOORS MADE OF METAL AND THEIR PARTS AND FITTINGS, NAMELY, CASINGS, FRAMES, JAMBS, STOPS, KICK PLATES AND TRIM; FITTINGS OF METAL FOR BUILDING, NAMELY, BUILDING FLASHING, LININGS OF METAL, METAL CLADDING AND TRIM; RINGS OF COMMON METAL FOR KEYS; CAR LOCKS OF METAL; CAR KEYS; SECURITY LOCKS MADE OF METAL FOR VEHICLES, IN CLASS 6 (U.S. CLS. 2, 12, 13, 14, 23, 25 AND 50).

FOR: ELECTRICALLY, ELECTRONICALLY, OPTICALLY AND ACOUSTICALLY CONTROLLED SECURITY, LOCKING AND ACCESS CONTROL DEVICES, NAMELY, COMPUTER HARDWARE AND SOFTWARE FOR MONITORING, MANAGING, CONTROLLING AND INTEGRATING LOCKING AND ACCESS CONTROL DEVICES; ELECTRONICALLY CONTROLLED DEVICES FOR

THE DELIVERY OF MONEY AND GOODS, NAMELY, AUTOMATIC TELLER MACHINES AND VENDING MACHINES; DATA PROCESSING DEVICES, NAMELY, DATA PROCESSORS AND COMPUTER HARDWARE AND SOFTWARE FOR DATA PROCESSING AND PARTS THEREOF, NAMELY, COMPUTER PERIPHERALS; COMPUTER SWITCHES; SEMI-CONDUCTORS; PRERECORDED MAGNETIC DATA CARRIERS FEATURING DATA ABOUT ELECTRONIC LOCKS AND ACCESS CONTROL DEVICES; PRE-RECORDED ELECTRONIC MEDIA FEATURING SOFTWARE FOR OPERATING SECURITY LOCKING AND ACCESS CONTROL DEVICES; ELECTRIC LOCKS FOR VEHICLES; TRANSPONDERS, IN CLASS 9 (U.S. CLS. 21, 23, 26, 36 AND 38).

THE MARK CONSISTS OF STANDARD CHARACTERS WITHOUT CLAIM TO ANY PARTICULAR FONT, STYLE, SIZE, OR COLOR.

PRIORITY DATE OF 1-25-2007 IS CLAIMED.

OWNER OF INTERNATIONAL REGISTRATION
0932413 DATED 5-24-2007, EXPIRES 5-24-2017.

SER. NO. 79-041,769, FILED 5-24-2007.

AMY MCMENAMIN, EXAMINING ATTORNEY

Int. Cl.: 25

Prior U.S. Cls.: 22 and 39

United States Patent and Trademark Office

Reg. No. 3,480,898

Registered Aug. 5, 2008

**TRADEMARK
PRINCIPAL REGISTER**

BEYOND PERFORMANCE

EIDER, SOCIÉTÉ PAR ACTIONS SIMPLIFIÉE
(FRANCE SOCIÉTÉ PAR ACTIONS SIMPLIFIÉE)

2 RUE DU PRÉ FAUCON
F-74940 ANNECY LE VIEUX
FRANCE

FOR: CLOTHING, PARTICULARLY FOR SKIING, ROCK-CLIMBING, MOUNTAINEERING AND HIKING, NAMELY, PANTS, JACKETS, SHIRTS, BELTS, FURS, NAMELY, FUR COATS AND FUR JACKETS, TROUSERS, JUMPERS, COATS, GLOVES, SCARVES, SHOULDER WRAPS, HOSIERY, SOCKS, BOOT LINERS, BEACH, SKI AND SPORTS FOOTWEAR, UNDERWEAR, HEAD-

GEAR, NAMELY, HATS AND CAPS, IN CLASS 25 (U.S. CLS. 22 AND 39).

PRIORITY DATE OF 1-23-2007 IS CLAIMED.

OWNER OF INTERNATIONAL REGISTRATION 0932416 DATED 7-5-2007, EXPIRES 7-5-2017.

SER. NO. 79-041,770, FILED 7-5-2007.

AMY HELLA, EXAMINING ATTORNEY

Int. Cls.: 7, 35 and 37

Prior U.S. Cls.: 13, 19, 21, 23, 31, 34, 35, 100, 101, 102, 103 and 106

Reg. No. 3,480,899

United States Patent and Trademark Office

Registered Aug. 5, 2008

**TRADEMARK
SERVICE MARK
PRINCIPAL REGISTER**



ATLAS COPCO AIRPOWER.; NAAMLOZE VEN-
NOOTSCHAP (BELGIUM NAAMLOZE VEN-
NOOTSCHAP)
BOOMSESTEENWEG 957
B-2610 WILRIJK
BELGIUM

FOR: AIR AND PISTON COMPRESSOR MA-
CHINES AND MACHINE TOOLS, NAMELY, BROA-
CHES, CHASERS AND MILLING CUTTERS;
ENGINES, OTHER THAN FOR LAND VEHICLES;
TRANSMISSION COUPLINGS AND BELTS FOR
MACHINES OTHER THAN FOR LAND VEHICLES;
ELECTRIC GENERATORS; COMPRESSORS FOR
MACHINES; AIR COMPRESSORS; PISTON COM-
PRESSORS, IN CLASS 7 (U.S. CLS. 13, 19, 21, 23, 31, 34
AND 35).

FOR: BUSINESS ADMINISTRATION; ADMINIS-
TRATIVE SERVICES, NAMELY, PROVIDING THE
PROCESSING OF PURCHASE ORDERS AND OF-
FICE ADMINISTRATION SERVICES; COMPILA-
TION OF BUSINESS AND COMMERCIAL
STATISTICS; COMMERCIAL INFORMATION
AGENCIES; MARKET RESEARCH STUDIES, RE-
SEARCH AND ANALYSIS IN THE FIELD OF THE
AIR AND PISTON COMPRESSION MACHINE IN-
DUSTRIES; RETAIL STORES FEATURING SEC-
OND-HAND AIR AND PISTON COMPRESSOR
TRADE-INS, IN CLASS 35 (U.S. CLS. 100, 101 AND
102).

FOR: MAINTENANCE AND REPAIR OF INDUS-
TRIAL MACHINERY INSTALLATIONS, NAMELY,
INDUSTRIAL COMPRESSORS AND GENERATORS
AND MAINTENANCE AND REPAIRS OF MA-
CHINES, NAMELY, COMPRESSORS, AIR COM-
PRESSORS AND PISTON COMPRESSORS, IN
CLASS 37 (U.S. CLS. 100, 103 AND 106).

PRIORITY DATE OF 12-21-2006 IS CLAIMED.

OWNER OF INTERNATIONAL REGISTRATION
0932426 DATED 5-11-2007, EXPIRES 5-11-2017.

THE COLOR(S) BLUE IS/ARE CLAIMED AS A
FEATURE OF THE MARK.

THE MARK CONSISTS OF THE COLOR BLUE
APPEARING IN THE WORDING "ORIGINAIR"
AND IN THE DESIGN OF THE TWO CURVED
ARROWS.

SER. NO. 79-041,773, FILED 5-11-2007.

AMY MCMENAMIN, EXAMINING ATTORNEY

Int. Cl.: 21

Prior U.S. Cls.: 2, 13, 23, 29, 30, 33, 40 and 50

United States Patent and Trademark Office

Reg. No. 3,480,900

Registered Aug. 5, 2008

TRADEMARK
PRINCIPAL REGISTER

pininfarina

PININFARINA EXTRA S.R.L. (ITALY SOCIÉTÉ À
RESPONSABILITÉ LIMITÉE (S.A.R.L.))
VIA BRUNO BUOZZI 6
I-10121 TORINO
ITALY

FIGURINES, IN CLASS 21 (U.S. CLS. 2, 13, 23, 29, 30,
33, 40 AND 50).

PRIORITY DATE OF 4-30-2007 IS CLAIMED.

FOR: HOUSEHOLD CONTAINERS, NOT OF PRE-
CIOUS METAL OR COATED THEREWITH; HOUSE-
HOLD AND KITCHEN UTENSILS, NAMELY,
CORKSCREW, DECANTERS, COMBS AND SPON-
GES FOR HOUSEHOLD PURPOSES; TOOTH BRU-
SHES; BRUSH-MAKING MATERIALS; CLEANING
EQUIPMENT, NAMELY, CLOTHS, AND STEEL
WOOL FOR CLEANING; UNWORKED OR SEMI-
WORKED GLASS, EXCEPT BUILDING GLASS;
DRINKING GLASSES, GLASSWARE, PORCELAIN
AND EARTHENWARE MUGS, STATUTES AND

OWNER OF INTERNATIONAL REGISTRATION
0932453 DATED 5-30-2007, EXPIRES 5-30-2017.

OWNER OF U.S. REG. NOS. 2,739,664 AND
3,207,068.

SER. NO. 79-041,785, FILED 5-30-2007.

SUSAN LESLIE DUBOIS, EXAMINING ATTORNEY

Int. Cl.: 30

Prior U.S. Cl.: 46

United States Patent and Trademark Office

Reg. No. 3,480,901

Registered Aug. 5, 2008

TRADEMARK
PRINCIPAL REGISTER



CHOCOLADEFABRIKEN LINDT & SPRÜNGLI
AG (SWITZERLAND SOCIÉTÉ ANONYME)
SEESTRASSE 204
CH-8802 KILCHBERG ZH
SWITZERLAND

FOR: CHOCOLATE; PRALINES, IN CLASS 30 (U.S.
CL. 46).

PRIORITY DATE OF 12-11-2006 IS CLAIMED.

OWNER OF INTERNATIONAL REGISTRATION
0932557 DATED 6-1-2007, EXPIRES 6-1-2017.

OWNER OF U.S. REG. NOS. 2,622,683 AND
2,890,112.

NO CLAIM IS MADE TO THE EXCLUSIVE
RIGHT TO USE "SEIT 1882" AND "WIEN", APART
FROM THE MARK AS SHOWN.

THE ENGLISH TRANSLATION OF THE WORDS
"SEIT" AND "WIEN" IN THE MARK IS "SINCE"
AND "VIENNA" RESPECTIVELY. AS FOR "HOF-
BAUER", THE FOREIGN WORDING IN THE MARK
TRANSLATES INTO ENGLISH AS 'COURTYARD'
OR 'FARM' (HOF) AND 'FARMER' (BAUER).

SER. NO. 79-041,833, FILED 6-1-2007.

SIMON TENG, EXAMINING ATTORNEY

Int. Cls.: 3, 5 and 10

Prior U.S. Cls.: 1, 4, 6, 18, 26, 39, 44, 46, 50, 51 and 52

Reg. No. 3,480,902

United States Patent and Trademark Office

Registered Aug. 5, 2008

**TRADEMARK
PRINCIPAL REGISTER**

HYALUDERM REVITALIZE

LABORATOIRE DE; CONTACTOLOGIE APPLI-
QUÉE - LCA (FRANCE SOCIÉTÉ ANONYME)
9 ALLÉE PROMÉTHÉE
F-28000 CHARTRES, FRANCE

FOR: COSMETIC ANTI-WRINKLE CREAMS;
SKIN CARE PRODUCTS, NAMELY, NON-MEDICA-
TED SKIN CREAMS, MILKS, FLUIDS, SERUMS,
LOTIONS, GELS, OILS, TONERS, CLEANSERS,
PEELS AND SOAPS; SKIN CARE PRODUCTS FOR
THE FACE, NAMELY, NON-MEDICATED TONING
AND ANTI-WRINKLE CREAMS, MILKS, FLUIDS,
SERUMS, LOTIONS, GELS, OILS, TONERS,
CLEANSERS, PEELS AND SOAPS; NON-MEDICA-
TED INJECTABLE SKIN CARE PRODUCTS FOR
THE FACE, NAMELY, NON-MEDICATED TONING
AND ANTI-WRINKLE SERUMS AND FLUIDS, IN
CLASS 3 (U.S. CLS. 1, 4, 6, 50, 51 AND 52).

FOR: PHARMACEUTICAL PREPARATIONS FOR
FILLING FACIAL WRINKLES; PHARMACEUTI-
CAL PREPARATIONS FOR DERMATOLOGICAL
USE; INJECTABLE PHARMACEUTICAL PREPARA-
TIONS FOR DERMATOLOGICAL USE, IN THE
FORM OF PRE-FILLED DISPOSABLE STERILE
SYRINGES CONTAINING ANTI-WRINKLE AND
TONING INJECTABLE PHARMACEUTICAL PRE-
PARATIONS FOR DERMATOLOGICAL USE CON-
TAINING SODIUM HYALURONATE, IN CLASS 5
(U.S. CLS. 6, 18, 44, 46, 51 AND 52).

FOR: MEDICAL DEVICES FOR INTRACORPOR-
EAL INJECTION, NAMELY, NEEDLES AND SYR-
INGES FOR INJECTIONS; MEDICAL DEVICES FOR
INTRACORPOREAL INJECTION COMPOSED OF A
DISPOSABLE STERILE SYRINGE , IN CLASS 10
(U.S. CLS. 26, 39 AND 44).

THE MARK CONSISTS OF STANDARD CHAR-
ACTERS WITHOUT CLAIM TO ANY PARTICULAR
FONT, STYLE, SIZE, OR COLOR.

PRIORITY DATE OF 12-11-2006 IS CLAIMED.

OWNER OF INTERNATIONAL REGISTRATION
0932577 DATED 6-5-2007, EXPIRES 6-5-2017.

NO CLAIM IS MADE TO THE EXCLUSIVE
RIGHT TO USE "REVITALIZE" FOR CLASSES 3
AND 5 ONLY, APART FROM THE MARK AS
SHOWN.

THE WORDING "HYALUDERM" HAS NO
MEANING IN A FOREIGN LANGUAGE.

SER. NO. 79-041,847, FILED 6-5-2007.

CHRISIE B. KING, EXAMINING ATTORNEY

Int. Cls.: 35 and 36

Prior U.S. Cls.: 100, 101 and 102

United States Patent and Trademark Office

Reg. No. 3,480,903

Registered Aug. 5, 2008

**SERVICE MARK
PRINCIPAL REGISTER**

EXANE DERIVATIVES

EXANE (FRANCE SOCIÉTÉ ANONYME À CONSEIL D'ADMINISTRATION)
16 AVENUE DE MATIGNON
F-75008 PARIS
FRANCE

FOR: BUSINESS MANAGEMENT ASSISTANCE, BUSINESS ORGANIZATION AND MANAGEMENT CONSULTING, PROFESSIONAL BUSINESS CONSULTING, EFFICIENCY EXPERTS, BUSINESS INFORMATION, BUSINESS SEARCHES AND INVESTIGATIONS, BUSINESS INQUIRIES, BUSINESS APPRAISALS, MARKET STUDY, MARKET RESEARCH, ECONOMIC FORECASTING, PROVIDING STATISTICAL INFORMATION, IN CLASS 35 (U.S. CLS. 100, 101 AND 102).

FOR: FINANCIAL AFFAIRS, NAMELY, FINANCIAL CONSULTATION; BANKING; FINANCIAL TRUST OPERATIONS; FINANCIAL TRANSACTIONS, NAMELY, INVESTMENT FUND TRANSFER AND TRANSACTION SERVICES; FINANCIAL ANALYSIS, FINANCIAL CONSULTING; FINANCIAL EVALUATIONS BY BANKS FOR INSURANCE PURPOSES; FISCAL EVALUATIONS; PROVIDING FINANCIAL INFORMATION IN THE FIELD OF FINANCIAL INVESTMENTS; SERVICES OF ESTABLISHMENT, INVESTMENT AND MANAGEMENT OF INTERESTS OR SHARES OF UCITS (UNDERTAKINGS FOR COLLECTIVE INVESTMENT IN TRANSFERABLE SECURITIES), NAMELY, ESTAB-

LISHING MUTUAL FUNDS FOR OTHERS AND FUNDS INVESTMENT SERVICES; SERVICES OF INVESTMENT AND MANAGEMENT OF PORTFOLIOS OF TRANSFERABLE SECURITIES, NAMELY, FINANCIAL PORTFOLIO MANAGEMENT AND INVESTMENT OF FUNDS FOR OTHERS, IN CLASS 36 (U.S. CLS. 100, 101 AND 102).

THE MARK CONSISTS OF STANDARD CHARACTERS WITHOUT CLAIM TO ANY PARTICULAR FONT, STYLE, SIZE, OR COLOR.

PRIORITY DATE OF 1-9-2007 IS CLAIMED.

OWNER OF INTERNATIONAL REGISTRATION 0932631 DATED 6-28-2007, EXPIRES 6-28-2017.

OWNER OF U.S. REG. NOS. 2,497,675, 3,058,646, AND 3,298,222.

NO CLAIM IS MADE TO THE EXCLUSIVE RIGHT TO USE "DERIVATIVES", APART FROM THE MARK AS SHOWN.

SER. NO. 79-041,862, FILED 6-28-2007.

CARRIE GENOVESE, EXAMINING ATTORNEY

Int. Cls.: 18 and 25

Prior U.S. Cls.: 1, 2, 3, 22, 39 and 41

United States Patent and Trademark Office

Reg. No. 3,480,904

Registered Aug. 5, 2008

**TRADEMARK
PRINCIPAL REGISTER**

PAMOISON

LANCEL INTERNATIONAL SA (SWITZERLAND
SOCIÉTÉ ANONYME (SA))
ROUTE DES BICHES 10
CH-1752 VILLARS-SUR-GLÂNE
SWITZERLAND

FOR: LEATHER GOODS AND SMALL LEATHER ITEMS, NAMELY, HANDBAGS, POCHETTES, HOLLARDS, BEGGARS' BAGS, SHOULDER BAGS, RUCKSACKS, COLLEGE SATCHELS, BEACH BAGS, TRAVELLING BAGS, SADDLE BAGS, SPORTS BAGS, GARMENT BAGS, TRAVELLING SETS CONSISTING OF SUITCASES AND TRAVEL BAGS, DOCUMENT CASES, CREDIT CARD CASES, BUSINESS AND NAME CARD CASES, WALLETS, CASES FOR NOTES AND OTHER RELATED DOCUMENTS, PURSES NOT OF PRECIOUS METAL, BRIEF CASES, ATTACHE CASES, SCHOOL BAGS, KEY CASES, VANITY CASES SOLD EMPTY, TRUNKS AND SUITCASES; AND UMBRELLAS, IN CLASS 18 (U.S. CLS. 1, 2, 3, 22 AND 41).

FOR: CLOTHING, NAMELY, SPORTSWEAR IN THE NATURE OF SPORTS TROUSERS, SPORTS SHORTS, SPORTS JACKETS, SPORTS SUITS,

SPORTS PANTS, SPORTS SKIRTS, SPORTS DRESSES, SPORTS JERSEYS, SPORTS SHIRTS, AND SPORTS SOCKS; SASHES FOR WEAR; SHAWLS; SCARVES; TIES; BRACES; GLOVES; BELTS; FOOTWEAR OTHER THAN ORTHOPAEDIC FOOTWEAR; AND HEADGEAR IN THE NATURE OF CAPS AND HATS, IN CLASS 25 (U.S. CLS. 22 AND 39).

THE MARK CONSISTS OF STANDARD CHARACTERS WITHOUT CLAIM TO ANY PARTICULAR FONT, STYLE, SIZE, OR COLOR.

PRIORITY DATE OF 11-30-2006 IS CLAIMED.

OWNER OF INTERNATIONAL REGISTRATION
0932670 DATED 5-30-2007, EXPIRES 5-30-2017.

SER. NO. 79-041,870, FILED 5-30-2007.

CAROLYN GRAY, EXAMINING ATTORNEY

Int. Cls.: 16, 21, 34, 39 and 43

Prior U.S. Cls.: 2, 5, 8, 9, 13, 17, 22, 23, 29, 30, 33, 37, 38, 40, 50, 100, 101 and 105

Reg. No. 3,480,905

United States Patent and Trademark Office

Registered Aug. 5, 2008

**TRADEMARK
SERVICE MARK
PRINCIPAL REGISTER**

**Novotel
Conçu comme un espace naturel**

ACCOR (FRANCE SOCIÉTÉ ANONYME)
2 RUE DE LA MARE NEUVE
F-91000 EVRY
FRANCE

FOR: PAPER AND CARDBOARD BEING UN-PROCESSED, SEMI-PROCESSED AND FOR STATIONERY AND PRINTING PURPOSES; PRINTED MATTER, NAMELY, BOOKS, MAGAZINES, BROCHURES IN THE FIELD OF TRAVEL AND TOURISM; WRITING PAPER PADS; PRINTED PAPER AND CARDBOARD SIGNS; CARDBOARD CARTONS, PAPERS FOR WRAPPING AND PACKAGING AND SMALL PAPER AND PLASTIC BAGS FOR WRAPPING; PRINTED MATTER FOR ADVERTISING PURPOSES, NAMELY, ADVERTISING BOARDS OF PAPER OR CARDBOARD, ADVERTISING PAMPHLETS; LETTER PAPER; POSTCARDS; VISITING CARDS; POSTERS AND ADVERTISING POSTERS, PRINTED PROSPECTUSES IN THE FIELD OF TRAVEL AND TOURISM, PRINTED PERIODICALS FEATURING REVIEWS IN THE FIELD OF TRAVEL AND TOURISM, PRINTED PUBLICATIONS, NAMELY, BOOKS, MAGAZINES, BROCHURES IN THE FIELD OF TRAVEL AND TOURISM, NEWSPAPERS AND PRINTED PERIODICALS IN THE FIELD OF TRAVEL AND TOURISM; BOOKS IN THE FIELD OF TRAVEL AND TOURISM, ALBUMS FOR COINS AND PHOTOGRAPHS AND CALENDARS; WRITING AND DRAWING MATERIALS, NAMELY, PENS, PENCILS, DRAWING PADS, DRAWING PAPERS, DRAWING BRUSHES; PRINTING BLOCKS; PHOTOGRAPHS; PRINTING TYPE, IN CLASS 16 (U.S. CLS. 2, 5, 22, 23, 29, 37, 38 AND 50).

FOR: NON-ELECTRIC HOUSEHOLD OR KITCHEN UTENSILS NOT OF PRECIOUS METAL OR COATED THEREWITH, NAMELY, SIEVES, SPATULAS, AND CONTAINERS FOR HOUSEHOLD AND KITCHEN USE NOT OF PRECIOUS METAL OR COATED THEREWITH; TABLEWARE MADE OF GLASS, PORCELAIN OR EARTHENWARE, NAMELY, BOWLS, PLATES; TABLE PLATES NOT OF

PRECIOUS METAL; COFFEE SERVICES NOT OF PRECIOUS METAL; TEA SERVICES NOT OF PRECIOUS METAL; DECANTERS; BEER MUGS; MENU CARD HOLDERS; BOTTLE OPENERS; TRAYS FOR DOMESTIC PURPOSES NOT OF PRECIOUS METAL; DISHES NOT OF PRECIOUS METAL; GLASS BEVERAGEWARE; DRINKING GLASSES; MILK JUGS AND SUGAR BOWLS NOT OF PRECIOUS METAL, IN CLASS 21 (U.S. CLS. 2, 13, 23, 29, 30, 33, 40 AND 50).

FOR: SMOKERS' ARTICLES NOT OF PRECIOUS METAL, NAMELY, CIGAR AND CIGARETTE CASES, CIGAR AND CIGARETTE HOLDERS, ASH-TRAYS NOT OF PRECIOUS METAL; MATCHES; MATCH BOXES AND MATCH HOLDERS NOT OF PRECIOUS METAL, IN CLASS 34 (U.S. CLS. 2, 8, 9 AND 17).

FOR: TRANSPORT OF PASSENGERS AND GOODS; FERRYBOAT OPERATING; VEHICLE BREAKDOWN ASSISTANCE, NAMELY, TOWING; PACKAGING OF GOODS FOR TRANSPORTATION; TRAVEL INFORMATION SERVICES FEATURING TRAVEL TICKET BOOKINGS; TRANSPORT VEHICLE RENTAL; ARRANGING OF TRAVEL TOURS; ARRANGING OF CRUISES, TRAVEL ARRANGEMENT, NAMELY, ARRANGING FOR TRAVEL VISAS, PASSPORTS AND TRAVEL DOCUMENTS FOR PERSONS TRAVELING ABROAD; CONDUCTING SIGHTSEEING TOURS FOR OTHERS; ESCORTING OF TRAVELERS, NAMELY, TOUR ESCORTING; VEHICLE GARAGE SERVICES, NAMELY, VEHICLE PARKING, RENTAL OF VEHICLE PARKING SPACES; RENTAL OF GARAGE SPACE; RENTAL OF WAREHOUSE SPACE, IN CLASS 39 (U.S. CLS. 100 AND 105).

FOR: HOTEL AND RESTAURANT SERVICES; PROVIDING TEMPORARY ACCOMMODATION; SERVICES OF MOTELS, RESTAURANTS, CAFETERIAS, TEA ROOMS, BARS NOT BEING CLUBS, HOLIDAY HOUSES IN THE NATURE OF BOARDING HOUSES; RESERVATION SERVICES FOR HO-

TEL ROOMS FOR TRAVELERS; ACCOMMODATION AGENCIES, NAMELY, ARRANGING TEMPORARY HOUSING ACCOMODATIONS IN HOTELS AND BOARDING HOUSES; MAKING HOTEL RESERVATIONS FOR OTHERS; MAKING TEMPORARY ACCOMMODATION RESERVATIONS FOR OTHERS; MAKING BOARDING HOUSE AND HOLIDAY HOUSE RESERVATIONS FOR OTHERS, IN CLASS 43 (U.S. CLS. 100 AND 101).

THE MARK CONSISTS OF STANDARD CHARACTERS WITHOUT CLAIM TO ANY PARTICULAR FONT, STYLE, SIZE, OR COLOR.

PRIORITY DATE OF 9-21-2006 IS CLAIMED.

OWNER OF INTERNATIONAL REGISTRATION 0932696 DATED 3-12-2007, EXPIRES 3-12-2017.

OWNER OF U.S. REG. NOS. 1,803,936 AND 3,286,528.

THE FOREIGN WORDING IN THE MARK TRANSLATES INTO ENGLISH AS "CONCEIVED LIKE A NATURAL SPACE".

SER. NO. 79-041,879, FILED 3-12-2007.

KRISTINA MORRIS, EXAMINING ATTORNEY

Int. Cl.: 28

Prior U.S. Cls.: 22, 23, 38 and 50

United States Patent and Trademark Office

Reg. No. 3,480,906

Registered Aug. 5, 2008

**TRADEMARK
PRINCIPAL REGISTER**

OmniGrip

ORANGE INTERNATIONAL TRADING; (TIANJIN) INC. (CHINA CORPORATION)
ROOM. 202 SUITE 1
155 XINGANG BIG ROAD.; FREE TRADE ZONE;-
TIANJIN
CHINA

FOR: BODY-TRAINING APPARATUS, NAMELY, ANKLE AND WRIST WEIGHT FOR EXERCISE, BARBELLS, DUMBBELLS, STRIKING BAGS, STRIKING SHIELDS, HAND WRAPS, BATTING GLOVES, ELLIPTICAL EXERCISE MACHINES, EXERCISE MACHINES, EXERCISE MACHINES INCORPORATING ELECTRONIC AND VIDEO GAME CONTROLLERS, EXERCISE BARS, EXERCISE BENCHES, ROWING MACHINES, EXERCISE TRAMPOLINES, EXERCISE TREADMILLS, EXERCISE WEIGHTS, EXERCISE WEIGHT CUFFS, EXERCISE WRIST WEIGHTS, WEIGHT LIFTING MACHINES, TRAMPOLINES, LEG WEIGHTS FOR

EXERCISING, YOGA MATS, WEIGHT LIFTING BENCHES AND BENCH ACCESSORIES, NAMELY, BARBELLS; CHECKERS; PLAYING BALLS, NAMELY, BEACH BALLS, BOWLING BALLS, FOOT BALLS; ARCHERY IMPLEMENTS, NAMELY, ARCHERY SETS; MACHINES FOR PHYSICAL EXERCISES, NAMELY, EXERCISE MACHINES; BATS FOR GAMES, NAMELY, BASEBALL BATS; GLOVES FOR GAMES, NAMELY, SOFT BALL GLOVES; FISHING TACKLE; PLAY SWIMMING POOLS, IN CLASS 28 (U.S. CLS. 22, 23, 38 AND 50).

OWNER OF INTERNATIONAL REGISTRATION
0932927 DATED 6-7-2007, EXPIRES 6-7-2017.

SER. NO. 79-041,963, FILED 6-7-2007.

RAMONA ORTIGA, EXAMINING ATTORNEY

Int. Cls.: 7, 37, 40 and 42

**Prior U.S. Cls.: 13, 19, 21, 23, 31, 34, 35, 100, 101, 103
and 106**

Reg. No. 3,480,907

United States Patent and Trademark Office

Registered Aug. 5, 2008

**TRADEMARK
SERVICE MARK
PRINCIPAL REGISTER**

SteamLab

STEAMLAB.SYSTEMS AG (FED REP GERMANY
CORPORATION)
AN DER ALSTER 6
20099 HAMBURG
FED REP GERMANY

FOR: MACHINERY FOR THE AGRICULTURAL,
FOOD AND PHARMACEUTICAL INDUSTRIES,
NAMELY, STEAM CLEANING MACHINES, IN
CLASS 7 (U.S. CLS. 13, 19, 21, 23, 31, 34 AND 35).

FOR: PEST CONTROL, EXCEPT FOR AGRICUL-
TURAL PURPOSES, FOR HIGH-VALUE FOODS
AND SUBSTANCES FOR THE PHARMACEUTICAL
INDUSTRY, IN CLASS 37 (U.S. CLS. 100, 103 AND
106).

FOR: TREATMENT OF MATERIALS, NAMELY,
PASTEURIZATION/STERILIZATION OF FOOD IN-
GREDIENTS, CHEMICALS AND PHARMACEUTI-
CALS, IN CLASS 40 (U.S. CLS. 100, 103 AND 106).

FOR: COMPUTER SOFTWARE DEVELOPMENT,
IN CLASS 42 (U.S. CLS. 100 AND 101).

OWNER OF INTERNATIONAL REGISTRATION
0932952 DATED 7-2-2007, EXPIRES 7-2-2017.

SER. NO. 79-041,972, FILED 7-2-2007.

FRED CARL, EXAMINING ATTORNEY

Int. Cls.: 6, 16 and 42

**Prior U.S. Cls.: 2, 5, 12, 13, 14, 22, 23, 25, 29, 37, 38,
50, 100 and 101**

Reg. No. 3,480,908

United States Patent and Trademark Office

Registered Aug. 5, 2008

**TRADEMARK
SERVICE MARK
PRINCIPAL REGISTER**

PREON

VALLOUREC & MANNESMANN TUBES
(FRANCE CORPORATION)
130, RUE DES SILLY
F-92100 BOULOGNE
FRANCE

FOR: SUPPORTING SYSTEMS, NAMELY, CON-
STRUCTIONS OF METAL FOR BUILDING COM-
PRISING ELEMENTS OF METAL IN THE NATURE
OF SUPPORTS, STRUTS AND UPRIGHTS; ROOF
CONSTRUCTIONS AND INSTALLATIONS OF MET-
AL FOR BRIDGING OVER LARGE RANGERS,
NAMELY, METAL ROOFING, METAL ROOF
TRUSSES, IN CLASS 6 (U.S. CLS. 2, 12, 13, 14, 23, 25
AND 50).

FOR: PRINTED MATTERS IN THE NATURE OF
BOOKS AND MAGAZINES IN THE FIELD OF
BUILDING CONSTRUCTIONS; PAMPHLETS IN
THE FIELD OF BUILDING CONSTRUCTION; PRO-
MOTIONAL AND ADVERTISING DOCUMENTS,
NAMELY, ADVERTISING SIGNS OF PAPER AND
CARDBOARD, ADVERTISING PAMPHLETS; OR-

DER FORMS; BUSINESS LETTER PAPER, IN CLASS
16 (U.S. CLS. 2, 5, 22, 23, 29, 37, 38 AND 50).

FOR: ENGINEER SERVICES; TECHNICAL CON-
SULTATION IN THE FIELD OF ARCHITECTURE
AND ARCHITECTURAL ENGINEERING; CON-
STRUCTION DRAFTING; ARCHITECTURAL CON-
SULTATION, IN CLASS 42 (U.S. CLS. 100 AND 101).

THE MARK CONSISTS OF STANDARD CHAR-
ACTERS WITHOUT CLAIM TO ANY PARTICULAR
FONT, STYLE, SIZE, OR COLOR.

PRIORITY DATE OF 11-14-2006 IS CLAIMED.

OWNER OF INTERNATIONAL REGISTRATION
0933009 DATED 5-14-2007, EXPIRES 5-14-2017.

SER. NO. 79-041,991, FILED 5-14-2007.

KRISTINA MORRIS, EXAMINING ATTORNEY

Int. Cl.: 19

Prior U.S. Cls.: 1, 12, 33 and 50

Reg. No. 3,480,909

United States Patent and Trademark Office

Registered Aug. 5, 2008

**TRADEMARK
PRINCIPAL REGISTER**

Tap & Go

YEKALON INDUSTRY, INC. (CHINA CORPORATION)
FLOOR 16RD, FLAT A, JINXIU BLDG
WENJIN MID ROAD; SHENZHEN CITY
CHINA

FOR: FLOOR BOARDS; PARQUET FLOORING
MADE OF CORK; FLOORING UNDERLAYMENT
MADE OF CORK, SLATE; GRANITE; MARBLE;
FIBERBOARDS; CERAMIC TILES; FLOOR TILES,
NOT OF METAL; BUILDING MATERIALS, NOT OF
METAL, NAMELY, A NONMETAL SUB-FLOOR
MEMBRANE FOR RESIDENTIAL AND COMMERCIAL
SOUNDPROOFING USE, PLANKS, LAMINATE
FLOORING, UNDERLAY FOR LAMINATE
FLOORING, BAMBOO FLOORING, FLOOR
BOARDS OF WOOD, FIBERBOARD; FABRIC FOR

UNDERLAYMENT OF FLOORING, FLOORING
UNDERLAYMENTS, GATES, NOT OF METAL;
FLOORS, NOT OF METAL, IN CLASS 19 (U.S. CLS.
1, 12, 33 AND 50).

PRIORITY DATE OF 9-11-2006 IS CLAIMED.

OWNER OF INTERNATIONAL REGISTRATION
0933092 DATED 2-6-2007, EXPIRES 2-6-2017.

SER. NO. 79-042,013, FILED 2-6-2007.

DAYNA BROWNE, EXAMINING ATTORNEY

Int. Cls.: 9, 18, 25, 35, 38 and 41

**Prior U.S. Cls.: 1, 2, 3, 21, 22, 23, 26, 36, 38, 39, 41,
100, 101, 102, 104 and 107**

Reg. No. 3,480,910

United States Patent and Trademark Office

Registered Aug. 5, 2008

**TRADEMARK
SERVICE MARK
PRINCIPAL REGISTER**



DEFECTED RECORDS LTD (UNITED KINGDOM LIMITED COMPANY)
8 CHARTERHOUSE BUILDING GOSWELL ROAD
LONDON, UNITED KINGDOM EC1M 7AN

FOR: APPARATUS FOR RECORDING, TRANSMISSION OR REPRODUCTION OF SOUND OR IMAGES; AMPLIFIERS; SOUND DECKS IN THE NATURE OF AUDIO CASSETTE DECKS FOR CARS AND RECORD DECKS; LOUDSPEAKERS AND CAR SPEAKERS; PHOTOGRAPHIC EQUIPMENT, NAMELY, CAMERAS, CAMERA TRIPODS AND CAMERA FLASHES; DATA STORAGE COMPONENTS, NAMELY, BLANK MAGNETIC DATA CARRIERS; MUSICAL SOUND RECORDINGS, VIDEOTAPES, RECORDS, AUDIO AND VIDEO TAPES, AUDIO AND VIDEO DISCS, AUDIO AND VIDEO CASSETTES, COMPACT DISCS AND LASER DISCS FEATURING MUSIC; SUNGLASSES, IN CLASS 9 (U.S. CLS. 21, 23, 26, 36 AND 38).

FOR: LEATHER AND IMITATION LEATHER GOODS, NAMELY, BAGS, TRUNKS AND TRAVELING BAGS; VALISES, SACHELS, CASES FOR TRAVEL KITS SOLD EMPTY, UNFITTED VANITY CASES, LEATHER AND IMITATION LEATHER POUCHES, SHOULDER BAGS, KITBAGS, RUCKSACKS, LEATHER AND IMITATION LEATHER SHOPPING BAGS, BEACH BAGS, HANDBAGS, BRIEFCASES, WALLETS, KEY CASES, WALLETS FOR CREDIT CARDS, WALLETS FOR BUSINESS CARDS, COIN PURSES; UMBRELLAS, PARASOLS, WALKING STICKS, IN CLASS 18 (U.S. CLS. 1, 2, 3, 22 AND 41).

FOR: CLOTHING, NAMELY, SHIRTS, PANTS, BELTS, SOCKS, TEE SHIRTS, TANK TOPS, BLOUSES, SHORTS, SKIRTS, SWIMWEAR, TROUSERS, JEANS, SWEATSHIRTS, JUMPERS, SWEATERS, VESTS, JACKETS, COATS, RAINCOATS, NIGHT-

GOWNS, PAJAMAS, UNDERGARMENTS, SCARVES, MUFFLERS, SHAWLS, NECK TIES, APRONS, GLOVES, NECKBANDS, WRIST BANDS AND HEADBANDS; HEADGEAR, NAMELY, HATS AND CAPS, IN CLASS 25 (U.S. CLS. 22 AND 39).

FOR: BUSINESS MANAGEMENT OF ARTISTS; MAIL ORDER RETAIL SERVICES FEATURING BAGS, CASES, CLOTHING, HEADGEAR, FOOTWEAR, SOUND AND VIDEO RECORDINGS, SOUND DECKS, RECORDS, TAPES, DISCS, CASSETTES, COMPACT DISCS, LASER DISCS, APPARATUS FOR RECORDING TRANSMISSION OR REPRODUCTION OF SOUND OR IMAGES, AMPLIFIERS, PHOTOGRAPHIC EQUIPMENT, PRINTED MATTER, BOOKS, JOURNALS, MAGAZINES, COMICS, PHOTOGRAPHS AND STATIONERY; RETAIL STORE SERVICES, MAIL ORDER RETAIL STORE SERVICES AND ONLINE RETAIL STORE SERVICES, ALL FEATURING A WIDE VARIETY OF CONSUMER GOODS OF OTHERS; MANAGEMENT OF PERFORMING ARTISTS, IN CLASS 35 (U.S. CLS. 100, 101 AND 102).

FOR: TELECOMMUNICATIONS SERVICES, NAMELY, REMOTE DATA ACCESS SERVICES PROVIDED VIA THE INTERNET, ELECTRONIC DATA INTERCHANGE SERVICES; ELECTRONIC DATA TRANSMISSION IN THE NATURE OF TRANSMISSION OF WEB PAGES, COMPUTER PROGRAMS AND OTHER DATA; PROVISION OF TELECOMMUNICATIONS ACCESS AND LINKS TO COMPUTER DATABASES AND TO THE INTERNET; DATA COMMUNICATION SERVICES IN THE NATURE OF SERVICES FOR THE COLLECTION AND TRANSMISSION OF MESSAGES, DATA AND INFORMATION BY ELECTRONIC AND COMPUTER MEANS; INFORMATION TRANSMISSION SERVICES VIA DIGITAL AND ELECTRONIC COM-

MUNICATIONS NETWORKS FOR BUSINESS AND PERSONAL USE; ON-LINE TRANSMISSION OF GRAPHICS, RADIO AND TELEVISION BROADCASTING, IN CLASS 38 (U.S. CLS. 100, 101 AND 104).

FOR: NIGHTCLUB AND DISCOTHEQUE SERVICES; DANCE CLUB SERVICES; PROVISION OF LIVE ENTERTAINMENT AND RECORDED ENTERTAINMENT, NAMELY, LIVE MUSICAL PERFORMANCES BY MUSICAL BANDS AND DJs, NON-DOWNLOADABLE RINGTONES, PRE-RECORDED MUSIC, VIDEO AND GRAPHICS TO MOBILE COMMUNICATIONS DEVICES VIA A GLOBAL COMPUTER NETWORK AND WIRELESS NETWORK; CINEMATIC AND VIDEO ENTERTAINMENT SERVICES, NAMELY, MOVIE THEATERS AND RENTAL OF MUSIC VIDEOS; ENTERTAINMENT, EDUCATION AND INSTRUCTION SERVICES RELATING TO RADIO AND TELEVISION, NAMELY, EDUCATION CLASSES AND SEMINARS IN THE FIELD OF MOVIE PRODUCTION, PROVISION OF ON-GOING RADIO AND TELEVISION SHOWS IN THE FIELD OF MUSIC, PRODUCTION OF TELEVISION AND RADIO PROGRAMS, MOTION PICTURE FILM AND VIDEO RECORDINGS; RENTAL OF VIDEOTAPES, MOVIES, SOUND RECORDINGS AND TELEVISION

SETS; PROVIDING FACILITIES FOR MOVIES, RADIO AND TELEVISION SHOWS; MUSIC STUDIOS, NAMELY, SOUND RECORDING STUDIOS; PUBLISHING SERVICES IN THE NATURE OF MUSIC PUBLISHING, BOOK AND REVIEW PUBLISHING; RENTAL OF EDUCATIONAL AND INSTRUCTIONAL MATERIALS, NAMELY, MAGAZINES, OVERHEAD PROJECTORS, MUSICAL INSTRUMENTS; MUSICAL ENTERTAINMENT IN THE NATURE OF LIVE VISUAL AND AUDIO PERFORMANCES BY ROCK GROUPS, MUSICAL GROUPS AND DJs; FASHION SHOWS; EXHIBITIONS, NAMELY, EXHIBITIONS CONCERNING MUSIC; PROVIDING ONLINE MUSIC SERVICES, NAMELY, PROVIDING PRERECORDED MUSIC, INFORMATION IN THE FIELD OF MUSIC, AND COMMENTARY AND ARTICLES ABOUT MUSIC VIA A GLOBAL COMPUTER NETWORK, IN CLASS 41 (U.S. CLS. 100, 101 AND 107).

OWNER OF INTERNATIONAL REGISTRATION 0933291 DATED 5-24-2007, EXPIRES 5-24-2017.

SER. NO. 79-042,098, FILED 5-24-2007.

JENNIFER VASQUEZ, EXAMINING ATTORNEY

Int. Cls.: 9, 18 and 25

Prior U.S. Cls.: 1, 2, 3, 21, 22, 23, 26, 36, 38, 39 and 41

United States Patent and Trademark Office

Reg. No. 3,480,911

Registered Aug. 5, 2008

**TRADEMARK
PRINCIPAL REGISTER**

DENIMATION

ANNUNZIATA, VINCENZO (ITALY INDIVIDUAL)
VIA POSILLIPO, 276
I-80121 NAPOLI
ITALY

FOR: SPECTACLE GLASSES, SUN GLASSES AND SPECTACLE FRAMES, IN CLASS 9 (U.S. CLS. 21, 23, 26, 36 AND 38).

FOR: LEATHER AND IMITATIONS OF LEATHER, AND GOODS MADE OF THESE MATERIALS NAMELY BAGS, HANDBAGS, BRIEFCASE, SUITCASE, WALLET, DOCUMENT CASE, KEY CASES, PURSE, LUGGAGE TRUNKS AND TRAVELING BAGS; ANIMAL SKINS AND HIDES; UMBRELLAS, PARASOLS AND WALKING STICKS; WHIPS, HARNESS AND SADDLERY, IN CLASS 18 (U.S. CLS. 1, 2, 3, 22 AND 41).

FOR: CLOTHING NAMELY JACKETS, HATS, CAPS, SHIRT, TIES, TROUSERS, COATS, SWEA-

TERS, SKIRT, PULLOVER, SOCKS, TIGHTS, GLOVES, SCARVES, JEANS, UNDERWEAR, NIGHTWEAR, TRACKSUIT, FOOTWEAR, IN CLASS 25 (U.S. CLS. 22 AND 39).

THE MARK CONSISTS OF STANDARD CHARACTERS WITHOUT CLAIM TO ANY PARTICULAR FONT, STYLE, SIZE, OR COLOR.

PRIORITY DATE OF 2-22-2007 IS CLAIMED.

OWNER OF INTERNATIONAL REGISTRATION 0933355 DATED 6-20-2007, EXPIRES 6-20-2017.

SER. NO. 79-042,122, FILED 6-20-2007.

KATHERINE STOIDES, EXAMINING ATTORNEY

Int. Cl.: 8

Prior U.S. Cls.: 23, 28 and 44

United States Patent and Trademark Office

Reg. No. 3,480,912

Registered Aug. 5, 2008

**TRADEMARK
PRINCIPAL REGISTER**

TOUCHBeauty

ZHOU ELIN (CHINA INDIVIDUAL)
UNIT 5B, BLDG 26, NANHAI
COASTAL GARDEN, SHEKOU.; NANSHAN DIS-
TRICT, SHENZHEN; GUANGDONG
CHINA

FOR: EYELASH CURLERS; NAIL BUFFERS,
ELECTRIC OR NON-ELECTRIC; RAZORS, ELEC-
TRIC OR NON-ELECTRIC; NAIL FILES, ELECTRIC;
BEARD CLIPPERS; HAIR CLIPPERS FOR PERSON-
AL USE, ELECTRIC OR NON-ELECTRIC; DEPI-
LATION APPLIANCES, ELECTRIC AND NON-

ELECTRIC; NON-ELECTRIC CURLING IRONS;
NON-ELECTRIC FLAT IRONS, IN CLASS 8 (U.S.
CLS. 23, 28 AND 44).

OWNER OF INTERNATIONAL REGISTRATION
0933360 DATED 5-25-2007, EXPIRES 5-25-2017.

SER. NO. 79-042,124, FILED 5-25-2007.

DOMINIC FATHY, EXAMINING ATTORNEY

Int. Cls.: 16, 28, 35, 41 and 42

**Prior U.S. Cls.: 2, 5, 22, 23, 29, 37, 38, 50, 100, 101, 102
and 107**

Reg. No. 3,480,913

United States Patent and Trademark Office

Registered Aug. 5, 2008

**TRADEMARK
SERVICE MARK
PRINCIPAL REGISTER**

ReakTsun

BMB-INSTITUTE GMBH & CO. KG (FED REP
GERMANY A LIMITED PARTNERSHIP WITH
A LIMITED LIABILITY COMPANY AS A
GENERAL PARTNER)
DÄNISCHE STR. 2-6
24103 KIEL
FED REP GERMANY

FOR: PRINTED MATTER, INSTRUCTIONAL
AND TEACHING MATERIALS IN THE FORM OF
BOOKS AND PERIODICALS IN THE FIELD OF
SPORTS, KINEMATICS AND MARTIAL ARTS, IN
CLASS 16 (U.S. CLS. 2, 5, 22, 23, 29, 37, 38 AND 50).

FOR: SPORTING ARTICLES, NAMELY, ARTI-
CLES FOR USE IN MARTIAL ARTS SPORTS AND
TRAINING, NAMELY, STICKS, STAFFS, FIGHT-
ING GLOVES AND MITTS, HAND PADS, ELBOW
PADS, FOREARM PADS, SHIN PADS, ANKLE
PADS, HEAD GUARDS, BODY ARMOR, CHEST
GUARDS, GUM SHIELDS AND TOOTH PROTEC-
TORS, SUPPORTS FOR KNEES, ELBOWS, WRISTS,
ANKLES, THIGHS AND BACKS, PUNCH BAGS,
TARGET PADS, SHIELDS FOR CONTACT SPORTS
PRACTICE, EXERCISE MACHINES AND APPARA-
TUS, MEDICINE BALLS, SKIPPING ROPES AND
SPORTS MATS, IN CLASS 28 (U.S. CLS. 22, 23, 38
AND 50).

FOR: FRANCHISING, NAMELY, THE PROVID-
ING OF COMMERCIAL AND ORGANIZATIONAL
KNOW-HOW IN THE OPERATION OF COLLEGES
OF PHYSICAL EDUCATION, GYMS, AND OTHER
BUSINESSES RELATED TO KINEMATICS, IN
CLASS 35 (U.S. CLS. 100, 101 AND 102).

FOR: PHYSICAL EDUCATION AND CONDUCT-
ING OF SEMINARS IN THE FIELD OF KINEMAT-
ICS, IN CLASS 41 (U.S. CLS. 100, 101 AND 107).

FOR: PROVIDING INFORMATION IN THE
FIELD OF KINEMATICS, IN CLASS 42 (U.S. CLS.
100 AND 101).

PRIORITY DATE OF 3-8-2007 IS CLAIMED.

OWNER OF INTERNATIONAL REGISTRATION
0933381 DATED 4-30-2007, EXPIRES 4-30-2017.

SER. NO. 79-042,132, FILED 4-30-2007.

SUNG IN, EXAMINING ATTORNEY

Int. Cl.: 30

Prior U.S. Cl.: 46

United States Patent and Trademark Office

Reg. No. 3,480,914

Registered Aug. 5, 2008

**TRADEMARK
PRINCIPAL REGISTER**

Jogofino

SONNINA SÜBWAREN GMBH (FED REP GER-
MANY GMBH (LIMITED LIABILITY COMPA-
NY))

HEBLINGSWEG 30
44309 DORTMUND
FED REP GERMANY

FOR: CANDIES IN THE NATURE OF SWEETS,
GUMMY SWEETS AND FOAMED GUMMY
SWEETS, IN CLASS 30 (U.S. CL. 46).

THE MARK CONSISTS OF STANDARD CHAR-
ACTERS WITHOUT CLAIM TO ANY PARTICULAR
FONT, STYLE, SIZE, OR COLOR.

OWNER OF INTERNATIONAL REGISTRATION
0933414 DATED 6-29-2007, EXPIRES 6-29-2017.

SER. NO. 79-042,151, FILED 6-29-2007.

NICHOLAS ALTREE, EXAMINING ATTORNEY

Int. Cl.: 25

Prior U.S. Cls.: 22 and 39

United States Patent and Trademark Office

Reg. No. 3,480,915

Registered Aug. 5, 2008

TRADEMARK
PRINCIPAL REGISTER

Vive le sport

VIVE LE SPORT DI MONTI FEDERICO (ITALY
SOCIÉTÉ INDIVIDUELLE)
VIA ORLANDI, 5 -
FRAZ. COLLE DI BUGGIANO; I-51011 BUGGIANO
(PT)
ITALY

FOR: CLOTHING, NAMELY, SHIRTS AND
PANTS; FOOTWEAR, HEADWEAR, BELTS, IN
CLASS 25 (U.S. CLS. 22 AND 39).

PRIORITY DATE OF 1-23-2007 IS CLAIMED.

OWNER OF INTERNATIONAL REGISTRATION
0933490 DATED 5-25-2007, EXPIRES 5-25-2017.

THE TRADEMARK COMPRISES THE INSCRIP-
TION "VIVE LE SPORT", IN FANCY LOWER-CASE
TYPE, WITH THE EXCEPTION OF THE LETTER "V"
OF THE WORD "VIVE", WHICH IS IN UPPER-CASE.

SER. NO. 79-042,188, FILED 5-25-2007.

JASON TURNER, EXAMINING ATTORNEY

Int. Cls.: 9, 38 and 42

Prior U.S. Cls.: 21, 23, 26, 36, 38, 100, 101 and 104

United States Patent and Trademark Office

Reg. No. 3,480,916

Registered Aug. 5, 2008

**TRADEMARK
SERVICE MARK
PRINCIPAL REGISTER**

PROTECTORIA

MESSAGE MANAGEMENT AS (NORWAY LTD
LIAB CO)
SKOTBUVEIEN 81
N-1409 SKOTBU
NORWAY

FOR: COMPUTER PROGRAMS FOR USE IN THE PROTECTION OF ELECTRONIC MAIL MESSAGES THROUGH THE USE OF ENCRYPTION AND AUTHENTICATION MECHANISMS , IN CLASS 9 (U.S. CLS. 21, 23, 26, 36 AND 38).

FOR: SERVICES RELATED TO ELECTRONIC MAIL, NAMELY, THE TRANSMISSION OF ELECTRONIC MAIL OVER COMPUTER NETWORKS; ENCRYPTION SERVICES, NAMELY, ELECTRONIC TRANSMISSION OF ELECTRONIC MAIL MESSAGES FEATURING ENCRYPTION; AUTHENTICATED ELECTRONIC MAIL MESSAGES TRANSMITTED OVER COMPUTER NETWORKS; SERVICES RELATED TO ACCESS TO COMPUTER NETWORKS, NAMELY, PROVIDING ACCESS TO ELECTRONIC SITES OVER COMPUTER NETWORKS, IN CLASS 38 (U.S. CLS. 100, 101 AND 104).

FOR: CONSULTANCY SERVICES IN THE FIELD OF INFORMATION TECHNOLOGY; COMPUTER SYSTEM DEVELOPMENT AND SYSTEM INTEGRATION RELATED TO INFORMATION SECURITY, IN CLASS 42 (U.S. CLS. 100 AND 101).

THE MARK CONSISTS OF STANDARD CHARACTERS WITHOUT CLAIM TO ANY PARTICULAR FONT, STYLE, SIZE, OR COLOR.

PRIORITY DATE OF 11-21-2006 IS CLAIMED.

OWNER OF INTERNATIONAL REGISTRATION 0933494 DATED 5-21-2007, EXPIRES 5-21-2017.

SER. NO. 79-042,191, FILED 5-21-2007.

WILLIAM ROSSMAN, EXAMINING ATTORNEY

Int. Cl.: 20

Prior U.S. Cls.: 2, 13, 22, 25, 32 and 50

United States Patent and Trademark Office

Reg. No. 3,480,917

Registered Aug. 5, 2008

**TRADEMARK
PRINCIPAL REGISTER**



恒 林

ZHEJIANG HENGLIN JIAJU; YOUXIAN GONGSI
(CHINA CORPORATION)

YANGGUANG GONGYEYUANQU

WUSHANSI CUN, DIPU ZHEN, ANJI XIAN

313300 ZHEJIANG, CHINA

FOR: FURNITURE, NAMELY, BENCHES,
DESKS, TABLES, CHAIRS, BEDS, SIDEBARDS,
MATTRESSES, CHESTS OF DRAWERS, SOFAS,
FILING CABINETS, BOOK SHELVES, CUPBOARDS,
COAT HANGERS, MAGAZINE RACKS AND
WARDROBES, IN CLASS 20 (U.S. CLS. 2, 13, 22, 25,
32 AND 50).

OWNER OF INTERNATIONAL REGISTRATION
0933549 DATED 8-2-2007, EXPIRES 8-2-2017.

THE NON-LATIN CHARACTER(S) IN THE
MARK TRANSLITERATES INTO "HENG LIN",
AND THIS MEANS "PERMANENT; WOODS" IN
ENGLISH.

SER. NO. 79-042,224, FILED 8-2-2007.

KATHERINE E. HALMEN, EXAMINING ATTOR-
NEY

Int. Cls.: 7, 12 and 37

**Prior U.S. Cls.: 13, 19, 21, 23, 31, 34, 35, 44, 100, 103
and 106**

Reg. No. 3,480,918

United States Patent and Trademark Office

Registered Aug. 5, 2008

**TRADEMARK
SERVICE MARK
PRINCIPAL REGISTER**



ELMHULTS KONSTRUKTION AB (SWEDEN
JOINT STOCK COMPANY)
BOX 174
SE-343 00 ÄLMHULT, SWEDEN

FOR: LIFTING APPARATUS AND INSTALLATIONS, NAMELY, MACHINES IN THE NATURE OF MECHANICALLY-OPERATED ROTATORS AND SPREADERS FOR USE WITH TRUCKS AND CRANES FOR THE HANDLING OF CONTAINERS, SWAP BODIES AND TRAILERS, AND PARTS AND FITTINGS THEREFOR, NAMELY, ROTATOR AND SPREADER PARTS SOLD AS COMPONENT PARTS OF THE ROTATORS AND SPREADERS, IN CLASS 7 (U.S. CLS. 13, 19, 21, 23, 31, 34 AND 35).

FOR: STRUCTURAL PARTS AND FITTINGS FOR FORK LIFT TRUCKS AND LIFTING TRUCKS, NAMELY, SPREADERS FOR HANDLING OF CONTAINERS, SWAP BODIES AND TRAILERS, SOLD AS STRUCTURAL PARTS FOR FORK LIFT TRUCKS AND LIFTING TRUCKS, IN CLASS 12 (U.S. CLS. 19, 21, 23, 31, 35 AND 44).

FOR: REPAIR OF HOISTING BEAMS, IN CLASS 37 (U.S. CLS. 100, 103 AND 106).

PRIORITY DATE OF 11-21-2006 IS CLAIMED.

OWNER OF INTERNATIONAL REGISTRATION 0933592 DATED 5-9-2007, EXPIRES 5-9-2017.

NO CLAIM IS MADE TO THE EXCLUSIVE RIGHT TO USE "SWEDISH SPREADER SYSTEMS", APART FROM THE MARK AS SHOWN.

THE COLOR(S) BLACK AND YELLOW IS/ARE CLAIMED AS A FEATURE OF THE MARK.

THE MARK CONSISTS OF THE WORDING "ELME SWEDISH SPREADER SYSTEMS" ALL OF WHICH APPEARS IN BLACK, WITH A SINGLE BLACK LINE FORMING A RECTANGLE AROUND THE WORDING WITH THE BACKGROUND OF THE RECTANGLE DEPICTED IN YELLOW.

SER. NO. 79-042,241, FILED 5-9-2007.

SHAILA SETTLES, EXAMINING ATTORNEY

Int. Cl.: 9

Prior U.S. Cls.: 21, 23, 26, 36 and 38

United States Patent and Trademark Office

Reg. No. 3,480,919

Registered Aug. 5, 2008

**TRADEMARK
PRINCIPAL REGISTER**

OMNIA

CONTROLLI S.R.L. (ITALY SOCIÉTÉ À RE-
SPONSABILITÉ LIMITÉE)
VIA CARLO LEVI, 52
I-16010 SANT'OLCESE (GE)
ITALY

FOR: DIGITAL CONTROLLERS FOR HEATING,
VENTILATION AND AIR CONDITIONING, IN
CLASS 9 (U.S. CLS. 21, 23, 26, 36 AND 38).

THE MARK CONSISTS OF STANDARD CHAR-
ACTERS WITHOUT CLAIM TO ANY PARTICULAR
FONT, STYLE, SIZE, OR COLOR.

PRIORITY DATE OF 6-8-2007 IS CLAIMED.

OWNER OF INTERNATIONAL REGISTRATION
0933624 DATED 7-2-2007, EXPIRES 7-2-2017.

SER. NO. 79-042,258, FILED 7-2-2007.

FRED CARL, EXAMINING ATTORNEY

Int. Cl.: 33

Prior U.S. Cls.: 47 and 49

United States Patent and Trademark Office

Reg. No. 3,480,920

Registered Aug. 5, 2008

TRADEMARK
PRINCIPAL REGISTER



AZIENDA VINICOLA SAN GIOVANNI DI PERINI DORIGO BERNADETTE & C. - S.N.C.
(ITALY PARTNERSHIP)
VIA MANZANA, 4
I-31015 CONEGLIANO (TREVISO), ITALY

FOR: APERITIF WINES; COOKING WINES; WINES IN GENERAL; PREPARED WINE COCKTAILS; WINE COOLERS, BEING DRINKS MADE FROM WINE; WINE PUNCHES, IN CLASS 33 (U.S. CLS. 47 AND 49).

PRIORITY DATE OF 3-8-2007 IS CLAIMED.

OWNER OF INTERNATIONAL REGISTRATION
0933675 DATED 3-29-2007, EXPIRES 3-29-2017.

OWNER OF U.S. REG. NO. 3,276,186.

THE MARK CONSISTS OF A SIGN COMPOSED OF THE WORDING "VILLA PERINI" IN FANCY CHARACTERS, PLACED IN COMBINATION WITH THE STYLIZED ILLUSTRATION OF A VILLA SURROUNDED BY TREES AND VINEYARDS.

THE ENGLISH TRANSLATION OF THE WORD "VILLA PERINI" IN THE MARK IS SMALL PEAR TREES VILLA.

SER. NO. 79-042,280, FILED 3-29-2007.

DOMINIC FATHY, EXAMINING ATTORNEY

Int. Cls.: 6, 16 and 20

**Prior U.S. Cls.: 2, 5, 12, 13, 14, 22, 23, 25, 29, 32, 37, 38
and 50**

Reg. No. 3,480,921

United States Patent and Trademark Office

Registered Aug. 5, 2008

**TRADEMARK
PRINCIPAL REGISTER**

PIXQUICK

KUNSTDÜNGER S.N.C.; DI C. WALZL & CO.
(ITALY GENERAL PARTNERSHIP)
ZONA INDUSTRIALE 112 -FRAZ. VEZZANO
I-39028 SILANDRO, BOLZANO, ITALY

THE MARK CONSISTS OF STANDARD CHAR-
ACTERS WITHOUT CLAIM TO ANY PARTICULAR
FONT, STYLE, SIZE, OR COLOR.

FOR: METAL HOLDERS FOR SIGNBOARDS, IN
CLASS 6 (U.S. CLS. 2, 12, 13, 14, 23, 25 AND 50).

PRIORITY DATE OF 9-18-2006 IS CLAIMED.

FOR: DOCUMENT HOLDERS, HOLDERS FOR
NOTEPADS, LETTER HOLDERS, DESKTOP DOCU-
MENT STANDS, METAL HOLDERS FOR DOCU-
MENTS, IN CLASS 16 (U.S. CLS. 2, 5, 22, 23, 29, 37, 38
AND 50).

OWNER OF INTERNATIONAL REGISTRATION
0933723 DATED 3-16-2007, EXPIRES 3-16-2017.

FOR: PLASTIC HOLDERS FOR SIGNBOARDS,
METAL DISPLAY STANDS, IN CLASS 20 (U.S. CLS.
2, 13, 22, 25, 32 AND 50).

SER. NO. 79-042,299, FILED 3-16-2007.

AHSEN KHAN, EXAMINING ATTORNEY

Int. Cl.: 25

Prior U.S. Cls.: 22 and 39

United States Patent and Trademark Office

Reg. No. 3,480,922

Registered Aug. 5, 2008

TRADEMARK
PRINCIPAL REGISTER

Verde Veronica^{***}

INTIMA MODA S.P.A. (ITALY JOINT STOCK
COMPANY)
VIA CAMPAGNA, 60
I-41010 MODENA, FRAZIONE COGNENTO
ITALY

FOR: SHIRTS; PANTS; JEANS; DRESSES; DRESSING GOWNS; PULLOVERS; CARDIGANS; JERSEYS; NECKTIES; NECKERCHIEFS; SOCKS; TIGHTS; TROUSERS; LEGGINGS; JERKINS; GLOVES; SKIRTS; SWEATERS; JUMPSUITS; BODY-SUITS; SWEATSHIRTS; SWEAT SHORTS; JACKETS; T-SHIRTS; VESTS; WAISTCOATS; JUMPERS; TRACK SUITS; BLOUSES; PANTIES; SUITS; OVER COATS; COATS; ANORAKS; RAINCOATS; UNDERWEAR; NIGHTWEAR; SINGLET; PETTICOATS; SHORT PETTICOATS; PETTI-PANTS; BOXER SHORTS; BERMUDA SHORTS; NIGHTGOWNS; PYJAMAS; BATHING SUITS; BATHING TRUNKS; BATHING COSTUMES; BIKINIS; TANKINIS; BATHROBES; BEACH COVERUPS; PAREOS; BEACH FOOTWEAR; CAPS; HATS; SWIM WEAR; BEACHWEAR LINGERIE; BRASSIERES; STRAPLESS BRAS; LINGERIE ACCESSORIES, NAMELY, REMOVABLE SILICONE BREAST ENHANCER PADS USED IN BRAS; BRIEFS; BUSTIERS; CULOTTES; SLIPS; HOSIERY; ROBES; CAFTANS; KIMONOS; CORSETS; CORSELETS; BELTS; GIRDLES; SUSPENDERS; SHOES; BOOTS; SLIPPERS; GARTER

BELTS; STOCKINGS; STOCKING SUSPENDERS; STRAPS FOR BRAS; WRAPS; FOULARDS; SCARVES; BANDANAS; BANDEAUX; STOLAS, IN CLASS 25 (U.S. CLS. 22 AND 39).

PRIORITY DATE OF 2-28-2007 IS CLAIMED.

OWNER OF INTERNATIONAL REGISTRATION
0933966 DATED 6-25-2007, EXPIRES 6-25-2017.

THE NAME "VERDE VERONICA" DOES NOT IDENTIFY A LIVING INDIVIDUAL.

THE MARK CONSISTS OF A PRINT REPRESENTING THE WORDING "VERDE VERONICA" IN FANCY CHARACTERS, WITH BOTH THE INITIAL LETTERS "V" IN GREATER DIMENSION AND HAVING THE LETTER "I" PUT UNDER A STYLIZED FIGURE OF THREE STARS.

THE ENGLISH TRANSLATION OF THE WORD "VERDE" IN THE MARK IS GREEN.

SER. NO. 79-042,404, FILED 6-25-2007.

AMY HELLA, EXAMINING ATTORNEY

Int. Cls.: 18 and 25

Prior U.S. Cls.: 1, 2, 3, 22, 39 and 41

Reg. No. 3,480,923

United States Patent and Trademark Office

Registered Aug. 5, 2008

**TRADEMARK
PRINCIPAL REGISTER**

CH-57

NAF NAF DISTRIBUTION B.V. (NETHERLANDS
BURGERLIJKE VENNOOTSCHAP)
KONINGIN WILHELMINAPLEIN 13
NL-1062 HH AMSTERDAM
NETHERLANDS

FOR: LEATHER AND IMITATION LEATHER;
TRUNKS AND SUITCASES; TRAVELLING
TRUNKS, BACKPACKS, HANDBAGS, LEATHER
SHOPPING BAGS, TRAVEL BAGS, BEACH BAGS,
ROLLER BAGS, GARMENT BAGS FOR TRAVEL,
TRAVELING CASE SETS, RUCKSACKS, SCHOOL
BAGS AND SATCHELS; WALLETS; PURSES NOT
OF PRECIOUS METAL; KEY CASES; UMBRELLAS,
PARASOLS AND WALKING STICKS; WHIPS;
SADDLERY, IN CLASS 18 (U.S. CLS. 1, 2, 3, 22 AND
41).

FOR: CLOTHING, NAMELY DRESSES, SKIRTS,
SUITS, TROUSERS, SHORTS, BERMUDA SHORTS,
DUNGAREES, JEANS, OVERALLS, COMBINA-
TIONS, SHIRTS, BLOUSES, T-SHIRTS, SWEAT
SHIRTS, TANK TOPS, PULLOVERS, SWEATERS,
KNITWEAR, NAMELY, KNIT SHIRTS, KNITTED
SWEATERS, KNITTED JUMPERS, KNITTED DRES-
SES, KNITTED TANK TOPS, KNITTED SCARVES,
KNITTED CAPS, KNITTED SLEEPWEAR, VESTS,
TRACKSUITS, COATS, PARKAS, RAINCOATS, PET-
TICOATS, OVERCOATS, WIND-RESISTANT JACK-
ETS, ANORAKS, CAR COATS, CAPES, PONCHOS,

SWIMMING SUITS, SWIM TRUNKS, UNDER-
WEAR, STOCKINGS, TIGHTS, SOCKS, BOXER
SHORTS, LEGGINGS, CAMISOLES, PANTS, SLIPS,
NIGHTGOWNS, NIGHT SHIRTS, DRESSING
GOWNS, BATH ROBES, LINGERIE, LAYETTES,
PAJAMAS, LEOTARDS, BELTS, TIES, GLOVES,
STOLES, SCARVES, SHAWLS; FOOTWEAR, NAME-
LY SHOES, THONGS, COURT SHOES, ESPA-
DRILLES, SANDALS, MULES, SLIPPERS, ANKLE
BOOTS, BOOTS, THIGH BOOTS, MOCCASINS, TEN-
NIS SHOES, PUMPS, GALOSHES; POCKET
SQUARES; HEADWEAR, IN CLASS 25 (U.S. CLS. 22
AND 39).

THE MARK CONSISTS OF STANDARD CHAR-
ACTERS WITHOUT CLAIM TO ANY PARTICULAR
FONT, STYLE, SIZE, OR COLOR.

PRIORITY DATE OF 10-25-2006 IS CLAIMED.

OWNER OF INTERNATIONAL REGISTRATION
0934072 DATED 4-23-2007, EXPIRES 4-23-2017.

SER. NO. 79-042,438, FILED 4-23-2007.

LESLIE RICHARDS, EXAMINING ATTORNEY

Int. Cls.: 1 and 2

Prior U.S. Cls.: 1, 5, 6, 10, 11, 16, 26 and 46

United States Patent and Trademark Office

Reg. No. 3,480,924

Registered Aug. 5, 2008

**TRADEMARK
PRINCIPAL REGISTER**

ImPPulse

BASF SE
CARL-BOSCH-STRASSE 38
67056 LUDWIGSHAFEN
FED REP GERMANY

FOR: CHEMICALS USED IN INDUSTRY, NAME-
LY, ADDITIVES FOR DYEING AND IMPRINTING
POLYPROPYLENE; UNPROCESSED PLASTIC MA-
TERIALS IN THE FORM OF POWDERS, GRAN-
ULES, CHIPS, DISPERSIONS, LIQUIDS OR PASTES
FOR GENERAL INDUSTRIAL AND COMMERCIAL
USES, IN CLASS 1 (U.S. CLS. 1, 5, 6, 10, 26 AND 46).

FOR: DYES, NAMELY, ADDITIVES FOR DYE-
ING AND IMPRINTING POLYPROPYLENE, IN
CLASS 2 (U.S. CLS. 6, 11 AND 16).

THE MARK CONSISTS OF STANDARD CHAR-
ACTERS WITHOUT CLAIM TO ANY PARTICULAR
FONT, STYLE, SIZE, OR COLOR.

PRIORITY DATE OF 2-1-2007 IS CLAIMED.

OWNER OF INTERNATIONAL REGISTRATION
0934201 DATED 7-9-2007, EXPIRES 7-9-2017.

SER. NO. 79-042,486, FILED 7-9-2007.

JANICE KIM, EXAMINING ATTORNEY

Int. Cl.: 29

Prior U.S. Cl.: 46

United States Patent and Trademark Office

Reg. No. 3,480,925

Registered Aug. 5, 2008

TRADEMARK
PRINCIPAL REGISTER



DROGA KOLINSKA, ZIVILSKA INDUSTRIJA,
D.D. (SLOVENIA CORPORATION)
KOLINSKA ULICA 1
SI-1544 LJUBLJANA
SLOVENIA

FOR: MEAT, FISH, POULTRY AND GAME;
MEAT EXTRACTS; MEAT PASTES; LIVER PÂTÉS;
FISH PÂTÉS; MEAT-BASED SPREADS; PRE-
SERVED, DRIED, COOKED AND FROZEN FRUITS
AND VEGETABLES; JELLIES, JAMS, IN CLASS 29
(U.S. CL. 46).

PRIORITY DATE OF 1-18-2007 IS CLAIMED.

OWNER OF INTERNATIONAL REGISTRATION
0934242 DATED 6-26-2007, EXPIRES 6-26-2017.

OWNER OF U.S. REG. NO. 2,822,107.

THE COLOR(S) ORANGE, BLUE, RED, WHITE,
BLACK AND YELLOW IS/ARE CLAIMED AS A
FEATURE OF THE MARK.

THE MARK CONSISTS OF CONCENTRIC CIR-
CULAR BANDS, STARTING FROM THE OUTER
MOST EDGE, OF ORANGE, WHITE AND ORANGE,
WITH A BLUE RIBBON OVERLAY IN THE CEN-
TER, AND THE WORD "ARGETA" IN RED LET-
TERING WITH WHITE BORDER, AND THE WORD
JUNIOR IN WHITE LETTERING WITH BLACK
BORDER, AND THE DESIGN OF A YELLOW DUCK
WITH BLUE SHIRT AND IRISES, BLACK PUPILS
AND ORANGE BILL AND TONGUE.

SER. NO. 79-042,500, FILED 6-26-2007.

WON TEAK OH, EXAMINING ATTORNEY

Int. Cl.: 29

Prior U.S. Cl.: 46

United States Patent and Trademark Office

Reg. No. 3,480,926

Registered Aug. 5, 2008

**TRADEMARK
PRINCIPAL REGISTER**



DROGA KOLINSKA, ZIVILSKA INDUSTRIJA,
D.D. (SLOVENIA CORPORATION)
KOLINSKA ULICA 1
SI-1544 LJUBLJANA
SLOVENIA

FOR: MEAT, FISH, POULTRY AND GAME;
MEAT EXTRACTS; MEAT PASTES; LIVER PÂTÉS;
FISH PÂTÉS; MEAT-BASED SPREADS; PRE-
SERVED, DRIED, COOKED AND FROZEN FRUITS
AND VEGETABLES; JELLIES, JAMS, IN CLASS 29
(U.S. CL. 46).

PRIORITY DATE OF 1-18-2007 IS CLAIMED.

OWNER OF INTERNATIONAL REGISTRATION
0934243 DATED 6-26-2007, EXPIRES 6-26-2017.

OWNER OF U.S. REG. NO. 2,822,107.

THE COLOR(S) ORANGE, BLUE, RED, WHITE,
BLACK AND YELLOW IS/ARE CLAIMED AS A
FEATURE OF THE MARK.

THE MARK CONSISTS OF OUTER LEFT EDGE
OR BAND IN ORANGE, FOLLOWED BY A WHITE
BAND, AND AN INNER ORANGE BAND, WITH A
BLUE RIBBON OVERLAY, AND THE WORD "AR-
GETA" IN RED LETTERING WITH WHITE BOR-
DER, AND THE WORD JUNIOR IN WHITE
LETTERING WITH BLACK BORDER, AND THE
DESIGN OF A YELLOW DUCK WITH BLUE SHIRT
AND IRISES, BLACK PUPILS AND ORANGE BILL
AND TONGUE.

SER. NO. 79-042,501, FILED 6-26-2007.

WON TEAK OH, EXAMINING ATTORNEY

Int. Cl.: 29

Prior U.S. Cl.: 46

United States Patent and Trademark Office

Reg. No. 3,480,927

Registered Aug. 5, 2008

TRADEMARK
PRINCIPAL REGISTER



DROGA KOLINSKA, ZIVILSKA INDUSTRIJA,
D.D. (SLOVENIA CORPORATION)

KOLINSKA ULICA 1
SI-1544 LJUBLJANA
SLOVENIA

FOR: MEAT, FISH, POULTRY AND GAME;
MEAT EXTRACTS; MEAT PASTES; LIVER PÂTÉS;
FISH PÂTÉS; MEAT-BASED SPREADS; PRE-
SERVED, DRIED, COOKED AND FROZEN FRUITS
AND VEGETABLES; JELLIES, JAMS, IN CLASS 29
(U.S. CL. 46).

PRIORITY DATE OF 1-18-2007 IS CLAIMED.

OWNER OF INTERNATIONAL REGISTRATION
0934244 DATED 6-26-2007, EXPIRES 6-26-2017.

OWNER OF U.S. REG. NO. 2,822,107.

THE MARK CONSISTS OF A CIRCULAR DESIGN
WITH CONCENTRIC, CONTRASTING BANDS,
WITH A DESIGN OF A BISCUIT WITH SPREAD IN
THE CENTER, OVER WHICH IS THE WORD "AR-
GETA", WITH A SERPENT SHAPED RIBBON OVER-
LAY.

SER. NO. 79-042,502, FILED 6-26-2007.

WON TEAK OH, EXAMINING ATTORNEY

Int. Cl.: 14

Prior U.S. Cls.: 2, 27, 28 and 50

United States Patent and Trademark Office

Reg. No. 3,480,928

Registered Aug. 5, 2008

**TRADEMARK
PRINCIPAL REGISTER**

LES MASQUES

RICHEMONT INTERNATIONAL SA (SWITZER-
LAND SOCIÉTÉ ANONYME (SA))
ROUTE DES BICHES 10
CH-1752 VILLARS-SUR-GLÂNE
SWITZERLAND

FOR: CUFFLINKS, TIE PINS, RINGS, BRACE-
LETS, EARRINGS, NECKLACES, BROOCHES, KEY
RINGS OF PRECIOUS METAL, WATCHES, STOP-
WATCHES, WALL CLOCKS; WATCH BANDS,
CASES OF PRECIOUS METAL FOR WATCHES
AND JEWELLERY, IN CLASS 14 (U.S. CLS. 2, 27, 28
AND 50).

THE MARK CONSISTS OF STANDARD CHAR-
ACTERS WITHOUT CLAIM TO ANY PARTICULAR
FONT, STYLE, SIZE, OR COLOR.

PRIORITY DATE OF 3-5-2007 IS CLAIMED.

OWNER OF INTERNATIONAL REGISTRATION
0934301 DATED 8-3-2007, EXPIRES 8-3-2017.

THE ENGLISH TRANSLATION OF THE FOR-
EIGN WORD(S) IN THE MARK IS: THE MASKS.

SER. NO. 79-042,545, FILED 8-3-2007.

MARILYN IZZI, EXAMINING ATTORNEY

Int. Cl.: 20

Prior U.S. Cls.: 2, 13, 22, 25, 32 and 50

United States Patent and Trademark Office

Reg. No. 3,480,929

Registered Aug. 5, 2008

**TRADEMARK
PRINCIPAL REGISTER**

Wilkhahn

WILKHAHN WILKENING + HAHNE GMBH +
CO. (FED REP GERMANY CORPORATION)
FRITZ-HAHNE-STR. 8
31848 BAD MÜNDER, FED REP GERMANY

FOR: FURNITURE, IN CLASS 20 (U.S. CLS. 2, 13,
22, 25, 32 AND 50).

THE MARK CONSISTS OF STANDARD CHAR-
ACTERS WITHOUT CLAIM TO ANY PARTICULAR
FONT, STYLE, SIZE, OR COLOR.

OWNER OF INTERNATIONAL REGISTRATION
0934343 DATED 7-23-2007, EXPIRES 7-23-2017.

OWNER OF U.S. REG. NOS. 1,220,939, 1,294,308,
AND 3,249,813.

SER. NO. 79-042,561, FILED 7-23-2007.

MICHAEL LEWIS, EXAMINING ATTORNEY

Int. Cls.: 3 and 4

Prior U.S. Cls.: 1, 4, 6, 15, 50, 51 and 52

United States Patent and Trademark Office

Reg. No. 3,480,930

Registered Aug. 5, 2008

**TRADEMARK
PRINCIPAL REGISTER**

**UPTOWN/DOWNTOWN, WINTERTIME
LA VILLE EN HIVER**

SHEERINO'KHO (FRANCE SOCIÉTÉ À RE-
SPONSABILITÉ LIMITÉE)
11 RUE BARBET DE JOUY
F-75007 PARIS
FRANCE

FOR: SOAPS; PERFUMES; ESSENTIAL OILS;
COSMETICS; HAIR LOTIONS; DENTIFRICES; DE-
PILATORIES; MAKE-UP REMOVING PREPARA-
TIONS; LIPSTICKS; BEAUTY MASKS; SHAVING
PRODUCTS, NAMELY SHAVING PREPARATIONS,
IN CLASS 3 (U.S. CLS. 1, 4, 6, 50, 51 AND 52).

FOR: CANDLES AND WICKS FOR CANDLES,
WICKS FOR OIL LAMPS, IN CLASS 4 (U.S. CLS. 1, 6
AND 15).

THE MARK CONSISTS OF STANDARD CHAR-
ACTERS WITHOUT CLAIM TO ANY PARTICULAR
FONT, STYLE, SIZE, OR COLOR.

OWNER OF INTERNATIONAL REGISTRATION
0934347 DATED 7-17-2007, EXPIRES 7-17-2017.

THE FOREIGN WORDING IN THE MARK
TRANSLATES INTO ENGLISH AS "THE CITY IN
WINTER."

SER. NO. 79-042,562, FILED 7-17-2007.

LAURA HAMMEL, EXAMINING ATTORNEY

Int. Cl.: 9

Prior U.S. Cls.: 21, 23, 26, 36 and 38

Reg. No. 3,480,931

United States Patent and Trademark Office

Registered Aug. 5, 2008

**TRADEMARK
PRINCIPAL REGISTER**

Ri4Power

RITTAL GMBH & CO. KG (FED REP GERMANY
LIMITED COMPANY)
AUF DEM STÜTZELBERG
35726 HERBORN
FED REP GERMANY

FOR: COMPONENTS FOR LOW-VOLTAGE ENERGY DISTRIBUTION, NAMELY, CABINETS ADAPTED FOR SWITCHGEARS; RACKS FOR HOLDING LOW VOLTAGE ELECTRIC ENERGY DISTRIBUTION COMPONENTS, NAMELY, DISTRIBUTION TRANSFORMERS, CONSOLES, BLOCKS AND UNITS; HOUSINGS FOR HOLDING LOW VOLTAGE ELECTRIC ENERGY DISTRIBUTION COMPONENTS, NAMELY, DISTRIBUTION TRANSFORMERS, CONSOLES, BLOCKS AND UNITS WHICH ARE USED PREFERABLY FOR MACHINES, PLANTS, BUILDINGS AND MOTOR CONTROL; ASSEMBLY CARRIERS FOR PLUG-IN ASSEMBLIES WITH ELECTRONIC CIRCUITS, ADAPTED TO IT-HARDWARE, NAMELY, RACKS, SUBRACKS, DRAWERS AND HOUSINGS MADE OF METAL AND/OR PLASTICS DESIGNED TO BE USED WITH COMPUTERS, INTERACTIVE COMPUTER TERMINALS, NETWORK SERVERS AND DATA PROCESSORS; SCIENTIFIC APPARATUS, NAMELY, SIGNALING DEVICES FOR MONITORING AND SAFEGUARDING SWITCHGEAR CABINETS; CURRENT-DISTRIBUTING COMPONENTS, NAMELY, BUS-BAR HOLDERS; RIDER SAFEGUARDING MEANS, NAMELY, SIGNAL RECEIVERS FOR SWITCHGEAR CABINETS, SIGNAL PROCESSORS AND SIGNAL EMITTERS FOR MONITORING AND SAFEGUARDING SWITCHGEAR CABINETS; CONDUCTOR TERMINALS, CONNECTION AND EQUIPMENT ADAPTERS AS WELL AS SIGNAL BAND LOAD SEPARATORS; MODULES AND SYSTEM COMPONENTS FOR MAIN ENERGY DISTRIBUTION AND SECONDARY ENERGY DISTRIBUTION, POWER SUPPLIES, NAMELY, POWER PACKS, ELECTRICAL ACCUMULATORS; STRUCTURALLY DIVIDED SWITCHING SYSTEMS, NAMELY, AIR CONDITIONED SWITCHING CABINETS FOR ELECTRONIC COMPONENTS; POWER SUPPLIES, NAMELY, INTERRUPTION-FREE POW-

ER SUPPLIES AS USV AND MODULAR CONSTRUCTION POWER SUPPLIES; DC/AC POWER CONVERTERS AND POWER INVERTERS; OVERLOAD PROTECTION FOR SENSITIVE ELECTRONIC EQUIPMENT AND COMPUTERS, NAMELY SAFETY DEVICES AND MONITORING UNITS, NAMELY, VOLTAGE SURGE SUPPRESSORS; ELECTRICAL ACCESS CHECKING EQUIPMENT AND SYSTEMS, NAMELY, ACCESS CONTROL AND ALARM MONITORING SYSTEMS; ELECTRICAL AND ELECTRONIC CONTROL EQUIPMENT AND SYSTEMS, NAMELY, ELECTRIC INSTALLATIONS FOR THE REMOTE CONTROL OF INDUSTRIAL OPERATIONS AND ELECTRIC CONTROL PANELS; ELECTRICALLY CONDUCTIVE CABLES FOR COMMAND POSTS, WATCH-TOWERS, CONSOLE WORKSTATIONS, AND MOTOR CONTROLS; SWITCH GEAR CABINET ACCESSORIES, NAMELY, CURRENT COLLECTING RAILS FOR HOLDING ELECTRICAL CURRENTS IN SWITCHGEAR CABINETS; CABLING AIDS FOR ELECTRICAL PURPOSES FORMED FROM METAL OR PLASTICS MATERIAL, NAMELY INTEGRATED CIRCUIT MODULES FOR CABLE MANAGEMENT COMPRISING CABLE GUIDE ELECTRICAL DUCTS, CABLE DIVERSION ELECTRICAL DUCTS, CABLE SECURING MEANS, NAMELY, CABLE CONNECTORS, CABLE INSERTS, NAMELY, ELECTRICAL PLUG DEVICE ENABLING CONNECTION AND DISCONNECTION OF POWER AND/OR CONTROL CABLES AND BUS-BAR HOLDERS, CONNECTION TERMINALS, NAMELY, BATTERY TERMINAL CONNECTOR CLAMPS; CABLE JUMP LEADS FOR SWITCHGEAR CABINETS ACCOMMODATING ELECTRICAL COMPONENTS; PROFILE RUBBER BATTERY TERMINAL CONNECTOR CLAMPS; SLIDE-IN UNITS FOR SUB-ASSEMBLY CARRIERS, NAMELY, PLUG-IN CARDS; BUSBARS, BLANK CASSETTES, PLUG-IN CONNECTORS, IN CLASS 9 (U.S. CLS. 21, 23, 26, 36 AND 38).

THE MARK CONSISTS OF STANDARD CHARACTERS WITHOUT CLAIM TO ANY PARTICULAR FONT, STYLE, SIZE, OR COLOR.

PRIORITY DATE OF 10-26-2006 IS CLAIMED.

SER. NO. 79-042,567, FILED 4-24-2007.

OWNER OF INTERNATIONAL REGISTRATION
0934358 DATED 4-24-2007, EXPIRES 4-24-2017.

WILLIAM ROSSMAN, EXAMINING ATTORNEY

Int. Cl.: 12

Prior U.S. Cls.: 19, 21, 23, 31, 35 and 44

Reg. No. 3,480,932

United States Patent and Trademark Office

Registered Aug. 5, 2008

TRADEMARK
PRINCIPAL REGISTER



RODMAN POLYSHIPS, S.A. (SPAIN SOCIEDAD ANÓNIMA)
RIOS-TEIS, S/N
E-36216 VIGO (PONTEVEDRA)
SPAIN

FOR: NAUTICAL VEHICLES, NAMELY, BOATS AND SHIPS, IN CLASS 12 (U.S. CLS. 19, 21, 23, 31, 35 AND 44).

OWNER OF INTERNATIONAL REGISTRATION 0934473 DATED 6-1-2007, EXPIRES 6-1-2017.

OWNER OF U.S. REG. NO. 2,694,258.

THE COLOR(S) SILVER AND BLACK IS/ARE CLAIMED AS A FEATURE OF THE MARK.

THE MARK CONSISTS OF THE WORDING "RODMAN MUSE" ON A SHADED BACKGROUND. THE COLOR SILVER APPEARS IN THE WORDING "RODMAN MUSE" AND IN THE HORIZONTAL LINE EXTENDING THROUGH THE TERM "MUSE". THE COLOR BLACK APPEARS AS THE SHADING FOR THE BACKGROUND OF THE MARK."

SER. NO. 79-042,610, FILED 6-1-2007.

ELI HELLMAN, EXAMINING ATTORNEY

Int. Cls.: 3, 18 and 24

Prior U.S. Cls.: 1, 2, 3, 4, 6, 22, 41, 42, 50, 51 and 52

United States Patent and Trademark Office

Reg. No. 3,480,933

Registered Aug. 5, 2008

TRADEMARK
PRINCIPAL REGISTER



IMAZ VILLAR, JULIAN (SPAIN INDIVIDUAL)
POLIG. IND. VALL DE GATA DRAPER, A
PARCELA 3; E-08350 ARENYS DE MAR (BARCEL,
SPAIN

FOR: SOAPS, PERFUMERY, ESSENTIAL OILS,
COSMETICS, HAIR LOTIONS, DENTIFRICES, IN
CLASS 3 (U.S. CLS. 1, 4, 6, 50, 51 AND 52).

FOR: LEATHER AND IMITATION LEATHER;
ANIMAL SKINS, HIDES; TRUNKS AND TRAVEL-
ING BAGS; UMBRELLAS, PARASOLS AND WALK-
ING STICKS; WHIPS AND SADDLERY;
HANDBAGS, LEATHER BAGS, BEACH BAGS, TRA-
VELING BAGS, WALLETS, TRAVELING SETS
MADE OF LEATHERWEAR, NAMELY, TRAVEL-
ING CASES OF LEATHER, TRAVELING BAGS OF
LEATHER; SADDLERY, KEY CASES MADE OF
LEATHERWEAR, RUCKSACKS, HAT BOXES OF
LEATHER FOR TRAVEL, IN CLASS 18 (U.S. CLS. 1,
2, 3, 22 AND 41).

FOR: TEXTILE FABRICS FOR HOME AND COM-
MERCIAL INTERIORS; CURTAINS MADE OF TEX-
TILE FABRICS; BED AND TABLE COVERS,

NAMELY, TEXTILE TABLECLOTHS AND BED
SPREADS, IN CLASS 24 (U.S. CLS. 42 AND 50).

OWNER OF INTERNATIONAL REGISTRATION
0934497 DATED 6-27-2007, EXPIRES 6-27-2017.

THE COLOR(S) BLACK AND RED IS/ARE
CLAIMED AS A FEATURE OF THE MARK.

THE COLOR BLACK APPEARS IN THE WORD
"FRIDAY'S" EXCEPT FOR THE LETTERS "A" AND
"S" WHICH ARE BOTH IN THE COLOR RED. THE
LETTER "A" IS CIRCLED SEVERAL TIMES IN RED
AND HAS A DOWNWARD POINTED ARROW IN
RED AT THE TOP LEFT CORNER. THE COLOR
BLACK ALSO APPEARS IN THE WORDING "PRO-
JECT" EXCEPT FOR THE LAST LETTER "T" IN
RED.

SER. NO. 79-042,618, FILED 6-27-2007.

WILLIAM ROSSMAN, EXAMINING ATTORNEY

Int. Cls.: 28, 35 and 38

Prior U.S. Cls.: 22, 23, 38, 50, 100, 101, 102 and 104

United States Patent and Trademark Office

Reg. No. 3,480,934

Registered Aug. 5, 2008

**TRADEMARK
SERVICE MARK
PRINCIPAL REGISTER**



MARIN FERNANDEZ, CRISTOBAL (SPAIN INDIVIDUAL)
PABLO PICASSO, 32
E-18210 PELIGROS, GRANADA
SPAIN

FOR: BOARD GAMES; CARD GAMES AND PLAYING CARDS; GAMES AND TOYS, NAMELY BALLS FOR GAMES, IN CLASS 28 (U.S. CLS. 22, 23, 38 AND 50).

FOR: ADVERTISING AND PROMOTIONAL SERVICES; IMPORT AND EXPORT SERVICES, NAMELY, IMPORT AND EXPORT AGENCIES IN THE FIELD OF GAMES, TOYS, BOARD GAMES AND PLAYING CARDS; PROCUREMENT SERVICES, NAMELY, PURCHASING GAMES, TOYS, BOARD GAMES AND PLAYING CARDS FOR OTHERS; RETAIL STORE SERVICES FEATURING GAMES, TOYS, BOARD GAMES AND PLAYING CARDS, IN CLASS 35 (U.S. CLS. 100, 101 AND 102).

FOR: TELECOMMUNICATIONS SERVICES, NAMELY, COMMUNICATIONS BY FIBRE OPTIC NETWORKS, COMMUNICATIONS VIA COMPUTER TERMINAL, IN CLASS 38 (U.S. CLS. 100, 101 AND 104).

OWNER OF INTERNATIONAL REGISTRATION 0934559 DATED 7-6-2007, EXPIRES 7-6-2017.

THE COLOR(S) YELLOW, LIGHT YELLOW, RED, GREEN, LIGHT GREEN, ORANGE, BLUE, PINK,

PURPLE, BLACK AND GREY IS/ARE CLAIMED AS A FEATURE OF THE MARK.

THE COLOR YELLOW APPEARS IN ONE OF THE I-SHAPED DESIGNS WITHIN THE OCTAGON AND IN THE BACKGROUND OF THE SMALL RECTANGLE DESIGN THAT CONTAINS THE WORD "OCTOGAME"; THE COLOR LIGHT YELLOW APPEARS IN THE BACKGROUND OF THE OCTAGON DESIGN; THE COLOR RED APPEARS IN ONE OF THE I-SHAPED DESIGNS WITHIN THE OCTAGON; THE COLOR GREEN APPEARS IN ONE OF THE I-SHAPED DESIGNS WITHIN THE OCTAGON; THE COLOR LIGHT GREEN APPEARS IN ONE OF THE I-SHAPED DESIGNS WITHIN THE OCTAGON; THE COLOR ORANGE APPEARS IN ONE OF THE I-SHAPED DESIGNS WITHIN THE OCTAGON; THE COLOR BLUE APPEARS IN ONE OF THE I-SHAPED DESIGNS WITHIN THE OCTAGON; THE COLOR PINK APPEARS IN ONE OF THE I-SHAPED DESIGNS WITHIN THE OCTAGON; THE COLOR PURPLE APPEARS IN ONE OF THE I-SHAPED DESIGNS WITHIN THE OCTAGON AND IN THE WORD "OCTOGAME"; THE COLOR BLACK APPEARS IN THE OUTLINING OF THE OCTAGON DESIGN; AND THE COLOR GRAY APPEARS IN THE LARGE RECTANGLE DESIGN WHICH SURROUNDS THE ENTIRE MARK.

SER. NO. 79-042,637, FILED 7-6-2007.

ANDREW RHIM, EXAMINING ATTORNEY

Int. Cl.: 41

Prior U.S. Cls.: 100, 101 and 107

United States Patent and Trademark Office

Reg. No. 3,480,935

Registered Aug. 5, 2008

**SERVICE MARK
PRINCIPAL REGISTER**

Triple Pocket

ANDERS ERICSSON (SWEDEN INDIVIDUAL)
INDUSTRIGATAN 2C
SE-112 46 STOCKHOLM
SWEDEN AND
ANDREAS HURTIG (SWEDEN INDIVIDUAL)
HAMMARN 3
SE-719 94 GRYTHYTTAN
SWEDEN AND
MATHIAS RINGBLOM (SWEDEN INDIVIDUAL)
VÄRINGEVÄGEN 5
SE-192 48 SOLLENTUNA
SWEDEN

FOR: PROVIDING GAMBLING SERVICES; ON-
LINE GAMING SERVICES; ONLINE GAMBLING
SERVICES IN THE FORM OF ONLINE POKER

GAMES AND GAMES OF CHANCE; CASINO SER-
VICES, IN CLASS 41 (U.S. CLS. 100, 101 AND 107).

THE MARK CONSISTS OF STANDARD CHAR-
ACTERS WITHOUT CLAIM TO ANY PARTICULAR
FONT, STYLE, SIZE, OR COLOR.

PRIORITY DATE OF 12-8-2006 IS CLAIMED.

OWNER OF INTERNATIONAL REGISTRATION
0934583 DATED 6-8-2007, EXPIRES 6-8-2017.

SER. NO. 79-042,644, FILED 6-8-2007.

WILLIAM ROSSMAN, EXAMINING ATTORNEY

Int. Cls.: 4, 6 and 32

**Prior U.S. Cls.: 1, 2, 6, 12, 13, 14, 15, 23, 25, 45, 46, 48
and 50**

Reg. No. 3,480,936

United States Patent and Trademark Office

Registered Aug. 5, 2008

**TRADEMARK
PRINCIPAL REGISTER**

GRIZZLY

GRIZZLY GAS HOLDING GMBH (AUSTRIA
LTD LIAB CO)
KÄRNTNER STRASSE 28/1/2/9
A-1010 WIEN, AUSTRIA

FOR: LIQUID GAS AND FUELS, INDUSTRIAL
OILS AND GREASES, LUBRICANTS, NAMELY,
OILS FOR INDUSTRIAL USE, IN CLASS 4 (U.S.
CLS. 1, 6 AND 15).

FOR: METAL CONTAINERS FOR COMPRESSED
GAS; METAL TUBES, IN CLASS 6 (U.S. CLS. 2, 12, 13,
14, 23, 25 AND 50).

FOR: MINERAL WATERS AND CARBONATED
WATERS AND OTHER NON-ALCOHOLIC BEV-
ERAGES, NAMELY, ENERGY DRINKS AND
SPORTS BEVERAGES, ISOTONIC BEVERAGES,
FRUIT DRINKS AND FRUIT JUICES; SYRUPS

AND OTHER PREPARATIONS FOR MAKING
DRINKS, IN CLASS 32 (U.S. CLS. 45, 46 AND 48).

THE MARK CONSISTS OF STANDARD CHAR-
ACTERS WITHOUT CLAIM TO ANY PARTICULAR
FONT, STYLE, SIZE, OR COLOR.

PRIORITY DATE OF 1-25-2007 IS CLAIMED.

OWNER OF INTERNATIONAL REGISTRATION
0935021 DATED 6-11-2007, EXPIRES 6-11-2017.

SER. NO. 79-042,758, FILED 6-11-2007.

WILLIAM ROSSMAN, EXAMINING ATTORNEY

Int. Cls.: 32 and 34

Prior U.S. Cls.: 2, 8, 9, 17, 45, 46 and 48

United States Patent and Trademark Office

Reg. No. 3,480,937

Registered Aug. 5, 2008

**TRADEMARK
PRINCIPAL REGISTER**

KICKUP

ÅBECO R & M AB (SWEDEN JOINT STOCK
COMPANY)
GÖTEBORGSVÄGEN 99
SE-504 60 BORÅS, SVERIGE, SWEDEN

FOR: MINERAL AND AERATED WATERS AND
OTHER NON-ALCOHOLIC DRINKS, NAMELY,
WATER AND SOFT DRINKS; FRUIT DRINKS
AND FRUIT JUICES; ENERGY BEVERAGES , IN
CLASS 32 (U.S. CLS. 45, 46 AND 48).

FOR: TOBACCO; SNUFF WITH AND WITHOUT
TOBACCO; MATCHES, IN CLASS 34 (U.S. CLS. 2, 8, 9
AND 17).

THE MARK CONSISTS OF STANDARD CHAR-
ACTERS WITHOUT CLAIM TO ANY PARTICULAR
FONT, STYLE, SIZE, OR COLOR.

PRIORITY DATE OF 9-26-2006 IS CLAIMED.

OWNER OF INTERNATIONAL REGISTRATION
0935047 DATED 3-23-2007, EXPIRES 3-23-2017.

SER. NO. 79-042,766, FILED 3-23-2007.

PETER B. BROMAGHIM, EXAMINING ATTORNEY

Int. Cl.: 3

Prior U.S. Cls.: 1, 4, 6, 50, 51 and 52

United States Patent and Trademark Office

Reg. No. 3,480,938

Registered Aug. 5, 2008

**TRADEMARK
PRINCIPAL REGISTER**

ROGER & GALLET

ROGER & GALLET; SOCIÉTÉ PAR ACTIONS
SIMPLIFIÉE (FRANCE SOCIÉTÉ PAR AC-
TIONS SIMPLIFIÉE (SAS))

20/26, BOULEVARD DU PARC
F-92200 NEUILLY-SUR-SEINE, FRANCE

FOR: PERFUMERY; BEAUTY PRODUCTS,
NAMELY, BEAUTY CREAMS, BEAUTY CREAMS
FOR BODY CARE, BEAUTY GELS, BEAUTY LO-
TIONS, BEAUTY MASKS, BEAUTY MILKS, SOAP
PRODUCTS, NAMELY, SOAPS FOR PERSONAL
USE, SOAPS FOR TOILET PURPOSES, SOAPS FOR
BODY CARE; MAKE-UP; ESSENTIAL OILS; COS-

METICS; HAIR LOTIONS; AND DENTIFRICES, IN
CLASS 3 (U.S. CLS. 1, 4, 6, 50, 51 AND 52).

OWNER OF INTERNATIONAL REGISTRATION
0208803 DATED 4-10-1958, EXPIRES 4-10-2018.

OWNER OF U.S. REG. NOS. 762,438, 762,878, AND
1,723,155.

SER. NO. 79-042,805, FILED 4-20-2007.

DAYNA BROWNE, EXAMINING ATTORNEY

Int. Cl.: 6

Prior U.S. Cls.: 2, 12, 13, 14, 23, 25 and 50

United States Patent and Trademark Office

Reg. No. 3,480,939

Registered Aug. 5, 2008

**TRADEMARK
PRINCIPAL REGISTER**

PEIKKO

PEIKKO FINLAND OY (FINLAND LTD LIAB
CO)
VIPUSENKATU 20
FI-15100 LAHTI
FINLAND

FOR: CONCRETE FIXING PRODUCTS AND
JOINING PIECES MADE OF STEEL, NAMELY,
FASTENING PLATES, BOLTS, COLUMN SHOES,
CORBELS, HANGARS, TIES, JOINT REINFORCERS,
LIFTING LUGS, LIFTING ANCHORS, LONG DOU-
BLE BARS USED FOR LIFTING COLUMNS, BAL-
CONY JOINTS, EXPANSION JOINTS; WOOD
CLAMPS, NAMELY, NAILS, SCREWS, NAIL
PLATES; LOAD-BEARING STEEL BEAMS AND
COLUMNS, IN CLASS 6 (U.S. CLS. 2, 12, 13, 14, 23,
25 AND 50).

THE MARK CONSISTS OF STANDARD CHAR-
ACTERS WITHOUT CLAIM TO ANY PARTICULAR
FONT, STYLE, SIZE, OR COLOR.

OWNER OF INTERNATIONAL REGISTRATION
0666206 DATED 11-22-1996, EXPIRES 11-22-2016.

THE WORDING "PEIKKO" IN THE MARK HAS
NO ENGLISH TRANSLATION

SER. NO. 79-042,827, FILED 5-7-2007.

WILLIAM ROSSMAN, EXAMINING ATTORNEY

Int. Cl.: 25

Prior U.S. Cls.: 22 and 39

United States Patent and Trademark Office

Reg. No. 3,480,940

Registered Aug. 5, 2008

TRADEMARK
PRINCIPAL REGISTER

verdissima

INTIMA MODA S.P.A. (ITALY JOINT STOCK
COMPANY)
VIA G. CAMPAGNA, 60
MODENA, FRAZIONE COGNENTO, ITALY I41010

FOR: SHIRTS; PANTS; JEANS; DRESSES; DRESS-
ING GOWNS; PULLOVERS; CARDIGANS; JER-
SEYS; NECKTIES; NECKERCHIEFS; SOCKS;
TIGHTS; TROUSERS; LEGGINGS; JERKINS;
GLOVES; SKIRTS; SWEATERS; JUMPSUITS; BODY-
SUITS; SWEATSHIRTS; SWEAT SHORTS; JACKETS;
T-SHIRTS; SHIRTS; VESTS; WAISTCOATS; JUM-
PERS; TRACK SUITS; BLOUSES; PANTIES; SUITS;
OVER COATS; COATS; ANORAKS; RAINCOATS;
UNDERWEAR; NIGHTWEAR; SINGLET; PETTI-
COATS; SHORT PETTICOATS; PETTY-PANTS; BOX-
ER SHORTS; BERMUDA SHORTS; NIGHTGOWNS;
PAJAMAS; BATHING SUITS; BATHING TRUNKS;
BATHING COSTUMES; BIKINIS; TANKINIS; BATH-
ING SUITS; BATHROBES; BEACH COVER-UPS;
PAREOS; BEACH FOOTWEAR; CAPS; HATS; SWIM

WEAR; BEACHWEAR LINGERIE; BRASSIERES;
STRAPLESS BRAS; LINGERIE ACCESSORIES,
NAMELY, REMOVABLE SILICONE BREAST EN-
HANCER PADS USED IN A BRAS; BRIEFS; BUSTI-
ERS; CULOTTES; SLIPS; HOSIERY; ROBES;
CAFTANS; KIMONOS; CORSETS; CORSELETS;
BELTS; GIRDLES; SUSPENDERS; SHOES; BOOTS;
SLIPPERS; GARTER BELTS; STOCKINGS; STOCK-
ING SUSPENDERS; STRAPS FOR BRAS; WRAPS;
FOULARDS; SCARVES; BANDANAS; BANDEAUX;
STOLES, IN CLASS 25 (U.S. CLS. 22 AND 39).

OWNER OF INTERNATIONAL REGISTRATION
0827594 DATED 5-12-2004, EXPIRES 5-12-2014.

SER. NO. 79-042,849, FILED 6-8-2007.

ELI HELLMAN, EXAMINING ATTORNEY

Int. Cl.: 14

Prior U.S. Cls.: 2, 27, 28 and 50

United States Patent and Trademark Office

Reg. No. 3,480,941

Registered Aug. 5, 2008

TRADEMARK
PRINCIPAL REGISTER

Paul Audet

MARC DANZINELLI (SWITZERLAND INDIVIDUAL)
LA REPRISE 2
CH-2400 LE LOCLE
SWITZERLAND

FOR: HANDS FOR CLOCK AND WATCH-MAKING, WATCH HANDS, WATCH CONTAINERS, WATCH CASES, WATCHBANDS, WATCH DIALS, WATCHES USED AS CHRONOGRAPHS, CHRONOSCOPES, CHRONOMETERS, CLOCKS, WATCHES, WRISTWATCHES, JEWELRY WATCHES, MOVEMENTS FOR TIMEPIECES, MOVEMENTS FOR WATCHES, WALL CLOCKS, SMALL CLOCKS,

ALARM CLOCKS, WATCH CRYSTALS, WATCH GLASSES, IN CLASS 14 (U.S. CLS. 2, 27, 28 AND 50).

OWNER OF INTERNATIONAL REGISTRATION
0879756 DATED 3-16-2006, EXPIRES 3-16-2016.

THE NAME(S), PORTRAIT(S), AND/OR SIGNATURE(S) SHOWN IN THE MARK DOES NOT IDENTIFY A PARTICULAR LIVING INDIVIDUAL.

SER. NO. 79-042,858, FILED 1-31-2007.

LINDA MICKLEBURGH, EXAMINING ATTORNEY

Int. Cl.: 29

Prior U.S. Cl.: 46

United States Patent and Trademark Office

Reg. No. 3,480,942

Registered Aug. 5, 2008

TRADEMARK
PRINCIPAL REGISTER



CONSERVERA GALLEGA, S.A. (SPAIN SOCIEDAD ANONIMA)
EL CASTRO, S/N
E-36620 VILLANUEVA DE AROSA (PONTEVEDRA)
SPAIN

FOR: PRESERVED MEAT, FISH, POULTRY AND GAME; PRESERVED MEAT EXTRACTS; PRESERVED FRUIT AND VEGETABLES; JELLIES, JAMS, COMPOTES, IN CLASS 29 (U.S. CL. 46).

OWNER OF INTERNATIONAL REGISTRATION
0935239 DATED 6-22-2007, EXPIRES 6-22-2017.

NO CLAIM IS MADE TO THE EXCLUSIVE RIGHT TO USE "S.A.", APART FROM THE MARK AS SHOWN.

THE COLOR(S) ORANGE, BLACK, WHITE IS/ARE CLAIMED AS A FEATURE OF THE MARK.

"THE MARK CONSISTS OF THE WORDING "CONSERVERA GALLEGA", S.A. IN STYLIZED TYPE IN THE COLOR ORANGE AND A DESIGN ELEMENT DEPICTING THE WROUGHT IRON WORK WHICH APPEARS IN THE COLOR BLACK."

"THE FOREIGN WORDING IN THE MARK TRANSLATES INTO ENGLISH AS GALICIAN CANNING."

SER. NO. 79-042,910, FILED 6-22-2007.

FLORENTINA BLANDU, EXAMINING ATTORNEY

Int. Cls.: 9, 16, 35, 36, 38, 40, 41, 42 and 45

**Prior U.S. Cls.: 2, 5, 21, 22, 23, 26, 29, 36, 37, 38, 50,
100, 101, 102, 103, 104, 106 and 107**

Reg. No. 3,480,943

United States Patent and Trademark Office

Registered Aug. 5, 2008

**TRADEMARK
SERVICE MARK
PRINCIPAL REGISTER**

SCOTT & YORK

SCOTT & YORK (UNITED KINGDOM LTD LIAB
CO)
45 GROSVENOR ROAD
ST ALBANS, HERTFORDSHIRE AL1 3AW
UNITED KINGDOM

FOR: COMPUTER SOFTWARE AND COMPUTER PROGRAMS FOR MANAGING DATA AND FOR DATA PROCESSING; COMPUTER SOFTWARE AND COMPUTER PROGRAMS FOR USE IN DATABASE MANAGEMENT, WORD PROCESSING, DATA STORAGE AND DOCUMENT PRODUCTION, IN THE FIELD OF INTELLECTUAL PROPERTY; DOWNLOADABLE COMPUTER SOFTWARE FOR MANAGING DATA AND FOR DATA PROCESSING, DATABASE MANAGEMENT, WORD PROCESSING, DATA STORAGE AND DOCUMENT PRODUCTION IN THE FIELD OF INTELLECTUAL PROPERTY AND DOWNLOADABLE PUBLICATIONS IN ELECTRONIC FORM IN THE FORM OF BROCHURES, NEWSLETTERS, GUIDES, MANUALS, LEAFLETS AND INFORMATION CIRCULARS IN THE FIELD OF INTELLECTUAL PROPERTY SUPPLIED ONLINE FROM DATABASES AND/OR FROM FACILITIES PROVIDED ON THE INTERNET INCLUDING WEBSITES; COMPUTER SOFTWARE TO ENABLE CONNECTION TO DATABASES AND THE INTERNET; TELECOMMUNICATIONS APPARATUS TO ENABLE CONNECTION TO DATABASES AND THE INTERNET, NAMELY, COMPUTER HARDWARE FOR TELECOMMUNICATIONS, TELECOMMUNICATIONS SWITCHES, TELECOMMUNICATIONS TRANSMITTERS, TELECOMMUNICATIONS EXCHANGERS, COMPUTER SOFTWARE TO ENABLE SEARCHING OF DATA; SLIDES FOR OVERHEAD PROJECTORS, NAMELY, PHOTOGRAPHIC SLIDES, PHOTOGRAPHIC SLIDES CONTAINING TEXT; TRANSPARENCY SLIDES, NAMELY, PHOTOGRAPHIC SLIDES, PHOTOGRAPHIC SLIDES CONTAINING TEXT, IN CLASS 9 (U.S. CLS. 21, 23, 26, 36 AND 38).

FOR: BOOKS IN THE FIELD OF INTELLECTUAL PROPERTY; PRINTED REPORTS FEATURING

CONTENT CONCERNING INTELLECTUAL PROPERTY; NEWSLETTERS, BROCHURES, GUIDES, MANUALS, PAMPHLETS AND LEAFLETS, INFORMATION CIRCULARS IN THE FIELD OF INTELLECTUAL PROPERTY, WRITING INSTRUMENTS; DIARIES; CALENDARS; PHOTOGRAPHS; DRAWINGS; PRINTED INSTRUCTIONAL AND TEACHING MATERIALS IN THE FIELD OF INTELLECTUAL PROPERTY, IN CLASS 16 (U.S. CLS. 2, 5, 22, 23, 29, 37, 38 AND 50).

FOR: ADVERTISING; PROVISION OF BUSINESS ADVICE AND INFORMATION; INVESTIGATIONS, RESEARCH, INFORMATION, CONSULTATION, INQUIRIES AND ADVISORY SERVICES IN THE FIELD OF BUSINESS; BUSINESS ADVISORY SERVICES RELATING TO NEW PRODUCT DEVELOPMENT SERVICES; COMPILATION AND PROVISION OF COMPANY INFORMATION, NAMELY, PROVIDING INFORMATION ABOUT COMMERCIAL BUSINESSES; BUSINESS FRANCHISING ADVISORY SERVICES; SECRETARIAL SERVICES; MARKET RESEARCH SERVICES; DOCUMENT REPRODUCTION; DISTRIBUTION OF PROSPECTUSES; PREPARATION OF BUSINESS REPORTS; MARKETING ADVICE AND CONSULTANCY SERVICES; INFORMATION, CONSULTANCY AND ADVISORY SERVICES RELATING TO ALL THE AFORESAID SERVICES, INCLUDING SUCH SERVICES PROVIDED ONLINE FROM A COMPUTER NETWORK AND/OR VIA THE INTERNET, IN CLASS 35 (U.S. CLS. 100, 101 AND 102).

FOR: FINANCIAL INFORMATION SERVICES, NAMELY, FINANCIAL INFORMATION PROCESSING, PROVISION OF FINANCIAL INFORMATION REGARDING COMPANIES, IN CLASS 36 (U.S. CLS. 100, 101 AND 102).

FOR: PROVIDING ACCESS INCLUDING ONLINE ACCESS TO COMPUTER DATABASES, IN CLASS 38 (U.S. CLS. 100, 101 AND 104).

FOR: PRINTING OF ADVERTISING MATERIAL, IN CLASS 40 (U.S. CLS. 100, 103 AND 106).

FOR: ORGANIZATION, CONDUCTING AND PRESENTATION OF SPEECHES, TUTORIALS, CLASSES, SEMINARS, WORKSHOPS, CONFERENCES, SYMPOSIUMS AND EXHIBITIONS IN THE FIELD OF INTELLECTUAL PROPERTY; LIBRARY SERVICES; PUBLISHING SERVICES, NAMELY, PUBLICATION OF BOOKS, NEWSLETTERS, REVIEWS, PUBLISHING OF ELECTRONIC PUBLICATIONS; ELECTRONIC PUBLISHING SERVICES, NAMELY, PUBLICATION OF TEXT AND GRAPHIC WORKS OF OTHERS ON CD, DVD AND ON-LINE; PUBLISHING OF PRINTED MATTER, NAMELY, BOOKS, MAGAZINES, NEWSLETTERS AND EDUCATIONAL MATERIALS; PROVIDING ON-LINE ELECTRONIC PUBLICATIONS IN THE NATURE OF REPORTS, NEWSLETTERS, GUIDES, MANUALS, BROCHURES IN THE FIELD OF INTELLECTUAL PROPERTY; INFORMATION, CONSULTANCY AND ADVISORY SERVICES RELATING TO THE AFORESAID, INCLUDING, SUCH SERVICES PROVIDED ONLINE FROM A COMPUTER NETWORK AND/OR VIA INTERNET; TRANSLATION SERVICES, IN CLASS 41 (U.S. CLS. 100, 101 AND 107).

FOR: PREPARATION OF TECHNICAL DRAWINGS AND PRINTS FOR USE IN INTELLECTUAL PROPERTY MATTERS AND IN FILING AND PROSECUTING PATENT, DESIGN AND TRADEMARK APPLICATIONS; INFORMATION SERVICES RELATING THERETO, IN CLASS 42 (U.S. CLS. 100 AND 101).

FOR: LEGAL SERVICES; PROFESSIONAL ADVISORY, INFORMATION AND CONSULTANCY SERVICES, ALL RELATING TO INDUSTRIAL AND INTELLECTUAL PROPERTY; ESTABLISHING, DRAFTING, FILING, PROSECUTING, REGISTER-

ING, OPPOSING, CANCELING, REVOKING, INVALIDATING, PROTECTING, MANAGING, MAINTAINING, RENEWING, AND ENFORCING INDUSTRIAL AND INTELLECTUAL PROPERTY RIGHTS; INTELLECTUAL PROPERTY LICENSING AND ASSIGNMENT SERVICES; INTELLECTUAL PROPERTY SERVICES, NAMELY, RECORDAL OF CHANGES OF NAMES AND ADDRESSES, DUE-DILIGENCE SERVICES, AND RECORD KEEPING SERVICES IN THE FIELD OF INTELLECTUAL PROPERTY; INTELLECTUAL PROPERTY SEARCHING AND RESEARCH SERVICES; LEGAL RESEARCH; PATENT AND TRADE MARK AGENCY AND ATTORNEY SERVICES; INTELLECTUAL PROPERTY PORTFOLIO MANAGEMENT AND AUDITING, NAMELY, INTELLECTUAL PROPERTY CONSULTATION; LEGAL SERVICES, NAMELY, REPRESENTATION OF CLIENTS BEFORE THE PATENT OFFICE, EUROPEAN PATENT OFFICE, PATENT COURT, PATENTS COUNTY COURT, TRADE MARK REGISTRIES, OFFICE FOR HARMONIZATION IN THE INTERNAL MARKET AND OTHER COURTS IN RELATION TO INTELLECTUAL PROPERTY ISSUES, IN CLASS 45 (U.S. CLS. 100 AND 101).

THE MARK CONSISTS OF STANDARD CHARACTERS WITHOUT CLAIM TO ANY PARTICULAR FONT, STYLE, SIZE, OR COLOR.

PRIORITY DATE OF 8-31-2006 IS CLAIMED.

OWNER OF INTERNATIONAL REGISTRATION 0935461 DATED 2-23-2007, EXPIRES 2-23-2017.

SER. NO. 79-043,002, FILED 2-23-2007.

TINA BROWN, EXAMINING ATTORNEY

Int. Cl.: 16

Prior U.S. Cls.: 2, 5, 22, 23, 29, 37, 38 and 50

United States Patent and Trademark Office

Reg. No. 3,480,944

Registered Aug. 5, 2008

TRADEMARK
PRINCIPAL REGISTER

GENIO CREATIVO

RICHEMONT ITALIA S.P.A. (ITALY SOCIETÀ
PER AZIONI (SPA))
VIA LUDOVICO DI BREME, 44
I-20156 MILANO
ITALY

FOR: WRITING INSTRUMENTS, NAMELY,
FOUNTAIN PENS, BALLPOINT PENS, FELT-TIP
PENS, ROLLER BALL PENS, DOCUMENT MAR-
KER PENS, PENCILS, WRITING BRUSHES; VAR-
IOUS PARTS OF THE AFOREMENTIONED
WRITING INSTRUMENTS, IN PARTICULAR NIBS;
WRITING INKS, REFILLS, AND CARTRIDGES
FOR THE AFOREMENTIONED VARIOUS TYPES
OF WRITING INSTRUMENTS; POUCHES FOR
WRITING INSTRUMENTS, GIFT CASES FITTED
FOR WRITING INSTRUMENTS; GIFT SETS COM-
PRISED OF THE VARIOUS AFOREMENTIONED
WRITING INSTRUMENTS AND GIFT CASES FIT-
TED THEREFORE; PEN AND PENCIL HOLDERS,
IN CLASS 16 (U.S. CLS. 2, 5, 22, 23, 29, 37, 38 AND 50).

THE MARK CONSISTS OF STANDARD CHAR-
ACTERS WITHOUT CLAIM TO ANY PARTICULAR
FONT, STYLE, SIZE, OR COLOR.

PRIORITY DATE OF 12-4-2006 IS CLAIMED.

OWNER OF INTERNATIONAL REGISTRATION
0935479 DATED 5-31-2007, EXPIRES 5-31-2017.

THE ENGLISH TRANSLATION OF "GENIO
CREATIVO" IS CREATIVE GENIUS.

SER. NO. 79-043,011, FILED 5-31-2007.

JERI J. FICKES, EXAMINING ATTORNEY

Int. Cls.: 7 and 10

Prior U.S. Cls.: 13, 19, 21, 23, 26, 31, 34, 35, 39 and 44

United States Patent and Trademark Office

Reg. No. 3,480,945

Registered Aug. 5, 2008

**TRADEMARK
PRINCIPAL REGISTER**

FLAEM NUOVA

FLAEM NUOVA S.P.A. (ITALY JOINT STOCK
COMPANY)
VIA COLLI STORICI 221-223-225
I-25010 SAN MARTINO DELLA BATTAGLIA (BRES-
CIA)
ITALY

FOR: VACUUM PACKAGING MACHINES USED
FOR EVACUATING AIR DURING PACKING AND
SEALING, IN CLASS 7 (U.S. CLS. 13, 19, 21, 23, 31, 34
AND 35).

FOR: ELECTROMEDICAL APPARATUS, NAME-
LY, AEROSOL DISPENSERS FOR MEDICAL PUR-
POSES, DEVICES FOR WASHING THE NASAL
CAVITIES, NEBULIZERS FOR ADMINISTERING A
MEDICATION AEROSOL, HUMIDIFIERS FOR USE
IN MEDICAL TREATMENT, BLOOD PRESSURE

MEASURING APPARATUS, IN CLASS 10 (U.S. CLS.
26, 39 AND 44).

OWNER OF INTERNATIONAL REGISTRATION
0935669 DATED 7-4-2007, EXPIRES 7-4-2017.

THIS TRADEMARK CONSISTS IN THE WORD-
ING "FLAEM NUOVA".

"THE FOREIGN WORDING IN THE MARK
TRANSLATES INTO ENGLISH AS NEW."

SER. NO. 79-043,085, FILED 7-4-2007.

FLORENTINA BLANDU, EXAMINING ATTORNEY

Int. Cls.: 18, 25 and 28

Prior U.S. Cls.: 1, 2, 3, 22, 23, 38, 39, 41 and 50

United States Patent and Trademark Office

Reg. No. 3,480,946

Registered Aug. 5, 2008

**TRADEMARK
PRINCIPAL REGISTER**

S P L E E N E

**RAINER KAUPER (FED REP GERMANY INDIVIDUAL)
SUTTNERSTRASSE 3
52080 AACHEN
FED REP GERMANY**

FOR: SUITCASES AND BAGS OF ALL KINDS INCLUDED IN THIS CLASS, NAMELY, TRAVELING CASES, BACKPACKS, HANDBAGS, BRIEFCASES, COSMETIC CASES SOLD EMPTY AND MONEYBAGS, IN CLASS 18 (U.S. CLS. 1, 2, 3, 22 AND 41).

FOR: CLOTHING FOR WOMEN, MEN AND CHILDREN, NAMELY, SPORT CLOTHING, NAMELY, PANTS MADE OF NYLON FABRIC TO WEAR OVER WET BATHING SUITS, PANTS MADE OF COTTON FABRICS TO WEAR AT THE BEACH, SHIRTS MADE OF COTTON FABRICS TO WEAR AT THE BEACH, AND T-SHIRTS MADE OF COTTON TO WEAR AT THE BEACH; SWIM SUITS, SHORTS, PANTS, JACKETS, FOOTWEAR, HEADGEAR, NAMELY, HATS, CAPS AND BEANIES, IN CLASS 25 (U.S. CLS. 22 AND 39).

FOR: SPORTING GOODS INCLUDED IN THIS CLASS, NAMELY, KITE BOARDS, SURFBOARDS, WINDSURF BOARDS, SNOWBOARDS AND SNOW KITE BOARDS AS WELL AS THEIR ELEMENTS AND EQUIPMENT, NAMELY, FINS, FOOT BLADES, FOOT PADS; BAGS AND SUITCASES FOR SPORT GOODS AND SPORT EQUIPMENT, CASES FOR KITE BOARDS; CASES FOR SNOWBOARDS, IN CLASS 28 (U.S. CLS. 22, 23, 38 AND 50).

THE MARK CONSISTS OF STANDARD CHARACTERS WITHOUT CLAIM TO ANY PARTICULAR FONT, STYLE, SIZE, OR COLOR.

**OWNER OF INTERNATIONAL REGISTRATION
0935808 DATED 4-26-2007, EXPIRES 4-26-2017.**

SER. NO. 79-043,130, FILED 4-26-2007.

WILLIAM ROSSMAN, EXAMINING ATTORNEY

Int. Cl.: 9

Prior U.S. Cls.: 21, 23, 26, 36 and 38

Reg. No. 3,480,947

United States Patent and Trademark Office

Registered Aug. 5, 2008

**TRADEMARK
PRINCIPAL REGISTER**



JS CABLE CO., LTD. (REPUBLIC OF KOREA CORPORATION)
569 BOSUNG-RI, PUNGSE-MYON
CHONAN-CITY; CHUNGCHEONGNAM-DO
REPUBLIC OF KOREA

OWNER OF INTERNATIONAL REGISTRATION
0935923 DATED 7-3-2007, EXPIRES 7-3-2017.

FOR: FIBER-OPTIC CABLES; BARE WIRES; POWER CABLES; ELECTRICITY WINDING WIRES; CABLES FOR RECEIVING, TRANSMITTING CABLE TELEVISION SIGNALS; ELECTRIC WIRES AND FIBERS FOR SOUND, IMAGE TRANSMISSION; COAXIAL CABLES; CABLES FOR TRANSMISSION OF ELECTRICAL OR OPTICAL SIGNALS; ELECTRIC CABLES; DUCTS FOR ELECTRIC CABLES; SHEATHS FOR ELECTRIC CABLES; JUNCTION SLEEVES FOR ELECTRIC CABLES; ELECTRIC WIRES AND CABLES; ELECTRICAL DUCTS; IDENTIFICATION SHEATHS FOR ELECTRIC WIRES; TELEGRAPH WIRES; TELECOMMUNICATIONS CABLES; COVERED WIRES; EXTENDED CABLES, IN CLASS 9 (U.S. CLS. 21, 23, 26, 36 AND 38).

NO CLAIM IS MADE TO THE EXCLUSIVE RIGHT TO USE "CABLE", APART FROM THE MARK AS SHOWN.

THE COLOR(S) RED, DARK GRAY, LIGHT GRAY IS/ARE CLAIMED AS A FEATURE OF THE MARK.

"JS" IS IN RED, "CABLE" IN DARK GRAY, CIRCLE IN LIGHT GRAY.

SER. NO. 79-043,167, FILED 7-3-2007.

PRIORITY DATE OF 4-13-2007 IS CLAIMED.

FLORENTINA BLANDU, EXAMINING ATTORNEY

Int. Cl.: 30

Prior U.S. Cl.: 46

United States Patent and Trademark Office

Reg. No. 3,480,948

Registered Aug. 5, 2008

**TRADEMARK
PRINCIPAL REGISTER**

TEA-CADDY

J.T. RONNEFELDT KG (FED REP GERMANY
LIMITED PARTNERSHIP)
KURFÜRSTENPLATZ 38
60486 FRANKFURT
FED REP GERMANY

OWNER OF INTERNATIONAL REGISTRATION
0838288 DATED 10-25-2004, EXPIRES 10-25-2014.

FOR: TEA IN TEABAGS, IN CLASS 30 (U.S. CL. 46).

SER. NO. 79-043,240, FILED 8-8-2007.

THE MARK CONSISTS OF STANDARD CHAR-
ACTERS WITHOUT CLAIM TO ANY PARTICULAR
FONT, STYLE, SIZE, OR COLOR.

LAURA HAMMEL, EXAMINING ATTORNEY

Int. Cl.: 10

Prior U.S. Cls.: 26, 39 and 44

United States Patent and Trademark Office

Reg. No. 3,480,949

Registered Aug. 5, 2008

**TRADEMARK
PRINCIPAL REGISTER**

LIPO M6

LPG SYSTEMS (SOCIÉTÉ ANONYME) (FRANCE
SOCIÉTÉ ANONYME)
30, RUE DU DOCTEUR ABEL
F-26000 VALENCE, FRANCE

OWNER OF INTERNATIONAL REGISTRATION
0936029 DATED 7-20-2007, EXPIRES 7-20-2017.

FOR: MASSAGE APPARATUS, IN CLASS 10 (U.S.
CLS. 26, 39 AND 44).

OWNER OF U.S. REG. NOS. 2,175,335 AND
2,438,748.

THE MARK CONSISTS OF STANDARD CHAR-
ACTERS WITHOUT CLAIM TO ANY PARTICULAR
FONT, STYLE, SIZE, OR COLOR.

SER. NO. 79-043,255, FILED 7-20-2007.

PRIORITY DATE OF 2-16-2007 IS CLAIMED.

DANIEL BRODY, EXAMINING ATTORNEY

Int. Cls.: 3 and 4

Prior U.S. Cls.: 1, 4, 6, 15, 50, 51 and 52

United States Patent and Trademark Office

Reg. No. 3,480,950

Registered Aug. 5, 2008

**TRADEMARK
PRINCIPAL REGISTER**

**EVENING DRESS
NUIT D'ECLAT**

SHEERINO'KHO (FRANCE SOCIÉTÉ À RE-
SPONSABILITÉ LIMITÉE)
11 RUE BARBET DE JOUY
F-75007 PARIS
FRANCE

FOR: SOAPS; PERFUMES; ESSENTIAL OILS;
COSMETICS; HAIR LOTIONS; DENTIFRICES; DE-
PILATORIES; MAKE-UP REMOVING PREPARA-
TIONS; LIPSTICK; BEAUTY MASKS; SHAVING
PRODUCTS, NAMELY, SHAVING PREPARATIONS,
IN CLASS 3 (U.S. CLS. 1, 4, 6, 50, 51 AND 52).

FOR: CANDLES AND WICKS FOR CANDLES,
WICKS FOR OIL LAMPS, IN CLASS 4 (U.S. CLS. 1, 6
AND 15).

THE MARK CONSISTS OF STANDARD CHAR-
ACTERS WITHOUT CLAIM TO ANY PARTICULAR
FONT, STYLE, SIZE, OR COLOR.

OWNER OF INTERNATIONAL REGISTRATION
0936077 DATED 7-17-2007, EXPIRES 7-17-2017.

THE FOREIGN WORDING IN THE MARK
TRANSLATES INTO ENGLISH AS "NIGHT OF
BRIGHTNESS."

SER. NO. 79-043,267, FILED 7-17-2007.

LAURA HAMMEL, EXAMINING ATTORNEY

Int. Cls.: 35, 36, 37 and 42

Prior U.S. Cls.: 100, 101, 102, 103 and 106

United States Patent and Trademark Office

Reg. No. 3,480,951

Registered Aug. 5, 2008

**SERVICE MARK
PRINCIPAL REGISTER**



TERRAVALLE LIMITED (BR.VIRGIN ISLANDS
SOCIÉTÉ A RESPONSABILITÉ LIMITÉE)
P.O. BOX 3175
ROAD TOWN; TORTOLA
BR.VIRGIN ISLANDS

FOR: BUSINESS ADMINISTRATION AND MANAGEMENT IN THE FIELD OF CONSTRUCTION AND DEVELOPMENT; COMMERCIAL OR INDUSTRIAL BUSINESS MANAGEMENT ASSISTANCE; MARKET STUDIES; ADVERTISING SERVICES; ON-LINE ADVERTISING ON A COMPUTER NETWORK; BUSINESS MANAGEMENT CONSULTING IN THE AREA OF CONSTRUCTION AND DEVELOPMENT; ORGANIZATION OF EXHIBITIONS AND TRADE FAIRS FOR COMMERCIAL AND ADVERTISING PURPOSES; SALES PROMOTION SERVICES FOR OTHERS; PUBLIC RELATIONS, IN CLASS 35 (U.S. CLS. 100, 101 AND 102).

FOR: REAL ESTATE AGENCIES; LEASING OF REAL ESTATE; REAL ESTATE RENTAL SERVICES, NAMELY, RENTAL OF RESIDENTIAL HOUSING AND NON-RESIDENTIAL BUILDINGS; REAL ESTATE MANAGEMENT; RESIDENTIAL REAL ESTATE MANAGEMENT, IN CLASS 36 (U.S. CLS. 100, 101 AND 102).

FOR: BUSINESS CONSTRUCTION SERVICES; SERVICES FOR REPAIR OF BUILDING PREMISES; INSTALLATION SERVICES FOR CONSTRUCTION MACHINERY FOR BUILDING HOTELS AND OTHER BUILDING; REPAIR AND MAINTENANCE OF DUCTS AND PIPING FOR BUILDINGS; LAYING, REPAIR AND REPLACEMENT OF WATER AND GAS PIPES; WALLPAPER HANGING; BUILD-

ING CONSTRUCTION AND REPAIR OF STORAGE FACILITIES; EXTERIOR AND INTERIOR CLEANING FOR BUILDINGS; SANDBLASTING; CONSTRUCTION MANAGEMENT IN THE NATURE OF SUPERVISION OF CONSTRUCTION WORK; ROOFING SERVICES FOR BUILDINGS; INSTALLATION, ASSEMBLY AND REPAIR OF ELECTRIC CONDUITS, OF WATER SUPPLY SYSTEMS, OF SANITARY, HEATING, GAS INSTALLATIONS IN BUILDINGS, OF AIR-CONDITIONING APPARATUS IN BUILDINGS, ELEVATORS, FIRE ALARMS, EMERGENCY ALARMS, TELEPHONES AND KITCHEN APPLIANCES; INSTALLATION, REPAIR AND MAINTENANCE OF MACHINE EQUIPMENT; ELECTRIC APPLIANCE INSTALLATION AND REPAIR; ASPHALTING; PLUMBING SERVICES; INSTALLATION OF BUILDING INSULATION; BUILDING SEALING SERVICES DURING CONSTRUCTION; MASONRY; BRICK LAYING, NAMELY, BRICK WORK; PAINTING WORK; PLASTERING; ROAD PAVING; ERECTION OF SCAFFOLDING; DEMOLITION OF BUILDINGS; INFORMATION WITH RELATION TO REPAIR SERVICES OF BUILDINGS; INFORMATION WITH RELATION TO CONSTRUCTION SERVICES; RENTAL OF BULLDOZERS AND EXCAVATORS; RENTAL OF ROAD SWEEPING MACHINES; RENTAL OF STREET CLEANING MACHINES; RENTAL OF CRANES IN THE NATURE OF CONSTRUCTION MACHINERY; RENTAL OF CONSTRUCTION EQUIPMENT, IN CLASS 37 (U.S. CLS. 100, 103 AND 106).

FOR: TECHNICAL PROJECT AND TECHNICAL PLAN STUDIES, NAMELY CONDUCTING OF FEASIBILITY STUDIES FOR THE CONSTRUCTION

INDUSTRY; COMPUTER PROGRAMMING, ENGINEERING SERVICES; DRAFTING OF CONSTRUCTION PROJECTS; ARCHITECTURAL DESIGN; INDUSTRIAL DESIGN; INTERIOR DESIGN; CONSULTING IN ARCHITECTURE AND CONSTRUCTION, IN CLASS 42 (U.S. CLS. 100 AND 101).

OWNER OF INTERNATIONAL REGISTRATION 0936156 DATED 12-5-2006, EXPIRES 12-5-2016.

THE COLOR(S) WHITE AND BLUE IS/ARE CLAIMED AS A FEATURE OF THE MARK.

ALL ELEMENTS OF THE MARK ARE BLUE ON A WHITE BACKGROUND.

THE MARK CONSISTS OF A PICTURE OF A BUILDING ENCIRCLED BY AN ORBIT AND THE WORD MIRAX.

SER. NO. 79-043,296, FILED 12-5-2006.

KAELIE KUNG, EXAMINING ATTORNEY

Int. Cls.: 9, 35, 38 and 42

Prior U.S. Cls.: 21, 23, 26, 36, 38, 100, 101, 102 and 104

United States Patent and Trademark Office

Reg. No. 3,480,952

Registered Aug. 5, 2008

**TRADEMARK
SERVICE MARK
PRINCIPAL REGISTER**

ACTARIS EASY

ACTARIS S.A.S. (FRANCE SOCIÉTÉ PAR ACTIONS SIMPLIFIÉE)
62 BIS AVENUE ANDRÉ MORIZET
BOULOGNE-BILLANCOURT, FRANCE F92100

FOR: FLOW METERS AND FLUID METERS FOR GAS, WATER AND THERMAL ENERGY; FLUID OSCILLATORS, ELECTROMAGNETIC STATIC FLOW METERS, ELECTRONIC OR MECHANICAL ELECTRICITY METERS; SPARE PARTS RELATED TO SUCH FLOW METERS, PREPAYMENT APPARATUS FOR SUCH FLOW METERS AND METERS, NAMELY, TOKEN-OPERATED, COIN-OPERATED, CARD-OPERATED, SMART-CARD OPERATED AND KEYPAD OPERATED METERS FOR ELECTRICITY, GAS AND FLUID FLOW METERS AND SUPPLY, APPARATUS FOR THE MEMORIZATION OF DATA RELATED TO SUCH FLOW METERS, NAMELY, EVENT RECORDERS AND COMPUTERS, APPARATUS, NAMELY, RADIO TRANSMITTERS, CABLE TRANSMITTERS FOR THE ELECTRONIC TRANSMISSION OF DATA, SYSTEMS CONSISTING OF COMPUTERS AND COMPUTER SOFTWARE FOR USE IN DATA MANAGEMENT, RADIO TRANSMITTERS, CABLE TRANSMITTERS, COMPUTER NETWORK HUBS AND COMPUTER PRINTERS FOR REMOTELY READING AND/OR REMOTELY TRANSMITTING, AND/OR REMOTELY RETRIEVING AND REVIEWING DATA RELATED TO SUCH METERS; ELECTRONIC MODEMS, ELECTRONIC PAYMENT TERMINALS, TERMINALS FOR TRANSACTION MANAGEMENT, IN CLASS 9 (U.S. CLS. 21, 23, 26, 36 AND 38).

FOR: UTILITY METERS READING SERVICES, NAMELY, READING AND RECORDING IN A COMPUTER FILE OF DATA RELATING TO WA-

TER, GAS, THERMAL ENERGY AND/OR ELECTRICITY METERS; AUTOMATIC BILLING SERVICE, REMOTE UTILITY METER READING, IN CLASS 35 (U.S. CLS. 100, 101 AND 102).

FOR: ELECTRONIC REMOTE TRANSMISSION OF DATA RELATING TO WATER, GAS, THERMAL ENERGY AND/OR ELECTRICITY METERS; RADIO, TELEGRAPH OR TELEPHONE COMMUNICATION SERVICES; ELECTRONIC DATA TRANSMISSION OF MESSAGES AND INFORMATION VIA ELECTRONIC COMMUNICATIONS NETWORK; COMMUNICATIONS BETWEEN COMPUTER TERMINALS AND/OR BETWEEN A METER, A DETECTOR, A DATA READER AND A COMPUTER TERMINAL, IN CLASS 38 (U.S. CLS. 100, 101 AND 104).

FOR: COMPUTER PROGRAMMING; PROVIDING TECHNICAL INFORMATION AND ADVICE RELATING TO REMOTE METER READING AND AUTOMATIC BILLING, IN CLASS 42 (U.S. CLS. 100 AND 101).

PRIORITY DATE OF 1-8-2007 IS CLAIMED.

OWNER OF INTERNATIONAL REGISTRATION 0936189 DATED 7-6-2007, EXPIRES 7-6-2017.

OWNER OF U.S. REG. NO. 2,699,744.

SER. NO. 79-043,314, FILED 7-6-2007.

KATINA MISTER, EXAMINING ATTORNEY

Int. Cls.: 3 and 4

Prior U.S. Cls.: 1, 4, 6, 15, 50, 51 and 52

United States Patent and Trademark Office

Reg. No. 3,480,953

Registered Aug. 5, 2008

**TRADEMARK
PRINCIPAL REGISTER**

**OUTDOOR MEETINGS, WINTERTIME
L'HIVER AU GRAND AIR**

SHEERINO'KHO (FRANCE SOCIÉTÉ À RE-
SPONSABILITÉ LIMITÉE)
11 RUE BARBET DE JOUY
F-75007 PARIS
FRANCE

FOR: SOAPS; PERFUMES; ESSENTIAL OILS;
COSMETICS; HAIR LOTIONS; DENTIFRICES; DE-
PILATORIES; MAKE-UP REMOVING PREPARA-
TIONS; LIPSTICK; BEAUTY MASKS; SHAVING
PRODUCTS, NAMELY, SHAVING PREPARATIONS,
IN CLASS 3 (U.S. CLS. 1, 4, 6, 50, 51 AND 52).

FOR: CANDLES AND WICKS FOR CANDLES,
WICKS FOR OIL LAMPS, IN CLASS 4 (U.S. CLS. 1, 6
AND 15).

THE MARK CONSISTS OF STANDARD CHAR-
ACTERS WITHOUT CLAIM TO ANY PARTICULAR
FONT, STYLE, SIZE, OR COLOR.

OWNER OF INTERNATIONAL REGISTRATION
0936478 DATED 7-17-2007, EXPIRES 7-17-2017.

THE FOREIGN WORDING IN THE MARK
TRANSLATES INTO ENGLISH AS "WINTER IN
THE GREAT OUTDOORS."

SER. NO. 79-043,432, FILED 7-17-2007.

LAURA HAMMEL, EXAMINING ATTORNEY

Int. Cls.: 1, 7 and 17

**Prior U.S. Cls.: 1, 5, 6, 10, 12, 13, 19, 21, 23, 26, 31, 34,
35, 46 and 50**

Reg. No. 3,480,954

United States Patent and Trademark Office

Registered Aug. 5, 2008

**TRADEMARK
PRINCIPAL REGISTER**



ALC FLENCO GROUP S.R.L. (ITALY LTD LIAB
CO)
CORSO TORINO, 2
I-10051 AVIGLIANA (TORINO)
ITALY

FOR: ADHESIVE MATERIALS FOR USE IN THE
FOOTWEAR AND LEATHER GOODS INDUSTRIES,
IN CLASS 1 (U.S. CLS. 1, 5, 6, 10, 26 AND 46).

FOR: MACHINE TOOLS FOR COUPLING ADHE-
SIVE TAPE FOR USE BY THE FOOTWEAR AND
LEATHER GOODS INDUSTRIES, IN CLASS 7 (U.S.
CLS. 13, 19, 21, 23, 31, 34 AND 35).

FOR: TWO-LAYER AND MULTILAYER ADHE-
SIVE TAPES FOR INDUSTRIAL AND COMMER-
CIAL USE, IN CLASS 17 (U.S. CLS. 1, 5, 12, 13, 35 AND
50).

PRIORITY DATE OF 3-26-2007 IS CLAIMED.

OWNER OF INTERNATIONAL REGISTRATION
0936504 DATED 7-13-2007, EXPIRES 7-13-2017.

SER. NO. 79-043,441, FILED 7-13-2007.

JENNY PARK, EXAMINING ATTORNEY

Int. Cls.: 12, 25 and 28

Prior U.S. Cls.: 19, 21, 22, 23, 31, 35, 38, 39, 44 and 50

United States Patent and Trademark Office

Reg. No. 3,480,955

Registered Aug. 5, 2008

**TRADEMARK
PRINCIPAL REGISTER**

pogo

SAMMELT, MARTIN (FED REP GERMANY INDIVIDUAL)

LINDENSTR. 13

74245 LOEWENSTEIN

FED REP GERMANY AND

MÄRZ, JOACHIM (FED REP GERMANY INDIVIDUAL)

LINDENSTR. 13

74245 LOEWENSTEIN

FED REP GERMANY

FOR: LAND VEHICLES WITHOUT ENGINES, EXCLUDING TRAILERS; BOATS, YACHTS, IN CLASS 12 (U.S. CLS. 19, 21, 23, 31, 35 AND 44).

FOR: MITTENS; NON-SLIPPING DEVICES FOR BOOTS AND SHOES IN THE NATURE OF INSERTS FOR PRIMARILY NON-ORTHOPEDIC PURPOSES; BELTS FOR CLOTHING; HALF-BOOTS; GLOVES, EAR MUFFS, AND HEADBANDS; TROUSERS; SUSPENDERS; HEADGEAR FOR WEAR, NAMELY, HATS, CAPS AND VISORS; CLOTHING OF LEATHER, NAMELY, LEATHER SHIRTS, PANTS, SHORTS, SKIRTS, DRESSES AND JACKETS; SWEAT-ABSORBENT UNDERWEAR; COATS; HEADWEAR, NAMELY, CAPS; PULLOVERS; SANDALS; LACE BOOTS; SKI BOOTS; SURF SKI BOOTS;

BOOTS FOR SPORTS; T-SHIRTS, IN CLASS 25 (U.S. CLS. 22 AND 39).

FOR: SKATEBOARDS; SOLE COVERINGS FOR SKIS; SKI BINDINGS; SKIS; EDGES OF SKIS; SCRAPERS FOR SKIS; WAX FOR SKIS; WATER SKIS; WATER SKI BINDINGS; BAGS ESPECIALLY DESIGNED FOR SKIS AND SURFBOARDS; SAILBOARDS; SURFBOARDS; HARNESS FOR SAILBOARDS, IN CLASS 28 (U.S. CLS. 22, 23, 38 AND 50).

THE MARK CONSISTS OF STANDARD CHARACTERS WITHOUT CLAIM TO ANY PARTICULAR FONT, STYLE, SIZE, OR COLOR.

PRIORITY DATE OF 2-1-2007 IS CLAIMED.

OWNER OF INTERNATIONAL REGISTRATION 0936559 DATED 7-20-2007, EXPIRES 7-20-2017.

SER. NO. 79-043,462, FILED 7-20-2007.

COLLEEN KEARNEY, EXAMINING ATTORNEY

Int. Cl.: 36

Prior U.S. Cls.: 100, 101 and 102

United States Patent and Trademark Office

Reg. No. 3,480,956

Registered Aug. 5, 2008

SERVICE MARK
PRINCIPAL REGISTER



THE OXFORD ASSET; MANAGEMENT COMPANY LIMITED (UNITED KINGDOM COMPANY)
BROAD STREET
OXFORD, OXFORDSHIRE OX1 3BP
UNITED KINGDOM

FOR: FINANCIAL SERVICES, NAMELY, FINANCIAL PLANNING, FINANCIAL ANALYSIS AND CONSULTATION, MONETARY CONSULTATION, MONETARY EXCHANGE, MONEY LENDING, CASH MANAGEMENT, ASSET MANAGEMENT, INVESTMENT MANAGEMENT, ESTATE TRUST MANAGEMENT, INVESTMENT ADVICE, FINANCIAL RISK MANAGEMENT; FUND MANAGEMENT, NAMELY, MANAGEMENT OF COLLECTIVE INVESTMENT SCHEMES, OFF-SHORE FUNDS, DOMESTIC FUNDS, HEDGE FUNDS, PRIVATE EQUITY FUNDS, LONG-ONLY FUNDS, ARBITRAGE FUNDS, CONVERTIBLE FUNDS, DISTRESSED DEBT FUNDS, MARKET NEUTRAL FUNDS, MUTUAL FUNDS, AND REAL-ESTATE FUNDS; FINANCIAL PORTFOLIO MANAGEMENT; STOCK AND SECURITY MANAGEMENT, NAMELY, THE MANAGEMENT AND BROKERAGE OF SECURITIES AND STOCKS, THE SALE AND PURCHASE OF SECURITIES AND STOCKS, BORROWING AND LENDING OF STOCKS; SECURITIES MANAGEMENT, NAMELY, MANAGEMENT OF UNIT TRUSTS; TRADING IN INVESTMENTS, UNIT TRUST SECURITIES, WARRANTS, OPTIONS, FUTURES AND OTHER DERIVATIVES AND OVER-THE-COUNTER DERIVATIVES; INVESTMENT SERVICES, NAMELY, MANAGEMENT OF COLLECTIVE INVESTMENT SCHEMES, OFF-SHORE FUND, DOMESTIC FUND, HEDGE FUND, PRIVATE EQUITY FUND, LONG-ONLY FUND, ARBITRAGE FUND, CONVERTIBLE FUND, DISTRESSED DEBT FUND, MARKET NEUTRAL FUND, REAL-ESTATE FUND, AND MUTUAL FUND INVESTMENT SERVICES;

FINANCIAL MANAGEMENT; BROKERAGE SERVICES, NAMELY, SECURITIES AND STOCKS BROKERAGE; ASSET AND INVESTMENT MANAGEMENT; FINANCIAL APPRAISAL, EVALUATION AND ANALYSIS, NAMELY, CONSULTATION RELATING TO THE APPRAISAL OF INVESTMENTS; PROVISION OF FINANCIAL INFORMATION, FINANCIAL RESEARCH, INVESTMENT RESEARCH; FINANCING, SAVINGS AND LOAN SERVICES, NAMELY, CORPORATE FINANCING, PROVIDING TEMPORARY LOANS AND CREDIT AGENCY SERVICES; BANKING SERVICES, NAMELY, INVESTMENT BANKING AND MERCHANT BANKING; FINANCIAL CLEARING HOUSE SERVICES; ADVISORY, CONSULTANCY AND INFORMATION SERVICES RELATING TO ALL OF THE FOREGOING FINANCIAL SERVICES; NONE OF THESE SERVICES BEING RENDERED IN RELATION TO THE CONSTRUCTION, BUILDING AND PUBLIC WORKS SECTOR, AND IN PARTICULAR TO THE RENTING OF EQUIPMENT IN SUCH SECTOR, IN CLASS 36 (U.S. CLS. 100, 101 AND 102).

OWNER OF INTERNATIONAL REGISTRATION
0936630 DATED 3-23-2007, EXPIRES 3-23-2017.

"THE COLOR(S) BLACK AND BLUE IS/ARE CLAIMED AS A FEATURE OF THE MARK."

"THE MARK CONSISTS OF THE WORD OXAM" WITH THE COLOR BLUE USED ON THE "X" PORTION OF THE MARK AND THE COLOR BLACK USED ON THE REMAINING LETTERS."

SER. NO. 79-043,502, FILED 3-23-2007.

CURTIS FRENCH, EXAMINING ATTORNEY

Int. Cls.: 12, 35 and 37

**Prior U.S. Cls.: 19, 21, 23, 31, 35, 44, 100, 101, 102,
103 and 106**

Reg. No. 3,480,957

United States Patent and Trademark Office

Registered Aug. 5, 2008

**TRADEMARK
SERVICE MARK
PRINCIPAL REGISTER**

VOLKSWAGEN. DAS AUTO.

VOLKSWAGEN AKTIENGESELLSCHAFT (FED
REP GERMANY JOINT STOCK COMPANY)
38436 WOLFSBURG, FED REP GERMANY

FOR: VEHICLES FOR LOCOMOTION BY LAND, AIR, OR WATER, NAMELY, AUTOMOBILES, TRUCKS, VANS, SPORT UTILITY VEHICLES, LORRIES, NAMELY, LIGHT LORRIES AND LORRIES FOR MINES, TRAILERS, BUSES, TRAINS, LOCOMOTIVES, BICYCLES, TRICYCLES, SNOWMOBILES, AIRPLANES, BOATS AND SHIPS, VEHICULAR HOT AIR BALLOONS AND DIRIGIBLE BALLOONS, CAMPING TRAILERS, FOLDING AND HARD SIDE TRUCK CAMPING TRAILERS, MOTOR HOMES, CONVERSION VANS, TRAVEL TRAILERS, CAMPER COACHES, AND STRUCTURAL PARTS THEREOF; MOTORIZED LAND VEHICLES IN THE NATURE OF AUTOMOBILES, TRUCKS, VANS, SPORT UTILITY VEHICLES, LORRIES, NAMELY, LIGHT LORRIES AND LORRIES FOR MINES, BUSES, TRAINS, LOCOMOTIVES, SNOWMOBILES, MOTOR HOMES, CONVERSION VANS, CAMPER COACHES, AND STRUCTURAL PARTS THEREOF, TRAILERS FOR VEHICLES AND STRUCTURAL PARTS THEREOF, ENGINES FOR LAND VEHICLES, TIRES FOR LAND VEHICLE WHEELS, RIMS FOR VEHICLE WHEELS, COMPLETE LAND VEHICLE WHEELS AND THEIR STRUCTURAL PARTS, MOTORIZED VEHICLES FOR CHILDREN IN THE NATURE OF GO-CARTS, MOTORIZED SCOOTERS FOR CHILDREN, AND MOTORIZED VEHICLES BEING AUTOMOBILES FOR CHILDREN, IN CLASS 12 (U.S. CLS. 19, 21, 23, 31, 35 AND 44).

FOR: RETAIL AND WHOLESALE STORE SERVICES FEATURING MOTOR VEHICLES AND THEIR PARTS AND FITTINGS, MAIL ORDER RETAIL AND WHOLESALE SERVICES FEATURING MOTOR VEHICLES AND THEIR PARTS AND FITTINGS, ONLINE RETAIL AND WHOLESALE STORE SERVICES FEATURING MOTOR VEHICLES AND THEIR PARTS AND FITTINGS, RETAIL AND WHOLESALE STORE SERVICES VIA TEleshopping FEATURING MOTOR VEHICLES AND THEIR PARTS AND FITTINGS; BRINGING TOGE-

TER, FOR THE BENEFIT OF OTHERS, OF A VARIETY OF MOTOR VEHICLES AND THEIR PARTS AND FITTINGS, ENABLING CUSTOMERS TO VIEW AND PURCHASE THEM; NEGOTIATION OF CONTRACTS FOR THIRD PARTIES REGARDING COMMERCIAL TRANSACTIONS, NAMELY, THE SALE AND PURCHASE OF MOTOR VEHICLES AND THEIR PARTS AND FITTINGS; PRESENTATION OF GOODS IN COMMUNICATIONS MEDIA FOR RETAIL PURPOSES; CONSUMER ADVICE, NAMELY, PROVISION OF CONSUMER INFORMATION AND CONSULTATION ABOUT TRADE AND BUSINESS ACTIVITIES; OFFICE ADMINISTRATION SERVICES, NAMELY, ADMINISTRATIVE HANDLING OF ORDERS; NEGOTIATION OF CONTRACTS FOR THIRD PARTIES REGARDING COMMERCIAL TRANSACTIONS, NAMELY, ABOUT SALE AND PURCHASE OF GOODS; PROVISION OF BUSINESS INFORMATION AND CONSULTANCY FOR CUSTOMERS IN THE RETAIL AND BUSINESS TRADE; ADVERTISING; BUSINESS MANAGEMENT; BUSINESS ADMINISTRATION AND OFFICE WORK, INCLUDING PERSONNEL RECRUITMENT, PERSONNEL MANAGEMENT CONSULTANCY, BUSINESS MANAGEMENT CONSULTANCY, PUBLIC RELATIONS, RADIO AND TELEVISION ADVERTISING, ORGANIZATION OF TRADE FAIRS FOR COMMERCIAL OR ADVERTISING PURPOSES, IN CLASS 35 (U.S. CLS. 100, 101 AND 102).

FOR: RECONSTRUCTION IN THE NATURE OF CUSTOM REBUILDING, REPAIR, SERVICING, DISMANTLING, CLEANING, MAINTENANCE AND VARNISHING OF VEHICLES AND THEIR STRUCTURAL PARTS AND OF MOTORS AND THEIR STRUCTURAL PARTS, INCLUDING VEHICLE REPAIR IN THE COURSE OF VEHICLE BREAKDOWN SERVICE; AUTOMOBILE MAINTENANCE AND REPAIR SERVICES, NAMELY, REFINEMENT AND TUNING OF AUTOMOBILES, IN CLASS 37 (U.S. CLS. 100, 103 AND 106).

THE MARK CONSISTS OF STANDARD CHARACTERS WITHOUT CLAIM TO ANY PARTICULAR FONT, STYLE, SIZE, OR COLOR.

OWNER OF INTERNATIONAL REGISTRATION 0936903 DATED 7-26-2007, EXPIRES 7-26-2017.

OWNER OF U.S. REG. NOS. 617,131, 3,117,285 AND OTHERS.

NO CLAIM IS MADE TO THE EXCLUSIVE RIGHT TO USE "AUTO", APART FROM THE MARK AS SHOWN.

THE ENGLISH TRANSLATION OF "VOLKSWAGEN. DAS AUTO." IS "PEOPLE'S CAR. THE CAR."

SER. NO. 79-043,628, FILED 7-26-2007.

LYDIA BELZER, EXAMINING ATTORNEY

Int. Cl.: 9

Prior U.S. Cls.: 21, 23, 26, 36 and 38

Reg. No. 3,480,958

United States Patent and Trademark Office

Registered Aug. 5, 2008

**TRADEMARK
PRINCIPAL REGISTER**

KROMID

KROMBERG & SCHUBERT GMBH & CO. KG
(FED REP GERMANY GMBH & CO. KG)
SPITZENSTR. 37
42389 WUPPERTAL
FED REP GERMANY

FOR: ELECTRICAL ONBOARD SYSTEMS FOR
MOTOR VEHICLES AND THEIR COMPONENTS,
NAMELY, CABLES AND INSULATED WIRES, IN-
TEGRATED WIRES AND WIRING HARNESSSES,
AND ELECTRICAL AND ELECTRONIC MODULES
FOR HOUSING ELECTRICAL WIRING, POWER
SUPPLIES, INTEGRATED CIRCUITS, IN CLASS 9
(U.S. CLS. 21, 23, 26, 36 AND 38).

THE MARK CONSISTS OF STANDARD CHAR-
ACTERS WITHOUT CLAIM TO ANY PARTICULAR
FONT, STYLE, SIZE, OR COLOR.

PRIORITY DATE OF 3-15-2007 IS CLAIMED.

OWNER OF INTERNATIONAL REGISTRATION
0937018 DATED 8-6-2007, EXPIRES 8-6-2017.

SER. NO. 79-043,673, FILED 8-6-2007.

REBECCA POVARCHUK, EXAMINING ATTOR-
NEY

Int. Cls.: 16 and 41

Prior U.S. Cls.: 2, 5, 22, 23, 29, 37, 38, 50, 100, 101 and 107

Reg. No. 3,480,959

United States Patent and Trademark Office

Registered Aug. 5, 2008

**TRADEMARK
SERVICE MARK
PRINCIPAL REGISTER**

Stories of Us

READYMADE PRODUCTIONS PTY LTD (AUSTRALIA CORPORATION)
311 GLEN OSMOND ROAD, SUITE 10
GLENUNGA, SA 5064
AUSTRALIA

FOR: PRINTED MATTER IN THE NATURE OF TEACHING MATERIALS, GUIDES, BROCHURES, NEWSLETTERS AND INFORMATIONAL CARDS IN THE FIELD OF EDUCATION, FILM AND VIDEO PRODUCTION; PHOTOGRAPHS, INSTRUCTIONAL AND TEACHING MATERIALS IN THE FIELD OF SOCIAL AND EMOTIONAL DEVELOPMENT, PEER RELATIONSHIPS, STUDENT MANAGEMENT, STUDENT MANAGEMENT, FILM AND VIDEO PRODUCTION, IN CLASS 16 (U.S. CLS. 2, 5, 22, 23, 29, 37, 38 AND 50).

FOR: EDUCATIONAL SERVICES, NAMELY, PROVIDING TRAINING COURSES IN THE FIELD OF STUDENT MANAGEMENT, SOCIAL AND EMO-

TIONAL DEVELOPMENT, PEER RELATIONSHIPS, FILM AND VIDEO PRODUCTION; ENTERTAINMENT SERVICES, NAMELY, PRODUCTION OF FILM AND VIDEO, IN CLASS 41 (U.S. CLS. 100, 101 AND 107).

THE MARK CONSISTS OF STANDARD CHARACTERS WITHOUT CLAIM TO ANY PARTICULAR FONT, STYLE, SIZE, OR COLOR.

PRIORITY DATE OF 12-22-2006 IS CLAIMED.

OWNER OF INTERNATIONAL REGISTRATION 0937053 DATED 6-20-2007, EXPIRES 6-20-2017.

SER. NO. 79-043,694, FILED 6-20-2007.

MICHAEL LEWIS, EXAMINING ATTORNEY

Int. Cls.: 9 and 37

Prior U.S. Cls.: 21, 23, 26, 36, 38, 100, 103 and 106

Reg. No. 3,480,960

United States Patent and Trademark Office

Registered Aug. 5, 2008

TRADEMARK
SERVICE MARK
PRINCIPAL REGISTER

BATHIUM

BOLLORE (FRANCE SOCIÉTÉ ANONYME)
ODET
F-29500 ERGUE GABERIC
FRANCE

FOR: POWER CELLS; ELECTRIC CELLS; CAPACITORS; SUPER CAPACITORS; ELECTRIC COUPLINGS; ELECTRIC BATTERIES; CHARGERS FOR ELECTRIC BATTERIES; AMPEREMETERS; ELECTRIC COILS; ELECTRIC BRANCH BOXES, ELECTRIC DISTRIBUTION BOXES; JUNCTION BOXES; ELECTRIC CABLES; ELECTRIC CONTROL PANELS; ELECTRIC APPARATUS FOR COMMUTATION, NAMELY, ELECTRIC COMMUTATORS; METERING APPARATUS, NAMELY, ELECTRIC METERS; ELECTRIC CONDUCTORS; CIRCUIT BREAKERS; ELECTRIC WIRES; ELECTRIC INDICATORS IN THE NATURE OF ELECTRIC INDICATOR PANELS FOR ELECTRIC VEHICLES; ELECTRIC SWITCHES; OHMMETERS; ELECTRIC BATTERIES; ELECTRICAL CONNECTORS; VOLTMETERS, IN CLASS 9 (U.S. CLS. 21, 23, 26, 36 AND 38).

FOR: REPAIR AND MAINTENANCE OF APPARATUS FOR LOCOMOTION BY AIR; REPAIR AND MAINTENANCE OF ELECTRICALLY-DRIVEN VEHICLES, ELECTRICALLY-DRIVEN LAND VEHICLES, ELECTRICALLY-DRIVEN SCOOTERS,

ELECTRICALLY-DRIVEN CONSTRUCTION MACHINERY, ELECTRICALLY-DRIVEN CLEANING VEHICLES AND ELECTRICALLY-DRIVEN SHIPS; INSTALLATION, REPAIR, SERVICING AND MAINTENANCE OF ELECTRIC APPARATUS AND INSTRUMENTS FOR CONDUCTING, SWITCHING, TRANSFORMING, ACCUMULATING, REGULATING AND CONTROLLING ELECTRICITY, NAMELY, BATTERIES, CAPACITORS, AND SUPER CAPACITORS, IN CLASS 37 (U.S. CLS. 100, 103 AND 106).

THE MARK CONSISTS OF STANDARD CHARACTERS WITHOUT CLAIM TO ANY PARTICULAR FONT, STYLE, SIZE, OR COLOR.

PRIORITY DATE OF 1-31-2007 IS CLAIMED.

OWNER OF INTERNATIONAL REGISTRATION
0937123 DATED 7-13-2007, EXPIRES 7-13-2017.

THE WORDING "BATHIUM" HAS NO MEANING IN A FOREIGN LANGUAGE.

SER. NO. 79-043,715, FILED 7-13-2007.

LINDA LAVACHE, EXAMINING ATTORNEY

Int. Cls.: 6 and 20

Prior U.S. Cls.: 2, 12, 13, 14, 22, 23, 25, 32 and 50

United States Patent and Trademark Office

Reg. No. 3,480,961

Registered Aug. 5, 2008

**TRADEMARK
PRINCIPAL REGISTER**

Polar

WOLFGANG BLINDOW (FED REP GERMANY
INDIVIDUAL)
AN DER STRUSBK 50
22926 AHRENSBURG
FED REP GERMANY

FOR: NAMEPLATES OF METAL, NAMELY,
CLIP-ON SIGNS FOR ATTACHING TO CLOTHING,
IN CLASS 6 (U.S. CLS. 2, 12, 13, 14, 23, 25 AND 50).

FOR: NON-METAL NAMEPLATES, NAMELY,
CLIP-ON SIGNS FOR ATTACHING TO CLOTHING,
IN CLASS 20 (U.S. CLS. 2, 13, 22, 25, 32 AND 50).

THE MARK CONSISTS OF STANDARD CHAR-
ACTERS WITHOUT CLAIM TO ANY PARTICULAR
FONT, STYLE, SIZE, OR COLOR.

OWNER OF INTERNATIONAL REGISTRATION
0937381 DATED 8-16-2007, EXPIRES 8-16-2017.

SER. NO. 79-043,819, FILED 8-16-2007.

ELI HELLMAN, EXAMINING ATTORNEY

Int. Cls.: 9, 10 and 16

**Prior U.S. Cls.: 2, 5, 21, 22, 23, 26, 29, 36, 37, 38, 39, 44
and 50**

Reg. No. 3,480,962

United States Patent and Trademark Office

Registered Aug. 5, 2008

**TRADEMARK
PRINCIPAL REGISTER**

**ДиаДЭНС
DиаDЭНС
DiaDENS**

OBSHCHESTVO S OGRANNICHENNOY; OT-
VETSTVENNOSTYU "INTERRA" (RUSSIAN
FED. LTD LIAB CO)
48-146, PR.LENINA
RU-620075 EKATERINBURG
RUSSIAN FED.

FOR: COMPUTER PROGRAMS FOR CONTROL-
LING ELECTRONIC STIMULATORS FOR MEDI-
CAL TREATMENT AND DIAGNOSING DISEASE,
IN CLASS 9 (U.S. CLS. 21, 23, 26, 36 AND 38).

FOR: MEDICAL AND VETERINARY APPARA-
TUS AND INSTRUMENTS FOR USE IN PHYSIO-
THERAPY, NAMELY, LOW FREQUENCY
ELECTRONIC STIMULATORS FOR SKIN, MUS-
CLES AND NERVES AND ELECTRODES FOR
THERAPEUTIC APPARATUS FOR MEDICAL USE,
IN CLASS 10 (U.S. CLS. 26, 39 AND 44).

FOR: PRINTED MATTER, INSTRUCTIONAL,
AND TEACHING MATERIAL, NAMELY, BOOKS,
BROCHURES, MAGAZINES, BOOKLETS, CATALO-
GUES, PROSPECTUSES AND INSTRUCTIONAL

AND TEACHING MATERIAL ALL IN THE FIELDS
OF MEDICINE, REFLEXOTHERAPY, COSMETOL-
OGY, SPORTS AND CARE FOR ANIMALS AND
PLANTS; CALENDARS; STICKERS; PLASTIC AND
PAPER BAGS FOR MERCHANDISE PACKAGING,
IN CLASS 16 (U.S. CLS. 2, 5, 22, 23, 29, 37, 38 AND 50).

OWNER OF INTERNATIONAL REGISTRATION
0937386 DATED 7-25-2007, EXPIRES 7-25-2017.

THE WORDING "DIADENS" HAS NO MEANING
IN A FOREIGN LANGUAGE.

THE NON-LATIN CHARACTER(S) IN THE
MARK TRANSLITERATES INTO DIADENS, DIA-
DENS, AND THIS MEANS NOTHING AND HAS NO
SIGNIFICANCE IN ENGLISH.

SER. NO. 79-043,823, FILED 7-25-2007.

BILL DAWE, EXAMINING ATTORNEY

Int. Cls.: 9, 10 and 16

Prior U.S. Cls.: 2, 5, 21, 22, 23, 26, 29, 36, 37, 38, 39, 44
and 50

Reg. No. 3,480,963

United States Patent and Trademark Office

Registered Aug. 5, 2008

TRADEMARK
PRINCIPAL REGISTER

DENAS

OBSHCHESTVO S OGRANNICHENNOY; OT-
VETSTVENNOSTYU "INTERRA" (RUSSIAN
FED. LTD LIAB CO)
48-146, PR.LENINA
RU-620075 EKATERINBURG
RUSSIAN FED.

FOR: COMPUTER PROGRAMS FOR CONTROL-
LING ELECTRONIC STIMULATORS FOR MEDI-
CAL TREATMENT AND DIAGNOSING DISEASE,
IN CLASS 9 (U.S. CLS. 21, 23, 26, 36 AND 38).

FOR: MEDICAL AND VETERINARY APPARA-
TUS AND INSTRUMENTS FOR USE IN PHYSIO-
THERAPY, NAMELY, LOW FREQUENCY
ELECTRONIC STIMULATORS FOR SKIN, MUS-
CLES AND NERVES AND ELECTRODES FOR
THERAPEUTIC APPARATUS FOR MEDICAL USE,
IN CLASS 10 (U.S. CLS. 26, 39 AND 44).

FOR: PRINTED MATTER, INSTRUCTIONAL,
AND TEACHING MATERIAL, NAMELY, BOOKS,
BROCHURES, MAGAZINES, BOOKLETS, CATALO-

GUES, PROSPECTUSES AND INSTRUCTIONAL
AND TEACHING MATERIAL ALL IN THE FIELDS
OF MEDICINE, REFLEXOTHERAPY, COSMETOL-
OGY, SPORTS AND CARE FOR ANIMALS AND
PLANTS; CALENDARS; STICKERS; PLASTIC AND
PAPER BAGS FOR MERCHANDISE PACKAGING,
IN CLASS 16 (U.S. CLS. 2, 5, 22, 23, 29, 37, 38 AND 50).

THE MARK CONSISTS OF STANDARD CHAR-
ACTERS WITHOUT CLAIM TO ANY PARTICULAR
FONT, STYLE, SIZE, OR COLOR.

OWNER OF INTERNATIONAL REGISTRATION
0937387 DATED 7-25-2007, EXPIRES 7-25-2017.

THE WORDING "DENAS" HAS NO MEANING IN
A FOREIGN LANGUAGE.

SER. NO. 79-043,824, FILED 7-25-2007.

BILL DAWE, EXAMINING ATTORNEY

Int. Cl.: 28

Prior U.S. Cls.: 22, 23, 38 and 50

United States Patent and Trademark Office

Reg. No. 3,480,964

Registered Aug. 5, 2008

**TRADEMARK
PRINCIPAL REGISTER**



BEIJING HUAYU WANJU YOUXIANGONGSI
(CHINA CORPORATION)
QIAN GAOMIDIANDONG
DAXINGQU; 102600 BEIJINGSHI
CHINA

FOR: TOYS, NAMELY, BATH TOYS, INFLATABLE TOYS, MECHANICAL TOYS, SAND TOYS, TOY FIGURES, TOY MODEL VEHICLES, REMOTE CONTROL TOYS, NAMELY, BOATS AND CARS, ROCKING HORSES; DOLLS; TEDDY BEARS; PLUSH TOYS; JIGSAW PUZZLES; PARLOR GAMES; TOY MOBILES; TOYS FOR PETS; ELECTRIC TOYS; INTELLIGENT TOYS, NAMELY, ELECTRONIC TOY PETS, COMPUTER PROGRAMMED TOY ROBOTS, COMPUTER PROGRAMMED REMOTE CONTROLLED TOY CARS, IN CLASS 28 (U.S. CLS. 22, 23, 38 AND 50).

OWNER OF INTERNATIONAL REGISTRATION
0937394 DATED 8-21-2007, EXPIRES 8-21-2017.

NO CLAIM IS MADE TO THE EXCLUSIVE RIGHT TO USE "TOY", APART FROM THE MARK AS SHOWN.

THE COLOR(S) BLUE, PURPLE, GREEN AND RED IS/ARE CLAIMED AS A FEATURE OF THE MARK.

THE MARK CONSISTS OF ENGLISH WORD "GEETOY". FROM LEFT TO RIGHT, THE LETTER "G" IS IN BLUE, THE FIRST LETTER "E" IS IN PURPLE, THE SECOND LETTER "E" IS IN RED. THE LETTER "T" IS IN GREEN, THE LETTER "O" IS IN PURPLE, THE LETTER "Y" IS IN RED.

SER. NO. 79-043,827, FILED 8-21-2007.

FLORENTINA BLANDU, EXAMINING ATTORNEY

Int. Cls.: 9, 12 and 28

Prior U.S. Cls.: 19, 21, 22, 23, 26, 31, 35, 36, 38, 44 and 50

Reg. No. 3,480,965

United States Patent and Trademark Office

Registered Aug. 5, 2008

**TRADEMARK
PRINCIPAL REGISTER**

WICLER

HOME MULTIENERGY, S.L. (SPAIN LIMITED COMPANY)
C/ CAPITÁN HAYA, 1
E-28020 MADRID
SPAIN

FOR: PORTABLE AND HANDHELD DIGITAL AND ANALOGICAL ELECTRONIC DEVICES IN THE NATURE OF MP3 PLAYERS WITH CAPABILITY OF DOWNLOADING, RECEIVING, MANIPULATING, REVIEWING, PROCESSING, REPRODUCING, PLAYING AND TRANSMITTING SOUND, IMAGES, VIDEO, MULTIMEDIA OR DATA; AUDIO FREQUENCY TRANSMISSION APPARATUS, NAMELY, INTERCOMS; RADIO COMMUNICATION APPARATUS, NAMELY, PORTABLE RADIO COMMUNICATION APPARATUS AND INTERCOMS; WALKIE-TALKIES; MICROPHONES, AUDIO SPEAKERS, COMMUNICATIONS HEADSETS FOR USE WITH COMMUNICATION RADIOS, INTERCOM SYSTEMS, OR OTHER COMMUNICATIONS NETWORK TRANSCEIVERS, BATTERIES, BATTERY CHARGERS, POWER SUPPLIES; HOUSINGS AND CASINGS OR COVERS AND HAND FREE HOLDERS FOR PORTABLE AND HANDHELD DIGITAL AND ANALOGICAL ELECTRONIC MP3 PLAYERS WITH CAPABILITY OF DOWNLOADING, RECEIVING, MANIPULATING, REVIEWING, PROCESSING, PLAYING AND TRANSMITTING SOUND, IMAGES AND DATA, FOR AUDIO FREQUENCY TRANSMISSION APPARATUS, NAMELY, INTERCOMS AND FOR RADIO COMMUNICATION APPARATUS, NAMELY, PORTABLE RADIO COMMUNICATION APPARATUS AND INTERCOMS; DIGITAL CAMERAS, MOTION PICTURE CAMERAS, VIDEO CAMERAS; ENCODED ELECTRONIC DATA CHIP CARDS CONTAINING ELECTRONIC GAME SOFTWARE; VIDEO GAME

CONSOLES FOR USE WITH AN EXTERNAL DOT MATRIX LIQUID DISPLAY SCREEN OR MONITOR, IN CLASS 9 (U.S. CLS. 21, 23, 26, 36 AND 38).

FOR: FIXING BRACKETS FOR BICYCLE PARTS, NAMELY, FIXTURES FOR SECURING PORTABLE AND HANDHELD DIGITAL AND ANALOGICAL ELECTRONIC DEVICES TO BICYCLES, IN CLASS 12 (U.S. CLS. 19, 21, 23, 31, 35 AND 44).

FOR: HAND HELD UNITS FOR PLAYING ELECTRONIC GAMES; HAND-HELD GAMES WITH LIQUID CRYSTAL DISPLAYS; POCKET-SIZED HAND HELD ELECTRONIC GAME UNITS; VIDEO GAME AMUSEMENT APPARATUS NOT ADAPTED FOR USE WITH TELEVISION RECEIVERS, IN THE NATURE OF STAND-ALONE VIDEO GAME MACHINES; TOY WALKIE-TALKIES; ELECTRONIC TOY COMMUNICATORS WHICH FEATURE MUSIC AND SOUNDS; PLUSH TOYS CONTAINING ELECTRONIC COMPONENTS WHICH FEATURE MUSIC AND SOUNDS, IN CLASS 28 (U.S. CLS. 22, 23, 38 AND 50).

PRIORITY DATE OF 11-16-2006 IS CLAIMED.

OWNER OF INTERNATIONAL REGISTRATION 0937550 DATED 4-26-2007, EXPIRES 4-26-2017.

THE WORDING "WICLER" HAS NO MEANING IN A FOREIGN LANGUAGE.

SER. NO. 79-043,870, FILED 4-26-2007.

VERNA BETH RIRIE, EXAMINING ATTORNEY

Int. Cl.: 17

Prior U.S. Cls.: 1, 5, 12, 13, 35 and 50

United States Patent and Trademark Office

Reg. No. 3,480,966

Registered Aug. 5, 2008

**TRADEMARK
PRINCIPAL REGISTER**

S O F T S H I N E

TOYO BOSEKI KABUSHIKI KAISHA (JAPAN
CORPORATION)
2-8, DOJIMA HAMA 2-CHOME
KITA-KU; OSAKA-SHI, OSAKA 530-8230
JAPAN

OWNER OF INTERNATIONAL REGISTRATION
0937812 DATED 9-4-2007, EXPIRES 9-4-2017.

FOR: PRE-TREATED POLYESTER FILM FOR
GENERAL USE IN INDUSTRY, IN CLASS 17 (U.S.
CLS. 1, 5, 12, 13, 35 AND 50).

SER. NO. 79-043,935, FILED 9-4-2007.

PRIORITY DATE OF 4-10-2007 IS CLAIMED.

GINA HAYES, EXAMINING ATTORNEY

Int. Cl.: 17

Prior U.S. Cls.: 1, 5, 12, 13, 35 and 50

United States Patent and Trademark Office

Reg. No. 3,480,967

Registered Aug. 5, 2008

**TRADEMARK
PRINCIPAL REGISTER**

C O S M O S H I N E

TOYO BOSEKI KABUSHIKI KAISHA (JAPAN
CORPORATION)
2-8, DOJIMA HAMA 2-CHOME
KITA-KU; OSAKA-SHI, OSAKA 530-8230
JAPAN

OWNER OF INTERNATIONAL REGISTRATION
0937813 DATED 9-4-2007, EXPIRES 9-4-2017.

SER. NO. 79-043,936, FILED 9-4-2007.

FOR: PRE-TREATED POLYESTER FILM FOR
GENERAL USE IN INDUSTRY, IN CLASS 17 (U.S.
CLS. 1, 5, 12, 13, 35 AND 50).

GINA HAYES, EXAMINING ATTORNEY

Int. Cls.: 9, 11 and 21

Prior U.S. Cls.: 2, 13, 21, 23, 26, 29, 30, 31, 33, 34, 36, 38, 40 and 50

Reg. No. 3,480,968

United States Patent and Trademark Office

Registered Aug. 5, 2008

**TRADEMARK
PRINCIPAL REGISTER**



PLANTCARE AG (SWITZERLAND AKTIENGESELLSCHAFT)
SENNHOF 460
CH-8332 RUSSIKON
SWITZERLAND

FOR: ELECTRICAL AND ELECTRONIC CONTROLS FOR IRRIGATION SYSTEMS, NAMELY, MEASURING APPARATUS AND ELECTRICAL AND ELECTRONIC INDICATORS TO BE USED IN EQUIPMENT FOR IRRIGATION OF INTERIOR OR GARDEN FLOWERS AND PLANTS, AND OF FLOWERPOTS AND PLANTPOTS AND WINDOW-BOXES AND PLANTERS, NAMELY, HYGROMETRIC AND ELECTRONIC SENSORS FOR CONTROLLING AND ADJUSTING IRRIGATION EQUIPMENT, WATER LEVEL INDICATORS, IN CLASS 9 (U.S. CLS. 21, 23, 26, 36 AND 38).

FOR: LIGHTING APPARATUS AND EQUIPMENT FOR PLANTS, EQUIPMENT FOR IRRIGATION OF INTERIOR AND GARDEN FLOWERS AND PLANTS NOT INCLUDED IN OTHER CLASSES, AS WELL AS FLOWERPOTS AND PLANTPOTS AND WINDOW-BOXES AND PLANTERS, NAMELY DROP-BY-DROP IRRIGATION DIFFUSERS, SPRINKLER HEADS, ANTI-SPLASH TAP NOZZLES, IRRIGATION SPRAY NOZZLES, IRRIGATION SPRINKLER, FILTERING UNIT FOR WATER FILTERING, IN CLASS 11 (U.S. CLS. 13, 21, 23, 31 AND 34).

FOR: FLOWERPOTS, PLANTPOTS, PLANTER FOR FLOWERS AND PLANTS, NAMELY, WINDOW-BOXES AND PLANTERS FOR CULTIVATION IN EARTH AND HYDROPONICALLY, IN PARTICULAR POTS AND TRAYS, ALSO MADE OF METAL, WHICH CAN BE SEPARATELY COMBINED AND ASSEMBLED; SYRINGES FOR WATERING FLOWERS AND PLANTS; NOZZLES FOR SPRINKLER HOSE; EQUIPMENT FOR INTERIOR AND GARDEN PLANTING, NAMELY, PLANTERS FOR FLOWERS AND PLANTS WHICH CAN BE SEPARATELY COMBINED WITH OPTIONAL EQUIPMENT FOR IRRIGATION OF INTERIOR AND GARDEN FLOWERS AND PLANTS, GARDEN ACCESSORIES, NAMELY, GARDENING GLOVES, IN CLASS 21 (U.S. CLS. 2, 13, 23, 29, 30, 33, 40 AND 50).

OWNER OF INTERNATIONAL REGISTRATION
0937862 DATED 6-8-2007, EXPIRES 6-8-2017.

NO CLAIM IS MADE TO THE EXCLUSIVE RIGHT TO USE "PLANT CARE", APART FROM THE MARK AS SHOWN.

SER. NO. 79-043,951, FILED 6-8-2007.

CHRISTINA SOBRAL, EXAMINING ATTORNEY

Int. Cl.: 14

Prior U.S. Cls.: 2, 27, 28 and 50

United States Patent and Trademark Office

Reg. No. 3,480,969

Registered Aug. 5, 2008

**TRADEMARK
PRINCIPAL REGISTER**

ORIS

ORIS HOLDING AG (SWITZERLAND SOCIÉTÉ
ANONYME)
RIBIGASSE 1
CH-4434 HÖLSTEIN
SWITZERLAND

OWNER OF INTERNATIONAL REGISTRATION
0937924 DATED 9-4-2007, EXPIRES 9-4-2017.

FOR: PRECIOUS METALS AND THEIR ALLOYS,
JEWELLERY, PRECIOUS STONES, HOROLOGICAL
AND CHRONOMETRIC INSTRUMENTS, IN CLASS
14 (U.S. CLS. 2, 27, 28 AND 50).

OWNER OF U.S. REG. NOS. 517,766 AND 2,611,552.

SER. NO. 79-043,973, FILED 9-4-2007.

THE MARK CONSISTS OF STANDARD CHAR-
ACTERS WITHOUT CLAIM TO ANY PARTICULAR
FONT, STYLE, SIZE, OR COLOR.

CARYN GLASSER, EXAMINING ATTORNEY

Int. Cl.: 25

Prior U.S. Cls.: 22 and 39

United States Patent and Trademark Office

Reg. No. 3,480,970

Registered Aug. 5, 2008

TRADEMARK
PRINCIPAL REGISTER



NEW MARBAS S.P.A. (ITALY JOINT STOCK
COMPANY)
VIA GROPPINA, 8
I-24020 PARRE (BERGAMO), ITALY

FOR: CLOTHES, NAMELY, LONG AND SHORT
SLEEVE POLO SHIRTS, JUMPERS, SHIRTS, JACK-
ETS, COATS, TROUSERS AND SHORTS, SHOES
AND HEADGEAR, NAMELY, CAPS AND HATS, IN
CLASS 25 (U.S. CLS. 22 AND 39).

PRIORITY DATE OF 6-29-2007 IS CLAIMED.

OWNER OF INTERNATIONAL REGISTRATION
0938032 DATED 7-27-2007, EXPIRES 7-27-2017.

THE COLOR(S) WHITE, RED AND BLUE IS/ARE
CLAIMED AS A FEATURE OF THE MARK.

THE TRADEMARK CONSISTS OF THE WORD-
ING "TWO" IN WHITE FANCY BLOCK CAPITAL
CHARACTERS; NEXT TO IT THERE APPEARS A
WHITE-RIMMED RED STYLIZED NUMBER "2"
FOLLOWED BY AN APOSTROPHE AND THE LET-
TER "S" IN REDUCED DIMENSIONS AND IN RED;
THE WHOLE WORDING IS ON A BLUE BACK-
GROUND.

SER. NO. 79-044,011, FILED 7-27-2007.

JORDAN BAKER, EXAMINING ATTORNEY

Int. Cl.: 25

Prior U.S. Cls.: 22 and 39

United States Patent and Trademark Office

Reg. No. 3,480,971

Registered Aug. 5, 2008

**TRADEMARK
PRINCIPAL REGISTER**

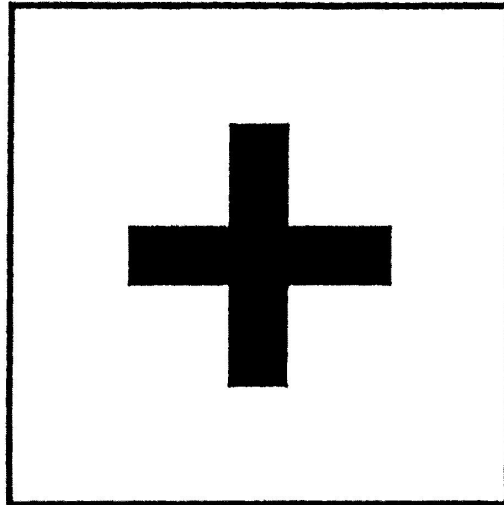

"DR. MAERTENS" MARKETING GMBH (FED
REP GERMANY GESELLSCHAFT MIT BES-
CHRÄNKTER HAFTUNG (GMBH))

AN DER ACH 3

SEESHAUPT, FED REP GERMANY 82402 AND

"DR. MARTENS" INTERNATIONAL; TRADING
GMBH (FED REP GERMANY GESELLSCHAFT
MIT BESCHRÄNKTER HAFTUNG (GMBH))

AHORNSTRASSE 8A

GRÄFELFING, FED REP GERMANY 82166

PRIORITY DATE OF 3-1-2007 IS CLAIMED.

OWNER OF INTERNATIONAL REGISTRATION
0938040 DATED 8-23-2007, EXPIRES 8-23-2017.

SER. NO. 79-044,013, FILED 8-23-2007.

FOR: FOOTWEAR AND PARTS THEREOF, IN
CLASS 25 (U.S. CLS. 22 AND 39).

ANGELA M. MICHELI, EXAMINING ATTORNEY

Int. Cl.: 14

Prior U.S. Cls.: 2, 27, 28 and 50

Reg. No. 3,480,972

United States Patent and Trademark Office

Registered Aug. 5, 2008

**TRADEMARK
PRINCIPAL REGISTER**

40-GOAL

RICHEMONT INTERNATIONAL SA (SWITZER-
LAND SOCIÉTÉ ANONYME (SA))
ROUTE DES BICHES 10
CH-1752 VILLARS-SUR-GLÂNE
SWITZERLAND

FOR: CUFF LINKS, TIE PINS, RINGS, BRACE-
LETS, EARRINGS, NECKLACES, BROOCHES, KEY
RINGS OF PRECIOUS METAL, MONEY CLIPS;
WATCHES, CHRONOMETERS, WALL CLOCKS;
WATCH BANDS, CASES OF PRECIOUS METAL
FOR WATCHES AND JEWELLERY, IN CLASS 14
(U.S. CLS. 2, 27, 28 AND 50).

THE MARK CONSISTS OF STANDARD CHAR-
ACTERS WITHOUT CLAIM TO ANY PARTICULAR
FONT, STYLE, SIZE, OR COLOR.

PRIORITY DATE OF 3-30-2007 IS CLAIMED.

OWNER OF INTERNATIONAL REGISTRATION
0938090 DATED 9-10-2007, EXPIRES 9-10-2017.

SER. NO. 79-044,029, FILED 9-10-2007.

MARILYN IZZI, EXAMINING ATTORNEY

Int. Cls.: 1, 16 and 17

**Prior U.S. Cls.: 1, 2, 5, 6, 10, 12, 13, 22, 23, 26, 29, 35,
37, 38, 46 and 50**

Reg. No. 3,480,973

United States Patent and Trademark Office

Registered Aug. 5, 2008

**TRADEMARK
PRINCIPAL REGISTER**

ELASTOSIL

WACKER CHEMIE AG (FED REP GERMANY
AKTIENGESELLSCHAFT)
HANNS-SEIDEL-PLATZ 4
81737 MÜNCHEN
FED REP GERMANY

FOR: PLASTIC MATERIALS, SYNTHETIC RESINS AND CHEMICAL RAW MATERIAL WHICH MAY BE TRANSFORMED INTO SYNTHETIC RESINS BY CROSS-LINKING REACTION, PARTICULARLY SILICONES; GLUES FOR INDUSTRIAL APPLICATIONS FOR USE IN THE CHEMICAL, PLASTICS, METALLURGICAL, GLASS, PAPER, CERAMICS, PHOTOGRAPHY, AGRICULTURAL, HORTICULTURAL, FORESTRY, COMMERCIAL AND RESIDENTIAL BUILDING, CONSTRUCTION, AUTOMOBILE, AUTOMOTIVE, INSULATION, PACKAGING, ENGINEERING, ENERGY, ELECTRONICS, PHARMACEUTICAL, COSMETIC, FRAGRANCE, TEXTILE, LEATHER, SYNTHETIC RUBBER, HEALTHCARE, FOOD, PAINT, MOULD MAKING, SEMI-CONDUCTOR, MICROCHIP AND TERRESTRIAL PHOTOVOLTAIC INDUSTRIES; CHEMICAL AGENTS FOR IMPREGNATION OF LEATHER, PAPER AND TEXTILE FABRIC, BASED ON SILICONES; SPECIAL CEMENTS AND MASTICS, NAMELY CONTACT CEMENT FOR USE WITH SHOES, PORCELAIN AND LEATHER; CEMENTS AND GLUES FOR USE IN AGRICULTURE, HORTICULTURE AND FORESTRY, CONTACT CEMENT FOR HORTICULTURAL PURPOSES, NAMELY FILLING CAVITIES IN TREES; CHEMICAL IMPRESSION COMPOUNDS FOR USE IN THE CHEMICAL, PLASTICS, METALLURGICAL, GLASS, PAPER, CERAMICS, PHOTOGRAPHY, AGRICULTURAL, HORTICULTURAL, FORESTRY, COMMERCIAL AND RESIDENTIAL BUILDING, CONSTRUCTION, AUTOMOBILE, AUTOMOTIVE, INSULATION, PACKAGING, ENGINEERING, ENERGY, ELECTRONICS, PHARMACEUTICAL, COSMETIC, FRAGRANCE, TEXTILE, LEATHER, SYNTHETIC RUBBER, HEALTHCARE, FOOD, PAINT, MOULD MAKING, SEMI-CONDUCTOR, MICROCHIP AND TERRESTRIAL PHOTOVOLTAIC

INDUSTRIES; SEALING AND COATING COMPOUND CONTAINING ORGANOSILICON COMPOUNDS; RELEASE AGENTS FOR USE IN THE CHEMICAL, PLASTICS, METALLURGICAL, GLASS, PAPER, CERAMICS, PHOTOGRAPHY, AGRICULTURAL, HORTICULTURAL, FORESTRY, COMMERCIAL AND RESIDENTIAL BUILDING, CONSTRUCTION, AUTOMOBILE, AUTOMOTIVE, INSULATION, PACKAGING, ENGINEERING, ENERGY, ELECTRONICS, PHARMACEUTICAL, COSMETIC, FRAGRANCE, TEXTILE, LEATHER, SYNTHETIC RUBBER, HEALTHCARE, FOOD, PAINT, MOULD MAKING, SEMI-CONDUCTOR, MICROCHIP AND TERRESTRIAL PHOTOVOLTAIC INDUSTRIES, IN CLASS 1 (U.S. CLS. 1, 5, 6, 10, 26 AND 46).

FOR: GLUES FOR HOUSEHOLD PURPOSES, IN CLASS 16 (U.S. CLS. 2, 5, 22, 23, 29, 37, 38 AND 50).

FOR: PLASTIC MATERIALS, ELASTOMERS, NAMELY, HOSES, PIPES, AND PADDING, MADE WITH SILICONES, AND FOR USE IN THE CHEMICAL, PLASTICS, METALLURGICAL, GLASS, PAPER, CERAMICS, PHOTOGRAPHY, AGRICULTURAL, HORTICULTURAL, FORESTRY, COMMERCIAL AND RESIDENTIAL BUILDING, CONSTRUCTION, AUTOMOBILE, AUTOMOTIVE, INSULATION, PACKAGING, ENGINEERING, ENERGY, ELECTRONICS, PHARMACEUTICAL, COSMETIC, FRAGRANCE, TEXTILE, LEATHER, SYNTHETIC RUBBER, HEALTHCARE, FOOD, PAINT, MOULD MAKING, SEMI-CONDUCTOR, MICROCHIP AND TERRESTRIAL PHOTOVOLTAIC INDUSTRIES, EXCLUDING THOSE USED IN MANUFACTURING AERATED CONCRETE AND FLOOR SCREEDS; MATERIALS DESIGNED TO BE CONVERTED INTO ELASTOMERS BY CROSS-LINKING, IN A SEMI-PROCESSED STATE, EXCLUDING THOSE FOR USE IN MANUFACTURING AERATED CONCRETE AND FLOOR SCREEDS, NAMELY, THOSE ON THE BASE OF ORGANOSILICON COMPOUNDS; SEALING, WRAPPING AND INSULATING MATERIALS

MADE WITH PLASTIC IN THE FORM OF BLOCKS, PLATES, RODS, GRANULATES, SHEETS, CORDS, TAPES OR FLEXIBLE HOSES FOR USE IN THE CHEMICAL, PLASTICS, METALLURGICAL, GLASS, PAPER, CERAMICS, PHOTOGRAPHY, AGRICULTURAL, HORTICULTURAL, FORESTRY, COMMERCIAL AND RESIDENTIAL BUILDING, CONSTRUCTION, AUTOMOBILE, AUTOMOTIVE, INSULATION, PACKAGING, ENGINEERING, ENERGY, ELECTRONICS, PHARMACEUTICAL, COSMETIC, FRAGRANCE, TEXTILE, LEATHER, SYNTHETIC RUBBER, HEALTHCARE, FOOD, PAINT, MOULD MAKING, SEMI-CONDUCTOR, MICROCHIP AND TERRESTRIAL PHOTOVOLTAIC INDUSTRIES; JOINT SEALANTS MADE OF PLASTIC, PACKING MADE OF PLASTIC MATERIALS, INSULATING PAINT, NAMELY, INSULATING

VARNISHES (OTHER THAN FLOOR SCREEDS); SEALANTS AND INSULATION FOR BUILDINGS MADE WITH PLASTIC FOR BONDS OR JOINTS FOR MASONRY, WINDOWS AND WINDOW PANES, IN CLASS 17 (U.S. CLS. 1, 5, 12, 13, 35 AND 50).

OWNER OF INTERNATIONAL REGISTRATION 0589182 DATED 1-21-1992, EXPIRES 1-21-2012.

OWNER OF U.S. REG. NO. 649,108.

SER. NO. 79-044,081, FILED 3-28-2007.

RICHARD A. STRASER, EXAMINING ATTORNEY

Int. Cl.: 9

Prior U.S. Cls.: 21, 23, 26, 36 and 38

United States Patent and Trademark Office

Reg. No. 3,480,974

Registered Aug. 5, 2008

**TRADEMARK
PRINCIPAL REGISTER**

GARHOPE

YANGZHOU GARHOPE INSTRUMENT CO.,
LTD (CHINA CORPORATION)
PRIVATE INDUSTRY PARK
SHUNTIAN ROAD, ECONOMIC DEVELOPMENT
ZONE
JIANGDU, JIANGSU, CHINA

FOR: BAROMETERS; THERMOMETERS; AUTO-
MATIC INDICATORS OF LOW PRESSURE IN VE-
HICLE TIRES; BLAST PRESSURE GAUGES;
PRESSURE INDICATORS; MEASURING INSTRU-
MENTS FOR MEASURING LENGTH; PRESSURE
INDICATOR PLUG FOR VALVES; PRECISION
MEASURING APPARATUS FOR MEASURING

TWO-DIMENSIONAL DISTRIBUTION OF FORCE
AND PRESSURE; AND LIQUID FILLED GAUGES
FOR MEASURING TEMPERATURE, IN CLASS 9
(U.S. CLS. 21, 23, 26, 36 AND 38).

OWNER OF INTERNATIONAL REGISTRATION
0938483 DATED 7-9-2007, EXPIRES 7-9-2017.

SER. NO. 79-044,217, FILED 7-9-2007.

DAYNA BROWNE, EXAMINING ATTORNEY

Int. Cl.: 25

Prior U.S. Cls.: 22 and 39

United States Patent and Trademark Office

Reg. No. 3,480,975

Registered Aug. 5, 2008

**TRADEMARK
PRINCIPAL REGISTER**



ZHEJIANG ZHONGHUI; FUR & LEATHER CO.,
LTD (CHINA CORPORATION)
NANMEN, CHONGFU TOWN
TONGXIANG CITY; 314511 ZHEJIANG PROVINCE,
CHINA

FOR: CLOTHING, NAMELY, LEATHER BELT-
S, LEATHER PANTS AND LEATHER COATS, HOSI-
ERY, FOOTWEAR, BASKETBALL SHOES,
BASKETBALL SNEAKERS, T-SHIRTS, SHIRTS,
SWEATSHIRTS, SWEATPANTS, PANTS, NIGHT-
SHIRTS, HATS, JACKETS, COATS, CAPS, GLOVES,
WOVEN AND KNIT SHIRTS, UNIFORMS, LAY-

ETTES, SCARVES, GIRDLES, NECKTIES, SWIM-
SUITS, IN CLASS 25 (U.S. CLS. 22 AND 39).

OWNER OF INTERNATIONAL REGISTRATION
0938716 DATED 8-28-2007, EXPIRES 8-28-2017.

THE MARK CONSISTS OF THE IMAGE OF A
STYLIZED BIRD

SER. NO. 79-044,297, FILED 8-28-2007.

DOMINIC FATHY, EXAMINING ATTORNEY

Int. Cl.: 7

Prior U.S. Cls.: 13, 19, 21, 23, 31, 34 and 35

United States Patent and Trademark Office

Reg. No. 3,480,976

Registered Aug. 5, 2008

**TRADEMARK
PRINCIPAL REGISTER**

EMERALD

VSM GROUP AB (SWEDEN JOINT STOCK COMPANY)
DROTTNINGGATAN 2
SE-561 84 HUSKVARNA
SWEDEN

FOR: SEWING MACHINES, IN CLASS 7 (U.S. CLS. 13, 19, 21, 23, 31, 34 AND 35).

THE MARK CONSISTS OF STANDARD CHARACTERS WITHOUT CLAIM TO ANY PARTICULAR FONT, STYLE, SIZE, OR COLOR.

PRIORITY DATE OF 8-29-2007 IS CLAIMED.

OWNER OF INTERNATIONAL REGISTRATION
0938914 DATED 9-21-2007, EXPIRES 9-21-2017.

SER. NO. 79-044,367, FILED 9-21-2007.

PAM WILLIS, EXAMINING ATTORNEY

Int. Cls.: 35 and 43

Prior U.S. Cls.: 100, 101 and 102

United States Patent and Trademark Office

Reg. No. 3,480,977

Registered Aug. 5, 2008

**SERVICE MARK
PRINCIPAL REGISTER**

PASTARITO

PASTARITO S.R.L. (ITALY LTD LIAB CO)
VIA NOBEL, 19
I-42100 REGGIO EMILIA
ITALY

FOR: ADVERTISING AND BUSINESS MANAGEMENT CONSULTANCY; FRANCHISING, NAMELY CONSULTATION AND ASSISTANCE IN BUSINESS MANAGEMENT AND BUSINESS ADMINISTRATION, IN CLASS 35 (U.S. CLS. 100, 101 AND 102).

FOR: CATERING SERVICES, PREPARATION OF FOOD AND BEVERAGES, RESTAURANTS, SELF-SERVICE RESTAURANTS, COFFEE SHOPS, SNACK BARS, PIZZA RESTAURANTS, CAFETERIAS, SELF-SERVICE CAFETERIAS, CANTEEN SERVICES, IN CLASS 43 (U.S. CLS. 100 AND 101).

THE MARK CONSISTS OF STANDARD CHARACTERS WITHOUT CLAIM TO ANY PARTICULAR FONT, STYLE, SIZE, OR COLOR.

PRIORITY DATE OF 6-27-2007 IS CLAIMED.

OWNER OF INTERNATIONAL REGISTRATION 0938947 DATED 7-10-2007, EXPIRES 7-10-2017.

OWNER OF U.S. REG. NO. 3,029,510.

SER. NO. 79-044,384, FILED 7-10-2007.

WARREN L. OLANDRIA, EXAMINING ATTORNEY

Int. Cl.: 28

Prior U.S. Cls.: 22, 23, 38 and 50

United States Patent and Trademark Office

Reg. No. 3,480,978

Registered Aug. 5, 2008

TRADEMARK
PRINCIPAL REGISTER



CAT,CAT,CAT!

MARI MEZON DO MYU CO., LTD; (MARIE
MAISON DE MIEUX CO., LTD) (JAPAN COR-
PORATION)

5-1, UMEGAENCHO
FUJIIDERA-SHI; OSAKA 583-0004
JAPAN

FOR: TOYS, NAMELY, STUFFED AND PLUSH
TOYS, DOLLS, ACTION FIGURES AND ACCES-
SORIES THEREFOR, FANTASY CHARACTER
TOYS, SOFT SCULPTURE TOYS, PUPPETS, POSI-
TIONABLE TOY FIGURES, AND CHILDREN'S
MULTIPLE ACTIVITY DOLL TOYS, IN CLASS 28
(U.S. CLS. 22, 23, 38 AND 50).

PRIORITY DATE OF 8-29-2007 IS CLAIMED.

OWNER OF INTERNATIONAL REGISTRATION
0939178 DATED 9-21-2007, EXPIRES 9-21-2017.

"THE NAME(S), PORTRAIT(S), AND/OR SIGNA-
TURE(S) SHOWN IN THE MARK DOES NOT IDENTI-
FY A PARTICULAR LIVING INDIVIDUAL."

THE FOREIGN WORDING IN THE MARK
TRANSLATES INTO ENGLISH AS MARY'S COZY
HOUSE "CAT, CAT, CAT!"

SER. NO. 79-044,509, FILED 9-21-2007.

ANTHONY RINKER, EXAMINING ATTORNEY

Int. Cl.: 35

Prior U.S. Cls.: 100, 101 and 102

United States Patent and Trademark Office

Reg. No. 3,480,979

Registered Aug. 5, 2008

**SERVICE MARK
PRINCIPAL REGISTER**



AICHELE GROUP GMBH & CO. KG (FED REP
GERMANY LIMITED PARTNERSHIP)
GEWERBESTRAÙE 44
75015 BRETTE
FED REP GERMANY

FOR: BUSINESS MANAGEMENT; ADVERTISING, IN CLASS 35 (U.S. CLS. 100, 101 AND 102).

PRIORITY DATE OF 3-5-2007 IS CLAIMED.

OWNER OF INTERNATIONAL REGISTRATION
0939334 DATED 8-31-2007, EXPIRES 8-31-2017.

NO CLAIM IS MADE TO THE EXCLUSIVE
RIGHT TO USE "GROUP", APART FROM THE
MARK AS SHOWN.

THE COLOR(S) DARK BLUE, DARK RED, AND
WHITE IS/ARE CLAIMED AS A FEATURE OF THE
MARK.

THE COLOR DARK BLUE APPEARS IN THE
WORDING "AICHELE GROUP". THE COLOR RED
APPEARS AS THE SHADING IN THE CIRCLE TO
THE LEFT OF THE WORDING "AICHELE GROUP"
AND IN A CURVED LINE DESIGN TO THE RIGHT
OF THE WORDING "AICHELE GROUP". THE COL-
OR WHITE APPEARS AS THE SHADING OF THE A
APPEARING IN THE CIRCLE DESIGN.

SER. NO. 79-044,546, FILED 8-31-2007.

ELI HELLMAN, EXAMINING ATTORNEY

Int. Cls.: 32 and 33

Prior U.S. Cls.: 45, 46, 47, 48 and 49

United States Patent and Trademark Office

Reg. No. 3,480,980

Registered Aug. 5, 2008

**TRADEMARK
PRINCIPAL REGISTER**

PIPER-HEIDSIECK

PIPER-HEIDSIECK, ANCIENNE MAISON; HEIDSIECK FONDÉE EN 1785.; COMPAGNIE CHAMPENOISE; (SOCIÉTÉ PAR ACTIONS SIMPLIFIÉE; UNIPERSONNELLE) (FRANCE SOCIÉTÉ PAR ACTIONS SIMPLIFIÉE UNIPERSONNELLE)

51, BOULEVARD HENRY VASNIER
F-51100 REIMS
FRANCE

FOR: MINERAL AND CARBONATED WATERS, BEER, LEMONADE, SYRUPS FOR MAKING BEVERAGES, FRUIT JUICES AND DE-ALCOHOLIZED WINES, IN CLASS 32 (U.S. CLS. 45, 46 AND 48).

FOR: WINES, SPARKLING WINES, WINES OF FRENCH ORIGIN, NAMELY, CHAMPAGNE,

HARD AND SOFT CIDER, APERITIFS, ALCOHOLIC BEVERAGES CONTAINING FRUITS, PREPARED ALCOHOLIC COCKTAILS, EAU-DE-VIE, LIQUEURS, RUM, SAKE, WHISKY, VODKA, IN CLASS 33 (U.S. CLS. 47 AND 49).

OWNER OF INTERNATIONAL REGISTRATION 0482506 DATED 1-26-1984, EXPIRES 1-26-2014.

OWNER OF U.S. REG. NOS. 575,785, 3,063,807 AND OTHERS.

SER. NO. 79-044,651, FILED 5-29-2007.

SHAILA SETTLES, EXAMINING ATTORNEY

Int. Cl.: 12

Prior U.S. Cls.: 19, 21, 23, 31, 35 and 44

United States Patent and Trademark Office

Reg. No. 3,480,981

Registered Aug. 5, 2008

**TRADEMARK
PRINCIPAL REGISTER**



PETLAS LASTIK; SANAYI VE TICARET ANONİM SİRKETİ (TURKEY JOINT STOCK COMPANY)

GÖLHISAR MEVKİİ P.K.:7

KIRSEHIR

TURKEY

FOR: TIRES FOR LAND VEHICLE WHEELS, TUBELESS TIRES FOR LAND VEHICLES, INNER TUBES FOR PNEUMATIC VEHICLE TIRES, REPAIR OUTFITS FOR INNER TUBES COMPRISED OF ADHESIVE RUBBER PATCHES FOR REPAIRING INNER TUBES FOR VEHICLE TIRES AND TIRE INFLATORS, ADHESIVE RUBBER PATCHES FOR REPAIRING INNER TUBES FOR VEHICLE TIRES, VALVES FOR VEHICLE TIRES, IN CLASS 12 (U.S. CLS. 19, 21, 23, 31, 35 AND 44).

OWNER OF INTERNATIONAL REGISTRATION 0883597 DATED 9-29-2005, EXPIRES 9-29-2015.

THE COLOR(S) RED AND WHITE IS/ARE CLAIMED AS A FEATURE OF THE MARK.

THE MARK CONSISTS OF THE WHITE WORDING "STARMAXX" ON A RED RECTANGULAR BACKGROUND.

SER. NO. 79-044,688, FILED 9-12-2007.

LYDIA BELZER, EXAMINING ATTORNEY

Int. Cls.: 40 and 42

Prior U.S. Cls.: 100, 101, 103 and 106

United States Patent and Trademark Office

Reg. No. 3,480,982

Registered Aug. 5, 2008

**SERVICE MARK
PRINCIPAL REGISTER**

OROGENTA

GLATT GMBH (FED REP GERMANY LTD LIAB
CO)
WERNER-GLATT-STRASSE 1
79589 BINZEN, FED REP GERMANY

FOR: MATERIAL TREATMENT FOR THE MANUFACTURE OF PHARMACEUTICAL, CHEMICAL, COSMETIC AND BIOTECHNICAL PRODUCTS AND FOODSTUFFS, NAMELY, METAL TREATMENT, PAPER TREATMENT, KNITTING AND DYEING OF FABRICS, CHEMICAL TREATMENT OF TEXTILES, APPLYING FINISHES TO CLOTHING AND FABRIC, IN CLASS 40 (U.S. CLS. 100, 103 AND 106).

FOR: NEW PRODUCT DEVELOPMENT SERVICES FOR THIRD PARTIES, NAMELY, FOR PHARMACEUTICAL, CHEMICAL, COSMETIC AND

BIOTECHNICAL PRODUCTS AND FOODSTUFFS, IN CLASS 42 (U.S. CLS. 100 AND 101).

THE MARK CONSISTS OF STANDARD CHARACTERS WITHOUT CLAIM TO ANY PARTICULAR FONT, STYLE, SIZE, OR COLOR.

PRIORITY DATE OF 12-16-2006 IS CLAIMED.

OWNER OF INTERNATIONAL REGISTRATION 0939786 DATED 6-12-2007, EXPIRES 6-12-2017.

SER. NO. 79-044,706, FILED 6-12-2007.

ERNEST SHOSHO, EXAMINING ATTORNEY

Int. Cl.: 14

Prior U.S. Cls.: 2, 27, 28 and 50

United States Patent and Trademark Office

Reg. No. 3,480,983

Registered Aug. 5, 2008

**TRADEMARK
PRINCIPAL REGISTER**

SOPHIE BY SOPHIE

SOPHIE MATTSSON MED FIRMA; SOPHIE GALLERY (SWEDEN COMPANY)
MAILBOX 143
SE-111 73 STOCKHOLM
SWEDEN

FOR: PRECIOUS METALS AND THEIR ALLOYS AND GOODS IN PRECIOUS METALS OR COATED THEREWITH, NAMELY, PRECIOUS STONES, JEWELRY INCLUDING EARRINGS, NECK CHAINS AND RINGS; HOROLOGICAL AND CHRONOMETRIC INSTRUMENTS, IN CLASS 14 (U.S. CLS. 2, 27, 28 AND 50).

THE MARK CONSISTS OF STANDARD CHARACTERS WITHOUT CLAIM TO ANY PARTICULAR FONT, STYLE, SIZE, OR COLOR.

PRIORITY DATE OF 3-6-2007 IS CLAIMED.

OWNER OF INTERNATIONAL REGISTRATION 0940105 DATED 9-6-2007, EXPIRES 9-6-2017.

THE NAME SOPHIE DOES NOT IDENTIFY A LIVING INDIVIDUAL.

SER. NO. 79-044,804, FILED 9-6-2007.

AISHA SALEM, EXAMINING ATTORNEY

Int. Cl.: 24

Prior U.S. Cls.: 42 and 50

United States Patent and Trademark Office

Reg. No. 3,480,984

Registered Aug. 5, 2008

**TRADEMARK
PRINCIPAL REGISTER**

HICCUPS

LINEN HOUSE PTY LTD (AUSTRALIA PROPRIETARY LIMITED COMPANY (P/L OR PTY. LTD.))
60 CORPORATE DRIVE
MOORABBIN VIC 3189
AUSTRALIA

FOR: LINEN AND TEXTILE GOODS, NAMELY, BED SHEETS, PILLOW CASES, SHAMS, PILLOW SHAMS, QUILTS, QUILT COVERS, DUVETS, DUVET COVERS, COMFORTERS, BED SPREADS, BED SKIRTS, FABRIC VALANCES AND DRAPERY AND TEXTILE BED COVERS; THROWS; COVERS FOR CUSHIONS; UNFITTED FABRIC COUCH COVERS; BED BLANKETS; BATH LINEN, NAMELY, TOWELS, BEACH TOWELS, FACE TOWELS, HAND TOWELS AND TEXTILE BATH MATS; NAPERY, NAMELY, TEXTILE TABLE CLOTHS, TABLE RUNNERS, TABLE TOPPERS, TEXTILE NAPKINS AND

TEXTILE PLACE MATS; TEXTILE OVEN MITTS AND POT HOLDERS; DISH TOWELS; TEA TOWELS; FABRIC WINDOW COVERINGS AND TREATMENTS, NAMELY, CURTAINS AND DRAPES; SHOWER CURTAINS, IN CLASS 24 (U.S. CLS. 42 AND 50).

THE MARK CONSISTS OF STANDARD CHARACTERS WITHOUT CLAIM TO ANY PARTICULAR FONT, STYLE, SIZE, OR COLOR.

OWNER OF INTERNATIONAL REGISTRATION 0880040 DATED 1-6-2006, EXPIRES 1-6-2016.

SER. NO. 79-044,923, FILED 3-22-2007.

IRA J. GOODSaid, EXAMINING ATTORNEY

Int. Cl.: 5

Prior U.S. Cls.: 6, 18, 44, 46, 51 and 52

Reg. No. 3,480,985

United States Patent and Trademark Office

Registered Aug. 5, 2008

**TRADEMARK
PRINCIPAL REGISTER**

WAYENT

NOVARTIS AG (SWITZERLAND CORPORATION)
CH-4002 BASEL
SWITZERLAND

FOR: PHARMACEUTICAL PREPARATIONS FOR THE PREVENTION OF AND TREATMENT OF DISEASES AND DISORDERS OF THE NERVOUS SYSTEM, THE IMMUNE SYSTEM, THE CARDIOVASCULAR SYSTEM, DIABETES AND METABOLIC DISEASES, THE RESPIRATORY SYSTEM, THE UROGENITAL SYSTEM, THE MUSCULOSKELETAL SYSTEM AND FOR THE TREATMENT OF INFLAMMATORY DISORDERS, AND FOR USE IN DERMATOLOGY, ONCOLOGY, HEMATOLOGY, OPHTHALMOLOGY, TRANSPLANTATION; PHARMACEUTICAL PREPARATIONS FOR USE IN GASTROENTEROLOGY, AND FOR THE PREVENTION AND TREATMENT OF OCULAR DISORDERS; ANTI-INFECTIVES, ANTIBIOTICS, ANTI-BACTER-

IALS, ANTIVIRALS AND ANTIFUNGALS, VACCINES, AND PHARMACEUTICAL PREPARATIONS FOR DIAGNOSTIC USE, IN CLASS 5 (U.S. CLS. 6, 18, 44, 46, 51 AND 52).

THE MARK CONSISTS OF STANDARD CHARACTERS WITHOUT CLAIM TO ANY PARTICULAR FONT, STYLE, SIZE, OR COLOR.

PRIORITY DATE OF 5-31-2007 IS CLAIMED.

OWNER OF INTERNATIONAL REGISTRATION 0940439 DATED 8-31-2007, EXPIRES 8-31-2017.

SER. NO. 79-045,010, FILED 8-31-2007.

KELLY MCCOY, EXAMINING ATTORNEY

Int. Cl.: 28

Prior U.S. Cls.: 22, 23, 38 and 50

United States Patent and Trademark Office

Reg. No. 3,480,986

Registered Aug. 5, 2008

**TRADEMARK
PRINCIPAL REGISTER**

WHEEL OF EXCELLENCE

RONALD BUSSINK AMUSEMENT DESIGN
GMBH (FED REP GERMANY GMBH)

KÖNIGSALLEE 88
40212 DÜSSELDORF
FED REP GERMANY

FOR: FAIRGROUND AND AMUSEMENT PARK
RIDES, IN CLASS 28 (U.S. CLS. 22, 23, 38 AND 50).

PRIORITY DATE OF 4-2-2007 IS CLAIMED.

OWNER OF INTERNATIONAL REGISTRATION
0940528 DATED 9-25-2007, EXPIRES 9-25-2017.

NO CLAIM IS MADE TO THE EXCLUSIVE
RIGHT TO USE "WHEEL", APART FROM THE
MARK AS SHOWN.

SER. NO. 79-045,050, FILED 9-25-2007.

EUGENIA MARTIN, EXAMINING ATTORNEY

Int. Cl.: 28

Prior U.S. Cls.: 22, 23, 38 and 50

United States Patent and Trademark Office

Reg. No. 3,480,987

Registered Aug. 5, 2008

**TRADEMARK
PRINCIPAL REGISTER**

WHEELS OF EXCELLENCE

RONALD BUSSINK AMUSEMENT DESIGN
GMBH (FED REP GERMANY GMBH)
KÖNIGSALLEE 88
40212 DÜSSELDORF
FED REP GERMANY

FOR: FAIRGROUND AND AMUSEMENT PARK
RIDES, IN CLASS 28 (U.S. CLS. 22, 23, 38 AND 50).

PRIORITY DATE OF 4-2-2007 IS CLAIMED.

OWNER OF INTERNATIONAL REGISTRATION
0940574 DATED 9-25-2007, EXPIRES 9-25-2017.

NO CLAIM IS MADE TO THE EXCLUSIVE
RIGHT TO USE "WHEELS", APART FROM THE
MARK AS SHOWN.

SER. NO. 79-045,070, FILED 9-25-2007.

EUGENIA MARTIN, EXAMINING ATTORNEY

Int. Cl.: 35

Prior U.S. Cls.: 100, 101 and 102

United States Patent and Trademark Office

Reg. No. 3,480,988

Registered Aug. 5, 2008

**SERVICE MARK
PRINCIPAL REGISTER**



KEYPLATFORM (FRANCE SOCIÉTÉ À RE-
SPONSABILITÉ LIMITEE, S.A.R.L.)
91 RUE DU FAUBOURG SAINT HONORÉ
PARIS, FRANCE F75008

FOR: PROFESSIONAL BUSINESS CONSULTAN-
CY, IN PARTICULAR, PROFESSIONAL BUSINESS
CONSULTANCY CONSISTING IN ANALYZING
PRODUCT FAMILIES (I.E., PRODUCTS SHARING
THE SAME FUNCTIONS, COMPONENTS, TECH-
NOLOGIES OR PRODUCTION METHODS) AND
PRODUCT PLATFORMS (I.E., A SET OF ELEMENTS
OF PRODUCTS SHARING CERTAIN CHARACTER-
ISTICS) AND PROPOSING SUITABLE TECHNICAL
SOLUTIONS, BUSINESS ORGANIZATION AND
MANAGEMENT ADVICE, COMMERCIAL OR IN-
DUSTRIAL BUSINESS MANAGEMENT ASSIS-
TANCE; COLLECTION AND SYSTEMATIZATION
OF TECHNICAL BUSINESS DATA IN A DATABASE;
SEARCHING FOR TECHNICAL BUSINESS INFOR-
MATION IN COMPUTER FILES FOR THIRD PAR-
TIES; BUSINESS INVESTIGATIONS; MARKET
STUDIES AND RESEARCH, IN CLASS 35 (U.S.
CLS. 100, 101 AND 102).

PRIORITY DATE OF 4-26-2007 IS CLAIMED.

OWNER OF INTERNATIONAL REGISTRATION
0941034 DATED 9-28-2007, EXPIRES 9-28-2017.

THE COLOR(S) BLACK AND PURPLE IS/ARE
CLAIMED AS A FEATURE OF THE MARK.

THE MARK CONSISTS OF A CURVED DESIGN
PORTION THAT IS PURPLE AND THE WORD
"KEYPLATFORM" THAT IS POSITIONED OVER
THE CURVED DESIGN PORTION THAT IS EN-
TIRELY BLACK.

SER. NO. 79-045,262, FILED 9-28-2007.

LINDA E. BLOHM, EXAMINING ATTORNEY

Int. Cl.: 5

Prior U.S. Cls.: 6, 18, 44, 46, 51 and 52

United States Patent and Trademark Office

Reg. No. 3,480,989

Registered Aug. 5, 2008

**TRADEMARK
PRINCIPAL REGISTER**

SUPER SENI

TORUNSKIE ZAKLADY MATERIALÓW; OPA-
TRUNKOWYCH SPÓŁKA AKCYJNA (PO-
LAND JOINT STOCK COMPANY)
UL. ZÓLKIEWSKIEGO 20/26
PL-87-100 TORUN, POLAND

FOR: NAPKINS FOR INCONTINENTS, IN CLASS
5 (U.S. CLS. 6, 18, 44, 46, 51 AND 52).

OWNER OF INTERNATIONAL REGISTRATION
0757152 DATED 4-30-2001, EXPIRES 4-30-2011.

OWNER OF U.S. REG. NO. 3,004,530.

THE WORDING "SENI" HAS NO MEANING IN A
FOREIGN LANGUAGE.

SER. NO. 79-045,331, FILED 7-13-2007.

MYRIAH HABEEB, EXAMINING ATTORNEY

Int. Cl.: 5

Prior U.S. Cls.: 6, 18, 44, 46, 51 and 52

Reg. No. 3,480,990

United States Patent and Trademark Office

Registered Aug. 5, 2008

**TRADEMARK
PRINCIPAL REGISTER**

SENI LADY

TORUNSKIE ZAKLADY MATERIALÓW; OPA-
TRUNKOWYCH SPÓLKA AKCYJNA (PO-
LAND JOINT STOCK COMPANY)
UL. ZÓLKIEWSKIEGO 20/26
PL-87-100 TORUN, POLAND

FOR: UROLOGICAL PADS, NAMELY, INCONTI-
NENCE PADS, IN CLASS 5 (U.S. CLS. 6, 18, 44, 46, 51
AND 52).

THE MARK CONSISTS OF STANDARD CHAR-
ACTERS WITHOUT CLAIM TO ANY PARTICULAR
FONT, STYLE, SIZE, OR COLOR.

OWNER OF INTERNATIONAL REGISTRATION
0797819 DATED 1-22-2003, EXPIRES 1-22-2013.

OWNER OF U.S. REG. NO. 3,004,530.

NO CLAIM IS MADE TO THE EXCLUSIVE
RIGHT TO USE "LADY", APART FROM THE
MARK AS SHOWN.

THE WORDING "SENI" HAS NO MEANING IN A
FOREIGN LANGUAGE.

SER. NO. 79-045,336, FILED 7-13-2007.

MYRIAH HABEEB, EXAMINING ATTORNEY

Int. Cl.: 5

Prior U.S. Cls.: 6, 18, 44, 46, 51 and 52

United States Patent and Trademark Office

Reg. No. 3,480,991

Registered Aug. 5, 2008

**TRADEMARK
PRINCIPAL REGISTER**

seni optima

TORUNSKIE ZAKLADY MATERIALÓW; OPA-
TRUNKOWYCH, SPÓLKA AKCYJNA (PO-
LAND JOINT STOCK COMPANY)
ZÓLKIEWSKIEGO 20/26
PL-87-100 TORUN, POLAND

FOR: DISPOSABLE DIAPERS AND DISPOSABLE
DIAPER PANTS FOR INCONTINENCE BEING HY-
GIENIC PRODUCTS, IN CLASS 5 (U.S. CLS. 6, 18, 44,
46, 51 AND 52).

OWNER OF INTERNATIONAL REGISTRATION
0905731 DATED 10-27-2006, EXPIRES 10-27-2016.

OWNER OF U.S. REG. NO. 3,004,530.

THE WORDING "SENI" HAS NO MEANING IN A
FOREIGN LANGUAGE.

SER. NO. 79-045,349, FILED 7-13-2007.

MYRIAH HABEEB, EXAMINING ATTORNEY

Int. Cls.: 35, 36, 42 and 45

Prior U.S. Cls.: 100, 101 and 102

United States Patent and Trademark Office

Reg. No. 3,480,992

Registered Aug. 5, 2008

**SERVICE MARK
PRINCIPAL REGISTER**

FONCIA

FONCIA (FRANCE SOCIÉTÉ ANONYME (SA))
13 AVENUE LEBRUN
F-92160 ANTONY
FRANCE

FOR: ADVERTISING; COMPUTER FILE MANAGEMENT IN CONNECTION WITH REAL ESTATE AND THE RENTAL OF REAL ESTATE PROPERTY; ASSISTANCE AND ADVICE REGARDING BUSINESS ORGANIZATION AND MANAGEMENT; BUSINESS MANAGEMENT; BUSINESS ADMINISTRATION; BUSINESS RESEARCH AND INVESTIGATIONS; ASSISTANCE IN INDUSTRIAL AND COMMERCIAL ENTERPRISE MANAGEMENT AND ESPECIALLY CARRYING OUT STRATEGIC BUSINESS AUDITS FOR COMPANIES; MARKET STUDIES; PROFESSIONAL BUSINESS CONSULTING; BUSINESS VALUATIONS AND APPRAISALS; ACCOUNTING; CONSULTING AND INFORMATION CONCERNING ACCOUNTING; TAX DECLARATION PREPARATION; ACCOUNT AUDITING; BOOKKEEPING; DRAWING UP OF STATEMENTS OF ACCOUNTS, IN CLASS 35 (U.S. CLS. 100, 101 AND 102).

FOR: REAL ESTATE AGENCIES; REAL ESTATE AFFAIRS, NAMELY, REAL ESTATE ADVERTISING SERVICES; PROVIDING HOME WARRANTY ADMINISTRATION; VALUATIONS, BUILDING AND PROPERTY MANAGEMENT; FLAT AND OFFICE RENTAL; RENTAL MANAGEMENT FOR REAL ESTATE PROPERTIES; ADVICE ON REAL ESTATE RENTAL; REAL ESTATE BROKERAGE; SERVICES OF REAL ESTATE MANAGEMENT PROVIDED BY MANAGEMENT AGENTS; REAL ESTATE TRANSACTIONS, NAMELY LENDING SERVICES; EVALUATIONS AND APPRAISALS OF APARTMENTS, APARTMENT BUILDINGS, INDUSTRIAL AND COMMERCIAL BUILDINGS, COMMERCIAL LAND, INDUSTRIAL LAND AND RURAL AREAS; INSURANCE AGENCIES; LIFE INSURANCE BROKERAGE; INSURANCE BROKERAGE; FINANCIAL AND MONETARY AFFAIRS, NAMELY, FI-

NANCIAL AND INSURANCE INFORMATION AND CONSULTING; FOREIGN EXCHANGE TRANSACTIONS; FINANCIAL MANAGEMENT; FISCAL VALUATIONS AND ASSESSMENTS; FINANCIAL LOANS AND ESPECIALLY FINANCIAL LOANS FOR THE PURCHASE AND THE CONSTRUCTION OF REAL ESTATE PROPERTY; FINANCIAL INVESTMENT IN THE FIELD OF REAL ESTATE; BUSINESS CONSULTING IN THE CONTEXT OF REAL ESTATE ACQUISITIONS, STOCK EXCHANGE LISTINGS FOR COMPANIES; CAPITAL CONSTITUTION AND INVESTMENT IN THE FORM OF REAL ESTATE WEALTH INVESTMENT TO BENEFIT FROM TAX REDUCTIONS OR FROM AMORTISATION MEASURES ON INVESTED CAPITAL; CONSULTING AND INFORMATION ON FISCAL EVALUATIONS AND ASSESSMENTS; FINANCIAL ANALYSIS, ESPECIALLY ACCOUNTS ANALYSIS; PROFESSIONAL CONSULTING RELATING TO FINANCE, IN CLASS 36 (U.S. CLS. 100, 101 AND 102).

FOR: EVALUATION AND TESTING OF REAL ESTATE FOR THE PRESENCE OF HAZARDOUS MATERIALS; CARRYING OUT TECHNICAL SURVEYS WITH REGARD TO THE PRESENCE OF ASBESTOS, LEAD, TERMITES OR ANY TYPE OF PARASITE IN THE CONTEXT OF REAL ESTATE EXPERT; COMPUTER SOFTWARE DESIGN AND COMPUTER PROGRAMMING IN THE FIELD OF REAL ESTATE MATTERS; UPDATING AND MAINTENANCE OF COMPUTER SOFTWARE ESPECIALLY IN THE INSURANCE AND REAL ESTATE SPHERE; ENGINEERING SERVICES FOR BUILDING AND PROPERTY CONDITION ASSESSMENT, FACILITY MANAGEMENT, REPAIR AND RESTORATION, BUILDING INSTRUMENTATION AND MONITORING, AND ENVIRONMENTAL CONSULTING; CONDUCTING ENGINEERING SURVEYS, IN CLASS 42 (U.S. CLS. 100 AND 101).

FOR: LEGAL SERVICES IN INSURANCE AND REAL ESTATE, NAMELY, PROVIDING LEGAL

CONSULTATION IN THE FIELD OF INSURANCE AND REAL ESTATE, IN CLASS 45 (U.S. CLS. 100 AND 101).

THE MARK CONSISTS OF STANDARD CHARACTERS WITHOUT CLAIM TO ANY PARTICULAR FONT, STYLE, SIZE, OR COLOR.

PRIORITY DATE OF 11-27-2006 IS CLAIMED.

OWNER OF INTERNATIONAL REGISTRATION 0941643 DATED 5-4-2007, EXPIRES 5-4-2017.

OWNER OF U.S. REG. NO. 2,611,273.

SER. NO. 79-045,445, FILED 5-4-2007.

ANTHONY RINKER, EXAMINING ATTORNEY

Int. Cl.: 31

Prior U.S. Cls.: 1 and 46

United States Patent and Trademark Office

Reg. No. 3,480,993

Registered Aug. 5, 2008

**TRADEMARK
PRINCIPAL REGISTER**

PERFEXAN

TROUW INTERNATIONAL B.V. (NETHERLANDS
BESLOTEN VENNOOTSCHAP)
VEERSTRAAT 38
NL-5831 JN BOXMEER
NETHERLANDS

FOR: NON-MEDICINAL FEEDING ADDITIVES
IN THE NATURE OF CONCENTRATES, SUPPLE-
MENTS AND MIXES TO BE PROCESSED IN FOOD-
STUFFS FOR ANIMALS, NAMELY, ANIMAL FEED
ADDITIVES FOR NONNUTRITIONAL PURPOSES
FOR USE AS AN INGREDIENT OR FILLER; NON-
MEDICINAL VITAMIN AND MINERAL PREPARA-
TIONS FOR ANIMALS, NAMELY, NUTRITIONAL
ADDITIVES FOR ANIMAL FOODSTUFFS, NOT
FOR MEDICAL PURPOSES; FOODSTUFFS FOR
ANIMALS, IN CLASS 31 (U.S. CLS. 1 AND 46).

THE MARK CONSISTS OF STANDARD CHAR-
ACTERS WITHOUT CLAIM TO ANY PARTICULAR
FONT, STYLE, SIZE, OR COLOR.

PRIORITY DATE OF 5-1-2007 IS CLAIMED.

OWNER OF INTERNATIONAL REGISTRATION
0942275 DATED 9-21-2007, EXPIRES 9-21-2017.

THE MARK HAS NO MEANING IN A FOREIGN
LANGUAGE.

SER. NO. 79-045,710, FILED 9-21-2007.

ROBERT STRUCK, EXAMINING ATTORNEY

Int. Cl.: 3

Prior U.S. Cls.: 1, 4, 6, 50, 51 and 52

Reg. No. 3,480,994

United States Patent and Trademark Office

Registered Aug. 5, 2008

**TRADEMARK
PRINCIPAL REGISTER**

★
NEJMA

MARIE-LISE BERCOVICI BISCHOFF (FRANCE
INDIVIDUAL)
C/O ME JEAN-PIERRE SCHMID
RUE DU MIDI 14
CH-1950 SION, SWITZERLAND

PRIORITY DATE OF 3-15-2007 IS CLAIMED.

OWNER OF INTERNATIONAL REGISTRATION
0942416 DATED 9-12-2007, EXPIRES 9-12-2017.

FOR: BLEACHING PREPARATIONS FOR LAUN-
DRY USE; SUBSTANCES FOR LAUNDRY USE
NAMELY, BLEACH, LAUNDRY DETERGENT,
LAUNDRY SOAP AND LAUNDRY STARCH; GEN-
ERAL PURPOSE CLEANING, POLISHING, AND
ABRASIVE LIQUIDS AND POWDERS; COSMETIC
SOAPS; PERFUMERY; ESSENTIAL OILS; COSMET-
ICS; HAIR LOTIONS; DENTIFRICES, IN CLASS 3
(U.S. CLS. 1, 4, 6, 50, 51 AND 52).

THE ENGLISH TRANSLATION OF THE FOR-
EIGN WORD IN THE MARK IS STAR.

SER. NO. 79-045,760, FILED 9-12-2007.

LYDIA BELZER, EXAMINING ATTORNEY

Int. Cls.: 7, 9 and 37

**Prior U.S. Cls.: 13, 19, 21, 23, 26, 31, 34, 35, 36, 38,
100, 103 and 106**

Reg. No. 3,480,995

United States Patent and Trademark Office

Registered Aug. 5, 2008

**TRADEMARK
SERVICE MARK
PRINCIPAL REGISTER**

REGISTRONIC

KOENIG & BAUER AG (FED REP GERMANY
CORPORATION)
4, FRIEDRICH-KOENIG-STRASSE
97080 WÜRZBURG
FED REP GERMANY

FOR: COMPONENTS OF PRINTING MACHINES
FOR COMMERCIAL OR INDUSTRIAL USE IN THE
NATURE OF MECHANICAL DEVICES FOR
MOUNTING AND ADJUSTING ROLLERS IN INK-
ING UNITS AND/OR CYLINDERS IN PRINTING
MACHINES FOR REGISTERING PRINTED COL-
ORS TO EACH OTHER, IN CLASS 7 (U.S. CLS. 13, 19,
21, 23, 31, 34 AND 35).

FOR: REGISTRATION CONTROL APPARATUS
FOR PRINTING PRESSES, IN CLASS 9 (U.S. CLS. 21,
23, 26, 36 AND 38).

FOR: INSTALLATION, MAINTENANCE AND
REPAIR SERVICE FOR PRINTING MACHINES,
MACHINES FOR THE GRAPHICS INDUSTRY, MA-
CHINES FOR FINISHING PRINTED MATTER OR
PAPER, AND PARTS THEREOF; CONSULTANCY
WITH REGARD TO THE INSTALLATION, MAIN-

TENANCE, PREVENTATIVE MAINTENANCE,
MAINTENANCE INSPECTION, AND REPAIR OF
PRINTING MACHINES, MACHINES FOR THE
GRAPHICS INDUSTRY, MACHINES FOR FINISH-
ING PRINTED MATTER OR PAPER, AND PARTS
THEREOF, IN CLASS 37 (U.S. CLS. 100, 103 AND 106).

THE MARK CONSISTS OF STANDARD CHAR-
ACTERS WITHOUT CLAIM TO ANY PARTICULAR
FONT, STYLE, SIZE, OR COLOR.

PRIORITY DATE OF 11-16-2006 IS CLAIMED.

OWNER OF INTERNATIONAL REGISTRATION
0942551 DATED 5-16-2007, EXPIRES 5-16-2017.

OWNER OF U.S. REG. NOS. 1,258,317, 2,888,586
AND OTHERS.

SER. NO. 79-045,814, FILED 5-16-2007.

TINA BROWN, EXAMINING ATTORNEY

Int. Cls.: 5, 29, 30 and 32

Prior U.S. Cls.: 6, 18, 44, 45, 46, 48, 51 and 52

United States Patent and Trademark Office

Reg. No. 3,480,996

Registered Aug. 5, 2008

**TRADEMARK
PRINCIPAL REGISTER**

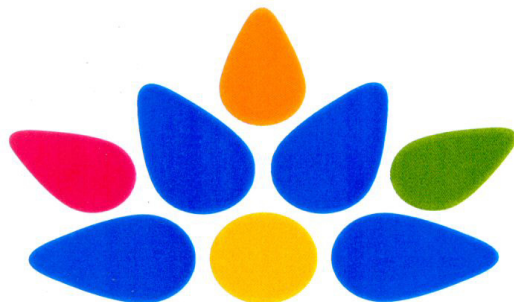

PARMALAT SPA (ITALY CORPORATION)
26, VIA ORESTE GRASSI
I-43044 COLLECCHIO
ITALY

FOR: FOOD FOR MEDICALLY RESTRICTED DIETS; BABY FOOD; MEAL REPLACEMENT DRINKS; NUTRITIONAL SUPPLEMENTS; DIETARY FOOD SUPPLEMENTS; DIETARY DRINK MIX FOR USE AS A MEAL REPLACEMENT; NUTRITIONAL DRINK MIX FOR USE AS A MEAL REPLACEMENT; FOOD SUPPLEMENTS; INFANT FORMULA; FOOD FOR INFANTS, IN CLASS 5 (U.S. CLS. 6, 18, 44, 46, 51 AND 52).

FOR: VITAMIN ENRICHED, MILK; MINERAL ENRICHED MILK, MILK ENRICHED WITH IRON; MILK ENRICHED WITH POLYUNSATURATED FATTY ACIDS (OMEGA 3); DAIRY-BASED BEVERAGES ENRICHED WITH POLYUNSATURATED FATTY ACIDS (OMEGA 3); MILK, CHOCOLATE MILK, ACIDOPHILUS MILK, SOY-BASED BEVERAGE USED AS A MILK SUBSTITUTE, SOY-BASED FOOD BEVERAGES USED AS A MILK SUBSTITUTE, DAIRY-BASED FOOD BEVERAGES, DAIRY-BASED CHOCOLATE FOOD BEVERAGES, VEGETABLE-BASED CHOCOLATE FOOD BEVERAGES, DAIRY-BASED DIPS; DAIRY PRODUCTS EXCLUDING ICE CREAM, ICE MILK AND FROZEN YOGURT, CREAM, MILK CREAM, WHIPPING CREAM, HALF AND HALF MILK AND CREAM MIXTURE, SOUR CREAM, DAIRY OR NON-DAIRY BASED WHIPPED TOPPING, YOGURT, BUTTER, MARGARINE, CHEESE IN GENERAL, COTTAGE CHEESE, GOUDA CHEESE, EDAM CHEESE, CHEDDAR CHEESE, PROCESSED CHEESE, CREAM CHEESE, EGG SUBSTITUTE; SOUPS; CANNED, COOKED OR OTHERWISE PROCESSED TOMATOES; ACIDOPHILUS FLAVORED MILK ADDED

WITH HERBAL COMPONENTS, CHEESE FOOD, CHEESE SPREADS, FOOD PACKAGE COMBINATIONS CONSISTING PRIMARILY OF CHEESE, MEAT AND/OR PROCESSED FRUIT, FLAVORED MILK; CAMEL-SPREAD MILK, IN CLASS 29 (U.S. CL. 46).

FOR: BECHAMEL SAUCE OR WHITE SAUCE; TEA, TEA BASED BEVERAGES WITH FRUIT FLAVORING; CHOCOLATE; ICE CREAM, SOY-BASED ICE CREAM SUBSTITUTES, SAUCES, CUSTARDS; TOMATO SAUCE; HERB TEA FOR FOOD PURPOSES, HERBAL FOOD BEVERAGES, ICE MILK, MILKSHAKES, BASES FOR MAKING MILKSHAKES, BASES FOR MAKING ICE CREAM; REFRIGERATED MILK BASED SPONGE CAKES, COFFEE AND COCOA, IN CLASS 30 (U.S. CL. 46).

FOR: FRUIT DRINKS, FRUIT FLAVORED SOFT DRINKS, FRUIT JUICES, AERATED FRUIT JUICES, FRUIT JUICE CONCENTRATES, FRUIT NECTARS, FRUIT-BASED SOFT DRINK FLAVORED WITH TEA, SPORTS DRINKS, SPRING WATER, AERATED WATER, NON-AERATED WATER, SLIGHTLY AERATED WATER, MINERAL WATER, BEVERAGES, NAMELY, TOMATO JUICE, FRUIT VITAMIN AND MINERAL ENRICHED JUICES ADDED OF MILK, VITAMIN AND MINERAL ENRICHED FRUIT BEVERAGES ADDED OF MILK, CALCIUM ENRICHED FRUIT JUICES, CALCIUM ENRICHED FRUIT DRINKS, VITAMIN ENRICHED FRUIT JUICES, VITAMIN ENRICHED FRUIT DRINKS; FOOD PACKAGE COMBINATIONS CONSISTING PRIMARILY OF FRUIT JUICES; SYRUPS FOR MAKING SOFT DRINKS, IN CLASS 32 (U.S. CLS. 45, 46 AND 48).

OWNER OF INTERNATIONAL REGISTRATION
0870078 DATED 12-28-2004, EXPIRES 12-28-2014.

THE COLOR(S) BLUE, RED, ORANGE, GREEN,
YELLOW, WHITE IS/ARE CLAIMED AS A FEAT-
TURE OF THE MARK.

AND GREEN AND PISTIL IN YELLOW, ALL ON A
WHITE BACKGROUND.

SER. NO. 79-045,937, FILED 11-15-2006.

THE MARK CONSISTS OF A HALF FLOWER
DEVICE WITH PETALS IN BLUE, RED, ORANGE

CHRIS WELLS, EXAMINING ATTORNEY

Int. Cl.: 9

Prior U.S. Cls.: 21, 23, 26, 36 and 38

United States Patent and Trademark Office

Reg. No. 3,480,997

Registered Aug. 5, 2008

TRADEMARK
PRINCIPAL REGISTER

TBEA

TBEA CO., LTD. (CHINA CORPORATION)
52 SOUTH YAN'AN ROAD
CHANGJI; XINJIANG
CHINA

FOR: TRANSFORMERS; ELECTRIC TRANSFORMERS; ELECTRICAL TRANSFORMERS; REACTORS, NAMELY, ELECTRIC CURRENT-LIMITING REACTORS, ELECTRIC NEUTRAL-EARTHING REACTORS AND ELECTRIC SHUNT REACTORS; INSTRUMENT TRANSFORMERS; ELECTRIC CABLES; ELECTRIC WIRES; ELECTRICAL SWITCHES; INTEGRAL UNIT SUBSTATION, NAMELY, A UNIT USED FOR SUPPLYING ELECTRICITY WHICH CONSISTS OF HIGH VOLTAGE SWITCH UNITS WITH INPUT WIRES, TRANSFORMER AND LOW VOLTAGE SWITCH UNITS WITH OUTPUT WIRES, CIRCUIT BREAKERS; ELECTRIC RELAYS; ELECTRICAL DISTRIBUTION BOXES; ELECTRICAL DISTRIBUTION CONSOLES; COMMUTATORS; ELECTRICAL WIRE CONNECTORS; ELECTRICAL DISTRIBUTION BOARDS; VOLTAGE REGULATORS; SLEEVES FOR PROTECTING CABLE TRUNKS, NAMELY, JUNCTION SLEEVES FOR ELECTRIC CABLES; ELECTRICAL INVERTERS; CONNECTORS FOR ELECTRIC CABLES; CONNECTORS FOR ELECTRIC POWER; HIGH AND LOW VOLTAGE SWITCHBOARDS; MAGNETIC WIRES, NAMELY, MAGNETIC TELEPHONE WIRES; IDENTIFICATION THREADS FOR ELEC-

TRIC WIRES; IDENTIFICATION SHEATHS FOR ELECTRIC WIRES; ELECTRIC TELEGRAPH WIRES; INSULATED ELECTRIC COPPER WIRE; ELECTRIC TELEPHONE WIRES; COAXIAL CABLES; ELECTRICAL TERMINALS, NAMELY, ELECTRICAL CONNECTIONS; SHEATHS FOR POWER CABLES; ELECTRICALLY HEATED SOCKETS; ELECTRICITY CONDUITS; ELECTRICAL REDUCERS, NAMELY, ELECTRICAL CONTROLLERS; ELECTRICAL DUCTS; ELECTRIC COUPLINGS; CONTROL PANELS FOR ELECTRICITY; SENSORS, NAMELY, PRESSURE SENSORS, TEMPERATURE SENSORS, TIMING SENSORS; STABILIZED VOLTAGE POWER SUPPLY, IN CLASS 9 (U.S. CLS. 21, 23, 26, 36 AND 38).

PRIORITY DATE OF 11-2-2006 IS CLAIMED.

OWNER OF INTERNATIONAL REGISTRATION
0942900 DATED 4-30-2007, EXPIRES 4-30-2017.

THE WORDING "TBEA" HAS NO MEANING IN A FOREIGN LANGUAGE.

SER. NO. 79-045,993, FILED 4-30-2007.

DOMINIC FATHY, EXAMINING ATTORNEY

Int. Cl.: 35

Prior U.S. Cls.: 100, 101 and 102

Reg. No. 3,480,998

United States Patent and Trademark Office

Registered Aug. 5, 2008

SERVICE MARK
PRINCIPAL REGISTER



Chantecler

CHANTECLER S.P.A. (ITALY CORPORATION)
VIALE GRAMSCI, 17/B
NAPOLI
ITALY

FOR: THE BRINGING TOGETHER, FOR THE BENEFIT OF OTHERS, A VARIETY OF GOODS, NAMELY BRACELETS, BROOCHES, CHAINS, MEDALLIONS, NECKLACES, PEARLS, PRECIOUS STONES, RINGS, WATCHES AND CLOCKS, DISHES OF PRECIOUS METAL, CUFFLINKS, PERFUMES, SOAPS, MAKEUP; EYEGGLASS FRAMES, EYEGGLASS CASES, EYEGGLASS CHAINS, HANDSETS, COMPUTERS, CUTLERY AND RAZORS, LAMPS, PENS, PEN CASES, WRITING SETS, BAGS, SUITCASES, WALLETS, CARD CASES, CANES, UMBRELLAS, SADDLERY, BELTS, JEWELRY CASES NOT OF METAL, PICTURE FRAMES NOT OF METAL, CERAMICS FOR HOUSEHOLD PURPOSES, PAINTED GLASSWARE, PORCELAIN WARE, FABRICS FOR TEXTILE USE, FACE TOWELS OF TEXTILE, TABLE CLOTHS NOT OF PAPER, FOULARDS, TIES, HEADGEAR FOR WEAR, SCARVES, SHIRTS, SHOES, SUITS, TROUSERS, LINGERIE, BROOCHES

BEING CLOTHING ACCESSORIES, BUCKLES BEING CLOTHING ACCESSORIES, SHOE BUCKLES, BUTTONS, HAIR ORNAMENTS, SPORT BAGS, GOLF CLUBS, PLAYING CARDS, TOYS, CIGAR AND CIGARETTE CASES NOT OF PRECIOUS METAL, LIGHTERS FOR SMOKERS, ALL OF WHICH ENABLE CUSTOMERS TO CONVENIENTLY VIEW AND PURCHASE THOSE GOODS; ELECTRONIC COMMERCE SERVICES, NAMELY, PROVIDING INFORMATION ABOUT THE FOREGOING GOODS VIA TELECOMMUNICATION NETWORKS FOR ADVERTISING AND SALES PURPOSES, IN CLASS 35 (U.S. CLS. 100, 101 AND 102).

OWNER OF INTERNATIONAL REGISTRATION
0833190 DATED 4-30-2004, EXPIRES 4-30-2014.

OWNER OF U.S. REG. NO. 2,748,572.

SER. NO. 79-046,206, FILED 7-26-2007.

JOHN DWYER, EXAMINING ATTORNEY

Int. Cl.: 14

Prior U.S. Cls.: 2, 27, 28 and 50

United States Patent and Trademark Office

Reg. No. 3,480,999

Registered Aug. 5, 2008

**TRADEMARK
PRINCIPAL REGISTER**

O'SO EZ

TGN 409 (FRANCE SOCIÉTÉ À RESPONSABILITÉ LIMITÉE)
21 MONTÉE DES SOLDATS
F-69300 CALUIRE ET CUIRE, FRANCE

FOR: JEWELLERY, PRECIOUS STONES, HOROLOGICAL AND CHRONOMETRIC INSTRUMENTS; WORKS OF ART OF PRECIOUS METAL; JEWELLERY CASES OR BOXES OF PRECIOUS METALS; WATCH CASES, STRAPS, CHAINS, SPRINGS OR GLASSES; FANCY KEY RINGS OF PRECIOUS METAL, STATUES OF PRECIOUS METAL, FIGURINES OF PRECIOUS METAL AND STATUETTES OF PRECIOUS METAL; CLOCK AND WATCH CASES; MEDALS, IN CLASS 14 (U.S. CLS. 2, 27, 28 AND 50).

THE MARK CONSISTS OF STANDARD CHARACTERS WITHOUT CLAIM TO ANY PARTICULAR FONT, STYLE, SIZE, OR COLOR.

OWNER OF INTERNATIONAL REGISTRATION
0943668 DATED 10-12-2007, EXPIRES 10-12-2017.

THE WORDING "O'SO EZ" HAS NO MEANING IN A FOREIGN LANGUAGE.

SER. NO. 79-046,311, FILED 10-12-2007.

MYRIAH HABEEB, EXAMINING ATTORNEY

Int. Cl.: 33

Prior U.S. Cls.: 47 and 49

United States Patent and Trademark Office

Reg. No. 3,481,000

Registered Aug. 5, 2008

**TRADEMARK
PRINCIPAL REGISTER**

RAFFAELLO

SOYO FOODS GMBH (SWITZERLAND LTD LIAB
CO)

TALSTRASSE 82

CH-8001 ZÜRICH

SWITZERLAND

THE MARK CONSISTS OF STANDARD CHAR-
ACTERS WITHOUT CLAIM TO ANY PARTICULAR
FONT, STYLE, SIZE, OR COLOR.

OWNER OF INTERNATIONAL REGISTRATION
0943959 DATED 10-26-2007, EXPIRES 10-26-2017.

FOR: WINES, ALCOHOLIC BEVERAGES, NAME-
LY, SPIRITS AND LIQUEURS, IN CLASS 33 (U.S.
CLS. 47 AND 49).

SER. NO. 79-046,429, FILED 10-26-2007.

MELISSA VALLILLO, EXAMINING ATTORNEY

Int. Cl.: 25

Prior U.S. Cls.: 22 and 39

United States Patent and Trademark Office

Reg. No. 3,481,001

Registered Aug. 5, 2008

**TRADEMARK
PRINCIPAL REGISTER**

PAKROS

FANTASY SHOES S.R.L. (ITALY SOCIETÀ A
RESPONSABILITÀ LIMITATA (SRL))
PIAZZA MARTIRI DI MARZABOTTO, 63
I-51015 MONSUMMANO TERME (PT)
ITALY

FOR: FOOTWEAR, NAMELY, SHOES, SANDALS,
BOOTS, ATHLETIC SHOES, BEACH SHOES, ESPA-
DRILLES, SLIPPERS, MOCCASINS, RAIN BOOTS,
IN CLASS 25 (U.S. CLS. 22 AND 39).

THE MARK CONSISTS OF STANDARD CHAR-
ACTERS WITHOUT CLAIM TO ANY PARTICULAR
FONT, STYLE, SIZE, OR COLOR.

OWNER OF INTERNATIONAL REGISTRATION
0944230 DATED 10-11-2007, EXPIRES 10-11-2017.

THE WORDING "PAKROS" HAS NO SIGNIFI-
CANCE EXCEPT FOR TRADEMARK SIGNIFI-
CANCE.

SER. NO. 79-046,526, FILED 10-11-2007.

KATHRYN COWARD, EXAMINING ATTORNEY

Int. Cl.: 29

Prior U.S. Cl.: 46

United States Patent and Trademark Office

Reg. No. 3,481,002

Registered Aug. 5, 2008

**TRADEMARK
PRINCIPAL REGISTER**

POLENGHI

PARMALAT S.P.A. (ITALY JOINT STOCK COMPANY)
VIA ORESTE GRASSI, 26
I-43044 COLLECCHIO (PARMA)
ITALY

FOR: CHEESE; DAIRY PRODUCTS DERIVED FROM MILK EXCLUDING ICE CREAM, ICE MILK AND FROZEN YOGURT; OTHER PRODUCTS DERIVED FROM MILK, NAMELY, BUTTER, CREAM, AND YOGURT, IN CLASS 29 (U.S. CL. 46).

THE MARK CONSISTS OF STANDARD CHARACTERS WITHOUT CLAIM TO ANY PARTICULAR FONT, STYLE, SIZE, OR COLOR.

PRIORITY DATE OF 8-31-2007 IS CLAIMED.

OWNER OF INTERNATIONAL REGISTRATION
0944232 DATED 10-16-2007, EXPIRES 10-16-2017.

SER. NO. 79-046,527, FILED 10-16-2007.

JAMES STEIN, EXAMINING ATTORNEY

Int. Cl.: 7

Prior U.S. Cls.: 13, 19, 21, 23, 31, 34 and 35

United States Patent and Trademark Office

Reg. No. 3,481,003

Registered Aug. 5, 2008

**TRADEMARK
PRINCIPAL REGISTER**

RCS

SATA GMBH & CO. KG (FED REP GERMANY
KOMMANDITGESELLSCHAFT)
DOMERTALSTR. 20
70806 KORNWESTHEIM
FED REP GERMANY

FOR: MACHINES, PARTICULARLY CLEANING
MACHINES, NAMELY, PNEUMATIC CLEANING
MACHINES FOR CLEANING OF PAINT SPRAY
APPARATUS, SPRAY GUNS AND PAINT CUPS, IN
CLASS 7 (U.S. CLS. 13, 19, 21, 23, 31, 34 AND 35).

PRIORITY DATE OF 10-18-2007 IS CLAIMED.

OWNER OF INTERNATIONAL REGISTRATION
0944316 DATED 10-26-2007, EXPIRES 10-26-2017.

SER. NO. 79-046,559, FILED 10-26-2007.

MELISSA VALLILLO, EXAMINING ATTORNEY

Int. Cl.: 25

Prior U.S. Cls.: 22 and 39

United States Patent and Trademark Office

Reg. No. 3,481,004

Registered Aug. 5, 2008

**TRADEMARK
PRINCIPAL REGISTER**

NeoMOD 南默

BEIJING NEOMOD ACCESSORIES CO., LTD.
(CHINA CORPORATION)
DAYANGFANG BEICUN
YIZHUANG TOWN, DAXING DISTRICT
BEIJING, CHINA 100023

FOR: HATS; SCARFS; NECKTIES; LEATHER BELTS AS CLOTHING; GLOVES AS CLOTHING; HOSIERY; BATHING SUITS; FOOTWEAR; UNDER-CLOTHES; SHIRTS , IN CLASS 25 (U.S. CLS. 22 AND 39).

OWNER OF INTERNATIONAL REGISTRATION
0944656 DATED 11-19-2007, EXPIRES 11-19-2017.

THE FOREIGN WORDING IN THE MARK TRANSLATES INTO ENGLISH AS THE FIRST CHARACTER IN THE MARK , NAN, MEANS SOUTH. THE SECOND CHARACTER, MO, MEANS SILENT.

THE NON-LATIN CHARACTER(S) IN THE MARK TRANSLITERATES INTO NAN MO, AND THIS MEANS HAS NO MEANING IN ENGLISH.

SER. NO. 79-046,665, FILED 11-19-2007.

ALLISON HOLTZ, EXAMINING ATTORNEY

Int. Cl.: 29

Prior U.S. Cl.: 46

United States Patent and Trademark Office

Reg. No. 3,481,005

Registered Aug. 5, 2008

TRADEMARK
PRINCIPAL REGISTER



GREAT CHEESE TAKES TIME.

BUTLERS FARMHOUSE CHEESE LIMITED
(UNITED KINGDOM LIMITED COMPANY)
WILSON FIELDS FARM,
INGLEWHITE; PRESTON, LANCASHIRE PR3 2LH
UNITED KINGDOM

NO CLAIM IS MADE TO THE EXCLUSIVE
RIGHT TO USE "FARMHOUSE CHEESES", APART
FROM THE MARK AS SHOWN.

FOR: CHEESE, IN CLASS 29 (U.S. CL. 46).

SER. NO. 79-046,736, FILED 10-15-2007.

OWNER OF INTERNATIONAL REGISTRATION
0944765 DATED 10-15-2007, EXPIRES 10-15-2017.

COLLEEN KEARNEY, EXAMINING ATTORNEY

Int. Cl.: 25

Prior U.S. Cls.: 22 and 39

United States Patent and Trademark Office

Reg. No. 3,481,006

Registered Aug. 5, 2008

**TRADEMARK
PRINCIPAL REGISTER**



WUXI GUANG MING (GROUP) CO., LTD. (CHINA CORPORATION)
NO. 148, YUNHE EAST ROAD
WUXI, JIANGSU PROVINCE
CHINA

FOR: CLOTHING, NAMELY, JACKETS, COATS, TROUSERS, VESTS, SHIRTS, PANTS, SKIRTS, DRESSES, SUITS, UNIFORMS, UNDERCLOTHES, JERSEYS, JERKINS, MANTLES, BLOUSES, NIGHTWEAR, SHORTS, T-SHIRTS, JEANS, JUMPERS, KNIT SKIRTS, LOUNGEWEAR, PULLOVERS, ROBES, SMOCKS, SWEATERS, SWIMSUITS; LAYETTES; SHOES; HEADGEAR, NAMELY, HATS, CAPS; HOSIERY; GLOVES; NECKTIES; WATER-PROOF CLOTHING, NAMELY, WATERPROOF

JACKETS AND PANTS, WATER SOCKS; LEATHER BELTS; SCARVES, IN CLASS 25 (U.S. CLS. 22 AND 39).

OWNER OF INTERNATIONAL REGISTRATION
0945012 DATED 11-15-2007, EXPIRES 11-15-2017.

A STYLIZED LETTER "P" IN THE MIDDLE WHICH IS HALF ENCIRCLED BY A LACELIKE EAR OF THE WHEAT.

SER. NO. 79-046,826, FILED 11-15-2007.

ROBERT STRUCK, EXAMINING ATTORNEY

Int. Cl.: 31

Prior U.S. Cls.: 1 and 46

United States Patent and Trademark Office

Reg. No. 3,481,007

Registered Aug. 5, 2008

**TRADEMARK
PRINCIPAL REGISTER**

Symphonie in Blue

ANTON PLATTNER (FED REP GERMANY IN-
DIVIDUAL)
HAAG 4
94501 ALDERSBACH
FED REP GERMANY

OWNER OF INTERNATIONAL REGISTRATION
0945088 DATED 11-12-2007, EXPIRES 11-12-2017.

FOR: LIVE ORNAMENTAL PLANT, IN CLASS 31
(U.S. CLS. 1 AND 46).

THE ENGLISH TRANSLATION OF "SYMPHO-
NIE" IN THE MARK IS SYMPHONY.

THE MARK CONSISTS OF STANDARD CHAR-
ACTERS WITHOUT CLAIM TO ANY PARTICULAR
FONT, STYLE, SIZE, OR COLOR.

SER. NO. 79-046,851, FILED 11-12-2007.

PRIORITY DATE OF 9-5-2007 IS CLAIMED.

FRED MANDIR, EXAMINING ATTORNEY

Int. Cl.: 20

Prior U.S. Cls.: 2, 13, 22, 25, 32 and 50

United States Patent and Trademark Office

Reg. No. 3,481,008

Registered Aug. 5, 2008

**TRADEMARK
PRINCIPAL REGISTER**

VERSUS

GIANNI VERSACE S.P.A. (ITALY CORPORATION)
VIA A. MANZONI, 38
I-20121 MILANO
ITALY

FOR: FURNITURE; MIRRORS; PICTURE FRAMES; CHAIRS; CUPBOARDS; CUSHIONS; DESKS; DIVANS; WOOD DOORKNOBS, NOT OF METAL OR GLASS; FIGURES OF BONE, IVORY, PLASTER, PLASTIC, WAX AND WOOD; FURNITURE HANDLES FOR DOORS; MAGAZINE RACKS; OFFICE FURNITURE; PILLOWS; AND STRUCTURAL PARTS AND FITTINGS FOR ALL THE AFORESAID GOODS, IN CLASS 20 (U.S. CLS. 2, 13, 22, 25, 32 AND 50).

THE MARK CONSISTS OF STANDARD CHARACTERS WITHOUT CLAIM TO ANY PARTICULAR FONT, STYLE, SIZE, OR COLOR.

PRIORITY DATE OF 10-3-2007 IS CLAIMED.

OWNER OF INTERNATIONAL REGISTRATION
0945161 DATED 10-30-2007, EXPIRES 10-30-2017.

SER. NO. 79-046,874, FILED 10-30-2007.

NAPOLEON SHARMA, EXAMINING ATTORNEY

Int. Cl.: 30

Prior U.S. Cl.: 46

United States Patent and Trademark Office

Reg. No. 3,481,009

Registered Aug. 5, 2008

**TRADEMARK
PRINCIPAL REGISTER**



ISHIMARU SEIMEN KABUSHIKI KAISHA (JAPAN CORPORATION)
701 OKA, KONAN-CHO
TAKAMATSU-SHI; KAGAWA 761-1401
JAPAN

FOR: PREPARATIONS MADE FROM CEREALS, NAMELY, UNCOOKED UDON NOODLES, INSTANT UDON NOODLES, REHYDRATABLE UDON NOODLES, UNCOOKED SOBA NOODLES, INSTANT SOBA NOODLES, REHYDRATABLE SOBA NOODLES, UNCOOKED SOMEN NOODLES, INSTANT SOMEN NOODLES, REHYDRATABLE SOMEN NOODLES, IN CLASS 30 (U.S. CL. 46).

OWNER OF INTERNATIONAL REGISTRATION
0946252 DATED 8-10-2007, EXPIRES 8-10-2017.

THE NON-LATIN CHARACTERS IN THE MARK
TRANSLITERATE TO "ISHI" AND THIS MEANS
STONE IN ENGLISH.

SER. NO. 79-047,279, FILED 8-10-2007.

STEVEN R. FOSTER, EXAMINING ATTORNEY

Int. Cl.: 11

Prior U.S. Cls.: 13, 21, 23, 31 and 34

United States Patent and Trademark Office

Reg. No. 3,481,010

Registered Aug. 5, 2008

**TRADEMARK
PRINCIPAL REGISTER**

SmartFix

VILLEROY & BOCH AG (FED REP GERMANY
CORPORATION)
SAARUFERSTRASSE 14-18
66693 METTLACH
FED REP GERMANY

FOR: SANITARY INSTALLATIONS, NAMELY,
WASH-HAND BASINS; SINKS; TOILETS; WATER-
CLOSETS; URINALS; PARTS AND COMPONENTS
FOR ALL AFOREMENTIONED GOODS, IN CLASS
11, IN CLASS 11 (U.S. CLS. 13, 21, 23, 31 AND 34).

THE MARK CONSISTS OF STANDARD CHAR-
ACTERS WITHOUT CLAIM TO ANY PARTICULAR
FONT, STYLE, SIZE, OR COLOR.

PRIORITY DATE OF 3-13-2007 IS CLAIMED.

OWNER OF INTERNATIONAL REGISTRATION
0946297 DATED 9-4-2007, EXPIRES 9-4-2017.

SER. NO. 79-047,297, FILED 9-4-2007.

SAIMA MAKHDOOM, EXAMINING ATTORNEY

Int. Cl.: 16

Prior U.S. Cls.: 2, 5, 22, 23, 29, 37, 38 and 50

Reg. No. 3,481,011

United States Patent and Trademark Office

Registered Aug. 5, 2008

**TRADEMARK
PRINCIPAL REGISTER**



UNI-MED VERLAG AKTIENGESELLSCHAFT
(FED REP GERMANY CORPORATION)
KURFÜRSTENALLEE 130
28211 BREMEN
FED REP GERMANY

FOR: MEDICAL REFERENCE BOOKS, IN CLASS
16 (U.S. CLS. 2, 5, 22, 23, 29, 37, 38 AND 50).

OWNER OF INTERNATIONAL REGISTRATION
0946377 DATED 11-16-2007, EXPIRES 11-16-2017.

THE COLOR(S) RED AND BLACK IS/ARE
CLAIMED AS A FEATURE OF THE MARK.

THE COLOR BLACK APPEARS IN THE TEXT OF
THE WORDING "UNI-MED". THE COLOR RED
APPEARS AS THE SHADING FOR THE CIRCLE
DESIGN.

SER. NO. 79-047,325, FILED 11-16-2007.

ELI HELLMAN, EXAMINING ATTORNEY

Int. Cls.: 9, 16 and 28

Prior U.S. Cls.: 2, 5, 21, 22, 23, 26, 29, 36, 37, 38 and 50

Reg. No. 3,481,012

United States Patent and Trademark Office

Registered Aug. 5, 2008

TRADEMARK
PRINCIPAL REGISTER



THE TEMPLAR COMPANY PLC (UNITED KINGDOM PUBLIC LIMITED COMPANY)
THE GRANARY, NORTH STREET,
DORKING, SURREY RH4 1DN
UNITED KINGDOM

FOR: PRE-RECORDED DVDS FEATURING ENTERTAINMENT AND GAMES FOR CHILDREN IN THE FIELD OF FANTASY, MAGIC AND MYTHICAL BEASTS; PRE-RECORDED COMPACT DISCS FEATURING MUSIC AND STORIES FOR CHILDREN IN THE FIELD OF FANTASY, MAGIC AND MYTHICAL BEASTS; DOWNLOADABLE ELECTRONIC PUBLICATIONS IN THE NATURE OF MAGAZINES IN THE FIELD OF FANTASY, MAGIC AND MYTHICAL BEASTS; INTERACTIVE COMPACT DISCS AND CD-ROMS FEATURING ENTERTAINMENT AND GAMES FOR CHILDREN IN THE FIELD OF FANTASY, MAGIC AND MYTHICAL BEASTS; COMPUTER GAME SOFTWARE; INTERACTIVE COMPUTER GAME SOFTWARE; ELECTRONIC GAME SOFTWARE; VIDEO GAME SOFTWARE; INTERACTIVE VIDEO GAME SOFTWARE, IN CLASS 9 (U.S. CLS. 21, 23, 26, 36 AND 38).

FOR: PRINTED MATTER, NAMELY, BOOKS FOR CHILDREN, MAGAZINES FOR CHILDREN IN THE FIELD OF FANTASY, MAGIC AND MYTHICAL BEASTS, PERIODICALS FOR CHILDREN IN THE FIELD OF FANTASY, MAGIC AND MYTHICAL BEASTS, NEWSLETTERS FOR CHILDREN IN THE FIELD OF FANTASY, MAGIC AND MYTHICAL BEASTS; PART-WORK PUBLICATIONS, NAMELY, MAGAZINES AND ACTIVITY BOOKS FOR CHILDREN IN THE FIELD OF FANTASY,

MAGIC AND MYTHICAL BEASTS; PRINTED INSTRUCTIONAL AND TEACHING MATERIALS IN THE FIELD OF MATH, NAMELY, CALCULATING TABLES; PAPER PRODUCTS, NAMELY, PAPER NAPKINS, PARTY INVITATION CARDS, STICKERS; CONTAINERS OF PAPER AND CARDBOARD; STATIONERY, GREETING CARDS; CALENDARS, DIARIES, BOOKMARKS, BLANK WRITING JOURNALS, PHOTOGRAPH ALBUMS; ARTISTS' MATERIALS, NAMELY, PENS, PENCILS, CRAYONS, CHALK, PAINT BOXES; PAINT BRUSHES, IN CLASS 16 (U.S. CLS. 2, 5, 22, 23, 29, 37, 38 AND 50).

FOR: TOYS, GAMES AND PLAYTHINGS, NAMELY, JIGSAW PUZZLES, BOARD GAMES, PLUSH TOYS; ELECTRONIC TOYS AND GAMES, NAMELY, HAND-HELD UNITS FOR PLAYING ELECTRONIC GAMES AND ELECTRONIC EDUCATIONAL GAME MACHINES FOR CHILDREN; TRADING CARD GAMES; PAPER PARTY HATS, IN CLASS 28 (U.S. CLS. 22, 23, 38 AND 50).

PRIORITY DATE OF 8-16-2007 IS CLAIMED.

OWNER OF INTERNATIONAL REGISTRATION
0946503 DATED 9-27-2007, EXPIRES 9-27-2017.

OWNER OF U.S. REG. NO. 3,237,608.

SER. NO. 79-047,357, FILED 9-27-2007.

AHSEN KHAN, EXAMINING ATTORNEY

Int. Cls.: 35 and 43

Prior U.S. Cls.: 100, 101 and 102

United States Patent and Trademark Office

Reg. No. 3,481,013

Registered Aug. 5, 2008

**SERVICE MARK
PRINCIPAL REGISTER**



LAGARDERE SERVICES (FRANCE SOCIÉTÉ ANONYME)
2 RUE LORD BYRON
F-75008 PARIS, FRANCE

FOR: RETAIL STORE SERVICES FEATURING VARIOUS GOODS, NAMELY, BEVERAGES, COLD AND HOT BEVERAGES, BEVERAGES WITH COFFEE, TEA, CACAO OR CHOCOLATE BASE, MINERAL AND CARBONATED WATERS, NON-ALCOHOLIC BEVERAGES, FRUIT BEVERAGES, FRUIT JUICES, OTHER PREPARATIONS FOR MAKING BEVERAGES, BEERS, ALCOHOLIC BEVERAGES, WINE, LIQUEURS, SANDWICHES, SALADS, PREPARED PASTA, FRUIT CAKES, CAKES, BISCUITS, SWEETS, NON-PHARMACEUTICAL SUGAR CONFECTIONERY, PASTRIES, EDIBLE ICES, ICE CREAM, GROCERY GOODS, CONFECTIONERY, CEREAL PREPARATIONS, CHEWING GUM NOT FOR MEDICAL PURPOSES, CLOTHING, FOOTWEAR, HEADGEAR, STOCKINGS, PRESS PRODUCTS, PRINTING PRODUCTS, PRINTED MATTER, PUBLICATIONS, ENTERTAINMENT, TEACHING OR SCIENTIFIC PUBLICATIONS, NEWSPAPERS, COMIC BOOKS, PERIODICALS, REVIEWS, MAGAZINES, BOOKS, SOAPS, PERFUMERY PREPARATIONS, COSMETICS, HAIR LOTIONS, DENTIFRICES, DOCUMENT HOLDERS, WALLETS, COIN HOLDERS, HANDBAGS, BRIEFCASES, RUCKSACKS AND TRAVEL BAGS, SUITCASES, UMBRELLAS, PARASOLS AND WALKING STICKS, CLOTHING, T-SHIRTS, FOOTWEAR, HEADGEAR, SPECTACLES AND SUNGLASSES, JEWELLERY ARTICLES, FASHION JEWELLERY, WATCHES, TIMEPIECES AND CHRONOMETRIC INSTRUMENTS, TOBACCO, SMOKERS' ARTICLES, MATCHES, GAMES AND TOYS, RECORDED OR BLANK MAGNETIC OR OPTICAL RECORDING MEDIA, AUDIO-VIDEO COMPACT DISCS, OPTICAL COMPACT DISCS, CD-ROMS, DVD-ROMS, VIDEO CASSETTES, SOFTWARE, RECORDED COMPUTER PROGRAMS, GAMEWARE, VIDEO

GAME CARTRIDGES, PHOTOGRAPHIC CAMERAS; THE BRINGING TOGETHER, FOR THE BENEFIT OF OTHERS, OF A VARIETY OF GOODS, ENABLING CONSUMERS TO VIEW AND BUY AT THEIR CONVENIENCE VARIOUS GOODS, NAMELY, BEVERAGES, COLD AND HOT BEVERAGES, BEVERAGES WITH COFFEE, TEA, CACAO OR CHOCOLATE BASE, MINERAL AND CARBONATED WATERS, NON-ALCOHOLIC BEVERAGES, FRUIT BEVERAGES, FRUIT JUICES, OTHER PREPARATIONS FOR MAKING BEVERAGES, BEERS, ALCOHOLIC BEVERAGES, WINE, LIQUEURS, SANDWICHES, SALADS, PREPARED PASTA, FRUIT CAKES, CAKES, BISCUITS, SWEETS, NON-PHARMACEUTICAL SUGAR CONFECTIONERY, PASTRIES, EDIBLE ICES, ICE CREAM, GROCERY GOODS, CONFECTIONERY, CEREAL PREPARATIONS, CHEWING GUM NOT FOR MEDICAL PURPOSES, CLOTHING, FOOTWEAR, HEADGEAR, STOCKINGS, PRESS PRODUCTS, PRINTING PRODUCTS, PRINTED MATTER, PUBLICATIONS, ENTERTAINMENT, TEACHING OR SCIENTIFIC PUBLICATIONS, NEWSPAPERS, COMIC BOOKS, PERIODICALS, REVIEWS, MAGAZINES, BOOKS, SOAPS, PERFUMERY PREPARATIONS, COSMETICS, HAIR LOTIONS, DENTIFRICES, DOCUMENT HOLDERS, WALLETS, COIN HOLDERS, HANDBAGS, BRIEFCASES, RUCKSACKS AND TRAVEL BAGS, SUITCASES, UMBRELLAS, PARASOLS AND WALKING STICKS, CLOTHING, T-SHIRTS, FOOTWEAR, HEADGEAR, SPECTACLES AND SUNGLASSES, JEWELLERY ARTICLES, FASHION JEWELLERY, WATCHES, TIMEPIECES AND CHRONOMETRIC INSTRUMENTS, TOBACCO, SMOKERS' ARTICLES, MATCHES, GAMES AND TOYS, RECORDED OR BLANK MAGNETIC OR OPTICAL RECORDING MEDIA, AUDIO-VIDEO COMPACT DISCS, OPTICAL COMPACT DISCS, CD-ROMS, DVD-ROMS, VIDEO CASSETTES, SOFTWARE, RECORDED COMPUTER PROGRAMS, GAMEWARE, VIDEO GAME CARTRIDGES, PHOTOGRAPHIC CAMERAS; ADVERTISING

SPACE RENTAL SERVICES, IN CLASS 35 (U.S. CLS. 100, 101 AND 102).

FOR: SERVICES FOR PROVIDING FOOD AND DRINK, BAR AND COFFEE SHOP SERVICES, CAFETERIAS; SELF-SERVICE RESTAURANTS, FAST-FOOD RESTAURANTS AND SNACKBARS, IN CLASS 43 (U.S. CLS. 100 AND 101).

PRIORITY DATE OF 3-20-2007 IS CLAIMED.

OWNER OF INTERNATIONAL REGISTRATION 0946552 DATED 9-6-2007, EXPIRES 9-6-2017.

NO CLAIM IS MADE TO THE EXCLUSIVE RIGHT TO USE "CONVENIENCE", APART FROM THE MARK AS SHOWN.

THE COLOR(S) LIGHT GREEN, DARK GREEN AND WHITE IS/ARE CLAIMED AS A FEATURE OF THE MARK.

BACKGROUND= LIGHT GREEN; CIRCLE AND CIRCLE ARCS SURROUNDING THE "HUB"= DARK GREEN; LETTERS OF "HUB CONVENIENCE"= WHITE.

SER. NO. 79-047,389, FILED 9-6-2007.

ROBERT STRUCK, EXAMINING ATTORNEY

Int. Cl.: 10

Prior U.S. Cls.: 26, 39 and 44

United States Patent and Trademark Office

Reg. No. 3,481,014

Registered Aug. 5, 2008

**TRADEMARK
PRINCIPAL REGISTER**

RESOUND X-PLORE

GN RESOUND A/S (DENMARK LTD LIAB CO)
LAUTRUPBJERG 9
DK-2750 BALLERUP
DENMARK

OWNER OF INTERNATIONAL REGISTRATION
0946803 DATED 10-27-2007, EXPIRES 10-27-2017.

FOR: HEARING AIDS, IN CLASS 10 (U.S. CLS. 26,
39 AND 44).

OWNER OF U.S. REG. NOS. 1,488,398, 3,137,803
AND OTHERS.

THE MARK CONSISTS OF STANDARD CHAR-
ACTERS WITHOUT CLAIM TO ANY PARTICULAR
FONT, STYLE, SIZE, OR COLOR.

SER. NO. 79-047,488, FILED 10-27-2007.

PRIORITY DATE OF 7-2-2007 IS CLAIMED.

TINA BROWN, EXAMINING ATTORNEY

Int. Cl.: 20

Prior U.S. Cls.: 2, 13, 22, 25, 32 and 50

United States Patent and Trademark Office

Reg. No. 3,481,015

Registered Aug. 5, 2008

**TRADEMARK
PRINCIPAL REGISTER**



MYKKO, NAAMLOZE VENNOOTSCHAP (BEL-
GIUM NAAMLOZE VENNOOTSCHAP)
LOSSINGSTRAAT 146
B-2900 SCHOTEN
BELGIUM

FOR: CHILDREN'S FURNITURE; BEDS FOR
CHILDREN; CRADLES; CARRY COTS AND CRA-
DLES; TRAVEL BEDS, PORTABLE BEDS; CHAIRS
AND CHILD SEATS; PLAYPENS FOR CHILDREN,
CUSHIONS AND MATTRESSES; WASHING CUSH-
IONS, NAPPY CHANGING CUSHIONS, CUSHIONS
FOR KNEES, IN CLASS 20 (U.S. CLS. 2, 13, 22, 25, 32
AND 50).

OWNER OF INTERNATIONAL REGISTRATION
0946844 DATED 10-18-2007, EXPIRES 10-18-2017.

THE COLOR(S) BLUE, RED AND WHITE IS/ARE
CLAIMED AS A FEATURE OF THE MARK.

THE MARK CONSISTS OF THE LITERAL ELE-
MENT "COSI-SLEEP" IN BLUE, WITH THE DOT OF
THE LETTER I IN RED, ALL APPEARING ON A
WHITE RECTANGLE BACKGROUND.

SER. NO. 79-047,512, FILED 10-18-2007.

THOMAS MANOR, EXAMINING ATTORNEY

Int. Cls.: 1 and 5

Prior U.S. Cls.: 1, 5, 6, 10, 18, 26, 44, 46, 51 and 52

United States Patent and Trademark Office

Reg. No. 3,481,016

Registered Aug. 5, 2008

**TRADEMARK
PRINCIPAL REGISTER**

PHYSIO ACTIVATOR

LABORATOIRES GOEMAR (FRANCE SOCIÉTÉ ANONYME)
AVENUE DU GÉNÉRAL PATTON
ZAC DE LA MADELEINE; F-35400 SAINT-MALO
FRANCE

FOR: CHEMICAL PRODUCTS INTENDED FOR AGRICULTURE, HORTICULTURE AND FORESTRY, NAMELY, CATALYSTS, CHLORINES, MINERAL FILTERING MATERIALS, AND FOLIAR NUTRITIONAL FORMULATION USED TO PROVIDE THE PLANTS WITH NITROGEN, MANGANESE, ZINC AND SULPHUR; EXCLUDING FUNGICIDES, HERBICIDES, INSECTICIDES AND PARASITICIDES; FERTILIZERS; FERTILIZING PREPARATIONS; PLANT GROWTH REGULATING PREPARATIONS; BIOSTIMULANTS AND FERTILIZERS FOR PLANT NUTRITION FOR LEAF SPRAYING, IN CLASS 1 (U.S. CLS. 1, 5, 6, 10, 26 AND 46).

FOR: PREPARATIONS FOR DESTROYING VERMIN; FUNGICIDES; HERBICIDES; INSECTICIDES;

PARASITICIDES, IN CLASS 5 (U.S. CLS. 6, 18, 44, 46, 51 AND 52).

THE MARK CONSISTS OF STANDARD CHARACTERS WITHOUT CLAIM TO ANY PARTICULAR FONT, STYLE, SIZE, OR COLOR.

PRIORITY DATE OF 4-23-2007 IS CLAIMED.

OWNER OF INTERNATIONAL REGISTRATION 0946845 DATED 10-19-2007, EXPIRES 10-19-2017.

NO CLAIM IS MADE TO THE EXCLUSIVE RIGHT TO USE "ACTIVATOR", APART FROM THE MARK AS SHOWN.

SER. NO. 79-047,513, FILED 10-19-2007.

CHRISTINE COOPER, EXAMINING ATTORNEY

Int. Cls.: 35, 38 and 41

Prior U.S. Cls.: 100, 101, 102, 104 and 107

United States Patent and Trademark Office

Reg. No. 3,481,017

Registered Aug. 5, 2008

**SERVICE MARK
PRINCIPAL REGISTER**

IMELOS

EXHIBIT APS; C/O SØREN DANDANELL NIELSEN (DENMARK ANPARTSSELSKAB (APS))
SANDBJERGVEJ 6 C
DK-2970 HØRSBOLM
DENMARK

FOR: RENTAL OF ADVERTISING SPACE, RENTAL OF ADVERTISING SPACE ON COMMUNICATION MEDIA; TELEVISION ADVERTISING SERVICES; ADVERTISING ON AN ONLINE COMPUTER NETWORK; COMMERCIAL ASSISTANCE TO ARTISTS AND PERFORMERS, NAMELY, MANAGEMENT OF PERFORMING ARTISTS, IN CLASS 35 (U.S. CLS. 100, 101 AND 102).

FOR: TELECOMMUNICATION ACCESS SERVICES; RADIO AND TELEVISION BROADCASTING; SATELLITE TRANSMISSION; TRANSMISSION BY CABLE TV, PROVISION OF USER ACCESS TO A GLOBAL COMPUTER NETWORK; COMMUNICATION BY COMPUTER TERMINALS; COMPUTER-AIDED TRANSMISSION OF DATA, SOUND, MESSAGES AND IMAGES, IN CLASS 38 (U.S. CLS. 100, 101 AND 104).

FOR: ENTERTAINMENT IN THE NATURE OF PRODUCTION OF CONCERTS AND MUSIC VIDEO RECORDINGS; ORGANIZING COMMUNITY SPORTING AND CULTURAL EVENTS; RENTAL OF FILMS; TELEVISION ENTERTAINMENT, NAMELY, TELEVISION PROGRAMMING; PRODUCTION OF TELEVISION OR RADIO PROGRAMS, ORGANIZATION AND ONLINE

PROVISION OF CONCERTS, NAMELY, ARRANGING AND CONDUCTING OF CONCERTS; SHOWING OF FILMS, NAMELY, MOTION PICTURE THEATERS; PRODUCTION OF TELEVISION SHOWS; BOOK PUBLISHING; NEWS PRESENTATION, NAMELY, NEWS REPORTING SERVICES ORGANIZATION AND CONDUCTING OF CONCERTS; ENTERTAINER SERVICES, NAMELY, LIVE, TELEVISED AND MOVIE APPEARANCES BY A PROFESSIONAL ENTERTAINER; ORGANIZATION OF SHOWS, NAMELY, PRESENTATION OF LIVE SHOW PERFORMANCES, IN CLASS 41 (U.S. CLS. 100, 101 AND 107).

THE MARK CONSISTS OF STANDARD CHARACTERS WITHOUT CLAIM TO ANY PARTICULAR FONT, STYLE, SIZE, OR COLOR.

PRIORITY DATE OF 8-22-2007 IS CLAIMED.

OWNER OF INTERNATIONAL REGISTRATION 0946926 DATED 9-13-2007, EXPIRES 9-13-2017.

THE MARK HAS NO MEANING IN A FOREIGN LANGUAGE.

SER. NO. 79-047,550, FILED 9-13-2007.

ROBERT STRUCK, EXAMINING ATTORNEY

Int. Cls.: 21, 25 and 33

**Prior U.S. Cls.: 2, 13, 22, 23, 29, 30, 33, 39, 40, 47, 49
and 50**

Reg. No. 3,481,018

United States Patent and Trademark Office

Registered Aug. 5, 2008

**TRADEMARK
PRINCIPAL REGISTER**

SUNTONIC

METAXA B.V. (NETHERLANDS B.V.)
WATTSTRAAT 61
NL-2723 RB ZOETERMEER
NETHERLANDS

FOR: GLASSWARE, NAMELY, BEVERAGE
GLASSWARE; PORCELAIN, NAMELY, PORCE-
LAIN MUGS; EARTHENWARE, NAMELY, EARTH-
ENWARE MUGS NOT INCLUDED IN OTHER
CLASSES, IN CLASS 21 (U.S. CLS. 2, 13, 23, 29, 30,
33, 40 AND 50).

FOR: CLOTHING, NAMELY, SHIRTS; FOOT-
WEAR; HEADGEAR, NAMELY, CAPS, HATS, IN
CLASS 25 (U.S. CLS. 22 AND 39).

FOR: ALCOHOLIC BEVERAGES EXCEPT BEERS,
IN CLASS 33 (U.S. CLS. 47 AND 49).

THE MARK CONSISTS OF STANDARD CHAR-
ACTERS WITHOUT CLAIM TO ANY PARTICULAR
FONT, STYLE, SIZE, OR COLOR.

PRIORITY DATE OF 10-1-2007 IS CLAIMED.

OWNER OF INTERNATIONAL REGISTRATION
0947344 DATED 10-16-2007, EXPIRES 10-16-2017.

SER. NO. 79-047,665, FILED 10-16-2007.

JAMES STEIN, EXAMINING ATTORNEY

Int. Cl.: 7

Prior U.S. Cls.: 13, 19, 21, 23, 31, 34 and 35

United States Patent and Trademark Office

Reg. No. 3,481,019

Registered Aug. 5, 2008

**TRADEMARK
PRINCIPAL REGISTER**

UNILOCK

UNILOCK DI UMBERTO CROSTI & C. S.A.S.
(ITALY SOCIETA IN ACCOMANDITA SEM-
PLICE (SAS))

VIA BEMBO, 13

I-20090 TREZZANO SUL NAVIGLIO (MILANO),
ITALY

FOR: PINCERS AND SPINDLES FOR MACHINE
TOOLS, IN CLASS 7 (U.S. CLS. 13, 19, 21, 23, 31, 34
AND 35).

THE MARK CONSISTS OF STANDARD CHAR-
ACTERS WITHOUT CLAIM TO ANY PARTICULAR
FONT, STYLE, SIZE, OR COLOR.

OWNER OF INTERNATIONAL REGISTRATION
0947521 DATED 10-11-2007, EXPIRES 10-11-2017.

SER. NO. 79-047,741, FILED 10-11-2007.

HEATHER THOMPSON, EXAMINING ATTORNEY

Int. Cl.: 28

Prior U.S. Cls.: 22, 23, 38 and 50

Reg. No. 3,481,020

United States Patent and Trademark Office

Registered Aug. 5, 2008

**TRADEMARK
PRINCIPAL REGISTER**



STADLBAUER MARKETING + VERTRIEB; GE-
SELLSCHAFT M.B.H. (AUSTRIA LTD LIAB
CO)
4, MAGAZINSTRASSE
A-5027 SALZBURG, AUSTRIA

FOR: WATER PISTOLS, IN CLASS 28 (U.S. CLS. 22,
23, 38 AND 50).

PRIORITY DATE OF 9-24-2007 IS CLAIMED.

OWNER OF INTERNATIONAL REGISTRATION
0947608 DATED 10-23-2007, EXPIRES 10-23-2017.

THE COLOR(S) BLACK AND GREEN IS/ARE
CLAIMED AS A FEATURE OF THE MARK.

THE COLOR BLACK AND GREEN APPEAR IN
THE WORDING "MIZUMI".

"MIZUMI" HAS NO MEANING IN A FOREIGN
LANGUAGE.

SER. NO. 79-047,777, FILED 10-23-2007.

SHANNON TWOHIG, EXAMINING ATTORNEY

Int. Cls.: 35, 36, 38 and 42

Prior U.S. Cls.: 100, 101, 102 and 104

United States Patent and Trademark Office

Reg. No. 3,481,021

Registered Aug. 5, 2008

**SERVICE MARK
PRINCIPAL REGISTER**

UNIENCE

NOSTER FINANCE, S.L. (SPAIN SOCIEDAD LIM-
ITADA)
PADILLA 32-IZQ., 1^o DCHA
E-28001 MADRID
SPAIN

FOR: ADVERTISING SERVICES; BUSINESS MANAGEMENT; BUSINESS ADMINISTRATION; PROVIDING OFFICE FUNCTIONS; COMPILATION AND SYSTEMIZATION OF INFORMATION INTO COMPUTER DATABASES; ARRANGING COMMERCIAL MARKET STUDIES AND COMPILING COMMERCIAL MARKET REPORTS; ECONOMIC FORECASTING AND ANALYSIS FOR BUSINESS AND FINANCIAL PURPOSES; MARKET ANALYSIS; ECONOMIC FORECASTING; BUSINESS MANAGEMENT ADVISORY SERVICES; MARKETING RESEARCH AND MARKETING STUDIES; PRICE COMPARISON SERVICES; ONLINE RETAIL STORE SERVICES FEATURING COMPUTER SOFTWARE IN THE FIELD OF INVESTMENTS; IMPORT-EXPORT AGENCIES, IN CLASS 35 (U.S. CLS. 100, 101 AND 102).

FOR: INSURANCE CONSULTATION; CONSULTATION CONCERNING FINANCIAL AFFAIRS; CONSULTATION CONCERNING MONETARY AFFAIRS; CONSULTATION CONCERNING REAL ESTATE AFFAIRS; FINANCIAL ANALYSIS; BANKING; CAPITAL INVESTMENT SERVICES; FINANCIAL CONSULTANCY; CREDIT CARD SERVICES; EXCHANGING MONEY; STOCK EXCHANGE QUOTATIONS; STOCKS AND BONDS BROKERAGE; CONSULTANCY AND ADVISORY SERVICES

IN RELATION TO FINANCIAL INVESTMENTS, IN CLASS 36 (U.S. CLS. 100, 101 AND 102).

FOR: TELECOMMUNICATIONS SERVICES, NAMELY, PERSONAL COMMUNICATION SERVICES; COMPUTER AIDED TRANSMISSION OF MESSAGES AND IMAGES; PROVIDING ACCESS TO DATABASES; PROVIDING INTERNET CHAT-ROOMS, IN CLASS 38 (U.S. CLS. 100, 101 AND 104).

FOR: SCIENTIFIC RESEARCH; TECHNOLOGICAL CONSULTATION IN THE TECHNOLOGY FIELD OF COMPUTER HARDWARE SYSTEMS; INDUSTRIAL ANALYSIS AND RESEARCH SERVICES IN THE FIELD OF COMPUTER SCIENCE; DESIGN AND DEVELOPMENT OF COMPUTER HARDWARE AND SOFTWARE; CREATING AND MAINTAINING WEB SITES FOR OTHERS; CONVERSION OF DATA OR DOCUMENTS FROM PHYSICAL TO ELECTRONIC MEDIA; DATA CONVERSION OF COMPUTER PROGRAM DATA; CONSULTANCY ON COMPUTER SOFTWARE, IN CLASS 42 (U.S. CLS. 100 AND 101).

OWNER OF INTERNATIONAL REGISTRATION 0948029 DATED 10-22-2007, EXPIRES 10-22-2017.

THE WORDING "UNIENCE" HAS NO MEANING IN A FOREIGN LANGUAGE.

SER. NO. 79-047,953, FILED 10-22-2007.

VERNA BETH RIRIE, EXAMINING ATTORNEY

Int. Cl.: 16

Prior U.S. Cls.: 2, 5, 22, 23, 29, 37, 38 and 50

United States Patent and Trademark Office

Reg. No. 3,481,022

Registered Aug. 5, 2008

**TRADEMARK
PRINCIPAL REGISTER**

taktifol

ALFRED STÖFFLER GMBH (FED REP GERMA-
NY LTD LIAB CO)
IM DERRÜCK 10
76776 NEUBURG AM RHEIN
FED REP GERMANY

FOR: PRINTED INSTRUCTIONAL AND TEACH-
ING MATERIAL, NAMELY, MOBILE, REUSABLE
AND SELF-ADHESIVE MAPS OF SPORT-FIELDS
SUCH AS SOCCER, HANDBALL, BASKETBALL
AND ICE HOCKEY FIELDS PRINTED ON THIN
FOILS AND CHARGED STATICALLY FOR THE
PURPOSE OF TACTICAL TRAINING AND IN-
STRUCTION IN SPORT CLUBS, IN CLASS 16 (U.S.
CLS. 2, 5, 22, 23, 29, 37, 38 AND 50).

THE MARK CONSISTS OF STANDARD CHAR-
ACTERS WITHOUT CLAIM TO ANY PARTICULAR
FONT, STYLE, SIZE, OR COLOR.

OWNER OF INTERNATIONAL REGISTRATION
0948032 DATED 10-30-2007, EXPIRES 10-30-2017.

SER. NO. 79-047,956, FILED 10-30-2007.

NAPOLEON SHARMA, EXAMINING ATTORNEY

Int. Cl.: 28

Prior U.S. Cls.: 22, 23, 38 and 50

Reg. No. 3,481,023

United States Patent and Trademark Office

Registered Aug. 5, 2008

**TRADEMARK
PRINCIPAL REGISTER**



SHENZHEN SION TRADE CO., LTD. (CHINA CORPORATION)
4B, YUNSONG BUILDING
BINHE ROAD., FUTIAN DISTRICT; SHENZHEN; 518000 GUANGDONG
CHINA

FOR: BALLS FOR GAMES; BODY-TRAINING APPARATUS; DUMB-BELLS; EXERCISERS, NAMELY, CHEST EXPANDERS; ELBOW GUARDS FOR SPORTS USE; KNEE GUARDS FOR SPORTS USE; GLOVES FOR BASEBALL; PROTECTIVE PADDINGS FOR PLAYING FOOTBALL; BODY REHABILITATION APPARATUS, NAMELY,

TREADMILLS; GRIP TAPES FOR RACKETS, IN CLASS 28 (U.S. CLS. 22, 23, 38 AND 50).

OWNER OF INTERNATIONAL REGISTRATION 0948514 DATED 10-24-2007, EXPIRES 10-24-2017.

NO CLAIM IS MADE TO THE EXCLUSIVE RIGHT TO USE "SPORTS", APART FROM THE MARK AS SHOWN.

SER. NO. 79-048,134, FILED 10-24-2007.

SHANNON TWOHIG, EXAMINING ATTORNEY

Int. Cl.: 20

Prior U.S. Cls.: 2, 13, 22, 25, 32 and 50

United States Patent and Trademark Office

Reg. No. 3,481,024

Registered Aug. 5, 2008

**TRADEMARK
PRINCIPAL REGISTER**

PORCUPINE DESK

VITRA PATENTE AG (SWITZERLAND CORPORATION)
KLÜNENFELDSTRASSE 22
CH-4132 MUTTENZ
SWITZERLAND

OWNER OF INTERNATIONAL REGISTRATION
0948706 DATED 12-17-2007, EXPIRES 12-17-2017.

FOR: FURNITURE, NAMELY, TABLES FOR CHILDREN, IN CLASS 20 (U.S. CLS. 2, 13, 22, 25, 32 AND 50).

NO CLAIM IS MADE TO THE EXCLUSIVE RIGHT TO USE "DESK", APART FROM THE MARK AS SHOWN.

THE MARK CONSISTS OF STANDARD CHARACTERS WITHOUT CLAIM TO ANY PARTICULAR FONT, STYLE, SIZE, OR COLOR.

SER. NO. 79-048,185, FILED 12-17-2007.

MARY CRAWFORD, EXAMINING ATTORNEY

Int. Cl.: 6

Prior U.S. Cls.: 2, 12, 13, 14, 23, 25 and 50

Reg. No. 3,481,025

United States Patent and Trademark Office

Registered Aug. 5, 2008

**TRADEMARK
PRINCIPAL REGISTER**

MIRRAX

UDDEHOLM TOOLING AKTIEBOLAG (SWEDEN LIMITED COMPANY)
SE-683 85 HAGFORS, SWEDEN

OWNER OF INTERNATIONAL REGISTRATION
0948936 DATED 12-17-2007, EXPIRES 12-17-2017.

FOR: COMMON METALS AND THEIR ALLOYS, NAMELY, ALLOYED AND UNALLOYED TOOL STEEL AND STAINLESS STEEL IN THE FORM OF BARS, BLOCKS, PLATES, RINGS, WIRES, STRIPS, TUBES AND CASTINGS, IN CLASS 6 (U.S. CLS. 2, 12, 13, 14, 23, 25 AND 50).

SER. NO. 79-048,270, FILED 12-17-2007.

PRIORITY DATE OF 8-22-2007 IS CLAIMED.

CARYN GLASSER, EXAMINING ATTORNEY

Int. Cl.: 9

Prior U.S. Cls.: 21, 23, 26, 36 and 38

United States Patent and Trademark Office

Reg. No. 3,481,026

Registered Aug. 5, 2008

**TRADEMARK
PRINCIPAL REGISTER**

IRBIS

INFRATEC GMBH INFRAROTSENSORIK; UND
MESSTECHNIK (FED REP GERMANY GMBH)
GOSTRITZER STR. 61-63
01217 DRESDEN
FED REP GERMANY

OWNER OF INTERNATIONAL REGISTRATION
0949270 DATED 11-16-2007, EXPIRES 11-16-2017.

FOR: SOFTWARE FOR THE OPERATION OF
INFRARED OPTICAL SUPERVISION APPARATUS
AND PROCESS CONTROL SOFTWARE FOR OPTI-
CAL SENSORS, IN CLASS 9 (U.S. CLS. 21, 23, 26, 36
AND 38).

THE FOREIGN WORDING IN THE MARK
TRANSLATES INTO ENGLISH AS SNOW LEO-
PARD.

SER. NO. 79-048,408, FILED 11-16-2007.

THE MARK CONSISTS OF STANDARD CHAR-
ACTERS WITHOUT CLAIM TO ANY PARTICULAR
FONT, STYLE, SIZE, OR COLOR.

ELI HELLMAN, EXAMINING ATTORNEY

Int. Cl.: 12

Prior U.S. Cls.: 19, 21, 23, 31, 35 and 44

Reg. No. 3,481,027

United States Patent and Trademark Office

Registered Aug. 5, 2008

**TRADEMARK
PRINCIPAL REGISTER**



NINGBO SUNSHINE TRAFFIC; EQUIPMENT
CO., LTD. (CHINA CORPORATION)
LINYU INDUSTRIAL ZONE
ZHENHAI, 315000 NINGBO, CHINA

FOR: WINDSCREEN WIPERS; WINDSHIELD WIPERS; LUGGAGE CARRIERS FOR VEHICLES; TRAILER HITCHES FOR VEHICLES; HORNS FOR VEHICLES; ANTI-THEFT ALARMS FOR VEHICLES; DIRECTION SIGNALS FOR VEHICLES; UP-HOLSTERY FOR VEHICLES; TURN SIGNALS FOR VEHICLES; SUN-BLINDS ADAPTED FOR AUTO-

MOBILES, IN CLASS 12 (U.S. CLS. 19, 21, 23, 31, 35 AND 44).

OWNER OF INTERNATIONAL REGISTRATION
0949826 DATED 1-7-2008, EXPIRES 1-7-2018.

SER. NO. 79-048,618, FILED 1-7-2008.

EDWARD FENNESSY, EXAMINING ATTORNEY

Int. Cls.: 10, 42 and 44

Prior U.S. Cls.: 26, 39, 44, 100 and 101

United States Patent and Trademark Office

Reg. No. 3,481,028

Registered Aug. 5, 2008

**TRADEMARK
SERVICE MARK
PRINCIPAL REGISTER**

U-Pee

PROSTALUND OPERATIONS AB (SWEDEN
JOINT STOCK COMPANY)
BOX 477
UPSALA, SWEDEN SE751 06

FOR: MEDICAL APPARATUS AND INSTRUMENTS FOR UROLOGICAL TREATMENT AND FOR HEAT TREATMENT OF BODY TISSUE; CATHETERS, TREATMENT CATHETERS , IN CLASS 10 (U.S. CLS. 26, 39 AND 44).

FOR: MEDICAL AND MEDICAL-TECHNICAL PROJECT STUDIES; MEDICAL AND MEDICAL-TECHNICAL RESEARCH; UROLOGICAL RESEARCH, IN CLASS 42 (U.S. CLS. 100 AND 101).

FOR: RENTAL OF MEDICAL EQUIPMENT IN THE FIELD OF UROLOGICAL TREATMENT AND

HEAT TREATMENT OF BODY TISSUE, IN CLASS 44 (U.S. CLS. 100 AND 101).

THE MARK CONSISTS OF STANDARD CHARACTERS WITHOUT CLAIM TO ANY PARTICULAR FONT, STYLE, SIZE, OR COLOR.

PRIORITY DATE OF 7-3-2007 IS CLAIMED.

OWNER OF INTERNATIONAL REGISTRATION 0949920 DATED 9-28-2007, EXPIRES 9-28-2017.

SER. NO. 79-048,659, FILED 9-28-2007.

PETER B. BROMAGHIM, EXAMINING ATTORNEY

Int. Cl.: 12

Prior U.S. Cls.: 19, 21, 23, 31, 35 and 44

United States Patent and Trademark Office

Reg. No. 3,481,029

Registered Aug. 5, 2008

**TRADEMARK
PRINCIPAL REGISTER**

RUFFNUTS

RUFFNUTS PTY LTD; (ACN 092856105) (AUSTRALIA AUSTRALIAN PROPRIETARY COMPANY, LIMITED BY SHARES)
15 CAMP STREET
FORBES, AUSTRALIA NSW 2871

FOR: SEAT COVERS FOR VEHICLES, BOATS, AIRCRAFT AND OTHER APPARATUS FOR LOCOMOTION BY LAND, AIR OR WATER, IN CLASS 12 (U.S. CLS. 19, 21, 23, 31, 35 AND 44).

THE MARK CONSISTS OF STANDARD CHARACTERS WITHOUT CLAIM TO ANY PARTICULAR FONT, STYLE, SIZE, OR COLOR.

PRIORITY DATE OF 9-6-2007 IS CLAIMED.

OWNER OF INTERNATIONAL REGISTRATION 0949956 DATED 12-19-2007, EXPIRES 12-19-2017.

SER. NO. 79-048,669, FILED 12-19-2007.

LINDA M. KING, EXAMINING ATTORNEY

Int. Cl.: 19

Prior U.S. Cls.: 1, 12, 33 and 50

United States Patent and Trademark Office

Reg. No. 3,481,030

Registered Aug. 5, 2008

TRADEMARK
PRINCIPAL REGISTER



ZHEJIANG HAoyun MUYE YOUXIAN GONGSI
(CHINA CORPORATION)

DONGCE, NANLIN DAQIAO

318 GUODAO, NANXUN ZHEN,; HUZHOu;
313009ZHEJIANG

CHINA

FOR: PLYWOOD, PARQUET FLOORING, FUR-
RINGS OF WOOD, SCANTLINGS FOR CARPEN-
TRY, WOOD PANELING, FLOOR BOARDS,
PARQUET FLOOR BOARDS, WOOD PAVING,
WORKED TIMBER, SEMI-WORKED WOOD, IN
CLASS 19 (U.S. CLS. 1, 12, 33 AND 50).

OWNER OF INTERNATIONAL REGISTRATION
0951140 DATED 1-7-2008, EXPIRES 1-7-2018.

THE ENGLISH TRANSLATION OF THE FOR-
EIGN WORD IN THE MARK IS "GOOD LUCK".

THE TRANSLITERATION OF THE NON-LATIN
CHARACTERS IN THE MARK IS "HAO YUN".

SER. NO. 79-049,081, FILED 1-7-2008.

TARAH HARDY, EXAMINING ATTORNEY

Int. Cls.: 12 and 28

Prior U.S. Cls.: 19, 21, 22, 23, 31, 35, 38, 44 and 50

United States Patent and Trademark Office

Reg. No. 3,481,031

Registered Aug. 5, 2008

**TRADEMARK
PRINCIPAL REGISTER**

SILVER GHOST

BAYERISCHE MOTOREN WERKE AKTIENGE-
SELLSCHAFT (FED REP GERMANY AKTIEN-
GESELLSCHAFT (JOINT STOCK COMPANY))

PETUELRING 130
80809 MÜNCHEN
FED REP GERMANY

FOR: AUTOMOBILES AND STRUCTURAL
PARTS THEREFOR, IN CLASS 12 (U.S. CLS. 19, 21,
23, 31, 35 AND 44).

FOR: MINIATURES OF AUTOMOBILES, IN
CLASS 28 (U.S. CLS. 22, 23, 38 AND 50).

THE MARK CONSISTS OF STANDARD CHAR-
ACTERS WITHOUT CLAIM TO ANY PARTICULAR
FONT, STYLE, SIZE, OR COLOR.

PRIORITY DATE OF 5-23-2007 IS CLAIMED.

OWNER OF INTERNATIONAL REGISTRATION
0951390 DATED 11-15-2007, EXPIRES 11-15-2017.

OWNER OF U.S. REG. NO. 1,067,640.

SER. NO. 79-049,148, FILED 11-15-2007.

EUGENIA MARTIN, EXAMINING ATTORNEY

Int. Cls.: 3 and 5

Prior U.S. Cls.: 1, 4, 6, 18, 44, 46, 50, 51 and 52

United States Patent and Trademark Office

Reg. No. 3,481,032

Registered Aug. 5, 2008

**TRADEMARK
PRINCIPAL REGISTER**



BEIERSDORF AG (FED REP GERMANY JOINT
STOCK COMPANY)
UNNASTRASSE 48
20253 HAMBURG
FED REP GERMANY

FOR: SOAPS, PERFUMERY, ESSENTIAL OILS,
COSMETICS, HAIR LOTIONS, IN CLASS 3 (U.S. CLS.
1, 4, 6, 50, 51 AND 52).

FOR: DIETARY AND NUTRITIONAL SUPPLE-
MENTS FOR HEALTH CARE, NAMELY, VITA-
MINS, MINERALS, TRACE ELEMENTS, EITHER
SEPARATELY OR IN COMBINATION; NUTRI-
TIONAL ADDITIVES FOR USE IN DIETARY SUP-
PLEMENTS, NUTRITIONAL SUPPLEMENTS AND
FOOD SUPPLEMENTS, NAMELY, AMINO ACIDS,
MINERALS, TRACE ELEMENTS, EITHER SEPA-
RATELY OR IN COMBINATION, AND ALSO IN
PILL FORM; VITAMIN PREPARATIONS; TRACE
ELEMENTS PREPARATIONS FOR USE IN NUTRI-
TIONAL SUPPLEMENTS, DIETARY SUPPLE-
MENTS AND FOOD SUPPLEMENTS, IN CLASS 5
(U.S. CLS. 6, 18, 44, 46, 51 AND 52).

PRIORITY DATE OF 8-27-2007 IS CLAIMED.

OWNER OF INTERNATIONAL REGISTRATION
0951550 DATED 11-16-2007, EXPIRES 11-16-2017.

OWNER OF U.S. REG. NOS. 2,641,914, 3,052,612,
AND 3,291,880.

THE COLOR(S) BLUE, SILVER AND WHITE IS/
ARE CLAIMED AS A FEATURE OF THE MARK.

THE COLOR WHITE APPEARS IN THE DESIG-
NATION "NIVEA". THE COLOR BLUE APPEARS IN
THE RECTANGULAR BACKGROUND PANEL.
THE COLOR SILVER APPEARS IN THE TOP AND
BOTTOM BORDERS OF THE PANEL.

SER. NO. 79-049,210, FILED 11-16-2007.

LINDA E. BLOHM, EXAMINING ATTORNEY

Int. Cl.: 12

Prior U.S. Cls.: 19, 21, 23, 31, 35 and 44

United States Patent and Trademark Office

Reg. No. 3,481,033

Registered Aug. 5, 2008

**TRADEMARK
PRINCIPAL REGISTER**

ContiESCContact

CONTINENTAL AKTIENGESELLSCHAFT (FED
REP GERMANY JOINT STOCK COMPANY)
VAHRENWALDER STRASSE 9
30165 HANNOVER, FED REP GERMANY

OWNER OF INTERNATIONAL REGISTRATION
0951595 DATED 12-7-2007, EXPIRES 12-7-2017.

FOR: VEHICLE TIRES; INNER TUBES FOR VE-
HICLE TIRES; SOLID RUBBER TIRES, IN CLASS 12
(U.S. CLS. 19, 21, 23, 31, 35 AND 44).

OWNER OF U.S. REG. NOS. 652,057, 3,133,200 AND
OTHERS.

THE MARK CONSISTS OF STANDARD CHAR-
ACTERS WITHOUT CLAIM TO ANY PARTICULAR
FONT, STYLE, SIZE, OR COLOR.

SER. NO. 79-049,238, FILED 12-7-2007.

PRIORITY DATE OF 9-5-2007 IS CLAIMED.

SHANNON TWOHIG, EXAMINING ATTORNEY

Int. Cl.: 40

Prior U.S. Cls.: 100, 103 and 106

United States Patent and Trademark Office

Reg. No. 3,481,034

Registered Aug. 5, 2008

**SERVICE MARK
PRINCIPAL REGISTER**



S T U D I O L A B E L S

STUDIO LABELS PTY LTD; ACN 125 870 304
(AUSTRALIA COMPANY LIMITED BY
SHARES)
59 HAMPTON ROAD
KESWICK SA 5035
AUSTRALIA

PRIORITY DATE OF 8-10-2007 IS CLAIMED.

OWNER OF INTERNATIONAL REGISTRATION
0951912 DATED 1-2-2008, EXPIRES 1-2-2018.

FOR: PRINTING SERVICES INCLUDING OFF-
SET PRINTING, LITHOGRAPHIC PRINTING, PHO-
TOGRAPHIC PRINTING, SCREEN PRINTING, IN
CLASS 40 (U.S. CLS. 100, 103 AND 106).

SER. NO. 79-049,365, FILED 1-2-2008.

KRISTIN DAHLING, EXAMINING ATTORNEY

Int. Cl.: 7

Prior U.S. Cls.: 13, 19, 21, 23, 31, 34 and 35

United States Patent and Trademark Office

Reg. No. 3,481,035

Registered Aug. 5, 2008

**TRADEMARK
PRINCIPAL REGISTER**

FLOCMASTER

J. F. KNAUER INDUSTRIE-ELEKTRONIK
GMBH (FED REP GERMANY GMBH)
DEUIL-LA-BARRESTR. 17
60437 FRANKFURT AM MAIN
FED REP GERMANY

FOR: MIXING MACHINES FOR MIXING CHEMICAL SUBSTANCES, IN PARTICULAR FLOCCULATION AGENTS, INTO LIQUIDS, SUSPENSIONS AND SLUDGES, IN PARTICULAR FOR THE CHEMICAL CONDITIONING OF SLUDGES BEFORE THEIR DEHYDRATION, IN CLASS 7 (U.S. CLS. 13, 19, 21, 23, 31, 34 AND 35).

PRIORITY DATE OF 12-14-2007 IS CLAIMED.

OWNER OF INTERNATIONAL REGISTRATION
0952590 DATED 12-28-2007, EXPIRES 12-28-2017.

SER. NO. 79-049,584, FILED 12-28-2007.

CHRISIE B. KING, EXAMINING ATTORNEY

Int. Cls.: 9, 16 and 25

**Prior U.S. Cls.: 2, 5, 21, 22, 23, 26, 29, 36, 37, 38, 39
and 50**

Reg. No. 3,481,036

United States Patent and Trademark Office

Registered Aug. 5, 2008

**TRADEMARK
PRINCIPAL REGISTER**

mediband

RANDALL COMMUNICATIONS PTY LTD (AUSTRALIA PROPRIETARY LIMITED COMPANY)
PO BOX 7310
ALEXANDRIA NSW 2015, AUSTRALIA

FOR: ELECTRONICALLY ENCODED IDENTITY WRISTBANDS, IN CLASS 9 (U.S. CLS. 21, 23, 26, 36 AND 38).

FOR: WRISTBANDS FOR THE RETENTION OF WRITING INSTRUMENTS, IN CLASS 16 (U.S. CLS. 2, 5, 22, 23, 29, 37, 38 AND 50).

FOR: WRISTBANDS AS CLOTHING, IN CLASS 25 (U.S. CLS. 22 AND 39).

THE MARK CONSISTS OF STANDARD CHARACTERS WITHOUT CLAIM TO ANY PARTICULAR FONT, STYLE, SIZE, OR COLOR.

PRIORITY DATE OF 11-19-2007 IS CLAIMED.

OWNER OF INTERNATIONAL REGISTRATION 0953030 DATED 12-10-2007, EXPIRES 12-10-2017.

SER. NO. 79-049,808, FILED 12-10-2007.

ALLISON HOLTZ, EXAMINING ATTORNEY

Int. Cl.: 34

Prior U.S. Cls.: 2, 8, 9 and 17

United States Patent and Trademark Office

Reg. No. 3,481,037

Registered Aug. 5, 2008

**TRADEMARK
PRINCIPAL REGISTER**

von Eicken Pipetime

JOH. WILH. VON EICKEN GMBH (FED REP
GERMANY GMBH (LIMITED LIABILITY
COMPANY ACCORDING GERMAN LAW))

DRECHSLERSTRASSE 1-3

23556 LÜBECK

FED REP GERMANY

FOR: PIPE TOBACCO, SMOKING TOBACCO, IN
CLASS 34 (U.S. CLS. 2, 8, 9 AND 17).

THE MARK CONSISTS OF STANDARD CHAR-
ACTERS WITHOUT CLAIM TO ANY PARTICULAR
FONT, STYLE, SIZE, OR COLOR.

OWNER OF INTERNATIONAL REGISTRATION
0953640 DATED 1-8-2008, EXPIRES 1-8-2018.

SER. NO. 79-050,035, FILED 1-8-2008.

JUDITH HELFMAN, EXAMINING ATTORNEY

Int. Cl.: 6

Prior U.S. Cls.: 2, 12, 13, 14, 23, 25 and 50

Reg. No. 3,481,038

United States Patent and Trademark Office

Registered Aug. 5, 2008

**TRADEMARK
PRINCIPAL REGISTER**

SLEIPNER

UDDEHOLM TOOLING AKTIEBOLAG (SWEDEN LIMITED COMPANY)
SE-683 85 HAGFORS
SWEDEN

FOR: COMMON METALS AND THEIR ALLOYS, NAMELY, ALLOYED AND UNALLOYED TOOL STEEL AND STAINLESS STEEL IN THE FORM OF BARS, BLOCKS, PLATES, RINGS, WIRES, STRIPS, TUBES AND CASTINGS, IN CLASS 6 (U.S. CLS. 2, 12, 13, 14, 23, 25 AND 50).

THE MARK CONSISTS OF STANDARD CHARACTERS WITHOUT CLAIM TO ANY PARTICULAR FONT, STYLE, SIZE, OR COLOR.

OWNER OF INTERNATIONAL REGISTRATION 0953873 DATED 1-22-2008, EXPIRES 1-22-2018.

SER. NO. 79-050,129, FILED 1-22-2008.

CARYN GLASSER, EXAMINING ATTORNEY

Int. Cl.: 9

Prior U.S. Cls.: 21, 23, 26, 36 and 38

Reg. No. 3,481,039

United States Patent and Trademark Office

Registered Aug. 5, 2008

**TRADEMARK
PRINCIPAL REGISTER**

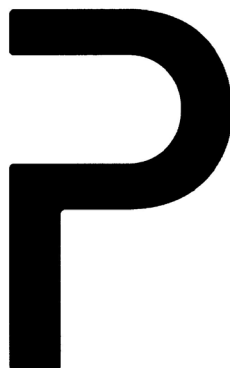

PIEZOCRYST ADVANCED SENSORIES GMBH
(AUSTRIA PRIVATE LIMITED COMPANY)
HANS-LIST-PLATZ 1
A-8020 GRAZ
AUSTRIA

FOR: ELECTROMECHANICAL, ELECTRO OPTIC AND OPTIC SENSORS, PRESSURE SENSORS, POWER SENSORS, ACCELERATION SENSORS, EXPANSION SENSORS, EXPANSION MEASURING STRIPS, MEASURING DEVICES FOR MEASURING OF PRESSURE, MEASURING OF POWER OR MEASURING OF ACCELERATION, ELECTRONIC AMPLIFIERS FOR ELECTROMECHANICAL, ELECTRO OPTIC AND OPTIC SENSORS, CALIBRATION AND CHECKING DEVICES FOR ELECTRO-

MECHANICAL, ELECTRO OPTIC AND OPTIC SENSORS, RESONATOR ELEMENTS, CRYSTAL SCALES, ELECTRO ACOUSTIC COMPONENTS, CAPACITIVE, INDUCTIVE AND RESISTIVE MEASURING TRANSFORMERS, IN CLASS 9 (U.S. CLS. 21, 23, 26, 36 AND 38).

OWNER OF INTERNATIONAL REGISTRATION
0956676 DATED 12-6-2007, EXPIRES 12-6-2017.

SER. NO. 79-051,097, FILED 12-6-2007.

FRED MANDIR, EXAMINING ATTORNEY

Int. Cls.: 41 and 42

Prior U.S. Cls.: 100, 101 and 107

United States Patent and Trademark Office

Reg. No. 3,481,040

Registered Aug. 5, 2008

SERVICE MARK
PRINCIPAL REGISTER



AZIENDA SPECIALE; "REAL PRECIOUS QUALITY" (ITALY UNINCORPORATED ADMINISTRATIVE ORGANIZATION)
VIA AVOGADRO, 1
I-62010 MONTELUPONE (MC)
ITALY

FOR: EDUCATIONAL SERVICES, NAMELY, PROVIDING CLASSES IN THE FIELD OF PRECIOUS METAL JEWELRY DESIGN, PROVIDING OF TRAINING IN THE FIELD OF MOLDING PRECIOUS METAL JEWELRY, AND PROVIDING INSTRUCTION IN THE FIELD OF TESTING PRECIOUS METALS USED IN THE MANUFACTURE OF PRECIOUS METAL JEWELRY; CULTURAL ACTIVITIES, NAMELY, ORGANIZING COMMUNITY CULTURAL EVENTS., IN CLASS 41 (U.S. CLS. 100, 101 AND 107).

FOR: SCIENTIFIC RESEARCH AND TECHNOLOGY CONSULTATION SERVICES AND RESEARCH AND DESIGN RELATING THERETO IN THE TECHNICAL FIELD OF PRECIOUS METAL USE IN

PRODUCTS; CHEMICAL AND CHEMICAL-PHYSICAL TEST LABORATORIES. , IN CLASS 42 (U.S. CLS. 100 AND 101).

OWNER OF INTERNATIONAL REGISTRATION
0887074 DATED 11-18-2005, EXPIRES 11-18-2015.

NO CLAIM IS MADE TO THE EXCLUSIVE RIGHT TO USE "REAL SILVER QUALITY", APART FROM THE MARK AS SHOWN.

SIGN "REAL SILVER QUALITY" IN SMALL LETTERS, WITH CAPITAL INITIAL LETTER. THE SIGN IS WRITTEN IN THREE LINES. ON LEFT IS REPRESENTED A CAPITAL "Q" AND INSIDE THE "Q" ARE IMPRINTED OVER THE CAPITAL LETTERS "R" AND "S".

SER. NO. 79-975,031, FILED 11-18-2005.

KAREN K. BUSH, EXAMINING ATTORNEY

Int. Cls.: 41 and 42

Prior U.S. Cls.: 100, 101 and 107

United States Patent and Trademark Office

Reg. No. 3,481,041

Registered Aug. 5, 2008

**SERVICE MARK
PRINCIPAL REGISTER**



AZIENDA SPECIALE; "REAL PRECIOUS QUALITY" (ITALY UNINCORPORATED ADMINISTRATIVE ORGANIZATION)

VIA AVOGADRO, 1
I-62010 MONTELUPONE (MC)
ITALY

FOR: EDUCATIONAL SERVICES, NAMELY, PROVIDING CLASSES IN THE FIELD OF PRECIOUS METAL JEWELRY DESIGN, PROVIDING OF TRAINING IN THE FIELD OF MOLDING PRECIOUS METAL JEWELRY, AND PROVIDING INSTRUCTION IN THE FIELD OF TESTING PRECIOUS METALS USED IN THE MANUFACTURE OF PRECIOUS METAL JEWELRY; CULTURAL ACTIVITIES, NAMELY, ORGANIZING COMMUNITY CULTURAL EVENTS., IN CLASS 41 (U.S. CLS. 100, 101 AND 107).

FOR: SCIENTIFIC RESEARCH AND TECHNOLOGY CONSULTATION SERVICES AND RESEARCH AND DESIGN RELATING THERETO IN THE TECHNICAL FIELD OF PRECIOUS METAL USE IN

PRODUCTS; CHEMICAL AND CHEMICAL-PHYSICAL TEST LABORATORIES. , IN CLASS 42 (U.S. CLS. 100 AND 101).

OWNER OF INTERNATIONAL REGISTRATION
0887050 DATED 11-18-2005, EXPIRES 11-18-2015.

NO CLAIM IS MADE TO THE EXCLUSIVE RIGHT TO USE "REAL PRECIOUS QUALITY", APART FROM THE MARK AS SHOWN.

SIGN "REAL PRECIOUS QUALITY" IN SMALL LETTERS, WITH CAPITAL INITIAL LETTER; THE SIGN IS WRITTEN IN THREE LINES; ON LEFT IS REPRESENTED A CAPITAL "Q" AND INSIDE THE "Q" ARE IMPRINTED OVER THE CAPITAL LETTERS "R" AND "P".

SER. NO. 79-975,032, FILED 11-18-2005.

KAREN K. BUSH, EXAMINING ATTORNEY

Int. Cl.: 19

Prior U.S. Cls.: 1, 12, 33, and 50

United States Patent and Trademark Office

Reg. No. 3,481,042

Registered Aug. 5, 2008

**TRADEMARK
PRINCIPAL REGISTER**

HERITAGE

MASONITE HOLDINGS, INC. (FLORIDA CORPORATION)
ONE NORTH DALE MABRY HIGHWAY
TAMPA, FL 33609

FIRST USE 1-1-2005; IN COMMERCE 9-10-2007.

SN 75-670,593, FILED 3-29-1999.

FOR: NON-METAL INTERIOR RESIDENTIAL DOORS, IN CLASS 19 (U.S. CLS. 1, 12, 33 AND 50).

KATHLEEN M. VANSTON, EXAMINING ATTORNEY

Int. Cl.: 42

Prior U.S. Cls.: 100 and 101

United States Patent and Trademark Office

Reg. No. 3,481,043

Registered Aug. 5, 2008

**SERVICE MARK
PRINCIPAL REGISTER**

PLANET EARTH VIDEO

PLANET EARTH FOUNDATION (WASHINGTON
NON-PROFIT CORPORATION)
P.O BOX 1190
SEATTLE, WA 98111

FOR: NEWS AGENCY SERVICES, NAMELY, DIS-
SEMINATION OF NEWS AND INFORMATION OF
LOCAL, NATIONAL AND GLOBAL INTEREST VIA
PRINTED PUBLICATIONS, AUDIO MEDIA,
AUDIO-VISUAL MEDIA, AND VIA A GLOBAL
COMPUTER NETWORK, IN CLASS 42 (U.S. CLS.
100 AND 101).

FIRST USE 5-1-2000; IN COMMERCE 5-1-2000.

NO CLAIM IS MADE TO THE EXCLUSIVE
RIGHT TO USE "VIDEO", APART FROM THE
MARK AS SHOWN.

SN 76-044,558, FILED 5-9-2000.

ROBERT C. CLARK JR., EXAMINING ATTORNEY

Int. Cl.: 42

Prior U.S. Cls.: 100 and 101

United States Patent and Trademark Office

Reg. No. 3,481,044

Registered Aug. 5, 2008

**SERVICE MARK
PRINCIPAL REGISTER**

PLANET EARTH BROADCAST

PLANET EARTH FOUNDATION (WASHINGTON
NON-PROFIT CORPORATION)
P.O. BOX 1190
SEATTLE, WA 98111

FOR: NEWS AGENCY SERVICES, NAMELY, DIS-
SEMINATION OF NEWS AND INFORMATION OF
LOCAL, NATIONAL AND GLOBAL INTEREST VIA
PRINTED PUBLICATIONS, AUDIO MEDIA,
AUDIO-VISUAL MEDIA, AND VIA A GLOBAL
COMPUTER NETWORK, IN CLASS 42 (U.S. CLS.
100 AND 101).

FIRST USE 5-1-2000; IN COMMERCE 5-1-2000.

NO CLAIM IS MADE TO THE EXCLUSIVE
RIGHT TO USE "BROADCAST", APART FROM
THE MARK AS SHOWN.

SN 76-044,578, FILED 5-9-2000.

ROBERT C. CLARK JR., EXAMINING ATTORNEY

Int. Cl.: 42

Prior U.S. Cls.: 100 and 101

United States Patent and Trademark Office

Reg. No. 3,481,045

Registered Aug. 5, 2008

**SERVICE MARK
PRINCIPAL REGISTER**

PLANET EARTH AUDIO

PLANET EARTH FOUNDATION (WASHINGTON
NON-PROFIT CORPORATION)
P.O. BOX 1190
SEATTLE, WA 98111

FOR: NEWS AGENCY SERVICES, NAMELY, DIS-
SEMINATION OF NEWS AND INFORMATION OF
LOCAL, NATIONAL AND GLOBAL INTEREST VIA
PRINTED PUBLICATIONS, AUDIO MEDIA,
AUDIO-VISUAL MEDIA, AND VIA A GLOBAL
COMPUTER NETWORK, IN CLASS 42 (U.S. CLS.
100 AND 101).

FIRST USE 5-1-2000; IN COMMERCE 5-1-2000.

NO CLAIM IS MADE TO THE EXCLUSIVE
RIGHT TO USE "AUDIO", APART FROM THE
MARK AS SHOWN.

SN 76-044,709, FILED 5-9-2000.

ROBERT C. CLARK JR., EXAMINING ATTORNEY

Int. Cl.: 42

Prior U.S. Cls.: 100 and 101

United States Patent and Trademark Office

Reg. No. 3,481,046

Registered Aug. 5, 2008

**SERVICE MARK
PRINCIPAL REGISTER**

PLANET EARTH TELECOM

PLANET EARTH FOUNDATION (WASHINGTON
NON-PROFIT CORPORATION)
P.O. BOX 1190
SEATTLE, WA 98111

FIRST USE 5-1-2000; IN COMMERCE 5-1-2000.

FOR: NEWS AGENCY SERVICES, NAMELY, DIS-
SEMINATION OF NEWS AND INFORMATION OF
LOCAL, NATIONAL AND GLOBAL INTEREST VIA
PRINTED PUBLICATIONS, AUDIO MEDIA,
AUDIO-VISUAL MEDIA, AND VIA A GLOBAL
COMPUTER NETWORK, IN CLASS 42 (U.S. CLS.
100 AND 101).

NO CLAIM IS MADE TO THE EXCLUSIVE
RIGHT TO USE "TELECOM", APART FROM THE
MARK AS SHOWN.

SN 76-044,710, FILED 5-9-2000.

ROBERT C. CLARK JR., EXAMINING ATTORNEY

Int. Cl.: 42

Prior U.S. Cls.: 100 and 101

United States Patent and Trademark Office

Reg. No. 3,481,047

Registered Aug. 5, 2008

**SERVICE MARK
PRINCIPAL REGISTER**

PLANET EARTH BROADBAND

PLANET EARTH FOUNDATION (WASHINGTON
NOT-PROFIT CORPORATION)
P.O. BOX 1190
SUITE 303
SEATTLE, WA 98111

FIRST USE 5-1-2000; IN COMMERCE 5-1-2000.

NO CLAIM IS MADE TO THE EXCLUSIVE
RIGHT TO USE "BROADBAND", APART FROM
THE MARK AS SHOWN.

FOR: NEWS AGENCY SERVICES, NAMELY, DIS-
SEMINATION OF NEWS AND INFORMATION OF
LOCAL, NATIONAL AND GLOBAL INTEREST VIA
PRINTED PUBLICATIONS, AUDIO MEDIA,
AUDIO-VISUAL MEDIA, AND VIA A GLOBAL
COMPUTER NETWORK, IN CLASS 42 (U.S. CLS.
100 AND 101).

SN 76-044,868, FILED 5-9-2000.

ROBERT C. CLARK JR., EXAMINING ATTORNEY

Int. Cl.: 42

Prior U.S. Cls.: 100 and 101

United States Patent and Trademark Office

Reg. No. 3,481,048

Registered Aug. 5, 2008

**SERVICE MARK
PRINCIPAL REGISTER**

PLANET EARTH REPORT

PLANET EARTH FOUNDATION (WASHINGTON
NOT-PROFIT CORPORATION)
P.O. BOX 1190
SEATTLE, WA 98111

FOR: NEWS AGENCY SERVICES, NAMELY, DIS-
SEMINATION OF NEWS AND INFORMATION OF
LOCAL, NATIONAL AND GLOBAL INTEREST VIA
PRINTED PUBLICATIONS, AUDIO MEDIA,
AUDIO-VISUAL MEDIA, AND VIA A GLOBAL
COMPUTER NETWORK, IN CLASS 42 (U.S. CLS.
100 AND 101).

FIRST USE 5-1-2000; IN COMMERCE 5-1-2000.

NO CLAIM IS MADE TO THE EXCLUSIVE
RIGHT TO USE "REPORT", APART FROM THE
MARK AS SHOWN.

SN 76-044,869, FILED 5-9-2000.

ROBERT C. CLARK JR., EXAMINING ATTORNEY

Int. Cl.: 10

Prior U.S. Cls.: 26, 39, and 44

United States Patent and Trademark Office

Reg. No. 3,481,049

Registered Aug. 5, 2008

**TRADEMARK
PRINCIPAL REGISTER**

CONQUEST

C. R. BARD, INC. (NEW JERSEY CORPORATION)
730 CENTRAL AVENUE
MURRAY HILL, NJ 07974

FIRST USE 3-27-2002; IN COMMERCE 3-27-2002.

SN 76-336,490, FILED 11-13-2001.

FOR: PERCUTANEOUS TRANSLUMINAL ANGIOPLASTY (PTA) BALLOON CATHETER, IN CLASS 10 (U.S. CLS. 26, 39 AND 44).

LEIGH CAROLINE CASE, EXAMINING ATTORNEY

Int. Cls.: 3, 5, 10, and 28

**Prior U.S. Cls.: 1, 4, 6, 18, 22, 23, 26, 38, 39, 44, 46, 50,
51, and 52**

Reg. No. 3,481,050

United States Patent and Trademark Office

Registered Aug. 5, 2008

**TRADEMARK
PRINCIPAL REGISTER**

YOUR HEALTH IS OUR BIZ

AGEWELL, P.C. (INDIANA CORPORATION)
9292 NORTH MERIDIAN STREET, SUITE 107
INDIANAPOLIS, IN 462601828

FOR: COSMETIC PREPARATIONS, NAMELY,
SKIN CREAM, LOTIONS, CLEANSERS FOR THE
BODY, IN CLASS 3 (U.S. CLS. 1, 4, 6, 50, 51 AND 52).

FIRST USE 8-6-2007; IN COMMERCE 8-6-2007.

FOR: THERAPEUTIC, HYGIENIC, AND PHAR-
MACEUTICAL PREPARATIONS FOR THE TREAT-
MENT OF COLDS, DRY SKIN, MEMORY LOSS,
ARTHRITIS, SLEEPING DISORDERS, VITAMINS,
MINERALS, NUTRITIONAL AND DIETARY SUP-
PLEMENTS, IN CLASS 5 (U.S. CLS. 6, 18, 44, 46, 51
AND 52).

FIRST USE 8-6-2007; IN COMMERCE 8-6-2007.

FOR: SURGICAL AND MEDICAL APPARATUS
AND INSTRUMENTS, NAMELY, MEDICATION
DISPENSERS, IN CLASS 10 (U.S. CLS. 26, 39 AND 44).

FIRST USE 8-6-2007; IN COMMERCE 8-6-2007.

FOR: SPORTING GOODS EQUIPMENT, NAME-
LY, EXERCISE BALLS, AND RESISTANCE BANDS,
IN CLASS 28 (U.S. CLS. 22, 23, 38 AND 50).

FIRST USE 8-6-2007; IN COMMERCE 8-6-2007.

SN 76-404,069, FILED 5-6-2002.

CURTIS FRENCH, EXAMINING ATTORNEY

Int. Cls.: 18, 25, and 42

Prior U.S. Cls.: 1, 2, 3, 22, 39, 41, 100, and 101

United States Patent and Trademark Office

Reg. No. 3,481,051

Registered Aug. 5, 2008

**TRADEMARK
SERVICE MARK
PRINCIPAL REGISTER**

COUTURE LAB

BUSQUETS, CARMEN (VENEZUELA INDIVIDUAL)
600 GRAPE TREE DRIVE, APT. B SOUTH
KEY BISCAYNE, FL 33149

FOR: LEATHER AND IMITATION LEATHER PRODUCTS, NAMELY, TRUNKS AND VALISES, HANDBAGS, STORAGE BAGS; ANIMAL SKINS AND PELTS; AND UMBRELLAS, IN CLASS 18 (U.S. CLS. 1, 2, 3, 22 AND 41).

FIRST USE 10-30-2006; IN COMMERCE 11-0-2005.

FOR: CLOTHING FOR MEN, WOMEN AND CHILDREN, NAMELY, SHOES OTHER THAN ORTHOPEDIC SHOES, BOOTS, SANDALS, MULES AND SLIPPERS; BELTS, GLOVES AND HATS; LINGERIE AND UNDERWEAR; SWIMWEAR; SHIRTS, BLOUSES, VEST, CARDIGANS, T-SHIRTS, SWEATSHIRTS AND POLO SHIRTS; CASHMERE SCARVES, SWEATERS, PULLOVERS AND CARDIGANS; PANTS, JEANS AND CORDUROY S; SKIRTS; SUITS AND DRESSES; JACKETS, COATS, CAPES;

AND TUXEDOS AND EVENING GOWNS, IN CLASS 25 (U.S. CLS. 22 AND 39).

FIRST USE 10-30-2006; IN COMMERCE 11-0-2005.

FOR: PROVIDING THE SERVICES OF FASHION DESIGNERS AND INDUSTRIAL DESIGNERS; RESEARCH AND DEVELOPMENT OF NEW PRODUCTS FOR OTHERS; AND CREATION OF DESIGN AND FASHION PATTERNS FOR OTHERS, IN CLASS 42 (U.S. CLS. 100 AND 101).

FIRST USE 10-30-2006; IN COMMERCE 11-0-2005.

NO CLAIM IS MADE TO THE EXCLUSIVE RIGHT TO USE "COUTURE", APART FROM THE MARK AS SHOWN.

SN 76-494,344, FILED 3-4-2003.

KEVON CHISOLM, EXAMINING ATTORNEY

Int. Cl.: 9

Prior U.S. Cls.: 21, 23, 26, 36, and 38

United States Patent and Trademark Office

Reg. No. 3,481,052

Registered Aug. 5, 2008

**TRADEMARK
PRINCIPAL REGISTER**

WAI LANA'S LITTLE YOGIS

WAI LAN YOGA TRUST (CALIFORNIA TRUST)
P.O. BOX 6146
MALIBU, CA 90264

OWNER OF U.S. REG. NOS. 2,315,533 AND
2,729,584.

FOR: PRERECORDED VIDEO TAPES FEATUR-
ING YOGA EXERCISES, CDS FEATURING RE-
LAXATION MUSIC, PRE-RECORDED DVDS
FEATURING YOGA EXERCISES AND RELAXA-
TION MUSIC, IN CLASS 9 (U.S. CLS. 21, 23, 26, 36
AND 38).

THE NAME "WAI LANA" IDENTIFIES A LIVING
INDIVIDUAL WHOSE CONSENT IS OF RECORD.

SN 76-520,306, FILED 5-28-2003.

FIRST USE 9-30-2003; IN COMMERCE 9-30-2003.

CAROLYN CATALDO, EXAMINING ATTORNEY

Int. Cl.: 1

Prior U.S. Cls.: 1, 5, 6, 10, 26, and 46

United States Patent and Trademark Office

Reg. No. 3,481,053

Registered Aug. 5, 2008

**TRADEMARK
PRINCIPAL REGISTER**

COMPO ENTEC

COMPO GMBH & CO. KG (FED REP GERMANY
CORPORATION)
GILDENSTRASSE 38
MUENSTER, FED REP GERMANY 48008

FIRST USE 5-14-2008; IN COMMERCE 5-14-2008.

OWNER OF U.S. REG. NO. 2,703,125.

FOR: CHEMICALS FOR USE IN THE MANUFACTURE OF FERTILIZERS; FERTILIZERS FOR AGRICULTURAL, HORTICULTURE AND FORESTRY USES, IN CLASS 1 (U.S. CLS. 1, 5, 6, 10, 26 AND 46).

SN 76-523,886, FILED 6-18-2003.

LINDA ESTRADA, EXAMINING ATTORNEY

Int. Cl.: 45

Prior U.S. Cls.: 100 and 101

United States Patent and Trademark Office

Reg. No. 3,481,054

Registered Aug. 5, 2008

**SERVICE MARK
PRINCIPAL REGISTER**

LINEA VIVA

TELIGENCE (CANADA), INC. (CANADA CORPORATION)
1045 HOWE STREET STE. 700
VANCOUVER, CANADA V6Z 2A9

FOR: SOCIAL INTRODUCTION AGENCIES AND
COMPUTER DATING SERVICES VIA A GLOBAL
COMPUTER NETWORK, IN CLASS 45 (U.S. CLS. 100
AND 101).

FIRST USE 6-1-2007; IN COMMERCE 6-1-2007.

THE ENGLISH TRANSLATION OF "LINEA
VIVA" IS "LIVE LINE".

SN 76-524,873, FILED 6-12-2003.

MARLENE BELL, EXAMINING ATTORNEY

Int. Cl.: 16

Prior U.S. Cls.: 2, 5, 22, 23, 29, 37, 38, and 50

Reg. No. 3,481,055

United States Patent and Trademark Office

Registered Aug. 5, 2008

**TRADEMARK
PRINCIPAL REGISTER**

CAR·I·OKE

WORKMAN PUBLISHING CO., INC. (NEW YORK CORPORATION)
225 VARICK STREET
NEW YORK, NY 100144381 AND
SCHILLER, DAVID (UNITED STATES INDIVIDUAL)
C/O WORKMAN PUBLISHING CO., INC.
225 VARICK STREET
NEW YORK, NY 100144381

FOR: SERIES OF NON-FICTION BOOKS IN THE FIELD OF ENTERTAINMENT, FEATURING SONG LYRICS, INFORMATION ABOUT SONGS, TRIVIA,

ACTIVITIES AND GAMES AND PRE-RECORDED COMPACT DISCS FEATURING INSTRUMENTAL MUSIC WITHOUT VOCALS, SOLD AS A UNIT, FOR USE WITH AUTOMOBILES, IN CLASS 16 (U.S. CLS. 2, 5, 22, 23, 29, 37, 38 AND 50).

FIRST USE 6-0-2003; IN COMMERCE 6-0-2003.

SN 76-533,292, FILED 7-16-2003.

KAREN BRACEY, EXAMINING ATTORNEY

Int. Cl.: 16

Prior U.S. Cls.: 2, 5, 22, 23, 29, 37, 38, and 50

United States Patent and Trademark Office

Reg. No. 3,481,056

Registered Aug. 5, 2008

**TRADEMARK
PRINCIPAL REGISTER**

JOY JOURNAL

ZWICKER SERVICES. INC. (PENNSYLVANIA
CORPORATION)
823 N. FAIRWAY ROAD
GLENSIDE, PA 19038

FOR: BOOKS PARTIALLY PRINTED AND FOR-
MATTED FOR REGULARLY RECORDING PERSONAL
INFORMATION INCLUDING EXPERIENCES,
IDEAS AND REFLECTIONS FOR KEEPSAKE PUR-
POSES , IN CLASS 16 (U.S. CLS. 2, 5, 22, 23, 29, 37, 38
AND 50).

FIRST USE 5-1-2004; IN COMMERCE 5-1-2004.

NO CLAIM IS MADE TO THE EXCLUSIVE
RIGHT TO USE "JOURNAL", APART FROM THE
MARK AS SHOWN.

SN 76-542,486, FILED 9-4-2003.

RUDY R. SINGLETON, EXAMINING ATTORNEY

Int. Cl.: 44

Prior U.S. Cls.: 100 and 101

United States Patent and Trademark Office

Reg. No. 3,481,057

Registered Aug. 5, 2008

**SERVICE MARK
PRINCIPAL REGISTER**

HOPE NETWORK

CONVOY OF HOPE (CALIFORNIA NOT-FOR-
PROFIT CORPORATION)
330 S. PATTERSON AVENUE
SPRINGFIELD, MO 65802

FOR: CHARITABLE SERVICES, NAMELY, PRO-
VIDING MEDICAL AND HEALTHCARE SERVICES
TO DISADVANTAGED PEOPLE; CHARITABLE
AND DISASTER RELIEF SERVICES, NAMELY,
PROVIDING BLANKETS FOR FIRST AID USE
AND PERSONAL HYGIENE PRODUCTS TO VIC-

TIMS OF NATURAL DISASTERS AND DISADVAN-
TAGED PEOPLE, IN CLASS 44 (U.S. CLS. 100 AND
101).

FIRST USE 5-28-2003; IN COMMERCE 5-28-2003.

SN 76-543,947, FILED 9-9-2003.

AISHA CLARKE, EXAMINING ATTORNEY

Int. Cl.: 43

Prior U.S. Cls.: 100 and 101

United States Patent and Trademark Office

Reg. No. 3,481,058

Registered Aug. 5, 2008

**SERVICE MARK
PRINCIPAL REGISTER**

HOPE NETWORK

CONVOY OF HOPE (CALIFORNIA NOT-FOR-
PROFIT CORPORATION)
330 S. PATTERSON AVENUE
SPRINGFIELD, MO 65802

FOR: CHARITABLE SERVICES, NAMELY, PRO-
VIDING FOOD TO DISADVANTAGED PEOPLE;
CHARITABLE AND DISASTER RELIEF SERVICES,
NAMELY, PROVIDING HOUSEHOLD ITEMS,
NAMELY, APPLIANCES, FURNITURE, WATER
PURIFICATION SYSTEMS, GENERATORS, AND

COOKING SUPPLIES TO VICTIMS OF NATURAL
DISASTERS AND DISADVANTAGED PEOPLE, IN
CLASS 43 (U.S. CLS. 100 AND 101).

FIRST USE 5-28-2003; IN COMMERCE 5-28-2003.

SN 76-543,948, FILED 9-9-2003.

AISHA CLARKE, EXAMINING ATTORNEY

Int. Cl.: 45

Prior U.S. Cls.: 100 and 101

United States Patent and Trademark Office

Reg. No. 3,481,059

Registered Aug. 5, 2008

**SERVICE MARK
PRINCIPAL REGISTER**

HOPE NETWORK

CONVOY OF HOPE (CALIFORNIA NOT-FOR-PROFIT CORPORATION)
330 S. PATTERSON AVENUE
SPRINGFIELD, MO 65802

FOR: CHARITABLE AND DISASTER RELIEF SERVICES, NAMELY, PROVIDING CLOTHING AND BLANKETS FOR BEDDING TO VICTIMS OF NATURAL DISASTERS AND DISADVANTAGED PEOPLE; DISASTER RELIEF SERVICES, NAMELY, DEVELOPING PLANS AND PROCEDURES FOR PROVIDING EMERGENCY AID AND SUPPLIES, WATER PURIFICATION, AND SANITATION FOR VICTIMS OF NATURAL DISASTERS, DISADVANTAGED PEOPLE, AND COMMUNITIES IN NEED; PROVIDING AND COORDINATING SOCIAL SERVICES PROGRAMS THAT OFFER SOCIAL SERVICE SUPPORT TO VICTIMS OF NATURAL DISASTERS AND DISADVANTAGED PEOPLE, NAMELY, GRIEF COUNSELING; PROVIDING IN-

FORMATION VIA A GLOBAL COMMUNICATIONS NETWORK IN THE FIELDS OF CHARITABLE SERVICES, NAMELY, PROVIDING CLOTHING AND BLANKETS FOR BEDDING TO VICTIMS OF NATURAL DISASTERS AND DISADVANTAGED PEOPLE, DEVELOPING PLANS AND PROCEDURES FOR PROVIDING EMERGENCY AID AND SUPPLIES, WATER PURIFICATION, AND SANITATION FOR VICTIMS OF NATURAL DISASTERS, DISADVANTAGED PEOPLE, AND COMMUNITIES IN NEED, AND GRIEF COUNSELING SERVICE PROGRAMS, IN CLASS 45 (U.S. CLS. 100 AND 101).

FIRST USE 5-28-2003; IN COMMERCE 5-28-2003.

SN 76-543,949, FILED 9-9-2003.

AISHA CLARKE, EXAMINING ATTORNEY

Int. Cls.: 29 and 30

Prior U.S. Cl.: 46

United States Patent and Trademark Office

Reg. No. 3,481,060

Registered Aug. 5, 2008

**TRADEMARK
PRINCIPAL REGISTER**

DOÑA LITA

CRIO INVERSIONES, S.A. DE C.V. (EL SALVADOR CORPORATION)
URBANIZACION INDUSTRIAL PLAN
DE LA LAGUNA, BLOCK B #14
ANTIGUO CUSCATLAN, EL SALVADOR

FOR: CANDIED FRUITS, IN CLASS 29 (U.S. CL. 46).

FIRST USE 12-16-2004; IN COMMERCE 12-16-2004.

FOR: SWEET BREADS, PASTRIES AND OTHER BREADS WITH OR WITHOUT FRUIT FILLING; COOKIES AND OTHER SIMILAR BAKED GOODS; TORTILLAS STUFFED WITH MEAT, CHEESE, AND/OR VEGETABLES NAMELY 'PUPUSAS'; CORN PASTE STUFFED WITH MEAT, CHEESE, AND/OR VEGETABLES, NAMELY, 'TAMALES';

OTHER BREADS STUFFED WITH MEAT, CHEESE, AND/OR VEGETABLES; PASTRIES STUFFED WITH FRUIT FILLING, NAMELY, 'PEPERECHAS', IN CLASS 30 (U.S. CL. 46).

FIRST USE 12-16-2004; IN COMMERCE 12-16-2004.

THE NAME(S), PORTRAIT(S), AND/OR SIGNATURE(S) SHOWN IN THE MARK DOES NOT IDENTIFY A PARTICULAR LIVING INDIVIDUAL.

THE ENGLISH TRANSLATION OF THE WORD "DOÑA LITA" IN THE MARK IS "LADY LITA".

SN 76-554,266, FILED 10-27-2003.

ANDREA SAUNDERS, EXAMINING ATTORNEY

Int. Cl.: 11

Prior U.S. Cls.: 13, 21, 23, 31, and 34

United States Patent and Trademark Office

Reg. No. 3,481,061

Registered Aug. 5, 2008

**TRADEMARK
PRINCIPAL REGISTER**

MISTERS UNLIMITED

MISTERS UNLIMITED, LLC (FLORIDA LTD
LIAB CO)
1301 EAST BROWARD BLVD.
FORT LAUDERDALE, FL 33301

FOR: EVAPORATIVE COOLING AND MISTING
SYSTEMS COMPRISED PRIMARILY OF PUMPS,
NOZZLES, FITTINGS, TUBING, FILTERS, FLUSH
MOUNTS AND HOUSINGS, AND ACCESSORIES
THEREFOR, NAMELY, MISTING RINGS, DRAIN
VALVES, SOLENOID VALVES, BALL VALVES, TUB-
ING CUTTERS, RELIEF VALVES, COUNTER BORE
AND PILOT BIT, TAP AND DRILL AND REMOTE

CONTRACTOR FOR REMOTE OPERATION OF
PUMPS, IN CLASS 11 (U.S. CLS. 13, 21, 23, 31 AND 34).

FIRST USE 10-0-2003; IN COMMERCE 10-0-2003.

NO CLAIM IS MADE TO THE EXCLUSIVE
RIGHT TO USE "MISTERS", APART FROM THE
MARK AS SHOWN.

SN 76-554,940, FILED 10-23-2003.

KELLY MCCOY, EXAMINING ATTORNEY

Int. Cl.: 37

Prior U.S. Cls.: 100, 103, and 106

United States Patent and Trademark Office

Reg. No. 3,481,062

Registered Aug. 5, 2008

**SERVICE MARK
PRINCIPAL REGISTER**

APPLIED GLOBAL SERVICES

APPLIED MATERIALS, INC. (DELAWARE CORPORATION)
3050 BOWERS AVENUE
MS/2061
SANTA CLARA, CA 95054

FOR: MAINTENANCE AND REPAIR OF SEMI-CONDUCTOR PROCESSING AND PRODUCTION EQUIPMENT, IN CLASS 37 (U.S. CLS. 100, 103 AND 106).

FIRST USE 4-30-2008; IN COMMERCE 4-30-2008.

THE MARK CONSISTS OF STANDARD CHARACTERS WITHOUT CLAIM TO ANY PARTICULAR FONT, STYLE, SIZE, OR COLOR.

NO CLAIM IS MADE TO THE EXCLUSIVE RIGHT TO USE "GLOBAL SERVICES", APART FROM THE MARK AS SHOWN.

SN 76-561,365, FILED 11-21-2003.

CHERYL CLAYTON, EXAMINING ATTORNEY

Int. Cl.: 9

Prior U.S. Cls.: 21, 23, 26, 36, and 38

United States Patent and Trademark Office

Reg. No. 3,481,063

Registered Aug. 5, 2008

**TRADEMARK
PRINCIPAL REGISTER**

CRS RETAILSTORE

CRS RETAIL SYSTEMS, INC. (NEW YORK CORPORATION)
15 GOVERNOR DRIVE
NEWBURGH, NY 12550

FIRST USE 3-31-2005; IN COMMERCE 3-31-2005.

FOR: COMPUTER SOFTWARE FOR OPERATING RETAIL AND CASH REGISTER SYSTEMS FOR POINT OF SALE AND OFFICE APPLICATIONS RELATING TO INVENTORY MANAGEMENT, TIME AND ATTENDANCE, STORE OPERATIONS, QUICK VIEWS, LEARNING MANAGEMENT AND PAYMENT AUTHORIZATION, IN CLASS 9 (U.S. CLS. 21, 23, 26, 36 AND 38).

NO CLAIM IS MADE TO THE EXCLUSIVE RIGHT TO USE "RETAIL STORE", APART FROM THE MARK AS SHOWN.

SN 76-566,710, FILED 12-23-2003.

JOHN E. MICHOS, EXAMINING ATTORNEY

Int. Cls.: 6, 14, and 21

**Prior U.S. Cls.: 2, 12, 13, 14, 23, 25, 27, 28, 29, 30, 33,
40, and 50**

Reg. No. 3,481,064

United States Patent and Trademark Office

Registered Aug. 5, 2008

**TRADEMARK
PRINCIPAL REGISTER**

BASICSPIRIT

BASIC SPIRIT INCORPORATED (CANADA CORPORATION)
P.O. BOX 108
PUGWASH, NOVA SCOTIA, CANADA B0K 1L0

FOR: METAL CLOTHING HOOKS AND PICTURE HOOKS; 3-D PEWTER FIGURINES, STATUETTES OF NON-PRECIOUS METAL; METAL SCULPTURES; DECORATIVE METAL BOXES; METAL JEWELRY BOXES; METAL PILL BOXES; METAL COLLECTABLE BOXES; METAL KEY RINGS AND CHAINS; CHRISTMAS TABLE TOP ORNAMENTS, NAMELY PEWTER FIGURINES, IN CLASS 6 (U.S. CLS. 2, 12, 13, 14, 23, 25 AND 50).

FIRST USE 1-15-2002; IN COMMERCE 1-15-2007.

FOR: JEWELRY; JEWELRY NAMELY PENDANTS, PINS, LAPEL PINS AND BROOCHES; COMMEMORATIVE METAL COINS AND TOKENS; COLLECTIBLE DECORATIVE METAL COINS AND TOKENS; JEWELRY, NAMELY EARRINGS, NECKLACES, RINGS, BRACELETS, BANGLES, IN CLASS 14 (U.S. CLS. 2, 27, 28 AND 50).

FIRST USE 1-1-2002; IN COMMERCE 1-15-2007.

FOR: IKEBANA FLOWER HOLDERS; FLOWER BLOSSOM HOLDERS; CANDLESTICKS NOT OF PRECIOUS METAL; CANDLE HOLDERS NOT OF PRECIOUS METAL; CANDLE SNUFFERS NOT OF PRECIOUS METAL; SERVING SPOONS; SERVING

FORKS; SALAD SERVING SPOONS AND FORKS; SPOON RACKS; CUTTING BOARDS; CUTTING BOARD AND KNIFE SETS SOLD AS A UNIT; WOOD SERVING TRAYS WITH PEWTER HANDLES; NAPKIN RINGS NOT OF PRECIOUS METAL; TRIVETS; PIE SERVERS; COASTERS NOT OF PAPER AND NOT BEING TABLE LINEN; NAPKIN HOLDERS; CORK SCREWS; HORS D'OEUVRES TOOTHPICKS; HOLLOWWARE, NAMELY SERVING DISHES, PLATES, SERVING TRAYS NOT OF PRECIOUS METAL, MUGS, CUPS, GOBLETS, WINE TASTERS AND BOWLS; TEA STRAINERS; HONEY DIPPERS; COFFEE SCOOPS; PIE AND CAKE SERVERS; SERVING SPOONS; INCENSE HOLDERS FOR DOMESTIC USE, IN CLASS 21 (U.S. CLS. 2, 13, 23, 29, 30, 33, 40 AND 50).

FIRST USE 1-1-2002; IN COMMERCE 7-1-2007.

THE MARK CONSISTS OF STANDARD CHARACTERS WITHOUT CLAIM TO ANY PARTICULAR FONT, STYLE, SIZE, OR COLOR.

PRIORITY CLAIMED UNDER SEC. 44(D) ON CANADA APPLICATION NO. 1,196,017, FILED 11-6-2003.

SN 76-590,173, FILED 5-3-2004.

EVELYN BRADLEY, EXAMINING ATTORNEY

Int. Cl.: 9

Prior U.S. Cls.: 21, 23, 26, 36, and 38

United States Patent and Trademark Office

Reg. No. 3,481,065

Registered Aug. 5, 2008

**TRADEMARK
PRINCIPAL REGISTER**

PUSH A BUTTON AND IT'S DONE

1099 PRO, INC. (CALIFORNIA CORPORATION)
23901 CALABASAS ROAD, SUITE 2080
CALABASAS, CA 91302

FIRST USE 5-1-2008; IN COMMERCE 5-1-2008.

SN 76-590,488, FILED 5-5-2004.

FOR: COMPUTER SOFTWARE PROGRAM FOR
TAX COMPLIANCE, IN CLASS 9 (U.S. CLS. 21, 23, 26,
36 AND 38).

GIANCARLO CASTRO, EXAMINING ATTORNEY

Int. Cl.: 16

Prior U.S. Cls.: 2, 5, 22, 23, 29, 37, 38, and 50

Reg. No. 3,481,066

United States Patent and Trademark Office

Registered Aug. 5, 2008

**TRADEMARK
PRINCIPAL REGISTER**

The logo for Sun Tattoos features the word "SUN" in a large, bold, black font with a white, flame-like or sunburst pattern inside the letters. Below "SUN" is the word "TATTOOS" in a smaller, bold, black, sans-serif font.

PROBASCO, TIMOTHY C. (UNITED STATES IN-
DIVIDUAL)
1225 SW 4TH COURT
APARTMENT A
FORT LAUDERDALE, FL 33312

NO CLAIM IS MADE TO THE EXCLUSIVE
RIGHT TO USE "SUN TATTOOS", APART FROM
THE MARK AS SHOWN.

FOR: COLORED APPLIQUES FOR BODY ORNA-
MENTATION, NAMELY, TEMPORARY TATTOOS,
IN CLASS 16 (U.S. CLS. 2, 5, 22, 23, 29, 37, 38 AND 50).

SN 76-604,199, FILED 7-26-2004.

FIRST USE 2-27-2008; IN COMMERCE 2-27-2008.

JENNIFER MARTIN, EXAMINING ATTORNEY

Int. Cl.: 25

Prior U.S. Cls.: 22 and 39

United States Patent and Trademark Office

Reg. No. 3,481,067

Registered Aug. 5, 2008

**TRADEMARK
PRINCIPAL REGISTER**

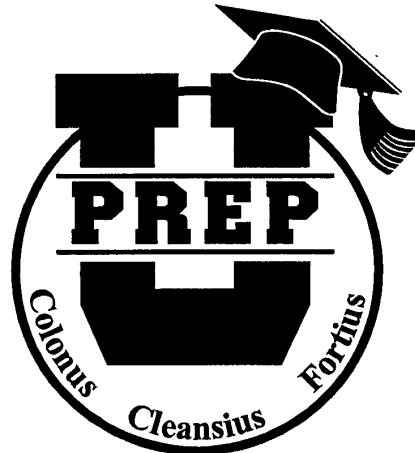

C.B. FLEET INVESTMENT CORPORATION (DE-
LAWARE CORPORATION)
103 FOULK ROAD STE 202
WILMINGTON, DE 19803

FIRST USE 10-0-2004; IN COMMERCE 10-0-2004.

SN 76-617,313, FILED 10-20-2004.

FOR: CLOTHING, NAMELY, BUTTON DOWN
SHIRTS, IN CLASS 25 (U.S. CLS. 22 AND 39).

STEVEN JACKSON, EXAMINING ATTORNEY

Int. Cl.: 30

Prior U.S. Cl.: 46

United States Patent and Trademark Office

Reg. No. 3,481,068

Registered Aug. 5, 2008

**TRADEMARK
PRINCIPAL REGISTER**



LIANG, SAM (UNITED STATES INDIVIDUAL)
9961 E. VALLEY BLVD., #A102
EL MONTE, CA 91731

FOR: FLOUR, SAUCES, SEASONINGS, SPICES,
SEASONING PASTES, AND FOOD ADDITIVES FOR
NON-NUTRITIONAL PURPOSES FOR USE AS A
FLAVORING OR FLAVORINGS, IN CLASS 30 (U.S.
CL. 46).

FIRST USE 6-18-2008; IN COMMERCE 6-18-2008.

THE COLOR(S) RED, YELLOW, GREEN AND
BLUE IS/ARE CLAIMED AS A FEATURE OF THE
MARK.

THE MARK CONSISTS OF THREE BELLS WITH
YELLOW AND RED COLORS INSIDE A GREEN
CIRCLE SURROUNDED BY A YELLOW CIRCULAR
BOUNDARY; SAID BOUNDARY BEING ON
TOP OF TWO RED TRIANGLES CONNECTING TO
EACH OTHER BY AND AT AN EDGE OF EACH OF
SAID TRIANGLES. THE WORDS "GOLDEN BELL"
APPEAR IN BLUE IN THE MARK UNDERNEATH
THE IMAGE OF THE BELLS.

SN 76-620,091, FILED 11-10-2004.

ELLEN BURNS, EXAMINING ATTORNEY

Int. Cl.: 43

Prior U.S. Cls.: 100 and 101

United States Patent and Trademark Office

Reg. No. 3,481,069

Registered Aug. 5, 2008

**SERVICE MARK
PRINCIPAL REGISTER**

ChelseaGrandHotel.com

HARTZ HOTEL SERVICES, INC. (NEW YORK CORPORATION), DBA GRAND HOSPITALITY,
400 PLAZA DRIVE
SECAUCUS, NJ 07094

FOR: RESERVATION SERVICES, NAMELY, MAKING RESERVATIONS FOR LODGING, IN CLASS 43 (U.S. CLS. 100 AND 101).

FIRST USE 0-0-2004; IN COMMERCE 0-0-2004.

THE MARK CONSISTS OF STANDARD CHARACTERS WITHOUT CLAIM TO ANY PARTICULAR FONT, STYLE, SIZE, OR COLOR.

OWNER OF U.S. REG. NOS. 2,191,860 AND 2,705,826.

SN 76-621,804, FILED 11-22-2004.

DAVID HOFFMAN, EXAMINING ATTORNEY

Int. Cl.: 14

Prior U.S. Cls.: 2, 27, 28, and 50

United States Patent and Trademark Office

Reg. No. 3,481,070

Registered Aug. 5, 2008

**TRADEMARK
PRINCIPAL REGISTER**

COUPLINGS

SHARON LOEFF DESIGNS, LLC (ARIZONA LTD
LIAB CO)
7869 EAST SANTA CATALINA DRIVE
SCOTTSDALE, AZ 85255

THE MARK CONSISTS OF STANDARD CHAR-
ACTERS WITHOUT CLAIM TO ANY PARTICULAR
FONT, STYLE, SIZE, OR COLOR.

FOR: JEWELRY, IN CLASS 14 (U.S. CLS. 2, 27, 28
AND 50).

SN 76-625,317, FILED 12-21-2004.

FIRST USE 1-24-2007; IN COMMERCE 1-24-2007.

JULIE GUTTADAURO, EXAMINING ATTORNEY

Int. Cl.: 41

Prior U.S. Cls.: 100, 101, and 107

United States Patent and Trademark Office

Reg. No. 3,481,071

Registered Aug. 5, 2008

**SERVICE MARK
PRINCIPAL REGISTER**

MIDNIGHT PLANET

PLANET HOLLYWOOD (REGION IV), INC. (DE-
LAWARE CORPORATION)
7598 W. SAND LAKE ROAD
ORLANDO, FL 32819

FOR: ENTERTAINMENT IN THE NATURE OF
TELEVISION PRODUCTION AND NIGHTCLUB
ENTERTAINMENT, IN CLASS 41 (U.S. CLS. 100,
101 AND 107).

FIRST USE 3-25-2008; IN COMMERCE 3-25-2008.

THE MARK CONSISTS OF STANDARD CHAR-
ACTERS WITHOUT CLAIM TO ANY PARTICULAR
FONT, STYLE, SIZE, OR COLOR.

SN 76-628,403, FILED 1-20-2005.

JOHN SCHUYLER YARD, EXAMINING ATTOR-
NEY

Int. Cl.: 36

Prior U.S. Cls.: 100, 101, and 102

United States Patent and Trademark Office

Reg. No. 3,481,072

Registered Aug. 5, 2008

**SERVICE MARK
PRINCIPAL REGISTER**



AMERICAN NEWLAND COMMUNITIES, LP
(DELAWARE LIMITED PARTNERSHIP)
9820 TOWNE CENTRE DRIVE
SAN DIEGO, CA 92121

FIRST USE 9-28-2004; IN COMMERCE 9-28-2004.

SN 76-628,568, FILED 1-13-2005.

FOR: ONLINE INFORMATION SERVICES IN
THE FIELD OF REAL ESTATE; PROVIDING WEB-
SITES IN THE FIELD OF REAL ESTATE, IN CLASS
36 (U.S. CLS. 100, 101 AND 102).

PAUL E. FAHRENKOPF, EXAMINING ATTORNEY

Int. Cl.: 10

Prior U.S. Cls.: 26, 39, and 44

United States Patent and Trademark Office

Reg. No. 3,481,073

Registered Aug. 5, 2008

**TRADEMARK
PRINCIPAL REGISTER**

SMILERETAINER

ORTHO-TAIN, INC. (PUERTO RICO CORPORATION)
950 GREEN BAY ROAD, SUITE 205
WINNETKA, IL 60093

FOR: ORTHODONTIC APPLIANCES, NAMELY, DENTAL AND ORTHODONTIC RETAINERS, REMOVABLE ORTHODONTIC APPLIANCES, TOOTH POSITIONERS, RETENTION DEVICES AND ACTIVATORS, IN CLASS 10 (U.S. CLS. 26, 39 AND 44).

FIRST USE 5-25-2007; IN COMMERCE 5-25-2007.

THE MARK CONSISTS OF STANDARD CHARACTERS WITHOUT CLAIM TO ANY PARTICULAR FONT, STYLE, SIZE, OR COLOR.

SN 76-630,333, FILED 2-3-2005.

DAWN FELDMAN, EXAMINING ATTORNEY

Int. Cl.: 18

Prior U.S. Cls.: 1, 2, 3, 22, and 41

United States Patent and Trademark Office

Reg. No. 3,481,074

Registered Aug. 5, 2008

**TRADEMARK
PRINCIPAL REGISTER**

TOTAL TRAVEL SYSTEM

APPLIED SEWING RESOURCES, INC. (CALI-
FORNIA CORPORATION)

1350 HAYES STREET, SUITE C-16

BENICIA, CA 94510

FOR: LUGGAGE, IN CLASS 18 (U.S. CLS. 1, 2, 3, 22
AND 41).

FIRST USE 8-24-2005; IN COMMERCE 8-24-2005.

THE MARK CONSISTS OF STANDARD CHAR-
ACTERS WITHOUT CLAIM TO ANY PARTICULAR
FONT, STYLE, SIZE, OR COLOR.

NO CLAIM IS MADE TO THE EXCLUSIVE
RIGHT TO USE "TRAVEL SYSTEM", APART FROM
THE MARK AS SHOWN.

SN 76-633,565, FILED 3-15-2005.

JOHN DWYER, EXAMINING ATTORNEY

Int. Cl.: 26

Prior U.S. Cls.: 37, 39, 40, 42, and 50

United States Patent and Trademark Office

Reg. No. 3,481,075

Registered Aug. 5, 2008

**TRADEMARK
PRINCIPAL REGISTER**

EXPAND-A-BUTT

JOHN B KEENE (UNITED STATES INDIVIDUAL)
JOHNFVJY@WINDSTREAM
3734 216 STREET
LAKE CITY, FL 32024

THE MARK CONSISTS OF STANDARD CHARACTERS WITHOUT CLAIM TO ANY PARTICULAR FONT, STYLE, SIZE, OR COLOR.

FOR: CLOTH AND LEATHER PATCHES FOR CLOTHING, IN CLASS 26 (U.S. CLS. 37, 39, 40, 42 AND 50).

SN 76-643,465, FILED 7-22-2005.

FIRST USE 10-1-2006; IN COMMERCE 5-23-2008.

MELISSA VALLILLO, EXAMINING ATTORNEY

Int. Cl.: 17

Prior U.S. Cls.: 1, 5, 12, 13, 35, and 50

United States Patent and Trademark Office

Reg. No. 3,481,076

Registered Aug. 5, 2008

**TRADEMARK
PRINCIPAL REGISTER**

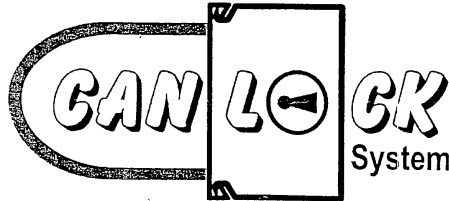

CANALPLAST S.P.A. (ITALY CORPORATION)
VIA TOLSTOI, 65
20051 - LIMBIATE (MI), ITALY

FOR: NON-METAL PLASTIC TUBES FOR ELECTRIC INSULATION AND TELEPHONE APPLICATIONS; AND PLASTIC BARS USED AS BASEBOARDS, IN CLASS 17 (U.S. CLS. 1, 5, 12, 13, 35 AND 50).

FIRST USE 9-20-2005; IN COMMERCE 10-3-2005.

NO CLAIM IS MADE TO THE EXCLUSIVE RIGHT TO USE "SYSTEM", APART FROM THE MARK AS SHOWN.

SN 76-646,814, FILED 9-14-2005.

SANDRA MANIOS, EXAMINING ATTORNEY

Int. Cl.: 16

Prior U.S. Cls.: 2, 5, 22, 23, 29, 37, 38, and 50

United States Patent and Trademark Office

Reg. No. 3,481,077

Registered Aug. 5, 2008

**TRADEMARK
PRINCIPAL REGISTER**

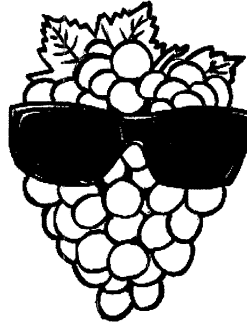

SAMBRAILO PACKAGING (CALIFORNIA CORPORATION)
800 WALKER STREET
WATSONVILLE, CA 95076

FOR: PROMOTIONAL MATERIALS, NAMELY, BROCHURES, AND NEWSLETTERS FEATURING VARIOUS PACKAGING PRODUCTS AND PACKAGING MATERIALS; DECALS, CALENDARS, DISTRIBUTED IN CONJUNCTION WITH APPLICANT'S PACKAGING PRODUCTS AND PACKAGING MATERIALS; PRINTED MATERIALS, NAMELY, PAPER SIGNS, PAPER LABELS, AND NOTEPADS, IN CLASS 16 (U.S. CLS. 2, 5, 22, 23, 29, 37, 38 AND 50).

FIRST USE 9-5-2005; IN COMMERCE 11-4-2005.

OWNER OF U.S. REG. NO. 2,821,024.

THE MARK CONSISTS OF A DRAWING OF A BUNCH OF GRAPES WEARING GLASSES.

SN 76-647,428, FILED 9-26-2005.

CHRISTOPHER BUONGIORNO, EXAMINING ATTORNEY

Int. Cl.: 41

Prior U.S. Cls.: 100, 101, and 107

United States Patent and Trademark Office

Reg. No. 3,481,078

Registered Aug. 5, 2008

**SERVICE MARK
PRINCIPAL REGISTER**

REDSTONE COLLEGE

ALTA COLLEGES, INC. (DELAWARE CORPORATION)
2000 S. COLORADO BLVD., SUITE 2940
DENVER, CO 80222

FOR: EDUCATIONAL SERVICES, NAMELY, PROVIDING COURSES OF INSTRUCTION AT THE COLLEGE, UNIVERSITY, AND ADULT EDUCATION LEVELS IN THE FIELDS OF AVIATION MECHANICS, AVIONICS, ELECTRONICS AND CABLING, HEATING, AIR CONDITIONING, AND REFRIGERATION, AUTOMOTIVE REPAIR AND MAINTENANCE, CONSTRUCTION MANAGEMENT, COMPUTER AIDED DESIGN, SURVEYING, AND LANDSCAPE DESIGN, AND DISTRIBUTING COURSE MATERIALS IN CONNECTION THEREWITH, IN CLASS 41 (U.S. CLS. 100, 101 AND 107).

FIRST USE 3-0-2006; IN COMMERCE 3-0-2006.

THE MARK CONSISTS OF STANDARD CHARACTERS WITHOUT CLAIM TO ANY PARTICULAR FONT, STYLE, SIZE, OR COLOR.

NO CLAIM IS MADE TO THE EXCLUSIVE RIGHT TO USE "COLLEGE", APART FROM THE MARK AS SHOWN.

SN 76-647,629, FILED 9-28-2005.

ANNE FARRELL, EXAMINING ATTORNEY

Int. Cl.: 9

Prior U.S. Cls.: 21, 23, 26, 36, and 38

Reg. No. 3,481,079

United States Patent and Trademark Office

Registered Aug. 5, 2008

**TRADEMARK
PRINCIPAL REGISTER**

GAMEKEEPER

ATLANTIC REPRESENTATIONS, INC. (CALI-
FORNIA CORPORATION), DBA ATLANTIC
INC.,
10018 SANTA FE SPRINGS ROAD
SANTA FE SPRINGS, CA 90670

FOR: HARD AND SOFT CONTAINERS AND
CARRYING CASES FOR VIDEO GAMES AND
FOR VIDEO GAME EQUIPMENT, IN CLASS 9 (U.S.
CLS. 21, 23, 26, 36 AND 38).

FIRST USE 1-31-2006; IN COMMERCE 1-31-2006.

THE MARK CONSISTS OF STANDARD CHAR-
ACTERS WITHOUT CLAIM TO ANY PARTICULAR
FONT, STYLE, SIZE, OR COLOR.

SN 76-649,906, FILED 11-7-2005.

DEZMONA MIZELLE, EXAMINING ATTORNEY

Int. Cl.: 30

Prior U.S. Cl.: 46

United States Patent and Trademark Office

Reg. No. 3,481,080

Registered Aug. 5, 2008

**TRADEMARK
PRINCIPAL REGISTER**

AUNT BETSY'S

AUNT BETSY'S LLC (CONNECTICUT LTD LIAB
CO)

680 CAMPBELL AVENUE

WEST HAVEN, CT 06516

FOR: RICE, SPICES, IN CLASS 30 (U.S. CL. 46).

FIRST USE 10-10-2006; IN COMMERCE 10-10-2006.

THE MARK CONSISTS OF STANDARD CHAR-
ACTERS WITHOUT CLAIM TO ANY PARTICULAR
FONT, STYLE, SIZE, OR COLOR.

THE NAME "AUNT BETSY" DOES NOT IDENTI-
FY A PARTICULAR LIVING INDIVIDUAL.

SN 76-650,248, FILED 11-14-2005.

LINDA ORNDORFF, EXAMINING ATTORNEY

Int. Cls.: 18 and 28

Prior U.S. Cls.: 1, 2, 3, 22, 23, 38, 41, and 50

Reg. No. 3,481,081

United States Patent and Trademark Office

Registered Aug. 5, 2008

**TRADEMARK
PRINCIPAL REGISTER**

YOHAN

INMAN, RONALD CALVIN (UNITED STATES INDIVIDUAL)

81 ED SESSOMS ROAD

PO BOX 1604

ELIZABETHTOWN, NC 28337 AND

INMAN, SUSAN (UNITED STATES INDIVIDUAL)

81 ED SESSOMS ROAD

PO BOX 1604

ELIZABETHTOWN, NC 28337 AND

INMAN, ALBERT LEROY (UNITED STATES INDIVIDUAL)

81 ED SESSOMS ROAD

PO BOX 1604

ELIZABETHTOWN, NC 28337 AND

INMAN, BRENDA SEYER (UNITED STATES INDIVIDUAL)

81 ED SESSOMS ROAD

PO BOX 1604

ELIZABETHTOWN, NC 28337 AND

FAIRCLOTH, SUSANNE INMAN (UNITED STATES INDIVIDUAL)

81 ED SESSOMS ROAD

PO BOX 1604

ELIZABETHTOWN, NC 28337 AND

FAIRCLOTH, DAVID JAMES (UNITED STATES INDIVIDUAL)

81 ED SESSOMS ROAD

PO BOX 1604

ELIZABETHTOWN, NC 28337

FOR: CARRYING ARTICLES, NAMELY, BACKPACKS, RUCKSACKS, DUFTLE BAGS, SHOULDER BAGS, DAYPACKS, AND SOFT-SIDED LUGGAGE, IN CLASS 18 (U.S. CLS. 1, 2, 3, 22 AND 41).

FIRST USE 12-1-2007; IN COMMERCE 12-1-2007.

FOR: CARRYING ARTICLES, NAMELY, PORTABLE SNOW SKI AND ACCESSORIES CARRIERS, IN CLASS 28 (U.S. CLS. 22, 23, 38 AND 50).

FIRST USE 12-1-2007; IN COMMERCE 12-1-2007.

THE MARK CONSISTS OF STANDARD CHARACTERS WITHOUT CLAIM TO ANY PARTICULAR FONT, STYLE, SIZE, OR COLOR.

SN 76-650,705, FILED 11-22-2005.

FLORENTINA BLANDU, EXAMINING ATTORNEY

Int. Cl.: 33

Prior U.S. Cls.: 47 and 49

United States Patent and Trademark Office

Reg. No. 3,481,082

Registered Aug. 5, 2008

**TRADEMARK
PRINCIPAL REGISTER**

Carnivale

THE SOLOMON WINE COMPANY (CALIFORNIA CORPORATION)
1131 KANSAS AVENUE
MODESTO, CA 95351

THE MARK CONSISTS OF STANDARD CHARACTERS WITHOUT CLAIM TO ANY PARTICULAR FONT, STYLE, SIZE, OR COLOR.

FOR: WINES, IN CLASS 33 (U.S. CLS. 47 AND 49).

SN 76-650,948, FILED 11-25-2005.

FIRST USE 4-25-2008; IN COMMERCE 4-25-2008.

HANNO RITTNER, EXAMINING ATTORNEY

Int. Cl.: 28

Prior U.S. Cls.: 22, 23, 38, and 50

United States Patent and Trademark Office

Reg. No. 3,481,083

Registered Aug. 5, 2008

**TRADEMARK
PRINCIPAL REGISTER**



KONAMI DIGITAL ENTERTAINMENT CO.,
LTD. (JAPAN CORPORATION)
6-10-1, ROPPONGI, MINATO-KU
TOKYO, JAPAN

FOR: ARCADE GAMES; ARCADE GAME MACHINES FOR USE IN AMUSEMENT ARCADES; STAND-ALONE VIDEO GAME MACHINES; COIN-OPERATED VIDEO GAMES, IN CLASS 28 (U.S. CLS. 22, 23, 38 AND 50).

FIRST USE 6-30-2006; IN COMMERCE 6-30-2006.

OWNER OF U.S. REG. NOS. 2,339,276, 2,848,207, AND OTHERS.

THE COLOR(S) BLACK, GREY, RED, ORANGE, YELLOW AND WHITE IS/ARE CLAIMED AS A FEATURE OF THE MARK.

THE COLOR BLACK APPEARS IN THE INSIDE AND OUTSIDE LINING OF EACH LETTER, THROUGHOUT PORTIONS OF THE STYLIZED CIRCLE LOCATED BEHIND THE WORDS "DANCE DANCE REVOLUTION SUPERNOVA", ALONG THE PERIMETER OF THE INNER SPHERE LOCATED IN THE CENTER OF THE STYLIZED CIRCLE AND AROUND THE PERIMETER OF THE ENTIRE MARK; THE COLOR GREY APPEARS IN THE

OUTSIDE LINING ALONG THE BOTTOM OF THE WORD "SUPERNOVA", ALONG THE PERIMETER OF THE INNER SPHERE LOCATED IN THE CENTER OF THE STYLIZED CIRCLE AND ALONG THE OUTERMOST PERIMETER OF THE ENTIRE MARK; THE COLOR RED APPEARS IN THE LINING OF EACH LETTER, AS THE COLOR OF THE GRAPH DESIGN LOCATED IN THE STYLIZED CIRCLE BEHIND THE WORDS "DANCE DANCE REVOLUTION SUPERNOVA", AND AT THE BOTTOM AND TOP OF THE INNER SPHERE LOCATED WITHIN THE STYLIZED CIRCLE; THE COLOR ORANGE APPEARS IN THE MIDDLE OF THE INNER SPHERE LOCATED WITHIN THE STYLIZED CIRCLE BEHIND THE WORDS "DANCE DANCE REVOLUTION SUPERNOVA"; THE COLOR YELLOW APPEARS IN THE CENTER OF THE INNER SPHERE LOCATED WITHIN THE STYLIZED CIRCLE BEHIND THE WORDS "DANCE DANCE REVOLUTION SUPERNOVA"; AND THE COLOR WHITE APPEARS IN THE LETTERING OF THE WORDS "DANCE DANCE REVOLUTION SUPERNOVA".

SN 76-651,950, FILED 12-15-2005.

MICHAEL GAAFAR, EXAMINING ATTORNEY

Int. Cl.: 35

Prior U.S. Cls.: 100, 101, and 102

United States Patent and Trademark Office

Reg. No. 3,481,084

Registered Aug. 5, 2008

**SERVICE MARK
PRINCIPAL REGISTER**



IBIQUITY DIGITAL CORPORATION (DELA-
WARE CORPORATION)
6711 COLUMBIA GATEWAY DRIVE, SUITE 500
COLUMBIA, MD 21046

FOR: PROMOTING THE PUBLIC AWARENESS
OF DIGITAL RADIO TECHNOLOGY AND PRO-
MOTING THE ADOPTION AND USE OF DIGITAL
RADIO TECHNOLOGY , IN CLASS 35 (U.S. CLS. 100,
101 AND 102).

FIRST USE 2-21-2006; IN COMMERCE 2-21-2006.

NO CLAIM IS MADE TO THE EXCLUSIVE
RIGHT TO USE "DIGITAL RADIO ALLIANCE",
APART FROM THE MARK AS SHOWN.

SN 76-652,278, FILED 12-13-2005.

ELLEN B. AWRICH, EXAMINING ATTORNEY

Int. Cl.: 9

Prior U.S. Cls.: 21, 23, 26, 36, and 38

Reg. No. 3,481,085

United States Patent and Trademark Office

Registered Aug. 5, 2008

**TRADEMARK
PRINCIPAL REGISTER**

The logo for "Trinity" features the word in a bold, sans-serif font. A thick, black curved line starts under the 'T', goes under the 'r', and then curves back up under the 'y', resembling a stylized smile or a swoosh.

DIABLOSPORT, LLC (FLORIDA LTD LIAB CO)
3500 NW BOCA RATON BLVD.
SUITE 504
BOCA RATON, FL 33431

FOR: VEHICLE PERFORMANCE PROGRAMMER AND DISPLAY APPARATUS, NAMELY, A FLASH PROGRAMMER HAVING ADVANCED DIAGNOSTICS WHICH ANALYZE VEHICLE INFORMATION, PERFORMS REAL TIME DATA MONITORING AND CAN CALIBRATE AND RE-CALIBRATE VEHICLE AND ENGINE PARAME-

TERS TO ENHANCE PERFORMANCE WHILE DISPLAYING ALL RELEVANT INFORMATION TO THE VEHICLE OCCUPANT, IN CLASS 9 (U.S. CLS. 21, 23, 26, 36 AND 38).

FIRST USE 12-9-2005; IN COMMERCE 8-0-2007.

OWNER OF U.S. REG. NO. 2,947,507.

SN 76-652,854, FILED 1-4-2006.

ALYSSA PALADINO, EXAMINING ATTORNEY

Int. Cl.: 39

Prior U.S. Cls.: 100 and 105

United States Patent and Trademark Office

Reg. No. 3,481,086

Registered Aug. 5, 2008

**SERVICE MARK
PRINCIPAL REGISTER**



NEW JERSEY TRANSIT CORPORATION (NEW
JERSEY CORPORATION)
ONE PENN PLAZA EAST
NEWARK, NJ 071052246

FOR: TICKETING SERVICES BY MAIL FOR
MASS TRANSIT PASSENGERS; AND MASS TRAN-
SIT FOR THE GENERAL PUBLIC AND TRAVEL
INFORMATION SERVICES; TRAVEL SERVICES,
NAMELY, TRANSPORTATION OF PASSENGERS
BY RAIL TO DESTINATIONS IN NEW JERSEY AND
NEW YORK, IN CLASS 39 (U.S. CLS. 100 AND 105).

FIRST USE 1-13-2006; IN COMMERCE 1-13-2006.

NO CLAIM IS MADE TO THE EXCLUSIVE
RIGHT TO USE "TUNNEL", APART FROM THE
MARK AS SHOWN.

THE MARK CONSISTS OF RAILROAD TRACKS
LEADING INTO A TUNNEL WITH THE WORDS
"THE TUNNEL" ABOVE THE TUNNEL AND THE
WORDS "DIG IT" BELOW THE RAILROAD
TRACKS CONTAINED WITHIN A CIRCLE.

SN 76-653,793, FILED 1-23-2006.

DAWN FELDMAN, EXAMINING ATTORNEY

Int. Cls.: 35 and 39

Prior U.S. Cls.: 100, 101, 102, and 105

United States Patent and Trademark Office

Reg. No. 3,481,087

Registered Aug. 5, 2008

**SERVICE MARK
PRINCIPAL REGISTER**



NEW JERSEY TRANSIT CORPORATION (NEW JERSEY CORPORATION)
ONE PENN PLAZA EAST
NEWARK, NJ 071052246

FOR: PROMOTING THE GOODS AND SERVICES OF OTHERS THROUGH THE DISTRIBUTION OF DISCOUNT CARDS FOR SCIENCE CENTERS, THEATER, ENTERTAINMENT, SHOPPING DESTINATIONS, HOTEL AND RESORT ACCOMMODATIONS, SPORT EVENTS AND AMUSEMENT PARKS, IN CLASS 35 (U.S. CLS. 100, 101 AND 102).

FIRST USE 8-18-1999; IN COMMERCE 4-22-2000.

FOR: MASS TRANSIT FOR THE GENERAL PUBLIC AND TRAVEL INFORMATION SERVICES, NAMELY, TRANSPORTATION OF PASSENGERS BY LIGHT RAIL TO DESTINATIONS IN HUDSON COUNTY AND BERGEN COUNTY, NEW JERSEY, IN CLASS 39 (U.S. CLS. 100 AND 105).

FIRST USE 8-18-1999; IN COMMERCE 4-22-2000.

NO CLAIM IS MADE TO THE EXCLUSIVE RIGHT TO USE "HUDSON-BERGEN LIGHT RAIL", APART FROM THE MARK AS SHOWN.

THE COLOR(S) BLUE, YELLOW AND GRAY IS/ ARE CLAIMED AS A FEATURE OF THE MARK.

THE COLOR BLUE APPEARS AS THE WORD "LIGHT" AND IN THE LEFT STRIPE IN THE DESIGN IN THE MARK; THE COLOR YELLOW APPEARS AS THE WORD "RAIL" AND IN THE RIGHT STRIPE IN THE DESIGN IN THE MARK; THE COLOR GRAY APPEARS AS THE WORDS "HUDSON-BERGEN" AND AS THE MIDDLE STRIPE IN THE DESIGN IN THE MARK.

SN 76-653,825, FILED 1-23-2006.

DAWN FELDMAN, EXAMINING ATTORNEY

Int. Cls.: 35 and 39

Prior U.S. Cls.: 100, 101, 102, and 105

United States Patent and Trademark Office

Reg. No. 3,481,088

Registered Aug. 5, 2008

**SERVICE MARK
PRINCIPAL REGISTER**



NEW JERSEY TRANSIT CORPORATION (NEW JERSEY CORPORATION)
ONE PENN PLAZA EAST
NEWARK, NJ 071052246

FOR: PROMOTING THE GOODS AND SERVICES OF OTHERS THROUGH THE DISTRIBUTION OF DISCOUNT CARDS FOR SCIENCE CENTERS, THEATER, ENTERTAINMENT, SHOPPING DESTINATIONS, HOTEL AND RESORT ACCOMMODATIONS, SPORT EVENTS AND AMUSEMENT PARKS, IN CLASS 35 (U.S. CLS. 100, 101 AND 102).

FIRST USE 8-18-1999; IN COMMERCE 4-22-2000.

FOR: MASS TRANSIT FOR THE GENERAL PUBLIC AND TRAVEL INFORMATION SERVICES,

NAMELY, TRANSPORTATION OF PASSENGERS BY LIGHT RAIL TO DESTINATIONS IN HUDSON COUNTY AND BERGEN COUNTY, NEW JERSEY, IN CLASS 39 (U.S. CLS. 100 AND 105).

FIRST USE 8-18-1999; IN COMMERCE 4-22-2000.

NO CLAIM IS MADE TO THE EXCLUSIVE RIGHT TO USE "HUDSON-BERGEN LIGHT RAIL", APART FROM THE MARK AS SHOWN.

SN 76-653,826, FILED 1-23-2006.

DAWN FELDMAN, EXAMINING ATTORNEY

Int. Cls.: 35 and 39

Prior U.S. Cls.: 100, 101, 102, and 105

United States Patent and Trademark Office

Reg. No. 3,481,089

Registered Aug. 5, 2008

SERVICE MARK
PRINCIPAL REGISTER



NEW JERSEY TRANSIT CORPORATION (NEW
JERSEY CORPORATION)
ONE PENN PLAZA EAST
NEWARK, NJ 071052246

FOR: PROMOTING THE GOODS AND SERVICES
OF OTHERS THROUGH THE DISTRIBUTION OF
DISCOUNT CARDS FOR SCIENCE CENTERS,
THEATER, ENTERTAINMENT, SHOPPING DESTI-
NATIONS, HOTEL AND RESORT ACCOMMODA-
TIONS, SPORT EVENTS AND AMUSEMENT
PARKS, IN CLASS 35 (U.S. CLS. 100, 101 AND 102).

FIRST USE 4-22-2000; IN COMMERCE 4-22-2000.

FOR: MASS TRANSIT FOR THE GENERAL PUB-
LIC AND TRAVEL INFORMATION SERVICES,

NAMELY, TRANSPORTATION OF PASSENGERS
BY LIGHT RAIL TO DESTINATIONS IN HUDSON
COUNTY AND BERGEN COUNTY, NEW JERSEY,
IN CLASS 39 (U.S. CLS. 100 AND 105).

FIRST USE 4-22-2000; IN COMMERCE 4-22-2000.

NO CLAIM IS MADE TO THE EXCLUSIVE
RIGHT TO USE "HUDSON-BERGEN LIGHT RAIL",
APART FROM THE MARK AS SHOWN.

SN 76-653,827, FILED 1-23-2006.

DAWN FELDMAN, EXAMINING ATTORNEY

Int. Cl.: 7

Prior U.S. Cls.: 13, 19, 21, 23, 31, 34, and 35

United States Patent and Trademark Office

Reg. No. 3,481,090

Registered Aug. 5, 2008

**TRADEMARK
PRINCIPAL REGISTER**

DIESEL DETECTIVE

SKC INC. (PENNSYLVANIA CORPORATION)
863 VALLEY VIEW ROAD
EIGHTY FOUR, PA 15330

FOR: VACUUM PUMPS THAT DISPLAY CON-
CENTRATION OF DIESEL IN THE AIR WHEN
CONNECTED TO AIR SAMPLING COLLECTION
MEDIA, IN CLASS 7 (U.S. CLS. 13, 19, 21, 23, 31, 34
AND 35).

FIRST USE 10-15-2007; IN COMMERCE 10-15-2007.

THE MARK CONSISTS OF STANDARD CHAR-
ACTERS WITHOUT CLAIM TO ANY PARTICULAR
FONT, STYLE, SIZE, OR COLOR.

NO CLAIM IS MADE TO THE EXCLUSIVE
RIGHT TO USE "DIESEL", APART FROM THE
MARK AS SHOWN.

SN 76-654,526, FILED 2-3-2006.

TEJBIR SINGH, EXAMINING ATTORNEY

Int. Cl.: 9

Prior U.S. Cls.: 21, 23, 26, 36, and 38

Reg. No. 3,481,091

United States Patent and Trademark Office

Registered Aug. 5, 2008

**TRADEMARK
PRINCIPAL REGISTER**

ADVANTAGE

VENTEX TECHNOLOGIES, INC. (FLORIDA
CORPORATION)
7830 BYRON DRIVE, SUITE #10
RIVIERA BEACH, FL 33404

THE MARK CONSISTS OF STANDARD CHAR-
ACTERS WITHOUT CLAIM TO ANY PARTICULAR
FONT, STYLE, SIZE, OR COLOR.

FOR: ELECTRONIC FLUORESCENT BALLASTS
AND ELECTRONIC POWER SUPPLIES, IN CLASS 9
(U.S. CLS. 21, 23, 26, 36 AND 38).

SN 76-654,615, FILED 2-6-2006.

FIRST USE 11-30-2006; IN COMMERCE 1-0-2008.

ALLISON SCHRODY, EXAMINING ATTORNEY

Int. Cl.: 42

Prior U.S. Cls.: 100 and 101

United States Patent and Trademark Office

Reg. No. 3,481,092

Registered Aug. 5, 2008

**SERVICE MARK
PRINCIPAL REGISTER**

MEDIA MOGUL OF THE HOME

INGLEY, CAROL (UNITED STATES INDIVIDUAL)
P.O. BOX 5547
WASHINGTON, DC 20016

THE MARK CONSISTS OF STANDARD CHARACTERS WITHOUT CLAIM TO ANY PARTICULAR FONT, STYLE, SIZE, OR COLOR.

FOR: PROVIDING INFORMATION VIA A WEB SITE FEATURING INFORMATION TECHNOLOGY FOR THE DIGITAL CONSUMER AND THE DIGITAL HOME, IN CLASS 42 (U.S. CLS. 100 AND 101).

SN 76-654,797, FILED 2-7-2006.

FIRST USE 11-1-2007; IN COMMERCE 2-17-2008.

WILLIAM P. SHANAHAN, EXAMINING ATTORNEY

Int. Cl.: 12

Prior U.S. Cls.: 19, 21, 23, 31, 35, and 44

United States Patent and Trademark Office

Reg. No. 3,481,093

Registered Aug. 5, 2008

**TRADEMARK
PRINCIPAL REGISTER**

ROLLIN ON VOGUES

VOGUE TYRE & RUBBER COMPANY (ILLINOIS
CORPORATION)
P.O. BOX 593
MOUNT PROSPECT, IL 60056

FOR: VEHICLE TIRES, IN CLASS 12 (U.S. CLS. 19,
21, 23, 31, 35 AND 44).

FIRST USE 5-31-2008; IN COMMERCE 5-31-2008.

THE MARK CONSISTS OF STANDARD CHAR-
ACTERS WITHOUT CLAIM TO ANY PARTICULAR
FONT, STYLE, SIZE, OR COLOR.

OWNER OF U.S. REG. NOS. 212,547 AND 1,803,710.

SN 76-656,988, FILED 3-21-2006.

REBECCA EISINGER, EXAMINING ATTORNEY

Int. Cl.: 9

Prior U.S. Cls.: 21, 23, 26, 36, and 38

Reg. No. 3,481,094

United States Patent and Trademark Office

Registered Aug. 5, 2008

**TRADEMARK
PRINCIPAL REGISTER**

OXILAB

ECIL NORTH AMERICA LLC (OHIO LTD LIAB
CO)
222 SOUTH MAIN STREET
AKRON, OH 44308

THE MARK CONSISTS OF STANDARD CHAR-
ACTERS WITHOUT CLAIM TO ANY PARTICULAR
FONT, STYLE, SIZE, OR COLOR.

FOR: ELECTRONIC DEVICES FOR PROVIDING
CHEMICAL AND TEMPERATURE MEASURE-
MENTS FOR MOLTEN METAL BATHS, IN CLASS
9 (U.S. CLS. 21, 23, 26, 36 AND 38).

SN 76-658,045, FILED 4-10-2006.

FIRST USE 1-15-2007; IN COMMERCE 1-15-2007.

MICHAEL LEWIS, EXAMINING ATTORNEY

Int. Cl.: 9

Prior U.S. Cls.: 21, 23, 26, 36, and 38

Reg. No. 3,481,095

United States Patent and Trademark Office

Registered Aug. 5, 2008

**TRADEMARK
PRINCIPAL REGISTER**

OXYTIP

ECIL NORTH AMERICA LLC (OHIO LTD LIAB
CO)
222 SOUTH MAIN STREET
AKRON, OH 44308

THE MARK CONSISTS OF STANDARD CHAR-
ACTERS WITHOUT CLAIM TO ANY PARTICULAR
FONT, STYLE, SIZE, OR COLOR.

FOR: EXPENDABLE IMMERSION SENSORS FOR
USE IN MOLTEN METAL BATHS TO MEASURE
THE OXYGEN CONTENT, IN CLASS 9 (U.S. CLS. 21,
23, 26, 36 AND 38).

SN 76-658,046, FILED 4-10-2006.

FIRST USE 2-22-2007; IN COMMERCE 2-22-2007.

MICHAEL LEWIS, EXAMINING ATTORNEY

Int. Cls.: 8, 9, and 21

**Prior U.S. Cls.: 2, 13, 21, 23, 26, 28, 29, 30, 33, 36, 38,
40, 44, and 50**

Reg. No. 3,481,096

United States Patent and Trademark Office

Registered Aug. 5, 2008

**TRADEMARK
PRINCIPAL REGISTER**

FRESHPREP

WENCO L.L.C. (NEW YORK LTD LIAB CO), DBA
SILVERMARK,
70 EAST 77TH STREET
NEW YORK CITY, NY 10021

LY, SPATULAS, SPAGHETTI SERVERS, AND
STRAINERS AND TURNERS FOR KITCHEN USE;
TEXTILE CLEANING CLOTHS, IN CLASS 21 (U.S.
CLS. 2, 13, 23, 29, 30, 33, 40 AND 50).

FOR: HOUSEHOLD SCISSORS AND SHEARS, IN
CLASS 8 (U.S. CLS. 23, 28 AND 44).

FIRST USE 3-0-2006; IN COMMERCE 3-0-2006.

FIRST USE 3-0-2006; IN COMMERCE 3-0-2006.

FOR: MEASURING CUPS, IN CLASS 9 (U.S. CLS.
21, 23, 26, 36 AND 38).

THE MARK CONSISTS OF STANDARD CHAR-
ACTERS WITHOUT CLAIM TO ANY PARTICULAR
FONT, STYLE, SIZE, OR COLOR.

FIRST USE 3-0-2006; IN COMMERCE 3-0-2006.

SN 76-658,145, FILED 4-10-2006.

FOR: BOWLS; CUTTING BOARDS; LADLES FOR
KITCHEN USE; HOUSEHOLD UTENSILS, NAME-

CHERYL CLAYTON, EXAMINING ATTORNEY

Int. Cl.: 19

Prior U.S. Cls.: 1, 12, 33, and 50

United States Patent and Trademark Office

Reg. No. 3,481,097

Registered Aug. 5, 2008

**TRADEMARK
PRINCIPAL REGISTER**

POLYTEC

TA CHEN INTERNATIONAL, INC. (CALIFORNIA CORPORATION)
5855 OBISPO AVENUE
LONG BEACH, CA 90805

FOR: WINDOW COVERINGS AND WINDOW TREATMENTS, INCLUDING REINFORCED WINDOW COVERINGS AND REINFORCED WINDOW TREATMENTS, NAMELY, WINDOW SHUTTERS MADE PRIMARILY OF NONMETAL, INCLUDING REINFORCED WINDOW SHUTTERS MADE PRIMARILY OF NONMETAL, IN CLASS 19 (U.S. CLS. 1, 12, 33 AND 50).

FIRST USE 3-1-2006; IN COMMERCE 3-1-2007.

THE MARK CONSISTS OF STANDARD CHARACTERS WITHOUT CLAIM TO ANY PARTICULAR FONT, STYLE, SIZE, OR COLOR.

SN 76-658,427, FILED 4-14-2006.

ALICE SUE CARRUTHERS, EXAMINING ATTORNEY

Int. Cl.: 19

Prior U.S. Cls.: 1, 12, 33, and 50

United States Patent and Trademark Office

Reg. No. 3,481,098

Registered Aug. 5, 2008

TRADEMARK
PRINCIPAL REGISTER

The logo for Poly TEC features the word "Poly" in a large, elegant, cursive script. A thick, black, horizontal brushstroke underline extends from the bottom of the "y" in "Poly" across the page. The word "TEC" is positioned to the right of "Poly" and is written in a bold, uppercase, sans-serif font.

TA CHEN INTERNATIONAL, INC. (CALIFORNIA CORPORATION)
5855 OBISPO AVENUE
LONG BEACH, CA 90805

FOR: WINDOW COVERINGS AND WINDOW TREATMENTS, INCLUDING REINFORCED WINDOW COVERINGS AND REINFORCED WINDOW TREATMENTS, NAMELY, WINDOW SHUTTERS MADE PRIMARILY OF NONMETAL, INCLUDING REINFORCED WINDOW SHUTTERS MADE PRI-

MARILY OF NONMETAL, IN CLASS 19 (U.S. CLS. 1, 12, 33 AND 50).

FIRST USE 3-1-2006; IN COMMERCE 3-1-2007.

SN 76-658,429, FILED 4-14-2006.

ALICE SUE CARRUTHERS, EXAMINING ATTORNEY

Int. Cl.: 3

Prior U.S. Cls.: 1, 4, 6, 50, 51, and 52

United States Patent and Trademark Office

Reg. No. 3,481,099

Registered Aug. 5, 2008

**TRADEMARK
PRINCIPAL REGISTER**

IT'S ALL GOOD

NOAH'S NATURALS, LLC (CALIFORNIA CORPORATION)
11400 W. OLYMPIC BLVD.
STE. 425
LOS ANGELES, CA 90064

FOR: AROMATHERAPY BODY CARE PRODUCTS, NAMELY, BODY LOTION, SHOWER GEL, CUTICLE CREAM, SHAMPOO, CONDITIONER, NON-MEDICATED LIP BALM, SOAP, BODY POL-

ISH, BODY AND FOOT SCRUB AND NON-MEDICATED FOOT CREAM, IN CLASS 3 (U.S. CLS. 1, 4, 6, 50, 51 AND 52).

FIRST USE 10-1-2006; IN COMMERCE 10-1-2006.

SN 76-658,919, FILED 4-24-2006.

MELVIN AXILBUND, EXAMINING ATTORNEY

Int. Cls.: 40, 41, and 42

Prior U.S. Cls.: 100, 101, 103, 106, and 107

United States Patent and Trademark Office

Reg. No. 3,481,100

Registered Aug. 5, 2008

**SERVICE MARK
PRINCIPAL REGISTER**

REGISTERED REHABILITATION TECHNOLOGY SUPPLIER

NATIONAL REGISTRY OF REHABILITATION
TECHNOLOGY SUPPLIERS (D.C. CORPORATION)
P.O. BOX 4033
LAGO VISTA, TX 78645

FOR: CUSTOM MANUFACTURING AND FITTING OF REHABILITATION THERAPY PRODUCTS TO MEET INDIVIDUAL USER REQUIREMENTS, IN CLASS 40 (U.S. CLS. 100, 103 AND 106).

FIRST USE 4-26-2006; IN COMMERCE 4-26-2006.

FOR: INSTRUCTING OTHERS ON THE USE OF AND CARE FOR REHABILITATION THERAPY PRODUCTS, IN CLASS 41 (U.S. CLS. 100, 101 AND 107).

FIRST USE 4-26-2006; IN COMMERCE 4-26-2006.

FOR: CUSTOM DESIGNING AND TESTING OF REHABILITATION THERAPY PRODUCTS, EVAL-

UATING THE NEEDS OF USERS OF WHEELCHAIRS, SEATING SYSTEMS AND OTHER REHABILITATION THERAPY PRODUCTS, IN CLASS 42 (U.S. CLS. 100 AND 101).

FIRST USE 4-26-2006; IN COMMERCE 4-26-2006.

THE MARK CONSISTS OF STANDARD CHARACTERS WITHOUT CLAIM TO ANY PARTICULAR FONT, STYLE, SIZE, OR COLOR.

OWNER OF U.S. REG. NOS. 2,283,562 AND 2,520,389.

NO CLAIM IS MADE TO THE EXCLUSIVE RIGHT TO USE "REHABILITATION TECHNOLOGY SUPPLIER", APART FROM THE MARK AS SHOWN.

SN 76-659,450, FILED 4-27-2006.

SANJEEV VOHRA, EXAMINING ATTORNEY

Int. Cl.: 6

Prior U.S. Cls.: 2, 12, 13, 14, 23, 25, and 50

Reg. No. 3,481,101

United States Patent and Trademark Office

Registered Aug. 5, 2008

**TRADEMARK
PRINCIPAL REGISTER**



HAWK

CHANGZHOU HAWK DISPLAY APPLIANCE
MANUFACTURE CO., LTD. (CHINA COR-
PORATION)
NO.3 BUILDING, HONGZHUANG INDUSTRY
AREA
XINZHUANG COMMUNITY, WUXING AVENUE
CHANGZHOU CITY, JIANGSU PROVINCE, CHINA

FOR: LATHS OF METAL; PROPS OF METAL,
NAMELY, METAL POSTER STANDS, METAL EX-
HIBITION STANDS; ADVERTISEMENT COLUMNS
OF METAL; FENCES OF METAL; SIGNBOARDS OF

METAL; WORKS OF ART OF COMMON METAL;
POSTS OF METAL; BUILDINGS OF METAL; ME-
TAL BUILDING MATERIALS, NAMELY, METAL
BOARDS AND METAL BUILDING PANELS, IN
CLASS 6 (U.S. CLS. 2, 12, 13, 14, 23, 25 AND 50).

FIRST USE 11-1-2002; IN COMMERCE 6-15-2005.

SN 76-659,461, FILED 4-27-2006.

SANJEEV VOHRA, EXAMINING ATTORNEY

Int. Cl.: 41

Prior U.S. Cls.: 100, 101, and 107

United States Patent and Trademark Office

Reg. No. 3,481,102

Registered Aug. 5, 2008

**SERVICE MARK
PRINCIPAL REGISTER**



AGA, SUSIE (UNITED STATES INDIVIDUAL)
13190 BIRMINGHAM HWY
ALPHARETTA, GA 30004

FOR: EDUCATIONAL SERVICES, NAMELY,
CONDUCTING IN-HOME LESSONS, GROUP CLAS-
SES AND IN-KENNEL TRAINING SESSIONS IN
THE FIELDS OF PET OBEDIENCE AND AGILITY,
IN CLASS 41 (U.S. CLS. 100, 101 AND 107).

FIRST USE 1-1-2007; IN COMMERCE 1-1-2007.

NO CLAIM IS MADE TO THE EXCLUSIVE
RIGHT TO USE "ATLANTA DOG TRAINER LLC",
APART FROM THE MARK AS SHOWN.

THE COLOR(S) BLUE AND BLACK IS/ARE
CLAIMED AS A FEATURE OF THE MARK.

THE MARK CONSISTS OF A SMALL DOG CO-
LORED BLUE STANDING IN FRONT OF A LARGE
DOG COLORED BLACK ON THE LEFT-HAND
SIDE OF THE MARK. THE WORDING "ATLANTA
DOG TRAINER" APPEARS IN BLACK TO THE
RIGHT OF THE DESIGN.

SN 76-660,171, FILED 5-17-2006.

WILLIAM ROSSMAN, EXAMINING ATTORNEY

Int. Cl.: 11

Prior U.S. Cls.: 13, 21, 23, 31, and 34

Reg. No. 3,481,103

United States Patent and Trademark Office

Registered Aug. 5, 2008

**TRADEMARK
PRINCIPAL REGISTER**



MR. AQUA CO., LTD. (TAIWAN CORPORATION)
NO. 246-2, SEC. 2, GANYUAN ST.
SHULIN CITY, TAIPEI COUNTY, TAIWAN 238

AQUARIUM WATER CLEANING UNITS, IN CLASS
11 (U.S. CLS. 13, 21, 23, 31 AND 34).

FOR: AQUARIUM LIGHTS, LIGHT BULBS,
FLUORESCENT ELECTRIC LIGHT BULBS, ILLU-
MINATING LIGHT BULBS, AQUARIUM WATER
TANK THERMOPHORES, AQUARIUM WATER
TANK FILTERS, AQUARIUM HEATERS, AND

FIRST USE 4-0-2001; IN COMMERCE 9-0-2003.

SN 76-661,281, FILED 6-8-2006.

JASON BLAIR, EXAMINING ATTORNEY

Int. Cl.: 36

Prior U.S. Cls.: 100, 101, and 102

United States Patent and Trademark Office

Reg. No. 3,481,104

Registered Aug. 5, 2008

**SERVICE MARK
PRINCIPAL REGISTER**



ASIAN PACIFIC BANCORP INC (MISSOURI CORPORATION)
8012 BONHOMME AVE., SUITE 300
CLAYTON, MO 63105

FOR: BANKING SERVICES AND FINANCIAL SERVICES, NAMELY, MONEY LENDING AND INVESTMENT BANKING SERVICES, IN CLASS 36 (U.S. CLS. 100, 101 AND 102).

FIRST USE 9-15-2006; IN COMMERCE 9-15-2006.

NO CLAIM IS MADE TO THE EXCLUSIVE RIGHT TO USE "ASIAN PACIFIC BANK CORP INC", APART FROM THE MARK AS SHOWN.

THE COLOR(S) RED, WHITE AND GOLD IS/ARE CLAIMED AS A FEATURE OF THE MARK.

THE COLOR RED APPEARS IN THE WORDS "ASIAN PACIFIC BANCORP INC"; IN THE HORIZONTAL STRAIGHT LINE; AND IN THE FILLING WITH THE CIRCLE DESIGN AND SURROUNDING THE WAVE PORTION OF THE DESIGN. THE COLOR GOLD APPEARS IN THE WORDS "PEOPLE AND OPPORTUNITIES" AND IN THE PERIMETER RING OF THE DESIGN. THE COLOR WHITE APPEARS IN THE WAVE PORTION OF THE DESIGN WITHIN THE RING.

SN 76-664,299, FILED 8-8-2006.

SARA THOMAS, EXAMINING ATTORNEY

Int. Cl.: 5

Prior U.S. Cls.: 6, 18, 44, 46, 51, and 52

United States Patent and Trademark Office

Reg. No. 3,481,105

Registered Aug. 5, 2008

**TRADEMARK
PRINCIPAL REGISTER**

BERRY BREEZE

MCNEIL NUTRITIONALS, LLC (DELAWARE
LTD LIAB CO)

601 OFFICE DRIVE

FORT WASHINGTON, PA 19034

FOR: VITAMINS AND DIETARY SUPPLEMENTS,
IN CLASS 5 (U.S. CLS. 6, 18, 44, 46, 51 AND 52).

FIRST USE 3-1-2007; IN COMMERCE 3-1-2007.

THE MARK CONSISTS OF STANDARD CHAR-
ACTERS WITHOUT CLAIM TO ANY PARTICULAR
FONT, STYLE, SIZE, OR COLOR.

NO CLAIM IS MADE TO THE EXCLUSIVE
RIGHT TO USE "BERRY", APART FROM THE
MARK AS SHOWN.

SN 76-664,492, FILED 8-11-2006.

ELISSA GARBER KON, EXAMINING ATTORNEY

Int. Cl.: 5

Prior U.S. Cls.: 6, 18, 44, 46, 51, and 52

United States Patent and Trademark Office

Reg. No. 3,481,106

Registered Aug. 5, 2008

**TRADEMARK
PRINCIPAL REGISTER**

FLAVOR GLIDES

MCNEIL NUTRITIONALS, LLC (DELAWARE
LTD LIAB CO)

601 OFFICE DRIVE

FORT WASHINGTON, PA 19034

FOR: VITAMINS AND DIETARY SUPPLEMENTS,
IN CLASS 5 (U.S. CLS. 6, 18, 44, 46, 51 AND 52).

FIRST USE 3-1-2007; IN COMMERCE 3-1-2007.

THE MARK CONSISTS OF STANDARD CHAR-
ACTERS WITHOUT CLAIM TO ANY PARTICULAR
FONT, STYLE, SIZE, OR COLOR.

NO CLAIM IS MADE TO THE EXCLUSIVE
RIGHT TO USE "FLAVOR", APART FROM THE
MARK AS SHOWN.

SN 76-664,493, FILED 8-11-2006.

ELISSA GARBER KON, EXAMINING ATTORNEY

Int. Cls.: 1, 16, and 19

**Prior U.S. Cls.: 1, 2, 5, 6, 10, 12, 22, 23, 26, 29, 33, 37,
38, 46, and 50**

Reg. No. 3,481,107

United States Patent and Trademark Office

Registered Aug. 5, 2008

**TRADEMARK
PRINCIPAL REGISTER**

ROCKET BOND

RHINO-HIDE, L.L.C. (FLORIDA LTD LIAB CO)
3125 REYNOLDS ROAD
LAKELAND, FL 33803

FOR: ADHESIVE AND REPAIR MATERIALS, NAMELY, POLYURETHANE ADHESIVES, INDUSTRIAL ADHESIVES FOR USE IN COATING AND SEALING, EPOXY GLUE FOR GENERAL BONDING AND REPAIR PURPOSES, FILLER FOR AUTOMOTIVE BODY REPAIR, SYNTHETIC POLYMER MODIFIED RESIN COMPOUND FOR USE IN CEMENTITIOUS REPAIRS; REPAIR MATERIALS, NAMELY ADHESIVE FOR SHOE SOLE REPAIR, IN CLASS 1 (U.S. CLS. 1, 5, 6, 10, 26 AND 46).

FIRST USE 10-31-2007; IN COMMERCE 10-31-2007.

FOR: ADHESIVE MATERIALS, NAMELY, BONDING ADHESIVE FOR HOUSEHOLD PURPOSES, IN CLASS 16 (U.S. CLS. 2, 5, 22, 23, 29, 37, 38 AND 50).

FIRST USE 10-31-2007; IN COMMERCE 10-31-2007.

FOR: ADHESIVE AND REPAIR MATERIALS, NAMELY, ADHESIVE MORTAR FOR BUILDING PURPOSES, IN CLASS 19 (U.S. CLS. 1, 12, 33 AND 50).

FIRST USE 10-31-2007; IN COMMERCE 10-31-2007.

THE MARK CONSISTS OF STANDARD CHARACTERS WITHOUT CLAIM TO ANY PARTICULAR FONT, STYLE, SIZE, OR COLOR.

OWNER OF U.S. REG. NOS. 2,985,122, 3,250,159, AND OTHERS.

NO CLAIM IS MADE TO THE EXCLUSIVE RIGHT TO USE "BOND", APART FROM THE MARK AS SHOWN.

SN 76-664,624, FILED 8-15-2006.

REBECCA POVARCHUK, EXAMINING ATTORNEY

Int. Cl.: 22

Prior U.S. Cls.: 1, 2, 7, 19, 22, 42, and 50

United States Patent and Trademark Office

Reg. No. 3,481,108

Registered Aug. 5, 2008

**TRADEMARK
PRINCIPAL REGISTER**

PLANTECTOR

WILD ROOT, LLC (TEXAS LTD LIAB CO)
5433 CHATHAM ROAD
DALLAS, TX 75220

THE MARK CONSISTS OF STANDARD CHAR-
ACTERS WITHOUT CLAIM TO ANY PARTICULAR
FONT, STYLE, SIZE, OR COLOR.

FOR: POLYPROPYLENE BAG COVERS FOR
PLANTS, IN CLASS 22 (U.S. CLS. 1, 2, 7, 19, 22, 42
AND 50).

SN 76-664,651, FILED 8-16-2006.

FIRST USE 10-0-2007; IN COMMERCE 10-0-2007.

DORITT L. CARROLL, EXAMINING ATTORNEY

Int. Cl.: 1

Prior U.S. Cls.: 1, 5, 6, 10, 26, and 46

United States Patent and Trademark Office

Reg. No. 3,481,109

Registered Aug. 5, 2008

**TRADEMARK
PRINCIPAL REGISTER**

FLORIGANIC

FORESTRY RESOURCES, INC. (FLORIDA CORPORATION)
4353 MICHIGAN LINK
FORT MYERS, FL 33916

THE MARK CONSISTS OF STANDARD CHARACTERS WITHOUT CLAIM TO ANY PARTICULAR FONT, STYLE, SIZE, OR COLOR.

FOR: COMPOST, PLANTING SOIL, AND POTTING SOIL HAVING ELEVATED CONTENT OF ORGANIC MATERIAL, MINERALS, AND NUTRIENTS, IN CLASS 1 (U.S. CLS. 1, 5, 6, 10, 26 AND 46).

SN 76-665,060, FILED 8-24-2006.

FIRST USE 4-1-2008; IN COMMERCE 4-1-2008.

BILL DAWE, EXAMINING ATTORNEY

Int. Cl.: 7

Prior U.S. Cls.: 13, 19, 21, 23, 31, 34, and 35

United States Patent and Trademark Office

Reg. No. 3,481,110

Registered Aug. 5, 2008

TRADEMARK
PRINCIPAL REGISTER



RON TAI IRON FACTORY (TAIWAN CORPORATION)
NO. 64-2, CHIU-SIR LANE, PEITUN DIST
TAICHUNG CITY, TAIWAN

FOR: MOTORS, NAMELY, ELECTRIC STARTER MOTORS, ELEVATOR MOTORS, LINEAR MOTORS, STARTER MOTORS; MACHINE PARTS, NAMELY, CONTROLLED DECELERATORS FOR STOPPING MOVING PARTS OF INDUSTRIAL MACHINERY AND ABSORBING THE KINETIC ENERGY OF THE PARTS; POWER-OPERATED

BLOWERS, IN CLASS 7 (U.S. CLS. 13, 19, 21, 23, 31, 34 AND 35).

FIRST USE 6-27-2007; IN COMMERCE 4-12-2008.

THE ENGLISH TRANSLATION OF THE WORD "BACCA" IN THE MARK IS BERRY.

SN 76-665,159, FILED 8-24-2006.

DARRYL SPRUILL, EXAMINING ATTORNEY

Int. Cl.: 37

Prior U.S. Cls.: 100, 103, and 106

United States Patent and Trademark Office

Reg. No. 3,481,111

Registered Aug. 5, 2008

**SERVICE MARK
PRINCIPAL REGISTER**

MOSSY OAK LAND ENHANCEMENT SERVICES

HAAS OUTDOORS, INC. (MISSISSIPPI CORPORATION)
200 E. MAIN STREET
P. O. DRAWER 757
WEST POINT, MS 39773

FOR: LAND DEVELOPMENT SERVICES; NAME-
LY, PLANNING AND LAYING OUT OF PROPERTY
AND RESIDENTIAL FACILITIES FOR AGRICUL-
TURE, HUNTING, FISHING, AND WILDLIFE
MANAGEMENT; CONSTRUCTION OF HUNTING
CAMPS, HUNTING PROPERTY, AND WILDLIFE
MANAGEMENT AREAS, IN CLASS 37 (U.S. CLS. 100,
103 AND 106).

FIRST USE 3-31-2005; IN COMMERCE 3-31-2005.

THE MARK CONSISTS OF STANDARD CHAR-
ACTERS WITHOUT CLAIM TO ANY PARTICULAR
FONT, STYLE, SIZE, OR COLOR.

OWNER OF U.S. REG. NOS. 1,525,739, 3,155,948,
AND OTHERS.

NO CLAIM IS MADE TO THE EXCLUSIVE
RIGHT TO USE "LAND ENHANCEMENT SERVI-
CES", APART FROM THE MARK AS SHOWN.

SN 76-665,164, FILED 8-25-2006.

HELENE LIWINSKI, EXAMINING ATTORNEY

Int. Cl.: 35

Prior U.S. Cls.: 100, 101, and 102

United States Patent and Trademark Office

Reg. No. 3,481,112

Registered Aug. 5, 2008

**SERVICE MARK
PRINCIPAL REGISTER**

GenuineStores

THE TRUSTEES OF THE RODNEY A. HAMIL-
TON LIVING TRUST A CALIFORNIA TRUST,
COMPRISING RODNEY A. HAMILTON, A
UNITED STATES C (CALIFORNIA TRUST)
5250 W. CENTURY BLVD.
SUITE 315
LOS ANGELES, CA 90045

FOR: ADVERTISING SERVICES FOR COMPU-
TERIZED ON-LINE ORDERING SERVICES, ON-
LINE RETAIL STORES SERVICES, WHOLESAL
DISTRIBUTORSHIPS AND DISTRIBUTORSHIPS
ALL FEATURING APPLIANCES, JEWELRY, ELEC-
TRONICS, AUTOS, CLOTHES, MUSIC, FOOD, MO-

TION PICTURES AND MULTIMEDIA PRODUCTS,
IN CLASS 35 (U.S. CLS. 100, 101 AND 102).

FIRST USE 10-30-2007; IN COMMERCE 10-30-2007.

THE MARK CONSISTS OF STANDARD CHAR-
ACTERS WITHOUT CLAIM TO ANY PARTICULAR
FONT, STYLE, SIZE, OR COLOR.

SN 76-665,413, FILED 8-31-2006.

BILL DAWE, EXAMINING ATTORNEY

Int. Cl.: 3

Prior U.S. Cls.: 1, 4, 6, 50, 51, and 52

United States Patent and Trademark Office

Reg. No. 3,481,113

Registered Aug. 5, 2008

**TRADEMARK
PRINCIPAL REGISTER**



VOODOO RIDE, LLC (DELAWARE LTD LIAB
CO)
325 W. HURON STREET, SUITE 404
CHICAGO, IL 60610

FIRST USE 1-7-2008; IN COMMERCE 1-7-2008.

SN 76-666,206, FILED 9-18-2006.

FOR: AUTOMOTIVE SURFACE CARE PRO-
DUCTS, NAMELY, AUTOMOBILE CLEANERS, AU-
TOMOBILE POLISHES AND WAXES, IN CLASS 3
(U.S. CLS. 1, 4, 6, 50, 51 AND 52).

KATHERINE CHANG, EXAMINING ATTORNEY

Int. Cl.: 41

Prior U.S. Cls.: 100, 101, and 107

United States Patent and Trademark Office

Reg. No. 3,481,114

Registered Aug. 5, 2008

**SERVICE MARK
PRINCIPAL REGISTER**



TEAM EDGE, LLC (NEW JERSEY CORPORATION)
749 HOPE ROAD
SUITE B
EATONTOWN, NJ 07724

SKILL LEVELS, IN CLASS 41 (U.S. CLS. 100, 101 AND 107).

FIRST USE 10-15-2006; IN COMMERCE 10-15-2006.

FOR: HEALTH CLUB SERVICES THAT PROMOTE FITNESS AND SPORTS PARTICIPATION AND ENHANCE ATHLETIC AND PERSONAL

SN 76-666,237, FILED 9-18-2006.

FLORENTINA BLANDU, EXAMINING ATTORNEY

Int. Cl.: 7

Prior U.S. Cls.: 13, 19, 21, 23, 31, 34, and 35

United States Patent and Trademark Office

Reg. No. 3,481,115

Registered Aug. 5, 2008

TRADEMARK
PRINCIPAL REGISTER



YANG BEY INDUSTRIAL CO., LTD. (TAIWAN CORPORATION)
NO.40, SEC.1, TA FU RD.
TANTZU HSIANG
TAICHUNG HSIEN 427, TAIWAN

FOR: PACKERS FOR PACKING PACKAGES, BOXES OR CASES, IN CLASS 7 (U.S. CLS. 13, 19, 21, 23, 31, 34 AND 35).

FIRST USE 12-6-2007; IN COMMERCE 12-6-2007.

"THE MARK CONSISTS OF POWER-HI IN A STYLIZED FONT WITHIN A RECTANGLE."

SN 76-666,491, FILED 9-22-2006.

GIANCARLO CASTRO, EXAMINING ATTORNEY

Int. Cl.: 35

Prior U.S. Cls.: 100, 101, and 102

United States Patent and Trademark Office

Reg. No. 3,481,116

Registered Aug. 5, 2008

**SERVICE MARK
PRINCIPAL REGISTER**

BICYCLE CITY

BICYCLE CITY, LLC (DELAWARE LTD LIAB
CO)
6740 CLOUGH PIKE SUITE 203
CINCINNATI, OH 45244

FOR: PROMOTING BUSINESS AND TOURISM IN
ALTERNATIVE COMMUNITIES, NAMELY, ENVIR-
ONMENTALLY-FRIENDLY RESIDENTIAL AND
COMMERCIAL PLANNED COMMUNITIES, IN
CLASS 35 (U.S. CLS. 100, 101 AND 102).

FIRST USE 7-0-2007; IN COMMERCE 7-0-2007.

THE MARK CONSISTS OF STANDARD CHAR-
ACTERS WITHOUT CLAIM TO ANY PARTICULAR
FONT, STYLE, SIZE, OR COLOR.

SN 76-667,406, FILED 10-12-2006.

LINDA POWELL, EXAMINING ATTORNEY

Int. Cl.: 42

Prior U.S. Cls.: 100 and 101

United States Patent and Trademark Office

Reg. No. 3,481,117

Registered Aug. 5, 2008

**SERVICE MARK
PRINCIPAL REGISTER**

QUICKRESERVES

ASSOCIATION RESERVES, INC. (CALIFORNIA
CORPORATION)
P.O. BOX 8637
CALABASAS, CA 91372

FOR: PROVIDING ONLINE NON-DOWNLOAD-
ABLE SOFTWARE USED FOR FINANCIAL CAL-
CULATIONS AND REPORTS FOR FACILITY
FUTURE EXPENSES AND CAPITAL PLANNING
NEEDS, IN CLASS 42 (U.S. CLS. 100 AND 101).

FIRST USE 12-1-2007; IN COMMERCE 12-1-2007.

THE MARK CONSISTS OF STANDARD CHAR-
ACTERS WITHOUT CLAIM TO ANY PARTICULAR
FONT, STYLE, SIZE, OR COLOR.

SN 76-667,525, FILED 10-16-2006.

SUE LAWRENCE, EXAMINING ATTORNEY

Int. Cl.: 16

Prior U.S. Cls.: 2, 5, 22, 23, 29, 37, 38, and 50

Reg. No. 3,481,118

United States Patent and Trademark Office

Registered Aug. 5, 2008

**TRADEMARK
PRINCIPAL REGISTER**

DR GORILLA PACK

TIMELY INVENTIONS LLC (DELAWARE LTD
LIAB CO)

8737 WILSHIRE BLVD.

BEVERLY HILLS, CA 90211

FOR: PACKAGING, NAMELY, BLISTER PACKS
AND BLISTER CARDS, IN CLASS 16 (U.S. CLS. 2, 5,
22, 23, 29, 37, 38 AND 50).

FIRST USE 11-0-2006; IN COMMERCE 11-0-2006.

THE MARK CONSISTS OF STANDARD CHAR-
ACTERS WITHOUT CLAIM TO ANY PARTICULAR
FONT, STYLE, SIZE, OR COLOR.

NO CLAIM IS MADE TO THE EXCLUSIVE
RIGHT TO USE "PACK", APART FROM THE MARK
AS SHOWN.

SN 76-668,434, FILED 11-2-2006.

DAVID TAYLOR, EXAMINING ATTORNEY

Int. Cl.: 41

Prior U.S. Cls.: 100, 101, and 107

United States Patent and Trademark Office

Reg. No. 3,481,119

Registered Aug. 5, 2008

**SERVICE MARK
PRINCIPAL REGISTER**

THE WIP

DANIELS, KATHARINE (UNITED STATES INDIVIDUAL)
C/O WILLIAM B. DANIELS, ESQ.
563 FIGUEROA STREET
MONTEREY, CA 939403232

FOR: ON-LINE PUBLICATIONS IN THE NATURE OF NEWS MAGAZINES FEATURING ARTICLES BY WOMEN JOURNALISTS IN THE FIELDS OF ARTS AND CULTURE, ECONOMICS, EDUCATION, POLITICS, SCIENCE, TECHNOLOGY, AND WORLD NEWS, IN CLASS 41 (U.S. CLS. 100, 101 AND 107).

FIRST USE 3-8-2007; IN COMMERCE 3-8-2007.

THE MARK CONSISTS OF STANDARD CHARACTERS WITHOUT CLAIM TO ANY PARTICULAR FONT, STYLE, SIZE, OR COLOR.

SN 76-668,644, FILED 11-7-2006.

LYDIA BELZER, EXAMINING ATTORNEY

Int. Cl.: 43

Prior U.S. Cls.: 100 and 101

United States Patent and Trademark Office

Reg. No. 3,481,120

Registered Aug. 5, 2008

**SERVICE MARK
PRINCIPAL REGISTER**

MERCAT

SAGE HOSPITALITY RESOURCES LLC (DELA-
WARE LTD LIAB CO)
1512 LARIMER STREET
SUITE NO. 800
DENVER, CO 80202

FIRST USE 3-10-2008; IN COMMERCE 3-10-2008.

SN 76-670,284, FILED 12-13-2006.

FOR: RESTAURANT SERVICES, IN CLASS 43
(U.S. CLS. 100 AND 101).

WENDY JUN, EXAMINING ATTORNEY

Int. Cl.: 12

Prior U.S. Cls.: 19, 21, 23, 31, 35, and 44

Reg. No. 3,481,121

United States Patent and Trademark Office

Registered Aug. 5, 2008

**TRADEMARK
PRINCIPAL REGISTER**

DON'T WORRY, THE BRAND IS WALD

WALD LLC (KENTUCKY LTD LIAB CO)
FIFTH & CENTER STREETS, P.O. BOX 10
MAYSVILLE, KY 41056

FOR: BICYCLE PARTS AND BICYCLE ACCESSORIES, NAMELY, FENDER BRACES, CHAIN GUARDS, REAR STANDS, SIDE STANDS, WIRE BASKETS, WIRE BASKET CLAMP SETS COMPRISED OF CLAMPS FOR SECURING WIRE BASKETS TO BICYCLE HANDLEBARS, WIRE BASKET BRACE SUPPORTS, MESH BASKETS, FOLDING BASKETS, BASKET HOLDERS, SADDLE BASKETS, SADDLE BASKET BRACKETS, HANDLEBAR STEMS, EXPANSION LUGS, HANDLEBARS, AXLES, HANDLEBAR STEM ASSEMBLY, KEY WASHERS, HEAD CUPS, ADJUSTABLE HEAD CONES, STATIONARY HEAD CONES, REPAIR CONES, FLASHLIGHT HOLDERS, SEAT POSTS, COASTER BRAKE STRAPS, CRANK HANGER

CUPS, FORK STEMS, REPAIR FORKS, BIKE BALANCERS, TRAINING WHEELS/STABILIZERS, WIRE CARRIERS, REAR RACKS, FENDERS, FENDER FITTINGS, SPLASH GUARDS, SPROCKETS, REFLECTOR BRACKET, WATER BOTTLE HOLDER MOUNTING BRACKET AND PEDALS, IN CLASS 12 (U.S. CLS. 19, 21, 23, 31, 35 AND 44).

FIRST USE 6-14-2007; IN COMMERCE 6-14-2007.

THE MARK CONSISTS OF STANDARD CHARACTERS WITHOUT CLAIM TO ANY PARTICULAR FONT, STYLE, SIZE, OR COLOR.

OWNER OF U.S. REG. NOS. 576,907 AND 1,029,657.

SN 76-670,370, FILED 12-15-2006.

JOHN DWYER, EXAMINING ATTORNEY

Int. Cl.: 36

Prior U.S. Cls.: 100, 101, and 102

United States Patent and Trademark Office

Reg. No. 3,481,122

Registered Aug. 5, 2008

**SERVICE MARK
PRINCIPAL REGISTER**

DeltaEdge 

DELTA EDGE MANAGEMENT GROUP, LP (DE-
LAWARE LIMITED PARTNERSHIP)
C/O MR. M. UNGAR
7 LANE STREET
MONSEY, NY 10952

INVESTMENT FUNDS, IN CLASS 36 (U.S. CLS. 100,
101 AND 102).

FIRST USE 3-3-2008; IN COMMERCE 3-3-2008.

FOR: INVESTMENT ADVISORY AND MANAGE-
MENT SERVICES FOR DOMESTIC AND OFF-
SHORE CLIENTS, NAMELY, INVESTMENT
MANAGEMENT TO ONE OR MORE PRIVATE

SN 76-670,659, FILED 12-21-2006.

REBECCA SMITH, EXAMINING ATTORNEY

Int. Cl.: 25

Prior U.S. Cls.: 22 and 39

United States Patent and Trademark Office

Reg. No. 3,481,123

Registered Aug. 5, 2008

**TRADEMARK
PRINCIPAL REGISTER**

VV SKIVVYS

STRANGE, VALERIE (UNITED STATES INDIVIDUAL)

3869 CREEK HOLLOW LANE

MIDDLEBURG, FL 32068 AND

WOODESHICK, ROCHELLE (UNITED STATES INDIVIDUAL)

622 ZENITH ROAD

NESCOPECK, PA 18635 AND

KROLIKOWSKI, JUNE (UNITED STATES INDIVIDUAL)

691 OVERLOOK ROAD

NESCOPECK, PA 18635

FOR: WOMEN'S PANTIES, IN CLASS 25 (U.S. CLS. 22 AND 39).

FIRST USE 5-9-2008; IN COMMERCE 5-9-2008.

THE MARK CONSISTS OF STANDARD CHARACTERS WITHOUT CLAIM TO ANY PARTICULAR FONT, STYLE, SIZE, OR COLOR.

NO CLAIM IS MADE TO THE EXCLUSIVE RIGHT TO USE "SKIVVYS", APART FROM THE MARK AS SHOWN.

SN 76-670,995, FILED 1-3-2007.

LESLIE RICHARDS, EXAMINING ATTORNEY

Int. Cl.: 36

Prior U.S. Cls.: 100, 101, and 102

United States Patent and Trademark Office

Reg. No. 3,481,124

Registered Aug. 5, 2008

SERVICE MARK
PRINCIPAL REGISTER



MARTIN, SAMUEL B. (UNITED STATES INDIVIDUAL)
P. O. BOX 213
WALKERTON, VA 23177

FOR: CHARITABLE FUND RAISING, NAMELY, GIVING PROCEEDS TO LOCAL FIRE DEPARTMENTS, RESCUE SQUADS, AND OTHER NON-PROFIT ORGANIZATIONS, IN CLASS 36 (U.S. CLS. 100, 101 AND 102).

FIRST USE 7-20-2007; IN COMMERCE 7-20-2007.

NO CLAIM IS MADE TO THE EXCLUSIVE RIGHT TO USE "VIRGINIA CLASSIC CAR SHOWS", APART FROM THE MARK AS SHOWN.

THE COLOR(S) BLUE, RED, AND WHITE IS/ARE CLAIMED AS A FEATURE OF THE MARK.

THE COLOR BLUE APPEARS ON THE WORDS "VIRGINIA CLASSIC CAR SHOWS"; THE COLORS BLUE, RED, AND WHITE APPEAR ON THE TRIANGULAR DESIGN.

SN 76-671,450, FILED 1-17-2007.

B. PARADEWELAI, EXAMINING ATTORNEY

Int. Cl.: 30

Prior U.S. Cl.: 46

United States Patent and Trademark Office

Reg. No. 3,481,125

Registered Aug. 5, 2008

**TRADEMARK
PRINCIPAL REGISTER**

SEELECT ORGANIC SYRUPS

SEELECT, INC. (CALIFORNIA CORPORATION)
1445 WEST SHELLY COURT
ORANGE, CA 926681200

OWNER OF U.S. REG. NO. 3,057,028.

FOR: FLAVORING SYRUP, IN CLASS 30 (U.S. CL. 46).

NO CLAIM IS MADE TO THE EXCLUSIVE RIGHT TO USE "ORGANIC SYRUPS", APART FROM THE MARK AS SHOWN.

FIRST USE 9-1-2002; IN COMMERCE 9-1-2002.

SN 76-671,620, FILED 1-22-2007.

THE MARK CONSISTS OF STANDARD CHARACTERS WITHOUT CLAIM TO ANY PARTICULAR FONT, STYLE, SIZE, OR COLOR.

SCOTT BIBB, EXAMINING ATTORNEY

Int. Cl.: 9

Prior U.S. Cls.: 21, 23, 26, 36, and 38

United States Patent and Trademark Office

Reg. No. 3,481,126

Registered Aug. 5, 2008

TRADEMARK
PRINCIPAL REGISTER

The logo for PianoSoft-Plus Graphics. "PianoSoft-Plus" is written in a bold, stylized font with a horizontal line through the middle of the letters. Below it, the word "Graphics" is written in a similar bold, stylized font, also with a horizontal line through the middle of the letters.

YAMAHA CORPORATION (JAPAN CORPORATION)
10-1, NAKAZAWA-CHO
HAMAMATSU-SHI
SHIZUOKA, JAPAN

FIRST USE 1-17-2008; IN COMMERCE 1-17-2008.

OWNER OF U.S. REG. NOS. 2,020,855, 2,517,013,
AND 2,621,927.

FOR: PRE-RECORDED OPTICAL DISCS WITH
DIGITAL FILES THAT CONTAIN AUDIO, TEXT,
STILL IMAGES AND GRAPHICS FILES FOR USE IN
THE OPERATION OF PLAYER PIANOS AND ELEC-
TRONIC MUSICAL INSTRUMENTS; PRE-RECOR-
DED OPTICAL DISCS FEATURING MUSIC AND
STILL IMAGES, IN CLASS 9 (U.S. CLS. 21, 23, 26, 36
AND 38).

NO CLAIM IS MADE TO THE EXCLUSIVE
RIGHT TO USE "GRAPHICS", APART FROM THE
MARK AS SHOWN.

SN 76-671,829, FILED 1-25-2007.

CHARLES L. JENKINS, EXAMINING ATTORNEY

Int. Cl.: 6

Prior U.S. Cls.: 2, 12, 13, 14, 23, 25, and 50

Reg. No. 3,481,127

United States Patent and Trademark Office

Registered Aug. 5, 2008

**TRADEMARK
PRINCIPAL REGISTER**

THE HIDDEN LINK

TY-LAN ENTERPRISES INC. (CANADA CORPORATION)
1570 NORTH ROUTLEDGE PARK
LONDON, CANADA N6H 5L6

FOR: METAL FASTENERS, NAMELY, BRACKETS AND CLIPS FOR USE IN THE CONSTRUCTION AND ASSEMBLY OF DECKING, IN CLASS 6 (U.S. CLS. 2, 12, 13, 14, 23, 25 AND 50).

FIRST USE 1-1-2007; IN COMMERCE 1-1-2007.

THE MARK CONSISTS OF STANDARD CHARACTERS WITHOUT CLAIM TO ANY PARTICULAR FONT, STYLE, SIZE, OR COLOR.

PRIORITY CLAIMED UNDER SEC. 44(D) ON CANADA APPLICATION NO. 1,325,758, FILED 11-21-2006.

SN 76-671,894, FILED 1-26-2007.

EMILY CARLSEN, EXAMINING ATTORNEY

Int. Cl.: 41

Prior U.S. Cls.: 100, 101, and 107

United States Patent and Trademark Office

Reg. No. 3,481,128

Registered Aug. 5, 2008

**SERVICE MARK
PRINCIPAL REGISTER**

AMERICAN ELITE

PERFECT IMAGE MEDICAL CORP. (CALIFORNIA CORPORATION)
6200 WILSHIRE BOULEVARD, SUITE 1710
LOS ANGELES, CA 90048

FOR: EDUCATIONAL SERVICES AT THE UNIVERSITY LEVEL, NAMELY, CONDUCTING CLASSES, SEMINARS AND WORKSHOPS ON GENERAL EDUCATION AND PROFESSIONAL EDUCATION COURSES, IN CLASS 41 (U.S. CLS. 100, 101 AND 107).

FIRST USE 2-22-2007; IN COMMERCE 2-22-2007.

THE MARK CONSISTS OF STANDARD CHARACTERS WITHOUT CLAIM TO ANY PARTICULAR FONT, STYLE, SIZE, OR COLOR.

SN 76-672,530, FILED 2-12-2007.

JOHN E. MICHOS, EXAMINING ATTORNEY

Int. Cl.: 3

Prior U.S. Cls.: 1, 4, 6, 50, 51, and 52

United States Patent and Trademark Office

Reg. No. 3,481,129

Registered Aug. 5, 2008

**TRADEMARK
PRINCIPAL REGISTER**

STEAMY

WALSH, JOHN P. (UNITED STATES INDIVIDUAL)
352 FOSTER STREET
NORTH ANDOVER, MA 01845

FOR: COLOGNE AND BODY WASH, IN CLASS 3
(U.S. CLS. 1, 4, 6, 50, 51 AND 52).

FIRST USE 7-31-2007; IN COMMERCE 7-31-2007.

THE MARK CONSISTS OF STANDARD CHARACTERS WITHOUT CLAIM TO ANY PARTICULAR FONT, STYLE, SIZE, OR COLOR.

SN 76-672,718, FILED 2-15-2007.

WILLIAM P. SHANAHAN, EXAMINING ATTORNEY

Int. Cl.: 38

Prior U.S. Cls.: 100, 101, and 104

United States Patent and Trademark Office

Reg. No. 3,481,130

Registered Aug. 5, 2008

**SERVICE MARK
PRINCIPAL REGISTER**

**THE PROFESSIONAL SOUND
FOR GO-ANYWHERE ENTREPRENEURS**

GOTVMAIL COMMUNICATIONS, LLC (MASSACHUSETTS DOMESTIC LIMITED LIABILITY COMPANY)
9 RIVERSIDE DRIVE
WESTON, MA 02493

FOR: TELECOMMUNICATIONS SERVICES, NAMELY, VOICE MAIL SERVICES, TOLL FREE TELEPHONE SERVICES, AND WIRELESS PBX SERVICES, IN CLASS 38 (U.S. CLS. 100, 101 AND 104).

FIRST USE 5-6-2008; IN COMMERCE 5-6-2008.

THE MARK CONSISTS OF STANDARD CHARACTERS WITHOUT CLAIM TO ANY PARTICULAR FONT, STYLE, SIZE, OR COLOR.

SN 76-673,181, FILED 2-26-2007.

JOHN E. MICHOS, EXAMINING ATTORNEY

Int. Cl.: 38

Prior U.S. Cls.: 100, 101, and 104

United States Patent and Trademark Office

Reg. No. 3,481,131

Registered Aug. 5, 2008

**SERVICE MARK
PRINCIPAL REGISTER**

CONNECT YOUR PEOPLE

GOTVMAIL COMMUNICATIONS, LLC (MASSACHUSETTS DOMESTIC LIMITED LIABILITY COMPANY)
9 RIVERSIDE DRIVE
WESTON, MA 02493

FOR: TELECOMMUNICATIONS SERVICES, NAMELY, VOICE MAIL SERVICES, TOLL FREE TELEPHONE SERVICES, AND WIRELESS PBX SERVICES, IN CLASS 38 (U.S. CLS. 100, 101 AND 104).

FIRST USE 5-6-2008; IN COMMERCE 5-6-2008.

THE MARK CONSISTS OF STANDARD CHARACTERS WITHOUT CLAIM TO ANY PARTICULAR FONT, STYLE, SIZE, OR COLOR.

SN 76-673,182, FILED 2-26-2007.

JOHN E. MICHOS, EXAMINING ATTORNEY

Int. Cl.: 38

Prior U.S. Cls.: 100, 101, and 104

United States Patent and Trademark Office

Reg. No. 3,481,132

Registered Aug. 5, 2008

**SERVICE MARK
PRINCIPAL REGISTER**

**CONNECT YOUR PEOPLE
SOUND MORE PROFESSIONAL**

GOTVMAIL COMMUNICATIONS, LLC (MASSACHUSETTS DOMESTIC LIMITED LIABILITY COMPANY)
9 RIVERSIDE DRIVE
WESTON, MA 02493

FOR: TELECOMMUNICATIONS SERVICES, NAMELY, VOICE MAIL SERVICES, TOLL FREE TELEPHONE SERVICES, AND WIRELESS PBX SERVICES, IN CLASS 38 (U.S. CLS. 100, 101 AND 104).

FIRST USE 5-6-2008; IN COMMERCE 5-6-2008.

THE MARK CONSISTS OF STANDARD CHARACTERS WITHOUT CLAIM TO ANY PARTICULAR FONT, STYLE, SIZE, OR COLOR.

SN 76-673,183, FILED 2-26-2007.

JOHN E. MICHOS, EXAMINING ATTORNEY

Int. Cl.: 38

Prior U.S. Cls.: 100, 101, and 104

United States Patent and Trademark Office

Reg. No. 3,481,133

Registered Aug. 5, 2008

**SERVICE MARK
PRINCIPAL REGISTER**

CONNECT YOUR PEOPLE PROTECT YOUR PRIVACY SOUND MORE PROFESSIONAL

GOTVMAIL COMMUNICATIONS, LLC (MASSACHUSETTS DOMESTIC LIMITED LIABILITY COMPANY)
9 RIVERSIDE DRIVE
WESTON, MA 02493

FOR: TELECOMMUNICATIONS SERVICES, NAMELY, VOICE MAIL SERVICES, TOLL FREE TELEPHONE SERVICES, AND WIRELESS PBX SERVICES, IN CLASS 38 (U.S. CLS. 100, 101 AND 104).

FIRST USE 5-6-2008; IN COMMERCE 5-6-2008.

THE MARK CONSISTS OF STANDARD CHARACTERS WITHOUT CLAIM TO ANY PARTICULAR FONT, STYLE, SIZE, OR COLOR.

SN 76-673,184, FILED 2-26-2007.

JOHN E. MICHOS, EXAMINING ATTORNEY

Int. Cls.: 16, 21, 25, and 28

**Prior U.S. Cls.: 2, 5, 13, 22, 23, 29, 30, 33, 37, 38, 39,
40, and 50**

Reg. No. 3,481,134

United States Patent and Trademark Office

Registered Aug. 5, 2008

**TRADEMARK
PRINCIPAL REGISTER**

JAMES RIVER STEAM BREWERY

D.G YUENGLING & SON, INC. (PENNSYLVANIA CORPORATION)
310 MILL CREEK AVENUE
POTTSVILLE, PA 17901

FOR: POSTERS, POSTCARDS, IN CLASS 16 (U.S. CLS. 2, 5, 22, 23, 29, 37, 38 AND 50).

FIRST USE 11-12-2007; IN COMMERCE 11-12-2007.

FOR: STEINS, MUGS, COASTERS, CUPS, INSULATED COOLERS, PLASTIC CUPS, PLASTIC PITCHERS, PLASTIC DRINK BOTTLES, AND BEVERAGE GLASSWARE, IN CLASS 21 (U.S. CLS. 2, 13, 23, 29, 30, 33, 40 AND 50).

FIRST USE 11-12-2007; IN COMMERCE 11-12-2007.

FOR: CLOTHING, NAMELY, HATS, CAPS, T-SHIRTS, SWEATSHIRTS, SWEATPANTS, SHORTS, SWEATERS, GOLF SHIRTS, SHIRTS, AND JACKETS, IN CLASS 25 (U.S. CLS. 22 AND 39).

FIRST USE 11-12-2007; IN COMMERCE 11-12-2007.

FOR: TOYS, NAMELY, TOY TRUCKS AND TOY VEHICLES; CHRISTMAS TREE ORNAMENTS; PLAYING CARDS, IN CLASS 28 (U.S. CLS. 22, 23, 38 AND 50).

FIRST USE 11-12-2007; IN COMMERCE 11-12-2007.

THE MARK CONSISTS OF STANDARD CHARACTERS WITHOUT CLAIM TO ANY PARTICULAR FONT, STYLE, SIZE, OR COLOR.

OWNER OF U.S. REG. NO. 2,059,723.

SN 76-673,621, FILED 3-5-2007.

SANJEEV VOHRA, EXAMINING ATTORNEY

Int. Cl.: 38

Prior U.S. Cls.: 100, 101, and 104

United States Patent and Trademark Office

Reg. No. 3,481,135

Registered Aug. 5, 2008

**SERVICE MARK
PRINCIPAL REGISTER**

STAY CONNECTED. SOUND MORE PROFESSIONAL.

GOTVMAIL COMMUNICATIONS, LLC (MASSACHUSETTS DOMESTIC LIMITED LIABILITY COMPANY)

9 RIVERSIDE DRIVE
WESTON, MA 02493

FOR: TELECOMMUNICATION SERVICES, NAMELY, VOICE MAIL SERVICES, TOLL FREE TELEPHONE SERVICES, AND WIRELESS PBX SERVICES, IN CLASS 38 (U.S. CLS. 100, 101 AND 104).

FIRST USE 5-6-2008; IN COMMERCE 5-6-2008.

THE MARK CONSISTS OF STANDARD CHARACTERS WITHOUT CLAIM TO ANY PARTICULAR FONT, STYLE, SIZE, OR COLOR.

SN 76-673,672, FILED 3-5-2007.

JOHN E. MICHOS, EXAMINING ATTORNEY

Int. Cl.: 38

Prior U.S. Cls.: 100, 101, and 104

United States Patent and Trademark Office

Reg. No. 3,481,136

Registered Aug. 5, 2008

**SERVICE MARK
PRINCIPAL REGISTER**

GO-ANYWHERE ENTREPRENEUR

GOTVMAIL COMMUNICATIONS, LLC (MASSACHUSETTS DOMESTIC LIMITED LIABILITY COMPANY)
9 RIVERSIDE DRIVE
WESTON, MA 02493

FOR: TELECOMMUNICATION SERVICES, NAMELY, VOICE MAIL SERVICES, TOLL FREE TELEPHONE SERVICES, AND WIRELESS PBX SERVICES, IN CLASS 38 (U.S. CLS. 100, 101 AND 104).

FIRST USE 5-6-2008; IN COMMERCE 5-6-2008.

THE MARK CONSISTS OF STANDARD CHARACTERS WITHOUT CLAIM TO ANY PARTICULAR FONT, STYLE, SIZE, OR COLOR.

SN 76-673,977, FILED 3-12-2007.

JOHN E. MICHOS, EXAMINING ATTORNEY

Int. Cl.: 38

Prior U.S. Cls.: 100, 101, and 104

United States Patent and Trademark Office

Reg. No. 3,481,137

Registered Aug. 5, 2008

**SERVICE MARK
PRINCIPAL REGISTER**

YOU ON DEMAND

BRIGHT HOUSE NETWORKS LLC (DELAWARE
LTD LIAB CO)
5000 CAMPUSWOOD DRIVE
EAST SYRACUSE, NY 13057

FOR: COMMUNICATION SERVICES, NAMELY,
TRANSMITTING PRE-RECORDED AUDIO AND
VIDEO MATERIAL THROUGH TELEVISION,
CABLE AND SATELLITE SYSTEMS AND ON THE
INTERNET; TRANSMISSION OF INFORMATION
THROUGH VIDEO AND AUDIO VIA DIGITAL
NETWORKS, ELECTRONIC COMMUNICATIONS
NETWORKS, CABLE AND SATELLITE SYSTEMS,
IN CLASS 38 (U.S. CLS. 100, 101 AND 104).

FIRST USE 4-25-2007; IN COMMERCE 4-25-2007.

THE MARK CONSISTS OF STANDARD CHAR-
ACTERS WITHOUT CLAIM TO ANY PARTICULAR
FONT, STYLE, SIZE, OR COLOR.

NO CLAIM IS MADE TO THE EXCLUSIVE
RIGHT TO USE "ON DEMAND", APART FROM
THE MARK AS SHOWN.

SN 76-674,557, FILED 3-26-2007.

TINA BROWN, EXAMINING ATTORNEY

Int. Cl.: 25

Prior U.S. Cls.: 22 and 39

United States Patent and Trademark Office

Reg. No. 3,481,138

Registered Aug. 5, 2008

**TRADEMARK
PRINCIPAL REGISTER**

SHIVAREE

TULLE HAT COMPANY (COLORADO COR-
PORATION)
224 HIDDEN VALLEY LANE
CASTLE ROCK, CO 80108

THE MARK CONSISTS OF STANDARD CHAR-
ACTERS WITHOUT CLAIM TO ANY PARTICULAR
FONT, STYLE, SIZE, OR COLOR.

FOR: HEADGEAR, NAMELY, HATS AND VEILS,
IN CLASS 25 (U.S. CLS. 22 AND 39).

SN 76-674,741, FILED 3-28-2007.

FIRST USE 4-30-2007; IN COMMERCE 4-30-2007.

NAAKWAMA ANKRAH, EXAMINING ATTORNEY

Int. Cl.: 18

Prior U.S. Cls.: 1, 2, 3, 22, and 41

United States Patent and Trademark Office

Reg. No. 3,481,139

Registered Aug. 5, 2008

**TRADEMARK
PRINCIPAL REGISTER**

BAD TO THE BONE

TRI-COASTAL DESIGN GROUP, INC. (NEW
JERSEY CORPORATION)
C/O THE LAW OFFICES OF LEVINE
1010 FRANKLIN AVENUE - 2ND FLOOR
GARDEN CITY, NY 11530

THE MARK CONSISTS OF STANDARD CHAR-
ACTERS WITHOUT CLAIM TO ANY PARTICULAR
FONT, STYLE, SIZE, OR COLOR.

FOR: DOG CLOTHING, DOG LEASHES, DOG
COLLARS, DOG HARNESES, DOG SHOES, DOG
HATS, IN CLASS 18 (U.S. CLS. 1, 2, 3, 22 AND 41).

SN 76-674,794, FILED 3-29-2007.

FIRST USE 5-30-2007; IN COMMERCE 5-30-2007.

DAVID YONTEF, EXAMINING ATTORNEY

Int. Cl.: 35

Prior U.S. Cls.: 100, 101, and 102

United States Patent and Trademark Office

Reg. No. 3,481,140

Registered Aug. 5, 2008

**SERVICE MARK
PRINCIPAL REGISTER**



MEDEX MERCHANDISING, INC. (ILLINOIS CORPORATION)
3003 HIRSCH STREET
MELROSE PARK, IL 60160

NO CLAIM IS MADE TO THE EXCLUSIVE RIGHT TO USE "AMERICA'S LEADING MEDICATIONS", APART FROM THE MARK AS SHOWN.

FOR: DISTRIBUTORSHIPS IN THE FIELD OF OVER-THE-COUNTER MEDICATIONS, IN CLASS 35 (U.S. CLS. 100, 101 AND 102).

SN 76-674,996, FILED 4-3-2007.

FIRST USE 2-1-2006; IN COMMERCE 2-1-2006.

DAVID YONTEF, EXAMINING ATTORNEY

Int. Cl.: 35

Prior U.S. Cls.: 100, 101, and 102

United States Patent and Trademark Office

Reg. No. 3,481,141

Registered Aug. 5, 2008

**SERVICE MARK
PRINCIPAL REGISTER**

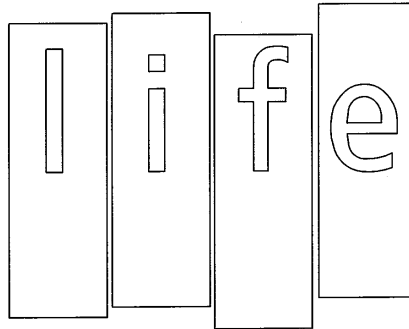

SAFeway INC. (DELAWARE CORPORATION)
5918 STONERIDGE MALL ROAD
PLEASANTON, CA 945882322

FOR: RETAIL GROCERY STORE, PHARMACY
AND DRUGSTORE SERVICES; RETAIL STORE
SERVICES FEATURING CONVENIENCE STORE
ITEMS AND GASOLINE; RETAIL STORE SERVICES
FEATURING A FULL LINE OF GROCERIES, PRE-

PARED FOODS, PHARMACEUTICAL GOODS AND
OTHER SUPERMARKET PRODUCTS, IN CLASS 35
(U.S. CLS. 100, 101 AND 102).

FIRST USE 4-18-2005; IN COMMERCE 4-18-2005.

SN 76-675,383, FILED 4-11-2007.

ZHALEH DELANEY, EXAMINING ATTORNEY

Int. Cls.: 35 and 38

Prior U.S. Cls.: 100, 101, 102, and 104

United States Patent and Trademark Office

Reg. No. 3,481,142

Registered Aug. 5, 2008

SERVICE MARK
PRINCIPAL REGISTER



EFINANCE PORTAL, INC. (NEW JERSEY CORPORATION)
2519 HWY. 35, BLDG. A
SUITE 202
MANASQUAN, NJ 08736

FOR: PROMOTING FINANCIAL SERVICES AND FINANCIAL PRODUCTS OF OTHERS WITH DEDICATED SEARCH ENGINES ON A GLOBAL COMPUTER NETWORK, IN CLASS 35 (U.S. CLS. 100, 101 AND 102).

FIRST USE 6-1-2007; IN COMMERCE 6-1-2007.

FOR: PROVIDING ON-LINE FORUMS FOR TRANSMISSION OF MESSAGES AMONG COMPUTER USERS CONCERNING FINANCIAL SERVICES

AND FINANCIAL PRODUCTS, IN CLASS 38 (U.S. CLS. 100, 101 AND 104).

FIRST USE 6-1-2007; IN COMMERCE 6-1-2007.

NO CLAIM IS MADE TO THE EXCLUSIVE RIGHT TO USE "FINANCE" AND "PORTAL", APART FROM THE MARK AS SHOWN.

THE STIPPLING IS NOT CONSIDERED PART OF THE MARK AND IS FOR SHADING PURPOSES ONLY.

SN 76-675,463, FILED 4-13-2007.

CHRISTOPHER BUONGIORNO, EXAMINING ATTORNEY

Int. Cl.: 36

Prior U.S. Cls.: 100, 101, and 102

United States Patent and Trademark Office

Reg. No. 3,481,143

Registered Aug. 5, 2008

**SERVICE MARK
PRINCIPAL REGISTER**

Children Of Davaonn'e

CHILDREN OF DAVAONN'E (VIRGINIA EDUCATIONAL CHARITY)
1801 BUFFLEHEAD DRIVE
CHESAPEAKE, VA 23320

FOR: ESTABLISHING INTEREST YIELD ACCOUNTS WITH CHILDREN FOR THEIR COMPLETION OF GRADE SCHOOL FOR PRIVATE OR PUBLIC SCHOOLING COMPLETING SCHOOL BY 20TH BIRTHDAY, IN CLASS 36 (U.S. CLS. 100, 101 AND 102).

FIRST USE 1-5-2008; IN COMMERCE 3-31-2007.

THE MARK CONSISTS OF STANDARD CHARACTERS WITHOUT CLAIM TO ANY PARTICULAR FONT, STYLE, SIZE, OR COLOR.

SN 76-675,468, FILED 4-13-2007.

LINDA E. BLOHM, EXAMINING ATTORNEY

Int. Cl.: 9

Prior U.S. Cls.: 21, 23, 26, 36, and 38

United States Patent and Trademark Office

Reg. No. 3,481,144

Registered Aug. 5, 2008

**TRADEMARK
PRINCIPAL REGISTER**

WAGON WHEEL

ABNP PRODUCTIONS LLC (OHIO LTD LIAB CO)
38238 WILSON AVENUE
WILLOUGHBY, OH 44094

FOR: VIDEO RECORDINGS FEATURING HISTORICAL AND SPECIAL INTEREST DOCUMENTARIES, IN CLASS 9 (U.S. CLS. 21, 23, 26, 36 AND 38).

FIRST USE 5-0-2007; IN COMMERCE 5-0-2007.

THE MARK CONSISTS OF STANDARD CHARACTERS WITHOUT CLAIM TO ANY PARTICULAR FONT, STYLE, SIZE, OR COLOR.

SN 76-675,615, FILED 4-17-2007.

ELISSA GARBER KON, EXAMINING ATTORNEY

Int. Cl.: 9

Prior U.S. Cls.: 21, 23, 26, 36, and 38

Reg. No. 3,481,145

United States Patent and Trademark Office

Registered Aug. 5, 2008

**TRADEMARK
PRINCIPAL REGISTER**

**THE GOOD & THE HARD TIMES
IN LA**

FARAR, JORDAN MARK (UNITED STATES IN-
DIVIDUAL)
4735 CLAIREMONT SQUARE #111
SAN DIEGO, CA 92117

NO CLAIM IS MADE TO THE EXCLUSIVE
RIGHT TO USE "LA", APART FROM THE MARK
AS SHOWN.

FOR: COMPACT DISCS FEATURING MUSIC, IN
CLASS 9 (U.S. CLS. 21, 23, 26, 36 AND 38).

SN 76-676,022, FILED 4-26-2007.

FIRST USE 3-3-2007; IN COMMERCE 3-23-2007.

THE MARK CONSISTS OF STANDARD CHAR-
ACTERS WITHOUT CLAIM TO ANY PARTICULAR
FONT, STYLE, SIZE, OR COLOR.

CIMMERIAN COLEMAN, EXAMINING ATTOR-
NEY

Int. Cl.: 35

Prior U.S. Cls.: 100, 101, and 102

United States Patent and Trademark Office

Reg. No. 3,481,146

Registered Aug. 5, 2008

**SERVICE MARK
PRINCIPAL REGISTER**

HOUSE OF TINY EGOS

TEO, SIE P. (SINGAPORE INDIVIDUAL)
70 CLERMONT AVENUE
BROOKLYN, NY 11205

THE MARK CONSISTS OF STANDARD CHAR-
ACTERS WITHOUT CLAIM TO ANY PARTICULAR
FONT, STYLE, SIZE, OR COLOR.

FOR: ART GALLERY SERVICES, IN CLASS 35
(U.S. CLS. 100, 101 AND 102).

SN 76-676,202, FILED 4-27-2007.

FIRST USE 6-5-2008; IN COMMERCE 6-5-2008.

JULIE GUTTADAURO, EXAMINING ATTORNEY

Int. Cl.: 10

Prior U.S. Cls.: 26, 39, and 44

United States Patent and Trademark Office

Reg. No. 3,481,147

Registered Aug. 5, 2008

**TRADEMARK
PRINCIPAL REGISTER**

LESS IS MORE

ELLMAN INNOVATIONS, LLC (NEW YORK LTD
LIAB CO)
3333 ROYAL AVE.
OCEANSIDE, NY 11572

FOR: MEDICAL DEVICES FOR THE PERFOR-
MANCE OF ELECTROSURGICAL PROCEDURES
INVOLVING THE USE OF RADIO-FREQUENCY
ENERGY AND ACCESSORIES THEREFOR IN THE
NATURE OF ELECTROSURGICAL ELECTRODES
AND ELECTROSURGICAL HANDPIECES, IN
CLASS 10 (U.S. CLS. 26, 39 AND 44).

FIRST USE 4-22-2008; IN COMMERCE 4-22-2008.

THE MARK CONSISTS OF STANDARD CHAR-
ACTERS WITHOUT CLAIM TO ANY PARTICULAR
FONT, STYLE, SIZE, OR COLOR.

SN 76-676,328, FILED 5-2-2007.

ALYSSA PALADINO, EXAMINING ATTORNEY

Int. Cl.: 35

Prior U.S. Cls.: 100, 101, and 102

United States Patent and Trademark Office

Reg. No. 3,481,148

Registered Aug. 5, 2008

**SERVICE MARK
PRINCIPAL REGISTER**

ERIC CASH

CASH ENTERTAINMENT, INC. (NEW YORK CORPORATION)
273 WEST 131ST STREET, APT. #5D
NYC, NY 10027

FOR: TALENT AGENCY SERVICES, NAMELY, REPRESENTATION AND MANAGEMENT OF MUSIC RECORDING ARTISTS; PROMOTING THE PARTIES AND SPECIAL EVENTS OF OTHERS, IN CLASS 35 (U.S. CLS. 100, 101 AND 102).

FIRST USE 8-19-2007; IN COMMERCE 8-19-2007.

THE NAME "ERIC CASH" IDENTIFIES A LIVING INDIVIDUAL WHOSE CONSENT IS OF RECORD.

SN 76-676,965, FILED 5-16-2007.

MARY I. SPARROW, EXAMINING ATTORNEY

Int. Cl.: 42

Prior U.S. Cls.: 100 and 101

United States Patent and Trademark Office

Reg. No. 3,481,149

Registered Aug. 5, 2008

**SERVICE MARK
PRINCIPAL REGISTER**



MA 2, INC. (CALIFORNIA CORPORATION)
P.O. BOX 31636
SAN FRANCISCO, CA 941310636

FOR: DESIGNING AND IMPLEMENTING SOFTWARE AND HARDWARE IN THE FIELD OF MEDIA BROADCASTING AND STORAGE AND STREAMING TECHNOLOGIES, IN CLASS 42 (U.S. CLS. 100 AND 101).

FIRST USE 10-10-2007; IN COMMERCE 10-10-2007.

NO CLAIM IS MADE TO THE EXCLUSIVE RIGHT TO USE "MEDIA APPLICATION & ARCHITECTURE", APART FROM THE MARK AS SHOWN.

SN 76-677,220, FILED 5-21-2007.

H. M. FISHER, EXAMINING ATTORNEY

Int. Cl.: 36

Prior U.S. Cls.: 100, 101, and 102

United States Patent and Trademark Office

Reg. No. 3,481,150

Registered Aug. 5, 2008

**SERVICE MARK
PRINCIPAL REGISTER**

ALWAYS HOME REAL ESTATE

ALWAYS HOME REAL ESTATE, INC. (TENNESSEE CORPORATION)

116 WILSON PIKE CIRCLE, #208

BRENTWOOD, TN 27027

FOR: REAL ESTATE BROKERAGE, IN CLASS 36
(U.S. CLS. 100, 101 AND 102).

FIRST USE 1-28-2007; IN COMMERCE 1-28-2007.

THE MARK CONSISTS OF STANDARD CHARACTERS WITHOUT CLAIM TO ANY PARTICULAR FONT, STYLE, SIZE, OR COLOR.

NO CLAIM IS MADE TO THE EXCLUSIVE RIGHT TO USE "REAL ESTATE", APART FROM THE MARK AS SHOWN.

SN 76-677,660, FILED 5-31-2007.

REBECCA SMITH, EXAMINING ATTORNEY

Int. Cls.: 39, 43, and 45

Prior U.S. Cls.: 100, 101, and 105

United States Patent and Trademark Office

Reg. No. 3,481,151

Registered Aug. 5, 2008

**SERVICE MARK
PRINCIPAL REGISTER**

LE REVE DESTINATION SERVICES

LE REVE DESTINATION SERVICES, INC. (CALIFORNIA CORPORATION)
28241 CROWN VALLEY PKWY.
SUITE F 310
LAGUNA NIGUEL, CA 92677

FOR: TRAVEL AGENCY SERVICES FOR THE BUSINESS AND VACATION TRAVELER, NAMELY, MAKING RESERVATIONS AND BOOKINGS FOR TRANSPORTATION; COORDINATING TRAVEL ARRANGEMENTS FOR INDIVIDUALS AND FOR GROUPS FOR BUSINESS AND VACATION TRAVEL, IN CLASS 39 (U.S. CLS. 100 AND 105).

FIRST USE 11-15-2007; IN COMMERCE 2-10-2008.

FOR: TRAVEL AGENCY SERVICES FOR THE BUSINESS AND VACATION TRAVELER, NAMELY, MAKING RESERVATIONS AND BOOKING FOR TEMPORARY LODGING, RESTAURANTS AND MEALS; PROVIDING TRAVEL LODGING INFORMATION SERVICES AND TRAVEL LODGING BOOKING AGENCY SERVICES FOR BUSINESS AND VACATION TRAVELERS, IN CLASS 43 (U.S. CLS. 100 AND 101).

FIRST USE 11-15-2007; IN COMMERCE 2-10-2008.

FOR: CONCIERGE SERVICES FOR OTHERS COMPRISING MAKING REQUESTED PERSONAL ARRANGEMENTS AND RESERVATIONS AND PROVIDING CUSTOMER-SPECIFIC INFORMATION TO MEET INDIVIDUAL NEEDS RENDERED TOGETHER IN VILLAS, RENTAL HOMES, AND TIMESHARE HOTELS, IN CLASS 45 (U.S. CLS. 100 AND 101).

FIRST USE 11-15-2007; IN COMMERCE 3-14-2008.

THE MARK CONSISTS OF STANDARD CHARACTERS WITHOUT CLAIM TO ANY PARTICULAR FONT, STYLE, SIZE, OR COLOR.

NO CLAIM IS MADE TO THE EXCLUSIVE RIGHT TO USE "DESTINATION SERVICES", APART FROM THE MARK AS SHOWN.

THE FOREIGN WORDING IN THE MARK TRANSLATES INTO ENGLISH AS THE DREAM.

SN 76-677,754, FILED 6-4-2007.

MICHAEL KEATING, EXAMINING ATTORNEY

Int. Cl.: 20

Prior U.S. Cls.: 2, 13, 22, 25, 32, and 50

Reg. No. 3,481,152

United States Patent and Trademark Office

Registered Aug. 5, 2008

**TRADEMARK
PRINCIPAL REGISTER**

BUSHMAN TANKS

CHANNELL COMMERCIAL CORPORATION
(DELAWARE CORPORATION)
76040 YNEZ ROAD
P.O. BOX 9022
TEMECULA, CA 925899022

FOR: POLYETHYLENE TANKS, NAMELY,
RAINWATER STORAGE TANKS, MOLASSES
TANKS, TRANSPORTER TANKS, BELLY TANKS;
OTHER POLYETHYLENE PRODUCTS, NAMELY,
GRADE LEVEL BOXES, VAULTS, AND HAND
HOLES, IN CLASS 20 (U.S. CLS. 2, 13, 22, 25, 32
AND 50).

FIRST USE 5-12-2008; IN COMMERCE 5-12-2006.

THE MARK CONSISTS OF STANDARD CHAR-
ACTERS WITHOUT CLAIM TO ANY PARTICULAR
FONT, STYLE, SIZE, OR COLOR.

OWNER OF U.S. REG. NO. 3,268,901.

NO CLAIM IS MADE TO THE EXCLUSIVE
RIGHT TO USE "TANKS", APART FROM THE
MARK AS SHOWN.

SN 76-678,455, FILED 6-20-2007.

GIANCARLO CASTRO, EXAMINING ATTORNEY

Int. Cl.: 29

Prior U.S. Cl.: 46

United States Patent and Trademark Office

Reg. No. 3,481,153

Registered Aug. 5, 2008

**TRADEMARK
PRINCIPAL REGISTER**

THE FLAVOR OF EL SALVADOR

TROPICAL CHEESE INDUSTRIES, INC. (NEW
JERSEY CORPORATION)
450-452 FAYETTE STREET
PERTH AMBOY, NJ 08861

OWNER OF U.S. REG. NOS. 2,358,191, 2,419,501,
AND OTHERS.

FOR: CHEESE, SOUR CREAM, MEAT, AND
HEAVY CREAM, IN CLASS 29 (U.S. CL. 46).

NO CLAIM IS MADE TO THE EXCLUSIVE
RIGHT TO USE "EL SALVADOR", APART FROM
THE MARK AS SHOWN.

FIRST USE 7-1-2007; IN COMMERCE 7-1-2007.

SN 76-678,623, FILED 6-22-2007.

THE MARK CONSISTS OF STANDARD CHAR-
ACTERS WITHOUT CLAIM TO ANY PARTICULAR
FONT, STYLE, SIZE, OR COLOR.

JENNY PARK, EXAMINING ATTORNEY

Int. Cl.: 25

Prior U.S. Cls.: 22 and 39

United States Patent and Trademark Office

Reg. No. 3,481,154

Registered Aug. 5, 2008

**TRADEMARK
PRINCIPAL REGISTER**

291

291 FROM VENICE, INC. (CALIFORNIA CORPORATION)
2320 ABBOTT KINNEY BOULEVARD, SUITE C
VENICE, CA 90291

THE MARK CONSISTS OF STANDARD CHARACTERS WITHOUT CLAIM TO ANY PARTICULAR FONT, STYLE, SIZE, OR COLOR.

FOR: CLOTHING, NAMELY, TOPS, BOTTOMS, HATS, T-SHIRTS, SWEATSHIRTS, AND RELATED ACCESSORIES, NAMELY, SCARVES, IN CLASS 25 (U.S. CLS. 22 AND 39).

SN 76-678,842, FILED 6-28-2007.

FIRST USE 1-0-2008; IN COMMERCE 1-0-2008.

DARRYL SPRUILL, EXAMINING ATTORNEY

Int. Cl.: 19

Prior U.S. Cls.: 1, 12, 33, and 50

United States Patent and Trademark Office

Reg. No. 3,481,155

Registered Aug. 5, 2008

**TRADEMARK
PRINCIPAL REGISTER**

BIODRAIN

GSE LINING TECHNOLOGY, INC. (DELAWARE
CORPORATION)
19103 GUNDLE ROAD
HOUSTON, TX 77073

FOR: GEOCOMPOSITE MATERIAL FOR USE AS
A DRAINAGE MEDIUM, NAMELY, A PLASTIC
GEONET MATERIAL LAMINATED WITH A NON-
WOVEN GEOTEXTILE ON ONE SIDE AND A
WOVEN GEOTEXTILE ON THE OTHER SIDE, IN
CLASS 19 (U.S. CLS. 1, 12, 33 AND 50).

FIRST USE 2-20-2004; IN COMMERCE 2-20-2004.

THE MARK CONSISTS OF STANDARD CHAR-
ACTERS WITHOUT CLAIM TO ANY PARTICULAR
FONT, STYLE, SIZE, OR COLOR.

SN 76-678,917, FILED 6-29-2007.

SUZANNE BLANE, EXAMINING ATTORNEY

Int. Cl.: 25

Prior U.S. Cls.: 22 and 39

United States Patent and Trademark Office

Reg. No. 3,481,156

Registered Aug. 5, 2008

**TRADEMARK
PRINCIPAL REGISTER**

GS-115

C.D.B. APPAREL, INC. (NEW YORK CORPORATION)
350 FIFTH AVENUE, SUITE 2220
NEW YORK, NY 10018

THE MARK CONSISTS OF STANDARD CHARACTERS WITHOUT CLAIM TO ANY PARTICULAR FONT, STYLE, SIZE, OR COLOR.

FOR: CLOTHING, NAMELY, JEANS, SHORTS, SHIRTS, TOPS, SWEATSHIRTS, SWIMWEAR, JACKETS, HATS, SCARVES, GLOVES, UNDERWEAR AND BELTS, IN CLASS 25 (U.S. CLS. 22 AND 39).

SN 76-679,056, FILED 7-2-2007.

FIRST USE 11-0-2006; IN COMMERCE 11-0-2006.

JOHN DWYER, EXAMINING ATTORNEY

Int. Cl.: 9

Prior U.S. Cls.: 21, 23, 26, 36, and 38

United States Patent and Trademark Office

Reg. No. 3,481,157

Registered Aug. 5, 2008

**TRADEMARK
PRINCIPAL REGISTER**

COSYNUS

SARTORIUS AG (FED REP GERMANY CORPORATION)
WEENDER LANDSTRASSE 94-108
D-37075 GOETTINGEN, FED REP GERMANY

FOR: ELECTRONIC LABORATORY INSTRUMENTS AND WEIGHING APPARATUS, NAMELY, SCALES, METAL DETECTORS AND ASSOCIATED MECHANICAL, ELECTRICAL AND ELECTRONIC COMPONENTS WITH SOFTWARE, DATA ENTRY, DISPLAY, TRANSFER AND CONTROL EQUIPMENT THEREFOR, IN CLASS 9 (U.S. CLS. 21, 23, 26, 36 AND 38).

FIRST USE 3-31-2008; IN COMMERCE 3-31-2008.

THE MARK CONSISTS OF STANDARD CHARACTERS WITHOUT CLAIM TO ANY PARTICULAR FONT, STYLE, SIZE, OR COLOR.

SN 76-679,846, FILED 7-23-2007.

SUZANNE BLANE, EXAMINING ATTORNEY

Int. Cl.: 25

Prior U.S. Cls.: 22 and 39

United States Patent and Trademark Office

Reg. No. 3,481,158

Registered Aug. 5, 2008

**TRADEMARK
PRINCIPAL REGISTER**

BICYCLE CITY

BICYCLE CITY, LLC (DELAWARE LTD LIAB
CO)
6504 RAINBOW LANE
CINCINNATI, OH 45230

FOR: CLOTHING, NAMELY, T-SHIRTS AND
HEADWEAR, IN CLASS 25 (U.S. CLS. 22 AND 39).

FIRST USE 4-23-2008; IN COMMERCE 4-23-2008.

THE MARK CONSISTS OF STANDARD CHAR-
ACTERS WITHOUT CLAIM TO ANY PARTICULAR
FONT, STYLE, SIZE, OR COLOR.

OWNER OF U.S. REG. NO. 3,451,431.

SN 76-978,711, FILED 10-12-2006.

LINDA POWELL, EXAMINING ATTORNEY

Int. Cls.: 9, 14, 18, and 24

Prior U.S. Cls.: 1, 2, 3, 21, 22, 23, 26, 27, 28, 36, 38, 41, 42, and 50

Reg. No. 3,481,159

United States Patent and Trademark Office

Registered Aug. 5, 2008

**TRADEMARK
PRINCIPAL REGISTER**

NOBO

WAL-MART STORES, INC. (DELAWARE CORPORATION)
702 S.W. 8TH STREET
BENTONVILLE, AR 727160520

FOR: EYEGLASSES AND EYEGLASS FRAMES, IN CLASS 9 (U.S. CLS. 21, 23, 26, 36 AND 38).

FIRST USE 7-31-2003; IN COMMERCE 7-31-2003.

FOR: JEWELRY; CLOCKS, IN CLASS 14 (U.S. CLS. 2, 27, 28 AND 50).

FIRST USE 7-31-2006; IN COMMERCE 7-31-2006.

FOR: HANDBAGS, IN CLASS 18 (U.S. CLS. 1, 2, 3, 22 AND 41).

FIRST USE 7-31-2003; IN COMMERCE 7-31-2003.

FOR: HOUSEHOLD LINENS FOR BED, IN CLASS 24 (U.S. CLS. 42 AND 50).

FIRST USE 6-30-2004; IN COMMERCE 6-30-2004.

SN 76-978,770, FILED 10-31-2003.

ROBERT C. CLARK JR., EXAMINING ATTORNEY

Int. Cls.: 18, 24, 30, 35, and 43

Prior U.S. Cls.: 1, 2, 3, 22, 41, 42, 46, 50, 100, 101, and 102

Reg. No. 3,481,160

United States Patent and Trademark Office

Registered Aug. 5, 2008

**TRADEMARK
SERVICE MARK
PRINCIPAL REGISTER**

CORNELIA

CORNELIA ZICU INTERNATIONAL, LLC (NEW YORK LTD LIAB CO)
663 FIFTH AVENUE, 8TH FLOOR
NEW YORK, NY 10022

FOR: COSMETIC BAGS SOLD EMPTY, IN CLASS 18 (U.S. CLS. 1, 2, 3, 22 AND 41).

FIRST USE 2-14-2005; IN COMMERCE 2-14-2005.

FOR: BEDDING AND HOME FURNISHINGS, NAMELY, BED BLANKETS, WOOL BLANKETS, TOWELS, BED SHEETS, COMFORTERS, NON-SCENTED PILLOWS AND NECK SUPPORTING PILLOWS, IN CLASS 24 (U.S. CLS. 42 AND 50).

FIRST USE 2-14-2005; IN COMMERCE 2-14-2005.

FOR: BEVERAGES MADE OF TEA; TEA; HONEY, IN CLASS 30 (U.S. CL. 46).

FIRST USE 1-30-2006; IN COMMERCE 1-30-2006.

FOR: RETAIL STORE SERVICES FEATURING SKIN AND HAIR CARE PREPARATIONS, COSMETICS, MEDICATED SKIN CARE PREPARATIONS, AMBIANCE PRODUCTS, NAMELY, OILS AND ROOM SPRAYS, COSMETIC BAGS, COSMETICS AND SKIN CARE APPLICATORS AND HAIR BRUSHES, HOME FURNISHINGS, BEDDING, FOOD

AND BEVERAGES AND TEA; MAIL ORDER CATALOG AND ONLINE RETAIL STORE SERVICES FEATURING SKIN AND HAIR CARE PREPARATIONS, COSMETICS, MEDICATED SKIN CARE PREPARATIONS, AMBIANCE PRODUCTS, NAMELY, CANDLES, OILS AND ROOM SPRAY, COSMETIC BAGS, COSMETIC AND SKIN CARE APPLICATORS, HAIR BRUSHES, HOME FURNISHINGS, BEDDING, FOOD AND BEVERAGES AND TEA, IN CLASS 35 (U.S. CLS. 100, 101 AND 102).

FIRST USE 2-14-2005; IN COMMERCE 2-14-2005.

FOR: BEAUTY SPA SERVICES, NAMELY, PROVIDING TEMPORARY ACCOMMODATIONS AND MEALS TO CLIENTS OF A HEALTH OR BEAUTY SPA; TEA ROOM SERVICES, IN CLASS 43 (U.S. CLS. 100 AND 101).

FIRST USE 2-14-2008; IN COMMERCE 2-14-2008.

THE MARK CONSISTS OF STANDARD CHARACTERS WITHOUT CLAIM TO ANY PARTICULAR FONT, STYLE, SIZE, OR COLOR.

SN 76-978,812, FILED 8-25-2004.

NELSON SNYDER, EXAMINING ATTORNEY

Int. Cl.: 18

Prior U.S. Cls.: 1, 2, 3, 22, and 41

United States Patent and Trademark Office

Reg. No. 3,481,161

Registered Aug. 5, 2008

**TRADEMARK
PRINCIPAL REGISTER**

BICYCLE CITY

BICYCLE CITY, LLC (DELAWARE LTD LIAB
CO)
6504 RAINBOW LANE
CINCINNATI, OH 45230

THE MARK CONSISTS OF STANDARD CHAR-
ACTERS WITHOUT CLAIM TO ANY PARTICULAR
FONT, STYLE, SIZE, OR COLOR.

FOR: BAGS, NAMELY, BACKPACKS, IN CLASS
18 (U.S. CLS. 1, 2, 3, 22 AND 41).

SN 76-978,842, FILED 10-12-2006.

FIRST USE 4-23-2008; IN COMMERCE 4-23-2008.

LINDA POWELL, EXAMINING ATTORNEY

Int. Cls.: 30 and 32

Prior U.S. Cls.: 45, 46, and 48

United States Patent and Trademark Office

Reg. No. 3,481,162

Registered Aug. 5, 2008

**TRADEMARK
PRINCIPAL REGISTER**

DEERFIELD TRADING CO.

WALGREEN CO. (ILLINOIS CORPORATION)
200 WILMOT ROAD
DEERFIELD, IL 60015

FOR: BEVERAGES, NAMELY, TEAS AND COFFEE; COOKIES; CRACKERS; CONFECTIONS, NAMELY, CANDY, GUM, MINTS AND CHOCOLATES; PROCESSED CEREALS AND PROCESSED WHOLE GRAINS; CORN CHIPS, PITA CHIPS AND TORTILLA CHIPS; SUGAR; FLOUR; SPICES; POWDERED FOODSTUFFS, NAMELY, FLAVORED AND SWEETENED GELATIN; CANNED CONDIMENTS, NAMELY, KETCHUP, IN CLASS 30 (U.S. CL. 46).

FIRST USE 12-12-2006; IN COMMERCE 12-12-2006.

FOR: BEVERAGES, NAMELY, ENERGY DRINKS AND WATER; NON-ALCOHOLIC BEVERAGES, NAMELY, FLAVORED CARBONATED BEVERA-

GES; DRINK MIX PREPARATIONS FOR MIXING FRUIT DRINKS, IN CLASS 32 (U.S. CLS. 45, 46 AND 48).

FIRST USE 7-17-2007; IN COMMERCE 7-17-2007.

THE MARK CONSISTS OF STANDARD CHARACTERS WITHOUT CLAIM TO ANY PARTICULAR FONT, STYLE, SIZE, OR COLOR.

OWNER OF U.S. REG. NO. 3,108,568.

NO CLAIM IS MADE TO THE EXCLUSIVE RIGHT TO USE "TRADING CO.", APART FROM THE MARK AS SHOWN.

SN 76-978,844, FILED 12-4-2006.

DANIEL BRODY, EXAMINING ATTORNEY

Int. Cl.: 30

Prior U.S. Cl.: 46

United States Patent and Trademark Office

Reg. No. 3,481,163

Registered Aug. 5, 2008

**TRADEMARK
PRINCIPAL REGISTER**

CHOCOCHIP - O!

MOLINOS DE EL SALVADOR, SOCIEDAD ANONIMA DE CAPITAL VARIABLE (EL SALVADOR SOCIEDAD ANONIMA)

EJERCITO NACIONAL BLVD., 50 NORTH AVE.

SAN SALVADOR, EL SALVADOR

FOR: COOKIES, IN CLASS 30 (U.S. CL. 46).

FIRST USE 3-14-2007; IN COMMERCE 3-14-2007.

THE MARK CONSISTS OF STANDARD CHARACTERS WITHOUT CLAIM TO ANY PARTICULAR FONT, STYLE, SIZE, OR COLOR.

NO CLAIM IS MADE TO THE EXCLUSIVE RIGHT TO USE "CHOCOCHIP", APART FROM THE MARK AS SHOWN.

SN 77-000,152, FILED 9-15-2006.

RICHARD A. STRASER, EXAMINING ATTORNEY

Int. Cl.: 44

Prior U.S. Cls.: 100 and 101

United States Patent and Trademark Office

Reg. No. 3,481,164

Registered Aug. 5, 2008

**SERVICE MARK
PRINCIPAL REGISTER**

SKIN REFABRICATION

COMPREHENSIVE AGE MANAGEMENT SYSTEMS & AESTHETIC PLASTIC SURGERY, PLLC (NEW YORK DOM-PROFESSIONAL LIMITED LIABILITY COMPANY)

655 PARK AVENUE
NEW YORK, NY 10021

FOR: MEDICAL SERVICES; MEDICAL CARE, NAMELY, LASER RESURFACING OF THE SKIN; HYGIENIC AND BEAUTY CARE SERVICES, NAMELY, LASER RESURFACING OF THE SKIN IN THE FIELD OF MEDICINE, IN CLASS 44 (U.S. CLS. 100 AND 101).

THE MARK CONSISTS OF STANDARD CHARACTERS WITHOUT CLAIM TO ANY PARTICULAR FONT, STYLE, SIZE, OR COLOR.

NO CLAIM IS MADE TO THE EXCLUSIVE RIGHT TO USE "SKIN", APART FROM THE MARK AS SHOWN.

SN 77-000,291, FILED 9-15-2006.

FIRST USE 1-31-2008; IN COMMERCE 1-31-2008.

KEVON CHISOLM, EXAMINING ATTORNEY

Int. Cl.: 32

Prior U.S. Cls.: 45, 46, and 48

United States Patent and Trademark Office

Reg. No. 3,481,165

Registered Aug. 5, 2008

**TRADEMARK
PRINCIPAL REGISTER**

RIPTIDE SPLIT

RWI RESOURCES, LLC (MICHIGAN LTD LIAB
CO)
P.O. BOX 72800
MARIETTA, GA 30007

FOR: BEVERAGES, NAMELY, FLAVORED AND
NON-FLAVORED SPARKLING WATER AND
SPRING WATER; CAFFEINATED AND NON-CAF-
FEINATED DRINKS, NAMELY, SOFT DRINKS
WITH OR WITHOUT FRUIT FLAVORING; FRUIT
JUICES , IN CLASS 32 (U.S. CLS. 45, 46 AND 48).

FIRST USE 3-28-2008; IN COMMERCE 3-28-2008.

THE MARK CONSISTS OF STANDARD CHAR-
ACTERS WITHOUT CLAIM TO ANY PARTICULAR
FONT, STYLE, SIZE, OR COLOR.

OWNER OF U.S. REG. NO. 2,875,637.

SN 77-000,613, FILED 9-15-2006.

CHERYL CLAYTON, EXAMINING ATTORNEY

Int. Cl.: 25

Prior U.S. Cls.: 22 and 39

United States Patent and Trademark Office

Reg. No. 3,481,166

Registered Aug. 5, 2008

**TRADEMARK
PRINCIPAL REGISTER**



RULE 66, LLC (CALIFORNIA LTD LIAB CO)
20780 FORTUNA DEL NORTE
ESCONDIDO, CA 92029

FIRST USE 1-1-2008; IN COMMERCE 1-1-2008.

FOR: WEARING APPAREL, NAMELY, SHIRTS,
SHORTS, PANTS AND CAPS, IN CLASS 25 (U.S. CLS.
22 AND 39).

SN 77-000,713, FILED 9-15-2006.

KHANH LE, EXAMINING ATTORNEY

Int. Cl.: 44

Prior U.S. Cls.: 100 and 101

United States Patent and Trademark Office

Reg. No. 3,481,167

Registered Aug. 5, 2008

**SERVICE MARK
PRINCIPAL REGISTER**

NERDHEALTH

NERDHEALTH, LLC (FLORIDA LTD LIAB CO)
1245 SOUTH POWERLINE ROAD
SUITE 300
POMPANO, FL 33069

THE MARK CONSISTS OF STANDARD CHAR-
ACTERS WITHOUT CLAIM TO ANY PARTICULAR
FONT, STYLE, SIZE, OR COLOR.

FOR: PROVIDING A WEBSITE THAT FEATURES
INFORMATION ON CHILDREN'S NUTRITION, IN
CLASS 44 (U.S. CLS. 100 AND 101).

SN 77-001,014, FILED 9-15-2006.

FIRST USE 2-23-2008; IN COMMERCE 2-23-2008.

REBECCA EISINGER, EXAMINING ATTORNEY

Int. Cl.: 43

Prior U.S. Cls.: 100 and 101

United States Patent and Trademark Office

Reg. No. 3,481,168

Registered Aug. 5, 2008

**SERVICE MARK
PRINCIPAL REGISTER**

**Our food is famous. Our
customers love us.**

BOJANGLES' INTERNATIONAL, LLC (DELA-
WARE LTD LIAB CO)
9432 SOUTHERN PINE BLVD.
CHARLOTTE, NC 28273

THE MARK CONSISTS OF STANDARD CHAR-
ACTERS WITHOUT CLAIM TO ANY PARTICULAR
FONT, STYLE, SIZE, OR COLOR.

FOR: RESTAURANT SERVICES, IN CLASS 43
(U.S. CLS. 100 AND 101).

SN 77-001,460, FILED 9-18-2006.

FIRST USE 12-10-2007; IN COMMERCE 12-10-2007.

SETH A. RAPPAPORT, EXAMINING ATTORNEY

Int. Cl.: 33

Prior U.S. Cls.: 47 and 49

United States Patent and Trademark Office

Reg. No. 3,481,169

Registered Aug. 5, 2008

**TRADEMARK
PRINCIPAL REGISTER**

OREGONICALLY GROWN

WILLIAM HATCHER WINES, LLC (OREGON
LTD LIAB CO)
P.O. BOX 489
DUNDEE, OR 97115

THE MARK CONSISTS OF STANDARD CHAR-
ACTERS WITHOUT CLAIM TO ANY PARTICULAR
FONT, STYLE, SIZE, OR COLOR.

FOR: WINES, IN CLASS 33 (U.S. CLS. 47 AND 49).

SN 77-001,774, FILED 9-18-2006.

FIRST USE 5-0-2008; IN COMMERCE 5-0-2008.

DAVID MURRAY, EXAMINING ATTORNEY

Int. Cl.: 30

Prior U.S. Cl.: 46

United States Patent and Trademark Office

Reg. No. 3,481,170

Registered Aug. 5, 2008

**TRADEMARK
PRINCIPAL REGISTER**

NUTRI-WAVES

CEREAL INGREDIENTS, INC. (DELAWARE
CORPORATION)
4720 SOUTH 13TH STREET
LEAVENWORTH, KS 66048

FOR: CEREAL GRAIN-BASED NUTRITIONAL-
LY-FORTIFIED FOOD PARTICLES USED AS AN
INGREDIENT FOR COMMERCIAL FOOD PRO-
DUCTS, IN CLASS 30 (U.S. CL. 46).

FIRST USE 6-13-2008; IN COMMERCE 6-13-2008.

THE MARK CONSISTS OF STANDARD CHAR-
ACTERS WITHOUT CLAIM TO ANY PARTICULAR
FONT, STYLE, SIZE, OR COLOR.

OWNER OF U.S. REG. NO. 3,104,646.

SN 77-002,271, FILED 9-19-2006.

KATHERINE CHANG, EXAMINING ATTORNEY

Int. Cl.: 30

Prior U.S. Cl.: 46

United States Patent and Trademark Office

Reg. No. 3,481,171

Registered Aug. 5, 2008

**TRADEMARK
PRINCIPAL REGISTER**

NUTRI-TWIGS

CEREAL INGREDIENTS, INC. (DELAWARE
CORPORATION)
4720 SOUTH 13TH STREET
LEAVENWORTH, KS 66048

FOR: CEREAL GRAIN-BASED NUTRITIONAL-
LY-FORTIFIED FOOD PARTICLES USED AS AN
INGREDIENT FOR COMMERCIAL FOOD PRO-
DUCTS, IN CLASS 30 (U.S. CL. 46).

FIRST USE 6-12-2008; IN COMMERCE 6-12-2008.

THE MARK CONSISTS OF STANDARD CHAR-
ACTERS WITHOUT CLAIM TO ANY PARTICULAR
FONT, STYLE, SIZE, OR COLOR.

OWNER OF U.S. REG. NO. 3,104,646.

SN 77-002,275, FILED 9-19-2006.

KATHERINE CHANG, EXAMINING ATTORNEY

Int. Cl.: 36

Prior U.S. Cls.: 100, 101, and 102

United States Patent and Trademark Office

Reg. No. 3,481,172

Registered Aug. 5, 2008

**SERVICE MARK
PRINCIPAL REGISTER**

THE INSTITUTIONAL SOLUTION

INDEPENDENT FUNDING, LLC (CALIFORNIA
LTD LIAB CO)
983 OLD EAGLE SCHOOL ROAD, SUITE 609
WAYNE, PA 19087

FOR: INSURANCE AND FINANCIAL AFFAIRS
SERVICES, NAMELY, FACILITATING FINANCIAL
TRANSACTIONS IN THE NATURE OF VALUA-
TION, LIQUIDATION, CONSOLIDATION,
BROKERAGE, AND TRANSFER OF FRACTIONA-
LIZED LIFE INSURANCE INTERESTS, IN CLASS 36
(U.S. CLS. 100, 101 AND 102).

FIRST USE 1-1-2007; IN COMMERCE 1-1-2007.

THE MARK CONSISTS OF STANDARD CHAR-
ACTERS WITHOUT CLAIM TO ANY PARTICULAR
FONT, STYLE, SIZE, OR COLOR.

SN 77-003,125, FILED 9-20-2006.

LEIGH CAROLINE CASE, EXAMINING ATTOR-
NEY

Int. Cl.: 10

Prior U.S. Cls.: 26, 39, and 44

United States Patent and Trademark Office

Reg. No. 3,481,173

Registered Aug. 5, 2008

**TRADEMARK
PRINCIPAL REGISTER**

SANACOR

SANACOR, L.L.C. (DELAWARE LTD LIAB CO)
765 E. 3400 S., SUITE 204
AMERICAN FORK, UT 84003

FOR: MEDICAL AND SURGICAL APPARATUS AND INSTRUMENTS, NAMELY, SURGICAL IMPLANTS COMPOSED OF ARTIFICIAL MATERIALS FOR THE TREATMENT OF DISEASES OF THE SPINE; VERTEBRAL DISCECTOMY APPARATUS AND INSTRUMENTS; VERTEBRAL ORTHOPEDIC APPARATUS AND INSTRUMENTS; ORTHOPEDIC FIXATION DEVICES USED IN VERTEBRAL IMPLANT SURGERY; PEDICLE SCREWS AND CONNECTING RODS USED IN VERTEBRAL SURGERY; SURGICAL INTERBODY SPACERS, CAGES, AND ASSOCIATED INSTRUMENTS, NAMELY, SURGICAL CUTTERS FOR IMPLANT SITE PREPARATION, IMPLANT TRIALS FOR VERIFYING A FIT BETWEEN THE SURGICAL SITE SIZE AND THE

IMPLANT SIZE, AND IMPLANT HOLDERS AND INSERTION TOOLS FOR HOLDING AND INSERTING THE IMPLANT INTO THE SITE; AND PARTS AND FITTINGS FOR MEDICAL IMAGING APPARATUS PROVIDING PATIENT AND INSTRUMENT POSITIONING DATA IN SPINAL SURGERY INCLUDING MINIMAL INVASIVE SURGICAL INSTRUMENTS, IN CLASS 10 (U.S. CLS. 26, 39 AND 44).

FIRST USE 1-1-2007; IN COMMERCE 1-1-2007.

THE MARK CONSISTS OF STANDARD CHARACTERS WITHOUT CLAIM TO ANY PARTICULAR FONT, STYLE, SIZE, OR COLOR.

SN 77-003,203, FILED 9-20-2006.

JILL PRATER, EXAMINING ATTORNEY

Int. Cl.: 35

Prior U.S. Cls.: 100, 101, and 102

United States Patent and Trademark Office

Reg. No. 3,481,174

Registered Aug. 5, 2008

**SERVICE MARK
PRINCIPAL REGISTER**

1st-choice directory

KISER, JOSEPH KENT (UNITED STATES INDIVIDUAL)
2146 LEFEVRE ROAD
TROY, OH 45373 AND
KISER, JOSEPH KENT (UNITED STATES INDIVIDUAL)
2146 LEFEVRE ROAD
TROY, OH 45373

FOR: ON LINE BUSINESS DIRECTORY FEATURING ATTORNEYS, RETAIL STORES, WHOLESALE STORES, MANUFACTURING COMPANIES, RESTAURANTS, BARS, AUTOMOTIVE DEALERS, AUTOMOTIVE REPAIR COMPANIES, CHURCHES, SCHOOLS, EMPLOYMENT AGENCIES, MUSIC AND LESSONS, PLASTIC COMPANIES, SIGN COMPANIES, TRAVEL AGENCIES, GENERAL CONSTRUCTION CONTRACTORS AND PHYSICIANS

AND CONTACT INFORMATION THEREOF, IN CLASS 35 (U.S. CLS. 100, 101 AND 102).

FIRST USE 9-1-2006; IN COMMERCE 4-6-2007.

THE MARK CONSISTS OF STANDARD CHARACTERS WITHOUT CLAIM TO ANY PARTICULAR FONT, STYLE, SIZE, OR COLOR.

NO CLAIM IS MADE TO THE EXCLUSIVE RIGHT TO USE "DIRECTORY", APART FROM THE MARK AS SHOWN.

SN 77-004,053, FILED 9-21-2006.

DAVID MURRAY, EXAMINING ATTORNEY

Int. Cl.: 25

Prior U.S. Cls.: 22 and 39

United States Patent and Trademark Office

Reg. No. 3,481,175

Registered Aug. 5, 2008

TRADEMARK
PRINCIPAL REGISTER



JSA INTERNATIONAL (FLORIDA CORPORATION)
SUITE #130
2950 N. ANDREWS AVENUE EXT.
POMPANO BEACH, FL 33064

FIRST USE 0-0-2005; IN COMMERCE 7-2-2007.

SN 77-004,345, FILED 9-21-2006.

FOR: BOXER BRIEFS; SHORT-SLEEVED OR
LONG-SLEEVED T-SHIRTS; UNDERWEAR, IN
CLASS 25 (U.S. CLS. 22 AND 39).

WILLIAM P. SHANAHAN, EXAMINING ATTORNEY

Int. Cl.: 41

Prior U.S. Cls.: 100, 101, and 107

United States Patent and Trademark Office

Reg. No. 3,481,176

Registered Aug. 5, 2008

**SERVICE MARK
PRINCIPAL REGISTER**

On the Auction Block

WATV, LLC (CALIFORNIA LTD LIAB CO)
12530 BEATRICE STREET
LOS ANGELES, CA 90066

THE MARK CONSISTS OF STANDARD CHAR-
ACTERS WITHOUT CLAIM TO ANY PARTICULAR
FONT, STYLE, SIZE, OR COLOR.

FOR: ENTERTAINMENT IN THE NATURE OF
ON-GOING TELEVISION PROGRAMS IN THE
FIELD OF VEHICLES, IN CLASS 41 (U.S. CLS. 100,
101 AND 107).

SN 77-004,815, FILED 9-21-2006.

FIRST USE 10-1-2006; IN COMMERCE 10-1-2006.

CHERYL CLAYTON, EXAMINING ATTORNEY

Int. Cl.: 9

Prior U.S. Cls.: 21, 23, 26, 36, and 38

Reg. No. 3,481,177

United States Patent and Trademark Office

Registered Aug. 5, 2008

**TRADEMARK
PRINCIPAL REGISTER**

THE SUITE LIFE

DISNEY ENTERPRISES, INC. (DELAWARE COR-
PORATION)
500 SOUTH BUENA VISTA STREET
BURBANK, CA 91521

THE MARK CONSISTS OF STANDARD CHAR-
ACTERS WITHOUT CLAIM TO ANY PARTICULAR
FONT, STYLE, SIZE, OR COLOR.

FOR: VIDEO GAME CARTRIDGES, IN CLASS 9
(U.S. CLS. 21, 23, 26, 36 AND 38).

SN 77-005,161, FILED 9-22-2006.

FIRST USE 10-31-2006; IN COMMERCE 10-31-2006.

SUZANNE BLANE, EXAMINING ATTORNEY

Int. Cls.: 29 and 33

Prior U.S. Cls.: 46, 47, and 49

United States Patent and Trademark Office

Reg. No. 3,481,178

Registered Aug. 5, 2008

TRADEMARK
PRINCIPAL REGISTER

The image shows the word "Empordalia" written in a stylized, cursive script. The letters are dark brown, and the word is centered on a white background. The 'E' is capitalized, and the rest of the letters are in lowercase. There is a small accent mark above the 'A'.

EMPORDALIA S.C.C.L. (SPAIN CORPORATION)
CTRA. DE ROSES, S/N
PAU, GIRONA, SPAIN 17494

FOR: CANNED PROCESSED OLIVES; EDIBLE
OIL; PRESERVED, DRIED AND COOKED OLIVES;
PROCESSED OLIVES, IN CLASS 29 (U.S. CL. 46).

FIRST USE 4-28-2005; IN COMMERCE 1-1-2007.

FOR: WINES, IN CLASS 33 (U.S. CLS. 47 AND 49).

FIRST USE 4-28-2005; IN COMMERCE 1-1-2007.

THE COLOR(S) BROWN AND BLACK IS/ARE
CLAIMED AS A FEATURE OF THE MARK.

THE MARK CONSISTS OF THE WORD "EMPOR-
DALIA" IN STYLIZED BROWN LETTERS. THE
LETTER "E" IN CAPITAL LETTERS AND THE REST
OF THE LETTERS IN LOWER CASE. THE ACCENT
ABOVE THE FIRST LETTER "A" IS IN COLOR
BLACK. THE COLOR BROWN APPEARS IN THE
LETTERS AND THE COLOR BLACK APPEARS IN
THE ACCENT ABOVE THE FIRST LETTER "A".

SN 77-005,916, FILED 9-23-2006.

PATRICIA EVANKO, EXAMINING ATTORNEY

Int. Cl.: 27

Prior U.S. Cls.: 19, 20, 37, 42, and 50

United States Patent and Trademark Office

Reg. No. 3,481,179

Registered Aug. 5, 2008

**TRADEMARK
PRINCIPAL REGISTER**

QUANTUM GUARD

MANNINGTON MILLS, INC. (NEW JERSEY
CORPORATION)
P.O. BOX 30
SALEM, NJ 08079

THE MARK CONSISTS OF STANDARD CHAR-
ACTERS WITHOUT CLAIM TO ANY PARTICULAR
FONT, STYLE, SIZE, OR COLOR.

FOR: VINYL FLOOR COVERINGS, IN CLASS 27
(U.S. CLS. 19, 20, 37, 42 AND 50).

SN 77-006,236, FILED 9-25-2006.

FIRST USE 1-3-2008; IN COMMERCE 1-3-2008.

PETER B. BROMAGHIM, EXAMINING ATTORNEY

Int. Cls.: 9 and 38

Prior U.S. Cls.: 21, 23, 26, 36, 38, 100, 101, and 104

United States Patent and Trademark Office

Reg. No. 3,481,180

Registered Aug. 5, 2008

**TRADEMARK
SERVICE MARK
PRINCIPAL REGISTER**

SIP XTREME

SIP XTREME, L.L.C. (ARIZONA LTD LIAB CO)
SUITE 118-487
3434 W. ANTHEM WAY
ANTHEM, AZ 85086

INTERNET PROTOCOL SERVICES, VIDEO TRANSMISSION, VIDEO STREAMING, AND INSTANT MESSAGING SERVICES, IN CLASS 38 (U.S. CLS. 100, 101 AND 104).

FOR: TELECOMMUNICATIONS SOFTWARE USED IN CONJUNCTION WITH VOICE OVER INTERNET PROTOCOL TELEPHONES; TELECOMMUNICATIONS SOFT PHONES; AND TELECOMMUNICATIONS HARDWARE USED IN CONJUNCTION WITH VOICE OVER INTERNET PROTOCOL TELEPHONES, NAMELY, SPEAKERS, CAMERAS, AND MICROPHONES, IN CLASS 9 (U.S. CLS. 21, 23, 26, 36 AND 38).

FIRST USE 11-0-2006; IN COMMERCE 11-0-2006.

THE MARK CONSISTS OF STANDARD CHARACTERS WITHOUT CLAIM TO ANY PARTICULAR FONT, STYLE, SIZE, OR COLOR.

NO CLAIM IS MADE TO THE EXCLUSIVE RIGHT TO USE "SIP", APART FROM THE MARK AS SHOWN.

FIRST USE 11-0-2006; IN COMMERCE 11-0-2006.

SN 77-007,904, FILED 9-26-2006.

FOR: TELECOMMUNICATIONS SERVICES OVER THE INTERNET, NAMELY, VOICE OVER

DAVID C. REIHNER, EXAMINING ATTORNEY

Int. Cl.: 25

Prior U.S. Cls.: 22 and 39

United States Patent and Trademark Office

Reg. No. 3,481,181

Registered Aug. 5, 2008

**TRADEMARK
PRINCIPAL REGISTER**

**GIRRRL U KNOW U WEARIN'
DEM JEANZ**

WALKER, C.S. (UNITED STATES INDIVIDUAL)
2805 DARTMOUTH LANE
OLYMPIA FIELDS, IL 60461

THE MARK CONSISTS OF STANDARD CHAR-
ACTERS WITHOUT CLAIM TO ANY PARTICULAR
FONT, STYLE, SIZE, OR COLOR.

FOR: CLOTHING, NAMELY, T-SHIRTS, SWEAT-
SHIRTS, SWEAT-SUITS, JACKETS, SHIRTS, AND
BLOUSES, IN CLASS 25 (U.S. CLS. 22 AND 39).

SN 77-008,278, FILED 9-27-2006.

FIRST USE 4-15-2008; IN COMMERCE 4-15-2008.

JULIE GUTTADAURO, EXAMINING ATTORNEY

Int. Cl.: 9

Prior U.S. Cls.: 21, 23, 26, 36, and 38

Reg. No. 3,481,182

United States Patent and Trademark Office

Registered Aug. 5, 2008

**TRADEMARK
PRINCIPAL REGISTER**

ADAPT

RAYTHEON COMPANY (DELAWARE COR-
PORATION)
870 WINTER STREET
WALTHAM, MA 024511449

THE MARK CONSISTS OF STANDARD CHAR-
ACTERS WITHOUT CLAIM TO ANY PARTICULAR
FONT, STYLE, SIZE, OR COLOR.

FOR: COMPUTER SOFTWARE FOR SIMULAT-
ING THE OPERATION OF A SURVEILLANCE
SYSTEM, IN CLASS 9 (U.S. CLS. 21, 23, 26, 36 AND 38).

SN 77-009,336, FILED 9-28-2006.

FIRST USE 12-31-2006; IN COMMERCE 12-31-2006.

BILL DAWE, EXAMINING ATTORNEY

Int. Cl.: 41

Prior U.S. Cls.: 100, 101, and 107

United States Patent and Trademark Office

Reg. No. 3,481,183

Registered Aug. 5, 2008

**SERVICE MARK
PRINCIPAL REGISTER**

**STUMBLING TOWARDS THE
FUTURE**

SUSTAINABLECIRCLES CORP. (DELAWARE
CORPORATION)
870 MARKET STREET, SUITE 1011
SAN FRANCISCO, CA 94102

FOR: ENTERTAINMENT SERVICES, NAMELY,
CONTINUING HEALTH, SOCIO-ECONOMIC, POLI-
TICAL AND PUBLIC POLICY EDUCATION SHOWS
BROADCAST VIA TELEVISION, SATELLITE, COM-
PUTER, AUDIO AND VIDEO MEDIA, IN CLASS 41
(U.S. CLS. 100, 101 AND 107).

FIRST USE 1-12-2007; IN COMMERCE 1-12-2007.

THE MARK CONSISTS OF STANDARD CHAR-
ACTERS WITHOUT CLAIM TO ANY PARTICULAR
FONT, STYLE, SIZE, OR COLOR.

SN 77-009,484, FILED 9-28-2006.

H. M. FISHER, EXAMINING ATTORNEY

Int. Cls.: 9 and 41

Prior U.S. Cls.: 21, 23, 26, 36, 38, 100, 101, and 107

United States Patent and Trademark Office

Reg. No. 3,481,184

Registered Aug. 5, 2008

**TRADEMARK
SERVICE MARK
PRINCIPAL REGISTER**

KAZ

BRYAN, FREDERICK D. (UNITED STATES INDIVIDUAL)
22418 NORTH SUMMIT RIDGE CIRCLE
CHATSWORTH, CA 91311

FOR: DOWNLOADABLE RING TONES, GRAPHICS AND MUSIC VIA A GLOBAL COMPUTER NETWORK AND WIRELESS DEVICES; MUSICAL SOUND RECORDINGS; DOWNLOADABLE MUSICAL SOUND RECORDINGS; PRE-RECORDED CD'S FEATURING MUSIC; PRERECORDED AUDIO TAPES FEATURING MUSIC; PHONOGRAPH RECORDS FEATURING MUSIC; PRERECORDED DIGITAL AUDIO TAPE FEATURING MUSIC; DOWNLOADABLE VIDEO RECORDINGS FEATURING MUSIC AND MUSICAL PERFORMANCES, IN CLASS 9 (U.S. CLS. 21, 23, 26, 36 AND 38).

FIRST USE 12-31-1991; IN COMMERCE 12-31-1991.

FOR: ENTERTAINMENT, NAMELY, LIVE PERFORMANCES BY AN INDIVIDUAL MUSICIAN AND A MUSICAL BAND; SONG WRITING SERVICES; MUSIC COMPOSITION FOR OTHERS; MUSIC PRODUCTION SERVICES, IN CLASS 41 (U.S. CLS. 100, 101 AND 107).

FIRST USE 12-31-1985; IN COMMERCE 11-14-1989.

THE MARK CONSISTS OF STANDARD CHARACTERS WITHOUT CLAIM TO ANY PARTICULAR FONT, STYLE, SIZE, OR COLOR.

"KAZ" IDENTIFIES A LIVING INDIVIDUAL WHOSE CONSENT IS OF RECORD.

SN 77-011,066, FILED 9-29-2006.

ROBIN MITTLER, EXAMINING ATTORNEY

Int. Cl.: 44

Prior U.S. Cls.: 100 and 101

United States Patent and Trademark Office

Reg. No. 3,481,185

Registered Aug. 5, 2008

**SERVICE MARK
PRINCIPAL REGISTER**

ACCU-CHEK INNER CIRCLE

ROCHE DIAGNOSTICS GMBH (FED REP GER-
MANY LIMITED COMPANY)
SANDHOFER STRASSE 116
68305 MANNHEIM, FED REP GERMANY

FOR: PROVIDING CUSTOMIZED MEDICAL
HEALTH CARE CONSULTANCY IN THE FIELD
OF DIABETES, NAMELY, MAINTAINING FILES
AND RECORDS CONCERNING THE MEDICAL
CONDITION OF INDIVIDUALS AND PROVIDING
INFORMATION ABOUT DIABETES VIA A WEB-
SITE ON THE INTERNET, IN CLASS 44 (U.S. CLS.
100 AND 101).

FIRST USE 3-31-2007; IN COMMERCE 3-31-2007.

THE MARK CONSISTS OF STANDARD CHAR-
ACTERS WITHOUT CLAIM TO ANY PARTICULAR
FONT, STYLE, SIZE, OR COLOR.

OWNER OF U.S. REG. NOS. 1,277,867, 3,076,905,
AND OTHERS.

SN 77-012,287, FILED 10-3-2006.

WILLIAM VERHOSEK, EXAMINING ATTORNEY

Int. Cl.: 9

Prior U.S. Cls.: 21, 23, 26, 36, and 38

United States Patent and Trademark Office

Reg. No. 3,481,186

Registered Aug. 5, 2008

**TRADEMARK
PRINCIPAL REGISTER**

side tracked records

SIDE TRACKED RECORDS (INDIANA LTD LIAB
CO)

111 W. MAIN ST. SUITE 100

CARMEL, IN 46032

FOR: AUDIO RECORDINGS FEATURING MU-
SIC, IN CLASS 9 (U.S. CLS. 21, 23, 26, 36 AND 38).

FIRST USE 1-1-2008; IN COMMERCE 1-1-2008.

THE MARK CONSISTS OF STANDARD CHAR-
ACTERS WITHOUT CLAIM TO ANY PARTICULAR
FONT, STYLE, SIZE, OR COLOR.

NO CLAIM IS MADE TO THE EXCLUSIVE
RIGHT TO USE "RECORDS", APART FROM THE
MARK AS SHOWN.

SN 77-012,813, FILED 10-3-2006.

CAROLINE WOOD, EXAMINING ATTORNEY

Int. Cl.: 16

Prior U.S. Cls.: 2, 5, 22, 23, 29, 37, 38, and 50

Reg. No. 3,481,187

United States Patent and Trademark Office

Registered Aug. 5, 2008

**TRADEMARK
PRINCIPAL REGISTER**

PSYCHIC OBSERVER

AQUARIAN FOUNDATION (WASHINGTON CORPORATION)
315 15TH AVENUE E.
SEATTLE, WA 98112

FOR: PRINTED MATERIALS, NAMELY, NEWSPAPERS, MAGAZINES, AND PICTORIAL JOURNALS ALL IN THE FIELD OF METAPHYSICS, PSYCHIC PHENOMENA AND SPIRITUALISM, IN CLASS 16 (U.S. CLS. 2, 5, 22, 23, 29, 37, 38 AND 50).

FIRST USE 0-0-1956; IN COMMERCE 4-30-2007.

THE MARK CONSISTS OF STANDARD CHARACTERS WITHOUT CLAIM TO ANY PARTICULAR FONT, STYLE, SIZE, OR COLOR.

NO CLAIM IS MADE TO THE EXCLUSIVE RIGHT TO USE "PSYCHIC", APART FROM THE MARK AS SHOWN.

SN 77-013,033, FILED 10-3-2006.

ANDREA SAUNDERS, EXAMINING ATTORNEY

Int. Cl.: 16

Prior U.S. Cls.: 2, 5, 22, 23, 29, 37, 38, and 50

Reg. No. 3,481,188

United States Patent and Trademark Office

Registered Aug. 5, 2008

**TRADEMARK
PRINCIPAL REGISTER**

CHIMES

AQUARIAN FOUNDATION (WASHINGTON
CORPORATION)
315 15TH AVENUE E.
SEATTLE, WA 98112

FOR: PRINTED MATERIALS, NAMELY, NEWS-
PAPERS, MAGAZINES, AND PICTORIAL JOUR-
NALS ALL IN THE FIELD OF METAPHYSICS,
PSYCHIC PHENOMENA AND SPIRITUALISM, IN
CLASS 16 (U.S. CLS. 2, 5, 22, 23, 29, 37, 38 AND 50).

FIRST USE 0-0-1955; IN COMMERCE 4-30-2007.

THE MARK CONSISTS OF STANDARD CHAR-
ACTERS WITHOUT CLAIM TO ANY PARTICULAR
FONT, STYLE, SIZE, OR COLOR.

SN 77-013,046, FILED 10-3-2006.

ANDREA SAUNDERS, EXAMINING ATTORNEY

Int. Cl.: 12

Prior U.S. Cls.: 19, 21, 23, 31, 35, and 44

United States Patent and Trademark Office

Reg. No. 3,481,189

Registered Aug. 5, 2008

**TRADEMARK
PRINCIPAL REGISTER**

CLIX

CLIX SYSTEMS, INC. (MASSACHUSETTS CORPORATION)
432 COLUMBIA STREET
CAMBRIDGE, MA 02141

FOR: BICYCLE WHEELS FEATURING A QUICK-RELEASE LEVER; BICYCLE PARTS, NAMELY, FORKS FEATURING A QUICK-RELEASE LEVER FOR WHEELS, IN CLASS 12 (U.S. CLS. 19, 21, 23, 31, 35 AND 44).

FIRST USE 7-0-2006; IN COMMERCE 7-0-2006.

THE MARK CONSISTS OF STANDARD CHARACTERS WITHOUT CLAIM TO ANY PARTICULAR FONT, STYLE, SIZE, OR COLOR.

SN 77-014,476, FILED 10-5-2006.

REBECCA EISINGER, EXAMINING ATTORNEY

Int. Cl.: 24

Prior U.S. Cls.: 42 and 50

United States Patent and Trademark Office

Reg. No. 3,481,190

Registered Aug. 5, 2008

**TRADEMARK
PRINCIPAL REGISTER**

**THE WARMTH OF WOOL + THE
COMFORT OF FLEECE**

GORDINI U.S.A. INC. (VERMONT CORPORATION)
67 ALLEN MARTIN DRIVE
ESSEX JUNCTION, VT 05451

THE MARK CONSISTS OF STANDARD CHARACTERS WITHOUT CLAIM TO ANY PARTICULAR FONT, STYLE, SIZE, OR COLOR.

FOR: POLYESTER AND WOOL FABRIC FOR USE IN CLOTHING, NAMELY, SOCKS, FACE PROTECTORS, UNDERWEAR AND LINING OF GLOVES, IN CLASS 24 (U.S. CLS. 42 AND 50).

SN 77-014,753, FILED 10-5-2006.

FIRST USE 12-11-2006; IN COMMERCE 12-11-2006.

SUZANNE BLANE, EXAMINING ATTORNEY

Int. Cl.: 25

Prior U.S. Cls.: 22 and 39

United States Patent and Trademark Office

Reg. No. 3,481,191

Registered Aug. 5, 2008

**TRADEMARK
PRINCIPAL REGISTER**

FUNSIZE

GONZALEZ, FEDERICO (UNITED STATES IN-
DIVIDUAL)
68760 RAPOSA ROAD
CATHEDRAL CITY, CA 92234

FOR: APPAREL, NAMELY, SHIRTS, SHOES,
SWEATSHIRTS, SWEATPANTS, PANTS, SHORTS,
SWIM SUITS, JACKETS, SKIRTS, OVERALLS, LEG-
GINGS, UNDER WEAR, SWEATERS, AND HATS, IN
CLASS 25 (U.S. CLS. 22 AND 39).

FIRST USE 6-1-2007; IN COMMERCE 6-1-2007.

THE MARK CONSISTS OF STANDARD CHAR-
ACTERS WITHOUT CLAIM TO ANY PARTICULAR
FONT, STYLE, SIZE, OR COLOR.

SN 77-015,383, FILED 10-6-2006.

SETH A. RAPPAPORT, EXAMINING ATTORNEY

Int. Cl.: 12

Prior U.S. Cls.: 19, 21, 23, 31, 35, and 44

Reg. No. 3,481,192

United States Patent and Trademark Office

Registered Aug. 5, 2008

**TRADEMARK
PRINCIPAL REGISTER**

VALENTE

VALLEY CUSTOM TIRE, INC. (CALIFORNIA CORPORATION)
6065 MALBURG WAY
VERNON, CA 90058

FOR: LAND VEHICLE AND OFF-ROAD VEHICLE PARTS; NAMELY, WHEELS AND WHEEL CAPS, IN CLASS 12 (U.S. CLS. 19, 21, 23, 31, 35 AND 44).

FIRST USE 6-14-2007; IN COMMERCE 6-14-2007.

THE MARK CONSISTS OF STANDARD CHARACTERS WITHOUT CLAIM TO ANY PARTICULAR FONT, STYLE, SIZE, OR COLOR.

THE ENGLISH TRANSLATION OF "VALENTE" IS "EFFICIENT".

SN 77-016,854, FILED 10-9-2006.

CAROLINE WOOD, EXAMINING ATTORNEY

Int. Cl.: 36

Prior U.S. Cls.: 100, 101, and 102

United States Patent and Trademark Office

Reg. No. 3,481,193

Registered Aug. 5, 2008

**SERVICE MARK
PRINCIPAL REGISTER**



PERIGEE INVESTMENT ADVISORS, LLC (PENNSYLVANIA LTD LIAB CO)
P. O. BOX 351
HERSHEY, PA 17033

FOR: INVESTMENT ADVISORY SERVICES, IN CLASS 36 (U.S. CLS. 100, 101 AND 102).

FIRST USE 11-1-2005; IN COMMERCE 6-11-2008.

THE MARK CONSISTS OF A CURVED EDGE SQUARE AND A LARGE CIRCLE WITHIN THE

SQUARE. INSIDE THE LARGE CIRCLE IS A SMALL CIRCLE TOWARDS THE UPPER RIGHT PART OF THE LARGE CIRCLE. HALFWAY BETWEEN THE SQUARE AND THE LARGE CIRCLE, IN THE UPPER RIGHT SIDE, IS A SMALLER CIRCLE WHICH ALSO IS PARTIALLY IN THE SMALL CIRCLE.

SN 77-016,862, FILED 10-9-2006.

DAVID YONTEF, EXAMINING ATTORNEY

Int. Cl.: 33

Prior U.S. Cls.: 47 and 49

United States Patent and Trademark Office

Reg. No. 3,481,194

Registered Aug. 5, 2008

**TRADEMARK
PRINCIPAL REGISTER**

ENROUTE

NICKEL & NICKEL VINEYARDS, LLC (CALI-
FORNIA LTD LIAB CO)
8164 ST. HELENA HIGHWAY
OAKVILLE, CA 94562

FOR: WINE, IN CLASS 33 (U.S. CLS. 47 AND 49).

FIRST USE 5-28-2008; IN COMMERCE 5-28-2008.

THE MARK CONSISTS OF STANDARD CHAR-
ACTERS WITHOUT CLAIM TO ANY PARTICULAR
FONT, STYLE, SIZE, OR COLOR.

SN 77-016,969, FILED 10-9-2006.

WILLIAM BRECKENFELD, EXAMINING ATTOR-
NEY

Int. Cl.: 44

Prior U.S. Cls.: 100 and 101

United States Patent and Trademark Office

Reg. No. 3,481,195

Registered Aug. 5, 2008

**SERVICE MARK
PRINCIPAL REGISTER**

WELLNESS WIRELESS

DIABETES WIRELESS, LLC (TEXAS LTD LIAB
CO)
3 RIVERWAY, SUITE 825
HOUSTON, TX 77056

FOR: HEALTH CARE; HEALTH CARE SERVICES,
NAMELY, WELLNESS PROGRAMS; HEALTH
CARE SERVICES, NAMELY, DISEASE MANAGE-
MENT PROGRAMS; HOME HEALTH CARE SERVI-
CES; MANAGED HEALTH CARE SERVICES;
PROVIDING HEALTH CARE INFORMATION BY
TELEPHONE; PROVIDING HEALTH CARE INFOR-

MATION BY TELEPHONE AND THE INTERNET,
IN CLASS 44 (U.S. CLS. 100 AND 101).

FIRST USE 5-0-2007; IN COMMERCE 5-0-2007.

THE MARK CONSISTS OF STANDARD CHAR-
ACTERS WITHOUT CLAIM TO ANY PARTICULAR
FONT, STYLE, SIZE, OR COLOR.

SN 77-017,214, FILED 10-9-2006.

STEVEN JACKSON, EXAMINING ATTORNEY

Int. Cl.: 25

Prior U.S. Cls.: 22 and 39

United States Patent and Trademark Office

Reg. No. 3,481,196

Registered Aug. 5, 2008

**TRADEMARK
PRINCIPAL REGISTER**

NORTH AMERICAN POLO LEAGUE

NORTH AMERICAN POLO LEAGUE, LLC (DE-
LAWARE LTD LIAB CO)
SUITE 425
109 NORTH POST OAK LANE
HOUSTON, TX 77024

FOR: CAPS; HATS; T-SHIRTS; SHIRTS; PANTS;
JACKETS; SHORTS; SKIRTS; SHOES; SWEATERS;
SOCKS; VESTS; SWEATSHIRTS; BELTS; TIES;
SCARVES , IN CLASS 25 (U.S. CLS. 22 AND 39).

FIRST USE 3-9-2007; IN COMMERCE 3-9-2007.

THE MARK CONSISTS OF STANDARD CHAR-
ACTERS WITHOUT CLAIM TO ANY PARTICULAR
FONT, STYLE, SIZE, OR COLOR.

NO CLAIM IS MADE TO THE EXCLUSIVE
RIGHT TO USE "NORTH AMERICAN", APART
FROM THE MARK AS SHOWN.

SN 77-018,229, FILED 10-10-2006.

ANGELA M. MICHELI, EXAMINING ATTORNEY

Int. Cl.: 44

Prior U.S. Cls.: 100 and 101

United States Patent and Trademark Office

Reg. No. 3,481,197

Registered Aug. 5, 2008

**SERVICE MARK
PRINCIPAL REGISTER**

JILLIAN DEMPSEY

BARDEEN AGENCY, INC. (CALIFORNIA CORPORATION)
661 NORTH HARPER AVENUE SUITE 201
LOS ANGELES, CA 90048

THE MARK CONSISTS OF STANDARD CHARACTERS WITHOUT CLAIM TO ANY PARTICULAR FONT, STYLE, SIZE, OR COLOR.

FOR: CONSULTING SERVICES IN THE FIELD OF COSMETICS, IN CLASS 44 (U.S. CLS. 100 AND 101).

SN 77-018,412, FILED 10-11-2006.

FIRST USE 10-0-2004; IN COMMERCE 10-0-2004.

KEVON CHISOLM, EXAMINING ATTORNEY

Int. Cl.: 11

Prior U.S. Cls.: 13, 21, 23, 31, and 34

United States Patent and Trademark Office

Reg. No. 3,481,198

Registered Aug. 5, 2008

**TRADEMARK
PRINCIPAL REGISTER**

VIGI-Lux

PERKINELMER, INC. (MASSACHUSETTS COR-
PORATION)
940 WINTER STREET
WALTHAM, MA 02451

THE MARK CONSISTS OF STANDARD CHAR-
ACTERS WITHOUT CLAIM TO ANY PARTICULAR
FONT, STYLE, SIZE, OR COLOR.

FOR: INFRARED ILLUMINATORS, IN CLASS 11
(U.S. CLS. 13, 21, 23, 31 AND 34).

SN 77-018,731, FILED 10-11-2006.

FIRST USE 5-10-2006; IN COMMERCE 5-10-2006.

CARRIE GENOVESE, EXAMINING ATTORNEY

Int. Cl.: 42

Prior U.S. Cls.: 100 and 101

United States Patent and Trademark Office

Reg. No. 3,481,199

Registered Aug. 5, 2008

**SERVICE MARK
PRINCIPAL REGISTER**

FUTURE MERCHANTS

FUTURE MERCHANTS, INC. (DELAWARE CORPORATION)
4TH FLOOR
141 WOOSTER STREET
NEW YORK, NY 10012

FOR: BUILDING AND CREATING INTERACTIVE WEBSITES AND ONLINE RETAIL SALES PORTALS POPULATED WITH PROPRIETARY SALES-ORIENTED VIDEO CONTENT, FOR OTHERS, IN CLASS 42 (U.S. CLS. 100 AND 101).

FIRST USE 11-2-2006; IN COMMERCE 11-2-2006.

THE MARK CONSISTS OF STANDARD CHARACTERS WITHOUT CLAIM TO ANY PARTICULAR FONT, STYLE, SIZE, OR COLOR.

SN 77-021,098, FILED 10-13-2006.

ESTHER BELENKER, EXAMINING ATTORNEY

Int. Cl.: 29

Prior U.S. Cl.: 46

United States Patent and Trademark Office

Reg. No. 3,481,200

Registered Aug. 5, 2008

**TRADEMARK
PRINCIPAL REGISTER**

LOMA LINDA

KELLOGG NORTH AMERICA COMPANY (DE-
LAWARE CORPORATION)
ONE KELLOGG SQUARE - P.O. BOX 3599
BATTLE CREEK, MI 490163599

FOR: VEGGIE FOOD PRODUCTS, NAMELY,
VEGETABLE BASED MEAT SUBSTITUTES; TEX-
TURED VEGETABLE OR SOY PROTEIN TO BE
USED AS A MEAT SUBSTITUTE, IN CLASS 29 (U.S.
CL. 46).

FIRST USE 10-1-1934; IN COMMERCE 10-1-1934.

THE MARK CONSISTS OF STANDARD CHAR-
ACTERS WITHOUT CLAIM TO ANY PARTICULAR
FONT, STYLE, SIZE, OR COLOR.

OWNER OF U.S. REG. NOS. 1,049,152, 1,050,845,
AND 1,079,971.

SN 77-021,339, FILED 10-14-2006.

SUSAN LESLIE DUBOIS, EXAMINING ATTORNEY

Int. Cls.: 2, 3, and 21

**Prior U.S. Cls.: 1, 2, 4, 6, 11, 13, 16, 23, 29, 30, 33, 40,
50, 51, and 52**

Reg. No. 3,481,201

United States Patent and Trademark Office

Registered Aug. 5, 2008

**TRADEMARK
PRINCIPAL REGISTER**

Souvenir Cosmetics

KRISTIANSEN, KATE (UNITED STATES INDIVIDUAL)
15640 SW BRISTOL LANE
BEAVERTON, OR 97007

FOR: LIQUID PIGMENTS, IN CLASS 2 (U.S. CLS. 6, 11 AND 16).

FIRST USE 6-1-2008; IN COMMERCE 6-1-2008.

FOR: COSMETICS, NAMELY, LIQUID, POWDER AND SEMI-SOLID MAKE-UP, NAMELY, FOUNDATION, MASCARA, PENCILS, COSMETIC GLITTERS FOR EYE SHADOW, CHEEK AND FACE HIGHLIGHTER, FOR SHOULDERS, ARMS OR DECOLLETE SHIMMER, FOR ACCENT TO HAIRSTYLES, BODY ART AND NAIL ART, MAKE-UP KITS COMPRISING A SINGLE PRESSED FACIAL POWDER, A SINGLE SHADE OF BLUSHER, A SINGLE SHADE OF BRONZER FOR FACE OR DECOLLETE, A DUO AND A QUAD OF EYE SHADOW COLORS, AND A LIPSTICK AND LIP GLOSS PALETTE; PERFUMES, HAIR LOTIONS, NAIL POLISH, ESSENTIAL OILS, SOAPS, SHAVING CREAMS AND

LOTIONS, AND COMPACTS CONTAINING MAKE-UP, IN CLASS 3 (U.S. CLS. 1, 4, 6, 50, 51 AND 52).

FIRST USE 6-1-2008; IN COMMERCE 6-1-2008.

FOR: COSMETIC BRUSHES, HAIR BRUSHES WITH NATURAL OR SYNTHETIC BRISTLES, EMPTY COSMETIC COMPACTS, SHAVING BRUSHES AND SHAVING BRUSH STANDS, IN CLASS 21 (U.S. CLS. 2, 13, 23, 29, 30, 33, 40 AND 50).

FIRST USE 6-1-2008; IN COMMERCE 6-1-2008.

THE MARK CONSISTS OF STANDARD CHARACTERS WITHOUT CLAIM TO ANY PARTICULAR FONT, STYLE, SIZE, OR COLOR.

NO CLAIM IS MADE TO THE EXCLUSIVE RIGHT TO USE "COSMETICS", APART FROM THE MARK AS SHOWN.

SN 77-022,281, FILED 10-16-2006.

ALEX KEAM, EXAMINING ATTORNEY

Int. Cl.: 5

Prior U.S. Cls.: 6, 18, 44, 46, 51, and 52

Reg. No. 3,481,202

United States Patent and Trademark Office

Registered Aug. 5, 2008

**TRADEMARK
PRINCIPAL REGISTER**

CLEARITUP

FLOR A. MAYORAL, M.D., P.A. (UNITED STATES INDIVIDUAL)
PENTHOUSE - WEST
7300 S.W. 62ND PLACE
MIAMI, FL 33143

FOR: MEDICATED SKIN PREPARATION FOR USE IN TREATING ACNE AND MELASMA; MEDICINAL CREAMS FOR SKIN CARE, IN CLASS 5 (U.S. CLS. 6, 18, 44, 46, 51 AND 52).

FIRST USE 2-1-2008; IN COMMERCE 2-1-2008.

THE MARK CONSISTS OF STANDARD CHARACTERS WITHOUT CLAIM TO ANY PARTICULAR FONT, STYLE, SIZE, OR COLOR.

SN 77-022,570, FILED 10-17-2006.

AMY ALFIERI, EXAMINING ATTORNEY

Int. Cl.: 1

Prior U.S. Cls.: 1, 5, 6, 10, 26, and 46

Reg. No. 3,481,203

United States Patent and Trademark Office

Registered Aug. 5, 2008

**TRADEMARK
PRINCIPAL REGISTER**

LIQUIMIDE

PERFORMANCE POLYMER SOLUTIONS, INC.
(DELAWARE CORPORATION)
91 WESTPARK ROAD
CENTERVILLE, OH 45459

THE MARK CONSISTS OF STANDARD CHARACTERS WITHOUT CLAIM TO ANY PARTICULAR FONT, STYLE, SIZE, OR COLOR.

FOR: CHEMICALS, NAMELY, IMIDE-BASED COMPOSITIONS FOR USE IN THE MANUFACTURE OF RESINS AND ADHESIVES, IN CLASS 1 (U.S. CLS. 1, 5, 6, 10, 26 AND 46).

SN 77-022,952, FILED 10-17-2006.

FIRST USE 6-10-2007; IN COMMERCE 6-10-2007.

RAMONA ORTIGA, EXAMINING ATTORNEY

Int. Cls.: 37 and 42

Prior U.S. Cls.: 100, 101, 103, and 106

United States Patent and Trademark Office

Reg. No. 3,481,204

Registered Aug. 5, 2008

**SERVICE MARK
PRINCIPAL REGISTER**



MY GIZMOS, INC. (NEVADA CORPORATION)
2248 MERIDIAN BLVD., STE. H
MINDEN, NV 89423

FOR: PROVIDING COMPUTER, COMPUTER HARDWARE AND COMPUTER NETWORK SUPPORT SERVICES, NAMELY, INSTALLATION, REPAIR, MAINTENANCE, UPDATING, AND UPGRADING OF COMPUTER HARDWARE, COMPUTER SYSTEMS AND COMPUTER NETWORKS, IN CLASS 37 (U.S. CLS. 100, 103 AND 106).

FIRST USE 10-18-2006; IN COMMERCE 10-18-2006.

FOR: COMPUTER NETWORK DESIGN FOR OTHERS; COMPUTER NETWORK DESIGN AND COMPUTER SOFTWARE DESIGN FOR BUSINESSES; COMPUTER SERVICES, NAMELY, DESIGNING AND IMPLEMENTING NETWORK WEB PAGES FOR OTHERS; COMPUTER SERVICES, NAMELY, PROVIDING SEARCH ENGINES FOR OBTAINING DATA ON A GLOBAL COMPUTER NETWORK; COMPUTER SERVICES, NAMELY, CREATING INDEXES OF INFORMATION, SITES AND OTHER RESOURCES AVAILABLE ON COMPUTER NETWORKS; DESIGN OF COMPUTER HARDWARE, INTEGRATED CIRCUITS, COMMUNICATIONS HARDWARE AND SOFTWARE AND COMPUTER NETWORKS FOR OTHERS; DESIGN OF COMPUTER NETWORKS AND SOFTWARE

FOR OTHERS FOR BUSINESSES; DEVELOPMENT OF SOFTWARE FOR SECURE NETWORK OPERATIONS; HOSTING THE WEB SITES OF OTHERS ON A COMPUTER SERVER FOR A GLOBAL COMPUTER NETWORK; PROVIDING COMPUTER SOFTWARE SUPPORT SERVICES, NAMELY, COMPUTER SOFTWARE INSTALLATION, REPAIR AND MAINTENANCE, AND UPDATING AND UPGRADING OF COMPUTER SOFTWARE FOR OTHERS; TECHNICAL SUPPORT SERVICES, NAMELY, MONITORING OF NETWORK SYSTEMS, IN CLASS 42 (U.S. CLS. 100 AND 101).

FIRST USE 10-18-2006; IN COMMERCE 10-18-2006.

THE COLOR(S) YELLOW, BLUE, BLACK AND WHITE IS/ARE CLAIMED AS A FEATURE OF THE MARK.

THE MARK CONSISTS OF A BLACK SPRING-LIKE SPIRAL DESIGN WITH WHITE AND BLACK EYES ON A SHADED YELLOW OVAL TO THE RIGHT OF, AND OVERLAPPING, A SHADED BLUE RECTANGLE CONTAINING THE WORDING "MY GIZMOS" IN WHITE.

SN 77-023,176, FILED 10-17-2006.

ELLEN BURNS, EXAMINING ATTORNEY

Int. Cl.: 35

Prior U.S. Cls.: 100, 101, and 102

United States Patent and Trademark Office

Reg. No. 3,481,205

Registered Aug. 5, 2008

**SERVICE MARK
PRINCIPAL REGISTER**

EXPRESS SAVINGS STATEMENT

EXPRESS SCRIPTS, INC. (DELAWARE CORPORATION)
ONE EXPRESS WAY
ST. LOUIS, MO 63121

FOR: PROVIDING INFORMATION TO MEMBERS IN A CONSUMER-DRIVEN HEALTHCARE BENEFIT PLAN REGARDING GENERIC PRESCRIPTION DRUGS, COST SAVINGS OPPORTUNITIES, AND MAXIMIZING BENEFITS , IN CLASS 35 (U.S. CLS. 100, 101 AND 102).

FIRST USE 4-15-2008; IN COMMERCE 4-15-2008.

THE MARK CONSISTS OF STANDARD CHARACTERS WITHOUT CLAIM TO ANY PARTICULAR FONT, STYLE, SIZE, OR COLOR.

NO CLAIM IS MADE TO THE EXCLUSIVE RIGHT TO USE "SAVINGS STATEMENT", APART FROM THE MARK AS SHOWN.

SN 77-023,222, FILED 10-17-2006.

KEVON CHISOLM, EXAMINING ATTORNEY

Int. Cl.: 35

Prior U.S. Cls.: 100, 101, and 102

United States Patent and Trademark Office

Reg. No. 3,481,206

Registered Aug. 5, 2008

**SERVICE MARK
PRINCIPAL REGISTER**

EXPRESS SAVINGS ALERT

EXPRESS SCRIPTS, INC. (DELAWARE CORPORATION)
ONE EXPRESS WAY
ST. LOUIS, MO 63121

FOR: PROVIDING INFORMATION TO MEMBERS IN A CONSUMER-DRIVEN HEALTHCARE BENEFIT PLAN REGARDING GENERIC PRESCRIPTION DRUGS, COST SAVINGS OPPORTUNITIES, AND MAXIMIZING BENEFITS, IN CLASS 35 (U.S. CLS. 100, 101 AND 102).

FIRST USE 5-27-2008; IN COMMERCE 5-27-2008.

THE MARK CONSISTS OF STANDARD CHARACTERS WITHOUT CLAIM TO ANY PARTICULAR FONT, STYLE, SIZE, OR COLOR.

NO CLAIM IS MADE TO THE EXCLUSIVE RIGHT TO USE "SAVINGS ALERT", APART FROM THE MARK AS SHOWN.

SN 77-023,223, FILED 10-17-2006.

KEVON CHISOLM, EXAMINING ATTORNEY

Int. Cls.: 35 and 37

Prior U.S. Cls.: 100, 101, 102, 103, and 106

United States Patent and Trademark Office

Reg. No. 3,481,207

Registered Aug. 5, 2008

**SERVICE MARK
PRINCIPAL REGISTER**

BGE HOME FOR YOUR BUSINESS

CONSTELLATION ENERGY GROUP, INC.
(MARYLAND CORPORATION)
750 EAST PRATT STREET
BALTIMORE, MD 21202

FOR: ON-LINE RETAIL STORE SERVICES, AND TELEPHONE ORDERING SERVICES IN THE FIELD OF HUMIDIFIERS, INDOOR AIR QUALITY SYSTEMS, DEHUMIDIFIERS, PLUMBING EQUIPMENT AND SYSTEMS, ELECTRICAL SYSTEMS, SURGE PROTECTION SYSTEMS, THERMOSTATS, AND HEATING, VENTILATION AND AIR CONDITIONING (HVAC) EQUIPMENT AND SYSTEMS; BUSINESS CONSULTING SERVICES FOR WHOLESALE, INDUSTRIAL AND COMMERCIAL CUSTOMERS IN THE FIELDS OF DESIGN, MAINTENANCE, UPGRADE AND OPERATIONS OF BUILDING AUTOMATION SYSTEMS, ENERGY POWER MONITORING AND CONTROL, HEATING, VENTILATION AND AIR CONDITIONING (HVAC), LIGHTING, ELECTRICAL AND ENVIRONMENTAL SYSTEMS, POWER DESIGN AND CONSTRUCTION; BUSINESS MANAGEMENT OF ALL BUILDING AND COMMERCIAL MECHANICAL, ELECTRICAL AND ELECTRONIC SYSTEMS FOR OTHERS, IN CLASS 35 (U.S. CLS. 100, 101 AND 102).

FIRST USE 11-1-2006; IN COMMERCE 11-1-2006.

FOR: INSTALLATION, MAINTENANCE AND REPAIR OF BUILDING AND COMMERCIAL MECHANICAL SYSTEMS AND HEATING, AIR CONDITIONING AND PLUMBING SYSTEMS; INSTALLATION OF AUTOMATED ELECTRONIC LIGHTING AND ENERGY CONTROLS; INSTALLATION, MAINTENANCE AND REPAIR OF BUILDING AUTOMATION AND ENERGY SYSTEMS, ELECTRICAL, HEATING, VENTILATION AND AIR CONDITIONING (HVAC) EQUIPMENT AND MAJOR APPLIANCES FOR WHOLESALE, INDUS-

TRIAL AND COMMERCIAL CUSTOMERS; PIPE FITTING INSTALLATION AND INDUSTRIAL CONSTRUCTION AND PIPE FITTING CONTRACTOR SERVICES; INSTALLATION, MAINTENANCE AND REPAIR OF ELECTRONIC EQUIPMENT, HUMIDIFIERS, INDOOR AIR QUALITY SYSTEMS, DEHUMIDIFIERS, PLUMBING SYSTEMS, ELECTRICAL SYSTEMS, SURGE PROTECTION SYSTEMS, THERMOSTATS, AND HEATING, VENTILATION AND AIR CONDITIONING EQUIPMENT AND SYSTEMS; PLUMBING SERVICES; ELECTRICAL CONTRACTING SERVICES; INSTALLATION OF LIGHTING, HEATING, COOLING AND REFRIGERATION SYSTEMS; INSTALLATION AND REPAIR OF ELECTRICAL AND ELECTRONIC DEVICES AND EQUIPMENT, NAMELY COMMERCIAL UTILITY SYSTEMS, HEATING, COOLING, LIGHTING, REFRIGERATION SYSTEMS, AND ELECTRIC POWER SYSTEMS INCLUDING GENERATION, TRANSMISSION, AND DISTRIBUTION FACILITIES, IN CLASS 37 (U.S. CLS. 100, 103 AND 106).

FIRST USE 11-1-2006; IN COMMERCE 11-1-2006.

THE MARK CONSISTS OF STANDARD CHARACTERS WITHOUT CLAIM TO ANY PARTICULAR FONT, STYLE, SIZE, OR COLOR.

OWNER OF U.S. REG. NOS. 1,964,556, 2,596,900, AND OTHERS.

NO CLAIM IS MADE TO THE EXCLUSIVE RIGHT TO USE "FOR YOUR BUSINESS", APART FROM THE MARK AS SHOWN.

SN 77-023,499, FILED 10-18-2006.

BARBARA GAYNOR, EXAMINING ATTORNEY

Int. Cl.: 18

Prior U.S. Cls.: 1, 2, 3, 22, and 41

Reg. No. 3,481,208

United States Patent and Trademark Office

Registered Aug. 5, 2008

**TRADEMARK
PRINCIPAL REGISTER**

EPOCH

O.C. TANNER COMPANY (UTAH CORPORATION)
1930 SOUTH STATE STREET
SALT LAKE CITY, UT 84115

THE MARK CONSISTS OF STANDARD CHARACTERS WITHOUT CLAIM TO ANY PARTICULAR FONT, STYLE, SIZE, OR COLOR.

FOR: GOODS MADE FROM LEATHER AND IMITATION LEATHER, NAMELY, LUGGAGE, IN CLASS 18 (U.S. CLS. 1, 2, 3, 22 AND 41).

SN 77-024,810, FILED 10-19-2006.

FIRST USE 5-27-2008; IN COMMERCE 5-27-2008.

FLORENTINA BLANDU, EXAMINING ATTORNEY

Int. Cl.: 20

Prior U.S. Cls.: 2, 13, 22, 25, 32, and 50

Reg. No. 3,481,209

United States Patent and Trademark Office

Registered Aug. 5, 2008

**TRADEMARK
PRINCIPAL REGISTER**

EPOCH

O.C.TANNER COMPANY (UTAH CORPORATION)
1930 SOUTH STATE STREET
SALT LAKE CITY, UT 84115

THE MARK CONSISTS OF STANDARD CHARACTERS WITHOUT CLAIM TO ANY PARTICULAR FONT, STYLE, SIZE, OR COLOR.

FOR: NON-METAL GOODS MADE FROM LUCITE OR WOOD, NAMELY, TROPHIES AND PLAQUES, IN CLASS 20 (U.S. CLS. 2, 13, 22, 25, 32 AND 50).

SN 77-024,816, FILED 10-19-2006.

FIRST USE 5-28-2008; IN COMMERCE 5-28-2008.

FLORENTINA BLANDU, EXAMINING ATTORNEY

Int. Cls.: 1 and 3

Prior U.S. Cls.: 1, 4, 5, 6, 10, 26, 46, 50, 51, and 52

United States Patent and Trademark Office

Reg. No. 3,481,210

Registered Aug. 5, 2008

**TRADEMARK
PRINCIPAL REGISTER**

CLEAN EARTH

THE HARTZ MOUNTAIN CORPORATION (NEW
JERSEY CORPORATION)
400 PLAZA DRIVE
SECAUCUS, NJ 07094

FOR: CHEMICAL SPRAYS USED TO AID IN
HOUSEBREAKING DOGS, IN CLASS 1 (U.S. CLS. 1,
5, 6, 10, 26 AND 46).

FIRST USE 1-1-2007; IN COMMERCE 1-1-2007.

FOR: ALL PURPOSE SHAMPOO, BODY SPRAY,
DEODORIZING SPRAY; SCENTED ROOM SPRAY,
IN CLASS 3 (U.S. CLS. 1, 4, 6, 50, 51 AND 52).

FIRST USE 1-1-2007; IN COMMERCE 1-1-2007.

THE MARK CONSISTS OF STANDARD CHAR-
ACTERS WITHOUT CLAIM TO ANY PARTICULAR
FONT, STYLE, SIZE, OR COLOR.

SN 77-025,363, FILED 10-19-2006.

JESSICA FATHY, EXAMINING ATTORNEY

Int. Cls.: 1 and 5

Prior U.S. Cls.: 1, 5, 6, 10, 18, 26, 44, 46, 51, and 52

United States Patent and Trademark Office

Reg. No. 3,481,211

Registered Aug. 5, 2008

**TRADEMARK
PRINCIPAL REGISTER**

MAGPLEX

LUMINEX CORPORATION (DELAWARE CORPORATION)
12212 TECHNOLOGY BOULEVARD
AUSTIN, TX 78727

FOR: DIAGNOSTIC REAGENTS AND MICROSPHERES FOR SCIENTIFIC OR RESEARCH USE FOR CONDUCTING MOLECULAR ANALYSIS FOR HEALTHCARE, ENVIRONMENTAL, AGRICULTURAL, DIAGNOSTIC, AND OTHER APPLICATIONS, IN CLASS 1 (U.S. CLS. 1, 5, 6, 10, 26 AND 46).

FIRST USE 2-0-2007; IN COMMERCE 2-0-2007.

FOR: DIAGNOSTIC REAGENTS AND MICROSPHERES FOR CLINICAL OR MEDICAL USE FOR

CONDUCTING MOLECULAR ANALYSIS FOR HEALTHCARE, ENVIRONMENTAL, AGRICULTURAL, DIAGNOSTIC, AND OTHER APPLICATIONS, IN CLASS 5 (U.S. CLS. 6, 18, 44, 46, 51 AND 52).

FIRST USE 2-0-2007; IN COMMERCE 2-0-2007.

THE MARK CONSISTS OF STANDARD CHARACTERS WITHOUT CLAIM TO ANY PARTICULAR FONT, STYLE, SIZE, OR COLOR.

SN 77-026,132, FILED 10-20-2006.

MICHAEL SOUDERS, EXAMINING ATTORNEY

Int. Cls.: 1 and 5

Prior U.S. Cls.: 1, 5, 6, 10, 18, 26, 44, 46, 51, and 52

United States Patent and Trademark Office

Reg. No. 3,481,212

Registered Aug. 5, 2008

**TRADEMARK
PRINCIPAL REGISTER**

MICROPLEX

LUMINEX CORPORATION (DELAWARE CORPORATION)
12212 TECHNOLOGY BOULEVARD
AUSTIN, TX 78727

FOR: DIAGNOSTIC REAGENTS AND MICROSPHERES FOR SCIENTIFIC OR RESEARCH USE FOR CONDUCTING MOLECULAR ANALYSIS FOR HEALTHCARE, ENVIRONMENTAL, AGRICULTURAL, DIAGNOSTIC, AND OTHER APPLICATIONS, IN CLASS 1 (U.S. CLS. 1, 5, 6, 10, 26 AND 46).

FIRST USE 5-2-2008; IN COMMERCE 5-2-2008.

FOR: DIAGNOSTIC REAGENTS AND MICROSPHERES FOR CLINICAL OR MEDICAL USE FOR

CONDUCTING MOLECULAR ANALYSIS FOR HEALTHCARE, ENVIRONMENTAL, AGRICULTURAL, DIAGNOSTIC, AND OTHER APPLICATIONS, IN CLASS 5 (U.S. CLS. 6, 18, 44, 46, 51 AND 52).

FIRST USE 5-2-2008; IN COMMERCE 5-2-2008.

THE MARK CONSISTS OF STANDARD CHARACTERS WITHOUT CLAIM TO ANY PARTICULAR FONT, STYLE, SIZE, OR COLOR.

SN 77-026,207, FILED 10-20-2006.

MICHAEL SOUDERS, EXAMINING ATTORNEY

Int. Cl.: 37

Prior U.S. Cls.: 100, 103, and 106

United States Patent and Trademark Office

Reg. No. 3,481,213

Registered Aug. 5, 2008

**SERVICE MARK
PRINCIPAL REGISTER**

DON'T DRIVE DIRTY!

S&D CARWASH MANAGEMENT, LLC (DELA-
WARE LTD LIAB CO)
6506 FAIR OAKS AVENUE
CARMICHAEL, CA 95608

THE MARK CONSISTS OF STANDARD CHAR-
ACTERS WITHOUT CLAIM TO ANY PARTICULAR
FONT, STYLE, SIZE, OR COLOR.

FOR: AUTOMOBILE WASHING; CAR CLEAN-
ING; CAR WASHING, IN CLASS 37 (U.S. CLS. 100,
103 AND 106).

SN 77-026,557, FILED 10-21-2006.

FIRST USE 7-11-2005; IN COMMERCE 7-11-2005.

MICHAEL SOUDERS, EXAMINING ATTORNEY

Int. Cl.: 28

Prior U.S. Cls.: 22, 23, 38, and 50

United States Patent and Trademark Office

Reg. No. 3,481,214

Registered Aug. 5, 2008

**TRADEMARK
PRINCIPAL REGISTER**

SPYDERWEB

ALL SEASONS ARCHERY, INC. (MICHIGAN
CORPORATION)
8080 CARMODY ROAD
WATERVLIET, MI 49098

FOR: ARCHERY TARGETS, ARCHERY TARGET
ACCESSORIES, NAMELY, TARGET STANDS, TAR-
GET SUPPORTS, PINS AND TARGET COVERS, FOR
COMMERCIAL ARCHERY RANGES AND ARCHE-
RY PRO-SHOPS, IN CLASS 28 (U.S. CLS. 22, 23, 38
AND 50).

FIRST USE 1-31-2007; IN COMMERCE 1-31-2007.

THE MARK CONSISTS OF STANDARD CHAR-
ACTERS WITHOUT CLAIM TO ANY PARTICULAR
FONT, STYLE, SIZE, OR COLOR.

SN 77-027,742, FILED 10-24-2006.

PAM WILLIS, EXAMINING ATTORNEY

Int. Cls.: 35 and 41

Prior U.S. Cls.: 100, 101, 102, and 107

United States Patent and Trademark Office

Reg. No. 3,481,215

Registered Aug. 5, 2008

**SERVICE MARK
PRINCIPAL REGISTER**

CAREFRONTING

PRISM, INCORPORATED (FLORIDA CORPORATION)
SUITE 100
670 WEST PALM VALLEY DRIVE
OVIEDO, FL 32765

FOR: BUSINESS LEADERSHIP CONSULTATION IN THE FIELD OF PROFESSIONAL LEADERSHIP FOR BUSINESSES AND EMPLOYEES, EXECUTIVE AND MANAGERIAL PERFORMANCE, HUMAN RESOURCES FOR BUSINESS PROFESSIONALS, AND BUSINESS SUCCESSION PLANNING AND JOB TRANSITIONS; BUSINESS EVALUATION OF HUMAN CAPITAL AS RELATED TO PROFESSIONAL LEADERSHIP FOR BUSINESSES AND EMPLOYEES, EXECUTIVE AND MANAGERIAL PERFORMANCE, HUMAN RESOURCES FOR BUSINESS PROFESSIONALS, BUSINESS SUCCESSION PLANNING AND JOB TRANSITIONS, IN CLASS 35 (U.S. CLS. 100, 101 AND 102).

FIRST USE 12-11-2007; IN COMMERCE 12-11-2007.

FOR: EDUCATIONAL SERVICES, NAMELY, CONDUCTING SEMINARS AND PROFESSIONAL

PERSONAL COACHING IN THE FIELD OF PROFESSIONAL LEADERSHIP FOR BUSINESSES AND EMPLOYEES, EXECUTIVE AND MANAGERIAL PERFORMANCE, HUMAN RESOURCES FOR BUSINESS PROFESSIONALS, BUSINESS SUCCESSION PLANNING AND JOB TRANSITIONS; AND ONLINE TRAINING AND EDUCATIONAL EVALUATIONS IN THE FIELD OF PROFESSIONAL LEADERSHIP FOR BUSINESSES AND EMPLOYEES, EXECUTIVE AND MANAGERIAL PERFORMANCE, HUMAN RESOURCES FOR BUSINESS PROFESSIONALS, BUSINESS SUCCESSION PLANNING AND JOB TRANSITIONS, IN CLASS 41 (U.S. CLS. 100, 101 AND 107).

FIRST USE 11-27-2007; IN COMMERCE 11-27-2007.

THE MARK CONSISTS OF STANDARD CHARACTERS WITHOUT CLAIM TO ANY PARTICULAR FONT, STYLE, SIZE, OR COLOR.

SN 77-028,300, FILED 10-24-2006.

INGRID C. EULIN, EXAMINING ATTORNEY

Int. Cls.: 35 and 41

Prior U.S. Cls.: 100, 101, 102, and 107

United States Patent and Trademark Office

Reg. No. 3,481,216

Registered Aug. 5, 2008

**SERVICE MARK
PRINCIPAL REGISTER**

RELATIONAL INTELLIGENCE

PRISM, INCORPORATED (FLORIDA CORPORATION)
SUITE 100
670 WEST PALM VALLEY DRIVE
OVIEDO, FL 32765

FOR: BUSINESS LEADERSHIP CONSULTATION IN THE FIELD OF PROFESSIONAL LEADERSHIP FOR BUSINESSES AND EMPLOYEES, EXECUTIVE AND MANAGERIAL PERFORMANCE, HUMAN RESOURCES FOR BUSINESS PROFESSIONALS, AND BUSINESS SUCCESSION PLANNING AND JOB TRANSITIONS; BUSINESS EVALUATION OF HUMAN CAPITAL AS RELATED TO PROFESSIONAL LEADERSHIP FOR BUSINESSES AND EMPLOYEES, EXECUTIVE AND MANAGERIAL PERFORMANCE, HUMAN RESOURCES FOR BUSINESS PROFESSIONALS, BUSINESS SUCCESSION PLANNING AND JOB TRANSITIONS, IN CLASS 35 (U.S. CLS. 100, 101 AND 102).

FIRST USE 12-11-2007; IN COMMERCE 12-11-2007.

FOR: EDUCATIONAL SERVICES, NAMELY, CONDUCTING SEMINARS AND PROFESSIONAL

PERSONAL COACHING IN THE FIELD OF PROFESSIONAL LEADERSHIP FOR BUSINESSES AND EMPLOYEES, EXECUTIVE AND MANAGERIAL PERFORMANCE, HUMAN RESOURCES FOR BUSINESS PROFESSIONALS, BUSINESS SUCCESSION PLANNING AND JOB TRANSITIONS; AND ONLINE TRAINING AND EDUCATIONAL EVALUATIONS IN THE FIELD OF PROFESSIONAL LEADERSHIP FOR BUSINESSES AND EMPLOYEES, EXECUTIVE AND MANAGERIAL PERFORMANCE, HUMAN RESOURCES FOR BUSINESS PROFESSIONALS, BUSINESS SUCCESSION PLANNING AND JOB TRANSITIONS, IN CLASS 41 (U.S. CLS. 100, 101 AND 107).

FIRST USE 11-27-2007; IN COMMERCE 11-27-2007.

THE MARK CONSISTS OF STANDARD CHARACTERS WITHOUT CLAIM TO ANY PARTICULAR FONT, STYLE, SIZE, OR COLOR.

SN 77-028,325, FILED 10-24-2006.

INGRID C. EULIN, EXAMINING ATTORNEY

Int. Cl.: 43

Prior U.S. Cls.: 100 and 101

United States Patent and Trademark Office

Reg. No. 3,481,217

Registered Aug. 5, 2008

**SERVICE MARK
PRINCIPAL REGISTER**

ROAST 2 COAST

DS WATERS OF AMERICA, INC. (DELAWARE
CORPORATION)
5660 NEW NORTHSIDE DRIVE
SUITE 500
ATLANTA, GA 30328

THE MARK CONSISTS OF STANDARD CHAR-
ACTERS WITHOUT CLAIM TO ANY PARTICULAR
FONT, STYLE, SIZE, OR COLOR.

FOR: COFFEE SUPPLY SERVICES FOR OFFICES,
IN CLASS 43 (U.S. CLS. 100 AND 101).

SN 77-028,792, FILED 10-25-2006.

FIRST USE 12-1-2007; IN COMMERCE 12-1-2007.

HANNO RITTNER, EXAMINING ATTORNEY

Int. Cl.: 30

Prior U.S. Cl.: 46

United States Patent and Trademark Office

Reg. No. 3,481,218

Registered Aug. 5, 2008

**TRADEMARK
PRINCIPAL REGISTER**

AERIE

RETAIL ROYALTY COMPANY (NEVADA COR-
PORATION)
101 CONVENTION CENTER DRIVE
LAS VEGAS, NV 89109

THE MARK CONSISTS OF STANDARD CHAR-
ACTERS WITHOUT CLAIM TO ANY PARTICULAR
FONT, STYLE, SIZE, OR COLOR.

FOR: CANDY, IN CLASS 30 (U.S. CL. 46).

SN 77-029,087, FILED 10-25-2006.

FIRST USE 10-0-2006; IN COMMERCE 10-0-2006.

JULIE GUTTADAURO, EXAMINING ATTORNEY

Int. Cl.: 36

Prior U.S. Cls.: 100, 101, and 102

United States Patent and Trademark Office

Reg. No. 3,481,219

Registered Aug. 5, 2008

**SERVICE MARK
PRINCIPAL REGISTER**

CMT ASSET MANAGEMENT

CMT ASSET MANAGEMENT LIMITED (CAY-
MAN ISLANDS EXEMPTED COMPANY)
SUITE 2630
500 WEST MONROE ST.
CHICAGO, IL 60661

FOR: FINANCIAL MANAGEMENT SERVICES,
NAMELY, HEDGE FUND MANAGEMENT SERVI-
CES; INVESTMENT MANAGEMENT SERVICES;
AND OFF SHORE HEDGE FUND MANAGEMENT
SERVICES, IN CLASS 36 (U.S. CLS. 100, 101 AND 102).

FIRST USE 12-0-2005; IN COMMERCE 12-0-2005.

THE MARK CONSISTS OF STANDARD CHAR-
ACTERS WITHOUT CLAIM TO ANY PARTICULAR
FONT, STYLE, SIZE, OR COLOR.

NO CLAIM IS MADE TO THE EXCLUSIVE
RIGHT TO USE "ASSET MANAGEMENT", APART
FROM THE MARK AS SHOWN.

SN 77-029,403, FILED 10-25-2006.

CAROLYN CATALDO, EXAMINING ATTORNEY

Int. Cl.: 41

Prior U.S. Cls.: 100, 101, and 107

United States Patent and Trademark Office

Reg. No. 3,481,220

Registered Aug. 5, 2008

SERVICE MARK
PRINCIPAL REGISTER



ELLIOTT, SHARON NORRIS (UNITED STATES
INDIVIDUAL)
9514 DOROTHY AVE.
SOUTH GATE, CA 90280

FOR: TRAINING SERVICES IN THE FIELD OF
WRITING; WRITTEN TEXT EDITING; EDUCA-
TIONAL SERVICES, NAMELY, CONDUCTING
SEMINARS IN THE FIELD OF WRITING AND
DISTRIBUTION OF COURSE MATERIAL IN CON-
NECTION THEREWITH, IN CLASS 41 (U.S. CLS. 100,
101 AND 107).

FIRST USE 1-1-2007; IN COMMERCE 1-1-2007.

THE MARK CONSISTS OF A FEATHER PEN
ATTACHED TO THE STYLIZED TEXT OF THE
WORDING "AUTHORIZEME".

SN 77-029,845, FILED 10-26-2006.

SHAUNIA CARLYLE, EXAMINING ATTORNEY

Int. Cl.: 36

Prior U.S. Cls.: 100, 101, and 102

United States Patent and Trademark Office

Reg. No. 3,481,221

Registered Aug. 5, 2008

**SERVICE MARK
PRINCIPAL REGISTER**



ADP OF NORTH AMERICA, INC. (DELAWARE CORPORATION)
2603 CAMINO RAMON, SUITE 200
SAN RAMON, CA 94583

FOR: EMPLOYEE BENEFITS SERVICES FOR OTHERS, NAMELY, ADMINISTRATION OF EMPLOYEE BENEFIT PLANS, EMPLOYEE PENSION AND INVESTMENT PLANS, AND WORKERS UNEMPLOYMENT COMPENSATION CLAIMS AND PLANS, IN CLASS 36 (U.S. CLS. 100, 101 AND 102).

FIRST USE 7-31-2005; IN COMMERCE 7-31-2005.

OWNER OF U.S. REG. NOS. 1,128,022, 2,338,000, AND OTHERS.

SN 77-030,320, FILED 10-26-2006.

REBECCA EISINGER, EXAMINING ATTORNEY

Int. Cl.: 44

Prior U.S. Cls.: 100 and 101

United States Patent and Trademark Office

Reg. No. 3,481,222

Registered Aug. 5, 2008

**SERVICE MARK
PRINCIPAL REGISTER**



CURA HOME CARE SERVICES, LLC (ARIZONA
LTD LIAB CO)
PO BOX 54727
PHOENIX, AZ 850784727

THE MARK CONSISTS OF FIGURES OUTLINED
IN BLACK; THE FIGURES HAVE A MAINLY BLUE
INTERIOR WITH SOME WHITE.

FOR: HOME HEALTH CARE SERVICES, IN
CLASS 44 (U.S. CLS. 100 AND 101).

SN 77-031,064, FILED 10-27-2006.

FIRST USE 11-0-2006; IN COMMERCE 11-0-2006.

THE COLOR(S) BLUE, BLACK, AND WHITE IS/
ARE CLAIMED AS A FEATURE OF THE MARK.

MARY CRAWFORD, EXAMINING ATTORNEY

Int. Cl.: 35

Prior U.S. Cls.: 100, 101, and 102

United States Patent and Trademark Office

Reg. No. 3,481,223

Registered Aug. 5, 2008

**SERVICE MARK
PRINCIPAL REGISTER**



ADP OF NORTH AMERICA, INC. (DELAWARE CORPORATION)
2603 CAMINO RAMON, SUITE 200
SAN RAMON, CA 94583

FOR: EMPLOYEE LEASING SERVICES, NAME-
LY, HUMAN RESOURCES MANAGEMENT, PAY-
ROLL PREPARATION, PAYROLL TAX DEPOSIT
FILING AND REPORTING, IN CLASS 35 (U.S. CLS.
100, 101 AND 102).

FIRST USE 7-31-2005; IN COMMERCE 7-31-2005.

OWNER OF U.S. REG. NOS. 1,128,022, 2,338,000,
AND OTHERS.

SN 77-031,277, FILED 10-27-2006.

REBECCA EISINGER, EXAMINING ATTORNEY

Int. Cl.: 9

Prior U.S. Cls.: 21, 23, 26, 36, and 38

Reg. No. 3,481,224

United States Patent and Trademark Office

Registered Aug. 5, 2008

**TRADEMARK
PRINCIPAL REGISTER**

RE-Q

MITEK CORPORATION (ILLINOIS CORPORATION)
4545 E. BASELINE ROAD
PHOENIX, AZ 85042

THE MARK CONSISTS OF STANDARD CHARACTERS WITHOUT CLAIM TO ANY PARTICULAR FONT, STYLE, SIZE, OR COLOR.

FOR: INTERFACE DEVICE FOR AUDIO EQUIPMENT, NAMELY, AMPLIFIERS AND HEAD UNITS, IN CLASS 9 (U.S. CLS. 21, 23, 26, 36 AND 38).

SN 77-031,501, FILED 10-27-2006.

FIRST USE 1-0-2007; IN COMMERCE 1-0-2007.

HEATHER SAPP, EXAMINING ATTORNEY

Int. Cl.: 16

Prior U.S. Cls.: 2, 5, 22, 23, 29, 37, 38, and 50

Reg. No. 3,481,225

United States Patent and Trademark Office

Registered Aug. 5, 2008

**TRADEMARK
PRINCIPAL REGISTER**

Luminosa

IBASIS, INC. (DELAWARE CORPORATION)
20 SECOND AVENUE
BURLINGTON, MA 01803

THE MARK CONSISTS OF STANDARD CHARACTERS WITHOUT CLAIM TO ANY PARTICULAR FONT, STYLE, SIZE, OR COLOR.

FOR: PRE-PAID TELEPHONE CALLING CARDS, NOT MAGNETICALLY ENCODED; TELEPHONE CALLING CARDS, NOT MAGNETICALLY ENCODED, IN CLASS 16 (U.S. CLS. 2, 5, 22, 23, 29, 37, 38 AND 50).

THE FOREIGN WORDING IN THE MARK TRANSLATES INTO ENGLISH AS ILLUMINATED.

SN 77-031,551, FILED 10-27-2006.

FIRST USE 5-30-2008; IN COMMERCE 5-30-2008.

EVELYN BRADLEY, EXAMINING ATTORNEY

Int. Cls.: 36 and 41

Prior U.S. Cls.: 100, 101, 102, and 107

United States Patent and Trademark Office

Reg. No. 3,481,226

Registered Aug. 5, 2008

**SERVICE MARK
PRINCIPAL REGISTER**

THE ROLEX INSTITUTE

ROLEX WATCH USA, INC. (NEW YORK CORPORATION)
665 FIFTH AVENUE
NEW YORK, NY 10022

FOR: FINANCIAL SPONSORSHIP AND PATRONAGE IN THE NATURE OF PROVIDING GRANTS AND FINANCIAL MANAGEMENT OF ARTISTIC, CULTURAL, EDUCATIONAL, PHILANTHROPIC AND SCIENTIFIC PROGRAMS AND ACTIVITIES, IN CLASS 36 (U.S. CLS. 100, 101 AND 102).

FIRST USE 5-31-2005; IN COMMERCE 5-31-2005.

FOR: EDUCATION AND TRAINING SERVICES, NAMELY, CONDUCTING PROGRAMS AND ACTIVITIES IN THE NATURE OF CLASSES, SEMINARS AND WORKSHOPS IN THE FIELDS OF

ARTS, CULTURE, EDUCATION, PHILANTHROPY AND SCIENCE, IN CLASS 41 (U.S. CLS. 100, 101 AND 107).

FIRST USE 5-31-2005; IN COMMERCE 5-31-2005.

THE MARK CONSISTS OF STANDARD CHARACTERS WITHOUT CLAIM TO ANY PARTICULAR FONT, STYLE, SIZE, OR COLOR.

NO CLAIM IS MADE TO THE EXCLUSIVE RIGHT TO USE "INSTITUTE", APART FROM THE MARK AS SHOWN.

SN 77-032,562, FILED 10-30-2006.

SARA THOMAS, EXAMINING ATTORNEY

Int. Cl.: 25

Prior U.S. Cls.: 22 and 39

United States Patent and Trademark Office

Reg. No. 3,481,227

Registered Aug. 5, 2008

**TRADEMARK
PRINCIPAL REGISTER**

BELLBOTTOM BLUES

SHAFFER, MARIE KENNEDY (UNITED STATES
INDIVIDUAL)
127 EAST 9TH, SUITE 501
LOS ANGELES, CA 90015 AND
SHAFFER, JAMES (UNITED STATES INDIVIDUAL)
127 EAST 9TH STREET, SUITE 501
LOS ANGELES, CA 90015

FOR: BLOUSES; BOTTOMS; COATS; DRESSES;
JACKETS; PANTS; SHIRTS; SHORT-SLEEVED OR
LONG-SLEEVED T-SHIRTS; SHORTS; SKIRTS; T-
SHIRTS; TOPS; VESTS, IN CLASS 25 (U.S. CLS. 22
AND 39).

FIRST USE 6-19-2007; IN COMMERCE 6-19-2007.

THE MARK CONSISTS OF STANDARD CHAR-
ACTERS WITHOUT CLAIM TO ANY PARTICULAR
FONT, STYLE, SIZE, OR COLOR.

NO CLAIM IS MADE TO THE EXCLUSIVE
RIGHT TO USE "BELLBOTTOM", APART FROM
THE MARK AS SHOWN.

SN 77-033,187, FILED 10-31-2006.

KEVON CHISOLM, EXAMINING ATTORNEY

Int. Cl.: 5

Prior U.S. Cls.: 6, 18, 44, 46, 51, and 52

Reg. No. 3,481,228

United States Patent and Trademark Office

Registered Aug. 5, 2008

**TRADEMARK
PRINCIPAL REGISTER**

MONTANA

ROTAM LTD. (HONG KONG CORPORATION)
7/F., CHEUNG TAT CENTRE
18 CHEUNG LEE STREET
CHAI WAN, HONG KONG

THE MARK CONSISTS OF STANDARD CHAR-
ACTERS WITHOUT CLAIM TO ANY PARTICULAR
FONT, STYLE, SIZE, OR COLOR.

FOR: INSECTICIDES, IN CLASS 5 (U.S. CLS. 6, 18,
44, 46, 51 AND 52).

SN 77-033,223, FILED 10-31-2006.

FIRST USE 7-0-2007; IN COMMERCE 7-0-2007.

JOHN E. MICHOS, EXAMINING ATTORNEY

Int. Cl.: 5

Prior U.S. Cls.: 6, 18, 44, 46, 51, and 52

Reg. No. 3,481,229

United States Patent and Trademark Office

Registered Aug. 5, 2008

**TRADEMARK
PRINCIPAL REGISTER**

VOLTA

ROTAM LTD. (HONG KONG CORPORATION)
7/F., CHEUNG TAT CENTRE
18 CHEUNG LEE STREET
CHAI WAN, HONG KONG

THE MARK CONSISTS OF STANDARD CHAR-
ACTERS WITHOUT CLAIM TO ANY PARTICULAR
FONT, STYLE, SIZE, OR COLOR.

FOR: AGRICULTURAL HERBICIDES, IN CLASS
5 (U.S. CLS. 6, 18, 44, 46, 51 AND 52).

SN 77-033,421, FILED 10-31-2006.

FIRST USE 12-0-2007; IN COMMERCE 12-0-2007.

JOHN E. MICHOS, EXAMINING ATTORNEY

Int. Cl.: 10

Prior U.S. Cls.: 26, 39, and 44

United States Patent and Trademark Office

Reg. No. 3,481,230

Registered Aug. 5, 2008

**TRADEMARK
PRINCIPAL REGISTER**

BEAM REACH

ALLUX MEDICAL, INC. (DELAWARE CORPORATION)
1430 O'BRIEN DRIVE, SUITE F
MENLO PARK, CA 94025

THE MARK CONSISTS OF STANDARD CHARACTERS WITHOUT CLAIM TO ANY PARTICULAR FONT, STYLE, SIZE, OR COLOR.

FOR: PHOTOTHERAPEUTIC APPARATUS FOR MEDICAL PURPOSES, IN CLASS 10 (U.S. CLS. 26, 39 AND 44).

SN 77-033,527, FILED 10-31-2006.

FIRST USE 3-0-2007; IN COMMERCE 3-0-2007.

SETH A. RAPPAPORT, EXAMINING ATTORNEY

Int. Cl.: 44

Prior U.S. Cls.: 100 and 101

United States Patent and Trademark Office

Reg. No. 3,481,231

Registered Aug. 5, 2008

SERVICE MARK
PRINCIPAL REGISTER



CENTENE CORPORATION (DELAWARE CORPORATION)
7711 CARONDELET, SUITE 800
CLAYTON, MO 63105

NO CLAIM IS MADE TO THE EXCLUSIVE
RIGHT TO USE "SUPERIOR HEALTH PLAN",
APART FROM THE MARK AS SHOWN.

FOR: MANAGED HEALTH CARE SERVICES, IN
CLASS 44 (U.S. CLS. 100 AND 101).

SN 77-035,387, FILED 11-2-2006.

FIRST USE 1-0-2007; IN COMMERCE 1-0-2007.

DAVID YONTEF, EXAMINING ATTORNEY

Int. Cl.: 19

Prior U.S. Cls.: 1, 12, 33, and 50

United States Patent and Trademark Office

Reg. No. 3,481,232

Registered Aug. 5, 2008

**TRADEMARK
PRINCIPAL REGISTER**

HIDDEN WATER POOLS

HIDDEN WATER POOLS, INC. (CALIFORNIA
CORPORATION)
642 HOSKA DRIVE
DEL MAR, CA 92014

FOR: NON-METAL IN-GROUND SWIMMING
POOLS CONTAINING METAL REINFORCE-
MENTS, IN CLASS 19 (U.S. CLS. 1, 12, 33 AND 50).

FIRST USE 1-1-2008; IN COMMERCE 2-1-2008.

THE MARK CONSISTS OF STANDARD CHAR-
ACTERS WITHOUT CLAIM TO ANY PARTICULAR
FONT, STYLE, SIZE, OR COLOR.

NO CLAIM IS MADE TO THE EXCLUSIVE
RIGHT TO USE "WATER POOLS", APART FROM
THE MARK AS SHOWN.

SN 77-035,534, FILED 11-2-2006.

DAWN FELDMAN, EXAMINING ATTORNEY

Int. Cl.: 9

Prior U.S. Cls.: 21, 23, 26, 36, and 38

United States Patent and Trademark Office

Reg. No. 3,481,233

Registered Aug. 5, 2008

**TRADEMARK
PRINCIPAL REGISTER**

XDOCK

CREATIVE TECHNOLOGY LTD. (SINGAPORE CORPORATION)
CREATIVE RESOURCE
31 INTERNATIONAL BUSINESS PARK
SINGAPORE, SINGAPORE 609921

FOR: APPARATUS FOR TRANSMISSION OR REPRODUCTION OF SOUND; COMPUTER HARDWARE; COMPUTER SOFTWARE TO CONTROL AND IMPROVE COMPUTER AND AUDIO EQUIPMENT SOUND QUALITY AND COMPUTER SOFTWARE FOR THE STORAGE, REPRODUCTION, TRANSMISSION AND EDITING OF SOUND IN COMPUTER AUDIO COMPONENTS AND MULTIMEDIA APPLICATIONS; COMPUTER PERIPHER-

ALS; DOWNLOADABLE ELECTRONIC MANUALS DISTRIBUTED THEREWITH; AUDIO VISUAL CONTROL SYSTEMS; AUDIO SIGNAL PROCESSOR, IN CLASS 9 (U.S. CLS. 21, 23, 26, 36 AND 38).

FIRST USE 1-31-2007; IN COMMERCE 1-31-2007.

THE MARK CONSISTS OF STANDARD CHARACTERS WITHOUT CLAIM TO ANY PARTICULAR FONT, STYLE, SIZE, OR COLOR.

SN 77-035,810, FILED 11-2-2006.

ANDREA SAUNDERS, EXAMINING ATTORNEY

Int. Cl.: 9

Prior U.S. Cls.: 21, 23, 26, 36, and 38

Reg. No. 3,481,234

United States Patent and Trademark Office

Registered Aug. 5, 2008

**TRADEMARK
PRINCIPAL REGISTER**

EZREADER

ACCU-SORT SYSTEMS, INC. (PENNSYLVANIA
CORPORATION)
2800 CRYSTAL DRIVE
HATFIELD, PA 19449

FOR: RADIO FREQUENCY IDENTIFICATION
(RFID) CREDENTIALS, NAMELY, CARDS AND
TAGS, AND READERS FOR RADIO FREQUENCY
IDENTIFICATION CREDENTIALS, IN CLASS 9 (U.S.
CLS. 21, 23, 26, 36 AND 38).

FIRST USE 3-14-2007; IN COMMERCE 3-14-2007.

THE MARK CONSISTS OF STANDARD CHAR-
ACTERS WITHOUT CLAIM TO ANY PARTICULAR
FONT, STYLE, SIZE, OR COLOR.

SN 77-036,183, FILED 11-3-2006.

KAPIL BHANOT, EXAMINING ATTORNEY

Int. Cl.: 9

Prior U.S. Cls.: 21, 23, 26, 36, and 38

United States Patent and Trademark Office

Reg. No. 3,481,235

Registered Aug. 5, 2008

**TRADEMARK
PRINCIPAL REGISTER**

EZTUNE

ACCU-SORT SYSTEMS, INC. (PENNSYLVANIA
CORPORATION)
2800 CRYSTAL DRIVE
HATFIELD, PA 19449

THE MARK CONSISTS OF STANDARD CHAR-
ACTERS WITHOUT CLAIM TO ANY PARTICULAR
FONT, STYLE, SIZE, OR COLOR.

FOR: ANTENNAE FOR AUTOMATIC TUNING
ON A RADIO FREQUENCY IDENTIFICATION DE-
VICE, IN CLASS 9 (U.S. CLS. 21, 23, 26, 36 AND 38).

SN 77-036,193, FILED 11-3-2006.

FIRST USE 3-14-2007; IN COMMERCE 3-14-2007.

KAPIL BHANOT, EXAMINING ATTORNEY

Int. Cl.: 12

Prior U.S. Cls.: 19, 21, 23, 31, 35, and 44

Reg. No. 3,481,236

United States Patent and Trademark Office

Registered Aug. 5, 2008

**TRADEMARK
PRINCIPAL REGISTER**

Da-Vee-Hull

DAVIS, WAYNE N. (UNITED STATES INDIVIDUAL)
404 HEATHER LANE
HUDDLESTON, VA 24104

THE MARK CONSISTS OF STANDARD CHARACTERS WITHOUT CLAIM TO ANY PARTICULAR FONT, STYLE, SIZE, OR COLOR.

FOR: BOAT HULLS, IN CLASS 12 (U.S. CLS. 19, 21, 23, 31, 35 AND 44).

SN 77-036,402, FILED 11-3-2006.

FIRST USE 8-29-2007; IN COMMERCE 2-15-2008.

H. M. FISHER, EXAMINING ATTORNEY

Int. Cl.: 25

Prior U.S. Cls.: 22 and 39

United States Patent and Trademark Office

Reg. No. 3,481,237

Registered Aug. 5, 2008

**TRADEMARK
PRINCIPAL REGISTER**



MAJOR LEAGUE LACROSSE LLC (VIRGINIA
LTD LIAB CO)
BRIGHTON LANDING EAST
20 GUEST STREET, SUITE 125
BRIGHTON, MA 02135

FOR: CLOTHING, NAMELY, SHIRTS, T-SHIRTS,
TANK TOPS, SWEAT SHIRTS, SWEAT SHORTS,
SWEAT PANTS, PULLOVERS, JACKETS, JERSEYS,
SHORTS, HEADWEAR, CAPS AND HATS, IN CLASS
25 (U.S. CLS. 22 AND 39).

FIRST USE 5-12-2007; IN COMMERCE 5-12-2007.

OWNER OF U.S. REG. NOS. 2,764,957 AND
2,764,958.

NO CLAIM IS MADE TO THE EXCLUSIVE
RIGHT TO USE "WASHINGTON", APART FROM
THE MARK AS SHOWN.

SN 77-037,801, FILED 11-6-2006.

JOHN WILKE, EXAMINING ATTORNEY

Int. Cl.: 28

Prior U.S. Cls.: 22, 23, 38, and 50

United States Patent and Trademark Office

Reg. No. 3,481,238

Registered Aug. 5, 2008

**TRADEMARK
PRINCIPAL REGISTER**

CREATE 'N PLAY

ELMER'S PRODUCTS, INC. (DELAWARE COR-
PORATION)
ONE EASTON OVAL
COLUMBUS, OH 43219

THE MARK CONSISTS OF STANDARD CHAR-
ACTERS WITHOUT CLAIM TO ANY PARTICULAR
FONT, STYLE, SIZE, OR COLOR.

FOR: HOBBY CRAFT SETS FOR CREATING
PAPER CRAFTS, IN CLASS 28 (U.S. CLS. 22, 23, 38
AND 50).

SN 77-037,842, FILED 11-6-2006.

FIRST USE 12-1-2006; IN COMMERCE 12-1-2006.

JEFF DEFORD, EXAMINING ATTORNEY

Int. Cl.: 28

Prior U.S. Cls.: 22, 23, 38, and 50

Reg. No. 3,481,239

United States Patent and Trademark Office

Registered Aug. 5, 2008

**TRADEMARK
PRINCIPAL REGISTER**

DELTA

BOEING MANAGEMENT COMPANY (DELA-
WARE CORPORATION)

M/S 110-SB36

2201 SEAL BEACH BOULEVARD

SEAL BEACH, CA 90740

FOR: TOY ROCKETS; TOY ROCKETS MADE OF
BUILDING BLOCKS; TOY MODEL ROCKETS IN
KIT FORM, IN CLASS 28 (U.S. CLS. 22, 23, 38 AND
50).

FIRST USE 12-20-2002; IN COMMERCE 9-30-2003.

THE MARK CONSISTS OF STANDARD CHAR-
ACTERS WITHOUT CLAIM TO ANY PARTICULAR
FONT, STYLE, SIZE, OR COLOR.

SN 77-037,884, FILED 11-6-2006.

SUZANNE BLANE, EXAMINING ATTORNEY

Int. Cl.: 14

Prior U.S. Cls.: 2, 27, 28, and 50

United States Patent and Trademark Office

Reg. No. 3,481,240

Registered Aug. 5, 2008

**TRADEMARK
PRINCIPAL REGISTER**

MIRADOR

BULOVA CORPORATION (NEW YORK COR-
PORATION)

ONE BULOVA AVENUE

WOODSIDE, NY 11377

FOR: WATCHES AND CLOCKS, IN CLASS 14 (U.S.
CLS. 2, 27, 28 AND 50).

FIRST USE 1-15-2007; IN COMMERCE 1-15-2007.

THE MARK CONSISTS OF STANDARD CHAR-
ACTERS WITHOUT CLAIM TO ANY PARTICULAR
FONT, STYLE, SIZE, OR COLOR.

THE SPANISH WORD "MIRADOR" TRANS-
LATES INTO ENGLISH AS "BAY WINDOW",
"LOOKOUT", AND "SPECTATOR".

SN 77-038,513, FILED 11-7-2006.

JESSICA FATHY, EXAMINING ATTORNEY

Int. Cl.: 25

Prior U.S. Cls.: 22 and 39

United States Patent and Trademark Office

Reg. No. 3,481,241

Registered Aug. 5, 2008

**TRADEMARK
PRINCIPAL REGISTER**

DOPEVILLE

DEINDE TUNDE DAWODU (UNITED STATES
INDIVIDUAL)
422 BUTTERNUT ST. NW APT # 17
WASHINGTON, DC 20012 AND
SEGUNDO NAZATI (UNITED STATES INDIVI-
DUAL)
526 U ST.
WASHINGTON, DC 20001

FOR: T-SHIRTS; HATS; JEANS; JACKETS; OUT-
ERWEAR, NAMELY, COATS, WIND-RESISTANT
JACKETS, HOODED SWEATSHIRTS, RAINCOATS;
SHORTS; UNDERWEAR; SHOES; SNEAKERS;
BOOTS; GARMENTS, NAMELY, POLO SHIRTS,
BLOUSES, SHIRTS, PANTS, SWEAT PANTS, SUITS;
SWEATSHIRTS; HOODED SWEATSHIRTS; TANK
TOPS; WOMEN'S COATS; WOMEN'S SHOES; WO-

MEN'S JEANS; WOMEN'S T-SHIRTS; WOMEN'S
TOPS; WOMEN'S OUTERWEAR, NAMELY, COATS,
WIND-RESISTANT JACKETS, HOODED SWEAT-
SHIRTS, RAINCOATS; AND WOMEN'S SHOES, IN
CLASS 25 (U.S. CLS. 22 AND 39).

FIRST USE 3-1-2003; IN COMMERCE 4-1-2003.

THE MARK CONSISTS OF STANDARD CHAR-
ACTERS WITHOUT CLAIM TO ANY PARTICULAR
FONT, STYLE, SIZE, OR COLOR.

SN 77-038,811, FILED 11-7-2006.

MICHAEL KEATING, EXAMINING ATTORNEY

Int. Cl.: 8

Prior U.S. Cls.: 23, 28, and 44

United States Patent and Trademark Office

Reg. No. 3,481,242

Registered Aug. 5, 2008

**TRADEMARK
PRINCIPAL REGISTER**



SUNEX INTERNATIONAL INC. (SOUTH CAROLINA CORPORATION)
315 HAWKINS ROAD
TRAVELERS REST, SC 296161029

FOR: HAND TOOLS, NAMELY, SOCKETS, SOCKET RATCHETS, AND EXTENSIONS; SOCKET WRENCH SETS, NAMELY, SOCKETS, SOCKET RATCHETS, AND EXTENSIONS SOLD AS A UNIT, IN CLASS 8 (U.S. CLS. 23, 28 AND 44).

FIRST USE 2-21-2008; IN COMMERCE 2-21-2008.

THE MARK CONSISTS OF THE REPRESENTATION OF THE HEAD OF A DOG WITH ITS MOUTH OPEN ENCLOSED IN A CIRCLE.

SN 77-039,210, FILED 11-8-2006.

ASMAT KHAN, EXAMINING ATTORNEY

Int. Cl.: 25

Prior U.S. Cls.: 22 and 39

United States Patent and Trademark Office

Reg. No. 3,481,243

Registered Aug. 5, 2008

**TRADEMARK
PRINCIPAL REGISTER**



NEW BALANCE ATHLETIC SHOE, INC. (MAS-
SACHUSETTS CORPORATION)
20 GUEST STREET
BOSTON, MA 02135

FOR: CLOTHING, NAMELY, T-SHIRTS, SHORTS,
PANTS, JACKETS; FOOTWEAR; HEADWEAR, IN
CLASS 25 (U.S. CLS. 22 AND 39).

FIRST USE 1-1-2007; IN COMMERCE 7-1-2007.

OWNER OF U.S. REG. NOS. 1,584,799 AND
2,832,197.

THE MARK CONSISTS OF STYLIZED "NBX".

SN 77-042,280, FILED 11-13-2006.

JASON BLAIR, EXAMINING ATTORNEY

Int. Cl.: 16

Prior U.S. Cls.: 2, 5, 22, 23, 29, 37, 38, and 50

United States Patent and Trademark Office

Reg. No. 3,481,244

Registered Aug. 5, 2008

TRADEMARK
PRINCIPAL REGISTER



ENPAPER MFG. CO., LTD. (REPUBLIC OF KOREA CORPORATION)
150 NUP-DONG, OSAN-SI
GYEONGGI-DO, REPUBLIC OF KOREA

FOR: CORRUGATED CARDBOARDS; PAPER FOR RECORDING MACHINES; ACID-RESISTANT PAPER; NAPKIN PAPER; STATIONERY STENCILS; RICE PAPER; EKG PAPER; LUMINOUS PAPER; WATERPROOF PAPER; OILPROOF PAPER; FIRE-PROOF PAPER; WHITE PAPERBOARD; DUPLICATING PAPER; CARDBOARD MADE FROM PAPER MULBERRY; CELLOPHANE PAPER; NEWSPRINT PAPER; ELECTROCARDIOGRAPH PAPER; ANPEE PAPER (WIKSTROEMIA SIKOKIANA PAPER); WET RECORDING PAPER FOR FISH DETECTOR, NAMELY, PAPER FOR RECORDING MACHINES; FILTER PAPER; PARAFFINED PAPER; OILED PAPER NOT FOR MEDICAL PURPOSES; PRINTING PAPER; HEAT TRANSFER PAPER; HANDKERCHIEFS OF PAPER; TOWELS OF PAPER; FACE TOWELS OF PAPER; CARBON PAPER; PAPER FILTERS FOR COFFEE MAKERS; BLANK PAPER TAPES AND CARDS FOR THE RECORDAL OF COMPUTER PROGRAMS; TYPEWRITING PAPER;

PAPERBOARD; FACSIMILE TRANSMISSION PAPER; POSTCARD PAPER; PACKING PAPER; MILLBOARD; WRITING AND DRAWING PAPER; XUAN PAPER FOR CHINESE PAINTING AND CALLIGRAPHY, NAMELY, ART PAPER; PAPIER MACHE; TOILET PAPER; COSMETIC REMOVING PAPER; TOILET TISSUE; PARCHMENT PAPER; STRAWBOARD, NAMELY, CARDBOARD MADE OF STRAW PULP, IN CLASS 16 (U.S. CLS. 2, 5, 22, 23, 29, 37, 38 AND 50).

FIRST USE 3-1-2008; IN COMMERCE 3-1-2008.

NO CLAIM IS MADE TO THE EXCLUSIVE RIGHT TO USE "PAPER", APART FROM THE MARK AS SHOWN.

THE FOREIGN WORDING IN THE MARK TRANSLATES INTO ENGLISH AS NEW LAKE.

SN 77-042,358, FILED 11-13-2006.

JOHN DWYER, EXAMINING ATTORNEY

Int. Cl.: 9

Prior U.S. Cls.: 21, 23, 26, 36, and 38

Reg. No. 3,481,245

United States Patent and Trademark Office

Registered Aug. 5, 2008

**TRADEMARK
PRINCIPAL REGISTER**

SWITCH/POWER

LEUPOLD & STEVENS, INC. (OREGON CORPORATION)
PO BOX 688
BEAVERTON, OR 97075

THE MARK CONSISTS OF STANDARD CHARACTERS WITHOUT CLAIM TO ANY PARTICULAR FONT, STYLE, SIZE, OR COLOR.

FOR: BINOCULARS; FEATURE OF OPTICAL LENS SCOPES, NAMELY, A MAGNIFICATION ADJUSTMENT DEVICE, IN CLASS 9 (U.S. CLS. 21, 23, 26, 36 AND 38).

SN 77-042,824, FILED 11-13-2006.

FIRST USE 1-22-2008; IN COMMERCE 1-22-2008.

TINA BROWN, EXAMINING ATTORNEY

Int. Cl.: 25

Prior U.S. Cls.: 22 and 39

United States Patent and Trademark Office

Reg. No. 3,481,246

Registered Aug. 5, 2008

**TRADEMARK
PRINCIPAL REGISTER**



THE CARTOON NETWORK, INC. (DELAWARE CORPORATION)
C/O TURNER BROADCASTING SYSTEM, INC.
ONE CNN CENTER, 13 NORTH
ATLANTA, GA 30303

FOR: CLOTHING FOR MEN, WOMEN AND CHILDREN FEATURING CHARACTERS FROM ANIMATED, ACTION ADVENTURE, COMEDY AND/OR DRAMA FEATURES, NAMELY, T-SHIRTS, IN CLASS 25 (U.S. CLS. 22 AND 39).

FIRST USE 1-18-2008; IN COMMERCE 1-18-2008.

THE MARK CONSISTS OF AN IMAGE OF A SKULL WITH STYLIZED WINGS AND THE WORDING "METALCALYPSE".

SN 77-043,203, FILED 11-14-2006.

TOBY BULLOFF, EXAMINING ATTORNEY

Int. Cl.: 9

Prior U.S. Cls.: 21, 23, 26, 36, and 38

Reg. No. 3,481,247

United States Patent and Trademark Office

Registered Aug. 5, 2008

**TRADEMARK
PRINCIPAL REGISTER**

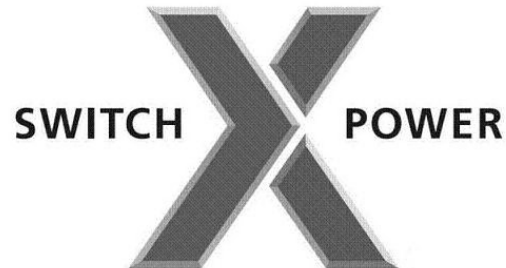

LEUPOLD & STEVENS, INC. (OREGON CORPORATION)
PO BOX 688
BEAVERTON, OR 97075

FOR: BINOCULARS; FEATURE OF OPTICAL LENS SCOPES, NAMELY, A MAGNIFICATION ADJUSTMENT DEVICE, IN CLASS 9 (U.S. CLS. 21, 23, 26, 36 AND 38).

FIRST USE 1-22-2008; IN COMMERCE 1-22-2008.

THE MARK CONSISTS OF THE WORDS "SWITCH" AND "POWER" ON EITHER SIDE OF A DESIGN UNIFYING ELEMENTS OF THE OPTICAL MAGNIFICATION SYMBOL AND THE GREATER THAN/LESS THAN SYMBOLS.

SN 77-044,332, FILED 11-15-2006.

TINA BROWN, EXAMINING ATTORNEY

Int. Cl.: 16

Prior U.S. Cls.: 2, 5, 22, 23, 29, 37, 38, and 50

United States Patent and Trademark Office

Reg. No. 3,481,248

Registered Aug. 5, 2008

**TRADEMARK
PRINCIPAL REGISTER**

Period PayCheck

PERIOD FINANCIAL CORPORATION (DELA-
WARE CORPORATION)
550 HIGHLAND STREET
FREDERICK, MD 21701

FOR: BANK CHECKS; CHECK BOOKS, IN CLASS
16 (U.S. CLS. 2, 5, 22, 23, 29, 37, 38 AND 50).

FIRST USE 7-15-2004; IN COMMERCE 7-15-2004.

THE MARK CONSISTS OF STANDARD CHAR-
ACTERS WITHOUT CLAIM TO ANY PARTICULAR
FONT, STYLE, SIZE, OR COLOR.

OWNER OF U.S. REG. NOS. 3,088,418 AND
3,125,818.

NO CLAIM IS MADE TO THE EXCLUSIVE
RIGHT TO USE "PAYCHECK", APART FROM THE
MARK AS SHOWN.

SN 77-045,117, FILED 11-15-2006.

ELISSA GARBER KON, EXAMINING ATTORNEY

Int. Cl.: 41

Prior U.S. Cls.: 100, 101, and 107

United States Patent and Trademark Office

Reg. No. 3,481,249

Registered Aug. 5, 2008

**SERVICE MARK
PRINCIPAL REGISTER**

SOLEIL RECORDS

CHARLES, PATRICK (UNITED STATES INDIVIDUAL)
20500 VENTURA BLVD. SUITE 216
WOODLAND HILLS, CA 91364

FOR: MUSIC PRODUCTION SERVICES, IN CLASS 41 (U.S. CLS. 100, 101 AND 107).

FIRST USE 5-0-2008; IN COMMERCE 5-0-2008.

THE MARK CONSISTS OF STANDARD CHARACTERS WITHOUT CLAIM TO ANY PARTICULAR FONT, STYLE, SIZE, OR COLOR.

NO CLAIM IS MADE TO THE EXCLUSIVE RIGHT TO USE "RECORDS", APART FROM THE MARK AS SHOWN.

THE ENGLISH TRANSLATION OF THE WORD "SOLEIL" IN THE MARK IS SUN.

SN 77-045,244, FILED 11-16-2006.

DARRYL SPRUILL, EXAMINING ATTORNEY

Int. Cl.: 35

Prior U.S. Cls.: 100, 101, and 102

United States Patent and Trademark Office

Reg. No. 3,481,250

Registered Aug. 5, 2008

**SERVICE MARK
PRINCIPAL REGISTER**



HOLLAND USA, INC. (MINNESOTA CORPORATION)
1725 ROE CREST DRIVE
NORTH MANKATO, MN 56003

FOR: ONLINE AND CATALOG ORDERING SERVICES FEATURING PROMOTIONAL ITEMS, ADVERTISING SPECIALTY ITEMS AND BUSINESS GIFT ITEMS, IN CLASS 35 (U.S. CLS. 100, 101 AND 102).

FIRST USE 3-31-2004; IN COMMERCE 3-31-2004.

THE MARK CONSISTS OF CIRCLE WITH HEART AND HANDS INSIDE.

SN 77-046,454, FILED 11-17-2006.

SUE LAWRENCE, EXAMINING ATTORNEY

Int. Cl.: 12

Prior U.S. Cls.: 19, 21, 23, 31, 35, and 44

United States Patent and Trademark Office

Reg. No. 3,481,251

Registered Aug. 5, 2008

**TRADEMARK
PRINCIPAL REGISTER**



LEGACY PADDLESPOITS LLC (NORTH CAROLINA LTD LIAB CO)
6012 HIGH POINT RD.
GREENSBORO, NC 27407

FOR: RECREATIONAL WATERCRAFT, NAME-
LY, KAYAKS AND KAYAK-LIKE BOATS, IN CLASS
12 (U.S. CLS. 19, 21, 23, 31, 35 AND 44).

FIRST USE 8-15-2006; IN COMMERCE 8-15-2006.

NO CLAIM IS MADE TO THE EXCLUSIVE
RIGHT TO USE "WATERCRAFT", APART FROM
THE MARK AS SHOWN.

THE COLOR(S) YELLOW AND BLACK IS/ARE
CLAIMED AS A FEATURE OF THE MARK.

THE MARK CONSISTS OF A YELLOW PETRO-
GLYPH OF A FISH ON A BLACK FIELD TO THE
LEFT OF A CURVED RECTANGULAR CARRIER,
WITH THE DEPICTION OF THE WORDS "NATIVE
WATERCRAFT" IN BLACK ON A YELLOW BACK-
GROUND TO THE RIGHT OF THE CURVED REC-
TANGULAR CARRIER.

SN 77-046,815, FILED 11-17-2006.

TRACY WHITTAKER-BROWN, EXAMINING AT-
TORNEY

Int. Cl.: 28

Prior U.S. Cls.: 22, 23, 38, and 50

United States Patent and Trademark Office

Reg. No. 3,481,252

Registered Aug. 5, 2008

**TRADEMARK
PRINCIPAL REGISTER**

BABY JAMZ

PLANET TOYS, INC. (DELAWARE CORPORATION)
121 WEST 27TH STREET
NEW YORK, NY 10001

FOR: TOYS, NAMELY, TOY CHAIRS, TOY
RADIOS, TOY KEY CHAINS, TOY BOOM-BOXES,
TOY PHONES, TOY VEHICLES AND TOY DANCE
MATS, IN CLASS 28 (U.S. CLS. 22, 23, 38 AND 50).

FIRST USE 8-1-2007; IN COMMERCE 8-1-2007.

THE MARK CONSISTS OF STANDARD CHARACTERS WITHOUT CLAIM TO ANY PARTICULAR FONT, STYLE, SIZE, OR COLOR.

NO CLAIM IS MADE TO THE EXCLUSIVE RIGHT TO USE "BABY", APART FROM THE MARK AS SHOWN.

SN 77-046,939, FILED 11-17-2006.

DAVID HOFFMAN, EXAMINING ATTORNEY

Int. Cl.: 33

Prior U.S. Cls.: 47 and 49

United States Patent and Trademark Office

Reg. No. 3,481,253

Registered Aug. 5, 2008

TRADEMARK
PRINCIPAL REGISTER



ZHEJIANG CEREALS, OILS & FOODSTUFFS
IMPORT & EXPORT CO., LTD. (CHINA COR-
PORATION)
NO. 229 TIYUCHANG ROAD
HANGZHOU, CHINA

FOR: WINE, IN CLASS 33 (U.S. CLS. 47 AND 49).

FIRST USE 9-8-2000; IN COMMERCE 1-2-2007.

OWNER OF U.S. REG. NOS. 1,452,435, 1,703,597,
AND 1,888,774.

NO CLAIM IS MADE TO THE EXCLUSIVE
RIGHT TO USE "BRAND" AND "AGED SHAO XING
RICE WINE" AND THE REPRESENTATION OF THE
CHINESE CHARACTERS THAT TRANSLATE IN
ENGLISH TO MEAN "BRAND" AND "EIGHT YEAR
OLD" AND "AGED SHAO XING RICE WINE",
APART FROM THE MARK AS SHOWN.

THE ENGLISH TRANSLATION OF THE WORD-
ING THE MARK IS AS FOLLOWS: "TA" MEANS
"PAGODA"; "PAI" MEANS "BRAND"; "BA NIAN
CHEN" MEANS "EIGHT-YEAR OLD"; "SHAO
XING" MEANS "SHAOXING"; "HUA" MEANS
"FLOWER"; "DIAO" MEANS "TO CARVE"; AND
"JIU" MEANS "WINE."

THE NON-LATIN CHARACTERS IN THE MARK
TRANSLITERATE TO TA; PAI; BA; NIAN; CHEN;
SHAO; XING; HUA; DIAO; JIU.

SN 77-047,463, FILED 11-20-2006.

MARLENE BELL, EXAMINING ATTORNEY

Int. Cl.: 28

Prior U.S. Cls.: 22, 23, 38, and 50

Reg. No. 3,481,254

United States Patent and Trademark Office

Registered Aug. 5, 2008

**TRADEMARK
PRINCIPAL REGISTER**

GLAM-OBILE

MATTEL, INC. (DELAWARE CORPORATION)
MAIL STOP M1-1518
333 CONTINENTAL BOULEVARD
EL SEGUNDO, CA 90245

FOR: TOYS, GAMES AND PLAYTHINGS, NAME-
LY, DOLLS, DOLL CLOTHING AND DOLL ACCES-
SORIES, DOLL PLAYSETS, TOY FIGURES, TOY
VEHICLES, TOY ANIMALS, AND ACCESSORIES
FOR ALL OF THE FOREGOING, IN CLASS 28 (U.S.
CLS. 22, 23, 38 AND 50).

FIRST USE 5-2-2008; IN COMMERCE 5-2-2008.

THE MARK CONSISTS OF STANDARD CHAR-
ACTERS WITHOUT CLAIM TO ANY PARTICULAR
FONT, STYLE, SIZE, OR COLOR.

SN 77-048,119, FILED 11-20-2006.

CIMMERIAN COLEMAN, EXAMINING ATTOR-
NEY

Int. Cl.: 44

Prior U.S. Cls.: 100 and 101

United States Patent and Trademark Office

Reg. No. 3,481,255

Registered Aug. 5, 2008

**SERVICE MARK
PRINCIPAL REGISTER**

Nerdhealth.com

NERDHEALTH, LLC (FLORIDA LTD LIAB CO)
1245 SOUTH POWERLINE ROAD
SUITE 300
POMPANO BEACH, FL 33069

THE MARK CONSISTS OF STANDARD CHAR-
ACTERS WITHOUT CLAIM TO ANY PARTICULAR
FONT, STYLE, SIZE, OR COLOR.

FOR: PROVIDING A WEBSITE THAT FEATURES
INFORMATION ON CHILDREN'S NUTRITION, IN
CLASS 44 (U.S. CLS. 100 AND 101).

SN 77-048,314, FILED 11-20-2006.

FIRST USE 2-23-2008; IN COMMERCE 2-23-2008.

REBECCA EISINGER, EXAMINING ATTORNEY

Int. Cls.: 36 and 37

Prior U.S. Cls.: 100, 101, 102, 103, and 106

United States Patent and Trademark Office

Reg. No. 3,481,256

Registered Aug. 5, 2008

**SERVICE MARK
PRINCIPAL REGISTER**

JOHN LAING HOMES
U R B A N

WL HOMES LLC (DELAWARE LTD LIAB CO)
895 DOVE STREET, SUITE 200
NEWPORT BEACH, CA 92660

FOR: REAL ESTATE ACQUISITION SERVICES; REAL ESTATE AGENCIES, REAL ESTATE BROKERAGE SERVICES, REAL ESTATE CONSULTATION, REAL ESTATE APPRAISAL; REAL ESTATE ESCROW SERVICES; REAL ESTATE INVESTMENT; REAL ESTATE LISTING; REAL ESTATE MANAGEMENT; REAL ESTATE MANAGEMENT CONSULTATION; REAL ESTATE PROCUREMENT FOR OTHERS; REAL ESTATE SYNDICATION; REAL ESTATE VALUATION SERVICES; PROVIDING INFORMATION IN THE FIELD OF REAL ESTATE BY MEANS OF WEBSITES FEATURING REAL ESTATE INFORMATION AND LINKING TO OTHER WEBSITES FEATURING REAL ESTATE INFORMATION; MORTGAGE LENDING, MORTGAGE BROKERAGE, MORTGAGE PROCUREMENT FOR OTHERS, MORTGAGE SERVICES, NAMELY, BUYER PRE-QUALIFICATION OF MORTGAGES FOR MORTGAGE BROKERS AND FINANCIAL INSTITUTIONS; MAINTAINING MORTGAGE ESCROW ACCOUNTS, IN CLASS 36 (U.S. CLS. 100, 101 AND 102).

FIRST USE 1-17-2007; IN COMMERCE 1-17-2007.

FOR: REAL ESTATE DEVELOPMENT SERVICES, RESIDENTIAL AND COMMERCIAL BUILDING

CONSTRUCTION, REAL ESTATE SITE SELECTION; CONSTRUCTION, MAINTENANCE AND RENOVATION OF PROPERTY; CONSTRUCTION CONSULTATION; CONSTRUCTION MANAGEMENT; CONSTRUCTION SERVICES, NAMELY, PLANNING, LAYING OUT AND CONSTRUCTION OF RESIDENTIAL AND COMMERCIAL COMMUNITIES; GENERAL CONSTRUCTION CONTRACTING; CUSTOM CONSTRUCTION OF HOMES; ROAD CONSTRUCTION, IN CLASS 37 (U.S. CLS. 100, 103 AND 106).

FIRST USE 1-17-2007; IN COMMERCE 1-17-2007.

OWNER OF U.S. REG. NOS. 2,567,065, 2,653,451, AND OTHERS.

NO CLAIM IS MADE TO THE EXCLUSIVE RIGHT TO USE "HOMES" AND "URBAN", APART FROM THE MARK AS SHOWN.

THE NAME(S), PORTRAIT(S), AND/OR SIGNATURE(S) SHOWN IN THE MARK DOES NOT IDENTIFY A PARTICULAR LIVING INDIVIDUAL.

THE MARK CONSISTS OF THE WORDS "JOHN LAING HOMES" WITH THE WORD "URBAN" APPEARING BELOW, ALL IN A STYLIZED FONT.

SN 77-049,143, FILED 11-21-2006.

JENNIFER DIXON, EXAMINING ATTORNEY

Int. Cl.: 41

Prior U.S. Cls.: 100, 101, and 107

United States Patent and Trademark Office

Reg. No. 3,481,257

Registered Aug. 5, 2008

**SERVICE MARK
PRINCIPAL REGISTER**

**Lotus Garden Meditation
Center**

LOTUS GARDEN MEDITATION CENTER (CALI-
FORNIA NON-PROFIT CORPORATION)
7225 LINCOLN AVE.
CARMICHAEL, CA 95608

FOR: EDUCATIONAL SERVICES, NAMELY,
CONDUCTING CLASSES, SEMINARS, WORK-
SHOPS, AND RETREATS IN THE FIELD OF THE
PHILOSOPHY AND PRACTICE OF THE SCIENCE
OF YOGA AND MEDITATION, VEGETARIAN
COOKING, HEALTHY EATING HABITS AND
HOW TO LIVE A HEALTHIER LIFESTYLE, TAI
CHI AND CHI KUNG, SUSTAINABLE AGRICUL-
TURE, ORGANIC GARDENING AND DISTRIBU-
TION OF COURSE MATERIAL IN CONNECTION
THEREWITH; YOGA INSTRUCTION, IN CLASS 41
(U.S. CLS. 100, 101 AND 107).

FIRST USE 12-23-2007; IN COMMERCE 3-1-2008.

THE MARK CONSISTS OF STANDARD CHAR-
ACTERS WITHOUT CLAIM TO ANY PARTICULAR
FONT, STYLE, SIZE, OR COLOR.

NO CLAIM IS MADE TO THE EXCLUSIVE
RIGHT TO USE "MEDITATION CENTER", APART
FROM THE MARK AS SHOWN.

SN 77-050,132, FILED 11-22-2006.

DORITT L. CARROLL, EXAMINING ATTORNEY

Int. Cl.: 25

Prior U.S. Cls.: 22 and 39

United States Patent and Trademark Office

Reg. No. 3,481,258

Registered Aug. 5, 2008

**TRADEMARK
PRINCIPAL REGISTER**

KRONIK ENERGY

CHOICE FIRST DISTRIBUTION, LLC (ARIZONA
LTD LIAB CO)
5225 N. CENTRAL AVE., SUITE 101
PHOENIX, AZ 85012

FOR: BASEBALL CAPS; BEANIES; BERETS;
BLOUSES; CAMISOLES; CAP VISORS; CAPS; CAPS
WITH VISORS; COATS FOR MEN AND WOMEN;
CYCLISTS' JERSEYS; DENIM JACKETS; DO RAGS;
DRESS SHIRTS; GLOVES; GYM SHORTS; GYM
SUITS; HALTER TOPS; HATS; HEAD SCARVES;
HEAD SWEATBANDS; HEAD WEAR; HEAD-
BANDS; HEADGEAR, NAMELY, FLAT BRIM
HATS; JACKETS; JEANS; JERSEYS; JOGGING OUT-
FITS; JOGGING PANTS; JOGGING SUITS; KER-
CHIEFS; KNIT SHIRTS; KNITTED CAPS; LEATHER
BELTS; LEATHER COATS; LEATHER HEADWEAR;
LEATHER JACKETS; LEATHER PANTS; LONG
JACKETS; MUSCLE TOPS; NECKERCHIEFS; PAN-
TIES; PANTIES, SHORTS AND BRIEFS; SCARVES;

SHIRTS; SHORTS; SKULL CAPS; SPORT COATS;
SPORT SHIRTS; SPORTS JACKETS; SPORTS JER-
SEYS; SUN VISORS; SWEAT BANDS; SWEAT
PANTS; SWEAT SHIRTS; SWEAT SHORTS; SWEAT
SUITS; SWEATERS; T-SHIRTS; TANK TOPS;
THONGS; THONGS; TURBANS; TURTLENECKS;
V-NECK SWEATERS; VISORS; WIND-JACKETS;
WOOLLY HATS; WRIST BANDS, IN CLASS 25 (U.S.
CLS. 22 AND 39).

FIRST USE 1-4-2007; IN COMMERCE 1-4-2007.

THE MARK CONSISTS OF STANDARD CHAR-
ACTERS WITHOUT CLAIM TO ANY PARTICULAR
FONT, STYLE, SIZE, OR COLOR.

SN 77-050,347, FILED 11-23-2006.

GIANCARLO CASTRO, EXAMINING ATTORNEY

Int. Cls.: 14, 16, and 35

Prior U.S. Cls.: 2, 5, 22, 23, 27, 28, 29, 37, 38, 50, 100, 101, and 102

Reg. No. 3,481,259

United States Patent and Trademark Office

Registered Aug. 5, 2008

**TRADEMARK
SERVICE MARK
PRINCIPAL REGISTER**

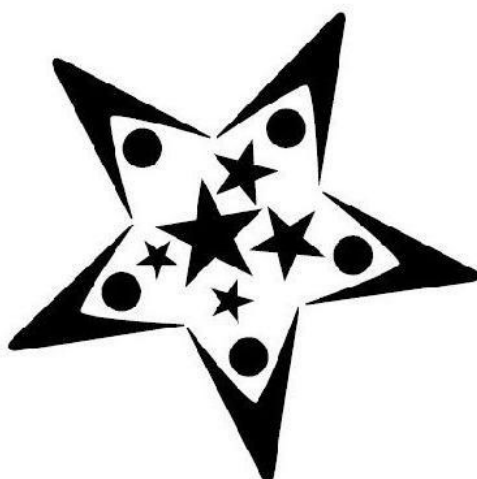

DURHAM CONVENTION & VISITORS BUREAU
(NORTH CAROLINA CORPORATION)
101 EAST MORGAN STREET
DURHAM, NC 27701

FOR: JEWELRY, IN CLASS 14 (U.S. CLS. 2, 27, 28 AND 50).

FIRST USE 9-29-2006; IN COMMERCE 9-29-2006.

FOR: PRINTED MATTER, NAMELY, CALENDARS, MAPS, BLANK CARDS, STICKERS, PAPER POSTERS AND BANNERS, AND PRINTED PUBLICATIONS, NAMELY, MAGAZINES, PAMPHLETS, REPORTS AND BROCHURES, ALL FEATURING INFORMATION ON ARTS, CULTURE, EVENTS, ACTIVITIES, ACCOMMODATIONS AND RESTAURANTS, IN CLASS 16 (U.S. CLS. 2, 5, 22, 23, 29, 37, 38 AND 50).

FIRST USE 9-9-2006; IN COMMERCE 9-9-2006.

FOR: CONVENTION AND VISITORS BUREAU SERVICES, NAMELY, PROMOTING TRAVEL, TOURISM AND BUSINESS IN THE DURHAM AREA, REFERRAL SERVICES IN THE FIELD OF VENDORS FOR CONVENTION ORGANIZERS, IN CLASS 35 (U.S. CLS. 100, 101 AND 102).

FIRST USE 9-29-2006; IN COMMERCE 9-29-2006.

THE MARK CONSISTS OF A FIVE-POINTED STAR WITH EACH POINT REPRESENTING RAISED ARMS ENCLOSING ONE EACH OF FIVE CIRCLES REPRESENTING HEADS OF CITIZENS, AND WITH A CONSTELLATION OF FIVE STARS IN THE CENTER.

SN 77-050,894, FILED 11-27-2006.

JASON TURNER, EXAMINING ATTORNEY

Int. Cl.: 35

Prior U.S. Cls.: 100, 101, and 102

United States Patent and Trademark Office

Reg. No. 3,481,260

Registered Aug. 5, 2008

SERVICE MARK
PRINCIPAL REGISTER



WILLIAM FRICK AND COMPANY (ILLINOIS CORPORATION)
2600 COMMERCE DRIVE
LIBERTYVILLE, IL 60048

FOR: COLLECTION, PREPARATION, COMPOSITION, STORAGE, PROCESSING, ACQUISITION AND PROVISION OF BUSINESS INFORMATION, DATA, STATISTICS AND INDICES; COMPUTERIZED TRACKING AND TRACING OF PACKAGES IN TRANSIT; DATA PROCESSING SERVICES; INFORMATION AND DATA COMPILING AND ANALYZING RELATING TO BUSINESS MANAGEMENT; INFORMATION, ADVISORY AND CONSULTANCY SERVICES RELATING TO BUSINESS AND MANAGEMENT OR BUSINESS ADMINISTRATION, INCLUDING SUCH SERVICES PROVIDED ON LINE OR VIA THE INTERNET; INTEGRATED TRACKING AND MANAGEMENT OF COMMERCIAL TRANSACTIONS ON A GLOBAL COMPUTER NETWORK; INVENTORY MANAGEMENT IN THE FIELD OF OUTDOOR DEPLOYED RESOURCES; MANAGEMENT AND BUSINESS CONSULTING SERVICES IN THE FIELD OF OUTDOOR DEPLOYED RESOURCES; MANAGEMENT AND COMPILATION OF COMPUTERISED DATABASES; MANAGEMENT ASSISTANCE; MONITORING AND TRACKING OF PACKAGE SHIPMENTS; PROVIDING BUSINESS INFORMATION, ALSO VIA INTERNET, THE CABLE NETWORK OR OTHER FORMS OF DATA TRANSFER;

PROVIDING ELECTRONIC TRACKING OF FREIGHT INFORMATION TO OTHERS; RENTAL OF DATA PROCESSING EQUIPMENT; STATISTICAL EVALUATIONS OF MARKETING DATA, IN CLASS 35 (U.S. CLS. 100, 101 AND 102).

FIRST USE 5-1-2007; IN COMMERCE 5-1-2007.

NO CLAIM IS MADE TO THE EXCLUSIVE RIGHT TO USE "GPS BASED TRACKING SOLUTIONS", APART FROM THE MARK AS SHOWN.

THE COLOR(S) WHITE, BLUE AND GREEN IS/ ARE CLAIMED AS A FEATURE OF THE MARK.

THE MARK CONSISTS OF THE COLOR BLUE IS IN THE TOP PART OF THE WORD "GEO-TAG" AND IS OVER THE COLOR GREEN WHICH IS IN THE BOTTOM PART OF THE WORD "GEO-TAG". THE WORDING IS DISSECTED BY A WHITE HORIZON AND WHITE STAR. UNDER THAT, THE LETTERS "GPS BASED" ARE IN BLUE AND THE WORDS "TRACKING SOLUTIONS" ARE IN GREEN.

SN 77-051,052, FILED 11-27-2006.

DEZMONA MIZELLE, EXAMINING ATTORNEY

Int. Cl.: 41

Prior U.S. Cls.: 100, 101, and 107

United States Patent and Trademark Office

Reg. No. 3,481,261

Registered Aug. 5, 2008

**SERVICE MARK
PRINCIPAL REGISTER**

Hu-Man Element

HU-MAN ELEMENT PRODUCTIONS, INC. (CALIFORNIA CORPORATION)
SUITE M-120
1201 WEST 5TH STREET
LOS ANGELES, CA 90017

FOR: ENTERTAINMENT SERVICES FEATURING FILM AND TELEVISION PRODUCTS, NAME-
LY, MOTION PICTURE, TELEVISION, AND VIDEO
AND AUDIO TAPE PRODUCTION SERVICES; VI-
DEO EDITING, AND VIDEO TAPE EDITING; FILM
EDITING; AND MULTIMEDIA ENTERTAINMENT
PRODUCTION SERVICES IN THE FIELDS OF VI-

DEO AND FILMS, IN CLASS 41 (U.S. CLS. 100, 101
AND 107).

FIRST USE 1-24-2008; IN COMMERCE 1-24-2008.

THE MARK CONSISTS OF STANDARD CHAR-
ACTERS WITHOUT CLAIM TO ANY PARTICULAR
FONT, STYLE, SIZE, OR COLOR.

SN 77-051,936, FILED 11-28-2006.

ANDREA SAUNDERS, EXAMINING ATTORNEY

Int. Cl.: 35

Prior U.S. Cls.: 100, 101, and 102

United States Patent and Trademark Office

Reg. No. 3,481,262

Registered Aug. 5, 2008

**SERVICE MARK
PRINCIPAL REGISTER**

ANTARUS

ANTARUS BIOTECH, INC. (DELAWARE CORPORATION)
127 HOLMES AVENUE NW
HUNTSVILLE, AL 35801

FOR: COMPUTERIZED ONLINE RETAIL STORE SERVICES FEATURING DNA ANALYSIS EQUIPMENT, NAMELY, THERMOCYCLERS, ASSOCIATED SOFTWARE, KITS OF REAGENTS FOR PCR AND NUCLEIC ACID BASED RESEARCH AND DIAGNOSTICS, IN CLASS 35 (U.S. CLS. 100, 101 AND 102).

FIRST USE 12-31-2006; IN COMMERCE 12-31-2006.

THE MARK CONSISTS OF STANDARD CHARACTERS WITHOUT CLAIM TO ANY PARTICULAR FONT, STYLE, SIZE, OR COLOR.

SN 77-051,948, FILED 11-28-2006.

DORITT L. CARROLL, EXAMINING ATTORNEY

Int. Cl.: 10

Prior U.S. Cls.: 26, 39, and 44

United States Patent and Trademark Office

Reg. No. 3,481,263

Registered Aug. 5, 2008

**TRADEMARK
PRINCIPAL REGISTER**

OASIS

HITACHI MEDICAL CORPORATION (JAPAN
CORPORATION)
4-14-1, SOTOKANDA
CHIYODA-KU, TOKYO, JAPAN

THE MARK CONSISTS OF STANDARD CHAR-
ACTERS WITHOUT CLAIM TO ANY PARTICULAR
FONT, STYLE, SIZE, OR COLOR.

FOR: MAGNETIC RESONANCE IMAGING AP-
PARATUS (MRI), IN CLASS 10 (U.S. CLS. 26, 39 AND
44).

SN 77-052,041, FILED 11-28-2006.

FIRST USE 11-26-2006; IN COMMERCE 11-26-2006.

CHRISTINA SOBRAL, EXAMINING ATTORNEY

Int. Cl.: 41

Prior U.S. Cls.: 100, 101, and 107

United States Patent and Trademark Office

Reg. No. 3,481,264

Registered Aug. 5, 2008

**SERVICE MARK
PRINCIPAL REGISTER**

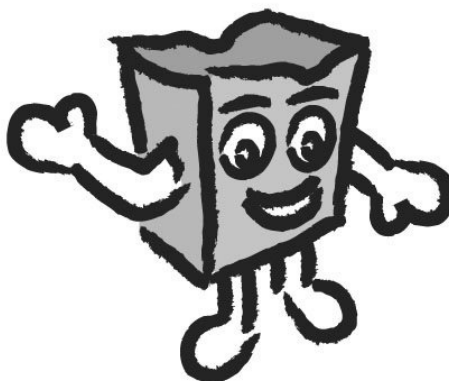

CONNECTICUT RESOURCES RECOVERY AUTHORITY (CONNECTICUT QUASI-PUBLIC ENTITY ORGANIZED UNDER CONNECTICUT GENERAL STATUTE 22A-261)

FORTNER@HALLORAN-SAGE.COM

100 CONSTITUTION PLAZA

HARTFORD, CT 061037722

FOR: EDUCATION SERVICES CONDUCTED OR SPONSORED BY STATE, REGIONAL, TOWN, LOCAL, OR MUNICIPAL GOVERNMENTAL AGENCIES, AUTHORITIES, OR AFFILIATES, INCLUDING THE STATE OF CONNECTICUT, NAMELY, PROVIDING LECTURES, APPEARANCES, EDUCATIONAL PROGRAMS, HANDS-ON AND INTERACTIVE EXHIBITS AND MUSEUM

SERVICES IN THE FIELD OF RECYCLING AND SOLID WASTE MANAGEMENT, IN CLASS 41 (U.S. CLS. 100, 101 AND 107).

FIRST USE 4-3-2007; IN COMMERCE 4-3-2007.

THE MARK CONSISTS OF A STYLIZED PAPER BAG WITH HUMAN FEATURES, CONSISTING OF ARMS, LEGS AND A FACE ON THE BODY OF THE BAG.

SN 77-052,166, FILED 11-28-2006.

DORITT L. CARROLL, EXAMINING ATTORNEY

Int. Cl.: 35

Prior U.S. Cls.: 100, 101, and 102

United States Patent and Trademark Office

Reg. No. 3,481,265

Registered Aug. 5, 2008

**SERVICE MARK
PRINCIPAL REGISTER**



THE NAKED ORCHID, LLC (NORTH CAROLINA LTD LIAB CO)
POST OFFICE BOX 1817
SOUTHERN PINES, NC 28388

THE MARK CONSISTS OF THE STYLIZED IMAGE OF A WOMAN EMERGING FROM A FLOWER.

FOR: ONLINE RETAIL STORE SERVICES IN THE FIELD OF LINGERIE, INTIMATES AND SLEEPWEAR, PERFUMES, PLANTS AND NOVELTY GIFTS, IN CLASS 35 (U.S. CLS. 100, 101 AND 102).

SN 77-052,620, FILED 11-29-2006.

FIRST USE 5-24-2008; IN COMMERCE 5-24-2008.

KAPIL BHANOT, EXAMINING ATTORNEY

Int. Cl.: 35

Prior U.S. Cls.: 100, 101, and 102

United States Patent and Trademark Office

Reg. No. 3,481,266

Registered Aug. 5, 2008

**SERVICE MARK
PRINCIPAL REGISTER**



THE NAKED ORCHID, LLC (NORTH CAROLINA LTD LIAB CO)
POST OFFICE BOX 1817
SOUTHERN PINES, NC 28388

FOR: ONLINE RETAIL STORE SERVICES IN THE FIELD OF LINGERIE, INTIMATES AND SLEEPWEAR, PERFUMES, AND PLANTS AND NOVELTY GIFTS, IN CLASS 35 (U.S. CLS. 100, 101 AND 102).

FIRST USE 5-24-2008; IN COMMERCE 5-24-2008.

THE MARK CONSISTS OF THE WORDING "THE NAKED ORCHID" NEXT TO THE STYLIZED IMAGE OF A WOMAN EMERGING FROM A FLOWER.

SN 77-052,622, FILED 11-29-2006.

KAPIL BHANOT, EXAMINING ATTORNEY

Int. Cl.: 12

Prior U.S. Cls.: 19, 21, 23, 31, 35, and 44

United States Patent and Trademark Office

Reg. No. 3,481,267

Registered Aug. 5, 2008

**TRADEMARK
PRINCIPAL REGISTER**

IT'S BRIDGESTONE OR NOTHING

BRIDGESTONE CORPORATION (JAPAN CORPORATION)
10-1, KYOBASHI 1-CHOME, CHUO-KU
TOKYO, JAPAN

FOR: VEHICLE TIRES, IN CLASS 12 (U.S. CLS. 19, 21, 23, 31, 35 AND 44).

FIRST USE 3-12-2007; IN COMMERCE 3-12-2007.

THE MARK CONSISTS OF STANDARD CHARACTERS WITHOUT CLAIM TO ANY PARTICULAR FONT, STYLE, SIZE, OR COLOR.

OWNER OF U.S. REG. NOS. 1,342,473, 3,085,843, AND OTHERS.

SN 77-053,766, FILED 11-30-2006.

JULIE GUTTADAURO, EXAMINING ATTORNEY

Int. Cl.: 14

Prior U.S. Cls.: 2, 27, 28, and 50

United States Patent and Trademark Office

Reg. No. 3,481,268

Registered Aug. 5, 2008

**TRADEMARK
PRINCIPAL REGISTER**

ARTSY DOTS

ARTSY DOTS, LLC (FLORIDA LTD LIAB CO)
2355 N.W. 184TH TERRACE
PEMBROKE PINES, FL 33029

THE MARK CONSISTS OF STANDARD CHAR-
ACTERS WITHOUT CLAIM TO ANY PARTICULAR
FONT, STYLE, SIZE, OR COLOR.

FOR: BRACELETS; CHARMS; JEWELRY, IN
CLASS 14 (U.S. CLS. 2, 27, 28 AND 50).

SN 77-053,817, FILED 11-30-2006.

FIRST USE 10-0-2006; IN COMMERCE 2-0-2008.

NICHOLAS ALTREE, EXAMINING ATTORNEY

Int. Cls.: 3 and 5

Prior U.S. Cls.: 1, 4, 6, 18, 44, 46, 50, 51, and 52

United States Patent and Trademark Office

Reg. No. 3,481,269

Registered Aug. 5, 2008

**TRADEMARK
PRINCIPAL REGISTER**

LAVENDER BREEZE

RECKITT BENCKISER INC. (DELAWARE CORPORATION)
399 INTERPACE PARKWAY
PARSIPPANY, NJ 07054

FOR: ALL PURPOSE CLEANING PREPARATION; GENERAL PURPOSE CLEANER WITH DISINFECTING PROPERTIES; GENERAL PURPOSE CLEANING, POLISHING AND SCOURING PREPARATIONS IN LIQUID, POWDER AND GEL FORM FOR HOUSEHOLD, COMMERCIAL, INDUSTRIAL AND INSTITUTIONAL USE; WIPES IMPREGNATED WITH CHEMICALS OR COMPOUNDS FOR CLEANING AND DISINFECTING HARD SURFACES, IN CLASS 3 (U.S. CLS. 1, 4, 6, 50, 51 AND 52).

FIRST USE 12-19-2005; IN COMMERCE 12-19-2005.

FOR: ALL PURPOSE DISINFECTING PREPARATIONS; ALL PURPOSE DISINFECTANT SPRAY; SANITIZERS FOR HOUSEHOLD, COMMERCIAL,

INDUSTRIAL AND INSTITUTIONAL USE; GERMICIDES; DEODORIZERS AND SANITIZERS FOR BATHROOMS AND TOILETS; ROOM DEODORANTS; ODOR NEUTRALIZING PREPARATIONS FOR USE ON CARPETS, TEXTILES AND IN THE AIR, IN CLASS 5 (U.S. CLS. 6, 18, 44, 46, 51 AND 52).

FIRST USE 12-19-2005; IN COMMERCE 12-19-2005.

THE MARK CONSISTS OF STANDARD CHARACTERS WITHOUT CLAIM TO ANY PARTICULAR FONT, STYLE, SIZE, OR COLOR.

NO CLAIM IS MADE TO THE EXCLUSIVE RIGHT TO USE "LAVENDER", APART FROM THE MARK AS SHOWN.

SN 77-054,162, FILED 11-30-2006.

ZHALEH DELANEY, EXAMINING ATTORNEY

Int. Cl.: 35

Prior U.S. Cls.: 100, 101, and 102

United States Patent and Trademark Office

Reg. No. 3,481,270

Registered Aug. 5, 2008

**SERVICE MARK
PRINCIPAL REGISTER**

America's First Region

HAMPTON ROADS PARTNERSHIP (VIRGINIA
CORPORATION)
430 WORLD TRADE CENTER
NORFOLK, VA 23510

THE MARK CONSISTS OF STANDARD CHAR-
ACTERS WITHOUT CLAIM TO ANY PARTICULAR
FONT, STYLE, SIZE, OR COLOR.

FOR: PROMOTING THE ECONOMIC DEVELOP-
MENT IN THE HAMPTON ROADS REGION, IN
CLASS 35 (U.S. CLS. 100, 101 AND 102).

SN 77-055,265, FILED 12-1-2006.

FIRST USE 12-13-2006; IN COMMERCE 12-13-2006.

JILL PRATER, EXAMINING ATTORNEY

Int. Cl.: 25

Prior U.S. Cls.: 22 and 39

United States Patent and Trademark Office

Reg. No. 3,481,271

Registered Aug. 5, 2008

**TRADEMARK
PRINCIPAL REGISTER**

Bulstif

MOORE, ANDREW (UNITED STATES INDIVIDUAL)
1001 SOUTH CEDAR, BOX 760
OTTAWA, KS 66067 AND
MAXWELL, ANDREW (UNITED STATES INDIVIDUAL)
2740 MAPLE TERRACE
OTTAWA, KS 66067

FOR: BERMUDA SHORTS; DENIM JACKETS;
GYM SHORTS; JACKETS; JOGGING PANTS;
SHORT-SLEEVED OR LONG-SLEEVED T-SHIRTS;
SPORT SHIRTS; SPORTS JACKETS; SPORTS
SHIRTS; SPORTS SHIRTS WITH SHORT SLEEVES;

SWEAT PANTS; SWEAT SHIRTS; T-SHIRTS, IN
CLASS 25 (U.S. CLS. 22 AND 39).

FIRST USE 4-22-2008; IN COMMERCE 4-22-2008.

THE MARK CONSISTS OF STANDARD CHARACTERS WITHOUT CLAIM TO ANY PARTICULAR FONT, STYLE, SIZE, OR COLOR.

SN 77-055,455, FILED 12-1-2006.

SUZANNE BLANE, EXAMINING ATTORNEY

Int. Cl.: 30

Prior U.S. Cl.: 46

United States Patent and Trademark Office

Reg. No. 3,481,272

Registered Aug. 5, 2008

**TRADEMARK
PRINCIPAL REGISTER**

**YOUR FAVORITE CHOCOLATE
BAR IN PERFECT PORTIONS**

MARS, INCORPORATED (DELAWARE COR-
PORATION)
6885 ELM STREET
MCLEAN, VA 22101

THE MARK CONSISTS OF STANDARD CHAR-
ACTERS WITHOUT CLAIM TO ANY PARTICULAR
FONT, STYLE, SIZE, OR COLOR.

FOR: CONFECTIONERY, NAMELY, CANDY;
AND A COOKIE AND CHOCOLATE SNACK, IN
CLASS 30 (U.S. CL. 46).

SN 77-055,499, FILED 12-1-2006.

FIRST USE 6-8-2007; IN COMMERCE 6-8-2007.

JOHN WILKE, EXAMINING ATTORNEY

Int. Cls.: 10 and 25

Prior U.S. Cls.: 22, 26, 39, and 44

United States Patent and Trademark Office

Reg. No. 3,481,273

Registered Aug. 5, 2008

**TRADEMARK
PRINCIPAL REGISTER**

WillyWankerWear

WANKER, WILLIAM P. (UNITED STATES INDIVIDUAL)
369 MONTEZUMA ST., #339
SANTA FE, NM 87501 AND
KELLY, PAMELA W. (UNITED STATES INDIVIDUAL)
369 MONTEZUMA ST., #456
SANTA FE, NM 87501

FOR: CONDOMS, IN CLASS 10 (U.S. CLS. 26, 39 AND 44).

FIRST USE 5-7-2008; IN COMMERCE 6-7-2008.

FOR: BERMUDA SHORTS; BOARD SHORTS; BOXER SHORTS; CAPS; CARGO PANTS; GYM SHORTS; HATS; JOGGING PANTS; PANTIES,

SHORTS AND BRIEFS; PANTS; RUGBY SHORTS; SHIRTS; SHORT TROUSERS; SHORT-SLEEVED OR LONG-SLEEVED T-SHIRTS; SKI PANTS; SNOW PANTS; SWEAT PANTS; SWEAT SHORTS; SWIMSUITS; T-SHIRTS; TIES, IN CLASS 25 (U.S. CLS. 22 AND 39).

FIRST USE 5-17-2008; IN COMMERCE 6-6-2008.

THE MARK CONSISTS OF STANDARD CHARACTERS WITHOUT CLAIM TO ANY PARTICULAR FONT, STYLE, SIZE, OR COLOR.

SN 77-056,403, FILED 12-4-2006.

MARCIE MILONE, EXAMINING ATTORNEY

Int. Cl.: 41

Prior U.S. Cls.: 100, 101, and 107

United States Patent and Trademark Office

Reg. No. 3,481,274

Registered Aug. 5, 2008

**SERVICE MARK
PRINCIPAL REGISTER**



AARP (D.C. NON-PROFIT CORPORATION)
601 E STREET, N.W.
WASHINGTON, DC 20049

FOR: PROVIDING ONLINE MAGAZINES AND NEWSLETTERS PROMOTING THE INTERESTS OF MATURE INDIVIDUALS AND IN THE FIELDS OF CAREGIVING, CHILDCARE, EDUCATION, MEDICAL SERVICES, ELDERCARE, EMPLOYMENT, ASSISTED CARE FACILITIES, LEGAL ASSISTANCE, BUSINESS, INSURANCE, REAL ESTATE, TRAVEL, ELDER ASSISTANCE, RETIREMENT, MATURE OR RETIRED LIFESTYLES, FINANCE, HEALTH, AGING, FAMILY RELATIONSHIPS, VOLUNTEER ACTIVITIES, CONSUMER ISSUES, ECONOMIC SECURITY, WORK, INDEPENDENT LIVING, EXERCISE, FITNESS, ATHLETICS AND SPORTS; EDUCATION AND TRAINING SERVICES, NAMELY, ARRANGING AND CONDUCTING CLASSES, ONLINE CLASSES, SEMINARS, CONFERENCES AND WORKSHOPS IN THE FIELDS OF CAREGIVING, CHILDCARE, EDUCATION, MEDICAL SERVICES, ELDERCARE, EMPLOYMENT, ASSISTED CARE FACILITIES, LEGAL ASSISTANCE, BUSINESS, INSURANCE, REAL ESTATE, TRAVEL, ELDER ASSISTANCE, RETIREMENT, MATURE OR RETIRED LIFESTYLES, FINANCE, HEALTH, AGING, FAMILY RELATIONSHIPS, VOLUNTEER ACTIVITIES, CONSUMER ISSUES, ECONOMIC SECURITY, WORK, INDEPENDENT LIVING, EXERCISE, FITNESS, ATHLETICS AND SPORTS; DISTRIBUTION OF COURSE MATERIALS IN CONNECTION THEREWITH; PROVIDING RECOGNITION AND INCENTIVES BY THE WAY OF AWARDS TO DEMONSTRATE EXCELLENCE IN THE FIELDS OF PUBLIC SERVICE, SIGNIFICANT ACHIEVEMENTS, MILESTONES AND CHARITABLE CONTRIBUTIONS IN THE FIELDS OF RETIREMENT, MATURE OR RETIRED LIFESTYLES, FINANCE, HEALTH, AGING, FAMILY RELATIONSHIPS,

CONSUMER ISSUES, ECONOMIC SECURITY, WORK, INDEPENDENT LIVING, AND ELDER ISSUES; ENTERTAINMENT SERVICES, NAMELY, CONDUCTING CONTESTS IN MAGAZINES FOR RECOGNITION IN THE FIELDS OF PUBLIC SERVICE, SIGNIFICANT ACHIEVEMENTS, MILESTONES AND CHARITABLE CONTRIBUTIONS IN THE FIELDS OF RETIREMENT, MATURE OR RETIRED LIFESTYLES, FINANCE, HEALTH, AGING, FAMILY RELATIONSHIPS, CONSUMER ISSUES, ECONOMIC SECURITY, WORK, INDEPENDENT LIVING, AND ELDER ISSUES; ARRANGING AND CONDUCTING EXERCISE, FITNESS, ATHLETIC AND SPORTS COMPETITIONS, CONTESTS, RACES AND EVENTS; CONSULTATION SERVICES PROVIDED IN CONNECTION THEREWITH; AND PROVIDING RADIO PROGRAMS PROMOTING THE INTERESTS OF MATURE INDIVIDUALS AND IN THE FIELDS OF CAREGIVING, CHILDCARE, EDUCATION, MEDICAL SERVICES, ELDERCARE, EMPLOYMENT, ASSISTED CARE FACILITIES, LEGAL ASSISTANCE, BUSINESS, INSURANCE, REAL ESTATE, TRAVEL, ELDER ASSISTANCE, RETIREMENT, MATURE OR RETIRED LIFESTYLES, FINANCE, HEALTH, AGING, FAMILY RELATIONSHIPS, VOLUNTEER ACTIVITIES, CONSUMER ISSUES, ECONOMIC SECURITY, WORK, INDEPENDENT LIVING, EXERCISE, FITNESS, ATHLETICS AND SPORTS; ARRANGING AND PRESENTATION OF MUSICAL PERFORMANCES, IN CLASS 41 (U.S. CLS. 100, 101 AND 107).

FIRST USE 1-0-2007; IN COMMERCE 1-0-2007.

OWNER OF U.S. REG. NOS. 741,334, 2,623,034, AND OTHERS.

THE COLOR(S) RED IS/ARE CLAIMED AS A FEATURE OF THE MARK.

THE MARK CONSISTS OF "AARP" SHOWN ALL IN RED, WITH A STYLIZED BANNER-LIKE DESIGN PROJECTING FROM THE HORIZONTAL ELEMENT OF THE FIRST "A".

SN 77-056,878, FILED 12-5-2006.

RON FAIRBANKS, EXAMINING ATTORNEY

Int. Cl.: 9

Prior U.S. Cls.: 21, 23, 26, 36, and 38

Reg. No. 3,481,275

United States Patent and Trademark Office

Registered Aug. 5, 2008

**TRADEMARK
PRINCIPAL REGISTER**



LIPYANEK, SUSAN E (NEW JERSEY LTD LIAB
CO)
499 DOROTHY PLACE
BRICK, NJ 08723

THE MARK CONSISTS OF A DESIGN WITH
WORDS, THE LETTER "X" INSIDE A CIRCLE WITH
THE "X" PROTRUDING OUT OF THE CIRCLE.

FOR: GOGGLES FOR SPORTS, IN CLASS 9 (U.S.
CLS. 21, 23, 26, 36 AND 38).

SN 77-058,302, FILED 12-6-2006.

FIRST USE 5-5-2005; IN COMMERCE 1-1-2007.

RON FAIRBANKS, EXAMINING ATTORNEY

Int. Cl.: 30

Prior U.S. Cl.: 46

United States Patent and Trademark Office

Reg. No. 3,481,276

Registered Aug. 5, 2008

**TRADEMARK
PRINCIPAL REGISTER**

NATURAL SALAD MIST

NO LIMIT, LLC (CONNECTICUT LTD LIAB CO)
246 POST ROAD EAST POB 791
WESTPORT, CT 068810791

FOR: SALAD DRESSINGS, IN CLASS 30 (U.S. CL.
46).

FIRST USE 12-27-2007; IN COMMERCE 12-27-2007.

THE MARK CONSISTS OF STANDARD CHAR-
ACTERS WITHOUT CLAIM TO ANY PARTICULAR
FONT, STYLE, SIZE, OR COLOR.

NO CLAIM IS MADE TO THE EXCLUSIVE
RIGHT TO USE "SALAD MIST", APART FROM
THE MARK AS SHOWN.

SN 77-058,868, FILED 12-7-2006.

CHERYL CLAYTON, EXAMINING ATTORNEY

Int. Cl.: 9

Prior U.S. Cls.: 21, 23, 26, 36, and 38

Reg. No. 3,481,277

United States Patent and Trademark Office

Registered Aug. 5, 2008

TRADEMARK
PRINCIPAL REGISTER

dragon

CALLPOD, INC. (ILLINOIS CORPORATION)
SUITE 260
850 W. JACKSON BLVD
CHICAGO, IL 60607

FOR: WIRELESS CELLULAR TELEPHONE
HEADSETS, IN CLASS 9 (U.S. CLS. 21, 23, 26, 36
AND 38).

FIRST USE 12-7-2006; IN COMMERCE 12-7-2006.

THE COLOR(S) BLACK AND GREEN IS/ARE
CLAIMED AS A FEATURE OF THE MARK.

THE MARK CONSISTS OF "D" "R" "A" "G" AND
"N" ARE BLACK AND "O" IS GREEN.

SN 77-059,196, FILED 12-7-2006.

SUNG IN, EXAMINING ATTORNEY

Int. Cl.: 35

Prior U.S. Cls.: 100, 101, and 102

United States Patent and Trademark Office

Reg. No. 3,481,278

Registered Aug. 5, 2008

**SERVICE MARK
PRINCIPAL REGISTER**

Brand is Behavior

BASKIN ASSOCIATES INC. (ILLINOIS CORPORATION)
480 WOODLAWN AVENUE
GLENCOE, IL 60022

FOR: ADVERTISING AND MARKETING; ADVERTISING SERVICES, NAMELY, PROMOTING AND MARKETING THE GOODS AND SERVICES OF OTHERS THROUGH ALL PUBLIC COMMUNICATION MEANS; ADVERTISING, MARKETING AND PROMOTION SERVICES; ADVICE IN THE FIELD OF BUSINESS MANAGEMENT AND MARKETING; ARRANGING AND CONDUCTING MARKETING PROMOTIONAL EVENTS FOR OTHERS; BUSINESS ADVICE AND ANALYSIS OF MARKETS; BUSINESS CONSULTATION AND MANAGEMENT REGARDING MARKETING ACTIVITIES AND LAUNCHING OF NEW PRODUCTS; BUSINESS MANAGEMENT CONSULTING WITH RELATION TO STRATEGY, MARKETING, PRODUCTION, PERSONNEL AND RETAIL SALE MATTERS; BUSINESS MARKETING AND DIRECT MAIL CONSULTING SERVICES; BUSINESS MARKETING CONSULTING SERVICES; CONDUCTING BUSINESS AND MARKET RESEARCH SURVEYS; CONDUCTING MARKETING STUDIES; COOPERATIVE ADVERTISING AND MARKETING; COOPERATIVE ADVERTISING AND MARKETING SERVICES BY WAY OF SOLICITATION, CUSTOMER SERVICE AND PROVIDING MARKETING INFORMATION VIA WEBSITES ON A GLOBAL COMPUTER NETWORK; CREATION OF MARKETING TOOLS DESIGNED TO INCREASE A CLIENT COMPANY'S KNOWLEDGE OF CUSTOMER NEEDS, AND ITS COMPETITORS' PRODUCTS AND SERVICES; PRICING, ADVERTISING STRATEGY AND SALES STRATEGY; DEVELOPMENT OF MARKETING STRATEGIES AND CONCEPTS; DIRECT MARKETING ADVERTISING FOR OTHERS; DIRECT MARKETING SERVICES; GENERAL BUSINESS MERCHANDISING SERVICES, NAMELY, MARKETING; IMPLEMENTATION AND FOLLOW-UP

OF ADVICE IN THE FIELDS OF MARKETING; INFORMATION OR ENQUIRIES ON BUSINESS AND MARKETING; MARKET ANALYSIS; MARKET MANIPULATION, RESEARCH AND ANALYSIS, WHETHER OR NOT VIA THE INTERNET; MARKET OPINION POLLING STUDIES; MARKET REPORTS AND STUDIES; MARKET RESEARCH; MARKET RESEARCH CONSULTATION; MARKET RESEARCH SERVICES; MARKET RESEARCH STUDIES; MARKET SEGMENTATION CONSULTATION; MARKET STUDY AND ANALYSIS OF MARKET STUDIES; MARKETING CONSULTING; MARKETING PLAN DEVELOPMENT; MARKETING SERVICES, NAMELY PROVIDING INFORMATIONAL WEB PAGES DESIGNED TO GENERATE SALES TRAFFIC VIA HYPERLINKS TO OTHER WEB SITES; MEDIA PLANNING, NAMELY, ADVISING THE CLIENT ON THE CORRECT TIMES AND STATIONS TO ADVERTISE BASED ON MEDIA ANALYSIS OF THE MARKET FOR THAT MEDIA; MULTI-LEVEL MARKETING BUSINESS SERVICES; ON-LINE ADVERTISING AND MARKETING SERVICES; OUTSOURCING IN THE FIELD OF SALES AND MARKETING OF COMPUTER SOFTWARE; PROMOTING, ADVERTISING AND MARKETING OF THE ON-LINE WEBSITES OF OTHERS; PROMOTION AND MARKETING SERVICES AND RELATED CONSULTING; PROMOTION, ADVERTISING AND MARKETING OF ON-LINE WEBSITES; PROVIDING ADVERTISING, MARKETING AND PROMOTIONAL SERVICES FOR THE PHARMACEUTICAL AND MEDICAL INDUSTRY; PROVIDING ADVERTISING, MARKETING AND PROMOTIONAL SERVICES FOR THE PHARMACEUTICAL AND MEDICAL PRODUCTS OF OTHERS; PROVIDING BUSINESS MARKETING INFORMATION; PROVIDING MARKETING AND PROMOTION OF SPECIAL EVENTS; PROVIDING PROMOTIONAL MARKETING SERVICES TO BUSINESSES IN THE BROADBAND AND MEDIA INDUSTRIES; STATISTICAL EVALUATIONS OF

MARKETING DATA, IN CLASS 35 (U.S. CLS. 100, 101 AND 102).

THE MARK CONSISTS OF STANDARD CHARACTERS WITHOUT CLAIM TO ANY PARTICULAR FONT, STYLE, SIZE, OR COLOR.

SN 77-059,773, FILED 12-8-2006.

FIRST USE 11-1-2004; IN COMMERCE 11-1-2004.

SCOTT BIBB, EXAMINING ATTORNEY

Int. Cl.: 44

Prior U.S. Cls.: 100 and 101

United States Patent and Trademark Office

Reg. No. 3,481,279

Registered Aug. 5, 2008

**SERVICE MARK
PRINCIPAL REGISTER**



GENESIS HEALTHCARE HOLDING COMPANY
II, INC. (DELAWARE CORPORATION)
101 E. STATE STREET
KENNETT SQUARE, PA 19348

FOR: HEALTH CARE SERVICES; HEALTH CARE SERVICES, NAMELY, PROVIDING PRIMARY HEALTH CARE CLINICS, PROVIDING HEALTH CARE SERVICES TO GERIATRIC PATIENTS, HOME HEALTH CARE SERVICES AND PHYSICAL REHABILITATION SERVICES, IN CLASS 44 (U.S. CLS. 100 AND 101).

FIRST USE 5-0-2006; IN COMMERCE 5-0-2006.

THE MARK CONSISTS OF THE WORDS "LIFE AT HOME" BELOW A DESIGN CONSISTING OF THREE HOUSES WITH A HEART SHAPE CUT OUT OF THE CENTER HOUSE, ALL UNDER A SOLID BLACK CIRCLE.

SN 77-060,035, FILED 12-8-2006.

REBECCA SMITH, EXAMINING ATTORNEY

Int. Cls.: 7, 37, and 42

**Prior U.S. Cls.: 13, 19, 21, 23, 31, 34, 35, 100, 101, 103,
and 106**

Reg. No. 3,481,280

United States Patent and Trademark Office

Registered Aug. 5, 2008

**TRADEMARK
SERVICE MARK
PRINCIPAL REGISTER**



SOS-BOLTING, INC. (DELAWARE CORPORATION)
220 E. DELAWARE AVENUE
NEWARK, DE 19711

FOR: POWER TOOLS, NAMELY, HYDRAULIC TORQUE WRENCHES, HYDRAULIC BOLT TENSIONERS, HYDRAULIC PUMPS, IMPACT SOCKETS, AND INDUCTION BOLT HEATING MACHINERY, IN CLASS 7 (U.S. CLS. 13, 19, 21, 23, 31, 34 AND 35).

FIRST USE 1-1-2007; IN COMMERCE 1-1-2007.

FOR: INDUSTRIAL BOLTING SERVICES, NAMELY, RENTAL OF BOLTING EQUIPMENT AND MACHINERY; CONSULTING IN THE OPERATION OF BOLTING EQUIPMENT AND MACHINERY, IN CLASS 37 (U.S. CLS. 100, 103 AND 106).

FIRST USE 1-1-2007; IN COMMERCE 1-1-2007.

FOR: INDUSTRIAL BOLTING SERVICES, NAMELY, CONSULTING IN THE DESIGN OF BOLTING EQUIPMENT AND MACHINERY, IN CLASS 42 (U.S. CLS. 100 AND 101).

FIRST USE 1-1-2007; IN COMMERCE 1-1-2007.

NO CLAIM IS MADE TO THE EXCLUSIVE RIGHT TO USE "BOLTING" AND THE ILLUSTRATION OF A BOLTING ASSEMBLY, APART FROM THE MARK AS SHOWN.

THE MARK CONSISTS OF "SOS BOLTING" AND DESIGN.

SN 77-060,674, FILED 12-8-2006.

HENRY S. ZAK, EXAMINING ATTORNEY

Int. Cl.: 16

Prior U.S. Cls.: 2, 5, 22, 23, 29, 37, 38, and 50

Reg. No. 3,481,281

United States Patent and Trademark Office

Registered Aug. 5, 2008

**TRADEMARK
PRINCIPAL REGISTER**

BEWARE OF GUN

DAUGERDAS, PAUL MICHAEL (UNITED STATES INDIVIDUAL)
55 S. VALLE VERDE DR. #235-173
HENDERSON, NV 89012

THE MARK CONSISTS OF STANDARD CHARACTERS WITHOUT CLAIM TO ANY PARTICULAR FONT, STYLE, SIZE, OR COLOR.

FOR: ADVERTISING SIGNS OF PAPER OR CARDBOARD, IN CLASS 16 (U.S. CLS. 2, 5, 22, 23, 29, 37, 38 AND 50).

SN 77-061,257, FILED 12-11-2006.

FIRST USE 6-22-2008; IN COMMERCE 6-22-2008.

SALLY SHIH, EXAMINING ATTORNEY

Int. Cl.: 10

Prior U.S. Cls.: 26, 39, and 44

United States Patent and Trademark Office

Reg. No. 3,481,282

Registered Aug. 5, 2008

**TRADEMARK
PRINCIPAL REGISTER**

ACCUFIT

CHANG, CALVIN (UNITED STATES INDIVIDUAL)
4999 E LA PALMA AVE.
ANAHEIM, CA 92807

FOR: ORTHOPEDIC FOOTWEAR; ORTHOPEDIC SOLES; ORTHOPEDIC SUPPORTS; ORTHOTIC INSERTS FOR FOOTWEAR; ORTHOTICS FOR FOOT; SUPPORTS FOR ANKLE, WRIST FOR MEDICAL USE, IN CLASS 10 (U.S. CLS. 26, 39 AND 44).

FIRST USE 8-1-2007; IN COMMERCE 8-1-2007.

THE MARK CONSISTS OF STANDARD CHARACTERS WITHOUT CLAIM TO ANY PARTICULAR FONT, STYLE, SIZE, OR COLOR.

SN 77-061,708, FILED 12-11-2006.

JANICE KIM, EXAMINING ATTORNEY

Int. Cl.: 31

Prior U.S. Cls.: 1 and 46

United States Patent and Trademark Office

Reg. No. 3,481,283

Registered Aug. 5, 2008

**TRADEMARK
PRINCIPAL REGISTER**

FIRST EDITIONS

BAILEY NURSERIES, INC. (MINNESOTA CORPORATION)
1325 BAILEY ROAD
SAINT PAUL, MN 55119

THE MARK CONSISTS OF STANDARD CHARACTERS WITHOUT CLAIM TO ANY PARTICULAR FONT, STYLE, SIZE, OR COLOR.

FOR: LIVE PLANTS, IN CLASS 31 (U.S. CLS. 1 AND 46).

SN 77-061,965, FILED 12-12-2006.

FIRST USE 1-9-2007; IN COMMERCE 4-20-2007.

SANI KHOURI, EXAMINING ATTORNEY

Int. Cls.: 16, 21, and 25

**Prior U.S. Cls.: 2, 5, 13, 22, 23, 29, 30, 33, 37, 38, 39,
40, and 50**

Reg. No. 3,481,284

United States Patent and Trademark Office

Registered Aug. 5, 2008

**TRADEMARK
PRINCIPAL REGISTER**

Small Dog Day

HARRIS, CHERYL (UNITED STATES INDIVIDUAL)
34540 BROCK LANE
ACTON, CA 93510

FIRST USE 10-1-2007; IN COMMERCE 10-1-2007.

FOR: GREETING CARDS; STATIONERY, IN CLASS 16 (U.S. CLS. 2, 5, 22, 23, 29, 37, 38 AND 50).

THE MARK CONSISTS OF STANDARD CHARACTERS WITHOUT CLAIM TO ANY PARTICULAR FONT, STYLE, SIZE, OR COLOR.

FIRST USE 11-10-2007; IN COMMERCE 11-10-2007.

FOR: PET FEEDING DISHES, IN CLASS 21 (U.S. CLS. 2, 13, 23, 29, 30, 33, 40 AND 50).

NO CLAIM IS MADE TO THE EXCLUSIVE RIGHT TO USE "SMALL DOG" , APART FROM THE MARK AS SHOWN.

FIRST USE 10-1-2007; IN COMMERCE 10-1-2007.

FOR: CLOTHING, NAMELY, T-SHIRTS, SHIRTS, SWEATS PANTS, SWEAT SUITS, SWEAT SHIRTS, HATS, IN CLASS 25 (U.S. CLS. 22 AND 39).

SN 77-062,100, FILED 12-12-2006.

CURTIS FRENCH, EXAMINING ATTORNEY

Int. Cl.: 25

Prior U.S. Cls.: 22 and 39

United States Patent and Trademark Office

Reg. No. 3,481,285

Registered Aug. 5, 2008

**TRADEMARK
PRINCIPAL REGISTER**

WILFLO

WILFLO (OHIO PARTNERSHIP)
2413 MONTANA AVE., APT. C-12
CINCINNATI, OH 45211

THE MARK CONSISTS OF STANDARD CHAR-
ACTERS WITHOUT CLAIM TO ANY PARTICULAR
FONT, STYLE, SIZE, OR COLOR.

FOR: CLOTHING, NAMELY, T-SHIRTS, SHIRTS,
JACKETS, HEADWEAR, SWEATSHIRTS, AND
SWEATPANTS, IN CLASS 25 (U.S. CLS. 22 AND 39).

SN 77-063,677, FILED 12-13-2006.

FIRST USE 11-1-2007; IN COMMERCE 11-1-2007.

DAVID HOFFMAN, EXAMINING ATTORNEY

Int. Cl.: 28

Prior U.S. Cls.: 22, 23, 38, and 50

United States Patent and Trademark Office

Reg. No. 3,481,286

Registered Aug. 5, 2008

**TRADEMARK
PRINCIPAL REGISTER**

WOBBLE POD

LANDSCAPE STRUCTURES, INC. (MINNESOTA
CORPORATION)
P.O. BOX 198
601 7TH STREET SOUTH
DELANO, MN 553280198

THE MARK CONSISTS OF STANDARD CHAR-
ACTERS WITHOUT CLAIM TO ANY PARTICULAR
FONT, STYLE, SIZE, OR COLOR.

FOR: PLAYGROUND EQUIPMENT, NAMELY,
BALANCING BOARD, CLIMBING STRUCTURES,
IN CLASS 28 (U.S. CLS. 22, 23, 38 AND 50).

SN 77-064,130, FILED 12-14-2006.

FIRST USE 12-7-2006; IN COMMERCE 12-7-2006.

EMILY CARLSEN, EXAMINING ATTORNEY

Int. Cl.: 10

Prior U.S. Cls.: 26, 39, and 44

Reg. No. 3,481,287

United States Patent and Trademark Office

Registered Aug. 5, 2008

**TRADEMARK
PRINCIPAL REGISTER**

G&H

G&H WIRE HOLDINGS, INC. (DELAWARE CORPORATION)
875 NORTH MICHIGAN AVENUE, SUITE 4020
CHICAGO, IL 60611

FOR: ORTHODONTIC APPLIANCES AND DENTAL INSTRUMENTS, NAMELY, ARCH-WIRES, STRAIGHT-LINED SYSTEM BRACKETS, NICKEL TITANIUM AND STAINLESS STEEL COIL SPRINGS, BUCCAL TUBES AND LINGUAL ATTACHMENTS, PATIENT ELASTIC BANDS, ELASTIC BAND DISPENSERS, HEADGEAR, ELASTOMERIC CHAINS, ELASTOMERIC LIGATURES, ELASTOMERIC THREADS, STAINLESS STEEL LIGATURES, STAINLESS STEEL PALATAL BARS, BONDING AND BANDING APPARATUS, MIRRORS, RETAINER CASES, DENTAL STORAGE

CASES, ELASTIC-KEY RING STERILIZATION CASSETTES, BITE STICKS, EXPANSION SCREWS, ORTHODONTIC PLIERS, AND BRACKET POSITIONING INSTRUMENTS, IN CLASS 10 (U.S. CLS. 26, 39 AND 44).

FIRST USE 12-31-1981; IN COMMERCE 12-31-1981.

THE MARK CONSISTS OF STANDARD CHARACTERS WITHOUT CLAIM TO ANY PARTICULAR FONT, STYLE, SIZE, OR COLOR.

SN 77-064,597, FILED 12-14-2006.

KAREN SEVERSON, EXAMINING ATTORNEY

Int. Cl.: 10

Prior U.S. Cls.: 26, 39, and 44

United States Patent and Trademark Office

Reg. No. 3,481,288

Registered Aug. 5, 2008

**TRADEMARK
PRINCIPAL REGISTER**

G&H WIRE COMPANY

G&H WIRE HOLDINGS, INC. (DELAWARE CORPORATION)
875 NORTH MICHIGAN AVENUE, SUITE 4020
CHICAGO, IL 60611

FOR: ORTHODONTIC APPLIANCES AND DENTAL INSTRUMENTS, NAMELY, ARCH-WIRES, STRAIGHT-LINED SYSTEM BRACKETS, NICKEL TITANIUM AND STAINLESS STEEL COIL SPRINGS, BUCCAL TUBES AND LINGUAL ATTACHMENTS, PATIENT ELASTIC BANDS, ELASTIC BAND DISPENSERS, HEADGEAR, ELASTOMERIC CHAINS, ELASTOMERIC LIGATURES, ELASTOMERIC THREADS, STAINLESS STEEL LIGATURES, STAINLESS STEEL PALATAL BARS, BONDING AND BANDING APPARATUS, MIRRORS, RETAINER CASES, DENTAL STORAGE CASES, ELASTIC-KEY RING STERILIZATION CASSETTES, BITE STICKS, EXPANSION SCREWS, OR-

THODONTIC PLIERS, AND BRACKET POSITIONING INSTRUMENTS, IN CLASS 10 (U.S. CLS. 26, 39 AND 44).

FIRST USE 12-31-1981; IN COMMERCE 12-31-1981.

THE MARK CONSISTS OF STANDARD CHARACTERS WITHOUT CLAIM TO ANY PARTICULAR FONT, STYLE, SIZE, OR COLOR.

NO CLAIM IS MADE TO THE EXCLUSIVE RIGHT TO USE "WIRE COMPANY", APART FROM THE MARK AS SHOWN.

SN 77-064,603, FILED 12-14-2006.

KAREN SEVERSON, EXAMINING ATTORNEY

Int. Cl.: 28

Prior U.S. Cls.: 22, 23, 38, and 50

United States Patent and Trademark Office

Reg. No. 3,481,289

Registered Aug. 5, 2008

**TRADEMARK
PRINCIPAL REGISTER**

**OHANA MANA HAWAIIAN
ADVENTURE GAME**

TUPMAN, EILEEN N. (UNITED STATES INDIVIDUAL)
3228 CANYON VIEW DRIVE
OCEANSIDE, CA 920547480

FOR: BOARD GAMES; CARD GAMES, IN CLASS 28 (U.S. CLS. 22, 23, 38 AND 50).

FIRST USE 3-22-2007; IN COMMERCE 3-22-2007.

THE MARK CONSISTS OF STANDARD CHARACTERS WITHOUT CLAIM TO ANY PARTICULAR FONT, STYLE, SIZE, OR COLOR.

NO CLAIM IS MADE TO THE EXCLUSIVE RIGHT TO USE "HAWAIIAN ADVENTURE GAME", APART FROM THE MARK AS SHOWN.

THE FOREIGN WORDING IN THE MARK TRANSLATES INTO ENGLISH AS FAMILY SPIRITUAL ENERGY.

SN 77-065,509, FILED 12-15-2006.

RENEE SERVANCE, EXAMINING ATTORNEY

Int. Cl.: 35

Prior U.S. Cls.: 100, 101, and 102

United States Patent and Trademark Office

Reg. No. 3,481,290

Registered Aug. 5, 2008

**SERVICE MARK
PRINCIPAL REGISTER**

SMARTCALL

SMARTTALENT LLC (WASHINGTON LTD LIAB
CO)
1321 FOURTH AVENUE
SEATTLE, WA 98101

FOR: BUSINESS SERVICES, NAMELY, BUSINESS CONSULTING IN THE FIELD OF HUMAN RESOURCES; TEMPORARY EMPLOYMENT STAFFING SERVICES, EMPLOYMENT RECRUITING AND PLACEMENT SERVICES IN AREAS INCLUDING INBOUND/OUTBOUND ACCOUNTS RECEIVABLES, SALES AND SALES SUPPORT, FULFILLMENT OF PURCHASE ORDERS, CREDIT AND COLLECTIONS, INTERNET OFFICE SUPPORT, MULTIMEDIA GAME SUPPORT, WIRELESS PHONE SUPPORT, AND CATALOG ORDERING CUSTOMER SERVICE; EMPLOYMENT PLACE-

MENT AGENCY SERVICES, NAMELY, ASSISTING CLIENTS OBTAIN EMPLOYMENT BY PROVIDING ONE HOUR REMINDER CALLS PRIOR TO THEIR INTERVIEW AND FOR HIRED CLIENTS PRIOR TO THEIR FIRST DAY OF WORK ON A NEW ASSIGNMENT, IN CLASS 35 (U.S. CLS. 100, 101 AND 102).

FIRST USE 0-0-2001; IN COMMERCE 0-0-2007.

THE MARK CONSISTS OF STANDARD CHARACTERS WITHOUT CLAIM TO ANY PARTICULAR FONT, STYLE, SIZE, OR COLOR.

SN 77-065,707, FILED 12-15-2006.

ALEX KEAM, EXAMINING ATTORNEY

Int. Cl.: 16

Prior U.S. Cls.: 2, 5, 22, 23, 29, 37, 38, and 50

United States Patent and Trademark Office

Reg. No. 3,481,291

Registered Aug. 5, 2008

**TRADEMARK
PRINCIPAL REGISTER**

GOSPEL FOR THE PEOPLE

OUG PRESS (PENNSYLVANIA LTD LIAB CO)
SUITE 1212
429 FORBES AVENUE
PITTSBURGH, PA 15219

FOR: BIBLES, IN CLASS 16 (U.S. CLS. 2, 5, 22, 23, 29,
37, 38 AND 50).

FIRST USE 5-29-2008; IN COMMERCE 5-29-2008.

THE MARK CONSISTS OF STANDARD CHAR-
ACTERS WITHOUT CLAIM TO ANY PARTICULAR
FONT, STYLE, SIZE, OR COLOR.

NO CLAIM IS MADE TO THE EXCLUSIVE
RIGHT TO USE "GOSPEL", APART FROM THE
MARK AS SHOWN.

SN 77-065,823, FILED 12-16-2006.

KELLY CHOE, EXAMINING ATTORNEY

Int. Cl.: 35

Prior U.S. Cls.: 100, 101, and 102

United States Patent and Trademark Office

Reg. No. 3,481,292

Registered Aug. 5, 2008

**SERVICE MARK
PRINCIPAL REGISTER**

SMARTLABOR

SMARTTALENT LLC (WASHINGTON LTD LIAB
CO)
1321 FOURTH AVENUE
SEATTLE, WA 98101

FOR: BUSINESS SERVICES, NAMELY, BUSINESS CONSULTING IN THE FIELDS OF HUMAN RESOURCES, MANAGEMENT CONSULTING, AND SCREENING, EVALUATION AND TRAINING JOB RECRUITS; TEMPORARY EMPLOYMENT STAFFING SERVICES; EMPLOYMENT RECRUITING PLACEMENT SERVICES IN THE FIELDS/POSITIONS/ROLES INCLUDING WAREHOUSE, PRODUCTION, DISTRIBUTION, TRANSPORTATION, FORKLIFT, SHIPPING AND RECEIVING, PACKAGING, MATERIAL HANDLER, STOCK CLERK, DRIVING, INSPECTION/QC CLERK, INVENTORY

CONTROL, MACHINE OPERATORS, ASSEMBLY WORKERS - MECHANICAL/ELECTRONIC, SOLDERING, TECHNICIANS, ASSEMBLERS, INSPECTION/QC CLERK, INVENTORY CONTROL, AND INJECTION MOLD, IN CLASS 35 (U.S. CLS. 100, 101 AND 102).

FIRST USE 0-0-2001; IN COMMERCE 0-0-2007.

THE MARK CONSISTS OF STANDARD CHARACTERS WITHOUT CLAIM TO ANY PARTICULAR FONT, STYLE, SIZE, OR COLOR.

SN 77-066,397, FILED 12-18-2006.

ALEX KEAM, EXAMINING ATTORNEY

Int. Cls.: 36 and 41

Prior U.S. Cls.: 100, 101, 102, and 107

United States Patent and Trademark Office

Reg. No. 3,481,293

Registered Aug. 5, 2008

**SERVICE MARK
PRINCIPAL REGISTER**



NATIONAL MULTIPLE SCLEROSIS SOCIETY
(NEW YORK NOT-FOR-PROFIT CORPORATION)

733 THIRD AVENUE, 3RD FLOOR
NEW YORK, NY 10017

FOR: CHARITABLE FUNDRAISING SERVICES,
IN CLASS 36 (U.S. CLS. 100, 101 AND 102).

FIRST USE 11-0-2006; IN COMMERCE 11-0-2006.

FOR: EDUCATION SERVICES, NAMELY, A PROGRAM TO RAISE AWARENESS OF MULTIPLE SCLEROSIS, IN CLASS 41 (U.S. CLS. 100, 101 AND 107).

FIRST USE 11-0-2006; IN COMMERCE 11-0-2006.

OWNER OF U.S. REG. NOS. 1,484,593, 2,915,135,
AND OTHERS.

NO CLAIM IS MADE TO THE EXCLUSIVE
RIGHT TO USE "MS", APART FROM THE MARK
AS SHOWN.

THE MARK CONSISTS OF "MS" SLASHED DESIGN.

SN 77-066,611, FILED 12-18-2006.

REBECCA EISINGER, EXAMINING ATTORNEY

Int. Cl.: 37

Prior U.S. Cls.: 100, 103, and 106

United States Patent and Trademark Office

Reg. No. 3,481,294

Registered Aug. 5, 2008

**SERVICE MARK
PRINCIPAL REGISTER**

LIGHTSTREAM

INTERNATIONAL PIPELINING TECHNOLOGIES, INC. (CALIFORNIA CORPORATION)
8250 CAMINO SANTA FE, SUITE H
SAN DIEGO, CA 92121

FOR: PIPELINE REHABILITATION SERVICES, NAMELY, THE REPAIR AND RELINING OF EXISTING PIPELINE; PIPELINE RESTORATION AND MAINTENANCE SERVICES, IN CLASS 37 (U.S. CLS. 100, 103 AND 106).

FIRST USE 12-1-2006; IN COMMERCE 12-1-2006.

THE MARK CONSISTS OF STANDARD CHARACTERS WITHOUT CLAIM TO ANY PARTICULAR FONT, STYLE, SIZE, OR COLOR.

SN 77-067,015, FILED 12-19-2006.

JAMES MACFARLANE, EXAMINING ATTORNEY

Int. Cl.: 37

Prior U.S. Cls.: 100, 103, and 106

United States Patent and Trademark Office

Reg. No. 3,481,295

Registered Aug. 5, 2008

**SERVICE MARK
PRINCIPAL REGISTER**

SPINTECH

INTERNATIONAL PIPELINING TECHNOLOGIES, INC. (CALIFORNIA CORPORATION)
8250 CAMINO SANTA FE, SUITE H
SAN DIEGO, CA 92121

FOR: PIPELINE REHABILITATION SERVICES, NAMELY, THE REPAIR AND RELINING OF EXISTING PIPELINE; PIPELINE RESTORATION AND MAINTENANCE SERVICES, IN CLASS 37 (U.S. CLS. 100, 103 AND 106).

FIRST USE 12-1-2006; IN COMMERCE 12-1-2006.

THE MARK CONSISTS OF STANDARD CHARACTERS WITHOUT CLAIM TO ANY PARTICULAR FONT, STYLE, SIZE, OR COLOR.

SN 77-067,029, FILED 12-19-2006.

JAMES MACFARLANE, EXAMINING ATTORNEY

Int. Cl.: 37

Prior U.S. Cls.: 100, 103, and 106

United States Patent and Trademark Office

Reg. No. 3,481,296

Registered Aug. 5, 2008

**SERVICE MARK
PRINCIPAL REGISTER**

AIRSTREAM

INTERNATIONAL PIPELINING TECHNOLOGIES, INC. (CALIFORNIA CORPORATION)
8250 CAMINO SANTA FE, SUITE H
SAN DIEGO, CA 92121

FOR: PIPELINE REHABILITATION SERVICES, NAMELY, THE REPAIR AND RELINING OF EXISTING PIPELINE; PIPELINE RESTORATION AND MAINTENANCE SERVICES, IN CLASS 37 (U.S. CLS. 100, 103 AND 106).

FIRST USE 12-1-2006; IN COMMERCE 12-1-2006.

THE MARK CONSISTS OF STANDARD CHARACTERS WITHOUT CLAIM TO ANY PARTICULAR FONT, STYLE, SIZE, OR COLOR.

SN 77-067,043, FILED 12-19-2006.

JAMES MACFARLANE, EXAMINING ATTORNEY

Int. Cl.: 29

Prior U.S. Cl.: 46

United States Patent and Trademark Office

Reg. No. 3,481,297

Registered Aug. 5, 2008

**TRADEMARK
PRINCIPAL REGISTER**

POCKET FRUIT

AU'SOME, INC. (NEW JERSEY CORPORATION)
SUITE E, BLDG A
2031 ROUTE 130
MONMOUTH, NJ 08852

FOR: FRUIT-BASED SNACK FOOD, IN CLASS 29
(U.S. CL. 46).

FIRST USE 5-29-2007; IN COMMERCE 5-29-2007.

THE MARK CONSISTS OF STANDARD CHAR-
ACTERS WITHOUT CLAIM TO ANY PARTICULAR
FONT, STYLE, SIZE, OR COLOR.

NO CLAIM IS MADE TO THE EXCLUSIVE
RIGHT TO USE "FRUIT", APART FROM THE
MARK AS SHOWN.

SN 77-068,778, FILED 12-20-2006.

KELLY CHOE, EXAMINING ATTORNEY

Int. Cl.: 28

Prior U.S. Cls.: 22, 23, 38, and 50

United States Patent and Trademark Office

Reg. No. 3,481,298

Registered Aug. 5, 2008

**TRADEMARK
PRINCIPAL REGISTER**

TOUR FIRE

DICK'S SPORTING GOODS, INC. (DELAWARE
CORPORATION)
300 INDUSTRY DRIVE
RIDC PARK WEST
PITTSBURGH, PA 15275

FOR: GOLF EQUIPMENT, NAMELY, GOLF
BALLS, IN CLASS 28 (U.S. CLS. 22, 23, 38 AND 50).

FIRST USE 5-0-2007; IN COMMERCE 5-0-2007.

THE MARK CONSISTS OF STANDARD CHAR-
ACTERS WITHOUT CLAIM TO ANY PARTICULAR
FONT, STYLE, SIZE, OR COLOR.

OWNER OF U.S. REG. NO. 2,333,113.

SN 77-068,834, FILED 12-20-2006.

MARGERY A. TIERNEY, EXAMINING ATTORNEY

Int. Cls.: 41 and 42

Prior U.S. Cls.: 100, 101, and 107

United States Patent and Trademark Office

Reg. No. 3,481,299

Registered Aug. 5, 2008

**SERVICE MARK
PRINCIPAL REGISTER**

CINNAFILM

CINNAFILM, INC. (NEW MEXICO CORPORATION)
11204 PARIS AVENUE NE
ALBUQUERQUE, NM 87111

FOR: ENTERTAINMENT, NAMELY, PREPARATION OF SPECIAL EFFECTS FOR FILM AND VIDEO AND SPECIAL EFFECTS ANIMATION SERVICES FOR FILM AND VIDEO, IN CLASS 41 (U.S. CLS. 100, 101 AND 107).

FIRST USE 5-1-2007; IN COMMERCE 5-1-2007.

FOR: SPECIAL EFFECTS SERVICES FOR FILM AND VIDEO, NAMELY, ANIMATION AND SPE-

CIAL EFFECTS DESIGN FOR OTHERS, IN CLASS 42 (U.S. CLS. 100 AND 101).

FIRST USE 5-1-2007; IN COMMERCE 5-1-2007.

THE MARK CONSISTS OF STANDARD CHARACTERS WITHOUT CLAIM TO ANY PARTICULAR FONT, STYLE, SIZE, OR COLOR.

SN 77-069,371, FILED 12-21-2006.

JENNIFER MARTIN, EXAMINING ATTORNEY

Int. Cl.: 7

Prior U.S. Cls.: 13, 19, 21, 23, 31, 34, and 35

Reg. No. 3,481,300

United States Patent and Trademark Office

Registered Aug. 5, 2008

**TRADEMARK
PRINCIPAL REGISTER**

NITEK

NOVANITEK, INC. (TEXAS CORPORATION)
10763 MAPLERIDGE DRIVE
DALLAS, TX 75238

THE MARK CONSISTS OF STANDARD CHAR-
ACTERS WITHOUT CLAIM TO ANY PARTICULAR
FONT, STYLE, SIZE, OR COLOR.

FOR: ELECTRIC MOTORS FOR MACHINES, IN
CLASS 7 (U.S. CLS. 13, 19, 21, 23, 31, 34 AND 35).

SN 77-069,866, FILED 12-21-2006.

FIRST USE 6-8-2007; IN COMMERCE 6-8-2007.

CURTIS FRENCH, EXAMINING ATTORNEY

Int. Cls.: 16 and 41

Prior U.S. Cls.: 2, 5, 22, 23, 29, 37, 38, 50, 100, 101, and 107

Reg. No. 3,481,301

United States Patent and Trademark Office

Registered Aug. 5, 2008

**TRADEMARK
SERVICE MARK
PRINCIPAL REGISTER**

TODAY IN PT

GANNETT SATELLITE INFORMATION NETWORK, INC. (DELAWARE CORPORATION)
7950 JONES BRANCH DRIVE
MCLEAN, VA 22107

FOR: PRINTED PUBLICATION, NAMELY, A MAGAZINE CONTAINING ARTICLES, INFORMATION AND ADVERTISING, ON THE SUBJECT OF PHYSICAL THERAPY AND ADDRESSING TOPICS OF INTEREST TO MEMBERS OF THE PHYSICAL THERAPIST PROFESSION, IN CLASS 16 (U.S. CLS. 2, 5, 22, 23, 29, 37, 38 AND 50).

FIRST USE 2-19-2007; IN COMMERCE 2-19-2007.

FOR: ONLINE PERIODICALS PROVIDING NEWS, INFORMATION, AND EMPLOYMENT OP-

PORTUNITIES IN THE PHYSICAL THERAPY FIELD, IN CLASS 41 (U.S. CLS. 100, 101 AND 107).

FIRST USE 4-2-2007; IN COMMERCE 4-2-2007.

THE MARK CONSISTS OF STANDARD CHARACTERS WITHOUT CLAIM TO ANY PARTICULAR FONT, STYLE, SIZE, OR COLOR.

NO CLAIM IS MADE TO THE EXCLUSIVE RIGHT TO USE "PT", APART FROM THE MARK AS SHOWN.

SN 77-070,123, FILED 12-22-2006.

ELLEN PERKINS, EXAMINING ATTORNEY

Int. Cl.: 25

Prior U.S. Cls.: 22 and 39

United States Patent and Trademark Office

Reg. No. 3,481,302

Registered Aug. 5, 2008

**TRADEMARK
PRINCIPAL REGISTER**

SWEET LOVE

PEEP, INC. (CALIFORNIA CORPORATION)
747 TOWNE AVENUE
LOS ANGELES, CA 90021

THE MARK CONSISTS OF STANDARD CHAR-
ACTERS WITHOUT CLAIM TO ANY PARTICULAR
FONT, STYLE, SIZE, OR COLOR.

FOR: DRESSES; JACKETS; SHIRTS; T-SHIRTS, IN
CLASS 25 (U.S. CLS. 22 AND 39).

SN 77-070,853, FILED 12-22-2006.

FIRST USE 2-4-2008; IN COMMERCE 2-4-2008.

REBECCA SMITH, EXAMINING ATTORNEY

Int. Cl.: 29

Prior U.S. Cl.: 46

United States Patent and Trademark Office

Reg. No. 3,481,303

Registered Aug. 5, 2008

**TRADEMARK
PRINCIPAL REGISTER**

Meals for LIFE

NEPHRO CUISINE, INC. (CALIFORNIA CORPORATION)
165 W. OLIVE ST.
COLTON, CA 92324

FOR: FROZEN MEALS CONSISTING PRIMARILY OF MEAT, FISH, POULTRY OR VEGETABLES, IN CLASS 29 (U.S. CL. 46).

FIRST USE 4-2-2008; IN COMMERCE 4-2-2008.

THE MARK CONSISTS OF STANDARD CHARACTERS WITHOUT CLAIM TO ANY PARTICULAR FONT, STYLE, SIZE, OR COLOR.

NO CLAIM IS MADE TO THE EXCLUSIVE RIGHT TO USE "MEALS", APART FROM THE MARK AS SHOWN.

SN 77-070,975, FILED 12-23-2006.

LYDIA BELZER, EXAMINING ATTORNEY

Int. Cl.: 9

Prior U.S. Cls.: 21, 23, 26, 36, and 38

Reg. No. 3,481,304

United States Patent and Trademark Office

Registered Aug. 5, 2008

**TRADEMARK
PRINCIPAL REGISTER**



SONY KABUSHIKI KAISHA (JAPAN CORPORATION), TA SONY CORPORATION,
1-7-1 KONAN, MINATO-KU
TOKYO, JAPAN

FOR: DIGITAL STILL CAMERAS, IN CLASS 9
(U.S. CLS. 21, 23, 26, 36 AND 38).

FIRST USE 3-31-2007; IN COMMERCE 3-31-2007.

NO CLAIM IS MADE TO THE EXCLUSIVE RIGHT TO USE "FACE DETECTION", APART FROM THE MARK AS SHOWN.

THE MARK CONSISTS OF THE WORDS "FACE DETECTION" WITH A HIGHLY STYLIZED DESIGN OF A FACE WITHIN A RECTANGLE.

SN 77-071,619, FILED 12-27-2006.

ELLEN PERKINS, EXAMINING ATTORNEY

Int. Cl.: 41

Prior U.S. Cls.: 100, 101, and 107

United States Patent and Trademark Office

Reg. No. 3,481,305

Registered Aug. 5, 2008

**SERVICE MARK
PRINCIPAL REGISTER**

**FAITH, FAMILY AND FREEDOM
CELEBRATION**

COLUMBIA BIBLE COLLEGE BROADCASTING
CO. (SOUTH CAROLINA NON-PROFIT COR-
PORATION)
7435 MONTICELLO ROAD
COLUMBIA, SC 29203

FOR: ENTERTAINMENT, NAMELY, LIVE MU-
SIC CONCERTS, IN CLASS 41 (U.S. CLS. 100, 101
AND 107).

FIRST USE 6-22-2008; IN COMMERCE 6-22-2008.

THE MARK CONSISTS OF STANDARD CHAR-
ACTERS WITHOUT CLAIM TO ANY PARTICULAR
FONT, STYLE, SIZE, OR COLOR.

NO CLAIM IS MADE TO THE EXCLUSIVE
RIGHT TO USE "CELEBRATION", APART FROM
THE MARK AS SHOWN.

SN 77-072,171, FILED 12-27-2006.

MICHAEL SOUDERS, EXAMINING ATTORNEY

Int. Cl.: 33

Prior U.S. Cls.: 47 and 49

United States Patent and Trademark Office

Reg. No. 3,481,306

Registered Aug. 5, 2008

**TRADEMARK
PRINCIPAL REGISTER**



STIRRINGS, LLC (DELAWARE LTD LIAB CO)
ONE WEST STREET
FALLS RIVER, MA 02720

FOR: ALCOHOLIC BEVERAGES, NAMELY, AL-
COHOLIC COCKTAIL MIXES, IN CLASS 33 (U.S.
CLS. 47 AND 49).

FIRST USE 10-5-2007; IN COMMERCE 10-5-2007.

OWNER OF U.S. REG. NO. 3,087,636.

THE MARK CONSISTS OF A STYLIZED CURVED
LINE PLACED ABOVE THE WORD, "STIRRINGS"
IN STYLIZED TEXT.

SN 77-072,669, FILED 12-28-2006.

BONNIE LUKEN, EXAMINING ATTORNEY

Int. Cl.: 3

Prior U.S. Cls.: 1, 4, 6, 50, 51, and 52

United States Patent and Trademark Office

Reg. No. 3,481,307

Registered Aug. 5, 2008

**TRADEMARK
PRINCIPAL REGISTER**

PROGESTIA

BNG ENTERPRISES, INC. (ARIZONA CORPORATION)
3312 E. BROADWAY ROAD
PHOENIX, AZ 85040

THE MARK CONSISTS OF STANDARD CHARACTERS WITHOUT CLAIM TO ANY PARTICULAR FONT, STYLE, SIZE, OR COLOR.

FOR: COSMETICS, NAMELY, BODY CREAMS AND BODY OILS, IN CLASS 3 (U.S. CLS. 1, 4, 6, 50, 51 AND 52).

SN 77-072,797, FILED 12-28-2006.

FIRST USE 5-15-2007; IN COMMERCE 5-15-2007.

GENE MACIOL, EXAMINING ATTORNEY

Int. Cl.: 41

Prior U.S. Cls.: 100, 101, and 107

United States Patent and Trademark Office

Reg. No. 3,481,308

Registered Aug. 5, 2008

**SERVICE MARK
PRINCIPAL REGISTER**

The Millionaire Zone

FAMILY FINANCIAL NETWORK, L.L.C. (FLOR-
IDA LTD LIAB CO)
6 WEST PUTNAM AVENUE
GREENWICH, CT 06830

FOR: EDUCATIONAL SERVICES, NAMELY,
PROVIDING ONLINE AND OFFLINE CLASSES
AND WORKSHOPS IN THE FIELD OF CAREERS,
ENTREPRENEURSHIP, INVESTMENTS AND FI-
NANCIAL PLANNING; PROVIDING ONLINE AND
OFFLINE EVENTS, NAMELY, CONFERENCES,
SEMINARS AND WEBINARS IN THE FIELDS OF
CAREERS, ENTREPRENEURSHIP, INVESTMENTS

AND FINANCIAL PLANNING, IN CLASS 41 (U.S.
CLS. 100, 101 AND 107).

FIRST USE 2-15-2006; IN COMMERCE 4-15-2006.

THE MARK CONSISTS OF STANDARD CHAR-
ACTERS WITHOUT CLAIM TO ANY PARTICULAR
FONT, STYLE, SIZE, OR COLOR.

SN 77-073,430, FILED 12-29-2006.

DAVID I, EXAMINING ATTORNEY

Int. Cl.: 37

Prior U.S. Cls.: 100, 103, and 106

United States Patent and Trademark Office

Reg. No. 3,481,309

Registered Aug. 5, 2008

**SERVICE MARK
PRINCIPAL REGISTER**



BARONE, MICHAEL A. (NEVADA SOLE PROPRIETORSHIP)
8741 POTENZA LANE
LAS VEGAS, NV 89117

FOR: STONE REPAIR, IN CLASS 37 (U.S. CLS. 100, 103 AND 106).

FIRST USE 6-15-2007; IN COMMERCE 6-15-2007.

NO CLAIM IS MADE TO THE EXCLUSIVE RIGHT TO USE "STONE" , APART FROM THE MARK AS SHOWN.

THE COLOR(S) BLUE, RED, WHITE, BLACK IS/ ARE CLAIMED AS A FEATURE OF THE MARK.

THE MARK CONSISTS OF A BLUE HORIZONTAL OVAL CONTAINING WHITE LINING, A RED FLATLINE HORIZONTALLY THROUGH THE CENTER OF THE OVAL, THE BLACK WORDING "THE STONE" INSIDE THE OVAL TO THE RIGHT AND ABOVE THE RED FLATLINE, THE BLACK WORDING "SURGEON" INSIDE THE OVAL TO THE RIGHT AND BELOW THE RED FLATLINE AND THE BLACK WORDING "SETTING NEW STANDARDS WITH NEW TECHNOLOGY" CURVED BELOW AND OUTSIDE THE BLUE OVAL.

SN 77-074,076, FILED 1-1-2007.

FRED MANDIR, EXAMINING ATTORNEY

Int. Cl.: 43

Prior U.S. Cls.: 100 and 101

United States Patent and Trademark Office

Reg. No. 3,481,310

Registered Aug. 5, 2008

SERVICE MARK
PRINCIPAL REGISTER



Bad Dawgs

BAD DAWGS, INC. (NEW HAMPSHIRE CORPORATION)
27 ROUTE 25
PLYMOUTH, NH 03264

FOR: RESTAURANT SERVICES, IN CLASS 43
(U.S. CLS. 100 AND 101).

FIRST USE 8-31-2006; IN COMMERCE 9-30-2007.

THE MARK CONSISTS OF A STYLIZED DOG'S FACE, CHEWING A BONE AND WEARING SUNGLASSES.

SN 77-074,220, FILED 1-2-2007.

CIMMERIAN COLEMAN, EXAMINING ATTORNEY

Int. Cl.: 10

Prior U.S. Cls.: 26, 39, and 44

United States Patent and Trademark Office

Reg. No. 3,481,311

Registered Aug. 5, 2008

**TRADEMARK
PRINCIPAL REGISTER**

OBCU

OLYMPUS MEDICAL SYSTEMS CORP. (JAPAN
JOINT STOCK COMPANY)
43-2, HATAGAYA 2-CHOME, SHIBUYA-KU
TOKYO, JAPAN

THE MARK CONSISTS OF STANDARD CHAR-
ACTERS WITHOUT CLAIM TO ANY PARTICULAR
FONT, STYLE, SIZE, OR COLOR.

FOR: MEDICAL APPARATUS AND INSTRU-
MENTS, NAMELY, BALLOON INFLATING AND
DEFLATING UNIT FOR ENDOSCOPES, IN CLASS
10 (U.S. CLS. 26, 39 AND 44).

SN 77-074,542, FILED 1-2-2007.

FIRST USE 5-19-2007; IN COMMERCE 5-19-2007.

REBECCA SMITH, EXAMINING ATTORNEY

Int. Cl.: 33

Prior U.S. Cls.: 47 and 49

United States Patent and Trademark Office

Reg. No. 3,481,312

Registered Aug. 5, 2008

**TRADEMARK
PRINCIPAL REGISTER**

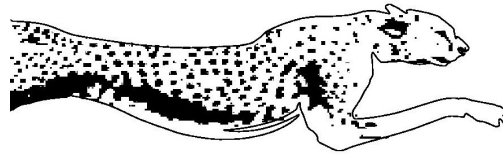

SEBEKA

E. & J. GALLO WINERY (CALIFORNIA CORPORATION)
600 YOSEMITE BOULEVARD
MODESTO, CA 95354

FOR: WINES, IN CLASS 33 (U.S. CLS. 47 AND 49).

FIRST USE 1-15-2007; IN COMMERCE 1-15-2007.

THE MARK CONSISTS OF A RUNNING CHEETAH.

THE WORDING "SEBEKA" HAS NO MEANING IN A FOREIGN LANGUAGE.

SN 77-075,432, FILED 1-3-2007.

PAM WILLIS, EXAMINING ATTORNEY

Int. Cls.: 35 and 44

Prior U.S. Cls.: 100, 101, and 102

United States Patent and Trademark Office

Reg. No. 3,481,313

Registered Aug. 5, 2008

**SERVICE MARK
PRINCIPAL REGISTER**

REMAKEHEALTH

INEXMARKET LLC (DELAWARE LTD LIAB CO)
#295
555 BRYANT STREET
PALO ALTO, CA 94301

FOR: HEALTH CARE REFERRAL SERVICES,
NAMELY, DOCTOR REFERRALS; HEALTH CARE
PRICING SERVICES, NAMELY, MEDICAL COST
MANAGEMENT, IN CLASS 35 (U.S. CLS. 100, 101
AND 102).

FIRST USE 2-27-2007; IN COMMERCE 9-1-2007.

FOR: HEALTH CARE SERVICES; AND HEALTH
CARE DATABASE REPOSITORY SERVICES,

NAMELY, MAINTAINING PERSONAL MEDICAL
HISTORY RECORDS AND FILES, IN CLASS 44 (U.S.
CLS. 100 AND 101).

FIRST USE 2-27-2007; IN COMMERCE 9-1-2007.

THE MARK CONSISTS OF STANDARD CHAR-
ACTERS WITHOUT CLAIM TO ANY PARTICULAR
FONT, STYLE, SIZE, OR COLOR.

SN 77-076,166, FILED 1-4-2007.

BILL DAWE, EXAMINING ATTORNEY

Int. Cl.: 20

Prior U.S. Cls.: 2, 13, 22, 25, 32, and 50

United States Patent and Trademark Office

Reg. No. 3,481,314

Registered Aug. 5, 2008

**TRADEMARK
PRINCIPAL REGISTER**

ACTIVE STORAGE SERIES

IRIS USA, INC. (ILLINOIS CORPORATION)

11111 80TH AVENUE

PLEASANT PRARIE, WI 53158

FOR: PLASTIC STORAGE UNITS FOR OFFICE
USE, IN CLASS 20 (U.S. CLS. 2, 13, 22, 25, 32 AND 50).

FIRST USE 2-11-2008; IN COMMERCE 2-11-2008.

THE MARK CONSISTS OF STANDARD CHAR-
ACTERS WITHOUT CLAIM TO ANY PARTICULAR
FONT, STYLE, SIZE, OR COLOR.

NO CLAIM IS MADE TO THE EXCLUSIVE
RIGHT TO USE "STORAGE SERIES", APART FROM
THE MARK AS SHOWN.

SN 77-076,211, FILED 1-4-2007.

BRIAN NEVILLE, EXAMINING ATTORNEY

Int. Cl.: 43

Prior U.S. Cls.: 100 and 101

United States Patent and Trademark Office

Reg. No. 3,481,315

Registered Aug. 5, 2008

**SERVICE MARK
PRINCIPAL REGISTER**

CRAZY PARROT

FUZION FOOD GROUP, INC. (SOUTH DAKOTA
CORPORATION)
501 W. 27TH STREET
SIOUX FALLS, SD 57105

THE MARK CONSISTS OF STANDARD CHAR-
ACTERS WITHOUT CLAIM TO ANY PARTICULAR
FONT, STYLE, SIZE, OR COLOR.

FOR: RESTAURANT AND BAR SERVICES, IN
CLASS 43 (U.S. CLS. 100 AND 101).

SN 77-076,594, FILED 1-5-2007.

FIRST USE 9-0-2007; IN COMMERCE 9-0-2007.

JILL PRATER, EXAMINING ATTORNEY

Int. Cl.: 30

Prior U.S. Cl.: 46

United States Patent and Trademark Office

Reg. No. 3,481,316

Registered Aug. 5, 2008

**TRADEMARK
PRINCIPAL REGISTER**

CURIOSLY CHOCOLATE

WM. WRIGLEY JR. COMPANY (DELAWARE
CORPORATION)
410 NORTH MICHIGAN AVENUE
CHICAGO, IL 60611

FOR: CONFECTIONERY, NAMELY, CHOCOLATE, IN CLASS 30 (U.S. CL. 46).

FIRST USE 11-1-2006; IN COMMERCE 11-1-2006.

THE MARK CONSISTS OF STANDARD CHARACTERS WITHOUT CLAIM TO ANY PARTICULAR FONT, STYLE, SIZE, OR COLOR.

OWNER OF U.S. REG. NOS. 1,250,585, 2,125,980,
AND OTHERS.

NO CLAIM IS MADE TO THE EXCLUSIVE
RIGHT TO USE "CHOCOLATE", APART FROM
THE MARK AS SHOWN.

SN 77-076,976, FILED 1-5-2007.

DARRYL SPRUILL, EXAMINING ATTORNEY

Int. Cls.: 35 and 40

Prior U.S. Cls.: 100, 101, 102, 103, and 106

United States Patent and Trademark Office

Reg. No. 3,481,317

Registered Aug. 5, 2008

**SERVICE MARK
PRINCIPAL REGISTER**

VISIONFUELS

VISION FUELS, LLC (IOWA LTD LIAB CO)

2641 86TH STREET

URBANDALE, IA 50322

FOR: DEVELOPMENT AND MANAGEMENT OF
BIOFUEL MANUFACTURING, PROCESSING, AND
TREATMENT PLANTS, IN CLASS 35 (U.S. CLS. 100,
101 AND 102).

FIRST USE 10-1-2006; IN COMMERCE 10-1-2006.

FOR: MANUFACTURE, PROCESSING, AND
TREATMENT OF FUELS, NAMELY, BIOFUELS,
IN CLASS 40 (U.S. CLS. 100, 103 AND 106).

FIRST USE 10-1-2006; IN COMMERCE 10-1-2006.

THE MARK CONSISTS OF STANDARD CHAR-
ACTERS WITHOUT CLAIM TO ANY PARTICULAR
FONT, STYLE, SIZE, OR COLOR.

SN 77-077,035, FILED 1-5-2007.

HANNO RITTNER, EXAMINING ATTORNEY

Int. Cl.: 9

Prior U.S. Cls.: 21, 23, 26, 36, and 38

United States Patent and Trademark Office

Reg. No. 3,481,318

Registered Aug. 5, 2008

**TRADEMARK
PRINCIPAL REGISTER**

RCG Research Credit Group

RESEARCH CREDIT GROUP, INC. (OHIO CORPORATION)
1295 CORPORATE DRIVE, SUITE 2
HUDSON, OH 44236

FOR: COMPUTER SOFTWARE FOR MAINTAINING RECORDS AND PROCESSING DATA RELATED TO STATE AND FEDERAL RESEARCH AND DEVELOPMENT TAX CREDITS, IN CLASS 9 (U.S. CLS. 21, 23, 26, 36 AND 38).

FIRST USE 5-8-2008; IN COMMERCE 5-8-2008.

THE MARK CONSISTS OF STANDARD CHARACTERS WITHOUT CLAIM TO ANY PARTICULAR FONT, STYLE, SIZE, OR COLOR.

SN 77-078,707, FILED 1-9-2007.

GIANCARLO CASTRO, EXAMINING ATTORNEY

Int. Cl.: 35

Prior U.S. Cls.: 100, 101, and 102

United States Patent and Trademark Office

Reg. No. 3,481,319

Registered Aug. 5, 2008

**SERVICE MARK
PRINCIPAL REGISTER**

PCMA I-ZONE

PROFESSIONAL CONVENTION MANAGEMENT
ASSOCIATION (ILLINOIS NON-PROFIT COR-
PORATION)
SUITE 1001
2301 SOUTH LAKE SHORE DRIVE
CHICAGO, IL 60616

FOR: PROVIDING A LIVE FORUM FOR COMPANIES TO SHOWCASE, DISPLAY, DEMONSTRATE AND PROMOTE NEW AND INNOVATIVE IDEAS, PRODUCTS AND SERVICES IN THE CONVENTION/MEETING MANAGEMENT ARENA, IN CLASS 35 (U.S. CLS. 100, 101 AND 102).

FIRST USE 1-0-2007; IN COMMERCE 1-0-2007.

THE MARK CONSISTS OF STANDARD CHARACTERS WITHOUT CLAIM TO ANY PARTICULAR FONT, STYLE, SIZE, OR COLOR.

SN 77-078,988, FILED 1-9-2007.

BRIAN NEVILLE, EXAMINING ATTORNEY

Int. Cl.: 9

Prior U.S. Cls.: 21, 23, 26, 36, and 38

Reg. No. 3,481,320

United States Patent and Trademark Office

Registered Aug. 5, 2008

**TRADEMARK
PRINCIPAL REGISTER**

AuditCA

PHARMACEUTICAL SERVICES CORPORATION
(DELAWARE CORPORATION)
700 CORPORATE CENTER DR, SUITE 201
POMONA, CA 91768

THE MARK CONSISTS OF STANDARD CHARACTERS WITHOUT CLAIM TO ANY PARTICULAR FONT, STYLE, SIZE, OR COLOR.

FOR: COMPUTER SOFTWARE THAT ENABLES THE USER TO SEARCH RELEVANT LAWS AND REGULATIONS, AND TO PREPARE OBSERVATIONS AND REPORTS WITH USER-INPUT TEXT WHICH UTILIZES TEXT FROM THE SELECTED REGULATIONS, IN CLASS 9 (U.S. CLS. 21, 23, 26, 36 AND 38).

THE WORDING "AUDITCA" HAS NO MEANING OTHER THAN TRADEMARK SIGNIFICANCE.

SN 77-080,297, FILED 1-10-2007.

FIRST USE 12-15-2006; IN COMMERCE 12-15-2006.

RENEE SERVANCE, EXAMINING ATTORNEY

Int. Cls.: 1, 2, and 6

**Prior U.S. Cls.: 1, 2, 5, 6, 10, 11, 12, 13, 14, 16, 23, 25,
26, 46, and 50**

Reg. No. 3,481,321

United States Patent and Trademark Office

Registered Aug. 5, 2008

**TRADEMARK
PRINCIPAL REGISTER**

NANOSCIENCE

COOKSON ELECTRONICS, INC. (DELAWARE
CORPORATION)
600 ROUTE 440
JERSEY CITY, NJ 07304

FOR: COATINGS USED IN THE MANUFACTURE
OF PRINTED CIRCUIT BOARDS; AND METAL
PLATING CHEMICAL COMPOSITIONS, IN CLASS
1 (U.S. CLS. 1, 5, 6, 10, 26 AND 46).

FIRST USE 11-1-2007; IN COMMERCE 11-1-2007.

FOR: COATINGS IN THE NATURE OF CONDUCTIVE
INKS FOR USE IN THE MANUFACTURE OF
PRINTED CIRCUIT BOARDS; COATINGS FOR METALS
AND PLASTICS, WHICH PROVIDE A DECORATIVE
APPEARANCE; AND CORROSION INHIBITING IN THE
NATURE OF A COATING, IN CLASS 2 (U.S. CLS. 6, 11
AND 16).

FIRST USE 11-1-2007; IN COMMERCE 11-1-2007.

FOR: SOLDER PASTES; AND PLATING COMPOSITIONS
COMPOSED OF METALS, IN CLASS 6 (U.S. CLS. 2, 12,
13, 14, 23, 25 AND 50).

FIRST USE 11-1-2007; IN COMMERCE 11-1-2007.

THE MARK CONSISTS OF STANDARD CHARACTERS
WITHOUT CLAIM TO ANY PARTICULAR FONT, STYLE,
SIZE, OR COLOR.

SN 77-080,966, FILED 1-11-2007.

BRENDAN MCCAULEY, EXAMINING ATTORNEY

Int. Cl.: 14

Prior U.S. Cls.: 2, 27, 28, and 50

United States Patent and Trademark Office

Reg. No. 3,481,322

Registered Aug. 5, 2008

**TRADEMARK
PRINCIPAL REGISTER**

EPMartin

MOBBSIX, LLC (OREGON LTD LIAB CO)
17410 WESTVIEW RD
LAKE OSWEGO, OR 97034

FOR: MECHANICAL AND AUTOMATIC
WATCHES; WATCH BOXES; WATCH FACES;
WATCHES; WRIST WATCHES, IN CLASS 14 (U.S.
CLS. 2, 27, 28 AND 50).

FIRST USE 8-30-2007; IN COMMERCE 8-30-2007.

THE NAME(S), PORTRAIT(S), AND/OR SIGNA-
TURE(S) SHOWN IN THE MARK DOES NOT IDENTI-
FY A PARTICULAR LIVING INDIVIDUAL.

THE MARK CONSISTS OF LETTERS WITH TWO
(RT) IN STYLIZED FORM.

SN 77-081,014, FILED 1-11-2007.

SAMUEL E. SHARPER JR., EXAMINING ATTOR-
NEY

Int. Cl.: 42

Prior U.S. Cls.: 100 and 101

United States Patent and Trademark Office

Reg. No. 3,481,323

Registered Aug. 5, 2008

**SERVICE MARK
PRINCIPAL REGISTER**

urecho

USHINO, ANTHONY T. (UNITED STATES INDIVIDUAL)
11901 SANTA MONICA BLVD., SUITE 456
LOS ANGELES, CA 90025 AND
DAO, PATRICIA (UNITED STATES INDIVIDUAL)
11901 SANTA MONICA BLVD., SUITE 456
WEST LOS ANGELES, CA 90025

FOR: COMPUTER SERVICES IN THE NATURE OF CUSTOMIZED WEB PAGES FEATURING USER-DEFINED INFORMATION, PERSONAL PROFILES AND INFORMATION; COMPUTER SERVICES, NAMELY, HOSTING ON-LINE WEB FACILITIES FOR OTHERS FOR ORGANIZING AND CONDUCTING ONLINE MEETINGS, GATHERINGS, AND

INTERACTIVE DISCUSSIONS, IN CLASS 42 (U.S. CLS. 100 AND 101).

FIRST USE 5-1-2007; IN COMMERCE 7-1-2007.

THE MARK CONSISTS OF STANDARD CHARACTERS WITHOUT CLAIM TO ANY PARTICULAR FONT, STYLE, SIZE, OR COLOR.

THE WORDING "URECHO" HAS NO MEANING IN A FOREIGN LANGUAGE.

SN 77-081,524, FILED 1-11-2007.

REBECCA EISINGER, EXAMINING ATTORNEY

Int. Cl.: 9

Prior U.S. Cls.: 21, 23, 26, 36, and 38

United States Patent and Trademark Office

Reg. No. 3,481,324

Registered Aug. 5, 2008

**TRADEMARK
PRINCIPAL REGISTER**

CrediTrack

RESEARCH CREDIT GROUP, INC. (OHIO CORPORATION)
1295 CORPORATE DRIVE, SUITE 2
HUDSON, OH 44236

FOR: COMPUTER SOFTWARE FOR MAINTAINING RECORDS AND PROCESSING DATA RELATED TO STATE AND FEDERAL RESEARCH AND DEVELOPMENT TAX CREDITS, IN CLASS 9 (U.S. CLS. 21, 23, 26, 36 AND 38).

FIRST USE 5-7-2007; IN COMMERCE 5-7-2007.

THE MARK CONSISTS OF STANDARD CHARACTERS WITHOUT CLAIM TO ANY PARTICULAR FONT, STYLE, SIZE, OR COLOR.

SN 77-081,589, FILED 1-12-2007.

GIANCARLO CASTRO, EXAMINING ATTORNEY

Int. Cl.: 16

Prior U.S. Cls.: 2, 5, 22, 23, 29, 37, 38, and 50

United States Patent and Trademark Office

Reg. No. 3,481,325

Registered Aug. 5, 2008

**TRADEMARK
PRINCIPAL REGISTER**

Sower Notes

FREEMAN, VIVIAN V. (UNITED STATES INDIVIDUAL)
BOX 213
23491 THOMASTON RD.
NEWSOMS, VA 23874

FOR: A SERIES OF BOOKS, WRITTEN ARTICLES, HANDOUTS AND WORKSHEETS IN THE FIELD OF RELIGIOUS INSPIRATIONAL MATERIAL AND PERSONAL MOTIVATIONAL MATERIAL; BOOKS IN THE FIELD OF RELIGIOUS INSPIRATIONAL MATERIAL AND PERSONAL MOTIVATIONAL MATERIAL; CARDS FEATURING RELIGIOUS INSPIRATIONAL MATERIAL AND PERSONAL MOTIVATIONAL MATERIAL; CHILDREN'S ACTIVITY BOOKS; CHILDREN'S BOOKS; COLORING BOOKS; EDUCATIONAL BOOKS FEATURING RELIGIOUS INSPIRATIONAL MATERIAL AND PERSONAL MOTIVATIONAL MATERIAL; FLIP BOOKS; GREETING CARDS; HOLIDAY CARDS; INDEX BOOKS; INDEX CARDS; INVITATION CARDS; MOTIVATIONAL CARDS; NOTE BOOKS; NOTE CARDS; OCCASION CARDS; POCKET MEMORANDUM BOOKS; PRAYER BOOKS; PRINTED INFOR-

MATIONAL CARDS IN THE FIELD OF RELIGIOUS INSPIRATIONAL MATERIAL AND PERSONAL MOTIVATIONAL MATERIAL; RELIGIOUS BOOKS; STORY BOOKS; VISITING CARDS; WIREBOUND BOOKS, IN CLASS 16 (U.S. CLS. 2, 5, 22, 23, 29, 37, 38 AND 50).

FIRST USE 2-8-2007; IN COMMERCE 9-24-2007.

THE MARK CONSISTS OF STANDARD CHARACTERS WITHOUT CLAIM TO ANY PARTICULAR FONT, STYLE, SIZE, OR COLOR.

OWNER OF U.S. REG. NO. 2,854,951.

NO CLAIM IS MADE TO THE EXCLUSIVE RIGHT TO USE "NOTES" , APART FROM THE MARK AS SHOWN.

SN 77-082,186, FILED 1-12-2007.

DAVID H. STINE, EXAMINING ATTORNEY

Int. Cls.: 43 and 44

Prior U.S. Cls.: 100 and 101

United States Patent and Trademark Office

Reg. No. 3,481,326

Registered Aug. 5, 2008

**SERVICE MARK
PRINCIPAL REGISTER**

ONE OCEAN

REMINGTON HOTEL CORPORATION (DELA-
WARE CORPORATION)
SUITE 1150
14185 DALLAS PARKWAY
DALLAS, TX 75254

FOR: HEALTH RESORT SERVICES, NAMELY,
PROVIDING FOOD AND LODGING THAT SPECIA-
LIZE IN PROMOTING PATRONS' GENERAL
HEALTH AND WELL-BEING; HOTEL SERVICES;
HOTEL, BAR AND RESTAURANT SERVICES; RE-
SORT HOTELS; RESORT LODGING SERVICES; SPA
SERVICES, NAMELY, PROVIDING TEMPORARY
ACCOMMODATIONS AND MEALS TO CLIENTS
OF A HEALTH OR BEAUTY SPA, IN CLASS 43 (U.S.
CLS. 100 AND 101).

FIRST USE 6-30-2007; IN COMMERCE 5-1-2008.

FOR: HEALTH SPA SERVICES FOR HEALTH
AND WELLNESS OF THE BODY AND SPIRIT
OFFERED AT A HEALTH RESORT; HEALTH SPA
SERVICES, NAMELY, COSMETIC BODY CARE
SERVICES, IN CLASS 44 (U.S. CLS. 100 AND 101).

FIRST USE 6-30-2007; IN COMMERCE 5-1-2008.

THE MARK CONSISTS OF STANDARD CHAR-
ACTERS WITHOUT CLAIM TO ANY PARTICULAR
FONT, STYLE, SIZE, OR COLOR.

SN 77-082,307, FILED 1-12-2007.

PATRICIA EVANKO, EXAMINING ATTORNEY

Int. Cls.: 14 and 25

Prior U.S. Cls.: 2, 22, 27, 28, 39, and 50

United States Patent and Trademark Office

Reg. No. 3,481,327

Registered Aug. 5, 2008

TRADEMARK
PRINCIPAL REGISTER

<3

L8-P INC (CANADA CORPORATION)
3764 BLOOMONTON CREST
MISSISSAUGA, ONTARIO L5M 0A2

FOR: JEWELRY, IN CLASS 14 (U.S. CLS. 2, 27, 28 AND 50).

FIRST USE 3-1-2007; IN COMMERCE 7-1-2007.

FOR: MEN'S, WOMAN'S, CHILDREN'S TODDLER'S AND BABIES' CLOTHING, NAMELY, DRESSES, SKIRTS, BLOUSES, JACKETS, COATS, BELTS, CAPS, HATS, FLEECE PULLOVERS, SWEATERS, JACKETS, JEANS, PANTS, OVERALLS, SWEAT PANTS, T-SHIRTS, POLO SHIRTS, UNDER-

SHIRTS, SWEATSHIRTS, TANK TOPS, SHORTS, UNDERWEAR, BRIEFS, THERMAL UNDERWEAR, THONGS, PANTIES, SWIM SUITS, TRUNKS, YOGA PANTS, CAPRI PANTS, SPORTS BRAS, BANDANAS, SOCKS, SHOES, IN CLASS 25 (U.S. CLS. 22 AND 39).

FIRST USE 3-1-2007; IN COMMERCE 7-1-2007.

THE MARK CONSISTS OF STANDARD CHARACTERS WITHOUT CLAIM TO ANY PARTICULAR FONT, STYLE, SIZE, OR COLOR.

SN 77-082,366, FILED 1-12-2007.

GIANCARLO CASTRO, EXAMINING ATTORNEY

Int. Cl.: 11

Prior U.S. Cls.: 13, 21, 23, 31, and 34

United States Patent and Trademark Office

Reg. No. 3,481,328

Registered Aug. 5, 2008

**TRADEMARK
PRINCIPAL REGISTER**

Tile-A-Drain

HICKOK, RICHARD, FIFIELD (UNITED STATES
INDIVIDUAL)
320 1/2 N. DETROIT ST.
BUCHANAN, MI 49107

THE MARK CONSISTS OF STANDARD CHAR-
ACTERS WITHOUT CLAIM TO ANY PARTICULAR
FONT, STYLE, SIZE, OR COLOR.

FOR: PLUMBING FIXTURES, NAMELY, SHOW-
ER DRAIN HEIGHT EXTENSION AND FLOOR
TILE ADAPTER, IN CLASS 11 (U.S. CLS. 13, 21, 23,
31 AND 34).

SN 77-082,650, FILED 1-14-2007.

FIRST USE 1-1-2008; IN COMMERCE 1-1-2008.

JOHN E. MICHOS, EXAMINING ATTORNEY

Int. Cl.: 28

Prior U.S. Cls.: 22, 23, 38, and 50

United States Patent and Trademark Office

Reg. No. 3,481,329

Registered Aug. 5, 2008

**TRADEMARK
PRINCIPAL REGISTER**

AQUAVEE

AQUA-VEE, LLC. (FLORIDA LTD LIAB CO)
13136 S.W. 187 STREET
MIAMI, FL 33177

FOR: SWIMMING EXERCISE DEVICE COM-
PRISED OF HANDLES AND A BELT THAT CON-
NECTS TO RESISTANCE BANDS FOR IN POOL
RESISTANCE TRAINING, IN CLASS 28 (U.S. CLS. 22,
23, 38 AND 50).

FIRST USE 2-0-2007; IN COMMERCE 2-0-2007.

THE MARK CONSISTS OF STANDARD CHAR-
ACTERS WITHOUT CLAIM TO ANY PARTICULAR
FONT, STYLE, SIZE, OR COLOR.

SN 77-082,819, FILED 1-15-2007.

ANNE FARRELL, EXAMINING ATTORNEY

Int. Cl.: 16

Prior U.S. Cls.: 2, 5, 22, 23, 29, 37, 38, and 50

Reg. No. 3,481,330

United States Patent and Trademark Office

Registered Aug. 5, 2008

**TRADEMARK
PRINCIPAL REGISTER**

TAUNTON'S SEWSTYLISH

THE TAUNTON PRESS, INC. (CONNECTICUT
CORPORATION)
P.O. BOX 5506
63 SOUTH MAIN STREET
NEWTOWN, CT 064705506

FOR: PRINTED PUBLICATIONS, NAMELY, MA-
GAZINES AND BOOKS ON THE SUBJECTS OF
SEWING AND FASHION, IN CLASS 16 (U.S. CLS. 2,
5, 22, 23, 29, 37, 38 AND 50).

FIRST USE 2-13-2007; IN COMMERCE 2-13-2007.

THE MARK CONSISTS OF STANDARD CHAR-
ACTERS WITHOUT CLAIM TO ANY PARTICULAR
FONT, STYLE, SIZE, OR COLOR.

OWNER OF U.S. REG. NOS. 2,791,259, 3,071,680,
AND OTHERS.

SN 77-083,473, FILED 1-16-2007.

TEJBIR SINGH, EXAMINING ATTORNEY

Int. Cl.: 5

Prior U.S. Cls.: 6, 18, 44, 46, 51, and 52

Reg. No. 3,481,331

United States Patent and Trademark Office

Registered Aug. 5, 2008

**TRADEMARK
PRINCIPAL REGISTER**

EQUITRX

KOEHN, RICHARD K. (UNITED STATES INDIVIDUAL)
615 ARAPEEN DRIVE, SUITE 110
SALT LAKE CITY, UT 84108

FIRST USE 9-1-2007; IN COMMERCE 2-1-2008.

FOR: WOUND HEALING TREATMENT FOR VETERINARY USE, NAMELY, TOPICAL CREAM, TOPICAL OINTMENT, PRE-MEDICATED FILM, PRE-MEDICATED WIPES, WOUND TREATMENT KITS CONTAINING GAUZE, BANDAGES, TOPICAL CREAM, BANDAGING TAPE, ANTISEPTIC STICKS, IN CLASS 5 (U.S. CLS. 6, 18, 44, 46, 51 AND 52).

THE MARK CONSISTS OF STANDARD CHARACTERS WITHOUT CLAIM TO ANY PARTICULAR FONT, STYLE, SIZE, OR COLOR.

SN 77-083,578, FILED 1-16-2007.

EMILY CARLSEN, EXAMINING ATTORNEY

Int. Cl.: 5

Prior U.S. Cls.: 6, 18, 44, 46, 51, and 52

United States Patent and Trademark Office

Reg. No. 3,481,332

Registered Aug. 5, 2008

**TRADEMARK
PRINCIPAL REGISTER**

FELITRX

KOEHN, RICHARD K. (UNITED STATES INDIVIDUAL)
615 ARAPEEN DRIVE, SUITE 110
SALT LAKE CITY, UT 84108

FOR: WOUND HEALING TREATMENT FOR VETERINARY USE, NAMELY, TOPICAL CREAM, TOPICAL OINTMENT, WOUND TREATMENT KITS CONTAINING, GAUZE, BANDAGES, TOPICAL CREAM, BANDAGING TAPE, ANTISEPTIC STICKS, IN CLASS 5 (U.S. CLS. 6, 18, 44, 46, 51 AND 52).

FIRST USE 9-1-2007; IN COMMERCE 2-1-2008.

THE MARK CONSISTS OF STANDARD CHARACTERS WITHOUT CLAIM TO ANY PARTICULAR FONT, STYLE, SIZE, OR COLOR.

SN 77-083,585, FILED 1-16-2007.

EMILY CARLSEN, EXAMINING ATTORNEY

Int. Cl.: 19

Prior U.S. Cls.: 1, 12, 33, and 50

United States Patent and Trademark Office

Reg. No. 3,481,333

Registered Aug. 5, 2008

**TRADEMARK
PRINCIPAL REGISTER**

PRECISION SHIFT

GEORGIA FOAM, INC. (GEORGIA CORPORATION)
BOX 742
FREDERICKSBURG, VA 22404

THE MARK CONSISTS OF STANDARD CHARACTERS WITHOUT CLAIM TO ANY PARTICULAR FONT, STYLE, SIZE, OR COLOR.

FOR: VINYL SIDING FOR USE ON THE EXTERIOR OF BUILDINGS AND HOMES, IN CLASS 19 (U.S. CLS. 1, 12, 33 AND 50).

SN 77-084,413, FILED 1-17-2007.

FIRST USE 6-1-2007; IN COMMERCE 6-1-2007.

SCOTT BIBB, EXAMINING ATTORNEY

Int. Cls.: 35 and 41

Prior U.S. Cls.: 100, 101, 102, and 107

United States Patent and Trademark Office

Reg. No. 3,481,334

Registered Aug. 5, 2008

**SERVICE MARK
PRINCIPAL REGISTER**

WE CONTROL THE WORLD

ISA-THE INSTRUMENTATION, SYSTEMS, AND
AUTOMATION SOCIETY (NORTH CAROLI-
NA NON-PROFIT CORPORATION)
P.O. BOX 1227 67 ALEXANDER DRIVE
RESEARCH TRIANGLE PARK, NC 27709

FOR: ASSOCIATION SERVICES, NAMELY, THE
PROMOTION OF THE INTERESTS OF THOSE IN
THE INSTRUMENTATION, SYSTEMS, AND AUTO-
MATION FIELDS INCLUDING THE DISSEMINA-
TION OF INFORMATION IN THE FIELD OF
INSTRUMENTATION, SYSTEMS, AND AUTOMA-
TION AND INSTRUMENTATION TECHNOLOGY,
IN CLASS 35 (U.S. CLS. 100, 101 AND 102).

FIRST USE 4-1-2007; IN COMMERCE 4-1-2007.

FOR: CONDUCTING LECTURES, SEMINARS,
CONFERENCES, MEETINGS, WORKSHOPS,
TRAINING COURSES, EXHIBITIONS, PRESENTA-

TIONS, CONVENTIONS, AND EDUCATIONAL DE-
MONSTRATIONS IN OR RELATED TO THE
FIELDS OF INSTRUMENTATION, MEASURE-
MENT AND CONTROL, SYSTEMS, AND AUTOMA-
TION, AND THE DEVELOPMENT AND
DISSEMINATION OF EDUCATIONAL MATERIALS
IN CONNECTION THEREWITH, IN CLASS 41 (U.S.
CLS. 100, 101 AND 107).

FIRST USE 4-1-2007; IN COMMERCE 4-1-2007.

THE MARK CONSISTS OF STANDARD CHAR-
ACTERS WITHOUT CLAIM TO ANY PARTICULAR
FONT, STYLE, SIZE, OR COLOR.

SN 77-084,858, FILED 1-17-2007.

KELLY CHOE, EXAMINING ATTORNEY

Int. Cl.: 41

Prior U.S. Cls.: 100, 101, and 107

United States Patent and Trademark Office

Reg. No. 3,481,335

Registered Aug. 5, 2008

SERVICE MARK
PRINCIPAL REGISTER

*precise*Ticker

ENTRACITY (CALIFORNIA SOLE PROPRIETOR-
SHIP)
2731 GALICIA WAY
CARLSBAD, CA 92009

FOR: PROVIDING NEWS IN THE NATURE OF
CURRENT EVENT REPORTING, IN CLASS 41 (U.S.
CLS. 100, 101 AND 107).

FIRST USE 2-1-2007; IN COMMERCE 2-1-2007.

THE MARK CONSISTS OF THE WORD "PRE-
CISE" ITALICIZED AND THE WORD "TICKER"
HAVING A CAPITAL "T", BOTH WORDS BEING
JOINED IN COMPOUND FORM.

SN 77-085,017, FILED 1-17-2007.

AISHA CLARKE, EXAMINING ATTORNEY

Int. Cl.: 7

Prior U.S. Cls.: 13, 19, 21, 23, 31, 34, and 35

Reg. No. 3,481,336

United States Patent and Trademark Office

Registered Aug. 5, 2008

**TRADEMARK
PRINCIPAL REGISTER**

1260

SCHLAGE LOCK COMPANY (CALIFORNIA
CORPORATION)
11819 N. PENNSYLVANIA STREET
CARMEL, IN 46032

THE MARK CONSISTS OF STANDARD CHAR-
ACTERS WITHOUT CLAIM TO ANY PARTICULAR
FONT, STYLE, SIZE, OR COLOR.

FOR: NON-ELECTRONIC, HYDRAULIC DOOR
CLOSERS, IN CLASS 7 (U.S. CLS. 13, 19, 21, 23, 31, 34
AND 35).

SN 77-086,910, FILED 1-19-2007.

FIRST USE 1-0-2008; IN COMMERCE 1-0-2008.

GIANCARLO CASTRO, EXAMINING ATTORNEY

Int. Cl.: 7

Prior U.S. Cls.: 13, 19, 21, 23, 31, 34, and 35

Reg. No. 3,481,337

United States Patent and Trademark Office

Registered Aug. 5, 2008

**TRADEMARK
PRINCIPAL REGISTER**

1261

SCHLAGE LOCK COMPANY (CALIFORNIA CORPORATION)
11819 N. PENNSYLVANIA STREET
CARMEL, IN 46032

THE MARK CONSISTS OF STANDARD CHARACTERS WITHOUT CLAIM TO ANY PARTICULAR FONT, STYLE, SIZE, OR COLOR.

FOR: NON-ELECTRONIC, HYDRAULIC DOOR CLOSERS, IN CLASS 7 (U.S. CLS. 13, 19, 21, 23, 31, 34 AND 35).

SN 77-086,918, FILED 1-19-2007.

FIRST USE 1-0-2008; IN COMMERCE 1-0-2008.

GIANCARLO CASTRO, EXAMINING ATTORNEY

Int. Cls.: 25 and 41

Prior U.S. Cls.: 22, 39, 100, 101, and 107

Reg. No. 3,481,338

United States Patent and Trademark Office

Registered Aug. 5, 2008

**TRADEMARK
SERVICE MARK
PRINCIPAL REGISTER**

4 Deserts

RACINGTHEPLANET LIMITED (HONG KONG CORPORATION)
C61 CAROLINA GARDENS, 28 COOMBE ROAD
THE PEAK, HONG KONG

FOR: CLOTHING, NAMELY, SHIRTS AND SHORTS; FOOTWEAR; HEADGEAR, NAMELY, HATS AND CAPS; SHOES; SLIPPERS; SANDALS; COATS; VESTS; GLOVES; HOSIERY; JACKETS; JUMPERS; MOTORISTS' CLOTHING, NAMELY, SHIRTS AND SHORTS; CYCLISTS' CLOTHING, NAMELY, PANTS, SHIRTS AND SHORTS; TIES; OUTERCLOTHING, NAMELY, COATS AND JACKETS; OVERALLS; PANTS; SCARVES; SHIRTS; SKIRTS; SOCKS; STOCKINGS; SWEATERS; SWIMSUITS; T-SHIRTS; TROUSERS; UNDERWEAR; BELTS, IN CLASS 25 (U.S. CLS. 22 AND 39).

FIRST USE 3-0-2005; IN COMMERCE 3-0-2005.

FOR: ENTERTAINMENT SERVICES, NAMELY, ENTERTAINMENT IN THE NATURE OF SPORTS COMPETITIONS IN THE FIELD OF HUMAN EN-

DURANCE RACING; ORGANIZING SPORTING EVENTS, NAMELY, HUMAN ENDURANCE RACES; ORGANIZING EXHIBITIONS FOR OUTDOOR HUMAN ENDURANCE SPORTING PURPOSES; PROVIDING A WEBSITE FEATURING SPORTING INFORMATION AND ENTERTAINMENT INFORMATION IN THE NATURE OF HUMAN ENDURANCE RACING COMPETITIONS; PROVIDING AN ON-GOING TELEVISION PROGRAM IN THE FIELDS OF SPORTS CONTESTS, SPORTS COMPETITIONS AND SPORTS EVENTS, IN CLASS 41 (U.S. CLS. 100, 101 AND 107).

FIRST USE 3-0-2005; IN COMMERCE 3-0-2005.

THE MARK CONSISTS OF STANDARD CHARACTERS WITHOUT CLAIM TO ANY PARTICULAR FONT, STYLE, SIZE, OR COLOR.

SN 77-087,587, FILED 1-22-2007.

TANYA AMOS, EXAMINING ATTORNEY

Int. Cl.: 3

Prior U.S. Cls.: 1, 4, 6, 50, 51, and 52

Reg. No. 3,481,339

United States Patent and Trademark Office

Registered Aug. 5, 2008

**TRADEMARK
PRINCIPAL REGISTER**

HYALIS

NEOCUTIS SA (SWITZERLAND CORPORATION)
STAND 6
PULLY, SWITZERLAND 1009

THE MARK CONSISTS OF STANDARD CHAR-
ACTERS WITHOUT CLAIM TO ANY PARTICULAR
FONT, STYLE, SIZE, OR COLOR.

FOR: COSMETIC PREPARATIONS FOR SKIN
RENEWAL, IN CLASS 3 (U.S. CLS. 1, 4, 6, 50, 51
AND 52).

SN 77-087,676, FILED 1-22-2007.

FIRST USE 11-12-2007; IN COMMERCE 11-12-2007.

LINDA ESTRADA, EXAMINING ATTORNEY

Int. Cl.: 2

Prior U.S. Cls.: 6, 11, and 16

United States Patent and Trademark Office

Reg. No. 3,481,340

Registered Aug. 5, 2008

**TRADEMARK
PRINCIPAL REGISTER**

TIOPREM

TOR MINERALS INTERNATIONAL, INC. (DE-
LAWARE CORPORATION)
722 BURLESON STREET, PO BOX 2544
CORPUS CHRISTI, TX 78402

THE MARK CONSISTS OF STANDARD CHAR-
ACTERS WITHOUT CLAIM TO ANY PARTICULAR
FONT, STYLE, SIZE, OR COLOR.

FOR: TITANIUM DIOXIDE PIGMENT, IN CLASS
2 (U.S. CLS. 6, 11 AND 16).

SN 77-088,361, FILED 1-22-2007.

FIRST USE 5-1-2008; IN COMMERCE 5-1-2008.

DANIEL CAPSHAW, EXAMINING ATTORNEY

Int. Cl.: 7

Prior U.S. Cls.: 13, 19, 21, 23, 31, 34, and 35

Reg. No. 3,481,341

United States Patent and Trademark Office

Registered Aug. 5, 2008

**TRADEMARK
PRINCIPAL REGISTER**

The Mini Sew Wonder

SLAMAN, PAUL (UNITED STATES INDIVIDUAL)

27214 CORCUBION

MISSION VIEJO, CA 92692

FOR: MINI SEWING MACHINE, IN CLASS 7 (U.S. CLS. 13, 19, 21, 23, 31, 34 AND 35).

FIRST USE 4-1-2007; IN COMMERCE 4-1-2007.

THE MARK CONSISTS OF STANDARD CHARACTERS WITHOUT CLAIM TO ANY PARTICULAR FONT, STYLE, SIZE, OR COLOR.

NO CLAIM IS MADE TO THE EXCLUSIVE RIGHT TO USE "MINI SEW", APART FROM THE MARK AS SHOWN.

SN 77-089,854, FILED 1-24-2007.

CHERYL CLAYTON, EXAMINING ATTORNEY

Int. Cl.: 9

Prior U.S. Cls.: 21, 23, 26, 36, and 38

Reg. No. 3,481,342

United States Patent and Trademark Office

Registered Aug. 5, 2008

**TRADEMARK
PRINCIPAL REGISTER**

ONEPASS

EURASIA CONCEPTS, INC. (CALIFORNIA CORPORATION)
6222 WILSHIRE BOULEVARD
SUITE 300, CA 90048

FOR: ELECTRIC FLAT IRONS; ELECTRIC HAIR CRIMPER; ELECTRIC HAIR CURLERS; ELECTRIC HAIR CURLING IRONS; ELECTRIC HAIR ROLLERS; ELECTRIC HAIR STRAIGHTENER; ELECTRIC HAIR STRAIGHTENING IRONS; ELECTRIC HAIR-CURLERS; ELECTRIC HAND-HELD HAIR STYLING IRONS; ELECTRIC IRONS FOR STYLING HAIR; ELECTRIC ROTARY HAIR BRUSH FOR STYLING A USER'S HAIR; ELECTRICALLY HE-

ATED HAIR BRUSHES; HOT AIR HAIR BRUSHES, IN CLASS 9 (U.S. CLS. 21, 23, 26, 36 AND 38).

FIRST USE 1-27-2007; IN COMMERCE 6-5-2007.

THE MARK CONSISTS OF STANDARD CHARACTERS WITHOUT CLAIM TO ANY PARTICULAR FONT, STYLE, SIZE, OR COLOR.

SN 77-089,887, FILED 1-24-2007.

ANDREA HACK, EXAMINING ATTORNEY

Int. Cl.: 8

Prior U.S. Cls.: 23, 28, and 44

United States Patent and Trademark Office

Reg. No. 3,481,343

Registered Aug. 5, 2008

**TRADEMARK
PRINCIPAL REGISTER**

POUND-IT-OUT

LIMMER, ROBERT (UNITED STATES INDIVIDUAL)
10 MAPLEWOOD ROAD
CLOSTER, NJ 07624

FOR: PLASTIC POUNDING DEVICE FOR USE AS A TENDERIZER FOR MEAT, POULTRY, VEGETABLE AND FISH, IN CLASS 8 (U.S. CLS. 23, 28 AND 44).

FIRST USE 5-7-2008; IN COMMERCE 5-7-2008.

THE MARK CONSISTS OF STANDARD CHARACTERS WITHOUT CLAIM TO ANY PARTICULAR FONT, STYLE, SIZE, OR COLOR.

SN 77-090,129, FILED 1-24-2007.

PRISCILLA MILTON, EXAMINING ATTORNEY

Int. Cl.: 30

Prior U.S. Cl.: 46

United States Patent and Trademark Office

Reg. No. 3,481,344

Registered Aug. 5, 2008

**TRADEMARK
PRINCIPAL REGISTER**

SOMEBODY'S MOTHER'S

LYNN DAVIS LASHER (UNITED STATES INDIVIDUAL)
5551 CEDAR CREEK
HOUSTON, TX 77056

THE MARK CONSISTS OF STANDARD CHARACTERS WITHOUT CLAIM TO ANY PARTICULAR FONT, STYLE, SIZE, OR COLOR.

FOR: SAUCES, IN CLASS 30 (U.S. CL. 46).

SN 77-091,148, FILED 1-25-2007.

FIRST USE 6-15-2007; IN COMMERCE 6-15-2007.

BONNIE LUKEN, EXAMINING ATTORNEY

Int. Cl.: 35

Prior U.S. Cls.: 100, 101, and 102

United States Patent and Trademark Office

Reg. No. 3,481,345

Registered Aug. 5, 2008

**SERVICE MARK
PRINCIPAL REGISTER**

HUNDREDS OF MEAL IDEAS

MYMENU CANADA INC. (CANADA CORPORATION)
PO BOX 2488
KITCHENER, ONTARIO, CANADA N2H 6M3

THE MARK CONSISTS OF STANDARD CHARACTERS WITHOUT CLAIM TO ANY PARTICULAR FONT, STYLE, SIZE, OR COLOR.

FOR: ONLINE AND TRADITIONAL RETAIL STORE SERVICES FEATURING FOOD PRODUCTS, IN CLASS 35 (U.S. CLS. 100, 101 AND 102).

SN 77-092,116, FILED 1-26-2007.

FIRST USE 5-30-2008; IN COMMERCE 5-30-2008.

JOHN E. MICHOS, EXAMINING ATTORNEY

Int. Cl.: 35

Prior U.S. Cls.: 100, 101, and 102

United States Patent and Trademark Office

Reg. No. 3,481,346

Registered Aug. 5, 2008

**SERVICE MARK
PRINCIPAL REGISTER**

**HUNDREDS OF MEAL IDEAS.
ONE AISLE.**

MYMENU CANADA INC. (CANADA CORPORATION)
PO BOX 2488
KITCHENER, ONTARIO, CANADA N2H 6M3

THE MARK CONSISTS OF STANDARD CHARACTERS WITHOUT CLAIM TO ANY PARTICULAR FONT, STYLE, SIZE, OR COLOR.

FOR: ONLINE AND TRADITIONAL RETAIL STORE SERVICES FEATURING FOOD PRODUCTS, IN CLASS 35 (U.S. CLS. 100, 101 AND 102).

SN 77-092,118, FILED 1-26-2007.

FIRST USE 5-30-2008; IN COMMERCE 5-30-2008.

JOHN E. MICHOS, EXAMINING ATTORNEY

Int. Cl.: 35

Prior U.S. Cls.: 100, 101, and 102

United States Patent and Trademark Office

Reg. No. 3,481,347

Registered Aug. 5, 2008

**SERVICE MARK
PRINCIPAL REGISTER**

SMARTMORTGAGE

SMARTTALENT LLC (WASHINGTON LTD LIAB
CO)
1321 4TH AVENUE
SEATTLE, WA 98101

FOR: BUSINESS SERVICES, NAMELY, BUSINESS CONSULTING SERVICES IN THE FIELD OF HUMAN RESOURCES; EMPLOYMENT STAFFING, RECRUITING, AND PLACEMENT SERVICES IN THE MORTGAGE AND BANKING FIELDS, INCLUDING, CREDIT ANALYST, LENDING OPERATIONS ANALYST, LOAN COORDINATOR, LOAN PROCESSOR, LOAN OFFICER, COMPLIANCE SPECIALIST, UNDERWRITER, FUNDER, DOCUMENT DRAWER, DEFAULT SPECIALIST, RECONVEYANCE REPRESENTATIVE, SETTLEMENTS AND CASH OPERATIONS, ABTRACTOR, CUSTOMER SERVICE REPRESENTATIVE, ESCROW ASSISTANT, ESCROW CLOSER, EXECUTIVE SECRETARY, LPO, PAYOFF EXPERT, POST CLOSER, SR/JR; ESCROW OFFICER, SR/JR; ESCROW PROCESSOR, TAX SPECIALIST, TITLE ASSISTANT, TITLE

OFFICER, TITLE PROCESSOR, TITLE EXAMINER, CALL CENTER REPRESENTATIVE, CONSUMER LOAN PROCESSOR, FINANCIAL SERVICES REPRESENTATIVE, LETTER OF CREDIT SPECIALIST, LOAN REPRESENTATIVE, LINE/VAULT TELLER, LOAN CONSULTANT, LOAN DOCUMENTATION CLERK, BANKING LOAN PROCESSOR, LOAN SERVICING SPECIALIST, PORTFOLIO ANALYST, PERSONAL BANKER AND RECEPTIONIST, IN CLASS 35 (U.S. CLS. 100, 101 AND 102).

FIRST USE 0-0-2007; IN COMMERCE 0-0-2007.

THE MARK CONSISTS OF STANDARD CHARACTERS WITHOUT CLAIM TO ANY PARTICULAR FONT, STYLE, SIZE, OR COLOR.

SN 77-092,598, FILED 1-26-2007.

ALEX KEAM, EXAMINING ATTORNEY

Int. Cl.: 35

Prior U.S. Cls.: 100, 101, and 102

United States Patent and Trademark Office

Reg. No. 3,481,348

Registered Aug. 5, 2008

**SERVICE MARK
PRINCIPAL REGISTER**

SMARTV.I.S.

SMARTTALENT LLC (WASHINGTON LTD LIAB
CO)
1321 4TH AVENUE
SEATTLE, WA 98101

FOR: BUSINESS SERVICES, NAMELY, BUSINESS
CONSULTING IN THE FIELD OF HUMAN RE-
SOURCEES; EMPLOYMENT VERIFICATION IN THE
NATURE OF VERIFYING THE EMPLOYMENT
ELIGIBILITY OF ALL NEW HIRES AS PART OF
EMPLOYMENT STAFFING SERVICES, IN CLASS 35
(U.S. CLS. 100, 101 AND 102).

FIRST USE 0-0-2006; IN COMMERCE 0-0-2007.

THE MARK CONSISTS OF STANDARD CHAR-
ACTERS WITHOUT CLAIM TO ANY PARTICULAR
FONT, STYLE, SIZE, OR COLOR.

SN 77-092,602, FILED 1-26-2007.

ALEX KEAM, EXAMINING ATTORNEY

Int. Cl.: 9

Prior U.S. Cls.: 21, 23, 26, 36, and 38

Reg. No. 3,481,349

United States Patent and Trademark Office

Registered Aug. 5, 2008

**TRADEMARK
PRINCIPAL REGISTER**

INSECTICIDE

CRACKPOT ENTERTAINMENT LLC (MASSA-
CHUSETTS LTD LIAB CO)
350 MARCH ROAD
SHELBURNE FALLS, MA 01370

THE MARK CONSISTS OF STANDARD CHAR-
ACTERS WITHOUT CLAIM TO ANY PARTICULAR
FONT, STYLE, SIZE, OR COLOR.

FOR: VIDEO GAME CARTRIDGES; VIDEO
GAME SOFTWARE, IN CLASS 9 (U.S. CLS. 21, 23,
26, 36 AND 38).

SN 77-093,014, FILED 1-28-2007.

FIRST USE 3-0-2008; IN COMMERCE 3-0-2008.

CARRIE GENOVESE, EXAMINING ATTORNEY

Int. Cl.: 41

Prior U.S. Cls.: 100, 101, and 107

United States Patent and Trademark Office

Reg. No. 3,481,350

Registered Aug. 5, 2008

**SERVICE MARK
PRINCIPAL REGISTER**

PDUS TO GO

OPTIMO, INC. (GEORGIA CORPORATION)
3565 PIEDMONT RD NE
TWO PIEDMONT CENTER, SUITE 318
ATLANTA, GA 30305

FOR: PROVIDING CONTINUING PROJECT
MANAGEMENT EDUCATION COURSES, IN CLASS
41 (U.S. CLS. 100, 101 AND 107).

FIRST USE 1-28-2007; IN COMMERCE 1-28-2007.

THE MARK CONSISTS OF STANDARD CHAR-
ACTERS WITHOUT CLAIM TO ANY PARTICULAR
FONT, STYLE, SIZE, OR COLOR.

NO CLAIM IS MADE TO THE EXCLUSIVE
RIGHT TO USE "PDUS", APART FROM THE MARK
AS SHOWN.

SN 77-093,048, FILED 1-28-2007.

ANDREW RHIM, EXAMINING ATTORNEY

Int. Cls.: 16 and 41

Prior U.S. Cls.: 2, 5, 22, 23, 29, 37, 38, 50, 100, 101, and 107

Reg. No. 3,481,351

United States Patent and Trademark Office

Registered Aug. 5, 2008

**TRADEMARK
SERVICE MARK
PRINCIPAL REGISTER**

BEGIN SMART

BEGIN SMART LLC (NEW YORK LTD LIAB CO)
387 PARK AVENUE SOUTH
NEW YORK, NY 10016

FOR: CHILDREN'S BOOKS, EDUCATIONAL BOOKS FEATURING A DEVELOPMENTAL PROGRAM FOR CHILDREN, IN CLASS 16 (U.S. CLS. 2, 5, 22, 23, 29, 37, 38 AND 50).

FIRST USE 6-4-2008; IN COMMERCE 6-4-2008.

FOR: BOOK PUBLISHING SERVICES, IN CLASS 41 (U.S. CLS. 100, 101 AND 107).

FIRST USE 6-4-2008; IN COMMERCE 6-4-2008.

THE MARK CONSISTS OF STANDARD CHARACTERS WITHOUT CLAIM TO ANY PARTICULAR FONT, STYLE, SIZE, OR COLOR.

SN 77-093,743, FILED 1-29-2007.

ANNE FARRELL, EXAMINING ATTORNEY

Int. Cl.: 29

Prior U.S. Cl.: 46

United States Patent and Trademark Office

Reg. No. 3,481,352

Registered Aug. 5, 2008

**TRADEMARK
PRINCIPAL REGISTER**

SIZZLE & SERVE

JONMOR INVESTMENTS, INC. (DELAWARE
CORPORATION)
103 BAYNARD BUILDING
3411 SILVERSIDE ROAD
WILMINGTON, DE 19810

THE MARK CONSISTS OF STANDARD CHAR-
ACTERS WITHOUT CLAIM TO ANY PARTICULAR
FONT, STYLE, SIZE, OR COLOR.

SN 77-093,769, FILED 1-29-2007.

FOR: SAUSAGE, IN CLASS 29 (U.S. CL. 46).

FIRST USE 7-13-2007; IN COMMERCE 7-13-2007.

NAAKWAMA ANKRAH, EXAMINING ATTORNEY

Int. Cl.: 40

Prior U.S. Cls.: 100, 103, and 106

United States Patent and Trademark Office

Reg. No. 3,481,353

Registered Aug. 5, 2008

**SERVICE MARK
PRINCIPAL REGISTER**

Asure

DURGIN & CROWELL LUMBER COMPANY,
INC. (NEW HAMPSHIRE CORPORATION)
231 FISHER CORNER ROAD
NEW LONDON, NH 03257

THE MARK CONSISTS OF STANDARD CHAR-
ACTERS WITHOUT CLAIM TO ANY PARTICULAR
FONT, STYLE, SIZE, OR COLOR.

FOR: APPLYING PROTECTIVE COATINGS TO
WOOD, NAMELY, APPLYING ULTRAVIOLET
COATINGS TO PINE WOOD BOARDS, IN CLASS
40 (U.S. CLS. 100, 103 AND 106).

SN 77-093,793, FILED 1-29-2007.

FIRST USE 8-1-2007; IN COMMERCE 8-1-2007.

BARBARA BROWN, EXAMINING ATTORNEY

Int. Cl.: 35

Prior U.S. Cls.: 100, 101, and 102

United States Patent and Trademark Office

Reg. No. 3,481,354

Registered Aug. 5, 2008

**SERVICE MARK
PRINCIPAL REGISTER**

IFIND GROUP

IFIND GROUP LLC (NEW YORK LTD LIAB CO)
415 MADISON AVENUE
NEW YORK, NY 10017

FOR: PERSONNEL PLACEMENT AND RECRUITMENT; EMPLOYMENT CONSULTING AND RECRUITING SERVICES, NAMELY, EXECUTIVE AND PROFESSIONAL SEARCH, RECRUITING, AND CONSULTING SERVICES, IN CLASS 35 (U.S. CLS. 100, 101 AND 102).

FIRST USE 2-1-2007; IN COMMERCE 2-1-2007.

THE MARK CONSISTS OF STANDARD CHARACTERS WITHOUT CLAIM TO ANY PARTICULAR FONT, STYLE, SIZE, OR COLOR.

NO CLAIM IS MADE TO THE EXCLUSIVE RIGHT TO USE "GROUP", APART FROM THE MARK AS SHOWN.

SN 77-093,862, FILED 1-29-2007.

CHRISTINA SOBRAL, EXAMINING ATTORNEY

Int. Cls.: 25 and 28

Prior U.S. Cls.: 22, 23, 38, 39, and 50

United States Patent and Trademark Office

Reg. No. 3,481,355

Registered Aug. 5, 2008

**TRADEMARK
PRINCIPAL REGISTER**

FRISDOO

FRISDOO, LLC (GEORGIA LTD LIAB CO)
277 ATLANTA AVENUE
ATLANTA, GA 30315

FOR: CLOTHING, NAMELY, T-SHIRTS, SHORTS,
HATS, SWEATSHIRTS, FLEECE JACKETS, AND
SWIMWEAR, IN CLASS 25 (U.S. CLS. 22 AND 39).

FIRST USE 7-1-2007; IN COMMERCE 7-1-2007.

FOR: EQUIPMENT SOLD AS A UNIT FOR PLAY-
ING A COMPETITIVE WATER SPORTS GAME
COMPRISED OF FLYING DISCS, COURSE MAR-
KERS, AND FLOATING DEVICES, TO BE USED IN

CONJUNCTION WITH A PERSONAL WATER
CRAFT, IN CLASS 28 (U.S. CLS. 22, 23, 38 AND 50).

FIRST USE 7-3-2007; IN COMMERCE 7-3-2007.

THE MARK CONSISTS OF STANDARD CHAR-
ACTERS WITHOUT CLAIM TO ANY PARTICULAR
FONT, STYLE, SIZE, OR COLOR.

SN 77-094,840, FILED 1-30-2007.

LEIGH CAROLINE CASE, EXAMINING ATTOR-
NEY

Int. Cl.: 33

Prior U.S. Cls.: 47 and 49

United States Patent and Trademark Office

Reg. No. 3,481,356

Registered Aug. 5, 2008

**TRADEMARK
PRINCIPAL REGISTER**

VINTERRA

ADLER FELS WINERY, LLC (MINNESOTA LTD
LIAB CO)
980 AIRWAY COURT, SUITE B
SANTA ROSA, CA 95403

THE MARK CONSISTS OF STANDARD CHAR-
ACTERS WITHOUT CLAIM TO ANY PARTICULAR
FONT, STYLE, SIZE, OR COLOR.

FOR: WINE, IN CLASS 33 (U.S. CLS. 47 AND 49).

SN 77-095,199, FILED 1-30-2007.

FIRST USE 6-13-2008; IN COMMERCE 6-13-2008.

TEJBIR SINGH, EXAMINING ATTORNEY

Int. Cl.: 7

Prior U.S. Cls.: 13, 19, 21, 23, 31, 34, and 35

Reg. No. 3,481,357

United States Patent and Trademark Office

Registered Aug. 5, 2008

**TRADEMARK
PRINCIPAL REGISTER**

ECONOMASTER

A. O. SMITH CORPORATION (DELAWARE CORPORATION)
11270 WEST PARK PLACE
MILWAUKEE, WI 532249509

THE MARK CONSISTS OF STANDARD CHARACTERS WITHOUT CLAIM TO ANY PARTICULAR FONT, STYLE, SIZE, OR COLOR.

FOR: ELECTRIC MOTORS FOR MACHINES, IN CLASS 7 (U.S. CLS. 13, 19, 21, 23, 31, 34 AND 35).

SN 77-095,956, FILED 1-31-2007.

FIRST USE 1-0-2008; IN COMMERCE 1-0-2008.

ANTHONY RINKER, EXAMINING ATTORNEY

Int. Cls.: 16, 38, and 41

Prior U.S. Cls.: 2, 5, 22, 23, 29, 37, 38, 50, 100, 101, 104, and 107

Reg. No. 3,481,358

United States Patent and Trademark Office

Registered Aug. 5, 2008

TRADEMARK
SERVICE MARK
PRINCIPAL REGISTER

HACKERS

DONG IN, CHO (REPUBLIC OF KOREA INDIVIDUAL)
HANBIT APT. 112-1004, EOEUN-DONG 99
YOOSUNG-GU, DAEJUN, REPUBLIC OF KOREA

FOR: NOTEBOOKS, MEMO PAPER, BUSINESS CARD PAPER, ENVELOPES, STATIONERY PADS, FILE FOLDERS FOR PAPER, POCKET NOTEBOOKS, PHOTOGRAPH AND SCRAPBOOK ALBUMS, PICTURE POSTCARDS, CALENDARS, BANK CHECKS, CHECKBOOK HOLDERS AND COVERS, BLANK WRITING AND DRAWING BOOKS, POSTCARDS, COMMEMORATIVE POSTAGE STAMP SHEETS, PRINTED FORMS, PRINTED TIMETABLES, DIARIES, TELEPHONE DIRECTORIES, GEOGRAPHICAL MAPS, PRINTED TICKETS, POSTERS AND FLASH CARDS; PRINTED INSTRUCTIONAL, EDUCATIONAL, AND TEACHING MATERIALS IN THE FIELDS OF ENGLISH, ENGLISH AS A SECOND LANGUAGE, FOREIGN LANGUAGES, HANDWRITING AND SCHOLASTIC TEST PREPARATION; AND BOOKS, BOOKLETS, NEWSPAPERS, MAGAZINES, PERIODICALS, CATALOGUES, PAMPHLETS, STUDY BOOKS, HANDBOOKS, AND NEWSLETTERS IN THE FIELDS OF ENGLISH, ENGLISH AS A SECOND LANGUAGE, FOREIGN LANGUAGES, HANDWRITING AND SCHOLASTIC TEST PREPARATION, IN CLASS 16 (U.S. CLS. 2, 5, 22, 23, 29, 37, 38 AND 50).

FOR: TRANSMISSION OF INFORMATION IN THE FIELDS OF ENGLISH, ENGLISH AS A SECOND LANGUAGE, FOREIGN LANGUAGES, HANDWRITING AND SCHOLASTIC TEST PREPARATION BY ELECTRONIC COMMUNICATIONS NETWORKS, COMPUTER NETWORKS AND WIRELESS COMMUNICATIONS NETWORKS; ELECTRONIC TRANSMISSION OF MESSAGES AND DATA IN THE FIELDS OF ENGLISH, ENGLISH AS A SECOND LANGUAGE, FOREIGN LANGUAGES,

HANDWRITING AND SCHOLASTIC TEST PREPARATION; PROVIDING MULTIPLE-USER ACCESS TO A GLOBAL COMPUTER INFORMATION NETWORK IN THE FIELDS OF ENGLISH, ENGLISH AS A SECOND LANGUAGE, FOREIGN LANGUAGES, HANDWRITING AND SCHOLASTIC TEST PREPARATION; PROVIDING ON-LINE ELECTRONIC BULLETIN BOARDS FOR TRANSMISSION OF MESSAGES AMONG COMPUTER USERS CONCERNING ENGLISH, ENGLISH AS A SECOND LANGUAGE, FOREIGN LANGUAGES, HANDWRITING AND SCHOLASTIC TEST PREPARATION; ELECTRONIC MAIL SERVICES IN THE FIELDS OF ENGLISH, ENGLISH AS A SECOND LANGUAGE, FOREIGN LANGUAGES, HANDWRITING AND SCHOLASTIC TEST PREPARATION; AND BROADCASTING PROGRAMS IN THE FIELDS OF ENGLISH, ENGLISH AS A SECOND LANGUAGE, FOREIGN LANGUAGES, HANDWRITING AND SCHOLASTIC TEST PREPARATION VIA A GLOBAL COMPUTER NETWORK, RADIO, AND TELEVISION, IN CLASS 38 (U.S. CLS. 100, 101 AND 104).

FIRST USE 2-28-2007; IN COMMERCE 2-28-2007.

FOR: PUBLICATION OF TEXTS, BOOKS, MAGAZINES AND OTHER PRINTED MATTER IN THE FIELDS OF ENGLISH, ENGLISH AS A SECOND LANGUAGE, FOREIGN LANGUAGES, HANDWRITING AND SCHOLASTIC TEST PREPARATION; ONLINE PUBLICATION OF ELECTRONIC BOOKS AND JOURNALS IN THE FIELDS OF ENGLISH, ENGLISH AS A SECOND LANGUAGE, FOREIGN LANGUAGES, HANDWRITING AND SCHOLASTIC TEST PREPARATION; PROVIDING ON-LINE ELECTRONIC PUBLICATIONS IN THE NATURE OF BOOKS, BOOKLETS, NEWSPAPERS, MAGAZINES, PERIODICALS, CATALOGUES,

PAMPHLETS, STUDY BOOKS, HANDBOOKS, AND NEWSLETTERS IN THE FIELDS OF ENGLISH, ENGLISH AS A SECOND LANGUAGE, FOREIGN LANGUAGES, HANDWRITING AND SCHOLASTIC TEST PREPARATION; NEWS REPORTING SERVICES IN THE FIELDS OF ENGLISH, ENGLISH AS A SECOND LANGUAGE, FOREIGN LANGUAGES, HANDWRITING AND SCHOLASTIC TEST PREPARATION; BOARDING SCHOOLS; ARRANGING AND CONDUCTING CLASSES, SEMINARS AND WORKSHOPS IN THE FIELDS OF ENGLISH, ENGLISH AS A SECOND LANGUAGE, FOREIGN LANGUAGES, HANDWRITING AND SCHOLASTIC TEST PREPARATION, AND DISTRIBUTION OF COURSE MATERIALS IN CONNECTION THEREWITH; LIBRARY AND READING ROOM SERVICES; ORGANIZATION OF EDUCATIONAL EXHIBITIONS IN THE FIELDS OF ENGLISH, ENGLISH AS A SECOND LANGUAGE, FOREIGN LANGUAGES, HANDWRITING AND SCHOLASTIC TEST PREPARATION FOR EDUCATIONAL PURPOSES; NURSERY SCHOOLS; EDUCATIONAL SERVICES, NAMELY, PROVIDING COURSES OF INSTRUCTION AT THE KINDERGARTEN LEVEL AND DISTRIBUTION OF COURSE MATERIAL IN CONNECTION THEREWITH; ARRANGING OF OVERSEAS CLASSES, SEMINARS AND WORKSHOPS IN THE FIELDS OF ENGLISH, ENGLISH AS A SECOND LANGUAGE, FOREIGN LANGUAGES, HANDWRITING AND SCHOLASTIC TEST PREPARATION; MOBILE LIBRARY SERVICES; EDUCATIONAL SERVICES IN THE NATURE OF CORRESPONDENCE SCHOOLS IN THE FIELDS OF

ENGLISH, ENGLISH AS A SECOND LANGUAGE, FOREIGN LANGUAGES, HANDWRITING AND SCHOLASTIC TEST PREPARATION; SPORTS CAMP SERVICES- ENTERTAINMENT SERVICES, NAMELY, PROVIDING ON-LINE COMPUTER GAMES; AMUSEMENT PARKS; PROVIDING SPORTS FACILITIES; PHYSICAL EDUCATION SERVICES; RECREATIONAL CAMPS; MICROFILM AND VIDEO FILM RECORDING SERVICES FOR OTHERS; PHOTOGRAPHY SERVICES; TRANSLATION SERVICES; VOCATIONAL GUIDANCE; AND EDUCATIONAL SERVICES, NAMELY, DEVELOPING, ARRANGING, AND CONDUCTING EDUCATIONAL CONFERENCES AND PROGRAMS AND PROVIDING COURSES OF INSTRUCTION IN THE FIELDS OF ENGLISH, ENGLISH AS A SECOND LANGUAGE, FOREIGN LANGUAGES, HANDWRITING AND SCHOLASTIC TEST PREPARATION, IN CLASS 41 (U.S. CLS. 100, 101 AND 107).

THE MARK CONSISTS OF STANDARD CHARACTERS WITHOUT CLAIM TO ANY PARTICULAR FONT, STYLE, SIZE, OR COLOR.

OWNER OF REPUBLIC OF KOREA REG. NO. 144595, DATED 2-14-2007, EXPIRES 2-14-2017.

OWNER OF REPUBLIC OF KOREA REG. NO. 687814, DATED 12-1-2006, EXPIRES 12-1-2016.

SN 77-096,904, FILED 2-1-2007.

MICHAEL SOUDERS, EXAMINING ATTORNEY

Int. Cls.: 16, 38, and 41

Prior U.S. Cls.: 2, 5, 22, 23, 29, 37, 38, 50, 100, 101, 104, and 107

Reg. No. 3,481,359

United States Patent and Trademark Office

Registered Aug. 5, 2008

TRADEMARK
SERVICE MARK
PRINCIPAL REGISTER

해커스

DONG IN, CHO (REPUBLIC OF KOREA INDIVIDUAL)

HANBIT APT. 112-1004, EOEUN-DONG 99
YOOSUNG-GU, DAEJUN, REPUBLIC OF KOREA

FOR: (BASED ON 44(E)) NOTEBOOKS, MEMO PAPER, BUSINESS CARD PAPER, ENVELOPES, STATIONERY PADS, FILE FOLDERS FOR PAPER, POCKET NOTEBOOKS, PHOTOGRAPH AND SCRAPBOOK ALBUMS, PICTURE POSTCARDS, CALENDARS, BANK CHECKS, CHECKBOOK HOLDERS AND COVERS, BLANK WRITING AND DRAWING BOOKS, POSTCARDS, COMMEMORATIVE POSTAGE STAMP SHEETS, PRINTED FORMS, PRINTED TIMETABLES, DIARIES, TELEPHONE DIRECTORIES, GEOGRAPHICAL MAPS, PRINTED TICKETS, POSTERS AND FLASH CARDS; PRINTED INSTRUCTIONAL, EDUCATIONAL, AND TEACHING MATERIALS IN THE FIELDS OF ENGLISH, ENGLISH AS A SECOND LANGUAGE, FOREIGN LANGUAGES, HANDWRITING AND SCHOLASTIC TEST PREPARATION; AND BOOKS, BOOKLETS, NEWSPAPERS, MAGAZINES, PERIODICALS, CATALOGUES, PAMPHLETS, STUDY BOOKS, HANDBOOKS, AND NEWSLETTERS IN THE FIELDS OF ENGLISH, ENGLISH AS A SECOND LANGUAGE, FOREIGN LANGUAGES, HANDWRITING AND SCHOLASTIC TEST PREPARATION, IN CLASS 16 (U.S. CLS. 2, 5, 22, 23, 29, 37, 38 AND 50).

FOR: (BASED ON USE IN COMMERCE) TRANSMISSION OF INFORMATION IN THE FIELDS OF ENGLISH, ENGLISH AS A SECOND LANGUAGE, FOREIGN LANGUAGES, HANDWRITING AND SCHOLASTIC TEST PREPARATION BY ELECTRONIC COMMUNICATIONS NETWORKS, COMPUTER NETWORKS AND WIRELESS COMMUNICATIONS NETWORKS; ELECTRONIC TRANSMISSION OF MESSAGES AND DATA IN

THE FIELDS OF ENGLISH, ENGLISH AS A SECOND LANGUAGE, FOREIGN LANGUAGES, HANDWRITING AND SCHOLASTIC TEST PREPARATION; PROVIDING MULTIPLE-USER ACCESS TO A GLOBAL COMPUTER INFORMATION NETWORK IN THE FIELDS OF ENGLISH, ENGLISH AS A SECOND LANGUAGE, FOREIGN LANGUAGES, HANDWRITING AND SCHOLASTIC TEST PREPARATION; PROVIDING ON-LINE ELECTRONIC BULLETIN BOARDS FOR TRANSMISSION OF MESSAGES AMONG COMPUTER USERS CONCERNING ENGLISH, ENGLISH AS A SECOND LANGUAGE, FOREIGN LANGUAGES, HANDWRITING AND SCHOLASTIC TEST PREPARATION; ELECTRONIC MAIL SERVICES IN THE FIELDS OF ENGLISH, ENGLISH AS A SECOND LANGUAGE, FOREIGN LANGUAGES, HANDWRITING AND SCHOLASTIC TEST PREPARATION; AND BROADCASTING PROGRAMS IN THE FIELDS OF ENGLISH, ENGLISH AS A SECOND LANGUAGE, FOREIGN LANGUAGES, HANDWRITING AND SCHOLASTIC TEST PREPARATION VIA A GLOBAL COMPUTER NETWORK, RADIO, AND TELEVISION, IN CLASS 38 (U.S. CLS. 100, 101 AND 104).

FIRST USE 2-28-2007; IN COMMERCE 2-28-2007.

FOR: (BASED ON 44(E)) PUBLICATION OF TEXTS, BOOKS, MAGAZINES AND OTHER PRINTED MATTER IN THE FIELDS OF ENGLISH, ENGLISH AS A SECOND LANGUAGE, FOREIGN LANGUAGES, HANDWRITING AND SCHOLASTIC TEST PREPARATION; ONLINE PUBLICATION OF ELECTRONIC BOOKS AND JOURNALS IN THE FIELDS OF ENGLISH, ENGLISH AS A SECOND LANGUAGE, FOREIGN LANGUAGES, HANDWRITING AND SCHOLASTIC TEST PREPARATION; PROVIDING ON-LINE ELECTRONIC

PUBLICATIONS IN THE NATURE OF BOOKS, BOOKLETS, NEWSPAPERS, MAGAZINES, PERIODICALS, CATALOGUES, PAMPHLETS, STUDY BOOKS, HANDBOOKS, AND NEWSLETTERS IN THE FIELDS OF ENGLISH, ENGLISH AS A SECOND LANGUAGE, FOREIGN LANGUAGES, HANDWRITING AND SCHOLASTIC TEST PREPARATION; NEWS REPORTING SERVICES IN THE FIELDS OF ENGLISH, ENGLISH AS A SECOND LANGUAGE, FOREIGN LANGUAGES, HANDWRITING AND SCHOLASTIC TEST PREPARATION; BOARDING SCHOOLS; ARRANGING AND CONDUCTING CLASSES, SEMINARS AND WORKSHOPS IN THE FIELDS OF ENGLISH, ENGLISH AS A SECOND LANGUAGE, FOREIGN LANGUAGES, HANDWRITING AND SCHOLASTIC TEST PREPARATION, AND DISTRIBUTION OF COURSE MATERIALS IN CONNECTION THEREWITH; LIBRARY AND READING ROOM SERVICES; ORGANIZATION OF EDUCATIONAL EXHIBITIONS IN THE FIELDS OF ENGLISH, ENGLISH AS A SECOND LANGUAGE, FOREIGN LANGUAGES, HANDWRITING AND SCHOLASTIC TEST PREPARATION FOR EDUCATIONAL PURPOSES; NURSERY SCHOOLS; EDUCATIONAL SERVICES, NAMELY, PROVIDING COURSES OF INSTRUCTION AT THE KINDERGARTEN LEVEL AND DISTRIBUTION OF COURSE MATERIAL IN CONNECTION THEREWITH; ARRANGING OF OVERSEAS CLASSES, SEMINARS AND WORKSHOPS IN THE FIELDS OF ENGLISH, ENGLISH AS A SECOND LANGUAGE, FOREIGN LANGUAGES, HANDWRITING AND SCHOLASTIC TEST PREPARATION; MOBILE LIBRARY SERVICES; EDUCATIONAL SERVICES IN THE NATURE OF CORRESPONDENCE SCHOOLS IN THE FIELDS OF ENGLISH, ENGLISH AS A SECOND LANGUAGE, FOREIGN LANGUAGES, HANDWRITING AND SCHOLASTIC TEST PREPARATION; SPORTS CAMP

SERVICES- ENTERTAINMENT SERVICES, NAMELY, PROVIDING ON-LINE COMPUTER GAMES; AMUSEMENT PARKS; PROVIDING SPORTS FACILITIES; PHYSICAL EDUCATION SERVICES; RECREATIONAL CAMPS; MICROFILM AND VIDEO FILM RECORDING SERVICES FOR OTHERS; PHOTOGRAPHY SERVICES; TRANSLATION SERVICES; VOCATIONAL GUIDANCE; AND EDUCATIONAL SERVICES, NAMELY, DEVELOPING, ARRANGING, AND CONDUCTING EDUCATIONAL CONFERENCES AND PROGRAMS AND PROVIDING COURSES OF INSTRUCTION IN THE FIELDS OF ENGLISH, ENGLISH AS A SECOND LANGUAGE, FOREIGN LANGUAGES, HANDWRITING AND SCHOLASTIC TEST PREPARATION, IN CLASS 41 (U.S. CLS. 100, 101 AND 107).

OWNER OF REPUBLIC OF KOREA REG. NO. 144597, DATED 2-14-2007, EXPIRES 2-14-2017.

OWNER OF REPUBLIC OF KOREA REG. NO. 687815, DATED 12-1-2006, EXPIRES 12-1-2016.

THE MARK CONSISTS OF KOREAN LANGUAGE PHONETIC CHARACTERS THAT ARE LOOSELY PRONOUNCED AS HACKERS.

THE FOREIGN WORDING IN THE MARK TRANSLATES INTO ENGLISH AS HACKERS.

THE NON-LATIN CHARACTER(S) IN THE MARK TRANSLITERATE INTO HEH K UH SE, AND THIS MEANS HACKERS IN ENGLISH.

SN 77-096,955, FILED 2-1-2007.

MICHAEL SOUDERS, EXAMINING ATTORNEY

Int. Cl.: 42

Prior U.S. Cls.: 100 and 101

United States Patent and Trademark Office

Reg. No. 3,481,360

Registered Aug. 5, 2008

**SERVICE MARK
PRINCIPAL REGISTER**

SOIL TO BOTTLE

AVEDA CORPORATION (DELAWARE CORPORATION)
4000 PHEASANT RIDGE DRIVE
MINNEAPOLIS, MN 55449

FOR: RESEARCH AND DEVELOPMENT IN THE FIELD OF ECOLOGICALLY AND ENVIRONMENTALLY-FRIENDLY SOURCES FOR ORGANIC, BIODYNAMIC OR WILD-HARVESTED INGREDIENTS FOR FRAGRANCES, BODY AND BEAUTY CARE PREPARATIONS, NON-MEDICATED SKIN CARE PREPARATIONS AND HAIR CARE PREPARATIONS, IN CLASS 42 (U.S. CLS. 100 AND 101).

FIRST USE 4-14-2008; IN COMMERCE 4-14-2008.

THE MARK CONSISTS OF STANDARD CHARACTERS WITHOUT CLAIM TO ANY PARTICULAR FONT, STYLE, SIZE, OR COLOR.

SN 77-097,390, FILED 2-1-2007.

JOHN E. MICHOS, EXAMINING ATTORNEY

Int. Cl.: 9

Prior U.S. Cls.: 21, 23, 26, 36, and 38

Reg. No. 3,481,361

United States Patent and Trademark Office

Registered Aug. 5, 2008

**TRADEMARK
PRINCIPAL REGISTER**

Athena Backup

BRONZE AGE SOFTWARE CORPORATION (CA-
NADA CORPORATION)
8B-250 GREENBANK ROAD
SUITE 219
OTTAWA, CANADA K2H1E9

FOR: BACKUP DRIVES FOR COMPUTERS, IN
CLASS 9 (U.S. CLS. 21, 23, 26, 36 AND 38).

FIRST USE 8-6-2007; IN COMMERCE 2-4-2008.

THE MARK CONSISTS OF STANDARD CHAR-
ACTERS WITHOUT CLAIM TO ANY PARTICULAR
FONT, STYLE, SIZE, OR COLOR.

NO CLAIM IS MADE TO THE EXCLUSIVE
RIGHT TO USE "BACKUP", APART FROM THE
MARK AS SHOWN.

SN 77-097,620, FILED 2-2-2007.

JILL C. ALT, EXAMINING ATTORNEY

Int. Cl.: 44

Prior U.S. Cls.: 100 and 101

United States Patent and Trademark Office

Reg. No. 3,481,362

Registered Aug. 5, 2008

**SERVICE MARK
PRINCIPAL REGISTER**

AGUA DULCE

AGUA DULCE EXTENDED CARE, INC. (ARIZONA CORPORATION)
4110 SWEETWATER
TUCSON, AZ 85745

FOR: MENTAL AND BEHAVIORAL HEALTH CARE SERVICES FOR WOMEN, IN CLASS 44 (U.S. CLS. 100 AND 101).

FIRST USE 6-24-2008; IN COMMERCE 6-24-2008.

THE MARK CONSISTS OF STANDARD CHARACTERS WITHOUT CLAIM TO ANY PARTICULAR FONT, STYLE, SIZE, OR COLOR.

THE FOREIGN WORDING IN THE MARK TRANSLATES INTO ENGLISH AS FRESH WATER.

SN 77-097,676, FILED 2-2-2007.

ALYSSA PALADINO, EXAMINING ATTORNEY

Int. Cl.: 6

Prior U.S. Cls.: 2, 12, 13, 14, 23, 25, and 50

United States Patent and Trademark Office

Reg. No. 3,481,363

Registered Aug. 5, 2008

**TRADEMARK
PRINCIPAL REGISTER**

ALLWALL

SKORKA, RICHARD (UNITED STATES INDIVIDUAL)
1605 BAR HARBOR
FLOWER MOUND, TX 75028

THE MARK CONSISTS OF STANDARD CHARACTERS WITHOUT CLAIM TO ANY PARTICULAR FONT, STYLE, SIZE, OR COLOR.

FOR: METAL FASTENING ANCHORS FOR SECURING OBJECTS TO WALLS, IN CLASS 6 (U.S. CLS. 2, 12, 13, 14, 23, 25 AND 50).

SN 77-097,912, FILED 2-2-2007.

FIRST USE 9-1-2007; IN COMMERCE 9-1-2007.

REBECCA SMITH, EXAMINING ATTORNEY

Int. Cl.: 9

Prior U.S. Cls.: 21, 23, 26, 36, and 38

United States Patent and Trademark Office

Reg. No. 3,481,364

Registered Aug. 5, 2008

TRADEMARK
PRINCIPAL REGISTER



SONY KABUSHIKI KAISHA (ALSO TRADING
AS SONY CORPORATION) (JAPAN COR-
PORATION)
1-7-1 KONAN, MINATO-KU
TOKYO, JAPAN

THE MARK CONSISTS OF THE WORD "MO-
TIONFLOW" IN STYLIZED TYPE WITH A PAT-
TERN OF ELONGATING RECTANGLES
APPEARING UNDERNEATH.

FOR: TELEVISION SETS; LCD TELEVISION SETS;
PROJECTION TELEVISION SETS, IN CLASS 9 (U.S.
CLS. 21, 23, 26, 36 AND 38).

SN 77-099,921, FILED 2-6-2007.

FIRST USE 6-30-2007; IN COMMERCE 6-30-2007.

AMY ALFIERI, EXAMINING ATTORNEY

Int. Cls.: 30 and 32

Prior U.S. Cls.: 45, 46, and 48

United States Patent and Trademark Office

Reg. No. 3,481,365

Registered Aug. 5, 2008

**TRADEMARK
PRINCIPAL REGISTER**

Sports Mania

FOOD SOLUTIONS, INC. (NORTH CAROLINA CORPORATION)
P.O. BOX 10184
GREENSBORO, NC 27404

FOR: CEREAL-BASED SNACK FOODS; TORTILLA CHIPS, IN CLASS 30 (U.S. CL. 46).

FIRST USE 10-23-2007; IN COMMERCE 10-23-2007.

FOR: NON-ALCOHOLIC COCKTAIL MIXES , IN CLASS 32 (U.S. CLS. 45, 46 AND 48).

FIRST USE 10-23-2007; IN COMMERCE 10-23-2007.

THE MARK CONSISTS OF STANDARD CHARACTERS WITHOUT CLAIM TO ANY PARTICULAR FONT, STYLE, SIZE, OR COLOR.

NO CLAIM IS MADE TO THE EXCLUSIVE RIGHT TO USE "SPORTS" AS TO CLASS 32, APART FROM THE MARK AS SHOWN.

SN 77-100,117, FILED 2-6-2007.

JUSTINE D. PARKER, EXAMINING ATTORNEY

Int. Cl.: 18

Prior U.S. Cls.: 1, 2, 3, 22, and 41

United States Patent and Trademark Office

Reg. No. 3,481,366

Registered Aug. 5, 2008

**TRADEMARK
PRINCIPAL REGISTER**

Cat Walks Dog

FAGES, CATHERINE (UNITED STATES INDIVIDUAL)
4578 MEADE STREET
DENVER, CO 80211

FOR: PET ACCESSORIES, NAMELY, COLLARS, LEASHES, CARRYING BAGS, AND HARNESES, PET BACKPACKS, PET CLOTHING, AND PROTECTIVE GARMENTS FOR PETS, NAMELY, BOOTIES, JACKETS AND VESTS, IN CLASS 18 (U.S. CLS. 1, 2, 3, 22 AND 41).

FIRST USE 12-4-2007; IN COMMERCE 12-4-2007.

THE MARK CONSISTS OF STANDARD CHARACTERS WITHOUT CLAIM TO ANY PARTICULAR FONT, STYLE, SIZE, OR COLOR.

SN 77-100,262, FILED 2-6-2007.

PRISCILLA MILTON, EXAMINING ATTORNEY

Int. Cl.: 35

Prior U.S. Cls.: 100, 101, and 102

United States Patent and Trademark Office

Reg. No. 3,481,367

Registered Aug. 5, 2008

**SERVICE MARK
PRINCIPAL REGISTER**

OPEN YOUR EYES

THE UNITED STATES SHOE CORPORATION
(DELAWARE CORPORATION)
44 HARBOR PARK DRIVE
PORT WASHINGTON, NY 11050

THE MARK CONSISTS OF STANDARD CHAR-
ACTERS WITHOUT CLAIM TO ANY PARTICULAR
FONT, STYLE, SIZE, OR COLOR.

FOR: RETAIL OPTICAL STORE SERVICES, IN
CLASS 35 (U.S. CLS. 100, 101 AND 102).

SN 77-101,106, FILED 2-7-2007.

FIRST USE 3-12-2007; IN COMMERCE 3-12-2007.

GEORGE LORENZO, EXAMINING ATTORNEY

Int. Cl.: 3

Prior U.S. Cls.: 1, 4, 6, 50, 51, and 52

Reg. No. 3,481,368

United States Patent and Trademark Office

Registered Aug. 5, 2008

**TRADEMARK
PRINCIPAL REGISTER**

DIVINEVA

NICHOLS, MARKYIA (UNITED STATES INDIVIDUAL)
9120 MARLOVE OAKS LN.
OWINGS MILLS, MD 21117

FOR: BODY OIL; BODY POWDER; BODY SCRUB;
BODY WASHES; FACE AND BODY BEAUTY
CREAMS; SOAPS FOR BODY CARE, IN CLASS 3
(U.S. CLS. 1, 4, 6, 50, 51 AND 52).

FIRST USE 9-1-2007; IN COMMERCE 11-1-2007.

THE MARK CONSISTS OF THE WORD "DIVINE-VA" WITH THE "N" IN DIFFERENT FONT AND SIZE THAN THE REMAINDER OF THE LETTERS FOR EMPHASIS.

SN 77-102,159, FILED 2-8-2007.

YAT SYE, LEE, EXAMINING ATTORNEY

Int. Cl.: 43

Prior U.S. Cls.: 100 and 101

United States Patent and Trademark Office

Reg. No. 3,481,369

Registered Aug. 5, 2008

**SERVICE MARK
PRINCIPAL REGISTER**

Zorkafor

ZORKAFOR'S SANDVEG INC (VIRGINIA CORPORATION)
1121 KING STREET
ALEXANDRIA, VA 22314

THE MARK CONSISTS OF STANDARD CHARACTERS WITHOUT CLAIM TO ANY PARTICULAR FONT, STYLE, SIZE, OR COLOR.

FOR: FAST-FOOD RESTAURANTS, IN CLASS 43 (U.S. CLS. 100 AND 101).

SN 77-102,274, FILED 2-8-2007.

FIRST USE 4-12-2008; IN COMMERCE 4-12-2008.

REBECCA SMITH, EXAMINING ATTORNEY

Int. Cl.: 3

Prior U.S. Cls.: 1, 4, 6, 50, 51, and 52

United States Patent and Trademark Office

Reg. No. 3,481,370

Registered Aug. 5, 2008

**TRADEMARK
PRINCIPAL REGISTER**

JOHNNY B. FUDDY GEL

ANORGA, ALFONSO JOSE, JR. (UNITED STATES INDIVIDUAL)
2016 CAMFIELD AVENUE
COMMERCE, CA 90040

FOR: HAIR CARE PREPARATIONS; HAIR GEL; HAIR STYLING GEL; HAIR STYLING PREPARATIONS, IN CLASS 3 (U.S. CLS. 1, 4, 6, 50, 51 AND 52).

FIRST USE 4-9-2007; IN COMMERCE 4-9-2007.

THE MARK CONSISTS OF STANDARD CHARACTERS WITHOUT CLAIM TO ANY PARTICULAR FONT, STYLE, SIZE, OR COLOR.

OWNER OF U.S. REG. NO. 2,504,361.

NO CLAIM IS MADE TO THE EXCLUSIVE RIGHT TO USE "GEL", APART FROM THE MARK AS SHOWN.

THE NAME(S), PORTRAIT(S), AND/OR SIGNATURE(S) SHOWN IN THE MARK DOES NOT IDENTIFY A PARTICULAR LIVING INDIVIDUAL.

SN 77-103,526, FILED 2-9-2007.

INGA ERVIN, EXAMINING ATTORNEY

Int. Cl.: 3

Prior U.S. Cls.: 1, 4, 6, 50, 51, and 52

United States Patent and Trademark Office

Reg. No. 3,481,371

Registered Aug. 5, 2008

**TRADEMARK
PRINCIPAL REGISTER**

JOHNNY B. MODE GEL

ANORGA, ALFONSO JOSE, JR. (UNITED STATES INDIVIDUAL)
2016 CAMFIELD AVENUE
COMMERCE, CA 90040

FOR: HAIR CARE PREPARATIONS; HAIR GEL; HAIR STYLING GEL; HAIR STYLING PREPARATIONS, IN CLASS 3 (U.S. CLS. 1, 4, 6, 50, 51 AND 52).

FIRST USE 4-9-2007; IN COMMERCE 4-9-2007.

THE MARK CONSISTS OF STANDARD CHARACTERS WITHOUT CLAIM TO ANY PARTICULAR FONT, STYLE, SIZE, OR COLOR.

OWNER OF U.S. REG. NO. 2,504,361.

NO CLAIM IS MADE TO THE EXCLUSIVE RIGHT TO USE "GEL", APART FROM THE MARK AS SHOWN.

THE NAME(S), PORTRAIT(S), AND/OR SIGNATURE(S) SHOWN IN THE MARK DOES NOT IDENTIFY A PARTICULAR LIVING INDIVIDUAL.

SN 77-103,528, FILED 2-9-2007.

INGA ERVIN, EXAMINING ATTORNEY

Int. Cl.: 9

Prior U.S. Cls.: 21, 23, 26, 36, and 38

United States Patent and Trademark Office

Reg. No. 3,481,372

Registered Aug. 5, 2008

**TRADEMARK
PRINCIPAL REGISTER**

M.A.C.H.

SIERRA ENTERTAINMENT, INC. (DELAWARE
CORPORATION)
6060 CENTER DRIVE, 5TH FLOOR
LOS ANGELES, CA 90045

FOR: COMPUTER GAME SOFTWARE; ENTERTAINMENT SOFTWARE IN THE NATURE OF A GAME CAPABLE OF BEING PLAYED ON A PORTABLE GAMING SYSTEM; VIDEO GAME CARTRIDGES, IN CLASS 9 (U.S. CLS. 21, 23, 26, 36 AND 38).

FIRST USE 1-5-2007; IN COMMERCE 2-20-2007.

THE MARK CONSISTS OF STANDARD CHARACTERS WITHOUT CLAIM TO ANY PARTICULAR FONT, STYLE, SIZE, OR COLOR.

SN 77-103,543, FILED 2-9-2007.

JIM RINGLE, EXAMINING ATTORNEY

Int. Cls.: 9 and 37

Prior U.S. Cls.: 21, 23, 26, 36, 38, 100, 103, and 106

United States Patent and Trademark Office

Reg. No. 3,481,373

Registered Aug. 5, 2008

**TRADEMARK
SERVICE MARK
PRINCIPAL REGISTER**

Andalay

AKEENA SOLAR INC. (DELAWARE CORPORATION)

605 UNIVERSITY AVE.

LOS GATOS, CA 95032

FOR: COMPUTER SOFTWARE FOR PHOTOVOLTAIC SYSTEMS FOR EVALUATING ELECTRIC CONSUMPTION, DETERMINING SYSTEM SIZING, ESTIMATING ELECTRICAL OUTPUT, ESTIMATING CUSTOMER COSTS, AND ESTIMATING FINANCIAL LIFE CYCLES SAVINGS, FOR USE BY CONSUMERS AND BUSINESSES, IN CLASS 9 (U.S. CLS. 21, 23, 26, 36 AND 38).

FIRST USE 7-15-2007; IN COMMERCE 7-15-2007.

FOR: INSTALLATION OF RENEWABLE ENERGY SYSTEMS, NAMELY, PHOTOVOLTAIC SYSTEMS COMPOSED OF PHOTOVOLTAIC SOLAR MODULES, BATTERIES, VOLTAGE REGULATORS, INVERTERS, RACKS, AND ELECTRIC CONTROLS, IN CLASS 37 (U.S. CLS. 100, 103 AND 106).

FIRST USE 7-15-2007; IN COMMERCE 7-15-2007.

THE MARK CONSISTS OF STANDARD CHARACTERS WITHOUT CLAIM TO ANY PARTICULAR FONT, STYLE, SIZE, OR COLOR.

SN 77-104,221, FILED 2-9-2007.

EMILY CHUO, EXAMINING ATTORNEY

Int. Cl.: 12

Prior U.S. Cls.: 19, 21, 23, 31, 35, and 44

United States Patent and Trademark Office

Reg. No. 3,481,374

Registered Aug. 5, 2008

**TRADEMARK
PRINCIPAL REGISTER**

POTENZA G019 GRID

BRIDGESTONE CORPORATION (JAPAN CORPORATION)
10-1, KYOBASHI 1-CHOME
CHUO-KU, TOKYO, JAPAN

OWNER OF U.S. REG. NOS. 1,281,463 AND 2,788,718.

FOR: VEHICLE TIRES, IN CLASS 12 (U.S. CLS. 19, 21, 23, 31, 35 AND 44).

THE FOREIGN WORDING IN THE MARK TRANSLATES INTO ENGLISH AS POWER.

FIRST USE 1-1-2008; IN COMMERCE 1-1-2008.

SN 77-104,807, FILED 2-12-2007.

THE MARK CONSISTS OF STANDARD CHARACTERS WITHOUT CLAIM TO ANY PARTICULAR FONT, STYLE, SIZE, OR COLOR.

JULIE GUTTADAURO, EXAMINING ATTORNEY

Int. Cl.: 28

Prior U.S. Cls.: 22, 23, 38, and 50

United States Patent and Trademark Office

Reg. No. 3,481,375

Registered Aug. 5, 2008

**TRADEMARK
PRINCIPAL REGISTER**

LIVE IT.

ROCKET BALL, LTD. (TEXAS LIMITED PART-
NERSHIP)
1510 POLK STREET
HOUSTON, TX 77002

FOR: TOYS, GAMES AND SPORTING GOODS, NAMELY, BASKETBALLS, GOLF BALLS, PLAYGROUND BALLS, SPORTS BALLS, RUBBER ACTION BALLS AND FOAM ACTION BALLS, PLUSH BALLS, PLASTIC BALLS, BASKETBALL NETS, BASKETBALL BACKBOARDS, MINIATURE BASKETBALL BACKBOARDS, PUMPS FOR INFLATING BASKETBALLS, NEEDLES FOR INFLATING BASKETBALLS, GOLF CLUBS, GOLF BAGS, GOLF PUTTERS, GOLF ACCESSORIES, NAMELY, DIVOT REPAIR TOOLS, TEES, BALL MARKERS, GOLF BAG COVERS, CLUB HEAD COVERS, GOLF GLOVES, GOLF BALL SLEEVES, ELECTRONIC BASKETBALL TABLE TOP GAMES, BASKETBALL TABLE TOP GAMES, BASKETBALL BOARD GAMES, ACTION SKILL GAMES, ADULT'S AND CHILDREN'S PARTY GAMES, TRIVIA INFORMATION GAMES AND ELECTRONIC VIDEO ARCADE GAME MACHINES, BASKETBALL KIT COMPRISED OF A NET AND WHISTLE, DOLLS, DECORATIVE DOLLS, COLLECTIBLE DOLLS, TOY ACTION FIGURES, BOBBLEHEAD ACTION FIGURES, STUFFED TOYS, NOVELTY PLUSH TOYS WITH WIGS, JIGSAW PUZZLES AND CHRISTMAS TREE ORNAMENTS, CHRISTMAS STOCKINGS; TOY VEHICLES IN THE NATURE OF CARS,

TRUCKS, TRAINS AND VANS, ALL CONTAINING BASKETBALL THEMES, NOVELTY FOAM TOYS IN THE SHAPES OF FINGERS AND TROPHIES, TOY TROPHIES, PLAYING CARDS, CARD GAMES, NOISEMAKERS, PET TOYS; BEACH TOYS, NAMELY, BEACH BALLS, INFLATABLE BALLS, TOY PAILS, TOY SHOVELS, SAND TOYS, SAND BOX TOYS, WATER-SQUIRTING TOYS; BEACH AND POOL ACCESSORIES, NAMELY, SWIM FLOATS, POOL FLOATS, FOAM FLOATS, SWIM RINGS, POOL RINGS, FOAM RINGS, BODY BOARDS, SURF BOARDS, SWIM FINS, SURF FINS, ARM FLOATS AND WATER WING SWIM AIDS FOR RECREATIONAL USE; INFLATABLE TOYS; TOY BUILDING BLOCKS, VOLLEYBALL GAME KITS COMPRISED OF BALL, NET, SIDELINES AND WHISTLE, AND WATER POLO GAME KITS COMPRISED OF BALL, NET AND WHISTLE, IN CLASS 28 (U.S. CLS. 22, 23, 38 AND 50).

FIRST USE 1-1-2008; IN COMMERCE 1-1-2008.

THE MARK CONSISTS OF STANDARD CHARACTERS WITHOUT CLAIM TO ANY PARTICULAR FONT, STYLE, SIZE, OR COLOR.

SN 77-106,300, FILED 2-13-2007.

BRIAN NEVILLE, EXAMINING ATTORNEY

Int. Cl.: 20

Prior U.S. Cls.: 2, 13, 22, 25, 32, and 50

United States Patent and Trademark Office

Reg. No. 3,481,376

Registered Aug. 5, 2008

TRADEMARK
PRINCIPAL REGISTER



BAUR, DAVIDA ANN (UNITED STATES INDIVIDUAL)

599 SHERWOOD AVE., UNIT 208

SATELLITE BEACH, FL 32937 AND

YOUNG, JOANNE (UNITED STATES INDIVIDUAL)

10768 S. TROPICAL TRAIL

MERRITT ISLAND, FL 32952

FIRST USE 6-10-2007; IN COMMERCE 6-10-2007.

NO CLAIM IS MADE TO THE EXCLUSIVE RIGHT TO USE "HANDS", APART FROM THE MARK AS SHOWN.

FOR: FOAM FINGER SEPARATORS FOR USE IN MANICURES, NAMELY, REUSABLE FOAM DISC FOR HOLDING, SEPARATING AND STEADYING FINGERS FOR MANICURES, IN CLASS 20 (U.S. CLS. 2, 13, 22, 25, 32 AND 50).

SN 77-106,717, FILED 2-13-2007.

LYDIA BELZER, EXAMINING ATTORNEY

Int. Cl.: 16

Prior U.S. Cls.: 2, 5, 22, 23, 29, 37, 38, and 50

United States Patent and Trademark Office

Reg. No. 3,481,377

Registered Aug. 5, 2008

**TRADEMARK
PRINCIPAL REGISTER**



FOXY'S LAIR, INC. (FLORIDA CORPORATION)
P.O. BOX 720
CAPE CANAVERAL, FL 32920

FIRST USE 2-14-2007; IN COMMERCE 1-0-2008.

FOR: PAPER GOODS AND PRINTED MATERIALS, NAMELY, TRADING CARDS, COLLECTIBLE CARDS FEATURING PHOTOGRAPHS OF FEMALE MODELS, POSTERS, COUPONS, PHOTOGRAPHIC PRINTS AND PHOTOGRAPHS FEATURING MODELS, TEMPORARY TATTOOS, BUMPER STICKERS, DECALS AND STICKERS, IN CLASS 16 (U.S. CLS. 2, 5, 22, 23, 29, 37, 38 AND 50).

THE MARK CONSISTS OF DESIGN OF FOX HEAD WITH NUMBER "4" IN CENTER OF BOW TIE.

SN 77-106,992, FILED 2-14-2007.

MARK SPARACINO, EXAMINING ATTORNEY

Int. Cl.: 45

Prior U.S. Cls.: 100 and 101

United States Patent and Trademark Office

Reg. No. 3,481,378

Registered Aug. 5, 2008

SERVICE MARK
PRINCIPAL REGISTER

LIVE^Ø

THE EVANGELICAL FREE CHURCH OF AMERICA (MINNESOTA NON-PROFIT CORPORATION)
901 EAST 78TH STREET
MINNEAPOLIS, MN 554201300

FOR: EVANGELICAL MISSIONARY AND MINISTERIAL SERVICES; CHARITABLE SERVICES, NAMELY, ORGANIZING GROUPS TO UNDERTAKE PROJECTS TO BENEFIT THE NEEDY AND THE COMMUNITY TO ENCOURAGE LEADERSHIP, CHARACTER, COMPASSION, AND GOOD CITIZENSHIP; COUNSELING SERVICES IN THE FIELD OF CHRISTIAN CONDUCT IN PERSONAL RELATIONSHIPS; PROVIDING ON-LINE INFOR-

MATION IN THE FIELD OF RELIGION, SPIRITUALITY, SELF-HELP, AND PERSONAL EMPOWERMENT SUBJECT MATTERS, IN CLASS 45 (U.S. CLS. 100 AND 101).

FIRST USE 12-1-2006; IN COMMERCE 12-1-2006.

THE MARK CONSISTS OF THE WORD "LIVE" TO THE POWER OF ZERO WITH THE NUMERAL ZERO CROSSED-OUT.

SN 77-107,679, FILED 2-14-2007.

SALLY SHIH, EXAMINING ATTORNEY

Int. Cl.: 45

Prior U.S. Cls.: 100 and 101

United States Patent and Trademark Office

Reg. No. 3,481,379

Registered Aug. 5, 2008

**SERVICE MARK
PRINCIPAL REGISTER**

**LIVE TO THE POWER OF
NOTHING**

THE EVANGELICAL FREE CHURCH OF AMERICA (MINNESOTA NON-PROFIT CORPORATION)
901 EAST 78TH STREET
MINNEAPOLIS, MN 554201300

FOR: EVANGELICAL MISSIONARY AND MINISTERIAL SERVICES; CHARITABLE SERVICES, NAMELY, ORGANIZING GROUPS TO UNDERTAKE PROJECTS TO BENEFIT THE NEEDY AND THE COMMUNITY TO ENCOURAGE LEADERSHIP, CHARACTER, COMPASSION, AND GOOD CITIZENSHIP; COUNSELING SERVICES IN THE FIELD OF CHRISTIAN CONDUCT IN PERSONAL RELATIONSHIPS; PROVIDING ON-LINE INFOR-

MATION IN THE FIELD OF RELIGION, SPIRITUALITY, SELF-HELP, AND PERSONAL EMPOWERMENT SUBJECT MATTERS, IN CLASS 45 (U.S. CLS. 100 AND 101).

FIRST USE 12-1-2006; IN COMMERCE 12-1-2006.

THE MARK CONSISTS OF STANDARD CHARACTERS WITHOUT CLAIM TO ANY PARTICULAR FONT, STYLE, SIZE, OR COLOR.

SN 77-107,693, FILED 2-14-2007.

SALLY SHIH, EXAMINING ATTORNEY

Int. Cl.: 36

Prior U.S. Cls.: 100, 101, and 102

United States Patent and Trademark Office

Reg. No. 3,481,380

Registered Aug. 5, 2008

**SERVICE MARK
PRINCIPAL REGISTER**

GLOBALFINGERPRINTS

THE EVANGELICAL FREE CHURCH OF AMERICA (MINNESOTA NON-PROFIT CORPORATION)
901 EAST 78TH STREET
MINNEAPOLIS, MN 554201300

FOR: CHARITABLE FUND RAISING SERVICES;
PHILANTHROPIC SERVICES CONCERNING
MONETARY DONATIONS, IN CLASS 36 (U.S. CLS.
100, 101 AND 102).

FIRST USE 2-19-2008; IN COMMERCE 2-19-2008.

THE MARK CONSISTS OF STANDARD CHARACTERS WITHOUT CLAIM TO ANY PARTICULAR FONT, STYLE, SIZE, OR COLOR.

SN 77-107,715, FILED 2-14-2007.

SALLY SHIH, EXAMINING ATTORNEY

Int. Cl.: 45

Prior U.S. Cls.: 100 and 101

United States Patent and Trademark Office

Reg. No. 3,481,381

Registered Aug. 5, 2008

**SERVICE MARK
PRINCIPAL REGISTER**

REACHGLOBAL

THE EVANGELICAL FREE CHURCH OF AMERICA (MINNESOTA NON-PROFIT CORPORATION)
901 EAST 78TH STREET
MINNEAPOLIS, MN 554201300

FOR: EVANGELICAL MISSIONARY AND MINISTERIAL SERVICES; CHARITABLE SERVICES, NAMELY, ORGANIZING GROUPS TO UNDERTAKE PROJECTS TO BENEFIT THE NEEDY AND THE COMMUNITY TO ENCOURAGE LEADERSHIP, CHARACTER, COMPASSION, AND GOOD CITIZENSHIP; COUNSELING SERVICES IN THE FIELD OF CHRISTIAN CONDUCT IN PERSONAL RELATIONSHIPS; PROVIDING ON-LINE INFOR-

MATION IN THE FIELD OF RELIGION, SPIRITUALITY, SELF-HELP, AND PERSONAL EMPOWERMENT SUBJECT MATTERS, IN CLASS 45 (U.S. CLS. 100 AND 101).

FIRST USE 4-1-2007; IN COMMERCE 4-1-2007.

THE MARK CONSISTS OF STANDARD CHARACTERS WITHOUT CLAIM TO ANY PARTICULAR FONT, STYLE, SIZE, OR COLOR.

SN 77-107,775, FILED 2-14-2007.

SALLY SHIH, EXAMINING ATTORNEY

Int. Cl.: 32

Prior U.S. Cls.: 45, 46, and 48

United States Patent and Trademark Office

Reg. No. 3,481,382

Registered Aug. 5, 2008

**TRADEMARK
PRINCIPAL REGISTER**

RISING MOON

COORS BREWING COMPANY (COLORADO
CORPORATION)
1225 17TH STREET
SUITE 3200
DENVER, CO 80202

THE MARK CONSISTS OF STANDARD CHAR-
ACTERS WITHOUT CLAIM TO ANY PARTICULAR
FONT, STYLE, SIZE, OR COLOR.

FOR: BEER, IN CLASS 32 (U.S. CLS. 45, 46 AND 48).

SN 77-108,007, FILED 2-15-2007.

FIRST USE 1-7-2008; IN COMMERCE 1-7-2008.

ASMAT KHAN, EXAMINING ATTORNEY

Int. Cl.: 35

Prior U.S. Cls.: 100, 101, and 102

United States Patent and Trademark Office

Reg. No. 3,481,383

Registered Aug. 5, 2008

**SERVICE MARK
PRINCIPAL REGISTER**

PITSTOP MEDIA

NEWAGE MARKETING CORPORATION
(RHODE ISLAND CORPORATION)
50 SUTTON AVENUE
EAST PROVIDENCE, RI 02914

FOR: ADVERTISING AND MARKETING SERVICES, NAMELY, DISSEMINATION OF INDOOR AND RESTROOM ADVERTISEMENTS; PROVIDING PROFESSIONAL ADVERTISING AND MARKETING SERVICES TO RESTROOM SPONSORS AND CLIENTS, NAMELY, PREPARING AND PLACING ADVERTISEMENTS, IN CLASS 35 (U.S. CLS. 100, 101 AND 102).

FIRST USE 5-19-2008; IN COMMERCE 5-19-2008.

THE MARK CONSISTS OF STANDARD CHARACTERS WITHOUT CLAIM TO ANY PARTICULAR FONT, STYLE, SIZE, OR COLOR.

NO CLAIM IS MADE TO THE EXCLUSIVE RIGHT TO USE "MEDIA", APART FROM THE MARK AS SHOWN.

SN 77-108,087, FILED 2-15-2007.

JANICE L. MCMORROW, EXAMINING ATTORNEY

Int. Cl.: 35

Prior U.S. Cls.: 100, 101, and 102

United States Patent and Trademark Office

Reg. No. 3,481,384

Registered Aug. 5, 2008

**SERVICE MARK
PRINCIPAL REGISTER**

We Put The BIO In Biofuels

BIOTECHNOLOGY INDUSTRY ORGANIZATION
(D.C. CORPORATION)
1201 MARYLAND AVENUE, S.W., SUITE 900
WASHINGTON, DC 20024

FOR: ORGANIZATION SERVICES, NAMELY,
PROMOTING THE INTERESTS OF BIOTECHNOL-
OGY COMPANIES, IN CLASS 35 (U.S. CLS. 100, 101
AND 102).

FIRST USE 12-21-2007; IN COMMERCE 12-21-2007.

THE MARK CONSISTS OF STANDARD CHAR-
ACTERS WITHOUT CLAIM TO ANY PARTICULAR
FONT, STYLE, SIZE, OR COLOR.

SN 77-108,127, FILED 2-15-2007.

CIMMERIAN COLEMAN, EXAMINING ATTOR-
NEY

Int. Cl.: 25

Prior U.S. Cls.: 22 and 39

United States Patent and Trademark Office

Reg. No. 3,481,385

Registered Aug. 5, 2008

**TRADEMARK
PRINCIPAL REGISTER**

ODOR CHECK

BIG ISLAND OUTDOOR GROUP, LLC (MINNE-
SOTA LTD LIAB CO)
21 WATER STREET
EXCELSIOR, MN 55334

FOR: ODOR CONTROL INSERTS FOR USE IN
CONNECTION WITH FOOTWEAR, NAMELY,
NON-ORTHOPEDIC FOOTWEAR INSERTS, IN
CLASS 25 (U.S. CLS. 22 AND 39).

FIRST USE 3-0-2008; IN COMMERCE 3-0-2008.

THE MARK CONSISTS OF STANDARD CHAR-
ACTERS WITHOUT CLAIM TO ANY PARTICULAR
FONT, STYLE, SIZE, OR COLOR.

NO CLAIM IS MADE TO THE EXCLUSIVE
RIGHT TO USE "ODOR", APART FROM THE
MARK AS SHOWN.

SN 77-109,286, FILED 2-16-2007.

TAMARA FRAZIER, EXAMINING ATTORNEY

Int. Cl.: 9

Prior U.S. Cls.: 21, 23, 26, 36, and 38

United States Patent and Trademark Office

Reg. No. 3,481,386

Registered Aug. 5, 2008

**TRADEMARK
PRINCIPAL REGISTER**

SPAMEDWARE

SPAMEDICA INTERNATIONAL SRL (BARBADOS CORPORATION)
2ND FLOOR, INTERNATIONAL TRADING CENTER
WARRENS, ST. MICHAEL, BARBADOS

FOR: COMPUTER SOFTWARE FOR USE IN MANAGING AND OPERATING MEDICAL SPAS, AND PLASTIC SURGERY, DERMATOLOGY, COSMETIC AND AESTHETIC PRACTICES, IN CLASS 9 (U.S. CLS. 21, 23, 26, 36 AND 38).

FIRST USE 12-31-2004; IN COMMERCE 3-1-2007.

THE MARK CONSISTS OF STANDARD CHARACTERS WITHOUT CLAIM TO ANY PARTICULAR FONT, STYLE, SIZE, OR COLOR.

SN 77-109,767, FILED 2-16-2007.

ELISSA GARBER KON, EXAMINING ATTORNEY

Int. Cl.: 35

Prior U.S. Cls.: 100, 101, and 102

United States Patent and Trademark Office

Reg. No. 3,481,387

Registered Aug. 5, 2008

**SERVICE MARK
PRINCIPAL REGISTER**

INSIGHT BEYOND THE NUMBERS

THE MARSTON GROUP, P.C. (TENNESSEE CORPORATION)
SUITE 450
6055 PRIMACY PARKWAY
MEMPHIS, TN 38119

FOR: BUSINESS ANALYSIS SERVICES, NAME-
LY, BUSINESS ADVICE AND ANALYSIS OF MAR-
KETS AND COMPANIES; PERFORMANCE
REPORTING SERVICES, NAMELY, ANALYZING
AND COMPILING DATA FOR MEASURING THE
PERFORMANCE OF MARKETS AND COMPANIES;
BUSINESS STRATEGIC ADVICE, NAMELY, CON-
SULTATION, BUSINESS ACCOUNTING AND IN-
TERNAL AUDITING SERVICES; TAX PLANNING,
CONSULTING, ADVISORY AND COMPLIANCE

SERVICES; BUSINESS SUSTAINABILITY ADVI-
SORY SERVICES IN THE NATURE OF REVIEW
OF TROUBLED BUSINESSES, IN CLASS 35 (U.S.
CLS. 100, 101 AND 102).

FIRST USE 2-16-2007; IN COMMERCE 2-16-2007.

THE MARK CONSISTS OF STANDARD CHAR-
ACTERS WITHOUT CLAIM TO ANY PARTICULAR
FONT, STYLE, SIZE, OR COLOR.

SN 77-110,530, FILED 2-19-2007.

WILLIAM P. SHANAHAN, EXAMINING ATTOR-
NEY

Int. Cl.: 9

Prior U.S. Cls.: 21, 23, 26, 36, and 38

United States Patent and Trademark Office

Reg. No. 3,481,388

Registered Aug. 5, 2008

**TRADEMARK
PRINCIPAL REGISTER**

GEN-STAR

HARRIS CORPORATION (DELAWARE CORPORATION)
1025 WEST NASA BOULEVARD
MELBOURNE, FL 32919

FOR: ELECTRONIC TEST AND MEASUREMENT DEVICES FOR USE IN THE FIELDS OF RADIO AND TELEVISION BROADCASTING, NAMELY, VIDEO SIGNAL GENERATORS, IN CLASS 9 (U.S. CLS. 21, 23, 26, 36 AND 38).

FIRST USE 4-30-2008; IN COMMERCE 4-30-2008.

THE MARK CONSISTS OF STANDARD CHARACTERS WITHOUT CLAIM TO ANY PARTICULAR FONT, STYLE, SIZE, OR COLOR.

SN 77-110,640, FILED 2-19-2007.

WENDY JUN, EXAMINING ATTORNEY

Int. Cl.: 5

Prior U.S. Cls.: 6, 18, 44, 46, 51, and 52

Reg. No. 3,481,389

United States Patent and Trademark Office

Registered Aug. 5, 2008

**TRADEMARK
PRINCIPAL REGISTER**

GET REAL. GET WELL.

IDEASONE, INC. (CALIFORNIA CORPORATION)
59-1526 KOHALA RANCH ROAD
KAMUELA, HI 96743

THE MARK CONSISTS OF STANDARD CHARACTERS WITHOUT CLAIM TO ANY PARTICULAR FONT, STYLE, SIZE, OR COLOR.

FOR: DIETARY SUPPLEMENTS, IN CLASS 5 (U.S. CLS. 6, 18, 44, 46, 51 AND 52).

SN 77-110,740, FILED 2-19-2007.

FIRST USE 8-16-2007; IN COMMERCE 8-16-2007.

PATRICIA EVANKO, EXAMINING ATTORNEY

Int. Cls.: 41 and 43

Prior U.S. Cls.: 100, 101, and 107

United States Patent and Trademark Office

Reg. No. 3,481,390

Registered Aug. 5, 2008

**SERVICE MARK
PRINCIPAL REGISTER**

Above and Beyond

PRIMLAND LTD. (VIRGINIA CORPORATION)
4621 BUSTED ROCK ROAD
MEADOWS OF DAN, VA 24120

FOR: HORSEBACK RIDING CAMPS; PROVIDING FACILITIES FOR RECREATION ACTIVITIES; PROVIDING GOLF FACILITIES; RECREATIONAL SERVICES IN THE NATURE OF FISHING, HUNTING, HORSEBACK RIDING, SKEET SHOOTING, HIKING, GOLFING, AND ALL-TERRAIN VEHICLES RIDING FACILITIES; RECREATIONAL SERVICES, NAMELY, PROVIDING HUNTING PRESERVES, IN CLASS 41 (U.S. CLS. 100, 101 AND 107).

FIRST USE 5-5-2008; IN COMMERCE 5-5-2008.

FOR: RESORT HOTELS; RESORT LODGING SERVICES, IN CLASS 43 (U.S. CLS. 100 AND 101).

FIRST USE 5-5-2008; IN COMMERCE 5-5-2008.

THE MARK CONSISTS OF STANDARD CHARACTERS WITHOUT CLAIM TO ANY PARTICULAR FONT, STYLE, SIZE, OR COLOR.

SN 77-111,119, FILED 2-20-2007.

WILLIAM P. SHANAHAN, EXAMINING ATTORNEY

Int. Cl.: 9

Prior U.S. Cls.: 21, 23, 26, 36, and 38

Reg. No. 3,481,391

United States Patent and Trademark Office

Registered Aug. 5, 2008

**TRADEMARK
PRINCIPAL REGISTER**

ALL THE KING'S GOLD

ARISTOCRAT TECHNOLOGIES AUSTRALIA
PTY LTD (AUSTRALIA CORPORATION)
71 LONGUEVILLE ROAD
LANE COVE, NSW, AUSTRALIA 2066

THE MARK CONSISTS OF STANDARD CHAR-
ACTERS WITHOUT CLAIM TO ANY PARTICULAR
FONT, STYLE, SIZE, OR COLOR.

FOR: GAMING MACHINES; COMPUTER HARD-
WARE; DOWNLOADABLE GAME SOFTWARE;
ELECTRONIC GAME SOFTWARE, IN CLASS 9
(U.S. CLS. 21, 23, 26, 36 AND 38).

SN 77-111,831, FILED 2-20-2007.

FIRST USE 12-20-2007; IN COMMERCE 12-20-2007.

WILLIAM ROSSMAN, EXAMINING ATTORNEY

Int. Cl.: 31

Prior U.S. Cls.: 1 and 46

United States Patent and Trademark Office

Reg. No. 3,481,392

Registered Aug. 5, 2008

TRADEMARK
PRINCIPAL REGISTER



NATURAL SELECTION FOODS, LLC (CALIFORNIA LTD LIAB CO)
1721 SAN JUAN HIGHWAY
SAN JUAN BAUTISTA, CA 95045

FOR: FRESH FRUITS; FRESH VEGETABLES; RAW VEGETABLES; FRESH LETTUCE AND FRESH LEAFY VEGETABLES, IN CLASS 31 (U.S. CLS. 1 AND 46).

FIRST USE 6-0-2006; IN COMMERCE 5-15-2008.

OWNER OF U.S. REG. NOS. 2,365,489, 3,244,499, AND 3,244,500.

NO CLAIM IS MADE TO THE EXCLUSIVE RIGHT TO USE "GREEN" OR "ORGANIC", APART FROM THE MARK AS SHOWN.

THE COLOR(S) GREEN, WHITE, YELLOW, AND BLUE IS/ARE CLAIMED AS A FEATURE OF THE MARK.

THE COLOR WHITE APPEARS IN THE WORDING "GREEN HARVEST," OUTLINES THE WORD "ORGANIC," APPEARS BEHIND THE SUN DESIGN, AND APPEARS IN STRIPED LINES BEHIND THE WORD "ORGANIC;" THE COLOR YELLOW APPEARS IN THE HALF SUN DESIGN; THE COLOR BLUE APPEARS IN THE WORD "ORGANIC;" THE COLOR GREEN APPEARS IN THE OVAL DESIGN, HILL DESIGN, AND IN THE STRIPED LINES BEHIND THE WORD "ORGANIC".

SN 77-111,946, FILED 2-20-2007.

LAURA HAMMEL, EXAMINING ATTORNEY

Int. Cl.: 1

Prior U.S. Cls.: 1, 5, 6, 10, 26, and 46

United States Patent and Trademark Office

Reg. No. 3,481,393

Registered Aug. 5, 2008

**TRADEMARK
PRINCIPAL REGISTER**

NDEMAND

WILBUR-ELLIS COMPANY (CALIFORNIA CORPORATION)
345 CALIFORNIA STREET, 27TH FLOOR
SAN FRANCISCO, CA 94104

FOR: FERTILIZERS, IN CLASS 1 (U.S. CLS. 1, 5, 6, 10, 26 AND 46).

FIRST USE 3-29-2007; IN COMMERCE 3-29-2007.

THE MARK CONSISTS OF STANDARD CHARACTERS WITHOUT CLAIM TO ANY PARTICULAR FONT, STYLE, SIZE, OR COLOR.

OWNER OF U.S. REG. NO. 2,780,090.

SN 77-111,977, FILED 2-20-2007.

PAUL CROWLEY, EXAMINING ATTORNEY

Int. Cl.: 9

Prior U.S. Cls.: 21, 23, 26, 36, and 38

Reg. No. 3,481,394

United States Patent and Trademark Office

Registered Aug. 5, 2008

**TRADEMARK
PRINCIPAL REGISTER**

SOLUTION-ON-CHIP

CHIPNUTS TECHNOLOGY (SHANGHAI) INC.
(CHINA CORPORATION)
500 ZHANGYANG ROAD
17F TIMES SQUARE
PUDONG, SHANGHAI, CHINA

FOR: ELECTRIC POCKET TRANSLATORS;
BLANK INTEGRATED CIRCUIT CARDS; DOWN-
LOADABLE SOFTWARE FOR USE IN DATABASE
MANAGEMENT; DOWNLOADABLE SOFTWARE
FOR USE AS A SPREADSHEET; DOWNLOADABLE
SOFTWARE FOR WORD PROCESSING; ELECTRIC
NAVIGATIONAL INSTRUMENTS; VIDEO-TELE-
PHONES; COMPUTER MONITORS; VIDEO MONI-
TORS; AMUSEMENT APPARATUS ADAPTED FOR
USE WITH TELEVISION RECEIVERS ONLY,
NAMELY, VIDEO OUTPUT GAME MACHINES

FOR USE WITH TELEVISIONS; CAMCORDERS;
PERSONAL STEREOS; EARPHONES; CD PLAYERS;
DVD PLAYERS; DIGITAL AUDIO PLAYERS; MED-
IA PLAYERS; MP3 PLAYERS; MP4 PLAYERS, IN
CLASS 9 (U.S. CLS. 21, 23, 26, 36 AND 38).

FIRST USE 10-8-2006; IN COMMERCE 2-15-2007.

THE MARK CONSISTS OF STANDARD CHAR-
ACTERS WITHOUT CLAIM TO ANY PARTICULAR
FONT, STYLE, SIZE, OR COLOR.

SN 77-112,557, FILED 2-21-2007.

SHAUNIA CARLYLE, EXAMINING ATTORNEY

Int. Cl.: 41

Prior U.S. Cls.: 100, 101, and 107

United States Patent and Trademark Office

Reg. No. 3,481,395

Registered Aug. 5, 2008

**SERVICE MARK
PRINCIPAL REGISTER**



LAWSON PRODUCTS, INC. (DELAWARE CORPORATION)
1666 EAST TOUHY AVENUE
DES PLAINES, IL 60018

FOR: EDUCATIONAL SERVICES, NAMELY, CONDUCTING CLASSES, SEMINARS, CONFERENCES AND WORKSHOPS IN THE FIELD OF INDUSTRIAL, COMMERCIAL AND INSTITUTIONAL MAINTENANCE, REPAIR AND REPLACEMENT PRODUCTS AND DISTRIBUTION OF COURSE MATERIAL IN CONNECTION THEREWITH, IN CLASS 41 (U.S. CLS. 100, 101 AND 107).

FIRST USE 1-18-2007; IN COMMERCE 2-27-2007.

NO CLAIM IS MADE TO THE EXCLUSIVE RIGHT TO USE "OPERATION SAFETY", APART FROM THE MARK AS SHOWN.

THE MARK CONSISTS OF THE LETTERS "OS" WITH A CROSS IN THE LETTER "O"; WITH THE WORD "OPERATION" ON THE NEXT LINE AND THE WORD "SAFETY" ON THE FOLLOWING LINE.

SN 77-113,325, FILED 2-22-2007.

DAYNA BROWNE, EXAMINING ATTORNEY

Int. Cl.: 9

Prior U.S. Cls.: 21, 23, 26, 36, and 38

Reg. No. 3,481,396

United States Patent and Trademark Office

Registered Aug. 5, 2008

**TRADEMARK
PRINCIPAL REGISTER**

XLNET

TRINTECH TECHNOLOGIES LIMITED (IRE-
LAND LTD LIAB CO)
BLOCK C, CENTRAL PARK
LEOPARDSTOWN DUBLIN, IRELAND 18

FOR: SOFTWARE FOR FINANCIAL SPREAD-
SHEET INVENTORY, MIGRATION, ANALYSIS, RE-
PORTING, AND AUDITING IN THE FIELD OF
FINANCIAL SERVICES , IN CLASS 9 (U.S. CLS. 21,
23, 26, 36 AND 38).

FIRST USE 5-10-2007; IN COMMERCE 5-10-2007.

THE MARK CONSISTS OF STANDARD CHAR-
ACTERS WITHOUT CLAIM TO ANY PARTICULAR
FONT, STYLE, SIZE, OR COLOR.

SN 77-113,609, FILED 2-22-2007.

EMILY CARLSEN, EXAMINING ATTORNEY

Int. Cl.: 7

Prior U.S. Cls.: 13, 19, 21, 23, 31, 34, and 35

Reg. No. 3,481,397

United States Patent and Trademark Office

Registered Aug. 5, 2008

**TRADEMARK
PRINCIPAL REGISTER**

THE PERFECT ICE BREAKER

HAMILTON BEACH BRANDS, INC. (DELA-
WARE CORPORATION)
4421 WATERFRONT DRIVE
GLEN ALLEN, VA 23060

THE MARK CONSISTS OF STANDARD CHAR-
ACTERS WITHOUT CLAIM TO ANY PARTICULAR
FONT, STYLE, SIZE, OR COLOR.

FOR: KITCHEN APPLIANCES, NAMELY, ELEC-
TRIC FOOD AND BEVERAGE BLENDERS, IN
CLASS 7 (U.S. CLS. 13, 19, 21, 23, 31, 34 AND 35).

SN 77-113,653, FILED 2-22-2007.

FIRST USE 4-24-2007; IN COMMERCE 4-24-2007.

PAUL E. FAHRENKOPF, EXAMINING ATTORNEY

Int. Cl.: 41

Prior U.S. Cls.: 100, 101, and 107

United States Patent and Trademark Office

Reg. No. 3,481,398

Registered Aug. 5, 2008

**SERVICE MARK
PRINCIPAL REGISTER**

**RED WHITE BLACK & BLUE
SUMMER**

VERSUS, L.P. (DELAWARE LIMITED PARTNER-
SHIP)
ONE COMCAST CENTER
PHILADELPHIA, PA 19103

FOR: ENTERTAINMENT SERVICES IN THE
NATURE OF TELEVISION PROGRAMMING; PRO-
DUCTION OF TELEVISION PROGRAMS AND DIS-
TRIBUTION OF TELEVISION PROGRAMMING TO
CABLE TELEVISION SYSTEMS; PROVIDING IN-
FORMATION RELATING TO TELEVISION PRO-
GRAMMING VIA A GLOBAL COMPUTER

NETWORK, IN CLASS 41 (U.S. CLS. 100, 101 AND
107).

FIRST USE 5-15-2007; IN COMMERCE 5-15-2007.

THE MARK CONSISTS OF STANDARD CHAR-
ACTERS WITHOUT CLAIM TO ANY PARTICULAR
FONT, STYLE, SIZE, OR COLOR.

SN 77-114,411, FILED 2-23-2007.

DAYNA BROWNE, EXAMINING ATTORNEY

Int. Cls.: 16 and 21

**Prior U.S. Cls.: 2, 5, 13, 22, 23, 29, 30, 33, 37, 38, 40,
and 50**

Reg. No. 3,481,399

United States Patent and Trademark Office

Registered Aug. 5, 2008

**TRADEMARK
PRINCIPAL REGISTER**



EATWARE INTELLECTUAL PROPERTIES LIM-
ITED (BR.VIRGIN ISLANDS CORPORATION)
23/F WESTIN CENTRE, 26 HUNG TO ROAD
KWUN TONG, HONG KONG

FOR: BIODEGRADABLE AND RECYCLABLE
PAPER PULP-BASED BOXES AND LIDS FOR USE
IN SERVING FOOD AND FOR SHORT-TERM STO-
RAGE OF FOOD, IN CLASS 16 (U.S. CLS. 2, 5, 22, 23,
29, 37, 38 AND 50).

FIRST USE 5-19-2008; IN COMMERCE 5-19-2008.

FOR: BIODEGRADABLE AND RECYCLABLE
PAPER PULP-BASED PLATES, BOWLS AND TRAYS

FOR USE IN SERVING FOOD AND FOR SHORT-
TERM STORAGE OF FOOD, IN CLASS 21 (U.S. CLS.
2, 13, 23, 29, 30, 33, 40 AND 50).

FIRST USE 5-6-2008; IN COMMERCE 5-6-2008.

THE MARK CONSISTS OF STYLIZED DESIGN
OF THREE FISH ABOVE THE LITERAL ELEMENT
"EATPLUS".

SN 77-114,447, FILED 2-23-2007.

SCOTT BIBB, EXAMINING ATTORNEY

Int. Cl.: 9

Prior U.S. Cls.: 21, 23, 26, 36, and 38

Reg. No. 3,481,400

United States Patent and Trademark Office

Registered Aug. 5, 2008

**TRADEMARK
PRINCIPAL REGISTER**

RADIIENT TECHNOLOGIES

RADIIENT TECHNOLOGIES, INC. (CALIFORNIA CORPORATION)
2084-A WALSH AVENUE
SANTA CLARA, CA 95050

FOR: WIRED ELECTRONIC EQUIPMENT FOR HOME ENTERTAINMENT, NAMELY, AUDIO TRANSMISSION APPARATUS, VIDEO TRANSMISSION APPARATUS, AND INTERNAL OPERATIONAL SOFTWARE FOR THE ABOVE MENTIONED ITEMS; WIRED ELECTRONIC EQUIPMENT FOR HOME ENTERTAINMENT, NAMELY, AUDIO SPEAKERS AND AUDIO SPEAKER ENCLOSURES; ELECTRONIC ACCESSORIES FOR ELECTRONIC EQUIPMENT FOR HOME ENTERTAINMENT, NAMELY, AUDIO AND VIDEO SIGNAL CABLES, AND AUDIO AND VIDEO SIGNAL WIRES; WIRED ELECTRONIC EQUIPMENT FOR HOME ENTERTAINMENT, NAMELY, AUDIO RECEIVERS, AUDIO-VIDEO RECEIVERS, AUDIO AMPLIFIERS, AND INTERNAL OPERATIONAL SOFTWARE FOR THE ABOVE MENTIONED ITEMS; WIRELESS ELECTRONIC EQUIPMENT FOR HOME ENTERTAINMENT, NAMELY, AUDIO RECEIVERS,

AUDIO-VIDEO RECEIVERS, AUDIO TRANSMISSION APPARATUS, VIDEO TRANSMISSION APPARATUS, AUDIO AMPLIFIERS, AND INTERNAL OPERATIONAL SOFTWARE AND SEMICONDUCTOR CHIPS FOR THE ABOVE MENTIONED ITEMS; SOFTWARE APPLICATION SPECIFIC SEMICONDUCTOR DEVICES, IN CLASS 9 (U.S. CLS. 21, 23, 26, 36 AND 38).

FIRST USE 6-7-2006; IN COMMERCE 6-7-2006.

THE MARK CONSISTS OF STANDARD CHARACTERS WITHOUT CLAIM TO ANY PARTICULAR FONT, STYLE, SIZE, OR COLOR.

NO CLAIM IS MADE TO THE EXCLUSIVE RIGHT TO USE "TECHNOLOGIES", APART FROM THE MARK AS SHOWN.

SN 77-114,506, FILED 2-23-2007.

GRETTA YAO, EXAMINING ATTORNEY

Int. Cl.: 12

Prior U.S. Cls.: 19, 21, 23, 31, 35, and 44

United States Patent and Trademark Office

Reg. No. 3,481,401

Registered Aug. 5, 2008

**TRADEMARK
PRINCIPAL REGISTER**

IMPERCEPTIBLE MOTION

CORECON, INC. (ILLINOIS CORPORATION)
775 DUVICK AVENUE
SANDWICH, IL 60548

THE MARK CONSISTS OF STANDARD CHAR-
ACTERS WITHOUT CLAIM TO ANY PARTICULAR
FONT, STYLE, SIZE, OR COLOR.

FOR: AUTOMATED GUIDED VEHICLES, IN
CLASS 12 (U.S. CLS. 19, 21, 23, 31, 35 AND 44).

SN 77-114,531, FILED 2-23-2007.

FIRST USE 10-15-2007; IN COMMERCE 10-15-2007.

PATRICIA EVANKO, EXAMINING ATTORNEY

Int. Cl.: 35

Prior U.S. Cls.: 100, 101, and 102

United States Patent and Trademark Office

Reg. No. 3,481,402

Registered Aug. 5, 2008

**SERVICE MARK
PRINCIPAL REGISTER**

Universeling

CAMPANELLA, DIANA (UNITED STATES INDIVIDUAL)
8034 E. GRANADA RD.
SCOTTSDALE, AZ 85257

THE MARK CONSISTS OF STANDARD CHARACTERS WITHOUT CLAIM TO ANY PARTICULAR FONT, STYLE, SIZE, OR COLOR.

FOR: PROMOTING PUBLIC AWARENESS ABOUT HOW TO ELIMINATE STEREOTYPING WITH NEW LABELING OF PERSONS AND GROUPS, IN CLASS 35 (U.S. CLS. 100, 101 AND 102).

SN 77-114,559, FILED 2-23-2007.

FIRST USE 3-3-1991; IN COMMERCE 4-29-2008.

JORDAN BAKER, EXAMINING ATTORNEY

Int. Cl.: 2

Prior U.S. Cls.: 6, 11, and 16

United States Patent and Trademark Office

Reg. No. 3,481,403

Registered Aug. 5, 2008

**TRADEMARK
PRINCIPAL REGISTER**

STEEL TUFF 316

BURKE INDUSTRIAL COATINGS (WASHINGTON CORPORATION)
600 S. 74TH PLACE SUITE 108
RIDGEFIELD, WA 98642

FOR: COATING COMPOSITION IN THE NATURE OF PAINT FOR INDUSTRIAL APPLICATIONS, IN CLASS 2 (U.S. CLS. 6, 11 AND 16).

FIRST USE 2-23-2007; IN COMMERCE 2-23-2007.

THE MARK CONSISTS OF STANDARD CHARACTERS WITHOUT CLAIM TO ANY PARTICULAR FONT, STYLE, SIZE, OR COLOR.

NO CLAIM IS MADE TO THE EXCLUSIVE RIGHT TO USE "STEEL" AND "316", APART FROM THE MARK AS SHOWN.

SN 77-114,639, FILED 2-23-2007.

MICHAEL LITZAU, EXAMINING ATTORNEY

Int. Cls.: 35 and 42

Prior U.S. Cls.: 100, 101, and 102

United States Patent and Trademark Office

Reg. No. 3,481,404

Registered Aug. 5, 2008

**SERVICE MARK
PRINCIPAL REGISTER**

TGI

THOR, INC. (CALIFORNIA CORPORATION)
SUITE 3900
3601 AVIATION BLVD.
MANHATTAN BEACH, CA 90266

FOR: PROVIDING TEMPORARY, LONG-TERM, PERMANENT, AND CONTRACTUAL EMPLOYMENT STAFFING SERVICES; PROVIDING EXECUTIVE PERSONNEL SEARCH AND PLACEMENT SERVICES; BUSINESS CONSULTING SERVICES IN THE FIELDS OF CUSTOMER RELATIONSHIP MANAGEMENT, ENTERPRISE RESOURCE PLANNING, STRATEGIC VENDOR PARTNERING, BUSINESS ALLIANCES, OUTSOURCING, PROJECT MANAGEMENT, DATA GATHERING AND ANALYSIS, BUSINESS PROCEDURES AND INFORMATION TECHNOLOGY AUDITS, AND

TELECOMMUNICATIONS, IN CLASS 35 (U.S. CLS. 100, 101 AND 102).

FIRST USE 10-0-1998; IN COMMERCE 10-0-1998.

FOR: COMPUTER CONSULTING SERVICES TO OTHERS, IN CLASS 42 (U.S. CLS. 100 AND 101).

FIRST USE 10-0-1998; IN COMMERCE 10-0-1998.

THE MARK CONSISTS OF STANDARD CHARACTERS WITHOUT CLAIM TO ANY PARTICULAR FONT, STYLE, SIZE, OR COLOR.

SN 77-115,203, FILED 2-23-2007.

RUDY R. SINGLETON, EXAMINING ATTORNEY

Int. Cls.: 35 and 44

Prior U.S. Cls.: 100, 101, and 102

United States Patent and Trademark Office

Reg. No. 3,481,405

Registered Aug. 5, 2008

**SERVICE MARK
PRINCIPAL REGISTER**



PFIZER INC (DELAWARE CORPORATION)
150/5
235 EAST 42ND STREET
NEW YORK, NY 10017

FOR: PHYSICIAN AND THERAPIST REFERRAL
SERVICES, IN CLASS 35 (U.S. CLS. 100, 101 AND 102).

FIRST USE 3-29-2007; IN COMMERCE 3-29-2007.

FOR: MEDICAL INFORMATION SERVICES,
NAMELY, PROVIDING INFORMATION REGARD-
ING PHYSICIANS AND THERAPISTS WHO PRAC-
TICE IN A FIELD RELATED TO MEN'S SEXUAL
HEALTH; ON-LINE INFORMATION SERVICES,
NAMELY, PROVIDING INFORMATION REGARD-
ING PHYSICIANS AND THERAPISTS WHO PRAC-
TICE IN A FIELD RELATED TO MEN'S SEXUAL
HEALTH, IN CLASS 44 (U.S. CLS. 100 AND 101).

FIRST USE 3-29-2007; IN COMMERCE 3-29-2007.

NO CLAIM IS MADE TO THE EXCLUSIVE
RIGHT TO USE "SEXUAL HEALTH DOCTORS",
APART FROM THE MARK AS SHOWN.

THE MARK CONSISTS OF THE TERMS SEXUAL
HEALTH OVER THE TERM DOCTOR WITH A
DESIGN OF A STETHOSCOPE WHICH IS AT-
TACHED TO A COMPUTER MOUSE. THE COMPU-
TER MOUSE REPLACES THE SECOND "O" IN THE
WORD DOCTORS.

SN 77-116,136, FILED 2-26-2007.

KIMBERLY PERRY, EXAMINING ATTORNEY

Int. Cl.: 35

Prior U.S. Cls.: 100, 101, and 102

United States Patent and Trademark Office

Reg. No. 3,481,406

Registered Aug. 5, 2008

SERVICE MARK
PRINCIPAL REGISTER

The logo for Cellfish Media. The word "Cellfish" is written in a bold, sans-serif font. The letter "i" in "fish" is stylized as a vertical line of small dots. Below "Cellfish" is the word "MEDIA" in a smaller, all-caps, sans-serif font.

CELLFISH MEDIA LLC (DELAWARE LTD LIAB
CO)
1633 BROADWAY
NEW YORK, NY 10019

FOR: COMMERCIAL ADMINISTRATION OF
THE LICENSING FOR OTHERS OF THEIR ELEC-
TRONIC CONTENT, NAMELY, PICTURES, GRA-
PHICS, TEXTUAL MATERIALS, DATA,
POSTCARDS, GROUP MESSAGES, ONLINE CHAT
SERVICES, VOICE, SOUND RECORDINGS, MO-
VIES, RADIO PROGRAMMING, TELEVISION PRO-
GRAMMING, VIDEO, MUSIC, GAMES AND
RINGTONES, FOR USE WITH MOBILE COMMU-
NICATIONS DEVICES; ONLINE RETAIL STORE
SERVICES FEATURING THE ELECTRONIC CON-
TENT OF OTHERS, NAMELY, PICTURES, GRA-
PHICS, TEXTUAL MATERIALS, DATA,
POSTCARDS, GROUP MESSAGES, ONLINE CHAT
SERVICES, VOICE, SOUND RECORDINGS, MO-
VIES, RADIO PROGRAMMING, TELEVISION PRO-

GRAMMING, VIDEO, MUSIC, GAMES AND
RINGTONES, TO USERS OF MOBILE COMMUNI-
CATIONS DEVICES, IN CLASS 35 (U.S. CLS. 100, 101
AND 102).

FIRST USE 4-10-2006; IN COMMERCE 4-10-2006.

NO CLAIM IS MADE TO THE EXCLUSIVE
RIGHT TO USE "MEDIA", APART FROM THE
MARK AS SHOWN.

THE MARK CONSISTS OF THE WORD "CELL-
FISH" WITH "CELL" IN BOLD LETTERS AND A
STYLIZED "I" ABOVE THE WORD "MEDIA" IN
CAPITAL LETTERS.

SN 77-116,911, FILED 2-27-2007.

MATTHEW PAPPAS, EXAMINING ATTORNEY

Int. Cl.: 35

Prior U.S. Cls.: 100, 101, and 102

United States Patent and Trademark Office

Reg. No. 3,481,407

Registered Aug. 5, 2008

**SERVICE MARK
PRINCIPAL REGISTER**

CELLFISH MEDIA

CELLFISH MEDIA LLC (DELAWARE LTD LIAB
CO)
1633 BROADWAY
NEW YORK, NY 10019

FOR: COMMERCIAL ADMINISTRATION OF
THE LICENSING FOR OTHERS OF THEIR ELEC-
TRONIC CONTENT, NAMELY, PICTURES, GRA-
PHICS, TEXTUAL MATERIALS, DATA,
POSTCARDS, GROUP MESSAGES, ONLINE CHAT
SERVICES, VOICE, SOUND RECORDINGS, MO-
VIES, RADIO PROGRAMMING, TELEVISION PRO-
GRAMMING, VIDEO, MUSIC, GAMES AND
RINGTONES, FOR USE WITH MOBILE COMMU-
NICATIONS DEVICES; ONLINE RETAIL STORE
SERVICES FEATURING THE ELECTRONIC CON-
TENT OF OTHERS, NAMELY, PICTURES, GRA-
PHICS, TEXTUAL MATERIALS, DATA,
POSTCARDS, GROUP MESSAGES, ONLINE CHAT
SERVICES, VOICE, SOUND RECORDINGS, MO-

VIES, RADIO PROGRAMMING, TELEVISION PRO-
GRAMMING, VIDEO, MUSIC, GAMES AND
RINGTONES, TO USERS OF MOBILE COMMUNI-
CATIONS DEVICES, IN CLASS 35 (U.S. CLS. 100, 101
AND 102).

FIRST USE 4-10-2006; IN COMMERCE 4-10-2006.

THE MARK CONSISTS OF STANDARD CHAR-
ACTERS WITHOUT CLAIM TO ANY PARTICULAR
FONT, STYLE, SIZE, OR COLOR.

NO CLAIM IS MADE TO THE EXCLUSIVE
RIGHT TO USE "MEDIA", APART FROM THE
MARK AS SHOWN.

SN 77-116,918, FILED 2-27-2007.

MATTHEW PAPPAS, EXAMINING ATTORNEY

Int. Cls.: 9 and 15

Prior U.S. Cls.: 2, 21, 23, 26, 36, and 38

United States Patent and Trademark Office

Reg. No. 3,481,408

Registered Aug. 5, 2008

**TRADEMARK
PRINCIPAL REGISTER**

LAGUNA

GUITAR CENTER, INC. (DELAWARE CORPORATION)
5795 LINDERO CANYON ROAD
WEST LAKE VILLAGE, CA 91362

FOR: CARRYING CASES AND COVERS SPECIFICALLY ADAPTED FOR DEEJAY EQUIPMENT, NAMELY, AUDIO VISUAL AND SPECIAL EFFECTS EQUIPMENT; SOUND REINFORCEMENT AND RECORDING EQUIPMENT, NAMELY, AUDIO TAPE RECORDERS, AMPLIFIERS, PUBLIC ADDRESS SYSTEMS, DIGITAL SOUND BOARDS FOR AMPLIFIERS, RACK EQUIPMENT, NAMELY, RACKS FOR LOUDSPEAKERS AND AMPLIFIERS, AUDIO CORDS FOR USE WITH SOUND AMPLIFIERS, ELECTRONIC EFFECTS PEDALS FOR USE WITH SOUNDS AMPLIFIERS, SIGNAL PROCESSORS, RACKS FOR LOUDSPEAKERS AND AMPLIFIERS, STANDS FOR MICROPHONES, MICROPHONES, IN CLASS 9 (U.S. CLS. 21, 23, 26, 36 AND 38).

FIRST USE 7-1-2007; IN COMMERCE 7-1-2007.

FOR: STRINGED MUSICAL INSTRUMENTS, NAMELY, ACOUSTIC, ACOUSTIC/ELECTRIC

AND ELECTRIC GUITARS; MUSICAL INSTRUMENTS, NAMELY, ELECTRIC SPANISH GUITARS, MANDOLINS, ELECTRIC BASSES, ACOUSTIC GUITARS, PEDAL STEEL GUITARS, AND STEEL GUITARS, AND COMPONENTS AND ACCESSORIES FOR GUITARS AND THE LIKE, NAMELY, LEGS, CASES, BAGS, STRINGS, POLISH, WAIST BELTS, STANDS, PICKS, STEELS, NECKS, HEADS, PICKUPS, PICKUP COVERS, PICKGUARDS, BRIDGE COVERS, TREMOLO HANDLES, CONTROL KNOBS AND STRAPS; CARRYING CASES AND COVERS SPECIFICALLY ADAPTED FOR MUSICAL INSTRUMENTS, IN CLASS 15 (U.S. CLS. 2, 21 AND 36).

FIRST USE 7-1-2007; IN COMMERCE 7-1-2007.

THE MARK CONSISTS OF STANDARD CHARACTERS WITHOUT CLAIM TO ANY PARTICULAR FONT, STYLE, SIZE, OR COLOR.

SN 77-117,443, FILED 2-27-2007.

PAM WILLIS, EXAMINING ATTORNEY

Int. Cl.: 5

Prior U.S. Cls.: 6, 18, 44, 46, 51, and 52

Reg. No. 3,481,409

United States Patent and Trademark Office

Registered Aug. 5, 2008

**TRADEMARK
PRINCIPAL REGISTER**

SILVAKOLLAGEN

DERMARITE INDUSTRIES, LLC (NEW JERSEY
LTD LIAB CO)
P.O. BOX 631
HAWTHORNE, NJ 07507

THE MARK CONSISTS OF STANDARD CHAR-
ACTERS WITHOUT CLAIM TO ANY PARTICULAR
FONT, STYLE, SIZE, OR COLOR.

FOR: ANTIBIOTIC OINTMENTS, IN CLASS 5 (U.S.
CLS. 6, 18, 44, 46, 51 AND 52).

SN 77-119,354, FILED 3-1-2007.

FIRST USE 1-1-2008; IN COMMERCE 3-1-2008.

MARY BOAGNI, EXAMINING ATTORNEY

Int. Cl.: 41

Prior U.S. Cls.: 100, 101, and 107

United States Patent and Trademark Office

Reg. No. 3,481,410

Registered Aug. 5, 2008

**SERVICE MARK
PRINCIPAL REGISTER**

CITA CON EL DOCTOR

GLR NETWORKS LLC (FLORIDA LTD LIAB CO)
4770 BISCAYNE BLVD, SUITE 700
MIAMI, FL 33137

FOR: RADIO ENTERTAINMENT, NAMELY,
RADIO PROGRAMS FEATURING NEWS, ENTER-
TAINMENT, TALK, SPORTS AND INTERVIEWS, IN
CLASS 41 (U.S. CLS. 100, 101 AND 107).

FIRST USE 3-12-2007; IN COMMERCE 3-12-2007.

THE MARK CONSISTS OF STANDARD CHAR-
ACTERS WITHOUT CLAIM TO ANY PARTICULAR
FONT, STYLE, SIZE, OR COLOR.

THE ENGLISH TRANSLATION OF "CITA CON
EL DOCTOR" IS "APPOINTMENT WITH THE DOC-
TOR"

SN 77-119,538, FILED 3-1-2007.

AISHA SALEM, EXAMINING ATTORNEY

Int. Cl.: 43

Prior U.S. Cls.: 100 and 101

United States Patent and Trademark Office

Reg. No. 3,481,411

Registered Aug. 5, 2008

**SERVICE MARK
PRINCIPAL REGISTER**

NEW PERSPECTIVE

GUNFLINT DEVELOPMENT GROUP, LLC (MINNESOTA LTD LIAB CO)
6371 PLEASANT VIEW COVE
CHANHASSEN, MN 55317

FOR: PROVIDING SENIOR HOUSING COMMUNITIES SERVICES, NAMELY, PROVIDING CONGREGATE LIVING FACILITIES, ASSISTED LIVING FACILITIES AND MEMORY CARE ASSISTED LIVING FACILITIES, IN CLASS 43 (U.S. CLS. 100 AND 101).

FIRST USE 6-6-2006; IN COMMERCE 6-6-2006.

THE MARK CONSISTS OF STANDARD CHARACTERS WITHOUT CLAIM TO ANY PARTICULAR FONT, STYLE, SIZE, OR COLOR.

SN 77-119,747, FILED 3-1-2007.

JAY BESCH, EXAMINING ATTORNEY

Int. Cl.: 21

Prior U.S. Cls.: 2, 13, 23, 29, 30, 33, 40, and 50

United States Patent and Trademark Office

Reg. No. 3,481,412

Registered Aug. 5, 2008

**TRADEMARK
PRINCIPAL REGISTER**

BUZZKUV

BOBBILEE GRANT (UNITED STATES INDIVIDUAL)
N. 25926 CHATTAROY CIRCLE
CHATTEROY, WA 99003

FOR: DECORATIVE COVERS AND CASES WITH A WOOD HOUSING FOR USE IN OBSCURING AND RETAINING INSECT TRAPS; HOUSINGS, NAMELY, SPECIALLY ADAPTED CASES FOR HANGING, RETAINING AND OBSCURING BEE AND YELLOW JACKET TRAPS, IN CLASS 21 (U.S. CLS. 2, 13, 23, 29, 30, 33, 40 AND 50).

FIRST USE 2-27-2007; IN COMMERCE 2-27-2007.

THE MARK CONSISTS OF STANDARD CHARACTERS WITHOUT CLAIM TO ANY PARTICULAR FONT, STYLE, SIZE, OR COLOR.

SN 77-120,147, FILED 3-1-2007.

GENE MACIOL, EXAMINING ATTORNEY

Int. Cl.: 35

Prior U.S. Cls.: 100, 101, and 102

United States Patent and Trademark Office

Reg. No. 3,481,413

Registered Aug. 5, 2008

**SERVICE MARK
PRINCIPAL REGISTER**

NutandBoltGuy Inc.

NUTANDBOLTGUY INC. (NEW YORK COR-
PORATION)
3822 ROUTE 52
PINE BUSH, NY 12566

FOR: DISTRIBUTORSHIPS IN THE FIELD OF
INDUSTRIAL THREADED FASTENERS AND
OTHER INDUSTRIAL MRO SUPPLIES, IN CLASS
35 (U.S. CLS. 100, 101 AND 102).

FIRST USE 1-2-2008; IN COMMERCE 1-2-2008.

THE MARK CONSISTS OF STANDARD CHAR-
ACTERS WITHOUT CLAIM TO ANY PARTICULAR
FONT, STYLE, SIZE, OR COLOR.

NO CLAIM IS MADE TO THE EXCLUSIVE
RIGHT TO USE "INC.", APART FROM THE MARK
AS SHOWN.

SN 77-120,301, FILED 3-1-2007.

ALICE SUE CARRUTHERS, EXAMINING ATTOR-
NEY

Int. Cl.: 1

Prior U.S. Cls.: 1, 5, 6, 10, 26, and 46

Reg. No. 3,481,414

United States Patent and Trademark Office

Registered Aug. 5, 2008

**TRADEMARK
PRINCIPAL REGISTER**

DYNAMITE

FLORIKAN-E.S.A. CORP. (FLORIDA CORPORATION)
1579 BARBER ROAD
SARASOTA, FL 34240

FOR: SOILS, NAMELY, POTTING SOILS, TREE AND SHRUB PLANTING SOILS, ANNUAL AND PERENNIAL BEDDING SOILS FOR PLANTING, IN CLASS 1 (U.S. CLS. 1, 5, 6, 10, 26 AND 46).

FIRST USE 2-15-2008; IN COMMERCE 2-15-2008.

THE MARK CONSISTS OF STANDARD CHARACTERS WITHOUT CLAIM TO ANY PARTICULAR FONT, STYLE, SIZE, OR COLOR.

OWNER OF U.S. REG. NOS. 1,903,310 AND 3,283,154.

SN 77-120,533, FILED 3-2-2007.

KELLY BOULTON, EXAMINING ATTORNEY

Int. Cl.: 35

Prior U.S. Cls.: 100, 101, and 102

United States Patent and Trademark Office

Reg. No. 3,481,415

Registered Aug. 5, 2008

**SERVICE MARK
PRINCIPAL REGISTER**

LIFE...SUPPLEMENTED

COUNCIL FOR RESPONSIBLE NUTRITION (D.C.
NON-PROFIT CORPORATION)
1828 L STREET, N.W., SUITE 510
WASHINGTON, DC 20036

FOR: PROMOTING PUBLIC AWARENESS OF
THE NEED FOR AND THE IMPORTANCE OF
DIETARY SUPPLEMENTS, IN CLASS 35 (U.S. CLS.
100, 101 AND 102).

FIRST USE 6-18-2007; IN COMMERCE 9-0-2007.

THE MARK CONSISTS OF STANDARD CHAR-
ACTERS WITHOUT CLAIM TO ANY PARTICULAR
FONT, STYLE, SIZE, OR COLOR.

SN 77-120,777, FILED 3-2-2007.

PRISCILLA MILTON, EXAMINING ATTORNEY

Int. Cls.: 3 and 44

Prior U.S. Cls.: 1, 4, 6, 50, 51, 52, 100, and 101

United States Patent and Trademark Office

Reg. No. 3,481,416

Registered Aug. 5, 2008

**TRADEMARK
SERVICE MARK
PRINCIPAL REGISTER**

7SSPA

THE TRUSTEE OF JK INVESTMENT TRUST
(AUSTRALIA TRUST)
59/338 WILINAU RD.
HALEIWA, HI 96712

FOR: BEAUTY CREAMS FOR BODY CARE;
BODY AND BEAUTY CARE COSMETICS; COSMET-
IC PREPARATIONS FOR BODY CARE; FACE AND
BODY BEAUTY CREAMS; HAIR CARE CREAMS;
HAIR CARE LOTIONS; HAIR CARE PREPARA-
TIONS; LOTIONS FOR FACE AND BODY CARE,
IN CLASS 3 (U.S. CLS. 1, 4, 6, 50, 51 AND 52).

FIRST USE 4-1-2007; IN COMMERCE 4-1-2007.

FOR: HEALTH SPA SERVICES FOR HEALTH
AND WELLNESS OF THE BODY AND SPIRIT
OFFERED AT A HEALTH RESORT; HEALTH SPA

SERVICES FOR HEALTH AND WELLNESS OF THE
MIND, BODY AND SPIRIT OFFERED IN OR FROM
A REMOTE, MOBILE OR TEMPORARY ON-SITE
LOCATION; HEALTH SPA SERVICES, NAMELY,
COSMETIC BODY CARE SERVICES , IN CLASS 44
(U.S. CLS. 100 AND 101).

FIRST USE 4-1-2007; IN COMMERCE 4-1-2007.

THE MARK CONSISTS OF STANDARD CHAR-
ACTERS WITHOUT CLAIM TO ANY PARTICULAR
FONT, STYLE, SIZE, OR COLOR.

SN 77-121,124, FILED 3-2-2007.

DAVID TAYLOR, EXAMINING ATTORNEY

Int. Cl.: 32

Prior U.S. Cls.: 45, 46, and 48

United States Patent and Trademark Office

Reg. No. 3,481,417

Registered Aug. 5, 2008

**TRADEMARK
PRINCIPAL REGISTER**

CHOOSE WATER

JUICY COUTURE, INC. (CALIFORNIA CORPORATION)
12720 WENTWORTH STREET
PACOIMA, CA 91331

FOR: BOTTLED DRINKING WATER; BOTTLED WATER; DRINKING WATER, IN CLASS 32 (U.S. CLS. 45, 46 AND 48).

FIRST USE 8-1-2007; IN COMMERCE 8-1-2007.

THE MARK CONSISTS OF STANDARD CHARACTERS WITHOUT CLAIM TO ANY PARTICULAR FONT, STYLE, SIZE, OR COLOR.

NO CLAIM IS MADE TO THE EXCLUSIVE RIGHT TO USE "WATER", APART FROM THE MARK AS SHOWN.

SN 77-121,192, FILED 3-2-2007.

JAMES LOVELACE, EXAMINING ATTORNEY

Int. Cl.: 11

Prior U.S. Cls.: 13, 21, 23, 31, and 34

Reg. No. 3,481,418

United States Patent and Trademark Office

Registered Aug. 5, 2008

TRADEMARK
PRINCIPAL REGISTER

EXTENHD
beyond HD

SIMA PRODUCTS CORPORATION (ILLINOIS
CORPORATION)
BUILDING NO. 5
140 PENNSYLVANIA AVENUE
OAKMONT, PA 15139

NO CLAIM IS MADE TO THE EXCLUSIVE
RIGHT TO USE "HD", APART FROM THE MARK
AS SHOWN.

FOR: SHELF MOUNTED LIGHTS, IN CLASS 11
(U.S. CLS. 13, 21, 23, 31 AND 34).

SN 77-122,103, FILED 3-5-2007.

FIRST USE 10-10-2007; IN COMMERCE 10-10-2007.

DANIEL CAPSHAW, EXAMINING ATTORNEY

Int. Cl.: 20

Prior U.S. Cls.: 2, 13, 22, 25, 32, and 50

United States Patent and Trademark Office

Reg. No. 3,481,419

Registered Aug. 5, 2008

**TRADEMARK
PRINCIPAL REGISTER**

FLUEKEEPER

DACS, INC. (VIRGINIA CORPORATION)
900 PORT CENTRE PARKWAY
PORTSMOUTH, VA 23704

THE MARK CONSISTS OF STANDARD CHAR-
ACTERS WITHOUT CLAIM TO ANY PARTICULAR
FONT, STYLE, SIZE, OR COLOR.

FOR: STORAGE SPACING DEVICE, NAMELY,
METAL STORAGE RACKS, FOR USE IN STORAGE
FACILITIES, IN CLASS 20 (U.S. CLS. 2, 13, 22, 25, 32
AND 50).

SN 77-122,429, FILED 3-5-2007.

FIRST USE 6-1-2008; IN COMMERCE 6-1-2008.

FRANK LATTUCA, EXAMINING ATTORNEY

Int. Cl.: 5

Prior U.S. Cls.: 6, 18, 44, 46, 51, and 52

Reg. No. 3,481,420

United States Patent and Trademark Office

Registered Aug. 5, 2008

**TRADEMARK
PRINCIPAL REGISTER**

TRIMFIZZ

WASSERMANN, THOMAS (AUSTRALIA INDIVIDUAL)
5850 CAMERON RUN TER. APT 1017
ALEXANDRIA, VA 22303

THE MARK CONSISTS OF STANDARD CHARACTERS WITHOUT CLAIM TO ANY PARTICULAR FONT, STYLE, SIZE, OR COLOR.

FOR: DIETARY FOOD SUPPLEMENTS, IN CLASS 5 (U.S. CLS. 6, 18, 44, 46, 51 AND 52).

SN 77-122,659, FILED 3-5-2007.

FIRST USE 4-0-2008; IN COMMERCE 4-0-2008.

BRENDAN MCCAULEY, EXAMINING ATTORNEY

Int. Cl.: 36

Prior U.S. Cls.: 100, 101, and 102

United States Patent and Trademark Office

Reg. No. 3,481,421

Registered Aug. 5, 2008

**SERVICE MARK
PRINCIPAL REGISTER**

REBATEJUNKIE.COM

GARDNER, COLIN J (UNITED STATES INDIVIDUAL)
950 S TERRACE ROAD
TEMPE, AZ 85281

THE MARK CONSISTS OF STANDARD CHARACTERS WITHOUT CLAIM TO ANY PARTICULAR FONT, STYLE, SIZE, OR COLOR.

FOR: PROVIDING REBATES AT PARTICIPATING ESTABLISHMENTS OF OTHERS THROUGH USE OF A MEMBERSHIP CARD, IN CLASS 36 (U.S. CLS. 100, 101 AND 102).

SN 77-122,847, FILED 3-6-2007.

FIRST USE 6-1-2007; IN COMMERCE 6-30-2007.

STEPHEN AQUILA, EXAMINING ATTORNEY

Int. Cl.: 16

Prior U.S. Cls.: 2, 5, 22, 23, 29, 37, 38, and 50

Reg. No. 3,481,422

United States Patent and Trademark Office

Registered Aug. 5, 2008

**TRADEMARK
PRINCIPAL REGISTER**

**A PROGRAM DESIGNED TO
BUILD A WINNING ATTITUDE**

THE MEYER RESOURCE GROUP, INC. (TEXAS
CORPORATION)
4565 LAKE SHORE DRIVE
WACO, TX 76710

FOR: BOOKS, BOOKLETS, MANUALS AND
PRINTED INSTRUCTIONAL MATERIALS RELAT-
ING TO PERSONAL DEVELOPMENT, SELF-MOTI-
VATION AND IMPROVEMENT, GOAL SETTING,
PLANNING, LEADERSHIP AND MANAGEMENT,
IN CLASS 16 (U.S. CLS. 2, 5, 22, 23, 29, 37, 38 AND 50).

FIRST USE 0-0-1985; IN COMMERCE 0-0-1985.

THE MARK CONSISTS OF STANDARD CHAR-
ACTERS WITHOUT CLAIM TO ANY PARTICULAR
FONT, STYLE, SIZE, OR COLOR.

SN 77-122,869, FILED 3-6-2007.

MONIQUE MILLER, EXAMINING ATTORNEY

Int. Cls.: 10 and 28

Prior U.S. Cls.: 22, 23, 26, 38, 39, 44, and 50

United States Patent and Trademark Office

Reg. No. 3,481,423

Registered Aug. 5, 2008

**TRADEMARK
PRINCIPAL REGISTER**



POWER PLATE NORTH AMERICA, INC. (NETHERLANDS CORPORATION)
3363 COMMERCIAL AVENUE
NORTHBROOK, IL 60062

FOR: MEDICAL MACHINE PRODUCING MECHANICAL VIBRATIONS FOR STIMULATION OF MUSCLES FOR USE IN CONNECTION WITH A MEDICAL TREATMENT PROGRAM, IN CLASS 10 (U.S. CLS. 26, 39 AND 44).

FIRST USE 3-31-2007; IN COMMERCE 3-31-2007.

FOR: FITNESS AND BODY BUILDING MACHINE PRODUCING MECHANICAL VIBRATIONS FOR STIMULATION OF MUSCLES FOR USE IN FITNESS AND BODY BUILDING PROGRAMS TO

INCREASE STRENGTH AND MUSCLE FLEXIBILITY, IN CLASS 28 (U.S. CLS. 22, 23, 38 AND 50).

FIRST USE 3-31-2007; IN COMMERCE 3-31-2007.

OWNER OF U.S. REG. NO. 3,059,186.

NO CLAIM IS MADE TO THE EXCLUSIVE RIGHT TO USE "PLATE", APART FROM THE MARK AS SHOWN.

THE STIPPLING IS A FEATURE OF THE MARK.

SN 77-123,040, FILED 3-6-2007.

RICHARD A. STRASER, EXAMINING ATTORNEY

Int. Cl.: 35

Prior U.S. Cls.: 100, 101, and 102

United States Patent and Trademark Office

Reg. No. 3,481,424

Registered Aug. 5, 2008

**SERVICE MARK
PRINCIPAL REGISTER**

**HOME TO A DIFFERENT KIND
OF SHOPPING EXPERIENCE**

FURNITURE ROW, LLC (COLORADO LTD LIAB
CO)
5641 N. BROADWAY
DENVER, CO 80216

THE MARK CONSISTS OF STANDARD CHAR-
ACTERS WITHOUT CLAIM TO ANY PARTICULAR
FONT, STYLE, SIZE, OR COLOR.

FOR: RETAIL STORE SERVICES FEATURING
FURNITURE, MATTRESSES, AND HOUSEHOLD
ACCESSORIES, IN CLASS 35 (U.S. CLS. 100, 101
AND 102).

SN 77-123,051, FILED 3-6-2007.

FIRST USE 7-15-2006; IN COMMERCE 7-15-2006.

RUDY R. SINGLETON, EXAMINING ATTORNEY

Int. Cl.: 41

Prior U.S. Cls.: 100, 101, and 107

United States Patent and Trademark Office

Reg. No. 3,481,425

Registered Aug. 5, 2008

**SERVICE MARK
PRINCIPAL REGISTER**

**CEO--CAREER EDUCATION &
OPPORTUNITIES**

INDIANA HEMOPHILIA & THROMBOSIS CENTER, INC. (INDIANA CORPORATION)
SUITE 500
8402 HARCOURT ROAD
INDIANAPOLIS, IN 46260

FOR: EDUCATIONAL SERVICES, NAMELY, PROVIDING SEMINARS AND WORKSHOPS IN THE AREAS OF SELF ESTEEM, COLLEGE PLANNING, CAREER PLANNING, AND ADULTHOOD PLANNING, IN CLASS 41 (U.S. CLS. 100, 101 AND 107).

FIRST USE 8-1-2006; IN COMMERCE 8-1-2006.

THE MARK CONSISTS OF STANDARD CHARACTERS WITHOUT CLAIM TO ANY PARTICULAR FONT, STYLE, SIZE, OR COLOR.

NO CLAIM IS MADE TO THE EXCLUSIVE RIGHT TO USE "CAREER EDUCATION", APART FROM THE MARK AS SHOWN.

SN 77-123,271, FILED 3-6-2007.

ALLISON SCHRODY, EXAMINING ATTORNEY

Int. Cl.: 3

Prior U.S. Cls.: 1, 4, 6, 50, 51, and 52

United States Patent and Trademark Office

Reg. No. 3,481,426

Registered Aug. 5, 2008

**TRADEMARK
PRINCIPAL REGISTER**

**ABERCROMBIE & FITCH NEW
YORK COLOGNE 41**

ABERCROMBIE & FITCH TRADING CO. (OHIO
CORPORATION)
6301 FITCH PATH
NEW ALBANY, OH 43054

OWNER OF U.S. REG. NOS. 1,999,665 AND
2,500,146.

FOR: COLOGNE; FRAGRANCES FOR PERSONAL
USE; PERFUME, IN CLASS 3 (U.S. CLS. 1, 4, 6,
50, 51 AND 52).

NO CLAIM IS MADE TO THE EXCLUSIVE
RIGHT TO USE "NEW YORK COLOGNE", APART
FROM THE MARK AS SHOWN.

FIRST USE 10-0-2007; IN COMMERCE 10-0-2007.

SN 77-123,598, FILED 3-6-2007.

THE MARK CONSISTS OF STANDARD CHAR-
ACTERS WITHOUT CLAIM TO ANY PARTICULAR
FONT, STYLE, SIZE, OR COLOR.

BILL DAWE, EXAMINING ATTORNEY

Int. Cl.: 3

Prior U.S. Cls.: 1, 4, 6, 50, 51, and 52

United States Patent and Trademark Office

Reg. No. 3,481,427

Registered Aug. 5, 2008

**TRADEMARK
PRINCIPAL REGISTER**

**ABERCROMBIE & FITCH NEW
YORK PERFUME 41**

ABERCROMBIE & FITCH TRADING CO. (OHIO
CORPORATION)
6301 FITCH PATH
NEW ALBANY, OH 43054

OWNER OF U.S. REG. NOS. 1,999,665 AND
2,500,146.

FOR: COLOGNE; FRAGRANCES FOR PERSONAL
USE; PERFUME, IN CLASS 3 (U.S. CLS. 1, 4, 6,
50, 51 AND 52).

NO CLAIM IS MADE TO THE EXCLUSIVE
RIGHT TO USE "NEW YORK PERFUME", APART
FROM THE MARK AS SHOWN.

FIRST USE 10-0-2007; IN COMMERCE 10-0-2007.

SN 77-123,611, FILED 3-6-2007.

THE MARK CONSISTS OF STANDARD CHAR-
ACTERS WITHOUT CLAIM TO ANY PARTICULAR
FONT, STYLE, SIZE, OR COLOR.

BILL DAWE, EXAMINING ATTORNEY

Int. Cl.: 16

Prior U.S. Cls.: 2, 5, 22, 23, 29, 37, 38, and 50

United States Patent and Trademark Office

Reg. No. 3,481,428

Registered Aug. 5, 2008

TRADEMARK
PRINCIPAL REGISTER

The logo for 'momenta' features the word in a lowercase, sans-serif font. The letter 'o' is colored orange, while the remaining letters 'm', 'e', 'n', 'e', 'n', 't', 'a' are colored blue.

MOMENTA, INC. (NEW HAMPSHIRE CORPORATION)
442 FIRST NH TURNPIKE
NORTHWOOD, NH 03261

FOR: ALBUMS FOR STICKERS, STICKERS, ENVELOPES FOR STATIONERY USE, PAPER STATIONERY, PASTES AND OTHER ADHESIVES FOR STATIONERY OR HOUSEHOLD PURPOSES, ADHESIVE WALL STICKERS, IN CLASS 16 (U.S. CLS. 2, 5, 22, 23, 29, 37, 38 AND 50).

FIRST USE 6-30-2007; IN COMMERCE 6-30-2007.

THE COLOR(S) BLUE AND ORANGE IS/ARE CLAIMED AS A FEATURE OF THE MARK.

THE MARK CONSISTS OF THE WORD "MOMENTA" IN BLUE WITH THE EXCEPTION OF THE LETTER "O" WHICH IS IN ORANGE.

SN 77-123,618, FILED 3-6-2007.

HOWARD B. LEVINE, EXAMINING ATTORNEY

Int. Cl.: 34

Prior U.S. Cls.: 2, 8, 9, and 17

United States Patent and Trademark Office

Reg. No. 3,481,429

Registered Aug. 5, 2008

**TRADEMARK
PRINCIPAL REGISTER**

KENBANO

BLACK PATCH CIGAR CO., LLC (KENTUCKY
LTD LIAB CO)
4804 CLIFFORD CIRCLE
LEXINGTON, KY 40515

FOR: CIGARS, IN CLASS 34 (U.S. CLS. 2, 8, 9 AND
17).

FIRST USE 5-1-2008; IN COMMERCE 5-1-2008.

THE MARK CONSISTS OF STANDARD CHAR-
ACTERS WITHOUT CLAIM TO ANY PARTICULAR
FONT, STYLE, SIZE, OR COLOR.

THE MARK "KENBANO" DOES NOT IDENTIFY
ANY LIVING INDIVIDUAL.

SN 77-123,731, FILED 3-6-2007.

RICHARD A. STRASER, EXAMINING ATTORNEY

Int. Cl.: 25

Prior U.S. Cls.: 22 and 39

United States Patent and Trademark Office

Reg. No. 3,481,430

Registered Aug. 5, 2008

TRADEMARK
PRINCIPAL REGISTER

Monkey Girl

ZIDZIK, JOHN (UNITED STATES INDIVIDUAL)
195 ROCKY STAR ST
HENDERSON, NV 89012 AND
ZIDZIK, KRISTEN (UNITED STATES INDIVIDUAL)
195 ROCKY STAR ST
HENDERSON, NV 89012

FOR: HATS; JACKETS; PANTS; SWEAT SHIRTS;
T-SHIRTS; TANK-TOPS; UNDERGARMENTS, IN
CLASS 25 (U.S. CLS. 22 AND 39).

FIRST USE 3-0-2007; IN COMMERCE 3-0-2007.

NO CLAIM IS MADE TO THE EXCLUSIVE
RIGHT TO USE "GIRL", APART FROM THE MARK
AS SHOWN.

THE MARK CONSISTS OF A STYLIZED FORM
OF THE WORDS "MONKEY GIRL".

SN 77-124,479, FILED 3-7-2007.

REBECCA EISINGER, EXAMINING ATTORNEY

Int. Cl.: 41

Prior U.S. Cls.: 100, 101, and 107

United States Patent and Trademark Office

Reg. No. 3,481,431

Registered Aug. 5, 2008

**SERVICE MARK
PRINCIPAL REGISTER**

USDA

YJ LICENSING COMPANY, INC. (GEORGIA
CORPORATION)
SUITE 130-318
3645 MARKETPLACE BLVD
EAST POINT, GA 30344

THE MARK CONSISTS OF STANDARD CHAR-
ACTERS WITHOUT CLAIM TO ANY PARTICULAR
FONT, STYLE, SIZE, OR COLOR.

FOR: ENTERTAINMENT SERVICES, NAMELY,
MUSICAL PERFORMANCES BY A MUSICAL
GROUP, IN CLASS 41 (U.S. CLS. 100, 101 AND 107).

SN 77-124,677, FILED 3-7-2007.

FIRST USE 5-22-2007; IN COMMERCE 5-22-2007.

MARGERY A. TIERNEY, EXAMINING ATTORNEY

Int. Cl.: 25

Prior U.S. Cls.: 22 and 39

United States Patent and Trademark Office

Reg. No. 3,481,432

Registered Aug. 5, 2008

**TRADEMARK
PRINCIPAL REGISTER**

YOU ARE SEXY

VANITY FAIR, INC. (DELAWARE CORPORATION)
LEGAL DEPARTMENT
ONE FRUIT OF THE LOOM DRIVE
BOWLING GREEN, KY 42103

THE MARK CONSISTS OF STANDARD CHARACTERS WITHOUT CLAIM TO ANY PARTICULAR FONT, STYLE, SIZE, OR COLOR.

FOR: LINGERIE, IN CLASS 25 (U.S. CLS. 22 AND 39).

SN 77-124,704, FILED 3-7-2007.

FIRST USE 6-1-2007; IN COMMERCE 6-1-2007.

BRIDGETT SMITH, EXAMINING ATTORNEY

Int. Cl.: 43

Prior U.S. Cls.: 100 and 101

United States Patent and Trademark Office

Reg. No. 3,481,433

Registered Aug. 5, 2008

**SERVICE MARK
PRINCIPAL REGISTER**



ISLE OF CAPRI CASINOS, INC. (DELAWARE CORPORATION)
600 EMERSON DRIVE, SUITE 300
ST. LOUIS, MO 63141

THE MARK CONSISTS OF THE WORDING "TRACKSIDE BAR" AND A DESIGN OF A HORSE AND BUGGY ATOP THREE CURVED LINES.

FOR: RESTAURANT AND BAR SERVICES, IN CLASS 43 (U.S. CLS. 100 AND 101).

SN 77-125,129, FILED 3-7-2007.

FIRST USE 6-0-2007; IN COMMERCE 6-0-2007.

PAM WILLIS, EXAMINING ATTORNEY

Int. Cl.: 9

Prior U.S. Cls.: 21, 23, 26, 36, and 38

Reg. No. 3,481,434

United States Patent and Trademark Office

Registered Aug. 5, 2008

**TRADEMARK
PRINCIPAL REGISTER**

LEGACY OF TRUTH

LEGACY OF TRUTH MINISTRIES, INC. (GEORGIA NON-PROFIT CORPORATION)
4178 RIVERVIEW DRIVE
DULUTH, GA 300972336

FOR: PRE-RECORDED CDS AND DVDS FEATURING RELIGION AND RELIGIOUS INSTRUCTION, IN CLASS 9 (U.S. CLS. 21, 23, 26, 36 AND 38).

FIRST USE 5-0-2008; IN COMMERCE 5-0-2008.

THE MARK CONSISTS OF STANDARD CHARACTERS WITHOUT CLAIM TO ANY PARTICULAR FONT, STYLE, SIZE, OR COLOR.

OWNER OF U.S. REG. NO. 2,311,587.

SN 77-125,315, FILED 3-8-2007.

ANDREA K. NADELMAN, EXAMINING ATTORNEY

Int. Cl.: 31

Prior U.S. Cls.: 1 and 46

United States Patent and Trademark Office

Reg. No. 3,481,435

Registered Aug. 5, 2008

**TRADEMARK
PRINCIPAL REGISTER**

Smart Grain Technology

CARGILL, INCORPORATED (DELAWARE CORPORATION)

15407 MCGINTY ROAD WEST

WAYZATA, MN 55391

FOR: ANIMAL FEED, IN CLASS 31 (U.S. CLS. 1 AND 46).

FIRST USE 3-31-2007; IN COMMERCE 3-31-2007.

THE MARK CONSISTS OF STANDARD CHARACTERS WITHOUT CLAIM TO ANY PARTICULAR FONT, STYLE, SIZE, OR COLOR.

NO CLAIM IS MADE TO THE EXCLUSIVE RIGHT TO USE "GRAIN TECHNOLOGY", APART FROM THE MARK AS SHOWN.

SN 77-125,428, FILED 3-8-2007.

BILL DAWE, EXAMINING ATTORNEY

Int. Cl.: 10

Prior U.S. Cls.: 26, 39, and 44

United States Patent and Trademark Office

Reg. No. 3,481,436

Registered Aug. 5, 2008

**TRADEMARK
PRINCIPAL REGISTER**

FAST

ROCKY MOUNTAIN BIOSYSTEMS, INC. (COL-
ORADO CORPORATION)
3934 YOUNGFIELD STREET
WHEAT RIDGE, CO 80033

FOR: DEVICE FOR MECHANICALLY REMOV-
ING LAYERS OF SKIN FOR TREATMENT OR
DIAGNOSIS, IN CLASS 10 (U.S. CLS. 26, 39 AND 44).

FIRST USE 7-11-2007; IN COMMERCE 7-11-2007.

THE MARK CONSISTS OF STANDARD CHAR-
ACTERS WITHOUT CLAIM TO ANY PARTICULAR
FONT, STYLE, SIZE, OR COLOR.

SN 77-125,638, FILED 3-8-2007.

LEIGH CAROLINE CASE, EXAMINING ATTOR-
NEY

Int. Cl.: 10

Prior U.S. Cls.: 26, 39, and 44

United States Patent and Trademark Office

Reg. No. 3,481,437

Registered Aug. 5, 2008

**TRADEMARK
PRINCIPAL REGISTER**

ci16200

ABBOTT LABORATORIES (ILLINOIS CORPORATION)
100 ABBOTT PARK ROAD
ABBOTT PARK, IL 60064

FOR: DIAGNOSTIC APPARATUS FOR THE MEDICAL ANALYSIS OF BODILY FLUIDS AND TISSUE, IN CLASS 10 (U.S. CLS. 26, 39 AND 44).

FIRST USE 1-31-2008; IN COMMERCE 1-31-2008.

THE MARK CONSISTS OF STANDARD CHARACTERS WITHOUT CLAIM TO ANY PARTICULAR FONT, STYLE, SIZE, OR COLOR.

OWNER OF U.S. REG. NO. 2,900,555.

SN 77-125,873, FILED 3-8-2007.

TINA KUAN, EXAMINING ATTORNEY

Int. Cl.: 9

Prior U.S. Cls.: 21, 23, 26, 36, and 38

Reg. No. 3,481,438

United States Patent and Trademark Office

Registered Aug. 5, 2008

**TRADEMARK
PRINCIPAL REGISTER**



ARGARD CO., LTD. (THAILAND COMPANY)
2571, LARDPRAO ROAD
WANGTHONGLANG, BANGKOK, THAILAND
10310

FIRST USE 2-7-2007; IN COMMERCE 2-15-2008.

SN 77-126,445, FILED 3-9-2007.

FOR: WIRELESS HEADSET FOR TELEPHONES,
IN CLASS 9 (U.S. CLS. 21, 23, 26, 36 AND 38).

DAVID TAYLOR, EXAMINING ATTORNEY

Int. Cl.: 9

Prior U.S. Cls.: 21, 23, 26, 36, and 38

Reg. No. 3,481,439

United States Patent and Trademark Office

Registered Aug. 5, 2008

**TRADEMARK
PRINCIPAL REGISTER**

STARTER SENTRY

MASTER LOCK COMPANY LLC (DELAWARE
LTD LIAB CO)
P.O. BOX 927
137 W. FOREST HILL AVENUE
OAK CREEK, WI 53154

FOR: ANTI-THEFT DEVICES FOR VEHICLES IN
THE NATURE OF ELECTRONIC VEHICLE IMMO-
BILIZERS, IN CLASS 9 (U.S. CLS. 21, 23, 26, 36 AND
38).

FIRST USE 10-1-2006; IN COMMERCE 10-1-2006.

NO CLAIM IS MADE TO THE EXCLUSIVE
RIGHT TO USE "STARTER", APART FROM THE
MARK AS SHOWN.

THE MARK CONSISTS OF THE WORD "STAR-
TER" IN A RECTANGLE SHAPE AND THE WORD
"SENTRY" APPEARING AFTER THAT.

SN 77-126,465, FILED 3-9-2007.

JILL PRATER, EXAMINING ATTORNEY

Int. Cl.: 9

Prior U.S. Cls.: 21, 23, 26, 36, and 38

Reg. No. 3,481,440

United States Patent and Trademark Office

Registered Aug. 5, 2008

**TRADEMARK
PRINCIPAL REGISTER**

ARGARD

ARGARD CO., LTD. (THAILAND COMPANY)
2571 LARDPRAO ROAD
WANGTHONGLANG, BANGKOK, THAILAND
10310

THE MARK CONSISTS OF STANDARD CHAR-
ACTERS WITHOUT CLAIM TO ANY PARTICULAR
FONT, STYLE, SIZE, OR COLOR.

FOR: WIRELESS HEADSET FOR TELEPHONES,
IN CLASS 9 (U.S. CLS. 21, 23, 26, 36 AND 38).

SN 77-126,468, FILED 3-9-2007.

FIRST USE 2-7-2007; IN COMMERCE 2-15-2008.

DAVID TAYLOR, EXAMINING ATTORNEY

Int. Cl.: 9

Prior U.S. Cls.: 21, 23, 26, 36, and 38

United States Patent and Trademark Office

Reg. No. 3,481,441

Registered Aug. 5, 2008

**TRADEMARK
PRINCIPAL REGISTER**

MASTER LOCK STARTER SENTRY

MASTER LOCK COMPANY LLC (DELAWARE
LTD LIAB CO)
P.O. BOX 927
137 W. FOREST HILL AVENUE
OAK CREEK, WI 53154

FOR: ANTI-THEFT DEVICES FOR VEHICLES IN
THE NATURE OF ELECTRONIC VEHICLE IMMO-
BILIZERS, IN CLASS 9 (U.S. CLS. 21, 23, 26, 36 AND
38).

FIRST USE 10-1-2006; IN COMMERCE 10-1-2006.

THE MARK CONSISTS OF STANDARD CHAR-
ACTERS WITHOUT CLAIM TO ANY PARTICULAR
FONT, STYLE, SIZE, OR COLOR.

NO CLAIM IS MADE TO THE EXCLUSIVE
RIGHT TO USE "STARTER", APART FROM THE
MARK AS SHOWN.

SN 77-126,473, FILED 3-9-2007.

JILL PRATER, EXAMINING ATTORNEY

Int. Cl.: 31

Prior U.S. Cls.: 1 and 46

United States Patent and Trademark Office

Reg. No. 3,481,442

Registered Aug. 5, 2008

**TRADEMARK
PRINCIPAL REGISTER**

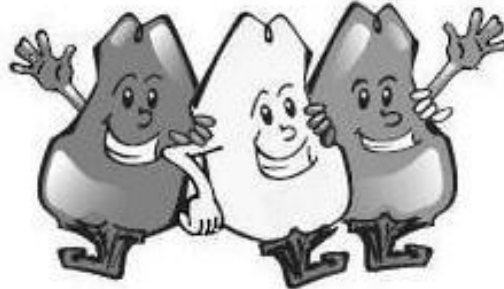

BIONOVA PRODUCE, INC. (ARIZONA CORPORATION)
3021 N. GRAND AVENUE
NOGALES, AZ 85621

THE MARK CONSISTS OF A STYLIZED REPRESENTATION OF THREE PEPPERS.

FOR: FRESH FRUITS AND VEGETABLES, IN CLASS 31 (U.S. CLS. 1 AND 46).

SN 77-126,947, FILED 3-9-2007.

FIRST USE 8-1-2007; IN COMMERCE 8-1-2007.

AMY ALFIERI, EXAMINING ATTORNEY

Int. Cl.: 3

Prior U.S. Cls.: 1, 4, 6, 50, 51, and 52

United States Patent and Trademark Office

Reg. No. 3,481,443

Registered Aug. 5, 2008

**TRADEMARK
PRINCIPAL REGISTER**

MADEMOISELLE DEBUTANTE

NU VISION GROUP LLC (NEW YORK LTD LIAB
CO)
SUITE 304
560 BROADWAY
NEW YORK, NY 10021

FOR: COLOGNE; COLOGNE WATER; EAU DE
COLOGNE; FRAGRANCES FOR PERSONAL USE;
PERFUME; TOILET WATER, IN CLASS 3 (U.S. CLS.
1, 4, 6, 50, 51 AND 52).

FIRST USE 5-0-2008; IN COMMERCE 5-0-2008.

THE MARK CONSISTS OF STANDARD CHAR-
ACTERS WITHOUT CLAIM TO ANY PARTICULAR
FONT, STYLE, SIZE, OR COLOR.

SN 77-127,345, FILED 3-9-2007.

PAM WILLIS, EXAMINING ATTORNEY

Int. Cl.: 16

Prior U.S. Cls.: 2, 5, 22, 23, 29, 37, 38, and 50

United States Patent and Trademark Office

Reg. No. 3,481,444

Registered Aug. 5, 2008

TRADEMARK
PRINCIPAL REGISTER

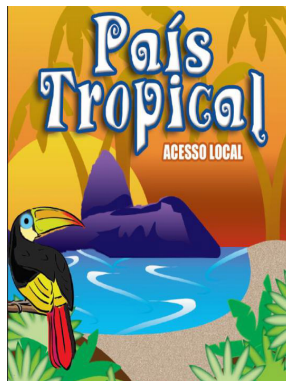

IBASIS, INC. (DELAWARE CORPORATION)
20 SECOND AVENUE
BURLINGTON, MA 01803

FOR: PRE-PAID TELEPHONE CALLING CARDS,
NOT MAGNETICALLY ENCODED; TELEPHONE
CALLING CARDS, NOT MAGNETICALLY ENCO-
DED, IN CLASS 16 (U.S. CLS. 2, 5, 22, 23, 29, 37, 38
AND 50).

FIRST USE 6-1-2008; IN COMMERCE 6-1-2008.

NO CLAIM IS MADE TO THE EXCLUSIVE
RIGHT TO USE "ACESSO LOCAL", APART FROM
THE MARK AS SHOWN.

THE COLOR(S) RED, ORANGE, PURPLE, BLUE,
GREEN, BLACK, YELLOW AND BROWN IS/ARE
CLAIMED AS A FEATURE OF THE MARK.

THE MARK CONSISTS OF AN IMAGE OF A
TROPICAL BEACH WITH A BIRD ON FOLIAGE IN
THE FOREGROUND AND MOUNTAINS IN THE
BACKGROUND, GREEN APPEARS IN THE FOLI-
AGE, BLACK, ORANGE, YELLOW, RED AND BLUE
ON THE BIRD, BLUE IN THE WATER, BROWN ON
THE BEACH AND AN ORANGE SUNSET IN THE
BACKGROUND.

THE FOREIGN WORDING IN THE MARK
TRANSLATES INTO ENGLISH AS COUNTRY TRO-
PICAL LOCAL ACCESS.

SN 77-127,416, FILED 3-9-2007.

CHERYL CLAYTON, EXAMINING ATTORNEY

Int. Cl.: 43

Prior U.S. Cls.: 100 and 101

United States Patent and Trademark Office

Reg. No. 3,481,445

Registered Aug. 5, 2008

**SERVICE MARK
PRINCIPAL REGISTER**

Beatrice & Woodsley

SCREAMING GIRAFFE, INC. (COLORADO CORPORATION)
38 SOUTH BROADWAY STREET
DENVER, CO 80209

THE MARK CONSISTS OF STANDARD CHARACTERS WITHOUT CLAIM TO ANY PARTICULAR FONT, STYLE, SIZE, OR COLOR.

FOR: RESTAURANTS, IN CLASS 43 (U.S. CLS. 100 AND 101).

SN 77-127,562, FILED 3-9-2007.

FIRST USE 5-2-2008; IN COMMERCE 5-2-2008.

NELSON SNYDER, EXAMINING ATTORNEY

Int. Cl.: 5

Prior U.S. Cls.: 6, 18, 44, 46, 51, and 52

United States Patent and Trademark Office

Reg. No. 3,481,446

Registered Aug. 5, 2008

**TRADEMARK
PRINCIPAL REGISTER**

The Ultimate Diet Formula

GAVEY, JAMES E (UNITED STATES INDIVIDUAL)
61 BLUEBERRY LANE
FAIRFIELD, CT 068252026

FOR: DIETARY SUPPLEMENTS, IN CLASS 5 (U.S. CLS. 6, 18, 44, 46, 51 AND 52).

FIRST USE 3-1-2008; IN COMMERCE 3-1-2008.

THE MARK CONSISTS OF STANDARD CHARACTERS WITHOUT CLAIM TO ANY PARTICULAR FONT, STYLE, SIZE, OR COLOR.

NO CLAIM IS MADE TO THE EXCLUSIVE RIGHT TO USE "DIET FORMULA", APART FROM THE MARK AS SHOWN.

SN 77-127,715, FILED 3-10-2007.

ALEXANDER L. POWERS, EXAMINING ATTORNEY

Int. Cl.: 30

Prior U.S. Cl.: 46

United States Patent and Trademark Office

Reg. No. 3,481,447

Registered Aug. 5, 2008

**TRADEMARK
PRINCIPAL REGISTER**

CARAMEL MOUNTAIN TRACKS

GENERAL CONTAINER COMPANY, LLC (MI-
CHIGAN LTD LIAB CO)
1615 OSBORN STREET
HILLSDALE, MI 49242

NO CLAIM IS MADE TO THE EXCLUSIVE
RIGHT TO USE "CARAMEL", APART FROM THE
MARK AS SHOWN.

FOR: ICE CREAM, IN CLASS 30 (U.S. CL. 46).

FIRST USE 7-11-2002; IN COMMERCE 1-29-2003.

SN 77-127,990, FILED 3-12-2007.

THE MARK CONSISTS OF STANDARD CHAR-
ACTERS WITHOUT CLAIM TO ANY PARTICULAR
FONT, STYLE, SIZE, OR COLOR.

MARLENE BELL, EXAMINING ATTORNEY

Int. Cl.: 41

Prior U.S. Cls.: 100, 101, and 107

United States Patent and Trademark Office

Reg. No. 3,481,448

Registered Aug. 5, 2008

**SERVICE MARK
PRINCIPAL REGISTER**

**KING JESUS INTERNATIONAL
MINISTRY**

MINISTERIO INTERNACIONAL EL REY JESUS,
INC. (FLORIDA CORPORATION)
14100 SW 144TH AVENUE
MIAMI, FL 33186

FOR: EDUCATIONAL SERVICES, NAMELY,
SPONSORING, HOSTING AND CONDUCTING
SEMINARS, CLASSES, SUNDAY SCHOOL CLASSES
AND COURSES OF INSTRUCTION ON RELIGION,
BIBLE STUDY, CHRISTIAN WORSHIP, EVANGE-
LISM AND MUSIC; AND FOR PRODUCTION AND
DISTRIBUTION OF LIVE AND PRE-RECORDED
RADIO AND TELEVISION BROADCASTS FEATUR-
ING WORSHIP SERVICES, SERMONS, RELIGIOUS
MUSIC AND CHRISTIAN EDUCATIONAL IN-
STRUCTION, IN CLASS 41 (U.S. CLS. 100, 101 AND
107).

FIRST USE 1-31-2007; IN COMMERCE 1-31-2007.

THE MARK CONSISTS OF STANDARD CHAR-
ACTERS WITHOUT CLAIM TO ANY PARTICULAR
FONT, STYLE, SIZE, OR COLOR.

OWNER OF U.S. REG. NOS. 2,900,337, 2,933,642,
AND OTHERS.

NO CLAIM IS MADE TO THE EXCLUSIVE
RIGHT TO USE "JESUS" OR "INTERNATIONAL
MINISTRY", APART FROM THE MARK AS
SHOWN.

SN 77-128,071, FILED 3-12-2007.

NANCY CLARKE, EXAMINING ATTORNEY

Int. Cl.: 3

Prior U.S. Cls.: 1, 4, 6, 50, 51, and 52

Reg. No. 3,481,449

United States Patent and Trademark Office

Registered Aug. 5, 2008

**TRADEMARK
PRINCIPAL REGISTER**

Disciple

PERFORMANCE BRANDS, INC. (FLORIDA
CORPORATION)
963 SHOTGUN ROAD
SUNRISE, FL 33326

THE MARK CONSISTS OF STANDARD CHAR-
ACTERS WITHOUT CLAIM TO ANY PARTICULAR
FONT, STYLE, SIZE, OR COLOR.

FOR: SUNTANNING PREPARATIONS, IN CLASS
3 (U.S. CLS. 1, 4, 6, 50, 51 AND 52).

SN 77-128,215, FILED 3-12-2007.

FIRST USE 10-1-2007; IN COMMERCE 10-1-2007.

KRISTINA MORRIS, EXAMINING ATTORNEY

Int. Cl.: 3

Prior U.S. Cls.: 1, 4, 6, 50, 51, and 52

Reg. No. 3,481,450

United States Patent and Trademark Office

Registered Aug. 5, 2008

**TRADEMARK
PRINCIPAL REGISTER**

Juicy Story

PERFORMANCE BRANDS, INC. (FLORIDA
CORPORATION)
963 SHOTGUN ROAD
SUNRISE, FL 33326

THE MARK CONSISTS OF STANDARD CHAR-
ACTERS WITHOUT CLAIM TO ANY PARTICULAR
FONT, STYLE, SIZE, OR COLOR.

FOR: SUNTANNING PREPARATIONS, IN CLASS
3 (U.S. CLS. 1, 4, 6, 50, 51 AND 52).

SN 77-128,218, FILED 3-12-2007.

FIRST USE 10-1-2007; IN COMMERCE 10-1-2007.

KRISTINA MORRIS, EXAMINING ATTORNEY

Int. Cl.: 33

Prior U.S. Cls.: 47 and 49

United States Patent and Trademark Office

Reg. No. 3,481,451

Registered Aug. 5, 2008

**TRADEMARK
PRINCIPAL REGISTER**

HELLFIRE

MT. DEFIANCE WINE COMPANY (OREGON
CORPORATION)
1808 COUNTRY CLUB RD.
HOOD RIVER, OR 97031

THE MARK CONSISTS OF STANDARD CHAR-
ACTERS WITHOUT CLAIM TO ANY PARTICULAR
FONT, STYLE, SIZE, OR COLOR.

FOR: WINE, IN CLASS 33 (U.S. CLS. 47 AND 49).

SN 77-128,300, FILED 3-12-2007.

FIRST USE 4-10-2008; IN COMMERCE 4-10-2008.

SUZANNE BLANE, EXAMINING ATTORNEY

Int. Cl.: 35

Prior U.S. Cls.: 100, 101, and 102

United States Patent and Trademark Office

Reg. No. 3,481,452

Registered Aug. 5, 2008

**SERVICE MARK
PRINCIPAL REGISTER**

TALENTSPRING

TALENTSPRING, INC. (DELAWARE CORPORATION)
16430 NE 50TH STREET
REDMOND, WA 98052

FOR: EMPLOYMENT HIRING, RECRUITING, PLACEMENT, STAFFING, AND CAREER NETWORKING SERVICES; PROVIDING ON-LINE EMPLOYMENT HIRING, RECRUITING, PLACEMENT, STAFFING, AND CAREER NETWORKING SERVICES OVER COMPUTER NETWORKS; COMPUTERIZED DATABASE MANAGEMENT, TRACKING, AND RANKING SERVICES FOR THE HUMAN RESOURCES, EMPLOYMENT, RECRUITING, AND

STAFFING FIELDS, IN CLASS 35 (U.S. CLS. 100, 101 AND 102).

FIRST USE 5-18-2008; IN COMMERCE 5-18-2008.

THE MARK CONSISTS OF STANDARD CHARACTERS WITHOUT CLAIM TO ANY PARTICULAR FONT, STYLE, SIZE, OR COLOR.

SN 77-128,774, FILED 3-12-2007.

DAVID TAYLOR, EXAMINING ATTORNEY

Int. Cl.: 41

Prior U.S. Cls.: 100, 101, and 107

United States Patent and Trademark Office

Reg. No. 3,481,453

Registered Aug. 5, 2008

SERVICE MARK
PRINCIPAL REGISTER



LIBERATION ENTERTAINMENT INC. (DELA-
WARE CORPORATION)
PENTHOUSE
1990 WESTWOOD BOULEVARD
LOS ANGELES, CA 90025

FOR: PRODUCTION AND DISTRIBUTION OF
TELEVISION SHOWS AND MOVIES, IN CLASS 41
(U.S. CLS. 100, 101 AND 107).

FIRST USE 11-30-2005; IN COMMERCE 11-30-2005.

NO CLAIM IS MADE TO THE EXCLUSIVE
RIGHT TO USE "ENTERTAINMENT", APART
FROM THE MARK AS SHOWN.

THE COLOR(S) BLUE, BEIGE, GREEN, BLACK
AND WHITE IS/ARE CLAIMED AS A FEATURE OF
THE MARK.

THE MARK CONSISTS OF A FANCIFUL RENDI-
TION OF A BEIGE HAND OUTLINED IN BLACK
HOLDING A BLACK LINED TORCH WITH A TWO-
TONED GREEN FLAME AND BLACK FLAME ON
A BEIGE PENNANT SHAPED BACKGROUND, ALL
TO THE LEFT OF THE LITERAL ELEMENT, "LIB-
ERATION ENTERTAINMENT", WITH THE TERM
"LIBERATION" IN WHITE OUTLINED IN BLACK
APPEARING AGAINST A BLUE BACKGROUND,
AND ABOVE THE TERM "ENTERTAINMENT",
WHICH HAS BLACK LETTERS.

SN 77-128,974, FILED 3-12-2007.

ROBIN CHOSID, EXAMINING ATTORNEY

Int. Cl.: 1

Prior U.S. Cls.: 1, 5, 6, 10, 26, and 46

United States Patent and Trademark Office

Reg. No. 3,481,454

Registered Aug. 5, 2008

**TRADEMARK
PRINCIPAL REGISTER**

Wear-Coat

FIBER-LINE, INC. (PENNSYLVANIA CORPORATION)
3050 CAMPUS DRIVE
HATFIELD, PA 19440

FOR: NON-METALLIC CHEMICAL FORMULATION FOR USE IN PROVIDING ABRASION-RESISTANT LAYERS OR IMPREGNATION ON FIBERS USED IN ROPE, CABLE, BELTS, HOSES, AND INDUSTRIAL FABRICS , IN CLASS 1 (U.S. CLS. 1, 5, 6, 10, 26 AND 46).

FIRST USE 4-4-2008; IN COMMERCE 4-4-2008.

THE MARK CONSISTS OF STANDARD CHARACTERS WITHOUT CLAIM TO ANY PARTICULAR FONT, STYLE, SIZE, OR COLOR.

SN 77-129,124, FILED 3-13-2007.

ANDREA BUTLER, EXAMINING ATTORNEY

Int. Cls.: 35 and 41

Prior U.S. Cls.: 100, 101, 102, and 107

United States Patent and Trademark Office

Reg. No. 3,481,455

Registered Aug. 5, 2008

**SERVICE MARK
PRINCIPAL REGISTER**

THE RAYMOND EXPERIENCE

RAYMOND CREATIVE, LLC (MISSOURI LTD
LIAB CO)
11918 GRAVOIS ROAD, UNIT 12
ST. LOUIS, MO 63127

FOR: PUBLIC RELATIONS; CONSULTANCY
SERVICES REGARDING BUSINESS STRATEGIES,
PERSONNEL AND INTERNAL CORPORATE IN-
ITIATIVES AND COMMUNICATIONS , IN CLASS 35
(U.S. CLS. 100, 101 AND 102).

FIRST USE 6-30-2007; IN COMMERCE 6-30-2007.

FOR: SPECIAL EVENT PLANNING; ARRAN-
GING OF SEMINARS AND CONFERENCES, IN
CLASS 41 (U.S. CLS. 100, 101 AND 107).

FIRST USE 6-30-2007; IN COMMERCE 6-30-2007.

THE MARK CONSISTS OF STANDARD CHAR-
ACTERS WITHOUT CLAIM TO ANY PARTICULAR
FONT, STYLE, SIZE, OR COLOR.

SN 77-129,126, FILED 3-13-2007.

CHERYL CLAYTON, EXAMINING ATTORNEY

Int. Cl.: 9

Prior U.S. Cls.: 21, 23, 26, 36, and 38

United States Patent and Trademark Office

Reg. No. 3,481,456

Registered Aug. 5, 2008

**TRADEMARK
PRINCIPAL REGISTER**



LEGACY OF TRUTH MINISTRIES, INC. (GEORGIA NON-PROFIT CORPORATION)
4178 RIVERVIEW DRIVE
DULUTH, GA 300972336

FOR: PRE-RECORDED CDS AND DVDS FEATURING RELIGION AND RELIGIOUS INSTRUCTION, IN CLASS 9 (U.S. CLS. 21, 23, 26, 36 AND 38).

FIRST USE 5-0-2008; IN COMMERCE 5-0-2008.

OWNER OF U.S. REG. NO. 2,311,587.

THE MARK CONSISTS OF THE WORD "LEGACY" FOLLOWED BY THE WORD "OF" FOLLOWED BY A SWORD SHAPED IN THE IMAGE OF A CROSS, FOLLOWED BY THE WORD "TRUTH".

SN 77-129,231, FILED 3-13-2007.

ANDREA K. NADELMAN, EXAMINING ATTORNEY

Int. Cl.: 41

Prior U.S. Cls.: 100, 101, and 107

United States Patent and Trademark Office

Reg. No. 3,481,457

Registered Aug. 5, 2008

**SERVICE MARK
PRINCIPAL REGISTER**



LEGACY OF TRUTH MINISTRIES, INC. (GEORGIA NON-PROFIT CORPORATION)
4178 RIVERVIEW DRIVE
DULUTH, GA 300972336

FOR: EDUCATIONAL SERVICES, NAMELY, CONDUCTING CLASSES, SEMINARS, CONFERENCES, AND WORKSHOPS IN THE FIELD OF RELIGION, IN CLASS 41 (U.S. CLS. 100, 101 AND 107).

FIRST USE 4-0-2008; IN COMMERCE 4-0-2008.

OWNER OF U.S. REG. NO. 2,311,587.

THE MARK CONSISTS OF THE WORD "LEGACY" FOLLOWED BY THE WORD "OF" FOLLOWED BY A SWORD SHAPED IN THE IMAGE OF A CROSS, FOLLOWED BY THE WORD "TRUTH".

SN 77-129,260, FILED 3-13-2007.

ANDREA K. NADELMAN, EXAMINING ATTORNEY

Int. Cl.: 36

Prior U.S. Cls.: 100, 101, and 102

United States Patent and Trademark Office

Reg. No. 3,481,458

Registered Aug. 5, 2008

**SERVICE MARK
PRINCIPAL REGISTER**



VAZQUEZ, RONALDO (UNITED STATES INDIVIDUAL)
1206 ARUBA CV UNIT 1
CHULA VISTA, CA 91915 AND
VAZQUEZ, RITA (UNITED STATES INDIVIDUAL)
1206 ARUBA CV UNIT 1
CHULA VISTA, CA 91915

FOR: CHARITABLE FUND RAISING, IN CLASS
36 (U.S. CLS. 100, 101 AND 102).

FIRST USE 6-1-2007; IN COMMERCE 3-1-2008.

THE MARK CONSISTS OF A SQUARE ON A
GRID THAT'S ENCLOSED IN A CIRCLE WITH
STYLIZED TEXT.

SN 77-129,347, FILED 3-13-2007.

WENDY JUN, EXAMINING ATTORNEY

Int. Cl.: 33

Prior U.S. Cls.: 47 and 49

United States Patent and Trademark Office

Reg. No. 3,481,459

Registered Aug. 5, 2008

**TRADEMARK
PRINCIPAL REGISTER**

THE CATCHER

PACIFIC VISION PROPRIETARY LTD. (AUSTRALIA CORPORATION)
SUITE 23
8-24 KIPPAX STREET
SURRY HILLS NSW 2010, AUSTRALIA

FOR: WINES, IN CLASS 33 (U.S. CLS. 47 AND 49).

FIRST USE 4-15-2007; IN COMMERCE 4-15-2007.

THE MARK CONSISTS OF STANDARD CHARACTERS WITHOUT CLAIM TO ANY PARTICULAR FONT, STYLE, SIZE, OR COLOR.

SN 77-129,621, FILED 3-13-2007.

CHERYL CLAYTON, EXAMINING ATTORNEY

Int. Cl.: 5

Prior U.S. Cls.: 6, 18, 44, 46, 51, and 52

United States Patent and Trademark Office

Reg. No. 3,481,460

Registered Aug. 5, 2008

**TRADEMARK
PRINCIPAL REGISTER**

IntraCleanse

HERBAL GROUPS INC. (CALIFORNIA CORPORATION)
9605 CANOGA AVENUE
CHATSWORTH, CA 91311

THE MARK CONSISTS OF STANDARD CHARACTERS WITHOUT CLAIM TO ANY PARTICULAR FONT, STYLE, SIZE, OR COLOR.

FOR: HERBAL SUPPLEMENTS, IN CLASS 5 (U.S. CLS. 6, 18, 44, 46, 51 AND 52).

SN 77-129,766, FILED 3-13-2007.

FIRST USE 2-10-2006; IN COMMERCE 2-10-2006.

JULIE GUTTADAURO, EXAMINING ATTORNEY

Int. Cl.: 33

Prior U.S. Cls.: 47 and 49

United States Patent and Trademark Office

Reg. No. 3,481,461

Registered Aug. 5, 2008

TRADEMARK
PRINCIPAL REGISTER

The logo features the words "Los Ilegales" in a highly stylized, blackletter or gothic font. The letters are thick and have sharp, decorative flourishes. The word "Los" is positioned above "Ilegales". The entire logo is centered on the page.

DESTILADORA SANTA VIRGINIA S.A. DE C.V.
(MEXICO CORPORATION)
SIERRA ORIENTAL 251 FRACC SIERRA HERMOSA
TEPATITLÁN DE MORELOS, JALISCO, MEXICO
47600

FOR: TEQUILA, IN CLASS 33 (U.S. CLS. 47 AND
49).

FIRST USE 5-30-2008; IN COMMERCE 6-2-2008.

THE MARK CONSISTS OF A STYLIZED LETTER
"L" , "A" STYLIZED LETTER "I".

THE FOREIGN WORDING IN THE MARK
TRANSLATES INTO ENGLISH AS THE ILLEGALS.

SN 77-129,847, FILED 3-13-2007.

AMOS T. MATTHEWS, JR., EXAMINING ATTOR-
NEY

Int. Cl.: 35

Prior U.S. Cls.: 100, 101, and 102

United States Patent and Trademark Office

Reg. No. 3,481,462

Registered Aug. 5, 2008

**SERVICE MARK
PRINCIPAL REGISTER**

Floors101.com

FLOORING 101, INC. (CALIFORNIA CORPORATION)
1660 SOUTH OXNARD BLVD.
OXNARD, CA 93030

THE MARK CONSISTS OF STANDARD CHARACTERS WITHOUT CLAIM TO ANY PARTICULAR FONT, STYLE, SIZE, OR COLOR.

FOR: ON-LINE RETAIL STORE SERVICES FEATURING CARPETS AND OTHER FLOOR COVERINGS, IN CLASS 35 (U.S. CLS. 100, 101 AND 102).

SN 77-130,278, FILED 3-13-2007.

FIRST USE 4-10-2008; IN COMMERCE 4-29-2008.

JULIE GUTTADAURO, EXAMINING ATTORNEY

Int. Cls.: 35, 38, 42, and 45

Prior U.S. Cls.: 100, 101, 102, and 104

United States Patent and Trademark Office

Reg. No. 3,481,463

Registered Aug. 5, 2008

**SERVICE MARK
PRINCIPAL REGISTER**

RBLOCK

RBLOCK, INC. (DELAWARE CORPORATION)
440 N WOLFE ROAD
SUNNYVALE, CA 94085

FOR: PROMOTING, MARKETING AND ADVERTISING THE GOODS AND SERVICES OF OTHERS VIA THE INTERNET, IN CLASS 35 (U.S. CLS. 100, 101 AND 102).

FIRST USE 4-1-2007; IN COMMERCE 4-1-2007.

FOR: PROVIDING ON-LINE ELECTRONIC BULLETIN BOARDS FOR TRANSMISSION OF MESSAGES AMONG COMPUTER USERS CONCERNING A GEOGRAPHICALLY DEFINED SOCIAL NETWORK, IN CLASS 38 (U.S. CLS. 100, 101 AND 104).

FIRST USE 4-1-2007; IN COMMERCE 4-1-2007.

FOR: COMPUTER SERVICES, NAMELY, CREATING AN ONLINE COMMUNITY FOR REGISTERED USERS TO ENGAGE IN SOCIAL NETWORKING; COMPUTER SERVICES, NAMELY, ACTING AS AN APPLICATION SERVICE PROVIDER IN THE FIELDS OF COLLABORATION AND KNOWLEDGE MANAGEMENT TO HOST COMPUTER APPLICATION SOFTWARE FOR THE CAPTURING, EXCHANGING, ORGANIZING, STORING, RETRIEVING, TRANSMITTING AND SHARING OF DATA AND INFORMATION; COMPUTER SERVICES, NAMELY, HOSTING ONLINE WEB FACILITIES FOR OTHERS FOR ORGANIZING AND CONDUCTING ONLINE MEETINGS, GATHERINGS, AND INTERACTIVE DISCUSSIONS; COMPU-

TER SERVICES IN THE NATURE OF CUSTOMIZED WEB PAGES FEATURING USER-DEFINED INFORMATION, PERSONAL PROFILES AND INFORMATION; PROVIDING AN ON-LINE COMPUTER DATABASE CONTAINING CUSTOMIZED WEB PAGES FEATURING USER DEFINED INFORMATION IN THE NATURE OF DATA ABOUT INDIVIDUALS CONSISTING OF THE RELATIONSHIPS BETWEEN THE INDIVIDUALS, THEIR CONTACT INFORMATION, PERSONAL CHARACTERISTICS, NAMELY, SKILLS, HOBBIES, INTERESTS, EDUCATIONAL INFORMATION, CAREER INFORMATION, HEALTH INFORMATION, DATING INFORMATION, RESULTS OF SELF ASSESSMENT TESTS, AND OTHER PERSONAL INFORMATION, IN CLASS 42 (U.S. CLS. 100 AND 101).

FIRST USE 4-1-2007; IN COMMERCE 4-1-2007.

FOR: INTERNET BASED SOCIAL NETWORKING, INTRODUCTION SERVICES TO FOSTER COMMUNITY BUILDING, INTRODUCTION, AND DATING SERVICES, IN CLASS 45 (U.S. CLS. 100 AND 101).

FIRST USE 4-1-2007; IN COMMERCE 4-1-2007.

THE MARK CONSISTS OF STANDARD CHARACTERS WITHOUT CLAIM TO ANY PARTICULAR FONT, STYLE, SIZE, OR COLOR.

SN 77-130,312, FILED 3-13-2007.

CAROLINE WOOD, EXAMINING ATTORNEY

Int. Cl.: 25

Prior U.S. Cls.: 22 and 39

United States Patent and Trademark Office

Reg. No. 3,481,464

Registered Aug. 5, 2008

**TRADEMARK
PRINCIPAL REGISTER**

PI DROP

GREENSPAN, AVIVA (CANADA INDIVIDUAL)
6021 YONGE ST., #970
TORONTO, CANADA M2M3W2

THE MARK CONSISTS OF STANDARD CHAR-
ACTERS WITHOUT CLAIM TO ANY PARTICULAR
FONT, STYLE, SIZE, OR COLOR.

FOR: SHIRTS; SWEAT SHIRTS; T-SHIRTS, IN
CLASS 25 (U.S. CLS. 22 AND 39).

SN 77-130,347, FILED 3-13-2007.

FIRST USE 3-16-2007; IN COMMERCE 3-16-2007.

JILL PRATER, EXAMINING ATTORNEY

Int. Cl.: 25

Prior U.S. Cls.: 22 and 39

United States Patent and Trademark Office

Reg. No. 3,481,465

Registered Aug. 5, 2008

**TRADEMARK
PRINCIPAL REGISTER**

GIANT PI

GREENSPAN, AVIVA (CANADA INDIVIDUAL)
6021 YONGE ST., #970
TORONTO, CANADA M2M3W2

THE MARK CONSISTS OF STANDARD CHAR-
ACTERS WITHOUT CLAIM TO ANY PARTICULAR
FONT, STYLE, SIZE, OR COLOR.

FOR: SHIRTS; SWEAT SHIRTS; T-SHIRTS, IN
CLASS 25 (U.S. CLS. 22 AND 39).

SN 77-130,350, FILED 3-13-2007.

FIRST USE 3-15-2007; IN COMMERCE 3-15-2007.

JILL PRATER, EXAMINING ATTORNEY

Int. Cl.: 28

Prior U.S. Cls.: 22, 23, 38, and 50

United States Patent and Trademark Office

Reg. No. 3,481,466

Registered Aug. 5, 2008

**TRADEMARK
PRINCIPAL REGISTER**

SPINE

WILSON SPORTING GOODS CO. (DELAWARE
CORPORATION)
8750 W. BRYN MAWR AVE.
CHICAGO, IL 60631

THE MARK CONSISTS OF STANDARD CHAR-
ACTERS WITHOUT CLAIM TO ANY PARTICULAR
FONT, STYLE, SIZE, OR COLOR.

FOR: GOLF CLUBS, IN CLASS 28 (U.S. CLS. 22, 23,
38 AND 50).

SN 77-130,569, FILED 3-14-2007.

FIRST USE 11-1-2007; IN COMMERCE 11-1-2007.

SUE LAWRENCE, EXAMINING ATTORNEY

Int. Cl.: 3

Prior U.S. Cls.: 1, 4, 6, 50, 51, and 52

Reg. No. 3,481,467

United States Patent and Trademark Office

Registered Aug. 5, 2008

**TRADEMARK
PRINCIPAL REGISTER**

PRETTY PEN

MICHAUD, JULIE (UNITED STATES INDIVIDUAL)
115 NEWBURY STREET, SUITE 204
BOSTON, MA 02116

FOR: COSMETICS; CONCEALERS AND FACIAL HIGHLIGHTERS FOR COSMETIC USE, IN CLASS 3 (U.S. CLS. 1, 4, 6, 50, 51 AND 52).

FIRST USE 4-30-2007; IN COMMERCE 4-30-2007.

THE MARK CONSISTS OF STANDARD CHARACTERS WITHOUT CLAIM TO ANY PARTICULAR FONT, STYLE, SIZE, OR COLOR.

NO CLAIM IS MADE TO THE EXCLUSIVE RIGHT TO USE "PEN", APART FROM THE MARK AS SHOWN.

SN 77-131,529, FILED 3-15-2007.

JUSTINE D. PARKER, EXAMINING ATTORNEY

Int. Cl.: 42

Prior U.S. Cls.: 100 and 101

United States Patent and Trademark Office

Reg. No. 3,481,468

Registered Aug. 5, 2008

**SERVICE MARK
PRINCIPAL REGISTER**

SKINNY SCIENCE

ALLEN, ANN DE WEES (UNITED STATES IN-
DIVIDUAL)
111 SECOND AVENUE NE
SUITE 512
ST. PETERSBURG, FL 33701

FOR: SCIENTIFIC RESEARCH FOR DEVELOP-
ING NUTRACEUTICAL AND PHARMACEUTICAL
FOOD AND BEVERAGE PRODUCTS THAT ARE
LOW IN GLYCEMIC CONTENT, NAMELY, DIET,
NUTRITION, FOODS AND DIETARY SUPPLE-
MENTS, IN CLASS 42 (U.S. CLS. 100 AND 101).

FIRST USE 1-1-2008; IN COMMERCE 1-1-2008.

THE MARK CONSISTS OF STANDARD CHAR-
ACTERS WITHOUT CLAIM TO ANY PARTICULAR
FONT, STYLE, SIZE, OR COLOR.

NO CLAIM IS MADE TO THE EXCLUSIVE
RIGHT TO USE "SCIENCE", APART FROM THE
MARK AS SHOWN.

SN 77-131,597, FILED 3-15-2007.

PAM WILLIS, EXAMINING ATTORNEY

Int. Cl.: 10

Prior U.S. Cls.: 26, 39, and 44

United States Patent and Trademark Office

Reg. No. 3,481,469

Registered Aug. 5, 2008

**TRADEMARK
PRINCIPAL REGISTER**

AIR COMFORT

CONAIR CORPORATION (DELAWARE COR-
PORATION)
ONE CUMMINGS POINT ROAD
STAMFORD, CT 06902

THE MARK CONSISTS OF STANDARD CHAR-
ACTERS WITHOUT CLAIM TO ANY PARTICULAR
FONT, STYLE, SIZE, OR COLOR.

FOR: MASSAGE APPARATUS, IN CLASS 10 (U.S.
CLS. 26, 39 AND 44).

SN 77-131,712, FILED 3-15-2007.

FIRST USE 8-30-2007; IN COMMERCE 8-30-2007.

BARBARA BROWN, EXAMINING ATTORNEY

Int. Cl.: 17

Prior U.S. Cls.: 1, 5, 12, 13, 35, and 50

Reg. No. 3,481,470

United States Patent and Trademark Office

Registered Aug. 5, 2008

**TRADEMARK
PRINCIPAL REGISTER**

ACOUSTICR

OWENS CORNING INTELLECTUAL CAPITAL,
LLC (DELAWARE LTD LIAB CO)
ONE OWENS CORNING PARKWAY
TOLEDO, OH 43659

THE MARK CONSISTS OF STANDARD CHAR-
ACTERS WITHOUT CLAIM TO ANY PARTICULAR
FONT, STYLE, SIZE, OR COLOR.

FOR: BUILDING INSULATION MATERIALS,
NAMELY, INSULATION USED IN DUCTWORK,
INSULATION USED AS DUCT LINER, IN CLASS 17
(U.S. CLS. 1, 5, 12, 13, 35 AND 50).

SN 77-131,745, FILED 3-15-2007.

FIRST USE 6-25-2007; IN COMMERCE 6-25-2007.

CARYN GLASSER, EXAMINING ATTORNEY

Int. Cl.: 17

Prior U.S. Cls.: 1, 5, 12, 13, 35, and 50

Reg. No. 3,481,471

United States Patent and Trademark Office

Registered Aug. 5, 2008

**TRADEMARK
PRINCIPAL REGISTER**

ACOUSTITEX

OWENS CORNING INTELLECTUAL CAPITAL,
LLC (DELAWARE LTD LIAB CO)
ONE OWENS CORNING PARKWAY
TOLEDO, OH 43659

THE MARK CONSISTS OF STANDARD CHAR-
ACTERS WITHOUT CLAIM TO ANY PARTICULAR
FONT, STYLE, SIZE, OR COLOR.

FOR: BUILDING INSULATION MATERIALS,
NAMELY, INSULATION USED IN DUCTWORK,
INSULATION USED AS DUCT LINER, IN CLASS 17
(U.S. CLS. 1, 5, 12, 13, 35 AND 50).

SN 77-131,782, FILED 3-15-2007.

FIRST USE 10-19-2007; IN COMMERCE 10-19-2007.

CARYN GLASSER, EXAMINING ATTORNEY

Int. Cl.: 21

Prior U.S. Cls.: 2, 13, 23, 29, 30, 33, 40, and 50

United States Patent and Trademark Office

Reg. No. 3,481,472

Registered Aug. 5, 2008

**TRADEMARK
PRINCIPAL REGISTER**

Cooler CAP

MR. H2O, LLC (CALIFORNIA LTD LIAB CO)
1223 WILSHIRE BLVD #925
SANTA MONICA, CA 90403

FOR: PLASTIC STORAGE CONTAINERS FOR
DOMESTIC USE; ALL PURPOSE PORTABLE
HOUSEHOLD CONTAINERS, IN CLASS 21 (U.S.
CLS. 2, 13, 23, 29, 30, 33, 40 AND 50).

FIRST USE 5-15-2008; IN COMMERCE 5-15-2008.

THE MARK CONSISTS OF STANDARD CHAR-
ACTERS WITHOUT CLAIM TO ANY PARTICULAR
FONT, STYLE, SIZE, OR COLOR.

NO CLAIM IS MADE TO THE EXCLUSIVE
RIGHT TO USE "COOLER", APART FROM THE
MARK AS SHOWN.

SN 77-131,910, FILED 3-15-2007.

BONNIE LUKEN, EXAMINING ATTORNEY

Int. Cl.: 25

Prior U.S. Cls.: 22 and 39

United States Patent and Trademark Office

Reg. No. 3,481,473

Registered Aug. 5, 2008

**TRADEMARK
PRINCIPAL REGISTER**

EVERY STITCH EVERY TIME

JOHN H. DANIEL COMPANY (TENNESSEE
CORPORATION)
120 W. JACKSON AVENUE
KNOXVILLE, TN 37902

THE MARK CONSISTS OF STANDARD CHAR-
ACTERS WITHOUT CLAIM TO ANY PARTICULAR
FONT, STYLE, SIZE, OR COLOR.

FOR: MEN'S CLOTHING, NAMELY, PANTS,
COATS, SUITS, SHIRTS AND TIES, IN CLASS 25
(U.S. CLS. 22 AND 39).

SN 77-132,202, FILED 3-15-2007.

FIRST USE 10-1-2007; IN COMMERCE 10-1-2007.

RUDY R. SINGLETON, EXAMINING ATTORNEY

Int. Cl.: 45

Prior U.S. Cls.: 100 and 101

United States Patent and Trademark Office

Reg. No. 3,481,474

Registered Aug. 5, 2008

**SERVICE MARK
PRINCIPAL REGISTER**

BISHOP ROCK SOFTWARE

BISHOP ROCK SOFTWARE LLC (DELAWARE
LTD LIAB CO)
25424 MORNINGSTAR ROAD
LAKE FOREST, CA 92630

FOR: COMPUTER SERVICES, NAMELY, PRO-
VIDING INTERACTIVE COMPUTERIZED INFOR-
MATION BY MEANS OF A GLOBAL COMPUTER
INFORMATION NETWORK TO AID IN THE DE-
PLOYMENT OF LAW ENFORCEMENT RESOUR-
CES, IN CLASS 45 (U.S. CLS. 100 AND 101).

FIRST USE 3-15-2007; IN COMMERCE 4-1-2007.

THE MARK CONSISTS OF STANDARD CHAR-
ACTERS WITHOUT CLAIM TO ANY PARTICULAR
FONT, STYLE, SIZE, OR COLOR.

NO CLAIM IS MADE TO THE EXCLUSIVE
RIGHT TO USE "SOFTWARE", APART FROM THE
MARK AS SHOWN.

SN 77-132,255, FILED 3-15-2007.

RUDY R. SINGLETON, EXAMINING ATTORNEY

Int. Cl.: 36

Prior U.S. Cls.: 100, 101, and 102

United States Patent and Trademark Office

Reg. No. 3,481,475

Registered Aug. 5, 2008

**SERVICE MARK
PRINCIPAL REGISTER**

INFOFX

BROWN BROTHERS HARRIMAN & CO. (NEW YORK PARTNERSHIP)
140 BROADWAY
NEW YORK, NY 10005

FOR: FINANCIAL INFORMATION PROCESSING; FINANCIAL INFORMATION PROVIDED BY ELECTRONIC MEANS; FINANCIAL MANAGEMENT; FINANCIAL PORTFOLIO MANAGEMENT; FINANCIAL RESEARCH; FINANCIAL SERVICES, NAMELY, ASSISTING OTHERS WITH THE COMPLETION OF FINANCIAL TRANSACTIONS FOR STOCKS, BONDS, SECURITIES AND EQUITIES; FINANCIAL SERVICES, NAMELY, PROVIDING INFORMATION IN THE FIELDS OF FOREIGN CURRENCY, COMMODITIES, FINANCIAL DERIVATIVES, INTEREST RATE PRODUCTS, AND EQUITIES VIA THE INTERNET AND INTRANET SYSTEMS; FINANCIAL SERVICES, NAMELY, PROVIDING ON-LINE STORED VALUE ACCOUNTS IN

AN ELECTRONIC ENVIRONMENT; FINANCIAL SERVICES, NAMELY, INVESTMENT FUND TRANSFER AND TRANSACTION SERVICES; FINANCIAL SERVICES, NAMELY, PROVIDING FOR THE EXCHANGE OF FOREIGN CURRENCY, COMMODITIES, FINANCIAL DERIVATIVES, INTEREST RATE PRODUCTS, AND EQUITIES VIA THE INTERNET AND INTRANET SYSTEMS, IN CLASS 36 (U.S. CLS. 100, 101 AND 102).

FIRST USE 10-0-2007; IN COMMERCE 10-0-2007.

THE MARK CONSISTS OF STANDARD CHARACTERS WITHOUT CLAIM TO ANY PARTICULAR FONT, STYLE, SIZE, OR COLOR.

SN 77-132,344, FILED 3-15-2007.

PAM WILLIS, EXAMINING ATTORNEY

Int. Cl.: 35

Prior U.S. Cls.: 100, 101, and 102

United States Patent and Trademark Office

Reg. No. 3,481,476

Registered Aug. 5, 2008

**SERVICE MARK
PRINCIPAL REGISTER**

BBH INFOFX

BROWN BROTHERS HARRIMAN & CO. (NEW
YORK PARTNERSHIP)
140 BROADWAY
NEW YORK, NY 10005

THE MARK CONSISTS OF STANDARD CHAR-
ACTERS WITHOUT CLAIM TO ANY PARTICULAR
FONT, STYLE, SIZE, OR COLOR.

FOR: FINANCIAL RECORDS MANAGEMENT,
IN CLASS 35 (U.S. CLS. 100, 101 AND 102).

SN 77-132,361, FILED 3-15-2007.

FIRST USE 10-0-2007; IN COMMERCE 10-0-2007.

PAM WILLIS, EXAMINING ATTORNEY

Int. Cl.: 30

Prior U.S. Cl.: 46

United States Patent and Trademark Office

Reg. No. 3,481,477

Registered Aug. 5, 2008

**TRADEMARK
PRINCIPAL REGISTER**

WHOLEMATO

THE BLEVINS GROUP, LLC (NEW YORK LTD
LIAB CO)
319 LAFAYETTE STREET, SUITE 188
NEW YORK, NY 10012

THE MARK CONSISTS OF STANDARD CHAR-
ACTERS WITHOUT CLAIM TO ANY PARTICULAR
FONT, STYLE, SIZE, OR COLOR.

FOR: KETCHUP, IN CLASS 30 (U.S. CL. 46).

SN 77-132,781, FILED 3-16-2007.

FIRST USE 4-26-2007; IN COMMERCE 4-26-2007.

MATTHEW PAPPAS, EXAMINING ATTORNEY

Int. Cl.: 21

Prior U.S. Cls.: 2, 13, 23, 29, 30, 33, 40, and 50

United States Patent and Trademark Office

Reg. No. 3,481,478

Registered Aug. 5, 2008

**TRADEMARK
PRINCIPAL REGISTER**

CORSET

CONAIR CORPORATION (DELAWARE CORPORATION)
ONE CUMMINGS POINT ROAD
STAMFORD, CT 06902

FOR: HAIR BRUSHES; MAKE-UP BRUSHES;
COMBS; ELECTRIC HAIR COMBS; HAIR COMBS,
IN CLASS 21 (U.S. CLS. 2, 13, 23, 29, 30, 33, 40 AND 50).

FIRST USE 1-25-2007; IN COMMERCE 1-25-2007.

THE MARK CONSISTS OF STANDARD CHARACTERS WITHOUT CLAIM TO ANY PARTICULAR FONT, STYLE, SIZE, OR COLOR.

SN 77-132,800, FILED 3-16-2007.

BARBARA BROWN, EXAMINING ATTORNEY

Int. Cl.: 21

Prior U.S. Cls.: 2, 13, 23, 29, 30, 33, 40, and 50

United States Patent and Trademark Office

Reg. No. 3,481,479

Registered Aug. 5, 2008

**TRADEMARK
PRINCIPAL REGISTER**

HEAT WAVES

CONAIR CORPORATION (DELAWARE CORPORATION)
ONE CUMMINGS POINT ROAD
STAMFORD, CT 06902

FOR: COSMETIC BRUSHES; HAIR BRUSHES;
MAKE-UP BRUSHES; COMBS; ELECTRIC HAIR
COMBS; HAIR COMBS, IN CLASS 21 (U.S. CLS. 2,
13, 23, 29, 30, 33, 40 AND 50).

FIRST USE 1-25-2007; IN COMMERCE 1-25-2007.

THE MARK CONSISTS OF STANDARD CHARACTERS WITHOUT CLAIM TO ANY PARTICULAR FONT, STYLE, SIZE, OR COLOR.

SN 77-132,830, FILED 3-16-2007.

BARBARA BROWN, EXAMINING ATTORNEY

Int. Cl.: 21

Prior U.S. Cls.: 2, 13, 23, 29, 30, 33, 40, and 50

Reg. No. 3,481,480

United States Patent and Trademark Office

Registered Aug. 5, 2008

**TRADEMARK
PRINCIPAL REGISTER**

THE HEAT IS ON FOR A BRAND
NEW WAVE

CONAIR CORPORATION (DELAWARE COR-
PORATION)
ONE CUMMINGS POINT ROAD
STAMFORD, CT 06902

THE MARK CONSISTS OF STANDARD CHAR-
ACTERS WITHOUT CLAIM TO ANY PARTICULAR
FONT, STYLE, SIZE, OR COLOR.

FOR: COSMETIC BRUSHES; HAIR BRUSHES;
MAKE-UP BRUSHES; COMBS; ELECTRIC HAIR
COMBS; HAIR COMBS, IN CLASS 21 (U.S. CLS. 2,
13, 23, 29, 30, 33, 40 AND 50).

SN 77-132,838, FILED 3-16-2007.

FIRST USE 1-25-2007; IN COMMERCE 1-25-2007.

BARBARA BROWN, EXAMINING ATTORNEY

Int. Cl.: 3

Prior U.S. Cls.: 1, 4, 6, 50, 51, and 52

United States Patent and Trademark Office

Reg. No. 3,481,481

Registered Aug. 5, 2008

TRADEMARK
PRINCIPAL REGISTER



MAURICE RASGON, INC. (CALIFORNIA CORPORATION)
2308 ABBOTT KINNEY BOULEVARD
VENICE, CA 90291

FOR: SKIN CARE PRODUCTS, NAMELY, FACE AND BODY CLEANSER AND WASHES, TONER, FACE AND BODY LOTION AND GELS, FRUIT ACID BASED FACIAL PEELS, MASKS, EYE CREAM AND GELS, BEAUTY SERUM, IN CLASS 3 (U.S. CLS. 1, 4, 6, 50, 51 AND 52).

FIRST USE 1-1-1999; IN COMMERCE 1-1-1999.

OWNER OF U.S. REG. NO. 2,583,832.

NO CLAIM IS MADE TO THE EXCLUSIVE RIGHT TO USE "NATURAL BEAUTY", APART FROM THE MARK AS SHOWN.

THE MARK CONSISTS OF AN OVAL CONTAINING THE WORD "DOLL" ABOVE THE WORD "FACE" AND THE WORDS "NATURAL BEAUTY COCKTAILS" AND TWO STARS ON EITHER SIDE OF THE WORDS "DOLL FACE".

SN 77-133,009, FILED 3-16-2007.

ELISSA GARBER KON, EXAMINING ATTORNEY

Int. Cl.: 16

Prior U.S. Cls.: 2, 5, 22, 23, 29, 37, 38, and 50

Reg. No. 3,481,482

United States Patent and Trademark Office

Registered Aug. 5, 2008

**TRADEMARK
PRINCIPAL REGISTER**

ENVIRO-TAB

ALDINE INC. (NEW YORK CORPORATION)
150 VARICK STREET, 6TH FLOOR
NEW YORK, NY 10013

THE MARK CONSISTS OF STANDARD CHAR-
ACTERS WITHOUT CLAIM TO ANY PARTICULAR
FONT, STYLE, SIZE, OR COLOR.

FOR: REINFORCED STATIONERY TABS, IN
CLASS 16 (U.S. CLS. 2, 5, 22, 23, 29, 37, 38 AND 50).

SN 77-133,142, FILED 3-16-2007.

FIRST USE 4-20-2007; IN COMMERCE 4-20-2007.

NANCY CLARKE, EXAMINING ATTORNEY

Int. Cl.: 39

Prior U.S. Cls.: 100 and 105

United States Patent and Trademark Office

Reg. No. 3,481,483

Registered Aug. 5, 2008

**SERVICE MARK
PRINCIPAL REGISTER**

POWER PONY

IRON PONY MOTORCYCLE RENTAL, LLC
(OHIO LTD LIAB CO)
8567 TYLER BLVD.
MENTOR, OH 44060

THE MARK CONSISTS OF STANDARD CHAR-
ACTERS WITHOUT CLAIM TO ANY PARTICULAR
FONT, STYLE, SIZE, OR COLOR.

FOR: MOTORCYCLE RENTAL, IN CLASS 39 (U.S.
CLS. 100 AND 105).

SN 77-133,212, FILED 3-16-2007.

FIRST USE 4-0-2008; IN COMMERCE 4-0-2008.

MARLENE BELL, EXAMINING ATTORNEY

Int. Cl.: 43

Prior U.S. Cls.: 100 and 101

United States Patent and Trademark Office

Reg. No. 3,481,484

Registered Aug. 5, 2008

**SERVICE MARK
PRINCIPAL REGISTER**

**FRESHNESS...TASTE THE
DIFFERENCE**

CSSR HOLDINGS, LLC (UTAH LTD LIAB CO)
313 SOUTH 740 EAST
AMERICAN FORK, UT 84003

THE MARK CONSISTS OF STANDARD CHAR-
ACTERS WITHOUT CLAIM TO ANY PARTICULAR
FONT, STYLE, SIZE, OR COLOR.

FOR: RESTAURANT SERVICES, IN CLASS 43
(U.S. CLS. 100 AND 101).

SN 77-133,283, FILED 3-16-2007.

FIRST USE 5-1-2008; IN COMMERCE 5-1-2008.

ALLISON SCHRODY, EXAMINING ATTORNEY

Int. Cl.: 31

Prior U.S. Cls.: 1 and 46

United States Patent and Trademark Office

Reg. No. 3,481,485

Registered Aug. 5, 2008

**TRADEMARK
PRINCIPAL REGISTER**

TASTE THE REAL DIFFERENCE

SHUMAN PRODUCE, INC. (GEORGIA COR-
PORATION)
P.O. BOX 60
COBBTOWN, GA 30420

THE MARK CONSISTS OF STANDARD CHAR-
ACTERS WITHOUT CLAIM TO ANY PARTICULAR
FONT, STYLE, SIZE, OR COLOR.

FOR: FRESH ONIONS, IN CLASS 31 (U.S. CLS. 1
AND 46).

SN 77-133,420, FILED 3-16-2007.

FIRST USE 1-1-2006; IN COMMERCE 1-1-2006.

STEVEN PEREZ, EXAMINING ATTORNEY

Int. Cl.: 41

Prior U.S. Cls.: 100, 101, and 107

United States Patent and Trademark Office

Reg. No. 3,481,486

Registered Aug. 5, 2008

**SERVICE MARK
PRINCIPAL REGISTER**

BOARDFEST TRIPLE THREAT

BOARDOM, INC. (CALIFORNIA CORPORATION)
16541 GOTHARD ST., SUITE 210
HUNTINGTON BEACH, CA 92647

FOR: ORGANIZING COMPETITIONS, EXHIBITIONS, AND FESTIVALS IN THE FIELD OF SNOWBOARDING, SURFING, AND SKATEBOARDING, IN CLASS 41 (U.S. CLS. 100, 101 AND 107).

FIRST USE 4-2-2007; IN COMMERCE 4-2-2007.

THE MARK CONSISTS OF STANDARD CHARACTERS WITHOUT CLAIM TO ANY PARTICULAR FONT, STYLE, SIZE, OR COLOR.

OWNER OF U.S. REG. NO. 3,059,540.

SN 77-133,475, FILED 3-16-2007.

TRACY WHITTAKER-BROWN, EXAMINING ATTORNEY

Int. Cl.: 30

Prior U.S. Cl.: 46

United States Patent and Trademark Office

Reg. No. 3,481,487

Registered Aug. 5, 2008

**TRADEMARK
PRINCIPAL REGISTER**

Chocolate Pi

JUDSON JAY PATTERSON (UNITED STATES
INDIVIDUAL)

1211 WELLSTONE CIRCLE

APEX, NC 27502

FOR: CHOCOLATE CANDIES, IN CLASS 30 (U.S.
CL. 46).

FIRST USE 6-1-2007; IN COMMERCE 11-1-2007.

THE MARK CONSISTS OF STANDARD CHAR-
ACTERS WITHOUT CLAIM TO ANY PARTICULAR
FONT, STYLE, SIZE, OR COLOR.

NO CLAIM IS MADE TO THE EXCLUSIVE
RIGHT TO USE "CHOCOLATE", APART FROM
THE MARK AS SHOWN.

SN 77-133,684, FILED 3-17-2007.

KATHERINE CHANG, EXAMINING ATTORNEY

Int. Cl.: 16

Prior U.S. Cls.: 2, 5, 22, 23, 29, 37, 38, and 50

Reg. No. 3,481,488

United States Patent and Trademark Office

Registered Aug. 5, 2008

**TRADEMARK
PRINCIPAL REGISTER**

THE SANKEI SHIMBUN

SANKEI SHIMBUN CO., LTD. (JAPAN CORPORATION)
7-2, 1-CHOME, OHTEMACHI, CHIYODA-KU
TOKYO, JAPAN

FOR: NEWSPAPERS, IN CLASS 16 (U.S. CLS. 2, 5, 22, 23, 29, 37, 38 AND 50).

FIRST USE 9-0-1969; IN COMMERCE 9-0-1969.

THE MARK CONSISTS OF STANDARD CHARACTERS WITHOUT CLAIM TO ANY PARTICULAR FONT, STYLE, SIZE, OR COLOR.

NO CLAIM IS MADE TO THE EXCLUSIVE RIGHT TO USE "SHIMBUN", APART FROM THE MARK AS SHOWN.

THE FOREIGN WORDING IN THE MARK TRANSLATES INTO ENGLISH AS SANKEI NEWSPAPER. THE WORDING "SANKEI" HAS NO MEANING IN A FOREIGN LANGUAGE.

SN 77-133,860, FILED 3-18-2007.

INGRID C. EULIN, EXAMINING ATTORNEY

Int. Cl.: 9

Prior U.S. Cls.: 21, 23, 26, 36, and 38

Reg. No. 3,481,489

United States Patent and Trademark Office

Registered Aug. 5, 2008

**TRADEMARK
PRINCIPAL REGISTER**

MVCS

SABEUS, INC. (DELAWARE CORPORATION)
SUITE 100
26610 AGOURA ROAD
CALABASAS, CA 91302

FOR: OPTICAL COMPONENTS AND SUB-SYSTEMS FOR FIBER OPTIC NETWORKS AND SYSTEMS, NAMELY, NON-MICROPHONIC, LOW-PHASE NOISE SOURCE LASERS, AND TUNABLE DFB (DISTRIBUTED FEEDBACK) LASERS FOR VARIOUS APPLICATIONS, NAMELY, STRUCTURAL IMAGING, STRUCTURAL, MONITORING, METROPOLITAN AND LONG HAUL DWDM (DENSE WAVELENGTH DIVISION MULTIPLEXING) NETWORKS, TEST AND MEASUREMENT SYSTEMS, DWDM/EDFA (DENSE WAVELENGTH DIVISION

MULTIPLEXING/ERBIUM-DOPED FIBER AMPLIFIER), INTERFEROMETRIC INTERROGATION SYSTEMS, AND SYSTEMS THAT MONITOR ACOUSTIC PRESSURE WAVES, IN CLASS 9 (U.S. CLS. 21, 23, 26, 36 AND 38).

FIRST USE 4-30-2007; IN COMMERCE 4-30-2007.

THE MARK CONSISTS OF STANDARD CHARACTERS WITHOUT CLAIM TO ANY PARTICULAR FONT, STYLE, SIZE, OR COLOR.

SN 77-134,268, FILED 3-19-2007.

MARLENE BELL, EXAMINING ATTORNEY

Int. Cl.: 7

Prior U.S. Cls.: 13, 19, 21, 23, 31, 34, and 35

Reg. No. 3,481,490

United States Patent and Trademark Office

Registered Aug. 5, 2008

**TRADEMARK
PRINCIPAL REGISTER**

POWER ADVANTAGE

CONAIR CORPORATION (DELAWARE CORPORATION)
ONE CUMMINGS POINT ROAD
STAMFORD, CT 06902

THE MARK CONSISTS OF STANDARD CHARACTERS WITHOUT CLAIM TO ANY PARTICULAR FONT, STYLE, SIZE, OR COLOR.

FOR: KITCHEN MACHINES, NAMELY, ELECTRIC STANDING MIXERS, IN CLASS 7 (U.S. CLS. 13, 19, 21, 23, 31, 34 AND 35).

SN 77-134,411, FILED 3-19-2007.

FIRST USE 5-0-2007; IN COMMERCE 5-0-2007.

BARBARA BROWN, EXAMINING ATTORNEY

Int. Cl.: 12

Prior U.S. Cls.: 19, 21, 23, 31, 35, and 44

United States Patent and Trademark Office

Reg. No. 3,481,491

Registered Aug. 5, 2008

**TRADEMARK
PRINCIPAL REGISTER**

KICK 'N GO

BRAVO SPORTS (CALIFORNIA CORPORATION)
12801 CARMENITA ROAD
SANTA FE SPRINGS, CA 90670

THE MARK CONSISTS OF STANDARD CHAR-
ACTERS WITHOUT CLAIM TO ANY PARTICULAR
FONT, STYLE, SIZE, OR COLOR.

FOR: NON-MOTORIZED SCOOTERS, IN CLASS
12 (U.S. CLS. 19, 21, 23, 31, 35 AND 44).

SN 77-134,751, FILED 3-19-2007.

FIRST USE 2-1-2008; IN COMMERCE 2-1-2008.

APRIL ROACH, EXAMINING ATTORNEY

Int. Cl.: 28

Prior U.S. Cls.: 22, 23, 38, and 50

United States Patent and Trademark Office

Reg. No. 3,481,492

Registered Aug. 5, 2008

**TRADEMARK
PRINCIPAL REGISTER**

NiñaDelMar

PEDRO J. LASALDE (PUERTO RICO INDIVIDUAL)
URB EL CONVENTO B39
CALLE 2
SAN GERMAN, PUERTO RICO 00683

FOR: FISHING RODS; FISHING REELS; ARTIFICIAL FISHING LURES, IN CLASS 28 (U.S. CLS. 22, 23, 38 AND 50).

FIRST USE 4-1-2007; IN COMMERCE 10-1-2007.

THE MARK CONSISTS OF STANDARD CHARACTERS WITHOUT CLAIM TO ANY PARTICULAR FONT, STYLE, SIZE, OR COLOR.

THE ENGLISH TRANSLATION OF "NIÑA DEL MAR" IS "GIRL OF THE SEA".

SN 77-134,945, FILED 3-19-2007.

JILL PRATER, EXAMINING ATTORNEY

Int. Cl.: 36

Prior U.S. Cls.: 100, 101, and 102

United States Patent and Trademark Office

Reg. No. 3,481,493

Registered Aug. 5, 2008

**SERVICE MARK
PRINCIPAL REGISTER**

WRH+CO

W.R. HAMBRECHT + CO., INC. (DELAWARE CORPORATION)
PIER 1, BAY 3
SAN FRANCISCO, CA 94111

FOR: INVESTMENT BANKING SERVICES; FINANCIAL SERVICES IN THE NATURE OF UNDERWRITING, DISTRIBUTION AND TRADING OF SECURITIES FOR OTHERS; SECURITIES BROKERAGE SERVICES; INVESTMENT RESEARCH SERVICES; INVESTMENT MANAGEMENT AND ADVICE; FINANCIAL SERVICES IN THE NATURE OF TRADING OPTIONS FOR OTHERS; MUTUAL FUND BROKERAGE, DISTRIBUTION AND INVESTMENT; DERIVATIVE SECURITIES INVESTMENT; FINANCIAL PLANNING SERVICES; BANKING SERVICES; VENTURE CAPITAL FUNDING SERVICES; PROVIDING FINANCIAL NEWS AND INFORMATION VIA A GLOBAL COMMUNICATIONS NETWORK; FINANCIAL SERVICES IN

THE NATURE OF MERGER, ACQUISITION, AND RESTRUCTURING; PROVIDING FINANCIAL SERVICES VIA A GLOBAL COMMUNICATIONS NETWORK, NAMELY, UNDERWRITING, DISTRIBUTION AND TRADING OF SECURITIES FOR OTHERS, SECURITIES BROKERAGE, INVESTMENT RESEARCH, INVESTMENT MANAGEMENT AND ADVICE, TRADING OPTIONS FOR OTHERS, IN CLASS 36 (U.S. CLS. 100, 101 AND 102).

FIRST USE 9-0-1999; IN COMMERCE 9-0-1999.

THE MARK CONSISTS OF STANDARD CHARACTERS WITHOUT CLAIM TO ANY PARTICULAR FONT, STYLE, SIZE, OR COLOR.

SN 77-135,009, FILED 3-20-2007.

MELVIN AXILBUND, EXAMINING ATTORNEY

Int. Cl.: 9

Prior U.S. Cls.: 21, 23, 26, 36, and 38

Reg. No. 3,481,494

United States Patent and Trademark Office

Registered Aug. 5, 2008

**TRADEMARK
PRINCIPAL REGISTER**

Q-SECURE

W2BI, INC. (NEW JERSEY CORPORATION)
3RD FLOOR
2401 MORRIS AVENUE
UNION, NJ 07083

FOR: COMPUTER SOFTWARE FOR DEVICE MANAGEMENT OF MOBILE TELEPHONES AND SMART DEVICES, NAMELY, POCKET PERSONAL COMPUTERS, PERSONAL DIGITAL ASSISTANTS, HANDHELD ELECTRONIC WIRELESS COMMUNICATION DEVICES, TABLET PERSONAL COMPUTERS, MP3 PLAYERS, MULTI-FUNCTION ELECTRONIC WIRELESS DIGITAL DEVICES FOR MANAGING, PLAYING AND RECORDING AUDIO, TEXT, AND DATA FILES, AND PERSONAL MESSAGING DEVICES; FOR THE REGISTERING OF USERS; CONFIGURING COMPANY AND USER PROFILES; ISSUING LICENSES TO COMPANIES AND USERS; ORGANIZING DEVICES INTO GROUPS AND DEPLOYING COMMON SOFTWARE APPLICATIONS, CONFIGURATIONS AND SET-

TINGS; SOFTWARE FOR DEVICE ASSET MANAGEMENT, VIEWING DEVICE ASSETS, AND VIEWING DEVICE FILES; SOFTWARE FOR REMOTE LAUNCHING OF COMMANDS ON THE SPECIFIED DEVICES; SOFTWARE FOR GENERATION OF OPERATIONAL REPORTS FOR SPECIFIED DEVICES; SOFTWARE FOR TRACKING DEVICES, LOCKING SELECTED DEVICES, AND DISABLING OR RESETTING SELECTED DEVICES, IN CLASS 9 (U.S. CLS. 21, 23, 26, 36 AND 38).

FIRST USE 3-26-2007; IN COMMERCE 3-26-2007.

THE MARK CONSISTS OF STANDARD CHARACTERS WITHOUT CLAIM TO ANY PARTICULAR FONT, STYLE, SIZE, OR COLOR.

SN 77-135,429, FILED 3-20-2007.

ESTHER BELENKER, EXAMINING ATTORNEY

Int. Cls.: 9 and 16

Prior U.S. Cls.: 2, 5, 21, 22, 23, 26, 29, 36, 37, 38, and 50

United States Patent and Trademark Office

Reg. No. 3,481,495

Registered Aug. 5, 2008

**TRADEMARK
PRINCIPAL REGISTER**

AT YOUR SERVICE

NEXSTAR, INC. (WISCONSIN CORPORATION)
125 LITTLE CANADA ROAD WEST
SUITE 200
LITTLE CANADA, MN 55117

FOR: DOWNLOADABLE ELECTRONIC NEWSLETTERS RELATING TO SERVICE PROVIDERS IN THE PLUMBING, ELECTRICAL, HEATING, VENTILATING, AND AIR CONDITIONING INDUSTRIES, IN CLASS 9 (U.S. CLS. 21, 23, 26, 36 AND 38).

FIRST USE 5-30-2002; IN COMMERCE 5-30-2002.

FOR: PRINTED NEWSLETTERS RELATING TO SERVICE PROVIDERS IN THE PLUMBING, ELEC-

TRICAL, HEATING, VENTILATING, AND AIR CONDITIONING INDUSTRIES, IN CLASS 16 (U.S. CLS. 2, 5, 22, 23, 29, 37, 38 AND 50).

FIRST USE 5-30-2002; IN COMMERCE 5-30-2002.

THE MARK CONSISTS OF STANDARD CHARACTERS WITHOUT CLAIM TO ANY PARTICULAR FONT, STYLE, SIZE, OR COLOR.

SN 77-135,481, FILED 3-20-2007.

JILL PRATER, EXAMINING ATTORNEY

Int. Cl.: 7

Prior U.S. Cls.: 13, 19, 21, 23, 31, 34, and 35

Reg. No. 3,481,496

United States Patent and Trademark Office

Registered Aug. 5, 2008

**TRADEMARK
PRINCIPAL REGISTER**

LP PLUS

GENERAL ELECTRIC COMPANY (NEW YORK CORPORATION)
1 RIVER ROAD
SCHENECTADY, NY 12345

FOR: STEAM TURBINE COMPONENTS, NAME-
LY, ROTORS, DIAPHRAGMS AND INNER SHELLS,
IN CLASS 7 (U.S. CLS. 13, 19, 21, 23, 31, 34 AND 35).

FIRST USE 4-30-2005; IN COMMERCE 4-30-2005.

THE MARK CONSISTS OF STANDARD CHAR-
ACTERS WITHOUT CLAIM TO ANY PARTICULAR
FONT, STYLE, SIZE, OR COLOR.

NO CLAIM IS MADE TO THE EXCLUSIVE
RIGHT TO USE "LP", APART FROM THE MARK
AS SHOWN.

SN 77-135,493, FILED 3-20-2007.

CARRIE GENOVESE, EXAMINING ATTORNEY

Int. Cl.: 28

Prior U.S. Cls.: 22, 23, 38, and 50

United States Patent and Trademark Office

Reg. No. 3,481,497

Registered Aug. 5, 2008

**TRADEMARK
PRINCIPAL REGISTER**

FEATHERED FUN

KAYTEE PRODUCTS INCORPORATED (WIS-
CONSIN CORPORATION)
P.O. BOX 230
CHILTON, WI 53014

THE MARK CONSISTS OF STANDARD CHAR-
ACTERS WITHOUT CLAIM TO ANY PARTICULAR
FONT, STYLE, SIZE, OR COLOR.

FOR: PET TOYS, NAMELY, PET BIRD ACTIVITY
CENTERS AND PET BIRD TOYS, IN CLASS 28 (U.S.
CLS. 22, 23, 38 AND 50).

SN 77-135,578, FILED 3-20-2007.

FIRST USE 3-1-2008; IN COMMERCE 3-1-2008.

TINA BROWN, EXAMINING ATTORNEY

Int. Cl.: 21

Prior U.S. Cls.: 2, 13, 23, 29, 30, 33, 40, and 50

United States Patent and Trademark Office

Reg. No. 3,481,498

Registered Aug. 5, 2008

**TRADEMARK
PRINCIPAL REGISTER**

Cérene

TAI-PAN TRADING INTERNATIONAL, INC.
(UTAH CORPORATION)
555 WEST 9000 SOUTH
SANDY, UT 84070

FOR: DINNERWARE, FOOD PREPARATION
AND SERVING DISHES AND VESSELS, AND BEV-
ERAGE SERVING VESSELS, ALL MADE FROM
CERAMICS, IN CLASS 21 (U.S. CLS. 2, 13, 23, 29, 30,
33, 40 AND 50).

FIRST USE 8-0-2007; IN COMMERCE 8-0-2007.

THE MARK CONSISTS OF STANDARD CHAR-
ACTERS WITHOUT CLAIM TO ANY PARTICULAR
FONT, STYLE, SIZE, OR COLOR.

SN 77-135,906, FILED 3-20-2007.

CHERYL CLAYTON, EXAMINING ATTORNEY

Int. Cl.: 41

Prior U.S. Cls.: 100, 101, and 107

United States Patent and Trademark Office

Reg. No. 3,481,499

Registered Aug. 5, 2008

**SERVICE MARK
PRINCIPAL REGISTER**



BOUNCING BRAIN PRODUCTIONS, LLC
(NORTH CAROLINA LTD LIAB CO)
SUITE 200
520 ELLIOT STREET
CHARLOTTE, NC 28202

THE MARK CONSISTS OF A DEPICTION OF A HUMAN BRAIN AS VIEWED FROM ABOVE. THE BRAIN IMAGE IS TRAILED BY A DOTTED LINE IN A "V" TRAJECTORY STEMMING FROM THE BOTTOM OF THE IMAGE.

FOR: TELEVISION SHOW PRODUCTION, IN CLASS 41 (U.S. CLS. 100, 101 AND 107).

SN 77-135,908, FILED 3-20-2007.

FIRST USE 6-11-2008; IN COMMERCE 6-11-2008.

ANDREA BUTLER, EXAMINING ATTORNEY

Int. Cl.: 35

Prior U.S. Cls.: 100, 101, and 102

United States Patent and Trademark Office

Reg. No. 3,481,500

Registered Aug. 5, 2008

**SERVICE MARK
PRINCIPAL REGISTER**

FOCUS IS EVERYTHING

THE OUTSOURCING PARTNERSHIP, LLC D/B/A
ACCUME PARTNERS LLC (DELAWARE LTD
LIAB CO)
341 NEW ALBANY ROAD
MOORESTOWN, NJ 08057

THE MARK CONSISTS OF STANDARD CHAR-
ACTERS WITHOUT CLAIM TO ANY PARTICULAR
FONT, STYLE, SIZE, OR COLOR.

FOR: BUSINESS AUDITING, IN CLASS 35 (U.S.
CLS. 100, 101 AND 102).

SN 77-136,189, FILED 3-21-2007.

FIRST USE 10-7-2007; IN COMMERCE 10-7-2007.

JEAN IM, EXAMINING ATTORNEY

Int. Cls.: 35 and 36

Prior U.S. Cls.: 100, 101, and 102

United States Patent and Trademark Office

Reg. No. 3,481,501

Registered Aug. 5, 2008

**SERVICE MARK
PRINCIPAL REGISTER**



Jeanie

FIFTH THIRD BANCORP (OHIO CORPORATION)
38 FOUNTAIN SQUARE PLAZA
CINCINNATI, OH 45263

FOR: OPERATION AND MANAGEMENT OF TELEPHONE CALL CENTERS FOR OTHERS; BANKING SERVICES, NAMELY, ELECTRONIC SIGNATURE VERIFICATION SERVICES PROVIDED IN CONNECTION WITH BANKING SERVICES; BANKING SERVICES, NAMELY, FACILITATING GROUP PURCHASE OF BANKING SERVICES, IN CLASS 35 (U.S. CLS. 100, 101 AND 102).

FIRST USE 1-0-2007; IN COMMERCE 1-0-2007.

FOR: FINANCIAL PAYMENT NETWORK SERVICES, NAMELY, FINANCIAL TRANSACTION SERVICES, NAMELY, PROVIDING SECURE COMMERCIAL TRANSACTIONS AND PAYMENT OPTIONS VIA A COMPUTER NETWORK; FINANCIAL PAYMENT NETWORK SERVICES, NAMELY, PROVIDING BILL PAYMENT SERVICES; FINANCIAL PAYMENT NETWORK SERVICES, NAMELY, ELECTRONIC PROCESSING AND TRANSMISSION OF BILL PAYMENT DATA; CREDIT CARD SERVICES; DEBIT CARD SERVICES; ATM AND POINT OF SALE SERVICES, NAMELY, PROVIDING SECURE COMMERCIAL TRANSACTIONS AND PAYMENT

OPTIONS USING A MOBILE DEVICE AT A POINT OF SALE AND ATM; ATM SERVICES, NAMELY, CASH REPLENISHMENT OF ATM MACHINES; AND BANKING SERVICES, NAMELY, INVESTMENT BANKING SERVICES; BANKING SERVICES, NAMELY, MORTGAGE BANKING, AND IN PARTICULAR, ORIGINATION, ACQUISITION, SERVICING, SECURITIZATION, AND BROKERAGE OF MORTGAGE LOANS; BANKING SERVICES, NAMELY, ON-LINE BANKING SERVICES, IN CLASS 36 (U.S. CLS. 100, 101 AND 102).

FIRST USE 1-0-2007; IN COMMERCE 1-0-2007.

OWNER OF U.S. REG. NOS. 1,120,703 AND 1,712,167.

THE NAME(S), PORTRAIT(S), AND/OR SIGNATURE(S) SHOWN IN THE MARK DOES NOT IDENTIFY A PARTICULAR LIVING INDIVIDUAL.

THE MARK CONSISTS OF THE WORD "JEANIE" WITH A STARBURST DESIGN OVER THE "I".

SN 77-136,201, FILED 3-21-2007.

DAWN FELDMAN, EXAMINING ATTORNEY

Int. Cl.: 43

Prior U.S. Cls.: 100 and 101

United States Patent and Trademark Office

Reg. No. 3,481,502

Registered Aug. 5, 2008

**SERVICE MARK
PRINCIPAL REGISTER**

BLUE JEWEL

MARRIOTT INTERNATIONAL, INC. (DELA-
WARE CORPORATION)
10400 FERNWOOD ROAD
BETHESDA, MD 20817

FOR: COCKTAIL LOUNGES; RESTAURANT
AND BAR SERVICES, IN CLASS 43 (U.S. CLS. 100
AND 101).

FIRST USE 7-0-2007; IN COMMERCE 7-0-2007.

THE MARK CONSISTS OF STANDARD CHAR-
ACTERS WITHOUT CLAIM TO ANY PARTICULAR
FONT, STYLE, SIZE, OR COLOR.

SN 77-136,223, FILED 3-21-2007.

CAROLYN CATALDO, EXAMINING ATTORNEY

Int. Cl.: 36

Prior U.S. Cls.: 100, 101, and 102

United States Patent and Trademark Office

Reg. No. 3,481,503

Registered Aug. 5, 2008

**SERVICE MARK
PRINCIPAL REGISTER**

PEOPLE ARE SMART

GMAC LLC (DELAWARE LTD LIAB CO)
PO BOX 200
200 RENAISSANCE CENTER
DETROIT, MI 482652000

FOR: MORTGAGE BANKING SERVICES, NAME-
LY, ORGINATION, ACQUISITION, SERVICING, SE-
CURITIZATION, AND BROKERAGE OF
MORTGAGE LOANS, IN CLASS 36 (U.S. CLS. 100,
101 AND 102).

FIRST USE 5-21-2008; IN COMMERCE 5-21-2008.

THE MARK CONSISTS OF STANDARD CHAR-
ACTERS WITHOUT CLAIM TO ANY PARTICULAR
FONT, STYLE, SIZE, OR COLOR.

SN 77-136,814, FILED 3-21-2007.

JULIE GUTTADAURO, EXAMINING ATTORNEY

Int. Cl.: 25

Prior U.S. Cls.: 22 and 39

United States Patent and Trademark Office

Reg. No. 3,481,504

Registered Aug. 5, 2008

**TRADEMARK
PRINCIPAL REGISTER**



NORTH AMERICAN POLO LEAGUE, LLC (DE-
LAWARE LTD LIAB CO)
109 NORTH POST OAK LANE
HOUSTON, TX 77024

FOR: BELTS; GOLF SHIRTS; PAJAMAS; SHIRTS;
T-SHIRTS; JACKETS; PANTS; FOOTWEAR;
SHORTS; SOCKS; SWEAT PANTS; SWEAT SHIRTS;
SWEAT SHORTS; SWEATERS; TIES; SCARVES;
VESTS; SUSPENDERS; GLOVES; HEADGEAR,
NAMELY, CAPS; HATS; HEADBANDS, IN CLASS
25 (U.S. CLS. 22 AND 39).

FIRST USE 3-9-2007; IN COMMERCE 3-9-2007.

NO CLAIM IS MADE TO THE EXCLUSIVE
RIGHT TO USE "NORTH AMERICAN", APART
FROM THE MARK AS SHOWN.

THE MARK CONSISTS OF THE LETTERS
"NAPL" AND THE WORDS "NORTH AMERICAN
POLO LEAGUE" WITH DESIGN CONSISTING OF A
POLO PLAYER ON HORSE.

SN 77-136,991, FILED 3-21-2007.

ANGELA M. MICHELI, EXAMINING ATTORNEY

Int. Cl.: 3

Prior U.S. Cls.: 1, 4, 6, 50, 51, and 52

United States Patent and Trademark Office

Reg. No. 3,481,505

Registered Aug. 5, 2008

**TRADEMARK
PRINCIPAL REGISTER**

FLASH BRILLIANCE

LAURENT D PRODUCT, INC. D/B/A PRIVE
PRODUCTS (CALIFORNIA CORPORATION)
SUITE 100
7250 BEVERLY BLVD
LOS ANGELES, CA 90036

THE MARK CONSISTS OF STANDARD CHAR-
ACTERS WITHOUT CLAIM TO ANY PARTICULAR
FONT, STYLE, SIZE, OR COLOR.

FOR: HAIR STYLING PREPARATIONS TO IM-
PART SHINE TO THE HAIR, IN CLASS 3 (U.S. CLS. 1,
4, 6, 50, 51 AND 52).

SN 77-137,097, FILED 3-21-2007.

FIRST USE 8-1-2007; IN COMMERCE 8-1-2007.

BRIAN CALLAGHAN, EXAMINING ATTORNEY

Int. Cl.: 25

Prior U.S. Cls.: 22 and 39

United States Patent and Trademark Office

Reg. No. 3,481,506

Registered Aug. 5, 2008

**TRADEMARK
PRINCIPAL REGISTER**



SHANTOU SAYONA FOOTWEAR CO., LTD.
(CHINA CORPORATION)
9/F SHANRONG BUILDING
NO. 116 JINSHA ROAD
SHANTOU, CHINA

FOR: THONGS; FLIP FLOPS; FOOTWEAR FOR
MEN; FOOTWEAR FOR MEN AND WOMEN;
FOOTWEAR FOR WOMEN, IN CLASS 25 (U.S. CLS.
22 AND 39).

FIRST USE 3-15-2004; IN COMMERCE 1-1-2008.

THE COLOR(S) BROWN AND BLACK IS/ARE
CLAIMED AS A FEATURE OF THE MARK.

THE COLOR BROWN APPEARS IN A RECTAN-
GLE AND IN A SERIES OF FANNED-OUT SHOE
SOLES. WITHIN THE BROWN RECTANGLE, THE
TEXT "SAYONA" APPEARS IN BLACK. WHITE
APPEARS IN THE DRAWING TO INDICATE A
TRANSPARENT BACKGROUND.

SN 77-137,267, FILED 3-22-2007.

REBECCA EISINGER, EXAMINING ATTORNEY

Int. Cl.: 16

Prior U.S. Cls.: 2, 5, 22, 23, 29, 37, 38, and 50

Reg. No. 3,481,507

United States Patent and Trademark Office

Registered Aug. 5, 2008

**TRADEMARK
PRINCIPAL REGISTER**

WEREWOLF BY NIGHT

MARVEL CHARACTERS, INC. (DELAWARE
CORPORATION)
9242 BEVERLY BLVD. SUITE 350
BEVERLY HILLS, CA 90210

FOR: PUBLICATIONS, NAMELY, COMIC BOOKS
AND COMIC MAGAZINES AND PRINTED STOR-
IES IN ILLUSTRATED FORM FEATURED IN
BOOKS AND MAGAZINES , IN CLASS 16 (U.S.
CLS. 2, 5, 22, 23, 29, 37, 38 AND 50).

FIRST USE 10-31-2005; IN COMMERCE 10-31-2005.

THE MARK CONSISTS OF STANDARD CHAR-
ACTERS WITHOUT CLAIM TO ANY PARTICULAR
FONT, STYLE, SIZE, OR COLOR.

SN 77-137,294, FILED 3-22-2007.

JUSTINE D. PARKER, EXAMINING ATTORNEY

Int. Cl.: 9

Prior U.S. Cls.: 21, 23, 26, 36, and 38

Reg. No. 3,481,508

United States Patent and Trademark Office

Registered Aug. 5, 2008

**TRADEMARK
PRINCIPAL REGISTER**

ITEST

THE FANFARE GROUP, INC. (DELAWARE CORPORATION)
SUITE 100
1091 N. SHORELINE BOULEVARD
MOUNTAIN VIEW, CA 94043

FOR: COMPUTER SOFTWARE FOR SYSTEMS VERIFICATION TESTING; COMPUTER SOFTWARE FOR TESTING AND ANALYZING THE PERFORMANCE AND INTEGRITY OF DEVICES AND PRODUCT FEATURES IN THE FIELD OF PRODUCT AND/OR SYSTEMS DESIGN, THE FIELD OF PRODUCT QUALITY ASSURANCE, AND THE FIELD OF PRODUCT AND/OR SYSTEMS TESTING; COMPUTER SOFTWARE FOR PRODUCT, DEVICE, AND/OR SYSTEM DESIGN MODELING AND TESTING; COMPUTER SOFTWARE

FOR USE IN DEVICE, PRODUCT AND/OR SYSTEM TEST PLANNING, TEST CASE DESIGN, TEST EXECUTION, TEST AUTOMATION, DEFECT ANALYSIS AND DOCUMENTATION, AND TEST RESULT TRACKING AND REPORTING, IN CLASS 9 (U.S. CLS. 21, 23, 26, 36 AND 38).

FIRST USE 7-11-2007; IN COMMERCE 7-11-2007.

THE MARK CONSISTS OF STANDARD CHARACTERS WITHOUT CLAIM TO ANY PARTICULAR FONT, STYLE, SIZE, OR COLOR.

SN 77-137,654, FILED 3-22-2007.

AHSEN KHAN, EXAMINING ATTORNEY

Int. Cl.: 45

Prior U.S. Cls.: 100 and 101

United States Patent and Trademark Office

Reg. No. 3,481,509

Registered Aug. 5, 2008

**SERVICE MARK
PRINCIPAL REGISTER**

FORCESIGHT

BISHOP ROCK SOFTWARE LLC (DELAWARE
LTD LIAB CO)
25424 MORNINGSTAR ROAD
LAKE FOREST, CA 92630

FOR: COMPUTER SERVICES, NAMELY, PROVIDING INTERACTIVE COMPUTERIZED INFORMATION BY MEANS OF A GLOBAL COMPUTER INFORMATION NETWORK TO AID IN THE DEPLOYMENT OF LAW ENFORCEMENT RESOURCES, IN CLASS 45 (U.S. CLS. 100 AND 101).

FIRST USE 3-15-2007; IN COMMERCE 4-1-2007.

THE MARK CONSISTS OF STANDARD CHARACTERS WITHOUT CLAIM TO ANY PARTICULAR FONT, STYLE, SIZE, OR COLOR.

SN 77-137,822, FILED 3-22-2007.

RUDY R. SINGLETON, EXAMINING ATTORNEY

Int. Cl.: 5

Prior U.S. Cls.: 6, 18, 44, 46, 51, and 52

Reg. No. 3,481,510

United States Patent and Trademark Office

Registered Aug. 5, 2008

**TRADEMARK
PRINCIPAL REGISTER**

MULTIFORCE

BIOFORCE SOUTH AFRICA (PROPRIETARY)
LIMITED (SOUTH AFRICA CORPORATION)
HALFWAY HOUSE
BIOFORCE HOUSE, 16TH ROAD
MIDRAND, GAUTENG, SOUTH AFRICA

FOR: SUPPLEMENT IN THE FORM OF A MI-
NERAL ALKALINE POWDER THAT CONTROLS/
BALANCES THE ACIDITY LEVEL IN ALL BODY
FLUIDS, IN CLASS 5 (U.S. CLS. 6, 18, 44, 46, 51 AND
52).

FIRST USE 8-10-2007; IN COMMERCE 8-10-2007.

THE MARK CONSISTS OF STANDARD CHAR-
ACTERS WITHOUT CLAIM TO ANY PARTICULAR
FONT, STYLE, SIZE, OR COLOR.

SN 77-137,831, FILED 3-22-2007.

WILLIAM P. SHANAHAN, EXAMINING ATTOR-
NEY

Int. Cl.: 11

Prior U.S. Cls.: 13, 21, 23, 31, and 34

United States Patent and Trademark Office

Reg. No. 3,481,511

Registered Aug. 5, 2008

**TRADEMARK
PRINCIPAL REGISTER**



FENIX

FENTON ENVIRONMENTAL TECHNOLOGIES,
INC. (LOUISIANA CORPORATION)
228 ST. CHARLES AVENUE, SUITE 1323
NEW ORLEANS, LA 70130

THE MARK CONSISTS OF THE HEAD AND
WING OF A BIRD ABOVE THE WORD FENIX.

FOR: MUNICIPAL AND INDUSTRIAL WASTE
DEHYDRATORS, IN CLASS 11 (U.S. CLS. 13, 21, 23,
31 AND 34).

SN 77-137,916, FILED 3-22-2007.

FIRST USE 5-5-2008; IN COMMERCE 5-5-2008.

CHERYL CLAYTON, EXAMINING ATTORNEY

Int. Cl.: 17

Prior U.S. Cls.: 1, 5, 12, 13, 35, and 50

Reg. No. 3,481,512

United States Patent and Trademark Office

Registered Aug. 5, 2008

**TRADEMARK
PRINCIPAL REGISTER**

ZERO

PAWLING CORPORATION (DELAWARE CORPORATION)
157 CHARLES COLEMAN BOULEVARD
PAWLING, NY 125941188

THE MARK CONSISTS OF STANDARD CHARACTERS WITHOUT CLAIM TO ANY PARTICULAR FONT, STYLE, SIZE, OR COLOR.

FOR: NON-METAL SEALS FOR USE IN SEALING INJECTION PORTS OF GAS CHROMATOGRAPHS, IN CLASS 17 (U.S. CLS. 1, 5, 12, 13, 35 AND 50).

SN 77-137,970, FILED 3-22-2007.

FIRST USE 9-17-2007; IN COMMERCE 9-17-2007.

KELLY MCCOY, EXAMINING ATTORNEY

Int. Cl.: 28

Prior U.S. Cls.: 22, 23, 38, and 50

United States Patent and Trademark Office

Reg. No. 3,481,513

Registered Aug. 5, 2008

**TRADEMARK
PRINCIPAL REGISTER**

BLESS ME BEAR

CHARISMA SALES, INC. (FLORIDA CORPORATION)

4417 13TH STREET #178

SAINT CLOUD, FL 34769

FOR: STUFFED TOY BEARS, IN CLASS 28 (U.S. CLS. 22, 23, 38 AND 50).

FIRST USE 3-1-2007; IN COMMERCE 3-1-2007.

THE MARK CONSISTS OF STANDARD CHARACTERS WITHOUT CLAIM TO ANY PARTICULAR FONT, STYLE, SIZE, OR COLOR.

NO CLAIM IS MADE TO THE EXCLUSIVE RIGHT TO USE "BEAR", APART FROM THE MARK AS SHOWN.

SN 77-138,414, FILED 3-23-2007.

NANCY CLARKE, EXAMINING ATTORNEY

Int. Cl.: 25

Prior U.S. Cls.: 22 and 39

United States Patent and Trademark Office

Reg. No. 3,481,514

Registered Aug. 5, 2008

**TRADEMARK
PRINCIPAL REGISTER**

**APPLYING THE SCIENCE OF
ERGONOMICS TO FOOTWEAR**

JOHNSON TECHNOLOGIES CORPORATION
(TENNESSEE CORPORATION)
2034 PITTSWAY DRIVE
NASHVILLE, TN 37207

FOR: FOOTWEAR; SHOES; SHOE INSERTS FOR
PRIMARILY NON-ORTHOPEDIC PURPOSES; IN-
SOLES FOR SHOES AND BOOTS, IN CLASS 25 (U.S.
CLS. 22 AND 39).

FIRST USE 3-0-2007; IN COMMERCE 3-0-2007.

THE MARK CONSISTS OF STANDARD CHAR-
ACTERS WITHOUT CLAIM TO ANY PARTICULAR
FONT, STYLE, SIZE, OR COLOR.

SN 77-138,430, FILED 3-23-2007.

CHRISTOPHER BUONGIORNO, EXAMINING AT-
TORNEY

Int. Cls.: 2 and 9

Prior U.S. Cls.: 6, 11, 16, 21, 23, 26, 36, and 38

United States Patent and Trademark Office

Reg. No. 3,481,515

Registered Aug. 5, 2008

**TRADEMARK
PRINCIPAL REGISTER**

COLD FUSION TECHNOLOGY

SAFETGARD SPORT OPTICS, LLC (COLORADO
LTD LIAB CO)
12105 W. CEDAR DRIVE
LAKEWOOD, CO 80228

FOR: OPTICAL LENS COATING TO ENHANCE
THE LIGHT GATHERING CAPABILITY OF SPORT
OPTIC LENSES, IN CLASS 2 (U.S. CLS. 6, 11 AND 16).

FIRST USE 1-31-2007; IN COMMERCE 1-31-2007.

FOR: SPORT OPTICS EQUIPMENT, NAMELY,
BINOCULARS, HUNTING BINOCULARS, GUN
SCOPES, PISTOL SCOPES, RIFLE SCOPES, AND
SPOTTING SCOPES INCORPORATING SPECIA-
LIZED LENS COATING AND APPLICATION TO
ENHANCE THE LIGHT GATHERING CAPABILITY

OF THE EQUIPMENT, IN CLASS 9 (U.S. CLS. 21, 23,
26, 36 AND 38).

FIRST USE 1-31-2007; IN COMMERCE 1-31-2007.

THE MARK CONSISTS OF STANDARD CHAR-
ACTERS WITHOUT CLAIM TO ANY PARTICULAR
FONT, STYLE, SIZE, OR COLOR.

NO CLAIM IS MADE TO THE EXCLUSIVE
RIGHT TO USE "TECHNOLOGY", APART FROM
THE MARK AS SHOWN.

SN 77-138,484, FILED 3-23-2007.

DOMINIC FATHY, EXAMINING ATTORNEY

Int. Cls.: 2 and 9

Prior U.S. Cls.: 6, 11, 16, 21, 23, 26, 36, and 38

United States Patent and Trademark Office

Reg. No. 3,481,516

Registered Aug. 5, 2008

**TRADEMARK
PRINCIPAL REGISTER**

CFT

SAFETGARD SPORT OPTICS, LLC (COLORADO
LTD LIAB CO)
12105 W. CEDAR DRIVE
LAKEWOOD, CO 80228

FOR: OPTICAL LENS COATING TO ENHANCE
THE LIGHT GATHERING CAPABILITY OF SPORT
OPTIC LENSES, IN CLASS 2 (U.S. CLS. 6, 11 AND 16).

FIRST USE 1-31-2007; IN COMMERCE 1-31-2007.

FOR: SPORT OPTICS EQUIPMENT, NAMELY,
BINOCULARS, HUNTING BINOCULARS, GUN
SCOPES, PISTOL SCOPES, RIFLE SCOPES, AND
SPOTTING SCOPES INCORPORATING SPECIA-

LIZED LENS COATING AND APPLICATION TO
ENHANCE THE LIGHT GATHERING CAPABILITY
OF THE EQUIPMENT, IN CLASS 9 (U.S. CLS. 21, 23,
26, 36 AND 38).

FIRST USE 1-31-2007; IN COMMERCE 1-31-2007.

THE MARK CONSISTS OF STANDARD CHAR-
ACTERS WITHOUT CLAIM TO ANY PARTICULAR
FONT, STYLE, SIZE, OR COLOR.

SN 77-138,497, FILED 3-23-2007.

DOMINIC FATHY, EXAMINING ATTORNEY

Int. Cls.: 1 and 5

Prior U.S. Cls.: 1, 5, 6, 10, 18, 26, 44, 46, 51, and 52

United States Patent and Trademark Office

Reg. No. 3,481,517

Registered Aug. 5, 2008

**TRADEMARK
PRINCIPAL REGISTER**

TurboFectin

ORIGENE TECHNOLOGIES, INC. (MARYLAND CORPORATION)
SUITE 100
6 TAFT COURT
ROCKVILLE, MD 20850

FOR: REAGENTS FOR SCIENTIFIC OR MEDICAL RESEARCH USE, IN CLASS 1 (U.S. CLS. 1, 5, 6, 10, 26 AND 46).

FIRST USE 4-1-2007; IN COMMERCE 4-1-2007.

FOR: BIOLOGICAL AND CHEMICAL PREPARATIONS AND REAGENTS FOR MEDICAL OR VE-

TERINARY USE, IN CLASS 5 (U.S. CLS. 6, 18, 44, 46, 51 AND 52).

FIRST USE 4-1-2007; IN COMMERCE 4-1-2007.

THE MARK CONSISTS OF STANDARD CHARACTERS WITHOUT CLAIM TO ANY PARTICULAR FONT, STYLE, SIZE, OR COLOR.

SN 77-138,541, FILED 3-23-2007.

WILLIAM VERHOSEK, EXAMINING ATTORNEY

Int. Cl.: 36

Prior U.S. Cls.: 100, 101, and 102

United States Patent and Trademark Office

Reg. No. 3,481,518

Registered Aug. 5, 2008

**SERVICE MARK
PRINCIPAL REGISTER**

HOSPITALITYCARE

PLANNED ADMINISTRATORS, INC. (SOUTH
CAROLINA CORPORATION)
1-20 AT ALPINE ROAD
COLUMBIA, SC 29219

THE MARK CONSISTS OF STANDARD CHAR-
ACTERS WITHOUT CLAIM TO ANY PARTICULAR
FONT, STYLE, SIZE, OR COLOR.

FOR: INSURANCE UNDERWRITING IN THE
FIELD OF HEALTH, IN CLASS 36 (U.S. CLS. 100,
101 AND 102).

SN 77-138,751, FILED 3-23-2007.

FIRST USE 1-1-2007; IN COMMERCE 1-1-2007.

REBECCA SMITH, EXAMINING ATTORNEY

Int. Cl.: 28

Prior U.S. Cls.: 22, 23, 38, and 50

United States Patent and Trademark Office

Reg. No. 3,481,519

Registered Aug. 5, 2008

**TRADEMARK
PRINCIPAL REGISTER**

OUTLASTS LIVE!

PURE FISHING, INC. (IOWA CORPORATION)
1900 18TH STREET
SPIRIT LAKE, IA 51360

FOR: ARTIFICIAL FISHING BAIT, IN CLASS 28
(U.S. CLS. 22, 23, 38 AND 50).

FIRST USE 11-0-2006; IN COMMERCE 6-15-2007.

THE MARK CONSISTS OF STANDARD CHAR-
ACTERS WITHOUT CLAIM TO ANY PARTICULAR
FONT, STYLE, SIZE, OR COLOR.

OWNER OF U.S. REG. NO. 3,022,276.

SN 77-139,323, FILED 3-23-2007.

ELISSA GARBER KON, EXAMINING ATTORNEY

Int. Cl.: 7

Prior U.S. Cls.: 13, 19, 21, 23, 31, 34, and 35

United States Patent and Trademark Office

Reg. No. 3,481,520

Registered Aug. 5, 2008

**TRADEMARK
PRINCIPAL REGISTER**

BLUELINE COBALT

BLUE LINE EQUIPMENT, LLC (ARIZONA LTD
LIAB CO)
2265 CROSSWIND
PRESCOTT, AZ 86301

FOR: CARPET AND FLOOR CLEANING MA-
CHINES, IN CLASS 7 (U.S. CLS. 13, 19, 21, 23, 31, 34
AND 35).

FIRST USE 7-25-2007; IN COMMERCE 7-25-2007.

THE MARK CONSISTS OF STANDARD CHAR-
ACTERS WITHOUT CLAIM TO ANY PARTICULAR
FONT, STYLE, SIZE, OR COLOR.

OWNER OF U.S. REG. NO. 3,056,753.

SN 77-140,681, FILED 3-26-2007.

ANGELA GAW, EXAMINING ATTORNEY

Int. Cl.: 9

Prior U.S. Cls.: 21, 23, 26, 36, and 38

Reg. No. 3,481,521

United States Patent and Trademark Office

Registered Aug. 5, 2008

**TRADEMARK
PRINCIPAL REGISTER**

WARRIOR

SPERIAN RESPIRATORY PROTECTION USA,
LLC (DELAWARE LTD LIAB CO)
3001 S. SUSAN STREET
SANTA ANA, CA 92704

FOR: SELF-CONTAINED BREATHING APPARATUS FOR USE BY INDUSTRIAL WORKERS, FIRE-FIGHTERS, SAFETY WORKERS, HAZARDOUS MATERIALS WORKERS, RESCUE WORKERS, AND CONSTRUCTION WORKERS, IN CLASS 9 (U.S. CLS. 21, 23, 26, 36 AND 38).

FIRST USE 5-0-2007; IN COMMERCE 5-0-2007.

THE MARK CONSISTS OF STANDARD CHARACTERS WITHOUT CLAIM TO ANY PARTICULAR FONT, STYLE, SIZE, OR COLOR.

SN 77-140,719, FILED 3-26-2007.

CARRIE GENOVESE, EXAMINING ATTORNEY

Int. Cl.: 25

Prior U.S. Cls.: 22 and 39

United States Patent and Trademark Office

Reg. No. 3,481,522

Registered Aug. 5, 2008

**TRADEMARK
PRINCIPAL REGISTER**



SHAFER BOWERS CORPORATION (CALIFORNIA CORPORATION)
4355 FRUITLAND
VERNON, CA 90058

FOR: CLOTHING, NAMELY, JACKETS, SHIRTS, PANTS, JEANS, SHORTS, HEADWEAR, IN CLASS 25 (U.S. CLS. 22 AND 39).

FIRST USE 1-1-2006; IN COMMERCE 3-1-2006.

OWNER OF U.S. REG. NO. 2,502,605.

THE MARK CONSISTS OF THREE FOUR POINT STARS SURROUNDING A CHEVRON.

SN 77-140,865, FILED 3-26-2007.

REBECCA SMITH, EXAMINING ATTORNEY

Int. Cl.: 25

Prior U.S. Cls.: 22 and 39

United States Patent and Trademark Office

Reg. No. 3,481,523

Registered Aug. 5, 2008

**TRADEMARK
PRINCIPAL REGISTER**

LOUD, FAST & OUTTA' CONTROL

SHAFER BOWERS CORPORATION (CALIFORNIA CORPORATION)
4355 FRUITLAND AVENUE
VERNON, CA 90058

THE MARK CONSISTS OF STANDARD CHARACTERS WITHOUT CLAIM TO ANY PARTICULAR FONT, STYLE, SIZE, OR COLOR.

FOR: CLOTHING, NAMELY, JACKETS, SHIRTS, AND HEADWEAR, IN CLASS 25 (U.S. CLS. 22 AND 39).

SN 77-140,900, FILED 3-26-2007.

FIRST USE 11-1-2005; IN COMMERCE 1-6-2006.

REBECCA SMITH, EXAMINING ATTORNEY

Int. Cl.: 25

Prior U.S. Cls.: 22 and 39

United States Patent and Trademark Office

Reg. No. 3,481,524

Registered Aug. 5, 2008

**TRADEMARK
PRINCIPAL REGISTER**

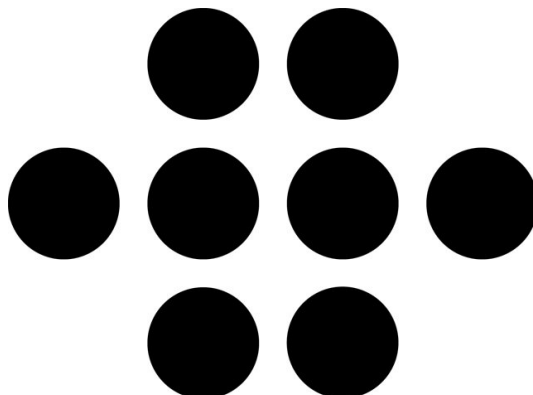

KIM, JEONG HO (REPUBLIC OF KOREA INDIVIDUAL)
APT 2F
341 EAST 33RD STREET
NEW YORK, NY 10016

FOR: BELTS; BIBS NOT OF CLOTH OR PAPER; CAPS; CHILDREN'S AND INFANTS' CLOTH BIBS; CHILDREN'S CLOTH EATING BIBS; CLOTH BIBS; CLOTH BIBS FOR ADULT DINERS; CLOTH BIBS FOR USE BY SENIOR CITIZENS OR PHYSICALLY-OR MENTALLY-CHALLENGED PERSONS; CLOTH DIAPERS; CLOTHING FOR WEAR IN JUDO PRACTICES; CLOTHING FOR WEAR IN WRESTLING GAMES; CLOTHING, NAMELY, ARM WARMERS; CLOTHING, NAMELY, FOLK COSTUMES; CLOTHING, NAMELY, KNEE WARMERS; CLOTHING, NAMELY, NECK TUBES; CLOTHING, NAMELY, WRAP-AROUNDS; CORSETS; DUSTERS; FIGURE SKATING CLOTHING, NAMELY, ONE-PIECE BODY SUITS, TIGHTS, SHIRTS, DRESSES, SKIRTS, AND PANTS; FOULARDS; HOODS; INFANT AND

TODDLER ONE PIECE CLOTHING; INFANT CLOTH DIAPERS; JERSEYS; LEATHER BELTS; MANTLES; MUFFLERS; NON-DISPOSABLE CLOTH TRAINING PANTS; PAPER HATS FOR USE AS CLOTHING ITEMS; PARTS OF CLOTHING, NAMELY, GUSSETS FOR TIGHTS, GUSSETS FOR STOCKINGS, GUSSETS FOR BATHING SUITS, GUSSETS FOR UNDERWEAR, GUSSETS FOR LEOTARDS AND GUSSETS FOR FOOTLETS; PERSPIRATION ABSORBENT UNDERWEAR CLOTHING; SHIRTS; SHORT SETS; SHOULDER WRAPS; SWADDLING CLOTHES; TIES; TOPS; UNDERARM CLOTHING SHIELDS; WRAPS, IN CLASS 25 (U.S. CLS. 22 AND 39).

FIRST USE 10-23-2006; IN COMMERCE 8-3-2006.

SN 77-140,932, FILED 3-27-2007.

JASON BLAIR, EXAMINING ATTORNEY

Int. Cl.: 42

Prior U.S. Cls.: 100 and 101

United States Patent and Trademark Office

Reg. No. 3,481,525

Registered Aug. 5, 2008

**SERVICE MARK
PRINCIPAL REGISTER**

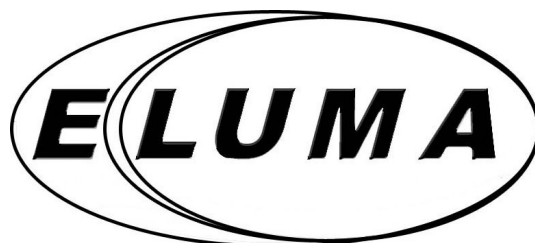

ELUMA, INC. (MASSACHUSETTS CORPORATION)
2 HIGHWOOD DRIVE
TEWKSBURY, MA 01876

FOR: COMPUTER CONSULTATION; COMPUTER PROGRAMMING; COMPUTER SERVICES IN THE NATURE OF CUSTOMIZED WEB PAGES FEATURING USER-DEFINED INFORMATION, PERSONAL PROFILES AND INFORMATION; COMPUTER SERVICES, NAMELY CREATING INDEXES OF INFORMATION, SITES AND OTHER RESOURCES AVAILABLE ON COMPUTER NETWORKS; COMPUTER SERVICES, NAMELY, CREATING AN ONLINE COMMUNITY FOR REGISTERED USERS TO PARTICIPATE IN COMPETITIONS, SHOWCASE THEIR SKILLS, GET FEEDBACK FROM THEIR PEERS, FORM VIRTUAL COMMUNITIES, ENGAGE IN SOCIAL NETWORKING AND IMPROVE THEIR TALENT; COMPUTER SERVICES, NAMELY, DESIGNING AND IMPLEMENTING NETWORK WEB PAGES FOR OTHERS; COMPUTER SERVICES, NAMELY, HOSTING ON-LINE INTERACTIVE PUBLIC CALENDARS THAT ALLOW MULTIPLE PARTICIPANTS TO SHARE EVENT SCHEDULES, FACILITY RESERVATIONS, AND TRANSPORTATION REQUESTS; COMPUTER SERVICES, NAMELY, HOSTING ON-LINE WEB FACILITIES FOR OTHERS FOR ORGANIZING AND CONDUCTING ONLINE MEETINGS, GATHERINGS, AND INTERACTIVE DISCUSSIONS; COMPUTER SERVICES, NAMELY, PROVIDING SEARCH ENGINES FOR OBTAINING DATA ON A GLOBAL COMPUTER NETWORK; COMPUTER SOFTWARE

CONSULTANCY; COMPUTER SOFTWARE CONSULTATION; COMPUTER SOFTWARE DESIGN, COMPUTER PROGRAMMING, OR MAINTENANCE OF COMPUTER SOFTWARE; CREATION AND PROVISION OF WEB PAGES TO AND FOR THIRD PARTIES; CUSTOMIZATION OF COMPUTER HARDWARE AND SOFTWARE; DESIGN AND DEVELOPMENT OF ON-LINE COMPUTER SOFTWARE SYSTEMS; DESIGN OF HOME PAGES; DESIGN OF HOME PAGES, COMPUTER SOFTWARE AND WEB SITES; DESIGN OF HOMEPAGES AND WEB-SITES; DESIGN OF HOMEPAGES AND WEBSITES; DESIGN, CREATION, HOSTING AND MAINTENANCE OF INTERNET SITES FOR THIRD PARTIES; DESIGN, CREATION, HOSTING, MAINTENANCE OF WEBSITES FOR OTHERS; HOSTING THE WEB SITES OF OTHERS ON A COMPUTER SERVER FOR A GLOBAL COMPUTER NETWORK; INSTALLATION OF COMPUTER SOFTWARE; INTEGRATION OF COMPUTER SYSTEMS AND NETWORKS; PROVIDING CUSTOMIZED ON-LINE WEB PAGES FEATURING USER-DEFINED INFORMATION, WHICH INCLUDES SEARCH ENGINES AND ON-LINE WEB LINKS TO OTHER WEB SITES; WEB SITE HOSTING SERVICES; WEBSITE DEVELOPMENT FOR OTHERS, IN CLASS 42 (U.S. CLS. 100 AND 101).

FIRST USE 12-18-2007; IN COMMERCE 12-18-2007.

SN 77-140,946, FILED 3-27-2007.

JASON BLAIR, EXAMINING ATTORNEY

Int. Cl.: 41

Prior U.S. Cls.: 100, 101, and 107

United States Patent and Trademark Office

Reg. No. 3,481,526

Registered Aug. 5, 2008

**SERVICE MARK
PRINCIPAL REGISTER**



NORTH AMERICAN POLO LEAGUE, LLC (DE-
LAWARE LTD LIAB CO)
109 NORTH POST OAK LANE
HOUSTON, TX 77024

FOR: ENTERTAINMENT SERVICES, NAMELY,
ON-GOING TELEVISION AND RADIO PROGRAMS
IN THE FIELD OF POLO; ENTERTAINMENT SER-
VICES, NAMELY, PRODUCTION OF SPORTS AND
SPORTS RELATED PROGRAMS AND DISTRIBU-
TION BY MEANS OF TELEVISION BROADCAST-
ING, CABLE TRANSMISSION, SATELLITE
TRANSMISSION, AND VIA THE INTERNET; PRO-
VIDING A WEB SITE FEATURING POLO NEWS
AND INFORMATION, IN CLASS 41 (U.S. CLS. 100,
101 AND 107).

FIRST USE 3-9-2007; IN COMMERCE 3-9-2007.

NO CLAIM IS MADE TO THE EXCLUSIVE
RIGHT TO USE "NORTH AMERICAN POLO LEA-
GUE", APART FROM THE MARK AS SHOWN.

THE MARK CONSISTS OF THE LETTERS
"NAPL" AND THE WORDS "NORTH AMERICAN
POLO LEAGUE" WITH DESIGN CONSISTING OF A
POLO PLAYER ON HORSE.

SN 77-140,965, FILED 3-27-2007.

ANGELA M. MICHELI, EXAMINING ATTORNEY

Int. Cl.: 25

Prior U.S. Cls.: 22 and 39

United States Patent and Trademark Office

Reg. No. 3,481,527

Registered Aug. 5, 2008

**TRADEMARK
PRINCIPAL REGISTER**

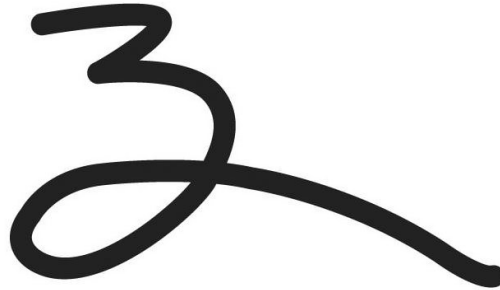

4004 INCORPORATED (PENNSYLVANIA CORPORATION)
12 HARBOR PARK DRIVE
PORT WASHINGTON, NY 11050

THE MARK CONSISTS OF A STYLIZED NUMER-
AL "3".

FOR: PANTS, JEANS, SHIRTS, SHORTS, SWEAT-
SHIRTS, FOOTWEAR, HEADWEAR, IN CLASS 25
(U.S. CLS. 22 AND 39).

SN 77-141,046, FILED 3-27-2007.

FIRST USE 8-17-2006; IN COMMERCE 8-17-2006.

JAMES MACFARLANE, EXAMINING ATTORNEY

Int. Cl.: 6

Prior U.S. Cls.: 2, 12, 13, 14, 23, 25, and 50

Reg. No. 3,481,528

United States Patent and Trademark Office

Registered Aug. 5, 2008

**TRADEMARK
PRINCIPAL REGISTER**

ELITEWOOD

METALS USA BUILDING PRODUCTS, L.P.
(TEXAS LIMITED PARTNERSHIP)
ONE RIVERWAY, SUITE 1100
DALLAS, TX 77056

FIRST USE 10-10-2007; IN COMMERCE 10-10-2007.

FOR: METAL ROOF AND PATIO SYSTEM COMPONENTS COMPRISING OF BEAMS, POSTS, RAFTERS, TUBES, AND SINGLE SKIN AND STRUCTURAL INSULATED ROOF PANELS, ALL MADE OF ALUMINUM OR METAL ALLOY, IN CLASS 6 (U.S. CLS. 2, 12, 13, 14, 23, 25 AND 50).

THE MARK CONSISTS OF STANDARD CHARACTERS WITHOUT CLAIM TO ANY PARTICULAR FONT, STYLE, SIZE, OR COLOR.

SN 77-141,066, FILED 3-27-2007.

SHAUNIA CARLYLE, EXAMINING ATTORNEY

Int. Cls.: 35, 41, and 42

Prior U.S. Cls.: 100, 101, 102, and 107

United States Patent and Trademark Office

Reg. No. 3,481,529

Registered Aug. 5, 2008

**SERVICE MARK
PRINCIPAL REGISTER**



JMV SERVICES, INC. (TEXAS CORPORATION)
SUITE 750
17950 PRESTON ROAD
DALLAS, TX 75252

FOR: BUSINESS CONSULTING SERVICES RELATING TO OPERATIONS MANAGEMENT IN THE FIELDS OF LIFE AND HEALTH AND PROPERTY AND CASUALTY INSURANCE; OUTSOURCING SERVICES IN THE FIELDS OF LIFE AND HEALTH AND PROPERTY AND CASUALTY INSURANCE AND SOFTWARE APPLICATION DEVELOPMENT; EMPLOYMENT HIRING, RECRUITING, PLACEMENT, AND STAFFING SERVICES FOR THE INSURANCE INDUSTRY, IN CLASS 35 (U.S. CLS. 100, 101 AND 102).

FIRST USE 1-1-1998; IN COMMERCE 1-1-1998.

FOR: EDUCATIONAL SERVICES, NAMELY, CONDUCTING TRAINING COURSES IN THE FIELD OF INSURANCE, IN CLASS 41 (U.S. CLS. 100, 101 AND 107).

FIRST USE 11-1-2005; IN COMMERCE 11-1-2005.

FOR: INFORMATION TECHNOLOGY CONSULTING SERVICES RELATING TO SYSTEMS AUTOMATION AND COMPUTER PROCESSING IN THE FIELDS OF LIFE AND HEALTH AND PROPERTY AND CASUALTY INSURANCE; INFORMATION TECHNOLOGY SUPPORT SERVICES, NAMELY, SOFTWARE APPLICATION CUSTOMIZATION, DEVELOPMENT, TESTING, INTEGRATION, CONVERSION, AND MAINTENANCE FOR THE INSURANCE INDUSTRY, IN CLASS 42 (U.S. CLS. 100 AND 101).

FIRST USE 1-1-1998; IN COMMERCE 1-1-1998.

THE MARK CONSISTS OF THE LETTERS "ITS" IN A STYLIZED FORMAT IN A PARTIAL OVAL DESIGN.

SN 77-141,087, FILED 3-27-2007.

ANDREA HACK, EXAMINING ATTORNEY

Int. Cl.: 21

Prior U.S. Cls.: 2, 13, 23, 29, 30, 33, 40, and 50

United States Patent and Trademark Office

Reg. No. 3,481,530

Registered Aug. 5, 2008

TRADEMARK
PRINCIPAL REGISTER



FLANNERY, NEIL M. (UNITED STATES INDIVIDUAL)
199 HELM ROAD
MANTOLOKING, PA 08738

FOR: BEVERAGE TRAY NOT MADE OF PRECIOUS METAL FOR HOLDING OR CONTAINING DRINKING VESSELS, DRINKING CUPS, DRINKING GLASSES AND BEVERAGE GLASSWARE WHILE IN USE; DRINKING VESSELS, DRINKING CUPS NOT OF PRECIOUS METAL, DRINKING GLASSES, AND BEVERAGE GLASSWARE, IN CLASS 21 (U.S. CLS. 2, 13, 23, 29, 30, 33, 40 AND 50).

FIRST USE 4-0-2008; IN COMMERCE 5-0-2008.

THE COLOR(S) GREEN, BLACK, WHITE, AND YELLOW IS/ARE CLAIMED AS A FEATURE OF THE MARK.

THE MARK CONSISTS OF A CARICATURE OF THREE DRINKING GLASSES. THE CARICATURES ARE OUTLINED IN BLACK; THE COLORS YELLOW AND GREEN APPEAR IN THE FACIAL FEATURES OF THE GLASSES; AND THE COLOR WHITE APPEARS IN TEETH AND EYES OF THE FACES ON THE GLASSES AND AS A BACKGROUND COLOR FOR THE UNFILLED PORTION OF THE GLASSES.

SN 77-141,282, FILED 3-27-2007.

JORDAN BAKER, EXAMINING ATTORNEY

Int. Cl.: 35

Prior U.S. Cls.: 100, 101, and 102

United States Patent and Trademark Office

Reg. No. 3,481,531

Registered Aug. 5, 2008

**SERVICE MARK
PRINCIPAL REGISTER**

BLUE 2

BLUE 2, LLC (MISSOURI LTD LIAB CO)
POST OFFICE BOX 410374
ST. LOUIS, MO 63141

THE MARK CONSISTS OF STANDARD CHAR-
ACTERS WITHOUT CLAIM TO ANY PARTICULAR
FONT, STYLE, SIZE, OR COLOR.

FOR: PROMOTION AND MARKETING SERVI-
CES AND RELATED CONSULTING, IN CLASS 35
(U.S. CLS. 100, 101 AND 102).

SN 77-141,361, FILED 3-27-2007.

FIRST USE 2-22-2007; IN COMMERCE 2-22-2007.

JAY BESCH, EXAMINING ATTORNEY

Int. Cl.: 15

Prior U.S. Cls.: 2, 21, and 36

United States Patent and Trademark Office

Reg. No. 3,481,532

Registered Aug. 5, 2008

**TRADEMARK
PRINCIPAL REGISTER**



GLOBAL SOURCING & INNOVATIONS, INC.
(DELAWARE CORPORATION)
481 PLEASANT STREET
LEE, MA 01238

FOR: MUSICAL INSTRUMENTS, IN CLASS 15
(U.S. CLS. 2, 21 AND 36).

FIRST USE 5-29-2008; IN COMMERCE 5-29-2008.

THE MARK CONSISTS OF THE WORDS "GEN
ONE" SUPERIMPOSED UPON A LARGE NUMER-
AL "1", THE NUMERAL "1" HAVING A SYMBOL

FOR A MUSICAL NOTE CENTRALLY LOCATED
UPON THE NUMERAL "1", AND THE WORDS
"GEN ONE" AND THE NUMERAL "1" ARE SUPER-
IMPOSED UPON A MUSICAL SCALE THAT IS
SLIGHTLY CURVED ALONG ITS HORIZONTAL
AXIS AND EXTENDS BEHIND AND SLIGHTLY
BEYOND THE LEFT AND RIGHT MARGINS OF
THE WORDS "GEN ONE."

SN 77-141,373, FILED 3-27-2007.

JENNIFER HETU, EXAMINING ATTORNEY

Int. Cl.: 16

Prior U.S. Cls.: 2, 5, 22, 23, 29, 37, 38, and 50

United States Patent and Trademark Office

Reg. No. 3,481,533

Registered Aug. 5, 2008

**TRADEMARK
PRINCIPAL REGISTER**

**Zaner-Bloser Handwriting
On the Road to Writing and
Reading for Prekindergarten**

ZANER-BLOSER, INC. (OHIO CORPORATION)
1201 DUBLIN ROAD
COLUMBUS, OH 43215

FOR: EDUCATIONAL BOOKS FEATURING MATERIALS GEARED TO PRE-KINDERGARTEN STUDENTS AND TEACHERS CONTAINING BEGINNING INSTRUCTION IN HANDWRITING, IN CLASS 16 (U.S. CLS. 2, 5, 22, 23, 29, 37, 38 AND 50).

FIRST USE 8-1-2007; IN COMMERCE 8-1-2007.

THE MARK CONSISTS OF STANDARD CHARACTERS WITHOUT CLAIM TO ANY PARTICULAR FONT, STYLE, SIZE, OR COLOR.

OWNER OF U.S. REG. NO. 2,763,322.

NO CLAIM IS MADE TO THE EXCLUSIVE RIGHT TO USE "HANDWRITING" AND "WRITING AND READING FOR PREKINDERGARTEN", APART FROM THE MARK AS SHOWN.

SN 77-141,566, FILED 3-27-2007.

PAUL F. GAST, EXAMINING ATTORNEY

Int. Cl.: 41

Prior U.S. Cls.: 100, 101, and 107

United States Patent and Trademark Office

Reg. No. 3,481,534

Registered Aug. 5, 2008

**SERVICE MARK
PRINCIPAL REGISTER**

JOHNNY NITRO

WORLD WRESTLING ENTERTAINMENT, INC.
(DELAWARE CORPORATION)
1241 EAST MAIN STREET
STAMFORD, CT 06902

FOR: ENTERTAINMENT SERVICES, NAMELY, WRESTLING EXHIBITIONS AND PERFORMANCES BY A PROFESSIONAL WRESTLER AND ENTERTAINER; PROVIDING WRESTLING NEWS AND INFORMATION VIA A GLOBAL COMPUTER NETWORK, IN CLASS 41 (U.S. CLS. 100, 101 AND 107).

FIRST USE 3-31-2004; IN COMMERCE 3-31-2004.

THE MARK CONSISTS OF STANDARD CHARACTERS WITHOUT CLAIM TO ANY PARTICULAR FONT, STYLE, SIZE, OR COLOR.

THE NAME(S), PORTRAIT(S), AND/OR SIGNATURE(S) SHOWN IN THE MARK DOES NOT IDENTIFY A PARTICULAR LIVING INDIVIDUAL.

SN 77-141,758, FILED 3-27-2007.

TASHIA BUNCH, EXAMINING ATTORNEY

Int. Cl.: 39

Prior U.S. Cls.: 100 and 105

United States Patent and Trademark Office

Reg. No. 3,481,535

Registered Aug. 5, 2008

**SERVICE MARK
PRINCIPAL REGISTER**

HIGHLAND FORWARDING

HIGHLAND FORWARDING, INC. (NEW HAMP-
SHIRE CORPORATION)
315 HIGHLAND WAY
MANCHESTER, NH 03103

FOR: FREIGHT FORWARDING SERVICES FOR
THE AREAS OF AIR AND OCEAN EXPORTS, AIR
AND OCEAN IMPORTS, SMALL PACKAGE COUR-
IER SHIPMENTS, DANGEROUS GOODS SHIP-
MENTS, FREIGHT SHIPPED BY DOMESTIC
TRUCKING, DOMESTIC AIR FREIGHT, AND PRO-
VIDING CUSTOM TRANSPORT CONSULTATION
SERVICES AND OVERSEAS CUSTOMER CLEAR-
ANCE SERVICES, IN CLASS 39 (U.S. CLS. 100 AND
105).

FIRST USE 7-1-1998; IN COMMERCE 7-1-1998.

THE MARK CONSISTS OF STANDARD CHAR-
ACTERS WITHOUT CLAIM TO ANY PARTICULAR
FONT, STYLE, SIZE, OR COLOR.

NO CLAIM IS MADE TO THE EXCLUSIVE
RIGHT TO USE "FORWARDING", APART FROM
THE MARK AS SHOWN.

SN 77-141,795, FILED 3-27-2007.

AMY HELLA, EXAMINING ATTORNEY

Int. Cl.: 28

Prior U.S. Cls.: 22, 23, 38, and 50

United States Patent and Trademark Office

Reg. No. 3,481,536

Registered Aug. 5, 2008

**TRADEMARK
PRINCIPAL REGISTER**

GoPet

GOPET, LLC (PENNSYLVANIA LTD LIAB CO)
544 GRISTMILL ROAD
MARTINDALE, PA 17549

THE MARK CONSISTS OF STANDARD CHAR-
ACTERS WITHOUT CLAIM TO ANY PARTICULAR
FONT, STYLE, SIZE, OR COLOR.

FOR: EXERCISE MACHINES, NAMELY, ROTA-
TABLE WHEELS FOR EXERCISING ANIMALS,
PARTICULARLY CANINES, IN CLASS 28 (U.S.
CLS. 22, 23, 38 AND 50).

SN 77-142,306, FILED 3-28-2007.

FIRST USE 8-6-2007; IN COMMERCE 2-6-2008.

PRISCILLA MILTON, EXAMINING ATTORNEY

Int. Cls.: 35 and 42

Prior U.S. Cls.: 100, 101, and 102

United States Patent and Trademark Office

Reg. No. 3,481,537

Registered Aug. 5, 2008

**SERVICE MARK
PRINCIPAL REGISTER**



SELLINGSOURCE.COM
Technology Driven Marketing Solutions

THE SELLING SOURCE, INC. (NEVADA LTD
LIAB CO)
325 E. WARM SPRINGS RD
LAS VEGAS, NV 89119

FOR: ONLINE MARKETING AND ADVERTISING SERVICES FOR OTHERS, IN CLASS 35 (U.S. CLS. 100, 101 AND 102).

FIRST USE 1-15-1998; IN COMMERCE 1-15-1998.

FOR: HOSTING AND MAINTENANCE OF WEBSITES FOR OTHERS, IN CLASS 42 (U.S. CLS. 100 AND 101).

FIRST USE 1-15-1998; IN COMMERCE 1-15-1998.

OWNER OF U.S. REG. NO. 3,050,772.

NO CLAIM IS MADE TO THE EXCLUSIVE RIGHT TO USE "TECHNOLOGY DRIVEN MARKETING SOLUTIONS", APART FROM THE MARK AS SHOWN.

THE COLOR(S) BLUE, WHITE, AND BLACK IS/ARE CLAIMED AS A FEATURE OF THE MARK.

THE MARK CONSISTS OF EGG SHAPED BLUE CIRCLE WITH WHITE SLASHES IN THE SHAPE OF AN "S", WORDING BELOW IN BLACK.

SN 77-142,502, FILED 3-28-2007.

JILL C. ALT, EXAMINING ATTORNEY

Int. Cls.: 9 and 38

Prior U.S. Cls.: 21, 23, 26, 36, 38, 100, 101, and 104

United States Patent and Trademark Office

Reg. No. 3,481,538

Registered Aug. 5, 2008

**TRADEMARK
SERVICE MARK
PRINCIPAL REGISTER**

W580i

SONY ERICSSON MOBILE COMMUNICATIONS
AB (SWEDEN CORPORATION)
NYA VATTENTORNET
LUND, SWEDEN SE-22188

FOR: CELLULAR OR MOBILE PHONES; CELLULAR OR MOBILE PHONES FEATURING THE CAPACITY TO FUNCTION IN ANY NUMBER OF EXTRA WAYS BEYOND JUST AS A PHONE, NAMELY, TO FUNCTION AS A CAMERA, TO PERFORM INSTANT MESSAGING, TO CONDUCT MULTIMEDIA MESSAGING, TO ACCESS AND COMMUNICATE WITH E-MAIL, TO ACCESS AND COMMUNICATE WITH THE INTERNET, TO ACCESS AND COMMUNICATE WITH INTRANETS OR PRIVATE COMPUTER NETWORKS, TO ACCESS AND COMMUNICATE DATA, TO FUNCTION AS A RADIO, TO RECORD, PLAY, TRANSMIT, RECEIVE, AND/OR MANAGE MUSIC, TO RECORD, PLAY, TRANSMIT, RECEIVE, EDIT, AND/OR MANAGE AUDIO OR VOICE, TO RECORD, PLAY, TRANSMIT, RECEIVE, EDIT, AND/OR MANAGE VIDEO, TO CREATE, VIEW, TRANSMIT, RECEIVE, EDIT, AND/OR MANAGE PHOTOGRAPHS OR PICTURES, TO UPLOAD, VIEW, TRANSMIT, RECEIVE, EDIT, AND/OR MANAGE GRAPHICS OR IMAGES, TO PLAY ELECTRONIC GAMES, TO UPLOAD PHOTOGRAPHS AND TEXT ONTO ONLINE JOURNALS OR WEB LOGS ALSO KNOWN AS BLOGS, TO MANAGE A CALENDAR AND CONTACT INFORMATION AND OTHERWISE FUNCTION AS A PERSONAL DIGITAL ASSISTANT (PDA), TO EFFECTUATE MOBILE PRINTING, TO PERFORM SATELLITE NAVIGATION, TO VIEW ELECTRONIC CITY GUIDES, TO FUNCTION AS A REMOTE CONTROL FOR COMPUTERS AND RUN MULTIMEDIA PRESENTATIONS, AND/OR TO TRANSMIT VIDEO, SOUND, AND/OR DATA TO WEBSITES; DOWNLOADABLE ELECTRONIC MANUALS IN

THE FIELD OF CELLULAR OR MOBILE PHONES; ACCESSORIES FOR CELLULAR OR MOBILE PHONES IN THE NATURE OF HEADSETS AND DEVICES FOR HANDS-FREE PHONE USE; AND ACCESSORIES FOR CELLULAR OR MOBILE PHONES IN THE NATURE OF CHARGERS, BATTERIES, CASES, COVERS, HOLDERS, DOCKING STANDS, AND CABLES, IN CLASS 9 (U.S. CLS. 21, 23, 26, 36 AND 38).

FIRST USE 7-0-2007; IN COMMERCE 7-0-2007.

FOR: TELECOMMUNICATIONS SERVICES IN THE NATURE OF TRANSMISSION OF SOUND, PICTURE, IMAGE, VIDEO, AND DATA SIGNALS; TRANSMISSION OF SOUND, PICTURE, IMAGE, VIDEO, AND DATA SIGNALS TO PERSONALIZE OR ENHANCE CELLULAR OR MOBILE PHONES; PROVIDING A WEBSITE THAT ENABLES TRANSMISSION OF SOUND, PICTURE, GRAPHIC, IMAGE, AND VIDEO SIGNALS TO THE WEBSITE, SO THE SIGNALS MAY BE EDITED, AND THEN DELIVERING THE EDITED SIGNALS TO COMPUTERS OR CELLULAR OR MOBILE PHONES, IN CLASS 38 (U.S. CLS. 100, 101 AND 104).

FIRST USE 7-0-2007; IN COMMERCE 7-0-2007.

THE MARK CONSISTS OF STANDARD CHARACTERS WITHOUT CLAIM TO ANY PARTICULAR FONT, STYLE, SIZE, OR COLOR.

OWNER OF U.S. REG. NOS. 3,218,258 AND 3,228,100.

SN 77-142,556, FILED 3-28-2007.

KRISTINA MORRIS, EXAMINING ATTORNEY

Int. Cls.: 37 and 42

Prior U.S. Cls.: 100, 101, 103, and 106

United States Patent and Trademark Office

Reg. No. 3,481,539

Registered Aug. 5, 2008

**SERVICE MARK
PRINCIPAL REGISTER**

ASD

ASSOCIATED SPACE DESIGN, INC. (GEORGIA CORPORATION)
SUITE 500
50 HURT PLAZA
ATLANTA, GA 30303

FOR: RESIDENTIAL AND BUILDING CONSTRUCTION CONSULTING; CONSTRUCTION PLANNING; LAND DEVELOPMENT SERVICES, NAMELY, PLANNING AND LAYING OUT OF RESIDENTIAL AND/OR COMMERCIAL COMMUNITIES, IN CLASS 37 (U.S. CLS. 100, 103 AND 106).

FIRST USE 9-1-1963; IN COMMERCE 9-1-1963.

FOR: ARCHITECTURAL DESIGN; COMMERCIAL ART DESIGN; DESIGN OF HOMEPAGES AND WEBSITES; GRAPHIC DESIGN SERVICES;

DESIGN OF SPECIALTY INTERIOR AND EXTERIOR ENVIRONMENT SETTINGS; PACKAGING DESIGN FOR OTHERS; INTERIOR DECORATION CONSULTATION; INTERIOR DECORATING; LAND USE PLANNING SERVICES; GRAPHIC ILLUSTRATION SERVICES FOR OTHERS; GRAPHIC ART DESIGN, IN CLASS 42 (U.S. CLS. 100 AND 101).

FIRST USE 9-1-1963; IN COMMERCE 9-1-1963.

THE MARK CONSISTS OF STANDARD CHARACTERS WITHOUT CLAIM TO ANY PARTICULAR FONT, STYLE, SIZE, OR COLOR.

SN 77-142,591, FILED 3-28-2007.

RICHARD A. STRASER, EXAMINING ATTORNEY

Int. Cls.: 9 and 38

Prior U.S. Cls.: 21, 23, 26, 36, 38, 100, 101, and 104

Reg. No. 3,481,540

United States Patent and Trademark Office

Registered Aug. 5, 2008

**TRADEMARK
SERVICE MARK
PRINCIPAL REGISTER**

Z750a

SONY ERICSSON MOBILE COMMUNICATIONS
AB (SWEDEN CORPORATION)
NYA VATTENTORNET
LUND, SWEDEN SE-22188

FOR: CELLULAR OR MOBILE PHONES; CELLULAR OR MOBILE PHONES FEATURING THE CAPACITY TO FUNCTION IN ANY NUMBER OF EXTRA WAYS BEYOND JUST AS A PHONE, NAMELY, TO FUNCTION AS A CAMERA, TO PERFORM INSTANT MESSAGING, TO CONDUCT MULTIMEDIA MESSAGING, TO ACCESS AND COMMUNICATE WITH E-MAIL, TO ACCESS AND COMMUNICATE WITH THE INTERNET, TO ACCESS AND COMMUNICATE WITH INTRANETS OR PRIVATE COMPUTER NETWORKS, TO ACCESS AND COMMUNICATE DATA, TO FUNCTION AS A RADIO, TO RECORD, PLAY, TRANSMIT, RECEIVE, AND/OR MANAGE MUSIC, TO RECORD, PLAY, TRANSMIT, RECEIVE, EDIT, AND/OR MANAGE AUDIO OR VOICE, TO RECORD, PLAY, TRANSMIT, RECEIVE, EDIT, AND/OR MANAGE VIDEO, TO CREATE, VIEW, TRANSMIT, RECEIVE, EDIT, AND/OR MANAGE PHOTOGRAPHS OR PICTURES, TO UPLOAD, VIEW, TRANSMIT, RECEIVE, EDIT, AND/OR MANAGE GRAPHICS OR IMAGES, TO PLAY ELECTRONIC GAMES, TO UPLOAD PHOTOGRAPHS AND TEXT ONTO ONLINE JOURNALS OR WEB LOGS ALSO KNOWN AS BLOGS, TO MANAGE A CALENDAR AND CONTACT INFORMATION AND OTHERWISE FUNCTION AS A PERSONAL DIGITAL ASSISTANT (PDA), TO EFFECTUATE MOBILE PRINTING, TO PERFORM SATELLITE NAVIGATION, TO VIEW ELECTRONIC CITY GUIDES, TO FUNCTION AS A REMOTE CONTROL FOR COMPUTERS AND RUN MULTIMEDIA PRESENTATIONS, AND/OR TO TRANSMIT VIDEO, SOUND, AND/OR DATA TO WEBSITES;

DOWNLOADABLE ELECTRONIC MANUALS IN THE FIELD OF CELLULAR OR MOBILE PHONES; ACCESSORIES FOR CELLULAR OR MOBILE PHONES IN THE NATURE OF HEADSETS AND DEVICES FOR HANDS-FREE PHONE USE; AND ACCESSORIES FOR CELLULAR OR MOBILE PHONES IN THE NATURE OF CHARGERS, BATTERIES, CASES, COVERS, HOLDERS, DOCKING STANDS, AND CABLES, IN CLASS 9 (U.S. CLS. 21, 23, 26, 36 AND 38).

FIRST USE 3-0-2008; IN COMMERCE 3-0-2008.

FOR: TELECOMMUNICATIONS SERVICES IN THE NATURE OF TRANSMISSION OF SOUND, PICTURE, IMAGE, VIDEO, AND DATA SIGNALS; TRANSMISSION OF SOUND, PICTURE, IMAGE, VIDEO, AND DATA SIGNALS TO PERSONALIZE OR ENHANCE CELLULAR OR MOBILE PHONES; PROVIDING A WEBSITE THAT ENABLES TRANSMISSION OF SOUND, PICTURE, GRAPHIC, IMAGE, AND VIDEO SIGNALS TO THE WEBSITE, SO THE SIGNALS MAY BE EDITED, AND THEN DELIVERING THE EDITED SIGNALS TO COMPUTERS OR CELLULAR OR MOBILE PHONES, IN CLASS 38 (U.S. CLS. 100, 101 AND 104).

FIRST USE 3-0-2008; IN COMMERCE 3-0-2008.

THE MARK CONSISTS OF STANDARD CHARACTERS WITHOUT CLAIM TO ANY PARTICULAR FONT, STYLE, SIZE, OR COLOR.

SN 77-142,595, FILED 3-28-2007.

KRISTINA MORRIS, EXAMINING ATTORNEY

Int. Cls.: 35 and 36

Prior U.S. Cls.: 100, 101, and 102

United States Patent and Trademark Office

Reg. No. 3,481,541

Registered Aug. 5, 2008

SERVICE MARK
PRINCIPAL REGISTER



WHOLE FOODS MARKET IP, L.P. (DELAWARE LIMITED PARTNERSHIP)
550 BOWIE STREET, 6TH FLOOR
AUSTIN, TX 78703

FOR: RETAIL GROCERY STORE SERVICES; PROMOTING THE GOODS AND SERVICES OF OTHERS BY DISTRIBUTING ADVERTISING MATERIALS THROUGH A VARIETY OF METHODS; PROMOTING PUBLIC AWARENESS OF, AND THE NEED TO SUPPORT, LOCAL FARMERS, GROWERS AND FOOD PRODUCERS, IN CLASS 35 (U.S. CLS. 100, 101 AND 102).

FIRST USE 6-0-2004; IN COMMERCE 6-0-2004.

FOR: FINANCIAL SERVICES IN THE FIELD OF MONEY LENDING, IN CLASS 36 (U.S. CLS. 100, 101 AND 102).

FIRST USE 4-0-2007; IN COMMERCE 4-0-2007.

THE COLOR(S) GREEN, RED, BROWN, GRAY, WHITE AND BLACK IS/ARE CLAIMED AS A FEATURE OF THE MARK.

THE MARK CONSISTS OF THE COLOR GREEN APPEARS IN DIFFERENT SHADES IN THE DESIGN OF THE LEAVES, FIELDS, BUSHES AND TREES; THE COLOR RED APPEARS IN THE DESIGN OF THE TRUCK; THE COLOR BROWN APPEARS IN DIFFERENT SHADES IN THE DEPICTION OF THE GROUND, ROAD, THE STRUCTURES' WALLS, THE TRUCK'S CARGO, THE BACKGROUND HILLS AND SKY, AS THE BACKGROUND FOR THE BANNER AND THE EDGING OF THE WORDING "LOCALLY GROWN", AND AS SHADING IN THE DESIGN OF THE LEAVES, FIELDS, BUSHES AND TREES; THE COLOR GRAY APPEARS IN DIFFERENT SHADES IN THE DESIGN OF THE STRUCTURES' ROOFS, AND THE TRUCK'S HUB CAPS, BUMPER, HEADLIGHTS, GRILL AND CARGO; THE COLOR WHITE APPEARS IN THE DESIGN OF THE FENCE; THE COLOR BLACK APPEARS IN THE WORDING "LOCALLY GROWN", THE TRUCK TIRES, THE STRUCTURES' WINDOWS AND DOORS, AND AS A BORDER AND EDGING TO THE VARIOUS DESIGN ELEMENTS DEPICTED IN THE MARK.

SN 77-142,878, FILED 3-28-2007.

C. DIONNE CLYBURN, EXAMINING ATTORNEY

Int. Cl.: 35

Prior U.S. Cls.: 100, 101, and 102

United States Patent and Trademark Office

Reg. No. 3,481,542

Registered Aug. 5, 2008

**SERVICE MARK
PRINCIPAL REGISTER**

Froma on Melrose

LA FROMAGERIE, INC. (CALIFORNIA CORPORATION)
7960 MELROSE
LOS ANGELES, CA 90046

FOR: RETAIL GOURMET AND SPECIALTY FOODS AND FINE WINES STORES, IN CLASS 35 (U.S. CLS. 100, 101 AND 102).

FIRST USE 1-1-2008; IN COMMERCE 1-1-2008.

THE MARK CONSISTS OF STANDARD CHARACTERS WITHOUT CLAIM TO ANY PARTICULAR FONT, STYLE, SIZE, OR COLOR.

NO CLAIM IS MADE TO THE EXCLUSIVE RIGHT TO USE "ON MELROSE", APART FROM THE MARK AS SHOWN.

SN 77-143,183, FILED 3-28-2007.

TOBY BULLOFF, EXAMINING ATTORNEY

Int. Cl.: 25

Prior U.S. Cls.: 22 and 39

United States Patent and Trademark Office

Reg. No. 3,481,543

Registered Aug. 5, 2008

**TRADEMARK
PRINCIPAL REGISTER**

1031

ELLIE SHOES, INC (CALIFORNIA CORPORATION)

#B

1050 N. BATAVIA STREET
ORANGE, CA 92867

FOR: WOMEN'S SHOES, NAMELY, HIGH FASHION AND EXOTIC PUMPS, SANDALS, STILETTOS, PLATFORMS AND BOOTS, IN CLASS 25 (U.S. CLS. 22 AND 39).

FIRST USE 6-1-2007; IN COMMERCE 6-1-2007.

THE MARK CONSISTS OF STANDARD CHARACTERS WITHOUT CLAIM TO ANY PARTICULAR FONT, STYLE, SIZE, OR COLOR.

SN 77-143,548, FILED 3-29-2007.

AMY HELLA, EXAMINING ATTORNEY

Int. Cl.: 5

Prior U.S. Cls.: 6, 18, 44, 46, 51, and 52

Reg. No. 3,481,544

United States Patent and Trademark Office

Registered Aug. 5, 2008

**TRADEMARK
PRINCIPAL REGISTER**

PHENOLMENAL! BALANCE

TBC WORLDWIDE, INC. (CALIFORNIA CORPORATION)
1825 SO. GRANT STREET
SAN MATEO, CA 94402

FOR: DIETARY SUPPLEMENT DRINKS COMPRISED OF JUICES, HERBS, VITAMINS, MINERALS, FRUIT EXTRACTS, AND OTHER PHYTONUTRIENTS, IN CLASS 5 (U.S. CLS. 6, 18, 44, 46, 51 AND 52).

FIRST USE 6-1-2007; IN COMMERCE 6-1-2007.

THE MARK CONSISTS OF STANDARD CHARACTERS WITHOUT CLAIM TO ANY PARTICULAR FONT, STYLE, SIZE, OR COLOR.

SN 77-144,257, FILED 3-29-2007.

DAWN FELDMAN, EXAMINING ATTORNEY

Int. Cl.: 16

Prior U.S. Cls.: 2, 5, 22, 23, 29, 37, 38, and 50

United States Patent and Trademark Office

Reg. No. 3,481,545

Registered Aug. 5, 2008

**TRADEMARK
PRINCIPAL REGISTER**

TOP READERS

WELDON OWEN, INC. (DELAWARE CORPORATION)

814 MONTGOMERY STREET

SAN FRANCISCO, CA 94133

FOR: CHILDREN'S BOOKS, IN CLASS 16 (U.S. CLS. 2, 5, 22, 23, 29, 37, 38 AND 50).

FIRST USE 2-1-2008; IN COMMERCE 2-1-2008.

THE MARK CONSISTS OF STANDARD CHARACTERS WITHOUT CLAIM TO ANY PARTICULAR FONT, STYLE, SIZE, OR COLOR.

NO CLAIM IS MADE TO THE EXCLUSIVE RIGHT TO USE "READERS", APART FROM THE MARK AS SHOWN.

SN 77-144,395, FILED 3-30-2007.

MICHAEL GAAFAR, EXAMINING ATTORNEY

Int. Cl.: 16

Prior U.S. Cls.: 2, 5, 22, 23, 29, 37, 38, and 50

Reg. No. 3,481,546

United States Patent and Trademark Office

Registered Aug. 5, 2008

**TRADEMARK
PRINCIPAL REGISTER**

SQUEEZE THE JUICE

SANTORO, LUCIO AND SANTORO, MEERA
(UNITED KINGDOM PARTNERSHIP)
WIMBLEDON
ROTUNDA POINT, 11 HARTFIELD CRESCENT
LONDON, UNITED KINGDOM

FOR: GREETING CARDS, POSTCARDS, MINI GREETING CARDS, GIFT WRAPPING PAPER; STATIONERY, NAMELY DIARIES, LOCKABLE DIARIES; PENCIL TINS, FABRIC PENCIL CASES; ZIP AROUND BINDERS, ASSIGNMENT NOTE BOOKS, AGENDAS, DIE CUT PAPER NOTEBOOKS; ERASERS; PAPER FOLDERS; PENS; PENCILS; CALENDARS; NOTEBOOKS; NOTEPADS; FABRIC COVERED NOTEBOOKS; ADDRESS BOOKS; LEVER ARCH FILE FOLDERS; RING BINDERS; PHOTO ALBUMS; PAPER GIFT BAGS; CARDBOARD STORAGE BOXES; STICKERS; ADDRESS LABELS; PAPER DOOR HANGERS; MEMO PADS; SKETCHBOOKS; FOUNTAIN PENS; BALLPOINT PENS; GEL ROLLER PENS; CRAYON PASTELS; COLOURING PENS; GLUE FOR STATIONERY OR HOUSEHOLD

USE; PENCIL SHARPENERS; PAPER KNIFE; PAPER CUTTER; STATIONERY SETS COMPRISED OF PAPER NOTEBOOKS, PAPER, ENVELOPES, PENS, PENCILS, RULERS, ERASERS, SOLD TOGETHER AS A UNIT; CARDBOARD GIFT BOXES; PHOTOGRAPHS; OFFICE REQUISITES, NAMELY STAPLERS, PAPER HOLE PUNCHES; ARTISTS MATERIALS, NAMELY PAINTBRUSHES; LUNCHBAGS AND FABRIC LUNCH BAGS, IN CLASS 16 (U.S. CLS. 2, 5, 22, 23, 29, 37, 38 AND 50).

FIRST USE 6-1-2008; IN COMMERCE 6-1-2008.

THE MARK CONSISTS OF STANDARD CHARACTERS WITHOUT CLAIM TO ANY PARTICULAR FONT, STYLE, SIZE, OR COLOR.

SN 77-144,542, FILED 3-30-2007.

SETH A. RAPPAPORT, EXAMINING ATTORNEY

Int. Cl.: 25

Prior U.S. Cls.: 22 and 39

United States Patent and Trademark Office

Reg. No. 3,481,547

Registered Aug. 5, 2008

**TRADEMARK
PRINCIPAL REGISTER**

AYYMU

BEIJING AIMER LINGERIE CO., LTD. (CHINA
CORPORATION)
NEW TECHNOLOGY DEVELOPMENT ZONE
NO. 218-220 LIZEZHONGYUAN WANGJING
CHAOYANG DISTRICT, CHINA

FOR: CLOTHING, NAMELY, SWIMWEAR,
FOOTWEAR, CAPS, SOCKS, GLOVES, SCARVES,
NECK CLOTH, NAMELY, NECK TUBES, NECK
BANDS, GIRDLES, UNDERWEAR, LAYETTES, IN
CLASS 25 (U.S. CLS. 22 AND 39).

FIRST USE 2-0-2007; IN COMMERCE 2-0-2007.

THE MARK CONSISTS OF STANDARD CHAR-
ACTERS WITHOUT CLAIM TO ANY PARTICULAR
FONT, STYLE, SIZE, OR COLOR.

THE WORDING "AYYMU" HAS NO MEANING
IN A FOREIGN LANGUAGE.

SN 77-144,545, FILED 3-30-2007.

CARYN GLASSER, EXAMINING ATTORNEY

Int. Cl.: 16

Prior U.S. Cls.: 2, 5, 22, 23, 29, 37, 38, and 50

United States Patent and Trademark Office

Reg. No. 3,481,548

Registered Aug. 5, 2008

**TRADEMARK
PRINCIPAL REGISTER**

Am Lich Vietnam

IBASIS, INC. (DELAWARE CORPORATION)
20 SECOND AVENUE
BURLINGTON, MA 01803

FOR: PRE-PAID TELEPHONE CALLING CARDS,
NOT MAGNETICALLY ENCODED; TELEPHONE
CALLING CARDS, NOT MAGNETICALLY ENCO-
DED, IN CLASS 16 (U.S. CLS. 2, 5, 22, 23, 29, 37, 38
AND 50).

FIRST USE 6-1-2008; IN COMMERCE 6-1-2008.

THE MARK CONSISTS OF STANDARD CHAR-
ACTERS WITHOUT CLAIM TO ANY PARTICULAR
FONT, STYLE, SIZE, OR COLOR.

NO CLAIM IS MADE TO THE EXCLUSIVE
RIGHT TO USE "VIETNAM", APART FROM THE
MARK AS SHOWN.

THE FOREIGN WORDING IN THE MARK
TRANSLATES INTO ENGLISH AS MY COUNTRY
VIETNAM.

SN 77-144,546, FILED 3-30-2007.

CHERYL CLAYTON, EXAMINING ATTORNEY

Int. Cl.: 14

Prior U.S. Cls.: 2, 27, 28, and 50

United States Patent and Trademark Office

Reg. No. 3,481,549

Registered Aug. 5, 2008

**TRADEMARK
PRINCIPAL REGISTER**

ZAZEN

NUAW DESIGNS, LLC (DELAWARE LTD LIAB
CO)
SUITE 400
2711 CENTERVILLE ROAD
WILMINGTON, DE 19808

THE MARK CONSISTS OF STANDARD CHAR-
ACTERS WITHOUT CLAIM TO ANY PARTICULAR
FONT, STYLE, SIZE, OR COLOR.

FOR: JEWELRY, IN CLASS 14 (U.S. CLS. 2, 27, 28
AND 50).

SN 77-144,941, FILED 3-30-2007.

FIRST USE 1-23-2008; IN COMMERCE 1-23-2008.

JOHN HWANG, EXAMINING ATTORNEY

Int. Cl.: 5

Prior U.S. Cls.: 6, 18, 44, 46, 51, and 52

Reg. No. 3,481,550

United States Patent and Trademark Office

Registered Aug. 5, 2008

**TRADEMARK
PRINCIPAL REGISTER**

PROVIABLE

NUTRAMAX LABORATORIES, INC. (MARY-
LAND CORPORATION)
2208 LAKESIDE BOULEVARD
EDGEWOOD, MD 21040

THE MARK CONSISTS OF STANDARD CHAR-
ACTERS WITHOUT CLAIM TO ANY PARTICULAR
FONT, STYLE, SIZE, OR COLOR.

FOR: DIETARY AND NUTRITIONAL SUPPLE-
MENTS, IN CLASS 5 (U.S. CLS. 6, 18, 44, 46, 51 AND
52).

SN 77-145,079, FILED 3-30-2007.

FIRST USE 2-7-2008; IN COMMERCE 2-7-2008.

DAVID MURRAY, EXAMINING ATTORNEY

Int. Cl.: 36

Prior U.S. Cls.: 100, 101, and 102

United States Patent and Trademark Office

Reg. No. 3,481,551

Registered Aug. 5, 2008

**SERVICE MARK
PRINCIPAL REGISTER**

WHITE ELM

IORIO, MATTHEW T. (UNITED STATES INDIVIDUAL)
537 STEAMBOAT ROAD
SUITE 300
GREENWICH, CT 06830

THE MARK CONSISTS OF STANDARD CHARACTERS WITHOUT CLAIM TO ANY PARTICULAR FONT, STYLE, SIZE, OR COLOR.

FOR: FINANCIAL SERVICES, NAMELY, INVESTMENT MANAGEMENT SERVICES, IN CLASS 36 (U.S. CLS. 100, 101 AND 102).

SN 77-145,221, FILED 3-30-2007.

FIRST USE 9-0-2007; IN COMMERCE 9-0-2007.

CHARISMA HAMPTON, EXAMINING ATTORNEY

Int. Cl.: 16

Prior U.S. Cls.: 2, 5, 22, 23, 29, 37, 38, and 50

United States Patent and Trademark Office

Reg. No. 3,481,552

Registered Aug. 5, 2008

TRADEMARK
PRINCIPAL REGISTER



IBASIS, INC. (DELAWARE CORPORATION)
20 SECOND AVENUE
BURLINGTON, MA 01803

FOR: PRE-PAID TELEPHONE CALLING CARDS,
NOT MAGNETICALLY ENCODED; TELEPHONE
CALLING CARDS, NOT MAGNETICALLY ENCO-
DED, IN CLASS 16 (U.S. CLS. 2, 5, 22, 23, 29, 37, 38
AND 50).

FIRST USE 6-1-2008; IN COMMERCE 6-1-2008.

NO CLAIM IS MADE TO THE EXCLUSIVE
RIGHT TO USE "QUALITY CALLS", APART FROM
THE MARK AS SHOWN.

THE COLOR(S) RED, YELLOW, ORANGE, BLUE,
WHITE, BLACK AND GREEN IS/ARE CLAIMED AS
A FEATURE OF THE MARK.

THE MARK CONSISTS OF AN ANIMATED
CHARACTER CONSISTING OF A PEPPER WEAR-
ING A HAT AND SUNGLASSES NEXT TO THE
STYLIZED WORDS "CHILE PICANTE" IN A WHITE
COLOR WITH AN ORANGE BORDER AND THE
TERM "QUALITY CALL FROM IBASIS", WITH THE
TERM "IBASIS" IN A RED AND BLUE STYLIZED
FORMAT.

THE ENGLISH TRANSLATION OF THE WORD
"PICANTE" IN THE MARK IS PEPPER.

SN 77-145,298, FILED 3-30-2007.

CHERYL CLAYTON, EXAMINING ATTORNEY

Int. Cl.: 16

Prior U.S. Cls.: 2, 5, 22, 23, 29, 37, 38, and 50

Reg. No. 3,481,553

United States Patent and Trademark Office

Registered Aug. 5, 2008

**TRADEMARK
PRINCIPAL REGISTER**

ARTILHIERO

IBASIS, INC. (DELAWARE CORPORATION)
20 SECOND AVENUE
BURLINGTON, MA 01803

FIRST USE 5-29-2008; IN COMMERCE 5-29-2008.

FOR: PRE-PAID TELEPHONE CALLING CARDS,
NOT MAGNETICALLY ENCODED; TELEPHONE
CALLING CARDS, NOT MAGNETICALLY ENCO-
DED, IN CLASS 16 (U.S. CLS. 2, 5, 22, 23, 29, 37, 38
AND 50).

THE MARK CONSISTS OF STANDARD CHAR-
ACTERS WITHOUT CLAIM TO ANY PARTICULAR
FONT, STYLE, SIZE, OR COLOR.

SN 77-145,359, FILED 3-30-2007.

CHERYL CLAYTON, EXAMINING ATTORNEY

Int. Cl.: 20

Prior U.S. Cls.: 2, 13, 22, 25, 32, and 50

Reg. No. 3,481,554

United States Patent and Trademark Office

Registered Aug. 5, 2008

**TRADEMARK
PRINCIPAL REGISTER**

Posture Advantage

NEUSTAT, PAULA (UNITED STATES INDIVIDUAL)
10 LONDON TERRACE
NEW CITY, NY 10956

THE MARK CONSISTS OF STANDARD CHARACTERS WITHOUT CLAIM TO ANY PARTICULAR FONT, STYLE, SIZE, OR COLOR.

FOR: CUSHIONS; FITTED FABRIC FURNITURE COVERS, IN CLASS 20 (U.S. CLS. 2, 13, 22, 25, 32 AND 50).

SN 77-145,636, FILED 4-1-2007.

FIRST USE 2-15-2008; IN COMMERCE 2-15-2008.

RENEE MCCRAY, EXAMINING ATTORNEY

Int. Cl.: 35

Prior U.S. Cls.: 100, 101, and 102

United States Patent and Trademark Office

Reg. No. 3,481,555

Registered Aug. 5, 2008

**SERVICE MARK
PRINCIPAL REGISTER**

DONT FIX IT - SELL IT

SAAL, ELAINE (UNITED STATES INDIVIDUAL)
101 WRIGHT AVE
DEER PARK, NY 11729

THE MARK CONSISTS OF STANDARD CHAR-
ACTERS WITHOUT CLAIM TO ANY PARTICULAR
FONT, STYLE, SIZE, OR COLOR.

FOR: PROVIDING USED CAR SALES LEADS
FOR OTHERS, IN CLASS 35 (U.S. CLS. 100, 101
AND 102).

SN 77-145,639, FILED 4-1-2007.

FIRST USE 2-22-2003; IN COMMERCE 2-22-2003.

SALLY SHIH, EXAMINING ATTORNEY

Int. Cl.: 16

Prior U.S. Cls.: 2, 5, 22, 23, 29, 37, 38, and 50

Reg. No. 3,481,556

United States Patent and Trademark Office

Registered Aug. 5, 2008

**TRADEMARK
PRINCIPAL REGISTER**

Northwest Avenues

MIND STRONG MEDIA, INC. (ILLINOIS CORPORATION)
1641 THACKER ST. SUITE 1W
DES PLAINES, IL 60016

FOR: MAGAZINES FEATURING ARTICLES AND EDITORIALS RELEVANT TO RESIDENTS OF THE NORTHWEST CHICAGO SUBURBS AND SURROUNDING AREAS, IN CLASS 16 (U.S. CLS. 2, 5, 22, 23, 29, 37, 38 AND 50).

FIRST USE 8-1-2007; IN COMMERCE 8-1-2007.

THE MARK CONSISTS OF STANDARD CHARACTERS WITHOUT CLAIM TO ANY PARTICULAR FONT, STYLE, SIZE, OR COLOR.

NO CLAIM IS MADE TO THE EXCLUSIVE RIGHT TO USE "NORTHWEST", APART FROM THE MARK AS SHOWN.

SN 77-145,716, FILED 4-1-2007.

JEFF DEFORD, EXAMINING ATTORNEY

Int. Cl.: 35

Prior U.S. Cls.: 100, 101, and 102

United States Patent and Trademark Office

Reg. No. 3,481,557

Registered Aug. 5, 2008

**SERVICE MARK
PRINCIPAL REGISTER**

Go Zippin!

GERE, TRAVIS M (UNITED STATES INDIVIDUAL)
231 HATHAWAY RD
WRJ, VT 05001

FOR: DISSEMINATION OF ADVERTISING MAINLY LOCAL EVENTS AND AREA HAPPENINGS FOR OTHERS VIA THE INTERNET; PROMOTING SPORTS COMPETITIONS AND/OR EVENTS OF OTHERS; PROMOTING THE PARTIES AND SPECIAL EVENTS OF OTHERS; PROVIDING CONSUMER INFORMATION SERVICES AND MAKING REFERRALS IN THE FIELD OF ENTERTAINMENT SERVICES FOR PRODUCTS, SERVICES, EVENTS, ACTIVITIES, FACILITIES AND LOCATIONS; PROVIDING MARKETING AND PROMOTION OF SPECIAL EVENTS; PROVIDING SPACE AT A WEB SITE FOR USER-DEFINED ADVERTISEMENTS OF THE GOODS AND SERVICES OF OTHERS, WHICH INCLUDES ON-LINE LINKS TO OTHER WEB SITES; PROVIDING ON-LINE DIRECTORY INFORMATION SERVICES ALSO FEATURING HYPERLINKS TO OTHER WEB SITES; PROVIDING A WEB SITE WHICH FEATURES ADVERTISEMENTS FOR THE GOODS AND SERVICES OF OTHERS ON A GLOBAL COM-

PUTER NETWORK; PROVIDING A WEB SITE THAT ENABLES USERS TO POST ITEMS FOR SALE THROUGH ON-LINE CLASSIFIED ADVERTISEMENTS; PROVIDING AN ON-LINE SEARCHABLE DATABASE FEATURING CLASSIFIED AD LISTINGS AND EMPLOYMENT OPPORTUNITIES; PROVIDING A WEB SITE AT WHICH USERS CAN OFFER GOODS FOR SALE AND BUY GOODS OFFERED BY OTHERS; DISSEMINATION OF ADVERTISING FOR OTHERS VIA AN ON-LINE COMMUNICATIONS NETWORK ON THE INTERNET; ADVERTISING VIA ELECTRONIC MEDIA AND SPECIFICALLY THE INTERNET, IN CLASS 35 (U.S. CLS. 100, 101 AND 102).

FIRST USE 6-20-2008; IN COMMERCE 6-20-2008.

THE MARK CONSISTS OF STANDARD CHARACTERS WITHOUT CLAIM TO ANY PARTICULAR FONT, STYLE, SIZE, OR COLOR.

SN 77-146,138, FILED 4-2-2007.

ELISSA GARBER KON, EXAMINING ATTORNEY

Int. Cl.: 42

Prior U.S. Cls.: 100 and 101

United States Patent and Trademark Office

Reg. No. 3,481,558

Registered Aug. 5, 2008

**SERVICE MARK
PRINCIPAL REGISTER**

CV-PRO

TETRA TECHNOLOGIES, INC. (DELAWARE
CORPORATION)
25025 I-45 NORTH
THE WOODLANDS, TX 77380

THE MARK CONSISTS OF STANDARD CHAR-
ACTERS WITHOUT CLAIM TO ANY PARTICULAR
FONT, STYLE, SIZE, OR COLOR.

FOR: ENGINEERING SERVICES, NAMELY,
USING PHYSICAL WELL DATA TO ASSIST IN
SELECTION OF WELL FLUIDS, IN CLASS 42 (U.S.
CLS. 100 AND 101).

SN 77-146,469, FILED 4-2-2007.

FIRST USE 3-30-2007; IN COMMERCE 3-30-2007.

RONALD MCMORROW, EXAMINING ATTORNEY

Int. Cl.: 42

Prior U.S. Cls.: 100 and 101

United States Patent and Trademark Office

Reg. No. 3,481,559

Registered Aug. 5, 2008

**SERVICE MARK
PRINCIPAL REGISTER**

TP-PRO

TETRA TECHNOLOGIES, INC. (DELAWARE
CORPORATION)
25025 I-45 NORTH
THE WOODLANDS, TX 77380

THE MARK CONSISTS OF STANDARD CHAR-
ACTERS WITHOUT CLAIM TO ANY PARTICULAR
FONT, STYLE, SIZE, OR COLOR.

FOR: ENGINEERING SERVICES, NAMELY,
USING PHYSICAL WELL DATA TO ASSIST IN
SELECTION OF WELL FLUIDS, IN CLASS 42 (U.S.
CLS. 100 AND 101).

SN 77-146,511, FILED 4-2-2007.

FIRST USE 3-30-2007; IN COMMERCE 3-30-2007.

RONALD MCMORROW, EXAMINING ATTORNEY

Int. Cl.: 10

Prior U.S. Cls.: 26, 39, and 44

United States Patent and Trademark Office

Reg. No. 3,481,560

Registered Aug. 5, 2008

**TRADEMARK
PRINCIPAL REGISTER**

HEM-AVERT

PLEXUS BIOMEDICAL, INC. (TENNESSEE COR-
PORATION)
7495 HWY 64
OAKLAND, TN 38060

THE MARK CONSISTS OF STANDARD CHAR-
ACTERS WITHOUT CLAIM TO ANY PARTICULAR
FONT, STYLE, SIZE, OR COLOR.

FOR: MEDICAL DEVICE IN THE NATURE OF A
PERIANAL STABILIZER USED TO PREVENT OR
REDUCE HEMORRHOID SEVERITY, IN CLASS 10
(U.S. CLS. 26, 39 AND 44).

SN 77-146,552, FILED 4-2-2007.

FIRST USE 8-10-2007; IN COMMERCE 8-10-2007.

TINA BROWN, EXAMINING ATTORNEY

Int. Cl.: 10

Prior U.S. Cls.: 26, 39, and 44

United States Patent and Trademark Office

Reg. No. 3,481,561

Registered Aug. 5, 2008

**TRADEMARK
PRINCIPAL REGISTER**

SOUND TOUCH FOR WOUND CARE

AROBELLA MEDICAL, LLC (MINNESOTA LTD
LIAB CO)
5929 BAKER ROAD, SUITE 470
MINNETONKA, MN 55345

NO CLAIM IS MADE TO THE EXCLUSIVE
RIGHT TO USE "FOR WOUND CARE", APART
FROM THE MARK AS SHOWN.

FOR: MEDICAL ULTRASOUND APPARATUS, IN
CLASS 10 (U.S. CLS. 26, 39 AND 44).

SN 77-146,737, FILED 4-2-2007.

FIRST USE 4-10-2008; IN COMMERCE 4-10-2008.

THE MARK CONSISTS OF STANDARD CHAR-
ACTERS WITHOUT CLAIM TO ANY PARTICULAR
FONT, STYLE, SIZE, OR COLOR.

CIMMERIAN COLEMAN, EXAMINING ATTOR-
NEY

Int. Cl.: 9

Prior U.S. Cls.: 21, 23, 26, 36, and 38

Reg. No. 3,481,562

United States Patent and Trademark Office

Registered Aug. 5, 2008

**TRADEMARK
PRINCIPAL REGISTER**

LET SEAGREEN DO THE HARD
STUFF

ECI SOFTWARE, INC. (CALIFORNIA CORPORATION)
79 DAILY DRIVE, SUITE 159
CAMARILLO, CA 93010

FIRST USE 12-1-2007; IN COMMERCE 12-1-2007.

FOR: COMPUTER SOFTWARE FOR ACCESSING DATABASES, NAMELY, COMPUTER SOFTWARE USED TO BUILD GRAPHICAL USER INTERFACES FOR ACCESSING A DATABASE VIA A GLOBAL COMPUTER NETWORK, IN CLASS 9 (U.S. CLS. 21, 23, 26, 36 AND 38).

THE MARK CONSISTS OF STANDARD CHARACTERS WITHOUT CLAIM TO ANY PARTICULAR FONT, STYLE, SIZE, OR COLOR.

SN 77-146,791, FILED 4-2-2007.

JOHN DWYER, EXAMINING ATTORNEY

Int. Cl.: 36

Prior U.S. Cls.: 100, 101, and 102

United States Patent and Trademark Office

Reg. No. 3,481,563

Registered Aug. 5, 2008

**SERVICE MARK
PRINCIPAL REGISTER**

Freedom Cove

VAN HOUTEN, LYNN ROSS (UNITED STATES
INDIVIDUAL)
10418 23RD STREET COURT EAST
EDGEWOOD, WA 98372

FOR: ADVICE RELATING TO INVESTMENTS;
FINANCIAL ANALYSIS AND CONSULTATION;
FINANCIAL CONSULTATION; FINANCIAL PLAN-
NING; FINANCIAL PLANNING CONSULTATION;
FINANCIAL PLANNING FOR RETIREMENT; FI-
NANCIAL PLANNING, NAMELY THE CREATION
OF PERSONALIZED STRATEGIES TO ACHIEVE
FINANCIAL INDEPENDENCE; FINANCIAL PORT-
FOLIO MANAGEMENT; FINANCIAL SERVICES IN
THE NATURE OF AN INVESTMENT SECURITY;
FINANCIAL SERVICES, NAMELY ASSISTING OTHERS
WITH THE COMPLETION OF FINANCIAL
TRANSACTIONS FOR STOCKS, BONDS, SECURI-
TIES AND EQUITIES; FINANCIAL SERVICES,
NAMELY, A TOTAL PORTFOLIO OFFERING FOR

HIGH NET WORTH CLIENTS CONSISTING OF
BOTH SEPARATE ACCOUNTS AND MUTUAL
FUNDS FOR EQUITY AND FIXED INCOME IN-
VESTMENTS; FUND INVESTMENT CONSULTA-
TION; INVESTMENT ADVICE; INVESTMENT
ADVISORY SERVICES; INVESTMENT CONSULTA-
TION; INVESTMENT MANAGEMENT; INVEST-
MENT OF FUNDS FOR OTHERS, IN CLASS 36
(U.S. CLS. 100, 101 AND 102).

FIRST USE 10-31-2007; IN COMMERCE 10-31-2007.

THE MARK CONSISTS OF STANDARD CHAR-
ACTERS WITHOUT CLAIM TO ANY PARTICULAR
FONT, STYLE, SIZE, OR COLOR.

SN 77-146,917, FILED 4-2-2007.

ANDREA SAUNDERS, EXAMINING ATTORNEY

Int. Cl.: 29

Prior U.S. Cl.: 46

United States Patent and Trademark Office

Reg. No. 3,481,564

Registered Aug. 5, 2008

**TRADEMARK
PRINCIPAL REGISTER**



MANN PACKING CO., INC. (CALIFORNIA CORPORATION)
1333 SCHILLING PLACE
SALINAS, CA 93101

FIRST USE 5-18-2007; IN COMMERCE 5-18-2007.

SN 77-147,098, FILED 4-3-2007.

FOR: PACKAGE COMBINATIONS CONSISTING
PRIMARILY OF FRESH PRE-CUT VEGETABLES
AND SAUCE, IN CLASS 29 (U.S. CL. 46).

BARBARA RUTLAND, EXAMINING ATTORNEY

Int. Cls.: 1 and 17

Prior U.S. Cls.: 1, 5, 6, 10, 12, 13, 26, 35, 46, and 50

United States Patent and Trademark Office

Reg. No. 3,481,565

Registered Aug. 5, 2008

**TRADEMARK
PRINCIPAL REGISTER**



FRANKLIN INTERNATIONAL, INC. (OHIO CORPORATION)
2020 BRUCK STREET
COLUMBUS, OH 43207

FOR: CONSTRUCTION ADHESIVES, IN CLASS 1 (U.S. CLS. 1, 5, 6, 10, 26 AND 46).

FIRST USE 8-0-2007; IN COMMERCE 8-0-2007.

FOR: ADHESIVE SEALANTS FOR GENERAL USE; CAULKING, IN CLASS 17 (U.S. CLS. 1, 5, 12, 13, 35 AND 50).

FIRST USE 8-0-2007; IN COMMERCE 8-0-2007.

THE MARK CONSISTS OF A LEAF.

SN 77-147,312, FILED 4-3-2007.

KATHERINE E. HALMEN, EXAMINING ATTORNEY

Int. Cls.: 26 and 28

Prior U.S. Cls.: 22, 23, 37, 38, 39, 40, 42, and 50

United States Patent and Trademark Office

Reg. No. 3,481,566

Registered Aug. 5, 2008

**TRADEMARK
PRINCIPAL REGISTER**

TREETOPIA

RED SLATE BRANDS, INC. (BR.VIRGIN ISLANDS CORPORATION)
TRINITY CHAMBERS, P.O. BOX 4301
ROAD TOWN, BR.VIRGIN ISLANDS

FOR: ARTIFICIAL GARLANDS; ARTIFICIAL PLANTS; ARTIFICIAL WREATHS, IN CLASS 26 (U.S. CLS. 37, 39, 40, 42 AND 50).

FIRST USE 9-10-2007; IN COMMERCE 9-10-2007.

FOR: ARTIFICIAL CHRISTMAS GARLANDS; ARTIFICIAL CHRISTMAS TREES; CHRISTMAS TREE DECORATIONS; CHRISTMAS TREE SKIRTS;

CHRISTMAS TREE STAND COVERS; CHRISTMAS TREE STANDS, IN CLASS 28 (U.S. CLS. 22, 23, 38 AND 50).

FIRST USE 9-10-2007; IN COMMERCE 9-10-2007.

THE MARK CONSISTS OF STANDARD CHARACTERS WITHOUT CLAIM TO ANY PARTICULAR FONT, STYLE, SIZE, OR COLOR.

SN 77-147,327, FILED 4-3-2007.

SUZANNE BLANE, EXAMINING ATTORNEY

Int. Cl.: 30

Prior U.S. Cl.: 46

United States Patent and Trademark Office

Reg. No. 3,481,567

Registered Aug. 5, 2008

**TRADEMARK
PRINCIPAL REGISTER**

DEMET'S

DEMET'S CANDY COMPANY (DELAWARE
CORPORATION)
C/O BRYNWOOD PARTNERS
8 SOUND SHORE DRIVE; SUITE 265
GREENWICH, CT 06830

THE MARK CONSISTS OF STANDARD CHAR-
ACTERS WITHOUT CLAIM TO ANY PARTICULAR
FONT, STYLE, SIZE, OR COLOR.

FOR: CANDY, IN CLASS 30 (U.S. CL. 46).

SN 77-147,517, FILED 4-3-2007.

FIRST USE 2-1-2008; IN COMMERCE 2-1-2008.

DANIEL BRODY, EXAMINING ATTORNEY

Int. Cl.: 12

Prior U.S. Cls.: 19, 21, 23, 31, 35, and 44

United States Patent and Trademark Office

Reg. No. 3,481,568

Registered Aug. 5, 2008

**TRADEMARK
PRINCIPAL REGISTER**

MOTO GATE

WEBER, STEVEN (UNITED STATES INDIVIDUAL)
24342 BRIDLE TRAIL RD
HIDDEN HILLS, CA 91302

FOR: AUTOMOTIVE PARTS, NAMELY, TRUCK BED EXTENDERS, IN CLASS 12 (U.S. CLS. 19, 21, 23, 31, 35 AND 44).

FIRST USE 12-1-2007; IN COMMERCE 6-1-2008.

THE MARK CONSISTS OF STANDARD CHARACTERS WITHOUT CLAIM TO ANY PARTICULAR FONT, STYLE, SIZE, OR COLOR.

NO CLAIM IS MADE TO THE EXCLUSIVE RIGHT TO USE "GATE", APART FROM THE MARK AS SHOWN.

SN 77-147,726, FILED 4-3-2007.

MARY CRAWFORD, EXAMINING ATTORNEY

Int. Cls.: 30 and 32

Prior U.S. Cls.: 45, 46, and 48

United States Patent and Trademark Office

Reg. No. 3,481,569

Registered Aug. 5, 2008

**TRADEMARK
PRINCIPAL REGISTER**

vida tea

HEALTHY INNOVATIONS INC. (NEVADA CORPORATION)
5651 PALMER WAY STE. E
CARLSBAD, CA 92010

FOR: BEVERAGES MADE OF TEA; GREEN TEA; TEA; TEA-BASED BEVERAGES WITH FRUIT FLAVORING, IN CLASS 30 (U.S. CL. 46).

FIRST USE 2-1-2007; IN COMMERCE 8-16-2007.

FOR: SOFT DRINKS FLAVORED WITH TEA, IN CLASS 32 (U.S. CLS. 45, 46 AND 48).

FIRST USE 2-1-2007; IN COMMERCE 8-16-2007.

THE MARK CONSISTS OF STANDARD CHARACTERS WITHOUT CLAIM TO ANY PARTICULAR FONT, STYLE, SIZE, OR COLOR.

NO CLAIM IS MADE TO THE EXCLUSIVE RIGHT TO USE "TEA", APART FROM THE MARK AS SHOWN.

THE ENGLISH TRANSLATION OF "VIDA" IS LIFE.

SN 77-147,908, FILED 4-3-2007.

KAREN K. BUSH, EXAMINING ATTORNEY

Int. Cl.: 35

Prior U.S. Cls.: 100, 101, and 102

United States Patent and Trademark Office

Reg. No. 3,481,570

Registered Aug. 5, 2008

**SERVICE MARK
PRINCIPAL REGISTER**

The logo for TAXXSOLUTIONS features a large, stylized capital letter 'T' on the left. The 'T' is rendered in a dark maroon color with a white outline and a drop shadow effect. To the right of the 'T', the word 'AXXSOLUTIONS' is written in a smaller, solid maroon, all-caps serif font. The entire logo is underlined with a thin maroon line.

BELTER FINANCIAL SERVICES, INC. (ILLINOIS CORPORATION)

3727 SUNBURST LANE

NAPERVILLE, IL 60564

FOR: BOOKKEEPING, TAX CONSULTATION AND TAX PREPARATION SERVICES, IN CLASS 35 (U.S. CLS. 100, 101 AND 102).

FIRST USE 1-3-2007; IN COMMERCE 1-3-2007.

THE COLOR(S) MAROON IS/ARE CLAIMED AS A FEATURE OF THE MARK.

THE MARK CONSISTS OF THREE DIMENSIONAL CAPITAL LETTER "T" BEING SOLID MAROON AND A SHADOWING CAPITAL LETTER "T" THAT IS WHITE AND OUTLINED IN MAROON. THE CAPITAL LETTER "T" HAS THE LARGEST FONT SIZE. THE REMAINING LETTERS ARE SOLID MAROON, SMALLER FONT THAN THE LETTER "T" AND ALL CAPITAL, WITH THE LETTERS "XX" BEING BOLD AND A SLIGHTLY LARGER FONT THAN THE OTHER LETTERS (BUT SMALLER THAN THE FONT FOR THE LETTER "T").

SN 77-147,995, FILED 4-3-2007.

NAAKWAMA ANKRAH, EXAMINING ATTORNEY

Int. Cl.: 9

Prior U.S. Cls.: 21, 23, 26, 36, and 38

Reg. No. 3,481,571

United States Patent and Trademark Office

Registered Aug. 5, 2008

**TRADEMARK
PRINCIPAL REGISTER**



ANDALE SOFTWARE, LLC (MINNESOTA LTD
LIAB CO)
4580 SCOTT TRAIL, #218
EAGAN, MN 55121

THE COLOR(S) GREEN, RED, BLUE, AND
BLACK IS/ARE CLAIMED AS A FEATURE OF
THE MARK.

FOR: COMPUTER SOFTWARE FOR HUMAN
RESOURCES, STAFFING AND PAYROLL COMPA-
NIES THAT ASSIST IN TRACKING INTERNAL
RESOURCES SUCH AS EMPLOYEES, EXTERNAL
RESOURCES SUCH AS CUSTOMERS, AND OR-
DERS, ASSIGNMENTS, PAYROLL, BILLING AND
ACCOUNTS RECEIVABLE, IN CLASS 9 (U.S. CLS. 21,
23, 26, 36 AND 38).

THE MARK CONSISTS OF ONE LARGE GREEN
SLASH GOING TO THE RIGHT WITH A MEDIUM
RED SLASH TO THE UPPER RIGHT OF A SMAL-
LER BLUE SLASH ABOVE THE WORD "AVIONTÉ"
IN BLACK.

SN 77-148,091, FILED 4-4-2007.

FIRST USE 5-0-2007; IN COMMERCE 5-0-2007.

LEIGH CAROLINE CASE, EXAMINING ATTOR-
NEY

Int. Cl.: 32

Prior U.S. Cls.: 45, 46, and 48

Reg. No. 3,481,572

United States Patent and Trademark Office

Registered Aug. 5, 2008

**TRADEMARK
PRINCIPAL REGISTER**

D FIB

AMERICAN INSTANTS, INC. (NEW JERSEY
CORPORATION)
117 BARTLEY FLANDERS ROAD
FLANDERS, NJ 07836

THE MARK CONSISTS OF STANDARD CHAR-
ACTERS WITHOUT CLAIM TO ANY PARTICULAR
FONT, STYLE, SIZE, OR COLOR.

FOR: NON-ALCOHOLIC BEVERAGES, NAMELY,
ENERGY DRINKS AND SPORTS DRINKS, IN
CLASS 32 (U.S. CLS. 45, 46 AND 48).

SN 77-148,434, FILED 4-4-2007.

FIRST USE 11-21-2007; IN COMMERCE 4-18-2008.

REBECCA EISINGER, EXAMINING ATTORNEY

Int. Cl.: 42

Prior U.S. Cls.: 100 and 101

United States Patent and Trademark Office

Reg. No. 3,481,573

Registered Aug. 5, 2008

**SERVICE MARK
PRINCIPAL REGISTER**

CE PRIME

CE PRIME, INC. (CALIFORNIA CORPORATION)
5205 AVENIDA ENCINAS, SUITE C
CARLSBAD, CA 92008

FOR: CIVIL ENGINEERING CONSULTING; SUR-
VEYING AND ENGINEERING CONSULTING, IN
CLASS 42 (U.S. CLS. 100 AND 101).

FIRST USE 6-1-2007; IN COMMERCE 6-1-2007.

THE MARK CONSISTS OF STANDARD CHAR-
ACTERS WITHOUT CLAIM TO ANY PARTICULAR
FONT, STYLE, SIZE, OR COLOR.

NO CLAIM IS MADE TO THE EXCLUSIVE
RIGHT TO USE "CE", APART FROM THE MARK
AS SHOWN.

SN 77-148,509, FILED 4-4-2007.

DAWN FELDMAN, EXAMINING ATTORNEY

Int. Cl.: 41

Prior U.S. Cls.: 100, 101, and 107

United States Patent and Trademark Office

Reg. No. 3,481,574

Registered Aug. 5, 2008

**SERVICE MARK
PRINCIPAL REGISTER**

GLI UNIVERSITY

GAMING LABORATORIES INTERNATIONAL,
INC. (NEW JERSEY CORPORATION)
600 AIRPORT ROAD
LAKEWOOD, NJ 08701

FOR: EDUCATIONAL SERVICES, NAMELY,
PROVIDING TRAINING COURSES FOR REGULA-
TORS, SUPPLIERS, AND CASINO OWNERS AND
OPERATORS WITH REGARD TO GAMING EQUIP-
MENT AND GAMING REGULATIONS, IN CLASS 41
(U.S. CLS. 100, 101 AND 107).

FIRST USE 5-13-2008; IN COMMERCE 5-13-2008.

THE MARK CONSISTS OF STANDARD CHAR-
ACTERS WITHOUT CLAIM TO ANY PARTICULAR
FONT, STYLE, SIZE, OR COLOR.

OWNER OF U.S. REG. NO. 2,800,298.

NO CLAIM IS MADE TO THE EXCLUSIVE
RIGHT TO USE "UNIVERSITY", APART FROM
THE MARK AS SHOWN.

SN 77-148,760, FILED 4-4-2007.

MATTHEW EINSTEIN, EXAMINING ATTORNEY

Int. Cl.: 42

Prior U.S. Cls.: 100 and 101

United States Patent and Trademark Office

Reg. No. 3,481,575

Registered Aug. 5, 2008

**SERVICE MARK
PRINCIPAL REGISTER**



CE PRIME, INC. (CALIFORNIA CORPORATION)
5205 AVENIDA ENCINAS, SUITE C
CARLSBAD, CA 92008

FOR: CIVIL ENGINEERING CONSULTING; SUR-
VEYING AND ENGINEERING CONSULTING, IN
CLASS 42 (U.S. CLS. 100 AND 101).

FIRST USE 6-1-2007; IN COMMERCE 6-1-2007.

THE MARK CONSISTS OF THE STYLIZED
WORD "CEPRIMEINC" PRECEDED BY THREE
CURVES BEFORE THE LETTER "C".

SN 77-148,825, FILED 4-4-2007.

DAWN FELDMAN, EXAMINING ATTORNEY

Int. Cl.: 25

Prior U.S. Cls.: 22 and 39

United States Patent and Trademark Office

Reg. No. 3,481,576

Registered Aug. 5, 2008

**TRADEMARK
PRINCIPAL REGISTER**

SPOLDA

KIM, JEONG HO (REPUBLIC OF KOREA INDIVIDUAL)
APT 2F
341 EAST 33RD STREET
NEW YORK, NY 10016

FOR: BELTS; BIBS NOT OF CLOTH OR PAPER; CAPS; CHILDREN'S AND INFANTS' CLOTH BIBS; CHILDREN'S CLOTH EATING BIBS; CLOTH BIBS; CLOTH BIBS FOR ADULT DINERS; CLOTH BIBS FOR USE BY SENIOR CITIZENS OR PHYSICALLY-OR MENTALLY-CHALLENGED PERSONS; CLOTH DIAPERS; CLOTHING FOR WEAR IN JUDO PRACTICES; CLOTHING FOR WEAR IN WRESTLING GAMES; CLOTHING, NAMELY, ARM WARMERS; CLOTHING, NAMELY, FOLK COSTUMES; CLOTHING, NAMELY, KNEE WARMERS; CLOTHING, NAMELY, NECK TUBES; CLOTHING, NAMELY, WRAP-AROUNDS; CORSETS; DUSTERS; FIGURE SKATING CLOTHING, NAMELY, ONE-PIECE BODY SUITS, TIGHTS, SHIRTS, DRESSES, SKIRTS, AND PANTS; FOULARDS; HOODS; INFANT AND TODDLER ONE PIECE CLOTHING; INFANT CLOTH DIAPERS; JERSEYS; LEATHER BELTS;

MANTLES; MUFFLERS; NON-DISPOSABLE CLOTH TRAINING PANTS; PAPER HATS FOR USE AS CLOTHING ITEMS; PARTS OF CLOTHING, NAMELY, GUSSETS FOR TIGHTS, GUSSETS FOR STOCKINGS, GUSSETS FOR BATHING SUITS, GUSSETS FOR UNDERWEAR, GUSSETS FOR LEOTARDS AND GUSSETS FOR FOOTLETS; PERSPIRATION ABSORBENT UNDERWEAR CLOTHING; SHIRTS; SHORT SETS; SHOULDER WRAPS; SWADDLING CLOTHES; TIES; TOPS; UNDERARM CLOTHING SHIELDS; WRAPS, IN CLASS 25 (U.S. CLS. 22 AND 39).

FIRST USE 10-23-2006; IN COMMERCE 8-3-2006.

THE MARK CONSISTS OF STANDARD CHARACTERS WITHOUT CLAIM TO ANY PARTICULAR FONT, STYLE, SIZE, OR COLOR.

SN 77-149,008, FILED 4-4-2007.

JASON BLAIR, EXAMINING ATTORNEY

Int. Cl.: 25

Prior U.S. Cls.: 22 and 39

United States Patent and Trademark Office

Reg. No. 3,481,577

Registered Aug. 5, 2008

**TRADEMARK
PRINCIPAL REGISTER**

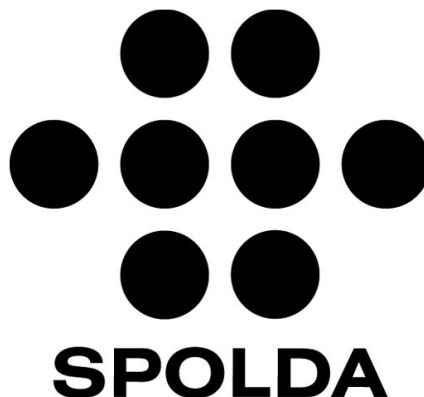

KIM, JEONG HO (REPUBLIC OF KOREA INDIVIDUAL)
APT 2F
341 EAST 33RD STREET
NEW YORK, NY 10016

FOR: INFANT CLOTH DIAPERS; JERSEYS; LEATHER BELTS; MANTLES; MUFFLERS; NON-DISPOSABLE CLOTH TRAINING PANTS; PAPER HATS FOR USE AS CLOTHING ITEMS; PARTS OF CLOTHING, NAMELY, GUSSETS FOR TIGHTS, GUSSETS FOR STOCKINGS, GUSSETS FOR BATHING SUITS, GUSSETS FOR UNDERWEAR, GUSSETS FOR LEOTARDS AND GUSSETS FOR FOOTLETS; PERSPIRATION ABSORBENT UNDERWEAR CLOTHING; SHIFTS; SHORT SETS; SHOULDER WRAPS; SWADDLING CLOTHES; TIES; TOPS; UNDERARM CLOTHING SHIELDS; WRAPS; CAPS; CHILDREN'S AND INFANTS' CLOTH BIBS; CHILDREN'S CLOTH EATING BIBS; CLOTH BIBS; CLOTH BIBS FOR ADULT DINERS; CLOTH BIBS FOR USE BY SENIOR CITIZENS OR

PHYSICALLY- OR MENTALLY-CHALLENGED PERSONS; CLOTH DIAPERS; CLOTHING FOR WEAR IN JUDO PRACTICES; CLOTHING FOR WEAR IN WRESTLING GAMES; CLOTHING, NAMELY, ARM WARMERS; CLOTHING, NAMELY, FOLK COSTUMES; CLOTHING, NAMELY, KNEE WARMERS; CLOTHING, NAMELY, NECK TUBES; CLOTHING, NAMELY, WRAP-AROUNDS; CORSETS; DUSTERS; FIGURE SKATING CLOTHING, NAMELY, ONE-PIECE BODY SUITS, TIGHTS, SHIRTS, DRESSES, SKIRTS, AND PANTS; FOU-LARDS; HOODS; INFANT AND TODDLER ONE PIECE CLOTHING; BELTS; BIBS NOT OF CLOTH OR PAPER, IN CLASS 25 (U.S. CLS. 22 AND 39).

FIRST USE 10-23-2006; IN COMMERCE 8-3-2006.

SN 77-149,038, FILED 4-4-2007.

JASON BLAIR, EXAMINING ATTORNEY

Int. Cl.: 36

Prior U.S. Cls.: 100, 101, and 102

United States Patent and Trademark Office

Reg. No. 3,481,578

Registered Aug. 5, 2008

**SERVICE MARK
PRINCIPAL REGISTER**

NLGROUP

NATIONAL LIFE INSURANCE COMPANY (VER-
MONT CORPORATION)
NATIONAL LIFE DRIVE
MONTPELIER, VT 05604

FOR: LIFE INSURANCE UNDERWRITING; AN-
NUITY UNDERWRITING; FINANCIAL ADMINIS-
TRATION OF RETIREMENT PLANS; BROKERAGE
OF SHARES OR STOCKS AND OTHER SECURI-
TIES; FINANCIAL SERVICES, NAMELY, ASSIST-
ING OTHERS WITH THE COMPLETION OF
FINANCIAL TRANSACTIONS FOR STOCKS,
BONDS, SECURITIES AND EQUITIES; INVEST-
MENT MANAGEMENT, IN CLASS 36 (U.S. CLS.
100, 101 AND 102).

FIRST USE 6-6-2008; IN COMMERCE 6-6-2008.

THE MARK CONSISTS OF STANDARD CHAR-
ACTERS WITHOUT CLAIM TO ANY PARTICULAR
FONT, STYLE, SIZE, OR COLOR.

OWNER OF U.S. REG. NOS. 2,504,266, 3,160,254,
AND OTHERS.

SN 77-149,088, FILED 4-5-2007.

CHERYL CLAYTON, EXAMINING ATTORNEY

Int. Cl.: 17

Prior U.S. Cls.: 1, 5, 12, 13, 35, and 50

Reg. No. 3,481,579

United States Patent and Trademark Office

Registered Aug. 5, 2008

**TRADEMARK
PRINCIPAL REGISTER**

BIOCUSHION

CORTEC CORPORATION (MINNESOTA CORPORATION)
4119 WHITE BEAR PARKWAY
ST. PAUL, MN 55110

FOR: PROTECTIVE PACKAGING MATERIALS, NAMELY, INFLATABLE PLASTIC BLADDERS USED TO FILL PACKAGE VOID SPACES AND CUSHION CONTENTS, IN CLASS 17 (U.S. CLS. 1, 5, 12, 13, 35 AND 50).

FIRST USE 6-13-2008; IN COMMERCE 6-13-2008.

THE MARK CONSISTS OF STANDARD CHARACTERS WITHOUT CLAIM TO ANY PARTICULAR FONT, STYLE, SIZE, OR COLOR.

SN 77-149,412, FILED 4-5-2007.

MICHELLE DUBOIS, EXAMINING ATTORNEY

Int. Cl.: 1

Prior U.S. Cls.: 1, 5, 6, 10, 26, and 46

Reg. No. 3,481,580

United States Patent and Trademark Office

Registered Aug. 5, 2008

**TRADEMARK
PRINCIPAL REGISTER**

SUCRALEAN

VITAL PHARMACEUTICALS, INC. (FLORIDA
CORPORATION)
15751 S.W. 41ST STREET, SUITE 300
DAVIE, FL 33331

THE MARK CONSISTS OF STANDARD CHAR-
ACTERS WITHOUT CLAIM TO ANY PARTICULAR
FONT, STYLE, SIZE, OR COLOR.

FOR: ARTIFICIAL SWEETENERS, IN CLASS 1
(U.S. CLS. 1, 5, 6, 10, 26 AND 46).

SN 77-149,604, FILED 4-5-2007.

FIRST USE 5-23-2008; IN COMMERCE 5-23-2008.

KEVON CHISOLM, EXAMINING ATTORNEY

Int. Cl.: 43

Prior U.S. Cls.: 100 and 101

United States Patent and Trademark Office

Reg. No. 3,481,581

Registered Aug. 5, 2008

**SERVICE MARK
PRINCIPAL REGISTER**

TOYS

RIVERA, ALEXANDRIA NICOLE (UNITED STATES INDIVIDUAL)
10620 SOUTHERN HIGHLANDS, SUITE 110-161
LAS VEGAS, NV 89141

THE MARK CONSISTS OF STANDARD CHARACTERS WITHOUT CLAIM TO ANY PARTICULAR FONT, STYLE, SIZE, OR COLOR.

FOR: RESTAURANTS, IN CLASS 43 (U.S. CLS. 100 AND 101).

SN 77-149,923, FILED 4-5-2007.

FIRST USE 2-17-2000; IN COMMERCE 1-5-2008.

JASON BLAIR, EXAMINING ATTORNEY

Int. Cl.: 24

Prior U.S. Cls.: 42 and 50

United States Patent and Trademark Office

Reg. No. 3,481,582

Registered Aug. 5, 2008

**TRADEMARK
PRINCIPAL REGISTER**

LYNOVA

STANDARD TEXTILE CO., INC. (ALABAMA
CORPORATION)
ONE KNOLLCREST DRIVE
CINCINNATI, OH 45237

THE MARK CONSISTS OF STANDARD CHAR-
ACTERS WITHOUT CLAIM TO ANY PARTICULAR
FONT, STYLE, SIZE, OR COLOR.

FOR: TEXTILE NAPKINS, TABLECLOTHS, AND
BANQUET TABLECLOTHS, IN CLASS 24 (U.S. CLS.
42 AND 50).

SN 77-149,993, FILED 4-5-2007.

FIRST USE 5-0-2007; IN COMMERCE 5-0-2007.

PAUL CROWLEY, EXAMINING ATTORNEY

Int. Cls.: 16 and 40

Prior U.S. Cls.: 2, 5, 22, 23, 29, 37, 38, 50, 100, 103, and 106

Reg. No. 3,481,583

United States Patent and Trademark Office

Registered Aug. 5, 2008

**TRADEMARK
SERVICE MARK
PRINCIPAL REGISTER**

I CAN DO THAT

F+W PUBLICATIONS, INC. (OHIO CORPORATION)
4700 GALBRAITH ROAD
CINCINNATI, OH 45236

FOR: MAGAZINE COLUMNS AND BOOKS IN THE AREA OF WOODWORKING AND DO-IT-YOURSELF PROJECTS, IN CLASS 16 (U.S. CLS. 2, 5, 22, 23, 29, 37, 38 AND 50).

FIRST USE 6-0-2006; IN COMMERCE 6-0-2006.

FOR: PROVIDING INFORMATION IN THE FIELD OF WOODWORKING AND DO-IT-YOUR-

SELF WOODWORKING PROJECTS VIA THE INTERNET, IN CLASS 40 (U.S. CLS. 100, 103 AND 106).

FIRST USE 6-0-2006; IN COMMERCE 6-0-2006.

THE MARK CONSISTS OF STANDARD CHARACTERS WITHOUT CLAIM TO ANY PARTICULAR FONT, STYLE, SIZE, OR COLOR.

SN 77-150,279, FILED 4-5-2007.

CIMMERIAN COLEMAN, EXAMINING ATTORNEY

Int. Cl.: 16

Prior U.S. Cls.: 2, 5, 22, 23, 29, 37, 38, and 50

United States Patent and Trademark Office

Reg. No. 3,481,584

Registered Aug. 5, 2008

**TRADEMARK
PRINCIPAL REGISTER**

HANDI-FILM

HANDI-FOIL CORPORATION (ILLINOIS CORPORATION)
135 E. HINTZ RD.
WHEELING, IL 60090

THE MARK CONSISTS OF STANDARD CHARACTERS WITHOUT CLAIM TO ANY PARTICULAR FONT, STYLE, SIZE, OR COLOR.

FOR: PLASTIC WRAP AND PLASTIC WRAPPING FILM FOR HOUSEHOLD USE, IN CLASS 16 (U.S. CLS. 2, 5, 22, 23, 29, 37, 38 AND 50).

SN 77-150,409, FILED 4-6-2007.

FIRST USE 6-10-2008; IN COMMERCE 6-10-2008.

JENNIFER MARTIN, EXAMINING ATTORNEY

Int. Cl.: 28

Prior U.S. Cls.: 22, 23, 38, and 50

United States Patent and Trademark Office

Reg. No. 3,481,585

Registered Aug. 5, 2008

**TRADEMARK
PRINCIPAL REGISTER**

PUSH FIGHT

PICOTTE, BRETT (UNITED STATES INDIVIDUAL)
6347 N. STATE HWY HH
WILLARD, MO 65781

THE MARK CONSISTS OF STANDARD CHARACTERS WITHOUT CLAIM TO ANY PARTICULAR FONT, STYLE, SIZE, OR COLOR.

FOR: GAME BOARD, PLAYING PIECES AND DOCUMENTATION SOLD AS A UNIT, IN CLASS 28 (U.S. CLS. 22, 23, 38 AND 50).

SN 77-150,436, FILED 4-6-2007.

FIRST USE 6-6-2008; IN COMMERCE 6-6-2008.

DAYNA BROWNE, EXAMINING ATTORNEY

Int. Cl.: 3

Prior U.S. Cls.: 1, 4, 6, 50, 51, and 52

Reg. No. 3,481,586

United States Patent and Trademark Office

Registered Aug. 5, 2008

**TRADEMARK
PRINCIPAL REGISTER**

PERIOE

LG HOUSEHOLD & HEALTH CARE LTD. (RE-
PUBLIC OF KOREA CORPORATION)
20, YOIDO-DONG, YONGDUNGPO-GU
SEOUL, REPUBLIC OF KOREA

FOR: COSMETIC TOOTH WHITENING PRE-
PARATIONS; PENCILS FOR TOOTH WHITENING
PURPOSES; TOOTH WHITENING PATCHES, IN
CLASS 3 (U.S. CLS. 1, 4, 6, 50, 51 AND 52).

FIRST USE 8-12-2007; IN COMMERCE 2-15-2008.

THE MARK CONSISTS OF STANDARD CHAR-
ACTERS WITHOUT CLAIM TO ANY PARTICULAR
FONT, STYLE, SIZE, OR COLOR.

OWNER OF U.S. REG. NO. 1,304,566.

SN 77-150,458, FILED 4-6-2007.

MICHAEL SOUDERS, EXAMINING ATTORNEY

Int. Cl.: 41

Prior U.S. Cls.: 100, 101, and 107

United States Patent and Trademark Office

Reg. No. 3,481,587

Registered Aug. 5, 2008

**SERVICE MARK
PRINCIPAL REGISTER**

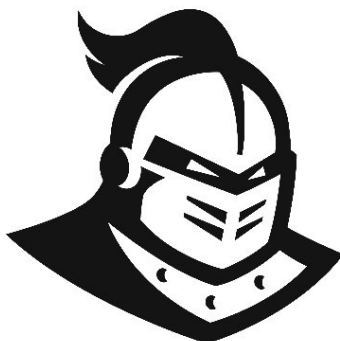

UNIVERSITY OF CENTRAL FLORIDA (FLORIDA STATE UNIVERSITY)
4000 CENTRAL FLORIDA BOULEVARD
ORLANDO, FL 32816

FOR: ENTERTAINMENT SERVICES, NAMELY, ORGANIZING AND CONDUCTING COLLEGE SPORTS COMPETITIONS, ATHLETIC EVENTS, TOURNAMENTS AND LIVE PERFORMANCES , IN CLASS 41 (U.S. CLS. 100, 101 AND 107).

FIRST USE 7-0-2007; IN COMMERCE 7-0-2007.

OWNER OF U.S. REG. NOS. 2,121,912, 3,156,265, AND OTHERS.

THE MARK CONSISTS OF KNIGHT HEAD WITH HELMET MASK WITH PLUME.

SN 77-150,468, FILED 4-6-2007.

SIMON TENG, EXAMINING ATTORNEY

Int. Cl.: 35

Prior U.S. Cls.: 100, 101, and 102

United States Patent and Trademark Office

Reg. No. 3,481,588

Registered Aug. 5, 2008

**SERVICE MARK
PRINCIPAL REGISTER**

PRESTIGE REWARDS PROGRAM

PRESTIGE REWARDS PROGRAM, INC. (FLOR-
IDA CORPORATION)
4134 PERRY PLACE
NEW PORT RICHEY, FL 34652

FOR: CUSTOMER LOYALTY SERVICES AND
CUSTOMER CLUB SERVICES, FOR COMMERCIAL,
PROMOTIONAL AND/OR ADVERTISING PURPO-
SES, IN CLASS 35 (U.S. CLS. 100, 101 AND 102).

FIRST USE 5-5-2008; IN COMMERCE 5-5-2008.

THE MARK CONSISTS OF STANDARD CHAR-
ACTERS WITHOUT CLAIM TO ANY PARTICULAR
FONT, STYLE, SIZE, OR COLOR.

NO CLAIM IS MADE TO THE EXCLUSIVE
RIGHT TO USE "REWARDS PROGRAM", APART
FROM THE MARK AS SHOWN.

SN 77-150,542, FILED 4-6-2007.

ANDREA BUTLER, EXAMINING ATTORNEY

Int. Cl.: 41

Prior U.S. Cls.: 100, 101, and 107

United States Patent and Trademark Office

Reg. No. 3,481,589

Registered Aug. 5, 2008

**SERVICE MARK
PRINCIPAL REGISTER**



UNIVERSITY OF CENTRAL FLORIDA (FLORIDA STATE UNIVERSITY)
4000 CENTRAL FLORIDA BOULEVARD
ORLANDO, FL 32816

FOR: ENTERTAINMENT SERVICES, NAMELY, ORGANIZING AND CONDUCTING COLLEGE SPORTS COMPETITIONS, ATHLETIC EVENTS, TOURNAMENTS AND LIVE PERFORMANCES, IN CLASS 41 (U.S. CLS. 100, 101 AND 107).

FIRST USE 7-0-2007; IN COMMERCE 7-0-2007.

OWNER OF U.S. REG. NOS. 2,118,135, 3,156,265, AND OTHERS.

THE MARK CONSISTS OF KNIGHT HOLDING SWORD (HALF BODY) ABOVE TERM "UCF" WITH WORD "KNIGHTS" BELOW "UCF".

SN 77-150,549, FILED 4-6-2007.

KATHERINE M. DUBRAY, EXAMINING ATTORNEY

Int. Cl.: 25

Prior U.S. Cls.: 22 and 39

United States Patent and Trademark Office

Reg. No. 3,481,590

Registered Aug. 5, 2008

**TRADEMARK
PRINCIPAL REGISTER**



UNIVERSITY OF CENTRAL FLORIDA (FLORIDA STATE UNIVERSITY)
4000 CENTRAL FLORIDA BOULEVARD
ORLANDO, FL 32816

FOR: CLOTHING, FOR MEN, WOMEN AND CHILDREN, NAMELY, T-SHIRTS, SWEATSHIRTS, TANK TOPS, SHIRTS, AND HATS AND CAPS, IN CLASS 25 (U.S. CLS. 22 AND 39).

FIRST USE 7-0-2007; IN COMMERCE 7-0-2007.

OWNER OF U.S. REG. NOS. 2,118,135, 3,062,706, AND OTHERS.

THE MARK CONSISTS OF KNIGHT HOLDING SWORD (HALF BODY) ABOVE TERM "UCF" WITH WORD "KNIGHTS" BELOW "UCF".

SN 77-150,557, FILED 4-6-2007.

SIMON TENG, EXAMINING ATTORNEY

Int. Cl.: 25

Prior U.S. Cls.: 22 and 39

United States Patent and Trademark Office

Reg. No. 3,481,591

Registered Aug. 5, 2008

**TRADEMARK
PRINCIPAL REGISTER**



UNIVERSITY OF CENTRAL FLORIDA (FLORIDA STATE UNIVERSITY)
4000 CENTRAL FLORIDA BOULEVARD
ORLANDO, FL 32816

FOR: CLOTHING, FOR MEN, WOMEN AND CHILDREN, NAMELY, JOGGING SUITS, SWEAT SUITS, T-SHIRTS, SWEATSHIRTS, SHIRTS, PANTS, PONCHOS, HATS AND CAPS, TIES, AND FOOTWEAR, IN CLASS 25 (U.S. CLS. 22 AND 39).

FIRST USE 7-0-2007; IN COMMERCE 7-0-2007.

OWNER OF U.S. REG. NOS. 2,118,135, 3,062,706, AND OTHERS.

THE MARK CONSISTS OF KNIGHT WITH SWORD (HALF BODY) ABOVE TERM "UCF".

SN 77-150,572, FILED 4-6-2007.

KATHERINE M. DUBRAY, EXAMINING ATTORNEY

Int. Cl.: 25

Prior U.S. Cls.: 22 and 39

United States Patent and Trademark Office

Reg. No. 3,481,592

Registered Aug. 5, 2008

**TRADEMARK
PRINCIPAL REGISTER**

SWEET ROMEO

SWEET ROMEO LLC (NEW YORK LTD LIAB
CO)
2ND FLOOR NORTH TOWER
499 SEVENTH AVENUE
NEW YORK, NY 10018

FOR: CLOTHING FOR USE BY WOMEN, NAME-
LY, BLAZERS; BLOUSES; BODYSUITS; BOLEROS;
CAMISOLES; CAPES; CARDIGANS; DRESSES; HAL-
TER TOPS; JACKETS; JEANS; JOGGING SUITS;
LEGGINGS; PANTS; PONCHOS; PULLOVERS;
SCARVES; SHAWLS; SHIRTS; SHORTS; UNDER-
SHIRTS; SWEAT SHORTS; SKIRTS; SPORT COATS;
SPORT SHIRTS; STOCKINGS; SUITS; SWEAT

PANTS; SWEAT SHIRTS; SWEATERS; T-SHIRTS;
TROUSERS; VESTS; AND WARM-UP SUITS, IN
CLASS 25 (U.S. CLS. 22 AND 39).

FIRST USE 1-31-1997; IN COMMERCE 1-31-1997.

THE MARK CONSISTS OF STANDARD CHAR-
ACTERS WITHOUT CLAIM TO ANY PARTICULAR
FONT, STYLE, SIZE, OR COLOR.

SN 77-150,649, FILED 4-6-2007.

MARCIE MILONE, EXAMINING ATTORNEY

Int. Cl.: 37

Prior U.S. Cls.: 100, 103, and 106

United States Patent and Trademark Office

Reg. No. 3,481,593

Registered Aug. 5, 2008

**SERVICE MARK
PRINCIPAL REGISTER**

HEROES AT HOME

SEARS BRANDS, LLC (ILLINOIS LTD LIAB CO)
3333 BEVERLY ROAD
HOFFMAN ESTATES, IL 60179

THE MARK CONSISTS OF STANDARD CHAR-
ACTERS WITHOUT CLAIM TO ANY PARTICULAR
FONT, STYLE, SIZE, OR COLOR.

FOR: CHARITABLE SERVICES, NAMELY,
BUILDING RESIDENTIAL HOUSING FOR WAR
VETERANS, IN CLASS 37 (U.S. CLS. 100, 103 AND
106).

SN 77-150,797, FILED 4-6-2007.

FIRST USE 5-0-2007; IN COMMERCE 5-0-2007.

SCOTT BIBB, EXAMINING ATTORNEY

Int. Cl.: 35

Prior U.S. Cls.: 100, 101, and 102

United States Patent and Trademark Office

Reg. No. 3,481,594

Registered Aug. 5, 2008

**SERVICE MARK
PRINCIPAL REGISTER**



KRISTEN JANE EDWARDS (CALIFORNIA
PARTNERSHIP)
125 4TH STREET
HERMOSA BEACH, CA 90254

FOR: RETAIL STORE SERVICES FEATURING CLOTHING SUCH AS ORGANIC SHIRTS, HATS, PANTS, AND JACKETS, HANDBAGS, TOTE BAGS, AND JEWELRY; RETAIL STORE SERVICES FEATURING ECO-LIFESTYLE PRODUCTS IN THE NATURE OF SOLAR BACKPACKS, COMPOST KITS, AND CLEAN TECHNOLOGY MACHINES, TOOLS, AND ELECTRONICS; PROMOTING PUBLIC AWARENESS OF SOLUTIONS TO ENVIRONMENTAL PROBLEMS, IN CLASS 35 (U.S. CLS. 100, 101 AND 102).

FIRST USE 5-31-2007; IN COMMERCE 12-1-2007.

THE COLOR(S) GREEN AND WHITE IS/ARE CLAIMED AS A FEATURE OF THE MARK.

THE MARK CONSISTS OF RECTANGULAR FLAG FEATURING A GREEN RECTANGLE IN THE UPPER HOIST-SIDE CORNER BEARING 50 SMALL, WHITE, FIVE-POINTED STARS ARRANGED IN NINE OFFSET HORIZONTAL ROWS OF SIX STARS IN THE TOP AND BOTTOM ROWS ALTERNATING WITH ROWS OF FIVE STARS. TO THE RIGHT AND BENEATH THE GREEN RECTANGULAR FIELD ARE THIRTEEN EQUAL HORIZONTAL STRIPES OF GREEN AT THE TOP AND BOTTOM ALTERNATING WITH WHITE STRIPES.

SN 77-151,410, FILED 4-8-2007.

KEVIN CORWIN, EXAMINING ATTORNEY

Int. Cl.: 12

Prior U.S. Cls.: 19, 21, 23, 31, 35, and 44

Reg. No. 3,481,595

United States Patent and Trademark Office

Registered Aug. 5, 2008

**TRADEMARK
PRINCIPAL REGISTER**

The logo for DURATOUGH features a stylized 'D' on the left, composed of horizontal lines of varying lengths that create a sense of motion or a tire tread. To the right of the 'D', the word 'URATOUGH' is written in a bold, italicized, sans-serif font. The letter 'O' is also stylized, with a small circle inside it.

YONGFANG, GUO (CHINA INDIVIDUAL)
71-1-601
QINGDAO MIDROAD, HUANCUI DISTRICT
WEIHAI CITY, CHINA 264200

INNER TUBES FOR THE WHEELS OF FORESTRY
VEHICLES, IN CLASS 12 (U.S. CLS. 19, 21, 23, 31, 35
AND 44).

FIRST USE 1-1-2006; IN COMMERCE 1-1-2007.

FOR: INNER TUBES; INNER TUBES FOR VEHI-
CLE TIRES; TIRES; TIRES FOR LAND VEHICLES;
TREAD USED TO RETREAD TIRES; TREADS FOR
RETREADING TIRES FOR CIVIL ENGINEERING
VEHICLES; TREADS FOR RETREADING TIRES
FOR FORESTRY VEHICLES; TREADS FOR RE-
TREADING TIRES FOR VEHICLES USED IN THE
CIVIL ENGINEERING INDUSTRY; TIRES AND

THE MARK CONSISTS OF "DURATOUGH"
WITH STYLIZED LETTERS "D" AND "O".

SN 77-151,464, FILED 4-9-2007.

JOHN WILKE, EXAMINING ATTORNEY

Int. Cl.: 11

Prior U.S. Cls.: 13, 21, 23, 31, and 34

United States Patent and Trademark Office

Reg. No. 3,481,596

Registered Aug. 5, 2008

**TRADEMARK
PRINCIPAL REGISTER**

ELODY

VILLEROY & BOCH A.G. (FED REP GERMANY
CORPORATION)
POSTFACH 1120
METTLACH, FED REP GERMANY D66688

THE MARK CONSISTS OF STANDARD CHAR-
ACTERS WITHOUT CLAIM TO ANY PARTICULAR
FONT, STYLE, SIZE, OR COLOR.

FOR: SANITARY EQUIPMENT, NAMELY, BATH
TUBS, WASH BASINS, LAVATORIES, TOILET
TANKS, AND TOILET SEATS, IN CLASS 11 (U.S.
CLS. 13, 21, 23, 31 AND 34).

SN 77-151,478, FILED 4-9-2007.

FIRST USE 0-0-2007; IN COMMERCE 0-0-2007.

JOHN WILKE, EXAMINING ATTORNEY

Int. Cl.: 11

Prior U.S. Cls.: 13, 21, 23, 31, and 34

Reg. No. 3,481,597

United States Patent and Trademark Office

Registered Aug. 5, 2008

**TRADEMARK
PRINCIPAL REGISTER**

TWIST

VILLEROY & BOCH A.G. (FED REP GERMANY
CORPORATION)
POSTFACH 1120
METTLACH, FED REP GERMANY D66688

THE MARK CONSISTS OF STANDARD CHAR-
ACTERS WITHOUT CLAIM TO ANY PARTICULAR
FONT, STYLE, SIZE, OR COLOR.

FOR: SANITARY EQUIPMENT, NAMELY, BATH
TUBS, WASH BASINS, LAVATORIES, TOILET
TANKS AND SEATS, IN CLASS 11 (U.S. CLS. 13, 21,
23, 31 AND 34).

SN 77-151,481, FILED 4-9-2007.

FIRST USE 0-0-2007; IN COMMERCE 0-0-2007.

JOHN WILKE, EXAMINING ATTORNEY

Int. Cl.: 19

Prior U.S. Cls.: 1, 12, 33, and 50

United States Patent and Trademark Office

Reg. No. 3,481,598

Registered Aug. 5, 2008

**TRADEMARK
PRINCIPAL REGISTER**

ENDURAGUARD

PELLA CORPORATION (IOWA CORPORATION)
102 MAIN STREET
PELLA, IA 50219

FOR: NON-METAL TREATED WINDOWS AND
DOORS AND THE COMPONENT PARTS SOLD AS
AN INTEGRAL PART THEREOF, IN CLASS 19 (U.S.
CLS. 1, 12, 33 AND 50).

FIRST USE 1-31-2008; IN COMMERCE 1-31-2008.

THE MARK CONSISTS OF STANDARD CHAR-
ACTERS WITHOUT CLAIM TO ANY PARTICULAR
FONT, STYLE, SIZE, OR COLOR.

OWNER OF U.S. REG. NOS. 2,054,961 AND
2,297,705.

SN 77-151,668, FILED 4-9-2007.

AISHA SALEM, EXAMINING ATTORNEY

Int. Cl.: 12

Prior U.S. Cls.: 19, 21, 23, 31, 35, and 44

Reg. No. 3,481,599

United States Patent and Trademark Office

Registered Aug. 5, 2008

TRADEMARK
PRINCIPAL REGISTER



WTW WHOLESALE TIRES & WHEELS, INC.
(CALIFORNIA CORPORATION)
12717 ANN STREET
SANTA FE SPRINGS, CA 906702971

FOR: AUTOMOBILE WHEELS, IN CLASS 12 (U.S.
CLS. 19, 21, 23, 31, 35 AND 44).

FIRST USE 2-28-1998; IN COMMERCE 2-28-1998.

OWNER OF U.S. REG. NO. 2,824,605.

NO CLAIM IS MADE TO THE EXCLUSIVE
RIGHT TO USE "WHEELS", APART FROM THE
MARK AS SHOWN.

THE MARK CONSISTS OF A LARGE STYLIZED
"G" WITH THE WORD "GIOVANNA" WITHIN THE
"G" AND WITH TWO LINES UNDER THE "G" AND
THE WORD "WHEELS" BELOW THE TWO LINES.

SN 77-151,901, FILED 4-9-2007.

DEZMONA MIZELLE, EXAMINING ATTORNEY

Int. Cl.: 9

Prior U.S. Cls.: 21, 23, 26, 36, and 38

United States Patent and Trademark Office

Reg. No. 3,481,600

Registered Aug. 5, 2008

**TRADEMARK
PRINCIPAL REGISTER**

INSIGHT

ARCADIA GROUP (GEORGIA LTD LIAB CO)
3235 ROSWELL ROAD, #606
ATLANTA, GA 30305

THE MARK CONSISTS OF STANDARD CHAR-
ACTERS WITHOUT CLAIM TO ANY PARTICULAR
FONT, STYLE, SIZE, OR COLOR.

FOR: BATHROOM SCALES, IN CLASS 9 (U.S. CLS.
21, 23, 26, 36 AND 38).

SN 77-151,957, FILED 4-9-2007.

FIRST USE 6-20-2008; IN COMMERCE 6-20-2008.

MICHAEL SOUDERS, EXAMINING ATTORNEY

Int. Cl.: 9

Prior U.S. Cls.: 21, 23, 26, 36, and 38

Reg. No. 3,481,601

United States Patent and Trademark Office

Registered Aug. 5, 2008

**TRADEMARK
PRINCIPAL REGISTER**

AXCELER

POWER TOOLS INC. (DELAWARE CORPORATION)
600 UNICORN PARK DRIVE
WOBURN, MA 01801

FOR: COMPUTER SOFTWARE FOR DESIGNING,
DEVELOPING, CUSTOMIZING, MAINTAINING
AND MANAGING APPLICATION SOFTWARE;
AND USER MANUALS SOLD AS A UNIT, IN CLASS
9 (U.S. CLS. 21, 23, 26, 36 AND 38).

FIRST USE 6-25-2008; IN COMMERCE 6-25-2008.

THE MARK CONSISTS OF STANDARD CHARACTERS WITHOUT CLAIM TO ANY PARTICULAR FONT, STYLE, SIZE, OR COLOR.

SN 77-151,976, FILED 4-9-2007.

RENEE MCCRAY, EXAMINING ATTORNEY

Int. Cl.: 9

Prior U.S. Cls.: 21, 23, 26, 36, and 38

Reg. No. 3,481,602

United States Patent and Trademark Office

Registered Aug. 5, 2008

**TRADEMARK
PRINCIPAL REGISTER**

PERFECT HIT

GAMING, KARAWAY (NEVADA CORPORATION)
8797 EAST BROADWAY
TUCSON, AZ 85710

THE MARK CONSISTS OF STANDARD CHARACTERS WITHOUT CLAIM TO ANY PARTICULAR FONT, STYLE, SIZE, OR COLOR.

FOR: ELECTRONIC GAME SOFTWARE, IN CLASS 9 (U.S. CLS. 21, 23, 26, 36 AND 38).

SN 77-152,300, FILED 4-9-2007.

FIRST USE 9-1-2007; IN COMMERCE 9-1-2007.

BARBARA BROWN, EXAMINING ATTORNEY

Int. Cls.: 38 and 41

Prior U.S. Cls.: 100, 101, 104, and 107

United States Patent and Trademark Office

Reg. No. 3,481,603

Registered Aug. 5, 2008

**SERVICE MARK
PRINCIPAL REGISTER**

**EVERYTHING ABOUT MOVIES –
24/7**

HUBBARD MEDIA GROUP, LLC (DELAWARE
LTD LIAB CO)
3415 UNIVERSITY AVENUE
ST. PAUL, MN 55114

FOR: TELEVISION, DIGITAL TELEVISION,
CABLE TELEVISION, AND SATELLITE TELEVI-
SION BROADCASTING AND TRANSMISSION SER-
VICES; BROADCASTING AND TRANSMISSION OF
TELEVISION PROGRAMS VIA THE INTERNET, IN
CLASS 38 (U.S. CLS. 100, 101 AND 104).

FIRST USE 5-9-2008; IN COMMERCE 5-9-2008.

FOR: TELEVISION, DIGITAL TELEVISION,
CABLE TELEVISION, AND SATELLITE TELEVI-
SION PROGRAMMING; PROGRAMMING ON A
GLOBAL COMPUTER NETWORK, NAMELY, PRO-

GRAMMING ON THE INTERNET; PRODUCTION
OF TELEVISION PROGRAMS; DISTRIBUTION OF
TELEVISION PROGRAMS FOR OTHERS; PROVID-
ING ENTERTAINMENT INFORMATION AND TEL-
EVISION PROGRAMS IN THE FIELD OF MOVIES
AND CINEMA OVER A GLOBAL COMPUTER NET-
WORK, IN CLASS 41 (U.S. CLS. 100, 101 AND 107).

FIRST USE 5-9-2008; IN COMMERCE 5-9-2008.

THE MARK CONSISTS OF STANDARD CHAR-
ACTERS WITHOUT CLAIM TO ANY PARTICULAR
FONT, STYLE, SIZE, OR COLOR.

SN 77-152,559, FILED 4-10-2007.

C. DIONNE CLYBURN, EXAMINING ATTORNEY

Int. Cl.: 25

Prior U.S. Cls.: 22 and 39

United States Patent and Trademark Office

Reg. No. 3,481,604

Registered Aug. 5, 2008

**TRADEMARK
PRINCIPAL REGISTER**

FUN & FLIRT BY JAPNA

JAPNA INC. (NEW JERSEY CORPORATION)
122 PRESTWICK WAY
EDISON, NJ 08820

THE MARK CONSISTS OF STANDARD CHAR-
ACTERS WITHOUT CLAIM TO ANY PARTICULAR
FONT, STYLE, SIZE, OR COLOR.

FOR: CLOTHING, NAMELY, LADIES TOPS, TU-
NICS, SHIRTS, BLOUSES, SWEATERS, JERSEYS,
SKIRTS, DRESSES AND SWIMSUITS, IN CLASS 25
(U.S. CLS. 22 AND 39).

SN 77-152,659, FILED 4-10-2007.

FIRST USE 1-1-2008; IN COMMERCE 1-1-2008.

BRENDAN MCCAULEY, EXAMINING ATTORNEY

Int. Cl.: 42

Prior U.S. Cls.: 100 and 101

United States Patent and Trademark Office

Reg. No. 3,481,605

Registered Aug. 5, 2008

**SERVICE MARK
PRINCIPAL REGISTER**



INTERNATIONAL ASSOCIATION OF PLUMBING AND MECHANICAL OFFICIALS (CALIFORNIA NON-PROFIT CORPORATION)
5001 EAST PHILADELPHIA STREET
ONTARIO, CA 917612816

FOR: EVALUATION OF BUILDING, CONSTRUCTION, AND SAFETY MATERIALS AND PRODUCTS OF OTHERS FOR PURPOSES OF CERTIFICATION, IN CLASS 42 (U.S. CLS. 100 AND 101).

FIRST USE 1-1-2006; IN COMMERCE 1-1-2006.

THE COLOR(S) BLACK, LIGHT BLUE, AND DARK BLUE IS/ARE CLAIMED AS A FEATURE OF THE MARK.

THE MARK CONSISTS OF THE WORDING "IAPMO" IN BLACK ABOUT A SHIELD SHADED IN LIGHT BLUE TO THE LEFT AND DARK BLUE TO THE RIGHT. THE SHIELD IS WITHIN AN OVAL SHADED IN DARK BLUE. THE LETTERING "ES" APPEARS IN BLACK ON THE SHIELD.

SN 77-153,242, FILED 4-10-2007.

ROBIN CHOSID, EXAMINING ATTORNEY

Int. Cl.: 1

Prior U.S. Cls.: 1, 5, 6, 10, 26, and 46

Reg. No. 3,481,606

United States Patent and Trademark Office

Registered Aug. 5, 2008

**TRADEMARK
PRINCIPAL REGISTER**

SIXCESS

STERIS INC. (DELAWARE CORPORATION)
43425 BUSINESS PARK DRIVE
TEMECULA, CA 92590

AND EQUIPMENT, IN CLASS 1 (U.S. CLS. 1, 5, 6, 10,
26 AND 46).

FIRST USE 10-31-2007; IN COMMERCE 10-31-2007.

FOR: CHEMICAL INDICATORS FOR USE IN
MONITORING THE FUNCTION AND PERFOR-
MANCE OF STERILIZATION PROCESSES AND
EQUIPMENT, NAMELY, CARRIERS IMPREGNA-
TED WITH CHEMICALS FOR HEALTH CARE AND
INDUSTRIAL USE TO TEST THE FUNCTION AND
PERFORMANCE OF STERILIZATION PROCESSES

THE MARK CONSISTS OF STANDARD CHAR-
ACTERS WITHOUT CLAIM TO ANY PARTICULAR
FONT, STYLE, SIZE, OR COLOR.

SN 77-153,802, FILED 4-11-2007.

REBECCA GILBERT, EXAMINING ATTORNEY

Int. Cls.: 3 and 4

Prior U.S. Cls.: 1, 4, 6, 15, 50, 51, and 52

United States Patent and Trademark Office

Reg. No. 3,481,607

Registered Aug. 5, 2008

**TRADEMARK
PRINCIPAL REGISTER**

GLOWOLOGY

NOODLE & BOO, LLC (CALIFORNIA LTD LIAB
CO)
1702 MERIDIAN AVENUE, #311
SAN JOSE, CA 95125

FOR: BODY WASHES; BODY SCRUB; SOAPS FOR
BODY CARE; TONING GELS; BATH OILS, BODY
OILS, LOTIONS FOR HANDS AND FEET, HAND
LOTIONS, SKIN LOTIONS, AND BODY CREAMS ,
IN CLASS 3 (U.S. CLS. 1, 4, 6, 50, 51 AND 52).

FIRST USE 10-2-2007; IN COMMERCE 10-2-2007.

FOR: CANDLES, IN CLASS 4 (U.S. CLS. 1, 6 AND
15).

FIRST USE 6-27-2008; IN COMMERCE 6-27-2008.

THE MARK CONSISTS OF STANDARD CHAR-
ACTERS WITHOUT CLAIM TO ANY PARTICULAR
FONT, STYLE, SIZE, OR COLOR.

SN 77-154,379, FILED 4-11-2007.

KATHERINE CHANG, EXAMINING ATTORNEY

Int. Cl.: 25

Prior U.S. Cls.: 22 and 39

United States Patent and Trademark Office

Reg. No. 3,481,608

Registered Aug. 5, 2008

**TRADEMARK
PRINCIPAL REGISTER**

2FEETSOUTH

2FEETSOUTH LLC (NEVADA LTD LIAB CO)
#1R
149 WEST STREET
GARDNER, MA 01440

THE MARK CONSISTS OF STANDARD CHARACTERS WITHOUT CLAIM TO ANY PARTICULAR FONT, STYLE, SIZE, OR COLOR.

FOR: HATS; PANTS; SHORTS; SWEAT SHIRTS; T-SHIRTS; WRISTBANDS, IN CLASS 25 (U.S. CLS. 22 AND 39).

SN 77-154,568, FILED 4-11-2007.

FIRST USE 4-1-2007; IN COMMERCE 8-1-2007.

ODESSA BIBBINS, EXAMINING ATTORNEY

Int. Cl.: 32

Prior U.S. Cls.: 45, 46, and 48

United States Patent and Trademark Office

Reg. No. 3,481,609

Registered Aug. 5, 2008

**TRADEMARK
PRINCIPAL REGISTER**

CHERRY WAVES

KRAFT FOODS HOLDINGS, INC. (DELAWARE
CORPORATION)

NF-577

THREE LAKES DRIVE
NORTHFIELD, IL 60093

FOR: FLAVORED WATERS, IN CLASS 32 (U.S.
CLS. 45, 46 AND 48).

FIRST USE 1-1-2008; IN COMMERCE 1-1-2008.

THE MARK CONSISTS OF STANDARD CHAR-
ACTERS WITHOUT CLAIM TO ANY PARTICULAR
FONT, STYLE, SIZE, OR COLOR.

NO CLAIM IS MADE TO THE EXCLUSIVE
RIGHT TO USE "CHERRY", APART FROM THE
MARK AS SHOWN.

SN 77-154,718, FILED 4-12-2007.

AHSEN KHAN, EXAMINING ATTORNEY

Int. Cl.: 45

Prior U.S. Cls.: 100 and 101

United States Patent and Trademark Office

Reg. No. 3,481,610

Registered Aug. 5, 2008

**SERVICE MARK
PRINCIPAL REGISTER**



BLAISE ANDRESKI (UNITED STATES INDIVIDUAL)
582 PENTOGA TRAIL
CRYSTAL FALLS, MI 49920 AND
JOAN ANDRESKI (UNITED STATES INDIVIDUAL)
582 PENTOGA TRAIL
CRYSTAL FALLS, MI 49920

FOR: ALTERNATIVE DISPUTE RESOLUTION, IN
CLASS 45 (U.S. CLS. 100 AND 101).

FIRST USE 4-1-2008; IN COMMERCE 6-18-2008.

THE MARK CONSISTS OF AN IMAGE OF THE
LADY OF JUSTICE.

SN 77-154,872, FILED 4-12-2007.

CAROLINE WOOD, EXAMINING ATTORNEY

Int. Cl.: 18

Prior U.S. Cls.: 1, 2, 3, 22, and 41

United States Patent and Trademark Office

Reg. No. 3,481,611

Registered Aug. 5, 2008

**TRADEMARK
PRINCIPAL REGISTER**

NEOPAX

NEOPAX (CALIFORNIA PARTNERSHIP)
12016 EDDLESTON DR.
NORTHRIDGE, CA 91326

FIRST USE 8-15-2007; IN COMMERCE 8-15-2007.

FOR: NEOPRENE BELTS WORN ON THE BODY WITH POUCHES SEWN ON THAT ATTACH WITH HOOK AND LOOP FASTENERS DESIGNED TO HOLD WIRELESS TRANSMITTERS THAT ARE TYPICALLY USED IN THE FILM AND TELEVISION INDUSTRY, IN CLASS 18 (U.S. CLS. 1, 2, 3, 22 AND 41).

THE MARK CONSISTS OF STANDARD CHARACTERS WITHOUT CLAIM TO ANY PARTICULAR FONT, STYLE, SIZE, OR COLOR.

SN 77-154,961, FILED 4-12-2007.

FRANK LATTUCA, EXAMINING ATTORNEY

Int. Cl.: 45

Prior U.S. Cls.: 100 and 101

United States Patent and Trademark Office

Reg. No. 3,481,612

Registered Aug. 5, 2008

**SERVICE MARK
PRINCIPAL REGISTER**

EZ DOB

INTERSECTIONS INC. (DELAWARE CORPORATION)
14901 BOGLE DRIVE
CHANTILLY, VA 20151

FOR: IDENTIFICATION VERIFICATION SERVICES, NAMELY, PROVIDING AUTHENTICATION OF PERSONAL IDENTIFICATION INFORMATION, IN CLASS 45 (U.S. CLS. 100 AND 101).

FIRST USE 5-28-2007; IN COMMERCE 5-28-2007.

THE MARK CONSISTS OF STANDARD CHARACTERS WITHOUT CLAIM TO ANY PARTICULAR FONT, STYLE, SIZE, OR COLOR.

NO CLAIM IS MADE TO THE EXCLUSIVE RIGHT TO USE "DOB", APART FROM THE MARK AS SHOWN.

SN 77-154,984, FILED 4-12-2007.

FRANK LATTUCA, EXAMINING ATTORNEY

Int. Cl.: 10

Prior U.S. Cls.: 26, 39, and 44

United States Patent and Trademark Office

Reg. No. 3,481,613

Registered Aug. 5, 2008

**TRADEMARK
PRINCIPAL REGISTER**

NIM-ECLIPSE

MEDTRONIC XOMED, INC. (DELAWARE CORPORATION)
6743 SOUTHPOINT DRIVE N
JACKSONVILLE, FL 322160980

FOR: NERVE INTEGRITY MONITOR AND COMPONENT PARTS THEREFOR, IN CLASS 10 (U.S. CLS. 26, 39 AND 44).

FIRST USE 5-30-2008; IN COMMERCE 5-30-2008.

THE MARK CONSISTS OF STANDARD CHARACTERS WITHOUT CLAIM TO ANY PARTICULAR FONT, STYLE, SIZE, OR COLOR.

OWNER OF U.S. REG. NOS. 1,727,352, 2,942,892, AND OTHERS.

SN 77-155,368, FILED 4-12-2007.

ALLISON SCHRODY, EXAMINING ATTORNEY

Int. Cl.: 8

Prior U.S. Cls.: 23, 28, and 44

United States Patent and Trademark Office

Reg. No. 3,481,614

Registered Aug. 5, 2008

**TRADEMARK
PRINCIPAL REGISTER**

Lift-N-Go

SAY, STEVEN R (UNITED STATES INDIVIDUAL)
9620 W MORROW DR
PEORIA, AZ 85382

THE MARK CONSISTS OF STANDARD CHARACTERS WITHOUT CLAIM TO ANY PARTICULAR FONT, STYLE, SIZE, OR COLOR.

FOR: HAND OPERATED LIFTING JACKS, IN CLASS 8 (U.S. CLS. 23, 28 AND 44).

SN 77-155,635, FILED 4-12-2007.

FIRST USE 1-15-2008; IN COMMERCE 5-12-2008.

GIANCARLO CASTRO, EXAMINING ATTORNEY

Int. Cls.: 25 and 28

Prior U.S. Cls.: 22, 23, 38, 39, and 50

United States Patent and Trademark Office

Reg. No. 3,481,615

Registered Aug. 5, 2008

**TRADEMARK
PRINCIPAL REGISTER**

CALLE

CALLE SOCCER LLC (UTAH LTD LIAB CO)
2255 NORTH 1450 EAST
PROVO, UT 84604

FOR: CLOTHING, NAMELY, SHIRTS, SHORTS,
SWEATSHIRTS, FOOTWEAR, AND HEADWEAR,
IN CLASS 25 (U.S. CLS. 22 AND 39).

FIRST USE 6-1-2006; IN COMMERCE 6-1-2006.

FOR: SOCCER SPORTS EQUIPMENT, NAMELY,
SOCCER BALLS AND SOCCER BALL SACKS, AND
BACKPACKS SPECIALLY ADAPTED AND DE-

SIGNED FOR HOLDING SOCCER EQUIPMENT,
IN CLASS 28 (U.S. CLS. 22, 23, 38 AND 50).

FIRST USE 6-1-2006; IN COMMERCE 6-1-2006.

THE MARK CONSISTS OF STANDARD CHAR-
ACTERS WITHOUT CLAIM TO ANY PARTICULAR
FONT, STYLE, SIZE, OR COLOR.

SN 77-156,102, FILED 4-13-2007.

JEFF DEFORD, EXAMINING ATTORNEY

Int. Cls.: 25 and 28

Prior U.S. Cls.: 22, 23, 38, 39, and 50

United States Patent and Trademark Office

Reg. No. 3,481,616

Registered Aug. 5, 2008

**TRADEMARK
PRINCIPAL REGISTER**

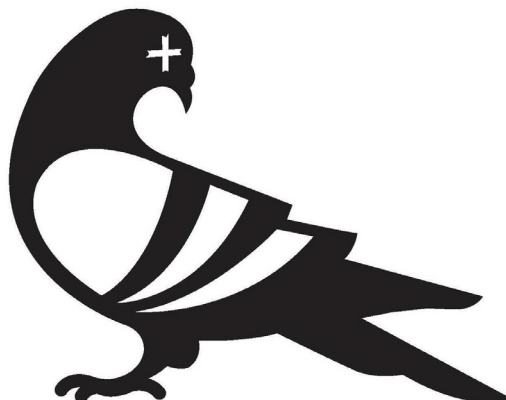

CALLE SOCCER LLC (UTAH LTD LIAB CO)
2255 NORTH 1450 EAST
PROVO, UT 84604

FOR: CLOTHING, NAMELY, SHIRTS, SHORTS,
SWEATSHIRTS, FOOTWEAR, AND HEADWEAR,
IN CLASS 25 (U.S. CLS. 22 AND 39).

FIRST USE 6-1-2006; IN COMMERCE 6-1-2006.

FOR: SOCCER SPORTS EQUIPMENT, NAMELY,
SOCCER BALLS, SOCCER BALL SACKS, AND

BACKPACKS SPECIALLY ADAPTED AND DE-
SIGNER FOR HOLDING SOCCER EQUIPMENT,
IN CLASS 28 (U.S. CLS. 22, 23, 38 AND 50).

FIRST USE 6-1-2006; IN COMMERCE 6-1-2006.

THE MARK CONSISTS OF A PIGEON.

SN 77-156,171, FILED 4-13-2007.

JEFF DEFORD, EXAMINING ATTORNEY

Int. Cl.: 16

Prior U.S. Cls.: 2, 5, 22, 23, 29, 37, 38, and 50

Reg. No. 3,481,617

United States Patent and Trademark Office

Registered Aug. 5, 2008

TRADEMARK
PRINCIPAL REGISTER

VENGEANCE

WORLD WRESTLING ENTERTAINMENT, INC.
(DELAWARE CORPORATION)
1241 EAST MAIN STREET
STAMFORD, CT 06902

FOR: PAPER HANGTAGS, CARDBOARD HANGTAGS; PACKAGING, NAMELY, BLISTER CARDS, PAPER FOR WRAPPING AND PACKAGING, PAPER POUCHES FOR PACKAGING, PLASTIC BAGS FOR PACKAGING, PLASTIC BUBBLE PACKS FOR WRAPPING OR PACKAGING; COLLECTOR ALBUMS, NAMELY, FOR STICKER COLLECTABLE CARDS, PHOTO COLLECTABLES; LABELS, NAMELY, PRINTED PAPER LABELS, PRINTED SHIPPING LABELS; RETURN ADDRESS LABELS NOT OF TEXTILE; FOLDERS; PLASTIC BAGS FOR GENERAL USE; PAPER TABLEWARE, NAMELY, PAPER PLACE MATS, PAPER TABLE MATS, PAPER NAPKINS, PAPER TABLE LINENS, PAPER TABLECLOTHS; PAPER LUNCH BAGS; STICKERS; BUMPER STICKERS; WINDOW DECALS; PENS; PENCILS; PENCIL SHARPENERS; PENCIL CASES; CHALK; ERASERS, NAMELY, RUBBER ERASERS, CHALK ERASERS, BLACKBOARD ERASERS; POSTERS; NOTEBOOKS; TRADING CARDS; CALENDARS; PHOTOGRAPHS; FRAMED PICTURES; PHOTOGRAPHIC PRINTS; PICTURES; PHOTO ALBUMS; BROCHURES, NEWSLETTERS, MAGAZINES, AND NEWSPAPERS CONCERNING SPORTS ENTERTAINMENT; POSTCARDS; GREETING CARDS; DECALS; TEMPORARY TATTOO TRANSFERS; COLORING BOOKS; CHILDREN'S ACTIVITY BOOKS; SOUVENIR PROGRAMS CON-

CERNING SPORTS ENTERTAINMENT; BOOKS FEATURING PICTORIAL BIOGRAPHIES; AUTOGRAPH BOOKS; COMIC BOOKS; PICTURE BOOKS; STICKER ALBUMS; BOOK COVERS; PAPER BOOK MARKERS; BOOKPLATES; MEMO PADS; SCRIBBLE PADS; DATE BOOKS; ADDRESS BOOKS; AGENDA BOOKS; RUBBER STAMPS; STAMP PADS; COLLECTIBLE PREPAID TELEPHONE CARDS NOT MAGNETICALLY ENCODED; COLLECTOR STAMPS, NAMELY, COMMEMORATIVE STAMP SHEETS; CUSTOMIZED PERSONAL CHECKS; CHECKBOOK COVERS; PAPER BANNERS; PRINTED PAPER SIGNS FOR DOORS; DRAWING RULERS; LITHOGRAPHS; PAPER PARTY BAGS; PAPER PARTY FAVORS, NAMELY, PAPER HATS; STENCILS FOR TRACING DESIGNS ONTO PAPER; PAPER GIFT WRAP; PAPER CAKE DECORATIONS, IN CLASS 16 (U.S. CLS. 2, 5, 22, 23, 29, 37, 38 AND 50).

FIRST USE 12-9-2001; IN COMMERCE 12-9-2001.

THE MARK CONSISTS OF STANDARD CHARACTERS WITHOUT CLAIM TO ANY PARTICULAR FONT, STYLE, SIZE, OR COLOR.

OWNER OF U.S. REG. NO. 2,978,955.

SN 77-156,582, FILED 4-13-2007.

WILLIAM VERHOSEK, EXAMINING ATTORNEY

Int. Cl.: 43

Prior U.S. Cls.: 100 and 101

United States Patent and Trademark Office

Reg. No. 3,481,618

Registered Aug. 5, 2008

**SERVICE MARK
PRINCIPAL REGISTER**

SIP.BITE.SHARE

LA DUNI CONCEPTS LLC (TEXAS LTD LIAB
CO)
4264 OAK LAWN AVE.
DALLAS, TX 75219

THE MARK CONSISTS OF STANDARD CHAR-
ACTERS WITHOUT CLAIM TO ANY PARTICULAR
FONT, STYLE, SIZE, OR COLOR.

FOR: RESTAURANT, CAFÉ, COFFEE HOUSE,
CATERING AND BAR SERVICES, IN CLASS 43 (U.S.
CLS. 100 AND 101).

SN 77-157,459, FILED 4-16-2007.

FIRST USE 1-0-2007; IN COMMERCE 1-0-2007.

BARBARA GAYNOR, EXAMINING ATTORNEY

Int. Cl.: 3

Prior U.S. Cls.: 1, 4, 6, 50, 51, and 52

United States Patent and Trademark Office

Reg. No. 3,481,619

Registered Aug. 5, 2008

**TRADEMARK
PRINCIPAL REGISTER**

BOTANICAL ESCAPES

ALFALFA NAIL SUPPLY, INC. (LOUISIANA
CORPORATION)
11488 S. CHOCTAW DRIVE
BATON ROUGE, LA 70815

FOR: AROMATIC PRODUCTS, NAMELY, SKIN
CREAMS AND LOTIONS, BATH AND SHOWER
SALTS, NON-MEDICATED FOOT GEL, NAIL
STRENGTHENER, CUTICLE OIL AND FOOT AND
HAND MASKS , IN CLASS 3 (U.S. CLS. 1, 4, 6, 50, 51
AND 52).

FIRST USE 7-0-2007; IN COMMERCE 7-0-2007.

THE MARK CONSISTS OF STANDARD CHAR-
ACTERS WITHOUT CLAIM TO ANY PARTICULAR
FONT, STYLE, SIZE, OR COLOR.

NO CLAIM IS MADE TO THE EXCLUSIVE
RIGHT TO USE "BOTANICAL", APART FROM
THE MARK AS SHOWN.

SN 77-157,580, FILED 4-16-2007.

CAROLINE WOOD, EXAMINING ATTORNEY

Int. Cl.: 12

Prior U.S. Cls.: 19, 21, 23, 31, 35, and 44

United States Patent and Trademark Office

Reg. No. 3,481,620

Registered Aug. 5, 2008

**TRADEMARK
PRINCIPAL REGISTER**

AMERICAN ALLEGIANCE

FLEETWOOD ENTERPRISES, INC. (DELAWARE CORPORATION)
3125 MYERS STREET, POST OFFICE BOX 7638
RIVERSIDE, CA 925137638

FOR: MOTOR HOMES, IN CLASS 12 (U.S. CLS. 19, 21, 23, 31, 35 AND 44).

FIRST USE 12-0-2007; IN COMMERCE 12-0-2007.

THE MARK CONSISTS OF STANDARD CHARACTERS WITHOUT CLAIM TO ANY PARTICULAR FONT, STYLE, SIZE, OR COLOR.

OWNER OF U.S. REG. NOS. 1,759,144, 2,318,980, AND OTHERS.

SN 77-157,794, FILED 4-16-2007.

PATRICIA EVANKO, EXAMINING ATTORNEY

Int. Cl.: 41

Prior U.S. Cls.: 100, 101, and 107

United States Patent and Trademark Office

Reg. No. 3,481,621

Registered Aug. 5, 2008

**SERVICE MARK
PRINCIPAL REGISTER**

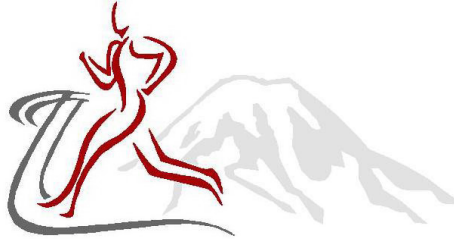

PRIME FITNESS, LLC (WASHINGTON LTD LIAB
CO)
18209 SR 410 EAST
BONNEY LAKE, WA 98391

FOR: HEALTH CLUB SERVICES, NAMELY, PRO-
VIDING INSTRUCTION AND EQUIPMENT IN THE
FIELD OF PHYSICAL EXERCISE, PROVIDING
CLASSROOM WORKSHOPS AND CLINICS IN THE
FIELD OF EXERCISE, SPORTS, AND STRENGTH
TRAINING, IN CLASS 41 (U.S. CLS. 100, 101 AND
107).

FIRST USE 11-30-2005; IN COMMERCE 1-31-2007.

THE COLOR(S) RED, LIGHT GREY, DARK
GREY, AND WHITE IS/ARE CLAIMED AS A FEAT-
TURE OF THE MARK.

THE MARK CONSISTS OF A STYLIZED RUN-
NER IN RED ON A DARK GRAY PATH IN THE
FOREGROUND, WITH A MOUNTAIN IN THE
BACKGROUND DEFINED BY LIGHT GREY SHAD-
ING AND INCLUDING WHITE AREAS TO DEPICT
A SNOW COVERED MOUNTAIN.

SN 77-157,915, FILED 4-16-2007.

KATHERINE CHANG, EXAMINING ATTORNEY

Int. Cl.: 37

Prior U.S. Cls.: 100, 103, and 106

United States Patent and Trademark Office

Reg. No. 3,481,622

Registered Aug. 5, 2008

**SERVICE MARK
PRINCIPAL REGISTER**

Luck Log Homes

MR LUCK, INC. (PENNSYLVANIA CORPORATION)

1609 RTE 507 PO BOX 246

GREENTOWN, PA 18426

FOR: CUSTOM CONSTRUCTION OF HOMES, IN CLASS 37 (U.S. CLS. 100, 103 AND 106).

FIRST USE 2-1-2007; IN COMMERCE 2-1-2007.

THE MARK CONSISTS OF STANDARD CHARACTERS WITHOUT CLAIM TO ANY PARTICULAR FONT, STYLE, SIZE, OR COLOR.

NO CLAIM IS MADE TO THE EXCLUSIVE RIGHT TO USE "LOG HOMES", APART FROM THE MARK AS SHOWN.

SN 77-158,175, FILED 4-17-2007.

CHERYL CLAYTON, EXAMINING ATTORNEY

Int. Cl.: 9

Prior U.S. Cls.: 21, 23, 26, 36, and 38

Reg. No. 3,481,623

United States Patent and Trademark Office

Registered Aug. 5, 2008

**TRADEMARK
PRINCIPAL REGISTER**

LAB BRICK

VAUNIX TECHNOLOGY CORPORATION (MASSACHUSETTS CORPORATION)
242 NECK ROAD
HAVERHILL, MA 01835

FOR: ELECTRONIC TEST EQUIPMENT, NAME-
LY, VOLTMETERS, AMMETERS, OHMMETERS,
SIGNAL ANALYZERS, VOLTAGE MONITORS,
CURRENT MONITORS, SIGNAL MONITORS,
AND RECORDERS FOR CALIBRATION OF SCIENTIFIC,
MEDICAL, TELECOMMUNICATIONS OR
ELECTRONIC EQUIPMENT; APPARATUS AND INSTRUMENTS,
NAMESLY, SPECTRUM ANALYZERS,
WAVEFORM ANALYZERS, DATA ANALYZERS,
LOGIC ANALYZERS, TRANSMISSION ANALYZERS,
NETWORK ANALYZERS, OSCILLOSCOPES,
POWER METERS, POWER MONITORS, FREQUENCY
COUNTERS AND MULTIMETERS FOR MEASURING
AND TESTING SIGNAL GENERATION,
SIGNAL PROCESSING, SIGNAL AMPLIFICATION,
SIGNAL CONVERSION, OR SIGNAL CONTROL;
APPARATUS AND INSTRUMENTS, NAMELY, SIGNAL
GENERATORS, FUNCTION GENERATORS,
SYNTHESIZERS, AMPLIFIERS, ATTENUATORS,
FILTERS, CONDITIONERS, CONVERTERS, MIXERS,
MODULATORS, DEMODULATORS, PRESCALERS,
DIVIDERS, COMBINERS, ISOLATORS,
CIRCULATORS, SWITCHES AND ROUTERS FOR

PERFORMING SIGNAL GENERATION, SIGNAL
PROCESSING, SIGNAL AMPLIFICATION, SIGNAL
CONVERSION, OR SIGNAL CONTROL; COMPUTER
HARDWARE FOR MEASURING AND TESTING
SIGNAL GENERATION, SIGNAL
PROCESSING, SIGNAL AMPLIFICATION, SIGNAL
CONVERSION, OR SIGNAL CONTROL; COMPUTER
SOFTWARE FOR MEASURING AND TESTING
SIGNAL GENERATION, SIGNAL PROCESSING,
SIGNAL AMPLIFICATION, SIGNAL CONVERSION,
OR SIGNAL CONTROL, IN CLASS 9 (U.S. CLS. 21, 23,
26, 36 AND 38).

FIRST USE 9-26-2007; IN COMMERCE 12-5-2007.

THE MARK CONSISTS OF STANDARD CHARACTERS
WITHOUT CLAIM TO ANY PARTICULAR FONT,
STYLE, SIZE, OR COLOR.

NO CLAIM IS MADE TO THE EXCLUSIVE
RIGHT TO USE "LAB", APART FROM THE MARK
AS SHOWN.

SN 77-158,468, FILED 4-17-2007.

DEZMONA MIZELLE, EXAMINING ATTORNEY

Int. Cl.: 35

Prior U.S. Cls.: 100, 101, and 102

United States Patent and Trademark Office

Reg. No. 3,481,624

Registered Aug. 5, 2008

**SERVICE MARK
PRINCIPAL REGISTER**

RAISE YOUR HAND

RAISE YOUR HAND FOR PUBLIC SCHOOLS
(TEXAS NON-PROFIT CORPORATION)
326 WASHINGTON
SAN ANTONIO, TX 78204

FOR: ASSOCIATION SERVICES, NAMELY, PROMOTING PUBLIC AWARENESS OF THE NEED FOR CHANGES IN STATE, LOCAL, AND NATIONAL EDUCATIONAL POLICIES AND EDUCATIONAL FUNDING; PROMOTING AND ADVOCATING CHANGES IN STATE, LOCAL, AND NATIONAL EDUCATIONAL POLICIES AND EDUCATIONAL FUNDING; COORDINATION OF LOBBYING AND ADVOCACY EFFORTS TO PROMOTE AND ADVOCATE CHANGES IN STATE, LOCAL, AND NATIONAL EDUCATIONAL POLICIES AND

EDUCATIONAL FUNDING; CHARITABLE SERVICES, NAMELY, ORGANIZING AND CONDUCTING VOLUNTEER PROGRAMS AND COMMUNITY SERVICE PROJECTS, IN CLASS 35 (U.S. CLS. 100, 101 AND 102).

FIRST USE 1-0-2007; IN COMMERCE 1-0-2007.

THE MARK CONSISTS OF STANDARD CHARACTERS WITHOUT CLAIM TO ANY PARTICULAR FONT, STYLE, SIZE, OR COLOR.

SN 77-158,501, FILED 4-17-2007.

MATTHEW EINSTEIN, EXAMINING ATTORNEY

Int. Cl.: 35

Prior U.S. Cls.: 100, 101, and 102

United States Patent and Trademark Office

Reg. No. 3,481,625

Registered Aug. 5, 2008

**SERVICE MARK
PRINCIPAL REGISTER**

RAISE YOUR HAND TEXAS

RAISE YOUR HAND FOR PUBLIC SCHOOLS
(TEXAS NON-PROFIT CORPORATION)
326 WASHINGTON
SAN ANTONIO, TX 78204

FOR: ASSOCIATION SERVICES, NAMELY, PROMOTING PUBLIC AWARENESS OF THE NEED FOR CHANGES IN STATE, LOCAL, AND NATIONAL EDUCATIONAL POLICIES AND EDUCATIONAL FUNDING; PROMOTING AND ADVOCATING CHANGES IN STATE, LOCAL, AND NATIONAL EDUCATIONAL POLICIES AND EDUCATIONAL FUNDING; COORDINATION OF LOBBYING AND ADVOCACY EFFORTS TO PROMOTE AND ADVOCATE CHANGES IN STATE, LOCAL, AND NATIONAL EDUCATIONAL POLICIES AND EDUCATIONAL FUNDING; CHARITABLE SERVICES, NAMELY, ORGANIZING AND CONDUCTING

VOLUNTEER PROGRAMS AND COMMUNITY SERVICE PROJECTS, IN CLASS 35 (U.S. CLS. 100, 101 AND 102).

FIRST USE 1-0-2007; IN COMMERCE 1-0-2007.

THE MARK CONSISTS OF STANDARD CHARACTERS WITHOUT CLAIM TO ANY PARTICULAR FONT, STYLE, SIZE, OR COLOR.

NO CLAIM IS MADE TO THE EXCLUSIVE RIGHT TO USE "TEXAS", APART FROM THE MARK AS SHOWN.

SN 77-158,613, FILED 4-17-2007.

MATTHEW EINSTEIN, EXAMINING ATTORNEY

Int. Cl.: 9

Prior U.S. Cls.: 21, 23, 26, 36, and 38

United States Patent and Trademark Office

Reg. No. 3,481,626

Registered Aug. 5, 2008

**TRADEMARK
PRINCIPAL REGISTER**

CERAMIC SILK

CONAIR CORPORATION (DELAWARE CORPORATION)
ONE CUMMINGS POINT ROAD
STAMFORD, CT 06902

FOR: ELECTRIC FLAT IRONS; ELECTRIC HAIR CURLING IRONS; ELECTRIC HAIR STRAIGHTENING IRONS; ELECTRIC HAND-HELD HAIR STYLING IRONS; ELECTRIC IRONS FOR STYLING HAIR, IN CLASS 9 (U.S. CLS. 21, 23, 26, 36 AND 38).

FIRST USE 3-0-2007; IN COMMERCE 3-0-2007.

THE MARK CONSISTS OF STANDARD CHARACTERS WITHOUT CLAIM TO ANY PARTICULAR FONT, STYLE, SIZE, OR COLOR.

OWNER OF U.S. REG. NO. 3,056,567.

NO CLAIM IS MADE TO THE EXCLUSIVE RIGHT TO USE "CERAMIC", APART FROM THE MARK AS SHOWN.

SN 77-158,662, FILED 4-17-2007.

MARY MUNSON, EXAMINING ATTORNEY

Int. Cl.: 35

Prior U.S. Cls.: 100, 101, and 102

United States Patent and Trademark Office

Reg. No. 3,481,627

Registered Aug. 5, 2008

**SERVICE MARK
PRINCIPAL REGISTER**



raise your hand

RAISE YOUR HAND FOR PUBLIC SCHOOLS
(TEXAS NON-PROFIT CORPORATION)
326 WASHINGTON
SAN ANTONIO, TX 78204

FOR: ASSOCIATION SERVICES, NAMELY, PROMOTING PUBLIC AWARENESS OF THE NEED FOR CHANGES IN STATE, LOCAL, AND NATIONAL EDUCATIONAL POLICIES AND EDUCATIONAL FUNDING; PROMOTING AND ADVOCATING CHANGES IN STATE, LOCAL, AND NATIONAL EDUCATIONAL POLICIES AND EDUCATIONAL FUNDING; COORDINATION OF LOBBYING AND ADVOCACY EFFORTS TO PROMOTE AND ADVOCATE

CHANGES IN STATE, LOCAL, AND NATIONAL EDUCATIONAL POLICIES AND EDUCATIONAL FUNDING; CHARITABLE SERVICES, NAMELY, ORGANIZING AND CONDUCTING VOLUNTEER PROGRAMS AND COMMUNITY SERVICE PROJECTS, IN CLASS 35 (U.S. CLS. 100, 101 AND 102).

FIRST USE 1-0-2007; IN COMMERCE 1-0-2007.

SN 77-159,384, FILED 4-18-2007.

MATTHEW EINSTEIN, EXAMINING ATTORNEY

Int. Cl.: 35

Prior U.S. Cls.: 100, 101, and 102

United States Patent and Trademark Office

Reg. No. 3,481,628

Registered Aug. 5, 2008

**SERVICE MARK
PRINCIPAL REGISTER**



raise your hand
— T E X A S —

RAISE YOUR HAND FOR PUBLIC SCHOOLS
(TEXAS NON-PROFIT CORPORATION)
326 WASHINGTON
SAN ANTONIO, TX 78204

FOR: ASSOCIATION SERVICES, NAMELY, PROMOTING PUBLIC AWARENESS OF THE NEED FOR CHANGES IN STATE, LOCAL, AND NATIONAL EDUCATIONAL POLICIES AND EDUCATIONAL FUNDING; PROMOTING AND ADVOCATING CHANGES IN STATE, LOCAL, AND NATIONAL EDUCATIONAL POLICIES AND EDUCATIONAL FUNDING; COORDINATION OF LOBBYING AND ADVOCACY EFFORTS TO PROMOTE AND ADVOCATE CHANGES IN STATE, LOCAL, AND NATIONAL EDUCATIONAL POLICIES AND

EDUCATIONAL FUNDING; CHARITABLE SERVICES, NAMELY, ORGANIZING AND CONDUCTING VOLUNTEER PROGRAMS AND COMMUNITY SERVICE PROJECTS, IN CLASS 35 (U.S. CLS. 100, 101 AND 102).

FIRST USE 1-0-2007; IN COMMERCE 1-0-2007.

NO CLAIM IS MADE TO THE EXCLUSIVE RIGHT TO USE "TEXAS", APART FROM THE MARK AS SHOWN.

SN 77-159,423, FILED 4-18-2007.

MATTHEW EINSTEIN, EXAMINING ATTORNEY

Int. Cl.: 9

Prior U.S. Cls.: 21, 23, 26, 36, and 38

Reg. No. 3,481,629

United States Patent and Trademark Office

Registered Aug. 5, 2008

**TRADEMARK
PRINCIPAL REGISTER**

EVOLVE

CHECKPOINT SYSTEMS, INC. (PENNSYLVANIA
CORPORATION)
P.O. BOX 188
101 WOLF DRIVE
THOROFARE, NJ 08086

THE MARK CONSISTS OF STANDARD CHAR-
ACTERS WITHOUT CLAIM TO ANY PARTICULAR
FONT, STYLE, SIZE, OR COLOR.

FOR: ELECTRONIC ANTENNAS FOR CONTROL
AND TRACKING OF ASSETS; ANTENNAS FOR
RADIO FREQUENCY TRACKING OF ASSETS, IN
CLASS 9 (U.S. CLS. 21, 23, 26, 36 AND 38).

SN 77-159,438, FILED 4-18-2007.

FIRST USE 6-11-2007; IN COMMERCE 6-11-2007.

LEIGH CAROLINE CASE, EXAMINING ATTOR-
NEY

Int. Cl.: 9

Prior U.S. Cls.: 21, 23, 26, 36, and 38

Reg. No. 3,481,630

United States Patent and Trademark Office

Registered Aug. 5, 2008

**TRADEMARK
PRINCIPAL REGISTER**

Poker Smash

VOID STAR CREATIONS LLC (SOUTH CAROLINA LTD LIAB CO)
70 ROCK COVE ROAD
SOUTH CAROLINA, SC 29072

FOR: COMPUTER GAME PROGRAMS; COMPUTER GAME SOFTWARE; INTERACTIVE MULTIMEDIA COMPUTER GAME PROGRAM, IN CLASS 9 (U.S. CLS. 21, 23, 26, 36 AND 38).

FIRST USE 5-1-2007; IN COMMERCE 2-6-2008.

THE MARK CONSISTS OF STANDARD CHARACTERS WITHOUT CLAIM TO ANY PARTICULAR FONT, STYLE, SIZE, OR COLOR.

NO CLAIM IS MADE TO THE EXCLUSIVE RIGHT TO USE "POKER", APART FROM THE MARK AS SHOWN.

SN 77-159,737, FILED 4-18-2007.

CARRIE GENOVESE, EXAMINING ATTORNEY

Int. Cl.: 9

Prior U.S. Cls.: 21, 23, 26, 36, and 38

Reg. No. 3,481,631

United States Patent and Trademark Office

Registered Aug. 5, 2008

**TRADEMARK
PRINCIPAL REGISTER**

RAPIDOSE

RADCAL CORPORATION (CALIFORNIA CORPORATION)
426 W. DUARTE ROAD
MONROVIA, CA 91016

THE MARK CONSISTS OF STANDARD CHARACTERS WITHOUT CLAIM TO ANY PARTICULAR FONT, STYLE, SIZE, OR COLOR.

FOR: RADIATION IONIZING MEASURING INSTRUMENTS, IN CLASS 9 (U.S. CLS. 21, 23, 26, 36 AND 38).

SN 77-159,753, FILED 4-18-2007.

FIRST USE 11-26-2007; IN COMMERCE 11-20-2007.

BONNIE LUKEN, EXAMINING ATTORNEY

Int. Cl.: 25

Prior U.S. Cls.: 22 and 39

United States Patent and Trademark Office

Reg. No. 3,481,632

Registered Aug. 5, 2008

TRADEMARK
PRINCIPAL REGISTER



KROTHER, JASON N (UNITED STATES INDIVIDUAL)

324 S. FAIRVIEW ST
BLOOMINGTON, IN 47403

FOR: AFTER SKI BOOTS; ANGLERS' SHOES; ANKLE BOOTS; ANKLE GARTERS; ANKLE SOCKS; ANKLETS; ANORAKS; ANTI-PERSPIRANT SOCKS; APRES-SKI SHOES; APRONS; ASCOTS; ATHLETIC FOOTWEAR; ATHLETIC SHOES; BANDANAS; BASEBALL CAPS; BASKETBALL SNEAKERS; BATH SLIPPERS; BATHING CAPS; BATHING SUITS; BATHING SUITS FOR MEN; BATHING TRUNKS; BATHROBES; BEACH COVERUPS; BEACH FOOTWEAR; BEACH SHOES; BEACHWEAR; BEANIES; BED JACKETS; BELTS; BELTS MADE OF LEATHER; BELTS OF TEXTILE; BERMUDA SHORTS; BIB OVERALLS; BICYCLE GLOVES; BICYCLING GLOVES; BIKINIS; BLAZERS; BLOOMERS; BLOUSES; BOARD SHORTS; BOARDSHORTS; BODY SUITS; BOLEROS; BOLO TIES; BONNETS; BOOTIES; BOOTS; BOTTOMS; BOW TIES; BOWLING SHOES; BOXER BRIEFS; BOXER SHORTS; BOXING SHOES; BRAS; BRASSIERES; BRIEFS; BRIEFS; BUTTON-FRONT ALOHA SHIRTS; CAMISOLES; CAMP SHIRTS; CANVAS SHOES; CAP VISORS; CAPELETS; CAPRI PANTS; CAPRIS; CAPS; CAPS WITH VISORS; CARDIGANS; CARGO PANTS; CHEMISES; CHEMISSETTES; CHILDREN'S AND INFANTS' CLOTH BIBS; CHILDREN'S CLOTH EATING BIBS; CHILDREN'S HEADWEAR; CLOGS; CLOTHING, NAMELY, ARM WARMERS; CLOTHING, NAMELY, KNEE WARMERS; CLOTHING, NAMELY, NECK TUBES; CLOTHING, NAMELY, WRAP-AROUNDS; COATS; COATS FOR MEN AND WOMEN; COATS MADE OF

COTTON; COATS OF DENIM; COVERALLS; COVERUPS; CYCLISTS' JERSEYS; DECK-SHOES; DENIM JACKETS; DENIMS; DICKIES; DO RAGS; DOWN JACKETS; DRESS SHIELDS; DRESS SHIRTS; DRESS SUITS; DRESSES; DRIVERS; DRY SUITS; DUNGAREES; EAR MUFFS; EARBANDS; FABRIC BELTS; FISHERMEN'S JACKETS; FISHING VESTS; FISHING WADERS; FLEECE PULLOVERS; FLEECE SHORTS; FLIP FLOPS; FOOTWEAR; FOOTWEAR; FOOTWEAR FOR MEN; FOOTWEAR FOR MEN AND WOMEN; FOOTWEAR FOR TRACK AND FIELD ATHLETICS; FOOTWEAR FOR WOMEN; FOOTWEAR MADE OF WOOD; FOOTWEAR NOT FOR SPORTS; FOOTWEAR, NAMELY, PUMPS; FOOTWEAR, NAMELY, RUBBERS; FOUL WEATHER GEAR; FUR COATS; FUR COATS AND JACKETS; FUR HATS; FUR JACKETS; FUR MUFFS; G-STRINGS; GALOSHES; GAUCHOS; GLOVES; GLOVES INCLUDING THOSE MADE OF SKIN, HIDE OR FUR; GOLF CAPS; GOLF SHIRTS; GOLF SHOES; GOLF TROUSERS; GREATCOATS; GYM SHORTS; GYM SUITS; HALTER TOPS; HAT BANDS; HATS; HEAD SCARVES; HEAD SWEATBANDS; HEAD WEAR; HEADBANDS; HEADBANDS AGAINST SWEATING; HEADWEAR; HEAVY JACKETS; HEELS; HIGH RAIN CLOGS (ASHIDA); HIKING BOOTS; HOODS; HOODS; HOUSECOATS; INFANT AND TODDLER ONE PIECE CLOTHING; INFANT SLEEPERS; INFANTS' SHOES AND BOOTS; INFANTS' TROUSERS; INFANTWEAR; JACKETS; JEANS; JERSEYS; JOGGING OUTFITS; JOGGING PANTS; JOGGING SUITS; JUMPERS; JUMPSUITS; KILTS; KNEE HIGHS; KNEE-HIGH STOCKINGS; KNICKERS; KNIT SHIRTS; KNITTED CAPS; KNITTED UNDERWEAR; LACE BOOTS; LADIES' BOOTS; LADIES' SUITS; LADIES' UNDER-

WEAR; LEATHER BELTS; LEATHER COATS; LEATHER HEADWEAR; LEATHER JACKETS; LEATHER PANTS; LEATHER SHOES; LEATHER SLIPPERS; LEG WARMERS; LEG-WARMERS; LEG-GINGS; LIGHT-REFLECTING COATS; LIGHT-REFLECTING JACKETS; LONG JACKETS; LONG SLEEVED VESTS; LOUNGEWEAR; MEN AND WOMEN JACKETS, COATS, TROUSERS, VESTS; MEN'S SOCKS; MEN'S SUITS; MEN'S SUITS, WOMEN'S SUITS; MINISKIRTS; MITTENS; MOCCASINS; MOCK TURTLE-NECK SWEATERS; MONEY BELTS; MORNING COATS; MOTORCYCLE GLOVES; MOTORCYCLIST BOOTS; MUSCLE TOPS; NECK BANDS; NECK GAITERS; NECKERCHIEFS; NECKERCHIEVES; NECKTIES; NECKWEAR; NIGHT GOWNS; NIGHT SHIRTS; NIGHTCAPS; NIGHTDRESSES; NIGHTIES; NIGHTWEAR; ONE PIECE GARMENT FOR INFANTS AND TODDLERS; OPEN-NECKED SHIRTS; OVER COATS; OVER-TROUSERS; OVERALLS; OVERCOATS; OVERSHOES; PAJAMAS; PANTIES; PANTIES, SHORTS AND BRIEFS; PANTS; PANTSUITS; PARKAS; PERSPIRATION ABSORBENT UNDERWEAR CLOTHING; PETTICOATS; PIQUE SHIRTS; PLASTIC BABY BIBS; PLAY SUITS; POCKET KERCHIEFS; POCKET SQUARES; POLO SHIRTS; PONCHOS; PULLOVERS; PUMPS; PYJAMAS; QUILTED VESTS; RAIN BOOTS; RAIN COATS; RAIN JACKETS; RAIN SLICKERS; RAIN SUITS; RAIN TROUSERS; RAINCOATS; RAINPROOF JACKETS; RAINWEAR; ROBES; RUBBER SHOES; RUBBERS; RUGBY SHORTS; RUGBY TOPS; RUNNING SHOES; SANDAL-CLOGS; SANDALS; SARIS; SARONGS; SASHES; SCARVES; SCRUBS NOT FOR MEDICAL PURPOSES; SHAWLS; SHAWLS; SHAWLS AND HEADSCARVES; SHAWLS AND STOLEES; SHIRTS; SHIRTS FOR SUITS; SHOES; SHORT PETTICOATS; SHORT SETS; SHORT TROUSERS; SHORT-SLEEVED OR LONG-SLEEVED T-SHIRTS; SHORT-SLEEVED SHIRTS; SHOWER CAPS; SILK SCARVES; SKI AND SNOWBOARD SHOES AND PARTS THEREOF; SKI BIBS; SKI BOOT BAGS; SKI GLOVES; SKI JACKETS; SKI MASKS; SKI PANTS; SKI SUITS; SKI SUITS FOR COMPETITION; SKI WEAR; SKIING SHOES; SKIRT SUITS; SKIRTS; SKIRTS AND DRESSES; SKIWEAR; SKULL CAPS; SKULLIES; SLACKS; SLEEP SHIRTS; SLEEPING GARMENTS; SLEEPWEAR; SLEEVED OR SLEEVELESS JACKETS; SLEEVELESS JERSEYS; SLIPPERS; SMALL HATS; SMOKING JACKETS; SNEAKERS; SNOW BOARDING SUITS; SNOW PANTS; SNOW SUITS; SNOWBOARD BOOTS; SNOWBOARD GLOVES; SNOWBOARD PANTS; SOCK SUSPENDERS; SOCKS; SOCKS AND STOCKINGS; SPORT

COATS; SPORT SHIRTS; SPORTS JACKETS; SPORTS JERSEYS; SPORTS JERSEYS AND BREECHES FOR SPORTS; SPORTS OVERUNIFORMS; SPORTS SHIRTS; SPORTS SHIRTS WITH SHORT SLEEVES; STOCKINGS; STOCKINGS; STUFF JACKETS; SUEDE JACKETS; SUIT COATS; SUITS; SUITS OF LEATHER; SUN VISORS; SUNSUITS; SURF WEAR; SUSPENDER BELTS FOR MEN; SUSPENDER BELTS FOR WOMEN; SUSPENDERS; SWEAT BANDS; SWEAT PANTS; SWEAT SHIRTS; SWEAT SHORTS; SWEAT SUITS; SWEATBANDS; SWEATERS; SWEATSOCKS; SWIM CAPS; SWIM TRUNKS; SWIM WEAR; SWIM WEAR FOR GENTLEMEN AND LADIES; SWIMMING CAPS; SWIMMING CAPS; SWIMMING COSTUMES; SWIMMING TRUNKS; SWIMSUITS; T-SHIRTS; TANK TOPS; TANK-TOPS; TEDDIES; TENNIS SHOES; TENNIS WEAR; THERMAL SOCKS; THERMAL UNDERWEAR; THONGS; TIES; TIGHTS; TOBOGGAN HATS, PANTS AND CAPS; TOP COATS; TOPCOATS; TOPS; TRACK PANTS; TRACK SUITS; TRACKSUITS; TRAINING SHOES; TRAINING SUITS; TRENCH COATS; TROUSERS; TROUSERS FOR SWEATING; TROUSERS OF LEATHER; TRUNKS; TUBE TOPS; TURTLENECK SWEATERS; TURTLENECKS; TUXEDO BELTS; TUXEDOS; UNDER GARMENTS; UNDERCLOTHES; UNDERGARMENTS; UNDERPANTS; UNDERSHIRTS; UNDERSKIRTS; UNDERWEAR; UNIFORMS; V-NECK SWEATERS; VESTED SUITS; VESTS; VISORS; WAIST BELTS; WAISTCOATS; WALKING SHORTS; WARM UP SUITS; WATER SOCKS; WATERPROOF JACKETS AND PANTS; WET SUIT GLOVES; WET SUITS; WET SUITS FOR WATER-SKIING AND SUB-AQUA; WIND COATS; WIND RESISTANT JACKETS; WIND SHIRTS; WIND VESTS; WIND-JACKETS; WINDSHIRTS; WINTER BOOTS; WOMEN'S SHOES; WOMEN'S UNDERWEAR; WOOLLEN SOCKS; WOOLLY HATS; WORK SHOES AND BOOTS; WORKING OVERALLS; WOVEN OR KNITTED UNDERWEAR; WRIST BANDS; WRISTBANDS; WRISTBANDS CONTAINING A COOLING SUBSTANCE TO COOL THE WEARER; ZOOT SUITS, IN CLASS 25 (U.S. CLS. 22 AND 39).

FIRST USE 5-20-2007; IN COMMERCE 5-20-2007.

THE MARK CONSISTS OF A CROSS OVERLAIN ON AN ANGULAR SHAPE.

SN 77-159,836, FILED 4-18-2007.

JAMES A. RAUEN, EXAMINING ATTORNEY

Int. Cl.: 7

Prior U.S. Cls.: 13, 19, 21, 23, 31, 34, and 35

Reg. No. 3,481,633

United States Patent and Trademark Office

Registered Aug. 5, 2008

**TRADEMARK
PRINCIPAL REGISTER**



THE DARIEN GROUP, INC. (DELAWARE CORPORATION)
10462 COLBY ROAD
DARIEN CENTER, NY 140409714

FOR: POWER-OPERATED ROTARY HEDGE TRIMMERS, IN CLASS 7 (U.S. CLS. 13, 19, 21, 23, 31, 34 AND 35).

FIRST USE 5-21-2008; IN COMMERCE 5-21-2008.

NO CLAIM IS MADE TO THE EXCLUSIVE RIGHT TO USE "YARD TRIMMER", APART FROM THE MARK AS SHOWN.

THE MARK CONSISTS OF A SWIRLING CARNIVOROUS-LOOKING HEDGE HOG ADJACENT THE LITERAL ELEMENT OF THE MARK.

SN 77-159,856, FILED 4-18-2007.

KAREN BRACEY, EXAMINING ATTORNEY

Int. Cls.: 37 and 42

Prior U.S. Cls.: 100, 101, 103, and 106

United States Patent and Trademark Office

Reg. No. 3,481,634

Registered Aug. 5, 2008

**SERVICE MARK
PRINCIPAL REGISTER**

TTG

THORNTON-TERMOHLEN GROUP CORPORATION (NEVADA CORPORATION)
1700 W. HORIZON RIDGE PARKWAY, SUITE 200
HENDERSON, NV 89012

FOR: REAL ESTATE DEVELOPMENT SERVICES AND CONSTRUCTION OF BUILDINGS, IN CLASS 37 (U.S. CLS. 100, 103 AND 106).

FIRST USE 6-0-2007; IN COMMERCE 6-0-2007.

FOR: CONSTRUCTION DESIGN SERVICES FOR OTHERS IN THE FIELD OF CONSTRUCTION, NAMELY, FOR THE CONSTRUCTION OF NEW

BUILDINGS AND FOR THE RENOVATION OF PRE-EXISTING BUILDINGS, IN CLASS 42 (U.S. CLS. 100 AND 101).

FIRST USE 6-0-2007; IN COMMERCE 6-0-2007.

THE MARK CONSISTS OF STANDARD CHARACTERS WITHOUT CLAIM TO ANY PARTICULAR FONT, STYLE, SIZE, OR COLOR.

SN 77-159,864, FILED 4-18-2007.

PRISCILLA MILTON, EXAMINING ATTORNEY

Int. Cl.: 16

Prior U.S. Cls.: 2, 5, 22, 23, 29, 37, 38, and 50

Reg. No. 3,481,635

United States Patent and Trademark Office

Registered Aug. 5, 2008

**TRADEMARK
PRINCIPAL REGISTER**

The People Skills Experts

NEW HEIGHTS MEDIA, INC. (NEW JERSEY
CORPORATION)
260 COLUMBIA AVENUE, SUITE 5
FORT LEE, NJ 07024

THE MARK CONSISTS OF STANDARD CHAR-
ACTERS WITHOUT CLAIM TO ANY PARTICULAR
FONT, STYLE, SIZE, OR COLOR.

FOR: A SERIES OF BOOKS, WRITTEN ARTICLES,
HANDOUTS AND WORKSHEETS IN THE FIELD
OF BUSINESS COMMUNICATIONS, IN CLASS 16
(U.S. CLS. 2, 5, 22, 23, 29, 37, 38 AND 50).

SN 77-160,230, FILED 4-18-2007.

FIRST USE 6-1-2007; IN COMMERCE 10-1-2007.

CHERYL CLAYTON, EXAMINING ATTORNEY

Int. Cl.: 41

Prior U.S. Cls.: 100, 101, and 107

United States Patent and Trademark Office

Reg. No. 3,481,636

Registered Aug. 5, 2008

SERVICE MARK
PRINCIPAL REGISTER

womensphere

BALARES, ANALISA (UNITED STATES INDIVIDUAL)
FRIDMAN LAW GROUP, PLLC
287 SPRING STREET
NEW YORK, NY 10013

FOR: PROVIDING CURRENT EVENT NEWS AND INFORMATION; PUBLICATION OF BOOKS, MAGAZINES AND JOURNALS; PROVIDING TELEVISION PROGRAMS IN THE FIELD OF SOCIAL INTRODUCTION, GENERAL INTEREST, GENDER ISSUES, BUSINESS, POLITICS, GLOBAL LEADERSHIP, COMMUNITY LEADERSHIP, ENTREPRENEURSHIP, EDUCATION, ENVIRONMENT, SCIENCE AND TECHNOLOGY, THEATER, ARTS, MUSIC, TRAVEL, HEALTH, SOCIAL CAUSES, FAMILY LIFE, AND CAMPUS LIFE; ARRANGING EDUCATIONAL MEETINGS, SEMINARS AND CONFERENCES IN THE FIELD OF SOCIAL INTRODUCTION, GENERAL INTEREST, GENDER ISSUES, BUSINESS, POLITICS, GLOBAL LEADERSHIP, COMMUNITY LEADERSHIP, ENTREPRENEURSHIP, EDUCATION, ENVIRONMENT, SCIENCE AND TECHNOLOGY, THEATER, ARTS, MUSIC, TRAVEL, HEALTH, SOCIAL CAUSES, FAMILY LIFE, AND CAMPUS LIFE; ON-LINE JOURNALS, NAMELY, BLOGS FEATURING VARIOUS TOPICS, NAMELY, SOCIAL INTRODUCTION, GENERAL INTEREST, GENDER ISSUES, BUSI-

NESS, POLITICS, GLOBAL LEADERSHIP, COMMUNITY LEADERSHIP, ENTREPRENEURSHIP, EDUCATION, ENVIRONMENT, SCIENCE AND TECHNOLOGY, THEATER, ARTS, MUSIC, TRAVEL, HEALTH, SOCIAL CAUSES, FAMILY LIFE, AND CAMPUS LIFE; PROVIDING A WEBSITE FEATURING INTERACTIVE EDUCATIONAL MEETINGS FEATURING VARIOUS TOPICS, NAMELY, SOCIAL INTRODUCTION, GENERAL INTEREST, GENDER ISSUES, BUSINESS, POLITICS, GLOBAL LEADERSHIP, COMMUNITY LEADERSHIP, ENTREPRENEURSHIP, EDUCATION, ENVIRONMENT, SCIENCE AND TECHNOLOGY, THEATER, ARTS, MUSIC, TRAVEL, HEALTH, SOCIAL CAUSES, FAMILY LIFE, AND CAMPUS LIFE; ORGANIZING AND PLANNING SPECIAL EVENTS, IN CLASS 41 (U.S. CLS. 100, 101 AND 107).

FIRST USE 4-2-2007; IN COMMERCE 4-2-2007.

THE MARK CONSISTS OF STANDARD CHARACTERS WITHOUT CLAIM TO ANY PARTICULAR FONT, STYLE, SIZE, OR COLOR.

SN 77-160,387, FILED 4-19-2007.

PAUL F. GAST, EXAMINING ATTORNEY

Int. Cl.: 9

Prior U.S. Cls.: 21, 23, 26, 36, and 38

United States Patent and Trademark Office

Reg. No. 3,481,637

Registered Aug. 5, 2008

**TRADEMARK
PRINCIPAL REGISTER**

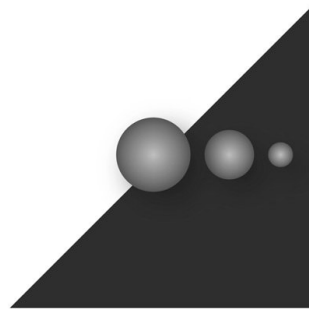

REALSynergy

OCWEN FINANCIAL CORPORATION (FLORIDA CORPORATION)
1661 WORTHINGTON ROAD
WEST PALM BEACH, FL 33409

FOR: COMPUTER SOFTWARE USED FOR THE MANAGEMENT AND ADMINISTRATION OF MORTGAGE LOANS AND INCOME-PRODUCING PROPERTY IN THE FIELD OF COMMERCIAL REAL-ESTATE, FINANCE, AND INVESTMENT, IN CLASS 9 (U.S. CLS. 21, 23, 26, 36 AND 38).

FIRST USE 4-26-2007; IN COMMERCE 6-1-2007.

OWNER OF U.S. REG. NO. 2,729,544.

SN 77-160,695, FILED 4-19-2007.

WILLIAM P. SHANAHAN, EXAMINING ATTORNEY

Int. Cl.: 35

Prior U.S. Cls.: 100, 101, and 102

United States Patent and Trademark Office

Reg. No. 3,481,638

Registered Aug. 5, 2008

SERVICE MARK
PRINCIPAL REGISTER

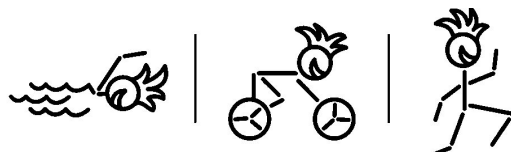

discover triathlon

TRIGUYS (ILLINOIS PARTNERSHIP)
11 N WILSHIRE LN
ARLINGTON HEIGHTS, IL 60004

FOR: ON-LINE RETAIL STORE SERVICES FEATURING HATS, SHIRTS, SOCKS, WATER BOTTLES, MUGS, MAGNETS, STICKERS, SHOES, BUTTONS, BAGS, NAMELY, DUFFLE, BACK PACK, TRAVEL, AND TOTE BAGS, CARDS, POSTERS, CALENDARS, STAMPS, HELMETS, BIKES, BIKE JERSEYS, SHORTS, SWEAT SHIRTS, T-SHIRTS, SWEAT PANTS, PENS, KNIVES, GLASSWARE, BOOKS, MAGAZINES, COLORING BOOKS, TOWELS, WATCHES, NECK TIES; RETAIL STORE SERVICES FEATURING HATS, SHIRTS, SOCKS, WATER BOTTLES, MUGS, MAGNETS, STICKERS, SHOES, BUTTONS, BAGS, NAMELY, DUFFLE, BACK PACK, TRAVEL, AND TOTE BAGS, CARDS, POSTERS, CALENDARS, STAMPS, HELMETS, BIKES, BIKE JERSEYS, SHORTS, SWEAT SHIRTS, T-SHIRTS, SWEAT PANTS, PENS, KNIVES, GLASSWARE, BOOKS, MAGAZINES, COLORING BOOKS, TO-

WELS, WATCHES, NECK TIES, IN CLASS 35 (U.S. CLS. 100, 101 AND 102).

FIRST USE 4-19-2007; IN COMMERCE 8-8-2007.

NO CLAIM IS MADE TO THE EXCLUSIVE RIGHT TO USE "TRIATHLON", APART FROM THE MARK AS SHOWN.

THE MARK CONSISTS OF THREE STICK FIGURES, EACH ONE WITH A SMILE, EACH ONE WITH HAIR SPIKED UP, (FROM LEFT TO RIGHT) ONE SWIMMING, ONE BIKING, ONE RUNNING, THERE IS A VERTICAL BAR SEPARATING THE SWIMMER FROM THE BIKER AND A VERTICAL BAR SEPARATING THE BIKER FROM THE RUNNER.

SN 77-161,197, FILED 4-19-2007.

YAT SYE, LEE, EXAMINING ATTORNEY

Int. Cl.: 9

Prior U.S. Cls.: 21, 23, 26, 36, and 38

Reg. No. 3,481,639

United States Patent and Trademark Office

Registered Aug. 5, 2008

**TRADEMARK
PRINCIPAL REGISTER**

SOLSTICE

NEWPORT CORPORATION (NEVADA CORPORATION)
1791 DEERE AVENUE
IRVINE, CA 92606

THE MARK CONSISTS OF STANDARD CHARACTERS WITHOUT CLAIM TO ANY PARTICULAR FONT, STYLE, SIZE, OR COLOR.

FOR: LASERS FOR NON-MEDICAL USE; LASER AMPLIFIERS, IN CLASS 9 (U.S. CLS. 21, 23, 26, 36 AND 38).

SN 77-161,202, FILED 4-19-2007.

FIRST USE 3-21-2008; IN COMMERCE 3-21-2008.

JOHN DWYER, EXAMINING ATTORNEY

Int. Cl.: 14

Prior U.S. Cls.: 2, 27, 28, and 50

United States Patent and Trademark Office

Reg. No. 3,481,640

Registered Aug. 5, 2008

**TRADEMARK
PRINCIPAL REGISTER**

Père de Temps

GLOVEBRUSH CORP. (CALIFORNIA CORPORATION)
3351 WOLF CREEK COURT
SIMI VALLEY, CA 93063

FOR: WATCHES, AND OTHER TIMING DEVICES, NAMELY, CHRONOGRAPHS FOR USE AS TIMEPIECES AND AS WATCHES, IN CLASS 14 (U.S. CLS. 2, 27, 28 AND 50).

FIRST USE 1-9-2008; IN COMMERCE 1-22-2008.

THE MARK CONSISTS OF STANDARD CHARACTERS WITHOUT CLAIM TO ANY PARTICULAR FONT, STYLE, SIZE, OR COLOR.

THE FOREIGN WORDING IN THE MARK TRANSLATES INTO ENGLISH AS FATHER OF TIME.

SN 77-161,321, FILED 4-19-2007.

PAUL F. GAST, EXAMINING ATTORNEY

Int. Cl.: 38

Prior U.S. Cls.: 100, 101, and 104

United States Patent and Trademark Office

Reg. No. 3,481,641

Registered Aug. 5, 2008

**SERVICE MARK
PRINCIPAL REGISTER**

MYRECIPES.COM

SPC DIGITAL, INC. (DELAWARE CORPORATION)
2100 LAKESHORE DRIVE
BIRMINGHAM, AL 35209

FOR: STREAMING OF AUDIO AND VIDEO MATERIAL ON THE INTERNET AND THROUGH MOBILE COMMUNICATIONS DEVICES IN THE FIELDS OF COOKING, FOODS, BEVERAGES, ENTERTAINING, KITCHEN EQUIPMENT AND LIFESTYLES, IN CLASS 38 (U.S. CLS. 100, 101 AND 104).

FIRST USE 6-26-2007; IN COMMERCE 6-26-2007.

THE MARK CONSISTS OF STANDARD CHARACTERS WITHOUT CLAIM TO ANY PARTICULAR FONT, STYLE, SIZE, OR COLOR.

SN 77-161,479, FILED 4-20-2007.

LYDIA BELZER, EXAMINING ATTORNEY

Int. Cl.: 38

Prior U.S. Cls.: 100, 101, and 104

United States Patent and Trademark Office

Reg. No. 3,481,642

Registered Aug. 5, 2008

**SERVICE MARK
PRINCIPAL REGISTER**

MYRECIPES

SPC DIGITAL, INC. (DELAWARE CORPORATION)
2100 LAKESHORE DRIVE
BIRMINGHAM, AL 35209

FOR: STREAMING OF AUDIO AND VIDEO MATERIAL ON THE INTERNET AND THROUGH MOBILE COMMUNICATIONS DEVICES IN THE FIELDS OF COOKING, FOODS, BEVERAGES, ENTERTAINING, KITCHEN EQUIPMENT AND LIFESTYLES, IN CLASS 38 (U.S. CLS. 100, 101 AND 104).

FIRST USE 6-26-2007; IN COMMERCE 6-26-2007.

THE MARK CONSISTS OF STANDARD CHARACTERS WITHOUT CLAIM TO ANY PARTICULAR FONT, STYLE, SIZE, OR COLOR.

SN 77-161,484, FILED 4-20-2007.

LYDIA BELZER, EXAMINING ATTORNEY

Int. Cl.: 9

Prior U.S. Cls.: 21, 23, 26, 36, and 38

Reg. No. 3,481,643

United States Patent and Trademark Office

Registered Aug. 5, 2008

**TRADEMARK
PRINCIPAL REGISTER**

RVA

CROSSROADS SYSTEMS, INC. (DELAWARE
CORPORATION)
11000 NORTH MOPAC EXPRESSWAY
AUSTIN, TX 78759

FOR: COMPUTER SOFTWARE FOR MONITOR-
ING, VALIDATING, AND REPORTING ON THE
PERFORMANCE AND UTILIZATION OF BACK UP
TAPES AND STORED DATA, IN CLASS 9 (U.S. CLS.
21, 23, 26, 36 AND 38).

FIRST USE 10-10-2007; IN COMMERCE 10-10-2007.

THE MARK CONSISTS OF STANDARD CHAR-
ACTERS WITHOUT CLAIM TO ANY PARTICULAR
FONT, STYLE, SIZE, OR COLOR.

SN 77-161,652, FILED 4-20-2007.

THOMAS MANOR, EXAMINING ATTORNEY

Int. Cl.: 3

Prior U.S. Cls.: 1, 4, 6, 50, 51, and 52

United States Patent and Trademark Office

Reg. No. 3,481,644

Registered Aug. 5, 2008

**TRADEMARK
PRINCIPAL REGISTER**

NIAGARA

THE BUTCHER COMPANY (DELAWARE COR-
PORATION)
8310 16TH STREET
STURTEVANT, WI 53177

THE MARK CONSISTS OF STANDARD CHAR-
ACTERS WITHOUT CLAIM TO ANY PARTICULAR
FONT, STYLE, SIZE, OR COLOR.

FOR: FLOOR CARE PREPARATIONS, NAMELY,
FLOOR FINISHING PREPARATIONS, IN CLASS 3
(U.S. CLS. 1, 4, 6, 50, 51 AND 52).

SN 77-162,073, FILED 4-20-2007.

FIRST USE 7-6-2007; IN COMMERCE 7-6-2007.

DAVID YONTEF, EXAMINING ATTORNEY

Int. Cl.: 43

Prior U.S. Cls.: 100 and 101

United States Patent and Trademark Office

Reg. No. 3,481,645

Registered Aug. 5, 2008

**SERVICE MARK
PRINCIPAL REGISTER**

**ROBERTA PACINO'S HOLLYWOOD
ESPRESSO**

RICHMAN, MARK (UNITED STATES INDIVIDUAL)
5321 RESIDENCIA
NEWPORT BEACH, CA 92660 AND
PACINO, ROBERTA (UNITED STATES INDIVIDUAL)
5321 RESIDENCIA
NEWPORT BEACH, CA 92660

FOR: COFFEE SHOPS; COFFEE-HOUSE AND
SNACK-BAR SERVICES, IN CLASS 43 (U.S. CLS.
100 AND 101).

FIRST USE 5-0-2008; IN COMMERCE 5-0-2008.

THE MARK CONSISTS OF STANDARD CHARACTERS WITHOUT CLAIM TO ANY PARTICULAR FONT, STYLE, SIZE, OR COLOR.

NO CLAIM IS MADE TO THE EXCLUSIVE RIGHT TO USE "ESPRESSO", APART FROM THE MARK AS SHOWN.

SN 77-162,664, FILED 4-22-2007.

JASON BLAIR, EXAMINING ATTORNEY

Int. Cl.: 20

Prior U.S. Cls.: 2, 13, 22, 25, 32, and 50

United States Patent and Trademark Office

Reg. No. 3,481,646

Registered Aug. 5, 2008

**TRADEMARK
PRINCIPAL REGISTER**

EZ LOAD

HENSCHEL-STEINAU, INC. (NEW JERSEY CORPORATION)
300 GRAND AVENUE
ENGLEWOOD, NJ 07631

FOR: POINT-OF-PURCHASE MERCHANDISE DISPLAY AND DISPENSING SYSTEMS, NAMELY, SHELF-MOUNTED DIVIDERS AND MERCHANDISE TRACKS, PUSHERS AND GATES FOR THE SELECTIVE DISPENSING OF MERCHANDISE PACKAGES AT A POINT-OF-PURCHASE LOCATION ALONG A DISPLAY SHELF, IN CLASS 20 (U.S. CLS. 2, 13, 22, 25, 32 AND 50).

FIRST USE 8-27-2007; IN COMMERCE 8-28-2007.

THE MARK CONSISTS OF STANDARD CHARACTERS WITHOUT CLAIM TO ANY PARTICULAR FONT, STYLE, SIZE, OR COLOR.

SN 77-162,782, FILED 4-23-2007.

JOHN HWANG, EXAMINING ATTORNEY

Int. Cl.: 20

Prior U.S. Cls.: 2, 13, 22, 25, 32, and 50

United States Patent and Trademark Office

Reg. No. 3,481,647

Registered Aug. 5, 2008

**TRADEMARK
PRINCIPAL REGISTER**

CONAIR

CONAIR CORPORATION (DELAWARE CORPORATION)
ONE CUMMINGS POINT ROAD
STAMFORD, CT 06902

FOR: SEAT CUSHIONS, IN CLASS 20 (U.S. CLS. 2, 13, 22, 25, 32 AND 50).

FIRST USE 6-1-2007; IN COMMERCE 6-1-2007.

THE MARK CONSISTS OF STANDARD CHARACTERS WITHOUT CLAIM TO ANY PARTICULAR FONT, STYLE, SIZE, OR COLOR.

OWNER OF U.S. REG. NOS. 2,238,852 AND 2,533,081.

SN 77-164,399, FILED 4-24-2007.

MARY MUNSON, EXAMINING ATTORNEY

Int. Cl.: 43

Prior U.S. Cls.: 100 and 101

United States Patent and Trademark Office

Reg. No. 3,481,648

Registered Aug. 5, 2008

**SERVICE MARK
PRINCIPAL REGISTER**

LET'S PLAY RESTAURANT

BRINKER INTERNATIONAL HOLDINGS, L.P.
(DELAWARE LIMITED PARTNERSHIP)

6820 LBJ FREEWAY

DALLAS, TX 75240

FOR: RESTAURANT, BAR AND CATERING SERVICES, IN CLASS 43 (U.S. CLS. 100 AND 101).

FIRST USE 9-8-2006; IN COMMERCE 9-8-2006.

THE MARK CONSISTS OF STANDARD CHARACTERS WITHOUT CLAIM TO ANY PARTICULAR FONT, STYLE, SIZE, OR COLOR.

NO CLAIM IS MADE TO THE EXCLUSIVE RIGHT TO USE "RESTAURANT", APART FROM THE MARK AS SHOWN.

SN 77-164,593, FILED 4-24-2007.

KEVON CHISOLM, EXAMINING ATTORNEY

Int. Cl.: 38

Prior U.S. Cls.: 100, 101, and 104

United States Patent and Trademark Office

Reg. No. 3,481,649

Registered Aug. 5, 2008

**SERVICE MARK
PRINCIPAL REGISTER**

GRANDEVISION

GRANDE COMMUNICATIONS NETWORKS,
INC. (DELAWARE CORPORATION)
401 CARLSON CIRCLE
SAN MARCOS, TX 78666

FOR: TELECOMMUNICATION SERVICES,
NAMELY, TELECOMMUNICATION ACCESS SER-
VICES; TELEVISION, CABLE TELEVISION, SUB-
SCRIPTION TELEVISION AND RADIO
BROADCASTING SERVICES; VIDEO BROADCAST-
ING SERVICES; SATELLITE TELEVISION BROAD-
CASTING SERVICES; COMMUNICATIONS BY
MEANS OF RADIO, SATELLITE, CABLE, FIBER
OPTIC NETWORKS, AND COMPUTER TERMIN-
ALS, NAMELY, TRANSMISSION OF DATA,

SOUND, IMAGES AND MESSAGES BY MEANS OF
RADIO, SATELLITE, CABLE, FIBER OPTIC NET-
WORKS, AND COMPUTER TERMINALS, IN CLASS
38 (U.S. CLS. 100, 101 AND 104).

FIRST USE 5-8-2007; IN COMMERCE 5-8-2007.

THE MARK CONSISTS OF STANDARD CHAR-
ACTERS WITHOUT CLAIM TO ANY PARTICULAR
FONT, STYLE, SIZE, OR COLOR.

SN 77-164,788, FILED 4-24-2007.

AMY HELLA, EXAMINING ATTORNEY

Int. Cl.: 14

Prior U.S. Cls.: 2, 27, 28, and 50

United States Patent and Trademark Office

Reg. No. 3,481,650

Registered Aug. 5, 2008

**TRADEMARK
PRINCIPAL REGISTER**

XOSKELETON

XOSKELETON, INC. (MARYLAND CORPORATION)
10462 WATERFOWL TERRACE
COLUMBIA, MD 21044

FOR: WATCH BANDS AND STRAPS; WATCH
FACES; WATCH PARTS; WATCHES; WRIST
WATCHES; CLOCKS; TIMEPIECES AND CHRONO-
METRIC INSTRUMENTS, IN CLASS 14 (U.S. CLS. 2,
27, 28 AND 50).

FIRST USE 6-4-2007; IN COMMERCE 6-4-2007.

THE MARK CONSISTS OF STANDARD CHAR-
ACTERS WITHOUT CLAIM TO ANY PARTICULAR
FONT, STYLE, SIZE, OR COLOR.

SN 77-165,074, FILED 4-25-2007.

CARYN GLASSER, EXAMINING ATTORNEY

Int. Cl.: 30

Prior U.S. Cl.: 46

United States Patent and Trademark Office

Reg. No. 3,481,651

Registered Aug. 5, 2008

**TRADEMARK
PRINCIPAL REGISTER**

SNACKING HAS NEVER FELT SO
NATURAL

PEPPERIDGE FARM, INCORPORATED (CON-
NECTICUT CORPORATION)
595 WESTPORT AVENUE
NORWALK, CT 06851

THE MARK CONSISTS OF STANDARD CHAR-
ACTERS WITHOUT CLAIM TO ANY PARTICULAR
FONT, STYLE, SIZE, OR COLOR.

FOR: CEREAL-BASED SNACK FOODS, IN CLASS
30 (U.S. CL. 46).

SN 77-165,297, FILED 4-25-2007.

FIRST USE 6-0-2007; IN COMMERCE 6-0-2007.

SIMON TENG, EXAMINING ATTORNEY

Int. Cl.: 36

Prior U.S. Cls.: 100, 101, and 102

United States Patent and Trademark Office

Reg. No. 3,481,652

Registered Aug. 5, 2008

**SERVICE MARK
PRINCIPAL REGISTER**

NYMEX 3-2-1 PLUS

NEW YORK MERCANTILE EXCHANGE, INC.
(DELAWARE CORPORATION)
WORLD FINANCIAL CENTER
ONE NORTH END AVENUE
NEW YORK, NY 10282

FOR: PROVIDING FINANCIAL AND INVESTMENT INFORMATION SERVICES; PROVIDING FINANCIAL SERVICES, NAMELY, TRADING OF FUTURES AND OPTIONS ON FUTURES CONTRACTS BASED ON A COMMODITY INDEX FOR OTHERS, THROUGH A COMPUTER NETWORK AND PROVIDING INFORMATION CONCERNING THE TRADING OF FUTURES AND OPTIONS ON FUTURES CONTRACTS BASED ON A COMMODITY INDEX, THROUGH A COMPUTER NETWORK, IN CLASS 36 (U.S. CLS. 100, 101 AND 102).

FIRST USE 12-21-2006; IN COMMERCE 12-21-2006.

THE MARK CONSISTS OF STANDARD CHARACTERS WITHOUT CLAIM TO ANY PARTICULAR FONT, STYLE, SIZE, OR COLOR.

OWNER OF U.S. REG. NOS. 1,731,593, 3,087,793, AND OTHERS.

SN 77-165,516, FILED 4-25-2007.

ANDREA K. NADELMAN, EXAMINING ATTORNEY

Int. Cl.: 30

Prior U.S. Cl.: 46

United States Patent and Trademark Office

Reg. No. 3,481,653

Registered Aug. 5, 2008

**TRADEMARK
PRINCIPAL REGISTER**

BIRTHDAY BASH

THE KROGER CO. OF MICHIGAN (MICHIGAN
CORPORATION)
18334 LAUREL PARK DRIVE NORTH
LIVONIA, MI 481522686

FOR: COOKIE DOUGH, IN CLASS 30 (U.S. CL. 46).

FIRST USE 6-1-2008; IN COMMERCE 6-1-2008.

THE MARK CONSISTS OF STANDARD CHAR-
ACTERS WITHOUT CLAIM TO ANY PARTICULAR
FONT, STYLE, SIZE, OR COLOR.

SN 77-166,382, FILED 4-26-2007.

CHERYL CLAYTON, EXAMINING ATTORNEY

Int. Cl.: 40

Prior U.S. Cls.: 100, 103, and 106

United States Patent and Trademark Office

Reg. No. 3,481,654

Registered Aug. 5, 2008

**SERVICE MARK
PRINCIPAL REGISTER**

WATERMD

GENERAL ELECTRIC COMPANY (NEW YORK
CORPORATION)
1 RIVER ROAD
SCHENECTADY, NY 12345

THE MARK CONSISTS OF STANDARD CHAR-
ACTERS WITHOUT CLAIM TO ANY PARTICULAR
FONT, STYLE, SIZE, OR COLOR.

FOR: TREATMENT OF WATER USED IN NU-
CLEAR REACTORS, IN CLASS 40 (U.S. CLS. 100, 103
AND 106).

SN 77-166,546, FILED 4-26-2007.

FIRST USE 10-31-2007; IN COMMERCE 10-31-2007.

CARRIE GENOVESE, EXAMINING ATTORNEY

Int. Cl.: 41

Prior U.S. Cls.: 100, 101, and 107

United States Patent and Trademark Office

Reg. No. 3,481,655

Registered Aug. 5, 2008

**SERVICE MARK
PRINCIPAL REGISTER**

DISCOVER THE SECRET FORMULA

THE COCA-COLA COMPANY (DELAWARE
CORPORATION)
ONE COCA-COLA PLAZA
ATLANTA, GA 30313

FOR: EXHIBITION SERVICES, NAMELY, THE
OPERATION OF A PAVILION WHICH DISPLAYS
EXHIBITS AND MEMORABILIA CONCERNING
THE COCA-COLA COMPANY, ITS HISTORY AND
ITS PRODUCTS FOR PUBLIC VIEWING, IN CLASS
41 (U.S. CLS. 100, 101 AND 107).

FIRST USE 5-0-2007; IN COMMERCE 5-0-2007.

THE MARK CONSISTS OF STANDARD CHAR-
ACTERS WITHOUT CLAIM TO ANY PARTICULAR
FONT, STYLE, SIZE, OR COLOR.

SN 77-166,566, FILED 4-26-2007.

TASHIA BUNCH, EXAMINING ATTORNEY

Int. Cl.: 3

Prior U.S. Cls.: 1, 4, 6, 50, 51, and 52

United States Patent and Trademark Office

Reg. No. 3,481,656

Registered Aug. 5, 2008

**TRADEMARK
PRINCIPAL REGISTER**

SUPERSHOCK

AVON PRODUCTS, INC. (NEW YORK CORPORATION)
LEGAL DEPARTMENT - 3RD FL.
1251 AVENUE OF THE AMERICAS
NEW YORK, NY 10020

THE MARK CONSISTS OF STANDARD CHARACTERS WITHOUT CLAIM TO ANY PARTICULAR FONT, STYLE, SIZE, OR COLOR.

FOR: MASCARA, IN CLASS 3 (U.S. CLS. 1, 4, 6, 50, 51 AND 52).

SN 77-166,663, FILED 4-26-2007.

FIRST USE 1-24-2008; IN COMMERCE 1-24-2008.

LOURDES AYALA, EXAMINING ATTORNEY

Int. Cl.: 42

Prior U.S. Cls.: 100 and 101

United States Patent and Trademark Office

Reg. No. 3,481,657

Registered Aug. 5, 2008

**SERVICE MARK
PRINCIPAL REGISTER**

MAPMETRIX

MARKET PLANNING SOLUTIONS INC. (DELA-
WARE CORPORATION)
4343 SOUTH 118 EAST AVENUE
TULSA, OK 74146

FOR: PROVIDING TEMPORARY USE OF ON-
LINE NON-DOWNLOADABLE SOFTWARE FOR
INTERACTIVE MARKET ANALYSIS, NAMELY,
FOR GEOGRAPHIC ANALYSIS, MAP PRODUC-
TION, AND INTERACTIVE ANALYSIS OF BUSI-
NESS PLANNING DATA, IN CLASS 42 (U.S. CLS. 100
AND 101).

FIRST USE 3-28-2008; IN COMMERCE 3-28-2008.

THE MARK CONSISTS OF STANDARD CHAR-
ACTERS WITHOUT CLAIM TO ANY PARTICULAR
FONT, STYLE, SIZE, OR COLOR.

OWNER OF U.S. REG. NO. 2,413,669.

SN 77-166,815, FILED 4-26-2007.

MARY MUNSON, EXAMINING ATTORNEY

Int. Cl.: 41

Prior U.S. Cls.: 100, 101, and 107

United States Patent and Trademark Office

Reg. No. 3,481,658

Registered Aug. 5, 2008

**SERVICE MARK
PRINCIPAL REGISTER**

SOCO MUSIC EXPERIENCE

SOUTHERN COMFORT PROPERTIES, INC. (CALIFORNIA CORPORATION)
4040 CIVIC CENTER DRIVE, SUITE 528
SAN RAFAEL, CA 94903

OWNER OF U.S. REG. NOS. 1,522,030, 2,254,264,
AND 2,650,502.

FOR: ARRANGING AND CONDUCTING OF CONCERTS, IN CLASS 41 (U.S. CLS. 100, 101 AND 107).

NO CLAIM IS MADE TO THE EXCLUSIVE RIGHT TO USE "MUSIC", APART FROM THE MARK AS SHOWN.

FIRST USE 5-20-2006; IN COMMERCE 5-20-2006.

SN 77-166,951, FILED 4-26-2007.

THE MARK CONSISTS OF STANDARD CHARACTERS WITHOUT CLAIM TO ANY PARTICULAR FONT, STYLE, SIZE, OR COLOR.

BILL DAWE, EXAMINING ATTORNEY

Int. Cl.: 33

Prior U.S. Cls.: 47 and 49

United States Patent and Trademark Office

Reg. No. 3,481,659

Registered Aug. 5, 2008

**TRADEMARK
PRINCIPAL REGISTER**

ROCKBROOK

BRONCO WINE COMPANY (CALIFORNIA COR-
PORATION)
6342 BYSTRUM ROAD
CERES, CA 95307

THE MARK CONSISTS OF STANDARD CHAR-
ACTERS WITHOUT CLAIM TO ANY PARTICULAR
FONT, STYLE, SIZE, OR COLOR.

FOR: WINE, IN CLASS 33 (U.S. CLS. 47 AND 49).

SN 77-166,961, FILED 4-26-2007.

FIRST USE 9-4-2007; IN COMMERCE 9-4-2007.

LINDSEY RUBIN, EXAMINING ATTORNEY

Int. Cl.: 9

Prior U.S. Cls.: 21, 23, 26, 36, and 38

Reg. No. 3,481,660

United States Patent and Trademark Office

Registered Aug. 5, 2008

**TRADEMARK
PRINCIPAL REGISTER**



NOIR LASER COMPANY, L.L.C. (MICHIGAN
LTD LIAB CO)
6155 PONTIAC TRAIL P.O. BOX 159
SOUTH LYON, MI 48178

FIRST USE 12-18-2002; IN COMMERCE 1-1-2003.

SN 77-167,209, FILED 4-27-2007.

FOR: PROTECTIVE EYEWEAR, IN CLASS 9 (U.S.
CLS. 21, 23, 26, 36 AND 38).

JASON BLAIR, EXAMINING ATTORNEY

Int. Cls.: 7, 8, and 9

**Prior U.S. Cls.: 13, 19, 21, 23, 26, 28, 31, 34, 35, 36, 38,
and 44**

Reg. No. 3,481,661

United States Patent and Trademark Office

Registered Aug. 5, 2008

**TRADEMARK
PRINCIPAL REGISTER**

IWORK

JPJ INVESTMENT HOLDING CO. (NEVADA
CORPORATION)
2533 NORTH CARSON STREET
CARSON CITY, NV 89706

FOR: POWER TOOLS, NAMELY, DRILLS, GRINDERS, ELECTRIC SCREWDRIVERS, SANDERS AND HOT-MELT GLUE GUNS; POWER TOOL ACCESSORIES, NAMELY, DRILL BITS, SCREWDRIVER BITS AND NUT DRIVERS, IN CLASS 7 (U.S. CLS. 13, 19, 21, 23, 31, 34 AND 35).

FIRST USE 4-4-2007; IN COMMERCE 8-13-2007.

FOR: HAND TOOLS, NAMELY, HAMMERS, SCREWDRIVERS, PLIERS, WRENCHES, NUT DRIVERS, SQUARES, FILES AND KNIVES, IN CLASS 8 (U.S. CLS. 23, 28 AND 44).

FIRST USE 4-4-2007; IN COMMERCE 8-13-2007.

FOR: TAPE MEASURES AND BUBBLE LEVELS, IN CLASS 9 (U.S. CLS. 21, 23, 26, 36 AND 38).

FIRST USE 4-4-2007; IN COMMERCE 8-13-2007.

THE MARK CONSISTS OF STANDARD CHARACTERS WITHOUT CLAIM TO ANY PARTICULAR FONT, STYLE, SIZE, OR COLOR.

SN 77-167,316, FILED 4-27-2007.

RONALD MCMORROW, EXAMINING ATTORNEY

Int. Cl.: 41

Prior U.S. Cls.: 100, 101, and 107

United States Patent and Trademark Office

Reg. No. 3,481,662

Registered Aug. 5, 2008

**SERVICE MARK
PRINCIPAL REGISTER**

YOU MADE THE TEAM

MINNESOTA VIKINGS FOOTBALL, LLC (DELA-
WARE LTD LIAB CO)
9520 VIKING DRIVE
EDEN PRAIRIE, MN 55344

FOR: ENTERTAINMENT SERVICES, NAMELY,
PRESENTATIONS IN THE NATURE OF PROFES-
SIONAL FOOTBALL GAMES AND EXHIBITIONS,
IN CLASS 41 (U.S. CLS. 100, 101 AND 107).

FIRST USE 4-28-2007; IN COMMERCE 4-28-2007.

THE MARK CONSISTS OF STANDARD CHAR-
ACTERS WITHOUT CLAIM TO ANY PARTICULAR
FONT, STYLE, SIZE, OR COLOR.

SN 77-167,476, FILED 4-27-2007.

MICHAEL TANNER, EXAMINING ATTORNEY

Int. Cl.: 41

Prior U.S. Cls.: 100, 101, and 107

United States Patent and Trademark Office

Reg. No. 3,481,663

Registered Aug. 5, 2008

**SERVICE MARK
PRINCIPAL REGISTER**

EVERYTHING PURPLE

MINNESOTA VIKINGS FOOTBALL, LLC (DELA-
WARE LTD LIAB CO)
9520 VIKING DRIVE
EDEN PRAIRIE, MN 55344

FOR: ENTERTAINMENT SERVICES, NAMELY,
PRESENTATIONS IN THE NATURE OF PROFES-
SIONAL FOOTBALL GAMES AND EXHIBITIONS,
IN CLASS 41 (U.S. CLS. 100, 101 AND 107).

FIRST USE 3-1-2006; IN COMMERCE 3-1-2006.

THE MARK CONSISTS OF STANDARD CHAR-
ACTERS WITHOUT CLAIM TO ANY PARTICULAR
FONT, STYLE, SIZE, OR COLOR.

SN 77-167,478, FILED 4-27-2007.

MICHAEL TANNER, EXAMINING ATTORNEY

Int. Cls.: 37 and 42

Prior U.S. Cls.: 100, 101, 103, and 106

United States Patent and Trademark Office

Reg. No. 3,481,664

Registered Aug. 5, 2008

**SERVICE MARK
PRINCIPAL REGISTER**



thornton :: termohlen
G R O U P

THORNTON-TERMOHLEN GROUP CORPORATION (NEVADA CORPORATION)
1700 W. HORIZON RIDGE PARKWAY, SUITE 200
HENDERSON, NV 89012

FOR: REAL ESTATE DEVELOPMENT SERVICES AND CONSTRUCTION OF BUILDINGS, IN CLASS 37 (U.S. CLS. 100, 103 AND 106).

FIRST USE 6-0-2007; IN COMMERCE 6-0-2007.

FOR: CONSTRUCTION DESIGN SERVICES FOR OTHERS IN THE FIELD OF CONSTRUCTION, NAMELY, FOR THE CONSTRUCTION OF NEW BUILDINGS AND FOR THE RENOVATION OF PRE-EXISTING BUILDINGS, IN CLASS 42 (U.S. CLS. 100 AND 101).

FIRST USE 6-0-2007; IN COMMERCE 6-0-2007.

NO CLAIM IS MADE TO THE EXCLUSIVE RIGHT TO USE "GROUP", APART FROM THE MARK AS SHOWN.

THE MARK CONSISTS OF AN OUTLINED SHADDED RECTANGLE WITH THE LETTERS "TTG" INSIDE OF THE RECTANGLE AND WITH THE WORDS "THORNTON TERMOHLEN GROUP" UNDERNEATH THE RECTANGLE.

SN 77-167,533, FILED 4-27-2007.

PRISCILLA MILTON, EXAMINING ATTORNEY

Int. Cl.: 31

Prior U.S. Cls.: 1 and 46

United States Patent and Trademark Office

Reg. No. 3,481,665

Registered Aug. 5, 2008

**TRADEMARK
PRINCIPAL REGISTER**

TRIANA

VILLAGE FARMS, L.P. (DELAWARE LIMITED
PARTNERSHIP)
7 CHRISTOPHER WAY
EATONTOWN, NJ 07724

THE MARK CONSISTS OF STANDARD CHAR-
ACTERS WITHOUT CLAIM TO ANY PARTICULAR
FONT, STYLE, SIZE, OR COLOR.

FOR: FRESH VEGETABLES; RAW VEGETABLES;
RAW FRUITS; UNPROCESSED FRUITS, IN CLASS
31 (U.S. CLS. 1 AND 46).

SN 77-167,599, FILED 4-27-2007.

FIRST USE 6-10-2008; IN COMMERCE 6-10-2008.

ZACHARY BELLO, EXAMINING ATTORNEY

Int. Cl.: 36

Prior U.S. Cls.: 100, 101, and 102

United States Patent and Trademark Office

Reg. No. 3,481,666

Registered Aug. 5, 2008

**SERVICE MARK
PRINCIPAL REGISTER**



NOVELLUS CAPITAL MANAGEMENT, LLC (DE-
LAWARE LTD LIAB CO)
19TH FLOOR
601 108TH AVENUE N.E.
BELLEVUE, WA 98004

FOR: FINANCIAL SERVICES, NAMELY, THE
PURCHASE OF RESIDENTIAL MORTGAGES ON
BEHALF OF OTHERS AND THE ISSUANCE OF
MORTGAGE-BACKED SECURITIES; FINANCIAL
SERVICES IN THE NATURE OF AN INVESTMENT
SECURITY; INVESTMENT ADVISORY SERVICES;
INVESTMENT MANAGEMENT; MUTUAL FUND
DISTRIBUTION, IN CLASS 36 (U.S. CLS. 100, 101
AND 102).

FIRST USE 4-1-2007; IN COMMERCE 4-1-2007.

NO CLAIM IS MADE TO THE EXCLUSIVE
RIGHT TO USE "CAPITAL MANAGEMENT",
APART FROM THE MARK AS SHOWN.

THE MARK CONSISTS OF A GEOMETRICAL
TRIANGULAR DESIGN ABOVE THE LITERAL
ELEMENT.

THE LATIN WORDING "NOVELLUS" IN THE
MARK TRANSLATES INTO ENGLISH AS NEW,
FRESH OR RECENT.

SN 77-168,179, FILED 4-27-2007.

SETH A. RAPPAPORT, EXAMINING ATTORNEY

Int. Cl.: 9

Prior U.S. Cls.: 21, 23, 26, 36, and 38

United States Patent and Trademark Office

Reg. No. 3,481,667

Registered Aug. 5, 2008

**TRADEMARK
PRINCIPAL REGISTER**

LOST PLANET COLONIES

CAPCOM CO. LTD. (JAPAN CORPORATION)
3-1-3 UCHIHIRANOMACHI
CHOU-KU, OSAKA, JAPAN

FOR: COMPUTER GAME SOFTWARE; COMPUTER GAME IN THE FORM OF CARTRIDGES, CASSETTES, DISCS OR TAPES; VIDEO GAME CARTRIDGES; VIDEO GAME MACHINES FOR USE WITH TELEVISION RECEIVERS; DOWNLOADABLE GAME SOFTWARE; DOWNLOADABLE COMPUTER GAMES; DOWNLOADABLE GAME SOFTWARE FOR PLAYING ON MOBILE PHONES; SCREEN SAVER SOFTWARE AND WALLPAPER SOFTWARE; DOWNLOADABLE SCREEN SAVER

SOFTWARE AND WALLPAPER SOFTWARE FOR MOBILE PHONES; DOWNLOADABLE IMAGES, MOVING IMAGES AND MUSIC FOR MOBILE PHONES, IN CLASS 9 (U.S. CLS. 21, 23, 26, 36 AND 38).

FIRST USE 5-27-2008; IN COMMERCE 5-27-2008.

THE MARK CONSISTS OF STANDARD CHARACTERS WITHOUT CLAIM TO ANY PARTICULAR FONT, STYLE, SIZE, OR COLOR.

SN 77-169,259, FILED 4-30-2007.

JULIE GUTTADAURO, EXAMINING ATTORNEY

Int. Cl.: 25

Prior U.S. Cls.: 22 and 39

United States Patent and Trademark Office

Reg. No. 3,481,668

Registered Aug. 5, 2008

TRADEMARK
PRINCIPAL REGISTER

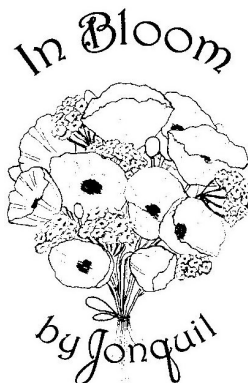

JONQUIL, INC. (CALIFORNIA CORPORATION)
1830 14TH STREET
SANTA MONICA, CA 90404

FOR: LINGERIE; SLEEPWEAR; PAJAMAS;
GOWNS; NIGHT GOWNS; ROBES; CHEMISES;
BABY DOLL PYJAMAS; PEIGNOIRS; NIGHT
SHIRTS; SLEEP SHIRTS; LOUNGEWEAR; WRAPS;
COVERUPS, IN CLASS 25 (U.S. CLS. 22 AND 39).

FIRST USE 8-10-2007; IN COMMERCE 1-31-2008.

OWNER OF U.S. REG. NO. 2,346,965.

THE MARK CONSISTS OF A BUNCH OR BOU-
QUET OF FLOWERS SURROUNDED BY THE STY-
LIZED WORDS "IN BLOOM" ABOVE THE
FLOWERS AND "BY JONQUIL" BELOW THE
FLOWERS.

SN 77-169,520, FILED 4-30-2007.

SANJEEV VOHRA, EXAMINING ATTORNEY

Int. Cl.: 28

Prior U.S. Cls.: 22, 23, 38, and 50

United States Patent and Trademark Office

Reg. No. 3,481,669

Registered Aug. 5, 2008

**TRADEMARK
PRINCIPAL REGISTER**

POWER RANGERS JUNGLE FURY

BVS ENTERTAINMENT, INC. (DELAWARE
CORPORATION)
500 SOUTH BUENA VISTA STREET
BURBANK, CA 91521

FOR: ACTION FIGURES AND ACCESSORIES
THEREFORE; BALLOONS; ELECTRIC ACTION
TOYS; MECHANICAL TOYS; SOCCER BALLS;
TALKING TOYS; TOY ACTION FIGURES; TOY
VEHICLES; TOY CARS; TOY FIGURES; BEACH
BALLS, IN CLASS 28 (U.S. CLS. 22, 23, 38 AND 50).

FIRST USE 6-9-2008; IN COMMERCE 6-9-2008.

THE MARK CONSISTS OF STANDARD CHAR-
ACTERS WITHOUT CLAIM TO ANY PARTICULAR
FONT, STYLE, SIZE, OR COLOR.

SN 77-170,454, FILED 5-1-2007.

MIDGE BUTLER, EXAMINING ATTORNEY

Int. Cl.: 42

Prior U.S. Cls.: 100 and 101

United States Patent and Trademark Office

Reg. No. 3,481,670

Registered Aug. 5, 2008

**SERVICE MARK
PRINCIPAL REGISTER**

MAILVICE

INGENIOUS SYSTEMS RESEARCH, LLC (DELA-
WARE LTD LIAB CO)
SUITE 134, BOX 164
4001 KENNETT PIKE
WILMINGTON, DE 198072000

THE MARK CONSISTS OF STANDARD CHAR-
ACTERS WITHOUT CLAIM TO ANY PARTICULAR
FONT, STYLE, SIZE, OR COLOR.

FOR: COMPUTER SERVICES, NAMELY, FILTER-
ING OF UNWANTED E-MAILS, IN CLASS 42 (U.S.
CLS. 100 AND 101).

SN 77-170,484, FILED 5-1-2007.

FIRST USE 1-1-2007; IN COMMERCE 1-1-2007.

DAVID I, EXAMINING ATTORNEY

Int. Cl.: 45

Prior U.S. Cls.: 100 and 101

United States Patent and Trademark Office

Reg. No. 3,481,671

Registered Aug. 5, 2008

**SERVICE MARK
PRINCIPAL REGISTER**



INTERSECTIONS INC. (DELAWARE CORPORATION)
14901 BOGLE DRIVE
CHANTILLY, VA 20151

FOR: IDENTIFICATION VERIFICATION SERVICES, NAMELY, PROVIDING AUTHENTICATION OF PERSONAL IDENTIFICATION INFORMATION, IN CLASS 45 (U.S. CLS. 100 AND 101).

FIRST USE 5-28-2007; IN COMMERCE 5-28-2007.

NO CLAIM IS MADE TO THE EXCLUSIVE RIGHT TO USE "DOB", APART FROM THE MARK AS SHOWN.

THE MARK CONSISTS OF THE LETTERS "EZ" IN WHITE SET IN IN A DARK SHADE OF GRAY AND THE LETTERS "DOB" IN WHITE IN A LIGHTER SHADE OF GRAY.

SN 77-170,689, FILED 5-2-2007.

FRANK LATTUCA, EXAMINING ATTORNEY

Int. Cl.: 10

Prior U.S. Cls.: 26, 39, and 44

United States Patent and Trademark Office

Reg. No. 3,481,672

Registered Aug. 5, 2008

**TRADEMARK
PRINCIPAL REGISTER**

Qoustic Qurette

AROBELLA MEDICAL, LLC (MINNESOTA LTD
LIAB CO)
5929 BAKER ROAD, SUITE 470
MINNETONKA, MN 55345

NO CLAIM IS MADE TO THE EXCLUSIVE
RIGHT TO USE "CURETTE", APART FROM THE
MARK AS SHOWN.

FOR: MEDICAL ULTRASOUND APPARATUS, IN
CLASS 10 (U.S. CLS. 26, 39 AND 44).

SN 77-170,761, FILED 5-2-2007.

FIRST USE 4-10-2008; IN COMMERCE 4-10-2008.

THE MARK CONSISTS OF STANDARD CHAR-
ACTERS WITHOUT CLAIM TO ANY PARTICULAR
FONT, STYLE, SIZE, OR COLOR.

CIMMERIAN COLEMAN, EXAMINING ATTOR-
NEY

Int. Cl.: 10

Prior U.S. Cls.: 26, 39, and 44

United States Patent and Trademark Office

Reg. No. 3,481,673

Registered Aug. 5, 2008

**TRADEMARK
PRINCIPAL REGISTER**



ACIST MEDICAL SYSTEMS, INC. (DELAWARE
CORPORATION)
7450 FLYING CLOUD ROAD, SUITE 150
EDEN PRAIRIE, MN 55344

FIRST USE 8-30-2007; IN COMMERCE 8-30-2007.

THE MARK CONSISTS OF STYLIZED LETTERS.

FOR: HAND HELD MEDICAL APPARATUS FOR
MEASURING THE LEVEL OF RENAL FUNCTION
PARAMETERS IN A PATIENT'S BLOOD, IN CLASS
10 (U.S. CLS. 26, 39 AND 44).

SN 77-170,853, FILED 5-2-2007.

GEORGIA CARTY, EXAMINING ATTORNEY

Int. Cl.: 12

Prior U.S. Cls.: 19, 21, 23, 31, 35, and 44

Reg. No. 3,481,674

United States Patent and Trademark Office

Registered Aug. 5, 2008

**TRADEMARK
PRINCIPAL REGISTER**

XTREME PEDESTAL COVER

ELRAE ENTERPRISES, INC. (ILLINOIS CORPORATION)
1810 ROBIN AVE.
MORTON, IL 61550

FOR: BOAT ACCESSORIES, NAMELY, METAL OR PLASTIC PEDESTAL COVERS, IN CLASS 12 (U.S. CLS. 19, 21, 23, 31, 35 AND 44).

FIRST USE 6-17-2008; IN COMMERCE 6-17-2008.

THE MARK CONSISTS OF STANDARD CHARACTERS WITHOUT CLAIM TO ANY PARTICULAR FONT, STYLE, SIZE, OR COLOR.

NO CLAIM IS MADE TO THE EXCLUSIVE RIGHT TO USE "PEDESTAL COVER", APART FROM THE MARK AS SHOWN.

SN 77-171,049, FILED 5-2-2007.

KATHY DE JONGE, EXAMINING ATTORNEY

Int. Cl.: 42

Prior U.S. Cls.: 100 and 101

United States Patent and Trademark Office

Reg. No. 3,481,675

Registered Aug. 5, 2008

**SERVICE MARK
PRINCIPAL REGISTER**

MRS

DSCI (NEW JERSEY CORPORATION)
PO BOX 7259
FREEHOLD, NJ 077287259

FIRST USE 6-2-2008; IN COMMERCE 6-2-2008.

FOR: COMPUTER SERVICE, NAMELY, ACTING AS AN APPLICATION SERVICE PROVIDER IN THE FIELD OF KNOWLEDGE MANAGEMENT TO HOST COMPUTER APPLICATION SOFTWARE FOR THE COLLECTION, EDITING, ORGANIZING, MODIFYING, BOOK MARKING, TRANSMISSION, STORAGE AND SHARING OF DATA AND INFORMATION, IN CLASS 42 (U.S. CLS. 100 AND 101).

THE MARK CONSISTS OF STANDARD CHARACTERS WITHOUT CLAIM TO ANY PARTICULAR FONT, STYLE, SIZE, OR COLOR.

SN 77-171,405, FILED 5-2-2007.

CARYN GLASSER, EXAMINING ATTORNEY

Int. Cl.: 5

Prior U.S. Cls.: 6, 18, 44, 46, 51, and 52

United States Patent and Trademark Office

Reg. No. 3,481,676

Registered Aug. 5, 2008

**TRADEMARK
PRINCIPAL REGISTER**

DURAMAX

DOW AGROSCIENCES LLC (DELAWARE LTD
LIAB CO)
TRADEMARK & COPYRIGHT DEPARTMENT
9330 ZIONSVILLE ROAD
INDIANAPOLIS, IN 46268

FOR: PESTICIDES AND PREPARATIONS FOR
DESTROYING VERMIN, NAMELY, HERBICIDES,
INSECTICIDES AND FUNGICIDES FOR AGRICUL-
TURE, HORTICULTURE, FORESTRY, TURF AND
ORNAMENTAL, COMMERCIAL, INDUSTRIAL
AND DOMESTIC USE, IN CLASS 5 (U.S. CLS. 6, 18,
44, 46, 51 AND 52).

FIRST USE 12-10-2007; IN COMMERCE 12-10-2007.

THE MARK CONSISTS OF STANDARD CHAR-
ACTERS WITHOUT CLAIM TO ANY PARTICULAR
FONT, STYLE, SIZE, OR COLOR.

SN 77-171,626, FILED 5-3-2007.

JAMES A. RAUEN, EXAMINING ATTORNEY

Int. Cl.: 28

Prior U.S. Cls.: 22, 23, 38, and 50

Reg. No. 3,481,677

United States Patent and Trademark Office

Registered Aug. 5, 2008

**TRADEMARK
PRINCIPAL REGISTER**

LOSI

HORIZON HOBBY, INC. (DELAWARE CORPORATION)
4105 FIELDSTONE ROAD
CHAMPAIGN, IL 61822

THE MARK CONSISTS OF STANDARD CHARACTERS WITHOUT CLAIM TO ANY PARTICULAR FONT, STYLE, SIZE, OR COLOR.

FOR: REMOTE CONTROLLED HOBBY MODEL LAND VEHICLES AND PARTS AND ACCESSORIES THEREFOR, IN CLASS 28 (U.S. CLS. 22, 23, 38 AND 50).

OWNER OF U.S. REG. NO. 1,528,416.

SN 77-172,126, FILED 5-3-2007.

FIRST USE 10-31-2007; IN COMMERCE 10-31-2007.

DANNEAN HETZEL, EXAMINING ATTORNEY

Int. Cl.: 33

Prior U.S. Cls.: 47 and 49

United States Patent and Trademark Office

Reg. No. 3,481,678

Registered Aug. 5, 2008

**TRADEMARK
PRINCIPAL REGISTER**

ADOBE

ANDERSON & MIDDLETON COMPANY (WA-
SHINGTON CORPORATION)
815 EIGHTH STREET
HOQUIAM, WA 98550

FOR: WINE, IN CLASS 33 (U.S. CLS. 47 AND 49).

FIRST USE 4-4-2006; IN COMMERCE 4-14-2006.

THE MARK CONSISTS OF STANDARD CHAR-
ACTERS WITHOUT CLAIM TO ANY PARTICULAR
FONT, STYLE, SIZE, OR COLOR.

SN 77-172,197, FILED 5-3-2007.

BRIAN CALLAGHAN, EXAMINING ATTORNEY

Int. Cl.: 10

Prior U.S. Cls.: 26, 39, and 44

United States Patent and Trademark Office

Reg. No. 3,481,679

Registered Aug. 5, 2008

**TRADEMARK
PRINCIPAL REGISTER**

**Qoustic Wound Therapy
System**

AROBELLA MEDICAL, LLC (MINNESOTA LTD
LIAB CO)
5929 BAKER ROAD, SUITE 470
MINNETONKA, MN 55345

NO CLAIM IS MADE TO THE EXCLUSIVE
RIGHT TO USE "WOUND THERAPY SYSTEM",
APART FROM THE MARK AS SHOWN.

FOR: MEDICAL ULTRASOUND APPARATUS, IN
CLASS 10 (U.S. CLS. 26, 39 AND 44).

SN 77-172,279, FILED 5-3-2007.

FIRST USE 4-10-2008; IN COMMERCE 4-10-2008.

THE MARK CONSISTS OF STANDARD CHAR-
ACTERS WITHOUT CLAIM TO ANY PARTICULAR
FONT, STYLE, SIZE, OR COLOR.

CIMMERIAN COLEMAN, EXAMINING ATTOR-
NEY

Int. Cl.: 7

Prior U.S. Cls.: 13, 19, 21, 23, 31, 34, and 35

Reg. No. 3,481,680

United States Patent and Trademark Office

Registered Aug. 5, 2008

**TRADEMARK
PRINCIPAL REGISTER**

PRO-V

SCAG POWER EQUIPMENT (WISCONSIN COR-
PORATION)
1000 METALCRAFT DRIVE
MAYVILLE, WI 53050

THE MARK CONSISTS OF STANDARD CHAR-
ACTERS WITHOUT CLAIM TO ANY PARTICULAR
FONT, STYLE, SIZE, OR COLOR.

FOR: LAWN MOWERS, IN CLASS 7 (U.S. CLS. 13,
19, 21, 23, 31, 34 AND 35).

SN 77-172,326, FILED 5-3-2007.

FIRST USE 10-1-2007; IN COMMERCE 12-13-2007.

ROBERT C. CLARK JR., EXAMINING ATTORNEY

Int. Cl.: 43

Prior U.S. Cls.: 100 and 101

United States Patent and Trademark Office

Reg. No. 3,481,681

Registered Aug. 5, 2008

**SERVICE MARK
PRINCIPAL REGISTER**

BAGGER DAVE'S

AMC BURGERS, INC. (MICHIGAN CORPORATION)
21751 W. ELEVEN MILE ROAD, SUITE 208
SOUTHFIELD, MI 48076

THE MARK CONSISTS OF STANDARD CHARACTERS WITHOUT CLAIM TO ANY PARTICULAR FONT, STYLE, SIZE, OR COLOR.

FOR: RESTAURANT SERVICES, IN CLASS 43 (U.S. CLS. 100 AND 101).

SN 77-172,731, FILED 5-4-2007.

FIRST USE 1-11-2008; IN COMMERCE 1-11-2008.

ODESSA BIBBINS, EXAMINING ATTORNEY

Int. Cl.: 25

Prior U.S. Cls.: 22 and 39

United States Patent and Trademark Office

Reg. No. 3,481,682

Registered Aug. 5, 2008

**TRADEMARK
PRINCIPAL REGISTER**

ERGO COMFORT

JOHNSON TECHNOLOGIES CORPORATION
(TENNESSEE CORPORATION)

2034 PITTSWAY DRIVE

NASHVILLE, TN 37207

FOR: FOOTWEAR; INSOLES; SHOES; SHOE INSERTS FOR PRIMARILY NON-ORTHOPEDIC PURPOSES, IN CLASS 25 (U.S. CLS. 22 AND 39).

FIRST USE 3-0-2007; IN COMMERCE 3-0-2007.

THE MARK CONSISTS OF STANDARD CHARACTERS WITHOUT CLAIM TO ANY PARTICULAR FONT, STYLE, SIZE, OR COLOR.

NO CLAIM IS MADE TO THE EXCLUSIVE RIGHT TO USE "COMFORT", APART FROM THE MARK AS SHOWN.

SN 77-173,099, FILED 5-4-2007.

CHRISTOPHER BUONGIORNO, EXAMINING ATTORNEY

Int. Cl.: 35

Prior U.S. Cls.: 100, 101, and 102

United States Patent and Trademark Office

Reg. No. 3,481,683

Registered Aug. 5, 2008

**SERVICE MARK
PRINCIPAL REGISTER**

Times is Hard

DAVID MILLER (UNITED STATES INDIVIDUAL)
P.O. BOX 12682
FORT HUACHUCA, AZ 85670

THE MARK CONSISTS OF STANDARD CHARACTERS WITHOUT CLAIM TO ANY PARTICULAR FONT, STYLE, SIZE, OR COLOR.

FOR: ONLINE STORE SERVICES FEATURING APPAREL, POSTERS, BUMPER STICKERS, AND MUGS, IN CLASS 35 (U.S. CLS. 100, 101 AND 102).

SN 77-174,017, FILED 5-7-2007.

FIRST USE 4-14-2007; IN COMMERCE 5-8-2007.

PRISCILLA MILTON, EXAMINING ATTORNEY

Int. Cl.: 44

Prior U.S. Cls.: 100 and 101

United States Patent and Trademark Office

Reg. No. 3,481,684

Registered Aug. 5, 2008

**SERVICE MARK
PRINCIPAL REGISTER**

TO EACH HER OWN

ALLERGAN, INC. (DELAWARE CORPORATION)
2525 DUPONT DRIVE
IRVINE, CA 92612

THE MARK CONSISTS OF STANDARD CHAR-
ACTERS WITHOUT CLAIM TO ANY PARTICULAR
FONT, STYLE, SIZE, OR COLOR.

FOR: PROVIDING MEDICAL INFORMATION TO
PATIENTS CONSIDERING AUGMENTATION AND
RECONSTRUCTIVE SURGERY AND BREAST IM-
PLANTS, IN CLASS 44 (U.S. CLS. 100 AND 101).

SN 77-174,255, FILED 5-7-2007.

FIRST USE 4-30-2007; IN COMMERCE 4-30-2007.

SIMON TENG, EXAMINING ATTORNEY

Int. Cl.: 9

Prior U.S. Cls.: 21, 23, 26, 36, and 38

United States Patent and Trademark Office

Reg. No. 3,481,685

Registered Aug. 5, 2008

**TRADEMARK
PRINCIPAL REGISTER**

EYE-HUGS

EYE-HUGS, LLC (OHIO LTD LIAB CO)
2071 LANGHAM ROAD
COLUMBUS, OH 43221

THE MARK CONSISTS OF STANDARD CHAR-
ACTERS WITHOUT CLAIM TO ANY PARTICULAR
FONT, STYLE, SIZE, OR COLOR.

FOR: DECORATIVE EYEWEAR ACCESSORIES,
NAMELY, ATTACHMENTS FOR THE EAR STEMS
OF EYEGLASSES, IN CLASS 9 (U.S. CLS. 21, 23, 26, 36
AND 38).

SN 77-174,273, FILED 5-7-2007.

FIRST USE 8-7-2007; IN COMMERCE 8-11-2007.

BERYL GARDNER, EXAMINING ATTORNEY

Int. Cl.: 16

Prior U.S. Cls.: 2, 5, 22, 23, 29, 37, 38, and 50

United States Patent and Trademark Office

Reg. No. 3,481,686

Registered Aug. 5, 2008

**TRADEMARK
PRINCIPAL REGISTER**



BLOOMSBURY PUBLISHING PLC (UNITED
KINGDOM PUBLIC LIMITED COMPANY
(PLC))
36 SOHO SQUARE
LONDON, UNITED KINGDOM W1D3QY

FOR: PUBLICATIONS, NAMELY, BOOKS, MA-
GAZINES, JOURNALS, BROCHURES, BOOKLETS,
AND TEACHING MATERIALS ON A VARIETY OF
TOPICS, IN CLASS 16 (U.S. CLS. 2, 5, 22, 23, 29, 37, 38
AND 50).

FIRST USE 1-0-2007; IN COMMERCE 1-0-2007.

THE MARK CONSISTS OF A LION WITH A
MANE MADE UP OF "W"'S.

SN 77-174,547, FILED 5-7-2007.

JOHN HWANG, EXAMINING ATTORNEY

Int. Cl.: 20

Prior U.S. Cls.: 2, 13, 22, 25, 32, and 50

Reg. No. 3,481,687

United States Patent and Trademark Office

Registered Aug. 5, 2008

**TRADEMARK
PRINCIPAL REGISTER**

Glidulator

MIDWEST PRINTING, INCORPORATED (ILLINOIS CORPORATION)
UNIT B2
600 WEST ROOSEVELT ROAD
WHEATON, IL 60187

THE MARK CONSISTS OF STANDARD CHARACTERS WITHOUT CLAIM TO ANY PARTICULAR FONT, STYLE, SIZE, OR COLOR.

FOR: DISPENSING CAPS MADE PRIMARILY NOT FROM METAL TO DELIVER GRADUATED AMOUNTS OF MATERIALS FROM CONTAINERS, IN CLASS 20 (U.S. CLS. 2, 13, 22, 25, 32 AND 50).

SN 77-174,725, FILED 5-7-2007.

FIRST USE 2-16-2007; IN COMMERCE 2-16-2007.

JANICE L. MCMORROW, EXAMINING ATTORNEY

Int. Cl.: 14

Prior U.S. Cls.: 2, 27, 28, and 50

United States Patent and Trademark Office

Reg. No. 3,481,688

Registered Aug. 5, 2008

**TRADEMARK
PRINCIPAL REGISTER**

Sima K

SIMA K, LLC (NEW YORK LTD LIAB CO)
36 WEST 44TH STREET, STE 1208
NEW YORK, NY 10036

FOR: JEWELRY, IN CLASS 14 (U.S. CLS. 2, 27, 28
AND 50).

FIRST USE 1-0-2008; IN COMMERCE 1-0-2008.

THE MARK CONSISTS OF STANDARD CHAR-
ACTERS WITHOUT CLAIM TO ANY PARTICULAR
FONT, STYLE, SIZE, OR COLOR.

THE NAME(S), PORTRAIT(S), AND/OR SIGNA-
TURE(S) SHOWN IN THE MARK IDENTIFIES
"SIMA KHORSANDI", WHOSE CONSENT(S) TO
REGISTER IS MADE OF RECORD.

SN 77-174,790, FILED 5-7-2007.

RENEE MCCRAY, EXAMINING ATTORNEY

Int. Cl.: 30

Prior U.S. Cl.: 46

United States Patent and Trademark Office

Reg. No. 3,481,689

Registered Aug. 5, 2008

TRADEMARK
PRINCIPAL REGISTER



PARKER PRODUCTS, INC. (TEXAS CORPORATION)
2737 TILLAR STREET
FORT WORTH, TX 76107

NO CLAIM IS MADE TO THE EXCLUSIVE
RIGHT TO USE "ORGANIC CONFECTIONS",
APART FROM THE MARK AS SHOWN.

FOR: CANDY, IN CLASS 30 (U.S. CL. 46).

SN 77-174,804, FILED 5-7-2007.

FIRST USE 1-16-2008; IN COMMERCE 1-16-2008.

STEVEN JACKSON, EXAMINING ATTORNEY

Int. Cl.: 4

Prior U.S. Cls.: 1, 6, and 15

United States Patent and Trademark Office

Reg. No. 3,481,690

Registered Aug. 5, 2008

**TRADEMARK
PRINCIPAL REGISTER**

HEAVEN TO HOME

HEAVEN TO HOME, LLC (ARIZONA LTD LIAB
CO)
1493 EAST MESQUITE STREET
GILBERT, AZ 85296

THE MARK CONSISTS OF STANDARD CHAR-
ACTERS WITHOUT CLAIM TO ANY PARTICULAR
FONT, STYLE, SIZE, OR COLOR.

FOR: CANDLES, IN CLASS 4 (U.S. CLS. 1, 6 AND
15).

SN 77-174,856, FILED 5-7-2007.

FIRST USE 6-1-2008; IN COMMERCE 6-1-2008.

REBECCA SMITH, EXAMINING ATTORNEY

Int. Cl.: 41

Prior U.S. Cls.: 100, 101, and 107

United States Patent and Trademark Office

Reg. No. 3,481,691

Registered Aug. 5, 2008

**SERVICE MARK
PRINCIPAL REGISTER**



HAWKINS, KEVIN LAWRENCE (UNITED STATES INDIVIDUAL)
448 S. LAKE ST., APT. 15
LOS ANGELES, CA 90057

FOR: PROVIDING INFORMATION IN THE FIELD OF EXERCISE TRAINING; PROVIDING A WEBSITE THAT FEATURES INFORMAL INSTRUCTION ON PROPER GYM ETIQUETTE, AND EQUIPMENT USAGE, IN CLASS 41 (U.S. CLS. 100, 101 AND 107).

FIRST USE 6-2-2008; IN COMMERCE 6-2-2008.

NO CLAIM IS MADE TO THE EXCLUSIVE RIGHT TO USE "GYM", APART FROM THE MARK AS SHOWN.

THE COLOR(S) RED, GRAY AND BLACK IS/ARE CLAIMED AS A FEATURE OF THE MARK.

THE MARK CONSISTS OF A GRAY EMBOSSED HORIZONTAL OVAL CONTAINING THE RED STYLIZED WORDS "GYM SENSE" SET ON TOP OF A GRAY HORIZONTAL BARBELL WITH SETS OF THREE (3) BLACK IMAGES OF WEIGHTS ON THE RIGHT AND LEFT SIDES OF THE BARBELL, A BLACK GRADUATION CAP IMAGE IS ON TOP OF THE LETTER "G" IN THE WORD "GYM SENSE".

SN 77-175,019, FILED 5-8-2007.

DAWN HAN, EXAMINING ATTORNEY

Int. Cl.: 16

Prior U.S. Cls.: 2, 5, 22, 23, 29, 37, 38, and 50

Reg. No. 3,481,692

United States Patent and Trademark Office

Registered Aug. 5, 2008

**TRADEMARK
PRINCIPAL REGISTER**

4W

4W INTERNACIONAL, S.A. (PANAMA SOCIE-
DAD ANONIMA)
ST. GEORGES BANK, PISO 14
CALLE 50Y74 SAN FRANCISCO EDIF.
PANAMA, PANAMA

FOR: PAPER; CARTOON STRIPS; ARTICLES,
NAMELY, MAGAZINE ARTICLES AND REPORTS
RELATED TO LUXURY PRODUCTS AND SERVI-
CES OF INTEREST TO A PUBLIC WITH A HIGH
PURCHASING POWER; PRINT PRODUCTS, NAME-
LY, GENERAL FEATURE MAGAZINES, IN CLASS
16 (U.S. CLS. 2, 5, 22, 23, 29, 37, 38 AND 50).

FIRST USE 2-28-2007; IN COMMERCE 2-28-2007.

THE MARK CONSISTS OF STANDARD CHAR-
ACTERS WITHOUT CLAIM TO ANY PARTICULAR
FONT, STYLE, SIZE, OR COLOR.

SN 77-175,038, FILED 5-8-2007.

JOHN WILKE, EXAMINING ATTORNEY

Int. Cl.: 9

Prior U.S. Cls.: 21, 23, 26, 36, and 38

Reg. No. 3,481,693

United States Patent and Trademark Office

Registered Aug. 5, 2008

TRADEMARK
PRINCIPAL REGISTER

AIRCELL AXXESS

AIRCELL LLC (DELAWARE LTD LIAB CO)
BUILDING B, SUITE 280
1172 CENTURY DRIVE
LOUISVILLE, CO 80027

FOR: COMPUTER AND TELECOMMUNICATIONS NETWORK HARDWARE AND SOFTWARE FOR IMPLEMENTING LOCAL AREA NETWORKS ONBOARD AIRCRAFTS TO ENABLE USERS TO TRANSMIT AND RECEIVE VOICE, VIDEO, AND DATA WITHIN THE AIRCRAFTS, BETWEEN THE AIRCRAFTS, BETWEEN THE AIRCRAFTS AND THE GROUND, AND BETWEEN THE GROUND AND THE AIRCRAFTS; LOCAL AREA NETWORK ACCESS POINTS FOR COMMUNICATING WITH COMPUTER AND TELECOMMUNICATIONS USERS LOCATED ONBOARD AIRCRAFTS FOR TRANSMITTING AND RECEIVING VOICE, VIDEO, AND DATA WITHIN THE AIRCRAFTS, BETWEEN THE AIRCRAFTS, BETWEEN THE AIRCRAFTS AND THE GROUND, AND BETWEEN THE GROUND AND THE AIRCRAFTS; COMPUTER AND TELECOMMUNICATIONS NETWORK HARDWARE AND SOFTWARE FOR TRANSMITTING AND RECEIVING VOICE, VIDEO, AND DATA BETWEEN COMPUTER AND TELECOMMUNICATIONS USERS, LOCATED ONBOARD AN AIRCRAFT, AND COMPUTER, AND

TELECOMMUNICATIONS SYSTEMS LOCATED ONBOARD THE AIRCRAFT, COMPUTER AND TELECOMMUNICATION SYSTEMS LOCATED ONBOARD ANOTHER AIRCRAFT, AND COMPUTER AND TELECOMMUNICATIONS SYSTEMS LOCATED ON THE GROUND; COMPUTER AND TELECOMMUNICATIONS NETWORK ACCESS SERVER HARDWARE AND SOFTWARE ONBOARD AIRCRAFTS FOR TRANSMITTING AND RECEIVING VOICE, VIDEO, AND DATA FROM THE GROUND TO IDENTIFIED USERS LOCATED ONBOARD THE AIRCRAFTS, FROM IDENTIFIED USERS LOCATED ONBOARD THE AIRCRAFTS TO THE GROUND, AND FROM IDENTIFIED USERS LOCATED ONBOARD ONE AIRCRAFT TO IDENTIFIED USERS ONBOARD ANOTHER AIRCRAFT, AND BETWEEN IDENTIFIED USERS WITHIN AN AIRCRAFT, IN CLASS 9 (U.S. CLS. 21, 23, 26, 36 AND 38).

FIRST USE 4-27-2005; IN COMMERCE 4-27-2005.

THE MARK CONSISTS OF STANDARD CHARACTERS WITHOUT CLAIM TO ANY PARTICULAR FONT, STYLE, SIZE, OR COLOR.

SN 77-175,191, FILED 5-8-2007.

BRENDAN MCCAULEY, EXAMINING ATTORNEY

Int. Cl.: 5

Prior U.S. Cls.: 6, 18, 44, 46, 51, and 52

United States Patent and Trademark Office

Reg. No. 3,481,694

Registered Aug. 5, 2008

**TRADEMARK
PRINCIPAL REGISTER**

UNIVERSAL FOODZYME

NATURAL ORGANICS, INC. (NEW YORK COR-
PORATION)
548 BROADHOLLOW ROAD
MELVILLE, NY 117473708

THE MARK CONSISTS OF STANDARD CHAR-
ACTERS WITHOUT CLAIM TO ANY PARTICULAR
FONT, STYLE, SIZE, OR COLOR.

FOR: DIETARY SUPPLEMENTS, IN CLASS 5 (U.S.
CLS. 6, 18, 44, 46, 51 AND 52).

SN 77-175,749, FILED 5-8-2007.

FIRST USE 6-2-2008; IN COMMERCE 6-2-2008.

KATHERINE CHANG, EXAMINING ATTORNEY

Int. Cls.: 39, 41, and 43

Prior U.S. Cls.: 100, 101, 105, and 107

United States Patent and Trademark Office

Reg. No. 3,481,695

Registered Aug. 5, 2008

**SERVICE MARK
PRINCIPAL REGISTER**

CARNIVAL FANTASY

CARNIVAL CORPORATION (PANAMA CORPORATION)
3655 N.W. 87TH AVENUE
MIAMI, FL 33178

FOR: CRUISE SHIP SERVICES, IN CLASS 39 (U.S. CLS. 100 AND 105).

FIRST USE 6-15-2007; IN COMMERCE 6-15-2007.

FOR: ENTERTAINMENT SERVICES, NAMELY, CASINO SERVICES, ORGANIZING AND CONDUCTING STAGE SHOWS, NIGHTCLUB SHOWS, CONTESTS, DANCES AND PARTIES, IN CLASS 41 (U.S. CLS. 100, 101 AND 107).

FIRST USE 6-15-2007; IN COMMERCE 6-15-2007.

FOR: HOTEL SERVICES AND RESTAURANT SERVICES, IN CLASS 43 (U.S. CLS. 100 AND 101).

FIRST USE 6-15-2007; IN COMMERCE 6-15-2007.

THE MARK CONSISTS OF STANDARD CHARACTERS WITHOUT CLAIM TO ANY PARTICULAR FONT, STYLE, SIZE, OR COLOR.

OWNER OF U.S. REG. NOS. 1,495,405, 3,189,529, AND OTHERS.

SN 77-175,757, FILED 5-8-2007.

MARCIE MILONE, EXAMINING ATTORNEY

Int. Cls.: 39, 41, and 43

Prior U.S. Cls.: 100, 101, 105, and 107

United States Patent and Trademark Office

Reg. No. 3,481,696

Registered Aug. 5, 2008

**SERVICE MARK
PRINCIPAL REGISTER**

CARNIVAL FASCINATION

CARNIVAL CORPORATION (PANAMA CORPORATION)
3655 N.W. 87TH AVENUE
MIAMI, FL 33178

FOR: CRUISE SHIP SERVICES, IN CLASS 39 (U.S. CLS. 100 AND 105).

FIRST USE 6-15-2007; IN COMMERCE 6-15-2007.

FOR: ENTERTAINMENT SERVICES, NAMELY, CASINO SERVICES, ORGANIZING AND CONDUCTING STAGE SHOWS, NIGHTCLUB SHOWS, CONTESTS, DANCES AND PARTIES, IN CLASS 41 (U.S. CLS. 100, 101 AND 107).

FIRST USE 6-15-2007; IN COMMERCE 6-15-2007.

FOR: HOTEL SERVICES AND RESTAURANT SERVICES, IN CLASS 43 (U.S. CLS. 100 AND 101).

FIRST USE 6-15-2007; IN COMMERCE 6-15-2007.

THE MARK CONSISTS OF STANDARD CHARACTERS WITHOUT CLAIM TO ANY PARTICULAR FONT, STYLE, SIZE, OR COLOR.

OWNER OF U.S. REG. NOS. 1,495,405, 3,189,529, AND OTHERS.

SN 77-175,777, FILED 5-8-2007.

MARCIE MILONE, EXAMINING ATTORNEY

Int. Cls.: 39, 41, and 43

Prior U.S. Cls.: 100, 101, 105, and 107

United States Patent and Trademark Office

Reg. No. 3,481,697

Registered Aug. 5, 2008

**SERVICE MARK
PRINCIPAL REGISTER**

CARNIVAL ELATION

CARNIVAL CORPORATION (PANAMA CORPORATION)
3655 N.W. 87TH AVENUE
MIAMI, FL 33178

FOR: CRUISE SHIP SERVICES, IN CLASS 39 (U.S. CLS. 100 AND 105).

FIRST USE 6-15-2007; IN COMMERCE 6-15-2007.

FOR: ENTERTAINMENT SERVICES, NAMELY, CASINO SERVICES, ORGANIZING AND CONDUCTING STAGE SHOWS, NIGHTCLUB SHOWS, CONTESTS, DANCES AND PARTIES, IN CLASS 41 (U.S. CLS. 100, 101 AND 107).

FIRST USE 6-15-2007; IN COMMERCE 6-15-2007.

FOR: HOTEL SERVICES AND RESTAURANT SERVICES, IN CLASS 43 (U.S. CLS. 100 AND 101).

FIRST USE 6-15-2007; IN COMMERCE 6-15-2007.

THE MARK CONSISTS OF STANDARD CHARACTERS WITHOUT CLAIM TO ANY PARTICULAR FONT, STYLE, SIZE, OR COLOR.

OWNER OF U.S. REG. NOS. 1,495,405, 3,189,529, AND OTHERS.

SN 77-175,780, FILED 5-8-2007.

MARCIE MILONE, EXAMINING ATTORNEY

Int. Cls.: 39, 41, and 43

Prior U.S. Cls.: 100, 101, 105, and 107

United States Patent and Trademark Office

Reg. No. 3,481,698

Registered Aug. 5, 2008

**SERVICE MARK
PRINCIPAL REGISTER**

CARNIVAL ECSTASY

CARNIVAL CORPORATION (PANAMA CORPORATION)
3655 N.W. 87TH AVENUE
MIAMI, FL 33178

FOR: CRUISE SHIP SERVICES, IN CLASS 39 (U.S. CLS. 100 AND 105).

FIRST USE 6-15-2007; IN COMMERCE 6-15-2007.

FOR: ENTERTAINMENT SERVICES, NAMELY, CASINO SERVICES, ORGANIZING AND CONDUCTING STAGE SHOWS, NIGHTCLUB SHOWS, CONTESTS, DANCES AND PARTIES, IN CLASS 41 (U.S. CLS. 100, 101 AND 107).

FIRST USE 6-15-2007; IN COMMERCE 6-15-2007.

FOR: HOTEL SERVICES AND RESTAURANT SERVICES, IN CLASS 43 (U.S. CLS. 100 AND 101).

FIRST USE 6-15-2007; IN COMMERCE 6-15-2007.

THE MARK CONSISTS OF STANDARD CHARACTERS WITHOUT CLAIM TO ANY PARTICULAR FONT, STYLE, SIZE, OR COLOR.

OWNER OF U.S. REG. NOS. 1,495,405, 3,189,529, AND OTHERS.

SN 77-175,787, FILED 5-8-2007.

MARCIE MILONE, EXAMINING ATTORNEY

Int. Cls.: 39, 41, and 43

Prior U.S. Cls.: 100, 101, 105, and 107

United States Patent and Trademark Office

Reg. No. 3,481,699

Registered Aug. 5, 2008

**SERVICE MARK
PRINCIPAL REGISTER**

CARNIVAL SENSATION

CARNIVAL CORPORATION (PANAMA CORPORATION)
3655 N.W. 87TH AVENUE
MIAMI, FL 33178

FOR: CRUISE SHIP SERVICES, IN CLASS 39 (U.S. CLS. 100 AND 105).

FIRST USE 6-15-2007; IN COMMERCE 6-15-2007.

FOR: ENTERTAINMENT SERVICES, NAMELY, CASINO SERVICES, ORGANIZING AND CONDUCTING STAGE SHOWS, NIGHTCLUB SHOWS, CONTESTS, DANCES AND PARTIES, IN CLASS 41 (U.S. CLS. 100, 101 AND 107).

FIRST USE 6-15-2007; IN COMMERCE 6-15-2007.

FOR: HOTEL SERVICES AND RESTAURANT SERVICES, IN CLASS 43 (U.S. CLS. 100 AND 101).

FIRST USE 6-15-2007; IN COMMERCE 6-15-2007.

THE MARK CONSISTS OF STANDARD CHARACTERS WITHOUT CLAIM TO ANY PARTICULAR FONT, STYLE, SIZE, OR COLOR.

OWNER OF U.S. REG. NOS. 1,495,405, 3,189,529, AND OTHERS.

SN 77-175,793, FILED 5-8-2007.

MARCIE MILONE, EXAMINING ATTORNEY

Int. Cls.: 39, 41, and 43

Prior U.S. Cls.: 100, 101, 105, and 107

United States Patent and Trademark Office

Reg. No. 3,481,700

Registered Aug. 5, 2008

**SERVICE MARK
PRINCIPAL REGISTER**

CARNIVAL PARADISE

CARNIVAL CORPORATION (PANAMA CORPORATION)
3655 N.W. 87TH AVENUE
MIAMI, FL 33178

FOR: CRUISE SHIP SERVICES, IN CLASS 39 (U.S. CLS. 100 AND 105).

FIRST USE 6-15-2007; IN COMMERCE 6-15-2007.

FOR: ENTERTAINMENT SERVICES, NAMELY, CASINO SERVICES, ORGANIZING AND CONDUCTING STAGE SHOWS, NIGHTCLUB SHOWS, CONTESTS, DANCES AND PARTIES, IN CLASS 41 (U.S. CLS. 100, 101 AND 107).

FIRST USE 6-15-2007; IN COMMERCE 6-15-2007.

FOR: HOTEL SERVICES AND RESTAURANT SERVICES, IN CLASS 43 (U.S. CLS. 100 AND 101).

FIRST USE 6-15-2007; IN COMMERCE 6-15-2007.

THE MARK CONSISTS OF STANDARD CHARACTERS WITHOUT CLAIM TO ANY PARTICULAR FONT, STYLE, SIZE, OR COLOR.

OWNER OF U.S. REG. NOS. 1,495,405, 3,189,529, AND OTHERS.

SN 77-175,798, FILED 5-8-2007.

MARCIE MILONE, EXAMINING ATTORNEY

Int. Cls.: 39, 41, and 43

Prior U.S. Cls.: 100, 101, 105, and 107

United States Patent and Trademark Office

Reg. No. 3,481,701

Registered Aug. 5, 2008

**SERVICE MARK
PRINCIPAL REGISTER**

CARNIVAL IMAGINATION

CARNIVAL CORPORATION (PANAMA CORPORATION)
3655 N.W. 87TH AVENUE
MIAMI, FL 33178

FOR: CRUISE SHIP SERVICES, IN CLASS 39 (U.S. CLS. 100 AND 105).

FIRST USE 6-15-2007; IN COMMERCE 6-15-2007.

FOR: ENTERTAINMENT SERVICES, NAMELY, CASINO SERVICES, ORGANIZING AND CONDUCTING STAGE SHOWS, NIGHTCLUB SHOWS, CONTESTS, DANCES AND PARTIES, IN CLASS 41 (U.S. CLS. 100, 101 AND 107).

FIRST USE 6-15-2007; IN COMMERCE 6-15-2007.

FOR: HOTEL SERVICES AND RESTAURANT SERVICES, IN CLASS 43 (U.S. CLS. 100 AND 101).

FIRST USE 6-15-2007; IN COMMERCE 6-15-2007.

THE MARK CONSISTS OF STANDARD CHARACTERS WITHOUT CLAIM TO ANY PARTICULAR FONT, STYLE, SIZE, OR COLOR.

OWNER OF U.S. REG. NOS. 1,495,405, 3,189,529, AND OTHERS.

SN 77-175,804, FILED 5-8-2007.

MARCIE MILONE, EXAMINING ATTORNEY

Int. Cl.: 9

Prior U.S. Cls.: 21, 23, 26, 36, and 38

United States Patent and Trademark Office

Reg. No. 3,481,702

Registered Aug. 5, 2008

**TRADEMARK
PRINCIPAL REGISTER**

SensRcore

GARMIN LTD. (CAYMAN ISLANDS CORPORATION)

P.O. BOX 10670

45 MARKET ST., SUITE 3206B, GARDENIA CT.

CAMANA BAY, CAYMAN ISLANDS KY11006

FOR: COMPUTER HARDWARE AND SOFTWARE FOR THE DEVELOPMENT OF WIRELESS DATA COMMUNICATION, IN CLASS 9 (U.S. CLS. 21, 23, 26, 36 AND 38).

FIRST USE 4-0-2007; IN COMMERCE 4-0-2007.

THE MARK CONSISTS OF STANDARD CHARACTERS WITHOUT CLAIM TO ANY PARTICULAR FONT, STYLE, SIZE, OR COLOR.

SN 77-177,783, FILED 5-10-2007.

LINDSEY RUBIN, EXAMINING ATTORNEY

Int. Cls.: 9 and 41

Prior U.S. Cls.: 21, 23, 26, 36, 38, 100, 101, and 107

United States Patent and Trademark Office

Reg. No. 3,481,703

Registered Aug. 5, 2008

**TRADEMARK
SERVICE MARK
PRINCIPAL REGISTER**

WINGS OF THE GODDESS

KABUSHIKI KAISHA SQUARE ENIX (JAPAN CORPORATION), TA SQUARE ENIX CO., LTD.,
3-22-7 YOYOGI, SHIBUYA-KU
TOKYO, JAPAN

FOR: COMPUTER GAME SOFTWARE; VIDEO GAME SOFTWARE, IN CLASS 9 (U.S. CLS. 21, 23, 26, 36 AND 38).

FIRST USE 11-20-2007; IN COMMERCE 11-20-2007.

FOR: PROVIDING ON-LINE COMPUTER GAMES AND/OR ON-LINE VIDEO GAMES; PROVIDING INFORMATION ON COMPUTER GAME STRATE-

GIES AND/OR VIDEO GAME STRATEGIES VIA COMPUTER NETWORKS AND/OR GLOBAL COMMUNICATION NETWORKS, IN CLASS 41 (U.S. CLS. 100, 101 AND 107).

FIRST USE 11-20-2007; IN COMMERCE 11-20-2007.

THE MARK CONSISTS OF STANDARD CHARACTERS WITHOUT CLAIM TO ANY PARTICULAR FONT, STYLE, SIZE, OR COLOR.

SN 77-177,784, FILED 5-10-2007.

SCOTT BIBB, EXAMINING ATTORNEY

Int. Cl.: 12

Prior U.S. Cls.: 19, 21, 23, 31, 35, and 44

United States Patent and Trademark Office

Reg. No. 3,481,704

Registered Aug. 5, 2008

**TRADEMARK
PRINCIPAL REGISTER**

RANGER CREW

POLARIS INDUSTRIES INC. (DELAWARE COR-
PORATION)
2100 HIGHWAY 55
MEDINA, MN 553409770

THE MARK CONSISTS OF STANDARD CHAR-
ACTERS WITHOUT CLAIM TO ANY PARTICULAR
FONT, STYLE, SIZE, OR COLOR.

FOR: ALL-TERRAIN UTILITY VEHICLES AND
STRUCTURAL PARTS THEREFOR, IN CLASS 12
(U.S. CLS. 19, 21, 23, 31, 35 AND 44).

SN 77-177,905, FILED 5-10-2007.

FIRST USE 11-1-2007; IN COMMERCE 11-1-2007.

ANGELA M. MICHELI, EXAMINING ATTORNEY

Int. Cl.: 43

Prior U.S. Cls.: 100 and 101

United States Patent and Trademark Office

Reg. No. 3,481,705

Registered Aug. 5, 2008

**SERVICE MARK
PRINCIPAL REGISTER**



K&N MANAGEMENT (TEXAS PARTNERSHIP)
11570 RESEARCH BLVD.
AUSTIN, TX 78759

FOR: RESTAURANT SERVICES, IN CLASS 43
(U.S. CLS. 100 AND 101).

FIRST USE 12-6-2007; IN COMMERCE 12-6-2007.

NO CLAIM IS MADE TO THE EXCLUSIVE
RIGHT TO USE "BURGERS FRIES SHAKES" ,
APART FROM THE MARK AS SHOWN.

THE MARK CONSISTS OF THE WORD "MIGHTY
FINE" WITH A STAR ABOVE THE MARK AND THE
WORDS "BURGERS", "FRIES" AND "SHAKES"
BELOW IT.

SN 77-178,478, FILED 5-11-2007.

MARK SPARACINO, EXAMINING ATTORNEY

Int. Cl.: 3

Prior U.S. Cls.: 1, 4, 6, 50, 51, and 52

United States Patent and Trademark Office

Reg. No. 3,481,706

Registered Aug. 5, 2008

**TRADEMARK
PRINCIPAL REGISTER**

WISH OF HAPPINESS

AVON PRODUCTS, INC. (NEW YORK CORPORATION)
LEGAL DEPARTMENT - 3RD FL.
1251 AVENUE OF THE AMERICAS
NEW YORK, NY 10020

THE MARK CONSISTS OF STANDARD CHARACTERS WITHOUT CLAIM TO ANY PARTICULAR FONT, STYLE, SIZE, OR COLOR.

FOR: EAU DE TOILETTE; SHOWER GEL; BODY LOTION, IN CLASS 3 (U.S. CLS. 1, 4, 6, 50, 51 AND 52).

SN 77-178,547, FILED 5-11-2007.

FIRST USE 12-13-2007; IN COMMERCE 12-13-2007.

LOURDES AYALA, EXAMINING ATTORNEY

Int. Cl.: 43

Prior U.S. Cls.: 100 and 101

United States Patent and Trademark Office

Reg. No. 3,481,707

Registered Aug. 5, 2008

**SERVICE MARK
PRINCIPAL REGISTER**



SRG, INC. (DELAWARE CORPORATION)
LEGAL DEPT.
5918 STONERIDGE MALL ROAD
PLEASANTON, CA 94588

FOR: RESTAURANT SERVICES, IN CLASS 43
(U.S. CLS. 100 AND 101).

FIRST USE 6-7-2007; IN COMMERCE 6-7-2007.

THE COLOR(S) DARK ORANGE, ORANGE,
PEACH AND GREEN IS/ARE CLAIMED AS A
FEATURE OF THE MARK.

THE MARK CONSISTS OF FOUR TRIANGLES
WITH CURVED SIDES BEING DARK ORANGE IN
THE UPPER RIGHT CORNER, ORANGE IN THE
LOWER RIGHT CORNER, PEACH IN THE LOWER
LEFT CORNER, AND ORANGE IN THE UPPER
LEFT CORNER WITH A GREEN POLYGON SHAPE
TO THE LEFT OF THE TRIANGLE AND THE
WORDING "CITRINE" BEING DARK ORANGE
LOCATED TO THE RIGHT OF THE DESIGN AND
BELOW "CITRINE" IS THE WORDING "DISCOVER
A NEW WORLD OF FLAVOR" BEING IN ORANGE.

SN 77-179,276, FILED 5-11-2007.

AMY HELLA, EXAMINING ATTORNEY

Int. Cl.: 25

Prior U.S. Cls.: 22 and 39

United States Patent and Trademark Office

Reg. No. 3,481,708

Registered Aug. 5, 2008

TRADEMARK
PRINCIPAL REGISTER

Jack Purcell

CONVERSE INC. (DELAWARE CORPORATION)
ONE HIGH STREET
NORTH ANDOVER, MA 018452601

FOR: FOOTWEAR; CLOTHING, NAMELY, T-SHIRTS, SHORTS, PANTS, TANK TOPS, VESTS, JACKETS, SWEATERS, JEANS, FLEECE TOPS AND BOTTOMS, WIND-RESISTANT SUITS AND JACKETS, WOVEN SHIRTS, SOCKS, SHORT AND LONG SLEEVED TOPS, SHORT AND LONG SLEEVED T-SHIRTS, TROUSERS, SKIRTS, BELTS, SCARVES, AND BLAZERS; EXERCISE WEAR, NAMELY, SWEAT SUITS, SWIMWEAR, SWEAT PANTS, SWEAT SHIRTS, GYM SHORTS, AND SWEAT SHORTS; AND HEADGEAR, NAMELY,

SPORTS CAPS AND KNIT CAPS, IN CLASS 25 (U.S. CLS. 22 AND 39).

FIRST USE 12-31-1935; IN COMMERCE 12-31-1935.

OWNER OF U.S. REG. NOS. 583,097 AND 938,918.

THE NAME "JACK PURCELL" DOES NOT IDENTIFY A LIVING INDIVIDUAL.

THE MARK CONSISTS OF A SIGNATURE.

SN 77-179,299, FILED 5-11-2007.

KATHERINE CHANG, EXAMINING ATTORNEY

Int. Cl.: 16

Prior U.S. Cls.: 2, 5, 22, 23, 29, 37, 38, and 50

Reg. No. 3,481,709

United States Patent and Trademark Office

Registered Aug. 5, 2008

**TRADEMARK
PRINCIPAL REGISTER**

BookPlot

LESOWSKE, CHARLES J (UNITED STATES IN-
DIVIDUAL)
16176 FOOTHILL LOOP SOUTH
SISTERS, OR 97759

THE MARK CONSISTS OF STANDARD CHAR-
ACTERS WITHOUT CLAIM TO ANY PARTICULAR
FONT, STYLE, SIZE, OR COLOR.

FOR: RELIGIOUS BOOKS, IN CLASS 16 (U.S. CLS.
2, 5, 22, 23, 29, 37, 38 AND 50).

SN 77-179,507, FILED 5-12-2007.

FIRST USE 0-0-2004; IN COMMERCE 0-0-2004.

JOHN E. MICHOS, EXAMINING ATTORNEY

Int. Cl.: 42

Prior U.S. Cls.: 100 and 101

United States Patent and Trademark Office

Reg. No. 3,481,710

Registered Aug. 5, 2008

**SERVICE MARK
PRINCIPAL REGISTER**

SMART ELIGIBILITY

TOPLINE SOLUTIONS, INC. (WASHINGTON CORPORATION)
2120 FUNSTON PLACE
OAKLAND, CA 946022523

FOR: COMPUTER SERVICES, NAMELY, PROVIDING TEMPORARY USE OF INTERNET-BASED NON-DOWNLOADABLE SOFTWARE FOR EXTRACTING AND PRESENTING INFORMATION REGARDING SPECIFIC TYPES OF HEALTH CARE SERVICES FOR USE IN ESTIMATING AND/OR COLLECTING PATIENT PAYMENTS AT THE TIME OF SERVICE, IN CLASS 42 (U.S. CLS. 100 AND 101).

FIRST USE 10-26-2007; IN COMMERCE 10-26-2007.

THE MARK CONSISTS OF STANDARD CHARACTERS WITHOUT CLAIM TO ANY PARTICULAR FONT, STYLE, SIZE, OR COLOR.

NO CLAIM IS MADE TO THE EXCLUSIVE RIGHT TO USE "ELIGIBILITY", APART FROM THE MARK AS SHOWN.

SN 77-179,715, FILED 5-13-2007.

MELISSA VALLILLO, EXAMINING ATTORNEY

Int. Cl.: 16

Prior U.S. Cls.: 2, 5, 22, 23, 29, 37, 38, and 50

United States Patent and Trademark Office

Reg. No. 3,481,711

Registered Aug. 5, 2008

**TRADEMARK
PRINCIPAL REGISTER**

CONNECT AIKEN COUNTY

SOUTHEASTERN NEWSPAPERS COMPANY,
LLC (GEORGIA LTD LIAB CO)
725 BROAD STREET
AUGUSTA, GA 30901

FOR: MAGAZINE SUPPLEMENTS TO NEWSPAPERS IN THE FIELD OF COMMUNITY EVENTS, CULTURE, ENTERTAINMENT, SHOPPING, DINING, PRODUCTS AND SERVICES OF INTEREST IN NORTH AUGUSTA, SOUTH CAROLINA AND AIKEN, SOUTH CAROLINA; MAGAZINES FEATURING COMMUNITY EVENTS, CULTURE, ENTERTAINMENT, SHOPPING, DINING, PRODUCTS AND SERVICES OF INTEREST IN NORTH AUGUSTA, SOUTH CAROLINA AND AIKEN, SOUTH CAROLINA, IN CLASS 16 (U.S. CLS. 2, 5, 22, 23, 29, 37, 38 AND 50).

FIRST USE 9-0-2007; IN COMMERCE 9-0-2007.

THE MARK CONSISTS OF STANDARD CHARACTERS WITHOUT CLAIM TO ANY PARTICULAR FONT, STYLE, SIZE, OR COLOR.

NO CLAIM IS MADE TO THE EXCLUSIVE RIGHT TO USE "AIKEN COUNTY", APART FROM THE MARK AS SHOWN.

SN 77-180,240, FILED 5-14-2007.

JORDAN BAKER, EXAMINING ATTORNEY

Int. Cl.: 41

Prior U.S. Cls.: 100, 101, and 107

United States Patent and Trademark Office

Reg. No. 3,481,712

Registered Aug. 5, 2008

**SERVICE MARK
PRINCIPAL REGISTER**

LITERACY SPEAKS!

RICHMOND, RAQUEL (KELI) (UNITED STATES
INDIVIDUAL)
1706 EDGEWATER AVE.
FORT WAYNE, IN 46805 AND
JOUSTRA, DIANNE (UNITED STATES INDIVI-
DUAL)
4298 PINESTONE DR.
NEW HAVEN, IN 46774

FOR: PROVIDING CLASSES IN SPEECH, LAN-
GUAGE AND LITERACY DEVELOPMENT FOR
YOUNG CHILDREN, IN CLASS 41 (U.S. CLS. 100,
101 AND 107).

FIRST USE 3-7-2008; IN COMMERCE 3-7-2008.

THE MARK CONSISTS OF STANDARD CHAR-
ACTERS WITHOUT CLAIM TO ANY PARTICULAR
FONT, STYLE, SIZE, OR COLOR.

NO CLAIM IS MADE TO THE EXCLUSIVE
RIGHT TO USE "LITERACY", APART FROM THE
MARK AS SHOWN.

SN 77-180,377, FILED 5-14-2007.

DORITT L. CARROLL, EXAMINING ATTORNEY

Int. Cl.: 20

Prior U.S. Cls.: 2, 13, 22, 25, 32, and 50

United States Patent and Trademark Office

Reg. No. 3,481,713

Registered Aug. 5, 2008

**TRADEMARK
PRINCIPAL REGISTER**

Simply Ergonomic

NEUSTAT, PAULA (UNITED STATES INDIVIDUAL)
10 LONDON TERRACE
NEW CITY, NY 10956

FOR: FITTED FABRIC FURNITURE COVERS; CUSHIONS, IN CLASS 20 (U.S. CLS. 2, 13, 22, 25, 32 AND 50).

FIRST USE 2-15-2008; IN COMMERCE 2-15-2008.

THE MARK CONSISTS OF STANDARD CHARACTERS WITHOUT CLAIM TO ANY PARTICULAR FONT, STYLE, SIZE, OR COLOR.

NO CLAIM IS MADE TO THE EXCLUSIVE RIGHT TO USE "ERGONOMIC", APART FROM THE MARK AS SHOWN.

SN 77-180,884, FILED 5-15-2007.

RENEE MCCRAY, EXAMINING ATTORNEY

Int. Cl.: 16

Prior U.S. Cls.: 2, 5, 22, 23, 29, 37, 38, and 50

Reg. No. 3,481,714

United States Patent and Trademark Office

Registered Aug. 5, 2008

**TRADEMARK
PRINCIPAL REGISTER**

CONNECT COLUMBIA COUNTY

SOUTHEASTERN NEWSPAPERS COMPANY,
LLC (GEORGIA LTD LIAB CO)
725 BROAD STREET
AUGUSTA, GA 30901

FIRST USE 5-0-2007; IN COMMERCE 5-0-2007.

THE MARK CONSISTS OF STANDARD CHARACTERS WITHOUT CLAIM TO ANY PARTICULAR FONT, STYLE, SIZE, OR COLOR.

FOR: MAGAZINE SUPPLEMENTS TO NEWSPAPERS IN THE FIELD OF COMMUNITY EVENTS, CULTURE, ENTERTAINMENT, SHOPPING, DINING, PRODUCTS AND SERVICES OF INTEREST IN THE AUGUSTA, GEORGIA METRO AREA; MAGAZINES FEATURING COMMUNITY EVENTS, CULTURE, ENTERTAINMENT, SHOPPING, DINING, PRODUCTS AND SERVICES OF INTEREST IN THE AUGUSTA, GEORGIA METRO AREA, IN CLASS 16 (U.S. CLS. 2, 5, 22, 23, 29, 37, 38 AND 50).

NO CLAIM IS MADE TO THE EXCLUSIVE RIGHT TO USE "COLUMBIA COUNTY", APART FROM THE MARK AS SHOWN.

SN 77-180,916, FILED 5-15-2007.

JORDAN BAKER, EXAMINING ATTORNEY

Int. Cl.: 3

Prior U.S. Cls.: 1, 4, 6, 50, 51, and 52

United States Patent and Trademark Office

Reg. No. 3,481,715

Registered Aug. 5, 2008

**TRADEMARK
PRINCIPAL REGISTER**

STEALTHSOLID

THE DIAL CORPORATION (DELAWARE CORPORATION)
M.S. 2214
15501 NORTH DIAL BOULEVARD
SCOTTSDALE, AZ 852601619

THE MARK CONSISTS OF STANDARD CHARACTERS WITHOUT CLAIM TO ANY PARTICULAR FONT, STYLE, SIZE, OR COLOR.

FOR: PERSONAL CARE PRODUCTS, NAMELY, ANTI-PERSPIRANTS AND DEODORANTS, IN CLASS 3 (U.S. CLS. 1, 4, 6, 50, 51 AND 52).

SN 77-181,149, FILED 5-15-2007.

FIRST USE 1-15-2008; IN COMMERCE 1-15-2008.

DAVID I, EXAMINING ATTORNEY

Int. Cls.: 35, 37, and 41

Prior U.S. Cls.: 100, 101, 102, 103, 106, and 107

United States Patent and Trademark Office

Reg. No. 3,481,716

Registered Aug. 5, 2008

**SERVICE MARK
PRINCIPAL REGISTER**

MAXPAK

AMERICAN CAR CARE CENTERS, INC. (DELAWARE CORPORATION)
5050 POPLAR AVENUE SUITE 920
MEMPHIS, TN 38157

FOR: PROVIDING AUTOMOTIVE PRODUCTS INFORMATION TO AUTOMOTIVE PARTS AND SERVICES RETAILERS FOR ADVERTISING PURPOSES; PROVIDING MARKETING, NAMELY, DIRECT MARKETING ADVERTISING FOR OTHERS AND COOPERATIVE MARKETING; PREPARING PROMOTIONAL AND MERCHANDISING MATERIAL FOR OTHERS IN THE TIRE BUSINESS; PREPARING ADVERTISEMENT FOR OTHERS IN THE TIRE BUSINESS; GROUP ADVERTISING, NAMELY, COOPERATIVE ADVERTISING AND MARKETING, DIRECT MAIL ADVERTISING, DISSEMINATION OF ADVERTISING FOR OTHERS VIA THE INTERNET AND DISSEMINATION OF ADVERTISING MATTER FOR OTHERS IN THE AUTOMOBILE TIRE BUSINESS; PRODUCT MERCHANDISING SERVICES TO INDEPENDENT COOPERATIVE DEALERS; ASSISTANCE IN MANAGEMENT OF BUSINESS ACTIVITIES; BUSINESS MANAGEMENT CONSULTANCY, AND BUSINESS MARKETING CONSULTATION, NAMELY, THE DEVELOPMENT OF PROCESSES FOR THE ANALYSIS AND THE IMPLEMENTATION OF MARKETING STRATEGIES AND PROJECT MANAGEMENT; PROVIDING BUSINESS MANAGEMENT INFORMATION ON A WIDE VARIETY OF VEHICLE-RELATED TOPICS TO THOSE IN THE VEHICLE SERVICE INDUSTRY; PROVIDING INFORMATION

ABOUT AUTOMOBILES FOR SALE VIA THE INTERNET, IN CLASS 35 (U.S. CLS. 100, 101 AND 102).

FIRST USE 1-13-2007; IN COMMERCE 3-13-2007.

FOR: PROVIDING AUTOMOTIVE-RELATED INFORMATION, NAMELY, INFORMATION ABOUT AUTOMOTIVE REPAIRS TO AUTOMOTIVE TECHNICIANS AND REPAIR SHOPS VIA THE INTERNET, IN CLASS 37 (U.S. CLS. 100, 103 AND 106).

FIRST USE 3-13-2007; IN COMMERCE 3-13-2007.

FOR: PROVIDING EDUCATIONAL SERVICES IN THE NATURE OF ORGANIZING AND CONDUCTING CLASSES, SEMINARS, WORKSHOPS AND CONFERENCES IN THE FIELD OF AUTOMOTIVE REPAIR AND MAINTENANCE, AND DISTRIBUTION OF PRINTED, AUDIO, VISUAL AND MULTIMEDIA COURSE MATERIALS IN CONNECTION THEREWITH, IN CLASS 41 (U.S. CLS. 100, 101 AND 107).

FIRST USE 3-13-2007; IN COMMERCE 3-13-2007.

THE MARK CONSISTS OF THE WORD "MAXPAK" IN 3-D STYLIZED UPPER CASE LETTERS WITH AN OUTLINE OF AN EAGLE'S HEAD WITHIN THE LETTER "M".

SN 77-181,290, FILED 5-15-2007.

REBECCA SMITH, EXAMINING ATTORNEY

Int. Cl.: 25

Prior U.S. Cls.: 22 and 39

United States Patent and Trademark Office

Reg. No. 3,481,717

Registered Aug. 5, 2008

**TRADEMARK
PRINCIPAL REGISTER**

CLASS PLAYER

CARLEN ENTERPRISES, INC. (CALIFORNIA
CORPORATION)
1000 N. STUDERBAKER ROAD # 6
LONG BEACH, CA 90815

FOR: CLOTHING, NAMELY, SHIRTS, BLAZERS,
JACKETS, HOODED-JACKETS, T-SHIRTS, SHORTS,
DRESSES, SKIRTS, UNDERWEAR, LINGERIE,
SWEATSHIRTS, SWEATPANTS, SWEATERS,
BELTS, HATS, SLACKS, PANTS AND JEANS, IN
CLASS 25 (U.S. CLS. 22 AND 39).

FIRST USE 11-12-2007; IN COMMERCE 11-12-2007.

THE MARK CONSISTS OF STANDARD CHAR-
ACTERS WITHOUT CLAIM TO ANY PARTICULAR
FONT, STYLE, SIZE, OR COLOR.

SN 77-182,392, FILED 5-16-2007.

HANNO RITTNER, EXAMINING ATTORNEY

Int. Cl.: 35

Prior U.S. Cls.: 100, 101, and 102

United States Patent and Trademark Office

Reg. No. 3,481,718

Registered Aug. 5, 2008

**SERVICE MARK
PRINCIPAL REGISTER**

Culinary Collective

POWER-SELLES IMPORTS, INC. (WASHINGTON CORPORATION)
14522 NE N WOODINVILLE WAY #201A
WOODINVILLE, WA 98072

FOR: GOODS IMPORT-EXPORT AGENCIES; BUSINESS MANAGEMENT SERVICES, NAMELY, MANAGING LOGISTICS, REVERSE LOGISTICS, SUPPLY CHAIN SERVICES, SUPPLY CHAIN VISIBILITY AND SYNCHRONIZATION, SUPPLY AND DEMAND FORECASTING AND PRODUCT DISTRIBUTION PROCESSES FOR OTHERS, IN CLASS 35 (U.S. CLS. 100, 101 AND 102).

FIRST USE 7-1-2007; IN COMMERCE 7-1-2007.

THE MARK CONSISTS OF STANDARD CHARACTERS WITHOUT CLAIM TO ANY PARTICULAR FONT, STYLE, SIZE, OR COLOR.

NO CLAIM IS MADE TO THE EXCLUSIVE RIGHT TO USE "CULINARY", APART FROM THE MARK AS SHOWN.

SN 77-182,590, FILED 5-16-2007.

REBECCA SMITH, EXAMINING ATTORNEY

Int. Cl.: 28

Prior U.S. Cls.: 22, 23, 38, and 50

United States Patent and Trademark Office

Reg. No. 3,481,719

Registered Aug. 5, 2008

**TRADEMARK
PRINCIPAL REGISTER**

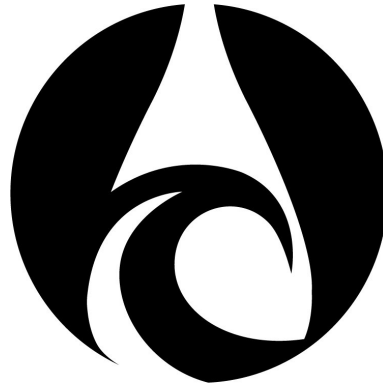

PADDLE SURF HAWAII, LLC (HAWAII LTD
LIAB CO)
98-030 HEKAHA STREET, SUITE 3
AIEA, HI 96701

THE MARK CONSISTS OF A PADDLE CEN-
TERED WITHIN A CIRCLE WITH AN OCEAN
WAVE IN IT.

FOR: PADDLE BOARDS; SURF BOARDS, IN
CLASS 28 (U.S. CLS. 22, 23, 38 AND 50).

SN 77-183,155, FILED 5-16-2007.

FIRST USE 11-1-2007; IN COMMERCE 11-1-2007.

JAY FLOWERS, EXAMINING ATTORNEY

Int. Cls.: 11 and 20

Prior U.S. Cls.: 2, 13, 21, 22, 23, 25, 31, 32, 34, and 50

United States Patent and Trademark Office

Reg. No. 3,481,720

Registered Aug. 5, 2008

TRADEMARK
PRINCIPAL REGISTER

RESTROOM

I N A B O X

TOILET PARTITIONS LOCKERS
SHOWER STALLS ACCESSORIES

PARTITION SYSTEMS INCORPORATED OF
SOUTH CAROLINA (SOUTH CAROLINA
CORPORATION)
825 GARLAND STREET
COLUMBIA, SC 29201

FOR: ELECTRIC HOT AIR HAND DRYERS;
WATER CLOSETS, IN CLASS 11 (U.S. CLS. 13, 21,
23, 31 AND 34).

FIRST USE 3-1-2007; IN COMMERCE 3-1-2007.

FOR: LOCKERS; FURNITURE PARTITIONS;
BATHROOM VANITIES; LOCKER MIRRORS, IN
CLASS 20 (U.S. CLS. 2, 13, 22, 25, 32 AND 50).

FIRST USE 3-1-2007; IN COMMERCE 3-1-2007.

NO CLAIM IS MADE TO THE EXCLUSIVE
RIGHT TO USE "TOILET", "PARTITIONS", "LOCK-
ERS", "SHOWER", "STALLS" AND "ACCESSORIES",
APART FROM THE MARK AS SHOWN.

THE MARK CONSISTS OF THE WORD "RE-
STROOM" IN BOLD OVER THE WORDS "IN A
BOX" NOT IN BOLD WITH A HORIZONTAL HOL-
LOW BAR BETWEEN THEM AND THE WORDS
"TOILET PARTITIONS LOCKERS" IN A SMALLER
FONT SIZE BELOW "IN A BOX" AND THE WORDS
"SHOWER STALLS ACCESSORIES" IN THE SAME
SMALLER FONT BELOW THAT.

SN 77-183,240, FILED 5-17-2007.

ELLEN PERKINS, EXAMINING ATTORNEY

Int. Cl.: 12

Prior U.S. Cls.: 19, 21, 23, 31, 35, and 44

Reg. No. 3,481,721

United States Patent and Trademark Office

Registered Aug. 5, 2008

TRADEMARK
PRINCIPAL REGISTER



MENARD, INC. (WISCONSIN CORPORATION)
4777 MENARD DRIVE
EAU CLAIRE, WI 54703

THE COLOR(S) RED, BLACK AND SILVER IS/
ARE CLAIMED AS A FEATURE OF THE MARK.

FOR: SEMI-FITTED VEHICLE COVERS, NAME-
LY, COVERS FOR BOATS, PERSONAL WATER-
CRAFT, SNOWMOBILES, MOTORCYCLES, ALL-
TERRAIN VEHICLES, AND AUTOMOBILES, IN
CLASS 12 (U.S. CLS. 19, 21, 23, 31, 35 AND 44).

THE MARK CONSISTS OF A BLACK GARAGE-
SHAPE OUTLINE; THE WORD "XTREME" IN RED
WITH THE LETTER "X" BEING LARGER THAN
THE OTHER LETTERS IN THE WORD; THE WORD
"XTREME" IN A STYLIZED FONT; THE WORD
"GARAGE" APPEARING AS IF IT IS SILVER
CHROME AND PORTRAYED AS THOUGH THERE
ARE CHROME RIVETS ON THE LETTERING.

FIRST USE 4-0-2007; IN COMMERCE 4-0-2007.

NO CLAIM IS MADE TO THE EXCLUSIVE
RIGHT TO USE "GARAGE", APART FROM THE
MARK AS SHOWN.

SN 77-183,284, FILED 5-17-2007.

KEVON CHISOLM, EXAMINING ATTORNEY

Int. Cl.: 12

Prior U.S. Cls.: 19, 21, 23, 31, 35, and 44

Reg. No. 3,481,722

United States Patent and Trademark Office

Registered Aug. 5, 2008

**TRADEMARK
PRINCIPAL REGISTER**

XTREME GARAGE

MENARD, INC. (WISCONSIN CORPORATION)
4777 MENARD DRIVE
EAU CLAIRE, WI 54703

FOR: SEMI-FITTED VEHICLE COVERS, NAME-
LY, COVERS FOR BOATS, PERSONAL WATER-
CRAFT, SNOWMOBILES, MOTORCYCLES, ALL-
TERRAIN VEHICLES, AND AUTOMOBILES, IN
CLASS 12 (U.S. CLS. 19, 21, 23, 31, 35 AND 44).

FIRST USE 4-0-2007; IN COMMERCE 4-0-2007.

THE MARK CONSISTS OF STANDARD CHAR-
ACTERS WITHOUT CLAIM TO ANY PARTICULAR
FONT, STYLE, SIZE, OR COLOR.

NO CLAIM IS MADE TO THE EXCLUSIVE
RIGHT TO USE "GARAGE", APART FROM THE
MARK AS SHOWN.

SN 77-183,613, FILED 5-17-2007.

KEVON CHISOLM, EXAMINING ATTORNEY

Int. Cl.: 14

Prior U.S. Cls.: 2, 27, 28, and 50

United States Patent and Trademark Office

Reg. No. 3,481,723

Registered Aug. 5, 2008

**TRADEMARK
PRINCIPAL REGISTER**

ROMUNDA

SPEIDEL, LLC. (RHODE ISLAND LTD LIAB CO)
25 FAIRMOUNT AVE.
EAST PROVIDENCE, RI 02914

FOR: WATCH BANDS AND STRAPS; WATCH
BRACELETS; WATCHES, IN CLASS 14 (U.S. CLS. 2,
27, 28 AND 50).

FIRST USE 11-1-2007; IN COMMERCE 11-1-2007.

THE MARK CONSISTS OF STANDARD CHAR-
ACTERS WITHOUT CLAIM TO ANY PARTICULAR
FONT, STYLE, SIZE, OR COLOR.

OWNER OF U.S. REG. NO. 1,059,182.

SN 77-183,839, FILED 5-17-2007.

JUDITH HELFMAN, EXAMINING ATTORNEY

Int. Cl.: 36

Prior U.S. Cls.: 100, 101, and 102

United States Patent and Trademark Office

Reg. No. 3,481,724

Registered Aug. 5, 2008

SERVICE MARK
PRINCIPAL REGISTER



1031 ADVISERS, INC. (FLORIDA CORPORATION)
10327 NAKEMA DR W
JACKSONVILLE, FL 32257

FOR: FINANCIAL CONSULTATION; REAL ESTATE CONSULTATION, IN CLASS 36 (U.S. CLS. 100, 101 AND 102).

FIRST USE 5-27-2008; IN COMMERCE 5-27-2008.

NO CLAIM IS MADE TO THE EXCLUSIVE RIGHT TO USE "1031", APART FROM THE MARK AS SHOWN.

THE MARK CONSISTS OF THE NUMBER "1031" ABOVE "DVISERS", ALL BETWEEN AN OIL RIG DESIGN AND A BUILDING DESIGN AND UPPER AND LOWER SWIRL DESIGNS, WITH THE OIL RIG DESIGN FORMING A LETTER "A".

SN 77-184,213, FILED 5-17-2007.

LAURA HAMMEL, EXAMINING ATTORNEY

Int. Cl.: 9

Prior U.S. Cls.: 21, 23, 26, 36, and 38

United States Patent and Trademark Office

Reg. No. 3,481,725

Registered Aug. 5, 2008

**TRADEMARK
PRINCIPAL REGISTER**

MovieSpin

DENATALE JR, JOHN (UNITED STATES INDIVIDUAL)
81-17 BEAVER SPUR
MORICHES, NY 11955

THE MARK CONSISTS OF STANDARD CHARACTERS WITHOUT CLAIM TO ANY PARTICULAR FONT, STYLE, SIZE, OR COLOR.

FOR: ROTATING DISPLAY HOLDER FOR DVDS, VIDEO GAMES, AND VCR TAPES, IN CLASS 9 (U.S. CLS. 21, 23, 26, 36 AND 38).

SN 77-184,417, FILED 5-18-2007.

FIRST USE 4-30-2008; IN COMMERCE 4-30-2008.

SANI KHOURI, EXAMINING ATTORNEY

Int. Cl.: 9

Prior U.S. Cls.: 21, 23, 26, 36, and 38

United States Patent and Trademark Office

Reg. No. 3,481,726

Registered Aug. 5, 2008

**TRADEMARK
PRINCIPAL REGISTER**

DynaLinx

LITHOTEL SOFTWARE DESIGN LTD. (CANADA
CORPORATION)
214 DUNDAS STREET EAST
WHITBY, CANADA L1N2H8

THE MARK CONSISTS OF STANDARD CHAR-
ACTERS WITHOUT CLAIM TO ANY PARTICULAR
FONT, STYLE, SIZE, OR COLOR.

FOR: COMPUTER SOFTWARE FOR FACILITAT-
ING THE LOCALIZED AND/OR REMOTE DIGITAL
DISPLAY OF PRE-PRESS COLOR CORRECTED
IMAGES, IN CLASS 9 (U.S. CLS. 21, 23, 26, 36 AND 38).

SN 77-184,431, FILED 5-18-2007.

FIRST USE 2-28-2008; IN COMMERCE 4-23-2008.

JASON BLAIR, EXAMINING ATTORNEY

Int. Cl.: 9

Prior U.S. Cls.: 21, 23, 26, 36, and 38

United States Patent and Trademark Office

Reg. No. 3,481,727

Registered Aug. 5, 2008

**TRADEMARK
PRINCIPAL REGISTER**

PROGRESSION

NOTION MUSIC, INC. (NORTH CAROLINA
CORPORATION)
SUITE 300
201 S. ELM STREET.
GREENSBORO, NC 27401

FOR: MUSICAL SOFTWARE, NAMELY, COMPU-
TER SOFTWARE FOR MUSICAL COMPOSITION,
PERFORMANCE, PRODUCTION, AND EDUCA-
TION, IN CLASS 9 (U.S. CLS. 21, 23, 26, 36 AND 38).

FIRST USE 9-17-2007; IN COMMERCE 9-17-2007.

THE MARK CONSISTS OF STANDARD CHAR-
ACTERS WITHOUT CLAIM TO ANY PARTICULAR
FONT, STYLE, SIZE, OR COLOR.

SN 77-184,693, FILED 5-18-2007.

SCOTT BIBB, EXAMINING ATTORNEY

Int. Cl.: 33

Prior U.S. Cls.: 47 and 49

United States Patent and Trademark Office

Reg. No. 3,481,728

Registered Aug. 5, 2008

**TRADEMARK
PRINCIPAL REGISTER**

RICARDUS CORCULUM

RICHARD HART (UNITED STATES INDIVIDUAL)
801 S. PITT STREET #225
ALEXANDRIA, VA 22314

THE NAME "RICARDUS CORCULUM" DOES NOT IDENTIFY A LIVING INDIVIDUAL.

FOR: WINE, IN CLASS 33 (U.S. CLS. 47 AND 49).

SN 77-185,155, FILED 5-18-2007.

FIRST USE 12-17-2007; IN COMMERCE 12-17-2007.

THE MARK CONSISTS OF STANDARD CHARACTERS WITHOUT CLAIM TO ANY PARTICULAR FONT, STYLE, SIZE, OR COLOR.

CIMMERIAN COLEMAN, EXAMINING ATTORNEY

Int. Cl.: 28

Prior U.S. Cls.: 22, 23, 38, and 50

United States Patent and Trademark Office

Reg. No. 3,481,729

Registered Aug. 5, 2008

**TRADEMARK
PRINCIPAL REGISTER**

VELINEON

TRAXXAS LP (TEXAS LIMITED PARTNERSHIP)
1100 KLEIN ROAD
PLANO, TX 75074

THE MARK CONSISTS OF STANDARD CHAR-
ACTERS WITHOUT CLAIM TO ANY PARTICULAR
FONT, STYLE, SIZE, OR COLOR.

FOR: SCALE MODEL VEHICLES AND PARTS
THEREFOR, IN CLASS 28 (U.S. CLS. 22, 23, 38 AND
50).

SN 77-185,780, FILED 5-21-2007.

FIRST USE 7-23-2007; IN COMMERCE 7-23-2007.

BARBARA RUTLAND, EXAMINING ATTORNEY

Int. Cl.: 39

Prior U.S. Cls.: 100 and 105

United States Patent and Trademark Office

Reg. No. 3,481,730

Registered Aug. 5, 2008

**SERVICE MARK
PRINCIPAL REGISTER**

KEEPSAKE WITH A MESSAGE

SUNDEEN, NANCY (UNITED STATES INDIVIDUAL)
15035 62ND AVENUE NORTH
MAPLE GROVE, MN 55311

THE MARK CONSISTS OF STANDARD CHARACTERS WITHOUT CLAIM TO ANY PARTICULAR FONT, STYLE, SIZE, OR COLOR.

FOR: DELIVERY OF GREETINGS ACCOMPANIED BY A PILLOW, IN CLASS 39 (U.S. CLS. 100 AND 105).

SN 77-185,799, FILED 5-21-2007.

FIRST USE 8-31-2007; IN COMMERCE 8-31-2007.

MONIQUE MILLER, EXAMINING ATTORNEY

Int. Cls.: 9 and 42

Prior U.S. Cls.: 21, 23, 26, 36, 38, 100, and 101

United States Patent and Trademark Office

Reg. No. 3,481,731

Registered Aug. 5, 2008

**TRADEMARK
SERVICE MARK
PRINCIPAL REGISTER**

SQUIRT

KALLENBACH, THOMAS J. (UNITED STATES
INDIVIDUAL)
155 ANNIE GLADE DRIVE
BOZEMAN, MT 59718

FOR: COMPUTER SOFTWARE FOR DESIGNING
WASTEWATER TREATMENT SYSTEMS FOR
HOMES, CLUSTERED COMMUNITIES AND COM-
MERCIAL DEVELOPMENTS THAT ARE NOT CON-
NECTED TO MUNICIPAL WASTEWATER
TREATMENT PLANTS AND CANNOT BE SERVED
BY STANDARD SEPTIC TANK/GRAVITY-DOSED
DRAINFIELD COMBINATIONS, IN CLASS 9 (U.S.
CLS. 21, 23, 26, 36 AND 38).

FIRST USE 11-8-2007; IN COMMERCE 11-8-2007.

FOR: PROVIDING ONLINE NON-DOWNLOAD-
ABLE COMPUTER SOFTWARE FOR DESIGNING

WASTEWATER TREATMENT SYSTEMS FOR
HOMES, CLUSTERED COMMUNITIES AND COM-
MERCIAL DEVELOPMENTS THAT ARE NOT CON-
NECTED TO MUNICIPAL WASTEWATER
TREATMENT PLANTS AND CANNOT BE SERVED
BY STANDARD SEPTIC TANK/GRAVITY-DOSED
DRAINFIELD COMBINATIONS, IN CLASS 42 (U.S.
CLS. 100 AND 101).

FIRST USE 4-28-2008; IN COMMERCE 4-28-2008.

THE MARK CONSISTS OF STANDARD CHAR-
ACTERS WITHOUT CLAIM TO ANY PARTICULAR
FONT, STYLE, SIZE, OR COLOR.

SN 77-188,003, FILED 5-23-2007.

BRIAN CALLAGHAN, EXAMINING ATTORNEY

Int. Cls.: 16 and 20

Prior U.S. Cls.: 2, 5, 13, 22, 23, 25, 29, 32, 37, 38, and 50

Reg. No. 3,481,732

United States Patent and Trademark Office

Registered Aug. 5, 2008

**TRADEMARK
PRINCIPAL REGISTER**



BURNES

BURNES HOME ACCENTS, LLC (DELAWARE
LTD LIAB CO)
21 CYPRESS BLVD.
ROUND ROCK, TX 78664

OWNER OF U.S. REG. NOS. 1,055,591 AND
1,645,234.

FOR: PHOTO ALBUMS, IN CLASS 16 (U.S. CLS. 2,
5, 22, 23, 29, 37, 38 AND 50).

THE MARK CONSISTS OF A BACKWARD B
NEXT TO THE LETTER B IN A CIRCLE OVER
THE WORD BURNES.

FIRST USE 10-31-2007; IN COMMERCE 10-31-2007.

FOR: PICTURE FRAMES, IN CLASS 20 (U.S. CLS.
2, 13, 22, 25, 32 AND 50).

SN 77-188,647, FILED 5-23-2007.

FIRST USE 2-22-2008; IN COMMERCE 2-22-2008.

PAM WILLIS, EXAMINING ATTORNEY

Int. Cls.: 16 and 20

Prior U.S. Cls.: 2, 5, 13, 22, 23, 25, 29, 32, 37, 38, and 50

Reg. No. 3,481,733

United States Patent and Trademark Office

Registered Aug. 5, 2008

**TRADEMARK
PRINCIPAL REGISTER**



BURNES HOME ACCENTS, LLC (DELAWARE
LTD LIAB CO)
21 CYPRESS BLVD.
SUITE 1010
ROUND ROCK, TX 78664

FIRST USE 10-31-2007; IN COMMERCE 10-31-2007.

OWNER OF U.S. REG. NOS. 1,055,591 AND
1,645,234.

FOR: PHOTO ALBUMS, IN CLASS 16 (U.S. CLS. 2,
5, 22, 23, 29, 37, 38 AND 50).

THE MARK CONSISTS OF A BACKWARD B
NEXT TO THE LETTER B IN A CIRCLE.

FIRST USE 10-31-2007; IN COMMERCE 10-31-2007.

SN 77-188,663, FILED 5-23-2007.

FOR: PICTURE FRAMES, IN CLASS 20 (U.S. CLS.
2, 13, 22, 25, 32 AND 50).

PAM WILLIS, EXAMINING ATTORNEY

Int. Cl.: 8

Prior U.S. Cls.: 23, 28, and 44

United States Patent and Trademark Office

Reg. No. 3,481,734

Registered Aug. 5, 2008

**TRADEMARK
PRINCIPAL REGISTER**

XTREME GARAGE

MENARD, INC. (WISCONSIN CORPORATION)
4777 MENARD DRIVE
EAU CLAIRE, WI 54703

OWNER OF U.S. REG. NOS. 3,126,317 AND
3,129,290.

FOR: MANUALLY-OPERATED JACKS, IN CLASS
8 (U.S. CLS. 23, 28 AND 44).

NO CLAIM IS MADE TO THE EXCLUSIVE
RIGHT TO USE "GARAGE", APART FROM THE
MARK AS SHOWN.

FIRST USE 1-24-2008; IN COMMERCE 1-24-2008.

SN 77-189,082, FILED 5-24-2007.

THE MARK CONSISTS OF STANDARD CHAR-
ACTERS WITHOUT CLAIM TO ANY PARTICULAR
FONT, STYLE, SIZE, OR COLOR.

KEVON CHISOLM, EXAMINING ATTORNEY

Int. Cl.: 12

Prior U.S. Cls.: 19, 21, 23, 31, 35, and 44

United States Patent and Trademark Office

Reg. No. 3,481,735

Registered Aug. 5, 2008

TRADEMARK
PRINCIPAL REGISTER



MENARD, INC. (WISCONSIN CORPORATION)
4777 MENARD DRIVE
EAU CLAIRE, WI 54703

FOR: MECHANICS CREEPERS, DOLLIES, IN
CLASS 12 (U.S. CLS. 19, 21, 23, 31, 35 AND 44).

FIRST USE 5-18-2006; IN COMMERCE 5-18-2006.

OWNER OF U.S. REG. NOS. 3,126,317 AND
3,129,290.

NO CLAIM IS MADE TO THE EXCLUSIVE
RIGHT TO USE "GARAGE", APART FROM THE
MARK AS SHOWN.

THE COLOR(S) RED, BLACK AND SILVER IS/
ARE CLAIMED AS A FEATURE OF THE MARK.

THE MARK CONSISTS OF A BLACK GARAGE-
SHAPE OUTLINE; THE WORD "XTREME" IN RED
WITH THE "X" BEING LARGER THAN THE
OTHER LETTERS IN THE WORD; THE WORD
"XTREME" IN A STYLIZED FONT; THE WORD
"GARAGE" APPEARING AS IF IT IS SILVER
CHROME AND PORTRAYED AS THOUGH THERE
ARE CHROME RIVETS ON THE LETTERING.

SN 77-189,085, FILED 5-24-2007.

KEVON CHISOLM, EXAMINING ATTORNEY

Int. Cl.: 20

Prior U.S. Cls.: 2, 13, 22, 25, 32, and 50

United States Patent and Trademark Office

Reg. No. 3,481,736

Registered Aug. 5, 2008

TRADEMARK
PRINCIPAL REGISTER



MENARD, INC. (WISCONSIN CORPORATION)
4777 MENARD DRIVE
EAU CLAIRE, WI 54703

FOR: SEATS, PLASTIC WHEEL CHOCKS, IN
CLASS 20 (U.S. CLS. 2, 13, 22, 25, 32 AND 50).

FIRST USE 1-24-2008; IN COMMERCE 1-24-2008.

OWNER OF U.S. REG. NOS. 3,126,317 AND
3,129,290.

NO CLAIM IS MADE TO THE EXCLUSIVE
RIGHT TO USE "GARAGE", APART FROM THE
MARK AS SHOWN.

THE COLOR(S) RED, BLACK AND SILVER IS/
ARE CLAIMED AS A FEATURE OF THE MARK.

THE MARK CONSISTS OF A BLACK GARAGE-
SHAPE OUTLINE; THE WORD "XTREME" IN RED
WITH THE LETTER "X" BEING LARGER THAN
THE OTHER LETTERS IN THE WORD; THE WORD
"XTREME" IN A STYLIZED FONT; THE WORD
"GARAGE" APPEARING AS IF IT IS SILVER
CHROME AND PORTRAYED AS THOUGH THERE
ARE CHROME RIVETS ON THE LETTERING.

SN 77-189,088, FILED 5-24-2007.

KEVON CHISOLM, EXAMINING ATTORNEY

Int. Cl.: 20

Prior U.S. Cls.: 2, 13, 22, 25, 32, and 50

United States Patent and Trademark Office

Reg. No. 3,481,737

Registered Aug. 5, 2008

**TRADEMARK
PRINCIPAL REGISTER**

XTREME GARAGE

MENARD, INC. (WISCONSIN CORPORATION)
4777 MENARD DRIVE
EAU CLAIRE, WI 54703

OWNER OF U.S. REG. NOS. 3,126,317 AND
3,129,290.

FOR: SEATS, PLASTIC WHEEL CHOCKS, IN
CLASS 20 (U.S. CLS. 2, 13, 22, 25, 32 AND 50).

NO CLAIM IS MADE TO THE EXCLUSIVE
RIGHT TO USE "GARAGE", APART FROM THE
MARK AS SHOWN.

FIRST USE 1-24-2008; IN COMMERCE 1-24-2008.

SN 77-189,090, FILED 5-24-2007.

THE MARK CONSISTS OF STANDARD CHAR-
ACTERS WITHOUT CLAIM TO ANY PARTICULAR
FONT, STYLE, SIZE, OR COLOR.

KEVON CHISOLM, EXAMINING ATTORNEY

Int. Cl.: 8

Prior U.S. Cls.: 23, 28, and 44

United States Patent and Trademark Office

Reg. No. 3,481,738

Registered Aug. 5, 2008

TRADEMARK
PRINCIPAL REGISTER



MENARD, INC. (WISCONSIN CORPORATION)
4777 MENARD DRIVE
EAU CLAIRE, WI 54703

FOR: MANUALLY-OPERATED JACKS, IN CLASS
8 (U.S. CLS. 23, 28 AND 44).

FIRST USE 1-24-2008; IN COMMERCE 1-24-2008.

OWNER OF U.S. REG. NOS. 3,126,317 AND
3,129,290.

NO CLAIM IS MADE TO THE EXCLUSIVE
RIGHT TO USE "GARAGE", APART FROM THE
MARK AS SHOWN.

THE COLOR(S) RED, BLACK AND SILVER IS/
ARE CLAIMED AS A FEATURE OF THE MARK.

THE MARK CONSISTS OF A BLACK GARAGE-
SHAPE OUTLINE; THE WORD "XTREME" IN RED
WITH THE LETTER "X" BEING LARGER THAN
THE OTHER LETTERS IN THE WORD; THE WORD
"XTREME" IN A STYLIZED FONT; THE WORD
"GARAGE" APPEARING AS IF IT IS SILVER
CHROME AND PORTRAYED AS THOUGH THERE
ARE CHROME RIVETS ON THE LETTERING.

SN 77-189,099, FILED 5-24-2007.

KEVON CHISOLM, EXAMINING ATTORNEY

Int. Cl.: 30

Prior U.S. Cl.: 46

United States Patent and Trademark Office

Reg. No. 3,481,739

Registered Aug. 5, 2008

**TRADEMARK
PRINCIPAL REGISTER**

PEACE BOMB

AVB, INC. (OREGON CORPORATION)
5209 SE INTERNATIONAL WAY
MILWAUKIE, OR 97222

THE MARK CONSISTS OF STANDARD CHAR-
ACTERS WITHOUT CLAIM TO ANY PARTICULAR
FONT, STYLE, SIZE, OR COLOR.

FOR: BREAD, IN CLASS 30 (U.S. CL. 46).

SN 77-189,955, FILED 5-24-2007.

FIRST USE 9-0-2007; IN COMMERCE 9-0-2007.

HENRY S. ZAK, EXAMINING ATTORNEY

Int. Cl.: 14

Prior U.S. Cls.: 2, 27, 28, and 50

United States Patent and Trademark Office

Reg. No. 3,481,740

Registered Aug. 5, 2008

**TRADEMARK
PRINCIPAL REGISTER**



MERIT DIAMOND CORPORATION (NEW YORK CORPORATION)

1900 TYLER STREET

HOLLYWOOD, FL 33020

FOR: JEWELRY; PRECIOUS METALS; PRECIOUS STONES; AND SEMI-PRECIOUS STONES, IN CLASS 14 (U.S. CLS. 2, 27, 28 AND 50).

FIRST USE 5-10-2007; IN COMMERCE 5-15-2007.

NO CLAIM IS MADE TO THE EXCLUSIVE RIGHT TO USE "FIT", APART FROM THE MARK AS SHOWN.

THE MARK CONSISTS OF THE LETTER "M" DISPOSED IN A RING SHAPED DESIGN ELEMENT AND THE ELEMENT "FIT" DISPOSED ADJACENT THERETO.

SN 77-190,374, FILED 5-25-2007.

EVELYN BRADLEY, EXAMINING ATTORNEY

Int. Cl.: 5

Prior U.S. Cls.: 6, 18, 44, 46, 51, and 52

Reg. No. 3,481,741

United States Patent and Trademark Office

Registered Aug. 5, 2008

**TRADEMARK
PRINCIPAL REGISTER**

TRIPLE FIT

RTM ENTERPRISES, LLC (NEW JERSEY LTD
LIAB CO)
SUITE 189
244 MADISON AVENUE
NEW YORK, NY 10016

THE MARK CONSISTS OF STANDARD CHAR-
ACTERS WITHOUT CLAIM TO ANY PARTICULAR
FONT, STYLE, SIZE, OR COLOR.

FOR: NUTRITIONAL SUPPLEMENTS, IN CLASS
5 (U.S. CLS. 6, 18, 44, 46, 51 AND 52).

SN 77-190,469, FILED 5-25-2007.

FIRST USE 6-5-2007; IN COMMERCE 6-5-2007.

DANIEL CAPSHAW, EXAMINING ATTORNEY

Int. Cl.: 28

Prior U.S. Cls.: 22, 23, 38, and 50

United States Patent and Trademark Office

Reg. No. 3,481,742

Registered Aug. 5, 2008

**TRADEMARK
PRINCIPAL REGISTER**

SHREDMASTER

DREAMGEAR, LLC (DELAWARE LTD LIAB CO)
20001 S. WESTERN AVENUE
TORRANCE, CA 90501

THE MARK CONSISTS OF STANDARD CHAR-
ACTERS WITHOUT CLAIM TO ANY PARTICULAR
FONT, STYLE, SIZE, OR COLOR.

FOR: TOY GUITAR FOR USE WITH VIDEO
GAMES, IN CLASS 28 (U.S. CLS. 22, 23, 38 AND 50).

SN 77-190,724, FILED 5-25-2007.

FIRST USE 10-30-2007; IN COMMERCE 10-30-2007.

SANJEEV VOHRA, EXAMINING ATTORNEY

Int. Cl.: 35

Prior U.S. Cls.: 100, 101, and 102

United States Patent and Trademark Office

Reg. No. 3,481,743

Registered Aug. 5, 2008

**SERVICE MARK
PRINCIPAL REGISTER**

REDPLUM

VALASSIS COMMUNICATIONS, INC. (DELA-
WARE CORPORATION)
19975 VICTOR PARKWAY
LIVONIA, MI 481527001

FOR: PROMOTING THE GOODS AND SERVICES
OF OTHERS THROUGH THE DISTRIBUTION OF
COUPONS, SAMPLES AND PRINTED ADVERTIS-
ING; ADVERTISING AND MEDIA PLANNING
SERVICES, NAMELY, BUSINESS MARKETING
CONSULTING SERVICES; MARKET ANALYSIS;
DISSEMINATION OF ADVERTISING FOR OTHERS
VIA ON-LINE ELECTRONIC COMMUNICATIONS

NETWORK, IN CLASS 35 (U.S. CLS. 100, 101 AND
102).

FIRST USE 1-3-2008; IN COMMERCE 1-3-2008.

THE MARK CONSISTS OF STANDARD CHAR-
ACTERS WITHOUT CLAIM TO ANY PARTICULAR
FONT, STYLE, SIZE, OR COLOR.

SN 77-190,841, FILED 5-25-2007.

REBECCA SMITH, EXAMINING ATTORNEY

Int. Cl.: 9

Prior U.S. Cls.: 21, 23, 26, 36, and 38

United States Patent and Trademark Office

Reg. No. 3,481,744

Registered Aug. 5, 2008

**TRADEMARK
PRINCIPAL REGISTER**

E.S.I.DISCOVER

TECHNOLOGY PATHWAYS, LLC (CALIFORNIA
LTD LIAB CO)
1132 FIRST STREET
CORONADO, CA 92118

FOR: COMPUTER SOFTWARE AND HARD-
WARE FOR IDENTIFYING, LOCATING OR EX-
TRACTING RELEVANT COMPUTER STORED
INFORMATION DURING AN INVESTIGATION
OR ELECTRONIC DISCOVERY PROCESS , IN
CLASS 9 (U.S. CLS. 21, 23, 26, 36 AND 38).

FIRST USE 6-2-2008; IN COMMERCE 6-2-2008.

THE MARK CONSISTS OF STANDARD CHAR-
ACTERS WITHOUT CLAIM TO ANY PARTICULAR
FONT, STYLE, SIZE, OR COLOR.

SN 77-191,932, FILED 5-29-2007.

DAVID YONTEF, EXAMINING ATTORNEY

Int. Cl.: 42

Prior U.S. Cls.: 100 and 101

United States Patent and Trademark Office

Reg. No. 3,481,745

Registered Aug. 5, 2008

**SERVICE MARK
PRINCIPAL REGISTER**

RIGHTPOINT CONSULTING

RIGHTPOINT GROUP, LLC. (ILLINOIS LTD
LIAB CO)
2699 LISA COURT
NORTHBROOK, IL 60062

FOR: CONSULTING SERVICES IN THE FIELD
OF DESIGN, SELECTION, IMPLEMENTATION
AND USE OF COMPUTER HARDWARE AND
SOFTWARE SYSTEMS FOR OTHERS, IN CLASS 42
(U.S. CLS. 100 AND 101).

FIRST USE 5-7-2007; IN COMMERCE 5-7-2007.

THE MARK CONSISTS OF STANDARD CHAR-
ACTERS WITHOUT CLAIM TO ANY PARTICULAR
FONT, STYLE, SIZE, OR COLOR.

NO CLAIM IS MADE TO THE EXCLUSIVE
RIGHT TO USE "CONSULTING", APART FROM
THE MARK AS SHOWN.

SN 77-192,064, FILED 5-29-2007.

SUE LAWRENCE, EXAMINING ATTORNEY

Int. Cls.: 36 and 45

Prior U.S. Cls.: 100, 101, and 102

United States Patent and Trademark Office

Reg. No. 3,481,746

Registered Aug. 5, 2008

**SERVICE MARK
PRINCIPAL REGISTER**

WELLS FARGO PAYMENT GATEWAY

WELLS FARGO & COMPANY (DELAWARE CORPORATION)
1700 WELLS FARGO CENTER, MAC N9305-176
SIXTH AND MARQUETTE
MINNEAPOLIS, MN 55479

FOR: BANKING AND FINANCIAL SERVICES, NAMELY, CREDIT CARD TRANSACTION PROCESSING SERVICES; ELECTRONIC PAYMENT PROCESSING SERVICES; FINANCIAL FRAUD AND RISK MANAGEMENT SERVICES WITH RESPECT TO CREDIT CARDS, AND ELECTRONIC CHECKS, NAMELY, FINANCIAL RISK MANAGEMENT IN THE FIELD OF CREDIT CARD, AND ELECTRONIC CHECKS, IN CLASS 36 (U.S. CLS. 100, 101 AND 102).

FIRST USE 8-31-2007; IN COMMERCE 8-31-2007.

FOR: FRAUD SERVICES WITH RESPECT TO CREDIT CARDS AND ELECTRONIC CHECKS,

NAMELY, FRAUD DETECTION SERVICES IN THE FIELD OF CREDIT CARD AND ELECTRONIC CHECKS, IN CLASS 45 (U.S. CLS. 100 AND 101).

FIRST USE 8-31-2007; IN COMMERCE 8-31-2007.

THE MARK CONSISTS OF STANDARD CHARACTERS WITHOUT CLAIM TO ANY PARTICULAR FONT, STYLE, SIZE, OR COLOR.

OWNER OF U.S. REG. NOS. 1,136,497, 2,846,212, AND OTHERS.

NO CLAIM IS MADE TO THE EXCLUSIVE RIGHT TO USE "PAYMENT GATEWAY", APART FROM THE MARK AS SHOWN.

SN 77-192,102, FILED 5-29-2007.

JAY BESCH, EXAMINING ATTORNEY

Int. Cl.: 28

Prior U.S. Cls.: 22, 23, 38, and 50

United States Patent and Trademark Office

Reg. No. 3,481,747

Registered Aug. 5, 2008

**TRADEMARK
PRINCIPAL REGISTER**

Poolmate

OVERTON'S, INC. (NORTH CAROLINA CORPORATION)
111 RED BANKS ROAD
GREENVILLE, NC 27834

THE MARK CONSISTS OF STANDARD CHARACTERS WITHOUT CLAIM TO ANY PARTICULAR FONT, STYLE, SIZE, OR COLOR.

FOR: INFLATABLE FLOAT MATTRESSES OR TUBES FOR RECREATIONAL USE, IN CLASS 28 (U.S. CLS. 22, 23, 38 AND 50).

SN 77-192,720, FILED 5-30-2007.

FIRST USE 5-0-2008; IN COMMERCE 5-0-2008.

CHERYL CLAYTON, EXAMINING ATTORNEY

Int. Cl.: 31

Prior U.S. Cls.: 1 and 46

United States Patent and Trademark Office

Reg. No. 3,481,748

Registered Aug. 5, 2008

TRADEMARK
PRINCIPAL REGISTER



HERGENREDER, JAMES E. (UNITED STATES
INDIVIDUAL)
1358 TRAIL RIDGE ROAD
LONGMONT, CO 80501

FOR: CORN SEEDS, IN CLASS 31 (U.S. CLS. 1 AND
46).

FIRST USE 2-16-2008; IN COMMERCE 3-8-2008.

NO CLAIM IS MADE TO THE EXCLUSIVE
RIGHT TO USE "CORN INTERNATIONAL" ,
APART FROM THE MARK AS SHOWN.

THE STIPPLING IS FOR SHADING PURPOSES
ONLY.

THE MARK CONSISTS OF CORN SEEDS ON A
CORN COB WITH A SUNSET IN THE MIDDLE OF
THE CORN COB. THE WORDS "PLANET CORN"
ON TOP WITH THE WORD "INTERNATIONAL" ON
THE BANNER.

SN 77-192,966, FILED 5-30-2007.

MARCIE MILONE, EXAMINING ATTORNEY

Int. Cl.: 35

Prior U.S. Cls.: 100, 101, and 102

United States Patent and Trademark Office

Reg. No. 3,481,749

Registered Aug. 5, 2008

**SERVICE MARK
PRINCIPAL REGISTER**

HIGHWAYHARBOR MANAGEMENT CO

HIGHWAYHARBOR MANAGEMENT CO. (MINNESOTA CORPORATION)
1111 RANGE STREET, SUITE 202
NORTH MANKATO, MN 56003

FOR: BUSINESS CONSULTING SERVICES IN THE FIELD OF HOTEL AND MOTEL MANAGEMENT; HOTEL AND MOTEL MANAGEMENT FOR OTHERS; ACCOUNTING CONSULTATION AND ACCOUNTING SERVICES FOR OTHERS, IN CLASS 35 (U.S. CLS. 100, 101 AND 102).

FIRST USE 3-22-2007; IN COMMERCE 3-22-2007.

THE MARK CONSISTS OF STANDARD CHARACTERS WITHOUT CLAIM TO ANY PARTICULAR FONT, STYLE, SIZE, OR COLOR.

NO CLAIM IS MADE TO THE EXCLUSIVE RIGHT TO USE "MANAGEMENT CO", APART FROM THE MARK AS SHOWN.

SN 77-195,634, FILED 6-1-2007.

JAY BESCH, EXAMINING ATTORNEY

Int. Cl.: 21

Prior U.S. Cls.: 2, 13, 23, 29, 30, 33, 40, and 50

United States Patent and Trademark Office

Reg. No. 3,481,750

Registered Aug. 5, 2008

**TRADEMARK
PRINCIPAL REGISTER**



CHRISTINE'S LLC (SOUTH CAROLINA LTD
LIAB CO)
103 WESTON ESTATES DRIVE
EASLEY, SC 29642

FOR: CAKE STANDS, IN CLASS 21 (U.S. CLS. 2, 13,
23, 29, 30, 33, 40 AND 50).

FIRST USE 6-18-2007; IN COMMERCE 6-18-2007.

NO CLAIM IS MADE TO THE EXCLUSIVE
RIGHT TO USE "CAKE" AND "WHEEL", APART
FROM THE MARK AS SHOWN.

THE MARK CONSISTS OF THE WORDING "THE
CAKE WHEEL" AND A DESIGN SHOWING A
SERIES OF SWIRLS AND CURVED LINES DEPICT-
ING A LAYERED CAKE.

SN 77-196,980, FILED 6-4-2007.

LAURA HAMMEL, EXAMINING ATTORNEY

Int. Cl.: 28

Prior U.S. Cls.: 22, 23, 38, and 50

United States Patent and Trademark Office

Reg. No. 3,481,751

Registered Aug. 5, 2008

**TRADEMARK
PRINCIPAL REGISTER**

SOCTOPUS BABIES

MASCHOTT LLC (VIRGINIA LTD LIAB CO)
10800 GLEN MIST LANE
FAIRFAX, VA 22030

FOR: PLUSH TOYS, IN CLASS 28 (U.S. CLS. 22, 23,
38 AND 50).

FIRST USE 5-21-2008; IN COMMERCE 5-21-2008.

THE MARK CONSISTS OF STANDARD CHAR-
ACTERS WITHOUT CLAIM TO ANY PARTICULAR
FONT, STYLE, SIZE, OR COLOR.

NO CLAIM IS MADE TO THE EXCLUSIVE
RIGHT TO USE "BABIES", APART FROM THE
MARK AS SHOWN.

SN 77-197,511, FILED 6-5-2007.

DAVID YONTEF, EXAMINING ATTORNEY

Int. Cl.: 25

Prior U.S. Cls.: 22 and 39

United States Patent and Trademark Office

Reg. No. 3,481,752

Registered Aug. 5, 2008

**TRADEMARK
PRINCIPAL REGISTER**

SALT VALLEY WESTERN

URBAN OUTFITTERS (DELAWARE), INC. (DE-
LAWARE CORPORATION)
5000 SOUTH BROAD STREET
PHILADELPHIA, PA 191121495

NO CLAIM IS MADE TO THE EXCLUSIVE
RIGHT TO USE "WESTERN", APART FROM THE
MARK AS SHOWN.

FOR: SHIRTS, IN CLASS 25 (U.S. CLS. 22 AND 39).

FIRST USE 2-15-2007; IN COMMERCE 2-15-2007.

SN 77-198,082, FILED 6-5-2007.

THE MARK CONSISTS OF STANDARD CHAR-
ACTERS WITHOUT CLAIM TO ANY PARTICULAR
FONT, STYLE, SIZE, OR COLOR.

JASON BLAIR, EXAMINING ATTORNEY

Int. Cl.: 3

Prior U.S. Cls.: 1, 4, 6, 50, 51, and 52

United States Patent and Trademark Office

Reg. No. 3,481,753

Registered Aug. 5, 2008

**TRADEMARK
PRINCIPAL REGISTER**

TRULY LASTING COLOR

REVLON CONSUMER PRODUCTS CORPORATION
(DELAWARE CORPORATION)

237 PARK AVENUE

NEW YORK, NY 10017

FOR: COSMETICS; MAKE-UP, IN CLASS 3 (U.S.
CLS. 1, 4, 6, 50, 51 AND 52).

FIRST USE 11-7-2007; IN COMMERCE 11-7-2007.

THE MARK CONSISTS OF STANDARD CHAR-
ACTERS WITHOUT CLAIM TO ANY PARTICULAR
FONT, STYLE, SIZE, OR COLOR.

NO CLAIM IS MADE TO THE EXCLUSIVE
RIGHT TO USE "LASTING COLOR", APART FROM
THE MARK AS SHOWN.

SN 77-198,691, FILED 6-6-2007.

BRIAN NEVILLE, EXAMINING ATTORNEY

Int. Cl.: 9

Prior U.S. Cls.: 21, 23, 26, 36, and 38

United States Patent and Trademark Office

Reg. No. 3,481,754

Registered Aug. 5, 2008

**TRADEMARK
PRINCIPAL REGISTER**



INNOVATIVE WIRELESS TECHNOLOGIES, INC.
(VIRGINIA CORPORATION)
1047 VISTA PARK DRIVE
FOREST, VA 24551

FOR: COMPUTER SOFTWARE FOR MANAGING, OPERATING, MONITORING AND CONTROLLING NETWORKS OF WIRELESS RADIO TRANSCEIVER NETWORKS AND OTHER ELECTRONIC DEVICES, IN CLASS 9 (U.S. CLS. 21, 23, 26, 36 AND 38).

FIRST USE 4-6-2006; IN COMMERCE 8-4-2006.

OWNER OF U.S. REG. NO. 3,253,060.

THE COLOR(S) BLUE, WHITE AND GRAY IS/ARE CLAIMED AS A FEATURE OF THE MARK.

THE MARK CONSISTS OF A LIGHT GRAY SHADED LETTER "M" AND DARK BLUE SHADED "PROV" SUPERIMPOSED ON A BACKGROUND OF A VARIOUSLY BLUE-SHADED DIAMOND CONTAINING THREE WHITE CRESCENTS AND A WHITE CIRCLE.

SN 77-198,761, FILED 6-6-2007.

DAWN FELDMAN, EXAMINING ATTORNEY

Int. Cl.: 41

Prior U.S. Cls.: 100, 101, and 107

United States Patent and Trademark Office

Reg. No. 3,481,755

Registered Aug. 5, 2008

**SERVICE MARK
PRINCIPAL REGISTER**

eccelingua

ADOLFO, CARCAÑO RICALDE GUSTAVO
(MEXICO INDIVIDUAL)
C-49 F # 276 X 46 Y 48 FCO DE MONTEJO
MERIDA, MEXICO

THE MARK CONSISTS OF STANDARD CHAR-
ACTERS WITHOUT CLAIM TO ANY PARTICULAR
FONT, STYLE, SIZE, OR COLOR.

FOR: EDUCATION SERVICES, NAMELY, PRO-
VIDING LIVE AND ON-LINE CLASSES, SEMINARS,
WORKSHOPS IN THE FIELD OF LANGUAGES, IN
CLASS 41 (U.S. CLS. 100, 101 AND 107).

SN 77-199,293, FILED 6-6-2007.

FIRST USE 2-2-2007; IN COMMERCE 4-1-2007.

JULIE GUTTADAURO, EXAMINING ATTORNEY

Int. Cl.: 2

Prior U.S. Cls.: 6, 11, and 16

United States Patent and Trademark Office

Reg. No. 3,481,756

Registered Aug. 5, 2008

**TRADEMARK
PRINCIPAL REGISTER**

GO GREEN

MASTERCHEM INDUSTRIES LLC (MISSOURI
LTD LIAB CO)
3135 HIGHWAY M
IMPERIAL, MO 63052

FOR: INTERIOR AND EXTERIOR PAINTS AND
PAINT PRIMERS, IN CLASS 2 (U.S. CLS. 6, 11 AND
16).

FIRST USE 6-5-2007; IN COMMERCE 6-5-2007.

THE MARK CONSISTS OF STANDARD CHAR-
ACTERS WITHOUT CLAIM TO ANY PARTICULAR
FONT, STYLE, SIZE, OR COLOR.

NO CLAIM IS MADE TO THE EXCLUSIVE
RIGHT TO USE "GREEN", APART FROM THE
MARK AS SHOWN.

SN 77-200,434, FILED 6-7-2007.

CHRISTINA SOBRAL, EXAMINING ATTORNEY

Int. Cl.: 4

Prior U.S. Cls.: 1, 6, and 15

United States Patent and Trademark Office

Reg. No. 3,481,757

Registered Aug. 5, 2008

**TRADEMARK
PRINCIPAL REGISTER**

ANGELS FOR ANIMALS

HEAVEN TO HOME, LLC (ARIZONA LTD LIAB
CO)
1493 EAST MESQUITE STREET
GILBERT, AZ 85296

THE MARK CONSISTS OF STANDARD CHAR-
ACTERS WITHOUT CLAIM TO ANY PARTICULAR
FONT, STYLE, SIZE, OR COLOR.

FOR: CANDLES, IN CLASS 4 (U.S. CLS. 1, 6 AND
15).

SN 77-200,595, FILED 6-7-2007.

FIRST USE 6-1-2008; IN COMMERCE 6-1-2008.

REBECCA SMITH, EXAMINING ATTORNEY

Int. Cl.: 41

Prior U.S. Cls.: 100, 101, and 107

United States Patent and Trademark Office

Reg. No. 3,481,758

Registered Aug. 5, 2008

**SERVICE MARK
PRINCIPAL REGISTER**

PROTECT THE FUTURE

HENLEY-PUTNAM UNIVERSITY (CALIFORNIA
CORPORATION)
25 METRO DRIVE
SUITE 500
SAN JOSE, CA 95110

FOR: EDUCATIONAL SERVICES, NAMELY,
PROVIDING UNDERGRADUATE, GRADUATE,
AND PROFESSIONAL COURSES TO OTHERS; PRO-
VIDING INFORMATION ABOUT UNIVERSITY LE-
VEL EDUCATION AND RESEARCH VIA A
WEBSITE ON A GLOBAL COMPUTER NETWORK;
ONLINE EDUCATIONAL SERVICES, NAMELY,
PROVIDING UNDERGRADUATE, GRADUATE,

AND PROFESSIONAL COURSES OF INSTRU-
TION VIA A GLOBAL COMPUTER NETWORK, IN
CLASS 41 (U.S. CLS. 100, 101 AND 107).

FIRST USE 5-14-2007; IN COMMERCE 5-14-2007.

THE MARK CONSISTS OF STANDARD CHAR-
ACTERS WITHOUT CLAIM TO ANY PARTICULAR
FONT, STYLE, SIZE, OR COLOR.

SN 77-200,693, FILED 6-7-2007.

JENNIFER VASQUEZ, EXAMINING ATTORNEY

Int. Cl.: 2

Prior U.S. Cls.: 6, 11, and 16

United States Patent and Trademark Office

Reg. No. 3,481,759

Registered Aug. 5, 2008

**TRADEMARK
PRINCIPAL REGISTER**



MASTERCHEM INDUSTRIES LLC (MISSOURI
LTD LIAB CO)
3135 HIGHWAY M
IMPERIAL, MO 63052

FOR: INTERIOR AND EXTERIOR PAINTS AND
PAINT PRIMERS, IN CLASS 2 (U.S. CLS. 6, 11 AND
16).

FIRST USE 6-5-2007; IN COMMERCE 6-5-2007.

NO CLAIM IS MADE TO THE EXCLUSIVE
RIGHT TO USE "GREEN LOW VOC", APART FROM
THE MARK AS SHOWN.

THE MARK CONSISTS OF A SQUARE WITH THE
WORDS "GO GREEN" WITHIN A TREE AND THE
WORDS "LOW VOC" ACROSS THE BOTTOM OF
THE SQUARE.

SN 77-201,025, FILED 6-8-2007.

CHRISTINA SOBRAL, EXAMINING ATTORNEY

Int. Cl.: 25

Prior U.S. Cls.: 22 and 39

United States Patent and Trademark Office

Reg. No. 3,481,760

Registered Aug. 5, 2008

**TRADEMARK
PRINCIPAL REGISTER**

Cooljam

MAHAFFEY, ANITA C (UNITED STATES INDIVIDUAL)
11206 SPENCERPORT WAY
SAN DIEGO, CA 92131

FOR: PAJAMA BOTTOMS; PAJAMAS; BATHROBES; NIGHTWEAR; CAPRI PANTS; LOUNGE PANTS; SWEAT PANTS; NIGHT SHIRTS; SLEEP SHIRTS IN CONNECTION WITH MOISTURE-WICKING SLEEPWEAR AMELIORATING PHYSICAL DISCOMFORT FROM NIGHT SWEATS, IN CLASS 25 (U.S. CLS. 22 AND 39).

FIRST USE 6-1-2005; IN COMMERCE 3-1-2006.

THE MARK CONSISTS OF STANDARD CHARACTERS WITHOUT CLAIM TO ANY PARTICULAR FONT, STYLE, SIZE, OR COLOR.

SN 77-201,826, FILED 6-8-2007.

EVELYN BRADLEY, EXAMINING ATTORNEY

Int. Cl.: 5

Prior U.S. Cls.: 6, 18, 44, 46, 51, and 52

Reg. No. 3,481,761

United States Patent and Trademark Office

Registered Aug. 5, 2008

**TRADEMARK
PRINCIPAL REGISTER**

Calcium MD

TRX LABS INC. (ARIZONA CORPORATION)
PO BOX 93477
PHOENIX, AZ 850703477

THE MARK CONSISTS OF STANDARD CHARACTERS WITHOUT CLAIM TO ANY PARTICULAR FONT, STYLE, SIZE, OR COLOR.

FOR: CALCIUM SUPPLEMENTS; DIETARY AND NUTRITIONAL SUPPLEMENTS; DIETARY SUPPLEMENTS FOR HUMAN CONSUMPTION, IN CLASS 5 (U.S. CLS. 6, 18, 44, 46, 51 AND 52).

NO CLAIM IS MADE TO THE EXCLUSIVE RIGHT TO USE "CALCIUM", APART FROM THE MARK AS SHOWN.

SN 77-202,171, FILED 6-9-2007.

FIRST USE 1-15-2008; IN COMMERCE 4-15-2008.

KAREN M. STRYZ, EXAMINING ATTORNEY

Int. Cls.: 10 and 11

Prior U.S. Cls.: 13, 21, 23, 26, 31, 34, 39, and 44

United States Patent and Trademark Office

Reg. No. 3,481,762

Registered Aug. 5, 2008

**TRADEMARK
PRINCIPAL REGISTER**

VAPROSURE

STERIS INC. (DELAWARE CORPORATION)
43425 BUSINESS PARK DRIVE
TEMECULA, CA 92590

FOR: VAPORIZED HYDROGEN PEROXIDE
STERILIZERS AND BIODECONTAMINATION SYS-
TEM COMPRISED OF STERILIZATION UNITS FOR
MEDICAL USE, IN CLASS 10 (U.S. CLS. 26, 39 AND
44).

FIRST USE 7-30-2007; IN COMMERCE 7-30-2007.

FOR: VAPORIZED HYDROGEN PEROXIDE
STERILIZERS AND BIODECONTAMINATION SYS-

TEM COMPRISED OF STERILIZERS NOT FOR
MEDICAL USE, IN CLASS 11 (U.S. CLS. 13, 21, 23,
31 AND 34).

FIRST USE 7-30-2007; IN COMMERCE 7-30-2007.

THE MARK CONSISTS OF STANDARD CHAR-
ACTERS WITHOUT CLAIM TO ANY PARTICULAR
FONT, STYLE, SIZE, OR COLOR.

SN 77-202,496, FILED 6-11-2007.

REBECCA GILBERT, EXAMINING ATTORNEY

Int. Cls.: 35 and 42

Prior U.S. Cls.: 100, 101, and 102

United States Patent and Trademark Office

Reg. No. 3,481,763

Registered Aug. 5, 2008

**SERVICE MARK
PRINCIPAL REGISTER**

MARKETPOINT

PIONEER HI-BRED INTERNATIONAL, INC.
(IOWA CORPORATION)
PO BOX 1014
7100 NW 62ND AVENUE
JOHNSTON, IA 501311014

FOR: PROVIDING AN ON-LINE EXCHANGE TO FACILITATE THE SALE AND PURCHASE OF AGRICULTURAL GRAIN BETWEEN FARMERS AND END-USERS BASED ON GRAIN CHARACTERISTICS, QUALITIES, AND QUANTITIES, IN CLASS 35 (U.S. CLS. 100, 101 AND 102).

FIRST USE 9-19-2007; IN COMMERCE 9-19-2007.

FOR: AGRICULTURAL RESEARCH, NAMELY, MONITORING GRAIN CHARACTERISTICS, QUALITIES, AND QUANTITIES FOR ON-LINE AGRICULTURAL GRAIN EXCHANGE LISTINGS, IN CLASS 42 (U.S. CLS. 100 AND 101).

FIRST USE 9-19-2007; IN COMMERCE 9-19-2007.

THE MARK CONSISTS OF STANDARD CHARACTERS WITHOUT CLAIM TO ANY PARTICULAR FONT, STYLE, SIZE, OR COLOR.

SN 77-202,544, FILED 6-11-2007.

KAREN K. BUSH, EXAMINING ATTORNEY

Int. Cl.: 9

Prior U.S. Cls.: 21, 23, 26, 36, and 38

Reg. No. 3,481,764

United States Patent and Trademark Office

Registered Aug. 5, 2008

**TRADEMARK
PRINCIPAL REGISTER**

TURBO-MASS

AMETEK, INC. (DELAWARE CORPORATION)
P.O. BOX 1764
37 NORTH VALLEY ROAD, BUILDING 4
PAOLI, PA 193010801

THE MARK CONSISTS OF STANDARD CHAR-
ACTERS WITHOUT CLAIM TO ANY PARTICULAR
FONT, STYLE, SIZE, OR COLOR.

FOR: FLOWMETERS, IN CLASS 9 (U.S. CLS. 21, 23,
26, 36 AND 38).

SN 77-202,753, FILED 6-11-2007.

FIRST USE 1-28-2008; IN COMMERCE 1-28-2008.

AMY HELLA, EXAMINING ATTORNEY

Int. Cl.: 11

Prior U.S. Cls.: 13, 21, 23, 31, and 34

United States Patent and Trademark Office

Reg. No. 3,481,765

Registered Aug. 5, 2008

**TRADEMARK
PRINCIPAL REGISTER**

SPYDER

BEGHELLI NORTH AMERICA (FLORIDA CORPORATION)
UNIT A
3250 CORPORATE WAY
MIRAMAR, FL 33025

FOR: ELECTRIC LUMINAIRES, LIGHT POST LUMINAIRES, LUMINAIRE REFRACTORS, LINEAR AND COMPACT FLUORESCENT LAMP SOURCES, NAMELY, FLORESCENT LAMPS AND FLORESCENT LAMP TUBES; HIGH PERFORMANCE, HIGH EFFICIENCY LINEAR LUMINAIRES FOR INDOOR AND OUTDOOR INDUSTRIAL USE, IN CLASS 11 (U.S. CLS. 13, 21, 23, 31 AND 34).

FIRST USE 12-0-2007; IN COMMERCE 12-0-2007.

THE MARK CONSISTS OF STANDARD CHARACTERS WITHOUT CLAIM TO ANY PARTICULAR FONT, STYLE, SIZE, OR COLOR.

"SPYDER" OR "SPIDER" HAS NO MEANING IN A FOREIGN LANGUAGE.

SN 77-203,730, FILED 6-12-2007.

AHSEN KHAN, EXAMINING ATTORNEY

Int. Cl.: 3

Prior U.S. Cls.: 1, 4, 6, 50, 51, and 52

United States Patent and Trademark Office

Reg. No. 3,481,766

Registered Aug. 5, 2008

**TRADEMARK
PRINCIPAL REGISTER**

FRENCH CLUB

SOCIETE PARISIENNE DE PARFUMS ET COS-
METIQUES (FRANCE CORPORATION)

11, RUE MARGUERITTE

PARIS, FRANCE 75017

FOR: PERFUMES AND COLOGNES, IN CLASS 3
(U.S. CLS. 1, 4, 6, 50, 51 AND 52).

FIRST USE 0-0-1995; IN COMMERCE 3-0-2008.

THE MARK CONSISTS OF STANDARD CHAR-
ACTERS WITHOUT CLAIM TO ANY PARTICULAR
FONT, STYLE, SIZE, OR COLOR.

NO CLAIM IS MADE TO THE EXCLUSIVE
RIGHT TO USE "FRENCH", APART FROM THE
MARK AS SHOWN.

SN 77-203,957, FILED 6-12-2007.

CARRIE GENOVESE, EXAMINING ATTORNEY

Int. Cl.: 10

Prior U.S. Cls.: 26, 39, and 44

United States Patent and Trademark Office

Reg. No. 3,481,767

Registered Aug. 5, 2008

**TRADEMARK
PRINCIPAL REGISTER**

NEVER STOP LOOKING

ICAD, INC. (DELAWARE CORPORATION)
SUITE 100
98 SPIT BROOK ROAD
NASHUA, NH 03062

FOR: MEDICAL APPARATUS, NAMELY, DIAG-
NOSTIC IMAGING APPARATUS FOR COMPUTER-
ASSISTED ANALYSIS OF ABNORMALITIES IN
MEDICAL IMAGES AND RELATED OPERATING
SOFTWARE, SOLD AS A UNIT , IN CLASS 10 (U.S.
CLS. 26, 39 AND 44).

FIRST USE 6-15-2007; IN COMMERCE 6-15-2007.

THE MARK CONSISTS OF STANDARD CHAR-
ACTERS WITHOUT CLAIM TO ANY PARTICULAR
FONT, STYLE, SIZE, OR COLOR.

SN 77-205,065, FILED 6-13-2007.

LEIGH CAROLINE CASE, EXAMINING ATTOR-
NEY

Int. Cl.: 5

Prior U.S. Cls.: 6, 18, 44, 46, 51, and 52

Reg. No. 3,481,768

United States Patent and Trademark Office

Registered Aug. 5, 2008

**TRADEMARK
PRINCIPAL REGISTER**

JOINT XPRESS

PROMAX NUTRITION, INC. (CALIFORNIA CORPORATION)

1915 MARK COURT, SUITE 150

CONCORD, CA 94520

FOR: NUTRITIONAL SUPPLEMENTS, IN CLASS 5 (U.S. CLS. 6, 18, 44, 46, 51 AND 52).

FIRST USE 8-1-2007; IN COMMERCE 8-1-2007.

THE MARK CONSISTS OF STANDARD CHARACTERS WITHOUT CLAIM TO ANY PARTICULAR FONT, STYLE, SIZE, OR COLOR.

NO CLAIM IS MADE TO THE EXCLUSIVE RIGHT TO USE "JOINT", APART FROM THE MARK AS SHOWN.

SN 77-205,502, FILED 6-13-2007.

MARLENE BELL, EXAMINING ATTORNEY

Int. Cl.: 43

Prior U.S. Cls.: 100 and 101

United States Patent and Trademark Office

Reg. No. 3,481,769

Registered Aug. 5, 2008

SERVICE MARK
PRINCIPAL REGISTER



HUNTINGTON HILL VENTURES, LLC. (OREGON LTD LIAB CO)
4585 SW TRAIL ROAD
TUALATIN, OR 97062

FOR: CAFE-RESTAURANTS; CAFES; CARRY-OUT RESTAURANTS; CATERING OF FOOD AND DRINKS; CHILD CARE; CHILD CARE CENTERS; CHILD CARE SERVICES; CHILD WELFARE SERVICES, NAMELY, PROVIDING RESIDENTIAL HOMES AND HOUSING FOR AT-RISK CHILDREN AND YOUTH; CHILDREN'S CRECHES; DAY CARE CENTERS; DELICATESSENS; HOTEL, BAR AND RESTAURANT SERVICES; FAST FOOD AND NON-STOP RESTAURANT SERVICES; PREPARATION OF FOOD AND BEVERAGES; PRESCHOOLER AND INFANT CARE AT DAYCARE CENTERS; PROVIDING OF FOOD AND DRINK FOR PATIENTS AND GUESTS; RESTAURANT AND BAR SERVICES; RESTAURANT SERVICES; RESTAURANTS; RESTAURANTS FEATURING HOME DELIVERY; SERVING FOOD AND DRINKS; SERVING

OF FOOD AND DRINK/BEVERAGES; TAKE-OUT RESTAURANT SERVICES; TEA ROOMS, IN CLASS 43 (U.S. CLS. 100 AND 101).

FIRST USE 4-9-2007; IN COMMERCE 7-1-2007.

THE NAME "GRANDMA LEETH" DOES NOT IDENTIFY A LIVING INDIVIDUAL.

THE MARK CONSISTS OF THE PHRASE "GRANDMA LEETH'S" STACKED AND POSITIONED ACROSS THE OPENING AND WITHIN A ROUGH BRUSHSTROKE THAT IS PAINTED CLOCKWISE IN THE SHAPE OF A PARTIAL CIRCLE DESIGN THAT SURROUNDS THE WORDING IN THE MARK.

SN 77-205,696, FILED S.R. 6-14-2007; AM. P.R. 11-16-2007.

SETH A. RAPPAPORT, EXAMINING ATTORNEY

Int. Cl.: 16

Prior U.S. Cls.: 2, 5, 22, 23, 29, 37, 38, and 50

United States Patent and Trademark Office

Reg. No. 3,481,770

Registered Aug. 5, 2008

**TRADEMARK
PRINCIPAL REGISTER**

FUSION

CRAYOLA PROPERTIES, INC. (DELAWARE
CORPORATION)
2035 EDGEWOOD AVENUE
EASTON, PA 18042

THE MARK CONSISTS OF STANDARD CHAR-
ACTERS WITHOUT CLAIM TO ANY PARTICULAR
FONT, STYLE, SIZE, OR COLOR.

FOR: MODELING MATERIALS AND COM-
POUNDS FOR USE BY CHILDREN, IN CLASS 16
(U.S. CLS. 2, 5, 22, 23, 29, 37, 38 AND 50).

SN 77-206,461, FILED 6-14-2007.

FIRST USE 7-30-2007; IN COMMERCE 7-30-2007.

PAUL F. GAST, EXAMINING ATTORNEY

Int. Cl.: 9

Prior U.S. Cls.: 21, 23, 26, 36, and 38

United States Patent and Trademark Office

Reg. No. 3,481,771

Registered Aug. 5, 2008

**TRADEMARK
PRINCIPAL REGISTER**

DIAMOND LANE GUIDANCE

MITSUBISHI MOTORS NORTH AMERICA, INC.
(CALIFORNIA CORPORATION)
6400 KATELLA AVENUE
CYPRESS, CA 906300064

FOR: NAVIGATION APPARATUS FOR VEHICLES, NAMELY, A NAVIGATION SYSTEM COMPRISING ON-BOARD TRANSMITTERS, RECEIVERS, COMPUTER HARDWARE, MEMORY CARDS AND COMPUTER SOFTWARE FOR OPERATION AND INTEGRATION OF SUCH SYSTEM, AND, CDROMS, DVDS, AND ELECTRONIC DATABASES RECORDED ON COMPUTER MEDIA ALL FEATURING ROADWAY, GEOGRAPHIC, MAP, CARPOOL, AND TRAVEL INFORMATION, IN CLASS 9 (U.S. CLS. 21, 23, 26, 36 AND 38).

FIRST USE 8-31-2007; IN COMMERCE 8-31-2007.

THE MARK CONSISTS OF STANDARD CHARACTERS WITHOUT CLAIM TO ANY PARTICULAR FONT, STYLE, SIZE, OR COLOR.

NO CLAIM IS MADE TO THE EXCLUSIVE RIGHT TO USE "LANE GUIDANCE", APART FROM THE MARK AS SHOWN.

SN 77-206,507, FILED 6-14-2007.

HANNO RITTNER, EXAMINING ATTORNEY

Int. Cl.: 30

Prior U.S. Cl.: 46

United States Patent and Trademark Office

Reg. No. 3,481,772

Registered Aug. 5, 2008

**TRADEMARK
PRINCIPAL REGISTER**

dr. dave's mega-O

DR. DAVE'S OMEGA-3 FOODS (WASHINGTON
LTD LIAB CO)
#310
2101 NORTH 55TH STREET
SEATTLE, WA 98103

THE MARK CONSISTS OF STANDARD CHAR-
ACTERS WITHOUT CLAIM TO ANY PARTICULAR
FONT, STYLE, SIZE, OR COLOR.

FOR: CHOCOLATE-BASED READY-TO-EAT
FOOD BARS; CHOCOLATE CANDIES; CHOCO-
LATE TRUFFLES, IN CLASS 30 (U.S. CL. 46).

SN 77-206,811, FILED 6-15-2007.

FIRST USE 11-3-2007; IN COMMERCE 11-12-2007.

BARBARA BROWN, EXAMINING ATTORNEY

Int. Cls.: 16 and 35

Prior U.S. Cls.: 2, 5, 22, 23, 29, 37, 38, 50, 100, 101, and 102

United States Patent and Trademark Office

Reg. No. 3,481,773

Registered Aug. 5, 2008

**TRADEMARK
SERVICE MARK
PRINCIPAL REGISTER**

CIGAR SAVVY

THOMPSON & CO. OF TAMPA, INC. (FLORIDA CORPORATION)
5401 HANGAR COURT
TAMPA, FL 33634

FOR: PRINT CATALOGS IN THE FIELD OF CIGARS, IN CLASS 16 (U.S. CLS. 2, 5, 22, 23, 29, 37, 38 AND 50).

FIRST USE 9-7-2007; IN COMMERCE 9-7-2007.

FOR: ELECTRONIC CATALOG SERVICES FEATURING CIGARS, IN CLASS 35 (U.S. CLS. 100, 101 AND 102).

FIRST USE 9-7-2007; IN COMMERCE 9-7-2007.

THE MARK CONSISTS OF STANDARD CHARACTERS WITHOUT CLAIM TO ANY PARTICULAR FONT, STYLE, SIZE, OR COLOR.

NO CLAIM IS MADE TO THE EXCLUSIVE RIGHT TO USE "CIGAR", APART FROM THE MARK AS SHOWN.

SN 77-206,882, FILED 6-15-2007.

SUNG IN, EXAMINING ATTORNEY

Int. Cl.: 30

Prior U.S. Cl.: 46

United States Patent and Trademark Office

Reg. No. 3,481,774

Registered Aug. 5, 2008

**TRADEMARK
PRINCIPAL REGISTER**

KOALA KRACKERS

HEALTHY HANDFULS, LLC (CALIFORNIA LTD
LIAB CO)
C/O ROGER REYNOLDS
ONE EMBARCADERO CENTER, SUITE 1200
SAN FRANCISCO, CA 94111

FOR: CRACKERS, IN CLASS 30 (U.S. CL. 46).

FIRST USE 6-3-2004; IN COMMERCE 6-4-2004.

THE MARK CONSISTS OF STANDARD CHAR-
ACTERS WITHOUT CLAIM TO ANY PARTICULAR
FONT, STYLE, SIZE, OR COLOR.

OWNER OF U.S. REG. NO. 3,186,398.

NO CLAIM IS MADE TO THE EXCLUSIVE
RIGHT TO USE "CRACKERS", APART FROM THE
MARK AS SHOWN.

SN 77-207,628, FILED 6-15-2007.

MATTHEW PAPPAS, EXAMINING ATTORNEY

Int. Cl.: 14

Prior U.S. Cls.: 2, 27, 28, and 50

United States Patent and Trademark Office

Reg. No. 3,481,775

Registered Aug. 5, 2008

**TRADEMARK
PRINCIPAL REGISTER**

GEFICA

DANIEL ROTH ET GÉRARD GENTA HAUTE
HORLOGERIE SA (SWITZERLAND COR-
PORATION)
CHEMIN DU GRAND-PUITS 42
1217 MEYRIN, SWITZERLAND

FOR: PRECIOUS METALS AND THEIR ALLOYS
SOLD IN BULK; JEWELLERY, JEWELS, PRECIOUS
STONES; HOROLOGICAL AND CHRONOMETRIC
INSTRUMENTS, NAMELY, CLOCKS, WATCHES,
WRISTWATCHES, TABLE CLOCKS AND CHRON-
OMETERS, IN CLASS 14 (U.S. CLS. 2, 27, 28 AND 50).

FIRST USE 0-0-1985; IN COMMERCE 0-0-1987.

THE MARK CONSISTS OF STANDARD CHAR-
ACTERS WITHOUT CLAIM TO ANY PARTICULAR
FONT, STYLE, SIZE, OR COLOR.

SN 77-208,393, FILED 6-18-2007.

LAURIE KAUFMAN, EXAMINING ATTORNEY

Int. Cl.: 35

Prior U.S. Cls.: 100, 101, and 102

United States Patent and Trademark Office

Reg. No. 3,481,776

Registered Aug. 5, 2008

**SERVICE MARK
PRINCIPAL REGISTER**

EXPRESS INVOICING

BANK OF AMERICA CORPORATION (DELA-
WARE CORPORATION)

100 NORTH TRYON STREET

CHARLOTTE, NC 28255

FOR: ONLINE INVOICING SERVICES, IN CLASS
35 (U.S. CLS. 100, 101 AND 102).

FIRST USE 8-0-2007; IN COMMERCE 8-0-2007.

THE MARK CONSISTS OF STANDARD CHAR-
ACTERS WITHOUT CLAIM TO ANY PARTICULAR
FONT, STYLE, SIZE, OR COLOR.

NO CLAIM IS MADE TO THE EXCLUSIVE
RIGHT TO USE "INVOICING", APART FROM THE
MARK AS SHOWN.

SN 77-209,558, FILED 6-19-2007.

TINA BROWN, EXAMINING ATTORNEY

Int. Cls.: 3 and 5

Prior U.S. Cls.: 1, 4, 6, 18, 44, 46, 50, 51, and 52

United States Patent and Trademark Office

Reg. No. 3,481,777

Registered Aug. 5, 2008

**TRADEMARK
PRINCIPAL REGISTER**

Activage

JUSTICE CO., LTD. (JAPAN CORPORATION)
2-4-13 UMEDA
KITA-KU
OSAKA, JAPAN

FOR: CAKES OF TOILET SOAP, COSMETIC
CREAMS, SKIN WHITENING CREAMS, LOTIONS
FOR COSMETIC PURPOSES, NAMELY, FOR ANTI-
AGING, BEAUTY MASKS, NON-MEDICATED COS-
METIC PREPARATIONS FOR SKIN CARE AND
NON-MEDICATED TOILETRIES, IN CLASS 3 (U.S.
CLS. 1, 4, 6, 50, 51 AND 52).

FIRST USE 10-20-2007; IN COMMERCE 2-3-2008.

FOR: DIETARY SUPPLEMENTS, IN CLASS 5 (U.S.
CLS. 6, 18, 44, 46, 51 AND 52).

FIRST USE 10-20-2007; IN COMMERCE 2-3-2008.

SN 77-209,634, FILED 6-19-2007.

HANNO RITTNER, EXAMINING ATTORNEY

Int. Cl.: 31

Prior U.S. Cls.: 1 and 46

United States Patent and Trademark Office

Reg. No. 3,481,778

Registered Aug. 5, 2008

**TRADEMARK
PRINCIPAL REGISTER**

FRESH 4 LIFE

PET VALU CANADA INC. (CANADA CORPORATION)
121 MCPHERSON STREET
MARKHAM, CANADA L3R3L3

THE MARK CONSISTS OF STANDARD CHARACTERS WITHOUT CLAIM TO ANY PARTICULAR FONT, STYLE, SIZE, OR COLOR.

FOR: CAT LITTER, IN CLASS 31 (U.S. CLS. 1 AND 46).

SN 77-209,790, FILED 6-19-2007.

FIRST USE 2-29-2008; IN COMMERCE 2-29-2008.

JUSTINE D. PARKER, EXAMINING ATTORNEY

Int. Cl.: 25

Prior U.S. Cls.: 22 and 39

United States Patent and Trademark Office

Reg. No. 3,481,779

Registered Aug. 5, 2008

**TRADEMARK
PRINCIPAL REGISTER**

BEVERLY HILLS PRINCESS

J&M SALES, INC. (DELAWARE CORPORATION)
15001 SOUTH FIGUEROA STREET
GARDENA, CA 90248

FOR: CLOTHING, NAMELY, PANTS, SHIRTS,
DRESSES, SKIRTS, BLOUSES AND JACKETS, IN
CLASS 25 (U.S. CLS. 22 AND 39).

FIRST USE 6-3-2008; IN COMMERCE 6-3-2008.

THE MARK CONSISTS OF STANDARD CHAR-
ACTERS WITHOUT CLAIM TO ANY PARTICULAR
FONT, STYLE, SIZE, OR COLOR.

NO CLAIM IS MADE TO THE EXCLUSIVE
RIGHT TO USE "BEVERLY HILLS", APART FROM
THE MARK AS SHOWN.

SN 77-210,439, FILED 6-20-2007.

ELLEN BURNS, EXAMINING ATTORNEY

Int. Cl.: 37

Prior U.S. Cls.: 100, 103, and 106

United States Patent and Trademark Office

Reg. No. 3,481,780

Registered Aug. 5, 2008

**SERVICE MARK
PRINCIPAL REGISTER**

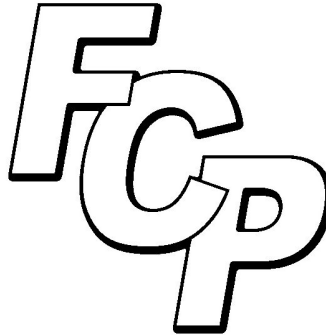

FREEDOM CONCRETE PUMPING, LLC (NEVA-
DA LTD LIAB CO)
812 GEORGETOWN STREET
CANTON, MI 48188

FOR: PUMPING CONCRETE SERVICES, IN
CLASS 37 (U.S. CLS. 100, 103 AND 106).

FIRST USE 1-2-2006; IN COMMERCE 1-16-2006.

THE MARK CONSISTS OF THE LETTERS "FCP"
IN A STYLIZED TEXT.

SN 77-211,332, FILED 6-20-2007.

ODESSA BIBBINS, EXAMINING ATTORNEY

Int. Cl.: 16

Prior U.S. Cls.: 2, 5, 22, 23, 29, 37, 38, and 50

Reg. No. 3,481,781

United States Patent and Trademark Office

Registered Aug. 5, 2008

**TRADEMARK
PRINCIPAL REGISTER**



SELLARS ABSORBENT MATERIALS, INC. (WIS-
CONSIN CORPORATION)
6540 NORTH INDUSTRIAL ROAD
MILWAUKEE, WI 53223

FIRST USE 9-7-2007; IN COMMERCE 9-7-2007.

SN 77-211,555, FILED 6-21-2007.

FOR: PAPER TOWELS COMPRISED OF WOOD
PULP AND BINDING AGENTS, IN CLASS 16 (U.S.
CLS. 2, 5, 22, 23, 29, 37, 38 AND 50).

KATINA MISTER, EXAMINING ATTORNEY

Int. Cl.: 28

Prior U.S. Cls.: 22, 23, 38, and 50

United States Patent and Trademark Office

Reg. No. 3,481,782

Registered Aug. 5, 2008

**TRADEMARK
PRINCIPAL REGISTER**

VERBAL VOLLEY

MINDFULL CORPORATION (MISSOURI CORPORATION)

2320 WELLINGTON ESTATES

CHESTERFIELD, MO 63017

FOR: EDUCATIONAL CARD GAMES, IN CLASS 28 (U.S. CLS. 22, 23, 38 AND 50).

FIRST USE 9-0-2007; IN COMMERCE 9-0-2007.

THE MARK CONSISTS OF STANDARD CHARACTERS WITHOUT CLAIM TO ANY PARTICULAR FONT, STYLE, SIZE, OR COLOR.

NO CLAIM IS MADE TO THE EXCLUSIVE RIGHT TO USE "VERBAL", APART FROM THE MARK AS SHOWN.

SN 77-211,866, FILED 6-21-2007.

JULIE GUTTADAURO, EXAMINING ATTORNEY

Int. Cl.: 20

Prior U.S. Cls.: 2, 13, 22, 25, 32, and 50

Reg. No. 3,481,783

United States Patent and Trademark Office

Registered Aug. 5, 2008

**TRADEMARK
PRINCIPAL REGISTER**



ARC LUXE LLC (NORTH CAROLINA LTD LIAB
CO)
1508 EAST FOURTH STREET
CHARLOTTE, NC 28204

FOR: BREAST SEPARATOR, NAMELY, AN ANTI-
SLIP SEPARATOR USED IN BETWEEN THE
BREASTS OF A HUMAN BEING FOR USE DURING
SLEEP, IN CLASS 20 (U.S. CLS. 2, 13, 22, 25, 32 AND
50).

FIRST USE 8-1-2007; IN COMMERCE 8-1-2007.

THE MARK CONSISTS OF THE STYLIZED
WORDING "KUSH" HAVING THE GRAPHIC RE-
PRESENTATION OF A STAR SUPERIMPOSED
OVER THE POINT OF INTERSECTION FOR ALL
THE LINES IN THE LETTER "K".

SN 77-211,906, FILED 6-21-2007.

WILLIAM BRECKENFELD, EXAMINING ATTOR-
NEY

Int. Cl.: 42

Prior U.S. Cls.: 100 and 101

United States Patent and Trademark Office

Reg. No. 3,481,784

Registered Aug. 5, 2008

**SERVICE MARK
PRINCIPAL REGISTER**

EARL

MEDICAL DEVELOPMENT INTERNATIONAL
LTD., INC. (DELAWARE CORPORATION)
822 HIGHWAY A1A NORTH, SUITE 310
PONTE VEDRA BEACH, FL 32082

FOR: PROVIDING TEMPORARY USE OF NON-
DOWNLOADABLE MEDICAL CARE SOFTWARE
ON THE INTERNET FOR ADMINISTRATION,
TRACKING AND ANALYSIS OF HEALTH ISSUES,
SEVERITY, TREATMENT, CLAIMS AND SPECIFIC
EXPENDITURES PER INDIVIDUAL PATIENT, IN
CLASS 42 (U.S. CLS. 100 AND 101).

FIRST USE 3-30-2007; IN COMMERCE 3-30-2007.

THE MARK CONSISTS OF STANDARD CHAR-
ACTERS WITHOUT CLAIM TO ANY PARTICULAR
FONT, STYLE, SIZE, OR COLOR.

SN 77-211,962, FILED 6-21-2007.

TANYA AMOS, EXAMINING ATTORNEY

Int. Cl.: 30

Prior U.S. Cl.: 46

United States Patent and Trademark Office

Reg. No. 3,481,785

Registered Aug. 5, 2008

**TRADEMARK
PRINCIPAL REGISTER**

SIMPLY PERFECT PASTA

NEW WORLD PASTA COMPANY (DELAWARE
CORPORATION)
85 SHANNON ROAD
HARRISBURG, PA 17112

NO CLAIM IS MADE TO THE EXCLUSIVE
RIGHT TO USE "PASTA", APART FROM THE
MARK AS SHOWN.

FOR: PASTA, IN CLASS 30 (U.S. CL. 46).

FIRST USE 12-7-2007; IN COMMERCE 12-7-2007.

SN 77-212,018, FILED 6-21-2007.

THE MARK CONSISTS OF STANDARD CHAR-
ACTERS WITHOUT CLAIM TO ANY PARTICULAR
FONT, STYLE, SIZE, OR COLOR.

SCOTT BIBB, EXAMINING ATTORNEY

Int. Cl.: 36

Prior U.S. Cls.: 100, 101, and 102

United States Patent and Trademark Office

Reg. No. 3,481,786

Registered Aug. 5, 2008

**SERVICE MARK
PRINCIPAL REGISTER**

**Precise, Predictive,
Profitable**

RONK, THOMAS C. (UNITED STATES INDIVIDUAL)
417 ORCHID AVE.
CORONA DEL MAR, CA 92625

FOR: ADVICE RELATING TO INVESTMENTS; CAPITAL INVESTMENT CONSULTATION; COMMODITY INVESTMENT ADVICE; EQUITY CAPITAL INVESTMENT; FINANCIAL SERVICES IN THE NATURE OF AN INVESTMENT SECURITY; FINANCIAL SERVICES, NAMELY, A TOTAL PORTFOLIO OFFERING FOR HIGH NET WORTH CLIENTS CONSISTING OF BOTH SEPARATE ACCOUNTS AND MUTUAL FUNDS FOR EQUITY AND FIXED INCOME INVESTMENTS; HEDGE FUND INVESTMENT SERVICES; INVESTMENT ADVICE; INVESTMENT ADVISORY SERVICES; INVESTMENT BROKERAGE; INVESTMENT BY ELECTRONIC MEANS; INVESTMENT CONSULTATION; INVESTMENT MANAGEMENT; INVEST-

MENT OF FUNDS FOR OTHERS; INVESTMENT SERVICES, NAMELY, ASSET ACQUISITION, CONSULTATION, DEVELOPMENT AND MANAGEMENT SERVICES; MANAGEMENT OF A CAPITAL INVESTMENT FUND; PUBLIC EQUITY INVESTMENT MANAGEMENT; SECURITIES TRADING AND INVESTING SERVICES FOR OTHERS VIA THE INTERNET, IN CLASS 36 (U.S. CLS. 100, 101 AND 102).

FIRST USE 6-21-2007; IN COMMERCE 6-21-2007.

THE MARK CONSISTS OF STANDARD CHARACTERS WITHOUT CLAIM TO ANY PARTICULAR FONT, STYLE, SIZE, OR COLOR.

SN 77-212,231, FILED 6-21-2007.

BARBARA RUTLAND, EXAMINING ATTORNEY

Int. Cl.: 28

Prior U.S. Cls.: 22, 23, 38, and 50

Reg. No. 3,481,787

United States Patent and Trademark Office

Registered Aug. 5, 2008

**TRADEMARK
PRINCIPAL REGISTER**

FLIG

SPIRIT RIVER, INC. (OREGON CORPORATION)
423 WINCHESTER STREET
ROSEBURG, OR 97470

THE MARK CONSISTS OF STANDARD CHAR-
ACTERS WITHOUT CLAIM TO ANY PARTICULAR
FONT, STYLE, SIZE, OR COLOR.

FOR: ARTIFICIAL FISHING LURES, IN CLASS 28
(U.S. CLS. 22, 23, 38 AND 50).

SN 77-212,486, FILED 6-21-2007.

FIRST USE 12-0-2007; IN COMMERCE 12-0-2007.

KATHERINE CHANG, EXAMINING ATTORNEY

Int. Cl.: 3

Prior U.S. Cls.: 1, 4, 6, 50, 51, and 52

United States Patent and Trademark Office

Reg. No. 3,481,788

Registered Aug. 5, 2008

**TRADEMARK
PRINCIPAL REGISTER**

DERMA SECRETS

DE CARACOL CORPORATION (MARYLAND CORPORATION)
9 MAYHILL COURT
GAITHERSBURG, MD 20879

FOR: SKIN CARE PREPARATIONS, NAMELY, LOTIONS, BODY CREAMS, FACE CREAMS, SKIN TONERS FOR COMETIC PURPOSES; HAIR CARE PRODUCTS, NAMELY, SHAMPOOS AND CONDITIONERS, IN CLASS 3 (U.S. CLS. 1, 4, 6, 50, 51 AND 52).

FIRST USE 5-18-2008; IN COMMERCE 5-18-2008.

THE MARK CONSISTS OF STANDARD CHARACTERS WITHOUT CLAIM TO ANY PARTICULAR FONT, STYLE, SIZE, OR COLOR.

NO CLAIM IS MADE TO THE EXCLUSIVE RIGHT TO USE "DERMA", APART FROM THE MARK AS SHOWN.

SN 77-212,974, FILED 6-22-2007.

ELLEN PERKINS, EXAMINING ATTORNEY

Int. Cl.: 36

Prior U.S. Cls.: 100, 101, and 102

United States Patent and Trademark Office

Reg. No. 3,481,789

Registered Aug. 5, 2008

**SERVICE MARK
PRINCIPAL REGISTER**

Build...Grow...Protect

TCS FINANCIAL SERVICES, INC. (DELAWARE CORPORATION)
PO BOX 1010
WESTTOWN, PA 19395

FOR: ADVICE RELATING TO INVESTMENTS; INVESTMENT ADVICE; INVESTMENT ADVISORY SERVICES; INVESTMENT BROKERAGE; INVESTMENT CONSULTATION; INVESTMENT MANAGEMENT; INVESTMENT OF FUNDS FOR OTHERS; INVESTMENT SERVICES, NAMELY, ASSET ACQUISITION, CONSULTATION, DEVELOPMENT AND MANAGEMENT SERVICES; MUTUAL FUND INVESTMENT; PRIVATE EQUITY FUND INVESTMENT SERVICES; SECURITIES TRADING AND INVESTING SERVICES FOR OTHERS VIA THE INTERNET; CAPITAL INVESTMENT CONSULTATION; COMMODITY INVESTMENT ADVICE; EQUITY CAPITAL INVESTMENT; FINANCIAL SERVICES IN THE NATURE OF AN INVESTMENT SECURITY; FINANCIAL SERVICES, NAMELY, A TOTAL PORTFOLIO OFFERING FOR HIGH NET WORTH CLIENTS CONSISTING OF BOTH SEPARATE ACCOUNTS AND MUTUAL FUNDS FOR EQUITY AND FIXED INCOME INVESTMENTS; FUND INVESTMENT CONSULTATION; FINANCIAL ANALYSIS AND CONSULTATION; FINANCIAL CONSULTATION; FINANCIAL EVALUATION FOR INSURANCE PURPOSES; FINANCIAL GUARANTEE AND SURETY; FINANCIAL MANAGEMENT; FINANCIAL PLANNING;

FINANCIAL PLANNING CONSULTATION; FINANCIAL PLANNING FOR RETIREMENT; FINANCIAL PLANNING, NAMELY, THE CREATION OF PERSONALIZED STRATEGIES TO ACHIEVE FINANCIAL INDEPENDENCE; FINANCIAL PORTFOLIO MANAGEMENT; FINANCIAL RISK MANAGEMENT; FINANCIAL SERVICES, NAMELY, ASSISTING OTHERS WITH THE COMPLETION OF FINANCIAL TRANSACTIONS FOR STOCKS, BONDS, SECURITIES AND EQUITIES; PROVIDING ON-LINE FINANCIAL CALCULATORS; INSURANCE AGENCY AND BROKERAGE; INSURANCE BROKERAGE; INSURANCE CONSULTATION; INSURANCE UNDERWRITING CONSULTATION; INSURANCE UNDERWRITING SERVICES FOR ALL TYPES OF INSURANCE; LIFE INSURANCE UNDERWRITING; MEDICAL INSURANCE UNDERWRITING; PROVIDING INFORMATION IN INSURANCE MATTERS, IN CLASS 36 (U.S. CLS. 100, 101 AND 102).

FIRST USE 7-1-2007; IN COMMERCE 7-1-2007.

THE MARK CONSISTS OF STANDARD CHARACTERS WITHOUT CLAIM TO ANY PARTICULAR FONT, STYLE, SIZE, OR COLOR.

SN 77-213,973, FILED 6-24-2007.

JUSTINE D. PARKER, EXAMINING ATTORNEY

Int. Cl.: 35

Prior U.S. Cls.: 100, 101, and 102

United States Patent and Trademark Office

Reg. No. 3,481,790

Registered Aug. 5, 2008

**SERVICE MARK
PRINCIPAL REGISTER**

THE PLEASURE IS YOURS

LOVER'S LANE I.P., LTD. (MICHIGAN CORPORATION)
46750 PORT STREET
PLYMOUTH, MI 481706031

FOR: RETAIL STORE SERVICES, SHOP-AT-HOME PARTY SERVICES, ONLINE, MAIL ORDER AND CATALOG ORDERING SERVICES ALL FEATURING NOVELTY ITEMS, TOYS, MARITAL AIDS, SEXUAL AIDS, SEXUAL ENHANCEMENT PRODUCTS, GIFT ITEMS, ADULT THEME MOVIES AND BOOKS, GREETING CARDS, LINGERIE, UNDERWEAR, SWIMWEAR, CLOTHING, COSTUMES

AND ACCESSORIES FOR WOMEN AND MEN, IN CLASS 35 (U.S. CLS. 100, 101 AND 102).

FIRST USE 1-13-2008; IN COMMERCE 1-13-2008.

THE MARK CONSISTS OF STANDARD CHARACTERS WITHOUT CLAIM TO ANY PARTICULAR FONT, STYLE, SIZE, OR COLOR.

SN 77-214,365, FILED 6-25-2007.

DAVID TAYLOR, EXAMINING ATTORNEY

Int. Cl.: 28

Prior U.S. Cls.: 22, 23, 38, and 50

Reg. No. 3,481,791

United States Patent and Trademark Office

Registered Aug. 5, 2008

**TRADEMARK
PRINCIPAL REGISTER**

Spear-It

SPIRIT RIVER, INC. (OREGON CORPORATION)
423 WINCHESTER STREET
ROSEBURG, OR 97470

THE MARK CONSISTS OF STANDARD CHAR-
ACTERS WITHOUT CLAIM TO ANY PARTICULAR
FONT, STYLE, SIZE, OR COLOR.

FOR: ARTIFICIAL FISHING LURES, IN CLASS 28
(U.S. CLS. 22, 23, 38 AND 50).

SN 77-214,565, FILED 6-25-2007.

FIRST USE 10-0-2007; IN COMMERCE 10-0-2007.

KATHERINE CHANG, EXAMINING ATTORNEY

Int. Cl.: 44

Prior U.S. Cls.: 100 and 101

United States Patent and Trademark Office

Reg. No. 3,481,792

Registered Aug. 5, 2008

**SERVICE MARK
PRINCIPAL REGISTER**

ROCKSHRINK

THALER, LISA J. (UNITED STATES INDIVIDUAL)
233 WEST 21 STREET, #6A
NEW YORK, NY 10011

THE MARK CONSISTS OF STANDARD CHARACTERS WITHOUT CLAIM TO ANY PARTICULAR FONT, STYLE, SIZE, OR COLOR.

FOR: PSYCHOTHERAPY SERVICES, IN CLASS 44 (U.S. CLS. 100 AND 101).

SN 77-214,924, FILED 6-25-2007.

FIRST USE 6-25-2007; IN COMMERCE 6-25-2007.

BENJAMIN ALLEN, EXAMINING ATTORNEY

Int. Cl.: 14

Prior U.S. Cls.: 2, 27, 28, and 50

United States Patent and Trademark Office

Reg. No. 3,481,793

Registered Aug. 5, 2008

TRADEMARK
PRINCIPAL REGISTER



STRICKLAND-FULLER PARTNERSHIP (KAN-
SAS PARTNERSHIP)
10021 WEST 21ST STREET
WICHITA, KS 67201

FOR: JEWELRY, BRACELETS, PENDANTS,
WATCHES AND CLOCKS, IN CLASS 14 (U.S. CLS.
2, 27, 28 AND 50).

FIRST USE 6-0-2007; IN COMMERCE 6-0-2007.

THE MARK CONSISTS OF TWO CONCENTRIC
CIRCLES. THE WORDING "NOW IS THE TIME"

APPEARS IN THE SPACE BETWEEN THE CIRCLES.
THE BACKGROUND AROUND THE WORD "NOW"
IS SHADED. THE INNER CIRCLE HAS A LOTUS
FLOWER AND ALTERNATING SHADED AND
LIGHT LINES RADIATING OUT FROM THE CEN-
TER REPRESENTING THE VARIOUS POSITIONS
ON A CLOCK FACE.

SN 77-216,184, FILED 6-26-2007.

JILL PRATER, EXAMINING ATTORNEY

Int. Cl.: 9

Prior U.S. Cls.: 21, 23, 26, 36, and 38

United States Patent and Trademark Office

Reg. No. 3,481,794

Registered Aug. 5, 2008

**TRADEMARK
PRINCIPAL REGISTER**

DEVCAT

ROSANDER, CHRISTINE (UNITED STATES IN-
DIVIDUAL)
4819 BEVERLY BOULEVARD
LOS ANGELES, CA 90004

FOR: SOUND RECORDINGS FEATURING MU-
SIC, NAMELY, PRE-RECORDED PHONOGRAPH
RECORDS, AUDIO TAPES, ENHANCED CD'S AND
COMPACT DISCS FEATURING MUSIC, IN CLASS 9
(U.S. CLS. 21, 23, 26, 36 AND 38).

FIRST USE 3-10-2008; IN COMMERCE 3-10-2008.

THE MARK CONSISTS OF STANDARD CHAR-
ACTERS WITHOUT CLAIM TO ANY PARTICULAR
FONT, STYLE, SIZE, OR COLOR.

SN 77-216,390, FILED 6-27-2007.

MATTHEW MCDOWELL, EXAMINING ATTOR-
NEY

Int. Cl.: 43

Prior U.S. Cls.: 100 and 101

United States Patent and Trademark Office

Reg. No. 3,481,795

Registered Aug. 5, 2008

**SERVICE MARK
PRINCIPAL REGISTER**

ABITA

ABITA BREWING COMPANY, LLC (LOUISIANA
LTD LIAB CO)
POST OFFICE BOX 1510
ABITA SPRINGS, LA 70420

FOR: RESTAURANT, BREWPUB, AND BAR SER-
VICES, IN CLASS 43 (U.S. CLS. 100 AND 101).

FIRST USE 5-1-1995; IN COMMERCE 5-1-1995.

THE MARK CONSISTS OF STANDARD CHAR-
ACTERS WITHOUT CLAIM TO ANY PARTICULAR
FONT, STYLE, SIZE, OR COLOR.

OWNER OF U.S. REG. NOS. 1,927,815 AND
2,178,241.

SN 77-219,396, FILED 6-29-2007.

SANJEEV VOHRA, EXAMINING ATTORNEY

Int. Cl.: 43

Prior U.S. Cls.: 100 and 101

United States Patent and Trademark Office

Reg. No. 3,481,796

Registered Aug. 5, 2008

**SERVICE MARK
PRINCIPAL REGISTER**

CASAVANA

GARCIA, LAZARO (UNITED STATES INDIVIDUAL)
12049 SW 75ST.
MIAMI, FL 33183 AND
GARCIA, JOSE (UNITED STATES INDIVIDUAL)
7470 SW 121 CT.
MIAMI, FL 33183

FOR: CAFE-RESTAURANTS; RESTAURANT AND BAR SERVICES; RESTAURANT SERVICES; RESTAURANTS; RESTAURANTS FEATURING HOME DELIVERY; SELF SERVICE RESTAURANTS; SELF-SERVICE RESTAURANTS; TAKE-OUT RESTAURANT SERVICES; CARRY-OUT RESTAURANTS; DELICATESSENS; FAST FOOD AND NON-STOP RESTAURANT SERVICES; FAST-FOOD

RESTAURANTS; FAST-FOOD RESTAURANTS AND SNACKBARS; HOTEL, BAR AND RESTAURANT SERVICES, IN CLASS 43 (U.S. CLS. 100 AND 101).

FIRST USE 6-15-2007; IN COMMERCE 6-15-2007.

THE MARK CONSISTS OF STANDARD CHARACTERS WITHOUT CLAIM TO ANY PARTICULAR FONT, STYLE, SIZE, OR COLOR.

SN 77-220,129, FILED 7-2-2007.

CHRISTOPHER BUONGIORNO, EXAMINING ATTORNEY

Int. Cl.: 11

Prior U.S. Cls.: 13, 21, 23, 31, and 34

Reg. No. 3,481,797

United States Patent and Trademark Office

Registered Aug. 5, 2008

**TRADEMARK
PRINCIPAL REGISTER**

METRO

CRAFTMADE INTERNATIONAL INC. (DELA-
WARE CORPORATION)
650 S. ROYAL LANE
COPPELL, TX 75039

THE MARK CONSISTS OF STANDARD CHAR-
ACTERS WITHOUT CLAIM TO ANY PARTICULAR
FONT, STYLE, SIZE, OR COLOR.

FOR: CEILING FANS, IN CLASS 11 (U.S. CLS. 13,
21, 23, 31 AND 34).

SN 77-220,322, FILED 7-2-2007.

FIRST USE 6-1-2007; IN COMMERCE 10-1-2007.

JAY FLOWERS, EXAMINING ATTORNEY

Int. Cl.: 9

Prior U.S. Cls.: 21, 23, 26, 36, and 38

United States Patent and Trademark Office

Reg. No. 3,481,798

Registered Aug. 5, 2008

TRADEMARK
PRINCIPAL REGISTER

The image shows the trademark "Entourage of 7" written in a red, cursive script font. The word "Entourage" is in a larger, more decorative script, and "of 7" is in a smaller, simpler script.

BROGAARD, RIKKE (UNITED STATES INDIVIDUAL)
23151 VERDUGO, SUITE 103
LAGUNA HILLS, CA 92653

THE COLOR(S) RED IS/ARE CLAIMED AS A FEATURE OF THE MARK.

FOR: EYEGLASSES AND EYEGLASS FRAMES, SUNGLASSES AND SUNGLASS FRAMES, EYEGLASS LENSES AND SUNGLASS LENSES, READING GLASSES AND READING GLASSES FRAMES, READING GLASS LENSES, EYEGLASS, SUNGLASS AND READING GLASS CASES, IN CLASS 9 (U.S. CLS. 21, 23, 26, 36 AND 38).

THE MARK CONSISTS OF STYLIZED, SCRIPT TEXT "ENTOURAGE OF" FOLLOWED IMMEDIATELY BY A STYLIZED, SCRIPT NUMERAL "7." ALL LETTERS IN THE SAME RED SCRIPT TEXT.

SN 77-220,549, FILED 7-2-2007.

FIRST USE 7-2-2007; IN COMMERCE 7-2-2007.

MICHAEL KEATING, EXAMINING ATTORNEY

Int. Cl.: 9

Prior U.S. Cls.: 21, 23, 26, 36, and 38

Reg. No. 3,481,799

United States Patent and Trademark Office

Registered Aug. 5, 2008

**TRADEMARK
PRINCIPAL REGISTER**



BROGAARD, RIKKE (UNITED STATES INDIVIDUAL)
23151 VERDUGO, SUITE 103
LAGUNA HILLS, CA 92653

FOR: EYEGASSES AND EYEGASS FRAMES, SUNGLASSES AND SUNGLASS FRAMES, EYEGASS LENSES AND SUNGLASS LENSES, READING GLASSES AND READING GLASSES FRAMES, READING GLASS LENSES, EYEGASS, SUNGLASS AND READING GLASS CASES, IN CLASS 9 (U.S. CLS. 21, 23, 26, 36 AND 38).

FIRST USE 7-2-2007; IN COMMERCE 7-2-2007.

THE COLOR(S) RED IS/ARE CLAIMED AS A FEATURE OF THE MARK.

THE MARK CONSISTS OF STYLIZED, SCRIPT TEXT CAPITAL "E" FOLLOWED IMMEDIATELY BY A STYLIZED, SCRIPT NUMERAL "7," ENCLOSED IN A RED CIRCLE. ALL LETTERS IN THE SAME RED SCRIPT TEXT.

SN 77-220,559, FILED 7-2-2007.

MICHAEL KEATING, EXAMINING ATTORNEY

Int. Cl.: 45

Prior U.S. Cls.: 100 and 101

United States Patent and Trademark Office

Reg. No. 3,481,800

Registered Aug. 5, 2008

**SERVICE MARK
PRINCIPAL REGISTER**

THE POWER TO PRESERVE

ROSENN, JENKINS & GREENWALD, L.L.P.
(PENNSYLVANIA PARTNERSHIP)
15 SOUTH FRANKLIN STREET
WILKES-BARRE, PA 18711

FOR: LEGAL SERVICES, IN CLASS 45 (U.S. CLS.
100 AND 101).

FIRST USE 11-1-2007; IN COMMERCE 11-1-2007.

THE MARK CONSISTS OF STANDARD CHAR-
ACTERS WITHOUT CLAIM TO ANY PARTICULAR
FONT, STYLE, SIZE, OR COLOR.

SN 77-220,647, FILED 7-2-2007.

CIMMERIAN COLEMAN, EXAMINING ATTOR-
NEY

Int. Cl.: 3

Prior U.S. Cls.: 1, 4, 6, 50, 51, and 52

United States Patent and Trademark Office

Reg. No. 3,481,801

Registered Aug. 5, 2008

**TRADEMARK
PRINCIPAL REGISTER**

lipnotize

BATTLE, SHANE (UNITED STATES INDIVIDUAL)
2820 TERRACE VIEW AVE
ANTIOCH, CA 94531

FOR: LIP BALM; LIP GLOSS; LIP GLOSS PALATTE; LIP LINER; LIP POLISHER; MAKE-UP KITS COMPRISED OF LIPSTICK, LIP GLOSS, LIP LINER, LIP POLISH; NON-MEDICATED LIP CARE PREPARATIONS; NON-MEDICATED LIP PROTECTOR; CLEANER FOR COSMETIC BRUSHES; COSMETIC PENCILS, IN CLASS 3 (U.S. CLS. 1, 4, 6, 50, 51 AND 52).

FIRST USE 5-21-2008; IN COMMERCE 5-21-2008.

THE MARK CONSISTS OF STANDARD CHARACTERS WITHOUT CLAIM TO ANY PARTICULAR FONT, STYLE, SIZE, OR COLOR.

SN 77-220,836, FILED 7-2-2007.

DAVID YONTEF, EXAMINING ATTORNEY

Int. Cl.: 36

Prior U.S. Cls.: 100, 101, and 102

United States Patent and Trademark Office

Reg. No. 3,481,802

Registered Aug. 5, 2008

**SERVICE MARK
PRINCIPAL REGISTER**

Building Wealthier Lives

WEALTH ARCHITECTS, LLC (CALIFORNIA
LTD LIAB CO)
SUITE 201
250 CAMBRIDGE AVENUE
PALO ALTO, CA 94306

FOR: FINANCIAL PLANNING, NAMELY, THE
CREATION OF PERSONALIZED STRATEGIES TO
ACHIEVE FINANCIAL INDEPENDENCE, IN CLASS
36 (U.S. CLS. 100, 101 AND 102).

FIRST USE 3-13-2008; IN COMMERCE 3-13-2008.

THE MARK CONSISTS OF STANDARD CHAR-
ACTERS WITHOUT CLAIM TO ANY PARTICULAR
FONT, STYLE, SIZE, OR COLOR.

SN 77-221,282, FILED 7-3-2007.

DAWN HAN, EXAMINING ATTORNEY

Int. Cl.: 9

Prior U.S. Cls.: 21, 23, 26, 36, and 38

Reg. No. 3,481,803

United States Patent and Trademark Office

Registered Aug. 5, 2008

**TRADEMARK
PRINCIPAL REGISTER**

Cerebral Project

CEREBRAL CHOICE SOFTWARE SOLUTIONS,
INC. (NEW YORK CORPORATION)
4434 TABITHA CREEK DR
SYRACUSE, NY 13215

FOR: COMPUTER SOFTWARE FOR PROJECT
MANAGEMENT, IN CLASS 9 (U.S. CLS. 21, 23, 26, 36
AND 38).

FIRST USE 1-1-2007; IN COMMERCE 1-1-2007.

THE MARK CONSISTS OF STANDARD CHAR-
ACTERS WITHOUT CLAIM TO ANY PARTICULAR
FONT, STYLE, SIZE, OR COLOR.

NO CLAIM IS MADE TO THE EXCLUSIVE
RIGHT TO USE "PROJECT", APART FROM THE
MARK AS SHOWN.

SN 77-221,299, FILED 7-3-2007.

GIANCARLO CASTRO, EXAMINING ATTORNEY

Int. Cl.: 11

Prior U.S. Cls.: 13, 21, 23, 31, and 34

United States Patent and Trademark Office

Reg. No. 3,481,804

Registered Aug. 5, 2008

**TRADEMARK
PRINCIPAL REGISTER**

Keep Me Cool

MORALES, ROBERT M. (UNITED STATES INDIVIDUAL)
102 W. NORWOOD COURT
SAN ANTONIO, TX 78212

THE MARK CONSISTS OF STANDARD CHARACTERS WITHOUT CLAIM TO ANY PARTICULAR FONT, STYLE, SIZE, OR COLOR.

FOR: COLD PACKS FOR COOLING THE BODY AND NOT FOR MEDICAL PURPOSES, IN CLASS 11 (U.S. CLS. 13, 21, 23, 31 AND 34).

SN 77-222,445, FILED 7-5-2007.

FIRST USE 1-1-2006; IN COMMERCE 3-19-2007.

BRIAN NEVILLE, EXAMINING ATTORNEY

Int. Cl.: 41

Prior U.S. Cls.: 100, 101, and 107

United States Patent and Trademark Office

Reg. No. 3,481,805

Registered Aug. 5, 2008

**SERVICE MARK
PRINCIPAL REGISTER**

INSPIRING YOUNG LIVES

THE ZONDERVAN CORPORATION L.L.C. (DE-
LAWARE LTD LIAB CO)
5300 PATTERSON S.E.
GRAND RAPIDS, MI 49530

FOR: BOOK PUBLISHING SERVICES; PROVID-
ING ON-LINE NEWSLETTERS IN THE FIELDS OF
RELIGION, BOOKS, LIFESTYLE AND EDUCA-
TION, IN CLASS 41 (U.S. CLS. 100, 101 AND 107).

FIRST USE 6-14-2007; IN COMMERCE 6-14-2007.

THE MARK CONSISTS OF STANDARD CHAR-
ACTERS WITHOUT CLAIM TO ANY PARTICULAR
FONT, STYLE, SIZE, OR COLOR.

SN 77-222,497, FILED 7-5-2007.

ELISSA GARBER KON, EXAMINING ATTORNEY

Int. Cl.: 36

Prior U.S. Cls.: 100, 101, and 102

United States Patent and Trademark Office

Reg. No. 3,481,806

Registered Aug. 5, 2008

**SERVICE MARK
PRINCIPAL REGISTER**

RIDE TO EMPOWER

Y-ME NATIONAL BREAST CANCER ORGANI-
ZATION (ILLINOIS NON-PROFIT TAX EX-
EMPT ORGANIZATION)
SUITE 1000
212 WEST VAN BUREN
CHICAGO, IL 60607

FOR: CHARITABLE FUND RAISING, IN CLASS
36 (U.S. CLS. 100, 101 AND 102).

FIRST USE 10-15-2007; IN COMMERCE 10-15-2007.

THE MARK CONSISTS OF STANDARD CHAR-
ACTERS WITHOUT CLAIM TO ANY PARTICULAR
FONT, STYLE, SIZE, OR COLOR.

OWNER OF U.S. REG. NO. 3,095,498.

SN 77-223,612, FILED 7-6-2007.

REBECCA SMITH, EXAMINING ATTORNEY

Int. Cl.: 19

Prior U.S. Cls.: 1, 12, 33, and 50

United States Patent and Trademark Office

Reg. No. 3,481,807

Registered Aug. 5, 2008

**TRADEMARK
PRINCIPAL REGISTER**



WOODMASTER DESIGNS INC. (CALIFORNIA CORPORATION)
30489 SAN ANTONIO STREET
HAYWARD, CA 94544

FOR: DECORATIVE ARCHITECTURAL MILLWORK, NAMELY, MANTELS, CORBELS, COLUMNS AND MOULDINGS, IN CLASS 19 (U.S. CLS. 1, 12, 33 AND 50).

FIRST USE 9-1-2007; IN COMMERCE 9-1-2007.

NO CLAIM IS MADE TO THE EXCLUSIVE RIGHT TO USE "DECORATIVE MILLWORK", APART FROM THE MARK AS SHOWN.

THE MARK CONSISTS OF A SIDE VIEW OF A CORBEL IN LINE ART WITH THE WORDS "FOSTER DECORATIVE MILLWORK" IN TIMES NEW ROMAN TYPEFACE.

SN 77-225,280, FILED 7-9-2007.

MICHAEL SOUDERS, EXAMINING ATTORNEY

Int. Cl.: 22

Prior U.S. Cls.: 1, 2, 7, 19, 22, 42, and 50

Reg. No. 3,481,808

United States Patent and Trademark Office

Registered Aug. 5, 2008

**TRADEMARK
PRINCIPAL REGISTER**

Pull-EZ

YOUNG, NANCY (UNITED STATES INDIVIDUAL)

793 S TRACY BLVD # 238

TRACY, CA 95376 AND

YOUNG, MARCELLUS (UNITED STATES INDIVIDUAL)

793 S TRACY BLVD #238

TRACY, CA 95376

FOR: SACKS OR BAGS FOR THE TRANSPORTATION OR STORAGE OF MATERIALS IN BULK; POLY PROPYLENE BAGS USED FOR THE STO-

RAGE OF RIBBON; CLOTH BAGS FOR STORAGE, IN CLASS 22 (U.S. CLS. 1, 2, 7, 19, 22, 42 AND 50).

FIRST USE 9-1-2007; IN COMMERCE 7-31-2007.

THE MARK CONSISTS OF STANDARD CHARACTERS WITHOUT CLAIM TO ANY PARTICULAR FONT, STYLE, SIZE, OR COLOR.

SN 77-225,300, FILED 7-9-2007.

ELLEN B. AWRICH, EXAMINING ATTORNEY

Int. Cl.: 32

Prior U.S. Cls.: 45, 46, and 48

Reg. No. 3,481,809

United States Patent and Trademark Office

Registered Aug. 5, 2008

**TRADEMARK
PRINCIPAL REGISTER**

APPLE-RIFFIC

DEAN INTELLECTUAL PROPERTY SERVICES
II, L.P. (DELAWARE LIMITED PARTNER-
SHIP)
SUITE 1200
2515 MCKINNEY AVENUE
DALLAS, TX 75201

THE MARK CONSISTS OF STANDARD CHAR-
ACTERS WITHOUT CLAIM TO ANY PARTICULAR
FONT, STYLE, SIZE, OR COLOR.

OWNER OF U.S. REG. NO. 1,458,563.

FOR: FRUIT JUICES, IN CLASS 32 (U.S. CLS. 45, 46
AND 48).

SN 77-226,163, FILED 7-10-2007.

FIRST USE 9-0-2007; IN COMMERCE 9-0-2007.

MYRIAH HABEEB, EXAMINING ATTORNEY

Int. Cl.: 9

Prior U.S. Cls.: 21, 23, 26, 36, and 38

United States Patent and Trademark Office

Reg. No. 3,481,810

Registered Aug. 5, 2008

**TRADEMARK
PRINCIPAL REGISTER**

SiteSpect QuickChange

SITESPECT, INC. (MASSACHUSETTS CORPORATION)
263 BEACON ST., 5TH FLOOR
BOSTON, MA 02116

FOR: COMPUTER SOFTWARE FOR TESTING, MEASURING AND VALIDATING WEB CONTENT CHANGES, IN CLASS 9 (U.S. CLS. 21, 23, 26, 36 AND 38).

FIRST USE 11-9-2007; IN COMMERCE 11-9-2007.

THE MARK CONSISTS OF STANDARD CHARACTERS WITHOUT CLAIM TO ANY PARTICULAR FONT, STYLE, SIZE, OR COLOR.

OWNER OF U.S. REG. NO. 2,940,146.

NO CLAIM IS MADE TO THE EXCLUSIVE RIGHT TO USE "QUICKCHANGE", APART FROM THE MARK AS SHOWN.

SN 77-226,256, FILED 7-10-2007.

AMOS T. MATTHEWS, JR., EXAMINING ATTORNEY

Int. Cl.: 42

Prior U.S. Cls.: 100 and 101

United States Patent and Trademark Office

Reg. No. 3,481,811

Registered Aug. 5, 2008

**SERVICE MARK
PRINCIPAL REGISTER**

BATTLE TESTING

BRANDJUICE CONSULTING INC (DELAWARE CORPORATION)
1700 EAST 17TH AVENUE
SUITE 200
DENVER, CO 80218

FOR: PRODUCT RESEARCH, NAMELY, CONDUCTING ALTERNATIVE AND NON-TRADITIONAL CONSUMER PRODUCT TESTS; PRODUCT DEVELOPMENT CONSULTATION, NAMELY, PROVIDING ANALYSIS OF ALTERNATIVE AND NON-TRADITIONAL CONSUMER PRODUCT TESTS, IN CLASS 42 (U.S. CLS. 100 AND 101).

FIRST USE 11-0-2007; IN COMMERCE 11-0-2007.

THE MARK CONSISTS OF STANDARD CHARACTERS WITHOUT CLAIM TO ANY PARTICULAR FONT, STYLE, SIZE, OR COLOR.

NO CLAIM IS MADE TO THE EXCLUSIVE RIGHT TO USE "TESTING", APART FROM THE MARK AS SHOWN.

SN 77-226,393, FILED 7-10-2007.

JASON BLAIR, EXAMINING ATTORNEY

Int. Cl.: 30

Prior U.S. Cl.: 46

United States Patent and Trademark Office

Reg. No. 3,481,812

Registered Aug. 5, 2008

**TRADEMARK
PRINCIPAL REGISTER**

FLAT AND FABULOUS

DIERBERGS MARKETS, INC. (MISSOURI COR-
PORATION)
16690 SWINGLEY RIDGE ROAD
CHESTERFIELD, MO 63017

THE MARK CONSISTS OF STANDARD CHAR-
ACTERS WITHOUT CLAIM TO ANY PARTICULAR
FONT, STYLE, SIZE, OR COLOR.

FOR: CRACKERS, IN CLASS 30 (U.S. CL. 46).

SN 77-227,335, FILED 7-11-2007.

FIRST USE 8-6-2007; IN COMMERCE 8-6-2007.

JASON BLAIR, EXAMINING ATTORNEY

Int. Cl.: 7

Prior U.S. Cls.: 13, 19, 21, 23, 31, 34, and 35

Reg. No. 3,481,813

United States Patent and Trademark Office

Registered Aug. 5, 2008

**TRADEMARK
PRINCIPAL REGISTER**

ALLPOWER+

DYNAMIC HARDWARE CONCEPTS LLC (NEW
JERSEY LTD LIAB CO)
400 LELAND AVE
PLAINFIELD, NJ 070621606

THE MARK CONSISTS OF STANDARD CHAR-
ACTERS WITHOUT CLAIM TO ANY PARTICULAR
FONT, STYLE, SIZE, OR COLOR.

FOR: MULTI-PURPOSE HIGH PRESSURE WASH-
ERS; PORTABLE ELECTRIC POWER GENERA-
TORS, IN CLASS 7 (U.S. CLS. 13, 19, 21, 23, 31, 34
AND 35).

SN 77-227,632, FILED 7-12-2007.

FIRST USE 3-15-2008; IN COMMERCE 3-15-2008.

GIANCARLO CASTRO, EXAMINING ATTORNEY

Int. Cl.: 35

Prior U.S. Cls.: 100, 101, and 102

United States Patent and Trademark Office

Reg. No. 3,481,814

Registered Aug. 5, 2008

**SERVICE MARK
PRINCIPAL REGISTER**

LUNCHBAGZ

LUNCHBAGZ, LLC (NEW YORK LTD LIAB CO)
1539 HEWLETT AVENUE
HEWLETT, NY 11557

FOR: ADVERTISING AND MARKETING; ADVERTISING, MARKETING AND PROMOTION SERVICES; BUSINESS MARKETING AND DIRECT MAIL CONSULTING SERVICES; BUSINESS MARKETING CONSULTING SERVICES; BUSINESS MARKETING SERVICES; CREATIVE MARKETING DESIGN SERVICES; DEVELOPMENT OF MARKETING STRATEGIES AND CONCEPTS; DIRECT MARKETING ADVERTISING FOR OTHERS; DIRECT MARKETING SERVICES; MARKETING PLAN DE-

VELOPMENT; PROMOTION AND MARKETING SERVICES AND RELATED CONSULTING, IN CLASS 35 (U.S. CLS. 100, 101 AND 102).

FIRST USE 8-24-2007; IN COMMERCE 8-24-2007.

THE MARK CONSISTS OF STANDARD CHARACTERS WITHOUT CLAIM TO ANY PARTICULAR FONT, STYLE, SIZE, OR COLOR.

SN 77-227,653, FILED 7-12-2007.

JANICE KIM, EXAMINING ATTORNEY

Int. Cl.: 42

Prior U.S. Cls.: 100 and 101

United States Patent and Trademark Office

Reg. No. 3,481,815

Registered Aug. 5, 2008

**SERVICE MARK
PRINCIPAL REGISTER**

PayGuard

FI-SOFT, LLC (TEXAS LTD LIAB CO)
SUITE L-146
8765 SPRING CYPRESS
SPRING, TX 77379

FIRST USE 7-12-2007; IN COMMERCE 7-12-2007.

THE MARK CONSISTS OF STANDARD CHARACTERS WITHOUT CLAIM TO ANY PARTICULAR FONT, STYLE, SIZE, OR COLOR.

FOR: INTEGRATED AND ON-LINE SECURITY SERVICES, NAMELY, PROVIDING SECURITY AND ANONYMITY FOR ELECTRONIC PAYMENT TRANSACTIONS, IN CLASS 42 (U.S. CLS. 100 AND 101).

SN 77-228,292, FILED 7-12-2007.

JIM RINGLE, EXAMINING ATTORNEY

Int. Cls.: 9 and 42

Prior U.S. Cls.: 21, 23, 26, 36, 38, 100, and 101

United States Patent and Trademark Office

Reg. No. 3,481,816

Registered Aug. 5, 2008

**TRADEMARK
SERVICE MARK
PRINCIPAL REGISTER**

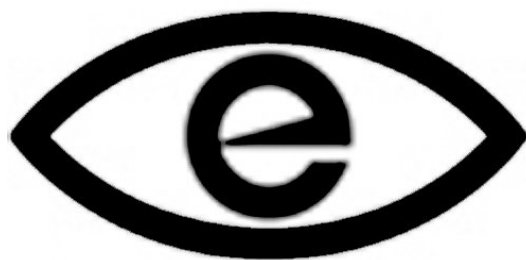

EEYE, INC. (DELAWARE CORPORATION)
111 THEORY, SUITE 250
IRVINE, CA 92617

FOR: COMPUTER SOFTWARE FOR USE IN
COMPUTER NETWORK SECURITY, IN CLASS 9
(U.S. CLS. 21, 23, 26, 36 AND 38).

FIRST USE 2-27-2007; IN COMMERCE 2-27-2007.

FOR: COMPUTER AND CONSULTING SERVI-
CES, NAMELY, COMPUTER SOFTWARE DESIGN,
DEVELOPMENT AND ANALYSIS RELATED TO
COMPUTER NETWORK SECURITY; PROVIDING
INFORMATION VIA A GLOBAL COMPUTER NET-

WORK RELATED TO COMPUTER NETWORK SE-
CURITY, IN CLASS 42 (U.S. CLS. 100 AND 101).

FIRST USE 1-16-2007; IN COMMERCE 1-16-2007.

OWNER OF U.S. REG. NOS. 2,484,500, 2,773,771,
AND 3,102,116.

THE MARK CONSISTS OF AN OVAL, ENCIR-
CLING A LOWER CASE "E", RESEMBLING A HU-
MAN EYE AND IRIS.

SN 77-228,448, FILED 7-12-2007.

BONNIE LUKEN, EXAMINING ATTORNEY

Int. Cl.: 43

Prior U.S. Cls.: 100 and 101

United States Patent and Trademark Office

Reg. No. 3,481,817

Registered Aug. 5, 2008

**SERVICE MARK
PRINCIPAL REGISTER**

HOLLYWOOD ESPRESSO

RICHMAN, MARK (UNITED STATES INDIVIDUAL)
SUITE 202
849 S BROADWAY
LOS ANGELES, CA 90014 AND
PACINO, ROBERTA (UNITED STATES INDIVIDUAL)
SUITE 202
849 S BROADWAY
LOS ANGELES, CA 90014

FOR: COFFEE SHOPS; COFFEE-HOUSE AND
SNACK-BAR SERVICES , IN CLASS 43 (U.S. CLS.
100 AND 101).

FIRST USE 5-0-2008; IN COMMERCE 5-0-2008.

THE MARK CONSISTS OF STANDARD CHARACTERS WITHOUT CLAIM TO ANY PARTICULAR FONT, STYLE, SIZE, OR COLOR.

NO CLAIM IS MADE TO THE EXCLUSIVE RIGHT TO USE "ESPRESSO", APART FROM THE MARK AS SHOWN.

SN 77-229,727, FILED 7-13-2007.

JASON BLAIR, EXAMINING ATTORNEY

Int. Cl.: 9

Prior U.S. Cls.: 21, 23, 26, 36, and 38

Reg. No. 3,481,818

United States Patent and Trademark Office

Registered Aug. 5, 2008

**TRADEMARK
PRINCIPAL REGISTER**

SPECTRUM

DAYMEN PHOTO MARKETING LP (CANADA
LIMITED PARTNERSHIP)
55 VALLEYWOOD DRIVE
MARKHAM, ONTARIO, CANADA L3R 5L9

THE MARK CONSISTS OF STANDARD CHAR-
ACTERS WITHOUT CLAIM TO ANY PARTICULAR
FONT, STYLE, SIZE, OR COLOR.

FOR: BAGS FOR CAMERAS AND PHOTO-
GRAPHIC EQUIPMENT, IN CLASS 9 (U.S. CLS. 21,
23, 26, 36 AND 38).

SN 77-229,752, FILED 7-13-2007.

FIRST USE 2-12-2008; IN COMMERCE 2-12-2008.

PAUL F. GAST, EXAMINING ATTORNEY

Int. Cl.: 11

Prior U.S. Cls.: 13, 21, 23, 31, and 34

Reg. No. 3,481,819

United States Patent and Trademark Office

Registered Aug. 5, 2008

**TRADEMARK
PRINCIPAL REGISTER**

NANOWAVE

HOLLINGSWORTH & VOSE COMPANY (MAS-
SACHUSETTS CORPORATION)
112 WASHINGTON STREET
EAST WALPOLE, MA 02032

THE MARK CONSISTS OF STANDARD CHAR-
ACTERS WITHOUT CLAIM TO ANY PARTICULAR
FONT, STYLE, SIZE, OR COLOR.

FOR: FILTER MEDIA COMPOSED OF SYNTHET-
IC FIBERS FOR LIQUID AND AIR FILTRATION
APPLICATIONS, IN CLASS 11 (U.S. CLS. 13, 21, 23, 31
AND 34).

SN 77-231,085, FILED 7-17-2007.

FIRST USE 7-27-2007; IN COMMERCE 7-27-2007.

ANTHONY RINKER, EXAMINING ATTORNEY

Int. Cl.: 36

Prior U.S. Cls.: 100, 101, and 102

United States Patent and Trademark Office

Reg. No. 3,481,820

Registered Aug. 5, 2008

**SERVICE MARK
PRINCIPAL REGISTER**

**Giving You The Absolute
Advantage**

ABSOLUTE ADVANTAGE MORTGAGE COR-
PORATION LLC (MARYLAND LTD LIAB CO)
2635 INWOOD DRIVE
ADAMSTOWN, MD 21710

FOR: MORTGAGE BROKERAGE, NAMELY,
ORIGINATION OF MORTGAGES FOR RESIDEN-
TIAL AND COMMERCIAL REAL ESTATE, IN
CLASS 36 (U.S. CLS. 100, 101 AND 102).

FIRST USE 9-9-2007; IN COMMERCE 9-9-2007.

THE MARK CONSISTS OF STANDARD CHAR-
ACTERS WITHOUT CLAIM TO ANY PARTICULAR
FONT, STYLE, SIZE, OR COLOR.

SN 77-231,254, FILED 7-17-2007.

JUSTINE D. PARKER, EXAMINING ATTORNEY

Int. Cl.: 9

Prior U.S. Cls.: 21, 23, 26, 36, and 38

United States Patent and Trademark Office

Reg. No. 3,481,821

Registered Aug. 5, 2008

**TRADEMARK
PRINCIPAL REGISTER**

BIOS

GENMAR IP LLC (DELAWARE LTD LIAB CO)
2900 IDS CENTER, 80 SOUTH EIGHTH STREET
MINNEAPOLIS, MN 55402

FOR: ELECTRONIC INSTRUMENT PANELS FOR
BOATS, IN CLASS 9 (U.S. CLS. 21, 23, 26, 36 AND 38).

FIRST USE 7-1-2007; IN COMMERCE 7-1-2007.

THE MARK CONSISTS OF STANDARD CHAR-
ACTERS WITHOUT CLAIM TO ANY PARTICULAR
FONT, STYLE, SIZE, OR COLOR.

SN 77-231,610, FILED 7-17-2007.

SHANNON TWOHIG, EXAMINING ATTORNEY

Int. Cl.: 6

Prior U.S. Cls.: 2, 12, 13, 14, 23, 25, and 50

United States Patent and Trademark Office

Reg. No. 3,481,822

Registered Aug. 5, 2008

TRADEMARK
PRINCIPAL REGISTER

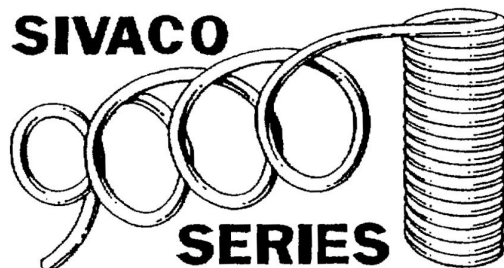

SIVACO WIRE GROUP 2004 L.P. (CANADA LIMITED PARTNERSHIP)
1 PLACE ALEXIS NIHON
3400 DE MAISONNEUVE W., SUITE 1501
MONTREAL, QUEBEC, CANADA H3Z3B8

FOR: SPECIALTY HIGH CARBON WIRE FOR THE MANUFACTURE OF AUTOMOTIVE, COMMERCIAL AND DYNAMICALLY LOADED LOW CYCLE PRODUCTS, IN CLASS 6 (U.S. CLS. 2, 12, 13, 14, 23, 25 AND 50).

FIRST USE 11-0-1996; IN COMMERCE 11-0-1996.

OWNER OF CANADA REG. NO. 515831, DATED 8-31-1999, EXPIRES 8-31-2014.

OWNER OF U.S. REG. NO. 1,092,655.

NO CLAIM IS MADE TO THE EXCLUSIVE RIGHT TO USE "SERIES", APART FROM THE MARK AS SHOWN.

THE MARK CONSISTS OF THE WORDS "SIVACO 9000 SERIES" AND A SPOOL OF WIRE DESIGN. THE NUMBER "9000" IS STYLIZED TO APPEAR THAT IT IS WIRE UNWINDING FROM THE SPOOL OF WIRE..

SN 77-232,561, FILED 7-18-2007.

WILLIAM P. SHANAHAN, EXAMINING ATTORNEY

Int. Cl.: 33

Prior U.S. Cls.: 47 and 49

United States Patent and Trademark Office

Reg. No. 3,481,823

Registered Aug. 5, 2008

**TRADEMARK
PRINCIPAL REGISTER**

THIS IS YOUR WAKE-UP CALL

CONSTELLATION SPIRITS INC. (DELAWARE
CORPORATION)
SUITE 1700
1 SOUTH DEARBORN
CHICAGO, IL 60603

THE MARK CONSISTS OF STANDARD CHAR-
ACTERS WITHOUT CLAIM TO ANY PARTICULAR
FONT, STYLE, SIZE, OR COLOR.

FOR: ALCOHOLIC BEVERAGES, NAMELY,
SCHNAPPS, IN CLASS 33 (U.S. CLS. 47 AND 49).

SN 77-232,831, FILED 7-18-2007.

FIRST USE 9-1-2007; IN COMMERCE 9-1-2007.

SUSAN STIGLITZ, EXAMINING ATTORNEY

Int. Cl.: 41

Prior U.S. Cls.: 100, 101, and 107

United States Patent and Trademark Office

Reg. No. 3,481,824

Registered Aug. 5, 2008

**SERVICE MARK
PRINCIPAL REGISTER**

OLWEUS

HAZELDEN FOUNDATION (MINNESOTA CORPORATION)
15245 PLEASANT VALLEY ROAD
CENTER CITY, MN 55012

FOR: TRAINING FOR OTHERS REGARDING BULLYING AND ANTISOCIAL BEHAVIOR PREVENTION PROGRAMS IN SCHOOLS AND ATHLETICS, IN CLASS 41 (U.S. CLS. 100, 101 AND 107).

FIRST USE 6-0-2006; IN COMMERCE 6-0-2006.

THE MARK CONSISTS OF STANDARD CHARACTERS WITHOUT CLAIM TO ANY PARTICULAR FONT, STYLE, SIZE, OR COLOR.

SN 77-232,861, FILED 7-18-2007.

ANDREW RHIM, EXAMINING ATTORNEY

Int. Cl.: 18

Prior U.S. Cls.: 1, 2, 3, 22, and 41

United States Patent and Trademark Office

Reg. No. 3,481,825

Registered Aug. 5, 2008

**TRADEMARK
PRINCIPAL REGISTER**

LOGISTERRA

NGUYEN, TAN (UNITED STATES INDIVIDUAL)
6190-K FAIRMOUNT AVENUE
SAN DIEGO, CA 92120

FIRST USE 6-19-2008; IN COMMERCE 6-19-2008.

FOR: HANDBAGS, BRIEFCASES, LUGGAGE,
TOTE BAGS, COSMETIC CASES SOLD EMPTY,
TOILETRY CASES SOLD EMPTY, SPORTS BAGS,
BACKPACKS AND FANNY PACKS, WALLETS,
KEY CASES AND CARRYING CASES , IN CLASS
18 (U.S. CLS. 1, 2, 3, 22 AND 41).

THE MARK CONSISTS OF STANDARD CHAR-
ACTERS WITHOUT CLAIM TO ANY PARTICULAR
FONT, STYLE, SIZE, OR COLOR.

SN 77-233,990, FILED 7-19-2007.

JOHN GARTNER, EXAMINING ATTORNEY

Int. Cl.: 25

Prior U.S. Cls.: 22 and 39

United States Patent and Trademark Office

Reg. No. 3,481,826

Registered Aug. 5, 2008

**TRADEMARK
PRINCIPAL REGISTER**

PRETTY ZEN

GLOBAL CLOTHING NETWORK, INC. (CALI-
FORNIA CORPORATION)
186 LAAUWE AVENUE
WAYNE, NJ 07470

FOR: CLOTHING, NAMELY, T-SHIRTS, SHIRTS,
SWEATERS, JACKETS, PANTS, SHORTS, ROM-
PERS, JOGGING SUITS, VESTS, DRESSES, JUMP
SUITS, HATS, SKIRTS, TOPS, IN CLASS 25 (U.S. CLS.
22 AND 39).

FIRST USE 12-30-2007; IN COMMERCE 12-30-2007.

THE MARK CONSISTS OF STANDARD CHAR-
ACTERS WITHOUT CLAIM TO ANY PARTICULAR
FONT, STYLE, SIZE, OR COLOR.

SN 77-235,186, FILED 7-20-2007.

WILLIAM BRECKENFELD, EXAMINING ATTOR-
NEY

Int. Cl.: 16

Prior U.S. Cls.: 2, 5, 22, 23, 29, 37, 38, and 50

Reg. No. 3,481,827

United States Patent and Trademark Office

Registered Aug. 5, 2008

**TRADEMARK
PRINCIPAL REGISTER**

ON KEY

PRESCRIPTIVE MUSIC, LLC (DELAWARE LTD
LIAB CO)
22020 CLARENDON STREET, SUITE 201
WOODLAND HILLS, CA 91367

FOR: PRINTED PROMOTIONAL PACKAGING
MADE OF PAPER OF VARYING WEIGHTS, FOR
HOLDING GIFT CARDS, CARD KEYS AND CDS/
DVDS, IN CLASS 16 (U.S. CLS. 2, 5, 22, 23, 29, 37, 38
AND 50).

FIRST USE 1-0-2006; IN COMMERCE 1-0-2006.

THE MARK CONSISTS OF STANDARD CHAR-
ACTERS WITHOUT CLAIM TO ANY PARTICULAR
FONT, STYLE, SIZE, OR COLOR.

SN 77-235,222, FILED 7-20-2007.

ELLEN BURNS, EXAMINING ATTORNEY

Int. Cl.: 25

Prior U.S. Cls.: 22 and 39

United States Patent and Trademark Office

Reg. No. 3,481,828

Registered Aug. 5, 2008

**TRADEMARK
PRINCIPAL REGISTER**

PRETTY SMART

GLOBAL CLOTHING NETWORK, INC. (CALI-
FORNIA CORPORATION)
186 LAAUWE AVENUE
WAYNE, NJ 07470

FOR: CLOTHING, NAMELY, T-SHIRTS, SHIRTS,
SWEATERS, JACKETS, PANTS, SHORTS, ROM-
PERS, JOGGING SUITS, VESTS, DRESSES, JUMP
SUITS, HATS, SKIRTS, TOPS, IN CLASS 25 (U.S. CLS.
22 AND 39).

FIRST USE 12-30-2007; IN COMMERCE 12-30-2007.

THE MARK CONSISTS OF STANDARD CHAR-
ACTERS WITHOUT CLAIM TO ANY PARTICULAR
FONT, STYLE, SIZE, OR COLOR.

SN 77-235,529, FILED 7-22-2007.

WILLIAM BRECKENFELD, EXAMINING ATTOR-
NEY

Int. Cl.: 30

Prior U.S. Cl.: 46

United States Patent and Trademark Office

Reg. No. 3,481,829

Registered Aug. 5, 2008

TRADEMARK
PRINCIPAL REGISTER



RECKITT BENCKISER INC. (DELAWARE CORPORATION)
399 INTERPACE PARKWAY
PARSIPPANY, NJ 07054

FOR: MUSTARD; DRIED MUSTARD; PREPARED MUSTARD POWDER; FOOD FLAVORINGS, NOT ESSENTIAL OILS; MARINADES FOR FOOD, NAMELY, WORCESTERSHIRE SAUCE, MUSTARD, IN CLASS 30 (U.S. CL. 46).

FIRST USE 3-13-2008; IN COMMERCE 3-13-2008.

OWNER OF U.S. REG. NOS. 545,030, 1,786,915, AND OTHERS.

THE COLOR(S) BLACK AND YELLOW IS/ARE CLAIMED AS A FEATURE OF THE MARK.

THE MARK CONSISTS OF THE WORDS "FOOD" AND "FRENCH'S" SEPARATED BY A HEART SHAPE ALL IN THE COLOR YELLOW WITH BLACK SHADOWING.

SN 77-236,230, FILED 7-23-2007.

JAMES LOVELACE, EXAMINING ATTORNEY

Int. Cl.: 35

Prior U.S. Cls.: 100, 101, and 102

United States Patent and Trademark Office

Reg. No. 3,481,830

Registered Aug. 5, 2008

**SERVICE MARK
PRINCIPAL REGISTER**



ELLIANOS, LLC (FLORIDA LTD LIAB CO)
426 S.W. COMMERCE DRIVE, SUITE 105
LAKE CITY, FL 32025

FOR: FRANCHISE SERVICES, NAMELY, OFFERING TECHNICAL AND BUSINESS MANAGEMENT ASSISTANCE IN THE ESTABLISHMENT AND OPERATION OF RESTAURANTS AND FEATURING AN INCENTIVE PROGRAM TO ENCOURAGE PARTICIPATION OF CURRENT AND FORMER MILITARY, LAW ENFORCEMENT AND FIRE FIGHTING PERSONNEL IN FRANCHISING OP-

PORTUNITIES, IN CLASS 35 (U.S. CLS. 100, 101 AND 102).

FIRST USE 6-1-2007; IN COMMERCE 6-1-2007.

THE MARK CONSISTS OF HERO FRAN & DESIGN.

SN 77-236,995, FILED 7-24-2007.

DAVID HOFFMAN, EXAMINING ATTORNEY

Int. Cls.: 9 and 42

Prior U.S. Cls.: 21, 23, 26, 36, 38, 100, and 101

United States Patent and Trademark Office

Reg. No. 3,481,831

Registered Aug. 5, 2008

**TRADEMARK
SERVICE MARK
PRINCIPAL REGISTER**

Service360

MAINTENANCENET, INC. (CALIFORNIA CORPORATION)
5963 LA PLACE COURT #300
CARLSBAD, CA 92008

FOR: COMPUTER SOFTWARE USED TO TRACK AND MANAGE MAINTENANCE CONTRACTS, NAMELY, PROVIDING SERVICE CONTRACT MANAGEMENT SERVICES, PARTNER PERFORMANCE MANAGEMENT SERVICES AND SERVICE SALES MANAGEMENT SERVICES, IN CLASS 9 (U.S. CLS. 21, 23, 26, 36 AND 38).

FIRST USE 4-1-2008; IN COMMERCE 4-1-2008.

FOR: PROVIDING TEMPORARY USE OF ON-LINE, NON-DOWNLOADABLE SOFTWARE TO STORE, MANAGE, TRACK, ANALYZE AND REPORT DATA IN THE FIELD OF TECHNOLOGY

MAINTENANCE CONTRACTS; PROVIDING TEMPORARY USE OF ON-LINE NON-DOWNLOADABLE SOFTWARE TO FACILITATE COMMUNICATING WITH TECHNOLOGY MANUFACTURERS AND THEIR CHANNEL PARTNERS IN THE ADVERTISING, MARKETING AND SALE OF MAINTENANCE SERVICE CONTRACTS, IN CLASS 42 (U.S. CLS. 100 AND 101).

FIRST USE 4-1-2008; IN COMMERCE 4-1-2008.

THE MARK CONSISTS OF STANDARD CHARACTERS WITHOUT CLAIM TO ANY PARTICULAR FONT, STYLE, SIZE, OR COLOR.

SN 77-237,309, FILED 7-24-2007.

SUSAN LESLIE DUBOIS, EXAMINING ATTORNEY

Int. Cls.: 3 and 21

**Prior U.S. Cls.: 1, 2, 4, 6, 13, 23, 29, 30, 33, 40, 50, 51,
and 52**

Reg. No. 3,481,832

United States Patent and Trademark Office

Registered Aug. 5, 2008

**TRADEMARK
PRINCIPAL REGISTER**

billybBEAUTY

BILLY B BEAUTY, L.L.C. (CALIFORNIA LTD
LIAB CO)
1152 NORTH ORANGE GROVE AVENUE
WEST HOLLYWOOD, CA 90046

FIRST USE 1-1-2006; IN COMMERCE 1-1-2007.

FOR: MAKE-UP FOR THE FACE AND BODY, IN
CLASS 3 (U.S. CLS. 1, 4, 6, 50, 51 AND 52).

THE MARK CONSISTS OF STANDARD CHAR-
ACTERS WITHOUT CLAIM TO ANY PARTICULAR
FONT, STYLE, SIZE, OR COLOR.

FIRST USE 5-1-2008; IN COMMERCE 5-1-2008.

SN 77-237,457, FILED 7-24-2007.

FOR: MAKE-UP BRUSHES, IN CLASS 21 (U.S.
CLS. 2, 13, 23, 29, 30, 33, 40 AND 50).

JASON TURNER, EXAMINING ATTORNEY

Int. Cl.: 30

Prior U.S. Cl.: 46

United States Patent and Trademark Office

Reg. No. 3,481,833

Registered Aug. 5, 2008

TRADEMARK
PRINCIPAL REGISTER



MEI, YUE QIN WILLIAM (UNITED STATES
INDIVIDUAL)
5410 W. ROOSEVELT ROAD
UNIT 111, DOCK 35B
CHICAGO, IL 60644

THE NON-LATIN CHARACTER(S) IN THE
MARK transliterate into "TAIKU", AND
THIS MEANS ANTIQUITY IN ENGLISH.

FOR: PASTRIES, IN CLASS 30 (U.S. CL. 46).

SN 77-237,467, FILED 7-24-2007.

FIRST USE 7-1-2007; IN COMMERCE 7-1-2007.

REBECCA SMITH, EXAMINING ATTORNEY

Int. Cl.: 7

Prior U.S. Cls.: 13, 19, 21, 23, 31, 34, and 35

Reg. No. 3,481,834

United States Patent and Trademark Office

Registered Aug. 5, 2008

**TRADEMARK
PRINCIPAL REGISTER**

SLURRY KING

TOMLINSON, CHARLES (UNITED STATES IN-
DIVIDUAL)
1635 N. GREENFIELD RD. #112
MESA, AZ 85205

FOR: MOTORIZED DEWATERING MACHINE
FOR USE IN THE TREATMENT OF LIQUIDS,
NAMELY, FOR REMOVING WATER FROM A
SLURRY MIXTURE OF CONCRETE DUST AND
WATER , IN CLASS 7 (U.S. CLS. 13, 19, 21, 23, 31, 34
AND 35).

FIRST USE 6-11-2007; IN COMMERCE 6-11-2007.

THE MARK CONSISTS OF STANDARD CHAR-
ACTERS WITHOUT CLAIM TO ANY PARTICULAR
FONT, STYLE, SIZE, OR COLOR.

NO CLAIM IS MADE TO THE EXCLUSIVE
RIGHT TO USE "SLURRY", APART FROM THE
MARK AS SHOWN.

SN 77-238,176, FILED 7-25-2007.

LAURA HAMMEL, EXAMINING ATTORNEY

Int. Cl.: 28

Prior U.S. Cls.: 22, 23, 38, and 50

United States Patent and Trademark Office

Reg. No. 3,481,835

Registered Aug. 5, 2008

**TRADEMARK
PRINCIPAL REGISTER**

BRIDGE PLAYER'S COMPANION

NOSSE, ROBERT T (UNITED STATES INDIVIDUAL)

1421 W. HURON ST.

ANN ARBOR, MI 481034225

FOR: CASES FOR PLAY ACCESSORIES, IN CLASS 28 (U.S. CLS. 22, 23, 38 AND 50).

FIRST USE 3-12-2007; IN COMMERCE 3-12-2007.

THE MARK CONSISTS OF STANDARD CHARACTERS WITHOUT CLAIM TO ANY PARTICULAR FONT, STYLE, SIZE, OR COLOR.

NO CLAIM IS MADE TO THE EXCLUSIVE RIGHT TO USE "BRIDGE", APART FROM THE MARK AS SHOWN.

SN 77-238,194, FILED 7-25-2007.

GIANCARLO CASTRO, EXAMINING ATTORNEY

Int. Cl.: 32

Prior U.S. Cls.: 45, 46, and 48

United States Patent and Trademark Office

Reg. No. 3,481,836

Registered Aug. 5, 2008

TRADEMARK
PRINCIPAL REGISTER



AIELLO, ANGELO M. (UNITED STATES INDIVIDUAL)
36 ARMAND WAY
HOPE, RI 02831 AND
AIELLO, DAVID J. (UNITED STATES INDIVIDUAL)
36 ARMAND WAY
HOPE, RI 02831

NO CLAIM IS MADE TO THE EXCLUSIVE
RIGHT TO USE "ACAIBERRI", APART FROM THE
MARK AS SHOWN.

SN 77-238,370, FILED 7-25-2007.

FOR: FRUIT JUICES, IN CLASS 32 (U.S. CLS. 45, 46
AND 48).

FIRST USE 12-15-2007; IN COMMERCE 12-15-2007.

AMOS T. MATTHEWS, JR., EXAMINING ATTORNEY

Int. Cl.: 6

Prior U.S. Cls.: 2, 12, 13, 14, 23, 25, and 50

United States Patent and Trademark Office

Reg. No. 3,481,837

Registered Aug. 5, 2008

**TRADEMARK
PRINCIPAL REGISTER**

The logo for HOLT features the word "HOLT" in a bold, black, sans-serif font. The letter "O" is replaced by a white square containing a black silhouette of a sailboat.

JACK HOLT LTD (UNITED KINGDOM CORPORATION)
EMBANKMENT
LONDON, UNITED KINGDOM SW151LB

FOR: ANCHORS; MARINE ANCHORS; BUCKLES OF COMMON METAL; CABLE THIMBLES OF METAL; EYE BOLTS; METAL EYE BOLTS; FERULES OF METAL FOR CANES AND WALKING-STICKS; METAL BOLLARDS; METAL CABLE WIRE; METAL CHAINS; METAL CLOSURES FOR CONTAINERS; METAL EXPANSION JOINTS FOR PIPING AND DUCTING; METAL HARDWARE NAMELY, PULLEYS; METAL HARDWARE, NAMELY, WASHERS; METAL HINGES; METAL HOOKS; METAL KEY RINGS; METAL LADDERS; METAL LATCHES; METAL MARINE HARDWARE, NAMELY, THIMBLES; METAL NUTS; METAL PIPE COUPLINGS AND JOINTS; METAL PLUGS; METAL

POLES; METAL POSTS; METAL PULLEYS, SPRINGS AND VALVES; METAL RIVETS; METAL SCREWS; METAL WEATHER VANES; METAL WINDOW FRAMES; NAILS; WIRE; WIRE ROPES; MOORING BOLLARDS OF METAL, IN CLASS 6 (U.S. CLS. 2, 12, 13, 14, 23, 25 AND 50).

FIRST USE 5-1-2008; IN COMMERCE 5-1-2008.

THE MARK CONSISTS OF FANCY BLACK LETTERS, WITH THE LETTER "O" SYMBOLIZED AS A SQUARE WITH A BLACK BOAT OVER A WHITE BACKGROUND.

SN 77-239,011, FILED 7-26-2007.

PATRICIA EVANKO, EXAMINING ATTORNEY

Int. Cl.: 2

Prior U.S. Cls.: 6, 11, and 16

United States Patent and Trademark Office

Reg. No. 3,481,838

Registered Aug. 5, 2008

**TRADEMARK
PRINCIPAL REGISTER**

WORKHORSE

KOP-COAT, INC. (OHIO CORPORATION)
3020 WILLIAM PITT WAY
PITTSBURGH, PA 15238

THE MARK CONSISTS OF STANDARD CHAR-
ACTERS WITHOUT CLAIM TO ANY PARTICULAR
FONT, STYLE, SIZE, OR COLOR.

FOR: WOOD PRESERVATIVES FOR WOOD AND
WOOD-BASED COMPOSITES FOR RESISTING DE-
CAY, STAIN, AND FUNGI, IN CLASS 2 (U.S. CLS. 6,
11 AND 16).

SN 77-240,409, FILED 7-27-2007.

FIRST USE 4-15-2008; IN COMMERCE 4-15-2008.

REBECCA SMITH, EXAMINING ATTORNEY

Int. Cl.: 31

Prior U.S. Cls.: 1 and 46

United States Patent and Trademark Office

Reg. No. 3,481,839

Registered Aug. 5, 2008

**TRADEMARK
PRINCIPAL REGISTER**

PERFORMANCETECH

SOUTHERN STATES COOPERATIVE, INCORPORATED (VIRGINIA CORPORATION)
6606 WEST BROAD STREET
RICHMOND, VA 232301717

THE MARK CONSISTS OF STANDARD CHARACTERS WITHOUT CLAIM TO ANY PARTICULAR FONT, STYLE, SIZE, OR COLOR.

FOR: ANIMAL FEED, IN CLASS 31 (U.S. CLS. 1 AND 46).

SN 77-240,506, FILED 7-27-2007.

FIRST USE 11-12-2007; IN COMMERCE 11-26-2007.

DAWN HAN, EXAMINING ATTORNEY

Int. Cls.: 9 and 41

Prior U.S. Cls.: 21, 23, 26, 36, 38, 100, 101, and 107

United States Patent and Trademark Office

Reg. No. 3,481,840

Registered Aug. 5, 2008

**TRADEMARK
SERVICE MARK
PRINCIPAL REGISTER**

PAC-MAN PLUS

NAMCO BANDAI GAMES INC. (JAPAN CORPORATION)
4-5-15 HIGASHI SHINAGAWA, SHINAGAWA-KU
TOKYO, JAPAN 140 8590

FOR: VIDEO GAME CARTRIDGES, COMPUTER GAME PROGRAMS, IN CLASS 9 (U.S. CLS. 21, 23, 26, 36 AND 38).

FIRST USE 10-8-2007; IN COMMERCE 10-8-2007.

FOR: ENTERTAINMENT, NAMELY, PROVIDING A COMPUTER GAME THAT MAY BE ACCESSED NETWORK-WIDE BY NETWORK USERS VIA MOBILE PHONES AND COMPUTERS; PROVIDING COMPUTER GAMES VIA NETWORK BETWEEN

COMMUNICATIONS NETWORKS AND COMPUTERS, IN CLASS 41 (U.S. CLS. 100, 101 AND 107).

FIRST USE 10-8-2007; IN COMMERCE 10-8-2007.

THE MARK CONSISTS OF STANDARD CHARACTERS WITHOUT CLAIM TO ANY PARTICULAR FONT, STYLE, SIZE, OR COLOR.

OWNER OF U.S. REG. NOS. 1,259,524, 3,048,436, AND OTHERS.

SN 77-240,619, FILED 7-27-2007.

DARRYL SPRUILL, EXAMINING ATTORNEY

Int. Cl.: 28

Prior U.S. Cls.: 22, 23, 38, and 50

United States Patent and Trademark Office

Reg. No. 3,481,841

Registered Aug. 5, 2008

**TRADEMARK
PRINCIPAL REGISTER**

SUPER SCOOPER

NAMCO BANDAI GAMES INC. (JAPAN CORPORATION)
4-5-15 HIGASHI SHINAGAWA, SHINAGAWA-KU
TOKYO, JAPAN 140 8590

THE MARK CONSISTS OF STANDARD CHARACTERS WITHOUT CLAIM TO ANY PARTICULAR FONT, STYLE, SIZE, OR COLOR.

FOR: COIN-OPERATED AMUSEMENT GAME MACHINES, IN CLASS 28 (U.S. CLS. 22, 23, 38 AND 50).

SN 77-240,629, FILED 7-27-2007.

FIRST USE 2-12-2008; IN COMMERCE 2-12-2008.

DARRYL SPRUILL, EXAMINING ATTORNEY

Int. Cl.: 38

Prior U.S. Cls.: 100, 101, and 104

United States Patent and Trademark Office

Reg. No. 3,481,842

Registered Aug. 5, 2008

**SERVICE MARK
PRINCIPAL REGISTER**

**THE WORST CELL PHONE BILL
IN AMERICA**

VALIDAS, INC. (DELAWARE CORPORATION)
7519 CHALK HILL ROAD
MISSOURI CITY, TX 77459

FOR: TELECOMMUNICATIONS AND WIRELESS
TELEPHONE COMMUNICATION SERVICES
NAMELY, TELECOMMUNICATION CONSULTA-
TION TO THIRD-PARTY USERS WITH ACCESS
TO TELECOMMUNICATION INFRASTRUCTURE
FOR PERSONAL COMMUNICATIONS SERVICES
CONCERNING BILLING AND TELEPHONE CALL-
ING PLANS BASED ON DATA TRANSMISSION
AND RECEPTION SERVICES AND EXCHANGE

OF DATA STORED IN A DATABASE ACCESSIBLE
VIA TELECOMMUNICATION MEANS, IN CLASS 38
(U.S. CLS. 100, 101 AND 104).

FIRST USE 9-10-2007; IN COMMERCE 9-10-2007.

THE MARK CONSISTS OF STANDARD CHAR-
ACTERS WITHOUT CLAIM TO ANY PARTICULAR
FONT, STYLE, SIZE, OR COLOR.

SN 77-241,839, FILED 7-30-2007.

CARRIE GENOVESE, EXAMINING ATTORNEY

Int. Cl.: 14

Prior U.S. Cls.: 2, 27, 28, and 50

United States Patent and Trademark Office

Reg. No. 3,481,843

Registered Aug. 5, 2008

**TRADEMARK
PRINCIPAL REGISTER**

OCIE

OSNAT GAD, INC. (NEW YORK CORPORATION)
608 FIFTH AVENUE
NEW YORK, NY 10020

FOR: JEWELRY, IN CLASS 14 (U.S. CLS. 2, 27, 28 AND 50).

FIRST USE 2-20-2006; IN COMMERCE 2-20-2006.

THE MARK CONSISTS OF STANDARD CHARACTERS WITHOUT CLAIM TO ANY PARTICULAR FONT, STYLE, SIZE, OR COLOR.

OWNER OF U.S. REG. NO. 3,024,718.

SN 77-241,852, FILED 7-30-2007.

BONNIE LUKEN, EXAMINING ATTORNEY

Int. Cl.: 3

Prior U.S. Cls.: 1, 4, 6, 50, 51, and 52

United States Patent and Trademark Office

Reg. No. 3,481,844

Registered Aug. 5, 2008

TRADEMARK
PRINCIPAL REGISTER



MAY, SANDRA J (UNITED STATES INDIVIDUAL)
2 BLUE HERON DRIVE
SOUTH AMBOY, NJ 08879

FOR: ALMOND SOAPS; BAR SOAP; BATH SOAPS; BATH SOAPS IN LIQUID, SOLID OR GEL FORM; BODY CREAM SOAP; COSMETIC SOAPS; CREAM SOAPS; GRANULATED SOAPS; HAND SOAPS; LIQUID BATH SOAPS; LIQUID SOAP; LIQUID SOAP USED IN FOOT BATH; LIQUID SOAPS; LIQUID SOAPS FOR HANDS AND FACE; LIQUID SOAPS FOR HANDS, FACE AND BODY; PERFUMED SOAP; PERFUMED SOAPS; SHAVING SOAP; SKIN SOAP; SOAP POWDER; SOAPS; SOAPS FOR BODY CARE; SOAPS FOR PERSONAL USE; WATERLESS SOAP, IN CLASS 3 (U.S. CLS. 1, 4, 6, 50, 51 AND 52).

FIRST USE 7-7-2007; IN COMMERCE 10-30-2007.

NO CLAIM IS MADE TO THE EXCLUSIVE RIGHT TO USE "SPA", APART FROM THE MARK AS SHOWN.

THE COLOR(S) BLACK, WHITE, PINK, GREEN, ORANGE IS/ARE CLAIMED AS A FEATURE OF THE MARK.

THE MARK CONSISTS OF BLACK LITERAL ELEMENT WITH BLACK SKETCH OF GIRL IN WHITE SPA ROBE AND TURBAN WITH GREEN CUCUMBERS ON EYES, PINK CIRCLES, PINK ICE CREAM CONE, PINK, GREEN AND ORANGE LOLLIPOPS IN PINK CIRCLES.

THE FOREIGN WORDING "SUCRERIES" IN THE MARK TRANSLATES INTO ENGLISH AS SWEETS OR ANYTHING MADE FROM SUGAR.

SN 77-242,594, FILED 7-30-2007.

ELIZABETH KAJUBI, EXAMINING ATTORNEY

Int. Cl.: 3

Prior U.S. Cls.: 1, 4, 6, 50, 51, and 52

United States Patent and Trademark Office

Reg. No. 3,481,845

Registered Aug. 5, 2008

**TRADEMARK
PRINCIPAL REGISTER**

ETERNAL FLAMES

DESIGNER SKIN, LLC (ARIZONA LTD LIAB CO)
1325 WEST 21ST STREET
TEMPE, AZ 85282

FOR: INDOOR TANNING PREPARATIONS, IN
CLASS 3 (U.S. CLS. 1, 4, 6, 50, 51 AND 52).

FIRST USE 1-1-2008; IN COMMERCE 1-1-2008.

THE MARK CONSISTS OF STANDARD CHAR-
ACTERS WITHOUT CLAIM TO ANY PARTICULAR
FONT, STYLE, SIZE, OR COLOR.

SN 77-242,940, FILED 7-31-2007.

DOMINIC J. FERRAIUOLO, EXAMINING ATTOR-
NEY

Int. Cl.: 9

Prior U.S. Cls.: 21, 23, 26, 36, and 38

United States Patent and Trademark Office

Reg. No. 3,481,846

Registered Aug. 5, 2008

**TRADEMARK
PRINCIPAL REGISTER**

NUPOINT

COMPUTER SERVICES, INC. (KENTUCKY CORPORATION)
3901 TECHNOLOGY DRIVE
PADUCAH, KY 42001

FOR: COMPUTER SOFTWARE FOR USE IN THE BANKING INDUSTRY BY BANK EMPLOYEES FOR SELECTIVELY INTERFACING CLIENT DATA RESIDING ON ENTERPRISE SYSTEMS, IN CLASS 9 (U.S. CLS. 21, 23, 26, 36 AND 38).

FIRST USE 9-1-2007; IN COMMERCE 9-1-2007.

THE MARK CONSISTS OF STANDARD CHARACTERS WITHOUT CLAIM TO ANY PARTICULAR FONT, STYLE, SIZE, OR COLOR.

SN 77-243,400, FILED 7-31-2007.

REBECCA SMITH, EXAMINING ATTORNEY

Int. Cl.: 21

Prior U.S. Cls.: 2, 13, 23, 29, 30, 33, 40, and 50

Reg. No. 3,481,847

United States Patent and Trademark Office

Registered Aug. 5, 2008

**TRADEMARK
PRINCIPAL REGISTER**

The Perfect Pasta Plate

BEACH BRANDS (CALIFORNIA CORPORATION)
125 TOP SAIL MALL
MARINA DEL REY, CA 90292

FOR: CERAMIC SCULPTURES, VASES, VESSELS, BOWLS, PLATES AND POTS; DINNERWARE, NAMELY, CERAMIC, PLASTIC, MELAMINE PLATES; DISHES AND PLATES; DISPOSABLE TABLE PLATES, IN CLASS 21 (U.S. CLS. 2, 13, 23, 29, 30, 33, 40 AND 50).

FIRST USE 8-1-2007; IN COMMERCE 9-1-2007.

THE MARK CONSISTS OF STANDARD CHARACTERS WITHOUT CLAIM TO ANY PARTICULAR FONT, STYLE, SIZE, OR COLOR.

NO CLAIM IS MADE TO THE EXCLUSIVE RIGHT TO USE "PLATE", APART FROM THE MARK AS SHOWN.

SN 77-243,743, FILED 7-31-2007.

SHANNON TWOHIG, EXAMINING ATTORNEY

Int. Cl.: 37

Prior U.S. Cls.: 100, 103, and 106

United States Patent and Trademark Office

Reg. No. 3,481,848

Registered Aug. 5, 2008

**SERVICE MARK
PRINCIPAL REGISTER**



LOVE, TIMOTHY (UNITED STATES INDIVIDUAL)
2145 GOOD HOPE ROAD
EDWARDS, MS 39066

FOR: SHARPENING AND REPAIR OF HAIR CLIPPER BLADES, SCISSORS, LAWN AND GARDEN TOOLS AND CHAIN SAWS, IN CLASS 37 (U.S. CLS. 100, 103 AND 106).

FIRST USE 1-1-2007; IN COMMERCE 1-1-2007.

NO CLAIM IS MADE TO THE EXCLUSIVE RIGHT TO USE "SHARPENING", APART FROM THE MARK AS SHOWN.

THE COLOR(S) RED, BLACK, BROWN, GRAY, BEIGE, GREEN, WHITE, PINK, AND YELLOW IS/ARE CLAIMED AS A FEATURE OF THE MARK.

THE MARK CONSISTS OF A CUPID HAVING BLACK OUTLINE DETAILING, BEIGE SKIN, BROWN HAIR, WHITE AND GRAY WINGS, AND HAVING A RED AND BLACK HEART TATTOO, WEARING RED TRUNKS, AND CARRYING BLACK AND RED ARROWS IN A BROWN QUIVER; THE TABLE AND STOOL APPEAR IN GRAY WITH BLACK OUTLINE, THE GRINDING WHEEL APPEARS IN BROWN, THE INSTRUMENTS ON THE TABLE APPEAR IN BROWN AND BLACK; THE STYLIZED SPARKS APPEAR IN PINK WITH RED HEARTS; THE LAWNMOWER APPEARS IN BLACK, YELLOW, AND GREEN, THE POWER SAW APPEARS IN YELLOW AND BLACK; THE WORD "LOVE'S" APPEARS IN RED; THE WORD "SHARPENING" APPEARS IN BLACK.

SN 77-243,911, FILED 8-1-2007.

IRA J. GOODSaid, EXAMINING ATTORNEY

Int. Cl.: 16

Prior U.S. Cls.: 2, 5, 22, 23, 29, 37, 38, and 50

Reg. No. 3,481,849

United States Patent and Trademark Office

Registered Aug. 5, 2008

**TRADEMARK
PRINCIPAL REGISTER**

**GOOD MANNERS ARE
CONTAGIOUS, PASS IT ON!**

WEINER, LORI (UNITED STATES INDIVIDUAL)
9391 FOX TROT LANE
BOCA RATON, FL 33496 AND
STONER, JODI (UNITED STATES INDIVIDUAL)
9391 FOX TROT LANE
BOCA RATON, FL 33496

FIRST USE 11-14-2007; IN COMMERCE 11-14-2007.

THE MARK CONSISTS OF STANDARD CHAR-
ACTERS WITHOUT CLAIM TO ANY PARTICULAR
FONT, STYLE, SIZE, OR COLOR.

FOR: CHILDREN'S BOOKS; CHILDREN'S ADHE-
SIVE STICKERS IN SAID BOOKS, IN CLASS 16 (U.S.
CLS. 2, 5, 22, 23, 29, 37, 38 AND 50).

SN 77-244,013, FILED 8-1-2007.

JOHN WILKE, EXAMINING ATTORNEY

Int. Cls.: 36 and 39

Prior U.S. Cls.: 100, 101, 102, and 105

United States Patent and Trademark Office

Reg. No. 3,481,850

Registered Aug. 5, 2008

**SERVICE MARK
PRINCIPAL REGISTER**



PHNOM PENH EXPRESS, INC. (CALIFORNIA CORPORATION)
2140 EAST ANAHEIM STREET
LONG BEACH, CA 90804

FOR: MONEY TRANSFER SERVICES, SPECIFICALLY TO CAMBODIA; ELECTRONIC TRANSFERS OF MONEY, SPECIFICALLY TO CAMBODIA, IN CLASS 36 (U.S. CLS. 100, 101 AND 102).

FIRST USE 10-6-2004; IN COMMERCE 1-6-2008.

FOR: TRAVEL AGENCY SERVICES, NAMELY, MAKING RESERVATIONS AND BOOKINGS FOR TRANSPORTATION, IN CLASS 39 (U.S. CLS. 100 AND 105).

FIRST USE 10-6-2004; IN COMMERCE 1-6-2008.

NO CLAIM IS MADE TO THE EXCLUSIVE RIGHT TO USE "PHNOM PENH" AND "EXPRESS", APART FROM THE MARK AS SHOWN.

THE COLOR(S) RED, BLUE, ORANGE, WHITE IS/ARE CLAIMED AS A FEATURE OF THE MARK.

THE MARK CONSISTS OF THE WORDS "PHNOM PENH" APPEARING IN BLUE, IN WHICH AN AIRPLANE IS DISPLAYED IN THE LETTER O - THE AIRPLANE CONSISTS OF THE FUSELAGE AND WINGS APPEARING IN WHITE, THE COCKPIT WINDOW AND NOSE GEAR APPEARING IN LIGHT BLUE, THE JET ENGINE AND PASSENGER WINDOWS LOCATED ON THE LEFT SIDE OF THE FUSELAGE APPEARING IN ORANGE - ALL OF WHICH IS DISPLAYED ABOVE FOUR SETS OF LINES, THE TOP TWO APPEARING IN RED AND THE BOTTOM TWO APPEARING IN BLUE, WHICH RUN INTO THE LETTER E OF EXPRESS APPEARING IN RED, WITH ONE LINE DISPLAYED DIAGONALLY PER EACH LETTER S.

SN 77-245,738, FILED 8-2-2007.

PRISCILLA MILTON, EXAMINING ATTORNEY

Int. Cl.: 3

Prior U.S. Cls.: 1, 4, 6, 50, 51, and 52

United States Patent and Trademark Office

Reg. No. 3,481,851

Registered Aug. 5, 2008

**TRADEMARK
PRINCIPAL REGISTER**

AROMACOLOR

DESIGNER SKIN, LLC (ARIZONA LTD LIAB CO)
6270 CORPORATE DRIVE
INDIANAPOLIS, IN 46278

FOR: INDOOR TANNING PREPARATIONS, IN
CLASS 3 (U.S. CLS. 1, 4, 6, 50, 51 AND 52).

FIRST USE 1-1-2008; IN COMMERCE 1-1-2008.

THE MARK CONSISTS OF STANDARD CHAR-
ACTERS WITHOUT CLAIM TO ANY PARTICULAR
FONT, STYLE, SIZE, OR COLOR.

SN 77-245,866, FILED 8-2-2007.

DOMINIC J. FERRAIUOLO, EXAMINING ATTOR-
NEY

Int. Cl.: 3

Prior U.S. Cls.: 1, 4, 6, 50, 51, and 52

United States Patent and Trademark Office

Reg. No. 3,481,852

Registered Aug. 5, 2008

**TRADEMARK
PRINCIPAL REGISTER**

GOLD MINE

DESIGNER SKIN, LLC (ARIZONA LTD LIAB CO)
6270 CORPORATE DRIVE
INDIANAPOLIS, IN 46278

FOR: INDOOR TANNING PREPARATIONS FOR
SALE IN TANNING SALONS, IN CLASS 3 (U.S. CLS.
1, 4, 6, 50, 51 AND 52).

FIRST USE 1-1-2008; IN COMMERCE 1-1-2008.

THE MARK CONSISTS OF STANDARD CHAR-
ACTERS WITHOUT CLAIM TO ANY PARTICULAR
FONT, STYLE, SIZE, OR COLOR.

SN 77-245,946, FILED 8-2-2007.

DOMINIC J. FERRAIUOLO, EXAMINING ATTOR-
NEY

Int. Cl.: 3

Prior U.S. Cls.: 1, 4, 6, 50, 51, and 52

United States Patent and Trademark Office

Reg. No. 3,481,853

Registered Aug. 5, 2008

**TRADEMARK
PRINCIPAL REGISTER**

BRONZE REDEMPTION

DESIGNER SKIN, LLC (ARIZONA LTD LIAB CO)
6270 CORPORATE DRIVE
INDIANAPOLIS, IN 46278

FOR: INDOOR TANNING PREPARATIONS, IN
CLASS 3 (U.S. CLS. 1, 4, 6, 50, 51 AND 52).

FIRST USE 1-1-2008; IN COMMERCE 1-1-2008.

THE MARK CONSISTS OF STANDARD CHAR-
ACTERS WITHOUT CLAIM TO ANY PARTICULAR
FONT, STYLE, SIZE, OR COLOR.

SN 77-246,894, FILED 8-3-2007.

DOMINIC J. FERRAIUOLO, EXAMINING ATTOR-
NEY

Int. Cl.: 3

Prior U.S. Cls.: 1, 4, 6, 50, 51, and 52

United States Patent and Trademark Office

Reg. No. 3,481,854

Registered Aug. 5, 2008

**TRADEMARK
PRINCIPAL REGISTER**

DIVINE WISDOM

DESIGNER SKIN, LLC (ARIZONA LTD LIAB CO)
1325 WEST 21ST STREET
TEMPE, AZ 85282

FOR: INDOOR TANNING PREPARATIONS, IN
CLASS 3 (U.S. CLS. 1, 4, 6, 50, 51 AND 52).

FIRST USE 1-1-2008; IN COMMERCE 1-1-2008.

THE MARK CONSISTS OF STANDARD CHAR-
ACTERS WITHOUT CLAIM TO ANY PARTICULAR
FONT, STYLE, SIZE, OR COLOR.

SN 77-246,949, FILED 8-3-2007.

DOMINIC J. FERRAIUOLO, EXAMINING ATTOR-
NEY

Int. Cl.: 3

Prior U.S. Cls.: 1, 4, 6, 50, 51, and 52

United States Patent and Trademark Office

Reg. No. 3,481,855

Registered Aug. 5, 2008

**TRADEMARK
PRINCIPAL REGISTER**

CROWN JEWEL

DESIGNER SKIN, LLC (ARIZONA LTD LIAB CO)
6270 CORPORATE DRIVE
INDIANAPOLIS, IN 46278

FOR: INDOOR TANNING PREPARATIONS, IN
CLASS 3 (U.S. CLS. 1, 4, 6, 50, 51 AND 52).

FIRST USE 1-1-2008; IN COMMERCE 1-1-2008.

THE MARK CONSISTS OF STANDARD CHAR-
ACTERS WITHOUT CLAIM TO ANY PARTICULAR
FONT, STYLE, SIZE, OR COLOR.

SN 77-246,980, FILED 8-3-2007.

DOMINIC J. FERRAIUOLO, EXAMINING ATTOR-
NEY

Int. Cl.: 3

Prior U.S. Cls.: 1, 4, 6, 50, 51, and 52

Reg. No. 3,481,856

United States Patent and Trademark Office

Registered Aug. 5, 2008

**TRADEMARK
PRINCIPAL REGISTER**

WOW!

DESIGNER SKIN, LLC (ARIZONA LTD LIAB CO)
6270 CORPORATE DRIVE
INDIANAPOLIS, IN 46278

THE MARK CONSISTS OF STANDARD CHAR-
ACTERS WITHOUT CLAIM TO ANY PARTICULAR
FONT, STYLE, SIZE, OR COLOR.

FOR: INDOOR TANNING LOTIONS, IN CLASS 3
(U.S. CLS. 1, 4, 6, 50, 51 AND 52).

SN 77-247,017, FILED 8-3-2007.

FIRST USE 1-1-2008; IN COMMERCE 1-1-2008.

IRA J. GOODSaid, EXAMINING ATTORNEY

Int. Cl.: 25

Prior U.S. Cls.: 22 and 39

United States Patent and Trademark Office

Reg. No. 3,481,857

Registered Aug. 5, 2008

TRADEMARK
PRINCIPAL REGISTER

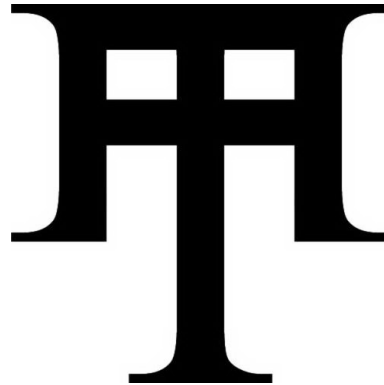

YEN, ALAIN (UNITED STATES INDIVIDUAL)
23879 BLUE BILL COURT
MORENO VALLEY, CA 92557

FOR: T-SHIRTS; DENIMS; LEATHER PANTS;
SWEAT PANTS; HATS; POLO SHIRTS; SHORT-
SLEEVED OR LONG-SLEEVED T-SHIRTS; ATHLET-
IC SHOES; SHOES, IN CLASS 25 (U.S. CLS. 22 AND
39).

FIRST USE 6-1-2008; IN COMMERCE 6-1-2008.

THE MARK CONSISTS OF THE LOGO REPRESENTATIVE OF THE COMPANY CALLED "THE ALLIANCE OF ART AND APPAREL" (AKA "THE ARTEL"). IT CONSISTS OF 2 LETTER "A"S THAT CONNECT TO FORM ONE LARGE "A" AND A LOWERCASE "T" IN THE CENTER.

SN 77-247,372, FILED 8-5-2007.

DARRYL SPRUILL, EXAMINING ATTORNEY

Int. Cl.: 16

Prior U.S. Cls.: 2, 5, 22, 23, 29, 37, 38, and 50

United States Patent and Trademark Office

Reg. No. 3,481,858

Registered Aug. 5, 2008

**TRADEMARK
PRINCIPAL REGISTER**

MODERN CONTRACTOR SOLUTIONS

HIGHLANDS PUBLICATIONS, INC. (ALABAMA CORPORATION)
312 LORNA SQUARE
BIRMINGHAM, AL 35216

FOR: MAGAZINES FEATURING INFORMATION FOR GENERAL AND CONCRETE CONTRACTORS, IN CLASS 16 (U.S. CLS. 2, 5, 22, 23, 29, 37, 38 AND 50).

FIRST USE 7-15-2007; IN COMMERCE 8-10-2007.

THE MARK CONSISTS OF STANDARD CHARACTERS WITHOUT CLAIM TO ANY PARTICULAR FONT, STYLE, SIZE, OR COLOR.

NO CLAIM IS MADE TO THE EXCLUSIVE RIGHT TO USE "CONTRACTOR", APART FROM THE MARK AS SHOWN.

SN 77-247,414, FILED 8-5-2007.

DOMINIC J. FERRAIUOLO, EXAMINING ATTORNEY

Int. Cl.: 5

Prior U.S. Cls.: 6, 18, 44, 46, 51, and 52

United States Patent and Trademark Office

Reg. No. 3,481,859

Registered Aug. 5, 2008

**TRADEMARK
PRINCIPAL REGISTER**

LongeviPlex

WALKER, RICHARD F. (UNITED STATES INDIVIDUAL)
456 HARBOR DRIVE SOUTH
INDIAN ROCKS BEACH, FL 33785

THE MARK CONSISTS OF STANDARD CHARACTERS WITHOUT CLAIM TO ANY PARTICULAR FONT, STYLE, SIZE, OR COLOR.

FOR: DIETARY SUPPLEMENTS, IN CLASS 5 (U.S. CLS. 6, 18, 44, 46, 51 AND 52).

SN 77-247,572, FILED 8-6-2007.

FIRST USE 11-19-2007; IN COMMERCE 11-19-2007.

JOHN E. MICHOS, EXAMINING ATTORNEY

Int. Cl.: 1

Prior U.S. Cls.: 1, 5, 6, 10, 26, and 46

Reg. No. 3,481,860

United States Patent and Trademark Office

Registered Aug. 5, 2008

**TRADEMARK
PRINCIPAL REGISTER**

TOPGUARD

BAKER HUGHES INCORPORATED (DELA-
WARE CORPORATION)
2929 ALLEN PARKWAY, SUITE 2100
HOUSTON, TX 77019

THE MARK CONSISTS OF STANDARD CHAR-
ACTERS WITHOUT CLAIM TO ANY PARTICULAR
FONT, STYLE, SIZE, OR COLOR.

FOR: CHEMICALS AND CHEMICAL ADDITIVES
FOR CONTROLLING OVERHEAD CORROSION IN
REFINERIES AND PETROCHEMICAL PLANTS, IN
CLASS 1 (U.S. CLS. 1, 5, 6, 10, 26 AND 46).

SN 77-247,927, FILED 8-6-2007.

FIRST USE 10-1-2007; IN COMMERCE 10-1-2007.

MICHAEL LITZAU, EXAMINING ATTORNEY

Int. Cl.: 41

Prior U.S. Cls.: 100, 101, and 107

United States Patent and Trademark Office

Reg. No. 3,481,861

Registered Aug. 5, 2008

**SERVICE MARK
PRINCIPAL REGISTER**

SPORTSBUBBLER

JOURNAL SENTINEL INC. (WISCONSIN CORPORATION)
333 WEST STATE STREET
MILWAUKEE, WI 53203

FOR: PROVIDING A WEBSITE FEATURING NEWS IN THE FIELD OF SPORTS, STORIES RELATED TO SPORTS, AND INFORMATION OF INTEREST TO SPORTS ENTHUSIASTS, NAMELY, INFORMATION IN THE FIELD OF SPORTS, IN CLASS 41 (U.S. CLS. 100, 101 AND 107).

FIRST USE 12-1-2007; IN COMMERCE 12-1-2007.

THE MARK CONSISTS OF STANDARD CHARACTERS WITHOUT CLAIM TO ANY PARTICULAR FONT, STYLE, SIZE, OR COLOR.

SN 77-248,257, FILED 8-6-2007.

CIMMERIAN COLEMAN, EXAMINING ATTORNEY

Int. Cl.: 41

Prior U.S. Cls.: 100, 101, and 107

United States Patent and Trademark Office

Reg. No. 3,481,862

Registered Aug. 5, 2008

**SERVICE MARK
PRINCIPAL REGISTER**

SPORTSBUBBLER.COM

JOURNAL SENTINEL INC. (WISCONSIN CORPORATION)
333 WEST STATE STREET
MILWAUKEE, WI 53203

FOR: PROVIDING A WEBSITE FEATURING NEWS IN THE FIELD OF SPORTS, STORIES RELATED TO SPORTS, AND INFORMATION OF INTEREST TO SPORTS ENTHUSIASTS, NAMELY, INFORMATION IN THE FIELD OF SPORTS, IN CLASS 41 (U.S. CLS. 100, 101 AND 107).

FIRST USE 12-1-2007; IN COMMERCE 12-1-2007.

THE MARK CONSISTS OF STANDARD CHARACTERS WITHOUT CLAIM TO ANY PARTICULAR FONT, STYLE, SIZE, OR COLOR.

SN 77-248,265, FILED 8-6-2007.

CIMMERIAN COLEMAN, EXAMINING ATTORNEY

Int. Cl.: 9

Prior U.S. Cls.: 21, 23, 26, 36, and 38

Reg. No. 3,481,863

United States Patent and Trademark Office

Registered Aug. 5, 2008

**TRADEMARK
PRINCIPAL REGISTER**

PLATEMAX

AXYGEN SCIENTIFIC, INC. (CALIFORNIA CORPORATION)
33210 CENTRAL AVE
UNION CITY, CA 94587

SCIENTIFIC, LABORATORY OR MEDICAL RESEARCH USE; LABORATORY ROBOTS, IN CLASS 9 (U.S. CLS. 21, 23, 26, 36 AND 38).

FIRST USE 9-25-2007; IN COMMERCE 12-11-2007.

FOR: HEAT SEALING MACHINES FOR APPLYING HEAT-SEALING FILMS TO MULTI-WELL MICROPLATES, HEAT SEALING FILMS FOR APPLICATION TO MULTI-WELL MICROPLATES OR ADHESIVE SEALING FILMS FOR APPLYING TO MULTI-WELL MICROPLATES; PLATES, GLASS SLIDES OR CHIPS HAVING MULTI-WELL ARRAYS THAT CAN BE USED IN CHEMICAL ANALYSIS, BIOLOGICAL ANALYSIS OR PATTERNING FOR

THE MARK CONSISTS OF STANDARD CHARACTERS WITHOUT CLAIM TO ANY PARTICULAR FONT, STYLE, SIZE, OR COLOR.

SN 77-248,468, FILED 8-6-2007.

CHERYL CLAYTON, EXAMINING ATTORNEY

Int. Cl.: 3

Prior U.S. Cls.: 1, 4, 6, 50, 51, and 52

United States Patent and Trademark Office

Reg. No. 3,481,864

Registered Aug. 5, 2008

**TRADEMARK
PRINCIPAL REGISTER**



AVEDA CORPORATION (DELAWARE CORPORATION)
4000 PHEASANT RIDGE DRIVE
MINNEAPOLIS, MN 55449

FOR: FRAGRANCES FOR PERSONAL USE; ESSENTIAL OILS FOR PERSONAL USE; SCENTED BODY SPRAY, IN CLASS 3 (U.S. CLS. 1, 4, 6, 50, 51 AND 52).

FIRST USE 3-31-2008; IN COMMERCE 3-31-2008.

THE MARK CONSISTS OF A SANSKRIT CHARACTER WITHIN A CIRCULAR-SHAPED DEVICE.

THE NON-LATIN CHARACTER(S) IN THE MARK TRANSLITERATE INTO "MULADHARA", AND THIS MEANS ROOT OR SUPPORT IN ENGLISH.

SN 77-248,770, FILED 8-7-2007.

DAVID YONTEF, EXAMINING ATTORNEY

Int. Cl.: 3

Prior U.S. Cls.: 1, 4, 6, 50, 51, and 52

Reg. No. 3,481,865

United States Patent and Trademark Office

Registered Aug. 5, 2008

**TRADEMARK
PRINCIPAL REGISTER**

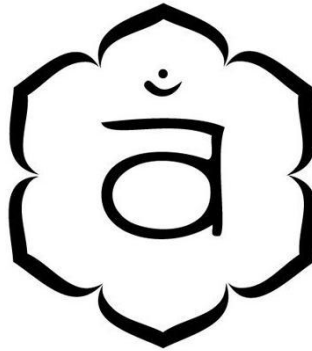

AVEDA CORPORATION (DELAWARE CORPORATION)
4000 PHEASANT RIDGE DRIVE
MINNEAPOLIS, MN 55449

FOR: FRAGRANCES FOR PERSONAL USE; ESSENTIAL OILS FOR PERSONAL USE, IN CLASS 3 (U.S. CLS. 1, 4, 6, 50, 51 AND 52).

FIRST USE 3-31-2008; IN COMMERCE 3-31-2008.

THE MARK CONSISTS OF A SANSKRIT CHARACTER WITHIN A CIRCULAR-SHAPED DEVICE.

THE NON-LATIN CHARACTER(S) IN THE MARK TRANSLITERATE INTO "SVADHISTHANA", AND THIS MEANS SWEETNESS IN ENGLISH.

SN 77-248,782, FILED 8-7-2007.

DAVID YONTEF, EXAMINING ATTORNEY

Int. Cl.: 3

Prior U.S. Cls.: 1, 4, 6, 50, 51, and 52

United States Patent and Trademark Office

Reg. No. 3,481,866

Registered Aug. 5, 2008

**TRADEMARK
PRINCIPAL REGISTER**

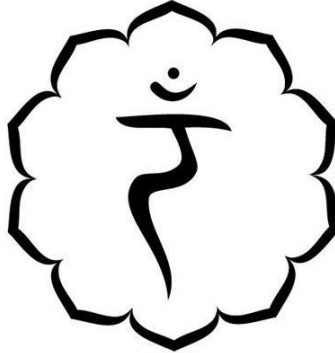

AVEDA CORPORATION (DELAWARE CORPORATION)
4000 PHEASANT RIDGE DRIVE
MINNEAPOLIS, MN 55449

FOR: FRAGRANCES FOR PERSONAL USE; ESSENTIAL OILS FOR PERSONAL USE, IN CLASS 3 (U.S. CLS. 1, 4, 6, 50, 51 AND 52).

FIRST USE 3-31-2008; IN COMMERCE 3-31-2008.

THE MARK CONSISTS OF A SANSKRIT CHARACTER WITHIN A CIRCULAR-SHAPED DEVICE.

THE NON-LATIN CHARACTER(S) IN THE MARK TRANSLITERATE INTO "MANIPURA", AND THIS MEANS LUSTROUS JEWEL IN ENGLISH.

SN 77-248,791, FILED 8-7-2007.

DAVID YONTEF, EXAMINING ATTORNEY

Int. Cl.: 3

Prior U.S. Cls.: 1, 4, 6, 50, 51, and 52

United States Patent and Trademark Office

Reg. No. 3,481,867

Registered Aug. 5, 2008

**TRADEMARK
PRINCIPAL REGISTER**

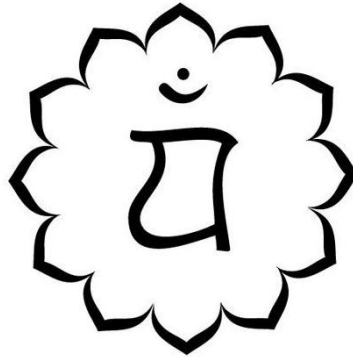

AVEDA CORPORATION (DELAWARE CORPORATION)

4000 PHEASANT RIDGE DRIVE
MINNEAPOLIS, MN 55449

FOR: FRAGRANCES FOR PERSONAL USE; ESSENTIAL OILS FOR PERSONAL USE, IN CLASS 3 (U.S. CLS. 1, 4, 6, 50, 51 AND 52).

FIRST USE 3-31-2008; IN COMMERCE 3-31-2008.

THE MARK CONSISTS OF A SANSKRIT CHARACTER WITHIN A CIRCULAR-SHAPED DEVICE.

THE NON-LATIN CHARACTER(S) IN THE MARK TRANSLITERATE INTO "ANAHATA", AND THIS MEANS UNSTRUCK IN ENGLISH.

SN 77-248,801, FILED 8-7-2007.

DAVID YONTEF, EXAMINING ATTORNEY

Int. Cl.: 3

Prior U.S. Cls.: 1, 4, 6, 50, 51, and 52

United States Patent and Trademark Office

Reg. No. 3,481,868

Registered Aug. 5, 2008

**TRADEMARK
PRINCIPAL REGISTER**

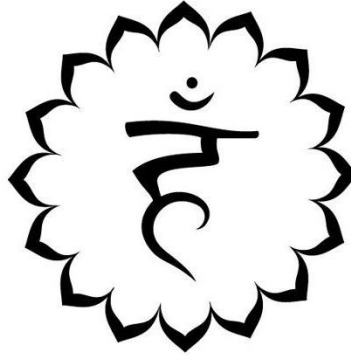

AVEDA CORPORATION (DELAWARE CORPORATION)

4000 PHEASANT RIDGE DRIVE
MINNEAPOLIS, MN 55449

FOR: FRAGRANCES FOR PERSONAL USE; ESSENTIAL OILS FOR PERSONAL USE, IN CLASS 3 (U.S. CLS. 1, 4, 6, 50, 51 AND 52).

FIRST USE 3-31-2008; IN COMMERCE 3-31-2008.

THE MARK CONSISTS OF A SANSKRIT CHARACTER WITHIN A CIRCULAR-SHAPED DEVICE.

THE NON-LATIN CHARACTER(S) IN THE MARK TRANSLITERATE INTO "VISSHUDHA", AND THIS MEANS TO PURIFY IN ENGLISH.

SN 77-248,815, FILED 8-7-2007.

DAVID YONTEF, EXAMINING ATTORNEY

Int. Cl.: 3

Prior U.S. Cls.: 1, 4, 6, 50, 51, and 52

United States Patent and Trademark Office

Reg. No. 3,481,869

Registered Aug. 5, 2008

**TRADEMARK
PRINCIPAL REGISTER**



AVEDA CORPORATION (DELAWARE CORPORATION)

4000 PHEASANT RIDGE DRIVE

MINNEAPOLIS, MN 55449

FOR: FRAGRANCES FOR PERSONAL USE; ESSENTIAL OILS FOR PERSONAL USE, IN CLASS 3 (U.S. CLS. 1, 4, 6, 50, 51 AND 52).

FIRST USE 3-31-2008; IN COMMERCE 3-31-2008.

THE MARK CONSISTS OF A SANSKRIT CHARACTER WITH A STYLIZED BRACKET ON THE LEFT AND RIGHT SIDES.

THE NON-LATIN CHARACTER(S) IN THE MARK TRANSLITERATE INTO "AJNA", AND THIS MEANS TO PERCEIVE IN ENGLISH.

SN 77-248,827, FILED 8-7-2007.

DAVID YONTEF, EXAMINING ATTORNEY

Int. Cl.: 3

Prior U.S. Cls.: 1, 4, 6, 50, 51, and 52

United States Patent and Trademark Office

Reg. No. 3,481,870

Registered Aug. 5, 2008

**TRADEMARK
PRINCIPAL REGISTER**

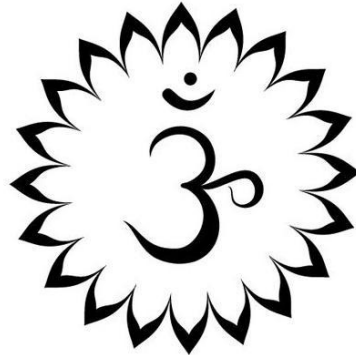

AVEDA CORPORATION (DELAWARE CORPORATION)
4000 PHEASANT RIDGE DRIVE
MINNEAPOLIS, MN 55449

FOR: FRAGRANCES FOR PERSONAL USE; ESSENTIAL OILS FOR PERSONAL USE, IN CLASS 3 (U.S. CLS. 1, 4, 6, 50, 51 AND 52).

FIRST USE 3-31-2008; IN COMMERCE 3-31-2008.

THE MARK CONSISTS OF A SANSKRIT CHARACTER WITHIN A CIRCULAR-SHAPED OR FLOWER-SHAPED DEVICE.

THE NON-LATIN CHARACTER(S) IN THE MARK TRANSLITERATE INTO "SAHASRARA", AND THIS MEANS THOUSAND-FOLD IN ENGLISH.

SN 77-248,832, FILED 8-7-2007.

DAVID YONTEF, EXAMINING ATTORNEY

Int. Cl.: 35

Prior U.S. Cls.: 100, 101, and 102

United States Patent and Trademark Office

Reg. No. 3,481,871

Registered Aug. 5, 2008

**SERVICE MARK
PRINCIPAL REGISTER**

The logo for Wallaby's features two stylized wallaby silhouettes facing each other, with their heads and ears forming the letter 'W'. To the right of this graphic, the word 'Wallaby's' is written in a cursive, handwritten-style font.

P&D ENTERPRISES, INC. (COLORADO CORPORATION), DBA WALLABY'S LIQUOR WAREHOUSE,
21821 LONGS PEAK LANE
PARKER, CO 80138

THE MARK CONSISTS OF THE WORDING "WALLABY'S", WHICH IS CREATED BY USING TWO WALLABIES TO FORM THE LETTER "W."

FOR: RETAIL LIQUOR STORES, IN CLASS 35 (U.S. CLS. 100, 101 AND 102).

SN 77-249,012, FILED 8-7-2007.

FIRST USE 10-31-2007; IN COMMERCE 10-31-2007.

JENNIFER HETU, EXAMINING ATTORNEY

Int. Cl.: 25

Prior U.S. Cls.: 22 and 39

United States Patent and Trademark Office

Reg. No. 3,481,872

Registered Aug. 5, 2008

**TRADEMARK
PRINCIPAL REGISTER**

BEACH DIVA

MALIBU DREAM GIRL (CALIFORNIA CORPORATION)

4941 S. EASTERN AVENUE

BELL, CA 902016301

FOR: SWIMWEAR AND COVER-UPS, IN CLASS 25 (U.S. CLS. 22 AND 39).

FIRST USE 7-14-2006; IN COMMERCE 3-5-2007.

THE MARK CONSISTS OF STANDARD CHARACTERS WITHOUT CLAIM TO ANY PARTICULAR FONT, STYLE, SIZE, OR COLOR.

NO CLAIM IS MADE TO THE EXCLUSIVE RIGHT TO USE "BEACH", APART FROM THE MARK AS SHOWN.

SN 77-251,179, FILED 8-9-2007.

MARLENE BELL, EXAMINING ATTORNEY

Int. Cl.: 28

Prior U.S. Cls.: 22, 23, 38, and 50

Reg. No. 3,481,873

United States Patent and Trademark Office

Registered Aug. 5, 2008

**TRADEMARK
PRINCIPAL REGISTER**

XerDance

SPORTWALL INTERNATIONAL INC. (DELA-
WARE CORPORATION)
6460 VIA REAL
CARPINTERIA, CA 93013

THE MARK CONSISTS OF STANDARD CHAR-
ACTERS WITHOUT CLAIM TO ANY PARTICULAR
FONT, STYLE, SIZE, OR COLOR.

FOR: EXERCISE MACHINES INCORPORATING
ELECTRONIC AND VIDEO GAME CONTROLLERS,
NAMELY, INTERACTIVE PORTABLE DANCE
FLOOR, IN CLASS 28 (U.S. CLS. 22, 23, 38 AND 50).

SN 77-251,482, FILED 8-9-2007.

FIRST USE 3-0-2008; IN COMMERCE 3-0-2008.

BRIAN NEVILLE, EXAMINING ATTORNEY

Int. Cls.: 16 and 20

Prior U.S. Cls.: 2, 5, 13, 22, 23, 25, 29, 32, 37, 38, and 50

Reg. No. 3,481,874

United States Patent and Trademark Office

Registered Aug. 5, 2008

**TRADEMARK
PRINCIPAL REGISTER**

BLINGSTRIPS

KARNOVA CORP. (CALIFORNIA CORPORATION)

3096 N. CLYBOURN AVENUE

BURBANK, NJ 91505

FOR: APPLIQUES IN THE FORM OF DECALS; DECALS; PLASTIC, VINYL TRANSFERS; STICKERS; DECORATIVE STICKERS FOR HELMETS; ADHESIVE PLASTIC FILM USED FOR MOUNTING IMAGES, IN CLASS 16 (U.S. CLS. 2, 5, 22, 23, 29, 37, 38 AND 50).

FIRST USE 8-10-2007; IN COMMERCE 8-10-2007.

FOR: VINYL APPLIQUES FOR ATTACHMENT TO WINDOWS, MIRRORS, AND OTHER SOLID SURFACES, IN CLASS 20 (U.S. CLS. 2, 13, 22, 25, 32 AND 50).

FIRST USE 8-10-2007; IN COMMERCE 8-10-2007.

THE MARK CONSISTS OF STANDARD CHARACTERS WITHOUT CLAIM TO ANY PARTICULAR FONT, STYLE, SIZE, OR COLOR.

SN 77-252,346, FILED 8-10-2007.

MARY CRAWFORD, EXAMINING ATTORNEY

Int. Cl.: 25

Prior U.S. Cls.: 22 and 39

United States Patent and Trademark Office

Reg. No. 3,481,875

Registered Aug. 5, 2008

**TRADEMARK
PRINCIPAL REGISTER**

**The Alliance of Art and
Apparel**

YEN, ALAIN (UNITED STATES INDIVIDUAL)
23879 BLUE BILL COURT
MORENO VALLEY, CA 92557

FOR: SHORT-SLEEVED OR LONG-SLEEVED T-SHIRTS; T-SHIRTS; DENIM JACKETS; DENIMS; LEATHER PANTS; PANTS; SWEAT PANTS; HATS; ATHLETIC SHOES; SHOES; POLO SHIRTS; BELTS, IN CLASS 25 (U.S. CLS. 22 AND 39).

FIRST USE 6-1-2008; IN COMMERCE 6-1-2008.

THE MARK CONSISTS OF STANDARD CHARACTERS WITHOUT CLAIM TO ANY PARTICULAR FONT, STYLE, SIZE, OR COLOR.

SN 77-252,399, FILED 8-10-2007.

DARRYL SPRUILL, EXAMINING ATTORNEY

Int. Cl.: 25

Prior U.S. Cls.: 22 and 39

United States Patent and Trademark Office

Reg. No. 3,481,876

Registered Aug. 5, 2008

**TRADEMARK
PRINCIPAL REGISTER**

The Artel

YEN, ALAIN (UNITED STATES INDIVIDUAL)
23879 BLUE BILL COURT
MORENO VALLEY, CA 92557

FOR: SHORT-SLEEVED OR LONG-SLEEVED T-SHIRTS; T-SHIRTS; DENIM JACKETS; DENIMS; LEATHER PANTS; PANTS; SWEAT PANTS; HATS; SHIRTS; POLO SHIRTS; ATHLETIC SHOES; SHOES, IN CLASS 25 (U.S. CLS. 22 AND 39).

FIRST USE 6-1-2008; IN COMMERCE 6-1-2008.

THE MARK CONSISTS OF STANDARD CHARACTERS WITHOUT CLAIM TO ANY PARTICULAR FONT, STYLE, SIZE, OR COLOR.

SN 77-252,575, FILED 8-10-2007.

DARRYL SPRUILL, EXAMINING ATTORNEY

Int. Cl.: 3

Prior U.S. Cls.: 1, 4, 6, 50, 51, and 52

Reg. No. 3,481,877

United States Patent and Trademark Office

Registered Aug. 5, 2008

**TRADEMARK
PRINCIPAL REGISTER**

DYNAMO HOUSE RED TEA

DYNAMO HOUSE PROPRIETARY LIMITED
(AUSTRALIA CORPORATION)
24 SIMLA STREET
MITCHAM, AUSTRALIA 3132

FOR: MASSAGE OILS AND CREAMS; PERSONAL CARE PRODUCTS FOR BODY, HAIR AND FACE, NAMELY, BODY LOTIONS, BODY MASKS, BODY MILKS, BODY POWDERS, BODY SCRUBS, BODY OILS, BODY SPRAYS, BODY WASHES, HAIR CARE PREPARATIONS, HAIR SHAMPOO, FACE CREAMS, AND FACE POWDERS; SCENTED PERFUMES FOR THE BODY, IN CLASS 3 (U.S. CLS. 1, 4, 6, 50, 51 AND 52).

FIRST USE 6-0-2007; IN COMMERCE 6-0-2007.

THE MARK CONSISTS OF STANDARD CHARACTERS WITHOUT CLAIM TO ANY PARTICULAR FONT, STYLE, SIZE, OR COLOR.

NO CLAIM IS MADE TO THE EXCLUSIVE RIGHT TO USE "RED TEA", APART FROM THE MARK AS SHOWN.

SN 77-252,824, FILED 8-10-2007.

BRENDAN MCCAULEY, EXAMINING ATTORNEY

Int. Cl.: 3

Prior U.S. Cls.: 1, 4, 6, 50, 51, and 52

Reg. No. 3,481,878

United States Patent and Trademark Office

Registered Aug. 5, 2008

**TRADEMARK
PRINCIPAL REGISTER**

DYNAMO HOUSE YUZU

DYNAMO HOUSE PROPRIETARY LIMITED
(AUSTRALIA CORPORATION)
24 SIMLA STREET
MITCHAM, AUSTRALIA 3132

FOR: MASSAGE OILS AND CREAMS; PERSONAL CARE PRODUCTS FOR BODY, HAIR AND FACE, NAMELY, BODY LOTIONS, BODY MASKS, BODY MILKS, BODY POWDERS, BODY SCRUBS, BODY OILS, BODY SPRAYS, BODY WASHES, HAIR CARE PREPARATIONS, HAIR SHAMPOO, FACE CREAMS, AND FACE POWDERS; SCENTED PERFUMES FOR THE BODY, IN CLASS 3 (U.S. CLS. 1, 4, 6, 50, 51 AND 52).

FIRST USE 4-0-2007; IN COMMERCE 4-0-2007.

THE MARK CONSISTS OF STANDARD CHARACTERS WITHOUT CLAIM TO ANY PARTICULAR FONT, STYLE, SIZE, OR COLOR.

NO CLAIM IS MADE TO THE EXCLUSIVE RIGHT TO USE "YUZU", APART FROM THE MARK AS SHOWN.

SN 77-252,832, FILED 8-10-2007.

BRENDAN MCCAULEY, EXAMINING ATTORNEY

Int. Cl.: 25

Prior U.S. Cls.: 22 and 39

United States Patent and Trademark Office

Reg. No. 3,481,879

Registered Aug. 5, 2008

**TRADEMARK
PRINCIPAL REGISTER**

**MOVING AT THE SPEED OF
LEISURE**

OZIO LIFESTYLES, LLC (CALIFORNIA LTD
LIAB CO)
5504 SEPULVEDA BOULEVARD
CULVER CITY, CA 90230

THE MARK CONSISTS OF STANDARD CHAR-
ACTERS WITHOUT CLAIM TO ANY PARTICULAR
FONT, STYLE, SIZE, OR COLOR.

FOR: CLOTHING, NAMELY, SWEAT SUITS,
SHIRTS, PANTS, JACKETS, ROBES, AND SHORTS,
IN CLASS 25 (U.S. CLS. 22 AND 39).

SN 77-253,600, FILED 8-13-2007.

FIRST USE 8-0-2007; IN COMMERCE 8-0-2007.

ALICE BENMAMAN, EXAMINING ATTORNEY

Int. Cl.: 37

Prior U.S. Cls.: 100, 103, and 106

United States Patent and Trademark Office

Reg. No. 3,481,880

Registered Aug. 5, 2008

**SERVICE MARK
PRINCIPAL REGISTER**

Ecollect

RESOURCE COMMERCIAL FLOORING NET-
WORK, LLC (COLORADO LTD LIAB CO)
23461 E. OTERO DRIVE
AURORA, CO 80016

THE MARK CONSISTS OF STANDARD CHAR-
ACTERS WITHOUT CLAIM TO ANY PARTICULAR
FONT, STYLE, SIZE, OR COLOR.

FOR: COLLECTION FOR RECYCLING OF USED
FLOORING MATERIALS, IN CLASS 37 (U.S. CLS.
100, 103 AND 106).

SN 77-254,025, FILED 8-13-2007.

FIRST USE 1-1-2008; IN COMMERCE 1-1-2008.

DAVID TAYLOR, EXAMINING ATTORNEY

Int. Cl.: 43

Prior U.S. Cls.: 100 and 101

United States Patent and Trademark Office

Reg. No. 3,481,881

Registered Aug. 5, 2008

**SERVICE MARK
PRINCIPAL REGISTER**

BIMBAMBOO

818 VENTURE PARTNERS, LLC (COLORADO
LTD LIAB CO)
818 CONFIDENCE DRIVE
LONGMONT, CO 80504

THE MARK CONSISTS OF STANDARD CHAR-
ACTERS WITHOUT CLAIM TO ANY PARTICULAR
FONT, STYLE, SIZE, OR COLOR.

FOR: RESTAURANT AND BAR SERVICES, IN
CLASS 43 (U.S. CLS. 100 AND 101).

SN 77-254,109, FILED 8-13-2007.

FIRST USE 12-20-2007; IN COMMERCE 12-20-2007.

GEORGE LORENZO, EXAMINING ATTORNEY

Int. Cl.: 30

Prior U.S. Cl.: 46

United States Patent and Trademark Office

Reg. No. 3,481,882

Registered Aug. 5, 2008

TRADEMARK
PRINCIPAL REGISTER

Todd's
DIRT

TODDCO, LLC (MARYLAND LTD LIAB CO)
102 IDLEWILD ROAD
SEVERNA PARK, MD 21146

FIRST USE 9-1-2007; IN COMMERCE 9-6-2007.

SN 77-254,248, FILED 8-13-2007.

FOR: SEASONINGS, MARINADES, DIPPING
SAUCES, SALAD DRESSING, IN CLASS 30 (U.S.
CL. 46).

SETH A. RAPPAPORT, EXAMINING ATTORNEY

Int. Cl.: 35

Prior U.S. Cls.: 100, 101, and 102

United States Patent and Trademark Office

Reg. No. 3,481,883

Registered Aug. 5, 2008

SERVICE MARK
PRINCIPAL REGISTER



DONMAR ENTERPRISES, INC. (NEW JERSEY CORPORATION)
SUITE C-13
250 ROCHELLE AVENUE
ROCHELLE PARK, NJ 07662

FOR: ON-LINE RETAIL STORE SERVICES FEATURING PET SUPPLIES, BEDS, CARRIERS, HEALTH ITEMS SUCH AS VITAMINS AND HEALTH AIDS, FLEA AND TICK PRODUCTS, DINNERWARE, HOUSEBREAKING TRAINING AIDS SUCH AS HALTER COLLARS, INFORMATIONAL DVDS, AND TREATS, IN CLASS 35 (U.S. CLS. 100, 101 AND 102).

FIRST USE 8-3-2007; IN COMMERCE 8-3-2007.

NO CLAIM IS MADE TO THE EXCLUSIVE RIGHT TO USE "ENTERPRISES, INC.", APART FROM THE MARK AS SHOWN.

THE MARK CONSISTS OF A OUTLINE OF CAT AND DOG, THE WORDS "DONMAR ENTERPRISES, INC" TO THE LEFT OF OUTLINE.

SN 77-254,743, FILED 8-14-2007.

JAMES A. RAUEN, EXAMINING ATTORNEY

Int. Cl.: 42

Prior U.S. Cls.: 100 and 101

United States Patent and Trademark Office

Reg. No. 3,481,884

Registered Aug. 5, 2008

**SERVICE MARK
PRINCIPAL REGISTER**

FACES IN THE CROWD

FACES IN THE CROWD, INC. (CONNECTICUT CORPORATION)
3 LOGAN LANE
WESTON, CT 06883

FOR: COMPUTER SERVICES, NAMELY, HOSTING AN ONLINE COMMUNITY FOR REGISTERED USERS TO PARTICIPATE IN COMPETITIONS, SHOWCASE THEIR SKILLS, GET FEEDBACK FROM THEIR PEERS, FORM VIRTUAL COMMUNITIES, ENGAGE IN SOCIAL NETWORKING AND IMPROVE THEIR TALENT, IN CLASS 42 (U.S. CLS. 100 AND 101).

FIRST USE 9-1-2007; IN COMMERCE 1-1-2008.

THE MARK CONSISTS OF STANDARD CHARACTERS WITHOUT CLAIM TO ANY PARTICULAR FONT, STYLE, SIZE, OR COLOR.

SN 77-254,836, FILED 8-14-2007.

AHSEN KHAN, EXAMINING ATTORNEY

Int. Cl.: 9

Prior U.S. Cls.: 21, 23, 26, 36, and 38

United States Patent and Trademark Office

Reg. No. 3,481,885

Registered Aug. 5, 2008

**TRADEMARK
PRINCIPAL REGISTER**

EVOLUTION

FUTURELOGIC INCORPORATED (CALIFORNIA
CORPORATION)
425 EAST COLORADO STREET
SUITE 100
GLENDALE, CA 91205

THE MARK CONSISTS OF STANDARD CHAR-
ACTERS WITHOUT CLAIM TO ANY PARTICULAR
FONT, STYLE, SIZE, OR COLOR.

FOR: THERMAL TICKET PRINTERS FOR CASH-
LESS GAMING MACHINES, IN CLASS 9 (U.S. CLS.
21, 23, 26, 36 AND 38).

SN 77-255,231, FILED 8-14-2007.

FIRST USE 10-11-2007; IN COMMERCE 10-11-2007.

CAROLYN CATALDO, EXAMINING ATTORNEY

Int. Cl.: 35

Prior U.S. Cls.: 100, 101, and 102

United States Patent and Trademark Office

Reg. No. 3,481,886

Registered Aug. 5, 2008

**SERVICE MARK
PRINCIPAL REGISTER**

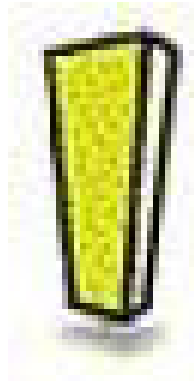

FLATBURGER, INC. (DELAWARE CORPORATION)
270 RIVER ST.
TROY, NY 12180

FOR: ON-LINE TRADING SERVICES TO FACILITATE THE SALE OF GOODS BY OTHERS VIA A COMPUTER NETWORK AND PROVIDING EVALUATIVE FEEDBACK AND RATINGS OF SELLERS' GOODS AND SERVICES, THE VALUE AND PRICES OF SELLERS' GOODS, BUYERS' AND SELLERS' PERFORMANCE, DELIVERY, AND OVERALL TRADING EXPERIENCE IN CONNECTION THEREWITH, IN CLASS 35 (U.S. CLS. 100, 101 AND 102).

FIRST USE 10-1-2007; IN COMMERCE 10-1-2007.

THE COLOR(S) YELLOW, DARK GRAY, AND GRAY IS/ARE CLAIMED AS A FEATURE OF THE MARK.

THE MARK CONSISTS OF A MONOLITH. THE COLOR YELLOW APPEARS IN THE DESIGN, THE COLOR DARK GRAY APPEARS AROUND THE PERIMETER, AND THE COLOR GRAY APPEARS IN THE SHADOW BEHIND THE DESIGN.

SN 77-255,500, FILED 8-15-2007.

LEIGH CAROLINE CASE, EXAMINING ATTORNEY

Int. Cl.: 11

Prior U.S. Cls.: 13, 21, 23, 31, and 34

United States Patent and Trademark Office

Reg. No. 3,481,887

Registered Aug. 5, 2008

**TRADEMARK
PRINCIPAL REGISTER**

ASHLYN

HUNTER FAN COMPANY (DELAWARE COR-
PORATION)
2500 FRISCO AVENUE
MEMPHIS, TN 38114

THE MARK CONSISTS OF STANDARD CHAR-
ACTERS WITHOUT CLAIM TO ANY PARTICULAR
FONT, STYLE, SIZE, OR COLOR.

FOR: CEILING FANS, IN CLASS 11 (U.S. CLS. 13,
21, 23, 31 AND 34).

SN 77-255,951, FILED 8-15-2007.

FIRST USE 12-2-2007; IN COMMERCE 12-2-2007.

ROBIN CHOSID, EXAMINING ATTORNEY

Int. Cl.: 9

Prior U.S. Cls.: 21, 23, 26, 36, and 38

United States Patent and Trademark Office

Reg. No. 3,481,888

Registered Aug. 5, 2008

**TRADEMARK
PRINCIPAL REGISTER**

JEWEL QUEST EXPEDITIONS

IWIN, INC. (DELAWARE CORPORATION)
SUITE 201
625 SECOND STREET
SAN FRANCISCO, CA 94107

FOR: PROGRAMMED COMPUTER GAME MEMORY CARDS, COMPUTER GAME PROGRAMS, COMPUTER GAME SOFTWARE, PROGRAMMED ELECTRONIC GAME MEMORY CARDS, ELECTRONIC GAME PROGRAMS, ELECTRONIC GAME SOFTWARE, PROGRAMMED INTERACTIVE GAME MEMORY CARDS, INTERACTIVE GAME PROGRAMS, INTERACTIVE GAME SOFTWARE, PROGRAMMED VIDEO GAME MEMORY CARDS, VIDEO GAME PROGRAMS, INTERACTIVE VIDEO GAME SOFTWARE, CARTRIDGES FEATURING ENTERTAINMENT CONTENT, NAMELY, GAMES, ELECTRONIC GAME CARTRIDGES, VIDEO GAME CARTRIDGES, AND VIDEO GAME SOFTWARE FOR USE WITH A PUZZLE GAME, THE OBJECT

OF WHICH IS TO ALIGN THREE SIMILAR JEWELS VERTICALLY AND HORIZONTALLY, IN CLASS 9 (U.S. CLS. 21, 23, 26, 36 AND 38).

FIRST USE 9-15-2007; IN COMMERCE 9-15-2007.

THE MARK CONSISTS OF STANDARD CHARACTERS WITHOUT CLAIM TO ANY PARTICULAR FONT, STYLE, SIZE, OR COLOR.

OWNER OF U.S. REG. NO. 3,047,845.

NO CLAIM IS MADE TO THE EXCLUSIVE RIGHT TO USE "JEWEL", APART FROM THE MARK AS SHOWN.

SN 77-256,318, FILED 8-15-2007.

JULIE WATSON, EXAMINING ATTORNEY

Int. Cl.: 27

Prior U.S. Cls.: 19, 20, 37, 42, and 50

Reg. No. 3,481,889

United States Patent and Trademark Office

Registered Aug. 5, 2008

**TRADEMARK
PRINCIPAL REGISTER**

PRIMUS

MANNINGTON MILLS, INC. (NEW JERSEY
CORPORATION)
75 MANNINGTON MILLS ROAD
SALEM, NJ 08079

THE MARK CONSISTS OF STANDARD CHAR-
ACTERS WITHOUT CLAIM TO ANY PARTICULAR
FONT, STYLE, SIZE, OR COLOR.

FOR: VINYL FLOOR COVERINGS, IN CLASS 27
(U.S. CLS. 19, 20, 37, 42 AND 50).

SN 77-256,711, FILED 8-16-2007.

FIRST USE 1-3-2008; IN COMMERCE 1-3-2008.

MICHAEL KEATING, EXAMINING ATTORNEY

Int. Cl.: 36

Prior U.S. Cls.: 100, 101, and 102

United States Patent and Trademark Office

Reg. No. 3,481,890

Registered Aug. 5, 2008

**SERVICE MARK
PRINCIPAL REGISTER**

ICE FUTURES U.S.

INTERCONTINENTALEXCHANGE, INC. (DELA-
WARE CORPORATION)
2100 RIVEREDGE PARKWAY, 5TH FLOOR
ATLANTA, GA 30328

FOR: ELECTRONIC COMMODITIES EXCHANGE SERVICES; PROVIDING FINANCIAL SERVICES IN THE NATURE OF PROVIDING AN EXCHANGE FOR COMMODITIES AND COMMODITIES DERIVATIVES, PROVIDING ONLINE EXCHANGE SERVICES IN THE NATURE OF ONLINE PURCHASING AND/OR SELLING OF COMMODITIES AND COMMODITIES DERIVATIVES; PROVIDING ONLINE COMMODITIES AND COMMODITY DERIVATIVES PRICING AND RELATED INFORMATION; FINANCIAL SERVICES IN THE NATURE OF ASSISTING OTHERS WITH THE COMPLETION OF FINANCIAL TRANSACTIONS FOR COMMODITIES AND COMMODITY DERIVATIVES; SERVICES RELATING TO FINANCIAL TRANSACTIONS, NAMELY, TRADING OF COMMODITIES AND COMMODITY DERIVATIVES; PROVIDING FINANCIAL SERVICES IN THE NATURE OF OFFERING, SPONSORING,

MANAGING AND/OR ADMINISTERING COMMODITIES, COMMODITY DERIVATIVES AND RELATED FINANCIAL INSTRUMENTS, IN CLASS 36 (U.S. CLS. 100, 101 AND 102).

FIRST USE 8-31-2007; IN COMMERCE 8-31-2007.

THE MARK CONSISTS OF STANDARD CHARACTERS WITHOUT CLAIM TO ANY PARTICULAR FONT, STYLE, SIZE, OR COLOR.

OWNER OF U.S. REG. NOS. 2,442,215, 3,277,230, AND OTHERS.

NO CLAIM IS MADE TO THE EXCLUSIVE RIGHT TO USE "FUTURES U.S.", APART FROM THE MARK AS SHOWN.

SN 77-256,972, FILED 8-16-2007.

JULIE WATSON, EXAMINING ATTORNEY

Int. Cl.: 10

Prior U.S. Cls.: 26, 39, and 44

United States Patent and Trademark Office

Reg. No. 3,481,891

Registered Aug. 5, 2008

**TRADEMARK
PRINCIPAL REGISTER**



NEOMED, INC. (GEORGIA CORPORATION)
SUITE 120
507 HICKORY RIDGE TRL.
WOODSTOCK, GA 30188

FOR: NEONATAL PRODUCTS, NAMELY, CATHETERIZATION TRAYS, NEONATAL PROCEDURE KITS COMPOSED OF STERILE FORCEPS, HEMOSTATS, SCISSORS, NEEDLES, STERILE SALINE, SCALPELS FOR USE IN CUT-DOWN PROCEDURES OR CATHETERIZATION PROCEDURES, URINARY DRAINAGE KITS COMPOSED OF URINARY CATHETER AND COLLECTION BURETTE, LUMBAR PUNCTURE KITS COMPOSED OF LUMBAR PUNCTURE NEEDLE AND SPINAL FLUID COLLECTION VIALS; NEONATAL AND PEDIATRIC ENTERAL PRODUCTS, NAMELY, FEEDING TUBES, ORAL SYRINGES AND ENTERAL EXTENSIONS THAT TOGETHER COMPRISE AN ENTERAL NUTRITION DELIVERY SYSTEM; CATHETERS, NAMELY, UMBILICAL CATHETERS AND URINARY DRAINAGE CATHETERS; SPECIALTY NEO-

NATAL AND PEDIATRIC ITEMS, NAMELY, POLYETHYLENE OCCLUSIVE SURGICAL DRAPES AND DRAPES USED FOR EXAMINATION PURPOSES DURING REHABILITATION, THAT NO NOT BLOCK HEAT, IN CLASS 10 (U.S. CLS. 26, 39 AND 44).

FIRST USE 2-28-2007; IN COMMERCE 3-31-2007.

THE COLOR(S) BLUE AND RED IS/ARE CLAIMED AS A FEATURE OF THE MARK.

THE MARK CONSISTS OF THE WORD "NEOMED" IN BLUE EXCEPT FOR THE "O" WHICH IS IN RED AS THE OUTLINE OF A SMILING FACE WITH A LOCK OF HAIR CURLING AWAY FROM IT.

SN 77-257,715, FILED 8-17-2007.

HENRY S. ZAK, EXAMINING ATTORNEY

Int. Cl.: 43

Prior U.S. Cls.: 100 and 101

United States Patent and Trademark Office

Reg. No. 3,481,892

Registered Aug. 5, 2008

**SERVICE MARK
PRINCIPAL REGISTER**



GARCIA, LAZARO (UNITED STATES INDIVIDUAL)

12049 SW 75TH ST.

MIAMI, FL 33183 AND

GARCIA, JOSE (UNITED STATES INDIVIDUAL)

12049 SW 75TH ST.

MIAMI, FL 33183

FOR: CAFE-RESTAURANTS; CARRY-OUT RESTAURANTS; DELICATESSENS; FAST FOOD AND NON-STOP RESTAURANT SERVICES; FAST-FOOD RESTAURANTS; FAST-FOOD RESTAURANTS AND SNACKBARS; HOTEL, BAR AND RESTAURANT SERVICES; RESTAURANT AND BAR SERVICES; RESTAURANT SERVICES; RESTAURANTS; RESTAURANTS FEATURING HOME DELIVERY; SELF SERVICE RESTAURANTS; SELF-SERVICE RESTAURANTS; TAKE-OUT RESTAURANT SERVICES, IN CLASS 43 (U.S. CLS. 100 AND 101).

FIRST USE 6-15-2007; IN COMMERCE 6-15-2007.

NO CLAIM IS MADE TO THE EXCLUSIVE RIGHT TO USE "CUBAN CUISINE", APART FROM THE MARK AS SHOWN.

THE MARK CONSISTS OF A SOLID DARK CIRCLE SUPERIMPOSED ON TOP OF A LARGER WHITE CIRCLE (WITH A DARK OUTLINE/BORDER) SLIGHTLY OFF-CENTER TOWARDS THE TOP OF THE IMAGE, WITH THE TEXT "CASAVANA CUBAN CUISINE" APPEARING IN A CONTRASTING LIGHTER SHADE ACROSS THE CENTER OF THE DARK CIRCLE. THE LIGHTER CIRCLE ALSO CONSISTS OF A SET OF FOUR STYLIZED FLAMES LOCATED AT THE TOP OF THE CIRCLE AND RISING DOWNWARD TOWARDS THE TEXT, SEEMING TO PENETRATE THE DARKER CIRCLE FROM ABOVE.

SN 77-258,484, FILED 8-17-2007.

CHRISTOPHER BUONGIORNO, EXAMINING ATTORNEY

Int. Cl.: 33

Prior U.S. Cls.: 47 and 49

United States Patent and Trademark Office

Reg. No. 3,481,893

Registered Aug. 5, 2008

**TRADEMARK
PRINCIPAL REGISTER**

O:TU

OTUWHERE ESTATE WINES LIMITED (NEW
ZEALAND CORPORATION)
2ND FLOOR, 137 VICTORIA STREET
CHRISTCHURCH, NEW ZEALAND

THE MARK CONSISTS OF STANDARD CHAR-
ACTERS WITHOUT CLAIM TO ANY PARTICULAR
FONT, STYLE, SIZE, OR COLOR.

FOR: WINE, IN CLASS 33 (U.S. CLS. 47 AND 49).

SN 77-258,943, FILED 8-20-2007.

FIRST USE 10-31-2006; IN COMMERCE 12-31-2007.

SIMON TENG, EXAMINING ATTORNEY

Int. Cl.: 5

Prior U.S. Cls.: 6, 18, 44, 46, 51, and 52

Reg. No. 3,481,894

United States Patent and Trademark Office

Registered Aug. 5, 2008

TRADEMARK
PRINCIPAL REGISTER

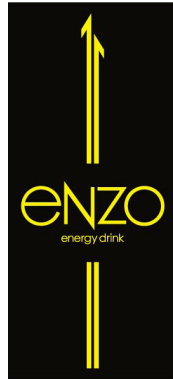

VON LUTZOW, JAMES ANTHONY (UNITED STATES INDIVIDUAL)
4511 E. FRANKLIN AVE.
GILBERT, AZ 85295

FOR: VITAMIN FORTIFIED BEVERAGES, IN CLASS 5 (U.S. CLS. 6, 18, 44, 46, 51 AND 52).

FIRST USE 8-20-2007; IN COMMERCE 5-15-2008.

NO CLAIM IS MADE TO THE EXCLUSIVE RIGHT TO USE "ENERGY DRINK", APART FROM THE MARK AS SHOWN.

THE COLOR(S) BLACK AND YELLOW IS/ARE CLAIMED AS A FEATURE OF THE MARK.

THE MARK CONSISTS OF THE WORD "ENZO" IN A LARGE FONT IN YELLOW. THE WORDS "ENERGY DRINK" BELOW THE WORD "ENZO" IN YELLOW. TWO VERTICAL ARROWS IN YELLOW, ONE OF THE POINTS REACHES HIGHER THAN THE OTHER.

SN 77-259,034, FILED 8-20-2007.

CAROLYN CATALDO, EXAMINING ATTORNEY

Int. Cl.: 9

Prior U.S. Cls.: 21, 23, 26, 36, and 38

Reg. No. 3,481,895

United States Patent and Trademark Office

Registered Aug. 5, 2008

**TRADEMARK
PRINCIPAL REGISTER**

TURN-TURN-TURN

ROSNER, CARY (UNITED STATES INDIVIDUAL)
7L
245-30 GRAND CENTRAL PKWY
BELLEROSE, NY 11426

THE MARK CONSISTS OF STANDARD CHARACTERS WITHOUT CLAIM TO ANY PARTICULAR FONT, STYLE, SIZE, OR COLOR.

FOR: COMPUTER SOFTWARE FOR FACILITATING THE DISPLAY OF DIGITAL DOCUMENTS, IN CLASS 9 (U.S. CLS. 21, 23, 26, 36 AND 38).

SN 77-260,272, FILED 8-21-2007.

FIRST USE 11-5-2007; IN COMMERCE 11-5-2007.

KATHERINE CHANG, EXAMINING ATTORNEY

Int. Cl.: 30

Prior U.S. Cl.: 46

United States Patent and Trademark Office

Reg. No. 3,481,896

Registered Aug. 5, 2008

**TRADEMARK
PRINCIPAL REGISTER**

**KELLOGG'S FROSTED FLAKES
GOLD**

KELLOGG NORTH AMERICA COMPANY (DE-
LAWARE CORPORATION)
ONE KELLOGG SQUARE, PO BOX 3599
BATTLE CREEK, MI 490163599

OWNER OF U.S. REG. NOS. 1,411,563, 1,422,158,
AND 3,322,369.

FOR: PROCESSED CEREAL-DERIVED FOOD
PRODUCT TO BE USED AS A BREAKFAST CER-
EAL, SNACK FOOD OR INGREDIENT FOR MAK-
ING FOOD, IN CLASS 30 (U.S. CL. 46).

NO CLAIM IS MADE TO THE EXCLUSIVE
RIGHT TO USE "FROSTED FLAKES", APART
FROM THE MARK AS SHOWN.

FIRST USE 12-31-2007; IN COMMERCE 12-31-2007.

SN 77-260,423, FILED 8-21-2007.

THE MARK CONSISTS OF STANDARD CHAR-
ACTERS WITHOUT CLAIM TO ANY PARTICULAR
FONT, STYLE, SIZE, OR COLOR.

KELLY MCCOY, EXAMINING ATTORNEY

Int. Cl.: 41

Prior U.S. Cls.: 100, 101, and 107

United States Patent and Trademark Office

Reg. No. 3,481,897

Registered Aug. 5, 2008

**SERVICE MARK
PRINCIPAL REGISTER**

NOTE THE DIFFERENCE

MEDISYNC HEALTHCARE SOLUTIONS, LLC
(OHIO LTD LIAB CO)
4700 SMITH ROAD SUITE A
CINCINNATI, OH 45212

FOR: TRAINING OF PHYSICIANS AND OTHER
MEDICAL PROFESSIONALS BY OFFERING
SMALL SEMINARS WITH TRAINING MATERIALS,
NAMELY, PATIENT ENCOUNTER RECORDING
FORMS, IN THE FIELD OF MAINTENANCE AND
RECORDING OF INFORMATION ABOUT PA-
TIENTS, IN CLASS 41 (U.S. CLS. 100, 101 AND 107).

FIRST USE 3-31-2008; IN COMMERCE 3-31-2008.

THE MARK CONSISTS OF STANDARD CHAR-
ACTERS WITHOUT CLAIM TO ANY PARTICULAR
FONT, STYLE, SIZE, OR COLOR.

SN 77-261,089, FILED 8-21-2007.

MATTHEW EINSTEIN, EXAMINING ATTORNEY

Int. Cl.: 11

Prior U.S. Cls.: 13, 21, 23, 31, and 34

United States Patent and Trademark Office

Reg. No. 3,481,898

Registered Aug. 5, 2008

**TRADEMARK
PRINCIPAL REGISTER**

TASKO

ELUMX LLC (GEORGIA LTD LIAB CO)
SUITE #5
119 FLAT CREEK TRAIL
FAYETTEVILLE, GA 30214

FIRST USE 6-8-2008; IN COMMERCE 6-16-2008.

FOR: LIGHTING FIXTURES; PORTABLE BATTERY-OPERATED LIGHTS THAT CAN BE PLACED ON SURFACES WHERE OTHER LIGHT SOURCES ARE UNAVAILABLE; LED AND HID LIGHT FIXTURES; ELECTRIC LIGHTING FIXTURES; FIXTURES FOR INCANDESCENT LIGHT BULBS, IN CLASS 11 (U.S. CLS. 13, 21, 23, 31 AND 34).

THE MARK CONSISTS OF STANDARD CHARACTERS WITHOUT CLAIM TO ANY PARTICULAR FONT, STYLE, SIZE, OR COLOR.

SN 77-261,344, FILED 8-22-2007.

LINDA ORNDORFF, EXAMINING ATTORNEY

Int. Cl.: 16

Prior U.S. Cls.: 2, 5, 22, 23, 29, 37, 38, and 50

Reg. No. 3,481,899

United States Patent and Trademark Office

Registered Aug. 5, 2008

**TRADEMARK
PRINCIPAL REGISTER**

uGLOSS

UNISOURCE WORLDWIDE, INC. (DELAWARE
CORPORATION)
6600 GOVERNORS LAKE PARKWAY
NORCROSS, GA 30071

FOR: PRINTING PAPER COATED ON EITHER
ONE OR TWO SIDES IN A VARIETY OF BASIS
WEIGHTS AND FINISHES, USED IN COMMER-
CIAL PRINTING APPLICATIONS, IN CLASS 16 (U.S.
CLS. 2, 5, 22, 23, 29, 37, 38 AND 50).

FIRST USE 3-1-2008; IN COMMERCE 3-1-2008.

THE MARK CONSISTS OF STANDARD CHAR-
ACTERS WITHOUT CLAIM TO ANY PARTICULAR
FONT, STYLE, SIZE, OR COLOR.

SN 77-261,616, FILED 8-22-2007.

JOHN E. MICHOS, EXAMINING ATTORNEY

Int. Cl.: 35

Prior U.S. Cls.: 100, 101, and 102

United States Patent and Trademark Office

Reg. No. 3,481,900

Registered Aug. 5, 2008

**SERVICE MARK
PRINCIPAL REGISTER**

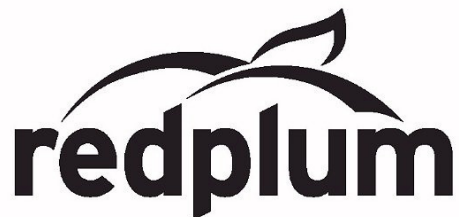

VALASSIS COMMUNICATIONS, INC. (DELA-
WARE CORPORATION)
19975 VICTOR PARKWAY
LIVONIA, MI 481527001

FOR: PROMOTING THE GOODS AND SERVICES
OF OTHERS THROUGH THE DISTRIBUTION OF
COUPONS, SAMPLES AND PRINTED ADVERTIS-
ING; ADVERTISING AND MEDIA PLANNING
SERVICES, NAMELY, BUSINESS MARKETING
CONSULTING SERVICES; MARKET ANALYSIS;
DISSEMINATION OF ADVERTISING FOR OTHERS
VIA ON-LINE ELECTRONIC COMMUNICATIONS
NETWORK, IN CLASS 35 (U.S. CLS. 100, 101 AND
102).

FIRST USE 1-3-2008; IN COMMERCE 1-3-2008.

THE MARK CONSISTS OF THE TOP OUTLINE
OF A LEAF WITH THE TOP OUTLINE OF A PLUM
UNDERNEATH, OUTLINE CONNECTS FROM THE
"R" TO THE "M" OF THE MARK "REDPLUM"
BELOW.

SN 77-261,642, FILED 8-22-2007.

REBECCA SMITH, EXAMINING ATTORNEY

Int. Cl.: 30

Prior U.S. Cl.: 46

United States Patent and Trademark Office

Reg. No. 3,481,901

Registered Aug. 5, 2008

**TRADEMARK
PRINCIPAL REGISTER**

The Process Matters

KELLEY, NICHOLAS T (UNITED STATES INDIVIDUAL)
1330B GUERRERO ST
SAN FRANCISCO, CA 94110

FOR: CEREAL BASED SNACK FOOD; CEREAL-BASED SNACK FOODS; GRANOLA; GRANOLA SNACKS; GRANOLA-BASED SNACK BARS, IN CLASS 30 (U.S. CL. 46).

FIRST USE 9-1-2007; IN COMMERCE 9-1-2007.

THE MARK CONSISTS OF STANDARD CHARACTERS WITHOUT CLAIM TO ANY PARTICULAR FONT, STYLE, SIZE, OR COLOR.

SN 77-262,109, FILED 8-22-2007.

NAAKWAMA ANKRAH, EXAMINING ATTORNEY

Int. Cl.: 41

Prior U.S. Cls.: 100, 101, and 107

United States Patent and Trademark Office

Reg. No. 3,481,902

Registered Aug. 5, 2008

**SERVICE MARK
PRINCIPAL REGISTER**

Nikki Sexx

GONZALES, JONATHAN M (UNITED STATES
INDIVIDUAL)
2368 EASTMAN AVE. #15
VENTURA, CA 93003

FOR: ENTERTAINMENT IN THE NATURE OF
NUDE DANCING, IN CLASS 41 (U.S. CLS. 100, 101
AND 107).

FIRST USE 6-3-2008; IN COMMERCE 6-3-2008.

THE MARK CONSISTS OF STANDARD CHAR-
ACTERS WITHOUT CLAIM TO ANY PARTICULAR
FONT, STYLE, SIZE, OR COLOR.

THE NAME "NIKKI SEXX" IDENTIFIES A LIV-
ING INDIVIDUAL WHOSE CONSENT IS OF RE-
CORD.

SN 77-262,269, FILED 8-22-2007.

TOBY BULLOFF, EXAMINING ATTORNEY

Int. Cl.: 12

Prior U.S. Cls.: 19, 21, 23, 31, 35, and 44

Reg. No. 3,481,903

United States Patent and Trademark Office

Registered Aug. 5, 2008

**TRADEMARK
PRINCIPAL REGISTER**

BATT

THE ARMORED GROUP (ARIZONA LTD LIAB
CO)
5221 N. SADDLE ROCK
PHOENIX, AZ 85018

THE MARK CONSISTS OF STANDARD CHAR-
ACTERS WITHOUT CLAIM TO ANY PARTICULAR
FONT, STYLE, SIZE, OR COLOR.

FOR: ARMORED VEHICLES, IN CLASS 12 (U.S.
CLS. 19, 21, 23, 31, 35 AND 44).

SN 77-262,604, FILED 8-23-2007.

FIRST USE 4-3-2006; IN COMMERCE 4-3-2006.

JENNIFER VASQUEZ, EXAMINING ATTORNEY

Int. Cl.: 7

Prior U.S. Cls.: 13, 19, 21, 23, 31, 34, and 35

United States Patent and Trademark Office

Reg. No. 3,481,904

Registered Aug. 5, 2008

**TRADEMARK
PRINCIPAL REGISTER**

OPTI-CUT

THE GLEASON WORKS (NEW YORK CORPORATION)
1000 UNIVERSITY AVENUE, P.O. BOX 22970
ROCHESTER, NY 146922970

FOR: POWER-OPERATED CUTTING TOOLS, NAMELY, GASHING, SHAPING AND HOBGING TOOLS HAVING REPLACEABLE CUTTING INSERTS, FOR THE MANUFACTURE OF GEARS AND OTHER TOOTHED ARTICLES; CUTTING INSERTS AND REPLACEMENT PARTS FOR SUCH TOOLS, IN CLASS 7 (U.S. CLS. 13, 19, 21, 23, 31, 34 AND 35).

FIRST USE 9-17-2007; IN COMMERCE 2-12-2008.

THE MARK CONSISTS OF STANDARD CHARACTERS WITHOUT CLAIM TO ANY PARTICULAR FONT, STYLE, SIZE, OR COLOR.

OWNER OF U.S. REG. NO. 2,529,739.

SN 77-263,325, FILED 8-24-2007.

MICHELLE DUBOIS, EXAMINING ATTORNEY

Int. Cl.: 25

Prior U.S. Cls.: 22 and 39

United States Patent and Trademark Office

Reg. No. 3,481,905

Registered Aug. 5, 2008

**TRADEMARK
PRINCIPAL REGISTER**



TEMLADOR, JOHN (UNITED STATES INDIVIDUAL)
UNIT 1
1885 CHEROKEE DR.
SALINAS, CA 939062393

THE MARK CONSISTS OF THE STYLIZED TEXT "WATER BOONY COOL HEADS PREVAIL!", WITH A CURVED LINE AND A HALF CIRCLE ABOVE THE CURVED LINE.

FOR: HATS, IN CLASS 25 (U.S. CLS. 22 AND 39).

SN 77-263,561, FILED 8-24-2007.

FIRST USE 1-1-2008; IN COMMERCE 1-1-2008.

JOHN WILKE, EXAMINING ATTORNEY

Int. Cl.: 4

Prior U.S. Cls.: 1, 6, and 15

United States Patent and Trademark Office

Reg. No. 3,481,906

Registered Aug. 5, 2008

**TRADEMARK
PRINCIPAL REGISTER**



BRIGHT OF AMERICA, LLC (WEST VIRGINIA CORPORATION)
300 GREENBRIER ROAD
SUMMERSVILLE, WV 26651

FOR: SOY BASED CANDLES AND CANDLES CONTAINING SOY DERIVATIVES, IN CLASS 4 (U.S. CLS. 1, 6 AND 15).

FIRST USE 1-1-2008; IN COMMERCE 1-1-2008.

NO CLAIM IS MADE TO THE EXCLUSIVE RIGHT TO USE "NATURAL", APART FROM THE MARK AS SHOWN.

THE MARK CONSISTS OF OUTER OVAL WITH RUFFLED EDGES CONTAINING INTERNAL

OVAL WITH INCOMPLETE SHADED LINE THROUGH CENTER AND SHADED CURVED LINES ON EITHER SIDE IN OUTER OVAL; CURVED WORD "NATURAL" AT TOP OF OUTER OVAL AND CURVED WORD "PERFECTION" AT BOTTOM OF OUTER OVAL AND WORDS "MORE SCENT" ABOVE THE SHADED LINE IN INNER OVAL AND "LESS SOOT" BELOW SHADED LINE IN INNER OVAL.

SN 77-264,143, FILED 8-24-2007.

CIMMERIAN COLEMAN, EXAMINING ATTORNEY

Int. Cl.: 32

Prior U.S. Cls.: 45, 46, and 48

United States Patent and Trademark Office

Reg. No. 3,481,907

Registered Aug. 5, 2008

**TRADEMARK
PRINCIPAL REGISTER**

BERRY LIMEADE BLAST

DR PEPPER/SEVEN UP, INC. (DELAWARE CORPORATION)

5301 LEGACY DRIVE

PLANO, TX 75024

FOR: FRUIT FLAVORED DRINK CONTAINING WATER, IN CLASS 32 (U.S. CLS. 45, 46 AND 48).

FIRST USE 1-0-2008; IN COMMERCE 1-0-2008.

THE MARK CONSISTS OF STANDARD CHARACTERS WITHOUT CLAIM TO ANY PARTICULAR FONT, STYLE, SIZE, OR COLOR.

NO CLAIM IS MADE TO THE EXCLUSIVE RIGHT TO USE "BERRY LIMEADE", APART FROM THE MARK AS SHOWN.

SN 77-264,722, FILED 8-27-2007.

YAT SYE, LEE, EXAMINING ATTORNEY

Int. Cl.: 41

Prior U.S. Cls.: 100, 101, and 107

United States Patent and Trademark Office

Reg. No. 3,481,908

Registered Aug. 5, 2008

**SERVICE MARK
PRINCIPAL REGISTER**

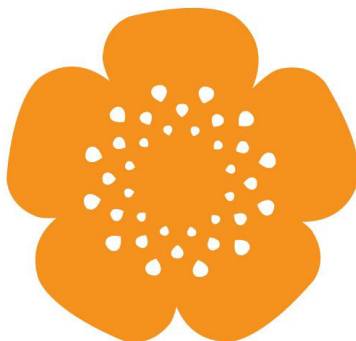

ENGENDERHEALTH, INC. (NEW JERSEY CORPORATION)
THIRTEENTH FLOOR
440 NINTH AVENUE
NEW YORK, NY 10001

FOR: ARRANGING PROFESSIONAL WORKSHOP AND TRAINING COURSES; CONDUCTING WORKSHOPS AND SEMINARS IN REPRODUCTIVE HEALTH AND FAMILY PLANNING; DEVELOPING EDUCATIONAL MANUALS FOR OTHERS IN THE FIELD OF REPRODUCTIVE HEALTH AND FAMILY PLANNING; EDUCATION SERVICES, NAMELY, PROVIDING TRAINING AND WORKSHOPS IN THE FIELDS OF REPRODUCTIVE HEALTH AND FAMILY PLANNING; MEDICAL TRAINING AND TEACHING; PRODUCTION OF DVDS, VIDEOTAPES AND TELEVISION PROGRAMS FEATURING REPRODUCTIVE HEALTH AND FAMILY PLANNING; PROVIDING NEWSLETTERS IN THE FIELD OF REPRODUCTIVE HEALTH AND FAMILY PLANNING VIA E-MAIL;

PUBLICATION OF BOOKS, OF MAGAZINES, OF JOURNALS, OF NEWSPAPERS, OF PERIODICALS, OF CATALOGS, OF BROCHURES, IN CLASS 41 (U.S. CLS. 100, 101 AND 107).

FIRST USE 12-1-2007; IN COMMERCE 12-1-2007.

THE COLOR(S) ORANGE AND WHITE IS/ARE CLAIMED AS A FEATURE OF THE MARK.

THE MARK CONSISTS OF AN ORANGE FLOWER, CONTAINING FIVE PETALS AND VARIOUS SIZED WHITE CIRCULAR HOLES IN THE SHAPE OF TEARDROP-SHAPED STAMENS RINGING THE CENTER OF THE FLOWER.

SN 77-264,773, FILED 8-27-2007.

CARRIE GENOVESE, EXAMINING ATTORNEY

Int. Cl.: 16

Prior U.S. Cls.: 2, 5, 22, 23, 29, 37, 38, and 50

United States Patent and Trademark Office

Reg. No. 3,481,909

Registered Aug. 5, 2008

**TRADEMARK
PRINCIPAL REGISTER**

uLABEL

UNISOURCE WORLDWIDE, INC. (DELAWARE
CORPORATION)
6600 GOVERNORS LAKE PARKWAY
NORCROSS, GA 30071

FOR: PRINTING PAPER COATED ON EITHER
ONE OR TWO SIDES IN A VARIETY OF BASIS
WEIGHTS AND FINISHES, USED IN COMMER-
CIAL PRINTING APPLICATIONS, IN CLASS 16 (U.S.
CLS. 2, 5, 22, 23, 29, 37, 38 AND 50).

FIRST USE 3-1-2008; IN COMMERCE 3-1-2008.

THE MARK CONSISTS OF STANDARD CHAR-
ACTERS WITHOUT CLAIM TO ANY PARTICULAR
FONT, STYLE, SIZE, OR COLOR.

SN 77-264,890, FILED 8-27-2007.

JOHN E. MICHOS, EXAMINING ATTORNEY

Int. Cl.: 26

Prior U.S. Cls.: 37, 39, 40, 42, and 50

United States Patent and Trademark Office

Reg. No. 3,481,910

Registered Aug. 5, 2008

**TRADEMARK
PRINCIPAL REGISTER**

THE FLYING TRAPEZE

HOBBY LOBBY STORES, INC. (OKLAHOMA
CORPORATION)
7707 SOUTHWEST 44TH STREET
OKLAHOMA CITY, OK 73179

THE MARK CONSISTS OF STANDARD CHAR-
ACTERS WITHOUT CLAIM TO ANY PARTICULAR
FONT, STYLE, SIZE, OR COLOR.

FOR: FEATHERS FOR ORNAMENTATION, IN
CLASS 26 (U.S. CLS. 37, 39, 40, 42 AND 50).

SN 77-265,412, FILED 8-27-2007.

FIRST USE 12-16-2007; IN COMMERCE 12-16-2007.

MELISSA VALLILLO, EXAMINING ATTORNEY

Int. Cl.: 3

Prior U.S. Cls.: 1, 4, 6, 50, 51, and 52

Reg. No. 3,481,911

United States Patent and Trademark Office

Registered Aug. 5, 2008

**TRADEMARK
PRINCIPAL REGISTER**

for the best in you...
mister blackwell cosmetics

FOR THE BEST IN YOU...MISTER BLACKWELL
COSMETICS INC, (GEORGIA CORPORA-
TION), DBA ARTIE FITZGERALD,
5026 SNAPPINGER WOODS DR.STE,103
DECATUR, GA 30035

FOR: HAIR CARE KITS COMPRISING NON-
MEDICATED HAIR CARE PREPARATIONS,
NAMELY, SPRITZ, LEAVE-IN CONDITIONERS,
GELS AND MOUSSES, IN CLASS 3 (U.S. CLS. 1, 4,
6, 50, 51 AND 52).

FIRST USE 2-6-2008; IN COMMERCE 2-6-2008.

THE MARK CONSISTS OF STANDARD CHAR-
ACTERS WITHOUT CLAIM TO ANY PARTICULAR
FONT, STYLE, SIZE, OR COLOR.

NO CLAIM IS MADE TO THE EXCLUSIVE
RIGHT TO USE "COSMETICS", APART FROM
THE MARK AS SHOWN.

SN 77-265,610, FILED 8-27-2007.

JAY FLOWERS, EXAMINING ATTORNEY

Int. Cl.: 41

Prior U.S. Cls.: 100, 101, and 107

United States Patent and Trademark Office

Reg. No. 3,481,912

Registered Aug. 5, 2008

**SERVICE MARK
PRINCIPAL REGISTER**

WHEREVER YOU ARE SATURDAYS

XM SATELLITE RADIO INC. (DELAWARE CORPORATION)
1500 ECKINGTON PLACE, N.E.
WASHINGTON, DC 20002

FOR: ENTERTAINMENT SERVICES, NAMELY,
AN ONGOING AUDIO PROGRAM IN THE FIELD
OF SPORTS, IN CLASS 41 (U.S. CLS. 100, 101 AND
107).

FIRST USE 9-1-2007; IN COMMERCE 9-1-2007.

THE MARK CONSISTS OF STANDARD CHARACTERS WITHOUT CLAIM TO ANY PARTICULAR FONT, STYLE, SIZE, OR COLOR.

SN 77-265,825, FILED 8-28-2007.

BRENDAN MCCAULEY, EXAMINING ATTORNEY

Int. Cl.: 35

Prior U.S. Cls.: 100, 101, and 102

United States Patent and Trademark Office

Reg. No. 3,481,913

Registered Aug. 5, 2008

**SERVICE MARK
PRINCIPAL REGISTER**

AUDIOSMART

MARKETING ARCHITECTS, INC. (MINNESOTA
CORPORATION)
110 CHESHIRE LANE, #200
MINNEAPOLIS, MN 55305

THE MARK CONSISTS OF STANDARD CHAR-
ACTERS WITHOUT CLAIM TO ANY PARTICULAR
FONT, STYLE, SIZE, OR COLOR.

FOR: ADVERTISING, MARKETING AND BUSI-
NESS CONSULTING SERVICES IN CONNECTION
WITH AUDIO MEDIA, IN CLASS 35 (U.S. CLS. 100,
101 AND 102).

SN 77-266,301, FILED 8-28-2007.

FIRST USE 10-1-2007; IN COMMERCE 10-1-2007.

HANNO RITTNER, EXAMINING ATTORNEY

Int. Cl.: 9

Prior U.S. Cls.: 21, 23, 26, 36, and 38

United States Patent and Trademark Office

Reg. No. 3,481,914

Registered Aug. 5, 2008

**TRADEMARK
PRINCIPAL REGISTER**

AlterImage

THINKLOGICAL (CONNECTICUT CORPORATION)
100 WASHINGTON STREET
MILFORD, CT 06460

FOR: COMPUTER NETWORK HUBS, SWITCHES
AND ROUTERS, IN CLASS 9 (U.S. CLS. 21, 23, 26, 36
AND 38).

FIRST USE 2-2-2008; IN COMMERCE 2-2-2008.

THE MARK CONSISTS OF STANDARD CHARACTERS WITHOUT CLAIM TO ANY PARTICULAR FONT, STYLE, SIZE, OR COLOR.

SN 77-267,383, FILED 8-29-2007.

AMY HELLA, EXAMINING ATTORNEY

Int. Cls.: 19 and 40

Prior U.S. Cls.: 1, 12, 33, 50, 100, 103, and 106

United States Patent and Trademark Office

Reg. No. 3,481,915

Registered Aug. 5, 2008

**TRADEMARK
SERVICE MARK
PRINCIPAL REGISTER**

CARTE BLANCHE

MARSHFIELD DOORSYSTEMS, INC. (DELA-
WARE CORPORATION)
1401 EAST FOURTH STREET
MARSHFIELD, WI 54449

FOR: NON-METAL DOOR UNITS; NON-METAL
DOORS, IN CLASS 19 (U.S. CLS. 1, 12, 33 AND 50).

FIRST USE 10-2-2007; IN COMMERCE 10-2-2007.

FOR: CUSTOM MANUFACTURE OF DOORS, IN
CLASS 40 (U.S. CLS. 100, 103 AND 106).

FIRST USE 10-2-2007; IN COMMERCE 10-2-2007.

THE MARK CONSISTS OF STANDARD CHAR-
ACTERS WITHOUT CLAIM TO ANY PARTICULAR
FONT, STYLE, SIZE, OR COLOR.

SN 77-268,399, FILED 8-30-2007.

JORDAN BAKER, EXAMINING ATTORNEY

Int. Cl.: 31

Prior U.S. Cls.: 1 and 46

United States Patent and Trademark Office

Reg. No. 3,481,916

Registered Aug. 5, 2008

**TRADEMARK
PRINCIPAL REGISTER**

DRM DERMATOLOGIC MANAGEMENT

SOCIETE DES PRODUITS NESTLE S.A. (SWIT-
ZERLAND SOCIETE ANONYME)
INTELLECTUAL PROPERTY DEPARTMENT
CASE POSTALE 353
VEVEY, SWITZERLAND 1800

FOR: PET FOOD, IN CLASS 31 (U.S. CLS. 1 AND
46).

FIRST USE 2-14-2008; IN COMMERCE 2-14-2008.

THE MARK CONSISTS OF STANDARD CHAR-
ACTERS WITHOUT CLAIM TO ANY PARTICULAR
FONT, STYLE, SIZE, OR COLOR.

NO CLAIM IS MADE TO THE EXCLUSIVE
RIGHT TO USE "DERMATOLOGIC MANAGE-
MENT", APART FROM THE MARK AS SHOWN.

SN 77-269,153, FILED 8-31-2007.

SAMUEL E. SHARPER JR., EXAMINING ATTOR-
NEY

Int. Cl.: 3

Prior U.S. Cls.: 1, 4, 6, 50, 51, and 52

Reg. No. 3,481,917

United States Patent and Trademark Office

Registered Aug. 5, 2008

**TRADEMARK
PRINCIPAL REGISTER**

Lash Sleeve

FISHER, DAWN (UNITED STATES INDIVIDUAL)

11020 SW ESQUILINE CIRCUS

PORTLAND, OR 97219

FOR: MASCARAS, IN CLASS 3 (U.S. CLS. 1, 4, 6, 50, 51 AND 52).

FIRST USE 6-15-2008; IN COMMERCE 6-15-2008.

THE MARK CONSISTS OF STANDARD CHARACTERS WITHOUT CLAIM TO ANY PARTICULAR FONT, STYLE, SIZE, OR COLOR.

NO CLAIM IS MADE TO THE EXCLUSIVE RIGHT TO USE "LASH", APART FROM THE MARK AS SHOWN.

SN 77-270,225, FILED 9-2-2007.

KELLY BOULTON, EXAMINING ATTORNEY

Int. Cl.: 16

Prior U.S. Cls.: 2, 5, 22, 23, 29, 37, 38, and 50

Reg. No. 3,481,918

United States Patent and Trademark Office

Registered Aug. 5, 2008

**TRADEMARK
PRINCIPAL REGISTER**



WETSPOT PRODUCTIONS (MICHIGAN SOLE
PROPRIETORSHIP)
41275 OLD MICHIGAN AVE #63
CANTON, MI 48188

FOR: GENERAL FEATURE MAGAZINES; MA-
GAZINES FEATURING ADULT CONTENT AND
EROTICA, IN CLASS 16 (U.S. CLS. 2, 5, 22, 23, 29, 37, 38
AND 50).

FIRST USE 12-22-2007; IN COMMERCE 12-22-2007.

THE MARK CONSISTS OF THE IMAGE OF A
WOMAN IN THE MIDDLE WITH TWO OVALS
AROUND HER, AND THE TEXT "WET SPOT"
UNDER THE WOMAN, WITH RAIN DROPS
THROUGHOUT AND WATER RUNNING DOWN
THE TEXT. THERE IS A SLIGHT REFLECTION OF
THE WORD "SPOT" DIRECTLY BELOW IT.

SN 77-271,451, FILED 9-4-2007.

AHSEN KHAN, EXAMINING ATTORNEY

Int. Cl.: 36

Prior U.S. Cls.: 100, 101, and 102

United States Patent and Trademark Office

Reg. No. 3,481,919

Registered Aug. 5, 2008

**SERVICE MARK
PRINCIPAL REGISTER**

CROSSING TRAILS

FARRIS ENTERPRISES, LLC (MONTANA LTD
LIAB CO)
500 RESOURCE LANE
WHITEFISH, MT 59937

THE MARK CONSISTS OF STANDARD CHAR-
ACTERS WITHOUT CLAIM TO ANY PARTICULAR
FONT, STYLE, SIZE, OR COLOR.

FOR: LEASING OF REAL ESTATE, IN CLASS 36
(U.S. CLS. 100, 101 AND 102).

SN 77-271,617, FILED 9-5-2007.

FIRST USE 10-1-2007; IN COMMERCE 10-1-2007.

SALLY SHIH, EXAMINING ATTORNEY

Int. Cl.: 29

Prior U.S. Cl.: 46

United States Patent and Trademark Office

Reg. No. 3,481,920

Registered Aug. 5, 2008

**TRADEMARK
PRINCIPAL REGISTER**



AB FOODS, LLC (MISSOURI LTD LIAB CO)
8 TERRY HILL LANE
ST. LOUIS, MO 63131

SUBSTITUTE, MEAT SUBSTITUTES, HAM SUBSTITUTION, BACON SUBSTITUTE, VEAL SUBSTITUTE, IN CLASS 29 (U.S. CL. 46).

FOR: MEAT SUBSTITUTES; PROTEIN FOR USE AS AN INGREDIENT IN COOKING, BAKED GOODS AND AS A MEAT ADDITIVE; PROTEIN FOOD PRODUCTS, NAMELY, CHOPPED BEEF SUBSTITUTE, CHICKEN SUBSTITUTE, PORK SUBSTITUTE, CRAB SUBSTITUTE, LAMB SUBSTITUTE, FISH SUBSTITUTE, SAUSAGE

FIRST USE 11-0-2007; IN COMMERCE 11-0-2007.

THE MARK CONSISTS OF A STYLIZED "M".

SN 77-272,798, FILED 9-6-2007.

JUSTINE D. PARKER, EXAMINING ATTORNEY

Int. Cl.: 5

Prior U.S. Cls.: 6, 18, 44, 46, 51, and 52

Reg. No. 3,481,921

United States Patent and Trademark Office

Registered Aug. 5, 2008

**TRADEMARK
PRINCIPAL REGISTER**

TOTALBERRY

WN PHARMACEUTICALS LTD. (CANADA CORPORATION)
2000 BRIGANTINE DRIVE
COQUITLAM, BC, CANADA V3K7B5

THE MARK CONSISTS OF STANDARD CHARACTERS WITHOUT CLAIM TO ANY PARTICULAR FONT, STYLE, SIZE, OR COLOR.

FOR: DIETARY AND NUTRITIONAL SUPPLEMENTS, IN CLASS 5 (U.S. CLS. 6, 18, 44, 46, 51 AND 52).

SN 77-273,026, FILED 9-6-2007.

FIRST USE 11-28-2007; IN COMMERCE 11-28-2007.

LAURIE KAUFMAN, EXAMINING ATTORNEY

Int. Cls.: 38 and 44

Prior U.S. Cls.: 100, 101, and 104

United States Patent and Trademark Office

Reg. No. 3,481,922

Registered Aug. 5, 2008

**SERVICE MARK
PRINCIPAL REGISTER**

C3life

HOLLISTER INCORPORATED (ILLINOIS CORPORATION)
2000 HOLLISTER DRIVE
LIBERTYVILLE, IL 60048

FOR: PROVIDING ON-LINE CHAT ROOMS AND ELECTRONIC BULLETIN BOARDS FOR TRANSMISSION OF MESSAGES AMONG USERS IN THE FIELD OF OSTOMY AND CONTINENCE ISSUES , IN CLASS 38 (U.S. CLS. 100, 101 AND 104).

FIRST USE 1-9-2008; IN COMMERCE 1-9-2008.

FOR: PROVIDING INFORMATION REGARDING OSTOMY AND CONTINENCE ISSUES; PROVIDING

AN INTERACTIVE WEBSITE REGARDING OSTOMY AND CONTINENCE ISSUES, IN CLASS 44 (U.S. CLS. 100 AND 101).

FIRST USE 1-9-2008; IN COMMERCE 1-9-2008.

THE MARK CONSISTS OF STANDARD CHARACTERS WITHOUT CLAIM TO ANY PARTICULAR FONT, STYLE, SIZE, OR COLOR.

SN 77-273,252, FILED 9-6-2007.

G. MAYERSCHOFF, EXAMINING ATTORNEY

Int. Cls.: 38 and 44

Prior U.S. Cls.: 100, 101, and 104

United States Patent and Trademark Office

Reg. No. 3,481,923

Registered Aug. 5, 2008

SERVICE MARK
PRINCIPAL REGISTER



HOLLISTER INCORPORATED (ILLINOIS CORPORATION)
2000 HOLLISTER DRIVE
LIBERTYVILLE, IL 60048

FOR: PROVIDING ON-LINE CHAT ROOMS AND ELECTRONIC BULLETIN BOARDS FOR TRANSMISSION OF MESSAGES AMONG USERS IN THE FIELD OF OSTOMY AND CONTINENCE ISSUES , IN CLASS 38 (U.S. CLS. 100, 101 AND 104).

FIRST USE 1-9-2008; IN COMMERCE 1-9-2008.

FOR: PROVIDING INFORMATION REGARDING OSTOMY AND CONTINENCE ISSUES; PROVIDING

AN INTERACTIVE WEBSITE REGARDING OSTOMY AND CONTINENCE ISSUES, IN CLASS 44 (U.S. CLS. 100 AND 101).

FIRST USE 1-9-2008; IN COMMERCE 1-9-2008.

THE MARK CONSISTS OF STYLIZED TREE FORMED WITH THE WORDS "LIVE MY LIFE LOVE MY LIFE".

SN 77-273,257, FILED 9-6-2007.

G. MAYERSCHOFF, EXAMINING ATTORNEY

Int. Cl.: 1

Prior U.S. Cls.: 1, 5, 6, 10, 26, and 46

Reg. No. 3,481,924

United States Patent and Trademark Office

Registered Aug. 5, 2008

**TRADEMARK
PRINCIPAL REGISTER**

COLD-PLUS

WILLIS, LARRELL I. (UNITED STATES INDIVIDUAL)
411 LONE PALM DRIVE
LAKELAND, FL 33815

THE MARK CONSISTS OF STANDARD CHARACTERS WITHOUT CLAIM TO ANY PARTICULAR FONT, STYLE, SIZE, OR COLOR.

FOR: CHEMICAL ADDITIVES FOR COOLING SYSTEMS, NAMELY, AIR CONDITIONING, REFRIGERATION EQUIPMENT, CHILLERS, AND AUTOMOTIVE AND TRUCK AIR CONDITIONING, IN CLASS 1 (U.S. CLS. 1, 5, 6, 10, 26 AND 46).

SN 77-275,045, FILED 9-9-2007.

FIRST USE 1-29-2008; IN COMMERCE 1-29-2008.

CHRISTINE BLOMQUIST, EXAMINING ATTORNEY

Int. Cl.: 8

Prior U.S. Cls.: 23, 28, and 44

United States Patent and Trademark Office

Reg. No. 3,481,925

Registered Aug. 5, 2008

**TRADEMARK
PRINCIPAL REGISTER**

UNGER REACH & GRAB

UNGER MARKETING INTERNATIONAL, LLC
(DELAWARE LTD LIAB CO)
425 ASYLUM STREET
BRIDGEPORT, CT 06610

FOR: HAND OPERATED GRIPPER TOOL, IN
CLASS 8 (U.S. CLS. 23, 28 AND 44).

FIRST USE 4-21-2008; IN COMMERCE 4-21-2008.

THE MARK CONSISTS OF STANDARD CHAR-
ACTERS WITHOUT CLAIM TO ANY PARTICULAR
FONT, STYLE, SIZE, OR COLOR.

OWNER OF U.S. REG. NOS. 1,369,049 AND
2,550,555.

SN 77-276,098, FILED 9-11-2007.

DARRYL SPRUILL, EXAMINING ATTORNEY

Int. Cl.: 11

Prior U.S. Cls.: 13, 21, 23, 31, and 34

United States Patent and Trademark Office

Reg. No. 3,481,926

Registered Aug. 5, 2008

**TRADEMARK
PRINCIPAL REGISTER**

DISCOVERY

HUNTER FAN COMPANY (DELAWARE COR-
PORATION)
2500 FRISCO AVENUE
MEMPHIS, TN 38114

THE MARK CONSISTS OF STANDARD CHAR-
ACTERS WITHOUT CLAIM TO ANY PARTICULAR
FONT, STYLE, SIZE, OR COLOR.

FOR: CEILING FANS, IN CLASS 11 (U.S. CLS. 13,
21, 23, 31 AND 34).

SN 77-276,373, FILED 9-11-2007.

FIRST USE 11-2-2007; IN COMMERCE 11-2-2007.

ROBIN CHOSID, EXAMINING ATTORNEY

Int. Cl.: 11

Prior U.S. Cls.: 13, 21, 23, 31, and 34

United States Patent and Trademark Office

Reg. No. 3,481,927

Registered Aug. 5, 2008

**TRADEMARK
PRINCIPAL REGISTER**

STONINGTON

HUNTER FAN COMPANY (DELAWARE COR-
PORATION)
2500 FRISCO AVENUE
MEMPHIS, TN 38114

THE MARK CONSISTS OF STANDARD CHAR-
ACTERS WITHOUT CLAIM TO ANY PARTICULAR
FONT, STYLE, SIZE, OR COLOR.

FOR: CEILING FANS, IN CLASS 11 (U.S. CLS. 13,
21, 23, 31 AND 34).

SN 77-276,379, FILED 9-11-2007.

FIRST USE 10-29-2007; IN COMMERCE 10-29-2007.

ROBIN CHOSID, EXAMINING ATTORNEY

Int. Cl.: 11

Prior U.S. Cls.: 13, 21, 23, 31, and 34

United States Patent and Trademark Office

Reg. No. 3,481,928

Registered Aug. 5, 2008

**TRADEMARK
PRINCIPAL REGISTER**

WESTBROOK

HUNTER FAN COMPANY (DELAWARE COR-
PORATION)
2500 FRISCO AVENUE
MEMPHIS, TN 38114

THE MARK CONSISTS OF STANDARD CHAR-
ACTERS WITHOUT CLAIM TO ANY PARTICULAR
FONT, STYLE, SIZE, OR COLOR.

FOR: CEILING FANS, IN CLASS 11 (U.S. CLS. 13,
21, 23, 31 AND 34).

SN 77-276,385, FILED 9-11-2007.

FIRST USE 12-6-2007; IN COMMERCE 12-6-2007.

ROBIN CHOSID, EXAMINING ATTORNEY

Int. Cl.: 42

Prior U.S. Cls.: 100 and 101

United States Patent and Trademark Office

Reg. No. 3,481,929

Registered Aug. 5, 2008

**SERVICE MARK
PRINCIPAL REGISTER**

MASHON

PLANETWIDE GAMES, INC. (DELAWARE CORPORATION)
SUITE 250
32 JOURNEY
ALISO VIEJO, CA 92656

FOR: COMPUTER SERVICES, NAMELY, HOSTING AND MAINTAINING AN ONLINE WEBSITE FOR OTHERS TO OBTAIN SOFTWARE AND TO COLLABORATE WITH OTHER USERS FOR THE CREATION OF IMAGES, STORIES AND ARTWORK; PROVIDING A WEBSITE FEATURING TEMPORARY USE OF NONDOWNLOADABLE SOFTWARE ALLOWING WEBSITE USERS TO UPLOAD ONLINE VIDEOS FOR SHARING WITH

OTHERS FOR ENTERTAINMENT PURPOSES, IN CLASS 42 (U.S. CLS. 100 AND 101).

FIRST USE 9-11-2007; IN COMMERCE 5-17-2008.

THE MARK CONSISTS OF STANDARD CHARACTERS WITHOUT CLAIM TO ANY PARTICULAR FONT, STYLE, SIZE, OR COLOR.

SN 77-276,944, FILED 9-11-2007.

CIMMERIAN COLEMAN, EXAMINING ATTORNEY

Int. Cl.: 35

Prior U.S. Cls.: 100, 101, and 102

United States Patent and Trademark Office

Reg. No. 3,481,930

Registered Aug. 5, 2008

**SERVICE MARK
PRINCIPAL REGISTER**

NOTESHUFFLE.COM

NOTESHUFFLE.COM, LLC (CALIFORNIA LTD
LIAB CO)
4335 VAN NUYS BLVD.
SUITE 293
SHERMAN OAKE, CA 91403

THE MARK CONSISTS OF STANDARD CHAR-
ACTERS WITHOUT CLAIM TO ANY PARTICULAR
FONT, STYLE, SIZE, OR COLOR.

FOR: OPERATING ON-LINE MARKETPLACES
FEATURING THE BUYING AND SELLING OF
COLLEGE LECTURE NOTES, IN CLASS 35 (U.S.
CLS. 100, 101 AND 102).

SN 77-276,981, FILED 9-11-2007.

FIRST USE 2-19-2008; IN COMMERCE 2-19-2008.

LEIGH CAROLINE CASE, EXAMINING ATTOR-
NEY

Int. Cl.: 12

Prior U.S. Cls.: 19, 21, 23, 31, 35, and 44

United States Patent and Trademark Office

Reg. No. 3,481,931

Registered Aug. 5, 2008

**TRADEMARK
PRINCIPAL REGISTER**

POLARIS

POLARIS INDUSTRIES INC. (DELAWARE CORPORATION)
2100 HIGHWAY 55
MEDINA, MN 553409770

FOR: BICYCLES AND STRUCTURAL PARTS THEREFOR, IN CLASS 12 (U.S. CLS. 19, 21, 23, 31, 35 AND 44).

FIRST USE 8-0-2007; IN COMMERCE 8-0-2007.

THE MARK CONSISTS OF STANDARD CHARACTERS WITHOUT CLAIM TO ANY PARTICULAR FONT, STYLE, SIZE, OR COLOR.

OWNER OF U.S. REG. NOS. 2,851,927, 3,343,562, AND OTHERS.

SN 77-277,430, FILED 9-12-2007.

KATHERINE M. DUBRAY, EXAMINING ATTORNEY

Int. Cl.: 20

Prior U.S. Cls.: 2, 13, 22, 25, 32, and 50

United States Patent and Trademark Office

Reg. No. 3,481,932

Registered Aug. 5, 2008

**TRADEMARK
PRINCIPAL REGISTER**

MyMagneTag

NAME BADGE PRODUCTIONS, LLC (WISCONSIN LTD LIAB CO)
6213 MIDDLETON SPRINGS DRIVE
MIDDLETON, WI 53562

THE MARK CONSISTS OF STANDARD CHARACTERS WITHOUT CLAIM TO ANY PARTICULAR FONT, STYLE, SIZE, OR COLOR.

FOR: PLASTIC NAME BADGE HOLDER WITH MAGNETIC MOUNT, IN CLASS 20 (U.S. CLS. 2, 13, 22, 25, 32 AND 50).

SN 77-277,807, FILED 9-12-2007.

FIRST USE 10-1-2007; IN COMMERCE 10-1-2007.

AMY GEARIN, EXAMINING ATTORNEY

Int. Cl.: 36

Prior U.S. Cls.: 100, 101, and 102

United States Patent and Trademark Office

Reg. No. 3,481,933

Registered Aug. 5, 2008

**SERVICE MARK
PRINCIPAL REGISTER**

MORTGAGEORB

ZACKIN PUBLICATIONS, INC. (CONNECTICUT CORPORATION)
100 WILLENBROCK ROAD
OXFORD, CT 06478

FOR: PROVIDING WEB SITE FEATURING INFORMATION PERTAINING TO THE REAL ESTATE FINANCING INDUSTRY, THE MORTGAGE MARKET, AND THE FINANCE INDUSTRY, IN CLASS 36 (U.S. CLS. 100, 101 AND 102).

FIRST USE 10-0-2007; IN COMMERCE 10-0-2007.

THE MARK CONSISTS OF STANDARD CHARACTERS WITHOUT CLAIM TO ANY PARTICULAR FONT, STYLE, SIZE, OR COLOR.

SN 77-278,487, FILED 9-13-2007.

LEIGH CAROLINE CASE, EXAMINING ATTORNEY

Int. Cl.: 35

Prior U.S. Cls.: 100, 101, and 102

United States Patent and Trademark Office

Reg. No. 3,481,934

Registered Aug. 5, 2008

**SERVICE MARK
PRINCIPAL REGISTER**

**DRIVING PERFORMANCE
EXCELLENCE**

GEMMA, ANTHONY (UNITED STATES INDIVIDUAL)
ONE WELLINGTON ROAD
LINCOLN, RI 02865

FOR: BUSINESS CONSULTING SERVICES RELATING TO SERVICE DELIVERY INDUSTRIES; BUSINESS ORGANIZATION CONSULTING AND BUSINESS MANAGEMENT CONSULTING RELATING TO SOFTWARE FOR STRUCTURING AND MANAGEMENT OF BUSINESSES IN SERVICE DELIVERY INDUSTRIES, IN CLASS 35 (U.S. CLS. 100, 101 AND 102).

FIRST USE 9-0-2007; IN COMMERCE 9-0-2007.

THE MARK CONSISTS OF STANDARD CHARACTERS WITHOUT CLAIM TO ANY PARTICULAR FONT, STYLE, SIZE, OR COLOR.

SN 77-278,813, FILED 9-13-2007.

DAVID YONTEF, EXAMINING ATTORNEY

Int. Cl.: 42

Prior U.S. Cls.: 100 and 101

United States Patent and Trademark Office

Reg. No. 3,481,935

Registered Aug. 5, 2008

**SERVICE MARK
PRINCIPAL REGISTER**

PEOPLE THINKS.COM

O. M. I. CREATIONS, LLC (NORTH CAROLINA
LTD LIAB CO)
4550 CHINABERRY LANE
WINSTON-SALEM, NC 27106

FOR: PROVIDING CUSTOMIZED ON-LINE WEB
PAGES FEATURING USER-DEFINED INFORMA-
TIONAL POSTINGS IN RESPONSE TO QUESTIONS
RAISED BY OTHERS ON VARIOUS TOPICS, IN
CLASS 42 (U.S. CLS. 100 AND 101).

FIRST USE 2-18-2008; IN COMMERCE 2-18-2008.

THE MARK CONSISTS OF STANDARD CHAR-
ACTERS WITHOUT CLAIM TO ANY PARTICULAR
FONT, STYLE, SIZE, OR COLOR.

NO CLAIM IS MADE TO THE EXCLUSIVE
RIGHT TO USE "PEOPLE", APART FROM THE
MARK AS SHOWN.

SN 77-278,832, FILED 9-13-2007.

DAVID YONTEF, EXAMINING ATTORNEY

Int. Cl.: 43

Prior U.S. Cls.: 100 and 101

United States Patent and Trademark Office

Reg. No. 3,481,936

Registered Aug. 5, 2008

**SERVICE MARK
PRINCIPAL REGISTER**

APPETITE FOR LIFE

VAIL TRADEMARKS, INC. (COLORADO CORPORATION)
P.O. BOX 7
VAIL, CO 81658

THE MARK CONSISTS OF STANDARD CHARACTERS WITHOUT CLAIM TO ANY PARTICULAR FONT, STYLE, SIZE, OR COLOR.

FOR: RESORT FOOD AND BEVERAGE SERVICES, NAMELY, RESTAURANT, CAFETERIA, SNACK BAR AND SNACK-STAND SERVICES, IN CLASS 43 (U.S. CLS. 100 AND 101).

SN 77-279,180, FILED 9-13-2007.

FIRST USE 11-5-2007; IN COMMERCE 11-5-2007.

SARA THOMAS, EXAMINING ATTORNEY

Int. Cl.: 35

Prior U.S. Cls.: 100, 101, and 102

United States Patent and Trademark Office

Reg. No. 3,481,937

Registered Aug. 5, 2008

SERVICE MARK
PRINCIPAL REGISTER



DIGITAL IMS, INC (DELAWARE CORPORATION)
100
1200 N STREET
LINCOLN, NE 68508

FOR: ADVERTISING AGENCIES, NAMELY, PROMOTING THE GOODS AND SERVICES OF OTHERS; ADVERTISING SERVICES, NAMELY, CREATING CORPORATE AND BRAND IDENTITY FOR OTHERS; ADVERTISING SERVICES, NAMELY, PROMOTING AND MARKETING THE GOODS AND SERVICES OF OTHERS THROUGH ALL PUBLIC COMMUNICATION MEANS; ADVERTISING, MARKETING AND PROMOTION SERVICES; FRANCHISE SERVICES, NAMELY, OFFERING TECHNICAL AND BUSINESS MANAGEMENT AS-

SISTANCE IN THE ESTABLISHMENT AND OPERATION OF INTERNET BASED ADVERTISING AGENCY AND WEB SITE DEVELOPMENT BUSINESSES, IN CLASS 35 (U.S. CLS. 100, 101 AND 102).

FIRST USE 10-1-2007; IN COMMERCE 10-1-2007.

THE MARK CONSISTS OF A CIRCULAR SHAPE WITH A STYLIZED "F" MEANDERING THROUGH THE MIDDLE AND THE TEXT "FIRESPRING" NEXT TO IT.

SN 77-279,625, FILED 9-14-2007.

JENNIFER VASQUEZ, EXAMINING ATTORNEY

Int. Cl.: 35

Prior U.S. Cls.: 100, 101, and 102

United States Patent and Trademark Office

Reg. No. 3,481,938

Registered Aug. 5, 2008

**SERVICE MARK
PRINCIPAL REGISTER**

NEW YORK IS BOOK COUNTRY

NIelsen BUSINESS MEDIA, INC. (DELAWARE CORPORATION)
770 BROADWAY
NEW YORK, NY 100039595

FOR: ARRANGING AND CONDUCTING TRADE SHOWS AND BUSINESS CONFERENCES IN THE FIELD OF BOOKS AND LITERATURE, DIRECTED TO THE LITERARY INDUSTRY, IN CLASS 35 (U.S. CLS. 100, 101 AND 102).

FIRST USE 8-1-2007; IN COMMERCE 8-1-2007.

THE MARK CONSISTS OF STANDARD CHARACTERS WITHOUT CLAIM TO ANY PARTICULAR FONT, STYLE, SIZE, OR COLOR.

NO CLAIM IS MADE TO THE EXCLUSIVE RIGHT TO USE "NEW YORK", APART FROM THE MARK AS SHOWN.

SN 77-279,744, FILED 9-14-2007.

SANJEEV VOHRA, EXAMINING ATTORNEY

Int. Cl.: 39

Prior U.S. Cls.: 100 and 105

United States Patent and Trademark Office

Reg. No. 3,481,939

Registered Aug. 5, 2008

**SERVICE MARK
PRINCIPAL REGISTER**

Fine Food. Fast.

KMGI CORP. (PANAMA CORPORATION)
C/O ALEX KONANYKHIN
18101 COLLINS AVENUE PH304
SUNNY ISLES BEACH, FL 33160

FOR: FOOD DELIVERY, IN CLASS 39 (U.S. CLS.
100 AND 105).

FIRST USE 12-7-2007; IN COMMERCE 12-7-2007.

THE MARK CONSISTS OF STANDARD CHAR-
ACTERS WITHOUT CLAIM TO ANY PARTICULAR
FONT, STYLE, SIZE, OR COLOR.

NO CLAIM IS MADE TO THE EXCLUSIVE
RIGHT TO USE "FOOD", APART FROM THE
MARK AS SHOWN.

SN 77-280,449, FILED 9-15-2007.

NAAKWAMA ANKRAH, EXAMINING ATTORNEY

Int. Cl.: 35

Prior U.S. Cls.: 100, 101, and 102

United States Patent and Trademark Office

Reg. No. 3,481,940

Registered Aug. 5, 2008

**SERVICE MARK
PRINCIPAL REGISTER**

THE WANT OUTLET

EDL TECHNOLOGY, LLC (MARYLAND LTD
LIAB CO)
9111 BRIEN PLACE
FREDERICK, MD 21704

FOR: PROVIDING AN ON-LINE SEARCHABLE
DATABASE FEATURING CLASSIFIED AD LIST-
INGS OF WANTED ITEMS, IN CLASS 35 (U.S. CLS.
100, 101 AND 102).

FIRST USE 7-3-2007; IN COMMERCE 8-16-2007.

THE MARK CONSISTS OF STANDARD CHAR-
ACTERS WITHOUT CLAIM TO ANY PARTICULAR
FONT, STYLE, SIZE, OR COLOR.

NO CLAIM IS MADE TO THE EXCLUSIVE
RIGHT TO USE "OUTLET", APART FROM THE
MARK AS SHOWN.

SN 77-280,858, FILED 9-17-2007.

SAMUEL E. SHARPER JR., EXAMINING ATTOR-
NEY

Int. Cl.: 5

Prior U.S. Cls.: 6, 18, 44, 46, 51, and 52

Reg. No. 3,481,941

United States Patent and Trademark Office

Registered Aug. 5, 2008

**TRADEMARK
PRINCIPAL REGISTER**

HEPATROL

PHARMA-NATURAL INC. (FLORIDA COR-
PORATION)
SUITE #4
2431 W. 80TH STREET
HIALEAH, FL 33016

THE MARK CONSISTS OF STANDARD CHAR-
ACTERS WITHOUT CLAIM TO ANY PARTICULAR
FONT, STYLE, SIZE, OR COLOR.

FOR: DIETARY SUPPLEMENTS; NUTRITIONAL
SUPPLEMENTS, IN CLASS 5 (U.S. CLS. 6, 18, 44, 46, 51
AND 52).

SN 77-281,366, FILED 9-17-2007.

FIRST USE 11-1-2007; IN COMMERCE 11-1-2007.

BILL DAWE, EXAMINING ATTORNEY

Int. Cl.: 3

Prior U.S. Cls.: 1, 4, 6, 50, 51, and 52

Reg. No. 3,481,942

United States Patent and Trademark Office

Registered Aug. 5, 2008

**TRADEMARK
PRINCIPAL REGISTER**

STAINSCRUBBERS

THE PROCTER & GAMBLE COMPANY (OHIO
CORPORATION)
1 P&G PLAZA
CINCINNATI, OH 45202

THE MARK CONSISTS OF STANDARD CHAR-
ACTERS WITHOUT CLAIM TO ANY PARTICULAR
FONT, STYLE, SIZE, OR COLOR.

FOR: LAUNDRY DETERGENT, IN CLASS 3 (U.S.
CLS. 1, 4, 6, 50, 51 AND 52).

SN 77-282,292, FILED 9-18-2007.

FIRST USE 1-21-2008; IN COMMERCE 1-21-2008.

MELVIN AXILBUND, EXAMINING ATTORNEY

Int. Cl.: 11

Prior U.S. Cls.: 13, 21, 23, 31, and 34

United States Patent and Trademark Office

Reg. No. 3,481,943

Registered Aug. 5, 2008

**TRADEMARK
PRINCIPAL REGISTER**

STOCKBRIDGE

HUNTER FAN COMPANY (DELAWARE COR-
PORATION)
2500 FRISCO AVENUE
MEMPHIS, TN 38114

THE MARK CONSISTS OF STANDARD CHAR-
ACTERS WITHOUT CLAIM TO ANY PARTICULAR
FONT, STYLE, SIZE, OR COLOR.

FOR: CEILING FANS, IN CLASS 11 (U.S. CLS. 13,
21, 23, 31 AND 34).

SN 77-282,294, FILED 9-18-2007.

FIRST USE 3-10-2008; IN COMMERCE 3-10-2008.

MICHAEL KEATING, EXAMINING ATTORNEY

Int. Cl.: 11

Prior U.S. Cls.: 13, 21, 23, 31, and 34

United States Patent and Trademark Office

Reg. No. 3,481,944

Registered Aug. 5, 2008

**TRADEMARK
PRINCIPAL REGISTER**

MARSALA

HUNTER FAN COMPANY (DELAWARE COR-
PORATION)
2500 FRISCO AVENUE
MEMPHIS, TN 38114

THE MARK CONSISTS OF STANDARD CHAR-
ACTERS WITHOUT CLAIM TO ANY PARTICULAR
FONT, STYLE, SIZE, OR COLOR.

FOR: CEILING FANS, IN CLASS 11 (U.S. CLS. 13,
21, 23, 31 AND 34).

SN 77-282,302, FILED 9-18-2007.

FIRST USE 1-16-2008; IN COMMERCE 1-16-2008.

MICHAEL KEATING, EXAMINING ATTORNEY

Int. Cl.: 3

Prior U.S. Cls.: 1, 4, 6, 50, 51, and 52

United States Patent and Trademark Office

Reg. No. 3,481,945

Registered Aug. 5, 2008

**TRADEMARK
PRINCIPAL REGISTER**

DAWN

THE PROCTER & GAMBLE COMPANY (OHIO
CORPORATION)
1 P&G PLAZA
CINCINNATI, OH 45202

FOR: LAUNDRY DETERGENT, IN CLASS 3 (U.S.
CLS. 1, 4, 6, 50, 51 AND 52).

FIRST USE 1-21-2008; IN COMMERCE 1-21-2008.

THE MARK CONSISTS OF STANDARD CHAR-
ACTERS WITHOUT CLAIM TO ANY PARTICULAR
FONT, STYLE, SIZE, OR COLOR.

OWNER OF U.S. REG. NOS. 562,962, 3,060,902,
AND OTHERS.

SN 77-282,306, FILED 9-18-2007.

MELVIN AXILBUND, EXAMINING ATTORNEY

Int. Cl.: 28

Prior U.S. Cls.: 22, 23, 38, and 50

United States Patent and Trademark Office

Reg. No. 3,481,946

Registered Aug. 5, 2008

**TRADEMARK
PRINCIPAL REGISTER**

FINGERLOOP

COLUMBUS PRECISION TOOL, INC. (OHIO
CORPORATION)
6240 FROST ROAD
WESTERVILLE, OH 43082

FOR: GOLF CLUB SWING AIDS, NAMELY, A
DEVICE TO ASSIST THE GOLFER WITH PROPER
CLUB POSITIONING IN THE HAND, IN CLASS 28
(U.S. CLS. 22, 23, 38 AND 50).

FIRST USE 3-6-2008; IN COMMERCE 3-6-2008.

THE MARK CONSISTS OF STANDARD CHAR-
ACTERS WITHOUT CLAIM TO ANY PARTICULAR
FONT, STYLE, SIZE, OR COLOR.

SN 77-284,109, FILED 9-20-2007.

SHAUNIA CARLYLE, EXAMINING ATTORNEY

Int. Cl.: 10

Prior U.S. Cls.: 26, 39, and 44

United States Patent and Trademark Office

Reg. No. 3,481,947

Registered Aug. 5, 2008

**TRADEMARK
PRINCIPAL REGISTER**

XerGames

SPORTWALL INTERNATIONAL INC. (DELA-
WARE CORPORATION)
6460 VIA REAL
CARPINTERIA, CA 93013

FOR: MEDICAL EQUIPMENT, NAMELY, PHYSI-
CAL EXERCISE APPARATUS FOR TREATMENT
OF MOTOR CO-ORDINATION AND INACTIVITY
BASED ILLNESSES SUCH AS: TYPE 2 DIABETES,
DYSLEXIA, ADHD, ALZHEIMER'S AND OBESITY,
IN CLASS 10 (U.S. CLS. 26, 39 AND 44).

FIRST USE 4-0-2007; IN COMMERCE 4-0-2007.

THE MARK CONSISTS OF STANDARD CHAR-
ACTERS WITHOUT CLAIM TO ANY PARTICULAR
FONT, STYLE, SIZE, OR COLOR.

SN 77-284,586, FILED 9-20-2007.

BRIAN NEVILLE, EXAMINING ATTORNEY

Int. Cl.: 3

Prior U.S. Cls.: 1, 4, 6, 50, 51, and 52

United States Patent and Trademark Office

Reg. No. 3,481,948

Registered Aug. 5, 2008

**TRADEMARK
PRINCIPAL REGISTER**

SPIRIPHYSICAL

BALTZ, BRUCE (UNITED STATES INDIVIDUAL)
144 NE 45TH STREET
MIAMI, FL 33137

FOR: SKIN LOTION; LOTIONS FOR FACE AND BODY CARE; FACIAL LOTION; BEAUTY CREAMS; BODY CREAM; CLEANSING CREAMS; COSMETIC CREAMS; CREAM SOAPS; EXFOLIANT CREAMS; FACE AND BODY CREAMS; HAND CREAMS; BODY SCRUB; FACIAL SCRUBS; BEAUTY MASKS; FACIAL MASKS; EYE CREAM; EXFOLIANTS FOR SKIN AND FACE; COSMETIC SOAPS; HAND SOAPS; SKIN SOAP; FACE AND BODY LOTIONS; MOISTURIZING CREAMS; SKIN MOISTURIZER;

SKIN MOISTURIZER MASKS; BODY OIL; SKIN TONERS, IN CLASS 3 (U.S. CLS. 1, 4, 6, 50, 51 AND 52).

FIRST USE 1-0-2008; IN COMMERCE 1-0-2008.

THE MARK CONSISTS OF STANDARD CHARACTERS WITHOUT CLAIM TO ANY PARTICULAR FONT, STYLE, SIZE, OR COLOR.

OWNER OF U.S. REG. NOS. 3,217,886 AND 3,227,569.

SN 77-285,063, FILED 9-20-2007.

KAPIL BHANOT, EXAMINING ATTORNEY

Int. Cl.: 1

Prior U.S. Cls.: 1, 5, 6, 10, 26, and 46

Reg. No. 3,481,949

United States Patent and Trademark Office

Registered Aug. 5, 2008

**TRADEMARK
PRINCIPAL REGISTER**

NATURAL TRACE

MARS FISHCARE NORTH AMERICA, INC.
(PENNSYLVANIA CORPORATION)
50 E. HAMILTON STREET, P.O. BOX 218
CHALFONT, PA 18914

FOR: CHEMICAL AND BACTERIA PREPARA-
TIONS FOR THE TREATMENT, CONDITIONING,
AND CLEANING OF AQUARIUMS AND AQUA-
RIUM WATER, IN CLASS 1 (U.S. CLS. 1, 5, 6, 10, 26
AND 46).

FIRST USE 10-0-2007; IN COMMERCE 10-0-2007.

THE MARK CONSISTS OF STANDARD CHAR-
ACTERS WITHOUT CLAIM TO ANY PARTICULAR
FONT, STYLE, SIZE, OR COLOR.

SN 77-286,274, FILED 9-21-2007.

BRENDAN MCCAULEY, EXAMINING ATTORNEY

Int. Cl.: 10

Prior U.S. Cls.: 26, 39, and 44

United States Patent and Trademark Office

Reg. No. 3,481,950

Registered Aug. 5, 2008

**TRADEMARK
PRINCIPAL REGISTER**

QUADRA PRO ALOFT

QUADRA PRO ALOFT LLC (ARIZONA LTD
LIAB CO)
7729 E TAILSPIN LN
SCOTTSDALE, AZ 85255

FOR: BOXED KIT COMPRISED OF SURGICAL
MASK, ANTISEPTIC HAND WIPES, NASAL SALINE
SPRAY, AND VITAMINS AND MINERAL SUPPLE-
MENTS, WHICH IS USED TO REDUCE TRANSMIS-
SION OF THE COMMON COLD , IN CLASS 10 (U.S.
CLS. 26, 39 AND 44).

FIRST USE 1-15-2008; IN COMMERCE 1-15-2008.

THE MARK CONSISTS OF STANDARD CHAR-
ACTERS WITHOUT CLAIM TO ANY PARTICULAR
FONT, STYLE, SIZE, OR COLOR.

NO CLAIM IS MADE TO THE EXCLUSIVE
RIGHT TO USE "PRO", APART FROM THE MARK
AS SHOWN.

SN 77-287,590, FILED 9-24-2007.

STEVEN R. FOSTER, EXAMINING ATTORNEY

Int. Cl.: 21

Prior U.S. Cls.: 2, 13, 23, 29, 30, 33, 40, and 50

United States Patent and Trademark Office

Reg. No. 3,481,951

Registered Aug. 5, 2008

**TRADEMARK
PRINCIPAL REGISTER**

MICROSMORES

AUGUSTINE, DAVID (UNITED STATES INDIVIDUAL)
4 WESTWIND
LAGUNA NIGUEL, CA 92677

THE MARK CONSISTS OF STANDARD CHARACTERS WITHOUT CLAIM TO ANY PARTICULAR FONT, STYLE, SIZE, OR COLOR.

FOR: COOKING POTS AND PANS, IN CLASS 21 (U.S. CLS. 2, 13, 23, 29, 30, 33, 40 AND 50).

SN 77-288,813, FILED 9-25-2007.

FIRST USE 6-5-2008; IN COMMERCE 6-5-2008.

PAM WILLIS, EXAMINING ATTORNEY

Int. Cl.: 9

Prior U.S. Cls.: 21, 23, 26, 36, and 38

Reg. No. 3,481,952

United States Patent and Trademark Office

Registered Aug. 5, 2008

**TRADEMARK
PRINCIPAL REGISTER**

SkipRanger

SAFEHOIST TECHNOLOGIES, INC. (WASHINGTON CORPORATION), DBA SAFEHOIST, INC.,
15902 N DALTON RD.
SPOKANE, WA 99208

THE MARK CONSISTS OF STANDARD CHARACTERS WITHOUT CLAIM TO ANY PARTICULAR FONT, STYLE, SIZE, OR COLOR.

FOR: ACCELEROMETERS, IN CLASS 9 (U.S. CLS. 21, 23, 26, 36 AND 38).

SN 77-289,210, FILED 9-26-2007.

FIRST USE 12-17-2007; IN COMMERCE 5-7-2008.

KIMBERLY FRYE, EXAMINING ATTORNEY

Int. Cl.: 9

Prior U.S. Cls.: 21, 23, 26, 36, and 38

United States Patent and Trademark Office

Reg. No. 3,481,953

Registered Aug. 5, 2008

**TRADEMARK
PRINCIPAL REGISTER**



HALL, SHELLIE L. (UNITED STATES INDIVIDUAL)
4803 N. HOYNE AVENUE
CHICAGO, IL 60625

FOR: AUDIO AND VIDEO RECORDINGS FEATURING CREATIVE MEDIA PUBLISHING; DOWNLOADABLE MP3 FILES, MP3 RECORDINGS, ONLINE DISCUSSION BOARDS, WEBCASTS AND PODCASTS FEATURING MUSIC, AUDIO BOOKS AND NEWS BROADCASTS; DOWNLOADABLE MULTIMEDIA FILE CONTAINING ARTWORK, TEXT, AUDIO, VIDEO, GAMES, AND INTERNET

WEB LINKS RELATING TO CREATIVE MEDIA PUBLISHING; DOWNLOADABLE PODCASTS IN THE FIELD OF CREATIVE MEDIA PUBLISHING; DOWNLOADABLE VIDEO RECORDINGS FEATURING CREATIVE MEDIA PUBLISHING, IN CLASS 9 (U.S. CLS. 21, 23, 26, 36 AND 38).

FIRST USE 11-1-2007; IN COMMERCE 11-1-2007.

SN 77-290,075, FILED 9-27-2007.

SHANNON TWOHIG, EXAMINING ATTORNEY

Int. Cl.: 3

Prior U.S. Cls.: 1, 4, 6, 50, 51, and 52

Reg. No. 3,481,954

United States Patent and Trademark Office

Registered Aug. 5, 2008

**TRADEMARK
PRINCIPAL REGISTER**

SOLAR RADIANCE

PRODUCT QUEST MANUFACTURING, INC.
(FLORIDA CORPORATION)
330 CARSWELL AVENUE
HOLLY HILL, FL 32117

FOR: NON-MEDICATED SKIN CARE PREPARATIONS, NAMELY, SUNSCREEN AND SUN BLOCK PREPARATIONS, SUNTANNING PREPARATIONS, AFTERSUN LOTIONS, IN CLASS 3 (U.S. CLS. 1, 4, 6, 50, 51 AND 52).

FIRST USE 1-8-2008; IN COMMERCE 1-8-2008.

THE MARK CONSISTS OF STANDARD CHARACTERS WITHOUT CLAIM TO ANY PARTICULAR FONT, STYLE, SIZE, OR COLOR.

NO CLAIM IS MADE TO THE EXCLUSIVE RIGHT TO USE "SOLAR", APART FROM THE MARK AS SHOWN.

SN 77-290,197, FILED 9-27-2007.

SETH A. RAPPAPORT, EXAMINING ATTORNEY

Int. Cl.: 28

Prior U.S. Cls.: 22, 23, 38, and 50

United States Patent and Trademark Office

Reg. No. 3,481,955

Registered Aug. 5, 2008

**TRADEMARK
PRINCIPAL REGISTER**

SOFT-TOSS

FRANKLIN SPORTS, INC. (GEORGIA CORPORATION)
17 CAMPANELLI PARKWAY
STOUGHTON, MA 02072

THE MARK CONSISTS OF STANDARD CHARACTERS WITHOUT CLAIM TO ANY PARTICULAR FONT, STYLE, SIZE, OR COLOR.

FOR: BASEBALL AND SOFTBALL TRAINING APPARATUS USED AS NET ASSEMBLY FOR CATCHING BASEBALLS AND SOFTBALLS, IN CLASS 28 (U.S. CLS. 22, 23, 38 AND 50).

SN 77-290,977, FILED 9-27-2007.

FIRST USE 4-1-2008; IN COMMERCE 4-1-2008.

ANTHONY RINKER, EXAMINING ATTORNEY

Int. Cls.: 35 and 41

Prior U.S. Cls.: 100, 101, 102, and 107

United States Patent and Trademark Office

Reg. No. 3,481,956

Registered Aug. 5, 2008

**SERVICE MARK
PRINCIPAL REGISTER**

GREENSTONE GROUP

NORTHEAST ENTREPRENEUR FUND, INC.
(MINNESOTA CORPORATION)
SUITE 100
8355 UNITY DRIVE
VIRGINIA, MN 55792

FOR: PROVIDING AN ONLINE DIRECTORY OF SERVICE PROVIDERS FOR ENTREPRENEURS TO ASSIST IN BUSINESS DEVELOPMENT, IN CLASS 35 (U.S. CLS. 100, 101 AND 102).

FIRST USE 3-14-2008; IN COMMERCE 3-14-2008.

FOR: EDUCATIONAL SERVICES, NAMELY, PROVIDING GROUP AND INDIVIDUAL TRAINING AND MENTORING TO OWNERS OF EXISTING AND START-UP BUSINESSES FOR THE PURPOSE OF TEACHING ENTREPRENEURIAL SKILLS TO FOSTER BUSINESS DEVELOPMENT AND GROWTH AND ASSISTING EDUCATIONAL

INSTITUTIONS IN THE DEVELOPMENT OF CURRICULUM WHICH TEACHES ENTREPRENEURIAL SKILLS, IN CLASS 41 (U.S. CLS. 100, 101 AND 107).

FIRST USE 4-3-2008; IN COMMERCE 4-3-2008.

THE MARK CONSISTS OF STANDARD CHARACTERS WITHOUT CLAIM TO ANY PARTICULAR FONT, STYLE, SIZE, OR COLOR.

NO CLAIM IS MADE TO THE EXCLUSIVE RIGHT TO USE "GROUP", APART FROM THE MARK AS SHOWN.

SN 77-291,117, FILED 9-28-2007.

KATINA MISTER, EXAMINING ATTORNEY

Int. Cl.: 28

Prior U.S. Cls.: 22, 23, 38, and 50

Reg. No. 3,481,957

United States Patent and Trademark Office

Registered Aug. 5, 2008

**TRADEMARK
PRINCIPAL REGISTER**

ZB

KARSTEN MANUFACTURING CORPORATION
(ARIZONA CORPORATION)
2201 WEST DESERT COVE
PHOENIX, AZ 85029

THE MARK CONSISTS OF STANDARD CHARACTERS WITHOUT CLAIM TO ANY PARTICULAR FONT, STYLE, SIZE, OR COLOR.

FOR: GOLF CLUBS, IN CLASS 28 (U.S. CLS. 22, 23, 38 AND 50).

SN 77-293,204, FILED 10-1-2007.

FIRST USE 4-1-2008; IN COMMERCE 4-1-2008.

JANICE L. MCMORROW, EXAMINING ATTORNEY

Int. Cl.: 44

Prior U.S. Cls.: 100 and 101

United States Patent and Trademark Office

Reg. No. 3,481,958

Registered Aug. 5, 2008

**SERVICE MARK
PRINCIPAL REGISTER**

**MACHINERYLINK THE SMARTER
HARVEST**

MACHINERYLINK, INC. (DELAWARE COR-
PORATION)
SUITE 700
1600 GENESSEE
KANSAS CITY, MO 64102

FOR: LEASING AND RENTAL OF AGRICUL-
TURAL AND FARM EQUIPMENT, IN CLASS 44
(U.S. CLS. 100 AND 101).

FIRST USE 12-14-2007; IN COMMERCE 12-14-2007.

THE MARK CONSISTS OF STANDARD CHAR-
ACTERS WITHOUT CLAIM TO ANY PARTICULAR
FONT, STYLE, SIZE, OR COLOR.

OWNER OF U.S. REG. NOS. 2,554,960, 3,306,385,
AND OTHERS.

SN 77-293,521, FILED 10-2-2007.

ALEXANDER L. POWERS, EXAMINING ATTOR-
NEY

Int. Cl.: 41

Prior U.S. Cls.: 100, 101, and 107

United States Patent and Trademark Office

Reg. No. 3,481,959

Registered Aug. 5, 2008

**SERVICE MARK
PRINCIPAL REGISTER**

Snyder

Dojo

SNYDER, CHRISTOPHER J (UNITED STATES
INDIVIDUAL)
10063 PORTAGE RD
PORTAGE, MI 49002

FOR: JUDO INSTRUCTION, IN CLASS 41 (U.S.
CLS. 100, 101 AND 107).

FIRST USE 5-20-2007; IN COMMERCE 10-15-2007.

NO CLAIM IS MADE TO THE EXCLUSIVE
RIGHT TO USE "DOJO", APART FROM THE MARK
AS SHOWN.

THE NAME(S), PORTRAIT(S), AND/OR SIGNA-
TURE(S) SHOWN IN THE MARK IDENTIFIES

"CHRISTOPHER J SNYDER", WHOSE CONSENT(S)
TO REGISTER IS MADE OF RECORD.

THE MARK CONSISTS OF IT A STYLIZED
KNOTTED BELT WITH THE TWO BELT ENDS
HANGING DOWN. "SNYDER" IS ABOVE BUT
SLIGHTLY OVERLAPPING THE BELT WITH
"DOJO" BELOW THE BELT.

THE FOREIGN WORDING IN THE MARK
TRANSLATES INTO ENGLISH AS MARTIAL ARTS
SCHOOL.

SN 77-295,626, FILED 10-3-2007.

CHRIS WELLS, EXAMINING ATTORNEY

Int. Cl.: 19

Prior U.S. Cls.: 1, 12, 33, and 50

United States Patent and Trademark Office

Reg. No. 3,481,960

Registered Aug. 5, 2008

**TRADEMARK
PRINCIPAL REGISTER**

FIRE OPAL

PEBBLE TECHNOLOGY, INC. (ARIZONA CORPORATION)
15540 NORTH 77TH STREET
SCOTTSDALE, AZ 85260

THE MARK CONSISTS OF STANDARD CHARACTERS WITHOUT CLAIM TO ANY PARTICULAR FONT, STYLE, SIZE, OR COLOR.

FOR: TILES FOR THE INTERIOR, BOTTOM, SIDES, AND PERIMETER OF SWIMMING POOLS AND SPAS, NAMELY, TILES MADE OF GLASS, IN CLASS 19 (U.S. CLS. 1, 12, 33 AND 50).

SN 77-296,096, FILED 10-4-2007.

FIRST USE 10-0-2007; IN COMMERCE 10-0-2007.

JAMES A. RAUEN, EXAMINING ATTORNEY

Int. Cl.: 19

Prior U.S. Cls.: 1, 12, 33, and 50

United States Patent and Trademark Office

Reg. No. 3,481,961

Registered Aug. 5, 2008

**TRADEMARK
PRINCIPAL REGISTER**

FINISHING TOUCHES

PEBBLE TECHNOLOGY, INC. (ARIZONA CORPORATION)
15540 NORTH 77TH STREET
SCOTTSDALE, AZ 85260

FOR: TILES FOR INTERIOR, BOTTOM, SIDES, AND PERIMETER OF SWIMMING POOLS AND SPAS, NAMELY, TILES MADE OF GLASS, CERAMIC, PORCELAIN, VINYL, GYPSUM AND CLAY, IN CLASS 19 (U.S. CLS. 1, 12, 33 AND 50).

FIRST USE 10-0-2007; IN COMMERCE 10-0-2007.

THE MARK CONSISTS OF STANDARD CHARACTERS WITHOUT CLAIM TO ANY PARTICULAR FONT, STYLE, SIZE, OR COLOR.

SN 77-296,097, FILED 10-4-2007.

JAMES A. RAUEN, EXAMINING ATTORNEY

Int. Cl.: 41

Prior U.S. Cls.: 100, 101, and 107

United States Patent and Trademark Office

Reg. No. 3,481,962

Registered Aug. 5, 2008

**SERVICE MARK
PRINCIPAL REGISTER**

LUX LEVEL

NATIONAL AMUSEMENTS, INC. (MARYLAND
CORPORATION)
200 ELM STREET
DEDHAM, MA 02026

FOR: PROVIDING FACILITIES FOR ENTERTAINMENT SERVICES IN THE NATURE OF MOTION PICTURES PRESENTATIONS AND LIVE PERFORMANCES, IN CLASS 41 (U.S. CLS. 100, 101 AND 107).

FIRST USE 12-0-2007; IN COMMERCE 12-0-2007.

THE MARK CONSISTS OF STANDARD CHARACTERS WITHOUT CLAIM TO ANY PARTICULAR FONT, STYLE, SIZE, OR COLOR.

SN 77-296,444, FILED 10-4-2007.

NICHOLAS ALTREE, EXAMINING ATTORNEY

Int. Cl.: 9

Prior U.S. Cls.: 21, 23, 26, 36, and 38

Reg. No. 3,481,963

United States Patent and Trademark Office

Registered Aug. 5, 2008

**TRADEMARK
PRINCIPAL REGISTER**

URBAN ATTACK

VIVENDI GAMES EUROPE S.A. (FRANCE SOCI-
ÉTÉ ANONYME (SA)), DBA VIVENDI GAMES
MOBILE,
IMMEUBLE LE NEWTON
9/11 RUE JEANNE BRACONNIER
MEUDON-LA-FORET CEDEX, FRANCE 92366

FIRST USE 12-25-2007; IN COMMERCE 12-25-2007.

THE MARK CONSISTS OF STANDARD CHAR-
ACTERS WITHOUT CLAIM TO ANY PARTICULAR
FONT, STYLE, SIZE, OR COLOR.

FOR: COMPUTER GAME SOFTWARE; DOWN-
LOADABLE SOFTWARE FOR USE IN CONNEC-
TION WITH COMPUTER GAMES; INTERACTIVE
MULTIMEDIA COMPUTER GAME PROGRAM, IN
CLASS 9 (U.S. CLS. 21, 23, 26, 36 AND 38).

SN 77-296,612, FILED 10-4-2007.

BARNEY CHARLON, EXAMINING ATTORNEY

Int. Cl.: 36

Prior U.S. Cls.: 100, 101, and 102

United States Patent and Trademark Office

Reg. No. 3,481,964

Registered Aug. 5, 2008

**SERVICE MARK
PRINCIPAL REGISTER**

GO FURTHER

JANUS INTERNATIONAL HOLDING LLC (NE-
VADA LTD LIAB CO)
ATTN CHARLES FLEMING LEGAL DEPT
151 DETROIT STREET
DENVER, CO 80206

FOR: FINANCIAL AND INVESTMENT SERVI-
CES, NAMELY, MANAGEMENT AND BROKER-
AGE IN THE FIELDS OF STOCKS, BONDS,
OPTIONS, COMMODITIES, FUTURES AND OTHER
SECURITIES, AND THE INVESTMENT OF FUNDS
OF OTHERS, IN CLASS 36 (U.S. CLS. 100, 101 AND
102).

FIRST USE 10-31-2007; IN COMMERCE 10-31-2007.

THE MARK CONSISTS OF STANDARD CHAR-
ACTERS WITHOUT CLAIM TO ANY PARTICULAR
FONT, STYLE, SIZE, OR COLOR.

SN 77-297,448, FILED 10-5-2007.

DAVID YONTEF, EXAMINING ATTORNEY

Int. Cl.: 36

Prior U.S. Cls.: 100, 101, and 102

United States Patent and Trademark Office

Reg. No. 3,481,965

Registered Aug. 5, 2008

**SERVICE MARK
PRINCIPAL REGISTER**

The Power of Growth

STEPHENS INVESTMENT MANAGMENT
GROUP, LLC (ARKANSAS LTD LIAB CO)
111 CENTER STREET
LITTLE ROCK, AR 72201

FOR: FINANCIAL ANALYSIS AND CONSULTA-
TION; INVESTMENT ADVICE; INVESTMENT MAN-
AGEMENT; MUTUAL FUND DISTRIBUTION AND
MUTUAL FUND INVESTMENT , IN CLASS 36 (U.S.
CLS. 100, 101 AND 102).

FIRST USE 3-28-2008; IN COMMERCE 3-28-2008.

THE MARK CONSISTS OF STANDARD CHAR-
ACTERS WITHOUT CLAIM TO ANY PARTICULAR
FONT, STYLE, SIZE, OR COLOR.

SN 77-297,676, FILED 10-5-2007.

RONALD MCMORROW, EXAMINING ATTORNEY

Int. Cl.: 16

Prior U.S. Cls.: 2, 5, 22, 23, 29, 37, 38, and 50

United States Patent and Trademark Office

Reg. No. 3,481,966

Registered Aug. 5, 2008

**TRADEMARK
PRINCIPAL REGISTER**

COMET OPAQUE

UNISOURCE WORLDWIDE, INC. (DELAWARE
CORPORATION)

6600 GOVERNORS LAKE PARKWAY

NORCROSS, GA 30071

FOR: PRINTING PAPER, IN CLASS 16 (U.S. CLS. 2,
5, 22, 23, 29, 37, 38 AND 50).

FIRST USE 3-20-2008; IN COMMERCE 3-20-2008.

THE MARK CONSISTS OF STANDARD CHAR-
ACTERS WITHOUT CLAIM TO ANY PARTICULAR
FONT, STYLE, SIZE, OR COLOR.

NO CLAIM IS MADE TO THE EXCLUSIVE
RIGHT TO USE "OPAQUE", APART FROM THE
MARK AS SHOWN.

SN 77-298,215, FILED 10-8-2007.

JOHN E. MICHOS, EXAMINING ATTORNEY

Int. Cl.: 35

Prior U.S. Cls.: 100, 101, and 102

United States Patent and Trademark Office

Reg. No. 3,481,967

Registered Aug. 5, 2008

**SERVICE MARK
PRINCIPAL REGISTER**

**IT'S YOUR LIFE...FREE IT
UP!**

PERLMAN ERIC (UNITED STATES INDIVIDUAL)
10343 RUBIO AVE
GRANADA HILLS, CA 91344

FOR: COMPUTERIZED ON-LINE GIFT ORDERING SERVICE WHICH MATCHES THE GIFT GIVER'S REQUIREMENTS WITH THE GIFT RECIPIENT'S WANTS AND NEEDS, IN CLASS 35 (U.S. CLS. 100, 101 AND 102).

FIRST USE 2-1-2003; IN COMMERCE 1-1-2008.

THE MARK CONSISTS OF STANDARD CHARACTERS WITHOUT CLAIM TO ANY PARTICULAR FONT, STYLE, SIZE, OR COLOR.

SN 77-298,320, FILED 10-8-2007.

JORDAN BAKER, EXAMINING ATTORNEY

Int. Cl.: 30

Prior U.S. Cl.: 46

United States Patent and Trademark Office

Reg. No. 3,481,968

Registered Aug. 5, 2008

**TRADEMARK
PRINCIPAL REGISTER**

ESSENCE

BP PRODUCTS NORTH AMERICA INC. (MARY-
LAND CORPORATION)
4101 WINFIELD ROAD
WARRENVILLE, IL 60555

THE MARK CONSISTS OF STANDARD CHAR-
ACTERS WITHOUT CLAIM TO ANY PARTICULAR
FONT, STYLE, SIZE, OR COLOR.

FOR: ICED TEA, IN CLASS 30 (U.S. CL. 46).

SN 77-299,080, FILED 10-9-2007.

FIRST USE 3-10-2008; IN COMMERCE 3-10-2008.

SIMON TENG, EXAMINING ATTORNEY

Int. Cl.: 9

Prior U.S. Cls.: 21, 23, 26, 36, and 38

Reg. No. 3,481,969

United States Patent and Trademark Office

Registered Aug. 5, 2008

**TRADEMARK
PRINCIPAL REGISTER**

ASSETOVERSEER

SPORIAN MICROSYSTEMS, INC. (COLORADO
CORPORATION)
515 COURTNEY WAY - SUITE B
LAFAYETTE, CO 80026

THE MARK CONSISTS OF STANDARD CHAR-
ACTERS WITHOUT CLAIM TO ANY PARTICULAR
FONT, STYLE, SIZE, OR COLOR.

FOR: ELECTRIC OR ELECTRONIC SENSORS
FOR TEMPERATURE, PRESSURE, HUMIDITY, VI-
BRATION, SHOCK, LOCATION, AND GAS SPECIES,
IN CLASS 9 (U.S. CLS. 21, 23, 26, 36 AND 38).

SN 77-299,331, FILED 10-9-2007.

FIRST USE 10-2-2007; IN COMMERCE 10-2-2007.

JULIE WATSON, EXAMINING ATTORNEY

Int. Cl.: 43

Prior U.S. Cls.: 100 and 101

United States Patent and Trademark Office

Reg. No. 3,481,970

Registered Aug. 5, 2008

SERVICE MARK
PRINCIPAL REGISTER



WHG TM CORP. (DELAWARE CORPORATION)
10750 WEST CHARLESTON BLVD., SUITE 130
LAS VEGAS, NV 89135

FOR: RESTAURANT SERVICES PROVIDED IN
HOTELS AND MOTELS, IN CLASS 43 (U.S. CLS. 100
AND 101).

FIRST USE 11-0-2007; IN COMMERCE 11-0-2007.

OWNER OF U.S. REG. NOS. 3,172,962, 3,226,449,
AND 3,232,172.

NO CLAIM IS MADE TO THE EXCLUSIVE
RIGHT TO USE "BREAKFAST", APART FROM
THE MARK AS SHOWN.

THE COLOR(S) BLUE, YELLOW, RED, WHITE IS/
ARE CLAIMED AS A FEATURE OF THE MARK.

THE MARK CONSISTS OF THE WORDS "BAY-
MONT BREAKFAST CORNER"; THE WORD "BAY-
MONT" APPEARS AGAINST A BLUE OVAL;
"BAYMONT" IS IN WHITE; THREE BANNERS
APPEAR ABOVE THE WORD "BAYMONT"; THE
FIRST BANNER IN BLUE, THE SECOND BANNER
IN RED, THE THIRD BANNER IN YELLOW; THE
WORDS "BREAKFAST CORNER" APPEAR
AGAINST A SINGLE BANNER WRAPPED
AROUND THE MIDDLE OF THE OVAL; "BREAK-
FAST CORNER" APPEARS IN WHITE; THE SINGLE
BANNER APPEARS IN RED; A GLASS, A PLATE OF
FOOD AND A MUG ON A PLATE APPEAR
AGAINST THE BLUE OVAL BELOW THE RED
BANNER. THE GLASS, PLATE AND MUG APPEAR
IN WHITE.

SN 77-299,710, FILED 10-9-2007.

ANNE E. GUSTASON, EXAMINING ATTORNEY

Int. Cl.: 25

Prior U.S. Cls.: 22 and 39

United States Patent and Trademark Office

Reg. No. 3,481,971

Registered Aug. 5, 2008

**TRADEMARK
PRINCIPAL REGISTER**

NOTSOX

BABYLEGS, LLC (WASHINGTON LTD LIAB CO)
6333 1ST AVE. S.
SEATTLE, WA 98108

THE MARK CONSISTS OF STANDARD CHAR-
ACTERS WITHOUT CLAIM TO ANY PARTICULAR
FONT, STYLE, SIZE, OR COLOR.

FOR: CLOTHING, NAMELY, LEG AND ARM
WARMERS FOR CHILDREN AND ADULTS, IN
CLASS 25 (U.S. CLS. 22 AND 39).

SN 77-299,880, FILED 10-9-2007.

FIRST USE 9-0-2007; IN COMMERCE 9-0-2007.

BRIAN CALLAGHAN, EXAMINING ATTORNEY

Int. Cl.: 5

Prior U.S. Cls.: 6, 18, 44, 46, 51, and 52

United States Patent and Trademark Office

Reg. No. 3,481,972

Registered Aug. 5, 2008

TRADEMARK
PRINCIPAL REGISTER

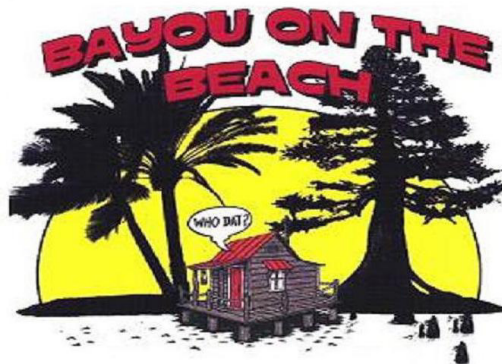

BUXTON, DONNA PATRICK (UNITED STATES INDIVIDUAL)
3613 OAK KNOLL CT
PANAMA CITY BEACH, FL 32408 AND
BUXTON, DAVID LLOYD (UNITED STATES INDIVIDUAL)
3613 OAK KNOLL CT
PANAMA CITY BEACH, FL 32408

FOR: BISCUITS, BREAD, BREAD ROLLS, CAKES, CEREAL PRODUCTS, CONFECTIONERY, CRACKERS, NOODLES, FISH SAUCE, RELISH, SAUCES, CEREAL-BASED SNACK-FOODS AND PREPARED DIETARY ITEMS THAT ARE GLUTEN-FREE TO ACCOMMODATE SPECIAL MEDICAL AND HEALTH CONDITIONS, IN CLASS 5 (U.S. CLS. 6, 18, 44, 46, 51 AND 52).

FIRST USE 6-1-2001; IN COMMERCE 2-1-2002.

THE COLOR(S) RED, BLACK, YELLOW, BROWN, AND WHITE IS/ARE CLAIMED AS A FEATURE OF THE MARK.

THE MARK CONSISTS OF A BLACK PALM TREE AND CYPRESS TREE, A YELLOW SETTING SUN IN BACKGROUND, A BROWN HOUSE WITH A RED ROOF, DOOR, AND AWNING, THE COLOR WHITE APPEARS IN THE WINDOW AND THE CAPTION WITH THE WORDING "WHO DAT" IN BLACK, WITH A WHITE BACKGROUND FOR THE WHOLE MARK AND THE WORDING "BAYOU ON THE BEACH" IN RED WITH BLACK OUTLINING.

SN 77-301,083, FILED 10-10-2007.

REBECCA SMITH, EXAMINING ATTORNEY

Int. Cl.: 6

Prior U.S. Cls.: 2, 12, 13, 14, 23, 25, and 50

Reg. No. 3,481,973

United States Patent and Trademark Office

Registered Aug. 5, 2008

**TRADEMARK
PRINCIPAL REGISTER**

NICOPP

AMERICAN GREASE STICK COMPANY (MICHIGAN LIMITED PARTNERSHIP), DBA AGS,
2651 HOYT STREET, P.O. BOX 729
MUSKEGON, MI 49443

THE MARK CONSISTS OF STANDARD CHARACTERS WITHOUT CLAIM TO ANY PARTICULAR FONT, STYLE, SIZE, OR COLOR.

FOR: METAL TUBING, IN CLASS 6 (U.S. CLS. 2, 12, 13, 14, 23, 25 AND 50).

SN 77-301,447, FILED 10-11-2007.

FIRST USE 12-15-2007; IN COMMERCE 1-30-2008.

EDWARD NELSON, EXAMINING ATTORNEY

Int. Cl.: 41

Prior U.S. Cls.: 100, 101, and 107

United States Patent and Trademark Office

Reg. No. 3,481,974

Registered Aug. 5, 2008

SERVICE MARK
PRINCIPAL REGISTER



THE CREATIVE WORKPLACE, LLC (KEN-
TUCKY LTD LIAB CO)
2005 B FRANKFORT AVE.
LOUISVILLE, KY 40206

FOR: ARRANGING PROFESSIONAL WORK-
SHOP AND TRAINING COURSES; EDUCATION
SERVICES, NAMELY, PROVIDING CLASSES AND
WORKSHOPS IN THE FIELDS OF PERSONAL AND
PROFESSIONAL ENRICHMENT, IN CLASS 41 (U.S.
CLS. 100, 101 AND 107).

FIRST USE 1-1-1994; IN COMMERCE 1-15-1998.

NO CLAIM IS MADE TO THE EXCLUSIVE
RIGHT TO USE "WORKSHOP", APART FROM
THE MARK AS SHOWN.

THE MARK CONSISTS OF AN OUTLINE OF A
LIGHTBULB WITH A W IN THE MIDDLE OF IT
AND 3 IDEA MARKS ON TOP, AND THE STYLIZED
TEXT "WORKSHOP THE CREATIVE WORK-
PLACE".

SN 77-303,953, FILED 10-15-2007.

KATINA MISTER, EXAMINING ATTORNEY

Int. Cls.: 16 and 25

Prior U.S. Cls.: 2, 5, 22, 23, 29, 37, 38, 39, and 50

United States Patent and Trademark Office

Reg. No. 3,481,975

Registered Aug. 5, 2008

**TRADEMARK
PRINCIPAL REGISTER**

DON'T BE A BASTARD

BACANI, SHARON L. (PHILIPPINES INDIVIDUAL)
1671 OBSERVATION WAY
ANTIOCH, CA 94531

FOR: STICKERS; POSTERS; PAPER HANG TAGS,
IN CLASS 16 (U.S. CLS. 2, 5, 22, 23, 29, 37, 38 AND 50).

FIRST USE 6-15-2008; IN COMMERCE 6-15-2008.

FOR: SHIRTS; HATS; PANTS; JACKETS; UNDERWEAR;
SWEATERS; BELTS; SWEAT BANDS; HEADBANDS
AGAINST SWEATING, IN CLASS 25 (U.S. CLS. 22 AND 39).

FIRST USE 6-15-2008; IN COMMERCE 6-15-2008.

THE MARK CONSISTS OF STANDARD CHARACTERS
WITHOUT CLAIM TO ANY PARTICULAR FONT, STYLE,
SIZE, OR COLOR.

SN 77-305,184, FILED 10-16-2007.

ALEXANDER L. POWERS, EXAMINING ATTORNEY

Int. Cl.: 5

Prior U.S. Cls.: 6, 18, 44, 46, 51, and 52

Reg. No. 3,481,976

United States Patent and Trademark Office

Registered Aug. 5, 2008

**TRADEMARK
PRINCIPAL REGISTER**

Lose the odor, keep your
lover. NodorO, get some.

SYNERFIED CAPITAL INC. (FLORIDA COR-
PORATION)
SUITE #1207
10 SW SOUTH RIVER DR.
MIAMI, FL 33130

THE MARK CONSISTS OF STANDARD CHAR-
ACTERS WITHOUT CLAIM TO ANY PARTICULAR
FONT, STYLE, SIZE, OR COLOR.

FOR: MEDICATED ANTIFUNGAL CREAM FOR
MEDICAL USE THAT REMOVES ODORS, IN CLASS
5 (U.S. CLS. 6, 18, 44, 46, 51 AND 52).

SN 77-306,815, FILED 10-17-2007.

FIRST USE 6-1-2007; IN COMMERCE 11-1-2007.

ANDREW RHIM, EXAMINING ATTORNEY

Int. Cl.: 32

Prior U.S. Cls.: 45, 46, and 48

United States Patent and Trademark Office

Reg. No. 3,481,977

Registered Aug. 5, 2008

**TRADEMARK
PRINCIPAL REGISTER**

AQUAPERK

FIREHOUSE NATURAL SPRING WATER II
(NEW JERSEY LTD LIAB CO)
18 MIDWOOD DRIVE
FLORHAM PARK, NJ 07932

THE MARK CONSISTS OF STANDARD CHAR-
ACTERS WITHOUT CLAIM TO ANY PARTICULAR
FONT, STYLE, SIZE, OR COLOR.

FOR: BOTTLED CAFFEINATED SPRING DRINK-
ING WATER, IN CLASS 32 (U.S. CLS. 45, 46 AND 48).

SN 77-307,829, FILED 10-18-2007.

FIRST USE 1-11-2008; IN COMMERCE 4-4-2008.

ROBIN CHOSID, EXAMINING ATTORNEY

Int. Cl.: 11

Prior U.S. Cls.: 13, 21, 23, 31, and 34

United States Patent and Trademark Office

Reg. No. 3,481,978

Registered Aug. 5, 2008

**TRADEMARK
PRINCIPAL REGISTER**

SUGAR N SPICE

HUNTER FAN COMPANY (DELAWARE COR-
PORATION)
2500 FRISCO AVENUE
MEMPHIS, TN 38114

THE MARK CONSISTS OF STANDARD CHAR-
ACTERS WITHOUT CLAIM TO ANY PARTICULAR
FONT, STYLE, SIZE, OR COLOR.

FOR: CEILING FANS, IN CLASS 11 (U.S. CLS. 13,
21, 23, 31 AND 34).

SN 77-308,187, FILED 10-19-2007.

FIRST USE 1-16-2008; IN COMMERCE 1-16-2008.

MICHAEL KEATING, EXAMINING ATTORNEY

Int. Cl.: 45

Prior U.S. Cls.: 100 and 101

United States Patent and Trademark Office

Reg. No. 3,481,979

Registered Aug. 5, 2008

**SERVICE MARK
PRINCIPAL REGISTER**

INSPIRE ME TODAY

INSPIRE ME TODAY, LLC (COLORADO LTD
LIAB CO)
3034 LINDEN DRIVE
BOULDER, CO 80304

THE MARK CONSISTS OF STANDARD CHAR-
ACTERS WITHOUT CLAIM TO ANY PARTICULAR
FONT, STYLE, SIZE, OR COLOR.

FOR: PROVIDING A WEBSITE FEATURING
SELF HELP AND PERSONAL IMPROVEMENT IN-
FORMATION, IN CLASS 45 (U.S. CLS. 100 AND 101).

SN 77-308,993, FILED 10-19-2007.

FIRST USE 4-15-2008; IN COMMERCE 4-15-2008.

MARY CRAWFORD, EXAMINING ATTORNEY

Int. Cl.: 25

Prior U.S. Cls.: 22 and 39

United States Patent and Trademark Office

Reg. No. 3,481,980

Registered Aug. 5, 2008

**TRADEMARK
PRINCIPAL REGISTER**



AMAZON TECHNOLOGIES, INC. (NEVADA CORPORATION)
ATTN: TRADEMARKS
PO BOX 8102
RENO, NV 89507

THE MARK CONSISTS OF THE WORD "CREATESPACE" WITH TWO CRESCENT SHAPES, ONE UPTURNED BELOW THE FIRST HALF OF THE WORD AND ONE DOWNTURNED ABOVE THE SECOND HALF OF THE WORD.

FOR: T-SHIRTS, IN CLASS 25 (U.S. CLS. 22 AND 39).

SN 77-314,459, FILED 10-26-2007.

FIRST USE 1-21-2008; IN COMMERCE 1-21-2008.

EVELYN BRADLEY, EXAMINING ATTORNEY

Int. Cl.: 35

Prior U.S. Cls.: 100, 101, and 102

United States Patent and Trademark Office

Reg. No. 3,481,981

Registered Aug. 5, 2008

**SERVICE MARK
PRINCIPAL REGISTER**

**YOUR PARTNER BEYOND THE
PLATE**

E & H DISTRIBUTING CO. (NEVADA CORPORATION)
1685 WEST CHEYENNE AVENUE
NORTH LAS VEGAS, NV 89030

FOR: WHOLESALE DISTRIBUTORSHIPS FEATURING FOOD, PAPER PRODUCTS, SUPPLIES AND EQUIPMENT RELATED TO THE FOOD SERVICE INDUSTRY, IN CLASS 35 (U.S. CLS. 100, 101 AND 102).

FIRST USE 2-0-2008; IN COMMERCE 2-0-2008.

THE MARK CONSISTS OF STANDARD CHARACTERS WITHOUT CLAIM TO ANY PARTICULAR FONT, STYLE, SIZE, OR COLOR.

SN 77-315,241, FILED 10-27-2007.

LOURDES AYALA, EXAMINING ATTORNEY

Int. Cl.: 10

Prior U.S. Cls.: 26, 39, and 44

United States Patent and Trademark Office

Reg. No. 3,481,982

Registered Aug. 5, 2008

**TRADEMARK
PRINCIPAL REGISTER**

NIPPLETTE

CALIFORNIA EXOTIC NOVELTIES LLC (CALI-
FORNIA LTD LIAB CO)
14235 RAMONA AVE.
CHINO, CA 91710

THE MARK CONSISTS OF STANDARD CHAR-
ACTERS WITHOUT CLAIM TO ANY PARTICULAR
FONT, STYLE, SIZE, OR COLOR.

FOR: ADULT SEXUAL AIDS, NAMELY, VIBRAT-
ING NIPPLE CLAMPS, IN CLASS 10 (U.S. CLS. 26, 39
AND 44).

SN 77-317,166, FILED 10-30-2007.

FIRST USE 6-1-2008; IN COMMERCE 6-1-2008.

JAMES MACFARLANE, EXAMINING ATTORNEY

Int. Cl.: 41

Prior U.S. Cls.: 100, 101, and 107

United States Patent and Trademark Office

Reg. No. 3,481,983

Registered Aug. 5, 2008

**SERVICE MARK
PRINCIPAL REGISTER**

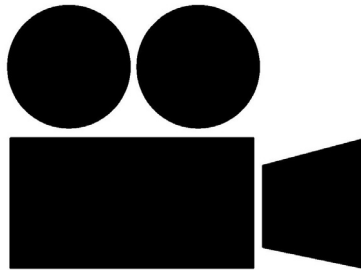

TWENTIETH CENTURY FOX FILM CORPORATION (DELAWARE CORPORATION)
10201 WEST PICO BOULEVARD
LOS ANGELES, CA 90035

FOR: ENTERTAINMENT SERVICES IN THE NATURE OF ON-GOING TELEVISION SEGMENTS FEATURING SPORTS; PROVIDING ON-LINE INFORMATION IN THE FIELD OF SPORTS, NEWS

AND ENTERTAINMENT, IN CLASS 41 (U.S. CLS. 100, 101 AND 107).

FIRST USE 8-27-2007; IN COMMERCE 8-27-2007.

SN 77-324,893, FILED 11-8-2007.

MICHAEL GAAFAR, EXAMINING ATTORNEY

Int. Cl.: 1

Prior U.S. Cls.: 1, 5, 6, 10, 26, and 46

United States Patent and Trademark Office

Reg. No. 3,481,984

Registered Aug. 5, 2008

**TRADEMARK
PRINCIPAL REGISTER**

AMS-EZ PLUS

MFA INCORPORATED (MISSOURI CORPORATION)
201 RAY YOUNG DRIVE
COLUMBIA, MO 652013599

FOR: AGRICULTURAL ADJUVANT TO ENHANCE HERBICIDE AND PESTICIDE PERFORMANCE, IN CLASS 1 (U.S. CLS. 1, 5, 6, 10, 26 AND 46).

FIRST USE 3-19-2008; IN COMMERCE 3-19-2008.

THE MARK CONSISTS OF STANDARD CHARACTERS WITHOUT CLAIM TO ANY PARTICULAR FONT, STYLE, SIZE, OR COLOR.

OWNER OF U.S. REG. NOS. 2,319,411 AND 2,470,250.

SN 77-330,148, FILED 11-15-2007.

KEVON CHISOLM, EXAMINING ATTORNEY

Int. Cl.: 5

Prior U.S. Cls.: 6, 18, 44, 46, 51, and 52

Reg. No. 3,481,985

United States Patent and Trademark Office

Registered Aug. 5, 2008

**TRADEMARK
PRINCIPAL REGISTER**

NUTRISEEDS

ROEX, INC. (CALIFORNIA CORPORATION)
16841 ARMSTRONG AVENUE
IRVINE, CA 92606

THE MARK CONSISTS OF STANDARD CHAR-
ACTERS WITHOUT CLAIM TO ANY PARTICULAR
FONT, STYLE, SIZE, OR COLOR.

FOR: DIETARY SUPPLEMENTS, IN CLASS 5 (U.S.
CLS. 6, 18, 44, 46, 51 AND 52).

SN 77-335,804, FILED 11-22-2007.

FIRST USE 2-12-2008; IN COMMERCE 2-12-2008.

MICHAEL TANNER, EXAMINING ATTORNEY

Int. Cl.: 10

Prior U.S. Cls.: 26, 39, and 44

United States Patent and Trademark Office

Reg. No. 3,481,986

Registered Aug. 5, 2008

**TRADEMARK
PRINCIPAL REGISTER**

ADVANTAGE Fit

BOSTON SCIENTIFIC SCIMED, INC. (MINNESOTA CORPORATION)

ONE SCIMED PLACE

MAPLE GROVE, MN 55311

FOR: TRANS-VAGINAL MID-URETHRAL SLING, IN CLASS 10 (U.S. CLS. 26, 39 AND 44).

FIRST USE 4-17-2008; IN COMMERCE 4-17-2008.

THE MARK CONSISTS OF STANDARD CHARACTERS WITHOUT CLAIM TO ANY PARTICULAR FONT, STYLE, SIZE, OR COLOR.

NO CLAIM IS MADE TO THE EXCLUSIVE RIGHT TO USE "FIT", APART FROM THE MARK AS SHOWN.

SN 77-347,941, FILED 12-10-2007.

CARYN GLASSER, EXAMINING ATTORNEY

Int. Cls.: 35 and 41

Prior U.S. Cls.: 100, 101, 102, and 107

United States Patent and Trademark Office

Reg. No. 3,481,987

Registered Aug. 5, 2008

**SERVICE MARK
PRINCIPAL REGISTER**

QUICKSAND

O'NEILL, ROSALINDA (UNITED STATES INDIVIDUAL)
SUITE 102
23622 CALABASAS ROAD
CALABASAS, CA 91302

FOR: MANAGEMENT AND BUSINESS CONSULTING SERVICES IN THE FIELD OF EMPLOYMENT COUNSELING IN LEADERSHIP, BUSINESS RELATIONSHIP AND MANAGEMENT TRAINING, CONFLICT RESOLUTION, STRATEGIC PLANNING, EMPLOYEE AND EXECUTIVE CONFLICT, WORK AND STRESS MANAGEMENT, IN CLASS 35 (U.S. CLS. 100, 101 AND 102).

FIRST USE 1-31-2007; IN COMMERCE 1-31-2007.

FOR: EDUCATION SERVICES, NAMELY, PROVIDING CLASSES AND WORKSHOPS IN THE

FIELD OF LEADERSHIP, RELATIONSHIP AND MANAGEMENT TRAINING, CONFLICT RESOLUTION, STRATEGIC PLANNING, EMPLOYEE AND EXECUTIVE CONFLICT, STRESS REDUCTION AND FAMILY TRAINING, IN CLASS 41 (U.S. CLS. 100, 101 AND 107).

FIRST USE 1-31-2007; IN COMMERCE 1-31-2007.

THE MARK CONSISTS OF STANDARD CHARACTERS WITHOUT CLAIM TO ANY PARTICULAR FONT, STYLE, SIZE, OR COLOR.

SN 77-975,341, FILED 10-25-2006.

NAPOLEON SHARMA, EXAMINING ATTORNEY

Int. Cl.: 42

Prior U.S. Cls.: 100 and 101

United States Patent and Trademark Office

Reg. No. 3,481,988

Registered Aug. 5, 2008

**SERVICE MARK
PRINCIPAL REGISTER**

TWINE

RADAR NETWORKS, INC. (DELAWARE CORPORATION)
410 TOWNSEND, SUITE 150
SAN FRANCISCO, CA 94107

FOR: COMPUTER SERVICES, NAMELY, PROVIDING ONLINE NON-DOWNLOADABLE COMPUTER SOFTWARE INTERFACES VIA GLOBAL COMPUTER NETWORKS FOR USE AS DATABASE APPLICATIONS BASED ON SEMANTIC STORAGE AND RETRIEVAL TECHNOLOGIES, FOR USE IN STORING, SEARCHING, NAVIGATING, COLLECTING, ORGANIZING, AUTHORING, EDITING, PUBLISHING, SHARING, MANAGING, AND TRANSMITTING DATA AND DOCUMENTS; COMPUTER SERVICES, NAMELY, PROVIDING ONLINE NON-DOWNLOADABLE SOFTWARE VIA GLOBAL COMPUTER NETWORKS TO ALLOW USERS TO PERFORM COLLABORATION AND MANAGE KNOWLEDGE TO PERMIT MULTIPLE USERS TO AUTHOR, EDIT AND SHARE DATA AND DOCUMENTS, TO NAVIGATE AND SEARCH DATA AND DOCUMENTS, TO COLLECT AND ORGANIZE

DATA AND DOCUMENTS, AND TO PERFORM ELECTRONIC TRANSACTIONS RELATED TO DATA AND DOCUMENTS; COMPUTER SERVICES, NAMELY, PROVIDING ONLINE NON-DOWNLOADABLE SOFTWARE VIA GLOBAL COMPUTER NETWORKS FOR ONLINE COLLABORATION, SOCIAL NETWORKING, SOCIAL MEDIA, MESSAGING, COLLABORATION, SEARCHING, COMMUNITY, PUBLISHING, ENTERTAINMENT, ADVERTISING AND E-COMMERCE, IN CLASS 42 (U.S. CLS. 100 AND 101).

FIRST USE 10-3-2007; IN COMMERCE 10-3-2007.

THE MARK CONSISTS OF STANDARD CHARACTERS WITHOUT CLAIM TO ANY PARTICULAR FONT, STYLE, SIZE, OR COLOR.

SN 77-975,464, FILED 7-17-2007.

REBECCA SMITH, EXAMINING ATTORNEY

Int. Cls.: 16 and 28

Prior U.S. Cls.: 2, 5, 22, 23, 29, 37, 38, and 50

United States Patent and Trademark Office

Reg. No. 3,481,989

Registered Aug. 5, 2008

**TRADEMARK
PRINCIPAL REGISTER**

ORIGINAL SOCCERVOLLEYBALL

BENSON, GEORGE L. (UNITED STATES INDIVIDUAL)
N11602 SCHUETT LANE
ELCHO, WI 54428

FOR: PRINTED LITERATURE, NAMELY, RULE BOOKS AND DIAGRAMS IN THE FIELD OF SPORTS INSTRUCTION, IN CLASS 16 (U.S. CLS. 2, 5, 22, 23, 29, 37, 38 AND 50).

FIRST USE 3-12-2008; IN COMMERCE 4-9-2008.

FOR: ATHLETIC GAME PLAYING EQUIPMENT, NAMELY, NETS FOR BALL GAMES AND BALLS FOR GAMES, IN CLASS 28 (U.S. CLS. 22, 23, 38 AND 50).

FIRST USE 3-12-2008; IN COMMERCE 4-18-2008.

THE MARK CONSISTS OF STANDARD CHARACTERS WITHOUT CLAIM TO ANY PARTICULAR FONT, STYLE, SIZE, OR COLOR.

NO CLAIM IS MADE TO THE EXCLUSIVE RIGHT TO USE "ORIGINAL", APART FROM THE MARK AS SHOWN.

SN 77-975,561, FILED 9-28-2006.

PAUL CROWLEY, EXAMINING ATTORNEY

Int. Cls.: 14 and 18

Prior U.S. Cls.: 1, 2, 3, 22, 27, 28, 41, and 50

United States Patent and Trademark Office

Reg. No. 3,481,990

Registered Aug. 5, 2008

**TRADEMARK
PRINCIPAL REGISTER**

SIGNORIA

GUCCI AMERICA, INC. (NEW YORK CORPORATION)
685 FIFTH AVENUE
NEW YORK, NY 10022

FOR: WATCHES, IN CLASS 14 (U.S. CLS. 2, 27, 28 AND 50).

FIRST USE 4-0-2007; IN COMMERCE 4-0-2007.

FOR: WALLETTS, PURSES, HANDBAGS, SHOULDER BAGS, CLUTCH BAGS, TOTE BAGS, DUFFEL BAGS, KEY CASES, COSMETIC CASES SOLD EMPTY, IN CLASS 18 (U.S. CLS. 1, 2, 3, 22 AND 41).

FIRST USE 9-0-2007; IN COMMERCE 9-0-2007.

THE MARK CONSISTS OF STANDARD CHARACTERS WITHOUT CLAIM TO ANY PARTICULAR FONT, STYLE, SIZE, OR COLOR.

THE FOREIGN WORDING IN THE MARK TRANSLATES INTO ENGLISH AS "LORDSHIP".

SN 77-975,650, FILED 5-8-2007.

MELVIN AXILBUND, EXAMINING ATTORNEY

Int. Cl.: 3

Prior U.S. Cls.: 1, 4, 6, 50, 51, and 52

Reg. No. 3,481,991

United States Patent and Trademark Office

Registered Aug. 5, 2008

**TRADEMARK
PRINCIPAL REGISTER**

CRYSTAL COVE

ABERCROMBIE & FITCH TRADING CO. (OHIO
CORPORATION)
6301 FITCH PATH
NEW ALBANY, OH 43054

THE MARK CONSISTS OF STANDARD CHAR-
ACTERS WITHOUT CLAIM TO ANY PARTICULAR
FONT, STYLE, SIZE, OR COLOR.

FOR: FRAGRANCES FOR PERSONAL USE;
BODY LOTION; BODY SPRAYS AND BODY WA-
SHES, IN CLASS 3 (U.S. CLS. 1, 4, 6, 50, 51 AND 52).

SN 77-975,657, FILED 3-29-2007.

FIRST USE 9-0-2007; IN COMMERCE 9-0-2007.

BERNICE MIDDLETON, EXAMINING ATTORNEY

Int. Cl.: 3

Prior U.S. Cls.: 1, 4, 6, 50, 51, and 52

Reg. No. 3,481,992

United States Patent and Trademark Office

Registered Aug. 5, 2008

**TRADEMARK
PRINCIPAL REGISTER**

BALBOA

ABERCROMBIE & FITCH TRADING CO. (OHIO
CORPORATION)
6301 FITCH PATH
NEW ALBANY, OH 43054

FIRST USE 9-0-2007; IN COMMERCE 9-0-2007.

FOR: FRAGRANCES FOR PERSONAL USE;
BODY SPRAY USED AS A PERSONAL DEODOR-
ANT AND AS FRAGRANCE; BODY SPRAYS; BODY
WASHES; DEODORANTS AND ANTIPERSPIR-
ANTS; AND DEODORANTS FOR BODY CARE, IN
CLASS 3 (U.S. CLS. 1, 4, 6, 50, 51 AND 52).

THE MARK CONSISTS OF STANDARD CHAR-
ACTERS WITHOUT CLAIM TO ANY PARTICULAR
FONT, STYLE, SIZE, OR COLOR.

SN 77-975,675, FILED 3-29-2007.

BERNICE MIDDLETON, EXAMINING ATTORNEY

Int. Cl.: 16

Prior U.S. Cls.: 2, 5, 22, 23, 29, 37, 38, and 50

United States Patent and Trademark Office

Reg. No. 3,481,993

Registered Aug. 5, 2008

**TRADEMARK
PRINCIPAL REGISTER**

ECONAUTS

VIRGIN COMICS, LLC (DELAWARE LTD LIAB
CO)
594 BROADWAY
SUITE 407
NEW YORK, NY 10012

FOR: PRINTED MATTER, NAMELY, COMIC
BOOKS AND GRAPHIC NOVELS; LUNCH BAGS,
IN CLASS 16 (U.S. CLS. 2, 5, 22, 23, 29, 37, 38 AND 50).

FIRST USE 3-1-2008; IN COMMERCE 3-1-2008.

THE MARK CONSISTS OF STANDARD CHAR-
ACTERS WITHOUT CLAIM TO ANY PARTICULAR
FONT, STYLE, SIZE, OR COLOR.

SN 77-975,679, FILED 3-8-2007.

KATHERINE M. DUBRAY, EXAMINING ATTOR-
NEY

Int. Cl.: 42

Prior U.S. Cls.: 100 and 101

United States Patent and Trademark Office

Reg. No. 3,481,994

Registered Aug. 5, 2008

**SERVICE MARK
PRINCIPAL REGISTER**

TABOOLA

TABOOLA.COM LTD. (ISRAEL PRIVATE LIMITED LIABILITY BY SHARES COMPANY)
8 HASHOMRON STREET
NEVE GANIM NEIGHBORHOOD
BET DAGAN, ISRAEL 50200

FOR: APPLICATION SERVICE PROVIDER, NAMELY, PROVIDING, HOSTING, MANAGING, DEVELOPING, AND MAINTAINING APPLICATIONS, SOFTWARE, WEBSITES, AND DATABASES IN THE FIELDS OF PERSONAL PRODUCTIVITY, WIRELESS COMMUNICATION, MOBILE INFORMATION ACCESS, AND REMOTE DATA MANAGEMENT, INCLUDING AUDIO, AUDIOVISUAL AND VIDEO CONTENT, FOR WIRELESS DELIVERY OF

CONTENT TO HANDHELD COMPUTERS, LAPTOPS AND MOBILE ELECTRONIC DEVICES, IN CLASS 42 (U.S. CLS. 100 AND 101).

FIRST USE 5-0-2008; IN COMMERCE 5-0-2008.

THE MARK CONSISTS OF STANDARD CHARACTERS WITHOUT CLAIM TO ANY PARTICULAR FONT, STYLE, SIZE, OR COLOR.

SN 77-975,684, FILED 3-2-2007.

REBECCA EISINGER, EXAMINING ATTORNEY

Int. Cls.: 35, 39, 40, and 42

Prior U.S. Cls.: 100, 101, 102, 103, 105, and 106

United States Patent and Trademark Office

Reg. No. 3,481,995

Registered Aug. 5, 2008

**SERVICE MARK
PRINCIPAL REGISTER**

**LEADING THE WAY IN
ELECTRICITY**

EDISON INTERNATIONAL (CALIFORNIA CORPORATION)
2244 WALNUT GROVE AVENUE
ROSEMEAD, CA 91770

FOR: PROVIDING CONSUMERS WITH INFORMATION REGARDING ENERGY PRICING AND COST MANAGEMENT; PROMOTING PUBLIC AWARENESS OF ENERGY CONSERVATION, RENEWABLE ENERGY SOURCES AND THE USE OF NON-CARBON FUELS, IN CLASS 35 (U.S. CLS. 100, 101 AND 102).

FIRST USE 3-0-2007; IN COMMERCE 3-0-2007.

FOR: UTILITY SERVICES, NAMELY, THE TRANSMISSION AND DISTRIBUTION OF ELECTRICITY AND WHOLESALE DISTRIBUTION OF ELECTRICITY TO OTHER UTILITIES AND ENERGY SERVICE PROVIDERS, IN CLASS 39 (U.S. CLS. 100 AND 105).

FIRST USE 3-0-2007; IN COMMERCE 3-0-2007.

FOR: GENERATING ELECTRICITY, IN CLASS 40 (U.S. CLS. 100, 103 AND 106).

FIRST USE 3-0-2007; IN COMMERCE 3-0-2007.

FOR: DEVELOPING HYDROGEN-POWERED ELECTRICITY PRODUCING POWER PLANTS; REAL-TIME MONITORING ELECTRIC POWER CONSUMPTION BY THIRD PARTIES FOR ELECTRIC POWER PROVIDERS, IN CLASS 42 (U.S. CLS. 100 AND 101).

FIRST USE 3-0-2007; IN COMMERCE 3-0-2007.

THE MARK CONSISTS OF STANDARD CHARACTERS WITHOUT CLAIM TO ANY PARTICULAR FONT, STYLE, SIZE, OR COLOR.

SN 77-975,686, FILED 3-15-2007.

KELLY BOULTON, EXAMINING ATTORNEY

Int. Cl.: 25

Prior U.S. Cls.: 22 and 39

United States Patent and Trademark Office

Reg. No. 3,481,996

Registered Aug. 5, 2008

**TRADEMARK
PRINCIPAL REGISTER**



ACADIA OUTDOORS HOLDINGS C.V. (NETHERLANDS CORPORATION)
PROFESOR J.H. BAVINCKLAAN 7
AMSTELVEEN, NETHERLANDS 1183-AT

FOR: OVERCOATS; ANORAKS; CAPES; FUR CLOAKS; SKI JACKETS; WIND RESISTANT JACKETS; WIND-JACKETS; JACKETS; LEATHER JACKETS; SLEEVED OR SLEEVELESS JACKETS; RAINPROOF JACKETS; BLAZERS; MEN'S SUITS; CLOTH BIBS; OVERALLS; TROUSERS; BREECHES; SHORTS; LADIES' SUITS; SKIRTS; DRESSES; BLOUSES; SHIRTS; SINGLETs; T-SHIRTS; TANK TOPS; PULLOVERS; SWEATERS; SWEAT SHIRTS; WAISTCOATS; VESTS; SKI SUITS; TRACK SUITS; SWIM WEAR; PANTYHOSE; SOCKS; STOCKINGS; TIGHTS; HOSIERY; FOOTWEAR; GLOVES; MIT-

TENS; COATS; BELTS MADE OF LEATHER; HEADGEAR, NAMELY, HATS AND CAPS; HOODS, IN CLASS 25 (U.S. CLS. 22 AND 39).

FIRST USE 12-22-2005; IN COMMERCE 1-23-2008.

THE MARK CONSISTS OF A RECTANGLE POSITIONED HORIZONTALLY OVER WHICH APPEARS A LIZARD, AND ABOVE THIS DESIGN THE WORD "TUKEKE" IN STYLIZED CAPITAL LETTERS.

SN 77-975,698, FILED 3-20-2007.

DAVID YONTEF, EXAMINING ATTORNEY

Int. Cl.: 42

Prior U.S. Cls.: 100 and 101

United States Patent and Trademark Office

Reg. No. 3,481,997

Registered Aug. 5, 2008

**SERVICE MARK
PRINCIPAL REGISTER**

TABOOLA.COM

TABOOLA.COM LTD. (ISRAEL PRIVATE LIMITED LIABILITY BY SHARES COMPANY)
8 HASHOMRON STREET
NEVE GANIM NEIGHBORHOOD
BET DAGAN, ISRAEL 50200

FOR: APPLICATION SERVICE PROVIDER, NAMELY, PROVIDING, HOSTING, MANAGING, DEVELOPING, AND MAINTAINING APPLICATIONS, SOFTWARE, WEBSITES, AND DATABASES IN THE FIELDS OF PERSONAL PRODUCTIVITY, WIRELESS COMMUNICATION, MOBILE INFORMATION ACCESS, AND REMOTE DATA MANAGEMENT, INCLUDING AUDIO, AUDIOVISUAL AND VIDEO CONTENT, FOR WIRELESS DELIVERY OF

CONTENT TO HANDHELD COMPUTERS, LAPTOPS AND MOBILE ELECTRONIC DEVICES, IN CLASS 42 (U.S. CLS. 100 AND 101).

FIRST USE 5-0-2008; IN COMMERCE 5-0-2008.

THE MARK CONSISTS OF STANDARD CHARACTERS WITHOUT CLAIM TO ANY PARTICULAR FONT, STYLE, SIZE, OR COLOR.

SN 77-975,721, FILED 3-2-2007.

REBECCA EISINGER, EXAMINING ATTORNEY

Int. Cl.: 36

Prior U.S. Cls.: 100, 101, and 102

United States Patent and Trademark Office

Reg. No. 3,481,998

Registered Aug. 5, 2008

SERVICE MARK
PRINCIPAL REGISTER



EAST RIVER REALTY COMPANY, LLC (NEW YORK LTD LIAB CO)

9 WEST 57TH STREET

NEW YORK, NY 10019

FOR: REAL ESTATE MANAGEMENT SERVICES IN MANHATTAN, NEW YORK; RENTAL OF APARTMENTS, RENTAL OF OFFICE SPACE, RENTAL OF BUILDINGS FOR PERMANENT OCCUPANCY, IN MANHATTAN, NEW YORK, IN CLASS 36 (U.S. CLS. 100, 101 AND 102).

FIRST USE 4-6-2008; IN COMMERCE 4-6-2008.

NO CLAIM IS MADE TO THE EXCLUSIVE RIGHT TO USE "TURTLE BAY", APART FROM THE MARK AS SHOWN.

THE COLOR(S) RED AND BLACK IS/ARE CLAIMED AS A FEATURE OF THE MARK.

THE MARK CONSISTS OF A DRAWING IN RED OF A TURTLE AND A LINE OVER THE WORDS "TURTLE BAY SOUTH".

SN 77-975,725, FILED 2-23-2007.

MARCIE MILONE, EXAMINING ATTORNEY

Int. Cl.: 28

Prior U.S. Cls.: 22, 23, 38, and 50

Reg. No. 3,481,999

United States Patent and Trademark Office

Registered Aug. 5, 2008

TRADEMARK
PRINCIPAL REGISTER

The image shows the word "impulse" written in a cursive, handwritten style. A small superscript "2" is positioned above the letter "e".

INRAY FITNESS PRODUCTS CORP. (TAIWAN CORPORATION)
16F-3, NO. 11, SECTION 2
HUANAN ROAD, PING-CHEN
TAOYUAN, TAIWAN 00000

FOR: GYMNASTIC HORIZONTAL BARS;
SPRING BARS FOR EXERCISING; MANUALLY-OPERATED EXERCISE EQUIPMENT; STATIONARY EXERCISE BICYCLES; AEROBIC STEP MACHINES; EXERCISE TRAMPOLINES; LEG WEIGHTS FOR EXERCISING; EXERCISING EQUIP-

MENT, NAMELY, ROWING MACHINES, WEIGHT LIFTING MACHINES, PULLEYS, MANUALLY OPERATED JOGGING MACHINES AND CHEST EXPANDERS, IN CLASS 28 (U.S. CLS. 22, 23, 38 AND 50).

FIRST USE 5-10-2005; IN COMMERCE 8-25-2006.

SN 78-078,772, FILED 8-11-2001.

REBECCA EISINGER, EXAMINING ATTORNEY

Int. Cl.: 9

Prior U.S. Cls.: 21, 23, 26, 36, and 38

United States Patent and Trademark Office

Reg. No. 3,482,000

Registered Aug. 5, 2008

**TRADEMARK
PRINCIPAL REGISTER**

BRAINY BOYS

THE BRAINY BABY COMPANY, LLC (GEORGIA
LTD LIAB CO)
1200 ALPHA DRIVE
SUITE B
ALPHARETTA, GA 30004

FOR: A SERIES OF PRERECORDED VIDEO
TAPES, AUDIO CASSETTES, COMPACT DISCS
AND DIGITAL VIDEO DISCS INTENDED TO IM-
PROVE AND DEVELOP THE CREATIVE AND IN-
TELLECTUAL FACULTIES OF INFANTS AND

CHILDREN, IN CLASS 9 (U.S. CLS. 21, 23, 26, 36
AND 38).

FIRST USE 1-15-2008; IN COMMERCE 1-15-2008.

OWNER OF U.S. REG. NO. 2,315,020.

SN 78-081,057, FILED 8-24-2001.

JAMES GRIFFIN, EXAMINING ATTORNEY

Int. Cl.: 25

Prior U.S. Cls.: 22 and 39

United States Patent and Trademark Office

Reg. No. 3,482,001

Registered Aug. 5, 2008

**TRADEMARK
PRINCIPAL REGISTER**

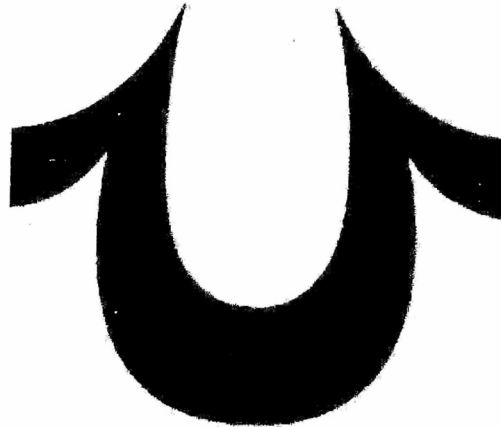

GURU DENIM INC. (CALIFORNIA CORPORATION)
2263 EAST VERNON AVENUE
VERNON, CA 90058

FOR: CLOTHING, NAMELY, MEN'S, WOMEN'S, AND CHILDREN'S PANTS, JEANS, SHORTS, OVERALLS, SHIRTS, T-SHIRTS, BLOUSES, VESTS, SKIRTS, JACKETS, COATS, SWEATERS, SWEATSHIRTS, SWEATPANTS, HATS, BELTS AND SHOES, IN CLASS 25 (U.S. CLS. 22 AND 39).

FIRST USE 9-1-2002; IN COMMERCE 9-1-2002.

OWNER OF U.S. REG. NO. 3,147,224.

THE MARK CONSISTS OF A STYLIZED REPRESENTATION OF THE LETTER "U".

SN 78-168,317, FILED 9-26-2002.

CYNTHIA SLOAN, EXAMINING ATTORNEY

Int. Cl.: 30

Prior U.S. Cl.: 46

United States Patent and Trademark Office

Reg. No. 3,482,002

Registered Aug. 5, 2008

TRADEMARK
PRINCIPAL REGISTER



BARMAR, LLC (NEW YORK LTD LIAB CO),
DBA LA PALAPA,
77 ST. MARK'S PLACE
NEW YORK, NY 22310

FOR: SALSAS, SAUCES, COFFEE BEANS, CORN-
BASED TORTILLA CHIPS, PRE-PACKAGED KITS
FOR MAKING MEXICAN-STYLE MEALS, CON-
SISTING PRIMARILY OF SAUCES, FLOUR, AND
CHILES, IN CLASS 30 (U.S. CL. 46).

FIRST USE 1-28-2008; IN COMMERCE 1-28-2008.

THE LINING IS A FEATURE OF THE MARK
AND DOES NOT INDICATE COLOR.

SN 78-176,433, FILED 10-21-2002.

REBECCA SMITH, EXAMINING ATTORNEY

Int. Cl.: 28

Prior U.S. Cls.: 22, 23, 38, and 50

United States Patent and Trademark Office

Reg. No. 3,482,003

Registered Aug. 5, 2008

**TRADEMARK
PRINCIPAL REGISTER**

PING U

KARSTEN MANUFACTURING CORPORATION
(ARIZONA CORPORATION)
2201 W. DESERT COVE, LEGAL DEPARTMENT
PHOENIX, AZ 85029

OWNER OF U.S. REG. NOS. 704,552, 1,647,448,
AND OTHERS.

FOR: GOLF CLUBS, IN CLASS 28 (U.S. CLS. 22, 23,
38 AND 50).

SN 78-206,741, FILED 1-24-2003.

FIRST USE 9-6-2006; IN COMMERCE 9-6-2006.

CHARLOTTE CORWIN, EXAMINING ATTORNEY

Int. Cls.: 9, 16, and 41

**Prior U.S. Cls.: 2, 5, 21, 22, 23, 26, 29, 36, 37, 38, 50,
100, 101, and 107**

Reg. No. 3,482,004

United States Patent and Trademark Office

Registered Aug. 5, 2008

**TRADEMARK
SERVICE MARK
PRINCIPAL REGISTER**

STANDARDS FOR SUCCESS

THE STATE OF OREGON ACTING BY AND
THROUGH THE STATE BOARD OF HIGHER
EDUCATION ON BEHALF OF THE UNIVER-
SITY OF OREGON (OREGON STATE AGEN-
CY)

1238 UNIVERSITY OF OREGON
EUGENE, OR 97403

FOR: PRERECORDED CD-ROMS FEATURING
INFORMATION ABOUT COLLEGE PREPARA-
TION, PLACEMENT, AND RETENTION, IN CLASS
9 (U.S. CLS. 21, 23, 26, 36 AND 38).

FIRST USE 0-0-2003; IN COMMERCE 0-0-2003.

FOR: PRINTED MATERIALS, NAMELY, BOOKS
AND BOOKLETS RELATING TO COLLEGE PRE-
PARATION, PLACEMENT, AND RETENTION, IN
CLASS 16 (U.S. CLS. 2, 5, 22, 23, 29, 37, 38 AND 50).

FIRST USE 0-0-2003; IN COMMERCE 0-0-2003.

FOR: CONDUCTING EDUCATIONAL RE-
SEARCH; DEVELOPING KNOWLEDGE AND
SKILLS STATEMENTS FOR AREAS OF CURRICU-
LUM; MAKING PUBLIC PRESENTATIONS ABOUT
COLLEGE PREPARATION, PLACEMENT AND RE-
TENTION; CONSULTING SERVICES IN THE
FIELDS OF EDUCATIONAL CURRICULUM, TEST-
ING, ANALYSIS, AND RESEARCH, INCLUDING
COLLEGE PREPARATION, APPLICATION TO COL-
LEGE, PLACEMENT, AND RETENTION; AND
CONSULTING SERVICES IN THE FIELD OF DE-
VELOPMENT OF TESTS AND OTHER INSTRU-
MENTS RELATING TO EDUCATIONAL
RESEARCH, IN CLASS 41 (U.S. CLS. 100, 101 AND
107).

FIRST USE 0-0-2003; IN COMMERCE 0-0-2003.

SN 78-208,840, FILED 1-30-2003.

KELLY BOULTON, EXAMINING ATTORNEY

Int. Cl.: 25

Prior U.S. Cls.: 22 and 39

United States Patent and Trademark Office

Reg. No. 3,482,005

Registered Aug. 5, 2008

**TRADEMARK
PRINCIPAL REGISTER**

IN GOLD I TRUST

HAYWARD, COLIN B. (UNITED STATES INDIVIDUAL)
1308 COLINA LANE
SANTA BARBARA, CA 93103

FOR: CAPS AND SPORTSWEAR, NAMELY, PANTS, SHIRTS, T-SHIRTS, SWEAT PANTS AND SWEATSHIRTS OFFERED FOR SALE AT COM-

MODIFY TRADE SHOWS, IN CLASS 25 (U.S. CLS. 22 AND 39).

FIRST USE 2-8-2008; IN COMMERCE 2-8-2008.

SN 78-261,454, FILED 6-12-2003.

MARLENE BELL, EXAMINING ATTORNEY

Int. Cl.: 31

Prior U.S. Cls.: 1 and 46

United States Patent and Trademark Office

Reg. No. 3,482,006

Registered Aug. 5, 2008

**TRADEMARK
PRINCIPAL REGISTER**

LYCOSWEET

HAZERA GENETICS LTD. (ISRAEL LTD LIAB JT
ST CO)
BRURIM
M.P. SHIKMIM 79837, ISRAEL

FIRST USE 11-30-2007; IN COMMERCE 11-30-2007.

SN 78-261,633, FILED 6-12-2003.

FOR: PLANT PROPAGATING MATERIAL, IN
CLASS 31 (U.S. CLS. 1 AND 46).

REBECCA SMITH, EXAMINING ATTORNEY

Int. Cl.: 30

Prior U.S. Cl.: 46

United States Patent and Trademark Office

Reg. No. 3,482,007

Registered Aug. 5, 2008

**TRADEMARK
PRINCIPAL REGISTER**

CONSCIOUS CUISINE

CULINARY INNOVATIONS LLC (ARIZONA LTD
LIAB CO)
PO BOX 183
LACKHAWAXEN, PA 18435

OWNER OF U.S. REG. NO. 2,777,602.

FOR: FRESH, FROZEN, PACKAGED AND PRE-
PARED ENTREES CONSISTING PRIMARILY OF
PASTA OR RICE; SALAD DRESSINGS, SAUCES, IN
CLASS 30 (U.S. CL. 46).

NO CLAIM IS MADE TO THE EXCLUSIVE
RIGHT TO USE "CUISINE", APART FROM THE
MARK AS SHOWN.

SN 78-273,692, FILED 7-14-2003.

FIRST USE 9-18-2007; IN COMMERCE 9-18-2007.

KAREN K. BUSH, EXAMINING ATTORNEY

Int. Cl.: 9

Prior U.S. Cls.: 21, 23, 26, 36, and 38

Reg. No. 3,482,008

United States Patent and Trademark Office

Registered Aug. 5, 2008

**TRADEMARK
PRINCIPAL REGISTER**

BABY SPROUT

AHA! STUDIOS, INC. (DELAWARE CORPORATION)
SUITE 2B
6929 MARINER DRIVE
RACINE, WI 53406

FIRST USE 3-15-2008; IN COMMERCE 3-15-2008.

SN 78-287,558, FILED 8-14-2003.

FOR: PRE-RECORDED DVD'S FEATURING MUSIC AND STORIES; PRE-RECORDED COMPACT DISCS FEATURING MUSIC AND STORIES, IN CLASS 9 (U.S. CLS. 21, 23, 26, 36 AND 38).

SAMUEL E. SHARPER JR., EXAMINING ATTORNEY

Int. Cls.: 9 and 41

Prior U.S. Cls.: 21, 23, 26, 36, 38, 100, 101, and 107

United States Patent and Trademark Office

Reg. No. 3,482,009

Registered Aug. 5, 2008

**TRADEMARK
SERVICE MARK
PRINCIPAL REGISTER**

PIRATES OF THE BURNING SEA

FLYING LAB SOFTWARE, LLC (WASHINGTON
LTD LIAB CO)
SUITE 300
1905 QUEEN ANNE AVE NORTH
SEATTLE, WA 98109

FOR: COMPUTER GAME SOFTWARE, IN CLASS
9 (U.S. CLS. 21, 23, 26, 36 AND 38).

FIRST USE 11-13-2007; IN COMMERCE 11-13-2007.

FOR: ENTERTAINMENT SERVICES, NAMELY,
PROVIDING A REAL TIME, ROLE PLAYING COM-
PUTER GAME FOR OTHERS VIA THE GLOBAL
COMPUTER NETWORK, IN CLASS 41 (U.S. CLS. 100,
101 AND 107).

FIRST USE 2-7-2003; IN COMMERCE 7-16-2007.

SN 78-297,045, FILED 9-7-2003.

ALEX KEAM, EXAMINING ATTORNEY

Int. Cl.: 25

Prior U.S. Cls.: 22 and 39

United States Patent and Trademark Office

Reg. No. 3,482,010

Registered Aug. 5, 2008

**TRADEMARK
PRINCIPAL REGISTER**

BIG BELIEVE IN GOD

B.I.G. CORPORATION (COLORADO CORPORATION)
630 FOREST STREET
DENVER, CO 80220

FOR: CLOTHING, NAMELY, SWEAT SHIRTS,
SHIRTS, HATS, COATS, JACKETS, IN CLASS 25
(U.S. CLS. 22 AND 39).

FIRST USE 9-30-2007; IN COMMERCE 9-30-2007.

OWNER OF U.S. REG. NO. 2,331,575.

SN 78-298,781, FILED 9-10-2003.

CHERYL CLAYTON, EXAMINING ATTORNEY

Int. Cl.: 35

Prior U.S. Cls.: 100, 101, and 102

United States Patent and Trademark Office

Reg. No. 3,482,011

Registered Aug. 5, 2008

**SERVICE MARK
PRINCIPAL REGISTER**



BELLA FIGURA, INC. (COLORADO CORPORATION)
3003 EAST 3RD AVENUE
DENVER, CO 80206

THE MARK CONSISTS OF OUTLINE OF A PREGNANT WOMAN.

FOR: RETAIL STORE SERVICES IN THE FIELD OF MATERNITY CLOTHING, IN CLASS 35 (U.S. CLS. 100, 101 AND 102).

SN 78-302,288, FILED 9-18-2003.

FIRST USE 12-1-2002; IN COMMERCE 12-1-2002.

SETH A. RAPPAPORT, EXAMINING ATTORNEY

Int. Cl.: 12

Prior U.S. Cls.: 19, 21, 23, 31, 35, and 44

United States Patent and Trademark Office

Reg. No. 3,482,012

Registered Aug. 5, 2008

**TRADEMARK
PRINCIPAL REGISTER**

TRU-SET

GUNITE CORPORATION (DELAWARE CORPORATION)
302 PEOPLES AVENUE
ROCKFORD, IL 61104

FOR: SYSTEM COMPRISED OF A BEARING SPACER, BEARING CUPS, BEARING CONES AND OIL/GREASE SEAL FOR WHEEL HUBS FOR

TRUCKS, TRUCK TRACTORS AND TRAILERS, IN CLASS 12 (U.S. CLS. 19, 21, 23, 31, 35 AND 44).

FIRST USE 12-0-2007; IN COMMERCE 12-0-2007.

SN 78-308,442, FILED 10-2-2003.

BILL DAWE, EXAMINING ATTORNEY

Int. Cl.: 3

Prior U.S. Cls.: 1, 4, 6, 50, 51, and 52

United States Patent and Trademark Office

Reg. No. 3,482,013

Registered Aug. 5, 2008

**TRADEMARK
PRINCIPAL REGISTER**

MISS JESSIE'S

AKIRO LLC (NEW YORK LTD LIAB CO)
120 HANCOCK STREET
BROOKLYN, NY 11216

FOR: COSMETIC AND HAIRCARE PRODUCTS,
NAMELY, HAIR CREAMS AND HAIR MILKS;
HAIRCARE PRODUCTS, NAMELY, SHAMPOOS,
CONDITIONERS, AND HAIR MOISTURIZING

CREAMS, IN CLASS 3 (U.S. CLS. 1, 4, 6, 50, 51 AND
52).

FIRST USE 12-0-2003; IN COMMERCE 12-0-2003.

SN 78-315,209, FILED 10-17-2003.

BILL DAWE, EXAMINING ATTORNEY

Int. Cls.: 35 and 41

Prior U.S. Cls.: 100, 101, 102, and 107

United States Patent and Trademark Office

Reg. No. 3,482,014

Registered Aug. 5, 2008

**SERVICE MARK
PRINCIPAL REGISTER**

**THE WATER QUALITY
PEOPLE**

WATER ENVIRONMENT FEDERATION (ILLINOIS CORPORATION)
601 WYTHE STREET
ALEXANDRIA, VA 22314

FOR: PROMOTING THE INTERESTS OF INDIVIDUALS AND ORGANIZATIONS WHO SHARE AN INTEREST IN WATER QUALITY AND WATER CONSERVATION AND PROMOTING PUBLIC AWARENESS OF THE NEED FOR PRESERVATION AND ENHANCEMENT OF THE GLOBAL WATER ENVIRONMENT, IN CLASS 35 (U.S. CLS. 100, 101 AND 102).

FIRST USE 11-30-2003; IN COMMERCE 12-31-2004.

FOR: EDUCATIONAL SERVICES, NAMELY, ORGANIZING AND CONDUCTING SEMINARS AND CONFERENCES AND DISTRIBUTING RELATED

EDUCATIONAL MATERIAL IN THE FIELD OF WATER QUALITY AND WATER CONSERVATION, IN CLASS 41 (U.S. CLS. 100, 101 AND 107).

FIRST USE 11-30-2003; IN COMMERCE 1-31-2004.

THE MARK CONSISTS OF STANDARD CHARACTERS WITHOUT CLAIM TO ANY PARTICULAR FONT, STYLE, SIZE, OR COLOR.

NO CLAIM IS MADE TO THE EXCLUSIVE RIGHT TO USE "WATER QUALITY", APART FROM THE MARK AS SHOWN.

SN 78-323,401, FILED 11-5-2003.

MONIQUE MILLER, EXAMINING ATTORNEY

Int. Cls.: 9 and 41

Prior U.S. Cls.: 21, 23, 26, 36, 38, 100, 101, and 107

United States Patent and Trademark Office

Reg. No. 3,482,015

Registered Aug. 5, 2008

**TRADEMARK
SERVICE MARK
PRINCIPAL REGISTER**

DARK SECTOR

1058822 ONTARIO LTD. (CANADA CORPORATION)
SUITE 1800
140 FULLARTON STREET
LONDON, ONTARIO, CANADA N6A 5P2

FOR: COMPUTER GAME SOFTWARE, ELECTRONIC GAME PROGRAMS, VIDEO GAME CARTRIDGES, AND VIDEO GAME SOFTWARE; AUDIO-VISUAL RECORDINGS IN THE FIELD OF VIDEO GAMES OR ACTION ADVENTURE, IN CLASS 9 (U.S. CLS. 21, 23, 26, 36 AND 38).

FIRST USE 3-25-2008; IN COMMERCE 3-25-2008.

FOR: ENTERTAINMENT SERVICES, NAMELY, THE PROVISION OF INTERACTIVE AND NON-INTERACTIVE INFORMATION ON THE GLOBAL COMPUTER NETWORK IN THE FIELD OF VIDEO

GAMES AND ELECTRONIC GAME PROGRAMS, IN CLASS 41 (U.S. CLS. 100, 101 AND 107).

FIRST USE 3-25-2008; IN COMMERCE 3-25-2008.

THE MARK CONSISTS OF STANDARD CHARACTERS WITHOUT CLAIM TO ANY PARTICULAR FONT, STYLE, SIZE, OR COLOR.

PRIORITY CLAIMED UNDER SEC. 44(D) ON CANADA APPLICATION NO. 1,193,798, FILED 10-23-2003, REG. NO. TMA670,656, DATED 8-22-2006, EXPIRES 8-22-2021.

SN 78-331,507, FILED 11-21-2003.

LOURDES AYALA, EXAMINING ATTORNEY

Int. Cl.: 3

Prior U.S. Cls.: 1, 4, 6, 50, 51, and 52

Reg. No. 3,482,016

United States Patent and Trademark Office

Registered Aug. 5, 2008

**TRADEMARK
PRINCIPAL REGISTER**



KOGENDO CO., LTD. (JAPAN CORPORATION)
1-8, AZABU-JYUBAN 4-CHOME, MINATO-KU
TOKYO, JAPAN

FOR: SKIN CLEANING CREAMS, SKIN LO-
TIONS, EMOLLIENT CREAMS FOR SKIN CARE;
FOUNDATION MAKEUP, NAMELY, CREAMY
FOUNDATIONS, LOOSE FACE POWDERS FOR

MAKE-UP PREPARATIONS, IN CLASS 3 (U.S. CLS.
1, 4, 6, 50, 51 AND 52).

FIRST USE 2-23-1987; IN COMMERCE 6-23-2007.

SN 78-334,685, FILED 12-1-2003.

BRENDAN MCCAULEY, EXAMINING ATTORNEY

Int. Cl.: 42

Prior U.S. Cls.: 100 and 101

United States Patent and Trademark Office

Reg. No. 3,482,017

Registered Aug. 5, 2008

**SERVICE MARK
PRINCIPAL REGISTER**

print24

LERCHL, WOLFGANG (FED REP GERMANY
INDIVIDUAL)
DARWINSTR. 6
01109 DRESDEN, FED REP GERMANY

THE MARK CONSISTS OF STANDARD CHAR-
ACTERS WITHOUT CLAIM TO ANY PARTICULAR
FONT, STYLE, SIZE, OR COLOR.

FOR: PROVIDING TEMPORARY USE OF NON-
DOWNLOADABLE SOFTWARE TO OBTAIN QUO-
TATIONS FOR PRINTING SERVICES VIA THE
INTERNET, IN CLASS 42 (U.S. CLS. 100 AND 101).

SN 78-340,905, FILED 12-15-2003.

FIRST USE 6-19-2008; IN COMMERCE 6-19-2008.

JIM RINGLE, EXAMINING ATTORNEY

Int. Cl.: 35

Prior U.S. Cls.: 100, 101, and 102

United States Patent and Trademark Office

Reg. No. 3,482,018

Registered Aug. 5, 2008

**SERVICE MARK
PRINCIPAL REGISTER**

MICHELE

FOSSIL, INC. (DELAWARE CORPORATION)
2280 N. GREENVILLE AVENUE
RICHARDSON, TX 75082

FOR: ONLINE RETAIL STORE SERVICES FEATURING SUNGLASSES AND WATCHES, IN CLASS 35 (U.S. CLS. 100, 101 AND 102).

FIRST USE 9-0-2006; IN COMMERCE 9-0-2006.

THE MARK CONSISTS OF STANDARD CHARACTERS WITHOUT CLAIM TO ANY PARTICULAR FONT, STYLE, SIZE, OR COLOR.

OWNER OF U.S. REG. NOS. 1,812,074, 2,129,528, AND 2,715,932.

SN 78-343,554, FILED 12-19-2003.

KAELIE KUNG, EXAMINING ATTORNEY

Int. Cl.: 10

Prior U.S. Cls.: 26, 39, and 44

United States Patent and Trademark Office

Reg. No. 3,482,019

Registered Aug. 5, 2008

**TRADEMARK
PRINCIPAL REGISTER**

SurgiSil

AMERICAN INSTITUTE FOR PLASTIC SUR-
GERY (TEXAS LIMITED LIABILITY PART-
NERSHIP)
SUITE 150
3801 W. 15TH STREET
PLANO, TX 75075

FOR: SURGICAL IMPLANTS MADE OF SILI-
CONE, IN CLASS 10 (U.S. CLS. 26, 39 AND 44).

FIRST USE 10-0-2007; IN COMMERCE 10-0-2007.

THE MARK CONSISTS OF STANDARD CHAR-
ACTERS WITHOUT CLAIM TO ANY PARTICULAR
FONT, STYLE, SIZE, OR COLOR.

SN 78-354,755, FILED 1-21-2004.

STEVEN R. FOSTER, EXAMINING ATTORNEY

Int. Cl.: 43

Prior U.S. Cls.: 100 and 101

United States Patent and Trademark Office

Reg. No. 3,482,020

Registered Aug. 5, 2008

**SERVICE MARK
PRINCIPAL REGISTER**

THE SPIRIT OF CUBA

RON MATUSALEM & MATUSA OF FLORIDA,
INC. (FLORIDA CORPORATION)
1205 S.W. 37TH AVENUE
MIAMI, FL 33135

FOR: RESTAURANT AND BAR SERVICES EX-
CLUDING RESTAURANT AND BAR SERVICES
PROVIDED ON A CRUISE SHIP; SERVING FOOD
AND DRINK EXCLUDING SERVICES FOR PRO-
VIDING FOOD AND DRINK ON A CRUISE SHIP, IN
CLASS 43 (U.S. CLS. 100 AND 101).

FIRST USE 2-18-2005; IN COMMERCE 2-18-2005.

THE MARK CONSISTS OF STANDARD CHAR-
ACTERS WITHOUT CLAIM TO ANY PARTICULAR
FONT, STYLE, SIZE, OR COLOR.

NO CLAIM IS MADE TO THE EXCLUSIVE
RIGHT TO USE "CUBA", APART FROM THE MARK
AS SHOWN.

SN 78-356,036, FILED 1-22-2004.

JENNIFER VASQUEZ, EXAMINING ATTORNEY

Int. Cl.: 36

Prior U.S. Cls.: 100, 101, and 102

United States Patent and Trademark Office

Reg. No. 3,482,021

Registered Aug. 5, 2008

**SERVICE MARK
PRINCIPAL REGISTER**

UNIFIEDMARKET

UNIFIEDMARKET, INC. (DELAWARE CORPORATION)
132 N. EL CAMINO REAL, #288
ENCINITAS, CA 92024

FOR: PROVIDING FINANCIAL INFORMATION BY ELECTRONIC MEANS RELATING TO ON-LINE MARKETS FOR LISTING FINANCIAL ASSETS USING THIRD PARTY CLEARING FACILITIES, IN CLASS 36 (U.S. CLS. 100, 101 AND 102).

FIRST USE 5-28-2008; IN COMMERCE 5-28-2008.

THE MARK CONSISTS OF STANDARD CHARACTERS WITHOUT CLAIM TO ANY PARTICULAR FONT, STYLE, SIZE, OR COLOR.

SN 78-360,967, FILED 2-2-2004.

JENNIFER VASQUEZ, EXAMINING ATTORNEY

Int. Cl.: 34

Prior U.S. Cls.: 2, 8, 9, and 17

United States Patent and Trademark Office

Reg. No. 3,482,022

Registered Aug. 5, 2008

**TRADEMARK
PRINCIPAL REGISTER**



EWESTERN INC. (WASHINGTON CORPORATION)
155 S. MAIN STREET
COLVILLE, WA 99114

THE LETTERING APPEARS IN RED AND THE TWO ARCHES APPEAR IN GREEN.

FOR: SMOKING PIPES, IN CLASS 34 (U.S. CLS. 2, 8, 9 AND 17).

SN 78-367,466, FILED 2-13-2004.

FIRST USE 1-1-2005; IN COMMERCE 1-1-2005.

THE COLOR(S) RED AND GREEN ARE CLAIMED AS A FEATURE OF THE MARK.

MARGARET POWER, EXAMINING ATTORNEY

Int. Cl.: 38

Prior U.S. Cls.: 100, 101, and 104

United States Patent and Trademark Office

Reg. No. 3,482,023

Registered Aug. 5, 2008

**SERVICE MARK
PRINCIPAL REGISTER**

LIFESIZE

LIFESIZE COMMUNICATIONS, INC. (DELA-
WARE CORPORATION)
901 S. MOPAC
BUILDING 3, SUITE 300
AUSTIN, TX 78746

FOR: AUDIO AND VIDEO CONFERENCING
SERVICES, NAMELY, PROVIDING INFORMATION
ABOUT AUDIO AND VIDEO CONFERENCING, IN
CLASS 38 (U.S. CLS. 100, 101 AND 104).

FIRST USE 10-23-2007; IN COMMERCE 10-23-2007.

THE MARK CONSISTS OF STANDARD CHAR-
ACTERS WITHOUT CLAIM TO ANY PARTICULAR
FONT, STYLE, SIZE, OR COLOR.

SN 78-371,705, FILED 2-20-2004.

LEIGH CAROLINE CASE, EXAMINING ATTOR-
NEY

Int. Cl.: 36

Prior U.S. Cls.: 100, 101, and 102

United States Patent and Trademark Office

Reg. No. 3,482,024

Registered Aug. 5, 2008

**SERVICE MARK
PRINCIPAL REGISTER**

OWN YOUR FUTURE

ESCO GLOBAL REALTY CORP. (COLORADO
CORPORATION)
594 DAGALL ROAD
MILL BAY, BC, CANADA V0R 2P0

FOR: REAL ESTATE AGENCIES; LEASING OF
REAL ESTATE FOR OTHERS; PERFORMING REAL
ESTATE APPRAISALS AND EVALUATIONS; PRO-
VIDING REAL ESTATE LISTINGS, IN CLASS 36
(U.S. CLS. 100, 101 AND 102).

FIRST USE 4-1-2006; IN COMMERCE 4-1-2006.

THE MARK CONSISTS OF STANDARD CHAR-
ACTERS WITHOUT CLAIM TO ANY PARTICULAR
FONT, STYLE, SIZE, OR COLOR.

SN 78-372,011, FILED 2-22-2004.

CURTIS FRENCH, EXAMINING ATTORNEY

Int. Cl.: 5

Prior U.S. Cls.: 6, 18, 44, 46, 51, and 52

Reg. No. 3,482,025

United States Patent and Trademark Office

Registered Aug. 5, 2008

**TRADEMARK
PRINCIPAL REGISTER**

BIG-BERRY

LUPIN PHARMACEUTICALS, INC. (VIRGINIA
CORPORATION)
21ST FLOOR, HARBORPLACE TOWER
111 SOUTH CALVERT STREET
BALTIMORE, MD 21202

THE MARK CONSISTS OF STANDARD CHAR-
ACTERS WITHOUT CLAIM TO ANY PARTICULAR
FONT, STYLE, SIZE, OR COLOR.

FOR: PHARMACEUTICAL PREPARATIONS FOR
THE TREATMENT OF BACTERIAL INFECTIONS,
IN CLASS 5 (U.S. CLS. 6, 18, 44, 46, 51 AND 52).

SN 78-374,877, FILED 2-26-2004.

FIRST USE 3-0-2004; IN COMMERCE 3-0-2004.

MONIQUE MILLER, EXAMINING ATTORNEY

Int. Cl.: 3

Prior U.S. Cls.: 1, 4, 6, 50, 51, and 52

United States Patent and Trademark Office

Reg. No. 3,482,026

Registered Aug. 5, 2008

**TRADEMARK
PRINCIPAL REGISTER**

PRE-OP

PHILOSOPHY, INC. (ARIZONA CORPORATION)
3809 EAST WATKINS STREET
PHOENIX, AZ 85034

FOR: MAKE-UP KITS AND GIFT SETS COM-
PRISED OF LIP BALM, NON-MEDICATED SKIN
CARE PRODUCTS, NAMELY, SCRUBS, EXFOLIA-
TORS, IN CLASS 3 (U.S. CLS. 1, 4, 6, 50, 51 AND 52).

FIRST USE 4-28-2008; IN COMMERCE 4-28-2008.

THE MARK CONSISTS OF STANDARD CHAR-
ACTERS WITHOUT CLAIM TO ANY PARTICULAR
FONT, STYLE, SIZE, OR COLOR.

SN 78-377,834, FILED 3-3-2004.

JACQUELINE A. LAVINE, EXAMINING ATTOR-
NEY

Int. Cl.: 28

Prior U.S. Cls.: 22, 23, 38, and 50

Reg. No. 3,482,027

United States Patent and Trademark Office

Registered Aug. 5, 2008

**TRADEMARK
PRINCIPAL REGISTER**

HII.Q.

ST. PIERRE, TRACY M. (UNITED STATES IN-
DIVIDUAL)
138 PLEASANT STREET
WAKEFIELD, MA 01880

THE MARK CONSISTS OF STANDARD CHAR-
ACTERS WITHOUT CLAIM TO ANY PARTICULAR
FONT, STYLE, SIZE, OR COLOR.

FOR: PET TOYS, IN CLASS 28 (U.S. CLS. 22, 23, 38
AND 50).

SN 78-384,606, FILED 3-15-2004.

FIRST USE 10-1-2006; IN COMMERCE 3-9-2007.

YONG KIM, EXAMINING ATTORNEY

Int. Cl.: 7

Prior U.S. Cls.: 13, 19, 21, 23, 31, 34, and 35

United States Patent and Trademark Office

Reg. No. 3,482,028

Registered Aug. 5, 2008

**TRADEMARK
PRINCIPAL REGISTER**

COOL DUALS

MBRP INC. (CANADA CORPORATION)
315 OLD FERGUSON ROAD, HUNSTVILLE
ONTARIO, CANADA PIH 2J2

FOR: VEHICULAR PRODUCTS, NAMELY, EX-
HAUST PIPES FOR DIESEL TRUCKS, IN CLASS 7
(U.S. CLS. 13, 19, 21, 23, 31, 34 AND 35).

FIRST USE 1-31-2007; IN COMMERCE 1-31-2007.

THE MARK CONSISTS OF STANDARD CHAR-
ACTERS WITHOUT CLAIM TO ANY PARTICULAR
FONT, STYLE, SIZE, OR COLOR.

PRIORITY CLAIMED UNDER SEC. 44(D) ON
CANADA APPLICATION NO. 1,210,154, FILED 3-18-
2004, REG. NO. TMA685680, DATED 4-5-2007, EX-
PIRES 4-5-2022.

SN 78-386,791, FILED 3-18-2004.

GIANCARLO CASTRO, EXAMINING ATTORNEY

Int. Cl.: 9

Prior U.S. Cls.: 21, 23, 26, 36, and 38

Reg. No. 3,482,029

United States Patent and Trademark Office

Registered Aug. 5, 2008

**TRADEMARK
PRINCIPAL REGISTER**

DIGISMART

GOODMAN COMPANY, L.P. (DELAWARE LIMITED PARTNERSHIP)
5151 SAN FELIPE, SUITE 500
HOUSTON, TX 77056

THE MARK CONSISTS OF STANDARD CHARACTERS WITHOUT CLAIM TO ANY PARTICULAR FONT, STYLE, SIZE, OR COLOR.

FOR: CONTROLS FOR AIR CONDITIONING AND HEATING EQUIPMENT, IN CLASS 9 (U.S. CLS. 21, 23, 26, 36 AND 38).

SN 78-391,296, FILED 3-26-2004.

FIRST USE 6-1-2008; IN COMMERCE 6-1-2008.

SALLY SHIH, EXAMINING ATTORNEY

Int. Cl.: 42

Prior U.S. Cls.: 100 and 101

United States Patent and Trademark Office

Reg. No. 3,482,030

Registered Aug. 5, 2008

**SERVICE MARK
PRINCIPAL REGISTER**

SOMBRERO MAN

SOMBRERO MAN ENTERPRISES, INC. (GEORGIA CORPORATION)
SUITE C-27
707 WHITLOCK AVENUE, SW
MARIETTA, GA 30064

THE MARK CONSISTS OF STANDARD CHARACTERS WITHOUT CLAIM TO ANY PARTICULAR FONT, STYLE, SIZE, OR COLOR.

FOR: GRAPHIC ART DESIGN, IN CLASS 42 (U.S. CLS. 100 AND 101).

SN 78-393,940, FILED 3-31-2004.

FIRST USE 1-31-2004; IN COMMERCE 1-31-2004.

ASMAT KHAN, EXAMINING ATTORNEY

Int. Cl.: 3

Prior U.S. Cls.: 1, 4, 6, 50, 51, and 52

Reg. No. 3,482,031

United States Patent and Trademark Office

Registered Aug. 5, 2008

**TRADEMARK
PRINCIPAL REGISTER**

BRONZE ILLUSIONS

PERFORMANCE BRANDS, INC. (FLORIDA
CORPORATION)
963 SHOTGUN ROAD
SUNRISE, FL 33326

FOR: INDOOR AND OUTDOOR SUN TANNING
PREPARATIONS, SUNLESS TANNING LOTIONS
AND GELS, IN CLASS 3 (U.S. CLS. 1, 4, 6, 50, 51
AND 52).

FIRST USE 4-1-2008; IN COMMERCE 4-1-2008.

THE MARK CONSISTS OF STANDARD CHAR-
ACTERS WITHOUT CLAIM TO ANY PARTICULAR
FONT, STYLE, SIZE, OR COLOR.

NO CLAIM IS MADE TO THE EXCLUSIVE
RIGHT TO USE "BRONZE", APART FROM THE
MARK AS SHOWN.

SN 78-400,156, FILED 4-12-2004.

REBECCA SMITH, EXAMINING ATTORNEY

Int. Cl.: 10

Prior U.S. Cls.: 26, 39, and 44

United States Patent and Trademark Office

Reg. No. 3,482,032

Registered Aug. 5, 2008

**TRADEMARK
PRINCIPAL REGISTER**

DESTINY

ICON INTERVENTIONAL SYSTEMS, INC. (DE-
LAWARE CORPORATION)

L1350

311 FERST DRIVE

ATLANTA, GA 30332

FOR: GRAFTS AND COATED GRAFTS, NAME-
LY, VASCULAR GRAFTS NOT OF LIVING TISSUE;
STENTS; AND ANGIOPLASTY PRODUCTS, NAME-
LY, BALLOON CATHETERS, GUIDING CATHE-
TERS, GUIDE WIRES, INTRODUCER SHEATHS,
GRAFT OR STENT INFLATION DEVICES, ARTER-

IAL ACCESS CLOSURE DEVICES, IN CLASS 10 (U.S.
CLS. 26, 39 AND 44).

FIRST USE 5-13-2008; IN COMMERCE 5-13-2008.

THE MARK CONSISTS OF STANDARD CHAR-
ACTERS WITHOUT CLAIM TO ANY PARTICULAR
FONT, STYLE, SIZE, OR COLOR.

SN 78-401,425, FILED 4-14-2004.

CHRISTINE BLOMQUIST, EXAMINING ATTOR-
NEY

Int. Cl.: 5

Prior U.S. Cls.: 6, 18, 44, 46, 51, and 52

United States Patent and Trademark Office

Reg. No. 3,482,033

Registered Aug. 5, 2008

**TRADEMARK
PRINCIPAL REGISTER**

BOLSTER

BAYER AKTIENGESELLSCHAFT (FED REP
GERMANY JOINT STOCK COMPANY)
D-51368
LEVERKUSEN-BAYERWERK, FED REP GERMA-
NY

FOR: INSECTICIDES FOR DOMESTIC AND
AGRICULTURAL USE, IN CLASS 5 (U.S. CLS. 6, 18,
44, 46, 51 AND 52).

FIRST USE 3-1-2005; IN COMMERCE 3-1-2005.

THE MARK CONSISTS OF STANDARD CHAR-
ACTERS WITHOUT CLAIM TO ANY PARTICULAR
FONT, STYLE, SIZE, OR COLOR.

SN 78-406,263, FILED 4-22-2004.

MARLENE BELL, EXAMINING ATTORNEY

Int. Cl.: 27

Prior U.S. Cls.: 19, 20, 37, 42, and 50

Reg. No. 3,482,034

United States Patent and Trademark Office

Registered Aug. 5, 2008

**TRADEMARK
PRINCIPAL REGISTER**



LORD AND MASON ENTERPRISES, INC.
(MARYLAND CORPORATION)
SUITE 202
29 PICKERING
GERMANTOWN, MD 20874

FIRST USE 10-0-2007; IN COMMERCE 10-0-2007.

SN 78-407,934, FILED 4-26-2004.

FOR: FLOOR MATS FOR VEHICLES, IN CLASS 27
(U.S. CLS. 19, 20, 37, 42 AND 50).

LINDA ESTRADA, EXAMINING ATTORNEY

Int. Cl.: 25

Prior U.S. Cls.: 22 and 39

United States Patent and Trademark Office

Reg. No. 3,482,035

Registered Aug. 5, 2008

TRADEMARK
PRINCIPAL REGISTER



NBA PROPERTIES, INC. (NEW YORK CORPORATION)
LEGAL DEPT./INTELLECTUAL PROPERTY GROUP
645 FIFTH AVENUE
NEW YORK, NY 10022

FOR: CLOTHING, NAMELY, HOSIERY, FOOTWEAR, BASKETBALL SHOES, BASKETBALL SNEAKERS, T-SHIRTS, SHIRTS, SWEATSHIRTS, SWEATPANTS, PANTS, TANK TOPS, JERSEYS, SHORTS, PAJAMAS, SPORT SHIRTS, RUGBY SHIRTS, SWEATERS, BELTS, TIES, NIGHTSHIRTS, HATS, CAPS, VISORS, WARM-UP SUITS, WARM-UP PANTS, WARM-UP TOPS/SHOOTING SHIRTS, JACKETS, WIND RESISTANT JACKETS, PARKAS, COATS, BABY BIBS NOT OF PAPER, HEAD BANDS, WRIST BANDS, APRONS, UNDERGARMENTS, BOXER SHORTS, SLACKS, CAPS, EAR MUFFS,

GLOVES, MITTENS, SCARVES, WOVEN AND KNIT SHIRTS, JERSEY DRESSES, DRESSES, CHEERLEADING DRESSES AND UNIFORMS, SWIM WEAR, BATHING SUITS, BEACH COVER-UPS, BATHING SUIT COVER-UPS, BATH SUIT WRAPS, AND BEACH SANDALS, NOVELTY HEADWEAR WITH WIGS, IN CLASS 25 (U.S. CLS. 22 AND 39).

FIRST USE 6-30-2005; IN COMMERCE 6-30-2005.

NO CLAIM IS MADE TO THE EXCLUSIVE RIGHT TO USE "BASKETBALL CLASSIC NEW YORK CITY", APART FROM THE MARK AS SHOWN.

SN 78-411,063, FILED 4-30-2004.

DAN VAVONESE, EXAMINING ATTORNEY

Int. Cls.: 16 and 25

Prior U.S. Cls.: 2, 5, 22, 23, 29, 37, 38, 39, and 50

United States Patent and Trademark Office

Reg. No. 3,482,036

Registered Aug. 5, 2008

**TRADEMARK
PRINCIPAL REGISTER**

BECAUSE . . .

TURNERWORLD LLC (GEORGIA LTD LIAB CO)
7026 BENNINGTON LANE
CUMMING, GA 30041

FOR: OFFICE SUPPLIES, NAMELY, PEN AND PENCIL SETS, NOTE BOOKS, WRITING PAPER PADS, NOTE PAPER PADS, STATIONERY, COASTERS MADE OF PAPER, CALENDARS, DAILY PLANNERS, DESK TOP PLANNERS, PAPERWEIGHTS, 3-RING BINDERS, POSTERS, STATIONERY-TYPE PORTFOLIOS AND STICKERS; TELEPHONE CALLING CARDS, NOT MAGNETICALLY ENCODED; BUSINESS CARDS; CREDIT CARDS WITHOUT MAGNETIC CODING; PLAYING CARDS; DECALS; POSTCARDS; GREETING CARDS, IN CLASS 16 (U.S. CLS. 2, 5, 22, 23, 29, 37, 38 AND 50).

FIRST USE 8-0-2003; IN COMMERCE 8-0-2003.

FOR: CLOTHING FOR MEN, WOMEN, AND CHILDREN, NAMELY, SWEAT PANTS AND SWEATSHIRTS; SWIM WEAR; BATHING SUITS; BEACH AND BATHING COVER-UPS; SWEAT SHORTS; GYM SHORTS; TOPS; JACKETS; COATS; SHIRTS; SPORT SHIRTS; T-SHIRTS; KNIT SHIRTS; POLO SHIRTS; PULLOVERS; SWEATERS; VESTS; TANK TOPS; CASUAL FOOTWEAR; SANDALS; HEAD WEAR; HATS; CAPS; VISORS; HEADBANDS; SWEATBANDS; WRIST BANDS; NECKWEAR; NECKTIES; NECKERCHIEFS; SCARVES; BANDANNAS; SLEEPWEAR; ROBES; PAJAMAS; NIGHT SHIRTS; BOXERS SHORTS; BELTS; LINGERIE, UNDERGARMENTS, HOSIERY; SOCKS; AFTER SKI BOOTS; ANKLET SOCKS; ANORAKS AND PAR-

KAS; APRONS; ASCOTS; ATHLETIC FOOTWEAR; ATHLETIC SHOES; ATHLETIC UNIFORMS; BABUSHKAS; BABY BUNTING; BAGS FOR SKI BOOTS; BALLOON PANTS; BANDEAUX; NECK BANDS; BATHING CAPS; BATHING TRUNKS; BATHROBES; BEACHWEAR; BED JACKETS; GARTER BELTS; MONEY BELTS; BERETS; CLOTH BIBS; SKI BIBS; BIKINIS; BLAZERS; BLOOMERS; BLOUSES; BLOUSON; BOAS; BODY SHAPERS; BODY SUITS; BOLEROS; BONNETS; BOOTIES; BOOTS; SKI BOOTS; BOTTOMS; BOW TIES; BRAS; BRASSIERES; BREECHES; UNDERWEAR BRIEFS; BUSTIERS; CAFTANS; CAMISOLES; CAPES; BATHING CAPS; SHOWER CAPS; CARDIGANS; CASSOCKS; CHAPS; CHEMISES; CLOGS; CLOTH BIBS; CLOTH DIAPERS; INFANT CLOTH DIAPERS; FUR COATS; LAB COATS; LEATHER COATS; OVERCOATS; RAINCOATS; SPORT COATS; SUIT COATS; TOP COATS; COLLARS; CORSELETS; CORSETS; HALLOWEEN COSTUMES; MASQUERADE COSTUMES; MASQUERADE COSTUMES AND MASKS SOLD IN CONNECTION THEREWITH; COVERALLS; COVER-UPS; CRAVATS; CREEPERS; CUFFS; CULLOTTES; CUMMERBUNDS; DICKIES; DRESSES; DRESSING GOWNS; DUNGAREES; DUSTERS; EAR MUFFS; ESPADRILLES; EVENING GOWNS; FISHING VESTS; FISHING WADERS; FLIGHT SUITS; FOOTWEAR, ATHLETIC; FOUL WEATHER GEAR; FROCKS; FUR JACKETS; FUR STOLEES; GABARDINES; GAITERS; GALOSHES; GAUCHOS; GIRDLES; GLOVES; SKI GLOVES; GOLF SHIRTS; GOLF SHOES; GOWNS; DRESSING GOWNS; NIGHTGOWNS; WEDDING GOWNS; GREATCOATS; GYM SUITS; HALTER TOPS; HEADWEAR, HEEL INSERTS; HEELS; HOODS; HOUSECOATS;

INFANTWEAR; INNER SOLES; INSOLES; LEATHER JACKETS; WIND RESISTANT JACKETS; JEANS; JERSEYS; JODHPURS; JOGGING SUITS; JUMPERS; JUMPSUITS; KERCHIEFS; KILTS; KIMONOS; KNEE HIGHS; KNICKERS; LEG WARMERS; LEGGINGS; LEOTARDS; LINGERIE; LOUNGEWEAR; MAILLOTS; MANTILLAS; MANTLES; MINISKIRTS; MITTENS; MOCCASINS; MUFFLERS; MUFFS; EAR MUFFS; MUKLUKS; MUU MUUS; NECK BANDS; NEGLIGEES; OVERALLS; OVERCOATS; OVERSHOES; SHOULDER PADS FOR CLOTHING; PANTALOONS; PANTIES; PANTS; SKI PANTS; SNOW PANTS; TAP PANTS; PANTSUITS; PANTYHOSE; PAREU; PEDAL PUSHERS; PEIGNOIRS; PETTICOATS; PINAFORES; PLAY SUITS; POCKET SQUARES; PONCHOS; QUILTED VESTS; RAIN COATS; RAINWEAR; ROMPERS; SARONGS; SASHES; SHAWLS; SHIFTS; UNDERSHIRTS; SHOES; SHORTALLS; SHORTS; BERMUDA SHORTS; BOXER SHORTS; SHOWER CAPS; SINGLET; SKI SUITS; SKI WEAR; SKIRTS; SLACKS; SLIPPERS; SLIPS; SMOCKS; SNEAKERS; SNOW SUITS; THERMAL SOCKS; STOCKINGS; STOLE;

FUR STOLE; SUITS; VESTED SUITS; WARM-UP SUITS; WET SUITS; SUN VISORS; SUSPENDERS; SWADDLING CLOTHES; SWEAT SUITS; TURTLE-NECK SWEATERS; V-NECK SWEATERS; SWEAT-SOCKS; SWIM TRUNKS; SWIMSUITS; TAILLEURS; TANGAS; TEDDIES; TENNIS WEAR; FOOTWEAR THONGS; TIES; TIGHTS; TOGAS; TOQUES; TRACKSUITS; TROUSERS; TUNICS; TURBANS; TUXEDOS; UNDERCLOTHES; UNDERGARMENTS; UNDERPANTS; UNDERSHIRTS; UNIFORMS; UNITARDS; VEILS; WAISTCOAT; WARM UP SUITS; LEG WARMERS; CLOTHING WRAPS; AND ZORI, IN CLASS 25 (U.S. CLS. 22 AND 39).

FIRST USE 8-0-2003; IN COMMERCE 8-0-2003.

THE MARK CONSISTS OF STANDARD CHARACTERS WITHOUT CLAIM TO ANY PARTICULAR FONT, STYLE, SIZE, OR COLOR.

SN 78-411,510, FILED 4-30-2004.

CHERYL CLAYTON, EXAMINING ATTORNEY

Int. Cl.: 9

Prior U.S. Cls.: 21, 23, 26, 36, and 38

Reg. No. 3,482,037

United States Patent and Trademark Office

Registered Aug. 5, 2008

**TRADEMARK
PRINCIPAL REGISTER**

ISENSE

DRESSER, INC. (DELAWARE CORPORATION)
11TH FLOOR, MILLENNIUM 1
15455 DALLAS PARKWAY
ADDISON, TX 75001

FIRST USE 7-0-2006; IN COMMERCE 7-0-2006.

FOR: HARDWARE AND SOFTWARE THAT
CONTROLS AND MONITORS FUEL DISPENSERS,
FUEL DISPENSING SYSTEMS, CREDIT, DEBIT
AND SMART CARD PROCESSING, ELECTRONIC
CASH REGISTERS, VIDEO SECURITY SYSTEMS,
CAR WASH MACHINERY AND UNDERGROUND
TANKS, IN CLASS 9 (U.S. CLS. 21, 23, 26, 36 AND 38).

THE MARK CONSISTS OF STANDARD CHAR-
ACTERS WITHOUT CLAIM TO ANY PARTICULAR
FONT, STYLE, SIZE, OR COLOR.

SN 78-412,012, FILED 5-3-2004.

BONNIE LUKEN, EXAMINING ATTORNEY

Int. Cl.: 25

Prior U.S. Cls.: 22 and 39

United States Patent and Trademark Office

Reg. No. 3,482,038

Registered Aug. 5, 2008

**TRADEMARK
PRINCIPAL REGISTER**

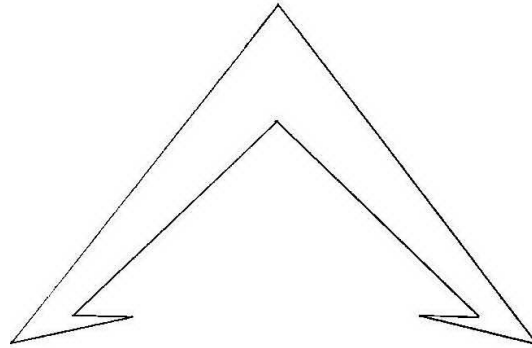

JASIC, INC. (TEXAS CORPORATION)
5815 MARCHMONT LANE
AUSTIN, TX 78749

FOR: FULL LINE OF SPORTS CLOTHING, NAMELY, CAPS, GLOVES, HATS, JACKETS, PANTS, RAINWEAR, SHIRTS, SKIRTS, SWEATERS, SHORTS, SOCKS, SWEATSHIRTS, T-SHIRTS, VESTS, VISORS, SANDALS, HEADBANDS, FOOTWEAR, SPORTS SHOES, ATHLETIC SHOES, JOGGING SHOES, BASKETBALL SHOES, AMERICAN FOOTBALL SHOES, FOOTBALL SHOES, SOCCER

SHOES, WEIGHTLIFTING SHOES, BOXING SHOES, WRESTLING SHOES, COURT SHOES, BASEBALL SHOES, TRACK AND FIELD SHOES, TRACK AND FIELD SPIKED SHOES, MARATHON SHOES, RUNNING SHOES, IN CLASS 25 (U.S. CLS. 22 AND 39).

FIRST USE 10-12-2007; IN COMMERCE 10-12-2007.

SN 78-413,666, FILED 5-5-2004.

WILLIAM P. SHANAHAN, EXAMINING ATTORNEY

Int. Cls.: 20 and 21

Prior U.S. Cls.: 2, 13, 22, 23, 25, 29, 30, 32, 33, 40, and 50

Reg. No. 3,482,039

United States Patent and Trademark Office

Registered Aug. 5, 2008

**TRADEMARK
PRINCIPAL REGISTER**

4COOKS

JOHN BOOS & CO. (ILLINOIS CORPORATION)
315 S. FIRST STREET
EFFINGHAM, IL 62401

FIRST USE 7-0-2005; IN COMMERCE 7-0-2005.

FOR: FURNITURE, NAMELY, TABLES, ISLANDS, IN CLASS 20 (U.S. CLS. 2, 13, 22, 25, 32 AND 50).

THE MARK CONSISTS OF STANDARD CHARACTERS WITHOUT CLAIM TO ANY PARTICULAR FONT, STYLE, SIZE, OR COLOR.

FIRST USE 11-0-2007; IN COMMERCE 11-0-2007.

SN 78-415,992, FILED 5-10-2004.

FOR: CUTTING BOARDS, IN CLASS 21 (U.S. CLS. 2, 13, 23, 29, 30, 33, 40 AND 50).

MICHAEL TANNER, EXAMINING ATTORNEY

Int. Cls.: 20 and 21

Prior U.S. Cls.: 2, 13, 22, 23, 25, 29, 30, 32, 33, 40, and 50

United States Patent and Trademark Office

Reg. No. 3,482,040

Registered Aug. 5, 2008

**TRADEMARK
PRINCIPAL REGISTER**

**4COOKS BY JOHN
BOOS**

JOHN BOOS & CO. (ILLINOIS CORPORATION)
315 S. FIRST STREET
EFFINGHAM, IL 62401

FIRST USE 7-0-2005; IN COMMERCE 7-0-2005.

FOR: FURNITURE, NAMELY, TABLES, ISLANDS, CARTS, IN CLASS 20 (U.S. CLS. 2, 13, 22, 25, 32 AND 50).

THE MARK CONSISTS OF STANDARD CHARACTERS WITHOUT CLAIM TO ANY PARTICULAR FONT, STYLE, SIZE, OR COLOR.

FIRST USE 11-0-2007; IN COMMERCE 11-0-2007.

SN 78-416,007, FILED 5-10-2004.

FOR: CUTTING BOARDS, IN CLASS 21 (U.S. CLS. 2, 13, 23, 29, 30, 33, 40 AND 50).

RICHARD WHITE, EXAMINING ATTORNEY

Int. Cl.: 25

Prior U.S. Cls.: 22 and 39

United States Patent and Trademark Office

Reg. No. 3,482,041

Registered Aug. 5, 2008

**TRADEMARK
PRINCIPAL REGISTER**



SONHO DE CRIANÇA PRODUTOS INFANTIS
LTDA. (BRAZIL LIMITED PARTNERSHIP)
RUA TIRADENTES, 2571
JARDIM MONTE LÍBANO
CIDADE DE BIRIGUI, ESTADO DE SÃO PAULO,
BRAZIL CEP 16200

FOR: SHOES, TENNIS SHOES, SANDALS, SLIP-
PERS, BOOTS, AND CLOGS FOR MEN, WOMEN
AND CHILDREN , IN CLASS 25 (U.S. CLS. 22 AND
39).

FIRST USE 2-12-1997; IN COMMERCE 7-24-2007.

NO CLAIM IS MADE TO THE EXCLUSIVE
RIGHT TO USE "CRIANÇA", APART FROM THE
MARK AS SHOWN.

THE MARK CONSISTS OF THE PHRASE "SONHO
DE CRIANÇA" IS STYLIZED LETTERS.

THE FOREIGN WORDING IN THE MARK
TRANSLATES INTO ENGLISH AS CHILD'S
DREAM.

SN 78-419,164, FILED 5-14-2004.

ERNEST SHOSHO, EXAMINING ATTORNEY

Int. Cls.: 7 and 9

Prior U.S. Cls.: 13, 19, 21, 23, 26, 31, 34, 35, 36, and 38

United States Patent and Trademark Office

Reg. No. 3,482,042

Registered Aug. 5, 2008

**TRADEMARK
PRINCIPAL REGISTER**

**NO DOWNTIME...
GUARANTEED!**

EASTWAY FAIR COMPANY LIMITED (BR.VIR-
GIN ISLANDS CORPORATION)
P.O. BOX 146
ROAD TOWN
TORTOLA, BR.VIRGIN ISLANDS

FOR: CORDLESS POWER TOOLS, NAMELY,
DRILLS, CIRCULAR SAWS, RECIPROCATING
SAWS, IMPACT DRIVERS, PLANERS, JIGSAWS
AND CAULK GUNS, IN CLASS 7 (U.S. CLS. 13, 19,
21, 23, 31, 34 AND 35).

FIRST USE 5-31-2007; IN COMMERCE 5-31-2007.

FOR: BATTERIES AND BATTERY CHARGERS,
IN CLASS 9 (U.S. CLS. 21, 23, 26, 36 AND 38).

FIRST USE 5-31-2007; IN COMMERCE 5-31-2007.

THE MARK CONSISTS OF STANDARD CHAR-
ACTERS WITHOUT CLAIM TO ANY PARTICULAR
FONT, STYLE, SIZE, OR COLOR.

SN 78-421,112, FILED 5-18-2004.

CAROLYN CATALDO, EXAMINING ATTORNEY

Int. Cl.: 5

Prior U.S. Cls.: 6, 18, 44, 46, 51, and 52

Reg. No. 3,482,043

United States Patent and Trademark Office

Registered Aug. 5, 2008

**TRADEMARK
PRINCIPAL REGISTER**

BIOMITE

NATURAL PLANT PROTECTION S.A. (FRANCE
CORPORATION)
ROUTE D'ARTIX BP 80
64150 NOGUERES, FRANCE

FOR: AGRICULTURAL AND HORTICULTURAL
PESTICIDE SPECIFIC TO CONTROL AND/OR
ELIMINATE MITES, IN CLASS 5 (U.S. CLS. 6, 18,
44, 46, 51 AND 52).

FIRST USE 6-1-2008; IN COMMERCE 6-1-2008.

THE MARK CONSISTS OF STANDARD CHAR-
ACTERS WITHOUT CLAIM TO ANY PARTICULAR
FONT, STYLE, SIZE, OR COLOR.

SN 78-422,865, FILED 5-21-2004.

JOHN HWANG, EXAMINING ATTORNEY

Int. Cl.: 27

Prior U.S. Cls.: 19, 20, 37, 42, and 50

United States Patent and Trademark Office

Reg. No. 3,482,044

Registered Aug. 5, 2008

**TRADEMARK
PRINCIPAL REGISTER**

NANS TROPISCAPES

NAN'S TROPISCAPES, INC. (FLORIDA CORPORATION)
5601 TURTLE BAY DRIVE, SUITE 1104
NAPLES, FL 34108

THE MARK CONSISTS OF STANDARD CHARACTERS WITHOUT CLAIM TO ANY PARTICULAR FONT, STYLE, SIZE, OR COLOR.

FOR: CLOTH WALL COVERINGS; NON-TEXTILE WALL COVERINGS; NON-TEXTILE WALL HANGINGS, IN CLASS 27 (U.S. CLS. 19, 20, 37, 42 AND 50).

SN 78-426,233, FILED 5-27-2004.

FIRST USE 10-16-2006; IN COMMERCE 10-16-2006.

MICHAEL SOUDERS, EXAMINING ATTORNEY

Int. Cls.: 11, 20, and 24

Prior U.S. Cls.: 2, 13, 21, 22, 23, 25, 31, 32, 34, 42, and 50

Reg. No. 3,482,045

United States Patent and Trademark Office

Registered Aug. 5, 2008

**TRADEMARK
PRINCIPAL REGISTER**

ATTITUDE

LNT MERCHANDISING COMPANY, LLC (DE-LAWARE LTD LIAB CO)
6 BRIGHTON ROAD
CLIFTON, NJ 07012

FOR: LAMPS, DESK LAMPS, READING LAMPS,
IN CLASS 11 (U.S. CLS. 13, 21, 23, 31 AND 34).

FIRST USE 6-0-2004; IN COMMERCE 6-0-2004.

FOR: PILLOWS, WINDOW BLINDS, WINDOW SHADES, DECORATIVE BEAD CURTAINS, LAUNDRY HAMPERS, PICTURE FRAMES NOT OF PRECIOUS METAL, JEWELRY BOXES NOT OF METAL, SHELVING, SHELVES FOR BOOKS AND MEDIA, MODULAR SHELVING UNITS FEATURING STACKABLE AND REMOVABLE SHELVES, STEP STOOLS, CHAIRS, OTTOMANS, END TABLES, AND BEDS, IN CLASS 20 (U.S. CLS. 2, 13, 22, 25, 32 AND 50).

FIRST USE 6-0-2004; IN COMMERCE 6-0-2004.

FOR: BEDDING AND ACCESSORIES, NAMELY, BED SHEETS, COMFORTERS, BLANKETS, DUVETS, DUVET COVERS BED SPREADS, QUILTS, THROWS, PILLOW CASES, PILLOW COVERS, MATTRESS PADS, MATTRESS TOPPERS, BED SKIRTS, CANOPIES; TOWELS, WASHCLOTHS, SHOWER CURTAINS, TABLE LINENS, TEXTILE NAPKINS, PLACE MATS NOT OF PAPER, UNFITTED FURNITURE COVERS, WINDOW CURTAINS, TEXTILE WALL HANGINGS, IN CLASS 24 (U.S. CLS. 42 AND 50).

FIRST USE 6-0-2004; IN COMMERCE 6-0-2004.

THE MARK CONSISTS OF STANDARD CHARACTERS WITHOUT CLAIM TO ANY PARTICULAR FONT, STYLE, SIZE, OR COLOR.

SN 78-427,854, FILED 6-1-2004.

SALLY SHIH, EXAMINING ATTORNEY

Int. Cl.: 16

Prior U.S. Cls.: 2, 5, 22, 23, 29, 37, 38, and 50

United States Patent and Trademark Office

Reg. No. 3,482,046

Registered Aug. 5, 2008

**TRADEMARK
PRINCIPAL REGISTER**

STICKERONI

HALLMARK LICENSING, INC. (DELAWARE
CORPORATION)
MD 339
2440 PERSHING ROAD
KANSAS CITY, MO 64108

FOR: STICKERS; ACTIVITY KITS CONSISTING
PRIMARILY OF STICKERS FOR USE BY CHIL-
DREN; VINYL BAGS, NAMELY, PLASTIC BAGS
FOR CARRYING STICKERS; CARDBOARD CON-
TAINERS FOR CARRYING STICKERS; TOY KITS
CONSISTING PRIMARILY OF STICKERS FOR USE
BY CHILDREN; TOY CARRYING CASES FOR

CONTAINING STICKERS, IN CLASS 16 (U.S. CLS.
2, 5, 22, 23, 29, 37, 38 AND 50).

FIRST USE 2-14-2005; IN COMMERCE 2-14-2005.

THE MARK CONSISTS OF STANDARD CHAR-
ACTERS WITHOUT CLAIM TO ANY PARTICULAR
FONT, STYLE, SIZE, OR COLOR.

SN 78-433,174, FILED 6-10-2004.

ANDREW RHIM, EXAMINING ATTORNEY

Int. Cl.: 16

Prior U.S. Cls.: 2, 5, 22, 23, 29, 37, 38, and 50

United States Patent and Trademark Office

Reg. No. 3,482,047

Registered Aug. 5, 2008

**TRADEMARK
PRINCIPAL REGISTER**

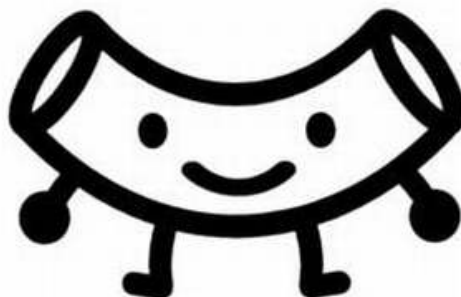

HALLMARK LICENSING, INC. (DELAWARE CORPORATION)
2440 PERSHING ROAD
MD 339
KANSAS CITY, MO 64108

FOR: STICKERS; ACTIVITY KITS CONSISTING PRIMARILY OF STICKERS FOR USE BY CHILDREN; VINYL BAGS, NAMELY, PLASTIC BAGS FOR CARRYING STICKERS; CARDBOARD CONTAINERS FOR CARRYING STICKERS; TOY KITS CONSISTING PRIMARILY OF STICKERS FOR USE BY CHILDREN; TOY CARRYING CASES FOR

CONTAINING STICKERS, IN CLASS 16 (U.S. CLS. 2, 5, 22, 23, 29, 37, 38 AND 50).

FIRST USE 2-14-2005; IN COMMERCE 2-14-2005.

THE MARK CONSISTS OF AN ANTHROPO-MORPHIC CURVED CYLINDER.

SN 78-433,288, FILED 6-10-2004.

ANDREW RHIM, EXAMINING ATTORNEY

Int. Cl.: 41

Prior U.S. Cls.: 100, 101, and 107

United States Patent and Trademark Office

Reg. No. 3,482,048

Registered Aug. 5, 2008

**SERVICE MARK
PRINCIPAL REGISTER**

HAVE A NICE WIN

GAMELOGIC INC. (DELAWARE CORPORATION)
411 WAVERLY OAKS ROAD, SUITE 312
WALTHAM, MA 02452

FOR: ENTERTAINMENT SERVICES, NAMELY,
PROVIDING AN ONLINE COMPUTER GAME;
ELECTRONIC CASINO GAMING SERVICES, IN
CLASS 41 (U.S. CLS. 100, 101 AND 107).

FIRST USE 5-28-2008; IN COMMERCE 5-28-2008.

THE MARK CONSISTS OF STANDARD CHARACTERS WITHOUT CLAIM TO ANY PARTICULAR FONT, STYLE, SIZE, OR COLOR.

SN 78-433,895, FILED 6-11-2004.

KEVON CHISOLM, EXAMINING ATTORNEY

Int. Cl.: 9

Prior U.S. Cls.: 21, 23, 26, 36, and 38

United States Patent and Trademark Office

Reg. No. 3,482,049

Registered Aug. 5, 2008

**TRADEMARK
PRINCIPAL REGISTER**

RoadTracker

ORBIMAGE SI OPCO INC. (DELAWARE CORPORATION), DBA/AKA/TA: DBA GEOEYE,
21700 ATLANTIC BLVD.
DULLES, VA 20166

FOR: COMPUTER SOFTWARE FOR EXTRACTING LINEAR FEATURES FROM IMAGERY FOR USE IN GEOGRAPHIC INFORMATION SYSTEMS TO MAKE DERIVED PRODUCTS FROM THE INFORMATION STORED IN THE GEOGRAPHIC INFORMATION SYSTEM DATABASES, IN CLASS 9 (U.S. CLS. 21, 23, 26, 36 AND 38).

FIRST USE 4-23-2008; IN COMMERCE 4-23-2008.

THE MARK CONSISTS OF STANDARD CHARACTERS WITHOUT CLAIM TO ANY PARTICULAR FONT, STYLE, SIZE, OR COLOR.

SN 78-441,732, FILED 6-25-2004.

REBECCA SMITH, EXAMINING ATTORNEY

Int. Cl.: 5

Prior U.S. Cls.: 6, 18, 44, 46, 51, and 52

Reg. No. 3,482,050

United States Patent and Trademark Office

Registered Aug. 5, 2008

**TRADEMARK
PRINCIPAL REGISTER**

QMATRIX

ALOECORP, INC. (DELAWARE CORPORATION)
2660 WILLAMETTE DR., N.E.
LACEY, WA 98516

FOR: DIETARY AND NUTRITIONAL SUPPLEMENTS; NUTRACEUTICALS FOR USE AS DIETARY SUPPLEMENTS; VETERINARY DIETARY SUPPLEMENTS; MEDICATED TRANSDERMAL PATCHES FOR ADMINISTERING NUTRITIONAL SUPPLEMENTS AND WOUND DRESSINGS; ANTI-SEPTICS; MEDICATION INFUSED DISPOSABLE DIAPERS FOR ADMINISTERING MOISTURIZER, WOUND DRESSING AND ANTI-INFLAMMATORY, MEDICATION INFUSED FACIAL TISSUE FOR ADMINISTERING MOISTURIZER, WOUND DRESSING AND ANTI-INFLAMMATORY, MEDI-

CATION INFUSED TOILET PAPER FOR ADMINISTERING MOISTURIZER, WOUND DRESSING AND ANTI-INFLAMMATORY AND MEDICATION INFUSED DISPOSABLE INCONTINENCE PADS, IN CLASS 5 (U.S. CLS. 6, 18, 44, 46, 51 AND 52).

FIRST USE 9-9-2005; IN COMMERCE 9-9-2005.

THE MARK CONSISTS OF STANDARD CHARACTERS WITHOUT CLAIM TO ANY PARTICULAR FONT, STYLE, SIZE, OR COLOR.

SN 78-443,298, FILED 6-29-2004.

MARLENE BELL, EXAMINING ATTORNEY

Int. Cl.: 27

Prior U.S. Cls.: 19, 20, 37, 42, and 50

Reg. No. 3,482,051

United States Patent and Trademark Office

Registered Aug. 5, 2008

**TRADEMARK
PRINCIPAL REGISTER**

SOFTRELLE

STRUDEX FIBRES LIMITED (CANADA CORPORATION)
65 NORTHFIELD DRIVE
WATERLOO, CANADA N2J 4J4

THE MARK CONSISTS OF STANDARD CHARACTERS WITHOUT CLAIM TO ANY PARTICULAR FONT, STYLE, SIZE, OR COLOR.

FOR: FLOOR COVERINGS, IN CLASS 27 (U.S. CLS. 19, 20, 37, 42 AND 50).

SN 78-444,052, FILED 6-30-2004.

FIRST USE 5-1-2004; IN COMMERCE 5-1-2004.

AISHA CLARKE, EXAMINING ATTORNEY

Int. Cl.: 9

Prior U.S. Cls.: 21, 23, 26, 36, and 38

United States Patent and Trademark Office

Reg. No. 3,482,052

Registered Aug. 5, 2008

**TRADEMARK
PRINCIPAL REGISTER**



AMERICAN HOFMANN CORPORATION (VIRGINIA CORPORATION)
3700 COHEN PLACE
LYNCHBURG, VA 24506

FOR: MEASURING AND BALANCING MACHINES AND EQUIPMENT, NAMELY, MANUAL, SEMI-AUTOMATIC OR FULLY AUTOMATIC MACHINES INTENDED TO MEASURE OR CORRECT INDUSTRIAL OR COMMERCIAL ROTATING PARTS, COMPONENTS OR ASSEMBLIES, ALL OF THE ABOVE SOLD WITH INSTRUCTION MANUALS AS A UNIT; EXCLUDING WHEEL BALANCERS, TIRE CHARGERS, WHEEL ALIGNERS, TEST STANDS FOR VEHICLE BRAKES, TEST STANDS FOR AUTOMOBILE ENGINES, TEST STANDS FOR TESTING WASTE GASES FROM

AUTOMOBILE ENGINES, IN CLASS 9 (U.S. CLS. 21, 23, 26, 36 AND 38).

FIRST USE 6-1-2006; IN COMMERCE 6-1-2006.

NO CLAIM IS MADE TO THE EXCLUSIVE RIGHT TO USE "AMERICAN" AND "CORPORATION", APART FROM THE MARK AS SHOWN.

THE MARK CONSISTS IN PART OF A STYLIZED LETTER "H" WITHIN A SQUARE.

SN 78-455,846, FILED 7-23-2004.

PRISCILLA MILTON, EXAMINING ATTORNEY

Int. Cl.: 35

Prior U.S. Cls.: 100, 101, and 102

United States Patent and Trademark Office

Reg. No. 3,482,053

Registered Aug. 5, 2008

**SERVICE MARK
PRINCIPAL REGISTER**

REDNECK WINERY

HARPER, CLETE D. (UNITED STATES INDIVIDUAL)
4124 GRANADA AVENUE
BAKERSFIELD, CA 93309

OWNER OF U.S. REG. NO. 2,695,589.

FOR: COMPUTERIZED ON-LINE RETAIL AND WHOLESALE STORE SERVICES IN THE FIELD OF BEER AND WINE, IN CLASS 35 (U.S. CLS. 100, 101 AND 102).

NO CLAIM IS MADE TO THE EXCLUSIVE RIGHT TO USE "WINERY", APART FROM THE MARK AS SHOWN.

FIRST USE 6-1-2008; IN COMMERCE 6-1-2008.

SN 78-457,957, FILED 7-28-2004.

THE MARK CONSISTS OF STANDARD CHARACTERS WITHOUT CLAIM TO ANY PARTICULAR FONT, STYLE, SIZE, OR COLOR.

CIMMERIAN COLEMAN, EXAMINING ATTORNEY

Int. Cls.: 29 and 31

Prior U.S. Cls.: 1 and 46

United States Patent and Trademark Office

Reg. No. 3,482,054

Registered Aug. 5, 2008

**TRADEMARK
PRINCIPAL REGISTER**

CandyCot

DRIVER, JOHN A (UNITED STATES INDIVIDUAL)
2601 TIM BELL ROAD
WATERFORD, CA 95386

FOR: DRIED APRICOTS, IN CLASS 29 (U.S. CL. 46).

FIRST USE 12-31-2007; IN COMMERCE 12-31-2007.

FOR: RAW APRICOT FRUITS, IN CLASS 31 (U.S. CLS. 1 AND 46).

FIRST USE 1-11-2008; IN COMMERCE 1-11-2008.

THE MARK CONSISTS OF STANDARD CHARACTERS WITHOUT CLAIM TO ANY PARTICULAR FONT, STYLE, SIZE, OR COLOR.

SN 78-466,767, FILED 8-12-2004.

LINDA ORNDORFF, EXAMINING ATTORNEY

Int. Cl.: 3

Prior U.S. Cls.: 1, 4, 6, 50, 51, and 52

Reg. No. 3,482,055

United States Patent and Trademark Office

Registered Aug. 5, 2008

**TRADEMARK
PRINCIPAL REGISTER**



KULWUTHIVILAS, VICHAI (THAILAND INDIVIDUAL)
48/68-70, VILLAGE NO. 5
WONGWAEN ROBNOK ROADBANG BON SUB-DISTRICT, BANG BON DISTRICTBANG BON SUB-DISTRICT, BANG BON DISTRICT
BANGKOK, THAILAND

FOR: SHAMPOO, HAIR CONDITIONER, FRAGRANT SOAP, DEODORANT FOR PERSONAL USE, HAIR-DYE, LIPSTICK, FACIAL POWDER, FACIAL CREAM, TOOTHPASTE, NAIL COATING, NAMELY, NAIL POLISH, COTTON BUDS FOR COSMETIC PURPOSES, SKIN CLEANING LOTION, BODY LOTION, AND NAIL CREAM FOR NOURISHING PURPOSES, IN CLASS 3 (U.S. CLS. 1, 4, 6, 50, 51 AND 52).

FIRST USE 3-24-1999; IN COMMERCE 3-0-1999.

THE MARK CONSISTS OF THE STYLIZED WORDS "POP POPULAR" WITH THAI WORDING UNDERNEATH.

THE FOREIGN WORDING IN THE MARK TRANSLATES INTO ENGLISH AS PAO MAI NAR.

THE NON-LATIN CHARACTERS IN THE MARK TRANSLITERATES INTO PAO MAI NAR, AND THIS MEANS BEAUTY AS GOLD IN ENGLISH.

SN 78-469,920, FILED 8-19-2004.

MELISSA VALLILLO, EXAMINING ATTORNEY

Int. Cls.: 3 and 21

**Prior U.S. Cls.: 1, 2, 4, 6, 13, 23, 29, 30, 33, 40, 50, 51,
and 52**

Reg. No. 3,482,056

United States Patent and Trademark Office

Registered Aug. 5, 2008

**TRADEMARK
PRINCIPAL REGISTER**

**The Natural Order
of Things**

BAHASH, TIMOTHY J. (UNITED STATES INDIVIDUAL)
775 SOUTH SIXTH STREET
PHILADELPHIA, PA 19147

FOR: BATH PRODUCTS, NAMELY, SOAPS, LOTIONS, SKIN CLEANSERS, FACIAL CLEANSERS AND ESSENTIAL OILS FOR PERSONAL USE, IN CLASS 3 (U.S. CLS. 1, 4, 6, 50, 51 AND 52).

FIRST USE 7-28-2003; IN COMMERCE 3-15-2004.

FOR: STORAGE CONTAINERS, NAMELY CONTAINERS FOR STORAGE OF SPICES, OILS AND

OTHER FOOD PRODUCTS, IN CLASS 21 (U.S. CLS. 2, 13, 23, 29, 30, 33, 40 AND 50).

FIRST USE 7-28-2003; IN COMMERCE 1-15-2008.

THE MARK CONSISTS OF STANDARD CHARACTERS WITHOUT CLAIM TO ANY PARTICULAR FONT, STYLE, SIZE, OR COLOR.

SN 78-473,999, FILED 8-26-2004.

CHERYL CLAYTON, EXAMINING ATTORNEY

Int. Cl.: 44

Prior U.S. Cls.: 100 and 101

United States Patent and Trademark Office

Reg. No. 3,482,057

Registered Aug. 5, 2008

**SERVICE MARK
PRINCIPAL REGISTER**

UNCOMMON KNOWLEDGE

UNCOMMON KNOWLEDGE LIMITED (UNITED
KINGDOM CORPORATION)
FIRST FLOOR
69 CHURCH ROAD
HOVE, UNITED KINGDOM BN3 2BB

FOR: THERAPY SERVICES, NAMELY, HYPNO-
THERAPY, PSYCHOTHERAPY, SOLUTION FO-
CUSED BRIEF THERAPY, COGNITIVE THERAPY,
BEHAVIOURAL THERAPY, HYPNOSIS, ANTI-
SMOKING THERAPY, AND PHYSICAL THERAPY,
IN CLASS 44 (U.S. CLS. 100 AND 101).

FIRST USE 6-4-2008; IN COMMERCE 6-4-2008.

THE MARK CONSISTS OF STANDARD CHAR-
ACTERS WITHOUT CLAIM TO ANY PARTICULAR
FONT, STYLE, SIZE, OR COLOR.

PRIORITY CLAIMED UNDER SEC. 44(D) ON
UNITED KINGDOM APPLICATION NO. 2357958,
FILED 3-10-2004, REG. NO. 2357958, DATED 9-3-2004,
EXPIRES 3-10-2014.

SN 78-480,848, FILED 9-9-2004.

WARREN L. OLANDRIA, EXAMINING ATTOR-
NEY

Int. Cl.: 25

Prior U.S. Cls.: 22 and 39

United States Patent and Trademark Office

Reg. No. 3,482,058

Registered Aug. 5, 2008

**TRADEMARK
PRINCIPAL REGISTER**



HOLMES, SCOTT W. (UNITED STATES INDIVIDUAL)
2120 ROCKLEDGE RD.
LOS ANGELES, CA 90068

FOR: CLOTHING, NAMELY, SHIRTS, JERSEYS, HOODS, BELTS, LEATHER BELTS, UNDERWEAR CLOTHING; FOOTWEAR; HEADGEAR, NAMELY, CAPS, HATS, IN CLASS 25 (U.S. CLS. 22 AND 39).

FIRST USE 9-1-2006; IN COMMERCE 5-10-2008.

THE MARK CONSISTS OF IN PART A STYLIZED EYEBALL OVER THE LETTER "I".

SN 78-482,135, FILED 9-12-2004.

ALEX KEAM, EXAMINING ATTORNEY

Int. Cl.: 11

Prior U.S. Cls.: 13, 21, 23, 31, and 34

United States Patent and Trademark Office

Reg. No. 3,482,059

Registered Aug. 5, 2008

**TRADEMARK
PRINCIPAL REGISTER**



ZANOTTI S.P.A. (ITALY CORPORATION)
VIA MARTIN LUTHER KING, 30
PEGOGNAGA (MANTOVA), ITALY I-46020

FOR: AIR CONDITIONING, DESICCATING,
DRYING AND REFRIGERATING APPARATUS
AND DEVICES, NAMELY, AIR CONDITIONERS,
DRYERS, DEHUMIDIFIERS, EVAPORATORS,
STEAM CONDENSERS AND REFRIGERATORS IN-
TENDED FOR USE IN ENVIRONMENTS WITH
MODIFIED ATMOSPHERE, SUCH AS CHEESE
AND SALAMI SEASONING ROOMS, MEAT PRO-
CESSING ROOMS, STORAGE BINS; PARTS AND

FITTINGS THEREOF; AIR CONDITIONERS AND
REFRIGERATORS FOR SHIPPING CONTAINERS,
IN CLASS 11 (U.S. CLS. 13, 21, 23, 31 AND 34).

FIRST USE 9-2-1996; IN COMMERCE 5-5-1997.

OWNER OF ITALY REG. NO. 684242, DATED 7-25-
1996, EXPIRES 2-19-2016.

SN 78-482,689, FILED 9-13-2004.

PAUL F. GAST, EXAMINING ATTORNEY

Int. Cl.: 9

Prior U.S. Cls.: 21, 23, 26, 36, and 38

Reg. No. 3,482,060

United States Patent and Trademark Office

Registered Aug. 5, 2008

**TRADEMARK
PRINCIPAL REGISTER**



NiOM

HUGHES, WILLIAM R. (UNITED STATES INDIVIDUAL)
4905 BRADLEY RD.
WESTLAKE, OH 44145

FOR: APPARATUS FOR RECORDING, TRANSMISSION OR REPRODUCTION OF SOUND OR IMAGES, NAMELY, COMPACT DISCS, RECORDS, AND PRE-RECORDED AUDIO AND VIDEO TAPES FEATURING MUSICAL ENTERTAINMENT AND

INTERVIEWS, IN CLASS 9 (U.S. CLS. 21, 23, 26, 36 AND 38).

FIRST USE 10-30-1983; IN COMMERCE 5-6-2008.

SN 78-484,471, FILED 9-16-2004.

CHERYL CLAYTON, EXAMINING ATTORNEY

Int. Cl.: 10

Prior U.S. Cls.: 26, 39, and 44

Reg. No. 3,482,061

United States Patent and Trademark Office

Registered Aug. 5, 2008

**TRADEMARK
PRINCIPAL REGISTER**

Gaitometer

SILK, JEFFREY E. (UNITED STATES INDIVIDUAL)
P.O. BOX 533
OREM, UT 84059

FOR: MEDICAL DEVICE, NAMELY, A DEVICE FOR GAIT ANALYSIS AND PHYSICAL THERAPY OF THE LOWER EXTREMITIES TO TREAT GAIT IRREGULARITIES, IN CLASS 10 (U.S. CLS. 26, 39 AND 44).

FIRST USE 6-2-2008; IN COMMERCE 6-2-2008.

THE MARK CONSISTS OF STANDARD CHARACTERS WITHOUT CLAIM TO ANY PARTICULAR FONT, STYLE, SIZE, OR COLOR.

SN 78-485,798, FILED 9-17-2004.

CIMMERIAN COLEMAN, EXAMINING ATTORNEY

Int. Cl.: 21

Prior U.S. Cls.: 2, 13, 23, 29, 30, 33, 40, and 50

Reg. No. 3,482,062

United States Patent and Trademark Office

Registered Aug. 5, 2008

**TRADEMARK
PRINCIPAL REGISTER**

AIM

CHURCH & DWIGHT CO., INC. (DELAWARE
CORPORATION)
469 NORTH HARRISON STREET
LAW DEPARTMENT
PRINCETON, NJ 08543

FOR: TOOTHBRUSHES, IN CLASS 21 (U.S. CLS. 2,
13, 23, 29, 30, 33, 40 AND 50).

FIRST USE 1-9-2008; IN COMMERCE 1-9-2008.

THE MARK CONSISTS OF STANDARD CHAR-
ACTERS WITHOUT CLAIM TO ANY PARTICULAR
FONT, STYLE, SIZE, OR COLOR.

OWNER OF U.S. REG. NO. 950,960.

SN 78-487,830, FILED 9-22-2004.

MATTHEW PAPPAS, EXAMINING ATTORNEY

Int. Cl.: 42

Prior U.S. Cls.: 100 and 101

United States Patent and Trademark Office

Reg. No. 3,482,063

Registered Aug. 5, 2008

**SERVICE MARK
PRINCIPAL REGISTER**

METERASSISTANT

XEROX CORPORATION (NEW YORK COR-
PORATION)
45 GLOVER AVE., P.O. BOX 4505
5059E
NORWALK, CT 068564505

FOR: MONITORING AND MEASUREMENT OF
USE, PERFORMANCE AND PRODUCTIVITY OF
THIRD PARTY REPRODUCTION AND OFFICE
EQUIPMENT VIA ACCESSED SOFTWARE INSTAL-
LED IN SUCH THIRD PARTY EQUIPMENT, IN
CLASS 42 (U.S. CLS. 100 AND 101).

FIRST USE 12-1-2005; IN COMMERCE 12-1-2005.

THE MARK CONSISTS OF STANDARD CHAR-
ACTERS WITHOUT CLAIM TO ANY PARTICULAR
FONT, STYLE, SIZE, OR COLOR.

SN 78-490,891, FILED 9-28-2004.

HENRY S. ZAK, EXAMINING ATTORNEY

Int. Cl.: 42

Prior U.S. Cls.: 100 and 101

United States Patent and Trademark Office

Reg. No. 3,482,064

Registered Aug. 5, 2008

**SERVICE MARK
PRINCIPAL REGISTER**

SUPPLIESASSISTANT

XEROX CORPORATION (NEW YORK CORPORATION)
45 GLOVER AVE., P.O. BOX 4505
NORWALK, CT 068564505

FOR: MONITORING AND MEASUREMENT OF CONSUMABLES OF THIRD PARTY REPRODUCTION AND OFFICE EQUIPMENT VIA ACCESSED SOFTWARE INSTALLED IN SUCH THIRD PARTY EQUIPMENT, IN CLASS 42 (U.S. CLS. 100 AND 101).

FIRST USE 12-1-2005; IN COMMERCE 12-1-2005.

THE MARK CONSISTS OF STANDARD CHARACTERS WITHOUT CLAIM TO ANY PARTICULAR FONT, STYLE, SIZE, OR COLOR.

SN 78-490,896, FILED 9-28-2004.

HENRY S. ZAK, EXAMINING ATTORNEY

Int. Cl.: 5

Prior U.S. Cls.: 6, 18, 44, 46, 51, and 52

United States Patent and Trademark Office

Reg. No. 3,482,065

Registered Aug. 5, 2008

**TRADEMARK
PRINCIPAL REGISTER**

SEPRACOR

SEPRACOR INC. (DELAWARE CORPORATION)
84 WATERFORD DRIVE
MARLBOROUGH, MA 01752

FOR: PHARMACEUTICAL PREPARATIONS,
NAMELY, ANALGESICS; ANTI-INFECTIVE; ANTI-
INFLAMMATORIES; PHARMACEUTICAL PRE-
PARATIONS FOR THE PREVENTION AND TREAT-
MENT OF DISORDERS AND DISEASES OF THE
CENTRAL NERVOUS, PERIPHERAL NERVOUS,
RESPIRATORY AND UROGENITAL SYSTEMS;
PHARMACEUTICAL PREPARATIONS FOR THE
PREVENTION AND TREATMENT OF SLEEP DIS-

ORDERS, IN CLASS 5 (U.S. CLS. 6, 18, 44, 46, 51 AND
52).

FIRST USE 4-16-1999; IN COMMERCE 4-16-1999.

THE MARK CONSISTS OF STANDARD CHAR-
ACTERS WITHOUT CLAIM TO ANY PARTICULAR
FONT, STYLE, SIZE, OR COLOR.

OWNER OF U.S. REG. NO. 2,252,782.

SN 78-491,661, FILED 9-29-2004.

DARRYL SPRUILL, EXAMINING ATTORNEY

Int. Cls.: 9 and 38

Prior U.S. Cls.: 21, 23, 26, 36, 38, 100, 101, and 104

United States Patent and Trademark Office

Reg. No. 3,482,066

Registered Aug. 5, 2008

**TRADEMARK
SERVICE MARK
PRINCIPAL REGISTER**

e-iV8

NETSTAIRS.COM, INC. (FLORIDA CORPORATION)
2821 EAST COMMERCIAL BLVD.
FT. LAUDERDALE, FL 33308

FOR: VIDEO E-MAIL SOFTWARE PROGRAM CONTAINED ON A COMPACT DISC; VIDEO E-MAIL SOFTWARE PROGRAM DOWNLOADABLE FROM THE INTERNET, IN CLASS 9 (U.S. CLS. 21, 23, 26, 36 AND 38).

FIRST USE 3-21-2005; IN COMMERCE 3-21-2005.

FOR: INTERNET BASED E-MAIL AND VIDEO TRANSMISSION SERVICES, IN CLASS 38 (U.S. CLS. 100, 101 AND 104).

FIRST USE 3-21-2005; IN COMMERCE 3-21-2005.

THE MARK CONSISTS OF STANDARD CHARACTERS WITHOUT CLAIM TO ANY PARTICULAR FONT, STYLE, SIZE, OR COLOR.

SN 78-491,937, FILED 9-30-2004.

SUNG IN, EXAMINING ATTORNEY

Int. Cl.: 16

Prior U.S. Cls.: 2, 5, 22, 23, 29, 37, 38, and 50

Reg. No. 3,482,067

United States Patent and Trademark Office

Registered Aug. 5, 2008

**TRADEMARK
PRINCIPAL REGISTER**

LIGHT OF HOPE

NATIONAL CASA ASSOCIATION (WASHINGTON PUBLIC BENEFIT CORPORATION)
NORTH TOWER, SUITE 500
100 WEST HARRISON
SEATTLE, WA 98119

FOR: PRINTED MATERIALS, NAMELY, BROCHURES AND NEWSLETTERS RELATING TO CHILD WELFARE, CHILDREN INVOLVED IN LEGAL ACTIONS AND VOLUNTEERS ACTING ON BEHALF OF CHILDREN; TRAINING MANUALS IN THE FIELDS OF CHILD WELFARE, CHILDREN INVOLVED IN LEGAL ACTIONS AND VOLUNTEERS ACTING ON BEHALF OF CHILDREN, IN CLASS 16 (U.S. CLS. 2, 5, 22, 23, 29, 37, 38 AND 50).

FIRST USE 10-0-1999; IN COMMERCE 10-0-1999.

THE MARK CONSISTS OF STANDARD CHARACTERS WITHOUT CLAIM TO ANY PARTICULAR FONT, STYLE, SIZE, OR COLOR.

OWNER OF U.S. REG. NO. 2,576,010.

SN 78-495,099, FILED 10-5-2004.

NELSON SNYDER, EXAMINING ATTORNEY

Int. Cl.: 30

Prior U.S. Cl.: 46

United States Patent and Trademark Office

Reg. No. 3,482,068

Registered Aug. 5, 2008

**TRADEMARK
PRINCIPAL REGISTER**

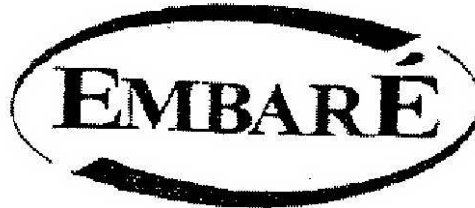

EMBARE INDUSTRIAS ALIMENTICIAS S/A
(BRAZIL CORPORATION)
AV. BRASIL 241
LAGOA DA PRATA, MINAS GERAIS, BRAZIL
35590-000

FOR: CARAMELS, IN CLASS 30 (U.S. CL. 46).

FIRST USE 0-0-1947; IN COMMERCE 0-0-1989.

OWNER OF BRAZIL REG. NO. 820283690, DATED
8-22-2000, EXPIRES 8-22-2010.

THE MARK CONSISTS OF AN OVAL WITH THE
WORD "EMBARE" IN THE CENTER OF THE OVAL.

THE ENGLISH TRANSLATION OF EMBARE IS
"TREE".

SN 78-501,214, FILED 10-18-2004.

CHRISTINE BLOMQUIST, EXAMINING ATTOR-
NEY

Int. Cl.: 25

Prior U.S. Cls.: 22 and 39

United States Patent and Trademark Office

Reg. No. 3,482,069

Registered Aug. 5, 2008

**TRADEMARK
PRINCIPAL REGISTER**

**BRIDGEPORT
REPUBLIC**

BEATTIE, CHRISTOPHER C. (UNITED STATES
INDIVIDUAL)
9200 SUNSET BLVD., STE 600
LOS ANGELES, CA 90069

FOR: CLOTHING, NAMELY, SHIRTS, SHORTS,
HATS, PANTS, SWEATSHIRTS, JACKETS, IN CLASS
25 (U.S. CLS. 22 AND 39).

FIRST USE 3-15-2007; IN COMMERCE 3-15-2007.

THE MARK CONSISTS OF STANDARD CHAR-
ACTERS WITHOUT CLAIM TO ANY PARTICULAR
FONT, STYLE, SIZE, OR COLOR.

NO CLAIM IS MADE TO THE EXCLUSIVE
RIGHT TO USE "BRIDGEPORT", APART FROM
THE MARK AS SHOWN.

SN 78-503,570, FILED 10-21-2004.

CHERYL CLAYTON, EXAMINING ATTORNEY

Int. Cl.: 27

Prior U.S. Cls.: 19, 20, 37, 42, and 50

Reg. No. 3,482,070

United States Patent and Trademark Office

Registered Aug. 5, 2008

**TRADEMARK
PRINCIPAL REGISTER**

FUEL

SAFETY HELMETS CANADA, INC. (TENNESSEE
CORPORATION)
122 GAYOSO
MEMPHIS, TN 38103

THE MARK CONSISTS OF STANDARD CHAR-
ACTERS WITHOUT CLAIM TO ANY PARTICULAR
FONT, STYLE, SIZE, OR COLOR.

FOR: AUTOMOTIVE ACCESSORIES, NAMELY,
FLOOR MATS, IN CLASS 27 (U.S. CLS. 19, 20, 37, 42
AND 50).

SN 78-511,988, FILED 11-5-2004.

FIRST USE 9-8-2005; IN COMMERCE 9-8-2005.

HELENE LIWINSKI, EXAMINING ATTORNEY

Int. Cl.: 41

Prior U.S. Cls.: 100, 101, and 107

United States Patent and Trademark Office

Reg. No. 3,482,071

Registered Aug. 5, 2008

**SERVICE MARK
PRINCIPAL REGISTER**

SEE FOR YOURSELF

SEA FOR YOURSELF, INC. (CALIFORNIA CORPORATION)
729 COLLEGE AVENUE
MENLO PARK, CA 940255203

THE MARK CONSISTS OF STANDARD CHARACTERS WITHOUT CLAIM TO ANY PARTICULAR FONT, STYLE, SIZE, OR COLOR.

FOR: CONDUCTING WORKSHOPS AND SEMINARS IN THE FIELD OF PHOTOGRAPHY, IN CLASS 41 (U.S. CLS. 100, 101 AND 107).

SN 78-514,148, FILED 11-9-2004.

FIRST USE 1-14-2008; IN COMMERCE 1-14-2008.

ALLISON SCHRODY, EXAMINING ATTORNEY

Int. Cl.: 2

Prior U.S. Cls.: 6, 11, and 16

United States Patent and Trademark Office

Reg. No. 3,482,072

Registered Aug. 5, 2008

**TRADEMARK
PRINCIPAL REGISTER**

VIDEOGARD

VERBATIM AMERICAS LLC (DELAWARE LTD
LIAB CO)
1200 W.T. HARRIS BLVD.
CHARLOTTE, NC 28262

FOR: COMPONENT FEATURE OF BLANK AND
PREFORMATTED OPTICAL DISKS, NAMELY,
SCRATCH-RESISTANT COATINGS OF BLANK
AND PREFORMATTED DVDS, MINI-DVDS, AND
CDS, IN CLASS 2 (U.S. CLS. 6, 11 AND 16).

FIRST USE 1-6-2005; IN COMMERCE 1-6-2005.

THE MARK CONSISTS OF STANDARD CHAR-
ACTERS WITHOUT CLAIM TO ANY PARTICULAR
FONT, STYLE, SIZE, OR COLOR.

SN 78-514,524, FILED 11-10-2004.

RAMONA ORTIGA, EXAMINING ATTORNEY

Int. Cl.: 28

Prior U.S. Cls.: 22, 23, 38, and 50

United States Patent and Trademark Office

Reg. No. 3,482,073

Registered Aug. 5, 2008

**TRADEMARK
PRINCIPAL REGISTER**

SUNNY DAY

MATTEL, INC. (DELAWARE CORPORATION)
LAW DEPARTMENT, M1-1518
333 CONTINENTAL BOULEVARD
EL SEGUNDO, CA 902455012

THE MARK CONSISTS OF STANDARD CHAR-
ACTERS WITHOUT CLAIM TO ANY PARTICULAR
FONT, STYLE, SIZE, OR COLOR.

FOR: TOYS, GAMES AND PLAYTHINGS, NAME-
LY, DOLL CLOTHING AND DOLL ACCESSORIES,
IN CLASS 28 (U.S. CLS. 22, 23, 38 AND 50).

SN 78-514,530, FILED 11-10-2004.

FIRST USE 5-3-2008; IN COMMERCE 5-3-2008.

ALLISON SCHRODY, EXAMINING ATTORNEY

Int. Cls.: 3 and 4

Prior U.S. Cls.: 1, 4, 6, 15, 50, 51, and 52

United States Patent and Trademark Office

Reg. No. 3,482,074

Registered Aug. 5, 2008

**TRADEMARK
PRINCIPAL REGISTER**

TROPICAL COLADA

BATH & BODY WORKS BRAND MANAGEMENT, INC. (DELAWARE CORPORATION)
7 LIMITED PARKWAY EAST
REYNOLDSBURG, OH 43068

FOR: PERSONAL CARE PRODUCTS, NAMELY, BATH CREAM, BODY BUTTER SKIN MOISTURIZING LOTIONS, BODY CREAM, FRAGRANT BODY SPRAY, BODY LOTION, BODY MIST, BODY SCRUB, BODY SMOOTHING SKIN MOISTURIZERS, BODY SOAP, BODY WASH, BUBBLE BATH, CREAM BODY WASH, CREAM CLEANSER, ESSENTIAL OILS FOR PERSONAL USE, FACE LOTION, FACE SOAP, FACE WASH, FACE CLEANSER, FACE CREAM, FOAM BATH, NON-MEDICATED FOOT CREAMS, NON-MEDICATED FOOT LOTIONS, FRAGRANT FOOT SPRAY, HAIR SHAMPOO, HAND MOISTURIZING BALMS, HAND CREAM, HAND LOTION, SHOWER CREAM, SHOWER

FOAM, SHOWER GEL, SKIN CREAM, SKIN LOTION, SKIN MOISTURIZER, IN CLASS 3 (U.S. CLS. 1, 4, 6, 50, 51 AND 52).

FIRST USE 5-9-2005; IN COMMERCE 5-9-2005.

FOR: CANDLES, IN CLASS 4 (U.S. CLS. 1, 6 AND 15).

FIRST USE 5-9-2005; IN COMMERCE 5-9-2005.

THE MARK CONSISTS OF STANDARD CHARACTERS WITHOUT CLAIM TO ANY PARTICULAR FONT, STYLE, SIZE, OR COLOR.

SN 78-515,132, FILED 11-11-2004.

KHANH LE, EXAMINING ATTORNEY

Int. Cl.: 25

Prior U.S. Cls.: 22 and 39

United States Patent and Trademark Office

Reg. No. 3,482,075

Registered Aug. 5, 2008

**TRADEMARK
PRINCIPAL REGISTER**

SEXY LIFT

VANITY FAIR, INC. (DELAWARE CORPORATION)
ONE FRUIT OF THE LOOM DR
LEGAL DEPARTMENT
BOWLING GREEN, KY 42103

FOR: LINGERIE, IN CLASS 25 (U.S. CLS. 22 AND 39).

FIRST USE 10-15-2007; IN COMMERCE 10-15-2007.

THE MARK CONSISTS OF STANDARD CHARACTERS WITHOUT CLAIM TO ANY PARTICULAR FONT, STYLE, SIZE, OR COLOR.

NO CLAIM IS MADE TO THE EXCLUSIVE RIGHT TO USE "LIFT", APART FROM THE MARK AS SHOWN.

SN 78-515,194, FILED 11-11-2004.

MIDGE BUTLER, EXAMINING ATTORNEY

Int. Cl.: 29

Prior U.S. Cl.: 46

United States Patent and Trademark Office

Reg. No. 3,482,076

Registered Aug. 5, 2008

**TRADEMARK
PRINCIPAL REGISTER**

CHIPPER

CHIPPER SNAX, INC. (UTAH CORPORATION)
SUITE 700
1750 SOUTH 500 WEST
SALT LAKE CITY, UT 84115

THE MARK CONSISTS OF STANDARD CHARACTERS WITHOUT CLAIM TO ANY PARTICULAR FONT, STYLE, SIZE, OR COLOR.

FOR: BEEF JERKY, IN CLASS 29 (U.S. CL. 46).

SN 78-515,565, FILED 11-11-2004.

FIRST USE 12-31-2006; IN COMMERCE 12-31-2006.

RICHARD WHITE, EXAMINING ATTORNEY

Int. Cl.: 5

Prior U.S. Cls.: 6, 18, 44, 46, 51, and 52

United States Patent and Trademark Office

Reg. No. 3,482,077

Registered Aug. 5, 2008

**TRADEMARK
PRINCIPAL REGISTER**

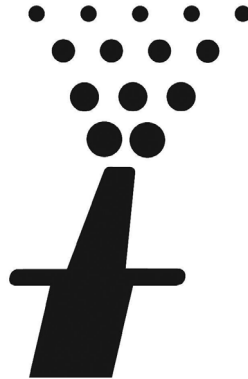

ALCON, INC. (SWITZERLAND CORPORATION)
BÖSCH 69
CH-6331 HÜNENBERG, SWITZERLAND

THE MARK CONSISTS OF PRODUCT APPLICATOR ACCOMPANIED BY A GEOMETRICAL ARRANGEMENT OF LIQUID DROPLETS.

FOR: OTORHINOLARYNGOLOGICAL PHARMACEUTICAL PREPARATIONS, IN CLASS 5 (U.S. CLS. 6, 18, 44, 46, 51 AND 52).

SN 78-516,934, FILED 11-15-2004.

FIRST USE 4-28-2008; IN COMMERCE 4-28-2008.

KIMBERLY FRYE, EXAMINING ATTORNEY

Int. Cl.: 9

Prior U.S. Cls.: 21, 23, 26, 36, and 38

United States Patent and Trademark Office

Reg. No. 3,482,078

Registered Aug. 5, 2008

**TRADEMARK
PRINCIPAL REGISTER**

VISIONMOS

VISIONMOS INTERNATIONAL, INC. (ARIZONA CORPORATION)
4500 SOUTH LAKESHORE DRIVE, SUITE 340
TEMPE, AZ 85282

FOR: COMPUTER HARDWARE; PRINTED CIRCUIT BOARDS; ELECTRONIC CIRCUIT BOARDS; COMPUTER CHIPSETS, NAMELY, FOR USE IN MULTIMEDIA DEVICES AND DIGITAL CAMERAS; COMPUTER PERIPHERALS; COMPUTER FIRMWARE, NAMELY, COMPUTER UTILITY SOFTWARE AND OTHER COMPUTER SOFTWARE USED TO MAINTAIN AND OPERATE COMPUTER SYSTEMS ALL STORED IN A COMPUTER'S READ-ONLY MEMORY (ROM) OR ELSEWHERE IN THE COMPUTER'S CIRCUITRY, AND OPERATING SYSTEM SOFTWARE; COMPUTER FIRMWARE FOR OPERATING AND MAINTAINING COMPUTER SYSTEMS, DIGITAL CAMERAS, DIGITAL VIDEO

CAMERAS, PERSONAL MEDIA PLAYERS, PERSONAL RECORDING DEVICES, CELLULAR TELEPHONES, PDAS, AND COMPUTER PERIPHERAL DEVICES; ALL THE FOREGOING SOLD WITH OR WITHOUT USER MANUALS FOR USE THEREWITH AND PARTS THEREFORE, IN CLASS 9 (U.S. CLS. 21, 23, 26, 36 AND 38).

FIRST USE 3-0-2007; IN COMMERCE 3-0-2007.

THE MARK CONSISTS OF STANDARD CHARACTERS WITHOUT CLAIM TO ANY PARTICULAR FONT, STYLE, SIZE, OR COLOR.

SN 78-517,302, FILED 11-15-2004.

HOWARD B. LEVINE, EXAMINING ATTORNEY

Int. Cls.: 9 and 41

Prior U.S. Cls.: 21, 23, 26, 36, 38, 100, 101, and 107

United States Patent and Trademark Office

Reg. No. 3,482,079

Registered Aug. 5, 2008

**TRADEMARK
SERVICE MARK
PRINCIPAL REGISTER**

THE MINDFUL BRAIN

SIEGEL, DANIEL J. (UNITED STATES INDIVIDUAL)
11980 SAN VICENTE, SUITE 809
LOS ANGELES, CA 90049

FOR: PRERECORDED DVDS, CD-ROMS, DIGITAL AUDIO TAPES FEATURING THE SUBJECT OF HUMAN DEVELOPMENT AND PERSONAL GROWTH , IN CLASS 9 (U.S. CLS. 21, 23, 26, 36 AND 38).

FIRST USE 10-0-2006; IN COMMERCE 10-0-2006.

FOR: EDUCATIONAL SERVICES, NAMELY, CONDUCTING PROGRAMS AND SEMINARS IN THE FIELD OF HUMAN DEVELOPMENT AND

PERSONAL GROWTH; PROVIDING A WEB SITE FEATURING INFORMATION ON THE SUBJECT OF HUMAN DEVELOPMENT AND PERSONAL GROWTH, IN CLASS 41 (U.S. CLS. 100, 101 AND 107).

FIRST USE 8-0-2006; IN COMMERCE 8-0-2006.

THE MARK CONSISTS OF STANDARD CHARACTERS WITHOUT CLAIM TO ANY PARTICULAR FONT, STYLE, SIZE, OR COLOR.

SN 78-518,989, FILED 11-18-2004.

KAPIL BHANOT, EXAMINING ATTORNEY

Int. Cls.: 9 and 41

Prior U.S. Cls.: 21, 23, 26, 36, 38, 100, 101, and 107

United States Patent and Trademark Office

Reg. No. 3,482,080

Registered Aug. 5, 2008

**TRADEMARK
SERVICE MARK
PRINCIPAL REGISTER**

MINDSIGHT

SIEGEL, DANIEL J. (UNITED STATES INDIVIDUAL)
11980 SAN VICENTE, SUITE 809
LOS ANGELES, CA 90049

FOR: PRERECORDED DVDS, CD-ROMS, DIGITAL AUDIO TAPES FEATURING THE SUBJECT OF HUMAN DEVELOPMENT AND PERSONAL GROWTH , IN CLASS 9 (U.S. CLS. 21, 23, 26, 36 AND 38).

FIRST USE 12-0-2005; IN COMMERCE 12-0-2005.

FOR: EDUCATIONAL SERVICES, NAMELY, CONDUCTING PROGRAMS AND SEMINARS IN THE FIELD OF HUMAN DEVELOPMENT AND

PERSONAL GROWTH; PROVIDING A WEB SITE FEATURING INFORMATION ON THE SUBJECT OF HUMAN DEVELOPMENT AND PERSONAL GROWTH, IN CLASS 41 (U.S. CLS. 100, 101 AND 107).

FIRST USE 12-0-2005; IN COMMERCE 12-0-2005.

THE MARK CONSISTS OF STANDARD CHARACTERS WITHOUT CLAIM TO ANY PARTICULAR FONT, STYLE, SIZE, OR COLOR.

SN 78-518,991, FILED 11-18-2004.

KAPIL BHANOT, EXAMINING ATTORNEY

Int. Cl.: 25

Prior U.S. Cls.: 22 and 39

United States Patent and Trademark Office

Reg. No. 3,482,081

Registered Aug. 5, 2008

**TRADEMARK
PRINCIPAL REGISTER**

FUTURE STAR

BALLET MAKERS, INC. (NEW YORK COR-
PORATION)
ONE CAMPUS ROAD
TOTOWA, NJ 07512

FOR: FOOTWEAR; BODY WEAR, NAMELY,
SKIRTS, DRESSES, LEOTARDS, WARM-UPS, COS-
TUMES AND UNIFORMS FOR DANCE, SHIRTS,
PANTS, SHORTS, AND TIGHTS; ACCESSORIES
FOR DANCE, NAMELY, LEG WARMERS, BELTS,
CAMISOLES, AND LEGGINGS, IN CLASS 25 (U.S.
CLS. 22 AND 39).

FIRST USE 8-1-2005; IN COMMERCE 8-1-2005.

THE MARK CONSISTS OF STANDARD CHAR-
ACTERS WITHOUT CLAIM TO ANY PARTICULAR
FONT, STYLE, SIZE, OR COLOR.

SN 78-519,101, FILED 11-18-2004.

KELLY BOULTON, EXAMINING ATTORNEY

Int. Cl.: 41

Prior U.S. Cls.: 100, 101, and 107

United States Patent and Trademark Office

Reg. No. 3,482,082

Registered Aug. 5, 2008

**SERVICE MARK
PRINCIPAL REGISTER**



NSS MUSIC (DELAWARE CORPORATION)
#2D
771 WEST END AVENUE
NEW YORK, NY 10025

FOR: MUSIC AND RECORD PRODUCTION SERVICES, IN CLASS 41 (U.S. CLS. 100, 101 AND 107).

FIRST USE 10-1-2006; IN COMMERCE 10-1-2006.

NO CLAIM IS MADE TO THE EXCLUSIVE RIGHT TO USE "MUSIC", APART FROM THE MARK AS SHOWN.

THE COLORS BLACK, GRAY, ORANGE ARE CLAIMED AS A FEATURE OF THE MARK.

THE LETTERING IS BLACK. THE TWO LINES ABOVE AND BELOW ARE BLACK WITH GRAY SHADOWING. THE SMALL LOGO TO THE RIGHT IS ORANGE WITH A THIN BLACK LINING.

SN 78-519,668, FILED 11-18-2004.

CHERYL CLAYTON, EXAMINING ATTORNEY

Int. Cl.: 25

Prior U.S. Cls.: 22 and 39

United States Patent and Trademark Office

Reg. No. 3,482,083

Registered Aug. 5, 2008

**TRADEMARK
PRINCIPAL REGISTER**

JOHN CRAIG

SOLE COMFORT, INC. (CALIFORNIA CORPORATION)

836 AVOCADO AVENUE

NEWPORT BEACH, CA 92660

FOR: FOOTWEAR, IN CLASS 25 (U.S. CLS. 22 AND 39).

FIRST USE 3-3-2006; IN COMMERCE 3-3-2006.

THE MARK CONSISTS OF STANDARD CHARACTERS WITHOUT CLAIM TO ANY PARTICULAR FONT, STYLE, SIZE, OR COLOR.

THE NAME, "JOHN CRAIG" SHOWN IN THE MARK DOES NOT IDENTIFY A PARTICULAR LIVING INDIVIDUAL.

SN 78-525,532, FILED 12-1-2004.

MATTHEW PAPPAS, EXAMINING ATTORNEY

Int. Cl.: 20

Prior U.S. Cls.: 2, 13, 22, 25, 32, and 50

United States Patent and Trademark Office

Reg. No. 3,482,084

Registered Aug. 5, 2008

**TRADEMARK
PRINCIPAL REGISTER**

REFLECT

HNI TECHNOLOGIES INC. (IOWA CORPORATION)
408 EAST 2ND STREET
MUSCATINE, IA 52761

THE MARK CONSISTS OF STANDARD CHARACTERS WITHOUT CLAIM TO ANY PARTICULAR FONT, STYLE, SIZE, OR COLOR.

FOR: FURNITURE, IN CLASS 20 (U.S. CLS. 2, 13, 22, 25, 32 AND 50).

SN 78-526,543, FILED 12-3-2004.

FIRST USE 0-0-2003; IN COMMERCE 0-0-2003.

JIM RINGLE, EXAMINING ATTORNEY

Int. Cl.: 9

Prior U.S. Cls.: 21, 23, 26, 36, and 38

United States Patent and Trademark Office

Reg. No. 3,482,085

Registered Aug. 5, 2008

**TRADEMARK
PRINCIPAL REGISTER**

MOVIE BEST SHOT

CASIO KEISANKI KABUSHIKI KAISHA (JAPAN CORPORATION), DBA CASIO COMPUTER CO., LTD.,
6-2, HON-MACHI, 1-CHOME
SHIBUYA-KU, JAPAN

FOR: DIGITAL CAMERAS, IN CLASS 9 (U.S. CLS. 21, 23, 26, 36 AND 38).

FIRST USE 2-0-2005; IN COMMERCE 2-0-2005.

THE MARK CONSISTS OF STANDARD CHARACTERS WITHOUT CLAIM TO ANY PARTICULAR FONT, STYLE, SIZE, OR COLOR.

OWNER OF U.S. REG. NO. 2,778,270.

NO CLAIM IS MADE TO THE EXCLUSIVE RIGHT TO USE "MOVIE", APART FROM THE MARK AS SHOWN.

SN 78-529,929, FILED 12-9-2004.

NANCY CLARKE, EXAMINING ATTORNEY

Int. Cl.: 30

Prior U.S. Cl.: 46

United States Patent and Trademark Office

Reg. No. 3,482,086

Registered Aug. 5, 2008

TRADEMARK
PRINCIPAL REGISTER



GUAN POH DIM SUM PTE LTD (SINGAPORE CORPORATION)
NO. 4 WOODLANDS TERRACE
SINGAPORE, SINGAPORE 738429

FOR: BREAD; PASTRIES; CONFECTIONERY CRYSTAL SUGAR PIECES, FONDANTS, ICE CREAM AND FROZEN CONFECTIONERY; BUNS; CAKES; CANDY FOR FOOD; CHOCOLATE; COFFEE; TEA; COCOA-BASED BEVERAGES; COOKIES; FARINACEOUS FOOD PASTES; FLOUR FOR FOOD; MEAT GRAVIES; NOODLES; INSTANT-COOKING NOODLES; PASTA; PEANUT CONFECTIONERY; ALMOND CONFECTIONERY; NUT CONFECTIONERY; CASHEW NUT CONFECTIONERY; PIES; RICE; SANDWICHES; SAUCES AND SEASONINGS, NAMELY, LIGHT SOYA SAUCE, PLUM PASTE IN THE NATURE OF A CONDIMENT, GARLIC GINGER CHILI SAUCE, DARK SOYA SAUCE, PLUM SAUCE, TIM SUM CHILI SAUCE, OYSTER SAUCE, HOT BEAN PASTE, SWEET AND SOUR SAUCE, LEMON SAUCE, BLACK BEAN GARLIC SAUCE, BARBECUE PORK RIB SAUCE, YELLOW BEAN PASTE, SAMBAL BELACAN CHILI PASTE; SPICES; BISCUITS; BAKERY DESSERTS AND DESSERT PUDDINGS; TARTS; SPRING ROLLS; RICE NOODLES; DUMPLINGS; PASTRY SKIN FOR SPRING ROLLS; SOY-BASED FOOD

PRODUCTS, NAMELY, SOY-BASED DESSERT PUDDINGS, SOY-BASED FOOD PRODUCTS, NAMELY, SOY-BASED DESSERT PUDDINGS, SOY SAUCE, SOY-BASED ICE CREAM SUBSTITUTE, SOYBEAN MILK SOY MILK, IN CLASS 30 (U.S. CL. 46).

FIRST USE 4-30-1994; IN COMMERCE 11-30-2001.

THE MARK CONSISTS OF THE TELESCOPED WORDS "GUANPOH" WITH LETTER "O" IN THE SHAPE OF AN INGOT, IN A RECTANGLE AND CHINESE CHARACTERS OUTSIDE THE RECTANGLE.

THE FOREIGN WORDING AND IDEOGRAMS IN THE MARK TRANSLATE INTO ENGLISH AS "SOURCE" AND "TREASURE".

THE NON-LATIN CHARACTERS IN THE MARK TRANSLITERATE INTO YUAN BAO.

SN 78-532,191, FILED 12-14-2004.

DAVID C. REIHNER, EXAMINING ATTORNEY

Int. Cl.: 31

Prior U.S. Cls.: 1 and 46

United States Patent and Trademark Office

Reg. No. 3,482,087

Registered Aug. 5, 2008

**TRADEMARK
PRINCIPAL REGISTER**

TOUGH AS NAILS

FLORAGEM, LLC (CALIFORNIA LIMITED LIABILITY CORPORATION)
3742 BLUE BIRD CANYON ROAD
VISTA, CA 92084

THE MARK CONSISTS OF STANDARD CHARACTERS WITHOUT CLAIM TO ANY PARTICULAR FONT, STYLE, SIZE, OR COLOR.

FOR: LIVE PLANTS, IN CLASS 31 (U.S. CLS. 1 AND 46).

SN 78-533,475, FILED 12-16-2004.

FIRST USE 6-15-2008; IN COMMERCE 6-15-2008.

DAVID MURRAY, EXAMINING ATTORNEY

Int. Cl.: 36

Prior U.S. Cls.: 100, 101, and 102

United States Patent and Trademark Office

Reg. No. 3,482,088

Registered Aug. 5, 2008

**SERVICE MARK
PRINCIPAL REGISTER**



MARSHALL BANKFIRST CORP. (MINNESOTA CORPORATION)
150 SOUTH FIFTH STREET, SUITE 2910
MINNEAPOLIS, MN 55402

FOR: BANKING SERVICES, IN CLASS 36 (U.S. CLS. 100, 101 AND 102).

FIRST USE 2-0-2004; IN COMMERCE 2-0-2004.

NO CLAIM IS MADE TO THE EXCLUSIVE RIGHT TO USE "BANK, N.A.", APART FROM THE MARK AS SHOWN.

THE COLOR(S) BLUE AND WHITE IS/ARE CLAIMED AS A FEATURE OF THE MARK.

THE MARK CONSISTS OF A DISTINCTIVE LOGO COMPRISING THE DESIGN OF A MOUNTAIN IN THE COLOR WHITE WITH A STYLIZED LETTER "M" IN THE COLOR BLUE INSIDE THE MOUNTAIN AND THE "MARSHALL BANK, N.A." MARK APPEARING IN THE COLOR WHITE BENEATH THE MOUNTAIN, ALL ON A BLUE COLORED BACKGROUND.

SN 78-533,672, FILED 12-16-2004.

LEIGH CAROLINE CASE, EXAMINING ATTORNEY

Int. Cl.: 21

Prior U.S. Cls.: 2, 13, 23, 29, 30, 33, 40, and 50

United States Patent and Trademark Office

Reg. No. 3,482,089

Registered Aug. 5, 2008

**TRADEMARK
PRINCIPAL REGISTER**

CLORALEX PLUS

INDUSTRIAS ALEN, S.A. DE C.V. (MEXICO
CORPORATION)
BLVD. DIAZ ORDAZ NO. 1000
COL. LOS TREVINO
SANTA CATARINA, N.L., MEXICO C.P.66350

FOR: CLEANING PRODUCTS, NAMELY, PRE-
MOISTENED TOWELETTES FOR CLEANING, IN
CLASS 21 (U.S. CLS. 2, 13, 23, 29, 30, 33, 40 AND 50).

FIRST USE 2-28-2007; IN COMMERCE 2-28-2007.

THE MARK CONSISTS OF STANDARD CHAR-
ACTERS WITHOUT CLAIM TO ANY PARTICULAR
FONT, STYLE, SIZE, OR COLOR.

OWNER OF U.S. REG. NOS. 1,489,799, 1,809,859,
AND 2,669,415.

SN 78-537,567, FILED 12-23-2004.

ESTHER BELENKER, EXAMINING ATTORNEY

Int. Cl.: 21

Prior U.S. Cls.: 2, 13, 23, 29, 30, 33, 40, and 50

United States Patent and Trademark Office

Reg. No. 3,482,090

Registered Aug. 5, 2008

**TRADEMARK
PRINCIPAL REGISTER**



MUNGO, PAUL (UNITED STATES INDIVIDUAL)
6364 JONATHANS COVE DRIVE
VIRGINIA BEACH, VA 23464

FOR: BOTTLE HOLDER IN THE NATURE OF A WINE RACK THAT HOLDS BOTTLES IN A HORIZONTAL POSITION, IN CLASS 21 (U.S. CLS. 2, 13, 23, 29, 30, 33, 40 AND 50).

FIRST USE 11-15-2007; IN COMMERCE 12-1-2007.

NO CLAIM IS MADE TO THE EXCLUSIVE RIGHT TO USE "BOTTLE" AND "WORLD'S FINEST BOTTLE HOLDER", APART FROM THE MARK AS SHOWN.

THE COLOR(S) RED AND BLACK IS/ARE CLAIMED AS A FEATURE OF THE MARK.

THE MARKS CONSISTS OF THE WORDS "THE" AND "BOTTLE" AND THE BOTTLE/BAR DESIGN IN THE COLOR RED AND THE WORDING "BEVEL" AND "THE WORLD'S FINEST BOTTLE HOLDER" IS IN BLACK.

THE WORDING "BEVEL" HAS NO MEANING IN A FOREIGN LANGUAGE.

SN 78-538,536, FILED 12-27-2004.

BONNIE LUKEN, EXAMINING ATTORNEY

Int. Cls.: 3, 14, and 25

Prior U.S. Cls.: 1, 2, 4, 6, 22, 27, 28, 39, 50, 51, and 52

United States Patent and Trademark Office

Reg. No. 3,482,091

Registered Aug. 5, 2008

**TRADEMARK
PRINCIPAL REGISTER**

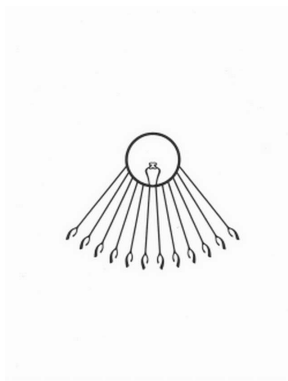

HUSSEIN, DAVID A. (UNITED STATES INDIVIDUAL)
442 49TH STREET
OAKLAND, CA 94609

FOR: SKIN CARE PRODUCTS, NAMELY, SOAPS, LOTIONS, LIP BALM, DEODORANTS AND COSMETICS, IN CLASS 3 (U.S. CLS. 1, 4, 6, 50, 51 AND 52).

FIRST USE 11-1-2004; IN COMMERCE 2-17-2005.

FOR: WATCHES AND JEWELRY, IN CLASS 14 (U.S. CLS. 2, 27, 28 AND 50).

FIRST USE 12-1-2004; IN COMMERCE 2-17-2005.

FOR: SHOES, HATS, JACKETS, PANTS, SHIRTS, UNDERWEAR, DRESSES, SKIRTS, BLAZERS, IN CLASS 25 (U.S. CLS. 22 AND 39).

FIRST USE 10-15-2004; IN COMMERCE 12-1-2004.

THE MARK CONSISTS OF A DESIGN OF THE SUN WITH TWELVE SUN RAY LIKE PROJECTIONS. INSIDE OF THE SUN IS A COBRA THAT RESTS ON THE INSIDE BOTTOM RING OF THE SUN.

SN 78-539,346, FILED 12-28-2004.

JOHN HWANG, EXAMINING ATTORNEY

Int. Cls.: 16, 41, and 44

Prior U.S. Cls.: 2, 5, 22, 23, 29, 37, 38, 50, 100, 101, and 107

Reg. No. 3,482,092

United States Patent and Trademark Office

Registered Aug. 5, 2008

**TRADEMARK
SERVICE MARK
PRINCIPAL REGISTER**

PINK POSITIVE

HAMMOND, CATHY (UNITED STATES INDIVIDUAL)
1133 SAPPHIRE STREET
SAN DIEGO, CA 92109

FOR: BOOKS, WORKBOOKS, NOTEBOOKS, MAGAZINES, JOURNALS, PAMPHLETS, GREETING CARDS, NEWSLETTERS, BROCHURES, CALENDARS, BUMPER STICKERS, POSTERS, AND PRINTED PRODUCTS, NAMELY, QUESTIONNAIRES, SURVEY ANSWER SHEETS; SURVEY RESULTS, NAMELY, REPORTS; PRINTED ARTICLES, SPEECHES, AND CHECKLISTS, ALL IN THE FIELD OF CANCER EDUCATION, RESEARCH, TREATMENT, CARE, SELF-CARE, REHABILITATION, AND LIFESTYLE CHANGES, IN CLASS 16 (U.S. CLS. 2, 5, 22, 23, 29, 37, 38 AND 50).

FIRST USE 3-1-2007; IN COMMERCE 3-1-2007.

FOR: PROVIDING EDUCATIONAL SERVICES IN THE FIELD OF CANCER RESEARCH, TREATMENT, CARE, SELF-CARE, REHABILITATION, AND LIFESTYLE CHANGES IN THE FORM OF LECTURES, WORKSHOPS, SEMINARS, COURSES, CLASSES, RETREATS, CONFERENCES, INDIVIDUAL INSTRUCTION, PERSONAL COACHING, AND DISTANCE EDUCATION ON THE INTERNET,

BY TELEPHONE, AND VIA OTHER DISTANCE EDUCATION MEDIA; PROVIDING NON-DOWNLOADABLE ONLINE JOURNALS, NEWSLETTERS AND SURVEY RESULTS, NAMELY, REPORTS, ALL IN THE FIELD OF CANCER EDUCATION, RESEARCH, TREATMENT, CARE, SELF-CARE, REHABILITATION, AND LIFESTYLE CHANGES, IN CLASS 41 (U.S. CLS. 100, 101 AND 107).

FIRST USE 10-20-2006; IN COMMERCE 10-20-2006.

FOR: PROVIDING ONLINE WEBSITES FEATURING HEALTH INFORMATION AND LINKS TO OTHER WEBSITES, IN THE FIELD OF CANCER EDUCATION, RESEARCH, TREATMENT, CARE, SELF-CARE, REHABILITATION, AND LIFESTYLE CHANGES, IN CLASS 44 (U.S. CLS. 100 AND 101).

FIRST USE 8-11-2005; IN COMMERCE 10-20-2006.

THE MARK CONSISTS OF STANDARD CHARACTERS WITHOUT CLAIM TO ANY PARTICULAR FONT, STYLE, SIZE, OR COLOR.

SN 78-544,259, FILED 1-7-2005.

ODESSA BIBBINS, EXAMINING ATTORNEY

Int. Cls.: 24 and 25

Prior U.S. Cls.: 22, 39, 42, and 50

United States Patent and Trademark Office

Reg. No. 3,482,093

Registered Aug. 5, 2008

**TRADEMARK
PRINCIPAL REGISTER**

ONLY GIRLS

INTERNATIONAL INTIMATES, INC. (DELA-
WARE CORPORATION), DBA BON BEBE,
SUITE 1908
112 WEST 34TH STREET
NEW YORK, NY 10120

FOR: ACCESSORIES FOR BABIES, NAMELY,
WASHCLOTHS, TOWELS, CRIB BLANKETS, CRIB
PADS, BUMPERS AND LINENS, IN CLASS 24 (U.S.
CLS. 42 AND 50).

FIRST USE 11-4-2005; IN COMMERCE 11-4-2005.

FOR: CLOTHING AND APPAREL FOR CHIL-
DREN AND INFANTS, NAMELY, UNDERGAR-
MENTS, PAJAMAS, BODYSUITS, ONE-PIECE

PLAYSUITS, LAYETTES, BIBS, BOOTIES AND
HEADWEAR, IN CLASS 25 (U.S. CLS. 22 AND 39).

FIRST USE 9-12-2005; IN COMMERCE 9-12-2005.

THE MARK CONSISTS OF STANDARD CHAR-
ACTERS WITHOUT CLAIM TO ANY PARTICULAR
FONT, STYLE, SIZE, OR COLOR.

NO CLAIM IS MADE TO THE EXCLUSIVE
RIGHT TO USE "GIRLS", APART FROM THE
MARK AS SHOWN.

SN 78-545,338, FILED 1-11-2005.

ELLEN PERKINS, EXAMINING ATTORNEY

Int. Cl.: 37

Prior U.S. Cls.: 100, 103, and 106

Reg. No. 3,482,094

United States Patent and Trademark Office

Registered Aug. 5, 2008

**SERVICE MARK
PRINCIPAL REGISTER**

DE YOUNG HOMES

DE YOUNG COMMUNITIES, INC. (CALIFORNIA
CORPORATION)
SUITE 101
2109 WEST BULLARD AVENUE
FRESNO, CA 93710

FOR: CONSTRUCTION SERVICES, NAMELY,
PLANNING, LAYING OUT AND CUSTOM CON-
STRUCTION OF RESIDENTIAL COMMUNITIES,
REAL ESTATE DEVELOPMENT AND CONSTRUC-
TION MANAGEMENT, IN CLASS 37 (U.S. CLS. 100,
103 AND 106).

FIRST USE 3-29-2008; IN COMMERCE 3-29-2008.

THE MARK CONSISTS OF STANDARD CHAR-
ACTERS WITHOUT CLAIM TO ANY PARTICULAR
FONT, STYLE, SIZE, OR COLOR.

NO CLAIM IS MADE TO THE EXCLUSIVE
RIGHT TO USE "HOMES", APART FROM THE
MARK AS SHOWN.

SN 78-548,872, FILED 1-17-2005.

DAVID MURRAY, EXAMINING ATTORNEY

Int. Cl.: 9

Prior U.S. Cls.: 21, 23, 26, 36, and 38

United States Patent and Trademark Office

Reg. No. 3,482,095

Registered Aug. 5, 2008

**TRADEMARK
PRINCIPAL REGISTER**

TRUSTCHIP

KOOLSPAN, INC. (DELAWARE CORPORATION)
11134 STEPHALEE LANE
NORTH BETHESDA, MD 208523656

FOR: COMPUTER CHIPS ENCODED TO ENABLE
ENCRYPTION AND SMART CARD FUNCTIONAL-
ITY AS WELL AS SECURITY AND AUTHENTICA-
TION USED IN CONNECTION WITH INTERNET
AND NETWORK ACCESSIBLE DEVICES, IN CLASS
9 (U.S. CLS. 21, 23, 26, 36 AND 38).

FIRST USE 2-0-2005; IN COMMERCE 4-0-2008.

THE MARK CONSISTS OF STANDARD CHAR-
ACTERS WITHOUT CLAIM TO ANY PARTICULAR
FONT, STYLE, SIZE, OR COLOR.

SN 78-550,581, FILED 1-20-2005.

SETH A. RAPPAPORT, EXAMINING ATTORNEY

Int. Cls.: 5 and 32

Prior U.S. Cls.: 6, 18, 44, 45, 46, 48, 51, and 52

United States Patent and Trademark Office

Reg. No. 3,482,096

Registered Aug. 5, 2008

**TRADEMARK
PRINCIPAL REGISTER**

ENERGY PRO

HANSEN BEVERAGE COMPANY (DELAWARE CORPORATION)
550 MONICA CIRCLE
SUITE 201
CORONA, CA 92880

FOR: NUTRITIONAL SUPPLEMENTS AND CARBONATED DRINKS, AND ENERGY SODAS FORTIFIED WITH VITAMINS, MINERALS, NUTRIENTS, AMINO ACIDS AND/OR HERBS , IN CLASS 5 (U.S. CLS. 6, 18, 44, 46, 51 AND 52).

FIRST USE 0-0-2006; IN COMMERCE 0-0-2006.

FOR: BEVERAGES, NAMELY, ENERGY DRINKS, IN CLASS 32 (U.S. CLS. 45, 46 AND 48).

FIRST USE 0-0-2006; IN COMMERCE 0-0-2006.

THE MARK CONSISTS OF STANDARD CHARACTERS WITHOUT CLAIM TO ANY PARTICULAR FONT, STYLE, SIZE, OR COLOR.

NO CLAIM IS MADE TO THE EXCLUSIVE RIGHT TO USE "ENERGY", APART FROM THE MARK AS SHOWN.

SN 78-559,365, FILED 2-2-2005.

DEZMONA MIZELLE, EXAMINING ATTORNEY

Int. Cl.: 41

Prior U.S. Cls.: 100, 101, and 107

United States Patent and Trademark Office

Reg. No. 3,482,097

Registered Aug. 5, 2008

**SERVICE MARK
PRINCIPAL REGISTER**

**LIQUID METAL JESUS
FILMS**

KACZANOWSKI, CONNIE (UNITED STATES IN-
DIVIDUAL)
960 PARK AVENUE, 1B
NEW YORK, NY 10028

FOR: ENTERTAINMENT SERVICES, NAMELY,
SCRIPT WRITING SERVICES; TELEVISION AND
MOTION PICTURE FILM PRODUCTIONS, IN
CLASS 41 (U.S. CLS. 100, 101 AND 107).

FIRST USE 5-1-2008; IN COMMERCE 5-1-2008.

THE MARK CONSISTS OF STANDARD CHAR-
ACTERS WITHOUT CLAIM TO ANY PARTICULAR
FONT, STYLE, SIZE, OR COLOR.

NO CLAIM IS MADE TO THE EXCLUSIVE
RIGHT TO USE "FILMS", APART FROM THE
MARK AS SHOWN.

SN 78-562,940, FILED 2-8-2005.

STEVEN PEREZ, EXAMINING ATTORNEY

Int. Cl.: 28

Prior U.S. Cls.: 22, 23, 38, and 50

United States Patent and Trademark Office

Reg. No. 3,482,098

Registered Aug. 5, 2008

**TRADEMARK
PRINCIPAL REGISTER**

**FOLLOW YOUR INNER
STAR**

AMERICAN GIRL, LLC (DELAWARE LTD LIAB
CO)
M1-1518
333 CONTINENTAL BLVD.
EL SEGUNDO, CA 902455012

FOR: DOLLS, DOLL CLOTHING, DOLL ACCES-
SORIES, TOYS, NAMELY, STUFFED TOYS, CLOTH-
ING AND ACCESSORIES FOR STUFFED TOYS;
PAPER DOLLS, CHILDREN'S GAMES, NAMELY,
CHILDREN'S PARTY GAMES, BOARD GAMES
AND PUZZLES, IN CLASS 28 (U.S. CLS. 22, 23, 38
AND 50).

FIRST USE 11-30-2006; IN COMMERCE 11-30-2006.

THE MARK CONSISTS OF STANDARD CHAR-
ACTERS WITHOUT CLAIM TO ANY PARTICULAR
FONT, STYLE, SIZE, OR COLOR.

SN 78-563,106, FILED 2-8-2005.

JILL PRATER, EXAMINING ATTORNEY

Int. Cl.: 41

Prior U.S. Cls.: 100, 101, and 107

United States Patent and Trademark Office

Reg. No. 3,482,099

Registered Aug. 5, 2008

**SERVICE MARK
PRINCIPAL REGISTER**



26 BRIX. LLC (CALIFORNIA LTD LIAB CO),
DBA B CELLARS,
30472 VIA FESTIVO
SAN JUAN CAPISTRANO, CA 92675

FOR: ENTERTAINMENT SERVICES, NAMELY,
WINE TASTINGS, IN CLASS 41 (U.S. CLS. 100, 101
AND 107).

FIRST USE 9-25-2007; IN COMMERCE 9-25-2007.

THE COLOR RED IS ARE CLAIMED AS A
FEATURE OF THE MARK.

THE COLOR RED APPEARS IN THE RECTAN-
GULAR BACKGROUND OF THE MARK.

SN 78-569,058, FILED 2-16-2005.

DAWN HAN, EXAMINING ATTORNEY

Int. Cl.: 9

Prior U.S. Cls.: 21, 23, 26, 36, and 38

Reg. No. 3,482,100

United States Patent and Trademark Office

Registered Aug. 5, 2008

**TRADEMARK
PRINCIPAL REGISTER**

PATROL POWER

AUTO ADDITIONS, INC. (OREGON CORPORATION)
4775 PORTLAND ROAD N.E.
SALEM, OR 97305

FOR: ELECTRICAL APPARATUS, NAMELY, ELECTRICAL PANELS, WIRING PANELS, WIRING DIAGRAMS, FUSE PANELS, ELECTRICAL WIRING HARNESES FOR USE WITHIN MOTOR VEHICLES, IN CLASS 9 (U.S. CLS. 21, 23, 26, 36 AND 38).

FIRST USE 10-10-2005; IN COMMERCE 10-10-2005.

THE MARK CONSISTS OF STANDARD CHARACTERS WITHOUT CLAIM TO ANY PARTICULAR FONT, STYLE, SIZE, OR COLOR.

NO CLAIM IS MADE TO THE EXCLUSIVE RIGHT TO USE "POWER", APART FROM THE MARK AS SHOWN.

SN 78-572,562, FILED 2-22-2005.

PAM WILLIS, EXAMINING ATTORNEY

Int. Cl.: 12

Prior U.S. Cls.: 19, 21, 23, 31, 35, and 44

Reg. No. 3,482,101

United States Patent and Trademark Office

Registered Aug. 5, 2008

**TRADEMARK
PRINCIPAL REGISTER**

**ANY TIME, ANY
WEATHER**

ZODIAC INTERNATIONAL, (FRANCE SOCIÉTÉ
PAR ACTIONS SIMPLIFIÉES)
2, RUE MAURICE MALLET
ISSY LES MOULINEAUX CEDEX, FRANCE 92130

FIRST USE 4-0-2008; IN COMMERCE 4-0-2008.

FOR: BOATS, INFLATABLE BOATS, TENDERS,
AND DINGHIES; COMPONENT PARTS FOR
BOATS, INFLATABLE BOATS, AND DINGHIES,
NAMELY, BENCHES, SEATS, AND SEAT BACKS,
STEERING WHEELS, WINDSHIELDS, DECK SEC-
TIONS, DECK DASHBOARDS, BOAT HOOKS, BOAT
TOPS, AND COVERS, IN CLASS 12 (U.S. CLS. 19, 21,
23, 31, 35 AND 44).

THE MARK CONSISTS OF STANDARD CHAR-
ACTERS WITHOUT CLAIM TO ANY PARTICULAR
FONT, STYLE, SIZE, OR COLOR.

SN 78-573,330, FILED 2-23-2005.

CAROL SPILS, EXAMINING ATTORNEY

Int. Cl.: 16

Prior U.S. Cls.: 2, 5, 22, 23, 29, 37, 38, and 50

United States Patent and Trademark Office

Reg. No. 3,482,102

Registered Aug. 5, 2008

**TRADEMARK
PRINCIPAL REGISTER**

RiDiSc

DATA SAFE-MEDIA LTD. (UNITED KINGDOM CORPORATION)
TERSTON HOUSE, 1 HULY HILL ROAD
NEWBRIDGE, EDINBURGH, LOTHIANS, UNITED KINGDOM EH28 8PH

FOR: PRINTED MATTER, NAMELY, MAGAZINES FEATURING INFORMATION ON PROTECTING COMPUTERS, DATA MANAGEMENT AND STORAGE; AND JOURNALS FEATURING INFORMATION ON PROTECTING COMPUTERS,

DATA MANAGEMENT AND STORAGE; STATIONERY, IN CLASS 16 (U.S. CLS. 2, 5, 22, 23, 29, 37, 38 AND 50).

FIRST USE 9-0-2005; IN COMMERCE 11-0-2006.

SN 78-578,097, FILED 3-2-2005.

PATRICIA EVANKO, EXAMINING ATTORNEY

Int. Cls.: 35 and 41

Prior U.S. Cls.: 100, 101, 102, and 107

United States Patent and Trademark Office

Reg. No. 3,482,103

Registered Aug. 5, 2008

**SERVICE MARK
PRINCIPAL REGISTER**



Sloan Career Cornerstone Center

ALFRED P. SLOAN FOUNDATION (DELAWARE CORPORATION)
630 FIFTH AVENUE
NEW YORK, NY 10111

FOR: PROVIDING CAREER INFORMATION VIA THE INTERNET ON NETWORKING, JOB HUNTING, CAREERS AND CAREER PLANNING IN THE FIELDS OF ENGINEERING, MATHEMATICS, INFORMATION TECHNOLOGY, AND THE PHYSICAL SCIENCES; AND PROVIDING INFORMATION VIA THE INTERNET RELATING TO THE TYPICAL WORK DAY OF PROFESSIONALS IN THE AFOREMENTIONED FIELDS, IN CLASS 35 (U.S. CLS. 100, 101 AND 102).

FIRST USE 4-15-2003; IN COMMERCE 4-15-2003.

FOR: PROVIDING INFORMATION VIA THE INTERNET ON EDUCATION IN THE FIELDS OF ENGINEERING, MATHEMATICS, INFORMATION TECHNOLOGY, AND THE PHYSICAL SCIENCES, IN CLASS 41 (U.S. CLS. 100, 101 AND 107).

FIRST USE 4-15-2003; IN COMMERCE 4-15-2003.

OWNER OF U.S. REG. NOS. 2,396,401, 2,627,856, AND OTHERS.

NO CLAIM IS MADE TO THE EXCLUSIVE RIGHT TO USE "CAREER" AND "CENTER", APART FROM THE MARK AS SHOWN.

THE MARK CONSISTS OF AN OPEN CUBE DESIGN DISPLAYING THE SIX SIDES OF A CUBE WITH NO MARKINGS. DISPLAYED TO THE SIDE OF THE CUBE IS A RECTANGLE WITH THE WORDS "SLOAN CAREER CORNERSTONE CENTER" DEPICTED INSIDE.

SN 78-579,065, FILED 3-3-2005.

PAULA MAHONEY, EXAMINING ATTORNEY

Int. Cl.: 33

Prior U.S. Cls.: 47 and 49

United States Patent and Trademark Office

Reg. No. 3,482,104

Registered Aug. 5, 2008

**TRADEMARK
PRINCIPAL REGISTER**

Divino

VILLANUEVA, CELIA (MEXICO INDIVIDUAL)
8950 RAILWOOD DRIVE
HOUSTON, TX 77078

FOR: MEZCAL, IN CLASS 33 (U.S. CLS. 47 AND
49).

FIRST USE 1-1-2005; IN COMMERCE 1-1-2005.

THE MARK CONSISTS OF STANDARD CHAR-
ACTERS WITHOUT CLAIM TO ANY PARTICULAR
FONT, STYLE, SIZE, OR COLOR.

THE ENGLISH TRANSLATION OF THE WORD
"DIVINO" IN THE MARK IS "DIVINE".

SN 78-579,272, FILED 3-3-2005.

ANNE MADDEN, EXAMINING ATTORNEY

Int. Cl.: 41

Prior U.S. Cls.: 100, 101, and 107

United States Patent and Trademark Office

Reg. No. 3,482,105

Registered Aug. 5, 2008

**SERVICE MARK
PRINCIPAL REGISTER**

HBBS

HBBS (CALIFORNIA SOLE PROPRIETORSHIP)
1376 ACORN STREET
COPPEROPOLIS, CA 95228

FOR: PROVIDING INFORMATION VIA THE INTERNET IN THE FIELD OF TRAINING COURSES IN STRATEGIC PLANNING RELATING TO ADVERTISING, PROMOTION, MARKETING AND BUSINESS; PROVIDING INFORMATION VIA THE INTERNET IN THE FIELD OF ONE-ON-ONE MENTORING IN THE FIELD OF ENTREPRENEURIAL SKILLS; PROVIDING INFORMATION VIA THE INTERNET IN THE FIELD OF PUBLICATION OF

ELECTRONIC BUSINESS-RELATED NEWSPAPERS ACCESSIBLE VIA A GLOBAL COMPUTER NETWORK, IN CLASS 41 (U.S. CLS. 100, 101 AND 107).

FIRST USE 12-29-2004; IN COMMERCE 3-12-2005.

THE MARK CONSISTS OF STANDARD CHARACTERS WITHOUT CLAIM TO ANY PARTICULAR FONT, STYLE, SIZE, OR COLOR.

SN 78-581,410, FILED 3-7-2005.

DAWN HAN, EXAMINING ATTORNEY

Int. Cl.: 9

Prior U.S. Cls.: 21, 23, 26, 36, and 38

United States Patent and Trademark Office

Reg. No. 3,482,106

Registered Aug. 5, 2008

**TRADEMARK
PRINCIPAL REGISTER**

EYE & EYE

RIAZI, SHIRIN (UNITED STATES INDIVIDUAL)
P.O. BOX 4777
WEST HILLS, CA 91308

THE MARK CONSISTS OF STANDARD CHAR-
ACTERS WITHOUT CLAIM TO ANY PARTICULAR
FONT, STYLE, SIZE, OR COLOR.

FOR: EYE GLASSES CASE, IN CLASS 9 (U.S. CLS.
21, 23, 26, 36 AND 38).

SN 78-582,750, FILED 3-8-2005.

FIRST USE 11-10-2007; IN COMMERCE 1-20-2008.

CHERYL CLAYTON, EXAMINING ATTORNEY

Int. Cl.: 44

Prior U.S. Cls.: 100 and 101

United States Patent and Trademark Office

Reg. No. 3,482,107

Registered Aug. 5, 2008

**SERVICE MARK
PRINCIPAL REGISTER**

**MOST VULNERABLE
UNIT**

THE CENTER FOR CASE MANAGEMENT, INC.
(MASSACHUSETTS CORPORATION)
6 PLEASANT STREET
SOUTH NATICK, MA 01760

FOR: CONSULTATION IN THE FIELD OF NURSING AND HEALTH CARE; PROVIDING NURSING AND HEALTH CARE INFORMATION; PROVIDING NURSING AND HEALTH CARE INFORMATION RELATING TO LOCATIONS IN HEALTH CARE FACILITIES WITH WHICH RISKS ARE ASSOCIATED, IN CLASS 44 (U.S. CLS. 100 AND 101).

FIRST USE 0-0-2005; IN COMMERCE 0-0-2005.

THE MARK CONSISTS OF STANDARD CHARACTERS WITHOUT CLAIM TO ANY PARTICULAR FONT, STYLE, SIZE, OR COLOR.

SN 78-590,029, FILED 3-18-2005.

JILL PRATER, EXAMINING ATTORNEY

Int. Cl.: 3

Prior U.S. Cls.: 1, 4, 6, 50, 51, and 52

Reg. No. 3,482,108

United States Patent and Trademark Office

Registered Aug. 5, 2008

TRADEMARK
PRINCIPAL REGISTER



BAGBLOCKER, INC. (INDIANA CORPORATION)
2159 DOCKSIDE DRIVE
GREENWOOD, IN 46143

FOR: FACIAL EYE COMPRESSION MASKS FOR
COSMETIC PURPOSES, IN CLASS 3 (U.S. CLS. 1, 4, 6,
50, 51 AND 52).

FIRST USE 5-1-2006; IN COMMERCE 5-1-2006.

NO CLAIM IS MADE TO THE EXCLUSIVE
RIGHT TO USE "EYE" AND "THERAPEUTIC EYE
WRAP", APART FROM THE MARK AS SHOWN.

THE MARK CONSISTS OF THE WORDING "EYE
LOVELY THERAPEUTIC EYE WRAP" WITH AN
OVAL AROUND THE TERM "EYE".

SN 78-592,363, FILED 3-22-2005.

ASMAT KHAN, EXAMINING ATTORNEY

Int. Cl.: 32

Prior U.S. Cls.: 45, 46, and 48

United States Patent and Trademark Office

Reg. No. 3,482,109

Registered Aug. 5, 2008

**TRADEMARK
PRINCIPAL REGISTER**

Lammsbräu

NEUMARKTER LAMMSBRÄU GEBR. EHRN-
SPERGER E.K. (FED REP GERMANY COR-
PORATION)
AMBERGER STRAÙE 1
NEUMARKT IN DER OBERPFALZ, FED REP GER-
MANY 92318

FOR: BEER, MINERAL WATER, LEMONADES,
FRUIT JUICES, FRUIT NECTARS, IN CLASS 32 (U.S.
CLS. 45, 46 AND 48).

FIRST USE 2-14-2008; IN COMMERCE 2-14-2008.

THE MARK CONSISTS OF STANDARD CHAR-
ACTERS WITHOUT CLAIM TO ANY PARTICULAR
FONT, STYLE, SIZE, OR COLOR.

SN 78-593,133, FILED 3-23-2005.

JILL PRATER, EXAMINING ATTORNEY

Int. Cls.: 35, 38, 41, 42, and 45

Prior U.S. Cls.: 100, 101, 102, 104, and 107

Reg. No. 3,482,110

United States Patent and Trademark Office

Registered Aug. 5, 2008

**SERVICE MARK
PRINCIPAL REGISTER**



GATHER INC. (DELAWARE CORPORATION)
85 DEVONSHIRE STREET, THIRD FLOOR
BOSTON, MA 02109

FOR: ADVERTISING TARGETING, PLACE-
MENT, TRACKING AND REPORTING SERVICES,
IN CLASS 35 (U.S. CLS. 100, 101 AND 102).

FIRST USE 6-1-2005; IN COMMERCE 6-1-2005.

FOR: INTEGRATED ON-LINE COMMUNITY
AND COMMUNICATIONS SERVICES, NAMELY,
GROUP MESSAGING, GROUP MODERATION
AND A MODERATING FORUM; NOTIFICATION
SERVICE IN THE NATURE OF PROVIDING AUTO-
MATIC MESSAGES TO MEMBERS IN A GROUP;
PROVIDING ELECTRONIC MAIL SERVICES; PRO-
VIDING ONLINE CHAT ROOMS AND ELECTRO-
NIC BULLETIN BOARDS FOR TRANSMISSION OF
MESSAGES AMONG USERS IN A FIELD OF GEN-
ERAL INTEREST, IN CLASS 38 (U.S. CLS. 100, 101
AND 104).

FIRST USE 6-1-2005; IN COMMERCE 6-1-2005.

FOR: ONLINE PUBLISHING OF TEXT AND
GRAPHIC WORKS IN ALL FIELDS; HOSTING
PARTIES FOR THE PURPOSE OF SOCIAL INTRO-

DUCTION AND NETWORKING; ORGANIZING
COMMUNITY ACTIVITIES AND CULTURAL
EVENTS, IN CLASS 41 (U.S. CLS. 100, 101 AND 107).

FIRST USE 6-1-2005; IN COMMERCE 6-1-2005.

FOR: COMPUTER SERVICES, NAMELY, PRO-
VIDING A SEARCH ENGINE FOR OBTAINING
INFORMATION FROM A GLOBAL OR LOCAL
COMPUTER NETWORK; INTEGRATED ON-LINE
COMMUNITY AND COMMUNICATIONS SERVI-
CES, NAMELY, PROVIDING SHARED GROUP-
HOSTING SPACE, IN CLASS 42 (U.S. CLS. 100 AND
101).

FIRST USE 9-15-2005; IN COMMERCE 9-15-2005.

FOR: INTERNET-BASED COMMUNITY NET-
WORKING SERVICES, PROVIDING FOR SOCIAL
NETWORKING AND PROVIDING PERSONAL IN-
FORMATION ABOUT OTHER MEMBERS IN A
GROUP, IN CLASS 45 (U.S. CLS. 100 AND 101).

FIRST USE 6-1-2005; IN COMMERCE 6-1-2005.

SN 78-597,499, FILED 3-29-2005.

DEBRA LEE, EXAMINING ATTORNEY

Int. Cl.: 41

Prior U.S. Cls.: 100, 101, and 107

United States Patent and Trademark Office

Reg. No. 3,482,111

Registered Aug. 5, 2008

**SERVICE MARK
PRINCIPAL REGISTER**

THE INDUSTRY COACH

MOIST, SHARON (UNITED STATES INDIVIDUAL)
P.O. BOX 11401
BOSEMAN, MT 59719

FOR: EDUCATIONAL SERVICES, NAMELY, CONDUCTING CLASSES, TELEVISED CLASSES, WORKSHOPS, SEMINARS, TELEVISED SEMINARS AND CONFERENCES IN THE FIELDS OF ACTING, ENTERTAINMENT, BUSINESS, EDUCATION AND CAREER DEVELOPMENT AND DISTRIBUTING COURSE MATERIAL, NAMELY, WORKBOOKS, HANDOUTS, PAMPHLETS, FLYERS AND BOOKS IN CONNECTION THEREWITH; PROVIDING INFORMATION IN THE FIELDS OF ACTING, ENTERTAINMENT, EDUCATION AND CAREER DEVELOPMENT VIA A GLOBAL COMPUTER NETWORK; EDUCATIONAL SERVICES, NAMELY, PERSONAL COACHING, PUBLIC AND PRIVATE

SPEAKING ENGAGEMENTS IN THE FIELDS OF ACTING, ENTERTAINMENT, EDUCATION AND CAREER PERSONAL DEVELOPMENT, IN CLASS 41 (U.S. CLS. 100, 101 AND 107).

FIRST USE 4-23-2005; IN COMMERCE 4-23-2005.

THE MARK CONSISTS OF STANDARD CHARACTERS WITHOUT CLAIM TO ANY PARTICULAR FONT, STYLE, SIZE, OR COLOR.

NO CLAIM IS MADE TO THE EXCLUSIVE RIGHT TO USE "COACH", APART FROM THE MARK AS SHOWN.

SN 78-597,507, FILED 3-29-2005.

RICHARD WHITE, EXAMINING ATTORNEY

Int. Cl.: 41

Prior U.S. Cls.: 100, 101, and 107

United States Patent and Trademark Office

Reg. No. 3,482,112

Registered Aug. 5, 2008

**SERVICE MARK
PRINCIPAL REGISTER**

PHANTOM ★ VOX

A PHANTOM VOX CORPORATION (PUERTO RICO CORPORATION)
1550 AVENUE, PONCE DE LEON, SUITE 700
SANTURCE, PUERTO RICO 00909

FOR: ENTERTAINMENT SERVICES, NAMELY,
PROVIDING A WEB SITE FEATURING MUSICAL
PERFORMANCES, MUSICAL VIDEOS, RELATED
FILM CLIPS, PHOTOGRAPHS, AND OTHER MUL-

TIMEDIA MATERIALS, IN CLASS 41 (U.S. CLS. 100,
101 AND 107).

FIRST USE 10-31-2001; IN COMMERCE 10-31-2001.

SN 78-599,614, FILED 3-31-2005.

CAROL SPILS, EXAMINING ATTORNEY

Int. Cl.: 18

Prior U.S. Cls.: 1, 2, 3, 22, and 41

United States Patent and Trademark Office

Reg. No. 3,482,113

Registered Aug. 5, 2008

**TRADEMARK
PRINCIPAL REGISTER**

FOX FILM ICONS

TWENTIETH CENTURY FOX FILM CORPORATION (DELAWARE CORPORATION)
10201 WEST PICO BOULEVARD
LOS ANGELES, CA 90035

OWNER OF U.S. REG. NOS. 2,553,757 AND 2,882,856.

FOR: HANDBAGS; TOTE BAGS, IN CLASS 18 (U.S. CLS. 1, 2, 3, 22 AND 41).

NO CLAIM IS MADE TO THE EXCLUSIVE RIGHT TO USE "FILM ICONS", APART FROM THE MARK AS SHOWN.

FIRST USE 8-31-2004; IN COMMERCE 8-31-2004.

SN 78-599,692, FILED 3-31-2005.

THE MARK CONSISTS OF STANDARD CHARACTERS WITHOUT CLAIM TO ANY PARTICULAR FONT, STYLE, SIZE, OR COLOR.

JIM RINGLE, EXAMINING ATTORNEY

Int. Cls.: 9, 16, and 42

**Prior U.S. Cls.: 2, 5, 21, 22, 23, 26, 29, 36, 37, 38, 50,
100, and 101**

Reg. No. 3,482,114

Registered Aug. 5, 2008

United States Patent and Trademark Office

**TRADEMARK
SERVICE MARK
PRINCIPAL REGISTER**

DS4000

INTERNATIONAL BUSINESS MACHINES COR-
PORATION (NEW YORK CORPORATION)
NEW ORCHARD ROAD
ARMONK, NY 10504

FOR: COMPUTER HARDWARE AND COMPU-
TER SOFTWARE FOR USE IN DATA STORAGE,
DATA ENCRYPTION, CONSOLIDATION OF DATA,
DISASTER TOLERANCE AND RECOVERY FOR
DATA, DATA PROTECTION, AND NETWORK
SHARING, AND INSTRUCTION MANUALS SOLD
AS A UNIT THEREWITH, IN CLASS 9 (U.S. CLS. 21,
23, 26, 36 AND 38).

FIRST USE 9-3-2004; IN COMMERCE 9-3-2004.

FOR: PRINTED MATTER, NAMELY, BRO-
CHURES, WRITTEN PRESENTATIONS AND
TEACHING MATERIALS IN THE FIELD OF DATA

STORAGE, IN CLASS 16 (U.S. CLS. 2, 5, 22, 23, 29, 37,
38 AND 50).

FIRST USE 9-3-2004; IN COMMERCE 9-3-2004.

FOR: COMPUTER CONSULTATION AND DE-
SIGN SERVICES IN THE FIELD OF DATA STO-
RAGE, IN CLASS 42 (U.S. CLS. 100 AND 101).

FIRST USE 9-3-2004; IN COMMERCE 9-3-2004.

THE MARK CONSISTS OF STANDARD CHAR-
ACTERS WITHOUT CLAIM TO ANY PARTICULAR
FONT, STYLE, SIZE, OR COLOR.

SN 78-603,450, FILED 4-6-2005.

MARY ROSSMAN, EXAMINING ATTORNEY

Int. Cls.: 5 and 10

Prior U.S. Cls.: 6, 18, 26, 39, 44, 46, 51, and 52

United States Patent and Trademark Office

Reg. No. 3,482,115

Registered Aug. 5, 2008

**TRADEMARK
PRINCIPAL REGISTER**

TBLUE

ZILA PHARMACEUTICALS, INC. (NEVADA CORPORATION)
ATTN: BRENDA PARSON
5227 N. 7TH STREET
PHOENIX, AZ 85014

FOR: MEDICAL PRODUCTS, NAMELY, CLINICAL MEDICAL REAGENTS AND DIAGNOSTIC PREPARATIONS FOR CLINICAL AND MEDICAL LABORATORY USE, IN CLASS 5 (U.S. CLS. 6, 18, 44, 46, 51 AND 52).

FIRST USE 1-30-2006; IN COMMERCE 1-30-2006.

FOR: MEDICAL DEVICES, NAMELY, ORAL PROBES FOR USE IN THE EXAMINATION AND EVALUATION OF PATIENTS; MEDICAL APPARATUS FOR INTRODUCING PHARMACEUTICAL

PREPARATIONS INTO THE HUMAN BODY CONTAINING AN ORAL SWABBING APPARATUS CONTAINING PHARMACEUTICAL PREPARATIONS FOR USE IN THE EXAMINATION AND EVALUATION OF PATIENTS, IN CLASS 10 (U.S. CLS. 26, 39 AND 44).

FIRST USE 1-30-2006; IN COMMERCE 1-30-2006.

THE MARK CONSISTS OF STANDARD CHARACTERS WITHOUT CLAIM TO ANY PARTICULAR FONT, STYLE, SIZE, OR COLOR.

SN 78-604,255, FILED 4-7-2005.

JAY BESCH, EXAMINING ATTORNEY

Int. Cl.: 41

Prior U.S. Cls.: 100, 101, and 107

United States Patent and Trademark Office

Reg. No. 3,482,116

Registered Aug. 5, 2008

**SERVICE MARK
PRINCIPAL REGISTER**

PARTS MANAGEMENT BOOTCAMP

NCM ASSOCIATES, INC. (MISSOURI CORPORATION)
SUITE 200
10551 BARKLEY
OVERLAND PARK, KS 66212

FOR: AUTOMOTIVE DEALER TRAINING, IN
CLASS 41 (U.S. CLS. 100, 101 AND 107).

FIRST USE 3-18-2008; IN COMMERCE 3-18-2008.

THE MARK CONSISTS OF STANDARD CHARACTERS WITHOUT CLAIM TO ANY PARTICULAR FONT, STYLE, SIZE, OR COLOR.

NO CLAIM IS MADE TO THE EXCLUSIVE RIGHT TO USE "PARTS MANAGEMENT", APART FROM THE MARK AS SHOWN.

SN 78-608,081, FILED 4-13-2005.

DAVID TAYLOR, EXAMINING ATTORNEY

Int. Cl.: 28

Prior U.S. Cls.: 22, 23, 38, and 50

United States Patent and Trademark Office

Reg. No. 3,482,117

Registered Aug. 5, 2008

**TRADEMARK
PRINCIPAL REGISTER**



HUONG MY TRADING CO., INC. (CALIFORNIA
CORPORATION)
11546 EDINGER AVE.
FOUNTAIN VALLEY, CA 92708

FIRST USE 1-0-2008; IN COMMERCE 1-0-2008.

SN 78-612,005, FILED 4-19-2005.

FOR: TENNIS BALLS, IN CLASS 28 (U.S. CLS. 22,
23, 38 AND 50).

DAWN HAN, EXAMINING ATTORNEY

Int. Cl.: 9

Prior U.S. Cls.: 21, 23, 26, 36, and 38

United States Patent and Trademark Office

Reg. No. 3,482,118

Registered Aug. 5, 2008

**TRADEMARK
PRINCIPAL REGISTER**

TURBO STEAM

SUNBEAM PRODUCTS, INC. (DELAWARE CORPORATION)
2381 EXECUTIVE CENTER DRIVE
BOCA RATON, FL 33431

FOR: ELECTRIC PRESSING IRONS AND ELECTRIC STEAM IRONS, IN CLASS 9 (U.S. CLS. 21, 23, 26, 36 AND 38).

FIRST USE 12-29-2007; IN COMMERCE 12-29-2007.

THE MARK CONSISTS OF STANDARD CHARACTERS WITHOUT CLAIM TO ANY PARTICULAR FONT, STYLE, SIZE, OR COLOR.

NO CLAIM IS MADE TO THE EXCLUSIVE RIGHT TO USE "STEAM", APART FROM THE MARK AS SHOWN.

SN 78-613,390, FILED 4-21-2005.

CHERYL CLAYTON, EXAMINING ATTORNEY

Int. Cl.: 20

Prior U.S. Cls.: 2, 13, 22, 25, 32, and 50

United States Patent and Trademark Office

Reg. No. 3,482,119

Registered Aug. 5, 2008

**TRADEMARK
PRINCIPAL REGISTER**

BUTTERFLY

BUTTERFLY WORLDWIDE, LLC (DELAWARE
CORPORATION)
772 AIRPORT BLVD.
ANN ARBOR, MI 48108

THE MARK CONSISTS OF STANDARD CHAR-
ACTERS WITHOUT CLAIM TO ANY PARTICULAR
FONT, STYLE, SIZE, OR COLOR.

FOR: METAL PICTURE FRAMES, METAL CUR-
TAIN RINGS, IN CLASS 20 (U.S. CLS. 2, 13, 22, 25, 32
AND 50).

SN 78-617,663, FILED 4-27-2005.

FIRST USE 7-27-2007; IN COMMERCE 7-27-2007.

MICHAEL WEBSTER, EXAMINING ATTORNEY

Int. Cl.: 6

Prior U.S. Cls.: 2, 12, 13, 14, 23, 25, and 50

Reg. No. 3,482,120

United States Patent and Trademark Office

Registered Aug. 5, 2008

**TRADEMARK
PRINCIPAL REGISTER**

AVF NEXUS

AVF GROUP LIMITED (UNITED KINGDOM
CORPORATION)
TELFORD SHROPSHIRE
ROAD 30, HORTONWOOD INDUSTRIAL ESTATE
TF1 7YE, UNITED KINGDOM

THE MARK CONSISTS OF STANDARD CHAR-
ACTERS WITHOUT CLAIM TO ANY PARTICULAR
FONT, STYLE, SIZE, OR COLOR.

FOR: METAL LCD AND PLASMA TELEVISION
WALL MOUNTS, IN CLASS 6 (U.S. CLS. 2, 12, 13, 14,
23, 25 AND 50).

SN 78-621,775, FILED 5-3-2005.

FIRST USE 10-31-2005; IN COMMERCE 10-31-2005.

HOWARD B. LEVINE, EXAMINING ATTORNEY

Int. Cl.: 35

Prior U.S. Cls.: 100, 101, and 102

United States Patent and Trademark Office

Reg. No. 3,482,121

Registered Aug. 5, 2008

**SERVICE MARK
PRINCIPAL REGISTER**

**STUDENTS SAVE. OTHERS
DON'T.**

JOURNEY EDUCATION MARKETING, INC.
(TEXAS CORPORATION)
13755 HUTTON DRIVE, SUITE 500
DALLAS, TX 75234

THE MARK CONSISTS OF STANDARD CHAR-
ACTERS WITHOUT CLAIM TO ANY PARTICULAR
FONT, STYLE, SIZE, OR COLOR.

FOR: CATALOG AND ONLINE RETAIL STORE
SERVICES FEATURING COMPUTER SOFTWARE,
COMPUTER HARDWARE AND BOOKS RELATING
THERE TO, IN CLASS 35 (U.S. CLS. 100, 101 AND 102).

SN 78-624,893, FILED 5-6-2005.

FIRST USE 2-28-2006; IN COMMERCE 2-28-2006.

JILL PRATER, EXAMINING ATTORNEY

Int. Cl.: 3

Prior U.S. Cls.: 1, 4, 6, 50, 51, and 52

Reg. No. 3,482,122

United States Patent and Trademark Office

Registered Aug. 5, 2008

**TRADEMARK
PRINCIPAL REGISTER**

ACTIVE RENEWAL SHIELD

COSMETIC DERMATOLOGY, INC. (FLORIDA
CORPORATION)
8798 NORTHWEST 15TH STREET
MIAMI, FL 33172

THE MARK CONSISTS OF STANDARD CHAR-
ACTERS WITHOUT CLAIM TO ANY PARTICULAR
FONT, STYLE, SIZE, OR COLOR.

FOR: AFTER SUN CREAMS, AFTER SUN LO-
TIONS, SUN BLOCKS, SUN CARE LOTIONS, SUN
CREAMS AND SUN SCREENS, IN CLASS 3 (U.S.
CLS. 1, 4, 6, 50, 51 AND 52).

SN 78-627,660, FILED 5-11-2005.

FIRST USE 3-16-2006; IN COMMERCE 3-16-2006.

BILL DAWE, EXAMINING ATTORNEY

Int. Cl.: 12

Prior U.S. Cls.: 19, 21, 23, 31, 35, and 44

Reg. No. 3,482,123

United States Patent and Trademark Office

Registered Aug. 5, 2008

**TRADEMARK
PRINCIPAL REGISTER**

TRANS SHUTTLE

THOR TECH, INC. (NEVADA CORPORATION)
SUITE 310
653 SOUTH SAGINAW STREET
SAGINAW, MI 48502

THE MARK CONSISTS OF STANDARD CHAR-
ACTERS WITHOUT CLAIM TO ANY PARTICULAR
FONT, STYLE, SIZE, OR COLOR.

FOR: COMMERCIAL BUSES, IN CLASS 12 (U.S.
CLS. 19, 21, 23, 31, 35 AND 44).

SN 78-631,818, FILED 5-17-2005.

FIRST USE 0-0-2005; IN COMMERCE 0-0-2005.

DAWN FELDMAN, EXAMINING ATTORNEY

Int. Cl.: 5

Prior U.S. Cls.: 6, 18, 44, 46, 51, and 52

Reg. No. 3,482,124

United States Patent and Trademark Office

Registered Aug. 5, 2008

**TRADEMARK
PRINCIPAL REGISTER**

ZYLOTRIM

OBESITY RESEARCH INSTITUTE, LLC (CALI-
FORNIA LTD LIAB CO)
5901 PRIESTLY DRIVE, SUITE 130
CARLSBAD, CA 92008

THE MARK CONSISTS OF STANDARD CHAR-
ACTERS WITHOUT CLAIM TO ANY PARTICULAR
FONT, STYLE, SIZE, OR COLOR.

FOR: DIETARY SUPPLEMENT, IN CLASS 5 (U.S.
CLS. 6, 18, 44, 46, 51 AND 52).

SN 78-632,186, FILED 5-18-2005.

FIRST USE 3-7-2008; IN COMMERCE 3-7-2008.

JENNIFER MARTIN, EXAMINING ATTORNEY

Int. Cl.: 36

Prior U.S. Cls.: 100, 101, and 102

United States Patent and Trademark Office

Reg. No. 3,482,125

Registered Aug. 5, 2008

**SERVICE MARK
PRINCIPAL REGISTER**



MARRIOTT INTERNATIONAL, INC. (DELA-
WARE CORPORATION)
10400 FERNWOOD ROAD
BETHESDA, MD 20817

FOR: REAL ESTATE SERVICES, NAMELY, LIST-
ING, LEASING, BROKERAGE, MANAGEMENT
AND OPERATION OF CONDOMINIUM RESIDENT
UNITS; REAL ESTATE FINANCING, IN CLASS 36
(U.S. CLS. 100, 101 AND 102).

FIRST USE 10-30-2004; IN COMMERCE 10-30-2004.

OWNER OF U.S. REG. NO. 2,268,939 AND OTH-
ERS.

THE MARK CONSISTS OF DESIGN OF A GRIF-
FIN.

SN 78-636,118, FILED 5-24-2005.

BRIAN NEVILLE, EXAMINING ATTORNEY

Int. Cl.: 9

Prior U.S. Cls.: 21, 23, 26, 36, and 38

United States Patent and Trademark Office

Reg. No. 3,482,126

Registered Aug. 5, 2008

**TRADEMARK
PRINCIPAL REGISTER**

EXIT 7A

MILLER, SCOTT A. (UNITED STATES INDIVIDUAL)
9 W. FRONT ST.
TRENTON, NJ 09608

FOR: PRE-RECORDED CD'S, DVD'S, AND VIDEOS FEATURING MUSIC AND MUSICAL PERFORMANCES, IN CLASS 9 (U.S. CLS. 21, 23, 26, 36 AND 38).

FIRST USE 1-8-2005; IN COMMERCE 1-8-2005.

THE MARK CONSISTS OF STANDARD CHARACTERS WITHOUT CLAIM TO ANY PARTICULAR FONT, STYLE, SIZE, OR COLOR.

SN 78-636,241, FILED 5-24-2005.

LEIGH CAROLINE CASE, EXAMINING ATTORNEY

Int. Cl.: 9

Prior U.S. Cls.: 21, 23, 26, 36, and 38

United States Patent and Trademark Office

Reg. No. 3,482,127

Registered Aug. 5, 2008

**TRADEMARK
PRINCIPAL REGISTER**

DSLXCEND

TRENDIUM, INC. (DELAWARE CORPORATION)
SUITE 200
13450 WEST SUNRISE BLVD.
SUNRISE, FL 33323

FOR: COMPUTER SOFTWARE USED FOR MANAGEMENT, MONITORING, MEASURING AND ANALYZING THE PERFORMANCE, TRAFFIC, USAGE AND UTILIZATION LEVELS OF GLOBAL COMPUTER AND BROADBAND TELECOMMUNICATIONS NETWORKS, IN CLASS 9 (U.S. CLS. 21, 23, 26, 36 AND 38).

FIRST USE 6-30-2006; IN COMMERCE 6-30-2006.

THE MARK CONSISTS OF STANDARD CHARACTERS WITHOUT CLAIM TO ANY PARTICULAR FONT, STYLE, SIZE, OR COLOR.

SN 78-636,388, FILED 5-24-2005.

MONIQUE MILLER, EXAMINING ATTORNEY

Int. Cl.: 18

Prior U.S. Cls.: 1, 2, 3, 22, and 41

United States Patent and Trademark Office

Reg. No. 3,482,128

Registered Aug. 5, 2008

**TRADEMARK
PRINCIPAL REGISTER**



DISNEY ENTERPRISES, INC. (DELAWARE CORPORATION)
500 SOUTH BUENA VISTA STREET
BURBANK, CA 91521

OWNER OF U.S. REG. NOS. 2,516,004, 2,784,058,
AND OTHERS.

FOR: CALLING CARD CASES; DUFFEL BAGS;
KNAPSACKS; OVERNIGHT BAGS, IN CLASS 18
(U.S. CLS. 1, 2, 3, 22 AND 41).

SN 78-637,112, FILED 5-25-2005.

FIRST USE 5-15-2008; IN COMMERCE 5-15-2008.

CARRIE GENOVESE, EXAMINING ATTORNEY

Int. Cl.: 24

Prior U.S. Cls.: 42 and 50

United States Patent and Trademark Office

Reg. No. 3,482,129

Registered Aug. 5, 2008

**TRADEMARK
PRINCIPAL REGISTER**



DISNEY ENTERPRISES, INC. (DELAWARE CORPORATION)
500 SOUTH BUENA VISTA STREET
BURBANK, CA 91521

FOR: BATH LINEN; BED LINEN; BED SHEETS; BED SKIRTS; COMFORTERS; CURTAINS; HOODED TOWELS; HOUSEHOLD LINEN; KITCHEN TOWELS; PILLOW CASES; PILLOW COVERS; POT HOLDERS; TABLE LINEN; TEXTILE PLACE MATS; WASHCLOTHS, IN CLASS 24 (U.S. CLS. 42 AND 50).

FIRST USE 5-15-2008; IN COMMERCE 5-15-2008.

OWNER OF U.S. REG. NOS. 2,516,004, 2,784,058, AND OTHERS.

SN 78-637,123, FILED 5-25-2005.

JANICE L. MCMORROW, EXAMINING ATTORNEY

Int. Cls.: 38 and 42

Prior U.S. Cls.: 100, 101, and 104

United States Patent and Trademark Office

Reg. No. 3,482,130

Registered Aug. 5, 2008

**SERVICE MARK
PRINCIPAL REGISTER**

UIONE

QUALCOMM INCORPORATED (DELAWARE CORPORATION)
5775 MOREHOUSE DRIVE
PATENT & TRADEMARK DEPT.
SAN DIEGO, CA 921211714

FOR: ELECTRONIC AND DIGITAL TRANSMISSION OF DATA, NAMELY, DOWNLOADING OF USER INTERFACES AND DIGITAL CONTENT FOR WIRELESS DEVICES, IN CLASS 38 (U.S. CLS. 100, 101 AND 104).

FIRST USE 6-2-2005; IN COMMERCE 6-2-2005.

FOR: COMPUTER SERVICES, NAMELY, COMPUTER CONSULTATION IN THE FIELD OF USER INTERFACES AND CONTENT FOR WIRELESS

DEVICES, PRODUCT DEVELOPMENT IN THE FIELD OF USER INTERFACES AND CONTENT FOR WIRELESS DEVICES, AND PRODUCT EVALUATION IN THE FIELD OF USER INTERFACES AND CONTENT FOR WIRELESS DEVICES, IN CLASS 42 (U.S. CLS. 100 AND 101).

FIRST USE 6-2-2005; IN COMMERCE 6-2-2005.

THE MARK CONSISTS OF STANDARD CHARACTERS WITHOUT CLAIM TO ANY PARTICULAR FONT, STYLE, SIZE, OR COLOR.

SN 78-637,391, FILED 5-25-2005.

ROBERT LAVACHE, EXAMINING ATTORNEY

Int. Cls.: 25 and 41

Prior U.S. Cls.: 22, 39, 100, 101, and 107

United States Patent and Trademark Office

Reg. No. 3,482,131

Registered Aug. 5, 2008

**TRADEMARK
SERVICE MARK
PRINCIPAL REGISTER**



NAACH COMPANY (CALIFORNIA SOLE PROPRIETORSHIP)
373 RIVER OAKS CIRCLE, APT 825
SAN JOSE, CA 95134

FOR: CLOTHING FOR DANCE, NAMELY, SHIRTS, TROUSERS, TRACK PANTS, T-SHIRTS, JACKETS, WRISTBANDS, BANDANAS, CAPS, SOCKS, SHORTS, BLOUSES, TOPS, SWEAT SHIRTS AND SWEAT PANTS, IN CLASS 25 (U.S. CLS. 22 AND 39).

FIRST USE 5-31-2006; IN COMMERCE 5-31-2006.

FOR: ENTERTAINMENT SERVICES, NAMELY, LIVE DANCE PERFORMANCES INCLUDING ETHNIC DANCES; EDUCATIONAL SERVICES, NAMELY, CLASSES IN THE FIELD OF DANCE; ENTERTAINMENT, NAMELY, PRODUCTION OF MOVIES AND STAGE EVENTS, IN CLASS 41 (U.S. CLS. 100, 101 AND 107).

FIRST USE 5-31-2006; IN COMMERCE 5-31-2006.

NO CLAIM IS MADE TO THE EXCLUSIVE RIGHT TO USE "NAACH" , APART FROM THE MARK AS SHOWN.

THE COLOR(S) WHITE, ORANGE, GOLD, AND RED IS/ARE CLAIMED AS A FEATURE OF THE MARK.

THE COLOR(S) WHITE APPEARS IN THE LETTERS, THE COLOR ORANGE APPEARS IN THE RECTANGLE FORMING THE BACKGROUND BEHIND THE LETTERS "NAA", THE COLOR RED APPEARS IN THE CROSS BARS IN THE LETTERS "N" AND "I" AND IN THE VERTICAL BARS AT THE RIGHT AND LEFT SIDES OF THE MARK, AND THE COLOR ORANGE APPEARS IN THE RECTANGLE FORMING THE BACK GROUND BEHIND THE LETTERS "CH".

THE FOREIGN WORDING IN THE MARK TRANSLATES INTO ENGLISH AS "MOVEMENT".

SN 78-639,068, FILED 5-27-2005.

ESTHER BELENKER, EXAMINING ATTORNEY

Int. Cl.: 36

Prior U.S. Cls.: 100, 101, and 102

United States Patent and Trademark Office

Reg. No. 3,482,132

Registered Aug. 5, 2008

**SERVICE MARK
PRINCIPAL REGISTER**

**FIDELITY PERSONAL
RETIREMENT ANNUITY**

FMR LLC (DELAWARE LTD LIAB CO)
F7D
82 DEVONSHIRE STREET
BOSTON, MA 02109

OWNER OF U.S. REG. NOS. 1,481,037, 2,156,688,
AND OTHERS.

FOR: ANNUITY UNDERWRITING AND INVEST-
MENT MANAGEMENT SERVICES, IN CLASS 36
(U.S. CLS. 100, 101 AND 102).

NO CLAIM IS MADE TO THE EXCLUSIVE
RIGHT TO USE "PERSONAL RETIREMENT ANNU-
ITY", APART FROM THE MARK AS SHOWN.

FIRST USE 8-15-2005; IN COMMERCE 8-15-2005.

SN 78-642,912, FILED 6-3-2005.

THE MARK CONSISTS OF STANDARD CHAR-
ACTERS WITHOUT CLAIM TO ANY PARTICULAR
FONT, STYLE, SIZE, OR COLOR.

CAROL SPILS, EXAMINING ATTORNEY

Int. Cl.: 1

Prior U.S. Cls.: 1, 5, 6, 10, 26, and 46

Reg. No. 3,482,133

United States Patent and Trademark Office

Registered Aug. 5, 2008

**TRADEMARK
PRINCIPAL REGISTER**

SPRAY-STICKER

J.R. SIMPLOT COMPANY (NEVADA CORPORATION)
P.O. BOX 27
BOISE, ID 83707

THE MARK CONSISTS OF STANDARD CHARACTERS WITHOUT CLAIM TO ANY PARTICULAR FONT, STYLE, SIZE, OR COLOR.

FOR: ADJUVANTS AND SURFACTANTS FOR USE WITH PESTICIDES AND FERTILIZERS FOR AGRICULTURAL, TURF, AND HORTICULTURAL USE, IN CLASS 1 (U.S. CLS. 1, 5, 6, 10, 26 AND 46).

SN 78-646,360, FILED 6-8-2005.

FIRST USE 3-27-2007; IN COMMERCE 3-27-2007.

BILL DAWE, EXAMINING ATTORNEY

Int. Cl.: 25

Prior U.S. Cls.: 22 and 39

United States Patent and Trademark Office

Reg. No. 3,482,134

Registered Aug. 5, 2008

**TRADEMARK
PRINCIPAL REGISTER**

DOWNTIME

HBI BRANDED APPAREL ENTERPRISES, LLC
(DELAWARE LTD LIAB CO)
1000 EAST HANES MILL ROAD
WINSTON-SALEM, NC 27105

FOR: PANTIES, BRIEFS, IN CLASS 25 (U.S. CLS. 22
AND 39).

FIRST USE 5-15-2006; IN COMMERCE 5-15-2006.

THE MARK CONSISTS OF STANDARD CHAR-
ACTERS WITHOUT CLAIM TO ANY PARTICULAR
FONT, STYLE, SIZE, OR COLOR.

OWNER OF U.S. REG. NO. 2,958,027.

SN 78-647,994, FILED 6-10-2005.

LINDA ESTRADA, EXAMINING ATTORNEY

Int. Cl.: 29

Prior U.S. Cl.: 46

United States Patent and Trademark Office

Reg. No. 3,482,135

Registered Aug. 5, 2008

TRADEMARK
PRINCIPAL REGISTER



C.K.F. FOODS, INC. (ILLINOIS CORPORATION)
325 WEST PROSPECT AVENUE
MOUNT PROSPECT, IL 60056

FOR: PORK; PORK SPARE RIB TIPS; MEAT; FROZEN ENTREES CONSISTING PRIMARILY OF MEAT; PREPARED ENTREES CONSISTING PRIMARILY OF MEAT; PACKAGED ENTREES CONSISTING PRIMARILY OF MEAT; FROZEN MEAT; PREPARED MEAT; AND PROCESSED MEAT, NAMELY, PORK, IN CLASS 29 (U.S. CL. 46).

FIRST USE 4-30-2005; IN COMMERCE 4-30-2005.

OWNER OF U.S. REG. NOS. 2,051,556 AND 2,626,024.

NO CLAIM IS MADE TO THE EXCLUSIVE RIGHT TO USE "EST. 1958", "FINEST QUALITY MEATS", AND "GREAT APPETIZER OR ENTRÉE!", APART FROM THE MARK AS SHOWN.

THE COLOR(S) WHITE, YELLOW, GOLD, RED, GREEN, BROWN, SILVER, AND BLACK IS/ARE CLAIMED AS A FEATURE OF THE MARK.

THE MARK CONSISTS OF THE COLOR BROWN APPEARS IN THE FOOD ON AND NEXT TO THE PLATE, IN THE SAUCE IN THE CUP, IN THE HANDLES OF THE UTENSILS, ON THE TRAY (BASKET) IN UPPER RIGHT PORTION OF THE MARK, IN THE OUTLINE OF THE STYLIZED WORDS "GREAT APPETIZER OR ENTRÉE!", AND IN THE OUTLINE OF THE BANNER FOR THE STYLIZED WORDS "GREAT APPETIZER OR ENTRÉE!" THE COLOR BLACK APPEARS ON THE FOOD ON AND NEXT TO THE PLATE, AS AN OUTLINE FOR THE STYLIZED WORDS "AUNT BESSIE'S EST. 1958", AS AN OUTLINE FOR THE

WHITE BANNER FOR THE STYLIZED WORDS "AUNT BESSIE'S EST. 1958", AND AS AN OUTLINE FOR THE RED BANNER FOR THE STYLIZED WORDS "FINEST QUALITY MEATS". THE COLOR WHITE APPEARS IN THE STYLIZED WORDS "GREAT APPETIZER OR ENTRÉE!", IN THE STYLIZED WORDS "FINEST QUALITY MEATS", IN THE BACKGROUND OF THE RECTANGULAR BANNER WITH ROUNDED CORNERS FOR THE STYLIZED WORDS "AUNT BESSIE'S EST. 1958", ON THE PLATE, ON THE RIM OF THE SAUCE CUP, ON PARTS OF THE CHECKERED NAPKIN ON AND NEXT TO THE TRAY (BASKET) IN THE UPPER RIGHT PORTION OF THE MARK. THE COLOR SILVER APPEARS IN THE FORK AND FORWARD ENDS OF THE UTENSILS. THE COLOR GOLD APPEARS IN THE BANNER FOR THE STYLIZED WORDS "GREAT APPETIZER OR ENTRÉE!", AND ON THE FOOD (CORNBREAD) ON THE TRAY (BASKET) IN THE UPPER RIGHT PORTION OF THE MARK. THE COLOR YELLOW APPEARS ON THE TABLE NEXT TO THE PLATE AND THE UTENSILS, AND ON THE FOOD (CORN BREAD) IN THE TRAY (BASKET) IN THE UPPER RIGHT PORTION OF THE MARK. THE COLOR GREEN APPEARS IN PARSLEY ON AND NEXT TO THE PLATE, ON THE STEMS OF THE TOMATOES, ON THE CHECKERED NAPKIN ON AND NEXT TO THE TRAY (BASKET) IN THE UPPER RIGHT PORTION OF THE MARK. THE COLOR RED APPEARS IN THE TOMATOES, IN THE FOR THE STYLIZED WORDS "AUNT BESSIE'S EST. 1958", IN THE BANNER FOR THE STYLIZED WORDS "FINEST QUALITY MEATS", AND AS BACKGROUND TO THE LEFT OF THE COFFEE CUP AND CHERRIES.

SN 78-648,466, FILED 6-10-2005.

CAROLYN CATALDO, EXAMINING ATTORNEY

Int. Cls.: 29, 30, and 35

Prior U.S. Cls.: 46, 100, 101, and 102

United States Patent and Trademark Office

Reg. No. 3,482,136

Registered Aug. 5, 2008

**TRADEMARK
SERVICE MARK
PRINCIPAL REGISTER**



NZN INTERNATIONAL LICENSING PTY LIMITED (AUSTRALIA COMPANY)
LEVEL 53, MLC CENTRE, MARTIN PLACE
SYDNEY, AUSTRALIA NSW 2000

FOR: YOGHURT BASED BEVERAGES, NAME-
LY, YOGHURT SMOOTHIES, YOGHURT DRINKS
INCLUDING FRUIT; MILK PRODUCTS, NAMELY,
MILK SMOOTHIES, IN CLASS 29 (U.S. CL. 46).

FIRST USE 4-0-2005; IN COMMERCE 4-0-2005.

FOR: FROZEN YOGHURT; ICE CREAM; FLA-
VORED ICES; MILK SHAKES, IN CLASS 30 (U.S. CL.
46).

FIRST USE 4-0-2005; IN COMMERCE 4-0-2005.

FOR: WHOLESALE AND RETAIL OUTLET AND
STORE SERVICES FEATURING ICE CREAM, ICES,
ICED COFFEE, FROZEN YOGHURT AND RELA-
TED EDIBLE FROZEN PRODUCTS, IN CLASS 35
(U.S. CLS. 100, 101 AND 102).

FIRST USE 7-13-2007; IN COMMERCE 7-13-2007.

THE MARK CONSISTS OF A FANCIFUL DESIGN
OF A LEAF.

SN 78-649,334, FILED 6-13-2005.

RONALD MCMORROW, EXAMINING ATTORNEY

Int. Cls.: 29, 30, 32, and 35

Prior U.S. Cls.: 45, 46, 48, 100, 101, and 102

United States Patent and Trademark Office

Reg. No. 3,482,137

Registered Aug. 5, 2008

**TRADEMARK
SERVICE MARK
PRINCIPAL REGISTER**



SUIZA DAIRY CORPORATION (PUERTO RICO CORPORATION)
P. O. BOX 363207, DE DIEGO AVENUE
CORNER SAN PATRICIO, URB. LA RIVIERA
SAN JUAN, PUERTO RICO 009693207

FOR: MILK AND COTTAGE CHEESE, IN CLASS 29 (U.S. CL. 46).

FIRST USE 1-22-2005; IN COMMERCE 1-22-2005.

FOR: ICE CREAM AND CHEESECAKE, IN CLASS 30 (U.S. CL. 46).

FIRST USE 1-22-2005; IN COMMERCE 1-22-2005.

FOR: NON-ALCOHOLIC BEVERAGES, NAMELY, FRUIT JUICES, IN CLASS 32 (U.S. CLS. 45, 46 AND 48).

FIRST USE 1-22-2005; IN COMMERCE 1-22-2005.

FOR: DISTRIBUTORSHIPS IN THE FIELD OF DAIRY PRODUCTS, IN CLASS 35 (U.S. CLS. 100, 101 AND 102).

FIRST USE 1-22-2005; IN COMMERCE 1-22-2005.

THE COLOR(S) RED AND WHITE IS/ARE CLAIMED AS A FEATURE OF THE MARK.

THE MARK CONSISTS OF THE SUN AND THE WORD "SUIZA" ARE RED AND THE BACKGROUND IS WHITE.

THE FOREIGN WORDING IN THE MARK TRANSLATES INTO ENGLISH AS "SWISS".

SN 78-649,432, FILED 6-13-2005.

JOHN WILKE, EXAMINING ATTORNEY

Int. Cl.: 9

Prior U.S. Cls.: 21, 23, 26, 36, and 38

United States Patent and Trademark Office

Reg. No. 3,482,138

Registered Aug. 5, 2008

**TRADEMARK
PRINCIPAL REGISTER**

RETROFIT AEROBIC PILATES RX

WINTROUB, BARBARA L. (UNITED STATES
INDIVIDUAL)
1821 WILSHIRE BLVD., SUITE 540
SANTA MONICA, CA 90403

OWNER OF U.S. REG. NO. 2,934,977.

FOR: PRE-RECORDED DVD'S FEATURING
CONTENT IN THE FIELD OF PILATES INSTRU-
CTION, IN CLASS 9 (U.S. CLS. 21, 23, 26, 36 AND 38).

NO CLAIM IS MADE TO THE EXCLUSIVE
RIGHT TO USE "AEROBIC PILATES", APART
FROM THE MARK AS SHOWN.

FIRST USE 5-14-2008; IN COMMERCE 5-14-2008.

SN 78-649,745, FILED 6-13-2005.

THE MARK CONSISTS OF STANDARD CHAR-
ACTERS WITHOUT CLAIM TO ANY PARTICULAR
FONT, STYLE, SIZE, OR COLOR.

BARNEY CHARLON, EXAMINING ATTORNEY

Int. Cls.: 35 and 40

Prior U.S. Cls.: 100, 101, 102, 103, and 106

United States Patent and Trademark Office

Reg. No. 3,482,139

Registered Aug. 5, 2008

**SERVICE MARK
PRINCIPAL REGISTER**



IMPRESSLINE, INC. (TEXAS CORPORATION)
3102 MAPLE AVE. SUITE 450
DALLAS, TX 75201

FOR: PROMOTING THE GOODS AND SERVICES OF OTHERS THROUGH THE MARKETING AND DISTRIBUTION OF PROMOTIONAL ITEMS; ON-LINE WHOLESALE STORE SERVICES FEATURING PROMOTIONAL ITEMS, NAMELY, CALCULATORS, CAPS, CARDHOLDERS, CIGARETTE LIGHTERS, CLOCKS, COIN BANKS, COMPACT DISC CASES, FOAM SPORTS BALLS, INSULATED BEVERAGE MUGS AND CONTAINERS, INSULATED CASES FOR BEVERAGES, KEY CHAINS, LETTER OPENERS, NOTEBOOKS, PENS, PEN AND PENCIL HOLDERS, PORTABLE RADIOS, SEWING KITS, AND UMBRELLAS, IN CLASS 35 (U.S. CLS. 100, 101 AND 102).

FIRST USE 7-0-2002; IN COMMERCE 2-0-2005.

FOR: CUSTOM MANUFACTURE OF PROMOTIONAL ITEMS, NAMELY, CALCULATORS, CAPS, CARDHOLDERS, CIGARETTE LIGHTERS, CLOCKS, COIN BANKS, COMPACT DISC CASES, FOAM SPORTS BALLS, INSULATED BEVERAGE MUGS AND CONTAINERS, INSULATED CASES FOR BEVERAGES, KEY CHAINS, LETTER OPENERS, NOTEBOOKS, PENS, PEN AND PENCIL HOLDERS, PORTABLE RADIOS, SEWING KITS, AND UMBRELLAS, IN CLASS 40 (U.S. CLS. 100, 103 AND 106).

FIRST USE 7-0-2002; IN COMMERCE 2-0-2005.

SN 78-650,655, FILED 6-14-2005.

SARA THOMAS, EXAMINING ATTORNEY

Int. Cl.: 25

Prior U.S. Cls.: 22 and 39

United States Patent and Trademark Office

Reg. No. 3,482,140

Registered Aug. 5, 2008

**TRADEMARK
PRINCIPAL REGISTER**

Austus

PAULITH USA, INC. (CALIFORNIA CORPORATION)
6460 CORVETTE STREET
COMMERCE, CA 90040

FOR: CLOTHING AND APPAREL, NAMELY, SHIRTS, JERSEYS, KNIT SHIRTS, POLO SHIRTS, SPORT SHIRTS, T-SHIRTS AND TOPS; CAPS, HATS, SWEATERS, JACKETS, PANTS, SWEAT PANTS, SKIRTS, UNDERWEAR, SOCKS, FOOTWEAR AND BELTS, IN CLASS 25 (U.S. CLS. 22 AND 39).

FIRST USE 1-1-2006; IN COMMERCE 1-1-2006.

THE MARK CONSISTS OF STANDARD CHARACTERS WITHOUT CLAIM TO ANY PARTICULAR FONT, STYLE, SIZE, OR COLOR.

SN 78-652,599, FILED 6-16-2005.

DOUGLAS LEE, EXAMINING ATTORNEY

Int. Cl.: 36

Prior U.S. Cls.: 100, 101, and 102

United States Patent and Trademark Office

Reg. No. 3,482,141

Registered Aug. 5, 2008

**SERVICE MARK
PRINCIPAL REGISTER**

FB TEN

AMERICAN FARM BUREAU FEDERATION (IL-
LINOIS CORPORATION)
SUITE 800
600 MARYLAND AVENUE, SW
WASHINGTON, DC 20024

FOR: PROVIDING A PROGRAM UNDER WHICH
HOLDERS OF TOBACCO QUOTAS MAY RECEIVE
ONE LUMP SUM PAYMENT, AT A DISCOUNTED
RATE, FOR THEIR TOBACCO QUOTAS, IN LIEU
OF ANNUAL PAYMENTS TO BUY OUT THEIR
QUOTAS UNDER THE USDA TOBACCO TRANSI-
TION PAYMENT PROGRAM, AND PROVIDING
FINANCIAL ADVICE IN CONNECTION THERE-
WITH, NAMELY, FINANCIAL PLANNING SERVI-
CES AND ESTATE, RETIREMENT AND

INVESTMENT PLANNING SERVICES, IN CLASS
36 (U.S. CLS. 100, 101 AND 102).

FIRST USE 8-1-2005; IN COMMERCE 8-1-2005.

THE MARK CONSISTS OF STANDARD CHAR-
ACTERS WITHOUT CLAIM TO ANY PARTICULAR
FONT, STYLE, SIZE, OR COLOR.

OWNER OF U.S. REG. NOS. 985,201, 2,960,158,
AND OTHERS.

SN 78-654,313, FILED 6-20-2005.

ALICE SUE CARRUTHERS, EXAMINING ATTOR-
NEY

Int. Cl.: 41

Prior U.S. Cls.: 100, 101, and 107

United States Patent and Trademark Office

Reg. No. 3,482,142

Registered Aug. 5, 2008

**SERVICE MARK
PRINCIPAL REGISTER**

The Seven Minute Coach

JML INDUSTRIES, INC. (ARKANSAS CORPORATION)
3827 CULBERHOUSE
JONESBORO, AR 72404

FOR: ORGANIZING AND CONDUCTING SEMINARS IN THE FIELD OF FINANCIAL AND PERSONAL PLANNING, IN CLASS 41 (U.S. CLS. 100, 101 AND 107).

FIRST USE 6-14-2005; IN COMMERCE 6-14-2005.

THE MARK CONSISTS OF STANDARD CHARACTERS WITHOUT CLAIM TO ANY PARTICULAR FONT, STYLE, SIZE, OR COLOR.

SN 78-654,550, FILED 6-20-2005.

BONNIE LUKEN, EXAMINING ATTORNEY

Int. Cl.: 42

Prior U.S. Cls.: 100 and 101

United States Patent and Trademark Office

Reg. No. 3,482,143

Registered Aug. 5, 2008

**SERVICE MARK
PRINCIPAL REGISTER**

BY DESIGN

INSPIRED DESIGN, LLC (MICHIGAN LTD LIAB
CO)
8200 DARBY ROAD
CLARKSVILLE, MI 48815

THE MARK CONSISTS OF STANDARD CHAR-
ACTERS WITHOUT CLAIM TO ANY PARTICULAR
FONT, STYLE, SIZE, OR COLOR.

FOR: DESIGN FOR OTHERS IN THE FIELD OF
JEWELRY, IN CLASS 42 (U.S. CLS. 100 AND 101).

SN 78-655,083, FILED 6-21-2005.

FIRST USE 5-16-2008; IN COMMERCE 5-16-2008.

PATRICIA EVANKO, EXAMINING ATTORNEY

Int. Cl.: 41

Prior U.S. Cls.: 100, 101, and 107

United States Patent and Trademark Office

Reg. No. 3,482,144

Registered Aug. 5, 2008

**SERVICE MARK
PRINCIPAL REGISTER**

EARTH AGENTS

PROTECT THE PLANET, INC. (HAWAII CORPORATION)
1593 ELUA STREET
HONOLULU, HI 96819

FOR: EDUCATIONAL AND ENTERTAINMENT SERVICES, NAMELY, PROVIDING A WEBSITE FEATURING VIDEOS, MOTION PICTURE CLIPS, PHOTOGRAPHS AND OTHER MULTIMEDIA MATERIALS RELATED TO ENVIRONMENTAL EDUCATION AND ENTERTAINMENT, IN CLASS 41 (U.S. CLS. 100, 101 AND 107).

FIRST USE 2-14-2008; IN COMMERCE 2-14-2008.

THE MARK CONSISTS OF STANDARD CHARACTERS WITHOUT CLAIM TO ANY PARTICULAR FONT, STYLE, SIZE, OR COLOR.

SN 78-655,485, FILED 6-21-2005.

INGRID C. EULIN, EXAMINING ATTORNEY

Int. Cl.: 28

Prior U.S. Cls.: 22, 23, 38, and 50

United States Patent and Trademark Office

Reg. No. 3,482,145

Registered Aug. 5, 2008

**TRADEMARK
PRINCIPAL REGISTER**

SprayZone

AQUA-LEISURE INDUSTRIES, INC. (MASSACHUSETTS CORPORATION)
525 BODWELL STREET
AVON, MA 02322

FOR: TOYS FOR USE IN AND AROUND WATER, NAMELY, WATER SQUIRTING TOYS; TARGET GAMES USED IN AND AROUND WATER; WATER BASKETBALL GOAL SETS; WEIGHTED STICKS, DISCS, AND RINGS FOR DIVE GAMES; WEIGHTED TOY HOOPS FOR USE IN SWIMMING POOL GAMES; INFLATABLE FLOATS FOR RECREATIONAL USE IN WATER; FLOAT ON WATER SPORTS GAMES UTILIZING BALLS AND FLOATS; INFLATABLE FLOATING WATER BOARDS; UN-

DERWATER GLIDERS, SKIMMERS AND DISCS; WATER SOAKING TOYS, IN CLASS 28 (U.S. CLS. 22, 23, 38 AND 50).

FIRST USE 5-0-2008; IN COMMERCE 5-0-2008.

THE MARK CONSISTS OF STANDARD CHARACTERS WITHOUT CLAIM TO ANY PARTICULAR FONT, STYLE, SIZE, OR COLOR.

SN 78-659,835, FILED 6-28-2005.

CHRISTOPHER BUONGIORNO, EXAMINING ATTORNEY

Int. Cl.: 41

Prior U.S. Cls.: 100, 101, and 107

United States Patent and Trademark Office

Reg. No. 3,482,146

Registered Aug. 5, 2008

**SERVICE MARK
PRINCIPAL REGISTER**

MAUI SANDS RESORT

BRIGHTON MANOR COMPANY (OHIO CORPORATION)
1625 EAST 31ST STREET
CLEVELAND, OH 44114

FOR: AMUSEMENT PARK SERVICES FEATURING WATER RIDES AND ATTRACTIONS, IN CLASS 41 (U.S. CLS. 100, 101 AND 107).

FIRST USE 5-30-2008; IN COMMERCE 5-30-2008.

THE MARK CONSISTS OF STANDARD CHARACTERS WITHOUT CLAIM TO ANY PARTICULAR FONT, STYLE, SIZE, OR COLOR.

NO CLAIM IS MADE TO THE EXCLUSIVE RIGHT TO USE "RESORT", APART FROM THE MARK AS SHOWN.

SN 78-661,951, FILED 6-30-2005.

AMY HELLA, EXAMINING ATTORNEY

Int. Cl.: 14

Prior U.S. Cls.: 2, 27, 28, and 50

United States Patent and Trademark Office

Reg. No. 3,482,147

Registered Aug. 5, 2008

**TRADEMARK
PRINCIPAL REGISTER**

**FOSTER'S HOME FOR
IMAGINARY FRIENDS**

THE CARTOON NETWORK, INC. (DELAWARE
CORPORATION)
C/O TURNER BROADCASTING SYSTEM
ONE CNN CENTER, 13 NORTH
ATLANTA, GA 303032762

FOR: CHARMS, LAPEL PINS AND COSTUME
JEWELRY, IN CLASS 14 (U.S. CLS. 2, 27, 28 AND 50).

FIRST USE 4-30-2007; IN COMMERCE 4-30-2007.

THE MARK CONSISTS OF STANDARD CHAR-
ACTERS WITHOUT CLAIM TO ANY PARTICULAR
FONT, STYLE, SIZE, OR COLOR.

SN 78-665,173, FILED 7-7-2005.

CARRIE GENOVESE, EXAMINING ATTORNEY

Int. Cl.: 31

Prior U.S. Cls.: 1 and 46

United States Patent and Trademark Office

Reg. No. 3,482,148

Registered Aug. 5, 2008

**TRADEMARK
PRINCIPAL REGISTER**

JORDAN STREET

ATWOOD, AARON D. (UNITED STATES INDIVIDUAL)
154 EAST MYRTLE ST.
PALMYRA, IL 62674

THE MARK CONSISTS OF STANDARD CHARACTERS WITHOUT CLAIM TO ANY PARTICULAR FONT, STYLE, SIZE, OR COLOR.

FOR: LIVING TREES, IN CLASS 31 (U.S. CLS. 1 AND 46).

SN 78-665,479, FILED 7-7-2005.

FIRST USE 1-5-2008; IN COMMERCE 3-15-2008.

KHANH LE, EXAMINING ATTORNEY

Int. Cl.: 20

Prior U.S. Cls.: 2, 13, 22, 25, 32, and 50

Reg. No. 3,482,149

United States Patent and Trademark Office

Registered Aug. 5, 2008

**TRADEMARK
PRINCIPAL REGISTER**

SLIDE-IT

NEWELL OPERATING COMPANY (DELAWARE
CORPORATION)
10B GELENLAKE PKWAY, SUITE 600
ATLANTA, GA 30328

THE MARK CONSISTS OF STANDARD CHAR-
ACTERS WITHOUT CLAIM TO ANY PARTICULAR
FONT, STYLE, SIZE, OR COLOR.

FOR: FURNITURE CASTERS, NAMELY, GLIDES
MADE OF PLASTIC, IN CLASS 20 (U.S. CLS. 2, 13, 22,
25, 32 AND 50).

SN 78-665,547, FILED 7-7-2005.

FIRST USE 8-22-2007; IN COMMERCE 8-22-2007.

KAREN K. BUSH, EXAMINING ATTORNEY

Int. Cls.: 37 and 42

Prior U.S. Cls.: 100, 101, 103, and 106

United States Patent and Trademark Office

Reg. No. 3,482,150

Registered Aug. 5, 2008

**SERVICE MARK
PRINCIPAL REGISTER**

RUSSULA

RUSSULA S.A. (SPAIN CORPORATION)
C/PASTEUR NO. 30 10
LA CORUÑA, SPAIN 15008

FOR: TECHNOLOGICAL SERVICES, NAMELY, INSTALLATION OF ELECTRONIC AND MECHANICAL COMPONENTS AND SYSTEMS IN THE FIELD OF METALS MANUFACTURING AND RELATED INDUSTRIES; INSTALLATION OF COMPUTER SYSTEMS, IN CLASS 37 (U.S. CLS. 100, 103 AND 106).

FIRST USE 0-0-1988; IN COMMERCE 11-0-2000.

FOR: SCIENTIFIC AND TECHNOLOGICAL SERVICES, NAMELY, PROVIDING DESIGN SERVICES FOR OTHERS IN THE FIELD OF ENGINEERING AND METALS MANUFACTURING AND RELATED INDUSTRIES AND SCIENTIFIC RESEARCH RELATED THERETO; INDUSTRIAL RESEARCH

AND ANALYSIS, NAMELY, ENGINEERING ANALYSIS OF ELECTRONIC AND MECHANICAL CONTROL SYSTEMS FOR THE METALS MANUFACTURING INDUSTRY TO IMPROVE PRODUCTIVITY AND EFFICIENCY; DESIGN AND DEVELOPMENT OF COMPUTERS AND SOFTWARE FOR OTHERS; AND ENGINEERING CONSULTATION SERVICES, IN CLASS 42 (U.S. CLS. 100 AND 101).

FIRST USE 0-0-1988; IN COMMERCE 11-0-2000.

THE MARK CONSISTS OF STANDARD CHARACTERS WITHOUT CLAIM TO ANY PARTICULAR FONT, STYLE, SIZE, OR COLOR.

SN 78-665,738, FILED 7-7-2005.

ANDREA SAUNDERS, EXAMINING ATTORNEY

Int. Cl.: 9

Prior U.S. Cls.: 21, 23, 26, 36, and 38

Reg. No. 3,482,151

United States Patent and Trademark Office

Registered Aug. 5, 2008

TRADEMARK
PRINCIPAL REGISTER



ALBIREO STUDIOS, LLC (VIRGINIA LTD LIAB
CO)
3567 ROCKYBAR HOLLOW LANE
FREE UNION, VA 22940

FOR: VIDEO GAME SOFTWARE, ELECTRONIC
GAME PROGRAMS, IN CLASS 9 (U.S. CLS. 21, 23, 26,
36 AND 38).

FIRST USE 8-28-2006; IN COMMERCE 8-28-2006.

NO CLAIM IS MADE TO THE EXCLUSIVE
RIGHT TO USE "STUDIOS", APART FROM THE
MARK AS SHOWN.

THE STIPLING IS FOR SHADING PURPOSES
ONLY.

SN 78-665,914, FILED 7-7-2005.

SAIMA MAKHDOOM, EXAMINING ATTORNEY

Int. Cl.: 35

Prior U.S. Cls.: 100, 101, and 102

United States Patent and Trademark Office

Reg. No. 3,482,152

Registered Aug. 5, 2008

**SERVICE MARK
PRINCIPAL REGISTER**



Turning innovation into productivity.

THE ITALIAN TRADE COMMISSION (ITALY
GOVERNMENT AGENCY)
401 N. MICHIGAN AVENUE
SUITE 3030
CHICAGO, IL 606114257

FOR: ORGANIZING EXHIBITIONS TO PRO-
MOTE MACHINERY, TECHNOLOGY AND MANU-
FACTURING PROCESSES FROM ITALY, IN CLASS
35 (U.S. CLS. 100, 101 AND 102).

FIRST USE 10-10-2007; IN COMMERCE 10-10-2007.

NO CLAIM IS MADE TO THE EXCLUSIVE
RIGHT TO USE "MACHINES ITALIA", APART
FROM THE MARK AS SHOWN.

THE ENGLISH TRANSLATION OF THE WORD-
ING "ITALIA" IS "ITALY".

SN 78-666,813, FILED 7-8-2005.

DAWN HAN, EXAMINING ATTORNEY

Int. Cl.: 9

Prior U.S. Cls.: 21, 23, 26, 36, and 38

Reg. No. 3,482,153

United States Patent and Trademark Office

Registered Aug. 5, 2008

**TRADEMARK
PRINCIPAL REGISTER**

E-GLUE

ANGELANTONI INDUSTRIE S.P.A. (ITALY SOCIETA PER AZIONI)
LOCALITA CIMACOLLE, 464
MASSA MARTANA (PERUGIA), ITALY I-06056

FOR: INTEROPERABILITY SOFTWARE FOR SCIENTIFIC DATA MANAGEMENT SYSTEMS FOR USE IN MANAGING BIO-REPOSITORIES AND STORING BIOLOGICAL SAMPLES , IN CLASS 9 (U.S. CLS. 21, 23, 26, 36 AND 38).

FIRST USE 4-30-2006; IN COMMERCE 4-30-2006.

THE MARK CONSISTS OF STANDARD CHARACTERS WITHOUT CLAIM TO ANY PARTICULAR FONT, STYLE, SIZE, OR COLOR.

PRIORITY CLAIMED UNDER SEC. 44(D) ON ERPN CMNTY TM OFC APPLICATION NO. 004498788, FILED 6-21-2005.

SN 78-667,409, FILED 7-11-2005.

DAVID TAYLOR, EXAMINING ATTORNEY

Int. Cl.: 1

Prior U.S. Cls.: 1, 5, 6, 10, 26, and 46

United States Patent and Trademark Office

Reg. No. 3,482,154

Registered Aug. 5, 2008

**TRADEMARK
PRINCIPAL REGISTER**

TEST TODAY FOR A HEALTHIER
TOMORROW

NATURALCHECK, LLC (DELAWARE LTD LIAB
CO)
3511 SILVERSIDE ROAD, SUITE 105
WILMINGTON, DE 19810

THE MARK CONSISTS OF STANDARD CHAR-
ACTERS WITHOUT CLAIM TO ANY PARTICULAR
FONT, STYLE, SIZE, OR COLOR.

FOR: TEST KITS CONSISTING PRIMARILY OF
REAGENTS FOR SCIENTIFIC USE AND INSTRUC-
TIONAL BOOKLETS, IN CLASS 1 (U.S. CLS. 1, 5, 6, 10,
26 AND 46).

SN 78-671,109, FILED 7-15-2005.

FIRST USE 4-21-2008; IN COMMERCE 4-21-2008.

SHAUNIA CARLYLE, EXAMINING ATTORNEY

Int. Cl.: 30

Prior U.S. Cl.: 46

United States Patent and Trademark Office

Reg. No. 3,482,155

Registered Aug. 5, 2008

TRADEMARK
PRINCIPAL REGISTER



FCW IMPORTS & EXPORTS, LLC (CALIFORNIA
LTD LIAB CO)
332 HARBOR WAY
SOUTH SAN FRANCISCO, CA 94080

FOR: BAKERY GOODS, COOKIES, CRACKERS
AND FLATBREAD, IN CLASS 30 (U.S. CL. 46).

FIRST USE 8-20-2007; IN COMMERCE 8-23-2007.

NO CLAIM IS MADE TO THE EXCLUSIVE
RIGHT TO USE "FINEST", APART FROM THE
MARK AS SHOWN.

THE COLOR(S) DARK BLUE, GOLD, GREEN,
RED AND WHITE IS/ARE CLAIMED AS A FEAT-
TURE OF THE MARK.

THE MARK CONSISTS OF THE STYLIZED
WORDS "OROBELLO'S FINEST" AND A WHEAT
SHEAF DESIGN SUPERIMPOSED ON A SEMI-REC-
TANGULAR DARK BLUE BACKGROUND WITH
RED AND GOLD BORDERS. THE LEADING LET-
TERS "O," "R" AND "O" OF THE WORD "OROBE-
LLO'S" ARE GOLD IN COLOR AND THE
FOLLOWING LETTERS "B," "E," "L," "L," "O" AND
"S" ARE WHITE IN COLOR. THE LETTERS OF THE
WORD "FINEST" ARE DARK BLUE AND EACH
LETTER IS OUTLINED IN WHITE WITH A DARK
BLUE SHADOW. THE WHEAT SHEAF DESIGN IS
SUBSTANTIALLY GOLD WITH GREEN HIGH-
LIGHTS AT THE TIPS.

SN 78-673,368, FILED 7-19-2005.

JENNIFER DIXON, EXAMINING ATTORNEY

Int. Cl.: 7

Prior U.S. Cls.: 13, 19, 21, 23, 31, 34, and 35

United States Patent and Trademark Office

Reg. No. 3,482,156

Registered Aug. 5, 2008

**TRADEMARK
PRINCIPAL REGISTER**

ADVANTA SERIES

MIELE, INC. (DELAWARE CORPORATION)
9 INDEPENDENCE WAY
PRINCETON, NJ 08540

FOR: DISH WASHING MACHINES, IN CLASS 7
(U.S. CLS. 13, 19, 21, 23, 31, 34 AND 35).

FIRST USE 1-1-2005; IN COMMERCE 6-30-2005.

THE MARK CONSISTS OF STANDARD CHARACTERS WITHOUT CLAIM TO ANY PARTICULAR FONT, STYLE, SIZE, OR COLOR.

NO CLAIM IS MADE TO THE EXCLUSIVE RIGHT TO USE "SERIES", APART FROM THE MARK AS SHOWN.

SN 78-674,545, FILED 7-20-2005.

JAMES GRIFFIN, EXAMINING ATTORNEY

Int. Cls.: 1 and 19

Prior U.S. Cls.: 1, 5, 6, 10, 12, 26, 33, 46, and 50

United States Patent and Trademark Office

Reg. No. 3,482,157

Registered Aug. 5, 2008

**TRADEMARK
PRINCIPAL REGISTER**

PermaFlash

JOHNS MANVILLE (DELAWARE CORPORATION)
717 SEVENTEENTH STREET
DENVER, CO 80202

FOR: ROOFING ADHESIVE, IN CLASS 1 (U.S. CLS. 1, 5, 6, 10, 26 AND 46).

FIRST USE 3-6-2007; IN COMMERCE 3-6-2007.

FOR: ROOFING FABRICS , IN CLASS 19 (U.S. CLS. 1, 12, 33 AND 50).

FIRST USE 3-6-2007; IN COMMERCE 3-6-2007.

THE MARK CONSISTS OF STANDARD CHARACTERS WITHOUT CLAIM TO ANY PARTICULAR FONT, STYLE, SIZE, OR COLOR.

SN 78-675,063, FILED 7-21-2005.

ANDREA SAUNDERS, EXAMINING ATTORNEY

Int. Cl.: 9

Prior U.S. Cls.: 21, 23, 26, 36, and 38

Reg. No. 3,482,158

United States Patent and Trademark Office

Registered Aug. 5, 2008

**TRADEMARK
PRINCIPAL REGISTER**

STRATIMAGIC

PARADIGM GEOPHYSICAL CORP. (DELAWARE CORPORATION)
820 GESSNER SUITE 400
TWO MEMORIAL PLAZA
HOUSTON, TX 77024

FOR: COMPUTER SOFTWARE FOR GENERATING, CHARACTERIZING, AND ANALYZING IMAGES OF THE SUBSURFACE FOR ALL STAGES OF OIL AND GAS EXPLORATION, APPRAISAL, AND PRODUCTION; COMPUTER SOFTWARE THAT EMPLOYS NEURAL NETWORK AND OTHER CLASSIFICATION METHODOLOGIES TO RELATE SUBSURFACE IMAGES OF SEISMIC DATA TO

GEOLOGIC FEATURES IN THE FIELDS OF OIL AND GAS EXPLORATION AND PRODUCTION, IN CLASS 9 (U.S. CLS. 21, 23, 26, 36 AND 38).

FIRST USE 0-0-1997; IN COMMERCE 0-0-1997.

THE MARK CONSISTS OF STANDARD CHARACTERS WITHOUT CLAIM TO ANY PARTICULAR FONT, STYLE, SIZE, OR COLOR.

SN 78-675,585, FILED 7-21-2005.

BILL DAWE, EXAMINING ATTORNEY

Int. Cl.: 9

Prior U.S. Cls.: 21, 23, 26, 36, and 38

United States Patent and Trademark Office

Reg. No. 3,482,159

Registered Aug. 5, 2008

**TRADEMARK
PRINCIPAL REGISTER**

NANOCHROME

INTELVAC CORPORATION (CANADA CORPORATION)
247 ARMSTRONG AVENUE
GEORGETOWN, ONTARIO, CANADA L7G 4X6

FOR: ELECTRON BEAM EVAPORATORS, IN CLASS 9 (U.S. CLS. 21, 23, 26, 36 AND 38).

FIRST USE 4-24-2008; IN COMMERCE 4-24-2008.

THE MARK CONSISTS OF STANDARD CHARACTERS WITHOUT CLAIM TO ANY PARTICULAR FONT, STYLE, SIZE, OR COLOR.

PRIORITY CLAIMED UNDER SEC. 44(D) ON CANADA APPLICATION NO. 1247628, FILED 2-17-2005, REG. NO. TMA665,224, DATED 5-30-2006, EXPIRES 5-30-2021.

SN 78-678,177, FILED 7-26-2005.

ATTIYA MALIK, EXAMINING ATTORNEY

Int. Cl.: 9

Prior U.S. Cls.: 21, 23, 26, 36, and 38

United States Patent and Trademark Office

Reg. No. 3,482,160

Registered Aug. 5, 2008

**TRADEMARK
PRINCIPAL REGISTER**

medi|mate

AMPHENOL-TUCHEL ELECTRONICS GMBH
(FED REP GERMANY CORPORATION)
AUGUST-HAUSSER-STR. 10
HEILBRONN, FED REP GERMANY 74080

FOR: ELECTRIC AND ELECTRONIC CONNECTORS AND PARTS THEREOF, NAMELY, ELECTRIC AND ELECTRONIC CONTACTS AND CONTACTING APPARATUS, IN PARTICULAR FOR POWER CONNECTORS, HEAVY DUTY CONNECTORS, CHIP CARDS AND MEMORY CARDS; ELECTRIC CONNECTORS FOR CONNECTION CABLES; ELECTRIC COUPLINGS; COUPLERS FOR DATA PROCESSING DEVICES; ELECTRIC PLUGS, ELECTRIC SOCKETS, ELECTRIC CONNECTORS; MICROPROCESSORS; CONNECTION CABLES FOR ELECTRIC LINES; ELECTRICAL CABLES FOR USE IN CONNECTIONS; ELECTRIC SWITCHES; ENCODED ELECTRONIC TAGS FOR USE IN THE FIELD OF PASSIVE LABELING, TRA-

CING OR TRACKING OF GOODS; SMART CARD ELECTRONIC CONNECTORS; SIM CARD READERS; ELECTRONIC MULTIMEDIA CARD CONNECTORS, NOT INCLUDING DATA TRANSMISSION APPARATUS FOR PERSONAL MEDICAL EMERGENCY RESPONSE PURPOSES, IN CLASS 9 (U.S. CLS. 21, 23, 26, 36 AND 38).

FIRST USE 10-4-2007; IN COMMERCE 10-4-2007.

PRIORITY CLAIMED UNDER SEC. 44(D) ON FED REP GERMANY APPLICATION NO. 30504484.2, FILED 1-27-2005, REG. NO. 30504484, DATED 3-31-2005, EXPIRES 3-31-2015.

SN 78-679,984, FILED 7-27-2005.

DARRYL SPRUILL, EXAMINING ATTORNEY

Int. Cl.: 28

Prior U.S. Cls.: 22, 23, 38, and 50

United States Patent and Trademark Office

Reg. No. 3,482,161

Registered Aug. 5, 2008

**TRADEMARK
PRINCIPAL REGISTER**

MISSION FUEL

MISSION ITECH HOCKEY, INC. (DELAWARE
CORPORATION)
175 TECHNOLOGY DRIVE, SUITE 150
IRVINE, CA 92618

FOR: ICE HOCKEY SKATES; HOCKEY PROTEC-
TIVE GEAR, NAMELY, SHOULDER PADS, ELBOW
PADS, SHIN GUARDS; AND HOCKEY GLOVES, IN
CLASS 28 (U.S. CLS. 22, 23, 38 AND 50).

FIRST USE 1-0-2006; IN COMMERCE 1-0-2006.

THE MARK CONSISTS OF STANDARD CHAR-
ACTERS WITHOUT CLAIM TO ANY PARTICULAR
FONT, STYLE, SIZE, OR COLOR.

OWNER OF U.S. REG. NOS. 2,211,348, 2,267,286,
AND 2,323,531.

SN 78-680,385, FILED 7-28-2005.

CAROLYN CATALDO, EXAMINING ATTORNEY

Int. Cl.: 9

Prior U.S. Cls.: 21, 23, 26, 36, and 38

United States Patent and Trademark Office

Reg. No. 3,482,162

Registered Aug. 5, 2008

**TRADEMARK
PRINCIPAL REGISTER**

GHOSTLY

V4 HOLDINGS, LLC (MICHIGAN LTD LIAB CO)
PO BOX 7120
ANN ARBOR, MI 48107

FOR: MOTION PICTURE FILMS AND DOWN-
LOADABLE MOTION PICTURE FILMS FEATUR-
ING LIVE ACTION, MUSIC, MUSIC GROUPS,
ANIMATION AND/OR DOCUMENTARY THEMES;
DOWNLOADABLE VIDEO RECORDINGS, NAME-
LY, RECORDINGS OF MOTION PICTURE FILMS
FEATURING LIVE ACTION, MUSIC, MUSIC
GROUPS, ANIMATION AND/OR DOCUMENTARY

THEMES, IN CLASS 9 (U.S. CLS. 21, 23, 26, 36 AND
38).

FIRST USE 5-13-2008; IN COMMERCE 5-13-2008.

THE MARK CONSISTS OF STANDARD CHAR-
ACTERS WITHOUT CLAIM TO ANY PARTICULAR
FONT, STYLE, SIZE, OR COLOR.

SN 78-680,450, FILED 7-28-2005.

JILL PRATER, EXAMINING ATTORNEY

Int. Cl.: 9

Prior U.S. Cls.: 21, 23, 26, 36, and 38

United States Patent and Trademark Office

Reg. No. 3,482,163

Registered Aug. 5, 2008

**TRADEMARK
PRINCIPAL REGISTER**



V4 HOLDINGS, LLC (MICHIGAN LTD LIAB CO)
PO BOX 7120
ANN ARBOR, MI 48107

FOR: MOTION PICTURE FILMS AND DOWN-
LOADABLE MOTION PICTURE FILMS FEATUR-
ING LIVE ACTION, MUSIC, MUSIC GROUPS,
ANIMATION AND/OR DOCUMENTARY THEMES;
DOWNLOADABLE VIDEO RECORDINGS, NAME-
LY, RECORDINGS OF MOTION PICTURE FILMS
FEATURING LIVE ACTION, MUSIC, MUSIC
GROUPS, ANIMATION AND/OR DOCUMENTARY

THEMES, IN CLASS 9 (U.S. CLS. 21, 23, 26, 36 AND
38).

FIRST USE 6-1-2007; IN COMMERCE 6-1-2007.

THE MARK CONSISTS OF AN ARTISTIC REN-
DERING OF A GHOST INSIDE A CIRCLE.

SN 78-680,491, FILED 7-28-2005.

JILL PRATER, EXAMINING ATTORNEY

Int. Cl.: 36

Prior U.S. Cls.: 100, 101, and 102

United States Patent and Trademark Office

Reg. No. 3,482,164

Registered Aug. 5, 2008

**SERVICE MARK
PRINCIPAL REGISTER**

TALL TREE

LENGA INVESTMENT MANAGEMENT HOLD-
CO, LLC (DELAWARE LTD LIAB CO)
C/O WILLIAM LENGA
P.O. BOX 06350
CHICAGO, IL 60606

FOR: ADVICE RELATING TO INVESTMENTS;
FINANCIAL MANAGEMENT; FUNDS INVEST-
MENT; INVESTMENT ADVICE; INVESTMENT
MANAGEMENT; INVESTMENT SERVICES, NAME-
LY, ASSET ACQUISITION, CONSULTATION, DE-
VELOPMENT AND MANAGEMENT SERVICES, IN
CLASS 36 (U.S. CLS. 100, 101 AND 102).

FIRST USE 7-31-2005; IN COMMERCE 7-31-2005.

THE MARK CONSISTS OF STANDARD CHAR-
ACTERS WITHOUT CLAIM TO ANY PARTICULAR
FONT, STYLE, SIZE, OR COLOR.

SN 78-682,433, FILED 8-1-2005.

HEATHER THOMPSON, EXAMINING ATTORNEY

Int. Cl.: 28

Prior U.S. Cls.: 22, 23, 38, and 50

United States Patent and Trademark Office

Reg. No. 3,482,165

Registered Aug. 5, 2008

**TRADEMARK
PRINCIPAL REGISTER**

PUPPY POWER

LAVELLE, GERALYN A. (UNITED STATES IN-
DIVIDUAL)
501 W. COLFAX
PALATINE, IL 60067

THE MARK CONSISTS OF STANDARD CHAR-
ACTERS WITHOUT CLAIM TO ANY PARTICULAR
FONT, STYLE, SIZE, OR COLOR.

FOR: BOARD GAMES, IN CLASS 28 (U.S. CLS. 22,
23, 38 AND 50).

SN 78-684,472, FILED 8-3-2005.

FIRST USE 4-15-2008; IN COMMERCE 4-15-2008.

LAURA HAMMEL, EXAMINING ATTORNEY

Int. Cl.: 41

Prior U.S. Cls.: 100, 101, and 107

United States Patent and Trademark Office

Reg. No. 3,482,166

Registered Aug. 5, 2008

**SERVICE MARK
PRINCIPAL REGISTER**

FASHIONONE

BIGFOOT ENTERTAINMENT LTD. (BR.VIRGIN
ISLANDS LTD LIAB CO)
45 CLUB STREET
SINGAPORE, SINGAPORE 069422

THE MARK CONSISTS OF STANDARD CHAR-
ACTERS WITHOUT CLAIM TO ANY PARTICULAR
FONT, STYLE, SIZE, OR COLOR.

FOR: ENTERTAINMENT IN THE NATURE OF
BEAUTY PAGEANTS, FASHION SHOWS AND
MODELING SHOWS IN THE FIELD OF FASHION,
IN CLASS 41 (U.S. CLS. 100, 101 AND 107).

SN 78-691,225, FILED 8-12-2005.

FIRST USE 10-1-2007; IN COMMERCE 10-1-2007.

DOMINIC FATHY, EXAMINING ATTORNEY

Int. Cl.: 41

Prior U.S. Cls.: 100, 101, and 107

United States Patent and Trademark Office

Reg. No. 3,482,167

Registered Aug. 5, 2008

**SERVICE MARK
PRINCIPAL REGISTER**

TAKE 5

XM SATELLITE RADIO INC. (DELAWARE CORPORATION)
1500 ECKINGTON PLACE, NE
WASHINGTON, DC 20002

FOR: ENTERTAINMENT SERVICES, NAMELY, PROVIDING SATELLITE RADIO AUDIO PROGRAMS FEATURING TALK AND LIFESTYLE ISSUES, SPECIFICALLY GEARED TO WOMEN, OFFERED EXCLUSIVELY TO SUBSCRIBERS AND PARTNERS OF XM SATELLITE RADIO'S DIGITAL AUDIO RADIO SERVICES, IN CLASS 41 (U.S. CLS. 100, 101 AND 107).

FIRST USE 10-3-2005; IN COMMERCE 10-3-2005.

THE MARK CONSISTS OF STANDARD CHARACTERS WITHOUT CLAIM TO ANY PARTICULAR FONT, STYLE, SIZE, OR COLOR.

SN 78-691,494, FILED 8-12-2005.

DAVID H. STINE, EXAMINING ATTORNEY

Int. Cl.: 10

Prior U.S. Cls.: 26, 39, and 44

United States Patent and Trademark Office

Reg. No. 3,482,168

Registered Aug. 5, 2008

**TRADEMARK
PRINCIPAL REGISTER**

EMBOL-X GLIDE

EDWARDS LIFESCIENCES CORPORATION (DE-
LAWARE CORPORATION)
ONE EDWARDS WAY
IRVINE, CA 92614

FOR: MEDICAL DEVICE, NAMELY, CANNULA,
IN CLASS 10 (U.S. CLS. 26, 39 AND 44).

FIRST USE 10-31-2005; IN COMMERCE 10-31-2005.

THE MARK CONSISTS OF STANDARD CHAR-
ACTERS WITHOUT CLAIM TO ANY PARTICULAR
FONT, STYLE, SIZE, OR COLOR.

OWNER OF U.S. REG. NOS. 2,501,037, 2,685,967,
AND OTHERS.

SN 78-700,425, FILED 8-25-2005.

JAMES GRIFFIN, EXAMINING ATTORNEY

Int. Cl.: 5

Prior U.S. Cls.: 6, 18, 44, 46, 51, and 52

Reg. No. 3,482,169

United States Patent and Trademark Office

Registered Aug. 5, 2008

**TRADEMARK
PRINCIPAL REGISTER**

XTRATA

NITTO DENKO CORPORATION (JAPAN CORPORATION)
1-2, SHIMOHUZUMI 1-CHOME, IBARAKI-SHI
OSAKA, JAPAN

FOR: ADHESIVE TAPES FOR MEDICAL PURPOSES, NAMELY, ADHESIVE PLASTER, SURGICAL TAPES, SURGICAL DRESSINGS, AND ADHESIVE DRESSINGS, EXCEPT FOR PHARMACEUTICAL PREPARATIONS, IN CLASS 5 (U.S. CLS. 6, 18, 44, 46, 51 AND 52).

FIRST USE 12-0-2005; IN COMMERCE 8-0-2007.

THE MARK CONSISTS OF STANDARD CHARACTERS WITHOUT CLAIM TO ANY PARTICULAR FONT, STYLE, SIZE, OR COLOR.

SN 78-702,479, FILED 8-29-2005.

TINA BROWN, EXAMINING ATTORNEY

Int. Cl.: 29

Prior U.S. Cl.: 46

United States Patent and Trademark Office

Reg. No. 3,482,170

Registered Aug. 5, 2008

**TRADEMARK
PRINCIPAL REGISTER**

Oyster King

LANZO, CHARLES PATRICK (UNITED STATES
INDIVIDUAL)
4220 S. MAIN ST.
ACWORTH, GA 30101

NO CLAIM IS MADE TO THE EXCLUSIVE
RIGHT TO USE "OYSTER", APART FROM THE
MARK AS SHOWN.

FOR: SEAFOOD, IN CLASS 29 (U.S. CL. 46).

SN 78-702,578, FILED 8-29-2005.

FIRST USE 5-1-2007; IN COMMERCE 5-1-2007.

THE MARK CONSISTS OF STANDARD CHAR-
ACTERS WITHOUT CLAIM TO ANY PARTICULAR
FONT, STYLE, SIZE, OR COLOR.

REBECCA POVARCHUK, EXAMINING ATTOR-
NEY

Int. Cls.: 9, 16, and 42

**Prior U.S. Cls.: 2, 5, 21, 22, 23, 26, 29, 36, 37, 38, 50,
100, and 101**

Reg. No. 3,482,171

United States Patent and Trademark Office

Registered Aug. 5, 2008

**TRADEMARK
SERVICE MARK
PRINCIPAL REGISTER**

ELLIPTIC SEMICONDUCTOR

ELLIPTIC SEMICONDUCTOR INC. (CANADA CORPORATION)
62 STEACIE DRIVE, STE 201
OTTAWA, CANADA K2K 2A9

FOR: SEMICONDUCTORS, INTEGRATED CIRCUITS, ELECTRONIC DESIGN AUTOMATIONS (EDA) COMPUTER SOFTWARE PROGRAMS FOR DESIGN, SUPPORT AND ANALYSIS OF ELECTRONIC INTEGRATED CIRCUITS, INTEGRATED CIRCUIT LAYOUTS, INTEGRATED CIRCUIT DESIGN BLOCKS, SOFTWARE APPLICATION DESIGN TOOLS FOR USE IN THE DESIGN OF INTEGRATED CIRCUITS, AND CD ROMS CONTAINING NON-CUSTOMISED INTEGRATED CIRCUIT DESIGNS, SUCH AS PRINTED CIRCUIT BOARDS, ALL FOR USE IN THE FIELD OF NETWORK SECURITY, IN CLASS 9 (U.S. CLS. 21, 23, 26, 36 AND 38).

FIRST USE 11-18-2002; IN COMMERCE 11-18-2002.

FOR: PRINTED DIAGRAMS AND DESIGNS OF INTEGRATED CIRCUITS FOR USE IN THE FIELD OF NETWORK SECURITY INCLUDING HIGH-LEVEL DESIGN LANGUAGE REPRESENTATIONS FOR INTEGRATED CIRCUITS OF COMMUNICATIONS AND SECURITY HARDWARE, ALGORITHMS, AND PROTOCOLS, IN CLASS 16 (U.S. CLS. 2, 5, 22, 23, 29, 37, 38 AND 50).

FIRST USE 11-18-2002; IN COMMERCE 11-18-2002.

FOR: INTEGRATED CIRCUIT DESIGN SERVICES, CONSULTING SERVICES RELATING TO INTEGRATED CIRCUIT DESIGN, AND DIAGNOSTIC TESTING OF INTEGRATED CIRCUITS, ALL FOR OTHERS, INTEGRATED CIRCUIT DESIGN SERVICES, NAMELY, PROVIDING CUSTOM DESIGNS OF INTEGRATED CIRCUITS INCLUDING HIGH LEVEL DESIGN LANGUAGE REPRESENTATIONS AND DIAGRAMS FOR INTEGRATED CIRCUITS FOR COMMUNICATIONS, ALGORITHMS, AND PROTOCOLS, ALL FOR USE IN THE FIELD OF NETWORK SECURITY, IN CLASS 42 (U.S. CLS. 100 AND 101).

FIRST USE 11-18-2002; IN COMMERCE 11-18-2002.

THE MARK CONSISTS OF STANDARD CHARACTERS WITHOUT CLAIM TO ANY PARTICULAR FONT, STYLE, SIZE, OR COLOR.

NO CLAIM IS MADE TO THE EXCLUSIVE RIGHT TO USE "SEMICONDUCTOR", APART FROM THE MARK AS SHOWN.

SN 78-702,921, FILED 8-29-2005.

BARBARA RUTLAND, EXAMINING ATTORNEY

Int. Cl.: 21

Prior U.S. Cls.: 2, 13, 23, 29, 30, 33, 40, and 50

United States Patent and Trademark Office

Reg. No. 3,482,172

Registered Aug. 5, 2008

**TRADEMARK
PRINCIPAL REGISTER**

WINDOW VISION

WHITNEY DESIGN, INC. (DELAWARE CORPORATION)
13213 CORPORATE EXCHANGE DRIVE
BRIDGETON, MO 630443721

THE MARK CONSISTS OF STANDARD CHARACTERS WITHOUT CLAIM TO ANY PARTICULAR FONT, STYLE, SIZE, OR COLOR.

FOR: ALL PURPOSE CONTAINERS FOR HOUSEHOLD USE, IN CLASS 21 (U.S. CLS. 2, 13, 23, 29, 30, 33, 40 AND 50).

SN 78-704,094, FILED 8-31-2005.

FIRST USE 4-11-2008; IN COMMERCE 4-11-2008.

SUZANNE BLANE, EXAMINING ATTORNEY

Int. Cl.: 20

Prior U.S. Cls.: 2, 13, 22, 25, 32, and 50

Reg. No. 3,482,173

United States Patent and Trademark Office

Registered Aug. 5, 2008

**TRADEMARK
PRINCIPAL REGISTER**

EV-EX

NUSSDORF, JEFFREY MARK (UNITED STATES
INDIVIDUAL)
2329 JANESVILLE LANE
HENDERSON, NV 89044

FOR: PORTABLE DISPLAY BOARDS AND PA-
NELS FOR USE AT EVENTS AND EXHIBITIONS
FOR THE USER TO DISPLAY AND PROMOTE
GOODS AND SERVICES , IN CLASS 20 (U.S. CLS. 2,
13, 22, 25, 32 AND 50).

FIRST USE 10-19-2005; IN COMMERCE 1-22-2007.

THE MARK CONSISTS OF STANDARD CHAR-
ACTERS WITHOUT CLAIM TO ANY PARTICULAR
FONT, STYLE, SIZE, OR COLOR.

SN 78-705,156, FILED 9-1-2005.

EDWARD NELSON, EXAMINING ATTORNEY

Int. Cls.: 16 and 41

Prior U.S. Cls.: 2, 5, 22, 23, 29, 37, 38, 50, 100, 101, and 107

Reg. No. 3,482,174

United States Patent and Trademark Office

Registered Aug. 5, 2008

**TRADEMARK
SERVICE MARK
PRINCIPAL REGISTER**

Exhibiting 101

HULME, NAOMI (UNITED STATES INDIVIDUAL)
P.O. BOX 600
ADDISON, TX 75001

FOR: PRINTED CORRESPONDENCE COURSE MATERIALS IN THE FIELD OF CONSUMER SHOW EXHIBITING; PRINTED GUIDES FOR CONSUMER SHOW EXHIBITING, IN CLASS 16 (U.S. CLS. 2, 5, 22, 23, 29, 37, 38 AND 50).

FIRST USE 9-13-2005; IN COMMERCE 9-13-2005.

FOR: ARRANGING OF EXHIBITIONS, SEMINARS AND CONFERENCES; EDUCATION SERVICES, NAMELY, PROVIDING SEMINARS AND CONFERENCES IN THE FIELD OF CONSUMER

SHOW EXHIBITING, IN CLASS 41 (U.S. CLS. 100, 101 AND 107).

FIRST USE 9-13-2005; IN COMMERCE 9-13-2005.

THE MARK CONSISTS OF STANDARD CHARACTERS WITHOUT CLAIM TO ANY PARTICULAR FONT, STYLE, SIZE, OR COLOR.

NO CLAIM IS MADE TO THE EXCLUSIVE RIGHT TO USE "EXHIBITING", APART FROM THE MARK AS SHOWN.

SN 78-707,150, FILED 9-6-2005.

ASMAT KHAN, EXAMINING ATTORNEY

Int. Cl.: 41

Prior U.S. Cls.: 100, 101, and 107

United States Patent and Trademark Office

Reg. No. 3,482,175

Registered Aug. 5, 2008

**SERVICE MARK
PRINCIPAL REGISTER**



MUNOZ, MICHAEL (UNITED STATES INDIVIDUAL)
639 LOS CERRITOS RD.
GLENORA, CA 91740

FOR: EDUCATION SERVICES, NAMELY, PROVIDING ONLINE COURSES IN THE FIELD OF DRIVERS' EDUCATION, IN CLASS 41 (U.S. CLS. 100, 101 AND 107).

FIRST USE 1-1-2006; IN COMMERCE 1-1-2006.

NO CLAIM IS MADE TO THE EXCLUSIVE RIGHT TO USE "TRAFFIC SCHOOL", APART FROM THE MARK AS SHOWN.

SN 78-708,418, FILED 9-7-2005.

EMILY CARLSEN, EXAMINING ATTORNEY

Int. Cl.: 16

Prior U.S. Cls.: 2, 5, 22, 23, 29, 37, 38, and 50

United States Patent and Trademark Office

Reg. No. 3,482,176

Registered Aug. 5, 2008

**TRADEMARK
PRINCIPAL REGISTER**

THIN MAN

THE HERFF JONES COMPANY OF INDIANA,
INC. (INDIANA CORPORATION)
4625 WEST 62ND STREET
INDIANAPOLIS, IN 46268

THE MARK CONSISTS OF STANDARD CHAR-
ACTERS WITHOUT CLAIM TO ANY PARTICULAR
FONT, STYLE, SIZE, OR COLOR.

FOR: ANATOMICAL MODELS FOR INSTRUC-
TIONAL AND EDUCATIONAL PURPOSES, IN
CLASS 16 (U.S. CLS. 2, 5, 22, 23, 29, 37, 38 AND 50).

SN 78-709,271, FILED 9-8-2005.

FIRST USE 0-0-1993; IN COMMERCE 0-0-1993.

ASMAT KHAN, EXAMINING ATTORNEY

Int. Cl.: 43

Prior U.S. Cls.: 100 and 101

United States Patent and Trademark Office

Reg. No. 3,482,177

Registered Aug. 5, 2008

**SERVICE MARK
PRINCIPAL REGISTER**

**WESTIN KIDS CLUB DISCOVERY
ROOM**

WESTIN HOTEL MANAGEMENT, L.P. (DELA-
WARE LIMITED PARTNERSHIP)
1111 WESTCHESTER AVENUE
WHITE PLAINS, NY 10604

FOR: HOTEL, MOTEL AND RESORT LODGING
SERVICES; CHILDREN'S DAY CARE SERVICES, IN
CLASS 43 (U.S. CLS. 100 AND 101).

FIRST USE 8-0-2005; IN COMMERCE 8-0-2005.

THE MARK CONSISTS OF STANDARD CHAR-
ACTERS WITHOUT CLAIM TO ANY PARTICULAR
FONT, STYLE, SIZE, OR COLOR.

NO CLAIM IS MADE TO THE EXCLUSIVE
RIGHT TO USE "KIDS CLUB", APART FROM THE
MARK AS SHOWN.

SN 78-710,676, FILED 9-11-2005.

NAAKWAMA ANKRAH, EXAMINING ATTORNEY

Int. Cl.: 25

Prior U.S. Cls.: 22 and 39

United States Patent and Trademark Office

Reg. No. 3,482,178

Registered Aug. 5, 2008

**TRADEMARK
PRINCIPAL REGISTER**

TSOL-7

CAMERON, WILLIAM, L. (UNITED STATES IN-
DIVIDUAL)
4644 HOMESTEAD PLACE
MATTHEWS, NC 28104

FOR: CLOTHING, NAMELY, SHIRTS, IN CLASS
25 (U.S. CLS. 22 AND 39).

FIRST USE 7-12-2007; IN COMMERCE 7-15-2007.

THE MARK CONSISTS OF STANDARD CHAR-
ACTERS WITHOUT CLAIM TO ANY PARTICULAR
FONT, STYLE, SIZE, OR COLOR.

SN 78-711,345, FILED 9-12-2005.

KATHLEEN M. VANSTON, EXAMINING ATTOR-
NEY

Int. Cl.: 11

Prior U.S. Cls.: 13, 21, 23, 31, and 34

United States Patent and Trademark Office

Reg. No. 3,482,179

Registered Aug. 5, 2008

**TRADEMARK
PRINCIPAL REGISTER**

Precision Technology

KWAK, TAE Y. (UNITED STATES INDIVIDUAL)
17855 FITCH AVE.
IRVINE, CA 92614

FOR: WATER HEATERS FOR DOMESTIC AND
SPACE HEATING, IN CLASS 11 (U.S. CLS. 13, 21, 23,
31 AND 34).

FIRST USE 6-2-2008; IN COMMERCE 6-2-2008.

THE MARK CONSISTS OF STANDARD CHAR-
ACTERS WITHOUT CLAIM TO ANY PARTICULAR
FONT, STYLE, SIZE, OR COLOR.

NO CLAIM IS MADE TO THE EXCLUSIVE
RIGHT TO USE "TECHNOLOGY", APART FROM
THE MARK AS SHOWN.

SN 78-711,475, FILED 9-12-2005.

NAAKWAMA ANKRAH, EXAMINING ATTORNEY

Int. Cl.: 12

Prior U.S. Cls.: 19, 21, 23, 31, 35, and 44

Reg. No. 3,482,180

United States Patent and Trademark Office

Registered Aug. 5, 2008

**TRADEMARK
PRINCIPAL REGISTER**

ROAD FORCE

THE HERCULES TIRE & RUBBER COMPANY
(CONNECTICUT CORPORATION)
SUITE 200
16380 U.S. ROUTE 224 EAST
FINDLAY, OH 45840

FOR: TIRES, IN CLASS 12 (U.S. CLS. 19, 21, 23, 31,
35 AND 44).

FIRST USE 5-1-2008; IN COMMERCE 5-1-2008.

THE MARK CONSISTS OF STANDARD CHAR-
ACTERS WITHOUT CLAIM TO ANY PARTICULAR
FONT, STYLE, SIZE, OR COLOR.

SN 78-714,648, FILED 9-16-2005.

LEIGH CAROLINE CASE, EXAMINING ATTOR-
NEY

Int. Cl.: 25

Prior U.S. Cls.: 22 and 39

United States Patent and Trademark Office

Reg. No. 3,482,181

Registered Aug. 5, 2008

**TRADEMARK
PRINCIPAL REGISTER**

RELIGION VINTAGE

WHITE HORSES TRADING COMPANY LIMITED
(GUERNSEY CORPORATION)
P.O. BOX 226
ANSON COURT, LA ROUTE DES CAMPS
ST. MARTIN, GUERNSEY, UNITED KINGDOM
GY4 6AD

FOR: CLOTHING, NAMELY, TROUSERS, T-SHIRTS, AND SWEATSHIRTS, IN CLASS 25 (U.S. CLS. 22 AND 39).

FIRST USE 3-0-2008; IN COMMERCE 3-0-2008.

THE MARK CONSISTS OF STANDARD CHARACTERS WITHOUT CLAIM TO ANY PARTICULAR FONT, STYLE, SIZE, OR COLOR.

OWNER OF U.S. REG. NO. 2,798,396.

SN 78-714,688, FILED 9-16-2005.

PRISCILLA MILTON, EXAMINING ATTORNEY

Int. Cl.: 35

Prior U.S. Cls.: 100, 101, and 102

United States Patent and Trademark Office

Reg. No. 3,482,182

Registered Aug. 5, 2008

**SERVICE MARK
PRINCIPAL REGISTER**



AMERICAN PUBLIC POWER ASSOCIATION
(D.C. CORPORATION)
2301 M STREET, N.W.
WASHINGTON, DC 22037

FOR: PROMOTING PUBLIC AWARENESS OF
ENERGY GENERATION AND SAFETY INNOVA-
TION AND EFFICIENCY ON BEHALF OF THIRD
PARTY MEMBERS, IN CLASS 35 (U.S. CLS. 100, 101
AND 102).

FIRST USE 5-29-2008; IN COMMERCE 5-29-2008.

THE COLOR(S) NAVY IS/ARE CLAIMED AS A
FEATURE OF THE MARK.

THE MARK CONSISTS OF THE GREEK LETTER
"ETA" ABOVE THE WORD "DEED", ALL IN THE
COLOR NAVY.

SN 78-720,177, FILED 9-26-2005.

ALEX KEAM, EXAMINING ATTORNEY

Int. Cl.: 39

Prior U.S. Cls.: 100 and 105

United States Patent and Trademark Office

Reg. No. 3,482,183

Registered Aug. 5, 2008

SERVICE MARK
PRINCIPAL REGISTER



TOY BOX, LLC. (UNITED STATES LLC)
3635 SOUTH PEBBLE PLACE
ATTN: RICKY R. MCCAULEY
BELLINGHAM, WA 98226

THE COLORS RED, ORANGE, YELLOW, AND BLACK ARE CLAIMED AS A FEATURE OF THE MARK.

FOR: STORAGE OF MOTOR VEHICLES, WATER CRAFT, TRAILERS, RECREATIONAL VEHICLES AND OTHER LARGE ITEMS, IN CLASS 39 (U.S. CLS. 100 AND 105).

THE "X" IN "EXTREME" APPEARS AS A PAINTED "X" IN ORANGE AND YELLOW, THE WORD "EXTREME" APPEARS IN RED, AND THE WORD "STORAGE" APPEARS IN BLACK.

FIRST USE 9-27-2005; IN COMMERCE 9-27-2005.

SN 78-721,157, FILED 9-27-2005.

NO CLAIM IS MADE TO THE EXCLUSIVE RIGHT TO USE "STORAGE", APART FROM THE MARK AS SHOWN.

LEIGH CAROLINE CASE, EXAMINING ATTORNEY

Int. Cl.: 28

Prior U.S. Cls.: 22, 23, 38, and 50

United States Patent and Trademark Office

Reg. No. 3,482,184

Registered Aug. 5, 2008

**TRADEMARK
PRINCIPAL REGISTER**

VLOCITY

JT SPORTS LLC (DELAWARE LTD LIAB CO)
1201 SE 30TH STREET
BENTONVILLE, AR 72712

FOR: PAINTBALL GAME EQUIPMENT, NAME-
LY, LOADERS, IN CLASS 28 (U.S. CLS. 22, 23, 38 AND
50).

FIRST USE 6-0-2005; IN COMMERCE 6-0-2005.

THE MARK CONSISTS OF STANDARD CHAR-
ACTERS WITHOUT CLAIM TO ANY PARTICULAR
FONT, STYLE, SIZE, OR COLOR.

OWNER OF U.S. REG. NO. 2,603,615.

SN 78-721,659, FILED 9-27-2005.

AMY ALFIERI, EXAMINING ATTORNEY

Int. Cl.: 36

Prior U.S. Cls.: 100, 101, and 102

United States Patent and Trademark Office

Reg. No. 3,482,185

Registered Aug. 5, 2008

**SERVICE MARK
PRINCIPAL REGISTER**

HOAG INVITATIONAL REGATTA

HOAG MEMORIAL HOSPITAL PRESBYTERIAN
(CALIFORNIA CORPORATION)

ONE HOAG DRIVE

NEWPORT BEACH, CA 92658

FOR: CONDUCTING AN ANNUAL CHARITABLE FUNDRAISING CAMPAIGN WHICH BENEFITS A NON-PROFIT ORGANIZATION, IN CLASS 36 (U.S. CLS. 100, 101 AND 102).

FIRST USE 4-7-2008; IN COMMERCE 4-7-2008.

THE MARK CONSISTS OF STANDARD CHARACTERS WITHOUT CLAIM TO ANY PARTICULAR FONT, STYLE, SIZE, OR COLOR.

OWNER OF U.S. REG. NO. 1,977,913.

NO CLAIM IS MADE TO THE EXCLUSIVE RIGHT TO USE "INVITATIONAL REGATTA", APART FROM THE MARK AS SHOWN.

SN 78-721,768, FILED 9-27-2005.

CAROLYN CATALDO, EXAMINING ATTORNEY

Int. Cl.: 5

Prior U.S. Cls.: 6, 18, 44, 46, 51, and 52

Reg. No. 3,482,186

United States Patent and Trademark Office

Registered Aug. 5, 2008

**TRADEMARK
PRINCIPAL REGISTER**

CYTO GAINER

CYTOSPORT, INC. (CALIFORNIA CORPORATION)
4795 INDUSTRIAL WAY
BENICIA, CA 94510

THE MARK CONSISTS OF STANDARD CHARACTERS WITHOUT CLAIM TO ANY PARTICULAR FONT, STYLE, SIZE, OR COLOR.

FOR: DIETARY AND NUTRITIONAL SUPPLEMENT; POWDERED NUTRITIONAL SUPPLEMENT FOR ADDING LIQUID BEVERAGE, IN CLASS 5 (U.S. CLS. 6, 18, 44, 46, 51 AND 52).

SN 78-723,462, FILED 9-29-2005.

FIRST USE 6-0-1999; IN COMMERCE 6-0-1999.

PAULA MAHONEY, EXAMINING ATTORNEY

Int. Cl.: 43

Prior U.S. Cls.: 100 and 101

United States Patent and Trademark Office

Reg. No. 3,482,187

Registered Aug. 5, 2008

**SERVICE MARK
PRINCIPAL REGISTER**



FOUNDED BY FIREMEN

FIREHOUSE RESTAURANT GROUP, INC.
(FLORIDA CORPORATION)
3410 KORI ROAD
JACKSONVILLE, FL 32257

FOR: RESTAURANT SERVICES, IN CLASS 43
(U.S. CLS. 100 AND 101).

FIRST USE 12-31-2005; IN COMMERCE 12-31-2005.

OWNER OF U.S. REG. NOS. 1,903,135, 2,606,263,
AND OTHERS.

NO CLAIM IS MADE TO THE EXCLUSIVE
RIGHT TO USE "SUBS" AND "FOUNDED BY FIRE-
MEN", APART FROM THE MARK AS SHOWN.

THE COLOR(S) RED, GOLD, WHITE AND
BLACK IS/ARE CLAIMED AS A FEATURE OF
THE MARK.

THE MARK CONSISTS OF THE WORDING
"FIREHOUSE" LETTERED IN WHITE WITH BLACK
OUTLINING ON A RED BACKGROUND AND THE
WORDING "SUBS" IN GOLD ON A BLACK BACK-
GROUND, ALL ON A PLAQUE HAVING GOLD
OUTLINING AND RIVETS, AND THE WORDS
"FOUNDED BY FIREMEN" IN BLACK.

SN 78-725,800, FILED 10-4-2005.

ALEX KEAM, EXAMINING ATTORNEY

Int. Cl.: 35

Prior U.S. Cls.: 100, 101, and 102

United States Patent and Trademark Office

Reg. No. 3,482,188

Registered Aug. 5, 2008

SERVICE MARK
PRINCIPAL REGISTER



FOUNDED BY FIREMEN

FIREHOUSE RESTAURANT GROUP, INC.
(FLORIDA CORPORATION)
3410 KORI ROAD
JACKSONVILLE, FL 32257

FOR: RESTAURANT FRANCHISING, IN CLASS
35 (U.S. CLS. 100, 101 AND 102).

FIRST USE 12-31-2005; IN COMMERCE 12-31-2005.

OWNER OF U.S. REG. NOS. 1,903,135, 2,606,263,
AND OTHERS.

NO CLAIM IS MADE TO THE EXCLUSIVE
RIGHT TO USE "SUBS" AND "FOUNDED BY FIRE-
MEN", APART FROM THE MARK AS SHOWN.

THE COLOR(S) RED, GOLD, WHITE AND
BLACK IS/ARE CLAIMED AS A FEATURE OF
THE MARK.

THE MARK CONSISTS OF THE WORDING
"FIREHOUSE" LETTERED IN WHITE WITH BLACK
OUTLINING ON A RED BACKGROUND AND THE
WORDING "SUBS" IN GOLD ON A BLACK BACK-
GROUND, ALL ON A PLAQUE HAVING GOLD
OUTLINING AND RIVETS AND THE WORDS
"FOUNDED BY FIREMEN" IN BLACK.

SN 78-725,806, FILED 10-4-2005.

ALEX KEAM, EXAMINING ATTORNEY

Int. Cl.: 44

Prior U.S. Cls.: 100 and 101

United States Patent and Trademark Office

Reg. No. 3,482,189

Registered Aug. 5, 2008

**SERVICE MARK
PRINCIPAL REGISTER**

GETBCFACTS.COM

ASTRAZENECA UK LIMITED (UNITED KING-
DOM LTD LIAB CO)
15 STANHOPE GATE
LONDON, ENGLAND W1Y 6LN

FOR: PROVISION OF INFORMATION AND AD-
VICE RELATING TO THE DIAGNOSIS AND
TREATMENT OF CANCER, IN CLASS 44 (U.S.
CLS. 100 AND 101).

FIRST USE 9-30-2005; IN COMMERCE 9-30-2005.

THE MARK CONSISTS OF STANDARD CHAR-
ACTERS WITHOUT CLAIM TO ANY PARTICULAR
FONT, STYLE, SIZE, OR COLOR.

SN 78-730,586, FILED 10-11-2005.

BARBARA RUTLAND, EXAMINING ATTORNEY

Int. Cl.: 43

Prior U.S. Cls.: 100 and 101

United States Patent and Trademark Office

Reg. No. 3,482,190

Registered Aug. 5, 2008

**SERVICE MARK
PRINCIPAL REGISTER**

STARR GRILL

PORTER, STARR (UNITED STATES INDIVIDUAL)
70 UPLAND AVENUE
MILL VALLEY, CA 94941

FOR: QUICK-CAUSAL RESTAURANT, IN CLASS
43 (U.S. CLS. 100 AND 101).

FIRST USE 2-15-2008; IN COMMERCE 2-15-2008.

THE MARK CONSISTS OF STANDARD CHARACTERS WITHOUT CLAIM TO ANY PARTICULAR FONT, STYLE, SIZE, OR COLOR.

OWNER OF U.S. REG. NO. 1,991,761.

NO CLAIM IS MADE TO THE EXCLUSIVE RIGHT TO USE "GRILL", APART FROM THE MARK AS SHOWN.

SN 78-733,676, FILED 10-14-2005.

SALLY SHIH, EXAMINING ATTORNEY

Int. Cls.: 6 and 11

Prior U.S. Cls.: 2, 12, 13, 14, 21, 23, 25, 31, 34, and 50

United States Patent and Trademark Office

Reg. No. 3,482,191

Registered Aug. 5, 2008

**TRADEMARK
PRINCIPAL REGISTER**

PURIST

KOHLER CO. (WISCONSIN CORPORATION)
444 HIGHLAND DRIVE
KOHLER, WI 53044

FOR: METAL ROBE HOOKS, IN CLASS 6 (U.S. CLS. 2, 12, 13, 14, 23, 25 AND 50).

FIRST USE 8-0-2001; IN COMMERCE 8-0-2001.

FOR: SHOWER DOORS; SHOWERS, NAMELY, SHOWER RECEPTORS; SHOWERHEADS; BATH-TUBS; BATH SPOUTS; WHIRLPOOLS; LAVATOR-IES; FAUCETS; TOILETS; PLUMBING FITTINGS, NAMELY, FAUCET TRIM AND VALVE TRIM; BATH DRAINS, IN CLASS 11 (U.S. CLS. 13, 21, 23, 31 AND 34).

FIRST USE 8-0-2001; IN COMMERCE 8-0-2001.

THE MARK CONSISTS OF STANDARD CHAR-
ACTERS WITHOUT CLAIM TO ANY PARTICULAR
FONT, STYLE, SIZE, OR COLOR.

OWNER OF U.S. REG. NOS. 2,855,038 AND
2,960,915.

SN 78-734,653, FILED 10-17-2005.

KATHERINE E. HALMEN, EXAMINING ATTOR-
NEY

Int. Cl.: 28

Prior U.S. Cls.: 22, 23, 38, and 50

Reg. No. 3,482,192

United States Patent and Trademark Office

Registered Aug. 5, 2008

**TRADEMARK
PRINCIPAL REGISTER**

sky
dream
jump

THREE LUCK CO., LTD. (JAPAN CORPORATION)
34-27, TOMOI 2-CHOME
HIGASHIOSAKASHI, JAPAN

THE MARK CONSISTS OF STANDARD CHARACTERS WITHOUT CLAIM TO ANY PARTICULAR FONT, STYLE, SIZE, OR COLOR.

FOR: GOLF CLUBS AND HEAD COVERS FOR GOLF CLUBS, IN CLASS 28 (U.S. CLS. 22, 23, 38 AND 50).

SN 78-741,877, FILED 10-27-2005.

FIRST USE 3-1-2006; IN COMMERCE 3-10-2008.

NAAKWAMA ANKRAH, EXAMINING ATTORNEY

Int. Cls.: 36 and 38

Prior U.S. Cls.: 100, 101, 102, and 104

United States Patent and Trademark Office

Reg. No. 3,482,193

Registered Aug. 5, 2008

**SERVICE MARK
PRINCIPAL REGISTER**

NYSE e-Quote

NYSE GROUP, INC. (DELAWARE CORPORATION)
11 WALL STREET
NEW YORK, NY 10005

FOR: CONDUCTING A SECURITIES EXCHANGE FEATURING DUAL AUCTION MARKET CAPABILITIES AND AUTOMATIC TRANSACTION EXECUTION CAPABILITIES VIA PHYSICAL CONVENTION AND ELECTRONICALLY; PROVIDING STOCK MARKET INFORMATION, IN CLASS 36 (U.S. CLS. 100, 101 AND 102).

FIRST USE 9-0-2006; IN COMMERCE 9-0-2006.

FOR: TRANSMISSION OF SECURITIES INFORMATION, NAMELY, BIDS AND OFFERS, TO AND BY OTHERS VIA ELECTRONIC COMMUNICATIONS NETWORKS, IN CLASS 38 (U.S. CLS. 100, 101 AND 104).

FIRST USE 9-0-2006; IN COMMERCE 9-0-2006.

THE MARK CONSISTS OF STANDARD CHARACTERS WITHOUT CLAIM TO ANY PARTICULAR FONT, STYLE, SIZE, OR COLOR.

OWNER OF U.S. REG. NOS. 909,350, 2,284,340, AND OTHERS.

NO CLAIM IS MADE TO THE EXCLUSIVE RIGHT TO USE "E-QUOTE", APART FROM THE MARK AS SHOWN.

SN 78-742,250, FILED 10-28-2005.

KYLE PEETE, EXAMINING ATTORNEY

Int. Cl.: 36

Prior U.S. Cls.: 100, 101, and 102

United States Patent and Trademark Office

Reg. No. 3,482,194

Registered Aug. 5, 2008

**SERVICE MARK
PRINCIPAL REGISTER**

NYSE Auction Limit Order

NYSE GROUP, INC. (DELAWARE CORPORATION)
11 WALL STREET
NEW YORK, NY 10005

FOR: CONDUCTING A SECURITIES EXCHANGE FEATURING DUAL AUCTION MARKET CAPABILITIES AND AUTOMATIC TRANSACTION EXECUTION CAPABILITIES VIA PHYSICAL CONVENTION AND ELECTRONICALLY FOR DESIGNATED SECURITIES ORDERS; PROVIDING STOCK MARKET INFORMATION, IN CLASS 36 (U.S. CLS. 100, 101 AND 102).

FIRST USE 0-0-2006; IN COMMERCE 0-0-2006.

THE MARK CONSISTS OF STANDARD CHARACTERS WITHOUT CLAIM TO ANY PARTICULAR FONT, STYLE, SIZE, OR COLOR.

OWNER OF U.S. REG. NOS. 909,350, 2,284,340, AND OTHERS.

NO CLAIM IS MADE TO THE EXCLUSIVE RIGHT TO USE "AUCTION LIMIT ORDER", APART FROM THE MARK AS SHOWN.

SN 78-742,258, FILED 10-28-2005.

KYLE PEETE, EXAMINING ATTORNEY

Int. Cl.: 36

Prior U.S. Cls.: 100, 101, and 102

United States Patent and Trademark Office

Reg. No. 3,482,195

Registered Aug. 5, 2008

**SERVICE MARK
PRINCIPAL REGISTER**

NYSE Auction Market Order

NYSE GROUP, INC. (DELAWARE CORPORATION)
11 WALL STREET
NEW YORK, NY 10005

FOR: CONDUCTING A SECURITIES EXCHANGE FEATURING DUAL AUCTION MARKET CAPABILITIES AND AUTOMATIC TRANSACTION EXECUTION CAPABILITIES VIA PHYSICAL CONVENTION AND ELECTRONICALLY FOR DESIGNATED SECURITIES ORDERS; PROVIDING STOCK MARKET INFORMATION, IN CLASS 36 (U.S. CLS. 100, 101 AND 102).

FIRST USE 0-0-2006; IN COMMERCE 0-0-2006.

THE MARK CONSISTS OF STANDARD CHARACTERS WITHOUT CLAIM TO ANY PARTICULAR FONT, STYLE, SIZE, OR COLOR.

OWNER OF U.S. REG. NOS. 909,350, 2,284,340, AND OTHERS.

NO CLAIM IS MADE TO THE EXCLUSIVE RIGHT TO USE "AUCTION MARKET ORDER", APART FROM THE MARK AS SHOWN.

SN 78-742,262, FILED 10-28-2005.

KYLE PEETE, EXAMINING ATTORNEY

Int. Cl.: 36

Prior U.S. Cls.: 100, 101, and 102

United States Patent and Trademark Office

Reg. No. 3,482,196

Registered Aug. 5, 2008

**SERVICE MARK
PRINCIPAL REGISTER**

**NYSE Liquidity
Replenishment Point**

NYSE GROUP, INC. (DELAWARE CORPORATION)
11 WALL STREET
NEW YORK, NY 10005

FOR: CONDUCTING A SECURITIES EXCHANGE FEATURING DUAL AUCTION MARKET CAPABILITIES AND AUTOMATIC TRANSACTION EXECUTION CAPABILITIES VIA PHYSICAL CONVENTION AND ELECTRONICALLY AND ELECTRONIC REGULATION OF PRICE MOVEMENTS OF LISTED SECURITIES; PROVIDING STOCK MARKET INFORMATION, IN CLASS 36 (U.S. CLS. 100, 101 AND 102).

FIRST USE 9-0-2006; IN COMMERCE 9-0-2006.

THE MARK CONSISTS OF STANDARD CHARACTERS WITHOUT CLAIM TO ANY PARTICULAR FONT, STYLE, SIZE, OR COLOR.

OWNER OF U.S. REG. NOS. 909,350, 2,284,340, AND OTHERS.

NO CLAIM IS MADE TO THE EXCLUSIVE RIGHT TO USE "LIQUIDITY REPLENISHMENT POINT", APART FROM THE MARK AS SHOWN.

SN 78-742,268, FILED 10-28-2005.

KYLE PEETE, EXAMINING ATTORNEY

Int. Cls.: 36 and 38

Prior U.S. Cls.: 100, 101, 102, and 104

United States Patent and Trademark Office

Reg. No. 3,482,197

Registered Aug. 5, 2008

**SERVICE MARK
PRINCIPAL REGISTER**

NYSE s-Quote

NYSE GROUP, INC. (DELAWARE CORPORATION)
11 WALL STREET
NEW YORK, NY 10005

FOR: CONDUCTING A SECURITIES EXCHANGE FEATURING DUAL AUCTION MARKET CAPABILITIES AND AUTOMATIC TRANSACTION EXECUTION CAPABILITIES VIA PHYSICAL CONVENTION AND ELECTRONICALLY; PROVIDING STOCK MARKET INFORMATION, IN CLASS 36 (U.S. CLS. 100, 101 AND 102).

FIRST USE 9-0-2006; IN COMMERCE 9-0-2006.

FOR: TRANSMISSION OF SECURITIES INFORMATION TO AND BY OTHERS VIA ELECTRONIC

COMMUNICATIONS NETWORKS, IN CLASS 38 (U.S. CLS. 100, 101 AND 104).

FIRST USE 9-0-2006; IN COMMERCE 9-0-2006.

THE MARK CONSISTS OF STANDARD CHARACTERS WITHOUT CLAIM TO ANY PARTICULAR FONT, STYLE, SIZE, OR COLOR.

OWNER OF U.S. REG. NOS. 909,350, 2,284,340, AND OTHERS.

SN 78-742,274, FILED 10-28-2005.

KYLE PEETE, EXAMINING ATTORNEY

Int. Cls.: 36 and 38

Prior U.S. Cls.: 100, 101, 102, and 104

United States Patent and Trademark Office

Reg. No. 3,482,198

Registered Aug. 5, 2008

**SERVICE MARK
PRINCIPAL REGISTER**

NYSE Specialist API

NYSE GROUP, INC. (DELAWARE CORPORATION)
11 WALL STREET
NEW YORK, NY 10005

FOR: CONDUCTING A SECURITIES EXCHANGE FEATURING DUAL AUCTION MARKET CAPABILITIES AND AUTOMATIC TRANSACTION EXECUTION CAPABILITIES VIA PHYSICAL CONVENTION AND ELECTRONICALLY FOR DESIGNATED SECURITIES ORDERS; PROVIDING STOCK MARKET INFORMATION, IN CLASS 36 (U.S. CLS. 100, 101 AND 102).

FIRST USE 9-0-2006; IN COMMERCE 9-0-2006.

FOR: ELECTRONIC TRANSMISSION OF SECURITIES DATA CONTAINING PROPRIETARY ALGORITHMS FROM EXTERNAL PROGRAMMING INTERFACES VIA ELECTRONIC COMMUNICA-

TION NETWORKS, IN CLASS 38 (U.S. CLS. 100, 101 AND 104).

FIRST USE 9-0-2006; IN COMMERCE 9-0-2006.

THE MARK CONSISTS OF STANDARD CHARACTERS WITHOUT CLAIM TO ANY PARTICULAR FONT, STYLE, SIZE, OR COLOR.

OWNER OF U.S. REG. NOS. 909,350, 2,284,340, AND OTHERS.

NO CLAIM IS MADE TO THE EXCLUSIVE RIGHT TO USE "SPECIALIST API", APART FROM THE MARK AS SHOWN.

SN 78-742,285, FILED 10-28-2005.

KYLE PEETE, EXAMINING ATTORNEY

Int. Cl.: 41

Prior U.S. Cls.: 100, 101, and 107

United States Patent and Trademark Office

Reg. No. 3,482,199

Registered Aug. 5, 2008

**SERVICE MARK
PRINCIPAL REGISTER**



WOLFINGTON, RYAN (UNITED STATES INDIVIDUAL)
4316 FORTUNE AVENUE
LAS VEGAS, NV 89107

FOR: ARRANGING FOR TICKET RESERVATIONS FOR SHOWS AND OTHER ENTERTAINMENT EVENTS; CONDUCTING ENTERTAINMENT EXHIBITIONS IN THE NATURE OF TENNIS HISTORY; EDUCATION SERVICES, NAMELY, MENTORING IN THE FIELD OF TENNIS; EDUCATION SERVICES, NAMELY, ONE-ON-ONE MENTORING IN THE FIELD OF TENNIS; EDUCATION SERVICES, NAMELY, PROVIDING INSTRUCTION, CLASSES AND CLINICS IN THE FIELD OF TENNIS; EDUCATIONAL AND ENTERTAINMENT SERVICES, NAMELY, PROVIDING MOTIVATIONAL AND EDUCATIONAL SPEAKERS; EDUCATIONAL DEMONSTRATIONS; EDUCATIONAL SERVICES, NAMELY, PROVIDING INCENTIVES TO PROFESSIONALS TO DEMONSTRATE EXCELLENCE IN THE FIELD OF TENNIS; EDUCATIONAL SERVICES, NAMELY, PROVIDING INCENTIVES TO PROFESSIONALS TO DEMONSTRATE EXCELLENCE IN THE FIELD OF TENNIS THROUGH THE ISSUANCE OF AWARDS; ENTERTAINMENT IN THE NATURE OF TENNIS TOURNAMENTS; ENTERTAINMENT SERVICES, NAMELY, PARTICIPATION IN TENNIS CLINICS AND TOURNAMENTS; ENTERTAINMENT SERVICES, NAMELY, PERSONAL APPEARANCES BY A

SPORTS CELEBRITY; MUSEUMS; RUNNING OF MUSEUMS; TENNIS INSTRUCTION, IN CLASS 41 (U.S. CLS. 100, 101 AND 107).

FIRST USE 5-10-2008; IN COMMERCE 5-10-2008.

NO CLAIM IS MADE TO THE EXCLUSIVE RIGHT TO USE "LAS VEGAS TENNIS HALL OF FAME", APART FROM THE MARK AS SHOWN.

THE COLOR(S) BLUE, WHITE AND GREY IS/ ARE CLAIMED AS A FEATURE OF THE MARK.

THE COLOR WHITE APPEARS IN THE LITERAL ELEMENTS OF THE MARK WHICH ARE OUTLINED IN BLUE; THE COLORS BLUE AND WHITE APPEAR IN THE TWO STYLIZED TENNIS BALLS; THE COLORS BLUE AND GREY APPEAR IN THE QUADRILATERAL AND TRIANGULAR ABSTRACT SHAPES AT THE CENTER OF THE MARK; THE COLOR BLUE APPEARS IN THE LINING THROUGHOUT THE MARK AGAINST A WHITE BACKGROUND.

SN 78-743,161, FILED 10-29-2005.

BARBARA RUTLAND, EXAMINING ATTORNEY

Int. Cl.: 41

Prior U.S. Cls.: 100, 101, and 107

United States Patent and Trademark Office

Reg. No. 3,482,200

Registered Aug. 5, 2008

**SERVICE MARK
PRINCIPAL REGISTER**



WOLFINGTON, RYAN (UNITED STATES INDIVIDUAL)
4316 FORTUNE AVENUE
LAS VEGAS, NV 89107

FOR: ARRANGING FOR TICKET RESERVATIONS FOR SHOWS AND OTHER ENTERTAINMENT EVENTS; CONDUCTING ENTERTAINMENT EXHIBITIONS IN THE NATURE OF TENNIS HISTORY; EDUCATION SERVICES, NAMELY, MENTORING IN THE FIELD OF TENNIS; EDUCATION SERVICES, NAMELY, ONE-ON-ONE MENTORING IN THE FIELD OF TENNIS; EDUCATION SERVICES, NAMELY, PROVIDING INSTRUCTION, CLASSES AND CLINICS IN THE FIELD OF TENNIS; EDUCATIONAL AND ENTERTAINMENT SERVICES, NAMELY, PROVIDING MOTIVATIONAL AND EDUCATIONAL SPEAKERS; EDUCATIONAL DEMONSTRATIONS; EDUCATIONAL SERVICES, NAMELY, PROVIDING INCENTIVES TO PROFESSIONALS TO DEMONSTRATE EXCELLENCE IN THE FIELD OF TENNIS; EDUCATIONAL SERVICES, NAMELY, PROVIDING INCENTIVES TO PROFESSIONALS TO DEMONSTRATE EXCELLENCE IN THE FIELD OF TENNIS THROUGH THE ISSUANCE OF AWARDS; ENTERTAINMENT IN THE NATURE OF TENNIS TOURNAMENTS; ENTERTAINMENT SERVICES, NAMELY, PARTICIPATION IN TENNIS CLINICS AND TOURNAMENTS; ENTERTAINMENT SERVICES, NAMELY, PERSONAL APPEARANCES BY A

SPORTS CELEBRITY; MUSEUMS; RUNNING OF MUSEUMS; TENNIS INSTRUCTION, IN CLASS 41 (U.S. CLS. 100, 101 AND 107).

FIRST USE 5-10-2008; IN COMMERCE 5-10-2008.

NO CLAIM IS MADE TO THE EXCLUSIVE RIGHT TO USE "NEVADA TENNIS HALL OF FAME", APART FROM THE MARK AS SHOWN.

THE COLOR(S) BLUE, WHITE AND GREY IS/ ARE CLAIMED AS A FEATURE OF THE MARK.

THE COLOR WHITE APPEARS IN THE LITERAL ELEMENTS OF THE MARK WHICH ARE OUTLINED IN BLUE; THE COLORS BLUE AND WHITE APPEAR IN THE TWO STYLIZED TENNIS BALLS; THE COLORS BLUE AND GREY APPEAR IN THE QUADRILATERAL AND TRIANGULAR ABSTRACT SHAPES AT THE CENTER OF THE MARK; THE COLOR BLUE APPEARS IN THE LINING THROUGHOUT THE MARK AGAINST A WHITE BACKGROUND.

SN 78-743,166, FILED 10-29-2005.

BARBARA RUTLAND, EXAMINING ATTORNEY

Int. Cl.: 41

Prior U.S. Cls.: 100, 101, and 107

United States Patent and Trademark Office

Reg. No. 3,482,201

Registered Aug. 5, 2008

**SERVICE MARK
PRINCIPAL REGISTER**



WOLFINGTON, RYAN (UNITED STATES INDIVIDUAL)
4316 FORTUNE AVENUE
LAS VEGAS, NV 89107

FOR: ARRANGING FOR TICKET RESERVATIONS FOR SHOWS AND OTHER ENTERTAINMENT EVENTS; CONDUCTING ENTERTAINMENT EXHIBITIONS IN THE NATURE OF TENNIS HISTORY; EDUCATION SERVICES, NAMELY, MENTORING IN THE FIELD OF TENNIS; EDUCATION SERVICES, NAMELY, ONE-ON-ONE MENTORING IN THE FIELD OF TENNIS; EDUCATION SERVICES, NAMELY, PROVIDING INSTRUCTION, CLASSES AND CLINICS IN THE FIELD OF TENNIS; EDUCATIONAL AND ENTERTAINMENT SERVICES, NAMELY, PROVIDING MOTIVATIONAL AND EDUCATIONAL SPEAKERS; EDUCATIONAL DEMONSTRATIONS; EDUCATIONAL SERVICES, NAMELY, PROVIDING INCENTIVES TO PROFESSIONALS TO DEMONSTRATE EXCELLENCE IN THE FIELD OF TENNIS; EDUCATIONAL SERVICES, NAMELY, PROVIDING INCENTIVES TO PROFESSIONALS TO DEMONSTRATE EXCELLENCE IN THE FIELD OF TENNIS THROUGH THE ISSUANCE OF AWARDS; ENTERTAINMENT IN THE NATURE OF TENNIS TOURNAMENTS; ENTERTAINMENT SERVICES, NAMELY, PARTICIPATION IN TENNIS CLINICS AND TOURNAMENTS; ENTERTAINMENT SERVICES, NAMELY, PERSONAL APPEARANCES BY A

SPORTS CELEBRITY; MUSEUMS; RUNNING OF MUSEUMS; TENNIS INSTRUCTION, IN CLASS 41 (U.S. CLS. 100, 101 AND 107).

FIRST USE 5-10-2008; IN COMMERCE 5-10-2008.

NO CLAIM IS MADE TO THE EXCLUSIVE RIGHT TO USE "TENNIS HALL OF FAME OF NEVADA", APART FROM THE MARK AS SHOWN.

THE COLOR(S) BLUE, WHITE AND GREY IS/ ARE CLAIMED AS A FEATURE OF THE MARK.

THE COLOR WHITE APPEARS IN THE LITERAL ELEMENTS OF THE MARK WHICH ARE OUTLINED IN BLUE; THE COLORS BLUE AND WHITE APPEAR IN THE TWO STYLIZED TENNIS BALLS; THE COLORS BLUE AND GREY APPEAR IN THE QUADRILATERAL AND TRIANGULAR ABSTRACT SHAPES AT THE CENTER OF THE MARK; THE COLOR BLUE APPEARS IN THE LINING THROUGHOUT THE MARK AGAINST A WHITE BACKGROUND.

SN 78-743,173, FILED 10-29-2005.

BARBARA RUTLAND, EXAMINING ATTORNEY

Int. Cl.: 41

Prior U.S. Cls.: 100, 101, and 107

United States Patent and Trademark Office

Reg. No. 3,482,202

Registered Aug. 5, 2008

**SERVICE MARK
PRINCIPAL REGISTER**

URBAN LIVIN'

BAILEY, HELEN (UNITED STATES INDIVIDUAL)
980 NORTH MICHIGAN AVE SUITE 1400
CHICAGO, IL 60611

THE MARK CONSISTS OF STANDARD CHARACTERS WITHOUT CLAIM TO ANY PARTICULAR FONT, STYLE, SIZE, OR COLOR.

FOR: TELEVISION SHOW PRODUCTION, IN CLASS 41 (U.S. CLS. 100, 101 AND 107).

SN 78-744,459, FILED 11-1-2005.

FIRST USE 0-0-2002; IN COMMERCE 0-0-2002.

BRIAN NEVILLE, EXAMINING ATTORNEY

Int. Cl.: 16

Prior U.S. Cls.: 2, 5, 22, 23, 29, 37, 38, and 50

Reg. No. 3,482,203

United States Patent and Trademark Office

Registered Aug. 5, 2008

**TRADEMARK
PRINCIPAL REGISTER**

CONFIDENCE

CELLYNNE CORPORATION (FLORIDA CORPORATION)
1006 MARLEY DRIVE
HAINES CITY, FL 33844

THE MARK CONSISTS OF STANDARD CHARACTERS WITHOUT CLAIM TO ANY PARTICULAR FONT, STYLE, SIZE, OR COLOR.

FOR: PAPER GOODS, NAMELY, TOILET PAPER, FACIAL TISSUE, TABLE NAPKINS AND PAPER TOWELS, IN CLASS 16 (U.S. CLS. 2, 5, 22, 23, 29, 37, 38 AND 50).

SN 78-744,583, FILED 11-1-2005.

FIRST USE 4-18-2008; IN COMMERCE 4-18-2008.

BONNIE LUKEN, EXAMINING ATTORNEY

Int. Cls.: 35, 40, and 41

Prior U.S. Cls.: 100, 101, 102, 103, 106, and 107

United States Patent and Trademark Office

Reg. No. 3,482,204

Registered Aug. 5, 2008

**SERVICE MARK
PRINCIPAL REGISTER**

PROOFPLUS

PUBLISHING DATA MANAGEMENT INC. (NEW YORK CORPORATION)
915 BROADWAY, 4TH FLOOR
NEW YORK, NY 10010

FOR: WORKFLOW PROCESS SERVICES, NAME-
LY, MANAGING THE ACTIVITIES OF A BUSINESS
BY MONITORING AND FACILITATING THE
FLOW OF WORK-IN-PROGRESS DOCUMENTS IN
THE FIELD OF PUBLISHING, IN CLASS 35 (U.S.
CLS. 100, 101 AND 102).

FIRST USE 6-18-2007; IN COMMERCE 6-18-2007.

FOR: DOCUMENT TYPESETTING, IN CLASS 40
(U.S. CLS. 100, 103 AND 106).

FIRST USE 6-18-2007; IN COMMERCE 6-18-2007.

FOR: WRITTEN DOCUMENT EDITING; DOCU-
MENT CREATION, NAME-
LY, DESKTOP PUBLISH-
ING FOR OTHERS, IN CLASS 41 (U.S. CLS. 100, 101
AND 107).

FIRST USE 6-18-2007; IN COMMERCE 6-18-2007.

THE MARK CONSISTS OF STANDARD CHAR-
ACTERS WITHOUT CLAIM TO ANY PARTICULAR
FONT, STYLE, SIZE, OR COLOR.

SN 78-744,851, FILED 11-1-2005.

ALEX KEAM, EXAMINING ATTORNEY

Int. Cl.: 25

Prior U.S. Cls.: 22 and 39

United States Patent and Trademark Office

Reg. No. 3,482,205

Registered Aug. 5, 2008

**TRADEMARK
PRINCIPAL REGISTER**



SOLE ASSETS HOLDINGS, INC. (CALIFORNIA CORPORATION)
28720 CANWOOD STREET
SUITE 108
AGOURA HILLS, CA 91301

FIRST USE 1-25-2006; IN COMMERCE 7-1-2006.

THE MARK CONSISTS OF A HUMANIZED LIGHTNING BOLT DESIGN.

FOR: APPAREL, NAMELY, BELTS, BOTTOMS, CAMISOLES, JACKETS, JEANS, JERSEYS, PANTS, SHIRTS, SHORTS, SKIRTS, SWEAT PANTS, SWEATERS, SWEAT SHIRTS, TANK TOPS, TOPS, T-SHIRTS, IN CLASS 25 (U.S. CLS. 22 AND 39).

SN 78-746,870, FILED 11-3-2005.

TEJBIR SINGH, EXAMINING ATTORNEY

Int. Cl.: 16

Prior U.S. Cls.: 2, 5, 22, 23, 29, 37, 38, and 50

Reg. No. 3,482,206

United States Patent and Trademark Office

Registered Aug. 5, 2008

**TRADEMARK
PRINCIPAL REGISTER**



THE CALIFORNIA SPEEDWAY CORPORATION
(DELAWARE CORPORATION)
ATTN: KAREN B. LEETZOW
1801 W. INTERNATIONAL SPEEDWAY BLVD.
DAYTONA BEACH, FL 32114

FOR: POSTERS, CALENDARS, STICKERS, BUM-
PERS STICKERS, DECALS, TRADING CARDS,
TRADING CARD ALBUMS, POSTCARDS, BOOK
COVERS, POSTERS NOTEBOOKS, LOOSE LEAF
BINDERS, AND MEMO PADS; PENS, PENCILS,

AND ERASERS; PAPER NAPKINS AND PAPER
PLACE MATS; AND CREDENTIAL HOLDERS, IN
CLASS 16 (U.S. CLS. 2, 5, 22, 23, 29, 37, 38 AND 50).

FIRST USE 2-24-2006; IN COMMERCE 2-24-2006.

SN 78-746,953, FILED 11-4-2005.

BRIAN NEVILLE, EXAMINING ATTORNEY

Int. Cl.: 1

Prior U.S. Cls.: 1, 5, 6, 10, 26, and 46

Reg. No. 3,482,207

United States Patent and Trademark Office

Registered Aug. 5, 2008

**TRADEMARK
PRINCIPAL REGISTER**

NATUR-TEC

NORTHERN TECHNOLOGIES INTERNATIONAL CORPORATION (DELAWARE CORPORATION)
23205 MERCANTILE ROAD
BEACHWOOD, OH 44122

FOR: BIODEGRADABLE AND/OR COMPOSTABLE POLYMER RESINS; BLENDED, COMPOUNDED AND/OR ALLOYED MIXTURES OF BIODEGRADABLE AND/OR COMPOSTABLE POLYMER RESINS; AND BIODEGRADABLE AND/OR COMPOSTABLE POLYMER BASE COMPOSITIONS, ALL USED IN THE MANUFACTURE

OF COMMERCIAL, INDUSTRIAL AND DOMESTIC GOODS, IN CLASS 1 (U.S. CLS. 1, 5, 6, 10, 26 AND 46).

FIRST USE 4-10-2007; IN COMMERCE 4-10-2007.

THE MARK CONSISTS OF STANDARD CHARACTERS WITHOUT CLAIM TO ANY PARTICULAR FONT, STYLE, SIZE, OR COLOR.

SN 78-749,729, FILED 11-8-2005.

BARNEY CHARLON, EXAMINING ATTORNEY

Int. Cl.: 16

Prior U.S. Cls.: 2, 5, 22, 23, 29, 37, 38, and 50

Reg. No. 3,482,208

United States Patent and Trademark Office

Registered Aug. 5, 2008

**TRADEMARK
PRINCIPAL REGISTER**

NATUR-TEC

NORTHERN TECHNOLOGIES INTERNATIONAL CORPORATION (DELAWARE CORPORATION)
23205 MERCANTILE ROAD
BEACHWOOD, OH 44122

FOR: PAPER, NAMELY, CARDBOARD, CRAFT PAPER, COPIER PAPER, AND CORRUGATED PAPER, COATED WITH AND/OR CONTAINING ONE OR MORE BIODEGRADABLE AND/OR COMPOSTABLE POLYMER RESINS, AND/OR ONE OR MORE BLENDED, COMPOUNDED AND/OR ALLOYED MIXTURES OF BIODEGRADABLE AND/OR COMPOSTABLE POLYMER RESINS; AND PAPER BAGS COATED WITH AND/OR CONTAINING ONE OR MORE BIODEGRADABLE AND/OR COM-

POSTABLE POLYMER RESINS, AND/OR ONE OR MORE BLENDED, COMPOUNDED AND/OR ALLOYED MIXTURES OF BIODEGRADABLE AND/OR COMPOSTABLE POLYMER RESINS, IN CLASS 16 (U.S. CLS. 2, 5, 22, 23, 29, 37, 38 AND 50).

FIRST USE 9-0-2007; IN COMMERCE 9-0-2007.

THE MARK CONSISTS OF STANDARD CHARACTERS WITHOUT CLAIM TO ANY PARTICULAR FONT, STYLE, SIZE, OR COLOR.

SN 78-749,762, FILED 11-8-2005.

BARNEY CHARLON, EXAMINING ATTORNEY

Int. Cls.: 35, 41, and 42

Prior U.S. Cls.: 100, 101, 102, and 107

United States Patent and Trademark Office

Reg. No. 3,482,209

Registered Aug. 5, 2008

**SERVICE MARK
PRINCIPAL REGISTER**

HEAVYOCITY

HEAVYOCITY MEDIA, INC. (NEW YORK CORPORATION)
SUITE 1203
307 SEVENTH AVENUE
NEW YORK, NY 10001

FOR: RETAIL STORES FEATURING AUDIO RECORDINGS THAT FEATURE AUDIO SAMPLING, IN CLASS 35 (U.S. CLS. 100, 101 AND 102).

FIRST USE 1-16-2008; IN COMMERCE 5-20-2008.

FOR: AUDIO SAMPLING RECORDING AND PRODUCTION, IN CLASS 41 (U.S. CLS. 100, 101 AND 107).

FIRST USE 1-16-2008; IN COMMERCE 5-20-2008.

FOR: LICENSING OF INTELLECTUAL PROPERTY ON BEHALF OF COMPOSERS AND PRODUCERS; DEVELOPMENT OF COMPUTER SOFTWARE WHICH ALLOWS THE USER TO CREATE, CONTROL AND DISTRIBUTE AUDIO SAMPLES AND VIRTUAL INSTRUMENTS, IN CLASS 42 (U.S. CLS. 100 AND 101).

FIRST USE 1-16-2008; IN COMMERCE 5-20-2008.

THE MARK CONSISTS OF STANDARD CHARACTERS WITHOUT CLAIM TO ANY PARTICULAR FONT, STYLE, SIZE, OR COLOR.

SN 78-750,339, FILED 11-9-2005.

LEIGH CAROLINE CASE, EXAMINING ATTORNEY

Int. Cl.: 41

Prior U.S. Cls.: 100, 101, and 107

United States Patent and Trademark Office

Reg. No. 3,482,210

Registered Aug. 5, 2008

**SERVICE MARK
PRINCIPAL REGISTER**

THE NOW

CHAPMAN, DALE A. (UNITED STATES INDIVIDUAL)
27 GRETNA ROAD
PLEASANT VALLEY, NY 12569 AND
BEGLEY, ROBERT (UNITED STATES INDIVIDUAL)
430 39TH CT
VERO BEACH, FL 32968

FOR: ENTERTAINMENT IN THE NATURE OF WRESTLING CONTESTS , IN CLASS 41 (U.S. CLS. 100, 101 AND 107).

FIRST USE 1-15-2006; IN COMMERCE 2-5-2006.

THE MARK CONSISTS OF STANDARD CHARACTERS WITHOUT CLAIM TO ANY PARTICULAR FONT, STYLE, SIZE, OR COLOR.

SN 78-751,449, FILED 11-10-2005.

ELISSA GARBER KON, EXAMINING ATTORNEY

Int. Cl.: 35

Prior U.S. Cls.: 100, 101, and 102

United States Patent and Trademark Office

Reg. No. 3,482,211

Registered Aug. 5, 2008

**SERVICE MARK
PRINCIPAL REGISTER**

SECRET SPOON

PROVIDE COMMERCE, INC. (DELAWARE CORPORATION)
5005 WATERIDGE VISTA DRIVE
SAN DIEGO, CA 92121

FOR: RETAIL AND ONLINE RETAIL STORE SERVICES FEATURING CANDY, CHOCOLATES, CONFECTIONS, COOKIES, DESSERTS, NUTS, GIFT BASKETS, BALLOONS AND STUFFED ANIMALS, IN CLASS 35 (U.S. CLS. 100, 101 AND 102).

FIRST USE 11-30-2005; IN COMMERCE 11-30-2005.

THE MARK CONSISTS OF STANDARD CHARACTERS WITHOUT CLAIM TO ANY PARTICULAR FONT, STYLE, SIZE, OR COLOR.

SN 78-753,655, FILED 11-14-2005.

MYRIAH HABEEB, EXAMINING ATTORNEY

Int. Cl.: 25

Prior U.S. Cls.: 22 and 39

United States Patent and Trademark Office

Reg. No. 3,482,212

Registered Aug. 5, 2008

**TRADEMARK
PRINCIPAL REGISTER**

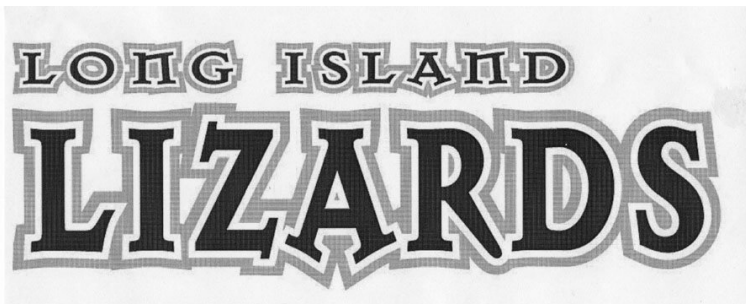

MAJOR LEAGUE LACROSSE LLC (VIRGINIA
LTD LIAB CO)
BRIGHTON LANDING EAST
20 GUEST STREET, SUITE 125
BRIGHTON, MA 02135

FOR: CLOTHING, NAMELY, SHIRTS, T-SHIRTS,
TANK TOPS, SWEAT SHIRTS, SWEAT SHORTS,
SWEAT PANTS, PULLOVERS, JACKETS, ATHLETIC
UNIFORMS, JERSEYS, SHORTS, HEADWEAR,
CAPS AND HATS, IN CLASS 25 (U.S. CLS. 22 AND
39).

FIRST USE 5-1-2004; IN COMMERCE 5-1-2004.

OWNER OF U.S. REG. NOS. 2,762,354 AND
2,976,647.

NO CLAIM IS MADE TO THE EXCLUSIVE
RIGHT TO USE "LONG ISLAND", APART FROM
THE MARK AS SHOWN.

SN 78-755,635, FILED 11-16-2005.

JILL PRATER, EXAMINING ATTORNEY

Int. Cl.: 16

Prior U.S. Cls.: 2, 5, 22, 23, 29, 37, 38, and 50

United States Patent and Trademark Office

Reg. No. 3,482,213

Registered Aug. 5, 2008

**TRADEMARK
PRINCIPAL REGISTER**



ON THE SAME PAGE PLANNER

TATE, MICHAEL ALAN (UNITED STATES IN-
DIVIDUAL)

SUITE 480

2100-A SOUTHBRIDGE PARKWAY

BIRMINGHAM, AL 35209

FOR: NON-FICTION BOOKS ON A VARIETY OF
TOPICS, IN CLASS 16 (U.S. CLS. 2, 5, 22, 23, 29, 37, 38
AND 50).

FIRST USE 3-15-2006; IN COMMERCE 10-15-2006.

NO CLAIM IS MADE TO THE EXCLUSIVE
RIGHT TO USE "PLANNER", APART FROM THE
MARK AS SHOWN.

THE COLOR(S) BLACK, WHITE, LIGHT GREY
AND DARK GREY IS/ARE CLAIMED AS A FEAT-
URE OF THE MARK.

THE MARK CONSISTS OF AN INVERTED PYR-
AMID, WITH BLACK BASE, BLACK LEFT SIDE, A
LIGHT GREY RIGHT SIDE AND A RHOMBOIDAL
SHADOW CAST IN DARK GREY BENEATH APEX
OF THE INVERTED PYRAMIDAL STRUCTURE.
THE COLOR WHITE APPEARS IN THE OUTLINE
OF THE INVERTED PYRAMID AND IN HORIZON-
TAL LINES CROSSING THE PYRAMID.

SN 78-756,016, FILED 11-17-2005.

SIMON TENG, EXAMINING ATTORNEY

Int. Cl.: 9

Prior U.S. Cls.: 21, 23, 26, 36, and 38

Reg. No. 3,482,214

United States Patent and Trademark Office

Registered Aug. 5, 2008

TRADEMARK
PRINCIPAL REGISTER



TERUMO MEDICAL CORPORATION (DELA-
WARE CORPORATION)
2101 COTTONTAIL LANE
SOMERSET, NJ 08873

FOR: COMPUTER SOFTWARE FOR THE MON-
ITORING, RECORDING, OUTPUTTING, AND
MANAGING OF DATA AND INFORMATION;
ELECTRONIC DEVICES FOR USE IN THE FIELD
OF WELDING FOR MANAGING DATA, NAMELY,
MONITORING, RECORDING, AND OUTPUTTING
DATA ON WELDING EQUIPMENT USED TO CON-
NECT SECTIONS OF MEDICAL GRADE THERMO-

PLASTIC TUBING, IN CLASS 9 (U.S. CLS. 21, 23, 26,
36 AND 38).

FIRST USE 3-7-2008; IN COMMERCE 3-7-2008.

NO CLAIM IS MADE TO THE EXCLUSIVE
RIGHT TO USE "TOTAL SYSTEM", APART FROM
THE MARK AS SHOWN.

SN 78-756,033, FILED 11-17-2005.

REBECCA EISINGER, EXAMINING ATTORNEY

Int. Cl.: 9

Prior U.S. Cls.: 21, 23, 26, 36, and 38

Reg. No. 3,482,215

United States Patent and Trademark Office

Registered Aug. 5, 2008

**TRADEMARK
PRINCIPAL REGISTER**

MOIXA

DANIEL, SIMON RICHARD (UNITED KINGDOM INDIVIDUAL)
ABBOTSWOOD, ROW HILLS, FARNHAM
SURREY, UNITED KINGDOM GU9 9AU

FOR: CONSUMER BATTERY PRODUCTS, NAMELY, ALKALINE DRY CELLS, BATTERIES, RECHARGEABLE BATTERIES, BATTERY CHARGERS, HEAVY DUTY BATTERIES, AUTOMOTIVE BATTERIES, INDUSTRIAL BATTERIES; COMPUTERS; COMPUTER HARDWARE; MODEMS; COMPUTER SOFTWARE FOR BROWSING OR ACCESSING THE INTERNET, FOR VISUALIZING INTERNET ACCESS, FOR CONTROL OF APPLICATIONS IN THE FIELD OF SOLAR TECHNOLOGIES, WIND, OR OFF-GRID POWER GENERATION TECHNOLOGIES, OR FOR MANAGING THE CHARGING OF RECHARGEABLE BATTERIES, PORTABLE ELECTRONIC DEVICES, AND PHONES; SOUND SYSTEMS, NAMELY, AUDIO RECEIVERS, AMPLIFIERS, AND SPEAKERS; OPTICAL SYSTEMS, NAMELY, OPTICAL READERS, SCANNERS, AND CABLES; SCIENTIFIC EQUIPMENT, NAMELY, OPTICAL SENSORS, ELECTRONIC SENSORS, AND QUANTUM SENSORS FOR

MEASURING MICROSCOPIC, NANO AND QUANTUM PLANCK LENGTH EFFECTS VIA QUANTUM MEASUREMENT MEANS; LIFE-SAVING APPARATUS, NAMELY, LIFE SAVING RAFTS; VENDING MACHINES; FIRE EXTINGUISHERS; STORAGE DEVICES, NAMELY, CD STORAGE RACKS AND COMPUTER HARD DRIVES; PHONE ACCESSORIES, NAMELY, CELL PHONE COVERS AND DEVICES FOR HANDS-FREE USE OF MOBILE PHONES, IN CLASS 9 (U.S. CLS. 21, 23, 26, 36 AND 38).

FIRST USE 9-30-2006; IN COMMERCE 9-30-2006.

THE MARK CONSISTS OF STANDARD CHARACTERS WITHOUT CLAIM TO ANY PARTICULAR FONT, STYLE, SIZE, OR COLOR.

OWNER OF UNITED KINGDOM REG. NO. 2345732, DATED 5-14-2004, EXPIRES 10-11-2013.

SN 78-756,382, FILED 11-17-2005.

JASON BLAIR, EXAMINING ATTORNEY

Int. Cl.: 34

Prior U.S. Cls.: 2, 8, 9, and 17

United States Patent and Trademark Office

Reg. No. 3,482,216

Registered Aug. 5, 2008

**TRADEMARK
PRINCIPAL REGISTER**

BABALU

HOLT'S COMPANY (DELAWARE CORPORATION)
12270 TOWNSEND ROAD
PHILADELPHIA, PA 19154

THE MARK CONSISTS OF STANDARD CHARACTERS WITHOUT CLAIM TO ANY PARTICULAR FONT, STYLE, SIZE, OR COLOR.

FOR: CIGAR BANDS, CIGAR BOXES NOT OF PRECIOUS METAL, CIGARS, IN CLASS 34 (U.S. CLS. 2, 8, 9 AND 17).

SN 78-758,150, FILED 11-21-2005.

FIRST USE 5-16-2008; IN COMMERCE 5-16-2008.

JUSTINE D. PARKER, EXAMINING ATTORNEY

Int. Cl.: 3

Prior U.S. Cls.: 1, 4, 6, 50, 51, and 52

United States Patent and Trademark Office

Reg. No. 3,482,217

Registered Aug. 5, 2008

**TRADEMARK
PRINCIPAL REGISTER**

EnviroSmart

ENVIROSMART LLC (ILLINOIS LTD LIAB CO)
213 N. MORGAN
CHICAGO, IL 60607

FOR: ENVIRONMENTALLY SAFE PRODUCTS
FOR THE HOME AND GARDEN, NAMELY,
CLEANING PREPARATIONS FOR HOUSEHOLD
PURPOSES, IN CLASS 3 (U.S. CLS. 1, 4, 6, 50, 51
AND 52).

FIRST USE 11-21-2005; IN COMMERCE 9-1-2007.

THE MARK CONSISTS OF STANDARD CHAR-
ACTERS WITHOUT CLAIM TO ANY PARTICULAR
FONT, STYLE, SIZE, OR COLOR.

SN 78-758,393, FILED 11-21-2005.

TIMOTHY FINNEGAN, EXAMINING ATTORNEY

Int. Cl.: 12

Prior U.S. Cls.: 19, 21, 23, 31, 35, and 44

Reg. No. 3,482,218

United States Patent and Trademark Office

Registered Aug. 5, 2008

**TRADEMARK
PRINCIPAL REGISTER**

WIDE OPEN

GULF STREAM COACH, INC. (INDIANA CORPORATION)
503 S. OAKLAND AVENUE
NAPPANEE, IN 46550

THE MARK CONSISTS OF STANDARD CHARACTERS WITHOUT CLAIM TO ANY PARTICULAR FONT, STYLE, SIZE, OR COLOR.

FOR: RECREATIONAL VEHICLES, NAMELY, MOTOR HOMES, FIFTH WHEEL TRAILERS AND TRAVEL TRAILERS, IN CLASS 12 (U.S. CLS. 19, 21, 23, 31, 35 AND 44).

SN 78-759,355, FILED 11-22-2005.

FIRST USE 2-10-2006; IN COMMERCE 2-10-2006.

KEVON CHISOLM, EXAMINING ATTORNEY

Int. Cl.: 25

Prior U.S. Cls.: 22 and 39

United States Patent and Trademark Office

Reg. No. 3,482,219

Registered Aug. 5, 2008

**TRADEMARK
PRINCIPAL REGISTER**

BISHOP OF SEVENTH

KARAM PRASAD, LLC (NEW YORK LTD LIAB
CO)
3 LIVINGSTON AVENUE
WHITE PLAINS, NY 10605

THE MARK CONSISTS OF STANDARD CHAR-
ACTERS WITHOUT CLAIM TO ANY PARTICULAR
FONT, STYLE, SIZE, OR COLOR.

FOR: DRESSES, SKIRTS AND JACKETS, IN
CLASS 25 (U.S. CLS. 22 AND 39).

SN 78-762,060, FILED 11-28-2005.

FIRST USE 3-0-2008; IN COMMERCE 3-0-2008.

ALYSSA PALADINO, EXAMINING ATTORNEY

Int. Cl.: 39

Prior U.S. Cls.: 100 and 105

United States Patent and Trademark Office

Reg. No. 3,482,220

Registered Aug. 5, 2008

**SERVICE MARK
PRINCIPAL REGISTER**



SDS GLOBAL LOGISTICS, INC. (NEW YORK CORPORATION)
52-09 31ST PLACE
LONG ISLAND CITY, NY 11101

FOR: GLOBAL TRANSPORTATION OF FREIGHT FOR OTHERS BY ALL AVAILABLE MEANS, IN CLASS 39 (U.S. CLS. 100 AND 105).

FIRST USE 1-1-2006; IN COMMERCE 1-1-2006.

NO CLAIM IS MADE TO THE EXCLUSIVE RIGHT TO USE "GLOBAL LOGISTICS", APART FROM THE MARK AS SHOWN.

THE COLOR(S) GREEN, BLACK, AND GRAY IS/ ARE CLAIMED AS A FEATURE OF THE MARK.

THE COLOR BLACK APPEARS IN THE WORDS "GLOBAL LOGISTICS." THE COLOR GRAY APPEARS IN THE DESIGN OF A GLOBE. THE COLOR GREEN APPEARS IN THE LINES BORDERING THE ENTIRE MARK AND THE LETTERS "SDS".

THE MARK CONSISTS OF THE WORDS "SDS" GLOBAL LOGISTICS ALONG WITH A GLOBE DESIGN.

SN 78-762,299, FILED 11-29-2005.

DANNEAN HETZEL, EXAMINING ATTORNEY

Int. Cl.: 36

Prior U.S. Cls.: 100, 101, and 102

United States Patent and Trademark Office

Reg. No. 3,482,221

Registered Aug. 5, 2008

**SERVICE MARK
PRINCIPAL REGISTER**



UNITED STATES ARTISTS, INC. (DELAWARE
CORPORATION)
5757 WILSHIRE BLVD., SUITE 580
LOS ANGELES, CA 90036

NO CLAIM IS MADE TO THE EXCLUSIVE
RIGHT TO USE "USA UNITED STATES ARTISTS",
APART FROM THE MARK AS SHOWN.

FOR: CHARITABLE FUND RAISING; PROVID-
ING GRANTS TO INDIVIDUAL ARTISTS, IN CLASS
36 (U.S. CLS. 100, 101 AND 102).

SN 78-762,897, FILED 11-29-2005.

FIRST USE 9-0-2006; IN COMMERCE 9-0-2006.

JAY BESCH, EXAMINING ATTORNEY

Int. Cl.: 17

Prior U.S. Cls.: 1, 5, 12, 13, 35, and 50

United States Patent and Trademark Office

Reg. No. 3,482,222

Registered Aug. 5, 2008

TRADEMARK
PRINCIPAL REGISTER

TopStop

THERMAFIBER, INC. (DELAWARE CORPORATION)
3711 WEST MILL STREET
WABASH, IN 469927778

FOR: ACOUSTICAL INSULATION FOR BUILDINGS, NAMELY, SOUND ABSORBERS AND DIFFUSERS; MINERAL WOOL FOR USE IN AND AROUND THE VOID SPACES ABOVE THE TOPS OF BUILDING WALLS CREATED BY THE INTERSECTION OF THE WALL AND THE METAL OR CONCRETE DECK TO SERVE AS AN ACOUSTICAL BARRIER BETWEEN ROOMS OR FLOORS; HIGH TEMPERATURE MINERAL WOOL INSULATION, INCLUDING PRE-FORMED BLOCKS, FOR USE IN AREAS ABOVE AND AROUND WINDOWS AND IN VERTICAL SPACES BETWEEN METAL OR CONCRETE DECKS TO DELAY THE SPREAD AND/OR TRANSFER OF FLAMES, HOT GASES AND HEAT

BETWEEN FLOORS AND ADD FIRE PROTECTION TO THE UNDERSIDE OF THE DECKS; WHEN INSTALLED IN COMBINATION WITH CLASSIFIED SMOKE SEAL PRODUCTS TO PROVIDE A SEALED BARRIER AGAINST SPREAD AND/OR TRANSFER OF PARTICULATE SMOKE AND AIR, IN CLASS 17 (U.S. CLS. 1, 5, 12, 13, 35 AND 50).

FIRST USE 1-1-2005; IN COMMERCE 1-1-2005.

THE MARK CONSISTS OF STANDARD CHARACTERS WITHOUT CLAIM TO ANY PARTICULAR FONT, STYLE, SIZE, OR COLOR.

SN 78-762,951, FILED 11-29-2005.

BARBARA GAYNOR, EXAMINING ATTORNEY

Int. Cls.: 11, 16, 20, 21, 24, 28, and 35

Prior U.S. Cls.: 2, 5, 13, 21, 22, 23, 25, 29, 30, 31, 32, 33, 34, 37, 38, 40, 42, 50, 100, 101, and 102

Reg. No. 3,482,223

United States Patent and Trademark Office

Registered Aug. 5, 2008

TRADEMARK
SERVICE MARK
PRINCIPAL REGISTER

burton
+BURTON
the TOTAL gift experience

FLOWERS, INC. (GEORGIA CORPORATION)
325 CLEVELAND ROAD
BOGART, GA 306221766

FOR: LAMPS, IN CLASS 11 (U.S. CLS. 13, 21, 23, 31 AND 34).

FIRST USE 6-5-2006; IN COMMERCE 6-19-2006.

FOR: PAPER BAGS FOR PACKAGING GIFTS, GIFT WRAPPING PAPER AND TISSUE; PRINTED CARDBOARD YARD SIGNS; SHREDDED PLASTIC AND PAPER STRIPS USED AS MATERIAL FOR PACKAGING GIFTS; CATALOGS AND NEWSLETTERS IN THE FIELD OF BALLOONS AND BALLOON ACCESSORIES, GIFTS AND GIFT ACCESSORIES, AND FLORAL AND CRAFT SUPPLIES; FLORAL AND CRAFT SUPPLIES, SPECIFICALLY, PAPER RIBBONS AND PAPER GIFT WRAPPING RIBBONS, CARDBOARD AND PAPER BOXES; PAPER, PLASTIC AND METALLIC GIFT WRAP; SHREDDED PAPER FOR PACKAGING, TISSUE PAPER FOR PACKAGING AND GIFT WRAPPING PURPOSES IN THE FORM OF SHEETS; PAPER, PLASTIC AND POLYETHELENE BAGS FOR PACKAGING, PLASTIC SHRINK WRAP FOR PACKAGING, PLASTIC ROLLS FOR GIFT WRAPPING AND PACKAGING; AND PAPER LINERS FOR BASKETS, IN CLASS 16 (U.S. CLS. 2, 5, 22, 23, 29, 37, 38 AND 50).

FIRST USE 6-5-2006; IN COMMERCE 6-19-2006.

FOR: HOME ACCENT ITEMS, SPECIFICALLY, WINE RACKS, STOOLS, CHAIRS, TABLES AND MIRRORS; FURNITURE AND PICTURE FRAMES; DECORATIVE TABLE TOP ITEMS, SPECIFICALLY, SCULPTURES IN THE FORM OF CHERUBS AND FIGURINES ALL MADE OF IVORY, WOOD, POLYSTONE AND POLYRESIN; PLANT STANDS AND PLANT RACKS; AND PLASTIC INSERTS FOR USE AS CONTAINER LINERS, IN CLASS 20 (U.S. CLS. 2, 13, 22, 25, 32 AND 50).

FIRST USE 6-5-2006; IN COMMERCE 6-19-2006.

FOR: MUGS AND GIFT PAILS; CERAMIC, CHINA AND PORCELAIN PRODUCTS, NAMELY, CUPS, MUGS, PLATES, PITCHERS, TEA POTS, BOWLS, PLATTERS, ORNAMENTS, FIGURES, SCULPTURES IN THE FORM OF CHERUBS, STATUES AND SCULPTURES; BASKETS FOR FLOWERS AND PLANTS, DECORATIVE BASKETS, AND BASKETS FOR USE AS HOME DÉCOR ITEMS, HOME ACCENT ITEMS, AND HOME FURNITURE ITEMS; PLANTERS, VASES, AND CANDLEHOLDERS; NON-METAL PIGGY BANKS; AND TRAYS, IN CLASS 21 (U.S. CLS. 2, 13, 23, 29, 30, 33, 40 AND 50).

FIRST USE 6-5-2006; IN COMMERCE 6-19-2006.

FOR: FABRIC GIFT WRAP, TEXTILE TABLE RUNNERS, TEXTILE PLACEMATS, AND TEXTILE WALL HANGINGS; AND FABRIC LINERS FOR BASKETS, IN CLASS 24 (U.S. CLS. 42 AND 50).

FIRST USE 6-5-2006; IN COMMERCE 6-19-2006.

FOR: FOIL AND LATEX BALLOONS; PLUSH STUFFED TOY ANIMALS AND DOLLS AND OTHER PLUSH TOYS, IN CLASS 28 (U.S. CLS. 22, 23, 38 AND 50).

FIRST USE 6-5-2006; IN COMMERCE 6-19-2006.

FOR: DISTRIBUTORSHIP SERVICES IN THE FIELD OF BALLOONS AND BALLOON ACCESSORIES, GIFTS AND GIFT ACCESSORIES, FLORAL SUPPLIES, HOME ACCENT ITEMS, HOME DECOR ITEMS, CERAMIC ITEMS, TABLE SETTING ITEMS, DECORATIVE TABLETOP ITEMS, PLUSH TOY ANIMALS AND OTHER PLUSH ITEMS, MUGS, GIFTS, GIFT PACKAGING, ORNAMENTS, FIGURES, STATUES AND SCULPTURES, BASKETS,

PLANTERS, VASES, CANDLEHOLDERS, AND SPECIALTY FOOD AND BEVERAGE ITEMS, IN CLASS 35 (U.S. CLS. 100, 101 AND 102).

FIRST USE 1-9-2006; IN COMMERCE 1-9-2006.

OWNER OF U.S. REG. NO. 2,658,030.

NO CLAIM IS MADE TO THE EXCLUSIVE RIGHT TO USE "GIFT", APART FROM THE MARK AS SHOWN.

SN 78-763,583, FILED 11-30-2005.

JUDITH HELFMAN, EXAMINING ATTORNEY

Int. Cls.: 16, 20, 21, 28, and 35

Prior U.S. Cls.: 2, 5, 13, 22, 23, 25, 29, 30, 32, 33, 37, 38, 40, 50, 100, 101, and 102

Reg. No. 3,482,224

United States Patent and Trademark Office

Registered Aug. 5, 2008

**TRADEMARK
SERVICE MARK
PRINCIPAL REGISTER**

**burton
+BURTON**

FLOWERS, INC. (GEORGIA CORPORATION)
325 CLEVELAND ROAD
BOGART, GA 306221766

FOR: PAPER BAGS FOR PACKAGING GIFTS, GIFT WRAPPING PAPER AND TISSUE; PRINTED CARDBOARD YARD SIGNS; SHREDDED PLASTIC AND PAPER STRIPS USED AS MATERIAL FOR PACKAGING GIFTS; CATALOGS AND NEWSLETTERS IN THE FIELD OF BALLOONS AND BALLOON ACCESSORIES, GIFTS AND GIFT ACCESSORIES, AND FLORAL AND CRAFT SUPPLIES; FLORAL AND CRAFT SUPPLIES, SPECIFICALLY, PAPER RIBBONS AND PAPER GIFT WRAPPING RIBBONS, CARDBOARD AND PAPER BOXES; PAPER, PLASTIC AND METALLIC GIFT WRAP; SHREDDED PAPER FOR PACKAGING, TISSUE PAPER FOR PACKAGING AND GIFT WRAPPING PURPOSES IN THE FORM OF SHEETS; PAPER, PLASTIC AND POLYETHELENE BAGS FOR PACKAGING, PLASTIC SHRINK WRAP FOR PACKAGING, PLASTIC ROLLS FOR GIFT WRAPPING AND PACKAGING; AND PAPER LINERS FOR BASKETS, IN CLASS 16 (U.S. CLS. 2, 5, 22, 23, 29, 37, 38 AND 50).

FIRST USE 6-5-2006; IN COMMERCE 6-19-2006.

FOR: HOME ACCENT ITEMS, SPECIFICALLY, WINE RACKS, STOOLS, CHAIRS, TABLES AND MIRRORS; FURNITURE AND PICTURE FRAMES; DECORATIVE TABLE TOP ITEMS, SPECIFICALLY, SCULPTURES IN THE FORM OF CHERUBS AND FIGURINES ALL MADE OF IVORY, WOOD, POLYSTONE AND POLYRESIN; PLANT STANDS AND PLANT RACKS; AND PLASTIC INSERTS FOR USE

AS CONTAINER LINERS, IN CLASS 20 (U.S. CLS. 2, 13, 22, 25, 32 AND 50).

FIRST USE 6-5-2006; IN COMMERCE 6-19-2006.

FOR: MUGS AND GIFT PAILS; CERAMIC, CHINA AND PORCELAIN PRODUCTS, NAMELY, CUPS, MUGS, PLATES, PITCHERS, TEA POTS, BOWLS, PLATTERS, ORNAMENTS, FIGURES, SCULPTURES IN THE FORM OF CHERUBS, STATUES AND SCULPTURES; BASKETS FOR FLOWERS AND PLANTS, DECORATIVE BASKETS, AND BASKETS FOR USE AS HOME DÉCOR ITEMS, HOME ACCENT ITEMS, AND HOME FURNITURE ITEMS; PLANTERS, VASES, AND CANDLEHOLDERS; NON-METAL PIGGY BANKS; AND TRAYS, IN CLASS 21 (U.S. CLS. 2, 13, 23, 29, 30, 33, 40 AND 50).

FIRST USE 6-5-2006; IN COMMERCE 6-19-2006.

FOR: FOIL AND LATEX BALLOONS; PLUSH STUFFED TOY ANIMALS AND DOLLS AND OTHER PLUSH TOYS, IN CLASS 28 (U.S. CLS. 22, 23, 38 AND 50).

FIRST USE 6-5-2006; IN COMMERCE 6-19-2006.

FOR: DISTRIBUTORSHIP SERVICES IN THE FIELD OF BALLOONS AND BALLOON ACCESSORIES, GIFTS AND GIFT ACCESSORIES, FLORAL SUPPLIES, HOME ACCENT ITEMS, HOME DECOR ITEMS, CERAMIC ITEMS, TABLE SETTING ITEMS, DECORATIVE TABLETOP ITEMS, PLUSH TOY ANIMALS AND OTHER PLUSH ITEMS, MUGS, GIFTS, GIFT PACKAGING, ORNAMENTS, FIGURES, STATUES AND SCULPTURES, BASKETS,

PLANTERS, VASES, CANDLEHOLDERS, AND SPECIALTY FOOD AND BEVERAGE ITEMS, IN CLASS 35 (U.S. CLS. 100, 101 AND 102).

FIRST USE 6-5-2006; IN COMMERCE 6-19-2006.

OWNER OF U.S. REG. NO. 2,658,030.

SN 78-763,721, FILED 11-30-2005.

JUDITH HELFMAN, EXAMINING ATTORNEY

Int. Cl.: 28

Prior U.S. Cls.: 22, 23, 38, and 50

United States Patent and Trademark Office

Reg. No. 3,482,225

Registered Aug. 5, 2008

**TRADEMARK
PRINCIPAL REGISTER**

PUPPY POKER

LAVELLE, GERALYN A. (UNITED STATES IN-
DIVIDUAL)

501 W. COLFAX

PALATINE, IL 60067

FOR: CARD GAMES; PLAYING CARDS, IN
CLASS 28 (U.S. CLS. 22, 23, 38 AND 50).

FIRST USE 4-15-2008; IN COMMERCE 4-15-2008.

THE MARK CONSISTS OF STANDARD CHAR-
ACTERS WITHOUT CLAIM TO ANY PARTICULAR
FONT, STYLE, SIZE, OR COLOR.

NO CLAIM IS MADE TO THE EXCLUSIVE
RIGHT TO USE "POKER", APART FROM THE
MARK AS SHOWN.

SN 78-763,778, FILED 11-30-2005.

LAURA HAMMEL, EXAMINING ATTORNEY

Int. Cls.: 16, 20, 21, 28, and 35

Prior U.S. Cls.: 2, 5, 13, 22, 23, 25, 29, 30, 32, 33, 37,
38, 40, 50, 100, 101, and 102

Reg. No. 3,482,226

United States Patent and Trademark Office

Registered Aug. 5, 2008

TRADEMARK
SERVICE MARK
PRINCIPAL REGISTER

the TOTAL gift experience

FLOWERS, INC. (GEORGIA CORPORATION)
325 CLEVELAND ROAD
BOGART, GA 306221766

FOR: PAPER BAGS FOR PACKAGING GIFTS, GIFT WRAPPING PAPER AND TISSUE; PRINTED CARDBOARD YARD SIGNS; SHREDDED PLASTIC AND PAPER STRIPS USED AS MATERIAL FOR PACKAGING GIFTS; CATALOGS AND NEWSLETTERS IN THE FIELD OF BALLOONS AND BALLOON ACCESSORIES, GIFTS AND GIFT ACCESSORIES, AND FLORAL AND CRAFT SUPPLIES; FLORAL AND CRAFT SUPPLIES, SPECIFICALLY, PAPER RIBBONS AND PAPER GIFT WRAPPING RIBBONS, CARDBOARD AND PAPER BOXES; PAPER, PLASTIC AND METALLIC GIFT WRAP; SHREDDED PAPER FOR PACKAGING, TISSUE PAPER FOR PACKAGING AND GIFT WRAPPING PURPOSES IN THE FORM OF SHEETS; PAPER, PLASTIC AND POLYETHELENE BAGS FOR PACKAGING, PLASTIC SHRINK WRAP FOR PACKAGING, PLASTIC ROLLS FOR GIFT WRAPPING AND PACKAGING; AND PAPER LINERS FOR BASKETS, IN CLASS 16 (U.S. CLS. 2, 5, 22, 23, 29, 37, 38 AND 50).

FIRST USE 6-5-2006; IN COMMERCE 6-19-2006.

FOR: HOME ACCENT ITEMS, SPECIFICALLY, WINE RACKS, STOOLS, CHAIRS, TABLES AND MIRRORS; FURNITURE AND PICTURE FRAMES; DECORATIVE TABLE TOP ITEMS, SPECIFICALLY, SCULPTURES IN THE FORM OF CHERUBS AND FIGURINES ALL MADE OF IVORY, WOOD, POLYSTONE AND POLYRESIN; PLANT STANDS AND PLANT RACKS; AND PLASTIC INSERTS FOR USE AS CONTAINER LINERS, IN CLASS 20 (U.S. CLS. 2, 13, 22, 25, 32 AND 50).

FIRST USE 6-5-2006; IN COMMERCE 6-19-2006.

FOR: MUGS AND GIFT PAILS; CERAMIC, CHINA AND PORCELAIN PRODUCTS, NAMELY, CUPS, MUGS, PLATES, PITCHERS, TEA POTS, BOWLS, PLATTERS, ORNAMENTS, FIGURES, SCULPTURES IN THE FORM OF CHERUBS, STATUES AND SCULPTURES; BASKETS FOR FLOWERS AND PLANTS, DECORATIVE BASKETS, AND BASKETS FOR USE AS HOME DÉCOR ITEMS, HOME ACCENT ITEMS, AND HOME FURNITURE ITEMS; PLANTERS, VASES, AND CANDLEHOLDERS; NON-METAL PIGGY BANKS; AND TRAYS, IN CLASS 21 (U.S. CLS. 2, 13, 23, 29, 30, 33, 40 AND 50).

FIRST USE 6-5-2006; IN COMMERCE 6-19-2006.

FOR: FOIL AND LATEX BALLOONS; PLUSH STUFFED TOY ANIMALS AND DOLLS AND OTHER PLUSH TOYS, IN CLASS 28 (U.S. CLS. 22, 23, 38 AND 50).

FIRST USE 6-5-2006; IN COMMERCE 6-19-2006.

FOR: DISTRIBUTORSHIP SERVICES IN THE FIELD OF BALLOONS AND BALLOON ACCESSORIES, GIFTS AND GIFT ACCESSORIES, FLORAL SUPPLIES, HOME ACCENT ITEMS, HOME DECOR ITEMS, CERAMIC ITEMS, TABLE SETTING ITEMS, DECORATIVE TABLETOP ITEMS, PLUSH TOY ANIMALS AND OTHER PLUSH ITEMS, MUGS, GIFTS, GIFT PACKAGING, ORNAMENTS, FIGURES, STATUES AND SCULPTURES, BASKETS, PLANTERS, VASES, CANDLEHOLDERS, AND SPECIALTY FOOD AND BEVERAGE ITEMS, IN CLASS 35 (U.S. CLS. 100, 101 AND 102).

FIRST USE 1-9-2006; IN COMMERCE 1-9-2006.

NO CLAIM IS MADE TO THE EXCLUSIVE
RIGHT TO USE "GIFT", APART FROM THE MARK
AS SHOWN.

SN 78-763,884, FILED 11-30-2005.

JUDITH HELFMAN, EXAMINING ATTORNEY

Int. Cls.: 11, 16, 20, 21, 24, 28, and 35

Prior U.S. Cls.: 2, 5, 13, 21, 22, 23, 25, 29, 30, 31, 32, 33, 34, 37, 38, 40, 42, 50, 100, 101, and 102

Reg. No. 3,482,227

United States Patent and Trademark Office

Registered Aug. 5, 2008

TRADEMARK
SERVICE MARK
PRINCIPAL REGISTER

burton
+BURTON

FLOWERS, INC. (GEORGIA CORPORATION)
325 CLEVELAND ROAD
BOGART, GA 306221766

FOR: LAMPS, IN CLASS 11 (U.S. CLS. 13, 21, 23, 31 AND 34).

FIRST USE 6-5-2006; IN COMMERCE 6-19-2006.

FOR: PAPER BAGS FOR PACKAGING GIFTS, GIFT WRAPPING PAPER AND TISSUE; PRINTED CARDBOARD YARD SIGNS; SHREDDED PLASTIC AND PAPER STRIPS USED AS MATERIAL FOR PACKAGING GIFTS; CATALOGS AND NEWSLETTERS IN THE FIELD OF BALLOONS AND BALLOON ACCESSORIES, GIFTS AND GIFT ACCESSORIES, AND FLORAL AND CRAFT SUPPLIES; FLORAL AND CRAFT SUPPLIES, SPECIFICALLY, PAPER RIBBONS AND PAPER GIFT WRAPPING RIBBONS, CARDBOARD AND PAPER BOXES; PAPER, PLASTIC AND METALLIC GIFT WRAP; SHREDDED PAPER FOR PACKAGING, TISSUE PAPER FOR PACKAGING AND GIFT WRAPPING PURPOSES IN THE FORM OF SHEETS; PAPER, PLASTIC AND POLYETHELENE BAGS FOR PACKAGING, PLASTIC SHRINK WRAP FOR PACKAGING, PLASTIC ROLLS FOR GIFT WRAPPING AND PACKAGING; AND PAPER LINERS FOR BASKETS, IN CLASS 16 (U.S. CLS. 2, 5, 22, 23, 29, 37, 38 AND 50).

FIRST USE 6-5-2006; IN COMMERCE 6-19-2006.

FOR: HOME ACCENT ITEMS, SPECIFICALLY, WINE RACKS, STOOLS, CHAIRS, TABLES AND

MIRRORS; FURNITURE AND PICTURE FRAMES; DECORATIVE TABLE TOP ITEMS, SPECIFICALLY, SCULPTURES IN THE FORM OF CHERUBS AND FIGURINES ALL MADE OF IVORY, WOOD, POLYSTONE AND POLYRESIN; PLANT STANDS AND PLANT RACKS; AND PLASTIC INSERTS FOR USE AS CONTAINER LINERS, IN CLASS 20 (U.S. CLS. 2, 13, 22, 25, 32 AND 50).

FIRST USE 6-5-2006; IN COMMERCE 6-19-2006.

FOR: MUGS AND GIFT PAILS; CERAMIC, CHINA AND PORCELAIN PRODUCTS, NAMELY, CUPS, MUGS, PLATES, PITCHERS, TEA POTS, BOWLS, PLATTERS, ORNAMENTS, FIGURES, SCULPTURES IN THE FORM OF CHERUBS, STATUES AND SCULPTURES; BASKETS FOR FLOWERS AND PLANTS, DECORATIVE BASKETS, AND BASKETS FOR USE AS HOME DÉCOR ITEMS, HOME ACCENT ITEMS, AND HOME FURNITURE ITEMS; PLANTERS, VASES, AND CANDLEHOLDERS; NON-METAL PIGGY BANKS; AND TRAYS, IN CLASS 21 (U.S. CLS. 2, 13, 23, 29, 30, 33, 40 AND 50).

FIRST USE 6-5-2006; IN COMMERCE 6-19-2006.

FOR: FABRIC GIFT WRAP, TEXTILE TABLE RUNNERS, TEXTILE PLACEMATS, AND TEXTILE WALL HANGINGS; AND FABRIC LINERS FOR BASKETS, IN CLASS 24 (U.S. CLS. 42 AND 50).

FIRST USE 6-5-2006; IN COMMERCE 6-19-2006.

FOR: FOIL AND LATEX BALLOONS; PLUSH STUFFED TOY ANIMALS AND DOLLS AND

OTHER PLUSH TOYS, IN CLASS 28 (U.S. CLS. 22, 23, 38 AND 50).

FIRST USE 6-5-2006; IN COMMERCE 6-19-2006.

FOR: DISTRIBUTORSHIP SERVICES IN THE FIELD OF BALLOONS AND BALLOON ACCESSORIES, GIFTS AND GIFT ACCESSORIES, FLORAL SUPPLIES, HOME ACCENT ITEMS, HOME DECOR ITEMS, CERAMIC ITEMS, TABLE SETTING ITEMS, DECORATIVE TABLETOP ITEMS, PLUSH TOY ANIMALS AND OTHER PLUSH ITEMS, MUGS, GIFTS, GIFT PACKAGING, ORNAMENTS, FIG-

URES, STATUES AND SCULPTURES, BASKETS, PLANTERS, VASES, CANDLEHOLDERS, AND SPECIALTY FOOD AND BEVERAGE ITEMS, IN CLASS 35 (U.S. CLS. 100, 101 AND 102).

FIRST USE 1-9-2006; IN COMMERCE 1-9-2006.

OWNER OF U.S. REG. NO. 2,658,030.

SN 78-763,898, FILED 11-30-2005.

JUDITH HELFMAN, EXAMINING ATTORNEY

Int. Cls.: 9, 11, 16, 18, 20, 21, 25, and 28

Prior U.S. Cls.: 1, 2, 3, 5, 13, 21, 22, 23, 25, 26, 29, 30, 31, 32, 33, 34, 36, 37, 38, 39, 40, 41, and 50

Reg. No. 3,482,228

United States Patent and Trademark Office

Registered Aug. 5, 2008

**TRADEMARK
PRINCIPAL REGISTER**

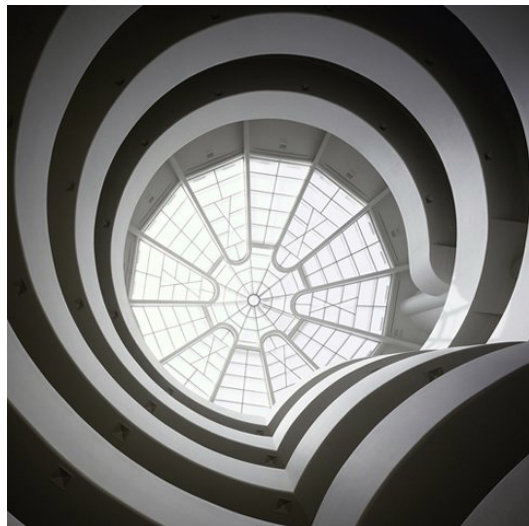

THE SOLOMON R. GUGGENHEIM FOUNDATION (NEW YORK NON-PROFIT CORPORATION)

1071 FIFTH AVENUE
NEW YORK, NY 10012

FOR: MAGNET, MOUSE PAD, IN CLASS 9 (U.S. CLS. 21, 23, 26, 36 AND 38).

FIRST USE 6-3-2008; IN COMMERCE 6-3-2008.

FOR: ELECTRIC NIGHT LIGHTS, IN CLASS 11 (U.S. CLS. 13, 21, 23, 31 AND 34).

FIRST USE 6-3-2008; IN COMMERCE 6-3-2008.

FOR: SKETCHBOOKS, NOTE PADS, PENCILS, POSTERS, BOOKS FEATURING INFORMATION ABOUT ART, ARTISTS AND ARCHITECTURE, BOOKMARKS, POSTCARDS, GIFT CARDS, PRINTS, IN CLASS 16 (U.S. CLS. 2, 5, 22, 23, 29, 37, 38 AND 50).

FIRST USE 3-31-2007; IN COMMERCE 3-31-2007.

FOR: UMBRELLAS, TOTE BAGS , IN CLASS 18 (U.S. CLS. 1, 2, 3, 22 AND 41).

FIRST USE 8-31-2007; IN COMMERCE 8-31-2007.

FOR: PICTURE FRAMES, DECORATIVE MOBILES, IN CLASS 20 (U.S. CLS. 2, 13, 22, 25, 32 AND 50).

FIRST USE 6-9-2008; IN COMMERCE 6-9-2008.

FOR: MUGS, CREAMER PITCHERS, PORCELAIN STORAGE JARS, TEAPOTS NOT OF PRECIOUS METAL, BOWLS, HOLIDAY ORNAMENTS OF PORCELAIN OR CERAMIC, IN CLASS 21 (U.S. CLS. 2, 13, 23, 29, 30, 33, 40 AND 50).

FIRST USE 11-30-2007; IN COMMERCE 11-30-2007.

FOR: T-SHIRTS, CAPS, SCARVES, TIES, IN CLASS 25 (U.S. CLS. 22 AND 39).

FIRST USE 3-31-2007; IN COMMERCE 3-31-2007.

FOR: SPRING TOYS, MOBILES FOR CHILDREN, SPINNING TOPS, CHRISTMAS TREE ORNAMENTS, IN CLASS 28 (U.S. CLS. 22, 23, 38 AND 50).

FIRST USE 3-31-2007; IN COMMERCE 3-31-2007.

THE MARK CONSISTS OF A REPRESENTATION OF THE INTERIOR OF A BUILDING.

SN 78-768,162, FILED 12-7-2005.

JAMES A. RAUEN, EXAMINING ATTORNEY

Int. Cl.: 36

Prior U.S. Cls.: 100, 101, and 102

United States Patent and Trademark Office

Reg. No. 3,482,229

Registered Aug. 5, 2008

**SERVICE MARK
PRINCIPAL REGISTER**

**FIRST NATIONAL BUSINESS
CORPORATION**

FIRST NATIONAL BUSINESS CORPORATION
(MISSOURI CORPORATION)
SUITE K 1335 EAST REPUBLIC ROAD
SPRINGFIELD, MO 65804

FOR: BUSINESS BROKERAGE SERVICES; CONSULTING SERVICES, NAMELY, PROVIDING ASSISTANCE IN THE NATURE OF FINANCING TO BUSINESS OWNERS AND BUSINESS BUYERS FOR BUYING AND SELLING BUSINESSES, IN CLASS 36 (U.S. CLS. 100, 101 AND 102).

FIRST USE 1-1-1999; IN COMMERCE 1-1-1999.

THE MARK CONSISTS OF STANDARD CHARACTERS WITHOUT CLAIM TO ANY PARTICULAR FONT, STYLE, SIZE, OR COLOR.

NO CLAIM IS MADE TO THE EXCLUSIVE RIGHT TO USE "NATIONAL BUSINESS CORPORATION", APART FROM THE MARK AS SHOWN.

SN 78-770,071, FILED 12-9-2005.

FLORENTINA BLANDU, EXAMINING ATTORNEY

Int. Cl.: 43

Prior U.S. Cls.: 100 and 101

United States Patent and Trademark Office

Reg. No. 3,482,230

Registered Aug. 5, 2008

**SERVICE MARK
PRINCIPAL REGISTER**



LING, WONG SIU (HONG KONG INDIVIDUAL)
FLAT B, 3/F, BLOCK 5
NO. 9 SHUNG KING ST., WHAMPOA GARDEN
HONG KONG, HONG KONG

FOR: BAR SERVICES; CAFE-RESTAURANTS;
CAFES; CAFETERIAS; CANTEEN SERVICES; CAR-
RY-OUT RESTAURANTS; CATERING OF FOOD
AND DRINKS; COFFEE-HOUSE AND SNACK-BAR
SERVICES; HOTELS; RESTAURANTS; SELF SER-
VICE RESTAURANTS; SELF-SERVICE RESTAU-
RANTS; SNACK BARS; TEA ROOMS, IN CLASS 43
(U.S. CLS. 100 AND 101).

FIRST USE 1-1-2003; IN COMMERCE 1-1-2007.

THE MARK CONSISTS OF CHINESE CHARAC-
TERS AND ENGLISH CHARACTERS SPELLING
"WING LAI YUEN".

THE FOREIGN WORDING IN THE MARK
TRANSLATES INTO ENGLISH AS CHANTING,
SINGING; GOOSEFOOT AND A GARDEN, A PARK.

THE NON-LATIN CHARACTER(S) IN THE
MARK TRANSLITERATES INTO YONG LI YUAN,
AND THIS MEANS NOTHING IN ENGLISH.

SN 78-770,935, FILED 12-12-2005.

KAREN BRACEY, EXAMINING ATTORNEY

Int. Cl.: 5

Prior U.S. Cls.: 6, 18, 44, 46, 51, and 52

Reg. No. 3,482,231

United States Patent and Trademark Office

Registered Aug. 5, 2008

**TRADEMARK
PRINCIPAL REGISTER**

NUTRASENTIAL

NUTRASENTIAL HEALTH PRODUCTS, INC.
(FLORIDA CORPORATION)
1245 N.E. 90TH STREET
MIAMI, FL 33138

THE MARK CONSISTS OF STANDARD CHAR-
ACTERS WITHOUT CLAIM TO ANY PARTICULAR
FONT, STYLE, SIZE, OR COLOR.

FOR: NUTRITIONAL SUPPLEMENTS, IN CLASS
5 (U.S. CLS. 6, 18, 44, 46, 51 AND 52).

SN 78-771,950, FILED 12-13-2005.

FIRST USE 6-18-2007; IN COMMERCE 6-18-2007.

JULIE GUTTADAURO, EXAMINING ATTORNEY

Int. Cl.: 17

Prior U.S. Cls.: 1, 5, 12, 13, 35, and 50

Reg. No. 3,482,232

United States Patent and Trademark Office

Registered Aug. 5, 2008

TRADEMARK
PRINCIPAL REGISTER

PERFREZ 

APPLIED SEALS CO., LTD. (TAIWAN CORPORATION)
1 F., NO. 201-1, DINGNIAN ST.
FUSING TOWNSHIP
CHANGHUA COUNTY, TAIWAN

FOR: SEALING COMPONENTS MADE OF SYNTHETIC RUBBER, NAMELY, SEALS, RODS, TUBES, SHEETS, SLABS, O-RINGS, AND V-RINGS FOR USE IN MANUFACTURING AND SEMICONDUCTOR INDUSTRIES, IN CLASS 17 (U.S. CLS. 1, 5, 12, 13, 35 AND 50).

FIRST USE 1-12-2007; IN COMMERCE 1-0-2008.

THE COLOR(S) BLACK, RED AND YELLOW IS/ARE CLAIMED AS A FEATURE OF THE MARK.

THE COLOR BLACK APPEARS IN THE WORD "PERFREZ" AND THE TOP OF THE DESIGN TO THE RIGHT OF THE WORD IS YELLOW AND THE BOTTOM HALF IS RED.

THE WORDING "PERFREZ" HAS NO MEANING IN A FOREIGN LANGUAGE.

SN 78-772,128, FILED 12-13-2005.

ALYSSA PALADINO, EXAMINING ATTORNEY

Int. Cls.: 9, 16, and 25

**Prior U.S. Cls.: 2, 5, 21, 22, 23, 26, 29, 36, 37, 38, 39,
and 50**

Reg. No. 3,482,233

United States Patent and Trademark Office

Registered Aug. 5, 2008

**TRADEMARK
PRINCIPAL REGISTER**

DEATH+TAXES

LIQUID PUBLISHING, LLC (FLORIDA LIMITED
LIABILITY COMPANY)
20855 NE 16TH AVENUE, SUITE C16
NORTH MIAMI BEACH, FL 33179

FOR: PRE-RECORDED DVDS AND CDS FEATURING MUSIC, BAND TOURS, AND MUSICAL ENTERTAINMENT, IN CLASS 9 (U.S. CLS. 21, 23, 26, 36 AND 38).

FIRST USE 3-30-2006; IN COMMERCE 3-30-2006.

FOR: PRINTED MATTER, NAMELY, MAGAZINES AND POSTERS IN THE FIELD OF MUSIC ENTERTAINMENT; MAGAZINES IN THE FIELD OF MUSIC, BAND TOURS, AND MUSICAL ENTERTAINMENT; NEWSPAPERS; SYNDICATED COLUMNS DEALING WITH EDITORIALS; STICKERS; POSTERS, PENS, PRINTED LABELS, PAPER BANNERS; PRINTED DVD AND CD COVERS IN THE

FIELD OF MUSIC, BAND TOURS AND MUSICAL ENTERTAINMENT, IN CLASS 16 (U.S. CLS. 2, 5, 22, 23, 29, 37, 38 AND 50).

FIRST USE 3-13-2006; IN COMMERCE 3-30-2006.

FOR: T-SHIRTS, BASEBALL CAPS, CAPS, HATS, VISORS, BLOUSES, IN CLASS 25 (U.S. CLS. 22 AND 39).

FIRST USE 3-27-2006; IN COMMERCE 3-27-2006.

THE MARK CONSISTS OF STANDARD CHARACTERS WITHOUT CLAIM TO ANY PARTICULAR FONT, STYLE, SIZE, OR COLOR.

SN 78-772,411, FILED 12-13-2005.

AMY HELLA, EXAMINING ATTORNEY

Int. Cl.: 5

Prior U.S. Cls.: 6, 18, 44, 46, 51, and 52

Reg. No. 3,482,234

United States Patent and Trademark Office

Registered Aug. 5, 2008

**TRADEMARK
PRINCIPAL REGISTER**

EcoSharp

ECOVAL CORPORATION (DELAWARE CORPORATION)
8604 MAIN STREET, SUITE 1
WILLIAMSVILLE, NY 14221

THE MARK CONSISTS OF STANDARD CHARACTERS WITHOUT CLAIM TO ANY PARTICULAR FONT, STYLE, SIZE, OR COLOR.

FOR: HERBICIDES FOR AGRICULTURAL, DOMESTIC AND HORTICULTURAL USE, IN CLASS 5 (U.S. CLS. 6, 18, 44, 46, 51 AND 52).

SN 78-772,442, FILED 12-13-2005.

FIRST USE 2-7-2007; IN COMMERCE 2-7-2007.

BONNIE LUKEN, EXAMINING ATTORNEY

Int. Cls.: 36 and 44

Prior U.S. Cls.: 100, 101, and 102

United States Patent and Trademark Office

Reg. No. 3,482,235

Registered Aug. 5, 2008

**SERVICE MARK
PRINCIPAL REGISTER**



COMPBENEFITS CORPORATION (DELAWARE CORPORATION)
500 WEST MAIN STREET
LOUISVILLE, KY 40202

FOR: ADMINISTRATION OF MANAGED DENTAL AND VISION CARE SUBSCRIPTION PLANS; DENTAL AND VISION HEALTH INSURANCE SERVICES IN THE NATURE OF PRE-PAID DENTAL AND VISION BENEFITS; ADMINISTERING DISCOUNT FEE-FOR-SERVICE DENTAL PLANS, PRE-PAID DENTAL PLANS, PPO DENTAL PLANS AND INDEMNITY DENTAL PLANS; ADMINISTERING DISCOUNT FEE-FOR-SERVICE VISION PLANS, PRE-PAID VISION PLANS, PPO VISION PLANS AND INDEMNITY VISION PLANS; ADMINISTRATION OF PREFERRED PROVIDER PROGRAMS IN THE FIELD OF DENTAL AND VISION CARE, IN CLASS 36 (U.S. CLS. 100, 101 AND 102).

FIRST USE 10-4-2005; IN COMMERCE 11-1-2005.

FOR: MANAGED DENTAL AND VISION CARE SERVICES, IN CLASS 44 (U.S. CLS. 100 AND 101).

FIRST USE 10-4-2005; IN COMMERCE 11-1-2005.

OWNER OF U.S. REG. NO. 2,706,012.

NO CLAIM IS MADE TO THE EXCLUSIVE RIGHT TO USE "DIRECT", APART FROM THE MARK AS SHOWN.

THE COLOR(S) BLUE, BLACK, GRAY AND WHITE IS/ARE CLAIMED AS A FEATURE OF THE MARK.

THE MARK CONSISTS OF THE COLOR BLUE INCORPORATED INTO THE WORD PREFIX "COMP," THE WORD "DIRECT" AND WITHIN THE CIRCLE DESIGN. THE WORD COMPONENT "BENEFITS" IS IN BLACK. TWO OF THE STYLIZED FIGURES WITHIN THE BLUE CIRCLE ARE WHITE, WHEREAS ONE OF THESE FIGURES IS IN GRAY.

SN 78-773,147, FILED 12-14-2005.

JASON BLAIR, EXAMINING ATTORNEY

Int. Cl.: 28

Prior U.S. Cls.: 22, 23, 38, and 50

United States Patent and Trademark Office

Reg. No. 3,482,236

Registered Aug. 5, 2008

**TRADEMARK
PRINCIPAL REGISTER**

**CAROUSEL BY MANHATTAN
TOY**

MANHATTAN GROUP, LLC (WYOMING LTD
LIAB CO)
SUITE 500
430 FIRST AVENUE NORTH
MINNEAPOLIS, MN 55401

FOR: TOYS, NAMELY, STUFFED TOY ANI-
MALS, STUFFED TOYS, PLUSH TOYS, PULL TOYS,
SOFT SCULPTURE TOYS, CHILDREN'S MULTIPLE
ACTIVITY TOYS, INFANT TOYS, INFANT DEVEL-
OPMENT TOYS, SQUEAKING TOYS, TOYS CON-
TAINING CRINKLE PAPER, FANTASY
CHARACTER TOYS, TRAVEL TOYS, MUSICAL
TOYS, CRIB TOYS, NOISE-MAKING TOYS, NAME-
LY, TOYS DESIGNED TO BE ATTACHED TO CAR
SEATS, CRIBS AND HIGH CHAIRS, IN CLASS 28
(U.S. CLS. 22, 23, 38 AND 50).

FIRST USE 7-31-2006; IN COMMERCE 7-31-2006.

THE MARK CONSISTS OF STANDARD CHAR-
ACTERS WITHOUT CLAIM TO ANY PARTICULAR
FONT, STYLE, SIZE, OR COLOR.

OWNER OF U.S. REG. NOS. 1,370,328, 2,695,090,
AND OTHERS.

NO CLAIM IS MADE TO THE EXCLUSIVE
RIGHT TO USE "TOY", APART FROM THE MARK
AS SHOWN.

SN 78-773,961, FILED 12-15-2005.

ALYSSA PALADINO, EXAMINING ATTORNEY

Int. Cl.: 9

Prior U.S. Cls.: 21, 23, 26, 36, and 38

Reg. No. 3,482,237

United States Patent and Trademark Office

Registered Aug. 5, 2008

**TRADEMARK
PRINCIPAL REGISTER**

Susol

LS INDUSTRIAL SYSTEMS CO., LTD. (REPUBLIC OF KOREA CORPORATION)
84-11, NAMDAEMUN-RO, 5-GA JUNG-GU
YONSEI JAEDAN SEVERANCE BUILDING
SEOUL, REPUBLIC OF KOREA

FOR: CIRCUIT BREAKERS; MOLDED CASE CIRCUIT BREAKERS; CONTACTORS; MAGNETIC SWITCHES; RELAYS; WATT HOUR METERS; ELECTRICITY TRANSFORMERS; ELECTRICITY INVERTERS; PROGRAMMABLE LOGIC CONTROLLERS; RADIO FREQUENCY TAG READERS;

RADIO FREQUENCY TAG RECOGNIZERS; TRANSPONDERS USED AS RADIO FREQUENCY RECOGNIZERS; RADIO FREQUENCY IDENTIFICATION, IN CLASS 9 (U.S. CLS. 21, 23, 26, 36 AND 38).

FIRST USE 3-1-2006; IN COMMERCE 3-1-2006.

SN 78-774,087, FILED 12-15-2005.

KEVON CHISOLM, EXAMINING ATTORNEY

Int. Cl.: 9

Prior U.S. Cls.: 21, 23, 26, 36, and 38

United States Patent and Trademark Office

Reg. No. 3,482,238

Registered Aug. 5, 2008

**TRADEMARK
PRINCIPAL REGISTER**

AGILENT OPENLAB

AGILENT TECHNOLOGIES, INC. (DELAWARE CORPORATION)
MS 1A-LC
5301 STEVENS CREEK BOULEVARD
SANTA CLARA, CA 95051

FOR: CHEMICAL AND BIOLOGICAL ANALYTICAL EQUIPMENT, NAMELY, A LABORATORY OPERATING SYSTEMS COMPRISING OF COMPUTER HARDWARE AND COMPUTER SOFTWARE TO FACILITATE THE INTERACTION AND MANAGEMENT OF INSTRUMENTS, SCIENTIFIC DATA AND BUSINESS PROCESS ELECTRONIC DATA, IN CLASS 9 (U.S. CLS. 21, 23, 26, 36 AND 38).

FIRST USE 6-0-2007; IN COMMERCE 6-0-2007.

THE MARK CONSISTS OF STANDARD CHARACTERS WITHOUT CLAIM TO ANY PARTICULAR FONT, STYLE, SIZE, OR COLOR.

OWNER OF U.S. REG. NOS. 2,461,406, 2,643,345, AND OTHERS.

SN 78-774,658, FILED 12-15-2005.

DAVID YONTEF, EXAMINING ATTORNEY

Int. Cl.: 9

Prior U.S. Cls.: 21, 23, 26, 36, and 38

Reg. No. 3,482,239

United States Patent and Trademark Office

Registered Aug. 5, 2008

**TRADEMARK
PRINCIPAL REGISTER**

IMAP

ALLIED TELESIS, INC. (DELAWARE CORPORATION)
19800 NORTH CREEK PARKWAY
SUITE 100
BOTHELL, WA 98011

FOR: COMPUTER NETWORKING HARDWARE, NAMELY, SWITCHES; FIRMWARE FOR USE IN COMMUNICATIONS NETWORKS USED IN CONNECTION THEREWITH, IN CLASS 9 (U.S. CLS. 21, 23, 26, 36 AND 38).

FIRST USE 2-0-2006; IN COMMERCE 2-0-2006.

THE MARK CONSISTS OF STANDARD CHARACTERS WITHOUT CLAIM TO ANY PARTICULAR FONT, STYLE, SIZE, OR COLOR.

SN 78-775,318, FILED 12-16-2005.

ALYSSA PALADINO, EXAMINING ATTORNEY

Int. Cl.: 41

Prior U.S. Cls.: 100, 101, and 107

United States Patent and Trademark Office

Reg. No. 3,482,240

Registered Aug. 5, 2008

**SERVICE MARK
PRINCIPAL REGISTER**

PIT CREW PAYOUT

GAMELOGIC INC. (DELAWARE CORPORATION)
411 WAVERLY OAKS ROAD, SUITE 312
WALTHAM, MA 02452

FOR: ENTERTAINMENT SERVICES, NAMELY,
PROVIDING ONLINE COMPUTER GAMES; ELECTRONIC CASINO GAMING SERVICES, IN CLASS 41 (U.S. CLS. 100, 101 AND 107).

FIRST USE 4-12-2006; IN COMMERCE 4-12-2006.

THE MARK CONSISTS OF STANDARD CHARACTERS WITHOUT CLAIM TO ANY PARTICULAR FONT, STYLE, SIZE, OR COLOR.

NO CLAIM IS MADE TO THE EXCLUSIVE RIGHT TO USE "PAYOUT", APART FROM THE MARK AS SHOWN.

SN 78-776,312, FILED 12-19-2005.

TRACY WHITTAKER-BROWN, EXAMINING ATTORNEY

Int. Cl.: 38

Prior U.S. Cls.: 100, 101, and 104

United States Patent and Trademark Office

Reg. No. 3,482,241

Registered Aug. 5, 2008

**SERVICE MARK
PRINCIPAL REGISTER**

"Plays Everything Country"

KROEGER MEDIA INC. (CANADA CORPORATION)
BOX 118
38 KINGSCREST
LA SALLE, CANADA R0G 1B0

FOR: RADIO BROADCASTING SERVICE, IN
CLASS 38 (U.S. CLS. 100, 101 AND 104).

FIRST USE 1-5-2007; IN COMMERCE 1-5-2007.

THE MARK CONSISTS OF STANDARD CHARACTERS WITHOUT CLAIM TO ANY PARTICULAR FONT, STYLE, SIZE, OR COLOR.

NO CLAIM IS MADE TO THE EXCLUSIVE RIGHT TO USE "COUNTRY", APART FROM THE MARK AS SHOWN.

SN 78-776,558, FILED 12-19-2005.

MATTHEW PAPPAS, EXAMINING ATTORNEY

Int. Cl.: 41

Prior U.S. Cls.: 100, 101, and 107

United States Patent and Trademark Office

Reg. No. 3,482,242

Registered Aug. 5, 2008

**SERVICE MARK
PRINCIPAL REGISTER**

**REAL MOMS, REAL STORIES,
REAL SAVVY**

MORPHOGENIX, LLC (DELAWARE CORPORATION)
SUITE 2300 SW
545 EIGHTH AVE
NEW YORK, NY 10018

FOR: EDUCATIONAL SERVICES, NAMELY, ONGOING TELEVISION PROGRAMS FEATURING INFORMATION ON HEALTH AND PARENTING, IN CLASS 41 (U.S. CLS. 100, 101 AND 107).

FIRST USE 1-0-2006; IN COMMERCE 1-0-2006.

THE MARK CONSISTS OF STANDARD CHARACTERS WITHOUT CLAIM TO ANY PARTICULAR FONT, STYLE, SIZE, OR COLOR.

SN 78-777,402, FILED 12-20-2005.

SALLY SHIH, EXAMINING ATTORNEY

Int. Cls.: 35 and 36

Prior U.S. Cls.: 100, 101, and 102

United States Patent and Trademark Office

Reg. No. 3,482,243

Registered Aug. 5, 2008

**SERVICE MARK
PRINCIPAL REGISTER**

SMALL IS THE NEW BIG

INNUIITY, INC. (UTAH CORPORATION)
8644 154TH AVENUE NE
REDMOND, WA 98052

FOR: PROMOTING THE GOODS AND SERVICES OF OTHERS BY PROVIDING A WEB SITE AT WHICH USERS CAN LINK TO MARKETING TOOLS, INFORMATION REGARDING SALES LEADS, PAY-PER-CLICK CAMPAIGN MANAGEMENT, AFFILIATE MARKETING MANAGEMENT, SEARCH ENGINE SUBMISSION, PERMISSION EMAIL MARKETING, WEB ANALYTICS TOOLS AND MANAGEMENT, DOMAIN NAME REGISTRATION, BUSINESS AND E-COMMERCE WEBSITES, CUSTOM DESIGN SERVICES, MERCHANT ACCOUNTS AND PAYMENT PROCESSING SERVICES FOR CREDIT CARDS AND AUTOMATED CLEARINGHOUSE (ACH) TRANSACTIONS, AND BILL PRESENTMENT AND PAYMENT; PROVIDING A SEARCHABLE ONLINE ADVERTISING GUIDE FEATURING THE GOODS AND SERVICES OF OTHER ONLINE VENDORS ON THE INTERNET; PROMOTING THE GOODS AND SERVICES OF OTHERS BY MEANS OF OPERATING AN ONLINE SHOPPING MALL WITH LINKS TO THE

RETAIL WEB SITES OF OTHERS; RETAIL STORE SERVICES FEATURING POINT-OF-SALE (POS) HARDWARE, SOFTWARE FOR ACCOUNTING, PAYROLL, CUSTOMER CARE, HUMAN RESOURCES, AND OTHER MANAGEMENT INFORMATION APPLICATIONS FOR E-COMMERCE AND SMALL BUSINESSES, IN CLASS 35 (U.S. CLS. 100, 101 AND 102).

FIRST USE 11-0-2005; IN COMMERCE 11-0-2005.

FOR: CREDIT CARD TRANSACTION PROCESSING SERVICES, IN CLASS 36 (U.S. CLS. 100, 101 AND 102).

FIRST USE 5-0-2007; IN COMMERCE 5-0-2007.

THE MARK CONSISTS OF STANDARD CHARACTERS WITHOUT CLAIM TO ANY PARTICULAR FONT, STYLE, SIZE, OR COLOR.

SN 78-777,496, FILED 12-20-2005.

RAMONA ORTIGA, EXAMINING ATTORNEY

Int. Cls.: 6, 35, and 40

Prior U.S. Cls.: 2, 12, 13, 14, 23, 25, 50, 100, 101, 102, 103, and 106

Reg. No. 3,482,244

United States Patent and Trademark Office

Registered Aug. 5, 2008

**TRADEMARK
SERVICE MARK
PRINCIPAL REGISTER**



RYERSON PROCUREMENT CORPORATION
(DELAWARE CORPORATION)
2621 WEST 15TH PLACE
CHICAGO, IL 60608

STEEL SHAPES AND METAL BANDS AND HOOPS;
METAL SHAFTING; MACHINED METAL RINGS
AND DISCS, IN CLASS 6 (U.S. CLS. 2, 12, 13, 14, 23, 25
AND 50).

FOR: STEEL IN BAR, ROD, SHEET, AND PLATE
FORM; STEEL FLOOR PLATES AND TREAD
PLATES; STRUCTURAL STEEL TUBING; EXPAN-
DED STEEL SHEETS; CORRUGATED STEEL
SHEETS; CORRUGATED STEEL SHEETS FOR CON-
STRUCTION PURPOSES, NAMELY, IN THE WALL
AND ROOF SECTION OF BUILDINGS; STAINLESS
STEEL SOLD IN BULK; METAL CONSTRUCTION
MATERIALS, NAMELY, BAR, ROD, SHEET, AND
PLATE SHAPES; METAL ROOFING AND ALUMI-
NUM SIDING; METAL FLOOR PLATES AND
TREAD PLATES; METAL OPEN FLOORING AND
GRATING; ARCHITECTURAL METAL ROOFING
IN STEEL AND ALUMINUM; METAL STRUCTUR-
AL TUBING; METAL EXPANDED SHEETS AND
GRATING; METAL PERFORATED SHEETS; MET-
AL MECHANICAL TUBING; METAL THREADED
TUBING AND BARS; METAL STRUCTURAL
SHAPES FOR USE IN THE FURTHER MANUFAC-
TURE OR FINISHED GOODS; METAL PIPE AND
PIPE FITTINGS; CARBON STEEL; ALLOY STEEL;
STRIP STEEL; SCREW STEEL; METAL SOLD IN
BULK FOR FURTHER MANUFACTURING; STAIN-
LESS STEEL; METAL FORGINGS; COLD ROLLED
STEEL, FLAME CUT METAL SHAPES, FLAME CUT

FIRST USE 3-31-2006; IN COMMERCE 3-31-2006.

FOR: WHOLESALE DISTRIBUTORSHIP AND RE-
TAIL SERVICES BY DIRECT SOLICITATION BY
SALES AGENTS IN THE FIELD OF STEEL, METAL
AND FABRICATED METAL AND STEEL PRO-
DUCTS MANUFACTURED BY OTHERS; AND PRO-
VIDING PERSONAL COMPUTER-BASED ON-LINE
ORDERING SERVICES FOR CARBON STEEL,
STAINLESS STEEL, ALLOY STEEL, COPPER, NICK-
EL, PLASTIC, AND ALUMINUM STRUCTURAL
COMPONENTS, NAMELY, ANGLES, BEAMS,
CHANNELS, TEES, PLATES, BARS, SHEETS, COILS,
TUBING, PIPE AND FLOORING AND GRATING
PRODUCTS, AND FOR THE PROCESSING, MA-
CHINING, AND FINISHING THEREOF; INVEN-
TORY CONTROL SERVICES IN THE NATURE OF
VENDOR MANAGEMENT OF CUSTOMER INVEN-
TORIES AND RECEIPT OF GOODS FOR CUSTO-
MER INVENTORIES, PROVIDING A MAIL ORDER
AND AN ON-LINE CATALOG OF THE GOODS
AND SERVICES OF OTHERS IN THE FIELD OF
STEEL, METAL, AND RELATED CONSTRUCTION
EQUIPMENT, IN CLASS 35 (U.S. CLS. 100, 101 AND
102).

FIRST USE 3-31-2006; IN COMMERCE 3-31-2006.

FOR: FABRICATION, PREPARATION, AND TREATMENT OF METALS AND METAL PRODUCTS COMPRISING FLAME CUTTING, SAWING, THREADING, PUNCHING, BENDING, WELDING, DRILLING, GRINDING, AND SHEARING, AND FABRICATION, PREPARATION, AND TREATMENT OF PLASTICS COMPRISING OF MILLING, SANDING, TURNING AND SPECIAL EXTRUSIONS, IN CLASS 40 (U.S. CLS. 100, 103 AND 106).

FIRST USE 3-31-2006; IN COMMERCE 3-31-2006.

OWNER OF U.S. REG. NOS. 567,013, 2,631,496, AND 2,649,199.

THE MARK CONSISTS OF A STYLIZED "R" DESIGN WITHIN A CIRCLE.

SN 78-777,519, FILED 12-20-2005.

CHERYL CLAYTON, EXAMINING ATTORNEY

Int. Cl.: 30

Prior U.S. Cl.: 46

United States Patent and Trademark Office

Reg. No. 3,482,245

Registered Aug. 5, 2008

**TRADEMARK
PRINCIPAL REGISTER**

THE ORIGINAL DIETER'S DREAM

LEWIS BROTHERS BAKERIES, INCORPORATED
(MISSOURI CORPORATION), DBA LEWIS
BAKERIES, INC.,

500 N. FULTON AVENUE
EVANSVILLE, IN 47710

FOR: BAGELS; MUFFINS, IN CLASS 30 (U.S. CL.
46).

FIRST USE 11-0-2007; IN COMMERCE 11-0-2007.

THE MARK CONSISTS OF STANDARD CHAR-
ACTERS WITHOUT CLAIM TO ANY PARTICULAR
FONT, STYLE, SIZE, OR COLOR.

NO CLAIM IS MADE TO THE EXCLUSIVE
RIGHT TO USE "ORIGINAL DIETER'S", APART
FROM THE MARK AS SHOWN.

SN 78-777,987, FILED 12-21-2005.

DEZMONA MIZELLE, EXAMINING ATTORNEY

Int. Cl.: 18

Prior U.S. Cls.: 1, 2, 3, 22, and 41

United States Patent and Trademark Office

Reg. No. 3,482,246

Registered Aug. 5, 2008

**TRADEMARK
PRINCIPAL REGISTER**

OM MY DOG

GARRISON, BRANDY (UNITED STATES JOINT APPLICANT)

523 GARFIELD STREET

OCEANSIDE, CA 92054 AND

GARRISON, PATRICK (UNITED STATES JOINT APPLICANT)

523 GARFIELD STREET

OCEANSIDE, CA 92054

FOR: DOG COLLARS, DOG LEASHES, IN CLASS 18 (U.S. CLS. 1, 2, 3, 22 AND 41).

FIRST USE 8-18-2006; IN COMMERCE 8-18-2006.

THE MARK CONSISTS OF STANDARD CHARACTERS WITHOUT CLAIM TO ANY PARTICULAR FONT, STYLE, SIZE, OR COLOR.

NO CLAIM IS MADE TO THE EXCLUSIVE RIGHT TO USE "DOG", APART FROM THE MARK AS SHOWN.

THE WORDING "OM" HAS NO MEANING IN A FOREIGN LANGUAGE.

SN 78-780,238, FILED 12-23-2005.

DOMINIC J. FERRAIUOLO, EXAMINING ATTORNEY

Int. Cl.: 18

Prior U.S. Cls.: 1, 2, 3, 22, and 41

United States Patent and Trademark Office

Reg. No. 3,482,247

Registered Aug. 5, 2008

**TRADEMARK
PRINCIPAL REGISTER**



BOOM INTERNATIONAL MARKETPLACE INC.
(CANADA CORPORATION)
172 OAKLAND AVENUE
LONDON, ONTARIO, CANADA N5W 4H9

FIRST USE 5-18-2008; IN COMMERCE 5-18-2008.

SN 78-780,292, FILED 12-23-2005.

FOR: HANDBAGS, WALLETS AND BEACH UMBRELLAS, IN CLASS 18 (U.S. CLS. 1, 2, 3, 22 AND 41).

LEIGH CAROLINE CASE, EXAMINING ATTORNEY

Int. Cl.: 10

Prior U.S. Cls.: 26, 39, and 44

United States Patent and Trademark Office

Reg. No. 3,482,248

Registered Aug. 5, 2008

**TRADEMARK
PRINCIPAL REGISTER**

CeraCrown

OLIVA OCHOA, JOSEP (SPAIN INDIVIDUAL)
C/JOSEP UMBERT 126
GRANOLLERS, SPAIN 08402 AND
OLIVA OCHOA, XAVIER (SPAIN INDIVIDUAL)
C/JOSEP UMBERT 126
GRANOLLERS, SPAIN

FOR: DENTAL APPARATUS AND INSTRUMENTS, NAMELY, DENTAL IMPLANTS; ARTIFICIAL LIMBS, EYES AND TEETH; ORTHOPEDIC ARTICLES, NAMELY, ORTHOPEDIC BRACES; SU-

TURE MATERIALS, NAMELY, SUTURES, IN CLASS 10 (U.S. CLS. 26, 39 AND 44).

FIRST USE 1-1-2004; IN COMMERCE 1-1-2004.

THE MARK CONSISTS OF STANDARD CHARACTERS WITHOUT CLAIM TO ANY PARTICULAR FONT, STYLE, SIZE, OR COLOR.

SN 78-780,553, FILED 12-23-2005.

HANNO RITTNER, EXAMINING ATTORNEY

Int. Cl.: 9

Prior U.S. Cls.: 21, 23, 26, 36, and 38

Reg. No. 3,482,249

United States Patent and Trademark Office

Registered Aug. 5, 2008

TRADEMARK
PRINCIPAL REGISTER



INVENTEC BESTA CO., LTD. (TAIWAN CORPORATION)
10 FL., NO. 36 - LANE 513
RUI GUANG ROAD, NEI HU DISTRICT
TAIPEI, TAIWAN

FOR: ELECTRONIC DICTIONARIES; ELECTRONIC NOTEBOOKS; ELECTRONIC GAME SOFTWARE; ELECTRONIC TRANSLATION MACHINES; ELECTRONIC PUBLICATIONS, NAMELY, ELECTRONIC BOOKS, MAGAZINES AND MANUALS FEATURING LANGUAGE INSTRUCTION AND MUSIC RECORDED ON COMPUTER MEDIA; INTEGRATED CIRCUIT CARDS; MEMORY CARDS; COMPUTERS; LIGHT PENS; INTERFACE CARDS; SOUND CARDS; APPARATUS FOR TRANSMITTING AND REPRODUCING SOUND OR IMAGES; TELEPHONE SETS; MOBILE TELEPHONES; CELLULAR TELEPHONES; CORDLESS TELEPHONES; TELEPHONE ANSWERING MACHINES; VIDEO TELEPHONES COMMUNICATIONS APPARATUS; PERSONAL DIGITAL ASSISTANTS; COMPUTER SOFTWARE FOR INSERTING DIGITAL IMAGES INTO MP3 PLAYERS OR DIGITAL AUDIO FILES; DIGITAL CAMERAS; VIDEO GAME SOFTWARE; TELEPHONE NETWORKS COMPRISING CELLULAR TELEPHONES, COMPUTER MONITORS, CAMERAS, MODEMS, HEAD-

PHONES, MICROPHONES AND COMPUTERS; ELECTRONIC PUBLICATIONS, NAMELY, BOOKS, AND NOTEBOOKS FEATURING NEWS, WEATHER, SPORTS, CURRENT EVENTS, AND REFERENCE MATERIALS RECORDED ON FLOPPY DISKS, COMPACT DISCS; MP3 PLAYERS; DIGITAL VIDEO CAMERAS; COMPUTER CONNECTING CORDS; TELEVISION SETS; DIGITAL TELEVISIONS; PLASMA TELEVISIONS, IN CLASS 9 (U.S. CLS. 21, 23, 26, 36 AND 38).

FIRST USE 12-1-2006; IN COMMERCE 1-22-2007.

THE MARK CONSISTS OF THREE KOREAN CHARACTERS AND THEIR TRANSLITERATION "NURIAN" AS WELL AS A "NU" DESIGN.

THE TRANSLITERATION AND TRANSLATION OF THE KOREAN CHARACTERS CONTAINED IN THE MARK ARE "NU; RI; AN" AND "PEOPLE IN THE WORLD", RESPECTIVELY.

SN 78-781,413, FILED 12-28-2005.

DOMINIC J. FERRAIUOLO, EXAMINING ATTORNEY

Int. Cl.: 10

Prior U.S. Cls.: 26, 39, and 44

United States Patent and Trademark Office

Reg. No. 3,482,250

Registered Aug. 5, 2008

**TRADEMARK
PRINCIPAL REGISTER**

BOW  TIE

OSBORNE ORTHOPEDIC GROUP, INC. (VIRGINIA CORPORATION)
10111 ROGERS DRIVE
NASSAWADOX, VA 23413

FOR: SURGICAL AND MEDICAL APPARATUS FOR USE IN GENERAL SURGERY; MEDICAL DEVICES, NAMELY, HOLDERS FOR ORGANIZING WIRES, CABLES, HOSES, TUBES, OR OTHER LINES, IN CLASS 10 (U.S. CLS. 26, 39 AND 44).

FIRST USE 4-0-2006; IN COMMERCE 4-0-2006.

THE MARK CONSISTS OF THE WORDS "BOW" AND "TIE" SEPARATED BY A FIGURE EIGHT, INFINITY SYMBOL, OR "BOW TIE" -STYLE ELEMENT.

SN 78-782,457, FILED 12-29-2005.

LYDIA BELZER, EXAMINING ATTORNEY

Int. Cl.: 9

Prior U.S. Cls.: 21, 23, 26, 36, and 38

United States Patent and Trademark Office

Reg. No. 3,482,251

Registered Aug. 5, 2008

**TRADEMARK
PRINCIPAL REGISTER**

ENERFUEL

ENER1 HOLDINGS, INC. (FLORIDA CORPORATION)
500 WEST CYPRESS CREEK ROAD, SUITE 100
FORT LAUDERDALE, FL 33309

THE MARK CONSISTS OF STANDARD CHARACTERS WITHOUT CLAIM TO ANY PARTICULAR FONT, STYLE, SIZE, OR COLOR.

FOR: ELECTRO-CHEMICAL FUEL CELLS FOR GENERATING ELECTRICITY, IN CLASS 9 (U.S. CLS. 21, 23, 26, 36 AND 38).

SN 78-782,458, FILED 12-29-2005.

FIRST USE 8-24-2007; IN COMMERCE 8-24-2007.

LYDIA BELZER, EXAMINING ATTORNEY

Int. Cl.: 41

Prior U.S. Cls.: 100, 101, and 107

United States Patent and Trademark Office

Reg. No. 3,482,252

Registered Aug. 5, 2008

**SERVICE MARK
PRINCIPAL REGISTER**

IntelliLabs

INTELLISPHERE, LLC (DELAWARE LTD LIAB
CO)
BUILDING 300
666 PLAINSBORO ROAD
PLAINSBORO, NJ 08536

THE MARK CONSISTS OF STANDARD CHAR-
ACTERS WITHOUT CLAIM TO ANY PARTICULAR
FONT, STYLE, SIZE, OR COLOR.

FOR: PUBLISHING OF REVIEWS, IN CLASS 41
(U.S. CLS. 100, 101 AND 107).

SN 78-782,850, FILED 12-30-2005.

FIRST USE 7-0-2003; IN COMMERCE 7-0-2003.

PRISCILLA MILTON, EXAMINING ATTORNEY

Int. Cl.: 44

Prior U.S. Cls.: 100 and 101

United States Patent and Trademark Office

Reg. No. 3,482,253

Registered Aug. 5, 2008

**SERVICE MARK
PRINCIPAL REGISTER**

**POEMS: PATIENT-ORIENTED
EVIDENCE THAT MATTERS**

WILEY SUBSCRIPTION SERVICES, INC. (DELA-
WARE CORPORATION)
111 RIVER STREET
HOBOKEN, NJ 07030

THE MARK CONSISTS OF STANDARD CHAR-
ACTERS WITHOUT CLAIM TO ANY PARTICULAR
FONT, STYLE, SIZE, OR COLOR.

FOR: PROVIDING MEDICAL INFORMATION, IN
CLASS 44 (U.S. CLS. 100 AND 101).

SN 78-782,889, FILED 12-30-2005.

FIRST USE 8-0-2001; IN COMMERCE 8-0-2001.

BRIAN NEVILLE, EXAMINING ATTORNEY

Int. Cl.: 20

Prior U.S. Cls.: 2, 13, 22, 25, 32, and 50

United States Patent and Trademark Office

Reg. No. 3,482,254

Registered Aug. 5, 2008

**TRADEMARK
PRINCIPAL REGISTER**

THE SOUND OF LEARNING

HAREBRAIN, INC. (MINNESOTA CORPORATION)
3500 48TH AVENUE NORTH
MINNEAPOLIS, MN 55429

FOR: VOCALIZING ASSIST DEVICES, NAMELY, PLASTIC, NON-ELECTRONIC DEVICES CONSISTING OF COMPONENTS CONFIGURED TO DIRECT A USER'S VOCALIZATIONS TO THE USER'S EAR TO ASSIST THAT PERSON TO HEAR HIMSELF OR HERSELF FOR PURPOSES OF VOCALIZATION ANALYSIS, IN CLASS 20 (U.S. CLS. 2, 13, 22, 25, 32 AND 50).

FIRST USE 1-1-2006; IN COMMERCE 1-1-2006.

THE MARK CONSISTS OF STANDARD CHARACTERS WITHOUT CLAIM TO ANY PARTICULAR FONT, STYLE, SIZE, OR COLOR.

SN 78-782,916, FILED 12-30-2005.

JAMES GRIFFIN, EXAMINING ATTORNEY

Int. Cl.: 16

Prior U.S. Cls.: 2, 5, 22, 23, 29, 37, 38, and 50

Reg. No. 3,482,255

United States Patent and Trademark Office

Registered Aug. 5, 2008

**TRADEMARK
PRINCIPAL REGISTER**

**CURRENT OPIOID MISUSE
MEASURE (COMM)**

INFLEXXION, INC. (MASSACHUSETTS CORPORATION)
320 NEEDHAM STREET, SUITE 100
NEWTON, MA 02464

FOR: QUESTIONNAIRE IN THE NATURE OF A TEST IN THE FIELD OF PAIN MANAGEMENT AND PRESCRIPTION DRUGS, IN CLASS 16 (U.S. CLS. 2, 5, 22, 23, 29, 37, 38 AND 50).

FIRST USE 8-22-2007; IN COMMERCE 8-22-2007.

THE MARK CONSISTS OF STANDARD CHARACTERS WITHOUT CLAIM TO ANY PARTICULAR FONT, STYLE, SIZE, OR COLOR.

NO CLAIM IS MADE TO THE EXCLUSIVE RIGHT TO USE "CURRENT OPIOID MISUSE MEASURE", APART FROM THE MARK AS SHOWN.

SN 78-783,477, FILED 12-31-2005.

MARCIE MILONE, EXAMINING ATTORNEY

Int. Cl.: 9

Prior U.S. Cls.: 21, 23, 26, 36, and 38

United States Patent and Trademark Office

Reg. No. 3,482,256

Registered Aug. 5, 2008

**TRADEMARK
PRINCIPAL REGISTER**

SIGNET

M GROUP LLC (OHIO LTD LIAB CO)
2745 NESBITT AVENUE
AKRON, OH 44319

THE MARK CONSISTS OF STANDARD CHAR-
ACTERS WITHOUT CLAIM TO ANY PARTICULAR
FONT, STYLE, SIZE, OR COLOR.

FOR: APPARATUS FOR TRANSMITTING AND
REPRODUCING SOUND, IN CLASS 9 (U.S. CLS. 21,
23, 26, 36 AND 38).

SN 78-784,182, FILED 1-3-2006.

FIRST USE 8-0-2006; IN COMMERCE 8-0-2006.

NAAKWAMA ANKRAH, EXAMINING ATTORNEY

Int. Cl.: 30

Prior U.S. Cl.: 46

United States Patent and Trademark Office

Reg. No. 3,482,257

Registered Aug. 5, 2008

**TRADEMARK
PRINCIPAL REGISTER**



TOPCO ASSOCIATES, LLC (DELAWARE LTD
LIAB CO)
7711 GROSS POINT ROAD
SKOKIE, IL 60077

NO CLAIM IS MADE TO THE EXCLUSIVE
RIGHT TO USE "FRUIT", APART FROM THE
MARK AS SHOWN.

FOR: BREAKFAST CEREALS, IN CLASS 30 (U.S.
CL. 46).

SN 78-784,907, FILED 1-4-2006.

FIRST USE 11-0-2005; IN COMMERCE 11-0-2005.

SHARON MEIER, EXAMINING ATTORNEY

Int. Cl.: 11

Prior U.S. Cls.: 13, 21, 23, 31, and 34

United States Patent and Trademark Office

Reg. No. 3,482,258

Registered Aug. 5, 2008

**TRADEMARK
PRINCIPAL REGISTER**

NIGHT TAMER

TAMER PRODUCTS, INC. (FLORIDA CORPORATION)
1380 N.W. 86TH WAY
CORAL SPRINGS, FL 33071

THE MARK CONSISTS OF STANDARD CHARACTERS WITHOUT CLAIM TO ANY PARTICULAR FONT, STYLE, SIZE, OR COLOR.

FOR: CHEMICALLY-ACTIVATED LIGHT STICKS, IN CLASS 11 (U.S. CLS. 13, 21, 23, 31 AND 34).

SN 78-785,713, FILED 1-5-2006.

FIRST USE 8-0-2005; IN COMMERCE 8-0-2005.

TEJBIR SINGH, EXAMINING ATTORNEY

Int. Cl.: 4

Prior U.S. Cls.: 1, 6, and 15

United States Patent and Trademark Office

Reg. No. 3,482,259

Registered Aug. 5, 2008

**TRADEMARK
PRINCIPAL REGISTER**



PROFI-TECH GMBH (FED REP GERMANY CORPORATION)
KIMMELGASSLE 1-3 D-73333
GINGEN, FED REP GERMANY

FOR: AUTOMOTIVE LUBRICANTS AND FUELS,
IN CLASS 4 (U.S. CLS. 1, 6 AND 15).

FIRST USE 7-5-2005; IN COMMERCE 7-5-2005.

NO CLAIM IS MADE TO THE EXCLUSIVE
RIGHT TO USE "PROFESSIONAL CAR TECHNOLOGY",
APART FROM THE MARK AS SHOWN.

THE COLOR(S) RED, BLUE, BLACK AND WHITE
IS/ARE CLAIMED AS A FEATURE OF THE MARK.

THE MARK CONSISTS OF THE WORDS "PROFI-CAR" IN A BOX. THE COLOR BLUE APPEARS IN THE CIRCLE AND WORDING "PROFI-CAR", THE COLOR RED APPEARS IN THE TRIANGLE WHICH OVERLIES THE BLUE CIRCLE AT LEFT SIDE OF MARK, THE COLOR BLACK APPEARS IN THE WORDING "PROFESSIONAL - CAR - TECHNOLOGY" AND THE OUTLINE OF THE BOX, AND THE COLOR WHITE APPEARS IN THE BOX. THE COLOR WHITE APPEARING IN THE CIRCLE AND TRIANGLE DESIGN APPEARS AS BACKGROUND AND IS NOT CLAIMED AS A FEATURE OF THE MARK.

SN 78-786,354, FILED 1-6-2006.

BONNIE LUKEN, EXAMINING ATTORNEY

Int. Cl.: 19

Prior U.S. Cls.: 1, 12, 33, and 50

United States Patent and Trademark Office

Reg. No. 3,482,260

Registered Aug. 5, 2008

**TRADEMARK
PRINCIPAL REGISTER**

ARCHITECTURALLY YOURS

THE ENKEBOLL CO. (CALIFORNIA CORPORATION), DBA ENKEBOLL DESIGNS,
16506 AVALON BLVD.
CARSON, CA 90746

FOR: ARCHITECTURAL WOOD CARVINGS, NAMELY, CORBELS, ONLAYS, COLUMNS AND PILASTERS; AND ARCHITECTURAL WOOD MOLDINGS, NAMELY, BASE MOLDINGS, CROWN MOLDINGS, ASTRAGAL MOLDINGS AND TRIM MOLDINGS, IN CLASS 19 (U.S. CLS. 1, 12, 33 AND 50).

FIRST USE 1-1-2006; IN COMMERCE 1-1-2006.

THE MARK CONSISTS OF STANDARD CHARACTERS WITHOUT CLAIM TO ANY PARTICULAR FONT, STYLE, SIZE, OR COLOR.

SN 78-786,896, FILED 1-6-2006.

HANNO RITTNER, EXAMINING ATTORNEY

Int. Cl.: 30

Prior U.S. Cl.: 46

United States Patent and Trademark Office

Reg. No. 3,482,261

Registered Aug. 5, 2008

**TRADEMARK
PRINCIPAL REGISTER**

FREEZET

SHILLING, LYNN DON (UNITED STATES INDIVIDUAL)
P.O. BOX 361
ALTOONA, IA 50009

THE MARK CONSISTS OF STANDARD CHARACTERS WITHOUT CLAIM TO ANY PARTICULAR FONT, STYLE, SIZE, OR COLOR.

FOR: PALATABLE ICE, IN CLASS 30 (U.S. CL. 46).

SN 78-788,581, FILED 1-10-2006.

FIRST USE 11-15-2007; IN COMMERCE 11-15-2007.

ANNE FARRELL, EXAMINING ATTORNEY

Int. Cls.: 16 and 25

Prior U.S. Cls.: 2, 5, 22, 23, 29, 37, 38, 39, and 50

United States Patent and Trademark Office

Reg. No. 3,482,262

Registered Aug. 5, 2008

**TRADEMARK
PRINCIPAL REGISTER**

Wicked Fairies

BAXA, THOMAS, MICHAEL (UNITED STATES
INDIVIDUAL)
1315 NOLDEN ST.
LOS ANGELES, CA 90042

FOR: ART PRINTS; CALENDARS; GREETING
CARDS; POSTCARDS; STATIONERY; STICKERS;
STORY BOOKS, IN CLASS 16 (U.S. CLS. 2, 5, 22, 23,
29, 37, 38 AND 50).

FIRST USE 5-25-2008; IN COMMERCE 5-25-2008.

FOR: T-SHIRTS, IN CLASS 25 (U.S. CLS. 22 AND
39).

FIRST USE 5-25-2008; IN COMMERCE 5-25-2008.

THE MARK CONSISTS OF STANDARD CHAR-
ACTERS WITHOUT CLAIM TO ANY PARTICULAR
FONT, STYLE, SIZE, OR COLOR.

NO CLAIM IS MADE TO THE EXCLUSIVE
RIGHT TO USE "FAIRIES", APART FROM THE
MARK AS SHOWN.

SN 78-788,769, FILED 1-10-2006.

ELLEN PERKINS, EXAMINING ATTORNEY

Int. Cl.: 41

Prior U.S. Cls.: 100, 101, and 107

United States Patent and Trademark Office

Reg. No. 3,482,263

Registered Aug. 5, 2008

**SERVICE MARK
PRINCIPAL REGISTER**

NICKTROPOLIS

VIACOM INTERNATIONAL INC. (DELAWARE
CORPORATION)
1515 BROADWAY
NEW YORK, NY 10036

FOR: ENTERTAINMENT SERVICES, NAMELY,
PROVIDING VIDEO AND AUDIO CONTENT FEATURING
SEGMENTS AND ELEMENTS OF ONGOING
TELEVISION PROGRAMS IN THE FIELD OF
COMEDY AND DRAMA; PROVIDING INFORMATION
IN THE FIELD OF TELEVISION VIA A
GLOBAL COMPUTER NETWORK, IN CLASS 41
(U.S. CLS. 100, 101 AND 107).

FIRST USE 3-30-2006; IN COMMERCE 1-30-2007.

THE MARK CONSISTS OF STANDARD CHARACTERS
WITHOUT CLAIM TO ANY PARTICULAR FONT,
STYLE, SIZE, OR COLOR.

OWNER OF U.S. REG. NOS. 2,808,509, 3,044,795,
AND OTHERS.

SN 78-789,235, FILED 1-11-2006.

AMY HELLA, EXAMINING ATTORNEY

Int. Cl.: 35

Prior U.S. Cls.: 100, 101, and 102

United States Patent and Trademark Office

Reg. No. 3,482,264

Registered Aug. 5, 2008

**SERVICE MARK
PRINCIPAL REGISTER**

CLEARPATH

PITNEY BOWES INC. (DELAWARE CORPORATION)
26-22
WORLD HEADQUARTERS ONE ELMCROFT ROAD
STAMFORD, CT 069260700

FOR: TRANSPORTATION LOGISTICS SERVICES, NAMELY, PROVIDING ON-LINE SHIPPING AND CUSTOMS CLEARANCE INFORMATION FEATURING CALCULATIONS OF LOGISTICS AND REVERSE LOGISTICS COSTS FOR SHIPPING AND HANDLING, CALCULATION OF TAXES, CUSTOMS DUTIES AND REVERSE LOGISTICS PROCESS; PROVIDING INFORMATION ABOUT CUSTOMS CLEARANCE IN THE NATURE OF INFORMATION ABOUT COMPLETION AND CLEAR-

ANCE OF CUSTOMS FORMS, PAYMENT OF TAXES, DUTIES, PAYMENT OF SHIPPERS AND HANDLERS; COMPUTERIZED TRACKING OF SHIPMENTS AND PACKAGES IN TRANSIT, IN CLASS 35 (U.S. CLS. 100, 101 AND 102).

FIRST USE 5-30-2006; IN COMMERCE 5-30-2006.

THE MARK CONSISTS OF STANDARD CHARACTERS WITHOUT CLAIM TO ANY PARTICULAR FONT, STYLE, SIZE, OR COLOR.

SN 78-789,509, FILED 1-11-2006.

ELI HELLMAN, EXAMINING ATTORNEY

Int. Cl.: 35

Prior U.S. Cls.: 100, 101, and 102

United States Patent and Trademark Office

Reg. No. 3,482,265

Registered Aug. 5, 2008

**SERVICE MARK
PRINCIPAL REGISTER**

QUICKHIRE

MONSTER (CALIFORNIA), INC. (CALIFORNIA CORPORATION)
11845 W. OLYMPIC BLVD.
SUITE 500
LOS ANGELES, CA 90064

FOR: ONLINE RECRUITING SERVICES, NAME-
LY, PROVIDING SEARCHABLE JOB POSTINGS, IN
CLASS 35 (U.S. CLS. 100, 101 AND 102).

FIRST USE 6-1-1996; IN COMMERCE 6-1-1996.

THE MARK CONSISTS OF STANDARD CHAR-
ACTERS WITHOUT CLAIM TO ANY PARTICULAR
FONT, STYLE, SIZE, OR COLOR.

OWNER OF U.S. REG. NO. 2,356,181.

SN 78-790,668, FILED 1-12-2006.

DAVID TAYLOR, EXAMINING ATTORNEY

Int. Cl.: 10

Prior U.S. Cls.: 26, 39, and 44

United States Patent and Trademark Office

Reg. No. 3,482,266

Registered Aug. 5, 2008

**TRADEMARK
PRINCIPAL REGISTER**



OPTIMEDICA CORPORATION (DELAWARE
CORPORATION)
3130 CORONADO DR.
SANTA CLARA, CA 95054

FIRST USE 6-21-2006; IN COMMERCE 6-21-2006.

SN 78-791,112, FILED 1-13-2006.

FOR: LASERS FOR MEDICAL USE, IN CLASS 10
(U.S. CLS. 26, 39 AND 44).

LYDIA BELZER, EXAMINING ATTORNEY

Int. Cl.: 11

Prior U.S. Cls.: 13, 21, 23, 31, and 34

United States Patent and Trademark Office

Reg. No. 3,482,267

Registered Aug. 5, 2008

**TRADEMARK
PRINCIPAL REGISTER**

ROBERN

ROBERN, INC. (PENNSYLVANIA CORPORATION)
701 NORTH WILSON AVENUE
BRISTOL, PA 19007

FOR: ELECTRIC LIGHTING FIXTURES, IN
CLASS 11 (U.S. CLS. 13, 21, 23, 31 AND 34).

FIRST USE 0-0-1982; IN COMMERCE 0-0-1982.

THE MARK CONSISTS OF STANDARD CHARACTERS WITHOUT CLAIM TO ANY PARTICULAR FONT, STYLE, SIZE, OR COLOR.

OWNER OF U.S. REG. NO. 2,105,339.

SN 78-791,606, FILED 1-13-2006.

MARY MUNSON, EXAMINING ATTORNEY

Int. Cl.: 39

Prior U.S. Cls.: 100 and 105

United States Patent and Trademark Office

Reg. No. 3,482,268

Registered Aug. 5, 2008

**SERVICE MARK
PRINCIPAL REGISTER**

PinzTrekHawaii.com

HAWAII FOREST & TRAIL, LTD. (HAWAII COR-
PORATION)
74-5035B QUEEN KAAHUMANU HIGHWAY
KAILUA-KONA, HI 96740

THE MARK CONSISTS OF STANDARD CHAR-
ACTERS WITHOUT CLAIM TO ANY PARTICULAR
FONT, STYLE, SIZE, OR COLOR.

FOR: CONDUCTING SIGHTSEEING TOURS FOR
OTHERS, IN CLASS 39 (U.S. CLS. 100 AND 105).

SN 78-791,748, FILED 1-13-2006.

FIRST USE 6-2-2006; IN COMMERCE 6-2-2006.

ELLEN PERKINS, EXAMINING ATTORNEY

Int. Cl.: 8

Prior U.S. Cls.: 23, 28, and 44

Reg. No. 3,482,269

United States Patent and Trademark Office

Registered Aug. 5, 2008

**TRADEMARK
PRINCIPAL REGISTER**

SALERNO

ANNIE INTERNATIONAL, INC. (PENNSYLVANIA CORPORATION)
500 CHURCH ROAD
NORTH WALES, PA 19454

THE MARK CONSISTS OF STANDARD CHARACTERS WITHOUT CLAIM TO ANY PARTICULAR FONT, STYLE, SIZE, OR COLOR.

FOR: HAIRCUTTING SCISSORS, IN CLASS 8 (U.S. CLS. 23, 28 AND 44).

SN 78-792,112, FILED 1-16-2006.

FIRST USE 6-17-2008; IN COMMERCE 6-17-2008.

KAPIL BHANOT, EXAMINING ATTORNEY

Int. Cl.: 1

Prior U.S. Cls.: 1, 5, 6, 10, 26, and 46

Reg. No. 3,482,270

United States Patent and Trademark Office

Registered Aug. 5, 2008

**TRADEMARK
PRINCIPAL REGISTER**

Maxigloss

DISTINCTIVE COSMETIC INGREDIENTS (NEW
YORK LIMITED PARTNERSHIP)
2259 SOUTH CLINTON AVE.
SOUTH CLINTON AVE., NM 07080

THE MARK CONSISTS OF STANDARD CHAR-
ACTERS WITHOUT CLAIM TO ANY PARTICULAR
FONT, STYLE, SIZE, OR COLOR.

FOR: CHEMICAL ADDITIVES FOR USE IN THE
MANUFACTURE OF COSMETICS, IN CLASS 1 (U.S.
CLS. 1, 5, 6, 10, 26 AND 46).

SN 78-792,151, FILED 1-16-2006.

FIRST USE 1-20-2006; IN COMMERCE 1-20-2006.

RONALD MCMORROW, EXAMINING ATTORNEY

Int. Cl.: 11

Prior U.S. Cls.: 13, 21, 23, 31, and 34

Reg. No. 3,482,271

United States Patent and Trademark Office

Registered Aug. 5, 2008

**TRADEMARK
PRINCIPAL REGISTER**

16 N 1

MEDICAL SOLUTIONS, INC. (VIRGINIA CORPORATION)
SUITE L
3901 CENTERVIEW DRIVE
CHANTILLY, VA 20151

FOR: MEDICAL AND SURGICAL WARMING CABINETS FOR MEDICAL AND SURGICAL FLUIDS, SOLUTIONS, INSTRUMENTS, MATERIALS, AND EQUIPMENT, IN CLASS 11 (U.S. CLS. 13, 21, 23, 31 AND 34).

FIRST USE 1-3-2008; IN COMMERCE 1-3-2008.

THE MARK CONSISTS OF STANDARD CHARACTERS WITHOUT CLAIM TO ANY PARTICULAR FONT, STYLE, SIZE, OR COLOR.

SN 78-792,450, FILED 1-16-2006.

DAVID MILLER, EXAMINING ATTORNEY

Int. Cl.: 9

Prior U.S. Cls.: 21, 23, 26, 36, and 38

Reg. No. 3,482,272

United States Patent and Trademark Office

Registered Aug. 5, 2008

**TRADEMARK
PRINCIPAL REGISTER**

SIFOSCOPE

O2MICRO, INC. (CALIFORNIA CORPORATION)
3118 PATRICK HENRY DRIVE
SANTA CLARA, CA 95054

THE MARK CONSISTS OF STANDARD CHAR-
ACTERS WITHOUT CLAIM TO ANY PARTICULAR
FONT, STYLE, SIZE, OR COLOR.

FOR: COMPUTER SOFTWARE FOR BROWSING
WEBSITES, NAMELY, FOR MONITORING OR
ANALYZING THE USE OF THE INTERNET, IN
CLASS 9 (U.S. CLS. 21, 23, 26, 36 AND 38).

SN 78-792,703, FILED 1-17-2006.

FIRST USE 7-1-2006; IN COMMERCE 7-1-2006.

VERNA BETH RIRIE, EXAMINING ATTORNEY

Int. Cl.: 40

Prior U.S. Cls.: 100, 103, and 106

United States Patent and Trademark Office

Reg. No. 3,482,273

Registered Aug. 5, 2008

**SERVICE MARK
PRINCIPAL REGISTER**



CPACKET NETWORKS INC. (DELAWARE CORPORATION)
2061 LANDINGS DRIVE
MOUNTAIN VIEW, CA 94043

FOR: CUSTOM MANUFACTURE OF COMPUTER HARDWARE WITH OR CONTAINING COMPUTER SOFTWARE FOR USE IN MONITORING, SECURING, RESPONDING TO AND CONTROLLING COMPUTER AND COMMUNICATIONS NETWORK TRAFFIC, IN CLASS 40 (U.S. CLS. 100, 103 AND 106).

FIRST USE 3-1-2006; IN COMMERCE 3-1-2006.

NO CLAIM IS MADE TO THE EXCLUSIVE RIGHT TO USE "NETWORKS", APART FROM THE MARK AS SHOWN.

THE COLOR(S) BLUE, BLACK AND WHITE IS/ARE CLAIMED AS A FEATURE OF THE MARK.

THE COLOR BLUE APPEARS IN THE PORTION OF THE BORDER OF THE CIRCLE COMPRISING THE TOP, LEFT, AND BOTTOM SIDES OF THE CIRCLE; THE COLOR BLACK APPEARS IN THE DOT INSIDE THE CIRCLE, THE PORTION OF THE BORDER OF THE CIRCLE COMPRISING THE RIGHT SIDE OF THE CIRCLE, AND IN THE WORDING "CPACKET NETWORKS"; THE COLOR WHITE APPEARS IN THE BREAKS IN THE BORDER OF THE CIRCLE AND THE BACKGROUND OF THE MARK.

SN 78-792,961, FILED 1-17-2006.

MICHAEL GAAFAR, EXAMINING ATTORNEY

Int. Cl.: 16

Prior U.S. Cls.: 2, 5, 22, 23, 29, 37, 38, and 50

Reg. No. 3,482,274

United States Patent and Trademark Office

Registered Aug. 5, 2008

**TRADEMARK
PRINCIPAL REGISTER**

WOBLEROOM

FIRST QUALITY RETAIL SERVICES, LLC (DE-
LAWARE LTD LIAB CO)
80 CUTTERMILL ROAD, SUITE 500
GREAT NECK, NY 11021

THE MARK CONSISTS OF STANDARD CHAR-
ACTERS WITHOUT CLAIM TO ANY PARTICULAR
FONT, STYLE, SIZE, OR COLOR.

FOR: ADHESIVE TABS FOR A DISPOSABLE
DIAPER SOLD AS A COMPONENT PART THERE-
OF, IN CLASS 16 (U.S. CLS. 2, 5, 22, 23, 29, 37, 38 AND
50).

SN 78-794,459, FILED 1-19-2006.

FIRST USE 8-31-2006; IN COMMERCE 8-31-2006.

DAWN FELDMAN, EXAMINING ATTORNEY

Int. Cls.: 9 and 42

Prior U.S. Cls.: 21, 23, 26, 36, 38, 100, and 101

United States Patent and Trademark Office

Reg. No. 3,482,275

Registered Aug. 5, 2008

**TRADEMARK
SERVICE MARK
PRINCIPAL REGISTER**



MONTEFIORE MEDICAL CENTER (NEW YORK
NON-PROFIT CORPORATION)
111 EAST 210 STREET
BRONX, NY 10467

FOR: COMPUTER SOFTWARE IN THE FIELD OF HEALTH CARE TO ALLOW USERS TO TRACK PATIENT CARE AND PROGRESS AND THE PROCESSES AND EFFICIENCY OF A HEALTH CARE SYSTEM THROUGH ALL STAGES OF MEDICAL TREATMENTS, HOSPITAL VISITS, LABORATORY SERVICES, REHABILITATION AND ANY OTHERS ASPECT OF THE CONTINUUM OF CARE AND TO PROVIDE DATA AND STATISTICS IN CONNECTION WITH MEDICAL TREATMENT AND HEALTH CARE REGARDING PATIENTS, PATIENT DIAGNOSIS, PATIENT DEMOGRAPHICS, FACILITY/CARE CENTERS AND MANAGED HEALTH CARE PROGRAMS, IN CLASS 9 (U.S. CLS. 21, 23, 26, 36 AND 38).

FIRST USE 5-5-2005; IN COMMERCE 6-5-2008.

FOR: PROVIDING TEMPORARY ONLINE USE OF NON-DOWNLOADABLE SOFTWARE IN THE FIELD OF HEALTH CARE TO ALLOW USERS TO TRACK PATIENT CARE AND PROGRESS AND THE PROCESSES AND EFFICIENCY OF A HEALTH CARE SYSTEM THROUGH ALL STAGES OF MEDICAL TREATMENTS, HOSPITAL VISITS, LABORATORY SERVICES, REHABILITATION AND ANY OTHER ASPECT OF THE CONTINUUM OF CARE AND TO PROVIDE DATA AND STATISTICS IN CONNECTION WITH MEDICAL TREATMENT AND HEALTH CARE REGARDING PATIENTS, PATIENT DIAGNOSIS, PATIENT DEMOGRAPHICS, FACILITY/CARE CENTERS AND MANAGED HEALTH CARE PROGRAMS, IN CLASS 42 (U.S. CLS. 100 AND 101).

FIRST USE 3-7-2005; IN COMMERCE 3-29-2006.

SN 78-794,562, FILED 1-19-2006.

CARRIE GENOVESE, EXAMINING ATTORNEY

Int. Cls.: 16 and 41

Prior U.S. Cls.: 2, 5, 22, 23, 29, 37, 38, 50, 100, 101, and 107

Reg. No. 3,482,276

United States Patent and Trademark Office

Registered Aug. 5, 2008

**TRADEMARK
SERVICE MARK
PRINCIPAL REGISTER**

DRIVING FOR SAFETY

ABBOTT LABORATORIES (ILLINOIS CORPORATION)
100 ABBOTT PARK ROAD
ABBOTT PARK, IL 60064

FOR: PRINTED MATERIALS, NAMELY, BROCHURES, PAMPHLETS, NEWSLETTERS AND REFERENCE MANUALS, ALL RELATED TO SAFE DRIVING FOR EMPLOYEES, IN CLASS 16 (U.S. CLS. 2, 5, 22, 23, 29, 37, 38 AND 50).

FIRST USE 5-31-2002; IN COMMERCE 5-31-2002.

FOR: EDUCATIONAL SERVICES, NAMELY, CLASSES AND WORKSHOPS IN THE FIELD OF

SAFE DRIVING FOR EMPLOYEES, IN CLASS 41 (U.S. CLS. 100, 101 AND 107).

FIRST USE 5-31-2002; IN COMMERCE 5-31-2002.

THE MARK CONSISTS OF STANDARD CHARACTERS WITHOUT CLAIM TO ANY PARTICULAR FONT, STYLE, SIZE, OR COLOR.

SN 78-795,107, FILED 1-19-2006.

AMY ALFIERI, EXAMINING ATTORNEY

Int. Cl.: 37

Prior U.S. Cls.: 100, 103, and 106

United States Patent and Trademark Office

Reg. No. 3,482,277

Registered Aug. 5, 2008

**SERVICE MARK
PRINCIPAL REGISTER**

INVISIBLE CAPTAIN

GODART, F. THOMAS (UNITED STATES INDIVIDUAL)
330 ISLE OF CAPRI
FORT LAUDERDALE, FL 33301

THE MARK CONSISTS OF STANDARD CHARACTERS WITHOUT CLAIM TO ANY PARTICULAR FONT, STYLE, SIZE, OR COLOR.

FOR: MAINTENANCE OF BOATS AND YACHTS,
IN CLASS 37 (U.S. CLS. 100, 103 AND 106).

SN 78-795,992, FILED 1-20-2006.

FIRST USE 2-0-2002; IN COMMERCE 2-0-2002.

MATTHEW PAPPAS, EXAMINING ATTORNEY

Int. Cl.: 7

Prior U.S. Cls.: 13, 19, 21, 23, 31, 34, and 35

Reg. No. 3,482,278

United States Patent and Trademark Office

Registered Aug. 5, 2008

**TRADEMARK
PRINCIPAL REGISTER**

DOUBLE BARREL HOPPER

STRUCTUS BUILDING TECHNOLOGIES, INC.
(OREGON CORPORATION)
SUITE 103
497 S.W. CENTURY DR.
BEND, OR 97702

NO CLAIM IS MADE TO THE EXCLUSIVE
RIGHT TO USE "HOPPER", APART FROM THE
MARK AS SHOWN.

FOR: MACHINES, NAMELY, DRYWALL MUD
HOPPERS, IN CLASS 7 (U.S. CLS. 13, 19, 21, 23, 31, 34
AND 35).

THE WORDING "DOUBLE BARREL" HAS NO
MEANING IN A FOREIGN LANGUAGE.

FIRST USE 5-1-2000; IN COMMERCE 5-1-2000.

SN 78-796,536, FILED 1-21-2006.

THE MARK CONSISTS OF STANDARD CHAR-
ACTERS WITHOUT CLAIM TO ANY PARTICULAR
FONT, STYLE, SIZE, OR COLOR.

PRISCILLA MILTON, EXAMINING ATTORNEY

Int. Cl.: 37

Prior U.S. Cls.: 100, 103, and 106

United States Patent and Trademark Office

Reg. No. 3,482,279

Registered Aug. 5, 2008

**SERVICE MARK
PRINCIPAL REGISTER**

GALPIN AUTO SPORTS

GALPIN AUTO SPORTS LLC (CALIFORNIA LIMITED LIABILITY COMPANY)

15600 ROSCOE BLVD.

VAN NUYS, CA 91406

FOR: AUTOMOBILE CUSTOMIZATION SERVICES, IN CLASS 37 (U.S. CLS. 100, 103 AND 106).

FIRST USE 1-31-2006; IN COMMERCE 1-31-2006.

THE MARK CONSISTS OF STANDARD CHARACTERS WITHOUT CLAIM TO ANY PARTICULAR FONT, STYLE, SIZE, OR COLOR.

NO CLAIM IS MADE TO THE EXCLUSIVE RIGHT TO USE "AUTO SPORTS", APART FROM THE MARK AS SHOWN.

SN 78-797,631, FILED 1-23-2006.

REBECCA EISINGER, EXAMINING ATTORNEY

Int. Cl.: 9

Prior U.S. Cls.: 21, 23, 26, 36, and 38

United States Patent and Trademark Office

Reg. No. 3,482,280

Registered Aug. 5, 2008

**TRADEMARK
PRINCIPAL REGISTER**

RFID NATIVE

RFID MEXICO, S.A. DE C.V. (MEXICO CORPORATION)
EDIFICIO LOSOLES DESP A-12
COLONIA RESIDENCIAL SAN AGUSTIN
SAN PEDRO GARZA GARCIA, NUEVO LEON C.P.,
MEXICO 66269

FOR: RADIO FREQUENCY IDENTIFICATION EQUIPMENT, NAMELY, READERS, ANTENNAS, TAGS, AND COMPUTERS FOR RECOGNIZING PRODUCTS, TOOLS, MACHINERY, AND INDIVIDUALS AND FOR INITIATING ACTIONS IN RESPONSE TO SUCH RECOGNITION; COMPUTER HARDWARE FOR RADIO FREQUENCY IDENTIFICATION EQUIPMENT; COMPUTER SOFTWARE FOR MONITORING PRODUCTS, TOOLS, MACHINERY AND WORKERS AND FOR RECOMMENDING ACTIONS BASED ON SUCH INFORMATION,

ALL FOR USE IN OPERATING RADIO FREQUENCY IDENTIFICATION EQUIPMENT, IN CLASS 9 (U.S. CLS. 21, 23, 26, 36 AND 38).

FIRST USE 8-0-2007; IN COMMERCE 8-0-2007.

THE MARK CONSISTS OF STANDARD CHARACTERS WITHOUT CLAIM TO ANY PARTICULAR FONT, STYLE, SIZE, OR COLOR.

NO CLAIM IS MADE TO THE EXCLUSIVE RIGHT TO USE "RFID", APART FROM THE MARK AS SHOWN.

SN 78-798,118, FILED 1-24-2006.

LYDIA BELZER, EXAMINING ATTORNEY

Int. Cl.: 34

Prior U.S. Cls.: 2, 8, 9, and 17

United States Patent and Trademark Office

Reg. No. 3,482,281

Registered Aug. 5, 2008

**TRADEMARK
PRINCIPAL REGISTER**

LIGA PRIVADA NO. 9

JONATHAN DREW, INC. (NEW YORK CORPORATION), DBA DREW ESTATE,

12415 SW 136TH AVENUE SUITE 2

MIAMI, FL 33186

FOR: CIGARS, TOBACCO, AND RELATED PRODUCTS, NAMELY, CIGARETTES, CIGAR BOXES, LIGHTERS AND HOLDERS NOT OF PRECIOUS METAL, ASHTRAYS, CIGAR BANDS, CIGAR CUTTERS, HUMIDORS, AND CIGAR TUBES, IN CLASS 34 (U.S. CLS. 2, 8, 9 AND 17).

FIRST USE 7-25-2007; IN COMMERCE 7-25-2007.

THE MARK CONSISTS OF STANDARD CHARACTERS WITHOUT CLAIM TO ANY PARTICULAR FONT, STYLE, SIZE, OR COLOR.

NO CLAIM IS MADE TO THE EXCLUSIVE RIGHT TO USE "LIGA", APART FROM THE MARK AS SHOWN.

THE ENGLISH TRANSLATION OF THE WORD "LIGA PRIVADA" IN THE MARK IS "PRIVATE BLEND".

SN 78-799,207, FILED 1-25-2006.

KEVIN DINALLO, EXAMINING ATTORNEY

Int. Cl.: 35

Prior U.S. Cls.: 100, 101, and 102

United States Patent and Trademark Office

Reg. No. 3,482,282

Registered Aug. 5, 2008

**SERVICE MARK
PRINCIPAL REGISTER**

GREEN FOR GOOD

GREEN FOR GOOD, INC. (WASHINGTON CORPORATION)
9793 EDMONDS WAY, #236
EDMONDS, WA 98020

FOR: ON-LINE RETAIL STORE SERVICES FEATURING A WIDE VARIETY OF ENVIRONMENTALLY CONSCIOUS CONSUMER GOODS OF OTHERS AND PROVIDING CONSUMER INFORMATION IN THE FIELD OF ENVIRONMENTAL CONSCIOUSNESS VIA THE GLOBAL COMPUTER NETWORK, IN CLASS 35 (U.S. CLS. 100, 101 AND 102).

FIRST USE 8-30-2005; IN COMMERCE 8-30-2005.

THE MARK CONSISTS OF STANDARD CHARACTERS WITHOUT CLAIM TO ANY PARTICULAR FONT, STYLE, SIZE, OR COLOR.

SN 78-799,504, FILED 1-25-2006.

KATHERINE M. DUBRAY, EXAMINING ATTORNEY

Int. Cl.: 11

Prior U.S. Cls.: 13, 21, 23, 31, and 34

United States Patent and Trademark Office

Reg. No. 3,482,283

Registered Aug. 5, 2008

**TRADEMARK
PRINCIPAL REGISTER**

HYDROXY

CONAIR CORPORATION (DELAWARE CORPORATION)
ONE CUMMINGS POINT ROAD
STAMFORD, CT 06902

THE MARK CONSISTS OF STANDARD CHARACTERS WITHOUT CLAIM TO ANY PARTICULAR FONT, STYLE, SIZE, OR COLOR.

FOR: SHOWER HEADS, IN CLASS 11 (U.S. CLS. 13, 21, 23, 31 AND 34).

SN 78-802,029, FILED 1-30-2006.

FIRST USE 1-1-2007; IN COMMERCE 1-1-2007.

JILL PRATER, EXAMINING ATTORNEY

Int. Cl.: 43

Prior U.S. Cls.: 100 and 101

United States Patent and Trademark Office

Reg. No. 3,482,284

Registered Aug. 5, 2008

**SERVICE MARK
PRINCIPAL REGISTER**

REGGAE J'S ISLAND GRILL

SOUTHERN RESTAURANT GROUP, INC. (DE-
LAWARE CORPORATION)

POST OFFICE BOX 99

DESTIN, FL 32540

FOR: RESTAURANT SERVICES, IN CLASS 43
(U.S. CLS. 100 AND 101).

FIRST USE 6-13-2008; IN COMMERCE 6-13-2008.

THE MARK CONSISTS OF STANDARD CHAR-
ACTERS WITHOUT CLAIM TO ANY PARTICULAR
FONT, STYLE, SIZE, OR COLOR.

NO CLAIM IS MADE TO THE EXCLUSIVE
RIGHT TO USE "GRILL", APART FROM THE
MARK AS SHOWN.

SN 78-802,072, FILED 1-30-2006.

JILL C. ALT, EXAMINING ATTORNEY

Int. Cl.: 10

Prior U.S. Cls.: 26, 39, and 44

United States Patent and Trademark Office

Reg. No. 3,482,285

Registered Aug. 5, 2008

**TRADEMARK
PRINCIPAL REGISTER**

VYCOR MEDICAL

VYCOR MEDICAL LLC (NEW YORK LTD LIAB
CO)
40 CHARDONAY DRIVE
CORAM, NY 11727

FOR: SURGICAL INSTRUMENTS FOR USE IN
CRANIAL, SPINAL AND GENERAL SURGERY, IN
CLASS 10 (U.S. CLS. 26, 39 AND 44).

FIRST USE 11-1-2005; IN COMMERCE 10-31-2007.

THE MARK CONSISTS OF STANDARD CHAR-
ACTERS WITHOUT CLAIM TO ANY PARTICULAR
FONT, STYLE, SIZE, OR COLOR.

NO CLAIM IS MADE TO THE EXCLUSIVE
RIGHT TO USE "MEDICAL", APART FROM THE
MARK AS SHOWN.

SN 78-803,141, FILED 1-31-2006.

GISELLE AGOSTO, EXAMINING ATTORNEY

Int. Cl.: 19

Prior U.S. Cls.: 1, 12, 33, and 50

United States Patent and Trademark Office

Reg. No. 3,482,286

Registered Aug. 5, 2008

**TRADEMARK
PRINCIPAL REGISTER**



RO-MAC LUMBER AND SUPPLY, INC (FLOR-
IDA CORPORATION)
610 EAST MAIN STREET
LEESBURG, FL 34748

FIRST USE 8-7-2007; IN COMMERCE 8-7-2007.

SN 78-803,537, FILED 1-31-2006.

FOR: NON-METAL BUILDING MATERIALS,
NAMELY, SOFFITTS, IN CLASS 19 (U.S. CLS. 1, 12,
33 AND 50).

LINDA LAVACHE, EXAMINING ATTORNEY

Int. Cl.: 36

Prior U.S. Cls.: 100, 101, and 102

United States Patent and Trademark Office

Reg. No. 3,482,287

Registered Aug. 5, 2008

**SERVICE MARK
PRINCIPAL REGISTER**

SECURE@ENT

ENT FEDERAL CREDIT UNION (UNITED
STATES FEDERALLY CHARTERED CREDIT
UNION)
7250 CAMPUS DRIVE
COLORADO SPRINGS, CO 80920

FOR: BANKING; BANKING CONSULTATION;
CHECKING ACCOUNT SERVICES; ON-LINE
BANKING SERVICES, IN CLASS 36 (U.S. CLS. 100,
101 AND 102).

FIRST USE 4-1-2007; IN COMMERCE 4-1-2007.

THE MARK CONSISTS OF STANDARD CHAR-
ACTERS WITHOUT CLAIM TO ANY PARTICULAR
FONT, STYLE, SIZE, OR COLOR.

SN 78-804,789, FILED 2-1-2006.

SUZANNE BLANE, EXAMINING ATTORNEY

Int. Cl.: 24

Prior U.S. Cls.: 42 and 50

United States Patent and Trademark Office

Reg. No. 3,482,288

Registered Aug. 5, 2008

**TRADEMARK
PRINCIPAL REGISTER**

HEALTHSHEET

JAB DISTRIBUTORS, LLC (ILLINOIS LTD LIAB
CO), DBA PROTECT-A-BED,
600 WAUKEGAN RD.
STE 16
GLENVIEW, IL 60025

FOR: POLYURETHANE MEMBRANE LAMINA-
TED ANTI-ALLERGENIC BED SHEETS, IN CLASS
24 (U.S. CLS. 42 AND 50).

FIRST USE 3-1-2008; IN COMMERCE 3-1-2008.

THE MARK CONSISTS OF STANDARD CHAR-
ACTERS WITHOUT CLAIM TO ANY PARTICULAR
FONT, STYLE, SIZE, OR COLOR.

NO CLAIM IS MADE TO THE EXCLUSIVE
RIGHT TO USE "SHEET", APART FROM THE
MARK AS SHOWN.

SN 78-805,290, FILED 2-2-2006.

DAVID MURRAY, EXAMINING ATTORNEY

Int. Cls.: 9 and 41

Prior U.S. Cls.: 21, 23, 26, 36, 38, 100, 101, and 107

United States Patent and Trademark Office

Reg. No. 3,482,289

Registered Aug. 5, 2008

**TRADEMARK
SERVICE MARK
PRINCIPAL REGISTER**

HOOKS

MANSON, DORIAN (UNITED STATES INDIVIDUAL)
6 DELIA CT.
YONKERS, NY 10710

FOR: MUSICAL SOUND RECORDINGS, IN CLASS 9 (U.S. CLS. 21, 23, 26, 36 AND 38).

FIRST USE 4-30-2008; IN COMMERCE 4-30-2008.

FOR: ENTERTAINMENT, NAMELY, LIVE PERFORMANCES BY A MUSICAL ARTIST AND/OR

MUSICAL BAND, IN CLASS 41 (U.S. CLS. 100, 101 AND 107).

FIRST USE 1-31-2001; IN COMMERCE 1-31-2001.

THE MARK CONSISTS OF STANDARD CHARACTERS WITHOUT CLAIM TO ANY PARTICULAR FONT, STYLE, SIZE, OR COLOR.

SN 78-806,026, FILED 2-2-2006.

BILL DAWE, EXAMINING ATTORNEY

Int. Cl.: 41

Prior U.S. Cls.: 100, 101, and 107

United States Patent and Trademark Office

Reg. No. 3,482,290

Registered Aug. 5, 2008

**SERVICE MARK
PRINCIPAL REGISTER**

No Force No Fear

WHITE, JENNIFER E. (UNITED STATES INDIVIDUAL), DBA LAUGHING DOG ENTERPRISES,
PO BOX 2702
WOODINVILLE, WA 98072

THE MARK CONSISTS OF STANDARD CHARACTERS WITHOUT CLAIM TO ANY PARTICULAR FONT, STYLE, SIZE, OR COLOR.

FOR: ANIMAL TRAINING, IN CLASS 41 (U.S. CLS. 100, 101 AND 107).

SN 78-806,991, FILED 2-3-2006.

FIRST USE 4-22-2008; IN COMMERCE 4-22-2008.

DAVID YONTEF, EXAMINING ATTORNEY

Int. Cl.: 25

Prior U.S. Cls.: 22 and 39

United States Patent and Trademark Office

Reg. No. 3,482,291

Registered Aug. 5, 2008

**TRADEMARK
PRINCIPAL REGISTER**



MAJOR LEAGUE LACROSSE LLC (VIRGINIA
LTD LIAB CO)
BRIGHTON LANDING EAST
20 GUEST STREET, SUITE 125
BRIGHTON, MA 02135

FOR: CLOTHING, NAMELY, SHIRTS, T-SHIRTS,
TANK TOPS, SWEAT SHIRTS, SWEAT SHORTS,
SWEAT PANTS, PULLOVERS, JACKETS, JERSEYS,
SHORTS, HEADWEAR, CAPS AND HATS, IN CLASS
25 (U.S. CLS. 22 AND 39).

FIRST USE 5-1-2005; IN COMMERCE 5-1-2005.

OWNER OF U.S. REG. NOS. 2,762,354, 2,976,647,
AND OTHERS.

NO CLAIM IS MADE TO THE EXCLUSIVE
RIGHT TO USE "LONG ISLAND" OR "LACROSSE",
APART FROM THE MARK AS SHOWN.

SN 78-808,214, FILED 2-6-2006.

JILL PRATER, EXAMINING ATTORNEY

Int. Cl.: 5

Prior U.S. Cls.: 6, 18, 44, 46, 51, and 52

United States Patent and Trademark Office

Reg. No. 3,482,292

Registered Aug. 5, 2008

**TRADEMARK
PRINCIPAL REGISTER**

FOLLICLE FOOD

HAIR TECH, INC. (GEORGIA CORPORATION)
SUITE 1800
1175 PEACHTREE STREET
ATLANTA, GA 30361

THE MARK CONSISTS OF STANDARD CHAR-
ACTERS WITHOUT CLAIM TO ANY PARTICULAR
FONT, STYLE, SIZE, OR COLOR.

FOR: VITAMIN SUPPLEMENT FOR THE HAIR,
IN CLASS 5 (U.S. CLS. 6, 18, 44, 46, 51 AND 52).

SN 78-809,482, FILED 2-7-2006.

FIRST USE 9-1-2006; IN COMMERCE 9-1-2006.

DAWN FELDMAN, EXAMINING ATTORNEY

Int. Cl.: 9

Prior U.S. Cls.: 21, 23, 26, 36, and 38

Reg. No. 3,482,293

United States Patent and Trademark Office

Registered Aug. 5, 2008

**TRADEMARK
PRINCIPAL REGISTER**

DAIRYCHEQ

DAIRYCHEQ INC. (CANADA CORPORATION)
5-60 BAFFIN PLACE
WATERLOO, ONTARIO, CANADA N2K 3A5

FIRST USE 3-8-2001; IN COMMERCE 3-8-2001.

FOR: ELECTRONIC EQUIPMENT, NAMELY,
TIME AND TEMPERATURE RECORDERS, DIGI-
TAL AND INTERLOG SENSORS AND MODEMS
FOR RECORDING AND MONITORING DAIRY
FARM PROCESSES, IN CLASS 9 (U.S. CLS. 21, 23,
26, 36 AND 38).

THE MARK CONSISTS OF STANDARD CHAR-
ACTERS WITHOUT CLAIM TO ANY PARTICULAR
FONT, STYLE, SIZE, OR COLOR.

SN 78-810,773, FILED 2-9-2006.

REBECCA SMITH, EXAMINING ATTORNEY

Int. Cl.: 30

Prior U.S. Cl.: 46

United States Patent and Trademark Office

Reg. No. 3,482,294

Registered Aug. 5, 2008

TRADEMARK
PRINCIPAL REGISTER

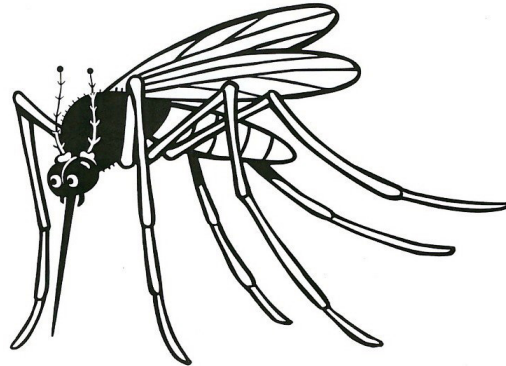

MCILHENNY COMPANY (MAINE CORPORATION)
HWY. 329
AVERY ISLAND, LA 70513

FOR: CONDIMENT, NAMELY, PEPPER SAUCE,
IN CLASS 30 (U.S. CL. 46).

FIRST USE 6-9-2008; IN COMMERCE 6-9-2008.

THE MARK CONSISTS OF A DESIGN OF A
MOSQUITO.

SN 78-812,904, FILED 2-12-2006.

ALEX KEAM, EXAMINING ATTORNEY

Int. Cls.: 9 and 42

Prior U.S. Cls.: 21, 23, 26, 36, 38, 100, and 101

United States Patent and Trademark Office

Reg. No. 3,482,295

Registered Aug. 5, 2008

**TRADEMARK
SERVICE MARK
PRINCIPAL REGISTER**

AgriWise

ENCORE ASSOCIATES, INC (CALIFORNIA CORPORATION)
SUITE 160
2333 SAN RAMON VALLEY BLVD.
SAN RAMON, CA 94583

FOR: COMPUTER SOFTWARE PLATFORMS FOR AGRICULTURAL DATA COLLECTION AND TRANSMITTAL SOFTWARE APPLICATIONS; COMPUTER SOFTWARE THAT PROVIDES REAL-TIME, INTEGRATED BUSINESS MANAGEMENT INTELLIGENCE BY COMBINING INFORMATION FROM VARIOUS DATABASES AND PRESENTING IT IN AN EASY-TO-UNDERSTAND USER INTERFACE; COMPUTER SOFTWARE TO AUTOMATE DATA WAREHOUSING, IN CLASS 9 (U.S. CLS. 21, 23, 26, 36 AND 38).

FIRST USE 5-7-2008; IN COMMERCE 5-7-2008.

FOR: AGRICULTURAL RESEARCH; APPLICATION SERVICE PROVIDER (ASP) FEATURING SOFTWARE IN THE FIELD OF AGRICULTURAL

DATA COLLECTION AND TRANSMITTAL SOFTWARE APPLICATIONS; APPLICATION SERVICE PROVIDER (ASP), NAMELY, HOSTING COMPUTER SOFTWARE APPLICATIONS OF OTHERS; COMPUTER SERVICE, NAMELY, ACTING AS AN APPLICATION SERVICE PROVIDER IN THE FIELD OF KNOWLEDGE MANAGEMENT TO HOST COMPUTER APPLICATION SOFTWARE FOR CREATING SEARCHABLE DATABASES OF INFORMATION AND DATA, IN CLASS 42 (U.S. CLS. 100 AND 101).

FIRST USE 3-5-2008; IN COMMERCE 3-5-2008.

THE MARK CONSISTS OF STANDARD CHARACTERS WITHOUT CLAIM TO ANY PARTICULAR FONT, STYLE, SIZE, OR COLOR.

SN 78-812,925, FILED 2-12-2006.

DAVID C. REIHNER, EXAMINING ATTORNEY

Int. Cl.: 9

Prior U.S. Cls.: 21, 23, 26, 36, and 38

Reg. No. 3,482,296

United States Patent and Trademark Office

Registered Aug. 5, 2008

**TRADEMARK
PRINCIPAL REGISTER**

RED LIONS

IGT (NEVADA CORPORATION)
9295 PROTOTYPE DRIVE
RENO, NV 895218986

THE MARK CONSISTS OF STANDARD CHAR-
ACTERS WITHOUT CLAIM TO ANY PARTICULAR
FONT, STYLE, SIZE, OR COLOR.

FOR: GAMING MACHINES, NAMELY, DEVICES
WHICH ACCEPT A WAGER, IN CLASS 9 (U.S. CLS.
21, 23, 26, 36 AND 38).

SN 78-813,278, FILED 2-13-2006.

FIRST USE 11-6-2007; IN COMMERCE 11-6-2007.

REBECCA SMITH, EXAMINING ATTORNEY

Int. Cl.: 14

Prior U.S. Cls.: 2, 27, 28, and 50

United States Patent and Trademark Office

Reg. No. 3,482,297

Registered Aug. 5, 2008

**TRADEMARK
PRINCIPAL REGISTER**

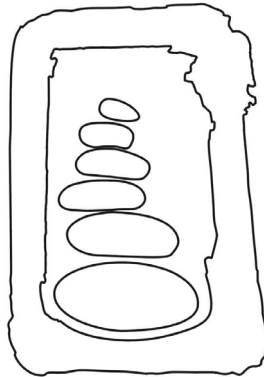

TARMA DESIGNS (CALIFORNIA SOLE PROPRIETORSHIP)
1722 DORSET DRIVE
PETALUMA, CA 94954

FIRST USE 1-31-2007; IN COMMERCE 1-31-2007.

SN 78-814,424, FILED 2-14-2006.

FOR: JEWELRY, IN CLASS 14 (U.S. CLS. 2, 27, 28 AND 50).

CIMMERIAN COLEMAN, EXAMINING ATTORNEY

Int. Cl.: 9

Prior U.S. Cls.: 21, 23, 26, 36, and 38

Reg. No. 3,482,298

United States Patent and Trademark Office

Registered Aug. 5, 2008

**TRADEMARK
PRINCIPAL REGISTER**

KILIMANJARO

IGT (NEVADA CORPORATION)
9295 PROTOTYPE DRIVE
RENO, NV 895218986

THE MARK CONSISTS OF STANDARD CHAR-
ACTERS WITHOUT CLAIM TO ANY PARTICULAR
FONT, STYLE, SIZE, OR COLOR.

FOR: GAMING MACHINES, NAMELY, DEVICES
WHICH ACCEPT A WAGER, IN CLASS 9 (U.S. CLS.
21, 23, 26, 36 AND 38).

SN 78-815,346, FILED 2-15-2006.

FIRST USE 2-13-2008; IN COMMERCE 3-12-2008.

REBECCA SMITH, EXAMINING ATTORNEY

Int. Cl.: 5

Prior U.S. Cls.: 6, 18, 44, 46, 51, and 52

United States Patent and Trademark Office

Reg. No. 3,482,299

Registered Aug. 5, 2008

**TRADEMARK
PRINCIPAL REGISTER**



AGRI LABORATORIES, LTD. (DELAWARE CORPORATION)
20927 STATE ROUTE K
ST. JOSEPH, MO 64505

FOR: FLEA AND TICK TOPICAL SOLUTION, IN CLASS 5 (U.S. CLS. 6, 18, 44, 46, 51 AND 52).

FIRST USE 2-7-2008; IN COMMERCE 4-1-2008.

THE COLOR(S) BLUE, PURPLE, WHITE, BLACK AND GRAY IS/ARE CLAIMED AS A FEATURE OF THE MARK.

THE COLOR BLUE APPEARS IN THE LEFT SIDE OF THE RINGS; THE COLOR PURPLE APPEARS IN THE RIGHT SIDE OF THE RINGS; THE COLOR BLACK APPEARS IN THE WORDING; THE COLOR GRAY APPEARS IN SHADOWING IN THE TERM "FORCE"; AND THE COLOR WHITE COMPOSES THE BACKGROUND FOR THE MARK.

SN 78-816,700, FILED 2-16-2006.

MELVIN AXILBUND, EXAMINING ATTORNEY

Int. Cl.: 30

Prior U.S. Cl.: 46

United States Patent and Trademark Office

Reg. No. 3,482,300

Registered Aug. 5, 2008

TRADEMARK
PRINCIPAL REGISTER



BLACKMUSTARD, INC. (SOUTH CAROLINA CORPORATION)
3107 TRENHOLM ROAD
P.O. BOX 6106
COLUMBIA, SC 29204

FOR: BARBECUE SAUCE, IN CLASS 30 (U.S. CL. 46).

FIRST USE 7-5-2006; IN COMMERCE 7-5-2006.

NO CLAIM IS MADE TO THE EXCLUSIVE RIGHT TO USE "BLACK MUSTARD BARBECUE SLATHER" AND "BBQ SLATHER.COM", APART FROM THE MARK AS SHOWN.

THE COLOR(S) RED, YELLOW, BLACK, TAN AND WHITE ARE CLAIMED AS A FEATURE OF THE MARK.

THE MARK CONSISTS OF THE WORDS "BLACKMUSTARD BARBECUE SLATHER", "BBQSLATHER.COM" AND A STYLIZED DEPICTION OF A CHICKEN AND PIG ON AN OVAL BACKGROUND. THE COLOR(S) RED APPEARS IN THE OUTLINE OF THE OVAL CARRIER AND IN THE BACKGROUND OF THE BANNER. THE COLOR YELLOW APPEARS IN THE INSIDE OF THE OVAL CARRIER, IN THE OUTLINE OF THE BANNER, AND IN THE WORDS "BARBECUE SLATHER". THE COLOR BLACK APPEARS IN THE OUTLINE OF THE OVAL CARRIER, THE WORDS "BLACKMUSTARD" AND "BBQSLATHER.COM", THE OUTLINE AND DETAILS OF THE CHICKEN AND PIG. THE COLORS TAN AND WHITE APPEAR INSIDE THE DESIGNS OF THE CHICKEN AND PIG.

SN 78-819,290, FILED 2-21-2006.

KHANH LE, EXAMINING ATTORNEY

Int. Cl.: 28

Prior U.S. Cls.: 22, 23, 38, and 50

United States Patent and Trademark Office

Reg. No. 3,482,301

Registered Aug. 5, 2008

TRADEMARK
PRINCIPAL REGISTER

SPY TECH

EDU-SCIENCE (H.K.) LIMITED (HONG KONG CORPORATION)
SUITE 701, 7/F, WING ON PLAZA
62 MODY ROAD, TSIM SHA TSUI EAST
KOWLOON, HONG KONG

FOR: SPY ROLE PLAYING TOYS, NAMELY TOY ELECTRONIC GLOVES, TOY CAMERAS, TOY BINOCULARS, TOY TELESCOPES, TOY MAGNIFYING GLASS, TOY ROOM DEFENDERS, NAMELY, MOTION SENSORS, TOY LISTENING DEVICES, TOY ALARMS, TOY COMPASS, TOY CARBINEER, TOY FLASHLIGHTS, TOY SECRET MESSAGE DEVICES, TOY WALKIE TALKIES, TOY SPY LAB KIT, NAMELY, KITS CONSISTING PRIMARILY OF BINOCULARS, HEARING AIDS, SONIC EXPLORERS AND FINGER PRINT TESTING KITS FOR USE IN

SPY ROLE PLAYING, IN CLASS 28 (U.S. CLS. 22, 23, 38 AND 50).

FIRST USE 10-1-2007; IN COMMERCE 10-1-2007.

THE MARK CONSISTS OF STANDARD CHARACTERS WITHOUT CLAIM TO ANY PARTICULAR FONT, STYLE, SIZE, OR COLOR.

NO CLAIM IS MADE TO THE EXCLUSIVE RIGHT TO USE "SPY", APART FROM THE MARK AS SHOWN.

SN 78-819,972, FILED 2-21-2006.

ELLEN PERKINS, EXAMINING ATTORNEY

Int. Cls.: 41 and 43

Prior U.S. Cls.: 100, 101, and 107

United States Patent and Trademark Office

Reg. No. 3,482,302

Registered Aug. 5, 2008

**SERVICE MARK
PRINCIPAL REGISTER**

KLC SCHOOL PARTNERSHIPS

KNOWLEDGE LEARNING CORPORATION (DE-
LAWARE CORPORATION)
650 N.E. HOLLADAY STREET
PORTLAND, OR 97232

FOR: EDUCATIONAL SERVICES, NAMELY,
PROVIDING COURSES OF INSTRUCTION AT
THE PRE-SCHOOL AND PRIMARY LEVELS; AND
SUMMER RECREATIONAL CAMPS , IN CLASS 41
(U.S. CLS. 100, 101 AND 107).

FIRST USE 9-1-2004; IN COMMERCE 9-1-2004.

FOR: CHILD CARE SERVICES AND BEFORE
AND AFTER SCHOOL EXTENDED DAY CARE
SERVICES, IN CLASS 43 (U.S. CLS. 100 AND 101).

FIRST USE 9-1-2004; IN COMMERCE 9-1-2004.

THE MARK CONSISTS OF STANDARD CHAR-
ACTERS WITHOUT CLAIM TO ANY PARTICULAR
FONT, STYLE, SIZE, OR COLOR.

NO CLAIM IS MADE TO THE EXCLUSIVE
RIGHT TO USE "SCHOOL PARTNERSHIPS",
APART FROM THE MARK AS SHOWN.

SN 78-820,322, FILED 2-22-2006.

ALLISON SCHRODY, EXAMINING ATTORNEY

Int. Cl.: 19

Prior U.S. Cls.: 1, 12, 33, and 50

United States Patent and Trademark Office

Reg. No. 3,482,303

Registered Aug. 5, 2008

**TRADEMARK
PRINCIPAL REGISTER**

SIMPLICITY OF A COMPOSITE
DECK BUT ALL THE
ADVANTAGES OF RIGID VINYL

U.S. POLYMERS, INC. (CALIFORNIA CORPORATION)
1057 SOUTH VAIL AVENUE
MONTEBELLO, CA 90640

FOR: VINYL DECK BUILDING MATERIALS, NAMELY, VINYL DECK PLANKS, VINYL END COVERS AND VINYL FASCIA BOARDS, IN CLASS 19 (U.S. CLS. 1, 12, 33 AND 50).

FIRST USE 6-0-2008; IN COMMERCE 6-0-2008.

THE MARK CONSISTS OF STANDARD CHARACTERS WITHOUT CLAIM TO ANY PARTICULAR FONT, STYLE, SIZE, OR COLOR.

NO CLAIM IS MADE TO THE EXCLUSIVE RIGHT TO USE "DECK", APART FROM THE MARK AS SHOWN.

SN 78-823,021, FILED 2-24-2006.

JOHN GARTNER, EXAMINING ATTORNEY

Int. Cl.: 30

Prior U.S. Cl.: 46

United States Patent and Trademark Office

Reg. No. 3,482,304

Registered Aug. 5, 2008

**TRADEMARK
PRINCIPAL REGISTER**

Paromi

PAROMI TEA, LLC (MARYLAND LTD LIAB CO)
6713 RIVER TRAIL CT.
BETHESDA, MD 20817

FIRST USE 10-16-2006; IN COMMERCE 10-16-2006.

FOR: BEVERAGES MADE OF TEA; BLACK TEA;
FLAVOURINGS OF TEA; FRUIT TEAS; GREEN
TEA; HERB TEA; HERBAL TEA; ICED TEA; JAPA-
NESE GREEN TEA; LIME TEA; OOLONG TEA;
SAGE TEA; TEA; TEA FOR INFUSIONS; TEA-
BASED BEVERAGES WITH FRUIT FLAVORING,
IN CLASS 30 (U.S. CL. 46).

THE MARK CONSISTS OF STANDARD CHAR-
ACTERS WITHOUT CLAIM TO ANY PARTICULAR
FONT, STYLE, SIZE, OR COLOR.

SN 78-823,989, FILED 2-27-2006.

SUE LAWRENCE, EXAMINING ATTORNEY

Int. Cls.: 35, 36, 39, 41, 42, 44, and 45

Prior U.S. Cls.: 100, 101, 102, 105, and 107

United States Patent and Trademark Office

Reg. No. 3,482,305

Registered Aug. 5, 2008

**SERVICE MARK
PRINCIPAL REGISTER**

Helium

HELIUM, INC. (DELAWARE CORPORATION)
300 BRICKSTONE SQUARE
ANDOVER, MA 01810

FOR: PROVIDING INFORMATION IN THE FIELD OF BUSINESS, NAMELY, PROVIDING USER-CONTRIBUTED ARTICLES ON BUSINESS, MARKETING, ADVERTISING, ENTREPRENEURSHIP, HUMAN RESOURCES, TRADE, INTERNATIONAL BUSINESS, MANAGEMENT, ONLINE BUSINESSES, SALES, AND HOME BUSINESSES; PROVIDING INFORMATION IN THE FIELD OF AUTOS, NAMELY, PROVIDING USER-CONTRIBUTED ARTICLES ON BUYING AND SELLING CARS, AND CONSUMER INFORMATION IN THE NATURE OF AUTOMOBILE REVIEWS; PROVIDING INFORMATION IN THE FIELD OF CAREERS, NAMELY, PROVIDING USER-CONTRIBUTED ARTICLES ON EMPLOYERS, JOB SEARCHING, OCCUPATIONS, AND ONLINE JOBS; PROVIDING INFORMATION IN THE FIELD OF AUTOS NAMELY PROVIDING USER-CONTRIBUTED ARTICLES PROMOTING PUBLIC AWARENESS OF SAFE AUTOMOBILE DRIVING, AUTOMOBILE SAFETY, AND FUEL EFFICIENT DRIVING; PROVIDING INFORMATION IN THE FIELD OF POLITICS, NAMELY PROVIDING USER-CONTRIBUTED ARTICLES ON POLITICAL CONFLICTS, ENVIRONMENTAL POLITICS, GENERAL POLITICS, AND GOVERNMENT; PROVIDING INFORMATION IN THE FIELD OF TECHNOLOGY, NAMELY PROVIDING USER-CONTRIBUTED ARTICLES FEATURING CONSUMER INFORMATION ON COMPUTING, ELECTRONICS, HARDWARE, SOFTWARE, TELEPHONES, AND ONLINE SHOPPING; ALL VIA A GLOBAL COMPUTER NETWORK; PROVIDING AN ONLINE DIRECTORY INFORMATION SERVICE FEATURING INFORMATION REGARDING ARTS, HUMANITIES, AUTOMOTIVE, BUSINESS, COMPUTING, TECHNOLOGY, EDUCATION, ENTERTAINMENT, FOOD, DRINK, HEALTH, FITNESS, HOBBIES, GAMES, HOME,

GARDEN, JOBS, CAREERS, PREGNANCY, PERSONAL FINANCE, PETS, ANIMALS, POLITICS, NEWS, RELATIONSHIPS, FAMILY, RELIGION, SPIRITUALITY, SCIENCE, SOCIETY, LIFESTYLE, SPORTS, OUTDOORS, STYLE, BEAUTY, AND TRAVEL, IN CLASS 35 (U.S. CLS. 100, 101 AND 102).

FIRST USE 8-29-2006; IN COMMERCE 8-29-2006.

FOR: PROVIDING INFORMATION IN THE FIELD OF FINANCE, NAMELY, PROVIDING USER-CONTRIBUTED ARTICLES ON FINANCE; PROVIDING INFORMATION IN THE FIELD OF REAL ESTATE, NAMELY PROVIDING USER-CONTRIBUTED ARTICLES ON REAL ESTATE; ALL VIA A GLOBAL COMPUTER NETWORK, IN CLASS 36 (U.S. CLS. 100, 101 AND 102).

FIRST USE 8-29-2006; IN COMMERCE 8-29-2006.

FOR: PROVIDING INFORMATION IN THE FIELD OF TRAVEL INFORMATION, NAMELY, PROVIDING USER-CONTRIBUTED ARTICLES ON MODES OF TRANSPORTATION, TRAVEL INFORMATION SERVICES, AND TRAVEL INFORMATION PLANNING; ALL VIA A GLOBAL COMPUTER NETWORK, IN CLASS 39 (U.S. CLS. 100 AND 105).

FIRST USE 8-29-2006; IN COMMERCE 8-29-2006.

FOR: PROVIDING INFORMATION IN THE FIELD OF EDUCATION, NAMELY, PROVIDING USER-CONTRIBUTED ARTICLES ON ADULT EDUCATION, ALTERNATIVE EDUCATION, COLLEGE AND UNIVERSITY EDUCATION, EARLY CHILDHOOD EDUCATION, GRADE SCHOOL EDUCATION, HIGH SCHOOL EDUCATION, LANGUAGES EDUCATION, AND SPECIAL NEEDS CLASSES; PROVIDING INFORMATION IN THE FIELD OF SPORTS, NAMELY, PROVIDING USER-CONTRIBUTED ARTICLES ON BASEBALL, BAS-

KETBALL, FOOTBALL, GOLF, OUTDOORS, RECREATIONAL AND YOUTH SPORTS, SOCCER, SPORTS CELEBRITIES, SPORTS TRAINING, EQUIPMENT, EXERCISE, AND FITNESS; PROVIDING INFORMATION IN THE FIELD OF ENTERTAINMENT, NAMELY, PROVIDING USER-CONTRIBUTED ARTICLES ON ENTERTAINMENT, CELEBRITIES, MOVIES, TELEVISION, MUSIC, MUSICAL INSTRUMENTS, MUSIC EDUCATION, MUSICIANS, BANDS, MUSIC PRODUCTION, MUSIC ENGINEERING, MUSIC REVIEWS; PROVIDING INFORMATION IN THE FIELD OF HOBBIES, NAMELY PROVIDING USER-CONTRIBUTED ARTICLES ON HOBBIES, ANTIQUES, COLLECTING, AND CRAFTS; PROVIDING INFORMATION IN THE FIELD OF GAMES, NAMELY, PROVIDING USER-CONTRIBUTED ARTICLES ON ELECTRONIC GAMES, BOARD GAMES, CARD GAMES, FANTASY GAMES, ROLE PLAYING GAMES, AND VIDEO GAMES; ALL VIA A GLOBAL COMPUTER NETWORK; INFORMATION IN THE FIELD OF PARENTING CONCERNING EDUCATION OF CHILDREN; INFORMATION IN THE FIELD OF PARENTING CONCERNING ENTERTAINMENT OF CHILDREN, IN CLASS 41 (U.S. CLS. 100, 101 AND 107).

FIRST USE 8-29-2006; IN COMMERCE 8-29-2006.

FOR: PROVIDING INFORMATION IN THE FIELD OF COMPUTER AND INFORMATION TECHNOLOGY, NAMELY, PROVIDING USER-CONTRIBUTED ARTICLES ABOUT THE INTERNET, ONLINE COMPUTER SECURITY, AND WEB DESIGN; PROVIDING INFORMATION IN THE FIELD OF SCIENCE, NAMELY, PROVIDING USER-CONTRIBUTED ARTICLES ON BIOLOGY, EARTH SCIENCE, MEDICAL SCIENCE, PHYSICAL SCIENCE, AND SOCIAL SCIENCE; ALL VIA A GLOBAL COMPUTER NETWORK; APPLICATION SERVICE PROVIDER, FEATURING SOFTWARE FOR USE IN RATING AND RANKING INFORMATION CONCERNING VARIOUS GENERAL INTEREST AND SPECIFIC INTEREST TOPICS, IN CLASS 42 (U.S. CLS. 100 AND 101).

FIRST USE 8-29-2006; IN COMMERCE 8-29-2006.

FOR: PROVIDING INFORMATION IN THE FIELD OF STYLE, NAMELY, PROVIDING USER-CONTRIBUTED ARTICLES ON INFORMATION ABOUT BEAUTY, BODY CARE, HAIR CARE, AND

SKIN CARE; PROVIDING INFORMATION IN THE FIELD OF HOME AND GARDEN, NAMELY, PROVIDING USER-CONTRIBUTED ARTICLES ON LAWN CARE, AND GARDEN CARE; PROVIDING INFORMATION IN THE FIELD OF HEALTH CONDITIONS, NAMELY, PROVIDING USER-CONTRIBUTED ARTICLES ON, ALLERGIES, ASTHMA, ALTERNATIVE HEALTH, DENTISTRY, WEIGHT REDUCTION DIET PLANNING, VARIOUS DISEASES, FIRST AID CARE, GENERAL HEALTH, MEDICAL ISSUES, MENTAL HEALTH, NUTRITION, PEDIATRIC CARE, HEALTH, SUBSTANCE ABUSE, ADDICTION, AND VISION; PROVIDING INFORMATION IN THE FIELD OF PETS AND ANIMALS, NAMELY, PROVIDING USER-CONTRIBUTED ARTICLES ON FEEDING AND HOUSING PETS, ANIMAL PEDIGREE AND BREEDING, AND ANIMAL HEALTH; ALL VIA A GLOBAL COMPUTER NETWORK; INFORMATION ABOUT PARENTING TOPICS, NAMELY, DRUG AND ALCOHOL AWARENESS; INFORMATION IN THE FIELD OF PARENTING CONCERNING THE HEALTH OF CHILDREN, IN CLASS 44 (U.S. CLS. 100 AND 101).

FIRST USE 8-29-2006; IN COMMERCE 8-29-2006.

FOR: PROVIDING INFORMATION RELATING TO DIVERSE HUMAN CULTURES, BELIEFS, LIFESTYLES AND RELATIONSHIPS, NAMELY PROVIDING USER-CONTRIBUTED ARTICLES ON FAMILY RELATIONSHIPS, HUMAN COMMUNICATION, CHILD DISCIPLINE, DATING, MARRIAGE, AND IMPROVING FRIENDSHIPS; PROVIDING INFORMATION IN THE FIELD OF RELIGION, NAMELY PROVIDING USER-CONTRIBUTED ARTICLES ON SPIRITUALITY, RELIGIOUS BELIEFS, AND RELIGIOUS THEORIES; ALL VIA A GLOBAL COMPUTER NETWORK; INFORMATION IN THE FIELD OF PARENTING CONCERNING INTRAFAMILY RELATIONSHIPS, IN CLASS 45 (U.S. CLS. 100 AND 101).

FIRST USE 8-29-2006; IN COMMERCE 8-29-2006.

THE MARK CONSISTS OF STANDARD CHARACTERS WITHOUT CLAIM TO ANY PARTICULAR FONT, STYLE, SIZE, OR COLOR.

SN 78-824,036, FILED 2-27-2006.

MELVIN AXILBUND, EXAMINING ATTORNEY

Int. Cl.: 44

Prior U.S. Cls.: 100 and 101

United States Patent and Trademark Office

Reg. No. 3,482,306

Registered Aug. 5, 2008

**SERVICE MARK
PRINCIPAL REGISTER**

**Sound Solutions Hearing
Center**

BILLEDEAUX HEARING CENTER, L.L.C.
(LOUISIANA LTD LIAB CO)
SUITE D
4414 JOHNSTON STREET
LAFAYETTE, LA 70503

FOR: HEARING AID SERVICES, IN CLASS 44
(U.S. CLS. 100 AND 101).

FIRST USE 4-1-2006; IN COMMERCE 4-1-2006.

THE MARK CONSISTS OF STANDARD CHARACTERS WITHOUT CLAIM TO ANY PARTICULAR FONT, STYLE, SIZE, OR COLOR.

NO CLAIM IS MADE TO THE EXCLUSIVE RIGHT TO USE "HEARING CENTER", APART FROM THE MARK AS SHOWN.

SN 78-824,424, FILED 2-27-2006.

BENJAMIN OKEKE, EXAMINING ATTORNEY

Int. Cl.: 10

Prior U.S. Cls.: 26, 39, and 44

United States Patent and Trademark Office

Reg. No. 3,482,307

Registered Aug. 5, 2008

**TRADEMARK
PRINCIPAL REGISTER**

LIGHTING THE WAY TO HEALING

NOMIR MEDICAL TECHNOLOGIES, INC. (DE-
LAWARE CORPORATION)
307 WAVERLY OAKS, SUITE 109
WALTHAM, MA 02452

THE MARK CONSISTS OF STANDARD CHAR-
ACTERS WITHOUT CLAIM TO ANY PARTICULAR
FONT, STYLE, SIZE, OR COLOR.

FOR: LASERS FOR SURGICAL AND MEDICAL
USE, IN CLASS 10 (U.S. CLS. 26, 39 AND 44).

SN 78-827,356, FILED 3-2-2006.

FIRST USE 2-1-2007; IN COMMERCE 11-1-2007.

HANNO RITTNER, EXAMINING ATTORNEY

Int. Cl.: 21

Prior U.S. Cls.: 2, 13, 23, 29, 30, 33, 40, and 50

Reg. No. 3,482,308

United States Patent and Trademark Office

Registered Aug. 5, 2008

**TRADEMARK
PRINCIPAL REGISTER**

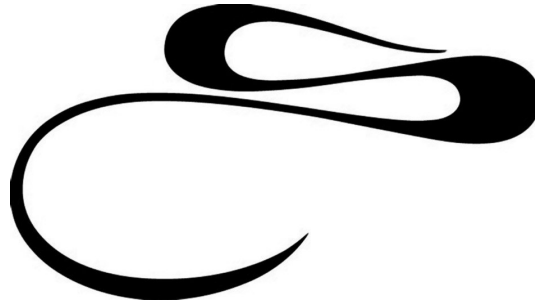

SARAMAR, L.L.C. (DELAWARE LIMITED LIABILITY COMPANY)
70 WEST MADISON STREET
THREE FIRST NATIONAL PLAZA
CHICAGO, IL 60602

FIRST USE 6-30-2006; IN COMMERCE 6-30-2006.

SN 78-828,335, FILED 3-3-2006.

FOR: DECANTERS, IN CLASS 21 (U.S. CLS. 2, 13, 23, 29, 30, 33, 40 AND 50).

CARRIE GENOVESE, EXAMINING ATTORNEY

Int. Cl.: 7

Prior U.S. Cls.: 13, 19, 21, 23, 31, 34, and 35

Reg. No. 3,482,309

United States Patent and Trademark Office

Registered Aug. 5, 2008

**TRADEMARK
PRINCIPAL REGISTER**

DYNA-PRO

PENTAIR WATER POOL AND SPA, INC. (DELA-
WARE CORPORATION)
1620 HAWKINS AVENUE
SANFORD, NC 27330

THE MARK CONSISTS OF STANDARD CHAR-
ACTERS WITHOUT CLAIM TO ANY PARTICULAR
FONT, STYLE, SIZE, OR COLOR.

FOR: CENTRIFUGAL PUMP FOR SWIMMING
POOLS AND SPAS, IN CLASS 7 (U.S. CLS. 13, 19, 21,
23, 31, 34 AND 35).

SN 78-828,411, FILED 3-3-2006.

FIRST USE 1-7-2008; IN COMMERCE 1-7-2008.

JASON BLAIR, EXAMINING ATTORNEY

Int. Cl.: 41

Prior U.S. Cls.: 100, 101, and 107

United States Patent and Trademark Office

Reg. No. 3,482,310

Registered Aug. 5, 2008

**SERVICE MARK
PRINCIPAL REGISTER**

BETJ

BLACK ENTERTAINMENT TELEVISION LLC
(D.C. LTD LIAB CO)
C/O DONNA S. COOPER, ESQ. LEGAL AFFAIRS
ONE BET PLAZA, 1235 W STREET, NE
WASHINGTON, DC 20018

FOR: ENTERTAINMENT SERVICES, NAMELY,
PROVIDING TELEVISION PROGRAMS IN THE
FIELDS OF MUSIC AND NEWS AND INFORMA-
TION RELATED TO MUSIC VIA THE INTERNET,
IN CLASS 41 (U.S. CLS. 100, 101 AND 107).

FIRST USE 3-8-2006; IN COMMERCE 3-8-2006.

THE MARK CONSISTS OF STANDARD CHAR-
ACTERS WITHOUT CLAIM TO ANY PARTICULAR
FONT, STYLE, SIZE, OR COLOR.

OWNER OF U.S. REG. NOS. 1,511,259, 2,572,634,
AND OTHERS.

SN 78-831,571, FILED 3-7-2006.

KATHERINE CHANG, EXAMINING ATTORNEY

Int. Cl.: 24

Prior U.S. Cls.: 42 and 50

United States Patent and Trademark Office

Reg. No. 3,482,311

Registered Aug. 5, 2008

**TRADEMARK
PRINCIPAL REGISTER**

PICK & BAG

K&K HOME FASHIONS, LTD. (NEW YORK CORPORATION)
529 CENTRAL PARK AVE.
SCARSDALE, NY 10583

FOR: BED BLANKETS; BED CANOPIES; BED LINEN; BED PADS; BED SHEETS; BED SHEETS OF PAPER; BED SKIRTS; BED SPREADS; FEATHER BEDS; PAPER BED COVERS; SILK BED BLANKETS, IN CLASS 24 (U.S. CLS. 42 AND 50).

FIRST USE 5-1-2008; IN COMMERCE 5-1-2008.

THE MARK CONSISTS OF STANDARD CHARACTERS WITHOUT CLAIM TO ANY PARTICULAR FONT, STYLE, SIZE, OR COLOR.

SN 78-832,345, FILED 3-8-2006.

DAVID HOFFMAN, EXAMINING ATTORNEY

Int. Cl.: 9

Prior U.S. Cls.: 21, 23, 26, 36, and 38

United States Patent and Trademark Office

Reg. No. 3,482,312

Registered Aug. 5, 2008

**TRADEMARK
PRINCIPAL REGISTER**

Thought Technologies

MYERS, HAROLD KEITH (CANADA INDIVIDUAL)
2180 BELGRAVE AVE.
MONTREAL, QUEBEC, CANADA H4A2L8

OWNER OF U.S. REG. NO. 2,966,846.

FOR: COMPUTER HARDWARE FOR MEDICAL DATA ACQUISITION, IN CLASS 9 (U.S. CLS. 21, 23, 26, 36 AND 38).

NO CLAIM IS MADE TO THE EXCLUSIVE RIGHT TO USE "TECHNOLOGIES", APART FROM THE MARK AS SHOWN.

FIRST USE 11-1-2004; IN COMMERCE 11-1-2004.

SN 78-832,434, FILED 3-8-2006.

THE MARK CONSISTS OF STANDARD CHARACTERS WITHOUT CLAIM TO ANY PARTICULAR FONT, STYLE, SIZE, OR COLOR.

RICHARD A. STRASER, EXAMINING ATTORNEY

Int. Cl.: 35

Prior U.S. Cls.: 100, 101, and 102

United States Patent and Trademark Office

Reg. No. 3,482,313

Registered Aug. 5, 2008

**SERVICE MARK
PRINCIPAL REGISTER**

ONCUE EXPRESS

ONCUE MARKETING, LLC (OKLAHOMA LTD
LIAB CO)
916 N. MAIN
STILLWATER, OK 74075

FOR: WHOLESALE DISTRIBUTORSHIPS FEATURING GASOLINE, IN CLASS 35 (U.S. CLS. 100, 101 AND 102).

FIRST USE 5-1-2006; IN COMMERCE 5-1-2006.

THE MARK CONSISTS OF STANDARD CHARACTERS WITHOUT CLAIM TO ANY PARTICULAR FONT, STYLE, SIZE, OR COLOR.

NO CLAIM IS MADE TO THE EXCLUSIVE RIGHT TO USE "EXPRESS", APART FROM THE MARK AS SHOWN.

SN 78-832,569, FILED 3-8-2006.

MICHAEL GAAFAR, EXAMINING ATTORNEY

Int. Cl.: 35

Prior U.S. Cls.: 100, 101, and 102

United States Patent and Trademark Office

Reg. No. 3,482,314

Registered Aug. 5, 2008

**SERVICE MARK
PRINCIPAL REGISTER**

RSVP

ROSS-SIMONS OF WARWICK, INC. (RHODE
ISLAND CORPORATION)
9 ROSS-SIMONS DRIVE
CRANSTON, RI 02920

THE MARK CONSISTS OF STANDARD CHAR-
ACTERS WITHOUT CLAIM TO ANY PARTICULAR
FONT, STYLE, SIZE, OR COLOR.

FOR: RETAIL STORE SERVICES FEATURING
JEWELRY, IN CLASS 35 (U.S. CLS. 100, 101 AND 102).

SN 78-832,983, FILED 3-9-2006.

FIRST USE 7-0-2007; IN COMMERCE 7-0-2007.

MICHAEL GAAFAR, EXAMINING ATTORNEY

Int. Cl.: 41

Prior U.S. Cls.: 100, 101, and 107

Reg. No. 3,482,315

United States Patent and Trademark Office

Registered Aug. 5, 2008

**SERVICE MARK
PRINCIPAL REGISTER**

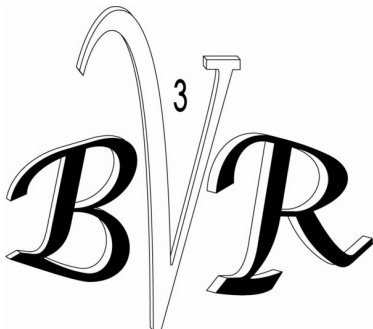

"THE BIG RED V ROCKS!"

ABBOTT, VINNIE (UNITED STATES INDIVIDUAL)
119 FIFTH AVENUE, 3RD FLOOR
C/O SERLING ROOKS & FERRARA, LLP
NEW YORK, NY 10003

FOR: ENTERTAINMENT SERVICES, NAMELY, AUDIO RECORDING AND PRODUCTION; MUSIC PRODUCTION SERVICES; RECORD PRODUCTION; VIDEOTAPE PRODUCTION; SOUND RECORDING STUDIOS; ENTERTAINMENT SERVICES, NAMELY, LIVE MUSIC CONCERTS; ENTERTAINMENT SERVICES, NAMELY, PROVIDING PRERECORDED MUSIC, INFORMATION IN THE FIELD OF MUSIC, AND COMMENTARY AND ARTICLES ABOUT MUSIC, ALL ON-LINE VIA A GLOBAL COMPUTER NETWORK; ENTERTAINMENT SERVICES, NAMELY, PROVIDING A WEB

SITE FEATURING MUSICAL PERFORMANCES, MUSICAL VIDEOS, RELATED FILM CLIPS, PHOTOGRAPHS, AND OTHER MULTIMEDIA MATERIALS; PRODUCTION AND DISTRIBUTION OF MOTION PICTURES; PRODUCTION OF TELEVISION PROGRAMS; DISTRIBUTION OF TELEVISION PROGRAMS FOR OTHERS; PROVIDING A SUBSCRIPTION BASED WEBSITE FEATURING NEWS AND INFORMATION IN THE FIELD OF ENTERTAINMENT, IN CLASS 41 (U.S. CLS. 100, 101 AND 107).

FIRST USE 5-1-2006; IN COMMERCE 5-1-2006.

SN 78-833,102, FILED 3-9-2006.

DAVID MURRAY, EXAMINING ATTORNEY

Int. Cl.: 36

Prior U.S. Cls.: 100, 101, and 102

United States Patent and Trademark Office

Reg. No. 3,482,316

Registered Aug. 5, 2008

**SERVICE MARK
PRINCIPAL REGISTER**



ASSURANCEAMERICA CORPORATION (NEVA-
DA CORPORATION)
SUITE 600
5500 INTERSTATE NORTH PARKWAY
ATLANTA, GA 30328

FOR: INSURANCE AGENCIES, IN CLASS 36 (U.S.
CLS. 100, 101 AND 102).

FIRST USE 4-1-2004; IN COMMERCE 4-1-2004.

OWNER OF U.S. REG. NOS. 2,961,353 AND
3,144,163.

NO CLAIM IS MADE TO THE EXCLUSIVE
RIGHT TO USE "LATINO", APART FROM THE
MARK AS SHOWN.

SN 78-834,412, FILED 3-10-2006.

SANJEEV VOHRA, EXAMINING ATTORNEY

Int. Cls.: 16 and 35

Prior U.S. Cls.: 2, 5, 22, 23, 29, 37, 38, 50, 100, 101, and 102

Reg. No. 3,482,317

United States Patent and Trademark Office

Registered Aug. 5, 2008

**TRADEMARK
SERVICE MARK
PRINCIPAL REGISTER**

Healogix

HEALTHSTAT, LLC (MARYLAND LTD LIAB
CO)
SUITE 120
2325 MARYLAND RD
WILLOW GROVE, PA 19090

FOR: PRINTED REPORTS FEATURING INFORMATION PERTAINING TO THE HEALTH CARE AND PHARMACEUTICAL INDUSTRIES, IN CLASS 16 (U.S. CLS. 2, 5, 22, 23, 29, 37, 38 AND 50).

FIRST USE 9-1-2006; IN COMMERCE 9-1-2006.

FOR: BUSINESS CONSULTATION SERVICES; MARKET RESEARCH SERVICES; CREATING

BUSINESS REPORTS RELATING TO THE HEALTH CARE AND PHARMACEUTICAL INDUSTRIES, IN CLASS 35 (U.S. CLS. 100, 101 AND 102).

FIRST USE 9-1-2006; IN COMMERCE 9-1-2006.

THE MARK CONSISTS OF STANDARD CHARACTERS WITHOUT CLAIM TO ANY PARTICULAR FONT, STYLE, SIZE, OR COLOR.

SN 78-835,734, FILED 3-13-2006.

FLORENTINA BLANDU, EXAMINING ATTORNEY

Int. Cl.: 11

Prior U.S. Cls.: 13, 21, 23, 31, and 34

Reg. No. 3,482,318

United States Patent and Trademark Office

Registered Aug. 5, 2008

**TRADEMARK
PRINCIPAL REGISTER**

ABYSS

BARBIER, JOHAN (BELGIUM INDIVIDUAL)
1010 NW 51ST PLACE
FORT LAUDERDALE, FL 33309 AND
BELHOSTE, MARC (FRANCE INDIVIDUAL)
1010 NW 51ST PLACE
FORT LAUDERDALE, FL 33309

FIRST USE 3-15-2006; IN COMMERCE 3-15-2006.

THE MARK CONSISTS OF STANDARD CHARACTERS WITHOUT CLAIM TO ANY PARTICULAR FONT, STYLE, SIZE, OR COLOR.

FOR: MARINE AND OCEANOGRAPHIC EQUIPMENT AND PARTS THEREOF, NAMELY, UNDERWATER LIGHTS, IN CLASS 11 (U.S. CLS. 13, 21, 23, 31 AND 34).

SN 78-835,947, FILED 3-13-2006.

JAMES MACFARLANE, EXAMINING ATTORNEY

Int. Cl.: 35

Prior U.S. Cls.: 100, 101, and 102

United States Patent and Trademark Office

Reg. No. 3,482,319

Registered Aug. 5, 2008

SERVICE MARK
PRINCIPAL REGISTER

CALSOTA

CALSOTA SUPPLY, LLC (MINNESOTA LTD
LIAB CO)
1615 PORTLAND AVENUE
ST. PAUL, MN 55104

FOR: ON-LINE RETAIL STORE SERVICES AND WHOLESALE DISTRIBUTORSHIP SERVICES FEATURING NETTING USED IN OR ON HOOP HOUSES, GREENHOUSES, FIELDS, CROPLAND, VINEYARDS AND ORCHARDS TO SHIELD AND PROTECT GRAPES, BLUEBERRIES, RASPBERRIES, STRAWBERRIES AND OTHER FRUITS FROM BIRD DAMAGE, AGRICULTURAL AND HORTICULTURAL PRODUCTS, NAMELY, NETTING USED IN OR ON HOOP HOUSES, GREENHOUSES, FIELDS, CROPLAND, VINEYARDS AND ORCHARDS TO SHIELD AND PROTECT GRAPES, BLUEBERRIES, RASPBERRIES, STRAWBERRIES AND OTHER FRUITS FROM BIRD DAMAGE, CONSTRUCTION MATERIALS AND PRODUCTS, NAMELY, ELECTRICAL TAPE, FLAGGING TAPE, BARRICADE TAPE, SILT FENCING AND SAND BAGS, INDUSTRIAL SUPPLIES AND PRODUCTS,

NAMELY, ELECTRICAL TAPE, FLAGGING TAPE, BARRICADE TAPE, SILT FENCING AND SAND BAGS, COMMERCIAL NETS USED ON AND IN MONUMENTS, BUILDINGS AND OTHER STRUCTURES TO PREVENT ACCESS OR PERCHING BY BIRDS, AND AGRICULTURAL AND HORTICULTURAL PRODUCTS, NAMELY, NETS USED ON AND IN MONUMENTS, BUILDINGS AND OTHER STRUCTURES TO PREVENT ACCESS OR PERCHING BY BIRDS, IN CLASS 35 (U.S. CLS. 100, 101 AND 102).

FIRST USE 6-0-2006; IN COMMERCE 6-0-2006.

THE MARK CONSISTS OF STANDARD CHARACTERS WITHOUT CLAIM TO ANY PARTICULAR FONT, STYLE, SIZE, OR COLOR.

SN 78-837,438, FILED 3-15-2006.

HANNO RITTNER, EXAMINING ATTORNEY

Int. Cls.: 9 and 20

Prior U.S. Cls.: 2, 13, 21, 22, 23, 25, 26, 32, 36, 38, and 50

United States Patent and Trademark Office

Reg. No. 3,482,320

Registered Aug. 5, 2008

**TRADEMARK
PRINCIPAL REGISTER**

SHOP ABOUT

ANTHRO CORPORATION (OREGON CORPORATION)
10450 SW MANHASSET DRIVE
TUALATIN, OR 97062

FOR: POWER SUPPLIES, IN CLASS 9 (U.S. CLS. 21, 23, 26, 36 AND 38).

FIRST USE 3-1-2006; IN COMMERCE 3-15-2006.

FOR: MODULAR, MOBILE FURNITURE FOR COMPUTERS, ELECTRONIC CASH REGISTERS, BATTERY POWERED MOBILE CASH REGISTERS, SCANNERS, BAR-CODE READERS, LABEL PRINTERS, AND OTHER HARDWARE AND ACCESSOR-

IES, NAMELY, SHELVES, DRAWERS, AND NON-METAL HANDLES, IN CLASS 20 (U.S. CLS. 2, 13, 22, 25, 32 AND 50).

FIRST USE 3-1-2006; IN COMMERCE 3-15-2006.

THE MARK CONSISTS OF STANDARD CHARACTERS WITHOUT CLAIM TO ANY PARTICULAR FONT, STYLE, SIZE, OR COLOR.

SN 78-837,569, FILED 3-15-2006.

DEBRA LEE, EXAMINING ATTORNEY

Int. Cl.: 25

Prior U.S. Cls.: 22 and 39

United States Patent and Trademark Office

Reg. No. 3,482,321

Registered Aug. 5, 2008

**TRADEMARK
PRINCIPAL REGISTER**



PAYLESS SHOESOURCE WORLDWIDE, INC.
(KANSAS CORPORATION)
JAYHAWK TOWERS, 700 SW JACKSON, STE 202
TOPEKA, KS 66603

FOR: FOOTWEAR AND APPAREL, NAMELY,
HEADWEAR, NECKWEAR, SCARVES, HATS,
GLOVES, BELTS, SOCKS, HOSIERY, PANTYHOSE,
KNEE-HIGH STOCKINGS, AND TIGHTS, IN CLASS
25 (U.S. CLS. 22 AND 39).

FIRST USE 12-1-2007; IN COMMERCE 12-1-2007.

OWNER OF U.S. REG. NOS. 2,126,943, 2,301,896,
AND OTHERS.

THE MARK CONSISTS OF A STYLIZED LETTER
"P" WHICH FORMS PART OF A CIRCLE, ALL IN
CLOSE PROXIMITY TO THE WORDS PAYLESS
SHOESOURCE.

SN 78-839,032, FILED 3-16-2006.

KAPIL BHANOT, EXAMINING ATTORNEY

Int. Cl.: 18

Prior U.S. Cls.: 1, 2, 3, 22, and 41

United States Patent and Trademark Office

Reg. No. 3,482,322

Registered Aug. 5, 2008

**TRADEMARK
PRINCIPAL REGISTER**

FENDERBUNNY

COLEMAN, ANDREA (UNITED STATES INDIVIDUAL)
25542 FITZGERALD AVENUE
STEVENSONRANCH, CA 91381

FOR: CHANGE PURSES; CLUTCH PURSES; CLUTCHES; COIN PURSES; COIN PURSES NOT MADE OF PRECIOUS METAL; COIN PURSES, NOT OF PRECIOUS METALS; LEATHER PURSES; MULTI-PURPOSE PURSES; PURSES; SMALL CLUTCH PURSES; SMALL PURSES; WRIST MOUNTED PURSES, IN CLASS 18 (U.S. CLS. 1, 2, 3, 22 AND 41).

FIRST USE 7-1-2006; IN COMMERCE 7-1-2006.

THE MARK CONSISTS OF STANDARD CHARACTERS WITHOUT CLAIM TO ANY PARTICULAR FONT, STYLE, SIZE, OR COLOR.

SN 78-839,212, FILED 3-16-2006.

DAVID MURRAY, EXAMINING ATTORNEY

Int. Cl.: 33

Prior U.S. Cls.: 47 and 49

United States Patent and Trademark Office

Reg. No. 3,482,323

Registered Aug. 5, 2008

TRADEMARK
PRINCIPAL REGISTER



BACARDI & COMPANY LIMITED (LIECHTEN-
STEIN CORPORATION)
AEULESTRASSE 5
VADUZ, LIECHTENSTEIN FL-9490

THE MARK CONSISTS OF A TROOP OF MARCH-
ING SCOTTISH HIGHLANDERS.

FOR: ALCOHOLIC BEVERAGES, NAMELY,
SCOTCH WHISKY, IN CLASS 33 (U.S. CLS. 47 AND
49).

SN 78-839,939, FILED 3-17-2006.

FIRST USE 7-31-2005; IN COMMERCE 7-31-2005.

GIANCARLO CASTRO, EXAMINING ATTORNEY

Int. Cl.: 35

Prior U.S. Cls.: 100, 101, and 102

United States Patent and Trademark Office

Reg. No. 3,482,324

Registered Aug. 5, 2008

**SERVICE MARK
PRINCIPAL REGISTER**



PAYLESS SHOESOURCE WORLDWIDE, INC.
(KANSAS CORPORATION)
JAYHAWK TOWERS, 700 SW JACKSON, STE 202
TOPEKA, KS 66603

FOR: RETAIL SHOE AND FASHION ACCESSORIES STORE SERVICES; COMPUTERIZED ON-LINE RETAIL SERVICES IN THE FIELD OF FOOTWEAR, APPAREL, PURSES, HANDBAGS, AND BACKPACKS, ACCESSIBLE VIA GLOBAL COMPUTER NETWORKS, IN CLASS 35 (U.S. CLS. 100, 101 AND 102).

FIRST USE 12-6-2007; IN COMMERCE 12-6-2007.

OWNER OF U.S. REG. NOS. 2,126,943, 2,301,896, AND OTHERS.

THE COLOR(S) ORANGE AND PALE BLUE IS/ARE CLAIMED AS A FEATURE OF THE MARK.

THE COLOR ORANGE APPEARS IN THE STYLIZED LETTER P AND THE TERMS PAYLESS SHOESOURCE; THE COLOR BLUE APPEARS IN THE ARC SHAPE OPPOSITE THE STYLIZED ORANGE LETTER P.

THE MARK CONSISTS OF A STYLIZED LETTER "P" WHICH FORMS PART OF A CIRCLE, ALL IN CLOSE PROXIMITY TO THE WORDS "PAYLESS SHOESOURCE".

SN 78-840,254, FILED 3-17-2006.

KAPIL BHANOT, EXAMINING ATTORNEY

Int. Cl.: 33

Prior U.S. Cls.: 47 and 49

United States Patent and Trademark Office

Reg. No. 3,482,325

Registered Aug. 5, 2008

**TRADEMARK
PRINCIPAL REGISTER**

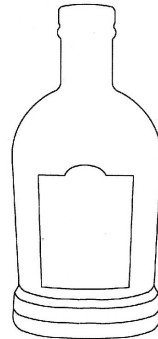

BACARDI & COMPANY LIMITED (LIECHTEN-
STEIN CORPORATION)
AEULESTRASSE 5 P.O. BOX 470
VADUZ, LIECHTENSTEIN FL-9490

FOR: ALCOHOLIC BEVERAGES, NAMELY,
WHISKY, IN CLASS 33 (U.S. CLS. 47 AND 49).

FIRST USE 1-12-2006; IN COMMERCE 8-18-2006.

THE MARK CONSISTS OF A DESIGN OF A
BOTTLE WITH A LABEL.

SN 78-840,276, FILED 3-17-2006.

GIANCARLO CASTRO, EXAMINING ATTORNEY

Int. Cl.: 9

Prior U.S. Cls.: 21, 23, 26, 36, and 38

Reg. No. 3,482,326

United States Patent and Trademark Office

Registered Aug. 5, 2008

**TRADEMARK
PRINCIPAL REGISTER**

BIT9 PARITYCENTER

BIT9, INC. (DELAWARE CORPORATION)
SUITE 201
TEN CANAL PARK
CAMBRIDGE, MA 02141

THE MARK CONSISTS OF STANDARD CHARACTERS WITHOUT CLAIM TO ANY PARTICULAR FONT, STYLE, SIZE, OR COLOR.

FOR: COMPUTER PROGRAMS FOR USE IN TRACKING SOFTWARE AND EXECUTABLE FILES IN COMPUTER NETWORKS, FOR USE IN IDENTIFYING NEW AND UNKNOWN SOFTWARE AND EXECUTABLE FILES AND FOR BLOCKING UNAUTHORIZED SOFTWARE EXECUTIONS, IN CLASS 9 (U.S. CLS. 21, 23, 26, 36 AND 38).

NO CLAIM IS MADE TO THE EXCLUSIVE RIGHT TO USE "PARITYCENTER", APART FROM THE MARK AS SHOWN.

SN 78-842,067, FILED 3-21-2006.

FIRST USE 3-22-2006; IN COMMERCE 3-22-2006.

JENNIFER VASQUEZ, EXAMINING ATTORNEY

Int. Cl.: 32

Prior U.S. Cls.: 45, 46, and 48

Reg. No. 3,482,327

United States Patent and Trademark Office

Registered Aug. 5, 2008

**TRADEMARK
PRINCIPAL REGISTER**

BEVITA

H2O TO GO, LLC (NEVADA LTD LIAB CO)
6575 CHESTNUT AVE.
MERCHANTVILLE, NJ 08109

THE MARK CONSISTS OF STANDARD CHAR-
ACTERS WITHOUT CLAIM TO ANY PARTICULAR
FONT, STYLE, SIZE, OR COLOR.

FOR: DISTILLED DRINKING WATER, SPRING
WATER, TABLE WATER, IN CLASS 32 (U.S. CLS. 45,
46 AND 48).

SN 78-842,121, FILED 3-21-2006.

FIRST USE 5-23-2008; IN COMMERCE 5-23-2008.

RICHARD WHITE, EXAMINING ATTORNEY

Int. Cl.: 16

Prior U.S. Cls.: 2, 5, 22, 23, 29, 37, 38, and 50

Reg. No. 3,482,328

United States Patent and Trademark Office

Registered Aug. 5, 2008

TRADEMARK
PRINCIPAL REGISTER



WARNER PRESS, INC. (INDIANA NON-PROFIT CORPORATION)
1201 EAST FIFTH STREET
ANDERSON, IN 46012

FIRST USE 5-0-2006; IN COMMERCE 7-0-2006.

OWNER OF U.S. REG. NOS. 1,174,577 AND 2,739,650.

FOR: PRINTED MATERIALS, NAMELY, RELIGIOUS BOOKS, AND CHILDREN'S BOOKS, PRINTED ATTENDANCE CHARTS, BULLETIN BOARDS, CHURCH BULLETINS, POSTERS, PAPER BANNERS, STORY BOARDS, MEMORY CARDS, NAMELY, STICKER BOOKS, ACTIVITY BOOKS, NAMELY CHILDREN ACTIVITY BOOKS, COLORING BOOKS, CARDS, NAMELY, BLANK CARDS AND MOTIVATIONAL CARDS, PENCILS, PENCIL SHARPENERS, PAPER FANS, AND CRAYONS, IN CLASS 16 (U.S. CLS. 2, 5, 22, 23, 29, 37, 38 AND 50).

NO CLAIM IS MADE TO THE EXCLUSIVE RIGHT TO USE "PRESS KIDS", APART FROM THE MARK AS SHOWN.

SN 78-845,703, FILED 3-24-2006.

CARYN GLASSER, EXAMINING ATTORNEY

Int. Cl.: 3

Prior U.S. Cls.: 1, 4, 6, 50, 51, and 52

Reg. No. 3,482,329

United States Patent and Trademark Office

Registered Aug. 5, 2008

**TRADEMARK
PRINCIPAL REGISTER**

REFRESHING CLEAN

CLOROX COMPANY, THE (DELAWARE CORPORATION)
1221 BROADWAY
OAKLAND, CA 94612

THE MARK CONSISTS OF STANDARD CHARACTERS WITHOUT CLAIM TO ANY PARTICULAR FONT, STYLE, SIZE, OR COLOR.

FOR: FRAGRANCE SOLD AS INTEGRAL PART OF ALL-PURPOSE CLEANERS, IN CLASS 3 (U.S. CLS. 1, 4, 6, 50, 51 AND 52).

SN 78-846,872, FILED 3-27-2006.

FIRST USE 1-31-2007; IN COMMERCE 1-31-2007.

TASHIA BUNCH, EXAMINING ATTORNEY

Int. Cl.: 35

Prior U.S. Cls.: 100, 101, and 102

United States Patent and Trademark Office

Reg. No. 3,482,330

Registered Aug. 5, 2008

**SERVICE MARK
PRINCIPAL REGISTER**

All Moms Go To Heaven

JOHNSON, JEAN (UNITED STATES INDIVIDUAL)
849 WOODCOVE COURT
CHESTERFIELD, MO 63017

FOR: ONLINE RETAIL STORE SERVICES FEATURING T-SHIRTS, GREETING CARDS, JEWELRY, MAGNETS, FLORAL ARRANGEMENTS, PHOTO ALBUMS, PICTURE FRAMES, BOOKS, CALENDARS, COFFEE MUGS, SUN VISORS, CHRISTMAS ORNAMENTS, JOURNALS, BOOKMARKS, AND GIFT ITEMS, IN CLASS 35 (U.S. CLS. 100, 101 AND 102).

FIRST USE 4-1-2006; IN COMMERCE 4-1-2006.

THE MARK CONSISTS OF STANDARD CHARACTERS WITHOUT CLAIM TO ANY PARTICULAR FONT, STYLE, SIZE, OR COLOR.

SN 78-849,540, FILED 3-29-2006.

BILL DAWE, EXAMINING ATTORNEY

Int. Cl.: 11

Prior U.S. Cls.: 13, 21, 23, 31, and 34

United States Patent and Trademark Office

Reg. No. 3,482,331

Registered Aug. 5, 2008

**TRADEMARK
PRINCIPAL REGISTER**

MAGIC FLAME

COLLINS INTERNATIONAL CO., LTD. (NEW
JERSEY CORPORATION)
2100 ROUTE 208
FAIR LAWN, NJ 07410

THE MARK CONSISTS OF STANDARD CHAR-
ACTERS WITHOUT CLAIM TO ANY PARTICULAR
FONT, STYLE, SIZE, OR COLOR.

FOR: BARBECUE GRILLS, IN CLASS 11 (U.S. CLS.
13, 21, 23, 31 AND 34).

SN 78-849,760, FILED 3-30-2006.

FIRST USE 5-30-2007; IN COMMERCE 5-30-2007.

SUE LAWRENCE, EXAMINING ATTORNEY

Int. Cl.: 35

Prior U.S. Cls.: 100, 101, and 102

United States Patent and Trademark Office

Reg. No. 3,482,332

Registered Aug. 5, 2008

**SERVICE MARK
PRINCIPAL REGISTER**



X, INC. (CALIFORNIA CORPORATION), DBA
ONE STOP SHOP,
6800 OWENSMOUTH AVENUE #220
CANOGA PARK, CA 91303

FOR: DISTRIBUTORSHIP SERVICES IN THE
FIELDS OF TONER AND TONER CARTRIDGES
FOR PRINTERS, FACSIMILE, PHOTOCOPYING
AND OTHER IMAGE REPRODUCING MACHINES;
DISTRIBUTORSHIP SERVICES IN THE FIELD OF
INK CARTRIDGES FOR PRINTERS, FACSIMILE,
PHOTOCOPYING AND OTHER IMAGE REPRODU-

CING MACHINES, IN CLASS 35 (U.S. CLS. 100, 101
AND 102).

FIRST USE 6-0-2006; IN COMMERCE 6-0-2006.

THE MARK CONSISTS OF THE LOGO BEING
USED WITH THE WORD MARK IN THE CLASSES
APPLIED FOR.

SN 78-850,594, FILED 3-30-2006.

TRACY WHITTAKER-BROWN, EXAMINING AT-
TORNEY

Int. Cls.: 9, 16, 35, and 41

**Prior U.S. Cls.: 2, 5, 21, 22, 23, 26, 29, 36, 37, 38, 50,
100, 101, 102, and 107**

Reg. No. 3,482,333

United States Patent and Trademark Office

Registered Aug. 5, 2008

**TRADEMARK
SERVICE MARK
PRINCIPAL REGISTER**

WOMANWISE

WATERSMOLITOR, INC. (MINNESOTA CORPORATION)
SUITE 600
1000 SHELARD PARKWAY
MINNEAPOLIS, MN 55426

FOR: PRE-RECORDED CDS, DVDS, VIDEOTAPES AND DOWNLOADABLE VIDEO RECORDINGS OF PODCASTS FEATURING INFORMATION RELATED TO ADVERTISING, MARKETING, BRANDING AND CONSUMER INSIGHT, IN CLASS 9 (U.S. CLS. 21, 23, 26, 36 AND 38).

FIRST USE 9-5-2006; IN COMMERCE 9-5-2006.

FOR: PRINTED LECTURES; PRINTED SPEECHES; BOOKS IN THE FIELDS OF ADVERTISING, MARKETING, BRANDING AND CONSUMER INSIGHT; NEWSLETTERS IN THE FIELDS OF ADVERTISING, MARKETING, BRANDING AND CONSUMER INSIGHT; PRINTED VISUALS IN THE NATURE OF PHOTOGRAPHS, INFORMATION GRAPHICS AND PROMOTIONAL MATERIALS; PRINTED WHITE PAPERS FEATURING INFORMATION RELATED TO ADVERTISING, MARKETING, BRANDING AND CONSUMER INSIGHT; A SERIES OF WRITTEN ARTICLES IN THE FIELDS OF ADVERTISING, MARKETING, BRANDING AND CONSUMER INSIGHT; PRINTED SEMINAR NOTES, IN CLASS 16 (U.S. CLS. 2, 5, 22, 23, 29, 37, 38 AND 50).

FIRST USE 9-5-2006; IN COMMERCE 9-5-2006.

FOR: ADVERTISING AND MARKETING SERVICES, NAMELY, CONSUMER RESEARCH, CONSUMER

INSIGHT, MARKET RESEARCH, CONDUCTING MARKETING STUDIES AND MARKET RESEARCH CONSULTATION; BUSINESS CONSULTING SERVICES IN THE FIELDS OF MARKETING, ADVERTISING, PROMOTION, PUBLIC RELATIONS, DIRECT MARKETING AND EVENTS, IN CLASS 35 (U.S. CLS. 100, 101 AND 102).

FIRST USE 9-5-2006; IN COMMERCE 9-5-2006.

FOR: PROVIDING NEWSLETTERS IN THE FIELDS OF ADVERTISING, MARKETING, BRANDING AND CONSUMER RESEARCH VIA E-MAIL; PROVIDING ON-LINE PUBLICATIONS, NAMELY, BOOKS, NEWSLETTERS, WHITE PAPERS, AND ARTICLES FEATURING INFORMATION RELATED TO ADVERTISING, MARKETING, BRANDING AND CONSUMER INSIGHT; ARRANGING OF SEMINARS; EDUCATIONAL SERVICES, NAMELY, PROVIDING SEMINARS AND GIVING SPEECHES IN THE FIELDS OF ADVERTISING, MARKETING, BRANDING AND CONSUMER INSIGHT, IN CLASS 41 (U.S. CLS. 100, 101 AND 107).

FIRST USE 9-5-2006; IN COMMERCE 9-5-2006.

THE MARK CONSISTS OF STANDARD CHARACTERS WITHOUT CLAIM TO ANY PARTICULAR FONT, STYLE, SIZE, OR COLOR.

SN 78-851,380, FILED 3-31-2006.

DOMINIC FATHY, EXAMINING ATTORNEY

Int. Cls.: 9, 38, and 41

Prior U.S. Cls.: 21, 23, 26, 36, 38, 100, 101, 104, and 107

Reg. No. 3,482,334

United States Patent and Trademark Office

Registered Aug. 5, 2008

**TRADEMARK
SERVICE MARK
PRINCIPAL REGISTER**



KAJEET, INC. (DELAWARE CORPORATION)
SUITE 1111
7101 WISCONSIN AVENUE
BETHESDA, MD 20814

FOR: MOBILE ELECTRONIC DEVICE PROVIDING TRANSMISSION AND STORAGE OF VOICE AND DATA, MESSAGING, GAMES, LOCATION SERVICES, PHOTOGRAPHY, AND OTHER MEDIA AND CONTENT AND RELATED TELECOMMUNICATIONS SERVICES, WITH OPTIONAL PARENTAL CONTROLS; COMPUTER HARDWARE AND SOFTWARE RELATED THERETO, AND DOWNLOADABLE COMPUTER GAMES, MUSIC AND EDUCATIONAL ACTIVITIES AND GAMES, IN CLASS 9 (U.S. CLS. 21, 23, 26, 36 AND 38).

FIRST USE 10-31-2006; IN COMMERCE 10-31-2006.

FOR: TELECOMMUNICATIONS SERVICES VIA A MOBILE ELECTRONIC DEVICE, NAMELY, TRANSMISSION OF VOICE AND DATA, MESSA-

GING, GAMES, LOCATION SERVICES, PHOTOGRAPHY, AND OTHER MEDIA AND CONTENT, WITH OPTIONAL PARENTAL CONTROLS, IN CLASS 38 (U.S. CLS. 100, 101 AND 104).

FIRST USE 10-31-2006; IN COMMERCE 10-31-2006.

FOR: ENTERTAINMENT SERVICES, NAMELY, PROVIDING ON-LINE NON-DOWNLOADABLE COMPUTER GAMES AND MUSIC VIA A MOBILE ELECTRONIC DEVICE; EDUCATION SERVICES, NAMELY, PROVIDING ON-LINE, NON-DOWNLOADABLE EDUCATIONAL ACTIVITIES FOR CHILDREN VIA A MOBILE ELECTRONIC DEVICE, IN CLASS 41 (U.S. CLS. 100, 101 AND 107).

FIRST USE 10-31-2006; IN COMMERCE 10-31-2006.

SN 78-851,944, FILED 4-1-2006.

DARRYL SPRUILL, EXAMINING ATTORNEY

Int. Cls.: 35 and 40

Prior U.S. Cls.: 100, 101, 102, 103, and 106

United States Patent and Trademark Office

Reg. No. 3,482,335

Registered Aug. 5, 2008

**SERVICE MARK
PRINCIPAL REGISTER**

SYNQ

SYNQ SOLUTIONS, INC. (GEORGIA CORPORATION)
655 LAMBERT DRIVE
ATLANTA, GA 30324

FOR: DEMAND PUBLISHING, NAMELY, PUBLISHING OF ADVERTISING TEXTS; REPROGRAPHIC SERVICES, NAMELY, PUBLISHING OF ADVERTISING TEXTS, IN CLASS 35 (U.S. CLS. 100, 101 AND 102).

FIRST USE 3-7-2007; IN COMMERCE 3-7-2007.

FOR: DEMAND PUBLISHING, NAMELY, PUBLISHING OF BOOKS, MAGAZINES; REPRO-

GRAPHIC SERVICES, NAMELY, PUBLISHING OF BOOKS, MAGAZINES, IN CLASS 40 (U.S. CLS. 100, 103 AND 106).

FIRST USE 3-7-2007; IN COMMERCE 3-7-2007.

THE MARK CONSISTS OF STANDARD CHARACTERS WITHOUT CLAIM TO ANY PARTICULAR FONT, STYLE, SIZE, OR COLOR.

SN 78-852,289, FILED 4-3-2006.

GILBERT SWIFT, EXAMINING ATTORNEY

Int. Cl.: 12

Prior U.S. Cls.: 19, 21, 23, 31, 35, and 44

United States Patent and Trademark Office

Reg. No. 3,482,336

Registered Aug. 5, 2008

**TRADEMARK
PRINCIPAL REGISTER**

RAIN PROTECTION SYSTEMS

RPS TECHNOLOGIES, INC. (DELAWARE CORPORATION)

1390 VANGUARD BLVD.

MIAMISBURG, OH 45342

FOR: WINDSHIELD WIPER BLADES, IN CLASS 12 (U.S. CLS. 19, 21, 23, 31, 35 AND 44).

FIRST USE 10-1-2007; IN COMMERCE 10-1-2007.

THE MARK CONSISTS OF STANDARD CHARACTERS WITHOUT CLAIM TO ANY PARTICULAR FONT, STYLE, SIZE, OR COLOR.

NO CLAIM IS MADE TO THE EXCLUSIVE RIGHT TO USE "RAIN" OR "SYSTEMS", APART FROM THE MARK AS SHOWN.

SN 78-853,220, FILED 4-4-2006.

LYDIA BELZER, EXAMINING ATTORNEY

Int. Cls.: 29 and 30

Prior U.S. Cl.: 46

United States Patent and Trademark Office

Reg. No. 3,482,337

Registered Aug. 5, 2008

**TRADEMARK
PRINCIPAL REGISTER**



FRESH EXPRESS INCORPORATED (DELAWARE CORPORATION)
P. O. BOX 80599
SALINAS, CA 93912

FOR: SALAD TOPPINGS, NAMELY, SHREDDED CHEESE, BACON BITS, DRIED VEGETABLES AND FRUITS, IN CLASS 29 (U.S. CL. 46).

FIRST USE 4-1-2005; IN COMMERCE 4-1-2005.

FOR: SALAD TOPPINGS, NAMELY, CROUTONS AND TORTILLA STRIPS, IN CLASS 30 (U.S. CL. 46).

FIRST USE 4-1-2005; IN COMMERCE 4-1-2005.

OWNER OF U.S. REG. NOS. 2,323,851, 3,028,912, AND OTHERS.

NO CLAIM IS MADE TO THE EXCLUSIVE RIGHT TO USE "FRESH", APART FROM THE MARK AS SHOWN.

THE MARK CONSISTS OF THE WORDS "FRESH EXPRESS" INSIDE A DARK BACKGROUND AND STYLIZED LEAVES ABOVE THE WORD "FRESH".

SN 78-854,235, FILED 4-5-2006.

ALLISON SCHRODY, EXAMINING ATTORNEY

Int. Cls.: 29 and 30

Prior U.S. Cl.: 46

United States Patent and Trademark Office

Reg. No. 3,482,338

Registered Aug. 5, 2008

**TRADEMARK
PRINCIPAL REGISTER**

FRESH EXPRESS

FRESH EXPRESS INCORPORATED (DELAWARE CORPORATION)
P. O. BOX 80599
SALINAS, CA 93912

FOR: SALAD TOPPINGS, NAMELY, SHREDDED CHEESE, BACON BITS AND DRIED VEGETABLES AND FRUITS, IN CLASS 29 (U.S. CL. 46).

FIRST USE 4-1-2005; IN COMMERCE 4-1-2005.

FOR: SALAD TOPPINGS, NAMELY, CROUTONS AND TORTILLA STRIPS, IN CLASS 30 (U.S. CL. 46).

FIRST USE 4-1-2005; IN COMMERCE 4-1-2005.

THE MARK CONSISTS OF STANDARD CHARACTERS WITHOUT CLAIM TO ANY PARTICULAR FONT, STYLE, SIZE, OR COLOR.

OWNER OF U.S. REG. NOS. 2,346,673, 2,363,302, AND OTHERS.

NO CLAIM IS MADE TO THE EXCLUSIVE RIGHT TO USE "FRESH", APART FROM THE MARK AS SHOWN.

SN 78-854,241, FILED 4-5-2006.

ALLISON SCHRODY, EXAMINING ATTORNEY

Int. Cl.: 9

Prior U.S. Cls.: 21, 23, 26, 36, and 38

Reg. No. 3,482,339

United States Patent and Trademark Office

Registered Aug. 5, 2008

**TRADEMARK
PRINCIPAL REGISTER**

StudentMate

ALTA HEIGHTS TECHNOLOGY CORPORATION
(DELAWARE CORPORATION)
108 ALTA HEIGHTS CT.
LOS GATOS, CA 95030

THE MARK CONSISTS OF STANDARD CHARACTERS WITHOUT CLAIM TO ANY PARTICULAR FONT, STYLE, SIZE, OR COLOR.

FOR: COMPUTER HARDWARE AND SOFTWARE FOR USE IN INDIVIDUALIZED STUDENT ASSESSMENT AND INSTRUCTION, USED TO IMPROVE SKILLS, MONITOR AND TRACK PERFORMANCE, IN CLASS 9 (U.S. CLS. 21, 23, 26, 36 AND 38).

SN 78-854,302, FILED 4-5-2006.

FIRST USE 4-0-2008; IN COMMERCE 4-0-2008.

WILLIAM P. SHANAHAN, EXAMINING ATTORNEY

Int. Cl.: 9

Prior U.S. Cls.: 21, 23, 26, 36, and 38

Reg. No. 3,482,340

United States Patent and Trademark Office

Registered Aug. 5, 2008

**TRADEMARK
PRINCIPAL REGISTER**



HOOPS L. P. (DELAWARE LIMITED PARTNERSHIP)

175 TOYOTA PLAZA, SUITE 150
MEMPHIS, TN 38103

FOR: AUDIO RECORDINGS AND VIDEO RECORDINGS IN THE FIELD OF BASKETBALL; AUDIO, VIDEO, COMPUTER AND LASER DISCS, PRE-RECORDED AUDIO AND VIDEO CASSETTES, PRE-RECORDED AUDIO AND VIDEO TAPES, PRE-RECORDED COMPACT DISCS, PRE-RECORDED COMPUTER DISCS, ALL RELATED TO BASKETBALL; COMPUTER ACCESSORIES, NAMELY, MOUSE PADS, MICE, DISC CASES, COMPUTER CARRY-ON CASES, KEYBOARD WRIST PADS, COMPUTER MONITOR CARDBOARD FRAMES, ALL RELATED TO BASKETBALL; COMPUTER PROGRAMS FOR VIEWING INFORMATION, STATISTICS OR TRIVIA ABOUT BASKETBALL; COMPUTER SOFTWARE, NAMELY, SCREEN SAVERS FEATURING BASKETBALL THEMES, COMPUTER SOFTWARE TO ACCESS AND VIEW COMPUTER WALLPAPER, COMPUTER BROWSERS, COMPUTER SKINS AND COMPUTER CURSORS; COMPUTER GAME SOFTWARE; VIDEO GAME SOFTWARE, VIDEO GAME CARTRIDGES AND VIDEO GAME MACHINES FOR USE WITH TELEVISIONS; WIRELESS TELEPHONES; RADIOS, TELEPHONES, AND CELL PHONE ACCESSORIES, NAMELY, FACE PLATES AND CELL PHONE COVERS; VIDEO MONITORS, COMPUTER MONITORS, BINOCULARS; SUNGLASSES; EYEGLASS FRAMES; EYEWEAR STRAPS AND CHAINS; EYEGLASS AND SUNGLASS CASES; MAGNETS; DISPOSABLE CAMERAS; CREDIT CARDS AND PREPAID TELEPHONE CALLING CARDS MAGNETI-

CALLY ENCODED, DOWNLOADABLE VIDEO RECORDINGS, VIDEO STREAM RECORDINGS, AND AUDIO RECORDINGS IN THE FIELD OF BASKETBALL PROVIDED OVER THE INTERNET; DOWNLOADABLE COMPUTER SOFTWARE FOR VIEWING DATABASES OF INFORMATION, STATISTICAL INFORMATION, TRIVIA, POLLING INFORMATION, AND INTERACTIVE POLLING IN THE FIELD OF BASKETBALL PROVIDED OVER THE INTERNET; DOWNLOADABLE COMPUTER GAME SOFTWARE; VIDEO GAME PROGRAMS, INTERACTIVE VIDEO GAMES AND TRIVIA GAME SOFTWARE PROVIDED OVER THE INTERNET; DOWNLOADABLE COMPUTER SOFTWARE FOR USE AS SCREENSAVERS, WALLPAPER, BROWSERS, SKINS, AVATARS AND CURSORS OVER THE INTERNET; DOWNLOADABLE ELECTRONIC PUBLICATIONS IN THE NATURE OF MAGAZINES, NEWSLETTERS, COLORING BOOKS, GAME SCHEDULES ALL IN THE FIELD OF BASKETBALL PROVIDED OVER THE INTERNET; DOWNLOADABLE CATALOGS PROVIDED OVER THE INTERNET FEATURING AN ARRAY OF BASKETBALL-THEMED PRODUCTS, IN CLASS 9 (U.S. CLS. 21, 23, 26, 36 AND 38).

FIRST USE 10-1-2007; IN COMMERCE 10-1-2007.

OWNER OF U.S. REG. NOS. 2,861,210, 3,056,500, AND OTHERS.

NO CLAIM IS MADE TO THE EXCLUSIVE RIGHT TO USE "MEMPHIS", APART FROM THE MARK AS SHOWN.

THE MARK CONSISTS OF A PICTURE OF A
BEAR'S HEAD.

SN 78-854,360, FILED 4-5-2006.

JOHN SCHUYLER YARD, EXAMINING ATTOR-
NEY

Int. Cls.: 9 and 42

Prior U.S. Cls.: 21, 23, 26, 36, 38, 100, and 101

United States Patent and Trademark Office

Reg. No. 3,482,341

Registered Aug. 5, 2008

**TRADEMARK
SERVICE MARK
PRINCIPAL REGISTER**



MONTEFIORE MEDICAL CENTER (NEW YORK
NON-PROFIT CORPORATION)
111 EAST 210 STREET
BRONX, NY 10467

FOR: COMPUTER SOFTWARE IN THE FIELD OF HEALTH CARE TO ALLOW USERS TO TRACK PATIENT CARE AND PROGRESS AND THE PROCESSES AND EFFICIENCY OF A HEALTH CARE SYSTEM THROUGH ALL STAGES OF MEDICAL TREATMENTS, HOSPITAL VISITS, LABORATORY SERVICES, REHABILITATION AND ANY OTHERS ASPECT OF THE CONTINUUM OF CARE AND TO PROVIDE DATA AND STATISTICS IN CONNECTION WITH MEDICAL TREATMENT AND HEALTH CARE REGARDING PATIENTS, PATIENT DIAGNOSIS, PATIENT DEMOGRAPHICS, FACILITY/CARE CENTERS AND MANAGED HEALTH CARE PROGRAMS, IN CLASS 9 (U.S. CLS. 21, 23, 26, 36 AND 38).

FIRST USE 5-19-2006; IN COMMERCE 6-5-2008.

FOR: PROVIDING TEMPORARY ONLINE USE OF NON-DOWNLOADABLE SOFTWARE IN THE FIELD OF HEALTH CARE TO ALLOW USERS TO TRACK PATIENT CARE AND PROGRESS AND THE PROCESSES AND EFFICIENCY OF A HEALTH CARE SYSTEM THROUGH ALL STAGES OF MEDICAL TREATMENTS, HOSPITAL VISITS, LABORATORY SERVICES, REHABILITATION AND ANY OTHER ASPECT OF THE CONTINUUM OF CARE AND TO PROVIDE DATA AND STATISTICS IN CONNECTION WITH MEDICAL TREATMENT AND HEALTH CARE REGARDING PATIENTS, PATIENT DIAGNOSIS, PATIENT DEMOGRAPHICS, FACILITY/CARE CENTERS AND MANAGED HEALTH CARE PROGRAMS, IN CLASS 42 (U.S. CLS. 100 AND 101).

FIRST USE 1-16-2007; IN COMMERCE 1-16-2007.

SN 78-854,900, FILED 4-5-2006.

CARRIE GENOVESE, EXAMINING ATTORNEY

Int. Cl.: 9

Prior U.S. Cls.: 21, 23, 26, 36, and 38

Reg. No. 3,482,342

United States Patent and Trademark Office

Registered Aug. 5, 2008

**TRADEMARK
PRINCIPAL REGISTER**

MV-RIG

GENERAL CABLE TECHNOLOGIES CORPORATION
(DELAWARE CORPORATION)
4 TESSENEER DRIVE
HIGHLAND HEIGHTS, KY 41076

THE MARK CONSISTS OF STANDARD CHARACTERS WITHOUT CLAIM TO ANY PARTICULAR FONT, STYLE, SIZE, OR COLOR.

FOR: ELECTRICAL CABLES, IN CLASS 9 (U.S. CLS. 21, 23, 26, 36 AND 38).

SN 78-855,261, FILED 4-6-2006.

FIRST USE 3-0-2008; IN COMMERCE 3-0-2008.

KATHY DE JONGE, EXAMINING ATTORNEY

Int. Cl.: 12

Prior U.S. Cls.: 19, 21, 23, 31, 35, and 44

United States Patent and Trademark Office

Reg. No. 3,482,343

Registered Aug. 5, 2008

**TRADEMARK
PRINCIPAL REGISTER**



CARGO BED LICENSING INC. (CANADA CORPORATION)
2800 SCOTIA PLACE 10060 JASPER AVE.
EDMONTON, CANADA T5J 3V9

FOR: ROLLING ACCESS DECK FOR VEHICLES,
IN CLASS 12 (U.S. CLS. 19, 21, 23, 31, 35 AND 44).

FIRST USE 9-30-2005; IN COMMERCE 9-30-2005.

THE COLOR(S) BLACK AND GREY IS/ARE
CLAIMED AS A FEATURE OF THE MARK.

THE MARK CONSISTS OF A STYLIZED LETTER
C AT THE FIRST LETTER OF THE WORD "CARGO"
AND A STYLIZED LETTER D AT THE LAST
LETTER OF THE WORD "BED"; ALL WORDS ARE
IN BLACK UPPER CASE LETTERS APPEARING
BETWEEN A SPLIT STYLIZED CIRCLE IN GREY.

SN 78-855,990, FILED 4-6-2006.

CHERYL CLAYTON, EXAMINING ATTORNEY

Int. Cl.: 9

Prior U.S. Cls.: 21, 23, 26, 36, and 38

Reg. No. 3,482,344

United States Patent and Trademark Office

Registered Aug. 5, 2008

**TRADEMARK
PRINCIPAL REGISTER**

**PROTECTING THOSE WHO
PROTECT AND SERVE**

DEFENSTECH INTERNATIONAL, INC. (CALI-
FORNIA CORPORATION)
SUITE 240
101 PACIFICA
IRVINE, CA 92618

THE MARK CONSISTS OF STANDARD CHAR-
ACTERS WITHOUT CLAIM TO ANY PARTICULAR
FONT, STYLE, SIZE, OR COLOR.

FOR: BULLET, BLAST AND ATTACK RESIS-
TANT BODY ARMOR, IN CLASS 9 (U.S. CLS. 21,
23, 26, 36 AND 38).

SN 78-856,167, FILED 4-6-2006.

FIRST USE 2-18-2006; IN COMMERCE 2-18-2006.

RENEE SERVANCE, EXAMINING ATTORNEY

Int. Cl.: 35

Prior U.S. Cls.: 100, 101, and 102

United States Patent and Trademark Office

Reg. No. 3,482,345

Registered Aug. 5, 2008

**SERVICE MARK
PRINCIPAL REGISTER**

TargetSmart Communications

TARGETSMART COMMUNICATIONS, INC.
(D.C. CORPORATION)
919 18TH STREET, N.W.
WASHINGTON, DC 20006

FOR: PROVIDING ONLINE AND DOWNLOAD-
ABLE DEMOGRAPHIC DATA, AND DATA INTE-
GRATION SERVICES FOR USE IN CONNECTION
WITH POLITICAL CONSULTATION AND ANALY-
SIS, IN CLASS 35 (U.S. CLS. 100, 101 AND 102).

FIRST USE 3-0-2006; IN COMMERCE 3-0-2006.

THE MARK CONSISTS OF STANDARD CHAR-
ACTERS WITHOUT CLAIM TO ANY PARTICULAR
FONT, STYLE, SIZE, OR COLOR.

NO CLAIM IS MADE TO THE EXCLUSIVE
RIGHT TO USE "COMMUNICATIONS", APART
FROM THE MARK AS SHOWN.

SN 78-856,738, FILED 4-7-2006.

AHSEN KHAN, EXAMINING ATTORNEY

Int. Cls.: 36 and 45

Prior U.S. Cls.: 100, 101, and 102

United States Patent and Trademark Office

Reg. No. 3,482,346

Registered Aug. 5, 2008

**SERVICE MARK
PRINCIPAL REGISTER**

ACCOUNT AUTOGRAPH

WASHINGTON MUTUAL, INC. (WASHINGTON CORPORATION)
1301 SECOND AVENUE
WMC 3501
SEATTLE, WA 98101

FOR: BANKING SERVICES, IN CLASS 36 (U.S. CLS. 100, 101 AND 102).

FIRST USE 4-29-2006; IN COMMERCE 4-29-2006.

FOR: ELECTRONIC SIGNATURE VERIFICATION SERVICES PROVIDED IN CONNECTION WITH BANKING AND FINANCIAL SERVICES, IN CLASS 45 (U.S. CLS. 100 AND 101).

FIRST USE 4-29-2006; IN COMMERCE 4-29-2006.

THE MARK CONSISTS OF STANDARD CHARACTERS WITHOUT CLAIM TO ANY PARTICULAR FONT, STYLE, SIZE, OR COLOR.

NO CLAIM IS MADE TO THE EXCLUSIVE RIGHT TO USE "ACCOUNT", APART FROM THE MARK AS SHOWN.

SN 78-856,967, FILED 4-7-2006.

CYNTHIA SLOAN, EXAMINING ATTORNEY

Int. Cl.: 25

Prior U.S. Cls.: 22 and 39

United States Patent and Trademark Office

Reg. No. 3,482,347

Registered Aug. 5, 2008

**TRADEMARK
PRINCIPAL REGISTER**



GALES, MELANIE M. (UNITED STATES INDIVIDUAL)
15540 VINE AVENUE
HARVEY, IL 60426

THE MARK CONSISTS OF THE WORD "MAJLEO" WITH A DESIGN OF A "J" AND "L" WITH A CIRCLE AROUND IT.

FOR: CLOTHING, NAMELY, T-SHIRTS, PANTS, JACKETS, SWEATSHIRTS, SWEATPANTS, HEADWEAR, IN CLASS 25 (U.S. CLS. 22 AND 39).

SN 78-857,390, FILED 4-9-2006.

FIRST USE 4-14-2007; IN COMMERCE 7-20-2007.

JOHN GARTNER, EXAMINING ATTORNEY

Int. Cl.: 35

Prior U.S. Cls.: 100, 101, and 102

United States Patent and Trademark Office

Reg. No. 3,482,348

Registered Aug. 5, 2008

**SERVICE MARK
PRINCIPAL REGISTER**



EDX ELECTRONICS, INC. (FLORIDA CORPORATION)
1040 WILLA SPRINGS DRIVE
WINTER SPRINGS, FL 32708

FOR: PROVIDING ON-LINE BUSINESS INFORMATION IN THE FIELDS OF SALES AND PURCHASE OF ELECTRONIC COMPONENTS, NAMELY, PROVIDING INFORMATION ABOUT COMPONENT AVAILABILITY, BENCHMARK PRICING, FACTORY LEAD TIME, SALES HISTORY, PURCHASE HISTORY AND GLOBAL AVAILABILITY SHOWING SUPPLIER INFORMATION SPECIFICS, NAMELY, QUANTITY OF PART

COMPONENT AVAILABILITY AND PART COMPONENT PRICING AND FACTORY DELIVERY LEAD TIME, ON ELECTRONIC PART COMPONENTS BEING SEARCHED, PAST CUSTOMER SALES AND ORDER HISTORY AND MANUFACTURERS REQUESTS FOR PRICES, IN CLASS 35 (U.S. CLS. 100, 101 AND 102).

FIRST USE 4-11-2006; IN COMMERCE 4-11-2006.

SN 78-857,666, FILED 4-10-2006.

REBECCA SMITH, EXAMINING ATTORNEY

Int. Cl.: 31

Prior U.S. Cls.: 1 and 46

United States Patent and Trademark Office

Reg. No. 3,482,349

Registered Aug. 5, 2008

**TRADEMARK
PRINCIPAL REGISTER**

Great Plains Flax Seeds

GREAT PLAINS FLAX SEEDS, INC. (COLORADO CORPORATION)

8150 WEST FAIRVIEW AVENUE

LITTLETON, CO 80128

FOR: FLAX SEEDS, IN CLASS 31 (U.S. CLS. 1 AND 46).

FIRST USE 2-20-2007; IN COMMERCE 2-20-2007.

THE MARK CONSISTS OF STANDARD CHARACTERS WITHOUT CLAIM TO ANY PARTICULAR FONT, STYLE, SIZE, OR COLOR.

NO CLAIM IS MADE TO THE EXCLUSIVE RIGHT TO USE "FLAX SEEDS", APART FROM THE MARK AS SHOWN.

SN 78-857,901, FILED 4-10-2006.

HANNO RITTNER, EXAMINING ATTORNEY

Int. Cl.: 3

Prior U.S. Cls.: 1, 4, 6, 50, 51, and 52

United States Patent and Trademark Office

Reg. No. 3,482,350

Registered Aug. 5, 2008

**TRADEMARK
PRINCIPAL REGISTER**

NEXXUS LEVEL

ALBERTO-CULVER USA, INC. (DELAWARE
CORPORATION)
2525 ARMITAGE AVENUE
MELROSE PARK, IL 60160

FOR: HAIR CARE PREPARATIONS, IN CLASS 3
(U.S. CLS. 1, 4, 6, 50, 51 AND 52).

FIRST USE 12-31-2005; IN COMMERCE 12-31-2005.

THE MARK CONSISTS OF STANDARD CHAR-
ACTERS WITHOUT CLAIM TO ANY PARTICULAR
FONT, STYLE, SIZE, OR COLOR.

OWNER OF U.S. REG. NOS. 2,444,553, 2,521,278,
AND OTHERS.

SN 78-859,058, FILED 4-11-2006.

CAROL SPILS, EXAMINING ATTORNEY

Int. Cl.: 26

Prior U.S. Cls.: 37, 39, 40, 42, and 50

United States Patent and Trademark Office

Reg. No. 3,482,351

Registered Aug. 5, 2008

**TRADEMARK
PRINCIPAL REGISTER**

SO SOFT SO REAL

GENERAL WIG MANUFACTURERS, INC.
(FLORIDA CORPORATION)
5800 N.W. 163RD STREET
MIAMI LAKES, FL 33014

THE MARK CONSISTS OF STANDARD CHAR-
ACTERS WITHOUT CLAIM TO ANY PARTICULAR
FONT, STYLE, SIZE, OR COLOR.

FOR: WIGS AND HAIRPIECES, IN CLASS 26 (U.S.
CLS. 37, 39, 40, 42 AND 50).

SN 78-859,301, FILED 4-11-2006.

FIRST USE 6-7-2006; IN COMMERCE 6-7-2006.

GEORGE LORENZO, EXAMINING ATTORNEY

Int. Cl.: 16

Prior U.S. Cls.: 2, 5, 22, 23, 29, 37, 38, and 50

Reg. No. 3,482,352

United States Patent and Trademark Office

Registered Aug. 5, 2008

**TRADEMARK
PRINCIPAL REGISTER**

BEGIN SMART

BEGIN SMART LLC (NEW YORK LTD LIAB CO)
387 PARK AVENUE SOUTH
NEW YORK, NY 10016

THE MARK CONSISTS OF STANDARD CHAR-
ACTERS WITHOUT CLAIM TO ANY PARTICULAR
FONT, STYLE, SIZE, OR COLOR.

FOR: EDUCATIONAL BOOKS FEATURING A
DEVELOPMENTAL PROGRAM FOR CHILDREN,
IN CLASS 16 (U.S. CLS. 2, 5, 22, 23, 29, 37, 38 AND 50).

SN 78-859,638, FILED 4-12-2006.

FIRST USE 6-4-2008; IN COMMERCE 6-4-2008.

JENNIFER VASQUEZ, EXAMINING ATTORNEY

Int. Cl.: 35

Prior U.S. Cls.: 100, 101, and 102

United States Patent and Trademark Office

Reg. No. 3,482,353

Registered Aug. 5, 2008

**SERVICE MARK
PRINCIPAL REGISTER**



CONNOR, ROBERT A. (UNITED STATES INDIVIDUAL)
100 3RD AVENUE SOUTH, #304
MINNEAPOLIS, MN 55401

FOR: DISSEMINATION OF ADVERTISING FOR OTHERS VIA THE INTERNET, IN CLASS 35 (U.S. CLS. 100, 101 AND 102).

FIRST USE 6-22-2008; IN COMMERCE 6-22-2008.

THE COLOR(S) RED, ORANGE AND YELLOW IS/ ARE CLAIMED AS A FEATURE OF THE MARK.

THE COLOR YELLOW APPEARS IN THE WORD, "HOLOPLAYERS" AND IN THE OVAL, THE COLOR RED APPEARS IN THE OUTLINES OF THE WORD, "HOLOPLAYERS", AND THE COLOR ORANGE APPEARS IN THE OVAL.

SN 78-861,475, FILED 4-13-2006.

CARRIE GENOVESE, EXAMINING ATTORNEY

Int. Cl.: 42

Prior U.S. Cls.: 100 and 101

United States Patent and Trademark Office

Reg. No. 3,482,354

Registered Aug. 5, 2008

**SERVICE MARK
PRINCIPAL REGISTER**

ANSIKO

DZMITRY KHAUSTOVICH (NEW YORK CORPORATION)
SUITE 1-A 101-11 86TH AVE
RICHMOND HILL, NY 11418

FOR: CHARITABLE SERVICES, NAMELY, PROVIDING WEB SITE DESIGN FOR OTHERS; COMPUTER SECURITY SERVICE, NAMELY, RESTRICTING ACCESS TO AND BY COMPUTER NETWORKS TO AND OF UNDESIREED WEB SITES, MEDIA AND INDIVIDUALS AND FACILITIES; COMPUTER SERVICES, NAMELY, CREATING AND MAINTAINING WEB SITES FOR OTHERS; COMPUTER SERVICES, NAMELY, DESIGNING AND IMPLEMENTING WEB SITES FOR OTHERS; COMPUTER SERVICES, NAMELY, MANAGING WEB SITES FOR OTHERS; CREATING OR MAINTAINING WEB SITES FOR OTHERS; CREATION AND MAINTENANCE OF WEB SITES FOR OTHERS; DESIGN OF HOME PAGES, COMPUTER SOFTWARE AND WEB SITES; DESIGN OF HOMEPAGES AND WEB-SITES; DISPLAYING THE WEB

SITES AND IMAGES OF OTHERS ON A COMPUTER SERVER; ELABORATION AND MAINTENANCE OF WEB SITES FOR THIRD PARTIES; HOSTING THE WEB SITES OF OTHERS ON A COMPUTER SERVER FOR A GLOBAL COMPUTER NETWORK; PROVIDING CUSTOMIZED ON-LINE WEB PAGES FEATURING USER-DEFINED INFORMATION, WHICH INCLUDES SEARCH ENGINES AND ON-LINE WEB LINKS TO OTHER WEB SITES, IN CLASS 42 (U.S. CLS. 100 AND 101).

FIRST USE 11-19-2004; IN COMMERCE 1-6-2007.

THE MARK CONSISTS OF STANDARD CHARACTERS WITHOUT CLAIM TO ANY PARTICULAR FONT, STYLE, SIZE, OR COLOR.

SN 78-861,518, FILED 4-14-2006.

JUSTINE D. PARKER, EXAMINING ATTORNEY

Int. Cl.: 25

Prior U.S. Cls.: 22 and 39

United States Patent and Trademark Office

Reg. No. 3,482,355

Registered Aug. 5, 2008

**TRADEMARK
PRINCIPAL REGISTER**

IMA WIFE

IMAJEN, LLC (VIRGINIA LIMITED LIABILITY CORPORATION)
3218 ELLIOTT STREET
BALTIMORE, MD 21224

FOR: CLOTHING, NAMELY, T-SHIRTS, TANK TOPS, SWEATSHIRTS, SWEATPANTS, PANTS, LINGERIE, SKIRTS, BEACH COVER-UPS, PAJAMAS, HATS, IN CLASS 25 (U.S. CLS. 22 AND 39).

FIRST USE 2-1-2008; IN COMMERCE 2-1-2008.

THE MARK CONSISTS OF STANDARD CHARACTERS WITHOUT CLAIM TO ANY PARTICULAR FONT, STYLE, SIZE, OR COLOR.

SN 78-861,652, FILED 4-14-2006.

CHRISTOPHER BUONGIORNO, EXAMINING ATTORNEY

Int. Cl.: 25

Prior U.S. Cls.: 22 and 39

United States Patent and Trademark Office

Reg. No. 3,482,356

Registered Aug. 5, 2008

**TRADEMARK
PRINCIPAL REGISTER**

JUDY BOND

ARIZONA MAIL ORDER COMPANY, INC. (DE-
LAWARE CORPORATION)
3740 EAST 34TH STREET
TUCSON, AZ 85713

FOR: WOMEN'S CLOTHING, NAMELY, BLOU-
SES, COATS, DRESSES, JACKETS, SHIRTS, SKIRTS,
SLACKS, SWEATSHIRTS, SWEATERS, T-TOPS, IN
CLASS 25 (U.S. CLS. 22 AND 39).

FIRST USE 9-5-2006; IN COMMERCE 9-5-2006.

THE MARK CONSISTS OF STANDARD CHAR-
ACTERS WITHOUT CLAIM TO ANY PARTICULAR
FONT, STYLE, SIZE, OR COLOR.

THE NAME(S), PORTRAIT(S), AND/OR SIGNA-
TURE(S) SHOWN IN THE MARK DOES NOT IDENTI-
FY A PARTICULAR LIVING INDIVIDUAL.

SN 78-861,661, FILED 4-14-2006.

DOMINIC J. FERRAIUOLO, EXAMINING ATTOR-
NEY

Int. Cl.: 11

Prior U.S. Cls.: 13, 21, 23, 31, and 34

United States Patent and Trademark Office

Reg. No. 3,482,357

Registered Aug. 5, 2008

**TRADEMARK
PRINCIPAL REGISTER**

SHOWERARC

HANSGROHE AG (FED REP GERMANY CORPORATION)
AUESTRABE 5-9
SCHILTACH, FED REP GERMANY D-77761

FOR: PLUMBING FITTINGS, NAMELY, MIXING VALVES WITH MANUAL AND AUTOMATIC CONTROLS; COMBINATION SHOWERS, NAMELY, PREASSEMBLED MULTIFUNCTION SHOWERS, SHOWERS AND SHOWER FITTINGS, NAMELY, SHOWER CONTROL VALVES, SHOWER SPRAYERS, SHOWER COMBINATIONS, NAMELY, HAND SHOWERS, BODY SHOWERS, SHOWER HEADS, LATERAL-JET SHOWERS, PIPES BEING PARTS OF SANITARY FACILITIES, NAMELY, SANITARY

FLEXIBLE TUBES, SPRAY NOZZLES, BEING PARTS FOR MULTIFUNCTION SHOWERS; PARTS OF THE AFORESAID GOODS, IN CLASS 11 (U.S. CLS. 13, 21, 23, 31 AND 34).

FIRST USE 6-28-2006; IN COMMERCE 6-28-2006.

THE MARK CONSISTS OF STANDARD CHARACTERS WITHOUT CLAIM TO ANY PARTICULAR FONT, STYLE, SIZE, OR COLOR.

SN 78-863,494, FILED 4-18-2006.

TINA BROWN, EXAMINING ATTORNEY

Int. Cl.: 41

Prior U.S. Cls.: 100, 101, and 107

United States Patent and Trademark Office

Reg. No. 3,482,358

Registered Aug. 5, 2008

**SERVICE MARK
PRINCIPAL REGISTER**



FORT KNOCKS ENTERTAINMENT, INC. (FLORIDA CORPORATION)
9521 TONI DRIVE
MIAMI, FL 33157

FOR: RECORD LABEL SERVICES, NAMELY, RECORD PRODUCTION AND AUDIO RECORDING; RECORDING STUDIO SERVICES; PROVIDING PRERECORDING MUSIC ON-LINE VIA A GLOBAL COMPUTER NETWORK, IN CLASS 41 (U.S. CLS. 100, 101 AND 107).

FIRST USE 10-0-2001; IN COMMERCE 10-0-2001.

THE LINING IS A FEATURE OF THE MARK AND DOES NOT INDICATE COLOR.

SN 78-863,875, FILED 4-18-2006.

DAVID YONTEF, EXAMINING ATTORNEY

Int. Cl.: 35

Prior U.S. Cls.: 100, 101, and 102

United States Patent and Trademark Office

Reg. No. 3,482,359

Registered Aug. 5, 2008

**SERVICE MARK
PRINCIPAL REGISTER**

TBI CLARITY

TURTLE BAY INSTITUTE, INC. (NEW YORK
CORPORATION)
195 NASSAU STREET
PRINCETON, NJ 08542

THE MARK CONSISTS OF STANDARD CHAR-
ACTERS WITHOUT CLAIM TO ANY PARTICULAR
FONT, STYLE, SIZE, OR COLOR.

FOR: MARKET RESEARCH SERVICES, IN CLASS
35 (U.S. CLS. 100, 101 AND 102).

SN 78-864,650, FILED 4-19-2006.

FIRST USE 7-12-2006; IN COMMERCE 7-12-2006.

MELVIN AXILBUND, EXAMINING ATTORNEY

Int. Cl.: 18

Prior U.S. Cls.: 1, 2, 3, 22, and 41

Reg. No. 3,482,360

United States Patent and Trademark Office

Registered Aug. 5, 2008

TRADEMARK
PRINCIPAL REGISTER



HARTZ MOUNTAIN CORPORATION, THE (NEW
JERSEY CORPORATION)
400 PLAZA DRIVE
SECAUCUS, NJ 07094

OWNER OF U.S. REG. NO. 3,072,575.

FOR: PET ACCESSORIES, NAMELY, RAWHIDE
DOG CHEWS AND DOG LEASHES AND PET
COLLARS, IN CLASS 18 (U.S. CLS. 1, 2, 3, 22 AND 41).

NO CLAIM IS MADE TO THE EXCLUSIVE
RIGHT TO USE "AMERICAN BEEFHIDE", APART
FROM THE MARK AS SHOWN.

SN 78-865,140, FILED 4-19-2006.

FIRST USE 4-0-2006; IN COMMERCE 4-0-2006.

DEZMONA MIZELLE, EXAMINING ATTORNEY

Int. Cl.: 18

Prior U.S. Cls.: 1, 2, 3, 22, and 41

United States Patent and Trademark Office

Reg. No. 3,482,361

Registered Aug. 5, 2008

TRADEMARK
PRINCIPAL REGISTER

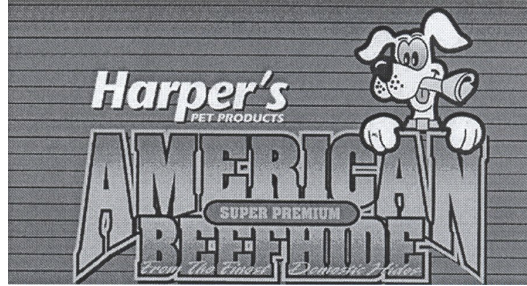

HARTZ MOUNTAIN CORPORATION, THE (NEW
JERSEY CORPORATION)
400 PLAZA DRIVE
SECAUCUS, NJ 07094

FOR: PET ACCESSORIES, NAMELY, RAWHIDE
DOG CHEWS, IN CLASS 18 (U.S. CLS. 1, 2, 3, 22 AND
41).

FIRST USE 4-11-2005; IN COMMERCE 4-11-2005.

OWNER OF U.S. REG. NOS. 2,307,034, 2,666,934,
AND 3,072,575.

NO CLAIM IS MADE TO THE EXCLUSIVE
RIGHT TO USE "PET PRODUCTS", "AMERICAN",
"BEEFHIDE", "SUPER PREMIUM", AND "FROM
THE FINEST DOMESTIC HIDES", APART FROM
THE MARK AS SHOWN.

SN 78-865,952, FILED 4-20-2006.

RON FAIRBANKS, EXAMINING ATTORNEY

Int. Cl.: 21

Prior U.S. Cls.: 2, 13, 23, 29, 30, 33, 40, and 50

United States Patent and Trademark Office

Reg. No. 3,482,362

Registered Aug. 5, 2008

**TRADEMARK
PRINCIPAL REGISTER**

NITRILE GARDEN CLUB

ABRAHMS, DARRYL (UNITED STATES INDIVIDUAL)

14515 NE 67TH COURT

REDMOND, WA 98052

FOR: GARDENING GLOVES, IN CLASS 21 (U.S. CLS. 2, 13, 23, 29, 30, 33, 40 AND 50).

FIRST USE 4-5-2006; IN COMMERCE 4-5-2006.

THE MARK CONSISTS OF STANDARD CHARACTERS WITHOUT CLAIM TO ANY PARTICULAR FONT, STYLE, SIZE, OR COLOR.

NO CLAIM IS MADE TO THE EXCLUSIVE RIGHT TO USE "NITRILE", APART FROM THE MARK AS SHOWN.

SN 78-866,295, FILED 4-20-2006.

GEORGE LORENZO, EXAMINING ATTORNEY

Int. Cl.: 11

Prior U.S. Cls.: 13, 21, 23, 31, and 34

United States Patent and Trademark Office

Reg. No. 3,482,363

Registered Aug. 5, 2008

**TRADEMARK
PRINCIPAL REGISTER**

LUXTILE

EQUICAP INVESTMENTS, LLC (TEXAS LLC)
SUITE 514
12700 PARK CENTRAL DRIVE
DALLAS, TX 75251

THE MARK CONSISTS OF STANDARD CHARACTERS WITHOUT CLAIM TO ANY PARTICULAR FONT, STYLE, SIZE, OR COLOR.

FOR: TILE REPLACEMENT PRODUCT, NAME-
LY, SHOWER ENCLOSURES AND SHOWER PA-
NELS, IN CLASS 11 (U.S. CLS. 13, 21, 23, 31 AND 34).

SN 78-866,667, FILED 4-21-2006.

FIRST USE 1-18-2007; IN COMMERCE 1-18-2007.

JAY FLOWERS, EXAMINING ATTORNEY

Int. Cl.: 7

Prior U.S. Cls.: 13, 19, 21, 23, 31, 34, and 35

Reg. No. 3,482,364

United States Patent and Trademark Office

Registered Aug. 5, 2008

**TRADEMARK
PRINCIPAL REGISTER**

LUMBER SMITH

POLLARD, ALBERT C. (UNITED STATES INDIVIDUAL)

268 MUSKREEK RD.

WHITE STONE, VA 22578

FOR: LUMBERING BAND SAWS, IN CLASS 7
(U.S. CLS. 13, 19, 21, 23, 31, 34 AND 35).

FIRST USE 1-1-2006; IN COMMERCE 3-7-2008.

THE MARK CONSISTS OF STANDARD CHARACTERS WITHOUT CLAIM TO ANY PARTICULAR FONT, STYLE, SIZE, OR COLOR.

NO CLAIM IS MADE TO THE EXCLUSIVE RIGHT TO USE "LUMBER", APART FROM THE MARK AS SHOWN.

SN 78-867,657, FILED 4-24-2006.

DAVID HOFFMAN, EXAMINING ATTORNEY

Int. Cl.: 42

Prior U.S. Cls.: 100 and 101

United States Patent and Trademark Office

Reg. No. 3,482,365

Registered Aug. 5, 2008

**SERVICE MARK
PRINCIPAL REGISTER**

PICTURECAST

GETTY IMAGES, INC. (DELAWARE CORPORATION)
601 NORTH 34TH STREET
SEATTLE, WA 98103

FOR: HOSTING OF DIGITAL CONTENT VIA A GLOBAL COMPUTER NETWORK, WIRED AND WIRELESS NETWORKS; PROVIDING INFORMATION IN RESPONSE TO END-USERS' REQUESTS VIA A GLOBAL COMPUTER NETWORK, WIRED AND WIRELESS NETWORKS; APPLICATION SERVICE PROVIDER (ASP) FEATURING SOFTWARE FOR USE IN CAPTURING, PROCESSING, DISTRIBUTING AND STREAMING DIGITAL CONTENT VIA A GLOBAL COMPUTER NETWORK, WIRED AND WIRELESS NETWORKS; PROVIDING ONLINE NON-DOWNLOADABLE COMPUTER SOFTWARE

WARE FOR USE IN CAPTURING, PROCESSING, DISTRIBUTING AND STREAMING DIGITAL CONTENT VIA A GLOBAL COMPUTER NETWORK, WIRED AND WIRELESS NETWORKS, IN CLASS 42 (U.S. CLS. 100 AND 101).

FIRST USE 4-30-2006; IN COMMERCE 4-30-2006.

THE MARK CONSISTS OF STANDARD CHARACTERS WITHOUT CLAIM TO ANY PARTICULAR FONT, STYLE, SIZE, OR COLOR.

SN 78-868,438, FILED 4-24-2006.

MARY MUNSON, EXAMINING ATTORNEY

Int. Cl.: 16

Prior U.S. Cls.: 2, 5, 22, 23, 29, 37, 38, and 50

United States Patent and Trademark Office

Reg. No. 3,482,366

Registered Aug. 5, 2008

**TRADEMARK
PRINCIPAL REGISTER**

SIGNATURE

APDN (B.V.I.) INC. (BR.VIRGIN ISLANDS COR-
PORATION)
NEMOURS CHAMBERS
P.O. BOX 3170
ROADTOWN, BR.VIRGIN ISLANDS

FOR: ANTI-COUNTERFEITING SYSTEM COM-
PRISED OF DNA COATING, NAMELY, MARKING
INK AND COATINGS CONTAINING DNA FOR
THE ENCRYPTION AND AUTHENTICATION
OF OBJECTS, IN CLASS 16 (U.S. CLS. 2, 5, 22, 23, 29,
37, 38 AND 50).

FIRST USE 1-28-2008; IN COMMERCE 1-28-2008.

THE MARK CONSISTS OF STANDARD CHAR-
ACTERS WITHOUT CLAIM TO ANY PARTICULAR
FONT, STYLE, SIZE, OR COLOR.

SN 78-871,967, FILED 4-28-2006.

FRANK LATTUCA, EXAMINING ATTORNEY

Int. Cl.: 9

Prior U.S. Cls.: 21, 23, 26, 36, and 38

United States Patent and Trademark Office

Reg. No. 3,482,367

Registered Aug. 5, 2008

**TRADEMARK
PRINCIPAL REGISTER**

MCCVECTORCONTROL

ALBANY INTERNATIONAL CORP. (DELAWARE
CORPORATION)
1373 BROADWAY
ALBANY, NY 12204

THE MARK CONSISTS OF STANDARD CHAR-
ACTERS WITHOUT CLAIM TO ANY PARTICULAR
FONT, STYLE, SIZE, OR COLOR.

FOR: ELECTRIC CONTROL PANEL FOR A
DOOR, IN CLASS 9 (U.S. CLS. 21, 23, 26, 36 AND 38).

SN 78-872,251, FILED 4-28-2006.

FIRST USE 5-11-2006; IN COMMERCE 5-11-2006.

DEZMONA MIZELLE, EXAMINING ATTORNEY

Int. Cl.: 25

Prior U.S. Cls.: 22 and 39

United States Patent and Trademark Office

Reg. No. 3,482,368

Registered Aug. 5, 2008

**TRADEMARK
PRINCIPAL REGISTER**

A tradition of dominance

DONAHOE, JAMES JOSEPH (UNITED STATES
INDIVIDUAL)
250 MARTINE AVENUE
WHITE PLAINS, NY 10601

THE MARK CONSISTS OF STANDARD CHAR-
ACTERS WITHOUT CLAIM TO ANY PARTICULAR
FONT, STYLE, SIZE, OR COLOR.

FOR: T-SHIRTS, IN CLASS 25 (U.S. CLS. 22 AND
39).

SN 78-873,853, FILED 5-1-2006.

FIRST USE 4-0-2007; IN COMMERCE 4-0-2007.

SUZANNE BLANE, EXAMINING ATTORNEY

Int. Cl.: 41

Prior U.S. Cls.: 100, 101, and 107

United States Patent and Trademark Office

Reg. No. 3,482,369

Registered Aug. 5, 2008

**SERVICE MARK
PRINCIPAL REGISTER**



BONUS.COM, INC. (DELAWARE CORPORATION)
2100 GENG ROAD, SUITE 105
PALO ALTO, CA 94303

FIRST USE 9-4-2007; IN COMMERCE 9-4-2007.

SN 78-874,788, FILED 5-2-2006.

FOR: ENTERTAINMENT SERVICES, NAMELY,
AN ON-LINE COMIC ADVENTURE SERIES, IN
CLASS 41 (U.S. CLS. 100, 101 AND 107).

LESLIE RICHARDS, EXAMINING ATTORNEY

Int. Cl.: 5

Prior U.S. Cls.: 6, 18, 44, 46, 51, and 52

Reg. No. 3,482,370

United States Patent and Trademark Office

Registered Aug. 5, 2008

**TRADEMARK
PRINCIPAL REGISTER**

Optima4

TRIVITA, INC. (ARIZONA CORPORATION)
SUITE 950
16100 GREENWAY HAYDEN LOOP
SCOTTSDALE, AZ 85260

THE MARK CONSISTS OF STANDARD CHAR-
ACTERS WITHOUT CLAIM TO ANY PARTICULAR
FONT, STYLE, SIZE, OR COLOR.

FOR: NUTRITIONAL SUPPLEMENT, IN CLASS 5
(U.S. CLS. 6, 18, 44, 46, 51 AND 52).

SN 78-875,916, FILED 5-3-2006.

FIRST USE 6-28-2006; IN COMMERCE 6-28-2006.

HENRY S. ZAK, EXAMINING ATTORNEY

Int. Cl.: 35

Prior U.S. Cls.: 100, 101, and 102

United States Patent and Trademark Office

Reg. No. 3,482,371

Registered Aug. 5, 2008

**SERVICE MARK
PRINCIPAL REGISTER**

all moms go to heaven

JOHNSON, JEAN (UNITED STATES INDIVIDUAL)
849 WOODCOVE COURT
CHESTERFIELD, MO 63017

FOR: ON-LINE RETAIL STORE SERVICES FEATURING T-SHIRTS, GREETING CARDS, JEWELRY, MAGNETS, FLORAL ARRANGEMENTS, PHOTO ALBUMS, PICTURE FRAMES, BOOKS, CALENDARS, COFFEE MUGS, SUN VISORS, CHRISTMAS ORNAMENTS, JOURNALS, BOOKMARKS,

AWARDS, TROPHIES, AND GIFT ITEMS, IN CLASS 35 (U.S. CLS. 100, 101 AND 102).

FIRST USE 6-1-2006; IN COMMERCE 6-1-2006.

THE MARK CONSISTS OF STYLIZED TEXT OF THE WORDING "ALL MOMS GO TO HEAVEN".

SN 78-875,988, FILED 5-3-2006.

BILL DAWE, EXAMINING ATTORNEY

Int. Cl.: 11

Prior U.S. Cls.: 13, 21, 23, 31, and 34

United States Patent and Trademark Office

Reg. No. 3,482,372

Registered Aug. 5, 2008

TRADEMARK
PRINCIPAL REGISTER

TOURMALINE
CERAMIC

CONAIR CORPORATION (CONNECTICUT CORPORATION)

ONE CUMMINGS POINT ROAD

STAMFORD, DE 06902

FOR: HAND-HELD ELECTRIC HAIR DRYERS,
IN CLASS 11 (U.S. CLS. 13, 21, 23, 31 AND 34).

FIRST USE 10-1-2006; IN COMMERCE 10-1-2006.

NO CLAIM IS MADE TO THE EXCLUSIVE
RIGHT TO USE "TOURMALINE CERAMIC",
APART FROM THE MARK AS SHOWN.

THE MARK CONSISTS OF THE TERMS "TOUR-
MALINE CERAMIC" WITH A DESIGN OF A JEWEL
IN THE PLACE OF THE "O".

SN 78-877,668, FILED 5-5-2006.

JILL PRATER, EXAMINING ATTORNEY

Int. Cl.: 35

Prior U.S. Cls.: 100, 101, and 102

United States Patent and Trademark Office

Reg. No. 3,482,373

Registered Aug. 5, 2008

**SERVICE MARK
PRINCIPAL REGISTER**



JOHNSON, JEAN (UNITED STATES INDIVIDUAL)
849 WOODCOVE COURT
CHESTERFIELD, MO 63017

FOR: ON-LINE RETAIL STORE SERVICES FEATURING T-SHIRTS, GREETING CARDS, JEWELRY, MAGNETS, FLORAL ARRANGEMENTS, PHOTO ALBUMS, PICTURE FRAMES, BOOKS, CALENDARS, COFFEE MUGS, SUN VISORS, CHRISTMAS ORNAMENTS, JOURNALS, BOOKMARKS, AND GIFT ITEMS; RETAIL STORES FEATURING T-SHIRTS, GREETING CARDS, JEWELRY, MAGNETS, FLORAL ARRANGEMENTS, PHOTO AL-

BUMS, PICTURE FRAMES, BOOKS, CALENDARS, COFFEE MUGS, SUN VISORS, CHRISTMAS ORNAMENTS, JOURNALS, BOOKMARKS, AND GIFT ITEMS, IN CLASS 35 (U.S. CLS. 100, 101 AND 102).

FIRST USE 6-1-2006; IN COMMERCE 6-1-2006.

THE MARK CONSISTS OF "A" STYLIZED "M" WITH A HALO.

SN 78-879,209, FILED 5-8-2006.

BILL DAWE, EXAMINING ATTORNEY

Int. Cl.: 30

Prior U.S. Cl.: 46

United States Patent and Trademark Office

Reg. No. 3,482,374

Registered Aug. 5, 2008

TRADEMARK
PRINCIPAL REGISTER



ORION CORPORATION (REPUBLIC OF KOREA CORPORATION)
30-10 MUNBAE-DONG
YONGSAN-KU SEOUL, REPUBLIC OF KOREA

FOR: BREADS; COOKIES AND CHOCOLATE CHIPS; PEANUT BRITTLE; BISCUITS; CHEWING GUM NOT FOR MEDICAL PURPOSES; SWEETMEATS CANDY; CANDY FOR FOOD; ALMOND CANDIES AND ALMOND CAKES; CHOCOLATE; CUSTARD; CARAMEL CANDY; CAKES; PIES; PASTRIES; SPONGE CAKE, IN CLASS 30 (U.S. CL. 46).

FIRST USE 9-30-2007; IN COMMERCE 9-30-2007.

THE COLOR(S) GREEN, YELLOW, BROWN, RED, BLACK, ORANGE AND WHITE IS/ARE CLAIMED AS A FEATURE OF THE MARK.

THE MARK CONSISTS OF A GREEN BACKGROUND. THE COLOR YELLOW APPEARS AS AN OVAL IN THE CENTER OF THE GREEN BACKGROUND. THE YELLOW OVAL IN THE MIDDLE OF THE MARK IS SURROUNDED BY A BROWN BORDER, WHICH IN TURN IS SURROUNDED BY A WHITE BORDER. BROWN ALSO APPEARS AS THE COLOR OF THE TEXT FOR THE WORD "ZANGLE", SHADED IN BLACK, WHICH IS IN THE MIDDLE OF THE YELLOW OVAL. THE BROWN TEXT "ZANGLE" IS SURROUNDED BY A WHITE BORDER. THE WORDS "ON SAFARI" APPEAR IN YELLOW ON A RED BACKGROUND WITH AN ORANGE BORDER.

SN 78-881,776, FILED 5-11-2006.

ELLEN PERKINS, EXAMINING ATTORNEY

Int. Cl.: 9

Prior U.S. Cls.: 21, 23, 26, 36, and 38

United States Patent and Trademark Office

Reg. No. 3,482,375

Registered Aug. 5, 2008

**TRADEMARK
PRINCIPAL REGISTER**

ENSITE CONNECT

ST. JUDE MEDICAL, ATRIAL FIBRILLATION
DIVISION, INC. (MINNESOTA CORPORATION)
14901 DEVEAU PLACE
MINNETONKA, MN 55345

FOR: COMPUTER HARDWARE AND COMPUTER SOFTWARE FOR FACILITATING REMOTE SUPPORT SERVICES FOR ELECTROPHYSIOLOGY, IN CLASS 9 (U.S. CLS. 21, 23, 26, 36 AND 38).

FIRST USE 6-0-2006; IN COMMERCE 6-0-2006.

THE MARK CONSISTS OF STANDARD CHARACTERS WITHOUT CLAIM TO ANY PARTICULAR FONT, STYLE, SIZE, OR COLOR.

OWNER OF U.S. REG. NOS. 2,084,362, 2,908,660, AND OTHERS.

NO CLAIM IS MADE TO THE EXCLUSIVE RIGHT TO USE "CONNECT", APART FROM THE MARK AS SHOWN.

SN 78-883,617, FILED 5-15-2006.

REBECCA POVARCHUK, EXAMINING ATTORNEY

Int. Cl.: 16

Prior U.S. Cls.: 2, 5, 22, 23, 29, 37, 38, and 50

Reg. No. 3,482,376

United States Patent and Trademark Office

Registered Aug. 5, 2008

**TRADEMARK
PRINCIPAL REGISTER**

**COMPENDIUM CONTINUING
EDUCATION FOR VETERINARIANS**

MEDIMEDIA USA, INC. (DELAWARE CORPORATION)
780 TOWNSHIP LINE ROAD
YARDLEY, PA 19067

FOR: PERIODICAL PUBLICATIONS, NAMELY, MAGAZINES FEATURING ARTICLES IN THE FIELD OF VETERINARY MEDICINE, IN CLASS 16 (U.S. CLS. 2, 5, 22, 23, 29, 37, 38 AND 50).

FIRST USE 6-15-2006; IN COMMERCE 6-15-2006.

THE MARK CONSISTS OF STANDARD CHARACTERS WITHOUT CLAIM TO ANY PARTICULAR FONT, STYLE, SIZE, OR COLOR.

NO CLAIM IS MADE TO THE EXCLUSIVE RIGHT TO USE "CONTINUING EDUCATION FOR VETERINARIANS", APART FROM THE MARK AS SHOWN.

SEC. 2(F) AS TO "COMPENDIUM".

SN 78-883,864, FILED 5-15-2006.

ANDREA K. NADELMAN, EXAMINING ATTORNEY

Int. Cl.: 16

Prior U.S. Cls.: 2, 5, 22, 23, 29, 37, 38, and 50

Reg. No. 3,482,377

United States Patent and Trademark Office

Registered Aug. 5, 2008

**TRADEMARK
PRINCIPAL REGISTER**

Sound Advice

KLEFEKER, JOHN M. (MASSACHUSETTS SOLE PROPRIETORSHIP), DBA FAMILY HEARING CARE CENTER,
534 MAIN STREET, SUITE 2
WEYMOUTH, MA 02190

FOR: SYNDICATED COLUMNS DEALING WITH HEARING LOSS, HEARING AIDS, AND RELATED HEARING PRODUCTS AND SERVICES , IN CLASS 16 (U.S. CLS. 2, 5, 22, 23, 29, 37, 38 AND 50).

FIRST USE 5-17-2006; IN COMMERCE 5-22-2006.

THE MARK CONSISTS OF STANDARD CHARACTERS WITHOUT CLAIM TO ANY PARTICULAR FONT, STYLE, SIZE, OR COLOR.

SN 78-884,561, FILED 5-16-2006.

PATRICIA EVANKO, EXAMINING ATTORNEY

Int. Cl.: 25

Prior U.S. Cls.: 22 and 39

United States Patent and Trademark Office

Reg. No. 3,482,378

Registered Aug. 5, 2008

**TRADEMARK
PRINCIPAL REGISTER**



DE HERRERA, JOHN ALLEN (UNITED STATES
INDIVIDUAL)
P.O. BOX 5888
MONTECITO, CA 93108

THE MARK CONSISTS OF A DOT, A FIVE-
POINTED STAR, A CIRCLE, TWO WINGS AND
THE WORD "ALIPES".

FOR: HEADGEAR, NAMELY, HATS, CAPS, VI-
SORS, IN CLASS 25 (U.S. CLS. 22 AND 39).

SN 78-884,765, FILED 5-16-2006.

FIRST USE 1-10-2005; IN COMMERCE 1-10-2005.

DAVID MURRAY, EXAMINING ATTORNEY

Int. Cl.: 36

Prior U.S. Cls.: 100, 101, and 102

United States Patent and Trademark Office

Reg. No. 3,482,379

Registered Aug. 5, 2008

SERVICE MARK
PRINCIPAL REGISTER

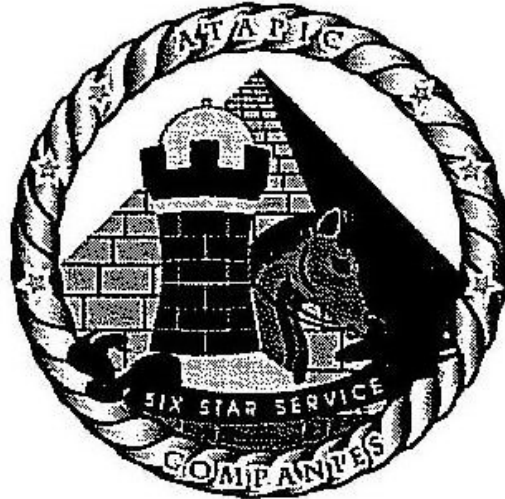

ATAPIC REAL ESTATE INVESTMENT, LLC
(FLORIDA LTD LIAB CO)
577 BROCKHAM DRIVE
JACKSONVILLE, FL 32221

FOR: FINANCIAL INVESTMENT IN THE FIELD
OF REAL ESTATE, IN CLASS 36 (U.S. CLS. 100, 101
AND 102).

FIRST USE 5-17-2006; IN COMMERCE 5-17-2006.

NO CLAIM IS MADE TO THE EXCLUSIVE
RIGHT TO USE "SERVICE" AND "COMPANIES",
APART FROM THE MARK AS SHOWN.

THE MARK CONSISTS OF CIRCULAR TWIST
BEARING STARS AND THE WORDS "ATAPIC
COMPANIES"; PYRAMID, CASTLE TOWER WITH
DOME, HORSE HEAD AND CHEST PROFILE,
SPROUTING SEEDS AND BANNER ACROSS BOT-
TOM INTERIOR BEARING WORDS "SIX STAR
SERVICE".

SN 78-885,495, FILED 5-17-2006.

RENEE MCCRAY, EXAMINING ATTORNEY

Int. Cls.: 1 and 17

Prior U.S. Cls.: 1, 5, 6, 10, 12, 13, 26, 35, 46, and 50

United States Patent and Trademark Office

Reg. No. 3,482,380

Registered Aug. 5, 2008

**TRADEMARK
PRINCIPAL REGISTER**

NANOPRENE

LANXESS DEUTSCHLAND GMBH (FED REP
GERMANY LTD LIAB CO)
D-51369
LEVERKUSEN, FED REP GERMANY

FOR: CHEMICAL PRODUCTS FOR INDUSTRIAL
USE, NAMELY, SYNTHETICALLY PREPARED
POLYMER PARTICLES; CHEMICAL ADDITIVES
FOR USE IN THE MANUFACTURE OF RUBBER
COMPOSITIONS; POLYMER PREPARATIONS FOR
INDUSTRIAL USE, NAMELY, POLYMER COMPO-
SITIONS USED IN THE MANUFACTURE OF COM-
MERCIAL AND INDUSTRIAL GOODS, IN CLASS 1
(U.S. CLS. 1, 5, 6, 10, 26 AND 46).

FIRST USE 4-0-2007; IN COMMERCE 4-0-2007.

FOR: SYNTHETIC RUBBER, IN CLASS 17 (U.S.
CLS. 1, 5, 12, 13, 35 AND 50).

FIRST USE 4-0-2007; IN COMMERCE 4-0-2007.

THE MARK CONSISTS OF STANDARD CHAR-
ACTERS WITHOUT CLAIM TO ANY PARTICULAR
FONT, STYLE, SIZE, OR COLOR.

SN 78-885,831, FILED 5-17-2006.

TINA BROWN, EXAMINING ATTORNEY

Int. Cls.: 9 and 16

Prior U.S. Cls.: 2, 5, 21, 22, 23, 26, 29, 36, 37, 38, and 50

Reg. No. 3,482,381

United States Patent and Trademark Office

Registered Aug. 5, 2008

**TRADEMARK
PRINCIPAL REGISTER**

GLITZ & GLITTER

GRIFFIN INTERNATIONAL COMPANIES, INC.
(MINNESOTA CORPORATION)
BUTLER SQUARE, SUITE 300C
100 NORTH 6TH STREET
MINNEAPOLIS, MN 55403

FOR: ACCESSORIES FOR ELECTRONIC DEVICES, NAMELY, EARPHONES, AUDIO SPEAKERS, IN CLASS 9 (U.S. CLS. 21, 23, 26, 36 AND 38).

FIRST USE 8-12-2006; IN COMMERCE 8-12-2006.

FOR: STICKERS; ADHESIVE GEMS, NAMELY, ADHESIVE-BACKED DECORATIVE GEMS FOR

APPLICATION TO PERSONAL ELECTRONICS, IN CLASS 16 (U.S. CLS. 2, 5, 22, 23, 29, 37, 38 AND 50).

FIRST USE 8-12-2006; IN COMMERCE 8-12-2006.

THE MARK CONSISTS OF STANDARD CHARACTERS WITHOUT CLAIM TO ANY PARTICULAR FONT, STYLE, SIZE, OR COLOR.

SN 78-886,560, FILED 5-18-2006.

TIMOTHY FINNEGAN, EXAMINING ATTORNEY

Int. Cl.: 2

Prior U.S. Cls.: 6, 11, and 16

United States Patent and Trademark Office

Reg. No. 3,482,382

Registered Aug. 5, 2008

**TRADEMARK
PRINCIPAL REGISTER**

THERMOLOCK

MATSUI INTERNATIONAL CO., INC. (NEW
JERSEY CORPORATION)
1501 W. 178TH STREET
GARDENA, CA 90248

THE MARK CONSISTS OF STANDARD CHAR-
ACTERS WITHOUT CLAIM TO ANY PARTICULAR
FONT, STYLE, SIZE, OR COLOR.

FOR: COLOR CHANGING DYES, COLORANTS,
PAINTS, AND PRINTING INKS FOR GENERAL
INDUSTRIAL USE AND USE IN THE SECURITY
FIELD, IN CLASS 2 (U.S. CLS. 6, 11 AND 16).

SN 78-886,897, FILED 5-18-2006.

FIRST USE 4-17-2008; IN COMMERCE 4-17-2008.

MARLENE BELL, EXAMINING ATTORNEY

Int. Cl.: 9

Prior U.S. Cls.: 21, 23, 26, 36, and 38

United States Patent and Trademark Office

Reg. No. 3,482,383

Registered Aug. 5, 2008

**TRADEMARK
PRINCIPAL REGISTER**

TEST MATE

GARCIA, ROBERT T. (UNITED STATES INDIVIDUAL)
11TH MEU BOX 555361
CAMP PENDLETON, CA 92055

FOR: COMPUTER SOFTWARE FOR SELF-EVALUATION OF SUBJECT MATTER COMPREHENSION, IN PREPARATION FOR STANDARDIZED TESTS, THAT MAY BE DOWNLOADED FROM A GLOBAL COMPUTER NETWORK, IN CLASS 9 (U.S. CLS. 21, 23, 26, 36 AND 38).

FIRST USE 4-1-2008; IN COMMERCE 4-1-2008.

THE MARK CONSISTS OF STANDARD CHARACTERS WITHOUT CLAIM TO ANY PARTICULAR FONT, STYLE, SIZE, OR COLOR.

NO CLAIM IS MADE TO THE EXCLUSIVE RIGHT TO USE "TEST", APART FROM THE MARK AS SHOWN.

SN 78-887,445, FILED 5-19-2006.

HEATHER BIDDULPH, EXAMINING ATTORNEY

Int. Cl.: 3

Prior U.S. Cls.: 1, 4, 6, 50, 51, and 52

Reg. No. 3,482,384

United States Patent and Trademark Office

Registered Aug. 5, 2008

**TRADEMARK
PRINCIPAL REGISTER**

DECIRCLING SERUM

YG LABORATORIES, INC. (CALIFORNIA CORPORATION)
15165 TRITON LANE
HUNTINGTON BEACH, CA 15165

FOR: NON-MEDICATED SKIN CARE PREPARATIONS, NAMELY, SERUMS, LOTIONS, CREAMS, GELS, MASKS AND SPRAYS, IN CLASS 3 (U.S. CLS. 1, 4, 6, 50, 51 AND 52).

FIRST USE 10-0-2006; IN COMMERCE 10-0-2006.

THE MARK CONSISTS OF STANDARD CHARACTERS WITHOUT CLAIM TO ANY PARTICULAR FONT, STYLE, SIZE, OR COLOR.

NO CLAIM IS MADE TO THE EXCLUSIVE RIGHT TO USE "SERUM", APART FROM THE MARK AS SHOWN.

SN 78-887,849, FILED 5-19-2006.

JOHN E. MICHOS, EXAMINING ATTORNEY

Int. Cl.: 38

Prior U.S. Cls.: 100, 101, and 104

United States Patent and Trademark Office

Reg. No. 3,482,385

Registered Aug. 5, 2008

**SERVICE MARK
PRINCIPAL REGISTER**



elynx Powered

ELYNX, LTD. (OHIO LTD LIAB CO)
7870 EAST KEMPER ROAD
SUITE 200
CINCINNATI, OH 45249

FIRST USE 11-1-2007; IN COMMERCE 11-1-2007.

SN 78-888,078, FILED 5-19-2006.

FOR: ELECTRONIC TRANSMISSION OF DATA
AND DOCUMENTS VIA THE WORLDWIDE WEB,
IN CLASS 38 (U.S. CLS. 100, 101 AND 104).

JILL PRATER, EXAMINING ATTORNEY

Int. Cl.: 38

Prior U.S. Cls.: 100, 101, and 104

United States Patent and Trademark Office

Reg. No. 3,482,386

Registered Aug. 5, 2008

**SERVICE MARK
PRINCIPAL REGISTER**

ENTER THE WORLD OF E

ELYNX, LTD. (OHIO LTD LIAB CO)
7870 EAST KEMPER ROAD
SUITE 200
CINCINNATI, OH 45249

THE MARK CONSISTS OF STANDARD CHAR-
ACTERS WITHOUT CLAIM TO ANY PARTICULAR
FONT, STYLE, SIZE, OR COLOR.

FOR: ELECTRONIC TRANSMISSION OF DATA
AND DOCUMENTS VIA THE WORLDWIDE WEB,
IN CLASS 38 (U.S. CLS. 100, 101 AND 104).

SN 78-888,088, FILED 5-19-2006.

FIRST USE 11-1-2007; IN COMMERCE 11-1-2007.

JILL PRATER, EXAMINING ATTORNEY

Int. Cl.: 3

Prior U.S. Cls.: 1, 4, 6, 50, 51, and 52

Reg. No. 3,482,387

United States Patent and Trademark Office

Registered Aug. 5, 2008

**TRADEMARK
PRINCIPAL REGISTER**

LIQUID NATURE

NORTHSIDE DEVELOPMENT, INC. (NEW YORK CORPORATION)
250 WEST 57 STREET, SUITE 2232
NEW YORK, NY 10107

FOR: PERSONAL CARE PRODUCTS IN THE AREA OF GROOMING AND HYGIENE, NAMELY, LIQUID SOAPS AND CLEANSERS FOR HANDS, FACE AND BODY; SHAMPOOS , IN CLASS 3 (U.S. CLS. 1, 4, 6, 50, 51 AND 52).

FIRST USE 9-1-2006; IN COMMERCE 9-1-2006.

THE MARK CONSISTS OF STANDARD CHARACTERS WITHOUT CLAIM TO ANY PARTICULAR FONT, STYLE, SIZE, OR COLOR.

NO CLAIM IS MADE TO THE EXCLUSIVE RIGHT TO USE "LIQUID", APART FROM THE MARK AS SHOWN.

SN 78-888,771, FILED 5-22-2006.

MICHELLE DUBOIS, EXAMINING ATTORNEY

Int. Cl.: 44

Prior U.S. Cls.: 100 and 101

United States Patent and Trademark Office

Reg. No. 3,482,388

Registered Aug. 5, 2008

**SERVICE MARK
PRINCIPAL REGISTER**



JOSEPH A. MENNA DMD, INC. (MASSACHUSETTS CORPORATION)
169 WEST MAIN STREET
HOPKINTON, MA 01748

FOR: DENTISTRY SERVICES, IN CLASS 44 (U.S. CLS. 100 AND 101).

FIRST USE 3-30-2006; IN COMMERCE 3-30-2006.

THE COLOR(S) GREEN, BROWN, BLACK, WHITE, GOLD, YELLOW, AND BLUE IS/ARE CLAIMED AS A FEATURE OF THE MARK.

THE PALM LEAVES ARE GREEN AND BLACK, THE TREE TRUNKS ARE BROWN AND BLACK, THE SUNGLASSES ARE BLACK, THE TOOTH IS WHITE WITH GOLD OUTLINES, THE SANDS ARE YELLOW AND BLACK AND THE HAMMOCK IS BLUE AND BLACK.

SN 78-889,733, FILED 5-23-2006.

JOHN E. MICHOS, EXAMINING ATTORNEY

Int. Cl.: 25

Prior U.S. Cls.: 22 and 39

United States Patent and Trademark Office

Reg. No. 3,482,389

Registered Aug. 5, 2008

**TRADEMARK
PRINCIPAL REGISTER**

CROWN BY SCHOTT N.Y.C.

SCHOTT BROS. INC. (NEW JERSEY CORPORATION)
1000 JEFFERSON AVENUE
ELIZABETH, NJ 07201

FOR: CLOTHING, NAMELY, COATS, JACKETS
AND PARKAS, IN CLASS 25 (U.S. CLS. 22 AND 39).

FIRST USE 1-31-2008; IN COMMERCE 1-31-2008.

THE MARK CONSISTS OF STANDARD CHARACTERS WITHOUT CLAIM TO ANY PARTICULAR FONT, STYLE, SIZE, OR COLOR.

OWNER OF U.S. REG. NOS. 1,167,412 AND
2,786,813.

NO CLAIM IS MADE TO THE EXCLUSIVE
RIGHT TO USE "N.Y.C.", APART FROM THE
MARK AS SHOWN.

SN 78-890,194, FILED 5-23-2006.

JOHN GARTNER, EXAMINING ATTORNEY

Int. Cls.: 29 and 30

Prior U.S. Cl.: 46

United States Patent and Trademark Office

Reg. No. 3,482,390

Registered Aug. 5, 2008

**TRADEMARK
PRINCIPAL REGISTER**

POPCHIPS

SONORA MILLS FOODS, INC. (DELAWARE
CORPORATION)
3064 MARIA STREET
RANCHO DOMINGUEZ, CA 90221

FOR: POTATO-BASED SNACK FOODS; VEGETA-
BLE-BASED SNACK FOODS, IN CLASS 29 (U.S. CL.
46).

FIRST USE 3-1-2007; IN COMMERCE 5-1-2007.

FOR: PUFFED CORN SNACKS, EXCLUDING
BREAKFAST CEREALS AND CEREAL BARS;
RICE-BASED SNACK FOODS, EXCLUDING
BREAKFAST CEREALS AND CEREAL BARS;
CORN-BASED SNACK FOODS, EXCLUDING

BREAKFAST CEREALS AND CEREAL BARS;
GRAIN-BASED CHIPS, EXCLUDING BREAKFAST
CEREALS AND CEREAL BARS, IN CLASS 30 (U.S.
CL. 46).

FIRST USE 3-1-2007; IN COMMERCE 5-1-2007.

THE MARK CONSISTS OF STANDARD CHAR-
ACTERS WITHOUT CLAIM TO ANY PARTICULAR
FONT, STYLE, SIZE, OR COLOR.

SN 78-892,669, FILED 5-25-2006.

GISELLE AGOSTO, EXAMINING ATTORNEY

Int. Cl.: 11

Prior U.S. Cls.: 13, 21, 23, 31, and 34

United States Patent and Trademark Office

Reg. No. 3,482,391

Registered Aug. 5, 2008

**TRADEMARK
PRINCIPAL REGISTER**



STOKES, ELBERT HARVEY, JR. (UNITED STATES INDIVIDUAL)
288 VAUGHN RD.
GLENWOOD, AR 71943

FOR: COOKING APPARATUS THAT SITS ON TOP OF THE GAS GRILL; IT USES WATER AND WOOD CHIPS AND THE GREASE FROM THE MEAT TO COOK THE MEAT WITH LITTLE OR NO MAINTENANCE, IN CLASS 11 (U.S. CLS. 13, 21, 23, 31 AND 34).

FIRST USE 11-27-2007; IN COMMERCE 11-27-2007.

THE COLOR(S) MAROON, GREEN AND WHITE IS/ARE CLAIMED AS A FEATURE OF THE MARK.

THE COLOR MAROON IS INSIDE THE LETTERING OF THE MARK WITH A WHITE OUTLINE. THE MARK IS PLACED ON A GREEN BACKGROUND AND THE COMPLETE MARK IS OUTLINED WITH A THIN LINE OF WHITE.

SN 78-895,661, FILED 5-30-2006.

RAUL CORDOVA, EXAMINING ATTORNEY

Int. Cl.: 3

Prior U.S. Cls.: 1, 4, 6, 50, 51, and 52

United States Patent and Trademark Office

Reg. No. 3,482,392

Registered Aug. 5, 2008

TRADEMARK
PRINCIPAL REGISTER



MIRACLE WORLD CORPORATION (CALIFORNIA CORPORATION)
2900 GORDON AVE. SUITE 100
SANTA CLARA, CA 95051

FOR: HAIR SHAMPOO AND CONDITIONER, IN CLASS 3 (U.S. CLS. 1, 4, 6, 50, 51 AND 52).

FIRST USE 5-1-2007; IN COMMERCE 5-1-2007.

OWNER OF U.S. REG. NO. 3,134,339.

NO CLAIM IS MADE TO THE EXCLUSIVE RIGHT TO USE "HAIR GROW", APART FROM THE MARK AS SHOWN.

THE COLOR(S) RED AND BLACK IS/ARE CLAIMED AS A FEATURE OF THE MARK.

THE MARK CONSISTS OF "HAIR GROW MIRACLE" WORDS ARE IN RED. THERE IS A BLACK HAIR-LIKE IMAGE ON THE TOP OF THE LETTER "O" IN THE WORD "GROW".

SN 78-895,800, FILED 5-30-2006.

JACQUELINE A. LAVINE, EXAMINING ATTORNEY

Int. Cl.: 30

Prior U.S. Cl.: 46

United States Patent and Trademark Office

Reg. No. 3,482,393

Registered Aug. 5, 2008

**TRADEMARK
PRINCIPAL REGISTER**

POWER GEL

WM. H. LEAHY ASSOCIATES, INC. (ILLINOIS
CORPORATION)
SUITE 200
2350 RAVINE WAY
GLENVIEW, IL 60025

FOR: FLAVORED GELATINS, IN CLASS 30 (U.S.
CL. 46).

FIRST USE 2-15-2008; IN COMMERCE 2-15-2008.

THE MARK CONSISTS OF STANDARD CHAR-
ACTERS WITHOUT CLAIM TO ANY PARTICULAR
FONT, STYLE, SIZE, OR COLOR.

NO CLAIM IS MADE TO THE EXCLUSIVE
RIGHT TO USE "GEL", APART FROM THE MARK
AS SHOWN.

SN 78-896,115, FILED 5-30-2006.

JILL PRATER, EXAMINING ATTORNEY

Int. Cls.: 38, 41, and 44

Prior U.S. Cls.: 100, 101, 104, and 107

United States Patent and Trademark Office

Reg. No. 3,482,394

Registered Aug. 5, 2008

**SERVICE MARK
PRINCIPAL REGISTER**

FITSUGAR

SUGAR PUBLISHING INCORPORATED (DELA-
WARE CORPORATION)
111 SUTTER STREET, 15TH FLOOR
SAN FRANCISCO, CA 94104

FOR: PROVIDING ON-LINE ELECTRONIC BUL-
LETIN BOARDS FOR TRANSMISSION OF MESSA-
GES AMONG COMPUTER USERS CONCERNING
HEALTH, BEAUTY, AND FITNESS, IN CLASS 38
(U.S. CLS. 100, 101 AND 104).

FIRST USE 11-2-2006; IN COMMERCE 11-2-2006.

FOR: PROVIDING ADVICE AND INFORMATION
OVER THE INTERNET IN THE FIELD OF FITNESS;
ON-LINE JOURNALS, NAMELY, BLOGS FEATUR-
ING INFORMATION ABOUT HEALTH, BEAUTY,
AND FITNESS, IN CLASS 41 (U.S. CLS. 100, 101 AND
107).

FIRST USE 11-2-2006; IN COMMERCE 11-2-2006.

FOR: PROVIDING ADVICE AND INFORMATION
OVER THE INTERNET IN THE FIELDS OF
HEALTH AND BEAUTY, IN CLASS 44 (U.S. CLS.
100 AND 101).

FIRST USE 11-2-2006; IN COMMERCE 11-2-2006.

THE MARK CONSISTS OF STANDARD CHAR-
ACTERS WITHOUT CLAIM TO ANY PARTICULAR
FONT, STYLE, SIZE, OR COLOR.

SN 78-897,027, FILED 5-31-2006.

ANNE E. GUSTASON, EXAMINING ATTORNEY

Int. Cls.: 38 and 41

Prior U.S. Cls.: 100, 101, 104, and 107

United States Patent and Trademark Office

Reg. No. 3,482,395

Registered Aug. 5, 2008

**SERVICE MARK
PRINCIPAL REGISTER**

GIGGLESUGAR

SUGAR PUBLISHING INCORPORATED (DELA-
WARE CORPORATION)
111 SUTTER STREET, 15TH FLOOR
SAN FRANCISCO, CA 94104

FOR: PROVIDING ON-LINE ELECTRONIC BUL-
LETIN BOARDS FOR TRANSMISSION OF MESSA-
GES AMONG COMPUTER USERS CONCERNING
JOKES, ANECDOTES, AND OTHER HUMOROUS
MATERIAL, IN CLASS 38 (U.S. CLS. 100, 101 AND
104).

FIRST USE 11-9-2006; IN COMMERCE 11-9-2006.

FOR: ENTERTAINMENT SERVICES, NAMELY,
PROVIDING A WEB SITE FEATURING JOKES,

ANECDOTES, AND OTHER HUMOROUS MATERI-
AL; ON-LINE JOURNALS, NAMELY, BLOGS FEAT-
URING JOKES, ANECDOTES, AND OTHER
HUMOROUS MATERIAL, IN CLASS 41 (U.S. CLS.
100, 101 AND 107).

FIRST USE 11-9-2006; IN COMMERCE 11-9-2006.

THE MARK CONSISTS OF STANDARD CHAR-
ACTERS WITHOUT CLAIM TO ANY PARTICULAR
FONT, STYLE, SIZE, OR COLOR.

SN 78-897,042, FILED 5-31-2006.

ANNE E. GUSTASON, EXAMINING ATTORNEY

Int. Cls.: 38, 41, and 43

Prior U.S. Cls.: 100, 101, 104, and 107

United States Patent and Trademark Office

Reg. No. 3,482,396

Registered Aug. 5, 2008

**SERVICE MARK
PRINCIPAL REGISTER**

YUMSUGAR

SUGAR PUBLISHING INCORPORATED (DELA-
WARE CORPORATION)
111 SUTTER STREET, 15TH FLOOR
SAN FRANCISCO, CA 94104

FOR: PROVIDING ON-LINE ELECTRONIC BUL-
LETIN BOARDS FOR TRANSMISSION OF MESSA-
GES AMONG COMPUTER USERS CONCERNING
FOOD AND COOKING , IN CLASS 38 (U.S. CLS. 100,
101 AND 104).

FIRST USE 12-14-2006; IN COMMERCE 12-14-2006.

FOR: ON-LINE JOURNALS, NAMELY, BLOGS
FEATURING FOOD AND COOKING, IN CLASS 41
(U.S. CLS. 100, 101 AND 107).

FIRST USE 12-14-2006; IN COMMERCE 12-14-2006.

FOR: PROVIDING INFORMATION AND ADVICE
OVER THE INTERNET IN THE FIELDS OF FOOD
AND COOKING, IN CLASS 43 (U.S. CLS. 100 AND
101).

FIRST USE 12-14-2006; IN COMMERCE 12-14-2006.

THE MARK CONSISTS OF STANDARD CHAR-
ACTERS WITHOUT CLAIM TO ANY PARTICULAR
FONT, STYLE, SIZE, OR COLOR.

SN 78-897,178, FILED 5-31-2006.

ANNE E. GUSTASON, EXAMINING ATTORNEY

Int. Cls.: 38, 41, and 44

Prior U.S. Cls.: 100, 101, 104, and 107

United States Patent and Trademark Office

Reg. No. 3,482,397

Registered Aug. 5, 2008

**SERVICE MARK
PRINCIPAL REGISTER**

PETSUGAR

SUGAR PUBLISHING INCORPORATED (DELA-
WARE CORPORATION)
111 SUTTER STREET, 15TH FLOOR
SAN FRANCISCO, CA 94104

FOR: PROVIDING ON-LINE ELECTRONIC BUL-
LETIN BOARDS FOR TRANSMISSION OF MESSA-
GES AMONG COMPUTER USERS CONCERNING
PETS AND ANIMAL CARE , IN CLASS 38 (U.S. CLS.
100, 101 AND 104).

FIRST USE 10-19-2007; IN COMMERCE 10-19-2007.

FOR: ON-LINE JOURNALS, NAMELY, BLOGS
FEATURING DISCUSSIONS ABOUT PETS AND
ANIMAL CARE, IN CLASS 41 (U.S. CLS. 100, 101
AND 107).

FIRST USE 10-19-2007; IN COMMERCE 10-19-2007.

FOR: PROVIDING ADVICE AND INFORMATION
OVER THE INTERNET IN THE FIELDS OF PETS
AND ANIMAL CARE, IN CLASS 44 (U.S. CLS. 100
AND 101).

FIRST USE 10-19-2007; IN COMMERCE 10-19-2007.

THE MARK CONSISTS OF STANDARD CHAR-
ACTERS WITHOUT CLAIM TO ANY PARTICULAR
FONT, STYLE, SIZE, OR COLOR.

SN 78-897,210, FILED 5-31-2006.

ANNE E. GUSTASON, EXAMINING ATTORNEY

Int. Cl.: 41

Prior U.S. Cls.: 100, 101, and 107

United States Patent and Trademark Office

Reg. No. 3,482,398

Registered Aug. 5, 2008

**SERVICE MARK
PRINCIPAL REGISTER**

KIDSCOUNT

KIDSCOUNT, LLC (DELAWARE CORPORATION)
350 S. RIVER RD., UNIT G7
SUSAN ALEXANDER
NEW HOPE, PA 18938

FOR: EDUCATIONAL PROGRAM FOR CHILDREN, NAMELY, CONDUCTING AT-HOME OR ON-LINE LEARNING IN THE FIELD OF WEIGHT LOSS WITH PARENT SUPERVISION FEATURING THE USE OF EXERCISE EQUIPMENT, GAMES, MAGNETIC TRACKING CHART, AND BOOKS, IN CLASS 41 (U.S. CLS. 100, 101 AND 107).

FIRST USE 1-10-2006; IN COMMERCE 2-1-2008.

THE MARK CONSISTS OF STANDARD CHARACTERS WITHOUT CLAIM TO ANY PARTICULAR FONT, STYLE, SIZE, OR COLOR.

SN 78-900,009, FILED 6-4-2006.

SUE LAWRENCE, EXAMINING ATTORNEY

Int. Cl.: 25

Prior U.S. Cls.: 22 and 39

United States Patent and Trademark Office

Reg. No. 3,482,399

Registered Aug. 5, 2008

TRADEMARK
PRINCIPAL REGISTER

Breezy

WILLIAMS, DOUGLAS (UNITED STATES INDIVIDUAL)
1549 1/2 ROSALIA ROAD
LOS ANGELES, CA 90027

FOR: RESORT CLOTHING, NAMELY, ATHLETIC SHOES; BASEBALL CAPS; BERMUDA SHORTS; BOARD SHORTS; CANVAS SHOES; CAP VISORS; CAPS; CAPS WITH VISORS; DECK-SHOES; DRESSES; FLEECE PULLOVERS; GLOVES; GOLF CAPS; GOLF SHIRTS; GOLF SHOES; GYM SHORTS; HATS; JACKETS; JEANS; JERSEYS; JOGGING SUITS; KNITTED CAPS; LEATHER BELTS; LEATHER COATS; LEATHER HEADWEAR; LEATHER SHOES; LEATHER SLIPPERS; PANTS; RAIN SUITS; RUNNING SHOES; SANDALS; SHIRTS; SHOES; SHORT SETS; SHORTS; SKI SUITS; SKIRT SUITS; SKIRTS; SNOW SUITS; SOCCER SHOES; SOCKS; SPORT

SHIRTS; SPORTS JACKETS; SPORTS JERSEYS; SWEAT PANTS; SWEAT SHIRTS; SWEAT SHORTS; SWEAT SUITS; SWEATERS; SWIM CAPS; T-SHIRTS; TENNIS SHOES; TRACK SUITS; TRAINING SHOES; TRAINING SUITS; WARM UP SUITS, IN CLASS 25 (U.S. CLS. 22 AND 39).

FIRST USE 10-1-2007; IN COMMERCE 10-1-2007.

THE MARK CONSISTS OF STANDARD CHARACTERS WITHOUT CLAIM TO ANY PARTICULAR FONT, STYLE, SIZE, OR COLOR.

SN 78-903,239, FILED 6-7-2006.

GIANCARLO CASTRO, EXAMINING ATTORNEY

Int. Cl.: 45

Prior U.S. Cls.: 100 and 101

United States Patent and Trademark Office

Reg. No. 3,482,400

Registered Aug. 5, 2008

**SERVICE MARK
PRINCIPAL REGISTER**

LIFE MINDERS

HOBBINS, MARK (UNITED STATES INDIVIDUAL)
1 SMOKETHOM
TRABUCO CANYON, CA 92679

FOR: PROVIDING INFORMATION ON PERSONAL ACTIVITY GOALS, NAMELY, PERSONAL GROWTH, SELF HELP AND MOTIVATION; REMINDER SERVICES IN THE AREA OF UPCOMING IMPORTANT DATES AND EVENTS , IN CLASS 45 (U.S. CLS. 100 AND 101).

FIRST USE 6-23-2008; IN COMMERCE 6-23-2008.

THE MARK CONSISTS OF STANDARD CHARACTERS WITHOUT CLAIM TO ANY PARTICULAR FONT, STYLE, SIZE, OR COLOR.

SN 78-903,345, FILED 6-7-2006.

REBECCA POVARCHUK, EXAMINING ATTORNEY

Int. Cl.: 42

Prior U.S. Cls.: 100 and 101

United States Patent and Trademark Office

Reg. No. 3,482,401

Registered Aug. 5, 2008

**SERVICE MARK
PRINCIPAL REGISTER**

BROWN TO GREEN

ROUX ASSOCIATES, INC. (NEW YORK CORPORATION)
209 SHAFTER STREET
ISLANDIA, NY 11749

FOR: ENVIRONMENTAL SERVICES, NAMELY, TECHNICAL CONSULTING SERVICES RELATING TO ENVIRONMENTAL RESTORATION AND SUSTAINABLE DEVELOPMENT; CONSULTING SERVICES RELATING TO ENGINEERING IN THE FIELD OF ENVIRONMENTAL RESTORATION AND SUSTAINABLE DEVELOPMENT, IN CLASS 42 (U.S. CLS. 100 AND 101).

FIRST USE 4-21-2008; IN COMMERCE 4-21-2008.

THE MARK CONSISTS OF STANDARD CHARACTERS WITHOUT CLAIM TO ANY PARTICULAR FONT, STYLE, SIZE, OR COLOR.

SN 78-903,639, FILED 6-8-2006.

RAMONA ORTIGA, EXAMINING ATTORNEY

Int. Cl.: 9

Prior U.S. Cls.: 21, 23, 26, 36, and 38

Reg. No. 3,482,402

United States Patent and Trademark Office

Registered Aug. 5, 2008

**TRADEMARK
PRINCIPAL REGISTER**

ARDIMUS

RITE TRACK EQUIPMENT SERVICES, INC.
(OHIO CORPORATION)
8655 RITE TRACK WAY
WEST CHESTER, OH 45069

THE MARK CONSISTS OF STANDARD CHARACTERS WITHOUT CLAIM TO ANY PARTICULAR FONT, STYLE, SIZE, OR COLOR.

FOR: SOFTWARE FOR CONFIGURING, SETTING AND MONITORING THE OPERATIONS OF SUBSTRATE PROCESSING EQUIPMENT, IN CLASS 9 (U.S. CLS. 21, 23, 26, 36 AND 38).

SN 78-903,829, FILED 6-8-2006.

FIRST USE 4-3-2006; IN COMMERCE 4-3-2006.

GISELLE AGOSTO, EXAMINING ATTORNEY

Int. Cls.: 7 and 12

Prior U.S. Cls.: 13, 19, 21, 23, 31, 34, 35, and 44

United States Patent and Trademark Office

Reg. No. 3,482,403

Registered Aug. 5, 2008

TRADEMARK
PRINCIPAL REGISTER

MAXXFORCE
INTERNATIONAL DIESEL POWER

INTERNATIONAL ENGINE INTELLECTUAL
PROPERTY COMPANY, LLC (ILLINOIS LTD
LIAB CO)

LAW DEPARTMENT
4201 WINFIELD ROAD
WARRENVILLE, IL 60555

FOR: INTERNAL COMBUSTION ENGINES, EX-
CEPT FOR LAND VEHICLES AND REPLACEMENT
PARTS THEREFOR, IN CLASS 7 (U.S. CLS. 13, 19, 21,
23, 31, 34 AND 35).

FIRST USE 3-23-2007; IN COMMERCE 3-23-2007.

FOR: INTERNAL COMBUSTION ENGINES FOR
LAND VEHICLES, IN CLASS 12 (U.S. CLS. 19, 21, 23,
31, 35 AND 44).

FIRST USE 3-23-2007; IN COMMERCE 3-23-2007.

NO CLAIM IS MADE TO THE EXCLUSIVE
RIGHT TO USE "INTERNATIONAL DIESEL POW-
ER", APART FROM THE MARK AS SHOWN.

THE NAME(S), PORTRAIT(S), AND/OR SIGNA-
TURE(S) SHOWN IN THE MARK IDENTIFIES
"MAXXFORCE", WHOSE CONSENT(S) TO REGIS-
TER IS SUBMITTED.

SN 78-904,576, FILED 6-9-2006.

DEZMONA MIZELLE, EXAMINING ATTORNEY

Int. Cls.: 35 and 37

Prior U.S. Cls.: 100, 101, 102, 103, and 106

United States Patent and Trademark Office

Reg. No. 3,482,404

Registered Aug. 5, 2008

SERVICE MARK
PRINCIPAL REGISTER



GRILL MEDIC, INC. (NORTH CAROLINA CORPORATION)
SUITE 406
120 SOUTHPARK DRIVE
MOORESVILLE, NC 28115

THE COLOR(S) BLACK, GRAY, RED AND WHITE IS/ARE CLAIMED AS A FEATURE OF THE MARK.

FOR: RETAIL STORE SERVICES AND ONLINE RETAIL STORE SERVICES FEATURING GAS, CHARCOAL AND ELECTRIC GRILLS AND SMOKERS, GRILL ACCESSORIES, COOKING ACCESSORIES AND UTENSILS, OUTDOOR COOKING APPLIANCES AND OUTDOOR HEATING SYSTEMS, IN CLASS 35 (U.S. CLS. 100, 101 AND 102).

THE MARK CONSISTS OF THE IMAGE OF A CHEF IN THE FOREGROUND. THE CHEF'S FACE IS WHITE AND HIS HAIR AND FACIAL FEATURES ARE BLACK. HE IS WEARING A RED SCARF. HIS HAT IS GRAY AND HAS A RED CROSS WITH A WHITE BACKGROUND ON THE LOWER PART OF THE HAT. IN THE BACKGROUND IS A FOUR SIDED SQUARE SIGN RESTING ON ONE CORNER. THE SIGN IS BLACK WITH A WHITE BORDER AND WHITE LETTERING. THE WHITE LETTERING STATES "THE GRILL MEDIC". ALSO DEPICTED IN WHITE IS THE OUTLINE OF A GENERIC GAS GRILL.

FIRST USE 11-14-2007; IN COMMERCE 11-14-2007.

FOR: INSTALLATION, MAINTENANCE AND/OR REPAIR OF GAS, CHARCOAL AND ELECTRIC GRILLS AND SMOKERS; REPAIR OF GAS LAMPS, GAS LOGS AND OUTDOOR HEATING SYSTEMS, IN CLASS 37 (U.S. CLS. 100, 103 AND 106).

FIRST USE 11-14-2007; IN COMMERCE 11-14-2007.

SN 78-904,694, FILED 6-9-2006.

NO CLAIM IS MADE TO THE EXCLUSIVE RIGHT TO USE "GRILL" , APART FROM THE MARK AS SHOWN.

DOMINIC J. FERRAIUOLO, EXAMINING ATTORNEY

Int. Cl.: 25

Prior U.S. Cls.: 22 and 39

United States Patent and Trademark Office

Reg. No. 3,482,405

Registered Aug. 5, 2008

**TRADEMARK
PRINCIPAL REGISTER**

SPICE & ROSES

RAHMANI, MAURICE (ALBANIA INDIVIDUAL)
2211 SAN YSIDRO DRIVE
BEVERLY HILLS, CA 90210

FOR: CLOTHING, NAMELY, BLOUSES, CAMI-
SOLES, DRESSES, JACKETS, KNICKERBOCKERS,
LEATHER JACKETS, PANTS, SHIRTS, SKIRTS,
TANK TOPS, TOPS, T-SHIRTS, AND TUNICS, IN
CLASS 25 (U.S. CLS. 22 AND 39).

FIRST USE 2-27-2007; IN COMMERCE 2-27-2007.

THE MARK CONSISTS OF STANDARD CHAR-
ACTERS WITHOUT CLAIM TO ANY PARTICULAR
FONT, STYLE, SIZE, OR COLOR.

SN 78-905,353, FILED 6-10-2006.

JULIE GUTTADAURO, EXAMINING ATTORNEY

Int. Cls.: 29 and 30

Prior U.S. Cl.: 46

United States Patent and Trademark Office

Reg. No. 3,482,406

Registered Aug. 5, 2008

TRADEMARK
PRINCIPAL REGISTER

PRINGLES SELECT

THE PROCTER & GAMBLE COMPANY (OHIO
CORPORATION)
ONE PROCTER & GAMBLE PLAZA
CINCINNATI, OH 45202

FOR: SNACK FOODS, NAMELY, THOSE DE-
RIVED FROM POTATO OR SWEET POTATO IN
CHIP, STICK, CRACKER OR BREADSTICK FORM,
IN CLASS 29 (U.S. CL. 46).

FIRST USE 12-11-2006; IN COMMERCE 12-11-2006.

FOR: SNACK FOODS, NAMELY, THOSE DE-
RIVED FROM RICE IN CHIP, STICK, CRACKER
OR BREADSTICK FORM, IN CLASS 30 (U.S. CL. 46).

FIRST USE 12-11-2006; IN COMMERCE 12-11-2006.

THE MARK CONSISTS OF STANDARD CHAR-
ACTERS WITHOUT CLAIM TO ANY PARTICULAR
FONT, STYLE, SIZE, OR COLOR.

OWNER OF U.S. REG. NOS. 875,749, 1,665,957,
AND 2,670,298.

NO CLAIM IS MADE TO THE EXCLUSIVE
RIGHT TO USE "SELECT", APART FROM THE
MARK AS SHOWN.

SN 78-905,772, FILED 6-12-2006.

MARTHA FROMM, EXAMINING ATTORNEY

Int. Cl.: 30

Prior U.S. Cl.: 46

United States Patent and Trademark Office

Reg. No. 3,482,407

Registered Aug. 5, 2008

**TRADEMARK
PRINCIPAL REGISTER**



GONZÁLEZ-TORRES, ABRAHAM MARCELO
(MEXICO INDIVIDUAL)
CALLE 4 SUR, 123, CD. INDUSTRIAL
TIZAYUCA, HIDALGO, MEXICO 43800

FOR: PUFFED CORN SNACKS; WHEAT-BASED
SNACK FOODS, IN CLASS 30 (U.S. CL. 46).

FIRST USE 5-20-2008; IN COMMERCE 5-20-2008.

THE COLORS BLUE, RED, WHITE, BLACK,
GREEN, YELLOW AND ORANGE ARE CLAIMED
AS A FEATURE OF THE MARK.

THE MARK CONSISTS OF A SMILING ADOLESCENT WHITE MALE RABBIT WITH GREEN EYES AND YELLOW AND ORANGE LINED EARS. HIS EARS ARE TWISTED. THE RABBIT IS WEARING A RED CAP BACKWARDS AND A YELLOW, BLUE AND RED LONG-SLEEVED T-SHIRT. HIS LOWER BODY IS NOT SEEN. HE IS HOLDING HIMSELF UP BY HIS RIGHT ARM AND HAS HIS LEFT ARM RAISED STRAIGHT UP.

SN 78-905,858, FILED 6-12-2006.

JOHN E. MICHOS, EXAMINING ATTORNEY

Int. Cl.: 25

Prior U.S. Cls.: 22 and 39

United States Patent and Trademark Office

Reg. No. 3,482,408

Registered Aug. 5, 2008

**TRADEMARK
PRINCIPAL REGISTER**

SPEEDZOOT

ZUITSPOORTS, INC. (CALIFORNIA CORPORATION)
2880 SCOTT STREET, SUITE 101
VISTA, CA 92081

THE MARK CONSISTS OF STANDARD CHARACTERS WITHOUT CLAIM TO ANY PARTICULAR FONT, STYLE, SIZE, OR COLOR.

FOR: SPORTSWEAR, NAMELY, SHORTS, PANTS, SHIRTS, HATS, AND WETSUITS, IN CLASS 25 (U.S. CLS. 22 AND 39).

SN 78-906,316, FILED 6-12-2006.

FIRST USE 6-0-2006; IN COMMERCE 2-0-2007.

ANGELA GAW, EXAMINING ATTORNEY

Int. Cls.: 9 and 16

Prior U.S. Cls.: 2, 5, 21, 22, 23, 26, 29, 36, 37, 38, and 50

Reg. No. 3,482,409

United States Patent and Trademark Office

Registered Aug. 5, 2008

**TRADEMARK
PRINCIPAL REGISTER**

VARIQUEST

BRADY WORLDWIDE, INC. (WISCONSIN CORPORATION)
6555 WEST GOOD HOPE ROAD
MILWAUKEE, WI 53223

FOR: PRINTERS, COMPUTER SOFTWARE FOR OPERATING PRINTERS AND LAMINATING MACHINES, ELECTRONICALLY-OPERATED CUTTING DIES SOLD AS A UNIT WITH PRINTERS AND ELECTRONIC CUT-OUT MAKERS, IN CLASS 9 (U.S. CLS. 21, 23, 26, 36 AND 38).

FIRST USE 12-18-2006; IN COMMERCE 1-15-2007.

FOR: PAPER FOR PRINTING MULTI-COLOR SIGNS, DOCUMENTS AND POSTERS FOR SCHOOLS AND EDUCATIONAL INSTITUTIONS; AUTOMATIC AND HAND-OPERATED LAMINAT-

ING MACHINES FOR OFFICE, SCHOOL, RETAIL, COMMERCIAL AND INDUSTRIAL USE AND SOFTWARE FOR OPERATING THE SAME SOLD AS A UNIT AND RELATED EQUIPMENT AND SUPPLIES, NAMELY PAPER TAPES AND ADHESIVE PAPER STICKERS, IN CLASS 16 (U.S. CLS. 2, 5, 22, 23, 29, 37, 38 AND 50).

FIRST USE 12-18-2006; IN COMMERCE 1-15-2007.

THE MARK CONSISTS OF STANDARD CHARACTERS WITHOUT CLAIM TO ANY PARTICULAR FONT, STYLE, SIZE, OR COLOR.

SN 78-906,548, FILED 6-13-2006.

G. MAYERSCHOFF, EXAMINING ATTORNEY

Int. Cls.: 42 and 44

Prior U.S. Cls.: 100 and 101

United States Patent and Trademark Office

Reg. No. 3,482,410

Registered Aug. 5, 2008

**SERVICE MARK
PRINCIPAL REGISTER**

HEALTHSTRING

HEALTHSTRING, LLC (DELAWARE LTD LIAB
CO)
1911 NORTH FREMONT STREET
CHICAGO, IL 60614

FOR: PROVIDING TEMPORARY USE OF ON-
LINE, NON-DOWNLOADABLE DATABASE MAN-
AGEMENT SOFTWARE FOR PURPOSES OF
HEALTH RISK ASSESSMENT AND HEALTH RISK
PROFILING BY ANALYZING USER-PROVIDED
INFORMATION IN THE FIELD OF PREVENTA-
TIVE HEALTH, IN CLASS 42 (U.S. CLS. 100 AND 101).

FIRST USE 7-15-2006; IN COMMERCE 7-15-2006.

FOR: CONSULTATION SERVICES, NAMELY,
ADVISING INDIVIDUALS HOW TO COLLECT, IN-
PUT AND REVIEW MEDICAL AND HEALTH CARE
DATA AND RELATED STORED INFORMATION

VIA A PERSONALIZED ONLINE COMPUTER DA-
TABASE; HEALTH INFORMATION SERVICES,
NAMELY, PROVIDING A PRIVATE USERS' ON-
LINE DATABASE OF PHYSICAL AND MENTAL
HEALTH RECORDS, AND ASSESSMENT SERVICES
FOR PURPOSES OF GUIDING PHYSICAL AND
MENTAL HEALTH MAINTENANCE, IN CLASS 44
(U.S. CLS. 100 AND 101).

FIRST USE 7-15-2006; IN COMMERCE 7-15-2006.

THE MARK CONSISTS OF STANDARD CHAR-
ACTERS WITHOUT CLAIM TO ANY PARTICULAR
FONT, STYLE, SIZE, OR COLOR.

SN 78-907,194, FILED 6-13-2006.

JUDITH HELFMAN, EXAMINING ATTORNEY

Int. Cls.: 42 and 44

Prior U.S. Cls.: 100 and 101

United States Patent and Trademark Office

Reg. No. 3,482,411

Registered Aug. 5, 2008

**SERVICE MARK
PRINCIPAL REGISTER**



HEALTHSTRING, LLC (DELAWARE LTD LIAB
CO)
1911 NORTH FREMONT STREET
CHICAGO, IL 60614

FOR: PROVIDING TEMPORARY USE OF ON-
LINE, NON-DOWNLOADABLE DATABASE MAN-
AGEMENT SOFTWARE FOR PURPOSES OF
HEALTH RISK ASSESSMENT AND HEALTH RISK
PROFILING BY ANALYZING USER-PROVIDED
INFORMATION IN THE FIELD OF PREVENTA-
TIVE HEALTH, IN CLASS 42 (U.S. CLS. 100 AND 101).

FIRST USE 7-15-2006; IN COMMERCE 7-15-2006.

FOR: CONSULTATION SERVICES, NAMELY,
ADVISING INDIVIDUALS HOW TO COLLECT, IN-
PUT AND REVIEW MEDICAL AND HEALTH CARE
DATA AND RELATED STORED INFORMATION
VIA A PERSONALIZED ONLINE COMPUTER DA-
TABASE; HEALTH INFORMATION SERVICES,
NAMELY, PROVIDING A PRIVATE USERS' ON-
LINE DATABASE OF PHYSICAL AND MENTAL
HEALTH RECORDS, AND ASSESSMENT SERVICES

FOR PURPOSES OF GUIDING PHYSICAL AND
MENTAL HEALTH MAINTENANCE, IN CLASS 44
(U.S. CLS. 100 AND 101).

FIRST USE 7-15-2006; IN COMMERCE 7-15-2006.

THE COLOR(S) BLUE IS/ARE CLAIMED AS A
FEATURE OF THE MARK.

THE MARK CONSISTS OF THE STYLIZED TEXT
"HEALTHSTRING" WITH A FANCIFUL STRING-
LIKE DESIGN OF A HEART TO THE LEFT OF THE
TEXT AND BOTH THE DESIGN AND TEXT AP-
PEAR ENTIRELY IN THE COLOR BLUE. NO SPE-
CIFIC COLOR CLAIM IS MADE WITH RESPECT TO
THE BACKGROUND.

SN 78-907,214, FILED 6-13-2006.

JUDITH HELFMAN, EXAMINING ATTORNEY

Int. Cl.: 15

Prior U.S. Cls.: 2, 21, and 36

United States Patent and Trademark Office

Reg. No. 3,482,412

Registered Aug. 5, 2008

**TRADEMARK
PRINCIPAL REGISTER**

X-TREM

KAHLER, GARY (UNITED STATES INDIVIDUAL)
2525 JASON COURT
OCEANSIDE, CA 92056

THE MARK CONSISTS OF STANDARD CHARACTERS WITHOUT CLAIM TO ANY PARTICULAR FONT, STYLE, SIZE, OR COLOR.

FOR: GUITAR PARTS; GUITAR TREMOLO DEVICES, IN CLASS 15 (U.S. CLS. 2, 21 AND 36).

SN 78-907,716, FILED 6-14-2006.

FIRST USE 1-0-2007; IN COMMERCE 1-0-2007.

JESSICA FATHY, EXAMINING ATTORNEY

Int. Cl.: 31

Prior U.S. Cls.: 1 and 46

United States Patent and Trademark Office

Reg. No. 3,482,413

Registered Aug. 5, 2008

**TRADEMARK
PRINCIPAL REGISTER**

JUSTRIPE!

WEST PAK AVOCADO, INC. (CALIFORNIA
CORPORATION)
42322 AVENIDA ALVARADO
TREVOR NEWHOUSE
TEMECULA, CA 92590

THE MARK CONSISTS OF STANDARD CHAR-
ACTERS WITHOUT CLAIM TO ANY PARTICULAR
FONT, STYLE, SIZE, OR COLOR.

FOR: FRESH FRUITS, IN CLASS 31 (U.S. CLS. 1
AND 46).

SN 78-908,465, FILED 6-14-2006.

FIRST USE 1-1-2008; IN COMMERCE 6-1-2008.

HANNO RITTNER, EXAMINING ATTORNEY

Int. Cl.: 25

Prior U.S. Cls.: 22 and 39

United States Patent and Trademark Office

Reg. No. 3,482,414

Registered Aug. 5, 2008

**TRADEMARK
PRINCIPAL REGISTER**

FALCONE

DON MART CLOTHES, INC. (PENNSYLVANIA
CORPORATION)
114 WALTON STREET
PHILLIPSBURG, PA 16866

FOR: MEN'S, LADIES AND BOYS' CLOTHING,
NAMELY, SHOES, SHIRTS, SHIRT SETS, TIES,
BELTS, AND HATS, IN CLASS 25 (U.S. CLS. 22
AND 39).

FIRST USE 9-19-2006; IN COMMERCE 9-19-2006.

THE MARK CONSISTS OF STANDARD CHAR-
ACTERS WITHOUT CLAIM TO ANY PARTICULAR
FONT, STYLE, SIZE, OR COLOR.

OWNER OF U.S. REG. NO. 1,179,323.

THE ENGLISH TRANSLATION OF "FALCONE"
IS FALCON.

SN 78-908,940, FILED 6-15-2006.

MATTHEW PAPPAS, EXAMINING ATTORNEY

Int. Cl.: 29

Prior U.S. Cl.: 46

Reg. No. 3,482,415

United States Patent and Trademark Office

Registered Aug. 5, 2008

**TRADEMARK
PRINCIPAL REGISTER**



HEB GROCERY COMPANY, L.P. (TEXAS LIMITED PARTNERSHIP)
646 SOUTH MAIN
SAN ANTONIO, TX 78204

NO CLAIM IS MADE TO THE EXCLUSIVE RIGHT TO USE "WILD CAUGHT" AND "PRODUCT OF THE U.S.A", APART FROM THE MARK AS SHOWN.

FOR: FRESH, FROZEN, PROCESSED OR UNPROCESSED SEAFOOD, IN CLASS 29 (U.S. CL. 46).

SN 78-910,246, FILED 6-16-2006.

FIRST USE 4-0-2007; IN COMMERCE 4-0-2007.

SUZANNE BLANE, EXAMINING ATTORNEY

Int. Cl.: 35

Prior U.S. Cls.: 100, 101, and 102

United States Patent and Trademark Office

Reg. No. 3,482,416

Registered Aug. 5, 2008

**SERVICE MARK
PRINCIPAL REGISTER**

THE FAMOUS RADIO RANCH

DOCSI CORPORATION (ILLINOIS CORPORATION)
1140 NORTH LA BREA
LOS ANGELES, CA 90038

FOR: CREATIVE PRODUCTION OF RADIO
COMMERCIALS, IN CLASS 35 (U.S. CLS. 100, 101
AND 102).

FIRST USE 3-0-1995; IN COMMERCE 3-0-1995.

THE MARK CONSISTS OF STANDARD CHARACTERS WITHOUT CLAIM TO ANY PARTICULAR FONT, STYLE, SIZE, OR COLOR.

NO CLAIM IS MADE TO THE EXCLUSIVE RIGHT TO USE "RADIO", APART FROM THE MARK AS SHOWN.

SN 78-910,365, FILED 6-16-2006.

MICHAEL WEBSTER, EXAMINING ATTORNEY

Int. Cl.: 45

Prior U.S. Cls.: 100 and 101

United States Patent and Trademark Office

Reg. No. 3,482,417

Registered Aug. 5, 2008

**SERVICE MARK
PRINCIPAL REGISTER**



Identity Theft Resource Center

IDENTITY THEFT RESOURCE CENTER (CALIFORNIA NON-PROFIT CORPORATION)

P.O. BOX 26883

SAN DIEGO, CA 92196

FOR: CONSULTATION IN THE FIELD OF DATA THEFT AND IDENTITY THEFT, IN CLASS 45 (U.S. CLS. 100 AND 101).

FIRST USE 4-22-2006; IN COMMERCE 4-22-2006.

NO CLAIM IS MADE TO THE EXCLUSIVE RIGHT TO USE "IDENTITY THEFT RESOURCE CENTER", APART FROM THE MARK AS SHOWN.

THE MARK CONSISTS OF THE STYLIZED LETTERS "I T R C" AND THE WORDS "IDENTITY THEFT RESOURCE CENTER".

SN 78-910,615, FILED 6-16-2006.

JAMES LOVELACE, EXAMINING ATTORNEY

Int. Cl.: 9

Prior U.S. Cls.: 21, 23, 26, 36, and 38

Reg. No. 3,482,418

United States Patent and Trademark Office

Registered Aug. 5, 2008

**TRADEMARK
PRINCIPAL REGISTER**

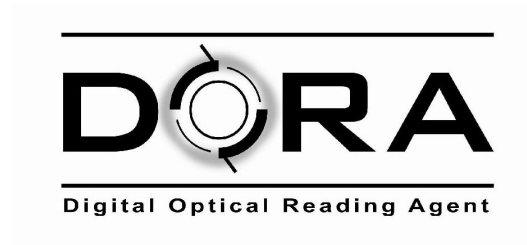

DUOS TECHNOLOGIES, INC. (FLORIDA CORPORATION)
6622 SOUTHPOINT DRIVE SOUTH
SUITE 310
JACKSONVILLE, FL 32217

FIRST USE 6-17-2006; IN COMMERCE 6-17-2006.

NO CLAIM IS MADE TO THE EXCLUSIVE RIGHT TO USE "DIGITAL OPTICAL READING", APART FROM THE MARK AS SHOWN.

FOR: VIDEO OPTICAL RECOGNITION, NAME-
LY, AN ELECTRONIC DEVICE TO PROVIDE OPTI-
CAL CHARACTER RECOGNITION FOR INBOUND
AND OUTBOUND TRAFFIC WHICH WILL CAP-
TURE THE CAR NUMBER, THE STENCIL INFOR-
MATION ON THE CAR, CAPTURE AN IMAGE OF
THE CAR AND INCORPORATE THIS INFORMA-
TION TO THE DATABASE, IN CLASS 9 (U.S. CLS. 21,
23, 26, 36 AND 38).

THE MARK CONSISTS OF THE LETTERS "D" "O"
"R" AND "A" IN UPPER CASE WITH THE LETTER
"O" WITH A SET OF DARKENED PORTIONS TO
DEPICT A CAMERA LENS.

SN 78-910,667, FILED 6-17-2006.

ARETHA SOMERVILLE, EXAMINING ATTORNEY

Int. Cls.: 35, 37, and 42

Prior U.S. Cls.: 100, 101, 102, 103, and 106

United States Patent and Trademark Office

Reg. No. 3,482,419

Registered Aug. 5, 2008

**SERVICE MARK
PRINCIPAL REGISTER**

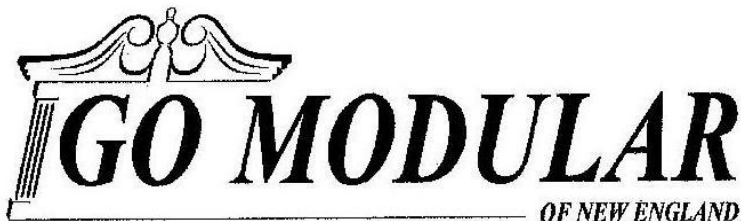

GO MODULAR INC. (MASSACHUSETTS CORPORATION)
77 WOLLCOTT AVE.
NORTH DARTMOUTH, MA 02747

FOR: RETAIL STORE SERVICES AND WHOLESALE DISTRIBUTORSHIPS IN THE FIELD OF MODULAR RESIDENCES AND OTHER BUILDINGS, IN CLASS 35 (U.S. CLS. 100, 101 AND 102).

FIRST USE 3-5-2008; IN COMMERCE 3-5-2008.

FOR: CONSTRUCTION, REMODELING AND REPAIR OF MODULAR RESIDENCES AND OTHER BUILDINGS, IN CLASS 37 (U.S. CLS. 100, 103 AND 106).

FIRST USE 3-5-2008; IN COMMERCE 3-5-2008.

FOR: DESIGN FOR OTHERS IN THE FIELD OF MODULAR RESIDENCES AND OTHER BUILDINGS, IN CLASS 42 (U.S. CLS. 100 AND 101).

FIRST USE 3-5-2008; IN COMMERCE 3-5-2008.

NO CLAIM IS MADE TO THE EXCLUSIVE RIGHT TO USE "MODULAR" AND "NEW ENGLAND", APART FROM THE MARK AS SHOWN.

THE MARK CONSISTS OF THE WORDS "GO MODULAR OF NEW ENGLAND" AND THE DESIGN OF A RAMS HEAD AND FINIAL DOOR PEDIMENT WITH A SINGLE SUPPORTING COLUMN.

SN 78-913,457, FILED 6-21-2006.

RENEE MCCRAY, EXAMINING ATTORNEY

Int. Cl.: 25

Prior U.S. Cls.: 22 and 39

United States Patent and Trademark Office

Reg. No. 3,482,420

Registered Aug. 5, 2008

**TRADEMARK
PRINCIPAL REGISTER**

TRAPPERBOY

SHABAZZ-EL, WISE (UNITED STATES INDIVIDUAL)
225 S WEBSTER AVE
SCRANTON, PA 18505

THE MARK CONSISTS OF STANDARD CHARACTERS WITHOUT CLAIM TO ANY PARTICULAR FONT, STYLE, SIZE, OR COLOR.

FOR: CLOTHING, NAMELY, SWEATSHIRTS, SHIRTS, JEANS, HATS, AND CAPS, IN CLASS 25 (U.S. CLS. 22 AND 39).

SN 78-913,576, FILED 6-21-2006.

FIRST USE 3-0-2008; IN COMMERCE 3-0-2008.

LINDA ESTRADA, EXAMINING ATTORNEY

Int. Cl.: 35

Prior U.S. Cls.: 100, 101, and 102

United States Patent and Trademark Office

Reg. No. 3,482,421

Registered Aug. 5, 2008

**SERVICE MARK
PRINCIPAL REGISTER**

THE BOKKA GROUP

BRAINCRUMBS DESIGN, INC. (OKLAHOMA CORPORATION), DBA THE BOKKA GROUP, 1422 DELGANY STREET STE 200 DENVER, CO 80202

FOR: ADVERTISING AGENCIES; ADVERTISING AGENCIES, NAMELY, PROMOTING THE GOODS AND SERVICES OF OTHERS; ADVERTISING AGENCIES, NAMELY, PROMOTING THE SERVICES OF RESIDENTIAL/COMMERCIAL DEVELOPERS AND MUSEUMS THROUGH THE DISTRIBUTION OF PRINTED AND AUDIO PROMOTIONAL MATERIALS AND BY RENDERING SALES PROMOTION ADVICE; ADVERTISING AND PUBLICITY SERVICES, NAMELY, PROMOTING THE GOODS, SERVICES, BRAND IDENTITY AND COMMERCIAL INFORMATION AND NEWS OF THIRD PARTIES THROUGH PRINT, AUDIO, VIDEO, DIGITAL AND ON-LINE MEDIUM; ADVER-

TISING, MARKETING AND PROMOTION SERVICES; PROMOTING, ADVERTISING AND MARKETING OF THE ON-LINE WEBSITES OF OTHERS, IN CLASS 35 (U.S. CLS. 100, 101 AND 102).

FIRST USE 11-1-2006; IN COMMERCE 11-1-2006.

THE MARK CONSISTS OF STANDARD CHARACTERS WITHOUT CLAIM TO ANY PARTICULAR FONT, STYLE, SIZE, OR COLOR.

NO CLAIM IS MADE TO THE EXCLUSIVE RIGHT TO USE GROUP, APART FROM THE MARK AS SHOWN.

SN 78-913,738, FILED 6-21-2006.

JANICE KIM, EXAMINING ATTORNEY

Int. Cl.: 8

Prior U.S. Cls.: 23, 28, and 44

United States Patent and Trademark Office

Reg. No. 3,482,422

Registered Aug. 5, 2008

**TRADEMARK
PRINCIPAL REGISTER**

It's a Corker!

LLOYDCO, LLC (CALIFORNIA LTD LIAB CO)
223 OAK COURT
MENLO PARK, CA 94025

THE MARK CONSISTS OF STANDARD CHAR-
ACTERS WITHOUT CLAIM TO ANY PARTICULAR
FONT, STYLE, SIZE, OR COLOR.

FOR: MANUALLY OPERATED APPARATUS
FOR INSERTING A RESILIENT STOPPER INTO A
BEVERAGE BOTTLE OR A WINE BOTTLE, IN
CLASS 8 (U.S. CLS. 23, 28 AND 44).

SN 78-913,949, FILED 6-22-2006.

FIRST USE 1-15-2007; IN COMMERCE 1-15-2007.

BRIAN NEVILLE, EXAMINING ATTORNEY

Int. Cl.: 21

Prior U.S. Cls.: 2, 13, 23, 29, 30, 33, 40, and 50

United States Patent and Trademark Office

Reg. No. 3,482,423

Registered Aug. 5, 2008

**TRADEMARK
PRINCIPAL REGISTER**



WHITE, DENNIS R. (UNITED STATES INDIVIDUAL)
5304 VIA VICENTE
YORBA LINDA, CA 92887

FIRST USE 5-16-2008; IN COMMERCE 5-16-2008.

SN 78-914,309, FILED 6-22-2006.

FOR: SPECIALTY PET FEEDING DISHES AND STANDS FOR DISHES, IN CLASS 21 (U.S. CLS. 2, 13, 23, 29, 30, 33, 40 AND 50).

KEVON CHISOLM, EXAMINING ATTORNEY

Int. Cl.: 25

Prior U.S. Cls.: 22 and 39

United States Patent and Trademark Office

Reg. No. 3,482,424

Registered Aug. 5, 2008

**TRADEMARK
PRINCIPAL REGISTER**

JESUS FOR LIFE

ADAMSON DESIGN GROUP, INC (OREGON
CORPORATION)
890 PROMONTORY PLACE SE
SALEM, OR 97302

THE MARK CONSISTS OF STANDARD CHAR-
ACTERS WITHOUT CLAIM TO ANY PARTICULAR
FONT, STYLE, SIZE, OR COLOR.

FOR: T-SHIRTS, SWEATSHIRTS, SPORT SHIRTS,
IN CLASS 25 (U.S. CLS. 22 AND 39).

SN 78-915,039, FILED 6-22-2006.

FIRST USE 6-24-2004; IN COMMERCE 6-15-2008.

JILL C. ALT, EXAMINING ATTORNEY

Int. Cl.: 9

Prior U.S. Cls.: 21, 23, 26, 36, and 38

Reg. No. 3,482,425

United States Patent and Trademark Office

Registered Aug. 5, 2008

**TRADEMARK
PRINCIPAL REGISTER**

Linktropy

APPOSITE TECHNOLOGIES, INC. (CALIFORNIA CORPORATION)
9025 WILSHIRE BLVD. SUITE 215
BEVERLY HILLS, CA 90211

FOR: COMPUTER NETWORK HUBS, SWITCHES AND ROUTERS; COMPUTER NETWORKING HARDWARE; TELECOMMUNICATIONS AND DATA NETWORKING HARDWARE, NAMELY, DEVICES FOR TRANSPORTING AND AGGREGATING VOICE, DATA, AND VIDEO COMMUNICATIONS ACROSS MULTIPLE NETWORK INFRASTRUCTURES AND COMMUNICATIONS PROTOCOLS; WAN (WIDE AREA

NETWORK) OPERATING SOFTWARE, IN CLASS 9 (U.S. CLS. 21, 23, 26, 36 AND 38).

FIRST USE 5-22-2007; IN COMMERCE 7-2-2007.

THE MARK CONSISTS OF STANDARD CHARACTERS WITHOUT CLAIM TO ANY PARTICULAR FONT, STYLE, SIZE, OR COLOR.

SN 78-917,357, FILED 6-26-2006.

CARYN GLASSER, EXAMINING ATTORNEY

Int. Cl.: 5

Prior U.S. Cls.: 6, 18, 44, 46, 51, and 52

United States Patent and Trademark Office

Reg. No. 3,482,426

Registered Aug. 5, 2008

TRADEMARK
PRINCIPAL REGISTER



TECHNOLOGIE BIOLACTIS INC. (CANADA CORPORATION)
2152, CHEMIN ST-JOSEPH, C.P. 1091
LA BAIE, CANADA G7B 3P3

FOR: DIETARY SUPPLEMENT, NAMELY, A MALLEABLE MOULD MADE OF LACTOSERUM PROTEINS, IN CLASS 5 (U.S. CLS. 6, 18, 44, 46, 51 AND 52).

FIRST USE 11-23-2006; IN COMMERCE 11-23-2006.

NO CLAIM IS MADE TO THE EXCLUSIVE RIGHT TO USE "100% LAITIER/DAIRY", APART FROM THE MARK AS SHOWN.

THE COLOR(S) PURPLE, RED AND WHITE IS/ ARE CLAIMED AS A FEATURE OF THE MARK.

THE COLORS PURPLE, RED AND WHITE APPEAR IN THE MARK, SPECIFICALLY, THE FLOWER DESIGN IS WHITE WITH A PURPLE OUTLINE WITH A RED HEART IN THE MIDDLE, THE WORDING IS WHITE ON A PURPLE BACKGROUND.

THE ENGLISH TRANSLATION OF THE FRENCH WORDING "LAITIER" IS "DAIRY".

SN 78-918,779, FILED 6-28-2006.

DOMINIC FATHY, EXAMINING ATTORNEY

Int. Cl.: 25

Prior U.S. Cls.: 22 and 39

United States Patent and Trademark Office

Reg. No. 3,482,427

Registered Aug. 5, 2008

**TRADEMARK
PRINCIPAL REGISTER**

G10

KARSTEN MANUFACTURING CORPORATION
(ARIZONA CORPORATION)
LEGAL DEPARTMENT
2201 WEST DESERT COVE
PHOENIX, AZ 85029

FOR: CLOTHING, NAMELY, SHIRTS, CAPS,
SWEATERS AND SUN VISORS, IN CLASS 25 (U.S.
CLS. 22 AND 39).

FIRST USE 9-24-2007; IN COMMERCE 9-24-2007.

THE MARK CONSISTS OF STANDARD CHAR-
ACTERS WITHOUT CLAIM TO ANY PARTICULAR
FONT, STYLE, SIZE, OR COLOR.

OWNER OF U.S. REG. NO. 3,451,349.

SN 78-918,787, FILED 6-28-2006.

LAURIE KAUFMAN, EXAMINING ATTORNEY

Int. Cl.: 33

Prior U.S. Cls.: 47 and 49

United States Patent and Trademark Office

Reg. No. 3,482,428

Registered Aug. 5, 2008

**TRADEMARK
PRINCIPAL REGISTER**

COPPERFISH

ASV WINES, INC. (CALIFORNIA CORPORATION)
1998 ROAD 152
DELANO, CA 93215

THE MARK CONSISTS OF STANDARD CHARACTERS WITHOUT CLAIM TO ANY PARTICULAR FONT, STYLE, SIZE, OR COLOR.

FOR: WINES, IN CLASS 33 (U.S. CLS. 47 AND 49).

SN 78-920,262, FILED 6-29-2006.

FIRST USE 2-16-2007; IN COMMERCE 2-16-2007.

LINDA LAVACHE, EXAMINING ATTORNEY

Int. Cl.: 35

Prior U.S. Cls.: 100, 101, and 102

United States Patent and Trademark Office

Reg. No. 3,482,429

Registered Aug. 5, 2008

**SERVICE MARK
PRINCIPAL REGISTER**

MLAB

THE WOODSIDE INSTITUTE, INC. (CALIFORNIA CORPORATION)
620 MOUNTAIN HOME ROAD
WOODSIDE, CA 94062

THE MARK CONSISTS OF STANDARD CHARACTERS WITHOUT CLAIM TO ANY PARTICULAR FONT, STYLE, SIZE, OR COLOR.

FOR: ARRANGING AND CONDUCTING BUSINESS MANAGEMENT CONFERENCES AND SEMINARS, IN CLASS 35 (U.S. CLS. 100, 101 AND 102).

SN 78-920,610, FILED 6-30-2006.

FIRST USE 5-28-2008; IN COMMERCE 5-28-2008.

LYDIA BELZER, EXAMINING ATTORNEY

Int. Cl.: 35

Prior U.S. Cls.: 100, 101, and 102

United States Patent and Trademark Office

Reg. No. 3,482,430

Registered Aug. 5, 2008

**SERVICE MARK
PRINCIPAL REGISTER**

MANAGEMENT 2.0

THE WOODSIDE INSTITUTE, INC. (CALIFORNIA CORPORATION)
620 MOUNTAIN HOME ROAD
WOODSIDE, CA 94062

FOR: ARRANGING AND CONDUCTING BUSINESS MANAGEMENT CONFERENCES AND SEMINARS, IN CLASS 35 (U.S. CLS. 100, 101 AND 102).

FIRST USE 5-28-2008; IN COMMERCE 5-28-2008.

THE MARK CONSISTS OF STANDARD CHARACTERS WITHOUT CLAIM TO ANY PARTICULAR FONT, STYLE, SIZE, OR COLOR.

NO CLAIM IS MADE TO THE EXCLUSIVE RIGHT TO USE "MANAGEMENT", APART FROM THE MARK AS SHOWN.

SN 78-920,623, FILED 6-30-2006.

LYDIA BELZER, EXAMINING ATTORNEY

Int. Cl.: 5

Prior U.S. Cls.: 6, 18, 44, 46, 51, and 52

United States Patent and Trademark Office

Reg. No. 3,482,431

Registered Aug. 5, 2008

**TRADEMARK
PRINCIPAL REGISTER**

FIRST IN ORGANIC MEDICINE

TRADITIONAL MEDICINALS, INC. (CALIFORNIA CORPORATION)
4515 ROSS ROAD
SEBASTOPOL, CA 95472

FOR: ANTI-COUGH DROPS; ASTRINGENTS; ASTRINGENTS FOR MEDICINAL PURPOSES; COUGH DROPS; COUGH LOZENGES; COUGH TREATMENT PREPARATIONS; HEMORRHOID TREATMENT PREPARATIONS; HERB TEAS FOR MEDICINAL PURPOSES; HERBAL TEAS FOR MEDICINAL PURPOSES; LAXATIVES; MEDICINAL PREPARATIONS FOR THE MOUTH TO BE APPLIED IN THE FORM OF DROPS, CAPSULES, TABLETS AND COMPRESSED TABLETS; ORAL ANALGESICS; PAIN RELIEF MEDICATION; PHARMACEUTICAL ANTITUSSIVE-COLD PREPARATIONS; PHARMACEUTICAL PREPARATIONS FOR THE TREATMENT OF DIGESTIVE CONDITIONS; PREPARATIONS FOR TREATING COLDS; THROAT LOZENGES, IN CLASS 5 (U.S. CLS. 6, 18, 44, 46, 51 AND 52).

FIRST USE 9-0-2006; IN COMMERCE 9-0-2006.

THE MARK CONSISTS OF STANDARD CHARACTERS WITHOUT CLAIM TO ANY PARTICULAR FONT, STYLE, SIZE, OR COLOR.

OWNER OF U.S. REG. NO. 2,090,512.

NO CLAIM IS MADE TO THE EXCLUSIVE RIGHT TO USE "ORGANIC MEDICINE", APART FROM THE MARK AS SHOWN.

SEC. 2(F) AS TO "FIRST IN".

SN 78-921,680, FILED 7-2-2006.

ROBIN CHOSID, EXAMINING ATTORNEY

Int. Cls.: 9, 16, and 36

**Prior U.S. Cls.: 2, 5, 21, 22, 23, 26, 29, 36, 37, 38, 50,
100, 101, and 102**

Reg. No. 3,482,432

United States Patent and Trademark Office

Registered Aug. 5, 2008

**TRADEMARK
SERVICE MARK
PRINCIPAL REGISTER**

**RUSSELL PENSION FUNDING
REPORT CARD**

FRANK RUSSELL COMPANY (WASHINGTON CORPORATION)
909 A STREET
TACOMA, WA 98402

FOR: DOWNLOADABLE ELECTRONIC PUBLICATIONS, NAMELY, FINANCIAL REPORTS, FINANCIAL BOOKLETS, FINANCIAL NEWSLETTERS, AND FINANCIAL BROCHURES, ALL IN THE RETIREMENT PLAN AND NON-QUALIFIED PLAN FIELDS; COMPUTER PROGRAMS FOR FINANCIAL ANALYSIS AND MEASUREMENT, GRAPHICAL PRESENTATION, OPERATIONS RESEARCH, DATA STORAGE AND RETRIEVAL AND COMMUNICATIONS, ALL IN THE RETIREMENT PLAN AND NON-QUALIFIED PLAN FIELDS; ELECTRONIC, MAGNETIC, OPTICAL AND OTHER MACHINE-READABLE MEDIA, NAMELY, COMPACT DISKS AND MAGNETIC DISKS CONTAINING FINANCIAL INFORMATION FOR USE IN THE RETIREMENT PLAN AND NON-QUALIFIED PLAN FIELDS; AUDIO VISUAL RECORDINGS FEATURING FINANCIAL INFORMATION IN THE RETIREMENT PLAN AND NON-QUALIFIED PLAN FIELDS, IN CLASS 9 (U.S. CLS. 21, 23, 26, 36 AND 38).

FIRST USE 7-0-2006; IN COMMERCE 7-0-2006.

FOR: FINANCIAL PUBLICATIONS, NAMELY, FINANCIAL REPORTS, FINANCIAL BOOKLETS, FINANCIAL NEWSLETTERS, AND FINANCIAL BROCHURES, ALL IN THE RETIREMENT PLAN AND NON-QUALIFIED PLAN FIELDS, IN CLASS 16 (U.S. CLS. 2, 5, 22, 23, 29, 37, 38 AND 50).

FIRST USE 7-0-2006; IN COMMERCE 7-0-2006.

FOR: FINANCIAL CONSULTING SERVICES; INVESTMENT PORTFOLIO MANAGER EVALUATION SERVICES; INVESTMENT PORTFOLIO MONITORING SERVICES; INVESTMENT PORTFOLIO PERFORMANCE ANALYSIS SERVICES; SECURITIES, COMMODITIES AND REAL ESTATE INVESTMENT RESEARCH SERVICES; TRUST AND INVESTMENT MANAGEMENT SERVICES; PROVIDING FINANCIAL INFORMATION BY ELECTRONIC MEANS; AND PROVIDING ON-LINE FINANCIAL CALCULATORS, IN CLASS 36 (U.S. CLS. 100, 101 AND 102).

FIRST USE 7-0-2006; IN COMMERCE 7-0-2006.

THE MARK CONSISTS OF STANDARD CHARACTERS WITHOUT CLAIM TO ANY PARTICULAR FONT, STYLE, SIZE, OR COLOR.

OWNER OF U.S. REG. NOS. 1,576,348, 2,533,922, AND OTHERS.

NO CLAIM IS MADE TO THE EXCLUSIVE RIGHT TO USE "PENSION FUNDING", APART FROM THE MARK AS SHOWN.

SN 78-921,923, FILED 7-3-2006.

DOMINIC FATHY, EXAMINING ATTORNEY

Int. Cl.: 36

Prior U.S. Cls.: 100, 101, and 102

United States Patent and Trademark Office

Reg. No. 3,482,433

Registered Aug. 5, 2008

**SERVICE MARK
PRINCIPAL REGISTER**

OWN YOUR OWN

AUTOMATED INSTALLMENT SYSTEMS, INC.
(MISSOURI CORPORATION)
955 EXECUTIVE PARKWAY SUITE 201
ST. LOUIS, MO 63141

FOR: INSURANCE PREMIUM FINANCING SERVICES FOR USE BY OTHERS BY MEANS OF THE INTERNET, IN CLASS 36 (U.S. CLS. 100, 101 AND 102).

FIRST USE 10-0-2005; IN COMMERCE 10-0-2005.

THE MARK CONSISTS OF STANDARD CHARACTERS WITHOUT CLAIM TO ANY PARTICULAR FONT, STYLE, SIZE, OR COLOR.

SN 78-922,955, FILED 7-5-2006.

CAROLYN CATALDO, EXAMINING ATTORNEY

Int. Cl.: 5

Prior U.S. Cls.: 6, 18, 44, 46, 51, and 52

Reg. No. 3,482,434

United States Patent and Trademark Office

Registered Aug. 5, 2008

**TRADEMARK
PRINCIPAL REGISTER**



LEE, YOUNG MIN (UNITED STATES INDIVIDUAL)
15 WINDWARD WAY
BUENA PARK, CA 90621

FIRST USE 2-5-2008; IN COMMERCE 2-5-2008.

SN 78-925,010, FILED 7-7-2006.

FOR: HERBAL DIETARY SUPPLEMENT TO ENHANCE SEXUAL PERFORMANCE, IN CLASS 5 (U.S. CLS. 6, 18, 44, 46, 51 AND 52).

STEVEN R. FOSTER, EXAMINING ATTORNEY

Int. Cl.: 25

Prior U.S. Cls.: 22 and 39

United States Patent and Trademark Office

Reg. No. 3,482,435

Registered Aug. 5, 2008

**TRADEMARK
PRINCIPAL REGISTER**

IS EYEWEAR

TRUSTUS INTERNATIONAL TRADING INC.
(CANADA CORPORATION)
1131 WILLIAM STREET
VANCOUVER, BRITISH COLUMBIA, CANADA V6A
2J1

FOR: CLOTHING, NAMELY, T-SHIRTS, SWEAT-
SHIRTS, CREW NECK SWEATSHIRTS, HOODED
SWEATSHIRTS, ZIPPERED FRONT SWEATSHIRTS,
HATS, BEANIES AND CLOTHING BELTS , IN
CLASS 25 (U.S. CLS. 22 AND 39).

FIRST USE 1-0-2008; IN COMMERCE 1-0-2008.

THE MARK CONSISTS OF STANDARD CHAR-
ACTERS WITHOUT CLAIM TO ANY PARTICULAR
FONT, STYLE, SIZE, OR COLOR.

SN 78-925,558, FILED 7-10-2006.

JENNY PARK, EXAMINING ATTORNEY

Int. Cl.: 44

Prior U.S. Cls.: 100 and 101

United States Patent and Trademark Office

Reg. No. 3,482,436

Registered Aug. 5, 2008

**SERVICE MARK
PRINCIPAL REGISTER**

**BRAIN BUILDING AND MIND
RECONSTRUCTION**

MISTER TWISTER IP, LLC (CALIFORNIA LIMITED LIABILITY CORPORATION)
49 WELLESLEY STREET
IRVINE, CA 92612

FOR: REHABILITATION OF ALCOHOL, DRUG AND NARCOTIC ADDICTED PATIENTS, IN CLASS 44 (U.S. CLS. 100 AND 101).

FIRST USE 8-31-2007; IN COMMERCE 8-31-2007.

THE MARK CONSISTS OF STANDARD CHARACTERS WITHOUT CLAIM TO ANY PARTICULAR FONT, STYLE, SIZE, OR COLOR.

SN 78-926,518, FILED 7-11-2006.

ALICE SUE CARRUTHERS, EXAMINING ATTORNEY

Int. Cls.: 37, 39, and 40

Prior U.S. Cls.: 100, 103, 105, and 106

United States Patent and Trademark Office

Reg. No. 3,482,437

Registered Aug. 5, 2008

**SERVICE MARK
PRINCIPAL REGISTER**

THE EVOLUTION OF ENERGY

DYNAMOTIVE ENERGY SYSTEMS CORPORATION (CANADA CORPORATION)
105 - 1700 WEST 75TH AVENUE
VANCOUVER, B.C., CANADA V6P 6G2

FOR: CONSTRUCTION OF INDUSTRIAL PLANTS USED TO CONVERT FOREST AND AGRICULTURAL WASTE PRODUCTS INTO FUEL TO BE USED FOR HEAT AND POWER GENERATION AND OTHER DERIVATIVE PRODUCTS, IN CLASS 37 (U.S. CLS. 100, 103 AND 106).

FIRST USE 11-30-2006; IN COMMERCE 11-30-2006.

FOR: DISTRIBUTION OF FUEL PRODUCED FROM FOREST AND AGRICULTURAL WASTE PRODUCTS FOR USE IN HEAT AND POWER GENERATION AND OTHER DERIVATIVE PRODUCTS, NAMELY, FUEL PRODUCED FROM FOREST AND AGRICULTURAL WASTE PRODUCTS FOR USE IN HEAT AND POWER GENERATION AND OTHER DERIVATIVE PRODUCTS DISTRIBUTION, TRANSPORTATION, AND STORAGE OF FUEL PRODUCED FROM FOREST AND AGRICULTURAL WASTE PRODUCTS FOR USE IN HEAT AND POWER GENERATION AND OTHER DERIVATIVE PRODUCTS, IN CLASS 39 (U.S. CLS. 100 AND 105).

FIRST USE 11-30-2006; IN COMMERCE 11-30-2006.

FOR: PRODUCTION OF ENERGY, NAMELY, PRODUCTION OF FUEL PRODUCED FROM FOREST AND AGRICULTURAL WASTE PRODUCTS FOR USE IN HEAT AND POWER GENERATION AND OTHER DERIVATIVE PRODUCTS, IN CLASS 40 (U.S. CLS. 100, 103 AND 106).

FIRST USE 11-30-2006; IN COMMERCE 11-30-2006.

THE MARK CONSISTS OF STANDARD CHARACTERS WITHOUT CLAIM TO ANY PARTICULAR FONT, STYLE, SIZE, OR COLOR.

PRIORITY CLAIMED UNDER SEC. 44(D) ON CANADA APPLICATION NO. 1306170, FILED 6-2-2006, REG. NO. TMA692258, DATED 7-18-2007, EXPIRES 7-18-2022.

NO CLAIM IS MADE TO THE EXCLUSIVE RIGHT TO USE "ENERGY", APART FROM THE MARK AS SHOWN.

SN 78-926,777, FILED 7-11-2006.

TINA BROWN, EXAMINING ATTORNEY

Int. Cl.: 32

Prior U.S. Cls.: 45, 46, and 48

Reg. No. 3,482,438

United States Patent and Trademark Office

Registered Aug. 5, 2008

**TRADEMARK
PRINCIPAL REGISTER**

embodi

VITALITA NUTRITIONAL PRODUCTS, LLC (IL-
LINOIS LTD LIAB CO)
SUITE 20
1213 NORTH RACINE AVE
CHICAGO, IL 60607

HIGH IN ANTIOXIDANTS; FRUIT JUICES , IN
CLASS 32 (U.S. CLS. 45, 46 AND 48).

FIRST USE 5-6-2008; IN COMMERCE 5-6-2008.

FOR: NON ALCOHOLIC FUNCTIONAL BEVERA-
GES IN THE NATURE OF A FRUIT DRINKS
CONTAINING BOTANICAL EXTRACTS AND

SN 78-927,684, FILED 7-12-2006.

PRISCILLA MILTON, EXAMINING ATTORNEY

Int. Cl.: 28

Prior U.S. Cls.: 22, 23, 38, and 50

Reg. No. 3,482,439

United States Patent and Trademark Office

Registered Aug. 5, 2008

**TRADEMARK
PRINCIPAL REGISTER**

FACEOFF

MACGREGOR GOLF NORTH AMERICA, INC.
(GEORGIA CORPORATION)
1000 PECAN GROVE DRIVE
ALBANY, GA 31701

THE MARK CONSISTS OF STANDARD CHAR-
ACTERS WITHOUT CLAIM TO ANY PARTICULAR
FONT, STYLE, SIZE, OR COLOR.

FOR: GOLF CLUBS; GOLF PUTTERS, IN CLASS
28 (U.S. CLS. 22, 23, 38 AND 50).

SN 78-928,024, FILED 7-12-2006.

FIRST USE 10-1-2006; IN COMMERCE 10-1-2006.

BILL DAWE, EXAMINING ATTORNEY

Int. Cl.: 33

Prior U.S. Cls.: 47 and 49

United States Patent and Trademark Office

Reg. No. 3,482,440

Registered Aug. 5, 2008

**TRADEMARK
PRINCIPAL REGISTER**

JACKARITA

JACK DANIEL'S PROPERTIES, INC. (DELA-
WARE CORPORATION)
4040 CIVIC CENTER DRIVE
SUITE 528
SAN RAFAEL, CA 94903

FOR: ALCOHOLIC BEVERAGES, NAMELY, DIS-
TILLED SPIRITS, IN CLASS 33 (U.S. CLS. 47 AND 49).

FIRST USE 12-20-2000; IN COMMERCE 12-20-2000.

THE MARK CONSISTS OF STANDARD CHAR-
ACTERS WITHOUT CLAIM TO ANY PARTICULAR
FONT, STYLE, SIZE, OR COLOR.

OWNER OF U.S. REG. NOS. 1,758,658, 2,815,221,
AND OTHERS.

THE WORDING "JACKARITA" HAS NO MEAN-
ING OTHER THAN TRADEMARK SIGNIFICANCE.

SN 78-929,051, FILED 7-13-2006.

MICHAEL GAAFAR, EXAMINING ATTORNEY

Int. Cl.: 9

Prior U.S. Cls.: 21, 23, 26, 36, and 38

Reg. No. 3,482,441

United States Patent and Trademark Office

Registered Aug. 5, 2008

**TRADEMARK
PRINCIPAL REGISTER**

YOUNG HOT ROD

TOOLE, RODNEY MAURICE (UNITED STATES
INDIVIDUAL)
C/O SEDLMAYR & ASSOC. P.C.
200 PARK AVENUE SOUTH-SUITE 1408
NEW YORK, NY 10003

FOR: MUSICAL SOUND RECORDINGS; AUDIO-
VISUAL RECORDINGS, NAMELY, COMPACT
DISCS, AUDIO DISCS, RECORDS, VIDEO DISCS,
PHONOGRAPHIC RECORDS, DVDS, MP3S, ALL
FEATURING MUSIC; DOWNLOADABLE MUSICAL
SOUND RECORDINGS; DOWNLOADABLE VIDEO

RECORDINGS FEATURING MUSIC, IN CLASS 9
(U.S. CLS. 21, 23, 26, 36 AND 38).

FIRST USE 7-0-2006; IN COMMERCE 10-0-2006.

THE MARK CONSISTS OF STANDARD CHAR-
ACTERS WITHOUT CLAIM TO ANY PARTICULAR
FONT, STYLE, SIZE, OR COLOR.

SN 78-929,154, FILED 7-13-2006.

DEZMONA MIZELLE, EXAMINING ATTORNEY

Int. Cl.: 21

Prior U.S. Cls.: 2, 13, 23, 29, 30, 33, 40, and 50

United States Patent and Trademark Office

Reg. No. 3,482,442

Registered Aug. 5, 2008

TRADEMARK
PRINCIPAL REGISTER



EXPRESSLY YOURS, INC. (COLORADO CORPORATION)

SUITE B

14697 E. EASTER AVENUE

CENTENNIAL, CO 80112

FOR: HAND-PAINTED POTTERY DINNERWARE, IN CLASS 21 (U.S. CLS. 2, 13, 23, 29, 30, 33, 40 AND 50).

FIRST USE 6-0-1991; IN COMMERCE 1-0-1995.

THE COLOR(S) RED AND BLACK IS/ARE CLAIMED AS A FEATURE OF THE MARK.

THE MARK CONSISTS OF A BLACK STYLIZED SCRIPT CAPITAL LETTER E HAVING A RED WINTER CAP ON THE "E", AND THE BLACK WORDING "EXPRESSLY YOURS" NEXT TO IT.

SN 78-929,240, FILED 7-13-2006.

LYDIA BELZER, EXAMINING ATTORNEY

Int. Cl.: 21

Prior U.S. Cls.: 2, 13, 23, 29, 30, 33, 40, and 50

United States Patent and Trademark Office

Reg. No. 3,482,443

Registered Aug. 5, 2008

**TRADEMARK
PRINCIPAL REGISTER**

SNOWARE

EXPRESSLY YOURS, INC. (COLORADO COR-
PORATION)
SUITE B
14697 E. EASTER AVENUE
CENTENNIAL, CO 80112

THE MARK CONSISTS OF STANDARD CHAR-
ACTERS WITHOUT CLAIM TO ANY PARTICULAR
FONT, STYLE, SIZE, OR COLOR.

FOR: HAND PAINTED POTTERY DINNER-
WARE, IN CLASS 21 (U.S. CLS. 2, 13, 23, 29, 30, 33,
40 AND 50).

SN 78-929,248, FILED 7-13-2006.

FIRST USE 1-0-1995; IN COMMERCE 1-0-1995.

LYDIA BELZER, EXAMINING ATTORNEY

Int. Cls.: 19 and 27

Prior U.S. Cls.: 1, 12, 19, 20, 33, 37, 42, and 50

United States Patent and Trademark Office

Reg. No. 3,482,444

Registered Aug. 5, 2008

**TRADEMARK
PRINCIPAL REGISTER**

ANGELA ADAMS

ARGYLE HOLDINGS, LLC (MAINE LTD LIAB
CO)
2 ATLANTIC STREET
PORTLAND, ME 04101

FOR: FLOOR COVERINGS, NAMELY, CON-
CRETE TILES, CERAMIC TILES, AND NON-METAL
TILES, IN CLASS 19 (U.S. CLS. 1, 12, 33 AND 50).

FIRST USE 9-0-2005; IN COMMERCE 9-0-2005.

FOR: FLOOR COVERINGS, NAMELY, CARPET
TILES AND CARPETS, IN CLASS 27 (U.S. CLS. 19, 20,
37, 42 AND 50).

FIRST USE 12-0-2006; IN COMMERCE 12-0-2006.

THE MARK CONSISTS OF STANDARD CHAR-
ACTERS WITHOUT CLAIM TO ANY PARTICULAR
FONT, STYLE, SIZE, OR COLOR.

OWNER OF U.S. REG. NOS. 3,058,433 AND
3,142,756.

THE NAME(S), PORTRAIT(S), AND/OR SIGNA-
TURE(S) SHOWN IN THE MARK IDENTIFIES
"ANGELA ADAMS", WHOSE CONSENT(S) TO REG-
ISTER IS SUBMITTED.

SN 78-929,859, FILED 7-14-2006.

BARBARA RUTLAND, EXAMINING ATTORNEY

Int. Cl.: 16

Prior U.S. Cls.: 2, 5, 22, 23, 29, 37, 38, and 50

United States Patent and Trademark Office

Reg. No. 3,482,445

Registered Aug. 5, 2008

**TRADEMARK
PRINCIPAL REGISTER**



GARZA, RAYNALDO (UNITED STATES INDIVIDUAL)
14 MONARCH BAY PLAZA, SUITE 475
MONARCH BEACH, CA 92629

FOR: PAPER AND CARDBOARD CONTAINERS, NAMELY, SANDWICH BAGS AND BOXES FOR FOOD, IN CLASS 16 (U.S. CLS. 2, 5, 22, 23, 29, 37, 38 AND 50).

FIRST USE 5-18-2001; IN COMMERCE 7-1-2007.

NO CLAIM IS MADE TO THE EXCLUSIVE RIGHT TO USE "KIDS MEAL", APART FROM THE MARK AS SHOWN.

THE COLOR(S) YELLOW AND RED IS/ARE CLAIMED AS A FEATURE OF THE MARK.

THE MARK CONSISTS OF THE WORDING "KIDZMEAL" IN WHICH THE LETTERS ARE RED, EACH OUTLINED IN YELLOW, AND TWO STARS, THE FIRST WHICH FORMS PART OF THE LETTER "A" IN YELLOW, AND THE SECOND IN RED WITH YELLOW OUTLINE OVER THE LETTER "I".

SN 78-930,273, FILED 7-14-2006.

HANNO RITTNER, EXAMINING ATTORNEY

Int. Cl.: 9

Prior U.S. Cls.: 21, 23, 26, 36, and 38

United States Patent and Trademark Office

Reg. No. 3,482,446

Registered Aug. 5, 2008

**TRADEMARK
PRINCIPAL REGISTER**

SHADOW PRO

RECOGNITION INSIGHT, LLC (FLORIDA LTD
LIAB CO)
6811 MOSSY GLENN DRIVE
FORT MYERS, FL 33908

FOR: COMPUTER SOFTWARE IN THE FIELD OF
SPORTS INSTRUCTION, NAMELY, SOFTWARE
FOR TRANSMITTING, RECORDING, STORING
AND PROVIDING AUDIO FEEDBACK AND VIDEO
DISPLAY OF INFORMATION RELATED TO THE
SWINGING OF AN APPARATUS IN VARIOUS
SPORTS, IN CLASS 9 (U.S. CLS. 21, 23, 26, 36 AND 38).

FIRST USE 8-15-2006; IN COMMERCE 10-1-2006.

THE MARK CONSISTS OF STANDARD CHAR-
ACTERS WITHOUT CLAIM TO ANY PARTICULAR
FONT, STYLE, SIZE, OR COLOR.

NO CLAIM IS MADE TO THE EXCLUSIVE
RIGHT TO USE "PRO", APART FROM THE MARK
AS SHOWN.

SN 78-930,547, FILED 7-17-2006.

CHERYL CLAYTON, EXAMINING ATTORNEY

Int. Cl.: 11

Prior U.S. Cls.: 13, 21, 23, 31, and 34

Reg. No. 3,482,447

United States Patent and Trademark Office

Registered Aug. 5, 2008

**TRADEMARK
PRINCIPAL REGISTER**

HICYCLER

CHEMICO INTERNATIONAL, INC. (TEXAS
CORPORATION)
4801 BALDWIN DRIVE
CORPUS CHRISTI, TX 78408

THE MARK CONSISTS OF STANDARD CHAR-
ACTERS WITHOUT CLAIM TO ANY PARTICULAR
FONT, STYLE, SIZE, OR COLOR.

FOR: WATER TREATMENT EQUIPMENT,
NAMELY, SIDESTREAM SOFTENING EQUIP-
MENT, COMPRISED OF MANIFOLDS, FLUID LE-
VEL CONTROLLERS, PUMPS AND VALVES, IN
CLASS 11 (U.S. CLS. 13, 21, 23, 31 AND 34).

OWNER OF U.S. REG. NO. 3,160,434.

SN 78-931,148, FILED 7-17-2006.

FIRST USE 6-10-2005; IN COMMERCE 6-10-2005.

JAY FLOWERS, EXAMINING ATTORNEY

Int. Cls.: 29 and 30

Prior U.S. Cl.: 46

United States Patent and Trademark Office

Reg. No. 3,482,448

Registered Aug. 5, 2008

**TRADEMARK
PRINCIPAL REGISTER**

THE MELTING POT

THE MELTING POT RESTAURANTS, INC.
(FLORIDA CORPORATION)
8810 TWIN LAKES BOULEVARD
TAMPA, FL 33614

THE MARK CONSISTS OF STANDARD CHAR-
ACTERS WITHOUT CLAIM TO ANY PARTICULAR
FONT, STYLE, SIZE, OR COLOR.

FOR: CHEESE; CHEESE FONDUE, IN CLASS 29
(U.S. CL. 46).

OWNER OF U.S. REG. NOS. 2,218,991, 2,270,457,
AND OTHERS.

FIRST USE 1-1-2008; IN COMMERCE 1-1-2008.

FOR: SAUCES; CHOCOLATE; CHOCOLATE FON-
DUE, IN CLASS 30 (U.S. CL. 46).

SN 78-931,174, FILED 7-17-2006.

FIRST USE 1-1-2008; IN COMMERCE 1-1-2008.

TIMOTHY FINNEGAN, EXAMINING ATTORNEY

Int. Cl.: 21

Prior U.S. Cls.: 2, 13, 23, 29, 30, 33, 40, and 50

United States Patent and Trademark Office

Reg. No. 3,482,449

Registered Aug. 5, 2008

**TRADEMARK
PRINCIPAL REGISTER**

WOW WHAT A CLOTH!

STARMAX RESOURCE LLC (DELAWARE LTD
LIAB CO)
SUITE 3
18901 EUCLID AVENUE
CLEVELAND, OH 44117

FOR: CLEANING CLOTHS, IN CLASS 21 (U.S.
CLS. 2, 13, 23, 29, 30, 33, 40 AND 50).

FIRST USE 2-25-2008; IN COMMERCE 2-25-2008.

THE MARK CONSISTS OF STANDARD CHAR-
ACTERS WITHOUT CLAIM TO ANY PARTICULAR
FONT, STYLE, SIZE, OR COLOR.

NO CLAIM IS MADE TO THE EXCLUSIVE
RIGHT TO USE "CLOTH", APART FROM THE
MARK AS SHOWN.

SN 78-931,474, FILED 7-18-2006.

ASMAT KHAN, EXAMINING ATTORNEY

Int. Cl.: 21

Prior U.S. Cls.: 2, 13, 23, 29, 30, 33, 40, and 50

United States Patent and Trademark Office

Reg. No. 3,482,450

Registered Aug. 5, 2008

**TRADEMARK
PRINCIPAL REGISTER**

ARMOR ALL

THE ARMOR ALL/STP PRODUCTS COMPANY
(DELAWARE CORPORATION)
1221 BROADWAY
OAKLAND, CA 94612

FOR: WIPING CLOTHS, NAMELY, CHAMOIS;
CLEANING, POLISHING, AND WASHING CLOTHS;
WINDOW CLEANER SQUEEGEE; SCRUBBING
AND WASHING BRUSHES , IN CLASS 21 (U.S.
CLS. 2, 13, 23, 29, 30, 33, 40 AND 50).

FIRST USE 1-30-2008; IN COMMERCE 1-30-2008.

THE MARK CONSISTS OF STANDARD CHAR-
ACTERS WITHOUT CLAIM TO ANY PARTICULAR
FONT, STYLE, SIZE, OR COLOR.

OWNER OF U.S. REG. NOS. 986,280, 2,004,078,
AND OTHERS.

SN 78-931,812, FILED 7-18-2006.

JILL PRATER, EXAMINING ATTORNEY

Int. Cl.: 3

Prior U.S. Cls.: 1, 4, 6, 50, 51, and 52

Reg. No. 3,482,451

United States Patent and Trademark Office

Registered Aug. 5, 2008

**TRADEMARK
PRINCIPAL REGISTER**

CONFIDERM

NOVOCOL, INC. (DELAWARE CORPORATION)
245-C QUIGLEY BOULEVARD
NEW CASTLE, DE 19720

THE MARK CONSISTS OF STANDARD CHARACTERS WITHOUT CLAIM TO ANY PARTICULAR FONT, STYLE, SIZE, OR COLOR.

FOR: HAND CREAM, IN CLASS 3 (U.S. CLS. 1, 4, 6, 50, 51 AND 52).

SN 78-932,549, FILED 7-19-2006.

FIRST USE 5-9-2008; IN COMMERCE 5-9-2008.

WILLIAM P. SHANAHAN, EXAMINING ATTORNEY

Int. Cl.: 39

Prior U.S. Cls.: 100 and 105

United States Patent and Trademark Office

Reg. No. 3,482,452

Registered Aug. 5, 2008

**SERVICE MARK
PRINCIPAL REGISTER**

BDS

BENCHMARK PERFORMANCE GROUP, INC.
(TEXAS CORPORATION)
2801 POST OAK, SUITE 400
HOUSTON, TX 77056

FOR: SUPPLY CHAIN, LOGISTICS AND REVERSE LOGISTICS SERVICES, NAMELY, STORAGE, TRANSPORTATION AND DELIVERY OF RAW MATERIALS, FINISHED GOODS, AND OTHER FREIGHT IN THE FIELD OF INDUSTRIAL AND OIL FIELD CHEMICALS AND INDUSTRIAL AND OIL FIELD EQUIPMENT BY BULK-LIQUID TANKERS, INDUSTRY STANDARD TRANSPORT CONTAINERS, BULK LIQUID CONTAINERS, DRY BULK CONTAINERS, CURTAIN-SIDE TRAILERS, DRY VANS, AND FLATBED TRAILERS; WAREHOUSING SERVICES IN THE FIELD OF INDUSTRIAL AND OIL FIELD CHEMICALS AND INDUSTRIAL AND OIL FIELD EQUIPMENT; TRANSPORTATION SERVICES, NAMELY, TRANSPORT OF GOODS BY LAND IN THE FIELD OF INDUSTRIAL AND OIL FIELD CHEMICALS AND

INDUSTRIAL AND OIL FIELD EQUIPMENT; DISTRIBUTION SERVICES, NAMELY, DELIVERY OF RAW MATERIALS, FINISHED GOODS AND OTHER FREIGHT IN THE FIELD OF INDUSTRIAL AND OIL FIELD CHEMICALS AND INDUSTRIAL AND OIL FIELD EQUIPMENT BY BULK-LIQUID TANKERS, INDUSTRY STANDARD TRANSPORT CONTAINERS, BULK LIQUID CONTAINERS, DRY BULK CONTAINERS, CURTAIN-SIDE TRAILERS, DRY VANS, AND FLATBED TRAILERS, IN CLASS 39 (U.S. CLS. 100 AND 105).

FIRST USE 7-1-2006; IN COMMERCE 7-1-2006.

THE MARK CONSISTS OF STANDARD CHARACTERS WITHOUT CLAIM TO ANY PARTICULAR FONT, STYLE, SIZE, OR COLOR.

SN 78-932,775, FILED 7-19-2006.

JAY BESCH, EXAMINING ATTORNEY

Int. Cl.: 30

Prior U.S. Cl.: 46

United States Patent and Trademark Office

Reg. No. 3,482,453

Registered Aug. 5, 2008

**TRADEMARK
PRINCIPAL REGISTER**

BAKE IT HAPPEN

VITALICIOUS, INC. (NEW YORK CORPORATION)
11 BROADWAY, SUITE 1155
NEW YORK, NY 10004

FOR: CAKE BATTER AND MUFFIN BATTER;
PREPARED FOOD MIXES, NAMELY, BREAD
MIXES AND MIXES WITH BREAD AS A SUBSTANTIAL
INGREDIENT, NAMELY, HOT BREAD
MIXES, STUFFING MIXES CONTAINING BREAD;
MUFFIN MIXES, PANCAKE MIXES, DOUGHNUT
MIXES, CAKE MIXES, FROSTING MIXES, PASTRY
MIXES, FLOUR-BASED BAKING MIXES FOR
MAKING BAKERY GOODS AND BREAD CRUMBS;

BROWNIES, CAKES, MUFFINS, MUFFIN TOPS,
PROCESSED CEREALS, COOKIES, IN CLASS 30
(U.S. CL. 46).

FIRST USE 6-16-2008; IN COMMERCE 6-16-2008.

THE MARK CONSISTS OF STANDARD CHARACTERS
WITHOUT CLAIM TO ANY PARTICULAR
FONT, STYLE, SIZE, OR COLOR.

SN 78-933,081, FILED 7-19-2006.

LOURDES AYALA, EXAMINING ATTORNEY

Int. Cl.: 39

Prior U.S. Cls.: 100 and 105

United States Patent and Trademark Office

Reg. No. 3,482,454

Registered Aug. 5, 2008

**SERVICE MARK
PRINCIPAL REGISTER**



BENCHMARK PERFORMANCE GROUP, INC.
(TEXAS CORPORATION)
2801 POST OAK, SUITE 400
HOUSTON, TX 77056

FOR: SUPPLY CHAIN, LOGISTICS AND REVERSE LOGISTICS SERVICES, NAMELY, STORAGE, TRANSPORTATION AND DELIVERY OF RAW MATERIALS, FINISHED GOODS, AND OTHER FREIGHT IN THE FIELD OF INDUSTRIAL AND OILFIELD CHEMICALS AND INDUSTRIAL AND OILFIELD EQUIPMENT BY BULK-LIQUID TANKERS, INDUSTRY STANDARD TRANSPORT CONTAINERS, BULK LIQUID CONTAINERS, DRY BULK CONTAINERS, CURTAIN-SIDE TRAILERS, DRY VANS, AND FLATBED TRAILERS; WAREHOUSING SERVICES IN THE FIELD OF INDUSTRIAL AND OILFIELD CHEMICALS AND INDUSTRIAL AND OILFIELD EQUIPMENT; TRANSPORTATION SERVICES, NAMELY, TRANSPORT OF GOODS BY LAND IN THE FIELD OF INDUSTRIAL AND OILFIELD CHEMICALS AND INDUSTRIAL AND OILFIELD EQUIPMENT; DISTRIBUTION SERVICES, NAMELY, DELIVERY OF

RAW MATERIALS, FINISHED GOODS AND OTHER FREIGHT IN THE FIELD OF INDUSTRIAL AND OILFIELD CHEMICALS AND INDUSTRIAL AND OILFIELD EQUIPMENT BY BULK-LIQUID TANKERS, INDUSTRY STANDARD TRANSPORT CONTAINERS, BULK LIQUID CONTAINERS, DRY BULK CONTAINERS, CURTAIN-SIDE TRAILERS, DRY VANS, AND FLATBED TRAILERS, IN CLASS 39 (U.S. CLS. 100 AND 105).

FIRST USE 7-1-2006; IN COMMERCE 7-1-2006.

OWNER OF U.S. REG. NO. 3,062,236.

"THE MARK CONSISTS OF THE STYLIZED WORDING BDS, HAVING A BANNER FORMED BY TWO WAVY LINES TO THE LEFT OF THE WORDING."

SN 78-933,437, FILED 7-20-2006.

JAY BESCH, EXAMINING ATTORNEY

Int. Cl.: 43

Prior U.S. Cls.: 100 and 101

United States Patent and Trademark Office

Reg. No. 3,482,455

Registered Aug. 5, 2008

SERVICE MARK
PRINCIPAL REGISTER



SODEXHO ALLIANCE (FRANCE CORPORATION)
3 AVENUE NEWTON
78180 MONTIGNY-LE-BRETONNEUX, FRANCE

FOR: SERVICES FOR PROVIDING DRINK, IN CLASS 43 (U.S. CLS. 100 AND 101).

FIRST USE 9-0-2006; IN COMMERCE 9-0-2006.

THE COLOR(S) DARK GREEN, MID GREEN, LIGHT GREEN AND WHITE IS/ARE CLAIMED AS A FEATURE OF THE MARK.

THE MARK CONSISTS OF THE WORD "ASPRETO" IN WHITE LOWER CASE LETTERS, ABOVE

THE WORDS "GOING FORWARD BY GIVING BACK" IN WHITE LOWER CASE LETTERS, AND A SHORT WHITE HORIZONTAL LINE BENEATH THOSE WORDS, ALL SHOWN BENEATH A WHITE QUADRILATERAL SHAPE WHOSE TOP IS WIDER THAN ITS BOTTOM AND WHICH IS SURROUNDED BY A LIGHT GREEN LINE HAVING THE SAME OVERALL SHAPE, WHICH IS IN TURN ENCLOSED WITHIN A SIMILAR MID GREEN LINE FORMED IN TWO SEGMENTS WITH ARROWS ON THE END OF EACH SEGMENT, ALL OF WHICH IS SHOWN ON A DARK GREEN BACKGROUND.

SN 78-933,841, FILED 7-20-2006.

AMY ALFIERI, EXAMINING ATTORNEY

Int. Cl.: 43

Prior U.S. Cls.: 100 and 101

United States Patent and Trademark Office

Reg. No. 3,482,456

Registered Aug. 5, 2008

SERVICE MARK
PRINCIPAL REGISTER



aspreto

going forward by giving back



SODEXHO ALLIANCE (FRANCE CORPORATION)
3 AVENUE NEWTON
MONTIGNY-LE-BRETONNEUX, FRANCE 78180

FOR: SERVICES FOR PROVIDING DRINK, IN CLASS 43 (U.S. CLS. 100 AND 101).

FIRST USE 9-0-2006; IN COMMERCE 9-0-2006.

THE COLOR(S) DARK GREEN, MID GREEN AND LIGHT GREEN IS/ARE CLAIMED AS A FEATURE OF THE MARK.

THE MARK CONSISTS OF THE WORD "ASPRETO" IN DARK GREEN LOWER CASE LETTERS, ABOVE THE WORDS "GOING FORWARD BY GIVING BACK" IN DARK GREEN LOWER CASE LETTERS, AND A SHORT DARK GREEN HORI-

ZONTAL LINE BENEATH THOSE WORDS, ALL SHOWN BENEATH A DARK GREEN QUADRILATERAL SHAPE WHOSE TOP IS WIDER THAN ITS BOTTOM AND WHICH IS SURROUNDED BY A MID GREEN LINE HAVING THE SAME OVERALL SHAPE, WHICH IS IN TURN ENCLOSED WITHIN A SIMILAR LIGHT GREEN LINE FORMED IN TWO SEGMENTS WITH ARROWS ON THE END OF EACH SEGMENT, ALL SHOWN ON A WHITE BACKGROUND, WHICH BACKGROUND ALSO IS VISIBLE BETWEEN THE QUADRILATERAL SHAPE AND ITS SURROUNDING LINES. THE COLOR WHITE IS NOT CLAIMED AS PART OF THE MARK."

SN 78-933,878, FILED 7-20-2006.

AMY ALFIERI, EXAMINING ATTORNEY

Int. Cl.: 25

Prior U.S. Cls.: 22 and 39

United States Patent and Trademark Office

Reg. No. 3,482,457

Registered Aug. 5, 2008

**TRADEMARK
PRINCIPAL REGISTER**

LARKSPUR

LARKSPUR HOTELS, LLC (DELAWARE LTD
LIAB CO)
STE. 200
125 E. SIR FRANCIS DRAKE BLVD.
LARKSPUR, CA 94939

FOR: CLOTHING, NAMELY, BATHROBES,
JACKETS AND SHIRTS; HEADGEAR, NAMELY,
CAPS; FOOTWEAR, IN CLASS 25 (U.S. CLS. 22 AND
39).

FIRST USE 6-0-2004; IN COMMERCE 3-0-2006.

THE MARK CONSISTS OF STANDARD CHAR-
ACTERS WITHOUT CLAIM TO ANY PARTICULAR
FONT, STYLE, SIZE, OR COLOR.

OWNER OF U.S. REG. NOS. 3,054,357, 3,100,004,
AND 3,125,907.

SN 78-934,120, FILED 7-20-2006.

MARLENE BELL, EXAMINING ATTORNEY

Int. Cl.: 9

Prior U.S. Cls.: 21, 23, 26, 36, and 38

Reg. No. 3,482,458

United States Patent and Trademark Office

Registered Aug. 5, 2008

**TRADEMARK
PRINCIPAL REGISTER**

ViewConn

LIGHTEL TECHNOLOGIES, INC. (WASHINGTON CORPORATION)
1034 CENTRAL AVE. S.
KENT, WA 98032

FOR: FIBER OPTIC CONNECTOR INSPECTION EQUIPMENT, NAMELY, VIDEO MICROSCOPES USED TO INSPECT AND CLEAN CONNECTOR END-FACES, IN CLASS 9 (U.S. CLS. 21, 23, 26, 36 AND 38).

FIRST USE 12-20-2006; IN COMMERCE 2-2-2007.

THE MARK CONSISTS OF STANDARD CHARACTERS WITHOUT CLAIM TO ANY PARTICULAR FONT, STYLE, SIZE, OR COLOR.

SN 78-934,213, FILED 7-20-2006.

SETH A. RAPPAPORT, EXAMINING ATTORNEY

Int. Cl.: 30

Prior U.S. Cl.: 46

United States Patent and Trademark Office

Reg. No. 3,482,459

Registered Aug. 5, 2008

**TRADEMARK
PRINCIPAL REGISTER**

PATEL FOODS

PB BRANDS, LLC (NEW YORK LTD LIAB CO)
56-05 55TH DRIVE
MASPETH, NY 11378

FOR: FLOUR AND RICE, IN CLASS 30 (U.S. CL.
46).

FIRST USE 1-0-2007; IN COMMERCE 1-0-2007.

THE MARK CONSISTS OF STANDARD CHAR-
ACTERS WITHOUT CLAIM TO ANY PARTICULAR
FONT, STYLE, SIZE, OR COLOR.

OWNER OF U.S. REG. NOS. 1,647,559, 2,955,255,
AND OTHERS.

NO CLAIM IS MADE TO THE EXCLUSIVE
RIGHT TO USE "FOODS", APART FROM THE
MARK AS SHOWN.

SEC. 2(F) "PATEL".

SN 78-934,835, FILED 7-21-2006.

PRISCILLA MILTON, EXAMINING ATTORNEY

Int. Cl.: 10

Prior U.S. Cls.: 26, 39, and 44

United States Patent and Trademark Office

Reg. No. 3,482,460

Registered Aug. 5, 2008

**TRADEMARK
PRINCIPAL REGISTER**

HYDROSOFT

MICROVENTION, INC. (DELAWARE CORPORATION)
75 COLUMBIA, SUITE A
ALISO VIEJO, CA 92656

THE MARK CONSISTS OF STANDARD CHARACTERS WITHOUT CLAIM TO ANY PARTICULAR FONT, STYLE, SIZE, OR COLOR.

FOR: MEDICAL DEVICES, NAMELY, INTRAVASCULAR IMPLANTS COMPRISED OF ARTIFICIAL MATERIAL, IN CLASS 10 (U.S. CLS. 26, 39 AND 44).

SN 78-935,835, FILED 7-24-2006.

FIRST USE 6-30-2007; IN COMMERCE 6-30-2007.

AMY ALFIERI, EXAMINING ATTORNEY

Int. Cl.: 16

Prior U.S. Cls.: 2, 5, 22, 23, 29, 37, 38, and 50

Reg. No. 3,482,461

United States Patent and Trademark Office

Registered Aug. 5, 2008

**TRADEMARK
PRINCIPAL REGISTER**

TRUSTED CONNECTIONS

TIME INC. (DELAWARE CORPORATION)
1271 AVENUE OF THE AMERICAS
NEW YORK, NY 10020

FIRST USE 7-31-2007; IN COMMERCE 7-31-2007.

FOR: PRINTED PUBLICATIONS, NAMELY, MAGAZINES IN THE FIELD OF NEWS AND GENERAL INTEREST INFORMATION, STICKERS, PRINTED PROMOTIONAL MATERIALS, NAMELY, BROCHURES IN THE FIELD OF NEWS AND GENERAL INTEREST INFORMATION, IN CLASS 16 (U.S. CLS. 2, 5, 22, 23, 29, 37, 38 AND 50).

THE MARK CONSISTS OF STANDARD CHARACTERS WITHOUT CLAIM TO ANY PARTICULAR FONT, STYLE, SIZE, OR COLOR.

SN 78-936,002, FILED 7-24-2006.

DAWN FELDMAN, EXAMINING ATTORNEY

Int. Cl.: 12

Prior U.S. Cls.: 19, 21, 23, 31, 35, and 44

Reg. No. 3,482,462

United States Patent and Trademark Office

Registered Aug. 5, 2008

**TRADEMARK
PRINCIPAL REGISTER**

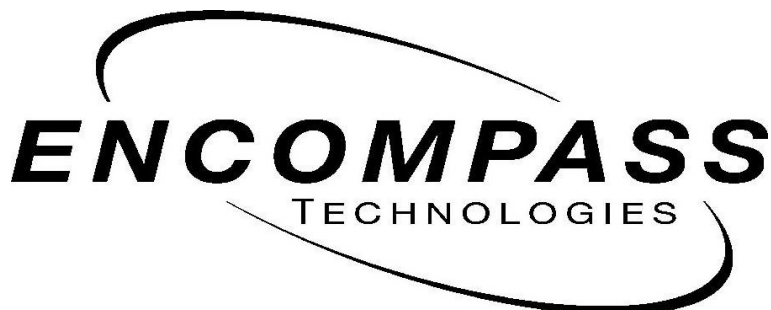

ATF, INC. (DELAWARE CORPORATION)
3550 WEST PRATT AVENUE
LINCOLNWOOD, IL 60712

NAMELY, STUD PLATES, HALO BRACKETS,
AND RETAINER BRACKETS, IN CLASS 12 (U.S.
CLS. 19, 21, 23, 31, 35 AND 44).

FOR: MULTIPLE COMPONENT ASSEMBLIES
FOR AUTOMOBILES CONSISTING OF VARIOUS
COMBINATIONS OF THE FOLLOWING COMPO-
NENT PARTS: METAL FASTENERS AND CLIPS,
PLASTIC FASTENERS AND CLIPS, HINGES, AIR-
BAG CHUTES, AIRBAG MOUNTING BRACKETS,
AIRBAG RETAINER BRACKETS, AND/OR DRUM
BRAKE ADJUSTERS; STAMPED METAL ASSEM-
BLIES AND COMPONENTS FOR VEHICLES,

FIRST USE 6-5-2008; IN COMMERCE 6-5-2008.

NO CLAIM IS MADE TO THE EXCLUSIVE
RIGHT TO USE "TECHNOLOGIES", APART FROM
THE MARK AS SHOWN.

SN 78-936,032, FILED 7-24-2006.

DAWN FELDMAN, EXAMINING ATTORNEY

Int. Cl.: 45

Prior U.S. Cls.: 100 and 101

United States Patent and Trademark Office

Reg. No. 3,482,463

Registered Aug. 5, 2008

**SERVICE MARK
PRINCIPAL REGISTER**

DOCUSURE

THE SERGIO CORPORATION (INDIANA COR-
PORATION)
1919 SOUTH MICHIGAN STREET
SOUTH BEND, IN 46613

FOR: COMPILING INVENTORIES OF PERSONAL
PROPERTY ITEMS FOR OTHERS FOR INSUR-
ANCE AND RISK MANAGEMENT PURPOSES, IN
CLASS 45 (U.S. CLS. 100 AND 101).

FIRST USE 5-30-2008; IN COMMERCE 5-30-2008.

THE MARK CONSISTS OF STANDARD CHAR-
ACTERS WITHOUT CLAIM TO ANY PARTICULAR
FONT, STYLE, SIZE, OR COLOR.

SN 78-936,050, FILED 7-24-2006.

LINDA ORNDORFF, EXAMINING ATTORNEY

Int. Cl.: 21

Prior U.S. Cls.: 2, 13, 23, 29, 30, 33, 40, and 50

United States Patent and Trademark Office

Reg. No. 3,482,464

Registered Aug. 5, 2008

**TRADEMARK
PRINCIPAL REGISTER**

LOEWYAL DOGTIN

JERICICH, TERESA (UNITED STATES INDIVIDUAL)

P.O. BOX 6195

GARDEN GROVE, CA 928466195

FOR: PET FEEDING DISHES, IN CLASS 21 (U.S. CLS. 2, 13, 23, 29, 30, 33, 40 AND 50).

FIRST USE 3-1-2008; IN COMMERCE 3-1-2008.

THE MARK CONSISTS OF STANDARD CHARACTERS WITHOUT CLAIM TO ANY PARTICULAR FONT, STYLE, SIZE, OR COLOR.

NO CLAIM IS MADE TO THE EXCLUSIVE RIGHT TO USE "DOGTIN", APART FROM THE MARK AS SHOWN.

SN 78-936,256, FILED 7-24-2006.

LINDA ESTRADA, EXAMINING ATTORNEY

Int. Cl.: 7

Prior U.S. Cls.: 13, 19, 21, 23, 31, 34, and 35

Reg. No. 3,482,465

United States Patent and Trademark Office

Registered Aug. 5, 2008

**TRADEMARK
PRINCIPAL REGISTER**

ADVANTI-FLOW

CTB IP, INC. (DELAWARE CORPORATION)
300 DELAWARE AVENUE, SUITE 1253
WILMINGTON, DE 19801

THE MARK CONSISTS OF STANDARD CHAR-
ACTERS WITHOUT CLAIM TO ANY PARTICULAR
FONT, STYLE, SIZE, OR COLOR.

FOR: MECHANICAL WATERING UNITS FOR
POULTRY, IN CLASS 7 (U.S. CLS. 13, 19, 21, 23, 31, 34
AND 35).

SN 78-937,681, FILED 7-26-2006.

FIRST USE 6-12-2008; IN COMMERCE 6-12-2008.

MICHAEL LITZAU, EXAMINING ATTORNEY

Int. Cl.: 35

Prior U.S. Cls.: 100, 101, and 102

United States Patent and Trademark Office

Reg. No. 3,482,466

Registered Aug. 5, 2008

**SERVICE MARK
PRINCIPAL REGISTER**

INNOVATION CONTEXT

WAGGENER EDSTROM WORLDWIDE, INC.
(OREGON CORPORATION)
THREE CENTERPOINTE DRIVE SUITE 300
LAKE OSWEGO, OR 97035

THE MARK CONSISTS OF STANDARD CHAR-
ACTERS WITHOUT CLAIM TO ANY PARTICULAR
FONT, STYLE, SIZE, OR COLOR.

FOR: PUBLIC RELATIONS SERVICES; MARKET
RESEARCH SERVICES, IN CLASS 35 (U.S. CLS. 100,
101 AND 102).

SN 78-937,816, FILED 7-26-2006.

FIRST USE 11-12-2007; IN COMMERCE 11-12-2007.

JAY FLOWERS, EXAMINING ATTORNEY

Int. Cl.: 35

Prior U.S. Cls.: 100, 101, and 102

United States Patent and Trademark Office

Reg. No. 3,482,467

Registered Aug. 5, 2008

**SERVICE MARK
PRINCIPAL REGISTER**

MASTER NARRATIVE

WAGGENER EDSTROM WORLDWIDE, INC.
(OREGON CORPORATION)
THREE CENTERPOINTE DRIVE SUITE 300
LAKE OSWEGO, OR 97035

THE MARK CONSISTS OF STANDARD CHAR-
ACTERS WITHOUT CLAIM TO ANY PARTICULAR
FONT, STYLE, SIZE, OR COLOR.

FOR: PUBLIC RELATIONS SERVICES; MARKET
RESEARCH SERVICES, IN CLASS 35 (U.S. CLS. 100,
101 AND 102).

SN 78-937,827, FILED 7-26-2006.

FIRST USE 12-18-2006; IN COMMERCE 12-18-2006.

JAY FLOWERS, EXAMINING ATTORNEY

Int. Cl.: 16

Prior U.S. Cls.: 2, 5, 22, 23, 29, 37, 38, and 50

United States Patent and Trademark Office

Reg. No. 3,482,468

Registered Aug. 5, 2008

TRADEMARK
PRINCIPAL REGISTER

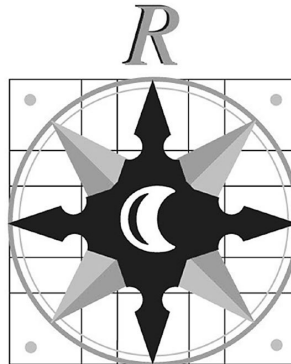

EDGEWATER MARINE INDUSTRIES, LLC
(MASSACHUSETTS LTD LIAB CO)
88 HATCH STREET, SUITE 403
NEW BEDFORD, MA 02745

FOR: BOOKS, BOOKLETS, AND PAMPHLETS
PERTAINING TO NAVIGATION; PRINTED NAUTI-
CAL CHARTS, NAMELY, WATERPROOF NAUTI-
CAL CHARTS; NAUTICAL CHARTS BOUND INTO
BOOKLET FORM; NAUTICAL-CHART BOOKLETS
WITH SYNTHETIC-STOCK WATERPROOF PAGES;
CHARTBOOKS INCORPORATING SUPPLEMEN-
TAL INFORMATION, NAMELY, NAVIGATIONAL

INFORMATION, CRUISING INFORMATION, AND
HARBOR AND FACILITY INFORMATION, IN
CLASS 16 (U.S. CLS. 2, 5, 22, 23, 29, 37, 38 AND 50).

FIRST USE 12-31-1996; IN COMMERCE 12-31-1996.

THE MARK CONSISTS OF A STYLISTIC COM-
PASS ROSE WITH THE LETTER "R" THEREABOVE.

SN 78-938,044, FILED 7-26-2006.

CARYN GLASSER, EXAMINING ATTORNEY

Int. Cl.: 28

Prior U.S. Cls.: 22, 23, 38, and 50

United States Patent and Trademark Office

Reg. No. 3,482,469

Registered Aug. 5, 2008

**TRADEMARK
PRINCIPAL REGISTER**

STELLAR DEFENDER

GOALKEEPER INCENTIVE SYSTEMS (CALIFORNIA SOLE PROPRIETORSHIP)
2225 DEL MAR SCENIC PARKWAY
DEL MAR, CA 92014

FOR: ACTION FIGURES AND ACCESSORIES THEREFOR; BOARD GAMES; CARD GAMES; DICE GAMES; PUZZLES; HAND-HELD UNIT FOR PLAYING ELECTRONIC GAMES; HAND-HELD UNIT FOR PLAYING VIDEO GAMES; STUFFED PLUSH TOYS; PUPPETS; LAWN TOYS, NAMELY, SPRINKLERS, WATER SLIDES, INFLATABLE SWIMMING POOLS, INFLATABLE POOL TOYS, SWINGS, SEESAWS, SLIDES, TUNNELS, CLIMBING FRAMES, JUNGLE GYMS, PLAY HOUSES, AND CLIMBING UNITS; SAND TOYS; INFLATABLE TOYS; BATTERY-POWERED ACTION TOYS; RIDE-ON TOYS; TOY MASKS; PLAYGROUND BALLS; BALLOONS; YO-YOS; ACTION PLAY SETS SOLD AS A UNIT FOR MAKE-BELIEVE PLAY BATTLE OR ADVEN-

TURE ACTIVITIES; TOY CHESTS; TOY BANKS; BUBBLE-MAKING WAND AND SOLUTION SETS; KITES; FLYING DISCS; TOY WATCHES; TOY MODEL HOBBYCRAFT KITS; TOY WEAPONS; THROW-AND-CATCH TOYS, NAMELY, BALLS AND GLOVES, MITTS; MARBLES; TOY VEHICLES AND ACCESSORIES THEREFOR; WATER-PLAY TOYS, NAMELY, SQUIRTERS AND FLOATING TOYS, IN CLASS 28 (U.S. CLS. 22, 23, 38 AND 50).

FIRST USE 10-6-2006; IN COMMERCE 2-14-2007.

THE MARK CONSISTS OF STANDARD CHARACTERS WITHOUT CLAIM TO ANY PARTICULAR FONT, STYLE, SIZE, OR COLOR.

SN 78-938,497, FILED 7-26-2006.

SUSAN STIGLITZ, EXAMINING ATTORNEY

Int. Cl.: 5

Prior U.S. Cls.: 6, 18, 44, 46, 51, and 52

Reg. No. 3,482,470

United States Patent and Trademark Office

Registered Aug. 5, 2008

**TRADEMARK
PRINCIPAL REGISTER**

RELIEF PAD

BRADLEY PHARMACEUTICALS, INC. (DELA-
WARE CORPORATION)
383 ROUTE 46 WEST
FAIRFIELD, NJ 07004

FOR: MEDICATED TOPICAL PREPARATIONS
FOR HUMAN USE TO PREVENT OR ALLEVIATE
THE SYMPTOMS OF PRURITUS, ECZEMA, DER-
MATITIS AND OTHER SKIN DISORDERS, AND
APPLICATORS OR PADS SOLD AS A COMPONENT
THEREWITH, IN CLASS 5 (U.S. CLS. 6, 18, 44, 46, 51
AND 52).

FIRST USE 6-1-2008; IN COMMERCE 6-1-2008.

THE MARK CONSISTS OF STANDARD CHAR-
ACTERS WITHOUT CLAIM TO ANY PARTICULAR
FONT, STYLE, SIZE, OR COLOR.

NO CLAIM IS MADE TO THE EXCLUSIVE
RIGHT TO USE "PAD", APART FROM THE MARK
AS SHOWN.

SN 78-938,573, FILED 7-27-2006.

ESTHER BELENKER, EXAMINING ATTORNEY

Int. Cl.: 36

Prior U.S. Cls.: 100, 101, and 102

United States Patent and Trademark Office

Reg. No. 3,482,471

Registered Aug. 5, 2008

**SERVICE MARK
PRINCIPAL REGISTER**

QUIET MILLIONAIRE

FINANCIAL MANAGEMENT GROUP, INC.
(OHIO CORPORATION)
10979 REED HARTMAN HIGHWAY SUITE 209
CINCINNATI, OH 45242

FOR: FINANCIAL SERVICES, NAMELY, PRO-
VIDING COMPREHENSIVE FINANCIAL PLAN-
NING AND INVESTMENT ADVISORY SERVICES,
IN CLASS 36 (U.S. CLS. 100, 101 AND 102).

FIRST USE 6-30-2007; IN COMMERCE 6-30-2007.

THE MARK CONSISTS OF STANDARD CHAR-
ACTERS WITHOUT CLAIM TO ANY PARTICULAR
FONT, STYLE, SIZE, OR COLOR.

SN 78-938,763, FILED 7-27-2006.

PAM WILLIS, EXAMINING ATTORNEY

Int. Cl.: 30

Prior U.S. Cl.: 46

United States Patent and Trademark Office

Reg. No. 3,482,472

Registered Aug. 5, 2008

**TRADEMARK
PRINCIPAL REGISTER**

TRESCERRO

DISTRIBUTION MARKETING SERVICES, L.P.
(DELAWARE LIMITED PARTNERSHIP)
16000 MEMORIAL DRIVE, SUITE 200
HOUSTON, TX 77079

FOR: COFFEE, TEA, COCOA AND HOT CHOCOLATE BEVERAGES, CAPPUCCINO, IN CLASS 30 (U.S. CL. 46).

FIRST USE 1-31-2007; IN COMMERCE 1-31-2007.

THE MARK CONSISTS OF STANDARD CHARACTERS WITHOUT CLAIM TO ANY PARTICULAR FONT, STYLE, SIZE, OR COLOR.

THE ENGLISH TRANSLATION OF THE WORDING TRESCERRO IN THE MARK IS THREE HILL.

SN 78-938,828, FILED 7-27-2006.

NATALIE POLZER, EXAMINING ATTORNEY

Int. Cl.: 30

Prior U.S. Cl.: 46

United States Patent and Trademark Office

Reg. No. 3,482,473

Registered Aug. 5, 2008

**TRADEMARK
PRINCIPAL REGISTER**

RIDGELINE COFFEE ROASTERS

DISTRIBUTION MARKETING SERVICES, L.P.
(DELAWARE LIMITED PARTNERSHIP)

16000 MEMORIAL DRIVE, SUITE 200

HOUSTON, TX 77079

FOR: COFFEE, BEVERAGES MADE FROM COFFEE, IN CLASS 30 (U.S. CL. 46).

FIRST USE 4-30-2007; IN COMMERCE 4-30-2007.

THE MARK CONSISTS OF STANDARD CHARACTERS WITHOUT CLAIM TO ANY PARTICULAR FONT, STYLE, SIZE, OR COLOR.

NO CLAIM IS MADE TO THE EXCLUSIVE RIGHT TO USE "COFFEE ROASTERS", APART FROM THE MARK AS SHOWN.

SN 78-938,834, FILED 7-27-2006.

NATALIE POLZER, EXAMINING ATTORNEY

Int. Cls.: 14 and 35

Prior U.S. Cls.: 2, 27, 28, 50, 100, 101, and 102

United States Patent and Trademark Office

Reg. No. 3,482,474

Registered Aug. 5, 2008

**TRADEMARK
SERVICE MARK
PRINCIPAL REGISTER**

PROMISE POWER

STARLING, ELAINE (UNITED STATES INDIVIDUAL)
5320 BIG CANYON RD
SHINGLE SPRINGS, CA 95682

FOR: JEWELRY, IN CLASS 14 (U.S. CLS. 2, 27, 28 AND 50).

FIRST USE 5-1-2007; IN COMMERCE 5-1-2007.

FOR: ON-LINE RETAIL STORE SERVICES FEATURING JEWELRY, BOOKS, CALENDARS, VIDEOS, DVDS, IN CLASS 35 (U.S. CLS. 100, 101 AND 102).

FIRST USE 2-1-2008; IN COMMERCE 2-1-2008.

THE MARK CONSISTS OF STANDARD CHARACTERS WITHOUT CLAIM TO ANY PARTICULAR FONT, STYLE, SIZE, OR COLOR.

SN 78-939,269, FILED 7-27-2006.

WILLIAM P. SHANAHAN, EXAMINING ATTORNEY

Int. Cl.: 21

Prior U.S. Cls.: 2, 13, 23, 29, 30, 33, 40, and 50

United States Patent and Trademark Office

Reg. No. 3,482,475

Registered Aug. 5, 2008

**TRADEMARK
PRINCIPAL REGISTER**

CUPCAKES N' MORE

WILTON INDUSTRIES, INC. (DELAWARE CORPORATION)
2240 WEST 75TH STREET
WOODRIDGE, IL 60517

FOR: BAKEWARE, IN CLASS 21 (U.S. CLS. 2, 13, 23, 29, 30, 33, 40 AND 50).

FIRST USE 7-31-2004; IN COMMERCE 7-31-2004.

THE MARK CONSISTS OF STANDARD CHARACTERS WITHOUT CLAIM TO ANY PARTICULAR FONT, STYLE, SIZE, OR COLOR.

OWNER OF U.S. REG. NO. 3,033,051.

NO CLAIM IS MADE TO THE EXCLUSIVE RIGHT TO USE "CUPCAKES", APART FROM THE MARK AS SHOWN.

SN 78-939,995, FILED 7-28-2006.

SUZANNE BLANE, EXAMINING ATTORNEY

Int. Cl.: 14

Prior U.S. Cls.: 2, 27, 28, and 50

United States Patent and Trademark Office

Reg. No. 3,482,476

Registered Aug. 5, 2008

**TRADEMARK
PRINCIPAL REGISTER**



PUSH INC. (NEW YORK CORPORATION), DBA
KAREN KARCH,
240 MULBERRY STREET
NEW YORK, NY 10042

FOR: ANKLE BRACELETS; BELT BUCKLES OF
PRECIOUS METAL; BRACELETS; BROOCHES;
CHARMS; CHOKERS; CLIP EARRINGS; CUF-
FLINKS; EARRINGS; EAR STUDS; FANCY KEY
RINGS OF PRECIOUS METAL; IDENTIFICATION
BRACELETS; LEATHER BRACELETS; MONEY
CLIPS OF PRECIOUS METAL; NECKLACES; PEN-

DANTS ON A LEATHER CORD; RINGS; SHIRT
STUDS; TIARAS, IN CLASS 14 (U.S. CLS. 2, 27, 28
AND 50).

FIRST USE 9-16-2006; IN COMMERCE 10-5-2006.

THE MARK CONSISTS OF THE LETTER K WITH
A ROSE IN THE CENTER.

SN 78-940,167, FILED 7-28-2006.

JASON BLAIR, EXAMINING ATTORNEY

Int. Cls.: 14 and 35

Prior U.S. Cls.: 2, 27, 28, 50, 100, 101, and 102

United States Patent and Trademark Office

Reg. No. 3,482,477

Registered Aug. 5, 2008

**TRADEMARK
SERVICE MARK
PRINCIPAL REGISTER**

KAREN KARCH

PUSH INC. (NEW YORK CORPORATION), DBA
KAREN KARCH,
240 MULBERRY STREET
NEW YORK, NY 10042

FOR: ANKLE BRACELETS; BELT BUCKLES OF
PRECIOUS METAL; BRACELETS; BROOCHES;
CHARMS; CHOKERS; CLIP EARRINGS; CUF-
FLINKS; EARRINGS; EAR STUDS; FANCY KEY
RINGS OF PRECIOUS METAL; IDENTIFICATION
BRACELETS; LEATHER BRACELETS; MONEY
CLIPS OF PRECIOUS METAL; NECKLACES; PEN-
DANTS ON A LEATHER CORD; RINGS; SHIRT
STUDS; TIARAS, IN CLASS 14 (U.S. CLS. 2, 27, 28
AND 50).

FIRST USE 9-19-2006; IN COMMERCE 10-5-2006.

FOR: RETAIL STORE SERVICES AND ONLINE
RETAIL STORE SERVICES FEATURING JEWELRY,
IN CLASS 35 (U.S. CLS. 100, 101 AND 102).

FIRST USE 9-19-2006; IN COMMERCE 9-19-2006.

THE MARK CONSISTS OF STANDARD CHAR-
ACTERS WITHOUT CLAIM TO ANY PARTICULAR
FONT, STYLE, SIZE, OR COLOR.

THE NAME "KAREN KARCH" IDENTIFIES A
LIVING INDIVIDUAL WHOSE CONSENT IS OF
RECORD.

SN 78-940,178, FILED 7-28-2006.

JASON BLAIR, EXAMINING ATTORNEY

Int. Cl.: 7

Prior U.S. Cls.: 13, 19, 21, 23, 31, 34, and 35

Reg. No. 3,482,478

United States Patent and Trademark Office

Registered Aug. 5, 2008

**TRADEMARK
PRINCIPAL REGISTER**

OIL BUD

BUD'S BIKER PARTS, INC. (MONTANA CORPORATION)

460 PARRIMAN

HELENA, MT 56902

FOR: MOTORCYCLE OIL COOLERS, IN CLASS 7
(U.S. CLS. 13, 19, 21, 23, 31, 34 AND 35).

FIRST USE 6-10-2008; IN COMMERCE 6-10-2008.

THE MARK CONSISTS OF STANDARD CHARACTERS WITHOUT CLAIM TO ANY PARTICULAR FONT, STYLE, SIZE, OR COLOR.

NO CLAIM IS MADE TO THE EXCLUSIVE RIGHT TO USE "OIL", APART FROM THE MARK AS SHOWN.

SN 78-940,222, FILED 7-28-2006.

BRIDGETT SMITH, EXAMINING ATTORNEY

Int. Cl.: 33

Prior U.S. Cls.: 47 and 49

United States Patent and Trademark Office

Reg. No. 3,482,479

Registered Aug. 5, 2008

**TRADEMARK
PRINCIPAL REGISTER**

OPERA PRIMA

J. GARCIA CARRION, S.A. (SPAIN CORPORATION)
CARRETERA DE MURCIA
JUMILLA (MURCIA), SPAIN S/N 30520

OWNER OF SPAIN REG. NO. 2583814, DATED 7-29-2004, EXPIRES 3-1-2014.

FOR: WINES AND SPARKLING WINES, IN CLASS 33 (U.S. CLS. 47 AND 49).

THE ENGLISH TRANSLATION OF "OPERA PRIMA" IN THE MARK IS FIRST ACT.

FIRST USE 0-0-2004; IN COMMERCE 0-0-2005.

SN 78-940,247, FILED 7-28-2006.

THE MARK CONSISTS OF STANDARD CHARACTERS WITHOUT CLAIM TO ANY PARTICULAR FONT, STYLE, SIZE, OR COLOR.

DAVID I, EXAMINING ATTORNEY

Int. Cl.: 9

Prior U.S. Cls.: 21, 23, 26, 36, and 38

Reg. No. 3,482,480

United States Patent and Trademark Office

Registered Aug. 5, 2008

**TRADEMARK
PRINCIPAL REGISTER**

XPONENT

AVID TECHNOLOGY, INC. (DELAWARE CORPORATION)
ATTN: TRADEMARK ADMINISTRATOR
ONE PARK WEST
TEWKSBURY, MA 01876

FOR: DJ EQUIPMENT, NAMELY, COMPUTER SOFTWARE FOR AUDIO PRODUCTION AND COMPUTER PERIPHERALS, IN CLASS 9 (U.S. CLS. 21, 23, 26, 36 AND 38).

FIRST USE 5-21-2007; IN COMMERCE 5-21-2007.

THE MARK CONSISTS OF STANDARD CHARACTERS WITHOUT CLAIM TO ANY PARTICULAR FONT, STYLE, SIZE, OR COLOR.

SN 78-940,919, FILED 7-31-2006.

ROBIN CHOSID, EXAMINING ATTORNEY

Int. Cl.: 9

Prior U.S. Cls.: 21, 23, 26, 36, and 38

Reg. No. 3,482,481

United States Patent and Trademark Office

Registered Aug. 5, 2008

**TRADEMARK
PRINCIPAL REGISTER**

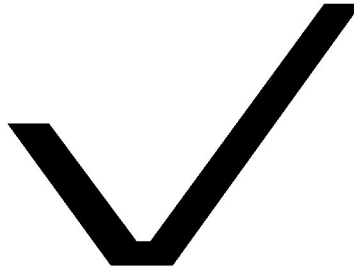

VICTAULIC COMPANY (NEW JERSEY CORPORATION)
4901 KESSLERSVILLE ROAD
EASTON, PA 18042

FOR: AUTOMATICALLY ACTIVATED VALVES FOR CONTROLLING THE FLOW OF FLUIDS; FIRE EXTINGUISHING WATER SPRINKLER HEADS; GAUGES, NAMELY, LEVEL GAUGES AND PRESSURE GAUGES; WATER METERS; FIRE ALARMS, CONTROL SWITCHES AND WATER SPRINKLER NOZZLES, ALL USED WITH FIRE PROTECTION

SYSTEMS, IN CLASS 9 (U.S. CLS. 21, 23, 26, 36 AND 38).

FIRST USE 5-15-2002; IN COMMERCE 5-15-2002.

THE MARK CONSISTS OF THE LETTER "V" IN STYLIZED FORM.

SN 78-941,288, FILED 7-31-2006.

JANICE KIM, EXAMINING ATTORNEY

Int. Cl.: 9

Prior U.S. Cls.: 21, 23, 26, 36, and 38

Reg. No. 3,482,482

United States Patent and Trademark Office

Registered Aug. 5, 2008

**TRADEMARK
PRINCIPAL REGISTER**

PRODIGY

PERFORMANCE MOTION DEVICES, INC. (MAS-
SACHUSETTS CORPORATION)
55 OLD BEDFORD ROAD
LINCOLN, MA 01773

FOR: MOTION CONTROL CARDS TO CONTROL
SERVO AND STEP MOTORS FOR USE BY ORIGI-
NAL EQUIPMENT MANUFACTURERS IN THE
FIELD OF MOTION CONTROL , IN CLASS 9 (U.S.
CLS. 21, 23, 26, 36 AND 38).

FIRST USE 7-31-2006; IN COMMERCE 11-10-2006.

THE MARK CONSISTS OF STANDARD CHAR-
ACTERS WITHOUT CLAIM TO ANY PARTICULAR
FONT, STYLE, SIZE, OR COLOR.

SN 78-941,427, FILED 7-31-2006.

JILL PRATER, EXAMINING ATTORNEY

Int. Cl.: 16

Prior U.S. Cls.: 2, 5, 22, 23, 29, 37, 38, and 50

Reg. No. 3,482,483

United States Patent and Trademark Office

Registered Aug. 5, 2008

**TRADEMARK
PRINCIPAL REGISTER**

STRIKE 'N SWIPE

REMARKABLE CONCEPTS LIMITED (NEW
ZEALAND LTD LIAB CO)
LEVEL 6, FORSYTH BARR HOUSE
764 COLOMBO STREET
CHRISTCHURCH, NEW ZEALAND

FOR: IMPACT MARKERS IN THE NATURE OF
PRESSURE SENSITIVE, RE-USABLE IMPACT LA-
BELS; IMPACT MARKERS IN THE NATURE OF
PRESSURE SENSITIVE, RE-USABLE IMPACT LA-
BELS FOR SPORTING ARTICLES, IN CLASS 16 (U.S.
CLS. 2, 5, 22, 23, 29, 37, 38 AND 50).

FIRST USE 1-1-2007; IN COMMERCE 1-1-2007.

THE MARK CONSISTS OF STANDARD CHAR-
ACTERS WITHOUT CLAIM TO ANY PARTICULAR
FONT, STYLE, SIZE, OR COLOR.

PRIORITY CLAIMED UNDER SEC. 44(D) ON
NEW ZEALAND APPLICATION NO. 742307, FILED
2-2-2006, REG. NO. 742307, DATED 2-2-2006, EXPIRES
2-2-2013.

SN 78-941,868, FILED 8-1-2006.

JENNIFER DIXON, EXAMINING ATTORNEY

Int. Cl.: 25

Prior U.S. Cls.: 22 and 39

United States Patent and Trademark Office

Reg. No. 3,482,484

Registered Aug. 5, 2008

**TRADEMARK
PRINCIPAL REGISTER**

AFTER THE SWEAT DRY

FRAZIER, LARRY (ALBANIA INDIVIDUAL)
86 BROADWAY
NEWBURGH, NY 12550

FOR: ANKLE SOCKS; ANTI-PERSPIRANT SOCKS; ATHLETIC UNIFORMS; BERMUDA SHORTS; BOARD SHORTS; BOXER SHORTS; CAMP SHIRTS; DRESS SHIRTS; GOLF SHIRTS; GYM SHORTS; HAT BANDS; HATS; HEADBANDS AGAINST SWEATING; HEADGEAR, NAMELY, HATS, CAPS; HEAVY JACKETS; JACKETS; MEN AND WOMEN JACKETS, COATS, TROUSERS, MEN'S SOCKS; OPEN-NECKED SHIRTS; SHORTS AND BRIEFS; PANTS; POLO SHIRTS; RAIN JACKETS; RAINPROOF JACKETS; SHIRTS; SHORT SETS; SHORT TROUSERS; SHORT-SLEEVED OR LONG-

SLEEVED T-SHIRTS; SHORT-SLEEVED SHIRTS; SHORTS; SOCKS; SPORT SHIRTS; SPORTS SHIRTS WITH SHORT SLEEVES; SWEAT BANDS; SWEAT SHIRTS; T-SHIRTS, IN CLASS 25 (U.S. CLS. 22 AND 39).

FIRST USE 2-28-2007; IN COMMERCE 2-28-2007.

THE MARK CONSISTS OF STANDARD CHARACTERS WITHOUT CLAIM TO ANY PARTICULAR FONT, STYLE, SIZE, OR COLOR.

SN 78-942,909, FILED 8-2-2006.

KIMBERLY FRYE, EXAMINING ATTORNEY

Int. Cl.: 9

Prior U.S. Cls.: 21, 23, 26, 36, and 38

Reg. No. 3,482,485

United States Patent and Trademark Office

Registered Aug. 5, 2008

**TRADEMARK
PRINCIPAL REGISTER**

ZERO-Click

AGAMATRIX, INC. (DELAWARE CORPORATION)
10 MANOR PARKWAY
SALEM, NH 03079

FOR: DIGITAL SIGNAL PROCESSING APPARATUS, NAMELY, A PROGRAMMED MICROPROCESSOR FOR INCORPORATION INTO ELECTROCHEMICAL METERS FOR THE MEDICAL PURPOSE OF ELECTROCHEMICAL MONITORING OF ANALYTES IN BIOLOGICAL FLUIDS; DIGITAL SIGNAL PROCESSING APPARATUS, NAMELY, A PROGRAMMED MICROPROCESSOR FOR INCORPORATION INTO ELECTROCHEMICAL METERS FOR THE MEDICAL PURPOSE OF ELECTROCHEMICAL MONITORING OF GLUCOSE IN BIOLOGICAL FLUIDS; DIGITAL SIGNAL PROCESSING APPARATUS, NAMELY, A PROGRAMMED MICROPROCESSOR FOR INCORPORATION INTO INSULIN PUMPS FOR THE MEDICAL PURPOSE OF CONTROLLING THE DELIVERY OF INSULIN TO A USER; DIGITAL SIGNAL PROCESSING APPARATUS, NAMELY, A PROGRAMMED MICROPROCESSOR FOR INCORPORATION INTO A COMBINED ELECTROCHEMICAL METER/INSULIN PUMP FOR THE MEDICAL PURPOSES OF MONITORING GLUCOSE IN BLOOD AND CONTROLLING THE DELIVERY OF INSULIN TO A USER; WIRED OR WIRELESS COMMUNICATION DEVICES FOR COMMUNICATION BETWEEN ANY OF THE DIGITAL SIGNAL PROCESSING APPARATUSES DESCRIBED HEREIN AND DATA TRANSFER OR EXTERNAL OR REMOTE STORAGE DEVICES, FOR EXAMPLE A CABLE FOR CONNECTING A DIGITAL SIGNAL PROCESSING AP-

PARATUS TO A PERSONAL COMPUTER OR WIRELESS COMMUNICATION HARDWARE SUCH AS TRANSMITTERS AND RECEIVERS; SOFTWARE FOR CONTROLLING ELECTROCHEMICAL METERS FOR THE MEDICAL PURPOSE OF ELECTROCHEMICAL MONITORING OF ANALYTES IN BIOLOGICAL FLUIDS; SOFTWARE FOR CONTROLLING ELECTROCHEMICAL METERS FOR THE MEDICAL PURPOSE OF ELECTROCHEMICAL MONITORING OF GLUCOSE IN BIOLOGICAL FLUIDS; SOFTWARE FOR CONTROLLING ELECTROCHEMICAL METERS FOR THE MEDICAL PURPOSE OF ELECTROCHEMICAL IMMUNOASSAYS OF BIOLOGICAL FLUIDS; SOFTWARE FOR CONTROLLING INSULIN PUMPS FOR THE MEDICAL PURPOSE OF CONTROLLING THE DELIVERY OF INSULIN TO A USER; SOFTWARE FOR CONTROLLING A COMBINED ELECTROCHEMICAL METER/INSULIN PUMP FOR THE MEDICAL PURPOSES OF MONITORING GLUCOSE IN BLOOD AND CONTROLLING THE DELIVERY OF INSULIN TO A USER; SOFTWARE FOR CONTROLLING WIRED OR WIRELESS COMMUNICATION DEVICES FOR COMMUNICATION BETWEEN ANY OF THE DIGITAL SIGNAL PROCESSING APPARATUSES DESCRIBED HEREIN AND A DATA TRANSFER OR EXTERNAL OR REMOTE STORAGE DEVICE; AND COMBINATIONS THEREOF SOLD AS A UNIT, IN CLASS 9 (U.S. CLS. 21, 23, 26, 36 AND 38).

FIRST USE 1-24-2007; IN COMMERCE 1-24-2007.

THE MARK CONSISTS OF THE WORDS "ZERO-CLICK" WHEREIN THE "O" OF THE WORD "ZERO" IS STYLIZED.

SN 78-943,040, FILED 8-2-2006.

ARETHA SOMERVILLE, EXAMINING ATTORNEY

Int. Cl.: 41

Prior U.S. Cls.: 100, 101, and 107

United States Patent and Trademark Office

Reg. No. 3,482,486

Registered Aug. 5, 2008

**SERVICE MARK
PRINCIPAL REGISTER**

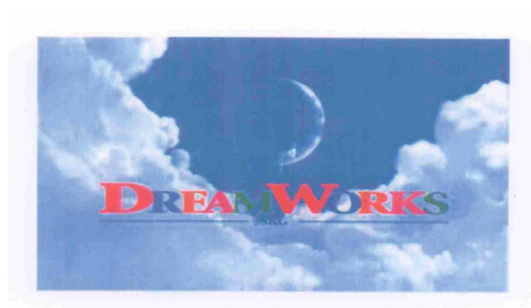

DREAMWORKS ANIMATION L.L.C. (DELA-
WARE LTD LIAB CO)
1000 FLOWER STREET
GLENDALE, CA 91201

FOR: ENTERTAINMENT SERVICES, NAMELY,
MOTION PICTURE, TELEVISION, DVD, AND VI-
DEO AND AUDIOTAPE PRODUCTION SERVICES,
IN CLASS 41 (U.S. CLS. 100, 101 AND 107).

FIRST USE 1-31-2008; IN COMMERCE 1-31-2008.

OWNER OF U.S. REG. NOS. 2,316,096, 2,326,951,
AND 2,416,011.

THE COLOR(S) BLUE, WHITE, RED, ORANGE,
PURPLE, AND GREEN IS/ARE CLAIMED AS A
FEATURE OF THE MARK.

THE MARK CONSISTS OF A BOY FISHING IN
THE MOON ABOVE THE WORDS "DREAMWORKS
SKG" AGAINST A BACKGROUND OF CLOUDS.
THE BACKGROUND IS BLUE WITH WHITE AND
BLUE CLOUDS. THE BOY IN THE MOON IS IN
BLUE AND WHITE. THE LETTERS "D" AND "W"
ARE IN RED. THE LETTERS "R" AND "O" ARE IN
BLUE. THE LETTERS "E" AND "R" ARE IN OR-
ANGE. THE LETTERS "A" AND "K" ARE IN
PURPLE. THE LETTERS "M" AND "S" ARE IN
GREEN. THE LETTERS "SKG" ARE IN BLUE.

SN 78-943,459, FILED 8-2-2006.

RENEE SERVANCE, EXAMINING ATTORNEY

Int. Cl.: 35

Prior U.S. Cls.: 100, 101, and 102

United States Patent and Trademark Office

Reg. No. 3,482,487

Registered Aug. 5, 2008

**SERVICE MARK
PRINCIPAL REGISTER**

HPO SCORES

BLANCHARD TRAINING AND DEVELOPMENT,
INC. (CALIFORNIA CORPORATION)
125 STATE PLACE
ESCONDIDO, CA 92029

FOR: BUSINESS CONSULTATION SERVICES IN
THE FIELD OF MANAGEMENT PRACTICES, IN
CLASS 35 (U.S. CLS. 100, 101 AND 102).

FIRST USE 10-1-2006; IN COMMERCE 10-1-2006.

THE MARK CONSISTS OF STANDARD CHAR-
ACTERS WITHOUT CLAIM TO ANY PARTICULAR
FONT, STYLE, SIZE, OR COLOR.

NO CLAIM IS MADE TO THE EXCLUSIVE
RIGHT TO USE "HPO", APART FROM THE MARK
AS SHOWN.

SN 78-944,092, FILED 8-3-2006.

MICHAEL WEBSTER, EXAMINING ATTORNEY

Int. Cl.: 20

Prior U.S. Cls.: 2, 13, 22, 25, 32, and 50

Reg. No. 3,482,488

United States Patent and Trademark Office

Registered Aug. 5, 2008

**TRADEMARK
PRINCIPAL REGISTER**

SHOWOFF

MERBETH, LAURA J. (UNITED STATES INDIVIDUAL)
N56 W27034 HWY. K
SUSSEX, WI 53089

THE MARK CONSISTS OF STANDARD CHARACTERS WITHOUT CLAIM TO ANY PARTICULAR FONT, STYLE, SIZE, OR COLOR.

FOR: RACKS FOR RETAINING AWARDS, RIBBONS, METALS OR TROPHIES, IN CLASS 20 (U.S. CLS. 2, 13, 22, 25, 32 AND 50).

SN 78-944,300, FILED 8-3-2006.

FIRST USE 10-19-2006; IN COMMERCE 10-19-2006.

KELLY BOULTON, EXAMINING ATTORNEY

Int. Cl.: 44

Prior U.S. Cls.: 100 and 101

United States Patent and Trademark Office

Reg. No. 3,482,489

Registered Aug. 5, 2008

**SERVICE MARK
PRINCIPAL REGISTER**

HCJB GLOBAL

WORLD RADIO MISSIONARY FELLOWSHIP,
INC. (FLORIDA NON-PROFIT CORPORATION)
1065 GARDEN OF THE GODS ROAD
COLORADO SPRINGS, CO 80907

FOR: CHARITABLE SERVICES, NAMELY, PROVIDING MEDICAL SERVICES, FIRST AID SUPPLIES AND MEDICAL SUPPLIES PRIMARILY TO UNDERDEVELOPED COUNTRIES , IN CLASS 44 (U.S. CLS. 100 AND 101).

FIRST USE 1-1-2007; IN COMMERCE 1-1-2007.

THE MARK CONSISTS OF STANDARD CHARACTERS WITHOUT CLAIM TO ANY PARTICULAR FONT, STYLE, SIZE, OR COLOR.

NO CLAIM IS MADE TO THE EXCLUSIVE RIGHT TO USE "GLOBAL", APART FROM THE MARK AS SHOWN.

SN 78-944,647, FILED 8-3-2006.

CAROL SPILS, EXAMINING ATTORNEY

Int. Cl.: 16

Prior U.S. Cls.: 2, 5, 22, 23, 29, 37, 38, and 50

Reg. No. 3,482,490

United States Patent and Trademark Office

Registered Aug. 5, 2008

**TRADEMARK
PRINCIPAL REGISTER**

HCJB GLOBAL VOICE

WORLD RADIO MISSIONARY FELLOWSHIP,
INC. (FLORIDA NON-PROFIT CORPORATION)

1065 GARDEN OF THE GODS ROAD
COLORADO SPRINGS, CO 80907

FOR: PRINTED INSTRUCTIONAL, EDUCATIONAL, AND TEACHING MATERIALS FOR USE IN THE FIELDS OF HUMAN CULTURES, COMMUNICATION AND COMMUNICATION TECHNOLOGY, HEALTHCARE AND HEALTHCARE TECHNOLOGY, AND CHRISTIAN THEOLOGY, MISSIONS AND PRACTICAL MINISTRY; PRINTED MATTER, NAMELY, MAGAZINES, FLIERS, NEWSLETTERS, BROCHURES AND BOOKS, ALL IN THE FIELD OF CHRISTIAN THEOLOGY, MISSIONS AND PRACTI-

CAL MINISTRY, IN CLASS 16 (U.S. CLS. 2, 5, 22, 23, 29, 37, 38 AND 50).

FIRST USE 1-1-2007; IN COMMERCE 1-1-2007.

THE MARK CONSISTS OF STANDARD CHARACTERS WITHOUT CLAIM TO ANY PARTICULAR FONT, STYLE, SIZE, OR COLOR.

NO CLAIM IS MADE TO THE EXCLUSIVE RIGHT TO USE "GLOBAL", APART FROM THE MARK AS SHOWN.

SN 78-944,654, FILED 8-3-2006.

CAROL SPILS, EXAMINING ATTORNEY

Int. Cl.: 38

Prior U.S. Cls.: 100, 101, and 104

United States Patent and Trademark Office

Reg. No. 3,482,491

Registered Aug. 5, 2008

**SERVICE MARK
PRINCIPAL REGISTER**

HCJB GLOBAL VOICE

WORLD RADIO MISSIONARY FELLOWSHIP,
INC. (FLORIDA NON-PROFIT CORPORATION)
1065 GARDEN OF THE GODS ROAD
COLORADO SPRINGS, CO 80907

FOR: VIDEO, SATELLITE, AND AUDIO BROADCASTING; BROADCASTING PROGRAMS VIA A GLOBAL COMPUTER NETWORK; BROADCASTING AND STREAMING OF AUDIO MATERIAL ON THE INTERNET; BROADCASTING AND STREAMING OF VIDEO MATERIAL ON THE INTERNET, IN CLASS 38 (U.S. CLS. 100, 101 AND 104).

FIRST USE 4-1-2008; IN COMMERCE 4-1-2008.

THE MARK CONSISTS OF STANDARD CHARACTERS WITHOUT CLAIM TO ANY PARTICULAR FONT, STYLE, SIZE, OR COLOR.

NO CLAIM IS MADE TO THE EXCLUSIVE RIGHT TO USE "GLOBAL", APART FROM THE MARK AS SHOWN.

SN 78-944,655, FILED 8-3-2006.

CAROL SPILS, EXAMINING ATTORNEY

Int. Cl.: 41

Prior U.S. Cls.: 100, 101, and 107

United States Patent and Trademark Office

Reg. No. 3,482,492

Registered Aug. 5, 2008

**SERVICE MARK
PRINCIPAL REGISTER**

HCJB GLOBAL VOICE

WORLD RADIO MISSIONARY FELLOWSHIP,
INC. (FLORIDA NON-PROFIT CORPORATION)
1065 GARDEN OF THE GODS ROAD
COLORADO SPRINGS, CO 80907

FOR: EDUCATION SERVICES, NAMELY, PROVIDING CLASSES, SEMINARS, WORKSHOPS, TUTORING, AND MENTORING IN THE FIELDS OF HUMAN CULTURES, COMMUNICATION AND COMMUNICATION TECHNOLOGY, HEALTHCARE AND HEALTHCARE TECHNOLOGY, AND CHRISTIAN THEOLOGY, MISSIONS AND PRACTICAL MINISTRY; CHARITABLE SERVICES, NAMELY, PROVIDING TRAINING IN THE FIELDS OF HUMAN CULTURES, COMMUNICATION AND COMMUNICATION TECHNOLOGY, HEALTHCARE AND HEALTHCARE TECHNOLOGY, PUBLIC HEALTH, AND CHRISTIAN THEOLOGY,

MISSIONS AND PRACTICAL MINISTRY; PRODUCTION OF RADIO PROGRAMS, IN CLASS 41 (U.S. CLS. 100, 101 AND 107).

FIRST USE 4-8-2008; IN COMMERCE 4-8-2008.

THE MARK CONSISTS OF STANDARD CHARACTERS WITHOUT CLAIM TO ANY PARTICULAR FONT, STYLE, SIZE, OR COLOR.

NO CLAIM IS MADE TO THE EXCLUSIVE RIGHT TO USE "GLOBAL", APART FROM THE MARK AS SHOWN.

SN 78-944,657, FILED 8-3-2006.

CAROL SPILS, EXAMINING ATTORNEY

Int. Cl.: 16

Prior U.S. Cls.: 2, 5, 22, 23, 29, 37, 38, and 50

Reg. No. 3,482,493

United States Patent and Trademark Office

Registered Aug. 5, 2008

**TRADEMARK
PRINCIPAL REGISTER**

HCJB GLOBAL HANDS

WORLD RADIO MISSIONARY FELLOWSHIP,
INC. (FLORIDA NON-PROFIT CORPORATION)

1065 GARDEN OF THE GODS ROAD
COLORADO SPRINGS, CO 80907

FOR: PRINTED INSTRUCTIONAL, EDUCATIONAL, AND TEACHING MATERIALS FOR USE IN THE FIELDS OF HUMAN CULTURES, COMMUNICATION AND COMMUNICATION TECHNOLOGY, HEALTHCARE AND HEALTHCARE TECHNOLOGY, AND CHRISTIAN THEOLOGY, MISSIONS AND PRACTICAL MINISTRY; PRINTED MATTER, NAMELY, MAGAZINES, FLIERS, NEWSLETTERS, BROCHURES AND BOOKS, ALL IN THE FIELD OF CHRISTIAN THEOLOGY, MISSIONS AND PRACTI-

CAL MINISTRY, IN CLASS 16 (U.S. CLS. 2, 5, 22, 23, 29, 37, 38 AND 50).

FIRST USE 1-1-2007; IN COMMERCE 1-1-2007.

THE MARK CONSISTS OF STANDARD CHARACTERS WITHOUT CLAIM TO ANY PARTICULAR FONT, STYLE, SIZE, OR COLOR.

NO CLAIM IS MADE TO THE EXCLUSIVE RIGHT TO USE "GLOBAL", APART FROM THE MARK AS SHOWN.

SN 78-944,658, FILED 8-3-2006.

CAROL SPILS, EXAMINING ATTORNEY

Int. Cl.: 35

Prior U.S. Cls.: 100, 101, and 102

United States Patent and Trademark Office

Reg. No. 3,482,494

Registered Aug. 5, 2008

**SERVICE MARK
PRINCIPAL REGISTER**



VETESSA PHARMACEUTICAL, INC. (FLORIDA CORPORATION)
10460 NW 37TH TERRACE
DORAL, FL 33178

NO CLAIM IS MADE TO THE EXCLUSIVE RIGHT TO USE "PHARMACEUTICAL", APART FROM THE MARK AS SHOWN.

FOR: MAIL ORDER CATALOG, INTERNET CATALOG AND DISTRIBUTORSHIP SERVICES FEATURING VETERINARY EQUIPMENT AND SUPPLIES, IN CLASS 35 (U.S. CLS. 100, 101 AND 102).

SN 78-946,018, FILED 8-7-2006.

FIRST USE 1-1-2007; IN COMMERCE 1-1-2007.

PAM WILLIS, EXAMINING ATTORNEY

Int. Cl.: 35

Prior U.S. Cls.: 100, 101, and 102

United States Patent and Trademark Office

Reg. No. 3,482,495

Registered Aug. 5, 2008

**SERVICE MARK
PRINCIPAL REGISTER**

**FIRST IN TOPICAL OXYGEN
THERAPY**

GWR MEDICAL, INC. (PENNSYLVANIA CORPORATION)
6 DICKINSON DRIVE, BUILDING 300, SUITE 1
CHADDS FORD, PA 19317

FOR: DISTRIBUTORSHIPS IN THE FIELD OF TOPICAL OXYGEN APPLICATION DEVICES, WOUND DRESSINGS, AND MEDICAL APPARATUS FOR APPLYING OXYGEN TO A WOUND, IN CLASS 35 (U.S. CLS. 100, 101 AND 102).

FIRST USE 2-0-2008; IN COMMERCE 2-0-2008.

THE MARK CONSISTS OF STANDARD CHARACTERS WITHOUT CLAIM TO ANY PARTICULAR FONT, STYLE, SIZE, OR COLOR.

OWNER OF U.S. REG. NO. 2,223,320.

NO CLAIM IS MADE TO THE EXCLUSIVE RIGHT TO USE "TOPICAL OXYGEN THERAPY", APART FROM THE MARK AS SHOWN.

SN 78-946,020, FILED 8-7-2006.

PAM WILLIS, EXAMINING ATTORNEY

Int. Cl.: 30

Prior U.S. Cl.: 46

United States Patent and Trademark Office

Reg. No. 3,482,496

Registered Aug. 5, 2008

**TRADEMARK
PRINCIPAL REGISTER**

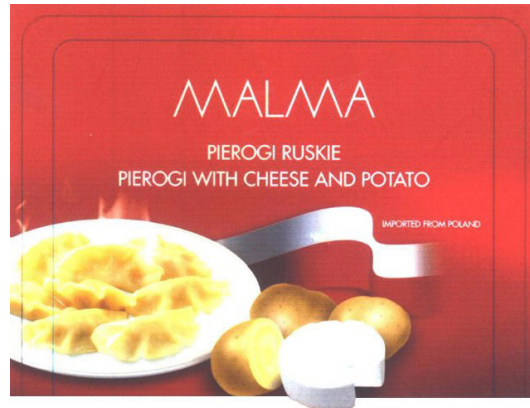

OLD II WARSAW BAKERY, INC. (ILLINOIS CORPORATION)
450 B FRONTIER WAY
BENSENVILLE, IL 60106

FOR: DUMPLINGS, IN CLASS 30 (U.S. CL. 46).

FIRST USE 9-1-2007; IN COMMERCE 9-1-2007.

NO CLAIM IS MADE TO THE EXCLUSIVE RIGHT TO USE "PIEROGI" AND "WITH CHEESE AND POTATO" AND "IMPORTED FROM POLAND", APART FROM THE MARK AS SHOWN.

THE COLOR(S) RED, WHITE AND YELLOW IS/ ARE CLAIMED AS A FEATURE OF THE MARK.

THE MARK CONSISTS, IN PART, OF A PLATE OF WARM PIEROGIS ADJACENT TO POTATOES AND CHEESE. THE COLOR RED APPEARS IN THE BACKGROUND, THE COLOR WHITE APPEARS IN THE WORDING AND IN THE SPECIAL FORM DRAWING OF A PLATE AND THE COLOR YELLOW APPEARS IN THE FOOD ITEMS DEPICTED IN THE DRAWING.

THE TERMS "MALMA" AND "PIEROGI" HAVE NO MEANING IN ANY FOREIGN LANGUAGE.

SN 78-946,160, FILED 8-7-2006.

PAM WILLIS, EXAMINING ATTORNEY

Int. Cl.: 36

Prior U.S. Cls.: 100, 101, and 102

United States Patent and Trademark Office

Reg. No. 3,482,497

Registered Aug. 5, 2008

**SERVICE MARK
PRINCIPAL REGISTER**

**Second Opinion Estate
Planning**

CLIENTS FIRST FINANCIAL (MASSACHUSETTS
CORPORATION)
72 SHARP STREET, SUITE A2
HINGHAM, MA 02043

FOR: ESTATE PLANNING CONSULTATION RE-
GARDING USE OF INSURANCE AS A PRIMARY
RETIREMENT FUNDING SOURCE, INCLUDING
ADVICE ON TITLING ASSETS AND INSURANCE
PLACEMENT AND EXCLUDING SERVICES RE-
LATING TO SALE OF SECURITIES, INVESTMENT
ADVICE OR FINANCIAL RESEARCH, IN CLASS 36
(U.S. CLS. 100, 101 AND 102).

FIRST USE 6-5-2008; IN COMMERCE 6-5-2008.

THE MARK CONSISTS OF STANDARD CHAR-
ACTERS WITHOUT CLAIM TO ANY PARTICULAR
FONT, STYLE, SIZE, OR COLOR.

NO CLAIM IS MADE TO THE EXCLUSIVE
RIGHT TO USE "ESTATE PLANNING", APART
FROM THE MARK AS SHOWN.

SN 78-946,873, FILED 8-7-2006.

STEVEN PEREZ, EXAMINING ATTORNEY

Int. Cls.: 35 and 37

Prior U.S. Cls.: 100, 101, 102, 103, and 106

United States Patent and Trademark Office

Reg. No. 3,482,498

Registered Aug. 5, 2008

**SERVICE MARK
PRINCIPAL REGISTER**

BELLA PORTA

BELLA PORTA LLC (NEW YORK LTD LIAB CO)
92 FRONT STREET
HEMPSTEAD, NY 11550

FOR: RETAIL STORES FEATURING DOORS
AND ACCESSORIES, IN CLASS 35 (U.S. CLS. 100,
101 AND 102).

FIRST USE 5-15-2006; IN COMMERCE 5-15-2006.

FOR: INSTALLATION OF DOORS AND ACCES-
SORIES, IN CLASS 37 (U.S. CLS. 100, 103 AND 106).

FIRST USE 5-15-2006; IN COMMERCE 5-15-2006.

THE MARK CONSISTS OF STANDARD CHAR-
ACTERS WITHOUT CLAIM TO ANY PARTICULAR
FONT, STYLE, SIZE, OR COLOR.

NO CLAIM IS MADE TO THE EXCLUSIVE
RIGHT TO USE "PORTA", APART FROM THE
MARK AS SHOWN.

THE ENGLISH TRANSLATION OF THE WORD
"BELLA PORTA" IN THE MARK IS BEAUTIFUL
DOOR.

SN 78-947,145, FILED 8-8-2006.

WENDY JUN, EXAMINING ATTORNEY

Int. Cl.: 35

Prior U.S. Cls.: 100, 101, and 102

United States Patent and Trademark Office

Reg. No. 3,482,499

Registered Aug. 5, 2008

**SERVICE MARK
PRINCIPAL REGISTER**

TRUSTCITE

TRUSTCITE LIMITED (NEW ZEALAND CORPORATION)
SUITE 2, BUILDING 1
218 LAKE ROAD
NORTH SHORE CITY, AU, NEW ZEALAND

FOR: ONLINE BUSINESS REFERRAL AND DIRECTORY SERVICES FEATURING CONSUMER RATINGS, RECOMMENDATIONS AND REVIEWS REGARDING THE SERVICES OF OTHERS , IN CLASS 35 (U.S. CLS. 100, 101 AND 102).

FIRST USE 3-24-2006; IN COMMERCE 3-24-2006.

THE MARK CONSISTS OF STANDARD CHARACTERS WITHOUT CLAIM TO ANY PARTICULAR FONT, STYLE, SIZE, OR COLOR.

SN 78-947,151, FILED 8-8-2006.

KELLY BOULTON, EXAMINING ATTORNEY

Int. Cl.: 3

Prior U.S. Cls.: 1, 4, 6, 50, 51, and 52

Reg. No. 3,482,500

United States Patent and Trademark Office

Registered Aug. 5, 2008

**TRADEMARK
PRINCIPAL REGISTER**

Triple Cushion

JACK BLACK, L.L.C. (DELAWARE LTD LIAB
CO)
2155 CHENAULT DR., # 509
CARROLLTON, TX 75006

THE MARK CONSISTS OF STANDARD CHAR-
ACTERS WITHOUT CLAIM TO ANY PARTICULAR
FONT, STYLE, SIZE, OR COLOR.

FOR: SHAVING CREAM, IN CLASS 3 (U.S. CLS. 1,
4, 6, 50, 51 AND 52).

SN 78-947,252, FILED 8-8-2006.

FIRST USE 10-1-2006; IN COMMERCE 10-1-2006.

ALYSSA PALADINO, EXAMINING ATTORNEY

Int. Cl.: 11

Prior U.S. Cls.: 13, 21, 23, 31, and 34

United States Patent and Trademark Office

Reg. No. 3,482,501

Registered Aug. 5, 2008

**TRADEMARK
PRINCIPAL REGISTER**

KUVINGS

NUC ELECTRONICS CO., LTD. (REPUBLIC OF
KOREA CORPORATION)
679 CHIMSAN-3 DONG, BUK-GU
DAEGU, REPUBLIC OF KOREA

FOR: ELECTRIC SOYMILK MAKER, ELECTRIC
YOGURT MAKERS, ELECTRICAL ICE-CREAM
MAKERS, ELECTRIC BREWING MACHINES FOR
COFFEE, LIQUOR AND TEA FOR HOUSEHOLD
PURPOSES, ELECTRIC DISH DISINFECTANT AP-
PARATUS FOR HOUSEHOLD PURPOSES, ELEC-
TRIC AIR DEODORIZING APPARATUS, ELECTRIC

COOKING OVENS, IN CLASS 11 (U.S. CLS. 13, 21, 23,
31 AND 34).

FIRST USE 6-2-2008; IN COMMERCE 6-2-2008.

THE MARK CONSISTS OF STANDARD CHAR-
ACTERS WITHOUT CLAIM TO ANY PARTICULAR
FONT, STYLE, SIZE, OR COLOR.

SN 78-947,326, FILED 8-8-2006.

ROBIN MITTLER, EXAMINING ATTORNEY

Int. Cl.: 41

Prior U.S. Cls.: 100, 101, and 107

United States Patent and Trademark Office

Reg. No. 3,482,502

Registered Aug. 5, 2008

**SERVICE MARK
PRINCIPAL REGISTER**

OPTIONS A TO Z

OPTIONS A TO Z (FLORIDA LTD LIAB CO)
1546 AUDUBON BLVD
DELRAY BEACH, FL 33444

FOR: EDUCATION SERVICES, NAMELY, PROVIDING CLASSES, WORKSHOPS, SEMINARS AND COMPUTER SOFTWARE PRESENTATIONS IN THE FIELDS OF INVESTMENT, FINANCES, OPTIONS INVESTING AND FINANCIAL MANAGEMENT, AND DISTRIBUTING COURSE MATERIALS, NAMELY PRINTED MATERIALS AND VIDEOS, THEREWITH; EDUCATIONAL SERVICES, NAMELY, CONDUCTING PROGRAMS IN THE FIELD OF INVESTMENT, FINANCES, OPTIONS INVESTING, AND FINANCIAL MANAGEMENT; DEVELOPMENT AND DISSEMINATION OF EDUCATIONAL MATERIALS OF OTHERS IN THE FIELDS OF

INVESTMENT, FINANCES, OPTIONS INVESTING AND FINANCIAL MANAGEMENT, IN CLASS 41 (U.S. CLS. 100, 101 AND 107).

FIRST USE 11-30-2007; IN COMMERCE 11-30-2007.

THE MARK CONSISTS OF STANDARD CHARACTERS WITHOUT CLAIM TO ANY PARTICULAR FONT, STYLE, SIZE, OR COLOR.

NO CLAIM IS MADE TO THE EXCLUSIVE RIGHT TO USE "OPTIONS", APART FROM THE MARK AS SHOWN.

SN 78-947,792, FILED 8-8-2006.

CARRIE GENOVESE, EXAMINING ATTORNEY

Int. Cl.: 25

Prior U.S. Cls.: 22 and 39

United States Patent and Trademark Office

Reg. No. 3,482,503

Registered Aug. 5, 2008

**TRADEMARK
PRINCIPAL REGISTER**

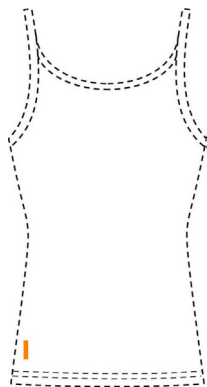

LUCY ACTIVEWEAR, INC. (DELAWARE CORPORATION)
222 SW COLUMBIA STREET, SUITE 300
PORTLAND, OR 97201

FOR: CLOTHING, NAMELY, TOPS, TANKS, T-SHIRTS, JACKETS, VESTS, WARM-UP SUITS, DRESSES, AND BRAS, IN CLASS 25 (U.S. CLS. 22 AND 39).

FIRST USE 12-0-2006; IN COMMERCE 12-0-2006.

THE COLOR(S) ORANGE IS/ARE CLAIMED AS A FEATURE OF THE MARK.

THE MARK CONSISTS OF AN ORANGE (PMS 144) LOWER CASE LETTER "L" APPLIED TO THE LOWER LEFT SIDE OF THE BACK OF THE GOODS. THE DOTTED LINES SHOWING THE OUTLINE OF A GARMENT FORM NO PART OF THE MARK, BUT SHOW THE PLACEMENT OF THE MARK ONLY.

SN 78-948,297, FILED 8-9-2006.

SETH A. RAPPAPORT, EXAMINING ATTORNEY

Int. Cl.: 33

Prior U.S. Cls.: 47 and 49

United States Patent and Trademark Office

Reg. No. 3,482,504

Registered Aug. 5, 2008

**TRADEMARK
PRINCIPAL REGISTER**

VINETTA

ROBERT MONDAVI WINERY (CALIFORNIA
CORPORATION)
841 LATOUR COURT
NAPA, CA 94558

THE MARK CONSISTS OF STANDARD CHAR-
ACTERS WITHOUT CLAIM TO ANY PARTICULAR
FONT, STYLE, SIZE, OR COLOR.

FOR: WINE, IN CLASS 33 (U.S. CLS. 47 AND 49).

SN 78-948,743, FILED 8-9-2006.

FIRST USE 1-0-2007; IN COMMERCE 1-0-2007.

DAWN HAN, EXAMINING ATTORNEY

Int. Cls.: 42, 44, and 45

Prior U.S. Cls.: 100 and 101

United States Patent and Trademark Office

Reg. No. 3,482,505

Registered Aug. 5, 2008

**SERVICE MARK
PRINCIPAL REGISTER**

RENOWN

RENOWN HEALTH (NEVADA CORPORATION)
1155 MILL STREET
RENO, NV 89502

FOR: MEDICAL RESEARCH SERVICES, MEDICAL LABORATORIES AND NEUROSCIENCE RESEARCH SERVICES, CLINICAL TRIAL SERVICES, IN CLASS 42 (U.S. CLS. 100 AND 101).

FIRST USE 9-21-2006; IN COMMERCE 9-21-2006.

FOR: HOSPITAL; MEDICAL SERVICES; INPATIENT AND OUTPATIENT DIAGNOSTIC IMAGING SERVICES; ACUTE INPATIENT AND OUTPATIENT REHABILITATION SERVICES; MENTAL REHABILITATION SERVICES; COMPLETE HEALTH CARE ORGANIZATION NAMELY, CANCER DIAGNOSTIC AND TREATMENT SERVICES, DIAGNOSIS AND TREATMENT OF HEART DISEASE, CARDIAC SURGERY SERVICES, ORTHOPEDIC SURGERY SERVICES, HEALTH AND WELLNESS PROGRAMS, HOME HEALTH CARE SERVICES, MENTAL HEALTH AND SUBSTANCE ABUSE TREATMENT; PSYCHIATRIC CONSULTATIONS, NAMELY MEDICATION MANAGEMENT, PSY-

CHOLOGICAL TESTING, PSYCHOLOGICAL THERAPY AND COUNSELING; PEDIATRIC MEDICAL SERVICES; PHYSICAL, OCCUPATIONAL AND SPEECH REHABILITATION AND THERAPY SERVICES; MEDICAL COUNSELING SERVICES, IN CLASS 44 (U.S. CLS. 100 AND 101).

FIRST USE 9-21-2006; IN COMMERCE 9-21-2006.

FOR: PROVIDING PERSONAL SUPPORT SERVICES FOR FAMILIES OF PATIENTS WITH LIFE THREATENING DISORDERS, NAMELY, COMPANIONSHIP, HELP WITH MEDICAL FORMS, COUNSELING AND EMOTIONAL SUPPORT, IN CLASS 45 (U.S. CLS. 100 AND 101).

FIRST USE 9-21-2006; IN COMMERCE 9-21-2006.

THE MARK CONSISTS OF STANDARD CHARACTERS WITHOUT CLAIM TO ANY PARTICULAR FONT, STYLE, SIZE, OR COLOR.

SN 78-949,670, FILED 8-10-2006.

DORITT L. CARROLL, EXAMINING ATTORNEY

Int. Cl.: 13

Prior U.S. Cls.: 2 and 9

United States Patent and Trademark Office

Reg. No. 3,482,506

Registered Aug. 5, 2008

**TRADEMARK
PRINCIPAL REGISTER**

SPEED SIGHTS

PRICE, DONALD H. (UNITED STATES INDIVIDUAL)
1240 W. SIMS WAY
PORT TOWNSEND, WA 98368

FOR: NON-TELESCOPIC AIMING AND SIGHTING DEVICES FOR FIREARMS, IN CLASS 13 (U.S. CLS. 2 AND 9).

FIRST USE 11-15-2006; IN COMMERCE 11-15-2006.

THE MARK CONSISTS OF STANDARD CHARACTERS WITHOUT CLAIM TO ANY PARTICULAR FONT, STYLE, SIZE, OR COLOR.

NO CLAIM IS MADE TO THE EXCLUSIVE RIGHT TO USE "SIGHTS", APART FROM THE MARK AS SHOWN.

SN 78-950,144, FILED 8-11-2006.

CAROLINE WOOD, EXAMINING ATTORNEY

Int. Cls.: 35 and 45

Prior U.S. Cls.: 100, 101, and 102

United States Patent and Trademark Office

Reg. No. 3,482,507

Registered Aug. 5, 2008

**SERVICE MARK
PRINCIPAL REGISTER**

Rx Mosaic Health

BRODEUR & PARTNERS, LLC (CALIFORNIA
LTD LIAB CO)
855 BOYLSTON STREET
BOSTON, MA 02116

FOR: PUBLIC RELATIONS SERVICES IN THE
PHARMACEUTICAL AND HEALTHCARE FIELDS;
ORGANIZING AND IMPLEMENTING PHARMA-
CEUTICAL PRODUCT LAUNCHES; ARRANGING
AND CONDUCTING TRADE SHOWS IN THE
PHARMACEUTICAL FIELD, IN CLASS 35 (U.S.
CLS. 100, 101 AND 102).

FIRST USE 8-1-2006; IN COMMERCE 8-1-2006.

FOR: PROVIDING ASSISTANCE TO PHARMA-
CEUTICAL COMPANIES IN CONNECTION WITH
THE REGULATORY APPROVAL PROCESS, NAME-
LY, REVIEWING STANDARDS AND PRACTICES

TO ASSURE COMPLIANCE WITH PHARMACEUTI-
CAL LAWS AND REGULATIONS, IN CLASS 45 (U.S.
CLS. 100 AND 101).

FIRST USE 8-1-2006; IN COMMERCE 8-1-2006.

THE MARK CONSISTS OF STANDARD CHAR-
ACTERS WITHOUT CLAIM TO ANY PARTICULAR
FONT, STYLE, SIZE, OR COLOR.

NO CLAIM IS MADE TO THE EXCLUSIVE
RIGHT TO USE "RX" AND "HEALTH", APART
FROM THE MARK AS SHOWN.

SN 78-951,249, FILED 8-14-2006.

PATRICIA EVANKO, EXAMINING ATTORNEY

Int. Cl.: 8

Prior U.S. Cls.: 23, 28, and 44

Reg. No. 3,482,508

United States Patent and Trademark Office

Registered Aug. 5, 2008

**TRADEMARK
PRINCIPAL REGISTER**

F.A.T. WRENCH

BATTENFELD TECHNOLOGIES, INC. (MISSOURI CORPORATION)
5885 W. VAN HORN TAVERN ROAD
COLUMBIA, MO 65203

FOR: MANUALLY OPERATED HAND TOOLS, NAMELY, WRENCHES USED EXCLUSIVELY WITH FIREARMS, IN CLASS 8 (U.S. CLS. 23, 28 AND 44).

FIRST USE 7-26-2006; IN COMMERCE 7-26-2006.

THE MARK CONSISTS OF STANDARD CHARACTERS WITHOUT CLAIM TO ANY PARTICULAR FONT, STYLE, SIZE, OR COLOR.

NO CLAIM IS MADE TO THE EXCLUSIVE RIGHT TO USE "WRENCH", APART FROM THE MARK AS SHOWN.

SN 78-951,746, FILED 8-14-2006.

MARK PILARO, EXAMINING ATTORNEY

Int. Cl.: 20

Prior U.S. Cls.: 2, 13, 22, 25, 32, and 50

United States Patent and Trademark Office

Reg. No. 3,482,509

Registered Aug. 5, 2008

**TRADEMARK
PRINCIPAL REGISTER**

A SAFE PLACE

MULVANEY, KATHLEEN (UNITED STATES IN-
DIVIDUAL)
106 FARRAGUT ROAD
WEST BABYLON, NY 11704

THE MARK CONSISTS OF STANDARD CHAR-
ACTERS WITHOUT CLAIM TO ANY PARTICULAR
FONT, STYLE, SIZE, OR COLOR.

FOR: WOOD BOXES, IN CLASS 20 (U.S. CLS. 2, 13,
22, 25, 32 AND 50).

SN 78-951,926, FILED 8-15-2006.

FIRST USE 3-15-2008; IN COMMERCE 3-15-2008.

GEOFFREY FOSDICK, EXAMINING ATTORNEY

Int. Cl.: 38

Prior U.S. Cls.: 100, 101, and 104

United States Patent and Trademark Office

Reg. No. 3,482,510

Registered Aug. 5, 2008

**SERVICE MARK
PRINCIPAL REGISTER**

800response

800 RESPONSE MARKETING LLC (VERMONT
LTD LIAB CO)
200 CHURCH STREET
BURLINGTON, VT 05401

FOR: TELEPHONE CALL MONITORING SERVI-
CES, IN CLASS 38 (U.S. CLS. 100, 101 AND 104).

FIRST USE 5-7-2003; IN COMMERCE 8-7-2003.

THE MARK CONSISTS OF STANDARD CHAR-
ACTERS WITHOUT CLAIM TO ANY PARTICULAR
FONT, STYLE, SIZE, OR COLOR.

OWNER OF U.S. REG. NO. 1,521,210.

SN 78-952,297, FILED 8-15-2006.

KEVON CHISOLM, EXAMINING ATTORNEY

Int. Cl.: 25

Prior U.S. Cls.: 22 and 39

United States Patent and Trademark Office

Reg. No. 3,482,511

Registered Aug. 5, 2008

**TRADEMARK
PRINCIPAL REGISTER**

SOUL LONDON

OCTEAU, GUY (CANADA INDIVIDUAL)
5425 METROPOLITAIN EAST BLVD.
MONTREAL, QUEBEC, CANADA H1P 1X2

FOR: SHIRTS, IN CLASS 25 (U.S. CLS. 22 AND 39).

FIRST USE 1-0-2006; IN COMMERCE 1-0-2006.

THE MARK CONSISTS OF STANDARD CHARACTERS WITHOUT CLAIM TO ANY PARTICULAR FONT, STYLE, SIZE, OR COLOR.

OWNER OF CANADA REG. NO. TMA629,591,
DATED 1-6-2005, EXPIRES 1-6-2020.

THE NAME(S), PORTRAIT(S), AND/OR SIGNATURE(S) SHOWN IN THE MARK DOES NOT IDENTIFY A PARTICULAR LIVING INDIVIDUAL.

SN 78-952,332, FILED 8-15-2006.

FLORENTINA BLANDU, EXAMINING ATTORNEY

Int. Cl.: 30

Prior U.S. Cl.: 46

United States Patent and Trademark Office

Reg. No. 3,482,512

Registered Aug. 5, 2008

**TRADEMARK
PRINCIPAL REGISTER**

TWIX

MARS, INCORPORATED (DELAWARE CORPORATION)
6885 ELM STREET
MCLEAN, VA 221013883

FOR: SNACK FOODS, NAMELY, CHOCOLATE AND GRANOLA FOODS BARS, AND GRAIN-BASED SNACKS CONTAINING VARIOUS FILLINGS, IN CLASS 30 (U.S. CL. 46).

FIRST USE 6-29-2007; IN COMMERCE 6-29-2007.

THE MARK CONSISTS OF STANDARD CHARACTERS WITHOUT CLAIM TO ANY PARTICULAR FONT, STYLE, SIZE, OR COLOR.

OWNER OF U.S. REG. NOS. 1,533,495, 2,618,227, AND OTHERS.

SN 78-952,548, FILED 8-15-2006.

JOHN WILKE, EXAMINING ATTORNEY

Int. Cl.: 5

Prior U.S. Cls.: 6, 18, 44, 46, 51, and 52

United States Patent and Trademark Office

Reg. No. 3,482,513

Registered Aug. 5, 2008

**TRADEMARK
PRINCIPAL REGISTER**

SHOO FLY

FNC MEDICAL CORPORATION (CALIFORNIA
CORPORATION)
6000 LELAND STREET
VENTURA, CA 93003

THE MARK CONSISTS OF STANDARD CHAR-
ACTERS WITHOUT CLAIM TO ANY PARTICULAR
FONT, STYLE, SIZE, OR COLOR.

FOR: NATURAL INSECTICIDE FOR HORSES, IN
CLASS 5 (U.S. CLS. 6, 18, 44, 46, 51 AND 52).

SN 78-952,704, FILED 8-15-2006.

FIRST USE 4-0-2006; IN COMMERCE 4-0-2006.

HENRY S. ZAK, EXAMINING ATTORNEY

Int. Cls.: 10 and 11

Prior U.S. Cls.: 13, 21, 23, 26, 31, 34, 39, and 44

United States Patent and Trademark Office

Reg. No. 3,482,514

Registered Aug. 5, 2008

**TRADEMARK
PRINCIPAL REGISTER**

HYDROTHER

1673911 ONTARIO LTD. (CANADA CORPORATION)
135 MATHESON BLVD. EAST
MISSISSAUGA, ONTARIO L4Z 1R2

FOR: MASSAGE BEDS, IN CLASS 10 (U.S. CLS. 26, 39 AND 44).

FIRST USE 9-1-2006; IN COMMERCE 9-1-2006.

FOR: HOT TUBS AND SPA PRODUCTS, NAME-
LY, SAUNAS, WHIRLPOOL BATHS, AND SHOW-

ERS FOR USE IN SPAS, IN CLASS 11 (U.S. CLS. 13, 21, 23, 31 AND 34).

FIRST USE 9-1-2006; IN COMMERCE 9-1-2006.

THE MARK CONSISTS OF STANDARD CHAR-
ACTERS WITHOUT CLAIM TO ANY PARTICULAR
FONT, STYLE, SIZE, OR COLOR.

SN 78-953,075, FILED 8-16-2006.

KHANH LE, EXAMINING ATTORNEY

Int. Cl.: 42

Prior U.S. Cls.: 100 and 101

United States Patent and Trademark Office

Reg. No. 3,482,515

Registered Aug. 5, 2008

**SERVICE MARK
PRINCIPAL REGISTER**

POWERED BY NYFIX

NYFIX, INC. (NEW YORK CORPORATION)
STAMFORD HARBOR PARK
333 LUDLOW STREET
STAMFORD, CT 06902

FOR: APPLICATION HOSTING SERVICES FEATURING SOFTWARE FOR USE IN CONNECTION WITH FINANCIAL ORDER MANAGEMENT, EXECUTION MANAGEMENT AND MESSAGING FOR USE BY INSTITUTIONAL INVESTORS BY MEANS OF THE INTERNET, IN CLASS 42 (U.S. CLS. 100 AND 101).

FIRST USE 8-0-2006; IN COMMERCE 8-0-2006.

THE MARK CONSISTS OF STANDARD CHARACTERS WITHOUT CLAIM TO ANY PARTICULAR FONT, STYLE, SIZE, OR COLOR.

OWNER OF U.S. REG. NOS. 2,446,661, 2,576,274, AND OTHERS.

SN 78-953,103, FILED 8-16-2006.

JUSTINE D. PARKER, EXAMINING ATTORNEY

Prior U.S. Cl.: B

United States Patent and Trademark Office

Reg. No. 3,482,516

Registered Aug. 5, 2008

CERTIFICATION MARK
SERVICES
PRINCIPAL REGISTER

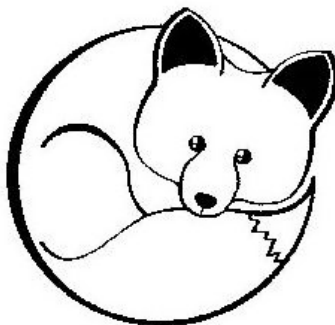

ANIMAL PROTECTION INSTITUTE (CALIFORNIA NON-PROFIT CORPORATION)
1122 S STREET
SACRAMENTO, CA 95822

FOR: RETAIL STORE SERVICES, IN CLASS B (U.S. CL. B).

FIRST USE 3-17-2008; IN COMMERCE 3-17-2008.

THE MARK CONSISTS OF A STYLIZED REPRESENTATION OF A FOX CURLED INTO A CIRCULAR CONFIGURATION.

NO ANIMAL FUR WAS USED TO MAKE PRODUCTS SOLD BY THIS RETAILER.

SN 78-953,704, FILED 8-16-2006.

JUSTINE D. PARKER, EXAMINING ATTORNEY

Int. Cl.: 9

Prior U.S. Cls.: 21, 23, 26, 36, and 38

Reg. No. 3,482,517

United States Patent and Trademark Office

Registered Aug. 5, 2008

**TRADEMARK
PRINCIPAL REGISTER**

TVEE

BOSTON ACOUSTICS, INC. (MASSACHUSETTS
CORPORATION)
300 JUBILEE DRIVE
PEABODY, MA 01960

FOR: LOUDSPEAKERS; AMPLIFIERS; RADIOS;
HOME THEATER SYSTEMS COMPRISED OF PRE-
AMPLIFIERS, STEREO SIGNAL PROCESSORS,
POWER AMPLIFIERS AND LOUDSPEAKER SYS-
TEMS; RADIO FREQUENCY TRANSMITTERS;
RADIO FREQUENCY RECEIVERS; AND WIRELESS
AUDIO PRODUCTS, NAMELY, WIRELESS LOUD-

SPEAKERS, IN CLASS 9 (U.S. CLS. 21, 23, 26, 36 AND
38).

FIRST USE 9-1-2007; IN COMMERCE 9-1-2007.

THE MARK CONSISTS OF STANDARD CHAR-
ACTERS WITHOUT CLAIM TO ANY PARTICULAR
FONT, STYLE, SIZE, OR COLOR.

SN 78-954,084, FILED 8-17-2006.

BILL DAWE, EXAMINING ATTORNEY

Int. Cl.: 32

Prior U.S. Cls.: 45, 46, and 48

United States Patent and Trademark Office

Reg. No. 3,482,518

Registered Aug. 5, 2008

TRADEMARK
PRINCIPAL REGISTER



L.R.A., L.L.C. (OKLAHOMA LIMITED LIABILITY COMPANY)
5600 SOUTH PENNSYLVANIA
OKLAHOMA CITY, OK 73159

FOR: SOFT DRINKS, NAMELY, NON-CARBONATED FRUIT JUICE DRINKS AND ENERGY DRINKS ENHANCED WITH VITAMINS, MINERALS, CAFFEINE, NUTRIENTS, AMINO ACIDS AND/OR HERBS, IN CLASS 32 (U.S. CLS. 45, 46 AND 48).

FIRST USE 6-30-2006; IN COMMERCE 6-30-2006.

OWNER OF U.S. REG. NO. 2,855,717.

THE COLOR(S) GREEN, YELLOW, RED, BLACK AND WHITE IS/ARE CLAIMED AS A FEATURE OF THE MARK.

THE COLOR GREEN APPEARS IN THE WORDING "GLORIA VIEJO" WHICH WORDS ARE SURROUNDED BY A YELLOW LINE AND FURTHER SURROUNDED BY A RED BORDER. THE DESIGN ELEMENT REPRESENTATION OF AN EAGLE APPEARS WITH THE EAGLE'S BODY AND WINGS IN RED AND THE HEAD IN WHITE AND THE EAGLE'S BEAK AND FEET ARE YELLOW. THE WORDS "EL AGUILA" APPEAR IN BLACK.

THE ENGLISH TRANSLATION OF THE WORD "GLORIA VIEJO EL AGUILA" IN THE MARK IS OLD GLORY THE EAGLE.

SN 78-954,279, FILED 8-17-2006.

SALLY SHIH, EXAMINING ATTORNEY

Int. Cl.: 35

Prior U.S. Cls.: 100, 101, and 102

United States Patent and Trademark Office

Reg. No. 3,482,519

Registered Aug. 5, 2008

**SERVICE MARK
PRINCIPAL REGISTER**

**YOUR TIME HAS NEVER BEEN
MORE REWARDING**

E-MILES, LLC (DELAWARE LTD LIAB CO)
8401 N. CENTRAL EXPRESSWAY, SUITE 1000
DALLAS, TX 75225

FOR: ADVERTISING SERVICES FOR OTHERS;
BUSINESS AND TECHNICAL CONSULTING SER-
VICES IN THE FIELD OF ADVERTISING SERVICES
AND CUSTOMER RELATIONSHIP MANAGE-
MENT (CRM) PROGRAMS; DESIGN, IMPLEMEN-
TATION AND MANAGEMENT OF CUSTOMER
LOYALTY PROGRAMS; CONDUCTING BUSINESS
AND MARKET RESEARCH, SURVEYS, AND ANA-
LYSES FOR OTHERS; PROMOTING THE GOODS
AND SERVICE OF OTHERS THROUGH INCEN-

TIVE PROGRAMS; AND MARKETING TECHNOL-
OGY OUTSOURCING SERVICES, IN CLASS 35 (U.S.
CLS. 100, 101 AND 102).

FIRST USE 10-17-2007; IN COMMERCE 10-17-2007.

THE MARK CONSISTS OF STANDARD CHAR-
ACTERS WITHOUT CLAIM TO ANY PARTICULAR
FONT, STYLE, SIZE, OR COLOR.

SN 78-954,435, FILED 8-17-2006.

CYNTHIA SLOAN, EXAMINING ATTORNEY

Int. Cl.: 9

Prior U.S. Cls.: 21, 23, 26, 36, and 38

United States Patent and Trademark Office

Reg. No. 3,482,520

Registered Aug. 5, 2008

**TRADEMARK
PRINCIPAL REGISTER**

MUSICIP MIXER

MUSICIP CORPORATION (DELAWARE CORPORATION)
SUITE 201
605 E. HUNTINGTON DRIVE
MONROVIA, CA 91016

FOR: CONTROL SOFTWARE FOR MANAGING, IDENTIFYING AND SELECTING MUSIC AND FOR CREATING MUSIC PLAYLISTS; SOFTWARE DEVELOPMENT KITS (SDK) FOR ADAPTING SUCH CONTROL SOFTWARE FOR USE WITH CONSUMER PRODUCTS SUCH AS MP3 PLAYERS, AND FIRMWARE EMBEDDED IN THIRD PARTY CONSUMER PRODUCTS AND ENTERPRISE NETWORK SERVERS TO ENABLE SUCH CONTROL SOFTWARE, IN CLASS 9 (U.S. CLS. 21, 23, 26, 36 AND 38).

FIRST USE 4-0-2006; IN COMMERCE 4-0-2006.

THE MARK CONSISTS OF STANDARD CHARACTERS WITHOUT CLAIM TO ANY PARTICULAR FONT, STYLE, SIZE, OR COLOR.

NO CLAIM IS MADE TO THE EXCLUSIVE RIGHT TO USE "MIXER", APART FROM THE MARK AS SHOWN.

SN 78-954,599, FILED 8-17-2006.

JASON BLAIR, EXAMINING ATTORNEY

Int. Cl.: 24

Prior U.S. Cls.: 42 and 50

United States Patent and Trademark Office

Reg. No. 3,482,521

Registered Aug. 5, 2008

**TRADEMARK
PRINCIPAL REGISTER**

FABRIC EXPRESSIONS

FABRIC EDITIONS, LLC. (SOUTH CAROLINA CORPORATION)
1 INDEPENDENCE POINTE, STUDIO 202
GREENVILLE, SC 29615

FOR: PRE-CUT, INDIVIDUALLY-PACKAGED COTTON FABRIC PIECES FOR USE AS COMPONENTS IN CRAFT PROJECTS, IN CLASS 24 (U.S. CLS. 42 AND 50).

FIRST USE 10-4-2006; IN COMMERCE 10-4-2006.

THE MARK CONSISTS OF STANDARD CHARACTERS WITHOUT CLAIM TO ANY PARTICULAR FONT, STYLE, SIZE, OR COLOR.

NO CLAIM IS MADE TO THE EXCLUSIVE RIGHT TO USE "FABRIC", APART FROM THE MARK AS SHOWN.

SN 78-954,677, FILED 8-17-2006.

JOHN WILKE, EXAMINING ATTORNEY

Int. Cl.: 25

Prior U.S. Cls.: 22 and 39

United States Patent and Trademark Office

Reg. No. 3,482,522

Registered Aug. 5, 2008

**TRADEMARK
PRINCIPAL REGISTER**



NEIL PRYDE LIMITED (HONG KONG COR-
PORATION)
20/F YKK BUILDING PHASE 2
NO. 2 SAN LIK STREET
TUEN MUN, HONG KONG

FIRST USE 3-0-2003; IN COMMERCE 3-0-2003.

SN 78-954,690, FILED 8-17-2006.

FOR: CLOTHING, NAMELY, SHIRTS, HATS,
JACKETS, PANTS, SWIMSUITS AND WETSUITS,
IN CLASS 25 (U.S. CLS. 22 AND 39).

SHAUNIA CARLYLE, EXAMINING ATTORNEY

Int. Cls.: 20, 22, and 24

Prior U.S. Cls.: 1, 2, 7, 13, 19, 22, 25, 32, 42, and 50

United States Patent and Trademark Office

Reg. No. 3,482,523

Registered Aug. 5, 2008

**TRADEMARK
PRINCIPAL REGISTER**

SILVER FILL

UNITED FEATHER & DOWN, INC. (NEW YORK CORPORATION)
414 EAST GOLF ROAD
DES PLAINES, IL 60016

FOR: PILLOWS, IN CLASS 20 (U.S. CLS. 2, 13, 22, 25, 32 AND 50).

FIRST USE 2-29-2008; IN COMMERCE 2-29-2008.

FOR: SYNTHETIC FIBERS, IN CLASS 22 (U.S. CLS. 1, 2, 7, 19, 22, 42 AND 50).

FIRST USE 2-29-2008; IN COMMERCE 2-29-2008.

FOR: BED BLANKETS; COMFORTERS; MATTRESS COVERS; MATTRESS PADS, IN CLASS 24 (U.S. CLS. 42 AND 50).

FIRST USE 2-29-2008; IN COMMERCE 2-29-2008.

THE MARK CONSISTS OF STANDARD CHARACTERS WITHOUT CLAIM TO ANY PARTICULAR FONT, STYLE, SIZE, OR COLOR.

NO CLAIM IS MADE TO THE EXCLUSIVE RIGHT TO USE "FILL", APART FROM THE MARK AS SHOWN.

SN 78-954,884, FILED 8-17-2006.

JAMES LOVELACE, EXAMINING ATTORNEY

Int. Cl.: 8

Prior U.S. Cls.: 23, 28, and 44

United States Patent and Trademark Office

Reg. No. 3,482,524

Registered Aug. 5, 2008

**TRADEMARK
PRINCIPAL REGISTER**

SPRINGER

TAYLOR BRANDS LLC (TENNESSEE LTD LIAB
CO)
1043 FORDTOWN RD.
KINGSPORT, TN 37663

THE MARK CONSISTS OF STANDARD CHAR-
ACTERS WITHOUT CLAIM TO ANY PARTICULAR
FONT, STYLE, SIZE, OR COLOR.

FOR: CUTLERY, NAMELY, KNIVES, IN CLASS 8
(U.S. CLS. 23, 28 AND 44).

SN 78-955,527, FILED 8-18-2006.

FIRST USE 5-14-2008; IN COMMERCE 5-14-2008.

ODESSA BIBBINS, EXAMINING ATTORNEY

Int. Cl.: 31

Prior U.S. Cls.: 1 and 46

United States Patent and Trademark Office

Reg. No. 3,482,525

Registered Aug. 5, 2008

**TRADEMARK
PRINCIPAL REGISTER**

SUNSCRIPTION VITA

SUN SEED COMPANY, INC. (OHIO CORPORATION)
P.O. BOX 33
BOWLING GREEN, OH 43402

FOR: FOOD AND TREATS FOR ANIMALS, NAMELY, BIRD FOOD AND TREATS, PET FOOD AND TREATS AND ANIMAL FOOD AND TREATS; FOOD AND TREATS FOR ANIMALS INCORPORATING VITAMINS AND MINERALS, NAMELY, BIRD FOOD AND TREATS, PET FOOD AND TREATS AND ANIMAL FOOD AND TREATS, IN CLASS 31 (U.S. CLS. 1 AND 46).

FIRST USE 9-0-2006; IN COMMERCE 9-0-2006.

THE MARK CONSISTS OF STANDARD CHARACTERS WITHOUT CLAIM TO ANY PARTICULAR FONT, STYLE, SIZE, OR COLOR.

SN 78-956,566, FILED 8-21-2006.

CARRIE GENOVESE, EXAMINING ATTORNEY

Int. Cl.: 31

Prior U.S. Cls.: 1 and 46

United States Patent and Trademark Office

Reg. No. 3,482,526

Registered Aug. 5, 2008

**TRADEMARK
PRINCIPAL REGISTER**



SUN SEED COMPANY, INC. (OHIO CORPORATION)
P.O. BOX 33
BOWLING GREEN, OH 43402

FOR: FOOD AND TREATS FOR ANIMALS, NAMELY, BIRD FOOD AND TREATS, PET FOOD AND TREATS AND ANIMAL FOOD AND TREATS; FOOD AND TREATS FOR ANIMALS INCORPORATING VITAMINS AND MINERALS, NAMELY,

BIRD FOOD AND TREATS, PET FOOD AND TREATS AND ANIMAL FOOD AND TREATS, IN CLASS 31 (U.S. CLS. 1 AND 46).

FIRST USE 9-0-2006; IN COMMERCE 9-0-2006.

SN 78-956,605, FILED 8-21-2006.

CARRIE GENOVESE, EXAMINING ATTORNEY

Int. Cl.: 9

Prior U.S. Cls.: 21, 23, 26, 36, and 38

Reg. No. 3,482,527

United States Patent and Trademark Office

Registered Aug. 5, 2008

**TRADEMARK
PRINCIPAL REGISTER**

Boogie Monsters

GLOBAL GAMING GROUP (NEVADA CORPORATION)
3035 E PATRICK LANE SUITE 14
LAS VEGAS, NV 89120

THE MARK CONSISTS OF STANDARD CHARACTERS WITHOUT CLAIM TO ANY PARTICULAR FONT, STYLE, SIZE, OR COLOR.

FOR: GAMING EQUIPMENT, NAMELY, SLOT MACHINES WITH OR WITHOUT VIDEO OUTPUT, IN CLASS 9 (U.S. CLS. 21, 23, 26, 36 AND 38).

SN 78-956,708, FILED 8-21-2006.

FIRST USE 2-15-2008; IN COMMERCE 2-15-2008.

MELVIN AXILBUND, EXAMINING ATTORNEY

Int. Cl.: 31

Prior U.S. Cls.: 1 and 46

United States Patent and Trademark Office

Reg. No. 3,482,528

Registered Aug. 5, 2008

**TRADEMARK
PRINCIPAL REGISTER**



SUN SEED COMPANY, INC. (OHIO CORPORATION)
P.O. BOX 33
BOWLING GREEN, OH 43402

BIRD FOOD AND TREATS, PET FOOD AND TREATS AND ANIMAL FOOD AND TREATS, IN CLASS 31 (U.S. CLS. 1 AND 46).

FOR: FOOD AND TREATS FOR ANIMALS, NAMELY, BIRD FOOD AND TREATS, PET FOOD AND TREATS AND ANIMAL FOOD AND TREATS; FOOD AND TREATS FOR ANIMALS INCORPORATING VITAMINS AND MINERALS, NAMELY,

FIRST USE 8-0-2007; IN COMMERCE 8-0-2007.

SN 78-956,723, FILED 8-21-2006.

CARRIE GENOVESE, EXAMINING ATTORNEY

Int. Cl.: 9

Prior U.S. Cls.: 21, 23, 26, 36, and 38

Reg. No. 3,482,529

United States Patent and Trademark Office

Registered Aug. 5, 2008

**TRADEMARK
PRINCIPAL REGISTER**

Big Bite

GLOBAL GAMING GROUP (NEVADA CORPORATION)
3035 E PATRICK LANE SUITE 14
LAS VEGAS, NV 89120

THE MARK CONSISTS OF STANDARD CHARACTERS WITHOUT CLAIM TO ANY PARTICULAR FONT, STYLE, SIZE, OR COLOR.

FOR: GAMING EQUIPMENT, NAMELY, SLOT MACHINES WITH OR WITHOUT VIDEO OUTPUT, IN CLASS 9 (U.S. CLS. 21, 23, 26, 36 AND 38).

SN 78-956,778, FILED 8-21-2006.

FIRST USE 1-5-2008; IN COMMERCE 1-5-2008.

DAVID MURRAY, EXAMINING ATTORNEY

Int. Cl.: 9

Prior U.S. Cls.: 21, 23, 26, 36, and 38

Reg. No. 3,482,530

United States Patent and Trademark Office

Registered Aug. 5, 2008

**TRADEMARK
PRINCIPAL REGISTER**

EPUMP

SFC FLUIDICS, LLC (ARKANSAS LTD LIAB CO)
535 W. RESEARCH CENTER BLVD, SUITE 135
FAYETTEVILLE, AR 72701

FIRST USE 12-5-2005; IN COMMERCE 12-5-2005.

FOR: TECHNICAL AND SCIENTIFIC APPARATUS, NAMELY, ELECTROCHEMICAL PUMP FOR CONTROL OF FLUID FLOW IN CHEMICAL AND BIOLOGICAL SYSTEM, IN CLASS 9 (U.S. CLS. 21, 23, 26, 36 AND 38).

THE MARK CONSISTS OF STANDARD CHARACTERS WITHOUT CLAIM TO ANY PARTICULAR FONT, STYLE, SIZE, OR COLOR.

SN 78-958,646, FILED 8-23-2006.

CHARLOTTE CORWIN, EXAMINING ATTORNEY

Int. Cl.: 9

Prior U.S. Cls.: 21, 23, 26, 36, and 38

Reg. No. 3,482,531

United States Patent and Trademark Office

Registered Aug. 5, 2008

**TRADEMARK
PRINCIPAL REGISTER**

MPUMP

SFC FLUIDICS, LLC (ARKANSAS LTD LIAB CO)
535 W. RESEARCH CENTER BLVD, SUITE 135
[HTTP://WWW.SFC-FLUIDICS.COM/](http://www.sfc-fluidics.com/)
FAYETTEVILLE, AR 72701

FOR: TECHNICAL AND SCIENTIFIC APPARATUS, NAMELY, MAGNETOHYDRODYNAMIC PUMP FOR MOVING AND STIRRING LIQUIDS IN CHEMICAL AND BIOLOGICAL SYSTEMS, IN CLASS 9 (U.S. CLS. 21, 23, 26, 36 AND 38).

FIRST USE 7-1-2006; IN COMMERCE 11-1-2007.

THE MARK CONSISTS OF STANDARD CHARACTERS WITHOUT CLAIM TO ANY PARTICULAR FONT, STYLE, SIZE, OR COLOR.

SN 78-958,705, FILED 8-23-2006.

CHARLOTTE CORWIN, EXAMINING ATTORNEY

Int. Cls.: 1, 40, and 42

Prior U.S. Cls.: 1, 5, 6, 10, 26, 46, 100, 101, 103, and 106

Reg. No. 3,482,532

United States Patent and Trademark Office

Registered Aug. 5, 2008

**TRADEMARK
SERVICE MARK
PRINCIPAL REGISTER**

PRIMORIGEN

PRIMORIGEN BIOSCIENCES LLC (WISCONSIN
LTD LIAB CO)
SUITE 257
510 CHARMANY DRIVE
MADISON, WI 53719

FOR: CHEMICAL AND BIOCHEMICAL REAGENTS AND BIOLOGICAL PRODUCTS FOR COMMERCIAL, INDUSTRIAL, SCIENTIFIC, CLINICAL LABORATORY OR RESEARCH USE, NAMELY, CELLS, STEM CELLS, CELL LINE ARRAYS, CELL LINE SLIDES, CELL CULTURE MEDIA, CELL GROWTH SUPPLEMENTS, NAMELY, HYPOTHALAMIC EXTRACTS, TISSUE ARRAYS, TISSUE SLIDES, ANTIBODIES, NAMELY, MONOCLONAL AND POLYCLONAL ANTIBODIES, ANTIBODY ARRAYS, LIGANDS, ENZYMES, ENZYME INHIBITORS FOR IN VITRO RESEARCH USE, VECTORS, LIPIDS, ASSAY KITS COMPRISED OF SLIDES ARRAYED WITH CAPTURE ANTIBODIES AND FRAMED WITH WELL FORMERS, PROTEIN STANDARDS AND CONTROLS, BIOTYNLATED DETECTION ANTIBODIES, STREPTAVIDIN FLUOR, WASH REAGENTS AND ASSOCIATED REAGENTS, LOADING CONTROLS IN THE NATURE OF LOADING CONTROL ANTIBODIES AND PROTEINS, TAGS AND MARKERS, NAMELY, TAG AND MARKER ANTIBODIES AND PROTEINS, PEPTIDES, MODIFIED AND PURIFIED RECOMBINANT PROTEINS, PURIFIED NATURAL PROTEINS; PROTEINS CONTAINING NON NATURAL AMINO ACIDS, PROTEIN ARRAYS, AND KITS FOR THE EXPRESSION, AMPLIFICATION, PURIFICATION AND ANALYSIS OF BIOLOGICAL SAMPLES, SAID KITS CONSISTING PRIMARILY OF ONE OR MORE OF THE FOLLOWING PROTEINS, NUCLEIC ACIDS, ANTIBODIES, CELLS, GELS, PROBES, BUFFERS, STAINS AND ASSOCIATED REAGENTS AND DEVICES, NAMELY, SLIDES FOR QUANTI-

TATION OF PROTEINS AND PEPTIDES FOR CARRYING OUT SAID PURPOSES, ALL FOR COMMERCIAL, INDUSTRIAL, SCIENTIFIC, CLINICAL LABORATORY OR RESEARCH USE, IN CLASS 1 (U.S. CLS. 1, 5, 6, 10, 26 AND 46).

FIRST USE 10-1-2007; IN COMMERCE 10-1-2007.

FOR: ANTIBODY GENERATION AND ANTIBODY PRODUCTION FOR OTHERS, ANTIBODY PURIFICATION, ANTIBODY FRAGMENTATION, MANUFACTURE OF ANTIBODIES FOR OTHERS, IN CLASS 40 (U.S. CLS. 100, 103 AND 106).

FIRST USE 9-30-2006; IN COMMERCE 12-26-2006.

FOR: PHARMACEUTICAL RESEARCH SERVICES, NAMELY, ANTIBODY AND ANTISERA SERVICES, NAMELY, ANTIBODY SCREENING, ANTIBODY LABELING, ANTIBODY PACKAGING, ANTIBODY TESTING, ANTIBODY CHARACTERIZATION, HYBRIDOMA CELL LINE DEVELOPMENT, IMMUNOGEN PREPARATION, IMMUNIZATION AND PRODUCTION, CUSTOM TISSUE CULTURE SERVICES, IMMUNOASSAY DEVELOPMENT AND TESTING, IN CLASS 42 (U.S. CLS . 100 AND 101).

FIRST USE 9-30-2006; IN COMMERCE 12-25-2006.

THE MARK CONSISTS OF STANDARD CHARACTERS WITHOUT CLAIM TO ANY PARTICULAR FONT, STYLE, SIZE, OR COLOR.

SN 78-959,099, FILED 8-23-2006.

Alice Benmaman, Examining Attorney

Int. Cl.: 3

Prior U.S. Cls.: 1, 4, 6, 50, 51, and 52

United States Patent and Trademark Office

Reg. No. 3,482,533

Registered Aug. 5, 2008

**TRADEMARK
PRINCIPAL REGISTER**

HYDROCLEAN ACTION

THE PROCTER & GAMBLE COMPANY (OHIO
CORPORATION)
ONE PROCTER & GAMBLE PLAZA
CINCINNATI, OH 45202

THE MARK CONSISTS OF STANDARD CHAR-
ACTERS WITHOUT CLAIM TO ANY PARTICULAR
FONT, STYLE, SIZE, OR COLOR.

FOR: AUTOMATIC DISHWASHING DETER-
GENT, IN CLASS 3 (U.S. CLS. 1, 4, 6, 50, 51 AND 52).

SN 78-959,694, FILED 8-24-2006.

FIRST USE 3-5-2007; IN COMMERCE 3-5-2007.

ELIZABETH BEYER, EXAMINING ATTORNEY

Int. Cls.: 35 and 43

Prior U.S. Cls.: 100, 101, and 102

United States Patent and Trademark Office

Reg. No. 3,482,534

Registered Aug. 5, 2008

**SERVICE MARK
PRINCIPAL REGISTER**



MATUR, S.L. (SPAIN CORPORATION)
C.I.F. B07029465, C/ D'ES CUBELLS, 32
07800 IBIZA, SPAIN

FOR: HOTEL BUSINESS ADMINISTRATION
AND MANAGEMENT CONSULTATION, IN CLASS
35 (U.S. CLS. 100, 101 AND 102).

FIRST USE 1-1-2001; IN COMMERCE 1-1-2001.

FOR: PROVIDING TEMPORARY ACCOMMODA-
TION, CAFE, RESTAURANT AND BAR SERVICES,
IN CLASS 43 (U.S. CLS. 100 AND 101).

FIRST USE 1-1-2001; IN COMMERCE 1-1-2001.

NO CLAIM IS MADE TO THE EXCLUSIVE
RIGHT TO USE "HOTELS", APART FROM THE
MARK AS SHOWN.

THE COLOR(S) BLUE, ORANGE, YELLOW AND
WHITE IS/ARE CLAIMED AS A FEATURE OF THE
MARK.

THE COLOR BLUE APPEARS IN THE WORDING
AND IN THE DESIGN OF OCEAN WAVES; THE
MERMAID DESIGN IS ORANGE; THE OVAL IS
YELLOW, THE DESIGN AND WORDS ARE
AGAINST A WHITE BACKGROUND.

THE FOREIGN WORDING IN THE MARK
TRANSLATES INTO ENGLISH AS OF THE MER-
MAID.

SN 78-959,786, FILED 8-24-2006.

IRA J. GOODSID, EXAMINING ATTORNEY

Int. Cl.: 25

Prior U.S. Cls.: 22 and 39

United States Patent and Trademark Office

Reg. No. 3,482,535

Registered Aug. 5, 2008

**TRADEMARK
PRINCIPAL REGISTER**

Me Time

COED SPORTSWEAR, INC. (NEW HAMPSHIRE CORPORATION)
27 PLEASANT STREET
NEWFIELDS, NH 03856

FOR: (FIRST USE 11-30-2006; IN COMMERCE 11-30-2006) IMPRINTED APPAREL, NAMELY, T-SHIRTS, SWEATSHIRTS AND TANKTOPS; (FIRST USE 09-30-2007; IN COMMERCE 09-30-2007) IMPRINTED APPAREL, NAMELY, SHORTS AND HEADWEAR, IN CLASS 25 (U.S. CLS. 22 AND 39).

FIRST USE 11-30-2006; IN COMMERCE 11-30-2006.

THE MARK CONSISTS OF STANDARD CHARACTERS WITHOUT CLAIM TO ANY PARTICULAR FONT, STYLE, SIZE, OR COLOR.

SN 78-960,274, FILED 8-25-2006.

MATTHEW PAPPAS, EXAMINING ATTORNEY

Int. Cl.: 17

Prior U.S. Cls.: 1, 5, 12, 13, 35, and 50

Reg. No. 3,482,536

United States Patent and Trademark Office

Registered Aug. 5, 2008

**TRADEMARK
PRINCIPAL REGISTER**

CORETEC

DELSTAR TECHNOLOGIES INC. (DELAWARE
CORPORATION)
601 INDUSTRIAL DRIVE
MIDDLETOWN, DE 19709

THE MARK CONSISTS OF STANDARD CHAR-
ACTERS WITHOUT CLAIM TO ANY PARTICULAR
FONT, STYLE, SIZE, OR COLOR.

FOR: PROFILE EXTRUDED SOLID AND HOL-
LOW SHAFTS, NAMELY, THERMOPLASTIC AND
FLUOROPOLYMER RODS, CORES, TUBES AND
SHAFTS, IN CLASS 17 (U.S. CLS. 1, 5, 12, 13, 35 AND
50).

SN 78-960,311, FILED 8-25-2006.

FIRST USE 4-2-2008; IN COMMERCE 4-2-2008.

WILLIAM P. SHANAHAN, EXAMINING ATTOR-
NEY

Int. Cl.: 28

Prior U.S. Cls.: 22, 23, 38, and 50

United States Patent and Trademark Office

Reg. No. 3,482,537

Registered Aug. 5, 2008

**TRADEMARK
PRINCIPAL REGISTER**

BAD BAGGER

MATTEL, INC. (DELAWARE CORPORATION)
MAIL STOP M1-1518
333 CONTINENTAL BOULEVARD
EL SEGUNDO, CA 90245

THE MARK CONSISTS OF STANDARD CHAR-
ACTERS WITHOUT CLAIM TO ANY PARTICULAR
FONT, STYLE, SIZE, OR COLOR.

FOR: TOYS, GAMES AND PLAYTHINGS, NAME-
LY, TOY VEHICLES AND ACCESSORIES THERE-
FOR, IN CLASS 28 (U.S. CLS. 22, 23, 38 AND 50).

SN 78-960,537, FILED 8-25-2006.

FIRST USE 12-1-2007; IN COMMERCE 12-1-2007.

AHSEN KHAN, EXAMINING ATTORNEY

Int. Cls.: 9, 35, 38, and 42

Prior U.S. Cls.: 21, 23, 26, 36, 38, 100, 101, 102, and 104

Reg. No. 3,482,538

United States Patent and Trademark Office

Registered Aug. 5, 2008

**TRADEMARK
SERVICE MARK
PRINCIPAL REGISTER**



PHILIP B. PARKER AND WAYNE M. WILLIAMS
(CALIFORNIA LTD LIAB CO), DBA MU-
ZLINK, LLC,
15423 SUTTON STREET
SHERMAN OAKS, CA 914033809

FOR: DOWNLOADABLE MULTIMEDIA FILE
CONTAINING ARTWORK, TEXT, AUDIO, VIDEO,
GAMES, AND INTERNET WEB LINKS RELATING
TO MUSIC, IN CLASS 9 (U.S. CLS. 21, 23, 26, 36 AND
38).

FIRST USE 8-2-2006; IN COMMERCE 11-18-2006.

FOR: ADVERTISING AND COMMERCIAL IN-
FORMATION SERVICES, VIA THE INTERNET;
ADVERTISING VIA ELECTRONIC MEDIA AND
SPECIFICALLY THE INTERNET; ADVICE AND
INFORMATION ABOUT CUSTOMER SERVICES
AND PRODUCT MANAGEMENT AND PRICES
ON INTERNET SITES IN CONNECTION WITH
PURCHASES MADE OVER THE INTERNET; DIS-
SEMINATION OF ADVERTISING FOR OTHERS
VIA AN ONLINE COMMUNICATIONS NETWORK
ON THE INTERNET; DISSEMINATION OF ADVER-
TISING FOR OTHERS VIA THE INTERNET; PRO-
VIDING A SEARCHABLE ONLINE ADVERTISING
GUIDE FEATURING THE GOODS AND SERVICES
OF OTHER ONLINE VENDORS ON THE INTER-
NET; PROVIDING AN ONLINE COMMERCIAL IN-
FORMATION DIRECTORY ON THE INTERNET;
PROVIDING AND RENTAL OF ADVERTISING
SPACE ON THE INTERNET; PROVIDING BUSI-
NESS INFORMATION, ALSO VIA INTERNET, THE
CABLE NETWORK OR OTHER FORMS OF DATA
TRANSFER; PROVIDING CONSUMER PRODUCT
INFORMATION VIA THE INTERNET, IN CLASS 35
(U.S. CLS. 100, 101 AND 102).

FIRST USE 8-2-2006; IN COMMERCE 8-2-2006.

FOR: COMMUNICATIONS SERVICES, NAMELY,
TRANSMITTING STREAMED SOUND AND
AUDIO-VISUAL RECORDINGS VIA THE INTER-
NET; STREAMING OF AUDIO MATERIAL ON THE
INTERNET; STREAMING OF VIDEO MATERIAL
ON THE INTERNET, IN CLASS 38 (U.S. CLS. 100, 101
AND 104).

FIRST USE 8-2-2006; IN COMMERCE 11-18-2006.

FOR: DESIGN, CREATION, HOSTING AND
MAINTENANCE OF INTERNET SITES FOR THIRD
PARTIES; HOSTING OF DIGITAL CONTENT ON
THE INTERNET; PROVIDING SPECIFIC INFOR-
MATION AS REQUESTED BY CUSTOMERS VIA
THE INTERNET, IN CLASS 42 (U.S. CLS. 100 AND
101).

FIRST USE 8-2-2006; IN COMMERCE 11-18-2006.

THE COLOR(S) BLUE AND RED IS/ARE
CLAIMED AS A FEATURE OF THE MARK.

THE MARK CONSISTS OF THE WORD "MU-
ZLINK" IN BLUE WITH SOUND WAVES IN RED AT
THE END OF THE WORD "MUZLINK" AND AN
EIGHTH NOTE USED FOR THE DOT OF THE "I" IN
THE WORD "MUZLINK".

SN 78-960,925, FILED 8-25-2006.

ELLEN BURNS, EXAMINING ATTORNEY

Int. Cl.: 9

Prior U.S. Cls.: 21, 23, 26, 36, and 38

United States Patent and Trademark Office

Reg. No. 3,482,539

Registered Aug. 5, 2008

**TRADEMARK
PRINCIPAL REGISTER**

OPTESSA

OPTESSA INC. (CANADA CORPORATION)
#905, 5555 WEBER CENTRE
EDMONTON ALBERTA, CANADA T6H5P9

FIRST USE 11-1-2006; IN COMMERCE 11-1-2006.

FOR: COMPUTER SOFTWARE PROGRAMS RELATED TO MANUFACTURING RESOURCE PLANNING, SCHEDULING AND SEQUENCING AND OPERATIONS MANUALS FOR USE THEREWITH, SOLD AS A UNIT, IN CLASS 9 (U.S. CLS. 21, 23, 26, 36 AND 38).

THE MARK CONSISTS OF STANDARD CHARACTERS WITHOUT CLAIM TO ANY PARTICULAR FONT, STYLE, SIZE, OR COLOR.

SN 78-960,931, FILED 8-25-2006.

ELLEN BURNS, EXAMINING ATTORNEY

Int. Cl.: 3

Prior U.S. Cls.: 1, 4, 6, 50, 51, and 52

Reg. No. 3,482,540

United States Patent and Trademark Office

Registered Aug. 5, 2008

**TRADEMARK
PRINCIPAL REGISTER**

BLOSSOMING ROMANCE

VICTORIA'S SECRET STORES BRAND MAN-
AGEMENT, INC. (DELAWARE CORPORA-
TION)
FOUR LIMITED PARKWAY
REYNOLDSBURG, OH 43068

FOR: PERSONAL CARE PRODUCTS, NAMELY,
BODY WASH, SMOOTHING BODY SCRUB, WHIP-
PED BODY CREAM, BODY BUTTER, BODY LO-
TIONS, HAND CREAM, BODY MIST, BODY SCRUB,
BODY WASH, BUBBLE BATH, COLOGNE, CREAM
FOR THE BODY, CREAM FOR THE HANDS, IN
CLASS 3 (U.S. CLS. 1, 4, 6, 50, 51 AND 52).

FIRST USE 1-18-2007; IN COMMERCE 1-18-2007.

THE MARK CONSISTS OF STANDARD CHAR-
ACTERS WITHOUT CLAIM TO ANY PARTICULAR
FONT, STYLE, SIZE, OR COLOR.

SN 78-961,452, FILED 8-28-2006.

ANGELA GAW, EXAMINING ATTORNEY

Int. Cls.: 7, 42, and 45

Prior U.S. Cls.: 13, 19, 21, 23, 31, 34, 35, 100, and 101

United States Patent and Trademark Office

Reg. No. 3,482,541

Registered Aug. 5, 2008

**TRADEMARK
SERVICE MARK
PRINCIPAL REGISTER**



SILICON GENESIS CORPORATION (CALIFORNIA CORPORATION)

61 DAGGETT DRIVE

SAN JOSE, CA 95134

FOR: ENGINEERED SUBSTRATE PROCESSING AND AUTOMATED HANDLING EQUIPMENT AND COMPONENTS, NAMELY, PLASMA ION IMPLANTERS, SURFACE FINISHERS, PLASMA ACTIVATORS, BONDERS, SUBSTRATE SEPARATORS AND CLEANERS; AND COMPUTER SOFTWARE SOLD AS A UNIT AND USED IN ASSOCIATION THEREWITH, IN CLASS 7 (U.S. CLS. 13, 19, 21, 23, 31, 34 AND 35).

FIRST USE 9-29-2006; IN COMMERCE 9-29-2006.

FOR: SCIENTIFIC RESEARCH AND DEVELOPMENT; PRODUCT RESEARCH AND DEVELOPMENT, IN CLASS 42 (U.S. CLS. 100 AND 101).

FIRST USE 7-26-2007; IN COMMERCE 7-26-2007.

FOR: LICENSING OF PATENTED TECHNOLOGY, IN CLASS 45 (U.S. CLS. 100 AND 101).

FIRST USE 7-26-2007; IN COMMERCE 7-26-2007.

NO CLAIM IS MADE TO THE EXCLUSIVE RIGHT TO USE "SILICON", APART FROM THE MARK AS SHOWN.

SN 78-961,539, FILED 8-28-2006.

STEVEN JACKSON, EXAMINING ATTORNEY

Int. Cl.: 9

Prior U.S. Cls.: 21, 23, 26, 36, and 38

United States Patent and Trademark Office

Reg. No. 3,482,542

Registered Aug. 5, 2008

**TRADEMARK
PRINCIPAL REGISTER**

DashDAQ

DREW TECHNOLOGIES, INC (MICHIGAN CORPORATION)
SUITE 10A
3915 RESEARCH PARK DRIVE
ANN ARBOR, MI 481082355

FOR: LCD COMPUTER DISPLAYS AND RELATED COMPUTER SOFTWARE TO COMMUNICATE WITH MOTOR VEHICLE ONBOARD DATA EQUIPMENT, AND TO DISPLAY MOTOR VEHICLE ENGINE PARAMETERS OTHER VEHICLE DATA IN NUMERIC AND GRAPHICAL FORMATS, IN CLASS 9 (U.S. CLS. 21, 23, 26, 36 AND 38).

FIRST USE 8-16-2006; IN COMMERCE 7-27-2007.

THE MARK CONSISTS OF STANDARD CHARACTERS WITHOUT CLAIM TO ANY PARTICULAR FONT, STYLE, SIZE, OR COLOR.

SN 78-961,922, FILED 8-28-2006.

NORA BUCHANAN WILL, EXAMINING ATTORNEY

Int. Cls.: 3 and 25

Prior U.S. Cls.: 1, 4, 6, 22, 39, 50, 51, and 52

United States Patent and Trademark Office

Reg. No. 3,482,543

Registered Aug. 5, 2008

**TRADEMARK
PRINCIPAL REGISTER**

LIFE IS MOVEMENT

WIGWAM MILLS, INC. (WISCONSIN CORPORATION)
P.O. BOX 818
3402 CROCKER AVENUE
SHEBOYGAN, WI 530820818

FOR: NON-MEDICATED FOOT CARE LOTIONS, GELS, SOAPS, SOAKS AND SPRAYS; SOAPS AND DETERGENT FOR WASHING KNITTED TEXTILE PRODUCTS, IN CLASS 3 (U.S. CLS. 1, 4, 6, 50, 51 AND 52).

FIRST USE 6-3-2008; IN COMMERCE 6-3-2008.

FOR: MEN'S, WOMEN'S AND CHILDREN'S SOCKS AND HOSIERY FOR THE FEET AND LEGS; SLIPPER SOCKS; HEAD WEAR, NAMELY, KNITTED HATS, SKI HATS, AND CAPS; EARMUFFS; HEADBANDS; ATHLETIC MASKS IN THE NATURE OF CLOTHING, NAMELY, KNITTED SKI MASKS, HEAD AND FACE MASKS, AND ANTI-COLD MASKS; NECKWEAR, NAMELY, KNITTED

SCARVES, NECK WARMERS, AND DICKIES; GLOVES AND MITTENS FOR CLOTHING, NAMELY, KNITTED ANTI-COLD GLOVES, MITTENS AND GLOVE LINERS FOR USE IN OUTDOOR ACTIVITIES; GLOVES AND MITTENS FOR CLOTHING, NAMELY, KNITTED ANTI-HEAT GLOVES, MITTENS, AND GLOVE LINERS FOR USE IN OUTDOOR ACTIVITIES, AND NOT INTENDED FOR USE TO PROTECT INDIVIDUALS FROM GRAVE INJURY SUCH AS FIRE PROTECTION, IN CLASS 25 (U.S. CLS. 22 AND 39).

FIRST USE 1-21-2008; IN COMMERCE 1-21-2008.

THE MARK CONSISTS OF STANDARD CHARACTERS WITHOUT CLAIM TO ANY PARTICULAR FONT, STYLE, SIZE, OR COLOR.

SN 78-961,996, FILED 8-28-2006.

DAWN FELDMAN, EXAMINING ATTORNEY

Int. Cl.: 41

Prior U.S. Cls.: 100, 101, and 107

United States Patent and Trademark Office

Reg. No. 3,482,544

Registered Aug. 5, 2008

**SERVICE MARK
PRINCIPAL REGISTER**

SUM IT UP

GOTTLIEB, THEODORE B. (UNITED STATES
INDIVIDUAL)
P.O. BOX 1488
ZEPHYR COVE, NV 89448 AND
BUTLER, PAMELA L. (UNITED STATES INDIVI-
DUAL)
P.O. BOX 1488
ZEPHYR COVE, NV 89448

FOR: CASINO SERVICES, NAMELY, CONDUCT-
ING A CASINO TABLE GAME OF CHANCE WHERE
A PLAYER RANKS THEIR POKER HAND

AGAINST THE HOUSE, IN CLASS 41 (U.S. CLS.
100, 101 AND 107).

FIRST USE 10-22-2006; IN COMMERCE 10-22-2006.

THE MARK CONSISTS OF STANDARD CHAR-
ACTERS WITHOUT CLAIM TO ANY PARTICULAR
FONT, STYLE, SIZE, OR COLOR.

SN 78-962,089, FILED 8-28-2006.

CARRIE GENOVESE, EXAMINING ATTORNEY

Int. Cls.: 3 and 25

Prior U.S. Cls.: 1, 4, 6, 22, 39, 50, 51, and 52

United States Patent and Trademark Office

Reg. No. 3,482,545

Registered Aug. 5, 2008

**TRADEMARK
PRINCIPAL REGISTER**

WIGWAM

WIGWAM MILLS, INC. (WISCONSIN CORPORATION)
P.O. BOX 818
3402 CROCKER AVENUE
SHEBOYGAN, WI 530820818

FOR: NON-MEDICATED FOOT CARE LOTIONS, GELS, SOAPS, SOAKS AND SPRAYS; SOAPS AND DETERGENT FOR WASHING KNITTED TEXTILE PRODUCTS, IN CLASS 3 (U.S. CLS. 1, 4, 6, 50, 51 AND 52).

FIRST USE 6-3-2008; IN COMMERCE 6-3-2008.

FOR: MEN'S, WOMEN'S AND CHILDREN'S SOCKS AND HOSIERY FOR THE FEET AND LEGS; SOCKS; SLIPPERS; HEADWEAR, NAMELY, KNITTED HATS, SKI HATS, AND CAPS; EARMUFFS; HEADBANDS; ATHLETIC MASKS IN THE NATURE OF CLOTHING, NAMELY, KNITTED SKI MASKS, HEAD AND FACE MASKS, AND ANTI-COLD MASKS; NECK WEAR, NAMELY, KNITTED

SCARVES, NECK WARMERS, AND DICKIES; GLOVES AND MITTENS FOR CLOTHING, NAMELY, KNITTED ANTI-COLD GLOVES, MITTENS AND GLOVE LINERS FOR USE IN OUTDOOR ACTIVITIES; GLOVES AND MITTENS FOR CLOTHING, NAMELY, KNITTED ANTI-HEAT GLOVES, MITTENS, AND GLOVE LINERS FOR USE IN OUTDOOR ACTIVITIES, AND NOT INTENDED FOR USE TO PROTECT INDIVIDUALS FROM GRAVE INJURY SUCH AS FIRE PROTECTION, IN CLASS 25 (U.S. CLS. 22 AND 39).

FIRST USE 1-21-2008; IN COMMERCE 1-21-2008.

OWNER OF U.S. REG. NOS. 543,445, 1,221,849, AND OTHERS.

SN 78-962,633, FILED 8-29-2006.

DAWN FELDMAN, EXAMINING ATTORNEY

Int. Cl.: 22

Prior U.S. Cls.: 1, 2, 7, 19, 22, 42, and 50

United States Patent and Trademark Office

Reg. No. 3,482,546

Registered Aug. 5, 2008

**TRADEMARK
PRINCIPAL REGISTER**

TOOLS AVER

ALPHASOURCE INC. (PENNSYLVANIA CORPORATION)
4837-49 N. STENTON AVENUE
PHILADELPHIA, PA 19144

FOR: DEVICE IN THE NATURE OF A LANYARD USED TO RETAIN HAND TOOLS, IMPLEMENTS AND INSTRUMENTS WORN BY A USER ON THE ARM, LEG OR NECK OR AS AN ATTACHMENT TO A TOOL BELT, TOOL BAG, TOOL POUCH OR SCUBA GEAR, IN CLASS 22 (U.S. CLS. 1, 2, 7, 19, 22, 42 AND 50).

FIRST USE 5-10-2006; IN COMMERCE 5-10-2006.

THE MARK CONSISTS OF STANDARD CHARACTERS WITHOUT CLAIM TO ANY PARTICULAR FONT, STYLE, SIZE, OR COLOR.

SN 78-962,701, FILED 8-29-2006.

KEVIN DINALLO, EXAMINING ATTORNEY

Int. Cl.: 2

Prior U.S. Cls.: 6, 11, and 16

United States Patent and Trademark Office

Reg. No. 3,482,547

Registered Aug. 5, 2008

**TRADEMARK
PRINCIPAL REGISTER**

FLUOROKEM

THE SHERWIN-WILLIAMS COMPANY (OHIO
CORPORATION)
101 PROSPECT AVENUE NW
CLEVELAND, OH 441151075

THE MARK CONSISTS OF STANDARD CHAR-
ACTERS WITHOUT CLAIM TO ANY PARTICULAR
FONT, STYLE, SIZE, OR COLOR.

FOR: PAINT, IN CLASS 2 (U.S. CLS. 6, 11 AND 16).

SN 78-962,749, FILED 8-29-2006.

FIRST USE 6-20-2007; IN COMMERCE 6-20-2007.

ESTHER BELENKER, EXAMINING ATTORNEY

Int. Cl.: 41

Prior U.S. Cls.: 100, 101, and 107

Reg. No. 3,482,548

United States Patent and Trademark Office

Registered Aug. 5, 2008

**SERVICE MARK
PRINCIPAL REGISTER**



FIT & HEALTHY SCHOOLS, INC. (VIRGINIA CORPORATION)
13198 CENTER POINTE WAY, #101
WOODBIDGE, VA 22193

FOR: TEACHING IN THE FIELD OF HEALTHY LIVING, NAMELY, FITNESS, NUTRITIONAL, AND WELLNESS, IN CLASS 41 (U.S. CLS. 100, 101 AND 107).

FIRST USE 6-1-2006; IN COMMERCE 12-1-2006.

NO CLAIM IS MADE TO THE EXCLUSIVE RIGHT TO USE "SCHOOLS", APART FROM THE MARK AS SHOWN.

THE MARK CONSISTS OF THREE BODIES AND THE STYLIZED TEXT OF THE WORDING "FIT & HEALTHY SCHOOLS".

SN 78-963,368, FILED 8-29-2006.

ELI HELLMAN, EXAMINING ATTORNEY

Int. Cl.: 5

Prior U.S. Cls.: 6, 18, 44, 46, 51, and 52

Reg. No. 3,482,549

United States Patent and Trademark Office

Registered Aug. 5, 2008

**TRADEMARK
PRINCIPAL REGISTER**

PRIVIGEN

CSL BEHRING AG (SWITZERLAND CORPORATION)
10 WANKDORFSTRASSE
BERN 22, SWITZERLAND 3000

FOR: INTRAVENOUS IMMUNOGLOBULINS FOR USE IN TREATMENT OF IMMUNODEFICIENCY DISORDERS AND IN IMMUNE REPLACEMENT THERAPY, IN CLASS 5 (U.S. CLS. 6, 18, 44, 46, 51 AND 52).

FIRST USE 12-20-2007; IN COMMERCE 12-20-2007.

THE MARK CONSISTS OF STANDARD CHARACTERS WITHOUT CLAIM TO ANY PARTICULAR FONT, STYLE, SIZE, OR COLOR.

PRIORITY CLAIMED UNDER SEC. 44(D) ON AUSTRALIA APPLICATION NO. 1130631, FILED 8-21-2006.

SN 78-963,560, FILED 8-30-2006.

FRED MANDIR, EXAMINING ATTORNEY

Int. Cl.: 40

Prior U.S. Cls.: 100, 103, and 106

United States Patent and Trademark Office

Reg. No. 3,482,550

Registered Aug. 5, 2008

**SERVICE MARK
PRINCIPAL REGISTER**

FIVE RIVERS

FIVE RIVERS, INC. (IDAHO CORPORATION)
2285 WARM SPRINGS AVENUE
BOISE, ID 83712

THE MARK CONSISTS OF STANDARD CHAR-
ACTERS WITHOUT CLAIM TO ANY PARTICULAR
FONT, STYLE, SIZE, OR COLOR.

FOR: CUSTOM MANUFACTURE OF FURNI-
TURE FOR OTHERS, IN CLASS 40 (U.S. CLS. 100,
103 AND 106).

SN 78-964,288, FILED 8-30-2006.

FIRST USE 4-0-1990; IN COMMERCE 4-0-1990.

JIM RINGLE, EXAMINING ATTORNEY

Int. Cl.: 10

Prior U.S. Cls.: 26, 39, and 44

United States Patent and Trademark Office

Reg. No. 3,482,551

Registered Aug. 5, 2008

**TRADEMARK
PRINCIPAL REGISTER**

COMPASS

MICROVENTION, INC. (DELAWARE CORPORATION)
75 COLUMBIA, SUITE A
ALISO VIEJO, CA 92656

FOR: MEDICAL DEVICES, NAMELY, INTRAVASCULAR IMPLANTS COMPRISED OF ARTIFICIAL MATERIAL, IN CLASS 10 (U.S. CLS. 26, 39 AND 44).

FIRST USE 9-30-2006; IN COMMERCE 9-30-2006.

THE MARK CONSISTS OF STANDARD CHARACTERS WITHOUT CLAIM TO ANY PARTICULAR FONT, STYLE, SIZE, OR COLOR.

SN 78-964,648, FILED 8-31-2006.

AMY ALFIERI, EXAMINING ATTORNEY

Int. Cls.: 25 and 28

Prior U.S. Cls.: 22, 23, 38, 39, and 50

United States Patent and Trademark Office

Reg. No. 3,482,552

Registered Aug. 5, 2008

**TRADEMARK
PRINCIPAL REGISTER**



HIRAIWA, TAKANORI (JAPAN INDIVIDUAL)
21-1, HOURAICHO, TANABE-SHI
WAKAYAMA, JAPAN

FOR: CLOTHING, NAMELY, SWEATERS,
SHIRTS, TROUSERS, RAIN COATS, HEADGEAR
IN THE NATURE OF HATS, CAPS AND FISHING
WADERS, IN CLASS 25 (U.S. CLS. 22 AND 39).

FIRST USE 10-1-1999; IN COMMERCE 11-1-2007.

FOR: FISHING TACKLE, IN CLASS 28 (U.S. CLS.
22, 23, 38 AND 50).

FIRST USE 10-1-1999; IN COMMERCE 11-1-2007.

THE MARK CONSISTS OF THE REPRESENTA-
TION OF A SCARY FACE.

SN 78-964,841, FILED 8-31-2006.

PRISCILLA MILTON, EXAMINING ATTORNEY

Int. Cl.: 3

Prior U.S. Cls.: 1, 4, 6, 50, 51, and 52

United States Patent and Trademark Office

Reg. No. 3,482,553

Registered Aug. 5, 2008

**TRADEMARK
PRINCIPAL REGISTER**

GRAPHITE BLUE BY REALITIES

LIZ CLAIBORNE, INC. (DELAWARE CORPORATION)
1441 BROADWAY
NEW YORK, NY 10018

FOR: PERFUMES, COLOGNES, IN CLASS 3 (U.S. CLS. 1, 4, 6, 50, 51 AND 52).

FIRST USE 1-15-2007; IN COMMERCE 1-15-2007.

THE MARK CONSISTS OF STANDARD CHARACTERS WITHOUT CLAIM TO ANY PARTICULAR FONT, STYLE, SIZE, OR COLOR.

OWNER OF U.S. REG. NO. 1,663,741.

SN 78-965,250, FILED 8-31-2006.

G. MAYERSCHOFF, EXAMINING ATTORNEY

Int. Cl.: 10

Prior U.S. Cls.: 26, 39, and 44

United States Patent and Trademark Office

Reg. No. 3,482,554

Registered Aug. 5, 2008

**TRADEMARK
PRINCIPAL REGISTER**

MESSAGE U

KLEIMAN, PAUL L. (UNITED STATES INDIVIDUAL)
3412 HELMS AVENUE, B
CULVER CITY, CA 90232

FOR: NON-ELECTRIC AND ELECTRIC MASSAGE APPARATUSES, IN CLASS 10 (U.S. CLS. 26, 39 AND 44).

FIRST USE 1-3-2008; IN COMMERCE 2-14-2008.

THE MARK CONSISTS OF STANDARD CHARACTERS WITHOUT CLAIM TO ANY PARTICULAR FONT, STYLE, SIZE, OR COLOR.

NO CLAIM IS MADE TO THE EXCLUSIVE RIGHT TO USE "MESSAGE", APART FROM THE MARK AS SHOWN.

SN 78-967,261, FILED 9-5-2006.

ODESSA BIBBINS, EXAMINING ATTORNEY

Int. Cl.: 35

Prior U.S. Cls.: 100, 101, and 102

United States Patent and Trademark Office

Reg. No. 3,482,555

Registered Aug. 5, 2008

**SERVICE MARK
PRINCIPAL REGISTER**

SNUGHOUSE

SNUGHOUSE ENERGY AUDITS LLC (WISCONSIN LTD LIAB CO)
W2159 BEULAH HEIGHTS RD. #C
EAST TROY, WI 53120

FOR: CONSULTING, ANALYSIS AND TESTING SERVICES IN THE FIELD OF ENERGY EFFICIENCY, CONSERVATION AND RENEWABLE ENERGY, NAMELY, ENERGY AUDITING AND TESTING OF THE CUSTOMER'S PREMISES; REVIEWING THE CUSTOMER'S ENERGY NEEDS, USES AND COSTS; PROVIDING ADVICE AND RECOMMENDATIONS REGARDING ENERGY OPTIONS, COST

OBJECTIVES AND SOLUTIONS TO PROBLEMS, IN CLASS 35 (U.S. CLS. 100, 101 AND 102).

FIRST USE 7-26-2007; IN COMMERCE 11-9-2007.

THE MARK CONSISTS OF STANDARD CHARACTERS WITHOUT CLAIM TO ANY PARTICULAR FONT, STYLE, SIZE, OR COLOR.

SN 78-967,410, FILED 9-5-2006.

KAREN K. BUSH, EXAMINING ATTORNEY

Int. Cls.: 21, 31, 37, and 44

**Prior U.S. Cls.: 1, 2, 13, 23, 29, 30, 33, 40, 46, 50, 100,
101, 103, and 106**

Reg. No. 3,482,556

United States Patent and Trademark Office

Registered Aug. 5, 2008

**TRADEMARK
SERVICE MARK
PRINCIPAL REGISTER**

SALT MADE EASY

A&M AQUATICS, INC. (MICHIGAN CORPORATION)
16260 NATIONAL PARKWAY
LANSING, MI 48906

FOR: AQUARIUMS, AQUARIUM FISH NETS, AQUARIUM HOODS, AQUARIUM COVERS, IN CLASS 21 (U.S. CLS. 2, 13, 23, 29, 30, 33, 40 AND 50).

FIRST USE 10-0-2006; IN COMMERCE 10-0-2006.

FOR: LIVE TROPICAL FISH, CORALS, AND LIVE INVERTEBRATES, NAMELY, ANEMONE, ALGAE, NUDIBRANCHS, CLAMS, CRABS, FEATHER DUSTERS, GORGONIAS, SHRIMP, SNAILS, SPONGES, STARFISH, AND URCHINS, IN CLASS 31 (U.S. CLS. 1 AND 46).

FIRST USE 11-0-2007; IN COMMERCE 11-0-2007.

FOR: PROVIDING INFORMATION IN THE FIELD OF CARE AND MAINTENANCE OF AQUARIUMS, IN CLASS 37 (U.S. CLS. 100, 103 AND 106).

FIRST USE 11-0-2007; IN COMMERCE 11-0-2007.

FOR: PROVIDING INFORMATION IN THE FIELD OF CARE AND MAINTENANCE OF LIVE TROPICAL FISH, CORALS, AND LIVE INVERTEBRATES, NAMELY, ANEMONE, ALGAE, NUDIBRANCHS, CLAMS, CRABS, FEATHER DUSTERS, GORGONIAS, SHRIMP, SNAILS, SPONGES, STARFISH, AND URCHINS, IN CLASS 44 (U.S. CLS. 100 AND 101).

FIRST USE 10-0-2007; IN COMMERCE 10-0-2007.

THE MARK CONSISTS OF STANDARD CHARACTERS WITHOUT CLAIM TO ANY PARTICULAR FONT, STYLE, SIZE, OR COLOR.

SN 78-969,017, FILED 9-7-2006.

AISHA SALEM, EXAMINING ATTORNEY

Int. Cl.: 45

Prior U.S. Cls.: 100 and 101

United States Patent and Trademark Office

Reg. No. 3,482,557

Registered Aug. 5, 2008

**SERVICE MARK
PRINCIPAL REGISTER**

FORESTARY

SILVA, DAVE (UNITED STATES INDIVIDUAL)
5320 WYLIE LANE
BOISE, ID 83703

THE MARK CONSISTS OF STANDARD CHAR-
ACTERS WITHOUT CLAIM TO ANY PARTICULAR
FONT, STYLE, SIZE, OR COLOR.

FOR: FUNERAL ARRANGEMENT SERVICES
FEATURING CREMATION AND BURIAL FACIL-
ITIES, IN CLASS 45 (U.S. CLS. 100 AND 101).

SN 78-969,292, FILED 9-7-2006.

FIRST USE 5-14-2008; IN COMMERCE 5-14-2008.

DAVID YONTEF, EXAMINING ATTORNEY

Int. Cls.: 9 and 41

Prior U.S. Cls.: 21, 23, 26, 36, 38, 100, 101, and 107

United States Patent and Trademark Office

Reg. No. 3,482,558

Registered Aug. 5, 2008

**TRADEMARK
SERVICE MARK
PRINCIPAL REGISTER**

**METAL GEAR SOLID PORTABLE
OPS**

KONAMI DIGITAL ENTERTAINMENT CO.,
LTD. (JAPAN CORPORATION)
6-10-1, ROPPONGI, MINATO-KU
TOKYO, JAPAN

FOR: VIDEO GAME SOFTWARE; VIDEO GAME
PROGRAMS; CARTRIDGES AND CASSETTES
CONTAINING GAME PROGRAMS FOR USE WITH
HAND-HELD VIDEO GAME MACHINE; GAME
DISCS AND CIRCUIT BOARDS CONTAINING
GAME PROGRAMS FOR USE WITH HAND-HELD
VIDEO GAME MACHINE, IN CLASS 9 (U.S. CLS. 21,
23, 26, 36 AND 38).

FIRST USE 12-5-2006; IN COMMERCE 12-5-2006.

FOR: ENTERTAINMENT SERVICES, NAMELY,
PROVIDING ON-LINE COMPUTER GAMES; PRO-
VIDING ON-LINE COMPUTER DATABASE IN THE
FIELD OF COMPUTER GAMES; PROVIDING IN-
FORMATION ABOUT COMPUTER GAMES

THROUGH THE WEB SITES, IN CLASS 41 (U.S.
CLS. 100, 101 AND 107).

FIRST USE 12-5-2006; IN COMMERCE 12-5-2006.

THE MARK CONSISTS OF STANDARD CHAR-
ACTERS WITHOUT CLAIM TO ANY PARTICULAR
FONT, STYLE, SIZE, OR COLOR.

OWNER OF U.S. REG. NOS. 2,797,719, 2,960,377,
AND OTHERS.

NO CLAIM IS MADE TO THE EXCLUSIVE
RIGHT TO USE "PORTABLE", APART FROM THE
MARK AS SHOWN.

SN 78-970,152, FILED 9-8-2006.

CARRIE GENOVESE, EXAMINING ATTORNEY

Int. Cl.: 45

Prior U.S. Cls.: 100 and 101

United States Patent and Trademark Office

Reg. No. 3,482,559

Registered Aug. 5, 2008

**SERVICE MARK
PRINCIPAL REGISTER**

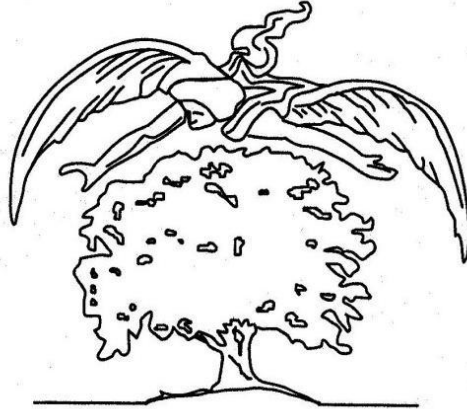

SILVA, DAVE (UNITED STATES INDIVIDUAL)
5320 WYLIE LANE
BOISE, ID 83703

FIRST USE 5-14-2008; IN COMMERCE 5-14-2008.

SN 78-971,037, FILED 9-11-2006.

FOR: FUNERAL ARRANGEMENT SERVICES
FEATURING CREMATION AND BURIAL FACIL-
ITIES, IN CLASS 45 (U.S. CLS. 100 AND 101).

DAVID YONTEF, EXAMINING ATTORNEY

Int. Cl.: 12

Prior U.S. Cls.: 19, 21, 23, 31, 35, and 44

Reg. No. 3,482,560

United States Patent and Trademark Office

Registered Aug. 5, 2008

**TRADEMARK
PRINCIPAL REGISTER**

MX-5

MAZDA MOTOR CORPORATION (JAPAN CORPORATION)
3-1, SHINCHI, FUCHU-CHO, AKI-GUN
HIROSHIMA, JAPAN

FOR: AUTOMOBILES AND STRUCTURAL PARTS THEREOF, BUT EXCLUDING TIRES, IN CLASS 12 (U.S. CLS. 19, 21, 23, 31, 35 AND 44).

FIRST USE 2-10-1989; IN COMMERCE 2-10-1989.

THE MARK CONSISTS OF STANDARD CHARACTERS WITHOUT CLAIM TO ANY PARTICULAR FONT, STYLE, SIZE, OR COLOR.

OWNER OF U.S. REG. NO. 1,738,207.

SN 78-972,384, FILED 9-12-2006.

LEIGH LOWRY, EXAMINING ATTORNEY

Int. Cl.: 36

Prior U.S. Cls.: 100, 101, and 102

United States Patent and Trademark Office

Reg. No. 3,482,561

Registered Aug. 5, 2008

**SERVICE MARK
PRINCIPAL REGISTER**

APM

ABSOLUTE PLUS MANAGEMENT LLC (NEW
YORK CORPORATION)
230 PARK AVENUE, SUITE 922
NEW YORK, NY 10169

FOR: INVESTMENT ADVISORY AND MANAGE-
MENT SERVICES FOR SUBSCRIPTION BY PRI-
VATE INVESTORS FEATURING A SYSTEMATIC
PRICE-BASED STRATEGY BASED ON PROPRIE-
TARY METHODOLOGIES TO CAPTURE MARKET
BEHAVIOR, IN CLASS 36 (U.S. CLS. 100, 101 AND
102).

FIRST USE 12-14-2006; IN COMMERCE 12-14-2006.

THE MARK CONSISTS OF STANDARD CHAR-
ACTERS WITHOUT CLAIM TO ANY PARTICULAR
FONT, STYLE, SIZE, OR COLOR.

APM" HAS NO MEANING IN A FOREIGN LAN-
GUAGE.

SN 78-973,048, FILED 9-13-2006.

SUE LAWRENCE, EXAMINING ATTORNEY

Int. Cl.: 36

Prior U.S. Cls.: 100, 101, and 102

United States Patent and Trademark Office

Reg. No. 3,482,562

Registered Aug. 5, 2008

**SERVICE MARK
PRINCIPAL REGISTER**

ABSOLUTE PLUS MANAGEMENT

ABSOLUTE PLUS MANAGEMENT LLC (NEW
YORK CORPORATION)
230 PARK AVENUE, SUITE 922
NEW YORK, NY 10169

FOR: INVESTMENT ADVISORY AND MANAGE-
MENT SERVICES FOR SUBSCRIPTION BY PRI-
VATE INVESTORS FEATURING A SYSTEMATIC
PRICE BASED STRATEGY BASED ON PROPRIE-
TARY METHODOLOGIES TO CAPTURE RECUR-
RING MARKET BEHAVIOR, IN CLASS 36 (U.S. CLS.
100, 101 AND 102).

FIRST USE 12-14-2006; IN COMMERCE 12-14-2006.

THE MARK CONSISTS OF STANDARD CHAR-
ACTERS WITHOUT CLAIM TO ANY PARTICULAR
FONT, STYLE, SIZE, OR COLOR.

NO CLAIM IS MADE TO THE EXCLUSIVE
RIGHT TO USE "MANAGEMENT", APART FROM
THE MARK AS SHOWN.

SN 78-973,081, FILED 9-13-2006.

SUE LAWRENCE, EXAMINING ATTORNEY

Int. Cl.: 40

Prior U.S. Cls.: 100, 103, and 106

United States Patent and Trademark Office

Reg. No. 3,482,563

Registered Aug. 5, 2008

**SERVICE MARK
PRINCIPAL REGISTER**



PHOINIX GLOBAL LLC (TEXAS LTD LIAB CO)
903 COMMERCE ROAD
ALICE, TX 78332

FIRST USE 8-0-2007; IN COMMERCE 8-0-2007.

SN 78-973,191, FILED 9-13-2006.

FOR: CUSTOM MANUFACTURE AND FABRI-
CATION OF HIGH PRESSURE WELL SERVICING
EQUIPMENT, IN CLASS 40 (U.S. CLS. 100, 103 AND
106).

LEIGH CAROLINE CASE, EXAMINING ATTOR-
NEY

Int. Cl.: 4

Prior U.S. Cls.: 1, 6, and 15

United States Patent and Trademark Office

Reg. No. 3,482,564

Registered Aug. 5, 2008

**TRADEMARK
PRINCIPAL REGISTER**

STANDARD ETHANOL

STANDARD ETHANOL, LLC (DELAWARE LTD
LIAB CO)

2402 WEST FRONT STREET

NORTH PLATTE, NE 69101

FOR: ETHANOL FUEL, IN CLASS 4 (U.S. CLS. 1, 6
AND 15).

FIRST USE 11-30-2006; IN COMMERCE 6-17-2008.

THE MARK CONSISTS OF STANDARD CHAR-
ACTERS WITHOUT CLAIM TO ANY PARTICULAR
FONT, STYLE, SIZE, OR COLOR.

NO CLAIM IS MADE TO THE EXCLUSIVE
RIGHT TO USE "ETHANOL", APART FROM THE
MARK AS SHOWN.

SN 78-973,572, FILED 9-13-2006.

DAWN FELDMAN, EXAMINING ATTORNEY

Int. Cls.: 35 and 45

Prior U.S. Cls.: 100, 101, and 102

United States Patent and Trademark Office

Reg. No. 3,482,565

Registered Aug. 5, 2008

**SERVICE MARK
PRINCIPAL REGISTER**

INTELLECTUAL VENTURES

PENKY LLC (DELAWARE LTD LIAB CO)
2711 CENTERVILLE ROAD, SUITE 400
WILMINGTON, DE 19808

FOR: BUSINESS CONSULTING SERVICES; BUSINESS MANAGEMENT AND ADMINISTRATION FOR OTHERS OF INVENTIONS, TECHNOLOGIES, METHODS, PROCESSES, IDEAS, DISCOVERIES, PATENT APPLICATIONS, PATENTS, TRADEMARKS, COPYRIGHTS AND TRADE SECRETS; BUSINESS CONSULTING, MANAGEMENT AND SUPERVISION IN THE FIELD OF THE DEVELOPMENT, ACQUISITION, AND LICENSING OF INTELLECTUAL PROPERTY RIGHTS, INVENTIONS, PATENT APPLICATIONS, PATENTS, TRADEMARKS, COPYRIGHTS AND TRADE SECRETS; SERVICES RELATING TO THE ANALYSIS, EVALUATION, CREATION AND BRAND ESTABLISHMENT OF TRADEMARKS; BUSINESS CONSULTING, MANAGEMENT AND SUPERVISION FOR OTHERS, NAMELY, THE EVALUATION, RECRUITING AND MANAGEMENT OF INVENTORS TO FACILITATE THE CREATION OF INVENTIONS, TECHNOLOGIES, METHODS, PROCESSES, IDEAS, AND DISCOVERIES, AND OF LEGAL, TECHNICAL, FINANCIAL AND OTHER PROFESSIONALS TO FACILITATE THE CREATION AND ADMINISTRATION OF INTELLECTUAL PROPERTY RIGHTS, INVENTIONS, PATENTS, PATENT APPLICATIONS, TRADEMARKS, COPYRIGHTS AND TRADE SECRETS; BUSINESS EVALUATION AND APPRAISALS OF INVENTIONS, TECHNOLOGIES, METHODS, PROCESSES, IDEAS, DISCOVERIES, INTELLECTUAL PROPERTY, PATENTS, PATENT APPLICATIONS, TRADEMARKS, COPYRIGHTS AND TRADE SECRETS FOR THE BENEFIT OF OTHERS; BRINGING TOGETHER, FOR THE BENEFIT OF OTHERS, INTELLECTUAL PROPERTY RIGHTS, INVENTIONS, PATENTS, PATENT APPLICATIONS, TRADEMARKS, COPYRIGHTS AND TRADE SECRETS TO FACILITATE OTHERS' ASSESSMENT AND LICENSING OF SUCH INTEL-

LECTUAL PROPERTY ASSETS; PROMOTION OF BUSINESS OPPORTUNITIES IN THE FIELD OF INTELLECTUAL PROPERTY; PROMOTING PUBLIC AWARENESS OF THE SOCIAL, POLITICAL AND ECONOMIC IMPORTANCE AND VALUE OF INTELLECTUAL PROPERTY RIGHTS, INVENTIONS, PATENTS, PATENT APPLICATIONS, TRADEMARKS, COPYRIGHTS AND TRADE SECRETS, IN CLASS 35 (U.S. CLS. 100, 101 AND 102).

FIRST USE 6-2-2008; IN COMMERCE 6-2-2008.

FOR: COPYRIGHT MANAGEMENT; COPYRIGHT MANAGEMENT CONSULTING; LICENSING OF INTELLECTUAL PROPERTY; PATENT AND PATENT APPLICATION LICENSING; LEGAL SERVICES; LICENSING SERVICES FOR INVENTORS, INVESTORS, FUNDS, UNIVERSITIES, RESEARCH INSTITUTIONS AND COMMERCIAL AND NON-PROFIT ENTITIES IN THE FIELDS OF INVENTIONS, TECHNOLOGIES, METHODS, PROCESSES, IDEAS, DISCOVERIES, INTELLECTUAL PROPERTY, PATENTS AND PATENT APPLICATIONS; INTELLECTUAL PROPERTY LICENSING SERVICES, NAMELY, LICENSING SERVICES FOR INVENTORS, INVESTORS, FUNDS, UNIVERSITIES, RESEARCH INSTITUTIONS AND COMMERCIAL AND NON-PROFIT ENTITIES IN THE FIELDS OF INVENTIONS, TECHNOLOGIES, METHODS, PROCESSES, IDEAS, DISCOVERIES, INTELLECTUAL PROPERTY, PATENTS AND PATENT APPLICATIONS; INTELLECTUAL PROPERTY CONSULTATION SERVICES FOR INVENTORS, UNIVERSITIES, RESEARCH INSTITUTIONS AND COMMERCIAL AND NON-PROFIT ENTITIES IN THE FIELDS OF INVENTIONS, TECHNOLOGIES, METHODS, PROCESSES, IDEAS, DISCOVERIES, PATENTS AND PATENT APPLICATIONS, IN CLASS 45 (U.S. CLS. 100 AND 101).

FIRST USE 6-2-2008; IN COMMERCE 6-2-2008.

THE MARK CONSISTS OF STANDARD CHAR-
ACTERS WITHOUT CLAIM TO ANY PARTICULAR
FONT, STYLE, SIZE, OR COLOR.

SN 78-973,926, FILED 9-13-2006.

ELLEN BURNS, EXAMINING ATTORNEY

Int. Cl.: 28

Prior U.S. Cls.: 22, 23, 38, and 50

United States Patent and Trademark Office

Reg. No. 3,482,566

Registered Aug. 5, 2008

**TRADEMARK
PRINCIPAL REGISTER**

bunnyfish

KITCHENS, ANTHONY DANIEL (UNITED STATES INDIVIDUAL)
1249 23RD ST., #D
SANTA MONICA, CA 90404

THE MARK CONSISTS OF STANDARD CHARACTERS WITHOUT CLAIM TO ANY PARTICULAR FONT, STYLE, SIZE, OR COLOR.

FOR: KNIT STUFFED ANIMAL, IN CLASS 28 (U.S. CLS. 22, 23, 38 AND 50).

SN 78-974,017, FILED 9-14-2006.

FIRST USE 6-1-2006; IN COMMERCE 6-1-2006.

SUE LAWRENCE, EXAMINING ATTORNEY

Int. Cls.: 25 and 41

Prior U.S. Cls.: 22, 39, 100, 101, and 107

Reg. No. 3,482,567

United States Patent and Trademark Office

Registered Aug. 5, 2008

**TRADEMARK
SERVICE MARK
PRINCIPAL REGISTER**



US AIR GUITAR LLC (DELAWARE LTD LIAB
CO)
APT. 5C
365 WEST 20TH STREET
NEW YORK, NY 10011

FOR: CLOTHING, NAMELY, T-SHIRTS, SWEAT-
SHIRTS, HATS AND ACCESSORIES, NAMELY,
WRISTBANDS AND HEADBANDS, THAT PRO-
MOTES AN ANNUAL CONTEST OR CONTESTS IN
WHICH PARTICIPANTS ARE JUDGED ON THEIR
ABILITY TO SIMULATE THE STRUMMING OF AN
INVISIBLE GUITAR TO LIVE OR RECORDED
MUSIC, IN CLASS 25 (U.S. CLS. 22 AND 39).

FIRST USE 6-6-2003; IN COMMERCE 6-6-2003.

FOR: ENTERTAINMENT IN THE NATURE OF
AN ANNUAL CONTEST OR CONTESTS IN WHICH
PARTICIPANTS ARE JUDGED ON THEIR ABILITY
TO SIMULATE THE STRUMMING OF AN INVISI-
BLE GUITAR TO LIVE OR RECORDED MUSIC, IN
CLASS 41 (U.S. CLS. 100, 101 AND 107).

FIRST USE 6-6-2003; IN COMMERCE 6-6-2003.

NO CLAIM IS MADE TO THE EXCLUSIVE
RIGHT TO USE "US" FOR CLASS 25 AND "US"
AND "AIR GUITAR" FOR CLASS 41, APART FROM
THE MARK AS SHOWN.

SN 78-974,105, FILED 9-14-2006.

KELLY CHOE, EXAMINING ATTORNEY

Int. Cl.: 43

Prior U.S. Cls.: 100 and 101

United States Patent and Trademark Office

Reg. No. 3,482,568

Registered Aug. 5, 2008

**SERVICE MARK
PRINCIPAL REGISTER**

SALAMANDER

JOHNSON, SHEILA C. (UNITED STATES INDIVIDUAL)
3074 ZULLA ROAD
THE PLAINS, VA 20198

FIRST USE 4-0-2007; IN COMMERCE 4-0-2007.

SN 78-975,178, FILED 10-23-2002.

FOR: HOTEL AND SPA SERVICES, IN CLASS 43
(U.S. CLS. 100 AND 101).

MATTHEW EINSTEIN, EXAMINING ATTORNEY

Int. Cl.: 35

Prior U.S. Cls.: 100, 101, and 102

United States Patent and Trademark Office

Reg. No. 3,482,569

Registered Aug. 5, 2008

**SERVICE MARK
PRINCIPAL REGISTER**

PACE

THE JOHNS HOPKINS HEALTH SYSTEM COR-
PORATION (MARYLAND CORPORATION)
600 NORTH WOLFE STREET
BALTIMORE, MD 21287

THE MARK CONSISTS OF STANDARD CHAR-
ACTERS WITHOUT CLAIM TO ANY PARTICULAR
FONT, STYLE, SIZE, OR COLOR.

FOR: BUSINESS CONSULTATION IN THE FIELD
OF NURSING COMPENSATION AND PRACTICE
AND NURSE RECRUITMENT AND RETENTION,
IN CLASS 35 (U.S. CLS. 100, 101 AND 102).

SN 78-977,820, FILED 2-23-2006.

FIRST USE 2-0-2001; IN COMMERCE 1-24-2002.

REBECCA GILBERT, EXAMINING ATTORNEY

Int. Cl.: 42

Prior U.S. Cls.: 100 and 101

United States Patent and Trademark Office

Reg. No. 3,482,570

Registered Aug. 5, 2008

**SERVICE MARK
PRINCIPAL REGISTER**

**OPTIMAL DESIGN
INITIATIVE**

AUTOMOTIVE CASTING TECHNOLOGY, INC.
(DELAWARE CORPORATION)
14638 APPLE DRIVE
FRUITPORT, MI 49415

FOR: NEW ALLOY PRODUCT DEVELOPMENT IN THE FIELD OF ALUMINUM CASTINGS; ADVANCED COMPUTER AIDED ENGINEERING SERVICES FOR OTHERS IN THE FIELD OF ALUMINUM CASTINGS FOR AUTOMOTIVE AND NON-AUTOMOTIVE APPLICATIONS, INCLUDING CHASSIS AND SUSPENSION COMPONENTS AND COMMERCIAL TRANSPORTATION COMPONENTS THAT REQUIRE STRUCTURAL STRENGTH; DESIGN FOR OTHERS IN THE FIELD OF ALUMINUM CASTINGS FOR AUTOMOTIVE AND NON-AUTOMOTIVE APPLICATIONS, INCLUDING CHASSIS AND SUSPENSION COMPO-

NENTS AND COMMERCIAL TRANSPORTATION COMPONENTS THAT REQUIRE STRUCTURAL STRENGTH, IN CLASS 42 (U.S. CLS. 100 AND 101).

FIRST USE 7-0-2004; IN COMMERCE 7-0-2004.

THE MARK CONSISTS OF STANDARD CHARACTERS WITHOUT CLAIM TO ANY PARTICULAR FONT, STYLE, SIZE, OR COLOR.

NO CLAIM IS MADE TO THE EXCLUSIVE RIGHT TO USE "OPTIMAL DESIGN", APART FROM THE MARK AS SHOWN.

SN 78-979,144, FILED 3-30-2005.

MARK SPARACINO, EXAMINING ATTORNEY

Int. Cls.: 21 and 24

Prior U.S. Cls.: 2, 13, 23, 29, 30, 33, 40, 42, and 50

Reg. No. 3,482,571

United States Patent and Trademark Office

Registered Aug. 5, 2008

**TRADEMARK
PRINCIPAL REGISTER**

ROYAL FAMILY CANNON

OFFICIAL PILLOWTEX LLC (DELAWARE LTD
LIAB CO)
103 FOULK ROAD
WILMINGTON, DE 19803

FOR: SOAP CONTAINERS; SOAP DISHES; SOAP
DISPENSERS; TOOTHBRUSH HOLDERS; TRASH
CANS; WASTEPAPER BASKETS, IN CLASS 21 (U.S.
CLS. 2, 13, 23, 29, 30, 33, 40 AND 50).

FIRST USE 9-0-2007; IN COMMERCE 9-0-2007.

FOR: BATH LINEN; BATH TOWELS; BED LINEN,
IN CLASS 24 (U.S. CLS. 42 AND 50).

FIRST USE 9-0-2007; IN COMMERCE 9-0-2007.

THE MARK CONSISTS OF STANDARD CHAR-
ACTERS WITHOUT CLAIM TO ANY PARTICULAR
FONT, STYLE, SIZE, OR COLOR.

OWNER OF U.S. REG. NOS. 729,513, 1,127,537,
AND OTHERS.

SN 78-979,504, FILED 7-8-2004.

CAROLINE WOOD, EXAMINING ATTORNEY

Int. Cl.: 9

Prior U.S. Cls.: 21, 23, 26, 36, and 38

United States Patent and Trademark Office

Reg. No. 3,482,572

Registered Aug. 5, 2008

**TRADEMARK
PRINCIPAL REGISTER**

FITMOM

FITMOM, INC. (CANADA CORPORATION)
4 PEPLER AVENUE
TORONTO, ONTARIO M4J 2Y6

THE MARK CONSISTS OF STANDARD CHARACTERS WITHOUT CLAIM TO ANY PARTICULAR FONT, STYLE, SIZE, OR COLOR.

FOR: PRE-RECORDED VIDEO TAPES FEATURING EXERCISE AND FITNESS PROGRAMS AND TRAINING, IN CLASS 9 (U.S. CLS. 21, 23, 26, 36 AND 38).

SN 78-979,544, FILED 2-14-2005.

FIRST USE 8-18-2006; IN COMMERCE 8-18-2006.

PAULA MAHONEY, EXAMINING ATTORNEY

Int. Cls.: 25 and 41

Prior U.S. Cls.: 22, 39, 100, 101, and 107

United States Patent and Trademark Office

Reg. No. 3,482,573

Registered Aug. 5, 2008

**TRADEMARK
SERVICE MARK
PRINCIPAL REGISTER**



STUDENTS IN FREE ENTERPRISE, INC. (TEXAS CORPORATION)
1959 EAST KERR STREET
SPRINGFIELD, MO 65803

FOR: SHIRTS AND JACKETS, IN CLASS 25 (U.S. CLS. 22 AND 39).

FIRST USE 5-0-2007, THE MARK WAS FIRST USED ANYWHERE IN A DIFFERENT FORM OTHER THAN THAT SOUGHT TO BE REGISTERED ON 00/00/1975.; IN COMMERCE 5-0-2007.

FOR: EDUCATION SERVICES, NAMELY, PROVIDING CLASSES, SEMINARS, WORKSHOPS AND COMPETITIONS IN THE FIELD OF THE FREE ENTERPRISE SYSTEM; PROVIDING RECOGNITION AND INCENTIVES BY THE WAY OF AWARDS TO DEMONSTRATE EXCELLENCE IN THE FIELDS OF EDUCATION AND BUSINESS, IN CLASS 41 (U.S. CLS. 100, 101 AND 107).

FIRST USE 9-0-2006, THE MARK WAS FIRST USED ANYWHERE IN A DIFFERENT FORM OTHER THAN THAT SOUGHT TO BE REGISTERED ON 00/00/1975.; IN COMMERCE 9-0-2006.

OWNER OF U.S. REG. NOS. 2,045,546 AND 2,810,580.

SN 78-979,673, FILED 8-9-2006.

YONG KIM, EXAMINING ATTORNEY

Int. Cl.: 30

Prior U.S. Cl.: 46

United States Patent and Trademark Office

Reg. No. 3,482,574

Registered Aug. 5, 2008

**TRADEMARK
PRINCIPAL REGISTER**

EMBARÉ

EMBARE INDUSTRIAS ALIMENTICIAS S/A
(BRAZIL CORPORATION)
AV. BRASIL 241
LAGOA DA PRATA, BRAZIL 35590-000

OWNER OF BRAZIL REG. NO. 005006791, DATED
9-29-1948, RENEWED AS REG. NO. 005006791, DA-
TED 9-29-1998, EXPIRES 9-28-2008.

FOR: CARAMELS, IN CLASS 30 (U.S. CL. 46).

SN 78-980,033, FILED 7-29-2004.

FIRST USE 0-0-1947; IN COMMERCE 0-0-1989.

THE MARK CONSISTS OF STANDARD CHAR-
ACTERS WITHOUT CLAIM TO ANY PARTICULAR
FONT, STYLE, SIZE, OR COLOR.

CHRISTINE BLOMQUIST, EXAMINING ATTOR-
NEY

Int. Cl.: 16

Prior U.S. Cls.: 2, 5, 22, 23, 29, 37, 38, and 50

Reg. No. 3,482,575

United States Patent and Trademark Office

Registered Aug. 5, 2008

**TRADEMARK
PRINCIPAL REGISTER**



SEVEN LIGHTS, LLC (DELAWARE LTD LIAB
CO)
1165 NORTH CLARK STREET
SUITE 614
CHICAGO, IL 60610

FIRST USE 8-9-2006; IN COMMERCE 8-9-2006.

SN 78-980,191, FILED 7-19-2006.

FOR: PRINTED MATERIAL AND PUBLICA-
TIONS, NAMELY, COMIC BOOKS, IN CLASS 16
(U.S. CLS. 2, 5, 22, 23, 29, 37, 38 AND 50).

NORA BUCHANAN WILL, EXAMINING ATTOR-
NEY

Int. Cl.: 16

Prior U.S. Cls.: 2, 5, 22, 23, 29, 37, 38, and 50

United States Patent and Trademark Office

Reg. No. 3,482,576

Registered Aug. 5, 2008

**TRADEMARK
PRINCIPAL REGISTER**

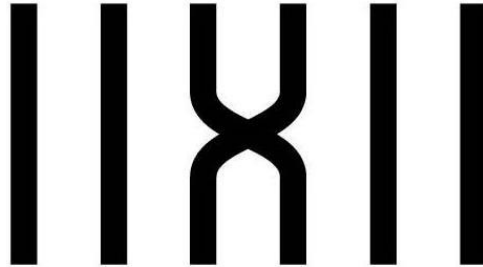

SEVEN LIGHTS, LLC (DELAWARE LTD LIAB
CO)
1165 NORTH CLARK STREET
SUITE 614
CHICAGO, IL 60610

FOR: PRINTED MATERIAL AND PUBLICA-
TIONS, NAMELY, COMIC BOOKS, IN CLASS 16
(U.S. CLS. 2, 5, 22, 23, 29, 37, 38 AND 50).

FIRST USE 8-9-2006; IN COMMERCE 8-9-2006.

THE MARK CONSISTS OF TWO CROSSED LINES
BETWEEN TWO PARALLEL VERTICAL LINES ON
EACH SIDE OF THE TWO CROSSED LINES.

SN 78-980,192, FILED 9-8-2006.

NORA BUCHANAN WILL, EXAMINING ATTOR-
NEY

Int. Cls.: 18, 25, 35, and 36

Prior U.S. Cls.: 1, 2, 3, 22, 39, 41, 100, 101, and 102

United States Patent and Trademark Office

Reg. No. 3,482,577

Registered Aug. 5, 2008

**TRADEMARK
SERVICE MARK
PRINCIPAL REGISTER**



RETAIL LICENSING COMPANY (NEVADA CORPORATION)
101 CONVENTION CENTER DRIVE
LAS VEGAS, NV 89109

FOR: BACKPACKS, BEACH BAGS, DUFFEL BAGS, TOTE BAGS, PURSES, COIN PURSES, SHOULDER BAGS, WALLETS, BUSINESS CARD CASES, CALLING CARD CASES, CREDIT CARD CASES, AND TOILETRY CASES SOLD EMPTY, IN CLASS 18 (U.S. CLS. 1, 2, 3, 22 AND 41).

FIRST USE 9-6-2006; IN COMMERCE 9-6-2006.

FOR: CLOTHING AND CLOTHING ACCESSORIES, NAMELY, CLOTHING BELTS, BLAZERS, BLOUSES, BOTTOMS, CAPES, COATS, RAIN WEAR, SPORT COATS, DRESSES, FOUL WEATHER GEAR, GLOVES, TOPS, HOSIERY, JACKETS, JEANS, JERSEYS, KERCHIEFS, LOUNGEWEAR, NECKWEAR, PANTS, SCARVES, SHAWLS, SHIRTS, SWEATSHIRTS, SHORTS, SKIRTS, SWEATERS, VESTS, FOOTWEAR, AND HEADWEAR, IN CLASS 25 (U.S. CLS. 22 AND 39).

FIRST USE 9-6-2006; IN COMMERCE 9-6-2006.

FOR: RETAIL STORE SERVICES, MAIL ORDER SERVICES, AND ELECTRONIC RETAIL SERVICES USING A GLOBAL COMPUTER AND/OR COMMUNICATIONS, NETWORK, ALL IN THE FIELD OF CLOTHING, CLOTHING ACCESSORIES, FOOTWEAR, HEADWEAR, BACKPACKS, PURSES, WALLETS, SUNGLASSES, JEWELRY, AND CANDLES, IN CLASS 35 (U.S. CLS. 100, 101 AND 102).

FIRST USE 9-6-2006; IN COMMERCE 9-6-2006.

FOR: STORED-VALUE CARD SERVICES, IN CLASS 36 (U.S. CLS. 100, 101 AND 102).

FIRST USE 9-6-2006; IN COMMERCE 9-6-2006.

SN 78-980,278, FILED 10-19-2005.

RON FAIRBANKS, EXAMINING ATTORNEY

Int. Cl.: 30

Prior U.S. Cl.: 46

United States Patent and Trademark Office

Reg. No. 3,482,578

Registered Aug. 5, 2008

**TRADEMARK
PRINCIPAL REGISTER**

KELLOGG'S

KELLOGG NORTH AMERICA COMPANY (DE-
LAWARE CORPORATION)
ONE KELLOGG SQUARE, PO BOX 3599
BATTLE CREEK, MI 49016

FOR: PROCESSED CEREAL-DERIVED FOOD
PRODUCT, TO BE USED AS BREAKFAST CEREAL,
CEREAL-BASED SNACK FOODS AND AN INGRE-
DIENT FOR MAKING FOOD; TOASTER PASTRIES,
WAFFLES, PANCAKES, CEREAL BASED SNACK
FOOD BARS, GRAIN BASED SNACK FOODS, IN
CLASS 30 (U.S. CL. 46).

FIRST USE 5-1-1907; IN COMMERCE 5-1-1907.

THE MARK CONSISTS OF STANDARD CHAR-
ACTERS WITHOUT CLAIM TO ANY PARTICULAR
FONT, STYLE, SIZE, OR COLOR.

OWNER OF U.S. REG. NOS. 147,454, 2,364,732,
AND OTHERS.

SN 78-980,312, FILED 10-11-2005.

AISHA CLARKE, EXAMINING ATTORNEY

Int. Cl.: 5

Prior U.S. Cls.: 6, 18, 44, 46, 51, and 52

Reg. No. 3,482,579

United States Patent and Trademark Office

Registered Aug. 5, 2008

**TRADEMARK
PRINCIPAL REGISTER**



ROTAM LTD. (HONG KONG CORPORATION)
18 CHEUNG LEE STREET
7/F., CHEUNG TAT CENTRE
CHAI WAN, HONG KONG

FOR: PHARMACEUTICAL AND VETERINARY
PREPARATIONS, NAMELY, CATTLE DIP; PRE-
PARATIONS FOR DESTROYING VERMIN; FUNGI-
CIDES, HERBICIDES, AND INSECTICIDES, ALL

FOR AGRICULTURAL USE, IN CLASS 5 (U.S. CLS.
6, 18, 44, 46, 51 AND 52).

FIRST USE 10-0-2007; IN COMMERCE 10-0-2007.

SN 78-980,316, FILED 9-5-2006.

JOHN E. MICHOS, EXAMINING ATTORNEY

Int. Cl.: 9

Prior U.S. Cls.: 21, 23, 26, 36, and 38

United States Patent and Trademark Office

Reg. No. 3,482,580

Registered Aug. 5, 2008

**TRADEMARK
PRINCIPAL REGISTER**

SHARP OSA

SHARP KABUSHIKI KAISHA (JAPAN CORPORATION), TA SHARP CORPORATION,
22-22 NAGAIKE-CHO, ABENO-KU
OSAKA, JAPAN 545-8522

OWNER OF U.S. REG. NOS. 1,405,542, 1,985,630,
AND OTHERS.

FOR: SOFTWARE FOR OPERATING COPYING MACHINES, PRINTERS, FACSIMILE MACHINES AND SCANNERS, IN CLASS 9 (U.S. CLS. 21, 23, 26, 36 AND 38).

NO CLAIM IS MADE TO THE EXCLUSIVE RIGHT TO USE "OSA", APART FROM THE MARK AS SHOWN.

FIRST USE 5-31-2006; IN COMMERCE 5-31-2006.

SN 78-980,333, FILED 11-10-2005.

THE MARK CONSISTS OF STANDARD CHARACTERS WITHOUT CLAIM TO ANY PARTICULAR FONT, STYLE, SIZE, OR COLOR.

LEIGH CAROLINE CASE, EXAMINING ATTORNEY

Int. Cl.: 9

Prior U.S. Cls.: 21, 23, 26, 36, and 38

Reg. No. 3,482,581

United States Patent and Trademark Office

Registered Aug. 5, 2008

**TRADEMARK
PRINCIPAL REGISTER**

ORACLE FUSION

ORACLE INTERNATIONAL CORPORATION
(CALIFORNIA CORPORATION)
500 ORACLE PARKWAY
REDWOOD CITY, CA 94065

FOR: COMPUTER SOFTWARE, NAMELY, A
FULL LINE OF MIDDLEWARE SOFTWARE, IN
CLASS 9 (U.S. CLS. 21, 23, 26, 36 AND 38).

FIRST USE 12-30-2005; IN COMMERCE 12-30-2005.

THE MARK CONSISTS OF STANDARD CHAR-
ACTERS WITHOUT CLAIM TO ANY PARTICULAR
FONT, STYLE, SIZE, OR COLOR.

OWNER OF U.S. REG. NOS. 1,200,239, 2,997,144,
AND OTHERS.

SN 78-980,351, FILED 4-25-2005.

LEIGH CAROLINE CASE, EXAMINING ATTOR-
NEY

Int. Cl.: 16

Prior U.S. Cls.: 2, 5, 22, 23, 29, 37, 38, and 50

Reg. No. 3,482,582

United States Patent and Trademark Office

Registered Aug. 5, 2008

**TRADEMARK
PRINCIPAL REGISTER**

Wii

NINTENDO OF AMERICA INC. (WASHINGTON CORPORATION)
4820 150TH AVENUE NE
REDMOND, WA 98052

FOR: (BASED ON USE) CALENDARS; GIFT WRAPPING PAPER; MAGAZINES, BOOKLETS, STRATEGY GUIDES, AND MANUALS REGARDING VIDEO GAMES, COMPUTER GAMES AND ENTERTAINMENT; PENS; POSTERS; AND MAGAZINES AND OTHER PRINTED MATTER, NAMELY, BOOKLETS AND MANUALS PERTAINING TO VIDEO GAMES; (BASED ON SECTION 44(E)) PAPER BANNERS; PAPER FLAGS; PAPER LABELS FOR BAGGAGE; CALLIGRAPHIC WORKS AND CALLIGRAPHIC PICTURES; PHOTOGRAPHS; STATIONERY; ADHESIVES FOR STATIONERY OR HOUSEHOLD USE; AND ELECTRICAL PENCIL SHARPENERS, IN CLASS 16 (U.S. CLS. 2, 5, 22, 23, 29, 37, 38 AND 50).

FIRST USE 11-19-2006; IN COMMERCE 11-19-2006.

THE MARK CONSISTS OF STANDARD CHARACTERS WITHOUT CLAIM TO ANY PARTICULAR FONT, STYLE, SIZE, OR COLOR.

PRIORITY CLAIMED UNDER SEC. 44(D) ON ITALY APPLICATION NO. 119872005M, FILED 11-11-2005.

OWNER OF JAPAN REG. NO. 4992560, DATED 9-29-2006, EXPIRES 9-29-2016.

SN 78-980,359, FILED 4-27-2006.

ROBERT LAVACHE, EXAMINING ATTORNEY

Int. Cls.: 35 and 36

Prior U.S. Cls.: 100, 101, and 102

United States Patent and Trademark Office

Reg. No. 3,482,583

Registered Aug. 5, 2008

**SERVICE MARK
PRINCIPAL REGISTER**

ONE BIG TABLE

KITCHEN CABINET CONSULTING, LLC (NEW
YORK LTD LIAB CO)
1463 MAIN STREET
RENSSELAERVILLE, NY 12147

FOR: PROMOTION OF PUBLIC AWARENESS OF
THE NEED TO END HUNGER AND ITS ROOT
CAUSES, IN CLASS 35 (U.S. CLS. 100, 101 AND 102).

FIRST USE 6-0-2004; IN COMMERCE 6-0-2004.

FOR: CHARITABLE FUNDRAISING SERVICES,
IN CLASS 36 (U.S. CLS. 100, 101 AND 102).

FIRST USE 6-0-2004; IN COMMERCE 6-0-2004.

THE MARK CONSISTS OF STANDARD CHAR-
ACTERS WITHOUT CLAIM TO ANY PARTICULAR
FONT, STYLE, SIZE, OR COLOR.

SN 78-980,378, FILED 3-18-2004.

WANDA KAY PRICE, EXAMINING ATTORNEY

Int. Cl.: 16

Prior U.S. Cls.: 2, 5, 22, 23, 29, 37, 38, and 50

Reg. No. 3,482,584

United States Patent and Trademark Office

Registered Aug. 5, 2008

**TRADEMARK
PRINCIPAL REGISTER**

PANDA

FIRST QUALITY TISSUE, LLC (DELAWARE LTD
LIAB CO)
SUITE 500
80 CUTTERMILL ROAD
GREAT NECK, NY 11021

THE MARK CONSISTS OF STANDARD CHAR-
ACTERS WITHOUT CLAIM TO ANY PARTICULAR
FONT, STYLE, SIZE, OR COLOR.

FOR: TOILET TISSUE, IN CLASS 16 (U.S. CLS. 2, 5,
22, 23, 29, 37, 38 AND 50).

SN 78-980,379, FILED 6-16-2006.

FIRST USE 2-27-2008; IN COMMERCE 2-27-2008.

HOWARD B. LEVINE, EXAMINING ATTORNEY

Int. Cl.: 25

Prior U.S. Cls.: 22 and 39

United States Patent and Trademark Office

Reg. No. 3,482,585

Registered Aug. 5, 2008

**TRADEMARK
PRINCIPAL REGISTER**

REALTREE GIRL

JORDAN OUTDOOR ENTERPRISES, LTD.
(GEORGIA CORPORATION)
1390 BOX CIRCLE
COLUMBUS, GA 31907

OWNER OF U.S. REG. NOS. 1,736,108, 2,206,463,
AND OTHERS.

FOR: CLOTHING, NAMELY, SHIRTS, PANTS,
JACKETS, SKIRTS, DRESSES, BELTS AND HATS,
IN CLASS 25 (U.S. CLS. 22 AND 39).

NO CLAIM IS MADE TO THE EXCLUSIVE
RIGHT TO USE "GIRL", APART FROM THE MARK
AS SHOWN.

FIRST USE 2-13-2007; IN COMMERCE 2-13-2007.

SN 78-980,400, FILED 12-6-2005.

THE MARK CONSISTS OF STANDARD CHAR-
ACTERS WITHOUT CLAIM TO ANY PARTICULAR
FONT, STYLE, SIZE, OR COLOR.

JANICE L. MCMORROW, EXAMINING ATTOR-
NEY

Int. Cl.: 38

Prior U.S. Cls.: 100, 101, and 104

United States Patent and Trademark Office

Reg. No. 3,482,586

Registered Aug. 5, 2008

**SERVICE MARK
PRINCIPAL REGISTER**

HORSELAND

HORSELAND LLC (DELAWARE LTD LIAB CO)
P.O BOX 5549
VERNON HILL, IL 60061

OF COMPUTER GAMING ENTERTAINMENT, IN
CLASS 38 (U.S. CLS. 100, 101 AND 104).

FIRST USE 8-1-1996; IN COMMERCE 8-1-1996.

FOR: PROVIDING ON-LINE CHAT ROOMS AND
FORUMS FOR TRANSMISSION OF MESSAGES
AMONG COMPUTER USERS CONCERNING TOPIC
OF COMPUTER GAMING ENTERTAINMENT;
PROVIDING ON-LINE ELECTRONIC BULLETIN
BOARDS FOR TRANSMISSION OF MESSAGES
AMONG COMPUTER USERS CONCERNING TOPIC

THE MARK CONSISTS OF STANDARD CHAR-
ACTERS WITHOUT CLAIM TO ANY PARTICULAR
FONT, STYLE, SIZE, OR COLOR.

SN 78-980,417, FILED 8-30-2006.

STEVEN JACKSON, EXAMINING ATTORNEY

Int. Cls.: 9 and 42

Prior U.S. Cls.: 21, 23, 26, 36, 38, 100, and 101

United States Patent and Trademark Office

Reg. No. 3,482,587

Registered Aug. 5, 2008

**TRADEMARK
SERVICE MARK
PRINCIPAL REGISTER**

Neusoft

NEUSOFT GROUP LTD. (CHINA CORPORATION)
BUILDING 149, HUN NAN INDUSTRIAL AREA
NEW & HIGH-TECH DEVELOPMENT ZONE
SHENYANG LIAONING PROVINCE, CHINA 110179

FOR: RECORDED SOFTWARE FOR NETWORK SECURITY; RECORDED SOFTWARE FOR BUDGETING, BUSINESS ACCOUNTING AND CAPITAL MANAGEMENT OF ENTERPRISES; RECORDED SOFTWARE FOR THE MANAGEMENT OF HUMAN RESOURCES; RECORDED E-LEARNING SOFTWARE FOR NETWORK STUDYING AND TRAINING, NAMELY, SOFTWARE, WITH MANAGEMENT AND SUPPORT OF WEB INTERFACE, FOR STUDYING AND TRAINING IN THE FIELD OF COMPUTER APPLICATIONS AND LANGUAGES; MEDICAL PICTURE ARCHIVING AND COMMUNICATION SOFTWARE (PACS), NAMELY, FOR COMPUTER-BASED IMAGE-STORAGE-AND-RETRIEVAL SYSTEM SOFTWARE THAT CAN STORE AND RECALL IMAGES IN DIGITAL FORMAT FROM SEVERAL DIFFERENT DIAGNOSTIC IMAGING MODALITIES, SUCH AS CT, MRI, COMPUTED RADIOGRAPHY (CR), DIGITAL RADIOGRAPHY, DIGITAL ANGIOGRAPHY, NUCLEAR MEDICINE, AND ULTRASOUND CONSISTING OF IMAGE MANIPULATION AND DISPLAY STATIONS COUPLED WITH IMAGE-ARCHIVING DEVICES AND NETWORKING CAPABILITIES, FOR ALLOWING DIGITAL IMAGE TRANSMISSION TO ANY NETWORKED PART OF THE HOSPITAL OR OUTSIDE THE HOSPITAL VIA A WIDE

AREA NETWORK (WAN) OR THE INTERNET, IN CLASS 9 (U.S. CLS. 21, 23, 26, 36 AND 38).

FIRST USE 3-22-2005; IN COMMERCE 2-19-2008.

FOR: SOFTWARE DESIGN AND PROGRAMMING SERVICES FOR AUTOMOTIVE ELECTRONICS; SOFTWARE DESIGN AND PROGRAMMING SERVICES FOR FINANCIAL AND SECURITY INDUSTRY; SOFTWARE DESIGN AND PROGRAMMING SERVICES FOR HEALTH CARE; SOFTWARE DESIGN AND PROGRAMMING SERVICES FOR MOBILE PHONES; SOFTWARE DESIGN AND PROGRAMMING SERVICES FOR TELECOMMUNICATION INDUSTRY; SOFTWARE DESIGN AND PROGRAMMING SERVICES FOR TRAFFIC INDUSTRY; ERP (ENTERPRISE RESOURCES PLANNING) IMPLEMENTING AND SERVICES, NAMELY, THE SYSTEMIZATION AND TRANSFERRING OF THE INFORMATION RELATED TO RAW MATERIALS, STORAGE, FINANCE, MANUFACTURE AND DISTRIBUTION THROUGH COMPUTER SOFTWARE SYSTEMS FOR THE PURPOSES OF RATIONALIZATION OF DEPLOYING AND USING OF THE ENTERPRISES; INSTALLATION SERVICES OF COMPUTER SOFTWARE, IN CLASS 42 (U.S. CLS. 100 AND 101).

FIRST USE 3-22-2005; IN COMMERCE 2-19-2008.

SN 78-980,426, FILED 1-10-2006.

HEATHER SAPP, EXAMINING ATTORNEY

Int. Cls.: 9, 16, 35, 38, 41, and 42

**Prior U.S. Cls.: 2, 5, 21, 22, 23, 26, 29, 36, 37, 38, 50,
100, 101, 102, 104, and 107**

Reg. No. 3,482,588

United States Patent and Trademark Office

Registered Aug. 5, 2008

**TRADEMARK
SERVICE MARK
PRINCIPAL REGISTER**

BLOOMBERG LAW

BLOOMBERG L.P. (DELAWARE LIMITED PART-
NERSHIP)
731 LEXINGTON AVENUE
NEW YORK, NY 10022

FOR: DOWNLOADABLE ELECTRONIC PUBLI-
CATIONS IN THE NATURE OF REPORTS, DI-
GESTS, DIRECTORIES, CHARTS, BROCHURES,
REFERENCE MATERIALS, MANUALS, NEWSLET-
TERS, BOOKLETS, PAMPHLETS AND JOURNALS
IN THE FIELDS OF NEWS, RESEARCH, COMPU-
TERIZED DATABASES AND OTHER INDEXES OF
INFORMATION, LAW, GOVERNMENT AND PUB-
LIC RECORDS, BUSINESS, IN CLASS 9 (U.S. CLS. 21,
23, 26, 36 AND 38).

FIRST USE 2-4-2003; IN COMMERCE 2-4-2003.

FOR: PUBLICATIONS, NAMELY, REPORTS, DI-
GESTS, DIRECTORIES, CHARTS, BROCHURES,
REFERENCE MATERIALS, BOOKLETS, PAMPH-
LETS, JOURNALS AND MAGAZINES IN THE
FIELDS OF NEWS, RESEARCH, COMPUTERIZED
DATABASES AND OTHER INDEXES OF INFOR-
MATION, LAW, GOVERNMENT AND PUBLIC RE-
CORDS, BUSINESS AND POLITICS, IN CLASS 16
(U.S. CLS. 2, 5, 22, 23, 29, 37, 38 AND 50).

FIRST USE 2-4-2003; IN COMMERCE 2-4-2003.

FOR: BUSINESS NEWS AND INFORMATION
SERVICES, NAMELY, COLLECTING AND PROVID-
ING BUSINESS, MANAGEMENT, DEMOGRAPHIC,
ECONOMIC, MARKETING, SALES, ADVERTISING,
TAX, ACCOUNTING, CREDIT RATING AND PER-
SONNEL DATA, REPORTS AND INFORMATION;
BUSINESS, ECONOMIC AND MARKET RESEARCH

SERVICES; PROMOTING THE GOODS AND SER-
VICES OF OTHERS BY DISSEMINATING ADVER-
TISEMENTS OVER, BY OR THROUGH LOCAL OR
WIDE AREA COMPUTER NETWORKS, WIRELESS
COMMUNICATION NETWORKS, GLOBAL COM-
PUTER INFORMATION NETWORKS AND OTHER
ELECTRONIC COMMUNICATION NETWORKS;
ARRANGING AND CONDUCTING BUSINESS
CONFERENCES; PROVIDING AN ON-LINE COM-
PUTER DATABASE IN THE FIELDS OF BUSINESS,
MANAGEMENT, FINANCIAL, ADVERTISING,
TAX, REPORTS AND INFORMATION, IN CLASS
35 (U.S. CLS. 100, 101 AND 102).

FIRST USE 2-4-2003; IN COMMERCE 2-4-2003.

FOR: PROVIDING MULTIPLE USER ACCESS TO
DATABASES OVER, BY OR THROUGH LOCAL OR
WIDE AREA COMPUTER NETWORKS, WIRELESS
COMMUNICATION NETWORKS, GLOBAL COM-
PUTER INFORMATION NETWORKS AND OTHER
ELECTRONIC COMMUNICATION NETWORKS, IN
CLASS 38 (U.S. CLS. 100, 101 AND 104).

FIRST USE 2-4-2003; IN COMMERCE 2-4-2003.

FOR: COMPUTER SERVICES, NAMELY, PRO-
VIDING ON-LINE PUBLICATIONS IN THE NAT-
URE OF REPORTS, DIGESTS, DIRECTORIES,
BROCHURES, REFERENCE MATERIALS, NEWS-
LETTERS, NEWSPAPERS, BOOKLETS, PAMPH-
LETS, AND TRADE AND PROFESSIONAL BOOKS
IN THE FIELDS OF NEWS, RESEARCH, COMPU-
TERIZED DATABASES AND OTHER INDEXES OF
INFORMATION, LAW, GOVERNMENT AND PUB-
LIC RECORDS, BUSINESS, FINANCE; NEWS
AGENCIES AND NEWS REPORTING SERVICES,

NAMELY, GATHERING AND DISSEMINATION OF NEWS BY COMPUTER, IN CLASS 41 (U.S. CLS. 100, 101 AND 107).

FIRST USE 2-4-2003; IN COMMERCE 2-4-2003.

FOR: LEGAL RESEARCH SERVICES; COMPUTER SERVICES, NAMELY, COMPUTERIZED LEGAL RESEARCH SERVICES OVER, BY OR THROUGH LOCAL OR WIDE AREA COMPUTER NETWORKS, WIRELESS COMMUNICATION NETWORKS, GLOBAL COMPUTER INFORMATION NETWORKS AND OTHER ELECTRONIC COMMUNICATION NETWORKS, IN CLASS 42 (U.S. CLS. 100 AND 101).

FIRST USE 2-4-2003; IN COMMERCE 2-4-2003.

THE MARK CONSISTS OF STANDARD CHARACTERS WITHOUT CLAIM TO ANY PARTICULAR FONT, STYLE, SIZE, OR COLOR.

OWNER OF U.S. REG. NOS. 2,045,947, 2,736,744, AND OTHERS.

NO CLAIM IS MADE TO THE EXCLUSIVE RIGHT TO USE "LAW" , APART FROM THE MARK AS SHOWN.

SEC. 2(F) AS TO "BLOOMBERG".

SN 78-980,427, FILED 6-4-2004.

ANGELA M. MICHELI, EXAMINING ATTORNEY

Int. Cl.: 21

Prior U.S. Cls.: 2, 13, 23, 29, 30, 33, 40, and 50

United States Patent and Trademark Office

Reg. No. 3,482,589

Registered Aug. 5, 2008

**TRADEMARK
SUPPLEMENTAL REGISTER**

FLIP TOP

SIMPLEHUMAN, LLC (CALIFORNIA LTD LIAB
CO)
19801 S. VERMONT AVE.
TORRANCE, CA 90502

THE MARK CONSISTS OF STANDARD CHAR-
ACTERS WITHOUT CLAIM TO ANY PARTICULAR
FONT, STYLE, SIZE, OR COLOR.

FOR: HOUSEWARES, NAMELY, PAPER TOWEL
HOLDERS AND DISH STANDS, IN CLASS 21 (U.S.
CLS. 2, 13, 23, 29, 30, 33, 40 AND 50).

SER. NO. 76-661,910, FILED P.R. 6-21-2006; AM. S.R.
6-24-2008.

FIRST USE 6-21-2006; IN COMMERCE 6-21-2006.

ALLISON SCHRODY, EXAMINING ATTORNEY

Int. Cl.: 41

Prior U.S. Cls.: 100, 101, and 107

United States Patent and Trademark Office

Reg. No. 3,482,590

Registered Aug. 5, 2008

**SERVICE MARK
SUPPLEMENTAL REGISTER**

**WORLD HAN KUM
DO FEDERATION**

KO, SOO RYONG (UNITED STATES INDIVIDUAL)
19147 BLOOMFIELD AVE.
CERRITOS, CA 90703

FOR: MARTIAL ARTS INSTRUCTION AND TRAINING IN HAN KUM DO, A TRADITIONAL KOREAN MARTIAL ART WITH AN EMPHASIS ON SWORDSMANSHIP, IN CLASS 41 (U.S. CLS. 100, 101 AND 107).

FIRST USE 3-1-2005; IN COMMERCE 3-1-2005.

THE MARK CONSISTS OF STANDARD CHARACTERS WITHOUT CLAIM TO ANY PARTICULAR FONT, STYLE, SIZE, OR COLOR.

NO CLAIM IS MADE TO THE EXCLUSIVE RIGHT TO USE "HAN KUM DO", APART FROM THE MARK AS SHOWN.

THE FOREIGN WORDING IN THE MARK TRANSLATES INTO ENGLISH AS "KOREAN ANCIENT SWORDSMANSHIP ARTS".

SER. NO. 76-678,576, FILED P.R. 6-22-2007; AM. S.R. 6-23-2008.

MICHAEL SOUDERS, EXAMINING ATTORNEY

Int. Cl.: 41

Prior U.S. Cls.: 100, 101, and 107

United States Patent and Trademark Office

Reg. No. 3,482,591

Registered Aug. 5, 2008

**SERVICE MARK
SUPPLEMENTAL REGISTER**

**WORLD HAN SUN
DO FEDERATION**

KO, SOO RYONG (UNITED STATES INDIVIDUAL)
19147 BLOOMFIELD AVE.
CERRITOS, CA 90703

FOR: MARTIAL ARTS INSTRUCTION AND TRAINING IN HAN SUN DO, A TRADITIONAL KOREAN MARTIAL ART WITH AN EMPHASIS ON SELF-DEFENSE, IN CLASS 41 (U.S. CLS. 100, 101 AND 107).

FIRST USE 3-1-2005; IN COMMERCE 3-1-2005.

THE MARK CONSISTS OF STANDARD CHARACTERS WITHOUT CLAIM TO ANY PARTICULAR FONT, STYLE, SIZE, OR COLOR.

NO CLAIM IS MADE TO THE EXCLUSIVE RIGHT TO USE "HAN SUN DO", APART FROM THE MARK AS SHOWN.

THE FOREIGN WORDING IN THE MARK TRANSLATES INTO ENGLISH AS "KOREAN ANCIENT RELIGIOUS MEDITATION AND MARTIAL ARTS".

SER. NO. 76-678,577, FILED P.R. 6-22-2007; AM. S.R. 6-23-2008.

MICHAEL SOUDERS, EXAMINING ATTORNEY

Int. Cl.: 10

Prior U.S. Cls.: 26, 39, and 44

United States Patent and Trademark Office

Reg. No. 3,482,592

Registered Aug. 5, 2008

**TRADEMARK
SUPPLEMENTAL REGISTER**

SMARTVEST WRAP

ELECTROMED, INC. (MINNESOTA CORPORATION)
502 6TH AVENUE NW
NEW PRAGUE, MN 56071

THE MARK CONSISTS OF STANDARD CHARACTERS WITHOUT CLAIM TO ANY PARTICULAR FONT, STYLE, SIZE, OR COLOR.

FOR: MEDICAL THORACIC GARMENT, NAME-
LY, A BAND HAVING AIR CHAMBERS ADAPTED
TO BE PLACED AROUND A PERSON'S THORAX
USED TO APPLY PRESSURE AND PRESSURE
PULSES TO THE PERSON'S THORAX , IN CLASS
10 (U.S. CLS. 26, 39 AND 44).

OWNER OF U.S. REG. NO. 3,016,390.

SER. NO. 76-683,215, FILED P.R. 10-22-2007; AM.
S.R. 6-23-2008.

FIRST USE 11-14-2007; IN COMMERCE 11-14-2007.

ZACHARY BELLO, EXAMINING ATTORNEY

Int. Cl.: 3

Prior U.S. Cls.: 1, 4, 6, 50, 51, and 52

Reg. No. 3,482,593

United States Patent and Trademark Office

Registered Aug. 5, 2008

**TRADEMARK
SUPPLEMENTAL REGISTER**

GREEN MARINE

SPRAY NINE CORPORATION (NEW YORK
CORPORATION)
251 NORTH COMRIE AVENUE
JOHNSTOWN, NY 120950290

THE MARK CONSISTS OF STANDARD CHAR-
ACTERS WITHOUT CLAIM TO ANY PARTICULAR
FONT, STYLE, SIZE, OR COLOR.

FOR: ALL PURPOSE CLEANING PREPARATION,
IN CLASS 3 (U.S. CLS. 1, 4, 6, 50, 51 AND 52).

SER. NO. 76-683,703, FILED P.R. 11-5-2007; AM. S.R.
6-13-2008.

FIRST USE 10-12-2007; IN COMMERCE 10-12-2007.

NAPOLEON SHARMA, EXAMINING ATTORNEY

Int. Cls.: 9 and 41

Prior U.S. Cls.: 21, 23, 26, 36, 38, 100, 101, and 107

United States Patent and Trademark Office

Reg. No. 3,482,594

Registered Aug. 5, 2008

**TRADEMARK
SERVICE MARK
SUPPLEMENTAL REGISTER**

P2P

PROGRESSIVE GAMING INTERNATIONAL
CORP. (NEVADA CORPORATION)
920 PILOT ROAD
LAS VEGAS, NV 89119

FOR: GAMING EQUIPMENT, NAMELY, GAMING MACHINES AND GAME SOFTWARE, IN CLASS 9 (U.S. CLS. 21, 23, 26, 36 AND 38).

FIRST USE 11-14-2006; IN COMMERCE 11-14-2006.

FOR: CASINO SERVICES, NAMELY, PROVIDING GAMES OF CHANCE AND WAGERING OPPORTUNITIES, IN CLASS 41 (U.S. CLS. 100, 101 AND 107).

FIRST USE 11-14-2006; IN COMMERCE 11-14-2006.

THE MARK CONSISTS OF STANDARD CHARACTERS WITHOUT CLAIM TO ANY PARTICULAR FONT, STYLE, SIZE, OR COLOR.

SER. NO. 77-001,016, FILED P.R. 9-15-2006; AM. S.R. 3-20-2008.

REBECCA EISINGER, EXAMINING ATTORNEY

Int. Cl.: 6

Prior U.S. Cls.: 2, 12, 13, 14, 23, 25, and 50

United States Patent and Trademark Office

Reg. No. 3,482,595

Registered Aug. 5, 2008

**TRADEMARK
SUPPLEMENTAL REGISTER**

Eastman

GARAGA INC. (CANADA CORPORATION)
8500, 25TH AVENUE, ST-GEORGES DE BEAUCE
QUEBEC, CANADA G6A1K5

FOR: METAL GARAGE DOORS, IN CLASS 6 (U.S.
CLS. 2, 12, 13, 14, 23, 25 AND 50).

OWNER OF CANADA REG. NO. TMA715586,
DATED 5-30-2008, EXPIRES 5-30-2023.

SER. NO. 77-004,253, FILED P.R. 9-21-2006; AM. S.R.
8-21-2007.

REGINA DRUMMOND, EXAMINING ATTORNEY

Int. Cl.: 35

Prior U.S. Cls.: 100, 101, and 102

United States Patent and Trademark Office

Reg. No. 3,482,596

Registered Aug. 5, 2008

**SERVICE MARK
SUPPLEMENTAL REGISTER**

Vacation2ndHome

SLAYDON, LES (UNITED STATES INDIVIDUAL)
#304
7635 JEFFERSON HWY
BATON ROUGE, LA 70809

THE MARK CONSISTS OF STANDARD CHAR-
ACTERS WITHOUT CLAIM TO ANY PARTICULAR
FONT, STYLE, SIZE, OR COLOR.

FOR: REAL ESTATE MARKETING SERVICES IN
THE FIELD OF RESORT CONDOMINIUMS AND
VACATION SECOND HOMES, IN CLASS 35 (U.S.
CLS. 100, 101 AND 102).

SER. NO. 77-012,462, FILED P.R. 10-3-2006; AM. S.R.
6-16-2008.

FIRST USE 10-31-2005; IN COMMERCE 10-31-2005.

TEJBIR SINGH, EXAMINING ATTORNEY

Int. Cl.: 35

Prior U.S. Cls.: 100, 101, and 102

United States Patent and Trademark Office

Reg. No. 3,482,597

Registered Aug. 5, 2008

**SERVICE MARK
SUPPLEMENTAL REGISTER**

Vacation2ndHome.com

SLAYDON, LES (UNITED STATES INDIVIDUAL)
#304
7635 JEFFERSON HWY
BATON ROUGE, LA 70809

THE MARK CONSISTS OF STANDARD CHARACTERS WITHOUT CLAIM TO ANY PARTICULAR FONT, STYLE, SIZE, OR COLOR.

FOR: REAL ESTATE MARKETING SERVICES IN THE FIELD OF RESORT CONDOMINIUMS AND VACATION SECOND HOMES, IN CLASS 35 (U.S. CLS. 100, 101 AND 102).

SER. NO. 77-012,536, FILED P.R. 10-3-2006; AM. S.R. 6-16-2008.

FIRST USE 10-31-2005; IN COMMERCE 10-31-2005.

TEJBIR SINGH, EXAMINING ATTORNEY

Int. Cl.: 36

Prior U.S. Cls.: 100, 101, and 102

United States Patent and Trademark Office

Reg. No. 3,482,598

Registered Aug. 5, 2008

**SERVICE MARK
SUPPLEMENTAL REGISTER**

AMERICA'S BEST BANK

COMMERCE BANCORP, INC. (NEW JERSEY CORPORATION)
1701 ROUTE 70 EAST
CHERRY HILL, NJ 08034

FOR: BANKING SERVICES; BANKING SERVICES PROVIDED VIA THE INTERNET; INVESTMENT BROKERAGE SERVICES; INVESTMENT BROKERAGE SERVICES PROVIDED VIA THE INTERNET; INSURANCE BROKERAGE SERVICES; INSURANCE BROKERAGE SERVICES PROVIDED VIA THE INTERNET, IN CLASS 36 (U.S. CLS. 100, 101 AND 102).

FIRST USE 10-26-2006; IN COMMERCE 10-26-2006.

THE MARK CONSISTS OF STANDARD CHARACTERS WITHOUT CLAIM TO ANY PARTICULAR FONT, STYLE, SIZE, OR COLOR.

NO CLAIM IS MADE TO THE EXCLUSIVE RIGHT TO USE "BANK", APART FROM THE MARK AS SHOWN.

SER. NO. 77-026,760, FILED P.R. 10-23-2006; AM. S.R. 6-13-2008.

GEOFFREY FOSDICK, EXAMINING ATTORNEY

Int. Cl.: 16

Prior U.S. Cls.: 2, 5, 22, 23, 29, 37, 38, and 50

United States Patent and Trademark Office

Reg. No. 3,482,599

Registered Aug. 5, 2008

**TRADEMARK
SUPPLEMENTAL REGISTER**

Public!ze

OPHTHONIX, INC. (DELAWARE CORPORATION)
1491 POINSETTIA AVENUE
VISTA, CA 92081

FOR: MARKETING KIT COMPROMISED PRIMARILY OF PRINTED PROMOTIONAL MATERIALS, GRAPHICS, BROCHURES, POSTERS, COUNTER CARDS AND PATIENT COMMUNICATIONS IN THE FIELD OF EYE CARE AND EYEWEAR FOR USE BY OTHERS IN THEIR PRACTICES AND BUSINESSES, IN CLASS 16 (U.S. CLS. 2, 5, 22, 23, 29, 37, 38 AND 50).

FIRST USE 11-30-2006; IN COMMERCE 11-30-2006.

THE MARK CONSISTS OF THE STYLIZED WORD "PUBLICIZE" WITH THE SECOND "I" INVERTED.

SER. NO. 77-028,576, FILED P.R. 10-24-2006; AM. S.R. 6-28-2008.

MARY ROSSMAN, EXAMINING ATTORNEY

Int. Cls.: 36 and 41

Prior U.S. Cls.: 100, 101, 102, and 107

United States Patent and Trademark Office

Reg. No. 3,482,600

Registered Aug. 5, 2008

**SERVICE MARK
SUPPLEMENTAL REGISTER**

BOWLING WITH THE STARS

ONE OF THE SEVENTY, INC. (CALIFORNIA
CORPORATION)
TRADEMARK
POST OFFICE BOX 15157
SAN DIEGO, CA 921755157

FOR: CHARITABLE FUNDRAISING THROUGH
ORGANIZING AND CONDUCTING SPORT BOWL-
ING COMPETITIONS, IN CLASS 36 (U.S. CLS. 100,
101 AND 102).

FIRST USE 9-1-2003; IN COMMERCE 9-1-2003.

FOR: ENTERTAINMENT SERVICES IN THE
NATURE OF ORGANIZING SPORT BOWLING
COMPETITIONS FOR CHARITY, IN CLASS 41 (U.S.
CLS. 100, 101 AND 107).

FIRST USE 9-1-2003; IN COMMERCE 9-1-2003.

THE MARK CONSISTS OF STANDARD CHAR-
ACTERS WITHOUT CLAIM TO ANY PARTICULAR
FONT, STYLE, SIZE, OR COLOR.

NO CLAIM IS MADE TO THE EXCLUSIVE
RIGHT TO USE "BOWLING", APART FROM THE
MARK AS SHOWN.

SER. NO. 77-043,740, FILED P.R. 11-14-2006; AM.
S.R. 5-15-2007.

MARCIE MILONE, EXAMINING ATTORNEY

Int. Cl.: 29

Prior U.S. Cl.: 46

United States Patent and Trademark Office

Reg. No. 3,482,601

Registered Aug. 5, 2008

**TRADEMARK
SUPPLEMENTAL REGISTER**

ALL EGGS

MICHAEL FOODS OF DELAWARE, INC. (DELA-
WARE CORPORATION)

301 CARLSON PARKWAY

MINNETONKA, MN 55305

FOR: LIQUID WHOLE EGG PRODUCT, IN CLASS
29 (U.S. CL. 46).

FIRST USE 2-25-2008; IN COMMERCE 2-25-2008.

THE MARK CONSISTS OF STANDARD CHAR-
ACTERS WITHOUT CLAIM TO ANY PARTICULAR
FONT, STYLE, SIZE, OR COLOR.

NO CLAIM IS MADE TO THE EXCLUSIVE
RIGHT TO USE "EGGS", APART FROM THE MARK
AS SHOWN.

SER. NO. 77-059,210, FILED P.R. 12-7-2006; AM. S.R.
6-12-2008.

SANJEEV VOHRA, EXAMINING ATTORNEY

Int. Cl.: 25

Prior U.S. Cls.: 22 and 39

United States Patent and Trademark Office

Reg. No. 3,482,602

Registered Aug. 5, 2008

**TRADEMARK
SUPPLEMENTAL REGISTER**

SHOESXL

CMRG APPAREL, LLC (DELAWARE LTD LIAB
CO)
555 TURNPIKE STREET
CANTON, MA 02021

FOR: FOOTWEAR, IN CLASS 25 (U.S. CLS. 22 AND
39).

FIRST USE 1-1-2007; IN COMMERCE 1-1-2007.

THE MARK CONSISTS OF STANDARD CHAR-
ACTERS WITHOUT CLAIM TO ANY PARTICULAR
FONT, STYLE, SIZE, OR COLOR.

SER. NO. 77-079,688, FILED P.R. 1-10-2007; AM. S.R.
4-3-2008.

COLLEEN DOMBROW, EXAMINING ATTORNEY

Int. Cls.: 35, 36, and 42

Prior U.S. Cls.: 100, 101, and 102

United States Patent and Trademark Office

Reg. No. 3,482,603

Registered Aug. 5, 2008

**SERVICE MARK
SUPPLEMENTAL REGISTER**

**CONSERVATION'S COMMUNITY
FOUNDATION**

EARTH FRIENDS WILDLIFE FOUNDATION
(D.C. CORPORATION)
P.O. BOX 11217
JACKSON, WY 83002

FOR: PROMOTING PUBLIC AWARENESS CONCERNING WILDLIFE PROTECTION, IN CLASS 35 (U.S. CLS. 100, 101 AND 102).

FIRST USE 12-0-2006; IN COMMERCE 12-0-2006.

FOR: CHARITABLE FUNDRAISING AND MAKING GRANTS FOR CONSERVATION AND WILDLIFE PROTECTION, IN CLASS 36 (U.S. CLS. 100, 101 AND 102).

FIRST USE 12-0-2006; IN COMMERCE 12-0-2006.

FOR: PROVIDING INFORMATION CONCERNING CONSERVATION AND WILDLIFE PROTECTION, IN CLASS 42 (U.S. CLS. 100 AND 101).

FIRST USE 12-0-2006; IN COMMERCE 12-0-2006.

THE MARK CONSISTS OF STANDARD CHARACTERS WITHOUT CLAIM TO ANY PARTICULAR FONT, STYLE, SIZE, OR COLOR.

NO CLAIM IS MADE TO THE EXCLUSIVE RIGHT TO USE "COMMUNITY FOUNDATION", APART FROM THE MARK AS SHOWN.

SER. NO. 77-089,167, FILED P.R. 1-23-2007; AM. S.R. 6-17-2008.

KELLY MCCOY, EXAMINING ATTORNEY

Int. Cl.: 9

Prior U.S. Cls.: 21, 23, 26, 36, and 38

United States Patent and Trademark Office

Reg. No. 3,482,604

Registered Aug. 5, 2008

**TRADEMARK
SUPPLEMENTAL REGISTER**

PI-DASHBOARD

HEALTHRX CORPORATION (VIRGINIA CORPORATION)
7001B LOISDALE ROAD
SPRINGFIELD, VA 22150

FOR: COMPUTER SOFTWARE FOR DATABASE MANAGEMENT IN THE FIELD OF BIOMEDICAL RESEARCH, IN CLASS 9 (U.S. CLS. 21, 23, 26, 36 AND 38).

FIRST USE 5-28-2008; IN COMMERCE 5-28-2008.

THE MARK CONSISTS OF STANDARD CHARACTERS WITHOUT CLAIM TO ANY PARTICULAR FONT, STYLE, SIZE, OR COLOR.

SER. NO. 77-093,131, FILED P.R. 1-29-2007; AM. S.R. 6-5-2008.

RENEE SERVANCE, EXAMINING ATTORNEY

Int. Cl.: 36

Prior U.S. Cls.: 100, 101, and 102

United States Patent and Trademark Office

Reg. No. 3,482,605

Registered Aug. 5, 2008

**SERVICE MARK
SUPPLEMENTAL REGISTER**

DEPOSIT RC

VANCO SERVICES, LLC (MINNESOTA LTD
LIAB CO)
SUITE 200
12600 WHITEWATER DRIVE
MINNETONKA, MN 55343

FOR: FINANCIAL SERVICES, NAMELY, ELEC-
TRONIC FUNDS TRANSFER SERVICES, IN CLASS
36 (U.S. CLS. 100, 101 AND 102).

FIRST USE 1-30-2007; IN COMMERCE 1-30-2007.

THE MARK CONSISTS OF STANDARD CHAR-
ACTERS WITHOUT CLAIM TO ANY PARTICULAR
FONT, STYLE, SIZE, OR COLOR.

NO CLAIM IS MADE TO THE EXCLUSIVE
RIGHT TO USE "DEPOSIT", APART FROM THE
MARK AS SHOWN.

SER. NO. 77-094,802, FILED P.R. 1-30-2007; AM. S.R.
11-23-2007.

ERIN FALK, EXAMINING ATTORNEY

Int. Cl.: 36

Prior U.S. Cls.: 100, 101, and 102

United States Patent and Trademark Office

Reg. No. 3,482,606

Registered Aug. 5, 2008

**SERVICE MARK
SUPPLEMENTAL REGISTER**

COPSRIDE

GRIFFIN, PATRICK J. (UNITED STATES INDIVIDUAL)
P.O. BOX 16
142 LADY SLIPPER ROAD
WOODSTOCK, NH 03293

FOR: CHARITABLE FUND RAISING BASED UPON MOTORCYCLE ACTIVITIES AND EVENTS TO RAISE MONEY FOR THE BENEFIT OF THE FAMILIES OF DECEASED LAW-ENFORCEMENT OFFICERS, IN CLASS 36 (U.S. CLS. 100, 101 AND 102).

FIRST USE 1-24-2007; IN COMMERCE 1-24-2007.

THE MARK CONSISTS OF STANDARD CHARACTERS WITHOUT CLAIM TO ANY PARTICULAR FONT, STYLE, SIZE, OR COLOR.

SER. NO. 77-099,587, FILED P.R. 2-5-2007; AM. S.R. 6-30-2008.

PAUL CROWLEY, EXAMINING ATTORNEY

Int. Cl.: 35

Prior U.S. Cls.: 100, 101, and 102

United States Patent and Trademark Office

Reg. No. 3,482,607

Registered Aug. 5, 2008

**SERVICE MARK
SUPPLEMENTAL REGISTER**

**MONITOR, TRACK, MANAGE:
ANYTHING, ANYWHERE**

SABIOSO, INC. (UTAH CORPORATION)
189 SOUTH STATE STREET, SUITE 250
CLEARFIELD, UT 84015

FOR: PROVIDING A WEB-BASED PORTAL FOR MONITORING, TRACKING, AND MANAGEMENT OF ASSETS, NAMELY, FREIGHT, PACKAGES, VEHICLES, AND CONTAINERS; COMPUTERIZED TRACKING AND TRACING OF FREIGHT, PACKAGES, VEHICLES AND CONTAINERS; LOGISTICS MANAGEMENT IN THE FIELD OF REMOTE MONITORING, TRACKING AND MANAGEMENT OF ASSETS, NAMELY, FREIGHT, PACKAGES, VEHI-

CLES, CONTAINERS AND INDIVIDUALS, IN CLASS 35 (U.S. CLS. 100, 101 AND 102).

FIRST USE 1-31-2004; IN COMMERCE 1-31-2004.

THE MARK CONSISTS OF STANDARD CHARACTERS WITHOUT CLAIM TO ANY PARTICULAR FONT, STYLE, SIZE, OR COLOR.

SER. NO. 77-104,147, FILED P.R. 2-9-2007; AM. S.R. 6-27-2008.

CORY BOONE, EXAMINING ATTORNEY

Int. Cl.: 9

Prior U.S. Cls.: 21, 23, 26, 36, and 38

United States Patent and Trademark Office

Reg. No. 3,482,608

Registered Aug. 5, 2008

**TRADEMARK
SUPPLEMENTAL REGISTER**

TrialManager

CRF INC. (DELAWARE CORPORATION)
C/O FRANK MANISCALCO, ESQ.
504 TOTTEN POND ROAD
WALTHAM, MA 02451

FOR: COMPUTER SOFTWARE FOR THE COL-
LECTION, EDITING, ORGANIZING, MODIFYING,
BOOK MARKING, TRANSMISSION, STORAGE
AND SHARING OF DATA AND INFORMATION ,
IN CLASS 9 (U.S. CLS. 21, 23, 26, 36 AND 38).

FIRST USE 9-25-2003; IN COMMERCE 9-25-2003.

THE MARK CONSISTS OF STANDARD CHAR-
ACTERS WITHOUT CLAIM TO ANY PARTICULAR
FONT, STYLE, SIZE, OR COLOR.

SER. NO. 77-105,148, FILED P.R. 2-12-2007; AM. S.R.
11-28-2007.

AHSEN KHAN, EXAMINING ATTORNEY

Int. Cl.: 41

Prior U.S. Cls.: 100, 101, and 107

United States Patent and Trademark Office

Reg. No. 3,482,609

Registered Aug. 5, 2008

**SERVICE MARK
SUPPLEMENTAL REGISTER**

The Original Race Report

ENDORPHIN SPORTS MEDIA (OHIO LTD LIAB
CO)
7670 ALAN PARKWAY
MIDDLEBURG HEIGHTS, OH 44130

FOR: PUBLICATION AND ONLINE PUBLICA-
TION OF REPORTS, BOOKS, AND POSTERS THAT
OUTLINE ACCOMPLISHMENTS IN SPORTING
EVENTS, NAMELY, RUNNING, CYCLING AND
SWIMMING, IN CLASS 41 (U.S. CLS. 100, 101 AND
107).

FIRST USE 1-1-2007; IN COMMERCE 1-1-2007.

THE MARK CONSISTS OF STANDARD CHAR-
ACTERS WITHOUT CLAIM TO ANY PARTICULAR
FONT, STYLE, SIZE, OR COLOR.

SER. NO. 77-105,876, FILED P.R. 2-13-2007; AM. S.R.
6-20-2008.

DAWN HAN, EXAMINING ATTORNEY

Int. Cl.: 3

Prior U.S. Cls.: 1, 4, 6, 50, 51, and 52

United States Patent and Trademark Office

Reg. No. 3,482,610

Registered Aug. 5, 2008

**TRADEMARK
SUPPLEMENTAL REGISTER**

REPAIR COMPLEX

NOVARTIS AG (SWITZERLAND AKTIENGE-
SELLSCHAFT)
CH 4002
BASEL, SWITZERLAND

FOR: NON-MEDICATED SKIN CARE PREPARA-
TIONS, IN CLASS 3 (U.S. CLS. 1, 4, 6, 50, 51 AND 52).

FIRST USE 7-31-2007; IN COMMERCE 7-31-2007.

THE MARK CONSISTS OF STANDARD CHAR-
ACTERS WITHOUT CLAIM TO ANY PARTICULAR
FONT, STYLE, SIZE, OR COLOR.

SER. NO. 77-110,414, FILED P.R. 2-19-2007; AM. S.R.
6-20-2008.

MICHAEL TANNER, EXAMINING ATTORNEY

Int. Cl.: 37

Prior U.S. Cls.: 100, 103, and 106

United States Patent and Trademark Office

Reg. No. 3,482,611

Registered Aug. 5, 2008

**SERVICE MARK
SUPPLEMENTAL REGISTER**

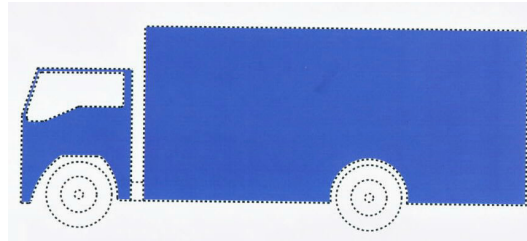

BENJAMIN FRANKLIN FRANCHISING, LLC
(MISSOURI LTD LIAB CO)
SUITE 920
50 CENTRAL AVE.
SARASOTA, FL 34236

FOR: REPAIR, MAINTENANCE, AND INSTAL-
LATION SERVICES IN THE FIELD OF PLUMBING,
IN CLASS 37 (U.S. CLS. 100, 103 AND 106).

FIRST USE 8-0-2004; IN COMMERCE 8-0-2004.

THE COLOR(S) BLUE (PMS 301) IS/ARE
CLAIMED AS A FEATURE OF THE MARK.

THE MARK CONSISTS OF THE COLOR BLUE
(PMS 301) USED OVER THE ENTIRE TRUCK. THE
MATTER SHOWN IN THE DRAWING IN BROKEN
LINES SERVES TO SHOW POSITIONING OF THE
MARK AND IS NOT A FEATURE OF THE MARK

SER. NO. 77-111,785, FILED P.R. 2-20-2007; AM. S.R.
6-27-2008.

TERESA M. RUPP, EXAMINING ATTORNEY

Int. Cl.: 41

Prior U.S. Cls.: 100, 101, and 107

United States Patent and Trademark Office

Reg. No. 3,482,612

Registered Aug. 5, 2008

**SERVICE MARK
SUPPLEMENTAL REGISTER**

KEEP GUNS "OUTTA" SCHOO!

CRIME CHECK OF SPOKANE COUNTY (WA-
SHINGTON CORPORATION)
STE. 1420
422 W. RIVERSIDE AVE.
SPOKANE, WA 99201

FOR: EDUCATIONAL SERVICES, NAMELY,
PROVIDING A PROGRAM TO KEEP GUNS OUT
OF SCHOOLS, IN CLASS 41 (U.S. CLS. 100, 101 AND
107).

FIRST USE 3-17-2004; IN COMMERCE 3-17-2004.

THE MARK CONSISTS OF STANDARD CHAR-
ACTERS WITHOUT CLAIM TO ANY PARTICULAR
FONT, STYLE, SIZE, OR COLOR.

SER. NO. 77-119,647, FILED P.R. 3-1-2007; AM. S.R.
5-22-2008.

TASHIA BUNCH, EXAMINING ATTORNEY

Int. Cl.: 41

Prior U.S. Cls.: 100, 101, and 107

United States Patent and Trademark Office

Reg. No. 3,482,613

Registered Aug. 5, 2008

**SERVICE MARK
SUPPLEMENTAL REGISTER**

AMERICA'S PSYCHIC CHALLENGE

LIFETIME ENTERTAINMENT SERVICES (NEW
YORK JOINT VENTURE)
309 WEST 49TH STREET
NEW YORK, NY 10019

FOR: ENTERTAINMENT SERVICES IN THE
NATURE OF AN ON-GOING REALITY BASED
TELEVISION PROGRAM; AND PROVIDING A
WEBSITE FEATURING INFORMATION ON A REA-
LITY-BASED TELEVISION SERIES, IN CLASS 41
(U.S. CLS. 100, 101 AND 107).

FIRST USE 10-12-2007; IN COMMERCE 10-12-2007.

THE MARK CONSISTS OF STANDARD CHAR-
ACTERS WITHOUT CLAIM TO ANY PARTICULAR
FONT, STYLE, SIZE, OR COLOR.

SER. NO. 77-121,427, FILED P.R. 3-2-2007; AM. S.R.
6-4-2008.

BENJAMIN OKEKE, EXAMINING ATTORNEY

Int. Cl.: 41

Prior U.S. Cls.: 100, 101, and 107

United States Patent and Trademark Office

Reg. No. 3,482,614

Registered Aug. 5, 2008

**SERVICE MARK
SUPPLEMENTAL REGISTER**

THE PENNSYLVANIA INSTITUTE
FOR ADVANCED DENTAL
EDUCATION

DR. CYRIL I EVIAN (UNITED STATES INDIVIDUAL)

10112 VALLEY FORGE CIRCLE

KING OF PRUSSIA, PA 19406

FOR: EDUCATIONAL SERVICES, NAMELY, PROVIDING CLASSES, WORKSHOPS, AND SEMINARS IN THE FIELD OF DENTISTRY, IN CLASS 41 (U.S. CLS. 100, 101 AND 107).

FIRST USE 6-1-2008; IN COMMERCE 6-1-2008.

THE MARK CONSISTS OF STANDARD CHARACTERS WITHOUT CLAIM TO ANY PARTICULAR FONT, STYLE, SIZE, OR COLOR.

NO CLAIM IS MADE TO THE EXCLUSIVE RIGHT TO USE "INSTITUTE FOR ADVANCED DENTAL EDUCATION", APART FROM THE MARK AS SHOWN.

SER. NO. 77-127,010, FILED P.R. 3-9-2007; AM. S.R. 6-24-2008.

KATHY DE JONGE, EXAMINING ATTORNEY

Int. Cl.: 25

Prior U.S. Cls.: 22 and 39

United States Patent and Trademark Office

Reg. No. 3,482,615

Registered Aug. 5, 2008

**TRADEMARK
SUPPLEMENTAL REGISTER**

TIMPA

MILLTEX GROUP, INC. (NEW YORK COR-
PORATION)
183 MADISON AVE, STE 1516
NEW YORK, NY 10016

FOR: BRAS, PANTIES, THONGS, BIKINIS,
BRIEFS AND BOXER SHORTS, IN CLASS 25 (U.S.
CLS. 22 AND 39).

FIRST USE 8-1-2006; IN COMMERCE 8-1-2007.

THE MARK CONSISTS OF STANDARD CHAR-
ACTERS WITHOUT CLAIM TO ANY PARTICULAR
FONT, STYLE, SIZE, OR COLOR.

SER. NO. 77-130,618, FILED P.R. 3-14-2007; AM. S.R.
6-26-2008.

TINA L. SNAPP, EXAMINING ATTORNEY

Int. Cl.: 35

Prior U.S. Cls.: 100, 101, and 102

United States Patent and Trademark Office

Reg. No. 3,482,616

Registered Aug. 5, 2008

**SERVICE MARK
SUPPLEMENTAL REGISTER**

MyRetailPoints

MICHAEL'S CLOSET, INC (NEW JERSEY CORPORATION)
55 WOODMONT DRIVE
RANDOLPH, NJ 07869

FOR: ON-LINE RETAIL STORE SERVICES FEATURING APPAREL, HEADWEAR AND ACCESSORIES FEATURING A BONUS INCENTIVE PROGRAM FOR CUSTOMERS, IN CLASS 35 (U.S. CLS. 100, 101 AND 102).

FIRST USE 12-1-2006; IN COMMERCE 12-1-2006.

THE MARK CONSISTS OF STANDARD CHARACTERS WITHOUT CLAIM TO ANY PARTICULAR FONT, STYLE, SIZE, OR COLOR.

SER. NO. 77-167,683, FILED P.R. 4-27-2007; AM. S.R. 6-28-2008.

ESTHER BELENKER, EXAMINING ATTORNEY

Int. Cl.: 36

Prior U.S. Cls.: 100, 101, and 102

United States Patent and Trademark Office

Reg. No. 3,482,617

Registered Aug. 5, 2008

**SERVICE MARK
SUPPLEMENTAL REGISTER**

BilltoMobile

DANAL, INC. (CALIFORNIA CORPORATION)
2387 BERING DRIVE
SAN JOSE, CA 95131

FOR: ELECTRONIC PAYMENT PROCESSING AND TRANSMISSION SERVICES, NAMELY, SERVICE WHICH ENABLES PURCHASE OF GOODS OR SERVICES TO BILL THE CHARGES TO AN END-USER'S MOBILE PHONE BILLING STATEMENT, IN CLASS 36 (U.S. CLS. 100, 101 AND 102).

FIRST USE 2-28-2008; IN COMMERCE 2-28-2008.

THE MARK CONSISTS OF STANDARD CHARACTERS WITHOUT CLAIM TO ANY PARTICULAR FONT, STYLE, SIZE, OR COLOR.

SER. NO. 77-178,247, FILED P.R. 5-10-2007; AM. S.R. 6-27-2008.

PETER B. BROMAGHIM, EXAMINING ATTORNEY

Int. Cl.: 35

Prior U.S. Cls.: 100, 101, and 102

United States Patent and Trademark Office

Reg. No. 3,482,618

Registered Aug. 5, 2008

**SERVICE MARK
SUPPLEMENTAL REGISTER**

SHOPPINGADVISOR

CHANNELADVISOR CORPORATION (DELA-
WARE CORPORATION)
2701 AERIAL CENTER PARKWAY
MORRISVILLE, NC 27560

FOR: COMPUTERIZED ONLINE ADVERTISING
MANAGEMENT SERVICES REGARDING DATA
SUBMITTED BY OTHERS IN THE FIELD OF RE-
TAIL COMPARISON MARKETING , IN CLASS 35
(U.S. CLS. 100, 101 AND 102).

FIRST USE 5-7-2007; IN COMMERCE 5-7-2007.

THE MARK CONSISTS OF STANDARD CHAR-
ACTERS WITHOUT CLAIM TO ANY PARTICULAR
FONT, STYLE, SIZE, OR COLOR.

SER. NO. 77-179,135, FILED P.R. 5-11-2007; AM. S.R.
6-30-2008.

DAVID YONTEF, EXAMINING ATTORNEY

Int. Cls.: 3 and 5

Prior U.S. Cls.: 1, 4, 6, 18, 44, 46, 50, 51, and 52

United States Patent and Trademark Office

Reg. No. 3,482,619

Registered Aug. 5, 2008

**TRADEMARK
SUPPLEMENTAL REGISTER**

CLINICAL TOPICALS

CLINICAL TOPICALS LLC (NEW YORK LTD
LIAB CO)
174 FIFTH AVENUE, SUITE 204
NEW YORK, NY 10010

FOR: SKIN CARE PRODUCTS, NAMELY, NON-
MEDICATED ACNE CREAMS AND PREPARA-
TIONS, IN CLASS 3 (U.S. CLS. 1, 4, 6, 50, 51 AND 52).

FIRST USE 5-15-2007; IN COMMERCE 5-15-2007.

FOR: ANALGESICS, IN CLASS 5 (U.S. CLS. 6, 18,
44, 46, 51 AND 52).

FIRST USE 3-16-2007; IN COMMERCE 3-16-2007.

THE MARK CONSISTS OF STANDARD CHAR-
ACTERS WITHOUT CLAIM TO ANY PARTICULAR
FONT, STYLE, SIZE, OR COLOR.

NO CLAIM IS MADE TO THE EXCLUSIVE
RIGHT TO USE "TOPICALS", APART FROM THE
MARK AS SHOWN.

SER. NO. 77-181,593, FILED P.R. 5-15-2007; AM. S.R.
6-10-2008.

REGINA DRUMMOND, EXAMINING ATTORNEY

Int. Cl.: 35

Prior U.S. Cls.: 100, 101, and 102

United States Patent and Trademark Office

Reg. No. 3,482,620

Registered Aug. 5, 2008

**SERVICE MARK
SUPPLEMENTAL REGISTER**

LOCAL INFO DIRECTORY

HARVEST INFO, INC. (OHIO CORPORATION)
116 KARL BROWN WAY
LOVELAND, OH 45140

FOR: PROVIDING ON-LINE DIRECTORY INFORMATION SERVICES ALSO FEATURING ADVERTISING SERVICES AND HYPERLINKS TO OTHER WEBSITES, IN CLASS 35 (U.S. CLS. 100, 101 AND 102).

FIRST USE 2-0-2007; IN COMMERCE 2-0-2007.

THE MARK CONSISTS OF STANDARD CHARACTERS WITHOUT CLAIM TO ANY PARTICULAR FONT, STYLE, SIZE, OR COLOR.

NO CLAIM IS MADE TO THE EXCLUSIVE RIGHT TO USE "INFO DIRECTORY", APART FROM THE MARK AS SHOWN.

SER. NO. 77-193,031, FILED P.R. 5-30-2007; AM. S.R. 5-16-2008.

RONALD AIKENS, EXAMINING ATTORNEY

Int. Cl.: 41

Prior U.S. Cls.: 100, 101, and 107

United States Patent and Trademark Office

Reg. No. 3,482,621

Registered Aug. 5, 2008

**SERVICE MARK
SUPPLEMENTAL REGISTER**

Integrative Kinesiology

MATHISON, JULIET C.J. (UNITED KINGDOM
INDIVIDUAL)
1036 SECOND STREET
STONE MOUNTAIN, GA 30083

FOR: EDUCATIONAL SERVICES, NAMELY,
TRAINING IN THE FIELD OF INTEGRATIVE KI-
NESIOLOGY, IN CLASS 41 (U.S. CLS. 100, 101 AND
107).

FIRST USE 5-14-2004; IN COMMERCE 5-14-2004.

THE MARK CONSISTS OF STANDARD CHAR-
ACTERS WITHOUT CLAIM TO ANY PARTICULAR
FONT, STYLE, SIZE, OR COLOR.

SER. NO. 77-210,007, FILED P.R. 6-19-2007; AM. S.R.
5-29-2008.

SAMUEL E. SHARPER JR., EXAMINING ATTOR-
NEY

Int. Cl.: 36

Prior U.S. Cls.: 100, 101, and 102

United States Patent and Trademark Office

Reg. No. 3,482,622

Registered Aug. 5, 2008

**SERVICE MARK
SUPPLEMENTAL REGISTER**

Business Owned Banking

GULLIATT, MARK (UNITED STATES INDIVIDUAL)
415 EAST 23RD STREET SUITE 205
FREMONT, NE 68025

FOR: INSURANCE CONSULTATION, IN CLASS
36 (U.S. CLS. 100, 101 AND 102).

FIRST USE 6-13-2007; IN COMMERCE 6-13-2007.

THE MARK CONSISTS OF STANDARD CHARACTERS WITHOUT CLAIM TO ANY PARTICULAR FONT, STYLE, SIZE, OR COLOR.

SER. NO. 77-213,419, FILED P.R. 6-22-2007; AM. S.R. 7-3-2008.

SKYE YOUNG, EXAMINING ATTORNEY

Int. Cls.: 25 and 41

Prior U.S. Cls.: 22, 39, 100, 101, and 107

United States Patent and Trademark Office

Reg. No. 3,482,623

Registered Aug. 5, 2008

TRADEMARK
SERVICE MARK
SUPPLEMENTAL REGISTER

LOUISIANA
Cajun
zydeco
FESTIVAL

NEW ORLEANS JAZZ & HERITAGE FESTIVAL
AND FOUNDATION, INC. (LOUISIANA COR-
PORATION)

1205 NORTH RAMPART STREET
NEW ORLEANS, LA 70116

FOR: T-SHIRTS; SHIRTS; PANTS; CAPS; HATS;
APRONS, IN CLASS 25 (U.S. CLS. 22 AND 39).

FIRST USE 6-8-2007; IN COMMERCE 6-8-2007.

FOR: CONDUCTING ENTERTAINMENT EXHI-
BITIONS IN THE NATURE OF MUSIC FESTIVALS;
EDUCATION SERVICES, NAMELY, PROVIDING
LECTURES, SEMINARS, WORKSHOPS AND CON-
FERENCES IN THE FIELDS OF SOUTH LOUISIANA
CULTURE, IN CLASS 41 (U.S. CLS. 100, 101 AND 107).

FIRST USE 5-23-2007; IN COMMERCE 5-23-2007.

OWNER OF U.S. REG. NOS. 2,607,336, 3,302,364,
AND OTHERS.

NO CLAIM IS MADE TO THE EXCLUSIVE
RIGHT TO USE "CAJUN ZYDECO FESTIVAL" AS
TO CLASS 41, APART FROM THE MARK AS
SHOWN.

THE MARK CONSISTS OF THE WORD "LOUISI-
ANA" PRINTED VERTICALLY, BOTTOM TO TOP,
ON THE LEFT; IN THE MIDDLE, THE WORD
"CAJUN" PRINTED HORIZONTALLY; BELOW "CA-
JUN", THE WORD "ZYDECO" PRINTED HORIZON-
TALLY; AND THE WORD "FESTIVAL" PRINTED
VERTICALLY, BOTTOM TO TOP.

SER. NO. 77-217,675, FILED P.R. 6-28-2007; AM. S.R.
5-28-2008.

JIM RINGLE, EXAMINING ATTORNEY

Int. Cl.: 9

Prior U.S. Cls.: 21, 23, 26, 36, and 38

Reg. No. 3,482,624

United States Patent and Trademark Office

Registered Aug. 5, 2008

**TRADEMARK
SUPPLEMENTAL REGISTER**

INTELLIGENT TRANSCRIPTION

HEALTH CARECHAIN, INC. (DELAWARE CORPORATION), DBA MD-IT,
4735 WALNUT ST.
SUITE 140
BOULDER, CO 80301

THE MARK CONSISTS OF STANDARD CHARACTERS WITHOUT CLAIM TO ANY PARTICULAR FONT, STYLE, SIZE, OR COLOR.

FOR: DOWNLOADABLE COMPUTER SOFTWARE FOR MEDICAL TRANSCRIPTION, IN CLASS 9 (U.S. CLS. 21, 23, 26, 36 AND 38).

SER. NO. 77-217,835, FILED P.R. 6-28-2007; AM. S.R. 5-30-2008.

FIRST USE 4-1-2005; IN COMMERCE 9-1-2005.

RAMONA ORTIGA, EXAMINING ATTORNEY

Int. Cl.: 35

Prior U.S. Cls.: 100, 101, and 102

United States Patent and Trademark Office

Reg. No. 3,482,625

Registered Aug. 5, 2008

**SERVICE MARK
SUPPLEMENTAL REGISTER**

INTELLIGENT TRANSCRIPTION

HEALTH CARECHAIN, INC. (DELAWARE CORPORATION), DBA MD-IT,
4735 WALNUT ST.
STE 140
BOULDER, CO 80301

FOR: MEDICAL TRANSCRIPTION SERVICES, IN
CLASS 35 (U.S. CLS. 100, 101 AND 102).

FIRST USE 4-1-2005; IN COMMERCE 9-1-2005.

THE MARK CONSISTS OF STANDARD CHARACTERS WITHOUT CLAIM TO ANY PARTICULAR FONT, STYLE, SIZE, OR COLOR.

SER. NO. 77-217,863, FILED P.R. 6-28-2007; AM. S.R. 5-31-2008.

RAMONA ORTIGA, EXAMINING ATTORNEY

Int. Cl.: 35

Prior U.S. Cls.: 100, 101, and 102

United States Patent and Trademark Office

Reg. No. 3,482,626

Registered Aug. 5, 2008

**SERVICE MARK
SUPPLEMENTAL REGISTER**

SUPER TRUCK SHOWROOM

IOWA 80 GROUP, INC. (IOWA CORPORATION)
515 STERLING DRIVE, P.O. BOX 639
WALCOTT, IA 52773

FOR: RETAIL STORE SERVICES FEATURING
TRUCK ACCESSORIES, IN CLASS 35 (U.S. CLS. 100,
101 AND 102).

FIRST USE 1-23-2006; IN COMMERCE 1-23-2006.

THE MARK CONSISTS OF STANDARD CHAR-
ACTERS WITHOUT CLAIM TO ANY PARTICULAR
FONT, STYLE, SIZE, OR COLOR.

NO CLAIM IS MADE TO THE EXCLUSIVE
RIGHT TO USE "SUPER TRUCK", APART FROM
THE MARK AS SHOWN.

SER. NO. 77-222,984, FILED P.R. 7-5-2007; AM. S.R.
6-19-2008.

KAPIL BHANOT, EXAMINING ATTORNEY

Int. Cl.: 31

Prior U.S. Cls.: 1 and 46

United States Patent and Trademark Office

Reg. No. 3,482,627

Registered Aug. 5, 2008

**TRADEMARK
SUPPLEMENTAL REGISTER**



AGROPECUARIA PIEDADENSE S.A. DE C.V.
(MEXICO CORPORATION)
CAMINO ANTIGÜO A LA ESTACIÓN DE FF NNS/N
SANTA ANA PACUECO, MEXICO 36910(MEX)

FOR: FRESH FRUITS; FRESH VEGETABLES, IN
CLASS 31 (U.S. CLS. 1 AND 46).

FIRST USE 6-5-2001; IN COMMERCE 2-20-2008.

SER. NO. 77-226,867, FILED P.R. 7-11-2007; AM. S.R.
4-11-2008.

LINDA E. BLOHM, EXAMINING ATTORNEY

Int. Cl.: 9

Prior U.S. Cls.: 21, 23, 26, 36, and 38

United States Patent and Trademark Office

Reg. No. 3,482,628

Registered Aug. 5, 2008

**TRADEMARK
SUPPLEMENTAL REGISTER**

MICRO.TAG

GT ACQUISITION SUB, INC. (MINNESOTA CORPORATION)
490 VILLAUME AVENUE
SOUTH ST. PAUL, MN 55075

THE MARK CONSISTS OF STANDARD CHARACTERS WITHOUT CLAIM TO ANY PARTICULAR FONT, STYLE, SIZE, OR COLOR.

FOR: RADIO FREQUENCY IDENTIFICATION TAGS FOR ANIMALS, IN CLASS 9 (U.S. CLS. 21, 23, 26, 36 AND 38).

SER. NO. 77-229,057, FILED P.R. 7-13-2007; AM. S.R. 6-28-2008.

FIRST USE 4-24-2008; IN COMMERCE 4-24-2008.

JAY BESCH, EXAMINING ATTORNEY

Int. Cls.: 35 and 41

Prior U.S. Cls.: 100, 101, 102, and 107

United States Patent and Trademark Office

Reg. No. 3,482,629

Registered Aug. 5, 2008

**SERVICE MARK
SUPPLEMENTAL REGISTER**

**Society for Science & the
Public**

SOCIETY FOR SCIENCE & THE PUBLIC (DELA-
WARE CORPORATION)
1719 N STREET, N.W.
WASHINGTON, DC 20036

FOR: PROFESSIONAL ASSOCIATION SERVICES,
NAMELY, PROMOTING THE INTERESTS OF SCI-
ENCE TEACHERS, SCIENCE STUDENTS, AND
PEOPLE INTERESTED IN SCIENCE , IN CLASS 35
(U.S. CLS. 100, 101 AND 102).

FIRST USE 1-10-2008; IN COMMERCE 1-10-2008.

FOR: EDUCATIONAL SERVICES, NAMELY,
PROVIDING INCENTIVES THROUGH COMPETI-
TIVE EXHIBITION AND AWARDS TO STUDENTS
WHO DEMONSTRATE EXCELLENCE IN THE

FIELD OF SCIENCE AND ENGINEERING, IN
CLASS 41 (U.S. CLS. 100, 101 AND 107).

FIRST USE 1-10-2008; IN COMMERCE 1-10-2008.

THE MARK CONSISTS OF STANDARD CHAR-
ACTERS WITHOUT CLAIM TO ANY PARTICULAR
FONT, STYLE, SIZE, OR COLOR.

NO CLAIM IS MADE TO THE EXCLUSIVE
RIGHT TO USE "SOCIETY", APART FROM THE
MARK AS SHOWN.

SER. NO. 77-232,316, FILED P.R. 7-18-2007; AM. S.R.
1-15-2008.

STEVEN R. FOSTER, EXAMINING ATTORNEY

Int. Cl.: 35

Prior U.S. Cls.: 100, 101, and 102

United States Patent and Trademark Office

Reg. No. 3,482,630

Registered Aug. 5, 2008

**SERVICE MARK
SUPPLEMENTAL REGISTER**

Dining Alliance

DINING ALLIANCE (NEW YORK CORPORATION)
16 MOUNTAIN ASH TRAIL
WEBSTER, NY 14450

FOR: ADVERTISING, MARKETING AND PROMOTION SERVICES; BUSINESS CONSULTING, INQUIRIES OR INFORMATION; BUSINESS MARKETING CONSULTING SERVICES; PROCUREMENT, NAMELY, PURCHASING RESTAURANT SUPPLIES FOR OTHERS, IN CLASS 35 (U.S. CLS. 100, 101 AND 102).

FIRST USE 8-1-2006; IN COMMERCE 8-1-2006.

THE MARK CONSISTS OF STANDARD CHARACTERS WITHOUT CLAIM TO ANY PARTICULAR FONT, STYLE, SIZE, OR COLOR.

SER. NO. 77-232,421, FILED 7-18-2007.

MARGERY A. TIERNEY, EXAMINING ATTORNEY

Int. Cl.: 12

Prior U.S. Cls.: 19, 21, 23, 31, 35, and 44

United States Patent and Trademark Office

Reg. No. 3,482,631

Registered Aug. 5, 2008

**TRADEMARK
SUPPLEMENTAL REGISTER**

BEACH ROVER

SHORELINE MANUFACTURING, LLC (MICHIGAN LTD LIAB CO)
5577 MADISON AVENUE
HUDSONVILLE, MI 49426

FOR: A SELF-POWERED MARINE TOTE DEVICE FOR THE LAUNCHING, RECEIVING, AND TRANSPORTING OF WATERCRAFT, IN CLASS 12 (U.S. CLS. 19, 21, 23, 31, 35 AND 44).

FIRST USE 7-1-2007; IN COMMERCE 7-1-2007.

THE MARK CONSISTS OF STANDARD CHARACTERS WITHOUT CLAIM TO ANY PARTICULAR FONT, STYLE, SIZE, OR COLOR.

NO CLAIM IS MADE TO THE EXCLUSIVE RIGHT TO USE "ROVER", APART FROM THE MARK AS SHOWN.

SER. NO. 77-236,335, FILED P.R. 7-23-2007; AM. S.R. 5-1-2008.

ODESSA BIBBINS, EXAMINING ATTORNEY

Int. Cl.: 43

Prior U.S. Cls.: 100 and 101

United States Patent and Trademark Office

Reg. No. 3,482,632

Registered Aug. 5, 2008

**SERVICE MARK
SUPPLEMENTAL REGISTER**

**ZUCKER'S BAGELS & SMOKED
FISH**

BCN PROVISIONS, LLC (NEW YORK LTD LIAB
CO)

146 CHAMBERS STREET

NEW YORK, NY 10013

FOR: RESTAURANT, BAKERY, CAFE AND CA-
TERING SERVICES, IN CLASS 43 (U.S. CLS. 100 AND
101).

FIRST USE 5-19-2007; IN COMMERCE 5-19-2007.

THE MARK CONSISTS OF STANDARD CHAR-
ACTERS WITHOUT CLAIM TO ANY PARTICULAR
FONT, STYLE, SIZE, OR COLOR.

NO CLAIM IS MADE TO THE EXCLUSIVE
RIGHT TO USE "BAGELS & SMOKED FISH",
APART FROM THE MARK AS SHOWN.

SER. NO. 77-244,338, FILED P.R. 8-1-2007; AM. S.R.
6-30-2008.

DARRYL SPRUILL, EXAMINING ATTORNEY

Int. Cl.: 3

Prior U.S. Cls.: 1, 4, 6, 50, 51, and 52

United States Patent and Trademark Office

Reg. No. 3,482,633

Registered Aug. 5, 2008

**TRADEMARK
SUPPLEMENTAL REGISTER**

CAROLINA COTTON

BARNHARDT MANUFACTURING COMPANY
(NORTH CAROLINA CORPORATION)
1100 HAWTHORNE LANE
CHARLOTTE, NC 28234

FOR: COTTON FOR COSMETIC PURPOSES,
NAMELY, COTTON TOWELETTES, COTTON TIS-
SUES, COTTON WIPES, COTTON GAUZE, COTTON
BALLS, COTTON SWABS, COTTON STICKS, COT-
TON COILS, COTTON APPLICATORS AND COT-
TON ROLLS, IN CLASS 3 (U.S. CLS. 1, 4, 6, 50, 51 AND
52).

FIRST USE 0-0-1998; IN COMMERCE 0-0-1998.

THE MARK CONSISTS OF STANDARD CHAR-
ACTERS WITHOUT CLAIM TO ANY PARTICULAR
FONT, STYLE, SIZE, OR COLOR.

NO CLAIM IS MADE TO THE EXCLUSIVE
RIGHT TO USE "COTTON", APART FROM THE
MARK AS SHOWN.

SER. NO. 77-244,628, FILED P.R. 8-1-2007; AM. S.R.
6-19-2008.

JENNIFER HETU, EXAMINING ATTORNEY

Int. Cl.: 41

Prior U.S. Cls.: 100, 101, and 107

United States Patent and Trademark Office

Reg. No. 3,482,634

Registered Aug. 5, 2008

**SERVICE MARK
SUPPLEMENTAL REGISTER**

X Stream Opera

KONSTANTIN POGOSOV (UNITED STATES IN-
DIVIDUAL)
1236 ASHLEY CREEK DRIVE
MATTHEWS, NC 28105

FOR: PRESENTATION OF MUSICAL PERFOR-
MANCE; MUSIC PRODUCTION SERVICES; ENTER-
TAINMENT, NAMELY, LIVE MUSIC CONCERTS,
IN CLASS 41 (U.S. CLS. 100, 101 AND 107).

FIRST USE 9-24-2006; IN COMMERCE 9-24-2006.

THE MARK CONSISTS OF STANDARD CHAR-
ACTERS WITHOUT CLAIM TO ANY PARTICULAR
FONT, STYLE, SIZE, OR COLOR.

NO CLAIM IS MADE TO THE EXCLUSIVE
RIGHT TO USE "OPERA", APART FROM THE
MARK AS SHOWN.

SER. NO. 77-249,226, FILED P.R. 8-7-2007; AM. S.R.
7-1-2008.

DAVID MURRAY, EXAMINING ATTORNEY

Int. Cl.: 16

Prior U.S. Cls.: 2, 5, 22, 23, 29, 37, 38, and 50

Reg. No. 3,482,635

United States Patent and Trademark Office

Registered Aug. 5, 2008

**TRADEMARK
SUPPLEMENTAL REGISTER**

GREENWRAP

GEÄMI LTD. (DELAWARE CORPORATION)
SUITE 140
200 INNOVATION AVENUE
MORRISVILLE, NC 27560

FOR: PAPER PACKAGING MATERIAL AND PROTECTIVE PACKAGE WRAPPING MATERIAL FOR PACKING, NAMELY, HONEYCOMBED WRAPPING AND CUSHIONING PAPER AND TISSUE PAPER; PAPER PADDED ENVELOPES FOR PACKING; CUSHIONING PADS MADE OF PAPER FOR TRANSPORTING OR SHIPPING GOODS; CUSHIONING, STUFFING AND PUFFS MADE OF PAPER FOR PACKING; ROLLED PAPER PROTECTIVE PACKAGING MATERIAL FOR WRAPPING

AND CUSHIONING; DISPENSERS FOR PACKAGING PAPER, IN CLASS 16 (U.S. CLS. 2, 5, 22, 23, 29, 37, 38 AND 50).

FIRST USE 9-25-2007; IN COMMERCE 9-25-2007.

THE MARK CONSISTS OF STANDARD CHARACTERS WITHOUT CLAIM TO ANY PARTICULAR FONT, STYLE, SIZE, OR COLOR.

SER. NO. 77-254,201, FILED P.R. 8-13-2007; AM. S.R. 6-29-2008.

SAIMA MAKHDOOM, EXAMINING ATTORNEY

Int. Cl.: 41

Prior U.S. Cls.: 100, 101, and 107

United States Patent and Trademark Office

Reg. No. 3,482,636

Registered Aug. 5, 2008

**SERVICE MARK
SUPPLEMENTAL REGISTER**

Authentic Wealth

SHABOOM INC. (WASHINGTON CORPORATION)
PO BOX 195
SUQUAMISH, WA 98392

FOR: CONDUCTING WORKSHOPS AND SEMINARS IN HAVING A HEALTHY RELATIONSHIP WITH MONEY AND WEALTH, IN CLASS 41 (U.S. CLS. 100, 101 AND 107).

FIRST USE 8-1-2006; IN COMMERCE 10-25-2006.

THE MARK CONSISTS OF STANDARD CHARACTERS WITHOUT CLAIM TO ANY PARTICULAR FONT, STYLE, SIZE, OR COLOR.

SER. NO. 77-261,516, FILED P.R. 8-22-2007; AM. S.R. 6-4-2008.

MICHAEL LEWIS, EXAMINING ATTORNEY

Int. Cl.: 44

Prior U.S. Cls.: 100 and 101

United States Patent and Trademark Office

Reg. No. 3,482,637

Registered Aug. 5, 2008

**SERVICE MARK
SUPPLEMENTAL REGISTER**

**CENTER FOR COMPASSIONATE
CARE**

FAMILY HOSPICE AND PALLIATIVE CARE
(PENNSYLVANIA NON-PROFIT CORPORATION)
50 MOFFETT STREET
PITTSBURGH, PA 15243

FOR: HOSPICE IN-PATIENT SERVICES, IN
CLASS 44 (U.S. CLS. 100 AND 101).

FIRST USE 7-0-2005; IN COMMERCE 7-0-2007.

THE MARK CONSISTS OF STANDARD CHAR-
ACTERS WITHOUT CLAIM TO ANY PARTICULAR
FONT, STYLE, SIZE, OR COLOR.

SER. NO. 77-261,638, FILED P.R. 8-22-2007; AM. S.R.
6-4-2008.

BRIAN PINO, EXAMINING ATTORNEY

Int. Cl.: 12

Prior U.S. Cls.: 19, 21, 23, 31, 35, and 44

United States Patent and Trademark Office

Reg. No. 3,482,638

Registered Aug. 5, 2008

**TRADEMARK
SUPPLEMENTAL REGISTER**

**BALLISTIC ARMORED TACTICAL
TRANSPORT**

THE ARMORED GROUP (ARIZONA LTD LIAB
CO)

5221 N. SADDLE ROCK

PHOENIX, AZ 85018

FOR: ARMORED VEHICLES, IN CLASS 12 (U.S.
CLS. 19, 21, 23, 31, 35 AND 44).

FIRST USE 4-3-2006; IN COMMERCE 4-3-2006.

THE MARK CONSISTS OF STANDARD CHAR-
ACTERS WITHOUT CLAIM TO ANY PARTICULAR
FONT, STYLE, SIZE, OR COLOR.

NO CLAIM IS MADE TO THE EXCLUSIVE
RIGHT TO USE "TACTICAL TRANSPORT", APART
FROM THE MARK AS SHOWN.

SER. NO. 77-262,612, FILED P.R. 8-23-2007; AM. S.R.
6-6-2008.

JENNIFER VASQUEZ, EXAMINING ATTORNEY

Int. Cl.: 35

Prior U.S. Cls.: 100, 101, and 102

United States Patent and Trademark Office

Reg. No. 3,482,639

Registered Aug. 5, 2008

**SERVICE MARK
SUPPLEMENTAL REGISTER**

INDIE EXCELLENCE

SMARKETING, LLC (CALIFORNIA LTD LIAB
CO)
C/O STIEFLER LAW, 3525 DEL MAR HEIGHTS R
SAN DIEGO, CA 921302122

FOR: CONDUCTING AUTHOR AWARD PRO-
GRAM TO PROMOTE BOOKS, TO PROMOTE IN-
TEREST AND EXCELLENCE IN AUTHORSHIP,
AND TO PROMOTE BOOK PUBLISHING BY PRE-
SENTING AWARDS AND PRIZES, IN CLASS 35 (U.S.
CLS. 100, 101 AND 102).

FIRST USE 6-19-2006; IN COMMERCE 6-19-2006.

THE MARK CONSISTS OF STANDARD CHAR-
ACTERS WITHOUT CLAIM TO ANY PARTICULAR
FONT, STYLE, SIZE, OR COLOR.

SER. NO. 77-262,891, FILED P.R. 8-23-2007; AM. S.R.
7-2-2008.

JENNIFER HETU, EXAMINING ATTORNEY

Int. Cl.: 35

Prior U.S. Cls.: 100, 101, and 102

United States Patent and Trademark Office

Reg. No. 3,482,640

Registered Aug. 5, 2008

**SERVICE MARK
SUPPLEMENTAL REGISTER**

**INTERNATIONAL MARINE
ELECTRONICS ASSOCIATION**

NATIONAL MARINE ELECTRONICS ASSOCIATION, INC. (MARYLAND CORPORATION)

7 RIGGS AVE.

SEVERNA PARK, MD 21146

FOR: ASSOCIATION SERVICES, NAMELY, PROMOTING THE INTERESTS OF THE MARINE ELECTRONICS, IN CLASS 35 (U.S. CLS. 100, 101 AND 102).

FIRST USE 6-6-2008; IN COMMERCE 6-6-2008.

THE MARK CONSISTS OF STANDARD CHARACTERS WITHOUT CLAIM TO ANY PARTICULAR FONT, STYLE, SIZE, OR COLOR.

NO CLAIM IS MADE TO THE EXCLUSIVE RIGHT TO USE "MARINE ELECTRONICS ASSOCIATION", APART FROM THE MARK AS SHOWN.

SER. NO. 77-264,820, FILED P.R. 8-27-2007; AM. S.R. 6-9-2008.

ZHALEH DELANEY, EXAMINING ATTORNEY

Int. Cl.: 24

Prior U.S. Cls.: 42 and 50

United States Patent and Trademark Office

Reg. No. 3,482,641

Registered Aug. 5, 2008

**TRADEMARK
SUPPLEMENTAL REGISTER**

PURE PLUSH

LION'S CREST LLC (PENNSYLVANIA LTD LIAB
CO)
56 LYNNE CIRCLE
PAOLI, PA 19301

FOR: FABRIC FOR USE IN MANUFACTURING
CLOTHING, IN CLASS 24 (U.S. CLS. 42 AND 50).

FIRST USE 8-30-2007; IN COMMERCE 6-11-2008.

THE MARK CONSISTS OF STANDARD CHAR-
ACTERS WITHOUT CLAIM TO ANY PARTICULAR
FONT, STYLE, SIZE, OR COLOR.

SER. NO. 77-268,716, FILED P.R. 8-30-2007; AM. S.R.
6-11-2008.

REBECCA SMITH, EXAMINING ATTORNEY

Int. Cl.: 35

Prior U.S. Cls.: 100, 101, and 102

United States Patent and Trademark Office

Reg. No. 3,482,642

Registered Aug. 5, 2008

**SERVICE MARK
SUPPLEMENTAL REGISTER**



SCUBA.COM (CALIFORNIA CORPORATION)
1752 LANGLEY AVENUE
IRVINE, CA 92614

FOR: ON-LINE RETAIL STORE SERVICES FEATURING SCUBA GEAR, IN CLASS 35 (U.S. CLS. 100, 101 AND 102).

FIRST USE 4-1-2000; IN COMMERCE 4-1-2000.

THE COLOR(S) BLUE, RED AND WHITE IS/ARE CLAIMED AS A FEATURE OF THE MARK.

THE COLOR BLUE APPEARS IN THE WORDING "SCUBA" AND "COM". THE COLORS RED AND WHITE APPEAR IN THE DESIGN COMPRISING THE PERIOD BETWEEN "SCUBA" AND "COM" SEPARATING THE WORDS "SCUBA" AND "COM". THE MARK APPEARS OVER A TRANSPARENT BACKGROUND.

SER. NO. 77-271,452, FILED P.R. 9-4-2007; AM. S.R. 6-16-2008.

AHSEN KHAN, EXAMINING ATTORNEY

Int. Cl.: 30

Prior U.S. Cl.: 46

United States Patent and Trademark Office

Reg. No. 3,482,643

Registered Aug. 5, 2008

**TRADEMARK
SUPPLEMENTAL REGISTER**

DOUBLE STUFFED ENCHILADAS

RITA RESTAURANT CORP. (DELAWARE COR-
PORATION)
150 HANCOCK STREET
MADISON, GA 30650

NO CLAIM IS MADE TO THE EXCLUSIVE
RIGHT TO USE "ENCHILADAS", APART FROM
THE MARK AS SHOWN.

FOR: ENCHILADAS, IN CLASS 30 (U.S. CL. 46).

FIRST USE 11-21-2007; IN COMMERCE 11-21-2007.

SER. NO. 77-274,032, FILED P.R. 9-7-2007; AM. S.R.
6-27-2008.

THE MARK CONSISTS OF STANDARD CHAR-
ACTERS WITHOUT CLAIM TO ANY PARTICULAR
FONT, STYLE, SIZE, OR COLOR.

MICHAEL SOUDERS, EXAMINING ATTORNEY

Int. Cl.: 35

Prior U.S. Cls.: 100, 101, and 102

United States Patent and Trademark Office

Reg. No. 3,482,644

Registered Aug. 5, 2008

**SERVICE MARK
SUPPLEMENTAL REGISTER**

**San Francisco Public Golf
Alliance**

SAN FRANCISCO PUBLIC GOLF ALLIANCE
(CALIFORNIA UNINC. ASSOCIATION)
220 MONTGOMERY STREET, #303
SAN FRANCISCO, CA 94104

THE MARK CONSISTS OF STANDARD CHAR-
ACTERS WITHOUT CLAIM TO ANY PARTICULAR
FONT, STYLE, SIZE, OR COLOR.

FOR: PROMOTING PUBLIC AWARENESS OF
THE NEED FOR PUBLIC GOLF COURSES, IN
CLASS 35 (U.S. CLS. 100, 101 AND 102).

SER. NO. 77-274,207, FILED P.R. 9-7-2007; AM. S.R.
6-12-2008.

FIRST USE 8-3-2007; IN COMMERCE 8-3-2007.

DANIEL CAPSHAW, EXAMINING ATTORNEY

Int. Cl.: 45

Prior U.S. Cls.: 100 and 101

United States Patent and Trademark Office

Reg. No. 3,482,645

Registered Aug. 5, 2008

**SERVICE MARK
SUPPLEMENTAL REGISTER**

HackAlert

YAO-WEN HUANG (DELAWARE CORPORATION)
SUITE 553, 5F, BUILDING E, #19-13
SANCHUNG ROAD, NANKANG DISTRICT,
TAIPEI CITY, TAIWAN 115

FOR: MONITORING OF COMPUTER SYSTEMS
FOR SECURITY PURPOSES, IN CLASS 45 (U.S. CLS.
100 AND 101).

FIRST USE 10-13-2007; IN COMMERCE 12-12-2007.

NO CLAIM IS MADE TO THE EXCLUSIVE
RIGHT TO USE "HACKALERT", APART FROM
THE MARK AS SHOWN.

THE COLOR(S) RED IS/ARE CLAIMED AS A
FEATURE OF THE MARK.

THE MARK CONSISTS OF ALL THE ALPHABETS
IN THE LOGO ARE IN RED COLOR.

SER. NO. 77-276,096, FILED 9-11-2007.

DARRYL SPRUILL, EXAMINING ATTORNEY

Int. Cls.: 35, 39, 40, 41, and 42

Prior U.S. Cls.: 100, 101, 102, 103, 105, 106, and 107

United States Patent and Trademark Office

Reg. No. 3,482,646

Registered Aug. 5, 2008

**SERVICE MARK
SUPPLEMENTAL REGISTER**

DIGITAL DATA SCAN

NATIONAL INDUSTRIES FOR THE BLIND
(NEW YORK NON-PROFIT CORPORATION)
1310 BRADDOCK PLACE
ALEXANDRIA, VA 22314

FOR: RECORDS MANAGEMENT, NAMELY, DOCUMENT INDEXING AND DOCUMENT INVENTORY MANAGEMENT FOR OTHERS; AND RECORDS MANAGEMENT, NAMELY, DOCUMENT CODING FOR INVENTORY MANAGEMENT PURPOSES, IN CLASS 35 (U.S. CLS. 100, 101 AND 102).

FIRST USE 11-19-2006; IN COMMERCE 11-19-2006.

FOR: ELECTRONIC STORAGE OF DATA AND DOCUMENTS; AND PHYSICAL STORAGE OF ELECTRONICALLY-STORED DATA AND DOCUMENTS, IN CLASS 39 (U.S. CLS. 100 AND 105).

FIRST USE 11-19-2006; IN COMMERCE 11-19-2006.

FOR: ELECTRONIC SCANNING OF DOCUMENTS, IN CLASS 40 (U.S. CLS. 100, 103 AND 106).

FIRST USE 11-19-2006; IN COMMERCE 11-19-2006.

FOR: DIGITAL IMAGING SERVICES, IN CLASS 41 (U.S. CLS. 100, 101 AND 107).

FIRST USE 11-19-2006; IN COMMERCE 11-19-2006.

FOR: CONVERSION OF DOCUMENTS FROM PHYSICAL TO ELECTRONIC MEDIA; AND DATA ENCRYPTION SERVICES, NAMELY, DOCUMENT CODING SERVICES, IN CLASS 42 (U.S. CLS. 100 AND 101).

FIRST USE 11-19-2006; IN COMMERCE 11-19-2006.

THE MARK CONSISTS OF STANDARD CHARACTERS WITHOUT CLAIM TO ANY PARTICULAR FONT, STYLE, SIZE, OR COLOR.

NO CLAIM IS MADE TO THE EXCLUSIVE RIGHT TO USE "SCAN", APART FROM THE MARK AS SHOWN.

SER. NO. 77-277,690, FILED P.R. 9-12-2007; AM. S.R. 7-1-2008.

ELLEN B. AWRICH, EXAMINING ATTORNEY

Int. Cl.: 8

Prior U.S. Cls.: 23, 28, and 44

United States Patent and Trademark Office

Reg. No. 3,482,647

Registered Aug. 5, 2008

TRADEMARK
SUPPLEMENTAL REGISTER



ACME UNITED CORPORATION (CONNECTI-
CUT CORPORATION)

60 ROUND HILL RD
FAIRFIELD, CT 06824

FOR: SCISSORS, IN CLASS 8 (U.S. CLS. 23, 28 AND
44).

FIRST USE 9-15-2006; IN COMMERCE 9-15-2006.

THE COLOR(S) GRAY, LIGHT ORANGE, DARK
ORANGE, BLACK AND WHITE IS/ARE CLAIMED
AS A FEATURE OF THE MARK.

THE MARK CONSISTS OF THE CONFIGURA-
TION OF A SCISSORS DESIGN WITH A LION HEAD
ABOVE THE SCISSOR BLADES. THE FACE IS
LIGHT ORANGE, BLACK AND WHITE, THE LIONS
MAIN IS DARK ORANGE WITH LIGHT ORANGE
LINES AND BLACK EYEBROWS. THE HANDLES
ARE LIGHT ORANGE WITH A DARK ORANGE
TAIL ON THE LEFT HANDLE. THE RIGHT BLADE
IS LIGHT ORANGE WITH DARK ORANGE SPLASH
OF COLOR AT THE TIP AND THE LEFT BLADE IS
THE COLOR GRAY.

SER. NO. 77-278,135, FILED P.R. 9-12-2007; AM. S.R.
6-19-2008.

DANIEL BRODY, EXAMINING ATTORNEY

Int. Cl.: 8

Prior U.S. Cls.: 23, 28, and 44

United States Patent and Trademark Office

Reg. No. 3,482,648

Registered Aug. 5, 2008

TRADEMARK
SUPPLEMENTAL REGISTER



ACME UNITED CORPORATION (CONNECTI-
CUT CORPORATION)
60 ROUND HILL RD
FAIRFIELD, CT 06824

FOR: SCISSORS, IN CLASS 8 (U.S. CLS. 23, 28 AND
44).

FIRST USE 9-15-2006; IN COMMERCE 9-15-2006.

THE COLOR(S) GRAY, ORANGE, BLACK AND
WHITE IS/ARE CLAIMED AS A FEATURE OF THE
MARK.

THE MARK CONSISTS OF THE CONFIGURA-
TION OF A SCISSORS DESIGN WITH A TIGER
HEAD ABOVE THE SCISSOR BLADES. THE TIGER
HEAD IS ORANGE, BLACK AND WHITE. THE
HANDLES HAVE ORANGE AND BLACK TIGER
STRIPES WITH THE TOP OF THE LEFT HANDLE
BEING A TIGER FOOT. THE RIGHT BLADE HAS
ORANGE AND BLACK TIGER STRIPES AND THE
LEFT BLADE IS THE COLOR GRAY.

SER. NO. 77-278,140, FILED P.R. 9-12-2007; AM. S.R.
6-19-2008.

DANIEL BRODY, EXAMINING ATTORNEY

Int. Cl.: 8

Prior U.S. Cls.: 23, 28, and 44

United States Patent and Trademark Office

Reg. No. 3,482,649

Registered Aug. 5, 2008

TRADEMARK
SUPPLEMENTAL REGISTER



ACME UNITED CORPORATION (CONNECTI-
CUT CORPORATION)
60 ROUND HILL RD
FAIRFIELD, CT 06824

FOR: SCISSORS, IN CLASS 8 (U.S. CLS. 23, 28 AND
44).

FIRST USE 9-15-2006; IN COMMERCE 9-15-2006.

THE MARK CONSISTS OF THE CONFIGURA-
TION OF A SCISSORS DESIGN WITH A ZEBRA
HEAD JUST ABOVE THE BLADES. THE ZEBRA
HEAD IS WHITE WITH BLACK STRIPES ON THE

FACE, BLACK MUZZLE, WHITE MOUTH AND
NOSTRILS AND BLACK AND WHITE EYES,
BLACK AND WHITE EARS AND A BLACK TUFT
OF HAIR ON THE FOREHEAD. THE HANDLES
ARE WHITE WITH BLACK ZEBRA STRIPES. A
BLACK TAIL IS LOCATED ON THE TOP OF THE
LEFT HANDLE. THE RIGHT BLADE IS WHITE
WITH BLACK STRIPES AND THE LEFT BLADE IS
GRAY.

SER. NO. 77-278,145, FILED P.R. 9-12-2007; AM. S.R.
6-19-2008.

DANIEL BRODY, EXAMINING ATTORNEY

Int. Cl.: 8

Prior U.S. Cls.: 23, 28, and 44

United States Patent and Trademark Office

Reg. No. 3,482,650

Registered Aug. 5, 2008

TRADEMARK
SUPPLEMENTAL REGISTER



ACME UNITED CORPORATION (CONNECTI-
CUT CORPORATION)

60 ROUND HILL RD
FAIRFIELD, CT 06824

FOR: SCISSORS, IN CLASS 8 (U.S. CLS. 23, 28 AND
44).

FIRST USE 9-15-2006; IN COMMERCE 9-15-2006.

THE COLOR(S) GRAY, YELLOW, WHITE AND
BROWN IS/ARE CLAIMED AS A FEATURE OF THE
MARK.

THE MARK CONSISTS OF OF THE CONFIG-
URATION OF A SCISSORS DESIGN WITH A GIR-
AFFE HEAD ABOVE THE SCISSOR BLADES. THE
GIRAFFE HEAD IS YELLOW AND BROWN WITH
BROWN AND WHITE EYES, BROWN ON THE
NOSE AND BROWN ON THE MOUTH. THE SCIS-
SOR HANDLES AND RIGHT SCISSOR BLADE
HAVE BROWN AND YELLOW GIRAFFE STRIPES.
THE LEFT SCISSOR BLADE APPEARS IN GRAY. A
BROWN TAIL IS LOCATED ON THE TOP OF THE
LEFT HANDLE.

SER. NO. 77-278,152, FILED P.R. 9-12-2007; AM. S.R.
6-19-2008.

DANIEL BRODY, EXAMINING ATTORNEY

Int. Cl.: 8

Prior U.S. Cls.: 23, 28, and 44

United States Patent and Trademark Office

Reg. No. 3,482,651

Registered Aug. 5, 2008

TRADEMARK
SUPPLEMENTAL REGISTER



ACME UNITED CORPORATION (CONNECTI-
CUT CORPORATION)
60 ROUND HILL RD
FAIRFIELD, CT 06824

FOR: SCISSORS, IN CLASS 8 (U.S. CLS. 23, 28 AND
44).

FIRST USE 9-15-2006; IN COMMERCE 9-15-2006.

THE COLOR(S) GRAY, BEIGE, BROWN, YEL-
LOW AND WHITE IS/ARE CLAIMED AS A FEAT-
URE OF THE MARK.

THE MARK CONSISTS OF THE CONFIGURA-
TION OF A SCISSORS DESIGN WITH A MONKEY

HEAD JUST ABOVE THE SCISSOR BLADES, MON-
KEY FEET ON TOP OF THE HANDLE AND BANANAS
ON THE RIGHT SCISSOR BLADE. THE LEFT
SCISSOR BLADE APPEARS IN GRAY AND THE
RIGHT SCISSOR BLADE APPEARS IN BROWN
WITH YELLOW BANANAS. THE SCISSOR HAN-
DLES ARE BROWN WITH BEIGE FEET ON TOP,
THE MONKEY HAS BROWN HAIR, A BEIGE FACE,
BROWN MOUTH AND EYEBROWS, BROWN AND
WHITE EYES AND A BROWN NOSE.

SER. NO. 77-278,162, FILED P.R. 9-12-2007; AM. S.R.
6-19-2008.

DANIEL BRODY, EXAMINING ATTORNEY

Int. Cl.: 36

Prior U.S. Cls.: 100, 101, and 102

United States Patent and Trademark Office

Reg. No. 3,482,652

Registered Aug. 5, 2008

**SERVICE MARK
SUPPLEMENTAL REGISTER**

**FIDUCIARY SOLUTIONS TO
ENHANCE & PRESERVE WEALTH**

LILLIE BEN (UNITED STATES INDIVIDUAL)
P.O. BOX 529
FRANKTOWN, CO 80116

FOR: FINANCIAL CONSULTATION BY FIDUCIARY REPRESENTATIVES IN THE FIELD OF RETIREMENT AND EMPLOYEE BENEFIT PLANS, IN CLASS 36 (U.S. CLS. 100, 101 AND 102).

FIRST USE 8-16-2007; IN COMMERCE 8-16-2007.

THE MARK CONSISTS OF STANDARD CHARACTERS WITHOUT CLAIM TO ANY PARTICULAR FONT, STYLE, SIZE, OR COLOR.

NO CLAIM IS MADE TO THE EXCLUSIVE RIGHT TO USE "FIDUCIARY", APART FROM THE MARK AS SHOWN.

SER. NO. 77-278,681, FILED P.R. 9-13-2007; AM. S.R. 6-17-2008.

ZHALEH DELANEY, EXAMINING ATTORNEY

Int. Cl.: 30

Prior U.S. Cl.: 46

United States Patent and Trademark Office

Reg. No. 3,482,653

Registered Aug. 5, 2008

**TRADEMARK
SUPPLEMENTAL REGISTER**

MICRONIZED SOY COMPLEX

SOY LABS, LLC (MISSOURI LTD LIAB CO)
3337 EMERALD LANE
JEFFERSON CITY, MO 65110

FOR: MICRO-MILLED SOY FLOUR FOR THE
MANUFACTURE OF SOY-BASED FOODS AND
SOY-BASED BEVERAGES, FUNCTIONAL FOODS,
FUNCTIONAL BEVERAGES, AND TOPICAL COS-
METIC PRODUCT APPLICATIONS, NAMELY,
FACE POWDERS AND FACE CREAMS, IN CLASS
30 (U.S. CL. 46).

FIRST USE 2-0-2007; IN COMMERCE 2-0-2007.

THE MARK CONSISTS OF STANDARD CHAR-
ACTERS WITHOUT CLAIM TO ANY PARTICULAR
FONT, STYLE, SIZE, OR COLOR.

NO CLAIM IS MADE TO THE EXCLUSIVE
RIGHT TO USE "SOY COMPLEX", APART FROM
THE MARK AS SHOWN.

SER. NO. 77-281,465, FILED P.R. 9-17-2007; AM. S.R.
6-20-2008.

JAY FLOWERS, EXAMINING ATTORNEY

Int. Cl.: 29

Prior U.S. Cl.: 46

United States Patent and Trademark Office

Reg. No. 3,482,654

Registered Aug. 5, 2008

**TRADEMARK
SUPPLEMENTAL REGISTER**

MICRONIZED SOY PROTEIN

SOY LABS, LLC (MISSOURI LTD LIAB CO)
3337 EMERALD LANE
JEFFERSON CITY, MO 65110

FOR: SOY PROTEIN FOR THE MANUFACTURE
OF SOY-BASED FOODS AND SOY-BASED BEVERA-
GES, FUNCTIONAL FOODS, AND FUNCTIONAL
BEVERAGES, IN CLASS 29 (U.S. CL. 46).

FIRST USE 2-0-2007; IN COMMERCE 2-0-2007.

THE MARK CONSISTS OF STANDARD CHAR-
ACTERS WITHOUT CLAIM TO ANY PARTICULAR
FONT, STYLE, SIZE, OR COLOR.

NO CLAIM IS MADE TO THE EXCLUSIVE
RIGHT TO USE "SOY PROTEIN", APART FROM
THE MARK AS SHOWN.

SER. NO. 77-281,471, FILED P.R. 9-17-2007; AM. S.R.
6-20-2008.

JAY FLOWERS, EXAMINING ATTORNEY

Int. Cl.: 30

Prior U.S. Cl.: 46

United States Patent and Trademark Office

Reg. No. 3,482,655

Registered Aug. 5, 2008

**TRADEMARK
SUPPLEMENTAL REGISTER**

FUNCTIONAL SOY COMPLEX

SOY LABS, LLC (MISSOURI LTD LIAB CO)
3337 EMERALD LANE
JEFFERSON CITY, MO 65110

FOR: SOY FLOUR FOR THE MANUFACTURE
OF SOY-BASED FOODS AND SOY-BASED BEVERA-
GES, FUNCTIONAL FOODS, FUNCTIONAL BEV-
ERAGES, AND TOPICAL COSMETIC PRODUCT
APPLICATIONS, NAMELY, FACE POWDERS AND
FACE CREAMS, IN CLASS 30 (U.S. CL. 46).

FIRST USE 2-0-2007; IN COMMERCE 2-0-2007.

THE MARK CONSISTS OF STANDARD CHAR-
ACTERS WITHOUT CLAIM TO ANY PARTICULAR
FONT, STYLE, SIZE, OR COLOR.

NO CLAIM IS MADE TO THE EXCLUSIVE
RIGHT TO USE "SOY COMPLEX", APART FROM
THE MARK AS SHOWN.

SER. NO. 77-281,478, FILED P.R. 9-17-2007; AM. S.R.
6-20-2008.

JAY FLOWERS, EXAMINING ATTORNEY

Int. Cl.: 29

Prior U.S. Cl.: 46

United States Patent and Trademark Office

Reg. No. 3,482,656

Registered Aug. 5, 2008

**TRADEMARK
SUPPLEMENTAL REGISTER**

FUNCTIONAL SOY PROTEIN

SOY LABS, LLC (MISSOURI LTD LIAB CO)
3337 EMERALD LANE
JEFFERSON CITY, MO 65110

FOR: SOY PROTEIN FOR THE MANUFACTURE
OF SOY-BASED FOODS AND SOY-BASED BEVERA-
GES, FUNCTIONAL FOODS, AND FUNCTIONAL
BEVERAGES, IN CLASS 29 (U.S. CL. 46).

FIRST USE 2-0-2007; IN COMMERCE 2-0-2007.

THE MARK CONSISTS OF STANDARD CHAR-
ACTERS WITHOUT CLAIM TO ANY PARTICULAR
FONT, STYLE, SIZE, OR COLOR.

NO CLAIM IS MADE TO THE EXCLUSIVE
RIGHT TO USE "SOY PROTEIN", APART FROM
THE MARK AS SHOWN.

SER. NO. 77-281,482, FILED P.R. 9-17-2007; AM. S.R.
6-20-2008.

JAY FLOWERS, EXAMINING ATTORNEY

Int. Cl.: 1

Prior U.S. Cls.: 1, 5, 6, 10, 26, and 46

Reg. No. 3,482,657

United States Patent and Trademark Office

Registered Aug. 5, 2008

**TRADEMARK
SUPPLEMENTAL REGISTER**

SHOE DRYER

DESICCARE, INC. (CALIFORNIA CORPORATION)
3400 POMONA BOULEVARD
POMONA, CA 917683236

FOR: MOISTURE REMOVERS, NAMELY, CHEMICAL COMPOUNDS IN THE FORM OF GRANULAR ABSORBENT MATERIAL PACKAGED IN PLASTIC PERFORATED CONTAINERS FOR USE IN THE TEXTILE AND SHOE INDUSTRY, IN CLASS 1 (U.S. CLS. 1, 5, 6, 10, 26 AND 46).

FIRST USE 12-31-2007; IN COMMERCE 12-31-2007.

THE MARK CONSISTS OF STANDARD CHARACTERS WITHOUT CLAIM TO ANY PARTICULAR FONT, STYLE, SIZE, OR COLOR.

SER. NO. 77-283,959, FILED P.R. 9-19-2007; AM. S.R. 7-2-2008.

DAVID MURRAY, EXAMINING ATTORNEY

Int. Cl.: 45

Prior U.S. Cls.: 100 and 101

United States Patent and Trademark Office

Reg. No. 3,482,658

Registered Aug. 5, 2008

**SERVICE MARK
SUPPLEMENTAL REGISTER**

SHUMAKER

SHUMAKER, LOOP & KENDRICK, LLP (OHIO
LIMITED LIABILITY PARTNERSHIP)
1000 JACKSON
TOLEDO, OH 436241573

FOR: LEGAL SERVICES, IN CLASS 45 (U.S. CLS.
100 AND 101).

FIRST USE 10-1-2007; IN COMMERCE 10-1-2007.

OWNER OF U.S. REG. NO. 2,713,228.

THE COLOR(S) BLACK AND BURNT ORANGE
IS/ARE CLAIMED AS A FEATURE OF THE MARK.

THE MARK CONSISTS OF THE WORD "SHU-
MAKER" IN BLACK AND THE LINE BELOW IT IS
IN BURNT ORANGE.

SER. NO. 77-285,385, FILED P.R. 9-21-2007; AM. S.R.
5-30-2008.

MARGARET POWER, EXAMINING ATTORNEY

Int. Cl.: 44

Prior U.S. Cls.: 100 and 101

United States Patent and Trademark Office

Reg. No. 3,482,659

Registered Aug. 5, 2008

**SERVICE MARK
SUPPLEMENTAL REGISTER**

KOWALS PEDIATRICS

KOWALS PEDIATRICS (WASHINGTON CORPORATION)

412 GIRARD STREET

BELLINGHAM, WA 98225

FOR: MEDICAL SERVICES, NAMELY, PEDIATRIC CARE, IN CLASS 44 (U.S. CLS. 100 AND 101).

FIRST USE 11-15-2007; IN COMMERCE 11-15-2007.

THE MARK CONSISTS OF STANDARD CHARACTERS WITHOUT CLAIM TO ANY PARTICULAR FONT, STYLE, SIZE, OR COLOR.

NO CLAIM IS MADE TO THE EXCLUSIVE RIGHT TO USE "PEDIATRICS", APART FROM THE MARK AS SHOWN.

SER. NO. 77-286,231, FILED P.R. 9-21-2007; AM. S.R. 6-27-2008.

JOHN DWYER, EXAMINING ATTORNEY

Int. Cl.: 21

Prior U.S. Cls.: 2, 13, 23, 29, 30, 33, 40, and 50

United States Patent and Trademark Office

Reg. No. 3,482,660

Registered Aug. 5, 2008

**TRADEMARK
SUPPLEMENTAL REGISTER**

**FAMILY MADE IN THE USA
SINCE 1896**

THE LIBMAN COMPANY (ILLINOIS CORPORATION)
220 N. SHELDON
ARCOLA, IL 61910

FOR: BRUSHES, NAMELY, BRUSHES FOR PARQUET FLOORS, DISHWASHING BRUSHES, DUSTING BRUSHES, FLOOR BRUSHES, SCRUBBING BRUSHES, SCRAPING BRUSHES, GRILL BRUSHES, TOILET BRUSHES, WIRE BRUSHES NOT BEING MACHINE PARTS, BATH BRUSHES, DUSTING BRUSHES, ROOFING BRUSHES, POT CLEANING BRUSHES; BROOMS, NAMELY, HARD BROOMS, PLASTIC BROOMS, CORN BROOMS, WHISK BROOMS; MOPS, NAMELY, SPONGE MOPS, TWIST MOPS, WET MOPS, DUST MOPS, AND THEIR REFILLS; CLEANING PADS, SOAP

HOLDERS AND DISPENSERS, DUST PANS, PLASTIC PAILS AND BUCKETS, TOILET BRUSH HOLDERS, IN CLASS 21 (U.S. CLS. 2, 13, 23, 29, 30, 33, 40 AND 50).

FIRST USE 10-31-2007; IN COMMERCE 10-31-2007.

THE MARK CONSISTS OF STANDARD CHARACTERS WITHOUT CLAIM TO ANY PARTICULAR FONT, STYLE, SIZE, OR COLOR.

OWNER OF U.S. REG. NO. 3,216,980.

SER. NO. 77-286,251, FILED P.R. 9-21-2007; AM. S.R. 6-26-2008.

TOBY BULLOFF, EXAMINING ATTORNEY

Int. Cls.: 16 and 42

Prior U.S. Cls.: 2, 5, 22, 23, 29, 37, 38, 50, 100, and 101

United States Patent and Trademark Office

Reg. No. 3,482,661

Registered Aug. 5, 2008

**TRADEMARK
SERVICE MARK
SUPPLEMENTAL REGISTER**

**KNOWLEDGE OF THE MODERN
CONSUMER MARKET**

MEDIA-SCREEN LLC (CALIFORNIA LTD LIAB
CO)
322 CORTLAND AVENUE
SAN FRANCISCO, CA 94110

FOR: PRINTED MATTER, NAMELY, PRINTED
GRAPHS, REPORTS AND INFORMATION GRA-
PHICS FEATURING INFORMATION IN THE
FIELDS OF MARKETING, ADVERTISING, AND
AUDIENCE MEASUREMENT, IN CLASS 16 (U.S.
CLS. 2, 5, 22, 23, 29, 37, 38 AND 50).

FIRST USE 11-1-2006; IN COMMERCE 11-1-2006.

FOR: ANALYSIS AND RESEARCH SERVICES,
NAMELY, MARKET RESEARCH AND CONSULT-

ING SERVICES, IN CLASS 42 (U.S. CLS. 100 AND
101).

FIRST USE 11-1-2006; IN COMMERCE 11-1-2006.

THE MARK CONSISTS OF STANDARD CHAR-
ACTERS WITHOUT CLAIM TO ANY PARTICULAR
FONT, STYLE, SIZE, OR COLOR.

NO CLAIM IS MADE TO THE EXCLUSIVE
RIGHT TO USE "KNOWLEDGE" , APART FROM
THE MARK AS SHOWN.

SER. NO. 77-286,289, FILED P.R. 9-21-2007; AM. S.R.
6-30-2008.

STEVEN PEREZ, EXAMINING ATTORNEY

Int. Cl.: 35

Prior U.S. Cls.: 100, 101, and 102

United States Patent and Trademark Office

Reg. No. 3,482,662

Registered Aug. 5, 2008

**SERVICE MARK
SUPPLEMENTAL REGISTER**

LAS VEGAS DESIGN CENTER

WORLD MARKET CENTER VENTURE, LLC
(DELAWARE LTD LIAB CO)
495 S. GRAND CENTRAL PARKWAY
LAS VEGAS, NV 89106

FOR: ARRANGING, ORGANIZING, PROMOTING AND CONDUCTING TRADE EXHIBITIONS, TRADE CONVENTIONS, TRADE SHOWS AND TRADE FAIRS IN THE FIELDS OF HOME, OFFICE AND HOSPITALITY FURNISHINGS; ADVERTISING AND MARKETING OF TRADE SHOWROOMS AND RELATED SHOWROOM FACILITIES AND SERVICES TO MANUFACTURERS OF GOODS IN THE FIELDS OF HOME, OFFICE AND HOSPITALITY FURNISHINGS; ADVERTISING AND MARKETING OF TRADE SHOWROOMS FOR DISPLAY AND EXHIBITION OF GOODS OF MANUFACTURERS IN THE FIELDS OF HOME, OFFICE AND

HOSPITALITY FURNISHINGS TO RETAILERS OF HOME, OFFICE AND HOSPITALITY FURNISHINGS, IN CLASS 35 (U.S. CLS. 100, 101 AND 102).

FIRST USE 5-1-2006; IN COMMERCE 5-1-2006.

THE MARK CONSISTS OF STANDARD CHARACTERS WITHOUT CLAIM TO ANY PARTICULAR FONT, STYLE, SIZE, OR COLOR.

NO CLAIM IS MADE TO THE EXCLUSIVE RIGHT TO USE "DESIGN CENTER", APART FROM THE MARK AS SHOWN.

SER. NO. 77-288,182, FILED P.R. 9-25-2007; AM. S.R. 6-23-2008.

ARETHA SOMERVILLE, EXAMINING ATTORNEY

Int. Cl.: 28

Prior U.S. Cls.: 22, 23, 38, and 50

United States Patent and Trademark Office

Reg. No. 3,482,663

Registered Aug. 5, 2008

**TRADEMARK
SUPPLEMENTAL REGISTER**

PADDLE GUARD

SURFCO HAWAII, INC. (HAWAII CORPORATION)
98-723 KUAHAO PLACE B-1
PEARL CITY, HI 96782

FOR: AN EXTRUDED PLASTIC PROTECTIVE
EDGING FOR RETROFITTING ONTO THE EDGE
OF CARBON AND WOODEN PADDLES, IN CLASS
28 (U.S. CLS. 22, 23, 38 AND 50).

FIRST USE 10-0-2007; IN COMMERCE 10-0-2007.

THE MARK CONSISTS OF STANDARD CHARACTERS WITHOUT CLAIM TO ANY PARTICULAR FONT, STYLE, SIZE, OR COLOR.

SER. NO. 77-292,750, FILED P.R. 10-1-2007; AM. S.R. 6-25-2008.

LINDA MICKLEBURGH, EXAMINING ATTORNEY

Int. Cl.: 14

Prior U.S. Cls.: 2, 27, 28, and 50

United States Patent and Trademark Office

Reg. No. 3,482,664

Registered Aug. 5, 2008

**TRADEMARK
SUPPLEMENTAL REGISTER**

PetStones

BOSWELL, LAUREN A. (UNITED STATES INDIVIDUAL)
17550 RED BANK ROAD
RED BLUFF, CA 96080

FOR: PET JEWELRY, IN CLASS 14 (U.S. CLS. 2, 27, 28 AND 50).

FIRST USE 10-1-2007; IN COMMERCE 5-1-2008.

THE MARK CONSISTS OF STANDARD CHARACTERS WITHOUT CLAIM TO ANY PARTICULAR FONT, STYLE, SIZE, OR COLOR.

SER. NO. 77-293,542, FILED P.R. 10-2-2007; AM. S.R. 6-9-2008.

JASON BLAIR, EXAMINING ATTORNEY

Int. Cl.: 16

Prior U.S. Cls.: 2, 5, 22, 23, 29, 37, 38, and 50

United States Patent and Trademark Office

Reg. No. 3,482,665

Registered Aug. 5, 2008

**TRADEMARK
SUPPLEMENTAL REGISTER**

I REALLY LOVE MY...

TIME INC. (DELAWARE CORPORATION)
1271 AVENUE OF THE AMERICAS
NEW YORK, NY 10020

FOR: MAGAZINE SECTIONS IN THE FIELD OF
CELEBRITY NEWS AND CELEBRITY FASHION;
MAGAZINES FEATURING CELEBRITY NEWS
AND CELEBRITY FASHION, IN CLASS 16 (U.S.
CLS. 2, 5, 22, 23, 29, 37, 38 AND 50).

FIRST USE 10-31-2002; IN COMMERCE 10-31-2002.

THE MARK CONSISTS OF STANDARD CHAR-
ACTERS WITHOUT CLAIM TO ANY PARTICULAR
FONT, STYLE, SIZE, OR COLOR.

SER. NO. 77-297,457, FILED P.R. 10-5-2007; AM. S.R.
6-24-2008.

DOMINIC FATHY, EXAMINING ATTORNEY

Int. Cl.: 9

Prior U.S. Cls.: 21, 23, 26, 36, and 38

United States Patent and Trademark Office

Reg. No. 3,482,666

Registered Aug. 5, 2008

**TRADEMARK
SUPPLEMENTAL REGISTER**

ImportSite

GELLER DATA SOLUTIONS, INC. (FLORIDA CORPORATION), DBA GDSI,
SUITE 171
8930 STATE ROAD 84
DAVIE, FL 33324

FOR: COMPUTER SOFTWARE FOR APPLICATION AND DATABASE INTEGRATION, IN CLASS 9 (U.S. CLS. 21, 23, 26, 36 AND 38).

FIRST USE 5-1-2007; IN COMMERCE 5-1-2007.

THE MARK CONSISTS OF STANDARD CHARACTERS WITHOUT CLAIM TO ANY PARTICULAR FONT, STYLE, SIZE, OR COLOR.

SER. NO. 77-297,940, FILED P.R. 10-6-2007; AM. S.R. 6-9-2008.

MARK RADEMACHER, EXAMINING ATTORNEY

Int. Cl.: 31

Prior U.S. Cls.: 1 and 46

United States Patent and Trademark Office

Reg. No. 3,482,667

Registered Aug. 5, 2008

**TRADEMARK
SUPPLEMENTAL REGISTER**

GREAT COMBINATIONS

W. ATLEE BURPEE COMPANY (DELAWARE
CORPORATION)
300 PARK AVENUE
WARMINSTER, PA 18974

FOR: SEEDS AND BULBS; LIVING PLANTS, IN
CLASS 31 (U.S. CLS. 1 AND 46).

FIRST USE 12-31-2007; IN COMMERCE 12-31-2007.

THE MARK CONSISTS OF STANDARD CHAR-
ACTERS WITHOUT CLAIM TO ANY PARTICULAR
FONT, STYLE, SIZE, OR COLOR.

SER. NO. 77-298,239, FILED P.R. 10-8-2007; AM. S.R.
6-23-2008.

RUDY R. SINGLETON, EXAMINING ATTORNEY

Int. Cl.: 41

Prior U.S. Cls.: 100, 101, and 107

United States Patent and Trademark Office

Reg. No. 3,482,668

Registered Aug. 5, 2008

**SERVICE MARK
SUPPLEMENTAL REGISTER**

THE DEER HUNTERS ROUNDUP

JACQUART FABRIC PRODUCTS, INC. (MICHIGAN CORPORATION)
1238 WALL STREET
IRONWOOD, MI 49938

FOR: ENTERTAINMENT SERVICES, NAMELY, PROVIDING A WEB SITE FEATURING PRERECORDED AUDIO PROGRAMS RELATED TO HUNTING FOR STREAMING OVER THE INTERNET, IN CLASS 41 (U.S. CLS. 100, 101 AND 107).

FIRST USE 11-14-2007; IN COMMERCE 11-14-2007.

THE MARK CONSISTS OF STANDARD CHARACTERS WITHOUT CLAIM TO ANY PARTICULAR FONT, STYLE, SIZE, OR COLOR.

SER. NO. 77-298,251, FILED P.R. 10-8-2007; AM. S.R. 6-6-2008.

BARBARA RUTLAND, EXAMINING ATTORNEY

Int. Cl.: 31

Prior U.S. Cls.: 1 and 46

United States Patent and Trademark Office

Reg. No. 3,482,669

Registered Aug. 5, 2008

**TRADEMARK
SUPPLEMENTAL REGISTER**

PRIZEWINNING COMBINATIONS

W. ATLEE BURPEE COMPANY (DELAWARE
CORPORATION)
300 PARK AVENUE
WARMINSTER, PA 18974

FOR: SEEDS AND BULBS; LIVING PLANTS, IN
CLASS 31 (U.S. CLS. 1 AND 46).

FIRST USE 12-31-2007; IN COMMERCE 12-31-2007.

THE MARK CONSISTS OF STANDARD CHAR-
ACTERS WITHOUT CLAIM TO ANY PARTICULAR
FONT, STYLE, SIZE, OR COLOR.

OWNER OF U.S. REG. NO. 1,962,263.

SER. NO. 77-298,275, FILED P.R. 10-8-2007; AM. S.R.
6-23-2008.

RUDY R. SINGLETON, EXAMINING ATTORNEY

Int. Cl.: 41

Prior U.S. Cls.: 100, 101, and 107

United States Patent and Trademark Office

Reg. No. 3,482,670

Registered Aug. 5, 2008

**SERVICE MARK
SUPPLEMENTAL REGISTER**

WORLD SCIENCE FESTIVAL

THE SCIENCE FESTIVAL FOUNDATION (DELA-
WARE NON-PROFIT CORPORATION)
603 W. 115TH STREET, SUITE 135
NEW YORK, NY 10025

FOR: ORGANIZING FESTIVALS FEATURING A
VARIETY OF ACTIVITIES, NAMELY, SCIENCE-
THEMED LECTURES, DEBATES AND PANEL DIS-
CUSSIONS, MUSIC AND DANCE PERFORMAN-
CES, FILM SHOWINGS, LITERARY SYMPOSIA
AND READINGS, IN CLASS 41 (U.S. CLS. 100, 101
AND 107).

FIRST USE 2-0-2006; IN COMMERCE 2-0-2006.

THE MARK CONSISTS OF STANDARD CHAR-
ACTERS WITHOUT CLAIM TO ANY PARTICULAR
FONT, STYLE, SIZE, OR COLOR.

NO CLAIM IS MADE TO THE EXCLUSIVE
RIGHT TO USE "SCIENCE FESTIVAL", APART
FROM THE MARK AS SHOWN.

SER. NO. 77-299,243, FILED P.R. 10-9-2007; AM. S.R.
6-24-2008.

LINDSEY RUBIN, EXAMINING ATTORNEY

Int. Cl.: 35

Prior U.S. Cls.: 100, 101, and 102

United States Patent and Trademark Office

Reg. No. 3,482,671

Registered Aug. 5, 2008

**SERVICE MARK
SUPPLEMENTAL REGISTER**

**National Aging in Place
Council**

NATIONAL AGING IN PLACE COUNCIL (D.C.
UNINC. ASSOCIATION)
SUITE 420
1400 16TH STREET NW
WASHINGTON, DC 20036

FOR: ASSOCIATION SERVICES, NAMELY, PROMOTING THE INTERESTS OF PROFESSIONALS IN THE FIELD OF SENIOR CITIZEN AFFAIRS, IN CLASS 35 (U.S. CLS. 100, 101 AND 102).

FIRST USE 11-18-2004; IN COMMERCE 11-18-2004.

THE MARK CONSISTS OF STANDARD CHARACTERS WITHOUT CLAIM TO ANY PARTICULAR FONT, STYLE, SIZE, OR COLOR.

NO CLAIM IS MADE TO THE EXCLUSIVE RIGHT TO USE "COUNCIL", APART FROM THE MARK AS SHOWN.

SER. NO. 77-300,429, FILED P.R. 10-10-2007; AM. S.R. 6-24-2008.

CHARISMA HAMPTON, EXAMINING ATTORNEY

Int. Cls.: 9 and 41

Prior U.S. Cls.: 21, 23, 26, 36, 38, 100, 101, and 107

United States Patent and Trademark Office

Reg. No. 3,482,672

Registered Aug. 5, 2008

**TRADEMARK
SERVICE MARK
SUPPLEMENTAL REGISTER**

MOBILE MARKETER

MIR MAQBOOL ALAM KHAN (INDIA INDIVIDUAL)
APT. 12E
395 SOUTH END AVENUE
NEW YORK, NY 10280

FOR: ELECTRONIC PUBLICATIONS, NAMELY, MAGAZINES, BOOKS, NEWSLETTERS, VIDEO MAGAZINES, BLOGS AND NEWSPAPERS FEATURING INFORMATION ABOUT MARKETING, COMMERCE, CONTENT, MEDIA, TECHNOLOGY AND TECHNOLOGY CARRIERS ALL RECORDED ON COMPUTER MEDIA, IN CLASS 9 (U.S. CLS. 21, 23, 26, 36 AND 38).

FIRST USE 11-26-2007; IN COMMERCE 11-26-2007.

FOR: PUBLICATION OF BOOKS, OF MAGAZINES, OF JOURNALS, OF NEWSPAPERS, OF PERIODICALS, OF CATALOGS, OF BROCHURES, IN CLASS 41 (U.S. CLS. 100, 101 AND 107).

FIRST USE 1-9-2008; IN COMMERCE 1-9-2008.

THE MARK CONSISTS OF STANDARD CHARACTERS WITHOUT CLAIM TO ANY PARTICULAR FONT, STYLE, SIZE, OR COLOR.

SER. NO. 77-303,020, FILED P.R. 10-12-2007; AM. S.R. 6-26-2008.

CHARISMA HAMPTON, EXAMINING ATTORNEY

Int. Cl.: 43

Prior U.S. Cl.: 200

United States Patent and Trademark Office

Reg. No. 3,482,673

Registered Aug. 5, 2008

**COLLECTIVE MEMBERSHIP
SUPPLEMENTAL REGISTER**

**National Aging in Place
Council**

NATIONAL AGING IN PLACE COUNCIL (D.C.
UNINC. ASSOCIATION)
SUITE 650
1400 16TH STREET NW
WASHINGTON, DC 20036

FOR: INDICATING MEMBERSHIP IN AN ORGA-
NIZATION OF PROFESSIONALS IN THE FIELD OF
SENIOR CITIZEN AFFAIRS, IN CLASS 200 (U.S. CL.
200).

FIRST USE 11-18-2004; IN COMMERCE 11-18-2004.

THE MARK CONSISTS OF STANDARD CHAR-
ACTERS WITHOUT CLAIM TO ANY PARTICULAR
FONT, STYLE, SIZE, OR COLOR.

NO CLAIM IS MADE TO THE EXCLUSIVE
RIGHT TO USE "COUNCIL", APART FROM THE
MARK AS SHOWN.

SER. NO. 77-306,069, FILED P.R. 10-17-2007; AM.
S.R. 6-24-2008.

CHARISMA HAMPTON, EXAMINING ATTORNEY

Int. Cl.: 24

Prior U.S. Cls.: 42 and 50

United States Patent and Trademark Office

Reg. No. 3,482,674

Registered Aug. 5, 2008

**TRADEMARK
SUPPLEMENTAL REGISTER**

Hands, Face & Teeth

KIRCHNER-LEIDA, VANESSA A. (MASSACHU-
SETTS SOLE PROPRIETORSHIP)
25 WOODLAND ROAD
BEDFORD, MA 01730

FOR: BATH TOWELS; BEACH TOWELS; CHIL-
DREN'S TOWELS; FACE TOWELS; GOLF TOWELS;
HAND TOWELS; HAND TOWELS OF TEXTILE;
HAND-TOWELS MADE OF TEXTILE FABRICS;
HOODED TOWELS; JAPANESE COTTON TOWELS
(TENUGUI); KITCHEN TOWELS; LARGE BATH
TOWELS; TEA TOWELS; TERRY TOWELS; TOWEL

SETS; TOWELLING COVERLETS; TOWELS; TO-
WELS, IN CLASS 24 (U.S. CLS. 42 AND 50).

FIRST USE 11-2-2007; IN COMMERCE 11-2-2007.

THE MARK CONSISTS OF STANDARD CHAR-
ACTERS WITHOUT CLAIM TO ANY PARTICULAR
FONT, STYLE, SIZE, OR COLOR.

SER. NO. 77-319,808, FILED P.R. 11-2-2007; AM. S.R.
5-10-2008.

STEPHANIE ALI, EXAMINING ATTORNEY

Int. Cl.: 43

Prior U.S. Cls.: 100 and 101

United States Patent and Trademark Office

Reg. No. 3,482,675

Registered Aug. 5, 2008

**SERVICE MARK
SUPPLEMENTAL REGISTER**

BY BRAZIL

KANG, SOPHIA (UNITED STATES INDIVIDUAL), DBA STESO,
1615 CABRILLO AVE.
TORRANCE, CA 90501 AND
KANG, STEFANO (UNITED STATES INDIVIDUAL),
DBA STESO,
1615 CABRILLO AVE.
TORRANCE, CA 90501

FOR: RESTAURANT SERVICES, IN CLASS 43
(U.S. CLS. 100 AND 101).

FIRST USE 0-0-2005; IN COMMERCE 0-0-2005.

THE MARK CONSISTS OF STANDARD CHARACTERS WITHOUT CLAIM TO ANY PARTICULAR FONT, STYLE, SIZE, OR COLOR.

SER. NO. 77-322,040, FILED P.R. 11-5-2007; AM. S.R. 6-27-2008.

ALEX KEAM, EXAMINING ATTORNEY

Int. Cl.: 45

Prior U.S. Cls.: 100 and 101

United States Patent and Trademark Office

Reg. No. 3,482,676

Registered Aug. 5, 2008

**SERVICE MARK
SUPPLEMENTAL REGISTER**

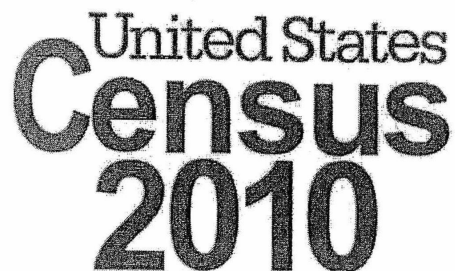
The logo for the United States Census 2010. It features the words "United States" in a smaller, serif font at the top. Below that, the word "Census" is written in a large, bold, sans-serif font. At the bottom, the year "2010" is written in a very large, bold, sans-serif font, overlapping the bottom of "Census".

U.S. BUREAU OF THE CENSUS (UNITED STATES AGENCY OF THE UNITED STATES GOVERNMENT)
1401 CONSTITUTION AVENUE, NW
WASHINGTON, DC 20230

FOR: RESEARCH SERVICES, NAMELY, CONDUCTING THE U.S. DECENNIAL CENSUS, INCLUDING THE PROVISION OF SUCH SERVICES BY MEANS OF THE INTERNET, IN CLASS 45 (U.S. CLS. 100 AND 101).

FIRST USE 12-31-2006; IN COMMERCE 12-31-2006.

OWNER OF U.S. REG. NOS. 2,296,084, 2,518,821, AND OTHERS.

NO CLAIM IS MADE TO THE EXCLUSIVE RIGHT TO USE "CENSUS 2010", APART FROM THE MARK AS SHOWN.

THE MARK CONSISTS OF THE WORDS "UNITED STATES CENSUS 2010", WITH THE WORDS "UNITED STATES" SITTING ATOP THE LARGER WORDS "CENSUS" AND "2010" .

SER. NO. 77-322,622, FILED P.R. 11-6-2007; AM. S.R. 5-13-2008.

PAULA MAHONEY, EXAMINING ATTORNEY

Int. Cl.: 16

Prior U.S. Cls.: 2, 5, 22, 23, 29, 37, 38, and 50

United States Patent and Trademark Office

Reg. No. 3,482,677

Registered Aug. 5, 2008

**TRADEMARK
SUPPLEMENTAL REGISTER**

"Inspiring Butterflies"

ZABORONEK, GINNY (NEW JERSEY JOINT
VENTURE)
11 FRONTAGE RD.
BLAIRSTOWN, NJ 07825 AND
RICHARDS, MARGARET (PENNSYLVANIA JOINT
VENTURE)
884 EMPRESS RD.
WEST CHESTER, PA 19382

FIRST USE 1-10-2008; IN COMMERCE 1-10-2008.

THE MARK CONSISTS OF STANDARD CHAR-
ACTERS WITHOUT CLAIM TO ANY PARTICULAR
FONT, STYLE, SIZE, OR COLOR.

SER. NO. 77-327,758, FILED 11-13-2007.

FOR: PRINTED INFORMATIONAL CARDS IN
THE FIELD OF INSPIRING BUTTERFLIES, IN
CLASS 16 (U.S. CLS. 2, 5, 22, 23, 29, 37, 38 AND 50).

SUSAN STIGLITZ, EXAMINING ATTORNEY

Int. Cl.: 20

Prior U.S. Cls.: 2, 13, 22, 25, 32, and 50

Reg. No. 3,482,678

United States Patent and Trademark Office

Registered Aug. 5, 2008

**TRADEMARK
SUPPLEMENTAL REGISTER**

RACX

DECADE PRODUCTS, LLC (MICHIGAN LTD
LIAB CO)
3400 INNOVATION COURT SE
GRAND RAPIDS, MI 49512

FOR: NON-METAL PALLETS, IN CLASS 20 (U.S.
CLS. 2, 13, 22, 25, 32 AND 50).

FIRST USE 2-26-2008; IN COMMERCE 3-11-2008.

THE MARK CONSISTS OF STANDARD CHAR-
ACTERS WITHOUT CLAIM TO ANY PARTICULAR
FONT, STYLE, SIZE, OR COLOR.

SER. NO. 77-328,070, FILED P.R. 11-13-2007; AM.
S.R. 3-17-2008.

ELISSA GARBER KON, EXAMINING ATTORNEY

Int. Cl.: 41

Prior U.S. Cls.: 100, 101, and 107

United States Patent and Trademark Office

Reg. No. 3,482,679

Registered Aug. 5, 2008

**SERVICE MARK
SUPPLEMENTAL REGISTER**

OfficeSuppliesBlog

BUYCOMPUTERNOW INC. (MINNESOTA CORPORATION), DBA BUYONLINENOW,
4865 19TH STREET NW STE 110
ROCHESTER, MN 55901

FOR: ON-LINE JOURNALS, NAMELY, BLOGS FEATURING OFFICE PRODUCTS, OFFICE SUPPLIES, OFFICE FURNITURE, AND INFORMATION ABOUT ONLINE RETAIL WEBSITES , IN CLASS 41 (U.S. CLS. 100, 101 AND 107).

FIRST USE 5-24-2007; IN COMMERCE 5-24-2007.

THE MARK CONSISTS OF STANDARD CHARACTERS WITHOUT CLAIM TO ANY PARTICULAR FONT, STYLE, SIZE, OR COLOR.

SER. NO. 77-328,980, FILED P.R. 11-14-2007; AM. S.R. 6-26-2008.

DANNEAN HETZEL, EXAMINING ATTORNEY

Int. Cl.: 35

Prior U.S. Cls.: 100, 101, and 102

United States Patent and Trademark Office

Reg. No. 3,482,680

Registered Aug. 5, 2008

**SERVICE MARK
SUPPLEMENTAL REGISTER**

IpAuctions

IPACTIONS, INC. (NEVADA CORPORATION)
2248 MERIDIAN BLVD.
SUITE H
MINDEN, NV 89423

FOR: ONLINE AUCTION SERVICES; ARRANGING AND CONDUCTING AUCTIONS IN THE FIELD OF INTELLECTUAL PROPERTY, TRADE SECRETS, PATENTS, TRADEMARKS, COPYRIGHTS, MAILING LISTS, CLIENT AND CUSTOMER DATABASES, DOMAIN NAMES, AND FINANCIAL INSTRUMENTS; ARRANGING AND CONDUCTION OF AUCTION SALES, IN CLASS 35 (U.S. CLS. 100, 101 AND 102).

FIRST USE 7-31-2001; IN COMMERCE 7-31-2001.

THE MARK CONSISTS OF STANDARD CHARACTERS WITHOUT CLAIM TO ANY PARTICULAR FONT, STYLE, SIZE, OR COLOR.

OWNER OF U.S. REG. NO. 2,756,143.

SER. NO. 77-338,649, FILED P.R. 11-28-2007; AM. S.R. 6-19-2008.

JENNIFER HETU, EXAMINING ATTORNEY

Int. Cl.: 30

Prior U.S. Cl.: 46

United States Patent and Trademark Office

Reg. No. 3,482,681

Registered Aug. 5, 2008

**TRADEMARK
SUPPLEMENTAL REGISTER**

PIKE PLACE

PIKE PLACE MARKET PRESERVATION AND
DEVELOPMENT AUTHORITY (WASHING-
TON PUBLIC BENEFIT CORPORATION)

ROOM 500

85 PIKE STREET

SEATTLE, WA 98101

FOR: COFFEE, IN CLASS 30 (U.S. CL. 46).

FIRST USE 4-8-2008; IN COMMERCE 4-8-2008.

THE MARK CONSISTS OF STANDARD CHAR-
ACTERS WITHOUT CLAIM TO ANY PARTICULAR
FONT, STYLE, SIZE, OR COLOR.

OWNER OF U.S. REG. NOS. 2,233,478 AND
2,361,042.

SER. NO. 77-341,488, FILED P.R. 11-30-2007; AM.
S.R. 7-1-2008.

CARYN GLASSER, EXAMINING ATTORNEY

Int. Cl.: 16

Prior U.S. Cls.: 2, 5, 22, 23, 29, 37, 38, and 50

United States Patent and Trademark Office

Reg. No. 3,482,682

Registered Aug. 5, 2008

TRADEMARK
SUPPLEMENTAL REGISTER

SECURITY Dealer
New Technology and Installation Solutions **& Integrator**

CYGNUS BUSINESS MEDIA, INC. (DELAWARE CORPORATION)
1233 JANESVILLE AVENUE
FORT ATKINSON, WI 53538

FOR: MAGAZINES FEATURING INTEGRATED SECURITY SYSTEMS INFORMATION, IN CLASS 16 (U.S. CLS. 2, 5, 22, 23, 29, 37, 38 AND 50).

FIRST USE 1-14-2008; IN COMMERCE 1-14-2008.

OWNER OF U.S. REG. NO. 1,557,912.

THE COLOR(S) RED, BLACK, AND WHITE IS/ARE CLAIMED AS A FEATURE OF THE MARK.

THE MARK CONSISTS OF THE WORDS "SECURITY" AND "INTEGRATOR" IN RED, THE WORD "DEALER" IN BLACK, A BLACK AMPERSAND, AND A RED RECTANGLE WITH THE WORDING "NEW TECHNOLOGY AND INSTALLATION SOLUTIONS" IN WHITE.

SER. NO. 77-345,310, FILED P.R. 12-6-2007; AM. S.R. 4-10-2008.

KATHLEEN LORENZO, EXAMINING ATTORNEY

Int. Cl.: 9

Prior U.S. Cls.: 21, 23, 26, 36, and 38

United States Patent and Trademark Office

Reg. No. 3,482,683

Registered Aug. 5, 2008

**TRADEMARK
SUPPLEMENTAL REGISTER**

Ear Plug Superstore

T. BERGMAN ENTERPRISES, INC. (OKLAHOMA CORPORATION)
PO BOX 8405
EDMOND, OK 73083

FOR: EAR PLUGS NOT FOR MEDICAL PURPOSES; EAR PLUGS FOR SLEEPING; EAR PLUGS FOR SOUNDPROOFING; EAR PLUGS FOR SWIMMING; EAR PLUGS FOR SWIMMING PURPOSES, IN CLASS 9 (U.S. CLS. 21, 23, 26, 36 AND 38).

FIRST USE 5-15-1999; IN COMMERCE 5-15-1999.

THE MARK CONSISTS OF STANDARD CHARACTERS WITHOUT CLAIM TO ANY PARTICULAR FONT, STYLE, SIZE, OR COLOR.

NO CLAIM IS MADE TO THE EXCLUSIVE RIGHT TO USE "EAR PLUG", APART FROM THE MARK AS SHOWN.

SER. NO. 77-346,117, FILED P.R. 12-6-2007; AM. S.R. 6-25-2008.

DANNEAN HETZEL, EXAMINING ATTORNEY

Int. Cl.: 42

Prior U.S. Cls.: 100 and 101

United States Patent and Trademark Office

Reg. No. 3,482,684

Registered Aug. 5, 2008

**SERVICE MARK
SUPPLEMENTAL REGISTER**

CONTENT SCM

INFOTRIEVE, INC. (DELAWARE CORPORATION)
SUITE 105
20 WESTPORT ROAD
WILTON, CT 06897

FOR: ONLINE, NON-DOWNLOADABLE SOFTWARE FOR USE IN MANAGEMENT, USAGE ANALYSIS, COPYRIGHT COMPLIANCE, RIGHTS ADMINISTRATION AND DELIVERY OF DOCUMENTS AND LITERATURE COLLECTIONS , IN CLASS 42 (U.S. CLS. 100 AND 101).

FIRST USE 10-11-2007; IN COMMERCE 10-11-2007.

THE MARK CONSISTS OF STANDARD CHARACTERS WITHOUT CLAIM TO ANY PARTICULAR FONT, STYLE, SIZE, OR COLOR.

NO CLAIM IS MADE TO THE EXCLUSIVE RIGHT TO USE "CONTENT", APART FROM THE MARK AS SHOWN.

SER. NO. 77-354,422, FILED P.R. 12-18-2007; AM. S.R. 6-26-2008.

DAVID HOFFMAN, EXAMINING ATTORNEY

Int. Cl.: 11

Prior U.S. Cls.: 13, 21, 23, 31, and 34

United States Patent and Trademark Office

Reg. No. 3,482,685

Registered Aug. 5, 2008

**TRADEMARK
SUPPLEMENTAL REGISTER**

WILLINGHAM

TOTO, U.S.A., INC. (DELAWARE CORPORATION)
1155 SOUTHERN ROAD
MORROW, GA 30260

FOR: PLUMBING FIXTURES, NAMELY, TOILETS, BIDETS, BATHTUBS, SHOWERS, SINKS, FAUCETS, AND LIGHTING FIXTURES, IN CLASS 11 (U.S. CLS. 13, 21, 23, 31 AND 34).

FIRST USE 2-1-2008; IN COMMERCE 2-1-2008.

THE MARK CONSISTS OF STANDARD CHARACTERS WITHOUT CLAIM TO ANY PARTICULAR FONT, STYLE, SIZE, OR COLOR.

SER. NO. 77-354,524, FILED P.R. 12-18-2007; AM. S.R. 6-24-2008.

CHARLES L. JENKINS, EXAMINING ATTORNEY

Int. Cl.: 38

Prior U.S. Cls.: 100, 101, and 104

United States Patent and Trademark Office

Reg. No. 3,482,686

Registered Aug. 5, 2008

**SERVICE MARK
SUPPLEMENTAL REGISTER**

CONTINUITY TALK

ROZANSKY & ASSOCIATES, LLC (ILLINOIS
LTD LIAB CO)
#713
650 S. RIVER ROAD
DESPLAINES, IL 60016

FOR: PODCASTING SERVICES, IN CLASS 38 (U.S.
CLS. 100, 101 AND 104).

FIRST USE 8-7-2007; IN COMMERCE 8-7-2007.

THE MARK CONSISTS OF STANDARD CHAR-
ACTERS WITHOUT CLAIM TO ANY PARTICULAR
FONT, STYLE, SIZE, OR COLOR.

SER. NO. 77-365,228, FILED P.R. 1-7-2008; AM. S.R.
7-1-2008.

JAY FLOWERS, EXAMINING ATTORNEY

Int. Cl.: 11

Prior U.S. Cls.: 13, 21, 23, 31, and 34

United States Patent and Trademark Office

Reg. No. 3,482,687

Registered Aug. 5, 2008

**TRADEMARK
SUPPLEMENTAL REGISTER**

STEADI-FLOW

CTB IP, INC. (DELAWARE CORPORATION)
300 DELAWARE AVENUE, SUITE 1253
WILMINGTON, DE 19801

FOR: MECHANIZED POULTRY LIVESTOCK
WATERERS, IN CLASS 11 (U.S. CLS. 13, 21, 23, 31
AND 34).

FIRST USE 12-17-2007; IN COMMERCE 12-17-2007.

THE MARK CONSISTS OF STANDARD CHAR-
ACTERS WITHOUT CLAIM TO ANY PARTICULAR
FONT, STYLE, SIZE, OR COLOR.

OWNER OF U.S. REG. NO. 3,024,203.

SER. NO. 77-371,213, FILED 1-14-2008.

NELSON SNYDER, EXAMINING ATTORNEY

Int. Cl.: 41

Prior U.S. Cls.: 100, 101, and 107

United States Patent and Trademark Office

Reg. No. 3,482,688

Registered Aug. 5, 2008

**SERVICE MARK
SUPPLEMENTAL REGISTER**

RIVALRY WEEKEND

ESPN, INC. (DELAWARE CORPORATION)
ESPN PLAZA
BRISTOL, CT 06010

FIRST USE 11-20-1994; IN COMMERCE 11-20-1994.

FOR: ENTERTAINMENT SERVICES, NAMELY, TELEVISION PROGRAMS IN THE FIELD OF COLLEGIATE FOOTBALL AND BASKETBALL, PRODUCTION AND DISTRIBUTION OF RADIO AND TELEVISION BROADCASTS OF COLLEGIATE FOOTBALL AND BASKETBALL GAMES, EVENTS, AND PROGRAMS, IN CLASS 41 (U.S. CLS. 100, 101 AND 107).

THE MARK CONSISTS OF STANDARD CHARACTERS WITHOUT CLAIM TO ANY PARTICULAR FONT, STYLE, SIZE, OR COLOR.

SER. NO. 77-374,052, FILED P.R. 1-17-2008; AM. S.R. 6-16-2008.

DAVID MILLER, EXAMINING ATTORNEY

Int. Cl.: 29

Prior U.S. Cl.: 46

United States Patent and Trademark Office

Reg. No. 3,482,689

Registered Aug. 5, 2008

**TRADEMARK
SUPPLEMENTAL REGISTER**

SeaCakes

HARBOR SEAFOOD, INC. (NEW YORK COR-
PORATION)
969 LAKEVILLE ROAD
NEW HYDE PARK, NY 11040

FOR: FROZEN SEAFOOD, IN CLASS 29 (U.S. CL.
46).

FIRST USE 2-22-2008; IN COMMERCE 2-22-2008.

THE MARK CONSISTS OF THE STYLIZED
WORD "SEACAKES".

SER. NO. 77-375,563, FILED P.R. 1-18-2008; AM. S.R.
6-27-2008.

SUE LAWRENCE, EXAMINING ATTORNEY

Int. Cls.: 29, 30, and 32

Prior U.S. Cls.: 45, 46, and 48

United States Patent and Trademark Office

Reg. No. 3,482,690

Registered Aug. 5, 2008

**TRADEMARK
SUPPLEMENTAL REGISTER**

FANCY FLAVORS

GEBAL CO., INC. (FLORIDA CORPORATION),
DBA FANCY FLAVORS,
3270 NW FEDERAL HWY
JENSEN BEACH, FL 34957

FOR: YOGURT; FRUIT SALADS AND VEGETA-
BLE SALADS, IN CLASS 29 (U.S. CL. 46).

FIRST USE 1-20-2008; IN COMMERCE 1-20-2008.

FOR: SANDWICHES , IN CLASS 30 (U.S. CL. 46).

FIRST USE 1-20-2008; IN COMMERCE 1-20-2008.

FOR: SMOOTHIES, IN CLASS 32 (U.S. CLS. 45, 46
AND 48).

FIRST USE 1-20-2008; IN COMMERCE 1-20-2008.

THE MARK CONSISTS OF STANDARD CHAR-
ACTERS WITHOUT CLAIM TO ANY PARTICULAR
FONT, STYLE, SIZE, OR COLOR.

SER. NO. 77-379,199, FILED P.R. 1-24-2008; AM. S.R.
6-29-2008.

MARCIE MILONE, EXAMINING ATTORNEY

Int. Cl.: 36

Prior U.S. Cls.: 100, 101, and 102

United States Patent and Trademark Office

Reg. No. 3,482,691

Registered Aug. 5, 2008

**SERVICE MARK
SUPPLEMENTAL REGISTER**

FLEXIBLE CHOICE WHOLE LIFE

THE PENN MUTUAL LIFE INSURANCE COM-
PANY (PENNSYLVANIA CORPORATION)

600 DRESHER ROAD

HORSHAM, PA 19044

FOR: LIFE INSURANCE UNDERWRITING, IN
CLASS 36 (U.S. CLS. 100, 101 AND 102).

FIRST USE 4-4-2008; IN COMMERCE 4-8-2008.

THE MARK CONSISTS OF STANDARD CHAR-
ACTERS WITHOUT CLAIM TO ANY PARTICULAR
FONT, STYLE, SIZE, OR COLOR.

NO CLAIM IS MADE TO THE EXCLUSIVE
RIGHT TO USE "WHOLE LIFE", APART FROM
THE MARK AS SHOWN.

SER. NO. 77-380,366, FILED P.R. 1-25-2008; AM. S.R.
6-19-2008.

MICHAEL KAZAZIAN, EXAMINING ATTORNEY

Int. Cl.: 35

Prior U.S. Cls.: 100, 101, and 102

United States Patent and Trademark Office

Reg. No. 3,482,692

Registered Aug. 5, 2008

**SERVICE MARK
SUPPLEMENTAL REGISTER**

eLegalsupply.com

ELEGALSUPPLY.COM LLC (NEW JERSEY LTD
LIAB CO)
341 MULLICA HILL ROAD
MULLICA HILL, NJ 08062

FOR: ON-LINE RETAIL STORE SERVICES FEATURING LEGAL OFFICE SUPPLIES, IN CLASS 35 (U.S. CLS. 100, 101 AND 102).

FIRST USE 0-0-1999; IN COMMERCE 0-0-1999.

THE MARK CONSISTS OF STANDARD CHARACTERS WITHOUT CLAIM TO ANY PARTICULAR FONT, STYLE, SIZE, OR COLOR.

SER. NO. 77-382,353, FILED P.R. 1-28-2008; AM. S.R. 6-27-2008.

RENEE MCCRAY, EXAMINING ATTORNEY

Int. Cl.: 9

Prior U.S. Cls.: 21, 23, 26, 36, and 38

United States Patent and Trademark Office

Reg. No. 3,482,693

Registered Aug. 5, 2008

**TRADEMARK
SUPPLEMENTAL REGISTER**

FIBRMAT

JM FIBER OPTICS, INC. (CALIFORNIA CORPORATION)
SUITE D
6251 SCHAEFER AVENUE
CHINO, CA 91710

THE MARK CONSISTS OF STANDARD CHARACTERS WITHOUT CLAIM TO ANY PARTICULAR FONT, STYLE, SIZE, OR COLOR.

FOR: FIBER OPTIC INTRUSION DETECTION SENSOR MAT, IN CLASS 9 (U.S. CLS. 21, 23, 26, 36 AND 38).

SER. NO. 77-383,717, FILED P.R. 1-29-2008; AM. S.R. 6-26-2008.

FIRST USE 5-28-1982; IN COMMERCE 5-28-1982.

GEORGIA CARTY, EXAMINING ATTORNEY

Int. Cl.: 29

Prior U.S. Cl.: 46

United States Patent and Trademark Office

Reg. No. 3,482,694

Registered Aug. 5, 2008

**TRADEMARK
SUPPLEMENTAL REGISTER**

FLAX USA

STOBER, JOHN (UNITED STATES INDIVIDUAL)
1661 7TH STREET NE
GOODRICH, ND 58444 AND
STOBER, STEPHANIE (UNITED STATES INDIVIDUAL)
1661 7TH STREET NE
GOODRICH, ND 58444

FOR: PROCESSED EDIBLE FLAX, NAMELY,
EDIBLE MILLED FLAXSEED, EDIBLE COLD MILLED
FLAXSEED, EDIBLE WHOLE SEED FLAXSEED,
EDIBLE PREGROUND FLAXSEED, AND

EDIBLE FLAX LIGNANS; EDIBLE FLAXSEED
OIL, IN CLASS 29 (U.S. CL. 46).

FIRST USE 10-1-2001; IN COMMERCE 10-1-2001.

THE MARK CONSISTS OF STANDARD CHARACTERS
WITHOUT CLAIM TO ANY PARTICULAR FONT,
STYLE, SIZE, OR COLOR.

SER. NO. 77-386,430, FILED 2-1-2008.

STEVEN R. FINE, EXAMINING ATTORNEY

Int. Cl.: 30

Prior U.S. Cl.: 46

United States Patent and Trademark Office

Reg. No. 3,482,695

Registered Aug. 5, 2008

**TRADEMARK
SUPPLEMENTAL REGISTER**

Freeport Coffee Roasting

SIMMONS, KENT A (UNITED STATES INDIVIDUAL), DBA FREEPORT COFFEE ROASTING,

8 EVERGREEN DRIVE

FREEPORT, ME 04032

FOR: COFFEE AND COFFEE SUBSTITUTES, IN CLASS 30 (U.S. CL. 46).

FIRST USE 4-28-2008; IN COMMERCE 4-28-2008.

THE MARK CONSISTS OF STANDARD CHARACTERS WITHOUT CLAIM TO ANY PARTICULAR FONT, STYLE, SIZE, OR COLOR.

NO CLAIM IS MADE TO THE EXCLUSIVE RIGHT TO USE "COFFEE", APART FROM THE MARK AS SHOWN.

SER. NO. 77-387,541, FILED P.R. 2-4-2008; AM. S.R. 6-19-2008.

ROBIN MITTLER, EXAMINING ATTORNEY

Int. Cl.: 16

Prior U.S. Cls.: 2, 5, 22, 23, 29, 37, 38, and 50

United States Patent and Trademark Office

Reg. No. 3,482,696

Registered Aug. 5, 2008

**TRADEMARK
SUPPLEMENTAL REGISTER**

Tattoos for Tots

TATTOOS FOR TOTS, LLC (CALIFORNIA LTD
LIAB CO)
P.O. BOX 6714
SAN MATEO, CA 94403

NO CLAIM IS MADE TO THE EXCLUSIVE
RIGHT TO USE "TATTOOS", APART FROM THE
MARK AS SHOWN.

FOR: TEMPORARY TATTOOS, IN CLASS 16 (U.S.
CLS. 2, 5, 22, 23, 29, 37, 38 AND 50).

SER. NO. 77-388,388, FILED P.R. 2-5-2008; AM. S.R.
6-24-2008.

FIRST USE 5-13-2005; IN COMMERCE 5-18-2005.

OWNER OF U.S. REG. NO. 3,110,753.

LINDA LAVACHE, EXAMINING ATTORNEY

Int. Cl.: 16

Prior U.S. Cls.: 2, 5, 22, 23, 29, 37, 38, and 50

United States Patent and Trademark Office

Reg. No. 3,482,697

Registered Aug. 5, 2008

**TRADEMARK
SUPPLEMENTAL REGISTER**



TATTOOS FOR TOTS, LLC (CALIFORNIA LTD
LIAB CO)
P.O. BOX 6714
SAN MATEO, CA 94403

NO CLAIM IS MADE TO THE EXCLUSIVE
RIGHT TO USE "TATTOOS", APART FROM THE
MARK AS SHOWN.

FOR: TEMPORARY TATTOOS, IN CLASS 16 (U.S.
CLS. 2, 5, 22, 23, 29, 37, 38 AND 50).

SER. NO. 77-388,390, FILED P.R. 2-5-2008; AM. S.R.
7-1-2008.

FIRST USE 5-13-2005; IN COMMERCE 5-18-2005.

OWNER OF U.S. REG. NO. 3,110,753.

LINDA LAVACHE, EXAMINING ATTORNEY

Int. Cls.: 35 and 44

Prior U.S. Cls.: 100, 101, and 102

United States Patent and Trademark Office

Reg. No. 3,482,698

Registered Aug. 5, 2008

**SERVICE MARK
SUPPLEMENTAL REGISTER**

Roadside Medical

LONG HAUL CLINCS LLC (FLORIDA LTD LIAB
CO)
4411 CLEVELAND AVENUE
FORT MYERS, FL 33901

FOR: PROVIDING ASSISTANCE, FITNESS EVALUATION AND CONSULTATION TO CORPORATE CLIENTS TO HELP THEIR EMPLOYEES MAKE HEALTH, WELLNESS AND NUTRITIONAL CHANGES IN THEIR DAILY LIVING TO INCREASE PRODUCTIVITY AND LOWER HEALTH CARE COSTS, IN CLASS 35 (U.S. CLS. 100, 101 AND 102).

FIRST USE 3-1-2007; IN COMMERCE 1-10-2008.

FOR: MEDICAL CLINICS; MEDICAL SERVICES, NAMELY, PRE-EMPLOYMENT DRUG SCREENING; HEALTH CARE; HEALTH CARE SERVICES, NAMELY, DISEASE MANAGEMENT PROGRAMS; HEALTH CARE SERVICES, NAMELY, WELLNESS

PROGRAMS; HEALTHCARE SERVICES, NAMELY, TREATMENT OF PATIENTS WITH SNORING AND SLEEP APNEA DISORDERS; MEDICAL SERVICES, NAMELY, CONVENIENT CARE, IN CLASS 44 (U.S. CLS. 100 AND 101).

FIRST USE 3-1-2007; IN COMMERCE 1-10-2008.

THE MARK CONSISTS OF STANDARD CHARACTERS WITHOUT CLAIM TO ANY PARTICULAR FONT, STYLE, SIZE, OR COLOR.

NO CLAIM IS MADE TO THE EXCLUSIVE RIGHT TO USE "MEDICAL", APART FROM THE MARK AS SHOWN.

SER. NO. 77-393,467, FILED P.R. 2-11-2008; AM. S.R. 6-25-2008.

KEVON CHISOLM, EXAMINING ATTORNEY

Int. Cl.: 43

Prior U.S. Cls.: 100 and 101

United States Patent and Trademark Office

Reg. No. 3,482,699

Registered Aug. 5, 2008

**SERVICE MARK
SUPPLEMENTAL REGISTER**

FALAFEL FUSION

BORDAY, ROBERT (UNITED STATES INDIVIDUAL)
332 OAK ST.
HOLLYWOOD, FL 33019

FOR: TAKE-OUT RESTAURANT SERVICES; RESTAURANT SERVICES; RESTAURANT SERVICES FEATURING SANDWICHES, IN CLASS 43 (U.S. CLS. 100 AND 101).

FIRST USE 11-7-2007; IN COMMERCE 11-7-2007.

THE MARK CONSISTS OF STANDARD CHARACTERS WITHOUT CLAIM TO ANY PARTICULAR FONT, STYLE, SIZE, OR COLOR.

SER. NO. 77-394,829, FILED P.R. 2-12-2008; AM. S.R. 6-24-2008.

BRIAN NEVILLE, EXAMINING ATTORNEY

Int. Cl.: 35

Prior U.S. Cls.: 100, 101, and 102

United States Patent and Trademark Office

Reg. No. 3,482,700

Registered Aug. 5, 2008

**SERVICE MARK
SUPPLEMENTAL REGISTER**

GREEN FLEET SYSTEMS

GREEN FLEET SYSTEMS, LLC (DELAWARE
LTD LIAB CO)
19530 ALAMEDA STREET
RANCHO DOMINQUEZ, CA 90221

FOR: TRANSPORTATION LOGISTICS SERVICES,
NAMELY, ARRANGING THE TRANSPORTATION
OF GOODS FOR OTHERS, IN CLASS 35 (U.S. CLS.
100, 101 AND 102).

FIRST USE 1-23-2008; IN COMMERCE 1-23-2008.

THE MARK CONSISTS OF STANDARD CHAR-
ACTERS WITHOUT CLAIM TO ANY PARTICULAR
FONT, STYLE, SIZE, OR COLOR.

SER. NO. 77-395,385, FILED P.R. 2-12-2008; AM. S.R.
6-23-2008.

G. MAYERSCHOFF, EXAMINING ATTORNEY

Int. Cl.: 21

Prior U.S. Cls.: 2, 13, 23, 29, 30, 33, 40, and 50

United States Patent and Trademark Office

Reg. No. 3,482,701

Registered Aug. 5, 2008

**TRADEMARK
SUPPLEMENTAL REGISTER**

Baiden

AYSE SEN (TURKEY INDIVIDUAL)
7491 COLLINS AVE #304
LA MESA, CA 91942

THE MARK CONSISTS OF STANDARD CHAR-
ACTERS WITHOUT CLAIM TO ANY PARTICULAR
FONT, STYLE, SIZE, OR COLOR.

FOR: HYGIENIC AND BEAUTY CARE PRO-
DUCTS, NAMELY, EXFOLIATING MITTS, IN
CLASS 21 (U.S. CLS. 2, 13, 23, 29, 30, 33, 40 AND 50).

SER. NO. 77-397,639, FILED P.R. 2-14-2008; AM. S.R.
6-9-2008.

FIRST USE 12-11-2007; IN COMMERCE 12-16-2007.

MELISSA VALLILLO, EXAMINING ATTORNEY

Int. Cls.: 9 and 16

Prior U.S. Cls.: 2, 5, 21, 22, 23, 26, 29, 36, 37, 38, and 50

United States Patent and Trademark Office

Reg. No. 3,482,702

Registered Aug. 5, 2008

**TRADEMARK
SUPPLEMENTAL REGISTER**

first care reality series

GOLD CROSS AMBULANCE SERVICE, INC.
(WISCONSIN CORPORATION)
1055 WITTMANN DRIVE
MENASHA, WI 54952

FOR: PRE-RECORDED DVD'S FEATURING
EMERGENCY FIRST AID TRAINING, IN CLASS 9
(U.S. CLS. 21, 23, 26, 36 AND 38).

FIRST USE 1-7-2008; IN COMMERCE 2-15-2008.

FOR: PRINTED MANUALS AND BROCHURES
RELATING TO EMERGENCY FIRST AID TRAIN-

ING, IN CLASS 16 (U.S. CLS. 2, 5, 22, 23, 29, 37, 38 AND
50).

FIRST USE 1-7-2008; IN COMMERCE 2-15-2008.

THE MARK CONSISTS OF STANDARD CHAR-
ACTERS WITHOUT CLAIM TO ANY PARTICULAR
FONT, STYLE, SIZE, OR COLOR.

SER. NO. 77-400,099, FILED P.R. 2-19-2008; AM. S.R.
6-26-2008.

RON FAIRBANKS, EXAMINING ATTORNEY

Int. Cl.: 37

Prior U.S. Cls.: 100, 103, and 106

United States Patent and Trademark Office

Reg. No. 3,482,703

Registered Aug. 5, 2008

**SERVICE MARK
SUPPLEMENTAL REGISTER**

**Salt Water Chlorinating
w/Co2 pH Control!**

WILLAWALL INVESTMENTS INC. (TEXAS COR-
PORATION)
STE. 108-105
14439 NW MILITARY HWY.
SAN ANTONIO, TX 78231

FOR: SWIMMING POOL MAINTENANCE, IN
CLASS 37 (U.S. CLS. 100, 103 AND 106).

FIRST USE 1-1-2007; IN COMMERCE 9-1-2007.

THE MARK CONSISTS OF STANDARD CHAR-
ACTERS WITHOUT CLAIM TO ANY PARTICULAR
FONT, STYLE, SIZE, OR COLOR.

SER. NO. 77-407,218, FILED P.R. 2-27-2008; AM. S.R.
6-25-2008.

NANCY CLARKE, EXAMINING ATTORNEY

Int. Cl.: 33

Prior U.S. Cls.: 47 and 49

United States Patent and Trademark Office

Reg. No. 3,482,704

Registered Aug. 5, 2008

**TRADEMARK
SUPPLEMENTAL REGISTER**



LATITUDE BEVERAGE COMPANY (MASSA-
CHUSETTS CORPORATION)
3RD FLOOR
8 FANEUIL HALL
BOSTON, MA 02109

FIRST USE 2-10-2008; IN COMMERCE 2-10-2008.

SER. NO. 77-408,338, FILED P.R. 2-28-2008; AM. S.R.
6-19-2008.

FOR: WINES, IN CLASS 33 (U.S. CLS. 47 AND 49).

JASON BLAIR, EXAMINING ATTORNEY

Int. Cl.: 9

Prior U.S. Cls.: 21, 23, 26, 36, and 38

United States Patent and Trademark Office

Reg. No. 3,482,705

Registered Aug. 5, 2008

**TRADEMARK
SUPPLEMENTAL REGISTER**

ROV MODELER

MUN, JOHNATHAN (UNITED STATES INDIVIDUAL)
2824 CEDRUS COURT
PLEASANTON, CA 94588

FOR: COMPUTER SOFTWARE FOR COMPUTING AND VALUING PROJECT RISKS, OPTIMIZING PORTFOLIOS, SIMULATING AND FORECASTING THE FUTURE OF VARIOUS CORPORATE, FINANCIAL AND ECONOMIC VARIABLES, DECISION ANALYSIS, AND VALUING OF BASIC TO ADVANCED FINANCIAL, CREDIT AND MARKET RISKS, IN CLASS 9 (U.S. CLS. 21, 23, 26, 36 AND 38).

FIRST USE 6-2-2008; IN COMMERCE 6-2-2008.

THE MARK CONSISTS OF STANDARD CHARACTERS WITHOUT CLAIM TO ANY PARTICULAR FONT, STYLE, SIZE, OR COLOR.

SER. NO. 77-412,137, FILED P.R. 3-4-2008; AM. S.R. 6-25-2008.

KATHERINE CONNOLLY, EXAMINING ATTORNEY

Int. Cl.: 9

Prior U.S. Cls.: 21, 23, 26, 36, and 38

United States Patent and Trademark Office

Reg. No. 3,482,706

Registered Aug. 5, 2008

**TRADEMARK
SUPPLEMENTAL REGISTER**

ROV OPTIMIZER

MUN, JOHNATHAN (UNITED STATES INDIVIDUAL)
2824 CEDRUS COURT
PLEASANTON, CA 94588

FOR: COMPUTER SOFTWARE FOR COMPUTING AND VALUING PROJECT RISKS, OPTIMIZING PORTFOLIOS, SIMULATING AND FORECASTING THE FUTURE OF VARIOUS CORPORATE, FINANCIAL AND ECONOMIC VARIABLES, DECISION ANALYSIS, AND VALUING OF BASIC TO ADVANCED FINANCIAL, CREDIT AND MARKET RISKS, IN CLASS 9 (U.S. CLS. 21, 23, 26, 36 AND 38).

FIRST USE 6-2-2008; IN COMMERCE 6-2-2008.

THE MARK CONSISTS OF STANDARD CHARACTERS WITHOUT CLAIM TO ANY PARTICULAR FONT, STYLE, SIZE, OR COLOR.

SER. NO. 77-412,153, FILED P.R. 3-4-2008; AM. S.R. 6-25-2008.

KATHERINE CONNOLLY, EXAMINING ATTORNEY

Int. Cl.: 9

Prior U.S. Cls.: 21, 23, 26, 36, and 38

United States Patent and Trademark Office

Reg. No. 3,482,707

Registered Aug. 5, 2008

**TRADEMARK
SUPPLEMENTAL REGISTER**

ROV VALUATOR

MUN, JOHNATHAN (UNITED STATES INDIVIDUAL)
2824 CEDRUS COURT
PLEASANTON, CA 94588

FOR: COMPUTER SOFTWARE FOR COMPUTING AND VALUING PROJECT RISKS, OPTIMIZING PORTFOLIOS, SIMULATING AND FORECASTING THE FUTURE OF VARIOUS CORPORATE, FINANCIAL AND ECONOMIC VARIABLES, DECISION ANALYSIS, AND VALUING OF BASIC TO ADVANCED FINANCIAL, CREDIT AND MARKET RISKS, IN CLASS 9 (U.S. CLS. 21, 23, 26, 36 AND 38).

FIRST USE 6-2-2008; IN COMMERCE 6-2-2008.

THE MARK CONSISTS OF STANDARD CHARACTERS WITHOUT CLAIM TO ANY PARTICULAR FONT, STYLE, SIZE, OR COLOR.

SER. NO. 77-412,157, FILED P.R. 3-4-2008; AM. S.R. 6-25-2008.

KATHERINE CONNOLLY, EXAMINING ATTORNEY

Int. Cl.: 16

Prior U.S. Cls.: 2, 5, 22, 23, 29, 37, 38, and 50

Reg. No. 3,482,708

United States Patent and Trademark Office

Registered Aug. 5, 2008

**TRADEMARK
SUPPLEMENTAL REGISTER**

Megapixels

BONNIER ACTIVE MEDIA, INC. (NEW YORK CORPORATION), DBA TIME4 MEDIA, INC.,
460 N. ORLANDO AVENUE, SUITE 200
WINTER PARK, FL 32789

FOR: PRINTED MATTER, NAMELY, A MONTHLY COLUMN IN A SCIENCE MAGAZINE FEATURING INSPIRING VISIONS FROM THE WORLD OF SCIENCE AND TECHNOLOGY, BILLED AS THE "MUST-SEE" PHOTOS OF THE MONTH, IN CLASS 16 (U.S. CLS. 2, 5, 22, 23, 29, 37, 38 AND 50).

FIRST USE 1-1-2006; IN COMMERCE 1-1-2006.

THE MARK CONSISTS OF STANDARD CHARACTERS WITHOUT CLAIM TO ANY PARTICULAR FONT, STYLE, SIZE, OR COLOR.

OWNER OF U.S. REG. NOS. 636,827 AND 3,231,383.

SER. NO. 77-412,532, FILED P.R. 3-4-2008; AM. S.R. 6-23-2008.

SHAUNIA CARLYLE, EXAMINING ATTORNEY

Int. Cl.: 43

Prior U.S. Cls.: 100 and 101

United States Patent and Trademark Office

Reg. No. 3,482,709

Registered Aug. 5, 2008

**SERVICE MARK
SUPPLEMENTAL REGISTER**

CAMP 4 DOGS

GUTIERREZ, JENNIFER (UNITED STATES IN-
DIVIDUAL)
P.O. BOX 235362
ENCINITAS, CA 92023

FOR: PET DAY CARE SERVICES, IN CLASS 43
(U.S. CLS. 100 AND 101).

FIRST USE 1-1-2008; IN COMMERCE 1-1-2008.

THE MARK CONSISTS OF STANDARD CHAR-
ACTERS WITHOUT CLAIM TO ANY PARTICULAR
FONT, STYLE, SIZE, OR COLOR.

SER. NO. 77-412,853, FILED P.R. 3-4-2008; AM. S.R.
6-16-2008.

TEJBIR SINGH, EXAMINING ATTORNEY

Int. Cl.: 9

Prior U.S. Cls.: 21, 23, 26, 36, and 38

United States Patent and Trademark Office

Reg. No. 3,482,710

Registered Aug. 5, 2008

**TRADEMARK
SUPPLEMENTAL REGISTER**

Site Decision Systems

X-SPAN RESULTS, LLC (NORTH CAROLINA
LTD LIAB CO)
207 EDUCATION AVENUE
DURHAM, NC 27713

FOR: COMPUTER SOFTWARE AND HARD-
WARE FOR HELPING ITS CLIENTS WORK
THROUGH VARIOUS REAL ESTATE AND SITE
MANAGEMENT EFFORTS, IN CLASS 9 (U.S. CLS.
21, 23, 26, 36 AND 38).

FIRST USE 2-4-2008; IN COMMERCE 2-4-2008.

THE MARK CONSISTS OF STANDARD CHAR-
ACTERS WITHOUT CLAIM TO ANY PARTICULAR
FONT, STYLE, SIZE, OR COLOR.

NO CLAIM IS MADE TO THE EXCLUSIVE
RIGHT TO USE "DECISION SYSTEMS", APART
FROM THE MARK AS SHOWN.

SER. NO. 77-413,111, FILED P.R. 3-4-2008; AM. S.R.
6-18-2008.

MELVIN AXILBUND, EXAMINING ATTORNEY

Int. Cl.: 35

Prior U.S. Cls.: 100, 101, and 102

United States Patent and Trademark Office

Reg. No. 3,482,711

Registered Aug. 5, 2008

**SERVICE MARK
SUPPLEMENTAL REGISTER**

Balan

BALAN BIOMEDICAL INC. (NEW YORK CORPORATION)
SUITE 100
150 LUCIUS GORDON DR.
WEST HENRIETTA, NY 14586

THE MARK CONSISTS OF STANDARD CHARACTERS WITHOUT CLAIM TO ANY PARTICULAR FONT, STYLE, SIZE, OR COLOR.

FOR: MARKET RESEARCH SERVICES, IN CLASS 35 (U.S. CLS. 100, 101 AND 102).

SER. NO. 77-424,849, FILED 3-18-2008.

FIRST USE 4-20-2006; IN COMMERCE 4-20-2006.

MICHAEL SOUDERS, EXAMINING ATTORNEY

Int. Cl.: 35

Prior U.S. Cls.: 100, 101, and 102

United States Patent and Trademark Office

Reg. No. 3,482,712

Registered Aug. 5, 2008

**SERVICE MARK
SUPPLEMENTAL REGISTER**

Balan Biomedical

BALAN BIOMEDICAL INC. (NEW YORK COR-
PORATION)
SUITE 100
150 LUCIUS GORDON DR.
WEST HENRIETTA, NY 14586

FOR: MARKET RESEARCH SERVICES, IN CLASS
35 (U.S. CLS. 100, 101 AND 102).

FIRST USE 4-20-2006; IN COMMERCE 4-20-2006.

THE MARK CONSISTS OF STANDARD CHAR-
ACTERS WITHOUT CLAIM TO ANY PARTICULAR
FONT, STYLE, SIZE, OR COLOR.

NO CLAIM IS MADE TO THE EXCLUSIVE
RIGHT TO USE "BIOMEDICAL", APART FROM
THE MARK AS SHOWN.

SER. NO. 77-424,875, FILED 3-18-2008.

MICHAEL SOUDERS, EXAMINING ATTORNEY

Int. Cl.: 39

Prior U.S. Cls.: 100 and 105

United States Patent and Trademark Office

Reg. No. 3,482,713

Registered Aug. 5, 2008

**SERVICE MARK
SUPPLEMENTAL REGISTER**

FRESH FOOD EXPRESS

PISCIOTTA, PHIL (UNITED STATES INDIVIDUAL)
3620 S. KETTERMAN
OAK GROVE, MO 64075

FOR: PICK UP, DELIVERY AND STORAGE OF PERSONAL PROPERTY; STORAGE AND DELIVERY OF GOODS; TRANSPORT AND DELIVERY OF GOODS; EXPRESS DELIVERY OF GOODS BY TRUCK; DELIVERY OF GOODS; ALL THE FOREGOING PRIMARILY RELATED TO FOOD AND FOOD RELATED GOODS, IN CLASS 39 (U.S. CLS. 100 AND 105).

FIRST USE 3-1-2008; IN COMMERCE 3-1-2008.

THE MARK CONSISTS OF STANDARD CHARACTERS WITHOUT CLAIM TO ANY PARTICULAR FONT, STYLE, SIZE, OR COLOR.

SER. NO. 77-425,671, FILED P.R. 3-19-2008; AM. S.R. 7-1-2008.

JAY BESCH, EXAMINING ATTORNEY

Int. Cl.: 16

Prior U.S. Cls.: 2, 5, 22, 23, 29, 37, 38, and 50

United States Patent and Trademark Office

Reg. No. 3,482,714

Registered Aug. 5, 2008

**TRADEMARK
SUPPLEMENTAL REGISTER**

ATLANTA PETZ

DUNKIN' CHERRIES PUBLISHING LLC (GEOR-
GIA LTD LIAB CO)
1031 FARRINGTON WAY
CUMMING, GA 30041

FOR: MAGAZINES FEATURING PETS, IN CLASS
16 (U.S. CLS. 2, 5, 22, 23, 29, 37, 38 AND 50).

FIRST USE 7-18-2007; IN COMMERCE 9-15-2007.

THE MARK CONSISTS OF STANDARD CHAR-
ACTERS WITHOUT CLAIM TO ANY PARTICULAR
FONT, STYLE, SIZE, OR COLOR.

SER. NO. 77-427,178, FILED P.R. 3-20-2008; AM. S.R.
6-26-2008.

PAM WILLIS, EXAMINING ATTORNEY

Int. Cl.: 41

Prior U.S. Cls.: 100, 101, and 107

United States Patent and Trademark Office

Reg. No. 3,482,715

Registered Aug. 5, 2008

**SERVICE MARK
SUPPLEMENTAL REGISTER**

THE KIDS CLUB FOR FLOWERS

BLATCHFORD, BARBARA (UNITED STATES
INDIVIDUAL)
1320 N. STATE PARKWAY
CHICAGO, IL 60610

FOR: EDUCATION SERVICES, NAMELY, MENTORING IN THE FIELD OF TEACHING CHILDREN ABOUT HORTICULTURE VIA ACTIVITIES WITH LIVE PLANTS AND FLOWERS, IN CLASS 41 (U.S. CLS. 100, 101 AND 107).

FIRST USE 1-1-1979; IN COMMERCE 1-1-1979.

THE MARK CONSISTS OF STANDARD CHARACTERS WITHOUT CLAIM TO ANY PARTICULAR FONT, STYLE, SIZE, OR COLOR.

SER. NO. 77-427,311, FILED P.R. 3-20-2008; AM. S.R. 6-30-2008.

DANNEAN HETZEL, EXAMINING ATTORNEY

Int. Cl.: 16

Prior U.S. Cls.: 2, 5, 22, 23, 29, 37, 38, and 50

United States Patent and Trademark Office

Reg. No. 3,482,716

Registered Aug. 5, 2008

**TRADEMARK
SUPPLEMENTAL REGISTER**

The Bible in 52 "Chunks"

SHORT, MELTON (UNITED STATES INDIVIDUAL)
P.O. BOX 412
CLANTON, AL 350460412

FOR: RELIGIOUS BOOKS AND PUBLICATIONS, NAMELY, TEXTBOOKS, WORKBOOKS, STUDY GUIDES AND TRAINING MATERIALS IN THE FIELD OF BIBLE INSTRUCTION, CHRISTIAN EDUCATION, AND DISCIPLESHIP, IN CLASS 16 (U.S. CLS. 2, 5, 22, 23, 29, 37, 38 AND 50).

FIRST USE 1-1-2008; IN COMMERCE 3-11-2008.

THE MARK CONSISTS OF STANDARD CHARACTERS WITHOUT CLAIM TO ANY PARTICULAR FONT, STYLE, SIZE, OR COLOR.

NO CLAIM IS MADE TO THE EXCLUSIVE RIGHT TO USE "BIBLE", APART FROM THE MARK AS SHOWN.

SER. NO. 77-427,884, FILED P.R. 3-20-2008; AM. S.R. 6-27-2008.

MELVIN AXILBUND, EXAMINING ATTORNEY

Int. Cls.: 35 and 43

Prior U.S. Cls.: 100, 101, and 102

United States Patent and Trademark Office

Reg. No. 3,482,717

Registered Aug. 5, 2008

**SERVICE MARK
SUPPLEMENTAL REGISTER**

WINE IMBIBER

HABEAS MIRTH CORP. (CALIFORNIA CORPORATION)
2336 GREENFIELD AVENUE
LOS ANGELES, CA 900641908

FOR: ADVERTISING SERVICES, NAMELY, PROVIDING INFORMATION AS TO THE AVAILABILITY OF WINE AND FOOD PRODUCTS AND SERVICES FOR RENT OR PURCHASE, IN CLASS 35 (U.S. CLS. 100, 101 AND 102).

FIRST USE 1-1-2008; IN COMMERCE 1-1-2008.

FOR: PROVIDING INFORMATION ABOUT WINE CHARACTERISTICS, IN CLASS 43 (U.S. CLS. 100 AND 101).

FIRST USE 1-1-2008; IN COMMERCE 1-1-2008.

THE MARK CONSISTS OF STANDARD CHARACTERS WITHOUT CLAIM TO ANY PARTICULAR FONT, STYLE, SIZE, OR COLOR.

NO CLAIM IS MADE TO THE EXCLUSIVE RIGHT TO USE "WINE", APART FROM THE MARK AS SHOWN.

SER. NO. 77-429,829, FILED P.R. 3-24-2008; AM. S.R. 6-27-2008.

MARY ROSSMAN, EXAMINING ATTORNEY

Int. Cl.: 44

Prior U.S. Cls.: 100 and 101

United States Patent and Trademark Office

Reg. No. 3,482,718

Registered Aug. 5, 2008

**SERVICE MARK
SUPPLEMENTAL REGISTER**

An easy eating plan to
maintain your ideal weight
for the rest of your life.

DOW, MICHAEL STEPHEN (UNITED STATES
INDIVIDUAL)
2449 S CASS AVE
TUCSON, AZ 85708

THE MARK CONSISTS OF STANDARD CHAR-
ACTERS WITHOUT CLAIM TO ANY PARTICULAR
FONT, STYLE, SIZE, OR COLOR.

FOR: WEIGHT REDUCTION DIET PLANNING
AND SUPERVISION, IN CLASS 44 (U.S. CLS. 100
AND 101).

SER. NO. 77-430,311, FILED P.R. 3-25-2008; AM. S.R.
6-27-2008.

FIRST USE 3-24-2008; IN COMMERCE 3-24-2008.

ZHALEH DELANEY, EXAMINING ATTORNEY

Int. Cl.: 9

Prior U.S. Cls.: 21, 23, 26, 36, and 38

Reg. No. 3,482,719

United States Patent and Trademark Office

Registered Aug. 5, 2008

**TRADEMARK
SUPPLEMENTAL REGISTER**

O.R. PEER

FRIEDRICK SCHWEITZER (MONTANA LTD
LIAB CO)
2155 SOUTH WALNUT, APT 2
BOULDER, CO 80302

FOR: EDUCATIONAL SOFTWARE FEATURING
INSTRUCTION IN OPERATING ROOM PREPARA-
TION, IN CLASS 9 (U.S. CLS. 21, 23, 26, 36 AND 38).

FIRST USE 6-30-2005; IN COMMERCE 6-30-2005.

THE MARK CONSISTS OF STANDARD CHAR-
ACTERS WITHOUT CLAIM TO ANY PARTICULAR
FONT, STYLE, SIZE, OR COLOR.

SER. NO. 77-433,165, FILED 3-27-2008.

CHRISTOPHER BUONGIORNO, EXAMINING AT-
TORNEY

Int. Cls.: 9 and 16

Prior U.S. Cls.: 2, 5, 21, 22, 23, 26, 29, 36, 37, 38, and 50

Reg. No. 3,482,720

United States Patent and Trademark Office

Registered Aug. 5, 2008

**TRADEMARK
SUPPLEMENTAL REGISTER**

DC

MODERN LUXURY MEDIA, LLC (DELAWARE
LTD LIAB CO)
200 WEST HUBBARD STREET
CHICAGO, IL 60610

FOR: ELECTRONIC PUBLICATIONS, NAMELY,
A MAGAZINE IN THE FIELD OF FASHION, AC-
CESSORIES, JEWELRY, HOME DESIGN, TRAVEL,
FINE FOOD AND WINE, CULTURE, ART, REAL
ESTATE, SOCIETY, CELEBRITY, AND GENERAL
LUXURY LIFESTYLE, IN CLASS 9 (U.S. CLS. 21, 23,
26, 36 AND 38).

FIRST USE 9-12-2005; IN COMMERCE 9-12-2005.

FOR: MAGAZINE IN THE FIELD OF FASHION,
ACCESSORIES, JEWELRY, HOME DESIGN, TRA-
VEL, FINE FOOD AND WINE, CULTURE, ART,
REAL ESTATE, SOCIETY, CELEBRITY, AND GEN-
ERAL LUXURY LIFESTYLE, IN CLASS 16 (U.S. CLS.
2, 5, 22, 23, 29, 37, 38 AND 50).

FIRST USE 9-12-2005; IN COMMERCE 9-12-2005.

SER. NO. 78-549,822, FILED P.R. 1-19-2005; AM. S.R.
5-25-2006.

FLORENTINA BLANDU, EXAMINING ATTORNEY

Int. Cl.: 5

Prior U.S. Cls.: 6, 18, 44, 46, 51, and 52

United States Patent and Trademark Office

Reg. No. 3,482,721

Registered Aug. 5, 2008

**TRADEMARK
SUPPLEMENTAL REGISTER**

**A Personal Space Air
Freshener**

WATSON, TRACI R. (UNITED STATES INDIVIDUAL)
2528 E. 125TH STREET
COMPTON, CA 90222

FOR: AIR FRESHNER, IN CLASS 5 (U.S. CLS. 6, 18, 44, 46, 51 AND 52).

FIRST USE 2-1-2005; IN COMMERCE 5-24-2005.

THE MARK CONSISTS OF STANDARD CHARACTERS WITHOUT CLAIM TO ANY PARTICULAR FONT, STYLE, SIZE, OR COLOR.

NO CLAIM IS MADE TO THE EXCLUSIVE RIGHT TO USE "AIR FRESHENER", APART FROM THE MARK AS SHOWN.

SER. NO. 78-671,329, FILED P.R. 7-15-2005; AM. S.R. 12-11-2007.

MATTHEW MCDOWELL, EXAMINING ATTORNEY

Int. Cl.: 41

Prior U.S. Cls.: 100, 101, and 107

United States Patent and Trademark Office

Reg. No. 3,482,722

Registered Aug. 5, 2008

**SERVICE MARK
SUPPLEMENTAL REGISTER**

AN AMERICAN VIRTUAL ACADEMY

THE INSTITUTE FOR EDUCATIONAL DEVELOPMENT, INC. (ARIZONA CORPORATION)
3029 N. ALMA SCHOOL RD., #226
CHANDLER, AZ 85224

FOR: EDUCATIONAL SERVICES, NAMELY, DEVELOPING AND PROVIDING HIGH SCHOOL LEVEL CURRICULA IN A VARIETY OF SUBJECTS VIA AN ONLINE COMMUNICATION NETWORK, IN CLASS 41 (U.S. CLS. 100, 101 AND 107).

FIRST USE 5-11-2004; IN COMMERCE 5-11-2004.

THE MARK CONSISTS OF STANDARD CHARACTERS WITHOUT CLAIM TO ANY PARTICULAR FONT, STYLE, SIZE, OR COLOR.

NO CLAIM IS MADE TO THE EXCLUSIVE RIGHT TO USE "ACADEMY", APART FROM THE MARK AS SHOWN.

SER. NO. 78-702,869, FILED P.R. 8-29-2005; AM. S.R. 10-17-2007.

MICHAEL WEBSTER, EXAMINING ATTORNEY

Int. Cl.: 33

Prior U.S. Cls.: 47 and 49

United States Patent and Trademark Office

Reg. No. 3,482,723

Registered Aug. 5, 2008

**TRADEMARK
SUPPLEMENTAL REGISTER**

Lost grape of Bordeaux

SCHWARTZ, NORMAN, S (UNITED STATES IN-
DIVIDUAL)
141 WEST 78TH STREET
NEW YORK, NY 10024

FOR: WINES, IN CLASS 33 (U.S. CLS. 47 AND 49).

FIRST USE 5-5-2008; IN COMMERCE 5-5-2008.

THE MARK CONSISTS OF STANDARD CHAR-
ACTERS WITHOUT CLAIM TO ANY PARTICULAR
FONT, STYLE, SIZE, OR COLOR.

SER. NO. 78-771,809, FILED P.R. 12-13-2005; AM.
S.R. 5-3-2008.

LYDIA BELZER, EXAMINING ATTORNEY

Int. Cl.: 38

Prior U.S. Cls.: 100, 101, and 104

United States Patent and Trademark Office

Reg. No. 3,482,724

Registered Aug. 5, 2008

**SERVICE MARK
SUPPLEMENTAL REGISTER**

MUSIC MAKER CHANNEL

THE MUSICIAN NETWORK, LLC (KANSAS LTD
LIAB CO)

#357

7111 W. 151ST STREET

OVERLAND PARK, KS 66223

FOR: BROADCASTING SERVICES, NAMELY, A
CABLE TELEVISION CHANNEL FEATURING
CONTENT SPECIFICALLY FOR MUSICIANS AND
MUSIC MAKERS, IN CLASS 38 (U.S. CLS. 100, 101
AND 104).

FIRST USE 4-16-2008; IN COMMERCE 4-16-2008.

THE MARK CONSISTS OF STANDARD CHAR-
ACTERS WITHOUT CLAIM TO ANY PARTICULAR
FONT, STYLE, SIZE, OR COLOR.

NO CLAIM IS MADE TO THE EXCLUSIVE
RIGHT TO USE "CHANNEL", APART FROM THE
MARK AS SHOWN.

SER. NO. 78-806,359, FILED P.R. 2-3-2006; AM. S.R.
4-16-2008.

LINDA ESTRADA, EXAMINING ATTORNEY

Int. Cls.: 16 and 43

Prior U.S. Cls.: 2, 5, 22, 23, 29, 37, 38, 50, 100, and 101

United States Patent and Trademark Office

Reg. No. 3,482,725

Registered Aug. 5, 2008

**TRADEMARK
SERVICE MARK
SUPPLEMENTAL REGISTER**

HEALTHY FAMILY DINNERS

MEREDITH CORPORATION (IOWA CORPORATION)
1716 LOCUST STREET
DES MOINES, IA 503093023

FOR: PRINTED PUBLICATIONS, NAMELY, A MAGAZINE COLUMN, MAGAZINES AND BOOKS THAT CONTAIN RECIPES THAT ARE CALORIE-, FAT- AND SODIUM-CONSCIOUS AND RECIPES THAT SHOWCASE A WIDE VARIETY OF FRUITS AND VEGETABLES, ALL FOCUSING ON THE IMPORTANCE OF NUTRITION IN A FAMILY'S LIFE, IN CLASS 16 (U.S. CLS. 2, 5, 22, 23, 29, 37, 38 AND 50).

FIRST USE 4-18-2006; IN COMMERCE 4-18-2006.

FOR: PROVIDING VIA THE INTERNET RECIPES THAT ARE CALORIE-, FAT- AND SODIUM-CON-

SCIOUS AND RECIPES THAT SHOWCASE A WIDE VARIETY OF FRUITS AND VEGETABLES, ALL FOCUSING ON THE IMPORTANCE OF NUTRITION IN A FAMILY'S LIFE, IN CLASS 43 (U.S. CLS. 100 AND 101).

FIRST USE 4-3-2008; IN COMMERCE 4-3-2008.

THE MARK CONSISTS OF STANDARD CHARACTERS WITHOUT CLAIM TO ANY PARTICULAR FONT, STYLE, SIZE, OR COLOR.

SER. NO. 78-811,193, FILED P.R. 2-9-2006; AM. S.R. 8-23-2007.

ANDREA K. NADELMAN, EXAMINING ATTORNEY

Int. Cl.: 7

Prior U.S. Cls.: 13, 19, 21, 23, 31, 34, and 35

Reg. No. 3,482,726

United States Patent and Trademark Office

Registered Aug. 5, 2008

**TRADEMARK
SUPPLEMENTAL REGISTER**

KONE

ROYAL APPLIANCE MFG. CO. (OHIO COR-
PORATION)
7005 COCHRAN ROAD
GLENWILLOW, OH 44139

THE MARK CONSISTS OF STANDARD CHAR-
ACTERS WITHOUT CLAIM TO ANY PARTICULAR
FONT, STYLE, SIZE, OR COLOR.

FOR: ELECTRICAL VACUUM CLEANERS FOR
BOTH DOMESTIC AND COMMERCIAL USE, IN
CLASS 7 (U.S. CLS. 13, 19, 21, 23, 31, 34 AND 35).

SER. NO. 78-822,501, FILED P.R. 2-24-2006; AM. S.R.
3-5-2008.

FIRST USE 2-28-2006; IN COMMERCE 2-28-2006.

ALLISON SCHRODY, EXAMINING ATTORNEY

Int. Cl.: 20

Prior U.S. Cls.: 2, 13, 22, 25, 32, and 50

Reg. No. 3,482,727

United States Patent and Trademark Office

Registered Aug. 5, 2008

**TRADEMARK
SUPPLEMENTAL REGISTER**

BAROQUE ENSEMBLE

WORLDWIDE CO., LTD. (REPUBLIC OF KOREA
CORPORATION)
#178-244, KAJOA-DONG, SEO-KU
INCHEON, REPUBLIC OF KOREA

THE MARK CONSISTS OF STANDARD CHAR-
ACTERS WITHOUT CLAIM TO ANY PARTICULAR
FONT, STYLE, SIZE, OR COLOR.

FOR: FURNITURE, IN CLASS 20 (U.S. CLS. 2, 13,
22, 25, 32 AND 50).

SER. NO. 78-831,458, FILED P.R. 3-7-2006; AM. S.R.
6-17-2008.

FIRST USE 6-20-2006; IN COMMERCE 6-20-2006.

JAY BESCH, EXAMINING ATTORNEY

Int. Cl.: 35

Prior U.S. Cls.: 100, 101, and 102

United States Patent and Trademark Office

Reg. No. 3,482,728

Registered Aug. 5, 2008

**SERVICE MARK
SUPPLEMENTAL REGISTER**

BAROQUE ENSEMBLE

WORLDWIDE CO., LTD. (REPUBLIC OF KOREA
CORPORATION)
#178-244, KAJOA-DONG, SEO-KU
INCHEON, REPUBLIC OF KOREA

FOR: RETAIL FURNITURE STORES; RETAIL
STORE SERVICES FEATURING FURNITURE;
AND RETAIL FURNITURE STORE SERVICES, IN
CLASS 35 (U.S. CLS. 100, 101 AND 102).

FIRST USE 6-20-2006; IN COMMERCE 6-20-2006.

THE MARK CONSISTS OF STANDARD CHAR-
ACTERS WITHOUT CLAIM TO ANY PARTICULAR
FONT, STYLE, SIZE, OR COLOR.

SER. NO. 78-831,479, FILED P.R. 3-7-2006; AM. S.R.
6-17-2008.

JAY BESCH, EXAMINING ATTORNEY

Int. Cl.: 5

Prior U.S. Cls.: 6, 18, 44, 46, 51, and 52

Reg. No. 3,482,729

United States Patent and Trademark Office

Registered Aug. 5, 2008

**TRADEMARK
SUPPLEMENTAL REGISTER**

GET OVER YOUR COLD FASTER

ZICAM, LLC (ARIZONA LTD LIAB CO)
2375 EAST CAMELBACK ROAD, SUITE 500
PHOENIX, AZ 85016

THE MARK CONSISTS OF STANDARD CHAR-
ACTERS WITHOUT CLAIM TO ANY PARTICULAR
FONT, STYLE, SIZE, OR COLOR.

FOR: OVER-THE-COUNTER PHARMACEUTI-
CAL AND HOMEOPATHIC PREPARATIONS FOR
THE RELIEF OF COLD AND ALLERGY SYMP-
TOMS, IN CLASS 5 (U.S. CLS. 6, 18, 44, 46, 51 AND 52).

SER. NO. 78-852,939, FILED P.R. 4-3-2006; AM. S.R.
6-17-2008.

FIRST USE 12-31-2002; IN COMMERCE 12-31-2002.

ALICE BENMAMAN, EXAMINING ATTORNEY

Int. Cl.: 9

Prior U.S. Cls.: 21, 23, 26, 36, and 38

United States Patent and Trademark Office

Reg. No. 3,482,730

Registered Aug. 5, 2008

**TRADEMARK
SUPPLEMENTAL REGISTER**

GLOKEYS

QRS MUSIC TECHNOLOGIES, INC. (DELAWARE
CORPORATION)
2011 SEWARD AVENUE
NAPLES, FL 34109

THE MARK CONSISTS OF STANDARD CHAR-
ACTERS WITHOUT CLAIM TO ANY PARTICULAR
FONT, STYLE, SIZE, OR COLOR.

FOR: ILLUMINATED PIANO KEYBOARDS HAV-
ING AN ELECTRONIC CONTROLLER, IN CLASS 9
(U.S. CLS. 21, 23, 26, 36 AND 38).

SER. NO. 78-866,609, FILED P.R. 4-21-2006; AM. S.R.
6-9-2008.

FIRST USE 1-31-2006; IN COMMERCE 1-31-2006.

INGA ERVIN, EXAMINING ATTORNEY

Int. Cl.: 5

Prior U.S. Cls.: 6, 18, 44, 46, 51, and 52

United States Patent and Trademark Office

Reg. No. 3,482,731

Registered Aug. 5, 2008

**TRADEMARK
SUPPLEMENTAL REGISTER**

Prostate Therapy

NATUR RESEARCH, INC. (ST.CHRIST-NEVIS
CORPORATION)

11155 MASSACHUSETTS AVENUE

LOS ANGELES, CA 90025

FOR: DIETARY SUPPLEMENTS, IN CLASS 5 (U.S.
CLS. 6, 18, 44, 46, 51 AND 52).

FIRST USE 5-1-2006; IN COMMERCE 5-1-2006.

THE MARK CONSISTS OF STANDARD CHAR-
ACTERS WITHOUT CLAIM TO ANY PARTICULAR
FONT, STYLE, SIZE, OR COLOR.

NO CLAIM IS MADE TO THE EXCLUSIVE
RIGHT TO USE "PROSTATE", APART FROM THE
MARK AS SHOWN.

SER. NO. 78-910,636, FILED P.R. 6-16-2006; AM. S.R.
12-21-2007.

SETH A. RAPPAPORT, EXAMINING ATTORNEY

Int. Cls.: 38, 39, and 40

Prior U.S. Cls.: 100, 101, 103, 104, 105, and 106

United States Patent and Trademark Office

Reg. No. 3,482,732

Registered Aug. 5, 2008

**SERVICE MARK
SUPPLEMENTAL REGISTER**

ONECLICK CAPTURE

GRM INFORMATION MANAGEMENT SERVICES, INC. (NEW JERSEY CORPORATION)
215 COLES STREET
JERSEY CITY, NJ 07310

FOR: PROVISION OF ACCESS TO DATA OR DOCUMENTS STORED ELECTRONICALLY IN CENTRAL FILES FOR REMOTE CONSULTATION, IN CLASS 38 (U.S. CLS. 100, 101 AND 104).

FIRST USE 8-31-2006; IN COMMERCE 8-31-2006.

FOR: DOCUMENT DELIVERY; ELECTRONIC STORAGE OF FILES AND DOCUMENTS; STORAGE OF ELECTRONIC MEDIA, NAMELY, IMAGES, TEXT AND AUDIO DATA; STORAGE SERVICES FOR ARCHIVING DATABASES, IMAGES AND OTHER ELECTRONIC DATA; WAREHOUSING SERVICES, NAMELY, STORAGE, DISTRIBUTION, PICK-UP, AND PACKING FOR SHIPMENT OF DOCUMENTS, PACKAGES, RAW MATERIALS, AND OTHER FREIGHT FOR OTHERS, IN CLASS 39 (U.S. CLS. 100 AND 105).

FIRST USE 8-31-2006; IN COMMERCE 8-31-2006.

FOR: DIGITAL COMPRESSION OF PAPER, DOCUMENTS, DATA, FILMS, RECORDINGS, BLUEPRINTS, DRAWINGS, X-RAYS, BOOKS, RECORDS AND FILES; DIGITAL ON-DEMAND PRINTING SERVICES OF BOOKS AND OTHER DOCUMENTS; DOCUMENT DESTRUCTION; ELECTRONIC DIGITIZING OF PHOTOGRAPHS INTO A COMPUTER READABLE MEDIA; ELECTRONIC IMAGING, SCANNING, DIGITIZING, ALTERATION AND/OR RETOUCHING OF PAPER, DOCUMENTS, DATA, FILMS, RECORDINGS, BLUEPRINTS, DRAWINGS, X-RAYS, BOOKS, RECORDS AND FILES; MEDIA DUPLICATION OF DATA AND DIGITAL INFORMATION; PHOTOGRAPHIC COMPUTER IMAGING, IN CLASS 40 (U.S. CLS. 100, 103 AND 106).

FIRST USE 8-31-2006; IN COMMERCE 8-31-2006.

THE MARK CONSISTS OF STANDARD CHARACTERS WITHOUT CLAIM TO ANY PARTICULAR FONT, STYLE, SIZE, OR COLOR.

SER. NO. 78-940,293, FILED P.R. 7-28-2006; AM. S.R. 5-16-2008.

DAWN FELDMAN, EXAMINING ATTORNEY

Int. Cl.: 31

Prior U.S. Cls.: 1 and 46

United States Patent and Trademark Office

Reg. No. 3,482,733

Registered Aug. 5, 2008

**TRADEMARK
SUPPLEMENTAL REGISTER**

GOURMET FILETS

MARS, INCORPORATED (DELAWARE CORPORATION)

6885 ELM STREET

MCLEAN, VA 221013883

FOR: PET FOOD, IN CLASS 31 (U.S. CLS. 1 AND 46).

FIRST USE 6-30-2007; IN COMMERCE 6-30-2007.

THE MARK CONSISTS OF STANDARD CHARACTERS WITHOUT CLAIM TO ANY PARTICULAR FONT, STYLE, SIZE, OR COLOR.

NO CLAIM IS MADE TO THE EXCLUSIVE RIGHT TO USE "FILETS", APART FROM THE MARK AS SHOWN.

SER. NO. 78-956,483, FILED P.R. 8-21-2006; AM. S.R. 7-9-2007.

JOHN WILKE, EXAMINING ATTORNEY

Int. Cl.: 9

Prior U.S. Cls.: 21, 23, 26, 36, and 38

United States Patent and Trademark Office

Reg. No. 3,482,734

Registered Aug. 5, 2008

**TRADEMARK
SUPPLEMENTAL REGISTER**

BlinkerSign

TRAFFIC & PARKING CONTROL CO., INC.
(WISCONSIN CORPORATION)
800 WALL STREET
ELM GROVE, WI 53122

FOR: TRAFFIC SIGN INCLUDING LIGHT EMITTING DIODES; LIGHT EMITTING DIODE DISPLAYS; LUMINOUS OR MECHANICAL ROAD SIGNS; LUMINOUS SIGNS , IN CLASS 9 (U.S. CLS. 21, 23, 26, 36 AND 38).

FIRST USE 2-1-2001; IN COMMERCE 2-1-2001.

THE MARK CONSISTS OF STANDARD CHARACTERS WITHOUT CLAIM TO ANY PARTICULAR FONT, STYLE, SIZE, OR COLOR.

SER. NO. 78-959,174, FILED P.R. 8-24-2006; AM. S.R. 5-13-2008.

SUSAN RICHARDS, EXAMINING ATTORNEY

Int. Cls.: 16 and 41

Prior U.S. Cls.: 2, 5, 22, 23, 29, 37, 38, 50, 100, 101, and 107

United States Patent and Trademark Office

Reg. No. 3,482,735

Registered Aug. 5, 2008

**TRADEMARK
SERVICE MARK
SUPPLEMENTAL REGISTER**

**LONG TERM CARE OUTREACH
& EDUCATION PROGRAM**

LTC FINANCIAL PARTNERS, LLC (WASHINGTON LTD LIAB CO)
5110 CARRILON POINT
KIRKLAND, WA 98033

FOR: PRINTED INSTRUCTIONAL AND EDUCATIONAL MATERIAL IN THE FIELD OF LONG-TERM CARE AND INSURANCE, IN CLASS 16 (U.S. CLS. 2, 5, 22, 23, 29, 37, 38 AND 50).

FIRST USE 12-31-2005; IN COMMERCE 12-31-2005.

FOR: EDUCATIONAL SERVICES, NAMELY, PROVIDING COURSES, WORKSHOPS AND SEMINARS IN THE FIELD OF LONG-TERM CARE AND INSURANCE, AND DISTRIBUTION OF COURSE MATERIALS THEREWITH, IN CLASS 41 (U.S. CLS. 100, 101 AND 107).

FIRST USE 12-31-2005; IN COMMERCE 12-31-2005.

THE MARK CONSISTS OF STANDARD CHARACTERS WITHOUT CLAIM TO ANY PARTICULAR FONT, STYLE, SIZE, OR COLOR.

NO CLAIM IS MADE TO THE EXCLUSIVE RIGHT TO USE "EDUCATION PROGRAM", APART FROM THE MARK AS SHOWN.

SER. NO. 78-978,873, FILED P.R. 4-26-2006; AM. S.R. 6-24-2008.

JUDITH HELFMAN, EXAMINING ATTORNEY