

Int. Cl.: 16

Prior U.S. Cls.: 2, 5, 22, 23, 29, 37, 38 and 50

United States Patent and Trademark Office

Reg. No. 3,474,320

Registered July 29, 2008

**TRADEMARK
PRINCIPAL REGISTER**

REMBRANDT

KONINKLIJKE TALENS B.V. (NETHERLANDS
PRIVATE LIMITED COMPANY)
SOPHIALAAN 46
7311 PD APELDOORN, NETHERLANDS

FOR: ARTISTS' PAPER; STATIONERY FOR AR-
TISTS; BROCHURES, CATALOGS AND LEAFLETS,
ALL RELATING TO ARTISTS' SUPPLIES, IN CLASS
16 (U.S. CLS. 2, 5, 22, 23, 29, 37, 38 AND 50).

OWNER OF ERPN CMNTY TM OFC REG. NO.
000119354, DATED 7-30-1998, EXPIRES 4-1-2016.

OWNER OF U.S. REG. NOS. 201,943 AND 506,915.

SER. NO. 75-373,992, FILED 10-16-1997.

MARTHA FROMM, EXAMINING ATTORNEY

Int. Cl.: 36

Prior U.S. Cls.: 100, 101 and 102

United States Patent and Trademark Office

Reg. No. 3,474,321

Registered July 29, 2008

**SERVICE MARK
PRINCIPAL REGISTER**

WHERE EVERYDAY IS PAYDAY

CASH AMERICA ADVANCE, INC. (CALIFORNIA
CORPORATION)
1600 W. 7TH STREET
FORT WORTH, TX 76102

FOR: FINANCIAL SERVICES, NAMELY, CHECK
CASHING SERVICES, SHORT TERM CONSUMER
LOAN SERVICES, DEFERRED DEPOSITS, AND

MONEY ORDERS , IN CLASS 36 (U.S. CLS. 100, 101
AND 102).

FIRST USE 9-0-1980; IN COMMERCE 9-0-1980.

SER. NO. 75-611,020, FILED 12-15-1998.

CAROLYN CATALDO, EXAMINING ATTORNEY

Int. Cl.: 28

Prior U.S. Cls.: 22, 23, 38 and 50

United States Patent and Trademark Office

Reg. No. 3,474,322

Registered July 29, 2008

**TRADEMARK
PRINCIPAL REGISTER**

TOMMY

MATTEL, INC. (DELAWARE CORPORATION)
333 CONTINENTAL BOULEVARD
EL SEGUNDO, CA 902455012

FIRST USE 6-18-1997; IN COMMERCE 6-18-1997.

SER. NO. 75-624,791, FILED 1-22-1999.

FOR: DOLLS, DOLL CLOTHING AND DOLL
ACCESSORIES, IN CLASS 28 (U.S. CLS. 22, 23, 38
AND 50).

TARAH HARDY, EXAMINING ATTORNEY

Int. Cls.: 16, 18, 25, 28, 38 and 42

**Prior U.S. Cls.: 1, 2, 3, 5, 22, 23, 29, 37, 38, 39, 41, 50,
100, 101 and 104**

Reg. No. 3,474,323

United States Patent and Trademark Office

Registered July 29, 2008

**TRADEMARK
SERVICE MARK
PRINCIPAL REGISTER**

ORANGE

ORANGE PERSONAL COMMUNICATIONS SERVICES LIMITED (UNITED KINGDOM COMPANY)

ST. JAMES COURT, GREAT PARK ROAD
ALMONDSBURY PARK, BRADLEY STOKE
BRISTOL BS12 4QJ, UNITED KINGDOM

FOR: PRINTED MATTER, NAMELY, POSTERS; LEAFLETS, BROCHURES, BOOKLETS, INSTRUCTION MANUALS AND INFORMATIONAL FLYERS RELATING TO TELECOMMUNICATIONS, INFORMATIONAL FLYERS, COMPUTERS, THE INTERNET, MOTOR RACING, THE ARTS, BUSINESS PRODUCT PROMOTION, REAL ESTATE, STOCKS AND SHARES, MAINTENANCE AND PRODUCT REPAIR OF PROPERTY, HOUSEHOLD ITEMS, VEHICLES, MAINTENANCE AND REPAIR OF TELECOMMUNICATIONS INSTALLATIONS, NETWORKS, TELEPHONES AND COMPUTER EQUIPMENT, TRAVEL, ENTERTAINMENT, SPORTS NOT INCLUDING THE PRESENTATION OF COLLEGE LEVEL SPORTING EVENTS, CULTURAL EVENTS, TRAVEL AND RESTAURANTS; BOOKS, MAGAZINES, NEWSPAPER AND MAGAZINE PERIODICALS, NEWSLETTERS RELATING TO THE SUBJECT OF TELECOMMUNICATIONS AND COMPUTING; BUT NOT INCLUDING GOODS ON THE SUBJECT OF ORANGES OR ANY SUCH GOODS COLORED ORANGE, IN CLASS 16 (U.S. CLS. 2, 5, 22, 23, 29, 37, 38 AND 50).

FOR: GOODS MADE FROM LEATHER OR IMITATION LEATHER, NAMELY, DUFFEL BAGS, TOTE BAGS, HAND BAGS, ATHLETIC BAGS, BEACH BAGS, BOOK BAGS, CARRY-ON BAGS, DIAPER BAGS, GYM BAGS, OVERNIGHT BAGS, MESH BAGS, SCHOOL BAGS, SHOULDER BAGS, LEATHER SHOPPING BAGS, MESH SHOPPING BAGS, TEXTILE SHOPPING BAGS, ATTACHE CASES, BUSINESS CARD CASES, CALLING CARD CASES, CREDIT CARD CASES, DOCUMENT CASES, KEY CASES, OVERNIGHT CASES, SUITCASES;

UMBRELLAS AND PARASOLS, WALKING STICKS, WALKING CANES FOR NON-MEDICAL PURPOSES; BUT NOT INCLUDING ANY SUCH GOODS COLORED ORANGE, IN CLASS 18 (U.S. CLS. 1, 2, 3, 22 AND 41).

FOR: HATS; TIES; T-SHIRTS; SWEAT SHIRTS; POLO SHIRTS; GOLF SHIRTS; UNDER SHIRTS; NIGHT SHIRTS; KNIT SHIRTS; GYM SHORTS; SWEAT SHORTS; FLEECE JACKETS; WIND RESISTANT JACKETS; LEATHER JACKETS; LONG SLEEVE SWEAT SHIRTS; SHIRTS; BASEBALL CAPS; HEAD BANDS; HEAD WEAR; RAIN COATS; BELTS; BUT NOT INCLUDING ANY SUCH GOODS COLORED ORANGE, IN CLASS 25 (U.S. CLS. 22 AND 39).

FOR: STAND ALONE VIDEO GAME MACHINES; PROMOTIONAL GAME MATERIALS; GAME TABLES; BOARD GAMES; CARD GAMES; HAND HELD UNIT FOR PLAYING ELECTRONIC GAMES; MANIPULATIVE GAMES; PARLOR GAMES; PINBALL TYPE GAMES; ELECTRIC ACTION TOYS; STAND ALONE VIDEO OUTPUT GAMES; SPORTS BALLS; GYMNAS TIC APPARATUS; GYMNAS TIC TRAINING STOOLS BUT NOT INCLUDING ANY SUCH GOODS COLORED ORANGE, IN CLASS 28 (U.S. CLS. 22, 23, 38 AND 50).

FOR: PROVIDING ACCESS TO AN ELECTRONIC ON-LINE NETWORK FOR INFORMATION RETRIEVAL, IN CLASS 38 (U.S. CLS. 100, 101 AND 104).

FOR: COMPUTER SERVICES, NAMELY, COMPILATION, CREATION AND MAINTENANCE OF REGISTER OF DOMAIN NAMES; COMPUTER RENTAL; DESIGN, DRAWING AND COMMISSIONED WRITING ALL FOR THE COMPILATION OF WEB PAGES ON A GLOBAL INFORMATION NETWORK; CREATING AND MAINTAINING WEB SITES; HOSTING WEB SITES OF OTHERS; INSTAL-

LATION AND MAINTENANCE OF COMPUTER SOFTWARE; COMPUTER PROGRAMMING SERVICES FOR OTHERS PERTAINING TO PROVIDING ACCESS TIME TO A COMPUTER DATABASE; COMPUTER PROGRAMMING SERVICES FOR OTHERS; INFORMATION SERVICES IN THE FIELD OF COMPUTERS AND COMPUTER NETWORK FACILITIES; ON-LINE COMPUTER PROGRAMMING FOR OTHERS, ARRANGING OF INSURANCE SECURITY REGISTRATION SERVICES FOR THE PROTECTION OF MOBILE TELEPHONES AND THEIR ACCESSORIES AGAINST LOST, THEFT, DAMAGE; CONSULTATION SERVICES RENDERED ON-LINE OR OTHERWISE IN CONJUNCTION WITH ALL THE AFOREMENTIONED SERVICES GIVEN ON-LINE FROM A COMPUTER DATABASE; HOTEL RESERVATION SERVICES FOR OTHERS; PREPARATION OF FOOD AND DRINK; CATERING SERVICES; RESTAURANT SERVICES; CAFE AND CAFETERIA SERVICES; SNACK BAR SERVICES; FAST-FOOD RESTAURANT SERVICES, HOROSCOPE FORECASTING, WEATHER FORECASTING; NEWS AND CURRENT AFFAIRS INFORMATION SERVICES, IN CLASS 42 (U.S. CLS. 100 AND 101).

OWNER OF UNITED KINGDOM REG. NO. 001078989, DATED 8-31-2004, EXPIRES 2-17-2009.

OWNER OF ERPN CMNTY TM OFC REG. NO. 001950740, DATED 8-1-2002, EXPIRES 8-1-2012.

OWNER OF ERPN CMNTY TM OFC REG. NO. 000127837, DATED 3-29-2001, EXPIRES 3-29-2011.

OWNER OF UNITED KINGDOM REG. NO. 2108402B, DATED 12-29-1998, EXPIRES 8-22-2016.

OWNER OF UNITED KINGDOM REG. NO. 2117705, DATED 12-26-1997, EXPIRES 12-5-2016.

OWNER OF UNITED KINGDOM REG. NO. 2030255, DATED 12-8-1995, RENEWED AS REG. NO. 2030255, DATED 12-8-2005, EXPIRES 12-8-2015.

OWNER OF U.S. REG. NOS. 920,090, 2,344,619, AND 2,396,644.

SER. NO. 75-730,632, FILED 6-16-1999.

JAMES A. RAUEN, EXAMINING ATTORNEY

Int. Cl.: 41

Prior U.S. Cls.: 100, 101 and 107

United States Patent and Trademark Office

Reg. No. 3,474,324

Registered July 29, 2008

**SERVICE MARK
PRINCIPAL REGISTER**

ARTISAN

ARTISAN CINEMATIC ENTERPRISES, INC.
(OHIO CORPORATION)
8408 FAIRWAY DRIVE
COLUMBUS, OH 432351113

FIRST USE 9-1-1985; IN COMMERCE 9-1-1985.

SER. NO. 75-765,407, FILED 8-26-1999.

FOR: MOTION PICTURE DEVELOPMENT AND
PRODUCTION, IN CLASS 41 (U.S. CLS. 100, 101 AND
107).

ARETHA SOMERVILLE, EXAMINING ATTORNEY

Int. Cl.: 41

Prior U.S. Cls.: 100, 101 and 107

United States Patent and Trademark Office

Reg. No. 3,474,325

Registered July 29, 2008

**SERVICE MARK
PRINCIPAL REGISTER**

STEALTH GERONTOLOGY

BOARD OF REGENTS, THE UNIVERSITY OF
TEXAS SYSTEM (TEXAS STATE AGENCY)
201 WEST 7TH STREET
AUSTIN, TX 78701

FOR: EDUCATIONAL SERVICES, NAMELY,
CONDUCTING CLASSES, SEMINARS, AND WORK-
SHOPS IN THE FIELD OF GERONTOLOGY FOR
EDUCATORS, IN CLASS 41 (U.S. CLS. 100, 101 AND
107).

FIRST USE 9-25-1998; IN COMMERCE 9-25-1998.

NO CLAIM IS MADE TO THE EXCLUSIVE
RIGHT TO USE "GERONTOLOGY", APART FROM
THE MARK AS SHOWN.

SER. NO. 75-913,140, FILED 2-7-2000.

PAUL F. GAST, EXAMINING ATTORNEY

Int. Cl.: 35

Prior U.S. Cls.: 100, 101 and 102

United States Patent and Trademark Office

Reg. No. 3,474,326

Registered July 29, 2008

**SERVICE MARK
PRINCIPAL REGISTER**

GRIZZLY.COM

GRIZZLY INDUSTRIAL, INC. (WASHINGTON CORPORATION)

1821 VALENCIA STREET
BELLINGHAM, WA 98226

FOR: RETAIL STORE SERVICES, ONLINE RETAIL STORE SERVICES, AND MAIL ORDER SERVICES FEATURING; ABRASIVES; AIR CLEANERS; AIR COMPRESSORS; AIR TANKS; AIR TOOLS; ANGLE FINDERS; ANTI-KICKBACK DEVICES; ANTI-VIBRATION MOUNTS; AUGER BITS; BEARINGS; BELTS; BENDERS; BEVELS; BLADE STABILIZERS; BOLT CUTTERS; BOOKS AND PLANS; BUFFING COMPOUNDS; BUFFING MACHINES; BUFFING WHEELS; BURRS; CABLE TIES; CALIPERS; CEMENT; CENTER PUNCHES; CHAIN HOISTS; CHISELS; CHUCKS; CLAMPS AND VISES; CLAMP HEADS; CONTAINERS; CORDLESS TOOLS; CUT-OFF WHEELS; CUTTERS; DIAL INDICATORS; DIES; DIGITAL READ OUTS; DISCS; DOLLIES; DOWEL CUTTING SAWS; DOWEL PINS; DRAFTING BOARDS; DRILL GUIDES; DUST COLLECTION ACCESSORIES; DUST PANS; DUST SEPARATORS; ELECTRIC MOTORS; END MILL HOLDERS; END MILLS; ENGINE STANDS; FEATHER BOARDS; FILE CARD FILES; FILTER BAGS; FLEXIBLE CURVES; GAUGES; GEAR PULLER; GLOVES; GOUGES; GRINDERS; GRINDING WHEELS; HACKSAWS; HAMMERS; HAND CLEANER; HAND PUNCHES; HAND SCREWS; HAND TRUCKS; HEX KEYS; HOSE REELS; HOSES; INSERTS FOR TOOLHOLDERS; JACKS; JIG SAW BLADES; JOINTER KNIVES; KNEE PADS; KNOBS; LAMINATE TRIMMER; LATHE ACCESSORIES; LIVE CENTERS; MACHINE MOUNTS; MAGNETIC BASES; MAGNETIC SHIMS; MAGNETIC SWITCHES; MALLETS; MANDRELS; MATS; MICROMETERS; MITER BOX; MITER TRIMMER; MORTISER MACHINE; MOULDER/PLANE; MOULDING HEAD; MOULDING HEAD KNIVES; MULTI-SPUR BITS; NAIL PULLER; NAILERS; NAILS; NOTCHES; PLANER KNIVES; PLIERS; PROTRACTOR; PULLEYS; PUNCHES; PUSH STICKS; RASPS; RATCHET KITS; REMOTE CONTROLLER;

ROUTER PADS; ROUTER TABLE; ROUTERS; RUST REMOVER; SAFES; SANDERS; SANDING BOXES; SANDING SEALER; SANDPAPER; SAW BLADES; SAW STOPS; SAWS; SCRAPERS; SCREW EXTRACTORS; SCREW GRABS; SCREWDRIVERS; SCREWS; SECURITY; SHOVELS; SLIDE TABLES; SLIP ROLLS; SOCKETS; SPACERS; SPINDLES; SPRAYERS; SQUARE; STAINS; STAPLERS; STAPLES; STORAGE BINS; SWITCHES; TAPPING MACHINE; TIE DOWN RATCHETS; TILE CUTTERS; TIN SNIPS; TOOL TABLES; TRAMMEL POINTS; WAGONS; WELDING ROD; WELDING SUPPLIES; WOOD FILLER; WRENCHES; BATTERY CHARGERS; CLOTHING; GENERATORS; LEVELS; PARTS WASHERS; PRESSURE WASHERS; SANDBLASTERS; SAW HORSES; SCAFFOLDING; SHOP VACUUMS; TOOL BOXES; TOOL ORGANIZERS; WHEEL BARROWS; CUTLERY; CUTTING TOOLS; DRILL PRESSES; DRILLING AND BORING EQUIPMENT, NAMELY, BRAD POINT BITS, COUNTERSINKS, DRILL BITS, EXTRACTORS, FORSTNER BITS, HOLE SAWS, PLUG CUTTERS, QUICK CHANGE BITS, REAMERS, SOLID CARBIDE BITS, SPADE BITS, STEP DRILL BITS, TAPERED BITS; DUST COLLECTION SYSTEMS; FASTENERS; FINISHING SUPPLIES, NAMELY, BRUSHES, FINISHES, FINISHING SUPPLIES, SPRAY GUNS, SPRAYERS; HAND TOOLS; HARDWARE, NAMELY, BRACKETS, BUMPERS, DOOR KNOCKERS, DRAWER PULLS, DRAWER SLIDES, HINGES, LOCK SETS, SHELF SUPPORTS; JIGS, FIXTURES; MACHINE ACCESSORIES, NAMELY, ARBORS, BELT PULLEYS, BLADE GUIDES, BORING HEADS, BUSHINGS AND SHAPERS, CHUCK INSERTS, CHUCKS, CLAMPING KITS, COLLET ATTACHMENTS, COLLETS, DIVIDING HEADS, DUST HOODS, ELECTRIC SWITCHES; FACE PLATES, FENCES, LATHE CENTERS, MAGNETIC CHUCKS, MILLING ATTACHMENTS, MITER GAUGE, MORTISING ATTACHMENTS, MOTORS, PHASE CONVERTERS, POWER FEED, RAILS, ROTARY TABLES, RUB COLLARS, SANDING ATTACHMENTS, SLEEVES, SLIDING TABLES, SPINDLES, STANDS, TAILSTOCK TURRETS, TOOL HOLDERS, TOOL POST SETS, TOOL RESTS, V-

BELTS, V-BLOCKS, WINGS, MATERIAL HANDLING EQUIPMENT, NAMELY, CARTS, CASTERS AND WHEELS, MOBILE BASES, OUTFEED TABLES AND STANDS, ROLLER STANDS, ROLLERS, TABLES, WORK STANDS; MEASURING TOOLS; METAL STOCK; METALWORKING MACHINES; PNEUMATIC TOOLS; POWER TOOLS; ROUTER BITS; SAFETY EQUIPMENT, NAMELY, EAR PROTECTORS, EYE PROTECTION, FIRST AID KITS, GLOVES, RESPIRATORS; SHAPER CUTTERS; SHOP ACCESSORIES, NAMELY, ANVILS, ARBOR PRESSES, BELT CLEANERS, DOWEL CENTERS, GLUE, GLUE BOTTLES, GLUE BRUSHES, LAMINATING, LUBRICANTS, MOISTURE METERS, PADS AND MATS, POWER BITS, PUSH BLOCKS, SAW GAUGES, SHARPENING EQUIPMENT, NAMELY, DRILL SHARPENERS, SHARPENING STONE SETS, STOP BLOCKS, TAPE, TWEEZERS; OPTICAL EQUIPMENT; HAND TOOLS; COFFEE; TOOLING EQUIPMENT, NAMELY, BORING BARS,

CENTER DRILLS, COUNTERSINKS, CUT-OFF AND PARTING, DOVETAIL CUTTERS, END MILLS, FLY CUTTERS, INDEXABLE TOOLING, INSERTS, KEY SEATS, MULTI-FUNCTION TOOLS, ROTARY BURRS, SLITTING SAWS, TAPS AND DIES, TOOL BITS; WELDING AND CUTTING MACHINES; WOOD PRODUCTS, NAMELY, BISCUITS, DETAIL KITS, DOWELS, EDGE BANDING, PINS, PLUGS, VENEER; AND WOODWORKING MACHINES, IN CLASS 35 (U.S. CLS. 100, 101 AND 102).

FIRST USE 6-30-1999; IN COMMERCE 6-30-1999.

OWNER OF U.S. REG. NOS. 2,312,226 AND 2,413,625.

SER. NO. 76-088,346, FILED 7-10-2000.

HELEN BRYAN, EXAMINING ATTORNEY

Int. Cl.: 35

Prior U.S. Cls.: 100, 101 and 102

United States Patent and Trademark Office

Reg. No. 3,474,327

Registered July 29, 2008

**SERVICE MARK
PRINCIPAL REGISTER**

STEELBUILDING.COM THE FUTURE OF METAL BUILDINGS

STEELBUILDING ACQUISITION, INC. (DELA-
WARE CORPORATION)
10943 NORTH SAM HOUSTON PARKWAY WES
HOUSTON, TX 77064

FOR: COMPUTERIZED ON-LINE RETAIL SER-
VICES IN THE FIELD OF PRE-ENGINEERED
STEEL BUILDINGS AND ROOFING SYSTEMS , IN
CLASS 35 (U.S. CLS. 100, 101 AND 102).

FIRST USE 6-1-2000; IN COMMERCE 9-29-2000.

NO CLAIM IS MADE TO THE EXCLUSIVE
RIGHT TO USE "METAL BUILDINGS", APART
FROM THE MARK AS SHOWN.

SEC. 2(F) AS TO "STEELBUILDING.COM".

SER. NO. 76-280,390, FILED 7-3-2001.

KHANH LE, EXAMINING ATTORNEY

Int. Cl.: 36

Prior U.S. Cls.: 100, 101 and 102

United States Patent and Trademark Office

Reg. No. 3,474,328

Registered July 29, 2008

**SERVICE MARK
PRINCIPAL REGISTER**

MORTGAGE GUARD PLUS

PROCTOR HOMER WARREN, INC. (MICHIGAN CORPORATION), DBA PROCTOR FINANCIAL INSURANCE CORP.
295 KIRTS BOULEVARD SUITE 100
TROY, MI 48084

FOR: INSURANCE UNDERWRITING AND ADMINISTRATION IN THE FIELDS OF LENDER-PLACED HAZARD AND FLOOD INSURANCE, MORTGAGE IMPAIRMENT INSURANCE, AND CLAIMS REPORTING THEREFOR, IN CLASS 36 (U.S. CLS. 100, 101 AND 102).

FIRST USE 10-29-2001; IN COMMERCE 10-29-2001.

OWNER OF U.S. REG. NOS. 1,976,769 AND 2,486,975.

NO CLAIM IS MADE TO THE EXCLUSIVE RIGHT TO USE "MORTGAGE", APART FROM THE MARK AS SHOWN.

SER. NO. 76-348,505, FILED 12-17-2001.

GEORGE LORENZO, EXAMINING ATTORNEY

Int. Cl.: 35

Prior U.S. Cls.: 100, 101 and 102

United States Patent and Trademark Office

Reg. No. 3,474,329

Registered July 29, 2008

**SERVICE MARK
PRINCIPAL REGISTER**



JOE WELLS ENTERPRISES, INC. (CALIFORNIA CORPORATION)
1641 S. SINCLAIR
ANAHEIM, CA 92860

FOR: RETAIL OUTLETS FEATURING NUTRITIONAL PRODUCTS, WORKOUT GEAR, AND FITNESS RELATED PRODUCTS AND SERVICES, IN CLASS 35 (U.S. CLS. 100, 101 AND 102).

FIRST USE 11-19-2000; IN COMMERCE 11-19-2000.

OWNER OF U.S. REG. NO. 2,216,577.

NO CLAIM IS MADE TO THE EXCLUSIVE RIGHT TO USE "NUTRITION & WORKOUT GEAR", APART FROM THE MARK AS SHOWN.

THE MARK CONSISTS OF FIGURE OF A HEAD WITH LIGHTNING BOLT HAIR WITH THE WORD "MAX" ON THE LEFT AND THE WORD "MUSCLE" ON THE RIGHT AND THE WORDS "NUTRITION & WORKOUT GEAR" BELOW.

SER. NO. 76-436,028, FILED 7-17-2002.

COLLEEN DOMBROW, EXAMINING ATTORNEY

Int. Cl.: 33

Prior U.S. Cls.: 47 and 49

United States Patent and Trademark Office

Reg. No. 3,474,330

Registered July 29, 2008

TRADEMARK
PRINCIPAL REGISTER



DESTYLERNIA "POLMOS" W KRAKOWIE S.A.
(POLAND CORPORATION)
UL. FABRYCZNA 13
31-553 KRAKOW, POLAND

FOR: ALCOHOLIC BEVERAGES, NAMELY WINES, SPARKLING WINES, CHAMPAGNE, LIQUEURS, APERITIFS, DISTILLED SPIRITS, WHISKEY, VODKA, ALCOHOL-BASED FROZEN ICE CREAM DRINK, ALCOHOLIC CIDER, RUMS, GINS, BOURBONS, COGNACS, IN CLASS 33 (U.S. CLS. 47 AND 49).

PRIORITY CLAIMED UNDER SEC. 44(D) ON POLAND APPLICATION NO. Z-251516, FILED 6-13-2002, REG. NO. 163891, DATED 8-3-2005, EXPIRES 6-13-2012.

OWNER OF U.S. REG. NOS. 1,969,271 AND 1,989,516.

NO CLAIM IS MADE TO THE EXCLUSIVE RIGHT TO USE THE COAT OF ARMS OF CRACOW, POLAND, APART FROM THE MARK AS SHOWN.

THE COLORS ORANGE, BLUE, RED, BLACK AND WHITE ARE CLAIMED AS FEATURES OF THE MARK.

THE MARK, REPRESENTING THE SHIELD OF THE POLISH TOWN OF CRACOW, CONSISTS OF VARIOUS ELEMENTS: AN ARMOR COLORED ORANGE IN THE CENTER, SURROUNDED BY A SOLID DARK BLUE, ABOVE A STYLIZED BRICK CASTLE, COMPRISING THREE TOWERS COLORED ORANGE, AND IN THE MIDDLE OF THE BRICK WORK SHOWING A POLISH NATIONAL EAGLE IN WHITE. THREE TOWERS INDIVIDUALLY SURROUNDED BY A SOLID DARK BLUE AND ABOVE THE ARMOR AN ORANGE CROWN WITH A RED STONE IN THE CENTER. THE ARMOR SHOWS A RED DECORATION NEAR THE BOTTOM CENTER OF THE BREAST PLATE. THE BAR-LIKE STRUCTURE OF THE ARMOR, COVERING THE FACE AREA, ALSO SHOWS THE COLOR RED. FANCY DECORATION IS SHOWN TO LEFT AND RIGHT AROUND THE SHIELD, HAVING A FEATHER-LIKE APPEARANCE IN BLACK AND WHITE. UNDER THE SHIELD, CAPTION-LIKE, IS THE NAME CRACOVIA IN SOLID BLUE CAPITAL LETTERS, EACH LETTER CONTOURED THINLY BY ORANGE COLOR.

SER. NO. 76-442,968, FILED 8-20-2002.

GEOFFREY FOSDICK, EXAMINING ATTORNEY

Int. Cl.: 41

Prior U.S. Cls.: 100, 101 and 107

United States Patent and Trademark Office

Reg. No. 3,474,331

Registered July 29, 2008

**SERVICE MARK
PRINCIPAL REGISTER**

HYPNOBABIES

TUSCHHOFF, KERRY (UNITED STATES INDIVIDUAL)
11629 MIDWAY DRIVE
CYPRESS, CA 90630

FOR: EDUCATION IN PREGNANCY AND
CHILDBIRTH PROVIDED THROUGH SEMINARS,
WORKSHOPS AND HOME STUDY COURSES
USING IN-PERSON TRAINING, PRINTED MATERIALS
AND/OR AUDIO TAPES, IN CLASS 41 (U.S. CLS. 100,
101 AND 107).

FIRST USE 10-5-2001, THE MARK WAS USED ANYWHERE IN A DIFFERENT FORM OTHER THAN THAT SOUGHT TO BE REGISTERED ON 09/01/2002; IN COMMERCE 10-5-2001, THE MARK WAS USED ANYWHERE IN A DIFFERENT FORM OTHER THAN THAT SOUGHT TO BE REGISTERED IN COMMERCE ON 09/01/2002..

SER. NO. 76-473,263, FILED 12-4-2002.

EUGENIA MARTIN, EXAMINING ATTORNEY

Int. Cl.: 41

Prior U.S. Cls.: 100, 101 and 107

United States Patent and Trademark Office

Reg. No. 3,474,332

Registered July 29, 2008

SERVICE MARK
PRINCIPAL REGISTER



TUSCHHOFF, KERRY (UNITED STATES INDIVIDUAL)
11629 MIDWAY DRIVE
CYPRESS, CA 90630

FOR: EDUCATION IN PREGNANCY AND
CHILDBIRTH PROVIDED THROUGH SEMINARS,
WORKSHOPS AND HOME STUDY COURSES
USING IN-PERSON TRAINING, PRINTED MATERIALS
AND/OR AUDIO TAPES, IN CLASS 41 (U.S. CLS. 100, 101 AND 107).

FIRST USE 9-1-2002, THE MARK WAS USED ANYWHERE IN A DIFFERENT FORM OTHER THAN THAT SOUGHT TO BE REGISTERED ON 10/05/2001.; IN COMMERCE 9-1-2002, THE MARK WAS USED ANYWHERE IN A DIFFERENT FORM OTHER THAN THAT SOUGHT TO BE REGISTERED IN COMMERCE ON 10/05/2001..

SER. NO. 76-473,264, FILED 12-4-2002.

EUGENIA MARTIN, EXAMINING ATTORNEY

Int. Cl.: 36

Prior U.S. Cls.: 100, 101 and 102

United States Patent and Trademark Office

Reg. No. 3,474,333

Registered July 29, 2008

**SERVICE MARK
PRINCIPAL REGISTER**

QUICKCARE TRAVEL

PTZ INSURANCE BROKERS LTD (CANADA
CORPORATION)
710 DORVAL DRIVE
OAKVILLE, CANADA L6K 3V7

FOR: UNDERWRITING HEALTH CARE INSUR-
ANCE FOR PETS, IN CLASS 36 (U.S. CLS. 100, 101
AND 102).

PRIORITY CLAIMED UNDER SEC. 44(D) ON
CANADA APPLICATION NO. 1157669, FILED 11-1-
2002, REG. NO. TMA611695, DATED 6-1-2004, EX-
PIRES 6-1-2019.

OWNER OF U.S. REG. NO. 2,646,187.

NO CLAIM IS MADE TO THE EXCLUSIVE
RIGHT TO USE "TRAVEL", APART FROM THE
MARK AS SHOWN.

SER. NO. 76-479,882, FILED 1-2-2003.

KAREN K. BUSH, EXAMINING ATTORNEY

Int. Cl.: 12

Prior U.S. Cls.: 19, 21, 23, 31, 35 and 44

United States Patent and Trademark Office

Reg. No. 3,474,334

Registered July 29, 2008

**TRADEMARK
PRINCIPAL REGISTER**

ROVER

LAND ROVER (UNITED KINGDOM COMPANY)
BANBURY ROAD
GAYDON, WARWICK, WARWICKSHIRE, UNITED
KINGDOM CV35 0RR

FOR: AUTOMOBILES AND STRUCTURAL
PARTS THEREFOR, IN CLASS 12 (U.S. CLS. 19, 21,
23, 31, 35 AND 44).

OWNER OF UNITED KINGDOM REG. NO.
1518902, DATED 11-14-1992, EXPIRES 11-14-2009.

SER. NO. 76-496,804, FILED 3-13-2003.

MARK SPARACINO, EXAMINING ATTORNEY

Int. Cl.: 36

Prior U.S. Cls.: 100, 101 and 102

United States Patent and Trademark Office

Reg. No. 3,474,335

Registered July 29, 2008

**SERVICE MARK
PRINCIPAL REGISTER**

BANK BY NET

AMTRUST BANK (OHIO FEDERALLY CHAR-
TERED SAVINGS BANK)
1801 EAST NINTH STREET
SUITE 200
CLEVELAND, OH 44114

FOR: BANKING SERVICES AND BANKING IN-
FORMATION SERVICES, PROVIDED BY MEANS
OF A GLOBAL COMPUTER NETWORK, IN CLASS
36 (U.S. CLS. 100, 101 AND 102).

FIRST USE 9-22-1997; IN COMMERCE 9-22-1997.

OWNER OF U.S. REG. NOS. 2,153,196 AND
2,200,269.

NO CLAIM IS MADE TO THE EXCLUSIVE
RIGHT TO USE "BANK", APART FROM THE
MARK AS SHOWN.

SEC. 2(F).

SER. NO. 76-515,554, FILED 5-19-2003.

TRACY WHITTAKER-BROWN, EXAMINING AT-
TORNEY

Int. Cl.: 40

Prior U.S. Cls.: 100, 103 and 106

United States Patent and Trademark Office

Reg. No. 3,474,336

Registered July 29, 2008

**SERVICE MARK
PRINCIPAL REGISTER**

CT-OP

SUMITOMO ELECTRIC INDUSTRIES, LTD. (JAPAN CORPORATION)
5-33, KITAHAMA 4-CHOME CHUO-KU, OSAKA-SH
CHUO-KU, OSAKA-SHI
OSAKA, 541-0041, JAPAN

FOR: METAL TREATMENT SERVICES INCLUDING PRESSURIZATION OF METAL WIRES, SUPERCONDUCTING WIRES, CABLES AND METAL MATERIALS, IN CLASS 40 (U.S. CLS. 100, 103 AND 106).

THE MARK CONSISTS OF STANDARD CHARACTERS WITHOUT CLAIM TO ANY PARTICULAR FONT, STYLE, SIZE, OR COLOR.

PRIORITY CLAIMED UNDER SEC. 44(D) ON JAPAN APPLICATION NO. 2003-092202, FILED 10-21-2003, REG. NO. 5112962, DATED 2-22-2008, EXPIRES 2-22-2018.

SER. NO. 76-586,504, FILED 4-13-2004.

ELLEN B. AWRICH, EXAMINING ATTORNEY

Int. Cl.: 35

Prior U.S. Cls.: 100, 101 and 102

United States Patent and Trademark Office

Reg. No. 3,474,337

Registered July 29, 2008

**SERVICE MARK
PRINCIPAL REGISTER**

**FASHION BUG AT
HOME**

C.S.F. CORP. (DELAWARE CORPORATION)
3411 SILVERSIDE ROAD
103 SPRINGER BUILDING
WILMINGTON, DE 19810

FOR: MAIL ORDER CATALOG SERVICES FEATURING LINEN PRODUCTS, HOUSEWARES AND HOME FURNISHINGS, IN CLASS 35 (U.S. CLS. 100, 101 AND 102).

FIRST USE 10-15-1998; IN COMMERCE 10-15-1998.

THE MARK CONSISTS OF STANDARD CHARACTERS WITHOUT CLAIM TO ANY PARTICULAR FONT, STYLE, SIZE, OR COLOR.

OWNER OF U.S. REG. NOS. 2,335,285, 2,716,247 AND OTHERS.

NO CLAIM IS MADE TO THE EXCLUSIVE RIGHT TO USE "HOME", APART FROM THE MARK AS SHOWN.

SER. NO. 76-604,832, FILED 7-30-2004.

CHERYL CLAYTON, EXAMINING ATTORNEY

Int. Cls.: 9, 14, 18, 20, 25, 41 and 42

Prior U.S. Cls.: 1, 2, 3, 13, 21, 22, 23, 25, 26, 27, 28, 32, 36, 38, 39, 41, 50, 100, 101 and 107

Reg. No. 3,474,338

United States Patent and Trademark Office

Registered July 29, 2008

**TRADEMARK
SERVICE MARK
PRINCIPAL REGISTER**



GHETTO PANDA DESIGNS INC. (CANADA CORPORATION)
131 BLOOR ST. WEST, SUITE 1109
TORONTO, ONTARIO, CANADA M5S 1S3

FOR: PRE-RECORDED AUDIOS AND VIDEOS IN THE FIELD OF MUSIC, DRAMA, COMEDY, FASHION, DOCUMENTARIES, LIVE ACTIONS, COMMERCIALS, THEME SONGS, MUSIC VIDEOS, LIVE PERFORMANCES AND PERFORMANCE ART, IN CLASS 9 (U.S. CLS. 21, 23, 26, 36 AND 38).

FOR: JEWELRY, IN CLASS 14 (U.S. CLS. 2, 27, 28 AND 50).

FOR: BAGS, NAMELY HANDBAGS, PURSES, KNAP-SACKS, BACK-PACKS, GYM BAGS, TOTE BAGS, TRAVEL BAGS, AND TOILETRY BAGS SOLD EMPTY, IN CLASS 18 (U.S. CLS. 1, 2, 3, 22 AND 41).

FOR: PORTABLE BEDS FOR PETS; PLASTIC SCULPTURES; SCULPTURES OF PLASTER, WAX, OR WOOD; SOFT SCULPTURE WALL DECORATIONS; DECORATIVE MOBILES; PILLOWS AND FURNITURE SCREENS, IN CLASS 20 (U.S. CLS. 2, 13, 22, 25, 32 AND 50).

FOR: MENSWEAR, NAMELY JACKETS, COATS, PANTS, SHIRTS, HATS, GLOVES, SHOES; WOMENSWEAR, NAMELY JACKETS, COATS, PANTS, SHIRTS, HATS, GLOVES, SHOES, IN CLASS 25 (U.S. CLS. 22 AND 39).

FOR: MUSIC PUBLISHING; CREATION, PRODUCTION AND RECORDING OF MUSICAL AND DRAMATIC PERFORMANCES; VIDEO PRODUCTIONS; STILL AND MOTION PICTURE PHOTOGRAPHY SERVICES; AND ENTERTAINMENT SERVICES IN THE NATURE OF LIVE PERFORMANCES BY INDIVIDUAL OR GROUPED MUSICIANS, ACTORS, SPEAKERS OR PERFORMERS, IN CLASS 41 (U.S. CLS. 100, 101 AND 107).

FOR: INTERIOR DESIGNING AND HOME DECORATION; AND GRAPHIC DESIGN SERVICES, IN CLASS 42 (U.S. CLS. 100 AND 101).

PRIORITY CLAIMED UNDER SEC. 44(D) ON CANADA APPLICATION NO. 1215998, FILED 5-6-2004, REG. NO. TMA676839, DATED 11-14-2006, EXPIRES 11-14-2021.

THE LINING IS A FEATURE OF THE MARK AND DOES NOT INDICATE COLOR.

THE MARK INCLUDES A PICTURE OF A BEAR, A BRICK WALL AND THE TERMS GHETTO AND PANDA IN STYLIZED FORMAT.

SER. NO. 76-619,596, FILED 11-8-2004.

JACQUELINE A. LAVINE, EXAMINING ATTORNEY

Int. Cl.: 41

Prior U.S. Cls.: 100, 101 and 107

United States Patent and Trademark Office

Reg. No. 3,474,339

Registered July 29, 2008

**SERVICE MARK
PRINCIPAL REGISTER**

THE NEW BIOLOGY

HIKARI HOLDINGS, L.C. (UTAH LTD LIAB CO)
16390 DIA DEL SOL
VALLEY CENTER, CA 920826025

FOR: EDUCATIONAL SERVICES, NAMELY WORKSHOPS, SEMINARS, CLASSES, CONFERENCE AND RETREATS, ORGANIZATION OF CONVENTIONS, PERSONAL COACHING SERVICES, PROVIDING NEWSLETTERS VIA EMAIL AND INTERNET, ALL IN THE FIELDS OF HEALTH, DIET, NUTRITION, DIETARY AND NUTRITIONAL SUPPLEMENTS, AND HEALTHY LIFESTYLES, IN CLASS 41 (U.S. CLS. 100, 101 AND 107).

FIRST USE 0-0-1988; IN COMMERCE 0-0-1988.

THE MARK CONSISTS OF STANDARD CHARACTERS WITHOUT CLAIM TO ANY PARTICULAR FONT, STYLE, SIZE, OR COLOR.

NO CLAIM IS MADE TO THE EXCLUSIVE RIGHT TO USE BIOLOGY, APART FROM THE MARK AS SHOWN.

SEC. 2(F).

SER. NO. 76-632,325, FILED 2-28-2005.

AMOS T. MATTHEWS, JR., EXAMINING ATTORNEY

Int. Cl.: 3

Prior U.S. Cls.: 1, 4, 6, 50, 51 and 52

Reg. No. 3,474,340

United States Patent and Trademark Office

Registered July 29, 2008

**TRADEMARK
PRINCIPAL REGISTER**

CLINELLE

BEUXSTAR SDN BHD (MALAYSIA PRIVATE LIMITED COMPANY)
WISMA DERMAL ESTHETICA, 58
JALAN SS 22/25, DAMANSARA JAYA 47400 PETALING JAYA
SELANGOR DARUL EHSAN, MALAYSIA 47400

FOR: ABRASIVE CLOTH; AFTER-SHAVE LOTIONS; ALMOND MILK FOR COSMETIC PURPOSES; TOILETRIES, NAMELY, ANTIPERSPIRANTS; AROMATIC ESSENTIAL OILS; BATH SALT - NOT FOR MEDICAL PURPOSES; COSMETIC PREPARATIONS FOR BATHS; BEAUTY MASKS; BLEACHING PREPARATIONS, NAMELY, DECOLORANTS FOR COSMETIC PURPOSES; ESSENTIAL OILS OF CEDARWOOD; HAIR COLOR-REMOVING PREPARATIONS; COSMETIC KITS COMPRISED OF FACE CREAM, SKIN MOISTURIZER, SKIN CLEANSER, SKIN TONER, SKIN MASK, LIPSTICK, EYE SHADOW, FACE POWDER, MAKEUP FOUNDATION AND MASCARA; COSMETIC PREPARATIONS FOR SLIMMING PURPOSES; COSMETICS; COTTON STICKS FOR COSMETIC PURPOSES; COTTON WOOL FOR COSMETIC PURPOSES; COSMETIC CREAMS; SKIN WHITENING CREAMS; DEODORANT SOAP; DEPILATORIES; DEPILATORY PREPARATIONS; ESSENTIAL OILS; PAPER GUIDES FOR EYE MAKE-UP; EYEBROW COSMETICS; EYEBROW PENCILS; ADHESIVES FOR AFFIXING FALSE EYELASHES; COSMETIC PREPARATIONS FOR EYELASHES; FALSE EYELASHES; HAIR COLORANTS; HAIR DYES; HAIR LOTIONS; HAIR SPRAY; HAIR WAVING PREPARATION; JASMINE OIL; JELLY PETROLEUM FOR COSMETIC PURPOSES;

LAVENDER OIL; ESSENTIAL OILS OF LEMON; LIPSTICKS; MAKE-UP; MAKE-UP POWDER; MAKE-UP PREPARATIONS FOR THE FACE AND BODY; MAKE-UP REMOVING PREPARATIONS; MASCARA; BEAUTY MASKS; MINT ESSENCE ESSENTIAL OIL; NAIL CARE PREPARATIONS; NAIL POLISH; NAIL VARNISH; FALSE NAILS; OILS FOR SKIN CLEANING PURPOSES; OILS FOR COSMETIC PURPOSES; OIL FOR PERFUMES AND SCENTS; OILS FOR TOILET PURPOSES; COSMETIC PENCILS; EYEBROW PENCILS; PERFUMERY; PERFUMES; MAKE-UP POWDER; SHAMPOO; SHAMPOOS FOR PETS; COSMETIC PREPARATIONS FOR SKIN CARE; LAUNDRY STARCH PREPARATIONS FOR SMOOTHING CLOTHING; SOAP; ANTIPERSPIRANT SOAP; DEODORANT SOAP; DISINFECTANT SOAP; COSMETIC SUN-TANNING PREPARATIONS; TALCUM POWDER FOR TOILET USE; DEPILATORY WAX; AND CREAM FOR WHITENING THE SKIN, IN CLASS 3 (U.S. CLS. 1, 4, 6, 50, 51 AND 52).

THE MARK CONSISTS OF STANDARD CHARACTERS WITHOUT CLAIM TO ANY PARTICULAR FONT, STYLE, SIZE, OR COLOR.

OWNER OF MALAYSIA REG. NO. 03017020, DATED 12-16-2003, EXPIRES 12-16-2013.

SER. NO. 76-632,617, FILED 3-3-2005.

FLORENTINA BLANDU, EXAMINING ATTORNEY

Int. Cl.: 16

Prior U.S. Cls.: 2, 5, 22, 23, 29, 37, 38 and 50

Reg. No. 3,474,341

United States Patent and Trademark Office

Registered July 29, 2008

**TRADEMARK
PRINCIPAL REGISTER**

PATRIOT

PARADISE PEN COMPANY (COLORADO CORPORATION)
2433 CURTIS STREET
DENVER, CO 80205

THE MARK CONSISTS OF STANDARD CHARACTERS WITHOUT CLAIM TO ANY PARTICULAR FONT, STYLE, SIZE, OR COLOR.

FOR: WRITING INSTRUMENTS, NAMELY, PENS, IN CLASS 16 (U.S. CLS. 2, 5, 22, 23, 29, 37, 38 AND 50).

SER. NO. 76-636,601, FILED 4-21-2005.

FIRST USE 8-31-2004; IN COMMERCE 8-31-2004.

RICHARD WHITE, EXAMINING ATTORNEY

Int. Cl.: 35

Prior U.S. Cls.: 100, 101 and 102

United States Patent and Trademark Office

Reg. No. 3,474,342

Registered July 29, 2008

**SERVICE MARK
PRINCIPAL REGISTER**

VIANOVO

VIANOVO, LLP (TEXAS LIMITED LIABILITY PARTNERSHIP)
327 CONGRESS AVENUE, SUITE 450
AUSTIN, TX 78701

FOR: BUSINESS MANAGEMENT CONSULTATION FOR OTHERS, NAMELY, STRATEGIC BUSINESS MANAGEMENT CONSULTATION SERVICES, AND PROMOTING THE INTERESTS OF CORPORATE ENTITIES, TRADE ASSOCIATIONS AND GOVERNMENT ENTITIES; PUBLIC AFFAIRS CONSULTING SERVICES, NAMELY, ADVISING OTHERS REGARDING THE TIMING, FORM AND CONTENT OF STRATEGIC BUSINESS STATEMENTS TO BE MADE TO THE PUBLIC, TO INDUSTRY AND TO GOVERNMENT, ADVISING OTHERS REGARDING THE APPROPRIATE RESPONSES TO MAKE WHEN CONFRONTED WITH PUBLIC AFFAIRS CRISES, AND PROMOTING AND MAINTAINING EFFECTIVE RELATIONSHIPS FOR OTHERS WITH THE MEDIA AND PRESS; CONDUCTING BUSINESS AND MARKET RESEARCH SURVEYS; PUBLIC OPINION RESEARCH, ANALYSIS AND CONSULTATION SERVICES, AND PUBLIC OPINION RISK ASSESSMENT

CONSULTATION SERVICES; ADVERTISING AGENCY SERVICES, NAMELY, PREPARING ADVERTISING AND MARKETING FOR OTHERS, PREPARING MARKETING AND ADVERTISING PLANS AND STRATEGIES FOR OTHERS; GOVERNMENTAL AFFAIRS SERVICES FOR OTHERS, NAMELY, PROMOTING AND MAINTAINING EFFECTIVE RELATIONS FOR OTHERS WITH THE LEGISLATIVE, EXECUTIVE AND JUDICIAL BRANCHES OF GOVERNMENT, IN CLASS 35 (U.S. CLS. 100, 101 AND 102).

FIRST USE 5-26-2005; IN COMMERCE 5-26-2005.

THE MARK CONSISTS OF STANDARD CHARACTERS WITHOUT CLAIM TO ANY PARTICULAR FONT, STYLE, SIZE, OR COLOR.

VIA [LATIN] PATH OR WAY NOVO [LATIN] NEW

SER. NO. 76-642,890, FILED 7-14-2005.

ANDREA SAUNDERS, EXAMINING ATTORNEY

Int. Cls.: 9, 41 and 42

Prior U.S. Cls.: 21, 23, 26, 36, 38, 100, 101 and 107

Reg. No. 3,474,343

United States Patent and Trademark Office

Registered July 29, 2008

**TRADEMARK
SERVICE MARK
PRINCIPAL REGISTER**

TOPO

CENTRE D'ACCÈS A L'INFORMATION JURIDI-
QUE (CANADA CORPORATION)
19, LE ROYER WEST, SUITE 101
MONTREAL, QUEBEC, CANADA H2Y 1W4

FOR: COMPUTER SOFTWARE FOR CONNECT-
ING COMPUTER NETWORK USERS TO ONLINE
DATABASES ON THE INTERNET FOR RESEARCH
OF LEGAL INFORMATION, NAMELY, LEGISLA-
TION, CASE LAW AND DOCTRINE, AND FOR
LOCATING SAID INFORMATION IN VARIOUS
LIBRARIES, IN CLASS 9 (U.S. CLS. 21, 23, 26, 36
AND 38).

FOR: ON-LINE ACADEMIC LIBRARY SERVICES
IN THE FIELD OF LEGAL INFORMATION, NAME-
LY, LEGISLATION, CASE LAW, AND DOCTRINE,
IN CLASS 41 (U.S. CLS. 100, 101 AND 107).

FOR: COMPUTER SERVICES, NAMELY, PRO-
VIDING SEARCH ENGINES FOR OBTAINING
DATA ON A GLOBAL COMPUTER NETWORK IN
THE FIELD OF LEGAL INFORMATION, NAMELY,

LEGISLATION, CASE LAW AND DOCTRINE; PRO-
VIDING ON-LINE COMPUTER DATABASES IN
THE FIELD OF LEGAL INFORMATION, NAMELY,
LEGISLATION, CASE LAW AND DOCTRINE; CON-
DUCTING RESEARCH OVER THE INTERNET FOR
OTHERS IN THE FIELD OF LEGAL INFORMA-
TION, NAMELY, LEGISLATION, CASE LAW AND
DOCTRINE, IN CLASS 42 (U.S. CLS. 100 AND 101).

THE MARK CONSISTS OF STANDARD CHAR-
ACTERS WITHOUT CLAIM TO ANY PARTICULAR
FONT, STYLE, SIZE, OR COLOR.

PRIORITY CLAIMED UNDER SEC. 44(D) ON
CANADA APPLICATION NO. 1,245,517, FILED 2-1-
2005, REG. NO. 677714, DATED 11-27-2006, EXPIRES
11-27-2021.

SER. NO. 76-643,280, FILED 7-20-2005.

STEVEN R. FOSTER, EXAMINING ATTORNEY

Int. Cl.: 1

Prior U.S. Cls.: 1, 5, 6, 10, 26 and 46

United States Patent and Trademark Office

Reg. No. 3,474,344

Registered July 29, 2008

**TRADEMARK
PRINCIPAL REGISTER**

CorroTriBlack

ATOTECH DEUTSCHLAND GMBH (FED REP
GERMANY CORPORATION)
POSTFACH 21 07 80
BERLIN, FED REP GERMANY D-10507

FOR: CHEMICAL PRODUCTS FOR TREATING
METAL SURFACES, CHEMICAL PRODUCTS FOR
ZINC AND ZINC ALLOY TREATMENT TO IM-
PROVE CORROSION RESISTANCE , IN CLASS 1
(U.S. CLS. 1, 5, 6, 10, 26 AND 46).

FIRST USE 1-22-2004; IN COMMERCE 1-22-2004.

THE MARK CONSISTS OF STANDARD CHAR-
ACTERS WITHOUT CLAIM TO ANY PARTICULAR
FONT, STYLE, SIZE, OR COLOR.

SER. NO. 76-651,121, FILED 11-28-2005.

NAAKWAMA ANKRAH, EXAMINING ATTORNEY

Int. Cls.: 7, 12, 37 and 42

**Prior U.S. Cls.: 13, 19, 21, 23, 31, 34, 35, 44, 100, 101,
103 and 106**

Reg. No. 3,474,345

United States Patent and Trademark Office

Registered July 29, 2008

**TRADEMARK
SERVICE MARK
PRINCIPAL REGISTER**

RED SHARK ENGINEERING, INC.

RED SHARK ENGINEERING, INC. (CALIFORNIA CORPORATION)
1621 W. 25TH STREET, #262
SAN PEDRO, CA 90732

FOR: ENGINE COMPONENT PARTS FOR AUTOMOBILES, MOTORCYCLES, AND RACE CARS, NAMELY, SUPERCHARGING SYSTEMS COMPRISED OF AIR INTAKE MANIFOLDS, COMPRESSOR BELT DRIVES, CRANKSHAFT DRIVE PULLEYS, BELT TENSIONER PULLEYS, BELT TENSIONER BRACKETS, COMPRESSOR DRIVE PULLEYS, CHARGE COOLER TANKS, CHARGE COOLER TUBES, COLD AIR INTAKE AND FILTER BOXES, THE SYSTEM IS USED TO INCREASE A GASOLINE ENGINE'S HORSEPOWER AND PERFORMANCE; NATURALLY ASPIRATED INTAKE SYSTEMS COMPRISED OF INTAKE TUBES, INTAKE MANIFOLDS, THROTTLE BODIES, ENGINE CONTROL TUNTS, FUEL INJECTORS, AIR FILTERS, MOUNTING BRACKETS, AND MOUNTING BRACKETS FOR CHARGING SYSTEMS; DRIVE BELT TENSIONING SYSTEMS COMPRISED OF BELTS, TENSIONERS, PULLEYS, MOUNTING BRACKETS; AND EXHAUST SYSTEMS COMPRISED OF EXHAUST MANIFOLDS, HEADERS, COLLECTORS, CATALYTIC CONVERTERS, MUFFLERS, SILENCERS, FLANGES, MOUNTING BRACKETS, AND CUSTOM REPLACEMENT TUNED EXHAUST HEADERS, THE SYSTEM USED TO ENHANCE EXHAUST FLOW TO INCREASE ENGINE PERFORMANCE; AND REPLACEMENT TUNED EXHAUST SYSTEMS COMPRISED OF HIGH FLOW CATALYTIC CONVERTERS AND RE-DESIGNED SILENCER CORES , IN CLASS 7 (U.S. CLS. 13, 19, 21, 23, 31, 34 AND 35).

FIRST USE 9-1-1999; IN COMMERCE 10-2-1999.

FOR: METALLIC AND COMPOSITE STRUCTURAL COMPONENT PARTS FOR AUTOMOBILES, MOTORCYCLES AND RACE CARS, NAMELY MOTORCYCLE FRAMES AND AUTOMOBILE CHASSIS, AND AUTOMOBILE SUSPENSION COMPONENTS CONSISTING OF CONTROL ARMS, SWAY BARS, AND UPRIGHTS, IN CLASS 12 (U.S. CLS. 19, 21, 23, 31, 35 AND 44).

FIRST USE 9-1-1999; IN COMMERCE 10-2-1999.

FOR: VEHICLE REPAIR, MAINTENANCE, RESTORATION AND REFINISHING, IN CLASS 37 (U.S. CLS. 100, 103 AND 106).

FIRST USE 9-1-1999; IN COMMERCE 10-2-1999.

FOR: AUTOMOTIVE ENGINEERING AND DESIGN SERVICES FOR OTHERS; MECHANICAL ENGINEERING AND DESIGN SERVICES FOR OTHERS, IN CLASS 42 (U.S. CLS. 100 AND 101).

FIRST USE 9-1-1999; IN COMMERCE 10-2-1999.

THE MARK CONSISTS OF STANDARD CHARACTERS WITHOUT CLAIM TO ANY PARTICULAR FONT, STYLE, SIZE, OR COLOR.

NO CLAIM IS MADE TO THE EXCLUSIVE RIGHT TO USE "ENGINEERING, INC.", APART FROM THE MARK AS SHOWN.

SER. NO. 76-653,202, FILED 1-9-2006.

ANDREW RHIM, EXAMINING ATTORNEY

Int. Cl.: 4

Prior U.S. Cls.: 1, 6 and 15

United States Patent and Trademark Office

Reg. No. 3,474,346

Registered July 29, 2008

**TRADEMARK
PRINCIPAL REGISTER**

CEDARCUT

CEDAR LUBRICANTS CORPORATION (DELA-
WARE CORPORATION)
C/O PATRICK R. BECK
6215 HAMPTON PLACE
DUBLIN, OH 43016

FOR: CUTTING METALWORKING FLUIDS AND
OILS, NAMELY, LUBRICANTS WITH COOLING
PROPERTIES, IN CLASS 4 (U.S. CLS. 1, 6 AND 15).

FIRST USE 3-0-1991; IN COMMERCE 3-0-1991.

THE MARK CONSISTS OF STANDARD CHAR-
ACTERS WITHOUT CLAIM TO ANY PARTICULAR
FONT, STYLE, SIZE, OR COLOR.

OWNER OF U.S. REG. NOS. 2,136,452, 2,138,108,
AND 2,152,387.

SER. NO. 76-655,894, FILED 3-1-2006.

DANNEAN HETZEL, EXAMINING ATTORNEY

Int. Cl.: 4

Prior U.S. Cls.: 1, 6 and 15

United States Patent and Trademark Office

Reg. No. 3,474,347

Registered July 29, 2008

**TRADEMARK
PRINCIPAL REGISTER**

CEDARCOOL

CEDAR LUBRICANTS CORPORATION (DELA-
WARE CORPORATION)
C/O PATRICK R. BECK
6215 HAMPTON PLACE
DUBLIN, OH 43016

FOR: CUTTING METALWORKING FLUIDS AND
OILS, NAMELY, LUBRICANTS WITH COOLING
PROPERTIES, IN CLASS 4 (U.S. CLS. 1, 6 AND 15).

FIRST USE 2-0-1991; IN COMMERCE 2-0-1991.

THE MARK CONSISTS OF STANDARD CHAR-
ACTERS WITHOUT CLAIM TO ANY PARTICULAR
FONT, STYLE, SIZE, OR COLOR.

OWNER OF U.S. REG. NOS. 2,136,452, 2,138,108,
AND 2,152,387.

SER. NO. 76-655,895, FILED 3-1-2006.

DANNEAN HETZEL, EXAMINING ATTORNEY

Int. Cl.: 35

Prior U.S. Cls.: 100, 101 and 102

United States Patent and Trademark Office

Reg. No. 3,474,348

Registered July 29, 2008

SERVICE MARK
PRINCIPAL REGISTER

남가주 기독교 교회 협의회
The Council of Korean Churches in Southern California

YOO, DANIEL DANG YEOL (UNITED STATES
INDIVIDUAL)
1325 12TH AVENUE
LOS ANGELES, CA 90019

FOR: BUSINESS MANAGEMENT ASSISTANCE
SERVICES TO CHURCHES RELATING TO THEIR
ORGANIZATION AND OPERATION, IN CLASS 35
(U.S. CLS. 100, 101 AND 102).

FIRST USE 10-11-2001; IN COMMERCE 10-11-2001.

OWNER OF U.S. REG. NO. 2,685,697.

NO CLAIM IS MADE TO THE EXCLUSIVE
RIGHT TO USE "COUNCIL" AND "CHURCHES"

SHOWN IN ENGLISH AND THE KOREAN IDEO-
GRAMS, APART FROM THE MARK AS SHOWN.

THE MARK CONSISTS OF NON-LATIN CHAR-
ACTERS WHICH TRANSLITERATE TO "NAMGAJU
KIDOKYO KYOHAE HYUPEUIHAE", WHICH IS
TRANSLATED INTO "THE COUNCIL OF KOREAN
CHURCHES IN SOUTHERN CALIFORNIA".

SEC. 2(F).

SER. NO. 76-656,079, FILED 3-3-2006.

DAVID C. REIHNER, EXAMINING ATTORNEY

Int. Cl.: 9

Prior U.S. Cls.: 21, 23, 26, 36 and 38

United States Patent and Trademark Office

Reg. No. 3,474,349

Registered July 29, 2008

**TRADEMARK
PRINCIPAL REGISTER**



GANDOLFO, ANTOINE S. (FRANCE INDIVIDUAL)
3888 MANNIX DRIVE
SUITE 318
NAPLES, FL 34114

FOR: A WIRELESS COMMUNICATION SYSTEM, NAMELY, A DEVICE COMPRISING A FIRST REMOTE COMPONENT HAVING AN EAR SET AND A MICROPHONE FITTED TO A HELMET, OR OTHER

OBJECT, AND A SECOND COMPONENT IN WIRELESS COMMUNICATION WITH THE REMOTE, IN CLASS 9 (U.S. CLS. 21, 23, 26, 36 AND 38).

FIRST USE 2-0-2002; IN COMMERCE 2-0-2002.

SER. NO. 76-658,211, FILED 4-11-2006.

HOWARD SMIGA, EXAMINING ATTORNEY

Int. Cl.: 25

Prior U.S. Cls.: 22 and 39

United States Patent and Trademark Office

Reg. No. 3,474,350

Registered July 29, 2008

**TRADEMARK
PRINCIPAL REGISTER**

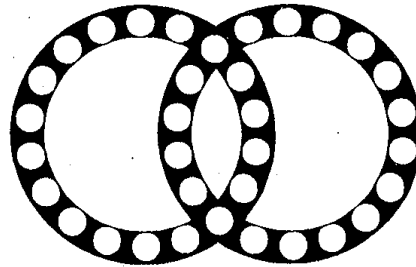

WANG, CHING YUN (TAIWAN INDIVIDUAL)
939 COTTONWOOD WAY
WALNUT, CA 91789

FOR: SHOES, IN CLASS 25 (U.S. CLS. 22 AND 39).

FIRST USE 6-10-2003; IN COMMERCE 6-10-2003.

THE COLOR(S) BLACK AND WHITE IS/ARE
CLAIMED AS A FEATURE OF THE MARK.

THE COLORS BLACK AND WHITE APPEAR IN
THE BODY OF TWO CROSSED RINGS, LOOKING
LIKE MANY SMALL WHITE BALLS ON THE BODY
OF THE 2 BLACK RINGS, AND THE TWO BLACK
RINGS ARE CROSSING EACH OTHER.

SER. NO. 76-658,906, FILED 4-24-2006.

LA TONIA FISHER, EXAMINING ATTORNEY

Int. Cls.: 37 and 42

Prior U.S. Cls.: 100, 101, 103 and 106

United States Patent and Trademark Office

Reg. No. 3,474,351

Registered July 29, 2008

**SERVICE MARK
PRINCIPAL REGISTER**

GREENHOMES AMERICA

HOME PERFORMANCE ENTERPRISES, LLC
(DELAWARE LTD LIAB CO)
1201 LOUISIANA STREET, SUITE 2700
HOUSTON, TX 77002

FOR: HEATING, VENTILATING AND AIR CONDITIONING REPAIR AND MAINTENANCE SERVICES; CONSULTATION IN THE FIELDS OF ENERGY-RELATED MODIFICATIONS FOR THE HOME, AND REPAIRING AND MAINTAINING HOME APPLIANCES; CONSTRUCTION, MAINTENANCE AND RENOVATION OF ENERGY-RELATED MODIFICATIONS FOR THE HOME; INSTALLATION OF REPLACEMENT WINDOWS AND INSULATION; MAINTENANCE OF HOME APPLIANCES, HEATING, VENTILATING, AND AIR CONDITIONING SYSTEMS, IN CLASS 37 (U.S. CLS. 100, 103 AND 106).

FIRST USE 12-10-2004; IN COMMERCE 12-10-2004.

FOR: TESTING, ANALYSIS AND EVALUATION OF HOME ENERGY EFFICIENCY; INSPECTION AND SAFETY ASSESSMENT OF THE PERFORMANCE OF HOME APPLIANCES, HEATING, VENTILATING, AND AIR CONDITIONING SYSTEMS, IN CLASS 42 (U.S. CLS. 100 AND 101).

FIRST USE 12-10-2004; IN COMMERCE 12-10-2004.

THE MARK CONSISTS OF STANDARD CHARACTERS WITHOUT CLAIM TO ANY PARTICULAR FONT, STYLE, SIZE, OR COLOR.

SEC. 2(F).

SER. NO. 76-662,745, FILED 7-10-2006.

TRACY CROSS, EXAMINING ATTORNEY

Int. Cl.: 35

Prior U.S. Cls.: 100, 101 and 102

United States Patent and Trademark Office

Reg. No. 3,474,352

Registered July 29, 2008

**SERVICE MARK
PRINCIPAL REGISTER**

U.S. TACTICAL SUPPLY

U.S. TACTICAL SUPPLY, INC. (OREGON CORPORATION)
2786 THREE LAKES ROAD
ALBANY, OR 97322

NO CLAIM IS MADE TO THE EXCLUSIVE RIGHT TO USE "TACTICAL SUPPLY", APART FROM THE MARK AS SHOWN.

FOR: RETAIL STORE SERVICES FEATURING TACTICAL GEAR AND GOVERNMENT TACTICAL GEAR, IN CLASS 35 (U.S. CLS. 100, 101 AND 102).

SEC. 2(F).

FIRST USE 2-0-2000; IN COMMERCE 2-0-2000.

SER. NO. 76-662,793, FILED 7-10-2006.

THE MARK CONSISTS OF STANDARD CHARACTERS WITHOUT CLAIM TO ANY PARTICULAR FONT, STYLE, SIZE, OR COLOR.

ERNEST SHOSHO, EXAMINING ATTORNEY

Int. Cls.: 35 and 42

Prior U.S. Cls.: 100, 101 and 102

United States Patent and Trademark Office

Reg. No. 3,474,353

Registered July 29, 2008

**SERVICE MARK
PRINCIPAL REGISTER**



DELTAWARE, INC. (TEXAS CORPORATION)
P.O. BOX 691226
SAN ANTONIO, TX 78269

FOR: ON-LINE RETAIL STORE SERVICES FEATURING COMPUTERS, SWITCHES, PERIPHERALS AND TELECOMMUNICATION ACCESSORIES, IN CLASS 35 (U.S. CLS. 100, 101 AND 102).

FIRST USE 12-31-1990; IN COMMERCE 12-31-1990.

FOR: DESIGNING COMPUTER AND WIDE AREA NETWORK HARDWARE SYSTEMS FOR OTHERS, IN CLASS 42 (U.S. CLS. 100 AND 101).

FIRST USE 12-31-1990; IN COMMERCE 12-31-1990.

SER. NO. 76-662,870, FILED 7-11-2006.

DAVID ELTON, EXAMINING ATTORNEY

Int. Cl.: 35

Prior U.S. Cls.: 100, 101 and 102

United States Patent and Trademark Office

Reg. No. 3,474,354

Registered July 29, 2008

**SERVICE MARK
PRINCIPAL REGISTER**

KNOPF AUTOMOTIVE

KNOPF AUTOMOTIVE, INC. (PENNSYLVANIA
CORPORATION)
3401 LEHIGH STREET
ALLENTOWN, PA 18103

NO CLAIM IS MADE TO THE EXCLUSIVE
RIGHT TO USE "AUTOMOTIVE", APART FROM
THE MARK AS SHOWN.

FOR: AUTOMOBILE DEALERSHIPS FEATUR-
ING NEW AND PRE-OWNED AUTOMOBILES, IN
CLASS 35 (U.S. CLS. 100, 101 AND 102).

SEC. 2(F).

FIRST USE 1-1-1969; IN COMMERCE 4-1-1969.

SER. NO. 76-664,806, FILED 8-18-2006.

THE MARK CONSISTS OF STANDARD CHAR-
ACTERS WITHOUT CLAIM TO ANY PARTICULAR
FONT, STYLE, SIZE, OR COLOR.

KAREN K. BUSH, EXAMINING ATTORNEY

Int. Cl.: 9

Prior U.S. Cls.: 21, 23, 26, 36 and 38

Reg. No. 3,474,355

United States Patent and Trademark Office

Registered July 29, 2008

**TRADEMARK
PRINCIPAL REGISTER**



DOT HILL SYSTEMS CORP. (DELAWARE CORPORATION)
2200 FARADAY AVE., SUITE. 100
CARLSBAD, CA 92008

FOR: COMPUTER HARDWARE IN THE FIELD OF EXTERNAL STORAGE SOLUTIONS AND RELATED DOWNLOADABLE COMPUTER SOFTWARE, IN CLASS 9 (U.S. CLS. 21, 23, 26, 36 AND 38).

FIRST USE 10-31-2005; IN COMMERCE 10-31-2005.

NO CLAIM IS MADE TO THE EXCLUSIVE RIGHT TO USE "RAPID", APART FROM THE MARK AS SHOWN.

THE MARK CONSISTS OF, FROM LEFT TO RIGHT, A BIG COLOR-GRADUATED SPHERE WITH A LETTER "R" IN ITS CENTER AND A SMALL COLOR-GRADUATED SPHERE LOCATED ABOVE IT ON THE RIGHT SIDE, A STRAIGHT VERTICAL LINE, AND A WORD "EVOLUTION" IN BIG LETTERING WITH A PHRASE "RAPID EVOLUTION" IN SMALL LETTERING BENEATH IT.

SER. NO. 76-665,482, FILED 9-1-2006.

KAPIL BHANOT, EXAMINING ATTORNEY

Int. Cls.: 9 and 41

Prior U.S. Cls.: 21, 23, 26, 36, 38, 100, 101 and 107

United States Patent and Trademark Office

Reg. No. 3,474,356

Registered July 29, 2008

**TRADEMARK
SERVICE MARK
PRINCIPAL REGISTER**

EDUCAUSE LEARNING INITIATIVE

EDUCAUSE CORPORATION (D.C. CORPORATION)
4772 WALNUT STREET
SUITE 206
BOULDER, CO 80301

FOR: DOWNLOADABLE ON-LINE PUBLICATIONS, NAMELY, BROCHURES, NEWSLETTERS AND ARTICLES IN THE FIELD OF THE USE OF INFORMATION TECHNOLOGY TO IMPROVE LEARNING IN HIGHER EDUCATION, IN CLASS 9 (U.S. CLS. 21, 23, 26, 36 AND 38).

FIRST USE 5-16-2005; IN COMMERCE 5-16-2005.

FOR: CONDUCTING ON-LINE SEMINARS AND CONDUCTING ON-LINE AND IN PERSON CONFERENCES IN THE FIELD OF THE USE OF INFORMATION TECHNOLOGY TO IMPROVE

LEARNING IN HIGHER EDUCATION, IN CLASS 41 (U.S. CLS. 100, 101 AND 107).

FIRST USE 5-16-2005; IN COMMERCE 5-16-2005.

THE MARK CONSISTS OF STANDARD CHARACTERS WITHOUT CLAIM TO ANY PARTICULAR FONT, STYLE, SIZE, OR COLOR.

OWNER OF U.S. REG. NOS. 2,323,313, 2,646,379 AND OTHERS.

NO CLAIM IS MADE TO THE EXCLUSIVE RIGHT TO USE "LEARNING", APART FROM THE MARK AS SHOWN.

SER. NO. 76-665,866, FILED 9-8-2006.

MARY MUNSON, EXAMINING ATTORNEY

Int. Cls.: 19 and 40

Prior U.S. Cls.: 1, 12, 33, 50, 100, 103 and 106

United States Patent and Trademark Office

Reg. No. 3,474,357

Registered July 29, 2008

**TRADEMARK
SERVICE MARK
PRINCIPAL REGISTER**



PACKAGE PAVEMENT COMPANY, INC. (NEW YORK CORPORATION)
P.O. BOX 408
STORMVILLE, NY 12582

FOR: CEMENT AND ASPHALT BASED PRODUCTS, NAMELY, CONCRETE MIXES THAT CONTAIN A DRY BLEND OF CEMENTITIOUS MATERIALS AND AGGREGATES; BLACKTOP PATCHING COMPOUND MADE OF A TAR BASE AND HIGH PERFORMANCE BLACKTOP PATCHING COMPOUNDS MADE OF A TAR BASE; PAVER SANDS, NAMELY, MASON SAND BLENDED WITH A POLYMER ADDITIVE WHICH IS USED TO FILL JOINTS BETWEEN BRICK AND CONCRETE PAVERS FOR PATIOS, DRIVEWAYS AND WALKWAYS; MORTAR AND MASONRY CEMENT MIXES; SAND-BASED CEMENT MIXES; QUICK-SETTING CEMENT; ANCHORING CEMENT; BONDING CEMENT; MASONRY GROUT; CEMENT-BASED STUCCO, NAMELY, BASE AND FINISH COAT STUCCOS USED AS A PROTECTIVE AND DECORATIVE FINISH ON WALLS; BLACKTOP PATCHING AND REPAIRING PRODUCTS, NAMELY, PACKAGED ASPHALT PATCHING COMPOUND MADE OF A TAR BASE FOR REPAIRING AND PATCHING BLACKTOP; ASPHALT PLUGS CONSISTING OF SOLID ASPHALT COMPOUND FOR THE REPAIR OF HOLES CREATED IN ASPHALT SURFACES, BAR HOLES AND TENT STAKE HOLES, IN CLASS 19 (U.S. CLS. 1, 12, 33 AND 50).

FIRST USE 7-11-2006; IN COMMERCE 7-11-2006.

FOR: MANUFACTURING SERVICES FOR OTHERS IN THE FIELD OF CEMENT AND ASPHALT FOR THE BUILDING AND CONSTRUCTION REPAIR INDUSTRY, IN PARTICULAR, THE MANUFACTURING OF CEMENT AND ASPHALT BASED PRODUCTS IN THE NATURE OF CONCRETE

MIXES THAT CONTAIN A DRY BLEND OF CEMENTITIOUS MATERIALS AND AGGREGATES, BLACKTOP PATCHING COMPOUND MADE OF A TAR BASE AND HIGH PERFORMANCE BLACKTOP PATCHING COMPOUNDS MADE OF A TAR BASE, PAVER SANDS, NAMELY, MASON SAND BLENDED WITH A POLYMER ADDITIVE WHICH IS USED TO FILL JOINTS BETWEEN BRICK AND CONCRETE PAVERS FOR PATIOS, DRIVEWAYS AND WALKWAYS, MORTAR AND MASONRY CEMENT MIXES, SAND-BASED CEMENT MIXES, QUICK-SETTING CEMENT, ANCHORING CEMENT; BONDING CEMENT, MASONRY GROUT, CEMENT-BASED STUCCO, NAMELY, BASE AND FINISH COAT STUCCOS USED AS A PROTECTIVE AND DECORATIVE FINISH ON WALLS, BLACKTOP PATCHING AND REPAIRING PRODUCTS, NAMELY, PACKAGED ASPHALT PATCHING COMPOUND MADE OF A TAR BASE FOR REPAIRING AND PATCHING BLACKTOP, ASPHALT PLUGS CONSISTING OF SOLID ASPHALT COMPOUND FOR THE REPAIR OF HOLES CREATED IN ASPHALT SURFACES, BAR HOLES AND TENT STAKE HOLES, IN CLASS 40 (U.S. CLS. 100, 103 AND 106).

FIRST USE 7-11-2006; IN COMMERCE 7-11-2006.

NO CLAIM IS MADE TO THE EXCLUSIVE RIGHT TO USE "PACKAGE PAVEMENT", APART FROM THE MARK AS SHOWN.

THE COLOR(S) BLACK, WHITE AND YELLOW IS/ARE CLAIMED AS A FEATURE OF THE MARK.

THE MARK INCLUDES THE WORDS "PACKAGE" AND "PAVEMENT" WHICH APPEAR IN THE COLOR BLACK. IN ADDITION, THERE APPEARS A LOGO DESIGN CONSISTING OF A BLACK-COLORED, BLOCK-LETTER "P", WHICH APPEARS

INSIDE A WHITE-COLORED SILHOUETTE OF THE LETTER "P", WHICH APPEARS INSIDE A BLACK-COLORED CIRCLE, WHICH IN TURN APPEARS INSIDE A WHITE-COLORED RINGED CIRCLE, WHICH IN TURN APPEARS INSIDE A YELLOW-COLORED RINGED CIRCLE, WHICH IN TURN

APPEARS INSIDE A BLACK-COLORED LINE CIRCLE.

SER. NO. 76-666,815, FILED 9-29-2006.

TANYA AMOS, EXAMINING ATTORNEY

Int. Cl.: 6

Prior U.S. Cls.: 2, 12, 13, 14, 23, 25 and 50

Reg. No. 3,474,358

United States Patent and Trademark Office

Registered July 29, 2008

**TRADEMARK
PRINCIPAL REGISTER**

HYDROMAX

TYLER PIPE COMPANY, A DIVISION OF RAN-
SOM INDUSTRIES, LP (ALABAMA LIMITED
PARTNERSHIP)
P.O. BOX 2027
TYLER, TX 757102027

FIRST USE 6-0-2003; IN COMMERCE 6-0-2003.

THE MARK CONSISTS OF STANDARD CHAR-
ACTERS WITHOUT CLAIM TO ANY PARTICULAR
FONT, STYLE, SIZE, OR COLOR.

FOR: ROOF DRAINING SYSTEM CONSISTING
MAINLY OF CAST IRON, COPPER, STEEL DRAIN
PIPES, IN CLASS 6 (U.S. CLS. 2, 12, 13, 14, 23, 25 AND
50).

SER. NO. 76-667,235, FILED 10-10-2006.

MIDGE BUTLER, EXAMINING ATTORNEY

Int. Cl.: 9

Prior U.S. Cls.: 21, 23, 26, 36 and 38

Reg. No. 3,474,359

United States Patent and Trademark Office

Registered July 29, 2008

**TRADEMARK
PRINCIPAL REGISTER**

DYNA DRIVE

ROLAND CORPORATION (JAPAN CORPORATION)
2036-1, NAKAGAWA
HOSOE-CHO, HAMAMATSU
SHIZUOKA-KEN 431-1304, JAPAN

FIRST USE 1-31-2007; IN COMMERCE 1-31-2007.

THE MARK CONSISTS OF STANDARD CHARACTERS WITHOUT CLAIM TO ANY PARTICULAR FONT, STYLE, SIZE, OR COLOR.

FOR: GUITAR EFFECTS PEDALS, NAMELY, ELECTRONIC EFFECT PEDALS FOR USE WITH SOUND AMPLIFIERS, IN CLASS 9 (U.S. CLS. 21, 23, 26, 36 AND 38).

SER. NO. 76-669,262, FILED 11-20-2006.

LAURIE KAUFMAN, EXAMINING ATTORNEY

Int. Cl.: 7

Prior U.S. Cls.: 13, 19, 21, 23, 31, 34 and 35

United States Patent and Trademark Office

Reg. No. 3,474,360

Registered July 29, 2008

**TRADEMARK
PRINCIPAL REGISTER**



ADEPCO TECHNOLOGIES CORPORATION (CANADA CORPORATION)
565 SPEERS ROAD
OAKVILLE, ONTARIO L6K 2G4, CANADA

FOR: SNOW PLOWS AND MECHANICAL SALT SPREADERS, IN CLASS 7 (U.S. CLS. 13, 19, 21, 23, 31, 34 AND 35).

FIRST USE 8-0-1998; IN COMMERCE 8-0-1998.

PRIORITY CLAIMED UNDER SEC. 44(D) ON CANADA APPLICATION NO. 1305512, FILED 6-15-2006, REG. NO. 694911, DATED 8-28-2007, EXPIRES 8-28-2022.

OWNER OF U.S. REG. NO. 2,393,983.

SER. NO. 76-669,547, FILED 11-27-2006.

JANICE L. MCMORROW, EXAMINING ATTORNEY

Int. Cls.: 35, 38, 41 and 42

Prior U.S. Cls.: 100, 101, 102, 104 and 107

Reg. No. 3,474,361

United States Patent and Trademark Office

Registered July 29, 2008

**SERVICE MARK
PRINCIPAL REGISTER**

**ENGAGE WITH ON-DEMAND
RICH MEDIA**

ACCELA COMMUNICATIONS, INC. (MASSACHUSETTS CORPORATION)
118 TURNPIKE ROAD
SOUTHBOROUGH, MA 01772

FOR: PROVIDING ON-LINE REGISTRATION SERVICES FOR ON-LINE PRESENTATIONS, DEMONSTRATIONS, TRAINING, AND SEMINARS; CONDUCTING AND PROVIDING THE RESULTS OF BUSINESS RESEARCH AND SURVEYS OVER THE INTERNET; BUSINESS MARKETING CONSULTING SERVICES IN THE FIELD OF ON-LINE PRESENTATIONS, DEMONSTRATIONS, TRAINING, AND COMMUNICATION; DATABASE MANAGEMENT SERVICES IN THE FIELD OF ONLINE PRESENTATIONS, DEMONSTRATIONS, TRAINING, AND COMMUNICATION; ARRANGING AND CONDUCTING BUSINESS CONFERENCES; ARRANGING AND CONDUCTING BUSINESS CONFERENCES, IN CLASS 35 (U.S. CLS. 100, 101 AND 102).

FIRST USE 10-1-2006; IN COMMERCE 10-1-2006.

FOR: STREAMING OF AUDIO AND VIDEO MATERIAL ON THE INTERNET; BROADCASTING PROGRAMS VIA A GLOBAL COMPUTER NETWORK; WEBCASTING SERVICES; COMMUNICATIONS SERVICES, NAMELY, ELECTRONIC TRANSMISSION OF DATA AND DOCUMENTS AMONG USERS OF COMPUTERS; COMMUNICATIONS SERVICES, NAMELY, TRANSMITTING STREAMED SOUND AND AUDIO-VISUAL RECORDS VIA THE INTERNET; ELECTRONIC AND DIGITAL TRANSMISSION OF VOICE, DATA, IMAGES, SIGNALS, AND MESSAGES OVER THE INTERNET; DELIVERING ON-LINE WEB PRESENTATIONS, NAMELY, ELECTRONIC TRANSMISSION OF ON-LINE WEB PRESENTATIONS FOR OTHERS FOR THE PURPOSE OF CON-

DUCTING ON-LINE DEMONSTRATIONS, TRAINING, COMMUNICATIONS AND INTERACTIVE DISCUSSIONS TO COLLECT, MEASURE AND ANALYZE ONLINE REGISTRATION DATA AND VIEWER METRICS FOR OTHERS, IN CLASS 38 (U.S. CLS. 100, 101 AND 104).

FIRST USE 10-1-2006; IN COMMERCE 10-1-2006.

FOR: ARRANGING AND CONDUCTING BUSINESS SEMINARS; EDUCATIONAL SERVICES, NAMELY, PROVIDING ON-LINE WEB PRESENTATIONS FOR OTHERS FOR THE EDUCATIONAL PURPOSE OF CONDUCTING ONLINE DEMONSTRATIONS, TRAINING, COMMUNICATIONS AND INTERACTIVE DISCUSSIONS TO COLLECT, MEASURE AND ANALYZE ONLINE REGISTRATION DATA AND VIEWER METRICS FOR OTHERS, IN CLASS 41 (U.S. CLS. 100, 101 AND 107).

FIRST USE 10-1-2006; IN COMMERCE 10-1-2006.

FOR: HOSTING OF DIGITAL CONTENT OVER THE INTERNET, IN CLASS 42 (U.S. CLS. 100 AND 101).

FIRST USE 10-1-2006; IN COMMERCE 10-1-2006.

THE MARK CONSISTS OF STANDARD CHARACTERS WITHOUT CLAIM TO ANY PARTICULAR FONT, STYLE, SIZE, OR COLOR.

NO CLAIM IS MADE TO THE EXCLUSIVE RIGHT TO USE "ON-DEMAND RICH MEDIA", APART FROM THE MARK AS SHOWN.

SER. NO. 76-669,671, FILED 11-29-2006.

LANA PHAM, EXAMINING ATTORNEY

Int. Cl.: 30

Prior U.S. Cl.: 46

United States Patent and Trademark Office

Reg. No. 3,474,362

Registered July 29, 2008

TRADEMARK
PRINCIPAL REGISTER

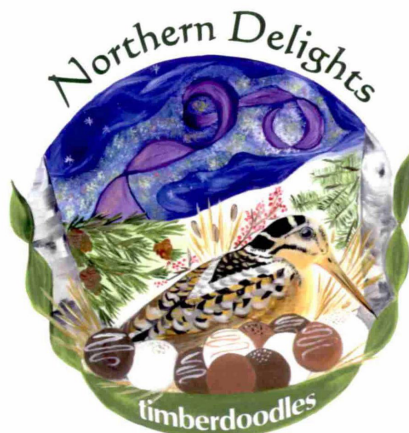

LIMMER, JULIE KAYE (UNITED STATES INDIVIDUAL)
#5 ROCKY HOLLOW LANE
P.O. BOX 515
GLEN, NH 03838

FOR: CHOCOLATES, IN CLASS 30 (U.S. CL. 46).

FIRST USE 1-9-2007; IN COMMERCE 1-9-2007.

"THE COLOR(S) GREEN,BROWN,WHITE,GOLD,-BLACK, GRAY,BLUE AND PURPLE IS/ARE CLAIMED AS A FEATURE OF THE MARK."

THE MARK CONSISTS OF A WOODCOCK WITH A FEATHER PATTERN OF BLACK ,WHITE, GOLD, AND GRAY SITTING IN A NEST OF CHOCOLATE TRUFFLES COLORED BROWN,DARK BROWN,

AND WHITE. THERE IS A WHITE MOUNTAIN BEHIND THE WOODCOCK AND TWO BIRCH TREES FRAMING THE PICTURE ON THE RIGHT AND LEFT. THE BIRCH TREES ARE JUST SHOWING THE TRUNKS WHICH ARE WHITE GRAY AND BLACK. THE SKY ABOVE THE WOODCOCK AND MOUNTAIN IS DEEP BLUE WITH A TWISTED PURPLE RIBBON REPRESENTING THE AURORA BOREALIS. A FEW WHITE STARS ARE FIXED IN THE BLUE SKY. A GREEN RIBBON ENCIRCLES THE LOWER HALF OF THE CIRCULAR PICTURE WITH WHITE LETTERING IN THE RIBBON THAT SAYS TIMBERDOODLES. THE WORDS NORTHERN DELIGHTS FRAMING THE TOP OF THE CIRCULAR DRAWING..

SER. NO. 76-672,548, FILED 2-12-2007.

LINDA MICKLEBURGH, EXAMINING ATTORNEY

Int. Cls.: 20 and 24

Prior U.S. Cls.: 2, 13, 22, 25, 32, 42 and 50

United States Patent and Trademark Office

Reg. No. 3,474,363

Registered July 29, 2008

**TRADEMARK
PRINCIPAL REGISTER**

BLOOMCRAFT HOME

P. KAUFMANN, INC. (NEW YORK CORPORATION)
3 PARK AVENUE
NEW YORK, NY 10016

FOR: PILLOWS AND DECORATIVE PILLOWS, IN CLASS 20 (U.S. CLS. 2, 13, 22, 25, 32 AND 50).

FIRST USE 4-1-2004; IN COMMERCE 4-1-2004.

FOR: BEDDING, NAMELY, BEDSPREADS, SHEETS, SHEET SETS, COVERLETS, DUVETS, DUVET SETS, COMFORTERS, AND COMFORTER SETS; SHOWER CURTAINS; WINDOW TREATMENTS, NAMELY, CURTAINS, FABRIC VALENCES, AND TIERS; TOWELS; PLACEMATS,

NAPKINS, AND TABLECLOTHS, ALL MADE OF FABRIC, IN CLASS 24 (U.S. CLS. 42 AND 50).

FIRST USE 4-1-2004; IN COMMERCE 4-1-2004.

THE MARK CONSISTS OF STANDARD CHARACTERS WITHOUT CLAIM TO ANY PARTICULAR FONT, STYLE, SIZE, OR COLOR.

NO CLAIM IS MADE TO THE EXCLUSIVE RIGHT TO USE "HOME" , APART FROM THE MARK AS SHOWN.

SER. NO. 76-672,724, FILED 2-15-2007.

LINDSEY RUBIN, EXAMINING ATTORNEY

Int. Cl.: 35

Prior U.S. Cls.: 100, 101 and 102

United States Patent and Trademark Office

Reg. No. 3,474,364

Registered July 29, 2008

**SERVICE MARK
PRINCIPAL REGISTER**

Two Guys Smoke Shop

GAROFALO, DAVID (UNITED STATES INDIVIDUAL)
16 LANTERN LANE
LONDONDERRY, NH 03053

FOR: RETAIL STORE SERVICES AND WHOLESALE DISTRIBUTORSHIPS, ALL FEATURING CIGARS, TOBACCO AND SMOKING ACCESSORIES, IN CLASS 35 (U.S. CLS. 100, 101 AND 102).

FIRST USE 11-1-1985; IN COMMERCE 5-1-1993.

THE MARK CONSISTS OF STANDARD CHARACTERS WITHOUT CLAIM TO ANY PARTICULAR FONT, STYLE, SIZE, OR COLOR.

NO CLAIM IS MADE TO THE EXCLUSIVE RIGHT TO USE "SMOKE SHOP", APART FROM THE MARK AS SHOWN.

SER. NO. 76-673,179, FILED 2-26-2007.

ANTHONY RINKER, EXAMINING ATTORNEY

Int. Cl.: 35

Prior U.S. Cls.: 100, 101 and 102

United States Patent and Trademark Office

Reg. No. 3,474,365

Registered July 29, 2008

**SERVICE MARK
PRINCIPAL REGISTER**



ALL EXCLUSIVE LEADS, LTD. (TEXAS LIMITED PARTNERSHIP)
9 KERN RAMBLE #A
AUSTIN, TX 78722

FIRST USE 12-1-2006; IN COMMERCE 12-1-2006.

SER. NO. 76-673,907, FILED 3-12-2007.

FOR: PROVIDING SALES REFERRALS FOR INSURANCE AGENTS, IN CLASS 35 (U.S. CLS. 100, 101 AND 102).

PAM WILLIS, EXAMINING ATTORNEY

Int. Cl.: 35

Prior U.S. Cls.: 100, 101 and 102

United States Patent and Trademark Office

Reg. No. 3,474,366

Registered July 29, 2008

SERVICE MARK
PRINCIPAL REGISTER



BOSO, R. DAVID (UNITED STATES INDIVIDUAL)
2 WALNUT ST
BELPRE, OH 45714

NO CLAIM IS MADE TO THE EXCLUSIVE RIGHT TO USE "MARINE", APART FROM THE MARK AS SHOWN.

FOR: RETAIL STORE SERVICES FEATURING BOATS AND MARINE PRODUCTS, IN CLASS 35 (U.S. CLS. 100, 101 AND 102).

SER. NO. 76-673,913, FILED 3-12-2007.

FIRST USE 4-0-1981; IN COMMERCE 4-0-1981.

JORDAN BAKER, EXAMINING ATTORNEY

Int. Cls.: 7 and 8

Prior U.S. Cls.: 13, 19, 21, 23, 28, 31, 34, 35 and 44

United States Patent and Trademark Office

Reg. No. 3,474,367

Registered July 29, 2008

**TRADEMARK
PRINCIPAL REGISTER**

AJAX

AJAX TOOL WORKS, INC. (ILLINOIS CORPORATION)
10801 FRANKLIN AVENUE
FRANKLIN PARK, IL 60131

FOR: TOOLS FOR MACHINES, NAMELY, BUSHING TOOLS, MACHINE OPERATED CHISELS, COUPLERS, POINT OF WORK PNEUMATIC CONTROL, NEEDLE SCALER ATTACHMENTS, NEEDLE SCALER PARTS, CHIPPING HAMMER RETAINERS, ZIP GUN AND RIVET HAMMER RETAINERS, RIVETING HAMMERS AND RIVET BUSTER SLEEVES, SWIVEL HOSE CONNECTORS, ELECTRIC HAMMER CHISELS, PAVING BREAKER CHISELS AND HYDRAULIC HAMMER BITS, AND RESCUE TOOLS AND KITS COMPRISING AIR HAMMERS AND MACHINE OPERATED CHISELS, IN CLASS 7 (U.S. CLS. 13, 19, 21, 23, 31, 34 AND 35).

FIRST USE 0-0-1947; IN COMMERCE 0-0-1947.

FOR: HAND TOOLS, NAMELY, CROWBARS, PINCH BARS, DIGGING BARS, PRY BARS, CHISEL

BARS, LINING BARS, FIT UP BARS, CONNECTING BARS, CHISELS, FLANGE SCRAPERS, WELDING PINS FOR USE IN ALIGNMENT, DRIFT PINS FOR USE IN ALIGNMENT, COTTER PIN PULLERS, COTTER PIN PULLERS AND SPREADERS, PUNCHES, TONGS, AND WEDGES, AND RESCUE TOOLS AND KITS COMPRISING CHISELS, IN CLASS 8 (U.S. CLS. 23, 28 AND 44).

FIRST USE 0-0-1947; IN COMMERCE 0-0-1947.

THE MARK CONSISTS OF STANDARD CHARACTERS WITHOUT CLAIM TO ANY PARTICULAR FONT, STYLE, SIZE, OR COLOR.

OWNER OF U.S. REG. NO. 3,210,486.

SER. NO. 76-674,768, FILED 3-29-2007.

KYLE PEETE, EXAMINING ATTORNEY

Int. Cl.: 44

Prior U.S. Cls.: 100 and 101

United States Patent and Trademark Office

Reg. No. 3,474,368

Registered July 29, 2008

SERVICE MARK
PRINCIPAL REGISTER

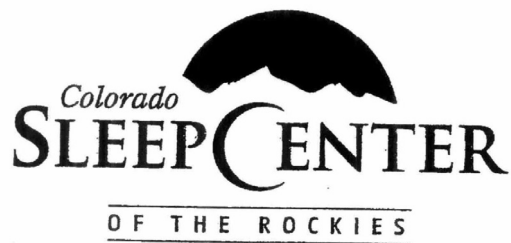

COLORADO SLEEP CENTER OF THE ROCKIES,
LLC (COLORADO LTD LIAB CO)
2500 ROCKY MOUNTAIN AVENUE, SUITE 310
LOVELAND, CO 80538

FOR: MEDICAL SERVICES, NAMELY, CONSULTATION, DIAGNOSIS, AND TREATMENT OF SLEEP DISORDERS, IN CLASS 44 (U.S. CLS. 100 AND 101).

FIRST USE 4-12-2007; IN COMMERCE 4-12-2007.

NO CLAIM IS MADE TO THE EXCLUSIVE RIGHT TO USE "COLORADO SLEEP CENTER OF THE ROCKIES", APART FROM THE MARK AS SHOWN.

SER. NO. 76-675,444, FILED S.R. 4-13-2007 AM. P.R. 12-19-2007.

SANI KHOURI, EXAMINING ATTORNEY

Int. Cl.: 20

Prior U.S. Cls.: 2, 13, 22, 25, 32 and 50

United States Patent and Trademark Office

Reg. No. 3,474,369

Registered July 29, 2008

**TRADEMARK
PRINCIPAL REGISTER**

ATLANTIC RENTALS AND SALES

ATLANTIC RENTALS AND SALES, INC. (NEW
JERSEY CORPORATION)
830-B OLD CORLIES AVENUE
NEPTUNE, NJ 07753

FOR: MERCHANDISE DISPLAY CASES AND
PARTS, NAMELY, SHOWCASES, WALLCASES
AND COUNTER CASES, IN CLASS 20 (U.S. CLS. 2,
13, 22, 25, 32 AND 50).

FIRST USE 9-1-1996; IN COMMERCE 9-1-1996.

THE MARK CONSISTS OF STANDARD CHAR-
ACTERS WITHOUT CLAIM TO ANY PARTICULAR
FONT, STYLE, SIZE, OR COLOR.

NO CLAIM IS MADE TO THE EXCLUSIVE
RIGHT TO USE "RENTALS AND SALES", APART
FROM THE MARK AS SHOWN.

SEC. 2(F).

SER. NO. 76-675,638, FILED 4-18-2007.

LINDA E. BLOHM, EXAMINING ATTORNEY

Int. Cl.: 20

Prior U.S. Cls.: 2, 13, 22, 25, 32 and 50

United States Patent and Trademark Office

Reg. No. 3,474,370

Registered July 29, 2008

**TRADEMARK
PRINCIPAL REGISTER**

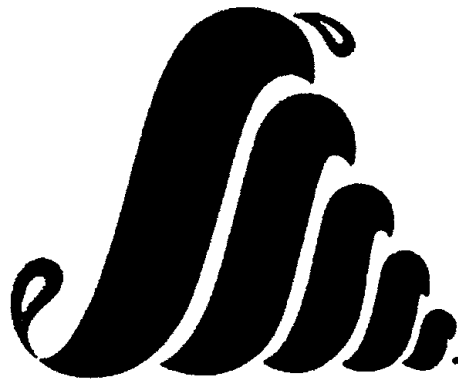

ATLANTIC RENTALS AND SALES, INC. (NEW
JERSEY CORPORATION)
830-B OLD CORLIES AVENUE
NEPTUNE, NJ 07753

FOR: MERCHANDISE DISPLAY CASES AND
PARTS, NAMELY, SHOWCASES, WALLCASES
AND COUNTER CASES, IN CLASS 20 (U.S. CLS. 2,
13, 22, 25, 32 AND 50).

FIRST USE 9-1-1996; IN COMMERCE 9-1-1996.

THE MARK IS COMPRISED OF THE DESIGN OF
A WAVE IN A TRIANGULAR FORM.

SER. NO. 76-675,639, FILED 4-18-2007.

LINDA E. BLOHM, EXAMINING ATTORNEY

Int. Cl.: 11

Prior U.S. Cls.: 13, 21, 23, 31 and 34

United States Patent and Trademark Office

Reg. No. 3,474,371

Registered July 29, 2008

**TRADEMARK
PRINCIPAL REGISTER**



UNIQUE LIGHTING SYSTEMS (CALIFORNIA CORPORATION)
1240 SIMPSON WAY
ESCONDIDO, CA 92029

FOR: OUTDOOR DECORATIVE ELECTRIC LUMINARIES, IN CLASS 11 (U.S. CLS. 13, 21, 23, 31 AND 34).

FIRST USE 1-31-2001; IN COMMERCE 1-31-2001.

NO CLAIM IS MADE TO THE EXCLUSIVE RIGHT TO USE "LIGHTING" AND "LOW VOLTAGE LIGHTING", APART FROM THE MARK AS SHOWN.

SER. NO. 76-675,854, FILED 4-23-2007.

CURTIS FRENCH, EXAMINING ATTORNEY

Int. Cls.: 38 and 41

Prior U.S. Cls.: 100, 101, 104 and 107

United States Patent and Trademark Office

Reg. No. 3,474,372

Registered July 29, 2008

**SERVICE MARK
PRINCIPAL REGISTER**

EYEGLU

ACCURATE COMMUNICATIONS CORPORATION (ARKANSAS CORPORATION), DBA EARGLUE
2650 THOUSAND OAKS BLVD., SUITE 2430
MEMPHIS, TN 381182450

FOR: CONTENT DELIVERY, NAMELY, DELIVERY OF USER-DEFINED CUSTOMIZED PRE-RECORDED CONTENT, NAMELY, INFORMATION, PROMOTIONAL MESSAGING, GENERAL INTEREST ENTERTAINMENT, AND EDUCATIONAL INFORMATION, PROVIDED AS DIGITAL VIDEO, AUDIO, AND MUSIC DELIVERED TO DIGITAL SIGNAGE VIA BROADBAND COMMUNICATIONS NETWORKS, IN CLASS 38 (U.S. CLS. 100, 101 AND 104).

FIRST USE 11-29-2006; IN COMMERCE 11-29-2006.

FOR: SCRIPT WRITING SERVICES FOR USER-DEFINED CONTENT TO BE DELIVERED TO DIGI-

TAL SIGNAGE VIA BROADBAND COMMUNICATIONS NETWORKS; AND AUDIO, VIDEO, AND MUSIC CONTENT RECORDING AND PRODUCTION SERVICES FOR USER-DEFINED CONTENT TO BE DELIVERED TO DIGITAL SIGNAGE VIA BROADBAND COMMUNICATIONS NETWORKS, IN CLASS 41 (U.S. CLS. 100, 101 AND 107).

FIRST USE 11-29-2006; IN COMMERCE 11-29-2006.

THE MARK CONSISTS OF STANDARD CHARACTERS WITHOUT CLAIM TO ANY PARTICULAR FONT, STYLE, SIZE, OR COLOR.

OWNER OF U.S. REG. NOS. 3,058,581 AND 3,058,582.

SER. NO. 76-676,241, FILED 4-30-2007.

MIDGE BUTLER, EXAMINING ATTORNEY

Int. Cls.: 38 and 41

Prior U.S. Cls.: 100, 101, 104 and 107

United States Patent and Trademark Office

Reg. No. 3,474,373

Registered July 29, 2008

**SERVICE MARK
PRINCIPAL REGISTER**

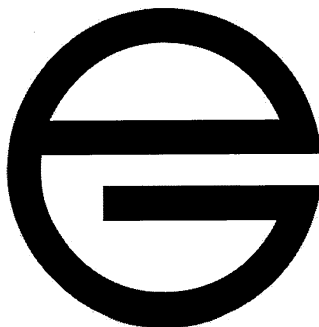

ACCURATE COMMUNICATIONS CORPORATION (ARKANSAS CORPORATION), DBA EARGLUE
2650 THOUSAND OAKS BLVD., SUITE 2430
MEMPHIS, TN 381182450

FOR: CONTENT DELIVERY, NAMELY, DELIVERY OF USER-DEFINED CUSTOMIZED PRE-RECORDED CONTENT, NAMELY, INFORMATION, PROMOTIONAL MESSAGING, GENERAL INTEREST ENTERTAINMENT, AND EDUCATIONAL INFORMATION, PROVIDED AS DIGITAL VIDEO, AUDIO, AND MUSIC DELIVERED TO DIGITAL SIGNAGE VIA BROADBAND COMMUNICATIONS NETWORKS, IN CLASS 38 (U.S. CLS. 100, 101 AND 104).

FIRST USE 11-29-2006; IN COMMERCE 11-29-2006.

FOR: SCRIPT WRITING SERVICES FOR USER-DEFINED CONTENT TO BE DELIVERED TO DIGI-

TAL SIGNAGE VIA BROADBAND COMMUNICATIONS NETWORKS; AND AUDIO, VIDEO, AND MUSIC CONTENT RECORDING AND PRODUCTION SERVICES FOR USER-DEFINED CONTENT TO BE DELIVERED TO DIGITAL SIGNAGE VIA BROADBAND COMMUNICATIONS NETWORKS, IN CLASS 41 (U.S. CLS. 100, 101 AND 107).

FIRST USE 11-29-2006; IN COMMERCE 11-29-2006.

OWNER OF U.S. REG. NOS. 3,058,581 AND 3,058,582.

THE MARK IS A STYLIZED COMBINATION OF THE LETTERS "E" AND "G".

SER. NO. 76-676,242, FILED 4-30-2007.

MIDGE BUTLER, EXAMINING ATTORNEY

Int. Cl.: 42

Prior U.S. Cls.: 100 and 101

United States Patent and Trademark Office

Reg. No. 3,474,374

Registered July 29, 2008

**SERVICE MARK
PRINCIPAL REGISTER**



MERICHEM COMPANY (DELAWARE CORPORATION)
5455 OLD SPANISH TRAIL
HOUSTON, TX 77023

FOR: CUSTOM DESIGN OF INDUSTRIAL EQUIPMENT FOR USE IN CHEMICAL, PETROCHEMICAL AND REFINERY PROCESSES BASED IN PART ON PERSONAL SELECTIONS MADE BY THE CUSTOMER; ENGINEERING SERVICES IN THE FIELDS OF CHEMICAL, PETROCHEMICAL AND REFINERY PROCESSES, IN CLASS 42 (U.S. CLS. 100 AND 101).

FIRST USE 1-0-1970; IN COMMERCE 1-0-1970.

THE MARK IS PRESENTED WITHOUT CLAIM TO ANY PARTICULAR SIZE OR COLOR AND CONSISTS OF A STYLIZED "M" WITH A REPRESENTATION OF VARIOUS CHEMICAL PROCESS EQUIPMENT.

SER. NO. 76-676,283, FILED 5-1-2007.

AMY ALFIERI, EXAMINING ATTORNEY

Int. Cls.: 3 and 5

Prior U.S. Cls.: 1, 4, 6, 18, 44, 46, 50, 51 and 52

United States Patent and Trademark Office

Reg. No. 3,474,375

Registered July 29, 2008

**TRADEMARK
PRINCIPAL REGISTER**

We Deliver the Beauty of Healthy Skin

EPISCIENCES, INC (IDAHO CORPORATION)
10211 W. EMERALD STREET
BOISE, ID 83704

FOR: TOPICALLY APPLIED COSMETICS, NAME-
LY, SKIN CREAMS, LOTIONS, POWDERS AND
GELS, IN CLASS 3 (U.S. CLS. 1, 4, 6, 50, 51 AND 52).

FIRST USE 1-17-2007; IN COMMERCE 1-17-2007.

FOR: TOPICALLY APPLIED NEUTRACEUTI-
CALS AND DERMATOLOGICALS, NAMELY,
CREAMS, LOTIONS, OILS, AND GELS FOR THE

TREATMENT OF SKIN CONDITIONS, IN CLASS 5
(U.S. CLS. 6, 18, 44, 46, 51 AND 52).

FIRST USE 1-17-2007; IN COMMERCE 1-17-2007.

THE MARK CONSISTS OF STANDARD CHAR-
ACTERS WITHOUT CLAIM TO ANY PARTICULAR
FONT, STYLE, SIZE, OR COLOR.

SER. NO. 76-676,479, FILED 5-7-2007.

WILLIAM P. SHANAHAN, EXAMINING ATTOR-
NEY

Int. Cl.: 6

Prior U.S. Cls.: 2, 12, 13, 14, 23, 25 and 50

United States Patent and Trademark Office

Reg. No. 3,474,376

Registered July 29, 2008

**TRADEMARK
PRINCIPAL REGISTER**



LEE AEROSPACE PRODUCTS, INC. (CALIFORNIA CORPORATION)
90 W. EASY ST. #5
SIMI VALLEY, CA 93065

FIRST USE 0-0-1977; IN COMMERCE 0-0-1977.

SER. NO. 76-676,480, FILED 5-7-2007.

FOR: METAL FASTENERS, NAMELY, BOLTS, SCREWS, PINS, STUDS, IN CLASS 6 (U.S. CLS. 2, 12, 13, 14, 23, 25 AND 50).

WILLIAM P. SHANAHAN, EXAMINING ATTORNEY

Int. Cl.: 35

Prior U.S. Cls.: 100, 101 and 102

United States Patent and Trademark Office

Reg. No. 3,474,377

Registered July 29, 2008

**SERVICE MARK
PRINCIPAL REGISTER**

AMERICAN DISCOVERY PUBLISHING

AMERICAN DISCOVERY PUBLISHING, LLC
(CALIFORNIA LTD LIAB CO)
1260 N. DUTTON AVENUE, SUITE 130
SANTA ROSA, CA 95401

THE MARK CONSISTS OF STANDARD CHARACTERS WITHOUT CLAIM TO ANY PARTICULAR FONT, STYLE, SIZE, OR COLOR.

FOR: ON-LINE BUSINESS DIRECTORIES FEATURING PRODUCTS AND SERVICES OF THIRD PARTIES AND ADVERTISING FOR OTHERS VIA THE INTERNET; AND PROVIDING BUSINESS NEWS AND BUSINESS INFORMATION VIA A GLOBAL COMPUTER INFORMATION NETWORK, IN CLASS 35 (U.S. CLS. 100, 101 AND 102).

NO CLAIM IS MADE TO THE EXCLUSIVE RIGHT TO USE "AMERICAN" AND "PUBLISHING", APART FROM THE MARK AS SHOWN.

SER. NO. 76-676,535, FILED 5-7-2007.

FIRST USE 12-14-2006; IN COMMERCE 12-14-2006.

DOMINIC FATHY, EXAMINING ATTORNEY

Int. Cls.: 9, 16 and 28

Prior U.S. Cls.: 2, 5, 21, 22, 23, 26, 29, 36, 37, 38 and 50

United States Patent and Trademark Office

Reg. No. 3,474,378

Registered July 29, 2008

TRADEMARK
PRINCIPAL REGISTER

POLE AEROBICS 

MOOCOW LIMITED (UNITED KINGDOM CORPORATION)

9-10 CHARLOTTE MEWS

LONDON W1T 4EF, UNITED KINGDOM

FOR: BLANK AUDIO AND VIDEO CASSETTES, TAPES, LASER DISCS, CDS, DVDS; PRE-RECORDED AUDIO AND VIDEO CASSETTES, TAPES, LASER DISCS, CDS, DVDS, FEATURING MUSIC, MOVIES, ANIMATION, GRAPHIC IMAGES, IN THE FIELD OF TEACHING, INSTRUCTION, ANALYSIS AND DEMONSTRATION OF PHYSICAL FITNESS, EXERCISE, AND POLE DANCING; ELECTRONIC BOOKS ON THE SUBJECT OF EXERCISE, DANCE AND POLE DANCING RECORDED ON COMPUTER MEDIA; ELECTRONIC INSTRUCTION MANUALS, FOR USE IN THE TEACHING, INSTRUCTION, ANALYSIS, OR DEMONSTRATION OF PHYSICAL FITNESS, EXERCISE AND POLE DANCING RECORDED ON COMPUTER MEDIA; VIDEO GAME CARTRIDGES AND SOFTWARE; FILMS, VIDEO, MUSIC, AUDIO, AUDIO-VISUAL AND DOWNLOADABLE FROM A COMPUTER DATABASE, THE INTERNET OR OTHER ELECTRONIC NETWORK, NAMELY, DOWNLOADABLE AUDIO AND VIDEO RECORDINGS FEATURING TEACHING, INSTRUCTION, ANALYSIS AND DEMONSTRATION OF PHYSICAL FITNESS, EXERCISE, AND POLE DANCING; DIGITAL MEDIA IN THE NATURE OF COMPUTER SOFTWARE FOR ACCESSING FILM AND PICTURES VIA VIDEO TELEPHONES, MOBILE TELEPHONES OR COMPUTERS; DOWNLOADABLE VIDEO AND AUDIO-VISUAL RECORDINGS FEATURING INSTRUCTIONAL AND DEMONSTRATION VIDEO OF PHYSICAL EXERCISE, DANCING AND POLE DANCING; DOWNLOADABLE RING TONES, GRAPHICS AND MUSIC VIA A GLOBAL COMPUTER NETWORK AND WIRELESS DEVICES; ENCODED ELECTRONIC CHIP CARDS CONTAINING PROGRAMMING USED TO PLAY ELECTRONIC GAMES DESIGNED FOR USE WITH TELEPHONES; COMPUTER GAME SOFTWARE; COMPUTER ENTERTAINMENT SOFTWARE FEATURING COMPUTER GAMES FOR USE WITH MOBILE TELEPHONES, MULTI-USER NETWORKS AND

THE INTERNET, IN CLASS 9 (U.S. CLS. 21, 23, 26, 36 AND 38).

FOR: PRINTED MATTER, NAMELY, INVITATIONS, FORMS, STATIONERY, GREETING CARDS, POSTCARDS AND PICTURE POSTCARDS, PHOTOGRAPHS; CALENDARS, POSTERS, WRITING PADS, WRITING PAPER, NOTEPAPER, STICKERS, HEAT TRANSFER PAPER; GIFT STATIONERY; WRAPPING PAPER; DECORATED PAPER CARRIER BAGS; DECORATED CARDBOARD BOXES; PAPER GIFT TAGS; WRITING INSTRUMENTS, PENCILS, PENS, PAINT BRUSHES; PAINTINGS FRAMED AND UNFRAMED; PRINTED PUBLICATIONS, NAMELY, BOOKS, INSTRUCTION MANUALS, PERIODICALS, MAGAZINES, MONTHLY MAGAZINES, NEWSPAPERS, IN THE FIELD OF TEACHING, INSTRUCTION, ANALYSIS AND DEMONSTRATION OF PHYSICAL FITNESS, EXERCISE, AND POLE DANCING; PRINTED MUSIC IN SHEET AND BOOK FORM; HANDKERCHIEFS OF PAPER; TABLE LINEN OF PAPER; TABLE MATS OF PAPER; TABLE NAPKINS OF PAPER, IN CLASS 16 (U.S. CLS. 2, 5, 22, 23, 29, 37, 38 AND 50).

FOR: ADULT TOYS, GAMES AND PLAYTHINGS, NAMELY, A PORTABLE POLE DANCING KIT COMPRISING A DANCE POLE, POLE BAG AND INSTRUCTION MANUAL; STUFFED DOLLS AND ANIMALS, INFLATABLE TOYS; MECHANICAL TOYS, TOY HANDCUFFS, BOARD GAMES, CARD GAMES, POKER CARD GAMES, DICE GAMES, DICE, PARLOR GAMES, PARTY GAMES, ROLE PLAYING GAME, CARNIVAL MASKS, FACE MASKS IN THE NATURE OF COSTUMERY; EXERCISE EQUIPMENT, NAMELY, A PORTABLE DANCE POLE, FREE WEIGHTS, STEPS, PERSONAL EXERCISE MATS, IN CLASS 28 (U.S. CLS. 22, 23, 38 AND 50).

PRIORITY CLAIMED UNDER SEC. 44(D) ON ERPN CMNTY TM OFC APPLICATION NO. 005546692, FILED 12-12-2006, REG. NO. 005546692, DATED 12-7-2007, EXPIRES 12-12-2016.

NO CLAIM IS MADE TO THE EXCLUSIVE
RIGHT TO USE "POLE AEROBICS", APART FROM
THE MARK AS SHOWN.

SER. NO. 76-676,657, FILED 5-10-2007.

ROBERT STRUCK, EXAMINING ATTORNEY

Int. Cl.: 45

Prior U.S. Cls.: 100 and 101

United States Patent and Trademark Office

Reg. No. 3,474,379

Registered July 29, 2008

**SERVICE MARK
PRINCIPAL REGISTER**

WILLIAMS KASTNER



WILLIAMS, KASTNER & GIBBS, PLLC (WA-
SHINGTON PROFESSIONAL LIMITED LIABILITY COMPANY)

TWO UNION SQUARE

601 UNION STREET, SUITE 4100

SEATTLE, WA 981012380

FOR: LEGAL SERVICES, IN CLASS 45 (U.S. CLS.
100 AND 101).

FIRST USE 3-1-2007; IN COMMERCE 3-1-2007.

OWNER OF U.S. REG. NOS. 2,697,777 AND
2,717,366.

THE COLOR(S) RED AND BLACK IS/ARE
CLAIMED AS A FEATURE OF THE MARK.

THE COLOR RED APPEARS IN THE OUTER
PORTION OF THE LETTER "K" BELOW THE
WORDS "WILLIAMS KASTNER". THE COLOR
BLACK APPEARS IN THE WORDING "WILLIAMS
KASTNER" AND IN THE THREE VERTICAL BARS
DESIGNED TO SIGNIFY A "W" AND A PORTION
OF THE "K".

SER. NO. 76-676,786, FILED 5-14-2007.

MARIAM MAHMOUDI, EXAMINING ATTORNEY

Int. Cl.: 41

Prior U.S. Cls.: 100, 101 and 107

United States Patent and Trademark Office

Reg. No. 3,474,380

Registered July 29, 2008

**SERVICE MARK
PRINCIPAL REGISTER**

HIDY OCHIAI'S S.A.F.E.

OCHIAI, HIDEHIKO (UNITED STATES INDIVIDUAL)
317 VESTAL PARKWAY WEST
VESTAL, NY 13850

FOR: CHARACTER EDUCATION SERVICES, NAMELY, PROVIDING ANTI-ABDUCTION GUIDANCE AND AWARENESS THROUGH NON-VIOLENT VICTIM AVOIDANCE CLASSES COMBINED WITH MIND-BODY CONNECTION , IN CLASS 41 (U.S. CLS. 100, 101 AND 107).

FIRST USE 2-0-2002; IN COMMERCE 2-0-2002.

THE MARK CONSISTS OF STANDARD CHARACTERS WITHOUT CLAIM TO ANY PARTICULAR FONT, STYLE, SIZE, OR COLOR.

SER. NO. 76-676,807, FILED 5-14-2007.

SEAN CROWLEY, EXAMINING ATTORNEY

Int. Cl.: 27

Prior U.S. Cls.: 19, 20, 37, 42 and 50

Reg. No. 3,474,381

United States Patent and Trademark Office

Registered July 29, 2008

**TRADEMARK
PRINCIPAL REGISTER**



KWIKRINK SYNTHETIC ICE (MINNESOTA LTD
LIAB CO)
18391 GLADSTONE BLVD
MAPLE GROVE, MN 55311

FOR: SYNTHETIC ICE SKATING SURFACE, IN
CLASS 27 (U.S. CLS. 19, 20, 37, 42 AND 50).

FIRST USE 1-1-2000; IN COMMERCE 1-1-2000.

NO CLAIM IS MADE TO THE EXCLUSIVE
RIGHT TO USE "SYNTHETIC ICE LLC", APART
FROM THE MARK AS SHOWN.

THE COLOR(S) RED AND BLUE IS/ARE
CLAIMED AS A FEATURE OF THE MARK.

THE MARK CONSISTS OF THE TERM "KWIK-
RINK" WITH A RED SKATE BLADE UNDER THE
BLUE TERM "KWIK", AND THE RED TERM
"RINK" INSIDE A BLUE OUTLINE OF A HOCKEY
RINK, WITH TWO BLUE AND ONE RED LINES
INSIDE THE OUTLINE. THE WORDING "SYN-
THETIC ICE LLC" APPEARS UNDER THE OUT-
LINED RINK IN RED. THE WORDING ""POND
HOCKEY ON COMMAND"" APPEARS UNDER-
NEATH THE OTHER ELEMENTS OF THE MARK
IN THE COLOR BLUE.

SER. NO. 76-676,844, FILED 5-14-2007.

BRENDAN MCCAULEY, EXAMINING ATTORNEY

Int. Cl.: 35

Prior U.S. Cls.: 100, 101 and 102

United States Patent and Trademark Office

Reg. No. 3,474,382

Registered July 29, 2008

**SERVICE MARK
PRINCIPAL REGISTER**

CHAN AND BEA ONLINE SHOP, LLC

CHAN AND BEA ONLINE SHOP, LLC (VIRGINIA LTD LIAB CO)
487 N. ARMISTEAD STREET, APT. 103
ALEXANDRIA, VA 22312

FOR: ONLINE RETAIL AND WHOLESALE STORE SERVICES IN THE FIELD ELECTRONICS, COMPUTERS AND COMPUTER SUPPLIES, VIDEO GAMES, AUTO PARTS, BOOKS, CANDLES, FRAGRANCES, GAMES AND TOYS, CLOTHING AND APPAREL, JEWELRY, LUGGAGE, OUTDOOR MERCHANDISE AND GIFTS, PET SUPPLIES, GIFT ITEMS, COLLECTIBLE ITEMS, HOUSEWARES, HOME-FURNISHINGS, BEAUTY AND PERSONAL CARE PRODUCTS, HOME DECORATIONS, SPORTING GOODS, TOOLS AND OTHER GENERAL

MERCHANDISE, IN CLASS 35 (U.S. CLS. 100, 101 AND 102).

FIRST USE 10-28-2006; IN COMMERCE 10-28-2006.

THE MARK CONSISTS OF STANDARD CHARACTERS WITHOUT CLAIM TO ANY PARTICULAR FONT, STYLE, SIZE, OR COLOR.

NO CLAIM IS MADE TO THE EXCLUSIVE RIGHT TO USE "ONLINE SHOP LLC", APART FROM THE MARK AS SHOWN.

SER. NO. 76-676,887, FILED 5-15-2007.

MICHAEL TANNER, EXAMINING ATTORNEY

Int. Cl.: 37

Prior U.S. Cls.: 100, 103 and 106

United States Patent and Trademark Office

Reg. No. 3,474,383

Registered July 29, 2008

**SERVICE MARK
PRINCIPAL REGISTER**

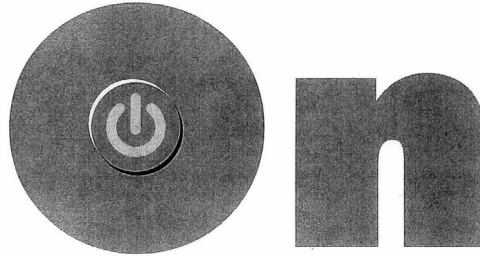

ON SERVICES LLC (TEXAS LTD LIAB CO)
11910 SHILOH ROAD, SUITE 130
DALLAS, TX 75228

FOR: MAINTENANCE AND REPAIR OF COM-
PUTER SYSTEMS COMPRISING THE COMPU-
TER'S POWER UNIT, NAMELY, THE
ELECTRICAL CURRENT POWER SUPPLY AND

THE BATTERY POWER SUPPLY, IN CLASS 37
(U.S. CLS. 100, 103 AND 106).

FIRST USE 2-11-2004; IN COMMERCE 2-11-2004.

SER. NO. 76-676,920, FILED 5-16-2007.

BARBARA BROWN, EXAMINING ATTORNEY

Int. Cl.: 35

Prior U.S. Cls.: 100, 101 and 102

United States Patent and Trademark Office

Reg. No. 3,474,384

Registered July 29, 2008

**SERVICE MARK
PRINCIPAL REGISTER**

THE AD PROPHET

PROPHIT MARKETING, INC. (WISCONSIN CORPORATION)

321 SAINT GEORGE STREET
GREEN BAY, WI 54302

FOR: MARKETING SERVICES, SPECIALIZING
IN BUSINESS-TO-CONSUMER MARKETING, IN
CLASS 35 (U.S. CLS. 100, 101 AND 102).

FIRST USE 3-1-2006; IN COMMERCE 3-1-2006.

THE MARK CONSISTS OF STANDARD CHARACTERS WITHOUT CLAIM TO ANY PARTICULAR FONT, STYLE, SIZE, OR COLOR.

NO CLAIM IS MADE TO THE EXCLUSIVE RIGHT TO USE "AD", APART FROM THE MARK AS SHOWN.

SER. NO. 76-677,117, FILED 5-18-2007.

KIMBERLY FRYE, EXAMINING ATTORNEY

Int. Cl.: 8

Prior U.S. Cls.: 23, 28 and 44

United States Patent and Trademark Office

Reg. No. 3,474,385

Registered July 29, 2008

**TRADEMARK
PRINCIPAL REGISTER**

IRON BRIDGE TOOLS

IRON BRIDGE TOOLS, INC. (FLORIDA CORPORATION)
450 FAIRWAY DRIVE, SUITE 204A
DEERFIELD BEACH, FL 33441

THE MARK CONSISTS OF STANDARD CHARACTERS WITHOUT CLAIM TO ANY PARTICULAR FONT, STYLE, SIZE, OR COLOR.

FOR: HAND OPERATED TOOLS, NAMELY, SCREWDRIVERS, WRENCHES, RATCHETS, PLIERS, HAMMERS, KNIVES, SAWS, UTILITY KNIVES, BOX CUTTERS, BLADES FOR UTILITY KNIVES AND BOX CUTTERS, SOCKET SETS, BITS FOR HAND DRILLS, SANDERS, MANUAL HEDGE CLIPPERS, AND SHEARS, IN CLASS 8 (U.S. CLS. 23, 28 AND 44).

NO CLAIM IS MADE TO THE EXCLUSIVE RIGHT TO USE "TOOLS", APART FROM THE MARK AS SHOWN.

SER. NO. 76-677,210, FILED 5-21-2007.

FIRST USE 12-0-2005; IN COMMERCE 12-0-2005.

H. M. FISHER, EXAMINING ATTORNEY

Int. Cl.: 43

Prior U.S. Cls.: 100 and 101

United States Patent and Trademark Office

Reg. No. 3,474,386

Registered July 29, 2008

**SERVICE MARK
PRINCIPAL REGISTER**

SHARE A MEAL

WHITE CASTLE MANAGEMENT CO. (DELA-
WARE CORPORATION)

555 WEST GOODALE ST.

COLUMBUS, OH 43215

FOR: RESTAURANT SERVICES, IN CLASS 43
(U.S. CLS. 100 AND 101).

FIRST USE 9-17-2006; IN COMMERCE 9-17-2006.

THE MARK CONSISTS OF STANDARD CHAR-
ACTERS WITHOUT CLAIM TO ANY PARTICULAR
FONT, STYLE, SIZE, OR COLOR.

NO CLAIM IS MADE TO THE EXCLUSIVE
RIGHT TO USE "MEAL", APART FROM THE
MARK AS SHOWN.

SER. NO. 76-677,265, FILED 5-22-2007.

DANIEL CAPSHAW, EXAMINING ATTORNEY

Int. Cl.: 9

Prior U.S. Cls.: 21, 23, 26, 36 and 38

Reg. No. 3,474,387

United States Patent and Trademark Office

Registered July 29, 2008

**TRADEMARK
PRINCIPAL REGISTER**



I.E. MANUFACTURING LLC (NEVADA LTD
LIAB CO)
3998 INLAND EMPIRE BLVD., SUITE 300
ONTARIO, CA 91764

FIRST USE 6-0-2005; IN COMMERCE 9-0-2005.

SER. NO. 76-677,375, FILED 5-24-2007.

FOR: SKI GOGGLES AND SNOW GOGGLES;
SUNGLASSES AND EYEWEAR, IN CLASS 9 (U.S.
CLS. 21, 23, 26, 36 AND 38).

SUZANNE BLANE, EXAMINING ATTORNEY

Int. Cl.: 30

Prior U.S. Cl.: 46

United States Patent and Trademark Office

Reg. No. 3,474,388

Registered July 29, 2008

**TRADEMARK
PRINCIPAL REGISTER**

ALL THE FLAVOR OF NEW ORLEANS . . . IN A CUP

AMERICAN COFFEE COMPANY, INC. (LOUISIANA CORPORATION)
800 MAGAZINE STREET
NEW ORLEANS, LA 70130

THE MARK CONSISTS OF STANDARD CHARACTERS WITHOUT CLAIM TO ANY PARTICULAR FONT, STYLE, SIZE, OR COLOR.

FOR: GROUND COFFEE, IN CLASS 30 (U.S. CL. 46).

SER. NO. 76-677,420, FILED 5-25-2007.

FIRST USE 10-31-1999; IN COMMERCE 10-31-1999.

EMILY CARLSEN, EXAMINING ATTORNEY

Int. Cls.: 35, 37 and 41

Prior U.S. Cls.: 100, 101, 102, 103, 106 and 107

Reg. No. 3,474,389

United States Patent and Trademark Office

Registered July 29, 2008

**SERVICE MARK
PRINCIPAL REGISTER**

IDC-USA

INDEPENDENT DISTRIBUTORS COOPERATIVE
- USA (INDIANA CORPORATION)
933 WESTERN DRIVE
INDIANAPOLIS, IN 46242

FOR: PROCUREMENT SERVICES, NAME-
LY, PURCHASING MACHINE COMPONENTS, NAME-
LY, SPROCKETS, ROLLER CHAINS, INDUSTRIAL
BEARINGS, LOCK WASHERS, INDUSTRIAL ADAP-
TERS, OIL SEALS, GEAR BOXES, BUSHINGS, IN-
DUSTRIAL BEARING HOUSINGS, INDUSTRIAL
COUPLINGS, AND SHEAVES, IN LARGE QUANTI-
TIES FOR OTHERS WHICH ARE THEN OFFERED
FOR SALE TO MEMBERS OF AN ORGANIZATION
OF DISTRIBUTORS FOR RESALE TO THE PUBLIC;
ASSOCIATION SERVICES, NAMELY, PROMOTING
THE INTERESTS OF MACHINE COMPONENT DIS-
TRIBUTORS, IN CLASS 35 (U.S. CLS. 100, 101 AND
102).

FIRST USE 10-0-2002; IN COMMERCE 10-0-2002.

FOR: PROVIDING ONLINE INFORMATION IN
THE FIELD OF INDUSTRIAL MAINTENANCE

AND REPAIR OF POWER TRANSMISSION PRO-
DUCTS AND SYSTEMS, OPERATIONS EQUIP-
MENT AND SUPPLIES, IN CLASS 37 (U.S. CLS. 100,
103 AND 106).

FIRST USE 10-0-2002; IN COMMERCE 10-0-2002.

FOR: PROVIDING ONLINE ARTICLES AND RE-
FERENCE MATERIALS IN THE FIELDS OF IN-
DUSTRIAL MAINTENANCE, REPAIR AND
OPERATIONS OF POWER TRANSMISSION PRO-
DUCTS AND SYSTEMS EQUIPMENT AND SUP-
PLIES, IN CLASS 41 (U.S. CLS. 100, 101 AND 107).

FIRST USE 10-1-2002; IN COMMERCE 10-1-2002.

OWNER OF U.S. REG. NOS. 2,064,385, 2,100,634
AND OTHERS.

SER. NO. 76-677,458, FILED 5-29-2007.

KATHERINE M. DUBRAY, EXAMINING ATTOR-
NEY

Int. Cl.: 18

Prior U.S. Cls.: 1, 2, 3, 22 and 41

Reg. No. 3,474,390

United States Patent and Trademark Office

Registered July 29, 2008

**TRADEMARK
PRINCIPAL REGISTER**

Cowboy Gold

EQUIBRAND PRODUCTS GROUP LP (DELA-
WARE LIMITED PARTNERSHIP)
P. O. BOX 2098
1301 WEATHERFORD HWY.
GRANBURY, TX 76048

FOR: LEATHER SADDLES AND EQUINE
GOODS, NAMELY, HORSE TACK, NAMELY, HEAD
STALLS AND BREAST COLLARS, IN CLASS 18 (U.S.
CLS. 1, 2, 3, 22 AND 41).

FIRST USE 3-1-2006; IN COMMERCE 3-8-2006.

THE MARK CONSISTS OF STANDARD CHAR-
ACTERS WITHOUT CLAIM TO ANY PARTICULAR
FONT, STYLE, SIZE, OR COLOR.

NO CLAIM IS MADE TO THE EXCLUSIVE
RIGHT TO USE "COWBOY", APART FROM THE
MARK AS SHOWN.

SER. NO. 76-677,688, FILED 6-1-2007.

BILL DAWE, EXAMINING ATTORNEY

Int. Cl.: 9

Prior U.S. Cls.: 21, 23, 26, 36 and 38

Reg. No. 3,474,391

United States Patent and Trademark Office

Registered July 29, 2008

TRADEMARK
PRINCIPAL REGISTER

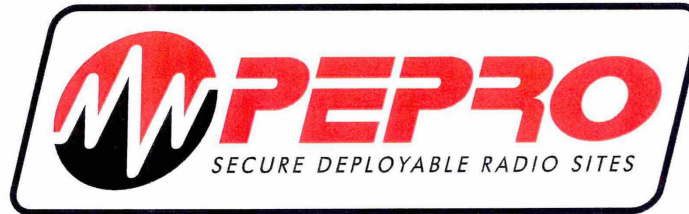

PIONEER ENERGY PRODUCTS, LLC (PENNSYLVANIA LIMITED LIABILITY CORPORATION), DBA PEPRO
BOX 1061
FRANKLIN, PA 16323

FOR: MOBILE SHIELDED RADIO ENCLOSURES WITH ANTENNA MASTS AND SHIELDED ENTRY PORTS FOR POWER CABLES, IN CLASS 9 (U.S. CLS. 21, 23, 26, 36 AND 38).

FIRST USE 10-10-2003; IN COMMERCE 10-10-2003.

NO CLAIM IS MADE TO THE EXCLUSIVE RIGHT TO USE "SECURE DEPLOYABLE RADIO SITES", APART FROM THE MARK AS SHOWN.

THE COLOR(S) RED AND BLACK IS/ARE CLAIMED AS A FEATURE OF THE MARK.

THE WORD "PEPRO" AND THE TOP HALF OF THE OVAL DESIGN ELEMENT APPEAR IN THE COLOR RED; THE WORDING "SECURE DEPLOYABLE RADIO SITES" AND THE BOTTOM PORTION OF THE OVAL DESIGN ELEMENT APPEAR IN THE COLOR BLACK; THE QUADRILATERAL BORDER APPEARS IN THE COLOR BLACK.

SER. NO. 76-677,691, FILED 6-1-2007.

RICHARD WHITE, EXAMINING ATTORNEY

Int. Cl.: 9

Prior U.S. Cls.: 21, 23, 26, 36 and 38

United States Patent and Trademark Office

Reg. No. 3,474,392

Registered July 29, 2008

**TRADEMARK
PRINCIPAL REGISTER**



CONSTRAINTS MANAGEMENT GROUP (WA-
SHINGTON LTD LIAB CO)
2355 GRIFFIN AVENUE, SUITE I
ENUMCLAW, WA 98022

FOR: COMPUTER SOFTWARE FOR INVEN-
TORY MANAGEMENT, IN CLASS 9 (U.S. CLS. 21,
23, 26, 36 AND 38).

FIRST USE 3-0-2005; IN COMMERCE 3-0-2005.

NO CLAIM IS MADE TO THE EXCLUSIVE
RIGHT TO USE "REPLENISHMENT", APART
FROM THE MARK AS SHOWN.

THE MARK CONSISTS OF AN UNDERLINED
STYLIZED WORD "REPLENISHMENT" NEXT TO A
"PLUS" SIGN; THE WORD "PLUS" LOCATED IN
THE CENTER OF THE "PLUS" DESIGN ALL OF
WHICH ARE ARRANGED ON A RECTANGULAR
BACKGROUND.

SER. NO. 76-677,703, FILED 6-1-2007.

YAT SYE, LEE, EXAMINING ATTORNEY

Int. Cl.: 35

Prior U.S. Cls.: 100, 101 and 102

United States Patent and Trademark Office

Reg. No. 3,474,393

Registered July 29, 2008

**SERVICE MARK
PRINCIPAL REGISTER**

CONTRACTOR'S BEST

CONTRACTOR'S BEST HOLDINGS, INC. (FLOR-
IDA CORPORATION)
1316 SAN MARCO BOULEVARD
JACKSONVILLE, FL 32207

FOR: RETAIL STORE SERVICES FEATURING
SURPLUS AND CLOSEOUT BUILDING MATERI-
ALS, NAMELY, ELECTRICAL LIGHTING FIX-
TURES, WOOD AND CERAMIC FLOORING,
KITCHEN AND BATH CABINETS, DOORS, WIN-
DOWS AND HARDWARE THEREFORE, ELECTRI-
CAL AND GAS APPLIANCES, ROOFING
MATERIALS, WOOD , COUNTERTOPS AND

PLUMBING FIXTURES, IN CLASS 35 (U.S. CLS.
100, 101 AND 102).

FIRST USE 5-5-2003; IN COMMERCE 7-0-2003.

THE MARK CONSISTS OF STANDARD CHAR-
ACTERS WITHOUT CLAIM TO ANY PARTICULAR
FONT, STYLE, SIZE, OR COLOR.

SER. NO. 76-677,959, FILED 6-7-2007.

PAULA MAHONEY, EXAMINING ATTORNEY

Int. Cl.: 41

Prior U.S. Cls.: 100, 101 and 107

United States Patent and Trademark Office

Reg. No. 3,474,394

Registered July 29, 2008

**SERVICE MARK
PRINCIPAL REGISTER**

OCEAN TUMBLERS

OCEAN TUMBLERS, INC. (VIRGINIA CORPORATION)
912-A PROFESSIONAL PLACE
CHESAPEAKE, VA 23320

FOR: PROVIDING CLASSES AND WORKSHOPS
IN THE FIELDS OF GYMNASTICS, CHEERLEADING,
AND KARATE, IN CLASS 41 (U.S. CLS. 100, 101
AND 107).

FIRST USE 2-1-1985; IN COMMERCE 2-1-1985.

THE MARK CONSISTS OF STANDARD CHARACTERS
WITHOUT CLAIM TO ANY PARTICULAR FONT,
STYLE, SIZE, OR COLOR.

NO CLAIM IS MADE TO THE EXCLUSIVE
RIGHT TO USE "TUMBLERS", APART FROM THE
MARK AS SHOWN.

SER. NO. 76-678,066, FILED 6-11-2007.

SETH A. RAPPAPORT, EXAMINING ATTORNEY

Int. Cl.: 36

Prior U.S. Cls.: 100, 101 and 102

United States Patent and Trademark Office

Reg. No. 3,474,395

Registered July 29, 2008

**SERVICE MARK
PRINCIPAL REGISTER**

GAIN

THE INSTITUTE OF INTERNAL AUDITORS,
INC. (NEW YORK CORPORATION)
247 MAITLAND AVENUE
ALTAMONTE SPRINGS, FL 327014201

FOR: PROVIDING ON-LINE FINANCIAL INFORMATION THAT ENABLES ORGANIZATIONS TO COMPARE THEIR AUDIT DEPARTMENT'S SIZE, EXPERIENCE, EXPERTISE AND OTHER AUDIT DEPARTMENT METRICS AGAINST AGGREGATED AVERAGES OF SIMILAR SIZED ORGANIZATIONS IN THEIR INDUSTRY, IN CLASS 36 (U.S. CLS. 100, 101 AND 102).

FIRST USE 12-0-1992; IN COMMERCE 12-0-1992.

THE MARK CONSISTS OF STANDARD CHARACTERS WITHOUT CLAIM TO ANY PARTICULAR FONT, STYLE, SIZE, OR COLOR.

SER. NO. 76-678,138, FILED 6-12-2007.

KRISTINA MORRIS, EXAMINING ATTORNEY

Int. Cls.: 35 and 43

Prior U.S. Cls.: 100, 101 and 102

United States Patent and Trademark Office

Reg. No. 3,474,396

Registered July 29, 2008

**SERVICE MARK
PRINCIPAL REGISTER**

KIM LONG

KIM LONG RESTAURANT PROPERTIES, LLC
(MISSOURI LTD LIAB CO)
511 CHERRY STREET
KANSAS CITY, MO 64106

THE MARK CONSISTS OF STANDARD CHARACTERS WITHOUT CLAIM TO ANY PARTICULAR FONT, STYLE, SIZE, OR COLOR.

FOR: RETAIL GROCERY STORE, IN CLASS 35
(U.S. CLS. 100, 101 AND 102).

THE NAME KIM LONG DOES NOT IDENTIFY A LIVING INDIVIDUAL.

FIRST USE 0-0-2001; IN COMMERCE 0-0-2001.

FOR: RESTAURANTS, IN CLASS 43 (U.S. CLS. 100 AND 101).

SER. NO. 76-678,284, FILED 6-15-2007.

FIRST USE 0-0-2001; IN COMMERCE 0-0-2001.

SETH A. RAPPAPORT, EXAMINING ATTORNEY

Int. Cl.: 29

Prior U.S. Cl.: 46

United States Patent and Trademark Office

Reg. No. 3,474,397

Registered July 29, 2008

TRADEMARK
PRINCIPAL REGISTER



POWER PLAY VENTURES LLC (MICHIGAN
LTD LIAB CO)
47734 PONTIAC TRAIL
WIXOM, MI 48393

FOR: CHICKEN WINGS, IN CLASS 29 (U.S. CL.
46).

FIRST USE 3-1-2007; IN COMMERCE 3-1-2007.

NO CLAIM IS MADE TO THE EXCLUSIVE
RIGHT TO USE "WING", APART FROM THE MARK
AS SHOWN.

THE COLOR(S) BLACK, BLUE, YELLOW, RED,
GRAY, WHITE IS/ARE CLAIMED AS A FEATURE
OF THE MARK.

THE WING STATION MARK IS AN OVAL SHAPE
CIRCLE OUTLINED IN BLACK THEN OUTLINED
IN GRAY. THE INTERIOR OF THE CIRCLE IS RED
WITH THE INNER CENTER OVER-LAID WITH
WHITE. ATTACHED TO THE TOP OF THE CIRCLE
IS 3 (THREE) PUFFS OF SMOKE OUTLINED IN
BLACK THEN OUTLINED IN GRAY. EACH PUFF
OF SMOKE HAS 1 (ONE) STREAK OF WHITE
DEPICTING A REFLECTION. THE 3 PUFFS OF
SMOKE ARE EXITING THE SMOKE STACK OF A

TRAIN ENGINE AND ARE ATTACHED TOGETHER.
ON THE SMOKE STACK IS ONE RED CIRCLE IN
THE CENTER DEPICTING A RED-LIGHT. TWO
WINDOWS COLORED IN WHITE ARE ON EACH
SIDE OF THE STACK WITH A BLACK DOT IN
EACH DEPICTING EYES. THERE IS A HALF
MOON SHAPE UPSIDE DOWN COLORED IN
GREY WITH 7 (SEVEN) RED DOTS. THIS
COMBINATION DEPICTS THE FRONT OF A
TRAIN ENGINE. TWO BLUE WINGS WITH
BLACK FEATHERS ON EACH WING ARE
ATTACHED TO EACH SIDE OF THE ENGINE.
WINGS HAVE THE ENGINE FACE CENTERED
IN THE MIDDLE WITH THE ENGINE COW
(PILOT) AT THE BOTTOM OF THE WING.
THE SNOW GUARD IS COLORED BLACK WITH
5 BLUE RIBS DEPICTING STEEL BRACES.
WINGS ARE OUTLINED IN BLACK THEN
GREY. ACROSS THE WINGS AND SNOW
PLATE ARE THE YELLOW LETTERS "THE
WING STATION" ON A BLACK BACKGROUND
OUTLINED IN BLACK. THE WORD "THE" IS
COLORED WHITE AND RESIDES UNDER THE
CURL OF THE "W" OF THE WORD "WING".

SER. NO. 76-678,304, FILED 6-15-2007.

SONYA STEPHENS, EXAMINING ATTORNEY

Int. Cls.: 35 and 40

Prior U.S. Cls.: 100, 101, 102, 103 and 106

United States Patent and Trademark Office

Reg. No. 3,474,398

Registered July 29, 2008

**SERVICE MARK
PRINCIPAL REGISTER**

PriceFitters
Pneumatic Components Direct

HP PRODUCTS, INC. (OHIO CORPORATION)
512 W. GORGAS ST.
LOUISVILLE, OH 44641

FOR: RETAIL OUTLET FEATURING TUBE BENDS, COUPLINGS, TUBE FITTINGS, VACUUM LINE, TUBE STRAIGHTS, HOSE ADAPTERS AND COUPLERS, AND HOSE, IN CLASS 35 (U.S. CLS. 100, 101 AND 102).

FIRST USE 2-28-2005; IN COMMERCE 2-28-2005.

FOR: TREATMENT OF METAL ITEMS, NAMELY SHOT PEENING, SPIRAL GROOVING, AND PORCELAIN LINING, IN CLASS 40 (U.S. CLS. 100, 103 AND 106).

FIRST USE 2-28-2005; IN COMMERCE 2-28-2005.

THE MARK CONSISTS OF STANDARD CHARACTERS WITHOUT CLAIM TO ANY PARTICULAR FONT, STYLE, SIZE, OR COLOR.

NO CLAIM IS MADE TO THE EXCLUSIVE RIGHT TO USE PNEUMATIC COMPONENTS DIRECT, APART FROM THE MARK AS SHOWN.

SER. NO. 76-678,356, FILED 6-18-2007.

TINA L. SNAPP, EXAMINING ATTORNEY

Int. Cls.: 35 and 40

Prior U.S. Cls.: 100, 101, 102, 103 and 106

United States Patent and Trademark Office

Reg. No. 3,474,399

Registered July 29, 2008

SERVICE MARK
PRINCIPAL REGISTER

PriceFitters
Pneumatic Components Direct

HP PRODUCTS, INC. (OHIO CORPORATION)
512 W. GORGAS ST.
LOUISVILLE, OH 44641

FOR: RETAIL OUTLET FEATURING TUBE BENDS, COUPLINGS, TUBE FITTINGS, VACUUM LINE, TUBE STRAIGHTS, HOSE ADAPTERS AND COUPLERS, AND HOSE, IN CLASS 35 (U.S. CLS. 100, 101 AND 102).

FIRST USE 2-28-2005; IN COMMERCE 2-28-2005.

FOR: TREATMENT OF METAL ITEMS, NAME-
LY, SHOT PEENING, SPIRAL GROOVING, AND

PORCELAIN LINING, IN CLASS 40 (U.S. CLS. 100,
103 AND 106).

FIRST USE 2-28-2005; IN COMMERCE 2-28-2005.

NO CLAIM IS MADE TO THE EXCLUSIVE
RIGHT TO USE "PNEUMATIC COMPONENTS DI-
RECT", APART FROM THE MARK AS SHOWN.

SER. NO. 76-678,357, FILED 6-18-2007.

TINA L. SNAPP, EXAMINING ATTORNEY

Int. Cl.: 28

Prior U.S. Cls.: 22, 23, 38 and 50

United States Patent and Trademark Office

Reg. No. 3,474,400

Registered July 29, 2008

**TRADEMARK
PRINCIPAL REGISTER**



OBITSU PLASTIC MANUFACTURING CO., LTD.
(JAPAN CORPORATION)
4-14-8, KANAMACHI
KATSUSHIKA-KU, TOKYO, JAPAN

FOR: DOLLS, NAMELY, HEADLESS DOLLS, DOLLS WITH HEADS, JAPANESE TRADITIONAL DOLLS, GIRLS' FESTIVAL DOLLS, BOYS' FESTIVAL DOLLS; PARTS OF DOLLS, NAMELY, BODIES, BONES, HEADS, NECKS, TRUNKS, CHESTS, ABDOMENS, GROINS, ARMS, HANDS, FINGERS, LEGS, FEET, TOES, EYES, EYELASHES, HAIR AND WIGS, POSABLE ACTION DOLLS THAT ALLOW FOR EACH PART OR PORTION OF THE TRUNK TO BE ATTACHED AND DETACHED AND EACH JOINT TO BE MOVED SMOOTHLY; MARIONETTE PUPPETS; TOY DOLL FIGURES; ACTION TOY DOLL FIGURES; DOLL CLOTHING; DOLL UNDERWEAR; DOLL FOOTWEAR AND SHOES; DOLL

HOSIERY AND SOCKS; DOLL EYEGLASSES, DOLL ACCESSORIES; DOLL FURNITURE; DOLL CARS; TOY FIGURES OF ANIMALS, BIRDS, FISH, SHELLS, INSECTS, WORMS, DINOSAURS, AND PLANTS; TOYS, NAMELY, INFLATABLE TOYS, TOY MODEL CARS, STUFFED TOYS, AND TOY BUILDING BLOCKS, IN CLASS 28 (U.S. CLS. 22, 23, 38 AND 50).

OWNER OF JAPAN REG. NO. 1557699, DATED 12-24-1982, EXPIRES 12-24-2012.

THE MARK CONSISTS OF THE WORD "OBITSU" IN AN ARCH OVER THE CARICATURE OF AN ELEPHANT.

SER. NO. 76-678,431, FILED 6-19-2007.

RONALD MCMORROW, EXAMINING ATTORNEY

Int. Cls.: 29 and 30

Prior U.S. Cl.: 46

United States Patent and Trademark Office

Reg. No. 3,474,401

Registered July 29, 2008

TRADEMARK
PRINCIPAL REGISTER

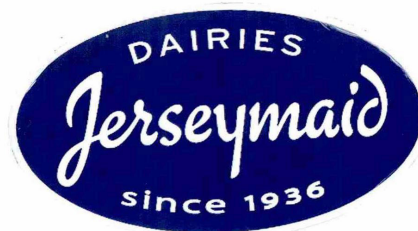

SAFEWAY INC. (DELAWARE CORPORATION)
5918 STONERIDGE MALL ROAD
PLEASANTON, CA 945882322

FOR: FLUID MILK, BUTTERMILK, FLUID CREAM, EGG NOG AND CHOCOLATE MILK, WHIPPING CREAM, SOUR CREAM, WHIPPED LIGHT CREAM, CHEESES, COTTAGE CHEESE, BUTTER, HALF AND HALF CREAMS, NON-DAIRY CREAMS, YOGURT, IN CLASS 29 (U.S. CL. 46).

FIRST USE 1-1-2006; IN COMMERCE 1-1-2006.

FOR: ICE CREAM, IN CLASS 30 (U.S. CL. 46).

FIRST USE 1-1-2006; IN COMMERCE 1-1-2006.

NO CLAIM IS MADE TO THE EXCLUSIVE RIGHT TO USE "DAIRIES" AND "SINCE 1936", APART FROM THE MARK AS SHOWN.

SER. NO. 76-678,709, FILED 6-25-2007.

ALYSSA PALADINO, EXAMINING ATTORNEY

Int. Cl.: 30

Prior U.S. Cl.: 46

United States Patent and Trademark Office

Reg. No. 3,474,403

Registered July 29, 2008

**TRADEMARK
PRINCIPAL REGISTER**

FINE BAKED GOODS IN THE EUROPEAN TRADITION

PENNANT FOODS COMPANY (DELAWARE
CORPORATION)
500 PARK BOULEVARD, SUITE 200
ITASCA, IL 60143

NO CLAIM IS MADE TO THE EXCLUSIVE
RIGHT TO USE "BAKED GOODS", APART FROM
THE MARK AS SHOWN.

FOR: CROISSANTS, CINNAMON ROLLS, DAN-
ISHES AND PUFF PASTRIES, IN CLASS 30 (U.S. CL.
46).

SEC. 2(F).

FIRST USE 1-0-1984; IN COMMERCE 1-0-1984.

SER. NO. 76-679,294, FILED 7-9-2007.

THE MARK CONSISTS OF STANDARD CHAR-
ACTERS WITHOUT CLAIM TO ANY PARTICULAR
FONT, STYLE, SIZE, OR COLOR.

JAMES STEIN, EXAMINING ATTORNEY

Int. Cl.: 7

Prior U.S. Cls.: 13, 19, 21, 23, 31, 34 and 35

Reg. No. 3,474,404

United States Patent and Trademark Office

Registered July 29, 2008

**TRADEMARK
PRINCIPAL REGISTER**



CJT KOOLCARB, INC. (ILLINOIS CORPORATION)
494 MISSION STREET
CAROL STREAM, IL 60188

FOR: POWER-OPERATED CUTTING TOOLS,
NAMELY, ROUTER AND DRILL BITS, IN CLASS 7
(U.S. CLS. 13, 19, 21, 23, 31, 34 AND 35).

FIRST USE 5-22-2007; IN COMMERCE 5-22-2007.

OWNER OF U.S. REG. NOS. 2,544,172, 2,569,188,
AND 3,005,589.

NO CLAIM IS MADE TO THE EXCLUSIVE
RIGHT TO USE "PRECISE CUTTING TOOLS",
APART FROM THE MARK AS SHOWN.

SER. NO. 76-679,312, FILED 7-9-2007.

LINDA E. BLOHM, EXAMINING ATTORNEY

Int. Cls.: 25 and 28

Prior U.S. Cls.: 22, 23, 38, 39 and 50

United States Patent and Trademark Office

Reg. No. 3,474,405

Registered July 29, 2008

**TRADEMARK
PRINCIPAL REGISTER**

DEADZONE

HOOLE, RICHARD J. (UNITED STATES INDIVIDUAL)
102 CUNNINGHAM DR.
NEW SMYRNA BEACH, FL 32168

FOR: CLOTHING, NAMELY, SHIRTS, HATS, JACKETS, SWEAT SHIRTS, SWEAT PANTS, T-SHIRTS, BANDANAS, AND EXERCISE CLOTHING, NAMELY, TANK TOPS, SHORTS, AND SPORTS BRAS, IN CLASS 25 (U.S. CLS. 22 AND 39).

FIRST USE 12-1-2007; IN COMMERCE 12-1-2007.

FOR: EXERCISE EQUIPMENT, NAMELY, EQUIPMENT USED IN CHANGING BAR BELL WEIGHTS

AND RUBBER MATS, IN CLASS 28 (U.S. CLS. 22, 23, 38 AND 50).

FIRST USE 12-1-2007; IN COMMERCE 12-1-2007.

THE MARK CONSISTS OF STANDARD CHARACTERS WITHOUT CLAIM TO ANY PARTICULAR FONT, STYLE, SIZE, OR COLOR.

SER. NO. 76-679,359, FILED 7-11-2007.

NAKWAMA ANKRAH, EXAMINING ATTORNEY

Int. Cl.: 24

Prior U.S. Cls.: 42 and 50

United States Patent and Trademark Office

Reg. No. 3,474,406

Registered July 29, 2008

**TRADEMARK
PRINCIPAL REGISTER**

REPELLEM

FEINBERG, TERRY (UNITED STATES INDIVIDUAL)
10 BRASSWOOD ROAD
ST. JAMES, NY 11780

THE MARK CONSISTS OF STANDARD CHARACTERS WITHOUT CLAIM TO ANY PARTICULAR FONT, STYLE, SIZE, OR COLOR.

FOR: TEXTILE AND PLASTIC TABLECLOTHS,
IN CLASS 24 (U.S. CLS. 42 AND 50).

SER. NO. 76-679,424, FILED 7-12-2007.

FIRST USE 11-10-2006; IN COMMERCE 11-10-2006.

MARGARET POWER, EXAMINING ATTORNEY

Int. Cl.: 1

Prior U.S. Cls.: 1, 5, 6, 10, 26 and 46

United States Patent and Trademark Office

Reg. No. 3,474,407

Registered July 29, 2008

**TRADEMARK
PRINCIPAL REGISTER**

ASARCO

ASARCO LLC (DELAWARE CORPORATION)
1150 N. 7TH AVENUE
TUCSON, AZ 85705

FOR: BISMUTH/SELENIDE, SELENIUM, TELLUR-
URIUM, MOLYBDENUM, AND SULFURIC ACID,
IN CLASS 1 (U.S. CLS. 1, 5, 6, 10, 26 AND 46).

FIRST USE 6-15-2005; IN COMMERCE 6-15-2005.

THE MARK CONSISTS OF STANDARD CHAR-
ACTERS WITHOUT CLAIM TO ANY PARTICULAR
FONT, STYLE, SIZE, OR COLOR.

OWNER OF U.S. REG. NO. 229,786.

SER. NO. 76-679,471, FILED 7-13-2007.

BARBARA BROWN, EXAMINING ATTORNEY

Int. Cl.: 28

Prior U.S. Cls.: 22, 23, 38 and 50

United States Patent and Trademark Office

Reg. No. 3,474,408

Registered July 29, 2008

**TRADEMARK
PRINCIPAL REGISTER**



FOREST SKATEBOARDS (CALIFORNIA CORPORATION)
16812 RED HILL AVE, SUITE A
IRVINE, CA 92606

FOR: SKATEBOARD DECKS, IN CLASS 28 (U.S. CLS. 22, 23, 38 AND 50).

FIRST USE 4-0-2007; IN COMMERCE 4-0-2007.

NO CLAIM IS MADE TO THE EXCLUSIVE RIGHT TO USE "SKATEBOARDS", APART FROM THE MARK AS SHOWN.

THE COLOR(S) BLACK, GRAY AND LIGHT GREEN IS/ARE CLAIMED AS A FEATURE OF THE MARK.

THE MARK CONSISTS OF "FOREST SKATEBOARDS" IN A STYLIZED BLACK FONT WITH A LIGHT GREEN LEAF OUTLINED IN GRAY CONTAINING A LIGHT GREEN VEIN.

SER. NO. 76-679,736, FILED 7-20-2007.

TOBY BULLOFF, EXAMINING ATTORNEY

Int. Cl.: 9

Prior U.S. Cls.: 21, 23, 26, 36 and 38

Reg. No. 3,474,409

United States Patent and Trademark Office

Registered July 29, 2008

**TRADEMARK
PRINCIPAL REGISTER**



EAGLE TECH COMPUTERS, INC. (CALIFORNIA CORPORATION)
18539 E. GALE AVE.
CITY OF INDUSTRY, CA 91748

FOR: COMPUTER BACKUP AND STORAGE DEVICES, NAMELY, EXTERNAL HARD DRIVE ENCLOSURES, EXTERNAL HARD DRIVES, EXTERNAL DVD DRIVES, NETWORK ATTACHED STORAGE AND RAID SUBSYSTEMS, IN CLASS 9 (U.S. CLS. 21, 23, 26, 36 AND 38).

FIRST USE 1-1-2007; IN COMMERCE 2-15-2007.

NO CLAIM IS MADE TO THE EXCLUSIVE RIGHT TO USE "STORAGE", APART FROM THE MARK AS SHOWN.

THE WORD "CONSUS" HAS NO MEANING IN A FOREIGN LANGUAGE.

SER. NO. 76-679,739, FILED 7-20-2007.

DAVID I, EXAMINING ATTORNEY

Int. Cl.: 29

Prior U.S. Cl.: 46

United States Patent and Trademark Office

Reg. No. 3,474,410

Registered July 29, 2008

**TRADEMARK
PRINCIPAL REGISTER**



UNILEVER SUPPLY CHAIN, INC. (DELAWARE CORPORATION)
1 JOHN STREET
CLINTON, CT 06413

FOR: VEGETABLE OIL SPREAD, IN CLASS 29 (U.S. CL. 46).

FIRST USE 10-0-2005; IN COMMERCE 10-0-2005.

OWNER OF U.S. REG. NOS. 1,507,377, 2,011,836 AND OTHERS.

NO CLAIM IS MADE TO THE EXCLUSIVE RIGHT TO USE "SPREAD" AND "SPREADABLE STICKS", APART FROM THE MARK AS SHOWN.

SER. NO. 76-679,857, FILED 7-24-2007.

FLORENTINA BLANDU, EXAMINING ATTORNEY

Int. Cl.: 40

Prior U.S. Cls.: 100, 103 and 106

United States Patent and Trademark Office

Reg. No. 3,474,411

Registered July 29, 2008

**SERVICE MARK
PRINCIPAL REGISTER**

POSTCARD PRESS

POSTCARD PRESS, INC. (CALIFORNIA CORPORATION)
18711 S. BROADWICK STREET
RANCHO DOMINGUEZ, CA 90220

NO CLAIM IS MADE TO THE EXCLUSIVE RIGHT TO USE "PRESS", APART FROM THE MARK AS SHOWN.

FOR: PRINTING SERVICES, NAMELY, CUSTOM PRINTING SERVICES FOR OTHERS, IN CLASS 40 (U.S. CLS. 100, 103 AND 106).

SEC. 2(F).

FIRST USE 12-0-1997; IN COMMERCE 12-0-1997.

SER. NO. 76-680,012, FILED 7-30-2007.

THE MARK CONSISTS OF STANDARD CHARACTERS WITHOUT CLAIM TO ANY PARTICULAR FONT, STYLE, SIZE, OR COLOR.

MICHELE SWAIN, EXAMINING ATTORNEY

Int. Cl.: 40

Prior U.S. Cls.: 100, 103 and 106

United States Patent and Trademark Office

Reg. No. 3,474,412

Registered July 29, 2008

**SERVICE MARK
PRINCIPAL REGISTER**

NEXTDAYFLYERS

POSTCARD PRESS, INC. (CALIFORNIA CORPORATION)
18711 S. BROADWICK STREET
RANCHO DOMINGUEZ, CA 90220

FOR: PRINTING SERVICES, NAMELY, CUSTOM
PRINTING SERVICES FOR OTHERS, IN CLASS 40
(U.S. CLS. 100, 103 AND 106).

FIRST USE 6-0-1999; IN COMMERCE 6-0-1999.

THE MARK CONSISTS OF STANDARD CHARACTERS WITHOUT CLAIM TO ANY PARTICULAR FONT, STYLE, SIZE, OR COLOR.

SEC. 2(F).

SER. NO. 76-680,021, FILED 7-30-2007.

MICHELE SWAIN, EXAMINING ATTORNEY

Int. Cl.: 40

Prior U.S. Cls.: 100, 103 and 106

United States Patent and Trademark Office

Reg. No. 3,474,413

Registered July 29, 2008

**SERVICE MARK
PRINCIPAL REGISTER**

POSTCARDPRESS

POSTCARD PRESS, INC. (CALIFORNIA CORPORATION)
18711 S. BROADWICK STREET
RANCHO DOMINGUEZ, CA 90220

FOR: PRINTING SERVICES, NAMELY, CUSTOM PRINTING SERVICES FOR OTHERS, IN CLASS 40 (U.S. CLS. 100, 103 AND 106).

FIRST USE 12-0-1997; IN COMMERCE 12-0-1997.

THE MARK CONSISTS OF STANDARD CHARACTERS WITHOUT CLAIM TO ANY PARTICULAR FONT, STYLE, SIZE, OR COLOR.

SEC. 2(F).

SER. NO. 76-680,022, FILED 7-30-2007.

MICHELE SWAIN, EXAMINING ATTORNEY

Int. Cl.: 40

Prior U.S. Cls.: 100, 103 and 106

United States Patent and Trademark Office

Reg. No. 3,474,414

Registered July 29, 2008

**SERVICE MARK
PRINCIPAL REGISTER**

NEXT DAY FLYERS

POSTCARD PRESS, INC. (CALIFORNIA CORPORATION)
18711 S. BROADWICK STREET
RANCHO DOMINGUEZ, CA 90220

NO CLAIM IS MADE TO THE EXCLUSIVE RIGHT TO USE "FLYERS", APART FROM THE MARK AS SHOWN.

FOR: PRINTING SERVICES, NAMELY, CUSTOM PRINTING SERVICES FOR OTHERS, IN CLASS 40 (U.S. CLS. 100, 103 AND 106).

SEC. 2(F).

FIRST USE 6-0-1999; IN COMMERCE 6-0-1999.

SER. NO. 76-680,023, FILED 7-30-2007.

THE MARK CONSISTS OF STANDARD CHARACTERS WITHOUT CLAIM TO ANY PARTICULAR FONT, STYLE, SIZE, OR COLOR.

MICHELE SWAIN, EXAMINING ATTORNEY

Int. Cl.: 35

Prior U.S. Cls.: 100, 101 and 102

United States Patent and Trademark Office

Reg. No. 3,474,415

Registered July 29, 2008

**SERVICE MARK
PRINCIPAL REGISTER**

METACOMMUNITY

GONGOS RESEARCH, INC. (MICHIGAN CORPORATION)
2365 PONTIAC ROAD
AUBURN HILLS, MI 48326

FOR: MARKET RESEARCH STUDIES AND SURVEYS UTILIZING ONLINE CONSUMER MARKET RESEARCH TO CONDUCT MARKET SURVEYS AND MARKET OPINION POLLING STUDIES, IN CLASS 35 (U.S. CLS. 100, 101 AND 102).

FIRST USE 2-13-2007; IN COMMERCE 2-13-2007.

THE MARK CONSISTS OF STANDARD CHARACTERS WITHOUT CLAIM TO ANY PARTICULAR FONT, STYLE, SIZE, OR COLOR.

SER. NO. 76-680,205, FILED 8-2-2007.

SHANNON TWOHIG, EXAMINING ATTORNEY

Int. Cls.: 37 and 39

Prior U.S. Cls.: 100, 103, 105 and 106

United States Patent and Trademark Office

Reg. No. 3,474,416

Registered July 29, 2008

**SERVICE MARK
PRINCIPAL REGISTER**

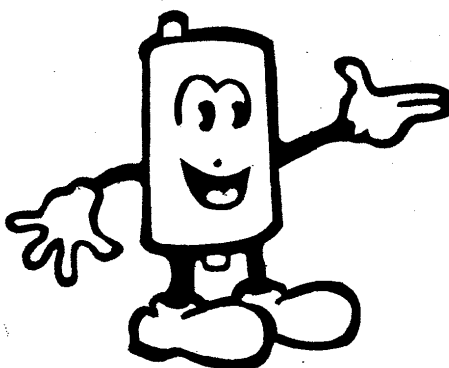

MUFFLER SHOP PLUS, INC. (PENNSYLVANIA CORPORATION)
10726 RT. 249
KNOXVILLE, PA 16928

FOR: INSTALLATION OF AUTOMOBILE EXHAUST SYSTEMS AND PARTS, IN CLASS 37 (U.S. CLS. 100, 103 AND 106).

FIRST USE 10-20-2003; IN COMMERCE 10-20-2003.

FOR: WAREHOUSING SERVICES, NAMELY, STORAGE, DISTRIBUTION, PICK-UP, PACKING

AND SHIPPING OF AUTOMOTIVE EXHAUST PRODUCTS TO CUSTOMERS, WAREHOUSES, SHOPS AND MANUFACTURING FACILITIES, IN CLASS 39 (U.S. CLS. 100 AND 105).

FIRST USE 10-20-2003; IN COMMERCE 10-20-2003.

SER. NO. 76-680,393, FILED 8-6-2007.

DAWN HAN, EXAMINING ATTORNEY

Int. Cl.: 41

Prior U.S. Cls.: 100, 101 and 107

United States Patent and Trademark Office

Reg. No. 3,474,417

Registered July 29, 2008

SERVICE MARK
PRINCIPAL REGISTER



THESPORTSROOSTER, LLC (FLORIDA LTD
LIAB CO)
15A HARGROVE GRADE
PALM COAST, FL 32137

FOR: ENTERTAINMENT SERVICES; NAMELY,
PROVIDING AN INTERNET WEBSITE FEATUR-
ING INFORMATION ABOUT HIGH SCHOOL AND
AMATEUR ATHLETIC COMPETITIONS; ON-LINE
JOURNALS, NAMELY, BLOGS FEATURING IN-
FORMATION IN THE FIELDS OF SPORTS, SOCIAL
NETWORKING, AND ONLINE SOCIAL NET-
WORKING; PROVIDING AN INTERNET WEBSITE
FEATURING NEWS IN THE FIELD OF HIGH

SCHOOL AND AMATEUR SPORTS, IN CLASS 41
(U.S. CLS. 100, 101 AND 107).

FIRST USE 6-20-2007; IN COMMERCE 6-20-2007.

THE MARK CONSISTS OF THE WORDING "THE
SPORTSROOSTER.COM NO ONE WAKES UP BE-
FORE THE ROOSTER." WITH A DESIGN OF A
ROOSTER.

SER. NO. 76-680,577, FILED 8-9-2007.

EVELYN BRADLEY, EXAMINING ATTORNEY

Int. Cls.: 36, 37 and 41

Prior U.S. Cls.: 100, 101, 102, 103, 106 and 107

United States Patent and Trademark Office

Reg. No. 3,474,418

Registered July 29, 2008

**SERVICE MARK
PRINCIPAL REGISTER**

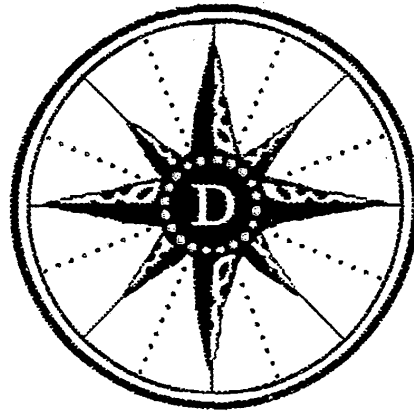

DISCOVERY LAND COMPANY, LLC (DELAWARE LTD LIAB CO)
14605 NORTH 73RD STREET
SCOTTSDALE, AZ 85260

FOR: REAL ESTATE SERVICES, NAMELY, REAL ESTATE BROKERAGE, REAL ESTATE MANAGEMENT, REAL ESTATE LISTING, REAL ESTATE INVESTMENT, NAMELY, FINANCIAL INVESTMENT IN REAL ESTATE AND PLANNED COMMUNITIES; ONLINE INFORMATION SERVICES IN THE FIELD OF REAL ESTATE, IN CLASS 36 (U.S. CLS. 100, 101 AND 102).

FIRST USE 8-1-2006; IN COMMERCE 8-1-2006.

FOR: REAL ESTATE DEVELOPMENT; REAL ESTATE SITE SELECTION; LAND DEVELOPMENT SERVICES, NAMELY, DEVELOPMENT OF PLANNED COMMUNITIES AND GOLF COURSES; PLANNING AND LAYING OUT OF RESIDENTIAL COMMUNITIES; CONSTRUCTION SERVICES, NAMELY, PLANNING, LAYING OUT, AND CUS-

TOM CONSTRUCTION OF RESIDENTIAL DEVELOPMENTS AND GOLF COURSES; ONLINE INFORMATION SERVICES IN THE FIELDS OF THE DEVELOPMENT OF PLANNED COMMUNITIES AND RESIDENTIAL DEVELOPMENTS, AND DEVELOPMENT OF RECREATIONAL FACILITIES AND GOLF COURSES, IN CLASS 37 (U.S. CLS. 100, 103 AND 106).

FIRST USE 8-1-2006; IN COMMERCE 8-1-2006.

FOR: COUNTRY CLUB SERVICES; GOLF COURSES; PROVIDING RECREATIONAL FACILITIES; ONLINE INFORMATION SERVICES IN THE FIELD OF GOLF, GOLF COURSES, RECREATIONAL FACILITIES AND RECREATION, IN CLASS 41 (U.S. CLS. 100, 101 AND 107).

FIRST USE 8-1-2006; IN COMMERCE 8-1-2006.

SER. NO. 76-680,710, FILED 8-15-2007.

ESTHER A. BORSUK, EXAMINING ATTORNEY

Int. Cl.: 41

Prior U.S. Cls.: 100, 101 and 107

United States Patent and Trademark Office

Reg. No. 3,474,419

Registered July 29, 2008

SERVICE MARK
PRINCIPAL REGISTER



DONNA VESSEY EVENTS, LLC (COLORADO
LTD LIAB CO)
900 SATURN DRIVE, #606
COLORADO SPRINGS, CO 809061812

FOR: SPECIAL EVENT PLANNING; SPECIAL
EVENT PLANNING CONSULTATION; EVENT
MANAGEMENT SERVICES, NAMELY, ORGANIZ-
ING EDUCATIONAL CONFERENCES, ORGANIZ-
ING SOCIAL ACTIVITIES, NAMELY, CULTURAL
EVENTS, AND ORGANIZING SEMINARS FOR
CULTURAL AND EDUCATIONAL PURPOSES, IN
CLASS 41 (U.S. CLS. 100, 101 AND 107).

FIRST USE 8-31-2006; IN COMMERCE 8-31-2006.

NO CLAIM IS MADE TO THE EXCLUSIVE
RIGHT TO USE "EVENTS", APART FROM THE
MARK AS SHOWN.

THE NAME "DONNA VESSEY" IDENTIFIES A
LIVING INDIVIDUAL WHOSE CONSENT IS OF
RECORD.

SER. NO. 76-680,875, FILED 8-20-2007.

BILL DAWE, EXAMINING ATTORNEY

Int. Cl.: 41

Prior U.S. Cls.: 100, 101 and 107

Reg. No. 3,474,420

United States Patent and Trademark Office

Registered July 29, 2008

**SERVICE MARK
PRINCIPAL REGISTER**



ST. ANNE'S SCHOOL OF ANNAPOLIS, INCORPORATED (MARYLAND NON-PROFIT CORPORATION)
3112 ARUNDEL ON THE BAY RD.
ANNAPOLIS, MD 214034605

FIRST USE 8-1-2007; IN COMMERCE 8-1-2007.

FOR: EDUCATIONAL SERVICES, NAMELY, AN INDEPENDENT, CO-EDUCATIONAL EPISCOPAL SCHOOL PROVIDING COURSES OF INSTRUCTION FOR STUDENTS AT THE PRESCHOOL THROUGH EIGHTH GRADE LEVELS, IN CLASS 41 (U.S. CLS. 100, 101 AND 107).

NO CLAIM IS MADE TO THE EXCLUSIVE RIGHT TO USE "SCHOOL OF ANNAPOLIS", APART FROM THE MARK AS SHOWN.

SER. NO. 76-681,139, FILED 8-24-2007.

ELI HELLMAN, EXAMINING ATTORNEY

Int. Cl.: 41

Prior U.S. Cls.: 100, 101 and 107

United States Patent and Trademark Office

Reg. No. 3,474,421

Registered July 29, 2008

**SERVICE MARK
PRINCIPAL REGISTER**

ST. ANNE'S SCHOOL OF ANNAPOLIS

ST. ANNE'S SCHOOL OF ANNAPOLIS, INCORPORATED (MARYLAND NON-PROFIT CORPORATION)
3112 ARUNDEL ON THE BAY RD.
ANNAPOLIS, MD 214034605

FOR: EDUCATIONAL SERVICES, NAMELY, AN INDEPENDENT, CO-EDUCATIONAL EPISCOPAL SCHOOL PROVIDING COURSES OF INSTRUCTION FOR STUDENTS AT THE PRESCHOOL THROUGH EIGHTH GRADE LEVELS, IN CLASS 41 (U.S. CLS. 100, 101 AND 107).

FIRST USE 8-1-2007; IN COMMERCE 8-1-2007.

THE MARK CONSISTS OF STANDARD CHARACTERS WITHOUT CLAIM TO ANY PARTICULAR FONT, STYLE, SIZE, OR COLOR.

NO CLAIM IS MADE TO THE EXCLUSIVE RIGHT TO USE "SCHOOL OF ANNAPOLIS", APART FROM THE MARK AS SHOWN.

SER. NO. 76-681,140, FILED 8-24-2007.

ELI HELLMAN, EXAMINING ATTORNEY

Int. Cl.: 41

Prior U.S. Cls.: 100, 101 and 107

United States Patent and Trademark Office

Reg. No. 3,474,422

Registered July 29, 2008

**SERVICE MARK
PRINCIPAL REGISTER**

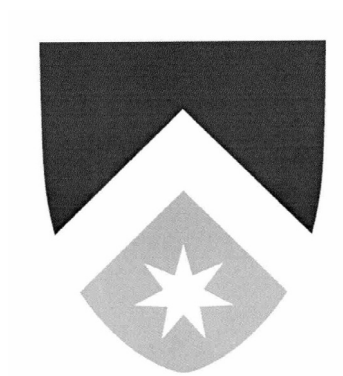

ST. ANNE'S SCHOOL OF ANNAPOLIS, INCORPORATED (MARYLAND NON-PROFIT CORPORATION)
3112 ARUNDEL ON THE BAY RD.
ANNAPOLIS, MD 214034605

FOR: EDUCATIONAL SERVICES, NAMELY, AN INDEPENDENT, CO-EDUCATIONAL EPISCOPAL SCHOOL PROVIDING COURSES OF INSTRUCTION FOR STUDENTS AT THE PRESCHOOL THROUGH

EIGHTH GRADE LEVELS, IN CLASS 41 (U.S. CLS. 100, 101 AND 107).

FIRST USE 8-1-2007; IN COMMERCE 8-1-2007.

SER. NO. 76-681,141, FILED 8-24-2007.

ELI HELLMAN, EXAMINING ATTORNEY

Int. Cl.: 41

Prior U.S. Cls.: 100, 101 and 107

United States Patent and Trademark Office

Reg. No. 3,474,423

Registered July 29, 2008

**SERVICE MARK
PRINCIPAL REGISTER**

WHERE SUCCESS STARTS

ST. ANNE'S SCHOOL OF ANNAPOLIS, INCORPORATED (MARYLAND NON-PROFIT CORPORATION)

3112 ARUNDEL ON THE BAY RD.
ANNAPOLIS, MD 214034605

FOR: EDUCATIONAL SERVICES, NAMELY, AN INDEPENDENT, CO-EDUCATIONAL EPISCOPAL SCHOOL PROVIDING COURSES OF INSTRUCTION FOR STUDENTS AT THE PRESCHOOL THROUGH EIGHTH GRADE LEVELS, IN CLASS 41 (U.S. CLS. 100, 101 AND 107).

FIRST USE 8-1-2007; IN COMMERCE 8-1-2007.

THE MARK CONSISTS OF STANDARD CHARACTERS WITHOUT CLAIM TO ANY PARTICULAR FONT, STYLE, SIZE, OR COLOR.

SER. NO. 76-681,142, FILED 8-24-2007.

ELI HELLMAN, EXAMINING ATTORNEY

Int. Cl.: 42

Prior U.S. Cls.: 100 and 101

United States Patent and Trademark Office

Reg. No. 3,474,424

Registered July 29, 2008

**SERVICE MARK
PRINCIPAL REGISTER**

THE MODE GROUP

MODE OF FASHION, INC. (D.C. CORPORATION), DBA THE MODE GROUP
3813-B "W" STREET, SE
WASHINGTON, DC 20020

FOR: CONSULTING SERVICES, NAMELY, INTERIOR DESIGN SERVICES FOR OTHERS, INTERIOR DECORATING, THE DESIGN OF CUSTOM WINDOW TREATMENTS, FURNITURE DESIGN SERVICES, AND PLANNING AND LAYOUT DESIGN FOR THE PLACEMENT OF FURNISHINGS IN INTERIOR SPACES, ALL PROVIDED TO COMMERCIAL AND RESIDENTIAL CUSTOMERS, IN CLASS 42 (U.S. CLS. 100 AND 101).

FIRST USE 8-6-1990; IN COMMERCE 8-6-1990.

THE MARK CONSISTS OF STANDARD CHARACTERS WITHOUT CLAIM TO ANY PARTICULAR FONT, STYLE, SIZE, OR COLOR.

OWNER OF U.S. REG. NOS. 2,238,565, 2,327,723, AND 2,463,640.

NO CLAIM IS MADE TO THE EXCLUSIVE RIGHT TO USE "GROUP", APART FROM THE MARK AS SHOWN.

SER. NO. 76-681,265, FILED 8-27-2007.

KAELIE KUNG, EXAMINING ATTORNEY

Int. Cls.: 16 and 35

Prior U.S. Cls.: 2, 5, 22, 23, 29, 37, 38, 50, 100, 101 and 102

Reg. No. 3,474,425

United States Patent and Trademark Office

Registered July 29, 2008

**TRADEMARK
SERVICE MARK
PRINCIPAL REGISTER**

METROCLAVE

METRO HISPANIC MEDIA, LLC (MARYLAND
LTD LIAB CO)
25 WEST MIDDLE LANE
ROCKVILLE, MD 20850

FOR: CLASSIFIED DIRECTORIES; TELEPHONE
DIRECTORIES; AND MAGAZINES FEATURING
GENERAL ADVERTISING , IN CLASS 16 (U.S. CLS.
2, 5, 22, 23, 29, 37, 38 AND 50).

FIRST USE 6-1-2007; IN COMMERCE 6-1-2007.

FOR: PROVIDING AN ON-LINE COMMERCIAL
INFORMATION DIRECTORY ON THE INTERNET;

PROVIDING ON-LINE DIRECTORY INFORMA-
TION SERVICES, IN CLASS 35 (U.S. CLS. 100, 101
AND 102).

FIRST USE 6-1-2007; IN COMMERCE 6-1-2007.

THE MARK CONSISTS OF STANDARD CHAR-
ACTERS WITHOUT CLAIM TO ANY PARTICULAR
FONT, STYLE, SIZE, OR COLOR.

SER. NO. 76-681,287, FILED 8-29-2007.

JENNIFER MARTIN, EXAMINING ATTORNEY

Int. Cl.: 20

Prior U.S. Cls.: 2, 13, 22, 25, 32 and 50

Reg. No. 3,474,426

United States Patent and Trademark Office

Registered July 29, 2008

**TRADEMARK
PRINCIPAL REGISTER**



KOVER KLAMPS LASCALA INTERNATIONAL
INC. (NEW YORK CORPORATION)
185 FORDHAM STREET
BRONX, NY 10464

FOR: NON METAL CLIP TO SECURE CANVAS,
PLASTIC, AND OTHER FABRICS IN PLACE, IN
CLASS 20 (U.S. CLS. 2, 13, 22, 25, 32 AND 50).

FIRST USE 8-1-2005; IN COMMERCE 8-1-2005.

THE COLOR(S) BLACK, WHITE, AND RED IS/
ARE CLAIMED AS A FEATURE OF THE MARK.

THE COLOR BLACK APPEARS IN THE WORD-
ING "KOVER KLIPS" AND THE DESIGN ELEMENT
CONSISTS OF A RED AND WHITE FLAG WITH
DOUBLE "K'S". THE COLORS ARE DIVIDED VER-
TICALLY IN THE CENTER OF THE FLAG WHICH
IS FLYING FROM A RED FLAG POLL. THE "K" IN
THE WORD "KOVER" IS ATTACHED TO THE "I" IN
THE WORD "KLIPS," WHICH FORMS ONE VERTI-
CAL LINE.

SER. NO. 76-681,370, FILED 8-31-2007.

H. M. FISHER, EXAMINING ATTORNEY

Int. Cl.: 16

Prior U.S. Cls.: 2, 5, 22, 23, 29, 37, 38 and 50

Reg. No. 3,474,427

United States Patent and Trademark Office

Registered July 29, 2008

**TRADEMARK
PRINCIPAL REGISTER**

1 1 4 2

PAXAR AMERICAS, INC. (DELAWARE CORPORATION)
170 MONARCH LANE
MIAMISBURG, OH 45342

THE MARK CONSISTS OF STANDARD CHARACTERS WITHOUT CLAIM TO ANY PARTICULAR FONT, STYLE, SIZE, OR COLOR.

FOR: LABEL PRINTING MACHINES FOR PRICE MARKING, IN CLASS 16 (U.S. CLS. 2, 5, 22, 23, 29, 37, 38 AND 50).

SER. NO. 76-681,576, FILED 9-4-2007.

FIRST USE 5-22-2007; IN COMMERCE 5-22-2007.

CARYN GLASSER, EXAMINING ATTORNEY

Int. Cls.: 35, 36 and 39

Prior U.S. Cls.: 100, 101, 102 and 105

United States Patent and Trademark Office

Reg. No. 3,474,428

Registered July 29, 2008

**SERVICE MARK
PRINCIPAL REGISTER**

WE GIVE YOU MORE

FLIGHT OPTIONS, LLC (DELAWARE LTD LIAB
CO)
26180 CURTISS-WRIGHT PARKWAY
CLEVELAND, OH 44143

FOR: PROVIDING TEMPORARY EMPLOYMENT SERVICES IN THE NATURE OF PROVIDING FLIGHT CREW SERVICES FOR OTHERS; AIRCRAFT MANAGEMENT SERVICES, NAMELY, ARRANGING FOR THE MAINTENANCE AND CREWING OF AIRCRAFT OWNERS; CONSUMER LOYALTY SERVICES FOR PROMOTIONAL AND ADVERTISING PURPOSES, NAMELY, ADMINISTRATION OF FREQUENT FLYER PROGRAM THAT PROVIDES FLYING TIME THROUGH USE OF A MEMBERSHIP JET CARD, IN CLASS 35 (U.S. CLS. 100, 101 AND 102).

FIRST USE 7-23-2007; IN COMMERCE 7-23-2007.

FOR: ARRANGING FOR THE SALE AND FINANCING OF OWNERSHIP INTERESTS IN AIRPLANES; MANAGING FRACTIONAL INTERESTS FOR AIRCRAFT; AIRPLANE BROKERAGE SERVICES, NAMELY, ARRANGING FOR THE ACQUISITION AND SALES, FRACTIONAL SALES, AND OWNERSHIP OF AIRPLANES FOR OTHERS, IN CLASS 36 (U.S. CLS. 100, 101 AND 102).

TION AND SALES, FRACTIONAL SALES, AND OWNERSHIP OF AIRPLANES FOR OTHERS, IN CLASS 36 (U.S. CLS. 100, 101 AND 102).

FIRST USE 7-23-2007; IN COMMERCE 7-23-2007.

FOR: AIRCRAFT CHARTERING SERVICES; LOANING AND RENTAL OF AIRPLANES; LEASING OF AIRCRAFT; AIR TRANSPORTATION SERVICES FEATURING A FREQUENT FLYER BONUS PROGRAM, NAMELY, PROVIDING FLYING TIME THROUGH USE OF A MEMBERSHIP JET CARD, IN CLASS 39 (U.S. CLS. 100 AND 105).

FIRST USE 7-23-2007; IN COMMERCE 7-23-2007.

THE MARK CONSISTS OF STANDARD CHARACTERS WITHOUT CLAIM TO ANY PARTICULAR FONT, STYLE, SIZE, OR COLOR.

SER. NO. 76-682,218, FILED 9-24-2007.

EMILY CHUO, EXAMINING ATTORNEY

Int. Cl.: 43

Prior U.S. Cls.: 100 and 101

United States Patent and Trademark Office

Reg. No. 3,474,429

Registered July 29, 2008

**SERVICE MARK
PRINCIPAL REGISTER**



CITTANUOVA, LLC (DELAWARE LTD LIAB CO)
29 NEWTOWN LANE
EAST HAMPTON, NY 11937

FIRST USE 6-17-2004; IN COMMERCE 6-17-2004.

SER. NO. 76-682,268, FILED 9-24-2007.

FOR: RESTAURANT SERVICES, IN CLASS 43
(U.S. CLS. 100 AND 101).

PATRICIA EVANKO, EXAMINING ATTORNEY

Int. Cl.: 35

Prior U.S. Cls.: 100, 101 and 102

United States Patent and Trademark Office

Reg. No. 3,474,430

Registered July 29, 2008

**SERVICE MARK
PRINCIPAL REGISTER**



MARKETING PARTNERS, INC. (PENNSYLVANIA CORPORATION)
6583 RUCH ROAD
BETHLEHEM, PA 18017

FOR: MARKETING CONSULTING, IN CLASS 35
(U.S. CLS. 100, 101 AND 102).

FIRST USE 9-0-2005; IN COMMERCE 9-0-2005.

NO CLAIM IS MADE TO THE EXCLUSIVE
RIGHT TO USE "MARKETING PARTNERS",
APART FROM THE MARK AS SHOWN.

THE COLOR(S) GREEN, WHITE AND GOLD IS/
ARE CLAIMED AS A FEATURE OF THE MARK.

THE WORD "PARTNERS," AND THE TOP OF
THE TRIANGLE AND BOTTOM OF THE OVAL
DESIGN IS GOLD; THE SLANTED PORTION OF
THE OVAL DESIGN IS WHITE; THE LEFT SWIRL IS
COLOR GREEN ALONG WITH THE BOTTOM
PENTAGONAL DESIGN IS GREEN; THE WORD
"MARKETING" AND THE WORDING "BRIDGING
THE MARKETING GAP" ARE GREEN.

SER. NO. 76-682,695, FILED 10-9-2007.

CHRISTOPHER BUONGIORNO, EXAMINING AT-
TORNEY

Int. Cl.: 9

Prior U.S. Cls.: 21, 23, 26, 36 and 38

Reg. No. 3,474,431

United States Patent and Trademark Office

Registered July 29, 2008

**TRADEMARK
PRINCIPAL REGISTER**

GREENPRINT ENTERTAINMENT

GREENPRINT ENTERTAINMENT, LLC (AR-
KANSAS LTD LIAB CO)
P.O. BOX 3313
WEST HELENA, AR 72390

FOR: MUSICAL SOUND RECORDINGS AND
MUSICAL VIDEO RECORDINGS, COMPACT
DISCS, CASSETTES, DVD'S, VIDEO TAPES ALL
FEATURING MUSICAL RECORDINGS, IN CLASS
9 (U.S. CLS. 21, 23, 26, 36 AND 38).

FIRST USE 8-16-2006; IN COMMERCE 4-20-2007.

THE MARK CONSISTS OF STANDARD CHAR-
ACTERS WITHOUT CLAIM TO ANY PARTICULAR
FONT, STYLE, SIZE, OR COLOR.

NO CLAIM IS MADE TO THE EXCLUSIVE
RIGHT TO USE "ENTERTAINMENT", APART
FROM THE MARK AS SHOWN.

SER. NO. 76-682,717, FILED 10-9-2007.

COLLEEN KEARNEY, EXAMINING ATTORNEY

Int. Cls.: 41 and 44

Prior U.S. Cls.: 100, 101 and 107

United States Patent and Trademark Office

Reg. No. 3,474,432

Registered July 29, 2008

**SERVICE MARK
PRINCIPAL REGISTER**

TALISKER FITNESS & SPA

TALISKER MOUNTAIN INCORPORATED (DE-
LAWARE CORPORATION)
900 MAIN STREET, SUITE 6111
PARK CITY, UT 84060

FOR: HEALTH CLUB SERVICES, NAMELY, PRO-
VIDING INSTRUCTION AND EQUIPMENT IN THE
FIELD OF PHYSICAL EXERCISE; PROVIDING FIT-
NESS AND EXERCISE FACILITIES; PHYSICAL FIT-
NESS CONSULTATION; PHYSICAL FITNESS
CONDITIONING CLASSES; PHYSICAL FITNESS
INSTRUCTION, IN CLASS 41 (U.S. CLS. 100, 101
AND 107).

FIRST USE 4-0-2007; IN COMMERCE 4-0-2007.

FOR: HEALTH SPA SERVICES FOR HEALTH
AND WELLNESS OF THE BODY AND SPIRIT
OFFERED AT A HEALTH RESORT; HEALTH SPA
SERVICES, NAMELY, COSMETIC BODY CARE
SERVICES; NUTRITION COUNSELING; VITAMIN
THERAPY; DERMATOLOGY SERVICES; HAIR IM-

PLANTATION, REPLACEMENT AND REMOVAL
SERVICES; HAIRDRESSING SALONS; TANNING
SALONS; NAIL CARE SALONS; SKIN CARE SAL-
ONS; MASSAGE SERVICES; MEDICAL TESTING
SERVICES, NAMELY, FITNESS EVALUATION, IN
CLASS 44 (U.S. CLS. 100 AND 101).

FIRST USE 4-0-2007; IN COMMERCE 4-0-2007.

THE MARK CONSISTS OF STANDARD CHAR-
ACTERS WITHOUT CLAIM TO ANY PARTICULAR
FONT, STYLE, SIZE, OR COLOR.

NO CLAIM IS MADE TO THE EXCLUSIVE
RIGHT TO USE "FITNESS & SPA", APART FROM
THE MARK AS SHOWN.

SER. NO. 76-682,733, FILED 10-9-2007.

RICHARD WHITE, EXAMINING ATTORNEY

Int. Cl.: 29

Prior U.S. Cl.: 46

United States Patent and Trademark Office

Reg. No. 3,474,433

Registered July 29, 2008

**TRADEMARK
PRINCIPAL REGISTER**

MESTRE ALFREDO

J. MONIZ COMPANY (MASSACHUSETTS CORPORATION)
91 WORDELL STREET
P.O. BOX 2797
FALL RIVER, MA 02722

FOR: PACKAGED, FROZEN AND CANNED FISH, NAMELY, TUNAFISH, IN CLASS 29 (U.S. CL. 46).

FIRST USE 7-0-2007; IN COMMERCE 7-0-2007.

THE MARK CONSISTS OF STANDARD CHARACTERS WITHOUT CLAIM TO ANY PARTICULAR FONT, STYLE, SIZE, OR COLOR.

THE ENGLISH TRANSLATION OF THE PORTUGUESE WORD "MESTRE" IN THE MARK IS "MASTER".

SER. NO. 76-683,105, FILED 10-18-2007.

WENDY JUN, EXAMINING ATTORNEY

Int. Cl.: 35

Prior U.S. Cls.: 100, 101 and 102

United States Patent and Trademark Office

Reg. No. 3,474,434

Registered July 29, 2008

SERVICE MARK
PRINCIPAL REGISTER

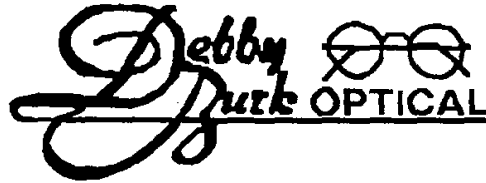

DEBBY BURK OPTICAL, LTD (NEW YORK CORPORATION)
7 OVERLOOK LANE
PLAINVIEW, NY 11803

FIRST USE 7-31-1997; IN COMMERCE 7-31-1997.

NO CLAIM IS MADE TO THE EXCLUSIVE RIGHT TO USE "OPTICAL", APART FROM THE MARK AS SHOWN.

THE NAME "DEBBY BURK" IDENTIFIES A LIVING INDIVIDUAL WHOSE CONSENT IS OF RECORD.

SER. NO. 76-683,155, FILED 10-19-2007.

FOR: ONLINE RETAIL STORE SERVICES FEATURING READING GLASSES, SUNGLASSES, MAGNIFYING GLASSES, EYEGLASS FRAMES, EYEGLASS CASES, EYEGLASS CORDS, EYEGLASS HOLDER, ANTI-GLARE GLASSES, ANTI-GLARE GLASSES FOR CHILDREN, EYEGLASS HOLDERS FOR DESK USE, CELL PHONE CASES, CHILDREN'S SUNGLASSES, OPTICAL MAGNIFYING MIRRORS, LOW VISION AIDS, NAMELY, NIGHT VISION GOGGLES, IN CLASS 35 (U.S. CLS. 100, 101 AND 102).

JOHN GARTNER, EXAMINING ATTORNEY

Int. Cl.: 35

Prior U.S. Cls.: 100, 101 and 102

United States Patent and Trademark Office

Reg. No. 3,474,435

Registered July 29, 2008

SERVICE MARK
PRINCIPAL REGISTER

健寧

LAI, SIU W. (UNITED STATES INDIVIDUAL)
25 RIDGE ROAD
GREEN BROOK, NJ 08812

FOR: RETAIL PHARMACY AND DRUG STORE,
IN CLASS 35 (U.S. CLS. 100, 101 AND 102).

FIRST USE 10-1-1993; IN COMMERCE 10-1-1993.

THE FIRST CHINESE CHARACTER IN THE
MARK TRANSLATES INTO "HEALTHY" AND
"STRENGTH" AND THE SECOND CHINESE CHAR-
ACTER TRANSLATES INTO "SERENITY" AND
"TRANQUILITY".

THE NON-LATIN CHARACTERS IN THE MARK,
READING FROM LEFT TO RIGHT TRANSLITE-
RATE TO KIN NING IN CANTONESE, AND THIS
MEANS "HEALTHY" AND "STRENGTH" IN THE
FIRST NON-LATIN CHARACTER AND "SEREN-
ITY" AND "TRANQUILITY" IN THE SECOND NON-
LATIN CHARACTER IN ENGLISH.

SER. NO. 76-683,169, FILED 10-22-2007.

WILLIAM ROSSMAN, EXAMINING ATTORNEY

Int. Cl.: 19

Prior U.S. Cls.: 1, 12, 33 and 50

United States Patent and Trademark Office

Reg. No. 3,474,436

Registered July 29, 2008

**TRADEMARK
PRINCIPAL REGISTER**

SCRATCH-GUARD

E S ROBBINS CORPORATION (ALABAMA CORPORATION)
2802 E. AVALON AVENUE
MUSCLE SHOALS, AL 35662

FOR: PLASTIC MATERIAL FOR USE AS STRIP
DOORS, IN CLASS 19 (U.S. CLS. 1, 12, 33 AND 50).

FIRST USE 9-25-1986; IN COMMERCE 9-25-1986.

THE MARK CONSISTS OF STANDARD CHARACTERS WITHOUT CLAIM TO ANY PARTICULAR FONT, STYLE, SIZE, OR COLOR.

OWNER OF U.S. REG. NO. 1,507,611.

SER. NO. 76-683,229, FILED 10-23-2007.

CHARLOTTE CORWIN, EXAMINING ATTORNEY

Int. Cl.: 35

Prior U.S. Cls.: 100, 101 and 102

United States Patent and Trademark Office

Reg. No. 3,474,437

Registered July 29, 2008

**SERVICE MARK
PRINCIPAL REGISTER**

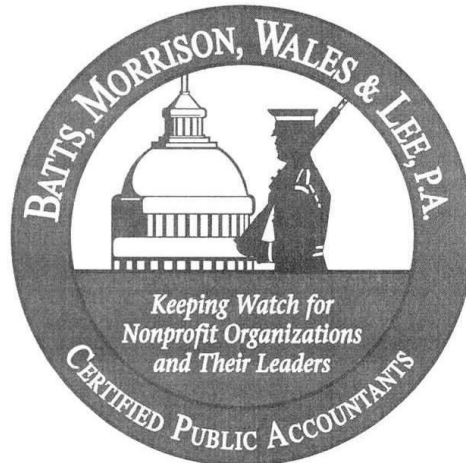

BATTS, MORRISON, WALES & LEE, P.A. (FLOR-
IDA CORPORATION)
1000 LEGION PLACE, SUITE 701
ORLANDO, FL 32801

FOR: ACCOUNTING AND BUSINESS AUDITING
SERVICES, IN CLASS 35 (U.S. CLS. 100, 101 AND 102).

FIRST USE 6-14-2007; IN COMMERCE 6-14-2007.

NO CLAIM IS MADE TO THE EXCLUSIVE
RIGHT TO USE "P.A." AND "CERTIFIED PUBLIC
ACCOUNTANTS", APART FROM THE MARK AS
SHOWN.

SER. NO. 76-683,286, FILED 10-25-2007.

KAREN SEVERSON, EXAMINING ATTORNEY

Int. Cl.: 35

Prior U.S. Cls.: 100, 101 and 102

United States Patent and Trademark Office

Reg. No. 3,474,438

Registered July 29, 2008

**SERVICE MARK
PRINCIPAL REGISTER**

PTS FINANCIAL SERVICES

PERSONAL TAX SERVICES, INC. (GEORGIA
CORPORATION)
113 N. PARK AVENUE
CALHOUN, GA 30701

OWNER OF U.S. REG. NOS. 2,608,837 AND
3,369,848.

FOR: BUSINESS MARKETING IN THE FIELD OF
FINANCIAL SERVICES, IN CLASS 35 (U.S. CLS. 100,
101 AND 102).

NO CLAIM IS MADE TO THE EXCLUSIVE
RIGHT TO USE "FINANCIAL SERVICES", APART
FROM THE MARK AS SHOWN.

FIRST USE 7-0-2007; IN COMMERCE 7-0-2007.

SER. NO. 76-683,304, FILED 10-25-2007.

THE MARK CONSISTS OF STANDARD CHAR-
ACTERS WITHOUT CLAIM TO ANY PARTICULAR
FONT, STYLE, SIZE, OR COLOR.

STEVEN JACKSON, EXAMINING ATTORNEY

Int. Cl.: 36

Prior U.S. Cls.: 100, 101 and 102

United States Patent and Trademark Office

Reg. No. 3,474,439

Registered July 29, 2008

**SERVICE MARK
PRINCIPAL REGISTER**

PTS DIRECT CHECK

PERSONAL TAX SERVICES, INC. (GEORGIA CORPORATION)

113 N. PARK AVENUE

CALHOUN, GA 30701

FOR: FINANCIAL SERVICES, NAMELY, PROVIDING DEPOSIT CHECKING ACCOUNT SERVICES, ISSUANCE OF BANK CHECKS, AND PROVIDING DEBIT CARD SERVICES, IN CLASS 36 (U.S. CLS. 100, 101 AND 102).

FIRST USE 7-0-2007; IN COMMERCE 7-0-2007.

THE MARK CONSISTS OF STANDARD CHARACTERS WITHOUT CLAIM TO ANY PARTICULAR FONT, STYLE, SIZE, OR COLOR.

OWNER OF U.S. REG. NOS. 2,608,837 AND 3,369,848.

NO CLAIM IS MADE TO THE EXCLUSIVE RIGHT TO USE "DIRECT CHECK", APART FROM THE MARK AS SHOWN.

SER. NO. 76-683,374, FILED 10-29-2007.

STEVEN JACKSON, EXAMINING ATTORNEY

Int. Cl.: 35

Prior U.S. Cls.: 100, 101 and 102

United States Patent and Trademark Office

Reg. No. 3,474,440

Registered July 29, 2008

**SERVICE MARK
PRINCIPAL REGISTER**

PEER REVIEWED BY HFMA

HEALTHCARE FINANCIAL MANAGEMENT AS-
SOCIATION (ILLINOIS CORPORATION)
TWO WESTBROOK CORPORATE CENTER
SUITE 700
WESTCHESTER, IL 60154

FOR: BUSINESS SERVICES, NAMELY, PROVID-
ING THIRD PARTY EVALUATION TO HEALTH-
CARE FINANCIAL MANAGERS OF PRODUCTS
AND SERVICES USED IN THE HEALTHCARE
FINANCE WORKPLACE, NAMELY, A REVIEW BY
A PEER REVIEW PANEL THAT EVALUATES THE
PERFORMANCE CLAIMS OF PRODUCTS AND
SERVICES BASED ON DEFINED CRITERIA, IN
CLASS 35 (U.S. CLS. 100, 101 AND 102).

FIRST USE 9-0-2004; IN COMMERCE 9-0-2004.

THE MARK CONSISTS OF STANDARD CHAR-
ACTERS WITHOUT CLAIM TO ANY PARTICULAR
FONT, STYLE, SIZE, OR COLOR.

OWNER OF U.S. REG. NOS. 1,102,425, 1,255,612,
AND 2,137,426.

NO CLAIM IS MADE TO THE EXCLUSIVE
RIGHT TO USE "PEER REVIEWED", APART FROM
THE MARK AS SHOWN.

SER. NO. 76-683,553, FILED 11-1-2007.

MIDGE BUTLER, EXAMINING ATTORNEY

Int. Cl.: 35

Prior U.S. Cls.: 100, 101 and 102

United States Patent and Trademark Office

Reg. No. 3,474,441

Registered July 29, 2008

**SERVICE MARK
PRINCIPAL REGISTER**

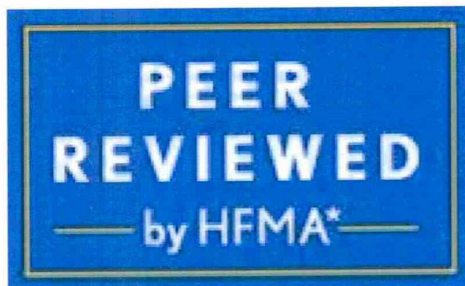

HEALTHCARE FINANCIAL MANAGEMENT AS-
SOCIATION (ILLINOIS CORPORATION)
TWO WESTBROOK CORPORATE CENTER
SUITE 700
WESTCHESTER, IL 60154

FOR: BUSINESS SERVICES, NAMELY, PROVID-
ING THIRD PARTY EVALUATION TO HEALTH-
CARE FINANCIAL MANAGERS OF PRODUCTS
AND SERVICES USED IN THE HEALTHCARE
FINANCE WORKPLACE, NAMELY, A REVIEW BY
A PEER REVIEW PANEL THAT EVALUATES THE
PERFORMANCE CLAIMS OF PRODUCTS AND
SERVICES BASED ON DEFINED CRITERIA, IN
CLASS 35 (U.S. CLS. 100, 101 AND 102).

FIRST USE 9-0-2004; IN COMMERCE 9-0-2004.

OWNER OF U.S. REG. NOS. 1,102,425, 1,255,612,
AND 2,137,426.

NO CLAIM IS MADE TO THE EXCLUSIVE
RIGHT TO USE "PEER REVIEWED", APART FROM
THE MARK AS SHOWN.

BLUE, WHITE AND ORANGE

THE COLOR WHITE APPEARS IN LETTERS OF
THE WORD "PEER REVIEWED BY HFMA" ON A
BLUE BACKGROUND. AN ORANGE LINED BOR-
DER APPEARS AROUND THE WORDING AND AN
ORANGE LINE EXTENDS HORIZONTALLY TO
THE LEFT AND RIGHT OF THE WORDS "BY
HFMA".

SER. NO. 76-683,554, FILED 11-1-2007.

MIDGE BUTLER, EXAMINING ATTORNEY

Int. Cl.: 11

Prior U.S. Cls.: 13, 21, 23, 31 and 34

United States Patent and Trademark Office

Reg. No. 3,474,442

Registered July 29, 2008

**TRADEMARK
PRINCIPAL REGISTER**

EXPRESS DEFROST

SHARP KABUSHIKI KAISHA (JAPAN CORPORATION), TA SHARP CORPORATION
22-22, NAGAIKE-CHO, ABENO-KU
OSAKA 545-8522, JAPAN

FOR: FEATURE OF MICROWAVE OVENS FOR COMMERCIAL USE, NAMELY, A TOUCH PANEL USED TO ENABLE DEFROSTING OF FOOD, IN CLASS 11 (U.S. CLS. 13, 21, 23, 31 AND 34).

FIRST USE 7-0-1989; IN COMMERCE 7-0-1989.

THE MARK CONSISTS OF STANDARD CHARACTERS WITHOUT CLAIM TO ANY PARTICULAR FONT, STYLE, SIZE, OR COLOR.

NO CLAIM IS MADE TO THE EXCLUSIVE RIGHT TO USE "DEFROST", APART FROM THE MARK AS SHOWN.

SER. NO. 76-683,606, FILED 11-2-2007.

DANIEL BRODY, EXAMINING ATTORNEY

Int. Cl.: 15

Prior U.S. Cls.: 2, 21 and 36

United States Patent and Trademark Office

Reg. No. 3,474,443

Registered July 29, 2008

TRADEMARK
PRINCIPAL REGISTER

Pick Pal

GABRIEL, GREG (UNITED STATES INDIVIDUAL)
150 W. EDITH AVENUE #31
LOS ALTOS, CA 94022

FOR: MUSICAL INSTRUMENT ACCESSORIES, NAMELY, DOUBLE-SIDED ADHESIVE GEL SHEETS AND STRIPS FOR HOLDING STRINGED INSTRUMENT PICKS TO INSTRUMENT, IN CLASS 15 (U.S. CLS. 2, 21 AND 36).

FIRST USE 8-17-2007; IN COMMERCE 8-17-2007.

THE MARK CONSISTS OF STANDARD CHARACTERS WITHOUT CLAIM TO ANY PARTICULAR FONT, STYLE, SIZE, OR COLOR.

NO CLAIM IS MADE TO THE EXCLUSIVE RIGHT TO USE "PICK", APART FROM THE MARK AS SHOWN.

SER. NO. 76-683,611, FILED 11-5-2007.

AMY GEARIN, EXAMINING ATTORNEY

Int. Cl.: 43

Prior U.S. Cls.: 100 and 101

United States Patent and Trademark Office

Reg. No. 3,474,444

Registered July 29, 2008

**SERVICE MARK
PRINCIPAL REGISTER**

Pischke's

ARMHOLDINGS, LLC (ARIZONA LTD LIAB CO)
11143 NORTH 107TH WAY
SCOTTSDALE, AZ 85259

FOR: RESTAURANT AND BAR SERVICES, IN
CLASS 43 (U.S. CLS. 100 AND 101).

FIRST USE 7-10-1986; IN COMMERCE 7-10-1986.

THE MARK CONSISTS OF STANDARD CHAR-
ACTERS WITHOUT CLAIM TO ANY PARTICULAR
FONT, STYLE, SIZE, OR COLOR.

SEC. 2(F).

SER. NO. 76-683,678, FILED 11-5-2007.

FLORENTINA BLANDU, EXAMINING ATTORNEY

Int. Cl.: 45

Prior U.S. Cls.: 100 and 101

United States Patent and Trademark Office

Reg. No. 3,474,445

Registered July 29, 2008

**SERVICE MARK
PRINCIPAL REGISTER**

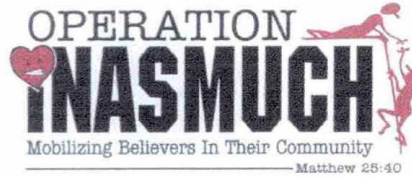

OPERATION INASMUCH, INC. (TENNESSEE CORPORATION)
4815 SANTA MONICA ROAD
KNOXVILLE, TN 37918

FOR: MINISTERIAL SERVICES, IN CLASS 45 (U.S. CLS. 100 AND 101).

FIRST USE 2-0-2004; IN COMMERCE 2-0-2004.

NO CLAIM IS MADE TO THE EXCLUSIVE RIGHT TO USE "MATTHEW 25:40", APART FROM THE MARK AS SHOWN.

THE COLOR(S) RED, BLACK AND WHITE IS/ ARE CLAIMED AS A FEATURE OF THE MARK.

THE MARK CONSISTS OF THE WORD "OPERATION" ABOVE THE WORD "INASMUCH", BOTH ABOVE THE PARTLY UNDERLINED PHRASE "MOBILIZING BELIEVERS IN THEIR COMMUNITY", ALL ABOVE THE WORDING "MATTHEW 25:40", ALL IN A STYLIZED BLACK FONT WITH A STYLIZED RED HEART WITH HUMAN ATTRIBUTES INCLUDING A WHITE MOUTH AND BLACK EYES IN A BLACK OUTLINE COMPRISING THE DOT OF THE LETTER "I" IN THE WORD "INASMUCH", AND A DEPICTION OF TWO STYLIZED RED HUMANS TO THE RIGHT OF THE WORDS "OPERATION" AND "INASMUCH".

SER. NO. 76-683,873, FILED 11-9-2007.

RAUL CORDOVA, EXAMINING ATTORNEY

Int. Cl.: 18

Prior U.S. Cls.: 1, 2, 3, 22 and 41

United States Patent and Trademark Office

Reg. No. 3,474,446

Registered July 29, 2008

**TRADEMARK
PRINCIPAL REGISTER**

TACKY-TACK

EQUI-TECH LABS, INC. (TENNESSEE SOLE
PROPRIETORSHIP)
715 INDUSTRIAL PARKWAY, P. O. BOX 2064
SHELBYVILLE, TN 37162

FOR: PADS FOR HORSE SADDLES; CUSHION
PADDING MADE FOR SADDLERY; SADDLEBAGS;
HORSE BREAST COLLARS; SEAT GRIPPERS,
NAMELY, PADS FOR HORSE SADDLES; HORSE
TACK, NAMELY, GIRTH STRAPS, IN CLASS 18
(U.S. CLS. 1, 2, 3, 22 AND 41).

FIRST USE 9-1-1999; IN COMMERCE 9-1-1999.

THE MARK CONSISTS OF STANDARD CHAR-
ACTERS WITHOUT CLAIM TO ANY PARTICULAR
FONT, STYLE, SIZE, OR COLOR.

SER. NO. 76-684,046, FILED 11-15-2007.

MICHAEL WIENER, EXAMINING ATTORNEY

Int. Cl.: 30

Prior U.S. Cl.: 46

United States Patent and Trademark Office

Reg. No. 3,474,447

Registered July 29, 2008

**TRADEMARK
PRINCIPAL REGISTER**

CHARLES RIVER CRUNCH

LIZZY'S ICE CREAM, LLC (MASSACHUSETTS
LTD LIAB CO)
367 MOODY STREET
WALTHAM, MA 02453

NO CLAIM IS MADE TO THE EXCLUSIVE
RIGHT TO USE "CHARLES RIVER", APART FROM
THE MARK AS SHOWN.

FOR: ICE CREAM, IN CLASS 30 (U.S. CL. 46).

FIRST USE 7-12-2007; IN COMMERCE 7-12-2007.

SER. NO. 76-684,053, FILED 11-15-2007.

THE MARK CONSISTS OF STANDARD CHAR-
ACTERS WITHOUT CLAIM TO ANY PARTICULAR
FONT, STYLE, SIZE, OR COLOR.

ROBERT STRUCK, EXAMINING ATTORNEY

Int. Cl.: 42

Prior U.S. Cls.: 100 and 101

United States Patent and Trademark Office

Reg. No. 3,474,448

Registered July 29, 2008

**SERVICE MARK
PRINCIPAL REGISTER**

**H E L I  S
S T R A T E G I E S**

STRATEGIC MARKETING INNOVATIONS, INC.
(D.C. CORPORATION)
1020 19TH STREET, N.W., SUITE 375
WASHINGTON, DC 200366118

FOR: RESEARCH AND DEVELOPMENT AND
CONSULTATION RELATED THERETO IN THE
FIELD OF FEDERAL REGULATIONS AND FUND-
ING RELATING TO RENEWABLE ENERGY AND
CLIMATE CHANGE, IN CLASS 42 (U.S. CLS. 100
AND 101).

FIRST USE 8-15-2007; IN COMMERCE 8-15-2007.

NO CLAIM IS MADE TO THE EXCLUSIVE
RIGHT TO USE "STRATEGIES", APART FROM
THE MARK AS SHOWN.

SER. NO. 76-684,124, FILED 11-16-2007.

MORGAN WYNNE, EXAMINING ATTORNEY

Int. Cl.: 25

Prior U.S. Cls.: 22 and 39

United States Patent and Trademark Office

Reg. No. 3,474,449

Registered July 29, 2008

**TRADEMARK
PRINCIPAL REGISTER**

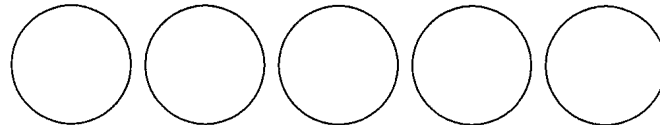

COOGI PARTNERS, LLC (NEW YORK LTD LIAB
CO)
112 WINDSOR GATE
LAKE SUCCESS, NY 11020

FOR: CLOTHING, NAMELY, SHIRTS, VESTS,
SWEATERS, CAPS, BANDANNAS, SHORTS, SWEAT
SHIRTS, PANTS, BELTS FOR CLOTHING, SOCKS,
SWIMWEAR, JACKETS, RAINWEAR, BLOUSES,
DRESSES, HOSIERY, SCARVES, HATS, HEAD
BANDS, PAJAMAS AND SLEEPWEAR, IN CLASS
25 (U.S. CLS. 22 AND 39).

FIRST USE 5-0-2004; IN COMMERCE 5-0-2004.

THE MARK CONSISTS OF FIVE IDENTICAL
CIRCLES ARRANGED HORIZONTALLY.

SER. NO. 76-684,288, FILED 11-26-2007.

LEIGH CAROLINE CASE, EXAMINING ATTOR-
NEY

Int. Cl.: 19

Prior U.S. Cls.: 1, 12, 33 and 50

Reg. No. 3,474,450

United States Patent and Trademark Office

Registered July 29, 2008

TRADEMARK
PRINCIPAL REGISTER



REAL WOOD FLOORS, LLC. (OKLAHOMA LTD
LIAB CO)
4121 W. RENO AVE.
OKLAHOMA CITY, OK 73107

FOR: FLOORING, NAMELY, HARDWOOD
FLOORS AND ENGINEERED HARDWOOD
FLOORING, IN CLASS 19 (U.S. CLS. 1, 12, 33 AND 50).

FIRST USE 6-24-2005; IN COMMERCE 11-22-2005.

NO CLAIM IS MADE TO THE EXCLUSIVE
RIGHT TO USE "REAL WOOD FLOORS", APART
FROM THE MARK AS SHOWN.

THE MARK CONSISTS OF A PANEL FRAME
FORMED IN THE SHAPE OF AN OVAL OVER-
LAPPED BY AN OBLONG RECTANGLE ON THE
PANEL FRAME, A CARPENTER'S PLANE WITH A
PIECE OF WOOD SHAVING APPEARS AT THE TOP,
THE STYLIZED WORDS "REAL WOOD" APPEAR
IN THE MIDDLE, AND THE WORD "FLOORS"
APPEARS AT THE BOTTOM WITH SCRIPT FLOUR-
ISHES ON BOTH SIDES OF THE WORD "FLOORS".

SER. NO. 76-684,421, FILED 11-21-2007.

BILL DAWE, EXAMINING ATTORNEY

Int. Cl.: 16

Prior U.S. Cls.: 2, 5, 22, 23, 29, 37, 38 and 50

United States Patent and Trademark Office

Reg. No. 3,474,451

Registered July 29, 2008

**TRADEMARK
PRINCIPAL REGISTER**

SIDELINER

ELWOOD PACKAGING, INC. (ILLINOIS CORPORATION)
5200 W. ROOSEVELT ROAD
CHICAGO, IL 60644

THE MARK CONSISTS OF STANDARD CHARACTERS WITHOUT CLAIM TO ANY PARTICULAR FONT, STYLE, SIZE, OR COLOR.

FOR: CORRUGATED PAPER PACKAGING WITH PLASTIC BAG INSERT USED FOR STORING LIQUID FOOD AND BEVERAGE PRODUCTS, IN CLASS 16 (U.S. CLS. 2, 5, 22, 23, 29, 37, 38 AND 50).

SER. NO. 76-684,627, FILED 12-4-2007.

FIRST USE 9-14-2007; IN COMMERCE 9-14-2007.

ANTHONY RINKER, EXAMINING ATTORNEY

Int. Cl.: 43

Prior U.S. Cls.: 100 and 101

United States Patent and Trademark Office

Reg. No. 3,474,452

Registered July 29, 2008

SERVICE MARK
PRINCIPAL REGISTER



ACTIUM (NEW JERSEY LTD LIAB CO)
151 THIRD STREET
HOBOKEN, NJ 07030

FOR: RESTAURANT SERVICES FEATURING GRILLED MEATS, SALADS, AND SOUPS PAIRED WITH FLATBREADS, IN CLASS 43 (U.S. CLS. 100 AND 101).

FIRST USE 3-27-2007; IN COMMERCE 3-27-2007.

NO CLAIM IS MADE TO THE EXCLUSIVE RIGHT TO USE "FLATBREAD GRILL", APART FROM THE MARK AS SHOWN.

THE COLOR(S) BROWN, WHITE AND BEIGE IS/ ARE CLAIMED AS A FEATURE OF THE MARK.

THE LITERAL ELEMENT OF THE MARK CONSISTS OF "FLATBREAD GRILL" THAT APPEARS IN BROWN, BEIGE AND WHITE. FLATBREAD IS ON TOP OF AN IMAGE OF 3/4 ROUND BREAD WITH GRILL MARKS ON IT THAT APPEARS IN BROWN AND BEIGE. UNDERNEATH THE LETTERINGS "FLATBREAD" IS A CONVEX CURVED LINE APPEARING IN BROWN, BENEATH WHICH THE TERM IS "GRILL" THAT APPEARS IN BEIGE.

SER. NO. 76-684,629, FILED 12-4-2007.

ANTHONY RINKER, EXAMINING ATTORNEY

Int. Cl.: 35

Prior U.S. Cls.: 100, 101 and 102

United States Patent and Trademark Office

Reg. No. 3,474,453

Registered July 29, 2008

**SERVICE MARK
PRINCIPAL REGISTER**

MODEL 12

JIM KIMBALL ENTERPRISES, INC. (FLORIDA
CORPORATION)
P.O. BOX 849
ZELLWOOD, FL 32798

THE MARK CONSISTS OF STANDARD CHAR-
ACTERS WITHOUT CLAIM TO ANY PARTICULAR
FONT, STYLE, SIZE, OR COLOR.

FOR: ON-LINE RETAIL STORE SERVICES FEA-
TURING T-SHIRTS, GOLF-SHIRTS, HATS, AND
STAINLESS STEEL KEY CHAINS, IN CLASS 35
(U.S. CLS. 100, 101 AND 102).

SER. NO. 76-684,641, FILED 12-5-2007.

FIRST USE 4-15-1998; IN COMMERCE 4-15-1998.

SUZANNE BLANE, EXAMINING ATTORNEY

Int. Cl.: 12

Prior U.S. Cls.: 19, 21, 23, 31, 35 and 44

United States Patent and Trademark Office

Reg. No. 3,474,454

Registered July 29, 2008

**TRADEMARK
PRINCIPAL REGISTER**

MODEL 12

JIM KIMBALL ENTERPRISES, INC. (FLORIDA
CORPORATION)
P.O. BOX 849
ZELLWOOD, FL 32798

THE MARK CONSISTS OF STANDARD CHAR-
ACTERS WITHOUT CLAIM TO ANY PARTICULAR
FONT, STYLE, SIZE, OR COLOR.

FOR: AIRPLANES AND STRUCTURAL PARTS
THEREFOR, IN CLASS 12 (U.S. CLS. 19, 21, 23, 31, 35
AND 44).

SER. NO. 76-684,643, FILED 12-5-2007.

FIRST USE 4-15-1998; IN COMMERCE 4-15-1998.

SUZANNE BLANE, EXAMINING ATTORNEY

Int. Cls.: 9 and 25

Prior U.S. Cls.: 21, 22, 23, 26, 36, 38 and 39

United States Patent and Trademark Office

Reg. No. 3,474,455

Registered July 29, 2008

**TRADEMARK
PRINCIPAL REGISTER**

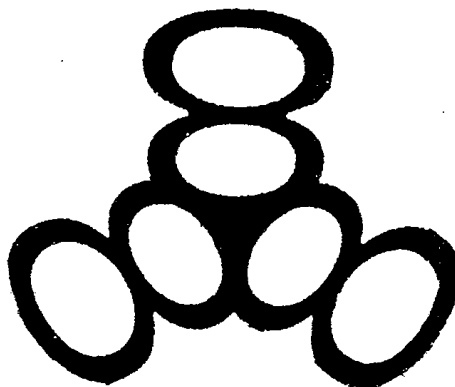

TRIPLE EIGHT DISTRIBUTION, INC. (NEW YORK CORPORATION)
915 BROADWAY SUITE 608
NEW YORK, NY 10010

OWNER OF U.S. REG. NOS. 2,018,852 AND 2,519,966.

FOR: PROTECTIVE HELMETS FOR USE IN SPORTS, IN CLASS 9 (U.S. CLS. 21, 23, 26, 36 AND 38).

THE MARK CONSISTS OF THREE STYLIZED NUMERAL "8'S". THE NUMERALS ARE POSITIONED SO THAT THE TOP OF EACH "8" TOUCHES THE TOPS OF THE OTHER TWO.

FIRST USE 8-0-1996; IN COMMERCE 8-0-1996.

FOR: CLOTHING NAMELY SHIRTS, IN CLASS 25 (U.S. CLS. 22 AND 39).

SER. NO. 76-684,687, FILED 12-6-2007.

FIRST USE 8-0-1996; IN COMMERCE 8-0-1996.

MARILYN IZZI, EXAMINING ATTORNEY

Int. Cl.: 41

Prior U.S. Cls.: 100, 101 and 107

United States Patent and Trademark Office

Reg. No. 3,474,456

Registered July 29, 2008

**SERVICE MARK
PRINCIPAL REGISTER**

MONEY MILLZ ENTERTAINMENT

TAVERAS, CARLOS ALBERTO, JR. (UNITED STATES INDIVIDUAL)
975 WALTON AVE APT#6FS
BRONX, NY 10452

FOR: MUSIC PRODUCTION SERVICES; ENTERTAINMENT SERVICES, NAMELY, RECORDING, PRODUCTION AND POST-PRODUCTION SERVICES IN THE FIELD OF MUSIC, IN CLASS 41 (U.S. CLS. 100, 101 AND 107).

FIRST USE 9-1-2002; IN COMMERCE 3-20-2007.

THE MARK CONSISTS OF STANDARD CHARACTERS WITHOUT CLAIM TO ANY PARTICULAR FONT, STYLE, SIZE, OR COLOR.

NO CLAIM IS MADE TO THE EXCLUSIVE RIGHT TO USE "ENTERTAINMENT", APART FROM THE MARK AS SHOWN.

SER. NO. 76-684,740, FILED 12-7-2007.

SUSAN STIGLITZ, EXAMINING ATTORNEY

Int. Cl.: 9

Prior U.S. Cls.: 21, 23, 26, 36 and 38

United States Patent and Trademark Office

Reg. No. 3,474,457

Registered July 29, 2008

**TRADEMARK
PRINCIPAL REGISTER**

GEOGENESIS

GEOGENESIS, INC. (DELAWARE CORPORATION)
345 WEST MAIN STREET
DURHAM, NC 27701

FOR: COMPUTER SOFTWARE, NAMELY, PHOTOGRAMMETRIC, THREE-DIMENSIONAL MODELING AND/OR IMAGE PROCESSING SOFTWARE, IN CLASS 9 (U.S. CLS. 21, 23, 26, 36 AND 38).

FIRST USE 9-0-2007; IN COMMERCE 9-0-2007.

THE MARK CONSISTS OF STANDARD CHARACTERS WITHOUT CLAIM TO ANY PARTICULAR FONT, STYLE, SIZE, OR COLOR.

SER. NO. 76-684,766, FILED 12-10-2007.

PAUL E. FAHRENKOPF, EXAMINING ATTORNEY

Int. Cls.: 2, 3, 37 and 39

**Prior U.S. Cls.: 1, 4, 6, 11, 16, 50, 51, 52, 100, 103, 105
and 106**

Reg. No. 3,474,458

United States Patent and Trademark Office

Registered July 29, 2008

**TRADEMARK
SERVICE MARK
PRINCIPAL REGISTER**

ENERGY RELEASE

ENERGY RELEASE LIMITED LIABILITY CO.
(MASSACHUSETTS LTD LIAB CO)
300 WHITNEY STREET
LEOMINSTER, MA 01453

FOR: AUTOMOTIVE PRODUCTS AND ACCESSORIES FOR THE AUTOMOTIVE AFTER MARKET INDUSTRY, NAMELY, AUTOMOTIVE ANTI-CORROSIVE PREPARATIONS, NAMELY, ANTI-CORROSIVE PAINTS; AUTOMOTIVE ANTIRUST PREPARATIONS, NAMELY, ANTI-RUST GREASES; AUTOMOTIVE FRICTION REDUCING COATINGS; TOUCHUP PAINTS FOR AUTOMOBILES; LEATHER STAINS; PIGMENTS; COLORANTS FOR USE IN THE MANUFACTURE OF FOOD; COLORANTS FOR USE IN THE MANUFACTURE OF PRINTING INK; UNDERCOATING FOR VEHICLE CHASSIS; NATURAL RESINS FOR USE IN THE MANUFACTURE OF ADHESIVES, IN CLASS 2 (U.S. CLS. 6, 11 AND 16).

FIRST USE 7-7-2006; IN COMMERCE 7-7-2006.

FOR: AUTOMOTIVE PRODUCTS AND ACCESSORIES FOR THE AUTOMOTIVE AFTER MARKET INDUSTRY, NAMELY, WINDSCREEN CLEANING LIQUIDS, POLISHING PREPARATIONS, POLISHING WAX, LEATHER POLISHES, WAXES FOR LEATHER, AUTOMOTIVE WAXES, AUTOMOTIVE WASH, CLEANING SOLVENT USED TO DEGREASE ENGINES, CARBURETOR JET CLEANER, RUST-REMOVING PREPARATIONS; WASHING-UP LIQUIDS; CLEANING AND POLISHING PAPER; ABRASIVE CLOTH, IN CLASS 3 (U.S. CLS. 1, 4, 6, 50, 51 AND 52).

FIRST USE 7-7-2006; IN COMMERCE 7-7-2006.

FOR: VEHICLE REPAIR AND MAINTENANCE; VEHICLE SERVICE STATIONS; ANTI-RUST TREATMENT FOR VEHICLES; VEHICLE POLISHING; VEHICLE LUBRICATION; CAR WASH; MO-

TOR VEHICLE MAINTENANCE AND REPAIR; SHIPBUILDING; MOTOR VEHICLE WASH; TIRE RETREADING; RUST-PROOFING; BUILDING CONSTRUCTION SUPERVISION; WAREHOUSE CONSTRUCTION AND REPAIR; MINING EXTRACTION; MACHINERY INSTALLATION, MAINTENANCE AND REPAIR; PHOTOGRAPHIC APPARATUS REPAIR; CLEANING OF EXTERNAL SURFACES OF BUILDINGS; HEATING EQUIPMENT INSTALLATION AND REPAIR; UPHOLSTERY REPAIR; FURNITURE MAINTENANCE; AIRPLANE MAINTENANCE AND REPAIR; CLOCK AND WATCH REPAIR; SAFE MAINTENANCE AND REPAIR; DRY CLEANING; DISINFECTING; PUMP REPAIR, IN CLASS 37 (U.S. CLS. 100, 103 AND 106).

FIRST USE 7-7-2006; IN COMMERCE 7-7-2006.

FOR: PACKAGING OF GOODS FOR TRANSPORTATION AND STORAGE, NAMELY, WRAPPING SERVICES IN THE NATURE OF WRAPPING OF GOODS WITH PLASTIC FILM OR OTHER WRAPPING MATERIAL FOR BAGGAGE PROTECTION DURING TRAVEL AND STORAGE; WAREHOUSING SERVICES, NAMELY, STORAGE, DISTRIBUTION, PICK-UP, AND PACKING FOR SHIPMENT OF DOCUMENTS, PACKAGES, RAW MATERIALS, AND OTHER FREIGHT FOR OTHERS; SUPPLY CHAIN, LOGISTICS, AND REVERSE LOGISTICS SERVICES, NAMELY, STORAGE, TRANSPORTATION AND DELIVERY OF DOCUMENTS, PACKAGES, RAW MATERIALS AND OTHER FREIGHT FOR OTHER BY AIR, RAIL, SHIP OR TRUCK, FREIGHT FORWARDING; TANKER TRANSPORT, IN CLASS 39 (U.S. CLS. 100 AND 105).

FIRST USE 7-7-2006; IN COMMERCE 7-7-2006.

THE MARK CONSISTS OF STANDARD CHARACTERS WITHOUT CLAIM TO ANY PARTICULAR FONT, STYLE, SIZE, OR COLOR.

OWNER OF U.S. REG. NOS. 2,276,678, 2,276,679,
AND 2,276,680.

SER. NO. 76-684,775, FILED 12-10-2007.

RENEE MCCRAY, EXAMINING ATTORNEY

Int. Cls.: 2, 3, 37 and 39

**Prior U.S. Cls.: 1, 4, 6, 11, 16, 50, 51, 52, 100, 103, 105
and 106**

Reg. No. 3,474,459

United States Patent and Trademark Office

Registered July 29, 2008

**TRADEMARK
SERVICE MARK
PRINCIPAL REGISTER**



ENERGY RELEASE LIMITED LIABILITY CO.
(MASSACHUSETTS LTD LIAB CO)
300 WHITNEY STREET
LEOMINSTER, MA 01453

FOR: AUTOMOTIVE PRODUCTS AND ACCESSORIES FOR THE AUTOMOTIVE AFTER MARKET INDUSTRY, NAMELY, AUTOMOTIVE ANTI-CORROSIVE PREPARATIONS, NAMELY, ANTI-CORROSIVE PAINTS; AUTOMOTIVE ANTI-RUST PREPARATIONS, NAMELY, ANTI-RUST GREASES; AUTOMOTIVE FRICTION REDUCING COATINGS; TOUCH-UP PAINTS FOR AUTOMOBILES; LEATHER STAINS; PIGMENTS; COLORANTS FOR USE IN THE MANUFACTURE OF FOOD; COLORANTS FOR USE IN THE MANUFACTURE OF PRINTING INK; UNDERCOATING FOR VEHICLE CHASSIS; NATURAL RESINS FOR USE IN THE MANUFACTURE OF ADHESIVES, IN CLASS 2 (U.S. CLS. 6, 11 AND 16).

FIRST USE 7-7-2006; IN COMMERCE 7-7-2006.

FOR: AUTOMOTIVE PRODUCTS AND ACCESSORIES FOR THE AUTOMOTIVE AFTER MARKET INDUSTRY, NAMELY, WINDSCREEN CLEANING LIQUIDS, POLISHING PREPARATIONS, POLISHING WAX, LEATHER POLISHES, WAXES FOR LEATHER, AUTOMOTIVE WAXES, AUTOMOTIVE WASH, CLEANING SOLVENT USED TO DEGREASE ENGINES, CARBURETOR JET CLEANER, RUST-REMOVING PREPARATIONS; WASHING-UP LIQUIDS; CLEANING AND POLISHING PAPER; ABRASIVE CLOTH, IN CLASS 3 (U.S. CLS. 1, 4, 6, 50, 51 AND 52).

FIRST USE 7-7-2006; IN COMMERCE 7-7-2006.

FOR: VEHICLE REPAIR AND MAINTENANCE; VEHICLE SERVICE STATIONS; ANTI-RUST TREATMENT FOR VEHICLES; VEHICLE POLISHING; VEHICLE LUBRICATION; CAR WASH; MOTOR VEHICLE MAINTENANCE AND REPAIR; SHIPBUILDING; MOTOR VEHICLE WASH; TIRE RETREADING; RUST-PROOFING; BUILDING CONSTRUCTION SUPERVISION; WAREHOUSE CONSTRUCTION AND REPAIR; MINING EXTRACTION; MACHINERY INSTALLATION, MAINTENANCE AND REPAIR; PHOTOGRAPHIC APPARATUS REPAIR; CLEANING OF EXTERNAL SURFACES OF BUILDINGS; HEATING EQUIPMENT INSTALLATION AND REPAIR; UPHOLSTERY REPAIR; FURNITURE MAINTENANCE; AIRPLANE MAINTENANCE AND REPAIR; CLOCK AND WATCH REPAIR; SAFE MAINTENANCE AND REPAIR; DRY CLEANING; DISINFECTING; PUMP REPAIR, IN CLASS 37 (U.S. CLS. 100, 103 AND 106).

FIRST USE 7-7-2006; IN COMMERCE 7-7-2006.

FOR: PACKAGING OF GOODS FOR TRANSPORTATION AND STORAGE, NAMELY, WRAPPING SERVICES IN THE NATURE OF WRAPPING OF GOODS WITH PLASTIC FILM OR OTHER WRAPPING MATERIAL FOR BAGGAGE PROTECTION DURING TRAVEL AND STORAGE; WAREHOUSING SERVICES, NAMELY, STORAGE, DISTRIBUTION, PICK-UP, AND PACKING FOR SHIPMENT OF DOCUMENTS, PACKAGES, RAW MATERIALS, AND OTHER FREIGHT FOR OTHERS; SUPPLY CHAIN, LOGISTICS, AND REVERSE LOGISTICS SERVICES, NAMELY, STORAGE, TRANSPORTATION AND DELIVERY OF DOCUMENTS, PACKAGES, RAW MATERIALS AND OTHER FREIGHT FOR OTHER BY AIR, RAIL, SHIP OR TRUCK,

FREIGHT FORWARDING; TANKER TRANSPORT,
IN CLASS 39 (U.S. CLS. 100 AND 105).

OWNER OF U.S. REG. NOS. 2,276,678, 2,276,679,
AND 2,276,680.

SER. NO. 76-684,777, FILED 12-10-2007.

FIRST USE 7-7-2006; IN COMMERCE 7-7-2006.

RENEE MCCRAY, EXAMINING ATTORNEY

Int. Cl.: 5

Prior U.S. Cls.: 6, 18, 44, 46, 51 and 52

Reg. No. 3,474,460

United States Patent and Trademark Office

Registered July 29, 2008

**TRADEMARK
PRINCIPAL REGISTER**



RONNENBERG, CLINTON T. (UNITED STATES
INDIVIDUAL), DBA OUTDOOR SAFETY
P.O. BOX 103
WINONA, MN 55987

NO CLAIM IS MADE TO THE EXCLUSIVE
RIGHT TO USE "OUTDOOR SAFETY", APART
FROM THE MARK AS SHOWN.

FOR: CANINE FIRST AID KIT, IN CLASS 5 (U.S.
CLS. 6, 18, 44, 46, 51 AND 52).

SER. NO. 76-684,818, FILED 12-11-2007.

FIRST USE 2-10-1995; IN COMMERCE 2-10-1995.

ANGELA M. MICHELI, EXAMINING ATTORNEY

Int. Cl.: 9

Prior U.S. Cls.: 21, 23, 26, 36 and 38

Reg. No. 3,474,461

United States Patent and Trademark Office

Registered July 29, 2008

**TRADEMARK
PRINCIPAL REGISTER**

PHASETECH

PHASE TECHNOLOGY CORPORATION (FLORIDA CORPORATION)
6400 YOUNGERMAN CIRCLE
JACKSONVILLE, FL 32244

THE MARK CONSISTS OF STANDARD CHARACTERS WITHOUT CLAIM TO ANY PARTICULAR FONT, STYLE, SIZE, OR COLOR.

FOR: AUDIO SPEAKERS AND LOUD SPEAKER SYSTEMS, IN CLASS 9 (U.S. CLS. 21, 23, 26, 36 AND 38).

SER. NO. 76-684,840, FILED 12-11-2007.

FIRST USE 6-29-1981; IN COMMERCE 6-29-1981.

CAROL SPILS, EXAMINING ATTORNEY

Int. Cl.: 28

Prior U.S. Cls.: 22, 23, 38 and 50

United States Patent and Trademark Office

Reg. No. 3,474,462

Registered July 29, 2008

**TRADEMARK
PRINCIPAL REGISTER**

STUD

WALGREEN CO. (ILLINOIS CORPORATION)
200 WILMOT ROAD
DEERFIELD, IL 60015

FOR: PLAYING CARDS AND DICE, IN CLASS 28
(U.S. CLS. 22, 23, 38 AND 50).

FIRST USE 2-3-1937; IN COMMERCE 2-3-1937.

THE MARK CONSISTS OF STANDARD CHAR-
ACTERS WITHOUT CLAIM TO ANY PARTICULAR
FONT, STYLE, SIZE, OR COLOR.

OWNER OF U.S. REG. NO. 2,129,833.

SEC. 2(F).

SER. NO. 76-684,874, FILED 12-12-2007.

KATHERINE CHANG, EXAMINING ATTORNEY

Int. Cl.: 44

Prior U.S. Cls.: 100 and 101

United States Patent and Trademark Office

Reg. No. 3,474,463

Registered July 29, 2008

**SERVICE MARK
PRINCIPAL REGISTER**

Dr. Chef

DR. CHEF, INC. (ARIZONA CORPORATION)
3927 EAST SEQUOIA TRAIL
SCOTTSDALE, AZ 85004

FOR: PROVIDING ON-LINE INFORMATION
OVER THE INTERNET IN THE FIELDS OF DIET,
NUTRITION AND WEIGHT LOSS, IN CLASS 44 (U.S.
CLS. 100 AND 101).

FIRST USE 9-25-2001; IN COMMERCE 9-25-2001.

THE MARK CONSISTS OF STANDARD CHAR-
ACTERS WITHOUT CLAIM TO ANY PARTICULAR
FONT, STYLE, SIZE, OR COLOR.

OWNER OF U.S. REG. NOS. 2,623,219 AND
2,623,285.

SER. NO. 76-684,888, FILED 12-13-2007.

ALYSSA PALADINO, EXAMINING ATTORNEY

Int. Cl.: 36

Prior U.S. Cls.: 100, 101 and 102

United States Patent and Trademark Office

Reg. No. 3,474,464

Registered July 29, 2008

**SERVICE MARK
PRINCIPAL REGISTER**

 **ACCESSbank**

3MV BANCORP, INC. (NEBRASKA CORPORATION)
210 NORTH 78TH STREET
OMAHA, NE 68114

FOR: BANKING SERVICES, NAMELY, BUSINESS AND CONSUMER BANKING SERVICES, PERSONAL AND BUSINESS CHECKING ACCOUNTS, SAVINGS ACCOUNTS, MONEY MARKET ACCOUNTS, TIME DEPOSITS; AUTOMATED TELLER MACHINE, INTERNET BANKING, CHECK CARD AND ON-LINE TRANSACTIONS; RETAIL AND ELECTRONIC BANKING AND FINANCIAL TRANSACTION SERVICES, NAMELY, INTERNET BANKING, TELEPHONE BANKING, ATM AND DEBIT CARD SERVICES, DIRECT DEPOSIT AND AUTOMATED CLEARING HOUSE TRANSACTIONS, CREDIT CARDS SERVICES, WIRING OF FUNDS, ELECTRONIC FUND TRANSFERS; PROVIDING PURCHASE AND REDEMPTION OF US SAVINGS BONDS, ISSUING MONEY ORDERS, CASHIER'S CHECKS AND TRAVELER'S CHECKS, INSTALLMENT, COMMERCIAL AND REAL ES-

TATE LOANS; MORTGAGE LOAN SERVICES, NAMELY, RESIDENTIAL MORTGAGE, HOME EQUITY, PERSONAL AND CONSUMER LOANS; FIDUCIARY ESCROW ACCOUNTS; CONSUMER FINANCIAL SERVICES, NAMELY, CHECKING ACCOUNTS, SAVINGS ACCOUNTS, CERTIFICATES OF DEPOSIT, INDIVIDUAL RETIREMENT ACCOUNTS; QUALIFIED RETIREMENT PLANS; SAFETY DEPOSIT BOX SERVICES; CASH MANAGEMENT SERVICES; PUBLIC SECTOR BANKING SERVICES FOR MUNICIPALITIES, COUNTIES, STATES, SCHOOL SYSTEMS, AND OTHER PUBLIC INSTITUTIONS AND POLITICAL JURISDICTIONS, IN CLASS 36 (U.S. CLS. 100, 101 AND 102).

FIRST USE 12-10-2007; IN COMMERCE 12-10-2007.

OWNER OF U.S. REG. NO. 3,013,203.

SER. NO. 76-684,918, FILED 12-13-2007.

WILLIAM ROSSMAN, EXAMINING ATTORNEY

Int. Cl.: 32

Prior U.S. Cls.: 45, 46 and 48

United States Patent and Trademark Office

Reg. No. 3,474,465

Registered July 29, 2008

**TRADEMARK
PRINCIPAL REGISTER**

**EVERYTHING ELSE IS JUST
WATER**

SARATOGA SPRING WATER COMPANY (DELA-
WARE CORPORATION)
11 GEYSER ROAD
SARATOGA SPRINGS, NY 12866

FOR: SPRING WATER, NAMELY, FLAVORED
SPRING WATER BEVERAGES, IN CLASS 32 (U.S.
CLS. 45, 46 AND 48).

FIRST USE 1-5-1998; IN COMMERCE 1-5-1998.

THE MARK CONSISTS OF STANDARD CHAR-
ACTERS WITHOUT CLAIM TO ANY PARTICULAR
FONT, STYLE, SIZE, OR COLOR.

SER. NO. 76-684,941, FILED 12-14-2007.

ESTHER BELENKER, EXAMINING ATTORNEY

Int. Cl.: 32

Prior U.S. Cls.: 45, 46 and 48

United States Patent and Trademark Office

Reg. No. 3,474,466

Registered July 29, 2008

**TRADEMARK
PRINCIPAL REGISTER**

SARATOGA SPLASH

SARATOGA SPRING WATER COMPANY (DELA-
WARE CORPORATION)
11 GEYSER ROAD
SARATOGA SPRINGS, NY 12866

OWNER OF U.S. REG. NOS. 129,867, 3,048,276 AND
OTHERS.

FOR: FLAVORED SPRING WATER, IN CLASS 32
(U.S. CLS. 45, 46 AND 48).

SEC. 2(F) AS TO "SARATOGA".

FIRST USE 7-8-1996; IN COMMERCE 7-19-1996.

SER. NO. 76-684,942, FILED 12-14-2007.

THE MARK CONSISTS OF STANDARD CHAR-
ACTERS WITHOUT CLAIM TO ANY PARTICULAR
FONT, STYLE, SIZE, OR COLOR.

ESTHER BELENKER, EXAMINING ATTORNEY

Int. Cl.: 21

Prior U.S. Cls.: 2, 13, 23, 29, 30, 33, 40 and 50

United States Patent and Trademark Office

Reg. No. 3,474,467

Registered July 29, 2008

**TRADEMARK
PRINCIPAL REGISTER**



AP&G CO., INC. (NEW YORK CORPORATION)
170 - 53RD STREET
BROOKLYN, NY 11232

FIRST USE 9-15-1985; IN COMMERCE 9-15-1985.

SER. NO. 76-684,982, FILED 12-17-2007.

FOR: GLUE TRAPS FOR TRAPPING RODENTS,
INSECTS, SNAKES, SCORPIONS, ROACHES AND
SPIDERS, IN CLASS 21 (U.S. CLS. 2, 13, 23, 29, 30, 33,
40 AND 50).

CIMMERIAN COLEMAN, EXAMINING ATTOR-
NEY

Int. Cl.: 16

Prior U.S. Cls.: 2, 5, 22, 23, 29, 37, 38 and 50

Reg. No. 3,474,468

United States Patent and Trademark Office

Registered July 29, 2008

**TRADEMARK
PRINCIPAL REGISTER**

RXLOGIX

NASHUA CORPORATION (MASSACHUSETTS
CORPORATION)
11 TRAFALGAR SQUARE
NASHUA, NH 03063

THE MARK CONSISTS OF STANDARD CHAR-
ACTERS WITHOUT CLAIM TO ANY PARTICULAR
FONT, STYLE, SIZE, OR COLOR.

FOR: PAPER LABELS FOR USE BY COMMER-
CIAL BUSINESSES, IN CLASS 16 (U.S. CLS. 2, 5, 22,
23, 29, 37, 38 AND 50).

SER. NO. 76-684,990, FILED 12-14-2007.

FIRST USE 8-0-2006; IN COMMERCE 8-0-2006.

BRIAN PINO, EXAMINING ATTORNEY

Int. Cl.: 41

Prior U.S. Cls.: 100, 101 and 107

United States Patent and Trademark Office

Reg. No. 3,474,469

Registered July 29, 2008

**SERVICE MARK
PRINCIPAL REGISTER**

THE COUPON GUY

DAUGIRDAS, JOSEPH A. (UNITED STATES IN-
DIVIDUAL)
38213 DODDS HILL DR.
WILLOUGHBY, OH 44094

FOR: PROVIDING EDUCATIONAL LECTURES
FOR CONSUMERS IN THE FIELD OF BARGAIN
SHOPPING AND MONEY SAVING TIPS, IN CLASS
41 (U.S. CLS. 100, 101 AND 107).

FIRST USE 11-1-2006; IN COMMERCE 11-1-2006.

THE MARK CONSISTS OF STANDARD CHAR-
ACTERS WITHOUT CLAIM TO ANY PARTICULAR
FONT, STYLE, SIZE, OR COLOR.

NO CLAIM IS MADE TO THE EXCLUSIVE
RIGHT TO USE "COUPON", APART FROM THE
MARK AS SHOWN.

SER. NO. 76-684,999, FILED 12-17-2007.

LINDA M. KING, EXAMINING ATTORNEY

Int. Cl.: 44

Prior U.S. Cls.: 100 and 101

United States Patent and Trademark Office

Reg. No. 3,474,470

Registered July 29, 2008

**SERVICE MARK
PRINCIPAL REGISTER**

DIABETESMINE

AMY TENDERICH LLC (CALIFORNIA LTD
LIAB CO)
1094 SPRINGFIELD DRIVE
MILLBRAE, CA 94030

THE MARK CONSISTS OF STANDARD CHAR-
ACTERS WITHOUT CLAIM TO ANY PARTICULAR
FONT, STYLE, SIZE, OR COLOR.

FOR: PROVIDING A WEB SITE WITH MEDICAL
INFORMATION ABOUT DIABETES AND HOW TO
LIVE WITH DIABETES, IN CLASS 44 (U.S. CLS. 100
AND 101).

SER. NO. 76-685,005, FILED 12-17-2007.

FIRST USE 0-0-2004; IN COMMERCE 2-0-2005.

JOHN E. MICHOS, EXAMINING ATTORNEY

Int. Cl.: 16

Prior U.S. Cls.: 2, 5, 22, 23, 29, 37, 38 and 50

United States Patent and Trademark Office

Reg. No. 3,474,471

Registered July 29, 2008

**TRADEMARK
PRINCIPAL REGISTER**

€URO

UNION TELECOM, INC. (ILLINOIS CORPORATION)
5420 NORTH HARLEM AVE
CHICAGO, IL 60656

THE MARK CONSISTS OF STANDARD CHARACTERS WITHOUT CLAIM TO ANY PARTICULAR FONT, STYLE, SIZE, OR COLOR.

FOR: PRE-PAID TELEPHONE CALLING CARDS,
NOT MAGNETICALLY ENCODED, IN CLASS 16
(U.S. CLS. 2, 5, 22, 23, 29, 37, 38 AND 50).

SER. NO. 76-685,015, FILED 12-17-2007.

FIRST USE 2-1-2007; IN COMMERCE 2-1-2007.

JORDAN BAKER, EXAMINING ATTORNEY

Int. Cl.: 21

Prior U.S. Cls.: 2, 13, 23, 29, 30, 33, 40 and 50

United States Patent and Trademark Office

Reg. No. 3,474,472

Registered July 29, 2008

**TRADEMARK
PRINCIPAL REGISTER**



AP&G CO., INC. (NEW YORK CORPORATION)
170 - 53RD STREET
BROOKLYN, NY 11232

FIRST USE 6-15-1990; IN COMMERCE 6-15-1990.

SER. NO. 76-685,046, FILED 12-18-2007.

FOR: FLY GLUE TRAPS, IN CLASS 21 (U.S. CLS. 2,
13, 23, 29, 30, 33, 40 AND 50).

CIMMERIAN COLEMAN, EXAMINING ATTOR-
NEY

Int. Cl.: 21

Prior U.S. Cls.: 2, 13, 23, 29, 30, 33, 40 and 50

United States Patent and Trademark Office

Reg. No. 3,474,473

Registered July 29, 2008

**TRADEMARK
PRINCIPAL REGISTER**



AP&G CO., INC. (NEW YORK CORPORATION)
170 - 53RD STREET
BROOKLYN, NY 11232

FIRST USE 6-15-1990; IN COMMERCE 6-15-1990.

SER. NO. 76-685,047, FILED 12-18-2007.

FOR: INSECT AND ROACH GLUE TRAPS, IN
CLASS 21 (U.S. CLS. 2, 13, 23, 29, 30, 33, 40 AND 50).

CIMMERIAN COLEMAN, EXAMINING ATTOR-
NEY

Int. Cl.: 9

Prior U.S. Cls.: 21, 23, 26, 36 and 38

United States Patent and Trademark Office

Reg. No. 3,474,474

Registered July 29, 2008

**TRADEMARK
PRINCIPAL REGISTER**

AIRBORN

AIRBORN, INC. (TEXAS CORPORATION)
4321 AIRBORN AVE.
ADDISON, TX 75001

THE MARK CONSISTS OF STANDARD CHAR-
ACTERS WITHOUT CLAIM TO ANY PARTICULAR
FONT, STYLE, SIZE, OR COLOR.

FOR: ELECTRICAL CONNECTORS, IN CLASS 9
(U.S. CLS. 21, 23, 26, 36 AND 38).

SER. NO. 76-685,069, FILED 12-18-2007.

FIRST USE 1-1-1974; IN COMMERCE 1-1-1989.

JEFFERY COWARD, EXAMINING ATTORNEY

Int. Cl.: 2

Prior U.S. Cls.: 6, 11 and 16

United States Patent and Trademark Office

Reg. No. 3,474,475

Registered July 29, 2008

**TRADEMARK
PRINCIPAL REGISTER**

SENOTHERM

WEILBURGER COATINGS GMBH (FED REP
GERMANY CORPORATION)
EIN UNTERNEHMEN DER GREBE GRUPPE
AHÄUSER WEG 12-22
35781 WEILBURG/LAHN, FED REP GERMANY

FOR: VARNISHES, LACQUERS, PAINTS AND
ENAMEL PAINTS FOR HIGH TEMPERATURE

USE ON METALLIC SUBSTRATES OR SURFACES
, IN CLASS 2 (U.S. CLS. 6, 11 AND 16).

FIRST USE 8-0-2005; IN COMMERCE 8-5-2005.

SER. NO. 76-685,112, FILED 12-20-2007.

ESTHER BELENKER, EXAMINING ATTORNEY

Int. Cl.: 41

Prior U.S. Cls.: 100, 101 and 107

United States Patent and Trademark Office

Reg. No. 3,474,476

Registered July 29, 2008

**SERVICE MARK
PRINCIPAL REGISTER**

TURNING AN ART INTO A SCIENCE

HENDRIE, STEPHANIE (UNITED STATES INDIVIDUAL), DBA HENDRIE COMMUNICATIONS
11121 CARLEEN COURT
TUJUNGA, CA 91042

FOR: EDUCATIONAL SERVICES, NAMELY, CONDUCTING TRAINING AND WORKSHOPS IN THE FIELD OF COMMUNICATION THROUGH SPEECH, IN CLASS 41 (U.S. CLS. 100, 101 AND 107).

FIRST USE 1-0-2000; IN COMMERCE 1-0-2000.

THE MARK CONSISTS OF STANDARD CHARACTERS WITHOUT CLAIM TO ANY PARTICULAR FONT, STYLE, SIZE, OR COLOR.

SER. NO. 76-685,124, FILED 12-20-2007.

SONYA STEPHENS, EXAMINING ATTORNEY

Int. Cl.: 8

Prior U.S. Cls.: 23, 28 and 44

United States Patent and Trademark Office

Reg. No. 3,474,477

Registered July 29, 2008

**TRADEMARK
PRINCIPAL REGISTER**

MERITool

MERITool LLC (NEW YORK LTD LIAB CO)
5 PARK AVENUE
P.O. BOX 745
ELLICOTTVILLE, NY 14731

THE MARK CONSISTS OF STANDARD CHARACTERS WITHOUT CLAIM TO ANY PARTICULAR FONT, STYLE, SIZE, OR COLOR.

FOR: WIRE CUTTERS/STRIPPERS AND HOSE CLAMP PLIERS, IN CLASS 8 (U.S. CLS. 23, 28 AND 44).

SER. NO. 76-685,163, FILED 12-21-2007.

FIRST USE 7-0-1998; IN COMMERCE 7-0-1998.

SUSAN RICHARDS, EXAMINING ATTORNEY

Int. Cl.: 7

Prior U.S. Cls.: 13, 19, 21, 23, 31, 34 and 35

United States Patent and Trademark Office

Reg. No. 3,474,478

Registered July 29, 2008

**TRADEMARK
PRINCIPAL REGISTER**

POWERPUSH

MERITool LLC (NEW YORK LTD LIAB CO)
5 PARK AVENUE
P.O. BOX 745
ELLICOTTVILLE, NY 14731

THE MARK CONSISTS OF STANDARD CHARACTERS WITHOUT CLAIM TO ANY PARTICULAR FONT, STYLE, SIZE, OR COLOR.

FOR: POWER-OPERATED CAULKING GUNS, IN CLASS 7 (U.S. CLS. 13, 19, 21, 23, 31, 34 AND 35).

SER. NO. 76-685,164, FILED 12-21-2007.

FIRST USE 9-0-2003; IN COMMERCE 9-0-2003.

SUSAN RICHARDS, EXAMINING ATTORNEY

Int. Cl.: 25

Prior U.S. Cls.: 22 and 39

United States Patent and Trademark Office

Reg. No. 3,474,479

Registered July 29, 2008

**TRADEMARK
PRINCIPAL REGISTER**

KALCO

IN, YONG JAI (REPUBLIC OF KOREA INDIVIDUAL)
4080 VIA MARISOL, # 126
LOS ANGELES, CA 90042

THE MARK CONSISTS OF STANDARD CHARACTERS WITHOUT CLAIM TO ANY PARTICULAR FONT, STYLE, SIZE, OR COLOR.

FOR: FOOTWEAR AND FOOTWEAR RELATED ITEMS NAMELY, BOOTS, SHOES AND SOLES; BELTS; GLOVES, IN CLASS 25 (U.S. CLS. 22 AND 39).

SER. NO. 76-685,205, FILED 12-26-2007.

FIRST USE 12-1-2006; IN COMMERCE 12-1-2006.

JENNIFER MARTIN, EXAMINING ATTORNEY

Int. Cl.: 9

Prior U.S. Cls.: 21, 23, 26, 36 and 38

United States Patent and Trademark Office

Reg. No. 3,474,480

Registered July 29, 2008

**TRADEMARK
PRINCIPAL REGISTER**

EYE HEARD THAT

EYE HEARD THAT LLC (ARKANSAS LTD LIAB
CO)
632 CREST DRIVE
FAYETTEVILLE, AR 72701

FOR: COMMUNICATION DEVICES TO ASSIST
HEARING IMPAIRED AND NON-ENGLISH-
SPEAKING PEOPLE WITH THE PLACING OF OR-
DERS AT DRIVE-THROUGH LOCATIONS, IN
CLASS 9 (U.S. CLS. 21, 23, 26, 36 AND 38).

FIRST USE 9-26-2007; IN COMMERCE 9-26-2007.

THE MARK CONSISTS OF STANDARD CHAR-
ACTERS WITHOUT CLAIM TO ANY PARTICULAR
FONT, STYLE, SIZE, OR COLOR.

SER. NO. 76-685,210, FILED 12-26-2007.

ALICE SUE CARRUTHERS, EXAMINING ATTOR-
NEY

Int. Cl.: 9

Prior U.S. Cls.: 21, 23, 26, 36 and 38

Reg. No. 3,474,481

United States Patent and Trademark Office

Registered July 29, 2008

**TRADEMARK
PRINCIPAL REGISTER**

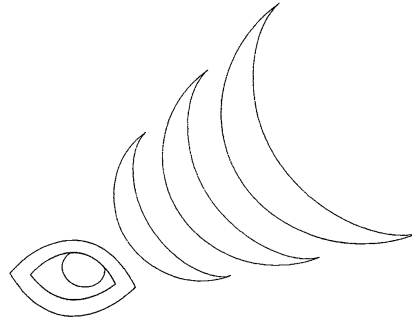

EYE HEARD THAT LLC (ARKANSAS LTD LIAB
CO)
632 CREST DRIVE
FAYETTEVILLE, AR 72701

FIRST USE 9-26-2007; IN COMMERCE 9-26-2007.

SER. NO. 76-685,211, FILED 12-26-2007.

FOR: COMMUNICATION DEVICES TO ASSIST
HEARING IMPAIRED AND NON-ENGLISH-
SPEAKING PEOPLE WITH THE PLACING OF OR-
DERS AT DRIVE-THROUGH LOCATIONS, IN
CLASS 9 (U.S. CLS. 21, 23, 26, 36 AND 38).

ALICE SUE CARRUTHERS, EXAMINING ATTOR-
NEY

Int. Cl.: 29

Prior U.S. Cl.: 46

United States Patent and Trademark Office

Reg. No. 3,474,482

Registered July 29, 2008

**TRADEMARK
PRINCIPAL REGISTER**



WALLACE'S OLD FASHION SKINS, INC.
(SOUTH CAROLINA CORPORATION)
826 SOUTH MCCURDY ROAD
FLORENCE, SC 29506

OWNER OF U.S. REG. NOS. 1,258,731 AND
2,669,013.

FOR: PORK SKINS, IN CLASS 29 (U.S. CL. 46).

SER. NO. 76-685,250, FILED 12-26-2007.

FIRST USE 11-1-1981; IN COMMERCE 11-1-1981.

PAUL CROWLEY, EXAMINING ATTORNEY

Int. Cl.: 35

Prior U.S. Cls.: 100, 101 and 102

United States Patent and Trademark Office

Reg. No. 3,474,483

Registered July 29, 2008

**SERVICE MARK
PRINCIPAL REGISTER**

Center44

PLUMADORE, PAUL (UNITED STATES INDIVIDUAL)
5800 ARLINGTON AVE #22T
RIVERDALE, NY 10471

FOR: RETAIL STORE SERVICES, ON-LINE RETAIL STORE SERVICES AND WHOLESALE DISTRIBUTORSHIPS, ALL FEATURING ANTIQUES, NAMELY, FURNITURE, LIGHTING, FINE ART AND HOME FURNISHINGS , IN CLASS 35 (U.S. CLS. 100, 101 AND 102).

FIRST USE 9-0-2005; IN COMMERCE 9-0-2005.

THE MARK CONSISTS OF STANDARD CHARACTERS WITHOUT CLAIM TO ANY PARTICULAR FONT, STYLE, SIZE, OR COLOR.

SER. NO. 76-685,320, FILED 12-26-2007.

PAUL CROWLEY, EXAMINING ATTORNEY

Int. Cl.: 13

Prior U.S. Cls.: 2 and 9

United States Patent and Trademark Office

Reg. No. 3,474,484

Registered July 29, 2008

**TRADEMARK
PRINCIPAL REGISTER**

SILVERADO

STOEGER INDUSTRIES, INC. (MARYLAND
CORPORATION)
17603 INDIAN HEAD HIGHWAY
ACCOKEEK, MD 20607

THE MARK CONSISTS OF STANDARD CHAR-
ACTERS WITHOUT CLAIM TO ANY PARTICULAR
FONT, STYLE, SIZE, OR COLOR.

FOR: FIREARMS, IN CLASS 13 (U.S. CLS. 2 AND
9).

SER. NO. 76-685,346, FILED 12-27-2007.

FIRST USE 11-30-2007; IN COMMERCE 11-30-2007.

EDWARD FENNESSY, EXAMINING ATTORNEY

Int. Cl.: 29

Prior U.S. Cl.: 46

United States Patent and Trademark Office

Reg. No. 3,474,485

Registered July 29, 2008

**TRADEMARK
PRINCIPAL REGISTER**

UNCLE JIM'S

WALLACE'S OLD FASHION SKINS, INC.
(SOUTH CAROLINA CORPORATION)
826 SOUTH MCCURDY ROAD
FLORENCE, SC 29506

THE MARK CONSISTS OF STANDARD CHAR-
ACTERS WITHOUT CLAIM TO ANY PARTICULAR
FONT, STYLE, SIZE, OR COLOR.

FOR: FRIED PORK SKINS, IN CLASS 29 (U.S. CL.
46).

SER. NO. 76-685,352, FILED 12-27-2007.

FIRST USE 8-25-1981; IN COMMERCE 8-25-1981.

PAUL CROWLEY, EXAMINING ATTORNEY

Int. Cl.: 9

Prior U.S. Cls.: 21, 23, 26, 36 and 38

United States Patent and Trademark Office

Reg. No. 3,474,486

Registered July 29, 2008

**TRADEMARK
PRINCIPAL REGISTER**

MICROSONIC MUSIC

MICROSONIC, INC. (PENNSYLVANIA CORPORATION)
2960 DUSS AVENUE
AMBRIDGE, PA 15003

THE MARK CONSISTS OF STANDARD CHARACTERS WITHOUT CLAIM TO ANY PARTICULAR FONT, STYLE, SIZE, OR COLOR.

FOR: EARPHONES; SOUND MONITORS NOT FOR MEDICAL PURPOSES, IN CLASS 9 (U.S. CLS. 21, 23, 26, 36 AND 38).

SER. NO. 76-685,355, FILED 12-28-2007.

FIRST USE 11-15-2007; IN COMMERCE 11-15-2007.

CHERYL CLAYTON, EXAMINING ATTORNEY

Int. Cl.: 9

Prior U.S. Cls.: 21, 23, 26, 36 and 38

United States Patent and Trademark Office

Reg. No. 3,474,487

Registered July 29, 2008

**TRADEMARK
PRINCIPAL REGISTER**

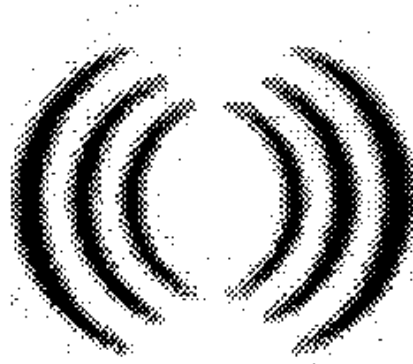

MICROSONIC, INC. (PENNSYLVANIA CORPORATION)
2960 DUSS AVENUE
AMBRIDGE, PA 15003

FOR: EARPHONES; SOUND MONITORS NOT FOR MEDICAL PURPOSES, IN CLASS 9 (U.S. CLS. 21, 23, 26, 36 AND 38).

FIRST USE 11-15-2007; IN COMMERCE 11-15-2007.

THE MARK CONSISTS OF THREE PARALLEL CONVEX WAVES OF DECREASING SIZE OPPOSING THREE PARALLEL CONVEX WAVES OF INCREASING SIZE.

SER. NO. 76-685,356, FILED 12-28-2007.

CHERYL CLAYTON, EXAMINING ATTORNEY

Int. Cl.: 7

Prior U.S. Cls.: 13, 19, 21, 23, 31, 34 and 35

Reg. No. 3,474,488

United States Patent and Trademark Office

Registered July 29, 2008

**TRADEMARK
PRINCIPAL REGISTER**

TORERO

CHU DAI INDUSTRIAL CO., LTD. (TAIWAN CORPORATION)
NO. 206-20, SEC 1, GUOGUANG RD.
DALI CITY TAICHUNG COUNTY, TAIWAN 412

FOR: POWER-DRIVEN WRENCHES; AIR-OPERATED POWER TOOLS, NAMELY TORQUE WRENCHES; AIR-OPERATED POWER TOOLS, NAMELY, IMPACT WRENCHES; AIR-OPERATED POWER TOOLS, NAMELY RATCHET WRENCHES; AIR-OPERATED POWER TOOLS, NAMELY DRILLS; AIR-OPERATED POWER TOOLS, NAMELY GRINDERS; POWER-OPERATED SCREWDRIVERS; IMPACT WRENCHES; POWER-OPERATED TOOLS, NAMELY GRINDERS; POWER TOOLS NAMELY REAMERS; HAND-HELD ELECTRIC DRILLS; ELECTRIC GLUE GUNS; HAND-HELD ELECTRIC HAMMERS; ELECTRIC PUMPS; ELECTRIC SCISSORS; ELECTRICAL DRILLS; PNEUMATIC HAM-

MERS; HAND-HELD PNEUMATIC HAMMERS; POWER DRILLS AND POWER DRILL BITS, IN CLASS 7 (U.S. CLS. 13, 19, 21, 23, 31, 34 AND 35).

FIRST USE 8-25-2006; IN COMMERCE 11-2-2007.

THE MARK CONSISTS OF STANDARD CHARACTERS WITHOUT CLAIM TO ANY PARTICULAR FONT, STYLE, SIZE, OR COLOR.

THE ENGLISH TRANSLATION OF THE WORD "TORERO" IN THE MARK IS "BULLFIGHTER".

SER. NO. 76-685,373, FILED 12-28-2007.

MATTHEW MCDOWELL, EXAMINING ATTORNEY

Int. Cl.: 9

Prior U.S. Cls.: 21, 23, 26, 36 and 38

United States Patent and Trademark Office

Reg. No. 3,474,489

Registered July 29, 2008

**TRADEMARK
PRINCIPAL REGISTER**

CAPTURE

DURRIDGE COMPANY INC. (MASSACHUSETTS
CORPORATION)
7 RAILROAD AVENUE, SUITE D
BEDFORD, MA 01730

THE MARK CONSISTS OF STANDARD CHAR-
ACTERS WITHOUT CLAIM TO ANY PARTICULAR
FONT, STYLE, SIZE, OR COLOR.

FOR: SOFTWARE FOR DOWNLOADING DATA
FROM RADON DETECTORS, IN CLASS 9 (U.S. CLS.
21, 23, 26, 36 AND 38).

SER. NO. 76-685,385, FILED 12-28-2007.

FIRST USE 0-0-1997; IN COMMERCE 0-0-1997.

DANNEAN HETZEL, EXAMINING ATTORNEY

Int. Cl.: 9

Prior U.S. Cls.: 21, 23, 26, 36 and 38

United States Patent and Trademark Office

Reg. No. 3,474,490

Registered July 29, 2008

**TRADEMARK
PRINCIPAL REGISTER**

MYSUPERCELL

MYSUPERCELL CORPORATION (CALIFORNIA CORPORATION)
39845 PASEO PADRE PKWY
FREMONT, CA 94538

THE MARK CONSISTS OF STANDARD CHARACTERS WITHOUT CLAIM TO ANY PARTICULAR FONT, STYLE, SIZE, OR COLOR.

FOR: COMPUTER SOFTWARE AND HARDWARE, NAMELY, SOFTWARE AND HARDWARE FOR WIRELESS CONTENT DELIVERY, IN CLASS 9 (U.S. CLS. 21, 23, 26, 36 AND 38).

SER. NO. 76-685,426, FILED 12-19-2007.

FIRST USE 11-6-2007; IN COMMERCE 11-6-2007.

CHARLOTTE CORWIN, EXAMINING ATTORNEY

Int. Cl.: 16

Prior U.S. Cls.: 2, 5, 22, 23, 29, 37, 38 and 50

United States Patent and Trademark Office

Reg. No. 3,474,491

Registered July 29, 2008

**TRADEMARK
PRINCIPAL REGISTER**

A VOICE FOR THE VOICELESS

CHILDERS, PAUL (UNITED STATES INDIVIDUAL)

75-5851 KAU KINA HIGHWAY #248

KAILU-KONA, HI 96740 AND

CHILDERS, SUSANNE (UNITED STATES INDIVIDUAL)

75-5851 KAU KINA HIGHWAY #248

KAILU-KONA, HI 96740

FOR: CALENDAR, POSTCARDS, PRAYER BOOKLETS, IN CLASS 16 (U.S. CLS. 2, 5, 22, 23, 29, 37, 38 AND 50).

FIRST USE 7-26-2003; IN COMMERCE 7-26-2003.

THE MARK CONSISTS OF STANDARD CHARACTERS WITHOUT CLAIM TO ANY PARTICULAR FONT, STYLE, SIZE, OR COLOR.

SER. NO. 76-685,442, FILED 12-31-2007.

WILLIAM VERHOSEK, EXAMINING ATTORNEY

Int. Cl.: 39

Prior U.S. Cls.: 100 and 105

United States Patent and Trademark Office

Reg. No. 3,474,492

Registered July 29, 2008

**SERVICE MARK
PRINCIPAL REGISTER**

SETTING NEW IDEAS IN MOTION

NUSSBAUM TRANSPORTATION SERVICES,
INC. (ILLINOIS CORPORATION)
2200 N. MAIN
NORMAL, IL 61761

THE MARK CONSISTS OF STANDARD CHAR-
ACTERS WITHOUT CLAIM TO ANY PARTICULAR
FONT, STYLE, SIZE, OR COLOR.

FOR: FREIGHT TRUCKING SERVICES, NAME-
LY, FREIGHT TRANSPORTATION BY TRUCK, IN
CLASS 39 (U.S. CLS. 100 AND 105).

SER. NO. 76-685,500, FILED 1-3-2008.

FIRST USE 11-15-2007; IN COMMERCE 11-15-2007.

ANDREW RHIM, EXAMINING ATTORNEY

Int. Cl.: 41

Prior U.S. Cls.: 100, 101 and 107

United States Patent and Trademark Office

Reg. No. 3,474,493

Registered July 29, 2008

**SERVICE MARK
PRINCIPAL REGISTER**



ADVANCE MAGAZINE PUBLISHERS INC. (NEW
YORK CORPORATION)
4 TIMES SQUARE
NEW YORK, NY 10036

FOR: PROVIDING INFORMATION, NEWS AND
COMMENTARY IN THE FIELD OF GENERAL
INTEREST NEWS AND CURRENT EVENTS
WHEREBY USERS VOTE AND RATE THE IMPOR-

TANCE OF NEWS AND CURRENT EVENTS ITEMS,
IN CLASS 41 (U.S. CLS. 100, 101 AND 107).

FIRST USE 6-28-2005; IN COMMERCE 6-28-2005.

SER. NO. 76-685,910, FILED 1-18-2008.

JENNIFER HETU, EXAMINING ATTORNEY

Int. Cls.: 1 and 4

Prior U.S. Cls.: 1, 5, 6, 10, 15, 26 and 46

Reg. No. 3,474,494

United States Patent and Trademark Office

Registered July 29, 2008

**TRADEMARK
PRINCIPAL REGISTER**

NANO ENERGY RELEASE

ENERGY RELEASE LIMITED LIABILITY CO.
(MASSACHUSETTS LTD LIAB CO)
300 WHITNEY STREET
LEOMINSTER, MA 01453

FOR: AUTOMOTIVE PRODUCTS AND ACCESSORIES FOR THE AUTOMOTIVE AFTER MARKET INDUSTRY, NAMELY, BRAKE FLUID, POWER STEERING FLUID, OCTANE BOOSTER FUEL CHEMICAL ADDITIVES, CHEMICAL DIESEL FUEL ADDITIVES TO IMPROVE OCTANE RATING AND TO REDUCE GELLING; CHEMICAL MOTOR OIL ADDITIVES TO IMPROVE VISCOSITY; CHEMICAL ADDITIVES FOR FUEL TREATMENT; RADIATOR FLUSH; AUTOMOBILE COOLING SYSTEM RUST INHIBITOR; WINDSHIELD WASHER ANTI-FREEZE; AUTOMOBILE ENGINE BLOCK SEALANT; ANTIFREEZE; COOLANT FOR VEHICLE ENGINES; ADHESIVES FOR USE IN THE AUTOMOBILE INDUSTRY; CHEMICAL PREPARATION FOR MELTING ICE, NAMELY, AUTOMOBILE LOCK DE-ICING FLUID; ANTI-KNOCK SUBSTANCES FOR INTERNAL COMBUSTION ENGINES; PETROLEUM DISPERSANTS AND ENGINE-DECARBONISING CHEMICALS; CHEMICAL ENGINE TREATMENT, NAMELY, TRANSMISSION SEALER AND CONDITIONER; WATERPROOFING CHEMICAL COMPOSITION FOR ARTICLES OF LEATHER; WATERPROOFING CHEMICAL COMPOSITIONS FOR ARTICLES OF FABRIC; SILICON; SODIUM SILICATE; HEAVY WATER; FLOWER PRESERVATIVE; CATALYSTS FOR CHEMICAL AND BIOCHEMICAL PROCESSES; BLUEPRINT PAPER; SYNTHETIC RESIN COMPOUNDS IN THE FORM OF MICROSPHERES USED TO INCORPORATE VARIOUS OTHER SUBSTANCES; CHEMICAL FERTILIZERS; FIRE EXTINGUISHING COMPOSITIONS; SOLDERING FLUXES; SACCHARIN; ANTRANILIC ACID; ADHESIVES FOR INDUSTRIAL PURPOSES; PAPER PULP FOR MANUFACTURING PURPOSES; CHEMICAL PREPARATIONS FOR CLEANING MOTOR VEHICLE FUEL SYSTEMS; CHEMICAL ADDITIVES FOR USE WITH INTERNAL COMBUSTION ENGINE FUELS; MO-

TOR FLUSH; EPOXY PUTTY FOR USE IN THE AUTOMOTIVE INDUSTRY, IN CLASS 1 (U.S. CLS. 1, 5, 6, 10, 26 AND 46).

FIRST USE 12-8-2007; IN COMMERCE 12-8-2007.

FOR: AUTOMOTIVE PRODUCTS AND ACCESSORIES FOR THE AUTOMOTIVE AFTER MARKET INDUSTRY, NAMELY, NON-MINERAL INDUSTRIAL OILS AND GREASES, MOTOR OIL, ENGINE OILS, NON-CHEMICAL ADDITIVES FOR MOTOR FUELS, LUBRICATING GREASE, AUTOMOBILE LUBRICANTS, CUTTING FLUIDS, ALL-PURPOSE LUBRICANTS FOR AUTOMOTIVE AND INDUSTRIAL USE; CUTTING OIL FOR METAL WORKING; AUTOMOTIVE LUBRICATOR, NAMELY, ANTI-FRICTION METAL CONDITIONER; MINERAL OILS FOR USE IN THE MANUFACTURE OF PAINTS; AUTOMOTIVE PENETRATING FLUIDS, NAMELY, PENETRATING OIL; LUBRICATING OIL FOR MOTOR VEHICLE ENGINES; FUEL FOR MOTOR VEHICLES, NAMELY, GASOLINE AND DIESEL; NON-CHEMICAL ENGINE TREATMENTS AND ADDITIVES FOR ENGINE OILS, GASOLINE AND DIESEL FUELS, TRANSMISSION FLUIDS AND COOLING SYSTEMS; WAX EMULSIONS AND WAX POWDERS FOR INDUSTRIAL APPLICATIONS; BEESWAX FOR USE IN THE MANUFACTURE OF CANDLES; DUST-BINDING COMPOSITIONS, IN CLASS 4 (U.S. CLS. 1, 6 AND 15).

FIRST USE 12-8-2007; IN COMMERCE 12-8-2007.

THE MARK CONSISTS OF STANDARD CHARACTERS WITHOUT CLAIM TO ANY PARTICULAR FONT, STYLE, SIZE, OR COLOR.

OWNER OF U.S. REG. NOS. 2,276,678, 2,276,679, AND 2,276,680.

SER. NO. 76-686,348, FILED 1-30-2008.

RENEE MCCRAY, EXAMINING ATTORNEY

Int. Cls.: 1 and 4

Prior U.S. Cls.: 1, 5, 6, 10, 15, 26 and 46

Reg. No. 3,474,495

United States Patent and Trademark Office

Registered July 29, 2008

**TRADEMARK
PRINCIPAL REGISTER**

NANO ER ENERGY RELEASE

ENERGY RELEASE LIMITED LIABILITY CO.
(MASSACHUSETTS LTD LIAB CO)
300 WHITNEY STREET
LEOMINSTER, MA 01453

FOR: AUTOMOTIVE PRODUCTS AND ACCESSORIES FOR THE AUTOMOTIVE AFTER MARKET INDUSTRY, NAMELY, BRAKE FLUID, POWER STEERING FLUID, OCTANE BOOSTER FUEL CHEMICAL ADDITIVES, CHEMICAL DIESEL FUEL ADDITIVES TO IMPROVE OCTANE RATING AND TO REDUCE GELLING; CHEMICAL MOTOR OIL ADDITIVES TO IMPROVE VISCOSITY; CHEMICAL ADDITIVES FOR FUEL TREATMENT; RADIATOR FLUSH; AUTOMOBILE COOLING SYSTEM RUST INHIBITOR; WINDSHIELD WASHER ANTI-FREEZE; AUTOMOBILE ENGINE BLOCK SEALANT; ANTIFREEZE; COOLANT FOR VEHICLE ENGINES; ADHESIVES FOR USE IN THE AUTOMOBILE INDUSTRY; CHEMICAL PREPARATION FOR MELTING ICE, NAMELY, AUTOMOBILE LOCK DE-ICING FLUID; ANTI-KNOCK SUBSTANCES FOR INTERNAL COMBUSTION ENGINES; PETROLEUM DISPERSANTS AND ENGINE-DECARBONISING CHEMICALS; CHEMICAL ENGINE TREATMENT, NAMELY, TRANSMISSION SEALER AND CONDITIONER; WATERPROOFING CHEMICAL COMPOSITION FOR ARTICLES OF LEATHER; WATERPROOFING CHEMICAL COMPOSITIONS FOR ARTICLES OF FABRIC; SILICON; SODIUM SILICATE; HEAVY WATER; FLOWER PRESERVATIVE; CATALYSTS FOR CHEMICAL AND BIO-CHEMICAL PROCESSES; BLUEPRINT PAPER; SYNTHETIC RESIN COMPOUNDS IN THE FORM OF MICROSPHERES USED TO INCORPORATE VARIOUS OTHER SUBSTANCES; CHEMICAL FERTILIZERS; FIRE EXTINGUISHING COMPOSITIONS; SOLDERING FLUXES; SACCHARIN; ANTRANILIC ACID; ADHESIVES FOR INDUSTRIAL PURPOSES; PAPER PULP FOR MANUFACTURING PURPOSES; CHEMICAL PREPARATIONS FOR CLEANING MOTOR VEHICLE FUEL SYSTEMS; CHEMICAL ADDITIVES FOR USE WITH INTERNAL COMBUSTION ENGINE FUELS; MO-

TOR FLUSH; EPOXY PUTTY FOR USE IN THE AUTOMOTIVE INDUSTRY, IN CLASS 1 (U.S. CLS. 1, 5, 6, 10, 26 AND 46).

FIRST USE 12-8-2007; IN COMMERCE 12-8-2007.

FOR: AUTOMOTIVE PRODUCTS AND ACCESSORIES FOR THE AUTOMOTIVE AFTER MARKET INDUSTRY, NAMELY, NON-MINERAL INDUSTRIAL OILS AND GREASES, MOTOR OIL, ENGINE OILS, NON-CHEMICAL ADDITIVES FOR MOTOR FUELS, LUBRICATING GREASE, AUTOMOBILE LUBRICANTS, CUTTING FLUIDS, ALL-PURPOSE LUBRICANTS FOR AUTOMOTIVE AND INDUSTRIAL USE; CUTTING OIL FOR METAL WORKING; AUTOMOTIVE LUBRICATOR, NAMELY, ANTI-FRICTION METAL CONDITIONER; MINERAL OILS FOR USE IN THE MANUFACTURE OF PAINTS; AUTOMOTIVE PENETRATING FLUIDS, NAMELY, PENETRATING OIL; LUBRICATING OIL FOR MOTOR VEHICLE ENGINES; FUEL FOR MOTOR VEHICLES, NAMELY, GASOLINE AND DIESEL; NON-CHEMICAL ENGINE TREATMENTS AND ADDITIVES FOR ENGINE OILS, GASOLINE AND DIESEL FUELS, TRANSMISSION FLUIDS AND COOLING SYSTEMS; WAX EMULSIONS AND WAX POWDERS FOR INDUSTRIAL APPLICATIONS; BEESWAX FOR USE IN THE MANUFACTURE OF CANDLES; DUST-BINDING COMPOSITIONS, IN CLASS 4 (U.S. CLS. 1, 6 AND 15).

FIRST USE 12-8-2007; IN COMMERCE 12-8-2007.

THE MARK CONSISTS OF STANDARD CHARACTERS WITHOUT CLAIM TO ANY PARTICULAR FONT, STYLE, SIZE, OR COLOR.

OWNER OF U.S. REG. NOS. 2,276,678, 2,276,679, AND 2,276,680.

SER. NO. 76-686,349, FILED 1-30-2008.

RENEE MCCRAY, EXAMINING ATTORNEY

Int. Cls.: 16 and 41

Prior U.S. Cls.: 2, 5, 22, 23, 29, 37, 38, 50, 100, 101 and 107

Reg. No. 3,474,496

United States Patent and Trademark Office

Registered July 29, 2008

**TRADEMARK
SERVICE MARK
PRINCIPAL REGISTER**

INSIDE LACROSSE

AMERICAN CITY BUSINESS JOURNALS INC.
(DELAWARE CORPORATION)
120 WEST MOREHEAD STREET, SUITE 400
CHARLOTTE, NC 28202

FOR: MAGAZINES FEATURING NEWS AND INFORMATION CONCERNING THE SPORT OF LACROSSE, IN CLASS 16 (U.S. CLS. 2, 5, 22, 23, 29, 37, 38 AND 50).

FIRST USE 1-1-1997; IN COMMERCE 1-1-1997.

FOR: PROVIDING AN INTERNET WEBSITE FEATURING NEWS AND INFORMATION CONCERNING THE SPORT OF LACROSSE, IN CLASS 41 (U.S. CLS. 100, 101 AND 107).

FIRST USE 4-26-1999; IN COMMERCE 4-26-1999.

THE MARK CONSISTS OF STANDARD CHARACTERS WITHOUT CLAIM TO ANY PARTICULAR FONT, STYLE, SIZE, OR COLOR.

NO CLAIM IS MADE TO THE EXCLUSIVE RIGHT TO USE "LACROSSE", APART FROM THE MARK AS SHOWN.

SER. NO. 76-686,537, FILED 2-4-2008.

EDWARD FENNESSY, EXAMINING ATTORNEY

Int. Cl.: 20

Prior U.S. Cls.: 2, 13, 22, 25, 32 and 50

United States Patent and Trademark Office

Reg. No. 3,474,497

Registered July 29, 2008

**TRADEMARK
PRINCIPAL REGISTER**

VISTAFILE

ADVANTUS CORP. (FLORIDA CORPORATION)
12276 SAN JOSE BOULEVARD, BUILDING 618
JACKSONVILLE, FL 32223

THE MARK CONSISTS OF STANDARD CHAR-
ACTERS WITHOUT CLAIM TO ANY PARTICULAR
FONT, STYLE, SIZE, OR COLOR.

FOR: FILING CABINETS, NAMELY, MOBILE
FILING CABINETS, IN CLASS 20 (U.S. CLS. 2, 13,
22, 25, 32 AND 50).

SER. NO. 76-686,698, FILED 2-11-2008.

FIRST USE 9-0-1998; IN COMMERCE 9-0-1999.

PAULA MAHONEY, EXAMINING ATTORNEY

Int. Cl.: 35

Prior U.S. Cls.: 100, 101 and 102

United States Patent and Trademark Office

Reg. No. 3,474,498

Registered July 29, 2008

SERVICE MARK
PRINCIPAL REGISTER



LUBECK, SUE B (UNITED STATES INDIVIDUAL)
4315 E MISSISSIPPI AVE
DENVER, CO 80246

FIRST USE 3-20-1976; IN COMMERCE 3-20-1976.

SER. NO. 76-687,606, FILED 3-11-2008.

FOR: RETAIL BOOK STORES FEATURING
BOOKS, TOYS AND STUFFED ANIMALS, IN CLASS
35 (U.S. CLS. 100, 101 AND 102).

REBECCA GILBERT, EXAMINING ATTORNEY

Int. Cls.: 16 and 36

Prior U.S. Cls.: 2, 5, 22, 23, 29, 37, 38, 50, 100, 101 and 102

Reg. No. 3,474,499

United States Patent and Trademark Office

Registered July 29, 2008

**TRADEMARK
SERVICE MARK
PRINCIPAL REGISTER**

THE SHADY LADIES

THE LUPUS RESEARCH INSTITUTE (NEW YORK 501C3 NON-PROFIT ORGANIZATION)
330 SEVENTH AVENUE, SUITE 1701
NEW YORK, NY 10001

FOR: PRINTED MATTER, NAMELY, POSTERS, MAGAZINES, BOOKS, PAMPHLETS, BROCHURES, MANUALS, TEACHING MATERIALS ALL IN THE FIELD OF CHARITABLE SERVICES, PHILANTHROPIC SERVICES, VOLUNTEER SERVICES, IN CLASS 16 (U.S. CLS. 2, 5, 22, 23, 29, 37, 38 AND 50).

FIRST USE 2-0-2006; IN COMMERCE 2-0-2006.

FOR: CHARITABLE FUNDRAISING SERVICES, NAMELY, PROVIDING THE PROCEEDS FROM

FASHION ACCESSORY AUCTIONS FOR THE BENEFIT OF OTHERS, IN CLASS 36 (U.S. CLS. 100, 101 AND 102).

FIRST USE 2-0-2006; IN COMMERCE 2-0-2006.

THE MARK CONSISTS OF STANDARD CHARACTERS WITHOUT CLAIM TO ANY PARTICULAR FONT, STYLE, SIZE, OR COLOR.

SER. NO. 76-978,766, FILED 7-18-2006.

CHARLES L. JENKINS, EXAMINING ATTORNEY

Int. Cl.: 43

Prior U.S. Cls.: 100 and 101

United States Patent and Trademark Office

Reg. No. 3,474,500

Registered July 29, 2008

**SERVICE MARK
PRINCIPAL REGISTER**



**KELKOR LTD. (ILLINOIS CORPORATION)
350 WEST NORTHWEST HWY
BARRINGTON, IL 60010**

**FOR: RENTAL OF TENTS; RENTAL OF DRINK-
ING WATER EQUIPMENT, NAMELY, COOLERS;
RENTAL OF FURNITURE FOR PARTIES, NAME-
LY, TABLES AND CHAIRS, IN CLASS 43 (U.S. CLS.
100 AND 101).**

FIRST USE 1-1-2005; IN COMMERCE 1-1-2005.

**NO CLAIM IS MADE TO THE EXCLUSIVE
RIGHT TO USE "RENTAL SERVICES", APART
FROM THE MARK AS SHOWN.**

SER. NO. 77-002,211, FILED 9-19-2006.

LYDIA BELZER, EXAMINING ATTORNEY

Int. Cl.: 35

Prior U.S. Cls.: 100, 101 and 102

United States Patent and Trademark Office

Reg. No. 3,474,501

Registered July 29, 2008

**SERVICE MARK
PRINCIPAL REGISTER**

FAIMA

FINANCIAL OPERATIONS NETWORKS LLC
(GEORGIA LTD LIAB CO)
2100 RIVEREDGE PARKWAY, SUITE 380
ATLANTA, GA 30328

FOR: INFORMATION IN THE FIELD OF BUSINESS INFORMATION MANAGEMENT, NAMELY, FREIGHT INFORMATION MANAGEMENT VIA THE INTERNET; PROVIDING INFORMATION IN THE FIELD OF FREIGHT BILLING, IN CLASS 35 (U.S. CLS. 100, 101 AND 102).

FIRST USE 9-12-2006; IN COMMERCE 9-12-2006.

THE MARK CONSISTS OF STANDARD CHARACTERS WITHOUT CLAIM TO ANY PARTICULAR FONT, STYLE, SIZE, OR COLOR.

SER. NO. 77-003,894, FILED 9-21-2006.

THOMAS MANOR, EXAMINING ATTORNEY

Int. Cl.: 6

Prior U.S. Cls.: 2, 12, 13, 14, 23, 25 and 50

United States Patent and Trademark Office

Reg. No. 3,474,502

Registered July 29, 2008

**TRADEMARK
PRINCIPAL REGISTER**



MARKWELL MANUFACTURING CO. (MASSACHUSETTS CORPORATION)
616 PLEASANT STREET
NORWOOD, MA 02062

FOR: METAL GLAZIER POINTS; METAL EYE BOLTS; METAL HARDWARE, NAMELY, METAL WASHERS; METAL CLAMPS; METAL STAPLES FOR CONSTRUCTION OR INDUSTRIAL USE; METAL HOOKS; METAL FASTENERS, NAMELY, BOLTS, NAILS, RIVETS AND SCREWS; METAL CLAMPS; TINS OF METAL; METAL BRADS; ME-

TAL BANDS, IN CLASS 6 (U.S. CLS. 2, 12, 13, 14, 23, 25 AND 50).

FIRST USE 1-1-1920; IN COMMERCE 1-1-1920.

OWNER OF U.S. REG. NO. 3,227,259.

SER. NO. 77-005,671, FILED 9-22-2006.

MICHELE SWAIN, EXAMINING ATTORNEY

Int. Cl.: 25

Prior U.S. Cls.: 22 and 39

United States Patent and Trademark Office

Reg. No. 3,474,503

Registered July 29, 2008

**TRADEMARK
PRINCIPAL REGISTER**

ART IS OF THE HEART

G.A.N.C INC. (NEW YORK CORPORATION)
223 EAST 82ND STREET
NEW YORK, NY 10028

FOR: SHORT-SLEEVED OR LONG-SLEEVED T-SHIRTS, IN CLASS 25 (U.S. CLS. 22 AND 39).

FIRST USE 1-15-2000; IN COMMERCE 1-15-2003.

THE COLOR(S) BLACK AND BLUE IS/ARE CLAIMED AS A FEATURE OF THE MARK.

THE MARK CONSISTS OF THE WORDING "ART IS OF THE HEART". THE WORDING APPEARS IN THE COLOR BLACK WITH THE EXCEPTION OF LETTERS "ART" IN "HEART" IN THE COLOR BLUE.

SER. NO. 77-005,834, FILED 9-22-2006.

EMILY CHUO, EXAMINING ATTORNEY

Int. Cl.: 25

Prior U.S. Cls.: 22 and 39

United States Patent and Trademark Office

Reg. No. 3,474,504

Registered July 29, 2008

**TRADEMARK
PRINCIPAL REGISTER**

I DON'T DO REALITY

G.A.N.C. INC (NEW YORK CORPORATION)
223 EAST 82ND STREET
NEW YORK, NY 10028

FOR: SHORT-SLEEVED OR LONG-SLEEVED T-SHIRTS, IN CLASS 25 (U.S. CLS. 22 AND 39).

FIRST USE 1-15-2000; IN COMMERCE 1-15-2003.

THE MARK CONSISTS OF STANDARD CHARACTERS WITHOUT CLAIM TO ANY PARTICULAR FONT, STYLE, SIZE, OR COLOR.

SEC. 2(F).

SER. NO. 77-005,908, FILED 9-22-2006.

JULIE GUTTADAURO, EXAMINING ATTORNEY

Int. Cl.: 41

Prior U.S. Cls.: 100, 101 and 107

United States Patent and Trademark Office

Reg. No. 3,474,505

Registered July 29, 2008

**SERVICE MARK
PRINCIPAL REGISTER**

OLD TOWN CLUB

OLD TOWN CLUB, INCORPORATED (NORTH
CAROLINA CORPORATION)
2875 OLD TOWN CLUB ROAD
WINSTON-SALEM, NC 271065232

NO CLAIM IS MADE TO THE EXCLUSIVE
RIGHT TO USE "CLUB", APART FROM THE MARK
AS SHOWN.

FOR: GOLF COURSE, GOLF COURSE SERVICES
AND GOLF CLUB SERVICES; COUNTY CLUB
SERVICES, IN CLASS 41 (U.S. CLS. 100, 101 AND 107).

SEC. 2(F).

FIRST USE 12-23-1939; IN COMMERCE 3-24-1941.

SER. NO. 77-006,403, FILED 9-25-2006.

THE MARK CONSISTS OF STANDARD CHAR-
ACTERS WITHOUT CLAIM TO ANY PARTICULAR
FONT, STYLE, SIZE, OR COLOR.

GEORGIA CARTY, EXAMINING ATTORNEY

Int. Cl.: 41

Prior U.S. Cls.: 100, 101 and 107

United States Patent and Trademark Office

Reg. No. 3,474,506

Registered July 29, 2008

**SERVICE MARK
PRINCIPAL REGISTER**

CONTINUING INSPIRATION

BOARD OF TRUSTEES OF THE UNIVERSITY OF
THE ARTS (PENNSYLVANIA NON-PROFIT
CORPORATION)
320 SOUTH BROAD STREET
PHILADELPHIA, PA 19102

FOR: EDUCATIONAL SERVICES, NAMELY,
CONCENTRATED INTENSIVE ART STUDY PRO-
GRAMS IN A WIDE RANGE OF DISCIPLINE CON-
CENTRATIONS COMPLEMENTED BY MUSEUM
VISITATIONS, IN CLASS 41 (U.S. CLS. 100, 101 AND
107).

FIRST USE 6-30-1997; IN COMMERCE 6-30-1997.

THE MARK CONSISTS OF STANDARD CHAR-
ACTERS WITHOUT CLAIM TO ANY PARTICULAR
FONT, STYLE, SIZE, OR COLOR.

SER. NO. 77-007,516, FILED 9-26-2006.

EDWARD FENNESSY, EXAMINING ATTORNEY

Int. Cl.: 42

Prior U.S. Cls.: 100 and 101

United States Patent and Trademark Office

Reg. No. 3,474,507

Registered July 29, 2008

**SERVICE MARK
PRINCIPAL REGISTER**

Global OneCheck

INTEGRASCREEN SINGAPORE PTE LTD (SINGAPORE CORPORATION)
LEVEL 14, 30 CECIL ST, PRUDENTIAL TOWER
SINGAPORE, SINGAPORE 049712

FOR: DATA MINING; DATA WAREHOUSING;
DATABASE DEVELOPMENT SERVICES; LEGAL
RESEARCH; PUBLIC DOCUMENT RETRIEVAL;
RETRIEVING PUBLIC DOCUMENTS , IN CLASS
42 (U.S. CLS. 100 AND 101).

FIRST USE 9-18-2006; IN COMMERCE 9-25-2006.

THE MARK CONSISTS OF STANDARD CHARACTERS WITHOUT CLAIM TO ANY PARTICULAR FONT, STYLE, SIZE, OR COLOR.

NO CLAIM IS MADE TO THE EXCLUSIVE RIGHT TO USE "GLOBAL", APART FROM THE MARK AS SHOWN.

SER. NO. 77-008,226, FILED 9-27-2006.

ELLEN BURNS, EXAMINING ATTORNEY

Int. Cl.: 9

Prior U.S. Cls.: 21, 23, 26, 36 and 38

Reg. No. 3,474,508

United States Patent and Trademark Office

Registered July 29, 2008

**TRADEMARK
PRINCIPAL REGISTER**



FUNAI ELECTRIC COMPANY LIMITED (JAPAN CORPORATION)

7-1, NAKAGAITO 7-CHOME, DAITO-SHI
OSAKA, JAPAN

FOR: TELEVISION RECEIVERS HAVING A SCHEME FOR PROJECTING IMAGES FROM THE BACK OF A SCREEN, TUNERS FOR STEREOS AND HIGH DEFINITION TELEVISIONS, TELEVISION IMAGE RECEIVERS HAVING A SET-TOP BOX, DIGITAL TELEVISION RECEIVERS, TELEVISION RECEIVERS WITH A DIGITAL VIDEO DISC PLAYER, TELEVISION SATELLITE RECEIVERS, INTEGRATED CIRCUITS AND CARDS FOR CONVERTING VIDEO AND IMAGE DATA FOR TELEVISION SETS AND DISPLAYS, TELEVISION RECEIVERS, TELEVISION RECEIVERS AND PARTS THEREOF, TUNERS FOR TELEVISION RECEIVERS, DISPLAYS FOR TELEVISION RECEIVERS, COVERS FOR TELEVISION RECEIVERS, REMOTE CONTROLLERS FOR TELEVISION RECEIVERS, TELEVISION IMAGE RECEIVING MONITORS, FILTERS FOR ADJUSTING COLOR TONES ON TELEVISION IMAGE RECEIVERS, SPATIAL LIGHT MODULATORS FOR TELEVISION IMAGE RECEIVERS, TELEVISION IMAGE RECEIVERS, FILTERS TO BE ATTACHED TO THE SCREENS OF TELEVISION IMAGE RECEIVERS, RETRANSMISSION AMPLIFIERS FOR COMMUNITY RECEPTION OF TELEVISION SIGNALS, MODULATORS FOR COMMUNITY RECEPTION OF TELEVISION SIGNALS, TELEVISION SIGNAL DISTRIBUTORS (SPLITTERS), TELEVISION SIGNAL DISTRIBUTORS, TELEVISION SIGNAL ATTENUATORS, TELEVISION SIGNAL MIXERS/BRANCHING FILTERS, CABLES AND CONNECTORS FOR CONNECTING RECEIVERS OF TELEVISION SIGNALS, TELEVISION SIGNAL AMPLIFIERS, ELECTRICAL OR ELECTRONIC OR BATTERY OPERATED POWER SUPPLIES FOR TELEVISION SIGNAL AMPLIFIERS,

FIELD INTENSITY METERS FOR TELEVISION SIGNALS, SPLITTERS/DISTRIBUTORS FOR TELEVISION SIGNALS, TELEVISION TRANSMITTER-RECEIVERS, ANTENNAS FOR TELEVISION TRANSMITTER-RECEIVERS, TELEVISION TRANSMITTERS, TUNERS FOR RECEIVING TELEVISION BROADCASTING, TELEVISION MONITORING CAMERAS, TELEVISION RECEIVERS USING A PLASMA DISPLAY, TELEVISION RECEIVERS USING PLASMA DISPLAY METHOD, PLASMA TELEVISION RECEIVERS, PROJECTION TELEVISION RECEIVERS AND PARTS THEREOF, PROJECTOR-TYPE TELEVISION RECEIVERS, SATELLITE TELEVISION BROADCAST RECEIVERS, TUNERS FOR SATELLITE TELEVISION BROADCAST RECEIVERS, TELEVISION IMAGE RECEIVERS FOR RECEIVING SATELLITE TELEVISION BROADCAST, TELEVISION RECEIVERS FOR SATELLITE BROADCAST, TELEVISION RECEIVERS WITH A LIQUID CRYSTAL DISPLAY SCREEN, LIQUID CRYSTAL TELEVISION RECEIVERS AND COMPONENTS THEREOF, MONITOR TELEVISION RECEIVERS USING LIQUID CRYSTAL, TELEVISION RECEIVERS USING LIQUID CRYSTAL, STARTERS FOR COIN-OPERATED TELEVISION IMAGE RECEIVERS, APPARATUS FOR COIN-OPERATED TELEVISION IMAGE RECEIVERS, ANTITHEFT SECURITY SYSTEMS FOR STORES, COMPRISING SOUND-COLLECTING MICROPHONE, VIDEO CAMERA, VIDEO TAPE RECORDER AND TELEVISION RECEIVER, TUNERS FOR RECEIVING DIGITAL TERRESTRIAL TELEVISION BROADCAST, TELEVISION RECEIVERS HAVING A FUNCTION TO DISPLAY ELECTRONIC PROGRAM GUIDE ON A TELEVISION SCREEN, IN CLASS 9 (U.S. CLS. 21, 23, 26, 36 AND 38).

PRIORITY CLAIMED UNDER SEC. 44(D) ON JAPAN APPLICATION NO. 2006-043443, FILED 5-12-

2006, REG. NO. 5024492, DATED 2-9-2007, EXPIRES 2-9-2017.

THE COLOR(S) RED, YELLOW, BLUE, GREEN, BLACK, GRAY, AND WHITE IS/ARE CLAIMED AS A FEATURE OF THE MARK.

THE MARK CONSISTS OF "CP" (STYLIZED IN THE COLORS RED, YELLOW, BLUE AND GREEN) "CLEAR PIX ENGINE".

SER. NO. 77-009,657, FILED 9-28-2006.

RICHARD A. STRASER, EXAMINING ATTORNEY

Int. Cl.: 42

Prior U.S. Cls.: 100 and 101

United States Patent and Trademark Office

Reg. No. 3,474,509

Registered July 29, 2008

**SERVICE MARK
PRINCIPAL REGISTER**



ROGERS, ALVIN (UNITED STATES INDIVIDUAL)
277 E 10TH STREET #7
NEW YORK, NY 10009

FOR: COMPUTER SERVICES, NAMELY, HOSTING ON-LINE WEB FACILITIES FOR OTHERS FOR ORGANIZING AND CONDUCTING ONLINE MEETINGS, GATHERINGS, AND INTERACTIVE DISCUSSIONS; COMPUTER SERVICES, NAMELY, MANAGING WEB SITES FOR OTHERS; DESIGN AND DEVELOPMENT OF ON-LINE COMPUTER SOFTWARE SYSTEMS; DESIGN OF COMPUTER NETWORKS AND SOFTWARE FOR OTHERS FOR THE FIELD OF EDUCATION; PROVIDING A WEBSITE THAT FEATURES INFORMATION ON COMPUTER TECHNOLOGY AND PROGRAMMING; REGISTRATION OF DOMAIN NAMES FOR IDENTIFICATION OF USERS ON A GLOBAL COMPU-

TER NETWORK, IN CLASS 42 (U.S. CLS. 100 AND 101).

FIRST USE 2-3-2003; IN COMMERCE 10-5-2005.

THE COLOR(S) ORANGE, NAVY BLUE IS/ARE CLAIMED AS A FEATURE OF THE MARK.

THE MARK CONSISTS OF PHAT IS ORANGE, TIME IS NAVY BLUE, THE T IN TIME IS LARGER THAN THE T IN PHAT.

SER. NO. 77-010,117, FILED 9-28-2006.

RAUL CORDOVA, EXAMINING ATTORNEY

Int. Cl.: 28

Prior U.S. Cls.: 22, 23, 38 and 50

United States Patent and Trademark Office

Reg. No. 3,474,510

Registered July 29, 2008

**TRADEMARK
PRINCIPAL REGISTER**



ZHANG, WEI (CHINA INDIVIDUAL)
DEVELOPMENT DISTRICT
NO. 105 HUIHE WEST ROAD
DALIAN, CHINA

GENT TOYS, NAMELY, REMOTE CONTROL CARS;
AND RADIO-CONTROLLED TOY VEHICLES, IN
CLASS 28 (U.S. CLS. 22, 23, 38 AND 50).

FOR: TOYS, NAMELY, TOY SCALE MODEL
VEHICLES, TOY VEHICLES, TOY MINICAR VEHI-
CLES; TOY DOLL ROOMS, NAMELY, TOY GAS
STATIONS AND GARAGES; ORNAMENTS FOR
CHRISTMAS TREES; TOY SCOOTERS; INTELLI-

FIRST USE 10-31-2001; IN COMMERCE 10-31-2001.

SER. NO. 77-011,980, FILED 10-2-2006.

INGRID C. EULIN, EXAMINING ATTORNEY

Int. Cls.: 9, 16, 35 and 41

**Prior U.S. Cls.: 2, 5, 21, 22, 23, 26, 29, 36, 37, 38, 50,
100, 101, 102 and 107**

Reg. No. 3,474,511

United States Patent and Trademark Office

Registered July 29, 2008

**TRADEMARK
SERVICE MARK
PRINCIPAL REGISTER**

**NATIONAL FATHERHOOD
INITIATIVE**

NATIONAL FATHERHOOD INITIATIVE (MARY-
LAND CORPORATION)
101 LAKE FOREST BLVD., SUITE 360
GAITHERSBURG, MD 20877

FOR: MULTIMEDIA COMPUTER SOFTWARE
FEATURING FATHERING AND FATHERHOOD
ADVICE AND EXERCISES, IN CLASS 9 (U.S. CLS.
21, 23, 26, 36 AND 38).

FIRST USE 12-31-2002; IN COMMERCE 12-31-2002.

FOR: BOOKS AND BROCHURES ON FATHER-
ING AND FATHERHOOD; POSTERS; POSTCARDS,
IN CLASS 16 (U.S. CLS. 2, 5, 22, 23, 29, 37, 38 AND 50).

FIRST USE 0-0-1995; IN COMMERCE 0-0-1995.

FOR: PROMOTING PUBLIC AWARENESS OF
THE NEED FOR FATHERHOOD IN OUR COMMU-
NITIES, IN CLASS 35 (U.S. CLS. 100, 101 AND 102).

FIRST USE 0-0-1995; IN COMMERCE 0-0-1995.

FOR: EDUCATIONAL SERVICES, NAMELY,
CONDUCTING CLASSES, SEMINARS, CONFEREN-
CES, WORKSHOPS, AND LECTURES TO EDUCATE
INDIVIDUALS AND THE PUBLIC CONCERNING
THE IMPORTANCE OF FATHERHOOD IN OUR
COMMUNITIES, IN CLASS 41 (U.S. CLS. 100, 101
AND 107).

FIRST USE 0-0-1995; IN COMMERCE 0-0-1995.

THE MARK CONSISTS OF STANDARD CHAR-
ACTERS WITHOUT CLAIM TO ANY PARTICULAR
FONT, STYLE, SIZE, OR COLOR.

OWNER OF U.S. REG. NO. 2,394,397.

SEC. 2(F).

SER. NO. 77-013,538, FILED 10-4-2006.

DAVID COLLIER, EXAMINING ATTORNEY

Int. Cls.: 4, 16 and 25

Prior U.S. Cls.: 1, 2, 5, 6, 15, 22, 23, 29, 37, 38, 39 and 50

Reg. No. 3,474,512

United States Patent and Trademark Office

Registered July 29, 2008

**TRADEMARK
PRINCIPAL REGISTER**



JOE GIBBS RACING, INC. (NORTH CAROLINA CORPORATION)
13416 REESE BOULEVARD W.
HUNTERSVILLE, NC 28078

FIRST USE 5-1-2006; IN COMMERCE 5-1-2006.

FOR: AUTOMOTIVE LUBRICANTS, NAMELY, MOTOR OILS AND GREASES FOR USE IN AUTOMOBILES AND TRUCKS FOR CONSUMER USE AND RACING , IN CLASS 4 (U.S. CLS. 1, 6 AND 15).

OWNER OF U.S. REG. NOS. 1,851,538 AND 2,408,260.

FIRST USE 5-1-2006; IN COMMERCE 5-1-2006.

FOR: PAPER SHOP TOWELS, IN CLASS 16 (U.S. CLS. 2, 5, 22, 23, 29, 37, 38 AND 50).

THE NAME(S), PORTRAIT(S), AND/OR SIGNATURE(S) SHOWN IN THE MARK IDENTIFIES "JOE GIBBS" , WHOSE CONSENT(S) TO REGISTER IS SUBMITTED.

FIRST USE 5-1-2006; IN COMMERCE 5-1-2006.

FOR: CLOTHING, NAMELY, SHIRTS, IN CLASS 25 (U.S. CLS. 22 AND 39).

THE MARK CONSISTS OF THE WORDS "JOE GIBBS DRIVEN" WITH OWNER'S ORIGINAL DESIGN.

SER. NO. 77-013,571, FILED 10-4-2006.

CHARLOTTE CORWIN, EXAMINING ATTORNEY

Int. Cls.: 9, 16, 35, 38 and 41

**Prior U.S. Cls.: 2, 5, 21, 22, 23, 26, 29, 36, 37, 38, 50,
100, 101, 102, 104 and 107**

Reg. No. 3,474,513

United States Patent and Trademark Office

Registered July 29, 2008

**TRADEMARK
SERVICE MARK
PRINCIPAL REGISTER**

SO ... THINK ABOUT THIS ...

RUBIN, JENAE C. (UNITED STATES INDIVIDUAL)
SUITE #200
1730 SW 106 TERRACE
FT. LAUDERDALE, FL 333241729

FOR: PRERECORDED ELECTRONIC MEDIA, NAMELY, AUDIO AND VIDEO CASSETTES, CDS AND DVDS ALL FEATURING INFORMATION ON ASSOCIATION MEMBERSHIP, BUSINESS, COMMUNICATIONS, COMPUTERS, EDUCATION, FINANCES, HOBBIES, HOME IMPROVEMENT, MANAGEMENT, MARKETING, MERCHANDISING, MOTIVATION, SELF-IMPROVEMENT, SOCIAL SKILLS AND SPORTS; COMPUTER PROGRAMMING SYSTEMS COMPRISING COMPUTER HARDWARE, COMPUTER PERIPHERALS AND OPERATING SOFTWARE; COMPUTER SOFTWARE AND HARDWARE FOR CONNECTING GLOBAL COMPUTER NETWORKS; COMPUTER HARDWARE AND COMPUTER SOFTWARE DEVELOPMENT TOOLS, IN CLASS 9 (U.S. CLS. 21, 23, 26, 36 AND 38).

FIRST USE 2-0-2006; IN COMMERCE 2-0-2006.

FOR: PAPER AND PRINTED MATTER, NAMELY, A SERIES OF ARTICLES FOR PUBLICATION IN BOOKLETS, BROCHURES, CATALOGS, GUIDES, MAGAZINES, MANUALS AND NEWSLETTERS ALL FEATURING INFORMATION ON ASSOCIATION MEMBERSHIP, BUSINESS, COMMUNICATIONS, COMPUTERS, EDUCATION, FINANCES, HOBBIES, HOME IMPROVEMENT, MANAGEMENT, MARKETING, MERCHANDISING, MOTIVATION, SELF-IMPROVEMENT, SOCIAL SKILLS AND SPORTS; FLASH CARDS; PAPERWEIGHTS, PHOTOGRAPHS MOUNTED AND UNMOUNTED; POSTERS; POSTCARDS; PRINTED GREETING CARDS; PRINTED EDUCATIONAL, INSTRUC-

TIONAL AND TEACHING MATERIALS ALL FEATURING INFORMATION ON ASSOCIATION MEMBERSHIP, BUSINESS, COMMUNICATIONS, COMPUTERS, EDUCATION, FINANCES, HOBBIES, HOME IMPROVEMENT, MANAGEMENT, MARKETING, MERCHANDISING, MOTIVATION, SELF-IMPROVEMENT, SOCIAL SKILLS AND SPORTS; SERIES OF NON-FICTION BOOKS ALL FEATURING INFORMATION ON ASSOCIATION MEMBERSHIP, BUSINESS, COMMUNICATIONS, COMPUTERS, EDUCATION, FINANCES, HOBBIES, HOME IMPROVEMENT, MANAGEMENT, MARKETING, MERCHANDISING, MOTIVATION, SELF-IMPROVEMENT, SOCIAL SKILLS AND SPORTS; FOLDERS, PENS, PENCILS, STICKERS AND WRITING PADS, IN CLASS 16 (U.S. CLS. 2, 5, 22, 23, 29, 37, 38 AND 50).

FIRST USE 2-0-2006; IN COMMERCE 2-0-2006.

FOR: ARRANGING AND CONDUCTING BUSINESS CONFERENCES AND EVENT PLANNING, NAMELY, ARRANGING AND ORGANIZING BUSINESS MEETINGS, CONFERENCES AND CONVENTIONS; BUSINESS MARKETING AND MANAGEMENT CONSULTING SERVICES; MARKETING STUDIES; PROVIDING INFORMATION ABOUT ASSOCIATION MEMBERSHIPS, BUSINESS MATTERS, ADVERTISING THROUGH COMPUTER COMMUNICATIONS NETWORKS, BUSINESS MANAGEMENT, MARKETING, MERCHANDISING; PRODUCTION AND DISTRIBUTION OF RADIO AND TELEVISION COMMERCIALS; PUBLICATION OF PUBLICITY TEXTS; PUBLICITY AGENTS SERVICES; PUBLIC RELATIONS; SERVICES OF A RADIO AND TELEVISION ADVERTISING AGENCY; ASSOCIATION SERVICES, NAMELY, PROMOTING PUBLIC AND PROFESSIONAL INTEREST AND AWARENESS IN THE

FIELDS OF BUSINESS COMMUNICATIONS, COMPUTERS FOR USE IN BUSINESS, BUSINESS EDUCATION, FINANCES, BUSINESS MANAGEMENT, MARKETING AND MERCHANDISING, IN CLASS 35 (U.S. CLS. 100, 101 AND 102).

FIRST USE 2-0-2006; IN COMMERCE 2-0-2006.

FOR: TELECOMMUNICATIONS SERVICES, NAMELY, BROADCASTING RADIO AND TELEVISION PROGRAMS AND FILMS VIA A GLOBAL COMPUTER NETWORK; ELECTRONIC, ELECTRIC AND DIGITAL TRANSMISSION OF VOICE, DATA, IMAGES, SOUND, DATA SIGNALS AND MESSAGES; ELECTRONIC TRANSMISSION OF BOOKS, E-ZINES AND NEWSLETTERS VIA A GLOBAL COMPUTER NETWORK; TRANSMISSION OF INFORMATION BY ELECTRONIC COMMUNICATIONS NETWORKS; VIDEO AND AUDIO TELECONFERENCING SERVICES VIA THE INTERNET, IN CLASS 38 (U.S. CLS. 100, 101 AND 104).

FIRST USE 2-0-2006; IN COMMERCE 2-0-2006.

FOR: EDUCATIONAL AND INSTRUCTIONAL SERVICES, NAMELY, CONDUCTING EDUCATIONAL CLASSES, CONFERENCES, RETREATS, SEMINARS AND WORKSHOPS ALL FEATURING INFORMATION ON ASSOCIATION MEMBERSHIP, BUSINESS, COMMUNICATIONS, COMPUTERS, EDUCATION, FINANCES, HOBBIES, HOME IM-

PROVEMENT, MANAGEMENT, MARKETING, MERCHANDISING, MOTIVATION, SELF-IMPROVEMENT, SOCIAL SKILLS AND SPORTS, AND DISTRIBUTING INSTRUCTIONAL MATERIALS IN CONNECTION THEREWITH; ENTERTAINMENT SERVICES AND EDUCATIONAL SERVICES, NAMELY, PROVIDING LIVE MOTIVATIONAL AND EDUCATIONAL SPEAKERS FEATURING INFORMATION ON ASSOCIATION MEMBERSHIP, BUSINESS, COMMUNICATIONS, COMPUTERS, EDUCATION, FINANCES, HOBBIES, HOME IMPROVEMENT, MANAGEMENT, MARKETING, MERCHANDISING, MOTIVATION, SELF-IMPROVEMENT, SOCIAL SKILLS AND SPORTS; PRODUCTION OF RADIO, TELEVISION, AND FILM PROGRAMS OF OTHERS FOR TRANSMISSION VIA BROADCAST, CABLE, DIGITAL AND GLOBAL COMPUTER NETWORK; PUBLICATION OF BOOKS, MAGAZINES AND NEWSLETTERS, IN CLASS 41 (U.S. CLS. 100, 101 AND 107).

FIRST USE 2-0-2006; IN COMMERCE 2-0-2006.

THE MARK CONSISTS OF STANDARD CHARACTERS WITHOUT CLAIM TO ANY PARTICULAR FONT, STYLE, SIZE, OR COLOR.

SER. NO. 77-013,573, FILED 10-4-2006.

GENE MACIOL, EXAMINING ATTORNEY

Int. Cls.: 4, 16 and 25

Prior U.S. Cls.: 1, 2, 5, 6, 15, 22, 23, 29, 37, 38, 39 and 50

United States Patent and Trademark Office

Reg. No. 3,474,514

Registered July 29, 2008

**TRADEMARK
PRINCIPAL REGISTER**

JOE GIBBS DRIVEN

JOE GIBBS RACING, INC. (NORTH CAROLINA CORPORATION)
13415 REESE BOULEVARD W.
HUNTERSVILLE, NC 28078

FOR: AUTOMOTIVE LUBRICANTS, NAMELY, MOTOR OILS AND GREASES FOR USE IN AUTOMOBILES AND TRUCKS FOR CONSUMER USE AND RACING, IN CLASS 4 (U.S. CLS. 1, 6 AND 15).

FIRST USE 5-1-2006; IN COMMERCE 5-1-2006.

FOR: PAPER SHOP TOWELS, IN CLASS 16 (U.S. CLS. 2, 5, 22, 23, 29, 37, 38 AND 50).

FIRST USE 5-1-2006; IN COMMERCE 5-1-2006.

FOR: CLOTHING, NAMELY, SHIRTS, IN CLASS 25 (U.S. CLS. 22 AND 39).

FIRST USE 5-1-2006; IN COMMERCE 5-1-2006.

THE MARK CONSISTS OF STANDARD CHARACTERS WITHOUT CLAIM TO ANY PARTICULAR FONT, STYLE, SIZE, OR COLOR.

OWNER OF U.S. REG. NOS. 1,851,538 AND 2,408,260.

THE NAME(S), PORTRAIT(S), AND/OR SIGNATURE(S) SHOWN IN THE MARK IDENTIFIES "JOE GIBBS", WHOSE CONSENT(S) TO REGISTER IS SUBMITTED.

SER. NO. 77-013,602, FILED 10-4-2006.

CHARLOTTE CORWIN, EXAMINING ATTORNEY

Int. Cls.: 35 and 37

Prior U.S. Cls.: 100, 101, 102, 103 and 106

United States Patent and Trademark Office

Reg. No. 3,474,515

Registered July 29, 2008

**SERVICE MARK
PRINCIPAL REGISTER**



FOOTPRINT RETAIL SERVICES (DELAWARE
LTD LIAB CO)
2200 WESTERN COURT, SUITE 150
LISLE, IL 60532

FOR: INVENTORY, DELIVERY AND RETURNS
MANAGEMENT, IN CLASS 35 (U.S. CLS. 100, 101
AND 102).

FIRST USE 10-2-2006; IN COMMERCE 10-2-2006.

FOR: INSTALLATION OF RETAIL DISPLAYS
AND FIXTURES, IN CLASS 37 (U.S. CLS. 100, 103
AND 106).

FIRST USE 10-2-2006; IN COMMERCE 10-2-2006.

NO CLAIM IS MADE TO THE EXCLUSIVE
RIGHT TO USE "RETAIL SERVICES", APART
FROM THE MARK AS SHOWN.

SER. NO. 77-013,711, FILED 10-4-2006.

KATHERINE STOIDES, EXAMINING ATTORNEY

Int. Cl.: 25

Prior U.S. Cls.: 22 and 39

United States Patent and Trademark Office

Reg. No. 3,474,516

Registered July 29, 2008

**TRADEMARK
PRINCIPAL REGISTER**

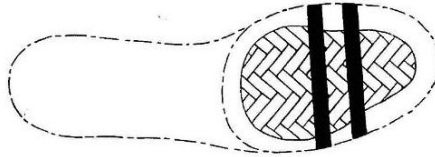

K-SWISS INC. (DELAWARE CORPORATION)
31248 OAK CREST DRIVE
WESTLAKE VILLAGE, CA 91361

FOR: SHOES, IN CLASS 25 (U.S. CLS. 22 AND 39).

FIRST USE 2-0-1990; IN COMMERCE 1-0-1991.

NO CLAIM IS MADE TO THE EXCLUSIVE
RIGHT TO USE THE PORTIONS OF THE MARK
SHOWN AS BROKEN LINES, APART FROM THE
MARK AS SHOWN.

"THE MARK CONSISTS OF A DESIGN ON THE
BOTTOM OUTSOLE OF A SHOE, THE DESIGN

CONSISTING OF A BRICK DESIGN, AND TWO
SOLID PARALLEL STRIPES TRAVERSING THE
WIDTH OF THE BRICK DESIGN. THE PORTION
OF THE DRAWING SHOWN BY THE DOTTED
LINES IS NOT A PART OF THE MARK AND THAT
IT SERVES ONLY TO SHOW THE POSITION OF
THE MARK.."

SEC. 2(F).

SER. NO. 77-015,243, FILED 10-5-2006.

BARBARA BROWN, EXAMINING ATTORNEY

Int. Cl.: 3

Prior U.S. Cls.: 1, 4, 6, 50, 51 and 52

Reg. No. 3,474,517

United States Patent and Trademark Office

Registered July 29, 2008

**TRADEMARK
PRINCIPAL REGISTER**



GABRIELLE STUDIO, INC. (NEW YORK CORPORATION)
550 SEVENTH AVENUE
NEW YORK, NY 10018

FOR: FRAGRANCES FOR PERSONAL USE, IN CLASS 3 (U.S. CLS. 1, 4, 6, 50, 51 AND 52).

FIRST USE 9-1-2006; IN COMMERCE 9-15-2006.

THE COLOR(S) GOLD AND BLACK IS/ARE CLAIMED AS A FEATURE OF THE MARK.

THE MARK CONSISTS OF THE CONFIGURATION OF A BOTTLE WHICH HAS GOLDEN SLEEVE/OVERLAY COVERING TWO SIDES OF THE BOTTLE. THE OVERLAY HAS A RAISED HAMMERED MISCELLANEOUS DESIGN IN THE CENTER OF THE SLEEVE ON BOTH SIDES. THE REMAINING TWO SIDES OF THE BOTTLE ARE CLEAR GLASS. THE BOTTLE HAS A BLACK CAP.

SER. NO. 77-017,814, FILED 10-10-2006.

MATTHEW PAPPAS, EXAMINING ATTORNEY

Int. Cl.: 30

Prior U.S. Cl.: 46

United States Patent and Trademark Office

Reg. No. 3,474,518

Registered July 29, 2008

TRADEMARK
PRINCIPAL REGISTER



SUMMIT CUISINE CORP. (UTAH CORPORATION)
499 ASPEN DRIVE
PARK CITY, UT 84098

FOR: SNACK MIX CONSISTING PRIMARILY OF SALTWATER TAFFY, PROCESSED FRUITS, PROCESSED NUTS AND/OR RAISINS, IN CLASS 30 (U.S. CL. 46).

FIRST USE 8-31-2006; IN COMMERCE 8-31-2006.

NO CLAIM IS MADE TO THE EXCLUSIVE RIGHT TO USE "WASATCH" AND "MUNCHIES", APART FROM THE MARK AS SHOWN.

COLOR IS NOT A CLAIMED FEATURE OF THE MARK.

SER. NO. 77-018,129, FILED 10-10-2006.

DARRYL SPRUILL, EXAMINING ATTORNEY

Int. Cl.: 36

Prior U.S. Cls.: 100, 101 and 102

United States Patent and Trademark Office

Reg. No. 3,474,519

Registered July 29, 2008

**SERVICE MARK
PRINCIPAL REGISTER**

PC Express

PERFORMANCE BANKERS, INC. (SOUTH DA-
KOTA CORPORATION)
201 N. EUCLID, PO BOX 7140
PIERRE, SD 571017140

FOR: BANKING SERVICES IN THE NATURE OF
ONLINE BANKING, IN CLASS 36 (U.S. CLS. 100, 101
AND 102).

FIRST USE 0-0-1997; IN COMMERCE 0-0-1997.

THE MARK CONSISTS OF STANDARD CHAR-
ACTERS WITHOUT CLAIM TO ANY PARTICULAR
FONT, STYLE, SIZE, OR COLOR.

NO CLAIM IS MADE TO THE EXCLUSIVE
RIGHT TO USE "PC", APART FROM THE MARK
AS SHOWN.

SER. NO. 77-019,341, FILED 10-12-2006.

THOMAS MANOR, EXAMINING ATTORNEY

Int. Cls.: 1 and 5

Prior U.S. Cls.: 1, 5, 6, 10, 18, 26, 44, 46, 51 and 52

United States Patent and Trademark Office

Reg. No. 3,474,520

Registered July 29, 2008

**TRADEMARK
PRINCIPAL REGISTER**

RELEASE

VALENT BISOSCIENCES CORPORATION (ILLINOIS CORPORATION)
870 TECHNOLOGY WAY
LIBERTYVILLE, IL 60048

FOR: SEED TREATMENTS, NAMELY, PLANT GROWTH REGULATOR FOR COMMERCIAL AND AGRICULTURAL USE, IN CLASS 1 (U.S. CLS. 1, 5, 6, 10, 26 AND 46).

FIRST USE 9-12-1989; IN COMMERCE 9-12-1989.

FOR: SEED TREATMENTS, NAMELY, INSECTICIDES AND NEMATOCIDES FOR COMMERCIAL

AND AGRICULTURAL USE, IN CLASS 5 (U.S. CLS. 6, 18, 44, 46, 51 AND 52).

FIRST USE 2-27-1990; IN COMMERCE 2-27-1990.

THE MARK CONSISTS OF STANDARD CHARACTERS WITHOUT CLAIM TO ANY PARTICULAR FONT, STYLE, SIZE, OR COLOR.

SER. NO. 77-019,849, FILED 10-12-2006.

DOMINICK J. SALEMI, EXAMINING ATTORNEY

Int. Cl.: 9

Prior U.S. Cls.: 21, 23, 26, 36 and 38

United States Patent and Trademark Office

Reg. No. 3,474,521

Registered July 29, 2008

**TRADEMARK
PRINCIPAL REGISTER**

QUALITY REPORT CARD

MUNRO & ASSOCIATES, INC. (MICHIGAN CORPORATION)
1749 NORTHWOOD DRIVE
TROY, MI 48084

FOR: COMPUTER SOFTWARE THAT PROVIDES A COST-BASED ASSESSMENT OF PRODUCT DESIGNS FROM CREATION THROUGH PRODUCTION, IN CLASS 9 (U.S. CLS. 21, 23, 26, 36 AND 38).

FIRST USE 1-1-1995; IN COMMERCE 1-1-1995.

THE MARK CONSISTS OF STANDARD CHARACTERS WITHOUT CLAIM TO ANY PARTICULAR FONT, STYLE, SIZE, OR COLOR.

OWNER OF U.S. REG. NO. 2,864,159.

NO CLAIM IS MADE TO THE EXCLUSIVE RIGHT TO USE "QUALITY", APART FROM THE MARK AS SHOWN.

THE WORDING "REPORT CARD" HAS NO MEANING IN A FOREIGN LANGUAGE.

SER. NO. 77-019,973, FILED 10-12-2006.

STEPHEN AQUILA, EXAMINING ATTORNEY

Int. Cl.: 9

Prior U.S. Cls.: 21, 23, 26, 36 and 38

Reg. No. 3,474,522

United States Patent and Trademark Office

Registered July 29, 2008

TRADEMARK
PRINCIPAL REGISTER

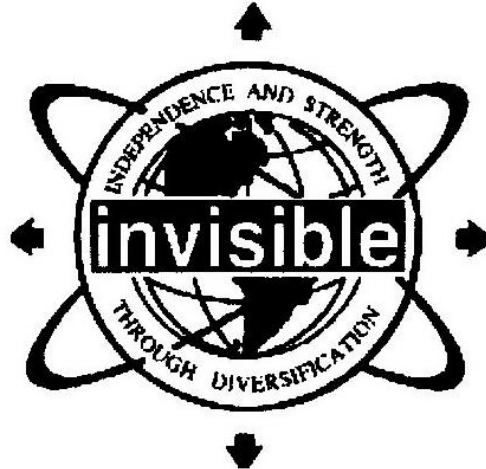

INVISIBLE RECORDS, INC. (ILLINOIS CORPORATION)
3919 S. LIUANICA
CHICAGO, IL 60608

FOR: SOUND RECORDINGS AND AUDIO-VISUAL RECORDINGS, NAMELY, COMPACT DISCS, TAPE CASSETTES, RECORDS, CD-ROMS, VIDEO TAPES, AND DVDS FEATURING MUSIC, DOWNLOADABLE SOUND RECORDINGS AND AUDIO-VISUAL RECORDINGS FEATURING MUSIC, IN CLASS 9 (U.S. CLS. 21, 23, 26, 36 AND 38).

FIRST USE 9-1-1988; IN COMMERCE 9-1-1988.

THE MARK CONSISTS OF THE WORDING "INVISIBLE" IN THE FOREGROUND, IN FRONT OF A GLOBE DESIGN. SURROUNDING THE GLOBE IS THE WORDING "INDEPENDENCE AND STRENGTH THROUGH DIVERSIFICATION". ORBITAL CIRCULAR LINES ALSO SURROUND THE GLOBE AND FOUR ARROWS APPEAR AROUND THE GLOBE DESIGN POINTING IN FOUR OPPOSITE DIRECTIONS.

SER. NO. 77-020,533, FILED 10-13-2006.

RICHARD A. STRASER, EXAMINING ATTORNEY

Int. Cl.: 7

Prior U.S. Cls.: 13, 19, 21, 23, 31, 34 and 35

United States Patent and Trademark Office

Reg. No. 3,474,523

Registered July 29, 2008

**TRADEMARK
PRINCIPAL REGISTER**

PRO SERIES

ESRMCO, INC. (DELAWARE CORPORATION)
LEGAL DEPARTMENT
2366 BERNVILLE ROAD
READING, PA 19605

FOR: BATTERY STACKER MACHINES FOR USE IN INDUSTRIAL BATTERY STORAGE AND HANDLING; BATTERY WASH RACK MACHINES USED TO SERVICE INDUSTRIAL BATTERIES; AND INDUSTRIAL BATTERY HANDLING EQUIPMENT, NAMELY, BATTERY STANDS, CHARGE STATIONS, TUGGERS, CHANGE CARS AND CRANES, IN CLASS 7 (U.S. CLS. 13, 19, 21, 23, 31, 34 AND 35).

FIRST USE 5-7-1986; IN COMMERCE 5-7-1986.

THE MARK CONSISTS OF STANDARD CHARACTERS WITHOUT CLAIM TO ANY PARTICULAR FONT, STYLE, SIZE, OR COLOR.

NO CLAIM IS MADE TO THE EXCLUSIVE RIGHT TO USE "SERIES", APART FROM THE MARK AS SHOWN.

SEC. 2(F).

SER. NO. 77-022,093, FILED 10-16-2006.

CARYN GLASSER, EXAMINING ATTORNEY

Int. Cl.: 25

Prior U.S. Cls.: 22 and 39

United States Patent and Trademark Office

Reg. No. 3,474,524

Registered July 29, 2008

TRADEMARK
PRINCIPAL REGISTER



HEDVAT, LEON (UNITED STATES INDIVIDUAL)
525 BRYANT AVENUE
ROSLYN HARBOR, NY 11576

FOR: LADIES' APPAREL, NAMELY, SWEATERS, KNIT TOPS, AND SWEATSUITS, IN CLASS 25 (U.S. CLS. 22 AND 39).

FIRST USE 1-1-2006; IN COMMERCE 1-1-2006.

THE COLOR(S) WHITE, GREY, RED AND BLACK IS/ARE CLAIMED AS A FEATURE OF THE MARK.

THE MARK CONSISTS OF THE WORDS, "SWEET JULIET" IN WHITE STYLIZED TEXT, BORDERED ON TOP AND BOTTOM BY A SINGLE RED ROSE WITH GREY LEAVES AND VINES, ALL OF WHICH RESTS ON A BLACK BACKGROUND.

SER. NO. 77-022,461, FILED 10-17-2006.

MARY ROSSMAN, EXAMINING ATTORNEY

Int. Cl.: 7

Prior U.S. Cls.: 13, 19, 21, 23, 31, 34 and 35

United States Patent and Trademark Office

Reg. No. 3,474,525

Registered July 29, 2008

**TRADEMARK
PRINCIPAL REGISTER**

BEKOKAT

BEKO CONDENSATE SYSTEMS CORPORATION
(DELAWARE CORPORATION), DBA BEKO
TECHNOLOGIES CORP.
236 RACEWAY DRIVE, SUITE 1
MOORESVILLE, NC 28117

THE MARK CONSISTS OF STANDARD CHAR-
ACTERS WITHOUT CLAIM TO ANY PARTICULAR
FONT, STYLE, SIZE, OR COLOR.

FOR: CATALYTIC CONVERTER FOR PURIFY-
ING OIL-LADEN AIR FROM COMPRESSORS, IN
CLASS 7 (U.S. CLS. 13, 19, 21, 23, 31, 34 AND 35).

SER. NO. 77-025,429, FILED 10-19-2006.

FIRST USE 9-10-2006; IN COMMERCE 9-10-2006.

JENNIFER MARTIN, EXAMINING ATTORNEY

Int. Cls.: 5 and 18

Prior U.S. Cls.: 1, 2, 3, 6, 18, 22, 41, 44, 46, 51 and 52

Reg. No. 3,474,526

United States Patent and Trademark Office

Registered July 29, 2008

**TRADEMARK
PRINCIPAL REGISTER**

SA SA

SA SA OVERSEAS LIMITED (BR.VIRGIN ISLANDS CORPORATION)
OFFSHORE INCORPORATIONS CENTRE
ROADTOWN, BR.VIRGIN ISLANDS

FOR: PHARMACEUTICAL PREPARATIONS FOR SKIN CARE AND HAIR CARE; MEDICATED SKIN CARE PREPARATIONS, MEDICATED HAIR CARE PREPARATIONS, HERBAL MUD PACKS FOR THERAPEUTIC SKIN CARE, MEDICATED DENTAL FLOSS; PHARMACEUTICAL PREPARATIONS FOR TREATING DANDRUFF IN THE NATURE OF DANDRUFF SHAMPOO; DERMATOLOGICAL PHARMACEUTICAL PREPARATIONS FOR TOPICAL WEIGHT CONTROL AND BODY SLIMMING PURPOSES; DERMATOLOGICAL PHARMACEUTICAL PREPARATIONS FOR TOPICAL BODY REFINING AND BODY SHAPING; MEDICINES OF CHINESE ORIGIN FOR SKIN CARE, HAIR CARE AND SLIMMING PURPOSES; MEDICINAL HERBAL EXTRACTS FOR MEDICAL PURPOSES; DIETETIC FOODS, SUGAR AND TONICS ADAPTED FOR MEDICAL USE; DIETARY SUPPLEMENTS; VITAMIN AND MINERAL SUPPLEMENTS; DIETARY FIBER AS AN ADDITIVE FOR FOOD SUPPLEMENTS; SOY PROTEIN FOR USE AS A NUTRITIONAL INGREDIENT IN FOOD SUPPLEMENTS; MEDICINAL ALCOHOL IN THE FORM OF WINES; GINSENG FOR MEDICINAL USE; FOOD SUPPLEMENTS CONTAINING GINSENG; MEDICINAL HERB EXTRACTS IN THE NATURE OF LINGZHI; ALOE VERA GEL FOR THERAPEUTIC PURPOSES; FOOD SUPPLEMENTS FOR MEDICINAL PURPOSES; BEE POLLEN FOR USE AS A DIETARY FOOD SUPPLEMENT; NUTRITIONAL SUPPLEMENTS; NUTRITIONALLY FORTIFIED BEVERAGES CONTAINING VITAMINS, MINERALS, FIBER AND DIETARY SUPPLEMENTS, AND PREPARATIONS FOR MAKING NUTRITIONALLY FORTIFIED BEVERAGES CONTAINING VITAMINS, MINERALS, FIBER AND DIETARY SUPPLEMENTS; HERBAL SUPPLEMENTS IN TABLET,

CAPSULE, PILL, LIQUID, JELLY, AND POWDER FORM, AND IN OINTMENT, CREAM OR LOTION FORM SOLD AS A COMPONENT OF NUTRITIONAL SKIN CARE PRODUCTS; NUTRITIONAL SUPPLEMENTS IN TABLET, CAPSULE, PILL, LIQUID, JELLY, AND POWDER FORM, AND IN OINTMENT, CREAM, OR LOTION FORM SOLD AS A COMPONENT OF NUTRITIONAL SKIN CARE PRODUCTS; DIET PILLS AND CAPSULES; STIMULATORY MEDICATIONS FOR USE IN WEIGHT CONTROL, SLIMMING, AND BODY REFINING AND SHAPING PROGRAMS IN TABLET, CAPSULE, PILL, LIQUID, JELLY AND POWDER FORM, AND IN OINTMENT, CREAM OR LOTION FORM SOLD AS A COMPONENT OF MEDICINAL SKIN CARE PREPARATIONS; MEDICATED PRE-MOISTENED WIPES FOR THE SKIN; SANITARY MEDICATED HAND WASH; MEDICATED SANITIZING WIPES, PADS AND TOWELETTES; INCONTINENCE DIAPERS, IN CLASS 5 (U.S. CLS. 6, 18, 44, 46, 51 AND 52).

FOR: LEATHER SOLD IN BULK; IMITATION LEATHER; LEATHER HANDBAGS; ANIMAL SKINS AND HIDES; TRUNKS BEING LUGGAGE, AND TRAVELING BAGS; UMBRELLAS, PARASOLS AND WALKING STICKS; WHIPS, HARNESSES AND SADDLERY; TOTE BAGS; PURSES; WALLETS; CARRYING CASES; LUGGAGE; POUCHES OF LEATHER; ATTACHÉ CASES; BACKPACKS; GARMENT BAGS FOR TRAVEL; LEATHER SHOPPING BAGS; CANES; BUSINESS CARD CASES; NAME CARD CASES; CREDIT CARD CASES; COLLARS FOR PETS; DOG COLLARS, HORSE COLLARS; KEY CASES; VANITY CASES SOLD EMPTY; MUZZLES; SCHOOL SATCHELS; HANDLES SOLD AS A COMPONENT PART OF SUITCASES; SUITCASES; SETS OF LEATHER TRAVELING BAGS; TRAVELING TRUNKS BEING LUGGAGE; UMBRELLA COVERS; UMBRELLA HANDLES; WALKING STICK SEATS; STRAPS FOR LUGGAGE IN BELT FORM; BEACH BAGS;

BRIEFCASES; LEATHER BOXES FOR STORING GREETING CARDS; LEATHER CASES; HANDBAGS; LEATHER STRAPS; MOUNTAINEERING STICKS; STRING NET BAGS FOR SHOPPING; RUCKSACKS; SCHOOL BAGS; LEATHER BAGS, ENVELOPES AND POUCHES FOR MERCHANDISE PACKAGING; LEATHER AND IMITATION LEATHER FOR FURNITURE; HANDBAG FRAMES; SLING BAGS FOR CARRYING INFANTS; SHOPPING BAGS WITH WHEELS ATTACHED, IN CLASS 18 (U.S. CLS. 1, 2, 3, 22 AND 41).

THE MARK CONSISTS OF STANDARD CHARACTERS WITHOUT CLAIM TO ANY PARTICULAR FONT, STYLE, SIZE, OR COLOR.

OWNER OF HONG KONG REG. NO. 300053072, DATED 7-25-2003, EXPIRES 7-25-2013.

OWNER OF HONG KONG REG. NO. 300366219, DATED 2-4-2005, EXPIRES 2-4-2015.

OWNER OF U.S. REG. NOS. 2,446,341, 2,857,114, AND 3,039,350.

SER. NO. 77-025,863, FILED 10-20-2006.

ZHALEH DELANEY, EXAMINING ATTORNEY

Int. Cl.: 33

Prior U.S. Cls.: 47 and 49

United States Patent and Trademark Office

Reg. No. 3,474,527

Registered July 29, 2008

**TRADEMARK
PRINCIPAL REGISTER**

ADVENTUROUS

HOLDENER, LANI J. (UNITED STATES INDIVIDUAL)
MACCHIA
12470 LOCKE ROAD
LOCKEFORD, CA 95237 AND
HOLDENER, TIM (UNITED STATES INDIVIDUAL)
MACCHIA
12470 LOCKE ROAD
LOCKEFORD, CA 95237 AND
LANI J. HOLDENER (UNITED STATES INDIVIDUAL)
12470 LOCKE ROAD
LOCKEFORD, CA 95237

FOR: WINES, IN CLASS 33 (U.S. CLS. 47 AND 49).

FIRST USE 8-1-2002; IN COMMERCE 8-1-2002.

THE MARK CONSISTS OF STANDARD CHARACTERS WITHOUT CLAIM TO ANY PARTICULAR FONT, STYLE, SIZE, OR COLOR.

SER. NO. 77-026,452, FILED 10-20-2006.

SUZANNE BLANE, EXAMINING ATTORNEY

Int. Cls.: 9 and 42

Prior U.S. Cls.: 21, 23, 26, 36, 38, 100 and 101

United States Patent and Trademark Office

Reg. No. 3,474,528

Registered July 29, 2008

**TRADEMARK
SERVICE MARK
PRINCIPAL REGISTER**

IPI.MANAGER

JSC «INTERNET PROJECTS» (RUSSIAN FED.
JOINT STOCK COMPANY)
BLOCK A, OFFICE 4
11 DERBENEVSKAYA NAB.
MOSCOW, RUSSIAN FED. 113114

FOR: COMPUTER UTILITY PROGRAMS; DOWN-
LOADABLE COMPUTER SOFTWARE FOR TASK
MANAGEMENT AND INCIDENT REPORTING
AND TRACKING, IN CLASS 9 (U.S. CLS. 21, 23, 26,
36 AND 38).

FIRST USE 9-26-2006; IN COMMERCE 9-26-2006.

FOR: APPLICATION SERVICE PROVIDER FEATURING SOFTWARE FOR TASK MANAGEMENT AND INCIDENT REPORTING; PROVIDING A WEBSITE THAT FEATURES ON THE SOFTWARE IN

THE FIELD OF TASK MANAGEMENT AND INCIDENT REPORTING; PROVIDING A WEBSITE FEATURING INTERACTIVE TECHNICAL SUPPORT SERVICES IN THE FIELD OF TASK MANAGEMENT AND INCIDENT REPORTING, IN CLASS 42 (U.S. CLS. 100 AND 101).

FIRST USE 9-26-2006; IN COMMERCE 9-26-2006.

THE MARK CONSISTS OF STANDARD CHARACTERS WITHOUT CLAIM TO ANY PARTICULAR FONT, STYLE, SIZE, OR COLOR.

SER. NO. 77-028,392, FILED 10-24-2006.

TEJBIR SINGH, EXAMINING ATTORNEY

Int. Cl.: 30

Prior U.S. Cl.: 46

United States Patent and Trademark Office

Reg. No. 3,474,529

Registered July 29, 2008

**TRADEMARK
PRINCIPAL REGISTER**

CHAI-NIS

GRUPO BIMBO, S.A. B. DE C.V. (MEXICO CORPORATION)
NO. 1000, COL. PENA BLANCA SANTA FE
PROLONGACION PASEO DE LA REFORMA
MEXICO CITY, MEXICO 01210

OWNER OF MEXICO REG. NO. 944517, DATED 7-25-2006, EXPIRES 6-23-2016.

FOR: BUBBLE GUM, IN CLASS 30 (U.S. CL. 46).

SER. NO. 77-030,397, FILED 10-26-2006.

THE MARK CONSISTS OF STANDARD CHARACTERS WITHOUT CLAIM TO ANY PARTICULAR FONT, STYLE, SIZE, OR COLOR.

HEATHER BIDDULPH, EXAMINING ATTORNEY

Int. Cl.: 9

Prior U.S. Cls.: 21, 23, 26, 36 and 38

United States Patent and Trademark Office

Reg. No. 3,474,530

Registered July 29, 2008

**TRADEMARK
PRINCIPAL REGISTER**

ABA

ARMOR HOLDINGS PRODUCTS, LLC (DELA-
WARE LTD LIAB CO)
13386 INTERNATIONAL PARKWAY
JACKSONVILLE, FL 32218

THE MARK CONSISTS OF STANDARD CHAR-
ACTERS WITHOUT CLAIM TO ANY PARTICULAR
FONT, STYLE, SIZE, OR COLOR.

FOR: BULLET PROOF AND BULLET RESISTANT
BODY ARMOR AND CLOTHING, IN CLASS 9 (U.S.
CLS. 21, 23, 26, 36 AND 38).

SER. NO. 77-030,848, FILED 10-27-2006.

FIRST USE 1-1-1969; IN COMMERCE 1-1-1969.

ANDREA BUTLER, EXAMINING ATTORNEY

Int. Cl.: 28

Prior U.S. Cls.: 22, 23, 38 and 50

United States Patent and Trademark Office

Reg. No. 3,474,531

Registered July 29, 2008

**TRADEMARK
PRINCIPAL REGISTER**

FAIRFIELD MINT

FAIRFIELD MINT, LLC (DELAWARE LTD LIAB
CO)
SUITE M
71 EAST STREET
NORWALK, CT 06851

FOR: DIE-CAST AND PLASTIC TOY VEHICLE,
TOY MODEL CARS, REPLICAS, TOY MODEL CARS
AND COLLECTIBLE TOY CARS; MODELED PLAS-
TIC TOY FIGURINES, IN CLASS 28 (U.S. CLS. 22, 23,
38 AND 50).

FIRST USE 8-0-1995; IN COMMERCE 8-0-1995.

THE MARK CONSISTS OF STANDARD CHAR-
ACTERS WITHOUT CLAIM TO ANY PARTICULAR
FONT, STYLE, SIZE, OR COLOR.

NO CLAIM IS MADE TO THE EXCLUSIVE
RIGHT TO USE "MINT", APART FROM THE MARK
AS SHOWN.

SER. NO. 77-032,486, FILED 10-30-2006.

WARREN L. OLANDRIA, EXAMINING ATTOR-
NEY

Int. Cl.: 41

Prior U.S. Cls.: 100, 101 and 107

United States Patent and Trademark Office

Reg. No. 3,474,532

Registered July 29, 2008

**SERVICE MARK
PRINCIPAL REGISTER**

DJ CUE

CUEVAS, FRANK W (UNITED STATES INDIVIDUAL)
1582 STILWELL RD APT G
SAN FRANCISCO, CA 94129

FOR: ENTERTAINMENT IN THE NATURE OF LIVE PERFORMANCES BY A DISC JOCKEY FOR PARTIES, CLUBS AND SPECIAL EVENTS, IN CLASS 41 (U.S. CLS. 100, 101 AND 107).

FIRST USE 9-1-1991; IN COMMERCE 9-1-1991.

THE MARK CONSISTS OF STANDARD CHARACTERS WITHOUT CLAIM TO ANY PARTICULAR FONT, STYLE, SIZE, OR COLOR.

NO CLAIM IS MADE TO THE EXCLUSIVE RIGHT TO USE "DJ", APART FROM THE MARK AS SHOWN.

SER. NO. 77-035,844, FILED 11-2-2006.

DEZMONA MIZELLE, EXAMINING ATTORNEY

Int. Cls.: 9, 16, 25 and 41

**Prior U.S. Cls.: 2, 5, 21, 22, 23, 26, 29, 36, 37, 38, 39,
50, 100, 101 and 107**

Reg. No. 3,474,533

United States Patent and Trademark Office

Registered July 29, 2008

**TRADEMARK
SERVICE MARK
PRINCIPAL REGISTER**

edible

EDIBLE COMMUNITIES, INC. (MONTANA CORPORATION)
210 NORTH HIGGINS, SUITE 222
MISSOULA, MT 59802

FOR: DOWNLOADABLE ELECTRONIC PUBLICATIONS IN THE NATURE OF MAGAZINES AND NEWSLETTERS FEATURING THE TOURISM, CULINARY AND AGRICULTURE INDUSTRIES; DOWNLOADABLE ELECTRONIC PUBLICATIONS IN THE NATURE OF MAGAZINES AND NEWSLETTERS FEATURING LOCAL GROWERS, FOOD RETAILERS, CHEFS AND FOOD ARTISANS; ELECTRONIC PUBLICATIONS, NAMELY, MAGAZINES AND NEWSLETTERS FEATURING THE TOURISM, CULINARY AND AGRICULTURE INDUSTRIES RECORDED ON COMPUTER MEDIA; ELECTRONIC PUBLICATIONS, NAMELY, MAGAZINES AND NEWSLETTERS FEATURING LOCAL GROWERS, FOOD RETAILERS, CHEFS AND FOOD ARTISANS RECORDED ON COMPUTER MEDIA , IN CLASS 9 (U.S. CLS. 21, 23, 26, 36 AND 38).

FIRST USE 1-5-2004; IN COMMERCE 1-5-2004.

FOR: PUBLICATIONS, NAMELY, MAGAZINES AND NEWSLETTERS FEATURING THE TOURISM, CULINARY AND AGRICULTURE INDUSTRIES; PUBLICATIONS, NAMELY, MAGAZINES AND

NEWSLETTERS FEATURING LOCAL GROWERS, FOOD RETAILERS, CHEFS AND FOOD ARTISANS, IN CLASS 16 (U.S. CLS. 2, 5, 22, 23, 29, 37, 38 AND 50).

FIRST USE 1-5-2004; IN COMMERCE 1-5-2004.

FOR: SHIRTS, T-SHIRTS, TANK-TOPS, APRONS, CAPS, TOPS , IN CLASS 25 (U.S. CLS. 22 AND 39).

FIRST USE 1-5-2004; IN COMMERCE 1-5-2004.

FOR: PROVIDING ON-LINE PUBLICATIONS IN THE NATURE OF MAGAZINES AND NEWSLETTERS FEATURING THE TOURISM, CULINARY AND AGRICULTURE INDUSTRIES; PROVIDING ON-LINE PUBLICATIONS IN THE NATURE OF MAGAZINES AND NEWSLETTERS FEATURING LOCAL GROWERS, FOOD RETAILERS, CHEFS AND FOOD ARTISANS, IN CLASS 41 (U.S. CLS. 100, 101 AND 107).

FIRST USE 1-5-2004; IN COMMERCE 1-5-2004.

OWNER OF U.S. REG. NO. 3,153,095.

SER. NO. 77-037,596, FILED 11-6-2006.

SAIMA MAKHDOOM, EXAMINING ATTORNEY

Int. Cl.: 35

Prior U.S. Cls.: 100, 101 and 102

United States Patent and Trademark Office

Reg. No. 3,474,534

Registered July 29, 2008

**SERVICE MARK
PRINCIPAL REGISTER**



EYE OPTIQUE, INC. (GEORGIA CORPORATION)
SUITE 220
10800 ALPHARETTA HIGHWAY
ROSWELL, GA 30076

FOR: RETAIL STORE SERVICES OFFERING
EYEWEAR, IN CLASS 35 (U.S. CLS. 100, 101 AND
102).

FIRST USE 5-0-1986; IN COMMERCE 5-0-1986.

NO CLAIM IS MADE TO THE EXCLUSIVE
RIGHT TO USE "EYE", APART FROM THE MARK
AS SHOWN.

THE MARK CONSISTS OF THE WORDS "EYE
OPTIQUE" WITH THE "O" AND "Q" FORMING
EYGLASSES.

SER. NO. 77-038,363, FILED 11-7-2006.

BERYL GARDNER, EXAMINING ATTORNEY

Int. Cls.: 33, 35 and 43

Prior U.S. Cls.: 47, 49, 100, 101 and 102

United States Patent and Trademark Office

Reg. No. 3,474,535

Registered July 29, 2008

TRADEMARK
SERVICE MARK
PRINCIPAL REGISTER

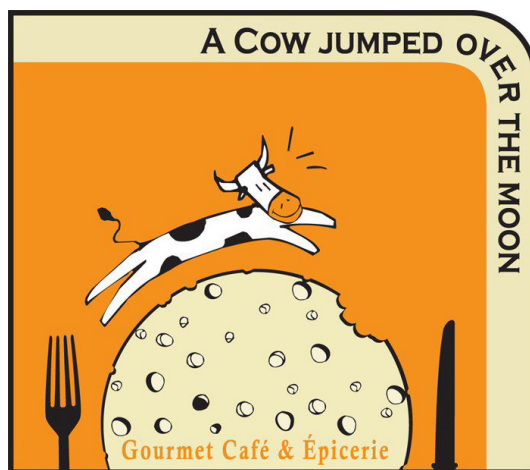

A COW ON RODEO, LLC (CALIFORNIA LTD
LIAB CO)
9629 BRIGHTON WAY
BEVERLY HILLS, CA 90210

FOR: ALCOHOLIC BEVERAGES, NAMELY
WINES, IN CLASS 33 (U.S. CLS. 47 AND 49).

FIRST USE 6-1-2006; IN COMMERCE 6-1-2006.

FOR: RETAIL BAKERY SHOP SERVICES; RE-
TAIL STORE SERVICES FEATURING A RANGE OF
SPECIALTY FOOD AND DRINK PRODUCTS AND
INGREDIENTS; AND FRANCHISE SERVICES,
NAMELY, OFFERING TECHNICAL AND BUSI-
NESS MANAGEMENT ASSISTANCE IN THE ES-
TABLISHMENT AND OPERATION OF
RESTAURANTS COMBINED WITH RETAIL BA-
KERY SHOPS AND RETAIL STORES FEATURING
FOOD AND DRINK PRODUCTS, IN CLASS 35 (U.S.
CLS. 100, 101 AND 102).

FIRST USE 6-1-2006; IN COMMERCE 6-1-2006.

FOR: PROVISION OF FOOD AND DRINKS IN
RESTAURANT, COFFEE SHOPS, BARS, CATERING
SERVICES, RESTAURANTS AND COFFEE HOUSE
SERVICES, IN CLASS 43 (U.S. CLS. 100 AND 101).

FIRST USE 6-1-2006; IN COMMERCE 6-1-2006.

NO CLAIM IS MADE TO THE EXCLUSIVE
RIGHT TO USE "GOURMET CAFE AND EPICERIE-
", APART FROM THE MARK AS SHOWN.

"THE COLOR(S) BLACK, WHITE, YELLOW, OR-
ANGE IS/ARE CLAIMED AS A FEATURE OF THE
MARK."

"THE MARK CONSISTS OF A BLACK AND
WHITE COW JUMPING OVER A YELLOW WHEEL
OF CHEESE WITH BLACK KNIFE ON THE RIGHT
SIDE AND A BLACK FORK ON THE LEFT SIDE ON
AN ORANGE BACKGROUND WITH THE WORDS
"A COW JUMPED OVER THE MOON" ON THE
UPPER RIGHT CORNER WRITTEN IN BLACK IN A
YELLOW BACKGROUND AND THE WORDS
"GOURMET CAFE AND EPICERIE" IN YELLOW
ON THE WHEEL OF CHEESE."

"THE FOREIGN WORDING IN THE MARK
TRANSLATES INTO ENGLISH AS GROCERY
STORE."

SER. NO. 77-039,124, FILED 11-7-2006.

CAROLYN CATALDO, EXAMINING ATTORNEY

Int. Cl.: 10

Prior U.S. Cls.: 26, 39 and 44

United States Patent and Trademark Office

Reg. No. 3,474,536

Registered July 29, 2008

**TRADEMARK
PRINCIPAL REGISTER**



AI MEDICAL DEVICES, INC. (MICHIGAN CORPORATION)
311 TURNER ROAD
WILLIAMSTON, MI 48895

FOR: MEDICAL INSTRUMENTS FOR USE IN PLACEMENT OR REMOVAL OF AN ENDOTRACHEAL TUBE, IN CLASS 10 (U.S. CLS. 26, 39 AND 44).

FIRST USE 10-15-2006; IN COMMERCE 10-15-2006.

NO CLAIM IS MADE TO THE EXCLUSIVE RIGHT TO USE "MEDICAL" AND "DEVICES INC.", APART FROM THE MARK AS SHOWN.

THE COLOR(S) BLACK, RED AND WHITE IS/ARE CLAIMED AS A FEATURE OF THE MARK.

THE MARK CONSISTS OF THE WORDING "AI MEDICAL DEVICES, INC." AND A LINE DESIGN-ELEMENT IN BLACK, A WHITE PLUS-SIGN ON A RED CIRCULAR BACKGROUND, AROUND WHICH ARE TWO RED AND TWO WHITE CONCENTRIC CIRCLES, WHICH CIRCLES ARE NUDGED SLIGHTLY TO THE LEFT. THE COLOR BLACK APPEARS IN THE LITERAL PORTIONS "AI MEDICAL DEVICES, INC.", AND IN THE LINE DESIGN-ELEMENT. THE COLOR WHITE APPEARS IN THE CIRCLE AND PLUS SYMBOL DESIGN-ELEMENTS. THE COLOR RED APPEARS IN THE CIRCLE DESIGN-ELEMENT.

SER. NO. 77-042,321, FILED 11-13-2006.

ANTHONY RINKER, EXAMINING ATTORNEY

Int. Cls.: 35, 41 and 42

Prior U.S. Cls.: 100, 101, 102 and 107

United States Patent and Trademark Office

Reg. No. 3,474,537

Registered July 29, 2008

**SERVICE MARK
PRINCIPAL REGISTER**

ZING

ZING COMMUNICATIONS PTY LTD. (AUSTRALIA PROPRIETARY LIMITED COMPANY)
SURRY HILLS
131-133 DEVONSHIRE STREET
NEW SOUTH WALES, AUSTRALIA 2010

FOR: MARKETING CONSULTING; BUSINESS PLANNING IN THE FIELD OF BROADCAST MEDIA; PUBLIC RELATIONS; COPYWRITING, NAMELY, THE WRITING OF ADVERTISING COPY DESIGNED TO SELL THE PRODUCTS OR SERVICES OF OTHERS; PREPARATION AND REALIZATION OF MEDIA AND ADVERTISING PLANS AND CONCEPTS; CORPORATE PUBLIC RELATIONS; ADVERTISING, MARKETING AND PROMOTION SERVICES; BUSINESS CONSULTATION AND MANAGEMENT REGARDING MARKETING ACTIVITIES AND LAUNCHING NEW PRODUCTS; PROMOTING AND ENDORSING THE GOODS AND SERVICES OF OTHERS THROUGH THE ISSUANCE OF PRODUCT AND SERVICE ENDORSEMENTS BY A SPORTS CELEBRITY, AND THROUGH ADVERTISING APPEARANCES OR PRODUCTS AND SERVICES BY A SPORTS CELEBRITY; DISSEMINATION OF ADVERTISING FOR OTHERS VIA THE INTERNET; AND SPONSORSHIP SEARCH SERVICES, IN CLASS 35 (U.S. CLS. 100, 101 AND 102).

FIRST USE 9-30-2004; IN COMMERCE 9-30-2004.

FOR: PRODUCTION OF VIDEO CASSETTES, DISCS AND TAPES FOR OTHERS; AND ENTERTAINMENT SERVICES, NAMELY, PERSONAL APPEARANCES BY A SPORTS, MUSIC, FILM OR TELEVISION CELEBRITY, IN CLASS 41 (U.S. CLS. 100, 101 AND 107).

FIRST USE 9-30-2004; IN COMMERCE 9-30-2004.

FOR: GRAPHIC ART DESIGN; GRAPHIC DESIGN SERVICES; AND DESIGN OF WEBSITES FOR OTHERS, IN CLASS 42 (U.S. CLS. 100 AND 101).

FIRST USE 9-30-2004; IN COMMERCE 9-30-2004.

THE MARK CONSISTS OF STANDARD CHARACTERS WITHOUT CLAIM TO ANY PARTICULAR FONT, STYLE, SIZE, OR COLOR.

SER. NO. 77-042,775, FILED 11-13-2006.

DAVID COLLIER, EXAMINING ATTORNEY

Int. Cl.: 16

Prior U.S. Cls.: 2, 5, 22, 23, 29, 37, 38 and 50

Reg. No. 3,474,538

United States Patent and Trademark Office

Registered July 29, 2008

**TRADEMARK
PRINCIPAL REGISTER**

LEONARD WREN

WREN, LEONARD (UNITED STATES INDIVIDUAL)
P O BOX 751
LOPEZ ISLAND, WA 98261

FOR: ORIGINAL ARTWORK, NAMELY, ORIGINAL PAINTINGS; REPRODUCTIONS OF ORIGINAL ARTWORK, NAMELY, GICLEE, LITHOGRAPHS, SERIGRAPHS, ETCHINGS, PRINTS, SKETCHES, DRAWINGS, POSTERS; PRINTED REPRODUCTIONS OF ORIGINAL ARTWORK; ART BOOKS; CALENDARS; NOTE CARDS; FILE FOLDERS; COMMEMORATIVE POSTAGE STAMPS; EXHIBITION AND PROMOTIONAL CATALOGS, NAMELY, IN THE FIELD OF ARTWORK; MURALS; PRINTED DIGITAL REPRODUCTIONS OF ORIGINAL PAINTINGS; COLORING BOOKS; MODELING CLAY; MODELING COMPOUND; MOLDS FOR MODELING CLAY; ART ETCHINGS;

ART MOUNTS; ART PAD; ART PAPER; ART PRINTS, IN CLASS 16 (U.S. CLS. 2, 5, 22, 23, 29, 37, 38 AND 50).

FIRST USE 3-31-1977; IN COMMERCE 3-31-1977.

THE MARK CONSISTS OF STANDARD CHARACTERS WITHOUT CLAIM TO ANY PARTICULAR FONT, STYLE, SIZE, OR COLOR.

THE NAME(S), PORTRAIT(S), AND/OR SIGNATURE(S) SHOWN IN THE MARK IDENTIFIES "LEONARD WREN", WHOSE CONSENT(S) TO REGISTER IS SUBMITTED.

SER. NO. 77-043,027, FILED 11-13-2006.

SAIMA MAKHDOOM, EXAMINING ATTORNEY

Int. Cl.: 9

Prior U.S. Cls.: 21, 23, 26, 36 and 38

United States Patent and Trademark Office

Reg. No. 3,474,539

Registered July 29, 2008

**TRADEMARK
PRINCIPAL REGISTER**

NETCOM

NETCOM, INC. (ILLINOIS CORPORATION)
599 WHEELING ROAD
WHEELING, IL 60090

FIRST USE 4-0-1977; IN COMMERCE 4-0-1977.

FOR: ELECTRONIC COMPONENTS SOLD TO ORIGINAL EQUIPMENT MANUFACTURERS, NAMELY, MONOLITHIC CRYSTAL FILTERS, BROADBAND CRYSTAL FILTERS, LC FILTERS, SINGLE SIDEBAND CRYSTAL FILTERS AND HIGH "Q" COILS, IN CLASS 9 (U.S. CLS. 21, 23, 26, 36 AND 38).

THE MARK CONSISTS OF STANDARD CHARACTERS WITHOUT CLAIM TO ANY PARTICULAR FONT, STYLE, SIZE, OR COLOR.

SER. NO. 77-043,280, FILED 11-14-2006.

SAIMA MAKHDOOM, EXAMINING ATTORNEY

Int. Cls.: 9 and 10

Prior U.S. Cls.: 21, 23, 26, 36, 38, 39 and 44

United States Patent and Trademark Office

Reg. No. 3,474,540

Registered July 29, 2008

**TRADEMARK
PRINCIPAL REGISTER**



NEMOTO KYORINDO CO., LTD. (JAPAN CORPORATION)
27-20, HONGO 2-CHOME, BUNKYO-KU
TOKYO, JAPAN 113-0033

FOR: COMPUTERS; BATTERIES, IN CLASS 9 (U.S. CLS. 21, 23, 26, 36 AND 38).

FOR: MEDICAL APPARATUS AND INSTRUMENTS, NAMELY, MEDICAL SYRINGES, MEDICAL FLUID INJECTORS, MEDICAL IMAGE DISPLAY APPARATUS, MEDICAL TUBES, MEDICAL NEEDLES, VESSELS FOR MEDICAL FLUIDS, PRESSURE JACKETS FOR SYRINGES, MEDICAL FLUID INJECTION PUMPS, ASPIRATORS, APPARATUS FOR MEDICAL DIAGNOSIS, NAMELY, CT SCANNERS, MRI SCANNERS, X-RAY DIAGNOSTIC APPARATUS, PET SCANNERS AND ANGIO-

GRAPHIC APPARATUS, IN CLASS 10 (U.S. CLS. 26, 39 AND 44).

OWNER OF JAPAN REG. NO. 5081582, DATED 10-5-2007, EXPIRES 10-5-2017.

NO CLAIM IS MADE TO THE EXCLUSIVE RIGHT TO USE "RFID", APART FROM THE MARK AS SHOWN.

THE MARK CONSISTS OF THE LETTERS "RFID" SURROUNDED BY AN OVAL DESIGN.

SER. NO. 77-043,441, FILED 11-14-2006.

MATTHEW MCDOWELL, EXAMINING ATTORNEY

Int. Cls.: 6, 7, 8, 9 and 12

Prior U.S. Cls.: 2, 12, 13, 14, 19, 21, 23, 25, 26, 28, 31, 34, 35, 36, 38, 44 and 50

Reg. No. 3,474,541

United States Patent and Trademark Office

Registered July 29, 2008

**TRADEMARK
PRINCIPAL REGISTER**

DURALAST

AUTOZONE PARTS, INC. (NEVADA CORPORATION)
123 SOUTH FRONT STREET
MEMPHIS, TN 38103

FOR: METAL TOOL BOXES EXCEPT FOR THOSE SPECIFICALLY DESIGNED AND INTENDED FOR USE IN ROOFING APPLICATIONS, IN CLASS 6 (U.S. CLS. 2, 12, 13, 14, 23, 25 AND 50).

FIRST USE 9-0-2005; IN COMMERCE 9-0-2005.

FOR: IGNITION COMPONENTS, NAMELY, IGNITION WIRES AND COIL ON SPARK PLUG INSULATORS FOR LAND VEHICLES; DISTRIBUTOR CAPS, WATER PUMPS, ALL FOR LAND VEHICLES; SPARK PLUGS, AND TIMING BELTS FOR ENGINES FOR LAND VEHICLES, IN CLASS 7 (U.S. CLS. 13, 19, 21, 23, 31, 34 AND 35).

FIRST USE 12-0-2004; IN COMMERCE 12-0-2004.

FOR: STANDS FOR HAND JACKS, IN CLASS 8 (U.S. CLS. 23, 28 AND 44).

FIRST USE 9-0-2006; IN COMMERCE 9-0-2006.

FOR: BATTERY CABLES; BATTERY TERMINAL PROTECTORS; MARINE BATTERIES; THERMOSTATS FOR MOTORS AND ENGINES; OXYGEN SENSORS FOR MOTORS AND ENGINES; WASHERS MADE OF FELT SPECIALLY ADAPTED FOR USE WITH CAR BATTERIES, IN CLASS 9 (U.S. CLS. 21, 23, 26, 36 AND 38).

FIRST USE 11-0-2004; IN COMMERCE 11-0-2004.

FOR: VEHICLE PARTS, NAMELY, BALL JOINTS, IDLER ARMS, KING PINS, CHASSIS, GEARS, UNIVERSAL JOINTS, CONTROL ARMS, TIE RODS ENDS, BUSHINGS, DRAG LINKS, CV AXLES, AND MASTER CYLINDERS; BRAKE DRUMS; BRAKE ROTORS FOR LAND VEHICLES; CLUTCH DISCS FOR LAND VEHICLES, CLUTCH SETS FOR LAND VEHICLES COMPOSED OF CLUTCH DISC, PRESSURE PLATE, RELEASE BEARING, PILOT BUSHING/BEARING AND ALIGNMENT TOOL; CONTROL ARM SHAFT KITS FOR SUSPENSIONS FOR VEHICLES CONSISTING OF A CONTROL ARM SHAFT, CONTROL ARM BUSHINGS, AND NUTS; LAND VEHICLE SUSPENSION PARTS, NAMELY, TORSION/SWAY BARS, COIL SPRINGS, SHOCK ABSORBERS, AND STABILIZER LINKS; V BELTS FOR LAND VEHICLE TRANSMISSIONS; MULTI V BELTS FOR LAND VEHICLE TRANSMISSIONS; UNIVERSAL JOINTS FOR LAND VEHICLES; WINDSHIELD WIPER BLADES, ALL FOR LAND VEHICLES, IN CLASS 12 (U.S. CLS. 19, 21, 23, 31, 35 AND 44).

FIRST USE 1-0-2005; IN COMMERCE 1-0-2005.

THE MARK CONSISTS OF STANDARD CHARACTERS WITHOUT CLAIM TO ANY PARTICULAR FONT, STYLE, SIZE, OR COLOR.

OWNER OF U.S. REG. NOS. 1,467,999, 1,607,305, AND 2,763,813.

SER. NO. 77-043,594, FILED 11-14-2006.

COLLEEN DOMBROW, EXAMINING ATTORNEY

Int. Cls.: 22 and 43

Prior U.S. Cls.: 1, 2, 7, 19, 22, 42, 50, 100 and 101

United States Patent and Trademark Office

Reg. No. 3,474,542

Registered July 29, 2008

**TRADEMARK
SERVICE MARK
PRINCIPAL REGISTER**

TOPTENT

GESTION PARABRIS INC. (CANADA COMPANY)
1562 VAN HORNE AVENUE, OUTREMONT
QUEBEC, CANADA H2V1L5

FOR: TENTS, IN CLASS 22 (U.S. CLS. 1, 2, 7, 19, 22,
42 AND 50).

FOR: RENTAL OF TENTS, IN CLASS 43 (U.S. CLS.
100 AND 101).

FIRST USE 1-5-2006; IN COMMERCE 1-5-2006.

THE MARK CONSISTS OF STANDARD CHARACTERS WITHOUT CLAIM TO ANY PARTICULAR FONT, STYLE, SIZE, OR COLOR.

PRIORITY CLAIMED UNDER SEC. 44(D) ON CANADA APPLICATION NO. 1323264, FILED 11-7-2006, REG. NO. TMA705059, DATED 1-21-2008, EXPIRES 1-21-2023.

SER. NO. 77-043,767, FILED 11-14-2006.

MARIAM MAHMOUDI, EXAMINING ATTORNEY

Int. Cls.: 35, 37 and 39

Prior U.S. Cls.: 100, 101, 102, 103, 105 and 106

United States Patent and Trademark Office

Reg. No. 3,474,543

Registered July 29, 2008

**SERVICE MARK
PRINCIPAL REGISTER**

VANGUARD TRUCK CENTERS

TOM GRADY ENTERPRISES, INC. (GEORGIA CORPORATION)
700 RUSKIN DRIVE
FOREST PARK, GA 30297

FOR: DEALERSHIP SERVICES IN THE FIELD OF NEW AND USED COMMERCIAL TRUCKS AND TRUCK PARTS, IN CLASS 35 (U.S. CLS. 100, 101 AND 102).

FIRST USE 2-1-2007; IN COMMERCE 2-1-2007.

FOR: COMMERCIAL TRUCK REPAIR AND MAINTENANCE, IN CLASS 37 (U.S. CLS. 100, 103 AND 106).

FIRST USE 2-1-2007; IN COMMERCE 2-1-2007.

FOR: LEASING OF COMMERCIAL TRUCKS, IN CLASS 39 (U.S. CLS. 100 AND 105).

FIRST USE 2-1-2007; IN COMMERCE 2-1-2007.

THE MARK CONSISTS OF STANDARD CHARACTERS WITHOUT CLAIM TO ANY PARTICULAR FONT, STYLE, SIZE, OR COLOR.

NO CLAIM IS MADE TO THE EXCLUSIVE RIGHT TO USE "TRUCK CENTERS", APART FROM THE MARK AS SHOWN.

SER. NO. 77-044,304, FILED 11-15-2006.

TEJBIR SINGH, EXAMINING ATTORNEY

Int. Cl.: 25

Prior U.S. Cls.: 22 and 39

United States Patent and Trademark Office

Reg. No. 3,474,544

Registered July 29, 2008

**TRADEMARK
PRINCIPAL REGISTER**



BAKER, PATRICK R. (UNITED STATES INDIVIDUAL)
7813 LABARRANCA CT.
SALT LAKE CITY, UT 84121

THE MARK CONSISTS OF A STYLIZED LETTER "B" AND A STYLIZED LETTER "H".

FOR: CLOTHING, NAMELY, SHIRTS, SWEATSHIRTS, HATS, AND SNOWBOARD AND SKI WEAR, IN CLASS 25 (U.S. CLS. 22 AND 39).

SER. NO. 77-044,364, FILED 11-15-2006.

FIRST USE 3-1-2006; IN COMMERCE 3-1-2006.

HEATHER BIDDULPH, EXAMINING ATTORNEY

Int. Cl.: 16

Prior U.S. Cls.: 2, 5, 22, 23, 29, 37, 38 and 50

United States Patent and Trademark Office

Reg. No. 3,474,545

Registered July 29, 2008

**TRADEMARK
PRINCIPAL REGISTER**

DEMO-2-DISPLAY

MASS CONNECTIONS, INC. (CALIFORNIA CORPORATION)
13131 EAST 166TH STREET
CERRITOS, CA 90703

THE MARK CONSISTS OF STANDARD CHARACTERS WITHOUT CLAIM TO ANY PARTICULAR FONT, STYLE, SIZE, OR COLOR.

FOR: CARDBOARD FLOOR DISPLAY UNITS
FOR MERCHANDISING PRODUCTS, IN CLASS 16
(U.S. CLS. 2, 5, 22, 23, 29, 37, 38 AND 50).

SER. NO. 77-044,427, FILED 11-15-2006.

FIRST USE 10-6-2003; IN COMMERCE 10-6-2003.

JORDAN BAKER, EXAMINING ATTORNEY

Int. Cl.: 16

Prior U.S. Cls.: 2, 5, 22, 23, 29, 37, 38 and 50

United States Patent and Trademark Office

Reg. No. 3,474,546

Registered July 29, 2008

**TRADEMARK
PRINCIPAL REGISTER**

SAMPLE & SELL IT

MASS CONNECTIONS, INC. (CALIFORNIA CORPORATION)
13131 EAST 166TH STREET
CERRITOS, CA 90703

THE MARK CONSISTS OF STANDARD CHARACTERS WITHOUT CLAIM TO ANY PARTICULAR FONT, STYLE, SIZE, OR COLOR.

FOR: CARDBOARD FLOOR DISPLAY UNITS FOR MERCHANDISING PRODUCTS, IN CLASS 16 (U.S. CLS. 2, 5, 22, 23, 29, 37, 38 AND 50).

SER. NO. 77-044,435, FILED 11-15-2006.

FIRST USE 10-6-2003; IN COMMERCE 10-6-2003.

JORDAN BAKER, EXAMINING ATTORNEY

Int. Cl.: 25

Prior U.S. Cls.: 22 and 39

United States Patent and Trademark Office

Reg. No. 3,474,547

Registered July 29, 2008

TRADEMARK
PRINCIPAL REGISTER

The image shows the handwritten trademark 'fs/ny' in black ink. The letters are in a cursive, lowercase font. The 'f' and 's' are connected, and the 'n' and 'y' are also connected. A vertical slash separates the 'fs' from the 'ny'.

FS/NY SHOES, LTD (NEW YORK CORPORATION)

985 LEXINGTON AVENUE

NEW YORK, NY 10021

FOR: SHOES, BOOTS, SLIPPERS, IN CLASS 25
(U.S. CLS. 22 AND 39).

FIRST USE 9-1-2004; IN COMMERCE 9-1-2004.

THE MARK CONSISTS OF STANDARD CHARACTERS WITHOUT CLAIM TO ANY PARTICULAR FONT, STYLE, SIZE, OR COLOR.

NO CLAIM IS MADE TO THE EXCLUSIVE RIGHT TO USE "NY", APART FROM THE MARK AS SHOWN.

SER. NO. 77-044,508, FILED 11-15-2006.

BRIAN PINO, EXAMINING ATTORNEY

Int. Cls.: 35 and 42

Prior U.S. Cls.: 100, 101 and 102

United States Patent and Trademark Office

Reg. No. 3,474,548

Registered July 29, 2008

**SERVICE MARK
PRINCIPAL REGISTER**

SPYDERWORKS

SPYDER WORKS INC. (CANADA CORPORATION)
3176 RIDGEWAY DRIVE, UNIT 59
MISSISSAUGA, CANADA L5L5S6

FOR: ADVERTISING SERVICES, MARKETING SERVICES AND CONSULTING SERVICES IN THE FIELD OF MARKETING, NAMELY, DEVELOPING MARKETING AND POSITIONING STRATEGIES FOR OTHERS, EVALUATING MARKETS FOR EXISTING PRODUCTS AND SERVICES OF OTHERS, DEVELOPING CORPORATE LOGOS AND IDENTIFICATIONS FOR OTHERS, PREPARING ADVERTISEMENTS FOR OTHERS, DEVELOPING IN-STORE DISPLAYS FOR OTHERS, ARRANGING FOR THE DEVELOPMENT OF PRODUCTS TO BE SOLD BY OTHERS, AND DESIGNING AND DEVELOPING PROMOTIONAL AND SALES LITERATURE AND MATERIAL FOR OTHERS, IN CLASS 35 (U.S. CLS. 100, 101 AND 102).

FOR: DESIGNING OF PACKAGING FOR PRODUCTS SOLD BY OTHERS; DESIGNING SHOWROOMS FOR OTHERS; DESIGNING AND DEVELOPING WEB SITES FOR OTHERS; PRODUCT DEVELOPMENT CONSULTATION, IN CLASS 42 (U.S. CLS. 100 AND 101).

THE MARK CONSISTS OF STANDARD CHARACTERS WITHOUT CLAIM TO ANY PARTICULAR FONT, STYLE, SIZE, OR COLOR.

PRIORITY CLAIMED UNDER SEC. 44(D) ON CANADA APPLICATION NO. 1304086, FILED 6-5-2006, REG. NO. TMA686725, DATED 4-27-2007, EXPIRES 4-27-2022.

SER. NO. 77-044,733, FILED 11-15-2006.

ANGELA M. MICHELI, EXAMINING ATTORNEY

Int. Cls.: 35, 41 and 44

Prior U.S. Cls.: 100, 101, 102 and 107

United States Patent and Trademark Office

Reg. No. 3,474,549

Registered July 29, 2008

**SERVICE MARK
PRINCIPAL REGISTER**

IHI

INTERACTIVE HEALTH SOLUTIONS, INC. (DELAWARE CORPORATION)
3800 NORTH WILKE ROAD SUITE 155
ARLINGTON HEIGHTS, IL 60004

FOR: MANAGEMENT OF HEALTH CARE INSURANCE AND BENEFITS COSTS, IN CLASS 35 (U.S. CLS. 100, 101 AND 102).

FIRST USE 1-0-2006; IN COMMERCE 1-0-2006.

FOR: EDUCATIONAL SERVICES, NAMELY, PROVIDING SEMINARS IN THE FIELDS OF HEALTH AND WELLNESS TO IMPROVE EMPLOYEE PRODUCTIVITY, IN CLASS 41 (U.S. CLS. 100, 101 AND 107).

FIRST USE 1-0-2006; IN COMMERCE 1-0-2006.

FOR: MEDICAL EVALUATION SERVICES, NAMELY, ON SITE HEALTH ASSESSMENTS FOR EMPLOYEES FOR PRODUCTIVITY PURPOSES; MEDICAL COUNSELING TO EMPLOYEES FOR PRODUCTIVITY PURPOSES, IN CLASS 44 (U.S. CLS. 100 AND 101).

FIRST USE 1-0-2006; IN COMMERCE 1-0-2006.

THE MARK CONSISTS OF STANDARD CHARACTERS WITHOUT CLAIM TO ANY PARTICULAR FONT, STYLE, SIZE, OR COLOR.

SER. NO. 77-044,921, FILED 11-15-2006.

MICHAEL ENGEL, EXAMINING ATTORNEY

Int. Cl.: 41

Prior U.S. Cls.: 100, 101 and 107

United States Patent and Trademark Office

Reg. No. 3,474,550

Registered July 29, 2008

**SERVICE MARK
PRINCIPAL REGISTER**

CALE GALE

GALE, CALE (UNITED STATES INDIVIDUAL)
3630 COUNTRY COURT SOUTH
MOBILE, AL 36619

FOR: ENTERTAINMENT SERVICES IN THE
NATURE OF PROFESSIONAL AUTOMOBILE RA-
CES AND RELATED RACING EXHIBITIONS, IN
CLASS 41 (U.S. CLS. 100, 101 AND 107).

FIRST USE 3-5-1985; IN COMMERCE 4-1-2000.

THE MARK CONSISTS OF STANDARD CHAR-
ACTERS WITHOUT CLAIM TO ANY PARTICULAR
FONT, STYLE, SIZE, OR COLOR.

THE NAME(S), PORTRAIT(S), AND/OR SIGNA-
TURE(S) SHOWN IN THE MARK IDENTIFIES
"CALE GALE", WHOSE CONSENT(S) TO REGISTER
IS SUBMITTED.

SER. NO. 77-047,429, FILED 11-19-2006.

VIVIAN MICZNIK FIRST, EXAMINING ATTOR-
NEY

Int. Cl.: 44

Prior U.S. Cls.: 100 and 101

United States Patent and Trademark Office

Reg. No. 3,474,551

Registered July 29, 2008

**SERVICE MARK
PRINCIPAL REGISTER**

RNSource

COMPSYCH CORPORATION (ILLINOIS CORPORATION)
13TH FLOOR
455 N. CITYFRONT PLAZA DRIVE
CHICAGO, IL 60611

FOR: PROVIDING HEALTH CARE INFORMATION BY TELEPHONE; PROVIDING HEALTH CARE INFORMATION BY TELEPHONE AND THE INTERNET; PROVIDING HEALTH INFORMATION , IN CLASS 44 (U.S. CLS. 100 AND 101).

FIRST USE 4-1-2005; IN COMMERCE 4-1-2005.

THE MARK CONSISTS OF STANDARD CHARACTERS WITHOUT CLAIM TO ANY PARTICULAR FONT, STYLE, SIZE, OR COLOR.

SER. NO. 77-049,555, FILED 11-22-2006.

JOHN DALIER, EXAMINING ATTORNEY

Int. Cl.: 28

Prior U.S. Cls.: 22, 23, 38 and 50

United States Patent and Trademark Office

Reg. No. 3,474,552

Registered July 29, 2008

**TRADEMARK
PRINCIPAL REGISTER**

Gift Bats

GIFT BATS, INC. (KENTUCKY CORPORATION)
3120 ALLEN STREET
OWENSBORO, KY 42303

THE MARK CONSISTS OF STANDARD CHAR-
ACTERS WITHOUT CLAIM TO ANY PARTICULAR
FONT, STYLE, SIZE, OR COLOR.

FOR: BASEBALL BATS, IN CLASS 28 (U.S. CLS. 22,
23, 38 AND 50).

SER. NO. 77-050,740, FILED 11-26-2006.

FIRST USE 7-26-2005; IN COMMERCE 7-26-2005.

ARETHA SOMERVILLE, EXAMINING ATTORNEY

Int. Cls.: 16 and 21

**Prior U.S. Cls.: 2, 5, 13, 22, 23, 29, 30, 33, 37, 38, 40
and 50**

Reg. No. 3,474,553

United States Patent and Trademark Office

Registered July 29, 2008

**TRADEMARK
PRINCIPAL REGISTER**



GIMEX INTERNATIONAL, S.A. (FRANCE CORPORATION)

PARC GUTENBERG, 2, VOIE LA CARDON
PALAISEAU CEDEX, FRANCE 91126

FOR: PLASTIC BAGS FOR CARRYING BOTTLES,
IN CLASS 16 (U.S. CLS. 2, 5, 22, 23, 29, 37, 38 AND 50).

FOR: PLASTIC BAGS USED AS TABLE-TOP AND
PORTABLE BOTTLED BEVERAGE CONTAINERS
AND PORTABLE BEVERAGE COOLERS, IN THE
NATURE OF ICE BUCKETS, IN CLASS 21 (U.S. CLS.
2, 13, 23, 29, 30, 33, 40 AND 50).

OWNER OF FRANCE REG. NO. 063451187, DATED 9-15-2006, EXPIRES 9-15-2016.

NO CLAIM IS MADE TO THE EXCLUSIVE
RIGHT TO USE "ICE BAG", APART FROM THE
MARK AS SHOWN.

THE MARK CONSISTS OF THE WORDS "ICE
BAG" IN SPECIAL LETTERS WITH A DOT APPEAR-
ING AFTER THE WORD "ICE" ALL APPEARING
ON A BLACK ENCLOSURE.

SER. NO. 77-052,257, FILED 11-28-2006.

MARK PILARO, EXAMINING ATTORNEY

Int. Cl.: 9

Prior U.S. Cls.: 21, 23, 26, 36 and 38

Reg. No. 3,474,554

United States Patent and Trademark Office

Registered July 29, 2008

**TRADEMARK
PRINCIPAL REGISTER**

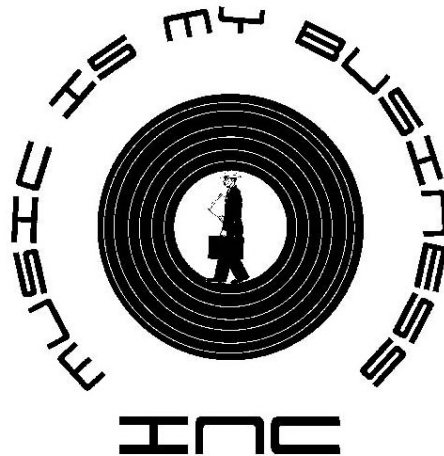

MUSIC IS MY BUSINESS, LLC (GEORGIA LTD
LIAB CO)
1741 COMMERCE DRIVE
ATLANTA, GA 30318

NO CLAIM IS MADE TO THE EXCLUSIVE
RIGHT TO USE "INC", APART FROM THE MARK
AS SHOWN.

FOR: AUDIO RECORDINGS FEATURING MU-
SIC; DOWNLOADABLE RING TONES, GRAPHICS
AND MUSIC VIA A GLOBAL COMPUTER NET-
WORK AND WIRELESS DEVICES; SOUND RE-
CORDINGS FEATURING MUSIC; VIDEO
RECORDINGS FEATURING DOCUMENTARY
ABOUT MUSIC; PRE-RECORDED CDS, VIDEO
TAPES, LASER DISKS AND DVDS FEATURING
MUSIC, IN CLASS 9 (U.S. CLS. 21, 23, 26, 36 AND 38).

THE MARK CONSISTS OF A MAN IN THE
MIDDLE OF A RECORD CARRYING A BRIEFCASE
AND THE STYLIZED TEXT OF THE WORDING
"MUSIC IS MY BUSINESS INC".

SER. NO. 77-052,797, FILED 11-29-2006.

FIRST USE 6-1-2005; IN COMMERCE 6-1-2005.

MARY ROSSMAN, EXAMINING ATTORNEY

Int. Cl.: 9

Prior U.S. Cls.: 21, 23, 26, 36 and 38

United States Patent and Trademark Office

Reg. No. 3,474,555

Registered July 29, 2008

**TRADEMARK
PRINCIPAL REGISTER**

TANK BUTLER

PARACO GAS CORPORATION (NEW YORK
CORPORATION)
2975 WESTCHESTER AVENUE
PURCHASE, NY 10577

FOR: ELECTRONIC TRANSMITTERS AND RE-
CEIVERS TO MONITOR PROPANE AND GAS
TANK LEVELS, IN CLASS 9 (U.S. CLS. 21, 23, 26, 36
AND 38).

FIRST USE 4-1-2002; IN COMMERCE 4-1-2002.

THE MARK CONSISTS OF STANDARD CHAR-
ACTERS WITHOUT CLAIM TO ANY PARTICULAR
FONT, STYLE, SIZE, OR COLOR.

NO CLAIM IS MADE TO THE EXCLUSIVE
RIGHT TO USE "TANK", APART FROM THE
MARK AS SHOWN.

SER. NO. 77-053,077, FILED 11-29-2006.

SCOTT BIBB, EXAMINING ATTORNEY

Int. Cl.: 30

Prior U.S. Cl.: 46

United States Patent and Trademark Office

Reg. No. 3,474,556

Registered July 29, 2008

TRADEMARK
PRINCIPAL REGISTER



MONTEREY GOURMET FOODS, INC. (DELA-
WARE CORPORATION)

1528 MOFFETT STREET

SALINAS, CA 93905

FOR: TAMALES, IN CLASS 30 (U.S. CL. 46).

FIRST USE 12-23-2002; IN COMMERCE 2-22-2005.

NO CLAIM IS MADE TO THE EXCLUSIVE
RIGHT TO USE KITCHEN, APART FROM THE
MARK AS SHOWN.

THE PORTRAIT IN THE MARK DOES NOT
IDENTIFY A LIVING INDIVIDUAL.

SER. NO. 77-054,145, FILED 11-30-2006.

JASON BLAIR, EXAMINING ATTORNEY

Int. Cl.: 24

Prior U.S. Cls.: 42 and 50

United States Patent and Trademark Office

Reg. No. 3,474,557

Registered July 29, 2008

**TRADEMARK
PRINCIPAL REGISTER**

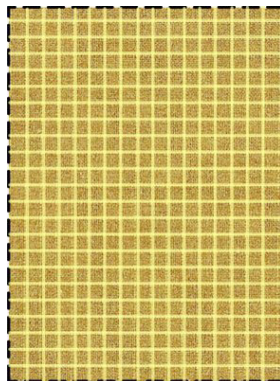

PBI PERFORMANCE PRODUCTS, INC. (DELA-
WARE CORPORATION)
9800-D SOUTHERN PINE BOULEVARD
CHARLOTTE, NC 28273

FOR: FLAME RESISTANT FABRIC, SAFETY
FABRIC, PROTECTIVE FABRIC, AND SHELL FAB-
RIC MADE WITH HIGH TEMPERATURE RESILI-
ENT SYNTHETIC FIBER FOR USE IN THE
MANUFACTURE OF PROTECTIVE AND/OR SAFE-
TY GARMENTS, NAMELY FIREMEN'S TURNOUT
GEAR; FLAME RESISTANT FABRIC, SAFETY FAB-
RIC, PROTECTIVE FABRIC, AND SHELL FABRIC
MADE WITH POLYBENZIMIDAZOLE FIBER FOR
USE IN THE MANUFACTURE OF PROTECTIVE
AND/OR SAFETY GARMENTS, NAMELY FIRE-
MEN'S TURNOUT GEAR, IN CLASS 24 (U.S. CLS.
42 AND 50).

FIRST USE 4-30-2003; IN COMMERCE 4-30-2003.

OWNER OF U.S. REG. NOS. 2,739,268 AND
2,977,768.

THE COLOR(S) GOLD WITH A CONTRASTING
YELLOW GRID. IS/ARE CLAIMED AS A FEATURE
OF THE MARK.

THE MARK CONSISTS OF GOLD WITH A CON-
TRASTING YELLOW GRID PATTERN BACK-
GROUND, THE OUTLINE OF THE GOODS
SHOWN IN BROKEN LINES SERVES TO SHOW
POSITIONING OF THE MARK AND IS NOT A
FEATURE OF THE MARK.

SEC. 2(F).

SER. NO. 77-055,226, FILED 12-1-2006.

TERESA M. RUPP, EXAMINING ATTORNEY

Int. Cl.: 25

Prior U.S. Cls.: 22 and 39

United States Patent and Trademark Office

Reg. No. 3,474,558

Registered July 29, 2008

**TRADEMARK
PRINCIPAL REGISTER**

Silverstone

SFI OF OXFORD ACQUISITION CORPORATION
(DELAWARE CORPORATION)
222 PIEDMONT AVE., NE
ATLANTA, GA 30308

THE MARK CONSISTS OF STANDARD CHAR-
ACTERS WITHOUT CLAIM TO ANY PARTICULAR
FONT, STYLE, SIZE, OR COLOR.

FOR: JACKETS; PANTS; SUITS, IN CLASS 25 (U.S.
CLS. 22 AND 39).

SER. NO. 77-057,223, FILED 12-5-2006.

FIRST USE 10-21-2005; IN COMMERCE 10-21-2005.

LESLIE RICHARDS, EXAMINING ATTORNEY

Int. Cl.: 21

Prior U.S. Cls.: 2, 13, 23, 29, 30, 33, 40 and 50

United States Patent and Trademark Office

Reg. No. 3,474,559

Registered July 29, 2008

**TRADEMARK
PRINCIPAL REGISTER**

CRYSTAL TUBES

LINGO, INC. (FLORIDA CORPORATION)
767 CLEARLAKE ROAD
COCOA, FL 32922

FOR: PLASTIC AND GLASS DRINK WARE,
NAMELY, DRINKING GLASSES, SHOT GLASSES
AND TUBULAR SHAPED DRINKING CONTAIN-
ERS, IN CLASS 21 (U.S. CLS. 2, 13, 23, 29, 30, 33, 40
AND 50).

FIRST USE 3-30-1992; IN COMMERCE 3-30-1992.

THE MARK CONSISTS OF STANDARD CHAR-
ACTERS WITHOUT CLAIM TO ANY PARTICULAR
FONT, STYLE, SIZE, OR COLOR.

NO CLAIM IS MADE TO THE EXCLUSIVE
RIGHT TO USE "TUBES", APART FROM THE
MARK AS SHOWN.

SEC. 2(F).

SER. NO. 77-058,353, FILED 12-6-2006.

ANDREA BUTLER, EXAMINING ATTORNEY

Int. Cls.: 28 and 35

Prior U.S. Cls.: 22, 23, 38, 50, 100, 101 and 102

United States Patent and Trademark Office

Reg. No. 3,474,560

Registered July 29, 2008

**TRADEMARK
SERVICE MARK
PRINCIPAL REGISTER**



DIGGIN ACTIVE INC. (DELAWARE CORPORATION)
5746 HOLLIS STREET
EMERYVILLE, CA 94608

FOR: ACTION SKILL GAMES; BALLS FOR GAMES; TARGET GAMES; PADDLE BALL GAMES; BASEBALL BATS; GOLF CLUBS; INFLATABLE TOYS; NETS FOR BALL GAMES, IN CLASS 28 (U.S. CLS. 22, 23, 38 AND 50).

FIRST USE 1-5-2006; IN COMMERCE 1-5-2006.

FOR: WHOLESALE DISTRIBUTORSHIP SERVICES OF SPORTING GOODS, GAMES, AND TOYS, IN CLASS 35 (U.S. CLS. 100, 101 AND 102).

FIRST USE 1-5-2006; IN COMMERCE 1-5-2006.

SER. NO. 77-059,472, FILED 12-7-2006.

JASON BLAIR, EXAMINING ATTORNEY

Int. Cl.: 9

Prior U.S. Cls.: 21, 23, 26, 36 and 38

Reg. No. 3,474,561

United States Patent and Trademark Office

Registered July 29, 2008

**TRADEMARK
PRINCIPAL REGISTER**

HPS

DRÄGER SAFETY AG & CO. KGAA (FED REP
GERMANY CORPORATION)
REVALSTR. 1
LÜBECK, FED REP GERMANY 23560

PRIORITY CLAIMED UNDER SEC. 44(D) ON
ERPNTY CMNTY TM OFC APPLICATION NO.
005531942, FILED 12-7-2006, REG. NO. 005531942,
DATED 1-3-2008, EXPIRES 12-7-2016.

FOR: SAFETY AND FIRE PROTECTION HEL-
METS, IN CLASS 9 (U.S. CLS. 21, 23, 26, 36 AND 38).

SER. NO. 77-059,777, FILED 12-8-2006.

THE MARK CONSISTS OF STANDARD CHAR-
ACTERS WITHOUT CLAIM TO ANY PARTICULAR
FONT, STYLE, SIZE, OR COLOR.

SIMON TENG, EXAMINING ATTORNEY

Int. Cls.: 37 and 42

Prior U.S. Cls.: 100, 101, 103 and 106

United States Patent and Trademark Office

Reg. No. 3,474,562

Registered July 29, 2008

**SERVICE MARK
PRINCIPAL REGISTER**

SolarCity

SOLARCITY CORPORATION (DELAWARE CORPORATION)
1153 TRITON DRIVE
SUITE D
FOSTER CITY, CA 94404

FOR: INSTALLATION, MAINTENANCE AND REPAIR OF SOLAR PANELS AND OTHER EQUIPMENT FOR USE IN CONVERTING SOLAR ENERGY INTO ELECTRICITY, IN CLASS 37 (U.S. CLS. 100, 103 AND 106).

FIRST USE 6-21-2006; IN COMMERCE 7-10-2006.

FOR: MONITORING OF SOLAR PANELS AND OTHER EQUIPMENT FOR USE IN CONVERTING SOLAR ENERGY INTO ELECTRICITY, IN CLASS 42 (U.S. CLS. 100 AND 101).

FIRST USE 6-21-2006; IN COMMERCE 7-10-2006.

THE MARK CONSISTS OF STANDARD CHARACTERS WITHOUT CLAIM TO ANY PARTICULAR FONT, STYLE, SIZE, OR COLOR.

SER. NO. 77-060,532, FILED 12-8-2006.

KAREN K. BUSH, EXAMINING ATTORNEY

Int. Cl.: 41

Prior U.S. Cls.: 100, 101 and 107

United States Patent and Trademark Office

Reg. No. 3,474,563

Registered July 29, 2008

**SERVICE MARK
PRINCIPAL REGISTER**



PITCHING CENTER, INC., THE (CALIFORNIA CORPORATION)
7070 COMMERCE CIR., SUITE B
PLEASANTON, CA 94588

FOR: EDUCATIONAL SERVICES IN THE FIELD OF BASEBALL AND SOFTBALL, NAMELY, PITCHING, HITTING, FIELDING, AND COACHING CLASSES, SEMINARS, PRIVATE AND SEMI-PRIVATE LESSONS, AND CAMP PROGRAMS, IN CLASS 41 (U.S. CLS. 100, 101 AND 107).

FIRST USE 11-26-2003; IN COMMERCE 11-26-2003.

NO CLAIM IS MADE TO THE EXCLUSIVE RIGHT TO USE "PITCHING CENTER", APART FROM THE MARK AS SHOWN.

THE MARK CONSISTS OF THE WORDS "THE PITCHING CENTER" ABOVE A STYLIZED BASEBALL WITH A PARTIAL RING SURROUNDING THE BOTTOM AND RIGHT SIDE OF THE WORDS AND THE STYLIZED BASEBALL.

SER. NO. 77-060,539, FILED 12-8-2006.

REBECCA EISINGER, EXAMINING ATTORNEY

Int. Cls.: 6 and 36

Prior U.S. Cls.: 2, 12, 13, 14, 23, 25, 50, 100, 101 and 102

Reg. No. 3,474,564

United States Patent and Trademark Office

Registered July 29, 2008

**TRADEMARK
SERVICE MARK
PRINCIPAL REGISTER**

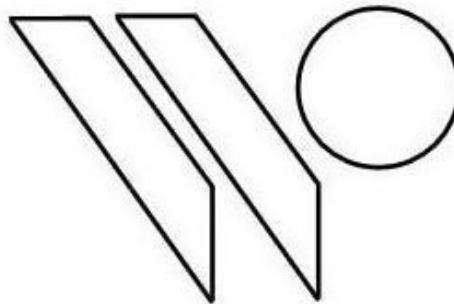

WOLFE METALS TRADING CORP. (FLORIDA CORPORATION)
208 SOUTH 28TH AVENUE
HOLLYWOOD, FL 33020

FOR: SCRAP METALS, NAMELY, ALLOY STEEL SCRAPS, IRON OR STEEL SCRAPS, AND LOW COPPER CARBON-STEEL SCRAPS , IN CLASS 6 (U.S. CLS. 2, 12, 13, 14, 23, 25 AND 50).

FIRST USE 12-31-2002; IN COMMERCE 9-30-2006.

FOR: BROKERAGE IN THE FIELD OF SCRAP METALS, IN CLASS 36 (U.S. CLS. 100, 101 AND 102).

FIRST USE 12-31-2002; IN COMMERCE 12-31-2002.

THE MARK CONSISTS OF THE STYLIZED DEPICTION OF THE WORD "WO".

SER. NO. 77-062,163, FILED 12-12-2006.

ALLISON SCHRODY, EXAMINING ATTORNEY

Int. Cls.: 1, 5, 10 and 42

Prior U.S. Cls.: 1, 5, 6, 10, 18, 26, 39, 44, 46, 51, 52, 100 and 101

Reg. No. 3,474,565

United States Patent and Trademark Office

Registered July 29, 2008

**TRADEMARK
SERVICE MARK
PRINCIPAL REGISTER**



KIRIN HOLDINGS KABUSHIKI KAISHA A/T/A
KIRIN HOLDINGS CO., LTD. (JAPAN CORPORATION)

10-1, SHINKAWA 2-CHOME, CHUO-KU
TOKYO, JAPAN

FOR: (BASED ON 44E) BIOCHEMICALS, NAME-
LY, MONOCLONAL ANTIBODIES FOR IN VITRO
SCIENTIFIC OR RESEARCH USE; CHEMICAL RE-
AGENTS FOR NON-MEDICAL AND NON-VETERI-
NARY PURPOSES, IN CLASS 1 (U.S. CLS. 1, 5, 6, 10,
26 AND 46).

FOR: (BASED ON 44E) PHARMACEUTICAL PRE-
PARATIONS FOR THE TREATMENT OF ANEMIA,
LEUKOPENIA, THROMBOCYTOPENIA, HYPER-
PHOSPHATEMIA, HYPERPARATHYROIDISM,
CANCER, LEUKEMIA, INFLUENZA, HIV, MYELO-
DYSPLASTIC SYNDROME, INFECTIOUS DISEA-
SES, AUTOIMMUNE DISEASES;
PHARMACEUTICAL PREPARATIONS FOR MOBI-
LIZATION OF PERIPHERAL BLOOD PROGENITOR
CELLS; PHARMACEUTICAL PREPARATIONS FOR
CONDITIONING TREATMENT PRIOR TO HEMA-
TOPOIETIC STEM CELL TRANSPLANTATION; DI-
AGNOSTIC AGENTS, PREPARATIONS AND
SUBSTANCES FOR MEDICAL AND VETERINARY
USE; PRE-FILLED SYRINGES FILLED WITH
PHARMACEUTICAL PREPARATIONS FOR THE
TREATMENT OF ANEMIA, LEUCOPENIA,
THROMBOCYTOPENIA, MOBILIZATION OF PERI-
PHERAL BLOOD PROGENITOR CELL, HYPER-
PHOSPHATEMIA, HYPERPARATHYROIDISM,
CANCER, LEUKEMIA, INFLUENZA, HIV, MYELO-
DYSPLASTIC SYNDROME, INFECTIOUS DISEA-
SES AND AUTOIMMUNE DISEASES, AND FOR
CONDITIONING TREATMENT PRIOR TO HEMA-

TOPOIETIC STEM CELL TRANSPLANTATION, IN
CLASS 5 (U.S. CLS. 6, 18, 44, 46, 51 AND 52).

FOR: (BASED ON 44E) SYRINGES FOR MEDICAL
PURPOSES; INJECTION DEVICES FOR PHARMA-
CEUTICALS; INJECTION NEEDLES; BLOOD
TRANSFUSION APPARATUS OR DEVICES; INFU-
SION APPARATUS OR DEVICES FOR THERAPEU-
TIC PURPOSES, IN CLASS 10 (U.S. CLS. 26, 39 AND
44).

FOR: (BASED ON USE IN COMMERCE) PATENT
LICENSING; DEVELOPMENT OF NEW TECHNOL-
OGY FOR OTHERS IN THE FIELD OF HUMAN
ANTIBODIES AND BIOTECHNOLOGY; MEDICAL
RESEARCH, IN CLASS 42 (U.S. CLS. 100 AND 101).

FIRST USE 7-1-2007; IN COMMERCE 7-1-2007.

PRIORITY CLAIMED UNDER SEC. 44(D) ON
JAPAN APPLICATION NO. 2006-94669, FILED 10-11-
2006, REG. NO. 5041372, DATED 4-13-2007, EXPIRES
4-13-2017.

OWNER OF U.S. REG. NOS. 2,701,995, 3,137,479
AND OTHERS.

NO CLAIM IS MADE TO THE EXCLUSIVE
RIGHT TO USE "PHARMA", APART FROM THE
MARK AS SHOWN.

THE COLOR(S) RED IS/ARE CLAIMED AS A
FEATURE OF THE MARK.

THE MARK CONSISTS OF THE WORDS "KIRIN
PHARMA" IN STYLIZED LETTERING, WITH THE

WORD "PHARMA" APPEARING UNDERNEATH
THE WORD "KIRIN," AND WITH A SWIRL DESIGN
AROUND THE LETTERS "MA" OF "PHARMA."
THE WORDING AND DESIGN ELEMENT ARE
BOTH RED IN COLOR.

SER. NO. 77-062,473, FILED 12-12-2006.

ELIZABETH HUGHITT, EXAMINING ATTORNEY

Int. Cl.: 5

Prior U.S. Cls.: 6, 18, 44, 46, 51 and 52

Reg. No. 3,474,566

United States Patent and Trademark Office

Registered July 29, 2008

**TRADEMARK
PRINCIPAL REGISTER**

**NUTRIENT OPTIMIZATION
SYSTEM OPTI-MEN**

OPTIMUM NUTRITION, INC. (FLORIDA CORPORATION)
ATTN: JEN LARIMER
700 N. COMMERCE STREET
AURORA, IL 60504

FOR: DIETARY AND NUTRITIONAL SUPPLEMENTS, IN CLASS 5 (U.S. CLS. 6, 18, 44, 46, 51 AND 52).

FIRST USE 12-1-2006; IN COMMERCE 12-1-2006.

THE MARK CONSISTS OF STANDARD CHARACTERS WITHOUT CLAIM TO ANY PARTICULAR FONT, STYLE, SIZE, OR COLOR.

NO CLAIM IS MADE TO THE EXCLUSIVE RIGHT TO USE "NUTRIENT" AND "SYSTEM", APART FROM THE MARK AS SHOWN.

SER. NO. 77-063,122, FILED 12-13-2006.

JULIE WATSON, EXAMINING ATTORNEY

Int. Cl.: 41

Prior U.S. Cls.: 100, 101 and 107

United States Patent and Trademark Office

Reg. No. 3,474,567

Registered July 29, 2008

**SERVICE MARK
PRINCIPAL REGISTER**

FIT ATTACK TRAINING

MOUTAFIS, STACY (UNITED STATES INDIVIDUAL)
10 SHADYVIEW CROSSING
MANORVILLE, NY 11949

FOR: PERSONAL TRAINER SERVICES; PHYSICAL FITNESS CONDITIONING CLASSES; PHYSICAL FITNESS CONSULTATION; PHYSICAL FITNESS INSTRUCTION, IN CLASS 41 (U.S. CLS. 100, 101 AND 107).

FIRST USE 7-0-2006; IN COMMERCE 7-0-2006.

THE MARK CONSISTS OF STANDARD CHARACTERS WITHOUT CLAIM TO ANY PARTICULAR FONT, STYLE, SIZE, OR COLOR.

NO CLAIM IS MADE TO THE EXCLUSIVE RIGHT TO USE "TRAINING", APART FROM THE MARK AS SHOWN.

SER. NO. 77-064,093, FILED 12-14-2006.

JOHN E. MICHOS, EXAMINING ATTORNEY

Int. Cls.: 25 and 35

Prior U.S. Cls.: 22, 39, 100, 101 and 102

United States Patent and Trademark Office

Reg. No. 3,474,568

Registered July 29, 2008

**TRADEMARK
SERVICE MARK
PRINCIPAL REGISTER**

CARING FOR THE CAREGIVER

I.C.U. INCREDIBLY COMFORTABLE UNI-
FORMS INC. (CANADA CORPORATION)
6041 GATEWAY BLVD.
EDMONTON, CANADA T6H2H3

FOR: MEDICAL UNIFORMS, IN CLASS 25 (U.S.
CLS. 22 AND 39).

FOR: ON-LINE RETAIL STORE SERVICES FEA-
TURING MEDICAL UNIFORMS, IN CLASS 35 (U.S.
CLS. 100, 101 AND 102).

THE MARK CONSISTS OF STANDARD CHAR-
ACTERS WITHOUT CLAIM TO ANY PARTICULAR
FONT, STYLE, SIZE, OR COLOR.

OWNER OF CANADA REG. NO. TMA707272,
DATED 2-12-2008, EXPIRES 2-12-2023.

SER. NO. 77-064,651, FILED 12-14-2006.

LINDSEY RUBIN, EXAMINING ATTORNEY

Int. Cl.: 44

Prior U.S. Cls.: 100 and 101

United States Patent and Trademark Office

Reg. No. 3,474,569

Registered July 29, 2008

**SERVICE MARK
PRINCIPAL REGISTER**

DYNAMIC WELLNESS CHALLENGE

DW GROUP, LLC (ILLINOIS LTD LIAB CO)
180 N. STETSON, SUITE 5100
2 PRUDENTIAL PLAZA
CHICAGO, IL 60601

OWNER OF U.S. REG. NOS. 2,546,976 AND
3,092,407.

FOR: HEALTH CARE SERVICES, NAMELY,
WELLNESS PROGRAMS, IN CLASS 44 (U.S. CLS.
100 AND 101).

NO CLAIM IS MADE TO THE EXCLUSIVE
RIGHT TO USE "WELLNESS CHALLENGE",
APART FROM THE MARK AS SHOWN.

FIRST USE 1-18-2006; IN COMMERCE 1-18-2006.

SER. NO. 77-065,358, FILED 12-15-2006.

THE MARK CONSISTS OF STANDARD CHAR-
ACTERS WITHOUT CLAIM TO ANY PARTICULAR
FONT, STYLE, SIZE, OR COLOR.

AISHA SALEM, EXAMINING ATTORNEY

Int. Cl.: 41

Prior U.S. Cls.: 100, 101 and 107

United States Patent and Trademark Office

Reg. No. 3,474,570

Registered July 29, 2008

**SERVICE MARK
PRINCIPAL REGISTER**

Grandma's Marathon

GRANDMA'S MARATHON-DULUTH, INC (MINNESOTA NON-PROFIT CORPORATION)
P.O. BOX 16234
DULUTH, MN 55816

FOR: ENCOURAGING AMATEUR SPORTS AND PHYSICAL EDUCATION BY ORGANIZING, PROMOTING, SPONSORING, SANCTIONING, CONDUCTING, ADMINISTERING, REGULATING AND GOVERNING AMATEUR ATHLETIC PROGRAMS AND ACTIVITIES, IN CLASS 41 (U.S. CLS. 100, 101 AND 107).

FIRST USE 1-1-1977; IN COMMERCE 1-1-1977.

THE MARK CONSISTS OF STANDARD CHARACTERS WITHOUT CLAIM TO ANY PARTICULAR FONT, STYLE, SIZE, OR COLOR.

NO CLAIM IS MADE TO THE EXCLUSIVE RIGHT TO USE "MARATHON", APART FROM THE MARK AS SHOWN.

SER. NO. 77-068,138, FILED 12-20-2006.

FLORENTINA BLANDU, EXAMINING ATTORNEY

Int. Cl.: 3

Prior U.S. Cls.: 1, 4, 6, 50, 51 and 52

United States Patent and Trademark Office

Reg. No. 3,474,571

Registered July 29, 2008

**TRADEMARK
PRINCIPAL REGISTER**



BELJUM BRANDS LLC (CALIFORNIA LTD LIAB
CO)
355 MANDELA PARKWAY
OAKLAND, CA 94607

FOR: SKIN CREAMS; SKIN LOTIONS; SKIN
MOISTURIZER, IN CLASS 3 (U.S. CLS. 1, 4, 6, 50, 51
AND 52).

FIRST USE 7-1-2006; IN COMMERCE 7-1-2006.

NO CLAIM IS MADE TO THE EXCLUSIVE
RIGHT TO USE "BELGIUM" AND "BUTTER",
APART FROM THE MARK AS SHOWN.

THE MARK CONSISTS OF AN OVALIZED SHAPE
SPLIT INTO THREE HORIZONTAL SECTIONS. THE
SECTIONS CONTAIN THE WORDS "BELJUM" /
"HARD CORE" / "BUDDER". THE OVALIZED
SHAPE IS TOPPED WITH A CROWN.

SER. NO. 77-068,199, FILED 12-20-2006.

SUNG IN, EXAMINING ATTORNEY

Int. Cl.: 9

Prior U.S. Cls.: 21, 23, 26, 36 and 38

Reg. No. 3,474,572

United States Patent and Trademark Office

Registered July 29, 2008

**TRADEMARK
PRINCIPAL REGISTER**



FORD MOTOR COMPANY (DELAWARE CORPORATION)
ONE AMERICAN ROAD
DEARBORN, MI 48126

FIRST USE 1-7-2007; IN COMMERCE 1-7-2007.

SEC. 2(F).

FOR: ELECTRONIC INTERFACE MODULES FOR WIRED AND WIRELESS INTERFACE OF MOBILE PHONES AND ELECTRONIC MEDIA PLAYERS WITH AN AUTOMOTIVE ELECTRICAL SYSTEM, IN CLASS 9 (U.S. CLS. 21, 23, 26, 36 AND 38).

SER. NO. 77-069,650, FILED 12-21-2006.

KEVIN DINALLO, EXAMINING ATTORNEY

Int. Cls.: 1, 6 and 9

**Prior U.S. Cls.: 1, 2, 5, 6, 10, 12, 13, 14, 21, 23, 25, 26,
36, 38, 46 and 50**

Reg. No. 3,474,573

United States Patent and Trademark Office

Registered July 29, 2008

**TRADEMARK
PRINCIPAL REGISTER**

The logo consists of the letters "SDS" in a bold, italicized, sans-serif font. The letters are dark grey with a lighter grey shadow effect. Behind the letters are several horizontal lines of varying lengths, creating a sense of motion or speed.

ADVANCED TECHNOLOGY MATERIALS, INC.
(DELAWARE CORPORATION)
7 COMMERCE DRIVE
DANBURY, CT 06810 AND
MATHESON TRI-GAS, INC. (DELAWARE COR-
PORATION)
959 ROUTE 46
EAST PARSIPPANY, NJ 07054

FOR: ADSORBED GAS FOR USE IN THE MAN-
UFACTURE OF SEMI-CONDUCTORS AND MI-
CROELECTRONIC PRODUCTS, AS PROVIDED IN
A GAS SUPPLY CONTAINER HOLDING ADSOR-
BENT MATERIAL, IN CLASS 1 (U.S. CLS. 1, 5, 6, 10,
26 AND 46).

FIRST USE 2-5-1996; IN COMMERCE 2-5-1996.

FOR: METAL GAS SUPPLY CONTAINERS
HOLDING ADSORBENT MATERIAL ON WHICH
ADSORBED GAS IS STORED AND FROM WHICH
GAS IS DESORBED FOR DISPENSING FROM THE

CONTAINER, IN CLASS 6 (U.S. CLS. 2, 12, 13, 14, 23,
25 AND 50).

FIRST USE 2-5-1996; IN COMMERCE 2-5-1996.

FOR: AUTOMATED GAS FLOW CONTROLLERS
AND GAS FLOW MONITORS, IN CLASS 9 (U.S. CLS.
21, 23, 26, 36 AND 38).

FIRST USE 2-5-1996; IN COMMERCE 2-5-1996.

OWNER OF U.S. REG. NOS. 2,115,190 AND
2,205,571.

THE MARK CONSISTS OF THE LETTERS "SDS"
SUPERIMPOSED ON BACKGROUND PATTERN OF
HORIZONTAL BAR ELEMENTS.

SER. NO. 77-073,901, FILED 12-31-2006.

JAMES A. RAUEN, EXAMINING ATTORNEY

Int. Cls.: 35 and 42

Prior U.S. Cls.: 100, 101 and 102

United States Patent and Trademark Office

Reg. No. 3,474,574

Registered July 29, 2008

**SERVICE MARK
PRINCIPAL REGISTER**

The logo for RDesign features the word "RDesign" in a blue, serif font. The letter "D" is stylized with a lightbulb shape integrated into its right side. The lightbulb is yellow with a blue filament and a blue base. The letters "gn" are also in blue, with the "n" having a decorative flourish.

R-DESIGN INC. (FLORIDA CORPORATION)
6161 DR. MLK, JR. ST. NORTH, SUITE 102
ST. PETERSBURG, FL 33703

FOR: ADVERTISING AND ADVERTISEMENT SERVICES; ADVERTISING AND BUSINESS MANAGEMENT CONSULTANCY; ADVERTISING AND COMMERCIAL INFORMATION SERVICES, VIA THE INTERNET; ADVERTISING AND MARKETING; ADVERTISING AND PUBLICITY SERVICES; ADVERTISING CONSULTATION; ADVERTISING PARTICULARLY SERVICES FOR THE PROMOTION OF GOODS; ADVERTISING SERVICES; ADVERTISING SERVICES, NAMELY, CREATING CORPORATE AND BRAND IDENTITY FOR OTHERS; ADVERTISING SERVICES, NAMELY, CREATING CORPORATE LOGOS FOR OTHERS; ADVERTISING VIA ELECTRONIC MEDIA AND SPECIFICALLY THE INTERNET; ADVERTISING, MARKETING AND PROMOTION SERVICES; CREATING AND UPDATING ADVERTISING MATERIAL; DISSEMINATION OF ADVERTISING FOR OTHERS VIA AN ON-LINE COMMUNICATIONS NETWORK ON THE INTERNET; DISSEMINATION OF ADVERTISING FOR OTHERS VIA THE INTERNET; ISSUING AND UPDATING OF ADVERTISING TEXTS; PREPARATION OF CUSTOM ADVERTISEMENTS FOR OTHERS; PREPARATION OF CUSTOM OR NON-CUSTOM ADVERTISING FOR BUSINESSES FOR DISSEMINATION VIA THE WEB, CD OR DVD FOR OPTIONAL UPLOAD OR

DOWNLOAD TO A COMPUTER; PREPARING ADVERTISEMENTS FOR OTHERS; PREPARING AND PLACING ADVERTISEMENTS FOR OTHERS; PREPARING AND PLACING OF ADVERTISEMENTS; PROVIDING AND RENTAL OF ADVERTISING SPACE ON THE INTERNET; PROVIDING SPACE AT A WEB SITE FOR THE ADVERTISEMENT OF THE GOODS AND SERVICES OF OTHERS, IN CLASS 35 (U.S. CLS. 100, 101 AND 102).

FIRST USE 11-30-2005; IN COMMERCE 11-30-2005.

FOR: DESIGNING WEBSITES FOR ADVERTISING PURPOSES, IN CLASS 42 (U.S. CLS. 100 AND 101).

FIRST USE 11-30-2005; IN COMMERCE 11-30-2005.

THE COLOR(S) BLUE AND YELLOW IS/ARE CLAIMED AS A FEATURE OF THE MARK.

THE COLOR BLUE APPEARS IN THE LETTERS "RDES" AND "GN" AND IN THE OUTLINE, FILAMENT AND BASE OF THE LIGHT BULB; THE COLOR YELLOW APPEARS IN THE INTERIOR OF THE LIGHT BULB.

SER. NO. 77-076,595, FILED 1-5-2007.

JULIE GUTTADAURO, EXAMINING ATTORNEY

Int. Cl.: 41

Prior U.S. Cls.: 100, 101 and 107

United States Patent and Trademark Office

Reg. No. 3,474,575

Registered July 29, 2008

**SERVICE MARK
PRINCIPAL REGISTER**



THE PITCHING CENTER, INC. (CALIFORNIA CORPORATION)
7070 COMMERCE CIR., SUITE B
PLEASANTON, CA 94588

FOR: EDUCATIONAL SERVICES IN THE FIELD OF BASEBALL AND SOFTBALL, NAMELY, PITCHING, HITTING, FIELDING, AND COACHING CLASSES, SEMINARS, PRIVATE AND SEMI-PRIVATE LESSONS, AND CAMP PROGRAMS, IN CLASS 41 (U.S. CLS. 100, 101 AND 107).

FIRST USE 12-1-2006; IN COMMERCE 12-1-2006.

NO CLAIM IS MADE TO THE EXCLUSIVE RIGHT TO USE "HITTING", APART FROM THE MARK AS SHOWN.

THE MARK CONSISTS OF THE WORDS "POWER HITTING" ON TOP OF A PARTIAL RING SLANTED FROM BOTTOM LEFT TO TOP RIGHT WITH THE LETTER "O" IN THE WORD "POWER" APPEARING AS A STYLIZED BASEBALL.

SER. NO. 77-081,067, FILED 1-11-2007.

REBECCA EISINGER, EXAMINING ATTORNEY

Int. Cl.: 16

Prior U.S. Cls.: 2, 5, 22, 23, 29, 37, 38 and 50

United States Patent and Trademark Office

Reg. No. 3,474,576

Registered July 29, 2008

**TRADEMARK
PRINCIPAL REGISTER**

101 Quilt Basting Spray

HELMAR AUSTRALIA PTY LTD (AUSTRALIA
CORPORATION)
POBOX 369
RIVERSTONE, AUSTRALIA 2765

FOR: ADHESIVES FOR STATIONERY OR
HOUSEHOLD PURPOSES, IN CLASS 16 (U.S. CLS.
2, 5, 22, 23, 29, 37, 38 AND 50).

FIRST USE 5-12-2005; IN COMMERCE 6-29-2005.

THE MARK CONSISTS OF STANDARD CHAR-
ACTERS WITHOUT CLAIM TO ANY PARTICULAR
FONT, STYLE, SIZE, OR COLOR.

NO CLAIM IS MADE TO THE EXCLUSIVE
RIGHT TO USE "QUILT BASTING SPRAY", APART
FROM THE MARK AS SHOWN.

SER. NO. 77-082,045, FILED 1-12-2007.

DANNEAN HETZEL, EXAMINING ATTORNEY

Int. Cl.: 35

Prior U.S. Cls.: 100, 101 and 102

United States Patent and Trademark Office

Reg. No. 3,474,577

Registered July 29, 2008

**SERVICE MARK
PRINCIPAL REGISTER**



I-TRADE INTERNATIONAL CONSULTING, LLC
(NEW JERSEY LTD LIAB CO)
17 CEDARWOOD TERRACE
WEST PATERSON, NJ 07424

FOR: INVENTORY MANAGEMENT IN THE
FIELD OF GENERAL CONSUMER GOODS; DI-
RECT MARKETING ADVERTISING FOR OTHERS;
MARKET STRATEGIES IN THE NATURE OF BUSI-

NESS ADVICE AND ANALYSIS OF MARKETS, IN
CLASS 35 (U.S. CLS. 100, 101 AND 102).

FIRST USE 7-1-2006; IN COMMERCE 7-1-2006.

SER. NO. 77-085,301, FILED 1-18-2007.

SALLY SHIH, EXAMINING ATTORNEY

Int. Cl.: 12

Prior U.S. Cls.: 19, 21, 23, 31, 35 and 44

United States Patent and Trademark Office

Reg. No. 3,474,578

Registered July 29, 2008

**TRADEMARK
PRINCIPAL REGISTER**

PaceKeeper 

PER REBY (DJIBOUTI CORPORATION)
SVEND DYRINGSVEJ 25
VEJLE, DENMARK 7100

005222195, FILED 7-26-2006, REG. NO. 005222195,
DATED 8-3-2007, EXPIRES 7-26-2016.

FOR: MOTORCYCLE, SCOOTER, AND MOTOR-
BIKE PARTS, NAMELY, THROTTLE LEVEL CON-
TROL MEANS, IN CLASS 12 (U.S. CLS. 19, 21, 23, 31,
35 AND 44).

THE MARK CONSISTS OF A STYLIZED PRE-
SENTATION OF THE WORDS "PACEKEEPER"
WITH AN ARROW THROUGH THE WORDS.

SER. NO. 77-085,715, FILED 1-18-2007.

PRIORITY CLAIMED UNDER SEC. 44(D) ON
ERPNTY CMNTY TM OFC APPLICATION NO.

DEZMONA MIZELLE, EXAMINING ATTORNEY

Int. Cl.: 5

Prior U.S. Cls.: 6, 18, 44, 46, 51 and 52

Reg. No. 3,474,579

United States Patent and Trademark Office

Registered July 29, 2008

**TRADEMARK
PRINCIPAL REGISTER**

Nutri-Fiber

UNICITY PROPERTIES, INC. (UTAH CORPORATION)
1201 N. 800 E.
OREM, UT 84097

THE MARK CONSISTS OF STANDARD CHARACTERS WITHOUT CLAIM TO ANY PARTICULAR FONT, STYLE, SIZE, OR COLOR.

FOR: DIETARY AND NUTRITIONAL SUPPLEMENTS; DIETARY FOOD SUPPLEMENTS; VITAMIN AND MINERAL SUPPLEMENTS, IN CLASS 5 (U.S. CLS. 6, 18, 44, 46, 51 AND 52).

SER. NO. 77-085,793, FILED 1-18-2007.

FIRST USE 1-16-2007; IN COMMERCE 1-17-2007.

SUNG IN, EXAMINING ATTORNEY

Int. Cl.: 16

Prior U.S. Cls.: 2, 5, 22, 23, 29, 37, 38 and 50

Reg. No. 3,474,580

United States Patent and Trademark Office

Registered July 29, 2008

TRADEMARK
PRINCIPAL REGISTER



PRACTICAL
GARDENING

INSTITUTE

PRACTICAL GARDENING INSTITUTE, LLC (MICHIGAN LTD LIAB CO)
29429 SIX MILE ROAD
LIVONIA, MI 48152

FOR: PRINTED INSTRUCTIONAL, EDUCATIONAL AND TEACHING MATERIALS CONSISTING OF PERIODICALS, NEWSLETTERS, BOOKLETS, PAMPHLETS, BROCHURES, POSTERS, BOOKS, WORKBOOKS, MAGAZINES, SYNDICATED MAGAZINE COLUMNS, SYNDICATED NEWSPAPER COLUMNS, CARDS, NAMELY INDEX CARDS, NOTE CARDS, GREETING CARDS, BLANK NOTE CARDS, BLANK CARDS, AND FLASHCARDS, CALENDARS, BOOKMARKS, BLANK BOOKS AND JOURNALS IN THE FIELD OF GARDENING, GARDEN DESIGN, PLANTS, PLANT FOOD, SOIL, SOIL CONDITIONERS AND AMENDMENTS, LAWNS, LAWN CARE, LAWN TOOLS, GARDEN INSTALLATION, GARDEN MAINTENANCE, GARDEN CARE, GARDEN TOOLS, LANDSCAPE GARDENS, LAND-

SCAPE GARDEN DESIGN, LANDSCAPE GARDEN INSTALLATION, LANDSCAPE GARDEN CARE, LANDSCAPE GARDEN MAINTENANCE, FERTILIZERS, HERBICIDES, FUNGICIDES, INSECTICIDES, HORTICULTURE, HYDROPONICS, SEEDS, AND PLANT PROPAGATION, IN CLASS 16 (U.S. CLS. 2, 5, 22, 23, 29, 37, 38 AND 50).

FIRST USE 2-20-2005; IN COMMERCE 2-20-2005.

NO CLAIM IS MADE TO THE EXCLUSIVE RIGHT TO USE "GARDENING INSTITUTE", APART FROM THE MARK AS SHOWN.

THE MARK CONSISTS OF A STYLIZED HAND HOLDING A PLANT.

SER. NO. 77-088,185, FILED 1-22-2007.

THOMAS MANOR, EXAMINING ATTORNEY

Int. Cl.: 16

Prior U.S. Cls.: 2, 5, 22, 23, 29, 37, 38 and 50

United States Patent and Trademark Office

Reg. No. 3,474,581

Registered July 29, 2008

TRADEMARK
PRINCIPAL REGISTER



SIMON & SCHUSTER, INC. (NEW YORK CORPORATION)
1230 AVENUE OF THE AMERICAS
NEW YORK, NY 10020

FOR: FICTION AND NON-FICTION BOOKS PERTAINING TO A WIDE VARIETY OF TOPICS, IN CLASS 16 (U.S. CLS. 2, 5, 22, 23, 29, 37, 38 AND 50).

FIRST USE 1-4-2005; IN COMMERCE 1-4-2005.

OWNER OF U.S. REG. NO. 3,104,492.

THE COLOR(S) PINK, BLUE, YELLOW AND BLACK IS/ARE CLAIMED AS A FEATURE OF THE MARK.

THE TERMS "THE" AND "CLUB" ARE IN PINK; THE TERM "MOTHERHOOD" IS IN BLUE WITH THE "O" IN THE SHAPE OF A HEART IN PINK; THE BACKGROUND IS IN YELLOW AND THE BORDER IS IN BLACK AND PINK; FOR THE "MC" ELEMENT IN THE BORDER, THE "M" IS PINK, THE "C" IS BLUE AND THE LIPS DESIGN IS IN PINK".

SER. NO. 77-088,327, FILED 1-22-2007.

ARETHA SOMERVILLE, EXAMINING ATTORNEY

Int. Cl.: 35

Prior U.S. Cls.: 100, 101 and 102

United States Patent and Trademark Office

Reg. No. 3,474,582

Registered July 29, 2008

**SERVICE MARK
PRINCIPAL REGISTER**



UNITED SUPERMARKETS, L.L.C. (TEXAS LTD
LIAB CO)
7830 ORLANDO AVENUE
LUBBOCK, TX 794936170

FOR: RETAIL STORE SERVICES, NAMELY,
PHARMACY, RETAIL DRUG STORE AND GENERAL
MERCHANDISE STORE SERVICES, IN CLASS 35
(U.S. CLS. 100, 101 AND 102).

FIRST USE 0-0-1983; IN COMMERCE 0-0-1983.

NO CLAIM IS MADE TO THE EXCLUSIVE
RIGHT TO USE "RX" OR "PHARMACY", APART
FROM THE MARK AS SHOWN.

THE MARK CONSISTS OF A LARGE RX CENTERED OVER THE WORD UNITED, WHICH IS CENTERED OVER THE WORD PHARMACY. BETWEEN RX AND PHARMACY THERE IS A HORIZONTAL LINE, AND SURROUNDING THE ENTIRE MARK IS A RECTANGLE WITH ROUNDED EDGES.

SER. NO. 77-089,637, FILED 1-24-2007.

ALYSSA PALADINO, EXAMINING ATTORNEY

Int. Cl.: 37

Prior U.S. Cls.: 100, 103 and 106

United States Patent and Trademark Office

Reg. No. 3,474,583

Registered July 29, 2008

SERVICE MARK
PRINCIPAL REGISTER



MEDIABANG, INC. (UTAH CORPORATION)
1604 WEST HILL FIELD RD. STE. 104
LAYTON, UT 84041

FOR: INSTALLATION OF COMMERCIAL AND RESIDENTIAL SYSTEMS FOR HOME THEATER, HOME AUTOMATION SYSTEMS, MULTI-ROOM AUDIO, LIGHTING CONTROL, STRUCTURED WIRING, TELEPHONE, INTERCOM, AUDIO EQUIPMENT, NAMELY, SPEAKERS, AMPLIFIERS, RECEIVERS CABLING, AND AUDIO CONTROL EQUIPMENT, VIDEO EQUIPMENT AND AUTOMATION CONTROLLERS, NAMELY VCRS, DVD PLAYERS, HD-DVD PLAYERS, VIDEO DISC PLAYERS, RECEIVERS, CABLING, AND VIDEO CONTROL EQUIPMENT, SATELLITE DISHES, AND VIDEO SURVEILLANCE, IN CLASS 37 (U.S. CLS. 100, 103 AND 106).

FIRST USE 11-1-2002; IN COMMERCE 11-1-2002.

NO CLAIM IS MADE TO THE EXCLUSIVE RIGHT TO USE "MEDIA" AND "CUSTOM HOME THEATER", APART FROM THE MARK AS SHOWN.

THE COLOR(S) BLACK, WHITE AND RED IS/ ARE CLAIMED AS A FEATURE OF THE MARK.

THE MARK CONSISTS OF THE WORD "MEDIA" APPEARING IN A FIRST RECTANGLE, WHERE THE BACKGROUND OF THE RECTANGLE IS BLACK AND THE WORD "MEDIA" APPEARS IN WHITE; THE WORD "BANG" APPEARING IN A SECOND RECTANGLE WHICH IS SUBSTANTIAL- LY THE SAME SIZE AS THE FIRST RECTANGLE AND IS LOCATED ADJACENT TO THE FIRST RECTANGLE, WHERE THE BACKGROUND OF THE SECOND RECTANGLE IS WHITE AND THE WORD "BANG" APPEARS IN RED; THE WORDS "CUSTOM HOME THEATER" APPEARING IN A THIRD RECTANGLE, WHERE THE THIRD REC- TANGLE IS LOCATED BENEATH THE FIRST TWO RECTANGLES AND HAS A LENGTH EQUAL TO THE SUM OF THE LENGTHS OF THE FIRST TWO RECTANGLES, WITH THE BACKGROUND OF THE THIRD RECTANGLE BEING RED AND THE WORDS "CUSTOM HOME THEATER" APPEARING IN WHITE.

SER. NO. 77-091,670, FILED 1-26-2007.

NATALIE POLZER, EXAMINING ATTORNEY

Int. Cl.: 3

Prior U.S. Cls.: 1, 4, 6, 50, 51 and 52

United States Patent and Trademark Office

Reg. No. 3,474,584

Registered July 29, 2008

**TRADEMARK
PRINCIPAL REGISTER**

**TRIPLE BENEFIT POST-SHAVE
REMEDY**

ARAMIS INC. (DELAWARE CORPORATION)
767 FIFTH AVENUE
NEW YORK, NY 10153

FOR: NON-MEDICATED SKIN CARE PREPARA-
TIONS, IN CLASS 3 (U.S. CLS. 1, 4, 6, 50, 51 AND 52).

FIRST USE 8-15-2006; IN COMMERCE 8-15-2006.

THE MARK CONSISTS OF STANDARD CHAR-
ACTERS WITHOUT CLAIM TO ANY PARTICULAR
FONT, STYLE, SIZE, OR COLOR.

NO CLAIM IS MADE TO THE EXCLUSIVE
RIGHT TO USE "POST-SHAVE", APART FROM
THE MARK AS SHOWN.

SER. NO. 77-091,767, FILED 1-26-2007.

GENE MACIOL, EXAMINING ATTORNEY

Int. Cl.: 41

Prior U.S. Cls.: 100, 101 and 107

United States Patent and Trademark Office

Reg. No. 3,474,585

Registered July 29, 2008

**SERVICE MARK
PRINCIPAL REGISTER**

BEAR MOUNTAIN

SNOW SUMMIT SKI CORPORATION (CALIFORNIA CORPORATION)
PO BOX 77, 880 SUMMIT BLVD.
BIG BEAR LAKE, CA 92315

FOR: PROVIDING FACILITIES FOR RECREATION ACTIVITIES, NAMELY, A SPORTING AND ENTERTAINMENT DESTINATION THAT PROVIDES ENTERTAINMENT AND RECREATIONAL SERVICES FOR YEAR ROUND SPORTING ACTIVITIES, NAMELY, SKIING AND SNOWBOARDING, PROVIDING SLOPES FOR RECREATIONAL SKIING AND SNOWBOARDING; ARRANGING AND CONDUCTING SKI AND SNOWBOARD COMPETITIONS, RACES, EXHIBITIONS, AND SHOWS; OFFERING SKI RENTALS, SKI INSTRUCTION, AND SNOWBOARDING CAMP; ARRANGING AND

CONDUCTING SPORTING EVENTS, NAMELY, GOLF, BIKING AND HIKING, IN CLASS 41 (U.S. CLS. 100, 101 AND 107).

FIRST USE 8-1-1988; IN COMMERCE 8-1-1988.

THE MARK CONSISTS OF STANDARD CHARACTERS WITHOUT CLAIM TO ANY PARTICULAR FONT, STYLE, SIZE, OR COLOR.

OWNER OF U.S. REG. NO. 1,545,722.

SER. NO. 77-093,889, FILED 1-29-2007.

NAPOLEON SHARMA, EXAMINING ATTORNEY

Int. Cl.: 25

Prior U.S. Cls.: 22 and 39

United States Patent and Trademark Office

Reg. No. 3,474,586

Registered July 29, 2008

**TRADEMARK
PRINCIPAL REGISTER**



SEASONAL MARKETING, INC. (OREGON CORPORATION)
14008 SE RUSK ROAD
MILWAUKIE, OR 97222

NO CLAIM IS MADE TO THE EXCLUSIVE RIGHT TO USE "WATERFOWL WADING SYSTEMS", APART FROM THE MARK AS SHOWN.

FOR: WADING PANTS, WADING OVERALLS, WADING BOOTS, BREATHABLE WADERS, NEOPRENE WADERS, WADING SHOES, IN CLASS 25 (U.S. CLS. 22 AND 39).

SER. NO. 77-094,714, FILED 1-30-2007.

FIRST USE 3-15-2007; IN COMMERCE 3-15-2007.

TRACY CROSS, EXAMINING ATTORNEY

Int. Cl.: 6

Prior U.S. Cls.: 2, 12, 13, 14, 23, 25 and 50

United States Patent and Trademark Office

Reg. No. 3,474,587

Registered July 29, 2008

**TRADEMARK
PRINCIPAL REGISTER**



MUL-T-LOCK TECHNOLOGIES LTD. (ISRAEL
CORPORATION)
MUL-T-LOCK PARK
HA'AZMAUT BLVD.
YAVNE, ISRAEL

FOR: LOCKS, LOCK BOLTS, DOOR BOLTS,
MORTISE LOCKS, PADLOCKS, KEYS FOR LOCKS
AND BLANKS FOR KEYS FOR LOCKS, BOLTS,
PADLOCK HASPS, LOCK CYLINDERS, SAFETY
CHAINS, KEY RINGS, BOXES, METAL NAME
PLATES, KING-PIN LOCKS, SHIPMENT CONTAIN-
ER LOCKS, AND PARTS THEREFOR, ALL OF THE
FOREGOING BEING NON-ELECTRIC AND MADE

OF METAL, IN CLASS 6 (U.S. CLS. 2, 12, 13, 14, 23, 25
AND 50).

FIRST USE 4-30-2003; IN COMMERCE 4-30-2003.

OWNER OF U.S. REG. NO. 2,965,591.

THE MARK CONSISTS OF THE LETTER "G"
AND A DESIGN.

SER. NO. 77-095,304, FILED 1-31-2007.

MARLENE BELL, EXAMINING ATTORNEY

Int. Cl.: 32

Prior U.S. Cls.: 45, 46 and 48

Reg. No. 3,474,588

United States Patent and Trademark Office

Registered July 29, 2008

TRADEMARK
PRINCIPAL REGISTER



NATURALISIMO, SOCIEDAD ANONIMA (GUATEMALA SOCIEDAD ANONIMA)
GERENCIAL LAS MARGARITAS TORRE 2, 14-1B
DIAGONAL 6, 10-01, ZONA 10, CENTRO
CIUDAD DE GUATEMALA, GUATEMALA 01010

FOR: FRUIT DRINKS AND BEVERAGES; FRESH SQUEEZED PASTEURIZED LEMONADE AND LEMON JUICE, IN CLASS 32 (U.S. CLS. 45, 46 AND 48).

FIRST USE 12-14-2007; IN COMMERCE 12-14-2007.

NO CLAIM IS MADE TO THE EXCLUSIVE RIGHT TO USE "NATURALISIMO", APART FROM THE MARK AS SHOWN.

"THE COLOR(S) BLACK AND GREEN IS/ARE CLAIMED AS A FEATURE OF THE MARK."

THE MARK CONSISTS OF THE LETTERS "NAT-URA" AND "ISIMO" IN STYLIZED FORM IN BLACK, WITH THE LETTER "L" BETWEEN "NAT-URA AND ISIMO" IN GREEN WITH A STYLIZED ELLIPTICAL LOOP AT THE TOP, AND A SEMI-CIRCLE ARCH AND THREE ELONGATED ELLIPTICAL SHAPES RESEMBLING THE LOOP OF THE LETTER "L" ADJACENT TO THE LOOP OF THE "L" BUT IN A LIGHTER SHADE OF GREEN AND DISPOSED ABOVE THE LETTERS "RALISI".

THE FOREIGN WORDING IN THE MARK TRANSLATES INTO ENGLISH AS THE MOST OR MAXIMUM NATURAL.

SER. NO. 77-095,373, FILED 1-31-2007.

STEVEN R. FINE, EXAMINING ATTORNEY

Int. Cls.: 9 and 41

Prior U.S. Cls.: 21, 23, 26, 36, 38, 100, 101 and 107

Reg. No. 3,474,589

United States Patent and Trademark Office

Registered July 29, 2008

**TRADEMARK
SERVICE MARK
PRINCIPAL REGISTER**

COUNCIL EDGE

THE COUNCIL OF INSURANCE AGENTS &
BROKERS (ILLINOIS CORPORATION)
701 PENNSYLVANIA AVENUE, NW
WASHINGTON, DC 20004

FOR: DOWNLOADABLE ELECTRONIC PUBLI-
CATIONS IN THE NATURE OF NEWSLETTERS
REGARDING NEWS AND GENERAL INTEREST IN
THE FIELD OF INSURANCE AND EMPLOYEE
BENEFITS, IN CLASS 9 (U.S. CLS. 21, 23, 26, 36
AND 38).

FIRST USE 1-11-2007; IN COMMERCE 1-11-2007.

FOR: PROVIDING ON-LINE PUBLICATIONS IN
THE NATURE OF NEWSLETTERS REGARDING

NEWS AND GENERAL INTEREST IN THE FIELD
OF INSURANCE AND EMPLOYEE BENEFITS, IN
CLASS 41 (U.S. CLS. 100, 101 AND 107).

FIRST USE 1-11-2007; IN COMMERCE 1-11-2007.

THE MARK CONSISTS OF STANDARD CHAR-
ACTERS WITHOUT CLAIM TO ANY PARTICULAR
FONT, STYLE, SIZE, OR COLOR.

SER. NO. 77-095,863, FILED 1-31-2007.

WILLIAM ROSSMAN, EXAMINING ATTORNEY

Int. Cl.: 33

Prior U.S. Cls.: 47 and 49

United States Patent and Trademark Office

Reg. No. 3,474,590

Registered July 29, 2008

**TRADEMARK
PRINCIPAL REGISTER**

GRIFFITH PARK

ISLAY JOY KENNEDY (AUSTRALIA INDIVIDUAL)
VICKERY HOUSE
3 RIDGEWOOD DRIVE
HARPENDEN, UNITED KINGDOM AL53NL

PRIORITY CLAIMED UNDER SEC. 44(D) ON
UNITED KINGDOM APPLICATION NO. 2431055,
FILED 8-29-2006, REG. NO. 2431055, DATED 2-16-
2007, EXPIRES 8-29-2016.

FOR: WINES, IN CLASS 33 (U.S. CLS. 47 AND 49).

SER. NO. 77-096,407, FILED 2-1-2007.

THE MARK CONSISTS OF STANDARD CHARACTERS WITHOUT CLAIM TO ANY PARTICULAR FONT, STYLE, SIZE, OR COLOR.

DAVID YONTEF, EXAMINING ATTORNEY

Int. Cl.: 9

Prior U.S. Cls.: 21, 23, 26, 36 and 38

Reg. No. 3,474,591

United States Patent and Trademark Office

Registered July 29, 2008

**TRADEMARK
PRINCIPAL REGISTER**

BATTERY TENDER

DELTONA TRANSFORMER CORPORATION
(FLORIDA CORPORATION)
801 U.S. HWY. 92, EAST
DELAND, FL 32724

FOR: BATTERY CHARGER FOR USE IN MAR-
INE INDUSTRY, MOTORCYCLES, AUTOMOTIVE
OR, IN ANY VEHICLE OR APPLICATION USING
LEAD ACID OR GEL BATTERIES, IN CLASS 9 (U.S.
CLS. 21, 23, 26, 36 AND 38).

FIRST USE 12-0-1991; IN COMMERCE 2-0-1992.

THE MARK CONSISTS OF STANDARD CHAR-
ACTERS WITHOUT CLAIM TO ANY PARTICULAR
FONT, STYLE, SIZE, OR COLOR.

NO CLAIM IS MADE TO THE EXCLUSIVE
RIGHT TO USE "BATTERY", APART FROM THE
MARK AS SHOWN.

SEC. 2(F).

SER. NO. 77-096,420, FILED 2-1-2007.

DAVID YONTEF, EXAMINING ATTORNEY

Int. Cls.: 35, 38 and 42

Prior U.S. Cls.: 100, 101, 102 and 104

United States Patent and Trademark Office

Reg. No. 3,474,592

Registered July 29, 2008

**SERVICE MARK
PRINCIPAL REGISTER**

VEODA

VEODA, LLC (VIRGINIA LTD LIAB CO)
6933 COMMONS PLAZA, SUITE 184
CHESTERFIELD, VA 23832

FOR: PROVIDING ADVERTISING SERVICES AND AN ADVERTISING OUTLET VIA A GLOBAL COMPUTER NETWORK, IN CLASS 35 (U.S. CLS. 100, 101 AND 102).

FIRST USE 2-20-2006; IN COMMERCE 2-20-2006.

FOR: COMPUTER SERVICES, NAMELY, PROVIDING ELECTRONIC MAIL AND WORKGROUP COMMUNICATIONS SERVICES OVER COMPUTER NETWORKS; INSTANT MESSAGING SERVICES; FILE SHARING SERVICES, NAMELY, ELECTRONIC TRANSMISSION OF DATA VIA GLOBAL COMPUTER NETWORKS, IN CLASS 38 (U.S. CLS. 100, 101 AND 104).

FIRST USE 2-20-2006; IN COMMERCE 2-20-2006.

FOR: COMPUTER SERVICES, NAMELY, PROVIDING SOFTWARE INTERFACES AVAILABLE OVER A NETWORK IN ORDER TO CREATE PERSONALIZED ON-LINE INFORMATION SERVICES; EXTRACTION AND RETRIEVAL OF INFORMATION AND DATA MINING BY MEANS OF GLOBAL COMPUTER NETWORKS; PROVIDING INFORMATION FROM SEARCHABLE INDICES AND DATABASES OF INFORMATION, INCLUDING TEXT, ELECTRONIC DOCUMENTS, DATABASES, GRAPHIC AND AUDIO VISUAL INFORMATION, BY MEANS OF GLOBAL COMPUTER INFORMATION NETWORKS, IN CLASS 42 (U.S. CLS. 100 AND 101).

FIRST USE 2-20-2006; IN COMMERCE 2-20-2006.

THE MARK CONSISTS OF STANDARD CHARACTERS WITHOUT CLAIM TO ANY PARTICULAR FONT, STYLE, SIZE, OR COLOR.

SER. NO. 77-097,838, FILED 2-2-2007.

JAMES A. RAUEN, EXAMINING ATTORNEY

Int. Cl.: 36

Prior U.S. Cls.: 100, 101 and 102

United States Patent and Trademark Office

Reg. No. 3,474,593

Registered July 29, 2008

**SERVICE MARK
PRINCIPAL REGISTER**

BLACKHOUSE FOUNDATION

SHINE, CAROL ANN (UNITED STATES INDIVIDUAL)
1413 SANBORN AVENUE
LOS ANGELES, CA 90027

FOR: CHARITABLE FUND RAISING SERVICES,
IN CLASS 36 (U.S. CLS. 100, 101 AND 102).

FIRST USE 3-1-2006; IN COMMERCE 1-17-2007.

THE MARK CONSISTS OF STANDARD CHARACTERS WITHOUT CLAIM TO ANY PARTICULAR FONT, STYLE, SIZE, OR COLOR.

OWNER OF U.S. REG. NO. 3,316,506.

NO CLAIM IS MADE TO THE EXCLUSIVE RIGHT TO USE "FOUNDATION", APART FROM THE MARK AS SHOWN.

SER. NO. 77-098,634, FILED 2-3-2007.

MICHAEL LITZAU, EXAMINING ATTORNEY

Int. Cl.: 35

Prior U.S. Cls.: 100, 101 and 102

United States Patent and Trademark Office

Reg. No. 3,474,594

Registered July 29, 2008

**SERVICE MARK
PRINCIPAL REGISTER**

SmartChoice

AUTONATION HOLDING CORP. (DELAWARE CORPORATION)
110 S.E. 6TH STREET, 20TH FLOOR
FT. LAUDERDALE, FL 33301

FOR: AUTOMOBILE DEALERSHIP SERVICES;
AND PROVIDING A COMPUTERIZED DATABASE
FEATURING PRICING, PAYMENT, AND SELECTION
INFORMATION IN THE FIELD OF NEW AND

USED AUTOMOBILES, IN CLASS 35 (U.S. CLS. 100,
101 AND 102).

FIRST USE 4-17-2006; IN COMMERCE 4-17-2006.

SER. NO. 77-099,383, FILED 2-5-2007.

WILLIAM VERHOSEK, EXAMINING ATTORNEY

Int. Cls.: 30, 35 and 43

Prior U.S. Cls.: 46, 100, 101 and 102

United States Patent and Trademark Office

Reg. No. 3,474,595

Registered July 29, 2008

TRADEMARK
SERVICE MARK
PRINCIPAL REGISTER



NABORS ENTERPRISES, INC. (ARKANSAS CORPORATION)
1012 U. S. HWY. 62-65 NORTH
HARRISON, AR 72601

FOR: BAKERY PRODUCTS, IN CLASS 30 (U.S. CL. 46).

FIRST USE 10-12-2006; IN COMMERCE 10-12-2006.

FOR: RETAIL BAKERY SHOPS, IN CLASS 35 (U.S. CLS. 100, 101 AND 102).

FIRST USE 10-12-2006; IN COMMERCE 10-12-2006.

FOR: CAFE SERVICES, IN CLASS 43 (U.S. CLS. 100 AND 101).

FIRST USE 10-12-2006; IN COMMERCE 10-12-2006.

NO CLAIM IS MADE TO THE EXCLUSIVE RIGHT TO USE "BAKERY & CAFE", APART FROM THE MARK AS SHOWN.

THE MARK CONSISTS OF A WOODCUT DRAWING OF THE ACTUAL BUILDING IN PRESENT USE. UNDER THE BUILDING ARE THE WORDS "NEIGHBOR'S MILL BAKERY & CAFE". THREE HEADS OF WHEAT WITH STEMS ARE UNDER THE WORD "NEIGHBOR'S", WITH THE STEMS APPEARING TO GO THROUGH THE BOTTOM OF THE LETTER "G". THE WORDS "NEIGHBOR'S MILL" ARE IN BLOCK TYPE AND THE WORDS "BAKERY & CAFE" ARE ITALICIZED.

SER. NO. 77-100,701, FILED 2-6-2007.

ANGELA GAW, EXAMINING ATTORNEY

Int. Cl.: 35

Prior U.S. Cls.: 100, 101 and 102

United States Patent and Trademark Office

Reg. No. 3,474,596

Registered July 29, 2008

**SERVICE MARK
PRINCIPAL REGISTER**

PURESAMPLE

GLOBAL MARKET INSITE, INC. (WASHINGTON CORPORATION)
FLOOR 5
2835 82ND AVENUE S.E.
MERCER ISLAND, WA 98040

FOR: PROVIDING AN ONLINE SEARCHABLE COMPUTER DATABASE IN THE FIELDS OF MARKET RESEARCH, STUDIES AND POLLS; PROVIDING AN ONLINE SEARCHABLE COMPUTER DATABASE TO RESEARCH AND REPORT ON THE INTEGRITY OF RESPONDENTS AND PANELISTS PARTICIPATING IN GLOBAL CONSUMER AND SPECIALTY PANELS USED FOR ONLINE MARKET RESEARCH; ONLINE REPORTING OF FRAUDULENT AND DISHONEST GLOBAL PANEL PARTICIPANTS, RESPONDENTS AND PANELISTS; COMPUTERIZED ONLINE INVESTIGATIVE AND INFORMATION SERVICES RELATIVE TO THE PARTICIPATION OF RESPONDENTS AND PANELISTS IN GLOBAL CONSUMER AND SPECIALTY

PANELS USED FOR ONLINE MARKET RESEARCH FOR ENABLING ACCURATE PANEL REPORTING AND RESULTS; BUSINESS INVESTIGATIVE AND INFORMATION SERVICES FOR MAINTAINING THE INTEGRITY OF RESPONDENTS AND PANELISTS PARTICIPATING IN GLOBAL CONSUMER AND SPECIALTY PANELS USED FOR ONLINE MARKET RESEARCH AND CUSTOMER AND CONSUMER POLLING PRACTICES, IN CLASS 35 (U.S. CLS. 100, 101 AND 102).

FIRST USE 9-15-2006; IN COMMERCE 9-15-2006.

THE MARK CONSISTS OF STANDARD CHARACTERS WITHOUT CLAIM TO ANY PARTICULAR FONT, STYLE, SIZE, OR COLOR.

SER. NO. 77-100,888, FILED 2-6-2007.

PAUL MORENO, EXAMINING ATTORNEY

Int. Cl.: 41

Prior U.S. Cls.: 100, 101 and 107

United States Patent and Trademark Office

Reg. No. 3,474,597

Registered July 29, 2008

**SERVICE MARK
PRINCIPAL REGISTER**

BLACK BELT WORLD

BLACK BELT WORLD, INC. (NORTH CAROLINA CORPORATION)
2821 SPRING FOREST RD.
RALEIGH, NC 27616

FOR: TRAINING SERVICES IN THE FIELD OF MARTIAL ARTS; EDUCATIONAL SERVICES, NAMELY, PROVIDING PROGRAMS, CLASSES, WORKSHOPS, SEMINARS, SUMMER CAMPS AND PRIVATE LESSONS IN THE FIELD OF MARTIAL ARTS, SELF-DEFENSE AND TAE KWON-DO; PROVIDING A WEBSITE FEATURING MARTIAL ARTS AND TAE KWON-DO INFORMATION, IN CLASS 41 (U.S. CLS. 100, 101 AND 107).

FIRST USE 1-1-1994; IN COMMERCE 1-1-1994.

THE MARK CONSISTS OF STANDARD CHARACTERS WITHOUT CLAIM TO ANY PARTICULAR FONT, STYLE, SIZE, OR COLOR.

NO CLAIM IS MADE TO THE EXCLUSIVE RIGHT TO USE "BLACK BELT", APART FROM THE MARK AS SHOWN.

SER. NO. 77-101,544, FILED 2-7-2007.

BARBARA GAYNOR, EXAMINING ATTORNEY

Int. Cl.: 41

Prior U.S. Cls.: 100, 101 and 107

United States Patent and Trademark Office

Reg. No. 3,474,598

Registered July 29, 2008

**SERVICE MARK
PRINCIPAL REGISTER**

PEM

PEABODY ESSEX MUSEUM, INC. (MASSACHU-
SETTS CORPORATION)
EAST INDIA SQUARE 161 ESSEX STREET
SALEM, MA 01970

FOR: MUSEUM SERVICES; CONDUCTING EX-
HIBITIONS, WORKSHOPS, SEMINARS, LECTURES,
TOURS, FILM AND VIDEO PRESENTATIONS IN
THE FIELDS OF ART, CULTURE AND DESIGN;
LIBRARIES AND STUDY CENTERS IN THE FIELDS
OF ART, CULTURE, AND DESIGN; PROVIDING
INFORMATION IN THE FIELDS OF ART AND
CULTURE OVER THE INTERNET; AND PUBLICA-
TION OF EDUCATIONAL MATERIAL IN THE

FIELDS OF ART, CULTURE, AND DESIGN, IN
CLASS 41 (U.S. CLS. 100, 101 AND 107).

FIRST USE 6-30-2003; IN COMMERCE 6-30-2003.

THE MARK CONSISTS OF STANDARD CHAR-
ACTERS WITHOUT CLAIM TO ANY PARTICULAR
FONT, STYLE, SIZE, OR COLOR.

SER. NO. 77-101,622, FILED 2-7-2007.

PAUL E. FAHRENKOPF, EXAMINING ATTORNEY

Int. Cl.: 41

Prior U.S. Cls.: 100, 101 and 107

United States Patent and Trademark Office

Reg. No. 3,474,599

Registered July 29, 2008

**SERVICE MARK
PRINCIPAL REGISTER**

PEABODY ESSEX MUSEUM

PEABODY ESSEX MUSEUM, INC. (MASSACHU-
SETTS CORPORATION)
EAST INDIA SQUARE
161 ESSEX STREET
SALEM, MA 01970

FOR: MUSEUM SERVICES; CONDUCTING EX-
HIBITIONS, WORKSHOPS, SEMINARS, LECTURES,
TOURS, FILM AND VIDEO PRESENTATIONS IN
THE FIELDS OF ART, CULTURE, AND DESIGN;
LIBRARIES AND STUDY CENTERS IN THE FIELDS
OF ART, CULTURE, AND DESIGN; PROVIDING
INFORMATION IN THE FIELDS OF ART AND
CULTURE OVER THE INTERNET; AND PUBLICA-
TION OF EDUCATIONAL MATERIAL IN THE
FIELDS OF ART, CULTURE, AND DESIGN, IN
CLASS 41 (U.S. CLS. 100, 101 AND 107).

FIRST USE 7-31-1992; IN COMMERCE 7-31-1992.

THE MARK CONSISTS OF STANDARD CHAR-
ACTERS WITHOUT CLAIM TO ANY PARTICULAR
FONT, STYLE, SIZE, OR COLOR.

NO CLAIM IS MADE TO THE EXCLUSIVE
RIGHT TO USE "MUSEUM" , APART FROM THE
MARK AS SHOWN.

SER. NO. 77-101,628, FILED 2-7-2007.

PAUL E. FAHRENKOPF, EXAMINING ATTORNEY

Int. Cl.: 28

Prior U.S. Cls.: 22, 23, 38 and 50

United States Patent and Trademark Office

Reg. No. 3,474,600

Registered July 29, 2008

**TRADEMARK
PRINCIPAL REGISTER**

SMELLIN' MELON

MATTEL, INC. (DELAWARE CORPORATION)
MAIL STOP M1-1518
333 CONTINENTAL BOULEVARD
EL SEGUNDO, CA 90245

FOR: TOYS, GAMES AND PLAYTHINGS, NAME-
LY, TOY VEHICLES, TOY FIGURES, AND ACCES-
SORIES FOR ALL OF THE FOREGOING, IN CLASS
28 (U.S. CLS. 22, 23, 38 AND 50).

FIRST USE 10-9-2007; IN COMMERCE 10-9-2007.

THE MARK CONSISTS OF STANDARD CHAR-
ACTERS WITHOUT CLAIM TO ANY PARTICULAR
FONT, STYLE, SIZE, OR COLOR.

NO CLAIM IS MADE TO THE EXCLUSIVE
RIGHT TO USE "MELON", APART FROM THE
MARK AS SHOWN.

SER. NO. 77-102,427, FILED 2-8-2007.

ANDREA SAUNDERS, EXAMINING ATTORNEY

Int. Cls.: 3 and 16

Prior U.S. Cls.: 1, 2, 4, 5, 6, 22, 23, 29, 37, 38, 50, 51
and 52

Reg. No. 3,474,601

United States Patent and Trademark Office

Registered July 29, 2008

TRADEMARK
PRINCIPAL REGISTER

the firm
for him
by **IU**

IU COSMETICS S.A. DE C.V. (MEXICO CORPORATION)
BLVD. JUAN ALONSO DE TORRES NO. 106
FRACC. SAN JERONIMO
LEON GTO, MEXICO 37204

FOR: SOAPS FOR PERSONAL USE, PERFUME, ESSENTIAL OILS, COSMETICS AND HAIR LOTIONS, IN CLASS 3 (U.S. CLS. 1, 4, 6, 50, 51 AND 52).

FOR: PAPER POSTERS; PRINTED PAPER SIGNS; PRINTED CARDBOARD SIGNS; PRINTED TICKETS; PAMPHLETS IN THE FIELD OF COSMETICS; PRINTED MATTER, NAMELY, CATALOGS IN THE FIELD OF COSMETICS; PLASTIC BAGS FOR PACKING, IN CLASS 16 (U.S. CLS. 2, 5, 22, 23, 29, 37, 38 AND 50).

PRIORITY CLAIMED UNDER SEC. 44(D) ON MEXICO APPLICATION NO. 800994, FILED 8-17-2006, REG. NO. 980462, DATED 4-19-2007, EXPIRES 8-17-2016.

PRIORITY CLAIMED UNDER SEC. 44(D) ON MEXICO APPLICATION NO. 800997, FILED 8-17-2006, REG. NO. 980464, DATED 4-19-2007, EXPIRES 8-17-2016.

NO CLAIM IS MADE TO THE EXCLUSIVE RIGHT TO USE "FOR HIM", APART FROM THE MARK AS SHOWN.

SER. NO. 77-103,114, FILED 2-8-2007.

ROBERT LAVACHE, EXAMINING ATTORNEY

Int. Cls.: 21, 25 and 41

**Prior U.S. Cls.: 2, 13, 22, 23, 29, 30, 33, 39, 40, 50, 100,
101 and 107**

Reg. No. 3,474,602

United States Patent and Trademark Office

Registered July 29, 2008

**TRADEMARK
SERVICE MARK
PRINCIPAL REGISTER**

Leadville Trail 100

LEADVILLE TRAIL 100 INC. (COLORADO CORPORATION)
213 HARRISON AVENUE
LEADVILLE, CO 80461

FOR: MUGS, CUPS AND PLATES, IN CLASS 21 (U.S. CLS. 2, 13, 23, 29, 30, 33, 40 AND 50).

FIRST USE 9-18-1989; IN COMMERCE 9-18-1989.

FOR: SHIRTS, T-SHIRTS, GOLF SHIRTS, POLO SHIRTS, TANK TOPS, WARM-UP SUITS, SWEATSHIRTS, SWEATPANTS, SWEATSHORTS, SHORTS, COMPRESSION SHORTS, TRUNKS, JACKETS, REVERSIBLE JACKETS, COATS, RAINWEAR, SWEATERS, TURTLENECK SHIRTS AND SWEATERS, VESTS, FLEECE VESTS, RUNNER'S VEST WITH REFLECTIVE STRIPES AND ADJUSTABLE STRAPS, TIGHTS, BODY STOCKINGS, KNIT HOSIERY, BODYSUITS, LEOTARDS, UNITARDS, BRIEFS, UNDERWEAR, BRAS, SPORTS BRAS, SINGLETs, HATS, CAPS, HEADBANDS, GLOVES, SCARVES, LOUNGEWEAR, SLEEPWEAR, SOCKS, SLIPPERS AND FOOTWEAR, IN CLASS 25 (U.S. CLS. 22 AND 39).

FIRST USE 9-18-1989; IN COMMERCE 9-18-1989.

FOR: ENTERTAINMENT SERVICES, NAMELY, ORGANIZING, CONDUCTING AND STAGING ATHLETIC CONTESTS, NAMELY, ATHLETIC BIKING AND RUNNING RACES, IN CLASS 41 (U.S. CLS. 100, 101 AND 107).

FIRST USE 9-18-1989; IN COMMERCE 9-18-1989.

THE MARK CONSISTS OF STANDARD CHARACTERS WITHOUT CLAIM TO ANY PARTICULAR FONT, STYLE, SIZE, OR COLOR.

SEC. 2(F).

THE 2(F) CLAIM IS RESTRICTED TO CLASS(ES) 041

SER. NO. 77-104,185, FILED 2-9-2007.

WENDY JUN, EXAMINING ATTORNEY

Int. Cl.: 16

Prior U.S. Cls.: 2, 5, 22, 23, 29, 37, 38 and 50

Reg. No. 3,474,603

United States Patent and Trademark Office

Registered July 29, 2008

**TRADEMARK
PRINCIPAL REGISTER**

RADCLIFFE QUARTERLY

PRESIDENT AND FELLOWS OF HARVARD
COLLEGE (MASSACHUSETTS CORPORATION)
124 MOUNT AUBURN ST., SUITE 570-N
CAMBRIDGE, MA 02138

FOR: PAPER GOODS AND PRINTED MATTER,
NAMELY, A JOURNAL RELATED TO SCHOLAR-
SHIP IN A WIDE RANGE OF ACADEMIC DISCI-
PLINES, PROFESSIONS, AND CREATIVE ARTS, IN
CLASS 16 (U.S. CLS. 2, 5, 22, 23, 29, 37, 38 AND 50).

FIRST USE 12-31-1916; IN COMMERCE 12-31-1916.

THE MARK CONSISTS OF STANDARD CHAR-
ACTERS WITHOUT CLAIM TO ANY PARTICULAR
FONT, STYLE, SIZE, OR COLOR.

NO CLAIM IS MADE TO THE EXCLUSIVE
RIGHT TO USE "QUARTERLY", APART FROM
THE MARK AS SHOWN.

SEC. 2(F).

SER. NO. 77-105,435, FILED 2-12-2007.

AISHA CLARKE, EXAMINING ATTORNEY

Int. Cls.: 36, 41 and 42

Prior U.S. Cls.: 100, 101, 102 and 107

United States Patent and Trademark Office

Reg. No. 3,474,604

Registered July 29, 2008

**SERVICE MARK
PRINCIPAL REGISTER**

**RADCLIFFE INSTITUTE FOR
ADVANCED STUDY**

PRESIDENT AND FELLOWS OF HARVARD
COLLEGE (MASSACHUSETTS CORPORATION)
124 MOUNT AUBURN ST., SUITE 570-N
CAMBRIDGE, MA 02138

FOR: PROVIDING EDUCATIONAL SCHOLARSHIPS AND FELLOWSHIPS IN SUPPORT OF SCHOLARS, SCIENTISTS, ARTISTS, AND WRITERS WORKING IN A WIDE RANGE OF ACADEMIC DISCIPLINES, PROFESSIONS, AND CREATIVE ARTS, IN CLASS 36 (U.S. CLS. 100, 101 AND 102).

FIRST USE 12-31-1999; IN COMMERCE 12-31-1999.

FOR: EDUCATIONAL SERVICES, NAMELY, DEVELOPING, ARRANGING, AND CONDUCTING EDUCATIONAL CONFERENCES AND LECTURES IN A WIDE RANGE OF ACADEMIC DISCIPLINES, PROFESSIONS, AND CREATIVE ARTS, IN CLASS 41 (U.S. CLS. 100, 101 AND 107).

FIRST USE 12-31-1999; IN COMMERCE 12-31-1999.

FOR: SCHOLARLY RESEARCH IN A WIDE RANGE OF ACADEMIC DISCIPLINES, PROFESSIONS, AND CREATIVE ARTS, NAMELY, IN THE FIELDS OF FINE ARTS, SCIENCE, HUMANITIES AND SOCIAL SCIENCE, IN CLASS 42 (U.S. CLS. 100 AND 101).

FIRST USE 12-31-1999; IN COMMERCE 12-31-1999.

THE MARK CONSISTS OF STANDARD CHARACTERS WITHOUT CLAIM TO ANY PARTICULAR FONT, STYLE, SIZE, OR COLOR.

NO CLAIM IS MADE TO THE EXCLUSIVE RIGHT TO USE "INSTITUTE FOR ADVANCED STUDY", APART FROM THE MARK AS SHOWN.

SEC. 2(F).

SER. NO. 77-105,439, FILED 2-12-2007.

AISHA CLARKE, EXAMINING ATTORNEY

Int. Cl.: 36

Prior U.S. Cls.: 100, 101 and 102

United States Patent and Trademark Office

Reg. No. 3,474,605

Registered July 29, 2008

SERVICE MARK
PRINCIPAL REGISTER



AMERICAS UNITED BANK (CALIFORNIA CORPORATION)
SUITE 1150
801 N. BRAND BLVD.
GLENDALE, CA 91203

FOR: ADMINISTRATION OF SAVINGS ACCOUNTS; ADVICE RELATING TO INVESTMENTS; BANKING; BANKING CONSULTATION; BROKERAGE OF SHARES AND OTHER SECURITIES; BUSINESS FINANCE PROCUREMENT SERVICES; CASH AND FOREIGN EXCHANGE TRANSACTIONS; CASH MANAGEMENT; CHECK CASHING; CHECK PROCESSING; CHECK VERIFICATION; CHECKING ACCOUNT SERVICES; COMMERCIAL LENDING SERVICES; COMMODITY INVESTMENT ADVICE; CONSUMER CREDIT CONSULTATION; CONSUMER LENDING SERVICES; CORPORATE SAVINGS ACCOUNT SERVICES; CREDIT AND CASH CARD SERVICES; CREDIT AND FINANCIAL CONSULTATION; CREDIT CARD SERVICES; CREDIT CARD TRANSACTION PROCESSING SERVICES; CREDIT CARD VERIFICATION; CREDIT CONSULTATION; CURRENCY EXCHANGE AND ADVICE; DEBIT CARD SERVICES; ELECTRONIC CASH TRANSACTIONS; ELECTRONIC CREDIT CARD TRANSACTIONS; ELECTRONIC DEBIT TRANSACTIONS; ELECTRONIC FINANCIAL SERVICE FOR THE PURCHASE OF SAVINGS BONDS; ELECTRONIC FUNDS TRANSFER; ELECTRONIC FUNDS TRANSFER BY TELECOMMUNICATIONS; ELECTRONIC PAYMENT, NAMELY, ELECTRONIC PROCESSING AND TRANSMISSION OF BILL PAYMENT DATA; ELECTRONIC TRANSFER OF MONEY; FINANCIAL ANALYSIS AND CONSULTATION; FINANCIAL CONSULTATION; FINANCIAL GUARANTEE AND SURETY; FINANCIAL LOAN CONSULTATION; FINANCIAL MANAGEMENT; FINANCIAL PLANNING; FINANCIAL PLANNING, NAMELY, THE CREATION OF PERSONALIZED STRATEGIES TO ACHIEVE FINANCIAL INDEPENDENCE; FINANCIAL PORTFOLIO

MANAGEMENT; FINANCIAL SERVICES IN THE FIELD OF MONEY LENDING; FINANCIAL SERVICES, NAMELY, ASSISTING OTHERS WITH THE COMPLETION OF FINANCIAL TRANSACTIONS FOR STOCKS, BONDS, SECURITIES AND EQUITIES; FINANCIAL SERVICES, NAMELY, MONEY LENDING; FINANCIAL SERVICES, NAMELY, PROVIDING ON-LINE STORED VALUE ACCOUNTS IN AN ELECTRONIC ENVIRONMENT; FINANCIAL SERVICES, NAMELY, A TOTAL PORTFOLIO OFFERING FOR HIGH NET WORTH CLIENTS CONSISTING OF BOTH SEPARATE ACCOUNTS AND MUTUAL FUNDS FOR EQUITY AND FIXED INCOME INVESTMENTS; FINANCIAL SERVICES, NAMELY, INVESTMENT FUND TRANSFER AND TRANSACTION SERVICES; FINANCIAL SERVICES, NAMELY, MORTGAGE PLANNING; FINANCIALLY-GUARANTEED FINANCING; FINANCING OF PURCHASES; FINANCING RELATING TO AUTOMOBILES; FINANCING SERVICES; HOME EQUITY LOANS; INSTALLMENT LOANS; INVESTMENT ADVICE; INVESTMENT BANKING SERVICES; INVESTMENT BROKERAGE; INVESTMENT MANAGEMENT; INVESTMENT SERVICES, NAMELY, ASSET ACQUISITION, CONSULTATION, DEVELOPMENT AND MANAGEMENT SERVICES; ISSUANCE OF BANK CHECKS; ISSUE OF TRAVELLER'S CHEQUES; ISSUING CREDIT CARDS; ISSUING OF CHECKS AND LETTERS OF CREDIT; ISSUING OF CHEQUES; LOAN FINANCING; MANAGEMENT OF A CAPITAL INVESTMENT FUND; MANAGEMENT OF PORTFOLIOS COMPRISING SECURITIES; MANAGEMENT OF PORTFOLIOS OF TRANSFERABLE SECURITIES; MORTGAGE BANKING SERVICES, NAMELY, ORIGINATION, ACQUISITION, SERVICING, SECURITIZATION AND BROKERAGE OF MORTGAGE LOANS; MORTGAGE BROKERAGE; MORTGAGE LENDING; MORTGAGE PROCUREMENT FOR OTHERS; MORTGAGE SERVICES, NAMELY, BUYER PRE-QUALIFICATION OF MORTGAGES FOR

MORTGAGE BROKERS AND BANKS; ON-LINE BANKING SERVICES; PROVIDING WORKING CAPITAL; REVOLVING LOANS; SAFE DEPOSIT BOX SERVICES; SAVINGS ACCOUNT SERVICES; SAVINGS AND LOAN SERVICES; SAVINGS BANK SERVICES; TRAVELERS' CHECK ISSUANCE, IN CLASS 36 (U.S. CLS. 100, 101 AND 102).

FIRST USE 11-9-2006; IN COMMERCE 11-9-2006.

NO CLAIM IS MADE TO THE EXCLUSIVE RIGHT TO USE "BANK", "THE BUSINESS BANK", "AMERICAS" AND "BANCO COMERCIAL", APART FROM THE MARK AS SHOWN.

THE COLOR(S) GREY, WHITE AND BLACK IS/ ARE CLAIMED AS A FEATURE OF THE MARK.

THE MARK CONSISTS OF THE WORDS "AMERICAS UNITED BANK" ON THREE LINES OF TEXT ON THE LEFT SIDE IN GREY; ONE LINE OF TEXT FOR EACH WORD. THE STYLIZED LETTERS "AUB" ON THE RIGHT IN A GREY-WHITE-GREY-WHITE-GREY DIAGONAL GRADIENT FILL THAT MAKES A METALLIC EFFECT AND A THIN LETTER OUTLINE IN BLACK. THE PHRASES "SU BANCO COMERCIAL" AND "THE BUSINESS BANK" IN GREY AT THE BOTTOM WITH A GREY DOT SEPARATING THESE TWO PHRASES.

THE FOREIGN WORDING IN THE MARK TRANSLATES INTO ENGLISH AS "YOUR BUSINESS BANK".

SER. NO. 77-106,372, FILED 2-13-2007.

ANGELA GAW, EXAMINING ATTORNEY

Int. Cl.: 19

Prior U.S. Cls.: 1, 12, 33 and 50

United States Patent and Trademark Office

Reg. No. 3,474,606

Registered July 29, 2008

**TRADEMARK
PRINCIPAL REGISTER**

IMPACTO

9031-1671 QUEBEC INC. (CANADA CORPORATION), DBA PRETECH
4800 ST-AMBROISE, SUITE 108
MONTREAL, CANADA H4C3N8

FOR: CONCRETE, IN CLASS 19 (U.S. CLS. 1, 12, 33 AND 50).

THE MARK CONSISTS OF STANDARD CHARACTERS WITHOUT CLAIM TO ANY PARTICULAR FONT, STYLE, SIZE, OR COLOR.

PRIORITY CLAIMED UNDER SEC. 44(D) ON CANADA APPLICATION NO. 1,334,652, FILED 2-8-2007, REG. NO. TMA709133, DATED 3-7-2008, EXPIRES 3-7-2023.

SER. NO. 77-107,732, FILED 2-14-2007.

H. M. FISHER, EXAMINING ATTORNEY

Int. Cl.: 5

Prior U.S. Cls.: 6, 18, 44, 46, 51 and 52

United States Patent and Trademark Office

Reg. No. 3,474,607

Registered July 29, 2008

**TRADEMARK
PRINCIPAL REGISTER**

TRIM

PRECISION WEIGHT LOSS, LLC (FLORIDA LTD
LIAB CO)
3850 TAMPA ROAD SUITE 102
PALM HARBOR, FL 34684

FIRST USE 1-5-2007; IN COMMERCE 1-5-2007.

SER. NO. 77-108,034, FILED S.R. 2-15-2007 AM. P.R.
12-11-2007.

FOR: WEIGHT LOSS SUPPLEMENT, IN CLASS 5
(U.S. CLS. 6, 18, 44, 46, 51 AND 52).

SIMON TENG, EXAMINING ATTORNEY

Int. Cls.: 35 and 41

Prior U.S. Cls.: 100, 101, 102 and 107

United States Patent and Trademark Office

Reg. No. 3,474,608

Registered July 29, 2008

**SERVICE MARK
PRINCIPAL REGISTER**

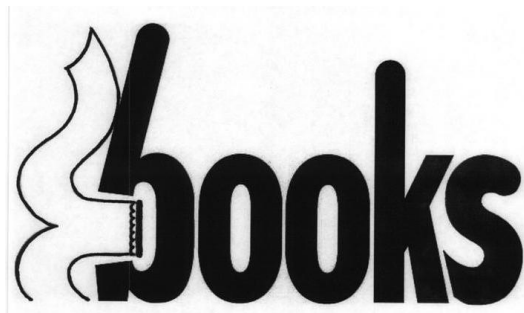

**B-BOOKS LTD. (OHIO LTD LIAB CO)
6977 FIVE MILE ROAD
CINCINNATI, OH 45230**

FOR: MANAGEMENT AND BUSINESS CONSULTING SERVICES IN THE FIELD OF ACADEMIC PUBLISHING, IN CLASS 35 (U.S. CLS. 100, 101 AND 102).

FIRST USE 12-28-2005; IN COMMERCE 3-17-2006.

FOR: EDITORIAL CONSULTATION; PUBLICATION AND EDITING OF PRINTED MATTER; PUBLICATION OF THE EDITORIAL CONTENT OF SITES ACCESSIBLE VIA A GLOBAL COMPUTER NETWORK; WRITTEN TEXT EDITING, IN CLASS 41 (U.S. CLS. 100, 101 AND 107).

FIRST USE 12-18-2005; IN COMMERCE 3-17-2006.

NO CLAIM IS MADE TO THE EXCLUSIVE RIGHT TO USE "BOOKS", APART FROM THE MARK AS SHOWN.

THE MARK CONSISTS OF AN OUTLINE OF AN OPEN BOOK WHICH CREATES A CAPITAL "B" WITH THE SPINE OF OPEN BOOK FORMING THE DASH THAT SEPARATES THE "B" FROM THE WORD "BOOKS", WHICH IS SET IN UNIQUE ROUNDED, BOLDFACE TYPE TO THE RIGHT OF THE OPEN BOOK OUTLINE.

SER. NO. 77-110,455, FILED 2-19-2007.

MORGAN WYNNE, EXAMINING ATTORNEY

Int. Cls.: 11 and 37

Prior U.S. Cls.: 13, 21, 23, 31, 34, 100, 103 and 106

United States Patent and Trademark Office

Reg. No. 3,474,609

Registered July 29, 2008

**TRADEMARK
SERVICE MARK
PRINCIPAL REGISTER**

ECOVECTOR

SMITH'S ENVIRONMENTAL PRODUCTS LIMITED (UNITED KINGDOM CORPORATION)
SOUTH WOODHAM FERRERS
3-7A BLACKALL INDUSTRIAL ESTATE
CHELMSFORD, UNITED KINGDOM CM35UW

FOR: APPARATUS, EQUIPMENT AND INSTALLATIONS FOR HEATING, COOLING, VENTILATING AND AIR-CONDITIONING, NAMELY, ELECTRIC RADIANT HEATERS, HEATING SYSTEMS COMPOSED PRIMARILY OF TUBES, PIPES AND PRE-ASSEMBLED MANIFOLDS THROUGH WHICH COLD OR LOW TEMPERATURE WATER CIRCULATES, HEAT PUMPS, FAN COILS, EVAPORATIVE AIR COOLING UNITS FOR DOMESTIC USE, AIR CONDITIONING APPARATUS, CENTRAL AIR-CONDITIONING INSTALLATIONS, EVAPORATORS FOR AIR CONDITIONERS, VENTILATORS FOR BUILDING AND FACTORY VENTILATION; FAN-ASSISTED HEATERS AND COOLERS, NAMELY, FAN-ASSISTED ELECTRIC RADIANT HEATERS AND EVAPORATIVE AIR COOLERS; ELECTRIC SPACE HEATERS; ELECTRIC CONVECTOR HEATERS; ELECTRIC FAN HEATERS; ELECTRIC PERIMETER HEATERS; CENTRAL HEATING RADIATORS; ELECTRIC RA-

DIATORS; HEAT EXCHANGERS; STRUCTURAL PARTS FOR ALL THE AFORESAID GOODS, IN CLASS 11 (U.S. CLS. 13, 21, 23, 31 AND 34).

FOR: INSTALLATION, REPAIR, MAINTENANCE, SERVICING AND CONSULTANCY SERVICES, ALL RELATING TO APPARATUS, EQUIPMENT AND INSTALLATIONS FOR HEATING, COOLING, VENTILATING AND AIR-CONDITIONING, IN CLASS 37 (U.S. CLS. 100, 103 AND 106).

THE MARK CONSISTS OF STANDARD CHARACTERS WITHOUT CLAIM TO ANY PARTICULAR FONT, STYLE, SIZE, OR COLOR.

PRIORITY CLAIMED UNDER SEC. 44(D) ON ERPNTM CMNTY TM OFC APPLICATION NO. 005490339, FILED 11-22-2006.

OWNER OF ERPNTM CMNTY TM OFC REG. NO. 005490339, DATED 11-7-2007, EXPIRES 11-22-2016.

SER. NO. 77-111,064, FILED 2-20-2007.

KELLY BOULTON, EXAMINING ATTORNEY

Int. Cl.: 19

Prior U.S. Cls.: 1, 12, 33 and 50

United States Patent and Trademark Office

Reg. No. 3,474,610

Registered July 29, 2008

**TRADEMARK
PRINCIPAL REGISTER**

ULTRAFORM

RICHMOND PLYWOOD CORPORATION LIM-
ITED (CANADA CORPORATION)
13911 VULCAN WAY
RICHMOND, CANADA V6V1K7

FOR: PLYWOOD, IN CLASS 19 (U.S. CLS. 1, 12, 33
AND 50).

FIRST USE 0-0-1999; IN COMMERCE 0-0-1999.

THE MARK CONSISTS OF STANDARD CHAR-
ACTERS WITHOUT CLAIM TO ANY PARTICULAR
FONT, STYLE, SIZE, OR COLOR.

PRIORITY CLAIMED UNDER SEC. 44(D) ON
CANADA APPLICATION NO. 1334248, FILED 2-6-
2007, REG. NO. TMA704381, DATED 1-10-2008, EX-
PIRES 1-10-2023.

SER. NO. 77-111,262, FILED 2-20-2007.

MICHAEL WEBSTER, EXAMINING ATTORNEY

Int. Cl.: 3

Prior U.S. Cls.: 1, 4, 6, 50, 51 and 52

United States Patent and Trademark Office

Reg. No. 3,474,611

Registered July 29, 2008

**TRADEMARK
PRINCIPAL REGISTER**

GLACIER SILT SOAP

GLACIER SMOOTHIE, LLC (ALASKA LTD LIAB
CO)
9444 PATRICIA PLACE
JUNEAU, AK 99803

FOR: BAR SOAPS; BATH SOAPS IN LIQUID,
SOLID OR GEL FORM; HAND SOAPS; PERFUMED
SOAPS; SKIN SOAPS; SOAPS FOR BODY CARE;
SOAPS FOR PERSONAL USE, IN CLASS 3 (U.S. CLS.
1, 4, 6, 50, 51 AND 52).

FIRST USE 11-23-2001; IN COMMERCE 11-23-2001.

THE MARK CONSISTS OF STANDARD CHAR-
ACTERS WITHOUT CLAIM TO ANY PARTICULAR
FONT, STYLE, SIZE, OR COLOR.

NO CLAIM IS MADE TO THE EXCLUSIVE
RIGHT TO USE "SOAP", APART FROM THE MARK
AS SHOWN.

SEC. 2(F).

SER. NO. 77-111,376, FILED 2-20-2007.

DAVID C. REIHNER, EXAMINING ATTORNEY

Int. Cls.: 25 and 35

Prior U.S. Cls.: 22, 39, 100, 101 and 102

United States Patent and Trademark Office

Reg. No. 3,474,612

Registered July 29, 2008

TRADEMARK
SERVICE MARK
PRINCIPAL REGISTER

MOKOPUNA

a child in sheep's clothing

PHIL & TEDS MOST EXCELLENT BUGGY COMPANY LIMITED (NEW ZEALAND COMPANY)
102-112 DANIELL STREET
NEWTOWN, WELLINGTON, NEW ZEALAND

FOR: CLOTHING FOR BABIES AND CHILDREN, NAMELY, INFANT AND BABY WEAR; FOOTWEAR; HEADGEAR FOR BABIES AND INFANTS, NAMELY, HATS, CAPS, AND BEANIES, IN CLASS 25 (U.S. CLS. 22 AND 39).

FOR: RETAIL AND WHOLESALE STORE SERVICES IN RELATION TO MOTHER AND BABY CARE PRODUCTS FEATURING BUGGIES, STROLLERS, PUSHCHAIRS, PRAMS, CAR SEATS, BACKPACKS FOR CARRYING CHILDREN, BABY CARRIERS, COTS, BEDS, BEDDING, LINEN, BLANKETS, CLOTHING, FOOTWEAR, HEADGEAR, NURSERY FURNITURE, NURSERY EQUIPMENT AND ACCESSORIES, BAGS, PACKS, MAGAZINES, BOOKS, GAMES, TOYS, AND PLAYTHINGS FOR CHILDREN, TOILETRIES, SKIN AND HAIR CARE PRODUCTS, FOOD, NAPPIES, HOUSEHOLD LINEN, BEDDING TRAVEL RUGS AND BLANKETS, AND

PARTS AND ACCESSORIES FOR THE AFORESAID GOODS, IN CLASS 35 (U.S. CLS. 100, 101 AND 102).

PRIORITY CLAIMED UNDER SEC. 44(D) ON NEW ZEALAND APPLICATION NO. 753702, FILED 8-22-2006, REG. NO. 753702, DATED 8-22-2006, EXPIRES 8-22-2013.

THE MARK CONSISTS OF THE LETTERS OF THE WORD "MOKOPUNA" EACH APPEAR WITHIN A DARK RECTANGLE AND ALL ARE LOCATED WITHIN A LARGER GRAY RECTANGLE WITH THE REMAINING WORDS IN THE MARK LOCATED THERE BELOW.

THE WORD "MOKOPUNA" IS OF MAORI ORIGIN AND CAN BEST BE TRANSLATED AS GRANDCHILD OR ALTERNATIVELY, DESCENDENT.

SER. NO. 77-112,096, FILED 2-21-2007.

MICHAEL SOUDERS, EXAMINING ATTORNEY

Int. Cls.: 6, 7, 9, 12, 14, 20, 25, 28, 36 and 40

Prior U.S. Cls.: 2, 12, 13, 14, 19, 21, 22, 23, 25, 26, 27, 28, 31, 32, 34, 35, 36, 38, 39, 44, 50, 100, 101, 102, 103 and 106

Reg. No. 3,474,613

United States Patent and Trademark Office

Registered July 29, 2008

**TRADEMARK
SERVICE MARK
PRINCIPAL REGISTER**



SEASTROM MANUFACTURING CO., INC. (IDAHO CORPORATION)
456 SEASTROM STREET
TWIN FALLS, ID 83301

FOR: METAL HARDWARE PARTS COMPRISING SPRING CLIP FASTENERS, WASHERS, EXPANSION PLUGS, CLAMP FASTENERS, BRACKETS, GASKETS, TERMINAL LUGS, CAPS, SHIMS, HOOKS, BANDS, STRAPS, SHEET METAL NUTS, SHEET METAL STRIPS, STAMPINGS, IDENTIFICATION TAGS FOR COMPONENTS IN ELECTRICAL SYSTEMS, RETAINING RINGS AND SPACERS; METAL KEY CHAINS; AND TROPHIES OF COMMON METAL, IN CLASS 6 (U.S. CLS. 2, 12, 13, 14, 23, 25 AND 50).

FIRST USE 9-19-2006; IN COMMERCE 9-19-2006.

FOR: ALL TERRAIN VEHICLE PARTS AND ACCESSORIES, NAMELY, STANDARD AND CUSTOMIZED EXHAUST SILENCERS; AND MOTORCYCLE PARTS AND ACCESSORIES, NAMELY, STANDARD AND CUSTOMIZED EXHAUST SILENCERS, IN CLASS 7 (U.S. CLS. 13, 19, 21, 23, 31, 34 AND 35).

FIRST USE 9-19-2006; IN COMMERCE 9-19-2006.

FOR: ELECTRICAL COMPONENTS IN THE NATURE OF ELECTRICAL CONDUCTORS COMPRISING BUS BARS, SOLDER LUGS, GROUNDING STRAPS, TERMINAL BLOCKS, INSULATING STRIPS AND JUMPERS, IN CLASS 9 (U.S. CLS. 21, 23, 26, 36 AND 38).

FIRST USE 9-19-2006; IN COMMERCE 9-19-2006.

FOR: STRUCTURAL PARTS AND ACCESSORIES FOR BICYCLES, NAMELY, FRONT SPACERS, ROOF RACK CAPS, PROTECTIVE GUARDS FOR THE CHAIN RING, CHAIN RING BOLTS, VALVE STEM COVERS, VALVE STEM CAPS AND COLLARS, HANDLEBAR END CAPS, HANDLEBAR GRIP TAPE, WATER BOTTLE CAGES AND MOUNTING SCREWS THEREFOR, BICYCLE FRAME HEADSET CAPS, BICYCLE FRAME HEADSET SCREWS, CUSTOM SPROCKETS, SIZING CRANKS, NAMELY, A CRANK ALLOWING THE CYCLIST TO ADJUST THE CRANK LENGTH TO PROPERLY FIT THE RIDER, ADJUSTABLE SEAT POSTS, SIZING STEM KITS COMPRISED PRIMARILY OF A SIZING STEM, A BAR CLAMP AND BAR LENGTH FOR ADJUSTING THE HEIGHT AND LENGTH OF A BICYCLE; MOTORCYCLE PARTS AND ACCESSORIES, NAMELY, VALVE STEM COVERS, BRAKE RESERVOIR COVERS, CLUTCH RESERVOIR COVERS, TIMER COVERS, FITTED GRILL COVERS, THUMB THROTTLE COVERS; AND ALL TERRAIN VEHICLE PARTS AND ACCESSORIES, NAMELY BRAKE RESERVOIR COVERS, THUMB THROTTLE COVERS, VALVE STEM COVERS, AND BRAKE BLOCKS, IN CLASS 12 (U.S. CLS. 19, 21, 23, 31, 35 AND 44).

FIRST USE 9-19-2006; IN COMMERCE 9-19-2006.

FOR: JEWELRY AND AWARD MEDALS, IN CLASS 14 (U.S. CLS. 2, 27, 28 AND 50).

FIRST USE 9-19-2006; IN COMMERCE 9-19-2006.

FOR: NON-METALLIC HARDWARE PARTS, NAMELY, WASHERS, GASKETS, SHIMS, O-RINGS, SPACERS, BANDS, CLAMP FASTENERS, BRACKETS AND IDENTIFICATION TAGS FOR COMPONENTS IN ELECTRICAL SYSTEMS; AND SPROCKET DISPLAY STANDS, IN CLASS 20 (U.S. CLS. 2, 13, 22, 25, 32 AND 50).

FIRST USE 9-19-2006; IN COMMERCE 9-19-2006.

FOR: CLOTHING, NAMELY, SHIRTS, PANTS AND HATS, IN CLASS 25 (U.S. CLS. 22 AND 39).

FIRST USE 9-19-2006; IN COMMERCE 9-19-2006.

FOR: TOYS, NAMELY, YO-YOS AND STRUCTURAL PARTS THEREFOR, NAMELY, YO-YO STRING, IN CLASS 28 (U.S. CLS. 22, 23, 38 AND 50).

FIRST USE 9-19-2006; IN COMMERCE 9-19-2006.

FOR: CHARITABLE FUND RAISING SERVICES, NAMELY, SHARING PROFITS WITH NOT-FOR-PROFIT ORGANIZATIONS FROM THE SALE OF AN ORGANIZATION'S LOGO ON A UNIQUE HITCH COVER, RESERVOIR CAP AND BRAKE BLOCK, IN CLASS 36 (U.S. CLS. 100, 101 AND 102).

FIRST USE 9-19-2006; IN COMMERCE 9-19-2006.

FOR: MANUFACTURE OF STANDARD AND CUSTOM AFTER-MARKET PARTS AND ACCESSORIES FOR VEHICLES OF ALL TYPES TO THE ORDER AND SPECIFICATION OF OTHERS, INCLUDING CUSTOM STAMPING, COMPUTER NUMERICAL CONTROL MACHINING, SCREW MACHINING, ASSEMBLY AND SPECIALTY PACKAGING, IN CLASS 40 (U.S. CLS. 100, 103 AND 106).

FIRST USE 9-19-2006; IN COMMERCE 9-19-2006.

OWNER OF U.S. REG. NOS. 1,388,013 AND 1,748,122.

THE MARK CONSISTS OF A WAVE DESCENDING OVER THE WORD "SEASTROM" WHICH IS ENCIRCLED BY AN OVAL.

SER. NO. 77-112,174, FILED 2-21-2007.

ANTHONY RINKER, EXAMINING ATTORNEY

Int. Cl.: 16

Prior U.S. Cls.: 2, 5, 22, 23, 29, 37, 38 and 50

United States Patent and Trademark Office

Reg. No. 3,474,614

Registered July 29, 2008

**TRADEMARK
PRINCIPAL REGISTER**

BANANA MANIA

CRAYOLA PROPERTIES, INC. (DELAWARE
CORPORATION)
2035 EDGEWOOD AVENUE
EASTON, PA 18042

FOR: CRAYONS, IN CLASS 16 (U.S. CLS. 2, 5, 22,
23, 29, 37, 38 AND 50).

FIRST USE 12-31-1998; IN COMMERCE 12-31-1998.

THE MARK CONSISTS OF STANDARD CHAR-
ACTERS WITHOUT CLAIM TO ANY PARTICULAR
FONT, STYLE, SIZE, OR COLOR.

SEC. 2(F).

SER. NO. 77-113,681, FILED 2-22-2007.

JEAN IM, EXAMINING ATTORNEY

Int. Cl.: 16

Prior U.S. Cls.: 2, 5, 22, 23, 29, 37, 38 and 50

United States Patent and Trademark Office

Reg. No. 3,474,615

Registered July 29, 2008

**TRADEMARK
PRINCIPAL REGISTER**



STICHTING GLOBAL REPORTING INITIATIVE
(NETHERLANDS NON-PROFIT ORGANIZATION)

KEIZERSGRACHT 209

1016 DT AMSTERDAM, NETHERLANDS

FOR: PUBLICATIONS, NAMELY, PRINTED GUIDES AND RESEARCH REPORTS FEATURING THE BEST PRACTICES AND TECHNIQUES FOR AN ORGANIZATION TO REPORT ITS SUSTAINABLE DEVELOPMENT, OR ITS ABILITY TO MEET THE ECONOMIC, ENVIRONMENTAL AND SOCIAL NEEDS OF THE PRESENT WITHOUT COMPROMISING ITS ABILITY TO MEET THESE SAME NEEDS IN THE FUTURE, AND ITS SUSTAINABILITY PERFORMANCE RELATED THERETO, TO

STAKEHOLDERS, IN CLASS 16 (U.S. CLS. 2, 5, 22, 23, 29, 37, 38 AND 50).

FIRST USE 6-0-2000; IN COMMERCE 6-0-2000.

NO CLAIM IS MADE TO THE EXCLUSIVE RIGHT TO USE "REPORTING INITIATIVE", APART FROM THE MARK AS SHOWN.

SEC. 2(F) AS TO "GLOBAL".

SER. NO. 77-114,322, FILED 2-23-2007.

ZHALEH DELANEY, EXAMINING ATTORNEY

Int. Cls.: 35 and 41

Prior U.S. Cls.: 100, 101, 102 and 107

United States Patent and Trademark Office

Reg. No. 3,474,616

Registered July 29, 2008

**SERVICE MARK
PRINCIPAL REGISTER**



STICHTING GLOBAL REPORTING INITIATIVE
(NETHERLANDS NON-PROFIT ORGANIZATION)

KEIZERSGRACHT 209
1016 DT AMSTERDAM, NETHERLANDS

FOR: PROVIDING AN ONLINE COMPUTER DATABASE IN THE BUSINESS FIELD REGARDING REPORTING ON THE SUSTAINABLE DEVELOPMENT OF A BUSINESS ORGANIZATION, OR ITS ABILITY TO MEET THE ECONOMIC, ENVIRONMENTAL, AND SOCIAL NEEDS OF THE PRESENT WITHOUT COMPROMISING ITS ABILITY TO MEET THE SAME NEEDS IN THE FUTURE, AND SUSTAINABILITY PERFORMANCE RELATED THERETO; PROVIDING BUSINESS INFORMATION IN THE FIELD OF THE SUSTAINABLE DEVELOPMENT OF A BUSINESS ORGANIZATION, OR ITS ABILITY TO MEET THE ECONOMIC, ENVIRONMENTAL, AND SOCIAL NEEDS OF THE PRESENT WITHOUT COMPROMISING ITS ABILITY TO MEET THE SAME NEEDS IN THE FUTURE, AND SUSTAINABILITY PERFORMANCE BUSINESS INFORMATION RELATED THERETO, ALL VIA A GLOBAL COMPUTER NETWORK, IN CLASS 35 (U.S. CLS. 100, 101 AND 102).

FIRST USE 11-0-1998; IN COMMERCE 11-0-1998.

FOR: EDUCATIONAL SERVICES, NAMELY, CONDUCTING PROGRAMS IN THE FIELD OF REPORTING ON THE SUSTAINABLE DEVELOPMENT OF A BUSINESS ORGANIZATION, OR ITS ABILITY TO MEET THE ECONOMIC, ENVIRONMENTAL AND SOCIAL NEEDS OF THE PRESENT WITHOUT COMPROMISING ITS ABILITY TO MEET THE SAME NEEDS IN THE FUTURE, AND

SUSTAINABILITY PERFORMANCE RELATED THERETO; PROVIDING ONLINE NON-DOWNLOADABLE PUBLICATIONS IN THE NATURE OF JOURNALS, ARTICLES, AND POD CASTS IN THE FIELD OF REPORTING ON THE SUSTAINABLE DEVELOPMENT OF A BUSINESS ORGANIZATION, OR ITS ABILITY TO MEET THE ECONOMIC, ENVIRONMENTAL, AND SOCIAL NEEDS OF THE PRESENT WITHOUT COMPROMISING ITS ABILITY TO MEET THE SAME NEEDS IN THE FUTURE, AND SUSTAINABILITY PERFORMANCE RELATED THERETO; DEVELOPMENT AND DISSEMINATION OF EDUCATIONAL MATERIALS OF OTHERS IN THE FIELD OF REPORTING ON SUSTAINABLE DEVELOPMENT AND SUSTAINABILITY PERFORMANCE OF A BUSINESS ORGANIZATION; ARRANGING PROFESSIONAL WORKSHOP AND TRAINING COURSES; TRAINING SERVICES IN THE FIELD OF REPORTING ON SUSTAINABLE DEVELOPMENT AND SUSTAINABILITY PERFORMANCE OF A BUSINESS ORGANIZATION; AND EDUCATIONAL RESEARCH, IN CLASS 41 (U.S. CLS. 100, 101 AND 107).

FIRST USE 11-0-1998; IN COMMERCE 11-0-1998.

NO CLAIM IS MADE TO THE EXCLUSIVE RIGHT TO USE "REPORTING INITIATIVE", APART FROM THE MARK AS SHOWN.

SEC. 2(F) AS TO "GLOBAL".

SER. NO. 77-114,326, FILED 2-23-2007.

ZHALEH DELANEY, EXAMINING ATTORNEY

Int. Cls.: 9 and 16

Prior U.S. Cls.: 2, 5, 21, 22, 23, 26, 29, 36, 37, 38 and 50

United States Patent and Trademark Office

Reg. No. 3,474,617

Registered July 29, 2008

**TRADEMARK
PRINCIPAL REGISTER**



GLOBAL CHORO MUSIC CORPORATION (CALIFORNIA CORPORATION)
859 CORPORATE WAY
FREMONT, CA 94539

FOR: DOWNLOADABLE MUSICAL SOUND RECORDINGS; MUSICAL SOUND RECORDINGS; VIDEO RECORDINGS FEATURING MUSIC, IN CLASS 9 (U.S. CLS. 21, 23, 26, 36 AND 38).

FIRST USE 5-9-2007; IN COMMERCE 6-12-2007.

FOR: PRINTED MUSIC BOOKS; SHEET MUSIC, IN CLASS 16 (U.S. CLS. 2, 5, 22, 23, 29, 37, 38 AND 50).

FIRST USE 5-9-2007; IN COMMERCE 6-12-2007.

NO CLAIM IS MADE TO THE EXCLUSIVE RIGHT TO USE "CHORO MUSIC.COM", APART FROM THE MARK AS SHOWN.

THE MARK CONSISTS OF A STYLIZED IMAGE OF A SEVEN STRING GUITAR WITH THE WORDING "CHORO MUSIC .COM" ON THE LOWER PORTION.

THE FOREIGN WORDING IN THE MARK TRANSLATES INTO ENGLISH AS TO CRY FROM THE PORTUGUESE.

SER. NO. 77-114,514, FILED S.R. 2-23-2007 AM. P.R. 4-3-2008.

SHARON MEIER, EXAMINING ATTORNEY

Int. Cl.: 25

Prior U.S. Cls.: 22 and 39

United States Patent and Trademark Office

Reg. No. 3,474,618

Registered July 29, 2008

**TRADEMARK
PRINCIPAL REGISTER**



THE ELAN LIFE, LLC (FLORIDA LTD LIAB CO)
3152 LITTLE ROAD
#208
TRINITY, FL 34655 AND
RODEO BEACH, LLC (FLORIDA LTD LIAB CO)
3152 LITTLE ROAD
#208
TRINITY, FL 34655

FOR: HATS; HEADGEAR, NAMELY, CAPS;
SHIRTS; T-SHIRTS, IN CLASS 25 (U.S. CLS. 22 AND
39).

FIRST USE 1-1-2006; IN COMMERCE 1-1-2006.

SER. NO. 77-115,418, FILED 2-24-2007.

ALEXANDER L. POWERS, EXAMINING ATTOR-
NEY

Int. Cl.: 16

Prior U.S. Cls.: 2, 5, 22, 23, 29, 37, 38 and 50

United States Patent and Trademark Office

Reg. No. 3,474,619

Registered July 29, 2008

TRADEMARK
PRINCIPAL REGISTER



MCGRAW-HILL COMPANIES, INC., THE (NEW
YORK CORPORATION)
1221 AVENUE OF THE AMERICAS
NEW YORK, NY 10020

FOR: SERIES OF BOOKS FEATURING ARTICLES
AND BOOK SELECTIONS IN THE FIELDS OF
SOCIAL SCIENCES, HUMANITIES, PHYSICAL
AND LIFE SCIENCES, BUSINESS, AND ECONOM-
ICS FOR USE IN COLLEGE AND CAREER EDUCA-
TION; PRINTED INSTRUCTIONAL,
EDUCATIONAL, AND TEACHING MATERIALS,
NAMELY, TESTS FEATURING ARTICLES AND
BOOK SELECTIONS RELATED TO THE ABOVE
SERIES OF BOOKS WHICH ARE USABLE BY

INSTRUCTORS FOR STUDENT ASSESSMENT,
FOR USE IN COLLEGE AND CAREER EDUCA-
TION, IN CLASS 16 (U.S. CLS. 2, 5, 22, 23, 29, 37, 38
AND 50).

FIRST USE 3-0-2006; IN COMMERCE 3-0-2006.

NO CLAIM IS MADE TO THE EXCLUSIVE
RIGHT TO USE "CLASSIC EDITION SOURCES",
APART FROM THE MARK AS SHOWN.

SER. NO. 77-116,894, FILED 2-27-2007.

LINDA M. KING, EXAMINING ATTORNEY

Int. Cl.: 35

Prior U.S. Cls.: 100, 101 and 102

United States Patent and Trademark Office

Reg. No. 3,474,620

Registered July 29, 2008

**SERVICE MARK
PRINCIPAL REGISTER**



DRAGON FONE LLC (NEVADA LTD LIAB CO)
UNIT 301-37
3430 EAST RUSSELL ROAD
LAS VEGAS, NV 89120

THE COLOR(S) GREEN, BLACK AND WHITE IS/
ARE CLAIMED AS A FEATURE OF THE MARK.

FOR: ON-LINE RETAIL STORE SERVICES FEATURING TELECOMMUNICATIONS GOODS AND SERVICES, NAMELY, TELEPHONES AND TELEPHONE SYSTEMS, IN CLASS 35 (U.S. CLS. 100, 101 AND 102).

THE MARK CONSISTS OF A GREEN CIRCLE WITH A BLACK INNER CIRCLE CONTAINING A WHITE DRAGON AND THE WORDS "DRAGON FONE" AROUND THE GREEN CIRCLE IN WHITE LETTERS.

FIRST USE 11-22-2006; IN COMMERCE 11-22-2006.

SER. NO. 77-117,036, FILED 2-27-2007.

NO CLAIM IS MADE TO THE EXCLUSIVE RIGHT TO USE "PHONE", APART FROM THE MARK AS SHOWN.

HENRY S. ZAK, EXAMINING ATTORNEY

Int. Cls.: 25 and 43

Prior U.S. Cls.: 22, 39, 100 and 101

United States Patent and Trademark Office

Reg. No. 3,474,621

Registered July 29, 2008

**TRADEMARK
SERVICE MARK
PRINCIPAL REGISTER**

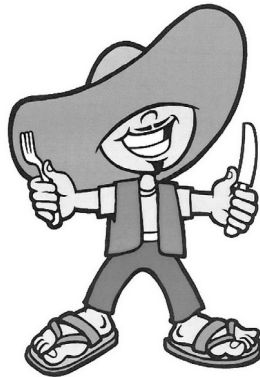

CORREA MANAGEMENT, INC. (CALIFORNIA CORPORATION)
8220 UNIVERSITY AVENUE, SUITE 101
LA MESA, CA 91941

FOR: HATS; SHIRTS, IN CLASS 25 (U.S. CLS. 22 AND 39).

FIRST USE 3-1-1997; IN COMMERCE 3-1-1997.

FOR: CATERING; RESTAURANT SERVICES, IN CLASS 43 (U.S. CLS. 100 AND 101).

FIRST USE 6-1-1998; IN COMMERCE 6-1-1998.

THE MARK CONSISTS OF A CHARACTER WEARING A HAT AND HOLDING UTENSILS.

SER. NO. 77-119,886, FILED 3-1-2007.

CHARLES L. JENKINS, EXAMINING ATTORNEY

Int. Cls.: 4, 35, 36, 37, 39, 40 and 42

Prior U.S. Cls.: 1, 6, 15, 100, 101, 102, 103, 105 and 106

United States Patent and Trademark Office

Reg. No. 3,474,622

Registered July 29, 2008

**TRADEMARK
SERVICE MARK
PRINCIPAL REGISTER**

MAERSK

A.P. MOLLER - MAERSK A/S (DENMARK CORPORATION)
ESPLANADEN 50
DK-1098 COPENHAGEN K, DENMARK

FOR: GAS FUELS; SOLIDIFIED NATURAL GAS; INDUSTRIAL OILS AND GREASES, FUEL OIL AND RAW AND REFINED PETROLEUM, FUELS AND MOTOR SPIRITS, IN CLASS 4 (U.S. CLS. 1, 6 AND 15).

FOR: INFORMATION REGARDING MANAGEMENT AND OPERATION OF CONTAINER TERMINALS AND OF AIR CARGO TERMINALS, IN CLASS 35 (U.S. CLS. 100, 101 AND 102).

FOR: CUSTOMS BROKERAGE; CUSTOMS BROKERAGE IN THE NATURE OF ISSUING OF TRANSPORTATION AND CUSTOMS PAPERS, CERTIFICATES, DOCUMENTS AS WELL AS SECURITIES FOR GOODS, IN CLASS 36 (U.S. CLS. 100, 101 AND 102).

FOR: OIL WELL DRILLING, GAS WELL DRILLING, OIL AND GAS EXTRACTION, CONSTRUCTION, INSTALLATION, REPAIR AND RENTAL OF OIL AND GAS PRODUCTION UNITS, LAYING OF SUBSEA CABLES; CLEANING UP OIL, GAS AND CHEMICAL SPILLS IN WATER BY USING FLOATING BOOMS TO CONFINE THE SPILLS AND/OR VACUUM HOSES TO VACUUM UP THE SPILLED MATERIAL, IN CLASS 37 (U.S. CLS. 100, 103 AND 106).

FOR: TRANSPORT OF GOODS; MARINE TRANSPORT; RAILWAY TRANSPORT; TRUCK TRANS-

PORT; AIR TRANSPORT; TRANSPORT OF OILS AND GASES BY PIPELINE; PACKAGING AND STORAGE OF GOODS FOR TRANSPORT; WAREHOUSE STORAGE; DELIVERY OF GOODS BY AIR, TRUCK AND RAIL; CARGO LOADING AND UNLOADING; FREIGHT FORWARDING; SHIPPING CONTAINER AND STORAGE CONTAINER RENTAL; INFORMATION REGARDING TRANSPORTATION AND STORAGE; LOGISTICS SERVICES RELATING TO TRANSPORTATION AND STORAGE, TOWING AND SALVAGING; AND SHIP BROKERAGE, IN CLASS 39 (U.S. CLS. 100 AND 105).

FOR: PROCESSING OF OIL AND GAS, IN CLASS 40 (U.S. CLS. 100, 103 AND 106).

FOR: GEOLOGICAL SURVEYS, GEOLOGICAL PROSPECTING, OIL PROSPECTING, OIL-FIELD SURVEYS, IN CLASS 42 (U.S. CLS. 100 AND 101).

THE MARK CONSISTS OF STANDARD CHARACTERS WITHOUT CLAIM TO ANY PARTICULAR FONT, STYLE, SIZE, OR COLOR.

OWNER OF DENMARK REG. NO. VR195600383, DATED 3-10-1956, EXPIRES 3-10-2016.

OWNER OF U.S. REG. NOS. 2,745,959 AND 2,821,987.

SER. NO. 77-121,108, FILED 3-2-2007.

PRISCILLA MILTON, EXAMINING ATTORNEY

Int. Cls.: 9 and 42

Prior U.S. Cls.: 21, 23, 26, 36, 38, 100 and 101

United States Patent and Trademark Office

Reg. No. 3,474,623

Registered July 29, 2008

**TRADEMARK
SERVICE MARK
PRINCIPAL REGISTER**

uTile300

ADVANTEST CORPORATION (JAPAN CORPORATION)
32-1, ASAHICHO 1-CHOME, NERIMA-KU
TOKYO, JAPAN

FOR: COMPUTER SOFTWARE FOR ELECTRON BEAM LITHOGRAPHY SYSTEM; COMPUTER SOFTWARE FOR USE IN ELECTRON BEAM LITHOGRAPHY SYSTEM WHICH EXPOSES ELECTRON BEAM ON THE WAFER TO FORM CIRCUIT PATTERNS; COMPUTER OPERATING SYSTEM FOR MANAGING OPERATION OF SOFTWARE FOR USE IN ELECTRON BEAM LITHOGRAPHY SYSTEM; COMPUTER OPERATING SYSTEM FOR MANAGING OPERATION OF APPLICATIONS SOFTWARE FOR USE IN ELECTRON BEAM LITHOGRAPHY SYSTEM; CONTROL SOFTWARE FOR WRITING ELECTRON BEAM ON THE WAFER, IN CLASS 9 (U.S. CLS. 21, 23, 26, 36 AND 38).

FOR: DESIGN, PROGRAMMING AND MAINTENANCE OF COMPUTER SOFTWARE FOR USE IN ELECTRON BEAM LITHOGRAPHY SYSTEM; DESIGN, PROGRAMMING AND MAINTENANCE OF COMPUTER SOFTWARE FOR USE IN ELECTRON BEAM LITHOGRAPHY SYSTEM WHICH EXPOSES ELECTRON BEAM ON THE WAFER TO FORM

CIRCUIT PATTERNS; DESIGN, PROGRAMMING AND MAINTENANCE OF COMPUTER OPERATING SYSTEM FOR MANAGING OPERATION OF SOFTWARE FOR USE IN ELECTRON BEAM LITHOGRAPHY SYSTEM; DESIGN, PROGRAMMING AND MAINTENANCE OF COMPUTER OPERATING SYSTEM FOR MANAGING OPERATION OF APPLICATION SOFTWARE FOR USE IN ELECTRON BEAM LITHOGRAPHY SYSTEM; DESIGN, PROGRAMMING AND MAINTENANCE OF CONTROL SOFTWARE FOR WRITING ELECTRON BEAM ON THE WAFER; DESIGN, PROGRAMMING AND MAINTENANCE OF COMPUTER SOFTWARE, IN CLASS 42 (U.S. CLS. 100 AND 101).

PRIORITY CLAIMED UNDER SEC. 44(D) ON JAPAN APPLICATION NO. 2007-014579, FILED 2-21-2007.

OWNER OF JAPAN REG. NO. 5098196, DATED 12-14-2007, EXPIRES 12-14-2017.

SER. NO. 77-122,086, FILED 3-5-2007.

DOMINIC J. FERRAIUOLO, EXAMINING ATTORNEY

Int. Cl.: 23

Prior U.S. Cl.: 43

United States Patent and Trademark Office

Reg. No. 3,474,624

Registered July 29, 2008

**TRADEMARK
PRINCIPAL REGISTER**

Mooncake Yarn Inc.

MOONCAKE YARN INC. (MINNESOTA CORPORATION)

12688 BASS LAKE ROAD

MAPLE GROVE, MN 55311

FOR: KNITTING YARN, IN CLASS 23 (U.S. CL. 43).

FIRST USE 11-1-2006; IN COMMERCE 1-3-2007.

THE MARK CONSISTS OF STANDARD CHARACTERS WITHOUT CLAIM TO ANY PARTICULAR FONT, STYLE, SIZE, OR COLOR.

NO CLAIM IS MADE TO THE EXCLUSIVE RIGHT TO USE "YARN INC.", APART FROM THE MARK AS SHOWN.

SER. NO. 77-123,046, FILED 3-6-2007.

HEATHER SAPP, EXAMINING ATTORNEY

Int. Cl.: 32

Prior U.S. Cls.: 45, 46 and 48

United States Patent and Trademark Office

Reg. No. 3,474,625

Registered July 29, 2008

TRADEMARK
PRINCIPAL REGISTER



COMPANIA CERVECERA DEL TROPICO, S.A.
DE C.V. (MEXICO CORPORATION)
COL. EX-HACIENDA EL YUCAL BLVD.
ANTONINO F. RODRIGUEZ #1
TUXTEPEC, OAX. 68365, MEXICO

FOR: ALCOHOLIC BEVERAGES, NAMELY
BEER, IN CLASS 32 (U.S. CLS. 45, 46 AND 48).

OWNER OF MEXICO REG. NO. 942795, DATED 7-
10-2006, EXPIRES 7-10-2016.

NO CLAIM IS MADE TO THE EXCLUSIVE
RIGHT TO USE "CERVEZA CLARA," "COMPANIA
CERVACERA," AND "DESDE 1900", APART FROM
THE MARK AS SHOWN.

THE MARK CONSISTS OF A MISCELLANEOUS
OVAL DESIGN ON A BACKGROUND WITH THE
WORDS CERVEZA CLARA APPEARING AT THE
TOP OF THE OVAL, AND COMPAÑIA CERVACERA
DEL TRÓPICO, S.A. DE C.V. APPEARING AT THE

BOTTOM OF THE OVAL. WITHIN THE OVAL THE
STYLIZED LETTER M IS ENTWINED WITH A
DESIGN OF GRIFFINS ON EITHER SIDE ON A
BACKGROUND. THE WORD MONTEJO APPEARS
IN LARGE STYLIZED LETTERS WITH SHADOWS
ON A BACKGROUND WITH THE WORDS DESDE
1900 BELOW IN A RECTANGULAR BORDER CON-
TAINING A LEAF DESIGN ON EITHER SIDE.

THE FOREIGN WORDING IN THE MARK CER-
VEZA CLARA TRANSLATES INTO ENGLISH AS
LAGER BEER. THE FOREIGN WORDING COMPA-
NIA CERVACERA DEL TROPICO TRANSLATES
INTO ENGLISH AS TROPICAL BEER COMPANY.
THE FOREIGN WORDING DESDE 1900 TRANS-
LATES INTO ENGLISH AS SINCE 1900.

SER. NO. 77-123,141, FILED 3-6-2007.

HEATHER SAPP, EXAMINING ATTORNEY

Int. Cls.: 29, 30 and 31

Prior U.S. Cls.: 1 and 46

United States Patent and Trademark Office

Reg. No. 3,474,626

Registered July 29, 2008

**TRADEMARK
PRINCIPAL REGISTER**

JUST EAT IT!

WERNER GOURMET MEAT SNACKS, INC.
(OREGON CORPORATION)
PO BOX 277
TILLAMOOK, OR 97141

FOR: SNACK MIXES CONSISTING PRIMARILY OF PROCESSED BEANS, PROCESSED FRUITS, PROCESSED NUTS, PROCESSED EDIBLE SEEDS AND/OR PROCESSED VEGETABLES; DRY SNACK FOODS, NAMELY, PROCESSED BEANS, PROCESSED NUTS, PROCESSED EDIBLE SEEDS, PROCESSED FRUITS, IN CLASS 29 (U.S. CL. 46).

FIRST USE 3-11-2006; IN COMMERCE 3-15-2006.

FOR: SNACK MIXES CONSISTING PRIMARILY OF CRACKERS, PRETZELS, CANDY, CANDY COATED PRETZELS, CANDY COATED NUTS, CANDY COATED FRUIT, SESAME STICKS, RICE CRACKERS AND/OR SPICES; CONFECTIONARIES,

NAMELY, CANDY, PRETZELS, CANDY COATED PRETZELS, CANDY COATED NUTS, CANDY COATED FRUIT, IN CLASS 30 (U.S. CL. 46).

FIRST USE 3-11-2006; IN COMMERCE 3-15-2006.

FOR: SNACK MIXES CONSISTING PRIMARILY OF RAW EDIBLE SEEDS, IN CLASS 31 (U.S. CLS. 1 AND 46).

FIRST USE 3-11-2006; IN COMMERCE 3-15-2006.

THE MARK CONSISTS OF STANDARD CHARACTERS WITHOUT CLAIM TO ANY PARTICULAR FONT, STYLE, SIZE, OR COLOR.

SER. NO. 77-123,903, FILED 3-6-2007.

JANICE KIM, EXAMINING ATTORNEY

Int. Cl.: 18

Prior U.S. Cls.: 1, 2, 3, 22 and 41

United States Patent and Trademark Office

Reg. No. 3,474,627

Registered July 29, 2008

**TRADEMARK
PRINCIPAL REGISTER**



GARCIA JORI, LUIS (SPAIN INDIVIDUAL)
PO. CIUTAT DE MALLORCA, 9-11
BARCELONA, SPAIN 08016

FOR: LEATHER HANDBAGS; SUITCASES; ALL
PURPOSE SPORT BAGS; ALL-PURPOSE CARRY-
ING BAGS; CARRY-ON BAGS; LUGGAGE; BRIEF-
CASES; PURSES; WALLETS, IN CLASS 18 (U.S. CLS.
1, 2, 3, 22 AND 41).

FIRST USE 12-11-2002; IN COMMERCE 12-11-2002.

THE MARK CONSISTS OF A TRIANGLE
FORMED BY THE POSITIONING OF FIVE SMALL-
ER FIGURES FOLLOWED BY THE WORDS

"DRAP BARCELONA" IN STYLIZED LETTERS.
THE WORD "DRAP" APPEARS IN BIG LOWER
CASE LETTERS AND THE WORD "BARCELONA"
APPEARS IN MUCH SMALLER LOWER CASE
LETTERS, DIRECTLY BELOW THE LETTERS
"DRA" OF THE WORD "DRAP".

THE ENGLISH TRANSLATION OF THE WORD
"DRAP" IN THE MARK IS CLOTH.

SEC. 2(F) AS TO "DRAP BARCELONA".

SER. NO. 77-124,107, FILED 3-7-2007.

JIM RINGLE, EXAMINING ATTORNEY

Int. Cls.: 9 and 41

Prior U.S. Cls.: 21, 23, 26, 36, 38, 100, 101 and 107

United States Patent and Trademark Office

Reg. No. 3,474,628

Registered July 29, 2008

**TRADEMARK
SERVICE MARK
PRINCIPAL REGISTER**

ARYTHMIA REKORDS

PALMER, STEPHEN (UNITED STATES INDIVIDUAL)
7210 BURTONWOOD DRIVE
ALEXANDRIA, VA 22307

FOR: SERIES OF PRE-RECORDED COMPACT DISCS, AUDIO TAPES, PHONOGRAPH RECORDS, MULTIMEDIA SOFTWARE RECORDED ON CD-ROMS, DVDS FEATURING DIGITAL AND ANALOG AUDIO ONLY RECORDINGS FEATURING MUSIC AND AUDIOVISUAL RECORDINGS FEATURING MUSIC AND LIVE PERFORMANCES BY A MUSICAL GROUP OR PERFORMING ARTIST, IN CLASS 9 (U.S. CLS. 21, 23, 26, 36 AND 38).

FIRST USE 12-1-2004; IN COMMERCE 12-1-2004.

FOR: AUDIO RECORDING AND PRODUCTION, IN CLASS 41 (U.S. CLS. 100, 101 AND 107).

FIRST USE 12-1-2004; IN COMMERCE 12-1-2004.

THE MARK CONSISTS OF STANDARD CHARACTERS WITHOUT CLAIM TO ANY PARTICULAR FONT, STYLE, SIZE, OR COLOR.

NO CLAIM IS MADE TO THE EXCLUSIVE RIGHT TO USE "RECORDS", APART FROM THE MARK AS SHOWN.

SER. NO. 77-125,125, FILED 3-7-2007.

LAURA HAMMEL, EXAMINING ATTORNEY

Int. Cl.: 9

Prior U.S. Cls.: 21, 23, 26, 36 and 38

Reg. No. 3,474,629

United States Patent and Trademark Office

Registered July 29, 2008

**TRADEMARK
PRINCIPAL REGISTER**

DEPOSMART

CLARITY LEGAL SOFTWARE LLC (TEXAS LTD
LIAB CO)
P.O. BOX 600581
DALLAS, TX 753600581

FOR: DOWNLOADABLE COMPUTER SOFTWARE FOR USE BY THE LEGAL PROFESSION, NAMELY, SOFTWARE, FOR ANALYZING AND ANNOTATING TRANSCRIPTS WITH REAL-TIME INDEXING CAPABILITIES, IMPORTING AND EXPORTING CASE MATERIALS SYNCHRONIZING VIDEO TO TRANSCRIPT TESTIMONY, CREATING VIDEO CLIPS, INCORPORATING EXHIBIT LINKS INTO TRANSCRIPTS, DESIGNED FOR USE ON

MULTIPLE OPERATING SYSTEMS, IN CLASS 9 (U.S. CLS. 21, 23, 26, 36 AND 38).

FIRST USE 10-15-2006; IN COMMERCE 1-2-2007.

THE MARK CONSISTS OF STANDARD CHARACTERS WITHOUT CLAIM TO ANY PARTICULAR FONT, STYLE, SIZE, OR COLOR.

SER. NO. 77-125,572, FILED 3-8-2007.

SAIMA MAKHDOOM, EXAMINING ATTORNEY

Int. Cl.: 9

Prior U.S. Cls.: 21, 23, 26, 36 and 38

Reg. No. 3,474,630

United States Patent and Trademark Office

Registered July 29, 2008

**TRADEMARK
PRINCIPAL REGISTER**

TRIALSMART

CLARITY LEGAL SOFTWARE LLC (TEXAS LTD
LIAB CO)
P.O. BOX 600581
DALLAS, TX 753600581

MULTIPLE OPERATING SYSTEMS, IN CLASS 9
(U.S. CLS. 21, 23, 26, 36 AND 38).

FIRST USE 10-15-2006; IN COMMERCE 1-2-2007.

FOR: DOWNLOADABLE COMPUTER SOFTWARE FOR USE BY THE LEGAL PROFESSION, NAMELY, SOFTWARE, FOR ANALYZING AND ANNOTATING TRANSCRIPTS WITH REAL-TIME INDEXING CAPABILITIES, IMPORTING AND EXPORTING CASE MATERIALS SYNCHRONIZING VIDEO TO TRANSCRIPT TESTIMONY, CREATING VIDEO CLIPS, INCORPORATING EXHIBIT LINKS INTO TRANSCRIPTS, DESIGNED FOR USE ON

THE MARK CONSISTS OF STANDARD CHARACTERS WITHOUT CLAIM TO ANY PARTICULAR FONT, STYLE, SIZE, OR COLOR.

SER. NO. 77-125,583, FILED 3-8-2007.

SAIMA MAKHDOOM, EXAMINING ATTORNEY

Int. Cl.: 5

Prior U.S. Cls.: 6, 18, 44, 46, 51 and 52

United States Patent and Trademark Office

Reg. No. 3,474,631

Registered July 29, 2008

**TRADEMARK
PRINCIPAL REGISTER**

ALTOLYN

THORNTON & ROSS LIMITED (UNITED KING-
DOM COMPANY)
LINTHWAITE
HUDDERSFIELD, UNITED KINGDOM HD75QH

FOR: PHARMACEUTICAL AND MEDICINAL
PREPARATIONS FOR THE TREATMENT OF AL-
LERGIC CONDITIONS AND/OR ALLERGIES, IN
CLASS 5 (U.S. CLS. 6, 18, 44, 46, 51 AND 52).

THE MARK CONSISTS OF STANDARD CHAR-
ACTERS WITHOUT CLAIM TO ANY PARTICULAR
FONT, STYLE, SIZE, OR COLOR.

OWNER OF ERPN CMNTY TM OFC REG. NO.
990309, DATED 12-23-1999, EXPIRES 11-16-2008.

SER. NO. 77-125,615, FILED 3-8-2007.

MARK SPARACINO, EXAMINING ATTORNEY

Int. Cl.: 9

Prior U.S. Cls.: 21, 23, 26, 36 and 38

United States Patent and Trademark Office

Reg. No. 3,474,632

Registered July 29, 2008

**TRADEMARK
PRINCIPAL REGISTER**

SheepScan

PARSONS, JAY R. (COLORADO CORPORATION)
3226 LEDGESTONE COURT
FORT COLLINS, CO 80528

THE MARK CONSISTS OF STANDARD CHAR-
ACTERS WITHOUT CLAIM TO ANY PARTICULAR
FONT, STYLE, SIZE, OR COLOR.

FOR: COMPUTER SOFTWARE FOR CREATING
SEARCHABLE DATABASES OF INFORMATION
AND DATA, IN CLASS 9 (U.S. CLS. 21, 23, 26, 36
AND 38).

SER. NO. 77-127,924, FILED 3-11-2007.

FIRST USE 11-1-2005; IN COMMERCE 11-1-2005.

PAULA MAHONEY, EXAMINING ATTORNEY

Int. Cl.: 38

Prior U.S. Cls.: 100, 101 and 104

United States Patent and Trademark Office

Reg. No. 3,474,633

Registered July 29, 2008

**SERVICE MARK
PRINCIPAL REGISTER**



DALLAS BASKETBALL LIMITED (TEXAS LIMITED PARTNERSHIP)
2909 TAYLOR STREET
DALLAS, TX 75226

FOR: AUDIO BROADCASTING; CABLE TELEVISION BROADCASTING; RADIO BROADCASTING; SUBSCRIPTION TELEVISION BROADCASTING; TELEVISION BROADCASTING; VIDEO BROADCASTING; WEBCASTING SERVICES IN THE NATURE OF PROVIDING ON-LINE CHAT ROOMS AND ON-LINE INTERACTIVE CHAT ROOMS WITH GUESTS FOR TRANSMISSION OF MESSAGES AMONG COMPUTER USERS CONCERNING THE FIELD OF BASKETBALL; BROADCASTING PROGRAMS OVER THE INTERNET; PROVIDING ON-LINE ELECTRONIC BULLETIN BOARDS FOR

TRANSMISSION OF MESSAGES AMONG COMPUTER USERS CONCERNING THE FIELD OF BASKETBALL, IN CLASS 38 (U.S. CLS. 100, 101 AND 104).

FIRST USE 4-1-2005; IN COMMERCE 4-1-2005.

OWNER OF U.S. REG. NOS. 2,753,700, 2,884,597, AND 2,992,551.

THE MARK CONSISTS OF "M" BALL AND SHIELD DESIGN.

SER. NO. 77-128,256, FILED 3-12-2007.

JORDAN BAKER, EXAMINING ATTORNEY

Int. Cls.: 29 and 30

Prior U.S. Cl.: 46

United States Patent and Trademark Office

Reg. No. 3,474,634

Registered July 29, 2008

**TRADEMARK
PRINCIPAL REGISTER**

CHEF'S OWN

GRIFFITH LABORATORIES INTERNATIONAL,
INC. (DELAWARE CORPORATION)
ONE GRIFFITH CENTER
ALSIP, IL 608033495

FOR: SEAFOOD AND SOUP BASES, IN CLASS 29
(U.S. CL. 46).

FIRST USE 2-26-1982; IN COMMERCE 2-26-1982.

FOR: SEASONING FOR SOUPS, FOR GRAVIES
AND FOR MEAT; GRAVY BASES AND SAUCE
BASES, IN CLASS 30 (U.S. CL. 46).

FIRST USE 3-2-1982; IN COMMERCE 3-2-1982.

THE MARK CONSISTS OF STANDARD CHAR-
ACTERS WITHOUT CLAIM TO ANY PARTICULAR
FONT, STYLE, SIZE, OR COLOR.

SER. NO. 77-129,025, FILED 3-12-2007.

NICHOLAS ALTREE, EXAMINING ATTORNEY

Int. Cl.: 42

Prior U.S. Cls.: 100 and 101

United States Patent and Trademark Office

Reg. No. 3,474,635

Registered July 29, 2008

**SERVICE MARK
PRINCIPAL REGISTER**

AUTOCLAVE TESTING SERVICE

AUTOCLAVE TESTING SERVICE, INC. /DBA/
A.T.S. INC. (CONNECTICUT CORPORATION)
30 NURNEY ST.
STAMFORD, CT 06902

NO CLAIM IS MADE TO THE EXCLUSIVE
RIGHT TO USE "TESTING SERVICE", APART
FROM THE MARK AS SHOWN.

FOR: PROVIDING PRODUCT TESTING SERVI-
CES FOR OTHERS IN THE FIELD OF STERILIZA-
TION OVENS, IN CLASS 42 (U.S. CLS. 100 AND 101).

SEC. 2(F).

FIRST USE 9-5-1986; IN COMMERCE 1-19-1987.

SER. NO. 77-129,267, FILED 3-13-2007.

THE MARK CONSISTS OF STANDARD CHAR-
ACTERS WITHOUT CLAIM TO ANY PARTICULAR
FONT, STYLE, SIZE, OR COLOR.

ANNE FARRELL, EXAMINING ATTORNEY

Int. Cls.: 35, 36, 43 and 45

Prior U.S. Cls.: 100, 101 and 102

United States Patent and Trademark Office

Reg. No. 3,474,636

Registered July 29, 2008

**SERVICE MARK
PRINCIPAL REGISTER**

**SUPPORTIVE HOUSING FOR
FAMILIES**

THE CONNECTION, INC. (CONNECTICUT CORPORATION)
955 SOUTH MAIN STREET
MIDDLETOWN, CT 06457

FOR: CHARITABLE SERVICES, NAMELY, PROVIDING ADMINISTRATION AND INTEGRATED CARE MANAGEMENT PLANNING OF CARE FACILITIES AND HOUSING FACILITIES FOR OTHERS, NAMELY, CHILDREN, FAMILIES, AND PEOPLE IN NEED; PUBLIC ADVOCACY TO PROMOTE AWARENESS CONCERNING THE NEED FOR ALL OF THE FOLLOWING SUPPORTIVE SERVICES: SUBSTANCE ABUSE TREATMENT SERVICES, FAMILY THERAPY, TRAUMA TREATMENT, COUNSELING, TRANSPORTATION, RELAPSE PREVENTION, CHILDREN'S SERVICES, EDUCATIONAL SUPPORT, PARENTING TRAINING, CHILD CARE, CRISIS INTERVENTION, CHILD DEVELOPMENT TRAINING, LIFE SKILLS TRAINING, HEALTH EDUCATION, EDUCATIONAL AND VOCATIONAL TRAINING, AND HOME MANAGEMENT TRAINING; CHARITABLE SERVICES, NAMELY, ORGANIZING AND CONDUCTING VOLUNTEER PUBLIC SERVICE OPPORTUNITIES AND COMMUNITY SERVICE PROJECTS, IN CLASS 35 (U.S. CLS. 100, 101 AND 102).

FIRST USE 12-31-1998; IN COMMERCE 12-31-1998.

FOR: PROVIDING FAMILY HOUSING SUBSIDIES, IN CLASS 36 (U.S. CLS. 100, 101 AND 102).

FIRST USE 12-31-1998; IN COMMERCE 12-31-1998.

FOR: PUBLIC HOUSING SERVICES, NAMELY, PROVIDING PERMANENT AFFORDABLE FAMILY HOUSING ACCOMMODATIONS, AND CHARITABLE SERVICES, NAMELY, PROVIDING FURNITURE TO PERSONS IN NEED, IN CLASS 43 (U.S. CLS. 100 AND 101).

FIRST USE 12-31-1998; IN COMMERCE 12-31-1998.

FOR: CASE MANAGEMENT AND COORDINATION SERVICES, NAMELY, COORDINATION OF HUMAN, CHILD WELFARE, AND SOCIAL SERVICES FOR CHILDREN, FAMILIES, AND PEOPLE IN NEED; PROVIDING INFORMATION IN THE FIELD OF CHILD SAFETY AND STABILITY, IN CLASS 45 (U.S. CLS. 100 AND 101).

FIRST USE 12-31-1998; IN COMMERCE 12-31-1998.

THE MARK CONSISTS OF STANDARD CHARACTERS WITHOUT CLAIM TO ANY PARTICULAR FONT, STYLE, SIZE, OR COLOR.

NO CLAIM IS MADE TO THE EXCLUSIVE RIGHT TO USE "HOUSING FOR FAMILIES", APART FROM THE MARK AS SHOWN.

SEC. 2(F).

SER. NO. 77-130,729, FILED 3-14-2007.

LINDSEY RUBIN, EXAMINING ATTORNEY

Int. Cl.: 9

Prior U.S. Cls.: 21, 23, 26, 36 and 38

Reg. No. 3,474,637

United States Patent and Trademark Office

Registered July 29, 2008

**TRADEMARK
PRINCIPAL REGISTER**

EASY TRUST

KABRA, RAKESH (UNITED STATES INDIVIDUAL)
212 N. CENTER DRIVE
NORTH BRUNSWICK, NJ 08902

FOR: COMPUTER SOFTWARE FOR LAW OFFICES ACCOUNTING IN THE FIELD OF TRUSTS AND ESCROWS ACCOUNTS, IN CLASS 9 (U.S. CLS. 21, 23, 26, 36 AND 38).

FIRST USE 1-1-1997; IN COMMERCE 1-1-1997.

THE MARK CONSISTS OF STANDARD CHARACTERS WITHOUT CLAIM TO ANY PARTICULAR FONT, STYLE, SIZE, OR COLOR.

NO CLAIM IS MADE TO THE EXCLUSIVE RIGHT TO USE "TRUST", APART FROM THE MARK AS SHOWN.

SER. NO. 77-130,898, FILED 3-14-2007.

HANNO RITTNER, EXAMINING ATTORNEY

Int. Cl.: 39

Prior U.S. Cls.: 100 and 105

United States Patent and Trademark Office

Reg. No. 3,474,638

Registered July 29, 2008

SERVICE MARK
PRINCIPAL REGISTER



BENNETT INTERNATIONAL GROUP, LLC
(GEORGIA LTD LIAB CO)
1001 INDUSTRIAL PARKWAY
MCDONOUGH, GA 30253

FOR: DELIVERY OF GOODS BY TRUCK, RAIL, AIR AND SHIP; FREIGHT BROKERAGE; FREIGHT FORWARDING; FREIGHT TRANSPORTATION BY TRUCK, RAIL, AIR AND SHIP; GLOBAL TRANSPORTATION OF FREIGHT FOR OTHERS BY ALL AVAILABLE MEANS; GOODS WAREHOUSING; PROVIDING OCEAN TRANSPORTATION, STORAGE AND DELIVERY SERVICES; SUPPLY CHAIN, LOGISTICS AND REVERSE LOGISTICS SERVICES, NAMELY, STORAGE, TRANSPORTATION AND DELIVERY OF DOCUMENTS, PACKAGES, RAW MATERIALS, AND OTHER FREIGHT FOR OTHERS BY AIR, RAIL, SHIP OR TRUCK; TRANSPORT BROKERAGE; TRANSPORT BY TRUCK, RAIL, AIR AND SHIP; TRANSPORT OF GOODS; TRUCK TRANSPORT; WAREHOUSING SERVICES, NAMELY, STORAGE, DISTRIBUTION, PICK-UP, AND PACKING FOR SHIPMENT OF DOCUMENTS, PACKAGES, RAW MATERIALS, AND OTHER FREIGHT FOR OTHERS, IN CLASS 39 (U.S. CLS. 100 AND 105).

FIRST USE 3-1-2007; IN COMMERCE 3-1-2007.

NO CLAIM IS MADE TO THE EXCLUSIVE RIGHT TO USE "INTERNATIONAL GROUP, LLC", APART FROM THE MARK AS SHOWN.

THE COLOR(S) BLUE IS/ARE CLAIMED AS A FEATURE OF THE MARK.

THE MARK CONSISTS OF THE WORDS "BENNETT" IN ALL CAPITAL LETTERS ABOVE A HORIZONTAL LINE WITH THE WORDS "INTERNATIONAL GROUP, LLC" BELOW THE LINE TO THE RIGHT OF THE GRAPHIC ALL IN THE COLOR BLUE. A PAIR OF CIRCULAR LINES OR SWOOSHES SURROUNDS A SLANTED HIGHWAY DESIGN TO THE LEFT OF THE TYPE TREATMENT AND LINE ALL IN THE COLORS BLUE AND WHITE.

SER. NO. 77-131,558, FILED 3-15-2007.

JAY FLOWERS, EXAMINING ATTORNEY

Int. Cls.: 37 and 42

Prior U.S. Cls.: 100, 101, 103 and 106

United States Patent and Trademark Office

Reg. No. 3,474,639

Registered July 29, 2008

**SERVICE MARK
PRINCIPAL REGISTER**

MARIN SOLAR

MARIN SOLAR, INC. (CALIFORNIA CORPORATION)
1163-B FRANCISCO BLVD. EAST
SAN RAFAEL, CA 94901

FOR: INSTALLATION, MAINTENANCE AND REPAIR OF SOLAR ELECTRICITY GENERATING SYSTEMS, COMPRISING SOLAR ELECTRICITY GENERATORS, IN CLASS 37 (U.S. CLS. 100, 103 AND 106).

FIRST USE 1-1-2002; IN COMMERCE 1-1-2002.

FOR: DESIGN FOR OTHERS IN THE FIELD OF SOLAR ELECTRICITY GENERATING SYSTEMS, COMPRISING SOLAR ELECTRICITY GENERATORS, IN CLASS 42 (U.S. CLS. 100 AND 101).

FIRST USE 1-1-2002; IN COMMERCE 1-1-2002.

THE MARK CONSISTS OF STANDARD CHARACTERS WITHOUT CLAIM TO ANY PARTICULAR FONT, STYLE, SIZE, OR COLOR.

THE FOREIGN WORDING IN THE MARK TRANSLATES INTO ENGLISH AS SAILOR OR MARINE.

SEC. 2(F).

SER. NO. 77-134,176, FILED 3-19-2007.

RICHARD A. STRASER, EXAMINING ATTORNEY

Int. Cl.: 33

Prior U.S. Cls.: 47 and 49

United States Patent and Trademark Office

Reg. No. 3,474,640

Registered July 29, 2008

**TRADEMARK
PRINCIPAL REGISTER**



CANYON'S EDGE WINERY, LLC (WASHINGTON LTD LIAB CO)
WWW.CANYONSEDGEWINERY.COM
1105 HALE ROAD
MABTON, WA 98935

FOR: PORT WINES, IN CLASS 33 (U.S. CLS. 47 AND 49).

FIRST USE 4-8-2006; IN COMMERCE 4-30-2006.

NO CLAIM IS MADE TO THE EXCLUSIVE RIGHT TO USE "CHOCOLATE PORT", APART FROM THE MARK AS SHOWN.

THE COLOR(S) GREEN, PINK, BURGUNDY, BLACK, DARK BROWN, LIGHT BROWN, GOLD, WHITE AND GRAY IS/ARE CLAIMED AS A FEATURE OF THE MARK.

THE MARK CONSISTS OF A GREEN FROG WITH A BLACK OUTLINE, PINK AND BURGUNDY CHEEK, BLACK AND WHITE EYE AND BLACK EYE BROW. HE IS HOLDING A DARK BROWN AND LIGHT BROWN PIECE OF CHOCOLATE. HE IS SITTING ON A WHITE WINE GLASS FILLED WITH GOLD AND DARK BROWN CHOCOLATES. THERE IS A BLACK BOTTLE BEHIND HIM WITH BURGUNDY AND GOLD STRIPES AND THE WORDING "JEREMIAH'S CHOCOLATE PORT" IN GOLD. ALL OF THIS APPEARS IN A GOLD SQUARE OUTLINED IN BURGUNDY, WHICH IS SET AGAINST A GRAY BACKGROUND. BELOW THE GOLD SQUARE IS THE WORDING, "HE MADE A MIGHTY FINE WINE" IN BURGUNDY.

SER. NO. 77-134,680, FILED 3-19-2007.

KATHERINE CHANG, EXAMINING ATTORNEY

Int. Cls.: 7 and 39

Prior U.S. Cls.: 13, 19, 21, 23, 31, 34, 35, 100 and 105

United States Patent and Trademark Office

Reg. No. 3,474,641

Registered July 29, 2008

**TRADEMARK
SERVICE MARK
PRINCIPAL REGISTER**

HELOVA

SAVOYE (FRANCE SOCIETE ANONYME)
18 BD DES GORGETS
DIJON, FRANCE 21000

FOR: MACHINES AND MACHINE TOOLS FOR STUFFING PACKAGING BOXES WITH AIR CUSHIONS AND AIR BAGS; MATERIAL HANDLING MACHINES, NAMELY, PALLETIZERS, CONVEYORS, AND PACKING MACHINES FOR BOXES OF CARDBOARD; MACHINE TOOLS AND EQUIPMENT, NAMELY, MACHINE TOOL HOLDERS, FOR LOADING AND UNLOADING AND STACKING OF PARCELS, GOODS AND MANUFACTURED PARTS; AUTOMATIC INDUSTRIAL LABELING MACHINES, ELECTROMECHANICAL MARKING MACHINES; WRAPPING MACHINES AND PACKAGING MACHINES AND STRUCTURAL PARTS THEREFOR, NAMELY, CHAINS; MACHINES FOR MANUFACTURING AND DISPENSING PACKAGING MATERIAL; MACHINES AND MACHINE TOOLS FOR THE CUTTING AND FORMING OF MATERIALS THROUGH THE USE OF THERMOSEALING, THERMOFORMING AND FOLDING; FILLING MACHINES; BOXING MACHINES; MACHINES AND EQUIPMENT THEREFOR FOR CLOSING PACKAGES, NAMELY, POWER STAPLERS, GUMMING MACHINES, HOOP CASING MACHINES AND BUNDLE TYING MACHINES; CONVEYORS, PNEUMATIC TRANSPORTERS;

MACHINES, NAMELY, INDUSTRIAL ROBOTS AND MACHINE-TOOLS FOR HANDLING AND CONVEYANCE OF PARCELS, GOODS AND MANUFACTURED PARTS; INDUSTRIAL ROBOTS FOR LOADING AND UNLOADING PARCELS, GOODS AND MANUFACTURED PARTS, IN CLASS 7 (U.S. CLS. 13, 19, 21, 23, 31, 34 AND 35).

FOR: TRANSPORT OF GOODS; PACKAGING OF GOODS FOR TRANSPORTATION; WAREHOUSE STORAGE OF GOODS, IN CLASS 39 (U.S. CLS. 100 AND 105).

THE MARK CONSISTS OF STANDARD CHARACTERS WITHOUT CLAIM TO ANY PARTICULAR FONT, STYLE, SIZE, OR COLOR.

PRIORITY CLAIMED UNDER SEC. 44(D) ON FRANCE APPLICATION NO. 073481496, FILED 2-14-2007, REG. NO. 073481496, DATED 2-14-2007, EXPIRES 2-13-2017.

THE WORDING "HELOVA" HAS NO MEANING IN A FOREIGN LANGUAGE.

SER. NO. 77-135,198, FILED 3-20-2007.

BRIAN CALLAGHAN, EXAMINING ATTORNEY

Int. Cls.: 3, 9 and 11

**Prior U.S. Cls.: 1, 4, 6, 13, 21, 23, 26, 31, 34, 36, 38, 50,
51 and 52**

Reg. No. 3,474,642

United States Patent and Trademark Office

Registered July 29, 2008

**TRADEMARK
PRINCIPAL REGISTER**

TCP

CIRTRAN CORPORATION (NEVADA CORPORATION)
4125 SOUTH 6000 WEST
WEST VALLEY CITY, UT 84128

FOR: HAIR CARE PRODUCTS, NAMELY, HAIR SHAMPOO, HAIR CONDITIONER, HAIR GEL, HAIR RELAXER, HAIR SPRAY, AND HAIR STRAIGHTENING PREPARATION, IN CLASS 3 (U.S. CLS. 1, 4, 6, 50, 51 AND 52).

FIRST USE 5-0-2004; IN COMMERCE 5-0-2004.

FOR: ELECTRIC HAIR CURLING IRON AND ELECTRIC HAIR STRAIGHTENING IRON, IN CLASS 9 (U.S. CLS. 21, 23, 26, 36 AND 38).

FIRST USE 5-0-2004; IN COMMERCE 5-0-2004.

FOR: HAIR DRYERS, IN CLASS 11 (U.S. CLS. 13, 21, 23, 31 AND 34).

FIRST USE 5-0-2004; IN COMMERCE 5-0-2004.

THE MARK CONSISTS OF STANDARD CHARACTERS WITHOUT CLAIM TO ANY PARTICULAR FONT, STYLE, SIZE, OR COLOR.

SER. NO. 77-135,869, FILED 3-20-2007.

THEODORE MCBRIDE, EXAMINING ATTORNEY

Int. Cl.: 9

Prior U.S. Cls.: 21, 23, 26, 36 and 38

Reg. No. 3,474,643

United States Patent and Trademark Office

Registered July 29, 2008

**TRADEMARK
PRINCIPAL REGISTER**

PROPITCH

DAKTRONICS, INC. (SOUTH DAKOTA CORPORATION)
331 32ND AVENUE
BROOKINGS, SD 57006

FIRST USE 12-21-2006; IN COMMERCE 12-21-2006.

FOR: VIDEO DISPLAY SCREENS, NAMELY, LARGE SCALE ELECTRONIC DISPLAY SYSTEMS COMPRISING COMPUTER HARDWARE, COMPUTER OPERATING SOFTWARE AND ONE OR MORE MODULAR DISPLAY PANELS CONTAINING A MATRIX OF LIGHT EMITTING DIODE PIXELS, IN CLASS 9 (U.S. CLS. 21, 23, 26, 36 AND 38).

THE MARK CONSISTS OF STANDARD CHARACTERS WITHOUT CLAIM TO ANY PARTICULAR FONT, STYLE, SIZE, OR COLOR.

SER. NO. 77-136,250, FILED 3-21-2007.

SAIMA MAKHDOOM, EXAMINING ATTORNEY

Int. Cl.: 9

Prior U.S. Cls.: 21, 23, 26, 36 and 38

Reg. No. 3,474,644

United States Patent and Trademark Office

Registered July 29, 2008

**TRADEMARK
PRINCIPAL REGISTER**

EMBLAZE

EMBLAZE LTD (ISRAEL LTD LIAB CO)
22 ZARCHIN ST
RA'ANANA, ISRAEL

TRANSMITTING AND VIEWING RICH MEDIA
CONTENT, IN CLASS 9 (U.S. CLS. 21, 23, 26, 36
AND 38).

FOR: COMPUTER HARDWARE AND PERIPH-
ERAL EQUIPMENT FOR MULTIMEDIA, AND TEL-
ECOMMUNICATION USE; COMPUTER
SOFTWARE FOR WIRELESS COMMUNICATIONS
FOR CREATING, TRANSMITTING AND VIEWING
RICH MEDIA CONTENT VIA COMPUTER NET-
WORKS; MOBILE PHONES AND PERSONAL DIGI-
TAL ASSISTANTS FOR CREATING,

FIRST USE 1-1-2006; IN COMMERCE 1-1-2006.

OWNER OF U.S. REG. NOS. 2,075,241 AND
2,677,229.

SER. NO. 77-137,306, FILED 3-22-2007.

JOHN GARTNER, EXAMINING ATTORNEY

Int. Cl.: 42

Prior U.S. Cls.: 100 and 101

United States Patent and Trademark Office

Reg. No. 3,474,645

Registered July 29, 2008

**SERVICE MARK
PRINCIPAL REGISTER**

opsis architecture

OPSIS ARCHITECTURE (TEXAS LIMITED PART-
NERSHIP)
920 NW 17TH
PORTLAND, OR 97209

FOR: ARCHITECTURAL DESIGN, IN CLASS 42
(U.S. CLS. 100 AND 101).

FIRST USE 9-1-1999; IN COMMERCE 9-1-1999.

NO CLAIM IS MADE TO THE EXCLUSIVE
RIGHT TO USE "ARCHITECTURE", APART FROM
THE MARK AS SHOWN.

THE COLOR(S) BLUE IS/ARE CLAIMED AS A
FEATURE OF THE MARK.

THE COLOR BLUE APPEARS IN THE WORDING
"OPSIS ARCHITECTURE".

SER. NO. 77-138,141, FILED 3-22-2007.

BARNEY CHARLON, EXAMINING ATTORNEY

Int. Cl.: 30

Prior U.S. Cl.: 46

United States Patent and Trademark Office

Reg. No. 3,474,646

Registered July 29, 2008

**TRADEMARK
PRINCIPAL REGISTER**



LUCKY 68, INC. (CALIFORNIA CORPORATION)
4646 CONVOY STREET, SUITE 113
SAN DIEGO, CA 92111

FOR: FROZEN YOGURT PRODUCTS, NAMELY,
FROZEN YOGURT AND FROZEN YOGURT
MIXES, IN CLASS 30 (U.S. CL. 46).

FIRST USE 2-17-2007; IN COMMERCE 2-17-2007.

NO CLAIM IS MADE TO THE EXCLUSIVE
RIGHT TO USE "YOGURT", APART FROM THE
MARK AS SHOWN.

THE COLOR(S) SANDY BROWN, LIME GREEN,
AND FOREST GREEN IS/ARE CLAIMED AS A
FEATURE OF THE MARK.

THE MARK CONSISTS OF THE WORDING "YO-
GURT WORLD" WITH THE LETTERS "Y" AND "O"
IN SANDY BROWN COLOR, THE LETTER "G" IN
STYLIZED DESIGN AND IN LIME GREEN COLOR;
THE LETTERS "U", "R" AND "T" ARE IN SANDY
BROWN COLOR, AND THE WORDING "WORLD"
IS IN FOREST GREEN COLOR.

SER. NO. 77-139,766, FILED 3-25-2007.

EMILY CHUO, EXAMINING ATTORNEY

Int. Cl.: 16

Prior U.S. Cls.: 2, 5, 22, 23, 29, 37, 38 and 50

United States Patent and Trademark Office

Reg. No. 3,474,647

Registered July 29, 2008

**TRADEMARK
PRINCIPAL REGISTER**

NOCHIP DIP

ETCHED IMAGES, INC. (CALIFORNIA CORPORATION)
1758 INDUSTRIAL WAY SUITE 101
NAPA, CA 94558

FOR: SEALING WAX USED AS AN ENCLOSURE FOR WINE BOTTLES AND OTHER BEVERAGE CONTAINERS, IN CLASS 16 (U.S. CLS. 2, 5, 22, 23, 29, 37, 38 AND 50).

FIRST USE 3-1-1993; IN COMMERCE 3-1-1993.

THE MARK CONSISTS OF STANDARD CHARACTERS WITHOUT CLAIM TO ANY PARTICULAR FONT, STYLE, SIZE, OR COLOR.

NO CLAIM IS MADE TO THE EXCLUSIVE RIGHT TO USE "DIP", APART FROM THE MARK AS SHOWN.

SER. NO. 77-140,177, FILED 3-26-2007.

JAY BESCH, EXAMINING ATTORNEY

Int. Cl.: 35

Prior U.S. Cls.: 100, 101 and 102

United States Patent and Trademark Office

Reg. No. 3,474,648

Registered July 29, 2008

**SERVICE MARK
PRINCIPAL REGISTER**

GODSPEED

LIVE NATION WORLDWIDE, INC. (DELAWARE
CORPORATION)
9348 CIVIC CENTER DRIVE
BEVERLY HILLS, CA 90210

THE MARK CONSISTS OF STANDARD CHAR-
ACTERS WITHOUT CLAIM TO ANY PARTICULAR
FONT, STYLE, SIZE, OR COLOR.

FOR: PROMOTING MUSICAL ENTERTAIN-
MENT EVENTS, EXCLUDING OPERAS AND MU-
SICALS, IN CLASS 35 (U.S. CLS. 100, 101 AND 102).

SER. NO. 77-140,750, FILED 3-26-2007.

FIRST USE 8-31-2002; IN COMMERCE 8-31-2002.

BERNICE MIDDLETON, EXAMINING ATTORNEY

Int. Cl.: 41

Prior U.S. Cls.: 100, 101 and 107

United States Patent and Trademark Office

Reg. No. 3,474,649

Registered July 29, 2008

**SERVICE MARK
PRINCIPAL REGISTER**

GODSPEED

LIVE NATION WORLDWIDE, INC. (DELAWARE
CORPORATION)
9348 CIVIC CENTER DRIVE
BEVERLY HILLS, CA 90210

FOR: ENTERTAINMENT SERVICES, NAMELY,
LIVE MUSIC CONCERTS EXCLUDING OPERAS
AND MUSICALS; ENTERTAINMENT IN THE NAT-
URE OF LIVE PERFORMANCES BY MUSICAL
ARTISTS, EXCLUDING OPERAS AND MUSICALS;
PRESENTATION OF LIVE SHOW PERFORMAN-
CES, EXCLUDING OPERAS AND MUSICALS, IN
CLASS 41 (U.S. CLS. 100, 101 AND 107).

FIRST USE 8-31-2002; IN COMMERCE 8-31-2002.

THE MARK CONSISTS OF STANDARD CHAR-
ACTERS WITHOUT CLAIM TO ANY PARTICULAR
FONT, STYLE, SIZE, OR COLOR.

SER. NO. 77-140,760, FILED 3-26-2007.

BERNICE MIDDLETON, EXAMINING ATTORNEY

Int. Cl.: 35

Prior U.S. Cls.: 100, 101 and 102

United States Patent and Trademark Office

Reg. No. 3,474,650

Registered July 29, 2008

**SERVICE MARK
PRINCIPAL REGISTER**

**SAVE TIME & MONEY. ONLINE
AND IN-STORE.**

SHOPLOCAL, LLC (DELAWARE LTD LIAB CO)
225 N. MICHIGAN AVENUE - 16TH FLOOR
CHICAGO, IL 60601

FOR: COMPREHENSIVE MARKETPLACE FOR
MULTI-CHANNEL SHOPPING AND ADVERTIS-
ING, NAMELY, PROVIDING COMMERCIAL IN-
FORMATION TO HELP MANUFACTURERS AND
RETAILERS BETTER TARGET AND REACH CON-
SUMERS, AND PROVIDING CONSUMERS WITH
INFORMATION ABOUT RETAILERS AND MANU-
FACTURERS AND THEIR PRODUCTS AND SER-
VICES, IN CLASS 35 (U.S. CLS. 100, 101 AND 102).

FIRST USE 1-1-2007; IN COMMERCE 1-1-2007.

THE MARK CONSISTS OF STANDARD CHAR-
ACTERS WITHOUT CLAIM TO ANY PARTICULAR
FONT, STYLE, SIZE, OR COLOR.

NO CLAIM IS MADE TO THE EXCLUSIVE
RIGHT TO USE "ONLINE AND IN-STORE", APART
FROM THE MARK AS SHOWN.

SER. NO. 77-142,246, FILED 3-28-2007.

FRANK LATTUCA, EXAMINING ATTORNEY

Int. Cl.: 9

Prior U.S. Cls.: 21, 23, 26, 36 and 38

Reg. No. 3,474,651

United States Patent and Trademark Office

Registered July 29, 2008

**TRADEMARK
PRINCIPAL REGISTER**

Z/IPMON

ILLUSTRO SYSTEMS INTERNATIONAL, LLC
(DELAWARE LTD LIAB CO)
1950 STEMMONS FREEWAY, SUITE 2016
DALLAS, TX 75207

FOR: COMPUTER SOFTWARE FOR USE WITH
MAINFRAME COMPUTER SYSTEMS FOR TRANS-
MISSION CONTROL PROTOCOL AND INTERNET
PROTOCOL MONITORING AND MANAGEMENT ,
IN CLASS 9 (U.S. CLS. 21, 23, 26, 36 AND 38).

FIRST USE 12-7-2007; IN COMMERCE 12-7-2007.

THE MARK CONSISTS OF STANDARD CHAR-
ACTERS WITHOUT CLAIM TO ANY PARTICULAR
FONT, STYLE, SIZE, OR COLOR.

SER. NO. 77-142,333, FILED 3-28-2007.

TANYA AMOS, EXAMINING ATTORNEY

Int. Cls.: 6, 9, 11 and 20

Prior U.S. Cls.: 2, 12, 13, 14, 21, 22, 23, 25, 26, 31, 32, 34, 36, 38 and 50

Reg. No. 3,474,652

United States Patent and Trademark Office

Registered July 29, 2008

**TRADEMARK
PRINCIPAL REGISTER**

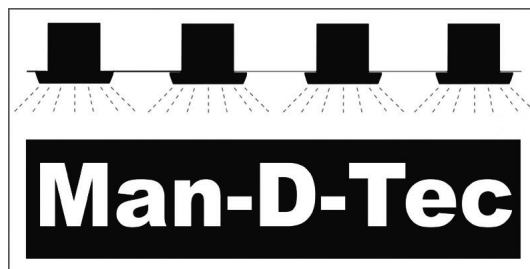

MAN-D-TEC (MICHIGAN CORPORATION)
8175 E. PARADISE LANE, SUITE 1
SCOTTSDALE, AZ 85253

FOR: METAL SECURITY PLATES FOR SECURING LIGHT BULBS IN ELEVATOR LIGHTING FIXTURES; METAL KEY SAFES AND KEY ACCESS BOXES FOR USE IN ELEVATOR MACHINE ROOMS, IN CLASS 6 (U.S. CLS. 2, 12, 13, 14, 23, 25 AND 50).

FIRST USE 2-28-1988; IN COMMERCE 2-28-1988.

FOR: EMERGENCY LIGHTS AND ALARMS, NAMELY, EMERGENCY ELEVATOR ALARM BELLS; AND EMERGENCY ELECTRICAL POWER SUPPLIES FOR FANS, ALL FOR USE IN ELEVATORS, IN CLASS 9 (U.S. CLS. 21, 23, 26, 36 AND 38).

FIRST USE 2-28-1988; IN COMMERCE 2-28-1988.

FOR: INCANDESCENT, LED, AND FLUORESCENT LIGHTING SYSTEMS COMPRISING LIGHTING FIXTURES, LIGHT DIFFUSING LENSES, LIGHTING FIXTURE MOUNTS, ELECTRICAL LIGHT SOCKETS, TRIM BEZELS, SLIP-ON TRIM BEZEL ENHANCER PLATES, PROTECTIVE LOUVERS THAT MOUNT TO LAMP TRIM FOR THEFT PREVENTION AND LIGHT BULB PROTECTION,

ELECTRICAL POWER SUPPLIES, ELECTRICAL POWER CONTROLLERS; LAMPS, NAMELY, FLUORESCENT LAMPS, INCANDESCENT BULBS, HALOGEN BULBS, KRYPTON BULBS, AND LED LAMPS; ELEVATOR EXHAUST FANS, AND ELEVATOR EXHAUST FAN GRILLES; ALL FOR USE IN ELEVATORS, IN CLASS 11 (U.S. CLS. 13, 21, 23, 31 AND 34).

FIRST USE 2-28-1988; IN COMMERCE 2-28-1988.

FOR: FRAMES FOR DISPLAYING PRINTED CERTIFICATES, HOTEL RESTAURANT MENUS, AND BUILDING INFORMATION; AND ELEVATOR SECURITY MIRRORS, ALL FOR USE IN ELEVATORS, IN CLASS 20 (U.S. CLS. 2, 13, 22, 25, 32 AND 50).

FIRST USE 2-28-1988; IN COMMERCE 2-28-1988.

THE MARK CONSISTS OF DASHED LINES EMANATING DOWNWARD FROM EACH OF FOUR LAMP-SHAPED SILHOUETTES ONTO A BLACK RECTANGLE CONTAINING THE LETTERS "MAN-D-TEC".

SER. NO. 77-145,025, FILED 3-30-2007.

RICHARD WHITE, EXAMINING ATTORNEY

Int. Cls.: 6, 9, 11 and 20

**Prior U.S. Cls.: 2, 12, 13, 14, 21, 22, 23, 25, 26, 31, 32,
34, 36, 38 and 50**

Reg. No. 3,474,653

United States Patent and Trademark Office

Registered July 29, 2008

**TRADEMARK
PRINCIPAL REGISTER**

MAN-D-TEC

MAN-D-TEC (MICHIGAN CORPORATION)
8175 E. PARADISE LANE, SUITE 1
SCOTTSDALE, AZ 85253

FOR: METAL SECURITY PLATES FOR SECURING LIGHT BULBS IN ELEVATOR LIGHTING FIXTURES; METAL KEY SAFES AND KEY ACCESS BOXES FOR USE IN ELEVATOR MACHINE ROOMS, IN CLASS 6 (U.S. CLS. 2, 12, 13, 14, 23, 25 AND 50).

FIRST USE 2-28-1988; IN COMMERCE 2-28-1988.

FOR: EMERGENCY LIGHTS AND ALARMS, NAMELY, EMERGENCY ELEVATOR ALARM BELLS; AND EMERGENCY ELECTRICAL POWER SUPPLIES FOR FANS, ALL FOR USE IN ELEVATORS, IN CLASS 9 (U.S. CLS. 21, 23, 26, 36 AND 38).

FIRST USE 2-28-1988; IN COMMERCE 2-28-1988.

FOR: INCANDESCENT, LED, AND FLUORESCENT LIGHTING SYSTEMS COMPRISING LIGHTING FIXTURES, LIGHT DIFFUSING LENSES, LIGHTING FIXTURE MOUNTS, ELECTRICAL LIGHT SOCKETS, TRIM BEZELS, SLIP-ON TRIM BEZEL ENHANCER PLATES, PROTECTIVE LOUVERS THAT MOUNT TO LAMP TRIM FOR THEFT

PREVENTION AND LIGHT BULB PROTECTION, ELECTRICAL POWER SUPPLIES, ELECTRICAL POWER CONTROLLERS; LAMPS, NAMELY, FLUORESCENT LAMPS, INCANDESCENT BULBS, HALOGEN BULBS, KRYPTON BULBS, AND LED LAMPS; ELEVATOR EXHAUST FANS, AND ELEVATOR EXHAUST FAN GRILLES; ALL FOR USE IN ELEVATORS, IN CLASS 11 (U.S. CLS. 13, 21, 23, 31 AND 34).

FIRST USE 2-28-1988; IN COMMERCE 2-28-1988.

FOR: FRAMES FOR DISPLAYING PRINTED CERTIFICATES, HOTEL RESTAURANT MENUS, AND BUILDING INFORMATION AND ELEVATOR SECURITY MIRRORS, ALL FOR USE IN ELEVATORS, IN CLASS 20 (U.S. CLS. 2, 13, 22, 25, 32 AND 50).

FIRST USE 2-28-1988; IN COMMERCE 2-28-1988.

THE MARK CONSISTS OF STANDARD CHARACTERS WITHOUT CLAIM TO ANY PARTICULAR FONT, STYLE, SIZE, OR COLOR.

SER. NO. 77-145,056, FILED 3-30-2007.

RICHARD WHITE, EXAMINING ATTORNEY

Int. Cls.: 41 and 42

Prior U.S. Cls.: 100, 101 and 107

United States Patent and Trademark Office

Reg. No. 3,474,654

Registered July 29, 2008

**SERVICE MARK
PRINCIPAL REGISTER**

**MAKE YOUR POINT.
BRILLIANTLY.**

POINT7WEST, INC. (CALIFORNIA CORPORATION)
45260 CLUB DRIVE
INDIAN WELLS, CA 92210

FOR: ELECTRONIC PUBLISHING SERVICES, NAMELY, PUBLICATION OF TEXT AND GRAPHIC WORKS OF OTHERS ON CD, DVD, AND ON-LINE FEATURING COMMERCIALS, ADVERTISEMENTS, AND PROMOTIONAL MATERIALS; ANIMATION PRODUCTION SERVICES; FILM EDITING; MULTIMEDIA ENTERTAINMENT SOFTWARE PRODUCTION SERVICES; PRODUCTION OF MOTION PICTURE FILMS, SHORT MOTION PICTURE FILMS, VIDEOTAPES, AND DVDS, IN CLASS 41 (U.S. CLS. 100, 101 AND 107).

FIRST USE 1-31-2006; IN COMMERCE 1-31-2006.

FOR: ANIMATION AND SPECIAL-EFFECTS DESIGN FOR OTHERS; GRAPHIC ILLUSTRATION SERVICES FOR OTHERS; DESIGN AND DEVELOPMENT OF MULTIMEDIA PRODUCTS; DEVELOPMENT, DESIGN, CREATION, AND UPDATING OF HOMEPAGES AND WEBSITES FOR OTHERS; DVD AUTHORIZING SERVICES, IN CLASS 42 (U.S. CLS. 100 AND 101).

FIRST USE 1-31-2006; IN COMMERCE 1-31-2006.

THE MARK CONSISTS OF STANDARD CHARACTERS WITHOUT CLAIM TO ANY PARTICULAR FONT, STYLE, SIZE, OR COLOR.

SER. NO. 77-145,431, FILED 3-31-2007.

CHARLOTTE CORWIN, EXAMINING ATTORNEY

Int. Cl.: 41

Prior U.S. Cls.: 100, 101 and 107

United States Patent and Trademark Office

Reg. No. 3,474,655

Registered July 29, 2008

**SERVICE MARK
PRINCIPAL REGISTER**

GLOBAL AXIS

TOOMBS, MICHAEL VANCE (UNITED STATES
INDIVIDUAL)
607 WEST 17TH STREET
KANSAS CITY, MO 64108

FOR: EDUCATION SERVICES, NAMELY, PROVIDING LIVE AND ON-LINE EDUCATION THROUGH CLASSES, SEMINARS, WORKSHOPS, IN-HOME TRAINING AND COURSES, LESSONS, AFTER SCHOOL PROGRAMS, IN THE FIELD OF STANDARD KINDERGARTEN THROUGH HIGH SCHOOL (K-12) CURRICULUM SUBJECT MATTER, NAMELY, MATH, ENGLISH, SOCIAL STUDIES, LITERATURE, SCIENCE, HISTORY, MUSIC, ART, FOREIGN LANGUAGE, SPELLING, WRITING AND GENERAL LANGUAGE SKILLS, IN CLASS 41 (U.S. CLS. 100, 101 AND 107).

FIRST USE 11-6-2006; IN COMMERCE 11-6-2006.

THE MARK CONSISTS OF STANDARD CHARACTERS WITHOUT CLAIM TO ANY PARTICULAR FONT, STYLE, SIZE, OR COLOR.

NO CLAIM IS MADE TO THE EXCLUSIVE RIGHT TO USE "GLOBAL" , APART FROM THE MARK AS SHOWN.

SER. NO. 77-145,898, FILED 4-2-2007.

LAURA HAMMEL, EXAMINING ATTORNEY

Int. Cl.: 43

Prior U.S. Cls.: 100 and 101

United States Patent and Trademark Office

Reg. No. 3,474,656

Registered July 29, 2008

SERVICE MARK
PRINCIPAL REGISTER



QOL RESTAURANT GROUP, INC. (WASHINGTON CORPORATION)
9820 N. NEVADA
SPOKANE, WA 99218

FOR: RESTAURANT AND BAR SERVICES, IN CLASS 43 (U.S. CLS. 100 AND 101).

FIRST USE 6-1-2001; IN COMMERCE 6-1-2001.

NO CLAIM IS MADE TO THE EXCLUSIVE RIGHT TO USE "BISTRO AND MARTINI BAR", APART FROM THE MARK AS SHOWN.

THE MARK CONSISTS OF THE WORD "TWIGS" IN A STYLIZED SAN SERIF SCRIPT FONT WITH THE WORDS "BISTRO AND MARTINI BAR" IN A SMALLER ALL CAPITALIZED NON-SCRIPT SAN SERIF FONT UNDERNEATH THE WORD "TWIGS".

SER. NO. 77-146,218, FILED 4-2-2007.

JAMES A. RAUEN, EXAMINING ATTORNEY

Int. Cls.: 9 and 41

Prior U.S. Cls.: 21, 23, 26, 36, 38, 100, 101 and 107

United States Patent and Trademark Office

Reg. No. 3,474,657

Registered July 29, 2008

**TRADEMARK
SERVICE MARK
PRINCIPAL REGISTER**

MY POOL TV

LARIMORE, LOIS (UNITED STATES INDIVIDUAL)
417 W. FOOTHILL BOULEVARD
SUITE 233
GLEN DORA, CA 91741

FOR: DOWNLOADABLE MULTIMEDIA FILE CONTAINING ARTWORK, TEXT, AUDIO, VIDEO, GAMES AND INTERNET WEB LINKS RELATING TO PARTICIPANTS IN BILLIARDS, IN CLASS 9 (U.S. CLS. 21, 23, 26, 36 AND 38).

FIRST USE 1-1-2006; IN COMMERCE 1-1-2006.

FOR: ENTERTAINMENT SERVICES, NAMELY, PROVIDING A WEB SITE FEATURING MUSICAL PERFORMANCES, MUSICAL VIDEOS, RELATED FILM CLIPS, PHOTOGRAPHS AND OTHER MULTIMEDIA MATERIALS; ENTERTAINMENT IN THE NATURE OF ON-GOING TELEVISION PROGRAMS IN THE FIELD OF VARIETY, COMEDY AND REALITY; ENTERTAINMENT IN THE NATURE OF VISUAL AND AUDIO PERFORMANCES AND

MUSICAL, VARIETY, NEWS AND COMEDY SHOWS; ENTERTAINMENT IN THE NATURE OF BILLIARD GAMES; ENTERTAINMENT IN THE NATURE OF BILLIARD TOURNAMENTS; ENTERTAINMENT SERVICES IN THE NATURE OF AN ON-GOING REALITY BASED TELEVISION PROGRAM, IN CLASS 41 (U.S. CLS. 100, 101 AND 107).

FIRST USE 1-1-2006; IN COMMERCE 1-1-2006.

THE MARK CONSISTS OF STANDARD CHARACTERS WITHOUT CLAIM TO ANY PARTICULAR FONT, STYLE, SIZE, OR COLOR.

NO CLAIM IS MADE TO THE EXCLUSIVE RIGHT TO USE "POOL TV", APART FROM THE MARK AS SHOWN.

SER. NO. 77-146,259, FILED 4-2-2007.

Laurie Mayes, Examining Attorney

Int. Cl.: 37

Prior U.S. Cls.: 100, 103 and 106

United States Patent and Trademark Office

Reg. No. 3,474,658

Registered July 29, 2008

**SERVICE MARK
PRINCIPAL REGISTER**



KING, CHERI A. (UNITED STATES INDIVIDUAL)
11378 TERRELL ROAD
SPRING HILL, FL 34608

FOR: REPAIR OR MAINTENANCE OF COMPUTERS, IN CLASS 37 (U.S. CLS. 100, 103 AND 106).

FIRST USE 3-15-2006; IN COMMERCE 3-15-2007.

THE COLOR(S) GREEN AND BLACK IS/ARE CLAIMED AS A FEATURE OF THE MARK.

THE COLOR GREEN APPEARS IN THE LITERAL PORTION OF THE MARK AND THE COLOR BLACK OUTLINES THE WORDING.

SER. NO. 77-148,110, FILED 4-4-2007.

ELIZABETH KAJUBI, EXAMINING ATTORNEY

Int. Cl.: 41

Prior U.S. Cls.: 100, 101 and 107

United States Patent and Trademark Office

Reg. No. 3,474,659

Registered July 29, 2008

**SERVICE MARK
PRINCIPAL REGISTER**

The Friday ITch

CMP MEDIA LLC (DELAWARE LTD LIAB CO)
600 COMMUNITY DRIVE
MANHASSET, NY 11030

FOR: ENTERTAINMENT IN THE NATURE OF
NON-DOWNLOADABLE ON-GOING SPECIAL
VARIETY, NEWS AND COMEDY SHOWS FEATUR-
ING ONLINE VIDEO PARODYING TECHNOLOGY
NEWS BROADCASTS, IN CLASS 41 (U.S. CLS. 100,
101 AND 107).

FIRST USE 3-30-2007; IN COMMERCE 3-30-2007.

THE MARK CONSISTS OF STANDARD CHAR-
ACTERS WITHOUT CLAIM TO ANY PARTICULAR
FONT, STYLE, SIZE, OR COLOR.

SER. NO. 77-149,488, FILED 4-5-2007.

TAMARA FRAZIER, EXAMINING ATTORNEY

Int. Cls.: 9, 16 and 41

**Prior U.S. Cls.: 2, 5, 21, 22, 23, 26, 29, 36, 37, 38, 50,
100, 101 and 107**

Reg. No. 3,474,660

United States Patent and Trademark Office

Registered July 29, 2008

**TRADEMARK
SERVICE MARK
PRINCIPAL REGISTER**

WALKER & COMPANY

BLOOMSBURY PUBLISHING PLC (UNITED
KINGDOM PUBLIC LIMITED COMPANY
(PLC))
36 SOHO SQUARE
LONDON, UNITED KINGDOM W1D3QY

FOR: DATA RECORDINGS, NAMELY, AUDIO,
VIDEO, STILL AND MOVING IMAGES AND TEXT
ON A VARIETY OF TOPICS; VIDEO CASSETTES,
AUDIOPASSETTES, COMPACT DISCS, AND CD-
ROMS ALL ON A VARIETY OF TOPICS; DOWN-
LOADABLE ELECTRONIC BOOKS AND AUDIO
BOOKS ON A VARIETY OF TOPICS; DOWNLOAD-
ABLE MP3 FILES, MP3 RECORDINGS, ONLINE
DISCUSSION BOARDS, WEB CASTS, POD CASTS
FEATURING MUSIC, AUDIO BOOKS; ELECTRO-
NIC PUBLICATIONS, NAMELY, BOOK, MAGA-
ZINE, MANUAL ON A VARIETY OF TOPICS
RECORDED ON COMPUTER MEDIA, IN CLASS 9
(U.S. CLS. 21, 23, 26, 36 AND 38).

FIRST USE 1-1-2003; IN COMMERCE 1-1-2003.

FOR: PUBLICATIONS, NAMELY, BOOKS, MA-
GAZINES, JOURNALS, BROCHURES, BOOKLETS,
AND TEACHING MATERIALS ON A VARIETY OF
TOPICS, IN CLASS 16 (U.S. CLS. 2, 5, 22, 23, 29, 37, 38
AND 50).

FIRST USE 1-1-2003; IN COMMERCE 1-1-2003.

FOR: PROVISION OF CLASSES, SEMINARS, IN-
STRUCTION, INFORMATION AND TRAINING IN
RELATION TO LITERATURE, WRITING AND
DRAMATIC WORKS; PUBLICATION OF ELECTRO-

NIC BOOKS, AUDIO BOOKS AND JOURNALS ON-
LINE; THE PROVISION OF DISCUSSION FORUMS
RELATED TO LITERATURE, WRITING, MUSIC
AND FILMS; PROVIDING ON-LINE PUBLICA-
TIONS IN THE NATURE OF BOOKS, MAGAZINES,
AND JOURNALS ON A VARIETY OF TOPICS;
PROVISION OF INFORMATION AND ADVISORY
SERVICES RELATING TO LITERATURE, DRA-
MATIC WORKS FOR THEATRE OR BROADCAST,
AUTHORSHIP, MUSIC AND FILM; ENTERTAIN-
MENT SERVICES, NAMELY, PROVIDING ON-LINE
REVIEWS OF MOVIES, BOOKS, MUSIC, COMPU-
TER GAMES; ENTERTAINMENT SERVICES,
NAMELY, PROVIDING A WEB SITE FEATURING
INFORMATION TOPICS ON MUSIC, CONCERTS,
FILM, VIDEOS, THEATRE, RADIO, TELEVISION,
CURRENT EVENT NEWS, SPORTS, GAMES AND
CULTURAL EVENTS AND ENTERTAINMENT-RE-
LATED PROGRAMS, IN CLASS 41 (U.S. CLS. 100, 101
AND 107).

FIRST USE 1-1-2003; IN COMMERCE 1-1-2003.

THE MARK CONSISTS OF STANDARD CHAR-
ACTERS WITHOUT CLAIM TO ANY PARTICULAR
FONT, STYLE, SIZE, OR COLOR.

NO CLAIM IS MADE TO THE EXCLUSIVE
RIGHT TO USE "COMPANY", APART FROM THE
MARK AS SHOWN.

SER. NO. 77-149,678, FILED 4-5-2007.

JOHN HWANG, EXAMINING ATTORNEY

Int. Cl.: 42

Prior U.S. Cls.: 100 and 101

United States Patent and Trademark Office

Reg. No. 3,474,661

Registered July 29, 2008

**SERVICE MARK
PRINCIPAL REGISTER**

SURVAIR

OHIO TRANSMISSION CORPORATION (OHIO
CORPORATION)
1900 JETWAY BLVD.
COLUMBUS, OH 43219

FOR: ANALYSIS OF AIR SYSTEMS FOR OTHERS, NAMELY, TESTING, ANALYZING THROUGH LOGGING AND GRAPHING DATA, AND REPORTING AIR SYSTEM FACTORS TO ASSIST IN MANAGEMENT OF AIR SYSTEMS , IN CLASS 42 (U.S. CLS. 100 AND 101).

FIRST USE 8-9-1999; IN COMMERCE 8-9-1999.

THE MARK CONSISTS OF STANDARD CHARACTERS WITHOUT CLAIM TO ANY PARTICULAR FONT, STYLE, SIZE, OR COLOR.

SER. NO. 77-150,032, FILED 4-5-2007.

JASON TURNER, EXAMINING ATTORNEY

Int. Cl.: 10

Prior U.S. Cls.: 26, 39 and 44

United States Patent and Trademark Office

Reg. No. 3,474,662

Registered July 29, 2008

**TRADEMARK
PRINCIPAL REGISTER**

CLINICAL CARDIOLOGY

RASHMAN CORPORATION (CALIFORNIA CORPORATION)
8600 WILBUR AVENUE
NORTHRIDGE, CA 913244499

FOR: MEDICAL EQUIPMENT AND ACCESSORIES, NAMELY, STETHOSCOPES AND PARTS THEREFOR, IN CLASS 10 (U.S. CLS. 26, 39 AND 44).

FIRST USE 7-0-2001; IN COMMERCE 7-0-2001.

THE MARK CONSISTS OF STANDARD CHARACTERS WITHOUT CLAIM TO ANY PARTICULAR FONT, STYLE, SIZE, OR COLOR.

OWNER OF U.S. REG. NO. 2,828,652.

NO CLAIM IS MADE TO THE EXCLUSIVE RIGHT TO USE "CARDIOLOGY", APART FROM THE MARK AS SHOWN.

SEC. 2(F).

SER. NO. 77-150,070, FILED 4-5-2007.

BARBARA RUTLAND, EXAMINING ATTORNEY

Int. Cl.: 12

Prior U.S. Cls.: 19, 21, 23, 31, 35 and 44

Reg. No. 3,474,663

United States Patent and Trademark Office

Registered July 29, 2008

**TRADEMARK
PRINCIPAL REGISTER**

EDGE 540

ZIVKO AERONAUTICS, INC. (OKLAHOMA CORPORATION)

502 AIRPORT ROAD, BUILDING 6

GUTHRIE, OK 73044

FOR: AIRCRAFT, IN CLASS 12 (U.S. CLS. 19, 21, 23, 31, 35 AND 44).

FIRST USE 1-0-1993; IN COMMERCE 1-0-1993.

THE MARK CONSISTS OF STANDARD CHARACTERS WITHOUT CLAIM TO ANY PARTICULAR FONT, STYLE, SIZE, OR COLOR.

NO CLAIM IS MADE TO THE EXCLUSIVE RIGHT TO USE "540", APART FROM THE MARK AS SHOWN.

SER. NO. 77-150,071, FILED 4-5-2007.

BARBARA RUTLAND, EXAMINING ATTORNEY

Int. Cl.: 21

Prior U.S. Cls.: 2, 13, 23, 29, 30, 33, 40 and 50

United States Patent and Trademark Office

Reg. No. 3,474,664

Registered July 29, 2008

**TRADEMARK
PRINCIPAL REGISTER**

BOTTLE PAL

BIOMARK INC. (WASHINGTON CORPORATION)
6 AVIS AVENUE
PUEBLO, CO 81005

FOR: HOLDERS FOR BOTTLES OR BEVERAGE CONTAINERS; PLASTIC GEL-FILLED COOLING AND HEATING SLEEVE HOLDERS FOR USE WITH BEVERAGE CONTAINERS; INSULATING SLEEVE HOLDERS FOR BEVERAGE CANS; THERMAL INSULATED CONTAINERS FOR BEVERAGE, IN CLASS 21 (U.S. CLS. 2, 13, 23, 29, 30, 33, 40 AND 50).

FIRST USE 7-21-1994; IN COMMERCE 12-31-1994.

THE MARK CONSISTS OF STANDARD CHARACTERS WITHOUT CLAIM TO ANY PARTICULAR FONT, STYLE, SIZE, OR COLOR.

OWNER OF FED REP GERMANY REG. NO. 39727698, DATED 9-26-1997, RENEWED AS REG. NO. 39727698, DATED 7-27-2007, EXPIRES 6-30-2017.

NO CLAIM IS MADE TO THE EXCLUSIVE RIGHT TO USE "BOTTLE", APART FROM THE MARK AS SHOWN.

SER. NO. 77-151,307, FILED 4-7-2007.

LESLEY LAMOTHE, EXAMINING ATTORNEY

Int. Cl.: 9

Prior U.S. Cls.: 21, 23, 26, 36 and 38

United States Patent and Trademark Office

Reg. No. 3,474,665

Registered July 29, 2008

**TRADEMARK
PRINCIPAL REGISTER**

InternetVue

ADDLOGIX (CALIFORNIA CORPORATION)
459 WALD
IRVINE, CA 92618

THE MARK CONSISTS OF STANDARD CHAR-
ACTERS WITHOUT CLAIM TO ANY PARTICULAR
FONT, STYLE, SIZE, OR COLOR.

FOR: FULL MOTION WIRELESS VIDEO ADAP-
TERS DESIGNED FOR USERS TO WATCH PC
CONTENTS ON PROJECTORS AND/OR TELEVI-
SIONS, IN CLASS 9 (U.S. CLS. 21, 23, 26, 36 AND 38).

SER. NO. 77-153,296, FILED 4-10-2007.

FIRST USE 3-19-2007; IN COMMERCE 4-9-2007.

HANNO RITTNER, EXAMINING ATTORNEY

Int. Cl.: 35

Prior U.S. Cls.: 100, 101 and 102

United States Patent and Trademark Office

Reg. No. 3,474,666

Registered July 29, 2008

**SERVICE MARK
PRINCIPAL REGISTER**



KAKOS, DENNY S (UNITED STATES INDIVIDUAL)

177 W ORANGE HEIGHTS LN

CORONA, CA 92882

FOR: PROMOTING THE GOODS AND SERVICES OF OTHERS BY ARRANGING FOR SPONSORS TO AFFILIATE THEIR GOODS AND SERVICES WITH AN AWARDS PROGRAM, A SPORTS COMPETITION AND SPORTING ACTIVITIES, IN CLASS 35 (U.S. CLS. 100, 101 AND 102).

FIRST USE 0-0-1996; IN COMMERCE 0-0-1996.

NO CLAIM IS MADE TO THE EXCLUSIVE RIGHT TO USE "NATURAL", APART FROM THE MARK AS SHOWN.

THE MARK CONSISTS OF THE WORDING "NATURAL" WITH A LARGE STYLIZED LETTER "O" APPEARING BENEATH THIS WORDING WITH LAUREL LEAVES ON EITHER SIDE OF THE LETTER "O". THE WORDING "INTEGRITY", "EXCELLENCE", "DEDICATION" AND "SPIRIT" APPEAR IN DESCENDING ORDER IN THE STYLIZED LETTER "O".

SER. NO. 77-153,534, FILED 4-10-2007.

TINA BROWN, EXAMINING ATTORNEY

Int. Cl.: 31

Prior U.S. Cls.: 1 and 46

United States Patent and Trademark Office

Reg. No. 3,474,667

Registered July 29, 2008

**TRADEMARK
PRINCIPAL REGISTER**

UltimateFlora Zoysia

ENVIRONMENTAL TURF, INC. (FLORIDA CORPORATION)
4366 E. KINSEY ROAD
AVON PARK, FL 33825

FOR: AGRICULTURAL AND HORTICULTURAL PRODUCTS, NAMELY, SOD AND TURF, LIVING PLANTS, NAMELY, LIVE GRASSES, IN CLASS 31 (U.S. CLS. 1 AND 46).

FIRST USE 6-30-2005; IN COMMERCE 8-25-2005.

THE MARK CONSISTS OF STANDARD CHARACTERS WITHOUT CLAIM TO ANY PARTICULAR FONT, STYLE, SIZE, OR COLOR.

NO CLAIM IS MADE TO THE EXCLUSIVE RIGHT TO USE "ZOYSIA", APART FROM THE MARK AS SHOWN.

SER. NO. 77-154,031, FILED 4-11-2007.

LEIGH CAROLINE CASE, EXAMINING ATTORNEY

Int. Cl.: 35

Prior U.S. Cls.: 100, 101 and 102

United States Patent and Trademark Office

Reg. No. 3,474,668

Registered July 29, 2008

**SERVICE MARK
PRINCIPAL REGISTER**

SOCCER SPOT

CALCAGNI'S, INC. (MASSACHUSETTS CORPORATION)
1 OVERLOOK CIRCLE
MILFORD, MA 01757

FOR: RETAIL STORE SERVICES IN THE FIELD OF SOCCER GEAR, CLOTHING, AND EQUIPMENT; COMPUTERIZED ONLINE RETAIL STORE SERVICES IN THE FIELD OF SOCCER GEAR, CLOTHING, AND EQUIPMENT; TEMPORARY RETAIL STORES SET UP ON-SITE FEATURING SOCCER GEAR, CLOTHING, AND EQUIPMENT AT TOURNAMENTS AND OTHER EVENTS, IN CLASS 35 (U.S. CLS. 100, 101 AND 102).

FIRST USE 12-31-1999; IN COMMERCE 12-31-1999.

THE MARK CONSISTS OF STANDARD CHARACTERS WITHOUT CLAIM TO ANY PARTICULAR FONT, STYLE, SIZE, OR COLOR.

NO CLAIM IS MADE TO THE EXCLUSIVE RIGHT TO USE "SOCCER", APART FROM THE MARK AS SHOWN.

SER. NO. 77-154,042, FILED 4-11-2007.

JESSICA FATHY, EXAMINING ATTORNEY

Int. Cl.: 35

Prior U.S. Cls.: 100, 101 and 102

United States Patent and Trademark Office

Reg. No. 3,474,669

Registered July 29, 2008

**SERVICE MARK
PRINCIPAL REGISTER**



CALCAGNI'S, INC. (MASSACHUSETTS CORPORATION)
1 OVERLOOK CIRCLE
MILFORD, MA 01757

THE COLOR(S) RED, BLUE, BLACK AND WHITE IS/ARE CLAIMED AS A FEATURE OF THE MARK.

FOR: RETAIL STORE SERVICES IN THE FIELD OF SOCCER GEAR, CLOTHING, AND EQUIPMENT; COMPUTERIZED ONLINE RETAIL STORE SERVICES IN THE FIELD OF SOCCER GEAR, CLOTHING, AND EQUIPMENT; TEMPORARY RETAIL STORES SET UP ON-SITE FEATURING SOCCER GEAR, CLOTHING, AND EQUIPMENT AT TOURNAMENTS AND OTHER EVENTS, IN CLASS 35 (U.S. CLS. 100, 101 AND 102).

THE MARK CONSISTS OF THE LETTERS "SCCER" IN RED WITH A BLACK OUTLINE; THE LETTERS "SPT" IN BLUE WITH A BLACK OUTLINE; THE LETTERS "O" IN THE WORDS EACH FORMED BY A DEPICTION OF A SOCCER BALL IN BLACK AND WHITE; AND A DEPICTION OF A SOCCER PLAYER SEPARATING THE WORDS, THE DEPICTION BEING IN WHITE, OUTLINED IN BLACK WITH RED AND BLUE HIGHLIGHTED PORTIONS.

FIRST USE 12-31-2000; IN COMMERCE 12-31-2000.

SER. NO. 77-154,134, FILED 4-11-2007.

NO CLAIM IS MADE TO THE EXCLUSIVE RIGHT TO USE "SOCCER", APART FROM THE MARK AS SHOWN.

JESSICA FATHY, EXAMINING ATTORNEY

Int. Cls.: 35, 36 and 39

Prior U.S. Cls.: 100, 101, 102 and 105

United States Patent and Trademark Office

Reg. No. 3,474,670

Registered July 29, 2008

**SERVICE MARK
PRINCIPAL REGISTER**

SANTANDER CONSUMER

BANCO SANTANDER CENTRAL HISPANO, S.A.
(SPAIN CORPORATION)
PASEO DE PEREDA, 9-12
SANTANDER, CANTABRIA, SPAIN 39004 AND
SANTANDER CONSUMER FINANCE, S.A. (SPAIN
CORPORATION)
CIUDAD GRUPO SANTANDER - EDIFICIO DEHE-
SA
BOADILLA DEL MONTE, MA, SPAIN 28660

FOR: (BASED ON FOREIGN REG #2676413) IM-
PORT/EXPORT AGENCY SERVICES; BUSINESS
MANAGEMENT AND CONSULTATION; PREPAR-
ING BUSINESS REPORTS; BOOKKEEPING, AC-
COUNTING AND BUSINESS AND ACCOUNT
AUDITING; COST PRICE ANALYSIS; CONDUCT-
ING MARKETING RESEARCH STUDIES; AND
ADVERTISING AGENCY SERVICES, IN CLASS 35
(U.S. CLS. 100, 101 AND 102).

FOR: (BASED ON FOREIGN REG #2676413)IN-
SURANCE AGENCY SERVICES; CURRENCY EX-
CHANGE SERVICES; FINANCIAL
CLEARINGHOUSE SERVICES; CO-OPERATIVE
CREDIT SERVICES; INVESTMENT TRUST SERVI-
CES FOR HOLDING COMPANIES; BROKERAGE
SERVICES RELATING TO STOCKS, BONDS AND
REAL ESTATE; REAL ESTATE TRUSTEE SERVICES
AND TRUSTEESHIP REPRESENTATIVES; ISSUING
OF TRAVELLERS CHECKS, CREDIT CARDS AND
LETTERS OF CREDIT; FINANCIAL ANALYSIS;
BANKING SERVICES; INVESTMENT CONSULTA-
TION SERVICES FOR OTHERS; COLLECTION AND
CREDIT AGENCIES; FIDUCIARY REPRESENTA-
TIVE, LEASE-PURCHASE AND LOAN FINANCING
SERVICES; REAL ESTATE APPRAISAL AND MAN-
AGEMENT; SAFE DEPOSIT BOX SERVICES, IN
CLASS 36 (U.S. CLS. 100, 101 AND 102).

FOR: (BASED ON FOREIGN REG
#2756379)TRANSPORT BROKERAGE; TRANSPOR-
TATION RESERVATION SERVICES; TRAVEL
BOOKING AGENCIES; TRAVEL CLUBS; TRAVEL
GUIDE SERVICES; TRAVEL INFORMATION SER-
VICES; ARRANGING TRAVEL TOURS; ARRAN-
GING TRAVEL TOURS AS A BONUS PROGRAM
FOR CREDIT CARDS CUSTOMERS; TRAVEL
AGENCY SERVICES, NAMELY, MAKING RESER-
VATIONS AND BOOKINGS FOR TRANSPORTA-
TION, IN CLASS 39 (U.S. CLS. 100 AND 105).

THE MARK CONSISTS OF STANDARD CHAR-
ACTERS WITHOUT CLAIM TO ANY PARTICULAR
FONT, STYLE, SIZE, OR COLOR.

PRIORITY CLAIMED UNDER SEC. 44(D) ON
SPAIN APPLICATION NO. 2.756.379, FILED 2-20-
2007, REG. NO. 2.756.379, DATED 7-27-2007, EXPIRES
2-20-2017.

OWNER OF SPAIN REG. NO. 2.676.413, DATED 7-
7-2006, EXPIRES 10-25-2015.

OWNER OF U.S. REG. NOS. 1,013,686, 2,650,944
AND OTHERS.

NO CLAIM IS MADE TO THE EXCLUSIVE
RIGHT TO USE "CONSUMER", APART FROM
THE MARK AS SHOWN.

SER. NO. 77-154,146, FILED 4-11-2007.

ERIN FALK, EXAMINING ATTORNEY

Int. Cls.: 36 and 42

Prior U.S. Cls.: 100, 101 and 102

United States Patent and Trademark Office

Reg. No. 3,474,671

Registered July 29, 2008

**SERVICE MARK
PRINCIPAL REGISTER**

UNITED FIRST FINANCIAL

UNITED FIRST FINANCIAL, LLC (UTAH LTD
LIAB CO)
SUITE 215
65 EAST WADSWORTH PARK DRIVE
DRAPER, UT 84020

FOR: REAL ESTATE FINANCIAL COUNSELING
SERVICES; FINANCIAL SERVICES IN THE FIELD
OF REAL ESTATE, IN CLASS 36 (U.S. CLS. 100, 101
AND 102).

FIRST USE 1-18-2006; IN COMMERCE 1-18-2006.

FOR: PROVIDING ON-LINE NON-DOWNLOAD-
ABLE SOFTWARE FOR BUDGET MANAGEMENT,
MORTGAGE PAYMENT MANAGEMENT AND FI-

NANCING ALL RELATED TO REAL ESTATE, IN
CLASS 42 (U.S. CLS. 100 AND 101).

FIRST USE 1-18-2006; IN COMMERCE 1-18-2006.

THE MARK CONSISTS OF STANDARD CHAR-
ACTERS WITHOUT CLAIM TO ANY PARTICULAR
FONT, STYLE, SIZE, OR COLOR.

NO CLAIM IS MADE TO THE EXCLUSIVE
RIGHT TO USE "FINANCIAL", APART FROM
THE MARK AS SHOWN.

SER. NO. 77-154,211, FILED 4-11-2007.

TEJBIR SINGH, EXAMINING ATTORNEY

Int. Cl.: 14

Prior U.S. Cls.: 2, 27, 28 and 50

United States Patent and Trademark Office

Reg. No. 3,474,672

Registered July 29, 2008

**TRADEMARK
PRINCIPAL REGISTER**

**ORO LAMINADO 18KT LAYERS
OF GOLD**

SKILLUS CORPORATION (FLORIDA CORPORATION)
3801 SW 47 AVENUE, SUITE 503
DAVIE, FL 33314

FOR: JEWELRY MADE SUBSTANTIALLY OR
PRIMARILY OF GOLD, IN CLASS 14 (U.S. CLS. 2,
27, 28 AND 50).

FIRST USE 11-0-2002; IN COMMERCE 11-0-2002.

THE MARK CONSISTS OF STANDARD CHAR-
ACTERS WITHOUT CLAIM TO ANY PARTICULAR
FONT, STYLE, SIZE, OR COLOR.

NO CLAIM IS MADE TO THE EXCLUSIVE
RIGHT TO USE "18KT", APART FROM THE MARK
AS SHOWN.

THE FOREIGN WORDING IN THE MARK
TRANSLATES INTO ENGLISH AS "LAYERS OF
GOLD".

SEC. 2(F).

SER. NO. 77-154,369, FILED 4-11-2007.

JANICE L. MCMORROW, EXAMINING ATTOR-
NEY

Int. Cl.: 41

Prior U.S. Cls.: 100, 101 and 107

United States Patent and Trademark Office

Reg. No. 3,474,673

Registered July 29, 2008

SERVICE MARK
PRINCIPAL REGISTER

HEALTH.SPORTS.FITNESS 4 GENERATIONS
LIFEXPO

LIFEXPO GROUP, LP (PENNSYLVANIA LIMITED PARTNERSHIP)
125 TECHNOLOGY DRIVE, SUITE 203
CANONSBURG, PA 15317

FOR: ENTERTAINMENT SERVICES, NAMELY, ARRANGING AND CONDUCTING EXHIBITIONS IN THE FIELD OF HEALTH, SPORTS AND FITNESS, IN CLASS 41 (U.S. CLS. 100, 101 AND 107).

FIRST USE 1-23-2007; IN COMMERCE 1-23-2007.

NO CLAIM IS MADE TO THE EXCLUSIVE RIGHT TO USE "HEALTH", "SPORTS" AND "FITNESS", APART FROM THE MARK AS SHOWN.

THE MARK CONSISTS OF THE WORDS "HEALTH, SPORTS, FITNESS, 4 GENERATIONS, LIFEXPO" IN A STYLIZED FORM.

SER. NO. 77-154,861, FILED 4-12-2007.

BERNICE MIDDLETON, EXAMINING ATTORNEY

Int. Cl.: 35

Prior U.S. Cls.: 100, 101 and 102

United States Patent and Trademark Office

Reg. No. 3,474,674

Registered July 29, 2008

**SERVICE MARK
PRINCIPAL REGISTER**

SPOTZERO

MURDICO, DAVID L (UNITED STATES INDIVIDUAL)
940 N. ORANGE DR. STE. 131
LOS ANGELES, CA 90038

FOR: PRODUCTION AND DISTRIBUTION OF COMMERCIALS FOR TELEVISION, RADIO, ONLINE USE AND MOBILE VIDEO USE; ADVERTISING AND MARKETING SERVICES, NAMELY, CREATIVE ADVERTISING AND MARKETING, ONLINE ADVERTISING AND MARKETING, ONLINE VIDEO ADVERTISING AND MARKETING, INTERACTIVE ADVERTISING VIA ONLINE SITES AND INTERACTIVE TELEVISION, PROVIDING CONSULTING SERVICES IN THE FIELD OF FACILITATING THE PLANNING AND BUYING OF MEDIA, CREATING CORPORATE LOGOS, CREATING CORPORATE AND BRAND IDENTITY, DIRECT MARKETING; PUBLIC RELATIONS AND PUBLICITY SERVICES; CREATIVE CONSULTING IN THE FIELD OF MARKETING; BUSINESS MANAGEMENT CONSULTING; BUSINESS PLANNING; BUSINESS MARKETING CONSULTING; BUSINESS MERGERS AND ACQUISITIONS CONSULTATION;

BUSINESS RESEARCH; PERSONNEL MANAGEMENT CONSULTATION; CONSULTATION SERVICES FOR THE PERFORMANCE EVALUATION AND MANAGEMENT OF EMPLOYEES; HUMAN RESOURCES CONSULTATION; PSYCHOLOGICAL TESTING FOR THE SELECTION OF PERSONNEL; CREATIVE MARKETING CONSULTING, NAMELY, ENSURING CLIENTS HAVE AN ADVERTISING MESSAGE CONSISTENT WITH THEIR BUSINESS PLAN, IN CLASS 35 (U.S. CLS. 100, 101 AND 102).

FIRST USE 5-1-2004; IN COMMERCE 5-29-2004.

THE MARK CONSISTS OF STANDARD CHARACTERS WITHOUT CLAIM TO ANY PARTICULAR FONT, STYLE, SIZE, OR COLOR.

OWNER OF U.S. REG. NO. 3,161,570.

SER. NO. 77-155,724, FILED 4-12-2007.

LINDA POWELL, EXAMINING ATTORNEY

Int. Cl.: 5

Prior U.S. Cls.: 6, 18, 44, 46, 51 and 52

United States Patent and Trademark Office

Reg. No. 3,474,675

Registered July 29, 2008

**TRADEMARK
PRINCIPAL REGISTER**

Mom's CHOICE

ULTRAS PHARMACEUTICALS, INC. (TEXAS
CORPORATION)
908 LEXINGTON CROSS DRIVE
LAS VEGAS, NV 89144

FOR: PHARMACEUTICAL ANTITUSSIVE-COLD
PREPARATIONS; PREPARATIONS FOR TREAT-
ING COLDS, IN CLASS 5 (U.S. CLS. 6, 18, 44, 46, 51
AND 52).

FIRST USE 2-1-2007; IN COMMERCE 2-1-2007.

THE MARK CONSISTS OF STANDARD CHAR-
ACTERS WITHOUT CLAIM TO ANY PARTICULAR
FONT, STYLE, SIZE, OR COLOR.

SER. NO. 77-156,804, FILED 4-14-2007.

TARAH HARDY, EXAMINING ATTORNEY

Int. Cl.: 43

Prior U.S. Cls.: 100 and 101

United States Patent and Trademark Office

Reg. No. 3,474,676

Registered July 29, 2008

SERVICE MARK
PRINCIPAL REGISTER



RED ROASTER LLC (COLORADO LTD LIAB CO)
4689 W 20TH STREET, UNIT A
GREELEY, CO 80634

FOR: COFFEE SHOPS, IN CLASS 43 (U.S. CLS. 100
AND 101).

FIRST USE 2-5-2007; IN COMMERCE 2-5-2007.

NO CLAIM IS MADE TO THE EXCLUSIVE
RIGHT TO USE "ROASTER" AND "HAND CRAFTED
COFFEE", APART FROM THE MARK AS
SHOWN.

THE COLOR(S) RED, GREEN BROWN, DARK
BROWN AND WHITE IS/ARE CLAIMED AS A
FEATURE OF THE MARK.

THE EXTERIOR OF THE COFFEE CUP IS RED,
WHITE AND WHITE TRIM AND DARK TRIM

INSIDE THE CUP. THE INTERIOR OF THE COFFEE
CUP IS WHITE. THE LEAVES ON THE COFFEE
BEANS ARE GREEN WITH DARK BROWN BOR-
DERS AND STERNS. THE FRONT-MOST COFFEE
BEAN IS BROWN WITH DARK BROWN BORDERS
AND LINES. THE COFFEE BEAN ON THE LEFT IS
RED WITH A WHITE CIRCLE AND OUTLINED IN
THE DARK BROWN. THE COFFEE BEAN ON THE
RIGHT IS GREEN WITH DARK BROWN BORDERS
AND A WHITE CIRCLE. THE TERMS "RED ROAST-
ER" ARE UNDER THE COFFEE CUP AND THE
TERMS "HAND CRAFTED COFFEE" IS UNDER
THE TERMS "RED ROASTER". THE TERM "RED"
IS IN RED. TERMS "ROASTER" AND "HAND
CRAFTED COFFEE" ARE DARK BROWN.

SER. NO. 77-157,742, FILED 4-16-2007.

MICHAEL KEATING, EXAMINING ATTORNEY

Int. Cl.: 41

Prior U.S. Cls.: 100, 101 and 107

United States Patent and Trademark Office

Reg. No. 3,474,677

Registered July 29, 2008

**SERVICE MARK
PRINCIPAL REGISTER**



AMERICAN AUDIO VISUAL CENTER, INC. (ARIZONA CORPORATION)
7434 E. MONTE CRISTO AVE.
SCOTTSDALE, AZ 85260

FOR: VIDEOTAPE PRODUCTION; AUDIO RECORDING AND PRODUCTION; ENTERTAINMENT, NAMELY, PRODUCTION OF THE MULTIMEDIA ASPECTS OF CORPORATE EVENTS; RENTAL OF AUDIO-VISUAL EQUIPMENT, IN CLASS 41 (U.S. CLS. 100, 101 AND 107).

FIRST USE 1-0-1993; IN COMMERCE 1-0-1993.

NO CLAIM IS MADE TO THE EXCLUSIVE RIGHT TO USE "AMERICAN AUDIO VISUAL CEN-

TER" AND "CUSTOMER SERVICE", APART FROM THE MARK AS SHOWN.

THE MARK CONSISTS OF THE WORDS "EXTREME CUSTOMER SERVICE" IN A SPHERE TO THE LEFT OF THREE TRIANGLES WITH THE WORD "AMERICAN" ABOVE THE TRIANGLES AND THE WORDS "AUDIO VISUAL CENTER" BELOW THE TRIANGLES.

SER. NO. 77-159,680, FILED 4-18-2007.

JESSICA FATHY, EXAMINING ATTORNEY

Int. Cl.: 25

Prior U.S. Cls.: 22 and 39

United States Patent and Trademark Office

Reg. No. 3,474,678

Registered July 29, 2008

**TRADEMARK
PRINCIPAL REGISTER**

fidiot

HARPER, DUANE (UNITED STATES INDIVIDUAL)
128 MORRIS ST. #11
SAN FRANCISCO, CA 94107

THE MARK CONSISTS OF STANDARD CHARACTERS WITHOUT CLAIM TO ANY PARTICULAR FONT, STYLE, SIZE, OR COLOR.

FOR: SHIRTS; HATS, IN CLASS 25 (U.S. CLS. 22 AND 39).

SER. NO. 77-159,867, FILED 4-18-2007.

FIRST USE 9-7-2000; IN COMMERCE 4-12-2007.

BENJAMIN OKEKE, EXAMINING ATTORNEY

Int. Cl.: 11

Prior U.S. Cls.: 13, 21, 23, 31 and 34

United States Patent and Trademark Office

Reg. No. 3,474,679

Registered July 29, 2008

**TRADEMARK
PRINCIPAL REGISTER**

EpiSound

CAUGER, DAVID M. (UNITED STATES INDIVIDUAL)
17 FONTAINE STREET
MARLBORO, MA 01752

FOR: FACIAL SAUNAS, IN CLASS 11 (U.S. CLS. 13, 21, 23, 31 AND 34).

FIRST USE 4-18-2007; IN COMMERCE 4-18-2007.

THE MARK CONSISTS OF STANDARD CHARACTERS WITHOUT CLAIM TO ANY PARTICULAR FONT, STYLE, SIZE, OR COLOR.

OWNER OF U.S. REG. NO. 3,010,464.

SER. NO. 77-160,729, FILED 4-19-2007.

SEAN CROWLEY, EXAMINING ATTORNEY

Int. Cl.: 16

Prior U.S. Cls.: 2, 5, 22, 23, 29, 37, 38 and 50

United States Patent and Trademark Office

Reg. No. 3,474,680

Registered July 29, 2008

**TRADEMARK
PRINCIPAL REGISTER**

Marvelous Mercer

MARVELOUS MERCER (VIRGINIA LTD LIAB
CO)
15097 WETHERBURN DRIVE
CENTREVILLE, VA 20120

THE MARK CONSISTS OF STANDARD CHAR-
ACTERS WITHOUT CLAIM TO ANY PARTICULAR
FONT, STYLE, SIZE, OR COLOR.

FOR: CHILDREN'S BOOKS, IN CLASS 16 (U.S.
CLS. 2, 5, 22, 23, 29, 37, 38 AND 50).

SER. NO. 77-161,228, FILED 4-19-2007.

FIRST USE 11-27-2006; IN COMMERCE 2-12-2007.

CURTIS FRENCH, EXAMINING ATTORNEY

Int. Cl.: 36

Prior U.S. Cls.: 100, 101 and 102

United States Patent and Trademark Office

Reg. No. 3,474,681

Registered July 29, 2008

SERVICE MARK
PRINCIPAL REGISTER

CONTRACTORS
—Coverall Plus—

MERCHANTS MUTUAL INSURANCE COMPAN-
NY (NEW YORK CORPORATION)
250 MAIN STREET
BUFFALO, NY 14202

FOR: INSURANCE UNDERWRITING IN THE
FIELD OF PROPERTY, LIABILITY, INLAND MAR-
INE AND CRIME, IN CLASS 36 (U.S. CLS. 100, 101
AND 102).

FIRST USE 10-1-1988; IN COMMERCE 10-1-1988.

NO CLAIM IS MADE TO THE EXCLUSIVE
RIGHT TO USE "CONTRACTORS", APART FROM
THE MARK AS SHOWN.

THE MARK CONSISTS OF THE WORD "CON-
TRACTORS", BEGINNING AND ENDING WITH A
LARGER FONT "C" AND "S" OVER THE WORDS
"COVERALL PLUS" WITH HORIZONTAL LINES
FROM THE END OF THE LARGER "C" TO "C" IN
"COVERALL" AND FROM THE "S" IN "PLUS" TO
THE LARGER "S" IN "CONTRACTORS".

SER. NO. 77-163,214, FILED 4-23-2007.

ELISSA GARBER KON, EXAMINING ATTORNEY

Int. Cl.: 36

Prior U.S. Cls.: 100, 101 and 102

United States Patent and Trademark Office

Reg. No. 3,474,682

Registered July 29, 2008

**SERVICE MARK
PRINCIPAL REGISTER**

MERCHANTS COVERALL PLUS

MERCHANTS MUTUAL INSURANCE COMPA-
NY (NEW YORK CORPORATION)
250 MAIN STREET
BUFFALO, NY 14202

FOR: INSURANCE UNDERWRITING IN THE
FIELD OF PROPERTY, LIABILITY, INLAND MAR-
INE AND CRIME, IN CLASS 36 (U.S. CLS. 100, 101
AND 102).

FIRST USE 4-1-2005; IN COMMERCE 4-1-2005.

THE MARK CONSISTS OF STANDARD CHAR-
ACTERS WITHOUT CLAIM TO ANY PARTICULAR
FONT, STYLE, SIZE, OR COLOR.

OWNER OF U.S. REG. NOS. 2,170,369, 2,604,533,
AND 2,662,340.

SER. NO. 77-163,219, FILED 4-23-2007.

ELISSA GARBER KON, EXAMINING ATTORNEY

Int. Cl.: 36

Prior U.S. Cls.: 100, 101 and 102

United States Patent and Trademark Office

Reg. No. 3,474,683

Registered July 29, 2008

**SERVICE MARK
PRINCIPAL REGISTER**



MERCHANTS MUTUAL INSURANCE COMPA-
NY (NEW YORK CORPORATION)
250 MAIN STREET
BUFFALO, NY 14202

FOR: INSURANCE UNDERWRITING IN THE
FIELD OF PROPERTY, LIABILITY, INLAND MAR-
INE AND CRIME, IN CLASS 36 (U.S. CLS. 100, 101
AND 102).

FIRST USE 4-1-2005; IN COMMERCE 4-1-2005.

OWNER OF U.S. REG. NOS. 2,170,369, 2,604,533,
AND 2,662,340.

THE MARK CONSISTS OF THE WORDS 'COVER-
ALL PLUS" OVER THE WORD "MERCHANTS"
WITH A STYLIZED "M" IN A LARGER FONT.

SER. NO. 77-163,226, FILED 4-23-2007.

ELISSA GARBER KON, EXAMINING ATTORNEY

Int. Cl.: 44

Prior U.S. Cls.: 100 and 101

United States Patent and Trademark Office

Reg. No. 3,474,684

Registered July 29, 2008

**SERVICE MARK
PRINCIPAL REGISTER**

Tan Bella

MURRAY, GREG (UNITED STATES INDIVIDUAL)
2185 MARKET ST.
SAN FRANCISCO, CA 94114

FOR: TANNING SALONS, IN CLASS 44 (U.S. CLS. 100 AND 101).

FIRST USE 11-13-2004; IN COMMERCE 11-13-2004.

THE MARK CONSISTS OF STANDARD CHARACTERS WITHOUT CLAIM TO ANY PARTICULAR FONT, STYLE, SIZE, OR COLOR.

NO CLAIM IS MADE TO THE EXCLUSIVE RIGHT TO USE "TAN", APART FROM THE MARK AS SHOWN.

THE FOREIGN WORDING IN THE MARK TRANSLATES INTO ENGLISH AS BEAUTIFUL.

SER. NO. 77-163,632, FILED 4-23-2007.

CYNTHIA SLOAN, EXAMINING ATTORNEY

Int. Cl.: 10

Prior U.S. Cls.: 26, 39 and 44

United States Patent and Trademark Office

Reg. No. 3,474,685

Registered July 29, 2008

**TRADEMARK
PRINCIPAL REGISTER**

IMAGE APN

MYCONE DENTAL SUPPLY CO., INC. (NEW
YORK CORPORATION)
616 HOLLYWOOD AVENUE
CHERRY HILL, NJ 08002

FOR: ARTIFICIAL TEETH, IN CLASS 10 (U.S. CLS.
26, 39 AND 44).

FIRST USE 2-0-2005; IN COMMERCE 2-0-2005.

THE MARK CONSISTS OF STANDARD CHAR-
ACTERS WITHOUT CLAIM TO ANY PARTICULAR
FONT, STYLE, SIZE, OR COLOR.

OWNER OF U.S. REG. NO. 2,945,579.

SER. NO. 77-163,987, FILED 4-24-2007.

PAUL E. FAHRENKOPF, EXAMINING ATTORNEY

Int. Cl.: 20

Prior U.S. Cls.: 2, 13, 22, 25, 32 and 50

United States Patent and Trademark Office

Reg. No. 3,474,686

Registered July 29, 2008

**TRADEMARK
PRINCIPAL REGISTER**



THE PROCTER & GAMBLE COMPANY (OHIO CORPORATION)

1 P&G PLAZA

CINCINNATI, OH 45202

FOR: NON-METAL CAGE FOR PROTECTING UNDERGARMENTS IN A WASHING MACHINE, IN CLASS 20 (U.S. CLS. 2, 13, 22, 25, 32 AND 50).

FIRST USE 9-30-2007; IN COMMERCE 9-30-2007.

OWNER OF U.S. REG. NOS. 424,339, 2,326,614 AND OTHERS.

THE COLOR(S) BLUE, YELLOW, ORANGE AND WHITE IS/ARE CLAIMED AS A FEATURE OF THE MARK.

THE MARK CONSISTS OF THE WORD "TIDE" IN THE COLOR BLUE OUTLINED IN WHITE, SUPERIMPOSED ON THREE RADIAL SYMMETRICAL BANDS IN THE COLORS YELLOW, WHITE AND ORANGE, RESPECTIVELY, WITH THE INNERMOST PORTION OF THE CIRCLE ALSO IN YELLOW.

SER. NO. 77-164,875, FILED 4-25-2007.

JASON ROTH, EXAMINING ATTORNEY

Int. Cl.: 20

Prior U.S. Cls.: 2, 13, 22, 25, 32 and 50

United States Patent and Trademark Office

Reg. No. 3,474,687

Registered July 29, 2008

**TRADEMARK
PRINCIPAL REGISTER**

TIDE

THE PROCTER & GAMBLE COMPANY (OHIO
CORPORATION)
1 P&G PLAZA
CINCINNATI, OH 45202

FOR: NON-METAL CAGE FOR PROTECTING
UNDERGARMENTS IN A WASHING MACHINE,
IN CLASS 20 (U.S. CLS. 2, 13, 22, 25, 32 AND 50).

FIRST USE 9-30-2007; IN COMMERCE 9-30-2007.

THE MARK CONSISTS OF STANDARD CHAR-
ACTERS WITHOUT CLAIM TO ANY PARTICULAR
FONT, STYLE, SIZE, OR COLOR.

OWNER OF U.S. REG. NOS. 424,339, 2,326,614 AND
OTHERS.

SER. NO. 77-164,880, FILED 4-25-2007.

JASON ROTH, EXAMINING ATTORNEY

Int. Cl.: 35

Prior U.S. Cls.: 100, 101 and 102

United States Patent and Trademark Office

Reg. No. 3,474,688

Registered July 29, 2008

**SERVICE MARK
PRINCIPAL REGISTER**

Your Silver Bullet

YOUR SILVER BULLET LLC (CALIFORNIA LTD
LIAB CO)
1744 NOVATO BLVD, SUITE 200
NOVATO, CA 94947

FOR: BUSINESS CONSULTATION SERVICES IN
THE FIELD OF COMPUTER SOFTWARE INTERO-
PERABILITY; SOFTWARE FACILITATION SERVI-
CES, NAMELY, BUSINESS CONSULTATION IN
THE FIELD OF COMPUTER SOFTWARE INTERO-
PERABILITY; BUSINESS MARKETING SERVICES
FOR OTHERS IN THE FIELD OF COMPUTER

SOFTWARE INTEROPERABILITY, IN CLASS 35
(U.S. CLS. 100, 101 AND 102).

FIRST USE 2-28-2007; IN COMMERCE 2-28-2007.

THE MARK CONSISTS OF STANDARD CHAR-
ACTERS WITHOUT CLAIM TO ANY PARTICULAR
FONT, STYLE, SIZE, OR COLOR.

SER. NO. 77-165,221, FILED 4-25-2007.

BRENDAN MCCAULEY, EXAMINING ATTORNEY

Int. Cl.: 4

Prior U.S. Cls.: 1, 6 and 15

United States Patent and Trademark Office

Reg. No. 3,474,689

Registered July 29, 2008

**TRADEMARK
PRINCIPAL REGISTER**

ROSE DE CHINE

STRANGE INVISIBLE PERFUMES, LLC (DELA-
WARE LTD LIAB CO)
DIEMER, ROSENTHAL & LAVIOLETTE, LLP
150 SOUTH RODEO DRIVE C/O BLOOM, HERGOTT
BEVERLY HILLS, CA 90212

FOR: CANDLES, IN CLASS 4 (U.S. CLS. 1, 6 AND
15).

FIRST USE 12-7-2005; IN COMMERCE 12-14-2005.

THE MARK CONSISTS OF STANDARD CHAR-
ACTERS WITHOUT CLAIM TO ANY PARTICULAR
FONT, STYLE, SIZE, OR COLOR.

NO CLAIM IS MADE TO THE EXCLUSIVE
RIGHT TO USE "ROSE", APART FROM THE MARK
AS SHOWN.

THE ENGLISH TRANSLATION OF THE WORDS
"DE CHINE" IS "OF CHINA."

SER. NO. 77-165,543, FILED 4-25-2007.

GENE MACIOL, EXAMINING ATTORNEY

Int. Cl.: 35

Prior U.S. Cls.: 100, 101 and 102

United States Patent and Trademark Office

Reg. No. 3,474,690

Registered July 29, 2008

**SERVICE MARK
PRINCIPAL REGISTER**



YOUR SILVER BULLET LLC (CALIFORNIA LTD
LIAB CO)
1744 NOVATO BLVD, SUITE 200
NOVATO, CA 94947

FOR: BUSINESS CONSULTATION SERVICES IN
THE FIELD OF COMPUTER SOFTWARE INTERO-
PERABILITY; SOFTWARE FACILITATION SERVI-
CES, NAMELY, BUSINESS CONSULTATION IN
THE FIELD OF COMPUTER SOFTWARE INTERO-
PERABILITY; BUSINESS MARKETING SERVICES
FOR OTHERS IN THE FIELD OF COMPUTER
SOFTWARE INTEROPERABILITY, IN CLASS 35
(U.S. CLS. 100, 101 AND 102).

FIRST USE 2-28-2007; IN COMMERCE 2-28-2007.

THE COLOR(S) BLUE AND SILVER IS/ARE
CLAIMED AS A FEATURE OF THE MARK.

THE MARK CONSISTS OF THE WORD "YOUR"
IN BLUE, THE WORD "SILVER" IN THE COLOR
SILVER AND THE WORD "BULLET" IN BLUE,
WITH A STYLIZED BULLET IN BLUE AND SILVER.

SER. NO. 77-165,787, FILED 4-25-2007.

BRENDAN MCCAULEY, EXAMINING ATTORNEY

Int. Cl.: 35

Prior U.S. Cls.: 100, 101 and 102

United States Patent and Trademark Office

Reg. No. 3,474,691

Registered July 29, 2008

**SERVICE MARK
PRINCIPAL REGISTER**

TAX DR_x

ETIENNE, SR., HUDSON (UNITED STATES IN-
DIVIDUAL)
47 W. WESTFIELD AVE
ROSELLE PARK, NJ 07204

FOR: INCOME TAX PREPARATION AND PLAN-
NING, AUDIT REPRESENTATION, BOOKKEEP-
ING, AND ACCOUNTING, IN CLASS 35 (U.S. CLS.
100, 101 AND 102).

FIRST USE 2-1-2005; IN COMMERCE 2-1-2005.

THE MARK CONSISTS OF STANDARD CHAR-
ACTERS WITHOUT CLAIM TO ANY PARTICULAR
FONT, STYLE, SIZE, OR COLOR.

NO CLAIM IS MADE TO THE EXCLUSIVE
RIGHT TO USE "TAX", APART FROM THE MARK
AS SHOWN.

SER. NO. 77-166,276, FILED 4-26-2007.

JOHN WILKE, EXAMINING ATTORNEY

Int. Cl.: 9

Prior U.S. Cls.: 21, 23, 26, 36 and 38

Reg. No. 3,474,692

United States Patent and Trademark Office

Registered July 29, 2008

**TRADEMARK
PRINCIPAL REGISTER**

DIG

THE PARADIGM ALLIANCE, INC. (KANSAS
CORPORATION)
222 S. RIDGE RD.
WICHITA, KS 67209

FOR: PROVIDING DOWNLOADABLE ELECTRO-
NIC REPORTS FEATURING DEMOGRAPHIC AND
GEOGRAPHIC PROFILES AND ADDRESSES OF
ACTUAL AND POTENTIAL CUSTOMERS, MEM-
BERS, CONTRIBUTORS, PARTICIPANTS AND
MARKETS FOR BUSINESSES AND PUBLIC
AWARENESS PROGRAMS REGARDING PIPE-

LINES AND UTILITY COMPANIES, IN CLASS 9
(U.S. CLS. 21, 23, 26, 36 AND 38).

FIRST USE 6-15-2006; IN COMMERCE 6-15-2006.

THE MARK CONSISTS OF STANDARD CHAR-
ACTERS WITHOUT CLAIM TO ANY PARTICULAR
FONT, STYLE, SIZE, OR COLOR.

SER. NO. 77-166,473, FILED 4-26-2007.

JIM RINGLE, EXAMINING ATTORNEY

Int. Cl.: 35

Prior U.S. Cls.: 100, 101 and 102

United States Patent and Trademark Office

Reg. No. 3,474,693

Registered July 29, 2008

**SERVICE MARK
PRINCIPAL REGISTER**

PRESSTO VALET

AUGUST GROUP, INC., THE (CALIFORNIA
CORPORATION)
5777 MADISON AVENUE, SUITE 1020
SACRAMENTO, CA 95841

FOR: WHOLESALE DISTRIBUTORSHIPS FEATURING BELLMAN CARTS, IRONS, IRON HOLDERS, LUGGAGE RACKS, REPLACEMENT COVERS AND PADS FOR IRONING BOARDS AND LAUNDRY AND HOUSEKEEPING ITEMS TO HOTELS, IN CLASS 35 (U.S. CLS. 100, 101 AND 102).

FIRST USE 5-2-1993; IN COMMERCE 9-1-1994.

THE MARK CONSISTS OF STANDARD CHARACTERS WITHOUT CLAIM TO ANY PARTICULAR FONT, STYLE, SIZE, OR COLOR.

SER. NO. 77-166,556, FILED 4-26-2007.

AISHA CLARKE, EXAMINING ATTORNEY

Int. Cl.: 9

Prior U.S. Cls.: 21, 23, 26, 36 and 38

Reg. No. 3,474,694

United States Patent and Trademark Office

Registered July 29, 2008

**TRADEMARK
PRINCIPAL REGISTER**

DRESSED TO KILL KOREA CO., LTD. (REPUBLIC OF KOREA CORPORATION)
6TH FLOOR EXR TOWER
488-6, BANGBAE-DONG, SEOCHO-GU
SEOUL, REPUBLIC OF KOREA

FOR: EYGLASSES, SUNGLASSES, SWIMMING GOGGLES, GOGGLES FOR SPORTS, EYGLASS CHAINS, EYGLASS CASES, EYGLASS FRAMES , IN CLASS 9 (U.S. CLS. 21, 23, 26, 36 AND 38).

PRIORITY CLAIMED UNDER SEC. 44(D) ON REPUBLIC OF KOREA APPLICATION NO. 2006-

0058500, FILED 11-20-2006, REG. NO. 731765, DATED 12-18-2007, EXPIRES 12-18-2017.

THE MARK CONSISTS OF THE REVERSE LETTER "D", ROMAN NUMERAL "II", THE LETTER "K".

SER. NO. 77-166,897, FILED 4-26-2007.

MELISSA VALLILLO, EXAMINING ATTORNEY

Int. Cl.: 25

Prior U.S. Cls.: 22 and 39

United States Patent and Trademark Office

Reg. No. 3,474,695

Registered July 29, 2008

**TRADEMARK
PRINCIPAL REGISTER**



DRESSED TO KILL KOREA CO., LTD. (REPUBLIC OF KOREA CORPORATION)
6TH FLOOR EXR TOWER
488-6, BANGBAE-DONG, SEOCHO-GU
SEOUL, REPUBLIC OF KOREA

FOR: TRAINING SHOES, SNEAKERS, RIDING BOOTS, KNEE TROUSERS, ANORAKS NOT FOR USE IN EXERCISING, JUMPERS, SHIRT FRONTS, BLUE JEANS, SWIMSUITS, SPORTS SHIRTS, TEE-SHIRTS, BANDANAS, NECKERCHIEFS, MUFFLERS, SOCKS, CAPS, BRACES FOR CLOTHING, SUSPENDERS, LEATHER BELTS, IN CLASS 25 (U.S. CLS. 22 AND 39).

PRIORITY CLAIMED UNDER SEC. 44(D) ON REPUBLIC OF KOREA APPLICATION NO. 2006-0058512, FILED 11-20-2006, REG. NO. 722615, DATED 8-28-2007, EXPIRES 8-28-2017.

THE MARK CONSISTS OF THE REVERSE LETTER D, THE ROMAN NUMERAL II, THE LETTER K.

SER. NO. 77-166,941, FILED 4-26-2007.

MELISSA VALLILLO, EXAMINING ATTORNEY

Int. Cl.: 33

Prior U.S. Cls.: 47 and 49

United States Patent and Trademark Office

Reg. No. 3,474,696

Registered July 29, 2008

**TRADEMARK
PRINCIPAL REGISTER**

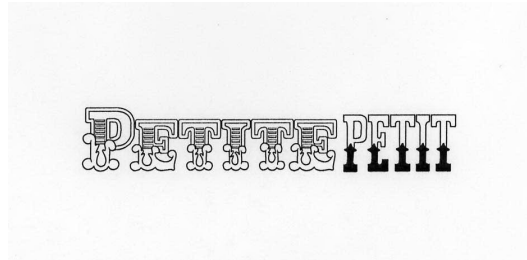

MICHAEL-DAVID, LLC (CALIFORNIA LTD
LIAB CO)
4580 WEST HIGHWAY 12
LODI, CA 95242

FOR: WINE, IN CLASS 33 (U.S. CLS. 47 AND 49).

FIRST USE 4-13-2007; IN COMMERCE 4-13-2007.

THE MARK CONSISTS OF STYLIZED LETTERS
SPELLING "PETITE PETIT".

THE ENGLISH TRANSLATION OF THE FRENCH
WORD "PETIT" IN THE MARK IS SMALL.

SER. NO. 77-167,491, FILED 4-27-2007.

AMY ALFIERI, EXAMINING ATTORNEY

Int. Cl.: 33

Prior U.S. Cls.: 47 and 49

United States Patent and Trademark Office

Reg. No. 3,474,697

Registered July 29, 2008

TRADEMARK
PRINCIPAL REGISTER

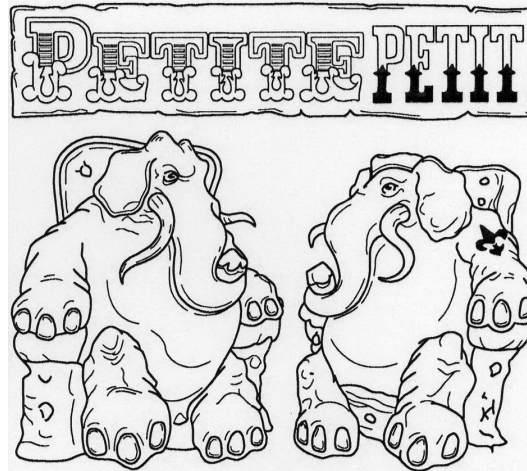

MICHAEL-DAVID, LLC (CALIFORNIA LTD
LIAB CO)

4580 WEST HIGHWAY 12

LODI, CA 95242

FOR: WINE, IN CLASS 33 (U.S. CLS. 47 AND 49).

FIRST USE 4-13-2007; IN COMMERCE 4-13-2007.

THE MARK CONSISTS OF STYLIZED LETTERS
SPELLING "PETITE PETIT" WITH TWO ELE-
PHANTS SITTING IN CHAIRS.

THE ENGLISH TRANSLATION OF THE FRENCH
WORD "PETIT" IN THE MARK IS SMALL.

SER. NO. 77-167,553, FILED 4-27-2007.

AMY ALFIERI, EXAMINING ATTORNEY

Int. Cl.: 3

Prior U.S. Cls.: 1, 4, 6, 50, 51 and 52

Reg. No. 3,474,698

United States Patent and Trademark Office

Registered July 29, 2008

**TRADEMARK
PRINCIPAL REGISTER**

ANXERI

INDUSTRIA DE DISEÑO TEXTIL, S.A. (SPAIN
CORPORATION)
PARCELA 79B POLIGANO INDUSTRIAL DE SA-
BON
ARTEIXO, LA CORUNA, SPAIN

FOR: SOAPS, NAMELY, SKIN SOAPS, LIQUID
HAND SOAPS AND BATH AND SHOWER GELS;
PERFUMERY, NAMELY, PERFUMES, TOILET WA-
TER, SCENTED BODY SPRAY, COLOGNES, POT-
POURRI, INCENSE AND SCENTED ROOM
SPRAYS; ESSENTIAL OILS AND AROMATHERAPY
OILS; COSMETICS, NAMELY, AFTER SHAVES,
AFTER SHAVE LOTIONS, AROMATHERAPY
CREAMS AND LOTIONS, SKIN CARE CREAMS,
BEAUTY CREAMS, DEPILATORY CREAMS AND
WAXES, SKIN CLEANING CREAMS, SUNSCREENS
AND SUNBLOCKS, FACIAL MAKE-UP, BLUSH,
ROUGE, MASCARA, EYE SHADOW, EYE LINER,
EYEBROW PENCILS, LIPSTICKS, LIP GLOSS, LIP
BALM, NAIL VARNISHES AND EMERY BOARDS,
ANTI-PERSPIRANTS, DEODORANTS, SKIN

MOISTURIZERS, TALCUM POWDER, PERFUMED
TALCUM POWDER, BATH BEADS, BATH SALTS
AND BUBBLE BATH; HAIR GELS, POMADES,
MOUSSE, SPRAYS, CONDITIONERS, SHAMPOOS,
TONICS, STYLING FIXATIVES, BLEACHING PRE-
PARATIONS AND LIGHTENERS; TOOTHPASTE, IN
CLASS 3 (U.S. CLS. 1, 4, 6, 50, 51 AND 52).

THE MARK CONSISTS OF STANDARD CHAR-
ACTERS WITHOUT CLAIM TO ANY PARTICULAR
FONT, STYLE, SIZE, OR COLOR.

OWNER OF ERPN CMNTY TM OFC REG. NO.
000018903, DATED 3-31-1998, EXPIRES 4-1-2016.

OWNER OF U.S. REG. NO. 2,314,817.

SER. NO. 77-168,174, FILED 4-27-2007.

JOHN DWYER, EXAMINING ATTORNEY

Int. Cl.: 25

Prior U.S. Cls.: 22 and 39

United States Patent and Trademark Office

Reg. No. 3,474,699

Registered July 29, 2008

**TRADEMARK
PRINCIPAL REGISTER**

Pure Pain Racing

KAKAR, WILLIAM A. (UNITED STATES INDIVIDUAL)
1880 E. KENT AVE.
CHANDLER, AZ 85225 AND
SUPPI, BRANDY C. (UNITED STATES INDIVIDUAL)
1880 E. KENT AVE.
CHANDLER, AZ 85225

FOR: CLOTHING AND CASUAL WEAR FOR MOTORCYCLE RACING, NAMELY, SHORT-SLEEVED OR LONG-SLEEVED T-SHIRTS, SWEAT SHIRTS, CAPRI PANTS, PANTS, BEANIES, HATS, JACKETS, WIND RESISTANT JACKETS, TANK-TOPS, TUBE TOPS, SWIM TRUNKS, SWIM WEAR, JERSEYS, BOARD SHORTS, PANTIES, SHORTS,

UNDERWEAR, BOY SHORTS, IN CLASS 25 (U.S. CLS. 22 AND 39).

FIRST USE 1-22-2005; IN COMMERCE 4-22-2007.

THE MARK CONSISTS OF STANDARD CHARACTERS WITHOUT CLAIM TO ANY PARTICULAR FONT, STYLE, SIZE, OR COLOR.

NO CLAIM IS MADE TO THE EXCLUSIVE RIGHT TO USE "RACING", APART FROM THE MARK AS SHOWN.

SER. NO. 77-168,199, FILED 4-27-2007.

JEFF DEFORD, EXAMINING ATTORNEY

Int. Cls.: 7, 11 and 20

**Prior U.S. Cls.: 2, 13, 19, 21, 22, 23, 25, 31, 32, 34, 35
and 50**

Reg. No. 3,474,700

United States Patent and Trademark Office

Registered July 29, 2008

**TRADEMARK
PRINCIPAL REGISTER**

SIMPLICA

ZHONGSHAN VANTAGE GAS APPLIANCES
STOCK CO., LTD. (CHINA LTD LIAB CO)
1 HUAYUAN ST, XIAOLAN SOUTH INDUSTRY RD
XIAOLAN, ZHONGSHAN, CHINA

FOR: MECHANICAL MIXING MACHINES;
ELECTRIC FRUIT SQUEEZERS FOR HOUSEHOLD
PURPOSES; ELECTRIC FOOD BLENDERS; ELEC-
TRIC CAN OPENERS, ELECTRIC FOOD PROCES-
SORS; BREAD CUTTING MACHINES, NAMELY,
ELECTRIC BREAD KNIVES, PACKAGING MA-
CHINES; SOYA MILK MAKING MACHINES FOR
HOUSEHOLD PURPOSE; ELECTRIC EGG BEA-
TERS; VEGETABLE CUTTING MACHINES FOR
HOUSEHOLD PURPOSES, NAMELY, ELECTRIC
KNIVES FOR CUTTING VEGETABLES; ELECTRIC
FOOD PREPARATION APPARATUS, NAMELY,
TUMBLERS FOR MARINATING FOOD; CLOTHES
WASHING MACHINES; ELECTRIC FOOD CRUSH-
ERS AND GRINDER FOR DOMESTIC USE; DISH
WASHING MACHINES, IN CLASS 7 (U.S. CLS. 13, 19,
21, 23, 31, 34 AND 35).

FIRST USE 9-4-2006; IN COMMERCE 3-1-2007.

FOR: GAS WATER HEATERS; ELECTRIC WA-
TER HEATERS; POINT OF USE HOT WATER
HEATERS; GAS BURNERS FOR DOMESTIC USE;

TOUCH SENSITIVE COOKING RANGES; ELEC-
TROMAGNETIC INDUCTION COOKERS; MICRO-
WAVE OVEN; ELECTRIC ROASTERS; ELECTRIC
COFFEE MAKERS; ELECTRIC KETTLES; FREE-
ZERS; RANGE HOODS; ELECTRIC RICE COO-
KERS; HOT WATER BOTTLES; CLOTHES
DRYING MACHINES; ELECTRIC FANS FOR DO-
MESTIC USE; SOLAR WATER HEATERS; WATER
FILTERING UNITS FOR DOMESTIC USE; DISH
DISINFECTANT APPARATUS FOR DOMESTIC
PURPOSES; ELECTRIC RADIATORS FOR DOME-
STIC PURPOSES FOR HEATING HOMES, IN CLASS
11 (U.S. CLS. 13, 21, 23, 31 AND 34).

FIRST USE 9-4-2006; IN COMMERCE 3-1-2007.

FOR: SIDEBOARDS; DRESSING TABLES FOR
USE IN WASHROOMS; KITCHEN CABINETS; FUR-
NITURE, NAMELY, SALES AND DISPLAY COUN-
TERS; CUPBOARDS, IN CLASS 20 (U.S. CLS. 2, 13, 22,
25, 32 AND 50).

FIRST USE 9-4-2006; IN COMMERCE 3-1-2007.

SER. NO. 77-168,615, FILED 4-30-2007.

KATHERINE CHANG, EXAMINING ATTORNEY

Int. Cl.: 10

Prior U.S. Cls.: 26, 39 and 44

United States Patent and Trademark Office

Reg. No. 3,474,701

Registered July 29, 2008

**TRADEMARK
PRINCIPAL REGISTER**

marionette

KINETIC SURGICAL LLC (CALIFORNIA LTD
LIAB CO)
6215 FERRIS SQUARE SUITE 100
SAN DIEGO, CA 92121

THE MARK CONSISTS OF STANDARD CHAR-
ACTERS WITHOUT CLAIM TO ANY PARTICULAR
FONT, STYLE, SIZE, OR COLOR.

FOR: SURGICAL AND MEDICAL APPARATUS
AND INSTRUMENTS FOR USE IN GENERAL SUR-
GERY, IN CLASS 10 (U.S. CLS. 26, 39 AND 44).

SER. NO. 77-168,892, FILED 4-30-2007.

FIRST USE 0-0-2005; IN COMMERCE 3-0-2007.

LINDA E. BLOHM, EXAMINING ATTORNEY

Int. Cls.: 35 and 39

Prior U.S. Cls.: 100, 101, 102 and 105

United States Patent and Trademark Office

Reg. No. 3,474,702

Registered July 29, 2008

**SERVICE MARK
PRINCIPAL REGISTER**



INTREPID AVIATION GROUP, LLC (DELA-
WARE LTD LIAB CO)
26TH FLOOR
650 MADISON AVENUE
NEW YORK, NY 10022

FOR: INVENTORY MANAGEMENT OF AIR-
CRAFT, AIRCRAFT MOTORS, AIRCRAFT EN-
GINES AND AIRCRAFT PARTS, IN CLASS 35 (U.S.
CLS. 100, 101 AND 102).

FIRST USE 1-12-2007; IN COMMERCE 1-12-2007.

FOR: LEASING OF COMMERCIAL AIRCRAFT,
AND AIRCRAFT MOTORS, ENGINES AND PARTS
TO COMMERCIAL AIRLINES AND OPERATORS,
IN CLASS 39 (U.S. CLS. 100 AND 105).

FIRST USE 1-12-2007; IN COMMERCE 1-12-2007.

SER. NO. 77-170,082, FILED 5-1-2007.

COLLEEN DOMBROW, EXAMINING ATTORNEY

Int. Cl.: 35

Prior U.S. Cls.: 100, 101 and 102

United States Patent and Trademark Office

Reg. No. 3,474,703

Registered July 29, 2008

**SERVICE MARK
PRINCIPAL REGISTER**

STOP||WATCH

TIVO BRANDS LLC (DELAWARE LTD LIAB CO)
2160 GOLD ST
ALVISO, CA 95002

FOR: MARKET RESEARCH SERVICES AND
MARKET RESEARCH CONSULTATION SERVICES,
NAMELY, PROVIDING INFORMATION RELAT-
ING TO THE COMMERCIAL ADVERTISING VIEW-
ING HABITS OF CONSUMERS; MARKET
REPORTS, NAMELY, PREPARING REPORTS IN

DIGITAL AND HARD COPY FORMAT RELATING
TO MARKET TRENDS OF CONSUMER TELEVI-
SION COMMERCIAL VIEWING, IN CLASS 35 (U.S.
CLS. 100, 101 AND 102).

FIRST USE 1-29-2007; IN COMMERCE 1-29-2007.

SER. NO. 77-171,359, FILED 5-2-2007.

JUSTINE D. PARKER, EXAMINING ATTORNEY

Int. Cls.: 35 and 44

Prior U.S. Cls.: 100, 101 and 102

United States Patent and Trademark Office

Reg. No. 3,474,704

Registered July 29, 2008

**SERVICE MARK
PRINCIPAL REGISTER**

ASSISTMED

ASSISTMED, INC. (CALIFORNIA CORPORATION)

#690

7095 HOLLYWOOD BLVD
LOS ANGELES, CA 90028

FOR: SERVICES CONSISTING OF THE REGISTRATION, COLLECTION, TRANSCRIPTION, COMPILATION AND SYSTEMIZATION OF WRITTEN COMMUNICATIONS AND DATA REGARDING PATIENTS' CLINICAL DOCUMENTS AND INFORMATION; INTERACTIVE RECORD-KEEPING SERVICES, REGARDING PATIENTS' CLINICAL DOCUMENTS AND INFORMATION, FOR USE IN RISK MANAGEMENT AND REGULATORY COMPLIANCE BY INSURERS AND PROFESSIONALS IN THE MEDICAL FIELD, IN CLASS 35 (U.S. CLS. 100, 101 AND 102).

FIRST USE 2-1-2000; IN COMMERCE 2-1-2000.

FOR: INTERACTIVE MEDICAL MONITORING AND ALERT SERVICE FOR REMINDING CLIENTS OF MEDICAL INFORMATION, NAMELY, MEDIC-

INAL DOSAGE, ALLERGIC SENSITIVITY, AND PRESCRIPTION REFILLS; PROVIDING AN INTERNET WEBSITE FOR MEDICAL PROFESSIONALS AND MEDICAL PATIENTS THAT ALLOWS FOR THE EXCHANGE OF INFORMATION FROM REMOTE LOCATIONS USING ELECTRONIC PATIENT MONITORING DEVICES THAT FEED INFORMATION TO THE WEBSITE THAT CAN BE ACCESSED IN REAL-TIME BY MEDICAL PROFESSIONALS FOR PURPOSES OF MONITORING AND DIAGNOSING MEDICAL CONDITIONS, IN CLASS 44 (U.S. CLS. 100 AND 101).

FIRST USE 2-1-2000; IN COMMERCE 2-1-2000.

THE MARK CONSISTS OF STANDARD CHARACTERS WITHOUT CLAIM TO ANY PARTICULAR FONT, STYLE, SIZE, OR COLOR.

SER. NO. 77-171,432, FILED 5-2-2007.

JESSICA FATHY, EXAMINING ATTORNEY

Int. Cls.: 35 and 39

Prior U.S. Cls.: 100, 101, 102 and 105

United States Patent and Trademark Office

Reg. No. 3,474,705

Registered July 29, 2008

**SERVICE MARK
PRINCIPAL REGISTER**



PACIFIC DISTRIBUTION SERVICES, INC. (CALIFORNIA CORPORATION)
655 MENLO DRIVE SUITE 200
ROCKLIN, CA 95765

FOR: LOGISTICS MANAGEMENT IN THE FIELDS OF TRANSPORTATION, WAREHOUSING AND SHIPPING AND DELIVERY OF FREIGHT, PACKAGES, DOCUMENTS AND GOODS FOR OTHERS, IN CLASS 35 (U.S. CLS. 100, 101 AND 102).

FIRST USE 3-14-2007; IN COMMERCE 3-28-2007.

FOR: TRANSPORTATION BROKERAGE; WAREHOUSE BROKERAGE; AND SHIPPING AND DELIVERY BROKERAGE, IN CLASS 39 (U.S. CLS. 100 AND 105).

FIRST USE 3-14-2007; IN COMMERCE 3-28-2007.

THE COLOR(S) BLACK AND WHITE IS/ARE CLAIMED AS A FEATURE OF THE MARK.

THE COLOR BLACK APPEARS IN THE LETTERS "IT" AND IN THE CURVED TAIL PORTION OF THE ROCKET CONTRAILS THAT COMPOSE THE FORWARD SLASH IN THE LETTER "X". THE COLOR WHITE APPEARS IN THE REMAINDER OF THE ROCKET CONTRAILS IN THE LETTER "X" AND IN THE LETTERING "EXPRESS". DUE TO THE WHITE LETTERS APPEARING ON A WHITE BACKGROUND, THE BLACK BORDER DRAWN AROUND THE WHITE LETTERS IS NOT A PART OF THE MARK, AND IS FOR CLARITY PURPOSES ONLY.

SER. NO. 77-172,637, FILED 5-4-2007.

KELLEY WELLS, EXAMINING ATTORNEY

Int. Cl.: 41

Prior U.S. Cls.: 100, 101 and 107

United States Patent and Trademark Office

Reg. No. 3,474,706

Registered July 29, 2008

**SERVICE MARK
PRINCIPAL REGISTER**

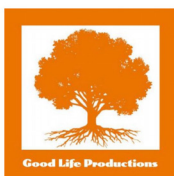

CRUZ, JULIA (UNITED STATES INDIVIDUAL)
84 HOLLAND STREET
SOMERVILLE, MA 02144 AND
ROBERT, NEAL (UNITED STATES INDIVIDUAL)
84 HOLLAND STREET
SOMERVILLE, MA 02144

FOR: OPERATION OF VIDEO EQUIPMENT OR
AUDIO EQUIPMENT ETC. FOR PRODUCTION OF
RADIO OR TELEVISION PROGRAMS; PHOTO-
GRAPHIC AND VIDEO SERVICES, NAMELY, PHO-
TOGRAPHIC AND VIDEO CAPTURE; POST-
PRODUCTION EDITING SERVICES IN THE FIELD
OF MUSIC, VIDEOS AND FILMS, IN CLASS 41 (U.S.
CLS. 100, 101 AND 107).

FIRST USE 7-1-2005; IN COMMERCE 7-1-2005.

NO CLAIM IS MADE TO THE EXCLUSIVE
RIGHT TO USE "PRODUCTIONS", APART FROM
THE MARK AS SHOWN.

THE COLOR(S) OF GOLDEN ROD AND OFF
WHITE IS/ARE CLAIMED AS A FEATURE OF THE
MARK.

THE MARK CONSISTS OF A LARGE TREE IN
FULL BLOOM WITH FULL ROOTS EXPOSED IN
THE COLOR OF DARK GOLDENROD SET
AGAINST AN OFF WHITE BACKGROUND SUR-
ROUNDED BY A GOLDEN ROD FRAME WITH
THE WORDS "GOOD LIFE PRODUCTIONS" IN THE
BOTTOM BAR OF THE FRAME LOCATED DIRECT-
LY BELOW THE ROOT PACK IN A UNIQUE
STYLIZED FONT .

SER. NO. 77-172,969, FILED 5-4-2007.

TRACY CROSS, EXAMINING ATTORNEY

Int. Cls.: 25 and 41

Prior U.S. Cls.: 22, 39, 100, 101 and 107

United States Patent and Trademark Office

Reg. No. 3,474,707

Registered July 29, 2008

**TRADEMARK
SERVICE MARK
PRINCIPAL REGISTER**



SARATOGA POLO

GREEN FIELDS DEVELOPMENT, LLC (NEW
YORK LTD LIAB CO)
511 BROADWAY
SARATOGA SPRINGS, NY 12866

FOR: T-SHIRTS, IN CLASS 25 (U.S. CLS. 22 AND
39).

FIRST USE 6-30-2004; IN COMMERCE 6-30-2004.

FOR: POLO CLUB SERVICES , IN CLASS 41 (U.S.
CLS. 100, 101 AND 107).

FIRST USE 6-30-2004; IN COMMERCE 6-30-2004.

OWNER OF U.S. REG. NO. 1,707,312.

NO CLAIM IS MADE TO THE EXCLUSIVE
RIGHT TO USE "SARATOGA POLO", APART FROM
THE MARK AS SHOWN.

THE STIPPLING IS FOR SHADING PURPOSES
ONLY.

THE MARK CONSISTS OF CROSSED POLO MAL-
LETS ON A CIRCULAR FIELD WITH A JOCKEY'S
HAT ABOVE THE MALLETS, POLO BALLS ON
EITHER SIDE AND THE LETTERS "SPA" BE-
NEATH; BELOW THE CIRCULAR FIELD AND
OTHER DESIGN ELEMENTS APPEAR THE WORDS
"SARATOGA POLO".

SER. NO. 77-173,142, FILED 5-4-2007.

KELLY MCCOY, EXAMINING ATTORNEY

Int. Cl.: 41

Prior U.S. Cls.: 100, 101 and 107

United States Patent and Trademark Office

Reg. No. 3,474,708

Registered July 29, 2008

**SERVICE MARK
PRINCIPAL REGISTER**

In Flight Radio

KRUG, DEVIN CHARLES (UNITED STATES IN-
DIVIDUAL)
5 EAST 2ND ST
BROOKLYN, NY 11218

FOR: ENTERTAINMENT IN THE NATURE OF
VISUAL AND AUDIO PERFORMANCES, NAMELY,
MUSICAL BAND, ROCK GROUP, GYMNASTIC,
DANCE, AND BALLET PERFORMANCES, IN
CLASS 41 (U.S. CLS. 100, 101 AND 107).

FIRST USE 12-7-2004; IN COMMERCE 12-7-2004.

THE MARK CONSISTS OF STANDARD CHAR-
ACTERS WITHOUT CLAIM TO ANY PARTICULAR
FONT, STYLE, SIZE, OR COLOR.

SER. NO. 77-173,462, FILED 5-4-2007.

JIM RINGLE, EXAMINING ATTORNEY

Int. Cl.: 44

Prior U.S. Cls.: 100 and 101

United States Patent and Trademark Office

Reg. No. 3,474,709

Registered July 29, 2008

**SERVICE MARK
PRINCIPAL REGISTER**



ROBERTO VÁZQUEZ-RAMOS (UNITED STATES
INDIVIDUAL)
CAMINO LAS MARIÁS, BO. JOBOS
CARR. 459 KM 10.0
ISABELA, PUERTO RICO 00662

FOR: HORSE BREEDING AND STUD SERVICES,
IN CLASS 44 (U.S. CLS. 100 AND 101).

FIRST USE 4-28-1995; IN COMMERCE 4-28-1995.

THE COLOR(S) GREEN, YELLOW, RED AND
BLUE IS/ARE CLAIMED AS A FEATURE OF THE
MARK.

THE PALM TREE DESIGN IS IN GREEN. BE-
NEATH THE PALM TREE DESIGN ARE THREE
WAVE SHAPES. THE TOP WAVE IN YELLOW, THE
MIDDLE WAVE IS RED AND THE BOTTOM WAVE
IS BLUE

SER. NO. 77-173,720, FILED 5-5-2007.

ERNEST SHOSHO, EXAMINING ATTORNEY

Int. Cls.: 35 and 40

Prior U.S. Cls.: 100, 101, 102, 103 and 106

United States Patent and Trademark Office

Reg. No. 3,474,710

Registered July 29, 2008

**SERVICE MARK
PRINCIPAL REGISTER**



AMISH HEIRLOOM FURNITURE (MARYLAND CORPORATION)
23905 MERVEL DEAN ROAD
HOLLYWOOD, MD 20636

FOR: RETAIL FURNITURE STORES, IN CLASS 35 (U.S. CLS. 100, 101 AND 102).

FIRST USE 8-15-2006; IN COMMERCE 8-15-2006.

FOR: MANUFACTURE OF FURNITURE TO ORDER AND/OR SPECIFICATION OF OTHERS, IN CLASS 40 (U.S. CLS. 100, 103 AND 106).

FIRST USE 8-15-2006; IN COMMERCE 8-15-2006.

NO CLAIM IS MADE TO THE EXCLUSIVE RIGHT TO USE "AMISH HEIRLOOM FURNITURE", APART FROM THE MARK AS SHOWN.

THE COLOR(S) TAN, GOLD, AND BLACK IS/ARE CLAIMED AS A FEATURE OF THE MARK.

THE MARK CONSISTS OF A HORSE DRAWN CARRIAGE WITH THE WORDS "AMISH HEIRLOOM" OVER THE CARRIAGE AND "FURNITURE" UNDERNEATH. THE MARK HAS A TAN BACKGROUND, THE HORSE AND CARRIAGE IS BLACK AND THE WORDING IS GOLD.

SER. NO. 77-173,779, FILED 5-5-2007.

JILL C. ALT, EXAMINING ATTORNEY

Int. Cl.: 9

Prior U.S. Cls.: 21, 23, 26, 36 and 38

Reg. No. 3,474,711

United States Patent and Trademark Office

Registered July 29, 2008

**TRADEMARK
PRINCIPAL REGISTER**



INTERLINQ SOLUTIONS (FLORIDA CORPORATION)
SUITE 1071
1485 INTERNATIONAL PARKWAY
HEATHROW, FL 32746

FOR: COMPUTER PROGRAMS FOR COMPLETION OF DAILY JOB REPORTS, INVENTORY, TIME SHEETS, AND EXPENSE REPORTS, IN CLASS 9 (U.S. CLS. 21, 23, 26, 36 AND 38).

FIRST USE 11-1-2006; IN COMMERCE 11-1-2006.

THE COLOR(S) BLUE AND BLACK IS/ARE CLAIMED AS A FEATURE OF THE MARK.

THE MARK CONSISTS OF THE WORD "PRO" WRITTEN IN BLUE AND THE WORD "LINQ", WITH A CAPITAL LETTER "Q", WRITTEN IN BLACK.

SER. NO. 77-174,576, FILED 5-7-2007.

CAROLINE WOOD, EXAMINING ATTORNEY

Int. Cl.: 25

Prior U.S. Cls.: 22 and 39

United States Patent and Trademark Office

Reg. No. 3,474,712

Registered July 29, 2008

**TRADEMARK
PRINCIPAL REGISTER**

IMPRESSION BRIDAL

IMPRESSION BRIDAL INC. (TEXAS CORPORATION)
11100 W. AIRPORT BLVD
HOUSTON, TX 77477

FOR: WEDDING GOWNS, WEDDING DRESSES, BRIDAL GOWNS, BRIDAL DRESSES, BRIDESMAID DRESSES, FLOWER-GIRL DRESSES, WEDDING AND BRIDAL VEILS, IN CLASS 25 (U.S. CLS. 22 AND 39).

FIRST USE 6-0-1986; IN COMMERCE 6-0-1986.

THE MARK CONSISTS OF STANDARD CHARACTERS WITHOUT CLAIM TO ANY PARTICULAR FONT, STYLE, SIZE, OR COLOR.

OWNER OF U.S. REG. NO. 3,368,632.

NO CLAIM IS MADE TO THE EXCLUSIVE RIGHT TO USE "BRIDAL", APART FROM THE MARK AS SHOWN.

SER. NO. 77-174,841, FILED 5-7-2007.

REBECCA EISINGER, EXAMINING ATTORNEY

Int. Cl.: 35

Prior U.S. Cls.: 100, 101 and 102

United States Patent and Trademark Office

Reg. No. 3,474,713

Registered July 29, 2008

**SERVICE MARK
PRINCIPAL REGISTER**

CONTRACTING ON DEMAND

TOP ECHELON CONTRACTING, INC. (OHIO
CORPORATION)
800 MARKET AVENUE, N.
CANTON, OH 44702

FOR: EMPLOYMENT STAFFING FOR OTHERS,
IN CLASS 35 (U.S. CLS. 100, 101 AND 102).

FIRST USE 7-3-2006; IN COMMERCE 7-3-2006.

THE MARK CONSISTS OF STANDARD CHAR-
ACTERS WITHOUT CLAIM TO ANY PARTICULAR
FONT, STYLE, SIZE, OR COLOR.

OWNER OF U.S. REG. NO. 1,899,148.

NO CLAIM IS MADE TO THE EXCLUSIVE
RIGHT TO USE "CONTRACTING", APART FROM
THE MARK AS SHOWN.

SER. NO. 77-175,140, FILED 5-8-2007.

KELLEY WELLS, EXAMINING ATTORNEY

Int. Cl.: 43

Prior U.S. Cls.: 100 and 101

United States Patent and Trademark Office

Reg. No. 3,474,714

Registered July 29, 2008

**SERVICE MARK
PRINCIPAL REGISTER**

KOTO

ZHANG, JIN R. (UNITED STATES INDIVIDUAL)
29 VALE DRIVE
SOUTH BURLINGTON, VT 05403

THE MARK CONSISTS OF STANDARD CHAR-
ACTERS WITHOUT CLAIM TO ANY PARTICULAR
FONT, STYLE, SIZE, OR COLOR.

FOR: RESTAURANT AND BAR SERVICES, IN
CLASS 43 (U.S. CLS. 100 AND 101).

SER. NO. 77-175,461, FILED 5-8-2007.

FIRST USE 9-21-1999; IN COMMERCE 10-21-1999.

HOWARD FRIEDMAN, EXAMINING ATTORNEY

Int. Cl.: 17

Prior U.S. Cls.: 1, 5, 12, 13, 35 and 50

United States Patent and Trademark Office

Reg. No. 3,474,715

Registered July 29, 2008

**TRADEMARK
PRINCIPAL REGISTER**

CALCARB

CALCARB LIMITED (SCOTLAND CORPORATION)
12 NORTH ROAD
BELLSHILL, UNITED KINGDOM ML41EN

FOR: CARBON BONDED FIBER INSULATION FOR USE AS A HIGH TEMPERATURE INSULATING MATERIAL IN THE MANUFACTURE AND OPERATION OF INDUSTRIAL FURNACES AND IN CASTING PROCESSES, IN CLASS 17 (U.S. CLS. 1, 5, 12, 13, 35 AND 50).

FIRST USE 10-31-1984; IN COMMERCE 10-31-1984.

THE MARK CONSISTS OF STANDARD CHARACTERS WITHOUT CLAIM TO ANY PARTICULAR FONT, STYLE, SIZE, OR COLOR.

PRIORITY CLAIMED UNDER SEC. 44(D) ON ERPN CMNTY TM OFC APPLICATION NO. 005611561, FILED 1-12-2007.

OWNER OF ERPN CMNTY TM OFC REG. NO. 005611561, DATED 11-13-2007, EXPIRES 1-12-2017.

SER. NO. 77-175,501, FILED 5-8-2007.

THOMAS MANOR, EXAMINING ATTORNEY

Int. Cl.: 25

Prior U.S. Cls.: 22 and 39

United States Patent and Trademark Office

Reg. No. 3,474,716

Registered July 29, 2008

**TRADEMARK
PRINCIPAL REGISTER**

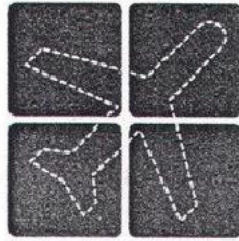

MERINOTRAVEL

AUSTRALIAN WOOL INNOVATION LIMITED
(AUSTRALIA COMPANY)
LEVEL 5, 16-20 BARRACK STREET
SYDNEY, AUSTRALIA

FOR: CLOTHING, NAMELY, SUITS MADE WITH
MERINO WOOL, IN CLASS 25 (U.S. CLS. 22 AND 39).

PRIORITY CLAIMED UNDER SEC. 44(D) ON
AUSTRALIA APPLICATION NO. 1146112, FILED
11-9-2006, REG. NO. 1146112, DATED 11-9-2006, EX-
PIRES 11-9-2016.

THE MARK CONSISTS OF THE PHRASE "MER-
INIOTRAVEL" WITH THE PICTURE OF A PLANE
TO ITS LEFT, DRAWN ON FOUR SHADED
SQUARES THAT ARE ARRANGED INTO ONE
LARGER SQUARE.

SER. NO. 77-175,542, FILED 5-8-2007.

FRANK LATTUCA, EXAMINING ATTORNEY

Int. Cl.: 9

Prior U.S. Cls.: 21, 23, 26, 36 and 38

Reg. No. 3,474,717

United States Patent and Trademark Office

Registered July 29, 2008

**TRADEMARK
PRINCIPAL REGISTER**

BIG CITY ADVENTURE

JOLLY BEAR GAMES, INC. (CANADA CORPORATION)
391 - 280 NELSON ST
VANCOUVER, CANADA V6B2E2

FIRST USE 4-2-2007; IN COMMERCE 4-2-2007.

FOR: DOWNLOADABLE COMPUTER GAMES AND COMPUTER SOFTWARE FEATURING GAMES, DOWNLOADABLE MULTIMEDIA FILES CONTAINING COMPUTER GAMES AND SOFTWARE FEATURING GAMES, IN CLASS 9 (U.S. CLS. 21, 23, 26, 36 AND 38).

THE MARK CONSISTS OF STANDARD CHARACTERS WITHOUT CLAIM TO ANY PARTICULAR FONT, STYLE, SIZE, OR COLOR.

SER. NO. 77-175,929, FILED 5-8-2007.

BENJAMIN OKEKE, EXAMINING ATTORNEY

Int. Cl.: 35

Prior U.S. Cls.: 100, 101 and 102

United States Patent and Trademark Office

Reg. No. 3,474,718

Registered July 29, 2008

**SERVICE MARK
PRINCIPAL REGISTER**



ANN JAQUELYN SCHON (UNITED STATES IN-
DIVIDUAL)
1225 ISLAND AV #113
SAN DIEGO, CA 92101

THE COLOR GREEN APPEARS IN THE ACCENT
ON TOP OF THE "B" AND THE COLOR BLACK
APPEARS IN THE WORDING "AVEZTA".

FOR: BUSINESS CONSULTING SERVICES RE-
LATING TO PRODUCT DISTRIBUTION, OPERA-
TIONS MANAGEMENT SERVICES, LOGISTICS,
REVERSE LOGISTICS, SUPPLY CHAIN, AND PRO-
DUCTION SYSTEMS AND DISTRIBUTION SOLU-
TIONS, IN CLASS 35 (U.S. CLS. 100, 101 AND 102).

THE ENGLISH TRANSLATION OF THE WORD
"AVEZTA" IN THE MARK IS HAS NO MEANING IN
A FOREIGN LANGUAGE.

FIRST USE 1-1-2006; IN COMMERCE 1-1-2006.

SER. NO. 77-176,060, FILED 5-9-2007.

THE COLOR(S) GREEN AND BLACK IS/ARE
CLAIMED AS A FEATURE OF THE MARK.

MARK SPARACINO, EXAMINING ATTORNEY

Int. Cl.: 20

Prior U.S. Cls.: 2, 13, 22, 25, 32 and 50

United States Patent and Trademark Office

Reg. No. 3,474,719

Registered July 29, 2008

**TRADEMARK
PRINCIPAL REGISTER**

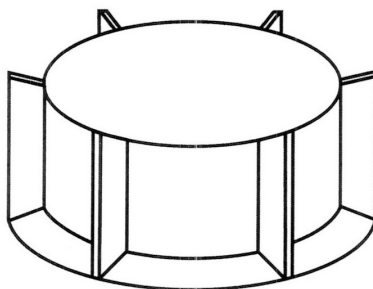

MILLIPORE CORPORATION (MASSACHUSETTS CORPORATION)
290 CONCORD ROAD
BILLERICA, MA 01821

FOR: LABORATORY FILTERS, NAMELY NON-METAL BOTTLE CAPS FOR USE IN STERILIZING FILTRATION IN LABORATORIES; STERILIZING FILTRATION UNITS FOR NON-MEDICAL USE, NAMELY NON-METAL BOTTLE CAPS FOR USE WITH STERILIZING FILTRATION UNITS IN LABORATORIES; NON-METAL BOTTLE CAPS, IN CLASS 20 (U.S. CLS. 2, 13, 22, 25, 32 AND 50).

FIRST USE 12-31-1997; IN COMMERCE 12-31-1997.

OWNER OF U.S. REG. NO. 2,354,166.

THE MARK CONSISTS OF A CONFIGURATION OF A BOTTLE CAP WHEREBY THE CAP IS CHARACTERIZED BY A PLURALITY OF TRANSVERSE PORTIONS ALONG THE CIRCUMFERENCE OF THE CAP AND A SKIRT NEAR THE CAP OPENING

SEC. 2(F).

SER. NO. 77-176,446, FILED 5-9-2007.

LINDA ORNDORFF, EXAMINING ATTORNEY

Int. Cls.: 35 and 42

Prior U.S. Cls.: 100, 101 and 102

United States Patent and Trademark Office

Reg. No. 3,474,720

Registered July 29, 2008

**SERVICE MARK
PRINCIPAL REGISTER**

EXPLOSIVE DATA ON DEMAND

LMCD MARKETING, INC. (NEVADA CORPORATION)
2248 MERIDIAN BLVD., SUITE H
MINDEN, NV 89423

FOR: MARKET ANALYSIS SERVICES IN THE FIELDS OF PRICE INFORMATION AND PRODUCT AVAILABILITY, IN CLASS 35 (U.S. CLS. 100, 101 AND 102).

FIRST USE 11-13-2006; IN COMMERCE 11-13-2006.

FOR: DATA MINING SERVICES IN THE FIELDS OF PRICE INFORMATION AND PRODUCT AVAILABILITY, IN CLASS 42 (U.S. CLS. 100 AND 101).

FIRST USE 11-13-2006; IN COMMERCE 11-13-2006.

THE MARK CONSISTS OF STANDARD CHARACTERS WITHOUT CLAIM TO ANY PARTICULAR FONT, STYLE, SIZE, OR COLOR.

NO CLAIM IS MADE TO THE EXCLUSIVE RIGHT TO USE "DATA ON DEMAND", APART FROM THE MARK AS SHOWN.

SER. NO. 77-176,461, FILED 5-9-2007.

HEATHER SAPP, EXAMINING ATTORNEY

Int. Cl.: 41

Prior U.S. Cls.: 100, 101 and 107

Reg. No. 3,474,721

United States Patent and Trademark Office

Registered July 29, 2008

**SERVICE MARK
PRINCIPAL REGISTER**

UC BERKELEY

THE REGENTS OF THE UNIVERSITY OF CALIFORNIA (CALIFORNIA CORPORATION)
1111 FRANKLIN STREET, 12TH FLOOR
OAKLAND, CA 946075200

FOR: EDUCATIONAL SERVICES, NAMELY, CONDUCTING CLASSES, CONFERENCES, AND WORKSHOPS IN THE FIELDS OF EDUCATION, PERSONAL AND PROFESSIONAL DEVELOPMENT, PHYSICAL DEVELOPMENT, SCIENCE, ENVIRONMENT, ECOLOGY, AND RECREATION; SPORT CAMPS; ARRANGING AND CONDUCTING ATHLETIC COMPETITIONS, PROVIDING INFORMATION IN THE FIELD OF ATHLETIC COMPETITIONS, NAMELY MEN'S BASKETBALL, WOMEN'S BASKETBALL, MEN'S CREW, WOMEN'S CREW, MEN'S CROSS COUNTRY, WOMEN'S CROSS COUNTRY, FIELD HOCKEY, FOOTBALL, MEN'S GOLF, WOMEN'S GOLF, MEN'S SOCCER, WOMEN'S SOCCER, MEN'S SWIMMING, WOMEN'S SWIMMING, MEN'S DIVING, WOMEN'S DIVING,

BASEBALL, SOFTBALL, MEN'S WATER POLO, WOMEN'S WATER POLO, MEN'S GYMNASTICS, WOMEN'S GYMNASTICS, LACROSSE, RUGBY, MEN'S TRACK AND FIELD, WOMEN'S TRACK AND FIELD, WOMEN'S VOLLEYBALL, IN CLASS 41 (U.S. CLS. 100, 101 AND 107).

FIRST USE 0-0-1960; IN COMMERCE 0-0-1960.

THE MARK CONSISTS OF STANDARD CHARACTERS WITHOUT CLAIM TO ANY PARTICULAR FONT, STYLE, SIZE, OR COLOR.

OWNER OF U.S. REG. NO. 2,410,875.

SEC. 2(F) AS TO "BERKELEY".

SER. NO. 77-176,543, FILED 5-9-2007.

BARBARA GAYNOR, EXAMINING ATTORNEY

Int. Cl.: 35

Prior U.S. Cls.: 100, 101 and 102

United States Patent and Trademark Office

Reg. No. 3,474,722

Registered July 29, 2008

**SERVICE MARK
PRINCIPAL REGISTER**

CSSI

COST SEGREGATION SERVICES, INC. (LOUISIANA CORPORATION)
9241 BLUEBONNET BLVD, SUITE A
BATON ROUGE, LA 70810

FOR: ACCOUNTING CONSULTATION AND SERVICES; TAX CONSULTING SERVICES RELATING TO ASSET VALUATION AND OPTIMIZATION; PERFORMING AND ANALYZING TAX BENEFIT STUDIES, NAMELY, TAX ADVISORY SERVICES; TAX AND TAXATION PLANNING, ADVICE, AND CONSULTANCY SERVICES, IN CLASS 35 (U.S. CLS. 100, 101 AND 102).

FIRST USE 11-30-2006; IN COMMERCE 11-30-2006.

THE MARK CONSISTS OF STANDARD CHARACTERS WITHOUT CLAIM TO ANY PARTICULAR FONT, STYLE, SIZE, OR COLOR.

SER. NO. 77-177,149, FILED 5-10-2007.

ANDREA HACK, EXAMINING ATTORNEY

Int. Cl.: 35

Prior U.S. Cls.: 100, 101 and 102

United States Patent and Trademark Office

Reg. No. 3,474,723

Registered July 29, 2008

**SERVICE MARK
PRINCIPAL REGISTER**

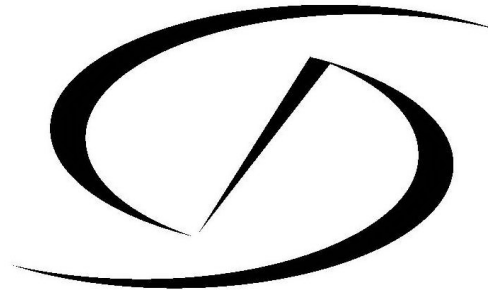

COST SEGREGATION SERVICES, INC. (LOUISIANA CORPORATION)
9241 BLUEBONNET BLVD, SUITE A
BATON ROUGE, LA 70810

FOR: ACCOUNTING CONSULTATION AND SERVICES; TAX CONSULTING SERVICES RELATING TO ASSET VALUATION AND OPTIMIZATION; PERFORMING AND ANALYZING TAX BENEFIT STUDIES, NAMELY, TAX ADVISORY SERVICES; TAX AND TAXATION PLANNING, ADVICE, AND CONSULTANCY SERVICES, IN CLASS 35 (U.S. CLS. 100, 101 AND 102).

FIRST USE 11-30-2006; IN COMMERCE 11-30-2006.

THE MARK CONSISTS OF A FANCIFUL DESIGN COMPRISING TWO ARCS WITH A BISECTING ELEMENT.

SER. NO. 77-177,151, FILED 5-10-2007.

ANDREA HACK, EXAMINING ATTORNEY

Int. Cls.: 10, 24 and 25

Prior U.S. Cls.: 22, 26, 39, 42, 44 and 50

Reg. No. 3,474,724

United States Patent and Trademark Office

Registered July 29, 2008

**TRADEMARK
PRINCIPAL REGISTER**

STANDARD CLASSIC

STANDARD TEXTILE CO., INC. (ALABAMA CORPORATION)
ONE KNOLLCREST DRIVE
CINCINNATI, OH 45237

FOR: MEDICAL AND PATIENT APPAREL, NAMELY, EXAMINATION GOWNS, TOPS AND BOTTOMS, AND SURGICAL APPAREL, NAMELY, SCRUB SHIRTS, SCRUB SUITS, SCRUB PANTS, AND SURGICAL GOWNS, IN CLASS 10 (U.S. CLS. 26, 39 AND 44).

FIRST USE 12-29-2003; IN COMMERCE 12-29-2003.

FOR: RECEIVING BLANKETS, BATH BLANKETS, TOWELS, FLAT SHEETS, AND DRAW SHEETS, IN CLASS 24 (U.S. CLS. 42 AND 50).

FIRST USE 12-29-2003; IN COMMERCE 12-29-2003.

FOR: MEDICAL AND PATIENT APPAREL, NAMELY, PAJAMAS, NON-EXAMINATION AND NON-SURGICAL GOWNS, SHIRTS, PANTS AND JACKETS, IN CLASS 25 (U.S. CLS. 22 AND 39).

FIRST USE 12-29-2003; IN COMMERCE 12-29-2003.

THE MARK CONSISTS OF STANDARD CHARACTERS WITHOUT CLAIM TO ANY PARTICULAR FONT, STYLE, SIZE, OR COLOR.

NO CLAIM IS MADE TO THE EXCLUSIVE RIGHT TO USE "CLASSIC", APART FROM THE MARK AS SHOWN.

SER. NO. 77-177,501, FILED 5-10-2007.

DEIRDRE ROBERTSON, EXAMINING ATTORNEY

Int. Cl.: 9

Prior U.S. Cls.: 21, 23, 26, 36 and 38

Reg. No. 3,474,725

United States Patent and Trademark Office

Registered July 29, 2008

**TRADEMARK
PRINCIPAL REGISTER**

ORICORE

BAI YUHONG (CHINA INDIVIDUAL)
ROOM 6C, QIANYI BUILDING
FENGZE DISTRICT, QUANZHOU CITY
FUJIAN PROVINCE, CHINA

FOR: PERSONAL STEREOS; NAVIGATION AP-
PARATUS FOR VEHICLES IN THE NATURE OF
ON-BOARD COMPUTERS; RECORDING AND
PLAYING DEVICES FOR SOUND AND IMAGE

CARRIERS; APPARATUS FOR TRANSMITTING
AND REPRODUCING SOUND OR IMAGES, IN
CLASS 9 (U.S. CLS. 21, 23, 26, 36 AND 38).

FIRST USE 6-1-2006; IN COMMERCE 12-26-2006.

SER. NO. 77-178,340, FILED 5-10-2007.

ERNEST SHOSHO, EXAMINING ATTORNEY

Int. Cl.: 9

Prior U.S. Cls.: 21, 23, 26, 36 and 38

United States Patent and Trademark Office

Reg. No. 3,474,726

Registered July 29, 2008

**TRADEMARK
PRINCIPAL REGISTER**

EYEON ROTATION

EYEON SOFTWARE INC. (CANADA CORPORATION)
SUITE 201
2181 QUEEN STREET EAST
TORONTO, CANADA M4E1E5

FOR: COMPUTER SOFTWARE FOR USE IN FILM, VIDEO AND MULTIMEDIA AS A NON-LINEAR EDITING AND POST-PRODUCTION TOOL FOR THE COMPOSITING OF IMAGES AND CREATION OF SPECIAL EFFECTS, IN CLASS 9 (U.S. CLS. 21, 23, 26, 36 AND 38).

FIRST USE 4-2-2007; IN COMMERCE 4-2-2007.

THE MARK CONSISTS OF STANDARD CHARACTERS WITHOUT CLAIM TO ANY PARTICULAR FONT, STYLE, SIZE, OR COLOR.

PRIORITY CLAIMED UNDER SEC. 44(D) ON CANADA APPLICATION NO. 1326708, FILED 12-4-2006, REG. NO. TMA702839, DATED 12-11-2007, EXPIRES 12-11-2022.

SER. NO. 77-178,509, FILED 5-11-2007.

JULIE WATSON, EXAMINING ATTORNEY

Int. Cl.: 16

Prior U.S. Cls.: 2, 5, 22, 23, 29, 37, 38 and 50

United States Patent and Trademark Office

Reg. No. 3,474,727

Registered July 29, 2008

**TRADEMARK
PRINCIPAL REGISTER**

PADDY-CAKES

PADDY-CAKES, LLC (WISCONSIN LTD LIAB
CO)
756 WATERS EDGE
RACINE, WI 53402

THE MARK CONSISTS OF STANDARD CHAR-
ACTERS WITHOUT CLAIM TO ANY PARTICULAR
FONT, STYLE, SIZE, OR COLOR.

FOR: CUSTOM MADE GIFT SETS, NAMELY,
DISPOSABLE DIAPERS IN A DECORATIVE CAKE
ARRANGEMENT, IN CLASS 16 (U.S. CLS. 2, 5, 22, 23,
29, 37, 38 AND 50).

SER. NO. 77-178,525, FILED 5-11-2007.

FIRST USE 4-20-2007; IN COMMERCE 4-26-2007.

EVELYN BRADLEY, EXAMINING ATTORNEY

Int. Cl.: 41

Prior U.S. Cls.: 100, 101 and 107

United States Patent and Trademark Office

Reg. No. 3,474,728

Registered July 29, 2008

**SERVICE MARK
PRINCIPAL REGISTER**

THREE LEGGED LEGS

THREE LEGGED LEGS, LLC (CALIFORNIA LTD
LIAB CO)
1554 16TH STREET
SANTA MONICA, CA 90404

FOR: PRODUCTION OF FILMS, IN CLASS 41 (U.S.
CLS. 100, 101 AND 107).

FIRST USE 12-31-2005; IN COMMERCE 12-31-2005.

THE MARK CONSISTS OF STANDARD CHAR-
ACTERS WITHOUT CLAIM TO ANY PARTICULAR
FONT, STYLE, SIZE, OR COLOR.

SER. NO. 77-179,387, FILED 5-11-2007.

AMOS T. MATTHEWS, JR., EXAMINING ATTOR-
NEY

Int. Cl.: 36

Prior U.S. Cls.: 100, 101 and 102

United States Patent and Trademark Office

Reg. No. 3,474,729

Registered July 29, 2008

**SERVICE MARK
PRINCIPAL REGISTER**

Siena Capital Management

STEPHEN LOUIS HICKS (UNITED STATES IN-
DIVIDUAL)
4754 ARAPAHO TRAIL
OKEMOS, MI 48864

FOR: ADVICE RELATING TO INVESTMENTS;
INVESTMENT ADVICE; INVESTMENT ADVISORY
SERVICES; INVESTMENT BROKERAGE; INVEST-
MENT CONSULTATION; INVESTMENT MANAGE-
MENT; INVESTMENT OF FUNDS FOR OTHERS;
INVESTMENT SERVICES, NAMELY, ASSET AC-
QUISITION, CONSULTATION, DEVELOPMENT
AND MANAGEMENT SERVICES; MUTUAL FUND
INVESTMENT; PRIVATE EQUITY FUND INVEST-
MENT SERVICES, IN CLASS 36 (U.S. CLS. 100, 101
AND 102).

FIRST USE 2-14-2006; IN COMMERCE 2-14-2006.

THE MARK CONSISTS OF STANDARD CHAR-
ACTERS WITHOUT CLAIM TO ANY PARTICULAR
FONT, STYLE, SIZE, OR COLOR.

NO CLAIM IS MADE TO THE EXCLUSIVE
RIGHT TO USE CAPITAL MANAGEMENT, APART
FROM THE MARK AS SHOWN.

SER. NO. 77-179,418, FILED 5-11-2007.

MARY CRAWFORD, EXAMINING ATTORNEY

Int. Cls.: 9 and 42

Prior U.S. Cls.: 21, 23, 26, 36, 38, 100 and 101

United States Patent and Trademark Office

Reg. No. 3,474,730

Registered July 29, 2008

**TRADEMARK
SERVICE MARK
PRINCIPAL REGISTER**

COWSIGNS

ABS GLOBAL, INC. (DELAWARE CORPORATION)

1525 RIVER ROAD
DEFOREST, WI 53532

FOR: COMPUTER SOFTWARE FOR THE COLLECTION OF DATA WITH RESPECT TO PARAMETERS WITH RESPECT TO A COW'S ENVIRONMENT, A COW'S PHYSICAL CHARACTERISTICS AND CONDITION, AND A COW'S MILK PRODUCTION; SOFTWARE USED TO COLLECT DATA AND MONITOR MULTIPLE PERFORMANCE INDICATORS OF A COW'S ENVIRONMENT BY COLLECTING DATA AND PROVIDING CUSTOMIZED REPORTING CAPABILITIES, IN CLASS 9 (U.S. CLS. 21, 23, 26, 36 AND 38).

FIRST USE 5-24-2005; IN COMMERCE 7-18-2005.

FOR: PROVIDING A WEBSITE FEATURING SCIENTIFIC RESEARCH DATA WITH RESPECT TO A MONITORED COW'S ENVIRONMENT, THE COW'S PHYSICAL CHARACTERISTICS AND CONDITION, AND THE COW'S MILK PRODUCTION, IN CLASS 42 (U.S. CLS. 100 AND 101).

FIRST USE 10-21-2005; IN COMMERCE 1-30-2007.

THE MARK CONSISTS OF STANDARD CHARACTERS WITHOUT CLAIM TO ANY PARTICULAR FONT, STYLE, SIZE, OR COLOR.

THE WORDING "COWSIGNS" HAS NO MEANING IN A FOREIGN LANGUAGE.

SER. NO. 77-179,585, FILED 5-12-2007.

PAUL MORENO, EXAMINING ATTORNEY

Int. Cl.: 35

Prior U.S. Cls.: 100, 101 and 102

United States Patent and Trademark Office

Reg. No. 3,474,731

Registered July 29, 2008

**SERVICE MARK
PRINCIPAL REGISTER**

SUSTERRA

SUSTERRA, INC. (NEVADA CORPORATION)
SUITE 1
3155 EAST PATRICK LANE
LAS VEGAS, NV 89120

FOR: BUSINESS MANAGEMENT CONSULTING;
BUSINESS CONSULTATION SERVICES IN THE
FIELD OF STRATEGIC PLANNING RELATING
TO INFORMATION TECHNOLOGY; BUSINESS
CONSULTING SERVICES IN THE FIELD OF PRO-
DUCTIVITY IMPROVEMENT, ORGANIZATIONAL
PERFORMANCE AND IMPLEMENTATION MAN-

AGEMENT AND BUSINESS MANAGEMENT, IN
CLASS 35 (U.S. CLS. 100, 101 AND 102).

FIRST USE 4-29-2004; IN COMMERCE 2-12-2005.

THE MARK CONSISTS OF STANDARD CHAR-
ACTERS WITHOUT CLAIM TO ANY PARTICULAR
FONT, STYLE, SIZE, OR COLOR.

SER. NO. 77-179,754, FILED 5-14-2007.

MICHAEL LEWIS, EXAMINING ATTORNEY

Int. Cl.: 44

Prior U.S. Cls.: 100 and 101

United States Patent and Trademark Office

Reg. No. 3,474,732

Registered July 29, 2008

**SERVICE MARK
PRINCIPAL REGISTER**

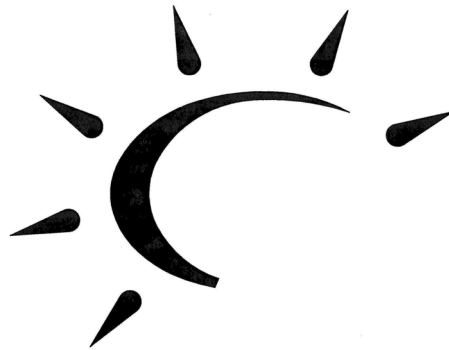

GRANE HEALTHCARE COMPANY (PENNSYLVANIA CORPORATION)
209 SIGMA DRIVE
PITTSBURGH, PA 15238

FOR: NURSING HOME SERVICES, SKILLED NURSING SERVICES, HOSPICE SERVICES, CENTERS FOR THE MEMORY IMPAIRED, MEDICAL ANALYSIS SERVICES, REHABILITATION THERAPY SERVICES, RESPIRATORY SERVICES, WOUND CARE SERVICES, CONSULTING SERVICES REGARDING PHARMACEUTICALS, PRESCRIPTION DRUGS AND MEDICATION, PHARMACISTS SERVICES TO MAKE UP PRESCRIPTIONS, MAINTAINING FILES AND RE-

CARDS CONCERNING THE MEDICAL CONDITION OF INDIVIDUALS, IN CLASS 44 (U.S. CLS. 100 AND 101).

FIRST USE 7-1-2001; IN COMMERCE 7-1-2001.

THE MARK CONSISTS OF "A" PARTIAL SUN WITH RAYS EXTENDING THEREFROM.

SER. NO. 77-180,339, FILED 5-14-2007.

JANICE L. MCMORROW, EXAMINING ATTORNEY

Int. Cl.: 35

Prior U.S. Cls.: 100, 101 and 102

United States Patent and Trademark Office

Reg. No. 3,474,733

Registered July 29, 2008

**SERVICE MARK
PRINCIPAL REGISTER**

ATCAN

UNIVERSAL AIR TRAVEL PLAN, INC. (DELA-
WARE CORPORATION)
1301 PENNSYLVANIA AVENUE, N.W.
WASHINGTON, DC 20004

FOR: PROVIDING ON-LINE DATABASES IN THE
FIELD OF AIR TRAVEL BUSINESS DATA, NAME-
LY, STATISTICS REGARDING AIR TICKET PUR-
CHASES, AIR TRAVEL VOLUME, INDIVIDUAL
AIRLINE PASSENGER DATA, AIRLINE EQUIP-
MENT PURCHASE AND MAINTENANCE DATA,
AIRLINE EMPLOYMENT DATA, AIRLINE SCHE-
DULING, AIRLINE RESERVATIONS, AND AIR-
LINE FLEETS, IN CLASS 35 (U.S. CLS. 100, 101
AND 102).

FIRST USE 6-0-2000; IN COMMERCE 6-0-2000.

THE MARK CONSISTS OF STANDARD CHAR-
ACTERS WITHOUT CLAIM TO ANY PARTICULAR
FONT, STYLE, SIZE, OR COLOR.

OWNER OF U.S. REG. NO. 2,640,642.

THE WORDING "ATCAN" HAS NO MEANING IN
A FOREIGN LANGUAGE.

SER. NO. 77-180,342, FILED 5-14-2007.

KRISTIN DAHLING, EXAMINING ATTORNEY

Int. Cl.: 36

Prior U.S. Cls.: 100, 101 and 102

United States Patent and Trademark Office

Reg. No. 3,474,734

Registered July 29, 2008

**SERVICE MARK
PRINCIPAL REGISTER**

USSS

UNIVERSAL AIR TRAVEL PLAN, INC. (DELA-
WARE CORPORATION)
1301 PENNSYLVANIA AVENUE, N.W.
WASHINGTON, DC 20004

FOR: CHARGE CARD AND DEBIT CARD SER-
VICES; ELECTRONIC PAYMENT, NAMELY, ELEC-
TRONIC PROCESSING AND TRANSMISSION OF
BILL PAYMENT DATA; FINANCIAL INFORMA-
TION PROVIDED BY ELECTRONIC MEANS; FI-
NANCIAL INFORMATION IN THE NATURE OF
RATES OF EXCHANGE, IN CLASS 36 (U.S. CLS. 100,
101 AND 102).

FIRST USE 1-0-2003; IN COMMERCE 1-0-2003.

THE MARK CONSISTS OF STANDARD CHAR-
ACTERS WITHOUT CLAIM TO ANY PARTICULAR
FONT, STYLE, SIZE, OR COLOR.

THE WORDING "USS" HAS NO MEANING IN A
FOREIGN LANGUAGE.

SER. NO. 77-180,390, FILED 5-14-2007.

KRISTIN DAHLING, EXAMINING ATTORNEY

Int. Cl.: 16

Prior U.S. Cls.: 2, 5, 22, 23, 29, 37, 38 and 50

Reg. No. 3,474,735

United States Patent and Trademark Office

Registered July 29, 2008

**TRADEMARK
PRINCIPAL REGISTER**

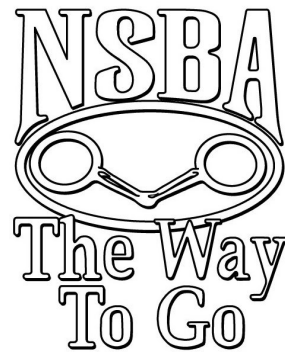

NATIONAL SNAFFLE BIT ASSOCIATION (OK-
LAHOMA CORPORATION)
4845 SOUTH SHERIDAN ROAD, SUITE 515
TULSA, OK 74145

THE MARK CONSISTS OF THE LETTERS NSBA
AND THE WORDS THE WAY TO GO WITH A
PICTURE OF A SNAFFLE BIT ENCLOSED WITHIN
AN OVAL..

FOR: MAGAZINES FEATURING HORSES, IN
CLASS 16 (U.S. CLS. 2, 5, 22, 23, 29, 37, 38 AND 50).

SER. NO. 77-180,472, FILED 5-14-2007.

FIRST USE 4-1-1987; IN COMMERCE 5-1-1987.

SONYA STEPHENS, EXAMINING ATTORNEY

Int. Cls.: 42 and 45

Prior U.S. Cls.: 100 and 101

United States Patent and Trademark Office

Reg. No. 3,474,736

Registered July 29, 2008

**SERVICE MARK
PRINCIPAL REGISTER**

WISCO

WISCO ENTERPRISES, L.P. (TEXAS LIMITED PARTNERSHIP)
11811 N. FREEWAY, SUITE 600
HOUSTON, TX 77060

FOR: INSPECTION SERVICES, NAMELY, SITE INSPECTION IN THE FIELD OF PETROCHEMICAL AND POWER GENERATION REFINERIES, ONSHORE AND OFFSHORE OIL AND GAS PRODUCTION SITES, SUB-SEA METAL EXPLORATION SITES; AND GENERAL FABRICATION INDUSTRIES; PROVIDING QUALITY ASSURANCE SERVICES IN THE FIELD OF PETROCHEMICAL AND POWER GENERATION REFINERIES, ONSHORE AND OFFSHORE OIL AND GAS PRODUCTION SITES, SUB-SEA METAL EXPLORATION SITES; AND GENERAL FABRICATION INDUSTRIES, IN CLASS 42 (U.S. CLS. 100 AND 101).

FIRST USE 7-25-1983; IN COMMERCE 7-25-1983.

FOR: SAFETY INSPECTION AUDITS TO IMPROVE SAFETY OF WORKERS ON PETROCHEM-

ICAL AND POWER GENERATION REFINERIES, ONSHORE AND OFFSHORE OIL AND GAS PRODUCTION SITES, SUB-SEA METAL EXPLORATION SITES, AND IN GENERAL FABRICATION INDUSTRIES; SECURITY INSPECTION SERVICES FOR OTHERS IN PETROCHEMICAL AND POWER GENERATION REFINERIES, ONSHORE AND OFFSHORE OIL AND GAS PRODUCTION SITES, SUB-SEA METAL EXPLORATION SITES, AND GENERAL FABRICATION INDUSTRIES, IN CLASS 45 (U.S. CLS. 100 AND 101).

FIRST USE 7-25-1983; IN COMMERCE 7-25-1983.

THE MARK CONSISTS OF STANDARD CHARACTERS WITHOUT CLAIM TO ANY PARTICULAR FONT, STYLE, SIZE, OR COLOR.

SER. NO. 77-180,475, FILED 5-14-2007.

SHARON MEIER, EXAMINING ATTORNEY

Int. Cl.: 36

Prior U.S. Cls.: 100, 101 and 102

United States Patent and Trademark Office

Reg. No. 3,474,737

Registered July 29, 2008

**SERVICE MARK
PRINCIPAL REGISTER**

UATP

UNIVERSAL AIR TRAVEL PLAN, INC. (DELA-
WARE CORPORATION)
1301 PENNSYLVANIA AVENUE, N.W.
WASHINGTON, DC 20004

FOR: FINANCIAL AND FINANCIALLY RELAT-
ED SERVICES, NAMELY, INTERNATIONAL
CHARGE CARD AND DEBIT CARD SERVICES
OFFERED IN CONNECTION WITH TRAVEL,
TRANSPORTATION AND HOSPITALITY SERVI-
CES; FOREIGN REMITTANCE SERVICES, NAME-
LY, CLEARINGHOUSE PAYMENT SETTLEMENT
SERVICES; ELECTRONIC FUNDS TRANSFER SER-
VICES; AND INSURANCE AGENCY SERVICES IN
THE FIELD OF TRAVEL RELATED INSURANCE,
EMERGENCY MEDICAL INSURANCE, LEGAL IN-
SURANCE, EVACUATION INSURANCE AND

CREDIT INSURANCE, IN CLASS 36 (U.S. CLS. 100,
101 AND 102).

FIRST USE 1-0-1976; IN COMMERCE 1-0-1976.

THE MARK CONSISTS OF STANDARD CHAR-
ACTERS WITHOUT CLAIM TO ANY PARTICULAR
FONT, STYLE, SIZE, OR COLOR.

OWNER OF U.S. REG. NO. 2,446,091.

THE WORDING "UATP" HAS NO MEANING IN
A FOREIGN LANGUAGE.

SER. NO. 77-180,595, FILED 5-14-2007.

KRISTIN DAHLING, EXAMINING ATTORNEY

Int. Cl.: 16

Prior U.S. Cls.: 2, 5, 22, 23, 29, 37, 38 and 50

Reg. No. 3,474,738

United States Patent and Trademark Office

Registered July 29, 2008

**TRADEMARK
PRINCIPAL REGISTER**

EASYSTEP

BRADY WORLDWIDE, INC. (WISCONSIN CORPORATION)
6555 WEST GOOD HOPE ROAD
MILWAUKEE, WI 53223

FIRST USE 11-3-1992; IN COMMERCE 11-3-1992.

FOR: SUPPLIES FOR OFFICE, INDUSTRIAL, AND BUSINESS LETTERING AND LABELING MACHINES, NAMELY, TREATED POLYESTER OR PAPER TAPES, INK OR DYE CARRYING RIBBONS, AND TYPEFACE FONTS, IN CLASS 16 (U.S. CLS. 2, 5, 22, 23, 29, 37, 38 AND 50).

THE MARK CONSISTS OF STANDARD CHARACTERS WITHOUT CLAIM TO ANY PARTICULAR FONT, STYLE, SIZE, OR COLOR.

SER. NO. 77-180,596, FILED 5-14-2007.

TERESA M. RUPP, EXAMINING ATTORNEY

Int. Cl.: 41

Prior U.S. Cls.: 100, 101 and 107

United States Patent and Trademark Office

Reg. No. 3,474,739

Registered July 29, 2008

**SERVICE MARK
PRINCIPAL REGISTER**

AMATEUR ALLURE

HARD DRIVE PRODUCTIONS, INC. (ARIZONA CORPORATION)

3402 N. 26TH PLACE

PHOENIX, AZ 85016

FOR: ENTERTAINMENT SERVICES IN THE NATURE OF ON-LINE ADULT ENTERTAINMENT BY MEANS OF A WORLD WIDE WEBSITE, IN CLASS 41 (U.S. CLS. 100, 101 AND 107).

FIRST USE 2-9-1999; IN COMMERCE 2-9-1999.

THE MARK CONSISTS OF STANDARD CHARACTERS WITHOUT CLAIM TO ANY PARTICULAR FONT, STYLE, SIZE, OR COLOR.

NO CLAIM IS MADE TO THE EXCLUSIVE RIGHT TO USE "AMATEUR", APART FROM THE MARK AS SHOWN.

SEC. 2(F).

SER. NO. 77-180,739, FILED 5-14-2007.

NAKIA HENRY, EXAMINING ATTORNEY

Int. Cl.: 43

Prior U.S. Cls.: 100 and 101

United States Patent and Trademark Office

Reg. No. 3,474,740

Registered July 29, 2008

**SERVICE MARK
PRINCIPAL REGISTER**

Island Destinations

M J SERVICES CORP (NEW YORK CORPORATION)
SUITE 209
1875 PALMER AVENUE
LARCHMONT, NY 10538

FOR: TRAVEL AGENCY SERVICES, NAMELY,
MAKING RESERVATIONS AND BOOKING FOR
TEMPORARY LODGING, IN CLASS 43 (U.S. CLS.
100 AND 101).

FIRST USE 4-19-1991; IN COMMERCE 4-19-1991.

THE MARK CONSISTS OF STANDARD CHARACTERS WITHOUT CLAIM TO ANY PARTICULAR FONT, STYLE, SIZE, OR COLOR.

SEC. 2(F).

SER. NO. 77-180,859, FILED 5-14-2007.

MICHELLE DUBOIS, EXAMINING ATTORNEY

Int. Cl.: 7

Prior U.S. Cls.: 13, 19, 21, 23, 31, 34 and 35

United States Patent and Trademark Office

Reg. No. 3,474,741

Registered July 29, 2008

**TRADEMARK
PRINCIPAL REGISTER**

EVOLUTION X5

WATERJET S.R.L. (ITALY LTD LIAB CO)
VIALE STUCCHI 66/5
MONZA, ITALY 20052

FOR: COMPUTER CONTROLLED CAD/CAM
HIGH-PRESSURE WATER MACHINES AND MA-
CHINE TOOLS FOR THE CUTTING AND FORM-
ING OF MATERIALS, IN CLASS 7 (U.S. CLS. 13, 19,
21, 23, 31, 34 AND 35).

FIRST USE 10-15-2004; IN COMMERCE 10-15-2004.

THE MARK CONSISTS OF STANDARD CHAR-
ACTERS WITHOUT CLAIM TO ANY PARTICULAR
FONT, STYLE, SIZE, OR COLOR.

SER. NO. 77-181,414, FILED 5-15-2007.

GINA HAYES, EXAMINING ATTORNEY

Int. Cl.: 16

Prior U.S. Cls.: 2, 5, 22, 23, 29, 37, 38 and 50

United States Patent and Trademark Office

Reg. No. 3,474,742

Registered July 29, 2008

**TRADEMARK
PRINCIPAL REGISTER**



PEDRO'S TAMALES, INC. (TEXAS CORPORATION)

P.O. BOX 3571

LUBBOCK, TX 79452

FOR: GIFT CARDS, IN CLASS 16 (U.S. CLS. 2, 5, 22, 23, 29, 37, 38 AND 50).

FIRST USE 9-0-2001; IN COMMERCE 9-0-2001.

NO CLAIM IS MADE TO THE EXCLUSIVE RIGHT TO USE "MARKET", APART FROM THE MARK AS SHOWN.

THE COLOR(S) SILVER, RED, GOLD, TAN, BLACK, YELLOW, GREEN, AND WHITE IS/ARE CLAIMED AS A FEATURE OF THE MARK.

THE COLOR SILVER APPEARING IN THE FORK TO THE LEFT OF THE PICTURE AND IN THE KNIFE AND SPOON APPEARING ON THE RIGHT. ON THE RIGHT OF THE FORK IS THE COLOR RED APPEARS IN THE FIRE EXTINGUISHER WITH A GOLD HANDLE AND OPERATING LEVER, A BLACK DISCHARGE NOZZLE AND A TAN LABEL WITH RED LETTERING. TO THE RIGHT OF THE FIRE EXTINGUISHER IS A WHITE PLATE WITH YELLOW WORDS "PEDRO'S MARKET" OUTLINED IN BLACK AND A RED CHILI PEPPER OUTLINED IN BLACK AND OUTLINED ON THE BOTTOM IN GREEN, WITH A GREEN STEM ON THE PLATE. THE COLOR WHITE IS IN THE BACKGROUND OF THE MARK.

SER. NO. 77-182,159, FILED 5-16-2007.

TASHIA BUNCH, EXAMINING ATTORNEY

Int. Cls.: 41 and 44

Prior U.S. Cls.: 100, 101 and 107

United States Patent and Trademark Office

Reg. No. 3,474,743

Registered July 29, 2008

**SERVICE MARK
PRINCIPAL REGISTER**

CRITTEROLOGY.COM

ESNEAULT, RICHARD (UNITED STATES INDIVIDUAL)
12021 SOUTH MEMORIAL PARKWAY, SUITE 0-1
HUNTSVILLE, AL 35802

FOR: PROVIDING ON-LINE INFORMATION TO VETERINARIANS AND PET AND ANIMAL OWNERS VIA A GLOBAL COMPUTER INFORMATION NETWORK IN THE FIELD OF ANIMAL TRAINING; ENTERTAINMENT SERVICES IN THE NATURE OF ON-LINE STORIES, PHOTOGRAPHS AND ENTERTAINMENT POLLS FEATURING ANIMALS, IN CLASS 41 (U.S. CLS. 100, 101 AND 107).

FIRST USE 12-30-2006; IN COMMERCE 12-30-2006.

FOR: PROVIDE ON-LINE INFORMATION TO VETERINARIANS AND PET AND ANIMAL OWN-

ERS VIA A GLOBAL COMPUTER INFORMATION NETWORK IN THE FIELDS OF VETERINARY CARE AND MEDICINE, ANIMAL HEALTH, ANIMAL CARE, PET AND ANIMAL NUTRITIONAL INFORMATION, PET AND ANIMAL FEEDING, AND ANIMAL GROOMING, IN CLASS 44 (U.S. CLS. 100 AND 101).

FIRST USE 12-30-2006; IN COMMERCE 12-30-2006.

THE MARK CONSISTS OF STANDARD CHARACTERS WITHOUT CLAIM TO ANY PARTICULAR FONT, STYLE, SIZE, OR COLOR.

SER. NO. 77-183,288, FILED 5-17-2007.

MICHELLE DUBOIS, EXAMINING ATTORNEY

Int. Cls.: 41 and 44

Prior U.S. Cls.: 100, 101 and 107

United States Patent and Trademark Office

Reg. No. 3,474,744

Registered July 29, 2008

**SERVICE MARK
PRINCIPAL REGISTER**



ESNEAULT, RICHARD (UNITED STATES INDIVIDUAL)

12021 SOUTH MEMORIAL PARKWAY, SUITE 0-1
HUNTSVILLE, AL 35802

FOR: PROVIDING ON-LINE INFORMATION TO VETERINARIANS AND PET AND ANIMAL OWNERS VIA A GLOBAL COMPUTER INFORMATION NETWORK IN THE FIELD OF ANIMAL TRAINING; ENTERTAINMENT SERVICES IN THE NATURE OF ON-LINE STORIES, PHOTOGRAPHS AND ENTERTAINMENT POLLS FEATURING ANIMALS, IN CLASS 41 (U.S. CLS. 100, 101 AND 107).

FIRST USE 12-30-2006; IN COMMERCE 12-30-2006.

FOR: PROVIDING ON-LINE INFORMATION TO VETERINARIANS AND PET AND ANIMAL OWNERS VIA A GLOBAL COMPUTER INFORMATION NETWORK IN THE FIELDS OF VETERINARY CARE AND MEDICINE, ANIMAL HEALTH, ANIMAL CARE, PET AND ANIMAL FEEDING, PET AND ANIMAL NUTRITIONAL INFORMATION, AND ANIMAL GROOMING, IN CLASS 44 (U.S. CLS. 100 AND 101).

FIRST USE 12-30-2006; IN COMMERCE 12-30-2006.

NO CLAIM IS MADE TO THE EXCLUSIVE RIGHT TO USE "THE PET ADVICE SITE", APART FROM THE MARK AS SHOWN.

THE COLOR(S) BLUE, LIGHT BLUE, YELLOW AND GREY, BROWN, TAN, CREAM, RED, GREEN, LAVENDER, TEAL, WHITE, BLACK, PINK, AND FUCHSIA IS/ARE CLAIMED AS A FEATURE OF THE MARK.

THE MARK CONSISTS OF AN ELONGATED BLUE OVAL WITH VARIOUS MULTI-COLORED ANIMALS USING GREY, BROWN, TAN, CREAM, RED, GREEN, TEAL, WHITE, BLACK, AND PINK, EACH DEPICTED WITHIN ONE OF THIRTEEN CIRCLES WITH A COLORED BACKGROUND OF (FROM LEFT TO RIGHT) YELLOW, LIGHT BLUE, FUCHSIA, LAVENDER, LIGHT BLUE, LIGHT BLUE, FUCHSIA, YELLOW, LIGHT BLUE, YELLOW, CREAM, GREEN, AND CREAM; A LIGHT BLUE STYLIZED "THE PET ADVICE SITE" AND BELOW STYLIZED WORDS, "CRITTEROLOGY.COM" IN YELLOW. THE ENTIRE MARK IS DISPLAYED ON A GREY BACKGROUND.

SER. NO. 77-183,289, FILED 5-17-2007.

MICHELLE DUBOIS, EXAMINING ATTORNEY

Int. Cl.: 9

Prior U.S. Cls.: 21, 23, 26, 36 and 38

Reg. No. 3,474,745

United States Patent and Trademark Office

Registered July 29, 2008

**TRADEMARK
PRINCIPAL REGISTER**

MusicCord

ESSENTIAL SOUND PRODUCTS, INC. (MICHIGAN CORPORATION)
P.O. BOX 81998
ROCHESTER, MI 483081998

ALL FOR USE BY THE AUDIO VIDEO ENTERTAINMENT MARKET; DETACHABLE A/C POWER CORD FOR AUDIO/VIDEO EQUIPMENT, IN CLASS 9 (U.S. CLS. 21, 23, 26, 36 AND 38).

FOR: A/C POWER CORDS, A/C MULTIPLE POWER OUTLET STRIP, A/C PLUGS AND OUTLETS, A/C POWER LINE CONDITIONER, A/C POWER SURGE SUPPRESSOR, MALE AND FEMALE IEC ELECTRICAL CONNECTORS AND JACK, AND AUDIO AND VIDEO CABLES USED TO TRANSMIT SIGNALS BETWEEN ELECTRONIC EQUIPMENT,

FIRST USE 4-30-2007; IN COMMERCE 4-30-2007.

SER. NO. 77-183,498, FILED 5-17-2007.

ANDREA BUTLER, EXAMINING ATTORNEY

Int. Cl.: 41

Prior U.S. Cls.: 100, 101 and 107

United States Patent and Trademark Office

Reg. No. 3,474,746

Registered July 29, 2008

**SERVICE MARK
PRINCIPAL REGISTER**

WILBUR

EKA PRODUCTIONS LLC (CALIFORNIA LTD
LIAB CO)
3525 DEL MAR HEIGHTS #421
SAN DIEGO, CA 92130

FOR: ENTERTAINMENT SERVICES, NAMELY, A
CONTINUING PROGRAM IN THE FIELD OF CHIL-
DREN'S EDUCATION AND ENTERTAINMENT,
ACCESSIBLE BY TELEVISION, SATELLITE, WIRE-
LESS NETWORK, FIBER OPTICS, CABLE, RADIO
AND A GLOBAL COMPUTER NETWORK; INFOR-
MATION REGARDING SAME PROVIDED VIA A

GLOBAL COMPUTER NETWORK, IN CLASS 41
(U.S. CLS. 100, 101 AND 107).

FIRST USE 4-16-2007; IN COMMERCE 4-16-2007.

THE MARK CONSISTS OF STANDARD CHAR-
ACTERS WITHOUT CLAIM TO ANY PARTICULAR
FONT, STYLE, SIZE, OR COLOR.

SER. NO. 77-183,871, FILED 5-17-2007.

ROBERT C. CLARK JR., EXAMINING ATTORNEY

Int. Cl.: 41

Prior U.S. Cls.: 100, 101 and 107

United States Patent and Trademark Office

Reg. No. 3,474,747

Registered July 29, 2008

**SERVICE MARK
PRINCIPAL REGISTER**



UNIVERSITY OF KANSAS (KANSAS UNIVERSITY)
2385 IRVING HILL RD.
LAWRENCE, KS 66045

SEC. 2(F) AS TO "CONTENT LITERACY CONTINUUM".

FOR: EDUCATIONAL AND TRAINING SERVICES FOR IMPROVING LITERACY IN SCHOOLS, IN CLASS 41 (U.S. CLS. 100, 101 AND 107).

SER. NO. 77-183,918, FILED 5-17-2007.

FIRST USE 11-1-2006; IN COMMERCE 1-1-2007.

TRACY CROSS, EXAMINING ATTORNEY

Int. Cls.: 9 and 16

Prior U.S. Cls.: 2, 5, 21, 22, 23, 26, 29, 36, 37, 38 and 50

Reg. No. 3,474,748

United States Patent and Trademark Office

Registered July 29, 2008

**TRADEMARK
PRINCIPAL REGISTER**



UNIVERSITY OF KANSAS (KANSAS UNIVERSITY)
2385 IRVING HILL RD.
LAWRENCE, KS 66045

FOR: EDUCATIONAL AND TRAINING MATERIALS, NAMELY, DISKETTES AND LESSONS RECORDED ON COMPUTER MEDIA FEATURING INFORMATION FOR IMPROVING LITERACY IN SCHOOLS, IN CLASS 9 (U.S. CLS. 21, 23, 26, 36 AND 38).

FIRST USE 7-19-2006; IN COMMERCE 7-19-2006.

FOR: PRINTED EDUCATIONAL AND TRAINING MATERIALS, NAMELY, EDUCATIONAL BOOKLETS, BOOKS FEATURING LESSONS FOR IMPROVING LITERACY IN SCHOOLS, IN CLASS 16 (U.S. CLS. 2, 5, 22, 23, 29, 37, 38 AND 50).

FIRST USE 7-19-2006; IN COMMERCE 7-19-2006.

SEC. 2(F) AS TO "STRATEGIC INSTRUCTION MODEL".

SER. NO. 77-183,943, FILED 5-17-2007.

TRACY CROSS, EXAMINING ATTORNEY

Int. Cl.: 9

Prior U.S. Cls.: 21, 23, 26, 36 and 38

United States Patent and Trademark Office

Reg. No. 3,474,749

Registered July 29, 2008

**TRADEMARK
PRINCIPAL REGISTER**

BODY TRAINING SYSTEMS

STEP COMPANY, THE (GEORGIA CORPORATION)
2130 NEWMARKET PARKWAY
MARIETTA, GA 30067

FOR: PRE-RECORDED VIDEO TAPES, DVDS
AND CDS USED IN CONJUNCTION WITH EXERCISE
ROUTINES, IN CLASS 9 (U.S. CLS. 21, 23, 26, 36
AND 38).

FIRST USE 5-1-2005; IN COMMERCE 5-1-2005.

THE MARK CONSISTS OF STANDARD CHARACTERS
WITHOUT CLAIM TO ANY PARTICULAR FONT,
STYLE, SIZE, OR COLOR.

OWNER OF U.S. REG. NOS. 2,489,730, 2,509,128,
AND 2,524,359.

SEC. 2(F).

SER. NO. 77-184,047, FILED 5-17-2007.

MARY BOAGNI, EXAMINING ATTORNEY

Int. Cl.: 9

Prior U.S. Cls.: 21, 23, 26, 36 and 38

United States Patent and Trademark Office

Reg. No. 3,474,750

Registered July 29, 2008

**TRADEMARK
PRINCIPAL REGISTER**



STEP COMPANY, THE (GEORGIA CORPORATION)
2130 NEWMARKET PARKWAY
MARIETTA, GA 30067

FOR: PRE-RECORDED VIDEO TAPES, DVDS
AND CDS USED IN CONJUNCTION WITH EXERCISE
ROUTINES, IN CLASS 9 (U.S. CLS. 21, 23, 26, 36
AND 38).

FIRST USE 5-1-2005; IN COMMERCE 5-1-2005.

OWNER OF U.S. REG. NOS. 2,489,730, 2,509,128,
AND 2,524,359.

THE MARK CONSISTS OF IN PART OF A
STYLIZED DESIGN OF HAND WEIGHTS.

SEC. 2(F) AS TO "BODY TRAINING SYSTEMS".

SER. NO. 77-184,080, FILED 5-17-2007.

MARY BOAGNI, EXAMINING ATTORNEY

Int. Cl.: 28

Prior U.S. Cls.: 22, 23, 38 and 50

United States Patent and Trademark Office

Reg. No. 3,474,751

Registered July 29, 2008

**TRADEMARK
PRINCIPAL REGISTER**

SAY WHAT

MATTEL, INC. (DELAWARE CORPORATION)
M1-1518
333 CONTINENTAL BLVD.
EL SEGUNDO, CA 90245

FOR: TOYS, GAMES AND PLAYTHINGS, NAME-
LY, HAND HELD UNIT FOR PLAYING ELECTRO-
NIC GAMES, TABLETOP UNITS FOR PLAYING
ELECTRONIC GAMES OTHER THAN IN CON-
JUNCTION WITH A TELEVISION OR COMPUTER,
IN CLASS 28 (U.S. CLS. 22, 23, 38 AND 50).

FIRST USE 6-20-2007; IN COMMERCE 6-20-2007.

THE MARK CONSISTS OF STANDARD CHAR-
ACTERS WITHOUT CLAIM TO ANY PARTICULAR
FONT, STYLE, SIZE, OR COLOR.

SER. NO. 77-184,117, FILED 5-17-2007.

MONIQUE MILLER, EXAMINING ATTORNEY

Int. Cls.: 35 and 41

Prior U.S. Cls.: 100, 101, 102 and 107

United States Patent and Trademark Office

Reg. No. 3,474,752

Registered July 29, 2008

**SERVICE MARK
PRINCIPAL REGISTER**

FIVECURRENTS

FIVECURRENTS, LLC (DELAWARE LTD LIAB
CO)
41000 HIGHWAY 1
MONTEREY, CA 93940

FOR: PRODUCTION AND BRANDING, NAME-
LY, CREATION OF TELEVISION COMMERCIALS,
PRINT, INTERNET, AND MULTI-MEDIA ADVER-
TISEMENTS AND PROMOTIONAL MATERIALS,
DEVELOPMENT OF MARKETING STRATEGIES
AND CONCEPTS, CREATING CORPORATE AND
BRAND IDENTITY FOR OTHERS IN THE FIELDS
OF ENTERTAINMENT, CULTURAL EVENTS AND
SPORTS; AND EVENT IMAGE DEVELOPMENT
SERVICES, AND CONCEPT AND BRAND DEVEL-
OPMENT IN THE FIELD OF ENTERTAINMENT,
CULTURAL, CHARITABLE, AND POLITICAL
EVENTS, AND SPORTS, IN CLASS 35 (U.S. CLS.
100, 101 AND 102).

FIRST USE 5-1-2007; IN COMMERCE 5-1-2007.

FOR: PRODUCTION OF LIVE ENTERTAIN-
MENT, NAMELY, LIVE MUSIC CONCERTS AND
MUSICAL, SPORTS, AND THEMED FESTIVALS;
ORGANIZING COMMUNITY SPORTING AND
THEMED CULTURAL EVENTS; MUSEUMS; AR-
RANGING AND CONDUCTING ATHLETIC COM-
PETITIONS; AND SPORTING EVENTS, IN CLASS 41
(U.S. CLS. 100, 101 AND 107).

FIRST USE 5-1-2007; IN COMMERCE 5-1-2007.

THE MARK CONSISTS OF STANDARD CHAR-
ACTERS WITHOUT CLAIM TO ANY PARTICULAR
FONT, STYLE, SIZE, OR COLOR.

SER. NO. 77-184,291, FILED 5-18-2007.

INGRID C. EULIN, EXAMINING ATTORNEY

Int. Cls.: 35 and 41

Prior U.S. Cls.: 100, 101, 102 and 107

United States Patent and Trademark Office

Reg. No. 3,474,753

Registered July 29, 2008

**SERVICE MARK
PRINCIPAL REGISTER**



FIVECURRENTS, LLC (DELAWARE LTD LIAB
CO)
41000 HIGHWAY 1
MONTEREY, CA 93940

FOR: PRODUCTION AND BRANDING, NAME-
LY, CREATION OF TELEVISION COMMERCIALS,
PRINT, INTERNET, AND MULTI-MEDIA ADVER-
TISEMENTS AND PROMOTIONAL MATERIALS,
DEVELOPMENT OF MARKETING STRATEGIES
AND CONCEPTS, CREATING CORPORATE AND
BRAND IDENTITY FOR OTHERS IN THE FIELDS
OF ENTERTAINMENT, CULTURAL EVENTS AND
SPORTS; AND EVENT IMAGE DEVELOPMENT
SERVICES, AND CONCEPT AND BRAND DEVEL-
OPMENT IN THE FIELD OF ENTERTAINMENT,
CULTURAL, CHARITABLE, AND POLITICAL
EVENTS, AND SPORTS, IN CLASS 35 (U.S. CLS.
100, 101 AND 102).

FIRST USE 5-1-2007; IN COMMERCE 5-1-2007.

FOR: PRODUCTION OF LIVE ENTERTAIN-
MENT, NAMELY, LIVE MUSIC CONCERTS AND
MUSICAL, SPORTS, AND THEMED FESTIVALS;
ORGANIZING COMMUNITY SPORTING AND
THEMED CULTURAL EVENTS; MUSEUMS; AR-
RANGING AND CONDUCTING ATHLETIC COM-
PETITIONS; AND SPORTING EVENTS, IN CLASS 41
(U.S. CLS. 100, 101 AND 107).

FIRST USE 5-1-2007; IN COMMERCE 5-1-2007.

SER. NO. 77-184,292, FILED 5-18-2007.

INGRID C. EULIN, EXAMINING ATTORNEY

Int. Cl.: 35

Prior U.S. Cls.: 100, 101 and 102

United States Patent and Trademark Office

Reg. No. 3,474,754

Registered July 29, 2008

**SERVICE MARK
PRINCIPAL REGISTER**

U-TECK

R. E. MASON ENTERPRISES, INC. (NORTH
CAROLINA CORPORATION)
515 PERSON STREET
FAYETTEVILLE, NC 28301

FOR: DISTRIBUTORSHIPS IN THE FIELD OF
OUTSIDE PLANT AND SAFETY EQUIPMENT,
NAMELY, VEGETATION CONTROL PRODUCTS,
PLASTIC SPLICER SEATS, LADDER WEDGES, SPE-
CIALTY WOOD PRODUCTS, BURIED CLOSURE
PROTECTIVE HOUSINGS, SEWN PRODUCTS, VEN-
TILATORS AND ACCESSORIES, GROUND OR
VENT TENTS, GAS DETECTORS, DEWATERING
PUMPS, EMERGENCY WORK LIGHT SYSTEMS,

DIELECTRIC OR WORK UMBRELLAS AND MAN-
HOLE COVER ACCESSORIES, IN CLASS 35 (U.S.
CLS. 100, 101 AND 102).

FIRST USE 9-12-1984; IN COMMERCE 9-12-1984.

THE MARK CONSISTS OF STANDARD CHAR-
ACTERS WITHOUT CLAIM TO ANY PARTICULAR
FONT, STYLE, SIZE, OR COLOR.

SER. NO. 77-184,781, FILED 5-18-2007.

LOURDES AYALA, EXAMINING ATTORNEY

Int. Cl.: 9

Prior U.S. Cls.: 21, 23, 26, 36 and 38

United States Patent and Trademark Office

Reg. No. 3,474,755

Registered July 29, 2008

**TRADEMARK
PRINCIPAL REGISTER**

SIDEKICK ID

T-MOBILE USA, INC. (DELAWARE CORPORATION)
12920 S.E. 38TH STREET
BELLEVUE, WA 98006

FOR: WIRELESS HANDHELD TELECOMMUNICATIONS DEVICES, NAMELY, CELLULAR TELEPHONE THAT COMBINES WIRELESS VOICE AND DATA TELECOMMUNICATIONS FUNCTIONS, DIGITAL IMAGING FUNCTIONS, COMPUTING FUNCTIONS, PERMITS THE TWO-WAY WIRELESS TRANSMISSION OF E-MAIL AND TEXT, AND PERMITS WIRELESS ACCESS TO A GLOBAL COMPUTER NETWORK, IN CLASS 9 (U.S. CLS. 21, 23, 26, 36 AND 38).

FIRST USE 4-13-2007; IN COMMERCE 4-13-2007.

THE MARK CONSISTS OF STANDARD CHARACTERS WITHOUT CLAIM TO ANY PARTICULAR FONT, STYLE, SIZE, OR COLOR.

OWNER OF U.S. REG. NOS. 3,012,845, 3,062,057 AND OTHERS.

SER. NO. 77-185,291, FILED 5-18-2007.

ESTHER A. BORSUK, EXAMINING ATTORNEY

Int. Cl.: 9

Prior U.S. Cls.: 21, 23, 26, 36 and 38

Reg. No. 3,474,756

United States Patent and Trademark Office

Registered July 29, 2008

**TRADEMARK
PRINCIPAL REGISTER**

VTEL

VTEL PRODUCTS CORPORATION (DELAWARE CORPORATION)
SUITE 150
9208 WATERFORD CENTRE
AUSTIN, TX 78758

FOR: VIDEO, AUDIO, FACSIMILE AND COMPUTER CONFERENCING COMPONENTS, NAMELY, COMPUTER HARDWARE AND COMPUTER SOFTWARE FOR THE CONTROL AND OPERATION OF VIDEO, AUDIO, FACSIMILE AND COMPUTER CONFERENCING COMPONENTS, VIDEO CAMERAS, VIDEO MONITORS, AUDIO SPEAKERS, DIGITAL VIDEO AND DIGITAL AUDIO RECORDERS, COMPUTER KEYBOARDS, POWER SUP-

PLIES AND MICROPHONES, IN CLASS 9 (U.S. CLS. 21, 23, 26, 36 AND 38).

FIRST USE 1-1-1993; IN COMMERCE 1-1-1993.

THE MARK CONSISTS OF STANDARD CHARACTERS WITHOUT CLAIM TO ANY PARTICULAR FONT, STYLE, SIZE, OR COLOR.

OWNER OF U.S. REG. NO. 2,649,704.

SER. NO. 77-185,373, FILED 5-19-2007.

STEPHEN AQUILA, EXAMINING ATTORNEY

Int. Cl.: 9

Prior U.S. Cls.: 21, 23, 26, 36 and 38

United States Patent and Trademark Office

Reg. No. 3,474,757

Registered July 29, 2008

**TRADEMARK
PRINCIPAL REGISTER**



VTEL PRODUCTS CORPORATION (DELAWARE CORPORATION)
SUITE 150
9208 WATERFORD CENTRE
AUSTIN, TX 78758

FOR: VIDEO, AUDIO, FACSIMILE AND COMPUTER CONFERENCING COMPONENTS, NAMELY, COMPUTER HARDWARE AND COMPUTER SOFTWARE FOR THE CONTROL AND OPERATION OF VIDEO, AUDIO, FACSIMILE AND COMPUTER CONFERENCING COMPONENTS, VIDEO CAMERAS, VIDEO MONITORS, AUDIO SPEAKERS, DIGITAL VIDEO AND DIGITAL AUDIO RECORDERS, COMPUTER KEYBOARDS, POWER SUP-

PLIES AND MICROPHONES, IN CLASS 9 (U.S. CLS. 21, 23, 26, 36 AND 38).

FIRST USE 3-20-1997; IN COMMERCE 3-20-1997.

OWNER OF U.S. REG. NO. 2,649,704.

THE MARK CONSISTS OF A CIRCLE WITH THE LETTER "V" INSIDE, WITH THE LITERAL ELEMENT "VTEL" TO THE RIGHT.

SER. NO. 77-185,377, FILED 5-19-2007.

STEPHEN AQUILA, EXAMINING ATTORNEY

Int. Cl.: 9

Prior U.S. Cls.: 21, 23, 26, 36 and 38

Reg. No. 3,474,758

United States Patent and Trademark Office

Registered July 29, 2008

**TRADEMARK
PRINCIPAL REGISTER**



VTEL

VTEL PRODUCTS CORPORATION (DELAWARE CORPORATION)
SUITE 150
9208 WATERFORD CENTRE
AUSTIN, TX 78758

FOR: VIDEO, AUDIO, FACSIMILE AND COMPUTER CONFERENCING COMPONENTS, NAMELY, COMPUTER HARDWARE AND COMPUTER SOFTWARE FOR THE CONTROL AND OPERATION OF VIDEO, AUDIO, FACSIMILE AND COMPUTER CONFERENCING COMPONENTS, VIDEO CAMERAS, VIDEO MONITORS, AUDIO SPEAKERS, DIGITAL VIDEO AND DIGITAL AUDIO RECORDERS, COMPUTER KEYBOARDS, POWER SUP-

PLIES AND MICROPHONES, IN CLASS 9 (U.S. CLS. 21, 23, 26, 36 AND 38).

FIRST USE 1-14-1998; IN COMMERCE 1-31-1998.

OWNER OF U.S. REG. NO. 2,649,704.

THE MARK CONSISTS OF A CIRCLE WITH THE LETTER "V" INSIDE, WITH THE LITERAL ELEMENT "VTEL" BELOW THE CIRCLE.

SER. NO. 77-185,382, FILED 5-19-2007.

STEPHEN AQUILA, EXAMINING ATTORNEY

Int. Cl.: 10

Prior U.S. Cls.: 26, 39 and 44

United States Patent and Trademark Office

Reg. No. 3,474,759

Registered July 29, 2008

**TRADEMARK
PRINCIPAL REGISTER**



PRO BAND SPORTS INDUSTRIES, INC. (CALIFORNIA CORPORATION)
POST OFFICE BOX 50509
SANTA BARBARA, CA 931500509

FOR: MEDICAL SUPPORT DEVICES, NAMELY, STRAP APPLIANCES FOR MECHANICALLY TREATING DYSFUNCTIONS BY COMPRESSION OF THE LEG, IN CLASS 10 (U.S. CLS. 26, 39 AND 44).

FIRST USE 1-4-1995; IN COMMERCE 1-4-1995.

OWNER OF U.S. REG. NOS. 1,915,818 AND 2,766,651.

THE MARK CONSISTS OF LETTERS OF THE MARK WITHIN A RECTANGULAR SHAPE AND SITTING ATOP THIS RECTANGLE IS A CHEVRON INSIGNIA

SER. NO. 77-186,221, FILED 5-21-2007.

WARREN L. OLANDRIA, EXAMINING ATTORNEY

Int. Cl.: 36

Prior U.S. Cls.: 100, 101 and 102

United States Patent and Trademark Office

Reg. No. 3,474,760

Registered July 29, 2008

**SERVICE MARK
PRINCIPAL REGISTER**

Delaware VIP

DELAWARE MANAGEMENT HOLDINGS, INC.
(DELAWARE CORPORATION)
SUITE 102
1430 FOULK ROAD
WILMINGTON, DE 19803

FOR: FUNDS INVESTMENT, IN CLASS 36 (U.S.
CLS. 100, 101 AND 102).

FIRST USE 4-30-2002; IN COMMERCE 4-30-2002.

THE MARK CONSISTS OF STANDARD CHAR-
ACTERS WITHOUT CLAIM TO ANY PARTICULAR
FONT, STYLE, SIZE, OR COLOR.

OWNER OF U.S. REG. NOS. 1,310,369, 1,332,508,
AND 2,302,698.

NO CLAIM IS MADE TO THE EXCLUSIVE
RIGHT TO USE "DELAWARE", APART FROM
THE MARK AS SHOWN.

SER. NO. 77-186,334, FILED 5-21-2007.

KRISTINA MORRIS, EXAMINING ATTORNEY

Int. Cl.: 36

Prior U.S. Cls.: 100, 101 and 102

United States Patent and Trademark Office

Reg. No. 3,474,761

Registered July 29, 2008

**SERVICE MARK
PRINCIPAL REGISTER**

Delaware Delchester

DELAWARE MANAGEMENT HOLDINGS, INC.
(DELAWARE CORPORATION)
SUITE 102
1403 FOULK ROAD
WILMINGTON, DE 19803

FOR: FUNDS INVESTMENT, IN CLASS 36 (U.S.
CLS. 100, 101 AND 102).

FIRST USE 8-16-1999; IN COMMERCE 8-16-1999.

THE MARK CONSISTS OF STANDARD CHAR-
ACTERS WITHOUT CLAIM TO ANY PARTICULAR
FONT, STYLE, SIZE, OR COLOR.

OWNER OF U.S. REG. NOS. 1,310,369, 1,332,508,
AND 2,302,698.

NO CLAIM IS MADE TO THE EXCLUSIVE
RIGHT TO USE "DELAWARE", APART FROM
THE MARK AS SHOWN.

SER. NO. 77-186,442, FILED 5-21-2007.

KRISTINA MORRIS, EXAMINING ATTORNEY

Int. Cl.: 10

Prior U.S. Cls.: 26, 39 and 44

United States Patent and Trademark Office

Reg. No. 3,474,762

Registered July 29, 2008

**TRADEMARK
PRINCIPAL REGISTER**

OHMEGA

LACIDEM HOLDING B.V. (NETHERLANDS
CORPORATION)
P.O. BOX 580
COLOSSEUM 25, 7521 PV ENSCHEDE
7500 AN ENSCHEDE, NETHERLANDS

FOR: MEDICAL DEVICES FOR MEASURING
AND RECORDING FOR GASTROINTESTINAL
TRACT FUNCTIONS, AND SOFTWARE USED
THEREWITH, SOLD AS A UNIT , IN CLASS 10
(U.S. CLS. 26, 39 AND 44).

FIRST USE 3-7-2006; IN COMMERCE 3-7-2006.

THE MARK CONSISTS OF STANDARD CHAR-
ACTERS WITHOUT CLAIM TO ANY PARTICULAR
FONT, STYLE, SIZE, OR COLOR.

SER. NO. 77-186,707, FILED 5-22-2007.

RENEE SERVANCE, EXAMINING ATTORNEY

Int. Cl.: 3

Prior U.S. Cls.: 1, 4, 6, 50, 51 and 52

Reg. No. 3,474,763

United States Patent and Trademark Office

Registered July 29, 2008

**TRADEMARK
PRINCIPAL REGISTER**

3 MORE INCHES

CLARKE, MICHAEL EVANGELUS (UNITED
KINGDOM INDIVIDUAL)
1 BEAUMONT STREET
LONDON WIN 1RA, ENGLAND

THE MARK CONSISTS OF STANDARD CHAR-
ACTERS WITHOUT CLAIM TO ANY PARTICULAR
FONT, STYLE, SIZE, OR COLOR.

FOR: HAIR CARE AND HAIR TREATMENT
PRODUCTS, NAMELY, SHAMPOOS, CONDITION-
ERS, CONDITIONING TREATMENTS, WAXES,
GELS, MOUSSES, CREAMS, SPRAYS, LOTIONS,
LACQUERS, TINTS AND OTHER HAIR COLOR-
ANTS, AND HAIR STRAIGHTENING PREPARA-
TIONS, IN CLASS 3 (U.S. CLS. 1, 4, 6, 50, 51 AND 52).

OWNER OF UNITED KINGDOM REG. NO.
2434187, DATED 9-29-2006, EXPIRES 9-29-2016.

SER. NO. 77-186,772, FILED 5-22-2007.

GINA HAYES, EXAMINING ATTORNEY

Int. Cl.: 28

Prior U.S. Cls.: 22, 23, 38 and 50

United States Patent and Trademark Office

Reg. No. 3,474,764

Registered July 29, 2008

**TRADEMARK
PRINCIPAL REGISTER**

TURBO TOPAZ

MATTEL, INC. (DELAWARE CORPORATION)

M1-1518

333 CONTINENTAL BLVD.

EL SEGUNDO, CA 90245

FOR: TOYS, GAMES AND PLAYTHINGS, NAME-
LY, TOY FIGURES, TOY VEHICLES, AND ACCES-
SORIES FOR ALL OF THE FOREGOING, IN CLASS
28 (U.S. CLS. 22, 23, 38 AND 50).

FIRST USE 2-13-2008; IN COMMERCE 2-13-2008.

THE MARK CONSISTS OF STANDARD CHAR-
ACTERS WITHOUT CLAIM TO ANY PARTICULAR
FONT, STYLE, SIZE, OR COLOR.

OWNER OF U.S. REG. NOS. 2,602,867, 3,282,543
AND OTHERS.

NO CLAIM IS MADE TO THE EXCLUSIVE
RIGHT TO USE "TOPAZ", APART FROM THE
MARK AS SHOWN.

SER. NO. 77-187,061, FILED 5-22-2007.

MONIQUE MILLER, EXAMINING ATTORNEY

Int. Cl.: 41

Prior U.S. Cls.: 100, 101 and 107

United States Patent and Trademark Office

Reg. No. 3,474,765

Registered July 29, 2008

**SERVICE MARK
PRINCIPAL REGISTER**

RING WARRIORS

SIDEKICKS USA BLACKBELT SCHOOL, INC.
(IDAHO CORPORATION)
204 THIRD AVENUE SOUTH
NAMPA, ID 83651

FOR: ENTERTAINMENT IN THE NATURE OF
MARTIAL ARTS/KICKBOXING/MIXED-MARTIAL
ARTS TOURNAMENTS, IN CLASS 41 (U.S. CLS. 100,
101 AND 107).

FIRST USE 9-1-2006; IN COMMERCE 9-1-2006.

THE MARK CONSISTS OF STANDARD CHAR-
ACTERS WITHOUT CLAIM TO ANY PARTICULAR
FONT, STYLE, SIZE, OR COLOR.

NO CLAIM IS MADE TO THE EXCLUSIVE
RIGHT TO USE "RING", APART FROM THE MARK
AS SHOWN.

SER. NO. 77-187,435, FILED 5-22-2007.

HOWARD B. LEVINE, EXAMINING ATTORNEY

Int. Cl.: 9

Prior U.S. Cls.: 21, 23, 26, 36 and 38

Reg. No. 3,474,766

United States Patent and Trademark Office

Registered July 29, 2008

**TRADEMARK
PRINCIPAL REGISTER**



D&P INTERNATIONAL RESEARCH & DEVELOPMENT CORPORATION (CALIFORNIA CORPORATION)

11541 SALINAZ DRIVE
GARDEN GROVE, CA 92843

FOR: BATTERIES, VEHICLE BATTERIES, IGNITION BATTERIES, AUTOMOTIVE AND MOTOR-CYCLE BATTERIES, CELLULAR TELEPHONE BATTERIES, GOLF CART BATTERIES, TRACTION BATTERIES, ELECTRIC STORAGE BATTERIES, RECHARGEABLE BATTERIES, BATTERY PACKS, BATTERY CABLES, BATTERY CHARGERS, INVERTERS, JUMPER CABLES, EMERGENCY WARNING LIGHTS, FLASHING SAFETY LIGHTS, POWER PROTECTION DEVICES FOR ELECTRONIC EQUIPMENT AND ELECTRICAL POWER SUPPLIES, NAMELY, ELECTRIC POWER SURGE

PROTECTORS, IN CLASS 9 (U.S. CLS. 21, 23, 26, 36 AND 38).

FIRST USE 2-19-2008; IN COMMERCE 2-19-2008.

THE MARK CONSISTS OF AN ARTISTIC REPRESENTATION OF A HORSE HEAD WITH THE "E" OF THE WORD "LEOCH" FORMING A PART OF THE MANE AND THE "C" FORMING A PART OF THE CHEST OF THE HORSE.

THE WORDING "LEOCH" HAS NO MEANING IN A FOREIGN LANGUAGE.

SER. NO. 77-187,470, FILED 5-22-2007.

PAUL E. FAHRENKOPF, EXAMINING ATTORNEY

Int. Cls.: 25 and 44

Prior U.S. Cls.: 22, 39, 100 and 101

United States Patent and Trademark Office

Reg. No. 3,474,767

Registered July 29, 2008

**TRADEMARK
SERVICE MARK
PRINCIPAL REGISTER**



AURORA SKIN CARE CENTER, P.C. (COLOR-
ADO CORPORATION)
SUITE 100
9570 KINGSTON COURT
ENGLEWOOD, CO 80112

FOR: CLOTHING, NAMELY, ROBES, JACKETS,
SHIRTS, BLOUSES, SWEATERS, SWEAT SHIRTS,
AND HATS, IN CLASS 25 (U.S. CLS. 22 AND 39).

FIRST USE 10-0-2004; IN COMMERCE 10-0-2004.

FOR: MEDICAL AESTHETIC SERVICES IN THE
FORM OF AESTHETIC SURGERY, NAMELY,
BLEMISH REMOVAL, CELLULITE REMOVAL,
COLLAGEN REMODELING, HAIR REMOVAL, LA-
SER HAIR REMOVAL, SKIN TIGHTENING, WRIN-
KLE REDUCTION AND WRINKLE REMOVAL;
MEDICAL HEALTH SPA SERVICES, NAMELY,
ANTI-CELLULITE TREATMENT, CELLULITE RE-
MOVAL, CHEMICAL DENERVATION, CHEMICAL
COSMETIC PEELS, DERMAL FILLER INJECTIONS
TO REDUCE THE APPEARANCE OF FACIAL
LINES, FRAXEL LASER THERAPY, HAIR REMOV-
AL, INTENSE PULSED LIGHT THERAPY, LASER

HAIR REMOVAL, LASER THERAPY, MICRODER-
MABRASION, RADIO FREQUENCY THERAPY TO
TIGHTEN SKIN, SCLEROTHERAPY, LASER,
LIGHT AND RADIO FREQUENCY SKIN RESUR-
FACING AND TATTOO REMOVAL; HEALTH SPA
SERVICES, NAMELY, PROVIDING COSMETIC
BODY CARE SERVICES CONSISTING OF FACIALS,
MAKE-UP CONSULTATION, MASSAGES AND
WAXING, IN CLASS 44 (U.S. CLS. 100 AND 101).

FIRST USE 10-0-2004; IN COMMERCE 10-0-2004.

THE MARK CONSISTS OF A STYLIZED HUMAN
FIGURE OF AN ANDROGYNOUS ADULT WITH
UPRAISED ARMS AGAINST AN OVAL BACK-
GROUND THAT IS VERTICALLY DIVIDED INTO
EQUAL PARTS BY CONTRASTING COLORS OR
SHADING AND A VERTICAL BAR WITHOUT
COLOR OR SHADING ABOVE THE HEAD OF THE
HUMAN FIGURE.

SER. NO. 77-187,629, FILED 5-22-2007.

CAROLYN GRAY, EXAMINING ATTORNEY

Int. Cls.: 11 and 21

Prior U.S. Cls.: 2, 13, 21, 23, 29, 30, 31, 33, 34, 40 and 50

United States Patent and Trademark Office

Reg. No. 3,474,768

Registered July 29, 2008

**TRADEMARK
PRINCIPAL REGISTER**

GREENPAN

DE VLEESSCHOUWER, ESTHER (BELGIUM INDIVIDUAL)
ROGIERLAAN 60/13
OOSTENDE, BELGIUM 8400

FOR: ELECTRIC AND NON-ELECTRIC FONDUE SETS COMPRISED OF ELECTRIC AND NON-ELECTRIC FONDUE POTS; ELECTRIC WATER KETTLES, IN CLASS 11 (U.S. CLS. 13, 21, 23, 31 AND 34).

FOR: PANS; POTS; NON-ELECTRIC COOKING UTENSILS, NAMELY, NON-ELECTRIC GRATERS AND GRILLS; FISH PANS; NON-ELECTRIC WOKS; NON-ELECTRIC WATER KETTLES; COOKING POTS; KITCHEN AND HOUSEHOLD CONTAINERS; THERMAL INSULATED CONTAINERS FOR PREPARING, PRESERVING, KEEPING HOT AND

SERVING FOOD AND BEVERAGES, IN CLASS 21 (U.S. CLS. 2, 13, 23, 29, 30, 33, 40 AND 50).

THE MARK CONSISTS OF STANDARD CHARACTERS WITHOUT CLAIM TO ANY PARTICULAR FONT, STYLE, SIZE, OR COLOR.

PRIORITY CLAIMED UNDER SEC. 44(D) ON BENELUX APPLICATION NO. 1132702, FILED 4-4-2007, REG. NO. 0821490, DATED 7-5-2007, EXPIRES 4-4-2017.

SER. NO. 77-187,898, FILED 5-23-2007.

DAVID MURRAY, EXAMINING ATTORNEY

Int. Cls.: 35 and 36

Prior U.S. Cls.: 100, 101 and 102

United States Patent and Trademark Office

Reg. No. 3,474,769

Registered July 29, 2008

**SERVICE MARK
PRINCIPAL REGISTER**

CURE YOUR BACK OFFICE BLUES

BRIDGEPORTFOLIO.COM, INC. (DELAWARE CORPORATION)
411 NORTH LASALLE, SUITE 400
CHICAGO, IL 60610

FOR: BUSINESS INFORMATION AND ACCOUNTING ADVISORY SERVICES; BACK OFFICE ACCOUNTING SERVICES; OUTSOURCING SERVICES IN THE FIELD OF FINANCIAL SERVICES, NAMELY, PERFORMANCE REPORTING, FEE BILLING CALCULATIONS, RISK AND ASSET ALLOCATION PROFILING, DYNAMIC MODEL PORTFOLIO SERVICES, ONLINE ACCOUNT OPENING, INCLUDING FORMS POPULATION, PROPOSAL AND INVESTMENT POLICY STATEMENT GENERATIONS, NEW ACCOUNT PAPERWORK AND FORMS PROCESSING, CUSTODIAL LIAISON SERVICES, IN CLASS 35 (U.S. CLS. 100, 101 AND 102).

FIRST USE 7-26-2002; IN COMMERCE 7-26-2002.

FOR: FINANCIAL SERVICES, NAMELY, ASSISTING OTHERS WITH THE COMPLETION OF FINANCIAL TRANSACTIONS FOR STOCKS, BONDS, TRADED FUNDS, SECURITIES, MUTUAL FUNDS AND EQUITIES; AND PROVIDING ONLINE STORED VALUE ACCOUNTS IN AN ELECTRONIC ENVIRONMENT, IN CLASS 36 (U.S. CLS. 100, 101 AND 102).

FIRST USE 7-26-2002; IN COMMERCE 7-26-2002.

THE MARK CONSISTS OF STANDARD CHARACTERS WITHOUT CLAIM TO ANY PARTICULAR FONT, STYLE, SIZE, OR COLOR.

SER. NO. 77-188,120, FILED 5-23-2007.

KIMBERLY PERRY, EXAMINING ATTORNEY

Int. Cls.: 9, 41 and 42

Prior U.S. Cls.: 21, 23, 26, 36, 38, 100, 101 and 107

United States Patent and Trademark Office

Reg. No. 3,474,770

Registered July 29, 2008

**TRADEMARK
SERVICE MARK
PRINCIPAL REGISTER**

NEVERFAIL

NEVERFAIL GROUP LIMITED (UNITED KING-
DOM CORPORATION)

MERLIN HOUSE
BRUNEL ROAD, THEALE, READING
BERKSHIRE, UNITED KINGDOM RG74AB

FOR: COMPUTER SOFTWARE, NAMELY, DATA
BACKUP AND RECOVERY SOFTWARE FOR CON-
TINUOUS DATA PROTECTION, IN CLASS 9 (U.S.
CLS. 21, 23, 26, 36 AND 38).

FIRST USE 4-29-2002; IN COMMERCE 4-29-2002.

FOR: TRAINING SERVICES IN THE FIELD OF
OPERATION OF DATA BACKUP AND RECOVERY
SOFTWARE FOR CONTINUOUS DATA PROTEC-
TION, IN CLASS 41 (U.S. CLS. 100, 101 AND 107).

FIRST USE 4-29-2002; IN COMMERCE 4-29-2002.

FOR: TECHNICAL SUPPORT FOR DATA BACK-
UP AND RECOVERY SOFTWARE FOR CONTINU-
OUS DATA PROTECTION, IN CLASS 42 (U.S. CLS.
100 AND 101).

FIRST USE 4-29-2002; IN COMMERCE 4-29-2002.

THE MARK CONSISTS OF STANDARD CHAR-
ACTERS WITHOUT CLAIM TO ANY PARTICULAR
FONT, STYLE, SIZE, OR COLOR.

SER. NO. 77-188,122, FILED 5-23-2007.

KIMBERLY PERRY, EXAMINING ATTORNEY

Int. Cl.: 9

Prior U.S. Cls.: 21, 23, 26, 36 and 38

United States Patent and Trademark Office

Reg. No. 3,474,771

Registered July 29, 2008

**TRADEMARK
PRINCIPAL REGISTER**



IT&E LIMITED (AUSTRALIA CORPORATION)
ABN 84 088 299 512 OF LEVEL 11
25 BLIGH STREET
SYDNEY, AUSTRALIA 2000

THE COLOR(S) ORANGE, RED, WHITE AND
BLACK IS/ARE CLAIMED AS A FEATURE OF
THE MARK.

FOR: COMPUTER PROGRAMS AND SOFTWARE
FOR FRONT END TRADING AND BACK OFFICE
PROCESSING OF FOREIGN EXCHANGE AND
MONEY MARKET TRADES; DOWNLOADABLE
COMPUTER PROGRAMS AND SOFTWARE FOR
FRONT END TRADING AND BACK OFFICE PRO-
CESSING OF FOREIGN EXCHANGE AND MONEY
MARKET TRADES, IN CLASS 9 (U.S. CLS. 21, 23, 26,
36 AND 38).

THE MARKS CONSISTS OF THE WORD "MON-
ARQUE" AND A MONARCH BUTTERFLY WITH
ORANGE, RED, WHITE AND BLACK MARKINGS
IN WING, AND A BLACK BODY AND ANTENNAS.

SER. NO. 77-188,159, FILED 5-23-2007.

FIRST USE 6-15-1993; IN COMMERCE 7-2-1993.

NAAKWAMA ANKRAH, EXAMINING ATTORNEY

Int. Cl.: 9

Prior U.S. Cls.: 21, 23, 26, 36 and 38

United States Patent and Trademark Office

Reg. No. 3,474,772

Registered July 29, 2008

**TRADEMARK
PRINCIPAL REGISTER**

MONARQUE

IT&E LIMITED (AUSTRALIA CORPORATION)
ABN 84 088 299 512 OF LEVEL 11
25 BLIGH STREET
SYDNEY, AUSTRALIA 2000

FOR: COMPUTER PROGRAMS AND SOFTWARE
FOR FRONT END TRADING AND BACK OFFICE
PROCESSING OF FOREIGN EXCHANGE AND
MONEY MARKET TRADES; DOWNLOADABLE
COMPUTER PROGRAMS AND SOFTWARE FOR
FRONT END TRADING AND BACK OFFICE PRO-
CESSING OF FOREIGN EXCHANGE AND MONEY

MARKET TRADES, IN CLASS 9 (U.S. CLS. 21, 23, 26,
36 AND 38).

FIRST USE 6-15-1993; IN COMMERCE 7-2-1993.

THE MARK CONSISTS OF STANDARD CHAR-
ACTERS WITHOUT CLAIM TO ANY PARTICULAR
FONT, STYLE, SIZE, OR COLOR.

SER. NO. 77-188,161, FILED 5-23-2007.

NAAKWAMA ANKRAH, EXAMINING ATTORNEY

Int. Cls.: 16, 25 and 41

**Prior U.S. Cls.: 2, 5, 22, 23, 29, 37, 38, 39, 50, 100, 101
and 107**

Reg. No. 3,474,773

United States Patent and Trademark Office

Registered July 29, 2008

**TRADEMARK
SERVICE MARK
PRINCIPAL REGISTER**

PILOBOLUS

PILOBOLUS, INC. (CONNECTICUT CORPORATION)
P.O. BOX 388
WASHINGTON DEPOT, CT 06794

FOR: PRINTED PUBLICATIONS, NAMELY, A SERIES OF BOOKS IN THE FIELD OF DANCE AND THE PERFORMING ARTS, CALENDARS, POSTERS, STATIONERY, GREETING CARDS, STICKERS, BUMPER STICKERS, PENS, NOTEBOOKS, PENCILS, POSTCARDS, IN CLASS 16 (U.S. CLS. 2, 5, 22, 23, 29, 37, 38 AND 50).

FIRST USE 1-0-1992; IN COMMERCE 1-0-1992.

FOR: CLOTHING, NAMELY, T-SHIRTS, HATS, SOCKS, COATS, VESTS, SWEATSHIRTS, SCARVES, TANK TOPS, BOXER SHORTS, UNDERWEAR, INFANT AND TODDLER ONE PIECE CLOTHING, BIBS NOT OF PAPER, APRONS, IN CLASS 25 (U.S. CLS. 22 AND 39).

FIRST USE 1-0-1992; IN COMMERCE 1-0-1992.

FOR: ENTERTAINMENT IN THE NATURE OF DANCE PERFORMANCES, IN CLASS 41 (U.S. CLS. 100, 101 AND 107).

FIRST USE 0-0-1971; IN COMMERCE 0-0-1971.

THE MARK CONSISTS OF STANDARD CHARACTERS WITHOUT CLAIM TO ANY PARTICULAR FONT, STYLE, SIZE, OR COLOR.

THE FOREIGN WORDING IN THE MARK TRANSLATES INTO ENGLISH AS A "THROWING BALL".

SER. NO. 77-188,614, FILED 5-23-2007.

YONG KIM, EXAMINING ATTORNEY

Int. Cl.: 3

Prior U.S. Cls.: 1, 4, 6, 50, 51 and 52

United States Patent and Trademark Office

Reg. No. 3,474,774

Registered July 29, 2008

**TRADEMARK
PRINCIPAL REGISTER**

EXTRAIT DE VIE

LANCOME PARFUMS ET BEAUTE & CIE
(FRANCE SOCIETE EN NOM COLLECTIF)

29, RUE DU FAUBOURG SAINT-HONORE

PARIS, FRANCE 75008

FOR: COSMETIC INGREDIENT COMPLEX USED
AS A COMPONENT OF NON-MEDICATED SKIN-
CARE PREPARATIONS, IN CLASS 3 (U.S. CLS. 1, 4, 6,
50, 51 AND 52).

FIRST USE 4-0-2006; IN COMMERCE 4-0-2006.

THE MARK CONSISTS OF STANDARD CHAR-
ACTERS WITHOUT CLAIM TO ANY PARTICULAR
FONT, STYLE, SIZE, OR COLOR.

OWNER OF U.S. REG. NO. 2,459,789.

THE FOREIGN WORDING IN THE MARK
TRANSLATES INTO ENGLISH AS EXTRACT OF
LIFE.

SER. NO. 77-189,119, FILED 5-24-2007.

KEVIN CORWIN, EXAMINING ATTORNEY

Int. Cl.: 37

Prior U.S. Cls.: 100, 103 and 106

United States Patent and Trademark Office

Reg. No. 3,474,775

Registered July 29, 2008

**SERVICE MARK
PRINCIPAL REGISTER**

**Precision Clean by
Bio-Medical Janitorial**

BIO-MEDICAL JANITORIAL, INC. (COLORADO
CORPORATION)
P. O. BOX 272982
FORT COLLINS, CO 80527

OWNER OF U.S. REG. NO. 3,184,250.

FOR: SANITARY CLEANING SERVICES FOR
COMMERCIAL BUILDINGS, IN CLASS 37 (U.S.
CLS. 100, 103 AND 106).

NO CLAIM IS MADE TO THE EXCLUSIVE
RIGHT TO USE "CLEAN" AND "BIO-MEDICAL
JANITORIAL", APART FROM THE MARK AS
SHOWN.

FIRST USE 1-1-2007; IN COMMERCE 1-31-2007.

SER. NO. 77-189,157, FILED 5-24-2007.

THE MARK CONSISTS OF STANDARD CHAR-
ACTERS WITHOUT CLAIM TO ANY PARTICULAR
FONT, STYLE, SIZE, OR COLOR.

HEATHER SAPP, EXAMINING ATTORNEY

Int. Cls.: 9 and 42

Prior U.S. Cls.: 21, 23, 26, 36, 38, 100 and 101

United States Patent and Trademark Office

Reg. No. 3,474,776

Registered July 29, 2008

**TRADEMARK
SERVICE MARK
PRINCIPAL REGISTER**

FATWIRE

FATWIRE CORPORATION (DELAWARE CORPORATION)
330 OLD COUNTRY ROAD, SUITE 207
MINEOLA, NY 11501

FOR: SOFTWARE RECORDED ON CD-ROM AND DOWNLOADABLE SOFTWARE FOR ELECTRONIC CONTENT MANAGEMENT, NAMELY, CREATING, EDITING, MANAGING, AND STORING ELECTRONIC CONTENT SUCH AS AUDIO, VIDEO, TEXT, AND MULTIMEDIA FILES, IN CLASS 9 (U.S. CLS. 21, 23, 26, 36 AND 38).

FIRST USE 7-3-1996; IN COMMERCE 7-3-1996.

FOR: PROVIDING ONLINE NON-DOWNLOADABLE COMPUTER SOFTWARE FOR ELECTRONIC CONTENT MANAGEMENT, NAMELY, CREATING, EDITING, MANAGING, AND STORING ELECTRO-

NIC CONTENT AUDIO, VIDEO, TEXT AND MULTIMEDIA FILES; CONSULTING SERVICES IN THE FIELD OF IMPLEMENTATION OF COMPUTER SOFTWARE SYSTEMS FOR OTHERS; TECHNICAL SUPPORT SERVICE, NAMELY, PROVIDING TECHNICAL ADVICE AND TROUBLESHOOTING OF COMPUTER SOFTWARE PROBLEMS FOR OTHERS, IN CLASS 42 (U.S. CLS. 100 AND 101).

FIRST USE 7-3-1996; IN COMMERCE 7-3-1996.

THE MARK CONSISTS OF STANDARD CHARACTERS WITHOUT CLAIM TO ANY PARTICULAR FONT, STYLE, SIZE, OR COLOR.

SER. NO. 77-189,372, FILED 5-24-2007.

SIMON TENG, EXAMINING ATTORNEY

Int. Cl.: 9

Prior U.S. Cls.: 21, 23, 26, 36 and 38

Reg. No. 3,474,777

United States Patent and Trademark Office

Registered July 29, 2008

**TRADEMARK
PRINCIPAL REGISTER**



LARGE ANIMAL LLC (NEW YORK LTD LIAB
CO)
27 WEST 24TH STREET, SUITE 10D
NEW YORK, NY 10010

FOR: COMPUTER GAME SOFTWARE; COMPU-
TER GAME SOFTWARE ENABLING USERS TO
PLAY GAMES ONLINE; DOWNLOADABLE COM-
PUTER GAME SOFTWARE; ELECTRONIC GAME
SOFTWARE, IN CLASS 9 (U.S. CLS. 21, 23, 26, 36 AND
38).

FIRST USE 4-0-2002; IN COMMERCE 4-0-2002.

NO CLAIM IS MADE TO THE EXCLUSIVE
RIGHT TO USE "GAMES", APART FROM THE
MARK AS SHOWN.

SER. NO. 77-189,474, FILED 5-24-2007.

TRACY CROSS, EXAMINING ATTORNEY

Int. Cl.: 35

Prior U.S. Cls.: 100, 101 and 102

United States Patent and Trademark Office

Reg. No. 3,474,778

Registered July 29, 2008

**SERVICE MARK
PRINCIPAL REGISTER**

ACT LIGHTING

A.C.T. LIGHTING, INC. (CALIFORNIA CORPORATION)
5308 DERRY AVENUE, UNIT R
AGOURA HILLS, CA 91301

FOR: WHOLESALE DISTRIBUTORSHIPS FEATURING ENTERTAINMENT LIGHTING EQUIPMENT, NAMELY, LIGHTING SYSTEMS, LIGHTING FIXTURES, LIGHTING CONTROL SYSTEMS, COMPUTER SOFTWARE FOR LIGHTING APPLICATIONS, FOG/SMOKE/HAZE EQUIPMENT, CABLES, CABLE ASSEMBLIES AND ELECTRICAL CONNECTORS, IN CLASS 35 (U.S. CLS. 100, 101 AND 102).

FIRST USE 7-1-2002; IN COMMERCE 7-1-2002.

THE MARK CONSISTS OF STANDARD CHARACTERS WITHOUT CLAIM TO ANY PARTICULAR FONT, STYLE, SIZE, OR COLOR.

NO CLAIM IS MADE TO THE EXCLUSIVE RIGHT TO USE "LIGHTING", APART FROM THE MARK AS SHOWN.

SER. NO. 77-189,492, FILED 5-24-2007.

ROBERT STRUCK, EXAMINING ATTORNEY

Int. Cl.: 16

Prior U.S. Cls.: 2, 5, 22, 23, 29, 37, 38 and 50

Reg. No. 3,474,779

United States Patent and Trademark Office

Registered July 29, 2008

**TRADEMARK
PRINCIPAL REGISTER**



I.R.A. PUBLISHING, INC. (CALIFORNIA CORPORATION)
5332 E. BEVERLY BLVD.
LOS ANGELES, CA 90022

FOR: MAGAZINES FEATURING CAR ADVERTISING, IN CLASS 16 (U.S. CLS. 2, 5, 22, 23, 29, 37, 38 AND 50).

FIRST USE 11-0-2004; IN COMMERCE 11-0-2004.

NO CLAIM IS MADE TO THE EXCLUSIVE RIGHT TO USE "AUTO", "MAGAZINE", AND THE GRAPHIC REPRESENTATION OF THE AUTOMOBILE, APART FROM THE MARK AS SHOWN.

THE MARK CONSISTS OF STYLIZED LETTERING AND A SPORTS CAR.

SER. NO. 77-189,648, FILED 5-24-2007.

SUZANNE BLANE, EXAMINING ATTORNEY

Int. Cl.: 10

Prior U.S. Cls.: 26, 39 and 44

United States Patent and Trademark Office

Reg. No. 3,474,780

Registered July 29, 2008

**TRADEMARK
PRINCIPAL REGISTER**

SOLAR

LACIDEM HOLDING B.V. (NETHERLANDS CORPORATION)
P.O. BOX 580
COLOSSEUM 25, 7521 PV ENSCHEDE
750 AN ENSCHEDE, NETHERLANDS

FOR: MEDICAL DIAGNOSTIC APPARATUS FOR USE IN DIAGNOSING URODYNAMIC, ANORECTAL, GASTROINTESTINAL AND NEUROLOGICAL DYSFUNCTION AND SOFTWARE USED THEREWITH, SOLD AS A UNIT; MEDICAL DIAGNOSTIC DEVICES FOR USE WITH URODYNAMIC, ANORECTAL, GASTROINTESTINAL AND NEUROLOGICAL IMAGING SYSTEMS AND SOFTWARE USED THEREWITH, SOLD AS A UNIT; MEDICAL EQUIPMENT, NAMELY, BIOFEEDBACK APPARATUS

FOR USE IN DIAGNOSING URODYNAMIC, ANORECTAL, GASTROINTESTINAL AND NEUROLOGICAL DISORDERS AND SOFTWARE USED THEREWITH, SOLD AS A UNIT, IN CLASS 10 (U.S. CLS. 26, 39 AND 44).

FIRST USE 12-31-2001; IN COMMERCE 12-31-2001.

THE MARK CONSISTS OF STANDARD CHARACTERS WITHOUT CLAIM TO ANY PARTICULAR FONT, STYLE, SIZE, OR COLOR.

SER. NO. 77-190,282, FILED 5-25-2007.

RENEE SERVANCE, EXAMINING ATTORNEY

Int. Cl.: 16

Prior U.S. Cls.: 2, 5, 22, 23, 29, 37, 38 and 50

Reg. No. 3,474,781

United States Patent and Trademark Office

Registered July 29, 2008

**TRADEMARK
PRINCIPAL REGISTER**

THE RULE OF KNOWLEDGE

HELIX GROUP PLC (UNITED KINGDOM PUBLIC LIMITED COMPANY (PLC))
ENGINE LANE, LYE, STOURBRIDGE
WEST MIDLANDS, UNITED KINGDOM DY97AJ

FOR: UNGRADUATED RULERS; UNGRADUATED RULERS WITH COMPARTMENTS FOR FACT SHEETS AND OTHER EDUCATIONAL MATERIALS, NAMELY, PRINTED FORMS AND INFORMATION SHEETS, MATHEMATICAL TABLES AND DATA SHEETS AND SCHOOL TIMETABLE FORMS, ALL FOR SCHOOL CHILDREN, IN CLASS 16 (U.S. CLS. 2, 5, 22, 23, 29, 37, 38 AND 50).

THE MARK CONSISTS OF STANDARD CHARACTERS WITHOUT CLAIM TO ANY PARTICULAR FONT, STYLE, SIZE, OR COLOR.

PRIORITY CLAIMED UNDER SEC. 44(D) ON UNITED KINGDOM APPLICATION NO. 2455112, FILED 5-9-2007, REG. NO. 2455112, DATED 5-9-2007, EXPIRES 5-9-2017.

SER. NO. 77-190,482, FILED 5-25-2007.

SHAUNIA CARLYLE, EXAMINING ATTORNEY

Int. Cl.: 41

Prior U.S. Cls.: 100, 101 and 107

United States Patent and Trademark Office

Reg. No. 3,474,782

Registered July 29, 2008

**SERVICE MARK
PRINCIPAL REGISTER**

**INTERNATIONAL ACADEMY OF
COSMETIC SURGERY**

INTERNATIONAL ACADEMY OF COSMETIC
SURGERY, INC. (SWITZERLAND CORPORA-
TION)

4F

1-10-2 EBISU-MINAMI
SHIBUYA-KU, TOKYO, JAPAN

FOR: TEACHING, TRAINING AND SPONSOR-
ING WORKSHOPS IN THE FIELD OF COSMETIC
SURGERY, IN CLASS 41 (U.S. CLS. 100, 101 AND 107).

FIRST USE 0-0-1972; IN COMMERCE 0-0-1972.

THE MARK CONSISTS OF STANDARD CHAR-
ACTERS WITHOUT CLAIM TO ANY PARTICULAR
FONT, STYLE, SIZE, OR COLOR.

NO CLAIM IS MADE TO THE EXCLUSIVE
RIGHT TO USE "ACADEMY", APART FROM THE
MARK AS SHOWN.

SEC. 2(F).

SER. NO. 77-190,628, FILED 5-25-2007.

EMILY CARLSEN, EXAMINING ATTORNEY

Int. Cl.: 7

Prior U.S. Cls.: 13, 19, 21, 23, 31, 34 and 35

United States Patent and Trademark Office

Reg. No. 3,474,783

Registered July 29, 2008

**TRADEMARK
PRINCIPAL REGISTER**

iMQL

HORKOS CORP (JAPAN CORPORATION)
2-24-20, KUSADO-CHO
FUKUYAMA-SHI, JAPAN 720-8650

FOR: MACHINE TOOLS AND THEIR PARTS FOR
METALWORKING, CUTTING, PROCESSING,
MOLDING, FORMING, OR ASSEMBLING OF MA-
TERIALS; WASHING MACHINE FOR INDUSTRIAL
PARTS, IN CLASS 7 (U.S. CLS. 13, 19, 21, 23, 31, 34
AND 35).

OWNER OF JAPAN REG. NO. 4685900, DATED 6-
27-2003, EXPIRES 6-27-2013.

OWNER OF U.S. REG. NOS. 2,411,787 AND
2,641,445.

SER. NO. 77-191,094, FILED 5-25-2007.

ESTHER BELENKER, EXAMINING ATTORNEY

Int. Cl.: 16

Prior U.S. Cls.: 2, 5, 22, 23, 29, 37, 38 and 50

United States Patent and Trademark Office

Reg. No. 3,474,784

Registered July 29, 2008

**TRADEMARK
PRINCIPAL REGISTER**

Play the Cancer Card

STAY POSITIVE GROUP, LLC (OHIO LTD LIAB
CO)
122 DEBBIE DRIVE
WESTERVILLE, OH 43081

THE MARK CONSISTS OF STANDARD CHAR-
ACTERS WITHOUT CLAIM TO ANY PARTICULAR
FONT, STYLE, SIZE, OR COLOR.

FOR: GREETING CARDS, IN CLASS 16 (U.S. CLS.
2, 5, 22, 23, 29, 37, 38 AND 50).

SER. NO. 77-191,377, FILED 5-27-2007.

FIRST USE 3-31-2007; IN COMMERCE 7-14-2007.

PAUL E. FAHRENKOPF, EXAMINING ATTORNEY

Int. Cls.: 35 and 41

Prior U.S. Cls.: 100, 101, 102 and 107

United States Patent and Trademark Office

Reg. No. 3,474,785

Registered July 29, 2008

**SERVICE MARK
PRINCIPAL REGISTER**

Adirondack Living

GREAT WHITE PRODUCTIONS, LLC (NEW YORK LTD LIAB CO)
10 CORPORATE DRIVE
CLIFTON PARK, NY 12065

FOR: CONDUCTING TRADE SHOWS IN THE FIELD OF RUSTIC FURNISHINGS, ART, ANTIQUES, CAMP STRUCTURES, CABINS, BOATS, DOCKS, AND CRAFTS; RETAIL STORE SERVICES IN THE FIELD OF RUSTIC FURNISHINGS, ART, ANTIQUES, CAMP STRUCTURES, CABINS, BOATS, DOCKS, AND CRAFTS, IN CLASS 35 (U.S. CLS. 100, 101 AND 102).

FIRST USE 4-18-2003; IN COMMERCE 4-18-2003.

FOR: DIRECTION OF MAKING RADIO OR TELEVISION PROGRAMS; DISTRIBUTION OF TELEVISION PROGRAMMING TO CABLE TELEVISION SYSTEMS; DISTRIBUTION OF TELEVISION PROGRAMS FOR OTHERS; NEWSPAPER PUBLISHING;

PUBLISHING OF BOOKS, MAGAZINES; PUBLISHING OF WEB MAGAZINES; TELEVISION PROGRAM SYNDICATION; TELEVISION SCHEDULING; TELEVISION SHOW PRODUCTION, IN CLASS 41 (U.S. CLS. 100, 101 AND 107).

FIRST USE 6-7-2006; IN COMMERCE 6-7-2006.

THE MARK CONSISTS OF STANDARD CHARACTERS WITHOUT CLAIM TO ANY PARTICULAR FONT, STYLE, SIZE, OR COLOR.

NO CLAIM IS MADE TO THE EXCLUSIVE RIGHT TO USE "ADIRONDACK", APART FROM THE MARK AS SHOWN.

SER. NO. 77-191,763, FILED 5-29-2007.

HENRY S. ZAK, EXAMINING ATTORNEY

Int. Cls.: 35 and 41

Prior U.S. Cls.: 100, 101, 102 and 107

United States Patent and Trademark Office

Reg. No. 3,474,786

Registered July 29, 2008

**SERVICE MARK
PRINCIPAL REGISTER**



**Tapestry
Networks**

TAPESTRY NETWORKS, INC. (DELAWARE CORPORATION)
SUITE 246
RESERVOIR PLACE, 1601 TRAPELO ROAD
WALTHAM, MA 02451

FOR: BUSINESS CONSULTING SERVICES RENDERED TO BOTH PUBLIC AND PRIVATE SECTOR CLIENTS IN THE FIELD OF NETWORKING APPROACHES TO COLLABORATION AND PROBLEM-SOLVING; BUSINESS MEETING PLANNING, NAMELY PLANNING NETWORKING MEETINGS; ARRANGING AND PLANNING BUSINESS CONFERENCES; BUSINESS NETWORKING, IN CLASS 35 (U.S. CLS. 100, 101 AND 102).

FIRST USE 10-1-2002; IN COMMERCE 10-1-2002.

FOR: SPECIAL EVENT PLANNING IN THE NATURE OF BUSINESS NETWORKING EVENTS; ARRANGING AND CONDUCTING PROFESSIONAL

WORKSHOPS IN THE FIELD OF BUSINESS MANAGEMENT, IN CLASS 41 (U.S. CLS. 100, 101 AND 107).

FIRST USE 10-1-2002; IN COMMERCE 10-1-2002.

NO CLAIM IS MADE TO THE EXCLUSIVE RIGHT TO USE "NETWORKS", APART FROM THE MARK AS SHOWN.

THE MARK CONSISTS OF THE WORDS "TAPESTRY NETWORKS" PRINTED IN STYLIZED FONT. TO THE LEFT OF THE WORDS IS AN ABSTRACT GEOMETRIC DESIGN CONSISTING OF INTERLOCKING CIRCLES AND ELLIPSES ENCLOSED IN A SQUARE.

SER. NO. 77-192,140, FILED 5-29-2007.

SHARON MEIER, EXAMINING ATTORNEY

Int. Cl.: 25

Prior U.S. Cls.: 22 and 39

United States Patent and Trademark Office

Reg. No. 3,474,787

Registered July 29, 2008

**TRADEMARK
PRINCIPAL REGISTER**

GemmaG

ELIZABETH GILLETT, LTD (NEW YORK LTD
LIAB CO)
242 WEST 38TH STREET
9TH FLOOR
NEW YORK, NY 10018

FOR: CLOTHING, NAMELY, WRAP-AROUNDS;
HOODS; SHIFTS; SHOULDER WRAPS; WRAPS;
SHRUGS; MANTLES; SCARVES; SHOULDER
SCARVES; TOPS; SKIRTS AND DRESSES, IN CLASS
25 (U.S. CLS. 22 AND 39).

FIRST USE 4-24-2007; IN COMMERCE 5-25-2007.

THE MARK CONSISTS OF STANDARD CHAR-
ACTERS WITHOUT CLAIM TO ANY PARTICULAR
FONT, STYLE, SIZE, OR COLOR.

SER. NO. 77-192,456, FILED 5-29-2007.

RONALD MCMORROW, EXAMINING ATTORNEY

Int. Cl.: 36

Prior U.S. Cls.: 100, 101 and 102

United States Patent and Trademark Office

Reg. No. 3,474,788

Registered July 29, 2008

**SERVICE MARK
PRINCIPAL REGISTER**

Hybrid Luxury

NEWPORT CAPITAL LENDING CORP. (CALIFORNIA CORPORATION)
109 23RD STREET
COSTA MESA, CA 92627

FOR: ASSESSMENT AND MANAGEMENT OF REAL ESTATE; PROVIDING REAL ESTATE LISTINGS AND REAL ESTATE INFORMATION VIA THE INTERNET; REAL ESTATE ACQUISITION SERVICES; REAL ESTATE AGENCIES; REAL ESTATE CONSULTANCY; REAL ESTATE INVESTMENT; REAL ESTATE LENDING SERVICES; COMMERCIAL LENDING SERVICES, IN CLASS 36 (U.S. CLS. 100, 101 AND 102).

FIRST USE 4-13-2007; IN COMMERCE 4-13-2007.

THE MARK CONSISTS OF STANDARD CHARACTERS WITHOUT CLAIM TO ANY PARTICULAR FONT, STYLE, SIZE, OR COLOR.

NO CLAIM IS MADE TO THE EXCLUSIVE RIGHT TO USE "HYBRID", APART FROM THE MARK AS SHOWN.

SER. NO. 77-192,643, FILED 5-30-2007.

CAROLYN GRAY, EXAMINING ATTORNEY

Int. Cl.: 25

Prior U.S. Cls.: 22 and 39

United States Patent and Trademark Office

Reg. No. 3,474,789

Registered July 29, 2008

**TRADEMARK
PRINCIPAL REGISTER**

TROPICAL VISIONS

HIRSCH, MARK DANIEL (UNITED STATES IN-
DIVIDUAL)
1233 OAK AVE.
CARLSBAD, CA 92008

FOR: CLOTHING, NAMELY, SHORT SETS; TOPS;
DENIM JACKETS; YOGA PANTS; CARGO PANTS;
DENIM SHIRTS; SWEAT PANTS; SHIRTS; BUTTON-
FRONT ALOHA SHIRTS; GOLF SHIRTS; NIGHT
SHIRTS; OPEN-NECKED SHIRTS; PIQUE SHIRTS;
POLO SHIRTS; SLEEP SHIRTS; SPORT SHIRTS;
SWEAT SHIRTS; T-SHIRTS; COATS; COATS MADE
OF COTTON; COATS MADE OF DENIM; BOXER
BRIEFS; BRIEFS; BIKINIS; BATHING COSTUMES;

BATHING SUITS; BATHING TRUNKS; SWEAT
SUITS; WET SUITS, IN CLASS 25 (U.S. CLS. 22 AND
39).

FIRST USE 6-1-1972; IN COMMERCE 6-1-1972.

THE MARK CONSISTS OF STANDARD CHAR-
ACTERS WITHOUT CLAIM TO ANY PARTICULAR
FONT, STYLE, SIZE, OR COLOR.

SER. NO. 77-192,647, FILED 5-30-2007.

CAROLYN GRAY, EXAMINING ATTORNEY

Int. Cls.: 29 and 30

Prior U.S. Cl.: 46

United States Patent and Trademark Office

Reg. No. 3,474,790

Registered July 29, 2008

**TRADEMARK
PRINCIPAL REGISTER**

CHIPATI

PIZZA HOUSE ANN ARBOR, INC. (MICHIGAN CORPORATION)
618 CHURCH STREET
ANN ARBOR, MI 48104

FOR: SALADS EXCEPT MACARONI, RICE, AND PASTA SALAD; VEGETABLE SALADS, IN CLASS 29 (U.S. CL. 46).

FIRST USE 7-31-1995; IN COMMERCE 7-31-1995.

FOR: SANDWICHES, NAMELY, LARGE ROLLS CONTAINING SALAD FILLINGS, IN CLASS 30 (U.S. CL. 46).

FIRST USE 7-31-1995; IN COMMERCE 7-31-1995.

THE MARK CONSISTS OF STANDARD CHARACTERS WITHOUT CLAIM TO ANY PARTICULAR FONT, STYLE, SIZE, OR COLOR.

OWNER OF U.S. REG. NO. 2,735,744.

SEC. 2(F).

SER. NO. 77-193,231, FILED 5-30-2007.

LA TONIA FISHER, EXAMINING ATTORNEY

Int. Cl.: 14

Prior U.S. Cls.: 2, 27, 28 and 50

United States Patent and Trademark Office

Reg. No. 3,474,791

Registered July 29, 2008

TRADEMARK
PRINCIPAL REGISTER



ACTIV-GEM, INC. (TEXAS CORPORATION)
SUITE 606
4141 SOUTHWEST FREEWAY
HOUSTON, TX 77027

FOR: DIAMONDS, IN CLASS 14 (U.S. CLS. 2, 27, 28
AND 50).

FIRST USE 5-25-2007; IN COMMERCE 5-25-2007.

THE MARK CONSISTS OF THE WORDS
"HEARTS BY STAR" AND A STYLIZED DESIGN
CONSISTING OF A SCROLL CONNECTED BY TWO
CIRCLES, ONE CONTAINING HEARTS, AND THE
OTHER CONTAINING ARROWS.

SER. NO. 77-193,688, FILED 5-30-2007.

MARY ROSSMAN, EXAMINING ATTORNEY

Int. Cl.: 31

Prior U.S. Cls.: 1 and 46

United States Patent and Trademark Office

Reg. No. 3,474,792

Registered July 29, 2008

**TRADEMARK
PRINCIPAL REGISTER**

SERGEANT'S

SERGEANT'S PET CARE PRODUCTS, INC. (NE-
VADA CORPORATION)
2625 S 158TH PLAZA
OMAHA, NE 681301770

FOR: PET TREATS, IN CLASS 31 (U.S. CLS. 1 AND
46).

FIRST USE 12-0-2000; IN COMMERCE 12-0-2000.

THE MARK CONSISTS OF STANDARD CHAR-
ACTERS WITHOUT CLAIM TO ANY PARTICULAR
FONT, STYLE, SIZE, OR COLOR.

OWNER OF U.S. REG. NOS. 3,081,652, 3,109,005,
AND 3,270,277.

SER. NO. 77-193,953, FILED 5-31-2007.

DAWN HAN, EXAMINING ATTORNEY

Int. Cl.: 30

Prior U.S. Cl.: 46

United States Patent and Trademark Office

Reg. No. 3,474,793

Registered July 29, 2008

TRADEMARK
PRINCIPAL REGISTER

DAMMANN
FRÈRES

R & P DAMMANN FRÈRES (FRANCE CORPORATION)
1761 ROUTE DE QUARANTE SOUS
ORGEVAL, FRANCE 78630

FOR: NATURAL AND FLAVOURED TEA SOLD
IN BULK, IN FLEXIBLE POUCHES OR IN BOXES;
HERB TEA, IN CLASS 30 (U.S. CL. 46).

FIRST USE 1-16-2002; IN COMMERCE 1-16-2002.

NO CLAIM IS MADE TO THE EXCLUSIVE
RIGHT TO USE "FRERES", APART FROM THE
MARK AS SHOWN.

THE MARK CONSISTS OF A STYLIZED WORD
MARK.

THE FOREIGN WORDING IN THE MARK
TRANSLATES INTO ENGLISH AS BROTHERS.

SEC. 2(F).

SER. NO. 77-194,043, FILED 5-31-2007.

KATHERINE STOIDES, EXAMINING ATTORNEY

Int. Cl.: 29

Prior U.S. Cl.: 46

United States Patent and Trademark Office

Reg. No. 3,474,794

Registered July 29, 2008

**TRADEMARK
PRINCIPAL REGISTER**

QUANTUM FOODS

QUANTUM FOODS, LLC (DELAWARE LTD
LIAB CO)

750 SOUTH SCHMIDT ROAD

BOLINGBROOK, IL 60440

FOR: PROCESSED MEATS, BEEF, PORK, POULTRY AND SEAFOOD SOLD IN PORTIONS; FULLY COOKED ENTREES CONSISTING PRIMARILY OF MEAT, BEEF, PORK, POULTRY OR SEAFOOD, IN CLASS 29 (U.S. CL. 46).

FIRST USE 8-24-2006; IN COMMERCE 8-24-2006.

THE MARK CONSISTS OF STANDARD CHARACTERS WITHOUT CLAIM TO ANY PARTICULAR FONT, STYLE, SIZE, OR COLOR.

OWNER OF U.S. REG. NOS. 2,547,835, 2,818,886 AND OTHERS.

NO CLAIM IS MADE TO THE EXCLUSIVE RIGHT TO USE "FOODS", APART FROM THE MARK AS SHOWN.

SER. NO. 77-194,576, FILED 5-31-2007.

HEATHER BIDDULPH, EXAMINING ATTORNEY

Int. Cl.: 3

Prior U.S. Cls.: 1, 4, 6, 50, 51 and 52

United States Patent and Trademark Office

Reg. No. 3,474,795

Registered July 29, 2008

**TRADEMARK
PRINCIPAL REGISTER**

REDEFINER

GRAYSON O. COMPANY (NORTH CAROLINA
CORPORATION)
6509 NEWELL AVENUE
KANNAPOLIS, NC 28081

FOR: HAIR CLEANING PREPARATIONS, IN
CLASS 3 (U.S. CLS. 1, 4, 6, 50, 51 AND 52).

FIRST USE 9-15-1989; IN COMMERCE 9-15-1989.

THE MARK CONSISTS OF STANDARD CHAR-
ACTERS WITHOUT CLAIM TO ANY PARTICULAR
FONT, STYLE, SIZE, OR COLOR.

SEC. 2(F).

SER. NO. 77-194,787, FILED 5-31-2007.

TINA KUAN, EXAMINING ATTORNEY

Int. Cl.: 41

Prior U.S. Cls.: 100, 101 and 107

United States Patent and Trademark Office

Reg. No. 3,474,796

Registered July 29, 2008

**SERVICE MARK
PRINCIPAL REGISTER**

SUMMER SKIN

WORLD WRESTLING ENTERTAINMENT, INC.
(DELAWARE CORPORATION)
1241 EAST MAIN STREET
STAMFORD, CT 06902

THE MARK CONSISTS OF STANDARD CHAR-
ACTERS WITHOUT CLAIM TO ANY PARTICULAR
FONT, STYLE, SIZE, OR COLOR.

FOR: PROVISION OF NON-DOWNLOADABLE
FILMS AND TV PROGRAMMES VIA A VIDEO-
ON-DEMAND SERVICE, IN CLASS 41 (U.S. CLS. 100,
101 AND 107).

SER. NO. 77-195,219, FILED 6-1-2007.

FIRST USE 6-1-2007; IN COMMERCE 6-1-2007.

SKYE YOUNG, EXAMINING ATTORNEY

Int. Cl.: 5

Prior U.S. Cls.: 6, 18, 44, 46, 51 and 52

United States Patent and Trademark Office

Reg. No. 3,474,797

Registered July 29, 2008

**TRADEMARK
PRINCIPAL REGISTER**

MIXTARD

NOVO NORDISK A/S (DENMARK CORPORATION)

NOVO ALLE

2880 BAGSVAERD, DENMARK

FOR: ORGANO-THERAPEUTICAL INJECTION PREPARATIONS BEING PRESCRIPTION ITEMS IN THE FORM OF INSULIN PREPARATIONS, IN CLASS 5 (U.S. CLS. 6, 18, 44, 46, 51 AND 52).

THE MARK CONSISTS OF STANDARD CHARACTERS WITHOUT CLAIM TO ANY PARTICULAR FONT, STYLE, SIZE, OR COLOR.

OWNER OF DENMARK REG. NO. VR19760132, DATED 4-9-1976, EXPIRES 4-9-2016.

SER. NO. 77-195,330, FILED 6-1-2007.

KIMBERLY FRYE, EXAMINING ATTORNEY

Int. Cl.: 29

Prior U.S. Cl.: 46

United States Patent and Trademark Office

Reg. No. 3,474,798

Registered July 29, 2008

**TRADEMARK
PRINCIPAL REGISTER**

OLD TIMES

WILKIN & SONS LIMITED (UNITED KINGDOM
CORPORATION)
TIPTREE FACTORY, TIPTREE
COLCHESTER, UNITED KINGDOM CO50RF

OWNER OF UNITED KINGDOM REG. NO.
830676, DATED 2-12-1962, RENEWED AS REG. NO.
830676, DATED 1-5-2007, EXPIRES 2-12-2017.

FOR: MARMALADE, IN CLASS 29 (U.S. CL. 46).

SER. NO. 77-195,738, FILED 6-1-2007.

THE MARK CONSISTS OF STANDARD CHAR-
ACTERS WITHOUT CLAIM TO ANY PARTICULAR
FONT, STYLE, SIZE, OR COLOR.

LOURDES AYALA, EXAMINING ATTORNEY

Int. Cl.: 44

Prior U.S. Cls.: 100 and 101

United States Patent and Trademark Office

Reg. No. 3,474,799

Registered July 29, 2008

**SERVICE MARK
PRINCIPAL REGISTER**



ALEMIS, ALEXANDER G. (UNITED STATES
INDIVIDUAL)
12151 S. 73RD AVENUE
PALOS HEIGHTS, IL 60463

NO CLAIM IS MADE TO THE EXCLUSIVE
RIGHT TO USE "FAMILY DENTAL CARE", APART
FROM THE MARK AS SHOWN.

FOR: DENTIST SERVICES, IN CLASS 44 (U.S. CLS.
100 AND 101).

SER. NO. 77-195,924, FILED 6-1-2007.

FIRST USE 9-15-1997; IN COMMERCE 9-15-1997.

OWNER OF U.S. REG. NO. 2,746,987.

SIMON TENG, EXAMINING ATTORNEY

Int. Cl.: 41

Prior U.S. Cls.: 100, 101 and 107

United States Patent and Trademark Office

Reg. No. 3,474,800

Registered July 29, 2008

**SERVICE MARK
PRINCIPAL REGISTER**

GREEN BY DESIGN

KAIZEN PRODUCTIONS, LLC (NEW JERSEY
LTD LIAB CO)
8 DOUGLAS ROAD
GLEN RIDGE, NJ 07028

FOR: ENTERTAINMENT, NAMELY, A CONTINUING TELEVISION SHOW IN THE FIELD OF THE ENVIRONMENT, IN CLASS 41 (U.S. CLS. 100, 101 AND 107).

FIRST USE 1-5-2007; IN COMMERCE 1-5-2007.

THE MARK CONSISTS OF STANDARD CHARACTERS WITHOUT CLAIM TO ANY PARTICULAR FONT, STYLE, SIZE, OR COLOR.

NO CLAIM IS MADE TO THE EXCLUSIVE RIGHT TO USE "GREEN", APART FROM THE MARK AS SHOWN.

SER. NO. 77-196,330, FILED 6-3-2007.

JOHN GARTNER, EXAMINING ATTORNEY

Int. Cl.: 41

Prior U.S. Cls.: 100, 101 and 107

United States Patent and Trademark Office

Reg. No. 3,474,801

Registered July 29, 2008

**SERVICE MARK
PRINCIPAL REGISTER**

EXTREME! GREEN

KAIZEN PRODUCTIONS, LLC (NEW JERSEY
LTD LIAB CO)
8 DOUGLAS ROAD
GLEN RIDGE, NJ 07028

FOR: ENTERTAINMENT, NAMELY, A CONTINUING TELEVISION SHOW IN THE FIELD OF THE ENVIRONMENT, IN CLASS 41 (U.S. CLS. 100, 101 AND 107).

FIRST USE 5-30-2007; IN COMMERCE 5-30-2007.

THE MARK CONSISTS OF STANDARD CHARACTERS WITHOUT CLAIM TO ANY PARTICULAR FONT, STYLE, SIZE, OR COLOR.

NO CLAIM IS MADE TO THE EXCLUSIVE RIGHT TO USE "GREEN", APART FROM THE MARK AS SHOWN.

SER. NO. 77-196,332, FILED 6-3-2007.

JOHN GARTNER, EXAMINING ATTORNEY

Int. Cl.: 41

Prior U.S. Cls.: 100, 101 and 107

Reg. No. 3,474,802

United States Patent and Trademark Office

Registered July 29, 2008

**SERVICE MARK
PRINCIPAL REGISTER**

NEWLYGREENS

KAIZEN PRODUCTIONS, LLC (NEW JERSEY
LTD LIAB CO)
8 DOUGLAS ROAD
GLEN RIDGE, NJ 07028

THE MARK CONSISTS OF STANDARD CHAR-
ACTERS WITHOUT CLAIM TO ANY PARTICULAR
FONT, STYLE, SIZE, OR COLOR.

FOR: ENTERTAINMENT, NAMELY, A CONTI-
NUING TELEVISION SHOW IN THE FIELD OF THE
ENVIRONMENT, IN CLASS 41 (U.S. CLS. 100, 101
AND 107).

SER. NO. 77-196,335, FILED 6-3-2007.

FIRST USE 5-30-2007; IN COMMERCE 5-30-2007.

JOHN GARTNER, EXAMINING ATTORNEY

Int. Cl.: 35

Prior U.S. Cls.: 100, 101 and 102

United States Patent and Trademark Office

Reg. No. 3,474,803

Registered July 29, 2008

**SERVICE MARK
PRINCIPAL REGISTER**

Unstoppable Traffic

TRAFFICCENTRAL LLC (FLORIDA LTD LIAB
CO)
SUITE 130
603 COQUINA CT.
NOKOMIS, FL 34275

FOR: DISSEMINATION OF ADVERTISING FOR
OTHERS VIA THE INTERNET, IN CLASS 35 (U.S.
CLS. 100, 101 AND 102).

FIRST USE 11-16-2003; IN COMMERCE 11-16-2003.

THE MARK CONSISTS OF STANDARD CHAR-
ACTERS WITHOUT CLAIM TO ANY PARTICULAR
FONT, STYLE, SIZE, OR COLOR.

OWNER OF U.S. REG. NOS. 3,049,164 AND
3,113,946.

NO CLAIM IS MADE TO THE EXCLUSIVE
RIGHT TO USE "TRAFFIC", APART FROM THE
MARK AS SHOWN.

SER. NO. 77-196,409, FILED 6-4-2007.

PAUL E. FAHRENKOPF, EXAMINING ATTORNEY

Int. Cl.: 42

Prior U.S. Cls.: 100 and 101

United States Patent and Trademark Office

Reg. No. 3,474,804

Registered July 29, 2008

**SERVICE MARK
PRINCIPAL REGISTER**



LEAD VENTURES, LLC (RHODE ISLAND LTD
LIAB CO)
42 LADD STREET, 2ND FLOOR
EAST GREENWICH, RI 02818

FIRST USE 3-16-2007; IN COMMERCE 3-16-2007.

FOR: PROVIDING TEMPORARY USE OF WEB
BASED NON-DOWNLOADABLE COMPUTER
SOFTWARE PLATFORM FOR COLLECTING
LEADS BY PERMITTING END USE CONSUMERS
TO REQUEST ASSISTANCE FROM SUPPLIERS
AND DISSEMINATING SUCH REQUEST TO DIS-
TRIBUTORS FOR FOLLOW-UP SALES, IN CLASS 42
(U.S. CLS. 100 AND 101).

NO CLAIM IS MADE TO THE EXCLUSIVE
RIGHT TO USE "PROMO LEADS", APART FROM
THE MARK AS SHOWN.

SER. NO. 77-196,841, FILED 6-4-2007.

MELISSA VALLILLO, EXAMINING ATTORNEY

Int. Cls.: 42 and 45

Prior U.S. Cls.: 100 and 101

United States Patent and Trademark Office

Reg. No. 3,474,805

Registered July 29, 2008

**SERVICE MARK
PRINCIPAL REGISTER**

EMERGING STRATEGIES

EMERGING STRATEGIES, PLLC (D.C. LTD LIAB
CO)
5440 31ST STREET, NW
WASHINGTON, DC 20015

FOR: PRODUCT DEVELOPMENT STRATEGY
CONSULTING SERVICES, IN CLASS 42 (U.S. CLS.
100 AND 101).

FIRST USE 9-6-2006; IN COMMERCE 9-6-2006.

FOR: INTELLECTUAL PROPERTY CONSULT-
ING SERVICES, NAMELY, COUNSELING, PROSE-
CUTING, PORTFOLIO MANAGEMENT,
LICENSING AND ALTERNATIVE DISPUTE RESO-
LUTION RELATED TO INTELLECTUAL PROPER-
TY, IN CLASS 45 (U.S. CLS. 100 AND 101).

FIRST USE 9-6-2006; IN COMMERCE 9-6-2006.

THE MARK CONSISTS OF STANDARD CHAR-
ACTERS WITHOUT CLAIM TO ANY PARTICULAR
FONT, STYLE, SIZE, OR COLOR.

NO CLAIM IS MADE TO THE EXCLUSIVE
RIGHT TO USE "STRATEGIES", APART FROM
THE MARK AS SHOWN.

SER. NO. 77-197,403, FILED 6-4-2007.

MARK T. MULLEN, EXAMINING ATTORNEY

Int. Cl.: 41

Prior U.S. Cls.: 100, 101 and 107

United States Patent and Trademark Office

Reg. No. 3,474,806

Registered July 29, 2008

**SERVICE MARK
PRINCIPAL REGISTER**

TAKE HOME CHEF

DISCOVERY COMMUNICATIOONS, LLC (DELA-
WARE LTD LIAB CO)
ONE DISCOVERY PLACE
SILVER SPRING, MD 20910

FOR: ENTERTAINMENT SERVICE IN THE NAT-
URE OF AN ON-GOING NONFICTION PROGRAM
ON THE SUBJECT OF CULINARY ARTS DISTRIB-
UTED THROUGH AUDIO AND VIDEO MEDIA,
NAMELY, TELEVISION, SATELLITE, BROAD-
BAND , MOBILE, WIRELESS, FIBER OPTICS,
CABLE, RADIO AND A GLOBAL COMPUTER NET-
WORK; INFORMATION REGARDING SAME PRO-
VIDED VIA A GLOBAL COMPUTER NETWORK, IN
CLASS 41 (U.S. CLS. 100, 101 AND 107).

FIRST USE 5-16-2006; IN COMMERCE 5-16-2006.

THE MARK CONSISTS OF STANDARD CHAR-
ACTERS WITHOUT CLAIM TO ANY PARTICULAR
FONT, STYLE, SIZE, OR COLOR.

NO CLAIM IS MADE TO THE EXCLUSIVE
RIGHT TO USE "CHEF", APART FROM THE MARK
AS SHOWN.

SER. NO. 77-197,523, FILED 6-5-2007.

KATHLEEN LORENZO, EXAMINING ATTORNEY

Int. Cl.: 42

Prior U.S. Cls.: 100 and 101

United States Patent and Trademark Office

Reg. No. 3,474,807

Registered July 29, 2008

**SERVICE MARK
PRINCIPAL REGISTER**

firepipes

ATLAS GROUP, INC. (CONNECTICUT CORPORATION)
P.O. BOX 1200
KENNEBUNK, ME 04043

FOR: SERVICES ASSOCIATED WITH PROVIDING NETWORK SECURITY, NAMELY, MONITORING, CONTROLLING AND FILTERING COMPUTER AND ONLINE NETWORKS AGAINST ELECTRONIC SECURITY RISKS, IN CLASS 42 (U.S. CLS. 100 AND 101).

FIRST USE 4-15-2007; IN COMMERCE 4-15-2007.

THE MARK CONSISTS OF STANDARD CHARACTERS WITHOUT CLAIM TO ANY PARTICULAR FONT, STYLE, SIZE, OR COLOR.

SER. NO. 77-197,542, FILED 6-5-2007.

LINDA MICKLEBURGH, EXAMINING ATTORNEY

Int. Cl.: 26

Prior U.S. Cls.: 37, 39, 40, 42 and 50

Reg. No. 3,474,808

United States Patent and Trademark Office

Registered July 29, 2008

**TRADEMARK
PRINCIPAL REGISTER**

GODICHE

KUM KANG TRADING USA, INC. (CALIFORNIA CORPORATION), DBA BLACK & GOLD CORPORATION
6433 ALONDRA BLVD.
PARAMOUNT, CA 90723

FOR: HAIR EXTENSIONS, IN CLASS 26 (U.S. CLS. 37, 39, 40, 42 AND 50).

FIRST USE 10-18-2006; IN COMMERCE 10-18-2006.

THE MARK CONSISTS OF STANDARD CHARACTERS WITHOUT CLAIM TO ANY PARTICULAR FONT, STYLE, SIZE, OR COLOR.

"GODICHE" HAS NO MEANING IN A FOREIGN LANGUAGE.

SER. NO. 77-197,852, FILED 6-5-2007.

JUSTINE D. PARKER, EXAMINING ATTORNEY

Int. Cl.: 41

Prior U.S. Cls.: 100, 101 and 107

United States Patent and Trademark Office

Reg. No. 3,474,809

Registered July 29, 2008

**SERVICE MARK
PRINCIPAL REGISTER**

RESPOND WITH H.E.A.R.T.

THE CLEVELAND CLINIC FOUNDATION (OHIO
CORPORATION)
9500 EUCLID AVENUE
CLEVELAND, OH 44195

FOR: EDUCATIONAL SERVICES, NAMELY, A
TRAINING PROGRAM FOR HEALTH CARE PER-
SONNEL CONSISTING OF CLASSES AND SEMI-
NARS IN THE FIELD OF RESPONDING TO AND
RESOLVING PATIENT SERVICE COMPLAINTS,
AND DISTRIBUTION OF COURSE MATERIALS IN
CONNECTION THEREWITH, IN CLASS 41 (U.S.
CLS. 100, 101 AND 107).

FIRST USE 12-31-2003; IN COMMERCE 6-20-2004.

THE MARK CONSISTS OF STANDARD CHAR-
ACTERS WITHOUT CLAIM TO ANY PARTICULAR
FONT, STYLE, SIZE, OR COLOR.

SER. NO. 77-197,869, FILED 6-5-2007.

TRACY CROSS, EXAMINING ATTORNEY

Int. Cl.: 41

Prior U.S. Cls.: 100, 101 and 107

United States Patent and Trademark Office

Reg. No. 3,474,810

Registered July 29, 2008

**SERVICE MARK
PRINCIPAL REGISTER**

H.E.A.R.T.

THE CLEVELAND CLINIC FOUNDATION (OHIO
CORPORATION)
9500 EUCLID AVENUE
CLEVELAND, OH 44195

FOR: EDUCATIONAL SERVICES, NAMELY, A
TRAINING PROGRAM FOR HEALTH CARE PER-
SONNEL CONSISTING OF CLASSES AND SEMI-
NARS IN THE FIELD OF RESPONDING TO AND
RESOLVING PATIENT SERVICE COMPLAINTS
AND DISTRIBUTION OF COURSE MATERIALS IN
CONNECTION THEREWITH, IN CLASS 41 (U.S.
CLS. 100, 101 AND 107).

FIRST USE 12-31-2003; IN COMMERCE 6-30-2004.

THE MARK CONSISTS OF STANDARD CHAR-
ACTERS WITHOUT CLAIM TO ANY PARTICULAR
FONT, STYLE, SIZE, OR COLOR.

SER. NO. 77-197,898, FILED 6-5-2007.

TRACY CROSS, EXAMINING ATTORNEY

Int. Cl.: 30

Prior U.S. Cl.: 46

United States Patent and Trademark Office

Reg. No. 3,474,811

Registered July 29, 2008

**TRADEMARK
PRINCIPAL REGISTER**

SWEETBLISS

ILENE C. SHANE, INC. (NEW YORK CORPORATION)
252 SEVENTH AVENUE, SUITE 5I
NEW YORK, NY 10001

FOR: CHOCOLATE, CHOCOLATE CANDY, CHOCOLATE PASTRY, CHOCOLATE COVERED FOOD BARS, IN CLASS 30 (U.S. CL. 46).

FIRST USE 2-5-2002; IN COMMERCE 2-5-2002.

THE MARK CONSISTS OF STANDARD CHARACTERS WITHOUT CLAIM TO ANY PARTICULAR FONT, STYLE, SIZE, OR COLOR.

SER. NO. 77-198,011, FILED 6-5-2007.

ALICE BENMAMAN, EXAMINING ATTORNEY

Int. Cl.: 35

Prior U.S. Cls.: 100, 101 and 102

United States Patent and Trademark Office

Reg. No. 3,474,812

Registered July 29, 2008

SERVICE MARK
PRINCIPAL REGISTER

Audiencetester

THE FOURNAISE MARKETING GROUP PTE
LTD (SINGAPORE CORPORATION)
#03-01 LIPPO BUILDING
1 PHILLIP STREET
SINGAPORE, SINGAPORE 048692

FOR: MARKET ANALYSIS SERVICES; MARKET CAMPAIGNS, NAMELY, DEVELOPMENT OF ADVERTISING CAMPAIGNS FOR COMMUNICATION MEDIUM, NAMELY, TELEVISION, PRINT AND INTERNET; MARKETING STRATEGIES RESULTS ANALYSIS; MARKET STUDIES; BUSINESS MARKETING SERVICES, NAMELY, MARKETING CONSULTANCY, STRATEGIES, RESEARCH, PROGRAM/CAMPAIGN MANAGEMENT AND RESULTS ANALYSIS PROVIDED ONLINE VIA A COMPUTER DATABASE OR THE INTERNET; CONSULTANCY RELATING TO THE ORGANIZATION OF PROMOTIONAL CAMPAIGNS FOR BUSINESS; MARKET RESEARCH FOR ADVERTISING; ONLINE ADVERTISING ON A COMPUTER NETWORK; CONDUCTING OF MARKET AND BUSINESS RESEARCH; MARKET RESEARCH STUDIES; ANALYSIS OF MARKET RESEARCH DATA AND STATISTICS; COMPUTERIZED BUSINESS AND MARKET RESEARCH; ON-LINE DATA PROCESSING SERVICES; CONDUCTING OF PUBLIC OPINION POLLS; PROVIDING BUSINESS MARKETING INFORMATION, NAMELY, MARKET DYNAMICS INFORMATION USING STATISTICAL MODELS; COMMERCIAL INFORMATION SERVICES PROVIDED BY ACCESS TO A COMPU-

TER DATABASE OR ONLINE VIA THE INTERNET; MARKET RESEARCH BY MEANS OF A COMPUTER DATA BASE; PROVIDING BUSINESS INFORMATION, NAMELY, BUSINESS STATISTICAL DATA; BUSINESS MARKETING SERVICES, NAMELY, MARKETING SERVICES FOR BUYER LOYALTY MANAGEMENT, MARKETING SERVICES FOR CUSTOMER SERVICE MANAGEMENT, MARKETING SERVICES FOR PERMISSION MARKETING AND MOBILE MANAGEMENT; PROVIDING CONSUMER PRODUCT INFORMATION; INVESTIGATIONS OF MARKETING STRATEGY; AUTOMATED DATA PROCESSING; DATA PROCESSING SERVICES, NAMELY, PROCESSING DATA OBTAINED FROM MARKET RESEARCH STUDIES; COMPUTERIZED DATA-BASE MANAGEMENT; SYSTEMIZATION OF INFORMATION INTO COMPUTER DATABASES; MARKET RESEARCH SERVICES , IN CLASS 35 (U.S. CLS. 100, 101 AND 102).

OWNER OF SINGAPORE REG. NO. T06/20777I,
DATED 10-5-2006, EXPIRES 10-5-2016.

THE MARK CONSISTS OF STYLIZED TEXT OF
"AUDIENCETESTER".

SER. NO. 77-198,196, FILED 6-5-2007.

MARK SPARACINO, EXAMINING ATTORNEY

Int. Cl.: 35

Prior U.S. Cls.: 100, 101 and 102

United States Patent and Trademark Office

Reg. No. 3,474,813

Registered July 29, 2008

**SERVICE MARK
PRINCIPAL REGISTER**

FACTORY HOUSE

UNDER ARMOUR, INC. (MARYLAND CORPORATION)
1020 HULL STREET
BALTIMORE, MD 21230

THE MARK CONSISTS OF STANDARD CHARACTERS WITHOUT CLAIM TO ANY PARTICULAR FONT, STYLE, SIZE, OR COLOR.

FOR: RETAIL STORE SERVICES FEATURING APPAREL AND SPORTING GOODS, IN CLASS 35 (U.S. CLS. 100, 101 AND 102).

SER. NO. 77-198,295, FILED 6-5-2007.

FIRST USE 6-1-2005; IN COMMERCE 6-1-2005.

BILL DAWE, EXAMINING ATTORNEY

Int. Cls.: 21, 25 and 41

**Prior U.S. Cls.: 2, 13, 22, 23, 29, 30, 33, 39, 40, 50, 100,
101 and 107**

Reg. No. 3,474,814

United States Patent and Trademark Office

Registered July 29, 2008

**TRADEMARK
SERVICE MARK
PRINCIPAL REGISTER**

**WOMEN IN POKER MAKING
HISTORY**

OCEANS 11 CASINO (CALIFORNIA PARTNER-
SHIP)
121 BROOKS STREET
OCEANSIDE, CA 92054

FOR: MUGS, IN CLASS 21 (U.S. CLS. 2, 13, 23, 29,
30, 33, 40 AND 50).

FIRST USE 9-0-2006; IN COMMERCE 9-0-2006.

FOR: CLOTHING, NAMELY, SHIRTS AND CAPS,
IN CLASS 25 (U.S. CLS. 22 AND 39).

FIRST USE 9-0-2006; IN COMMERCE 9-0-2006.

FOR: ENTERTAINMENT SERVICES, NAMELY,
CONDUCTING GAMING EVENTS AND TOURNA-

MENTS FOR WOMEN, IN CLASS 41 (U.S. CLS. 100,
101 AND 107).

FIRST USE 9-0-2006; IN COMMERCE 9-0-2006.

THE MARK CONSISTS OF STANDARD CHAR-
ACTERS WITHOUT CLAIM TO ANY PARTICULAR
FONT, STYLE, SIZE, OR COLOR.

NO CLAIM IS MADE TO THE EXCLUSIVE
RIGHT TO USE "WOMEN" AND "POKER", APART
FROM THE MARK AS SHOWN.

SER. NO. 77-198,476, FILED 6-5-2007.

NAAKWAMA ANKRAH, EXAMINING ATTORNEY

Int. Cl.: 19

Prior U.S. Cls.: 1, 12, 33 and 50

United States Patent and Trademark Office

Reg. No. 3,474,815

Registered July 29, 2008

**TRADEMARK
PRINCIPAL REGISTER**

FOREST HIGHLANDS CLASSICS

PINNACLE INTERIOR ELEMENTS, LTD.
(TEXAS LIMITED PARTNERSHIP)

2525 TARPLEY ROAD, SUITE 112

CARROLLTON, TX 75006

FOR: HARDWOOD FLOORING, IN CLASS 19
(U.S. CLS. 1, 12, 33 AND 50).

FIRST USE 1-1-2006; IN COMMERCE 1-1-2006.

THE MARK CONSISTS OF STANDARD CHARACTERS WITHOUT CLAIM TO ANY PARTICULAR FONT, STYLE, SIZE, OR COLOR.

NO CLAIM IS MADE TO THE EXCLUSIVE RIGHT TO USE "CLASSICS", APART FROM THE MARK AS SHOWN.

SER. NO. 77-198,797, FILED 6-6-2007.

DAWN FELDMAN, EXAMINING ATTORNEY

Int. Cl.: 9

Prior U.S. Cls.: 21, 23, 26, 36 and 38

Reg. No. 3,474,816

United States Patent and Trademark Office

Registered July 29, 2008

**TRADEMARK
PRINCIPAL REGISTER**

CONNTEK

CONNTEK INTEGRATED SOLUTIONS, INC.
(WISCONSIN CORPORATION)
734 IMPERIAL DRIVE
RACINE, WI 53402

FOR: GENERAL ELECTRICAL POWER CORDS;
ELECTRICAL POWER CORDS FOR RANGES AND
DRYERS; EXTENSION CORDS; ADAPTERS; WIR-
ING DEVICES, NAMELY, ELECTRIC PLUGS AND
PLUG CONNECTORS; AND ELECTRICAL PRO-
DUCTS FOR MARINE, RV, TRAILER AND
TRUCKS, NAMELY, ELECTRICAL POWER CORDS

AND EXTENSION CORDS, IN CLASS 9 (U.S. CLS. 21,
23, 26, 36 AND 38).

FIRST USE 11-1-2005; IN COMMERCE 11-1-2005.

THE MARK CONSISTS OF STANDARD CHAR-
ACTERS WITHOUT CLAIM TO ANY PARTICULAR
FONT, STYLE, SIZE, OR COLOR.

SER. NO. 77-198,869, FILED 6-6-2007.

JENNY PARK, EXAMINING ATTORNEY

Int. Cl.: 7

Prior U.S. Cls.: 13, 19, 21, 23, 31, 34 and 35

United States Patent and Trademark Office

Reg. No. 3,474,817

Registered July 29, 2008

**TRADEMARK
PRINCIPAL REGISTER**

TERMINUS

TERMINUS TECHNOLOGIES, INC. (MISSOURI
CORPORATION)
11640 ADIE ROAD
ST. LOUIS, MO 63043

THE MARK CONSISTS OF STANDARD CHAR-
ACTERS WITHOUT CLAIM TO ANY PARTICULAR
FONT, STYLE, SIZE, OR COLOR.

FOR: POWER TOOLS, NAMELY, CUTTER-
HEADS, IN CLASS 7 (U.S. CLS. 13, 19, 21, 23, 31, 34
AND 35).

SER. NO. 77-198,917, FILED 6-6-2007.

FIRST USE 12-0-1991; IN COMMERCE 12-0-1991.

GINA HAYES, EXAMINING ATTORNEY

Int. Cl.: 15

Prior U.S. Cls.: 2, 21 and 36

United States Patent and Trademark Office

Reg. No. 3,474,818

Registered July 29, 2008

**TRADEMARK
PRINCIPAL REGISTER**

Atlanta Guitar Works

JOY, TIMOTHY D (GEORGIA SOLE PROPRIETORSHIP)
1530 HICKORY LANE
LILBURN, GA 30047

FOR: ACOUSTIC GUITARS; BASS GUITARS; ELECTRIC GUITARS; GUITAR PLAYING ASSISTANCE DEVICES, NAMELY, A SLIDING CLAMP-LIKE STRUCTURE POSITIONED ONTO THE GUITAR NECK TO FORM AND SOUND GUITAR CHORDS AND NOTES; GUITAR STRAPS; GUITARS, IN CLASS 15 (U.S. CLS. 2, 21 AND 36).

FIRST USE 6-1-2001; IN COMMERCE 6-1-2001.

THE MARK CONSISTS OF STANDARD CHARACTERS WITHOUT CLAIM TO ANY PARTICULAR FONT, STYLE, SIZE, OR COLOR.

NO CLAIM IS MADE TO THE EXCLUSIVE RIGHT TO USE "GUITAR", APART FROM THE MARK AS SHOWN.

SEC. 2(F).

SER. NO. 77-198,961, FILED 6-6-2007.

JOHN GARTNER, EXAMINING ATTORNEY

Int. Cl.: 25

Prior U.S. Cls.: 22 and 39

United States Patent and Trademark Office

Reg. No. 3,474,819

Registered July 29, 2008

**TRADEMARK
PRINCIPAL REGISTER**



OAK, KWI-SEON (UNITED STATES INDIVIDUAL)
921 W. COUNTRY VIEW
LA HABRA, CA 90631

THE MARK CONSISTS OF A SMALL BOAT INSIDE OF A SHADED SQUARE, WITH STYLIZED TEXT, NAMELY, "OCEAN SKY".

FOR: JACKETS; JEANS; PANTS; POLO SHIRTS; SHIRTS; SHORTS; SWEATERS; T-SHIRTS, IN CLASS 25 (U.S. CLS. 22 AND 39).

SER. NO. 77-199,013, FILED 6-6-2007.

FIRST USE 9-10-2005; IN COMMERCE 12-26-2006.

WANDA KAY PRICE, EXAMINING ATTORNEY

Int. Cl.: 36

Prior U.S. Cls.: 100, 101 and 102

United States Patent and Trademark Office

Reg. No. 3,474,820

Registered July 29, 2008

**SERVICE MARK
PRINCIPAL REGISTER**

**The Investment Company of
the World**

AMERICAN FUNDS DISTRIBUTORS, INC. (CALIFORNIA CORPORATION)
ATTN: MICHELE YANG, 55TH FLOOR
333 SOUTH HOPE STREET
LOS ANGELES, CA 90071

FOR: FINANCIAL SERVICES, NAMELY, FINANCIAL ANALYSIS, EVALUATION AND CONSULTATION; INVESTMENT MANAGEMENT AND ADVICE; MUTUAL FUND INVESTMENT MANAGEMENT AND DISTRIBUTION; ANNUITY SERVICES, NAMELY, INVESTMENT MANAGEMENT AND DISTRIBUTION OF VARIABLE ANNUITIES; FIDUCIARY SERVICES, NAMELY, SERVING AS TRUSTEE FOR DIRECTED AND DISCRETIONARY TRUST ACCOUNTS; ESTATE PLANNING; AND

ADMINISTRATION OF EMPLOYEE BENEFIT, PENSION AND RETIREMENT PLANS IN CONNECTION THEREWITH, IN CLASS 36 (U.S. CLS. 100, 101 AND 102).

FIRST USE 3-29-2001; IN COMMERCE 3-29-2001.

THE MARK CONSISTS OF STANDARD CHARACTERS WITHOUT CLAIM TO ANY PARTICULAR FONT, STYLE, SIZE, OR COLOR.

SER. NO. 77-199,050, FILED 6-6-2007.

CHERYL CLAYTON, EXAMINING ATTORNEY

Int. Cls.: 18, 25 and 35

Prior U.S. Cls.: 1, 2, 3, 22, 39, 41, 100, 101 and 102

Reg. No. 3,474,821

United States Patent and Trademark Office

Registered July 29, 2008

**TRADEMARK
SERVICE MARK
PRINCIPAL REGISTER**

**S T U A R T
W E I T Z M A N**

STUART WEITZMAN IP, LLC (DELAWARE LTD
LIAB CO)

#506

2400 EAST COMMERCIAL BOULEVARD

FT. LAUDERDALE, FL 33308

FOR: HANDBAGS, IN CLASS 18 (U.S. CLS. 1, 2, 3,
22 AND 41).

FIRST USE 3-0-1987; IN COMMERCE 3-0-1987.

FOR: SHOES, IN CLASS 25 (U.S. CLS. 22 AND 39).

FIRST USE 3-0-1987; IN COMMERCE 3-0-1987.

FOR: RETAIL STORE SERVICES FEATURING
SHOES, HANDBAGS AND POCKETBOOKS, IN
CLASS 35 (U.S. CLS. 100, 101 AND 102).

FIRST USE 6-0-1994; IN COMMERCE 6-0-1994.

THE NAME SHOWN IN THE MARK IDENTIFIES
"STUART WEITZMAN" WHOSE CONSENT IS OF
RECORD.

THE MARK CONSISTS OF THE NAME "STUART
WEITZMAN" IN LOGO FORMAT.

SER. NO. 77-199,400, FILED 6-6-2007.

B. PARADEWELAI, EXAMINING ATTORNEY

Int. Cls.: 6 and 7

**Prior U.S. Cls.: 2, 12, 13, 14, 19, 21, 23, 25, 31, 34, 35
and 50**

Reg. No. 3,474,822

United States Patent and Trademark Office

Registered July 29, 2008

**TRADEMARK
PRINCIPAL REGISTER**

LINEBOAR

ALTEX TECHNOLOGIES INC. (CANADA COR-
PORATION)
12001 149 STREET
EDMONTON, CANADA T5L2J2

FOR: PIPELINE METAL ISOLATION PLUGS;
PIPELINE FREEZING JACKETS PRIMARILY OF
METAL, IN CLASS 6 (U.S. CLS. 2, 12, 13, 14, 23, 25
AND 50).

FOR: INDUSTRIAL PIPELINE PIGS USED FOR
CLEANING AND CLEARING OBSTRUCTIONS IN
PIPELINES, IN CLASS 7 (U.S. CLS. 13, 19, 21, 23, 31, 34
AND 35).

THE MARK CONSISTS OF STANDARD CHAR-
ACTERS WITHOUT CLAIM TO ANY PARTICULAR
FONT, STYLE, SIZE, OR COLOR.

PRIORITY CLAIMED UNDER SEC. 44(D) ON
CANADA APPLICATION NO. 1327043, FILED 12-6-
2006, REG. NO. TMA700,671, DATED 11-13-2007,
EXPIRES 11-13-2022.

SER. NO. 77-199,581, FILED 6-6-2007.

WILLIAM VERHOSEK, EXAMINING ATTORNEY

Int. Cl.: 41

Prior U.S. Cls.: 100, 101 and 107

United States Patent and Trademark Office

Reg. No. 3,474,823

Registered July 29, 2008

**SERVICE MARK
PRINCIPAL REGISTER**

4CHOSEN

STARLINE PICTURES, L.L.C. (NEW JERSEY LTD
LIAB CO)
348 ROUTE 17 NORTH
UPPER SADDLE RIVER, NJ 07458

THE MARK CONSISTS OF STANDARD CHAR-
ACTERS WITHOUT CLAIM TO ANY PARTICULAR
FONT, STYLE, SIZE, OR COLOR.

FOR: PRODUCTION AND DISTRIBUTION OF
TELEVISION SHOWS AND MOVIES, IN CLASS 41
(U.S. CLS. 100, 101 AND 107).

SER. NO. 77-199,784, FILED 6-6-2007.

FIRST USE 0-0-2004; IN COMMERCE 0-0-2004.

PAM WILLIS, EXAMINING ATTORNEY

Int. Cl.: 35

Prior U.S. Cls.: 100, 101 and 102

United States Patent and Trademark Office

Reg. No. 3,474,824

Registered July 29, 2008

**SERVICE MARK
PRINCIPAL REGISTER**

A Gifted Solution

A GIFTED SOLUTION INC. (NEW YORK CORPORATION)
315 CENTRAL PARK WEST
NEW YORK, NY 10025

FOR: COMPUTERIZED ON-LINE GIFT ORDERING SERVICE WHICH MATCHES THE GIFT GIVER'S REQUIREMENTS WITH THE GIFT RECIPIENT'S WANTS AND NEEDS, IN CLASS 35 (U.S. CLS. 100, 101 AND 102).

FIRST USE 5-30-2000; IN COMMERCE 5-30-2000.

THE MARK CONSISTS OF STANDARD CHARACTERS WITHOUT CLAIM TO ANY PARTICULAR FONT, STYLE, SIZE, OR COLOR.

SER. NO. 77-199,851, FILED 6-6-2007.

MICHAEL WEBSTER, EXAMINING ATTORNEY

Int. Cl.: 39

Prior U.S. Cls.: 100 and 105

United States Patent and Trademark Office

Reg. No. 3,474,825

Registered July 29, 2008

**SERVICE MARK
PRINCIPAL REGISTER**



RAPID ENTERPRISES, INC. (NEVADA CORPORATION)
7910 SOUTH 3500 EAST
SALT LAKE CITY, UT 84121

FOR: EXPRESS DELIVERY OF DOCUMENTS AND GENERALLY SMALL GOODS, NOT INCLUDING GOODS THAT REQUIRE SPECIALIZED PACKAGING AND/OR ARE DIFFICULT TO PACKAGE, OR HIGHLY FRAGILE, BY MEANS OF AIR AND TRUCK; PACKAGING SUCH ARTICLES FOR OTHERS FOR TRANSPORTATION, IN CLASS 39 (U.S. CLS. 100 AND 105).

FIRST USE 7-31-2004; IN COMMERCE 7-31-2004.

NO CLAIM IS MADE TO THE EXCLUSIVE RIGHT TO USE "EXPRESS", APART FROM THE MARK AS SHOWN.

THE MARK CONSISTS OF THE TERM "EXPRESS" AND THE NUMERAL "1" SUPERIMPOSED ON A GRAPHICAL REPRESENTATION OF A GLOBE.

SER. NO. 77-200,024, FILED 6-7-2007.

CHERYL CLAYTON, EXAMINING ATTORNEY

Int. Cl.: 41

Prior U.S. Cls.: 100, 101 and 107

United States Patent and Trademark Office

Reg. No. 3,474,826

Registered July 29, 2008

**SERVICE MARK
PRINCIPAL REGISTER**

RESPECT RX

MACAVINTA, COURTNEY (UNITED STATES
INDIVIDUAL)
576 E. REED ST.
SAN JOSE, CA 95112

FOR: PROVIDING ONLINE JOURNALS, NAME-
LY, BLOGS FEATURING ADVICE ABOUT TEEN
ISSUES, NAMELY, BODY IMAGE, RELATION-
SHIPS, FRIENDSHIPS, SELF-RESPECT, ACTIVISM
AND SELF-ESTEEM AND EDUCATIONAL SERVI-
CES, NAMELY, CONDUCTING WORKSHOPS IN
THE FIELD OF SELF ESTEEM AND DISTRIBU-
TION OF COURSE MATERIAL IN CONNECTION

THEREWITH, IN CLASS 41 (U.S. CLS. 100, 101 AND
107).

FIRST USE 2-1-2006; IN COMMERCE 2-1-2006.

THE MARK CONSISTS OF STANDARD CHAR-
ACTERS WITHOUT CLAIM TO ANY PARTICULAR
FONT, STYLE, SIZE, OR COLOR.

SER. NO. 77-200,157, FILED 6-7-2007.

SCOTT BIBB, EXAMINING ATTORNEY

Int. Cl.: 28

Prior U.S. Cls.: 22, 23, 38 and 50

United States Patent and Trademark Office

Reg. No. 3,474,827

Registered July 29, 2008

**TRADEMARK
PRINCIPAL REGISTER**

EXO-CLAWS MAX

MATTEL, INC. (DELAWARE CORPORATION)
M1-1518
333 CONTINENTAL BLVD.
EL SEGUNDO, CA 90245

FOR: TOYS, GAMES AND PLAYTHINGS, NAME-
LY, TOY ACTION FIGURES, TOY FIGURES, AND
ACCESSORIES FOR ALL OF THE FOREGOING, IN
CLASS 28 (U.S. CLS. 22, 23, 38 AND 50).

FIRST USE 2-6-2008; IN COMMERCE 2-6-2008.

THE MARK CONSISTS OF STANDARD CHAR-
ACTERS WITHOUT CLAIM TO ANY PARTICULAR
FONT, STYLE, SIZE, OR COLOR.

SER. NO. 77-200,833, FILED 6-7-2007.

INGA ERVIN, EXAMINING ATTORNEY

Int. Cl.: 9

Prior U.S. Cls.: 21, 23, 26, 36 and 38

Reg. No. 3,474,828

United States Patent and Trademark Office

Registered July 29, 2008

**TRADEMARK
PRINCIPAL REGISTER**

Catch 'Em-Cam

MORETON BAY CORPORATION PTY LTD (AUSTRALIA LTD LIAB CO)
U32, CLEVELAND HOUSE, 120 BLOOMFIELD ST.
CLEVELAND, AUSTRALIA 4163

FOR: WIRED AND OR WIRELESS SECURITY CAMERA; WIRED AND OR WIRELESS SURVEILLANCE CAMERA; PORTABLE STANDALONE DIGITAL SECURITY CAMERA COMPRISING OF AN INBUILT IMAGE RECORDING FUNCTION, IN-FRA-RED SPOTLIGHT FOR NIGHT VISION, SOLAR PANEL AND RE-CHARGEABLE BATTERY, IN CLASS 9 (U.S. CLS. 21, 23, 26, 36 AND 38).

THE MARK CONSISTS OF STANDARD CHARACTERS WITHOUT CLAIM TO ANY PARTICULAR FONT, STYLE, SIZE, OR COLOR.

OWNER OF AUSTRALIA REG. NO. 1178653, DATED 5-29-2007, EXPIRES 5-29-2017.

NO CLAIM IS MADE TO THE EXCLUSIVE RIGHT TO USE "CAM", APART FROM THE MARK AS SHOWN.

SER. NO. 77-200,962, FILED 6-7-2007.

JOHN E. MICHOS, EXAMINING ATTORNEY

Int. Cls.: 6, 10 and 19

**Prior U.S. Cls.: 1, 2, 12, 13, 14, 23, 25, 26, 33, 39, 44
and 50**

Reg. No. 3,474,829

United States Patent and Trademark Office

Registered July 29, 2008

**TRADEMARK
PRINCIPAL REGISTER**

HYDROWORX

HYDROWORX INTERNATIONAL, INC. (PENNSYLVANIA CORPORATION)
SUITE C
1420 STONERIDGE DRIVE
MIDDLETOWN, PA 17057

FOR: METAL SWIMMING POOLS INCORPORATING TREADMILLS FOR EXERCISE USE, IN CLASS 6 (U.S. CLS. 2, 12, 13, 14, 23, 25 AND 50).

FIRST USE 5-15-1997; IN COMMERCE 5-15-1997.

FOR: THERAPY POOLS FOR PHYSICAL REHABILITATION, IN CLASS 10 (U.S. CLS. 26, 39 AND 44).

FIRST USE 5-15-1997; IN COMMERCE 5-15-1997.

FOR: NON-METAL SWIMMING POOLS INCORPORATION TREADMILLS FOR EXERCISE USE, IN CLASS 19 (U.S. CLS. 1, 12, 33 AND 50).

FIRST USE 5-15-1997; IN COMMERCE 5-15-1997.

THE MARK CONSISTS OF STANDARD CHARACTERS WITHOUT CLAIM TO ANY PARTICULAR FONT, STYLE, SIZE, OR COLOR.

SER. NO. 77-201,084, FILED 6-8-2007.

STEVEN PEREZ, EXAMINING ATTORNEY

Int. Cls.: 6, 10 and 19

**Prior U.S. Cls.: 1, 2, 12, 13, 14, 23, 25, 26, 33, 39, 44
and 50**

Reg. No. 3,474,830

United States Patent and Trademark Office

Registered July 29, 2008

**TRADEMARK
PRINCIPAL REGISTER**



HYDROWORX INTERNATIONAL, INC. (PENNSYLVANIA CORPORATION)
SUITE C
1420 STONERIDGE DRIVE
MIDDLETOWN, PA 17057

FOR: METAL SWIMMING POOLS INCORPORATING TREADMILLS FOR EXERCISE USE, IN CLASS 6 (U.S. CLS. 2, 12, 13, 14, 23, 25 AND 50).

FIRST USE 5-15-1997; IN COMMERCE 5-15-1997.

FOR: THERAPY POOLS FOR PHYSICAL REHABILITATION, IN CLASS 10 (U.S. CLS. 26, 39 AND 44).

FIRST USE 5-15-1997; IN COMMERCE 5-15-1997.

FOR: NON-METAL SWIMMING POOLS INCORPORATING TREADMILLS FOR EXERCISE USE, IN CLASS 19 (U.S. CLS. 1, 12, 33 AND 50).

FIRST USE 5-15-1997; IN COMMERCE 5-15-1997.

THE MARK CONSISTS OF A DESIGN COMPRISED OF NINE DIAMONDS AND THE WORD "HYDROWORX".

SER. NO. 77-201,091, FILED 6-8-2007.

STEVEN PEREZ, EXAMINING ATTORNEY

Int. Cl.: 19

Prior U.S. Cls.: 1, 12, 33 and 50

United States Patent and Trademark Office

Reg. No. 3,474,831

Registered July 29, 2008

**TRADEMARK
PRINCIPAL REGISTER**



COMPLETE FLOORING SUPPLY CORPORATION (GEORGIA CORPORATION)
3371 MARTIN FARM ROAD
SUWANEE, GA 30024

FOR: FLOORING AND LAMINATE FLOORING ACCESSORIES, NAMELY, QUARTER ROUND, STAIR NOSING, WALL BASE, T-MOLD, FLUSH REDUCER, THRESHOLD, AIR VENTS AND STAIR TREADS, ALL MADE OF WOOD, BAMBOO OR COMPOSITES CONTAINING WOOD, BAMBOO, FIBERS, OR LAMINATES, IN CLASS 19 (U.S. CLS. 1, 12, 33 AND 50).

FIRST USE 1-1-2005; IN COMMERCE 1-1-2005.

NO CLAIM IS MADE TO THE EXCLUSIVE RIGHT TO USE "WOOD", APART FROM THE MARK AS SHOWN.

THE MARK CONSISTS OF THE WORD "BRIDGEPORT", WITH THE WORD "WOOD", IN A DESIGN FONT, DIRECTLY BELOW AND TO THE RIGHT OF THE WORD "BRIDGEPORT" WITH AN ANIMAL DESIGN WEARING A CROWN TO THE RIGHT OF THE WORDS "BRIDGEPORT AND WOOD".

SER. NO. 77-201,179, FILED 6-8-2007.

TRACY CROSS, EXAMINING ATTORNEY

Int. Cl.: 19

Prior U.S. Cls.: 1, 12, 33 and 50

United States Patent and Trademark Office

Reg. No. 3,474,832

Registered July 29, 2008

**TRADEMARK
PRINCIPAL REGISTER**



COMPLETE FLOORING SUPPLY CORPORATION (GEORGIA CORPORATION)
3371 MARTIN FARM ROAD
SUWANEE, GA 30024

FOR: FLOORING AND LAMINATE FLOORING ACCESSORIES, NAMELY, QUARTER ROUND, STAIR NOSING, WALL BASE, T-MOLD, FLUSH REDUCER, THRESHOLD, AIR VENTS AND STAIR TREADS, ALL MADE OF WOOD, BAMBOO OR COMPOSITES CONTAINING WOOD, BAMBOO, FIBERS, OR LAMINATES, IN CLASS 19 (U.S. CLS. 1, 12, 33 AND 50).

FIRST USE 1-1-2005; IN COMMERCE 1-1-2005.

NO CLAIM IS MADE TO THE EXCLUSIVE RIGHT TO USE "TIMBER CLASSIC", APART FROM THE MARK AS SHOWN.

THE MARK CONSISTS OF THE WORDS "TIMBER CLASSIC" IN A DESIGN FONT, OVERLYING A DESIGN PATTERN.

SER. NO. 77-201,187, FILED 6-8-2007.

TRACY CROSS, EXAMINING ATTORNEY

Int. Cl.: 36

Prior U.S. Cls.: 100, 101 and 102

United States Patent and Trademark Office

Reg. No. 3,474,833

Registered July 29, 2008

SERVICE MARK
PRINCIPAL REGISTER



MINISTRY PARTNERS
INVESTMENT • CORPORATION

MINISTRY PARTNERS INVESTMENT CORPORATION (CALIFORNIA CORPORATION)
955 W. IMPERIAL HIGHWAY, SUITE 101
BREA, CA 92821

FOR: FINANCIAL SERVICES, NAMELY, PROVIDING FINANCIAL SERVICES IN ASSISTING OTHERS IN COMPLETING FINANCING TRANSACTIONS, PROVIDING LOAN ORIGINATION AND UNDERWRITING SERVICES; ENGAGING IN SALES OF LOANS AND LOAN PORTFOLIOS; PROVIDING INVESTMENT PRODUCTS, SECURITIES AND SERVICES THAT LINK MINISTRY MINDED INVESTORS WITH MINISTRY PROJECTS, IN CLASS 36 (U.S. CLS. 100, 101 AND 102).

FIRST USE 10-22-1991; IN COMMERCE 10-22-1991.

NO CLAIM IS MADE TO THE EXCLUSIVE RIGHT TO USE "INVESTMENT CORPORATION", APART FROM THE MARK AS SHOWN.

THE MARK CONSISTS OF A FLOWER WITH TWO LEAVES CENTERED INSIDE OF A PARTIALLY SHADED QUADRILATERAL AND POSITIONED ON TOP OF TWO LINES OF TEXT, THE FIRST LINE OF TEXT CONTAINING THE WORDS "MINISTRY PARTNERS" IN LARGE LETTERS AND THE SECOND LINE OF TEXT CONTAINING THE WORDS "INVESTMENT CORPORATION" IN SMALL LETTERS.

SEC. 2(F) AS TO "MINISTRY PARTNERS INVESTMENT CORPORATION".

SER. NO. 77-201,463, FILED 6-8-2007.

ANNE MADDEN, EXAMINING ATTORNEY

Int. Cl.: 17

Prior U.S. Cls.: 1, 5, 12, 13, 35 and 50

United States Patent and Trademark Office

Reg. No. 3,474,834

Registered July 29, 2008

**TRADEMARK
PRINCIPAL REGISTER**

PS-ABSOLVE

PACE INDUSTRIES, INC. (WISCONSIN CORPORATION)
1400 INDUSTRIAL STREET
REEDSBURG, WI 53959

THE MARK CONSISTS OF STANDARD CHARACTERS WITHOUT CLAIM TO ANY PARTICULAR FONT, STYLE, SIZE, OR COLOR.

FOR: PLASTIC MATERIAL IN EXTRUDED FORM FOR USE IN PRODUCTION, IN CLASS 17 (U.S. CLS. 1, 5, 12, 13, 35 AND 50).

SER. NO. 77-201,684, FILED 6-8-2007.

FIRST USE 8-1-2006; IN COMMERCE 8-1-2006.

DAYNA BROWNE, EXAMINING ATTORNEY

Int. Cl.: 17

Prior U.S. Cls.: 1, 5, 12, 13, 35 and 50

United States Patent and Trademark Office

Reg. No. 3,474,835

Registered July 29, 2008

**TRADEMARK
PRINCIPAL REGISTER**

COOL-HIPS

PACE INDUSTRIES, INC. (WISCONSIN CORPORATION)
1400 INDUSTRIAL STREET
REEDSBURG, WI 53959

THE MARK CONSISTS OF STANDARD CHARACTERS WITHOUT CLAIM TO ANY PARTICULAR FONT, STYLE, SIZE, OR COLOR.

FOR: PLASTIC MATERIAL IN EXTRUDED FORM FOR USE IN PRODUCTION, IN CLASS 17 (U.S. CLS. 1, 5, 12, 13, 35 AND 50).

SER. NO. 77-201,715, FILED 6-8-2007.

FIRST USE 6-1-2005; IN COMMERCE 6-1-2005.

DAYNA BROWNE, EXAMINING ATTORNEY

Int. Cl.: 34

Prior U.S. Cls.: 2, 8, 9 and 17

United States Patent and Trademark Office

Reg. No. 3,474,836

Registered July 29, 2008

TRADEMARK
PRINCIPAL REGISTER



PHILIP MORRIS USA INC. (VIRGINIA CORPORATION)
6601 WEST BROAD STREET
RICHMOND, VA 23230

FOR: TOBACCO, RAW OR MANUFACTURED, NAMELY, SNUS TOBACCO, IN CLASS 34 (U.S. CLS. 2, 8, 9 AND 17).

FIRST USE 8-6-2007; IN COMMERCE 8-6-2007.

OWNER OF U.S. REG. NOS. 68,502, 938,510 AND OTHERS.

NO CLAIM IS MADE TO THE EXCLUSIVE RIGHT TO USE "SNUS SPICE", APART FROM THE MARK AS SHOWN.

THE COLOR(S) ORANGE, DARK ORANGE, GRAY, WHITE AND METALLIC GOLD IS/ARE CLAIMED AS A FEATURE OF THE MARK.

THE MARK CONSISTS OF THE THREE DIMENSIONAL CONFIGURATION OF THE DISTINCTIVE PACKAGING FOR THE GOODS, WHICH IN-

CLUDES A GEOMETRIC DESIGN FEATURING TWO SQUARE WINDOWS PLACED VERTICALLY. THE LOWER SQUARE AND UPPER SQUARE FEATURE HORIZONTAL, DARK ORANGE STRIPES. THE LOWER AND UPPER SQUARES ARE DIVIDED DIAGONALLY. THE LEFT SIDE OF EACH SQUARE IS DARK ORANGE AND THE RIGHT SIDE OF EACH SQUARE IS ORANGE. THE DARK ORANGE HALVES OF EACH SQUARE MEET TO FORM A ROOF DESIGN. THE WORD "MARLBORO" APPEARS VERTICALLY ACROSS BOTH SQUARES. THE WORDS "SNUS" AND "SPICE" APPEAR VERTICALLY ACROSS THE TOP SQUARE. THE WORDS "MARLBORO" AND "SPICE" APPEAR IN WHITE. THE WORD "SNUS" APPEARS IN METALLIC GOLD. THE OUTER PORTIONS, INNER RAISED CONTOURS, INNER PORTIONS AND FLAT SURFACES OF THE CONFIGURATION OF THE PACKAGE APPEAR IN GRAY. APPLICANT CLAIMS THE DISTINCTIVE SHAPE OF THE PACKAGE AS A FEATURE OF THE MARK.

SER. NO. 77-201,781, FILED 6-8-2007.

MARK SPARACINO, EXAMINING ATTORNEY

Int. Cl.: 36

Prior U.S. Cls.: 100, 101 and 102

United States Patent and Trademark Office

Reg. No. 3,474,837

Registered July 29, 2008

**SERVICE MARK
PRINCIPAL REGISTER**

INSIGHT

INSIGHT DIRECT USA, INC. (ILLINOIS CORPORATION)
6820 SOUTH HARL AVENUE
TEMPE, AZ 85283

FOR: FINANCIAL SERVICES, NAMELY, FINANCING SERVICES RELATED TO COMPUTER HARDWARE, SOFTWARE, SERVER, NETWORKS, AND WORK STATIONS; UNDERWRITING WARRANTY PROGRAMS IN THE FIELD OF COMPUTER HARDWARE, SOFTWARE, SERVERS, NETWORKS, AND WORK STATIONS; WARRANTY CLAIMS ADMINISTRATION SERVICES, NAMELY, PROCESSING WARRANTY CLAIMS FOR COMPUTER HARDWARE, SOFTWARE, SERVERS, NETWORKS AND

WORK STATIONS, IN CLASS 36 (U.S. CLS. 100, 101 AND 102).

FIRST USE 3-0-1997; IN COMMERCE 3-0-1997.

THE MARK CONSISTS OF STANDARD CHARACTERS WITHOUT CLAIM TO ANY PARTICULAR FONT, STYLE, SIZE, OR COLOR.

OWNER OF U.S. REG. NO. 1,940,956.

SER. NO. 77-201,946, FILED 6-8-2007.

INGRID C. EULIN, EXAMINING ATTORNEY

Int. Cl.: 38

Prior U.S. Cls.: 100, 101 and 104

United States Patent and Trademark Office

Reg. No. 3,474,838

Registered July 29, 2008

**SERVICE MARK
PRINCIPAL REGISTER**

gTalk

GENUSYS INC. (TEXAS CORPORATION)
17106 PRESTON BEND DRIVE
DALLAS, TX 75248

THE MARK CONSISTS OF STANDARD CHAR-
ACTERS WITHOUT CLAIM TO ANY PARTICULAR
FONT, STYLE, SIZE, OR COLOR.

FOR: INTERNET TELEPHONY SERVICES, IN
CLASS 38 (U.S. CLS. 100, 101 AND 104).

SER. NO. 77-202,769, FILED 6-11-2007.

FIRST USE 1-1-2005; IN COMMERCE 1-1-2005.

BRENDAN MCCAULEY, EXAMINING ATTORNEY

Int. Cl.: 26

Prior U.S. Cls.: 37, 39, 40, 42 and 50

United States Patent and Trademark Office

Reg. No. 3,474,839

Registered July 29, 2008

TRADEMARK
PRINCIPAL REGISTER



IGWEMADU, NNEKA C (UNITED STATES INDIVIDUAL)
268 NELSON ST.
PROVIDENCE, RI 02908

FOR: ORIENTAL HAIR PINS; TOUPEES; WIGS, HAIRPIECES, AND ADD-IN AND ADD-ON HAIR ACCESSORIES CONSTRUCTED PRIMARILY OF SYNTHETIC AND/OR HUMAN HAIR; HAIR ACCESSORIES, NAMELY, TWISTERS; HAIR BOWS; HAIR BUCKLES; HAIR CHOPSTICKS; HAIR CLAMPS; HAIR CLIPS; HAIR EXTENSIONS; HAIR ORNAMENTS; HAIR ORNAMENTS IN THE FORM OF COMBS; HAIR PIECES; HAIR PINS; BARRETTES; CLAM CLIPS FOR HAIR; HAIR ACCESSORIES, NAMELY, CLAW CLIPS; HAIR ACCESSORIES, NAMELY, JAW CLIPS; HAIR ACCESSORIES, NAMELY, SNAP CLIPS, IN CLASS 26 (U.S. CLS. 37, 39, 40, 42 AND 50).

FIRST USE 4-2-2004; IN COMMERCE 10-1-2006.

NO CLAIM IS MADE TO THE EXCLUSIVE RIGHT TO USE "LACE", APART FROM THE MARK AS SHOWN.

THE COLOR(S) MAROON AND BROWN IS/ARE CLAIMED AS A FEATURE OF THE MARK.

THE MARK CONSISTS OF THE WORD ELITE AND VERTICAL LINE IN MAROON AND WORD LACE IN BROWN.

SER. NO. 77-202,783, FILED 6-11-2007.

KRISTIN DAHLING, EXAMINING ATTORNEY

Int. Cls.: 9 and 40

Prior U.S. Cls.: 21, 23, 26, 36, 38, 100, 103 and 106

United States Patent and Trademark Office

Reg. No. 3,474,840

Registered July 29, 2008

**TRADEMARK
SERVICE MARK
PRINCIPAL REGISTER**

media ① off

KEN COOK CO. (WISCONSIN CORPORATION)
9929 WEST SILVER SPRING DRIVE
MILWAUKEE, WI 53225

FOR: COMPUTER SOFTWARE FOR USE IN PROVIDING AUTOMATED LITERATURE FULFILLMENT AND PRODUCTION PROCESSES, NAMELY, SOFTWARE FOR AUTOMATING PRODUCTION EQUIPMENT FUNCTIONS SUCH AS PRINTERS AND DIGITAL MEDIA DUPLICATORS, IN CLASS 9 (U.S. CLS. 21, 23, 26, 36 AND 38).

FIRST USE 1-1-2005; IN COMMERCE 2-1-2005.

FOR: PRINTING SERVICES, NAMELY, AUTOMATED LITERATURE FULFILLMENT FOR OTHERS, IN CLASS 40 (U.S. CLS. 100, 103 AND 106).

FIRST USE 1-1-2005; IN COMMERCE 2-1-2005.

NO CLAIM IS MADE TO THE EXCLUSIVE RIGHT TO USE "MEDIA", APART FROM THE MARK AS SHOWN.

THE MARK CONSISTS OF THE STYLIZED WORD "MEDIA" FOLLOWED BY THE NUMBER "1" IN A CIRCLE FOLLOWED BY THE STYLIZED WORD "OFF".

SER. NO. 77-203,003, FILED 6-11-2007.

CORY BOONE, EXAMINING ATTORNEY

Int. Cl.: 12

Prior U.S. Cls.: 19, 21, 23, 31, 35 and 44

United States Patent and Trademark Office

Reg. No. 3,474,841

Registered July 29, 2008

**TRADEMARK
PRINCIPAL REGISTER**

CORVUS

GRATTAN, ALAN (CANADA INDIVIDUAL)
R.R. #2
BROCKVILLE, CANADA K6V5T2

FOR: A STORAGE AND/OR SECURITY BOX FOR
USE WITH SPORT UTILITY VEHICLES, VANS, OR
PICK-UP TRUCKS WHICH CAN BE CONVERTED
INTO A BED LINER OR FLOOR PROTECTOR, IN
CLASS 12 (U.S. CLS. 19, 21, 23, 31, 35 AND 44).

FIRST USE 6-0-2007; IN COMMERCE 6-0-2007.

THE MARK CONSISTS OF STANDARD CHAR-
ACTERS WITHOUT CLAIM TO ANY PARTICULAR
FONT, STYLE, SIZE, OR COLOR.

PRIORITY CLAIMED UNDER SEC. 44(D) ON
CANADA APPLICATION NO. 1330826, FILED 1-10-
2007, REG. NO. TMA702783, DATED 12-11-2007, EX-
PIRES 12-11-2022.

SER. NO. 77-203,008, FILED 6-11-2007.

CORY BOONE, EXAMINING ATTORNEY

Int. Cl.: 41

Prior U.S. Cls.: 100, 101 and 107

United States Patent and Trademark Office

Reg. No. 3,474,842

Registered July 29, 2008

**SERVICE MARK
PRINCIPAL REGISTER**



NORTH HARRIS MONTGOMERY COMMUNITY
COLLEGE DISTRICT (TEXAS CORPORATION)
5000 RESEARCH FOREST DRIVE
THE WOODLANDS, TX 77381

NO CLAIM IS MADE TO THE EXCLUSIVE
RIGHT TO USE "NORTH HARRIS MONTGOMERY
COMMUNITY COLLEGE DISTRICT", APART
FROM THE MARK AS SHOWN.

FOR: EDUCATION SERVICES IN THE NATURE
OF COURSES AT THE UNIVERSITY LEVEL, IN
CLASS 41 (U.S. CLS. 100, 101 AND 107).

SER. NO. 77-203,009, FILED 6-11-2007.

FIRST USE 10-0-1991; IN COMMERCE 10-0-1991.

LINDSEY RUBIN, EXAMINING ATTORNEY

Int. Cl.: 41

Prior U.S. Cls.: 100, 101 and 107

United States Patent and Trademark Office

Reg. No. 3,474,843

Registered July 29, 2008

**SERVICE MARK
PRINCIPAL REGISTER**



NORTH HARRIS MONTGOMERY COMMUNITY
COLLEGE DISTRICT (TEXAS CORPORATION)
5000 RESEARCH FOREST DRIVE
THE WOODLANDS, TX 77381

NO CLAIM IS MADE TO THE EXCLUSIVE
RIGHT TO USE "KINGWOOD COLLEGE", APART
FROM THE MARK AS SHOWN.

FOR: EDUCATION SERVICES IN THE NATURE
OF COURSES AT THE UNIVERSITY LEVEL, IN
CLASS 41 (U.S. CLS. 100, 101 AND 107).

SER. NO. 77-203,046, FILED 6-11-2007.

FIRST USE 10-0-1991; IN COMMERCE 10-0-1991.

LINDSEY RUBIN, EXAMINING ATTORNEY

Int. Cl.: 41

Prior U.S. Cls.: 100, 101 and 107

United States Patent and Trademark Office

Reg. No. 3,474,844

Registered July 29, 2008

**SERVICE MARK
PRINCIPAL REGISTER**

KINGWOOD COLLEGE

NORTH HARRIS MONTGOMERY COMMUNITY
COLLEGE DISTRICT (TEXAS CORPORATION)

5000 RESEARCH FOREST DRIVE

THE WOODLANDS, TX 77381

FOR: EDUCATION SERVICES IN THE NATURE
OF COURSES AT THE UNIVERSITY LEVEL, IN
CLASS 41 (U.S. CLS. 100, 101 AND 107).

FIRST USE 10-0-1991; IN COMMERCE 10-0-1991.

THE MARK CONSISTS OF STANDARD CHAR-
ACTERS WITHOUT CLAIM TO ANY PARTICULAR
FONT, STYLE, SIZE, OR COLOR.

NO CLAIM IS MADE TO THE EXCLUSIVE
RIGHT TO USE "COLLEGE", APART FROM THE
MARK AS SHOWN.

SEC. 2(F).

SER. NO. 77-203,054, FILED 6-11-2007.

LINDSEY RUBIN, EXAMINING ATTORNEY

Int. Cl.: 41

Prior U.S. Cls.: 100, 101 and 107

United States Patent and Trademark Office

Reg. No. 3,474,845

Registered July 29, 2008

**SERVICE MARK
PRINCIPAL REGISTER**

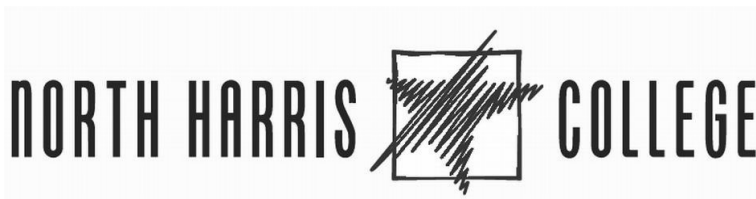

NORTH HARRIS MONTGOMERY COMMUNITY
COLLEGE DISTRICT (TEXAS CORPORATION)
5000 RESEARCH FOREST DRIVE
THE WOODLANDS, TX 77381

NO CLAIM IS MADE TO THE EXCLUSIVE
RIGHT TO USE "NORTH HARRIS COLLEGE",
APART FROM THE MARK AS SHOWN.

FOR: EDUCATION SERVICES IN THE NATURE
OF COURSES AT THE UNIVERSITY LEVEL, IN
CLASS 41 (U.S. CLS. 100, 101 AND 107).

SER. NO. 77-203,062, FILED 6-11-2007.

FIRST USE 10-0-1991; IN COMMERCE 10-0-1991.

LINDSEY RUBIN, EXAMINING ATTORNEY

Int. Cl.: 41

Prior U.S. Cls.: 100, 101 and 107

United States Patent and Trademark Office

Reg. No. 3,474,846

Registered July 29, 2008

**SERVICE MARK
PRINCIPAL REGISTER**

NORTH HARRIS COLLEGE

NORTH HARRIS MONTGOMERY COMMUNITY
COLLEGE DISTRICT (TEXAS CORPORATION)

5000 RESEARCH FOREST DRIVE

THE WOODLANDS, TX 77381

FOR: EDUCATION SERVICES IN THE NATURE
OF COURSES AT THE UNIVERSITY LEVEL, IN
CLASS 41 (U.S. CLS. 100, 101 AND 107).

FIRST USE 0-0-1973; IN COMMERCE 0-0-1973.

THE MARK CONSISTS OF STANDARD CHAR-
ACTERS WITHOUT CLAIM TO ANY PARTICULAR
FONT, STYLE, SIZE, OR COLOR.

NO CLAIM IS MADE TO THE EXCLUSIVE
RIGHT TO USE "COLLEGE", APART FROM THE
MARK AS SHOWN.

SEC. 2(F).

SER. NO. 77-203,070, FILED 6-11-2007.

LINDSEY RUBIN, EXAMINING ATTORNEY

Int. Cl.: 41

Prior U.S. Cls.: 100, 101 and 107

United States Patent and Trademark Office

Reg. No. 3,474,847

Registered July 29, 2008

**SERVICE MARK
PRINCIPAL REGISTER**

CY-FAIR COLLEGE

NORTH HARRIS MONTGOMERY COMMUNITY
COLLEGE DISTRICT (TEXAS CORPORATION)

5000 RESEARCH FOREST DRIVE

THE WOODLANDS, TX 77381

FOR: EDUCATION SERVICES IN THE NATURE
OF COURSES AT THE UNIVERSITY LEVEL, IN
CLASS 41 (U.S. CLS. 100, 101 AND 107).

FIRST USE 8-25-2003; IN COMMERCE 8-25-2003.

THE MARK CONSISTS OF STANDARD CHAR-
ACTERS WITHOUT CLAIM TO ANY PARTICULAR
FONT, STYLE, SIZE, OR COLOR.

NO CLAIM IS MADE TO THE EXCLUSIVE
RIGHT TO USE "COLLEGE", APART FROM THE
MARK AS SHOWN.

SEC. 2(F).

SER. NO. 77-203,081, FILED 6-11-2007.

LINDSEY RUBIN, EXAMINING ATTORNEY

Int. Cl.: 41

Prior U.S. Cls.: 100, 101 and 107

United States Patent and Trademark Office

Reg. No. 3,474,848

Registered July 29, 2008

**SERVICE MARK
PRINCIPAL REGISTER**



NORTH HARRIS MONTGOMERY COMMUNITY
COLLEGE DISTRICT (TEXAS CORPORA-
TION)
5000 RESEARCH FOREST DRIVE
THE WOODLANDS, TX 77381

NO CLAIM IS MADE TO THE EXCLUSIVE
RIGHT TO USE "CY-FAIR COLLEGE", APART
FROM THE MARK AS SHOWN.

FOR: EDUCATION SERVICES IN THE NATURE
OF COURSES AT THE UNIVERSITY LEVEL, IN
CLASS 41 (U.S. CLS. 100, 101 AND 107).

SER. NO. 77-203,090, FILED 6-11-2007.

FIRST USE 8-0-2005; IN COMMERCE 8-0-2005.

LINDSEY RUBIN, EXAMINING ATTORNEY

Int. Cl.: 41

Prior U.S. Cls.: 100, 101 and 107

United States Patent and Trademark Office

Reg. No. 3,474,849

Registered July 29, 2008

**SERVICE MARK
PRINCIPAL REGISTER**

MONTGOMERY COLLEGE

NORTH HARRIS MONTGOMERY COMMUNITY
COLLEGE DISTRICT (TEXAS CORPORATION)

5000 RESEARCH FOREST DRIVE
THE WOODLANDS, TX 77381

FOR: EDUCATION SERVICES IN THE NATURE
OF COURSES AT THE UNIVERSITY LEVEL, IN
CLASS 41 (U.S. CLS. 100, 101 AND 107).

FIRST USE 8-14-1995; IN COMMERCE 8-14-1995.

THE MARK CONSISTS OF STANDARD CHAR-
ACTERS WITHOUT CLAIM TO ANY PARTICULAR
FONT, STYLE, SIZE, OR COLOR.

NO CLAIM IS MADE TO THE EXCLUSIVE
RIGHT TO USE "COLLEGE", APART FROM THE
MARK AS SHOWN.

SEC. 2(F).

SER. NO. 77-203,110, FILED 6-11-2007.

LINDSEY RUBIN, EXAMINING ATTORNEY

Int. Cl.: 41

Prior U.S. Cls.: 100, 101 and 107

United States Patent and Trademark Office

Reg. No. 3,474,850

Registered July 29, 2008

**SERVICE MARK
PRINCIPAL REGISTER**



NORTH HARRIS MONTGOMERY COMMUNITY
COLLEGE DISTRICT (TEXAS CORPORATION)
5000 RESEARCH FOREST DRIVE
THE WOODLANDS, TX 77381

NO CLAIM IS MADE TO THE EXCLUSIVE
RIGHT TO USE "THE UNIVERSITY CENTER",
APART FROM THE MARK AS SHOWN.

FOR: EDUCATION SERVICES IN THE NATURE
OF COURSES AT THE UNIVERSITY LEVEL, IN
CLASS 41 (U.S. CLS. 100, 101 AND 107).

SER. NO. 77-203,133, FILED 6-11-2007.

FIRST USE 11-0-2005; IN COMMERCE 11-0-2005.

LINDSEY RUBIN, EXAMINING ATTORNEY

Int. Cl.: 41

Prior U.S. Cls.: 100, 101 and 107

United States Patent and Trademark Office

Reg. No. 3,474,851

Registered July 29, 2008

**SERVICE MARK
PRINCIPAL REGISTER**



NORTH HARRIS MONTGOMERY COMMUNITY
COLLEGE DISTRICT (TEXAS CORPORATION)
5000 RESEARCH FOREST DRIVE
THE WOODLANDS, TX 77381

NO CLAIM IS MADE TO THE EXCLUSIVE
RIGHT TO USE "DISTRICT SERVICES & TRAINING
CENTER", APART FROM THE MARK AS SHOWN.

FOR: EDUCATION SERVICES IN THE NATURE
OF COURSES AT THE UNIVERSITY LEVEL, IN
CLASS 41 (U.S. CLS. 100, 101 AND 107).

SER. NO. 77-203,158, FILED 6-11-2007.

FIRST USE 8-0-2004; IN COMMERCE 8-0-2004.

LINDSEY RUBIN, EXAMINING ATTORNEY

Int. Cl.: 16

Prior U.S. Cls.: 2, 5, 22, 23, 29, 37, 38 and 50

United States Patent and Trademark Office

Reg. No. 3,474,852

Registered July 29, 2008

**TRADEMARK
PRINCIPAL REGISTER**

HAVE A JESUS FILLED EASTER

CHAPMAN, ROY GENE (UNITED STATES INDIVIDUAL)
PO BOX 3146
PORTER, TX 77365 AND
CHAPMAN, ANN MAYS (UNITED STATES INDIVIDUAL)
PO BOX 3146
PORTER, TX 77365

FOR: DECALS, IRON-ON OR PLASTIC TRANSFERS, STICKERS, APPLIQUES IN THE FORM OF DECALS, PAPER LABELS, ADDRESS LABELS, APPOINTMENT BOOKS, BALL-POINT PENS, PENS, PENCILS, BOOKMARKS, BUMPER STICKERS, CALENDARS, WALL CALENDARS, CARDS, NAMELY, GREETING CARDS, NOTE CARDS, GIFT CARDS, AND MOTIVATIONAL CARDS, DAY PLANNERS, GIFT WRAPPING PAPER, POSTERS, PRAYER BOOKS, STATIONERY, ENVELOPES FOR STATIONERY USE, ADHESIVE NOTE PADS, BULLETINS FEATURING INFORMATION ABOUT CHRISTIAN RELIGION PRINTED PUBLICATIONS,

NAMELY, BROCHURES, BOOKLETS, AND TEACHING MATERIALS FEATURING INFORMATION ABOUT CHRISTIAN RELIGION, PRINTED PUBLICATIONS, NAMELY, BOOKS AND INSTRUCTIONAL MANUALS FEATURING INFORMATION ABOUT CHRISTIAN RELIGION, IN CLASS 16 (U.S. CLS. 2, 5, 22, 23, 29, 37, 38 AND 50).

FIRST USE 2-7-2005; IN COMMERCE 2-5-2006.

THE MARK CONSISTS OF STANDARD CHARACTERS WITHOUT CLAIM TO ANY PARTICULAR FONT, STYLE, SIZE, OR COLOR.

OWNER OF U.S. REG. NOS. 3,215,558, 3,237,857 AND OTHERS.

SER. NO. 77-203,204, FILED 6-11-2007.

ANGELA M. MICHELI, EXAMINING ATTORNEY

Int. Cl.: 35

Prior U.S. Cls.: 100, 101 and 102

United States Patent and Trademark Office

Reg. No. 3,474,853

Registered July 29, 2008

**SERVICE MARK
PRINCIPAL REGISTER**



UNITED HEALTH PROGRAMS OF AMERICA,
INC. (DELAWARE CORPORATION)
160 EILEEN WAY
SYOSSET, NY 11791

THE COLOR(S) DARK GREEN IS/ARE CLAIMED
AS A FEATURE OF THE MARK.

FOR: OPERATION AND ADMINISTRATION OF
PROGRAMS THAT ENABLE PARTICIPANTS TO
OBTAIN DISCOUNTS ON ACUPUNCTURE, MAS-
SAGE THERAPY, NUTRITION COUNSELING AND
NATUROPATHIC SERVICES FROM A NETWORK
OF PARTICIPATING PROVIDERS, IN CLASS 35
(U.S. CLS. 100, 101 AND 102).

THE MARK CONSISTS OF THE LETTERS "UHP"
RESTING ON THE HORIZONTAL STEM OF A
STYLIZED PLANT. THE STEM HAS THREE
LEAVES. THE WORDS "UNITED HOLISTIC PRO-
GRAMS" ARE BELOW THE STEM. THE MARK IS
GREEN ON A TRANSPARENT BACKGROUND.

FIRST USE 12-31-2004; IN COMMERCE 12-31-2004.

SER. NO. 77-203,652, FILED 6-12-2007.

NO CLAIM IS MADE TO THE EXCLUSIVE
RIGHT TO USE "HOLISTIC PROGRAMS", APART
FROM THE MARK AS SHOWN.

DAVID MILLER, EXAMINING ATTORNEY

Int. Cl.: 45

Prior U.S. Cls.: 100 and 101

United States Patent and Trademark Office

Reg. No. 3,474,854

Registered July 29, 2008

**SERVICE MARK
PRINCIPAL REGISTER**



RESIDENTIAL TITLE & ESCROW SERVICES,
P.C. (MASSACHUSETTS CORPORATION)
800 SOUTH MAIN STREET
MANSFIELD, MA 02048

FOR: LEGAL SERVICES IN THE FIELD OF TITLE
SEARCHES AND REAL ESTATE CLOSINGS, IN
CLASS 45 (U.S. CLS. 100 AND 101).

FIRST USE 7-0-2005; IN COMMERCE 7-0-2005.

OWNER OF U.S. REG. NO. 2,577,659.

THE MARK CONSISTS OF A STYLIZED HOUSE
COUPLED WITH THE LITERAL ELEMENT "RES/
TITLE".

SER. NO. 77-203,873, FILED 6-12-2007.

JIM RINGLE, EXAMINING ATTORNEY

Int. Cl.: 41

Prior U.S. Cls.: 100, 101 and 107

United States Patent and Trademark Office

Reg. No. 3,474,855

Registered July 29, 2008

**SERVICE MARK
PRINCIPAL REGISTER**

ONNETWORKS

ONNETWORKS, INC. (TEXAS CORPORATION)
504 LAVACA STREET
AUSTIN, TX 78701

THE MARK CONSISTS OF STANDARD CHAR-
ACTERS WITHOUT CLAIM TO ANY PARTICULAR
FONT, STYLE, SIZE, OR COLOR.

FOR: ENTERTAINMENT SERVICES, NAMELY,
PROVIDING A WEBSITE FEATURING ORIGINAL
FILMS AND VIDEO SERIES ON A VARIETY OF
TOPICS, IN CLASS 41 (U.S. CLS. 100, 101 AND 107).

SER. NO. 77-204,018, FILED 6-12-2007.

FIRST USE 3-14-2007; IN COMMERCE 3-14-2007.

STEPHANIE ALI, EXAMINING ATTORNEY

Int. Cl.: 12

Prior U.S. Cls.: 19, 21, 23, 31, 35 and 44

United States Patent and Trademark Office

Reg. No. 3,474,856

Registered July 29, 2008

**TRADEMARK
PRINCIPAL REGISTER**

DYNALIFTER

OHIO AIRSHIPS, INC. (OHIO CORPORATION)
11177 BOWEN RD.
MANTUA, OH 44255

THE MARK CONSISTS OF STANDARD CHAR-
ACTERS WITHOUT CLAIM TO ANY PARTICULAR
FONT, STYLE, SIZE, OR COLOR.

FOR: AIRSHIPS, IN CLASS 12 (U.S. CLS. 19, 21, 23,
31, 35 AND 44).

SER. NO. 77-204,158, FILED 6-12-2007.

FIRST USE 12-11-2004; IN COMMERCE 12-11-2004.

LINDA M. KING, EXAMINING ATTORNEY

Int. Cl.: 35

Prior U.S. Cls.: 100, 101 and 102

United States Patent and Trademark Office

Reg. No. 3,474,857

Registered July 29, 2008

**SERVICE MARK
PRINCIPAL REGISTER**



UNITED HEALTH PROGRAMS OF AMERICA,
INC. (DELAWARE CORPORATION)
160 EILEEN WAY
SYOSSET, NY 11791

FOR: OPERATION AND ADMINISTRATION OF
PROGRAMS THAT ENABLE PARTICIPANTS TO
OBTAIN DISCOUNTS ON EYE CARE SERVICES
FROM A NETWORK OF PARTICIPATING PROVI-
DERS, IN CLASS 35 (U.S. CLS. 100, 101 AND 102).

FIRST USE 7-19-2006; IN COMMERCE 7-19-2006.

NO CLAIM IS MADE TO THE EXCLUSIVE
RIGHT TO USE "VISION NETWORK", APART
FROM THE MARK AS SHOWN.

THE COLOR(S) DARK BLUE, LIGHT BLUE, AND
GRAY IS/ARE CLAIMED AS A FEATURE OF THE
MARK.

THE WORDING "QVN" AND "QUALITY VISION
NETWORK" ARE DARK BLUE. THE EYEGLOSS
LENSES ARE LIGHT BLUE. THE EYEGLOSS
FRAME IS GRAY. THE MARK APPEARS ON A
TRANSPARENT BACKGROUND, AND NO OTHER
COLOR IS CLAIMED AS A FEATURE OF THE
MARK.

SER. NO. 77-204,203, FILED 6-12-2007.

DAVID MILLER, EXAMINING ATTORNEY

Int. Cl.: 7

Prior U.S. Cls.: 13, 19, 21, 23, 31, 34 and 35

Reg. No. 3,474,858

United States Patent and Trademark Office

Registered July 29, 2008

**TRADEMARK
PRINCIPAL REGISTER**



SUPERIOR INDUSTRIES, LLC (MINNESOTA
LTD LIAB CO)
315 EAST STATE HWY 28
MORRIS, MN 56267

THE MARK CONSISTS OF THE WORD "SUPERIOR" IN WHITE LETTERS WITHIN A BLACK OVAL WITH AN ORANGE EDGE AROUND THE BLACK OVAL.

FOR: CONVEYORS, IN CLASS 7 (U.S. CLS. 13, 19,
21, 23, 31, 34 AND 35).

SEC. 2(F).

FIRST USE 3-22-2000; IN COMMERCE 3-22-2000.

SER. NO. 77-204,214, FILED 6-12-2007.

THE COLOR(S) BLACK, WHITE AND ORANGE
IS/ARE CLAIMED AS A FEATURE OF THE MARK.

JAMES A. RAUEN, EXAMINING ATTORNEY

Int. Cl.: 35

Prior U.S. Cls.: 100, 101 and 102

United States Patent and Trademark Office

Reg. No. 3,474,859

Registered July 29, 2008

**SERVICE MARK
PRINCIPAL REGISTER**

THE MEATRIX

GRACE (DELAWARE CORPORATION)
215 LEXINGTON AVENUE, SUITE 1001
NEW YORK, NY 10016

FOR: PROMOTING PUBLIC AWARENESS OF INDUSTRIAL FARMING AND ITS EFFECT ON HUMANS, ANIMALS, AND THE ENVIRONMENT THROUGH A SERIES OF ONLINE, NONDOWNLOADABLE ANIMATED MOTION PICTURES , IN CLASS 35 (U.S. CLS. 100, 101 AND 102).

FIRST USE 11-3-2003; IN COMMERCE 11-3-2003.

THE MARK CONSISTS OF STANDARD CHARACTERS WITHOUT CLAIM TO ANY PARTICULAR FONT, STYLE, SIZE, OR COLOR.

SER. NO. 77-204,223, FILED 6-12-2007.

ALICE BENMAMAN, EXAMINING ATTORNEY

Int. Cls.: 35 and 36

Prior U.S. Cls.: 100, 101 and 102

United States Patent and Trademark Office

Reg. No. 3,474,860

Registered July 29, 2008

**SERVICE MARK
PRINCIPAL REGISTER**



CASH AMERICA INC. OF NEVADA (NEVADA CORPORATION)

1600 W. 7TH STREET
FORT WORTH, TX 76102

FOR: RETAIL STORE SERVICES FEATURING JEWELRY, IN CLASS 35 (U.S. CLS. 100, 101 AND 102).

FIRST USE 10-26-2005; IN COMMERCE 10-26-2005.

FOR: PAWN SHOP SERVICES; FINANCIAL SERVICES, NAMELY, CHECK CASHING, MONEY LENDING SERVICES, LOAN BROKER SERVICES, MONEY ORDER SERVICES, ELECTRONIC FUNDS TRANSFER SERVICES, BILL PAYMENT SERVICES, IN CLASS 36 (U.S. CLS. 100, 101 AND 102).

FIRST USE 10-26-2005; IN COMMERCE 10-26-2005.

OWNER OF U.S. REG. NOS. 1,782,911 AND 2,230,522.

NO CLAIM IS MADE TO THE EXCLUSIVE RIGHT TO USE "PAWN", APART FROM THE MARK AS SHOWN.

THE MARK CONSISTS OF THE WORDS "CASH AMERICA" WITH INITIAL CAPS AND A STAR AS THE DOT FOR THE "I" IN "AMERICA." THE WORDS "CASH AMERICA" APPEAR ABOVE THE WORD "SUPER", WHICH IS IN ALL CAPITAL LETTERS. THE WORD "PAWN" IS ON THE RIGHT SIDE IN ALL CAPS AND IS THE SAME HEIGHT AS "CASH AMERICA" AND "SUPER" TOGETHER.

SER. NO. 77-204,530, FILED 6-12-2007.

TINA L. SNAPP, EXAMINING ATTORNEY

Int. Cl.: 16

Prior U.S. Cls.: 2, 5, 22, 23, 29, 37, 38 and 50

United States Patent and Trademark Office

Reg. No. 3,474,861

Registered July 29, 2008

**TRADEMARK
PRINCIPAL REGISTER**



MADJICAL, INC. (CALIFORNIA CORPORATION)
12056 SUNSHINE VALLEY ROAD
GRASS VALLEY, CA 95945

FOR: CLOTH CENTERPIECE WITH CONVERSATION AND CONTRIBUTION CARDS, IN CLASS 16 (U.S. CLS. 2, 5, 22, 23, 29, 37, 38 AND 50).

FIRST USE 3-8-2006; IN COMMERCE 4-23-2007.

THE COLOR(S) GOLD, YELLOW, BROWN AND WHITE IS/ARE CLAIMED AS A FEATURE OF THE MARK.

THE MARK CONSISTS OF STYLIZED FONT WITH THE LETTERS IN BROWN AND SHADOWED WITH WHITE WITH A GOLD AND YELLOW BACKGROUND.

SER. NO. 77-204,577, FILED 6-13-2007.

INGRID C. EULIN, EXAMINING ATTORNEY

Int. Cl.: 16

Prior U.S. Cls.: 2, 5, 22, 23, 29, 37, 38 and 50

United States Patent and Trademark Office

Reg. No. 3,474,862

Registered July 29, 2008

TRADEMARK
PRINCIPAL REGISTER



Memorable Mealtimes

MADJICAL, INC. (CALIFORNIA CORPORATION)
12056 SUNSHINE VALLEY ROAD
GRASS VALLEY, CA 95945

FOR: CLOTH CENTERPIECE WITH CONVERSATION AND CONTRIBUTION CARDS, IN CLASS 16 (U.S. CLS. 2, 5, 22, 23, 29, 37, 38 AND 50).

FIRST USE 3-8-2006; IN COMMERCE 4-23-2007.

THE COLOR(S) GREEN, BROWN, CREAM, WHITE IS/ARE CLAIMED AS A FEATURE OF THE MARK.

THE MARK CONSISTS OF "MEMORABLE MEALTIMES" WRITTEN IN BROWN ROUND "M" MARK HAS STYLIZED "M" IN WHITE OVER ANOTHER "M" IN CREAM WITH A BROWN OUTLINE WITH GREEN BACKGROUND SURROUNDED BY WHITE AND GREEN DESIGN SURROUNDED BY BROWN DESIGN.

SER. NO. 77-204,582, FILED 6-13-2007.

INGRID C. EULIN, EXAMINING ATTORNEY

Int. Cl.: 36

Prior U.S. Cls.: 100, 101 and 102

United States Patent and Trademark Office

Reg. No. 3,474,863

Registered July 29, 2008

**SERVICE MARK
PRINCIPAL REGISTER**

**"Your Eyes and Ears in the
Field"**

NATIONAL CREDITORS CONNECTION, INC.
(CALIFORNIA CORPORATION)
NATIONALCREDITORS.COM
14 ORCHARD ROAD
LAKE FOREST, CA 92630

THE MARK CONSISTS OF STANDARD CHAR-
ACTERS WITHOUT CLAIM TO ANY PARTICULAR
FONT, STYLE, SIZE, OR COLOR.

FOR: COLLECTION OF DEBTS, IN CLASS 36 (U.S.
CLS. 100, 101 AND 102).

SER. NO. 77-204,909, FILED 6-13-2007.

FIRST USE 1-31-1992; IN COMMERCE 1-31-1992.

STEVEN JACKSON, EXAMINING ATTORNEY

Int. Cl.: 19

Prior U.S. Cls.: 1, 12, 33 and 50

United States Patent and Trademark Office

Reg. No. 3,474,864

Registered July 29, 2008

**TRADEMARK
PRINCIPAL REGISTER**

DURABRACE

COX WOOD PRESERVING COMPANY (SOUTH
CAROLINA CORPORATION)
P.O. BOX 1124
ORANGEBURG, SC 29116

THE MARK CONSISTS OF STANDARD CHAR-
ACTERS WITHOUT CLAIM TO ANY PARTICULAR
FONT, STYLE, SIZE, OR COLOR.

FOR: NON-METAL UTILITY POLE BRACES, IN
CLASS 19 (U.S. CLS. 1, 12, 33 AND 50).

SER. NO. 77-205,034, FILED 6-13-2007.

FIRST USE 11-1-2006; IN COMMERCE 11-1-2006.

HEATHER THOMPSON, EXAMINING ATTORNEY

Int. Cls.: 25 and 41

Prior U.S. Cls.: 22, 39, 100, 101 and 107

United States Patent and Trademark Office

Reg. No. 3,474,865

Registered July 29, 2008

**TRADEMARK
SERVICE MARK
PRINCIPAL REGISTER**



METRO ATLANTIC ATHLETIC CONFERENCE
(NEW JERSEY NON-PROFIT CORPORATION)
712 AMBOY AVENUE
EDISON, NJ 08837

FOR: CLOTHING, NAMELY, SHIRTS, T-SHIRTS, SWEATSHIRTS, SWEATPANTS, PANTS, JACKETS, COATS, AND HEAD WEAR, IN CLASS 25 (U.S. CLS. 22 AND 39).

FIRST USE 7-1-1995; IN COMMERCE 7-1-1995.

FOR: EDUCATIONAL SERVICES, NAMELY, CONDUCTING CLASSES, WORKSHOPS AND SEMINARS FOR STUDENTS AT THE COLLEGE LEVEL REGARDING ATHLETICS, ACADEMICS AND LIFE SKILLS; ENTERTAINMENT SERVICES, NAMELY, CONDUCTING ATHLETIC GAMES AT THE COLLEGE LEVEL, SUCH AS BASEBALL, BAS-

KETBALL, CROSS COUNTRY, FOOTBALL, GOLF, SOFTBALL, SOCCER, TENNIS AND VOLLEYBALL, IN CLASS 41 (U.S. CLS. 100, 101 AND 107).

FIRST USE 7-1-1995; IN COMMERCE 7-1-1995.

THE MARK CONSISTS OF TWO CONCENTRIC CIRCLES WITH NAME OF ORGANIZATION IN THEM. "MAAC" IN CURVED DESIGN SUPERIMPOSED ON THE CIRCLES.

SEC. 2(F) AS TO "METRO ATLANTIC ATHLETIC CONFERENCE".

SER. NO. 77-205,037, FILED 6-13-2007.

HEATHER THOMPSON, EXAMINING ATTORNEY

Int. Cls.: 16, 21 and 28

Prior U.S. Cls.: 2, 5, 13, 22, 23, 29, 30, 33, 37, 38, 40
and 50

Reg. No. 3,474,866

United States Patent and Trademark Office

Registered July 29, 2008

TRADEMARK
PRINCIPAL REGISTER



FAIRKEEP PRODUCTS, LLC (ARKANSAS LTD
LIAB CO)
905 SE 21ST STEET
BENTONVILLE, AR 72712

FOR: METALLIC PAPER PARTY DECORA-
TIONS; PAPER PARTY BAGS; PAPER PARTY DEC-
ORATIONS; PAPER PARTY FAVORS; PAPER
PARTY HATS; PARTY GOODIE BAGS OF PAPER
OR PLASTIC; PARTY ORNAMENTS OF PAPER;
PAPER CAKE DECORATIONS, IN CLASS 16 (U.S.
CLS. 2, 5, 22, 23, 29, 37, 38 AND 50).

FIRST USE 1-8-2007; IN COMMERCE 1-8-2007.

FOR: CUPS; DRINKING CUPS; PAPER CUPS;
PLASTIC CUPS, IN CLASS 21 (U.S. CLS. 2, 13, 23, 29,
30, 33, 40 AND 50).

FIRST USE 1-8-2007; IN COMMERCE 1-8-2007.

FOR: BLOW-OUTS; PARTY FAVORS IN THE
NATURE OF CRACKERS AND NOISEMAKERS;
PARTY FAVORS IN THE NATURE OF SMALL
TOYS, IN CLASS 28 (U.S. CLS. 22, 23, 38 AND 50).

FIRST USE 1-8-2007; IN COMMERCE 1-8-2007.

NO CLAIM IS MADE TO THE EXCLUSIVE
RIGHT TO USE "PARTIES MADE EASY", APART
FROM THE MARK AS SHOWN.

THE MARK CONSISTS OF THE WORDS "PAR-
TIES MADE EZ" WITH THE LETTER "I" REPLACED
WITH A BIRTHDAY CANDLE, ALL OF WHICH IS
INSIDE OF A STAR.

SER. NO. 77-205,178, FILED 6-13-2007.

INGA ERVIN, EXAMINING ATTORNEY

Int. Cl.: 36

Prior U.S. Cls.: 100, 101 and 102

United States Patent and Trademark Office

Reg. No. 3,474,867

Registered July 29, 2008

**SERVICE MARK
PRINCIPAL REGISTER**

LEGACY PLANNER

ALLIANZ LIFE INSURANCE COMPANY OF
NORTH AMERICA (MINNESOTA CORPORATION)
P.O. BOX 1344
MINNEAPOLIS, MN 554161297

FOR: INSURANCE SERVICES, NAMELY, UNDERWRITING, ISSUING AND ADMINISTRATION OF LIFE INSURANCE, IN CLASS 36 (U.S. CLS. 100, 101 AND 102).

FIRST USE 6-11-2007; IN COMMERCE 6-11-2007.

THE MARK CONSISTS OF STANDARD CHARACTERS WITHOUT CLAIM TO ANY PARTICULAR FONT, STYLE, SIZE, OR COLOR.

SER. NO. 77-205,181, FILED 6-13-2007.

NAAKWAMA ANKRAH, EXAMINING ATTORNEY

Int. Cl.: 44

Prior U.S. Cls.: 100 and 101

United States Patent and Trademark Office

Reg. No. 3,474,868

Registered July 29, 2008

**SERVICE MARK
PRINCIPAL REGISTER**

ZIONS+MED

ZIONS BANCORPORATION, INC. (UTAH CORPORATION)
ZIONS BANK BUILDING
ONE SOUTH MAIN - 7TH FLOOR
SALT LAKE CITY, UT 84111

FOR: LEASING OF MEDICAL EQUIPMENT, IN CLASS 44 (U.S. CLS. 100 AND 101).

FIRST USE 9-15-2006; IN COMMERCE 9-15-2006.

THE MARK CONSISTS OF STANDARD CHARACTERS WITHOUT CLAIM TO ANY PARTICULAR FONT, STYLE, SIZE, OR COLOR.

SER. NO. 77-205,391, FILED 6-13-2007.

MICHAEL LEWIS, EXAMINING ATTORNEY

Int. Cl.: 37

Prior U.S. Cls.: 100, 103 and 106

United States Patent and Trademark Office

Reg. No. 3,474,869

Registered July 29, 2008

**SERVICE MARK
PRINCIPAL REGISTER**

REMODEL AMERICA LLC

REMODEL AMERICA LLC (CONNECTICUT LTD
LIAB CO)
207 SILVER BROOK LANE
TORRINGTON, CT 06790

FOR: REMODELING OF HOMES; CONSULTATION IN BUILDING CONSTRUCTION SUPERVISION; RESIDENTIAL AND BUILDING CONSTRUCTION CONSULTING; BUILDING CONSTRUCTION SERVICES; CONSTRUCTION AND RENOVATION OF BUILDINGS; CONSTRUCTION AND REPAIR OF BUILDINGS, IN CLASS 37 (U.S. CLS. 100, 103 AND 106).

FIRST USE 2-15-2003; IN COMMERCE 2-15-2003.

THE MARK CONSISTS OF STANDARD CHARACTERS WITHOUT CLAIM TO ANY PARTICULAR FONT, STYLE, SIZE, OR COLOR.

NO CLAIM IS MADE TO THE EXCLUSIVE RIGHT TO USE "REMODEL" AND "LLC", APART FROM THE MARK AS SHOWN.

SEC. 2(F).

SER. NO. 77-205,431, FILED 6-13-2007.

JEAN IM, EXAMINING ATTORNEY

Int. Cl.: 42

Prior U.S. Cls.: 100 and 101

United States Patent and Trademark Office

Reg. No. 3,474,870

Registered July 29, 2008

**SERVICE MARK
PRINCIPAL REGISTER**

ZIONS+MED

ZIONS BANCORPORATION, INC. (UTAH CORPORATION)
ZION BANK BUILDING
ONE SOUTH MAIN - 7TH FLOOR
SALT LAKE CITY, UT 84111

THE MARK CONSISTS OF STANDARD CHARACTERS WITHOUT CLAIM TO ANY PARTICULAR FONT, STYLE, SIZE, OR COLOR.

FOR: LEASING OF COMPUTERS, IN CLASS 42 (U.S. CLS. 100 AND 101).

SER. NO. 77-205,482, FILED 6-13-2007.

FIRST USE 9-15-2006; IN COMMERCE 9-15-2006.

MICHAEL LEWIS, EXAMINING ATTORNEY

Int. Cl.: 41

Prior U.S. Cls.: 100, 101 and 107

United States Patent and Trademark Office

Reg. No. 3,474,871

Registered July 29, 2008

**SERVICE MARK
PRINCIPAL REGISTER**

GANA CON LANITA

TELEMUNDO OF LOS ANGELES, INC. (DELA-
WARE CORPORATION)
SUITE 1357-C
3000 W. ALAMEDA AVENUE
BURBANK, CA 91523

FOR: ENTERTAINMENT SERVICES, NAMELY,
CONDUCTING CONTESTS, IN CLASS 41 (U.S. CLS.
100, 101 AND 107).

FIRST USE 8-17-2006; IN COMMERCE 8-17-2006.

THE MARK CONSISTS OF STANDARD CHAR-
ACTERS WITHOUT CLAIM TO ANY PARTICULAR
FONT, STYLE, SIZE, OR COLOR.

THE FOREIGN WORDING IN THE MARK
TRANSLATES INTO ENGLISH AS WIN WITH LA-
NITA.

SER. NO. 77-205,946, FILED 6-14-2007.

HOWARD SMIGA, EXAMINING ATTORNEY

Int. Cl.: 35

Prior U.S. Cls.: 100, 101 and 102

United States Patent and Trademark Office

Reg. No. 3,474,872

Registered July 29, 2008

**SERVICE MARK
PRINCIPAL REGISTER**

**REPUBLIC NATIONAL
DISTRIBUTING COMPANY**

REPUBLIC NATIONAL DISTRIBUTING COMPAN-
NY, L.L.C. (DELAWARE LTD LIAB CO)
809 JEFFERSON HIGHWAY
NEW ORLEANS, LA 70121

FOR: WHOLESALE DISTRIBUTORSHIP SERVI-
CES FEATURING ALCOHOLIC AND NON-ALCO-
HOLIC BEVERAGES, IN CLASS 35 (U.S. CLS. 100, 101
AND 102).

FIRST USE 5-1-2007; IN COMMERCE 5-1-2007.

THE MARK CONSISTS OF STANDARD CHAR-
ACTERS WITHOUT CLAIM TO ANY PARTICULAR
FONT, STYLE, SIZE, OR COLOR.

NO CLAIM IS MADE TO THE EXCLUSIVE
RIGHT TO USE "NATIONAL DISTRIBUTING COM-
PANY", APART FROM THE MARK AS SHOWN.

SER. NO. 77-205,989, FILED 6-14-2007.

ALYSSA PALADINO, EXAMINING ATTORNEY

Int. Cl.: 39

Prior U.S. Cls.: 100 and 105

United States Patent and Trademark Office

Reg. No. 3,474,873

Registered July 29, 2008

**SERVICE MARK
PRINCIPAL REGISTER**

**REPUBLIC NATIONAL
DISTRIBUTING COMPANY**

REPUBLIC NATIONAL DISTRIBUTING COMPAN-
NY, L.L.C. (DELAWARE LTD LIAB CO)
809 JEFFERSON HIGHWAY
NEW ORLEANS, LA 70121

FOR: PROVIDING WAREHOUSING AND
TRANSPORT SERVICES BY TRUCK, VANS, MO-
TOR VEHICLES, AUTOMOBILES, AIR, RAIL,
FREIGHT, SHIPS, AND THE LIKE, FOR ALCOHOL-
IC AND NON-ALCOHOLIC BEVERAGES, IN CLASS
39 (U.S. CLS. 100 AND 105).

FIRST USE 5-1-2007; IN COMMERCE 5-1-2007.

THE MARK CONSISTS OF STANDARD CHAR-
ACTERS WITHOUT CLAIM TO ANY PARTICULAR
FONT, STYLE, SIZE, OR COLOR.

NO CLAIM IS MADE TO THE EXCLUSIVE
RIGHT TO USE "NATIONAL DISTRIBUTING COM-
PANY", APART FROM THE MARK AS SHOWN.

SER. NO. 77-206,033, FILED 6-14-2007.

ALYSSA PALADINO, EXAMINING ATTORNEY

Int. Cl.: 35

Prior U.S. Cls.: 100, 101 and 102

United States Patent and Trademark Office

Reg. No. 3,474,874

Registered July 29, 2008

**SERVICE MARK
PRINCIPAL REGISTER**

"Real-World" Trainers

FUTURE TEK, INC. (MISSISSIPPI CORPORATION)
663 S. FRONTAGE RD
COLUMBUS, MS 39701

THE MARK CONSISTS OF STANDARD CHARACTERS WITHOUT CLAIM TO ANY PARTICULAR FONT, STYLE, SIZE, OR COLOR.

FOR: MANUFACTURER REPRESENTATIVES IN THE FIELD OF EDUCATIONAL TRAINING EQUIPMENT FOR TECHNICAL PROGRAMS, IN CLASS 35 (U.S. CLS. 100, 101 AND 102).

SER. NO. 77-206,130, FILED 6-14-2007.

FIRST USE 2-10-1997; IN COMMERCE 2-10-1998.

BARBARA BROWN, EXAMINING ATTORNEY

Int. Cls.: 35 and 41

Prior U.S. Cls.: 100, 101, 102 and 107

United States Patent and Trademark Office

Reg. No. 3,474,875

Registered July 29, 2008

**SERVICE MARK
PRINCIPAL REGISTER**

Got Screened?

GOT SCREENED WORLDWIDE (NEW JERSEY
LTD LIAB CO)
24 CENTRAL AVENUE
FLEMINGTON, NJ 08822

FOR: DISSEMINATION OF ADVERTISING FOR
OTHERS, NAMELY, PHARMACEUTICAL COMPANIES,
HEALTH CARE PROVIDERS, AND PROVIDERS OF
MEDICAL SCREENING SERVICES, IN CLASS 35
(U.S. CLS. 100, 101 AND 102).

FIRST USE 3-1-2007; IN COMMERCE 3-1-2007.

FOR: EDUCATIONAL SERVICES, NAMELY,
PROVIDING INFORMAL PROGRAMS IN THE
FIELD OF DISEASE PREVENTION AND MEDICAL

SCREENING, USING ON-LINE ACTIVITIES AND
INTERACTIVE EXHIBITS, NAMELY, JOURNAL
ARTICLES, EXPERT INTERVIEWS, NON-DOWN-
LOADABLE SCIENTIFIC DATA, IN CLASS 41 (U.S.
CLS. 100, 101 AND 107).

FIRST USE 3-1-2007; IN COMMERCE 3-1-2007.

THE MARK CONSISTS OF STANDARD CHAR-
ACTERS WITHOUT CLAIM TO ANY PARTICULAR
FONT, STYLE, SIZE, OR COLOR.

SER. NO. 77-206,170, FILED 6-14-2007.

ANGELA GAW, EXAMINING ATTORNEY

Int. Cl.: 35

Prior U.S. Cls.: 100, 101 and 102

United States Patent and Trademark Office

Reg. No. 3,474,876

Registered July 29, 2008

**SERVICE MARK
PRINCIPAL REGISTER**



**REPUBLIC
NATIONAL
DISTRIBUTING COMPANY**

REPUBLIC NATIONAL DISTRIBUTING COMPAN-
NY, L.L.C. (DELAWARE LTD LIAB CO)
809 JEFFERSON HIGHWAY
NEW ORLEANS, LA 70121

FOR: WHOLESALE DISTRIBUTORSHIP SERVI-
CES FEATURING ALCOHOL AND NON-ALCO-
HOLIC BEVERAGES, IN CLASS 35 (U.S. CLS. 100,
101 AND 102).

FIRST USE 5-1-2007; IN COMMERCE 5-1-2007.

NO CLAIM IS MADE TO THE EXCLUSIVE
RIGHT TO USE "NATIONAL DISTRIBUTING COM-
PANY", APART FROM THE MARK AS SHOWN.

THE MARK CONSISTS OF THE WORDS "RE-
PUBLIC NATIONAL DISTRIBUTING COMPANY"
BELOW A DIVIDED RECTANGLE CONTAINING A
RING IN THE LEFT HALF OF THE RECTANGLE
AND A STYLIZED STAR INSIDE A CIRCLE IN THE
RIGHT HALF OF THE RECTANGLE.

SER. NO. 77-206,187, FILED 6-14-2007.

ALYSSA PALADINO, EXAMINING ATTORNEY

Int. Cl.: 42

Prior U.S. Cls.: 100 and 101

United States Patent and Trademark Office

Reg. No. 3,474,877

Registered July 29, 2008

**SERVICE MARK
PRINCIPAL REGISTER**

DXR

FISERV SOLUTIONS, INC. (WISCONSIN CORPORATION)
255 FISERV DRIVE
BROOKFIELD, WI 53045

FOR: DOCUMENT DATA TRANSFER AND PHYSICAL CONVERSION FROM ONE MEDIA TO ANOTHER MEDIA, IN CLASS 42 (U.S. CLS. 100 AND 101).

FIRST USE 9-1-1995; IN COMMERCE 9-1-1995.

THE MARK CONSISTS OF STANDARD CHARACTERS WITHOUT CLAIM TO ANY PARTICULAR FONT, STYLE, SIZE, OR COLOR.

SER. NO. 77-206,210, FILED 6-14-2007.

SAMUEL E. SHARPER JR., EXAMINING ATTORNEY

Int. Cl.: 35

Prior U.S. Cls.: 100, 101 and 102

United States Patent and Trademark Office

Reg. No. 3,474,878

Registered July 29, 2008

**SERVICE MARK
PRINCIPAL REGISTER**

MOUNT OLYMPUS AWARDS

MOUNT OLYMPUS AWARDS, LLC (MISSOURI
LTD LIAB CO)
SUITE 203
2700 NORTH BELT HIGHWAY
ST. JOSEPH, MO 64506

FOR: WHOLESALE AND RETAIL STORE SERVICES AVAILABLE ON LINE, BY FACSIMILE, TELEPHONE AND CATALOG FEATURING CHENILLE PRODUCTS, NAMELY, BANNERS, BARS AND INSERTS, BLANKETS, CHEERLEADING ITEMS, CHEVRONS, EMBLEMS, LETTER JACKETS, LETTER SWEATERS, LETTERS, AWARDS, NAMES, NUMBERS, PATCHES AND TACKLE TWILL, CORPORATE AND CASUAL APPAREL, CAPS AND BAGS, BABY ITEMS AND APPAREL AND CORPO-

RATE GIFTS, IN CLASS 35 (U.S. CLS. 100, 101 AND 102).

FIRST USE 7-1-2005; IN COMMERCE 10-1-2005.

THE MARK CONSISTS OF STANDARD CHARACTERS WITHOUT CLAIM TO ANY PARTICULAR FONT, STYLE, SIZE, OR COLOR.

NO CLAIM IS MADE TO THE EXCLUSIVE RIGHT TO USE "AWARDS" , APART FROM THE MARK AS SHOWN.

SER. NO. 77-206,217, FILED 6-14-2007.

MARK PILARO, EXAMINING ATTORNEY

Int. Cl.: 39

Prior U.S. Cls.: 100 and 105

United States Patent and Trademark Office

Reg. No. 3,474,879

Registered July 29, 2008

**SERVICE MARK
PRINCIPAL REGISTER**



REPUBLIC
NATIONAL
DISTRIBUTING COMPANY

REPUBLIC NATIONAL DISTRIBUTING COMPAN-
NY, L.L.C. (DELAWARE LTD LIAB CO)
809 JEFFERSON HIGHWAY
NEW ORLEANS, LA 70121

FOR: PROVIDING WAREHOUSING AND
TRANSPORT SERVICES BY TRUCK, VANS, MO-
TOR VEHICLES, AUTOMOBILES, AIR, RAIL,
FREIGHT, SHIPS, AND THE LIKE, FOR ALCOHOL-
IC AND NON-ALCOHOLIC BEVERAGES, IN CLASS
39 (U.S. CLS. 100 AND 105).

FIRST USE 5-1-2007; IN COMMERCE 5-1-2007.

NO CLAIM IS MADE TO THE EXCLUSIVE
RIGHT TO USE "NATIONAL DISTRIBUTING COM-
PANY", APART FROM THE MARK AS SHOWN.

THE MARK CONSISTS OF THE WORDS "RE-
PUBLIC NATIONAL DISTRIBUTING COMPANY"
BELOW A DIVIDED RECTANGLE CONTAINING A
RING IN THE LEFT HALF OF THE RECTANGLE
AND A STYLIZED STAR INSIDE A CIRCLE IN THE
RIGHT HALF OF THE RECTANGLE.

SER. NO. 77-206,228, FILED 6-14-2007.

ALYSSA PALADINO, EXAMINING ATTORNEY

Int. Cls.: 10 and 44

Prior U.S. Cls.: 26, 39, 44, 100 and 101

United States Patent and Trademark Office

Reg. No. 3,474,880

Registered July 29, 2008

TRADEMARK
SERVICE MARK
PRINCIPAL REGISTER



HEALING ENERGY, LLC (KANSAS LTD LIAB
CO)
15240 BROADMOOR
OVERLAND PARK, KS 66223

FOR: MASSAGE APPARATUS; MASSAGE TA-
BLES; MASSAGE APPARATUS FOR PERSONAL
USE, IN CLASS 10 (U.S. CLS. 26, 39 AND 44).

FIRST USE 9-17-2006; IN COMMERCE 9-23-2006.

FOR: PROVIDING RELAXATION SERVICES,
NAMELY, PROVIDING MASSAGE SESSIONS AND
SHIATSU MASSAGE, IN CLASS 44 (U.S. CLS. 100
AND 101).

FIRST USE 9-17-2006; IN COMMERCE 9-23-2006.

THE MARK CONSISTS OF A LINE DRAWING
DEPICTING A STICK FIGURE HUMAN RELAXING
IN A HAMMOCK STRUNG BETWEEN TWO PALM
TREES WITH WATER LAPPING BENEATH. THE
DRAWING IS FRAMED BY THE PHRASE "LIKE A
DAY" ABOVE IT AND "AT THE BEACH" BELOW IT.

SER. NO. 77-206,341, FILED 6-14-2007.

KIMBERLY PERRY, EXAMINING ATTORNEY

Int. Cl.: 19

Prior U.S. Cls.: 1, 12, 33 and 50

United States Patent and Trademark Office

Reg. No. 3,474,881

Registered July 29, 2008

**TRADEMARK
PRINCIPAL REGISTER**

TREWRENUÉ

PEERY BROS LUMBER CO., INC. (CALIFORNIA CORPORATION)
140 NORTH WILLOW AVENUE
CITY OF INDUSTRY, CA 91746

FOR: BUILDING MATERIALS, NAMELY, ENVIRONMENTALLY CERTIFIED LUMBER, WOOD, BOARDS, PLYWOOD, AND WOOD PRODUCTS, NAMELY, WOOD PANELS, WOOD BOARDS, WOOD BEAMS, WOOD TRUSSES, WOOD PLANKS, WOOD TRIMS, AND WOOD JOISTS, TREATED WITH PRESERVATIVE OR FIRE RETARDANT, IN CLASS 19 (U.S. CLS. 1, 12, 33 AND 50).

FIRST USE 5-23-2007; IN COMMERCE 5-23-2007.

THE MARK CONSISTS OF STANDARD CHARACTERS WITHOUT CLAIM TO ANY PARTICULAR FONT, STYLE, SIZE, OR COLOR.

THE WORDING "TREWRENUÉ" HAS NO MEANING IN A FOREIGN LANGUAGE.

SER. NO. 77-206,392, FILED 6-14-2007.

SIMON TENG, EXAMINING ATTORNEY

Int. Cl.: 42

Prior U.S. Cls.: 100 and 101

United States Patent and Trademark Office

Reg. No. 3,474,882

Registered July 29, 2008

**SERVICE MARK
PRINCIPAL REGISTER**

PowerMap

BATTERYCORP, INC. (DELAWARE CORPORATION)
44 OAK STREET
NEWTON, MA 02464

FOR: REMOTE MONITORING OF INDUSTRIAL BATTERY SYSTEMS BY RETRIEVING BATTERY PLANT DATA FROM REMOTE LOCATIONS, IN CLASS 42 (U.S. CLS. 100 AND 101).

FIRST USE 5-31-2007; IN COMMERCE 5-31-2007.

THE MARK CONSISTS OF STANDARD CHARACTERS WITHOUT CLAIM TO ANY PARTICULAR FONT, STYLE, SIZE, OR COLOR.

OWNER OF U.S. REG. NO. 3,076,015.

THE WORDING "POWERMAP" HAS NO MEANING IN A FOREIGN LANGUAGE.

SER. NO. 77-206,453, FILED 6-14-2007.

EVELYN BRADLEY, EXAMINING ATTORNEY

Int. Cls.: 35 and 41

Prior U.S. Cls.: 100, 101, 102 and 107

United States Patent and Trademark Office

Reg. No. 3,474,883

Registered July 29, 2008

**SERVICE MARK
PRINCIPAL REGISTER**

AlphaBioCom

ALPHABIOCOM, LLC (PENNSYLVANIA LTD
LIAB CO)
MARPLE COMMONS, SUITE 200
2004 SPROUL ROAD
BROOMALL, PA 19008

FOR: ADVERTISING AND MARKETING SERVICES FOR THE PHARMACEUTICAL, BIOSCIENCES AND LIFE SCIENCES FIELDS, IN CLASS 35 (U.S. CLS. 100, 101 AND 102).

FIRST USE 1-26-2007; IN COMMERCE 1-26-2007.

FOR: WRITING ARTICLES FOR MEDICAL AND SCIENTIFIC JOURNALS IN THE FIELDS OF PHARMACEUTICALS, BIOSCIENCES AND LIFE SCIEN-

CES FIELDS; EDUCATIONAL SERVICES, NAMELY, CONDUCTING SEMINARS AND CONFERENCES RELATING TO THE PHARMACEUTICAL, BIOSCIENCES AND LIFE SCIENCES FIELDS, IN CLASS 41 (U.S. CLS. 100, 101 AND 107).

FIRST USE 1-26-2007; IN COMMERCE 1-26-2007.

THE MARK CONSISTS OF STANDARD CHARACTERS WITHOUT CLAIM TO ANY PARTICULAR FONT, STYLE, SIZE, OR COLOR.

SER. NO. 77-206,455, FILED 6-14-2007.

MICHELE SWAIN, EXAMINING ATTORNEY

Int. Cl.: 14

Prior U.S. Cls.: 2, 27, 28 and 50

United States Patent and Trademark Office

Reg. No. 3,474,884

Registered July 29, 2008

TRADEMARK
PRINCIPAL REGISTER

HAVE A JESUS FILLED DAY

CHAPMAN, ROY GENE (UNITED STATES INDIVIDUAL)
PO BOX 3146
PORTER, TX 77365 AND
CHAPMAN, ANN MAYS (UNITED STATES INDIVIDUAL)
PO BOX 3146
PORTER, TX 77365

FOR: ALARM CLOCKS; ANKLE BRACELETS; APPARATUS FOR TIMING SPORTS EVENTS; BOLO TIES WITH PRECIOUS METAL TIPS; BRACELETS; BRACELETS OF PRECIOUS METAL; BRONZE JEWELRY; BROOCHES; BUCKLES FOR WATCHSTRAPS; CASES FOR WATCHES AND CLOCKS; CHARITY BRACELETS; CHARMS; CHOKERS; CLIP EARRINGS; CLOCK AND WATCH HANDS; CLOCK CABINETS; CLOCKS; CLOCKS INCORPORATING RADIOS; COLLECTIBLE COINS; COMMEMORATIVE COINS; COMMEMORATIVE STATUARY CUPS MADE OF PRECIOUS METAL; COSTUME JEWELRY; CUFF-LINKS; DESKTOP STATUARY MADE OF PRECIOUS METAL; DIAMOND BELTS; DIVING WATCHES; EAR CLIPS; EAR STUDS; EARRINGS; FANCY KEY RINGS OF PRECIOUS METALS; FIGURES OF PRECIOUS METAL; FIGURINES OF PRECIOUS METAL; GRAVE MARKERS OF PRECIOUS METAL; HOLIDAY ORNAMENTS OF PRECIOUS METAL THAT ARE NOT TREE ORNAMENTS; IDENTIFICATION BRACELETS; INSIGNIAS OF PRECIOUS METAL; JADE; JEWEL CHAINS; JEWEL PENDANTS; JEWELRY; JEWELRY BOXES; JEWELRY BOXES NOT OF METAL; JEWELRY BOXES OF METAL; JEWELRY BOXES OF PRECIOUS METAL; JEWELRY CASES; JEWELRY CASES NOT OF PRECIOUS METAL; JEWELRY CASES OF PRECIOUS METAL; JEWELRY CASKETS; JEWELRY CASKETS OF PRECIOUS METAL; JEWELRY CHAINS; JEWELRY FINDINGS; JEWELRY FOR THE HEAD; JEWELRY PINS FOR USE ON HATS; JEWELRY RING HOLDERS; JEWELRY WATCHES; JEWELRY, NAMELY, AMULETS;

JEWELRY, NAMELY, CROSSES; JEWELRY, NAMELY, PRECIOUS METAL PLATED REAL LEAVES AND FLOWERS; KEY CHAINS OF PRECIOUS METAL; KEY HOLDERS OF PRECIOUS METALS; KEY RINGS OF PRECIOUS METAL; LAPEL PINS; LEATHER JEWELRY AND ACCESSORY BOXES; MECHANICAL AND AUTOMATIC WATCHES; MEDALLIONS; MEDALS; NECK CHAINS; NECKLACES; NECKTIE FASTENERS; NON-MONETARY COINS; ORNAMENTAL LAPEL PINS; ORNAMENTAL PINS; ORNAMENTS OF PRECIOUS METAL; PENDANTS; PENDULUM CLOCKS; PET JEWELRY; POCKET WATCHES; PRECIOUS METAL TROPHIES; RINGS; RINGS BEING JEWELRY; RUBBER OR SILICONE WRISTBANDS IN THE NATURE OF A BRACELET; SCULPTURES MADE OF PRECIOUS METAL; SHIRT STUDS; SLIDES FOR BOLO TIES; SMALL CLOCKS; STOP WATCHES; TABLE CLOCKS; TIE BARS; TIE CLIPS; TIE FASTENERS; TIE PINS; TIMEPIECES; WALL CLOCKS; WATCH BANDS AND STRAPS; WATCH BOXES; WATCH BRACELETS; WATCH CASES; WATCH CHAINS; WATCH CLASPS; WATCH FACES; WATCH POUCHES; WATCH STRAPS; WATCHES; WATCHSTRAPS MADE OF LEATHER; WOODEN JEWELRY BOXES; WRISTWATCHES, IN CLASS 14 (U.S. CLS. 2, 27, 28 AND 50).

FIRST USE 7-17-2003; IN COMMERCE 9-19-2003.

THE MARK CONSISTS OF STANDARD CHARACTERS WITHOUT CLAIM TO ANY PARTICULAR FONT, STYLE, SIZE, OR COLOR.

OWNER OF U.S. REG. NOS. 3,215,558, 3,237,857 AND OTHERS.

SER. NO. 77-206,519, FILED 6-14-2007.

SAIMA MAKHDOOM, EXAMINING ATTORNEY

Int. Cls.: 35 and 41

Prior U.S. Cls.: 100, 101, 102 and 107

United States Patent and Trademark Office

Reg. No. 3,474,885

Registered July 29, 2008

**SERVICE MARK
PRINCIPAL REGISTER**



GLOBAL SPORTS, INC. (NEW JERSEY CORPORATION)
SUITE 713
313 STATE ST.
PERTH AMBOY, NJ 08861

FOR: ADVERTISING AND PROMOTION SERVICES AND RELATED CONSULTING; DISTRIBUTION OF ADVERTISEMENTS AND COMMERCIAL ANNOUNCEMENTS; MANAGEMENT OF PROFESSIONAL ATHLETES; TALENT AGENCIES, IN CLASS 35 (U.S. CLS. 100, 101 AND 102).

FIRST USE 3-1-2007; IN COMMERCE 5-15-2007.

FOR: POST-PRODUCTION EDITING SERVICES IN THE FIELD OF MUSIC, VIDEOS AND FILMS; PRODUCTION OF SOUND AND MUSIC VIDEO RECORDINGS; TRAINING SERVICES IN THE

FIELD OF ATHLETICS, IN CLASS 41 (U.S. CLS. 100, 101 AND 107).

FIRST USE 3-1-2007; IN COMMERCE 5-15-2007.

OWNER OF U.S. REG. NO. 2,966,967.

NO CLAIM IS MADE TO THE EXCLUSIVE RIGHT TO USE "SPORTS & ENTERTAINMENT AGENCY", APART FROM THE MARK AS SHOWN.

THE MARK CONSISTS OF GLOBE(IMAGE) - GSEA(STYLE TEXT) GLOBAL SPORTS & ENTERTAINMENT AGENCY (TEXT).

SER. NO. 77-206,705, FILED 6-14-2007.

KYLE PEETE, EXAMINING ATTORNEY

Int. Cl.: 9

Prior U.S. Cls.: 21, 23, 26, 36 and 38

Reg. No. 3,474,886

United States Patent and Trademark Office

Registered July 29, 2008

**TRADEMARK
PRINCIPAL REGISTER**

gPlex

GENUSYS INC. (TEXAS CORPORATION)
17106 PRESTON BEND DRIVE
DALLAS, TX 75248

THE MARK CONSISTS OF STANDARD CHAR-
ACTERS WITHOUT CLAIM TO ANY PARTICULAR
FONT, STYLE, SIZE, OR COLOR.

FOR: TELECOMMUNICATION SWITCHES, IN
CLASS 9 (U.S. CLS. 21, 23, 26, 36 AND 38).

SER. NO. 77-206,785, FILED 6-15-2007.

FIRST USE 1-1-2006; IN COMMERCE 1-1-2006.

BRENDAN MCCAULEY, EXAMINING ATTORNEY

Int. Cl.: 14

Prior U.S. Cls.: 2, 27, 28 and 50

United States Patent and Trademark Office

Reg. No. 3,474,887

Registered July 29, 2008

**TRADEMARK
PRINCIPAL REGISTER**



DONG LONG JU

DONG LONG JU CO., LTD. (TAIWAN CORPORATION)
NO. 53-6, YUYING ST., YINGGE TOWNSHIP
TAIPEI HSIEN, TAIWAN

FOR: JEWELRY; PENDANT OF PRECIOUS METAL; BRACELETS; NECKLACES; EARRINGS; RINGS; COLLAR CLAMPS OF PRECIOUS METAL, NAMELY, PRECIOUS METAL CLAMPS OR BUTTONS USED WITH COLLAR CHAINS; CHAINS OF PRECIOUS METAL; BUCKLES OF PRECIOUS METAL, NAMELY, FASTENERS, CLIPS AND BACKS USED ON NECKTIE CHAINS AND NECKTIE TACKS, BROOCHES AND EARRINGS; JEWELRY MADE WITH PRECIOUS METAL AND SET WITH

OR WITHOUT GEMS; BROOCHES OF PRECIOUS METAL, IN CLASS 14 (U.S. CLS. 2, 27, 28 AND 50).

FIRST USE 5-26-2007; IN COMMERCE 6-4-2007.

THE MARK CONSISTS OF ARROWHEAD-LIKE DESIGN OVER THE TEXTUAL ELEMENT.

THE FOREIGN WORDING IN THE MARK TRANSLATES INTO ENGLISH AS EASTERN DRAGON BALL.

SER. NO. 77-206,935, FILED 6-15-2007.

LINDA M. KING, EXAMINING ATTORNEY

Int. Cl.: 25

Prior U.S. Cls.: 22 and 39

United States Patent and Trademark Office

Reg. No. 3,474,888

Registered July 29, 2008

**TRADEMARK
PRINCIPAL REGISTER**

LIL JOEY

BELL FATIGUE COMPANY, INC. (GEORGIA
CORPORATION)
P. O. BOX 14307
AUGUSTA, GA 30919

FOR: CLOTHING, NAMELY, SHIRTS, PANTS,
KNIT PANTS, JACKETS, T-SHIRTS, SWEATSHIRTS,
SWEATPANTS, BIB OVERALLS, CAPS, HATS, BIBS,
JUMPERS, ROMPERS, DIAPER COVERS, DIAPER
SHIRTS, DRESSES, CREEPERS, AND UNION SUITS,
IN CLASS 25 (U.S. CLS. 22 AND 39).

FIRST USE 1-1-1997; IN COMMERCE 1-1-1997.

THE MARK CONSISTS OF STANDARD CHAR-
ACTERS WITHOUT CLAIM TO ANY PARTICULAR
FONT, STYLE, SIZE, OR COLOR.

SER. NO. 77-207,020, FILED 6-15-2007.

EDWARD FENNESSY, EXAMINING ATTORNEY

Int. Cls.: 41 and 44

Prior U.S. Cls.: 100, 101 and 107

United States Patent and Trademark Office

Reg. No. 3,474,889

Registered July 29, 2008

**SERVICE MARK
PRINCIPAL REGISTER**



ALL CHILDREN'S HOSPITAL, INC. (FLORIDA
NON-PROFIT CORPORATION)

801 SIXTH STREET SOUTH
ST. PETERSBURG, FL 33701

FOR: COUNSELING SERVICES IN THE FIELD
OF PHYSICAL FITNESS; PHYSICAL FITNESS IN-
STRUCTION, IN CLASS 41 (U.S. CLS. 100, 101 AND
107).

FIRST USE 7-1-2007; IN COMMERCE 9-19-2007.

FOR: HEALTH CARE RELATED SERVICES FOR
CHILDREN AND FAMILIES IN THE FIELD OF
WEIGHT MANAGEMENT; PREVENTION SERVI-
CES FOR THE HEALTH AND WELLNESS OF
FAMILIES, NAMELY, MEDICAL COUNSELING
SERVICES IN THE FIELD OF FITNESS AND
WEIGHT MANAGEMENT, IN CLASS 44 (U.S. CLS.
100 AND 101).

FIRST USE 7-1-2007; IN COMMERCE 9-19-2007.

OWNER OF U.S. REG. NOS. 1,908,977 AND
1,972,375.

NO CLAIM IS MADE TO THE EXCLUSIVE
RIGHT TO USE "CHILDREN'S HOSPITAL" , APART
FROM THE MARK AS SHOWN.

THE COLOR(S) BLUE, PURPLE, ORANGE, YEL-
LOW, RED, AND PINK IS/ARE CLAIMED AS A
FEATURE OF THE MARK.

THE MARK CONSISTS OF THE STYLIZED
TERMS "ALL CHILDREN'S HOSPITAL" AND A
FANCIFUL REPRESENTATION OF THREE CHIL-
DREN IN BLUE; SEVEN SQUARES UNDERNEATH
IN PURPLE, ORANGE, BLUE, YELLOW, RED,
PINK, AND BLUE; AND THE STYLIZED TERM
"FIT4ALLKIDS" IN BLUE.

SER. NO. 77-207,072, FILED 6-15-2007.

KAPIL BHANOT, EXAMINING ATTORNEY

Int. Cl.: 42

Prior U.S. Cls.: 100 and 101

United States Patent and Trademark Office

Reg. No. 3,474,890

Registered July 29, 2008

**SERVICE MARK
PRINCIPAL REGISTER**

iTalent

ITALENT CORPORATION (CALIFORNIA CORPORATION)
5201 GREAT AMERICA PARKWAY
SANTA CLARA, CA 95054

THE MARK CONSISTS OF STANDARD CHARACTERS WITHOUT CLAIM TO ANY PARTICULAR FONT, STYLE, SIZE, OR COLOR.

FOR: INFORMATION TECHNOLOGY CONSULTATION, IN CLASS 42 (U.S. CLS. 100 AND 101).

SER. NO. 77-207,112, FILED 6-15-2007.

FIRST USE 5-1-2005; IN COMMERCE 5-1-2005.

CAROL SPILS, EXAMINING ATTORNEY

Int. Cls.: 37 and 42

Prior U.S. Cls.: 100, 101, 103 and 106

United States Patent and Trademark Office

Reg. No. 3,474,891

Registered July 29, 2008

**SERVICE MARK
PRINCIPAL REGISTER**

CurrentSafe

TEGG CORPORATION (DELAWARE CORPORATION)
2801 LIBERTY AVENUE
PITTSBURGH, PA 15219

FOR: MAINTENANCE OF RESIDENTIAL ELECTRICAL SYSTEMS, IN CLASS 37 (U.S. CLS. 100, 103 AND 106).

FIRST USE 1-1-2006; IN COMMERCE 1-1-2006.

FOR: TESTING OF RESIDENTIAL ELECTRICAL SYSTEMS, IN CLASS 42 (U.S. CLS. 100 AND 101).

FIRST USE 1-1-2006; IN COMMERCE 1-1-2006.

THE MARK CONSISTS OF STANDARD CHARACTERS WITHOUT CLAIM TO ANY PARTICULAR FONT, STYLE, SIZE, OR COLOR.

SER. NO. 77-207,263, FILED 6-15-2007.

ELLEN B. AWRICH, EXAMINING ATTORNEY

Int. Cls.: 35 and 39

Prior U.S. Cls.: 100, 101, 102 and 105

United States Patent and Trademark Office

Reg. No. 3,474,892

Registered July 29, 2008

**SERVICE MARK
PRINCIPAL REGISTER**

INSTANT COMFORT

AGL RESOURCES, INC. (GEORGIA CORPORATION)

10 PEACHTREE PLACE, SUITE 1000

ATLANTA, GA 30309

FOR: ADMINISTRATION OF FINANCIAL INCENTIVE PROGRAMS FOR CUSTOMERS IN PROMOTING THE USE OF NATURAL GAS, IN CLASS 35 (U.S. CLS. 100, 101 AND 102).

FIRST USE 5-7-2007; IN COMMERCE 5-7-2007.

FOR: TRANSPORTATION, STORAGE AND NATURAL GAS DISTRIBUTION, IN CLASS 39 (U.S. CLS. 100 AND 105).

FIRST USE 5-7-2007; IN COMMERCE 5-7-2007.

THE MARK CONSISTS OF STANDARD CHARACTERS WITHOUT CLAIM TO ANY PARTICULAR FONT, STYLE, SIZE, OR COLOR.

SER. NO. 77-207,299, FILED 6-15-2007.

ODESSA BIBBINS, EXAMINING ATTORNEY

Int. Cl.: 28

Prior U.S. Cls.: 22, 23, 38 and 50

United States Patent and Trademark Office

Reg. No. 3,474,893

Registered July 29, 2008

**TRADEMARK
PRINCIPAL REGISTER**

CATCH FIRE

BLIP, LLC (MINNESOTA LTD LIAB CO)
15255 MINNETONKA BOULEVARD
MINNETONKA, MN 55345

FOR: TOY GUNS FOR SHOOTING BALLS, IN
CLASS 28 (U.S. CLS. 22, 23, 38 AND 50).

FIRST USE 6-1-2007; IN COMMERCE 6-1-2007.

THE MARK CONSISTS OF STANDARD CHAR-
ACTERS WITHOUT CLAIM TO ANY PARTICULAR
FONT, STYLE, SIZE, OR COLOR.

SER. NO. 77-207,333, FILED 6-15-2007.

KATHERINE M. DUBRAY, EXAMINING ATTOR-
NEY

Int. Cl.: 35

Prior U.S. Cls.: 100, 101 and 102

United States Patent and Trademark Office

Reg. No. 3,474,894

Registered July 29, 2008

**SERVICE MARK
PRINCIPAL REGISTER**

**ASSOCIATION FOR RETARDED
CITIZENS**

THE ARC OF THE UNITED STATES, INC.
(MARYLAND NON-PROFIT CORPORATION)
1010 WAYNE AVENUE, SUITE 650
SILVER SPRING, MD 20910

FOR: PROMOTING PUBLIC AWARENESS OF THE NEEDS OF CITIZENS WITH INTELLECTUAL AND DEVELOPMENTAL DISABILITIES; AND ASSOCIATION SERVICES, NAMELY, PROMOTING THE INTERESTS AND RIGHTS OF CITIZENS WITH INTELLECTUAL AND DEVELOPMENTAL DISABILITIES, IN CLASS 35 (U.S. CLS. 100, 101 AND 102).

FIRST USE 1-18-1979; IN COMMERCE 1-18-1979.

THE MARK CONSISTS OF STANDARD CHARACTERS WITHOUT CLAIM TO ANY PARTICULAR FONT, STYLE, SIZE, OR COLOR.

NO CLAIM IS MADE TO THE EXCLUSIVE RIGHT TO USE "ASSOCIATION", APART FROM THE MARK AS SHOWN.

SEC. 2(F).

SER. NO. 77-207,396, FILED 6-15-2007.

MICHELE SWAIN, EXAMINING ATTORNEY

Int. Cl.: 21

Prior U.S. Cls.: 2, 13, 23, 29, 30, 33, 40 and 50

United States Patent and Trademark Office

Reg. No. 3,474,895

Registered July 29, 2008

**TRADEMARK
PRINCIPAL REGISTER**

FlySentry

SPENCER ABATEMENT SERVICES, LLC (GEOR-
GIA LTD LIAB CO)
P.O. BOX 2117
ROSWELL, GA 30077

THE MARK CONSISTS OF STANDARD CHAR-
ACTERS WITHOUT CLAIM TO ANY PARTICULAR
FONT, STYLE, SIZE, OR COLOR.

FOR: FLY PROTECTION SYSTEM AND APPA-
RATUS, NAMELY, BAITED TRAPS FOR ABATING
INSECTS, IN CLASS 21 (U.S. CLS. 2, 13, 23, 29, 30, 33,
40 AND 50).

SER. NO. 77-207,461, FILED 6-15-2007.

FIRST USE 12-6-2006; IN COMMERCE 12-6-2006.

STEVEN JACKSON, EXAMINING ATTORNEY

Int. Cls.: 36 and 42

Prior U.S. Cls.: 100, 101 and 102

United States Patent and Trademark Office

Reg. No. 3,474,896

Registered July 29, 2008

**SERVICE MARK
PRINCIPAL REGISTER**

MEDAMORPH

MEDAMORPH, LLC (COLORADO LTD LIAB CO)
667 S. PIERCE AVENUE
LOUISVILLE, CO 80027

FOR: COLLECTION OF DEBTS; BILL PAYMENT;
AND ELECTRONIC PROCESSING OF INSURANCE
CLAIMS AND PAYMENT DATA, IN CLASS 36 (U.S.
CLS. 100, 101 AND 102).

FIRST USE 2-19-2002; IN COMMERCE 6-15-2007.

FOR: APPLICATION SERVICE PROVIDER,
NAMELY, HOSTING COMPUTER SOFTWARE AP-

PLICATIONS OF OTHERS; AND INFORMATION
TECHNOLOGY CONSULTATION SERVICES, IN
CLASS 42 (U.S. CLS. 100 AND 101).

FIRST USE 2-19-2002; IN COMMERCE 6-15-2007.

THE MARK CONSISTS OF STANDARD CHAR-
ACTERS WITHOUT CLAIM TO ANY PARTICULAR
FONT, STYLE, SIZE, OR COLOR.

SER. NO. 77-207,514, FILED 6-15-2007.

MATTHEW PAPPAS, EXAMINING ATTORNEY

Int. Cl.: 41

Prior U.S. Cls.: 100, 101 and 107

United States Patent and Trademark Office

Reg. No. 3,474,897

Registered July 29, 2008

**SERVICE MARK
PRINCIPAL REGISTER**



SOUTHERN STATES COOPERATIVE, INCORPORATED (VIRGINIA CORPORATION)

P.O. BOX 26234

RICHMOND, VA 232606234

FOR: TRAINING IN THE USE AND SALE OF ANIMAL FEED, IN CLASS 41 (U.S. CLS. 100, 101 AND 107).

FIRST USE 3-3-2005; IN COMMERCE 3-3-2005.

NO CLAIM IS MADE TO THE EXCLUSIVE RIGHT TO USE "CERTIFIED FEED SPECIALIST", APART FROM THE MARK AS SHOWN.

THE MARK CONSISTS OF THE WORDS "FEEDMASTER CERTIFIED FEED SPECIALIST" UNDER A STYLIZED RIBBON, SURROUNDED BY A WHITE LINE BOX.

SER. NO. 77-207,521, FILED 6-15-2007.

HOWARD SMIGA, EXAMINING ATTORNEY

Int. Cl.: 41

Prior U.S. Cls.: 100, 101 and 107

United States Patent and Trademark Office

Reg. No. 3,474,898

Registered July 29, 2008

**SERVICE MARK
PRINCIPAL REGISTER**

FEEDMASTER

SOUTHERN STATES COOPERATIVE, INCORPORATED (VIRGINIA CORPORATION)
P.O. BOX 26234
RICHMOND, VA 232606234

THE MARK CONSISTS OF STANDARD CHARACTERS WITHOUT CLAIM TO ANY PARTICULAR FONT, STYLE, SIZE, OR COLOR.

FOR: TRAINING IN THE USE AND SALE OF ANIMAL FEED, IN CLASS 41 (U.S. CLS. 100, 101 AND 107).

SER. NO. 77-207,534, FILED 6-15-2007.

FIRST USE 3-3-2005; IN COMMERCE 3-3-2005.

HOWARD SMIGA, EXAMINING ATTORNEY

Int. Cls.: 40 and 42

Prior U.S. Cls.: 100, 101, 103 and 106

United States Patent and Trademark Office

Reg. No. 3,474,899

Registered July 29, 2008

**SERVICE MARK
PRINCIPAL REGISTER**

**PRODUCTION CENTER OF
EXCELLENCE**

SCHLUMBERGER TECHNOLOGY CORPORATION
(TEXAS CORPORATION)

SUITE 1700

5599 SAN FELIPE

HOUSTON, TX 77027

FOR: CONSULTING SERVICES IN THE FIELD
OF OIL AND GAS PRODUCTION, IN CLASS 40 (U.S.
CLS. 100, 103 AND 106).

FIRST USE 0-0-2006; IN COMMERCE 0-0-2006.

FOR: CONSULTING SERVICES IN THE FIELD
OF OIL & GAS EXPLORATION, IN CLASS 42 (U.S.
CLS. 100 AND 101).

FIRST USE 0-0-2006; IN COMMERCE 0-0-2006.

THE MARK CONSISTS OF STANDARD CHAR-
ACTERS WITHOUT CLAIM TO ANY PARTICULAR
FONT, STYLE, SIZE, OR COLOR.

SER. NO. 77-207,544, FILED 6-15-2007.

KIMBERLY PERRY, EXAMINING ATTORNEY

Int. Cl.: 9

Prior U.S. Cls.: 21, 23, 26, 36 and 38

Reg. No. 3,474,900

United States Patent and Trademark Office

Registered July 29, 2008

**TRADEMARK
PRINCIPAL REGISTER**

RANKSENSE

NEMEDIASOFT INC. (DELAWARE CORPORATION)
ZONA FRANCA SAN ISIDRO, EDIF. MULTIUSO 2
SANTO DOMINGO ESTE, DOMINICAN REP

FOR: COMPUTER SEARCH ENGINE SOFTWARE, COMPUTER SOFTWARE FOR THE COLLECTION, EDITING, ORGANIZING, MODIFYING, BOOK MARKING, TRANSMISSION, STORAGE AND SHARING OF DATA AND INFORMATION, COMPUTER SOFTWARE THAT PROVIDES REAL-TIME, INTEGRATED BUSINESS MANAGEMENT INTELLIGENCE BY COMBINING INFORMATION FROM VARIOUS DATABASES AND PRESENTING IT IN AN EASY-TO-UNDERSTAND USER INTERFACE, COMPUTER SOFTWARE FOR SEARCH ENGINE OPTIMIZATION, NAMELY, TO IMPROVE

THE VOLUME AND QUALITY OF TRAFFIC TO A WEB SITE FROM SEARCH ENGINES VIA SEARCH RESULTS FOR TARGETED KEYWORDS, THAT MAY BE DOWNLOADED FROM A GLOBAL COMPUTER NETWORK, IN CLASS 9 (U.S. CLS. 21, 23, 26, 36 AND 38).

FIRST USE 7-28-2003; IN COMMERCE 7-28-2003.

THE MARK CONSISTS OF STANDARD CHARACTERS WITHOUT CLAIM TO ANY PARTICULAR FONT, STYLE, SIZE, OR COLOR.

SER. NO. 77-207,611, FILED 6-15-2007.

SHARON MEIER, EXAMINING ATTORNEY

Int. Cl.: 35

Prior U.S. Cls.: 100, 101 and 102

United States Patent and Trademark Office

Reg. No. 3,474,901

Registered July 29, 2008

**SERVICE MARK
PRINCIPAL REGISTER**

THINK JOBS

THINK RESOURCES, INC. (GEORGIA CORPORATION)
225 SCIENTIFIC DRIVE
NORCROSS, GA 30092

FOR: TEMPORARY, PERMANENT AND CONTRACT EMPLOYMENT STAFFING SERVICES; PROVIDING AN ONLINE COMPUTER DATABASE OF JOB OPPORTUNITY INFORMATION; BUSINESS SERVICES, NAMELY, PROVIDING ASSISTANCE IN FINDING EMPLOYMENT; COUNSELING BUSINESSES, NAMELY, BUSINESS CONSULTING REGARDING MANAGEMENT, PERSONNEL RETIREMENT TRANSITION, APPRAISAL, AND SUCCESSION, IN CLASS 35 (U.S. CLS. 100, 101 AND 102).

FIRST USE 2-1-1999; IN COMMERCE 2-1-1999.

THE MARK CONSISTS OF STANDARD CHARACTERS WITHOUT CLAIM TO ANY PARTICULAR FONT, STYLE, SIZE, OR COLOR.

OWNER OF U.S. REG. NOS. 1,161,850, 2,309,290, AND 2,478,916.

NO CLAIM IS MADE TO THE EXCLUSIVE RIGHT TO USE "JOBS", APART FROM THE MARK AS SHOWN.

SER. NO. 77-207,737, FILED 6-15-2007.

RUDY R. SINGLETON, EXAMINING ATTORNEY

Int. Cl.: 38

Prior U.S. Cls.: 100, 101 and 104

United States Patent and Trademark Office

Reg. No. 3,474,902

Registered July 29, 2008

**SERVICE MARK
PRINCIPAL REGISTER**



B2 NETWORKS, INC. (TEXAS CORPORATION)
SUITE 308
13330 NOEL ROAD
DALLAS, TX 75240

FOR: BROADCASTING PROGRAMS VIA A GLOBAL COMPUTER NETWORK, BROADBAND, WIRED AND WIRELESS NETWORKS; INTERNET, TELEVISION, VIDEO AND AUDIO BROADCASTING SERVICES; BROADCASTING SERVICES AND PROVISION OF TELECOMMUNICATION ACCESS TO VIDEO AND AUDIO CONTENT, FILMS AND TV PROGRAMS, PROVIDED VIA A VIDEO-ON-DEMAND SERVICE VIA THE INTERNET; AUDIO AND VIDEO BROADCASTING SERVICES OVER THE INTERNET; BROADCASTING SERVICES AND PROVISION OF BROADBAND ACCESS TO LIVE AND DELAYED PROGRAMS VIA PAY-PER-VIEW, SUBSCRIPTION OR FREE VIA BROADBAND ENABLED FIXED OR MOBILE, WIRED OR WIRELESS VIDEO DISPLAY DEVICES; CABLE AND SATELLITE TELEVISION BROADCASTING; SUBSCRIPTION TELEVISION BROADCASTING, IN CLASS 38 (U.S. CLS. 100, 101 AND 104).

FIRST USE 10-1-2005; IN COMMERCE 10-1-2005.

NO CLAIM IS MADE TO THE EXCLUSIVE RIGHT TO USE "NETWORKS" AND "BROADBAND BROADCASTS", APART FROM THE MARK AS SHOWN.

THE COLOR(S) LIGHT BLUE, DARK BLUE, BLACK, GREY, AND WHITE IS/ARE CLAIMED AS A FEATURE OF THE MARK.

THE MARK CONSISTS OF "B2" WRITTEN IN DARK BLUE, POSITIONED ABOVE THE WORD "NETWORKS", WRITTEN IN BLACK, SUPERIMPOSED OVER A GREY PYRAMID, POSITIONED ABOVE THE WORDS "BROADBAND BROADCASTS", WRITTEN IN WHITE WITH BLACK SHADOWING, SUPERIMPOSED ON A LIGHT BLUE RECTANGLE.

SER. NO. 77-207,796, FILED 6-15-2007.

ARETHA SOMERVILLE, EXAMINING ATTORNEY

Int. Cl.: 20

Prior U.S. Cls.: 2, 13, 22, 25, 32 and 50

United States Patent and Trademark Office

Reg. No. 3,474,903

Registered July 29, 2008

**TRADEMARK
PRINCIPAL REGISTER**

HC28

HC28 LIMITED (HONG KONG CORPORATION)
118 CONNAUGHT ROAD WEST
ROOMS 3603-9, 36/F YAT CHAU INT'L PLAZA
CENTRAL, HONG KONG

OWNER OF HONG KONG REG. NO. 300784198,
DATED 12-21-2006, EXPIRES 12-21-2016.

SER. NO. 77-208,233, FILED 6-18-2007.

FOR: FURNITURE, MIRRORS, PICTURE
FRAMES, IN CLASS 20 (U.S. CLS. 2, 13, 22, 25, 32
AND 50).

KATHERINE M. DUBRAY, EXAMINING ATTOR-
NEY

Int. Cl.: 25

Prior U.S. Cls.: 22 and 39

United States Patent and Trademark Office

Reg. No. 3,474,904

Registered July 29, 2008

**TRADEMARK
PRINCIPAL REGISTER**

AIR MESH ULTRA

BASS PRO TRADEMARKS, L.L.C. (MISSOURI
LTD LIAB CO)
2500 EAST KEARNEY
SPRINGFIELD, MO 65898

FOR: CLOTHING, NAMELY, SHIRTS, PANTS,
GLOVES, HEADGEAR, NAMELY, HATS, CAPS,
AND BALACLAVAS, IN CLASS 25 (U.S. CLS. 22
AND 39).

FIRST USE 6-0-2004; IN COMMERCE 6-0-2004.

THE MARK CONSISTS OF STANDARD CHAR-
ACTERS WITHOUT CLAIM TO ANY PARTICULAR
FONT, STYLE, SIZE, OR COLOR.

NO CLAIM IS MADE TO THE EXCLUSIVE
RIGHT TO USE "AIR MESH", APART FROM THE
MARK AS SHOWN.

SER. NO. 77-208,253, FILED 6-18-2007.

KATHY DE JONGE, EXAMINING ATTORNEY

Int. Cls.: 36, 43 and 44

Prior U.S. Cls.: 100, 101 and 102

United States Patent and Trademark Office

Reg. No. 3,474,905

Registered July 29, 2008

**SERVICE MARK
PRINCIPAL REGISTER**



CHRISTIAN LIVING COMMUNITIES (COLORADO CORPORATION)
7000 E. BELLEVIEW AVE, SUITE 250
GREENWOOD VILLAGE, CO 80111

FOR: LEASING AND RENTAL OF INDEPENDENT LIVING RETIREMENT APARTMENTS, IN CLASS 36 (U.S. CLS. 100, 101 AND 102).

FIRST USE 7-0-2005; IN COMMERCE 7-0-2005.

FOR: PROVIDING ASSISTED LIVING FACILITIES, IN CLASS 43 (U.S. CLS. 100 AND 101).

FIRST USE 7-0-2005; IN COMMERCE 7-0-2005.

FOR: PROVIDING SKILLED NURSING CARE SERVICES FOR SENIORS, IN CLASS 44 (U.S. CLS. 100 AND 101).

FIRST USE 7-0-2005; IN COMMERCE 7-0-2005.

OWNER OF U.S. REG. NOS. 2,669,244 AND 2,675,127.

NO CLAIM IS MADE TO THE EXCLUSIVE RIGHT TO USE "CHRISTIAN LIVING COMMUNITIES", APART FROM THE MARK AS SHOWN.

THE COLOR(S) PLUM AND GOLD IS/ARE CLAIMED AS A FEATURE OF THE MARK.

THE MARK CONSISTS OF A PLUM COLORED DOUBLE FLEUR-DE-LIS WITH A LOOPING TAIL WITH THE WORDS "CHRISTIAN LIVING" IN GOLD ABOVE THE WORD "COMMUNITIES" IN PLUM.

SER. NO. 77-208,434, FILED 6-18-2007.

CIMMERIAN COLEMAN, EXAMINING ATTORNEY

Int. Cl.: 33

Prior U.S. Cls.: 47 and 49

United States Patent and Trademark Office

Reg. No. 3,474,906

Registered July 29, 2008

TRADEMARK
PRINCIPAL REGISTER



MAR DE FRADES, S.L. (SPAIN LTD LIAB CO)
AVDA. COLON 136-146
CARTAGENA, SPAIN

FOR: WINES, IN CLASS 33 (U.S. CLS. 47 AND 49).

FIRST USE 2-28-2003; IN COMMERCE 6-0-2003.

THE COLOR(S) BLUE AND ORANGE IS/ARE
CLAIMED AS A FEATURE OF THE MARK.

THE MARK CONSISTS OF - THE FOLLOWING:
THE COLOR BLUE APPEARS ON THE BIRD DE-
SIGN, THE WAVE DESIGN AND THE ON WORD-
ING "MAR DE FRADES". THE COLOR ORANGE
APPEARS ON THE SUN DESIGN AND ON THE
WAVE DESIGN.

THE FOREIGN WORDING IN THE MARK
TRANSLATES INTO ENGLISH AS SEA OF.

SER. NO. 77-208,629, FILED 6-18-2007.

RUDY R. SINGLETON, EXAMINING ATTORNEY

Int. Cls.: 29 and 30

Prior U.S. Cl.: 46

United States Patent and Trademark Office

Reg. No. 3,474,907

Registered July 29, 2008

**TRADEMARK
PRINCIPAL REGISTER**

MANAR MEDITERRANEAN

LIPARI FOODS, INC. (MICHIGAN CORPORATION)
26661 BUNERT RD.
WARREN, MI 48089

FOR: CHEESE; CONDIMENTS, NAMELY, PEPPER OIL; CUT VEGETABLES; DAIRY-BASED BEVERAGES; DIPS; EDIBLE OIL; FRUIT SALADS; GARLIC-BASED SPREAD; HUMMUS; FRUIT-BASED FOOD BEVERAGE; GARDEN SALADS; PRE-PACKAGED DINNERS CONSISTING OF SPINACH PIE OR STUFFED GRAPE LEAVES; PROCESSED MEAT; PROCESSED BEANS; PROCESSED VEGETABLES; PROCESSED OLIVES; NUT MEATS; PEANUT-BASED FOOD BEVERAGES; POULTRY SUBSTITUTES; PREPARATIONS FOR MAKING BOUILLON; SALADS EXCEPT MACARONI, RICE, AND PASTA SALAD; TAHINI; VEGETABLE SALADS; YOGURT; VEGETABLE-BASED FOOD BEVERAGES; VEGETABLE-BASED SPREADS; YOGURT-BASED BEVERAGES; OLIVE OIL, IN CLASS 29 (U.S. CL. 46).

FIRST USE 4-9-2007; IN COMMERCE 4-9-2007.

FOR: BAKERY DESSERTS; BEVERAGES MADE OF COFFEE; BEVERAGES MADE OF TEA; BISCUITS; CANDY; COUSCOUS; DIPPING SAUCES; FLOUR-BASED CHIPS; MACARONI SALAD; PASTA SALAD; PITA; PITA CHIPS; RICE; RICE SALAD; TABOULI; UNLEAVENED BREAD IN THIN SHEETS, IN CLASS 30 (U.S. CL. 46).

FIRST USE 4-9-2007; IN COMMERCE 4-9-2007.

THE MARK CONSISTS OF STANDARD CHARACTERS WITHOUT CLAIM TO ANY PARTICULAR FONT, STYLE, SIZE, OR COLOR.

NO CLAIM IS MADE TO THE EXCLUSIVE RIGHT TO USE "MEDITERRANEAN", APART FROM THE MARK AS SHOWN.

SER. NO. 77-208,733, FILED 6-18-2007.

NANCY CLARKE, EXAMINING ATTORNEY

Int. Cl.: 9

Prior U.S. Cls.: 21, 23, 26, 36 and 38

Reg. No. 3,474,908

United States Patent and Trademark Office

Registered July 29, 2008

**TRADEMARK
PRINCIPAL REGISTER**

LARGE ANIMAL

LARGE ANIMAL LLC (NEW YORK LTD LIAB
CO)
27 WEST 24TH STREET, SUITE 10D
NEW YORK, NY 10010

FOR: COMPUTER GAME SOFTWARE; COMPU-
TER GAME SOFTWARE ENABLING USERS TO
PLAY GAMES ONLINE; DOWNLOADABLE COM-
PUTER GAME SOFTWARE; ELECTRONIC GAME
SOFTWARE, IN CLASS 9 (U.S. CLS. 21, 23, 26, 36 AND
38).

FIRST USE 4-0-2002; IN COMMERCE 4-0-2002.

THE MARK CONSISTS OF STANDARD CHAR-
ACTERS WITHOUT CLAIM TO ANY PARTICULAR
FONT, STYLE, SIZE, OR COLOR.

SER. NO. 77-208,859, FILED 6-18-2007.

TRACY CROSS, EXAMINING ATTORNEY

Int. Cl.: 16

Prior U.S. Cls.: 2, 5, 22, 23, 29, 37, 38 and 50

Reg. No. 3,474,909

United States Patent and Trademark Office

Registered July 29, 2008

**TRADEMARK
PRINCIPAL REGISTER**

CABLECAST

TELEMEDIA PUBLICATIONS, INC. (LOUISIANA
CORPORATION)
SUITE C
7920 WRENWOOD BLVD.
BATON ROUGE, LA 70809

FOR: MAGAZINES FEATURING TELEVISION
PROGRAMS, IN CLASS 16 (U.S. CLS. 2, 5, 22, 23, 29,
37, 38 AND 50).

FIRST USE 12-31-1975; IN COMMERCE 12-31-1975.

THE MARK CONSISTS OF STANDARD CHAR-
ACTERS WITHOUT CLAIM TO ANY PARTICULAR
FONT, STYLE, SIZE, OR COLOR.

SEC. 2(F).

SER. NO. 77-208,880, FILED 6-18-2007.

B. PARADEWELAI, EXAMINING ATTORNEY

Int. Cl.: 9

Prior U.S. Cls.: 21, 23, 26, 36 and 38

Reg. No. 3,474,910

United States Patent and Trademark Office

Registered July 29, 2008

**TRADEMARK
PRINCIPAL REGISTER**

Performance Transparency

SEVONE INC (DELAWARE CORPORATION)
SUITE 200
5 INNOVATION WAY
NEWARK, DE 19711

THE MARK CONSISTS OF STANDARD CHAR-
ACTERS WITHOUT CLAIM TO ANY PARTICULAR
FONT, STYLE, SIZE, OR COLOR.

FOR: COMPUTER NETWORKING HARDWARE,
IN CLASS 9 (U.S. CLS. 21, 23, 26, 36 AND 38).

SER. NO. 77-208,962, FILED 6-18-2007.

FIRST USE 1-30-2007; IN COMMERCE 1-30-2007.

CORY BOONE, EXAMINING ATTORNEY

Int. Cl.: 20

Prior U.S. Cls.: 2, 13, 22, 25, 32 and 50

Reg. No. 3,474,911

United States Patent and Trademark Office

Registered July 29, 2008

**TRADEMARK
PRINCIPAL REGISTER**

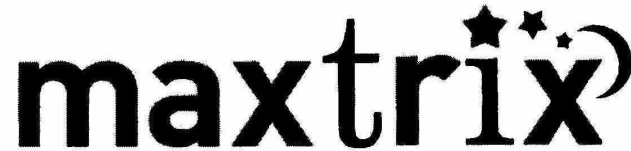
The logo for 'maxtrix' is written in a bold, lowercase, sans-serif font. The letters 'i' and 'x' are stylized with three small stars above them. A large, stylized 'x' is positioned to the right of the main 'maxtrix' text, partially overlapping the 'x' at the end of the word.

MAXWOOD FURNITURE LLC (CONNECTICUT
LTD LIAB CO)
2ND FLOOR
480 BARNUM AVENUE
BRIDGEPORT, CT 06608

BLES; TOY BOXES, IN CLASS 20 (U.S. CLS. 2, 13, 22,
25, 32 AND 50).

FIRST USE 10-12-2005; IN COMMERCE 10-12-2005.

FOR: BEDROOM FURNITURE; CABINETS; COM-
PUTER FURNITURE; CUSHIONS, FITTED FABRIC
FURNITURE COVERS, FURNITURE; FURNITURE
CHESTS; DRESSERS; WARDROBES; MIRRORS; TA-

SER. NO. 77-209,250, FILED 6-19-2007.

PAUL MORENO, EXAMINING ATTORNEY

Int. Cl.: 35

Prior U.S. Cls.: 100, 101 and 102

United States Patent and Trademark Office

Reg. No. 3,474,912

Registered July 29, 2008

**SERVICE MARK
PRINCIPAL REGISTER**

UA UNDER ARMOUR FACTORY
HOUSE

UNDER ARMOUR, INC. (MARYLAND COR-
PORATION)
1020 HULL STREET
BALTIMORE, MD 21230

FOR: RETAIL STORE SERVICES FEATURING
APPAREL AND SPORTING GOODS, IN CLASS 35
(U.S. CLS. 100, 101 AND 102).

FIRST USE 6-1-2005; IN COMMERCE 6-1-2005.

THE MARK CONSISTS OF STANDARD CHAR-
ACTERS WITHOUT CLAIM TO ANY PARTICULAR
FONT, STYLE, SIZE, OR COLOR.

OWNER OF U.S. REG. NOS. 2,727,031, 3,178,549
AND OTHERS.

SER. NO. 77-209,251, FILED 6-19-2007.

BILL DAWE, EXAMINING ATTORNEY

Int. Cl.: 35

Prior U.S. Cls.: 100, 101 and 102

United States Patent and Trademark Office

Reg. No. 3,474,913

Registered July 29, 2008

**SERVICE MARK
PRINCIPAL REGISTER**

CHEERS 4 CHARITY

CHEERS 4 CHARITY, LLC (DELAWARE LTD
LIAB CO)
4720 YENDER AVENUE, SUITE 200
LISLE, IL 60532

FOR: RETAIL STORE SERVICES AND ONLINE
RETAIL STORE SERVICES FEATURING WINE
AND CUSTOMIZED LABELED WINE, IN CLASS 35
(U.S. CLS. 100, 101 AND 102).

FIRST USE 5-14-2007; IN COMMERCE 5-14-2007.

THE MARK CONSISTS OF STANDARD CHAR-
ACTERS WITHOUT CLAIM TO ANY PARTICULAR
FONT, STYLE, SIZE, OR COLOR.

SER. NO. 77-209,472, FILED 6-19-2007.

KEVON CHISOLM, EXAMINING ATTORNEY

Int. Cl.: 40

Prior U.S. Cls.: 100, 103 and 106

United States Patent and Trademark Office

Reg. No. 3,474,914

Registered July 29, 2008

**SERVICE MARK
PRINCIPAL REGISTER**

CERAMLOK

THE EX ONE COMPANY (PENNSYLVANIA
CORPORATION)
P.O. BOX 1111
8075 PENNSYLVANIA AVENUE
IRWIN, PA 15642

FOR: CUSTOM MANUFACTURE OF SURFACE
TEXTURIZATION COMPRISING AN IRREGULAR
SURFACE OF BONDED PARTICLES ON METAL
OR CERAMIC DENTAL RESTORATIONS , IN
CLASS 40 (U.S. CLS. 100, 103 AND 106).

FIRST USE 2-7-2007; IN COMMERCE 2-7-2007.

THE MARK CONSISTS OF STANDARD CHAR-
ACTERS WITHOUT CLAIM TO ANY PARTICULAR
FONT, STYLE, SIZE, OR COLOR.

SER. NO. 77-209,511, FILED 6-19-2007.

ELLEN PERKINS, EXAMINING ATTORNEY

Int. Cl.: 5

Prior U.S. Cls.: 6, 18, 44, 46, 51 and 52

United States Patent and Trademark Office

Reg. No. 3,474,915

Registered July 29, 2008

**TRADEMARK
PRINCIPAL REGISTER**

STAYBRED

PFIZER INC. (DELAWARE CORPORATION)
235 EAST 42ND STREET
NEW YORK, NY 100175755

THE MARK CONSISTS OF STANDARD CHAR-
ACTERS WITHOUT CLAIM TO ANY PARTICULAR
FONT, STYLE, SIZE, OR COLOR.

FOR: VETERINARY VACCINES FOR USE IN
BOVINE REPRODUCTION, IN CLASS 5 (U.S. CLS.
6, 18, 44, 46, 51 AND 52).

SER. NO. 77-209,538, FILED 6-19-2007.

FIRST USE 6-0-1989; IN COMMERCE 6-0-1989.

PAM WILLIS, EXAMINING ATTORNEY

Int. Cl.: 32

Prior U.S. Cls.: 45, 46 and 48

United States Patent and Trademark Office

Reg. No. 3,474,916

Registered July 29, 2008

**TRADEMARK
PRINCIPAL REGISTER**

GLACEAU ESSENCEWATER

ENERGY BRANDS, INC. (NEW YORK COR-
PORATION)
17-20 WHITESTONE EXPRESSWAY
WHITESTONE, NY 11357

FOR: NON-ALCOHOLIC BEVERAGES, NAMELY,
WATERS AND FLAVORED WATERS, IN CLASS 32
(U.S. CLS. 45, 46 AND 48).

FIRST USE 8-0-2005; IN COMMERCE 8-0-2005.

THE MARK CONSISTS OF STANDARD CHAR-
ACTERS WITHOUT CLAIM TO ANY PARTICULAR
FONT, STYLE, SIZE, OR COLOR.

OWNER OF U.S. REG. NOS. 1,876,824, 3,009,857
AND OTHERS.

SER. NO. 77-209,590, FILED 6-19-2007.

MARILYN IZZI, EXAMINING ATTORNEY

Int. Cl.: 38

Prior U.S. Cls.: 100, 101 and 104

United States Patent and Trademark Office

Reg. No. 3,474,917

Registered July 29, 2008

**SERVICE MARK
PRINCIPAL REGISTER**

INSTANETFAX

CONCEPTS IN DATA MANAGEMENT, INC.
(CANADA CORPORATION)
P.O. BOX 220 LAMBETH STATION
LONDON, CANADA N6P1P9

FOR: FACSIMILE TRANSMISSION; FACSIMILE
COMMUNICATION; PROVIDING ONLINE FACSI-
MILE TRANSMISSION SERVICES; FACSIMILE
TRANSMISSION WHEREIN THE FACSIMILE IS
DELIVERABLE TO AN E-MAIL ADDRESS, IN
CLASS 38 (U.S. CLS. 100, 101 AND 104).

FIRST USE 3-31-2007; IN COMMERCE 3-31-2007.

THE MARK CONSISTS OF STANDARD CHAR-
ACTERS WITHOUT CLAIM TO ANY PARTICULAR
FONT, STYLE, SIZE, OR COLOR.

SER. NO. 77-209,663, FILED 6-19-2007.

BARBARA BROWN, EXAMINING ATTORNEY

Int. Cl.: 41

Prior U.S. Cls.: 100, 101 and 107

United States Patent and Trademark Office

Reg. No. 3,474,918

Registered July 29, 2008

**SERVICE MARK
PRINCIPAL REGISTER**

NOCCA

THE NEW ORLEANS CENTER FOR CREATIVE
ARTS INSTITUTE (LOUISIANA NON-PROFIT
CORPORATION)

2800 CHARTRES STREET
NEW ORLEANS, LA 70117

FOR: EDUCATION SERVICES, NAMELY, PRO-
VIDING CLASSES, SEMINARS, AND WORKSHOPS
IN THE FIELDS OF DANCE, MEDIA ARTS, MUSIC,
THEATER, CREATIVE WRITING, AND VISUAL
ARTS; ENTERTAINMENT IN THE NATURE OF
VISUAL AND AUDIO PERFORMANCES, NAMELY,

DANCE, MUSICAL, AND THEATRICAL PERFOR-
MANCES, IN CLASS 41 (U.S. CLS. 100, 101 AND 107).

FIRST USE 1-10-1974; IN COMMERCE 1-10-1974.

THE MARK CONSISTS OF STANDARD CHAR-
ACTERS WITHOUT CLAIM TO ANY PARTICULAR
FONT, STYLE, SIZE, OR COLOR.

SER. NO. 77-209,929, FILED 6-19-2007.

MONIQUE MILLER, EXAMINING ATTORNEY

Int. Cl.: 9

Prior U.S. Cls.: 21, 23, 26, 36 and 38

Reg. No. 3,474,919

United States Patent and Trademark Office

Registered July 29, 2008

**TRADEMARK
PRINCIPAL REGISTER**

THE PLUS REPORT

PHYSICIANS PLUS INSURANCE CORPORATION (WISCONSIN CORPORATION)
22 EAST MIFFLIN STREET, SUITE 200
MADISON, WI 53703

FOR: PROVIDING DOWNLOADABLE ELECTRONIC NEWSLETTERS FEATURING INFORMATION ABOUT HEALTH AND WELLNESS, FITNESS, NUTRITION, WEIGHT LOSS, HEALTHY LIVING, MAINTAINING A HEALTHY LIFESTYLE, HEALTH NEWS, COMMUNITY HEALTH EVENTS, NEW HEALTH SERVICES, HEALTH INSURANCE AND OTHER MEDICAL, HEALTH AND WELLNESS RELATED TOPICS; AND PROVIDING DOWNLOADABLE ELECTRONIC NEWSLETTERS TO MEMBERS AND ENROLLEES OF A HEALTH CARE INSURANCE PLAN FEATURING INFORMATION ABOUT HEALTH CARE INSURANCE PLAN SER-

VICES, BENEFITS AND COVERAGES, IN CLASS 9 (U.S. CLS. 21, 23, 26, 36 AND 38).

FIRST USE 10-0-2001; IN COMMERCE 10-0-2001.

THE MARK CONSISTS OF STANDARD CHARACTERS WITHOUT CLAIM TO ANY PARTICULAR FONT, STYLE, SIZE, OR COLOR.

NO CLAIM IS MADE TO THE EXCLUSIVE RIGHT TO USE "REPORT", APART FROM THE MARK AS SHOWN.

SER. NO. 77-209,947, FILED 6-19-2007.

LINDSEY RUBIN, EXAMINING ATTORNEY

Int. Cl.: 12

Prior U.S. Cls.: 19, 21, 23, 31, 35 and 44

United States Patent and Trademark Office

Reg. No. 3,474,920

Registered July 29, 2008

TRADEMARK
PRINCIPAL REGISTER



KNOCKOUT MOTORCYCLE CO., LLC (ARIZONA LTD LIAB CO)
638 W. BROADWAY ROAD, SUITE 314
MESA, AZ 85210

FOR: MOTORCYCLES; MOTORCYCLES AND STRUCTURAL PARTS THEREFOR, IN CLASS 12 (U.S. CLS. 19, 21, 23, 31, 35 AND 44).

FIRST USE 1-1-2007; IN COMMERCE 1-1-2007.

NO CLAIM IS MADE TO THE EXCLUSIVE RIGHT TO USE "MOTORCYCLE CO.", APART FROM THE MARK AS SHOWN.

THE COLOR(S) RED, YELLOW, BEIGE, BLACK AND WHITE IS/ARE CLAIMED AS A FEATURE OF THE MARK.

THE MARK CONSISTS OF TWO MUSCULAR FIGURES WITH SKULLS AS HEADS BOXING

EACH OTHER, WITH FLAMES IN THE BACKGROUND, AND THE WORD "KNOCKOUT" ABOVE, AND THE WORDS "MOTORCYCLE CO.", BELOW THE FIGURES. BOTH FIGURES ARE WEARING PANTS BUT ARE NOT WEARING SHIRTS. THE MARK CONSISTS OF THE COLORS BLACK, RED, YELLOW, WHITE AND BEIGE, AND THE COLORS ARE CLAIMED AS A FEATURE OF THE MARK. THE COLOR BLACK APPEARS IN ALL LETTERING, IN THE OUTLINE, IN THE BODIES, AND ON THE PANTS, OF THE BOXING FIGURES. THE COLOR WHITE APPEARS AS A BACKDROP IN ALL THE LETTERS, AND ON THE TEETH OF EACH OF THE BOXING FIGURES. THE COLOR YELLOW APPEARS INSIDE THE FLAMES. THE COLOR BEIGE APPEARS IN THE TORSO OF EACH OF THE BOXING FIGURES.

SER. NO. 77-209,965, FILED 6-19-2007.

ELISSA GARBER KON, EXAMINING ATTORNEY

Int. Cl.: 25

Prior U.S. Cls.: 22 and 39

United States Patent and Trademark Office

Reg. No. 3,474,921

Registered July 29, 2008

**TRADEMARK
PRINCIPAL REGISTER**



SEARS BRANDS, LLC (ILLINOIS LTD LIAB CO)
3333 BEVERLY ROAD
HOFFMAN ESTATES, IL 60179

FOR: CLOTHING AND WEARING APPAREL,
NAMELY, SHIRTS, TOPS, DRESSES, JUMPERS,
JACKETS, SHORTS, PANTS, CAPRIS, JEANS,
SKIRTS, SKORTS, UNDERWEAR, SOCKS, TIGHTS
AND FOOTWEAR FOR INFANTS, TODDLERS,
GIRLS AND BOYS, IN CLASS 25 (U.S. CLS. 22 AND
39).

FIRST USE 6-1-2007; IN COMMERCE 6-1-2007.

OWNER OF U.S. REG. NO. 2,261,451.

NO CLAIM IS MADE TO THE EXCLUSIVE
RIGHT TO USE "KIDS", APART FROM THE MARK
AS SHOWN.

THE COLOR(S) TURQUOISE, ORANGE AND
WHITE IS/ARE CLAIMED AS A FEATURE OF
THE MARK.

THE MARK CONSISTS OF THE COLOR ORANGE
APPEARING IN THE BACKGROUND OF THE
INNER CIRCLE, THE COLOR TURQUOISE AP-
PEARING IN THE BACKGROUND OF THE OUTER
CIRCLE, AND THE COLOR WHITE APPEARING IN
THE WORDING.

SER. NO. 77-209,995, FILED 6-19-2007.

DARRYL SPRUILL, EXAMINING ATTORNEY

Int. Cl.: 7

Prior U.S. Cls.: 13, 19, 21, 23, 31, 34 and 35

Reg. No. 3,474,922

United States Patent and Trademark Office

Registered July 29, 2008

**TRADEMARK
PRINCIPAL REGISTER**

GRIP PAD

BUFF AND SHINE MANUFACTURING, INC.
(CALIFORNIA CORPORATION)
2139 E. DEL AMO BLVD.
RANCHO DOMINGUEZ, CA 90220

FOR: PADS FOR USE WITH BUFFING MACHINES, POLISHING MACHINES, AND OTHER SURFACE PREPARATION MACHINES FOR VEHICLES, IN CLASS 7 (U.S. CLS. 13, 19, 21, 23, 31, 34 AND 35).

FIRST USE 6-15-1997; IN COMMERCE 6-15-1997.

THE MARK CONSISTS OF STANDARD CHARACTERS WITHOUT CLAIM TO ANY PARTICULAR FONT, STYLE, SIZE, OR COLOR.

NO CLAIM IS MADE TO THE EXCLUSIVE RIGHT TO USE "PAD", APART FROM THE MARK AS SHOWN.

SER. NO. 77-210,099, FILED 6-19-2007.

ANTHONY RINKER, EXAMINING ATTORNEY

Int. Cl.: 35

Prior U.S. Cls.: 100, 101 and 102

United States Patent and Trademark Office

Reg. No. 3,474,923

Registered July 29, 2008

SERVICE MARK
PRINCIPAL REGISTER



HAWAIIAN SOUTH SHORE LLC (HAWAII LTD
LIAB CO)

320 WARD AVE., SUITE 112

HONOLULU, HI 96814

FOR: RETAIL STORE AND ON-LINE RETAIL
STORE SERVICES FEATURING CLOTHING, SURF
BOARDS AND SURFING ACCESSORIES, IN CLASS
35 (U.S. CLS. 100, 101 AND 102).

FIRST USE 1-1-1998; IN COMMERCE 8-1-1999.

NO CLAIM IS MADE TO THE EXCLUSIVE
RIGHT TO USE "HAWAIIAN SOUTH SHORE",
APART FROM THE MARK AS SHOWN.

THE MARK CONSISTS OF IMAGE OF A HIBIS-
CUS FLOWER APPEARING TO THE LEFT OF THE
STYLIZED WORDING "HAWAIIAN SOUTH
SHORE".

SER. NO. 77-210,301, FILED 6-20-2007.

WENDY GOODMAN, EXAMINING ATTORNEY

Int. Cl.: 10

Prior U.S. Cls.: 26, 39 and 44

United States Patent and Trademark Office

Reg. No. 3,474,924

Registered July 29, 2008

**TRADEMARK
PRINCIPAL REGISTER**

The trademark logo consists of the letters 'Ti' in a bold, serif font, followed by a superscript '6'. The 'i' has a dot, and the '6' is positioned to the right and slightly above the 'i'.

KOBY VENTURES, L.P. (TEXAS LIMITED PART-
NERSHIP)
SUITE 101
16350 PARK 10 PLACE
HOUSTON, TX 77084

FOR: MEDICAL INSTRUMENTS AND METAL
SURGICAL IMPLANTS FOR USE IN LOWER EX-
TREMITY MID, FOREFOOT AND REARFOOT
FIXATION PROCEDURES, NAMELY, BONE
SCREWS AND KITS CONTAINING DRIVERS,
DEPTH GAUGES, BONE CLAMPS, SCREW REMOV-

ERS AND GUIDE WIRES, IN CLASS 10 (U.S. CLS. 26,
39 AND 44).

FIRST USE 7-21-2006; IN COMMERCE 7-21-2006.

THE MARK CONSISTS OF STYLIZED LETTERS
"TI" AND SUPERSCRIP "6".

SER. NO. 77-210,355, FILED 6-20-2007.

SHARON MEIER, EXAMINING ATTORNEY

Int. Cl.: 10

Prior U.S. Cls.: 26, 39 and 44

Reg. No. 3,474,925

United States Patent and Trademark Office

Registered July 29, 2008

**TRADEMARK
PRINCIPAL REGISTER**

BioArch

WRIGHT MEDICAL TECHNOLOGY, INC. (DE-
LAWARE CORPORATION)
5677 AIRLINE ROAD
ARLINGTON, TN 380029501

FOR: MEDICAL INSTRUMENTS AND SURGI-
CAL IMPLANTS COMPRISING ARTIFICIAL MA-
TERIAL FOR SURGICAL PROCEDURES OF THE
LOWER EXTREMITY INCLUDING SUBTALAR IM-
PLANTATION, NAMELY, SURGICAL IMPLANTS
COMPRISING ARTIFICIAL MATERIAL AND KITS
CONTAINING TRIAL SIZERS PROBES, DRIVERS

AND REMOVAL TOOLS, IN CLASS 10 (U.S. CLS. 26,
39 AND 44).

FIRST USE 6-4-2007; IN COMMERCE 6-4-2007.

THE MARK CONSISTS OF STANDARD CHAR-
ACTERS WITHOUT CLAIM TO ANY PARTICULAR
FONT, STYLE, SIZE, OR COLOR.

SER. NO. 77-210,412, FILED 6-20-2007.

SHARON MEIER, EXAMINING ATTORNEY

Int. Cl.: 9

Prior U.S. Cls.: 21, 23, 26, 36 and 38

Reg. No. 3,474,926

United States Patent and Trademark Office

Registered July 29, 2008

**TRADEMARK
PRINCIPAL REGISTER**

DataModes

DATA MODES, INC. (OKLAHOMA CORPORATION)
SUITE 202
4200 PERIMETER CENTER
OKLAHOMA CITY, OK 73112

FOR: COMPUTER SOFTWARE THAT PROVIDES REAL-TIME, INTEGRATED BUSINESS MANAGEMENT INTELLIGENCE BY COMBINING INFORMATION FROM VARIOUS DATABASES AND PRESENTING IT IN AN EASY-TO-UNDERSTAND USER INTERFACE; COMPUTER SOFTWARE TO AUTOMATE DATA WAREHOUSING; COMPUTER SOFTWARE TO MONITOR AND CONTROL FACTORY MANUFACTURING PROCESSES; COMPUTER SOFTWARE FOR USE IN CUSTOMER RELATIONSHIP MANAGEMENT, IN CLASS 9 (U.S. CLS. 21, 23, 26, 36 AND 38).

FIRST USE 6-11-1982; IN COMMERCE 12-1-1982.

THE MARK CONSISTS OF STANDARD CHARACTERS WITHOUT CLAIM TO ANY PARTICULAR FONT, STYLE, SIZE, OR COLOR.

OWNER OF U.S. REG. NO. 1,765,673.

SEC. 2(F).

SER. NO. 77-210,473, FILED 6-20-2007.

MATTHEW MCDOWELL, EXAMINING ATTORNEY

Int. Cl.: 7

Prior U.S. Cls.: 13, 19, 21, 23, 31, 34 and 35

Reg. No. 3,474,927

United States Patent and Trademark Office

Registered July 29, 2008

**TRADEMARK
PRINCIPAL REGISTER**

Kenrie

KENRIE, INC. (MICHIGAN CORPORATION)
400 136TH AVENUE, BUILDING 100
HOLLAND, MI 49424

FORMING METAL PARTS, IN CLASS 7 (U.S. CLS.
13, 19, 21, 23, 31, 34 AND 35).

FIRST USE 7-1-2006; IN COMMERCE 7-1-2006.

FOR: POWER-OPERATED MACHINES FOR ASSEMBLING COMPONENTS, NAMELY, WRIST PINS, PISTON RINGS, SEALING RINGS AND BEARING RINGS; POWER-OPERATED MACHINES FOR GRINDING, HONING, AND FORMING METAL PARTS, AND ABRASIVE TOOLS, NAMELY, FLAT STONES THAT ARE IN A CIRCULAR PATTERN, USED WITH POWER OPERATED MACHINES, FOR GRINDING, HONING, AND

THE MARK CONSISTS OF STANDARD CHARACTERS WITHOUT CLAIM TO ANY PARTICULAR FONT, STYLE, SIZE, OR COLOR.

SER. NO. 77-210,593, FILED 6-20-2007.

RENEE MCCRAY, EXAMINING ATTORNEY

Int. Cl.: 7

Prior U.S. Cls.: 13, 19, 21, 23, 31, 34 and 35

United States Patent and Trademark Office

Reg. No. 3,474,928

Registered July 29, 2008

**TRADEMARK
PRINCIPAL REGISTER**



KENRIE, INC. (MICHIGAN CORPORATION)
400 136TH AVENUE, BUILDING 100
HOLLAND, MI 49424

FOR: POWER-OPERATED MACHINES FOR ASSEMBLING COMPONENT, NAMELY, WRIST PINS, PISTON RINGS, SEALING RINGS AND BEARING RINGS; POWER-OPERATED MACHINES FOR GRINDING, HONING AND FORMING METAL PARTS, AND ABRASIVE TOOLS, NAMELY, FLAT STONES THAT ARE IN A CIRCULAR PATTERN, USED WITH POWER OPERATED MACHINES, FOR GRINDING, HONING, AND FORMING METAL

PARTS, IN CLASS 7 (U.S. CLS. 13, 19, 21, 23, 31, 34 AND 35).

FIRST USE 7-1-2006; IN COMMERCE 7-1-2006.

THE MARK CONSISTS OF A BLACK CIRCLE WITH A WHITE STRIPE GOING THROUGH IT WITH THE WORD "KENRIE" ON IT, THE BLACK CIRCLE IS ALSO OUTLINED IN BLACK AS WELL.

SER. NO. 77-210,613, FILED 6-20-2007.

RENEE MCCRAY, EXAMINING ATTORNEY

Int. Cl.: 35

Prior U.S. Cls.: 100, 101 and 102

United States Patent and Trademark Office

Reg. No. 3,474,929

Registered July 29, 2008

**SERVICE MARK
PRINCIPAL REGISTER**



ABIOMED, INC. (DELAWARE CORPORATION)
22 CHERRY HILL DRIVE
DANVERS, MA 01923

FIRST USE 9-15-2006; IN COMMERCE 9-15-2006.

OWNER OF U.S. REG. NOS. 1,332,596, 1,650,057
AND OTHERS.

FOR: CONSULTING SERVICES IN THE MAN-
AGEMENT OF HEALTH CARE FACILITIES; CON-
SULTING SERVICES IN THE ADMINISTRATION
OF PATIENT AND HOSPITAL REIMBURSEMENT
PROGRAMS, IN CLASS 35 (U.S. CLS. 100, 101 AND
102).

SER. NO. 77-211,209, FILED 6-20-2007.

ALICIA COLLINS, EXAMINING ATTORNEY

Int. Cl.: 14

Prior U.S. Cls.: 2, 27, 28 and 50

United States Patent and Trademark Office

Reg. No. 3,474,930

Registered July 29, 2008

**TRADEMARK
PRINCIPAL REGISTER**

Bowlerine

FORDITE CORPORATION (CALIFORNIA CORPORATION)
425 S. PHELPS AVE.
ARLINGTON HEIGHTS, IL 60004

THE MARK CONSISTS OF STANDARD CHARACTERS WITHOUT CLAIM TO ANY PARTICULAR FONT, STYLE, SIZE, OR COLOR.

FOR: UNWROUGHT AND SEMI-WROUGHT PRECIOUS STONES AND THEIR IMITATIONS, IN CLASS 14 (U.S. CLS. 2, 27, 28 AND 50).

SER. NO. 77-211,273, FILED 6-20-2007.

FIRST USE 5-15-2006; IN COMMERCE 8-8-2006.

GISELLE AGOSTO, EXAMINING ATTORNEY

Int. Cl.: 41

Prior U.S. Cls.: 100, 101 and 107

United States Patent and Trademark Office

Reg. No. 3,474,931

Registered July 29, 2008

**SERVICE MARK
PRINCIPAL REGISTER**



CENTURY SKYSONG TV & MOVIE HOLDINGS
INC. (CALIFORNIA CORPORATION)
2010 BATSON AVE.,
#252 ROWLAND HITS,, CA 91748

FOR: AMATEUR YOUTH SPORTS SERVICES, NAMELY, ORGANIZING, PROVIDING AND MANAGING YOUTH SPORTS ACTIVITIES; AMUSEMENT CENTERS; ANIMATION PRODUCTION SERVICES; ARRANGING FOR TICKET RESERVATIONS FOR SHOWS AND OTHER ENTERTAINMENT EVENTS; ARRANGING OF EXHIBITIONS, SEMINARS AND CONFERENCES; AUDIO RECORDING AND PRODUCTION; CABLE TELEVISION PROGRAMMING; CHARITABLE SERVICES, NAMELY, PROVIDING BOOKS TO YOUTH; CHARITABLE SERVICES, NAMELY, PROVIDING TELEVISIONS TO THOSE IN NEED; CINEMA STUDIO; CINEMA THEATERS; CINEMATOGRAPHIC ADAPTATION AND EDITING; COMPOSITION OF MUSIC FOR OTHERS; CONDUCTING ENTERTAINMENT EXHIBITIONS IN THE NATURE OF MUSIC SHOW; CONTINUING PUBLIC SERVICE PROGRAMS IN THE FIELD OF MUSIC PRODUCED AND DISTRIBUTED OVER TELEVISION, SATELLITE, FILM, AUDIO, VIDEO, INTERNET, AND 3-D VIRTUAL REALITY MEDIA; DESKTOP PUBLISHING FOR OTHERS; DEVELOPING EDUCATIONAL

MANUALS FOR OTHERS IN THE FIELD OF MUSIC; DIGITAL IMAGING SERVICES; DIRECTION OF MAKING RADIO OR TELEVISION PROGRAMS; DIRECTION OR PRESENTATION OF PLAYS, IN CLASS 41 (U.S. CLS. 100, 101 AND 107).

FIRST USE 4-1-2007; IN COMMERCE 4-1-2007.

THE MARK CONSISTS OF A DEVICE FILM, CHINESE CHARACTERS AND ENGLISH WORDING "SHIJITIANGE".

THE FOREIGN WORDING IN THE MARK TRANSLATES INTO ENGLISH AS GENERATION, AGE, SKY AND SONG SEPARATELY, BUT READ TOGETHER IT HAS NO MEANING.

THE NON-LATIN CHARACTER(S) IN THE MARK TRANSLITERATE INTO "SHI", "JI", "TIAN" AND "GE", AND THIS MEANS GENERATION, AGE, SKY AND SONG SEPARATELY, BUT READ TOGETHER IT HAS NO MEANING IN ENGLISH.

SER. NO. 77-211,471, FILED 6-21-2007.

KATHERINE STOIDES, EXAMINING ATTORNEY

Int. Cl.: 35

Prior U.S. Cls.: 100, 101 and 102

United States Patent and Trademark Office

Reg. No. 3,474,932

Registered July 29, 2008

**SERVICE MARK
PRINCIPAL REGISTER**

LAST CALL

LFC CORPORATE SERVICES, INC. (CALIFORNIA CORPORATION)
17 CORPORATE PLAZA DR.
NEWPORT BEACH, CA 92660

FOR: AUCTIONEERING; AUCTIONING VIA TELECOMMUNICATION NETWORKS; REAL ESTATE ADVERTISING SERVICES; REAL ESTATE AUCTIONS; REAL ESTATE MARKETING SERVICES, NAMELY, ON-LINE SERVICES FEATURING TOURS OF RESIDENTIAL AND COMMERCIAL REAL ESTATE; REAL ESTATE SALES MANAGEMENT; ADVERTISING AND COMMERCIAL INFORMATION SERVICES, VIA THE INTERNET;

ADVERTISING AND MARKETING, IN CLASS 35 (U.S. CLS. 100, 101 AND 102).

FIRST USE 6-1-1997; IN COMMERCE 6-1-1997.

THE MARK CONSISTS OF STANDARD CHARACTERS WITHOUT CLAIM TO ANY PARTICULAR FONT, STYLE, SIZE, OR COLOR.

SER. NO. 77-211,635, FILED 6-21-2007.

LORETTA C. BECK, EXAMINING ATTORNEY

Int. Cl.: 9

Prior U.S. Cls.: 21, 23, 26, 36 and 38

United States Patent and Trademark Office

Reg. No. 3,474,933

Registered July 29, 2008

**TRADEMARK
PRINCIPAL REGISTER**

**RADIUS TRAVEL INSIDER
RADIUS**

WTT, INC. (DELAWARE CORPORATION)
SUITE 1100
4330 EAST WEST HIGHWAY
BETHESDA, MD 20814

FOR: PROVIDING DOWNLOADABLE ELECTRONIC NEWSLETTERS FEATURING TRAVEL INFORMATION, HOTEL INFORMATION, AND NEWS AND PROMOTIONS FOR SUPPLIERS AND VENDORS IN THE TRAVEL INDUSTRY, IN CLASS 9 (U.S. CLS. 21, 23, 26, 36 AND 38).

FIRST USE 1-2-2007; IN COMMERCE 1-2-2007.

THE MARK CONSISTS OF STANDARD CHARACTERS WITHOUT CLAIM TO ANY PARTICULAR FONT, STYLE, SIZE, OR COLOR.

OWNER OF U.S. REG. NO. 2,587,691.

NO CLAIM IS MADE TO THE EXCLUSIVE RIGHT TO USE "TRAVEL INSIDER", APART FROM THE MARK AS SHOWN.

SER. NO. 77-211,755, FILED 6-21-2007.

RICHARD A. STRASER, EXAMINING ATTORNEY

Int. Cl.: 9

Prior U.S. Cls.: 21, 23, 26, 36 and 38

United States Patent and Trademark Office

Reg. No. 3,474,934

Registered July 29, 2008

**TRADEMARK
PRINCIPAL REGISTER**

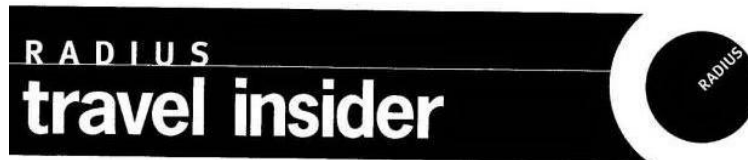

WTT, INC. (DELAWARE CORPORATION)
SUITE 1100
4330 EAST WEST HIGHWAY
BETHESDA, MD 20814

FOR: PROVIDING DOWNLOADABLE ELECTRONIC NEWSLETTERS FEATURING TRAVEL INFORMATION, HOTEL INFORMATION, AND NEWS AND PROMOTIONS FOR SUPPLIERS AND VENDORS IN THE TRAVEL INDUSTRY, IN CLASS 9 (U.S. CLS. 21, 23, 26, 36 AND 38).

FIRST USE 1-2-2007; IN COMMERCE 1-2-2007.

OWNER OF U.S. REG. NO. 2,587,691.

NO CLAIM IS MADE TO THE EXCLUSIVE RIGHT TO USE "TRAVEL INSIDER", APART FROM THE MARK AS SHOWN.

SER. NO. 77-211,771, FILED 6-21-2007.

RICHARD A. STRASER, EXAMINING ATTORNEY

Int. Cl.: 31

Prior U.S. Cls.: 1 and 46

United States Patent and Trademark Office

Reg. No. 3,474,935

Registered July 29, 2008

**TRADEMARK
PRINCIPAL REGISTER**

PAMELA

BALOIAN PACKING CO., INC. (CALIFORNIA
CORPORATION)
P. O. BOX 11337, 446 N. BLYTHE AVENUE
FRESNO, CA 93772

FOR: FRESH FRUITS; FRESH VEGETABLES, IN
CLASS 31 (U.S. CLS. 1 AND 46).

FIRST USE 7-22-1966; IN COMMERCE 8-10-1966.

THE MARK CONSISTS OF STANDARD CHAR-
ACTERS WITHOUT CLAIM TO ANY PARTICULAR
FONT, STYLE, SIZE, OR COLOR.

OWNER OF U.S. REG. NO. 830,284.

SER. NO. 77-211,791, FILED 6-21-2007.

MATTHEW EINSTEIN, EXAMINING ATTORNEY

Int. Cl.: 36

Prior U.S. Cls.: 100, 101 and 102

United States Patent and Trademark Office

Reg. No. 3,474,936

Registered July 29, 2008

**SERVICE MARK
PRINCIPAL REGISTER**

ACTIVIST SPOTLIGHT

INVESTOR COMMUNICATIONS NETWORK,
LLC (NEW YORK CORPORATION)
SUITE 7A
200 E 61ST STREET
NEW YORK, NY 10021

FOR: PROVIDING FINANCIAL INFORMATION
REGARDING SHAREHOLDER ACTIONS VIA THE
INTERNET, IN CLASS 36 (U.S. CLS. 100, 101 AND
102).

FIRST USE 4-23-2007; IN COMMERCE 4-23-2007.

THE MARK CONSISTS OF STANDARD CHAR-
ACTERS WITHOUT CLAIM TO ANY PARTICULAR
FONT, STYLE, SIZE, OR COLOR.

NO CLAIM IS MADE TO THE EXCLUSIVE
RIGHT TO USE "ACTIVIST", APART FROM THE
MARK AS SHOWN.

SER. NO. 77-211,873, FILED 6-21-2007.

ESTHER BELENKER, EXAMINING ATTORNEY

Int. Cl.: 26

Prior U.S. Cls.: 37, 39, 40, 42 and 50

United States Patent and Trademark Office

Reg. No. 3,474,937

Registered July 29, 2008

TRADEMARK
PRINCIPAL REGISTER



BEAUTY NETWORK, INC. (NEW JERSEY CORPORATION)
125-D GALWAY PL.
TEANECK, NJ 07666

FOR: WIGS, HAIRPIECES, AND ADD-IN AND ADD-ON HAIR ACCESSORIES CONSTRUCTED PRIMARILY OF SYNTHETIC AND/OR HUMAN HAIR, IN CLASS 26 (U.S. CLS. 37, 39, 40, 42 AND 50).

FIRST USE 3-29-2005; IN COMMERCE 4-19-2005.

NO CLAIM IS MADE TO THE EXCLUSIVE RIGHT TO USE "HAIR COLLECTION", APART FROM THE MARK AS SHOWN.

THE COLOR(S) BLACK AND GOLD IS/ARE CLAIMED AS A FEATURE OF THE MARK.

THE MARK CONSISTS OF BLACK BACKGROUND WITH THE TERM "BELLE" WRITTEN IN GOLD. THE BLACK BACKGROUND HAS GOLD BORDER. THERE IS A WHITE STARLIGHT DESIGN BEHIND THE FIRST "L" IN "BELLE".

THE ENGLISH TRANSLATION OF "BELLE" IS BEAUTIFUL GIRL.

SER. NO. 77-212,040, FILED 6-21-2007.

MATTHEW MCDOWELL, EXAMINING ATTORNEY

Int. Cl.: 38

Prior U.S. Cls.: 100, 101 and 104

United States Patent and Trademark Office

Reg. No. 3,474,938

Registered July 29, 2008

SERVICE MARK
PRINCIPAL REGISTER

The logo for SpectraRep features the word "SpectraRep" in a bold, italicized serif font. A horizontal line is drawn beneath the text. A large, dark, curved swoosh or arc is positioned behind the text, starting under the 'S' and ending under the 'p', partially overlapping the horizontal line.

SPECTRAREP, INC. (VIRGINIA CORPORATION)
15120 ENTERPRISE COURT
CHANTILLY, VA 20151

FOR: ELECTRONIC, ELECTRIC, AND DIGITAL
TRANSMISSION OF VOICE, DATA, IMAGES, SIG-
NALS, AND MESSAGES; ELECTRONIC DATA
TRANSMISSION; WIRELESS ELECTRONIC
TRANSMISSION OF VOICE SIGNALS, DATA, FAC-
SIMILES, IMAGES AND INFORMATION; SATEL-
LITE TRANSMISSION SERVICES;
TELECOMMUNICATION SERVICES, NAMELY,
LOCAL AND LONG DISTANCE TRANSMISSION

OF VOICE, DATA, GRAPHICS BY MEANS OF
TELEPHONE, TELEGRAPHIC, CABLE, RADIO
AND SATELLITE TRANSMISSIONS, IN CLASS 38
(U.S. CLS. 100, 101 AND 104).

FIRST USE 1-0-2007; IN COMMERCE 1-0-2007.

OWNER OF U.S. REG. NOS. 2,520,169 AND
2,554,990.

SER. NO. 77-212,048, FILED 6-21-2007.

JASON LOTT, EXAMINING ATTORNEY

Int. Cls.: 35, 38 and 42

Prior U.S. Cls.: 100, 101, 102 and 104

United States Patent and Trademark Office

Reg. No. 3,474,939

Registered July 29, 2008

**SERVICE MARK
PRINCIPAL REGISTER**

**CREATIVE MOBILE
TECHNOLOGIES**

CREATIVE MOBILE TECHNOLOGIES, LLC
(NEW YORK LTD LIAB CO)
42-50 24TH STREET
LONG ISLAND CITY, NY 11101

FOR: ADVERTISING, NAMELY, PROMOTING THE SALE OF ARTICLES AND SERVICES FOR THIRD PARTIES BY THE DISSEMINATION OF ADVERTISING MATERIAL AND THE DISSEMINATION OF ADVERTISING MESSAGES ON MOBILE COMPUTER NETWORKS; PROMOTING THE GOODS AND SERVICES OF OTHERS VIA A GLOBAL MOBILE COMPUTER NETWORK; PROVIDING CONSUMER INFORMATION ABOUT THE GOODS AND SERVICES OF OTHERS VIA A GLOBAL MOBILE COMPUTER NETWORK, IN CLASS 35 (U.S. CLS. 100, 101 AND 102).

FIRST USE 6-1-2005; IN COMMERCE 6-1-2005.

FOR: COMMUNICATIONS SERVICES, NAMELY, COMMUNICATING TO MOBILE DEVICES INDEXES OF INFORMATION, SITES, AND OTHER RESOURCES, NAMELY, TRAFFIC INFORMATION, ENTERTAINMENT, FINANCIAL AND OTHER MEDIA, VIA A COMPUTER NETWORK, IN CLASS 38 (U.S. CLS. 100, 101 AND 104).

FIRST USE 6-1-2005; IN COMMERCE 6-1-2005.

FOR: PROVIDING ONLINE NON-DOWNLOADABLE COMPUTER NETWORK SOFTWARE FOR COMMUNICATION IN THE MOBILE TRANSPORTATION INDUSTRY; COMPUTER SERVICES, NAMELY, CREATING INDEXES OF INFORMATION, SITES, AND OTHER RESOURCES AVAILABLE ON COMPUTER NETWORKS, IN CLASS 42 (U.S. CLS. 100 AND 101).

FIRST USE 6-1-2005; IN COMMERCE 6-1-2005.

THE MARK CONSISTS OF STANDARD CHARACTERS WITHOUT CLAIM TO ANY PARTICULAR FONT, STYLE, SIZE, OR COLOR.

NO CLAIM IS MADE TO THE EXCLUSIVE RIGHT TO USE "MOBILE TECHNOLOGIES", APART FROM THE MARK AS SHOWN.

SER. NO. 77-212,127, FILED 6-21-2007.

HEATHER THOMPSON, EXAMINING ATTORNEY

Int. Cl.: 35

Prior U.S. Cls.: 100, 101 and 102

United States Patent and Trademark Office

Reg. No. 3,474,940

Registered July 29, 2008

**SERVICE MARK
PRINCIPAL REGISTER**

SMARTAUCTIONOPEN

GMAC LLC (DELAWARE LTD LIAB CO)
P.O. BOX 200
200 RENAISSANCE CENTER
DETROIT, MI 482652000

FOR: AUCTIONS ON THE GLOBAL COMPUTER
NETWORK FOR USED MOTOR LAND VEHICLES,
IN CLASS 35 (U.S. CLS. 100, 101 AND 102).

FIRST USE 6-9-2007; IN COMMERCE 6-9-2007.

THE MARK CONSISTS OF STANDARD CHAR-
ACTERS WITHOUT CLAIM TO ANY PARTICULAR
FONT, STYLE, SIZE, OR COLOR.

OWNER OF U.S. REG. NO. 3,142,435.

SER. NO. 77-212,344, FILED 6-21-2007.

DEIRDRE ROBERTSON, EXAMINING ATTORNEY

Int. Cl.: 30

Prior U.S. Cl.: 46

United States Patent and Trademark Office

Reg. No. 3,474,941

Registered July 29, 2008

**TRADEMARK
PRINCIPAL REGISTER**

OZARK MOUNTAIN TEA CO.

TWO-WHEELER, LLC (MISSOURI LTD LIAB CO)
4082 NORTH 20TH STREET
OZARK, MO 65721

FOR: TEA, IN CLASS 30 (U.S. CL. 46).

FIRST USE 12-31-1997; IN COMMERCE 12-31-1997.

THE MARK CONSISTS OF STANDARD CHAR-
ACTERS WITHOUT CLAIM TO ANY PARTICULAR
FONT, STYLE, SIZE, OR COLOR.

OWNER OF U.S. REG. NO. 3,203,696.

NO CLAIM IS MADE TO THE EXCLUSIVE
RIGHT TO USE "TEA CO.", APART FROM THE
MARK AS SHOWN.

SEC. 2(F).

SER. NO. 77-212,358, FILED 6-21-2007.

ELIZABETH HUGHITT, EXAMINING ATTORNEY

Int. Cl.: 35

Prior U.S. Cls.: 100, 101 and 102

United States Patent and Trademark Office

Reg. No. 3,474,942

Registered July 29, 2008

**SERVICE MARK
PRINCIPAL REGISTER**



HAN, TAEK SUN (UNITED STATES INDIVIDUAL)
62-11 35TH AVENUE
WOODSIDE, NY 11377

FOR: SUPERMARKETS, IN CLASS 35 (U.S. CLS. 100, 101 AND 102).

FIRST USE 7-0-1986; IN COMMERCE 7-0-1986.

NO CLAIM IS MADE TO THE EXCLUSIVE RIGHT TO USE "MART" , APART FROM THE MARK AS SHOWN.

"THE COLOR(S) GREEN, BLUE, BLACK AND WHITE IS/ARE CLAIMED AS A FEATURE OF THE MARK."

THE MARK CONSISTS OF IN PART OF A SPLIT OVAL DESIGN. THE COLOR GREEN APPEARS IN

THE TOP PORTION OF THE SPLIT OVAL AND THE COLOR BLUE APPEARS IN THE BOTTOM PORTION. THE COLOR WHITE APPEARS IN THE KOREAN LETTERING THAT IS SUPERIMPOSED ON THE SPLIT OVAL AND IN THE HORIZONTAL LINE THAT DIVIDES THE TOP AND BOTTOM PORTIONS. THE COLOR BLACK APPEARS IN THE WORDING "HANYANG MART".

THE NON-LATIN CHARACTER(S) IN THE MARK TRANSLITERATE INTO "HANYANG", AND THIS IS THE ANCIENT NAME OF SEOUL, KOREA IN ENGLISH.

SER. NO. 77-212,473, FILED 6-21-2007.

NANCY CLARKE, EXAMINING ATTORNEY

Int. Cl.: 45

Prior U.S. Cls.: 100 and 101

United States Patent and Trademark Office

Reg. No. 3,474,943

Registered July 29, 2008

**SERVICE MARK
PRINCIPAL REGISTER**

MyJerks

POWELL, VICKIE A. (UNITED STATES INDIVIDUAL)
79 PLUMOSA LN
APTOS, CA 95003

FOR: PROVIDING AN ONLINE COMPUTER DATABASE OF INDIVIDUALS WHO HAVE PREVIOUSLY MADE FALSE CLAIMS DESCRIBING THEMSELVES TO MEMBERS OF ONLINE AND BY-PHONE DATING AND SOCIAL NETWORKING SERVICES , IN CLASS 45 (U.S. CLS. 100 AND 101).

FIRST USE 1-8-2007; IN COMMERCE 1-8-2007.

THE MARK CONSISTS OF STANDARD CHARACTERS WITHOUT CLAIM TO ANY PARTICULAR FONT, STYLE, SIZE, OR COLOR.

SER. NO. 77-212,637, FILED 6-21-2007.

CHARLES L. JENKINS, EXAMINING ATTORNEY

Int. Cl.: 40

Prior U.S. Cls.: 100, 103 and 106

United States Patent and Trademark Office

Reg. No. 3,474,944

Registered July 29, 2008

**SERVICE MARK
PRINCIPAL REGISTER**



DEERE & COMPANY (DELAWARE CORPORATION)
TRADEMARK LAW GROUP
ONE JOHN DEERE PLACE
MOLINE, IL 61265

FOR: MANUFACTURE OF ELECTRONIC CONTROLS, DISPLAYS, USER INTERFACES, SENSORS, AND ELECTRONIC SYSTEMS TO THE ORDER AND SPECIFICATION OF OTHERS , IN CLASS 40 (U.S. CLS. 100, 103 AND 106).

FIRST USE 7-31-1994; IN COMMERCE 7-31-1994.

THE MARK CONSISTS OF A DESIGN OF A BIRD.

SER. NO. 77-212,853, FILED 6-22-2007.

JOHN KELLY, EXAMINING ATTORNEY

Int. Cl.: 40

Prior U.S. Cls.: 100, 103 and 106

United States Patent and Trademark Office

Reg. No. 3,474,945

Registered July 29, 2008

**SERVICE MARK
PRINCIPAL REGISTER**



DEERE & COMPANY (DELAWARE CORPORATION)
TRADEMARK LAW GROUP
ONE JOHN DEERE PLACE
MOLINE, IL 61265

FOR: PROTOTYPING, NAMELY, PROTOTYPE
FABRICATION OF NEW PRODUCTS FOR OTHERS;
MANUFACTURE OF ELECTROMECHANICAL
SYSTEMS AND CONTROLS FOR VEHICLES TO
THE ORDER AND SPECIFICATION OF OTHERS;

ASSEMBLY OF FINAL PRODUCTS FOR OTHERS,
IN CLASS 40 (U.S. CLS. 100, 103 AND 106).

FIRST USE 7-31-1994; IN COMMERCE 7-31-1994.

THE MARK CONSISTS OF A DESIGN OF A BIRD.

SER. NO. 77-212,892, FILED 6-22-2007.

JOHN KELLY, EXAMINING ATTORNEY

Int. Cl.: 36

Prior U.S. Cls.: 100, 101 and 102

United States Patent and Trademark Office

Reg. No. 3,474,946

Registered July 29, 2008

**SERVICE MARK
PRINCIPAL REGISTER**

AAXIA

AAXIA CHEMICAL INSURANCE SERVICES
(OHIO LTD LIAB CO)
SUITE 300
ONE PARK CENTRE DRIVE
WADSWORTH, OH 44281

FIRST USE 12-30-2004; IN COMMERCE 12-30-2004.

THE MARK CONSISTS OF STANDARD CHARACTERS WITHOUT CLAIM TO ANY PARTICULAR FONT, STYLE, SIZE, OR COLOR.

FOR: INSURANCE SERVICES, NAMELY, INSURANCE BROKERAGE AND INSURANCE CONSULTATION IN THE CHEMICAL INDUSTRY, IN CLASS 36 (U.S. CLS. 100, 101 AND 102).

SER. NO. 77-212,970, FILED 6-22-2007.

CHRISTINA SOBRAL, EXAMINING ATTORNEY

Int. Cl.: 36

Prior U.S. Cls.: 100, 101 and 102

United States Patent and Trademark Office

Reg. No. 3,474,947

Registered July 29, 2008

**SERVICE MARK
PRINCIPAL REGISTER**



AAXIA CHEMICAL INSURANCE SERVICES
(OHIO LTD LIAB CO)
SUITE 300
ONE PARK CENTRE DRIVE
WADSWORTH, OH 44281

FOR: INSURANCE SERVICES, NAMELY, INSURANCE BROKERAGE AND INSURANCE CONSULTATION IN THE CHEMICAL INDUSTRY, IN CLASS 36 (U.S. CLS. 100, 101 AND 102).

FIRST USE 12-30-2004; IN COMMERCE 12-30-2004.

NO CLAIM IS MADE TO THE EXCLUSIVE RIGHT TO USE "CHEMICAL INSURANCE SERVICES", APART FROM THE MARK AS SHOWN.

THE MARK CONSISTS OF THE WORD AAXIA WITH A BOX ENCOMPASSING THE FIRST TWO A'S.

SER. NO. 77-212,993, FILED 6-22-2007.

CHRISTINA SOBRAL, EXAMINING ATTORNEY

Int. Cl.: 35

Prior U.S. Cls.: 100, 101 and 102

United States Patent and Trademark Office

Reg. No. 3,474,948

Registered July 29, 2008

**SERVICE MARK
PRINCIPAL REGISTER**

MEDIACURVES.COM

HCD RESEARCH, INC. (NEW JERSEY CORPORATION)
260 US HIGHWAY 202/31, SUITE 1000
FLEMINGTON, NJ 08822

FOR: MARKET RESEARCH SERVICES, NAME-
LY, PROVIDING A WEBSITE WHERE USERS CAN
VIEW RESEARCH RESULTS SHOWING VIEWERS'
PERCEPTIONS OF MEDIA EVENTS AND ADVER-
TISEMENTS , IN CLASS 35 (U.S. CLS. 100, 101 AND
102).

FIRST USE 1-2-2007; IN COMMERCE 1-3-2007.

THE MARK CONSISTS OF STANDARD CHAR-
ACTERS WITHOUT CLAIM TO ANY PARTICULAR
FONT, STYLE, SIZE, OR COLOR.

SER. NO. 77-213,021, FILED 6-22-2007.

MICHELE SWAIN, EXAMINING ATTORNEY

Int. Cl.: 42

Prior U.S. Cls.: 100 and 101

United States Patent and Trademark Office

Reg. No. 3,474,949

Registered July 29, 2008

**SERVICE MARK
PRINCIPAL REGISTER**

ASSETWISE

GMAC MORTGAGE GROUP, LLC (DELAWARE
LTD LIAB CO)
P.O. BOX 200
200 RENAISSANCE CENTER
DETROIT, MI 482652000

FOR: PROVIDING USE OF NON-DOWNLOAD-
ABLE SOFTWARE FOR AUTOMATED LOAN EVA-
LUATION, IN CLASS 42 (U.S. CLS. 100 AND 101).

FIRST USE 6-0-1997; IN COMMERCE 6-0-1997.

THE MARK CONSISTS OF STANDARD CHAR-
ACTERS WITHOUT CLAIM TO ANY PARTICULAR
FONT, STYLE, SIZE, OR COLOR.

OWNER OF U.S. REG. NO. 2,707,254.

SER. NO. 77-213,094, FILED 6-22-2007.

JEAN IM, EXAMINING ATTORNEY

Int. Cl.: 16

Prior U.S. Cls.: 2, 5, 22, 23, 29, 37, 38 and 50

United States Patent and Trademark Office

Reg. No. 3,474,950

Registered July 29, 2008

TRADEMARK
PRINCIPAL REGISTER



REGENTS OF THE UNIVERSITY OF MINNESOTA (MINNESOTA CORPORATION)
600 MCNAMARA ALUMNI CENTER
200 OAK ST. SE
MINNEAPOLIS, MN 55455

FOR: PAPER GOODS AND PRINTED MATTER, NAMELY, DECALS, PADS OF PAPER, PAPER NAPKINS, PAD HOLDERS, PENS, PENCILS, PORTFOLIOS, 3-RING BINDERS, NOTEBOOKS, IN CLASS 16 (U.S. CLS. 2, 5, 22, 23, 29, 37, 38 AND 50).

FIRST USE 0-0-1994; IN COMMERCE 0-0-1994.

OWNER OF U.S. REG. NOS. 1,224,605 AND 2,788,911.

THE COLOR(S) BLACK, TAN, WHITE, BROWN, GOLD AND MAROON IS/ARE CLAIMED AS A FEATURE OF THE MARK.

THE MARK CONSISTS OF AN IMAGE OF A GOPHER WEARING A UNIVERSITY OF MINNESOTA LETTER SWEATER, LEANING WITH AN ARM AGAINST A MAROON, BLOCK LETTER "M", OTHER HAND ON HIP, FACING THE VIEWER, HIS STRIPED TAIL RISING BEHIND HIM AND SHOWING TWO, LARGE FRONT TEETH. SHADES OF THE COLOR MAROON APPEAR IN THE IMAGE OF THE SWEATER AND BLOCK "M"; THE COLOR GOLD APPEARS IN THE LETTER "M" AND STRIPES ON THE SWEATER; THE COLOR TAN APPEARS AS THE COLOR OF THE GOPHER; THE COLORS BROWN AND WHITE APPEAR AS STRIPES ON THE TAIL; AND THE COLORS BLACK AND WHITE APPEAR THROUGHOUT THE MARK FOR HIGHLIGHTING PURPOSES.

SER. NO. 77-213,282, FILED 6-22-2007.

ANNE E. GUSTASON, EXAMINING ATTORNEY

Int. Cl.: 37

Prior U.S. Cls.: 100, 103 and 106

United States Patent and Trademark Office

Reg. No. 3,474,951

Registered July 29, 2008

**SERVICE MARK
PRINCIPAL REGISTER**



CESSNA AIRCRAFT COMPANY (KANSAS CORPORATION)
5800 EAST PAWNEE
WICHITA, KS 67218

FOR: AIRCRAFT REPAIR AND MAINTENANCE,
IN CLASS 37 (U.S. CLS. 100, 103 AND 106).

FIRST USE 4-30-2007; IN COMMERCE 4-30-2007.

OWNER OF U.S. REG. NOS. 896,675, 2,059,252 AND
OTHERS.

NO CLAIM IS MADE TO THE EXCLUSIVE
RIGHT TO USE "SERVICE CENTER", APART
FROM THE MARK AS SHOWN.

THE MARK CONSISTS OF WORDS "CESSNA/
CITATION" TO THE RIGHT OF A STYLIZED
ROCKET; WORDS "SERVICE CENTER" BELOW
CESSNA/CITATION.

SER. NO. 77-213,350, FILED 6-22-2007.

JASON BLAIR, EXAMINING ATTORNEY

Int. Cl.: 33

Prior U.S. Cls.: 47 and 49

United States Patent and Trademark Office

Reg. No. 3,474,952

Registered July 29, 2008

**TRADEMARK
PRINCIPAL REGISTER**

**BULLY HILL VINEYARDS
SEASONS**

BULLY HILL VINEYARDS, INC. (NEW YORK CORPORATION)
8843 GREYTON H. TAYLOR MEMORIAL DR.
HAMMONDSPORT, NY 14840

FOR: WINE, IN CLASS 33 (U.S. CLS. 47 AND 49).

FIRST USE 0-0-1992; IN COMMERCE 0-0-1992.

THE MARK CONSISTS OF STANDARD CHARACTERS WITHOUT CLAIM TO ANY PARTICULAR FONT, STYLE, SIZE, OR COLOR.

OWNER OF U.S. REG. NO. 1,438,127.

NO CLAIM IS MADE TO THE EXCLUSIVE RIGHT TO USE "VINEYARDS", APART FROM THE MARK AS SHOWN.

THE NAME(S), PORTRAIT(S), AND/OR SIGNATURE(S) SHOWN IN THE MARK "BULLY HILL" DOES NOT IDENTIFY A PARTICULAR LIVING INDIVIDUAL.

SER. NO. 77-213,471, FILED 6-22-2007.

MATTHEW MCDOWELL, EXAMINING ATTORNEY

Int. Cl.: 41

Prior U.S. Cls.: 100, 101 and 107

United States Patent and Trademark Office

Reg. No. 3,474,953

Registered July 29, 2008

**SERVICE MARK
PRINCIPAL REGISTER**

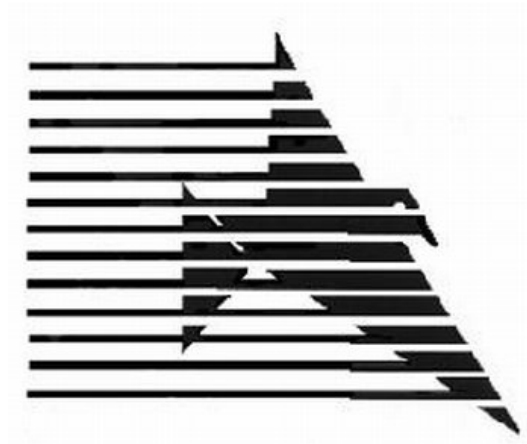

FLORIDA AIR ACADEMY OF MELBOURNE,
INC. (FLORIDA CORPORATION)
1950 S. ACADEMY DRIVE
MELBOURNE, FL 32901

FOR: EDUCATING AT SENIOR HIGH SCHOOLS;
EDUCATIONAL SERVICES IN THE NATURE OF
PRIVATE SECONDARY MILITARY BOARDING
SCHOOLS, IN CLASS 41 (U.S. CLS. 100, 101 AND 107).

FIRST USE 0-0-1990; IN COMMERCE 0-0-1990.

THE MARK CONSISTS OF FLYING BIRD WITH
A SERIES OF TRAILING LINES.

SER. NO. 77-213,572, FILED 6-22-2007.

GIANCARLO CASTRO, EXAMINING ATTORNEY

Int. Cl.: 1

Prior U.S. Cls.: 1, 5, 6, 10, 26 and 46

Reg. No. 3,474,954

United States Patent and Trademark Office

Registered July 29, 2008

**TRADEMARK
PRINCIPAL REGISTER**

UNIT PAK

DESICCARE, INC. (CALIFORNIA CORPORATION)
3400 POMONA BOULEVARD
POMONA, CA 917863236

THE MARK CONSISTS OF STANDARD CHARACTERS WITHOUT CLAIM TO ANY PARTICULAR FONT, STYLE, SIZE, OR COLOR.

FOR: DESICCANTS, MOISTURE ABSORBERS, DESICCANT MATERIALS, NAMELY, CLAY, SILICA GEL, MOLECULAR SIEVE AND ACTIVATED CARBON FOR ABSORBING GASSES ALL FOR USE IN PACKAGING AND SHIPPING CONTAINERS FOR PHARMACEUTICALS, ELECTRONICS, FOOD PRODUCTS, CLOTHING AND CONSUMER PRODUCTS, IN CLASS 1 (U.S. CLS. 1, 5, 6, 10, 26 AND 46).

NO CLAIM IS MADE TO THE EXCLUSIVE RIGHT TO USE PACK, APART FROM THE MARK AS SHOWN.

SER. NO. 77-213,682, FILED 6-22-2007.

FIRST USE 9-30-1994; IN COMMERCE 9-30-1994.

JAMES GRIFFIN, EXAMINING ATTORNEY

Int. Cl.: 35

Prior U.S. Cls.: 100, 101 and 102

United States Patent and Trademark Office

Reg. No. 3,474,955

Registered July 29, 2008

**SERVICE MARK
PRINCIPAL REGISTER**

ORGANIC ZING

AMAZON SUN (NEW YORK LTD LIAB CO)
P.O. BOX 622
WHITE PLAINS, NY 10602

FOR: DISTRIBUTORSHIPS IN THE FIELD OF
NATURAL SPECIALTY FOOD AND GENERAL
MERCHANDISE, PERSONAL CARE ITEMS AND
NUTRITIONAL SUPPLEMENTS; ON-LINE RETAIL
STORE SERVICES FEATURING NATURAL SPECI-
ALTY FOOD AND GENERAL MERCHANDISE,
PERSONAL CARE ITEMS AND NUTRITIONAL

SUPPLEMENTS, IN CLASS 35 (U.S. CLS. 100, 101
AND 102).

FIRST USE 1-15-2007; IN COMMERCE 1-15-2007.

THE MARK CONSISTS OF STANDARD CHAR-
ACTERS WITHOUT CLAIM TO ANY PARTICULAR
FONT, STYLE, SIZE, OR COLOR.

SER. NO. 77-213,851, FILED 6-23-2007.

JEFF DEFORD, EXAMINING ATTORNEY

Int. Cl.: 35

Prior U.S. Cls.: 100, 101 and 102

United States Patent and Trademark Office

Reg. No. 3,474,956

Registered July 29, 2008

SERVICE MARK
PRINCIPAL REGISTER



GOT TO BEAD LLC (TEXAS LTD LIAB CO)
511 N HEWITT DR
HEWITT, TX 76643

FOR: RETAIL STORE SERVICES FEATURING
JEWELRY AND BEADING SUPPLIES, IN CLASS 35
(U.S. CLS. 100, 101 AND 102).

FIRST USE 6-0-2005; IN COMMERCE 6-0-2005.

NO CLAIM IS MADE TO THE EXCLUSIVE
RIGHT TO USE "BEAD", APART FROM THE MARK
AS SHOWN.

THE COLOR(S) GREEN, PURPLE AND BLACK
IS/ARE CLAIMED AS A FEATURE OF THE MARK.

THE MARK CONSISTS OF THE STYLIZED
WORDS "GOT TO BEAD!" APPEARING TO THE
RIGHT OF THE IMAGE OF A STRING OF GREEN
AND PURPLE BEADS. THE COLORS GREEN AND
PURPLE APPEAR IN THE DESIGN OF THE BEADS.
THE COLOR BLACK APPEARS IN THE WORDING
"GOT TO BEAD!" AND IN THE STRING AND
OUTLINE OF THE BEADS.

SER. NO. 77-213,949, FILED 6-23-2007.

JANET LEE, EXAMINING ATTORNEY

Int. Cl.: 35

Prior U.S. Cls.: 100, 101 and 102

United States Patent and Trademark Office

Reg. No. 3,474,957

Registered July 29, 2008

**SERVICE MARK
PRINCIPAL REGISTER**

**AUSTRALIAN BEEF -
WHOLESOME IS OUR NATURE**

MEAT & LIVESTOCK AUSTRALIA, LTD. (AUSTRALIA LTD LIAB CO)
SUITE 602
1401 K STREET
WASHINGTON, DC 20005

FOR: ASSOCIATION SERVICES, NAMELY, PROMOTING THE INTERESTS OF THE BEEF AND BEEF PRODUCT INDUSTRY BY DISSEMINATING ADVERTISING AND PROMOTIONAL MATERIALS , IN CLASS 35 (U.S. CLS. 100, 101 AND 102).

FIRST USE 6-21-2007; IN COMMERCE 6-21-2007.

THE MARK CONSISTS OF STANDARD CHARACTERS WITHOUT CLAIM TO ANY PARTICULAR FONT, STYLE, SIZE, OR COLOR.

NO CLAIM IS MADE TO THE EXCLUSIVE RIGHT TO USE "AUSTRALIAN BEEF", APART FROM THE MARK AS SHOWN.

SER. NO. 77-214,247, FILED 6-25-2007.

TRACY CROSS, EXAMINING ATTORNEY

Int. Cls.: 35, 38 and 42

Prior U.S. Cls.: 100, 101, 102 and 104

United States Patent and Trademark Office

Reg. No. 3,474,958

Registered July 29, 2008

**SERVICE MARK
PRINCIPAL REGISTER**



CREATIVE MOBILE TECHNOLOGIES, LLC
(NEW YORK LTD LIAB CO)
42-50 24TH STREET
LONG ISLAND CITY, NY 11101

FOR: ADVERTISING, NAMELY, PROMOTING THE SALE OF ARTICLES AND SERVICES FOR THIRD PARTIES BY THE DISSEMINATION OF ADVERTISING MATERIAL AND THE DISSEMINATION OF ADVERTISING MESSAGES ON MOBILE COMPUTER NETWORKS; PROMOTING THE GOODS AND SERVICES OF OTHERS VIA A GLOBAL MOBILE COMPUTER NETWORK; PROVIDING CONSUMER INFORMATION ABOUT THE GOODS AND SERVICES OF OTHERS VIA A GLOBAL MOBILE COMPUTER NETWORK, IN CLASS 35 (U.S. CLS. 100, 101 AND 102).

FIRST USE 6-1-2005; IN COMMERCE 6-1-2005.

FOR: COMMUNICATIONS SERVICES, NAMELY, COMMUNICATING TO MOBILE DEVICES INDEXES OF INFORMATION, SITES, AND OTHER RESOURCES, NAMELY, TRAFFIC INFORMATION, ENTERTAINMENT, FINANCIAL AND OTHER MEDIA, VIA A COMPUTER NETWORK, IN CLASS 38 (U.S. CLS. 100, 101 AND 104).

FIRST USE 6-1-2005; IN COMMERCE 6-1-2005.

FOR: PROVIDING ONLINE NON-DOWNLOADABLE COMPUTER NETWORK SOFTWARE FOR COMMUNICATION IN THE MOBILE TRANSPORTATION INDUSTRY; COMPUTER SERVICES, NAMELY, CREATING INDEXES OF INFORMATION, SITES, AND OTHER RESOURCES AVAIL-

ABLE ON COMPUTER NETWORKS, IN CLASS 42 (U.S. CLS. 100 AND 101).

FIRST USE 6-1-2005; IN COMMERCE 6-1-2005.

NO CLAIM IS MADE TO THE EXCLUSIVE RIGHT TO USE "MOBILE TECHNOLOGIES", APART FROM THE MARK AS SHOWN.

THE COLOR(S) YELLOW, BLACK, WHITE AND GRAY IS/ARE CLAIMED AS A FEATURE OF THE MARK.

THE MARK CONSISTS OF A BANNER, DIVIDED INTO THREE SECTIONS, WHEREIN THE TOP AND BOTTOM SECTIONS ARE SMALLER THAN THE MIDDLE, AND THE TOP SECTION IS COMPRISED OF A BLACK AND WHITE CHECKED PATTERN. BENEATH, THE MIDDLE SECTION IS YELLOW WITH CREATIVE APPEARING IN LARGER, BLACK STYLIZED FONT. MOBILE TECHNOLOGIES IS DISPLAYED IN THE BOTTOM SECTION WHICH IS BLACK. MOBILE APPEARS IN A STYLIZED, WHITE FONT AND TECHNOLOGIES IS IN A STYLIZED, YELLOW FONT. THERE IS A COMPUTER SCREEN IMMEDIATELY TO THE RIGHT OF THE BANNER, WITH A GRAY BORDER AND BLACK SCREEN. CMT APPEARS IN A YELLOW FONT AND IN THE CENTER OF THE SCREEN.

SER. NO. 77-214,298, FILED 6-25-2007.

HEATHER THOMPSON, EXAMINING ATTORNEY

Int. Cl.: 44

Prior U.S. Cls.: 100 and 101

United States Patent and Trademark Office

Reg. No. 3,474,959

Registered July 29, 2008

**SERVICE MARK
PRINCIPAL REGISTER**

ZHEN REFLECTIONS

SHELLY AND MARK DEVELOPMENT LLC
(MINNESOTA LTD LIAB CO)
4100 SPRING STREET
SPRING PARK, MN 55384

FOR: HEALTH SPA SERVICES, NAMELY, COSMETIC BODY CARE SERVICES; HEALTH AND BEAUTY SALON SERVICES, NAMELY, MASSAGES, FACIALS, MANICURES, PEDICURES, FLOTATION THERAPY, RELAXATION THERAPY, BODY AND FACE WAXING, MAKE-UP APPLICATION SERVICES; HAIR SALON SERVICES; OPERATION OF HAMMAM, NAMELY, TURKISH STEAM ROOM, IN CLASS 44 (U.S. CLS. 100 AND 101).

FIRST USE 4-0-2007; IN COMMERCE 4-0-2007.

THE MARK CONSISTS OF STANDARD CHARACTERS WITHOUT CLAIM TO ANY PARTICULAR FONT, STYLE, SIZE, OR COLOR.

THE FOREIGN WORDING IN THE MARK TRANSLATES INTO ENGLISH AS JADE.

SER. NO. 77-214,628, FILED 6-25-2007.

STEPHANIE ALI, EXAMINING ATTORNEY

Int. Cl.: 44

Prior U.S. Cls.: 100 and 101

United States Patent and Trademark Office

Reg. No. 3,474,960

Registered July 29, 2008

SERVICE MARK
PRINCIPAL REGISTER



SHELLY AND MARK DEVELOPMENT LLC
(MINNESOTA LTD LIAB CO)
4100 SPRING STREET
SPRING PARK, MN 55384

FOR: HEALTH SPA SERVICES, NAMELY, COSMETIC BODY CARE SERVICES; HEALTH AND BEAUTY SALON SERVICES, NAMELY, MASSAGES, FACIALS, MANICURES, PEDICURES, FLOTATION THERAPY, RELAXATION THERAPY, BODY AND FACE WAXING, MAKE-UP APPLICATION SERVICES; HAIR SALON SERVICES; OPERATION OF HAMMAM, NAMELY, TURKISH STEAM ROOM, IN CLASS 44 (U.S. CLS. 100 AND 101).

FIRST USE 4-0-2007; IN COMMERCE 4-0-2007.

NO CLAIM IS MADE TO THE EXCLUSIVE RIGHT TO USE "SPA & SALON", APART FROM THE MARK AS SHOWN.

THE FOREIGN WORDING IN THE MARK TRANSLATES INTO ENGLISH AS JADE.

SER. NO. 77-214,671, FILED 6-25-2007.

STEPHANIE ALI, EXAMINING ATTORNEY

Int. Cls.: 35 and 37

Prior U.S. Cls.: 100, 101, 102, 103 and 106

United States Patent and Trademark Office

Reg. No. 3,474,961

Registered July 29, 2008

**SERVICE MARK
PRINCIPAL REGISTER**



BRICKELL FINANCIAL
CENTRE

BRICKELL FINANCIAL CENTRE, LLC (FLORIDA LTD LIAB CO)
SUITE 808
777 BRICKELL AVENUE
MIAMI, FL 33131

FOR: REAL ESTATE MARKETING SERVICES IN THE FIELD OF CLASS-A OFFICE SPACE AND RETAIL SPACE COMMITTED TO SUSTAINABLE GREEN DESIGN AND ECOLOGICAL AWARENESS AND EFFICIENCY, IN CLASS 35 (U.S. CLS. 100, 101 AND 102).

FIRST USE 4-2-2007; IN COMMERCE 4-2-2007.

FOR: REAL ESTATE DEVELOPMENT IN THE FIELD OF CLASS-A OFFICE SPACE AND RETAIL SPACE COMMITTED TO SUSTAINABLE GREEN DESIGN AND ECOLOGICAL AWARENESS AND EFFICIENCY, IN CLASS 37 (U.S. CLS. 100, 103 AND 106).

FIRST USE 9-26-2007; IN COMMERCE 9-26-2007.

NO CLAIM IS MADE TO THE EXCLUSIVE RIGHT TO USE "BRICKELL FINANCIAL CENTRE", APART FROM THE MARK AS SHOWN.

THE COLOR(S) GRAY, WHITE, GREEN AND BLACK IS/ARE CLAIMED AS A FEATURE OF THE MARK.

THE MARK CONSISTS OF WHITE HORIZONTAL RECTANGLE INSIDE AND 4/5TH OF THE WAY TOWARDS THE BOTTOM OF A GRAY VERTICAL RECTANGLE WITH GREEN HORIZONTAL RECTANGLE DIRECTLY TO THE RIGHT OF THE WHITE HORIZONTAL RECTANGLE WITH THE WORDS "BRICKELL FINANCIAL CENTRE" IN BLACK DIRECTLY BELOW THE GRAY VERTICAL RECTANGLE.

SER. NO. 77-214,758, FILED 6-25-2007.

CHARLOTTE CORWIN, EXAMINING ATTORNEY

Int. Cls.: 35 and 37

Prior U.S. Cls.: 100, 101, 102, 103 and 106

United States Patent and Trademark Office

Reg. No. 3,474,962

Registered July 29, 2008

**SERVICE MARK
PRINCIPAL REGISTER**

The Ideal Business Climate

BRICKELL FINANCIAL CENTRE, LLC (FLORIDA LTD LIAB CO)
SUITE 808
777 BRICKELL AVENUE
MIAMI, FL 33131

FOR: REAL ESTATE MARKETING SERVICES IN THE FIELDS OF CLASS A OFFICE SPACE AND RETAIL SPACE COMMITTED TO SUSTAINABLE GREEN DESIGN AND ECOLOGICAL AWARENESS AND EFFICIENCY, IN CLASS 35 (U.S. CLS. 100, 101 AND 102).

FIRST USE 4-2-2007; IN COMMERCE 4-2-2007.

FOR: REAL ESTATE DEVELOPMENT SERVICES IN THE FIELDS OF CLASS A OFFICE SPACE AND

RETAIL SPACE COMMITTED TO SUSTAINABLE GREEN DESIGN AND ECOLOGICAL AWARENESS AND EFFICIENCY, IN CLASS 37 (U.S. CLS. 100, 103 AND 106).

FIRST USE 9-26-2007; IN COMMERCE 9-26-2007.

THE MARK CONSISTS OF STANDARD CHARACTERS WITHOUT CLAIM TO ANY PARTICULAR FONT, STYLE, SIZE, OR COLOR.

SER. NO. 77-214,897, FILED 6-25-2007.

CHARLOTTE CORWIN, EXAMINING ATTORNEY

Int. Cl.: 35

Prior U.S. Cls.: 100, 101 and 102

United States Patent and Trademark Office

Reg. No. 3,474,963

Registered July 29, 2008

**SERVICE MARK
PRINCIPAL REGISTER**



MEAT & LIVESTOCK AUSTRALIA, LTD. (AUSTRALIA LTD LIAB CO)
SUITE 602
1401 K STREET
WASHINGTON, DC 20005

FOR: ASSOCIATION SERVICES, NAMELY, PROMOTING THE INTERESTS OF THE BEEF AND BEEF PRODUCT INDUSTRY BY DISSEMINATING ADVERTISING AND PROMOTIONAL MATERIALS , IN CLASS 35 (U.S. CLS. 100, 101 AND 102).

FIRST USE 6-21-2007; IN COMMERCE 6-21-2007.

NO CLAIM IS MADE TO THE EXCLUSIVE RIGHT TO USE "AUSTRALIAN BEEF" AND THE

MAP OUTLINE OF AUSTRALIA, APART FROM THE MARK AS SHOWN.

THE MARK CONSISTS OF A CIRCLE ENCLOSED WITH THE WORDS "AUSTRALIAN" ALONG THE TOP CONTOUR, "WHOLESOME IS OUR NATURE" ALONG THE BOTTOM CONTOUR AND "BEEF" IN THE MIDDLE. A MAP OF CONTINENTAL AUSTRALIA SURROUNDS THE WORD "BEEF". THE BOTTOM HALF OF THE CIRCLE IS SHADED, WHILE THE TOP HALF IS NOT.

SER. NO. 77-215,315, FILED 6-26-2007.

TRACY CROSS, EXAMINING ATTORNEY

Int. Cl.: 5

Prior U.S. Cls.: 6, 18, 44, 46, 51 and 52

United States Patent and Trademark Office

Reg. No. 3,474,964

Registered July 29, 2008

**TRADEMARK
PRINCIPAL REGISTER**

HAIR FACTORS

ISI BRANDS INC. (MICHIGAN CORPORATION)
3133 ORCHARD VISTA DRIVE
GRAND RAPIDS, MI 49546

FOR: DIETARY FOOD SUPPLEMENT, IN CLASS
5 (U.S. CLS. 6, 18, 44, 46, 51 AND 52).

FIRST USE 11-4-1982; IN COMMERCE 11-4-1982.

THE MARK CONSISTS OF STANDARD CHAR-
ACTERS WITHOUT CLAIM TO ANY PARTICULAR
FONT, STYLE, SIZE, OR COLOR.

NO CLAIM IS MADE TO THE EXCLUSIVE
RIGHT TO USE "HAIR", APART FROM THE MARK
AS SHOWN.

SER. NO. 77-215,324, FILED 6-26-2007.

RONALD AIKENS, EXAMINING ATTORNEY

Int. Cl.: 35

Prior U.S. Cls.: 100, 101 and 102

United States Patent and Trademark Office

Reg. No. 3,474,965

Registered July 29, 2008

**SERVICE MARK
PRINCIPAL REGISTER**

Louisiana Lightning

RON GUIDRY (UNITED STATES INDIVIDUAL)
SUITE 1300
C/O CABOT MARKS, 485 MADISON AVENUE
NEW YORK, NY 10022

FOR: PROMOTING THE GOODS AND/OR SERVICES OF OTHERS THROUGH THE ISSUANCE OF PRODUCT ENDORSEMENTS, IN CLASS 35 (U.S. CLS. 100, 101 AND 102).

FIRST USE 6-17-1978; IN COMMERCE 6-17-1978.

THE MARK CONSISTS OF STANDARD CHARACTERS WITHOUT CLAIM TO ANY PARTICULAR FONT, STYLE, SIZE, OR COLOR.

THE NAME APPEARING AS THE MARK IS A NICKNAME OF THE PERSON SEEKING REGISTRATION.

SER. NO. 77-215,673, FILED 6-26-2007.

HENRY S. ZAK, EXAMINING ATTORNEY

Int. Cl.: 17

Prior U.S. Cls.: 1, 5, 12, 13, 35 and 50

Reg. No. 3,474,966

United States Patent and Trademark Office

Registered July 29, 2008

**TRADEMARK
PRINCIPAL REGISTER**

DZ

DING-ZING CHEMICAL PRODUCTS CO., LTD.
(TAIWAN CORPORATION)
NO. 8-1, PEI-LIN RD., HSIAO-KANG DIST.
KAOHSIUNG, TAIWAN

FOR: PLASTIC BARS; RUBBER BARS; PLASTIC LAMINATES IN THE NATURE OF A PLASTIC SHEET COATING FOR USE ON CREDIT CARDS, IDENTIFICATION CARDS, MEMBERSHIP CARDS, DEBIT CARDS AND CHECK CARDS; RUBBER HOSES FOR MOTORS; PLASTIC HOSES FOR USE IN VENTILATION; RUBBER HIGH-PRESSURE HOSES FOR USE IN AIR-OPERATED POWER TOOLS, NAMELY, IMPACT WRENCHES, RATCHET WRENCHES, DRILLS, GRINDERS, ORBITAL SANDERS; INSULATING AND PROTECTIVE INTERLAYER PLASTIC FILMS FOR USE IN SEMICONDUCTORS; HEAT-PLASTICIZED POLYURETHANE PENETRATING FILMS FOR USE IN THE INNER LAYER OF SNOW WEAR AND GLOVES; PLASTIC FOAM CLOTHS MADE OF THERMOPLASTIC POLYURETHANE FILM FOR USE IN THE MANUFACTURING OF CLOTHING, GLOVES OR SNEAKERS; SOUND-PROOF MATERIAL FOR BUILDINGS; NON-METAL OIL SEALS FOR USE IN PNEUMATIC CYLINDER AND HYDRAULIC CYLINDER; LININGS MADE OF THERMOPLASTIC POLYURETHANE FILM FOR USE IN THE MANUFACTURING OF CLOTHING,

GLOVES OR SNEAKERS; NON-METAL GASKETS FOR USE IN PNEUMATIC CYLINDER AND HYDRAULIC CYLINDER; NON-METAL WASHERS FOR USE IN PNEUMATIC CYLINDER AND HYDRAULIC CYLINDER; O-RINGS OF RUBBER FOR USE AS PIPE CONNECTION SEALS, OIL PROTECTIVE RINGS FOR USE AS PIPE CONNECTION SEALS; PLASTIC VIBRATION-PROOF MATS MADE OF THERMOPLASTIC POLYURETHANE FILM FOR USE IN THE MANUFACTURING OF CLOTHING, GLOVES OR SNEAKERS; CARD PROTECTIVE PLASTIC FILMS IN THE NATURE OF A PLASTIC SHEET COATING FOR USE ON CREDIT CARDS, IDENTIFICATION CARDS, MEMBERSHIP CARDS, DEBIT CARDS, AND CHECK CARDS; HEAT-PLASTICIZED POLYURETHANE FILMS FOR USE IN THE INNER LAYER OF SNEAKERS AND SOCCER BALLS, IN CLASS 17 (U.S. CLS. 1, 5, 12, 13, 35 AND 50).

FIRST USE 1-1-1992; IN COMMERCE 5-1-1992.

THE MARK CONSISTS OF STANDARD CHARACTERS WITHOUT CLAIM TO ANY PARTICULAR FONT, STYLE, SIZE, OR COLOR.

SER. NO. 77-215,705, FILED 6-26-2007.

MICHAEL KEATING, EXAMINING ATTORNEY

Int. Cl.: 12

Prior U.S. Cls.: 19, 21, 23, 31, 35 and 44

United States Patent and Trademark Office

Reg. No. 3,474,967

Registered July 29, 2008

**TRADEMARK
PRINCIPAL REGISTER**

SEACRAFT

MAKO MARINE INTERNATIONAL, INC. (FLOR-
IDA CORPORATION)
4355 N.W. 128TH STREET
MIAMI, FL 33054

FOR: PERSONAL RECREATIONAL BOATS,
NAMELY, MOTOR BOATS, IN CLASS 12 (U.S. CLS.
19, 21, 23, 31, 35 AND 44).

FIRST USE 6-15-1961; IN COMMERCE 6-15-1961.

THE MARK CONSISTS OF STANDARD CHAR-
ACTERS WITHOUT CLAIM TO ANY PARTICULAR
FONT, STYLE, SIZE, OR COLOR.

OWNER OF U.S. REG. NO. 2,551,226.

SEC. 2(F).

SER. NO. 77-215,757, FILED 6-26-2007.

MICHAEL SOUDERS, EXAMINING ATTORNEY

Int. Cl.: 29

Prior U.S. Cl.: 46

United States Patent and Trademark Office

Reg. No. 3,474,968

Registered July 29, 2008

**TRADEMARK
PRINCIPAL REGISTER**

GARDENBURGER GOURMET

WHOLESOME & HEARTY FOODS, INC. (DELA-
WARE CORPORATION)
SUITE 350
15615 ALTON PARKWAY
IRVINE, CA 92618

FOR: UNFORMED AND FORMED TEXTURED
MEAT SUBSTITUTES AND MEAT EXTENDERS
CONSISTING PRIMARILY OF VEGETABLES,
GRAINS OR SOY, IN CLASS 29 (U.S. CL. 46).

FIRST USE 6-25-2007; IN COMMERCE 6-25-2007.

THE MARK CONSISTS OF STANDARD CHAR-
ACTERS WITHOUT CLAIM TO ANY PARTICULAR
FONT, STYLE, SIZE, OR COLOR.

OWNER OF U.S. REG. NOS. 1,400,966, 2,103,410,
AND 2,103,545.

NO CLAIM IS MADE TO THE EXCLUSIVE
RIGHT TO USE "GOURMET", APART FROM THE
MARK AS SHOWN.

SER. NO. 77-215,786, FILED 6-26-2007.

GEORGIA CARTY, EXAMINING ATTORNEY

Int. Cl.: 35

Prior U.S. Cls.: 100, 101 and 102

United States Patent and Trademark Office

Reg. No. 3,474,969

Registered July 29, 2008

SERVICE MARK
PRINCIPAL REGISTER

francounselgroup

FRANCOUNSEL GROUP, LLC (GEORGIA LTD
LIAB CO)
419 ALLISON DRIVE
ATLANTA, GA 30342

FOR: FRANCHISE CONSULTING SERVICES,
NAMELY, CONSULTATION IN THE FIELD OF
FRANCHISE BUSINESS MANAGEMENT, ORGANI-
ZATION AND PROMOTION; LICENSE CONSULT-
ING, NAMELY, CONSULTATION ABOUT THE
COMMERCIAL ADMINISTRATION OF THE LI-
CENSING OF THE GOODS AND SERVICES OF
OTHERS; CONSULTATION IN THE FIELD OF DIS-
TRIBUTION OF ADVERTISEMENTS AND COM-

MERCIAL ANNOUNCEMENTS, IN CLASS 35 (U.S.
CLS. 100, 101 AND 102).

FIRST USE 12-15-2005; IN COMMERCE 12-15-2005.

THE MARK CONSISTS OF STANDARD CHAR-
ACTERS WITHOUT CLAIM TO ANY PARTICULAR
FONT, STYLE, SIZE, OR COLOR.

SER. NO. 77-215,861, FILED 6-26-2007.

NELSON SNYDER, EXAMINING ATTORNEY

Int. Cl.: 41

Prior U.S. Cls.: 100, 101 and 107

United States Patent and Trademark Office

Reg. No. 3,474,970

Registered July 29, 2008

**SERVICE MARK
PRINCIPAL REGISTER**

World Allergy Day

WORLD ALLERGY ORGANIZATION, INC. (WIS-
CONSIN CORPORATION)
STE 1100
555 E. WELLS ST.
MILWAUKEE, WI 53202

FOR: EDUCATIONAL SERVICES, NAMELY,
CONDUCTING CLASSES, SEMINARS, CONFEREN-
CES, SYMPOSIA, AND WORKSHOPS IN THE FIELD
OF ALLERGY, ASTHMA, AND CLINICAL IMMUNO-
LOGY, AND DISTRIBUTING COURSE MATERI-
ALS IN CONNECTION THEREWITH, IN CLASS 41
(U.S. CLS. 100, 101 AND 107).

FIRST USE 7-1-2005; IN COMMERCE 7-1-2005.

THE MARK CONSISTS OF STANDARD CHAR-
ACTERS WITHOUT CLAIM TO ANY PARTICULAR
FONT, STYLE, SIZE, OR COLOR.

NO CLAIM IS MADE TO THE EXCLUSIVE
RIGHT TO USE "WORLD ALLERGY", APART
FROM THE MARK AS SHOWN.

SER. NO. 77-215,887, FILED 6-26-2007.

ROBIN CHOSID, EXAMINING ATTORNEY

Int. Cl.: 43

Prior U.S. Cls.: 100 and 101

United States Patent and Trademark Office

Reg. No. 3,474,971

Registered July 29, 2008

**SERVICE MARK
PRINCIPAL REGISTER**

TIGG'S CATERING

CANTEEN SERVICES, INC. (MICHIGAN CORPORATION)

5695 W. RIVER DRIVE., N.E.

BELMONT, MI 49306

FOR: RESTAURANT AND CATERING SERVICES, IN CLASS 43 (U.S. CLS. 100 AND 101).

FIRST USE 6-12-2006; IN COMMERCE 6-12-2006.

THE MARK CONSISTS OF STANDARD CHARACTERS WITHOUT CLAIM TO ANY PARTICULAR FONT, STYLE, SIZE, OR COLOR.

NO CLAIM IS MADE TO THE EXCLUSIVE RIGHT TO USE "CATERING", APART FROM THE MARK AS SHOWN.

SER. NO. 77-215,896, FILED 6-26-2007.

MARGERY A. TIERNEY, EXAMINING ATTORNEY

Int. Cl.: 42

Prior U.S. Cls.: 100 and 101

United States Patent and Trademark Office

Reg. No. 3,474,972

Registered July 29, 2008

**SERVICE MARK
PRINCIPAL REGISTER**

World Allergy Day

WORLD ALLERGY ORGANIZATION, INC. (WIS-
CONSIN NON-STOCK CORPORATION)
STE. 1100
555 E. WELLS ST.
MILWAUKEE, WI 53202

FOR: PROVIDING INFORMATION ABOUT SCI-
ENTIFIC ADVANCES IN THE FIELD OF ALLERGY,
ASTHMA, AND CLINICAL IMMUNOLOGY, IN
CLASS 42 (U.S. CLS. 100 AND 101).

FIRST USE 7-1-2005; IN COMMERCE 7-1-2005.

THE MARK CONSISTS OF STANDARD CHAR-
ACTERS WITHOUT CLAIM TO ANY PARTICULAR
FONT, STYLE, SIZE, OR COLOR.

NO CLAIM IS MADE TO THE EXCLUSIVE
RIGHT TO USE "WORLD ALLERGY", APART
FROM THE MARK AS SHOWN.

SER. NO. 77-215,922, FILED 6-26-2007.

MICHAEL WEBSTER, EXAMINING ATTORNEY

Int. Cl.: 43

Prior U.S. Cls.: 100 and 101

United States Patent and Trademark Office

Reg. No. 3,474,973

Registered July 29, 2008

**SERVICE MARK
PRINCIPAL REGISTER**

TIGG'S DINING

CANTEEN SERVICES, INC. (MICHIGAN CORPORATION)

5695 W. RIVER DRIVE., N.E.

BELMONT, MI 49306

FOR: RESTAURANT AND CATERING SERVICES, IN CLASS 43 (U.S. CLS. 100 AND 101).

FIRST USE 6-12-2006; IN COMMERCE 6-12-2006.

THE MARK CONSISTS OF STANDARD CHARACTERS WITHOUT CLAIM TO ANY PARTICULAR FONT, STYLE, SIZE, OR COLOR.

NO CLAIM IS MADE TO THE EXCLUSIVE RIGHT TO USE "DINING", APART FROM THE MARK AS SHOWN.

SER. NO. 77-215,949, FILED 6-26-2007.

MARGERY A. TIERNEY, EXAMINING ATTORNEY

Int. Cl.: 16

Prior U.S. Cls.: 2, 5, 22, 23, 29, 37, 38 and 50

United States Patent and Trademark Office

Reg. No. 3,474,974

Registered July 29, 2008

**TRADEMARK
PRINCIPAL REGISTER**

One Skein Wonder

JAPEL, STEFANIE (UNITED STATES INDIVIDUAL)

1810 BOSTON DRIVE

LAS CRUCES, NM 88001

FOR: PATTERNS FOR KNITTING, IN CLASS 16
(U.S. CLS. 2, 5, 22, 23, 29, 37, 38 AND 50).

FIRST USE 11-27-2005; IN COMMERCE 11-27-2005.

THE MARK CONSISTS OF STANDARD CHARACTERS WITHOUT CLAIM TO ANY PARTICULAR FONT, STYLE, SIZE, OR COLOR.

NO CLAIM IS MADE TO THE EXCLUSIVE RIGHT TO USE "ONE SKEIN", APART FROM THE MARK AS SHOWN.

SER. NO. 77-216,177, FILED 6-26-2007.

JIM RINGLE, EXAMINING ATTORNEY

Int. Cl.: 9

Prior U.S. Cls.: 21, 23, 26, 36 and 38

Reg. No. 3,474,975

United States Patent and Trademark Office

Registered July 29, 2008

**TRADEMARK
PRINCIPAL REGISTER**

Entrance and Exit Light's

MICOVICH, CHARLES (UNITED STATES INDIVIDUAL)
19935 FIVE POINTS
REDFORD, MI 48240

FOR: COMPUTER SOFTWARE FOR USE IN DATABASE MANAGEMENT IN THE FIELD OF ASTROLOGY; PRE-RECORDED CDS, VIDEO TAPES, LASER DISKS AND DVDS FEATURING CHARTS, MUSIC, EDUCATIONAL INSTRUCTION AND MOVIES IN THE FIELD OF ASTROLOGY; EDUCATIONAL SOFTWARE FEATURING IN-

STRUCTION IN ASTROLOGY, IN CLASS 9 (U.S. CLS. 21, 23, 26, 36 AND 38).

FIRST USE 1-1-2007; IN COMMERCE 3-1-2007.

THE MARK CONSISTS OF STANDARD CHARACTERS WITHOUT CLAIM TO ANY PARTICULAR FONT, STYLE, SIZE, OR COLOR.

SER. NO. 77-216,265, FILED 6-26-2007.

CHERYL CLAYTON, EXAMINING ATTORNEY

Int. Cl.: 16

Prior U.S. Cls.: 2, 5, 22, 23, 29, 37, 38 and 50

United States Patent and Trademark Office

Reg. No. 3,474,976

Registered July 29, 2008

**TRADEMARK
PRINCIPAL REGISTER**

COMMUNITY BUYERS GUIDE

COMMUNITY BUYERS GUIDE, LTD. (PENNSYLVANIA CORPORATION)
P.O. BOX 234
FORT WASHINGTON, PA 19034

NO CLAIM IS MADE TO THE EXCLUSIVE RIGHT TO USE "BUYERS GUIDE", APART FROM THE MARK AS SHOWN.

FOR: CLASSIFIED DIRECTORIES, IN CLASS 16 (U.S. CLS. 2, 5, 22, 23, 29, 37, 38 AND 50).

SEC. 2(F).

FIRST USE 1-1-1947; IN COMMERCE 1-1-1947.

SER. NO. 77-216,313, FILED 6-26-2007.

THE MARK CONSISTS OF STANDARD CHARACTERS WITHOUT CLAIM TO ANY PARTICULAR FONT, STYLE, SIZE, OR COLOR.

PATRICIA EVANKO, EXAMINING ATTORNEY

Int. Cl.: 3

Prior U.S. Cls.: 1, 4, 6, 50, 51 and 52

United States Patent and Trademark Office

Reg. No. 3,474,977

Registered July 29, 2008

**TRADEMARK
PRINCIPAL REGISTER**

SUPER FLUSH

HIGHSIDE CHEMICALS, INC. (MISSISSIPPI
CORPORATION)
11114 REICHHOLD ROAD
GULFPORT, MS 39503

FOR: INTERNAL LIQUID CLEANER AND
FLUSH FOR AIR CONDITIONING AND REFRIG-
ERATION SYSTEMS, IN CLASS 3 (U.S. CLS. 1, 4, 6, 50,
51 AND 52).

FIRST USE 12-15-1997; IN COMMERCE 12-15-1997.

THE MARK CONSISTS OF STANDARD CHAR-
ACTERS WITHOUT CLAIM TO ANY PARTICULAR
FONT, STYLE, SIZE, OR COLOR.

SEC. 2(F).

SER. NO. 77-216,477, FILED 6-27-2007.

JENNIFER HETU, EXAMINING ATTORNEY

Int. Cl.: 1

Prior U.S. Cls.: 1, 5, 6, 10, 26 and 46

Reg. No. 3,474,978

United States Patent and Trademark Office

Registered July 29, 2008

**TRADEMARK
PRINCIPAL REGISTER**

TRAX

HIGHSIDE CHEMICALS, INC. (MISSISSIPPI
CORPORATION)
11114 REICHHOLD ROAD
GULFPORT, MS 39503

THE MARK CONSISTS OF STANDARD CHAR-
ACTERS WITHOUT CLAIM TO ANY PARTICULAR
FONT, STYLE, SIZE, OR COLOR.

FOR: LIQUID CHEMICAL SOLUTION CONSIST-
ING OF SURFACTANTS USED TO DETECT GAS
LEAKS, IN CLASS 1 (U.S. CLS. 1, 5, 6, 10, 26 AND 46).

SER. NO. 77-216,484, FILED 6-27-2007.

FIRST USE 2-1-1993; IN COMMERCE 2-1-1993.

JENNIFER HETU, EXAMINING ATTORNEY

Int. Cl.: 9

Prior U.S. Cls.: 21, 23, 26, 36 and 38

United States Patent and Trademark Office

Reg. No. 3,474,979

Registered July 29, 2008

**TRADEMARK
PRINCIPAL REGISTER**

PRIMORDIAL

PRIMORDIAL, INC. (DELAWARE CORPORATION)
1835 ENERGY PARK DRIVE
ST. PAUL, MN 55108

FOR: COMPUTER SOFTWARE FOR USE IN GENERATING COMPUTERIZED TRAVEL ROUTES THROUGH OFF-ROAD TERRAIN USING GEOGRAPHIC DATA; COMPUTER SOFTWARE FOR USE IN ENABLING SOLDIERS TO DIFFERENTIATE FRIEND FROM FOE, FIND TARGETS, AND REQUEST SUPPORT WHEN UNDER ENEMY FIRE; COMPUTER SOFTWARE FOR USE AS PROGRAMMING TOOLS IN DEVELOPING SOFTWARE

APPLICATIONS, IN CLASS 9 (U.S. CLS. 21, 23, 26, 36 AND 38).

FIRST USE 4-12-2005; IN COMMERCE 12-1-2005.

THE MARK CONSISTS OF STANDARD CHARACTERS WITHOUT CLAIM TO ANY PARTICULAR FONT, STYLE, SIZE, OR COLOR.

SER. NO. 77-216,501, FILED 6-27-2007.

ANDREW RHIM, EXAMINING ATTORNEY

Int. Cls.: 42 and 45

Prior U.S. Cls.: 100 and 101

United States Patent and Trademark Office

Reg. No. 3,474,980

Registered July 29, 2008

**SERVICE MARK
PRINCIPAL REGISTER**

E-DIRECT

GRIFFITH INC. (PENNSYLVANIA CORPORATION), TA ALPHA SYSTEMS
458 PIKE ROAD
HUNTINGDON VALLEY, PA 19006

FOR: PROVIDING TEMPORARY USE OF NON-DOWNLOADABLE COMPUTER SOFTWARE FOR REVIEWING DISCOVERY AND LITIGATION MATERIALS, IN CLASS 42 (U.S. CLS. 100 AND 101).

FIRST USE 0-0-2002; IN COMMERCE 0-0-2002.

FOR: LITIGATION SUPPORT SERVICES, IN CLASS 45 (U.S. CLS. 100 AND 101).

FIRST USE 0-0-2002; IN COMMERCE 0-0-2002.

THE MARK CONSISTS OF STANDARD CHARACTERS WITHOUT CLAIM TO ANY PARTICULAR FONT, STYLE, SIZE, OR COLOR.

SER. NO. 77-216,673, FILED 6-27-2007.

SANJEEV VOHRA, EXAMINING ATTORNEY

Int. Cls.: 35 and 42

Prior U.S. Cls.: 100, 101 and 102

United States Patent and Trademark Office

Reg. No. 3,474,981

Registered July 29, 2008

**SERVICE MARK
PRINCIPAL REGISTER**

FIRST INSIGHTS

FIRST INSIGHTS LLC (NEW YORK LTD LIAB
CO)
90 BROAD STREET SUITE 1503
NEW YORK, NY 10004

FOR: BUSINESS MARKETING AND CONSULTING SERVICES FOR OTHERS, NAMELY, DEVELOPING, ANALYZING AND CUSTOMIZING MARKETING PLANS AND MATERIALS AND PRODUCTS THROUGH MARKET RESEARCH, USABILITY TESTING, FOCUS GROUPS, INTERFACE DESIGN, ETHNOGRAPHIC RESEARCH, COMPETITIVE ANALYSIS, SURVEYS AND HEURISTIC EVALUATIONS, IN CLASS 35 (U.S. CLS. 100, 101 AND 102).

FIRST USE 2-23-2004; IN COMMERCE 4-10-2004.

FOR: CONSULTING SERVICES FOR OTHERS, NAMELY, DESIGNING, ANALYZING, AND CUS-

TOMIZING WEB SITES, INTRANET SITES, SOFTWARE APPLICATIONS AND USER INTERFACES THROUGH MARKET RESEARCH, USABILITY TESTING, FOCUS GROUPS, QUESTIONNAIRES, ETHNOGRAPHIC RESEARCH, COMPETITIVE ANALYSIS, SURVEYS AND HEURISTIC EVALUATIONS, IN CLASS 42 (U.S. CLS. 100 AND 101).

FIRST USE 2-23-2004; IN COMMERCE 4-10-2004.

THE MARK CONSISTS OF STANDARD CHARACTERS WITHOUT CLAIM TO ANY PARTICULAR FONT, STYLE, SIZE, OR COLOR.

SER. NO. 77-216,776, FILED 6-27-2007.

KATHERINE M. DUBRAY, EXAMINING ATTORNEY

Int. Cl.: 35

Prior U.S. Cls.: 100, 101 and 102

United States Patent and Trademark Office

Reg. No. 3,474,982

Registered July 29, 2008

**SERVICE MARK
PRINCIPAL REGISTER**

RESUMES FOR RELATIONSHIPS

GREEN, SABAH (UNITED STATES INDIVIDUAL)
421 4TH LANE
PALM BEACH GARDENS, FL 33418

FOR: COMPILING OF PERSONAL INFORMATION ABOUT SUBSCRIBING MEMBERS ON A COMPUTER SERVER FOR ACCESS VIA THE INTERNET, IN CLASS 35 (U.S. CLS. 100, 101 AND 102).

FIRST USE 11-19-2007; IN COMMERCE 11-19-2007.

THE MARK CONSISTS OF STANDARD CHARACTERS WITHOUT CLAIM TO ANY PARTICULAR FONT, STYLE, SIZE, OR COLOR.

SER. NO. 77-216,932, FILED 6-27-2007.

EDWARD NELSON, EXAMINING ATTORNEY

Int. Cl.: 18

Prior U.S. Cls.: 1, 2, 3, 22 and 41

United States Patent and Trademark Office

Reg. No. 3,474,983

Registered July 29, 2008

**TRADEMARK
PRINCIPAL REGISTER**

I FEEL PRETTY

THE LEONARD BERNSTEIN OFFICE, INC.
(NEW YORK CORPORATION)
SUITE 1104
121 WEST 27TH STREET
NEW YORK, NY 10001

FOR: LEATHER AND IMITATION LEATHER
COSMETIC BAGS SOLD EMPTY, LEATHER CASES,
LEATHER PURSES, AND LEATHER POCKET-
BOOKS, IN CLASS 18 (U.S. CLS. 1, 2, 3, 22 AND 41).

FIRST USE 3-0-2007; IN COMMERCE 3-0-2007.

THE MARK CONSISTS OF STANDARD CHAR-
ACTERS WITHOUT CLAIM TO ANY PARTICULAR
FONT, STYLE, SIZE, OR COLOR.

OWNER OF U.S. REG. NOS. 3,312,694 AND
3,391,980.

SER. NO. 77-217,056, FILED 6-27-2007.

NAPOLEON SHARMA, EXAMINING ATTORNEY

Int. Cl.: 41

Prior U.S. Cls.: 100, 101 and 107

United States Patent and Trademark Office

Reg. No. 3,474,984

Registered July 29, 2008

**SERVICE MARK
PRINCIPAL REGISTER**

LAGNIAPPE

UNIVERSITY OF LOUISIANA AT LAFAYETTE
(LOUISIANA STATE UNIVERSITY)
P. O. BOX 43610
LAFAYETTE, LA 70504

FOR: PROFESSIONAL DEVELOPMENT SERVICES FOR EDUCATORS, NAMELY, TRAINING IN THE FIELD OF GIFTED EDUCATION AND DIFFERENTIATED CURRICULUM AND INSTRUCTION FOR TALENT DEVELOPMENT AND CHILD DEVELOPMENT, IN CLASS 41 (U.S. CLS. 100, 101 AND 107).

FIRST USE 7-31-1997; IN COMMERCE 7-31-1997.

THE MARK CONSISTS OF STANDARD CHARACTERS WITHOUT CLAIM TO ANY PARTICULAR FONT, STYLE, SIZE, OR COLOR.

THE FOREIGN WORDING IN THE MARK TRANSLATES INTO ENGLISH AS SOMETHING EXTRA; AN UNEXPECTED GIFT OR BENEFIT.

SER. NO. 77-217,065, FILED 6-27-2007.

SKYE YOUNG, EXAMINING ATTORNEY

Int. Cl.: 28

Prior U.S. Cls.: 22, 23, 38 and 50

United States Patent and Trademark Office

Reg. No. 3,474,985

Registered July 29, 2008

**TRADEMARK
PRINCIPAL REGISTER**

WINKY DINK

HARRY W. PRICHETT AND EDWIN BRIT
WYCKOFF PARTNERSHIP, THE (NEW YORK
PARTNERSHIP)

160 CABRINI BOULEVARD
NEW YORK, NY 10033

FOR: EQUIPMENT SOLD AS A UNIT FOR PLAY-
ING A PARLOR GAME, NAMELY, TRANSPARENT
PLASTIC SCREEN, CRAYONS, PLASTIC CUTOUTS,
ERASING CLOTH AND MOLDED DIMENSIONAL
STICK-ON GAME PIECES, AND FEATURING VI-
DEO GAME DVDS AND CASSETTES FOR USE IN

PLAYING A TELEVISION GAME, ALL SOLD AS A
UNIT, IN CLASS 28 (U.S. CLS. 22, 23, 38 AND 50).

FIRST USE 10-1-1953; IN COMMERCE 10-1-1953.

THE MARK CONSISTS OF STANDARD CHAR-
ACTERS WITHOUT CLAIM TO ANY PARTICULAR
FONT, STYLE, SIZE, OR COLOR.

SER. NO. 77-217,133, FILED 6-27-2007.

ANNE E. GUSTASON, EXAMINING ATTORNEY

Int. Cl.: 31

Prior U.S. Cls.: 1 and 46

United States Patent and Trademark Office

Reg. No. 3,474,986

Registered July 29, 2008

**TRADEMARK
PRINCIPAL REGISTER**

OUR ROOTS RUN DEEP

ALABAMA FARMERS COOPERATIVE, INC.
(ALABAMA CORPORATION)
POST OFFICE BOX 2227
DECATUR, AL 35609

THE MARK CONSISTS OF STANDARD CHAR-
ACTERS WITHOUT CLAIM TO ANY PARTICULAR
FONT, STYLE, SIZE, OR COLOR.

FOR: LIVE PLANTS, NAMELY, VEGETABLES,
FRUIT PLANTS AND HERB PLANTS, IN CLASS 31
(U.S. CLS. 1 AND 46).

SER. NO. 77-217,259, FILED 6-27-2007.

FIRST USE 1-0-2006; IN COMMERCE 1-0-2006.

BILL DAWE, EXAMINING ATTORNEY

Int. Cl.: 3

Prior U.S. Cls.: 1, 4, 6, 50, 51 and 52

United States Patent and Trademark Office

Reg. No. 3,474,987

Registered July 29, 2008

**TRADEMARK
PRINCIPAL REGISTER**

LID SCRUB

OCUSOFT, INC. (TEXAS CORPORATION)
P.O. BOX 429
RICHMOND, TX 774060429

FOR: SKIN CLEANSERS FORMULATED TO
CLEANSE EYELIDS; DISPOSABLE WIPES IMPREG-
NATED WITH CLEANSING COMPOUNDS FOR
USE ON EYELIDS, IN CLASS 3 (U.S. CLS. 1, 4, 6, 50,
51 AND 52).

FIRST USE 1-1-1987; IN COMMERCE 1-1-1987.

THE MARK CONSISTS OF STANDARD CHAR-
ACTERS WITHOUT CLAIM TO ANY PARTICULAR
FONT, STYLE, SIZE, OR COLOR.

NO CLAIM IS MADE TO THE EXCLUSIVE
RIGHT TO USE "LID", APART FROM THE MARK
AS SHOWN.

SEC. 2(F).

SER. NO. 77-217,300, FILED 6-27-2007.

CYNTHIA SLOAN, EXAMINING ATTORNEY

Int. Cls.: 35, 40 and 42

Prior U.S. Cls.: 100, 101, 102, 103 and 106

United States Patent and Trademark Office

Reg. No. 3,474,988

Registered July 29, 2008

**SERVICE MARK
PRINCIPAL REGISTER**

THE CONSTANT MARKETER

BLUE SKY CREATIVE, INC. (OHIO CORPORATION)
14 SUNNYBROOK DRIVE
CINCINNATI, OH 45237

FOR: MARKETING SERVICES FOR BUSINESS CLIENTS, NAMELY, DATABASE MANAGEMENT AND DIRECT MAIL ADVERTISING CAMPAIGNS, IN CLASS 35 (U.S. CLS. 100, 101 AND 102).

FIRST USE 3-31-2007; IN COMMERCE 3-31-2007.

FOR: PRINTING OF ADVERTISING MATERIAL FOR BUSINESS CLIENTS, IN CLASS 40 (U.S. CLS. 100, 103 AND 106).

FIRST USE 3-31-2007; IN COMMERCE 3-31-2007.

FOR: WEBSITE DESIGN AND MAINTENANCE AND DATABASE CREATION FOR BUSINESS CLIENTS, IN CLASS 42 (U.S. CLS. 100 AND 101).

FIRST USE 3-31-2007; IN COMMERCE 3-31-2007.

THE MARK CONSISTS OF STANDARD CHARACTERS WITHOUT CLAIM TO ANY PARTICULAR FONT, STYLE, SIZE, OR COLOR.

NO CLAIM IS MADE TO THE EXCLUSIVE RIGHT TO USE "MARKETER", APART FROM THE MARK AS SHOWN.

SER. NO. 77-217,556, FILED 6-28-2007.

MARK PILARO, EXAMINING ATTORNEY

Int. Cls.: 35, 36, 37, 42 and 44

Prior U.S. Cls.: 100, 101, 102, 103 and 106

United States Patent and Trademark Office

Reg. No. 3,474,989

Registered July 29, 2008

**SERVICE MARK
PRINCIPAL REGISTER**

**APPALACHIAN REGIONAL
HEALTHCARE**

APPALACHIAN REGIONAL HEALTHCARE,
INC. (KENTUCKY CORPORATION)
P.O. BOX 8086
LEXINGTON, KY 40533

FOR: RETAIL PHARMACY SERVICES; RETAIL
STORE SERVICES FEATURING MEDICAL EQUIP-
MENT, IN CLASS 35 (U.S. CLS. 100, 101 AND 102).

FIRST USE 3-4-1986; IN COMMERCE 3-4-1986.

FOR: CHARITABLE FUND RAISING, IN CLASS
36 (U.S. CLS. 100, 101 AND 102).

FIRST USE 3-1-2001; IN COMMERCE 3-1-2001.

FOR: LAUNDRY SERVICES, IN CLASS 37 (U.S.
CLS. 100, 103 AND 106).

FIRST USE 3-4-1986; IN COMMERCE 3-4-1986.

FOR: MEDICAL LABORATORIES, IN CLASS 42
(U.S. CLS. 100 AND 101).

FIRST USE 3-4-1986; IN COMMERCE 3-4-1986.

FOR: HOME HEALTH CARE SERVICES; NUR-
SING CARE; HOSPITALS; PSYCHIATRIC SERVI-
CES; RENTAL OF MEDICAL EQUIPMENT; SPEECH
AND HEARING THERAPY; OCCUPATIONAL
THERAPY SERVICES; PHYSICAL THERAPY, IN
CLASS 44 (U.S. CLS. 100 AND 101).

FIRST USE 3-4-1986; IN COMMERCE 3-4-1986.

THE MARK CONSISTS OF STANDARD CHAR-
ACTERS WITHOUT CLAIM TO ANY PARTICULAR
FONT, STYLE, SIZE, OR COLOR.

NO CLAIM IS MADE TO THE EXCLUSIVE
RIGHT TO USE "HEALTHCARE", APART FROM
THE MARK AS SHOWN.

SEC. 2(F).

SER. NO. 77-217,654, FILED 6-28-2007.

JENNIFER DIXON, EXAMINING ATTORNEY

Int. Cl.: 10

Prior U.S. Cls.: 26, 39 and 44

Reg. No. 3,474,990

United States Patent and Trademark Office

Registered July 29, 2008

**TRADEMARK
PRINCIPAL REGISTER**

TOO STICKY

KOI CONCEPTS, LLC (CALIFORNIA LTD LIAB
CO)
1191 HUNTINGTON DR #310
DUARTE, CA 91010

FOR: ADULT SEXUAL AIDS; NAMELY, ELECTRIC AND NON-ELECTRIC MASSAGE DEVICES AND ACCESSORIES THEREFOR FOR USE IN MASSAGING OR VIBRATING PORTIONS OF THE FACE AND BODY; IMITATION SEXUAL ORGANS, NAMELY, PENISES, PENISES AND TESTICLES, AND DILDOES; DEVICES FOR AIDING IN SEXUAL INTERCOURSE AND MASTURBATION, NAMELY REPRODUCTIONS OF PARTS OF THE MALE AND FEMALE ANATOMY; STIMULATION DEVICES FOR AIDING IN SEXUAL AROUSAL AND SEXUAL PERFORMANCE; VIBRATORS AND VIBRATOR

SLEEVES; ERECTION AND ORGASM-ENHANCING ARTICLES FOR IMMEDIATE APPLICATION TO THE HUMAN BODY, NAMELY VIBRATORS AND PENIS ENLARGERS, IN CLASS 10 (U.S. CLS. 26, 39 AND 44).

FIRST USE 10-21-2004; IN COMMERCE 3-25-2005.

THE MARK CONSISTS OF STANDARD CHARACTERS WITHOUT CLAIM TO ANY PARTICULAR FONT, STYLE, SIZE, OR COLOR.

SER. NO. 77-217,778, FILED 6-28-2007.

CAROL SPILS, EXAMINING ATTORNEY

Int. Cl.: 42

Prior U.S. Cls.: 100 and 101

United States Patent and Trademark Office

Reg. No. 3,474,991

Registered July 29, 2008

**SERVICE MARK
PRINCIPAL REGISTER**

eachday
WATCH LIFE UNFOLD

ELLIOTT, TREVOR (UNITED STATES INDIVIDUAL)
389 N BRENT ST
VENTURA, CA 93003

FOR: PROVIDING A WEBSITE FEATURING TEMPORARY USE OF NON-DOWNLOADABLE COMPUTER SOFTWARE ALLOWING USERS TO UPLOAD PHOTOGRAPHS, VIDEO, AUDIO AND TEXT FOR SHARING WITH OTHERS FOR ENTER-

TAINMENT PURPOSES, IN CLASS 42 (U.S. CLS. 100 AND 101).

FIRST USE 12-12-2004; IN COMMERCE 12-12-2004.

SER. NO. 77-217,803, FILED 6-28-2007.

NANCY CLARKE, EXAMINING ATTORNEY

Int. Cl.: 9

Prior U.S. Cls.: 21, 23, 26, 36 and 38

Reg. No. 3,474,992

United States Patent and Trademark Office

Registered July 29, 2008

**TRADEMARK
PRINCIPAL REGISTER**



CKO INC. (D.C. CORPORATION)
#700
1300 PENNSYLVANIA AVE
WASHINGTON, DC 20004

AND TELEWORKING MOBILE OFFICES, IN CLASS
9 (U.S. CLS. 21, 23, 26, 36 AND 38).

FIRST USE 1-1-2007; IN COMMERCE 1-1-2007.

FOR: COMPUTER MOBILE SOFTWARE USING A
PROJECT BASED OPERATING SYSTEM FOR
KNOWLEDGE MANAGEMENT FOR USE IN THE
FOLLOWING: COMPLIANCE WITH SEC SAR-
BANES/OXLEY REGULATIONS, COMPLIANCE
WITH DCAA AND PERFORMANCE BASED CON-
TRACTING FOR GOVERNMENT CONTRACTORS,

THE MARK CONSISTS OF THE LETTERS "CYI-
PRO" IN A STLYIZED TEXT.

SER. NO. 77-217,824, FILED 6-28-2007.

NORA BUCHANAN WILL, EXAMINING ATTOR-
NEY

Int. Cl.: 25

Prior U.S. Cls.: 22 and 39

United States Patent and Trademark Office

Reg. No. 3,474,993

Registered July 29, 2008

**TRADEMARK
PRINCIPAL REGISTER**

BAREFIT

ZUITSPOORTS, INC. (DELAWARE CORPORATION)
SUITE 101
2880 SCOTT STREET
VISTA, CA 92081

FOR: FOOTWEAR AND COMPONENTS THEREOF, NAMELY, INSOLES, HEEL PADS AND FOOT CUSHIONS, ALL OF A NON-ORTHOTIC NATURE, IN CLASS 25 (U.S. CLS. 22 AND 39).

FIRST USE 6-1-2007; IN COMMERCE 6-1-2007.

THE MARK CONSISTS OF STANDARD CHARACTERS WITHOUT CLAIM TO ANY PARTICULAR FONT, STYLE, SIZE, OR COLOR.

SER. NO. 77-218,025, FILED 6-28-2007.

CAROLYN CATALDO, EXAMINING ATTORNEY

Int. Cl.: 25

Prior U.S. Cls.: 22 and 39

United States Patent and Trademark Office

Reg. No. 3,474,994

Registered July 29, 2008

**TRADEMARK
PRINCIPAL REGISTER**

Z-BOUND

ZUITSPOORTS, INC. (DELAWARE CORPORATION)
SUITE 101
2880 SCOTT STREET
VISTA, CA 92081

FOR: FOOTWEAR AND COMPONENTS THEREOF, NAMELY INSOLES, HEEL PADS AND FOOT CUSHIONS, ALL OF A NON-ORTHOTIC NATURE, IN CLASS 25 (U.S. CLS. 22 AND 39).

FIRST USE 6-1-2007; IN COMMERCE 6-1-2007.

THE MARK CONSISTS OF STANDARD CHARACTERS WITHOUT CLAIM TO ANY PARTICULAR FONT, STYLE, SIZE, OR COLOR.

SER. NO. 77-218,028, FILED 6-28-2007.

CAROLYN CATALDO, EXAMINING ATTORNEY

Int. Cl.: 25

Prior U.S. Cls.: 22 and 39

United States Patent and Trademark Office

Reg. No. 3,474,995

Registered July 29, 2008

**TRADEMARK
PRINCIPAL REGISTER**

CARBONSPAN

ZUITSPO RTS, INC. (CALIFORNIA CORPORA-
TION)
SUITE 101
2880 SCOTT STREET
VISTA, CA 92081

FOR: FOOTWEAR AND COMPONENTS THERE-
OF, NAMELY INSOLES, HEEL PADS AND FOOT
CUSHIONS, ALL OF A NON-ORTHOTIC NATURE,
IN CLASS 25 (U.S. CLS. 22 AND 39).

FIRST USE 6-1-2007; IN COMMERCE 6-1-2007.

THE MARK CONSISTS OF STANDARD CHAR-
ACTERS WITHOUT CLAIM TO ANY PARTICULAR
FONT, STYLE, SIZE, OR COLOR.

SER. NO. 77-218,035, FILED 6-28-2007.

CAROLYN CATALDO, EXAMINING ATTORNEY

Int. Cl.: 25

Prior U.S. Cls.: 22 and 39

United States Patent and Trademark Office

Reg. No. 3,474,996

Registered July 29, 2008

**TRADEMARK
PRINCIPAL REGISTER**

CARBONSPAN+

ZUITSPOORTS, INC. (DELAWARE CORPORATION)
SUITE 101
2880 SCOTT STREET
VISTA, CA 92081

FOR: FOOTWEAR AND COMPONENTS THEREOF, NAMELY, INSOLES, HEEL PADS AND FOOT CUSHIONS, ALL OF A NON-ORTHOTIC NATURE, IN CLASS 25 (U.S. CLS. 22 AND 39).

FIRST USE 6-1-2007; IN COMMERCE 6-1-2007.

THE MARK CONSISTS OF STANDARD CHARACTERS WITHOUT CLAIM TO ANY PARTICULAR FONT, STYLE, SIZE, OR COLOR.

SER. NO. 77-218,046, FILED 6-28-2007.

CAROLYN CATALDO, EXAMINING ATTORNEY

Int. Cl.: 25

Prior U.S. Cls.: 22 and 39

United States Patent and Trademark Office

Reg. No. 3,474,997

Registered July 29, 2008

**TRADEMARK
PRINCIPAL REGISTER**

IMPRESS FOAM

ZUITSPOORTS, INC. (DELAWARE CORPORATION)
SUITE 101
2880 SCOTT STREET
VISTA, CA 92081

FOR: FOOTWEAR AND COMPONENTS THEREOF, NAMELY INSOLES, HEEL PADS AND FOOT CUSHIONS, ALL OF A NON-ORTHOTIC NATURE, IN CLASS 25 (U.S. CLS. 22 AND 39).

FIRST USE 6-1-2007; IN COMMERCE 6-1-2007.

THE MARK CONSISTS OF STANDARD CHARACTERS WITHOUT CLAIM TO ANY PARTICULAR FONT, STYLE, SIZE, OR COLOR.

NO CLAIM IS MADE TO THE EXCLUSIVE RIGHT TO USE "FOAM", APART FROM THE MARK AS SHOWN.

SER. NO. 77-218,053, FILED 6-28-2007.

CAROLYN CATALDO, EXAMINING ATTORNEY

Int. Cl.: 25

Prior U.S. Cls.: 22 and 39

United States Patent and Trademark Office

Reg. No. 3,474,998

Registered July 29, 2008

**TRADEMARK
PRINCIPAL REGISTER**

Z-VA

ZUITSPOORTS, INC. (CALIFORNIA CORPORATION)
SUITE 101
2880 SCOTT STREET
VISTA, CA 92081

FOR: FOOTWEAR AND COMPONENTS THEREOF, NAMELY, INSOLES, HEEL PADS AND FOOT CUSHIONS, ALL OF A NON-ORTHOTIC NATURE, IN CLASS 25 (U.S. CLS. 22 AND 39).

FIRST USE 6-1-2007; IN COMMERCE 6-1-2007.

THE MARK CONSISTS OF STANDARD CHARACTERS WITHOUT CLAIM TO ANY PARTICULAR FONT, STYLE, SIZE, OR COLOR.

SER. NO. 77-218,061, FILED 6-28-2007.

CAROLYN CATALDO, EXAMINING ATTORNEY

Int. Cl.: 14

Prior U.S. Cls.: 2, 27, 28 and 50

United States Patent and Trademark Office

Reg. No. 3,474,999

Registered July 29, 2008

**TRADEMARK
PRINCIPAL REGISTER**

HAKKIN.IT

OROBIANCO S.R.L. (ITALY LTD LIAB CO)
VIA SCHIAPPARELLI, 10
GALLARATE (VARESE), ITALY

FOR: PRECIOUS METALS AND THEIR ALLOYS;
JEWELRY; PRECIOUS STONES; HOROLOGICAL
AND CHRONOMETRIC INSTRUMENTS, IN CLASS
14 (U.S. CLS. 2, 27, 28 AND 50).

THE MARK CONSISTS OF STANDARD CHAR-
ACTERS WITHOUT CLAIM TO ANY PARTICULAR
FONT, STYLE, SIZE, OR COLOR.

OWNER OF ITALY REG. NO. 0001086227, DATED
1-8-2008, EXPIRES 6-18-2017.

OWNER OF U.S. REG. NO. 3,000,722.

THE WORD "HAKKIN" OR "HAKKIN" HAS NO
SIGNIFICANCE MEANING IN A FOREIGN LAN-
GUAGE.

SER. NO. 77-218,185, FILED 6-28-2007.

STEVEN JACKSON, EXAMINING ATTORNEY

Int. Cl.: 41

Prior U.S. Cls.: 100, 101 and 107

United States Patent and Trademark Office

Reg. No. 3,475,000

Registered July 29, 2008

SERVICE MARK
PRINCIPAL REGISTER



"life happens. live in the flow"
bliss life yoga

FOSTER, KAREN (UNITED STATES INDIVIDUAL)
12 PECK STREET
REHOBOTH, MA 02769

FOR: EDUCATION SERVICES, NAMELY, PROVIDING LIVE AND ON-LINE CLASSES, WORKSHOPS, RETREATS, TRAININGS, SEMINARS, EVENTS, AND INSPIRATIONAL SPEAKINGS IN AN INDIVIDUAL OR GROUP SETTING IN THE FIELD OF YOGA, MASSAGE, MIND-BODY THERAPY, MEDITATION, ENERGY HEALING, REIKI NATURAL HEALING, INTEGRATED ENERGY THERAPY, INTUITIVE ENERGY HEALING, HERBAL EAR CONING, INTERFAITH MINISTRY, HYP-

NOTHERAPY, SPIRITUALITY, HEALING, HEALTH, AND WELLNESS; YOGA INSTRUCTION, IN CLASS 41 (U.S. CLS. 100, 101 AND 107).

FIRST USE 2-0-2007; IN COMMERCE 4-0-2007.

NO CLAIM IS MADE TO THE EXCLUSIVE RIGHT TO USE "YOGA", APART FROM THE MARK AS SHOWN.

SER. NO. 77-218,415, FILED 6-28-2007.

JULIE GUTTADAURO, EXAMINING ATTORNEY

Int. Cl.: 36

Prior U.S. Cls.: 100, 101 and 102

United States Patent and Trademark Office

Reg. No. 3,475,001

Registered July 29, 2008

**SERVICE MARK
PRINCIPAL REGISTER**



CALIFORNIA EAGLE ESCROW, INC. (CALIFORNIA CORPORATION)
10101 SLATER AVENUE, SUITE 202
FOUNTAIN VALLEY, CA 92708

NO CLAIM IS MADE TO THE EXCLUSIVE RIGHT TO USE "CALIFORNIA" AND "ESCROW, INC", APART FROM THE MARK AS SHOWN.

FOR: REAL ESTATE ESCROW SERVICES, IN CLASS 36 (U.S. CLS. 100, 101 AND 102).

SER. NO. 77-218,465, FILED 6-28-2007.

FIRST USE 1-1-2007; IN COMMERCE 1-1-2007.

APRIL ROACH, EXAMINING ATTORNEY

Int. Cl.: 30

Prior U.S. Cl.: 46

United States Patent and Trademark Office

Reg. No. 3,475,002

Registered July 29, 2008

**TRADEMARK
PRINCIPAL REGISTER**

FREVO

FRANCO, WALDO (BRAZIL INDIVIDUAL)

2110 ARTESIA BLVD., #440

REDONDO BEACH, CA 90278

FOR: CREPES, IN CLASS 30 (U.S. CL. 46).

FIRST USE 6-2-2007; IN COMMERCE 6-2-2007.

THE MARK CONSISTS OF STANDARD CHARACTERS WITHOUT CLAIM TO ANY PARTICULAR FONT, STYLE, SIZE, OR COLOR.

THE WORDING "FREVO" HAS NO MEANING IN A FOREIGN LANGUAGE.

SER. NO. 77-218,543, FILED 6-28-2007.

TRACY CROSS, EXAMINING ATTORNEY

Int. Cl.: 36

Prior U.S. Cls.: 100, 101 and 102

United States Patent and Trademark Office

Reg. No. 3,475,003

Registered July 29, 2008

**SERVICE MARK
PRINCIPAL REGISTER**

**Central Minnesota Federal
Credit Union**

CENTRAL MINNESOTA FEDERAL CREDIT UNION (MINNESOTA CORPORATION)
20 S 4TH AVE E
MELROSE, MN 56352

NO CLAIM IS MADE TO THE EXCLUSIVE RIGHT TO USE "FEDERAL CREDIT UNION", APART FROM THE MARK AS SHOWN.

FOR: CREDIT UNIONS, IN CLASS 36 (U.S. CLS. 100, 101 AND 102).

SEC. 2(F).

FIRST USE 8-1-2001; IN COMMERCE 8-1-2001.

SER. NO. 77-218,780, FILED 6-29-2007.

THE MARK CONSISTS OF STANDARD CHARACTERS WITHOUT CLAIM TO ANY PARTICULAR FONT, STYLE, SIZE, OR COLOR.

DEZMONA MIZELLE, EXAMINING ATTORNEY

Int. Cls.: 19 and 37

Prior U.S. Cls.: 1, 12, 33, 50, 100, 103 and 106

United States Patent and Trademark Office

Reg. No. 3,475,004

Registered July 29, 2008

**TRADEMARK
SERVICE MARK
PRINCIPAL REGISTER**



C B STRUCTURES, INC. (PENNSYLVANIA CORPORATION)
202 ORLAN ROAD
NEW HOLLAND, PA 17557

FOR: NON-METAL PREFABRICATED BUILDINGS; NON-METAL PREFABRICATED FRAME BUILDINGS WITH A METAL EXTERIOR SHELL; NON-METAL POLE BARNs; PREFABRICATED WOODEN BUILDINGS; AND NON-METAL UTILITY BUILDINGS, IN CLASS 19 (U.S. CLS. 1, 12, 33 AND 50).

FIRST USE 7-31-2005; IN COMMERCE 7-31-2005.

FOR: CONSTRUCTION SERVICES FOR THE CONSTRUCTION AND ERECTION OF NON-METAL BUILDINGS, NON-METAL FRAME BUILDINGS WITH A METAL EXTERIOR SHELL, NON-

METAL POLE BARNs, WOODEN BUILDINGS, AND NON-METAL UTILITY BUILDINGS, IN CLASS 37 (U.S. CLS. 100, 103 AND 106).

FIRST USE 7-31-2005; IN COMMERCE 7-31-2005.

NO CLAIM IS MADE TO THE EXCLUSIVE RIGHT TO USE POLE BARNs, APART FROM THE MARK AS SHOWN.

THE MARK CONSISTS OF A DRAWING OF A MULE BESIDE AN ARCHED CONFIGURATION OF THE WORD "DUTCHWAY" OVER TOP OF THE WORDS "POLE BARNs".

SER. NO. 77-219,177, FILED 6-29-2007.

CHARLES L. JENKINS, EXAMINING ATTORNEY

Int. Cls.: 18 and 25

Prior U.S. Cls.: 1, 2, 3, 22, 39 and 41

United States Patent and Trademark Office

Reg. No. 3,475,005

Registered July 29, 2008

**TRADEMARK
PRINCIPAL REGISTER**



BLACK SHEEP S.P.A. (ITALY JOINT STOCK
COMPANY)
LOCALITA CAPALLE
VIA S. QUIRICO, 199/B
CAMPIT BISENZIO, ITALY 50010

FOR: BACKPACKS, RUCKSACKS, BOSTON
BAGS, BRIEFCASES, COIN PURSES, COSMETIC
CASES SOLD EMPTY, HANDBAGS, BEACH BAGS,
DUFFEL BAGS, SHOULDER BAGS, SCHOOL BAGS,
SPORTS BAGS, KEY CASES, KEY WALLETS, LEA-
THER AND IMITATION LEATHER BAGS, LUG-
GAGE, PARASOLS, POCKET WALLETS,
UMBRELLAS, WALKING STICKS, IN CLASS 18
(U.S. CLS. 1, 2, 3, 22 AND 41).

FOR: ARTICLES OF CLOTHING, NAMELY, T-
SHIRTS, SHIRTS, SUITS, SKIRTS, TROUSERS,
PULLOVERS, JACKETS, WAISTCOATS, RAIN-
COATS, COATS, HATS, GLOVES, SCARVES, SHOES
AND BOOTS, MONEY BELTS, IN CLASS 25 (U.S.
CLS. 22 AND 39).

PRIORITY CLAIMED UNDER SEC. 44(D) ON
ITALY APPLICATION NO. FI2007C00076, FILED 2-
25-2007, REG. NO. 0001061827, DATED 2-25-2007,
EXPIRES 5-25-2017.

SER. NO. 77-219,249, FILED 6-29-2007.

KIMBERLY FRYE, EXAMINING ATTORNEY

Int. Cls.: 26 and 41

Prior U.S. Cls.: 37, 39, 40, 42, 50, 100, 101 and 107

United States Patent and Trademark Office

Reg. No. 3,475,006

Registered July 29, 2008

**TRADEMARK
SERVICE MARK
PRINCIPAL REGISTER**

NXS HAIR

NXS HAIR, INC. (CALIFORNIA CORPORATION)
31441 SANTA MARGARITA PARKWAY, STE. A269
RANCHO SANTA MARGARITA, CA 92688

FOR: HAIR EXTENSIONS, HAIRPIECES, AND
KITS CONSISTING PRIMARILY OF HAIR EXTEN-
SIONS OR HAIRPIECES FOR USE BY PROFESSION-
AL HAIR STYLISTS FOR STYLING HAIR IN HAIR
SALONS, IN CLASS 26 (U.S. CLS. 37, 39, 40, 42 AND
50).

FIRST USE 12-1-2005; IN COMMERCE 12-1-2005.

FOR: INSTRUCTION OR EDUCATION IN THE
NATURE OF CLASSES AND SEMINARS REGARD-
ING THE PROPER APPLICATION AND USE OF

HAIR EXTENSIONS OR HAIRPIECES, IN CLASS 41
(U.S. CLS. 100, 101 AND 107).

FIRST USE 12-1-2005; IN COMMERCE 12-1-2005.

THE MARK CONSISTS OF STANDARD CHAR-
ACTERS WITHOUT CLAIM TO ANY PARTICULAR
FONT, STYLE, SIZE, OR COLOR.

NO CLAIM IS MADE TO THE EXCLUSIVE
RIGHT TO USE "HAIR", APART FROM THE MARK
AS SHOWN.

SER. NO. 77-219,270, FILED 6-29-2007.

JUSTINE D. PARKER, EXAMINING ATTORNEY

Int. Cl.: 35

Prior U.S. Cls.: 100, 101 and 102

United States Patent and Trademark Office

Reg. No. 3,475,007

Registered July 29, 2008

**SERVICE MARK
PRINCIPAL REGISTER**

NYC OPEN/BOOK

NYC & COMPANY, INC. (NEW YORK CORPORATION)

810 SEVENTH AVENUE

NEW YORK, NY 10019

FOR: PROMOTING BUSINESS AND TOURISM IN THE CITY OF NEW YORK; PROMOTING ECONOMIC DEVELOPMENT IN THE CITY OF NEW YORK; PROMOTING THE CITY OF NEW YORK AS A SITE FOR CULTURAL EVENTS, ENTERTAINMENT, EXHIBITIONS AND SPORTS COMPETITIONS AND GAMES, IN CLASS 35 (U.S. CLS. 100, 101 AND 102).

FIRST USE 12-19-2006; IN COMMERCE 12-19-2006.

PRIORITY CLAIMED UNDER SEC. 44(D) ON UNITED KINGDOM APPLICATION NO. 2442553, FILED 12-29-2006.

OWNER OF UNITED KINGDOM REG. NO. 2442553, DATED 12-29-2006, EXPIRES 12-29-2016.

NO CLAIM IS MADE TO THE EXCLUSIVE RIGHT TO USE "NYC", APART FROM THE MARK AS SHOWN.

THE MARK CONSISTS OF NYC OPEN/BOOK IN BLACK & WHITE.

SER. NO. 77-219,278, FILED 6-29-2007.

SANJEEV VOHRA, EXAMINING ATTORNEY

Int. Cls.: 7 and 8

Prior U.S. Cls.: 13, 19, 21, 23, 28, 31, 34, 35 and 44

Reg. No. 3,475,008

United States Patent and Trademark Office

Registered July 29, 2008

**TRADEMARK
PRINCIPAL REGISTER**

OOPS

THE L.S. STARRETT COMPANY (MASSACHU-
SETTS CORPORATION)
121 CRESCENT STREET
ATHOL, MA 01331

FOR: POWER TOOLS, NAMELY, HOLE SAWS
AND ARBORS, IN CLASS 7 (U.S. CLS. 13, 19, 21, 23, 31,
34 AND 35).

FIRST USE 0-0-1998; IN COMMERCE 0-0-1998.

FOR: HAND TOOLS, NAMELY, HOLE SAWS
AND ARBORS, IN CLASS 8 (U.S. CLS. 23, 28 AND 44).

FIRST USE 0-0-1998; IN COMMERCE 0-0-1998.

THE MARK CONSISTS OF STANDARD CHAR-
ACTERS WITHOUT CLAIM TO ANY PARTICULAR
FONT, STYLE, SIZE, OR COLOR.

SER. NO. 77-219,290, FILED 6-29-2007.

RONALD MCMORROW, EXAMINING ATTORNEY

Int. Cl.: 9

Prior U.S. Cls.: 21, 23, 26, 36 and 38

Reg. No. 3,475,009

United States Patent and Trademark Office

Registered July 29, 2008

TRADEMARK
PRINCIPAL REGISTER



HAWAIIAN OPTICS LLC (HAWAII LTD LIAB
CO)
PO BOX 510042
KEALIA, HI 96751

FOR: SUNGLASSES, SUNGLASS LENSES, SUN-
GLASS FRAMES, SUNGLASS POUCHES, SUN-
GLASS CASES, SUNGLASS CORDS, MOTOR
SPORT GOGGLES, MOTOR SPORT GOGGLE
CASES, AND MOTOR SPORT HELMETS , IN CLASS
9 (U.S. CLS. 21, 23, 26, 36 AND 38).

FIRST USE 6-1-2007; IN COMMERCE 6-1-2007.

NO CLAIM IS MADE TO THE EXCLUSIVE
RIGHT TO USE "HAWAIIAN OPTICS", APART
FROM THE MARK AS SHOWN.

THE MARK CONSISTS OF THE WORD "HAWAI-
IAN" WITH A TRIANGLE THROUGH THE CENTER
AND THE WORD "OPTICS" UNDER AND TO THE
RIGHT.

SER. NO. 77-219,337, FILED 6-29-2007.

MARY ROSSMAN, EXAMINING ATTORNEY

Int. Cl.: 36

Prior U.S. Cls.: 100, 101 and 102

United States Patent and Trademark Office

Reg. No. 3,475,010

Registered July 29, 2008

**SERVICE MARK
PRINCIPAL REGISTER**



NORTHERN STATE BANK (NEW JERSEY
CHARTERED BANK)
530 PIERMONT ROAD
CLOSTER, NJ 07624

FOR: BANKING SERVICES, NAMELY, CHECK-
ING ACCOUNT SERVICES, SAVINGS ACCOUNT
SERVICES, CHECK CASHING AND CHECK ISSU-
ANCE, CHECK VERIFICATION, AUTOMATED
TELLER MACHINE SERVICES, ON-LINE BANK-
ING SERVICES, CERTIFICATE OF DEPOSIT SER-
VICES, LINE OF CREDIT SERVICES, MONEY
MARKET DEPOSIT ACCOUNT SERVICES AND
RETIREMENT ACCOUNT SERVICES, CREDIT
CARD SERVICES, DEBIT CARD SERVICES, ELEC-
TRONIC DEBIT TRANSACTIONS AND ELECTRO-
NIC CHECK PROCESSING TRANSACTIONS AND
PROVIDING FINANCIAL INFORMATION BY

ELECTRONIC MEANS VIA A GLOBAL COMPUTER
NETWORK, SAFE DEPOSIT BOX SERVICES, COM-
MERCIAL LENDING SERVICES, NAMELY, PRO-
VIDING LINES OF CREDIT AND EQUIPMENT
LOANS, ISSUING LETTERS OF CREDIT, IN CLASS
36 (U.S. CLS. 100, 101 AND 102).

FIRST USE 3-15-2006; IN COMMERCE 3-15-2006.

THE MARK CONSISTS OF A SUBURBAN CITY
FROM A DISTANT PROSPECTIVE WITHIN AN
INCOMPLETE CIRCLE.

SER. NO. 77-219,364, FILED 6-29-2007.

TRACY CROSS, EXAMINING ATTORNEY

Int. Cl.: 41

Prior U.S. Cls.: 100, 101 and 107

United States Patent and Trademark Office

Reg. No. 3,475,011

Registered July 29, 2008

**SERVICE MARK
PRINCIPAL REGISTER**

PIXIE MONROE

MONROE, PIXIE (UNITED STATES INDIVIDUAL)
SUITE 206
211 N. VALLEY STREET
BURBANK, CA 91505

FOR: PROVIDING ENTERTAINMENT SERVICES
IN THE NATURE OF THEATER CASTING AND
PRODUCTION SERVICES, IN CLASS 41 (U.S. CLS.
100, 101 AND 107).

FIRST USE 9-1-2001; IN COMMERCE 9-1-2001.

THE MARK CONSISTS OF STANDARD CHARACTERS WITHOUT CLAIM TO ANY PARTICULAR FONT, STYLE, SIZE, OR COLOR.

SER. NO. 77-219,413, FILED 6-29-2007.

TINA KUAN, EXAMINING ATTORNEY

Int. Cl.: 9

Prior U.S. Cls.: 21, 23, 26, 36 and 38

Reg. No. 3,475,012

United States Patent and Trademark Office

Registered July 29, 2008

**TRADEMARK
PRINCIPAL REGISTER**

The logo for "Sound Director" features the word "SOUND" in a bold, sans-serif font. A thick black line starts from the top of the letter "D" in "DIRECTOR", arches over the "O" in "SOUND", and then descends to underline the "D" in "DIRECTOR".

ACTION SPORTS MEDIA, INC. (WASHINGTON CORPORATION)
SUITE E
3401 RUSS CIRCLE
ALCOA, TN 37701

FIRST USE 3-7-2007; IN COMMERCE 6-7-2007.

THE MARK CONSISTS OF THE WORD "SOUND" WITH THE "D" BEING ONE SIDE OF A HEADPHONE AND ANOTHER "D" BEING THE OTHER SIDE OF A HEADPHONE WITH THAT "D" STARTING THE WORD "DIRECTOR".

FOR: SOFTWARE WHICH ALLOWS A USER TO CREATE OR HAVE INSTANT ACCESS TO AUDIO VISUAL DISPLAYS, MUSIC, SIGHT AND SOUND EFFECTS FOR PRESENTATION AT A LIVE OR PUBLIC EVENT, IN CLASS 9 (U.S. CLS. 21, 23, 26, 36 AND 38).

SER. NO. 77-219,459, FILED 6-29-2007.

PAUL E. FAHRENKOPF, EXAMINING ATTORNEY

Int. Cl.: 44

Prior U.S. Cls.: 100 and 101

United States Patent and Trademark Office

Reg. No. 3,475,013

Registered July 29, 2008

**SERVICE MARK
PRINCIPAL REGISTER**



OWENSBORO MEDICAL HEALTH SYSTEM,
INC. (KENTUCKY CORPORATION)
811 EAST PARRISH AVENUE
OWENSBORO, KY 42303

FOR: HEALTH CARE SERVICES, NAMELY, IMPROVING THE QUALITY OF PATIENT CARE IN HOSPITALS, IN CLASS 44 (U.S. CLS. 100 AND 101).

FIRST USE 6-4-2006; IN COMMERCE 6-4-2006.

THE MARK CONSISTS OF A CAPITAL "Q" BELOW A SEMICIRCLE. FIVE LINES WHICH ARE PERPENDICULAR TO THE SEMICIRCLE ARE INCLUDED ABOVE THE SEMICIRCLE.

SER. NO. 77-219,844, FILED 6-30-2007.

SKYE YOUNG, EXAMINING ATTORNEY

Int. Cl.: 35

Prior U.S. Cls.: 100, 101 and 102

United States Patent and Trademark Office

Reg. No. 3,475,014

Registered July 29, 2008

**SERVICE MARK
PRINCIPAL REGISTER**

TELEQUEST

TELEQUEST HOLDINGS, LLC (TEXAS LTD
LIAB CO)
15851 NORTH DALLAS PARKWAY, SUITE 600
ADDISON, TX 75001

FOR: MARKETING SERVICES, NAMELY, PRO-
VIDING BUSINESS LEADS FOR OTHERS, CUSTO-
MER RELATIONSHIP MANAGEMENT,
APPOINTMENT SETTING, AND TELEMARKE-
TING, IN CLASS 35 (U.S. CLS. 100, 101 AND 102).

FIRST USE 6-29-2004; IN COMMERCE 6-29-2004.

THE MARK CONSISTS OF STANDARD CHAR-
ACTERS WITHOUT CLAIM TO ANY PARTICULAR
FONT, STYLE, SIZE, OR COLOR.

SER. NO. 77-220,100, FILED 7-2-2007.

SUZANNE BLANE, EXAMINING ATTORNEY

Int. Cl.: 28

Prior U.S. Cls.: 22, 23, 38 and 50

United States Patent and Trademark Office

Reg. No. 3,475,015

Registered July 29, 2008

**TRADEMARK
PRINCIPAL REGISTER**

LILA CABANA

MATTEL, INC. (DELAWARE CORPORATION)

M1-1518

333 CONTINENTAL BLVD.

EL SEGUNDO, CA 90245

FOR: TOYS, GAMES AND PLAYTHINGS, NAME-
LY, TOY FIGURE PLAYSETS AND ACCESSORIES
THEREFOR, IN CLASS 28 (U.S. CLS. 22, 23, 38 AND
50).

FIRST USE 10-18-2007; IN COMMERCE 10-18-2007.

THE MARK CONSISTS OF STANDARD CHAR-
ACTERS WITHOUT CLAIM TO ANY PARTICULAR
FONT, STYLE, SIZE, OR COLOR.

OWNER OF U.S. REG. NOS. 1,687,194 AND
2,953,161.

NO CLAIM IS MADE TO THE EXCLUSIVE
RIGHT TO USE "CABANA", APART FROM THE
MARK AS SHOWN.

SER. NO. 77-220,176, FILED 7-2-2007.

JEAN IM, EXAMINING ATTORNEY

Int. Cl.: 35

Prior U.S. Cls.: 100, 101 and 102

United States Patent and Trademark Office

Reg. No. 3,475,016

Registered July 29, 2008

**SERVICE MARK
PRINCIPAL REGISTER**

JORGEN'S SHINE SHOP

SNAP LOCK INDUSTRIES, INC. (UTAH CORPORATION)
2330 WEST CALIFORNIA AVENUE
SALT LAKE CITY, UT 84104

FOR: ONLINE RETAIL STORE SERVICES FEATURING GARAGE RELATED PRODUCTS, NAMELY, AUTOMOTIVE PARTS AND ACCESSORIES, AUTOMOTIVE ART, TOOLS, TOOL BOXES, LIGHTING, FLOORING, CAR CARE PRODUCTS, AND GARAGE STORAGE FURNITURE, IN CLASS 35 (U.S. CLS. 100, 101 AND 102).

FIRST USE 6-5-2007; IN COMMERCE 6-5-2007.

THE MARK CONSISTS OF STANDARD CHARACTERS WITHOUT CLAIM TO ANY PARTICULAR FONT, STYLE, SIZE, OR COLOR.

NO CLAIM IS MADE TO THE EXCLUSIVE RIGHT TO USE "SHOP", APART FROM THE MARK AS SHOWN.

SER. NO. 77-220,228, FILED 7-2-2007.

MICHAEL GAAFAR, EXAMINING ATTORNEY

Int. Cl.: 14

Prior U.S. Cls.: 2, 27, 28 and 50

United States Patent and Trademark Office

Reg. No. 3,475,017

Registered July 29, 2008

**TRADEMARK
PRINCIPAL REGISTER**

VENETIAN

LAS VEGAS SANDS CORP. (NEVADA CORPORATION)
3355 LAS VEGAS BOULEVARD SOUTH
LAS VEGAS, NV 89109

FOR: JEWELRY; LAPEL PINS, IN CLASS 14 (U.S. CLS. 2, 27, 28 AND 50).

FIRST USE 3-29-2007; IN COMMERCE 3-29-2007.

THE MARK CONSISTS OF STANDARD CHARACTERS WITHOUT CLAIM TO ANY PARTICULAR FONT, STYLE, SIZE, OR COLOR.

OWNER OF U.S. REG. NOS. 2,326,994, 2,427,247, AND 2,427,621.

SER. NO. 77-220,415, FILED 7-2-2007.

JAY FLOWERS, EXAMINING ATTORNEY

Int. Cl.: 18

Prior U.S. Cls.: 1, 2, 3, 22 and 41

United States Patent and Trademark Office

Reg. No. 3,475,018

Registered July 29, 2008

**TRADEMARK
PRINCIPAL REGISTER**

VENETIAN

LAS VEGAS SANDS CORP. (NEVADA CORPORATION)
3355 LAS VEGAS BOULEVARD SOUTH
LAS VEGAS, NV 89109

FOR: TOTE BAGS; LUGGAGE TAGS, IN CLASS 18
(U.S. CLS. 1, 2, 3, 22 AND 41).

FIRST USE 3-29-2007; IN COMMERCE 3-29-2007.

THE MARK CONSISTS OF STANDARD CHARACTERS WITHOUT CLAIM TO ANY PARTICULAR FONT, STYLE, SIZE, OR COLOR.

OWNER OF U.S. REG. NOS. 2,326,994, 2,427,247, AND 2,427,621.

SER. NO. 77-220,430, FILED 7-2-2007.

JAY FLOWERS, EXAMINING ATTORNEY

Int. Cl.: 41

Prior U.S. Cls.: 100, 101 and 107

United States Patent and Trademark Office

Reg. No. 3,475,019

Registered July 29, 2008

**SERVICE MARK
PRINCIPAL REGISTER**

PRINCESS RADIO

MATTEL, INC. (DELAWARE CORPORATION)
M1-1518
333 CONTINENTAL BLVD.
EL SEGUNDO, CA 90245

FOR: ONLINE GAMES AND ACTIVITIES, NAME-
LY, PROVIDING STREAMING AUDIO CONTENT
VIA THE INTERNET FEATURING ENTERTAIN-
MENT FOR CHILDREN, IN CLASS 41 (U.S. CLS. 100,
101 AND 107).

FIRST USE 3-25-2008; IN COMMERCE 3-25-2008.

THE MARK CONSISTS OF STANDARD CHAR-
ACTERS WITHOUT CLAIM TO ANY PARTICULAR
FONT, STYLE, SIZE, OR COLOR.

NO CLAIM IS MADE TO THE EXCLUSIVE
RIGHT TO USE "RADIO", APART FROM THE
MARK AS SHOWN.

SER. NO. 77-220,666, FILED 7-2-2007.

SHANNON TWOHIG, EXAMINING ATTORNEY

Int. Cl.: 41

Prior U.S. Cls.: 100, 101 and 107

United States Patent and Trademark Office

Reg. No. 3,475,020

Registered July 29, 2008

**SERVICE MARK
PRINCIPAL REGISTER**



UNIVERSITY OF LOUISIANA AT LAFAYETTE
(LOUISIANA STATE UNIVERSITY)
P. O. BOX 43610
LAFAYETTE, LA 70504

FOR: PROFESSIONAL DEVELOPMENT SERVICES FOR EDUCATORS, NAMELY, TRAINING IN THE FIELD OF GIFTED EDUCATION AND DIFFERENTIATED CURRICULUM AND INSTRUCTION FOR TALENT DEVELOPMENT AND CHILD DEVELOPMENT, IN CLASS 41 (U.S. CLS. 100, 101 AND 107).

FIRST USE 2-28-1998; IN COMMERCE 2-28-1998.

THE MARK CONSISTS OF THREE CURVED BARS SURROUNDING A FLEUR DE LIS.

SER. NO. 77-220,758, FILED 7-2-2007.

SKYE YOUNG, EXAMINING ATTORNEY

Int. Cl.: 9

Prior U.S. Cls.: 21, 23, 26, 36 and 38

United States Patent and Trademark Office

Reg. No. 3,475,021

Registered July 29, 2008

**TRADEMARK
PRINCIPAL REGISTER**

**YOUR MOBILE CONNECTION TO
LIGHT**

VOLERE, INC. (CALIFORNIA CORPORATION)
556 S. FAIR OAKS AVE., #10
PASADENA, CA 91105

FOR: POWER SUPPLIES; POWER SUPPLY CONNECTORS AND ADAPTORS FOR USE WITH PORTABLE ELECTRONIC DEVICES; VOLTAGE STABILIZING POWER SUPPLY; APPARATUS FOR CONVERTING ELECTRONIC RADIATION TO ELECTRICAL ENERGY, NAMELY, PHOTOVOLTAIC SOLAR MODULES; PHOTOVOLTAIC CELLS; BATTERIES; BATTERY CASES; BATTERY CHARGE DEVICES; BATTERY CHARGERS; BATTERY PACKS; ELECTRIC STORAGE BATTERIES; ELECTRICAL CELLS AND BATTERIES; ELECTRICAL STORAGE BATTERIES; MOBILE TELEPHONE BATTERIES; RECHARGEABLE ELECTRIC BATTERIES; RENEWABLE BATTERY SYSTEM TO PRO-

VIDE BACKUP POWER; CARRYING CASES SPECIALLY ADAPTED FOR POCKET CALCULATORS AND CELLPHONES; COMPUTER CARRYING CASES; LAPTOP CARRYING CASES; PROTECTIVE CARRYING CASES FOR PORTABLE MUSIC PLAYERS NAMELY MP3 PLAYERS, IN CLASS 9 (U.S. CLS. 21, 23, 26, 36 AND 38).

FIRST USE 8-2-2005; IN COMMERCE 1-5-2006.

THE MARK CONSISTS OF STANDARD CHARACTERS WITHOUT CLAIM TO ANY PARTICULAR FONT, STYLE, SIZE, OR COLOR.

SER. NO. 77-220,821, FILED 7-2-2007.

PAUL CROWLEY, EXAMINING ATTORNEY

Int. Cl.: 36

Prior U.S. Cls.: 100, 101 and 102

United States Patent and Trademark Office

Reg. No. 3,475,022

Registered July 29, 2008

**SERVICE MARK
PRINCIPAL REGISTER**

IRON EAGLE

MICHAEL HON (UNITED STATES INDIVIDUAL)
1159 E. IRON EAGLE DRIVE, SUITE 170
EAGLE, ID 83616

FOR: LEASING OF REAL ESTATE; FINANCIAL INVESTMENT IN THE FIELD OF REAL ESTATE; REAL ESTATE INVESTMENT; REAL ESTATE INVESTMENT SERVICES IN THE NATURE OF PURCHASING AND SELLING OF REAL ESTATE FOR OTHERS; PROVIDING INFORMATION IN THE FIELD OF REAL ESTATE BY MEANS OF LINKING THE WEB SITE TO OTHER WEB SITES FEATURING REAL ESTATE INFORMATION; PROVIDING INFORMATION IN THE FIELD OF REAL ESTATE VIA THE INTERNET; PROVIDING REAL ESTATE LISTINGS AND REAL ESTATE INFORMATION VIA THE INTERNET; REAL ESTATE ACQUISITION

SERVICES; REAL ESTATE AGENCIES; REAL ESTATE APPRAISAL; REAL ESTATE BROKERAGE; REAL ESTATE CONSULTATION; REAL ESTATE LISTING; REAL ESTATE MANAGEMENT; REAL ESTATE PROCUREMENT FOR OTHERS, IN CLASS 36 (U.S. CLS. 100, 101 AND 102).

FIRST USE 12-1-2006; IN COMMERCE 12-1-2006.

THE MARK CONSISTS OF STANDARD CHARACTERS WITHOUT CLAIM TO ANY PARTICULAR FONT, STYLE, SIZE, OR COLOR.

SER. NO. 77-220,897, FILED 7-2-2007.

KYLE PEETE, EXAMINING ATTORNEY

Int. Cl.: 35

Prior U.S. Cls.: 100, 101 and 102

United States Patent and Trademark Office

Reg. No. 3,475,023

Registered July 29, 2008

**SERVICE MARK
PRINCIPAL REGISTER**

Gameonpro

GAMEONPRO, LLC (FLORIDA LTD LIAB CO)
217 FLORES WAY
JACKSONVILLE, FL 32259

FIRST USE 1-1-2005; IN COMMERCE 2-20-2007.

FOR: ADVERTISING VIA THE INTERNET,
NAMELY, PROMOTION OF PRODUCTS AND SER-
VICES OF THIRD PARTIES THROUGH SPONSOR-
ING ARRANGEMENTS AND LICENSE
AGREEMENTS RELATING TO INTERNATIONAL
SPORTS' EVENTS, IN CLASS 35 (U.S. CLS. 100, 101
AND 102).

THE MARK CONSISTS OF STANDARD CHAR-
ACTERS WITHOUT CLAIM TO ANY PARTICULAR
FONT, STYLE, SIZE, OR COLOR.

SER. NO. 77-220,965, FILED 7-2-2007.

CHARLOTTE CORWIN, EXAMINING ATTORNEY

Int. Cl.: 35

Prior U.S. Cls.: 100, 101 and 102

United States Patent and Trademark Office

Reg. No. 3,475,024

Registered July 29, 2008

**SERVICE MARK
PRINCIPAL REGISTER**



MASTERS OF FOXHOUNDS ASSOCIATION OF
AMERICA (VIRGINIA CORPORATION)
P.O. BOX 363
MILLWOOD, VA 22646

FOR: ASSOCIATION SERVICES, NAMELY, PRO-
MOTING THE INTERESTS OF MASTERS OF FOX-
HUNTS, IN CLASS 35 (U.S. CLS. 100, 101 AND 102).

FIRST USE 8-0-2005; IN COMMERCE 8-0-2005.

NO CLAIM IS MADE TO THE EXCLUSIVE
RIGHT TO USE "1907", APART FROM THE MARK
AS SHOWN.

THE MARK CONSISTS OF A CIRCULAR LOGO.
THE INSIDE TOP PORTION OF THE CIRCULAR
LOGO CONTAINS A HORN, STIRRUP, AND BIT.
THE LOWER PORTION OF THE CIRCULAR LOGO
CONTAINS AN IMAGE OF A DOG AND A SHIELD.

SEC. 2(F) AS TO "MASTERS OF FOXHOUNDS
ASSOCIATION OF AMERICA".

SER. NO. 77-221,046, FILED 7-3-2007.

MICHAEL KEATING, EXAMINING ATTORNEY

Int. Cl.: 5

Prior U.S. Cls.: 6, 18, 44, 46, 51 and 52

United States Patent and Trademark Office

Reg. No. 3,475,025

Registered July 29, 2008

**TRADEMARK
PRINCIPAL REGISTER**

LYTESPEED

JRBB, LLC (DELAWARE LTD LIAB CO)
#173
48 BROAD STREET
RED BANK, NJ 07701

THE MARK CONSISTS OF STANDARD CHAR-
ACTERS WITHOUT CLAIM TO ANY PARTICULAR
FONT, STYLE, SIZE, OR COLOR.

FOR: NUTRITIONAL SUPPLEMENTS FOR ANI-
MALS, IN CLASS 5 (U.S. CLS. 6, 18, 44, 46, 51 AND 52).

SER. NO. 77-221,128, FILED 7-3-2007.

FIRST USE 4-1-2001; IN COMMERCE 4-1-2001.

ALYSSA PALADINO, EXAMINING ATTORNEY

Int. Cl.: 33

Prior U.S. Cls.: 47 and 49

United States Patent and Trademark Office

Reg. No. 3,475,026

Registered July 29, 2008

**TRADEMARK
PRINCIPAL REGISTER**

STEPHEN VINCENT

STEPHEN VINCENT WINES INC. (CALIFORNIA
CORPORATION)
P.O. BOX 182
PETALUMA, CA 94953

THE NAME(S), PORTRAIT(S), AND/OR SIGNA-
TURE(S) SHOWN IN THE MARK DOES NOT IDEN-
TIFY A PARTICULAR LIVING INDIVIDUAL.

FOR: WINES, IN CLASS 33 (U.S. CLS. 47 AND 49).

FIRST USE 12-0-2003; IN COMMERCE 12-0-2003.

SER. NO. 77-221,192, FILED 7-3-2007.

THE MARK CONSISTS OF STANDARD CHAR-
ACTERS WITHOUT CLAIM TO ANY PARTICULAR
FONT, STYLE, SIZE, OR COLOR.

BARBARA BROWN, EXAMINING ATTORNEY

Int. Cl.: 33

Prior U.S. Cls.: 47 and 49

United States Patent and Trademark Office

Reg. No. 3,475,027

Registered July 29, 2008

**TRADEMARK
PRINCIPAL REGISTER**

STEPHEN VINCENT CRIMSON

STEPHEN VINCENT WINES INC. (CALIFORNIA
CORPORATION)
P.O. BOX 182
PETALUMA, CA 94953

FOR: WINES, IN CLASS 33 (U.S. CLS. 47 AND 49).

FIRST USE 9-0-2005; IN COMMERCE 9-0-2005.

THE MARK CONSISTS OF STANDARD CHAR-
ACTERS WITHOUT CLAIM TO ANY PARTICULAR
FONT, STYLE, SIZE, OR COLOR.

NO CLAIM IS MADE TO THE EXCLUSIVE
RIGHT TO USE "CRIMSON", APART FROM THE
MARK AS SHOWN.

THE NAME(S), PORTRAIT(S), AND/OR SIGNA-
TURE(S) SHOWN IN THE MARK DOES NOT IDEN-
TIFY A PARTICULAR LIVING INDIVIDUAL.

SER. NO. 77-221,200, FILED 7-3-2007.

BARBARA BROWN, EXAMINING ATTORNEY

Int. Cl.: 35

Prior U.S. Cls.: 100, 101 and 102

United States Patent and Trademark Office

Reg. No. 3,475,028

Registered July 29, 2008

**SERVICE MARK
PRINCIPAL REGISTER**

The Pros From Dover

THE PROS FROM DOVER, INC. (COLORADO
CORPORATION)
418 S. JAY STREET
LAKEWOOD, CO 80226

FOR: BUSINESS CONSULTING AND BUSINESS
INFORMATION FOR ENTERPRISES, IN CLASS 35
(U.S. CLS. 100, 101 AND 102).

FIRST USE 11-3-1999; IN COMMERCE 11-3-1999.

THE MARK CONSISTS OF STANDARD CHAR-
ACTERS WITHOUT CLAIM TO ANY PARTICULAR
FONT, STYLE, SIZE, OR COLOR.

NO CLAIM IS MADE TO THE EXCLUSIVE
RIGHT TO USE "DOVER", APART FROM THE
MARK AS SHOWN.

SER. NO. 77-221,214, FILED 7-3-2007.

LOURDES AYALA, EXAMINING ATTORNEY

Int. Cl.: 33

Prior U.S. Cls.: 47 and 49

United States Patent and Trademark Office

Reg. No. 3,475,029

Registered July 29, 2008

**TRADEMARK
PRINCIPAL REGISTER**

ROBERT GOYETTE

STEPHEN VINCENT WINES INC. (CALIFORNIA
CORPORATION)
P.O. BOX 182
PETALUMA, CA 94953

THE NAME(S), PORTRAIT(S), AND/OR SIGNA-
TURE(S) SHOWN IN THE MARK IDENTIFIES
"ROBERT GOYETTE", WHOSE CONSENT(S) TO
REGISTER IS MADE OF RECORD.

FOR: WINES, IN CLASS 33 (U.S. CLS. 47 AND 49).

FIRST USE 12-0-2006; IN COMMERCE 12-0-2006.

SER. NO. 77-221,227, FILED 7-3-2007.

THE MARK CONSISTS OF STANDARD CHAR-
ACTERS WITHOUT CLAIM TO ANY PARTICULAR
FONT, STYLE, SIZE, OR COLOR.

BARBARA BROWN, EXAMINING ATTORNEY

Int. Cl.: 41

Prior U.S. Cls.: 100, 101 and 107

United States Patent and Trademark Office

Reg. No. 3,475,030

Registered July 29, 2008

**SERVICE MARK
PRINCIPAL REGISTER**

My Body My Way

LOUIS, DIMITRI (UNITED STATES INDIVIDUAL)
1926 21ST PLACE S.E.
WASHINGTON, DC 20020

FOR: PROVIDING ASSISTANCE, PERSONAL TRAINING AND PHYSICAL FITNESS CONSULTATION TO INDIVIDUALS TO HELP THEM MAKE PHYSICAL FITNESS, STRENGTH, CONDITIONING, AND EXERCISE IMPROVEMENT IN THEIR DAILY LIVING, IN CLASS 41 (U.S. CLS. 100, 101 AND 107).

FIRST USE 8-1-2005; IN COMMERCE 8-25-2005.

THE MARK CONSISTS OF STANDARD CHARACTERS WITHOUT CLAIM TO ANY PARTICULAR FONT, STYLE, SIZE, OR COLOR.

SER. NO. 77-221,413, FILED 7-3-2007.

TEJBIR SINGH, EXAMINING ATTORNEY

Int. Cls.: 35 and 36

Prior U.S. Cls.: 100, 101 and 102

United States Patent and Trademark Office

Reg. No. 3,475,031

Registered July 29, 2008

**SERVICE MARK
PRINCIPAL REGISTER**



HOMETOWN AMERICA
C O M M U N I T I E S

HOMETOWN AMERICA, L.L.C. (DELAWARE
LTD LIAB CO)
150 NORTH WACKER DRIVE
SUITE 2800
CHICAGO, IL 60606

FIRST USE 12-31-1999; IN COMMERCE 1-31-2000.

OWNER OF U.S. REG. NOS. 2,337,580, 3,210,433,
AND 3,214,947.

FOR: DISTRIBUTORSHIP OF MANUFACTURED
HOUSING AND RECREATIONAL VEHICLES, IN
CLASS 35 (U.S. CLS. 100, 101 AND 102).

NO CLAIM IS MADE TO THE EXCLUSIVE
RIGHT TO USE "AMERICA COMMUNITIES",
APART FROM THE MARK AS SHOWN.

FIRST USE 12-31-1999; IN COMMERCE 1-31-2000.

FOR: REAL ESTATE MANAGEMENT, NAMELY,
MANAGEMENT OF MANUFACTURED HOUSING
COMMUNITIES AND RECREATIONAL VEHICLE
COMMUNITIES; BROKERAGE OF PREVIOUSLY-
OWNED MANUFACTURED HOUSING AND RE-
CREATIONAL VEHICLES; FINANCING OF MAN-
UFACTURED HOUSING AND RECREATIONAL
VEHICLES; AND INSURANCE BROKERAGE IN
THE FIELDS OF PROPERTY AND CASUALTY
INSURANCE, IN CLASS 36 (U.S. CLS. 100, 101 AND
102).

THE MARK CONSISTS OF OUTLINES OF
HOUSES, BUILDINGS, A BUILDING DOME WITH
A FLAG ON TOP, TREES, AND A FIELD, AND TO
THE RIGHT OF SUCH PICTURE THE UNDER-
LINED WORDS "HOMETOWN AMERICA" ABOVE
THE UNDERLINED WORD "COMMUNITIES",
PROVIDED THAT THE MARK IS IN BLACK AND
WHITE WITH GRAY FOR SHADING PURPOSES
ONLY AND NOT TO INDICATE COLOR.

SER. NO. 77-221,511, FILED 7-3-2007.

PATRICIA EVANKO, EXAMINING ATTORNEY

Int. Cls.: 35 and 36

Prior U.S. Cls.: 100, 101 and 102

United States Patent and Trademark Office

Reg. No. 3,475,032

Registered July 29, 2008

**SERVICE MARK
PRINCIPAL REGISTER**



HOMETOWN AMERICA, L.L.C. (DELAWARE
LTD LIAB CO)
150 NORTH WACKER DRIVE
SUITE 2800
CHICAGO, IL 60606

FOR: DISTRIBUTORSHIP OF MANUFACTURED
HOUSING AND RECREATIONAL VEHICLES, IN
CLASS 35 (U.S. CLS. 100, 101 AND 102).

FIRST USE 12-31-1999; IN COMMERCE 1-31-2000.

FOR: REAL ESTATE MANAGEMENT, NAMELY,
MANAGEMENT OF MANUFACTURED HOUSING
COMMUNITIES AND RECREATIONAL VEHICLE
COMMUNITIES; BROKERAGE OF PREVIOUSLY-
OWNED MANUFACTURED HOUSING AND RE-
CREATIONAL VEHICLES; FINANCING OF MAN-
UFACTURED HOUSING AND RECREATIONAL
VEHICLES; AND INSURANCE BROKERAGE IN
THE FIELDS OF PROPERTY AND CASUALTY
INSURANCE, IN CLASS 36 (U.S. CLS. 100, 101 AND
102).

FIRST USE 12-31-1999; IN COMMERCE 1-31-2000.

OWNER OF U.S. REG. NOS. 2,337,580, 3,210,433,
AND 3,214,947.

NO CLAIM IS MADE TO THE EXCLUSIVE
RIGHT TO USE "AMERICA COMMUNITIES",
APART FROM THE MARK AS SHOWN.

THE COLOR(S) BLUE AND RED IS/ARE
CLAIMED AS A FEATURE OF THE MARK.

THE MARK CONSISTS OF OUTLINES OF
HOUSES, BUILDINGS, A BUILDING DOME WITH
A FLAG ON TOP, TREES, AND A FIELD, WITH THE
LEFT HALF THE PICTURE IN RED AND THE
RIGHT HALF IN BLUE, AND TO THE RIGHT OF
SUCH PICTURE THE UNDERLINED WORDS
"HOMETOWN AMERICA" ABOVE THE UNDER-
LINED WORD "COMMUNITIES".

SER. NO. 77-221,531, FILED 7-3-2007.

PATRICIA EVANKO, EXAMINING ATTORNEY

Int. Cl.: 41

Prior U.S. Cls.: 100, 101 and 107

United States Patent and Trademark Office

Reg. No. 3,475,033

Registered July 29, 2008

**SERVICE MARK
PRINCIPAL REGISTER**

Body After Baby Yes

LOUIS, DIMITRI (UNITED STATES INDIVIDUAL)
1926 21ST PLACE S.E.
WASHINGTON, DC 20020

FOR: PROVIDING ASSISTANCE, PERSONAL TRAINING AND PHYSICAL FITNESS CONSULTATION TO INDIVIDUALS TO HELP THEM MAKE PHYSICAL FITNESS, STRENGTH, CONDITIONING, AND EXERCISE IMPROVEMENT IN THEIR DAILY LIVING, IN CLASS 41 (U.S. CLS. 100, 101 AND 107).

FIRST USE 2-13-1998; IN COMMERCE 8-24-1998.

THE MARK CONSISTS OF STANDARD CHARACTERS WITHOUT CLAIM TO ANY PARTICULAR FONT, STYLE, SIZE, OR COLOR.

SER. NO. 77-221,541, FILED 7-3-2007.

TEJBIR SINGH, EXAMINING ATTORNEY

Int. Cl.: 37

Prior U.S. Cls.: 100, 103 and 106

United States Patent and Trademark Office

Reg. No. 3,475,034

Registered July 29, 2008

**SERVICE MARK
PRINCIPAL REGISTER**

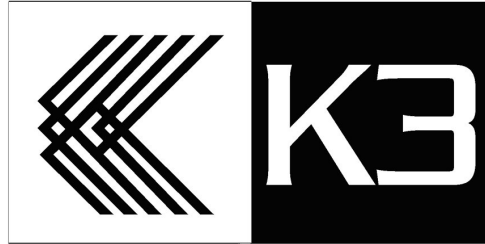

CONSTRUCTION GROUP

K3 CONSTRUCTION GROUP, INC. (VIRGINIA CORPORATION)
11307 SUNSET HILLS ROAD
RESTON, VA 20190

FOR: BUILDING CONSTRUCTION SERVICES; CONSTRUCTION MANAGEMENT; AND GENERAL CONTRACTOR SERVICES, NAMELY, BUILDING CONSTRUCTION CONSULTING AND INSPECTION, IN CLASS 37 (U.S. CLS. 100, 103 AND 106).

FIRST USE 1-2-2007; IN COMMERCE 1-2-2007.

OWNER OF U.S. REG. NO. 1,880,069.

NO CLAIM IS MADE TO THE EXCLUSIVE RIGHT TO USE "CONSTRUCTION GROUP", APART FROM THE MARK AS SHOWN.

THE MARK CONSISTS OF INVERTED CHEVRONS THAT FORM THE LETTER "K" WITH THE WORD "K3" TO THE RIGHT OF THE DESIGN AND THE WORDS "CONSTRUCTION GROUP BELOW K K3."

SER. NO. 77-221,627, FILED 7-3-2007.

MICHAEL WEBSTER, EXAMINING ATTORNEY

Int. Cl.: 41

Prior U.S. Cls.: 100, 101 and 107

United States Patent and Trademark Office

Reg. No. 3,475,035

Registered July 29, 2008

**SERVICE MARK
PRINCIPAL REGISTER**

**HEALTHY EATING ACTIVE
LIVING**

HEAL, INC. (ALABAMA CORPORATION)
P.O. BOX 660827
BIRMINGHAM, AL 35266

FIRST USE 11-1-2006; IN COMMERCE 11-1-2006.

FOR: EDUCATIONAL SERVICES, NAMELY,
EDUCATIONAL DEMONSTRATIONS AND TRAIN-
ING IN THE FIELDS OF NUTRITION, EXERCISE
AND FITNESS AND DISTRIBUTION OF COURSE
MATERIALS IN CONNECTION THEREWITH , IN
CLASS 41 (U.S. CLS. 100, 101 AND 107).

THE MARK CONSISTS OF STANDARD CHAR-
ACTERS WITHOUT CLAIM TO ANY PARTICULAR
FONT, STYLE, SIZE, OR COLOR.

SER. NO. 77-221,884, FILED 7-3-2007.

DANIEL CAPSHAW, EXAMINING ATTORNEY

Int. Cl.: 41

Prior U.S. Cls.: 100, 101 and 107

United States Patent and Trademark Office

Reg. No. 3,475,036

Registered July 29, 2008

**SERVICE MARK
PRINCIPAL REGISTER**

HEAL

HEAL, INC. (ALABAMA CORPORATION)
P.O. BOX 660827
BIRMINGHAM, AL 35266

FIRST USE 11-1-2006; IN COMMERCE 11-1-2006.

FOR: EDUCATIONAL SERVICES, NAMELY,
EDUCATIONAL DEMONSTRATIONS AND TRAIN-
ING IN THE FIELDS OF NUTRITION, EXERCISE
AND FITNESS AND DISTRIBUTION OF COURSE
MATERIALS IN CONNECTION THEREWITH , IN
CLASS 41 (U.S. CLS. 100, 101 AND 107).

THE MARK CONSISTS OF STANDARD CHAR-
ACTERS WITHOUT CLAIM TO ANY PARTICULAR
FONT, STYLE, SIZE, OR COLOR.

SER. NO. 77-221,897, FILED 7-3-2007.

DANIEL CAPSHAW, EXAMINING ATTORNEY

Int. Cl.: 41

Prior U.S. Cls.: 100, 101 and 107

United States Patent and Trademark Office

Reg. No. 3,475,037

Registered July 29, 2008

**SERVICE MARK
PRINCIPAL REGISTER**

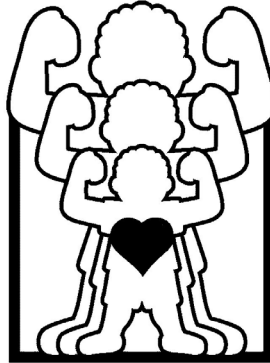

HEAL, INC. (ALABAMA CORPORATION)
P.O. BOX 660827
BIRMINGHAM, AL 35266

FOR: EDUCATIONAL SERVICES, NAMELY,
EDUCATIONAL DEMONSTRATIONS AND TRAIN-
ING IN THE FIELDS OF NUTRITION, EXERCISE
AND FITNESS AND DISTRIBUTION OF COURSE
MATERIALS IN CONNECTION THEREWITH , IN
CLASS 41 (U.S. CLS. 100, 101 AND 107).

FIRST USE 11-1-2006; IN COMMERCE 11-1-2006.

THE MARK CONSISTS OF A HEART SUPER-
IMPOSED ON SILHOUETTES OF THREE CHIL-
DREN.

SER. NO. 77-221,906, FILED 7-3-2007.

DANIEL CAPSHAW, EXAMINING ATTORNEY

Int. Cl.: 41

Prior U.S. Cls.: 100, 101 and 107

United States Patent and Trademark Office

Reg. No. 3,475,038

Registered July 29, 2008

SERVICE MARK
PRINCIPAL REGISTER



HEAL, INC. (ALABAMA CORPORATION)
P.O. BOX 660827
BIRMINGHAM, AL 35266

THE STIPLING IS FOR SHADING PURPOSES
ONLY.

FOR: EDUCATIONAL SERVICES, NAMELY,
EDUCATIONAL DEMONSTRATIONS AND TRAIN-
ING IN THE FIELDS OF NUTRITION, EXERCISE
AND FITNESS AND DISTRIBUTION OF COURSE
MATERIALS IN CONNECTION THEREWITH , IN
CLASS 41 (U.S. CLS. 100, 101 AND 107).

THE MARK CONSISTS OF THE WORD "HEAL"
SUPERIMPOSED ON THE WORD "HEAL".

SER. NO. 77-221,922, FILED 7-3-2007.

FIRST USE 11-15-2003; IN COMMERCE 11-15-2003.

DANIEL CAPSHAW, EXAMINING ATTORNEY

Int. Cl.: 9

Prior U.S. Cls.: 21, 23, 26, 36 and 38

Reg. No. 3,475,039

United States Patent and Trademark Office

Registered July 29, 2008

**TRADEMARK
PRINCIPAL REGISTER**

PLANAM

PLANAM-ARBEITSSCHUTZ VERTRIEBS GMBH
(FED REP GERMANY GMBH)
50, LETTER STRASSE 33442
HERZEBROCK-CLARHOLZ, FED REP GERMANY
33442

FOR: PROTECTIVE CLOTHING FOR INDUSTRIAL USE, NAMELY, WELDER JACKETS, WELDER TROUSERS, WELDER DUNGAREES, WELDER OVERALLS, HIGH VISIBLE JACKETS, HIGH VISIBLE TROUSERS, HIGH VISIBLE DUNGAREES, HIGH VISIBLE OVERALLS, HIGH VISIBLE VESTS, JACKETS FOR COLD PROTECTION, TROUSERS FOR COLD PROTECTION, DUNGAREES FOR COLD PROTECTION, OVERALLS FOR COLD PROTECTION, VESTS FOR COLD PROTECTION, HATS

AND CAPS FOR COLD PROTECTION, PROTECTIVE GLOVES, SAFETY SHOES AND BOOTS, IN CLASS 9 (U.S. CLS. 21, 23, 26, 36 AND 38).

THE MARK CONSISTS OF STANDARD CHARACTERS WITHOUT CLAIM TO ANY PARTICULAR FONT, STYLE, SIZE, OR COLOR.

OWNER OF FED REP GERMANY REG. NO. 2086217, DATED 11-29-1994, RENEWED AS REG. NO. 2086217, EXPIRES 11-29-2019.

SER. NO. 77-222,266, FILED 7-5-2007.

MARK SPARACINO, EXAMINING ATTORNEY

Int. Cl.: 36

Prior U.S. Cls.: 100, 101 and 102

United States Patent and Trademark Office

Reg. No. 3,475,040

Registered July 29, 2008

**SERVICE MARK
PRINCIPAL REGISTER**

PROVIDENCE
BY HOMETOWN AMERICA



HOMETOWN AMERICA, L.L.C. (DELAWARE
LTD LIAB CO)
150 NORTH WACKER DRIVE
SUITE 2800
CHICAGO, IL 60606

FOR: REAL ESTATE MANAGEMENT, NAMELY,
MANAGEMENT OF MANUFACTURED HOUSING
COMMUNITIES, IN CLASS 36 (U.S. CLS. 100, 101
AND 102).

FIRST USE 11-1-2003; IN COMMERCE 11-1-2003.

OWNER OF U.S. REG. NOS. 2,337,580, 3,210,433,
AND 3,214,947.

NO CLAIM IS MADE TO THE EXCLUSIVE
RIGHT TO USE "AMERICA", APART FROM THE
MARK AS SHOWN.

THE MARK CONSISTS OF OUTLINES OF
HOUSES, BUILDINGS, A BUILDING DOME WITH
A FLAG ON TOP, TREES, AND A FIELD AND, TO
THE LEFT OF ALL OF THE FOREGOING, THE
WORD "PROVIDENCE" WITH A LINE ABOVE AND
BELOW IT, AND BELOW SUCH WORD "PROVI-
DENCE" AND THE LINE BELOW IT, THE SMAL-
LER WORDS "BY HOMETOWN AMERICA",
PROVIDED THAT THE MARK IS IN BLACK AND
WHITE WITH GRAY FOR SHADING PURPOSES
ONLY AND NOT TO INDICATE COLOR.

SER. NO. 77-222,487, FILED 7-5-2007.

PATRICIA EVANKO, EXAMINING ATTORNEY

Int. Cls.: 35 and 36

Prior U.S. Cls.: 100, 101 and 102

United States Patent and Trademark Office

Reg. No. 3,475,041

Registered July 29, 2008

**SERVICE MARK
PRINCIPAL REGISTER**

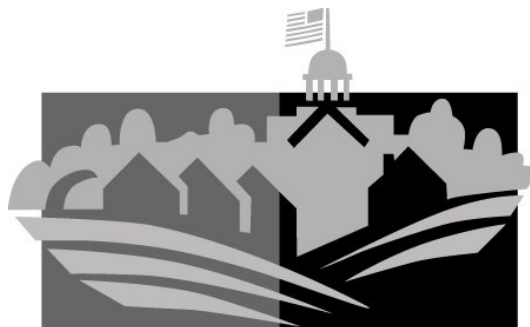

HOMETOWN AMERICA, L.L.C. (DELAWARE
LTD LIAB CO)
150 NORTH WACKER DRIVE
SUITE 2800
CHICAGO, IL 60606

FOR: DISTRIBUTORSHIP OF MANUFACTURED
HOUSING AND RECREATIONAL VEHICLES, IN
CLASS 35 (U.S. CLS. 100, 101 AND 102).

FIRST USE 11-1-2003; IN COMMERCE 11-1-2003.

FOR: REAL ESTATE MANAGEMENT, NAMELY,
MANAGEMENT OF MANUFACTURED HOUSING
COMMUNITIES AND RECREATIONAL VEHICLE
COMMUNITIES; BROKERAGE OF PREVIOUSLY-
OWNED MANUFACTURED HOUSING AND RE-
CREATIONAL VEHICLES; FINANCING OF MAN-
UFACTURED HOUSING AND RECREATIONAL

VEHICLES; AND INSURANCE BROKERAGE IN
THE FIELDS OF PROPERTY AND CASUALTY
INSURANCE, IN CLASS 36 (U.S. CLS. 100, 101 AND
102).

FIRST USE 11-1-2003; IN COMMERCE 11-1-2003.

THE MARK CONSISTS OF OUTLINES OF
HOUSES, BUILDINGS, A BUILDING DOME WITH
A FLAG ON TOP, TREES, AND A FIELD, PROVI-
DED THAT THE MARK IS IN BLACK AND WHITE
WITH GRAY FOR SHADING PURPOSES ONLY
AND NOT TO INDICATE COLOR.

SER. NO. 77-222,517, FILED 7-5-2007.

PATRICIA EVANKO, EXAMINING ATTORNEY

Int. Cl.: 35

Prior U.S. Cls.: 100, 101 and 102

United States Patent and Trademark Office

Reg. No. 3,475,042

Registered July 29, 2008

**SERVICE MARK
PRINCIPAL REGISTER**

Regency Furniture

REGENCY FURNITURE, INC. (MARYLAND CORPORATION)
7900 CEDARVILLE ROAD
BRANDYWINE, MD 20613

NO CLAIM IS MADE TO THE EXCLUSIVE RIGHT TO USE "FURNITURE", APART FROM THE MARK AS SHOWN.

FOR: RETAIL FURNITURE STORES, IN CLASS 35 (U.S. CLS. 100, 101 AND 102).

SEC. 2(F).

FIRST USE 3-22-2000; IN COMMERCE 3-22-2000.

SER. NO. 77-223,181, FILED 7-6-2007.

THE MARK CONSISTS OF STANDARD CHARACTERS WITHOUT CLAIM TO ANY PARTICULAR FONT, STYLE, SIZE, OR COLOR.

SIMON TENG, EXAMINING ATTORNEY

Int. Cl.: 16

Prior U.S. Cls.: 2, 5, 22, 23, 29, 37, 38 and 50

Reg. No. 3,475,043

United States Patent and Trademark Office

Registered July 29, 2008

**TRADEMARK
PRINCIPAL REGISTER**

LAUNCH

THE GLIDDEN COMPANY (DELAWARE COR-
PORATION)
15885 WEST SPRAGUE ROAD
STRONGSVILLE, OH 44136

THE MARK CONSISTS OF STANDARD CHAR-
ACTERS WITHOUT CLAIM TO ANY PARTICULAR
FONT, STYLE, SIZE, OR COLOR.

FOR: PAINT BRUSHES, IN CLASS 16 (U.S. CLS. 2,
5, 22, 23, 29, 37, 38 AND 50).

SER. NO. 77-223,217, FILED 7-6-2007.

FIRST USE 4-30-2002; IN COMMERCE 4-30-2002.

CORY BOONE, EXAMINING ATTORNEY

Int. Cl.: 35

Prior U.S. Cls.: 100, 101 and 102

United States Patent and Trademark Office

Reg. No. 3,475,044

Registered July 29, 2008

**SERVICE MARK
PRINCIPAL REGISTER**

PCOP SUPERSTORE

TCG BUSINESS SYSTEMS, INC. (CALIFORNIA CORPORATION), DBA PACIFIC COAST OFFICE PRODUCTS
BUILDING K
3440 W. WARNER AVENUE
SANTA ANA, CA 92704

FOR: PROVIDING INFORMATION ABOUT OFFICE PRODUCTS FOR SALE BY MEANS OF THE INTERNET, IN CLASS 35 (U.S. CLS. 100, 101 AND 102).

FIRST USE 6-29-2007; IN COMMERCE 6-29-2007.

THE MARK CONSISTS OF STANDARD CHARACTERS WITHOUT CLAIM TO ANY PARTICULAR FONT, STYLE, SIZE, OR COLOR.

NO CLAIM IS MADE TO THE EXCLUSIVE RIGHT TO USE "SUPERSTORE", APART FROM THE MARK AS SHOWN.

SER. NO. 77-223,474, FILED 7-6-2007.

TINA KUAN, EXAMINING ATTORNEY

Int. Cl.: 3

Prior U.S. Cls.: 1, 4, 6, 50, 51 and 52

United States Patent and Trademark Office

Reg. No. 3,475,045

Registered July 29, 2008

**TRADEMARK
PRINCIPAL REGISTER**

LUTEX

LUTEX COMPANY LIMITED (HONG KONG CORPORATION)
50 GLOUCESTER ROAD
20/F, MALAYSIA BUILDING
WANCHAI, HONG KONG

FOR: BLEACHING PREPARATIONS FOR LAUNDRY USE; CLEANING, POLISHING, SCOURING AND ABRASIVE PREPARATIONS FOR HOUSEHOLD USE; SOAPS; PERFUMERY; ESSENTIAL OILS; BATH TABLETS, BATH PEARLS, BATH SALTS, BATH CRYSTALS, BATH SOAK, NAMELY, BATH OILS, MILK BATH; BODY LOTION, HAND CREAM, NON-MEDICATED FOOT CREAM; BODY SOUFFLE, BODY MIST, BODY POLISHER, NAMELY, EXFOLIANT SCRUB GEL, EXFOLIATING FOOT SCRUB; BATH PREPARATIONS, NAMELY, BATH CREAM, GEL EYE MASKS, INCENSE; SCEN-

TED GOODS, NAMELY, SCENTED ROCKS; SHOWER GEL, BODY WASH, BATH GEL, SHAVING SOAP; BODY AND FACIAL SCRUBS, NAMELY, SUGAR SCRUB; TALCUM POWDER, HAIR LOTIONS; DENTIFRICES, IN CLASS 3 (U.S. CLS. 1, 4, 6, 50, 51 AND 52).

THE MARK CONSISTS OF STANDARD CHARACTERS WITHOUT CLAIM TO ANY PARTICULAR FONT, STYLE, SIZE, OR COLOR.

OWNER OF HONG KONG REG. NO. 300906129, DATED 7-5-2007, EXPIRES 7-5-2017.

SER. NO. 77-223,669, FILED 7-6-2007.

JAY FLOWERS, EXAMINING ATTORNEY

Int. Cl.: 34

Prior U.S. Cls.: 2, 8, 9 and 17

United States Patent and Trademark Office

Reg. No. 3,475,046

Registered July 29, 2008

**TRADEMARK
PRINCIPAL REGISTER**

GINA LIGHTZ

ONE WORLD, INC (GEORGIA CORPORATION)
100 SE 2ND STREET, SUITE 4250
MIAMI, FL 33131

OWNER OF U.S. REG. NO. 2,354,743.

FOR: SAFETY MATCHES, IN CLASS 34 (U.S. CLS.
2, 8, 9 AND 17).

NO CLAIM IS MADE TO THE EXCLUSIVE
RIGHT TO USE "LIGHTS", APART FROM THE
MARK AS SHOWN.

FIRST USE 6-6-2000; IN COMMERCE 6-6-2000.

SER. NO. 77-223,815, FILED 7-6-2007.

THE MARK CONSISTS OF STANDARD CHAR-
ACTERS WITHOUT CLAIM TO ANY PARTICULAR
FONT, STYLE, SIZE, OR COLOR.

MATTHEW PAPPAS, EXAMINING ATTORNEY

Int. Cl.: 8

Prior U.S. Cls.: 23, 28 and 44

United States Patent and Trademark Office

Reg. No. 3,475,047

Registered July 29, 2008

**TRADEMARK
PRINCIPAL REGISTER**

TRU-SPRING

EIKON DEVICE INC. (CANADA CORPORATION)
692 MCKAY STREET
KINGSTON, ONTARIO, CANADA K7M7G2

FOR: TATTOO MACHINE PARTS, NAMELY,
SPRINGS AND ARMATURE BARS; SPRING AND
ARMATURE BAR KITS FOR TATTOO MACHINES,
CONSISTING OF SPRINGS, ARMATURES, SHIMS,
WASHERS AND SCREWS , IN CLASS 8 (U.S. CLS. 23,
28 AND 44).

FIRST USE 1-0-2001; IN COMMERCE 1-0-2001.

THE MARK CONSISTS OF STANDARD CHAR-
ACTERS WITHOUT CLAIM TO ANY PARTICULAR
FONT, STYLE, SIZE, OR COLOR.

PRIORITY CLAIMED UNDER SEC. 44(D) ON
CANADA APPLICATION NO. 1350523, FILED 6-6-
2007.

SER. NO. 77-223,844, FILED 7-6-2007.

LA TONIA FISHER, EXAMINING ATTORNEY

Int. Cl.: 42

Prior U.S. Cls.: 100 and 101

United States Patent and Trademark Office

Reg. No. 3,475,048

Registered July 29, 2008

**SERVICE MARK
PRINCIPAL REGISTER**

BOOZE MAIL

RENKOO, INC. (CALIFORNIA CORPORATION)
386 MAIN STREET, FIRST FLOOR
REDWOOD CITY, CA 94063

FOR: COMPUTER SERVICES, NAMELY, HOSTING ON-LINE WEB FACILITIES FOR OTHERS FOR ORGANIZING, PLANNING AND SCHEDULING EVENTS; PROVIDING TEMPORARY USE OF ON-LINE NON-DOWNLOADABLE SOFTWARE FOR THE PREPARATION OF ELECTRONIC INVITATIONS, IN CLASS 42 (U.S. CLS. 100 AND 101).

FIRST USE 6-29-2007; IN COMMERCE 6-29-2007.

THE MARK CONSISTS OF STANDARD CHARACTERS WITHOUT CLAIM TO ANY PARTICULAR FONT, STYLE, SIZE, OR COLOR.

SER. NO. 77-224,015, FILED 7-6-2007.

JACQUELINE A. LAVINE, EXAMINING ATTORNEY

Int. Cl.: 35

Prior U.S. Cls.: 100, 101 and 102

United States Patent and Trademark Office

Reg. No. 3,475,049

Registered July 29, 2008

**SERVICE MARK
PRINCIPAL REGISTER**

SACRED VALLEY

AMAZON SUN (NEW YORK LTD LIAB CO)
P.O. BOX 622
WHITE PLAINS, NY 10602

FOR: DISTRIBUTORSHIPS IN THE FIELD OF NATURAL SPECIALTY FOOD AND GENERAL MERCHANDISE, PERSONAL CARE ITEMS AND NUTRITIONAL SUPPLEMENTS; ON-LINE RETAIL STORE SERVICES FEATURING NATURAL SPECIALTY FOOD AND GENERAL MERCHANDISE, PERSONAL CARE ITEMS AND NUTRITIONAL SUPPLEMENTS.; PROVIDING BUSINESS AND COMMERCIAL INFORMATION IN THE FIELD OF BUSINESS TRAVEL MANAGEMENT AND THE BUSINESS TRAVEL INDUSTRY; ADVERTISING AND PUBLICITY SERVICES, NAMELY, PROMOTING THE GOODS, SERVICES, BRAND IDENTITY

AND COMMERCIAL INFORMATION AND NEWS OF THIRD PARTIES THROUGH PRINT, AUDIO, VIDEO, DIGITAL AND ON-LINE MEDIUM; DISTRIBUTION AND DISSEMINATION OF ADVERTISING MATERIALS, IN CLASS 35 (U.S. CLS. 100, 101 AND 102).

FIRST USE 7-8-2007; IN COMMERCE 7-8-2007.

THE MARK CONSISTS OF STANDARD CHARACTERS WITHOUT CLAIM TO ANY PARTICULAR FONT, STYLE, SIZE, OR COLOR.

SER. NO. 77-224,309, FILED 7-8-2007.

JEFF DEFORD, EXAMINING ATTORNEY

Int. Cl.: 28

Prior U.S. Cls.: 22, 23, 38 and 50

United States Patent and Trademark Office

Reg. No. 3,475,050

Registered July 29, 2008

**TRADEMARK
PRINCIPAL REGISTER**

DUAL AXIS ALIGNMENT

ROGER CLEVELAND GOLF COMPANY, INC.
(CALIFORNIA CORPORATION)
5601 SKYLAB ROAD
HUNTINGTON BEACH, CA 92647

FOR: GOLF CLUBS, NAMELY, PUTTERS; GOLF
CLUB GRIPS, IN CLASS 28 (U.S. CLS. 22, 23, 38 AND
50).

FIRST USE 6-1-2007; IN COMMERCE 6-1-2007.

THE MARK CONSISTS OF STANDARD CHAR-
ACTERS WITHOUT CLAIM TO ANY PARTICULAR
FONT, STYLE, SIZE, OR COLOR.

NO CLAIM IS MADE TO THE EXCLUSIVE
RIGHT TO USE "ALIGNMENT", APART FROM
THE MARK AS SHOWN.

SER. NO. 77-224,409, FILED 7-9-2007.

LYDIA BELZER, EXAMINING ATTORNEY

Int. Cl.: 28

Prior U.S. Cls.: 22, 23, 38 and 50

United States Patent and Trademark Office

Reg. No. 3,475,051

Registered July 29, 2008

**TRADEMARK
PRINCIPAL REGISTER**

Q-IGLU

Q-FACTORY AG (SWITZERLAND CORPORATION)
UNTERE BRUHMATT
LAUPERSDORF, SWITZERLAND CH-4712

FOR: TOY PUPPETS, IN CLASS 28 (U.S. CLS. 22, 23,
38 AND 50).

THE MARK CONSISTS OF STANDARD CHARACTERS WITHOUT CLAIM TO ANY PARTICULAR FONT, STYLE, SIZE, OR COLOR.

PRIORITY CLAIMED UNDER SEC. 44(D) ON SWITZERLAND APPLICATION NO. 50335/2007, FILED 1-10-2007, REG. NO. 559011, DATED 6-1-2007, EXPIRES 1-10-2017.

SER. NO. 77-224,425, FILED 7-9-2007.

ANGELA M. MICHELI, EXAMINING ATTORNEY

Int. Cl.: 44

Prior U.S. Cls.: 100 and 101

United States Patent and Trademark Office

Reg. No. 3,475,052

Registered July 29, 2008

**SERVICE MARK
PRINCIPAL REGISTER**



HOME HEALTH MATES L.L.C. (NEW JERSEY
LTD LIAB CO)
MATTHEW S. NEUGEBOREN, ESQ.
192 JACK MARTIN BLVD. BUILDING 4
BRICK, NJ 08724

FOR: HOME HEALTH CARE SERVICES, IN
CLASS 44 (U.S. CLS. 100 AND 101).

FIRST USE 11-7-2006; IN COMMERCE 11-7-2006.

NO CLAIM IS MADE TO THE EXCLUSIVE
RIGHT TO USE "HOME HEALTH", APART FROM
THE MARK AS SHOWN.

THE COLOR(S) BLUE AND LIGHT BLUE IS/ARE
CLAIMED AS A FEATURE OF THE MARK.

THE MARK CONSISTS OF "HOME HEALTH
MATES" WITH THE FIRST LETTER OF EACH
WORD CAPITALIZED AND THE WORDS BEING
OF THE SAME FONT AND BEING BLUE WITH
"MATES" BEING BOLDED AND THE WORDS
"BECAUSE WE CARE" UNDERNEATH "HOME
HEALTH MATES" IN THE LIGHT BLUE AND THE
SPECIALIZED DRAWING DESIGN IN LIGHT BLUE
WRAPPED AROUND THE "HOME" IN "HOME
HEALTH MATES".

SER. NO. 77-224,475, FILED 7-9-2007.

BRIAN CALLAGHAN, EXAMINING ATTORNEY

Int. Cl.: 9

Prior U.S. Cls.: 21, 23, 26, 36 and 38

Reg. No. 3,475,053

United States Patent and Trademark Office

Registered July 29, 2008

**TRADEMARK
PRINCIPAL REGISTER**

Hydroclean RP

JORDI FLP (MASSACHUSETTS LIMITED PART-
NERSHIP)
4 MILL STREET
BELLINGHAM, MA 02019

THE MARK CONSISTS OF STANDARD CHAR-
ACTERS WITHOUT CLAIM TO ANY PARTICULAR
FONT, STYLE, SIZE, OR COLOR.

FOR: HYDROPHILIC AND LIPOPHILIC POLY-
MERIC DELIVERY MEDIA FOR CLINICAL RE-
VERSE PHASE SOLID PHASE EXTRACTION
APPLICATIONS USED IN LIQUID CHROMATO-
GRAPHY, NAMELY, CHROMATOGRAPHY EX-
TRACTION CARTRIDGES, PLATES AND
COLUMNS, IN CLASS 9 (U.S. CLS. 21, 23, 26, 36
AND 38).

NO CLAIM IS MADE TO THE EXCLUSIVE
RIGHT TO USE "RP", APART FROM THE MARK
AS SHOWN.

SER. NO. 77-224,655, FILED 7-9-2007.

FIRST USE 2-24-2007; IN COMMERCE 2-24-2007.

KRISTIN DAHLING, EXAMINING ATTORNEY

Int. Cl.: 41

Prior U.S. Cls.: 100, 101 and 107

United States Patent and Trademark Office

Reg. No. 3,475,054

Registered July 29, 2008

SERVICE MARK
PRINCIPAL REGISTER



THOMAS MCLAUGHLIN (MASSACHUSETTS
LTD LIAB CO)
30 GREAT ROAD
ACTON, MA 01453

FOR: OPERATION OF SPORTS CAMPS; ORGANIZING SPORTING EVENTS, NAMELY, SOCCER GAMES, FOOTBALL GAMES, BASKETBALL GAMES, VOLLEYBALL GAMES, LACROSSE GAMES, ROLLER HOCKEY GAMES, DODGEBALL GAMES, FIELD HOCKEY GAMES; PROVIDING FACILITIES FOR SPORTS TOURNAMENTS; PROVIDING SPORTS FACILITIES; SPORT CAMPS, IN CLASS 41 (U.S. CLS. 100, 101 AND 107).

FIRST USE 11-0-2006; IN COMMERCE 11-0-2006.

THE COLOR(S) BLACK, WHITE, GREY, BLUE IS/
ARE CLAIMED AS A FEATURE OF THE MARK.

THE MARK CONSISTS OF THE TOP OF THE MARK CONSISTS OF FIVE SMALLER FILLED-IN BLUE STARS AND TWO PEOPLE GIVING EACH OTHER A HIGH-FIVE IN BLACK DIRECTLY ABOVE A TRANSPARENT STAR THAT IS OUTLINED, BUT NOT FILLED-IN, IN BLACK. UNDERNEATH IS THE WORDING "TEAMWORKS" THAT TAKES THE SHAPE OF A SIDWAYS HOURGLASS. THE "TEAMWORKS" WORDING IS IN ALL CAPITAL LETTERS IN BLUE COLORS WITH WHITE, GREY, AND BLACK OUTLINES SO THAT THERE IS THE ILLUSION THAT THE WORDING IS SHADOWED AND THREE-DIMENSIONAL. UNDERNEATH THIS WORDING IS THE SLOGAN "WE WORK HARD AT PLAY." WITH THE LETTERS IN WHITE INSIDE A BLACK BANNER.

SER. NO. 77-224,930, FILED 7-9-2007.

TEJBIR SINGH, EXAMINING ATTORNEY

Int. Cl.: 35

Prior U.S. Cls.: 100, 101 and 102

United States Patent and Trademark Office

Reg. No. 3,475,055

Registered July 29, 2008

**SERVICE MARK
PRINCIPAL REGISTER**

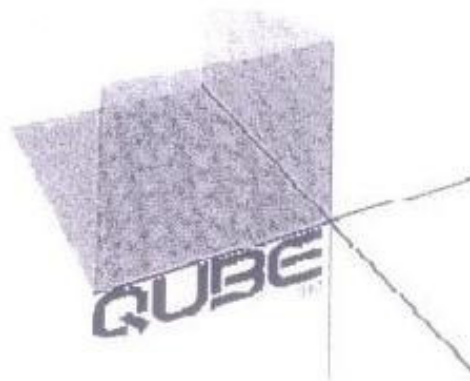

STARCOM MEDIAVEST GROUP, INC. (DELA-
WARE CORPORATION)
35 WEST WACKER DRIVE
CHICAGO, IL 60601

FOR: ADVERTISING AGENCY SERVICES,
NAMELY, EVALUATING THE QUALITY OF MED-
IA TELEVISION PURCHASES TO DETERMINE
HOW TO CREATE MORE COST EFFECTIVE AD-
VERTISEMENTS, IN CLASS 35 (U.S. CLS. 100, 101
AND 102).

THE MARK CONSISTS OF A VERTICAL AND
HORIZONTAL INTERSECTING LINES WITH THE
WORD "QUBE" UNDERNEATH THE RIGHT SIDE
OF THE HORIZONTAL LINE WITH AN OPEN CUBE
SHAPED BOX ABOVE IT AND A DIAGONAL LINE
INTERSECTING THE HORIZONTAL AND VERTI-
CAL LINES.

SER. NO. 77-225,062, FILED 7-9-2007.

FIRST USE 12-31-2004; IN COMMERCE 12-31-2004.

KELLEY WELLS, EXAMINING ATTORNEY

Int. Cl.: 41

Prior U.S. Cls.: 100, 101 and 107

United States Patent and Trademark Office

Reg. No. 3,475,056

Registered July 29, 2008

**SERVICE MARK
PRINCIPAL REGISTER**

TRUYU

DUNCAN, TAMEKA DONYLE (UNITED STATES INDIVIDUAL)
1201 RIVERFOREST DR. #1217
FLINT, MI 48532

THE MARK CONSISTS OF STANDARD CHARACTERS WITHOUT CLAIM TO ANY PARTICULAR FONT, STYLE, SIZE, OR COLOR.

FOR: PUBLICATION OF ELECTRONIC MAGAZINES FEATURING CONTENT OF INTEREST TO AFRICAN AMERICAN WOMEN, IN CLASS 41 (U.S. CLS. 100, 101 AND 107).

SER. NO. 77-225,374, FILED 7-9-2007.

FIRST USE 8-1-2000; IN COMMERCE 8-1-2000.

PAUL F. GAST, EXAMINING ATTORNEY

Int. Cl.: 36

Prior U.S. Cls.: 100, 101 and 102

United States Patent and Trademark Office

Reg. No. 3,475,057

Registered July 29, 2008

**SERVICE MARK
PRINCIPAL REGISTER**

CAA Value Insurance Plan

CAA RENTAL HOUSING INSURANCE BRO-
KERS, INC. (CALIFORNIA CORPORATION)
980 9TH STREET
STE 200
SACRAMENTO, CA 95814

FOR: INSURANCE ADMINISTRATION IN THE
FIELD OF RENTAL HOUSING, IN CLASS 36 (U.S.
CLS. 100, 101 AND 102).

FIRST USE 6-29-2007; IN COMMERCE 7-9-2007.

THE MARK CONSISTS OF STANDARD CHAR-
ACTERS WITHOUT CLAIM TO ANY PARTICULAR
FONT, STYLE, SIZE, OR COLOR.

NO CLAIM IS MADE TO THE EXCLUSIVE
RIGHT TO USE "VALUE INSURANCE PLAN",
APART FROM THE MARK AS SHOWN.

SER. NO. 77-225,581, FILED 7-10-2007.

KELLEY WELLS, EXAMINING ATTORNEY

Int. Cl.: 36

Prior U.S. Cls.: 100, 101 and 102

United States Patent and Trademark Office

Reg. No. 3,475,058

Registered July 29, 2008

**SERVICE MARK
PRINCIPAL REGISTER**

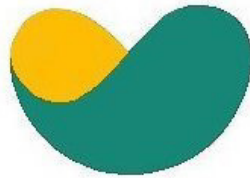

MEIJI YASUDA LIFE INSURANCE COMPANY
(JAPAN CORPORATION)
1-1, MARUNOUCHI 2-CHOME
CHIYODA-KU, TOKYO, JAPAN

FOR: REINSURANCE UNDERWRITING, IN
CLASS 36 (U.S. CLS. 100, 101 AND 102).

FIRST USE 1-4-2004; IN COMMERCE 1-31-2004.

THE COLOR(S) BLUE-GREEN AND YELLOW IS/
ARE CLAIMED AS A FEATURE OF THE MARK.

THE MARK CONSISTS OF OF A HALF SPHERE
WITH A CONCAVE CUTOUT. THE UPPER POR-
TION OF THE CONCAVE DESIGN COMPRISING
THE MARK IS YELLOW AND THE BOTTOM POR-
TION IS BLUE-GREEN.

SER. NO. 77-225,841, FILED 7-10-2007.

ELLEN PERKINS, EXAMINING ATTORNEY

Int. Cl.: 36

Prior U.S. Cls.: 100, 101 and 102

United States Patent and Trademark Office

Reg. No. 3,475,059

Registered July 29, 2008

**SERVICE MARK
PRINCIPAL REGISTER**

MEIJI YASUDA

MEIJI YASUDA LIFE INSURANCE COMPANY
(JAPAN CORPORATION)
1-1, MARUNOUCHI 2-CHOME
CHIYODA-KU
TOKYO, JAPAN

OWNER OF U.S. REG. NO. 3,294,559.

FOR: REINSURANCE UNDERWRITING, IN
CLASS 36 (U.S. CLS. 100, 101 AND 102).

THE ENGLISH TRANSLATION OF THE WORD
"MEIJI" IN THE MARK IS ENLIGHTENED REIGN.
THERE IS NO ENGLISH TRANSLATION OF THE
TERM "YASUDA".

FIRST USE 1-4-2004; IN COMMERCE 1-31-2004.

SER. NO. 77-225,844, FILED 7-10-2007.

THE MARK CONSISTS OF STANDARD CHAR-
ACTERS WITHOUT CLAIM TO ANY PARTICULAR
FONT, STYLE, SIZE, OR COLOR.

ELLEN PERKINS, EXAMINING ATTORNEY

Int. Cl.: 5

Prior U.S. Cls.: 6, 18, 44, 46, 51 and 52

United States Patent and Trademark Office

Reg. No. 3,475,060

Registered July 29, 2008

**TRADEMARK
PRINCIPAL REGISTER**

REDS N' THINGS

NEXGEN PHARMA, INC. (CALIFORNIA CORPORATION)
46 CORPORATE PARK, SUITE 100
IRVINE, CA 92606

OWNER OF U.S. REG. NO. 3,292,096.

FOR: DIETARY AND NUTRITIONAL SUPPLEMENTS, IN CLASS 5 (U.S. CLS. 6, 18, 44, 46, 51 AND 52).

NO CLAIM IS MADE TO THE EXCLUSIVE RIGHT TO USE "REDS", APART FROM THE MARK AS SHOWN.

FIRST USE 11-12-2007; IN COMMERCE 11-12-2007.

SER. NO. 77-226,071, FILED 7-10-2007.

THE MARK CONSISTS OF STANDARD CHARACTERS WITHOUT CLAIM TO ANY PARTICULAR FONT, STYLE, SIZE, OR COLOR.

NELSON SNYDER, EXAMINING ATTORNEY

Int. Cl.: 43

Prior U.S. Cls.: 100 and 101

United States Patent and Trademark Office

Reg. No. 3,475,061

Registered July 29, 2008

SERVICE MARK
PRINCIPAL REGISTER

食彩庵 茅場
KAYABA

WANOBA GROUP, INC. (CALIFORNIA CORPORATION)
SUITE 235
1815 W. 213TH STREET
TORRANCE, CA 90501

FOR: RESTAURANT SERVICES, IN CLASS 43
(U.S. CLS. 100 AND 101).

FIRST USE 11-30-2003; IN COMMERCE 11-30-2003.

NO CLAIM IS MADE TO THE EXCLUSIVE RIGHT TO USE THE NON-LATIN CHARACTERS THAT MEAN "A PLACE THAT SERVES A VARIETY OF FOOD", APART FROM THE MARK AS SHOWN.

THE MARK CONSISTS OF JAPANESE CHARACTERS.

THE WORDING "SHOKUSAIAN" MEANS "FOOD", "COLOR" AND "HUT" IN ENGLISH, WHICH CREATES A JAPANESE CULTURAL ASSOCIATION FOR "A PLACE THAT SERVES A VARIETY OF FOOD". THE WORDING "KAYABA" HAS NO MEANING IN ENGLISH.

THE NON-LATIN CHARACTERS IN THE MARK TRANSLITERATE TO "SHOKUSAIAN KAYABA."

SER. NO. 77-226,231, FILED 7-10-2007.

MARIAM MAHMOUDI, EXAMINING ATTORNEY

Int. Cl.: 43

Prior U.S. Cls.: 100 and 101

United States Patent and Trademark Office

Reg. No. 3,475,062

Registered July 29, 2008

**SERVICE MARK
PRINCIPAL REGISTER**

KAYABA

WANOBA GROUP, INC. (CALIFORNIA CORPORATION)
SUITE 235
1815 W. 213TH STREET
TORRANCE, CA 90501

FOR: RESTAURANT SERVICES, IN CLASS 43
(U.S. CLS. 100 AND 101).

FIRST USE 11-30-2003; IN COMMERCE 11-30-2003.

THE MARK CONSISTS OF STANDARD CHARACTERS WITHOUT CLAIM TO ANY PARTICULAR FONT, STYLE, SIZE, OR COLOR.

THE WORDING "KAYABA" HAS NO MEANING IN ENGLISH.

SER. NO. 77-226,239, FILED 7-10-2007.

MARIAM MAHMOUDI, EXAMINING ATTORNEY

Int. Cl.: 43

Prior U.S. Cls.: 100 and 101

United States Patent and Trademark Office

Reg. No. 3,475,063

Registered July 29, 2008

**SERVICE MARK
PRINCIPAL REGISTER**

SANUKI SANDO UDON

WANOKA GROUP, INC. (CALIFORNIA CORPORATION)
SUITE 235
1815 W. 213TH STREET
TORRANCE, CA 90501

FOR: RESTAURANT SERVICES, IN CLASS 43
(U.S. CLS. 100 AND 101).

FIRST USE 10-1-2004; IN COMMERCE 10-1-2004.

THE MARK CONSISTS OF STANDARD CHARACTERS WITHOUT CLAIM TO ANY PARTICULAR FONT, STYLE, SIZE, OR COLOR.

NO CLAIM IS MADE TO THE EXCLUSIVE RIGHT TO USE "SANUKI" AND "UDON", APART FROM THE MARK AS SHOWN.

THE WORDING "SANDO" MEANS "MOUNTAIN PATH" IN ENGLISH. THE WORDING "SANUKI UDON" REFERS TO A VARIETY/TYPE OF JAPANESE NOODLE.

SER. NO. 77-226,259, FILED 7-10-2007.

MARIAM MAHMOUDI, EXAMINING ATTORNEY

Int. Cl.: 43

Prior U.S. Cls.: 100 and 101

United States Patent and Trademark Office

Reg. No. 3,475,064

Registered July 29, 2008

SERVICE MARK
PRINCIPAL REGISTER



WANOBA GROUP, INC. (CALIFORNIA CORPORATION)
SUITE 235
1815 W. 213TH STREET
TORRANCE, CA 90501

FOR: RESTAURANT SERVICES, IN CLASS 43
(U.S. CLS. 100 AND 101).

FIRST USE 10-1-2004; IN COMMERCE 10-1-2004.

NO CLAIM IS MADE TO THE EXCLUSIVE RIGHT TO USE "SANUKI" AND "UDON" AND THE NON-LATIN CHARACTERS THAT TRANSLITERATE TO "SANUKI" AND "UDON", APART FROM THE MARK AS SHOWN.

THE MARK CONSISTS OF JAPANESE CHARACTERS.

THE WORDING "SANDO" MEANS "MOUNTAIN PATH" IN ENGLISH. THE WORDING "SANUKI UDON" REFERS TO A VARIETY/TYPE OF JAPANESE NOODLE.

THE NON-LATIN CHARACTERS IN THE MARK TRANSLITERATE TO "SANUKI SANDO UDON."

SER. NO. 77-226,268, FILED 7-10-2007.

MARIAM MAHMOUDI, EXAMINING ATTORNEY

Int. Cl.: 28

Prior U.S. Cls.: 22, 23, 38 and 50

United States Patent and Trademark Office

Reg. No. 3,475,065

Registered July 29, 2008

**TRADEMARK
PRINCIPAL REGISTER**

MBX DINO FLT

MATTEL, INC. (DELAWARE CORPORATION)
M1-1518
333 CONTINENTAL BLVD.
EL SEGUNDO, CA 90245

FOR: TOYS, GAMES AND PLAYTHINGS, NAME-
LY, TOY VEHICLES AND ACCESSORIES THERE-
FOR, IN CLASS 28 (U.S. CLS. 22, 23, 38 AND 50).

FIRST USE 3-26-2008; IN COMMERCE 3-26-2008.

THE MARK CONSISTS OF STANDARD CHAR-
ACTERS WITHOUT CLAIM TO ANY PARTICULAR
FONT, STYLE, SIZE, OR COLOR.

OWNER OF U.S. REG. NO. 3,103,395.

SER. NO. 77-226,618, FILED 7-11-2007.

MATTHEW MCDOWELL, EXAMINING ATTOR-
NEY

Int. Cl.: 16

Prior U.S. Cls.: 2, 5, 22, 23, 29, 37, 38 and 50

United States Patent and Trademark Office

Reg. No. 3,475,066

Registered July 29, 2008

**TRADEMARK
PRINCIPAL REGISTER**

Think Your Way to Riches

ANGEL VISION LLC (MICHIGAN LTD LIAB CO)
1539 CLARK LAKE RD
BRIGHTON, MI 48114

THE MARK CONSISTS OF STANDARD CHAR-
ACTERS WITHOUT CLAIM TO ANY PARTICULAR
FONT, STYLE, SIZE, OR COLOR.

FOR: SERIES OF NON-FICTION BOOKS IN THE
FIELD OF SELF IMPROVEMENT, IN CLASS 16 (U.S.
CLS. 2, 5, 22, 23, 29, 37, 38 AND 50).

SER. NO. 77-226,813, FILED 7-11-2007.

FIRST USE 2-23-2006; IN COMMERCE 5-30-2006.

STEVEN JACKSON, EXAMINING ATTORNEY

Int. Cls.: 35, 38 and 42

Prior U.S. Cls.: 100, 101, 102 and 104

United States Patent and Trademark Office

Reg. No. 3,475,067

Registered July 29, 2008

**SERVICE MARK
PRINCIPAL REGISTER**

CMT

CREATIVE MOBILE TECHNOLOGIES, LLC
(NEW YORK LTD LIAB CO)
42-50 24TH STREET
LONG ISLAND CITY, NY 11101

FOR: ADVERTISING, NAMELY, PROMOTING THE SALE OF ARTICLES AND SERVICES FOR THIRD PARTIES BY THE DISSEMINATION OF ADVERTISING MATERIAL AND THE DISSEMINATION OF ADVERTISING MESSAGES ON MOBILE COMPUTER NETWORKS; PROMOTING THE GOODS AND SERVICES OF OTHERS VIA A GLOBAL MOBILE COMPUTER NETWORK; PROVIDING CONSUMER INFORMATION ABOUT THE GOODS AND SERVICES OF OTHERS VIA A GLOBAL MOBILE COMPUTER NETWORK, IN CLASS 35 (U.S. CLS. 100, 101 AND 102).

FIRST USE 6-1-2005; IN COMMERCE 6-1-2005.

FOR: COMMUNICATIONS SERVICES, NAMELY, COMMUNICATING TO MOBILE DEVICES INDEXES OF INFORMATION, SITES, AND OTHER RESOURCES, NAMELY, TRAFFIC INFORMATION, ENTERTAINMENT, FINANCIAL AND OTHER

MEDIA, VIA A COMPUTER NETWORK, IN CLASS 38 (U.S. CLS. 100, 101 AND 104).

FIRST USE 6-1-2005; IN COMMERCE 6-1-2005.

FOR: PROVIDING ONLINE NON-DOWNLOADABLE COMPUTER NETWORK SOFTWARE FOR COMMUNICATION IN THE MOBILE TRANSPORTATION INDUSTRY; COMPUTER SERVICES, NAMELY, CREATING INDEXES OF INFORMATION, SITES, AND OTHER RESOURCES AVAILABLE ON COMPUTER NETWORKS, IN CLASS 42 (U.S. CLS. 100 AND 101).

FIRST USE 6-1-2005; IN COMMERCE 6-1-2005.

THE MARK CONSISTS OF STANDARD CHARACTERS WITHOUT CLAIM TO ANY PARTICULAR FONT, STYLE, SIZE, OR COLOR.

SER. NO. 77-227,250, FILED 7-11-2007.

HEATHER THOMPSON, EXAMINING ATTORNEY

Int. Cl.: 44

Prior U.S. Cls.: 100 and 101

United States Patent and Trademark Office

Reg. No. 3,475,068

Registered July 29, 2008

**SERVICE MARK
PRINCIPAL REGISTER**



QUALITAS LLC (FLORIDA LTD LIAB CO)
12212 ASTER AVENUE
BRADENTON, FL 34212

FOR: COMPREHENSIVE PEDIATRIC MEDICAL SERVICES, NAMELY, PEDIATRICIAN SERVICES, HYPNOSIS, MASSAGE, ACUPUNCTURE, TRADITIONAL CHINESE MEDICINE, REIKI, PHYSICAL THERAPY, OCCUPATIONAL THERAPY, SPEECH THERAPY, BEHAVIORAL THERAPY, NUTRITION COUNSELING, IN CLASS 44 (U.S. CLS. 100 AND 101).

FIRST USE 4-15-2007; IN COMMERCE 6-11-2007.

NO CLAIM IS MADE TO THE EXCLUSIVE RIGHT TO USE "WHOLE CHILD PEDIATRICS", APART FROM THE MARK AS SHOWN.

THE MARK CONSISTS OF A HEART WITH A FIGURE OF A CHILD AND A STAR WITH THE WORDS "WHOLE CHILD PEDIATRICS" IN A STYLIZED TEXT.

SER. NO. 77-227,541, FILED 7-11-2007.

KELLY MCCOY, EXAMINING ATTORNEY

Int. Cl.: 35

Prior U.S. Cls.: 100, 101 and 102

United States Patent and Trademark Office

Reg. No. 3,475,069

Registered July 29, 2008

**SERVICE MARK
PRINCIPAL REGISTER**

HASKINS REALTY

HASKINS REALTY, INCORPORATED (OREGON CORPORATION)
10011 SE DIVISION STE 209
PORTLAND, OR 97266

FOR: PROVIDING REAL ESTATE LEADS FOR PROSPECTIVE PURCHASERS; REAL ESTATE ADVERTISING SERVICES; REAL ESTATE MARKETING SERVICES IN THE FIELD OF RESIDENTIAL REAL ESTATE, IN CLASS 35 (U.S. CLS. 100, 101 AND 102).

FIRST USE 12-31-1984; IN COMMERCE 12-31-1995.

THE MARK CONSISTS OF STANDARD CHARACTERS WITHOUT CLAIM TO ANY PARTICULAR FONT, STYLE, SIZE, OR COLOR.

NO CLAIM IS MADE TO THE EXCLUSIVE RIGHT TO USE "REALTY", APART FROM THE MARK AS SHOWN.

THE NAME(S), PORTRAIT(S), AND/OR SIGNATURE(S) SHOWN IN THE MARK IDENTIFIES "ROBERT HASKINS", PRESIDENT OF APPLICANT, WHOSE CONSENT(S) TO REGISTER IS MADE OF RECORD.

SEC. 2(F) AS TO "HASKINS" .

SER. NO. 77-228,006, FILED 7-12-2007.

SHAUNIA CARLYLE, EXAMINING ATTORNEY

Int. Cl.: 9

Prior U.S. Cls.: 21, 23, 26, 36 and 38

Reg. No. 3,475,070

United States Patent and Trademark Office

Registered July 29, 2008

**TRADEMARK
PRINCIPAL REGISTER**

WOWZA

WOWZATV LLC, DBA WOWZA MEDIA SYSTEMS (CALIFORNIA LTD LIAB CO)
5655 SILVER CREEK VALLEY ROAD, #435
SAN JOSE, CA 95138

THE MARK CONSISTS OF STANDARD CHARACTERS WITHOUT CLAIM TO ANY PARTICULAR FONT, STYLE, SIZE, OR COLOR.

FOR: COMPUTER SOFTWARE FOR USE IN SENDING AND RECEIVING MEDIA OVER THE INTERNET, INCLUDING VIDEO, AUDIO AND DATA, IN CLASS 9 (U.S. CLS. 21, 23, 26, 36 AND 38).

SER. NO. 77-228,035, FILED 7-12-2007.

FIRST USE 11-29-2005; IN COMMERCE 6-21-2006.

JANICE L. MCMORROW, EXAMINING ATTORNEY

Int. Cl.: 9

Prior U.S. Cls.: 21, 23, 26, 36 and 38

Reg. No. 3,475,071

United States Patent and Trademark Office

Registered July 29, 2008

**TRADEMARK
PRINCIPAL REGISTER**

WOWZA MEDIA SERVER

WOWZATV LLC, DBA WOWZA MEDIA SYSTEMS (CALIFORNIA LTD LIAB CO), DBA WOWZA MEDIA SYSTEMS
5655 SILVER CREEK VALLEY ROAD, #435
SAN JOSE, CA 95138

FOR: COMPUTER SOFTWARE FOR USE IN SENDING AND RECEIVING MEDIA OVER THE INTERNET, INCLUDING VIDEO, AUDIO AND DATA, IN CLASS 9 (U.S. CLS. 21, 23, 26, 36 AND 38).

FIRST USE 10-31-2006; IN COMMERCE 10-31-2006.

THE MARK CONSISTS OF STANDARD CHARACTERS WITHOUT CLAIM TO ANY PARTICULAR FONT, STYLE, SIZE, OR COLOR.

NO CLAIM IS MADE TO THE EXCLUSIVE RIGHT TO USE "MEDIA SERVER", APART FROM THE MARK AS SHOWN.

SER. NO. 77-228,052, FILED 7-12-2007.

JANICE L. MCMORROW, EXAMINING ATTORNEY

Int. Cl.: 41

Prior U.S. Cls.: 100, 101 and 107

United States Patent and Trademark Office

Reg. No. 3,475,072

Registered July 29, 2008

**SERVICE MARK
PRINCIPAL REGISTER**



FACTORY

AUDIO VISUAL FACTORY, INC (WASHINGTON CORPORATION)

8011 S. 187TH STREET

KENT, WA 98032

FOR: RENTAL OF AUDIO-VISUAL EQUIPMENT,
IN CLASS 41 (U.S. CLS. 100, 101 AND 107).

FIRST USE 11-30-2003; IN COMMERCE 11-30-2003.

THE COLOR(S) BLACK AND RED IS/ARE CLAIMED AS A FEATURE OF THE MARK.

THE MARK CONSISTS OF THE TERM "FACTORY" WHICH IS IN BLACK AND A BLACK CIRCLE WITH RED UP AND DOWN ARROWS.

SER. NO. 77-228,162, FILED 7-12-2007.

BILL DAWE, EXAMINING ATTORNEY

Int. Cl.: 9

Prior U.S. Cls.: 21, 23, 26, 36 and 38

Reg. No. 3,475,073

United States Patent and Trademark Office

Registered July 29, 2008

**TRADEMARK
PRINCIPAL REGISTER**



WOWZATV LLC, DBA WOWZA MEDIA SYSTEMS (CALIFORNIA LTD LIAB CO), DBA WOWZA MEDIA SYSTEMS
5655 SILVER CREEK VALLEY ROAD, #435
SAN JOSE, CA 95138

FOR: COMPUTER SOFTWARE FOR USE IN SENDING AND RECEIVING MEDIA OVER THE INTERNET, INCLUDING VIDEO, AUDIO AND DATA , IN CLASS 9 (U.S. CLS. 21, 23, 26, 36 AND 38).

FIRST USE 10-31-2006; IN COMMERCE 10-31-2006.

NO CLAIM IS MADE TO THE EXCLUSIVE RIGHT TO USE "MEDIA SYSTEMS", APART FROM THE MARK AS SHOWN.

THE COLOR(S) WHITE, COPPER AND GRAY IS/ ARE CLAIMED AS A FEATURE OF THE MARK.

THE MARK CONSISTS OF A CIRCLE CONTAINING A WHITE LETTER "W", A COPPER TOP PORTION AND A GRAY BOTTOM PORTION, AND THE WORD "WOWZA" IN COPPER AND THE WORDS "MEDIA SYSTEMS" IN GRAY.

SER. NO. 77-228,180, FILED 7-12-2007.

JANICE L. MCMORROW, EXAMINING ATTORNEY

Int. Cl.: 41

Prior U.S. Cls.: 100, 101 and 107

United States Patent and Trademark Office

Reg. No. 3,475,074

Registered July 29, 2008

**SERVICE MARK
PRINCIPAL REGISTER**

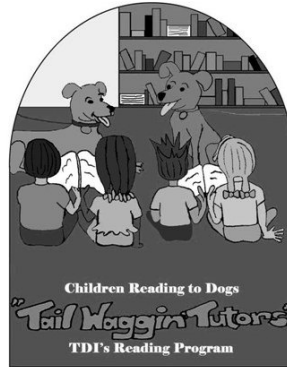

THERAPY DOGS INTERNATIONAL, INC. (NEW JERSEY CORPORATION)
88 BARTLEY ROAD
FLANDERS, NJ 07836

FOR: EDUCATION SERVICES, NAMELY, PROVIDING TUTORING IN THE FIELD OF READING, IN CLASS 41 (U.S. CLS. 100, 101 AND 107).

FIRST USE 6-8-2007; IN COMMERCE 6-8-2007.

NO CLAIM IS MADE TO THE EXCLUSIVE RIGHT TO USE "TUTORS", "CHILDREN READING

TO DOGS", "READING PROGRAM", APART FROM THE MARK AS SHOWN.

GREY IS NOT A FEATURE OF THE MARK.

THE MARK CONSISTS OF CHILDREN, DOGS AND BOOKSHELF WITH BOOKS.

SER. NO. 77-229,071, FILED 7-13-2007.

ATTIYA MALIK, EXAMINING ATTORNEY

Int. Cl.: 43

Prior U.S. Cls.: 100 and 101

United States Patent and Trademark Office

Reg. No. 3,475,075

Registered July 29, 2008

SERVICE MARK
PRINCIPAL REGISTER



WILEY, CYNTHIA A. (UNITED STATES INDIVIDUAL)
3807 MESQUITE DRIVE
BEAVERCREEK, OH 45440

FOR: RESTAURANT SERVICES, IN CLASS 43 (U.S. CLS. 100 AND 101).

FIRST USE 10-15-2006; IN COMMERCE 3-23-2007.

NO CLAIM IS MADE TO THE EXCLUSIVE RIGHT TO USE "BURRITOS" , APART FROM THE MARK AS SHOWN.

THE COLOR(S) RED, ORANGE, YELLOW, BLACK AND WHITE IS/ARE CLAIMED AS A FEATURE OF THE MARK.

THE MARK CONSISTS OF THE WORDS "HOT HEAD" IN RED, ORANGE AND YELLOW WITH A YELLOW SMILEY FACE WITH FLAMES EMANATING FROM HEAD IN BETWEEN "HOT" AND "HEAD"; THE WORD "BURRITOS" IN BLACK AND WHITE DIRECTLY BENEATH "HOT HEAD".

SER. NO. 77-229,212, FILED 7-13-2007.

MARILYN IZZI, EXAMINING ATTORNEY

Int. Cl.: 3

Prior U.S. Cls.: 1, 4, 6, 50, 51 and 52

United States Patent and Trademark Office

Reg. No. 3,475,076

Registered July 29, 2008

**TRADEMARK
PRINCIPAL REGISTER**



BIO-KOR METICKS (ISRAEL CORPORATION)
7 HAHASHMONAIM ST.
BNEI-BRAK, ISRAEL

FOR: BODY AND BEAUTY CARE COSMETICS;
COSMETIC CREAMS; COSMETIC CREAMS FOR
SKIN CARE; FACE CREAMS FOR COSMETIC USE;
SKIN AND BODY TOPICAL LOTIONS, CREAMS

AND OILS FOR COSMETIC USE , IN CLASS 3 (U.S.
CLS. 1, 4, 6, 50, 51 AND 52).

FIRST USE 1-1-2001; IN COMMERCE 1-1-2001.

SER. NO. 77-229,927, FILED 7-15-2007.

DAWN FELDMAN, EXAMINING ATTORNEY

Int. Cl.: 35

Prior U.S. Cls.: 100, 101 and 102

United States Patent and Trademark Office

Reg. No. 3,475,077

Registered July 29, 2008

**SERVICE MARK
PRINCIPAL REGISTER**



JATOBA SOLUTIONS, INC. (VIRGINIA CORPORATION), DBA EASYBUYINSURANCE.COM

46807 SNOW HILL WAY, STE 100
POTOMAC FALLS, VA 20165

FOR: INSURANCE LEAD COLLECTION AND MATCHING SERVICES, NAMELY, MATCHING CONSUMER REQUESTS FOR LIFE, HEALTH AND INTERNATIONAL TRAVEL RELATED INSURANCE POLICY QUOTES COLLECTED OVER THE INTERNET TO PRE-QUALIFIED INSURANCE BROKERS, AGENTS AND AGENCIES INTERESTED IN THOSE REQUESTS, IN CLASS 35 (U.S. CLS. 100, 101 AND 102).

FIRST USE 7-15-2007; IN COMMERCE 7-15-2007.

NO CLAIM IS MADE TO THE EXCLUSIVE RIGHT TO USE "INSURANCE.COM", APART FROM THE MARK AS SHOWN.

THE MARK CONSISTS OF "A" TREE IN THE BACKGROUND WITH A "V" SHAPED FORK IN THE MAIN TRUNK. "EASYBUYINSURANCE.COM" SPLIT OVER TWO LINES. THE WORDS OVERLAPPING THE RIGHT HALF OF THE TREE.

SER. NO. 77-230,044, FILED 7-15-2007.

JOHN DALIER, EXAMINING ATTORNEY

Int. Cl.: 36

Prior U.S. Cls.: 100, 101 and 102

United States Patent and Trademark Office

Reg. No. 3,475,078

Registered July 29, 2008

**SERVICE MARK
PRINCIPAL REGISTER**



Helping accident victims recover and grow again.

PRE-SETTLEMENT FINANCE, LLC (NEW YORK
LTD LIAB CO), DBA PS FINANCE
183 NEW DORP LANE
STATEN ISLAND, NY 10306

FOR: FACILITATING AND ARRANGING FOR
THE FINANCING OF LEGAL SETTLEMENTS, IN
CLASS 36 (U.S. CLS. 100, 101 AND 102).

FIRST USE 7-1-2007; IN COMMERCE 7-1-2007.

NO CLAIM IS MADE TO THE EXCLUSIVE
RIGHT TO USE "FINANCE", APART FROM THE
MARK AS SHOWN.

THE MARK CONSISTS OF THE CAPITAL LET-
TERS "P" AND "S" IN A CIRCLE, FOLLOWED BY
THE WORD, "FINANCE" ABOVE THE SLOGAN,
"HELPING ACCIDENT VICTIMS RECOVER AND
GROW AGAIN."

SER. NO. 77-230,160, FILED 7-16-2007.

PRISCILLA MILTON, EXAMINING ATTORNEY

Int. Cl.: 5

Prior U.S. Cls.: 6, 18, 44, 46, 51 and 52

Reg. No. 3,475,079

United States Patent and Trademark Office

Registered July 29, 2008

**TRADEMARK
PRINCIPAL REGISTER**

MULTISSENTIALS

INDOMITUS ASSET MANAGEMENT, L.L.C.
(PENNSYLVANIA LTD LIAB CO)
1579 JACK DRIVE
NORTH HUNTINGDON, PA 15642

THE MARK CONSISTS OF STANDARD CHAR-
ACTERS WITHOUT CLAIM TO ANY PARTICULAR
FONT, STYLE, SIZE, OR COLOR.

FOR: DIETARY SUPPLEMENTS, IN CLASS 5 (U.S.
CLS. 6, 18, 44, 46, 51 AND 52).

SER. NO. 77-230,979, FILED 7-16-2007.

FIRST USE 2-2-2007; IN COMMERCE 6-28-2007.

IRA J. GOODSaid, EXAMINING ATTORNEY

Int. Cl.: 9

Prior U.S. Cls.: 21, 23, 26, 36 and 38

Reg. No. 3,475,080

United States Patent and Trademark Office

Registered July 29, 2008

**TRADEMARK
PRINCIPAL REGISTER**

INSTYLE

TIME INC. (DELAWARE CORPORATION)
1271 AVENUE OF THE AMERICAS
NEW YORK, NY 10020

FOR: DOWNLOADABLE GRAPHICS VIA CELL PHONES AND MOBILE WIRELESS DEVICES; DOWNLOADABLE PHOTOGRAPHS RECORDED ON SOFTWARE; DOWNLOADABLE SOFTWARE THAT ALLOWS USERS TO SEND AND RECEIVE ELECTRONIC MAIL VIA CELL PHONES AND MOBILE COMMUNICATIONS DEVICES; DOWNLOADABLE TEXT FEATURING INFORMATION IN THE FIELD OF FASHION, BEAUTY, CULTURE, ENTERTAINMENT NEWS, CELEBRITY LIFE-

STYLES AND EVENTS VIA CELL PHONES, IN CLASS 9 (U.S. CLS. 21, 23, 26, 36 AND 38).

FIRST USE 11-20-2006; IN COMMERCE 11-20-2006.

THE MARK CONSISTS OF STANDARD CHARACTERS WITHOUT CLAIM TO ANY PARTICULAR FONT, STYLE, SIZE, OR COLOR.

OWNER OF U.S. REG. NOS. 2,202,536, 2,564,142 AND OTHERS.

SER. NO. 77-231,192, FILED 7-17-2007.

MARK SPARACINO, EXAMINING ATTORNEY

Int. Cl.: 41

Prior U.S. Cls.: 100, 101 and 107

United States Patent and Trademark Office

Reg. No. 3,475,081

Registered July 29, 2008

**SERVICE MARK
PRINCIPAL REGISTER**

FOODSMART AND FIT

COMMUNITY HEALTH CENTER, INC. (CON-
NECTICUT CORPORATION)
635 MAIN STREET
MIDDLETOWN, CT 06457

FOR: EDUCATIONAL SERVICES, NAMELY,
CONDUCTING PROGRAMS, CLASSES, AND SEMI-
NARS IN THE FIELD OF WOMEN'S HEALTH,
WEIGHT LOSS, AND FITNESS AND DISTRIBUTION
OF COURSE MATERIAL IN CONNECTION
THEREWITH, IN CLASS 41 (U.S. CLS. 100, 101 AND
107).

FIRST USE 1-30-2007; IN COMMERCE 1-30-2007.

THE MARK CONSISTS OF STANDARD CHAR-
ACTERS WITHOUT CLAIM TO ANY PARTICULAR
FONT, STYLE, SIZE, OR COLOR.

SER. NO. 77-232,220, FILED 7-18-2007.

BRIAN CALLAGHAN, EXAMINING ATTORNEY

Int. Cl.: 40

Prior U.S. Cls.: 100, 103 and 106

United States Patent and Trademark Office

Reg. No. 3,475,082

Registered July 29, 2008

**SERVICE MARK
PRINCIPAL REGISTER**



CITY OF MORENO VALLEY (CALIFORNIA MUNICIPAL CORPORATION)
14177 FREDERICK STREET
MORENO VALLEY, CA 92552

FOR: CUSTOMIZED PRINTING OF COMPANY NAMES AND LOGOS FOR PROMOTIONAL AND ADVERTISING PURPOSES ON THE GOODS OF OTHERS, IN CLASS 40 (U.S. CLS. 100, 103 AND 106).

FIRST USE 5-17-2007; IN COMMERCE 5-17-2007.

NO CLAIM IS MADE TO THE EXCLUSIVE RIGHT TO USE "MORENO VALLEY", APART FROM THE MARK AS SHOWN.

THE COLOR(S) ORANGE, RED, BROWN AND BLACK IS/ARE CLAIMED AS A FEATURE OF THE MARK.

THE MARK CONSISTS OF THE COLOR BLACK APPEARING IN THE WORDING "MORENO VALLEY". THE COLOR BROWN APPEARS IN THE WORDING "WHERE DREAMS SOAR". THE COLORS ORANGE AND RED APPEAR IN THE DESIGN OF A BIRD WITH ITS WINGS SPREAD. THE COLORS ORANGE, RED AND BROWN APPEAR IN THE DESIGN OF A TREE AND GROUND FORMING AN UNDERLINE, HAVING THE COLORS DESCENDING FROM ORANGE AT THE TOP TO RED TO BROWN AT THE BOTTOM.

SER. NO. 77-232,661, FILED 7-18-2007.

JAY BESCH, EXAMINING ATTORNEY

Int. Cl.: 36

Prior U.S. Cls.: 100, 101 and 102

United States Patent and Trademark Office

Reg. No. 3,475,084

Registered July 29, 2008

**SERVICE MARK
PRINCIPAL REGISTER**

**PRUDENTIAL BACHE
COMMODITIES**

THE PRUDENTIAL INSURANCE COMPANY OF
AMERICA (NEW JERSEY CORPORATION)
LAW DEPARTMENT
751 BROAD STREET
NEWARK, NJ 07102

FOR: FULL SERVICE COMMODITIES BROKER-
AGE FIRM SERVICES, NAMELY, CLEARING AND
TRADING FUTURES AND OPTIONS POSITIONS
FOR INSTITUTIONAL AND CORPORATE CLI-
ENTS; TRADING AND CLEARING FUTURES
AND OPTIONS POSITIONS FOR RETAIL CLIENTS;
FOREIGN EXCHANGE TRANSACTIONS; AND RE-
SEARCH SERVICES RELATING TO FUTURES AND
COMMODITIES, IN CLASS 36 (U.S. CLS. 100, 101
AND 102).

FIRST USE 2-5-2007; IN COMMERCE 2-5-2007.

THE MARK CONSISTS OF STANDARD CHAR-
ACTERS WITHOUT CLAIM TO ANY PARTICULAR
FONT, STYLE, SIZE, OR COLOR.

OWNER OF U.S. REG. NOS. 2,120,633, 3,085,261
AND OTHERS.

NO CLAIM IS MADE TO THE EXCLUSIVE
RIGHT TO USE "COMMODITIES" , APART FROM
THE MARK AS SHOWN.

SER. NO. 77-233,672, FILED 7-19-2007.

ALEX KEAM, EXAMINING ATTORNEY

Int. Cls.: 16, 24, 25 and 41

**Prior U.S. Cls.: 2, 5, 22, 23, 29, 37, 38, 39, 42, 50, 100,
101 and 107**

Reg. No. 3,475,085

United States Patent and Trademark Office

Registered July 29, 2008

**TRADEMARK
SERVICE MARK
PRINCIPAL REGISTER**



THE NATIONAL COLLEGIATE ATHLETIC ASSOCIATION (INDIANA UNINC. ASSOCIATION)

P.O. BOX 6222

INDIANAPOLIS, IN 46206

FOR: PUBLICATIONS IN THE FIELD OF COLLEGIATE GOLF, NAMELY, SOUVENIR BOOKS AND RULES BOOKS, IN CLASS 16 (U.S. CLS. 2, 5, 22, 23, 29, 37, 38 AND 50).

FIRST USE 5-0-2007; IN COMMERCE 5-0-2007.

FOR: GOLF TOWELS, IN CLASS 24 (U.S. CLS. 42 AND 50).

FIRST USE 5-0-2007; IN COMMERCE 5-0-2007.

FOR: CLOTHING, NAMELY, SHIRTS, SHORTS, SWEATPANTS, PANTS, JACKETS, COATS, CAPS AND HATS, IN CLASS 25 (U.S. CLS. 22 AND 39).

FIRST USE 5-0-2007; IN COMMERCE 5-0-2007.

FOR: ENTERTAINMENT SERVICES IN THE NATURE OF ATHLETIC CONTESTS, GAMES, TOURNAMENTS, EXHIBITIONS AND EVENTS, IN CLASS 41 (U.S. CLS. 100, 101 AND 107).

FIRST USE 5-0-2007; IN COMMERCE 5-0-2007.

THE MARK CONSISTS OF FIGURE OF MALE GOLF PLAYER.

SER. NO. 77-233,685, FILED 7-19-2007.

NELSON SNYDER, EXAMINING ATTORNEY

Int. Cl.: 16

Prior U.S. Cls.: 2, 5, 22, 23, 29, 37, 38 and 50

United States Patent and Trademark Office

Reg. No. 3,475,086

Registered July 29, 2008

**TRADEMARK
PRINCIPAL REGISTER**

Fold-a-Stand

MESA PRODUCT INNOVATIONS (IDAHO SOLE
PROPRIETORSHIP)
1309 HOWARD ST
BOISE, ID 83706

THE MARK CONSISTS OF STANDARD CHAR-
ACTERS WITHOUT CLAIM TO ANY PARTICULAR
FONT, STYLE, SIZE, OR COLOR.

FOR: BOOK HOLDERS, IN CLASS 16 (U.S. CLS. 2,
5, 22, 23, 29, 37, 38 AND 50).

SER. NO. 77-234,067, FILED 7-19-2007.

FIRST USE 7-17-2007; IN COMMERCE 7-17-2007.

JANICE KIM, EXAMINING ATTORNEY

Int. Cl.: 3

Prior U.S. Cls.: 1, 4, 6, 50, 51 and 52

United States Patent and Trademark Office

Reg. No. 3,475,087

Registered July 29, 2008

**TRADEMARK
PRINCIPAL REGISTER**

THE BALM

SHIPMAN ASSOCIATES, INC. (DELAWARE
CORPORATION), DBA THEBALM
2101 SACRAMENTO STREET, #402
SAN FRANCISCO, CA 94109

OWNER OF U.S. REG. NOS. 2,791,157, 3,282,677
AND OTHERS.

FOR: COSMETICS, IN CLASS 3 (U.S. CLS. 1, 4, 6, 50,
51 AND 52).

SEC. 2(F).

FIRST USE 3-13-2001; IN COMMERCE 3-13-2001.

SER. NO. 77-234,084, FILED 7-19-2007.

THE MARK CONSISTS OF STANDARD CHAR-
ACTERS WITHOUT CLAIM TO ANY PARTICULAR
FONT, STYLE, SIZE, OR COLOR.

TRACY CROSS, EXAMINING ATTORNEY

Int. Cl.: 32

Prior U.S. Cls.: 45, 46 and 48

United States Patent and Trademark Office

Reg. No. 3,475,088

Registered July 29, 2008

TRADEMARK
PRINCIPAL REGISTER



KEEP ROCKIN', LLC (WASHINGTON LTD LIAB
CO)
1508 O STREET, SW #105
AUBURN, WA 98001

FOR: BEER; ALE, IN CLASS 32 (U.S. CLS. 45, 46
AND 48).

FIRST USE 8-0-1996; IN COMMERCE 8-0-1996.

NO CLAIM IS MADE TO THE EXCLUSIVE
RIGHT TO USE "BLACK" , APART FROM THE
MARK AS SHOWN.

THE NAME(S), PORTRAIT(S), AND/OR SIGNA-
TURE(S) SHOWN IN THE MARK DOES NOT IDENTI-
FY A PARTICULAR LIVING INDIVIDUAL.

THE MARK CONSISTS OF A HUMAN SKULL
WITH A CLOWN CAP PLACED ON THE UPPER
EDGE OF A DIAMOND-SHAPED BACKGROUND.

SER. NO. 77-234,274, FILED 7-19-2007.

DAVID I, EXAMINING ATTORNEY

Int. Cl.: 32

Prior U.S. Cls.: 45, 46 and 48

United States Patent and Trademark Office

Reg. No. 3,475,089

Registered July 29, 2008

TRADEMARK
PRINCIPAL REGISTER



KEEP ROCKIN', LLC (WASHINGTON LTD LIAB
CO)

1508 O STREET, SW #105

AUBURN, WA 98001

FOR: BEER; ALE, IN CLASS 32 (U.S. CLS. 45, 46
AND 48).

FIRST USE 8-0-1996; IN COMMERCE 8-0-1996.

NO CLAIM IS MADE TO THE EXCLUSIVE
RIGHT TO USE "HONEY WHEAT BEER" , APART
FROM THE MARK AS SHOWN.

THE MARK CONSISTS OF A "HONEY" BEE
PLAYING A GUITAR ON A CIRCULAR BACK-
GROUND.

SER. NO. 77-234,281, FILED 7-19-2007.

DAVID I, EXAMINING ATTORNEY

Int. Cl.: 41

Prior U.S. Cls.: 100, 101 and 107

United States Patent and Trademark Office

Reg. No. 3,475,090

Registered July 29, 2008

**SERVICE MARK
PRINCIPAL REGISTER**



MUSIC STUDIO OF ALBANY NEW YORK, LTD.
(NEW YORK CORPORATION)
1237 CENTRAL AVENUE
ALBANY, NY 12205

FOR: INSTRUCTION IN THE FIELD OF MUSIC;
PROVIDING FACILITIES FOR MUSIC TRAINING;
ENTERTAINMENT, NAMELY, LIVE MUSIC CON-
CERTS, IN CLASS 41 (U.S. CLS. 100, 101 AND 107).

FIRST USE 7-31-1977; IN COMMERCE 9-30-2004.

NO CLAIM IS MADE TO THE EXCLUSIVE
RIGHT TO USE "THE MUSIC STUDIO", APART
FROM THE MARK AS SHOWN.

THE MARK CONSISTS OF A SILHOUETTE OF A
PIANO TOGETHER WITH THE WORDS "THE MU-
SIC STUDIO".

SER. NO. 77-234,739, FILED 7-20-2007.

KEVIN DINALLO, EXAMINING ATTORNEY

Int. Cl.: 41

Prior U.S. Cls.: 100, 101 and 107

United States Patent and Trademark Office

Reg. No. 3,475,091

Registered July 29, 2008

**SERVICE MARK
PRINCIPAL REGISTER**



MUSIC STUDIO OF ALBANY NEW YORK, LTD.
(NEW YORK CORPORATION)
1237 CENTRAL AVENUE
ALBANY, NY 12205

FOR: INSTRUCTION IN THE FIELD OF MUSIC;
PROVIDING FACILITIES FOR MUSIC TRAINING;
ENTERTAINMENT, NAMELY, LIVE MUSIC CON-
CERTS, IN CLASS 41 (U.S. CLS. 100, 101 AND 107).

FIRST USE 7-31-1977; IN COMMERCE 9-30-2004.

THE MARK CONSISTS OF A SILHOUETTE OF A
PIANO.

SER. NO. 77-234,786, FILED 7-20-2007.

STEVEN JACKSON, EXAMINING ATTORNEY

Int. Cl.: 20

Prior U.S. Cls.: 2, 13, 22, 25, 32 and 50

United States Patent and Trademark Office

Reg. No. 3,475,092

Registered July 29, 2008

**TRADEMARK
PRINCIPAL REGISTER**

LITTLEMISSMATCHED

MISS MATCHED, INC. (DELAWARE CORPORATION)
740 W. BOSTON POST RD.
MAMARONECK, NY 10543

THE MARK CONSISTS OF STANDARD CHARACTERS WITHOUT CLAIM TO ANY PARTICULAR FONT, STYLE, SIZE, OR COLOR.

FOR: FURNITURE, IN CLASS 20 (U.S. CLS. 2, 13, 22, 25, 32 AND 50).

SER. NO. 77-235,100, FILED 7-20-2007.

FIRST USE 4-4-2006; IN COMMERCE 4-4-2006.

FRANK LATTUCA, EXAMINING ATTORNEY

Int. Cl.: 40

Prior U.S. Cls.: 100, 103 and 106

United States Patent and Trademark Office

Reg. No. 3,475,093

Registered July 29, 2008

**SERVICE MARK
PRINCIPAL REGISTER**

GREEN IS GOOD

FOUR THIRTEEN VENTURES LLC (CALIFORNIA LTD LIAB CO)
P.O. BOX 2428
FRESNO, CA 93745

FOR: ENVIRONMENTALLY SAFE SORTING AND DISPOSAL OF OBSOLETE ELECTRONIC GOODS, IN CLASS 40 (U.S. CLS. 100, 103 AND 106).

FIRST USE 7-20-2007; IN COMMERCE 7-20-2007.

THE MARK CONSISTS OF STANDARD CHARACTERS WITHOUT CLAIM TO ANY PARTICULAR FONT, STYLE, SIZE, OR COLOR.

NO CLAIM IS MADE TO THE EXCLUSIVE RIGHT TO USE "GREEN", APART FROM THE MARK AS SHOWN.

SER. NO. 77-235,381, FILED 7-21-2007.

RICHARD A. STRASER, EXAMINING ATTORNEY

Int. Cl.: 9

Prior U.S. Cls.: 21, 23, 26, 36 and 38

Reg. No. 3,475,094

United States Patent and Trademark Office

Registered July 29, 2008

**TRADEMARK
PRINCIPAL REGISTER**

**SEATRADE CRUISE SHIPPING
CONVENTION**

CMP PRINCETON INC. (NEW YORK CORPORATION)
SUITE 220
125 VILLAGE BOULEVARD
PRINCETON, NJ 08540

FOR: PRE-RECORDED CD ROM FEATURING MATERIAL IN THE FIELD OF CRUISE INDUSTRY, SHIPPING INDUSTRY, TOURISM, FINANCE, MARINE EQUIPMENTS, DESTINATIONS, HIGH TECHNOLOGY; DOWNLOADABLE ELECTRONIC MATERIAL IN THE NATURE OF MAGAZINES, NEWSLETTERS, BROCHURES, DIRECTORIES AND GUIDES IN THE FIELDS OF CRUISE INDUSTRY, SHIPPING INDUSTRY, TOURISM, FINANCE, MARINE EQUIPMENTS, DESTINATIONS, HIGH TECHNOLOGY, IN CLASS 9 (U.S. CLS. 21, 23, 26, 36 AND 38).

FIRST USE 10-31-2006; IN COMMERCE 10-31-2006.

THE MARK CONSISTS OF STANDARD CHARACTERS WITHOUT CLAIM TO ANY PARTICULAR FONT, STYLE, SIZE, OR COLOR.

OWNER OF U.S. REG. NOS. 2,922,075, 2,956,536, AND 3,012,509.

NO CLAIM IS MADE TO THE EXCLUSIVE RIGHT TO USE "CRUISE" AND "SHIPPING", APART FROM THE MARK AS SHOWN.

SER. NO. 77-235,515, FILED 7-22-2007.

KEVIN DINALLO, EXAMINING ATTORNEY

Int. Cl.: 3

Prior U.S. Cls.: 1, 4, 6, 50, 51 and 52

United States Patent and Trademark Office

Reg. No. 3,475,095

Registered July 29, 2008

**TRADEMARK
PRINCIPAL REGISTER**



SHABAZZ, MAHDI (UNITED STATES INDIVIDUAL)
106 CONVENT AVENUE SUITE 5
NEW YORK, NY 10027

FOR: COSMETICS, IN CLASS 3 (U.S. CLS. 1, 4, 6, 50, 51 AND 52).

FIRST USE 7-7-2007; IN COMMERCE 7-7-2007.

THE MARK CONSISTS OF A CONCENTRIC RING WITH A FLOWER INSIDE.

SER. NO. 77-235,711, FILED S.R. 7-23-2007 AM. P.R. 7-23-2007.

ALEXANDER L. POWERS, EXAMINING ATTORNEY

Int. Cls.: 35 and 42

Prior U.S. Cls.: 100, 101 and 102

United States Patent and Trademark Office

Reg. No. 3,475,096

Registered July 29, 2008

**SERVICE MARK
PRINCIPAL REGISTER**

White Tangerine

WHITE TANGERINE, LLC (GEORGIA LTD LIAB
CO)
SUITE 520-426
3535 PEACHTREE ROAD
ATLANTA, GA 30326

FOR: MARKETING, CONSULTING, AND AD-
VERTISING SERVICES, NAMELY, CREATING
CORPORATE AND BRAND IDENTITY FOR OTH-
ERS, IN CLASS 35 (U.S. CLS. 100, 101 AND 102).

FIRST USE 1-11-2005; IN COMMERCE 1-11-2005.

FOR: GRAPHIC DESIGN SERVICES, IN CLASS 42
(U.S. CLS. 100 AND 101).

FIRST USE 1-11-2005; IN COMMERCE 1-11-2005.

THE MARK CONSISTS OF STANDARD CHAR-
ACTERS WITHOUT CLAIM TO ANY PARTICULAR
FONT, STYLE, SIZE, OR COLOR.

SER. NO. 77-235,992, FILED 7-23-2007.

BERNICE MIDDLETON, EXAMINING ATTORNEY

Int. Cl.: 16

Prior U.S. Cls.: 2, 5, 22, 23, 29, 37, 38 and 50

Reg. No. 3,475,097

United States Patent and Trademark Office

Registered July 29, 2008

**TRADEMARK
PRINCIPAL REGISTER**

SEATRADE TODAY

CMP PRINCETON INC. (NEW YORK CORPORATION)
125 VILLAGE BOULEVARD, SUITE 220
PRINCETON, NJ 08540

FOR: PUBLICATIONS IN THE NATURE OF MAGAZINES AND NEWSLETTERS RELATING TO THE CRUISE INDUSTRY, SHIPPING INDUSTRY, TOURISM FINANCE, MARINE EQUIPMENTS AND DESTINATIONS, IN CLASS 16 (U.S. CLS. 2, 5, 22, 23, 29, 37, 38 AND 50).

FIRST USE 3-31-1989; IN COMMERCE 3-31-1989.

THE MARK CONSISTS OF STANDARD CHARACTERS WITHOUT CLAIM TO ANY PARTICULAR FONT, STYLE, SIZE, OR COLOR.

OWNER OF U.S. REG. NOS. 2,922,075, 2,956,536, AND 3,012,509.

SER. NO. 77-236,214, FILED 7-23-2007.

KEVIN DINALLO, EXAMINING ATTORNEY

Int. Cls.: 32 and 40

Prior U.S. Cls.: 45, 46, 48, 100, 103 and 106

United States Patent and Trademark Office

Reg. No. 3,475,098

Registered July 29, 2008

**TRADEMARK
SERVICE MARK
PRINCIPAL REGISTER**

BALLAST POINT

HOME BREW MART, INC. (CALIFORNIA CORPORATION)
SUITE B
10051 OLD GROVE ROAD
SAN DIEGO, CA 92131

FOR: BEER, IN CLASS 32 (U.S. CLS. 45, 46 AND 48).

FIRST USE 4-4-1996; IN COMMERCE 4-4-1996.

FOR: BREWERY SERVICES , IN CLASS 40 (U.S. CLS. 100, 103 AND 106).

FIRST USE 4-4-1996; IN COMMERCE 4-4-1996.

THE MARK CONSISTS OF STANDARD CHARACTERS WITHOUT CLAIM TO ANY PARTICULAR FONT, STYLE, SIZE, OR COLOR.

SER. NO. 77-236,623, FILED 7-23-2007.

TEJBIR SINGH, EXAMINING ATTORNEY

Int. Cl.: 31

Prior U.S. Cls.: 1 and 46

United States Patent and Trademark Office

Reg. No. 3,475,099

Registered July 29, 2008

TRADEMARK
PRINCIPAL REGISTER



RED TOMATO, INC. (MASSACHUSETTS NON-PROFIT CORPORATION)
1033 TURNPIKE STREET
CANTON, MA 02021

THE MARK CONSISTS OF A "TOMATO" WITH AN ARROW AROUND IT.

FOR: FRESH FRUITS AND FRESH VEGETABLES, IN CLASS 31 (U.S. CLS. 1 AND 46).

SEC. 2(F).

FIRST USE 12-31-1996; IN COMMERCE 12-31-1996.

SER. NO. 77-236,788, FILED 7-24-2007.

NO CLAIM IS MADE TO THE EXCLUSIVE RIGHT TO USE "RED TOMATO", APART FROM THE MARK AS SHOWN.

KRISTIN DAHLING, EXAMINING ATTORNEY

Int. Cls.: 40 and 42

Prior U.S. Cls.: 100, 101, 103 and 106

United States Patent and Trademark Office

Reg. No. 3,475,100

Registered July 29, 2008

**SERVICE MARK
PRINCIPAL REGISTER**

BENZSEP

TRANS IONICS CORPORATION (TEXAS CORPORATION)
SUITE D-5
2408 TIMBERLOCH PLACE
THE WOODLANDS, TX 77380

FOR: FUEL TREATMENT SERVICES FEATURING A MEMBRANE-BASED SEPARATION PROCESS FOR BENZENE, IN CLASS 40 (U.S. CLS. 100, 103 AND 106).

FIRST USE 7-1-2007; IN COMMERCE 7-1-2007.

FOR: RESEARCH AND ENGINEERING SERVICES IN THE FIELD OF FUEL TREATMENT FEATURING A MEMBRANE-BASED SEPARATION PROCESS FOR BENZENE, IN CLASS 42 (U.S. CLS. 100 AND 101).

TURING A MEMBRANE BASED SEPARATION PROCESS FOR BENZENE, IN CLASS 42 (U.S. CLS. 100 AND 101).

FIRST USE 7-1-2007; IN COMMERCE 7-1-2007.

THE MARK CONSISTS OF STANDARD CHARACTERS WITHOUT CLAIM TO ANY PARTICULAR FONT, STYLE, SIZE, OR COLOR.

SER. NO. 77-237,127, FILED 7-24-2007.

ERNEST SHOSHO, EXAMINING ATTORNEY

Int. Cl.: 42

Prior U.S. Cls.: 100 and 101

United States Patent and Trademark Office

Reg. No. 3,475,101

Registered July 29, 2008

**SERVICE MARK
PRINCIPAL REGISTER**

WSI IM

1175856 ONTARIO LTD. (CANADA CORPORATION)
SUITE 600
5580 EXPLORER DRIVE
MISSISSAUGA, ONTARIO, CANADA L4W4Y1

FOR: WEBSITE DEVELOPMENT AND DESIGN AND WEB HOSTING SERVICES, NAMELY, HOSTING THE WEBSITES OF OTHERS ON A COMPUTER SERVER FOR A GLOBAL COMPUTER NETWORK; TECHNICAL CONSULTING SERVICES TO BUSINESSES IN THE FIELD OF INTERNET WEBSITE USE, IN CLASS 42 (U.S. CLS. 100 AND 101).

FIRST USE 9-14-2006; IN COMMERCE 9-14-2006.

THE MARK CONSISTS OF STANDARD CHARACTERS WITHOUT CLAIM TO ANY PARTICULAR FONT, STYLE, SIZE, OR COLOR.

OWNER OF U.S. REG. NOS. 2,718,655, 2,944,476, AND 3,270,371.

NO CLAIM IS MADE TO THE EXCLUSIVE RIGHT TO USE "IM", APART FROM THE MARK AS SHOWN.

SER. NO. 77-237,128, FILED 7-24-2007.

JEFFERY COWARD, EXAMINING ATTORNEY

Int. Cl.: 41

Prior U.S. Cls.: 100, 101 and 107

United States Patent and Trademark Office

Reg. No. 3,475,102

Registered July 29, 2008

**SERVICE MARK
PRINCIPAL REGISTER**

GenderTalk Works

CONNIE GLASER (UNITED STATES INDIVIDUAL)
740 OLD CAMPUS TRAIL
ATLANTA, GA 30328

FOR: EDUCATIONAL SERVICES, NAMELY, PROVIDING, LECTURES, CLASSES, SEMINARS, WORKSHOPS, TUTORING, MENTORING, AND COACHING IN THE FIELDS OF GENDER COMMUNICATIONS, LEADERSHIP, AND WORKPLACE EQUALITY AND DISTRIBUTION OF PRINTED MATERIALS IN CONNECTION THEREWITH; PROVIDING ONLINE PUBLICATIONS IN THE NATURE OF WORKBOOKS, BOOKS, SYNDICATED COLUMNS, AND MANUALS IN THE FIELD OF GEN-

DER COMMUNICATIONS, LEADERSHIP, AND WORKPLACE EQUALITY, IN CLASS 41 (U.S. CLS. 100, 101 AND 107).

FIRST USE 12-21-2006; IN COMMERCE 4-1-2007.

THE MARK CONSISTS OF STANDARD CHARACTERS WITHOUT CLAIM TO ANY PARTICULAR FONT, STYLE, SIZE, OR COLOR.

SER. NO. 77-237,259, FILED 7-24-2007.

TARAH HARDY, EXAMINING ATTORNEY

Int. Cl.: 41

Prior U.S. Cls.: 100, 101 and 107

United States Patent and Trademark Office

Reg. No. 3,475,103

Registered July 29, 2008

**SERVICE MARK
PRINCIPAL REGISTER**

GenderTalk

GLASER, CONNIE (UNITED STATES INDIVIDUAL)
740 OLD CAMPUS TRAIL
ATLANTA, GA 30328

FOR: EDUCATIONAL SERVICES, NAMELY, PROVIDING, LECTURES, CLASSES, SEMINARS, WORKSHOPS, TUTORING, MENTORING, AND COACHING IN THE FIELDS OF GENDER COMMUNICATIONS, LEADERSHIP, AND WORKPLACE EQUALITY AND DISTRIBUTION OF PRINTED MATERIALS IN CONNECTION THEREWITH; PROVIDING ONLINE PUBLICATIONS IN THE NATURE OF WORKBOOKS, BOOKS, SYNDICATED COLUMNS, AND MANUALS IN THE FIELD OF GEN-

DER COMMUNICATIONS, LEADERSHIP, AND WORKPLACE EQUALITY, IN CLASS 41 (U.S. CLS. 100, 101 AND 107).

FIRST USE 12-21-2006; IN COMMERCE 4-1-2007.

THE MARK CONSISTS OF STANDARD CHARACTERS WITHOUT CLAIM TO ANY PARTICULAR FONT, STYLE, SIZE, OR COLOR.

SER. NO. 77-237,924, FILED 7-25-2007.

TARAH HARDY, EXAMINING ATTORNEY

Int. Cl.: 39

Prior U.S. Cls.: 100 and 105

United States Patent and Trademark Office

Reg. No. 3,475,104

Registered July 29, 2008

**SERVICE MARK
PRINCIPAL REGISTER**

Black Cat Tours

MARK R. JONES (UNITED STATES INDIVIDUAL)
1323 JACKWOOD COURT
CHARLESTON, SC 29407 AND
KARI BESCHTA (UNITED STATES INDIVIDUAL)
1323 JACKWOOD COURT
CHARLESTON, SC 29407

FOR: ORGANIZATION OF EXCURSIONS, SIGHTSEEING TOURS, HOLIDAYS, TOURS AND TRAVEL; TOUR CONDUCTING; TOUR CONDUCTING OR ESCORTING; TOUR GUIDE SERVICES; TRAVEL AND TOUR INFORMATION SERVICE, IN CLASS 39 (U.S. CLS. 100 AND 105).

FIRST USE 7-20-2007; IN COMMERCE 7-20-2007.

THE MARK CONSISTS OF STANDARD CHARACTERS WITHOUT CLAIM TO ANY PARTICULAR FONT, STYLE, SIZE, OR COLOR.

NO CLAIM IS MADE TO THE EXCLUSIVE RIGHT TO USE "TOURS", APART FROM THE MARK AS SHOWN.

SER. NO. 77-238,041, FILED 7-25-2007.

KRISTINA MORRIS, EXAMINING ATTORNEY

Int. Cls.: 9 and 41

Prior U.S. Cls.: 21, 23, 26, 36, 38, 100, 101 and 107

United States Patent and Trademark Office

Reg. No. 3,475,105

Registered July 29, 2008

**TRADEMARK
SERVICE MARK
PRINCIPAL REGISTER**

MICHAEL BOLTON

MICHAEL BOLTON (UNITED STATES INDIVIDUAL)
C/O BELL, BOYD & LLOYD LLP
27 KINGS HIGHWAY NORTH
WESTPORT, CT 06880

FOR: SOUND AND VIDEO RECORDINGS FEATURING MUSIC, IN CLASS 9 (U.S. CLS. 21, 23, 26, 36 AND 38).

FIRST USE 0-0-1981; IN COMMERCE 0-0-1983.

FOR: ENTERTAINMENT SERVICES IN THE NATURE OF LIVE PERFORMANCES BY A POPU-

LAR SINGER; RECORD PRODUCTION; AND SONGWRITING SERVICES, IN CLASS 41 (U.S. CLS. 100, 101 AND 107).

FIRST USE 0-0-1981; IN COMMERCE 0-0-1983.

THE MARK CONSISTS OF STANDARD CHARACTERS WITHOUT CLAIM TO ANY PARTICULAR FONT, STYLE, SIZE, OR COLOR.

SER. NO. 77-238,302, FILED 7-25-2007.

JILL C. ALT, EXAMINING ATTORNEY

Int. Cl.: 25

Prior U.S. Cls.: 22 and 39

United States Patent and Trademark Office

Reg. No. 3,475,106

Registered July 29, 2008

**TRADEMARK
PRINCIPAL REGISTER**

SHOES THAT LOVE YOU

OKABASHI BRANDS, INC. (DELAWARE COR-
PORATION)
4823 ROY CARLSON BOULEVARD
BUFORD, GA 30518

THE MARK CONSISTS OF STANDARD CHAR-
ACTERS WITHOUT CLAIM TO ANY PARTICULAR
FONT, STYLE, SIZE, OR COLOR.

FOR: FOOTWEAR; SHOES, IN CLASS 25 (U.S. CLS.
22 AND 39).

SER. NO. 77-238,328, FILED 7-25-2007.

FIRST USE 11-0-2004; IN COMMERCE 11-0-2004.

LINDA LAVACHE, EXAMINING ATTORNEY

Int. Cl.: 4

Prior U.S. Cls.: 1, 6 and 15

United States Patent and Trademark Office

Reg. No. 3,475,107

Registered July 29, 2008

**TRADEMARK
PRINCIPAL REGISTER**

NCS-30

JET-LUBE, INC. (DELAWARE CORPORATION)
SUITE 200 4849 HOMESTEAD RD.
HOUSTON, TX 77028

FOR: LUBRICANTS AND GREASES, NAMELY, ALL PURPOSE OIL FIELD LUBRICANTS, DRILLING LUBRICANTS, INDUSTRIAL LUBRICANTS, LUBRICANTS FOR AIRCRAFT ENGINES, LUBRICANTS FOR INDUSTRIAL MACHINERY, MARINE LUBRICANTS, LUBRICATING OILS AND GREASES, GENERAL PURPOSE GREASES, GREASES FOR MACHINES, INDUSTRIAL GREASES, LUBRICATING GREASES, MINERAL OILS AND GREASES FOR INDUSTRIAL PURPOSES, NON-MINERAL OILS AND GREASES FOR INDUSTRIAL PURPOSES, LUBRICANTS FOR LUBRICATING THREA-

DED CONNECTIONS, LUBRICANTS FOR PREVENTING SEIZING OF THREADED CONNECTIONS, VALVE LUBRICANTS AND GREASES, AND OFF-SHORE PLATFORM LUBRICANTS AND GREASES, IN CLASS 4 (U.S. CLS. 1, 6 AND 15).

FIRST USE 6-1-2006; IN COMMERCE 6-1-2006.

THE MARK CONSISTS OF STANDARD CHARACTERS WITHOUT CLAIM TO ANY PARTICULAR FONT, STYLE, SIZE, OR COLOR.

SER. NO. 77-238,406, FILED 7-25-2007.

JIM RINGLE, EXAMINING ATTORNEY

Int. Cl.: 38

Prior U.S. Cls.: 100, 101 and 104

United States Patent and Trademark Office

Reg. No. 3,475,108

Registered July 29, 2008

**SERVICE MARK
PRINCIPAL REGISTER**



CITY OF DUBLIN (OHIO MUNICIPAL CORPORATION)
5200 EMERALD PARKWAY
DUBLIN, OH 430171066

FOR: PROVIDING COMMUNICATIONS VIA A FIBER OPTIC NETWORK, IN CLASS 38 (U.S. CLS. 100, 101 AND 104).

FIRST USE 10-19-2005; IN COMMERCE 10-19-2005.

NO CLAIM IS MADE TO THE EXCLUSIVE RIGHT TO USE "CENTRAL OHIO RESEARCH NETWORK", APART FROM THE MARK AS SHOWN.

THE MARK CONSISTS OF A VERTICAL CORN ON THE COB WITH THREE GRADUATING CONCENTRIC RINGS AROUND IT WITH THE INITIALS CORN ON THE FIRST LINE BELOW AND THE WORDS "CENTRAL OHIO RESEARCH NETWORK" ON THE SECOND LINE BELOW.

SER. NO. 77-239,119, FILED 7-26-2007.

ALYSSA PALADINO, EXAMINING ATTORNEY

Int. Cl.: 41

Prior U.S. Cls.: 100, 101 and 107

United States Patent and Trademark Office

Reg. No. 3,475,109

Registered July 29, 2008

**SERVICE MARK
PRINCIPAL REGISTER**



RED MOUNTAIN THEATRE COMPANY, INC.
(ALABAMA CORPORATION)
403
2329 1ST AVENUE NORTH
BIRMINGHAM, AL 35203

NO CLAIM IS MADE TO THE EXCLUSIVE RIGHT TO USE "RED MOUNTAIN THEATRE COMPANY", APART FROM THE MARK AS SHOWN.

FOR: ENTERTAINMENT IN THE NATURE OF THEATER PRODUCTIONS; EDUCATION SERVICES, NAMELY, PROVIDING THEATER PERFORMANCE AND PRODUCTION CLASSES AND WORKSHOPS , IN CLASS 41 (U.S. CLS. 100, 101 AND 107).

THE MARK CONSISTS OF A STYLIZED DANCER WITH CANE AND TOP HAT, AND WORDS, "RED MOUNTAIN THEATRE COMPANY".

SER. NO. 77-239,191, FILED 7-26-2007.

FIRST USE 5-25-2006; IN COMMERCE 4-28-2007.

ESTHER A. BORSUK, EXAMINING ATTORNEY

Int. Cl.: 35

Prior U.S. Cls.: 100, 101 and 102

United States Patent and Trademark Office

Reg. No. 3,475,110

Registered July 29, 2008

**SERVICE MARK
PRINCIPAL REGISTER**

RECRUITMENT THAT WORKS!

FKM/RAS, LLP (TEXAS LIMITED LIABILITY PARTNERSHIP), DBA MITTON MEDIA
846 MERRICK
SUGAR LAND, TX 77478

FOR: ADVERTISING SERVICES, NAMELY, PERSONNEL RECRUITMENT ADVERTISING FOR OTHERS; BUSINESS SERVICES, NAMELY, BUSINESS PLANNING, BUSINESS MANAGEMENT; ADVERTISING AND BUSINESS SERVICES, NAMELY, SECURING AIRTIME ON ALL FORMS OF MEDIA COMMUNICATIONS STATIONS, SYSTEMS, NETWORKS, AND SERVICES FOR THE PURPOSE OF PROMOTING THE GOODS AND SERVICES OF OTHERS; ADVERTISING VIA ELECTRONIC MEDIA AND SPECIFICALLY THE INTERNET; PREPARATION AND REALIZATION OF MEDIA AND ADVERTISING PLANS AND CONCEPTS; MEDIA PLANNING, NAMELY, ADVISING THE CLIENT ON THE CORRECT TIMES AND STATIONS TO ADVERTISE BASED ON MEDIA ANALYSIS OF THE MARKET FOR THAT MEDIA; EMPLOYMENT

COUNSELING AND RECRUITING; CONSULTING FOR THE PROMOTION OF EMPLOYEE RETENTION; PERSONNEL PLACEMENT AND RECRUITMENT; JOB PLACEMENT; AND BUSINESS CONSULTATION, IN CLASS 35 (U.S. CLS. 100, 101 AND 102).

FIRST USE 2-12-2007; IN COMMERCE 2-12-2007.

THE MARK CONSISTS OF STANDARD CHARACTERS WITHOUT CLAIM TO ANY PARTICULAR FONT, STYLE, SIZE, OR COLOR.

NO CLAIM IS MADE TO THE EXCLUSIVE RIGHT TO USE "RECRUITMENT", APART FROM THE MARK AS SHOWN.

SER. NO. 77-239,226, FILED 7-26-2007.

G. MAYERSCHOFF, EXAMINING ATTORNEY

Int. Cl.: 25

Prior U.S. Cls.: 22 and 39

United States Patent and Trademark Office

Reg. No. 3,475,111

Registered July 29, 2008

**TRADEMARK
PRINCIPAL REGISTER**



PLAYBOY ENTERPRISES INTERNATIONAL,
INC. (DELAWARE CORPORATION)
680 N. LAKE SHORE DRIVE
CHICAGO, IL 60611

FOR: LINGERIE, IN CLASS 25 (U.S. CLS. 22 AND
39).

FIRST USE 6-7-2006; IN COMMERCE 6-7-2006.

OWNER OF U.S. REG. NO. 3,234,488.

THE NAME(S), PORTRAIT(S), AND/OR SIGNA-
TURE(S) SHOWN IN THE MARK DOES NOT IDENTI-
FY A PARTICULAR LIVING INDIVIDUAL.

THE MARK CONSISTS OF WOMAN DRESSED IN
BUNNY COSTUME.

SER. NO. 77-240,383, FILED 7-27-2007.

HENRY S. ZAK, EXAMINING ATTORNEY

Int. Cl.: 39

Prior U.S. Cls.: 100 and 105

United States Patent and Trademark Office

Reg. No. 3,475,112

Registered July 29, 2008

**SERVICE MARK
PRINCIPAL REGISTER**



ENTERPRISE RENT-A-CAR COMPANY (MISSOURI CORPORATION)
600 CORPORATE PARK DRIVE
ST. LOUIS, MO 63105

FOR: VEHICLE RENTAL AND LEASING SERVICES; AND RESERVATION SERVICES FOR THE RENTAL AND LEASING OF VEHICLES, NAMELY, RENTAL RESERVATIONS FOR AUTOMOBILES, TRUCKS, CARS, LAND VEHICLES, IN CLASS 39 (U.S. CLS. 100 AND 105).

FIRST USE 4-19-2007; IN COMMERCE 4-19-2007.

OWNER OF U.S. REG. NOS. 1,343,167, 2,010,244 AND OTHERS.

NO CLAIM IS MADE TO THE EXCLUSIVE RIGHT TO USE "RENT-A-CAR", APART FROM THE MARK AS SHOWN.

THE COLOR(S) GREEN, WHITE AND BLACK IS/ARE CLAIMED AS A FEATURE OF THE MARK.

THE MARK CONSISTS OF A GREEN SQUARE, AND THE LETTER "E" IS IN WHITE AND GREEN IN THE GREEN SQUARE AND THE LITERAL ELEMENT "ENTERPRISE RENT-A-CAR" IS IN WHITE OUTLINED BY BLACK TO THE RIGHT OF THE GREEN SQUARE.

SER. NO. 77-240,924, FILED 7-27-2007.

KATHY DE JONGE, EXAMINING ATTORNEY

Int. Cl.: 39

Prior U.S. Cls.: 100 and 105

United States Patent and Trademark Office

Reg. No. 3,475,113

Registered July 29, 2008

**SERVICE MARK
PRINCIPAL REGISTER**



ENTERPRISE RENT-A-CAR COMPANY (MISSOURI CORPORATION)
600 CORPORATE PARK DRIVE
ST. LOUIS, MO 63105

FOR: VEHICLE RENTAL AND LEASING SERVICES; AND RESERVATION SERVICES FOR THE RENTAL AND LEASING OF VEHICLES, NAMELY, RENTAL RESERVATIONS FOR AUTOMOBILES, TRUCKS, CARS, LAND VEHICLES, IN CLASS 39 (U.S. CLS. 100 AND 105).

FIRST USE 5-30-2007; IN COMMERCE 5-30-2007.

OWNER OF U.S. REG. NOS. 1,343,167, 2,010,244 AND OTHERS.

NO CLAIM IS MADE TO THE EXCLUSIVE RIGHT TO USE "RENT-A-CAR", APART FROM THE MARK AS SHOWN.

THE COLOR(S) GREEN, WHITE AND BLACK IS/ARE CLAIMED AS A FEATURE OF THE MARK.

THE MARK CONSISTS OF A GREEN SQUARE, AND THE LETTER "E" IS IN WHITE AND GREEN IN THE GREEN SQUARE AND THE LITERAL ELEMENT "ENTERPRISE RENT-A-CAR" IS IN BLACK TO THE RIGHT OF THE GREEN SQUARE.

SER. NO. 77-240,958, FILED 7-27-2007.

KATHY DE JONGE, EXAMINING ATTORNEY

Int. Cl.: 35

Prior U.S. Cls.: 100, 101 and 102

United States Patent and Trademark Office

Reg. No. 3,475,114

Registered July 29, 2008

**SERVICE MARK
PRINCIPAL REGISTER**

OLD HARBOR OUTFITTERS

OLD HARBOR OUTFITTERS (CONNECTICUT
LTD LIAB CO)
3RD FLOOR
540 BARNUM AVE
BRIDGEPORT, CT 06608

FOR: RETAIL STORE SERVICES FEATURING
APPAREL AND EQUIPMENT FOR OUTDOOR AC-
TIVITIES, IN CLASS 35 (U.S. CLS. 100, 101 AND 102).

FIRST USE 3-16-2006; IN COMMERCE 3-16-2006.

THE MARK CONSISTS OF STANDARD CHAR-
ACTERS WITHOUT CLAIM TO ANY PARTICULAR
FONT, STYLE, SIZE, OR COLOR.

OWNER OF U.S. REG. NO. 1,244,634.

NO CLAIM IS MADE TO THE EXCLUSIVE
RIGHT TO USE "OUTFITTERS", APART FROM
THE MARK AS SHOWN.

SER. NO. 77-241,118, FILED 7-27-2007.

ELIZABETH HUGHITT, EXAMINING ATTORNEY

Int. Cls.: 16 and 41

Prior U.S. Cls.: 2, 5, 22, 23, 29, 37, 38, 50, 100, 101 and 107

Reg. No. 3,475,115

United States Patent and Trademark Office

Registered July 29, 2008

**TRADEMARK
SERVICE MARK
PRINCIPAL REGISTER**

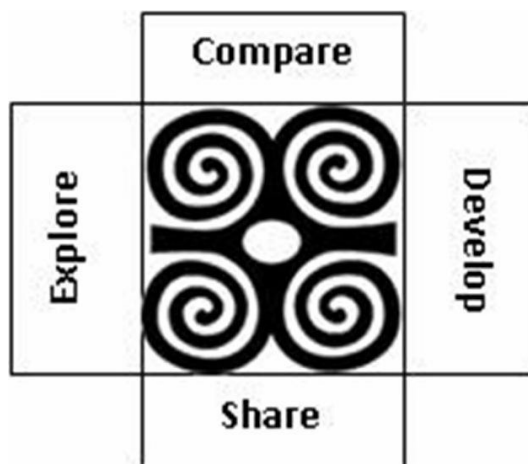

MCKINLEY, JOHNNIE H. (UNITED STATES INDIVIDUAL)
2328 SOUTH SPOKANE STREET
SEATTLE, WA 98144

FOR: EDUCATIONAL PUBLICATIONS, NAMELY, TRAINING MANUALS IN THE FIELD OF CULTURALLY RESPONSIVE TEACHING AND LEARNING, IN CLASS 16 (U.S. CLS. 2, 5, 22, 23, 29, 37, 38 AND 50).

FIRST USE 8-1-2005; IN COMMERCE 8-1-2005.

FOR: TRAINING SERVICES IN THE FIELD OF MULTICULTURAL EDUCATION, IN CLASS 41 (U.S. CLS. 100, 101 AND 107).

FIRST USE 8-1-2005; IN COMMERCE 8-1-2005.

THE MARK CONSISTS OF "A" LARGE RECTANGLE WHOSE INTERIOR IS DIVIDED INTO 9 RECTANGLES, ONE OF WHICH IS A SQUARE IN ITS CENTER WHICH CONTAINS THE LOGO, AN ADINKRA TRIBAL SYMBOL FOR STRENGTH AND HUMILITY. THE NINE RECTANGLES FORM 3 ROWS INSIDE THE LARGE RECTANGLE. THE

FOUR CORNERS OF THE RECTANGLE ARE OPEN WHITE SQUARE SHAPED SPACES. THE TOP ROW OF 3 RECTANGLES INCLUDES A WHITE RECTANGLE CONTAINING THE WORD "COMPARE" IN THE HORIZONTAL ORIENTATION IN ITS CENTER. THE SECOND ROW OF 3 RECTANGLES INCLUDES, FROM LEFT TO RIGHT, A WHITE RECTANGLE CONTAINING THE WORD "EXPLORE" IN THE VERTICAL ORIENTATION, THE CENTER SQUARE CONTAINING THE ADINKRA SYMBOL FOR STRENGTH AND HUMILITY, AND A WHITE RECTANGLE WITH THE WORD "DEVELOP" IN THE VERTICAL ORIENTATION. THE BOTTOM ROW OF RECTANGLES INCLUDES A WHITE RECTANGLE CONTAINING THE WORD "SHARE" IN HORIZONTAL ORIENTATION IN ITS CENTER. THE ADINKRA SYMBOL IN THE CENTER OF THE RECTANGLE IS A TRADITIONAL SYMBOL OF "A"SHANTI TRIBES IN "A"FRICA WHICH SYMBOLIZES AND RESEMBLES THE RAM'S HORNS FROM WHICH IT WAS DEvised.

SER. NO. 77-241,194, FILED 7-27-2007.

ANGELA M. MICHELI, EXAMINING ATTORNEY

Int. Cl.: 21

Prior U.S. Cls.: 2, 13, 23, 29, 30, 33, 40 and 50

Reg. No. 3,475,116

United States Patent and Trademark Office

Registered July 29, 2008

**TRADEMARK
PRINCIPAL REGISTER**



NURSERY SUPPLIES, INC. (NEW JERSEY CORPORATION)
1415 ORCHARD DRIVE
CHAMBERSBURG, PA 17201

NO CLAIM IS MADE TO THE EXCLUSIVE RIGHT TO USE "NURSERY SUPPLIES INC.", APART FROM THE MARK AS SHOWN.

FOR: PLASTIC NURSERY CONTAINERS FOR GROWING TREES AND PLANTS, NAMELY, FLOWER AND PLANT POTS, HANGING BASKETS, TRAYS, BEDDING FLATS, AND BEDDING FLAT CONTAINERS, IN CLASS 21 (U.S. CLS. 2, 13, 23, 29, 30, 33, 40 AND 50).

THE MARK CONSISTS OF THE LINES FORMING THE STYLIZED LETTERS "NSI" ABOVE THE WORDS "NURSERY SUPPLIES INC."

SER. NO. 77-241,813, FILED 7-30-2007.

FIRST USE 1-1-1985; IN COMMERCE 1-1-1985.

KAREN BRACEY, EXAMINING ATTORNEY

Int. Cl.: 21

Prior U.S. Cls.: 2, 13, 23, 29, 30, 33, 40 and 50

United States Patent and Trademark Office

Reg. No. 3,475,117

Registered July 29, 2008

**TRADEMARK
PRINCIPAL REGISTER**



PINEDA, MANUEL (UNITED STATES INDIVIDUAL)
575 E. ST. JOHN STREET
SAN JOSE, CA 95112

FOR: COOKING UTENSILS, NAMELY, POTS, PANS AND SKILLETS, IN CLASS 21 (U.S. CLS. 2, 13, 23, 29, 30, 33, 40 AND 50).

FIRST USE 11-30-2001; IN COMMERCE 11-30-2001.

NO CLAIM IS MADE TO THE EXCLUSIVE RIGHT TO USE "WARE", APART FROM THE MARK AS SHOWN.

THE COLOR(S) RED, BLACK & WHITE IS/ARE CLAIMED AS A FEATURE OF THE MARK.

THE MARK CONSISTS OF THE WORDS "TRULY WARE" IN BLACK LETTERS, SET IN A WHITE TRIANGLE, WHICH IS FURTHER SET IN A RED CIRCLE.

SER. NO. 77-241,961, FILED 7-30-2007.

MICHAEL LEWIS, EXAMINING ATTORNEY

Int. Cl.: 35

Prior U.S. Cls.: 100, 101 and 102

United States Patent and Trademark Office

Reg. No. 3,475,118

Registered July 29, 2008

**SERVICE MARK
PRINCIPAL REGISTER**

THE 5 STONES GROUP

THE 5 STONES GROUP, INC. (OHIO CORPORATION)
515 EAST MAIN STREET, SUITE D
COLUMBUS, OH 43215

FOR: ADVERTISING AND PUBLICITY SERVICES, NAMELY, PROMOTING THE GOODS, SERVICES, BRAND IDENTITY AND COMMERCIAL INFORMATION AND NEWS OF THIRD PARTIES THROUGH AUDIO, VIDEO, DIGITAL AND ON-LINE MEDIUM; CREATION AND PRODUCTION OF IMAGES, AUDIO, AND VIDEO RECORDINGS FOR USE IN TELEVISION COMMERCIALS, RADIO COMMERCIALS, PRINT ADVERTISEMENTS, OR INTERNET WEBSITES, ALL CREATED FOR THE PURPOSE OF ADVERTISING AND PROMOTING THE PRODUCTS, SERVICES, AND COMMERCIAL INFORMATION OF OTHERS; PREPARATION AND REALIZATION OF MEDIA AND ADVERTISING

PLANS AND CONCEPTS; PROMOTION USING AUDIOVISUAL MEDIA; DEMOGRAPHIC CONSULTATION IN THE FIELD OF MARKETING, IN CLASS 35 (U.S. CLS. 100, 101 AND 102).

FIRST USE 2-4-2005; IN COMMERCE 2-4-2005.

THE MARK CONSISTS OF STANDARD CHARACTERS WITHOUT CLAIM TO ANY PARTICULAR FONT, STYLE, SIZE, OR COLOR.

NO CLAIM IS MADE TO THE EXCLUSIVE RIGHT TO USE "GROUP", APART FROM THE MARK AS SHOWN.

SER. NO. 77-242,660, FILED 7-31-2007.

KELLY BOULTON, EXAMINING ATTORNEY

Int. Cl.: 6

Prior U.S. Cls.: 2, 12, 13, 14, 23, 25 and 50

Reg. No. 3,475,119

United States Patent and Trademark Office

Registered July 29, 2008

**TRADEMARK
PRINCIPAL REGISTER**



MICHAEL P WALTON (UNITED STATES INDIVIDUAL)
2830 BRISTOL ROAD
WARRINGTON, PA 189761408

FOR: METAL CLIPS FOR USE BY ELECTRICAL CONTRACTORS, IN CLASS 6 (U.S. CLS. 2, 12, 13, 14, 23, 25 AND 50).

FIRST USE 3-7-2007; IN COMMERCE 7-16-2007.

THE COLOR(S) BLACK AND WHITE ONLY IS/ARE CLAIMED AS A FEATURE OF THE MARK.

THE MARK CONSISTS OF A IMAGE OF A LARGE SOMEWHAT SQUARE CAPITAL LETTER "G" WITH THE ADDITION OF A MACHINE SCREW, WITH THREADS SHOWING, PENETRATING THE LEFT VERTICAL SIDE AT THE MID-POINT AND ALSO HAVING A TANG DECENDING IN A DOWNWARD DIRECTION FROM THE UPPER RIGHT HAND SIDE OF THE LETTER.

SER. NO. 77-243,446, FILED 7-31-2007.

RONALD AIKENS, EXAMINING ATTORNEY

Int. Cl.: 35

Prior U.S. Cls.: 100, 101 and 102

United States Patent and Trademark Office

Reg. No. 3,475,120

Registered July 29, 2008

**SERVICE MARK
PRINCIPAL REGISTER**

SERVE TO PRESERVE FLORIDA

THE FLORIDA COMMISSION ON COMMUNITY
SERVICE (FLORIDA COMMISSION ON THE
EXECUTIVE BRANCH OF GOVERNMENT),
DBA THE GOVERNOR'S COMMISSION ON
VOLUNTEERISM AND COMMUNITY SER-
VICE, VOLUNTEER FLORIDA
THE ELLIOT BUILDING
401 SOUTH MONROE ST
TALLAHASSEE, FL 32301

FOR: CHARITABLE SERVICES, NAMELY, OR-
GANIZING AND CONDUCTING VOLUNTEER
PROGRAMS AND COMMUNITY SERVICE PRO-
JECTS FOR THE EXECUTION OF ENVIRONMEN-
TAL, CONSERVATION, RESTORATION, AND
EDUCATION PROJECTS TO PRESERVE AND PRO-
TECT ENVIRONMENTAL RESOURCES, IN CLASS
35 (U.S. CLS. 100, 101 AND 102).

FIRST USE 5-25-2007; IN COMMERCE 5-25-2007.

THE MARK CONSISTS OF STANDARD CHAR-
ACTERS WITHOUT CLAIM TO ANY PARTICULAR
FONT, STYLE, SIZE, OR COLOR.

NO CLAIM IS MADE TO THE EXCLUSIVE
RIGHT TO USE "FLORIDA" , APART FROM THE
MARK AS SHOWN.

SER. NO. 77-243,974, FILED 8-1-2007.

KATHLEEN M. VANSTON, EXAMINING ATTOR-
NEY

Int. Cls.: 12 and 25

Prior U.S. Cls.: 19, 21, 22, 23, 31, 35, 39 and 44

United States Patent and Trademark Office

Reg. No. 3,475,121

Registered July 29, 2008

**TRADEMARK
PRINCIPAL REGISTER**



YAMAHA MOTOR CORPORATION, U.S.A. (CALIFORNIA CORPORATION)
6555 KATELLA AVENUE
CYPRESS, CA 90630

FOR: MOTORCYCLES AND STRUCTURAL PARTS THEREFOR; ACCESSORIES FOR MOTORCYCLES, SNOWMOBILES, ALL-TERRAIN VEHICLES AND PERSONAL WATERCRAFT, NAMELY, HANDLE PADS AND SEAT SHAPED UPHOLSTERY, TRAILERS, WINDSHIELDS, ENGINE GUARDS, MUD FLAPS, ROTOR COVERS, SEAT COVERS, HANDLEPOLE COVERS, FITTED VEHICLE COVERS, IN CLASS 12 (U.S. CLS. 19, 21, 23, 31, 35 AND 44).

FIRST USE 12-31-1972; IN COMMERCE 12-31-1972.

FOR: CLOTHING, NAMELY, TOPS, T-SHIRTS, SHIRTS, SPORT SHIRTS, POLO SHIRTS, TANK TOPS, SWEATSHIRTS, WORK SHIRTS, JACKETS, LEATHER JACKETS, VARSITY JACKETS, VESTS, CHAPS, GLOVES, BELTS, BANDANNAS, BOTTOMS, PANTS, SHORTS, SKIRTS, SWEATPANTS, OVERALLS, HEADWEAR AND FOOTWEAR; MOTORCYCLE RIDING PANTS, SHIRTS AND JACKETS, IN CLASS 25 (U.S. CLS. 22 AND 39).

FIRST USE 12-31-1972; IN COMMERCE 12-31-1972.

THE MARK CONSISTS OF HORIZONTAL LADDER DESIGN.

SER. NO. 77-244,258, FILED 8-1-2007.

GIANCARLO CASTRO, EXAMINING ATTORNEY

Int. Cl.: 35

Prior U.S. Cls.: 100, 101 and 102

United States Patent and Trademark Office

Reg. No. 3,475,122

Registered July 29, 2008

**SERVICE MARK
PRINCIPAL REGISTER**

BRONC-BUSTER

BRONC-BUSTER INCORPORATED (MONTANA CORPORATION)
81305 GALLATIN RD. SUITE 1B
BOZEMAN, MT 59715

FOR: RETAIL STORE AND COMPUTER ON-LINE RETAIL STORE SERVICES FEATURING WESTERN CLOTHING, SHIRTS, HATS, JACKETS, BELT BUCKLES, ACCESSORIES, BLANKETS, SADDLES, AND ART PIECES INCLUDING DRAWINGS, PAINTINGS, PRINTS, SCULPTURES AND CUSTOM MADE FURNITURE, IN CLASS 35 (U.S. CLS. 100, 101 AND 102).

FIRST USE 7-18-2007; IN COMMERCE 7-31-2007.

THE MARK CONSISTS OF STANDARD CHARACTERS WITHOUT CLAIM TO ANY PARTICULAR FONT, STYLE, SIZE, OR COLOR.

SER. NO. 77-244,909, FILED 8-1-2007.

CHRIS WELLS, EXAMINING ATTORNEY

Int. Cl.: 42

Prior U.S. Cls.: 100 and 101

United States Patent and Trademark Office

Reg. No. 3,475,123

Registered July 29, 2008

**SERVICE MARK
PRINCIPAL REGISTER**

Superior  Design

SDC INFORMATION SERVICES, INC. (NEW
YORK CORPORATION)
250 INTERNATIONAL DRIVE
WILLIAMSVILLE, NY 14221

FOR: PROVIDING OUTSOURCED COMPUTER-
AIDED DESIGN (CAD) AND DRAFTING SERVI-
CES, IN CLASS 42 (U.S. CLS. 100 AND 101).

FIRST USE 10-15-2006; IN COMMERCE 10-15-2006.

NO CLAIM IS MADE TO THE EXCLUSIVE
RIGHT TO USE 'DESIGN', APART FROM THE
MARK AS SHOWN.

THE MARK CONSISTS OF THE WORDS 'SUPER-
IOR DESIGN' WITH A FOUR-PART WOVEN CIR-
CLE SURROUNDING A CENTER DOT
FOLLOWING THE WORD 'SUPERIOR'.

SEC. 2(F) AS TO "SUPERIOR".

SER. NO. 77-245,026, FILED 8-2-2007.

JUSTINE D. PARKER, EXAMINING ATTORNEY

Int. Cl.: 35

Prior U.S. Cls.: 100, 101 and 102

United States Patent and Trademark Office

Reg. No. 3,475,124

Registered July 29, 2008

**SERVICE MARK
PRINCIPAL REGISTER**

Superior  Staff Resources

SDC INFORMATION SERVICES, INC. (NEW
YORK CORPORATION)
250 INTERNATIONAL DRIVE
WILLIAMSVILLE, NY 14221

FOR: TEMPORARY STAFFING SERVICES,
NAMELY, MANAGING AND SUPPLYING TEM-
PORARY AND DIRECT ADMINISTRATIVE, CLE-
RICAL, ACCOUNTING, CUSTOMER SERVICE,
MARKETING, AND LIGHT INDUSTRIAL TEM-
PORARY WORKERS, IN CLASS 35 (U.S. CLS. 100,
101 AND 102).

FIRST USE 10-15-2006; IN COMMERCE 10-15-2006.

NO CLAIM IS MADE TO THE EXCLUSIVE
RIGHT TO USE "STAFF RESOURCES", APART
FROM THE MARK AS SHOWN.

THE MARK CONSISTS OF THE WORDS "SUPER-
IOR STAFF RESOURCES" WITH A FOUR-PART
WOVEN CIRCLE SURROUNDING A CENTER DOT
FOLLOWING THE WORD "SUPERIOR".

SEC. 2(F) AS TO "SUPERIOR".

SER. NO. 77-245,071, FILED 8-2-2007.

ALEXANDER L. POWERS, EXAMINING ATTOR-
NEY

Int. Cl.: 3

Prior U.S. Cls.: 1, 4, 6, 50, 51 and 52

United States Patent and Trademark Office

Reg. No. 3,475,125

Registered July 29, 2008

**TRADEMARK
PRINCIPAL REGISTER**

PHYTOLUMIERE

CASTER (FRANCE CORPORATION)

35, AVENUE FRANKLIN ROOSEVELT

75008 PARIS, FRANCE

FOR: NON MEDICAL COSMETIC PREPARATIONS FOR CARE, BEAUTY AND EMBELLISHMENT OF THE HAIR, NAMELY, SHAMPOOS, HAIR LOTIONS, HAIR WAVING LOTIONS, IN CLASS 3 (U.S. CLS. 1, 4, 6, 50, 51 AND 52).

THE MARK CONSISTS OF STANDARD CHARACTERS WITHOUT CLAIM TO ANY PARTICULAR FONT, STYLE, SIZE, OR COLOR.

PRIORITY CLAIMED UNDER SEC. 44(D) ON FRANCE APPLICATION NO. 073480637, FILED 2-7-2007, REG. NO. 073480637, DATED 2-7-2007, EXPIRES 2-7-2017.

SER. NO. 77-245,176, FILED 8-2-2007.

G. MAYERSCHOFF, EXAMINING ATTORNEY

Int. Cl.: 28

Prior U.S. Cls.: 22, 23, 38 and 50

United States Patent and Trademark Office

Reg. No. 3,475,126

Registered July 29, 2008

**TRADEMARK
PRINCIPAL REGISTER**

RESORT

MATTEL, INC. (DELAWARE CORPORATION)
M1-1518
333 CONTINENTAL BLVD.
EL SEGUNDO, CA 90245

THE MARK CONSISTS OF STANDARD CHAR-
ACTERS WITHOUT CLAIM TO ANY PARTICULAR
FONT, STYLE, SIZE, OR COLOR.

FOR: TOYS, GAMES AND PLAYTHINGS, NAME-
LY, DOLLS, DOLL CLOTHING AND DOLL ACCES-
SORIES, TOY FIGURES AND ACCESSORIES
THEREFOR, IN CLASS 28 (U.S. CLS. 22, 23, 38 AND
50).

OWNER OF U.S. REG. NO. 3,080,463.

SER. NO. 77-245,187, FILED 8-2-2007.

FIRST USE 3-26-2008; IN COMMERCE 3-26-2008.

JEAN IM, EXAMINING ATTORNEY

Int. Cl.: 35

Prior U.S. Cls.: 100, 101 and 102

United States Patent and Trademark Office

Reg. No. 3,475,127

Registered July 29, 2008

SERVICE MARK
PRINCIPAL REGISTER

Visibles

VISIBLES INC (MICHIGAN CORPORATION)
35886 CASTLEMEADOW DRIVE
FARMINGTON HILLS, MI 48335

FOR: ADVERTISING AGENCIES; ADVERTISING AGENCIES, NAMELY, PROMOTING THE GOODS AND SERVICES OF OTHERS; ADVERTISING AND MARKETING; ADVERTISING FLYER DISTRIBUTION; ADVERTISING PARTICULARLY SERVICES FOR THE PROMOTION OF GOODS; ADVERTISING SERVICES; ADVERTISING SERVICES, NAMELY, CREATING CORPORATE AND BRAND IDENTITY FOR OTHERS; ADVERTISING SERVICES, NAMELY, CREATING CORPORATE LOGOS FOR OTHERS; ADVERTISING SERVICES, NAMELY, PROMOTING AND MARKETING THE GOODS AND SERVICES OF OTHERS THROUGH ALL PUBLIC COMMUNICATION MEANS; ADVERTISING THROUGH ALL PUBLIC COMMUNICATION MEANS; ADVERTISING, INCLUDING PROMOTION RELATING TO THE SALE OF ARTICLES AND SERVICES FOR THIRD PARTIES BY THE TRANSMISSION OF ADVERTISING MATERIAL AND THE DISSEMINATION OF ADVERTISING MESSAGES ON COMPUTER NETWORKS; CREATING AND UPDATING ADVERTISING MATERIAL; CUSTOMER LOYALTY SERVICES AND CUSTOMER CLUB SERVICES, FOR COMMERCIAL, PROMOTIONAL AND/OR ADVERTISING PURPOSES; DESIGN OF ADVERTISING MATERIALS FOR

OTHERS; DESIGN OF INTERNET ADVERTISING; DIRECT MAIL ADVERTISING; DIRECT MARKETING ADVERTISING FOR OTHERS; DISPLAYING ADVERTISEMENTS FOR OTHERS; DISSEMINATION OF ADVERTISEMENTS AND OF ADVERTISING MATERIAL; DISSEMINATION OF ADVERTISING MATERIAL; DISTRIBUTION OF ADVERTISING MAIL AND OF ADVERTISING SUPPLEMENTS ATTACHED TO REGULAR EDITIONS; DISTRIBUTION OF PRODUCTS FOR ADVERTISING PURPOSES; LAYOUT SERVICES FOR ADVERTISING PURPOSES; PROMOTING THE GOODS AND SERVICES OF OTHERS BY DISTRIBUTING ADVERTISING MATERIALS THROUGH A VARIETY OF METHODS; PROVIDING ADVERTISING SERVICES USING 3D AND ANIMATION DESIGNS, IN CLASS 35 (U.S. CLS. 100, 101 AND 102).

FIRST USE 2-0-1993; IN COMMERCE 2-0-1993.

THE MARK CONSISTS OF STANDARD CHARACTERS WITHOUT CLAIM TO ANY PARTICULAR FONT, STYLE, SIZE, OR COLOR.

SEC. 2(F).

SER. NO. 77-245,253, FILED 8-2-2007.

REBECCA SMITH, EXAMINING ATTORNEY

Int. Cls.: 16 and 35

Prior U.S. Cls.: 2, 5, 22, 23, 29, 37, 38, 50, 100, 101 and 102

Reg. No. 3,475,128

United States Patent and Trademark Office

Registered July 29, 2008

**TRADEMARK
SERVICE MARK
PRINCIPAL REGISTER**



TESSCO COMMUNICATIONS INCORPORATED
(DELAWARE CORPORATION)
11126 MCCORMICK ROAD
HUNT VALLEY, MD 210311494

FOR: JOURNALS, CATALOGS AND NEWSLETTERS PUBLISHED PERIODICALLY FEATURING SUBJECT MATTER IN THE COMMUNICATION FIELD, IN CLASS 16 (U.S. CLS. 2, 5, 22, 23, 29, 37, 38 AND 50).

FIRST USE 1-0-2007; IN COMMERCE 1-0-2007.

FOR: WHOLESALE AND RETAIL DISTRIBUTORSHIPS IN THE FIELD OF TELECOMMUNICATIONS; AND BUSINESS CONSULTING SERVICES RELATING TO SUPPLY CHAIN SOLUTIONS TO THE PROFESSIONALS THAT DESIGN, BUILD, RUN, USE AND MAINTAIN WIRELESS VOICE, DATA, MESSAGING, LOCATION TRACKING

AND INTERNET SYSTEMS, IN CLASS 35 (U.S. CLS. 100, 101 AND 102).

FIRST USE 1-0-2007; IN COMMERCE 1-0-2007.

OWNER OF U.S. REG. NOS. 1,664,567, 1,752,510, AND 1,825,093.

THE COLOR(S) RED AND WHITE IS/ARE CLAIMED AS A FEATURE OF THE MARK.

THE MARK CONSISTS OF A RED BOX AND THE WORDING "YOUR TOTAL SOURCE" IN WHITE.

SEC. 2(F).

SER. NO. 77-245,285, FILED 8-2-2007.

LYDIA BELZER, EXAMINING ATTORNEY

Int. Cl.: 25

Prior U.S. Cls.: 22 and 39

United States Patent and Trademark Office

Reg. No. 3,475,129

Registered July 29, 2008

**TRADEMARK
PRINCIPAL REGISTER**

STUDIT-OUT

MELVIN GUILLORY (UNITED STATES INDIVIDUAL)
11916 BISSONNET
HOUSTON, TX 77099

FOR: T-SHIRTS, SHIRTS, JACKETS, HATS AND
BASEBALL CAPS, IN CLASS 25 (U.S. CLS. 22 AND
39).

FIRST USE 3-1-2007; IN COMMERCE 3-1-2007.

THE MARK CONSISTS OF " STUDIT-OUT".

SER. NO. 77-245,608, FILED 8-2-2007.

MARK T. MULLEN, EXAMINING ATTORNEY

Int. Cl.: 19

Prior U.S. Cls.: 1, 12, 33 and 50

United States Patent and Trademark Office

Reg. No. 3,475,130

Registered July 29, 2008

**TRADEMARK
PRINCIPAL REGISTER**

FOUR CORNERS MATERIALS

OLDCASTLE SW GROUP, INC. (COLORADO CORPORATION), DBA FOUR CORNERS MATERIALS
P.O. BOX 1969
BAYFIELD, CO 81122

FOR: BUILDING MATERIALS, NAMELY, ASPHALT, SAND, GRAVEL, CONCRETE, CEMENT MIXES, AGGREGATE ROAD BASE MATERIALS COMPOSED OF A COMBINATION OF SAND AND GRAVEL, RIPRAP, NATURAL STONE, FIELD STONE, QUARRY STONE, DECORATIVE ROCK; ROCK FOR USE IN CONNECTION WITH CONSTRUCTION, MIXING, LANDSCAPING, SAND, GRAVEL AND CONCRETE, IN CLASS 19 (U.S. CLS. 1, 12, 33 AND 50).

FIRST USE 1-1-1999; IN COMMERCE 3-10-1999.

THE MARK CONSISTS OF STANDARD CHARACTERS WITHOUT CLAIM TO ANY PARTICULAR FONT, STYLE, SIZE, OR COLOR.

NO CLAIM IS MADE TO THE EXCLUSIVE RIGHT TO USE "MATERIALS", APART FROM THE MARK AS SHOWN.

SER. NO. 77-245,627, FILED 8-2-2007.

AMOS T. MATTHEWS, JR., EXAMINING ATTORNEY

Int. Cl.: 39

Prior U.S. Cls.: 100 and 105

United States Patent and Trademark Office

Reg. No. 3,475,131

Registered July 29, 2008

**SERVICE MARK
PRINCIPAL REGISTER**

FOUR CORNERS MATERIALS

OLDCASTLE SW GROUP, INC. (COLORADO CORPORATION), DBA FOUR CORNERS MATERIALS
P.O. BOX 1969
BAYFIELD, CO 81122

FOR: DELIVERY OF ASPHALT, SAND, GRAVEL, CONCRETE, CEMENT MIXES, AGGREGATE, TOP SOIL, RIPRAP, FILL DIRT, NATURAL STONE, FIELD STONE, QUARRY STONE, DECORATIVE ROCK, ROCK FOR USE IN CONNECTION WITH CONSTRUCTION, MIXING, IN CLASS 39 (U.S. CLS. 100 AND 105).

FIRST USE 1-1-1999; IN COMMERCE 3-10-1999.

THE MARK CONSISTS OF STANDARD CHARACTERS WITHOUT CLAIM TO ANY PARTICULAR FONT, STYLE, SIZE, OR COLOR.

NO CLAIM IS MADE TO THE EXCLUSIVE RIGHT TO USE "MATERIALS", APART FROM THE MARK AS SHOWN.

SER. NO. 77-245,632, FILED 8-2-2007.

AMOS T. MATTHEWS, JR., EXAMINING ATTORNEY

Int. Cl.: 35

Prior U.S. Cls.: 100, 101 and 102

United States Patent and Trademark Office

Reg. No. 3,475,132

Registered July 29, 2008

**SERVICE MARK
PRINCIPAL REGISTER**

INTELLIGENT SATURATION

CAMPBELL AUTOMOTIVE MARKETING, INC.
(SOUTH CAROLINA CORPORATION)
510 SUNSET DRIVE
CLOVER, SC 29710

FOR: MARKETING AND PROMOTION SERVICES FOR TARGETING PROSPECTIVE CUSTOMERS FOR AUTOMOBILE DEALERS, IN CLASS 35 (U.S. CLS. 100, 101 AND 102).

FIRST USE 7-17-2007; IN COMMERCE 7-17-2007.

THE MARK CONSISTS OF STANDARD CHARACTERS WITHOUT CLAIM TO ANY PARTICULAR FONT, STYLE, SIZE, OR COLOR.

NO CLAIM IS MADE TO THE EXCLUSIVE RIGHT TO USE "SATURATION", APART FROM THE MARK AS SHOWN.

SER. NO. 77-246,404, FILED 8-3-2007.

DAVID COLLIER, EXAMINING ATTORNEY

Int. Cl.: 20

Prior U.S. Cls.: 2, 13, 22, 25, 32 and 50

United States Patent and Trademark Office

Reg. No. 3,475,133

Registered July 29, 2008

TRADEMARK
PRINCIPAL REGISTER



Crates of Distinction

WARD, JEFFREY J. (VIRGINIA SOLE PROPRIETORSHIP)

2444 HILLSBORO QUAY

VIRGINIA BEACH, VA 23456 AND

MARY ANN WARD (VIRGINIA SOLE PROPRIETORSHIP)

2444 HILLSBORO QUAY

VIRGINIA BEACH, VA 23456

NO CLAIM IS MADE TO THE EXCLUSIVE RIGHT TO USE "CRATES", APART FROM THE MARK AS SHOWN.

THE MARK CONSISTS OF A STYLIZED PROFILE OF A GORDON SETTER DOG.

FOR: PET CRATES, IN CLASS 20 (U.S. CLS. 2, 13, 22, 25, 32 AND 50).

SER. NO. 77-247,267, FILED 8-4-2007.

FIRST USE 8-2-2007; IN COMMERCE 8-2-2007.

JENNY PARK, EXAMINING ATTORNEY

Int. Cls.: 35 and 40

Prior U.S. Cls.: 100, 101, 102, 103 and 106

United States Patent and Trademark Office

Reg. No. 3,475,134

Registered July 29, 2008

**SERVICE MARK
PRINCIPAL REGISTER**



IMAGES LLC (MARYLAND LTD LIAB CO)
10501 RHODE ISLAND AVENUE
BELTSVILLE, MD 20705

FOR: MAIL ORDER SERVICES FOR PHOTOGRAPHIC FILM PROCESSING, DEVELOPING, PRINTING AND ENLARGEMENT, IN CLASS 35 (U.S. CLS. 100, 101 AND 102).

FIRST USE 4-0-2003; IN COMMERCE 4-0-2003.

FOR: PHOTOGRAPHIC AND IMAGE PROCESSING SERVICES, NAMELY, DEVELOPING, REPRINTING AND MODIFYING IMAGES; TRANSFERRING PHOTOGRAPHIC AND DIGITAL IMAGES FROM PHOTOGRAPHIC NEGATIVES

AND UPLOADED DIGITAL IMAGES TO IMPRINTABLE SURFACES, IN CLASS 40 (U.S. CLS. 100, 103 AND 106).

FIRST USE 4-0-2003; IN COMMERCE 4-0-2003.

OWNER OF U.S. REG. NOS. 1,087,466 AND 2,086,321.

NO CLAIM IS MADE TO THE EXCLUSIVE RIGHT TO USE "COLOR LAB", APART FROM THE MARK AS SHOWN.

SER. NO. 77-248,259, FILED 8-6-2007.

DARRYL SPRUILL, EXAMINING ATTORNEY

Int. Cl.: 3

Prior U.S. Cls.: 1, 4, 6, 50, 51 and 52

United States Patent and Trademark Office

Reg. No. 3,475,135

Registered July 29, 2008

**TRADEMARK
PRINCIPAL REGISTER**



LACY, JARVIS M. (UNITED STATES INDIVIDUAL)
2707 SCARBOROUGH DRIVE
GRAND PRAIRIE, TX 75052

FOR: BATH SALTS, IN CLASS 3 (U.S. CLS. 1, 4, 6, 50, 51 AND 52).

FIRST USE 7-18-2007; IN COMMERCE 7-18-2007.

NO CLAIM IS MADE TO THE EXCLUSIVE RIGHT TO USE "VITAMIN C BATH SALTS", APART FROM THE MARK AS SHOWN.

THE COLOR(S) ROYAL BLUE, CYAN, BLACK, WHITE, AND GRAY IS/ARE CLAIMED AS A FEATURE OF THE MARK.

THE MARK CONSISTS OF "VITASEASALT". THE TERM "VITA" AND "SALT" ARE IN ROYAL BLUE. THE TERM "SEA" IS IN CYAN. THE WORDING "VITAMIN C BATH SALTS" CONSISTS OF THE COLOR BLACK, THE SOAP BUBBLES AND THEIR SHADOWS CONSIST OF VARIOUS SHADES OF GRAY WITH HIGHLIGHTS CONSISTING OF WHITE, GRAY, AND BLACK, WHITE APPEARS IN THE BACKGROUND OF THE MARK.

SER. NO. 77-248,404, FILED 8-6-2007.

MONIQUE MILLER, EXAMINING ATTORNEY

Prior U.S. Cl.: A

United States Patent and Trademark Office

Reg. No. 3,475,136

Registered July 29, 2008

CERTIFICATION MARK
PRINCIPAL REGISTER



SAN DIEGO COUNTY FARM BUREAU (CALIFORNIA CORPORATION)
1670 EAST VALLEY PARKWAY
ESCONDIDO, CA 92027

FOR: LIVE PLANTS; FRESH FRUITS; FRESH VEGETABLES, IN CLASS A (U.S. CL. A).

FIRST USE 8-9-2004; IN COMMERCE 8-9-2004.

THE COLOR(S) RED AND WHITE IS/ARE CLAIMED AS A FEATURE OF THE MARK.

THE MARK CONSISTS OF A RED CIRCLE WITH A SAWTOOTH EDGE THAT CONTAINS A WHITE

HALF SUN BENEATH A WHITE NUMERAL "365" AND THE PHRASE "SAN DIEGO GROWN" IN WHITE LETTERING AROUND THE INSIDE LEFT AND TOP OF THE RED CIRCLE .

THE CERTIFICATION MARK, AS USED BY AUTHORIZED PERSONS, CERTIFIES ORIGIN OF THE GOODS FROM THE SAN DIEGO COUNTY, CALIFORNIA, GEOGRAPHIC REGION

SER. NO. 77-248,885, FILED 8-7-2007.

KIMBERLY FRYE, EXAMINING ATTORNEY

Int. Cls.: 35, 36, 37, 41 and 45

Prior U.S. Cls.: 100, 101, 102, 103, 106 and 107

United States Patent and Trademark Office

Reg. No. 3,475,137

Registered July 29, 2008

**SERVICE MARK
PRINCIPAL REGISTER**

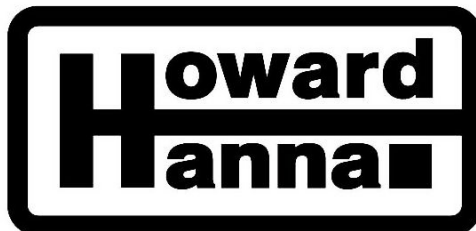

HANNA HOLDINGS, INC. (PENNSYLVANIA CORPORATION)
119 GAMMA DRIVE
PITTSBURGH, PA 15238

FOR: RELOCATION SERVICES, NAMELY, PLANNING AND IMPLEMENTING MOVES OF HOMES, IN CLASS 35 (U.S. CLS. 100, 101 AND 102).

FIRST USE 12-31-1983; IN COMMERCE 12-31-1983.

FOR: FINANCIAL SERVICES, NAMELY, MORTGAGE LENDING AND INSURANCE BROKERAGE IN THE FIELD OF HOMEOWNERS, FLOOD COVERAGE, VACANT HOMES, MINE SUBSIDENCE, SCHEDULED PERSONAL VALUABLE ITEMS, AUTO, WATERCRAFT, RECREATION VEHICLES, LIFE, DISABILITY, HEALTH, MORTGAGE PROTECTION, COMMERCIAL AND BUSINESS INTERRUPTION INSURANCES AS WELL AS PERSONAL AND BUSINESS LIABILITY UMBRELLAS; MORTGAGE LENDING; REAL ESTATE SERVICES, NAMELY, BROKERAGE, APPRAISAL AND MANAGEMENT, IN CLASS 36 (U.S. CLS. 100, 101 AND 102).

FIRST USE 12-31-1983; IN COMMERCE 12-31-1983.

FOR: LAND DEVELOPMENT SERVICES, NAMELY, PLANNING, LAYING OUT AND CONSTRUCTION MANAGEMENT FOR PROPERTY OWNERS AND DEVELOPERS, IN CLASS 37 (U.S. CLS. 100, 103 AND 106).

FIRST USE 12-31-1983; IN COMMERCE 12-31-1983.

FOR: EDUCATIONAL SERVICES, NAMELY, CONDUCTING CLASSES, SEMINARS, CONFERENCES, AND WORKSHOPS IN THE FIELD OF REAL ESTATE BROKERAGE, REAL ESTATE APPRAISAL, AND REAL ESTATE MANAGEMENT, IN CLASS 41 (U.S. CLS. 100, 101 AND 107).

FIRST USE 12-31-1983; IN COMMERCE 12-31-1983.

FOR: REAL ESTATE CLOSING SERVICES; TITLE SEARCHING, IN CLASS 45 (U.S. CLS. 100 AND 101).

FIRST USE 12-31-1983; IN COMMERCE 12-31-1983.

OWNER OF U.S. REG. NOS. 2,381,125 AND 2,531,196.

THE NAME "HOWARD HANNA" IDENTIFIES A LIVING INDIVIDUAL WHOSE CONSENT IS OF RECORD.

THE MARK CONSISTS OF THE LETTER "H" ON THE INSIDE LEFT CENTER OF A RECTANGLE OUTLINE; AN EXTENDED LINE FROM THE LETTER "H" SEPARATES THE LETTERING "OWARD" (ABOVE THE EXTENDED LINE) AND "ANNA" (BELOW THE EXTENDED LINE) CAUSING THE "H" TO APPEAR AS THOUGH IT IS THE FIRST LETTER OF BOTH WORDS, NAMELY, APPEARING AS "HOWARD HANNA".

SER. NO. 77-249,005, FILED 8-7-2007.

TRICIA SONNEBORN, EXAMINING ATTORNEY

Int. Cls.: 35 and 37

Prior U.S. Cls.: 100, 101, 102, 103 and 106

United States Patent and Trademark Office

Reg. No. 3,475,138

Registered July 29, 2008

**SERVICE MARK
PRINCIPAL REGISTER**



AUDIO VIDEO WORLD

AUDIO VIDEO WORLD, LLC (NEW YORK LTD
LIAB CO)
136 FIRST STREET
NANUET, NY 10954

FOR: DISTRIBUTORSHIP SERVICES IN THE
FIELD OF AUDIO AND VIDEO SYSTEMS, EQUIP-
MENT AND ACCESSORIES, IN CLASS 35 (U.S. CLS.
100, 101 AND 102).

FIRST USE 6-1-2006; IN COMMERCE 6-1-2006.

FOR: INSTALLATION OF RESIDENTIAL AND
COMMERCIAL AUDIO AND VIDEO SYSTEMS,
EQUIPMENT AND ACCESSORIES, IN CLASS 37
(U.S. CLS. 100, 103 AND 106).

FIRST USE 6-1-2006; IN COMMERCE 6-1-2006.

NO CLAIM IS MADE TO THE EXCLUSIVE
RIGHT TO USE "AUDIO VIDEO", APART FROM
THE MARK AS SHOWN.

THE MARK CONSISTS OF THE LITERAL ELE-
MENT "AUDIO VIDEO WORLD" WITH STYLIZED
LETTERS "AV".

SER. NO. 77-249,258, FILED 8-7-2007.

JANICE L. MCMORROW, EXAMINING ATTOR-
NEY

Int. Cl.: 9

Prior U.S. Cls.: 21, 23, 26, 36 and 38

Reg. No. 3,475,139

United States Patent and Trademark Office

Registered July 29, 2008

**TRADEMARK
PRINCIPAL REGISTER**

MENACE AUDIO

HOUSE OF DEALS OF PHILADELPHIA, INC.
(PENNSYLVANIA CORPORATION)
309 CAMER DRIVE, UNIT 7
BENSALEM, PA 19020

FOR: AUDIO EQUIPMENT, NAMELY, LOUD-SPEAKERS, TWEETERS, WOOFERS, SUBWOOFERS, CD CASES, SPEAKER ENCLOSURES; CABINETS SPECIALLY ADAPTED FOR DJ SPEAKERS COMPRISING DJ RACKS AND DJ BOXES; SPEAKER HORNS; AMPLIFIER KITS COMPRISING AUDIO CABLE AND CONNECTORS, IN CLASS 9 (U.S. CLS. 21, 23, 26, 36 AND 38).

FIRST USE 12-16-2004; IN COMMERCE 12-16-2004.

THE MARK CONSISTS OF STANDARD CHARACTERS WITHOUT CLAIM TO ANY PARTICULAR FONT, STYLE, SIZE, OR COLOR.

NO CLAIM IS MADE TO THE EXCLUSIVE RIGHT TO USE "AUDIO", APART FROM THE MARK AS SHOWN.

SER. NO. 77-249,719, FILED 8-8-2007.

JULIE GUTTADAURO, EXAMINING ATTORNEY

Int. Cl.: 41

Prior U.S. Cls.: 100, 101 and 107

United States Patent and Trademark Office

Reg. No. 3,475,140

Registered July 29, 2008

**SERVICE MARK
PRINCIPAL REGISTER**

AZ PROMISED

HAYES, RAYSHAWN (UNITED STATES INDIVIDUAL)

475 EAST 127

CLEVELAND, OH 44108 AND

NAIM, TAJUAN (UNITED STATES INDIVIDUAL)

475 EAST 127

CLEVELAND, OH 44108 AND

HAYES, DONALD (UNITED STATES INDIVIDUAL)

475 EAST 127

CLEVELAND, OH 44108

FOR: COMPOSITION OF MUSIC FOR OTHERS; ENTERTAINMENT IN THE NATURE OF VISUAL AND AUDIO PERFORMANCES, NAMELY, MUSICAL BAND, ROCK GROUP, GYMNASTIC, DANCE, AND BALLET PERFORMANCES; ENTERTAINMENT, NAMELY, LIVE PERFORMANCES BY A MUSICAL BAND; ENTERTAINMENT, NAMELY, LIVE MUSIC CONCERTS; ENTERTAINMENT, NAMELY, LIVE PERFORMANCES BY MUSICAL BANDS; MUSIC COMPOSITION AND TRANSCRIPTION FOR OTHERS; MUSIC COMPOSITION FOR OTHERS; MUSIC PRODUCTION SERVICES; MUSIC

PUBLISHING SERVICES; PRESENTATION OF MUSICAL PERFORMANCE; PRODUCTION OF SOUND AND MUSIC VIDEO RECORDINGS; ENTERTAINMENT SERVICES, NAMELY, PROVIDING A WEB SITE FEATURING MUSICAL PERFORMANCES, MUSICAL VIDEOS, RELATED FILM CLIPS, PHOTOGRAPHS, AND OTHER MULTIMEDIA MATERIALS; PLANNING ARRANGEMENT OF SHOWING MOVIES, SHOWS, PLAYS OR MUSICAL PERFORMANCES; ENTERTAINMENT, NAMELY, LIVE PERFORMANCES BY ROCK GROUPS, IN CLASS 41 (U.S. CLS. 100, 101 AND 107).

FIRST USE 1-1-2005; IN COMMERCE 1-1-2005.

THE MARK CONSISTS OF STANDARD CHARACTERS WITHOUT CLAIM TO ANY PARTICULAR FONT, STYLE, SIZE, OR COLOR.

SER. NO. 77-249,814, FILED 8-8-2007.

KIMBERLY PERRY, EXAMINING ATTORNEY

Int. Cl.: 25

Prior U.S. Cls.: 22 and 39

United States Patent and Trademark Office

Reg. No. 3,475,141

Registered July 29, 2008

**TRADEMARK
PRINCIPAL REGISTER**

CHRIST JESUS GENES

BAGBY PROMOTIONS, INC. (MARYLAND CORPORATION)
5 PUTTING WAY
REISTERSTOWN, MD 21136

THE MARK CONSISTS OF STANDARD CHARACTERS WITHOUT CLAIM TO ANY PARTICULAR FONT, STYLE, SIZE, OR COLOR.

FOR: CLOTHING, NAMELY, JEANS, JACKETS, HATS, SHIRTS, T-SHIRTS, SHOES, SOCKS, IN CLASS 25 (U.S. CLS. 22 AND 39).

SER. NO. 77-250,385, FILED 8-8-2007.

FIRST USE 8-0-2001; IN COMMERCE 8-0-2001.

SUE LAWRENCE, EXAMINING ATTORNEY

Int. Cl.: 9

Prior U.S. Cls.: 21, 23, 26, 36 and 38

Reg. No. 3,475,142

United States Patent and Trademark Office

Registered July 29, 2008

**TRADEMARK
PRINCIPAL REGISTER**

EXAM STUDIO

ZOOMORPHIX SYSTEMS (AUSTRALIA COR-
PORATION)
SUITE 407, 737 BURWOOD ROAD
HAWTHORN, AUSTRALIA 3122

THE MARK CONSISTS OF STANDARD CHAR-
ACTERS WITHOUT CLAIM TO ANY PARTICULAR
FONT, STYLE, SIZE, OR COLOR.

FOR: DATABASE MANAGEMENT SOFTWARE
FOR COMPUTER BASED TESTING. COMPUTER
SOFTWARE FOR MANAGEMENT OF TESTING, IN
CLASS 9 (U.S. CLS. 21, 23, 26, 36 AND 38).

SER. NO. 77-250,728, FILED 8-8-2007.

FIRST USE 7-29-2006; IN COMMERCE 7-29-2006.

LINDA MICKLEBURGH, EXAMINING ATTORNEY

Int. Cls.: 35 and 42

Prior U.S. Cls.: 100, 101 and 102

United States Patent and Trademark Office

Reg. No. 3,475,143

Registered July 29, 2008

**SERVICE MARK
PRINCIPAL REGISTER**

METAJIVA

SOLUTIONSIQ, INC. (WASHINGTON CORPORATION)
SUITE 250
10785 WILLOWS ROAD NE
REDMOND, WA 98052

FOR: BUSINESS MANAGEMENT CONSULTATION IN THE FIELD OF EXECUTIVE AND LEADERSHIP DEVELOPMENT; BUSINESS SERVICES, NAMELY, PROCURING QUALIFIED AND CREDENTIALLED THIRD-PARTY EXPERTS, PROFESSIONALS AND OTHER QUALIFIED PERSONNEL, AND DOCUMENTATION AND INFORMATION ALL ON BEHALF OF OTHERS; CONSULTING SERVICES IN THE FIELD OF HUMAN RESOURCES DEVELOPMENT, NAMELY, FOR THE PROMOTION OF EMPLOYEE RETENTION, CAREER GROWTH, AND INCREASED PRODUCTIVITY FOR EMPLOYEES AND EMPLOYERS; EMPLOYMENT AGENCIES; EMPLOYMENT COUNSELING AND RECRUITING; EMPLOYMENT HIRING, RECRUITING, PLACEMENT, STAFFING AND CAREER NETWORKING SERVICES; PERSONNEL PLACEMENT AND RECRUITMENT; PROVIDING AN ON-LINE SEARCHABLE DATABASE FEATURING CLASSIFIED AD LISTINGS AND EMPLOY-

MENT OPPORTUNITIES; TESTING TO DETERMINE EMPLOYMENT SKILLS; CREATION OF MARKETING TOOLS DESIGNED TO INCREASE A CLIENT COMPANY'S KNOWLEDGE OF CUSTOMER NEEDS, AND ITS COMPETITORS' PRODUCTS AND SERVICES, PRICING, ADVERTISING STRATEGY AND SALES STRATEGY, IN CLASS 35 (U.S. CLS. 100, 101 AND 102).

FIRST USE 4-14-2001; IN COMMERCE 4-14-2001.

FOR: PROVIDING ON-LINE NON-DOWNLOADABLE SOFTWARE FOR TRACKING AND REPORTING PERSONNEL RECRUITING AND PLACEMENT, IN CLASS 42 (U.S. CLS. 100 AND 101).

FIRST USE 5-29-2005; IN COMMERCE 5-29-2005.

THE MARK CONSISTS OF STANDARD CHARACTERS WITHOUT CLAIM TO ANY PARTICULAR FONT, STYLE, SIZE, OR COLOR.

SER. NO. 77-250,878, FILED 8-9-2007.

RAMONA ORTIGA, EXAMINING ATTORNEY

Int. Cl.: 41

Prior U.S. Cls.: 100, 101 and 107

United States Patent and Trademark Office

Reg. No. 3,475,144

Registered July 29, 2008

**SERVICE MARK
PRINCIPAL REGISTER**



COGNIMED INC. (NEW JERSEY CORPORATION)
SUITE 200
70 SOUTH ORANGE AVENUE
LIVINGSTON, NJ 07039

FOR: EDUCATIONAL SERVICES, NAMELY, SEMINARS FOR HEALTH CARE PROVIDERS IN THE FIELD OF MEN'S HEALTH, IN CLASS 41 (U.S. CLS. 100, 101 AND 107).

FIRST USE 6-9-2007; IN COMMERCE 6-9-2007.

NO CLAIM IS MADE TO THE EXCLUSIVE RIGHT TO USE "TESTOSTERONE UPDATE" AND

"COLLABORATIVE FOR IMPROVED CLINICAL OUTCOMES IN HYPOGONADISM", APART FROM THE MARK AS SHOWN.

THE MARK CONSISTS OF THE LETTERS "TU" FOLLOWED BY THE WORDS "TESTOSTERONEUPDATE COLLABORATIVE FOR IMPROVED CLINICAL OUTCOMES IN HYPOGONADISM".

SER. NO. 77-252,260, FILED 8-10-2007.

EMILY CHUO, EXAMINING ATTORNEY

Int. Cl.: 3

Prior U.S. Cls.: 1, 4, 6, 50, 51 and 52

United States Patent and Trademark Office

Reg. No. 3,475,145

Registered July 29, 2008

**TRADEMARK
PRINCIPAL REGISTER**

PEACHES & CREME

KISS MY FACE CORPORATION (NEW YORK
CORPORATION)
144 MAIN STREET
GARDINER, NY 12525

THE MARK CONSISTS OF STANDARD CHAR-
ACTERS WITHOUT CLAIM TO ANY PARTICULAR
FONT, STYLE, SIZE, OR COLOR.

FOR: PERSONAL CARE PRODUCTS, NAMELY,
SKIN MOISTURIZERS AND SHAVING CREAMS
FOR FACE AND BODY, IN CLASS 3 (U.S. CLS. 1, 4,
6, 50, 51 AND 52).

SER. NO. 77-252,367, FILED 8-10-2007.

FIRST USE 12-29-1978; IN COMMERCE 12-29-1978.

YAT SYE, LEE, EXAMINING ATTORNEY

Int. Cls.: 12 and 20

**Prior U.S. Cls.: 2, 13, 19, 21, 22, 23, 25, 31, 32, 35, 44
and 50**

Reg. No. 3,475,146

United States Patent and Trademark Office

Registered July 29, 2008

**TRADEMARK
PRINCIPAL REGISTER**

RK EXCEL

RK EXCEL CO., LTD. (JAPAN CORPORATION)
611 ANTON BLVD., 14TH FLOOR
COSTA MESA, CA 92626

FIRST USE 0-0-1991; IN COMMERCE 0-0-1991.

FOR: MOTORCYCLE ACCESSORIES, NAMELY,
WHEEL RIMS, WHEEL HUBS, LIFT STANDS, TRI-
ANGLE STANDS, EXCLUDING TIRES, IN CLASS 12
(U.S. CLS. 19, 21, 23, 31, 35 AND 44).

THE MARK CONSISTS OF STANDARD CHAR-
ACTERS WITHOUT CLAIM TO ANY PARTICULAR
FONT, STYLE, SIZE, OR COLOR.

FIRST USE 0-0-1991; IN COMMERCE 0-0-1991.

SER. NO. 77-252,688, FILED 8-10-2007.

FOR: NON-METAL TOOL BOXES, IN CLASS 20
(U.S. CLS. 2, 13, 22, 25, 32 AND 50).

LEIGH CAROLINE CASE, EXAMINING ATTOR-
NEY

Int. Cl.: 12

Prior U.S. Cls.: 19, 21, 23, 31, 35 and 44

Reg. No. 3,475,147

United States Patent and Trademark Office

Registered July 29, 2008

**TRADEMARK
PRINCIPAL REGISTER**

RK

RK EXCEL CO., LTD. (JAPAN CORPORATION)
2645 VISTA PACIFIC DRIVE
OCEANSIDE, CA 92056

FOR: MOTORCYCLE ACCESSORIES, NAMELY,
MOTORCYCLE DRIVE CHAINS AND KITS COM-
PRISED OF MOTORCYCLE CHAINS AND SPROCK-
ETS, IN CLASS 12 (U.S. CLS. 19, 21, 23, 31, 35 AND 44).

FIRST USE 0-0-1981; IN COMMERCE 0-0-1981.

THE MARK CONSISTS OF STANDARD CHAR-
ACTERS WITHOUT CLAIM TO ANY PARTICULAR
FONT, STYLE, SIZE, OR COLOR.

OWNER OF U.S. REG. NO. 2,294,114.

SER. NO. 77-252,692, FILED 8-10-2007.

LEIGH CAROLINE CASE, EXAMINING ATTOR-
NEY

Int. Cl.: 12

Prior U.S. Cls.: 19, 21, 23, 31, 35 and 44

Reg. No. 3,475,148

United States Patent and Trademark Office

Registered July 29, 2008

**TRADEMARK
PRINCIPAL REGISTER**

TAKASAGO EXCEL

RK EXCEL CO., LTD. (JAPAN CORPORATION)
2645 VISTA PACIFIC DRIVE
OCEANSIDE, CA 92056

OWNER OF U.S. REG. NO. 2,294,114.

FOR: MOTORCYCLE ACCESSORIES, NAMELY,
WHEEL RIMS, WHEEL HUBS, LIFT STANDS, TRI-
ANGLE STANDS EXCLUDING TIRES, IN CLASS 12
(U.S. CLS. 19, 21, 23, 31, 35 AND 44).

THE FOREIGN WORDING IN THE MARK
TRANSLATES INTO ENGLISH AS CONGRATULA-
TIONS.

FIRST USE 0-0-1989; IN COMMERCE 0-0-1989.

SER. NO. 77-252,693, FILED 8-10-2007.

THE MARK CONSISTS OF STANDARD CHAR-
ACTERS WITHOUT CLAIM TO ANY PARTICULAR
FONT, STYLE, SIZE, OR COLOR.

LEIGH CAROLINE CASE, EXAMINING ATTOR-
NEY

Int. Cl.: 41

Prior U.S. Cls.: 100, 101 and 107

United States Patent and Trademark Office

Reg. No. 3,475,149

Registered July 29, 2008

**SERVICE MARK
PRINCIPAL REGISTER**



LUEDERS, KRISTIN (UNITED STATES INDIVIDUAL), DBA LIZ LUEDERS
957 HYPERION AVE.
1155 HACIENDA PL.
LOS ANGELES, CA 90029 AND
WOLDRICH, JENNIFER (UNITED STATES INDIVIDUAL)
957 HYPERION AVE.
1155 HACIENDA PLAPT. 209
LOS ANGELES, CA 90029

FOR: PRODUCTION AND DISTRIBUTION OF
TELEVISION SHOWS AND MOVIES, IN CLASS 41
(U.S. CLS. 100, 101 AND 107).

FIRST USE 6-30-2007; IN COMMERCE 8-1-2007.

NO CLAIM IS MADE TO THE EXCLUSIVE
RIGHT TO USE "PRODUCTIONS", APART FROM
THE MARK AS SHOWN.

THE MARK CONSISTS OF A STYLIZED STICK
FIGURE MAN, STANDING TO THE LEFT OF THE
WORD "WISCO", WHICH IS STACKED ON TOP OF
THE WORD "PRODUCTIONS".

THE WORDING "WISCO" HAS NO MEANING IN
A FOREIGN LANGUAGE.

SER. NO. 77-253,089, FILED 8-11-2007.

DAVID MILLER, EXAMINING ATTORNEY

Int. Cl.: 45

Prior U.S. Cls.: 100 and 101

United States Patent and Trademark Office

Reg. No. 3,475,150

Registered July 29, 2008

**SERVICE MARK
PRINCIPAL REGISTER**

Legally Wed

THE EDWARDS LAW PRACTICE LLC (NEW JERSEY LTD LIAB CO), DBA LEGALLY WED
16 SOUTH AVENUE WEST #228
CRANFORD, NJ 07016

FOR: LEGAL DOCUMENT PREPARATION AND RESEARCH SERVICES FOR ATTORNEYS; LEGAL SERVICES; LICENSING OF INTELLECTUAL PROPERTY; LICENSING OF LEGAL AND FAMILY PLANNING DOCUMENTS, AS WELL AS, PRODUCTS, NAMELY, SPORTING GOODS, FILM, MUSIC, CLOTHING, GIFTS, GAMES, PLAYING CARDS, STATIONERY, JOURNALS, AND PRINTED PUBLICATIONS, NAMELY, BOOKS, NEWSLETTERS, MAGAZINES, TELEVISION/BROADCAST SCRIPTS AND VIDEOS, FEATURING THE LEGAL ASPECTS OF PRE- AND POST-NUPTIAL SUBJECTS

RELATED TO BRIDAL SERVICES, ENGAGEMENT, WEDDING, HONEYMOON AND/OR SPECIAL EVENT PLANNING, AND MARITAL RELATIONSHIPS; MEDIATION; PROVIDING INFORMATION RELATING TO LEGAL AFFAIRS, IN CLASS 45 (U.S. CLS. 100 AND 101).

FIRST USE 11-12-2005; IN COMMERCE 11-12-2005.

THE MARK CONSISTS OF STANDARD CHARACTERS WITHOUT CLAIM TO ANY PARTICULAR FONT, STYLE, SIZE, OR COLOR.

SER. NO. 77-253,108, FILED 8-11-2007.

MICHAEL KAZAZIAN, EXAMINING ATTORNEY

Int. Cl.: 11

Prior U.S. Cls.: 13, 21, 23, 31 and 34

United States Patent and Trademark Office

Reg. No. 3,475,151

Registered July 29, 2008

**TRADEMARK
PRINCIPAL REGISTER**

relaxxtherm comfort

BSH BOSCH UND SIEMENS HAUSGERAETE
GMBH (FED REP GERMANY CORPORA-
TION)

CARL-WERY-STRASSE 34

MUNICH, FED REP GERMANY 81739

FOR: ELECTRIC HEATING PADS NOT FOR
MEDICAL PURPOSES AND REPLACEMENT
PARTS THEREFOR; ELECTRIC BLANKETS NOT
FOR MEDICAL PURPOSES AND REPLACEMENT
PARTS THEREFOR, IN CLASS 11 (U.S. CLS. 13, 21, 23,
31 AND 34).

THE MARK CONSISTS OF STANDARD CHAR-
ACTERS WITHOUT CLAIM TO ANY PARTICULAR
FONT, STYLE, SIZE, OR COLOR.

PRIORITY CLAIMED UNDER SEC. 44(D) ON FED
REP GERMANY APPLICATION NO. 30710443.5,
FILED 2-19-2007, REG. NO. 30710443, DATED 4-27-
2007, EXPIRES 2-28-2017.

SER. NO. 77-253,926, FILED 8-13-2007.

ESTHER A. BORSUK, EXAMINING ATTORNEY

Int. Cl.: 9

Prior U.S. Cls.: 21, 23, 26, 36 and 38

Reg. No. 3,475,152

United States Patent and Trademark Office

Registered July 29, 2008

**TRADEMARK
PRINCIPAL REGISTER**

GIOVANI DI VENEZIA

MODERN OPTICAL INTERNATIONAL, LTD.
(ILLINOIS CORPORATION)
585 CONGRESS CIRCLE NORTH
ROSELLE, IL 60172

FOR: EYEWEAR, NAMELY, SUNGLASSES, EYE-
GLASSES AND OPHTHALMIC FRAMES; AND CASES
THEREFOR, IN CLASS 9 (U.S. CLS. 21, 23, 26, 36 AND
38).

FIRST USE 12-0-1992; IN COMMERCE 12-0-1992.

THE MARK CONSISTS OF STANDARD CHAR-
ACTERS WITHOUT CLAIM TO ANY PARTICULAR
FONT, STYLE, SIZE, OR COLOR.

THE FOREIGN WORDING IN THE MARK
TRANSLATES INTO ENGLISH AS "YOUNG PEOP-
LE OF VENICE".

SER. NO. 77-254,377, FILED 8-14-2007.

JENNIFER MARTIN, EXAMINING ATTORNEY

Int. Cl.: 3

Prior U.S. Cls.: 1, 4, 6, 50, 51 and 52

Reg. No. 3,475,153

United States Patent and Trademark Office

Registered July 29, 2008

**TRADEMARK
PRINCIPAL REGISTER**

SKULL SHINE

GENERAL SALES AND SERVICE, INC. (MICHIGAN CORPORATION)
110 M-51 N. - P.O. BOX 185
DECATUR, MI 49045

THE MARK CONSISTS OF STANDARD CHARACTERS WITHOUT CLAIM TO ANY PARTICULAR FONT, STYLE, SIZE, OR COLOR.

FOR: AUTOMOTIVE CLEANING PREPARATIONS, NAMELY, MULTI-PURPOSE DEGREASERS, AUTOMOTIVE POLISH AND WAX, AUTOMOTIVE WIPE AND SHINE GLOSS, AUTOMOTIVE TIRE SHINE AND SEAL, AUTOMOTIVE WASH SOLUTIONS, AND AUTOMOTIVE PRE-WASH SOLUTIONS, IN CLASS 3 (U.S. CLS. 1, 4, 6, 50, 51 AND 52).

NO CLAIM IS MADE TO THE EXCLUSIVE RIGHT TO USE "SHINE", APART FROM THE MARK AS SHOWN.

SER. NO. 77-254,392, FILED 8-14-2007.

FIRST USE 6-30-2006; IN COMMERCE 6-30-2006.

DANNEAN HETZEL, EXAMINING ATTORNEY

Int. Cl.: 9

Prior U.S. Cls.: 21, 23, 26, 36 and 38

Reg. No. 3,475,154

United States Patent and Trademark Office

Registered July 29, 2008

**TRADEMARK
PRINCIPAL REGISTER**

ExecuKeys

INFORMEDIATE, INC. (OHIO CORPORATION)
2032 FRONT STREET
CUYAHOGA FALLS, OH 44221

FOR: COMPUTER SOFTWARE FOR PROVIDING AN ON-LINE DATABASE IN THE FIELD OF TRANSACTION PROCESSING TO UPLOAD TRANSACTIONAL DATA, PROVIDE STATISTICAL ANALYSIS, AND PRODUCE NOTIFICATIONS AND REPORTS; COMPUTER SOFTWARE FOR THE FIELD OF WAREHOUSING AND DISTRIBUTION, TO MANAGE TRANSACTIONAL DATA, PROVIDE STATISTICAL ANALYSIS, AND PRODUCE NOTI-

FICATIONS AND REPORTS, IN CLASS 9 (U.S. CLS. 21, 23, 26, 36 AND 38).

FIRST USE 1-1-2007; IN COMMERCE 1-1-2007.

THE MARK CONSISTS OF STANDARD CHARACTERS WITHOUT CLAIM TO ANY PARTICULAR FONT, STYLE, SIZE, OR COLOR.

SER. NO. 77-254,753, FILED 8-14-2007.

KATHERINE CONNOLLY, EXAMINING ATTORNEY

Int. Cl.: 41

Prior U.S. Cls.: 100, 101 and 107

United States Patent and Trademark Office

Reg. No. 3,475,155

Registered July 29, 2008

**SERVICE MARK
PRINCIPAL REGISTER**

D.A.W.G. MAN

GIBILISCO, MIKE (UNITED STATES INDIVIDUAL)
2005 TREE FORK LANE, STE 113
LONGWOOD, FL 32750

FOR: FILM DISTRIBUTION; MOTION PICTURE FILM PRODUCTION; MOTION PICTURE SONG PRODUCTION; PRODUCTION AND DISTRIBUTION OF INDEPENDENT MOTION PICTURES; PRODUCTION AND DISTRIBUTION OF MOTION PICTURES, IN CLASS 41 (U.S. CLS. 100, 101 AND 107).

FIRST USE 4-1-2007; IN COMMERCE 8-1-2007.

THE COLOR(S) ORANGE IS/ARE CLAIMED AS A FEATURE OF THE MARK.

THE MARK CONSISTS OF THE LITERAL ELEMENT OF THE MARK "D.A.W.G. MAN" IS IN BOLD CAPITALIZED ORANGE LETTERING.

SER. NO. 77-254,950, FILED 8-14-2007.

GENE MACIOL, EXAMINING ATTORNEY

Int. Cls.: 38 and 41

Prior U.S. Cls.: 100, 101, 104 and 107

United States Patent and Trademark Office

Reg. No. 3,475,156

Registered July 29, 2008

**SERVICE MARK
PRINCIPAL REGISTER**

THE BONES FAMILY

RODOLFO SEALTIEL RIVA PALACIO ALATRISTE (MEXICO INDIVIDUAL)
COLONIA DEL VALLE
LUZ SAVIÑON 513, PISO 2
MEXICO, D.F., MEXICO 03100 AND
GABRIEL ENRIQUE RIVA PALACIO ALATRISTE
(MEXICO INDIVIDUAL)
COLONIA DEL VALLE
LUZ SAVIÑON 513, PISO 2
MEXICO, D.F., MEXICO 03100

FOR: DATA TRANSMISSION AND RECEPTION SERVICES VIA TELECOMMUNICATION MEANS; PROVIDING ON-LINE COMMUNICATIONS LINKS WHICH TRANSFER THE WEBSITE USER TO OTHER LOCAL AND GLOBAL WEB PAGES; TRANSMISSION OF INFORMATION ON OPTICAL TELECOMMUNICATION NETWORKS; TRANSMISSION OF DATABASE INFORMATION VIA TELECOMMUNICATIONS NETWORKS; ELECTRONIC EXCHANGE OF DATA STORED IN DATABASES ACCESSIBLE VIA TELECOMMUNICATION NETWORKS; BROADCAST OF CABLE TELEVISION PROGRAMMES , IN CLASS 38 (U.S. CLS. 100, 101 AND 104).

FOR: (BASED ON 44(D) PRIORITY APPLICATION) ENTERTAINMENT IN THE NATURE OF ON-GOING TELEVISION PROGRAMS IN THE FIELD OF CARTOON SHOWS; ENTERTAINMENT NAMELY, PRODUCTION OF TELEVISION CAR-

TOON SHOWS; ENTERTAINMENT, NAMELY A CONTINUING CARTOON SHOW BROADCAST OVER TELEVISION, SATELLITE, AUDIO, AND VIDEO MEDIA; TELEVISION PRODUCTION; ANIMATION PRODUCTION SERVICES; DIRECTION OF MAKING RADIO OR TELEVISION PROGRAMS; PRODUCTION OF CABLE TELEVISION PROGRAMS; PRODUCTION OF CLOSED CAPTION TELEVISION PROGRAMS; PROVISION OF NON-DOWNLOADABLE FILMS AND TV PROGRAMMES VIA A VIDEO-ON-DEMAND SERVICE; PRODUCTION AND DISTRIBUTION OF MOTION PICTURES; ENTERTAINMENT IN THE NATURE OF TELEVISION PROGRAMS FEATURING CARTOON SHOWS, IN CLASS 41 (U.S. CLS. 100, 101 AND 107).

THE MARK CONSISTS OF STANDARD CHARACTERS WITHOUT CLAIM TO ANY PARTICULAR FONT, STYLE, SIZE, OR COLOR.

OWNER OF MEXICO REG. NO. 1003839, DATED 9-25-2007, EXPIRES 8-10-2017.

OWNER OF MEXICO REG. NO. 1003838, DATED 9-25-2007, EXPIRES 8-10-2017.

SER. NO. 77-255,079, FILED 8-14-2007.

HEATHER THOMPSON, EXAMINING ATTORNEY

Int. Cl.: 8

Prior U.S. Cls.: 23, 28 and 44

United States Patent and Trademark Office

Reg. No. 3,475,157

Registered July 29, 2008

**TRADEMARK
PRINCIPAL REGISTER**

ULTRAGRIP

THE GILLETTE COMPANY (DELAWARE COR-
PORATION)
PRUDENTIAL TOWER BUILDING
BOSTON, MA 02199

FOR: HANDLES SOLD AS A COMPONENT OF
DISPOSABLE RAZORS, IN CLASS 8 (U.S. CLS. 23, 28
AND 44).

FIRST USE 4-30-2000; IN COMMERCE 4-30-2000.

THE MARK CONSISTS OF STANDARD CHAR-
ACTERS WITHOUT CLAIM TO ANY PARTICULAR
FONT, STYLE, SIZE, OR COLOR.

OWNER OF U.S. REG. NO. 2,419,888.

SER. NO. 77-255,452, FILED 8-15-2007.

KATHY DE JONGE, EXAMINING ATTORNEY

Int. Cl.: 16

Prior U.S. Cls.: 2, 5, 22, 23, 29, 37, 38 and 50

United States Patent and Trademark Office

Reg. No. 3,475,158

Registered July 29, 2008

**TRADEMARK
PRINCIPAL REGISTER**

VISUAL VOYAGE

UNIVERSAL MAP ENTERPRISES, INC. (MICHIGAN CORPORATION)
795 PROGRESS COURT
WILLIAMSTOWN, MI 48895

FOR: ATLASES; MAPS; PLACE MATS OF PAPER,
IN CLASS 16 (U.S. CLS. 2, 5, 22, 23, 29, 37, 38 AND 50).

FIRST USE 8-25-1995; IN COMMERCE 8-25-1995.

THE MARK CONSISTS OF STANDARD CHARACTERS WITHOUT CLAIM TO ANY PARTICULAR FONT, STYLE, SIZE, OR COLOR.

OWNER OF U.S. REG. NO. 2,072,460.

SER. NO. 77-255,472, FILED 8-15-2007.

ELIZABETH HUGHITT, EXAMINING ATTORNEY

Int. Cl.: 21

Prior U.S. Cls.: 2, 13, 23, 29, 30, 33, 40 and 50

United States Patent and Trademark Office

Reg. No. 3,475,159

Registered July 29, 2008

TRADEMARK
PRINCIPAL REGISTER



RONG, ZHENG QIU (CHINA INDIVIDUAL)
FENGXI ZONE
CANGLONG CHETOU AREA
CHAOZHOU GUANGDONG, CHINA

FOR: PLATES, BOWLS, MUGS, CUPS, SAUCERS, TEA POTS, CREAM POTS, SERVING AND MIXING SPOONS, BASTING SPOONS AND RICE SPOONS, SALT AND PEPPER SHAKERS, SERVING DISHES, BAKE WARE, PIE PLATES, SOUFFLÉ PLATES, SAUCE BOTTLES FOR SERVING SAUCES, BUTTER DISHES, BUTTER SPREADERS, CHOPSTICK RESTS, CASSEROLE DISHES, POTS, CERAMIC LIDS, CERAMIC CANISTERS, ROASTING PANS, FOOD PRESERVING JARS OF PORCELAIN, PLATTERS, TRAYS, BOTTLES, NAMELY PORCELAIN BOTTLES SOLD EMPTY, CERAMIC CYLINDER

PLANTERS, GRAVY BOATS, CREAMERS, IN CLASS 21 (U.S. CLS. 2, 13, 23, 29, 30, 33, 40 AND 50).

FIRST USE 3-1-2001; IN COMMERCE 3-1-2001.

THE NAME(S), PORTRAIT(S), AND/OR SIGNATURE(S) SHOWN IN THE MARK DOES NOT IDENTIFY A PARTICULAR LIVING INDIVIDUAL.

THE MARK CONSISTS OF THE WORD "CHENG'S" IN A SCRIPT FORMAT.

SEC. 2(F).

SER. NO. 77-256,106, FILED 8-15-2007.

ROBIN CHOSID, EXAMINING ATTORNEY

Int. Cl.: 36

Prior U.S. Cls.: 100, 101 and 102

United States Patent and Trademark Office

Reg. No. 3,475,160

Registered July 29, 2008

**SERVICE MARK
PRINCIPAL REGISTER**

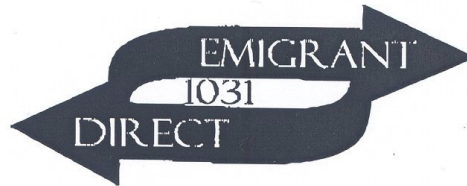

EMIGRANT BANK (NEW YORK CORPORATION)
5 EAST 42ND STREET
NEW YORK, NY 10017

FOR: FINANCIAL SERVICES, NAMELY, BANKING, MORTGAGE LENDING AND MONEY LENDING, IN CLASS 36 (U.S. CLS. 100, 101 AND 102).

FIRST USE 6-14-2007; IN COMMERCE 6-14-2007.

OWNER OF U.S. REG. NOS. 2,672,020, 3,144,434, AND 3,202,178.

NO CLAIM IS MADE TO THE EXCLUSIVE RIGHT TO USE "1031" AND "DIRECT", APART FROM THE MARK AS SHOWN.

THE MARK CONSISTS OF THE WORD "EMIGRANT" APPEARS IN A RIGHT ARROW AND THE WORD "DIRECTS" APPEAR IN A LEFT ARROW AND THE NUMBERS "1031" APPEARS IN THE MIDDLE.

SER. NO. 77-256,688, FILED 8-16-2007.

DARRYL SPRUILL, EXAMINING ATTORNEY

Int. Cl.: 14

Prior U.S. Cls.: 2, 27, 28 and 50

United States Patent and Trademark Office

Reg. No. 3,475,161

Registered July 29, 2008

**TRADEMARK
PRINCIPAL REGISTER**

Expressions Collection

BERNARD'S WHOLESALE INC. (MASSACHU-
SETTS CORPORATION)
SUITE 634
333 WASHINGTON ST
BOSTON, MA 02108

FOR: BEADS FOR USE IN THE MANUFACTURE
OF JEWELRY; BRACELETS; BRONZE JEWELRY;
BROOCHES; CHARMS; COSTUME JEWELRY; DIA-
MOND JEWELRY; GEMSTONE JEWELRY; IDENTI-
FICATION BRACELETS; JEWELRY; JEWELRY
BOXES; JEWELRY BOXES NOT OF METAL; JEW-
ELRY BOXES OF METAL; JEWELRY BOXES OF
PRECIOUS METAL; JEWELRY CASES; JEWELRY
CASES NOT OF PRECIOUS METAL; JEWELRY
CASES OF PRECIOUS METAL; JEWELRY CAS-
KETS; JEWELRY CASKETS OF PRECIOUS METAL;
JEWELRY CHAINS; JEWELRY FINDINGS; JEWEL-
RY FOR THE HEAD; JEWELRY PINS FOR USE ON
HATS; JEWELRY RING HOLDERS; JEWELRY TO
BE AFFIXED TO BIKINIS; JEWELRY WATCHES;
JEWELRY, NAMELY, AMULETS; JEWELRY,

NAMELY, CROSSES; JEWELRY, NAMELY, PRE-
CIOUS METAL PLATED REAL LEAVES AND
FLOWERS; LAPEL PINS; LEATHER JEWELRY
AND ACCESSORY BOXES; PET JEWELRY; PINS
BEING JEWELRY; RINGS BEING JEWELRY, IN
CLASS 14 (U.S. CLS. 2, 27, 28 AND 50).

FIRST USE 1-1-2006; IN COMMERCE 1-1-2006.

THE MARK CONSISTS OF STANDARD CHAR-
ACTERS WITHOUT CLAIM TO ANY PARTICULAR
FONT, STYLE, SIZE, OR COLOR.

NO CLAIM IS MADE TO THE EXCLUSIVE
RIGHT TO USE "COLLECTION", APART FROM
THE MARK AS SHOWN.

SER. NO. 77-257,361, FILED 8-16-2007.

KELLEY WELLS, EXAMINING ATTORNEY

Int. Cl.: 16

Prior U.S. Cls.: 2, 5, 22, 23, 29, 37, 38 and 50

Reg. No. 3,475,162

United States Patent and Trademark Office

Registered July 29, 2008

**TRADEMARK
PRINCIPAL REGISTER**

SECOND LIFE

LINDEN RESEARCH, INC. (DELAWARE CORPORATION)
945 BATTERY STREET
SAN FRANCISCO, CA 94111

FIRST USE 6-30-2003; IN COMMERCE 6-30-2003.

FOR: PRINTED PUBLICATIONS IN THE NATURE OF BOOKS, MAGAZINES, AND EDUCATIONAL CURRICULA IN THE NATURE OF INSTRUCTIONAL, EDUCATIONAL AND TEACHING MATERIALS AND TRAINING MANUALS, ALL IN THE FIELD OF COMPUTERS, SOFTWARE AND 3D VIRTUAL ENVIRONMENTS, IN CLASS 16 (U.S. CLS. 2, 5, 22, 23, 29, 37, 38 AND 50).

THE MARK CONSISTS OF STANDARD CHARACTERS WITHOUT CLAIM TO ANY PARTICULAR FONT, STYLE, SIZE, OR COLOR.

SER. NO. 77-257,436, FILED 8-16-2007.

DAVID ELTON, EXAMINING ATTORNEY

Int. Cl.: 16

Prior U.S. Cls.: 2, 5, 22, 23, 29, 37, 38 and 50

United States Patent and Trademark Office

Reg. No. 3,475,163

Registered July 29, 2008

**TRADEMARK
PRINCIPAL REGISTER**



LINDEN RESEARCH, INC. (DELAWARE CORPORATION)
945 BATTERY STREET
SAN FRANCISCO, CA 94111

FOR: PRINTED PUBLICATIONS IN THE NATURE OF BOOKS, MAGAZINES, AND EDUCATIONAL CURRICULA IN THE NATURE OF INSTRUCTIONAL, EDUCATIONAL AND TEACHING MATERIALS AND TRAINING MANUALS, ALL IN THE FIELD OF COMPUTERS, SOFTWARE AND 3D VIRTUAL ENVIRONMENTS, IN CLASS 16 (U.S. CLS. 2, 5, 22, 23, 29, 37, 38 AND 50).

FIRST USE 6-30-2003; IN COMMERCE 6-30-2003.

OWNER OF U.S. REG. NOS. 2,813,096 AND 2,954,675.

THE MARK CONSISTS OF A STYLIZED DRAWING OF AN EYE-TO-HAND DESIGN.

SER. NO. 77-257,447, FILED 8-16-2007.

DAVID ELTON, EXAMINING ATTORNEY

Int. Cl.: 19

Prior U.S. Cls.: 1, 12, 33 and 50

Reg. No. 3,475,164

United States Patent and Trademark Office

Registered July 29, 2008

**TRADEMARK
PRINCIPAL REGISTER**

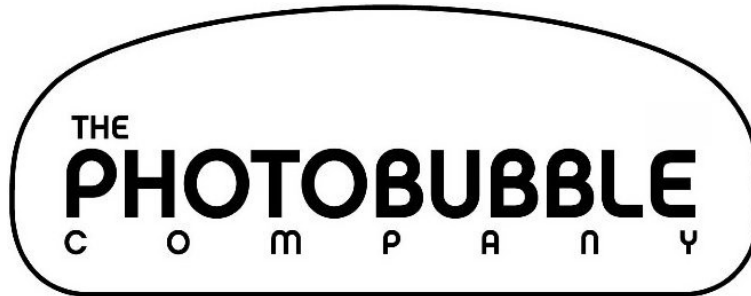

THE PHOTOBUBBLE COMPANY, INC (CALIFORNIA CORPORATION)
6761 WANDERMERE ROAD
MALIBU, CA 90265

NO CLAIM IS MADE TO THE EXCLUSIVE RIGHT TO USE "COMPANY", APART FROM THE MARK AS SHOWN.

FOR: INFLATABLE STAGE, IN CLASS 19 (U.S. CLS. 1, 12, 33 AND 50).

SER. NO. 77-257,849, FILED 8-17-2007.

FIRST USE 8-1-2005; IN COMMERCE 8-1-2005.

MELVIN AXILBUND, EXAMINING ATTORNEY

Int. Cls.: 35 and 39

Prior U.S. Cls.: 100, 101, 102 and 105

United States Patent and Trademark Office

Reg. No. 3,475,165

Registered July 29, 2008

**SERVICE MARK
PRINCIPAL REGISTER**



HUB GROUP, INC. (DELAWARE CORPORATION)
3050 HIGHLAND PARKWAY, SUITE 100
DOWNS GROVE, IL 60515

FOR: ARRANGING FREIGHT TRANSPORTATION BY TRUCK, IN CLASS 35 (U.S. CLS. 100, 101 AND 102).

FIRST USE 0-0-1990; IN COMMERCE 0-0-1990.

FOR: DRAYAGE SERVICES, NAMELY, COMMON CARRIER AND CONTRACT CARRIER SERVICES; TRANSPORTATION BROKERING, IN CLASS 39 (U.S. CLS. 100 AND 105).

FIRST USE 6-1-1994; IN COMMERCE 6-1-1994.

OWNER OF U.S. REG. NOS. 1,997,149, 2,151,187, AND 2,579,075.

NO CLAIM IS MADE TO THE EXCLUSIVE RIGHT TO USE "LOGISTICS", APART FROM THE MARK AS SHOWN.

THE MARK CONSISTS OF A GLOBE AND A SILHOUETTE OF A TRUCK ALONG WITH THE WORDS "COMTRAK LOGISTICS".

SER. NO. 77-258,027, FILED 8-17-2007.

KATHERINE STOIDES, EXAMINING ATTORNEY

Int. Cl.: 25

Prior U.S. Cls.: 22 and 39

United States Patent and Trademark Office

Reg. No. 3,475,166

Registered July 29, 2008

**TRADEMARK
PRINCIPAL REGISTER**

Pipe Posse

SONGER, RICK (UNITED STATES INDIVIDUAL)
301 CAMINO BRABADO
SAN CLEMENTE, CA 92673

FOR: CLOTHING, NAMELY, WETSUITS, SWIMWEAR, T-SHIRTS, SHIRTS, SWEAT SHIRTS, JACKETS, SHORTS, PANTS, JEANS, SKIRTS; HEADWEAR, NAMELY, CAPS, BEANIES; FOOTWEAR, NAMELY, SHOES, AND THONGED AND STRAPPED SANDALS, IN CLASS 25 (U.S. CLS. 22 AND 39).

FIRST USE 3-11-2007; IN COMMERCE 3-11-2007.

THE MARK CONSISTS OF STANDARD CHARACTERS WITHOUT CLAIM TO ANY PARTICULAR FONT, STYLE, SIZE, OR COLOR.

SER. NO. 77-258,052, FILED 8-17-2007.

ERNEST SHOSHO, EXAMINING ATTORNEY

Int. Cl.: 7

Prior U.S. Cls.: 13, 19, 21, 23, 31, 34 and 35

United States Patent and Trademark Office

Reg. No. 3,475,167

Registered July 29, 2008

**TRADEMARK
PRINCIPAL REGISTER**

Lone Star Bit

LSBC, INC. (TEXAS CORPORATION), DBA LONE
STAR BIT CO. INC.
PO BOX 1219
STAFFORD, TX 77497

FOR: BITS FOR MINING MACHINES; CORE
DRILLING BITS; DRILL BITS FOR ROCK DRIL-
LING; DRILLING MACHINES AND PARTS THERE-
FOR; DRILLS FOR THE MINING INDUSTRY;
MINING BITS; POWER OPERATED TOOLS, NAME-
LY, DRILL HAMMERS; ROCK DRILLS; WELL
DRILLING MACHINES, IN CLASS 7 (U.S. CLS. 13,
19, 21, 23, 31, 34 AND 35).

FIRST USE 5-15-1984; IN COMMERCE 5-15-1984.

THE MARK CONSISTS OF STANDARD CHAR-
ACTERS WITHOUT CLAIM TO ANY PARTICULAR
FONT, STYLE, SIZE, OR COLOR.

NO CLAIM IS MADE TO THE EXCLUSIVE
RIGHT TO USE "BIT", APART FROM THE MARK
AS SHOWN.

SER. NO. 77-258,841, FILED 8-19-2007.

ALEXANDER L. POWERS, EXAMINING ATTOR-
NEY

Int. Cl.: 5

Prior U.S. Cls.: 6, 18, 44, 46, 51 and 52

Reg. No. 3,475,168

United States Patent and Trademark Office

Registered July 29, 2008

**TRADEMARK
PRINCIPAL REGISTER**

Leva-pak

DAIICHI SANKYO COMPANY, LIMITED (JA-
PAN JOINT STOCK COMPANY)
3-5-1 NIHONBASHI HONCHO, CHUO-KU
TOKYO 103-8426, JAPAN

THE MARK CONSISTS OF STANDARD CHAR-
ACTERS WITHOUT CLAIM TO ANY PARTICULAR
FONT, STYLE, SIZE, OR COLOR.

FOR: ANTIBACTERIAL AGENTS, NAMELY, AN-
TIBACTERIAL PHARMACEUTICALS, IN CLASS 5
(U.S. CLS. 6, 18, 44, 46, 51 AND 52).

SER. NO. 77-259,514, FILED 8-20-2007.

FIRST USE 12-1-2003; IN COMMERCE 12-1-2003.

ALLISON HOLTZ, EXAMINING ATTORNEY

Prior U.S. Cl.: 200

United States Patent and Trademark Office

Reg. No. 3,475,169

Registered July 29, 2008

COLLECTIVE MEMBERSHIP
PRINCIPAL REGISTER

LEADING JEWELERS OF THE
WORLD

LJOW HOLDINGS, LLC (NEW YORK LTD LIAB
CO)
12TH FLOOR
500 SEVENTH AVENUE
NEW YORK, NY 10018

FOR: INDICATING MEMBERSHIP IN AN ORGA-
NIZATION WHICH SELLS DIAMOND JEWELRY,
IN CLASS 200 (U.S. CL. 200).

FIRST USE 9-20-2001; IN COMMERCE 9-20-2001.

THE MARK CONSISTS OF STANDARD CHAR-
ACTERS WITHOUT CLAIM TO ANY PARTICULAR
FONT, STYLE, SIZE, OR COLOR.

OWNER OF U.S. REG. NOS. 2,703,309, 2,716,705,
AND 3,274,145.

SEC. 2(F).

SER. NO. 77-260,273, FILED 8-21-2007.

LINDA M. KING, EXAMINING ATTORNEY

Int. Cl.: 35

Prior U.S. Cls.: 100, 101 and 102

United States Patent and Trademark Office

Reg. No. 3,475,170

Registered July 29, 2008

**SERVICE MARK
PRINCIPAL REGISTER**

**LEADING JEWELERS OF THE
WORLD**

LJOW HOLDINGS, LLC (NEW YORK LTD LIAB
CO)
12TH FLOOR
500 SEVENTH AVENUE
NEW YORK, NY 10018

FOR: ASSOCIATION SERVICES, NAMELY, PRO-
MOTING THE INTERESTS OF VENDORS OF
QUALITY DIAMONDS AND DIAMOND JEWELRY,
IN CLASS 35 (U.S. CLS. 100, 101 AND 102).

FIRST USE 5-31-2001; IN COMMERCE 5-31-2001.

THE MARK CONSISTS OF STANDARD CHAR-
ACTERS WITHOUT CLAIM TO ANY PARTICULAR
FONT, STYLE, SIZE, OR COLOR.

OWNER OF U.S. REG. NOS. 2,703,309, 2,716,705,
AND 3,274,145.

SEC. 2(F).

SER. NO. 77-260,279, FILED 8-21-2007.

LINDA M. KING, EXAMINING ATTORNEY

Int. Cl.: 35

Prior U.S. Cls.: 100, 101 and 102

United States Patent and Trademark Office

Reg. No. 3,475,171

Registered July 29, 2008

**SERVICE MARK
PRINCIPAL REGISTER**

**GELB GROUP A FAMILY OF
COMPANIES**

RMG MANAGEMENT INC. (CALIFORNIA CORPORATION)
17547 VENTURA BLVD. STE. 201
ENCINO, CA 91316

FOR: CHARITABLE SERVICES, NAMELY ORGANIZING AND CONDUCTING VOLUNTEER PROGRAMS AND COMMUNITY SERVICE PROJECTS; CHARITABLE SERVICES, NAMELY, PROVIDING OFFICE FACILITIES TO THOSE IN NEED; NEGOTIATION AND RENEGOTIATION OF LEASES AND SUBLEASES AND THE PURCHASE AND SALE OF BUILDINGS; COMMERCIAL MANAGEMENT; MANAGEMENT ON BEHALF OF INDUSTRIAL AND COMMERCIAL ENTERPRISES IN TERMS OF SUPPLYING THEM WITH OFFICE REQUISITES, IN CLASS 35 (U.S. CLS. 100, 101 AND 102).

FIRST USE 5-1-2006; IN COMMERCE 5-1-2006.

THE MARK CONSISTS OF STANDARD CHARACTERS WITHOUT CLAIM TO ANY PARTICULAR FONT, STYLE, SIZE, OR COLOR.

NO CLAIM IS MADE TO THE EXCLUSIVE RIGHT TO USE "GROUP" AND "A FAMILY OF COMPANIES", APART FROM THE MARK AS SHOWN.

THE FOREIGN WORDING IN THE MARK TRANSLATES INTO ENGLISH AS "YELLOW".

SER. NO. 77-260,475, FILED 8-21-2007.

JOHN KELLY, EXAMINING ATTORNEY

Int. Cl.: 36

Prior U.S. Cls.: 100, 101 and 102

United States Patent and Trademark Office

Reg. No. 3,475,172

Registered July 29, 2008

**SERVICE MARK
PRINCIPAL REGISTER**

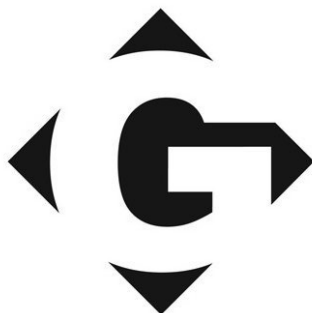

GELB GROUP
A FAMILY OF COMPANIES

RMG MANAGEMENT INC. (CALIFORNIA CORPORATION)

17547 VENTURA BLVD., STE. 201
ENCINO, CA 91316

FOR: CHARITABLE SERVICES, NAMELY, GRANTING FUNDS TO SCHOOLS; PHILANTHROPIC SERVICES CONCERNING MONETARY DONATIONS; REAL ESTATE ACQUISITION SERVICES; ASSESSMENT AND MANAGEMENT OF REAL ESTATE; FINANCIAL INVESTMENT IN THE FIELD OF REAL ESTATE; LAND ACQUISITION, NAMELY, REAL ESTATE BROKERAGE; LEASING OF REAL ESTATE; PROVIDING INFORMATION IN THE FIELD OF REAL ESTATE VIA THE INTERNET; PROVIDING REAL ESTATE LISTINGS AND REAL ESTATE INFORMATION VIA THE INTERNET; REAL ESTATE EQUITY SHARING, NAMELY, MANAGING AND ARRANGING FOR CO-OWNER-

SHIP OF REAL ESTATE; REAL ESTATE INVESTMENT; REAL ESTATE MANAGEMENT; LEASING OF REAL PROPERTY, IN CLASS 36 (U.S. CLS. 100, 101 AND 102).

FIRST USE 5-1-2006; IN COMMERCE 5-1-2006.

NO CLAIM IS MADE TO THE EXCLUSIVE RIGHT TO USE "GROUP" AND "A FAMILY OF COMPANIES", APART FROM THE MARK AS SHOWN.

THE FOREIGN WORDING IN THE MARK TRANSLATES INTO ENGLISH AS "YELLOW".

SER. NO. 77-260,568, FILED 8-21-2007.

JOHN KELLY, EXAMINING ATTORNEY

Int. Cl.: 37

Prior U.S. Cls.: 100, 103 and 106

United States Patent and Trademark Office

Reg. No. 3,475,173

Registered July 29, 2008

**SERVICE MARK
PRINCIPAL REGISTER**

**GELB GROUP A FAMILY OF
COMPANIES**

RMG MANAGEMENT INC. (CALIFORNIA CORPORATION)

17547 VENTURA BLVD., STE. 201

ENCINO, CA 91316

FOR: REAL ESTATE DEVELOPMENT; REAL ESTATE SITE SELECTION; BUILDING MAINTENANCE AND REPAIR; MAINTENANCE AND REPAIR OF BUILDINGS; INSTALLATION OF SECURITY SYSTEM, IN CLASS 37 (U.S. CLS. 100, 103 AND 106).

FIRST USE 5-1-2006; IN COMMERCE 5-1-2006.

THE MARK CONSISTS OF STANDARD CHARACTERS WITHOUT CLAIM TO ANY PARTICULAR FONT, STYLE, SIZE, OR COLOR.

NO CLAIM IS MADE TO THE EXCLUSIVE RIGHT TO USE "GROUP" AND "A FAMILY OF COMPANIES", APART FROM THE MARK AS SHOWN.

THE FOREIGN WORDING IN THE MARK TRANSLATES INTO ENGLISH AS "YELLOW".

SER. NO. 77-260,599, FILED 8-21-2007.

JOHN KELLY, EXAMINING ATTORNEY

Int. Cl.: 41

Prior U.S. Cls.: 100, 101 and 107

United States Patent and Trademark Office

Reg. No. 3,475,174

Registered July 29, 2008

**SERVICE MARK
PRINCIPAL REGISTER**

**GELB GROUP A FAMILY OF
COMPANIES**

RMG MANAGEMENT INC. (CALIFORNIA CORPORATION)
17547 VENTURA BLVD., STE. 201
ENCINO, CA 91316

FOR: CHARITABLE SERVICES, NAMELY, PROVIDING BOOKS TO PEOPLE; CHARITABLE SERVICES, NAMELY, PROVIDING BOOKS TO CHILDREN; CHARITABLE SERVICES, NAMELY, PROVIDING SCHOOL SUPPLIES TO CHILDREN IN NEED; CHARITABLE SERVICES, NAMELY, PROVIDING TOYS TO NEEDY CHILDREN, IN CLASS 41 (U.S. CLS. 100, 101 AND 107).

FIRST USE 5-1-2006; IN COMMERCE 5-1-2006.

THE MARK CONSISTS OF STANDARD CHARACTERS WITHOUT CLAIM TO ANY PARTICULAR FONT, STYLE, SIZE, OR COLOR.

NO CLAIM IS MADE TO THE EXCLUSIVE RIGHT TO USE "GROUP" AND "A FAMILY OF COMPANIES", APART FROM THE MARK AS SHOWN.

"THE FOREIGN WORDING IN THE MARK TRANSLATES INTO ENGLISH AS YELLOW."

SER. NO. 77-260,620, FILED 8-21-2007.

JOHN KELLY, EXAMINING ATTORNEY

Int. Cl.: 35

Prior U.S. Cls.: 100, 101 and 102

United States Patent and Trademark Office

Reg. No. 3,475,175

Registered July 29, 2008

**SERVICE MARK
PRINCIPAL REGISTER**

DISCERN CONSULTING

D'ANDREA, GUY (UNITED STATES INDIVIDUAL)
1501 SULGRAVE AVENUE, SUITE 302
BALTIMORE, MD 21209

FOR: CONSULTING SERVICES IN THE COST AND PAYMENT MANAGEMENT OF HEALTH CARE, IN CLASS 35 (U.S. CLS. 100, 101 AND 102).

FIRST USE 3-1-2005; IN COMMERCE 3-1-2005.

THE MARK CONSISTS OF STANDARD CHARACTERS WITHOUT CLAIM TO ANY PARTICULAR FONT, STYLE, SIZE, OR COLOR.

NO CLAIM IS MADE TO THE EXCLUSIVE RIGHT TO USE "CONSULTING", APART FROM THE MARK AS SHOWN.

SER. NO. 77-261,462, FILED 8-22-2007.

SONYA STEPHENS, EXAMINING ATTORNEY

Int. Cls.: 39 and 43

Prior U.S. Cls.: 100, 101 and 105

United States Patent and Trademark Office

Reg. No. 3,475,176

Registered July 29, 2008

**SERVICE MARK
PRINCIPAL REGISTER**

Vacatio

VACATIO, INC. (DELAWARE CORPORATION)
14435 5TH AVENUE SOUTH
SEATTLE, WA 98168

FOR: TRAVEL AGENCY SERVICES, NAMELY, MAKING RESERVATIONS AND BOOKINGS FOR TRANSPORTATION AND PROVIDING TRAVEL AND BOOKING INFORMATION OVER COMPUTER NETWORKS AND THE INTERNET. VACATION PLANNING SERVICES, NAMELY TRAVEL ARRANGEMENTS AND ORGANIZATION OF TRAVEL, IN CLASS 39 (U.S. CLS. 100 AND 105).

FIRST USE 5-15-2006; IN COMMERCE 7-15-2006.

FOR: VACATION PLANNING SERVICES, NAMELY, MAKING RESERVATIONS AND BOOKINGS

FOR TEMPORARY LODGING AND PROVIDING TEMPORARY LODGING AND BOOKING INFORMATION OVER COMPUTER NETWORKS AND THE INTERNET, IN CLASS 43 (U.S. CLS. 100 AND 101).

FIRST USE 5-15-2006; IN COMMERCE 7-15-2006.

THE MARK CONSISTS OF STANDARD CHARACTERS WITHOUT CLAIM TO ANY PARTICULAR FONT, STYLE, SIZE, OR COLOR.

SER. NO. 77-261,503, FILED 8-22-2007.

DAVID TOOLEY, EXAMINING ATTORNEY

Int. Cl.: 30

Prior U.S. Cl.: 46

United States Patent and Trademark Office

Reg. No. 3,475,177

Registered July 29, 2008

**TRADEMARK
PRINCIPAL REGISTER**

PRIME
FOOD CORP.

PRIME FOOD PROCESSING CORP. (NEW YORK CORPORATION)
300 VANDERVOORT AVE.
BROOKLYN, NY 11211

FOR: BUNS; STEAMED BUNS STUFFED WITH MINCED MEAT (NIKU-MANJU); POTSTICKERS; CHOW MEIN NOODLES; INSTANT NOODLES; NOODLES; NOODLES, SAUCE, AND TOPPING COMBINED IN UNITARY PACKAGES; UDON NOODLES, IN CLASS 30 (U.S. CL. 46).

FIRST USE 8-31-1996; IN COMMERCE 8-31-1996.

OWNER OF U.S. REG. NOS. 2,154,673, 2,154,674, AND 2,867,691.

NO CLAIM IS MADE TO THE EXCLUSIVE RIGHT TO USE "FOOD CORP.", APART FROM THE MARK AS SHOWN.

SEC. 2(F).

SER. NO. 77-261,993, FILED 8-22-2007.

CHRISTOPHER BUONGIORNO, EXAMINING ATTORNEY

Int. Cl.: 17

Prior U.S. Cls.: 1, 5, 12, 13, 35 and 50

United States Patent and Trademark Office

Reg. No. 3,475,178

Registered July 29, 2008

**TRADEMARK
PRINCIPAL REGISTER**

NO SKIDDING

MARA HOLDINGS INC. (CANADA CORPORATION)
266 WILDCAT ROAD
TORONTO, CANADA M3J2N5

FOR: NON-SLIP SAFETY TAPE, IN CLASS 17 (U.S. CLS. 1, 5, 12, 13, 35 AND 50).

FIRST USE 0-0-1995; IN COMMERCE 0-0-1995.

THE MARK CONSISTS OF STANDARD CHARACTERS WITHOUT CLAIM TO ANY PARTICULAR FONT, STYLE, SIZE, OR COLOR.

OWNER OF U.S. REG. NO. 2,439,945.

SER. NO. 77-262,763, FILED 8-23-2007.

FRANK LATTUCA, EXAMINING ATTORNEY

Int. Cl.: 44

Prior U.S. Cls.: 100 and 101

United States Patent and Trademark Office

Reg. No. 3,475,179

Registered July 29, 2008

**SERVICE MARK
PRINCIPAL REGISTER**



ADAMS RESPIRATORY OPERATIONS, INC. (DE-
LAWARE CORPORATION)
14841 SOVEREIGN ROAD
FORT WORTH, TX 76155

FOR: PROVIDING INFORMATION, NAMELY,
NEWS AND ITEMS OF INTEREST CONCERNING
RESPIRATORY AND PULMONARY CONDITIONS,
VIA A GLOBAL NETWORK, IN CLASS 44 (U.S. CLS.
100 AND 101).

FIRST USE 10-27-2005; IN COMMERCE 10-27-2005.

OWNER OF U.S. REG. NO. 3,116,483.

THE MARK CONSISTS OF A MALE CHARAC-
TER WEARING A SHIRT, PANTS AND TUXEDO
JACKET.

SER. NO. 77-262,850, FILED 8-23-2007.

INGRID C. EULIN, EXAMINING ATTORNEY

Int. Cl.: 43

Prior U.S. Cls.: 100 and 101

United States Patent and Trademark Office

Reg. No. 3,475,180

Registered July 29, 2008

**SERVICE MARK
PRINCIPAL REGISTER**

SFOGLIA

THE SUHANOSKY FAMILY (DELAWARE LTD
LIAB CO)
130 PLEASANT STREET
NANTUCKET, MA 02554

FOR: RESTAURANT SERVICES, IN CLASS 43
(U.S. CLS. 100 AND 101).

FIRST USE 10-30-2000; IN COMMERCE 10-30-2000.

THE MARK CONSISTS OF STANDARD CHAR-
ACTERS WITHOUT CLAIM TO ANY PARTICULAR
FONT, STYLE, SIZE, OR COLOR.

THE FOREIGN WORDING IN THE MARK
TRANSLATES INTO ENGLISH AS UNCUT SHEET
OF PASTA.

SEC. 2(F).

SER. NO. 77-263,143, FILED 8-23-2007.

KATHRYN COWARD, EXAMINING ATTORNEY

Int. Cls.: 3 and 5

Prior U.S. Cls.: 1, 4, 6, 18, 44, 46, 50, 51 and 52

United States Patent and Trademark Office

Reg. No. 3,475,181

Registered July 29, 2008

**TRADEMARK
PRINCIPAL REGISTER**

KORFF

ARTSANA S.P.A. (ITALY JOINT STOCK COMPANY)
VIA SALDARINI CATELLI 1
22070 GRANDATE, COMO, ITALY

FOR: BODY AND FACE SOAPS; PERFUMES; COSMETICS, NAMELY, FACE AND BODY MOISTURIZERS, TONICS, CREAMS AND LOTIONS; SUN TAN AND SUN BLOCK LOTIONS AND CREAMS, LIPSTICKS, EYE SHADOWS, COLOURING PENCILS, MASCARA, BLUSH, FACE POWDER, FOUNDATIONS; NAIL POLISH; LOTIONS FOR THE HAIR; TOOTHPASTE; HYGIENE PRODUCTS FOR PERSONAL USE, NAMELY, DEODORANTS AND ANTIPERSPIRANTS, IN CLASS 3 (U.S. CLS. 1, 4, 6, 50, 51 AND 52).

FOR: PHARMACEUTICALS PREPARATIONS FOR THE TREATMENT OF ACNE, RHAGADES,

CELLULITIS, COUPEROSE, STRETCH MARKS, IN CLASS 5 (U.S. CLS. 6, 18, 44, 46, 51 AND 52).

THE MARK CONSISTS OF STANDARD CHARACTERS WITHOUT CLAIM TO ANY PARTICULAR FONT, STYLE, SIZE, OR COLOR.

OWNER OF ITALY REG. NO. 847308, DATED 5-30-2001, EXPIRES 5-30-2011.

OWNER OF U.S. REG. NO. 1,449,154.

SEC. 2(F).

SER. NO. 77-263,527, FILED 8-24-2007.

MONIQUE MILLER, EXAMINING ATTORNEY

Int. Cls.: 25 and 41

Prior U.S. Cls.: 22, 39, 100, 101 and 107

United States Patent and Trademark Office

Reg. No. 3,475,182

Registered July 29, 2008

**TRADEMARK
SERVICE MARK
PRINCIPAL REGISTER**



METRO ATLANTIC ATHLETIC CONFERENCE
(NEW JERSEY NON-PROFIT CORPORATION)
712 AMBOY AVENUE
EDISON, NJ 08837

FOR: CLOTHING AND GOODS, NAMELY,
SHIRTS, T-SHIRTS, SWEATSHIRTS, SWEATPANTS,
PANTS, JACKETS, COATS AND HEADWEAR, IN
CLASS 25 (U.S. CLS. 22 AND 39).

FIRST USE 9-1-1980; IN COMMERCE 9-1-1980.

FOR: EDUCATIONAL SERVICES, NAMELY,
CONDUCTING CLASSES, WORKSHOPS AND
SEMINARS FOR STUDENTS AT THE COLLEGE
LEVEL REGARDING ATHLETICS, ACADEMICS
AND LIFE SKILLS; ENTERTAINMENT SERVICES,
NAMELY, CONDUCTING ATHLETIC GAMES AT
THE COLLEGE LEVEL IN BASEBALL, SOFTBALL,

BASKETBALL, FOOTBALL, SOCCER, GOLF, TEN-
NIS AND VOLLEYBALL, IN CLASS 41 (U.S. CLS. 100,
101 AND 107).

FIRST USE 9-1-1980; IN COMMERCE 9-1-1980.

THE MARK CONSISTS OF CIRCULAR OR EL-
LIPTICAL SEAL/CIRCLE WITH A DECORATIVE
BORDER, INCLUDING SCALLOPED, RUFFLED
AND ZIG-ZAG EDGES/ TWO CONCENTRIC CIR-
CLES.

SEC. 2(F) AS TO "METRO ATLANTIC ATHLETIC
CONFERENCE".

SER. NO. 77-263,665, FILED 8-24-2007.

HEATHER THOMPSON, EXAMINING ATTORNEY

Int. Cls.: 25 and 41

Prior U.S. Cls.: 22, 39, 100, 101 and 107

Reg. No. 3,475,183

United States Patent and Trademark Office

Registered July 29, 2008

**TRADEMARK
SERVICE MARK
PRINCIPAL REGISTER**



METRO ATLANTIC ATHLETIC CONFERENCE
(NEW JERSEY NON-PROFIT CORPORATION)
712 AMBOY AVENUE
EDISON, NJ 08837

FOR: CLOTHING, NAMELY, SHIRTS, T-SHIRTS,
SWEATSHIRTS, SWEATPANTS, PANTS, JACKETS,
COATS, AND HEADWEAR, IN CLASS 25 (U.S. CLS.
22 AND 39).

FIRST USE 9-1-1980; IN COMMERCE 9-1-1980.

FOR: EDUCATIONAL SERVICES NAMELY,
CONDUCTING CLASSES, WORKSHOPS AND
SEMINARS FOR STUDENTS AT THE COLLEGE
LEVEL REGARDING ATHLETICS, ACADEMICS
AND LIFE SKILLS; ENTERTAINMENT SERVICES,
NAMELY, CONDUCTING FOOTBALL ATHLETIC
GAMES AT THE COLLEGE LEVEL, IN CLASS 41
(U.S. CLS. 100, 101 AND 107).

FIRST USE 9-1-1980; IN COMMERCE 9-1-1980.

NO CLAIM IS MADE TO THE EXCLUSIVE
RIGHT TO USE "FOOTBALL LEAGUE", APART
FROM THE MARK AS SHOWN.

COLOR IS NOT CLAIMED AS A FEATURE OF
THE MARK.

THE MARK CONSISTS OF DESIGN PLUS
WORDS WITH A WHISTLE AND A FOOTBALL.

SER. NO. 77-263,714, FILED 8-24-2007.

HEATHER THOMPSON, EXAMINING ATTORNEY

Int. Cl.: 2

Prior U.S. Cls.: 6, 11 and 16

United States Patent and Trademark Office

Reg. No. 3,475,184

Registered July 29, 2008

**TRADEMARK
PRINCIPAL REGISTER**

DURAMER

SEWERKOTE LLC (NORTH CAROLINA LTD
LIAB CO)
607 ELLIS RD BLDG 54-B, STE 8
DURHAM, NC 27703

THE MARK CONSISTS OF STANDARD CHAR-
ACTERS WITHOUT CLAIM TO ANY PARTICULAR
FONT, STYLE, SIZE, OR COLOR.

FOR: POLYUREA PROTECTIVE COATINGS FOR
CONCRETE OR METAL OBJECTS, IN CLASS 2 (U.S.
CLS. 6, 11 AND 16).

SER. NO. 77-264,557, FILED 8-26-2007.

FIRST USE 5-25-2005; IN COMMERCE 4-8-2006.

KAREN SEVERSON, EXAMINING ATTORNEY

Int. Cl.: 31

Prior U.S. Cls.: 1 and 46

United States Patent and Trademark Office

Reg. No. 3,475,185

Registered July 29, 2008

TRADEMARK
PRINCIPAL REGISTER



VERITAS V, LLC (CALIFORNIA LTD LIAB CO)
401 MONTEREY STREET, SUITE 201
SALINAS, CA 93901

FOR: ORGANIC FRESH VEGETABLES, IN CLASS
31 (U.S. CLS. 1 AND 46).

FIRST USE 5-1-2007; IN COMMERCE 5-1-2007.

NO CLAIM IS MADE TO THE EXCLUSIVE
RIGHT TO USE "GOOD CLEAN GREENS", APART
FROM THE MARK AS SHOWN.

THE COLOR(S) RED, ORANGE, GREEN AND
BLACK IS/ARE CLAIMED AS A FEATURE OF THE
MARK.

THE MARK IS COMPRISED OF THE WORDING
"ORGANICGIRL" AND "GOOD CLEAN GREENS"
AND THE DESIGN OF A TOMATO, CARROT AND
LETTUCE LEAF IN A RECTANGULAR BACK-
GROUND CARRIER WITH A SINGLE LINE DIS-

SECTING THE RECTANGLE BELOW THE
WORDING. THE COLOR RED APPEARS IN THE
TOMATO DESIGN AND IN THE WORDING GIRL.
THE COLOR GREEN APPEARS IN THE LEAF
DESIGN AND ON THE LEAVES SHOWN ON THE
VEGETABLES. THE COLOR ORANGE APPEARS IN
THE CARROT DESIGN. THE COLOR BLACK AP-
PEARS IN THE WORDING "ORGANIC", IN THE
WORDING "GOOD CLEAN GREENS", IN THE
OUTLINE OF THE VEGETABLES, IN THE OUT-
LINE OF THE RECTANGLE, AND IN THE DESIGN
OF THE LINE. THE COLOR WHITE APPEARS ON
THE SHADING PART OF THE TOMATO. THE
WHITE AREA THAT COMPRISES THE BACK-
GROUND AREA OF THE MARK WITHIN THE
RECTANGLE IS INTENDED AS A TRANSPARENT
AREA AND IS NOT PART OF THE MARK.

SER. NO. 77-264,898, FILED 8-27-2007.

CIMMERIAN COLEMAN, EXAMINING ATTOR-
NEY

Int. Cls.: 2, 16 and 36

**Prior U.S. Cls.: 2, 5, 6, 11, 16, 22, 23, 29, 37, 38, 50,
100, 101 and 102**

Reg. No. 3,475,186

United States Patent and Trademark Office

Registered July 29, 2008

**TRADEMARK
SERVICE MARK
PRINCIPAL REGISTER**



AMPART, LLC (VIRGINIA LTD LIAB CO)
836 QUAIL POINT COVE
VIRGINIA BEACH, VA 23454

FOR: PAINT FOR ARTISTS; PAINTING SETS FOR
ARTISTS, IN CLASS 2 (U.S. CLS. 6, 11 AND 16).

FOR: ART PAPER; ART PADS; ARTS AND
CRAFT PAINT KITS; CANVAS PANELS FOR AR-
TISTS; PAPER DROP CLOTHS, IN CLASS 16 (U.S.
CLS. 2, 5, 22, 23, 29, 37, 38 AND 50).

FOR: CHARITABLE FUND-RAISING SERVICES,
NAMELY, SHARING PROFITS FROM SALES OF
ARTS AND CRAFTS SUPPLIES WITH NOT-FOR-
PROFIT ORGANIZATIONS, IN CLASS 36 (U.S. CLS.
100, 101 AND 102).

PRIORITY CLAIMED UNDER SEC. 44(D) ON
UNITED KINGDOM APPLICATION NO. 2463679,
FILED 8-8-2007, REG. NO. 2463679, DATED 8-8-2007,
EXPIRES 8-8-2017.

THE MARK CONSISTS OF TWO PAINTBRUSHES
WITH HANDLES TOUCHING AT THEIR BASES TO
FORM A "V" AND WITH TWO ARCS OF PAINT
ABOVE THE BRISTLES SO THAT TOGETHER THE
BRUSHES AND ARCS FORM A HEART-SHAPED
DESIGN; THE WORDS "DO YOUR PART
THROUGH ART" APPEAR TO THE LOWER LEFT
OF THE HEART-SHAPED DESIGN.

SER. NO. 77-264,984, FILED 8-27-2007.

RAUL CORDOVA, EXAMINING ATTORNEY

Int. Cls.: 29 and 30

Prior U.S. Cl.: 46

United States Patent and Trademark Office

Reg. No. 3,475,187

Registered July 29, 2008

TRADEMARK
PRINCIPAL REGISTER



PRIMEFOOD PROCESSING CORP. (NEW YORK CORPORATION)
300 VANDERVOORT AVENUE
BROOKLYN, NY 11211

FOR: FROZEN, PROCESSED, PRESERVED AND DRIED MEATS AND POULTRY; SAUSAGES CONSISTING OF PROCESSED MEATS AND POULTRY; FROZEN MEALS CONTAINING PROCESSED MEATS, SEAFOOD, POULTRY AND VEGETABLES, IN CLASS 29 (U.S. CL. 46).

FIRST USE 8-31-1996; IN COMMERCE 8-31-1996.

FOR: FROZEN DIM SUMS CONTAINING PROCESSED MEATS, SEAFOOD, POULTRY AND VEGETABLES IN WHEAT OR RICE FLOUR WRAPPINGS; FROZEN DUMPLINGS CONTAINING PROCESSED MEATS, SEAFOOD, POULTRY AND VEGETABLES IN WHEAT OR RICE FLOUR WRAPPINGS; FROZEN BUNS, BREADS OR ROLLS CONTAINING PROCESSED MEATS, POULTRY AND VEGETABLES IN WHEAT OR RICE FLOUR WRAPPINGS, IN CLASS 30 (U.S. CL. 46).

FIRST USE 8-31-1996; IN COMMERCE 8-31-1996.

OWNER OF U.S. REG. NOS. 2,154,673, 2,154,674, AND 2,867,691.

NO CLAIM IS MADE TO THE EXCLUSIVE RIGHT TO USE "PRIME FOOD", APART FROM THE MARK AS SHOWN.

THE MARK CONSISTS OF CHINESE CHARACTERS THAT MEAN "GOOD" INSIDE A SHADED RECTANGLE; UNDERNEATH THE RECTANGLE IS THE WORDING "PRIME FOOD" WITH A HORIZONTAL LINE UNDERNEATH THE WORDING.

THE CHINESE SYMBOLS IN THE MARK IS PRONOUNCED "JIA JIA" IN MANDARIN AND "KA KA" IN CANTONESE. THE CHINESE CHARACTER "JIA" OR "KA" COMES FROM "JIA BIN" MEANING "HONORED GUEST" OR "JIA JIANG" MEANING "PRAISEWORTHY." "JIA JIA" OR "KA KA" HAS BEEN USED AS NICKNAMES FOR CHILDREN, MEANING "GOOD BOY OR GOOD GIRL".

THE NON-LATIN CHARACTER(S) IN THE MARK TRANSLITERATE INTO "KAKA", AND THIS MEANS "GOOD" IN ENGLISH.

SEC. 2(F).

SER. NO. 77-265,246, FILED 8-27-2007.

CHRISTOPHER BUONGIORNO, EXAMINING ATTORNEY

Int. Cls.: 29 and 30

Prior U.S. Cl.: 46

United States Patent and Trademark Office

Reg. No. 3,475,188

Registered July 29, 2008

TRADEMARK
PRINCIPAL REGISTER



PRIME FOOD PROCESSING CORP. (NEW YORK CORPORATION)
300 VANDERVOORT AVE.
BROOKLYN, NY 11211

FOR: FROZEN, PROCESSED, PRESERVED AND DRIED MEATS AND POULTRY; SAUSAGES CONSISTING OF PROCESSED MEATS AND POULTRY; FROZEN MEALS CONTAINING PROCESSED MEATS, SEAFOOD, POULTRY AND VEGETABLES, IN CLASS 29 (U.S. CL. 46).

FIRST USE 8-31-1996; IN COMMERCE 8-31-1996.

FOR: FROZEN DIM SUMS CONTAINING PROCESSED MEATS, SEAFOOD, POULTRY AND VEGETABLES IN WHEAT OR RICE FLOUR WRAPPINGS; FROZEN DUMPLINGS CONTAINING PROCESSED MEATS, SEAFOOD, POULTRY AND VEGETABLES IN WHEAT OR RICE FLOUR WRAPPINGS; FROZEN BUNS, BREADS OR ROLLS CONTAINING PROCESSED MEATS, POULTRY AND VEGETABLES IN WHEAT OR RICE FLOUR WRAPPINGS, IN CLASS 30 (U.S. CL. 46).

FIRST USE 8-31-1996; IN COMMERCE 8-31-1996.

OWNER OF U.S. REG. NOS. 2,154,673, 2,154,674, AND 2,867,691.

NO CLAIM IS MADE TO THE EXCLUSIVE RIGHT TO USE "PRIME" AND "FOOD CORP.", APART FROM THE MARK AS SHOWN.

THE MARK CONSISTS OF BOY'S FACE WITH HIS TONGUE OUT WEARING A CHEF'S HAT; UNDERNEATH THE HEAD OF THE BOY IS THE STYLIZED TERM "PRIME"; UNDERNEATH THAT TERM IS THE WORDING "FOOD CORP."

SEC. 2(F).

SER. NO. 77-265,363, FILED 8-27-2007.

CHRISTOPHER BUONGIORNO, EXAMINING ATTORNEY

Int. Cl.: 19

Prior U.S. Cls.: 1, 12, 33 and 50

United States Patent and Trademark Office

Reg. No. 3,475,189

Registered July 29, 2008

**TRADEMARK
PRINCIPAL REGISTER**

EVERSTRONG

EASTERN WHOLESALE FENCE CO., INC. (NEW
YORK CORPORATION)
274 MIDDLE ISLAND ROAD
MEDFORD, NY 11763

THE MARK CONSISTS OF STANDARD CHAR-
ACTERS WITHOUT CLAIM TO ANY PARTICULAR
FONT, STYLE, SIZE, OR COLOR.

FOR: VINYL FENCE PROFILES, IN CLASS 19
(U.S. CLS. 1, 12, 33 AND 50).

SER. NO. 77-266,408, FILED 8-28-2007.

FIRST USE 7-0-2006; IN COMMERCE 8-0-2006.

TARAH HARDY, EXAMINING ATTORNEY

Int. Cls.: 3 and 44

Prior U.S. Cls.: 1, 4, 6, 50, 51, 52, 100 and 101

United States Patent and Trademark Office

Reg. No. 3,475,190

Registered July 29, 2008

**TRADEMARK
SERVICE MARK
PRINCIPAL REGISTER**

FREE THAT CURL

OIDAD LICENSING LLC (DELAWARE LTD
LIAB CO), DBA OUIDAD LICENSING COR-
PORATION

4TH FLOOR
37 WEST 57TH STREET
NEW YORK, NY 10019

FOR: HAIR CARE CREAMS; HAIR CARE PRE-
PARATIONS; HAIR CLEANING PREPARATIONS;
HAIR CONDITIONERS; HAIR FIXERS; HAIR LO-
TIONS; HAIR RINSES; HAIR SHAMPOO; HAIR
SPRAY; HAIR STYLING GEL, IN CLASS 3 (U.S.
CLS. 1, 4, 6, 50, 51 AND 52).

FIRST USE 7-20-2007; IN COMMERCE 8-1-2007.

FOR: HAIR CUTTING; HAIR SALON SERVICES;
HAIR STYLING; PROVIDING INFORMATION IN

THE FIELD OF HAIR STYLING, IN CLASS 44 (U.S.
CLS. 100 AND 101).

FIRST USE 7-20-2007; IN COMMERCE 8-1-2007.

THE MARK CONSISTS OF STANDARD CHAR-
ACTERS WITHOUT CLAIM TO ANY PARTICULAR
FONT, STYLE, SIZE, OR COLOR.

NO CLAIM IS MADE TO THE EXCLUSIVE
RIGHT TO USE "CURL", APART FROM THE MARK
AS SHOWN.

SER. NO. 77-267,606, FILED 8-29-2007.

WARREN L. OLANDRIA, EXAMINING ATTOR-
NEY

Int. Cls.: 42 and 44

Prior U.S. Cls.: 100 and 101

United States Patent and Trademark Office

Reg. No. 3,475,191

Registered July 29, 2008

**SERVICE MARK
PRINCIPAL REGISTER**

**LEADING THE SEARCH FOR
TOMORROW'S CURES**

THE JACKSON LABORATORY (MAINE CORPORATION)
600 MAIN STREET
BAR HARBOR, ME 04609

FOR: BIOMEDICAL RESEARCH SERVICES, IN CLASS 42 (U.S. CLS. 100 AND 101).

FIRST USE 2-1-2007; IN COMMERCE 2-1-2007.

FOR: MICE BREEDING, IN CLASS 44 (U.S. CLS. 100 AND 101).

FIRST USE 2-1-2007; IN COMMERCE 2-1-2007.

THE MARK CONSISTS OF STANDARD CHARACTERS WITHOUT CLAIM TO ANY PARTICULAR FONT, STYLE, SIZE, OR COLOR.

SER. NO. 77-268,080, FILED 8-30-2007.

ELISSA GARBER KON, EXAMINING ATTORNEY

Int. Cl.: 21

Prior U.S. Cls.: 2, 13, 23, 29, 30, 33, 40 and 50

Reg. No. 3,475,192

United States Patent and Trademark Office

Registered July 29, 2008

**TRADEMARK
PRINCIPAL REGISTER**

EMBER  GUARD

RENFROW, STEPHEN M. (UNITED STATES IN-
DIVIDUAL)
625 ATTERDAG RD.
SOLVANG, CA 93463

FOR: CAMPING GRILL COVERS, NAMELY,
CAMPFIRE SPARK-ARRESTING ENCLOSURE, IN
CLASS 21 (U.S. CLS. 2, 13, 23, 29, 30, 33, 40 AND 50).

FIRST USE 4-0-2004; IN COMMERCE 9-0-2005.

NO CLAIM IS MADE TO THE EXCLUSIVE
RIGHT TO USE "EMBER" AND "GUARD", APART
FROM THE MARK AS SHOWN.

THE MARK CONSISTS OF THE WORDING "EM-
BER GUARD" WITH AN IMAGE OF A CAMPFIRE
BETWEEN THE TWO WORDS.

SER. NO. 77-268,768, FILED 8-30-2007.

BRIAN PINO, EXAMINING ATTORNEY

Int. Cl.: 41

Prior U.S. Cls.: 100, 101 and 107

United States Patent and Trademark Office

Reg. No. 3,475,193

Registered July 29, 2008

**SERVICE MARK
PRINCIPAL REGISTER**



LEWIS, RICKI (UNITED STATES INDIVIDUAL)
STE. #7
4319 REDWOOD AVENUE
MARINA DEL REY, CA 90292

THE MARK CONSISTS OF A GENIE LAMP WITH
A STYLIZED "S" EMINATING FROM ITS SPOUT;
GENIE EYES IN THE TOP LOOP OF THE STYLIZED
"S".

FOR: PARTY AND EVENT PLANNING AND
CONSULTATION IN THE FIELD OF WEDDINGS,
PARTY AND SPECIAL EVENTS, IN CLASS 41 (U.S.
CLS. 100, 101 AND 107).

SER. NO. 77-269,204, FILED 8-31-2007.

FIRST USE 12-26-2005; IN COMMERCE 12-26-2005.

EUGENIA MARTIN, EXAMINING ATTORNEY

Int. Cl.: 3

Prior U.S. Cls.: 1, 4, 6, 50, 51 and 52

Reg. No. 3,475,194

United States Patent and Trademark Office

Registered July 29, 2008

**TRADEMARK
PRINCIPAL REGISTER**

L'Edent tips

NAILS 2000 INTERNATIONAL INC. (CALIFORNIA CORPORATION)
10892 FORBES AVENUE
GARDEN GROVE, CA 92843

FOR: NAIL GROOMING PRODUCTS, NAMELY, TIPS, GLUE, LACQUER AND GLITTER, IN CLASS 3 (U.S. CLS. 1, 4, 6, 50, 51 AND 52).

FIRST USE 12-15-2006; IN COMMERCE 12-15-2006.

THE MARK CONSISTS OF STANDARD CHARACTERS WITHOUT CLAIM TO ANY PARTICULAR FONT, STYLE, SIZE, OR COLOR.

NO CLAIM IS MADE TO THE EXCLUSIVE RIGHT TO USE "TIPS", APART FROM THE MARK AS SHOWN.

SER. NO. 77-269,368, FILED 8-31-2007.

JENNIFER HETU, EXAMINING ATTORNEY

Int. Cl.: 30

Prior U.S. Cl.: 46

United States Patent and Trademark Office

Reg. No. 3,475,195

Registered July 29, 2008

TRADEMARK
PRINCIPAL REGISTER



ENVISION PRODUCTS, INC. (COLORADO CORPORATION), DBA THE ZESTY MOOSE
420 PROSPECTORS POINT
GRAND JUNCTION, CO 81503

THE MARK CONSISTS OF STYLIZED LETTERING FOR "THE ZESTY" WITH A MOOSE SILHOUTTE REPRESENTING THE "M" IN "MOOSE" WITH STYLIZED REMAINING LETTERS OF THE WORD MOOSE, "OOSE".

FOR: SEASONINGS, IN CLASS 30 (U.S. CL. 46).

SER. NO. 77-270,181, FILED 9-1-2007.

FIRST USE 8-28-2007; IN COMMERCE 8-28-2007.

NICHOLAS ALTREE, EXAMINING ATTORNEY

Int. Cl.: 9

Prior U.S. Cls.: 21, 23, 26, 36 and 38

Reg. No. 3,475,196

United States Patent and Trademark Office

Registered July 29, 2008

**TRADEMARK
PRINCIPAL REGISTER**



PRADIGIOUS PRODUCTIONS (NORTH CAROLINA LTD LIAB CO)
6850 BRACHNELL VIEW DRIVE
CHARLOTTE, NC 28269

FOR: AUDIO RECORDINGS FEATURING MUSIC; DOWNLOADABLE MP3 FILES, MP3 RECORDINGS, ONLINE DISCUSSION BOARDS, WEBCASTS AND PODCASTS FEATURING MUSIC, AUDIO BOOKS AND NEWS BROADCASTS; DOWNLOADABLE MUSICAL SOUND RECORDINGS; DOWNLOADABLE RING TONES, GRAPHICS AND MUSIC VIA A GLOBAL COMPUTER NETWORK AND WIRELESS DEVICES; DOWNLOADABLE VIDEO RECORDINGS FEATURING MUSIC & PHOTOGRAPHS; DOWNLOADABLE MUSIC, RING TONES, PHOTOGRAPHS & VIDEO VIA THE INTERNET AND WIRELESS DEVICES; MUSICAL SOUND

RECORDINGS; MUSICAL VIDEO RECORDINGS, IN CLASS 9 (U.S. CLS. 21, 23, 26, 36 AND 38).

FIRST USE 5-7-2007; IN COMMERCE 5-7-2007.

THE MARK CONSISTS OF THE WORD "FIF" IS SEEN IN THE SYMBOL. THE FIRST "F" IS REVERSED IN ORDER TO GIVE THE APPEARANCE OF A FLYING OBJECT. BOTH "F"S HAVE BEEN STRETCHED TO RESEMBLE WINGS WITH THE "I" BEING THE BODY OF THE ENTITY. OBJECT SIMILAR TO A BUTTERFLY. "I" IS LOWERCASED TO REPRESENT THE HEAD AND BODY OF THE OBJECT. "FIF" STAND FOR "FIRST IN FLIGHT".

SER. NO. 77-270,186, FILED 9-1-2007.

STEPHANIE ALI, EXAMINING ATTORNEY

Int. Cls.: 7 and 9

Prior U.S. Cls.: 13, 19, 21, 23, 26, 31, 34, 35, 36 and 38

United States Patent and Trademark Office

Reg. No. 3,475,197

Registered July 29, 2008

**TRADEMARK
PRINCIPAL REGISTER**

GENERATION EASY

WOLF, CHRISTIAN (FED REP GERMANY INDIVIDUAL)
SONNENHALDE 11
MOSBACH, FED REP GERMANY D-74821

FOR: PACKAGING MACHINES, IN PARTICULAR PACKAGING MACHINES FOR PACKAGING WELDED PLASTIC FOILS; ELECTRIC WELDING APPARATUS AND ELECTRIC PLASTIC WELDING APPARATUS, NAMELY, ELECTRIC WELDING MACHINES, ELECTRIC ARC WELDING MACHINES, GAS WELDING MACHINES, OXY-ACETYLENE WELDING MACHINES, IN CLASS 7 (U.S. CLS. 13, 19, 21, 23, 31, 34 AND 35).

FOR: ELECTRIC WELDING APPARATUS FOR PLASTIC PACKAGING AND ELECTRIC PLASTIC WELDING APPARATUS FOR SEALING PLASTIC CONTAINERS THROUGH WELDING, NAMELY, LASER WELDING DEVICES, WELDING ELECTRODES, WELDING TRANSFORMERS; ELECTRIC FOIL SEALING APPARATUS FOR WELDING PLAS-

TIC PACKAGING FOILS AND FOR SEALING STERILE GOODS PACKAGING AND ELECTRIC FOIL SEALING APPARATUS WITH VACUUM FUNCTION FOR SEALING AND VACUUMING PLASTIC PACKAGING FOILS, NAMELY, HEAT SEALING MACHINES, IN CLASS 9 (U.S. CLS. 21, 23, 26, 36 AND 38).

THE MARK CONSISTS OF STANDARD CHARACTERS WITHOUT CLAIM TO ANY PARTICULAR FONT, STYLE, SIZE, OR COLOR.

PRIORITY CLAIMED UNDER SEC. 44(D) ON ERPN CMNTY TM OFC APPLICATION NO. 005754551, FILED 3-13-2007, REG. NO. 005754551, DATED 2-4-2008, EXPIRES 3-13-2017.

SER. NO. 77-270,533, FILED 9-4-2007.

GISELLE AGOSTO, EXAMINING ATTORNEY

Int. Cl.: 18

Prior U.S. Cls.: 1, 2, 3, 22 and 41

United States Patent and Trademark Office

Reg. No. 3,475,198

Registered July 29, 2008

**TRADEMARK
PRINCIPAL REGISTER**

Handmaiden



JACKSON, GWEN (UNITED STATES INDIVIDUAL)
UPPER
3355 WEST BLVD
CLEVELAND, OH 44111

FIRST USE 4-1-2005; IN COMMERCE 4-1-2005.

SER. NO. 77-270,582, FILED 9-4-2007.

FOR: HANDBAGS; PURSES, IN CLASS 18 (U.S. CLS. 1, 2, 3, 22 AND 41).

MICHAEL KAZAZIAN, EXAMINING ATTORNEY

Int. Cl.: 24

Prior U.S. Cls.: 42 and 50

United States Patent and Trademark Office

Reg. No. 3,475,199

Registered July 29, 2008

**TRADEMARK
PRINCIPAL REGISTER**

Nickel Quilts

SPETH, PATRICIA K. (UNITED STATES INDIVIDUAL)
3514 W. 31ST STREET
DAVENPORT, IA 52804

NO CLAIM IS MADE TO THE EXCLUSIVE RIGHT TO USE "QUILTS", APART FROM THE MARK AS SHOWN.

FOR: QUILTS, IN CLASS 24 (U.S. CLS. 42 AND 50).

SEC. 2(F).

FIRST USE 6-1-2001; IN COMMERCE 2-1-2002.

SER. NO. 77-270,614, FILED 9-4-2007.

THE MARK CONSISTS OF STANDARD CHARACTERS WITHOUT CLAIM TO ANY PARTICULAR FONT, STYLE, SIZE, OR COLOR.

GISELLE AGOSTO, EXAMINING ATTORNEY

Int. Cl.: 36

Prior U.S. Cls.: 100, 101 and 102

United States Patent and Trademark Office

Reg. No. 3,475,200

Registered July 29, 2008

**SERVICE MARK
PRINCIPAL REGISTER**

EARTH AS CENTER

MARSHALL D. KAPPELE (UNITED STATES IN-
DIVIDUAL)
610 ANDERSON BLVD.
GENEVA, IL 60134

THE MARK CONSISTS OF STANDARD CHAR-
ACTERS WITHOUT CLAIM TO ANY PARTICULAR
FONT, STYLE, SIZE, OR COLOR.

FOR: FINANCIAL SERVICES, NAMELY, ASSIST-
ING OTHERS IN THE SELECTION OF STOCKS
AND OTHER INVESTMENT FUNDS, IN CLASS 36
(U.S. CLS. 100, 101 AND 102).

SER. NO. 77-271,259, FILED 9-4-2007.

FIRST USE 7-30-2007; IN COMMERCE 7-31-2007.

MIDGE BUTLER, EXAMINING ATTORNEY

Int. Cl.: 40

Prior U.S. Cls.: 100, 103 and 106

United States Patent and Trademark Office

Reg. No. 3,475,201

Registered July 29, 2008

**SERVICE MARK
PRINCIPAL REGISTER**

PLASTOMER TECHNOLOGIES

COLTEC INDUSTRIES INC. (PENNSYLVANIA CORPORATION)
5605 CARNEGIE BOULEVARD
CHARLOTTE, NC 28209

FOR: MANUFACTURE OF PLASTIC PARTS, TAPES, FILMS, AND FIBERS TO THE ORDER AND/OR SPECIFICATION OF OTHERS; PROTOTYPE FABRICATION OF NEW PLASTIC PRODUCTS TO THE ORDER AND/OR SPECIFICATION OF OTHERS; MACHINE SHOP SERVICES, NAMELY, MACHINING PARTS FOR OTHERS; MOLDING SERVICES, NAMELY, CREATING CUSTOM MOLDED POLYTETRAFLUOROETHYLENE SHAPES AND PARTS THROUGH COMPRESSION MOLDING, ISOSTATIC MOLDING, AND AUTO MOLDING; ETCHING OF FLUOROPOLYMER SHEETS, TUBING, AND THREE-DIMEN-

SIONAL SHAPES, IN CLASS 40 (U.S. CLS. 100, 103 AND 106).

FIRST USE 0-0-2001; IN COMMERCE 0-0-2001.

THE MARK CONSISTS OF STANDARD CHARACTERS WITHOUT CLAIM TO ANY PARTICULAR FONT, STYLE, SIZE, OR COLOR.

NO CLAIM IS MADE TO THE EXCLUSIVE RIGHT TO USE "PLASTOMER", APART FROM THE MARK AS SHOWN.

SEC. 2(F).

SER. NO. 77-271,937, FILED 9-5-2007.

DOMINICK J. SALEMI, EXAMINING ATTORNEY

Int. Cl.: 41

Prior U.S. Cls.: 100, 101 and 107

United States Patent and Trademark Office

Reg. No. 3,475,202

Registered July 29, 2008

**SERVICE MARK
PRINCIPAL REGISTER**

When Women Walk

OWNED BY THE CORPORATION (NEVADA
LTD LIAB CO), DBA WHEN WOMEN WALK
LLC
1468 JAMES ROAD
GARDNERVILLE, NV 89460

FOR: EDUCATIONAL SERVICES, NAMELY,
CONDUCTING SEMINARS, WORKSHOPS AND
PRIVATE COACHING IN THE FIELD OF PRE-
SENCE, POSTURE AND THE LOST ART OF GRACE
AND DISTRIBUTION OF COURSE MATERIAL IN
CONNECTION THEREWITH, IN CLASS 41 (U.S.
CLS. 100, 101 AND 107).

FIRST USE 2-10-2007; IN COMMERCE 3-10-2007.

THE MARK CONSISTS OF STANDARD CHAR-
ACTERS WITHOUT CLAIM TO ANY PARTICULAR
FONT, STYLE, SIZE, OR COLOR.

SER. NO. 77-272,398, FILED 9-5-2007.

STEVEN JACKSON, EXAMINING ATTORNEY

Int. Cl.: 35

Prior U.S. Cls.: 100, 101 and 102

United States Patent and Trademark Office

Reg. No. 3,475,203

Registered July 29, 2008

SERVICE MARK
PRINCIPAL REGISTER



2CAPRICORNS, LLC (LOUISIANA LTD LIAB CO)
12313 SCHLAYER, AVE.
BATON ROUGE, LA 70816

FIRST USE 3-0-2007; IN COMMERCE 3-0-2007.

FOR: PROVIDING CONSUMER INFORMATION IN THE FIELD OF FOOD AND THE FOOD INDUSTRY VIA THE INTERNET; ADVERTISING SERVICES, NAMELY, PROMOTING THE GOODS AND SERVICES OF OTHERS, NAMELY, COOKBOOKS AND THE GOODS AND SERVICES OFFERED BY RESTAURANTS, GROCERY STORES, COOKWARE RETAILERS, AND COOKWARE MANUFACTURERS, IN CLASS 35 (U.S. CLS. 100, 101 AND 102).

THE MARK CONSISTS OF THE WORDS EAT LIKE, FOLLOWED BY A FIGURE DRESSED AS A NATIVE, WHOSE TORSO FORMS THE LETTER A, WHICH IS FOLLOWED BY THE WORD NATIVE.

SER. NO. 77-272,488, FILED 9-5-2007.

JOHN KELLY, EXAMINING ATTORNEY

Int. Cl.: 41

Prior U.S. Cls.: 100, 101 and 107

United States Patent and Trademark Office

Reg. No. 3,475,204

Registered July 29, 2008

**SERVICE MARK
PRINCIPAL REGISTER**

Saaphyri

SAAPHYRI WINDSOR, LLC (CALIFORNIA LTD
LIAB CO)
13354 VAN OWEN ST #202
VAN NUYS, CA 91405

FOR: ENTERTAINMENT IN THE NATURE OF
LIVE PERFORMANCES BY SAAPHYRI WINDSOR;
ENTERTAINMENT SERVICES, NAMELY, PERSONAL
APPEARANCES BY A TELEVISION PERSONALITY
AND ACTRESS, IN CLASS 41 (U.S. CLS. 100,
101 AND 107).

FIRST USE 12-1-1999; IN COMMERCE 12-1-1999.

THE MARK CONSISTS OF STANDARD CHARACTERS
WITHOUT CLAIM TO ANY PARTICULAR
FONT, STYLE, SIZE, OR COLOR.

THE NAME "SAAPHYRI" IDENTIFIES A LIVING
INDIVIDUAL WHOSE CONSENT IS OF RECORD.

SER. NO. 77-272,558, FILED 9-5-2007.

MICHAEL ENGEL, EXAMINING ATTORNEY

Int. Cl.: 9

Prior U.S. Cls.: 21, 23, 26, 36 and 38

United States Patent and Trademark Office

Reg. No. 3,475,205

Registered July 29, 2008

**TRADEMARK
PRINCIPAL REGISTER**



SIMPLE CONTROL, INC. (TENNESSEE CORPORATION), DBA SIMPLE CONTROL
2701 WOODSON DR
KNOXVILLE, TN 37920

FOR: HOME AND OFFICE AUTOMATION SYSTEMS COMPRISING WIRELESS AND WIRED CONTROLLERS, CONTROLLED DEVICES, AND SOFTWARE FOR LIGHTING, HVAC, SECURITY, SAFETY AND OTHER HOME AND OFFICE MONITORING AND CONTROL APPLICATIONS, IN CLASS 9 (U.S. CLS. 21, 23, 26, 36 AND 38).

FIRST USE 12-1-2006; IN COMMERCE 12-28-2006.

NO CLAIM IS MADE TO THE EXCLUSIVE RIGHT TO USE "SIMPLE CONTROL", APART FROM THE MARK AS SHOWN.

THE COLOR(S) BLUE, ORANGE, AND WHITE IS/ ARE CLAIMED AS A FEATURE OF THE MARK.

THE MARK CONSISTS OF THE COLORS BLUE, ORANGE, AND WHITE ARE CLAIMED AS A FEATURE OF THE MARK. THE COLOR BLUE APPEARS IN THE WORDING "SIMPLE CONTROL" AND IN THE DESIGN OF A HAND. THE COLOR ORANGE APPEARS IN THE BUTTON THAT REPLACES THE DOT OVER THE "I" AND IN THE DESIGN OF THE HOUSE. THE COLOR WHITE IS LOCATED IN THE DESIGN OF THE HAND AND IN THE DESIGN OF THE HOUSE.

SER. NO. 77-272,791, FILED 9-6-2007.

HEATHER SAPP, EXAMINING ATTORNEY

Int. Cl.: 35

Prior U.S. Cls.: 100, 101 and 102

United States Patent and Trademark Office

Reg. No. 3,475,206

Registered July 29, 2008

**SERVICE MARK
PRINCIPAL REGISTER**

BILLBOARD

NIELSEN BUSINESS MEDIA, INC. (DELAWARE
CORPORATION)
770 BROADWAY
NEW YORK, NY 100039595

FOR: ADVERTISING, MARKETING AND PRO-
MOTION SERVICES, EXCLUDING ADVERTISING
BY USE OF BILLBOARDS; ARRANGING AND
CONDUCTING BUSINESS CONFERENCES, IN
CLASS 35 (U.S. CLS. 100, 101 AND 102).

FIRST USE 1-5-1977; IN COMMERCE 1-5-1977.

THE MARK CONSISTS OF STANDARD CHAR-
ACTERS WITHOUT CLAIM TO ANY PARTICULAR
FONT, STYLE, SIZE, OR COLOR.

OWNER OF U.S. REG. NOS. 606,753, 1,528,168 AND
OTHERS.

SEC. 2(F).

SER. NO. 77-273,122, FILED 9-6-2007.

SANJEEV VOHRA, EXAMINING ATTORNEY

Int. Cls.: 1 and 9

Prior U.S. Cls.: 1, 5, 6, 10, 21, 23, 26, 36, 38 and 46

United States Patent and Trademark Office

Reg. No. 3,475,207

Registered July 29, 2008

**TRADEMARK
PRINCIPAL REGISTER**

FACE

PROZYME, INC. (CALIFORNIA CORPORATION)
1933 DAVIS STREET, SUITE 207
SAN LEANDRO, CA 945771258

FOR: ENZYMES, GLYCANS, PROTEIN PREPARATIONS, BIOCHEMICAL REAGENTS, AND ELECTROPHORESIS GELS, FOR USE IN SCIENTIFIC AND MEDICAL RESEARCH, IN CLASS 1 (U.S. CLS. 1, 5, 6, 10, 26 AND 46).

FIRST USE 1-31-1997; IN COMMERCE 1-31-1997.

FOR: SCIENTIFIC INSTRUMENTS, NAMELY, ELECTROPHORESIS APPARATUS, ELECTROPHORESIS GEL VIEWERS, REACTION VESSELS, FILTER CARTRIDGES, CHROMATOGRAPHY

COLUMNS, FOR THE DETECTION, QUALIFICATION, STRUCTURAL ANALYSIS OF GLYCOPROTEIN AND GLYCANS FOR SCIENTIFIC AND MEDICAL RESEARCH, IN CLASS 9 (U.S. CLS. 21, 23, 26, 36 AND 38).

FIRST USE 5-31-1995; IN COMMERCE 5-31-1995.

THE MARK CONSISTS OF STANDARD CHARACTERS WITHOUT CLAIM TO ANY PARTICULAR FONT, STYLE, SIZE, OR COLOR.

SER. NO. 77-273,485, FILED 9-6-2007.

TAMARA FRAZIER, EXAMINING ATTORNEY

Int. Cl.: 42

Prior U.S. Cls.: 100 and 101

United States Patent and Trademark Office

Reg. No. 3,475,208

Registered July 29, 2008

**SERVICE MARK
PRINCIPAL REGISTER**

defiantGoat

WARD, JASON NEAL (UNITED STATES INDIVIDUAL), DBA DEFIANTGOAT
P.O. BOX 84
RIVERSIDE, CA 92502

FOR: COMPUTER SERVICES IN THE NATURE OF CUSTOMIZED WEB PAGES FEATURING USER-DEFINED INFORMATION, PERSONAL PROFILES AND INFORMATION; COMPUTER SERVICES, NAMELY, CREATING AND MAINTAINING WEB SITES FOR OTHERS; COMPUTER SERVICES, NAMELY, DESIGNING AND IMPLEMENTING NETWORK WEB PAGES FOR OTHERS; COMPUTER SERVICES, NAMELY, DESIGNING AND IMPLEMENTING WEB SITES FOR OTHERS; COMPUTER SERVICES, NAMELY, MANAGING WEB SITES FOR OTHERS; CREATING OR MAINTAINING WEB SITES FOR OTHERS; CREATION AND MAINTENANCE OF WEB SITES FOR OTHERS; CREATION AND PROVISION OF WEB PAGES TO AND FOR THIRD PARTIES; ANIMATION AND SPECIAL-EFFECTS DESIGN FOR OTHERS; COMMERCIAL ART DESIGN; DESIGN AND DEVELOPMENT OF MULTIMEDIA PRODUCTS; DESIGN OF HOME PAGES; DESIGN OF HOME PAGES, COMPUTER SOFTWARE AND WEB SITES; DESIGN OF HOMEPAGES AND WEB-SITES; DESIGN OF HOMEPAGES AND WEBSITES; DESIGNING OF PACKAGING AND WRAPPING MATERIALS; DESIGNING THEME GRAPHICS AND MULTIMEDIA SHOWS FOR CONVENTIONS, PRODUCT LAUN-

CHES, TRADE SHOWS, KEY NOTE ADDRESSES AND AWARD CEREMONIES FOR OTHERS; DESIGNING WEBSITES FOR ADVERTISING PURPOSES; DEVELOPMENT, DESIGN AND UPDATING OF HOME PAGES; DISPLAYING THE WEB SITES AND IMAGES OF OTHERS ON A COMPUTER SERVER; ELABORATION AND MAINTENANCE OF WEB SITES FOR THIRD PARTIES; GRAPHIC ART DESIGN; GRAPHIC DESIGN SERVICES; PACKAGING DESIGN FOR OTHERS; PROVIDING CUSTOMIZED ON-LINE WEB PAGES FEATURING USER-DEFINED INFORMATION, WHICH INCLUDES SEARCH ENGINES AND ON-LINE WEB LINKS TO OTHER WEB SITES; VISUAL DESIGN SERVICES IN THE NATURE OF DESIGNING VISUAL ELEMENTS FOR ONLINE, BROADCAST, PRINT, OUTDOOR AND OTHER COMMUNICATION MEDIA, IN CLASS 42 (U.S. CLS. 100 AND 101).

FIRST USE 5-1-2007; IN COMMERCE 8-15-2007.

THE MARK CONSISTS OF STANDARD CHARACTERS WITHOUT CLAIM TO ANY PARTICULAR FONT, STYLE, SIZE, OR COLOR.

SER. NO. 77-274,506, FILED 9-7-2007.

MATTHEW MCDOWELL, EXAMINING ATTORNEY

Int. Cls.: 3 and 21

**Prior U.S. Cls.: 1, 2, 4, 6, 13, 23, 29, 30, 33, 40, 50, 51
and 52**

Reg. No. 3,475,209

United States Patent and Trademark Office

Registered July 29, 2008

**TRADEMARK
PRINCIPAL REGISTER**

ECOBALLS

ECOZONE (UK) LIMITED (UNITED KINGDOM
CORPORATION)
UNIT 1A TANNERY CLOSE
BECKENHAM, KENT, UNITED KINGDOM BR34BY

FOR: WASHING PREPARATIONS; BLEACHING
PREPARATIONS FOR LAUNDRY USE; LAUNDRY
PREPARATIONS, NAMELY, BLEACH, SOAPS, DE-
TERGENTS, FABRIC SOFTENERS AND DECALCI-
FIERS FOR FABRIC CONDITIONING; CLEANING,
POLISHING, AND SCOURING PREPARATIONS;
GENERAL PURPOSE ABRASIVE PREPARATIONS;
SOAPS AND DETERGENTS; FABRIC SOFTENERS;
FABRIC CONDITIONERS; STAIN REMOVAL PRE-
PARATIONS; FRESHENING PREPARATIONS FOR
USE ON CLOTHING, LAUNDRY AND TEXTILES;
BRIGHTENING PREPARATIONS FOR LAUNDRY;
DEGREASING PREPARATIONS NOT USED IN
MANUFACTURING PROCESS FOR HOUSEHOLD
LAUNDRY USE; PREPARATIONS FOR REMOV-
ING WRINKLES FROM CLOTHING, LAUNDRY
AND TEXTILES; PREPARATIONS FOR REDUC-
TION OF STATIC FROM CLOTHING, LAUNDRY

AND TEXTILES, IN CLASS 3 (U.S. CLS. 1, 4, 6, 50, 51
AND 52).

FOR: HOUSEHOLD UTENSILS AND ARTICLES
FOR CLEANING PURPOSES ALL BEING LAUN-
DRY WASHING DEVICES, NAMELY, SMALL
HAND-HELD PLASTIC DISPENSERS FOR SOAP,
DETERGENT AND LIQUID LAUNDRY PREPARA-
TIONS; FOAM SPONGE RINGS; ALL PLACED IN-
SIDE WASHING MACHINES TO AID WASHING
PROCESS (NOT PARTS OF MACHINES), IN CLASS
21 (U.S. CLS. 2, 13, 23, 29, 30, 33, 40 AND 50).

THE MARK CONSISTS OF STANDARD CHAR-
ACTERS WITHOUT CLAIM TO ANY PARTICULAR
FONT, STYLE, SIZE, OR COLOR.

OWNER OF UNITED KINGDOM REG. NO.
2443204, DATED 7-6-2007, EXPIRES 1-10-2017.

SER. NO. 77-275,269, FILED 9-10-2007.

AMY MCMENAMIN, EXAMINING ATTORNEY

Int. Cl.: 25

Prior U.S. Cls.: 22 and 39

United States Patent and Trademark Office

Reg. No. 3,475,210

Registered July 29, 2008

**TRADEMARK
PRINCIPAL REGISTER**

Rabid Fightwear

RABID FIGHTWEAR (TENNESSEE SOLE PROPRIETORSHIP)
418 BLACKBURN LANE
LENOIR CITY, TN 37771

FOR: SHIRTS; SWEAT SHIRTS; T-SHIRTS; UNDERWEAR; HATS; TOBOGGAN HATS; CAPS; SHORTS; TANK TOPS; JERSEYS; BRIEFS; JACKETS, IN CLASS 25 (U.S. CLS. 22 AND 39).

FIRST USE 7-1-2007; IN COMMERCE 7-21-2007.

THE MARK CONSISTS OF STANDARD CHARACTERS WITHOUT CLAIM TO ANY PARTICULAR FONT, STYLE, SIZE, OR COLOR.

NO CLAIM IS MADE TO THE EXCLUSIVE RIGHT TO USE "FIGHTWEAR", APART FROM THE MARK AS SHOWN.

SER. NO. 77-275,363, FILED 9-10-2007.

JEFF DEFORD, EXAMINING ATTORNEY

Int. Cl.: 7

Prior U.S. Cls.: 13, 19, 21, 23, 31, 34 and 35

United States Patent and Trademark Office

Reg. No. 3,475,211

Registered July 29, 2008

**TRADEMARK
PRINCIPAL REGISTER**

MDV

ADVANCED FLOW ENGINEERING, INC. (CALI-
FORNIA CORPORATION)
252 GRANITE STREET
CORONA, CA 92879

FOR: PARTS AND ACCESSORIES FOR VEHICLE
COMBUSTION ENGINES, NAMELY, AIR FLOW
SYSTEMS COMPRISING AIR INTAKE MANI-
FOLDS, AIR FILTERS, AIR FILTER HOUSINGS,
AIR INTAKE TUBES, AND EXHAUST MANI-
FOLDS, SOLD SEPARATELY AS SUBASSEMBLIES
OR AS A UNIT, IN CLASS 7 (U.S. CLS. 13, 19, 21, 23, 31,
34 AND 35).

FIRST USE 8-15-2007; IN COMMERCE 8-15-2007.

THE MARK CONSISTS OF STANDARD CHAR-
ACTERS WITHOUT CLAIM TO ANY PARTICULAR
FONT, STYLE, SIZE, OR COLOR.

SER. NO. 77-275,581, FILED 9-10-2007.

BENJAMIN OKEKE, EXAMINING ATTORNEY

Int. Cl.: 9

Prior U.S. Cls.: 21, 23, 26, 36 and 38

United States Patent and Trademark Office

Reg. No. 3,475,212

Registered July 29, 2008

**TRADEMARK
PRINCIPAL REGISTER**



KABUSHIKI KAISHA HITACHI SEISAKUSHO
(JAPAN CORPORATION), DBA HITACHI,
LTD.
6-6, MARUNOUCHI 1-CHOME, CHIYODA-KU
TOKYO, JAPAN

FOR: TELEVISION SETS, CAMCORDERS AND
DIGITAL IMAGE VIDEO PROCESSORS FOR CAM-
CORDERS AND TELEVISIONS, IN CLASS 9 (U.S.
CLS. 21, 23, 26, 36 AND 38).

OWNER OF JAPAN REG. NO. 4913022, DATED 12-
2-2005, EXPIRES 12-2-2015.

NO CLAIM IS MADE TO THE EXCLUSIVE
RIGHT TO USE "PICTURE", APART FROM THE
MARK AS SHOWN.

THE MARK CONSISTS OF THE WORDS "PIC-
TURE MASTER" AND NINE CUBES.

SER. NO. 77-276,378, FILED 9-11-2007.

PAUL CROWLEY, EXAMINING ATTORNEY

Int. Cl.: 9

Prior U.S. Cls.: 21, 23, 26, 36 and 38

United States Patent and Trademark Office

Reg. No. 3,475,213

Registered July 29, 2008

TRADEMARK
PRINCIPAL REGISTER



ArrayUnlock

INTEGROMICS, S.L. (SPAIN SOCIEDAD DE RESPONSABILIDAD LIMITADA (SL))
BIC GRANADA, AVDA. DE LA INNOVACIÓN, 1
ES-18100 ARMILLA, SPAIN

FOR: COMPUTER SOFTWARE FOR USE IN EXTRACTION OF INFORMATION FROM DATABASES IN DATA MANAGEMENT, INTEGRATION, DATA ANALYSIS AND DATA MINING IN THE FIELD OF GENOMICS, PROTEOMICS AND DRUG

DISCOVERY, IN CLASS 9 (U.S. CLS. 21, 23, 26, 36 AND 38).

FIRST USE 1-0-2003; IN COMMERCE 5-0-2006.

SER. NO. 77-277,253, FILED 9-12-2007.

MATTHEW PAPPAS, EXAMINING ATTORNEY

Int. Cl.: 9

Prior U.S. Cls.: 21, 23, 26, 36 and 38

Reg. No. 3,475,214

United States Patent and Trademark Office

Registered July 29, 2008

**TRADEMARK
PRINCIPAL REGISTER**



INTEGROMICS, S.L. (SPAIN SOCIEDAD DE RESPONSABILIDAD LIMITADA (SL))
BIC GRANADA, AVDA. DE LA INNOVACIÓN, 1
ES-18100 ARMILLA, SPAIN

DATA MINING IN THE FIELD OF GENOMICS, PROTEOMICS AND DRUG DISCOVERY, IN CLASS 9 (U.S. CLS. 21, 23, 26, 36 AND 38).

FOR: COMPUTER SOFTWARE DATABASE APPLICATION FOR USE IN STORAGE, ORGANIZATION AND TRACKING OF INFORMATION FOR MICROARRAY EXPERIMENTS IN DATA MANAGEMENT, INTEGRATION, DATA ANALYSIS AND

FIRST USE 1-0-2003; IN COMMERCE 5-0-2006.

SER. NO. 77-277,257, FILED 9-12-2007.

MATTHEW PAPPAS, EXAMINING ATTORNEY

Int. Cl.: 19

Prior U.S. Cls.: 1, 12, 33 and 50

United States Patent and Trademark Office

Reg. No. 3,475,215

Registered July 29, 2008

**TRADEMARK
PRINCIPAL REGISTER**



MOSAICS OF AMERICA, INC. (FLORIDA CORPORATION), DBA ARTISTRY IN MOSAICS
901 S 3RD ST
FT. PIERCE, FL 34950

FOR: CERAMIC TILES; CERAMIC TILES FOR FLOORING AND FACING; CERAMIC TILES FOR FLOORING AND LINING; CERAMIC TILES FOR TILE FLOORS AND COVERINGS, IN CLASS 19 (U.S. CLS. 1, 12, 33 AND 50).

FIRST USE 1-1-1987; IN COMMERCE 1-1-1987.

THE MARK CONSISTS OF THE NAME "ARTISTRYINMOSAICS" DEPICTED AS ONE WORD, WITH THE LETTERS "ART" APPEARING WITHIN THE GRAPHICAL ICON OF A WAVE. THE TOP OF THE WAVE ICON APPEARS AS A MOSAIC PATTERN.

SEC. 2(F).

SER. NO. 77-277,320, FILED 9-12-2007.

PRISCILLA MILTON, EXAMINING ATTORNEY

Int. Cls.: 41 and 45

Prior U.S. Cls.: 100, 101 and 107

United States Patent and Trademark Office

Reg. No. 3,475,216

Registered July 29, 2008

**SERVICE MARK
PRINCIPAL REGISTER**

BOOT CAMP
for
GODDESSES

GODDESS INTERNATIONAL INC. (PENNSYLVANIA CORPORATION)
PMB 117 113 7TH STREET
MILFORD, PA 18337

FOR: PROVIDING ASSISTANCE, PERSONAL TRAINING AND PHYSICAL FITNESS CONSULTATION TO INDIVIDUALS TO HELP THEM MAKE PHYSICAL FITNESS, STRENGTH, CONDITIONING, AND EXERCISE IMPROVEMENT IN THEIR DAILY LIVING; YOGA INSTRUCTION, IN CLASS 41 (U.S. CLS. 100, 101 AND 107).

FIRST USE 12-1-1995; IN COMMERCE 12-1-1995.

FOR: PROVIDING BOTH IN-PERSON AND ON-LINE HOLISTIC SPIRITUAL COUNSELING SERVICES; PROVIDING ON-LINE INFORMATION IN THE FIELD OF SPIRITUALITY, SELF-HELP, AND PERSONAL EMPOWERMENT SUBJECT MATTERS; PROVIDING SPIRITUAL REHABILITATION SERVICES, IN CLASS 45 (U.S. CLS. 100 AND 101).

FIRST USE 12-1-1995; IN COMMERCE 12-1-1995.

NO CLAIM IS MADE TO THE EXCLUSIVE RIGHT TO USE "BOOT CAMP", APART FROM THE MARK AS SHOWN.

THE COLOR(S) GREEN, BLACK AND PINK IS/ ARE CLAIMED AS A FEATURE OF THE MARK.

THE COLOR GREEN APPEARS IN THE WORDING "BOOT CAMP," THE COLOR BLACK APPEARS IN THE WORD "FOR" AND THE COLOR PINK APPEARS IN THE WORDING "GODDESSES".

SER. NO. 77-277,412, FILED S.R. 9-12-2007 AM. P.R. 4-9-2008.

KAREN BRACEY, EXAMINING ATTORNEY

Int. Cl.: 28

Prior U.S. Cls.: 22, 23, 38 and 50

United States Patent and Trademark Office

Reg. No. 3,475,217

Registered July 29, 2008

**TRADEMARK
PRINCIPAL REGISTER**



GONGE CREATIVE LEARNING APS (DEN-
MARK CORPORATION)
ENGDALSVEJ 96B
BRABRAND, DENMARK 8220

FOR: CHILDREN'S GAMES AND PLAYTHINGS
TO STIMULATE MOVEMENT, COGNITIVE AND
SOCIAL DEVELOPMENT, NAMELY, TACTILE
DISCS, WHEELED TOY PLATFORMS, INTERCON-
NECTING TOY STRUCTURAL TOY PLAY PIECES,
STILTS, PARACHUTE SHAPED FABRIC TOYS,
THROW TARGETS, TOPS IN THE NATURE OF A
TOY IN WHICH CHILDREN SIT FOR THE PUR-
POSE OF ROCKING OR SPINNING, AND MAG-
NETIC STRUCTURAL BUILDING BALLS;
CHILDREN'S GYMNAS TIC AND SPORTS ARTI-
CLES TO STIMULATE MOVEMENT, COGNITIVE
AND SOCIAL DEVELOPMENT OF CHILDREN,

NAMELY, JUMPING, STEPPING, CLIMBING AND
BALANCING TOY PIECES; PUNCHING BAGS;
TRAMPOLINES; BALANCING BOARDS, AND
BARS, IN CLASS 28 (U.S. CLS. 22, 23, 38 AND 50).

FIRST USE 8-31-2006; IN COMMERCE 8-31-2006.

THE MARK CONSISTS OF THE WORD "GONGE"
BELOW A FANCIFUL CONE DESIGN.

THE WORDING "GONGE" HAS NO MEANING
IN A FOREIGN LANGUAGE.

SER. NO. 77-277,540, FILED 9-12-2007.

SHAILA SETTLES, EXAMINING ATTORNEY

Int. Cl.: 35

Prior U.S. Cls.: 100, 101 and 102

United States Patent and Trademark Office

Reg. No. 3,475,218

Registered July 29, 2008

**SERVICE MARK
PRINCIPAL REGISTER**

Act Vertical

KURT SALMON ASSOCIATES, INC. (DELA-
WARE CORPORATION)
SUITE 900, 1355 PEACHTREE ST. NE
ATLANTA, GA 30309

THE MARK CONSISTS OF STANDARD CHAR-
ACTERS WITHOUT CLAIM TO ANY PARTICULAR
FONT, STYLE, SIZE, OR COLOR.

FOR: BUSINESS CONSULTING SERVICES RELA-
TED TO SUPPLY CHAIN NETWORKS FOR RETAI-
LERS AND SUPPLIERS, IN CLASS 35 (U.S. CLS. 100,
101 AND 102).

SER. NO. 77-278,514, FILED 9-13-2007.

FIRST USE 5-10-2005; IN COMMERCE 5-10-2005.

DAVID MURRAY, EXAMINING ATTORNEY

Int. Cl.: 44

Prior U.S. Cls.: 100 and 101

United States Patent and Trademark Office

Reg. No. 3,475,219

Registered July 29, 2008

**SERVICE MARK
PRINCIPAL REGISTER**



GENTLE LASER CENTER, LLC (VIRGINIA CORPORATION)
1308 WEST MAIN STREET
SALEM, VA 24153

FOR: PERMANENT HAIR REMOVAL AND REDUCTION, IN CLASS 44 (U.S. CLS. 100 AND 101).

FIRST USE 6-1-2006; IN COMMERCE 6-1-2006.

NO CLAIM IS MADE TO THE EXCLUSIVE RIGHT TO USE "CENTER", APART FROM THE MARK AS SHOWN.

THE MARK CONSISTS OF THE WORDS "GENTLE LASER" WITH A SILHOUETTE OF A PERSON LYING DOWN WITH THE WORD "CENTER" UNDER THE SILHOUETTE. COLOR IS NOT CLAIMED AS A FEATURE OF THE MARK.

SER. NO. 77-279,537, FILED 9-14-2007.

KELLY BOULTON, EXAMINING ATTORNEY

Int. Cls.: 35 and 41

Prior U.S. Cls.: 100, 101, 102 and 107

United States Patent and Trademark Office

Reg. No. 3,475,220

Registered July 29, 2008

**SERVICE MARK
PRINCIPAL REGISTER**

BRANDMILL

BRANDMILL, LLC (PENNSYLVANIA LTD LIAB
CO)

C/O STEPHEN WAYHART

125 BLACK OAK DRIVE

PITTSBURGH, PA 15220

FOR: ADVERTISING, MARKETING AND PRO-
MOTION SERVICES, IN CLASS 35 (U.S. CLS. 100, 101
AND 102).

FIRST USE 3-21-2000; IN COMMERCE 3-21-2000.

FOR: CONDUCTING WORKSHOPS AND SEMI-
NARS IN MARKETING, IN CLASS 41 (U.S. CLS. 100,
101 AND 107).

FIRST USE 3-21-2000; IN COMMERCE 3-21-2000.

THE MARK CONSISTS OF STANDARD CHAR-
ACTERS WITHOUT CLAIM TO ANY PARTICULAR
FONT, STYLE, SIZE, OR COLOR.

SER. NO. 77-280,383, FILED 9-14-2007.

JESSICA FATHY, EXAMINING ATTORNEY

Int. Cl.: 7

Prior U.S. Cls.: 13, 19, 21, 23, 31, 34 and 35

United States Patent and Trademark Office

Reg. No. 3,475,221

Registered July 29, 2008

TRADEMARK
PRINCIPAL REGISTER



BITIMEC INTERNATIONAL INC (CONNECTICUT CORPORATION)
15 E. PUTNAM AV (#290)
GREENWICH, CT 06830

FOR: VEHICLE WASHING INSTALLATIONS; VEHICLE WASHING MACHINES, IN CLASS 7 (U.S. CLS. 13, 19, 21, 23, 31, 34 AND 35).

FIRST USE 1-12-1998; IN COMMERCE 2-2-2003.

NO CLAIM IS MADE TO THE EXCLUSIVE RIGHT TO USE "WASH", APART FROM THE MARK AS SHOWN.

THE COLOR(S) RED, WHITE AND BLUE IS/ARE CLAIMED AS A FEATURE OF THE MARK.

THE COLOR RED APPEARS IN THE WORDS "SPEEDY WASH", IN THE LOWER OF THE TWO

CURVED LINES UNDER THE WORD "SPEEDY", AND IN THE TWO HORIZONTAL BARS UNDER THE WORD "BITIMEC"; THE COLOR BLUE APPEARS IN THE FRAME AROUND THE ENTIRE MARK, IN THE UPPER OF THE TWO CURVED LINES UNDER THE WORD "SPEEDY", AND IN THE WORDS "BY BITIMEC", EXCEPT FOR THE UPPER PART OF THE FIRST LETTER "I" IN "BITIMEC", WHICH IS SHOWN AS A FIVE-POINTED STAR OUTLINED IN BLUE; AND THE COLOR WHITE APPEARS IN THE BACKGROUND OF THE ENTIRE MARK, IN THE SMALL STAR ABOVE THE FIRST LETTER "I" IN "BITIMEC", AND IN THE WORDING "WWW.BITIMEC.COM".

SER. NO. 77-280,715, FILED 9-17-2007.

ESTHER BELENKER, EXAMINING ATTORNEY

Int. Cl.: 16

Prior U.S. Cls.: 2, 5, 22, 23, 29, 37, 38 and 50

United States Patent and Trademark Office

Reg. No. 3,475,222

Registered July 29, 2008

**TRADEMARK
PRINCIPAL REGISTER**

SANGRE DE CRISTO CHRONICLE

NEW MEXICAN, INC., THE (NEW MEXICO
CORPORATION)
202 EAST MARCY STREET
ALBUQUERQUE, NM 875012021

FOR: PRINTED PUBLICATIONS, NAMELY,
NEWSPAPERS, IN CLASS 16 (U.S. CLS. 2, 5, 22, 23,
29, 37, 38 AND 50).

FIRST USE 2-1-1975; IN COMMERCE 2-1-1975.

THE MARK CONSISTS OF STANDARD CHAR-
ACTERS WITHOUT CLAIM TO ANY PARTICULAR
FONT, STYLE, SIZE, OR COLOR.

NO CLAIM IS MADE TO THE EXCLUSIVE
RIGHT TO USE "CHRONICLE", APART FROM
THE MARK AS SHOWN.

THE ENGLISH TRANSLATION OF "SANGRE DE
CRISTO" IS BLOOD OF CHRIST

SER. NO. 77-281,202, FILED 9-17-2007.

CARYN GLASSER, EXAMINING ATTORNEY

Int. Cl.: 16

Prior U.S. Cls.: 2, 5, 22, 23, 29, 37, 38 and 50

Reg. No. 3,475,223

United States Patent and Trademark Office

Registered July 29, 2008

**TRADEMARK
PRINCIPAL REGISTER**

SENSO

GOLDSTEIN, IRA (UNITED STATES INDIVIDUAL)
6104 MADDY OAKS COURT
RALEIGH, NC 27616 AND
GOLDSTEIN, DAVID (UNITED STATES INDIVIDUAL)
6104 MADDY OAKS COURT
RALEIGH, NC 27616

THE MARK CONSISTS OF STANDARD CHARACTERS WITHOUT CLAIM TO ANY PARTICULAR FONT, STYLE, SIZE, OR COLOR.

THE ENGLISH TRANSLATION OF THE FOREIGN WORDING "SENSO" IN THE MARK IS SENSE.

FOR: ARTIST'S MATERIALS, NAMELY, ARTIST'S CANVAS PANELS, CANVAS FOR PAINTING, IN CLASS 16 (U.S. CLS. 2, 5, 22, 23, 29, 37, 38 AND 50).

SER. NO. 77-281,375, FILED 9-17-2007.

FIRST USE 3-27-2007; IN COMMERCE 3-27-2007.

JAY BESCH, EXAMINING ATTORNEY

Int. Cl.: 30

Prior U.S. Cl.: 46

United States Patent and Trademark Office

Reg. No. 3,475,224

Registered July 29, 2008

TRADEMARK
PRINCIPAL REGISTER



MEDITERRANEAN GYROS PRODUCTS INC
(NEW YORK CORPORATION), DBA CORFU
TASTY GYROS INC
1102 38TH AVENUE
LONG ISLAND CITY, NY 111016041

FOR: PITA BREAD, IN CLASS 30 (U.S. CL. 46).

FIRST USE 6-1-1997; IN COMMERCE 6-1-1997.

NO CLAIM IS MADE TO THE EXCLUSIVE
RIGHT TO USE "MEDITERRANEAN PITA BREAD",
APART FROM THE MARK AS SHOWN.

THE MARK CONSISTS OF CIRCULAR LOGO
WITH DECORATIVE BORDER WITH RUFFLED
AND SCALLOPED, ZIG ZAG EDGES CONSISTING
OF THREE OR MORE CONCENTRIC CIRCLES
WITH LETTERING INCLUDING "MEDITERRA-
NEAN PITA BREAD" AND A STALK OF GRAIN
IN THE CENTER.

SER. NO. 77-282,386, FILED 9-18-2007.

JAY FLOWERS, EXAMINING ATTORNEY

Int. Cls.: 35 and 36

Prior U.S. Cls.: 100, 101 and 102

United States Patent and Trademark Office

Reg. No. 3,475,225

Registered July 29, 2008

**SERVICE MARK
PRINCIPAL REGISTER**

LOANS THAT CHANGE LIVES

KIVA MICROFUNDS (CALIFORNIA NON-PROFIT CORPORATION)

3180 18TH STREET, SUITE 201

SAN FRANCISCO, CA 94110

FOR: MATCHING BORROWERS WITH POTENTIAL LENDERS IN THE FIELD OF LOW INCOME ENTREPRENEURIAL LENDING IN THE DEVELOPING WORLD, IN CLASS 35 (U.S. CLS. 100, 101 AND 102).

FIRST USE 3-1-2005; IN COMMERCE 4-5-2005.

FOR: COMMERCIAL LENDING SERVICES AND PEER-TO-PEER LENDING SERVICES, IN CLASS 36 (U.S. CLS. 100, 101 AND 102).

FIRST USE 3-1-2005; IN COMMERCE 4-5-2005.

THE MARK CONSISTS OF STANDARD CHARACTERS WITHOUT CLAIM TO ANY PARTICULAR FONT, STYLE, SIZE, OR COLOR.

SER. NO. 77-282,727, FILED 9-18-2007.

THEODORE MCBRIDE, EXAMINING ATTORNEY

Int. Cls.: 35 and 36

Prior U.S. Cls.: 100, 101 and 102

United States Patent and Trademark Office

Reg. No. 3,475,226

Registered July 29, 2008

**SERVICE MARK
PRINCIPAL REGISTER**

KIVA

KIVA MICROFUNDS (CALIFORNIA NON-PROFIT CORPORATION)

3180 18TH STREET, SUITE 201
SAN FRANCISCO, CA 94110

FOR: MATCHING BORROWERS WITH POTENTIAL LENDERS IN THE FIELD OF LOW INCOME ENTREPRENEURIAL LENDING IN THE DEVELOPING WORLD, IN CLASS 35 (U.S. CLS. 100, 101 AND 102).

FIRST USE 3-1-2005; IN COMMERCE 4-5-2005.

FOR: COMMERCIAL LENDING SERVICES AND PEER-TO-PEER LENDING SERVICES, IN CLASS 36 (U.S. CLS. 100, 101 AND 102).

FIRST USE 3-1-2005; IN COMMERCE 4-5-2005.

THE MARK CONSISTS OF STANDARD CHARACTERS WITHOUT CLAIM TO ANY PARTICULAR FONT, STYLE, SIZE, OR COLOR.

SER. NO. 77-282,826, FILED 9-18-2007.

THEODORE MCBRIDE, EXAMINING ATTORNEY

Int. Cls.: 35 and 36

Prior U.S. Cls.: 100, 101 and 102

United States Patent and Trademark Office

Reg. No. 3,475,227

Registered July 29, 2008

**SERVICE MARK
PRINCIPAL REGISTER**

Score, Fix & Lock

PATHWAY DATA, INC. (NEVADA CORPORATION)
3187 REDHILL AVE, SUITE 100
COSTA MESA, CA 92626

FOR: MONITORING CONSUMER CREDIT REPORTS AND PROVIDING AN ALERT AS TO ANY CHANGES THEREIN, OVER COMPUTER NETWORKS, IN CLASS 35 (U.S. CLS. 100, 101 AND 102).

FIRST USE 7-15-2007; IN COMMERCE 7-15-2007.

FOR: FINANCIAL ANALYSIS, NAMELY, CREDIT RISK ANALYSIS PROVIDED OVER COMPUTER NETWORKS; FINANCIAL MANAGEMENT, NAMELY, CREDIT MANAGEMENT AND ANALYSIS

PROVIDED OVER COMPUTER NETWORKS; PROVIDING FINANCIAL INFORMATION IN THE FIELD OF CREDIT MANAGEMENT OVER COMPUTER NETWORKS, IN CLASS 36 (U.S. CLS. 100, 101 AND 102).

FIRST USE 7-15-2007; IN COMMERCE 7-15-2007.

THE MARK CONSISTS OF STANDARD CHARACTERS WITHOUT CLAIM TO ANY PARTICULAR FONT, STYLE, SIZE, OR COLOR.

SER. NO. 77-282,943, FILED 9-18-2007.

EVELYN BRADLEY, EXAMINING ATTORNEY

Int. Cl.: 25

Prior U.S. Cls.: 22 and 39

United States Patent and Trademark Office

Reg. No. 3,475,228

Registered July 29, 2008

**TRADEMARK
PRINCIPAL REGISTER**

LOCATION

S & M HOSIERY CO LTD (UNITED KINGDOM
LIMITED COMPANY (LTD.))
7 BURY NEW ROAD
MANCHESTER, M8 8FW, UNITED KINGDOM

FOR: JACKETS, COATS, PARKAS, PANTS, TOPS,
SHORTS, T-SHIRTS, SWEATSHIRTS, SWEAT-
PANTS, SKIRTS, SWIMWEAR, SWEATERS, BLOU-
SES, SOCKS, HOSIERY, FOOTWEAR, HEADWEAR ,
IN CLASS 25 (U.S. CLS. 22 AND 39).

THE MARK CONSISTS OF STANDARD CHAR-
ACTERS WITHOUT CLAIM TO ANY PARTICULAR
FONT, STYLE, SIZE, OR COLOR.

OWNER OF UNITED KINGDOM REG. NO.
1159556, DATED 8-14-1981, EXPIRES 8-14-2012.

SER. NO. 77-283,203, FILED 9-19-2007.

DEIRDRE ROBERTSON, EXAMINING ATTORNEY

Int. Cl.: 36

Prior U.S. Cls.: 100, 101 and 102

United States Patent and Trademark Office

Reg. No. 3,475,229

Registered July 29, 2008

**SERVICE MARK
PRINCIPAL REGISTER**



FULL BELLY PROJECT LTD. (NORTH CAROLINA NON-PROFIT ORGANIZATION)
AZALEA STATION
P.O. BOX 7874
WILMINGTON, NC 28406

FIRST USE 7-8-2006; IN COMMERCE 7-8-2006.

FOR: CHARITABLE FUND RAISING; CHARITABLE FINANCIAL SERVICES FOR THOSE IN NEED, NAMELY, ACCEPTING AND ADMINISTERING MONETARY CHARITABLE CONTRIBUTIONS; FINANCIAL SPONSORSHIP OF FUND RAISING EVENTS AND EVENTS DESIGNED TO RAISE THE PROFILE OF CHARITABLE AND SOCIAL ISSUES; FINANCIAL MANAGEMENT, NAMELY, MANAGEMENT OF FUNDS FOR CHARITIES; INVESTMENT OF FUNDS FOR OTHERS; PROJECT FINANCING, IN CLASS 36 (U.S. CLS. 100, 101 AND 102).

NO CLAIM IS MADE TO THE EXCLUSIVE RIGHT TO USE "PROJECT", APART FROM THE MARK AS SHOWN.

THE MARK CONSISTS OF THE WORDS "FULL BELLY PROJECT", AN IMAGE OF AN UPPER BODY HOLDING A GLOBE, AND TWO CONCENTRIC CIRCLES.

SER. NO. 77-283,487, FILED 9-19-2007.

SONYA STEPHENS, EXAMINING ATTORNEY

Int. Cls.: 42 and 44

Prior U.S. Cls.: 100 and 101

United States Patent and Trademark Office

Reg. No. 3,475,230

Registered July 29, 2008

**SERVICE MARK
PRINCIPAL REGISTER**

ONE SOURCE, MANY RESOURCES

ELSEVIER INC. (NEW YORK CORPORATION)
1105 NORTH MARKET STREET, SUITE 501
WILMINGTON, DE 19801

FOR: PROVIDING A WEBSITE FEATURING
MEDICAL INFORMATION REGARDING CANCER
RESEARCH AND PROVIDING LINKS TO THE
WEBSITES OF OTHERS FEATURING SUCH IN-
FORMATION , IN CLASS 42 (U.S. CLS. 100 AND 101).

FIRST USE 9-7-2007; IN COMMERCE 9-7-2007.

FOR: PROVIDING A WEBSITE FEATURING IN-
FORMATION REGARDING THE PREVENTION,

DIAGNOSIS AND TREATMENT OF CANCER, IN
CLASS 44 (U.S. CLS. 100 AND 101).

FIRST USE 9-7-2007; IN COMMERCE 9-7-2007.

THE MARK CONSISTS OF STANDARD CHAR-
ACTERS WITHOUT CLAIM TO ANY PARTICULAR
FONT, STYLE, SIZE, OR COLOR.

SER. NO. 77-283,490, FILED 9-19-2007.

GEOFFREY FOSDICK, EXAMINING ATTORNEY

Int. Cl.: 25

Prior U.S. Cls.: 22 and 39

United States Patent and Trademark Office

Reg. No. 3,475,231

Registered July 29, 2008

**TRADEMARK
PRINCIPAL REGISTER**

Ankle-biter Couture

CROSS, MIKA C (CALIFORNIA SOLE PROPRIETORSHIP), DBA ANKLE-BITER COUTURE

2600 W. LA HABRA BLVD. #138

LA HABRA, CA 90631

FOR: T-SHIRTS, IN CLASS 25 (U.S. CLS. 22 AND 39).

FIRST USE 4-3-2006; IN COMMERCE 7-7-2007.

THE MARK CONSISTS OF STANDARD CHARACTERS WITHOUT CLAIM TO ANY PARTICULAR FONT, STYLE, SIZE, OR COLOR.

NO CLAIM IS MADE TO THE EXCLUSIVE RIGHT TO USE "COUTURE", APART FROM THE MARK AS SHOWN.

SER. NO. 77-283,931, FILED 9-19-2007.

TINA KUAN, EXAMINING ATTORNEY

Int. Cl.: 16

Prior U.S. Cls.: 2, 5, 22, 23, 29, 37, 38 and 50

United States Patent and Trademark Office

Reg. No. 3,475,232

Registered July 29, 2008

**TRADEMARK
PRINCIPAL REGISTER**

EL POPULAR

CAMACHO, GEORGE (MEXICO INDIVIDUAL)
208 TRUXTUN AVENUE
BAKERSFIELD, CA 93301

FOR: NEWSPAPERS, IN CLASS 16 (U.S. CLS. 2, 5,
22, 23, 29, 37, 38 AND 50).

FIRST USE 8-26-1983; IN COMMERCE 8-26-1983.

THE MARK CONSISTS OF STANDARD CHAR-
ACTERS WITHOUT CLAIM TO ANY PARTICULAR
FONT, STYLE, SIZE, OR COLOR.

THE ENGLISH TRANSLATION OF THE WORD
"EL POPULAR" IN THE MARK IS THE POPULAR
ONE.

SEC. 2(F).

SER. NO. 77-283,953, FILED 9-19-2007.

ANGELA GAW, EXAMINING ATTORNEY

Int. Cl.: 42

Prior U.S. Cls.: 100 and 101

United States Patent and Trademark Office

Reg. No. 3,475,233

Registered July 29, 2008

**SERVICE MARK
PRINCIPAL REGISTER**

**ACCREDITED STAGING
PROFESSIONAL MASTERS**

BARB, INC. (WASHINGTON CORPORATION),
DBA STAGED HOMES
4807 CLAYTON RD. SUITE #200
CONCORD, CA 94521

FOR: ACCREDITATION SERVICES, NAMELY,
DEVELOPING, EVALUATING, AND TESTING
STANDARDS FOR HOME RENOVATION, DESIGN
AND DECORATION FOR THE PURPOSE OF AC-
CREDITATION, IN CLASS 42 (U.S. CLS. 100 AND
101).

FIRST USE 11-30-2001; IN COMMERCE 11-30-2001.

THE MARK CONSISTS OF STANDARD CHAR-
ACTERS WITHOUT CLAIM TO ANY PARTICULAR
FONT, STYLE, SIZE, OR COLOR.

NO CLAIM IS MADE TO THE EXCLUSIVE
RIGHT TO USE "ACCREDITED STAGING", APART
FROM THE MARK AS SHOWN.

SEC. 2(F).

SER. NO. 77-284,328, FILED 9-20-2007.

DAWN HAN, EXAMINING ATTORNEY

Int. Cls.: 16 and 41

Prior U.S. Cls.: 2, 5, 22, 23, 29, 37, 38, 50, 100, 101 and 107

Reg. No. 3,475,234

United States Patent and Trademark Office

Registered July 29, 2008

**TRADEMARK
SERVICE MARK
PRINCIPAL REGISTER**

Nutrition Business Journal

PENTON MEDIA, INC. (DELAWARE CORPORATION)
4TH FLOOR
249 WEST 17TH STREET
NEW YORK, NY 10011

FOR: TRADE JOURNALS IN THE FIELD OF THE NUTRITION, NATURAL PRODUCTS AND ALTERNATIVE HEALTH CARE INDUSTRIES; NEWSLETTERS IN THE FIELD OF THE NUTRITION, NATURAL PRODUCTS AND ALTERNATIVE HEALTH CARE INDUSTRIES, IN CLASS 16 (U.S. CLS. 2, 5, 22, 23, 29, 37, 38 AND 50).

FIRST USE 8-0-1996; IN COMMERCE 8-0-1996.

FOR: PROVIDING ON-LINE PUBLICATIONS IN THE NATURE OF JOURNALS AND NEWSLETTERS IN THE FIELD OF THE NUTRITION, NATURAL PRODUCTS AND ALTERNATIVE HEALTH CARE

INDUSTRIES, IN CLASS 41 (U.S. CLS. 100, 101 AND 107).

FIRST USE 11-0-1998; IN COMMERCE 11-0-1998.

THE MARK CONSISTS OF STANDARD CHARACTERS WITHOUT CLAIM TO ANY PARTICULAR FONT, STYLE, SIZE, OR COLOR.

NO CLAIM IS MADE TO THE EXCLUSIVE RIGHT TO USE "BUSINESS JOURNAL", APART FROM THE MARK AS SHOWN.

SEC. 2(F).

SER. NO. 77-284,601, FILED 9-20-2007.

MARTHA FROMM, EXAMINING ATTORNEY

Int. Cl.: 41

Prior U.S. Cls.: 100, 101 and 107

United States Patent and Trademark Office

Reg. No. 3,475,235

Registered July 29, 2008

**SERVICE MARK
PRINCIPAL REGISTER**

**ATTITUDE, DISCIPLINE, AND
RESPECT ARE THE GOALS;
KARATE IS THE METHOD**

PEPPER, CODY (UNITED STATES INDIVIDUAL)
SUITE 108
2500 S. BROADWAY
EDMOND, OK 73013

FOR: MARTIAL ARTS INSTRUCTION, IN CLASS
41 (U.S. CLS. 100, 101 AND 107).

FIRST USE 8-1-2006; IN COMMERCE 8-1-2006.

THE MARK CONSISTS OF STANDARD CHAR-
ACTERS WITHOUT CLAIM TO ANY PARTICULAR
FONT, STYLE, SIZE, OR COLOR.

NO CLAIM IS MADE TO THE EXCLUSIVE
RIGHT TO USE "KARATE", APART FROM THE
MARK AS SHOWN.

SER. NO. 77-284,768, FILED 9-20-2007.

JACQUELINE A. LAVINE, EXAMINING ATTOR-
NEY

Int. Cl.: 11

Prior U.S. Cls.: 13, 21, 23, 31 and 34

United States Patent and Trademark Office

Reg. No. 3,475,236

Registered July 29, 2008

**TRADEMARK
PRINCIPAL REGISTER**

RESERVEPRO

GENERAL FILTERS, INC. (MICHIGAN CORPORATION)
43800 GRAND RIVER
NOVI, MI 483751115

FOR: MAINTENANCE AND REPLACEMENT PARTS FOR HVAC UNITS, NAMELY, AIR FILTERS, AIR CLEANERS; VAPOR PADS; EVAPORATOR PADS; EVAPORATOR SLEEVES; EVAPORATOR PLATES; PARTS FOR HUMIDIFIERS, NAMELY, WATER STRAINERS, WATER ORIFICES, HUMIDIFIER DISTRIBUTOR TUBES, SOLENOID VALVES, SENDING RELAYS, STEAM CYLINDERS AND

VENTILATING FANS, IN CLASS 11 (U.S. CLS. 13, 21, 23, 31 AND 34).

FIRST USE 7-15-2006; IN COMMERCE 9-10-2006.

THE MARK CONSISTS OF STANDARD CHARACTERS WITHOUT CLAIM TO ANY PARTICULAR FONT, STYLE, SIZE, OR COLOR.

SER. NO. 77-285,538, FILED 9-21-2007.

MARY ROSSMAN, EXAMINING ATTORNEY

Int. Cls.: 16 and 41

Prior U.S. Cls.: 2, 5, 22, 23, 29, 37, 38, 50, 100, 101 and 107

Reg. No. 3,475,237

United States Patent and Trademark Office

Registered July 29, 2008

**TRADEMARK
SERVICE MARK
PRINCIPAL REGISTER**

JA Economics

JA WORLDWIDE (COLORADO CORPORATION)
1 EDUCATION WAY
COLORADO SPRINGS, CO 809064477

FOR: PRINTED EDUCATIONAL MATERIALS AND KITS FOR TEACHING ECONOMICS TO CHILDREN AND YOUNG ADULTS COMPRISING TEACHING AND VOLUNTEER MANUALS AND GUIDES, STUDENT INSTRUCTIONAL MANUALS AND MATERIALS, GUIDES AND WORKSHEETS, BROCHURES FOR ECONOMICS EDUCATION, ECONOMICS FORMS FOR TEACHING, CERTIFICATES OF ACHIEVEMENT AND A CD ROM CONTAINING SUCH MATERIALS, IN CLASS 16 (U.S. CLS. 2, 5, 22, 23, 29, 37, 38 AND 50).

FIRST USE 7-1-2000; IN COMMERCE 7-1-2000.

FOR: EDUCATIONAL SERVICES, NAMELY, CONDUCTING ECONOMIC EDUCATION PRO-

GRAMS, SEMINARS, CONFERENCES AND WORKSHOPS FOR TEACHING CHILDREN AND YOUNG ADULTS, IN CLASS 41 (U.S. CLS. 100, 101 AND 107).

FIRST USE 7-1-2000; IN COMMERCE 7-1-2000.

THE MARK CONSISTS OF STANDARD CHARACTERS WITHOUT CLAIM TO ANY PARTICULAR FONT, STYLE, SIZE, OR COLOR.

OWNER OF U.S. REG. NOS. 3,139,601, 3,324,172 AND OTHERS.

NO CLAIM IS MADE TO THE EXCLUSIVE RIGHT TO USE "ECONOMICS", APART FROM THE MARK AS SHOWN.

SER. NO. 77-286,238, FILED 9-21-2007.

TEJBIR SINGH, EXAMINING ATTORNEY

Int. Cls.: 9 and 41

Prior U.S. Cls.: 21, 23, 26, 36, 38, 100, 101 and 107

Reg. No. 3,475,238

United States Patent and Trademark Office

Registered July 29, 2008

**TRADEMARK
SERVICE MARK
PRINCIPAL REGISTER**

**Serious Games, Serious
Learning**

DECISIVE-POINT LLC (MISSOURI LTD LIAB
CO)
3800 N.MULBERRY DR, SUITE 302
KANSAS CITY, MO 64116

FOR: COMPUTER GAME SOFTWARE, IN CLASS
9 (U.S. CLS. 21, 23, 26, 36 AND 38).

FIRST USE 4-13-2007; IN COMMERCE 7-14-2007.

FOR: EDUCATION SERVICES, NAMELY, PRO-
VIDING SEMINARS IN THE FIELDS OF LEADER-
SHIP AND TEAM-BUILDING, IN CLASS 41 (U.S.
CLS. 100, 101 AND 107).

FIRST USE 4-13-2007; IN COMMERCE 7-30-2007.

THE MARK CONSISTS OF STANDARD CHAR-
ACTERS WITHOUT CLAIM TO ANY PARTICULAR
FONT, STYLE, SIZE, OR COLOR.

NO CLAIM IS MADE TO THE EXCLUSIVE
RIGHT TO USE "SERIOUS GAMES", APART FROM
THE MARK AS SHOWN.

SER. NO. 77-286,288, FILED 9-21-2007.

JASON TURNER, EXAMINING ATTORNEY

Int. Cl.: 9

Prior U.S. Cls.: 21, 23, 26, 36 and 38

United States Patent and Trademark Office

Reg. No. 3,475,239

Registered July 29, 2008

**TRADEMARK
PRINCIPAL REGISTER**

RAPID RESTORE

KANE, JR, TOM (UNITED STATES INDIVIDUAL)
674 6TH STREET
SAINT PAUL, MN 55106 AND
LOWENSTEIN, CHAIM (UNITED STATES INDIVIDUAL)
2030 SOUTH 3RD STREET, SUITE 119
JACKSONVILLE, FL 32250

FOR: ANTI-SPYWARE SOFTWARE; COMPUTER HARDWARE; COMPUTER SOFTWARE FOR USE IN THE SAFEGUARDING OF DIGITAL FILES, INCLUDING AUDIO, VIDEO, TEXT, BINARY, STILL IMAGES, GRAPHICS AND MULTIMEDIA FILES; COMPUTER SOFTWARE FOR SAFEGUARDING AND RESTORING FILES; COMPUTER SOFTWARE FOR BACKUP AND RECOVERY OF FILES THAT MAY BE DOWNLOADED FROM A

GLOBAL COMPUTER NETWORK; COMPUTER CHIPS; SOFTWARE FOR ENSURING THE SECURITY OF ELECTRONIC MAIL, IN CLASS 9 (U.S. CLS. 21, 23, 26, 36 AND 38).

FIRST USE 12-30-2002; IN COMMERCE 12-30-2002.

THE MARK CONSISTS OF STANDARD CHARACTERS WITHOUT CLAIM TO ANY PARTICULAR FONT, STYLE, SIZE, OR COLOR.

SEC. 2(F).

SER. NO. 77-286,641, FILED 9-23-2007.

ESTHER BELENKER, EXAMINING ATTORNEY

Int. Cl.: 28

Prior U.S. Cls.: 22, 23, 38 and 50

United States Patent and Trademark Office

Reg. No. 3,475,240

Registered July 29, 2008

**TRADEMARK
PRINCIPAL REGISTER**

Toward Pro

HSUEH, CHIEN-CHUN (TAIWAN INDIVIDUAL)
16F-2, NO. 233, SEC. 2, YUNG HE RD
YUNG HE CITY, TAIWAN

THE MARK CONSISTS OF STANDARD CHAR-
ACTERS WITHOUT CLAIM TO ANY PARTICULAR
FONT, STYLE, SIZE, OR COLOR.

FOR: REMOTE AND RADIO CONTROLLED
TOYS AND PARTS THEREOF, NAMELY, CARS,
RACE CARS, AIRPLANES, BOATS, AND ROBOTS,
IN CLASS 28 (U.S. CLS. 22, 23, 38 AND 50).

SER. NO. 77-286,955, FILED 9-24-2007.

FIRST USE 8-1-2007; IN COMMERCE 8-1-2007.

TINA L. SNAPP, EXAMINING ATTORNEY

Int. Cl.: 40

Prior U.S. Cls.: 100, 103 and 106

United States Patent and Trademark Office

Reg. No. 3,475,241

Registered July 29, 2008

**SERVICE MARK
PRINCIPAL REGISTER**

GOD'S UNIFORMS

CALIGONE, ANGELA E. (UNITED STATES INDIVIDUAL), DBA GOD'S UNIFORMS
16210 LOS ALTOS
HOUSTON, TX 77083 AND
CALIGONE, ALLAN R. (UNITED STATES INDIVIDUAL), DBA GOD'S UNIFORMS
16210 LOS ALTOS
HOUSTON, TX 77083

FOR: IMPRINTING MESSAGES ON WEARING APPAREL, ACCESSORIES AND MUGS, IN CLASS 40 (U.S. CLS. 100, 103 AND 106).

FIRST USE 3-31-2007; IN COMMERCE 4-14-2007.

THE MARK CONSISTS OF STANDARD CHARACTERS WITHOUT CLAIM TO ANY PARTICULAR FONT, STYLE, SIZE, OR COLOR.

NO CLAIM IS MADE TO THE EXCLUSIVE RIGHT TO USE "UNIFORMS", APART FROM THE MARK AS SHOWN.

SER. NO. 77-287,287, FILED 9-24-2007.

AISHA CLARKE, EXAMINING ATTORNEY

Int. Cl.: 9

Prior U.S. Cls.: 21, 23, 26, 36 and 38

Reg. No. 3,475,242

United States Patent and Trademark Office

Registered July 29, 2008

**TRADEMARK
PRINCIPAL REGISTER**

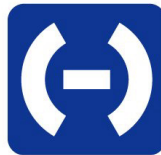

HJC MOTORSPORTS

HJC AMERICA, INC. (CALIFORNIA CORPORATION), DBA HJC HELMETS
16918 EDWARDS RD.
CERRITOS, CA 90703

FOR: SAFETY HELMETS, IN CLASS 9 (U.S. CLS. 21, 23, 26, 36 AND 38).

FIRST USE 9-1-2007; IN COMMERCE 9-1-2007.

NO CLAIM IS MADE TO THE EXCLUSIVE RIGHT TO USE "MOTORSPORTS", APART FROM THE MARK AS SHOWN.

THE COLOR(S) BLUE AND WHITE IS/ARE CLAIMED AS A FEATURE OF THE MARK.

THE COLOR BLUE APPEARS IN THE WORDING "HJC MOTORSPORTS", AND IN THE SQUARE DESIGN, AND THE COLOR WHITE APPEARS AS A STYLIZED "H" WITHIN THE BLUE SQUARE DESIGN.

SER. NO. 77-287,634, FILED 9-24-2007.

TEJBIR SINGH, EXAMINING ATTORNEY

Int. Cl.: 35

Prior U.S. Cls.: 100, 101 and 102

United States Patent and Trademark Office

Reg. No. 3,475,243

Registered July 29, 2008

SERVICE MARK
PRINCIPAL REGISTER



JOHN G. THROWER (UNITED STATES INDIVIDUAL)
5503 FORESTHAVEN DR.
HOUSTON, TX 77066

FOR: BUSINESS MARKETING SERVICES, NAMELY, CREATING, CONDUCTING, CONSULTING AND COORDINATING MULTIMEDIA CAMPAIGNS FOR OTHERS AND PROVIDING MARKETING MATERIALS IN CONJUNCTION THEREWITH RELATING TO THE SALE OF MOTOR VEHICLES, IN CLASS 35 (U.S. CLS. 100, 101 AND 102).

FIRST USE 2-10-2005; IN COMMERCE 2-10-2005.

NO CLAIM IS MADE TO THE EXCLUSIVE RIGHT TO USE "AUTO CREDIT", APART FROM THE MARK AS SHOWN.

THE COLOR(S) GREEN, BLACK, RED AND WHITE IS/ARE CLAIMED AS A FEATURE OF THE MARK.

THE MARK CONSISTS OF A GREEN CROSS WITH A BLACK BORDER AND WORDS WITHIN THE CROSS, THE WORDS "THE", "HOSPITAL" AND ".COM" IN WHITE WITH A BLACK BORDER AND THE WORDS "AUTO CREDIT" IN RED WITH A WHITE BORDER FURTHER SURROUNDED BY A BLACK BORDER.

SER. NO. 77-287,726, FILED 9-24-2007.

PAM WILLIS, EXAMINING ATTORNEY

Int. Cl.: 12

Prior U.S. Cls.: 19, 21, 23, 31, 35 and 44

United States Patent and Trademark Office

Reg. No. 3,475,244

Registered July 29, 2008

**TRADEMARK
PRINCIPAL REGISTER**



GERALD L. BOLDT (UNITED STATES INDIVIDUAL)
420 FIRST ST. N.
WINSTED, MN 55395

THE MARK CONSISTS OF SUN AND RAYS IN BACKGROUND. WORDS IN FOREGROUND. CROSS SHAPE IN CENTER OF LETTER "C" IN CHAPEL. SLOGAN BENEATH.

FOR: VANS, IN CLASS 12 (U.S. CLS. 19, 21, 23, 31, 35 AND 44).

SER. NO. 77-287,844, FILED 9-25-2007.

FIRST USE 8-12-2007; IN COMMERCE 8-12-2007.

NO CLAIM IS MADE TO THE EXCLUSIVE RIGHT TO USE "FIRST RESPONSE MOBILE CHAPEL", APART FROM THE MARK AS SHOWN.

EUGENIA MARTIN, EXAMINING ATTORNEY

Int. Cl.: 9

Prior U.S. Cls.: 21, 23, 26, 36 and 38

United States Patent and Trademark Office

Reg. No. 3,475,245

Registered July 29, 2008

**TRADEMARK
PRINCIPAL REGISTER**

CLAMAV

SOURCEFIRE, INC. (DELAWARE CORPORATION)
9770 PATUXENT WOODS DRIVE
COLUMBIA, MD 21046

FOR: COMPUTER PROGRAMS FOR CONTENT FILTERING, FOR BLOCKING COMPUTER VIRUSES AND WORMS, ANTI-SPAM PROTECTION, E-MAIL SCANNING; COMPUTER PROGRAMS, NAMELY, ELECTRONICALLY DOWNLOADABLE SOFTWARE FOR CONTENT FILTERING, FOR BLOCKING COMPUTER VIRUSES AND WORMS, ANTI-SPAM PROTECTION, E-MAIL SCANNING;

ANTI-VIRUS COMPUTER PROGRAMS, IN CLASS 9 (U.S. CLS. 21, 23, 26, 36 AND 38).

FIRST USE 5-8-2002; IN COMMERCE 5-8-2002.

THE MARK CONSISTS OF STANDARD CHARACTERS WITHOUT CLAIM TO ANY PARTICULAR FONT, STYLE, SIZE, OR COLOR.

SER. NO. 77-288,144, FILED 9-25-2007.

WANDA KAY PRICE, EXAMINING ATTORNEY

Int. Cl.: 9

Prior U.S. Cls.: 21, 23, 26, 36 and 38

United States Patent and Trademark Office

Reg. No. 3,475,246

Registered July 29, 2008

**TRADEMARK
PRINCIPAL REGISTER**



SOURCEFIRE, INC. (DELAWARE CORPORATION)
9770 PATUXENT WOODS DRIVE
COLUMBIA, MD 21046

FOR: COMPUTER PROGRAMS FOR CONTENT FILTERING, FOR BLOCKING COMPUTER VIRUSES AND WORMS, ANTI-SPAM PROTECTION, E-MAIL SCANNING; COMPUTER PROGRAMS, NAMELY, ELECTRONICALLY DOWNLOADABLE SOFTWARE FOR CONTENT FILTERING, FOR BLOCKING COMPUTER VIRUSES AND WORMS, ANTI-SPAM PROTECTION, E-MAIL SCANNING; ANTI-VIRUS COMPUTER PROGRAMS, IN CLASS 9 (U.S. CLS. 21, 23, 26, 36 AND 38).

FIRST USE 11-12-2003; IN COMMERCE 11-12-2003.

THE COLOR(S) RED, BLACK, AND WHITE IS/ARE CLAIMED AS A FEATURE OF THE MARK.

THE MARK CONSISTS OF A RED FACE WITH RED SPIKES EXTENDING FROM CORNERS OF THE FACE, AND WITH LIGHT RED EYES FEATURING WHITE INSIDE THE EYES, WHICH EYES ARE FROWNING.

SER. NO. 77-288,165, FILED 9-25-2007.

WANDA KAY PRICE, EXAMINING ATTORNEY

Int. Cls.: 29, 30 and 43

Prior U.S. Cls.: 46, 100 and 101

United States Patent and Trademark Office

Reg. No. 3,475,247

Registered July 29, 2008

**TRADEMARK
SERVICE MARK
PRINCIPAL REGISTER**

MOISHES

MOISHES INC. (CANADA CORPORATION)
3961, BOULEVARD ST-LAURENT
MONTREAL, QUEBEC, CANADA H2W1Y4

FOR: FOOD PRODUCTS, NAMELY, SALADS EXCEPT MACARONI, RICE AND PASTA SALAD; COLESLAW; PICKLES, FRIED POTATOES, PROCESSED POTATOES, CHOPPED LIVER, CHOPPED BEEF, BEEF PATTIES, VEAL PATTIES, CHICKEN PATTIES, SAUSAGES, STUFFED CHICKEN, STUFFED DERMA; SOUR CREAM AND CHEESE; HERRINGS; PICKLED PRODUCTS, NAMELY, PICKLED VEGETABLES AND PICKLED FISH; MARINATED PRODUCTS, NAMELY, MARINATED PEPPERS, MARINATED VEGETABLES, MARINATED MEATS, MARINATED CHICKEN, MARINATED FISH, IN CLASS 29 (U.S. CL. 46).

FOR: SALAD DRESSINGS, RELISHES, PANCAKES, PIES, CAKES, BREAD DUMPLINGS, SPICES, HORSERADISH; SAUCES, NAMELY,

SEAFOOD SAUCE, AND STEAK SAUCE; MARI-NADES; CHEESECAKE, IN CLASS 30 (U.S. CL. 46).

FOR: RESTAURANT AND CATERING SERVI-CE, IN CLASS 43 (U.S. CLS. 100 AND 101).

THE MARK CONSISTS OF STANDARD CHAR-ACTERS WITHOUT CLAIM TO ANY PARTICULAR FONT, STYLE, SIZE, OR COLOR.

OWNER OF CANADA REG. NO. TMA499289, DATED 8-26-1998, EXPIRES 8-26-2013.

THE NAME(S), PORTRAIT(S), AND/OR SIGNA-TURE(S) SHOWN IN THE MARK DOES NOT IDENTIFY A PARTICULAR LIVING INDIVIDUAL.

SER. NO. 77-288,185, FILED 9-25-2007.

SUZANNE BLANE, EXAMINING ATTORNEY

Int. Cl.: 9

Prior U.S. Cls.: 21, 23, 26, 36 and 38

United States Patent and Trademark Office

Reg. No. 3,475,248

Registered July 29, 2008

TRADEMARK
PRINCIPAL REGISTER



SOURCEFIRE, INC. (MARYLAND CORPORATION)
9770 PATUXENT WOODS DRIVE
COLUMBIA, MD 21046

FOR: COMPUTER PROGRAMS FOR CONTENT FILTERING, FOR BLOCKING COMPUTER VIRUSES AND WORMS, ANTI-SPAM PROTECTION, E-MAIL SCANNING; COMPUTER PROGRAMS, NAMELY, ELECTRONICALLY DOWNLOADABLE SOFTWARE FOR CONTENT FILTERING, FOR BLOCKING COMPUTER VIRUSES AND WORMS, ANTI-SPAM PROTECTION, E-MAIL SCANNING; ANTI-VIRUS COMPUTER PROGRAMS, IN CLASS 9 (U.S. CLS. 21, 23, 26, 36 AND 38).

FIRST USE 11-12-2003; IN COMMERCE 11-12-2003.

THE COLOR(S) BLUE, TAN, RED, BLACK, AND WHITE IS/ARE CLAIMED AS A FEATURE OF THE MARK.

THE MARK CONSISTS OF A CLAM SHELL IN TAN; SUPERIMPOSED ON THE CLAMSHELL IS A CROSSHAIRS IN BLUE; INSIDE THE CROSSHAIRS IS A RED FACE WITH RED SPIKES EXTENDING FROM CORNERS OF THE FACE, AND WITH LIGHT RED EYES FEATURING WHITE INSIDE THE EYES, WHICH EYES ARE FROWNING; THE WORDING "CLAMAV" APPEARS IN THE LOWER LEFT CORNER.

SER. NO. 77-288,186, FILED 9-25-2007.

WANDA KAY PRICE, EXAMINING ATTORNEY

Int. Cl.: 41

Prior U.S. Cls.: 100, 101 and 107

United States Patent and Trademark Office

Reg. No. 3,475,249

Registered July 29, 2008

**SERVICE MARK
PRINCIPAL REGISTER**

WONDERLAND EXPRESS

CHICAGO HORTICULTURAL SOCIETY (ILLI-
NOIS NON-PROFIT CORPORATION)
1000 LAKE COOK ROAD
GLENCOE, IL 60022

FOR: ENTERTAINMENT SERVICES IN THE
NATURE OF SEASONAL EVENTS, NAMELY, AR-
RANGING AND CONDUCTING SPECIAL EVENTS
WITH A SEASONAL THEME , IN CLASS 41 (U.S.
CLS. 100, 101 AND 107).

FIRST USE 12-2-2006; IN COMMERCE 12-2-2006.

THE MARK CONSISTS OF STANDARD CHAR-
ACTERS WITHOUT CLAIM TO ANY PARTICULAR
FONT, STYLE, SIZE, OR COLOR.

SER. NO. 77-288,211, FILED 9-25-2007.

SUZANNE BLANE, EXAMINING ATTORNEY

Int. Cl.: 44

Prior U.S. Cls.: 100 and 101

United States Patent and Trademark Office

Reg. No. 3,475,250

Registered July 29, 2008

SERVICE MARK
PRINCIPAL REGISTER



GROUND'S FOR HEALTH (VERMONT NON-PROFIT CORPORATION)

32 LAKESIDE AVENUE
BURLINGTON, VT 05401

FOR: PROVIDING MEDICAL SERVICES TO WOMEN IN UNDERDEVELOPED COUNTRIES, IN CLASS 44 (U.S. CLS. 100 AND 101).

FIRST USE 1-1-2000; IN COMMERCE 1-1-2000.

THE COLOR(S) BLUE AND BROWN IS/ARE CLAIMED AS A FEATURE OF THE MARK.

THE MARK CONSISTS OF THE WORDS "GROUND'S FOR HEALTH" WITH EACH WORD ON A SEPARATE LINE. THE WORDS "GROUND'S" AND "HEALTH" ARE IN LOWER-CASE LETTERS, AND THE WORD "FOR" IS IN UPPER-CASE LETTERS. A DEPICTION OF A COFFEE BEAN, COLORED BROWN, IS USED IN PLACE OF THE LETTER "O" IN THE WORD "GROUND'S". THE REMAINDER OF THE LETTERS IN THE WORDS "GROUND'S" AND "HEALTH" ARE COLORED BLUE. THE WORD "FOR" IS COLORED BROWN.

SER. NO. 77-288,550, FILED 9-25-2007.

PAM WILLIS, EXAMINING ATTORNEY

Int. Cl.: 25

Prior U.S. Cls.: 22 and 39

United States Patent and Trademark Office

Reg. No. 3,475,251

Registered July 29, 2008

**TRADEMARK
PRINCIPAL REGISTER**

OTGS

ARNOLD, EDWARD, H (UNITED STATES INDIVIDUAL)
315 EQUESTRIAN WAY
ARROYO GRANDE, CA 93420

FOR: (BASED ON USE IN COMMERCE) LONG-SLEEVED SHIRTS; SHIRTS; SHORT-SLEEVED OR LONG-SLEEVED T-SHIRTS; SHORT-SLEEVED SHIRTS; T-SHIRTS; TEE SHIRTS(BASED ON INTENT TO USE) DRESS SHIRTS; GOLF SHIRTS; KNIT SHIRTS; NIGHT SHIRTS; OPEN-NECKED SHIRTS; PIQUE SHIRTS; POLO SHIRTS; RUGBY SHIRTS; WIND SHIRTS; YOGA SHIRTS; HATS; HEADGEAR, NAMELY, CAPS; BASEBALL CAPS;

CAP VISORS; CAPS; CAPS WITH VISORS; GOLF CAPS; KNITTED CAPS, IN CLASS 25 (U.S. CLS. 22 AND 39).

FIRST USE 3-19-2007; IN COMMERCE 3-19-2007.

THE MARK CONSISTS OF STANDARD CHARACTERS WITHOUT CLAIM TO ANY PARTICULAR FONT, STYLE, SIZE, OR COLOR.

SER. NO. 77-288,761, FILED 9-25-2007.

HEATHER SAPP, EXAMINING ATTORNEY

Int. Cl.: 42

Prior U.S. Cls.: 100 and 101

United States Patent and Trademark Office

Reg. No. 3,475,252

Registered July 29, 2008

**SERVICE MARK
PRINCIPAL REGISTER**

**Collaborative for High
Performance Schools**

COLLABORATIVE FOR HIGH PERFORMANCE
SCHOOLS, INC. (CALIFORNIA CORPORATION)
142 MINNA STREET, 2ND FLOOR
SAN FRANCISCO, CA 94105

FOR: TECHNICAL CONSULTATION, RESEARCH AND STANDARDS IN THE FIELDS OF HIGH PERFORMANCE, ENVIRONMENTALLY RESPONSIVE, HEALTHY AND COMFORTABLE LEARNING ENVIRONMENTS; ACCREDITATION SERVICES, NAMELY, SETTING AND PROVIDING STANDARDS FOR HIGH PERFORMANCE SCHOOL DESIGN, CONSTRUCTION AND MAINTENANCE FOR THE PURPOSE OF ACCREDITATION, IN CLASS 42 (U.S. CLS. 100 AND 101).

FIRST USE 11-30-1999; IN COMMERCE 1-31-2000.

THE MARK CONSISTS OF STANDARD CHARACTERS WITHOUT CLAIM TO ANY PARTICULAR FONT, STYLE, SIZE, OR COLOR.

NO CLAIM IS MADE TO THE EXCLUSIVE RIGHT TO USE "HIGH PERFORMANCE SCHOOLS", APART FROM THE MARK AS SHOWN.

SEC. 2(F).

SER. NO. 77-288,922, FILED 9-26-2007.

REGINA DRUMMOND, EXAMINING ATTORNEY

Int. Cl.: 43

Prior U.S. Cls.: 100 and 101

United States Patent and Trademark Office

Reg. No. 3,475,253

Registered July 29, 2008

SERVICE MARK
PRINCIPAL REGISTER



JIA HOSPITALITY KITCHEN, INC. (CALIFORNIA CORPORATION)
8526 BEVERLY BOULEVARD
LOS ANGELES, CA 90048

FOR: RESTAURANT SERVICES, IN CLASS 43
(U.S. CLS. 100 AND 101).

FIRST USE 5-7-2007; IN COMMERCE 5-7-2007.

NO CLAIM IS MADE TO THE EXCLUSIVE RIGHT TO USE "KOREAN BBQ" AND "HOLLYWOOD", APART FROM THE MARK AS SHOWN.

THE NAME(S), PORTRAIT(S), AND/OR SIGNATURE(S) SHOWN IN THE MARK DOES NOT IDENTIFY A PARTICULAR LIVING INDIVIDUAL.

THE MARK CONSISTS OF A MAN IN COSTUME WITH THE WORDS "AUTHENTIC HOSPITALITY JIAN" "KOREAN BBQ" "HOLLYWOOD" WITH SILHOUETTES OF LIONS ON EITHER SIDE OF THE WORDS AND A CHILI PEPPER.

"THE FOREIGN WORDING IN THE MARK TRANSLATES INTO ENGLISH AS BRANCH HOUSE, WHICH IS A FANCIFUL WORD CREATED BY APPLICANT BY COMBINING THE KOREAN WORD FOR BRANCH WITH THE JAPANESE WORD FOR HOUSE."

SER. NO. 77-289,121, FILED 9-26-2007.

SHARON MEIER, EXAMINING ATTORNEY

Int. Cl.: 9

Prior U.S. Cls.: 21, 23, 26, 36 and 38

Reg. No. 3,475,254

United States Patent and Trademark Office

Registered July 29, 2008

**TRADEMARK
PRINCIPAL REGISTER**

ARMADILLO

KADENA INDUSTRIES COMPANY, LTD (HONG
KONG CORPORATION)
A06 9-11 JIUSHENG ROAD
HANGZHOU, CHINA

FOR: BODY ARMOR, RACING ARMOR FOR
THE CHEST, BACK AND ELBOWS, LEATHER
BODY ARMOR, PROTECTIVE LEATHER JACKETS,
PROTECTIVE LEATHER RACING SUITS, PROTEC-
TIVE HELMETS, ALL BEING PROTECTIVE GEAR
FOR USE IN MOTOCROSS AND BY MOTORCY-
CLING ENTHUSIASTS, IN CLASS 9 (U.S. CLS. 21, 23,
26, 36 AND 38).

FIRST USE 10-6-2007; IN COMMERCE 10-6-2007.

THE MARK CONSISTS OF STANDARD CHAR-
ACTERS WITHOUT CLAIM TO ANY PARTICULAR
FONT, STYLE, SIZE, OR COLOR.

SER. NO. 77-289,296, FILED 9-26-2007.

WILLIAM BRECKENFELD, EXAMINING ATTOR-
NEY

Int. Cls.: 35, 36 and 41

Prior U.S. Cls.: 100, 101, 102 and 107

United States Patent and Trademark Office

Reg. No. 3,475,255

Registered July 29, 2008

**SERVICE MARK
PRINCIPAL REGISTER**

**INTERNATIONAL CREATIVE
MANAGEMENT**

INTERNATIONAL CREATIVE MANAGEMENT,
INC. (DELAWARE CORPORATION)
10250 CONSTELLATION BOULEVARD
LOS ANGELES, CA 90067

FOR: TALENT AGENCY SERVICES; ARRANGING FOR MARKETING OF MOTION PICTURES AND MOTION PICTURE SCRIPTS; BUSINESS DEVELOPMENT SERVICES, NAMELY, BUSINESS CONSULTING, AND ADVISORY SERVICES PROVIDED TO MEDIA/ENTERTAINMENT COMPANIES, AND RECOMMENDING KEY STRATEGY PARTNERSHIPS TO, MEDIA/ENTERTAINMENT COMPANIES, STRATEGIC BUSINESS PLANNING AND BUSINESS CONSULTING SERVICES PROVIDED TO, MEDIA/ENTERTAINMENT COMPANIES, IN CLASS 35 (U.S. CLS. 100, 101 AND 102).

FIRST USE 1-15-1975; IN COMMERCE 1-15-1975.

FOR: ASSISTING SCREENWRITERS AND MOTION PICTURE PRODUCERS IN OBTAINING FINANCING, IN CLASS 36 (U.S. CLS. 100, 101 AND 102).

FIRST USE 0-0-1993; IN COMMERCE 0-0-1993.

FOR: PROVIDING THE SERVICES OF LECTURERS AND SPEAKERS TO PERSONS AND ORGANI-

ZATIONS CONDUCTING CONFERENCES AND LECTURES SERIES, RELATING TO A VARIETY OF TOPICS INCLUDING ENTERTAINMENT, THE ARTS, LITERATURE, ECONOMIC AND POLITICAL AFFAIRS, CONTEMPORARY EVENTS AND TOPICS OF GENERAL INTEREST; BOOKING AGENCY SERVICES RELATING TO MUSICAL PERFORMANCES, ORCHESTRAL PERFORMANCES, MIME, DANCE, AND COMEDY PERFORMANCES, IN CLASS 41 (U.S. CLS. 100, 101 AND 107).

FIRST USE 12-0-1976; IN COMMERCE 12-0-1976.

THE MARK CONSISTS OF STANDARD CHARACTERS WITHOUT CLAIM TO ANY PARTICULAR FONT, STYLE, SIZE, OR COLOR.

OWNER OF U.S. REG. NOS. 1,037,015 AND 2,158,041.

SEC. 2(F).

SER. NO. 77-289,398, FILED 9-26-2007.

PAM WILLIS, EXAMINING ATTORNEY

Int. Cl.: 35

Prior U.S. Cls.: 100, 101 and 102

United States Patent and Trademark Office

Reg. No. 3,475,256

Registered July 29, 2008

**SERVICE MARK
PRINCIPAL REGISTER**

CARECULTURE BLUEPRINT

CARELEADERS, LLC (DELAWARE LTD LIAB
CO)
3011 N IH-35
AUSTIN, TX 78722

FOR: MANAGEMENT AND BUSINESS CONSULTING SERVICES IN THE FIELD OF HEALTH-CARE, NAMELY, CONSULTING SERVICES IN THE FIELDS OF HUMAN RESOURCE DEVELOPMENT, NAMELY, PERSONNEL HIRING, PLACEMENT, ADMINISTRATION AND MANAGEMENT, AND PLANNING AND ADMINISTRATION OF EMPLOYEE BENEFIT PLANS.; BUSINESS ORGANIZATION CONSULTING; BUSINESS PLANNING; BUSINESS CONSULTATION SERVICES; BUSINESS MANAGEMENT AND CONSULTATION IN THE FIELD OF PATIENT SAFETY PRACTICES; AND CONSULTING SERVICES IN CUSTOMER SERVICE AND RELATIONSHIP MANAGEMENT IN THE FIELD OF CLIENTS' PRODUCTS AND SERVICES.; BUSINESS ORGANIZATION AND MANAGEMENT

CONSULTING; BUSINESS MANAGEMENT CONSULTATION IN THE FIELD OF EXECUTIVE AND LEADERSHIP DEVELOPMENT; BUSINESS MANAGEMENT PLANNING, IN CLASS 35 (U.S. CLS. 100, 101 AND 102).

FIRST USE 6-28-2006; IN COMMERCE 6-28-2006.

THE MARK CONSISTS OF STANDARD CHARACTERS WITHOUT CLAIM TO ANY PARTICULAR FONT, STYLE, SIZE, OR COLOR.

NO CLAIM IS MADE TO THE EXCLUSIVE RIGHT TO USE "BLUEPRINT", APART FROM THE MARK AS SHOWN.

SER. NO. 77-289,711, FILED 9-26-2007.

HEATHER THOMPSON, EXAMINING ATTORNEY

Int. Cl.: 35

Prior U.S. Cls.: 100, 101 and 102

United States Patent and Trademark Office

Reg. No. 3,475,257

Registered July 29, 2008

**SERVICE MARK
PRINCIPAL REGISTER**

CARECULTURE REWARDS

CARELEADERS, LLC (DELAWARE LTD LIAB
CO)
3011 N IH-35
AUSTIN, TX 78722

FOR: MANAGEMENT AND BUSINESS CONSULTING SERVICES IN THE FIELD OF HEALTH-CARE, NAMELY, CONSULTING SERVICES IN THE FIELDS OF HUMAN RESOURCE DEVELOPMENT NAMELY, PERSONNEL HIRING, PLACEMENT, ADMINISTRATION AND MANAGEMENT, AND PLANNING AND ADMINISTRATION OF EMPLOYEE BENEFIT PLANS.; BUSINESS MANAGEMENT CONSULTATION IN THE FIELD OF EXECUTIVE AND LEADERSHIP DEVELOPMENT; BUSINESS ORGANIZATION AND MANAGEMENT CONSULTING; BUSINESS MANAGEMENT PLANNING; BUSINESS ORGANIZATIONAL CONSULTATION; BUSINESS PLANNING; BUSINESS CONSULTATION SERVICES; BUSINESS MANAGEMENT AND CONSULTATION IN THE FIELD OF PATIENT

SAFETY PRACTICES; AND CONSULTING SERVICES IN CUSTOMER SERVICE AND RELATIONSHIP MANAGEMENT IN THE FIELD OF CLIENTS' PRODUCTS AND SERVICES, IN CLASS 35 (U.S. CLS. 100, 101 AND 102).

FIRST USE 6-28-2006; IN COMMERCE 6-28-2006.

THE MARK CONSISTS OF STANDARD CHARACTERS WITHOUT CLAIM TO ANY PARTICULAR FONT, STYLE, SIZE, OR COLOR.

NO CLAIM IS MADE TO THE EXCLUSIVE RIGHT TO USE "REWARDS", APART FROM THE MARK AS SHOWN.

SER. NO. 77-289,871, FILED 9-26-2007.

HEATHER THOMPSON, EXAMINING ATTORNEY

Int. Cl.: 24

Prior U.S. Cls.: 42 and 50

United States Patent and Trademark Office

Reg. No. 3,475,258

Registered July 29, 2008

**TRADEMARK
PRINCIPAL REGISTER**

Challenge It

SWEENEY, JAMES G. (UNITED STATES INDIVIDUAL)
14 NEW LONDON LANE
OAKMONT, PA 15139

THE MARK CONSISTS OF STANDARD CHARACTERS WITHOUT CLAIM TO ANY PARTICULAR FONT, STYLE, SIZE, OR COLOR.

FOR: NOVELTY ITEMS, NAMELY, RED TOWELS TO BE HELD UP BY FANS AT SPORTING EVENTS, IN CLASS 24 (U.S. CLS. 42 AND 50).

SER. NO. 77-290,350, FILED 9-27-2007.

FIRST USE 12-9-2006; IN COMMERCE 1-14-2008.

SAIMA MAKHDOOM, EXAMINING ATTORNEY

Int. Cls.: 41 and 42

Prior U.S. Cls.: 100, 101 and 107

United States Patent and Trademark Office

Reg. No. 3,475,259

Registered July 29, 2008

**SERVICE MARK
PRINCIPAL REGISTER**

SUCCESS MADE EASY

TACO, INC. (RHODE ISLAND CORPORATION)
1160 CRANSTON STREET
CRANSTON, RI 02920

FOR: EDUCATIONAL SERVICES, IN THE NATURE OF PROVIDING TRAINING TO TRADESMAN AND BUILDING CONTRACTORS IN THE FIELDS OF SYSTEM DESIGN, INSTALLATION AND SALES OF HYDRONIC SYSTEMS AND COMPONENTS, IN CLASS 41 (U.S. CLS. 100, 101 AND 107).

FIRST USE 5-15-2007; IN COMMERCE 5-15-2007.

FOR: PROVIDING TECHNICAL SUPPORT, NAMELY, DESIGN OF HYDRONIC SYSTEMS

AND HYDRONIC COMPONENTS, TO TRADESMAN AND BUILDING CONTRACTORS, IN CLASS 42 (U.S. CLS. 100 AND 101).

FIRST USE 5-15-2007; IN COMMERCE 5-15-2007.

THE MARK CONSISTS OF STANDARD CHARACTERS WITHOUT CLAIM TO ANY PARTICULAR FONT, STYLE, SIZE, OR COLOR.

SER. NO. 77-290,477, FILED 9-27-2007.

EUGENIA MARTIN, EXAMINING ATTORNEY

Int. Cls.: 41 and 42

Prior U.S. Cls.: 100, 101 and 107

United States Patent and Trademark Office

Reg. No. 3,475,260

Registered July 29, 2008

**SERVICE MARK
PRINCIPAL REGISTER**

FloPro

TACO, INC. (RHODE ISLAND CORPORATION)
1160 CRANSTON STREET
CRANSTON, RI 02920

FOR: EDUCATIONAL SERVICES, IN THE NATURE OF PROVIDING TRAINING TO TRADESMAN AND BUILDING CONTRACTORS IN THE FIELDS OF SYSTEM DESIGN, INSTALLATION AND SALES OF HYDRONIC SYSTEMS AND COMPONENTS, IN CLASS 41 (U.S. CLS. 100, 101 AND 107).

FIRST USE 5-15-2007; IN COMMERCE 5-15-2007.

FOR: PROVIDING TECHNICAL SUPPORT, NAMELY, DESIGN OF HYDRONIC SYSTEMS

AND HYDRONIC COMPONENTS, TO TRADESMAN AND BUILDING CONTRACTORS, IN CLASS 42 (U.S. CLS. 100 AND 101).

FIRST USE 5-15-2007; IN COMMERCE 5-15-2007.

THE MARK CONSISTS OF STANDARD CHARACTERS WITHOUT CLAIM TO ANY PARTICULAR FONT, STYLE, SIZE, OR COLOR.

SER. NO. 77-290,492, FILED 9-27-2007.

EUGENIA MARTIN, EXAMINING ATTORNEY

Int. Cl.: 35

Prior U.S. Cls.: 100, 101 and 102

United States Patent and Trademark Office

Reg. No. 3,475,261

Registered July 29, 2008

**SERVICE MARK
PRINCIPAL REGISTER**



Kiss My Bundt
BAKERY

WILSON, CHRYSTA (UNITED STATES INDIVIDUAL)
535 S. CURSON AVE, #2K
LOS ANGELES, CA 90036

FOR: RETAIL BAKERY SHOPS, IN CLASS 35 (U.S. CLS. 100, 101 AND 102).

FIRST USE 6-20-2005; IN COMMERCE 7-1-2005.

NO CLAIM IS MADE TO THE EXCLUSIVE RIGHT TO USE "BAKERY", APART FROM THE MARK AS SHOWN.

THE COLOR(S) LIGHT PINK AND HOT PINK IS/ARE CLAIMED AS A FEATURE OF THE MARK.

THE MARK CONSISTS OF LIGHT PINK LIPS WITH A DARK HOT PINK OUTLINE. BENEATH THE LIPS IS TEXT THAT SAYS "KISS MY BUNDT BAKERY" IN THE SAME LIGHT PINK COLOR USED INSIDE THE LIPS. OUTSIDE OF THE LIPS ARE PINK SQUIGGLE MARKS THAT DENOTE MOTION OF THE LIPS.

SER. NO. 77-290,593, FILED 9-27-2007.

ALICE SUE CARRUTHERS, EXAMINING ATTORNEY

Int. Cl.: 38

Prior U.S. Cls.: 100, 101 and 104

United States Patent and Trademark Office

Reg. No. 3,475,262

Registered July 29, 2008

**SERVICE MARK
PRINCIPAL REGISTER**

AIR-NET

AIRNET WIFI LIMITED (UNITED KINGDOM
LTD LIAB CO)
33 DIAMOND ROAD
DROMORE, UNITED KINGDOM BT251PH

FOR: INTERNET CAFE SERVICES, NAMELY,
PROVIDING TELECOMMUNICATIONS CONNEC-
TIONS TO THE INTERNET IN A CAFE ENVIRON-
MENT; PROVIDING ACCESS TO
TELECOMMUNICATION NETWORKS; PROVID-
ING ELECTRONIC TELECOMMUNICATION CON-
N E C T I O N S ; P R O V I D I N G
TELECOMMUNICATIONS CONNECTIONS TO A
GLOBAL COMPUTER NETWORK; PROVIDING
THIRD PARTY USERS WITH ACCESS TO TELE-
COMMUNICATION INFRASTRUCTURE; TELE-
COMMUNICATION ACCESS SERVICES;
TELECOMMUNICATION CONSULTATION IN
THE NATURE OF TECHNICAL CONSULTING IN

THE FIELD OF AUDIO, TEXT AND VISUAL DATA
TRANSMISSION AND COMMUNICATION; TELE-
COMMUNICATION SERVICES, NAMELY, PROVID-
ING INTERNET ACCESS VIA BROADBAND
OPTICAL OR WIRELESS NETWORKS; TELECOM-
MUNICATIONS CONSULTATION; TELECOMMU-
NICATIONS GATEWAY SERVICES, IN CLASS 38
(U.S. CLS. 100, 101 AND 104).

FIRST USE 4-21-2004; IN COMMERCE 5-17-2004.

THE MARK CONSISTS OF STANDARD CHAR-
ACTERS WITHOUT CLAIM TO ANY PARTICULAR
FONT, STYLE, SIZE, OR COLOR.

SER. NO. 77-290,596, FILED 9-27-2007.

DAVID HOFFMAN, EXAMINING ATTORNEY

Int. Cl.: 21

Prior U.S. Cls.: 2, 13, 23, 29, 30, 33, 40 and 50

United States Patent and Trademark Office

Reg. No. 3,475,263

Registered July 29, 2008

**TRADEMARK
PRINCIPAL REGISTER**



HUA SHIA CORP. (CALIFORNIA CORPORATION)
6318 LA JOLLA BLVD.
LA JOLLA, CA 92037

FOR: KITCHEN AND HOUSEHOLD PRODUCTS MADE OF WOOD AND BAMBOO, NAMELY, BREAD BOARDS, BREAD BOXES, CAKE SERVERS, CANDLE HOLDERS, CANISTER SETS, CARVING BOARDS, COASTERS NOT OF PAPER AND NOT BEING TABLE LINEN, COFFEE SERVERS, COOLING RACKS FOR BAKED GOODS, CUTTING BOARDS, DISH DRYING RACKS, DISHES AND PLATES, EGG BOXES, FLOWER POTS, FRUIT BOWLS, HOUSEHOLD CONTAINERS FOR FOOD, ICE CONTAINERS, KNIFE BLOCKS AND RESTS, MIXING SPOONS, NAPKIN HOLDERS, POT STANDS, RECIPE BOXES, RICE BOWLS, ROLLING PINS, SALAD BOWLS, SALAD SPINNERS, SALT AND PEPPER MILLS, SALT AND PEPPER SHAKERS, SANDWICH BOXES, SERVING BOWLS, SERVING FORKS, SERVING TRAYS, SERVING PLATTERS, SOAP BOXES, SPICE RACKS, TOILET

PAPER DISPENSERS, TOWEL RACKS, TRIVETS, WOOD CHOPPING BLOCKS, WOOD LADLE AND JAPANESE STYLE WOODEN PESTLES, IN CLASS 21 (U.S. CLS. 2, 13, 23, 29, 30, 33, 40 AND 50).

FIRST USE 7-25-2007; IN COMMERCE 9-4-2007.

NO CLAIM IS MADE TO THE EXCLUSIVE RIGHT TO USE "DANISH DESIGN", APART FROM THE MARK AS SHOWN.

THE NAME "KARE TOFTE" IDENTIFIES A LIVING INDIVIDUAL WHOSE CONSENT IS OF RECORD.

THE MARK CONSISTS OF THE STYLIZED WORDS "DANISH DESIGN BY KARE TOFTE".

SER. NO. 77-290,779, FILED 9-27-2007.

JAY FLOWERS, EXAMINING ATTORNEY

Int. Cl.: 33

Prior U.S. Cls.: 47 and 49

United States Patent and Trademark Office

Reg. No. 3,475,264

Registered July 29, 2008

**TRADEMARK
PRINCIPAL REGISTER**

SWIRLL

WINE PRODUCTIONS, LLC (TEXAS LTD LIAB
CO)
1311 MAIN STREET
DALLAS, TX 75202

THE MARK CONSISTS OF STANDARD CHAR-
ACTERS WITHOUT CLAIM TO ANY PARTICULAR
FONT, STYLE, SIZE, OR COLOR.

FOR: WINE, IN CLASS 33 (U.S. CLS. 47 AND 49).

SER. NO. 77-290,885, FILED 9-27-2007.

FIRST USE 10-7-2004; IN COMMERCE 10-7-2004.

JASON TURNER, EXAMINING ATTORNEY

Int. Cl.: 35

Prior U.S. Cls.: 100, 101 and 102

United States Patent and Trademark Office

Reg. No. 3,475,265

Registered July 29, 2008

**SERVICE MARK
PRINCIPAL REGISTER**

The Riskipedia

CURIOTI PUBLISHING, LLC (COLORADO LTD
LIAB CO)
7860 E. 26TH AVE.
DENVER, CO 80238

THE MARK CONSISTS OF STANDARD CHAR-
ACTERS WITHOUT CLAIM TO ANY PARTICULAR
FONT, STYLE, SIZE, OR COLOR.

FOR: BUSINESS ADVICE, INQUIRIES OR INFOR-
MATION, IN CLASS 35 (U.S. CLS. 100, 101 AND 102).

SER. NO. 77-291,053, FILED 9-27-2007.

FIRST USE 2-1-2007; IN COMMERCE 2-1-2007.

BARNEY CHARLON, EXAMINING ATTORNEY

Int. Cl.: 41

Prior U.S. Cls.: 100, 101 and 107

United States Patent and Trademark Office

Reg. No. 3,475,266

Registered July 29, 2008

**SERVICE MARK
PRINCIPAL REGISTER**

CPAPlus NETWORK

THE CPAPLUS NETWORK (SOUTH CAROLINA
CORPORATION)
P.O. BOX 5109
SPARTANBURG, SC 29304

FOR: EDUCATION SERVICES, NAMELY, PRO-
VIDING LIVE AND ON-LINE SEMINARS AND
WORKSHOPS IN THE FIELD OF BUSINESS DEVEL-
OPMENT, IN CLASS 41 (U.S. CLS. 100, 101 AND 107).

FIRST USE 6-16-2007; IN COMMERCE 9-5-2007.

THE MARK CONSISTS OF STANDARD CHAR-
ACTERS WITHOUT CLAIM TO ANY PARTICULAR
FONT, STYLE, SIZE, OR COLOR.

NO CLAIM IS MADE TO THE EXCLUSIVE
RIGHT TO USE "NETWORK", APART FROM THE
MARK AS SHOWN.

SER. NO. 77-291,129, FILED 9-28-2007.

MARILYN IZZI, EXAMINING ATTORNEY

Int. Cl.: 1

Prior U.S. Cls.: 1, 5, 6, 10, 26 and 46

Reg. No. 3,475,267

United States Patent and Trademark Office

Registered July 29, 2008

**TRADEMARK
PRINCIPAL REGISTER**

RP-M

LEARCO INDUSTRIAL CERAMICS (NEW YORK
CORPORATION)
PO BOX 212
ORCHARD PARK, NY 14127

THE MARK CONSISTS OF STANDARD CHAR-
ACTERS WITHOUT CLAIM TO ANY PARTICULAR
FONT, STYLE, SIZE, OR COLOR.

FOR: CEMENT ADDITIVE IN THE NATURE OF
A MIX OF POZZOLANS USED TO IMPROVE PER-
FORMANCE OF CEMENT, IN CLASS 1 (U.S. CLS. 1,
5, 6, 10, 26 AND 46).

SER. NO. 77-291,305, FILED 9-28-2007.

FIRST USE 1-25-2003; IN COMMERCE 4-1-2004.

DANIEL CAPSHAW, EXAMINING ATTORNEY

Int. Cl.: 35

Prior U.S. Cls.: 100, 101 and 102

United States Patent and Trademark Office

Reg. No. 3,475,268

Registered July 29, 2008

**SERVICE MARK
PRINCIPAL REGISTER**

CRU48 CRISIS RESPONSE UNIT

CROSS COUNTRY TRAVCORPS, INC. (DELA-
WARE CORPORATION)
6551 PARK OF COMMERCE BLVD., NW
BOCA RATON, FL 33487

FOR: PERSONNEL, JOB PLACEMENT, AND
STAFFING SERVICES FOR THE HEALTHCARE
INDUSTRY, IN CLASS 35 (U.S. CLS. 100, 101 AND
102).

FIRST USE 8-1-2007; IN COMMERCE 8-1-2007.

THE MARK CONSISTS OF STANDARD CHAR-
ACTERS WITHOUT CLAIM TO ANY PARTICULAR
FONT, STYLE, SIZE, OR COLOR.

NO CLAIM IS MADE TO THE EXCLUSIVE
RIGHT TO USE "CRISIS RESPONSE UNIT", APART
FROM THE MARK AS SHOWN.

SER. NO. 77-291,501, FILED 9-28-2007.

ELLEN PERKINS, EXAMINING ATTORNEY

Int. Cl.: 36

Prior U.S. Cls.: 100, 101 and 102

United States Patent and Trademark Office

Reg. No. 3,475,269

Registered July 29, 2008

**SERVICE MARK
PRINCIPAL REGISTER**

ICON

ICON CAPITAL CORP. (DELAWARE CORPORATION)
100 FIFTH AVENUE, 4TH FLOOR
NEW YORK, NY 10011

THE MARK CONSISTS OF STANDARD CHARACTERS WITHOUT CLAIM TO ANY PARTICULAR FONT, STYLE, SIZE, OR COLOR.

FOR: FUNDS INVESTMENT, NAMELY, OFFERING INVESTMENTS IN LIMITED PARTNERSHIPS AND DIRECT PARTICIPATION PROGRAMS, IN CLASS 36 (U.S. CLS. 100, 101 AND 102).

SER. NO. 77-292,022, FILED 9-28-2007.

FIRST USE 12-15-1985; IN COMMERCE 12-15-1985.

CHARISMA HAMPTON, EXAMINING ATTORNEY

Int. Cl.: 41

Prior U.S. Cls.: 100, 101 and 107

United States Patent and Trademark Office

Reg. No. 3,475,270

Registered July 29, 2008

**SERVICE MARK
PRINCIPAL REGISTER**

Sountrac

DILALLO, RICHARD A (UNITED STATES INDIVIDUAL), DBA SOUNTRAC
43 HEWLETT POINT AVENUE
EAST ROCKAWAY, NY 11518

FOR: ENTERTAINMENT IN THE NATURE OF VISUAL AND AUDIO PERFORMANCES, AND MUSICAL, VARIETY, NEWS AND COMEDY SHOWS; ENTERTAINMENT IN THE NATURE OF PRESENTATION OF MUSICAL PERFORMANCE; ENTERTAINMENT, NAMELY, LIVE PERFORMANCES BY A MUSICAL BAND, IN CLASS 41 (U.S. CLS. 100, 101 AND 107).

FIRST USE 1-25-1983; IN COMMERCE 4-1-2005.

THE MARK CONSISTS OF STANDARD CHARACTERS WITHOUT CLAIM TO ANY PARTICULAR FONT, STYLE, SIZE, OR COLOR.

SER. NO. 77-292,362, FILED 9-30-2007.

KATHERINE E. HALMEN, EXAMINING ATTORNEY

Int. Cl.: 41

Prior U.S. Cls.: 100, 101 and 107

United States Patent and Trademark Office

Reg. No. 3,475,271

Registered July 29, 2008

**SERVICE MARK
PRINCIPAL REGISTER**

Little Learning

LITTLE LEARNING, INC. (NEW YORK CORPORATION)
110 EAST 17TH STREET, 3F
NEW YORK, NY 10003

FOR: EDUCATION SERVICES, NAMELY, PROVIDING PRESCHOOL ENRICHMENT SERVICES FOR CHILDREN IN THE FIELD OF MATH AND READING, IN CLASS 41 (U.S. CLS. 100, 101 AND 107).

FIRST USE 8-1-2004; IN COMMERCE 8-1-2004.

NO CLAIM IS MADE TO THE EXCLUSIVE RIGHT TO USE "LEARNING", APART FROM THE MARK AS SHOWN.

THE MARK CONSISTS OF THE WORDS "LITTLE LEARNING" WITH STYLIZED LETTERING.

SER. NO. 77-292,412, FILED 9-30-2007.

BRENDAN REGAN, EXAMINING ATTORNEY

Int. Cls.: 9, 35 and 41

Prior U.S. Cls.: 21, 23, 26, 36, 38, 100, 101, 102 and 107

Reg. No. 3,475,272

United States Patent and Trademark Office

Registered July 29, 2008

**TRADEMARK
SERVICE MARK
PRINCIPAL REGISTER**



PREMIER ELECTION SOLUTIONS, INC. (DELA-
WARE CORPORATION)
1253 ALLEN STATION PARKWAY
ALLEN, TX 75002

FOR: VOTING MACHINES, IN CLASS 9 (U.S. CLS.
21, 23, 26, 36 AND 38).

FIRST USE 9-30-2007; IN COMMERCE 9-30-2007.

FOR: ELECTION SERVICES, NAMELY, PROCES-
SING OF ELECTION BALLOTS; PROVIDING POLI-
TICAL ELECTION CONSULTING SERVICES
CONCERNING THE PLANNING , ADMINISTER-
ING AND TABULATING THE RESULTS OF ELEC-
TIONS, IN CLASS 35 (U.S. CLS. 100, 101 AND 102).

FIRST USE 9-30-2007; IN COMMERCE 9-30-2007.

FOR: LAYOUT SERVICES IN THE FIELD OF
VOTING BALLOTS, IN CLASS 41 (U.S. CLS. 100, 101
AND 107).

FIRST USE 9-30-2007; IN COMMERCE 9-30-2007.

NO CLAIM IS MADE TO THE EXCLUSIVE
RIGHT TO USE "ELECTION SOLUTIONS", APART
FROM THE MARK AS SHOWN.

THE MARK CONSISTS OF A CHECK MARK
MADE UP OF DOTS TO THE LEFT OF THE WORDS
"PREMIER ELECTION SOLUTIONS".

SER. NO. 77-292,441, FILED 9-30-2007.

MICHAEL LITZAU, EXAMINING ATTORNEY

Int. Cls.: 9, 35 and 41

Prior U.S. Cls.: 21, 23, 26, 36, 38, 100, 101, 102 and 107

United States Patent and Trademark Office

Reg. No. 3,475,273

Registered July 29, 2008

**TRADEMARK
SERVICE MARK
PRINCIPAL REGISTER**

PREMIER

PREMIER ELECTION SOLUTIONS, INC. (DELA-
WARE CORPORATION)
1253 ALLEN STATION PARKWAY
ALLEN, TX 75002

FOR: VOTING MACHINES, IN CLASS 9 (U.S. CLS.
21, 23, 26, 36 AND 38).

FIRST USE 9-30-2007; IN COMMERCE 9-30-2007.

FOR: ELECTION SERVICES, NAMELY, PROCES-
SING OF ELECTION BALLOTS; PROVIDING POLI-
TICAL ELECTION CONSULTING SERVICES
CONCERNING THE PLANNING, ADMINISTER-
ING AND TABULATING THE RESULTS OF ELEC-
TIONS, IN CLASS 35 (U.S. CLS. 100, 101 AND 102).

FIRST USE 9-30-2007; IN COMMERCE 9-30-2007.

FOR: LAYOUT SERVICES IN THE FIELD OF
VOTING BALLOTS, IN CLASS 41 (U.S. CLS. 100, 101
AND 107).

FIRST USE 9-30-2007; IN COMMERCE 9-30-2007.

THE MARK CONSISTS OF STANDARD CHAR-
ACTERS WITHOUT CLAIM TO ANY PARTICULAR
FONT, STYLE, SIZE, OR COLOR.

SER. NO. 77-292,457, FILED 9-30-2007.

MICHAEL LITZAU, EXAMINING ATTORNEY

Int. Cl.: 41

Prior U.S. Cls.: 100, 101 and 107

United States Patent and Trademark Office

Reg. No. 3,475,274

Registered July 29, 2008

SERVICE MARK
PRINCIPAL REGISTER



BLUE HEART TOURS, INC. (VIRGINIA CORPORATION), DBA CLASSICAL MOVEMENTS
319 CAMERON STREET
ALEXANDRIA, VA 22314

FOR: EDUCATION SERVICES, NAMELY, ORGANIZING AND CONDUCTING MUSICAL WORKSHOPS FOR CHILDREN AND ADULTS; ENTERTAINMENT SERVICES, NAMELY, ORGANIZING LIVE PERFORMANCES AND MUSICAL CONCERTS BY CHOIRS OF ADULTS AND CHILDREN, IN CLASS 41 (U.S. CLS. 100, 101 AND 107).

FIRST USE 9-18-2007; IN COMMERCE 9-18-2007.

THE COLOR(S) BLACK, WHITE, GREEN, YELLOW, BLUE, RED, AND TAN IS/ARE CLAIMED AS A FEATURE OF THE MARK.

THE MARK CONSISTS OF A FRAME OUTLINED IN RED, YELLOW, BLUE, AND GREEN TRIANGLES, EACH OF WHICH ARE OUTLINED IN BLACK, AS IS THE INNER AND OUTER BORDER FOR THE FRAME ITSELF. IN EACH CORNER OF THE FRAME IS AN INVERTED NARROWER BLACK TRIANGLE WITH A SMALLER WHITE

DOT IN THE CENTER OF THE NARROWER PORTION OF THE TRIANGLE AND A LARGER WHITE DOT IN THE CENTER OF THE LARGER PORTION OF THE TRIANGLE. INSIDE THE FRAME ARE 4 PERFORMERS EACH OF WHICH ARE DEPICTED IN BLACK, EACH HOLDING OPEN SHEET MUSIC WHICH IS DEPICTED IN WHITE WITH BLACK OUTLINES, ALL OF WHICH ARE STANDING ON THE LEFT SIDE OF A SUPERIMPOSED TAN COLORED MAP OF AFRICA WHICH IS IN THE CENTER OF THE INSIDE OF THE FRAME AGAINST A WHITE BACKGROUND. STANDING IN THE BOTTOM RIGHT CORNER OF THE FRAME AND EXTENDING UP INTO THE INSIDE OF PORTION OF THE FRAME AND OVER THE RIGHT EDGE OF THE MAP OF AFRICA IS A CONDUCTOR WITH A BATON, DEPICTED IN BLACK. BELOW THE FRAME IS THE WORD "IHLOMBE" IN BLACK LETTERING WITH A FILLED IN BLACK CIRCLE INSIDE THE LETTER "O", AGAINST A WHITE BACKGROUND.

SER. NO. 77-292,929, FILED 10-1-2007.

KIMBERLY PERRY, EXAMINING ATTORNEY

Int. Cls.: 9 and 42

Prior U.S. Cls.: 21, 23, 26, 36, 38, 100 and 101

United States Patent and Trademark Office

Reg. No. 3,475,275

Registered July 29, 2008

**TRADEMARK
SERVICE MARK
PRINCIPAL REGISTER**

DATA AGE

DATA AGE BUSINESS SYSTEMS, INC. (FLORIDA CORPORATION)
10225 ULMERTON ROAD, SUITE 10A
LARGO, FL 33771

FOR: HOUSE MARK FOR COMPUTER SOFTWARE ON CD-ROM THAT IS PURCHASED AND INSTALLED ON A COMPUTER OR COMPUTER NETWORK THAT ALLOWS USER(S) TO PERFORM BUSINESS TRANSACTIONS IN PAWN BROKERAGE, PAYDAY ADVANCE, CREDIT CARD PROCESSING, CHECK CASHING, TITLE LOAN AND LIQUOR STORE RETAIL INDUSTRIES, IN CLASS 9 (U.S. CLS. 21, 23, 26, 36 AND 38).

FIRST USE 6-21-1988; IN COMMERCE 6-21-1988.

FOR: COMPUTER SERVICES, NAMELY, CONSULTING IN THE FIELD OF COMPUTER SOFTWARE AND MAINTENANCE OF COMPUTER SOFTWARE, ALL IN THE FIELD OF PAWN BROKERAGE, PAYDAY ADVANCE, CHECK CASHING, CREDIT CARD PROCESSING, TITLE LOAN

AND LIQUOR STORE RETAIL SERVICES; TECHNICAL SUPPORT SERVICES, NAMELY, TROUBLESHOOTING OF COMPUTER SOFTWARE PROBLEMS IN THE FIELD OF PAWN BROKERAGE, PAYDAY ADVANCE, CHECK CASHING, CREDIT CARD PROCESSING, TITLE LOAN AND LIQUOR STORE RETAIL SERVICES, IN CLASS 42 (U.S. CLS. 100 AND 101).

FIRST USE 6-21-1988; IN COMMERCE 6-21-1988.

THE MARK CONSISTS OF STANDARD CHARACTERS WITHOUT CLAIM TO ANY PARTICULAR FONT, STYLE, SIZE, OR COLOR.

NO CLAIM IS MADE TO THE EXCLUSIVE RIGHT TO USE "DATA" , APART FROM THE MARK AS SHOWN.

SER. NO. 77-293,009, FILED 10-1-2007.

ERNEST SHOSHO, EXAMINING ATTORNEY

Int. Cl.: 41

Prior U.S. Cls.: 100, 101 and 107

United States Patent and Trademark Office

Reg. No. 3,475,276

Registered July 29, 2008

**SERVICE MARK
PRINCIPAL REGISTER**

Thank a Farmer

ROSS, RHONDA (UNITED STATES INDIVIDUAL)
PO BOX 60806
LAS VEGAS, NV 89160

FOR: ENTERTAINMENT IN THE NATURE OF LIVE PERFORMANCES BY A GROUP WHOSE PURPOSE IS TO EDUCATE THE PUBLIC ABOUT AGRICULTURE AND FARMERS, IN CLASS 41 (U.S. CLS. 100, 101 AND 107).

FIRST USE 2-28-2006; IN COMMERCE 2-28-2006.

THE MARK CONSISTS OF STANDARD CHARACTERS WITHOUT CLAIM TO ANY PARTICULAR FONT, STYLE, SIZE, OR COLOR.

NO CLAIM IS MADE TO THE EXCLUSIVE RIGHT TO USE "FARMER", APART FROM THE MARK AS SHOWN.

SER. NO. 77-293,374, FILED 10-1-2007.

KATINA MISTER, EXAMINING ATTORNEY

Int. Cl.: 35

Prior U.S. Cls.: 100, 101 and 102

United States Patent and Trademark Office

Reg. No. 3,475,277

Registered July 29, 2008

**SERVICE MARK
PRINCIPAL REGISTER**



SIBERS GROUP LTD (BR.VIRGIN ISLANDS LTD
LIAB CO), DBA SIBERS, KEY-SOFT, HIRER-
USSIANS LLC
AKARA B. 24 DE CASTRO ST. WICKHAMS CAY 1
ROAD TOWN, TORTOLA, BR.VIRGIN ISLANDS

FOR: OUTSOURCING IN THE FIELD OF SOFT-
WARE DEVELOPMENT, IN CLASS 35 (U.S. CLS. 100,
101 AND 102).

FIRST USE 7-1-2006; IN COMMERCE 7-1-2006.

THE COLOR(S) BLACK, GRAY, BLUE, RED IS/
ARE CLAIMED AS A FEATURE OF THE MARK.

THE MARK CONSISTS OF THE WORD "SIBERS"
TYPED IN BLACK IN PIXEL FONT WITH GRAY
PIXEL DESIGNS IN THE WORD, AND WITH A RED
DOT ABOVE "I" AND A BLUE DOT AFTER THE
SECOND "S" IN THE TOP RIGHT CORNER.

SER. NO. 77-293,454, FILED 10-2-2007.

TEJBIR SINGH, EXAMINING ATTORNEY

Int. Cl.: 11

Prior U.S. Cls.: 13, 21, 23, 31 and 34

United States Patent and Trademark Office

Reg. No. 3,475,278

Registered July 29, 2008

**TRADEMARK
PRINCIPAL REGISTER**

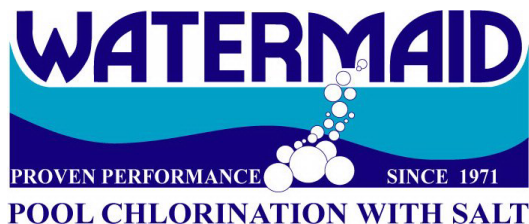

WATERMAID PTY LTD (AUSTRALIA CORPORATION)
24 TEPKO ROAD
TERREY HILLS, AUSTRALIA 2084

FOR: SWIMMING POOL CHLORINATING UNITS, IN CLASS 11 (U.S. CLS. 13, 21, 23, 31 AND 34).

OWNER OF AUSTRALIA REG. NO. A276830, DATED 3-14-1974, RENEWED AS REG. NO. A276830, DATED 3-14-2009, EXPIRES 3-14-2019.

NO CLAIM IS MADE TO THE EXCLUSIVE RIGHT TO USE "SINCE 1971 POOL CHLORINATION WITH SALT", APART FROM THE MARK AS SHOWN.

THE COLOR(S) DARK BLUE, LIGHT BLUE AND WHITE IS/ARE CLAIMED AS A FEATURE OF THE MARK.

THE MARK CONSISTS OF THE WORD "WATERMAID" AT THE TOP IN DARK BLUE. BELOW THE WORD "WATERMAID" ARE TWO WAVES (OF WATER), THE BOTTOM WAVE IN DARK BLUE AND TOP WAVE IN LIGHT BLUE. ACROSS THE BOTTOM OF THE DARK BLUE WAVE IN WHITE ARE THE WORDS "PROVEN PERFORMANCE SINCE 1971". BELOW THE DARK BLUE WAVE IN DARK BLUE ARE THE WORDS "POOL CHLORINATION WITH SALT". IN FRONT OF THE TWO WAVES ARE SEVERAL BUBBLES (ABOUT TWO THIRDS OF THE WAY ACROSS FROM THE LEFT OF THE MARK), WHICH START LARGE IN SIZE AT THE BOTTOM OF THE DARK BLUE WAVE AND THEN GET PROGRESSIVELY SMALLER AS THEY RISE (LEADING UP THROUGH THE LIGHT BLUE WAVE) TO FINISH JUST BELOW THE "M" IN "WATERMAID".

SER. NO. 77-293,466, FILED 10-2-2007.

TINA KUAN, EXAMINING ATTORNEY

Int. Cl.: 35

Prior U.S. Cls.: 100, 101 and 102

United States Patent and Trademark Office

Reg. No. 3,475,279

Registered July 29, 2008

**SERVICE MARK
PRINCIPAL REGISTER**



T. S. KEARNS & CO., CPA, (A PROFESSIONAL CORPORATION) (LOUISIANA CORPORATION)
501 CANAL BOULEVARD
THIBODAUX, LA 70301

FOR: ACCOUNTING SERVICES; TAX CONSULTATION; TAX FILING SERVICES; TAX LIEN MANAGEMENT SERVICES, IN CLASS 35 (U.S. CLS. 100, 101 AND 102).

FIRST USE 3-1-1998; IN COMMERCE 3-1-1998.

NO CLAIM IS MADE TO THE EXCLUSIVE RIGHT TO USE "CO." AND "CPA", APART FROM THE MARK AS SHOWN.

THE NAME(S), PORTRAIT(S), AND/OR SIGNATURE(S) SHOWN IN THE MARK IDENTIFIES "TIMOTHY S. KEARNS", WHOSE CONSENT(S) TO REGISTER IS SUBMITTED.

THE MARK CONSISTS OF THE STYLIZED WORDS "T.S. KEARNS & CO. CPA". THE LETTERS "CPA" IN AN OVAL MERGED INTO THE BOTTOM AND A HORIZONTAL LINE UNDER THE NAME.

SER. NO. 77-293,719, FILED 10-2-2007.

MICHAEL LITZAU, EXAMINING ATTORNEY

Int. Cl.: 17

Prior U.S. Cls.: 1, 5, 12, 13, 35 and 50

Reg. No. 3,475,280

United States Patent and Trademark Office

Registered July 29, 2008

**TRADEMARK
PRINCIPAL REGISTER**

"PAINT PREP MADE EASY"

ERDFARB, JEFFREY (NEW JERSEY CORPORATION), DBA J&A DEVELOPMENT ASSOCIATES, INC./DBA: PAINT GUARDS
1305 DICKERSON RD.
TEANECK, NJ 07666

FOR: PAINT GUARDS AND SHIELDS, NAMELY, SHEETS OF THERMOFORMED PLASTIC FILM USED TO COVER AND PROTECT OBJECTS WHILE PAINTING, IN CLASS 17 (U.S. CLS. 1, 5, 12, 13, 35 AND 50).

FIRST USE 1-1-2007; IN COMMERCE 5-29-2007.

THE MARK CONSISTS OF STANDARD CHARACTERS WITHOUT CLAIM TO ANY PARTICULAR FONT, STYLE, SIZE, OR COLOR.

SER. NO. 77-294,050, FILED 10-2-2007.

ERNEST SHOSHO, EXAMINING ATTORNEY

Int. Cl.: 38

Prior U.S. Cls.: 100, 101 and 104

United States Patent and Trademark Office

Reg. No. 3,475,281

Registered July 29, 2008

**SERVICE MARK
PRINCIPAL REGISTER**

MEEBO, INC. (DELAWARE CORPORATION)
215 CASTRO STREET, THIRD FLOOR
MOUNTAIN VIEW, CA 94041

FOR: INSTANT MESSAGING SERVICES, IN
CLASS 38 (U.S. CLS. 100, 101 AND 104).

FIRST USE 9-4-2005; IN COMMERCE 9-14-2005.

OWNER OF U.S. REG. NO. 3,249,184.

THE MARK CONSISTS OF THE WORD "MEEBO"
IN ROUNDED LOWER-CASE, WITH TWO SMALL
CIRCLES PROCEEDING IN A DIAGONAL LINE
FROM THE LETTER "O".

SER. NO. 77-294,199, FILED 10-2-2007.

DAWN FELDMAN, EXAMINING ATTORNEY

Int. Cl.: 36

Prior U.S. Cls.: 100, 101 and 102

United States Patent and Trademark Office

Reg. No. 3,475,282

Registered July 29, 2008

**SERVICE MARK
PRINCIPAL REGISTER**

ABLECO

ABLECO FINANCE LLC (DELAWARE LTD LIAB
CO)
299 PARK AVENUE
NEW YORK, NY 10171

FOR: FINANCIAL SERVICES, NAMELY, COMMERCIAL LENDING SERVICES FOR FINANCING, REFINANCING, BUSINESS RESTRUCTURING, RECAPITALIZATION OF BUSINESSES, BUSINESS ACQUISITIONS, BUSINESS EXPANSIONS, BUSINESS BUYOUTS, BUSINESS REORGANIZATION, AND MANAGED BUYOUTS OF BUSINESSES; REAL ESTATE FINANCING, CONSTRUCTION FINANCING, INVENTORY FINANCING, COMMERCIAL LENDING SERVICES, NAMELY, COMMERCIAL ASSET-BASED LENDING, COMMERCIAL LENDING SERVICES, NAMELY, COMMERCIAL CASH-FLOW

LENDING, LOAN FINANCING, NAMELY, REAL ESTATE LOAN SERVICING, FINANCIAL SERVICES, NAMELY, GENERAL BUSINESS LENDING, IN CLASS 36 (U.S. CLS. 100, 101 AND 102).

FIRST USE 2-0-1999; IN COMMERCE 2-0-1999.

THE MARK CONSISTS OF STANDARD CHARACTERS WITHOUT CLAIM TO ANY PARTICULAR FONT, STYLE, SIZE, OR COLOR.

OWNER OF U.S. REG. NO. 2,806,796.

SER. NO. 77-294,251, FILED 10-2-2007.

HENRY S. ZAK, EXAMINING ATTORNEY

Int. Cl.: 36

Prior U.S. Cls.: 100, 101 and 102

United States Patent and Trademark Office

Reg. No. 3,475,283

Registered July 29, 2008

**SERVICE MARK
PRINCIPAL REGISTER**

ABLECO FINANCE LLC

ABLECO FINANCE LLC (DELAWARE LTD LIAB
CO)
299 PARK AVENUE
NEW YORK, NY 10171

FOR: FINANCIAL SERVICES, NAMELY, COMMERCIAL LENDING SERVICES FOR FINANCING, REFINANCING, BUSINESS RESTRUCTURING, RECAPITALIZATION OF BUSINESSES, BUSINESS ACQUISITIONS, BUSINESS EXPANSIONS, BUSINESS BUYOUTS, BUSINESS REORGANIZATION, AND MANAGED BUYOUTS OF BUSINESSES; REAL ESTATE FINANCING, CONSTRUCTION FINANCING, INVENTORY FINANCING, COMMERCIAL LENDING SERVICES, NAMELY, COMMERCIAL ASSET-BASED LENDING, COMMERCIAL LENDING SERVICES, NAMELY, COMMERCIAL CASH-FLOW LENDING, LOAN FINANCING, NAMELY, REAL ESTATE LOAN SERVICING, FINANCIAL SERVI-

CES, NAMELY, GENERAL BUSINESS LENDING, IN CLASS 36 (U.S. CLS. 100, 101 AND 102).

FIRST USE 2-0-1999; IN COMMERCE 2-0-1999.

THE MARK CONSISTS OF STANDARD CHARACTERS WITHOUT CLAIM TO ANY PARTICULAR FONT, STYLE, SIZE, OR COLOR.

OWNER OF U.S. REG. NO. 2,806,796.

NO CLAIM IS MADE TO THE EXCLUSIVE RIGHT TO USE "FINANCE LLC", APART FROM THE MARK AS SHOWN.

SER. NO. 77-294,255, FILED 10-2-2007.

HENRY S. ZAK, EXAMINING ATTORNEY

Int. Cl.: 29

Prior U.S. Cl.: 46

United States Patent and Trademark Office

Reg. No. 3,475,284

Registered July 29, 2008

TRADEMARK
PRINCIPAL REGISTER



KINDLY EGGS CO., LTD. (TAIWAN CORPORATION)
65, SAN FUH ST.
SAN KUAY TSUEN, JEOU RU HSIANG
PING TUNG HSIEN, TAIWAN

FOR: PRESERVED EGGS, EGGS, EGG POWDER,
DUCK EGGS, SALTED DUCK EGGS, QUAIL EGGS,
BIRD EGGS NOT FOR HATCHING, IN CLASS 29
(U.S. CL. 46).

FIRST USE 3-16-2003; IN COMMERCE 3-16-2003.

THE NON-LATIN CHARACTER(S) IN THE
MARK TRANSLITERATE INTO KUANG YU, AND
THIS MEANS EXTENSIVE AND IMPERIAL IN
ENGLISH.

SER. NO. 77-295,101, FILED 10-3-2007.

GRETТА YAO, EXAMINING ATTORNEY

Int. Cls.: 5, 18, 28, 31, 35 and 44

**Prior U.S. Cls.: 1, 2, 3, 6, 18, 22, 23, 38, 41, 44, 46, 50,
51, 52, 100, 101 and 102**

Reg. No. 3,475,285

United States Patent and Trademark Office

Registered July 29, 2008

**TRADEMARK
SERVICE MARK
PRINCIPAL REGISTER**

Feeding Pets for Life

KRISER'S FEEDING PETS FOR LIFE, LLC (DE-
LAWARE LTD LIAB CO)
SUITE 201
1229 N. BRANCH STREET
CHICAGO, IL 60622

FOR: FEED SUPPLEMENTS FOR PETS; ANIMAL
FEED SUPPLEMENTS , IN CLASS 5 (U.S. CLS. 6, 18,
44, 46, 51 AND 52).

FIRST USE 1-1-2006; IN COMMERCE 1-1-2006.

FOR: DOG APPAREL; DOG CLOTHING; DOG
COLLARS; DOG LEASHES; RAWHIDE CHEWS FOR
DOGS, IN CLASS 18 (U.S. CLS. 1, 2, 3, 22 AND 41).

FIRST USE 1-1-2006; IN COMMERCE 1-1-2006.

FOR: DOG TOYS; CAT TOYS, IN CLASS 28 (U.S.
CLS. 22, 23, 38 AND 50).

FIRST USE 1-1-2006; IN COMMERCE 1-1-2006.

FOR: DIGESTIBLE CHEWING BONES FOR
DOGS; DOG BISCUITS; DOG FOOD; DOG TREATS;

CAT FOOD; CAT LITTER; CAT TREATS, IN CLASS
31 (U.S. CLS. 1 AND 46).

FIRST USE 1-1-2006; IN COMMERCE 1-1-2006.

FOR: RETAIL PET STORES, IN CLASS 35 (U.S.
CLS. 100, 101 AND 102).

FIRST USE 1-1-2006; IN COMMERCE 1-1-2006.

FOR: PET CARE SERVICES, NAMELY, DOG
WALKING, DOG BATHING AND NON-MEDICA-
TED PET GROOMING; ANIMAL GROOMING, IN
CLASS 44 (U.S. CLS. 100 AND 101).

FIRST USE 1-1-2006; IN COMMERCE 1-1-2006.

THE MARK CONSISTS OF STANDARD CHAR-
ACTERS WITHOUT CLAIM TO ANY PARTICULAR
FONT, STYLE, SIZE, OR COLOR.

SER. NO. 77-295,146, FILED 10-3-2007.

ALLISON SCHRODY, EXAMINING ATTORNEY

Int. Cl.: 41

Prior U.S. Cls.: 100, 101 and 107

United States Patent and Trademark Office

Reg. No. 3,475,286

Registered July 29, 2008

**SERVICE MARK
PRINCIPAL REGISTER**



PATRIOT DEFENSE GROUP, LLC. (FLORIDA
LTD LIAB CO)
400 PARK AVENUE SOUTH, SUITE 150
WINTER PARK, FL 32789

FOR: TRAINING SERVICES IN THE FIELD OF
CURRICULUM DEVELOPMENT, SPECIALIZED
TRAINING, AND LOGISTICS FOR GOVERNMENT
AND COMMERCIAL CUSTOMERS IN THE FIELD
OF SECURITY OPERATIONS, IN CLASS 41 (U.S.
CLS. 100, 101 AND 107).

FIRST USE 2-5-2005; IN COMMERCE 3-0-2005.

NO CLAIM IS MADE TO THE EXCLUSIVE
RIGHT TO USE "DEFENSE GROUP, LLC.", APART
FROM THE MARK AS SHOWN.

THE COLOR(S) NAVY BLUE, ROYAL BLUE,
RED, WHITE IS/ARE CLAIMED AS A FEATURE
OF THE MARK.

THE MARK CONSISTS OF A PORTION OF A
WAVY AMERICAN FLAG, CONTAINING STARS
IN WHITE ON A NAVY BACKGROUND AND A
SMALL PORTION OF A RED AND WHITE STRIPE
LOCATED IN THE BOTTOM RIGHT HAND COR-
NER. DIRECTLY UNDERNEATH THE FLAG DE-
SIGN, THE WORDS "PATRIOT DEFENSE GROUP,
LLC." IN ROYAL BLUE BOLDFACE, ROYAL BLUE
UNDERLINED, UPPER CASE TYPE. THE SECOND
LINE CONTAINS THE ROYAL BLUE WORDING
"SERVING THOSE WHO DEFEND AMERICA." IN
ITALIC, MIXED CASE TYPE.

SER. NO. 77-295,176, FILED 10-3-2007.

BRIAN PINO, EXAMINING ATTORNEY

Int. Cl.: 9

Prior U.S. Cls.: 21, 23, 26, 36 and 38

Reg. No. 3,475,287

United States Patent and Trademark Office

Registered July 29, 2008

**TRADEMARK
PRINCIPAL REGISTER**

MESHPLUS

AXIOMETRIC, LLC (MARYLAND LTD LIAB CO)
10718 VISTA ROAD
COLUMBIA, MD 21044

FOR: DEVICES AND APPARATUS FOR RECORDING AND WIRELESSLY TRANSMITTING DATA, NAMELY, WIRELESS NETWORK ADAPTERS, WIRELESS ANTENNAE, WIRELESS EXTENDERS, AND WIRELESS DEVICE CONTROLLERS FOR COLLECTING, MANAGING, AND TRANSMITTING DATA; WIRELESS COMMUNICATION DEVICES FOR INTERFACING WIRELESS MESH NETWORKS WITH CONVENTIONAL WIRED OR WIRELESS NETWORKS, NAMELY, WIRELESS RANGE EXTENDERS, REPEATERS, GATEWAYS, AND COMPONENTS ENABLING WIRELESS MONITORING AND CONTROL OF DATA COLLECTION DEVICES, NAMELY, PORTABLE WIRELESS-EN-

ABLED DEVICES SUCH AS HANDHELD COMPUTING DEVICES AND LAPTOP COMPUTERS; COMPUTING AND OPERATING PLATFORMS CONSISTING OF DATA TRANSCEIVERS AND WIRELESS NETWORKS AND GATEWAYS FOR COLLECTION, MANAGEMENT AND TRANSMISSION OF DATA, IN CLASS 9 (U.S. CLS. 21, 23, 26, 36 AND 38).

FIRST USE 6-5-2007; IN COMMERCE 6-5-2007.

THE MARK CONSISTS OF STANDARD CHARACTERS WITHOUT CLAIM TO ANY PARTICULAR FONT, STYLE, SIZE, OR COLOR.

SER. NO. 77-295,200, FILED 10-3-2007.

GINA HAYES, EXAMINING ATTORNEY

Int. Cls.: 5, 18, 28, 31, 35 and 44

Prior U.S. Cls.: 1, 2, 3, 6, 18, 22, 23, 38, 41, 44, 46, 50, 51, 52, 100, 101 and 102

Reg. No. 3,475,288

Registered July 29, 2008

United States Patent and Trademark Office

**TRADEMARK
SERVICE MARK
PRINCIPAL REGISTER**



KRISER'S FEEDING PETS FOR LIFE, LLC (DE-
LAWARE LTD LIAB CO)
SUITE 201
1229 N. BRANCH STREET
CHICAGO, IL 60622

FOR: ANIMAL FEED SUPPLEMENTS; FEED
SUPPLEMENTS FOR PETS , IN CLASS 5 (U.S. CLS.
6, 18, 44, 46, 51 AND 52).

FIRST USE 1-1-2006; IN COMMERCE 1-1-2006.

FOR: DOG APPAREL; DOG CLOTHING; DOG
COLLARS; DOG LEASHES; RAWHIDE CHEWS FOR
DOGS, IN CLASS 18 (U.S. CLS. 1, 2, 3, 22 AND 41).

FIRST USE 1-1-2006; IN COMMERCE 1-1-2006.

FOR: DOG TOYS; CAT TOYS, IN CLASS 28 (U.S.
CLS. 22, 23, 38 AND 50).

FIRST USE 1-1-2006; IN COMMERCE 1-1-2006.

FOR: DIGESTIBLE CHEWING BONES FOR
DOGS; DOG BISCUITS; DOG FOOD; DOG TREATS;
CAT FOOD; CAT LITTER; CAT TREATS, IN CLASS
31 (U.S. CLS. 1 AND 46).

FIRST USE 1-1-2006; IN COMMERCE 1-1-2006.

FOR: RETAIL PET STORES, IN CLASS 35 (U.S.
CLS. 100, 101 AND 102).

FIRST USE 1-1-2006; IN COMMERCE 1-1-2006.

FOR: PET CARE SERVICES, NAMELY, DOG
WALKING, DOG BATHING AND NON-MEDICA-
TED PET GROOMING; ANIMAL GROOMING, IN
CLASS 44 (U.S. CLS. 100 AND 101).

FIRST USE 1-1-2006; IN COMMERCE 1-1-2006.

THE MARK CONSISTS OF DARK SHADED LAR-
GER SIZED DOG LAYERED WITH A WHITE CAT
IN FRONT WHICH THEN HAS A LIGHT SHADED
PARROT LAYERED IN FRONT OF CAT WHICH
THEN HAS A WHITE FISH WITH LIGHTLY SHA-
DED BOREDER LAYERED IN FRONT PARROT.

SER. NO. 77-295,231, FILED 10-3-2007.

ALLISON SCHRODY, EXAMINING ATTORNEY

Int. Cls.: 5, 18, 28, 31, 35 and 44

**Prior U.S. Cls.: 1, 2, 3, 6, 18, 22, 23, 38, 41, 44, 46, 50,
51, 52, 100, 101 and 102**

Reg. No. 3,475,289

United States Patent and Trademark Office

Registered July 29, 2008

**TRADEMARK
SERVICE MARK
PRINCIPAL REGISTER**

Kriser's 

KRISER'S FEEDING PETS FOR LIFE, LLC (DE-
LAWARE LTD LIAB CO)
1229 N. BRANCH STREET, SUITE 201
CHICAGO, IL 60622

FOR: FEED SUPPLEMENTS FOR PETS, IN CLASS
5 (U.S. CLS. 6, 18, 44, 46, 51 AND 52).

FIRST USE 1-1-2006; IN COMMERCE 1-1-2006.

FOR: DOG APPAREL; DOG CLOTHING; DOG
COLLARS; DOG LEASHES; RAWHIDE CHEWS FOR
DOGS, IN CLASS 18 (U.S. CLS. 1, 2, 3, 22 AND 41).

FIRST USE 1-1-2006; IN COMMERCE 1-1-2006.

FOR: DOG TOYS; CAT TOYS, IN CLASS 28 (U.S.
CLS. 22, 23, 38 AND 50).

FIRST USE 1-1-2006; IN COMMERCE 1-1-2006.

FOR: DIGESTIBLE CHEWING BONES FOR
DOGS; DOG BISCUITS; DOG FOOD; DOG TREATS;
CAT FOOD; CAT LITTER; CAT TREATS, IN CLASS
31 (U.S. CLS. 1 AND 46).

FIRST USE 1-1-2006; IN COMMERCE 1-1-2006.

FOR: RETAIL PET STORES, IN CLASS 35 (U.S.
CLS. 100, 101 AND 102).

FIRST USE 1-1-2006; IN COMMERCE 1-1-2006.

FOR: PET CARE SERVICES, NAMELY, DOG
WALKING, DOG BATHING AND NON-MEDICA-
TED PET GROOMING; ANIMAL GROOMING, IN
CLASS 44 (U.S. CLS. 100 AND 101).

FIRST USE 1-1-2006; IN COMMERCE 1-1-2006.

THE MARK CONSISTS OF KRISER'S WITH A
CAPITAL "K" AND AN IGUANA AS THE APOS-
TROPHE.

SER. NO. 77-295,268, FILED 10-3-2007.

ALLISON SCHRODY, EXAMINING ATTORNEY

Int. Cls.: 9, 16 and 41

**Prior U.S. Cls.: 2, 5, 21, 22, 23, 26, 29, 36, 37, 38, 50,
100, 101 and 107**

Reg. No. 3,475,290

United States Patent and Trademark Office

Registered July 29, 2008

**TRADEMARK
SERVICE MARK
PRINCIPAL REGISTER**

LYNDA.COM

LYNDA.COM INC. (CALIFORNIA CORPORATION)
4171 MARKET STREET, SUITE C
VENTURA, CA 930038300

FOR: PRE-RECORDED CD'S, VIDEO TAPES,
AND DVD'S FEATURING INSTRUCTION IN THE
FIELD OF COMPUTERS, IN CLASS 9 (U.S. CLS. 21,
23, 26, 36 AND 38).

FIRST USE 6-1-1998; IN COMMERCE 6-1-1998.

FOR: EDUCATIONAL BOOKS IN THE FIELD OF
COMPUTERS AND FOR COMPUTER TRAINING
PURPOSES, IN CLASS 16 (U.S. CLS. 2, 5, 22, 23, 29, 37,
38 AND 50).

FIRST USE 6-1-1998; IN COMMERCE 6-1-1998.

FOR: COMPUTER SERVICES, NAMELY, PRO-
VIDING ON-LINE TRAINING MATERIALS AND
SELF-PACED COURSES OF INSTRUCTION IN THE
FIELD OF COMPUTERS; PROVIDING AN ONLINE
COMPUTER DATABASE FEATURING INFORMA-

TION IN THE NATURE OF DIGITAL COMPUTER
TRAINING VIDEOS IN THE FIELD OF COMPUTER
SOFTWARE, COLOR THEORY, DESIGN PRINCIPLES,
AND TYPOGRAPHY AND PROVIDING A
WEBSITE FEATURING NONDOWNLOADABLE IN-
STRUCTIONAL VIDEOS IN THE FIELD OF COM-
PUTER SOFTWARE, COLOR THEORY, DESIGN
PRINCIPLES, AND TYPOGRAPHY, IN CLASS 41
(U.S. CLS. 100, 101 AND 107).

FIRST USE 6-1-1998; IN COMMERCE 6-1-1998.

THE MARK CONSISTS OF STANDARD CHAR-
ACTERS WITHOUT CLAIM TO ANY PARTICULAR
FONT, STYLE, SIZE, OR COLOR.

OWNER OF U.S. REG. NOS. 2,613,079 AND
2,993,356.

SER. NO. 77-295,365, FILED 10-3-2007.

WON TEAK OH, EXAMINING ATTORNEY

Int. Cl.: 41

Prior U.S. Cls.: 100, 101 and 107

United States Patent and Trademark Office

Reg. No. 3,475,291

Registered July 29, 2008

**SERVICE MARK
PRINCIPAL REGISTER**



CARDIORHUMBA FITNESS, INC. (FLORIDA CORPORATION)
6934 SEA DAISY LANE
LANTANA, FL 33462

FOR: PHYSICAL FITNESS AND EXERCISE INSTRUCTION SERVICES, IN CLASS 41 (U.S. CLS. 100, 101 AND 107).

FIRST USE 7-25-2007; IN COMMERCE 7-25-2007.

NO CLAIM IS MADE TO THE EXCLUSIVE RIGHT TO USE "CARDIO RHUMBA", APART FROM THE MARK AS SHOWN.

THE COLOR(S) ORANGE, WHITE AND BLUE IS/ARE CLAIMED AS A FEATURE OF THE MARK.

THE MARK CONSISTS OF AN ORANGE BOX CONSISTING OF A WHITE GRAPHIC DEPICTION OF A MAN AND WOMAN INSIDE THE ORANGE BOX AND THE WORDS "CARDIO RHUMBA" UNDERNEATH THE ORANGE BOX WITH THE LETTER "H" IN "RHUMBA" FEATURED IN ORANGE AND THE REMAINING LETTERING FEATURED IN BLUE.

SER. NO. 77-295,509, FILED 10-3-2007.

DEIRDRE ROBERTSON, EXAMINING ATTORNEY

Int. Cl.: 25

Prior U.S. Cls.: 22 and 39

United States Patent and Trademark Office

Reg. No. 3,475,292

Registered July 29, 2008

**TRADEMARK
PRINCIPAL REGISTER**

ORIGINAL TOURNAMENT TAPPERS

ON CALL CASINO SERVICES, INC. (NEVADA
CORPORATION)
A101-222
4045 S. BUFFALO DRIVE
LAS VEGAS, NV 89147

FOR: CLOTHING, NAMELY, GLOVES FOR USE
IN PLAYING VIDEO OR SLOT MACHINES, IN
CLASS 25 (U.S. CLS. 22 AND 39).

FIRST USE 8-25-1007; IN COMMERCE 8-25-2007.

THE MARK CONSISTS OF STANDARD CHAR-
ACTERS WITHOUT CLAIM TO ANY PARTICULAR
FONT, STYLE, SIZE, OR COLOR.

NO CLAIM IS MADE TO THE EXCLUSIVE
RIGHT TO USE "ORIGINAL", APART FROM THE
MARK AS SHOWN.

SER. NO. 77-295,521, FILED 10-3-2007.

DAVID MURRAY, EXAMINING ATTORNEY

Int. Cl.: 43

Prior U.S. Cls.: 100 and 101

United States Patent and Trademark Office

Reg. No. 3,475,293

Registered July 29, 2008

**SERVICE MARK
PRINCIPAL REGISTER**



KANG, SOPHIA (UNITED STATES INDIVIDUAL), DBA STESO
1615 CABRILLO AVE.
TORRANCE, CA 90501 AND
KANG, STEFANO (UNITED STATES INDIVIDUAL),
DBA STESO
1615 CABRILLO AVE.
TORRANCE, CA 90501

FOR: RESTAURANT SERVICES, IN CLASS 43
(U.S. CLS. 100 AND 101).

FIRST USE 0-0-2005; IN COMMERCE 0-0-2005.

NO CLAIM IS MADE TO THE EXCLUSIVE
RIGHT TO USE "BY BRAZIL", APART FROM THE
MARK AS SHOWN.

SER. NO. 77-295,536, FILED 10-3-2007.

ALEX KEAM, EXAMINING ATTORNEY

Int. Cl.: 25

Prior U.S. Cls.: 22 and 39

United States Patent and Trademark Office

Reg. No. 3,475,294

Registered July 29, 2008

**TRADEMARK
PRINCIPAL REGISTER**



KOMEX INTERNATIONAL, INC. (CALIFORNIA CORPORATION)
850 EAST 62ND STREET
LOS ANGELES, CA 90001

NO CLAIM IS MADE TO THE EXCLUSIVE RIGHT TO USE "AMERICAN", APART FROM THE MARK AS SHOWN.

FOR: CLOTHING, NAMELY, JEANS, PANTS, SHIRTS, BLOUSES, SKIRTS, T-SHIRTS, IN CLASS 25 (U.S. CLS. 22 AND 39).

THE MARK CONSISTS OF THE WORDS "AMERICAN FLAVOUR" AND A STAR DESIGN.

FIRST USE 6-1-2006; IN COMMERCE 6-1-2006.

SER. NO. 77-295,543, FILED 10-3-2007.

OWNER OF U.S. REG. NOS. 2,758,874, 3,042,460 AND OTHERS.

ALEX KEAM, EXAMINING ATTORNEY

Int. Cl.: 36

Prior U.S. Cls.: 100, 101 and 102

United States Patent and Trademark Office

Reg. No. 3,475,295

Registered July 29, 2008

**SERVICE MARK
PRINCIPAL REGISTER**

PREMIER PACIFIC VINEYARDS

PREMIER PACIFIC VINEYARDS, L.P. (CALI-
FORNIA LIMITED PARTNERSHIP)
P.O. BOX 3989
NAPA, CA 94558

NO CLAIM IS MADE TO THE EXCLUSIVE
RIGHT TO USE "VINEYARDS", APART FROM
THE MARK AS SHOWN.

FOR: FINANCIAL INVESTMENT IN THE FIELD
OF VINEYARDS, WINERIES AND RELATED
LAND, IN CLASS 36 (U.S. CLS. 100, 101 AND 102).

SEC. 2(F).

FIRST USE 7-15-1998; IN COMMERCE 7-15-1998.

SER. NO. 77-295,563, FILED 10-3-2007.

THE MARK CONSISTS OF STANDARD CHAR-
ACTERS WITHOUT CLAIM TO ANY PARTICULAR
FONT, STYLE, SIZE, OR COLOR.

DAVID MILLER, EXAMINING ATTORNEY

Int. Cl.: 41

Prior U.S. Cls.: 100, 101 and 107

United States Patent and Trademark Office

Reg. No. 3,475,296

Registered July 29, 2008

**SERVICE MARK
PRINCIPAL REGISTER**

Blues No More

RIZZONE, VINCENT E. (UNITED STATES INDIVIDUAL)
1003 FILMORE AVE.
ERIE, PA 165054131

FOR: ENTERTAINMENT, NAMELY, LIVE PERFORMANCES BY A MUSICAL BAND, IN CLASS 41 (U.S. CLS. 100, 101 AND 107).

FIRST USE 3-19-2006; IN COMMERCE 3-19-2006.

THE MARK CONSISTS OF STANDARD CHARACTERS WITHOUT CLAIM TO ANY PARTICULAR FONT, STYLE, SIZE, OR COLOR.

NO CLAIM IS MADE TO THE EXCLUSIVE RIGHT TO USE "BLUES", APART FROM THE MARK AS SHOWN.

SER. NO. 77-295,605, FILED 10-3-2007.

ALICE BENMAMAN, EXAMINING ATTORNEY

Int. Cl.: 25

Prior U.S. Cls.: 22 and 39

United States Patent and Trademark Office

Reg. No. 3,475,297

Registered July 29, 2008

**TRADEMARK
PRINCIPAL REGISTER**

LUCKY BUCKY

DONNA LEA TAYLOR (UNITED STATES INDIVIDUAL)
87 OLD MOLINO ROAD
FAYETTEVILLE, TN 37334

FOR: CLOTHING, NAMELY, MENS, WOMENS, AND CHILDRENS, SHIRTS, T-SHIRTS, COLLARED SHIRTS, WOVEN SHIRTS, TANK TOPS, PAJAMAS, SWEATSHIRTS, BALL CAPS, SOLD THROUGH EQUESTRIAN RELATED RETAIL STORES, EQUESTRIAN EVENTS, CO-OP STORES, FEED AND SEED STORES, TACK STORES, FARM SUPPLY STORES, COUNTRY-THEMED AND WESTERN-THEMED

STORES, AND WEBSITES RELATED TO THE FOREGOING, IN CLASS 25 (U.S. CLS. 22 AND 39).

FIRST USE 1-1-2006; IN COMMERCE 3-1-2006.

THE MARK CONSISTS OF STANDARD CHARACTERS WITHOUT CLAIM TO ANY PARTICULAR FONT, STYLE, SIZE, OR COLOR.

SER. NO. 77-295,890, FILED 10-4-2007.

JULIE WATSON, EXAMINING ATTORNEY

Int. Cl.: 9

Prior U.S. Cls.: 21, 23, 26, 36 and 38

United States Patent and Trademark Office

Reg. No. 3,475,298

Registered July 29, 2008

**TRADEMARK
PRINCIPAL REGISTER**

SIS GLOBAL RESEARCH MEDIA

SIS INTERNATIONAL, INC. (NEW YORK CORPORATION)
FLOOR 2
11 EAST 22ND STREET
NEW YORK, NY 10010

FOR: PRE-RECORDED CD-ROMS AND DVDS FEATURING INFORMATION IN THE FIELD OF FIELD OF GLOBAL MARKET INTELLIGENCE RESEARCH, NAMELY, BUSINESS SECTOR AND INDUSTRY DATA AND RESEARCH AND ELECTRONIC DATABASES IN THE FIELD OF MARKET INTELLIGENCE RESEARCH AND MARKET STUDIES RECORDED ON COMPUTER MEDIA, IN CLASS 9 (U.S. CLS. 21, 23, 26, 36 AND 38).

FIRST USE 9-1-2007; IN COMMERCE 9-1-2007.

THE MARK CONSISTS OF STANDARD CHARACTERS WITHOUT CLAIM TO ANY PARTICULAR FONT, STYLE, SIZE, OR COLOR.

NO CLAIM IS MADE TO THE EXCLUSIVE RIGHT TO USE "GLOBAL RESEARCH MEDIA", APART FROM THE MARK AS SHOWN.

SER. NO. 77-296,093, FILED 10-4-2007.

PAUL F. GAST, EXAMINING ATTORNEY

Int. Cl.: 35

Prior U.S. Cls.: 100, 101 and 102

United States Patent and Trademark Office

Reg. No. 3,475,299

Registered July 29, 2008

**SERVICE MARK
PRINCIPAL REGISTER**

**THE ABUNDANT LIFE MODEL
FOR THE COMMUNITY**

HORIZON FINANCIAL & INSURANCE GROUP,
INC. (UTAH CORPORATION)
1376 GOLDEN CIRCLE DRIVE
FRUIT HEIGHTS, UT 84037

FOR: PROMOTING PUBLIC AWARENESS OF
INSURANCE AND FINANCIAL PLANNING SER-
VICES; PROMOTING PUBLIC AWARENESS OF
THE NEED FOR INSURANCE AND FINANCIAL
PLANNING SERVICES, IN CLASS 35 (U.S. CLS. 100,
101 AND 102).

FIRST USE 12-15-2006; IN COMMERCE 12-15-2006.

THE MARK CONSISTS OF STANDARD CHAR-
ACTERS WITHOUT CLAIM TO ANY PARTICULAR
FONT, STYLE, SIZE, OR COLOR.

SER. NO. 77-296,169, FILED 10-4-2007.

ERNEST SHOSHO, EXAMINING ATTORNEY

Int. Cl.: 41

Prior U.S. Cls.: 100, 101 and 107

United States Patent and Trademark Office

Reg. No. 3,475,300

Registered July 29, 2008

**SERVICE MARK
PRINCIPAL REGISTER**

**Balance U Integration U
Corporation U**

BALANCE INTEGRATION CORPORATION
(NEW YORK CORPORATION)
212 W. 22ND STREET 2B
NEW YORK, NY 10011

FOR: EDUCATION SERVICES, NAMELY, PROVIDING INDIVIDUAL TUTORIALS AND GROUP INSTRUCTION IN THE FIELDS OF STRESS MANAGEMENT, YOGA TECHNIQUES, PRODUCTIVITY IMPROVEMENT, AND ACHIEVING WORK/LIFE BALANCE, IN CLASS 41 (U.S. CLS. 100, 101 AND 107).

FIRST USE 9-6-2002; IN COMMERCE 9-6-2002.

THE MARK CONSISTS OF STANDARD CHARACTERS WITHOUT CLAIM TO ANY PARTICULAR FONT, STYLE, SIZE, OR COLOR.

NO CLAIM IS MADE TO THE EXCLUSIVE RIGHT TO USE "BALANCE", AND "CORPORATION", APART FROM THE MARK AS SHOWN.

SER. NO. 77-296,227, FILED 10-4-2007.

EUGENIA MARTIN, EXAMINING ATTORNEY

Int. Cl.: 3

Prior U.S. Cls.: 1, 4, 6, 50, 51 and 52

United States Patent and Trademark Office

Reg. No. 3,475,301

Registered July 29, 2008

**TRADEMARK
PRINCIPAL REGISTER**

INTERMIX

INTERMIX, INC. (NEW YORK CORPORATION)
48 WEST 25TH STREET
NEW YORK, NY 10010

THE MARK CONSISTS OF STANDARD CHAR-
ACTERS WITHOUT CLAIM TO ANY PARTICULAR
FONT, STYLE, SIZE, OR COLOR.

FOR: PERFUMES AND FRAGRANCES, IN CLASS
3 (U.S. CLS. 1, 4, 6, 50, 51 AND 52).

SER. NO. 77-296,943, FILED 10-5-2007.

FIRST USE 12-9-2004; IN COMMERCE 12-9-2004.

MARK T. MULLEN, EXAMINING ATTORNEY

Int. Cls.: 20, 35, 40 and 42

**Prior U.S. Cls.: 2, 13, 22, 25, 32, 50, 100, 101, 102, 103
and 106**

Reg. No. 3,475,302

United States Patent and Trademark Office

Registered July 29, 2008

**TRADEMARK
SERVICE MARK
PRINCIPAL REGISTER**

Crystal D

DAHLGREN ENTERPRISES, INC. (MINNESOTA CORPORATION), DBA CRYSTAL D
505 ATWATER CIRCLE
ST. PAUL, MN 55103

FOR: NON-METAL SCULPTURAL AWARDS AND TROPHIES, IN CLASS 20 (U.S. CLS. 2, 13, 22, 25, 32 AND 50).

FIRST USE 1-31-2007; IN COMMERCE 1-31-2007.

FOR: MAIL ORDER CATALOG SERVICES AND ONLINE RETAIL STORE FEATURING PERFORMANCE, ACHIEVEMENT AND RECOGNITION AWARDS, TROPIES AND PLAQUES, IN CLASS 35 (U.S. CLS. 100, 101 AND 102).

FIRST USE 1-31-2007; IN COMMERCE 1-31-2007.

FOR: ENGRAVING AND ETCHING SERVICES FOR ITEMS MADE OF GLASS, CRYSTAL, STONE

AND WOOD, IN CLASS 40 (U.S. CLS. 100, 103 AND 106).

FIRST USE 1-31-2007; IN COMMERCE 1-31-2007.

FOR: DESIGNING CUSTOMIZED AWARDS FOR OTHERS, IN CLASS 42 (U.S. CLS. 100 AND 101).

FIRST USE 1-31-2007; IN COMMERCE 1-31-2007.

THE MARK CONSISTS OF STANDARD CHARACTERS WITHOUT CLAIM TO ANY PARTICULAR FONT, STYLE, SIZE, OR COLOR.

NO CLAIM IS MADE TO THE EXCLUSIVE RIGHT TO USE "CRYSTAL", APART FROM THE MARK AS SHOWN.

SER. NO. 77-297,132, FILED 10-5-2007.

KEVON CHISOLM, EXAMINING ATTORNEY

Int. Cls.: 4, 8, 21, 24, 27 and 30

Prior U.S. Cls.: 1, 2, 6, 13, 15, 19, 20, 23, 28, 29, 30, 33,
37, 40, 42, 44, 46 and 50

Reg. No. 3,475,303

United States Patent and Trademark Office

Registered July 29, 2008

TRADEMARK
PRINCIPAL REGISTER



MARTHA STEWART LIVING OMNIMEDIA, INC.
(DELAWARE CORPORATION)
11 WEST 42ND STREET
NEW YORK, NY 10036

FOR: CANDLES, IN CLASS 4 (U.S. CLS. 1, 6 AND 15).

FIRST USE 7-15-2007; IN COMMERCE 7-15-2007.

FOR: NON-ELECTRIC CAN OPENERS, NON-ELECTRIC FRUIT AND VEGETABLE PEELERS, PIZZA CUTTERS, APPLE CORERS, ZESTERS, CHEESE SLICERS; CUTLERY, IN CLASS 8 (U.S. CLS. 23, 28 AND 44).

FIRST USE 7-15-2007; IN COMMERCE 7-15-2007.

FOR: HOUSEHOLD UTENSILS, NAMELY, GRATERS, SPATULAS, TURNERS, WHISKS, COLANDERS FOR HOUSEHOLD USE, FLOUR SIFTERS FOR HOUSEHOLD USE, PIE SERVERS, POTATO MASHERS, MELON BALLERS, ICE CREAM SCOOPS, BOTTLE OPENERS, CAKE STANDS, SKIMMERS, VEGETABLE BRUSHES, PASTRY BRUSHES, MIXING BOWLS, TRIVETS, GARLIC PRESSES, CITRUS PRESSES, BRUSHES FOR BASTING MEAT, SIEVES FOR HOUSEHOLD PURPOSES, COOKING STRAINER, COLLAPSIBLE STEAMERS, FUNNELS WITH STRAINERS, SERVING TONGS, SPOON RESTS, SLOTTED SPOONS,

SERVING SPOONS, BASTING SPOONS, MIXING SPOONS, KITCHEN LADLES, TRAYS NOT MADE OF PRECIOUS METALS, DISH DRYING RACKS, TEA BALLS NOT OF PRECIOUS METAL, CITRUS REAMERS FOR FRUIT JUICE, STOVE TOP BURNER COVERS, CHROME-PLATED PAPER TOWEL HOLDERS; CUTTING BOARDS, CORKSCREWS, ROLLING PINS, COOKIE CUTTERS, CANISTER SETS, SALT AND PEPPER MILLS; DINNERWARE, BEVERAGE WARE, BAKEWARE; COOKWARE, NAMELY, SKILLETS, PANS, POTS, STEAMERS, GRIDDLES, ROASTING PANS, FRYING PANS AND WOKS; SOAP AND LOTION DISPENSERS, SOAP DISHES, TUMBLERS, CERAMIC TISSUE BOX COVERS, TOOTH BRUSH HOLDERS, WASTE BASKETS, PITCHERS, AND NAPKIN RINGS NOT MADE OF PRECIOUS METAL, IN CLASS 21 (U.S. CLS. 2, 13, 23, 29, 30, 33, 40 AND 50).

FIRST USE 7-15-2007; IN COMMERCE 7-15-2007.

FOR: BEDDING, NAMELY, COMFORTERS, QUILTS, BED SPREADS, BED SKIRTS, DUVETS, COMFORTER COVERS, BLANKETS, MATTRESS PADS, PILLOW CASES AND PILLOW SHAMS; FEATHERBEDS, SHEETS, TOWELS, SHOWER CURTAINS, DISHCLOTHS, TABLECLOTHS NOT OF PAPER, TABLE LINENS, NAMELY, CLOTH NAPKINS, POT HOLDERS AND TEXTILE PLACE MATS, IN CLASS 24 (U.S. CLS. 42 AND 50).

FIRST USE 7-15-2007; IN COMMERCE 7-15-2007.

FOR: RUGS, IN CLASS 27 (U.S. CLS. 19, 20, 37, 42 AND 50).

FIRST USE 7-15-2007; IN COMMERCE 7-15-2007.

FOR: CAKE MIXES, SUGAR, EDIBLE CAKE DECORATIONS, SALT, PEPPER, SPICES, IN CLASS 30 (U.S. CL. 46).

FIRST USE 7-15-2007; IN COMMERCE 7-15-2007.

OWNER OF U.S. REG. NOS. 2,186,450, 2,911,894 AND OTHERS.

THE NAME "MARTHA STEWART" IDENTIFIES A LIVING INDIVIDUAL WHOSE CONSENT IS OF RECORD.

SER. NO. 77-297,652, FILED 10-5-2007.

ANDREA BUTLER, EXAMINING ATTORNEY

Int. Cls.: 18 and 25

Prior U.S. Cls.: 1, 2, 3, 22, 39 and 41

United States Patent and Trademark Office

Reg. No. 3,475,304

Registered July 29, 2008

**TRADEMARK
PRINCIPAL REGISTER**

Claudia Roldani

MARKS, MARIA C. (UNITED STATES INDIVIDUAL)
9310 FLANAGAN CT.
MANASSAS, VA 20110

FOR: HANDBAGS, TOTE BAGS, EVENING BAGS, WALLETS, PURSES, IN CLASS 18 (U.S. CLS. 1, 2, 3, 22 AND 41).

FIRST USE 4-1-2004; IN COMMERCE 4-1-2004.

FOR: SHAWLS, BELTS, PONCHOS, STOLES, SKIRTS, BLOUSES, IN CLASS 25 (U.S. CLS. 22 AND 39).

FIRST USE 4-1-2004; IN COMMERCE 4-1-2004.

THE MARK CONSISTS OF STANDARD CHARACTERS WITHOUT CLAIM TO ANY PARTICULAR FONT, STYLE, SIZE, OR COLOR.

THE NAME "CLAUDIA ROLDANI" DOES NOT IDENTIFY A LIVING INDIVIDUAL.

SER. NO. 77-298,033, FILED 10-7-2007.

CURTIS FRENCH, EXAMINING ATTORNEY

Int. Cl.: 28

Prior U.S. Cls.: 22, 23, 38 and 50

Reg. No. 3,475,305

United States Patent and Trademark Office

Registered July 29, 2008

**TRADEMARK
PRINCIPAL REGISTER**

ARMIS

AMITENEJAH, J (UNITED STATES INDIVIDUAL)

8345 CONCORD BLVD. WEST

JACKSONVILLE, FL 32208

FOR: BOARD GAMES, IN CLASS 28 (U.S. CLS. 22, 23, 38 AND 50).

FIRST USE 8-20-2007; IN COMMERCE 9-5-2007.

THE MARK CONSISTS OF STANDARD CHARACTERS WITHOUT CLAIM TO ANY PARTICULAR FONT, STYLE, SIZE, OR COLOR.

THE FOREIGN WORDING IN THE MARK TRANSLATES INTO ENGLISH AS TO TAKE BY FORCE .

SER. NO. 77-298,170, FILED 10-8-2007.

BARBARA BROWN, EXAMINING ATTORNEY

Int. Cl.: 41

Prior U.S. Cls.: 100, 101 and 107

United States Patent and Trademark Office

Reg. No. 3,475,306

Registered July 29, 2008

**SERVICE MARK
PRINCIPAL REGISTER**

CARECULTURE

CARELEADERS, LLC (DELAWARE LTD LIAB
CO)
3011 N IH-35
AUSTIN, TX 78722

FOR: ARRANGING AND CONDUCTING EDUCATIONAL CONFERENCES; EDUCATION SERVICES, NAMELY, PROVIDING, FACILITATING AND COACHING CLASSES, SEMINARS, CONFERENCES, WORKSHOPS AND ONLINE COURSES IN THE FIELDS OF THE HEALTHCARE INDUSTRY; EDUCATIONAL SERVICES, NAMELY, CONDUCTING CLASSES, SEMINARS, CONFERENCES, WORKSHOPS AND ONLINE COURSES IN THE FIELD OF HUMAN RESOURCE DEVELOPMENT, NAMELY, PERSONNEL HIRING, PLACEMENT, AND ADMINISTRATION, AND PLANNING AND ADMINISTRATION OF EMPLOYEE BENEFIT PLANS; BUSINESS ORGANIZATIONAL PLANNING AND DEVELOPMENT, NAMELY, IN THE DEVELOPMENT OF PROCESSES FOR THE ANALYSIS AND IMPLEMENTATION OF PERFORMANCE AND EMPLOYEE RETENTION PLANS; EXECUTIVE AND LEADERSHIP DEVELOPMENT, NAMELY, STRATEGIC PLANNING; CUSTOMER SERVICE, NAMELY, THE DEVELOPMENT OF PRO-

CESSSES FOR THE ANALYSIS AND IMPLEMENTATION OF CUSTOMER RETENTION PLANS; AND DISTRIBUTION OF COURSE MATERIAL IN CONNECTION THEREWITH; EDUCATIONAL SERVICES, NAMELY, DEVELOPING, ARRANGING, AND CONDUCTING EDUCATIONAL CONFERENCES AND PROGRAMS AND PROVIDING COURSES OF INSTRUCTION IN THE FIELD OF HUMAN RESOURCE DEVELOPMENT, BUSINESS ORGANIZATIONAL PLANNING AND DEVELOPMENT, AND EXECUTIVE LEADERSHIP DEVELOPMENT FOR THE HEALTHCARE INDUSTRY; BUSINESS TRAINING, IN CLASS 41 (U.S. CLS. 100, 101 AND 107).

FIRST USE 6-28-2006; IN COMMERCE 6-28-2006.

THE MARK CONSISTS OF STANDARD CHARACTERS WITHOUT CLAIM TO ANY PARTICULAR FONT, STYLE, SIZE, OR COLOR.

SER. NO. 77-298,713, FILED 10-8-2007.

HEATHER THOMPSON, EXAMINING ATTORNEY

Int. Cl.: 41

Prior U.S. Cls.: 100, 101 and 107

United States Patent and Trademark Office

Reg. No. 3,475,307

Registered July 29, 2008

**SERVICE MARK
PRINCIPAL REGISTER**

CAREPIX

CARELEADERS, LLC (DELAWARE LTD LIAB
CO)
3011 N IH-35
AUSTIN, TX 78722

FOR: ARRANGING AND CONDUCTING EDUCATIONAL CONFERENCES; EDUCATIONAL SERVICES, NAMELY, PROVIDING , FACILITATING AND COACHING CLASSES, SEMINARS, CONFERENCES, WORKSHOPS AND ONLINE COURSES IN THE FIELDS OF THE HEALTHCARE INDUSTRY; EDUCATIONAL SERVICES, NAMELY, CONDUCTING CLASSES, SEMINARS, CONFERENCES, WORKSHOPS AND ONLINE COURSES IN THE FIELD OF HUMAN RESOURCE DEVELOPMENT, NAMELY, PERSONNEL HIRING, PLACEMENT, AND ADMINISTRATION, AND PLANNING AND ADMINISTRATION OF EMPLOYEE BENEFIT PLANS; BUSINESS ORGANIZATIONAL PLANNING AND DEVELOPMENT, NAMELY, IN THE DEVELOPMENT OF PROCESSES FOR THE ANALYSIS AND IMPLEMENTATION OF PERFORMANCE AND EMPLOYEE RETENTION PLANS; EXECUTIVE AND LEADERSHIP DEVELOPMENT, NAMELY, STRATEGIC PLANNING; CUSTOMER SERVICE, NAMELY, THE DEVELOPMENT OF PRO-

CESSSES FOR THE ANALYSIS AND IMPLEMENTATION OF CUSTOMER RETENTION PLANS; AND DISTRIBUTION OF COURSE MATERIAL IN CONNECTION THEREWITH; EDUCATIONAL SERVICES, NAMELY, DEVELOPING, ARRANGING, AND CONDUCTING EDUCATIONAL CONFERENCES AND PROGRAMS AND PROVIDING COURSES OF INSTRUCTION IN THE FIELD OF HUMAN RESOURCE DEVELOPMENT, BUSINESS ORGANIZATIONAL PLANNING AND DEVELOPMENT, AND EXECUTIVE LEADERSHIP DEVELOPMENT FOR THE HEALTHCARE INDUSTRY; BUSINESS TRAINING, IN CLASS 41 (U.S. CLS. 100, 101 AND 107).

FIRST USE 6-28-2006; IN COMMERCE 6-28-2006.

THE MARK CONSISTS OF STANDARD CHARACTERS WITHOUT CLAIM TO ANY PARTICULAR FONT, STYLE, SIZE, OR COLOR.

SER. NO. 77-298,790, FILED 10-8-2007.

HEATHER THOMPSON, EXAMINING ATTORNEY

Int. Cl.: 41

Prior U.S. Cls.: 100, 101 and 107

United States Patent and Trademark Office

Reg. No. 3,475,308

Registered July 29, 2008

**SERVICE MARK
PRINCIPAL REGISTER**

CAREBIZ

CARELEADERS, LLC (DELAWARE LTD LIAB
CO)
3011 N IH-35
AUSTIN, TX 78722

FOR: ARRANGING AND CONDUCTING EDUCATIONAL CONFERENCES; EDUCATIONAL SERVICES, NAMELY, CONDUCTING CLASSES, SEMINARS, CONFERENCES, WORKSHOPS AND ONLINE COURSES IN THE FIELD OF HUMAN RESOURCE DEVELOPMENT, NAMELY, PERSONNEL HIRING, PLACEMENT, AND ADMINISTRATION, AND PLANNING AND ADMINISTRATION OF EMPLOYEE BENEFIT PLANS; BUSINESS ORGANIZATIONAL PLANNING AND DEVELOPMENT, NAMELY, IN THE DEVELOPMENT OF PROCESSES FOR THE ANALYSIS AND IMPLEMENTATION OF PERFORMANCE AND EMPLOYEE RETENTION PLANS; EXECUTIVE AND LEADERSHIP DEVELOPMENT, NAMELY, STRATEGIC PLANNING; CUSTOMER SERVICE, NAMELY, THE DEVELOPMENT OF PROCESSES FOR THE ANALYSIS AND IMPLEMENTATION OF CUSTOMER RETENTION PLANS; AND DISTRIBUTION OF COURSE MATERIAL IN CONNECTION THERE-

WITH; EDUCATIONAL SERVICES, NAMELY, DEVELOPING, ARRANGING, AND CONDUCTING EDUCATIONAL CONFERENCES AND PROGRAMS AND PROVIDING COURSES OF INSTRUCTION IN THE FIELD OF HUMAN RESOURCE DEVELOPMENT, BUSINESS ORGANIZATIONAL PLANNING AND DEVELOPMENT, AND EXECUTIVE LEADERSHIP DEVELOPMENT FOR THE HEALTHCARE INDUSTRY; BUSINESS TRAINING; EDUCATION SERVICES, NAMELY, PROVIDING , FACILITATING AND COACHING CLASSES, SEMINARS, CONFERENCES, WORKSHOPS AND ONLINE COURSES IN THE FIELDS OF THE HEALTHCARE INDUSTRY, IN CLASS 41 (U.S. CLS. 100, 101 AND 107).

FIRST USE 6-28-2006; IN COMMERCE 6-28-2006.

THE MARK CONSISTS OF STANDARD CHARACTERS WITHOUT CLAIM TO ANY PARTICULAR FONT, STYLE, SIZE, OR COLOR.

SER. NO. 77-298,859, FILED 10-8-2007.

HEATHER THOMPSON, EXAMINING ATTORNEY

Int. Cl.: 25

Prior U.S. Cls.: 22 and 39

United States Patent and Trademark Office

Reg. No. 3,475,309

Registered July 29, 2008

**TRADEMARK
PRINCIPAL REGISTER**

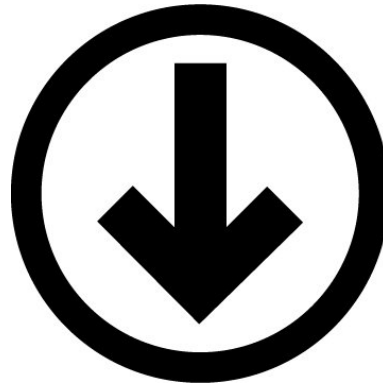

LEE, ANTHONY J (UNITED STATES INDIVIDUAL)
13749 CHOISSER LN
LAKESIDE, CA 92040

FOR: DRESS SHIRTS; GOLF SHIRTS; LONG-SLEEVED SHIRTS; NIGHT SHIRTS; OPEN-NECKED SHIRTS; PIQUE SHIRTS; POLO SHIRTS; SHIRTS; SHORT-SLEEVED OR LONG-SLEEVED T-SHIRTS; SHORT-SLEEVED SHIRTS; SPORT SHIRTS; T-SHIRTS; JACKETS; HATS; BEANIES; SWEAT BANDS; SWEAT PANTS; SWEAT SHIRTS; SOCKS; BOARD SHORTS; BOXER SHORTS; GYM SHORTS;

PANTIES, SHORTS AND BRIEFS; THONGS; SHORTS, IN CLASS 25 (U.S. CLS. 22 AND 39).

FIRST USE 1-1-2007; IN COMMERCE 1-1-2007.

OWNER OF U.S. REG. NO. 3,350,598.

THE MARK CONSISTS OF A CIRCLE WITH AN ARROW ON THE INSIDE POINTING DOWN.

SER. NO. 77-298,973, FILED 10-9-2007.

PETER B. BROMAGHIM, EXAMINING ATTORNEY

Int. Cl.: 37

Prior U.S. Cls.: 100, 103 and 106

United States Patent and Trademark Office

Reg. No. 3,475,310

Registered July 29, 2008

**SERVICE MARK
PRINCIPAL REGISTER**



ENERGY ELECTRIC CO., INC. (MASSACHU-
SETTS CORPORATION)
740 QUAKER HIGHWAY
UXBRIDGE, MA 01569

FIRST USE 1-1-2003; IN COMMERCE 1-1-2003.

SER. NO. 77-299,129, FILED 10-9-2007.

FOR: ELECTRICAL CONTRACTOR SERVICES,
IN CLASS 37 (U.S. CLS. 100, 103 AND 106).

MIDGE BUTLER, EXAMINING ATTORNEY

Int. Cl.: 36

Prior U.S. Cls.: 100, 101 and 102

United States Patent and Trademark Office

Reg. No. 3,475,311

Registered July 29, 2008

**SERVICE MARK
PRINCIPAL REGISTER**

Performance Fundamentals

SUNTRUST REAL ESTATE CORPORATION
(TEXAS CORPORATION)
1519 WEST HERMINE
SAN ANTONIO, TX 78201

FOR: APPRAISAL OF REAL ESTATE; ASSESSMENT AND MANAGEMENT OF REAL ESTATE; EVALUATION OF REAL PROPERTY; FINANCIAL INVESTMENT IN THE FIELD OF REAL ESTATE; FINANCIAL VALUATION OF PERSONAL PROPERTY AND REAL ESTATE; REAL ESTATE ACQUISITION SERVICES; REAL ESTATE APPRAISAL; REAL ESTATE BROKERAGE; REAL ESTATE CONSULTANCY; REAL ESTATE CONSULTATION; REAL ESTATE INVESTMENT; REAL ESTATE INVESTMENT SERVICES IN THE NATURE OF PURCHASING AND SELLING OF REAL ESTATE FOR OTHERS; REAL ESTATE LENDING SERVICES; REAL ESTATE MANAGEMENT; REAL ESTATE MANAGEMENT CONSULTATION; REAL ESTATE PROCUREMENT FOR OTHERS; REAL ESTATE VALUATION SERVICES; REAL ESTATE VALUATIONS; PROVIDING INFORMATION IN THE FIELD OF REAL ESTATE VIA THE INTERNET; CAPITAL INVESTMENT CONSULTATION; FINANCIAL CONSULTATION; FINANCIAL CONSULTATION IN THE FIELD OF REAL ESTATE;

FINANCIAL CONSULTING; FINANCIAL PLANNING CONSULTATION; FINANCIAL RISK MANAGEMENT CONSULTATION; INVESTMENT CONSULTATION; INVESTMENT SERVICES, NAMELY, ASSET ACQUISITION, CONSULTATION, DEVELOPMENT AND MANAGEMENT SERVICES; ADVICE RELATING TO INVESTMENTS; FINANCIAL PLANNING AND INVESTMENT ADVISORY SERVICES; INVESTMENT ADVICE; INVESTMENT ADVISORY SERVICES; INVESTMENT MANAGEMENT; INVESTMENT OF FUNDS FOR OTHERS, IN CLASS 36 (U.S. CLS. 100, 101 AND 102).

FIRST USE 10-3-2007; IN COMMERCE 10-3-2007.

THE MARK CONSISTS OF STANDARD CHARACTERS WITHOUT CLAIM TO ANY PARTICULAR FONT, STYLE, SIZE, OR COLOR.

NO CLAIM IS MADE TO THE EXCLUSIVE RIGHT TO USE "PERFORMANCE", APART FROM THE MARK AS SHOWN.

SER. NO. 77-300,076, FILED 10-9-2007.

PAUL F. GAST, EXAMINING ATTORNEY

Int. Cl.: 41

Prior U.S. Cls.: 100, 101 and 107

United States Patent and Trademark Office

Reg. No. 3,475,312

Registered July 29, 2008

**SERVICE MARK
PRINCIPAL REGISTER**

CARECULTURE REWARDS

CARELEADERS, LLC (DELAWARE LTD LIAB
CO)
3011 N IH-35
AUSTIN, TX 78722

FOR: ARRANGING AND CONDUCTING EDUCATIONAL CONFERENCES; EDUCATIONAL SERVICES, NAMELY, PROVIDING, FACILITATING AND COACHING CLASSES, SEMINARS, CONFERENCES, WORKSHOPS AND ONLINE COURSES IN THE FIELDS OF THE HEALTHCARE INDUSTRY; EDUCATIONAL SERVICES, NAMELY, CONDUCTING CLASSES, SEMINARS, CONFERENCES, WORKSHOPS AND ONLINE COURSES IN THE FIELD OF HUMAN RESOURCE DEVELOPMENT, NAMELY, PERSONNEL HIRING, PLACEMENT, AND ADMINISTRATION, AND PLANNING AND ADMINISTRATION OF EMPLOYEE BENEFIT PLANS; BUSINESS ORGANIZATIONAL PLANNING AND DEVELOPMENT, NAMELY IN THE DEVELOPMENT OF PROCESSES FOR THE ANALYSIS AND IMPLEMENTATION OF PERFORMANCE AND EMPLOYEE RETENTION PLANS; EXECUTIVE AND LEADERSHIP DEVELOPMENT, NAMELY STRATEGIC PLANNING; CUSTOMER SERVICE, NAMELY THE DEVELOPMENT OF PROCESSES FOR THE ANALYSIS AND IMPLEMENTATION OF CUSTOMER RETENTION PLANS; AND

DISTRIBUTION OF COURSE MATERIAL IN CONNECTION THEREWITH; EDUCATIONAL SERVICES, NAMELY, DEVELOPING, ARRANGING, AND CONDUCTING EDUCATIONAL CONFERENCES AND PROGRAMS AND PROVIDING COURSES OF INSTRUCTION IN THE FIELD OF HUMAN RESOURCE DEVELOPMENT, BUSINESS ORGANIZATIONAL PLANNING AND DEVELOPMENT, AND EXECUTIVE LEADERSHIP DEVELOPMENT FOR THE HEALTHCARE INDUSTRY; BUSINESS TRAINING, IN CLASS 41 (U.S. CLS. 100, 101 AND 107).

FIRST USE 6-28-2006; IN COMMERCE 6-28-2006.

THE MARK CONSISTS OF STANDARD CHARACTERS WITHOUT CLAIM TO ANY PARTICULAR FONT, STYLE, SIZE, OR COLOR.

NO CLAIM IS MADE TO THE EXCLUSIVE RIGHT TO USE "REWARDS", APART FROM THE MARK AS SHOWN.

SER. NO. 77-300,341, FILED 10-10-2007.

HEATHER THOMPSON, EXAMINING ATTORNEY

Int. Cl.: 7

Prior U.S. Cls.: 13, 19, 21, 23, 31, 34 and 35

United States Patent and Trademark Office

Reg. No. 3,475,313

Registered July 29, 2008

**TRADEMARK
PRINCIPAL REGISTER**

MASTER QUALITY

UNIT PARTS COMPANY (DELAWARE COR-
PORATION)
4600 SE 59TH STREET
OKLAHOMA CITY, OK 73135

FOR: STARTER MOTORS; STARTERS FOR MO-
TORS AND ENGINES; ALTERNATORS FOR LAND
VEHICLES, IN CLASS 7 (U.S. CLS. 13, 19, 21, 23, 31, 34
AND 35).

FIRST USE 9-30-1982; IN COMMERCE 9-30-1982.

THE MARK CONSISTS OF STANDARD CHAR-
ACTERS WITHOUT CLAIM TO ANY PARTICULAR
FONT, STYLE, SIZE, OR COLOR.

NO CLAIM IS MADE TO THE EXCLUSIVE
RIGHT TO USE "QUALITY", APART FROM THE
MARK AS SHOWN.

SER. NO. 77-300,610, FILED 10-10-2007.

DAVID TOOLEY, EXAMINING ATTORNEY

Int. Cl.: 6

Prior U.S. Cls.: 2, 12, 13, 14, 23, 25 and 50

Reg. No. 3,475,314

United States Patent and Trademark Office

Registered July 29, 2008

**TRADEMARK
PRINCIPAL REGISTER**

MERIDIAN

MERIDIAN MANUFACTURING GROUP, INC.
(IOWA CORPORATION)
2897 EXPANSION BLVD.
STORM LAKE, IA 50588

THE MARK CONSISTS OF STANDARD CHARACTERS WITHOUT CLAIM TO ANY PARTICULAR FONT, STYLE, SIZE, OR COLOR.

FOR: METAL AGRICULTURAL AND COMMERCIAL STORAGE BINS AND CONTAINERS, IN CLASS 6 (U.S. CLS. 2, 12, 13, 14, 23, 25 AND 50).

SER. NO. 77-300,739, FILED 10-10-2007.

FIRST USE 2-1-2007; IN COMMERCE 2-1-2007.

RICHARD A. STRASER, EXAMINING ATTORNEY

Int. Cl.: 35

Prior U.S. Cls.: 100, 101 and 102

United States Patent and Trademark Office

Reg. No. 3,475,315

Registered July 29, 2008

**SERVICE MARK
PRINCIPAL REGISTER**

SEIU FOR YOU

SERVICE EMPLOYEES INTERNATIONAL UNION (D.C. UNINC. ASSOCIATION)
1800 MASSACHUSETTS AVENUE, NW
WASHINGTON, DC 20036

FOR: ADMINISTRATION OF A PROGRAM FOR QUALIFYING PARTICIPANTS TO OBTAIN DISCOUNTS ON DENTAL AND VISION EXAMINATIONS, HEALTH CARE INSURANCE COVERAGE AND PRESCRIPTION DRUG COVERAGE; PROMOTING THE GOODS AND SERVICES OF A THIRD PARTY THAT COUNSELS INDIVIDUALS REGARDING THE AVAILABILITY OF TAX CREDITS AND PUBLIC BENEFIT PROGRAMS BY MEANS OF DISTRIBUTION OF PRINTED MATE-

RIALS AND VIA PERSONAL CONSULTATIONS, IN CLASS 35 (U.S. CLS. 100, 101 AND 102).

FIRST USE 7-29-2006; IN COMMERCE 7-29-2006.

THE MARK CONSISTS OF STANDARD CHARACTERS WITHOUT CLAIM TO ANY PARTICULAR FONT, STYLE, SIZE, OR COLOR.

OWNER OF U.S. REG. NOS. 2,461,777, 2,801,944 AND OTHERS.

SER. NO. 77-300,787, FILED 10-10-2007.

SUSAN STIGLITZ, EXAMINING ATTORNEY

Int. Cl.: 35

Prior U.S. Cls.: 100, 101 and 102

United States Patent and Trademark Office

Reg. No. 3,475,316

Registered July 29, 2008

**SERVICE MARK
PRINCIPAL REGISTER**

SEIU FOR YOU

SERVICE EMPLOYEES INTERNATIONAL UNION (D.C. UNINC. ASSOCIATION)
1800 MASSACHUSETTS AVENUE, NW
WASHINGTON, DC 20036

FOR: PROMOTING THE AVAILABILITY OF PATIENT ASSISTANCE PROGRAMS OF OTHERS THAT PROVIDE LOW-COST OR FREE DRUGS TO QUALIFYING PARTICIPANTS BY MEANS OF DISTRIBUTION OF PRINTED MATERIALS AND VIA PERSONAL CONSULTATIONS, IN CLASS 35 (U.S. CLS. 100, 101 AND 102).

FIRST USE 7-29-2006; IN COMMERCE 7-29-2006.

THE MARK CONSISTS OF STANDARD CHARACTERS WITHOUT CLAIM TO ANY PARTICULAR FONT, STYLE, SIZE, OR COLOR.

OWNER OF U.S. REG. NOS. 2,461,777, 2,801,944 AND OTHERS.

SER. NO. 77-300,792, FILED 10-10-2007.

SUSAN STIGLITZ, EXAMINING ATTORNEY

Int. Cl.: 41

Prior U.S. Cls.: 100, 101 and 107

United States Patent and Trademark Office

Reg. No. 3,475,317

Registered July 29, 2008

**SERVICE MARK
PRINCIPAL REGISTER**

CARECULTUREEXE

CARELEADERS, LLC (DELAWARE LTD LIAB
CO)
3011 N IH-35
AUSTIN, TX 78722

FOR: ARRANGING AND CONDUCTING EDUCATIONAL CONFERENCES; EDUCATIONAL SERVICES, NAMELY, PROVIDING , FACILITATING AND COACHING CLASSES, SEMINARS, CONFERENCES, WORKSHOPS AND ONLINE COURSES IN THE FIELDS OF THE HEALTHCARE INDUSTRY; EDUCATIONAL SERVICES, NAMELY, CONDUCTING CLASSES, SEMINARS, CONFERENCES, WORKSHOPS AND ONLINE COURSES IN THE FIELD OF HUMAN RESOURCE DEVELOPMENT, NAMELY, PERSONNEL HIRING, PLACEMENT, AND ADMINISTRATION, AND PLANNING AND ADMINISTRATION OF EMPLOYEE BENEFIT PLANS; BUSINESS ORGANIZATIONAL PLANNING AND DEVELOPMENT, NAMELY, IN THE DEVELOPMENT OF PROCESSES FOR THE ANALYSIS AND IMPLEMENTATION OF PERFORMANCE AND EMPLOYEE RETENTION PLANS; EXECUTIVE AND LEADERSHIP DEVELOPMENT, NAMELY, STRATEGIC PLANNING; CUSTOMER SERVICE, NAMELY, THE DEVELOPMENT OF PRO-

CESSSES FOR THE ANALYSIS AND IMPLEMENTATION OF CUSTOMER RETENTION PLANS; AND DISTRIBUTION OF COURSE MATERIAL IN CONNECTION THEREWITH; EDUCATIONAL SERVICES, NAMELY, DEVELOPING, ARRANGING, AND CONDUCTING EDUCATIONAL CONFERENCES AND PROGRAMS AND PROVIDING COURSES OF INSTRUCTION IN THE FIELD OF HUMAN RESOURCE DEVELOPMENT, BUSINESS ORGANIZATIONAL PLANNING AND DEVELOPMENT, AND EXECUTIVE LEADERSHIP DEVELOPMENT FOR THE HEALTHCARE INDUSTRY; BUSINESS TRAINING, IN CLASS 41 (U.S. CLS. 100, 101 AND 107).

FIRST USE 6-28-2006; IN COMMERCE 6-28-2006.

THE MARK CONSISTS OF STANDARD CHARACTERS WITHOUT CLAIM TO ANY PARTICULAR FONT, STYLE, SIZE, OR COLOR.

SER. NO. 77-300,821, FILED 10-10-2007.

HEATHER THOMPSON, EXAMINING ATTORNEY

Int. Cl.: 28

Prior U.S. Cls.: 22, 23, 38 and 50

United States Patent and Trademark Office

Reg. No. 3,475,318

Registered July 29, 2008

**TRADEMARK
PRINCIPAL REGISTER**

FROM START TO FINISH

TRAXXAS LP (TEXAS LIMITED PARTNERSHIP)
1100 KLEIN ROAD
PLANO, TX 75074

THE MARK CONSISTS OF STANDARD CHAR-
ACTERS WITHOUT CLAIM TO ANY PARTICULAR
FONT, STYLE, SIZE, OR COLOR.

FOR: RADIO-CONTROLLED MODEL VEHICLES
AND PARTS THEREFOR, IN CLASS 28 (U.S. CLS. 22,
23, 38 AND 50).

SER. NO. 77-301,049, FILED 10-10-2007.

FIRST USE 11-1-1994; IN COMMERCE 11-1-1994.

CAROLYN GRAY, EXAMINING ATTORNEY

Int. Cl.: 43

Prior U.S. Cls.: 100 and 101

United States Patent and Trademark Office

Reg. No. 3,475,319

Registered July 29, 2008

**SERVICE MARK
PRINCIPAL REGISTER**

DAY ONE

CORNERSTONE ADVOCACY SERVICE (MINNESOTA NON-PROFIT CORPORATION)
1000 EAST 80TH STREET
BLOOMINGTON, MN 55420

FOR: PROVIDING INFORMATION TO VICTIMS OF DOMESTIC ABUSE IN THE FIELD OF LOCATING TEMPORARY EMERGENCY HOUSING, IN CLASS 43 (U.S. CLS. 100 AND 101).

FIRST USE 7-0-1996; IN COMMERCE 1-0-2002.

THE MARK CONSISTS OF STANDARD CHARACTERS WITHOUT CLAIM TO ANY PARTICULAR FONT, STYLE, SIZE, OR COLOR.

SER. NO. 77-301,302, FILED 10-11-2007.

LINDA LAVACHE, EXAMINING ATTORNEY

Int. Cl.: 35

Prior U.S. Cls.: 100, 101 and 102

United States Patent and Trademark Office

Reg. No. 3,475,320

Registered July 29, 2008

**SERVICE MARK
PRINCIPAL REGISTER**



AMERICAN CASH FLOW CORPORATION
(FLORIDA CORPORATION)
SUITE 600
255 S. ORANGE AVENUE
ORLANDO, FL 32801

FOR: ASSOCIATION SERVICES, NAMELY, THE PROMOTION OF EDUCATION, COMMUNICATION, GROWTH AND PROFESSIONALISM IN THE CASH FLOW INDUSTRY, THROUGH SERVICES AND PRODUCTS AVAILABLE TO ITS MEMBERS, IN CLASS 35 (U.S. CLS. 100, 101 AND 102).

FIRST USE 6-1-1999; IN COMMERCE 6-1-1999.

OWNER OF U.S. REG. NO. 2,258,990.

NO CLAIM IS MADE TO THE EXCLUSIVE RIGHT TO USE "AMERICAN CASH FLOW ASSOCIATION", APART FROM THE MARK AS SHOWN.

THE MARK CONSISTS OF LOWER CASE LETTERS: ACFA PRINTED TO THE LEFT OF UPPER CASE WORDS: "AMERICAN CASH FLOW ASSOCIATION", ALL UNDERLINED AND ENCLOSED WITHIN A RECTANGULAR BOX.

SER. NO. 77-301,480, FILED 10-11-2007.

SHAUNIA CARLYLE, EXAMINING ATTORNEY

Int. Cl.: 25

Prior U.S. Cls.: 22 and 39

United States Patent and Trademark Office

Reg. No. 3,475,321

Registered July 29, 2008

**TRADEMARK
PRINCIPAL REGISTER**

AVENUE SIGNATURECHINO

UNITED RETAIL INCORPORATED (DELAWARE
CORPORATION)

365 WEST PASSAIC STREET

ROCHELLE PARK, NJ 07662

FOR: PANTS, IN CLASS 25 (U.S. CLS. 22 AND 39).

FIRST USE 12-0-2006; IN COMMERCE 12-0-2006.

THE MARK CONSISTS OF STANDARD CHAR-
ACTERS WITHOUT CLAIM TO ANY PARTICULAR
FONT, STYLE, SIZE, OR COLOR.

OWNER OF U.S. REG. NOS. 1,678,620, 2,144,949
AND OTHERS.

SER. NO. 77-301,559, FILED 10-11-2007.

DAWN HAN, EXAMINING ATTORNEY

Int. Cls.: 9, 14, 18, 25 and 28

**Prior U.S. Cls.: 1, 2, 3, 21, 22, 23, 26, 27, 28, 36, 38, 39,
41 and 50**

Reg. No. 3,475,322

United States Patent and Trademark Office

Registered July 29, 2008

**TRADEMARK
PRINCIPAL REGISTER**

NKB

BOARDS & MORE HOLDING SA (SWITZER-
LAND CORPORATION)
RUE DU COLLEGE 26
CLARENS/MONTREUX, SWITZERLAND 1815

FOR: LIFE JACKETS; PROTECTIVE HELMETS
FOR SPORTS; FACE PROTECTORS FOR SPORTS,
NAMELY, PROTECTIVE FACE MASKS NOT FOR
MEDICAL PURPOSES, IN CLASS 9 (U.S. CLS. 21, 23,
26, 36 AND 38).

FOR: PRECIOUS METALS AND THEIR ALLOYS;
JEWELRY, PRECIOUS STONES; HOROLOGICAL
AND CHRONOMETRIC INSTRUMENTS, IN CLASS
14 (U.S. CLS. 2, 27, 28 AND 50).

FOR: TRUNKS IN THE NATURE OF LUGGAGE;
SUITCASES; SPORTS BAGS; HANDBAGS; GAR-
MENT BAGS FOR TRAVEL; BACKPACKS; PARA-
SOLS, IN CLASS 18 (U.S. CLS. 1, 2, 3, 22 AND 41).

FOR: CLOTHING, NAMELY, CLOTHING FOR
SPORT AND LEISURE AND SPECIAL WATER
SPORTS APPAREL FOR SURFING, WINDSURF-
ING, KITESURFING, WATERSKIING, WAKE-
BOARDING, WAKESKATING, NAMELY,

WETSUITS, VESTS, GLOVES, SHOES, SWIMSUITS,
HATS, CAPS, VISORS, BEANIES, BONNETS, SWIM-
MING CAPS, IN CLASS 25 (U.S. CLS. 22 AND 39).

FOR: GYMNASTIC AND SPORTING ARTICLES
AND APPARATUS FOR WATER SPORTS, NAME-
LY, SURFBOARDS, WINDSURFING BOARDS AND
SAILS, KITESURFING BOARDS, KITESURFING
KITES, KITESURFING BINDINGS, KITESURFING
ROPES, HAND GRIPS AND BARS FOR KITESURF-
ING, WATER SKIS, WAKE BOARDS AND WAKE
BOARD BINDINGS, WAKE SKATES, IN CLASS 28
(U.S. CLS. 22, 23, 38 AND 50).

THE MARK CONSISTS OF STANDARD CHAR-
ACTERS WITHOUT CLAIM TO ANY PARTICULAR
FONT, STYLE, SIZE, OR COLOR.

OWNER OF SWITZERLAND REG. NO. 560145,
DATED 7-10-2007, EXPIRES 7-10-2017.

SER. NO. 77-302,012, FILED 10-11-2007.

CHARLES L. JENKINS, EXAMINING ATTORNEY

Int. Cl.: 41

Prior U.S. Cls.: 100, 101 and 107

United States Patent and Trademark Office

Reg. No. 3,475,323

Registered July 29, 2008

**SERVICE MARK
PRINCIPAL REGISTER**

Caught UP

ICKOVIC, JOSHUA S. (UNITED STATES INDIVIDUAL)
5115 KESTER AVE # 13
SHERMAN OAKS, CA 91403

THE MARK CONSISTS OF STANDARD CHARACTERS WITHOUT CLAIM TO ANY PARTICULAR FONT, STYLE, SIZE, OR COLOR.

FOR: ENTERTAINMENT, NAMELY, LIVE PERFORMANCES BY A MUSICAL BAND, IN CLASS 41 (U.S. CLS. 100, 101 AND 107).

SER. NO. 77-302,293, FILED 10-11-2007.

FIRST USE 9-1-2005; IN COMMERCE 9-1-2005.

SHAILA SETTLES, EXAMINING ATTORNEY

Int. Cl.: 20

Prior U.S. Cls.: 2, 13, 22, 25, 32 and 50

Reg. No. 3,475,324

United States Patent and Trademark Office

Registered July 29, 2008

TRADEMARK
PRINCIPAL REGISTER



AQUABAREL LLC (MARYLAND LTD LIAB CO)
#25
878 MUDDY BRANCH RD
GAITHERSBURG, MD 20878

FOR: PLASTIC RAINWATER COLLECTION
CONTAINERS FOR DOMESTIC PURPOSES, IN
CLASS 20 (U.S. CLS. 2, 13, 22, 25, 32 AND 50).

FIRST USE 3-1-2007; IN COMMERCE 4-1-2007.

NO CLAIM IS MADE TO THE EXCLUSIVE
RIGHT TO USE "AQUABARREL", APART FROM
THE MARK AS SHOWN.

THE MARK CONSISTS OF THE WORDING
"AQUABARREL" WITH THE LETTER "A" AND
PART OF THE LETTER "Q" IN "AQUABARREL"
DEPICTED ON TOP OF A RAINDROP.

SER. NO. 77-302,398, FILED 10-12-2007.

SHAILA SETTLES, EXAMINING ATTORNEY

Int. Cl.: 42

Prior U.S. Cls.: 100 and 101

United States Patent and Trademark Office

Reg. No. 3,475,325

Registered July 29, 2008

**SERVICE MARK
PRINCIPAL REGISTER**

CARECULTURE BLUEPRINT

CARELEADERS, LLC (DELAWARE LTD LIAB
CO)
3011 N IH-35
AUSTIN, TX 78722

FOR: APPLICATION SERVICE PROVIDER (ASP)
FEATURING SOFTWARE FOR USE IN THE
HEALTHCARE INDUSTRY IN THE FIELDS OF
KNOWLEDGE MANAGEMENT AND BUSINESS
PROCESS MANAGEMENT, NAMELY, FOR USE
IN: PERSONNEL PLANNING, HIRING, PLACE-
MENT, ADMINISTRATION AND MANAGEMENT;
BUSINESS ORGANIZATIONAL PLANNING AND
DEVELOPMENT, NAMELY, THE ANALYSIS AND
IMPLEMENTATION OF PERFORMANCE AND EM-
PLOYEE RETENTION PLANS; EXECUTIVE AND
LEADERSHIP PLANNING AND DEVELOPMENT;
HUMAN RESOURCE DEVELOPMENT PLANNING;
PLANNING AND ADMINISTERING EMPLOYEE
BENEFIT PLANS; CUSTOMER SERVICE, NAMELY,

THE ANALYSIS AND IMPLEMENTATION OF CUS-
TOMER RETENTION PLANS; AND PLANNING,
MANAGING, AND REPORTING PATIENT SAFELY
PRACTICES, IN CLASS 42 (U.S. CLS. 100 AND 101).

FIRST USE 6-25-2006; IN COMMERCE 6-28-2006.

THE MARK CONSISTS OF STANDARD CHAR-
ACTERS WITHOUT CLAIM TO ANY PARTICULAR
FONT, STYLE, SIZE, OR COLOR.

NO CLAIM IS MADE TO THE EXCLUSIVE
RIGHT TO USE "BLUEPRINT", APART FROM
THE MARK AS SHOWN.

SER. NO. 77-302,725, FILED 10-12-2007.

HEATHER THOMPSON, EXAMINING ATTORNEY

Int. Cls.: 35, 38 and 40

Prior U.S. Cls.: 100, 101, 102, 103, 104 and 106

United States Patent and Trademark Office

Reg. No. 3,475,326

Registered July 29, 2008

**SERVICE MARK
PRINCIPAL REGISTER**



CAPITAL PRINTING SYSTEMS, INC. (NEW YORK CORPORATION)
140 EAST 45TH STREET
NEW YORK, NY 10017

FOR: PROVIDING SECURED ACCESS DATABASES VIA THE INTERNET THROUGH WHICH DOCUMENTS AND IMAGES CAN BE VIEWED, COPIED, AND PRINTED FOR PURPOSES OF CONDUCTING CORPORATE DUE DILIGENCE REVIEWS AND CONDUCTING CORPORATE TRANSACTIONS, IN CLASS 35 (U.S. CLS. 100, 101 AND 102).

FIRST USE 4-16-2007; IN COMMERCE 4-16-2007.

FOR: ELECTRONIC TRANSMISSION, DISSEMINATION, AND FILING OF DOCUMENTS REQUIRED FOR COMPLIANCE WITH SECURITIES LAWS, FOR OTHERS VIA THE INTERNET AND

OTHER COMPUTER NETWORKS, IN CLASS 38 (U.S. CLS. 100, 101 AND 104).

FIRST USE 4-16-2007; IN COMMERCE 4-16-2007.

FOR: PRINTING SERVICES, NAMELY, PRINTING FINANCIAL DOCUMENTS FOR OTHERS; COMMERCIAL PRINTING SERVICES; CUSTOMIZED PRINTING SERVICES, IN CLASS 40 (U.S. CLS. 100, 103 AND 106).

FIRST USE 4-16-2007; IN COMMERCE 4-16-2007.

NO CLAIM IS MADE TO THE EXCLUSIVE RIGHT TO USE "SYSTEMS", APART FROM THE MARK AS SHOWN.

SER. NO. 77-302,828, FILED 10-12-2007.

NAAKWAMA ANKRAH, EXAMINING ATTORNEY

Int. Cl.: 9

Prior U.S. Cls.: 21, 23, 26, 36 and 38

United States Patent and Trademark Office

Reg. No. 3,475,327

Registered July 29, 2008

**TRADEMARK
PRINCIPAL REGISTER**



APPLE, INC. (CALIFORNIA CORPORATION)

1 INFINITE LOOP

CUPERTINO, CA 95014

FOR: HANDHELD MOBILE DIGITAL ELECTRONIC DEVICES COMPRISED OF A MOBILE PHONE, DIGITAL AUDIO AND VIDEO PLAYER, HANDHELD COMPUTER, PERSONAL DIGITAL ASSISTANT, ELECTRONIC PERSONAL ORGANIZER, POCKET COMPUTER FOR NOTE-TAKING, ELECTRONIC CALENDAR, CALCULATOR, AND CAMERA, AND CAPABLE OF PROVIDING ACCESS TO THE INTERNET AND SENDING AND RECEIVING ELECTRONIC MAIL, DIGITAL AUDIO, VIDEO, TEXT, IMAGES, GRAPHICS AND MULTIMEDIA FILES, IN CLASS 9 (U.S. CLS. 21, 23, 26, 36 AND 38).

FIRST USE 1-9-2007; IN COMMERCE 6-29-2007.

THE COLOR(S) GRAY, SILVER AND BLACK IS/ARE CLAIMED AS A FEATURE OF THE MARK.

THE MARK CONSISTS OF THE CONFIGURATION OF A HANDHELD MOBILE DIGITAL ELECTRONIC DEVICE. THE MATERIAL SHOWN IN DOTTED LINES, NAMELY, THE BUTTONS AND OPENINGS ON THE DEVICE SHOW THE POSITION OF THE MARK IN RELATION TO THE DEVICE AND ARE NOT CONSIDERED A PART OF THE MARK. THE COLOR GRAY APPEARS AS A RECTANGLE AT THE FRONT, CENTER OF THE DEVICE. THE COLOR BLACK APPEARS ON THE FRONT OF THE DEVICE ABOVE AND BELOW THE GRAY RECTANGLE AND ON THE CURVED CORNERS OF THE DEVICE. THE COLOR SILVER APPEARS AS THE OUTER BORDER AND SIDES OF THE DEVICE. THE COLOR WHITE IS SHOWN SOLELY TO IDENTIFY PLACEMENT OF THE MARK AND IS NOT CLAIMED AS A PART OF THE MARK.

SEC. 2(F).

SER. NO. 77-303,049, FILED 10-12-2007.

SKYE YOUNG, EXAMINING ATTORNEY

Int. Cl.: 35

Prior U.S. Cls.: 100, 101 and 102

United States Patent and Trademark Office

Reg. No. 3,475,328

Registered July 29, 2008

**SERVICE MARK
PRINCIPAL REGISTER**

ADSHIP

OVERNIGHTMEDIA, LLC (DELAWARE LTD
LIAB CO)
1000 5TH STREET, 2ND FLOOR
MIAMI BEACH, FL 33139

FOR: ADVERTISING SERVICES, NAMELY, PROVIDING ONLINE AUCTION BIDDING SERVICES FOR ADVERTISERS TO BID ON ADVERTISEMENT OPPORTUNITIES WITH SHIPPERS, PROVIDING FOR THE DISTRIBUTION OF ADVERTISEMENTS VIA ELECTRONIC MEDIA AND PRINT MEDIA IN SHIPMENTS, IN CLASS 35 (U.S. CLS. 100, 101 AND 102).

FIRST USE 9-9-2007; IN COMMERCE 9-9-2007.

THE MARK CONSISTS OF STANDARD CHARACTERS WITHOUT CLAIM TO ANY PARTICULAR FONT, STYLE, SIZE, OR COLOR.

SER. NO. 77-303,082, FILED 10-12-2007.

LAURIE MAYES, EXAMINING ATTORNEY

Int. Cl.: 42

Prior U.S. Cls.: 100 and 101

United States Patent and Trademark Office

Reg. No. 3,475,329

Registered July 29, 2008

**SERVICE MARK
PRINCIPAL REGISTER**

CARECULTURE REWARDS

CARELEADERS, LLC (DELAWARE LTD LIAB
CO)
3011 N IH-35
AUSTIN, TX 78722

FOR: APPLICATION SERVICE PROVIDER (ASP)
FEATURING SOFTWARE FOR USE IN THE
HEALTHCARE INDUSTRY IN THE FIELDS OF
KNOWLEDGE MANAGEMENT AND BUSINESS
PROCESS MANAGEMENT, NAMELY, FOR USE
IN: PERSONNEL PLANNING, HIRING, PLACE-
MENT, ADMINISTRATION AND MANAGEMENT;
BUSINESS ORGANIZATIONAL PLANNING AND
DEVELOPMENT, NAMELY, THE ANALYSIS AND
IMPLEMENTATION OF PERFORMANCE AND EM-
PLOYEE RETENTION PLANS; EXECUTIVE AND
LEADERSHIP PLANNING AND DEVELOPMENT;
HUMAN RESOURCE DEVELOPMENT PLANNING;
PLANNING AND ADMINISTERING EMPLOYEE
BENEFIT PLANS; CUSTOMER SERVICE, NAMELY,

THE ANALYSIS AND IMPLEMENTATION OF CUS-
TOMER RETENTION PLANS; AND PLANNING,
MANAGING, AND REPORTING PATIENT SAFELY
PRACTICES, IN CLASS 42 (U.S. CLS. 100 AND 101).

FIRST USE 6-28-2006; IN COMMERCE 6-28-2006.

THE MARK CONSISTS OF STANDARD CHAR-
ACTERS WITHOUT CLAIM TO ANY PARTICULAR
FONT, STYLE, SIZE, OR COLOR.

NO CLAIM IS MADE TO THE EXCLUSIVE
RIGHT TO USE "REWARDS", APART FROM THE
MARK AS SHOWN.

SER. NO. 77-303,162, FILED 10-12-2007.

HEATHER THOMPSON, EXAMINING ATTORNEY

Int. Cl.: 25

Prior U.S. Cls.: 22 and 39

United States Patent and Trademark Office

Reg. No. 3,475,330

Registered July 29, 2008

**TRADEMARK
PRINCIPAL REGISTER**

Kingdom Dreams

KINGDOM DREAMS, INC (MICHIGAN CORPORATION), DBA KINGDOM DREAMS
SUITE 203
1305 S. CEDAR STREET
LANSING, MI 489101528

FOR: MEN'S, WOMEN'S AND CHILDREN'S CLOTHING, NAMELY, T-SHIRTS, PANTS, SHIRTS, COATS, SWEATSHIRTS, SUITS, KNIT SHIRTS, JEANS, DRESS SHIRTS, VESTS, SWEATERS, SHORTS, SWIMWEAR, JACKETS, RAINWEAR, BLOUSES, DRESSES, SOCKS, HOSIERY, UNDERWEAR, FOOTWEAR, PAJAMAS, SLEEPWEAR, BOXER SHORTS AND WOMEN'S LINGERIE AND FASHION ACCESSORIES, NAMELY, BELTS, LEA-

TER GLOVES, SCARVES, HATS, HEADBANDS, BANDANNAS AND NECK TIES, IN CLASS 25 (U.S. CLS. 22 AND 39).

FIRST USE 7-27-2005; IN COMMERCE 7-27-2005.

THE MARK CONSISTS OF STANDARD CHARACTERS WITHOUT CLAIM TO ANY PARTICULAR FONT, STYLE, SIZE, OR COLOR.

SER. NO. 77-303,298, FILED 10-12-2007.

CAROLINE WOOD, EXAMINING ATTORNEY

Int. Cl.: 36

Prior U.S. Cls.: 100, 101 and 102

United States Patent and Trademark Office

Reg. No. 3,475,331

Registered July 29, 2008

SERVICE MARK
PRINCIPAL REGISTER

GRRETT FUN

LEE, JAMES GAO (UNITED STATES INDIVIDUAL)
19203 ALLVIEW LANE
HOUSTON, TX 77094

FOR: FINANCIAL MANAGEMENT; FINANCIAL PLANNING; FINANCIAL PLANNING AND INVESTMENT ADVISORY SERVICES; FINANCIAL PLANNING CONSULTATION; FINANCIAL PLANNING FOR RETIREMENT; FINANCIAL PLANNING, NAMELY, THE CREATION OF PERSONALIZED STRATEGIES TO ACHIEVE FINANCIAL INDEPENDENCE; FINANCIAL PORTFOLIO ANALYSIS SERVICES; FINANCIAL PORTFOLIO MANAGEMENT; FINANCIAL RESEARCH; FINANCIAL RISK MANAGEMENT; FINANCIAL RISK MANAGEMENT CONSULTATION; FINANCIAL SERVICES IN THE FIELD OF MONEY LENDING; FINANCIAL SERVICES IN THE NATURE OF AN INVESTMENT SECURITY; FINANCIAL SERVICES, NAMELY, ASSISTING OTHERS WITH THE COMPLETION OF FINANCIAL TRANSACTIONS FOR STOCKS, BONDS, SECURITIES AND EQUITIES; FUND INVESTMENT CONSULTATION; FUNDS INVESTMENT; HEDGE FUND INVESTMENT SERVICES; INVESTMENT ADVISORY SERVICES; INVESTMENT BY ELECTRONIC MEANS; INVESTMENT CONSULTATION; INVESTMENT MANAGEMENT; INVESTMENT OF FUNDS FOR OTHERS; MANAGEMENT OF A CAPITAL INVESTMENT FUND; MANAGEMENT OF PORTFOLIOS COMPRISING SECURITIES; MANAGEMENT OF PORTFOLIOS OF TRANSFERABLE SECURITIES; MANAGEMENT OF PRIVATE EQUITY FUNDS; MUTUAL FUND DISTRIBUTION; MUTUAL FUND INVESTMENT; PRIVATE EQUITY FUND INVESTMENT SERVICES; ADVICE RELATING TO INVESTMENTS; CAPITAL INVESTMENT CONSULTATION; COMMODITY INVESTMENT ADVICE; CONSULTATION IN ART AS AN INVESTMENT; EQUITY CAPITAL INVESTMENT; FINANCIAL AND INVESTMENT SERVICES, NAMELY, MANAGEMENT

AND BROKERAGE IN THE FIELDS OF STOCKS, BONDS, OPTIONS, COMMODITIES, FUTURES AND OTHER SECURITIES, AND THE INVESTMENT OF FUNDS OF OTHERS; FINANCIAL INVESTMENT IN THE FIELD OF ALTERNATIVE INVESTMENTS, PRIVATE EQUITY, HEDGE FUNDS, AND/OR REAL ESTATE; FINANCIAL SERVICES, NAMELY, A TOTAL PORTFOLIO OFFERING FOR HIGH NET WORTH CLIENTS CONSISTING OF BOTH SEPARATE ACCOUNTS AND MUTUAL FUNDS FOR EQUITY AND FIXED INCOME INVESTMENTS; FINANCIAL SERVICES, NAMELY, INVESTMENT FUND TRANSFER AND TRANSACTION SERVICES; INVESTMENT ADVICE; PROVIDING INFORMATION AND ADVICE IN THE FIELD OF FINANCE, FINANCIAL INVESTMENTS, FINANCIAL VALUATIONS, AND THE FINANCIAL ASPECTS OF RETIREMENT; PUBLIC EQUITY INVESTMENT MANAGEMENT; SECURITIES TRADING AND INVESTING SERVICES FOR OTHERS VIA THE INTERNET; PRIVATE PLACEMENTS OF HEDGE FUNDS, PRIVATE EQUITY FUNDS, SECURITIES AND DERIVATIVES FOR OTHERS; FINANCIAL SERVICES, NAMELY, PROVIDING INFORMATION IN THE FIELDS OF FOREIGN CURRENCY, COMMODITIES, FINANCIAL DERIVATIVES, INTEREST RATE PRODUCTS, AND EQUITIES VIA THE INTERNET AND INTRANET SYSTEMS; FINANCIAL SERVICES, NAMELY, PROVIDING FOR THE EXCHANGE OF FOREIGN CURRENCY, COMMODITIES, FINANCIAL DERIVATIVES, INTEREST RATE PRODUCTS, AND EQUITIES VIA THE INTERNET AND INTRANET SYSTEMS, IN CLASS 36 (U.S. CLS. 100, 101 AND 102).

FIRST USE 10-1-2005; IN COMMERCE 10-1-2007.

THE MARK CONSISTS OF STANDARD CHARACTERS WITHOUT CLAIM TO ANY PARTICULAR FONT, STYLE, SIZE, OR COLOR.

SER. NO. 77-303,645, FILED 10-14-2007.

JULIE WATSON, EXAMINING ATTORNEY

Int. Cl.: 42

Prior U.S. Cls.: 100 and 101

United States Patent and Trademark Office

Reg. No. 3,475,332

Registered July 29, 2008

**SERVICE MARK
PRINCIPAL REGISTER**

PowerSkills Agenda

POWERSKILLS, INC. (DELAWARE CORPORATION)
PO BOX 611
GLOUCESTER, MA 01931

OWNER OF U.S. REG. NOS. 2,615,059 AND 2,705,342.

FOR: APPLICATION SERVICE PROVIDER (ASP) FEATURING SOFTWARE IN THE FIELD OF STRATEGIC MANAGEMENT, IN CLASS 42 (U.S. CLS. 100 AND 101).

NO CLAIM IS MADE TO THE EXCLUSIVE RIGHT TO USE "AGENDA", APART FROM THE MARK AS SHOWN.

FIRST USE 6-29-2007; IN COMMERCE 6-29-2007.

SER. NO. 77-303,778, FILED 10-15-2007.

THE MARK CONSISTS OF STANDARD CHARACTERS WITHOUT CLAIM TO ANY PARTICULAR FONT, STYLE, SIZE, OR COLOR.

JANICE KIM, EXAMINING ATTORNEY

Int. Cl.: 44

Prior U.S. Cls.: 100 and 101

United States Patent and Trademark Office

Reg. No. 3,475,333

Registered July 29, 2008

**SERVICE MARK
PRINCIPAL REGISTER**

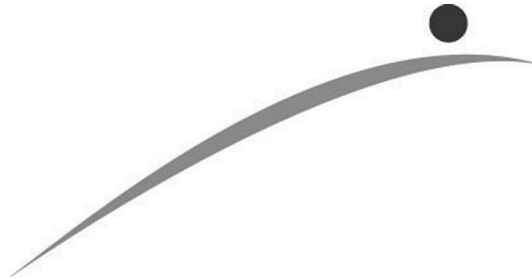

REBOUND PHYSICAL THERAPY, LLC (MASSACHUSETTS LTD LIAB CO)
203 OAK STREET
NATICK, MA 01760

THE MARK CONSISTS OF AN UPWARD SLANTING LINE AND A DOT.

FOR: PHYSICAL THERAPY, IN CLASS 44 (U.S. CLS. 100 AND 101).

SER. NO. 77-303,811, FILED 10-15-2007.

FIRST USE 10-5-2005; IN COMMERCE 10-5-2005.

LINDSEY RUBIN, EXAMINING ATTORNEY

Int. Cl.: 35

Prior U.S. Cls.: 100, 101 and 102

United States Patent and Trademark Office

Reg. No. 3,475,334

Registered July 29, 2008

SERVICE MARK
PRINCIPAL REGISTER



THE HOMEOWNER'S CONTRACTOR CONNECTION

URBAN REFERRALS SERVICES, INC. (D.C. CORPORATION), DBA URBAN REFERRALS SUITE 102
1420 N STREET, N.W.
WASHINGTON, DC 20005

FOR: PROVIDING CONSUMER INFORMATION TO HOMEOWNERS FEATURING REFERRALS IN THE FIELD OF HOME IMPROVEMENT CONTRACTORS, IN CLASS 35 (U.S. CLS. 100, 101 AND 102).

FIRST USE 10-12-2007; IN COMMERCE 10-12-2007.

OWNER OF U.S. REG. NO. 3,001,426.

NO CLAIM IS MADE TO THE EXCLUSIVE RIGHT TO USE "URBAN REFERRALS" AND "HOMEOWNER'S CONTRACTOR", APART FROM THE MARK AS SHOWN.

THE COLOR(S) RED, BLACK, WHITE, YELLOW AND GRAY IS/ARE CLAIMED AS A FEATURE OF THE MARK.

THE MARK CONSISTS OF FOUR TOWNHOUSES. IN THE BUILDING TO THE FAR LEFT, THE COLOR BLACK APPEARS IN THE ROOF AND IN THE THREE RECTANGLES IN THE DOOR; IN THE

THIRD BUILDING TO THE LEFT, THE COLOR BLACK IS IN THE WINDOWS AND IN THE DOOR WINDOWS; IN THE SECOND BUILDING TO THE LEFT, THE COLOR BLACK IS IN THE THREE SEMI-CIRCLES NEAR THE ROOF AND IN THE TOP PORTION OF THE DOORWAY; IN THE BUILDING ON THE RIGHT, THE COLOR BLACK IS IN THE ROOF AND IN THE THREE RECTANGLES IN THE DOOR; THE WORDING "THE HOMEOWNER'S CONTRACTOR CONNECTION" AND THE LINE ABOVE THE WORDING ARE ALL THE COLOR BLACK; THE COLOR WHITE APPEARS IN THE WINDOW PANES AND DOOR PANES IN THE MARK; THE COLOR GRAY APPEARS IN THE STAIRWELLS AND BRICK WORK OF THE FOUR BUILDINGS AS WELL AS THE FACADE OF THE SECOND BUILDING FROM THE RIGHT; THE COLOR RED APPEARS IN THE BRICK WORK AND FACADE OF THE FOUR BUILDINGS AS WELL AS THE WORD "REFERRALS" IN THE MARK. THE COLOR YELLOW APPEARS IN THE WINDOWS OF THE FOUR BUILDINGS AND THE WORD "URBAN" IN THE MARK.

SER. NO. 77-304,074, FILED 10-15-2007.

BERYL GARDNER, EXAMINING ATTORNEY

Int. Cls.: 14 and 25

Prior U.S. Cls.: 2, 22, 27, 28, 39 and 50

United States Patent and Trademark Office

Reg. No. 3,475,335

Registered July 29, 2008

TRADEMARK
PRINCIPAL REGISTER



RODERICK JETER (UNITED STATES INDIVIDUAL)

864 N. 2ND ST #369
EL CAJON, CA 92021

FOR: JEWELRY, IN CLASS 14 (U.S. CLS. 2, 27, 28 AND 50).

FIRST USE 11-4-1999; IN COMMERCE 11-4-1999.

FOR: LONG-SLEEVED SHIRTS; POLO SHIRTS; SHORT-SLEEVED SHIRTS; SWEAT SHIRTS; T-SHIRTS; HEADGEAR, NAMELY, BALL CAPS,

HATS; JACKETS; JOGGING PANTS, IN CLASS 25 (U.S. CLS. 22 AND 39).

FIRST USE 10-15-1998; IN COMMERCE 10-15-1998.

OWNER OF U.S. REG. NO. 2,622,581.

THE MARK CONSISTS OF A STYLIZED LETTER "J" AND A STYLIZED LETTER "R" COMBINED TO FORM ONE SYMBOL.

SER. NO. 77-304,108, FILED 10-15-2007.

ALICE BENMAMAN, EXAMINING ATTORNEY

Int. Cl.: 19

Prior U.S. Cls.: 1, 12, 33 and 50

United States Patent and Trademark Office

Reg. No. 3,475,336

Registered July 29, 2008

**TRADEMARK
PRINCIPAL REGISTER**



TREX COMPANY, INC. (DELAWARE CORPORATION)
160 EXETER DRIVE
WINCHESTER, VA 22603

FOR: BUILDING MATERIALS, NAMELY, CELLULAR PVC TRIM, IN CLASS 19 (U.S. CLS. 1, 12, 33 AND 50).

FIRST USE 12-15-2007; IN COMMERCE 12-15-2007.

OWNER OF U.S. REG. NOS. 1,881,449, 1,938,516, AND 2,937,507.

NO CLAIM IS MADE TO THE EXCLUSIVE RIGHT TO USE "TRIM", APART FROM THE MARK AS SHOWN.

THE MARK CONSISTS OF THE WORD "TREX" ABOVE THE WORD "TRIM" WITH THE IMAGE OF THE TOP OF A HOUSE TO THE RIGHT OF THE WORD "TRIM".

SER. NO. 77-304,487, FILED 10-15-2007.

DORITT L. CARROLL, EXAMINING ATTORNEY

Int. Cl.: 19

Prior U.S. Cls.: 1, 12, 33 and 50

United States Patent and Trademark Office

Reg. No. 3,475,337

Registered July 29, 2008

**TRADEMARK
PRINCIPAL REGISTER**

THE COMFORT CROSS

HOLY LAND STONE CO., LLC (FLORIDA LTD
LIAB CO)
3111 SKYWAY CIRCLE, STE 109
MELBOURNE, FL 32934

FOR: ORNAMENTAL CUT STONE PLAQUES IN THE NATURE OF A HANDCRAFTED CROSS THAT HAS BEEN CUT INTO TWO CROSSES AND TIED TOGETHER WITH A LEATHER STRAP WITH THE INTENT OF GIVING IT AS A CONNECTION GIFT: USED FOR BEREAVEMENT WHERE ONE GOES IN THE CASKET/CREMATION URN AND THE OTHER AS A KEEPSAKE FOR THE LOVED ONE LEFT BEHIND, SEPARATION WHERE ONE GOING AWAY TO MILITARY/COLLEGE, ETC., BAPTISM WITH GODPARENT TO GODCHILD, CONFIRMATION WITH SPONSOR TO CONFIRMATION CANDIDATE, PRAYER CONNECTION, AND

NUMEROUS OTHER OCCASIONS, IN CLASS 19 (U.S. CLS. 1, 12, 33 AND 50).

FIRST USE 1-1-2003; IN COMMERCE 1-1-2003.

THE MARK CONSISTS OF STANDARD CHARACTERS WITHOUT CLAIM TO ANY PARTICULAR FONT, STYLE, SIZE, OR COLOR.

NO CLAIM IS MADE TO THE EXCLUSIVE RIGHT TO USE "CROSS", APART FROM THE MARK AS SHOWN.

SER. NO. 77-304,599, FILED 10-15-2007.

KEVIN DINALLO, EXAMINING ATTORNEY

Int. Cl.: 45

Prior U.S. Cls.: 100 and 101

United States Patent and Trademark Office

Reg. No. 3,475,338

Registered July 29, 2008

**SERVICE MARK
PRINCIPAL REGISTER**

LIVING WORD LIVE

LIVING WORD CHRISTIAN CENTER (MINNESOTA NON-PROFIT CORPORATION)
9201 75TH AVE N
BROOKLYN PARK, MN 55428

FOR: EVANGELISTIC AND MINISTERIAL RELIGIOUS SERVICES THROUGH ELECTRONIC MEDIA AND DIGITAL NETWORKS, NAMELY, INTERNET, WEBCASTS AND TELEVISION , IN CLASS 45 (U.S. CLS. 100 AND 101).

FIRST USE 10-22-2006; IN COMMERCE 10-22-2006.

THE MARK CONSISTS OF STANDARD CHARACTERS WITHOUT CLAIM TO ANY PARTICULAR FONT, STYLE, SIZE, OR COLOR.

NO CLAIM IS MADE TO THE EXCLUSIVE RIGHT TO USE "LIVE", APART FROM THE MARK AS SHOWN.

SER. NO. 77-305,005, FILED 10-16-2007.

JAY FLOWERS, EXAMINING ATTORNEY

Int. Cl.: 25

Prior U.S. Cls.: 22 and 39

United States Patent and Trademark Office

Reg. No. 3,475,339

Registered July 29, 2008

TRADEMARK
PRINCIPAL REGISTER

San Franpsycho

ROUTZEN, CHRISTIAN (UNITED STATES INDIVIDUAL)
2469 27TH AVE.
SAN FRANCISCO, CA 94116

FOR: CLOTHING, NAMELY, ANKLE SOCKS, ANKLETS, ANTI-PERSPIRANT SOCKS, ATHLETIC SHOES, ATHLETIC FOOTWEAR, BANDANAS, BASEBALL CAPS, BATHING SUITS, BATHING SUITS FOR MEN, BATHING TRUNKS, BATHROBES, BEACH FOOTWEAR, BEANIES, BELTS MADE OF LEATHER, BELTS OF TEXTILE, BERETS, BOARDSHORTS, BOXER BRIEFS, BOXER SHORTS, BLAZERS, BOOTIES, BOOTS, BOTTOMS, BRALLETTES, BRIEFS, CAPS, CANVAS SHOES, CARGO PANTS, CAPS WITH VISORS, PANTS, COATS, CREWNECK SWEATERS, CREWNECK TEE SHIRTS, CROP TOPS, DOWN JACKETS, DRESS SHIRTS, DRIVERS (SHOES), FLIP FLOPS (FOOTWEAR), FOOTWEAR FOR MEN AND WOMEN, GYM SHORT, G-STRINGS, GYM SUITS, HALLOWEEN COSTUMES, HALTER TOPS, HAT BANDS, HATS, HEAD SCARVES, HEAD SWEATBANDS, HEAD WEAR, HEAD BANDS, HEAVY COATS, HEAVY JACKETS, PULLOVERS, HOODS, JACKETS, JEANS, JERSEYS, JOGGING OUTFITS, JOGGING PANTS, JOGGING SUITS, KERCHIEFS, KNIT SHIRTS, KNITTED CAPS, LADIES' UNDERWEAR, LEATHER BELTS, LEATHER JACKETS, LEATHER HEADWEAR, LEG WARMERS, LEOTARDS, LONG-SLEEVED SHIRTS, LOUNGEWEAR, VESTS, MEN'S SOCKS, MINISKIRTS, TANK TOPS, NECKWEAR, NECKERCHIEFS, NIGHTWEAR, OPEN-NECKED SHIRTS, V NECK SHIRTS, ROUND NECK SHIRTS, PAJAMAS, PANTIES, SHORTS, BRIEFS, POLO SHIRTS, PULLOVERS, HOODED SWEAT SHIRTS, RASH GUARDS, REVERSIBLE JACKETS, ROBES,

SANDALS, SARONGS, SASHES, SCARVES, SHAWLS AND HEADSCARVES, SHELL JACKETS, SHIRTS, SHIRTS, SHOES, SHORT-SLEEVED SHIRTS, SKIRTS AND DRESSES, SLEEPWEAR, SLEEVED OR SLEEVELESS JERSEYS, SLEEVED OR SLEEVELESS JACKETS, SPORTS BRAS, SLEEVED OR SLEEVELESS SPORTS JERSEYS, STRETCH PANTS, SUN VISORS, SURF WEAR, SUNSUITS, SUSPENDER BELTS, SUSPENDERS, SWEAT PANTS, SWEAT SHIRTS, SWEAT SHORTS, SWEAT SUITS, SWEATBANDS, SWEATERS, SWEATSOCKS, SWIM TRUNKS, SWIM WEAR FOR GENTLEMAN AND LADIES, SWIMSUITS, TANKINIS, TEE SHIRTS, THONGS (FOOTWEAR), THONGS (UNDERWEAR), TIES, TIGHTS, TOPS, TRACK PANTS, TRACKSUITS, TUBE TOPS, T-SHIRTS, UNDERPANTS, UNDERSHIRTS, UNDER GARMENTS, UNDERWEAR, VISORS, V-NECK SWEATERS, WAIST BELTS, WAISTBANDS, SHORTS, WARM UP SUITS, WETSUIT GLOVES, WETSUITS, WIND RESISTANT JACKETS, WIND COATS, WIND VESTS, WINDSHIRTS, WIND-JACKETS, WOMEN'S UNDERWEAR, WOMEN'S SHOES, WRAPS AND WRISTBANDS, IN CLASS 25 (U.S. CLS. 22 AND 39).

FIRST USE 5-1-2001; IN COMMERCE 5-1-2002.

THE MARK CONSISTS OF STANDARD CHARACTERS WITHOUT CLAIM TO ANY PARTICULAR FONT, STYLE, SIZE, OR COLOR.

SEC. 2(F).

SER. NO. 77-305,090, FILED 10-16-2007.

KATHY DE JONGE, EXAMINING ATTORNEY

Int. Cl.: 35

Prior U.S. Cls.: 100, 101 and 102

United States Patent and Trademark Office

Reg. No. 3,475,340

Registered July 29, 2008

**SERVICE MARK
PRINCIPAL REGISTER**

advertRx

PRADO, MANUEL (UNITED STATES INDIVIDUAL)
231 SOUTHVIEW STREET
231 SOUTHVIEW STREET
SANTA CRUZ, CA 95060

FOR: ADVERTISING AND ADVERTISEMENT SERVICES, IN CLASS 35 (U.S. CLS. 100, 101 AND 102).

FIRST USE 6-1-2007; IN COMMERCE 6-1-2007.

THE MARK CONSISTS OF STANDARD CHARACTERS WITHOUT CLAIM TO ANY PARTICULAR FONT, STYLE, SIZE, OR COLOR.

SER. NO. 77-305,326, FILED 10-16-2007.

TEJBIR SINGH, EXAMINING ATTORNEY

Int. Cl.: 35

Prior U.S. Cls.: 100, 101 and 102

United States Patent and Trademark Office

Reg. No. 3,475,341

Registered July 29, 2008

**SERVICE MARK
PRINCIPAL REGISTER**

advoiceRx

PRADO, MANUEL (UNITED STATES INDIVIDUAL)
231 SOUTHVIEW STREET
231 SOUTHVIEW STREET
SANTA CRUZ, CA 95060

FOR: ADVERTISING AND ADVERTISEMENT SERVICES, IN CLASS 35 (U.S. CLS. 100, 101 AND 102).

FIRST USE 6-1-2007; IN COMMERCE 6-1-2007.

THE MARK CONSISTS OF STANDARD CHARACTERS WITHOUT CLAIM TO ANY PARTICULAR FONT, STYLE, SIZE, OR COLOR.

SER. NO. 77-305,392, FILED 10-16-2007.

TEJBIR SINGH, EXAMINING ATTORNEY

Int. Cl.: 36

Prior U.S. Cls.: 100, 101 and 102

United States Patent and Trademark Office

Reg. No. 3,475,342

Registered July 29, 2008

SERVICE MARK
PRINCIPAL REGISTER

The logo for ASSURED GUARANTY features the word "ASSURED" in a large, bold, serif font above the word "GUARANTY" in a similar, slightly larger serif font. The letter "A" in "ASSURED" is stylized with three vertical lines to its left. The entire logo is set against a light gray background.

ASSURED GUARANTY RE LTD. (BERMUDA
LTD LIAB CO)
30 WOODBOURNE AVENUE
HAMILTON HM 08, BERMUDA

OWNER OF U.S. REG. NOS. 3,048,061, 3,122,510
AND OTHERS.

FOR: INSURANCE SERVICES, NAMELY, UN-
DERWRITING FINANCIAL GUARANTY INSUR-
ANCE AND REINSURANCE FOR MUNICIPAL
AND STRUCTURED FINANCE OBLIGATIONS
AND MORTGAGE GUARANTY INSURANCE
AND REINSURANCE, IN CLASS 36 (U.S. CLS. 100,
101 AND 102).

NO CLAIM IS MADE TO THE EXCLUSIVE
RIGHT TO USE "GUARANTY", APART FROM
THE MARK AS SHOWN.

SER. NO. 77-305,521, FILED 10-16-2007.

FIRST USE 10-0-2007; IN COMMERCE 10-0-2007.

BILL DAWE, EXAMINING ATTORNEY

Int. Cl.: 36

Prior U.S. Cls.: 100, 101 and 102

United States Patent and Trademark Office

Reg. No. 3,475,343

Registered July 29, 2008

**SERVICE MARK
PRINCIPAL REGISTER**

A-SIDE PLUS

PROGRESSIVE CASUALTY INSURANCE COM-
PANY (OHIO CORPORATION)
6300 WILSON MILLS ROAD
MAYFIELD VILLAGE, OH 44143

FOR: INSURANCE UNDERWRITING, CLAIMS
PROCESSING, CLAIMS ADJUSTMENT AND AD-
MINISTRATION SERVICES IN THE FIELD OF
DIRECTORS AND OFFICERS LIABILITY INSUR-
ANCE , IN CLASS 36 (U.S. CLS. 100, 101 AND 102).

FIRST USE 10-5-2007; IN COMMERCE 10-8-2007.

THE MARK CONSISTS OF STANDARD CHAR-
ACTERS WITHOUT CLAIM TO ANY PARTICULAR
FONT, STYLE, SIZE, OR COLOR.

SER. NO. 77-305,797, FILED 10-17-2007.

TIMOTHY FINNEGAN, EXAMINING ATTORNEY

Int. Cls.: 30 and 39

Prior U.S. Cls.: 46, 100 and 105

United States Patent and Trademark Office

Reg. No. 3,475,344

Registered July 29, 2008

**TRADEMARK
SERVICE MARK
PRINCIPAL REGISTER**



INSOMNIA COOKIES, LLC (PENNSYLVANIA LTD LIAB CO)
369 LEXINGTON AVENUE, 28TH FLOOR
NEW YORK, NY 10017

FOR: BAKERY GOODS, COOKIES AND BROWNIES, IN CLASS 30 (U.S. CL. 46).

FIRST USE 7-22-2003; IN COMMERCE 7-22-2003.

FOR: FOOD DELIVERY; DELIVERY OF GOODS BY MESSENGER, IN CLASS 39 (U.S. CLS. 100 AND 105).

FIRST USE 7-22-2003; IN COMMERCE 7-22-2003.

NO CLAIM IS MADE TO THE EXCLUSIVE RIGHT TO USE "COOKIES", APART FROM THE MARK AS SHOWN.

THE COLOR(S) BLACK, PURPLE, WHITE, DARK BROWN IS/ARE CLAIMED AS A FEATURE OF THE MARK.

THE MARK CONSISTS OF SEVERAL CONCENTRIC ELEMENTS, DESCRIBED HERE IN THE ORDER OF THE INNERMOST TO THE OUTERMOST: A) A DARK BROWN CRESCENT WITH BLACK HOLES RESEMBLING A CHOCOLATE CHIP COOKIE WITH A BITE TAKEN OUT OF IT, SUPERIMPOSED ON A BLACK CIRCLE WITH THREE WHITE STARS LOCATED TO THE RIGHT OF THE CONCAVE SIDE OF THE CRESCENT; B) ENCLOSED BY THE FIRST WHITE RING COUNTING FROM THE INSIDE OUT, WHICH IS SURROUNDED IN TURN BY THE FIRST PURPLE RING COUNTING FROM THE INSIDE OUT, INSIDE WHICH THE WORDS "INSOMNIA COOKIES" ARE WRITTEN IN LOWER-CASE WHITE LETTERS ABOVE AND BELOW, RESPECTIVELY, THE FIRST WHITE RING; C) ENCLOSED BY THE SECOND WHITE RING; D) ENCLOSED BY THE SECOND PURPLE RING; E) ENCLOSED BY THE THIRD WHITE OUTERMOST RING.

SER. NO. 77-305,892, FILED 10-17-2007.

DAWN FELDMAN, EXAMINING ATTORNEY

Int. Cl.: 32

Prior U.S. Cls.: 45, 46 and 48

United States Patent and Trademark Office

Reg. No. 3,475,345

Registered July 29, 2008

**TRADEMARK
PRINCIPAL REGISTER**

RAINFORESTA

RAINFORESTA ORGANIC INC. (NEW YORK
CORPORATION)
12-11 38TH AVENUE
LONG ISLAND CITY, NY 11101

THE MARK CONSISTS OF STANDARD CHAR-
ACTERS WITHOUT CLAIM TO ANY PARTICULAR
FONT, STYLE, SIZE, OR COLOR.

FOR: FRUIT JUICE BASES; FRUIT JUICE CON-
CENTRATES; HERBAL JUICES; JUICE BASE CON-
CENTRATES, IN CLASS 32 (U.S. CLS. 45, 46 AND 48).

SER. NO. 77-305,910, FILED 10-17-2007.

FIRST USE 10-2-2007; IN COMMERCE 10-2-2007.

JIM RINGLE, EXAMINING ATTORNEY

Int. Cl.: 30

Prior U.S. Cl.: 46

United States Patent and Trademark Office

Reg. No. 3,475,346

Registered July 29, 2008

**TRADEMARK
PRINCIPAL REGISTER**

GRANNY'S GRANOLI

SCHMIDT, DIANA L (UNITED STATES INDIVIDUAL), DBA GRANNY'S GOURMET KITCHEN

SUITE 1

4123 MUIRFIELD LOOP

LAKE WALES, FL 33859

FOR: GRANOLA SNACKS, IN CLASS 30 (U.S. CL. 46).

FIRST USE 10-28-2007; IN COMMERCE 10-28-2007.

THE MARK CONSISTS OF STANDARD CHARACTERS WITHOUT CLAIM TO ANY PARTICULAR FONT, STYLE, SIZE, OR COLOR.

NO CLAIM IS MADE TO THE EXCLUSIVE RIGHT TO USE "GRANOLI", APART FROM THE MARK AS SHOWN.

SER. NO. 77-306,270, FILED S.R. 10-17-2007 AM.
P.R. 3-27-2008.

TOBY BULLOFF, EXAMINING ATTORNEY

Int. Cls.: 35 and 45

Prior U.S. Cls.: 100, 101 and 102

United States Patent and Trademark Office

Reg. No. 3,475,347

Registered July 29, 2008

**SERVICE MARK
PRINCIPAL REGISTER**

Humanbook

HUMANBOOK, INC. (DELAWARE CORPORATION)

PO BOX 81362

WELLESLEY HILLS, MA 02481

FOR: PROVIDING ON-LINE DIRECTORY SERVICE FEATURING INFORMATION ABOUT CLASSMATES AND CO-WORKERS, IN CLASS 35 (U.S. CLS. 100, 101 AND 102).

FIRST USE 12-15-2002; IN COMMERCE 12-15-2002.

FOR: ONLINE PERSONAL NETWORKING SERVICES, NAMELY, ONLINE SOCIAL NETWORKING SERVICES, IN CLASS 45 (U.S. CLS. 100 AND 101).

FIRST USE 12-15-2002; IN COMMERCE 12-15-2002.

THE MARK CONSISTS OF STANDARD CHARACTERS WITHOUT CLAIM TO ANY PARTICULAR FONT, STYLE, SIZE, OR COLOR.

SER. NO. 77-306,460, FILED 10-17-2007.

DAYNA BROWNE, EXAMINING ATTORNEY

Int. Cl.: 36

Prior U.S. Cls.: 100, 101 and 102

United States Patent and Trademark Office

Reg. No. 3,475,348

Registered July 29, 2008

SERVICE MARK
PRINCIPAL REGISTER



3C INCORPORATED (MARYLAND CORPORATION)
8930 STANFORD BOULEVARD
COLUMBIA, MD 21045

FOR: FINANCIAL SERVICES, NAMELY, EXPENSE MANAGEMENT, BILL PAYMENT AND PRESENTMENT, DEBT ASSISTANCE PROGRAM, NAMELY, DEBT MANAGEMENT COUNSELING, BUDGET MANAGEMENT TOOLS, NAMELY, CALCULATORS AND OUTLINES FOR DEBT INFORMATION, EXPENSE SAVING SERVICE, NAMELY, PROVIDING COST INFORMATION ON LOAN PRODUCTS FOR EXPENSE CATEGORIES, REVENUE MANAGEMENT SERVICES, ONLINE ACCOUNT AGGREGATION, AND PROVIDING FINANCIAL INFORMATION, NAMELY, LIBRARY OF INFORMATION AND ARTICLES RESPECTING MANAGING FINANCES AND TOOLS FOR QUANTIFYING, CALCULATING AND CATEGORIZING DEBT AND EXPENDITURES; AND FINANCIAL SERVICES, NAMELY, EXPENSE MANAGEMENT, BILL PAYMENT AND PRESENTMENT, DEBT ASSISTANCE PROGRAM, NAMELY, DEBT MANAGEMENT COUNSELING, BUDGET MANAGEMENT TOOLS, NAMELY, CALCULATORS AND OUTLINES FOR INFORMATION, EX-

PENSE SAVING SERVICES, NAMELY, PROVIDING COST INFORMATION ON LOAN PRODUCTS FOR EXPENSE CATEGORIES, REVENUE MANAGEMENT SERVICES, ONLINE ACCOUNT AGGREGATION, AND PROVISION OF CONTENT LIBRARY OF INFORMATION AND ARTICLES RESPECTING MANAGING FINANCES AND TOOLS FOR QUANTIFYING, CALCULATING AND CATEGORIZING DEBT AND EXPENDITURES, VIA A GLOBAL COMPUTER NETWORK, IN CLASS 36 (U.S. CLS. 100, 101 AND 102).

FIRST USE 9-1-2002; IN COMMERCE 9-1-2002.

NO CLAIM IS MADE TO THE EXCLUSIVE RIGHT TO USE "CREDIT COUNSELING", APART FROM THE MARK AS SHOWN.

THE MARK CONSISTS OF AN ABSTRACT PERSON LEAPING TOWARD AN ABSTRACT STAR ABOVE THE WORDS "CAREONE CREDIT COUNSELING".

SER. NO. 77-306,551, FILED 10-17-2007.

FLORENTINA BLANDU, EXAMINING ATTORNEY

Int. Cl.: 9

Prior U.S. Cls.: 21, 23, 26, 36 and 38

Reg. No. 3,475,349

United States Patent and Trademark Office

Registered July 29, 2008

**TRADEMARK
PRINCIPAL REGISTER**

SUBSAVER

PM&D ENGINEERING, INC. (INDIANA CORPORATION)
4129 WEST FULTON STREET
BROKEN ARROW, OK 74012

THE MARK CONSISTS OF STANDARD CHARACTERS WITHOUT CLAIM TO ANY PARTICULAR FONT, STYLE, SIZE, OR COLOR.

FOR: ELECTRICAL SURGE SUPPRESSORS FOR PROTECTING OIL FIELD EQUIPMENT, NAMELY, SUBMERSIBLE PUMPS, FROM LIGHTNING DAMAGE, IN CLASS 9 (U.S. CLS. 21, 23, 26, 36 AND 38).

SER. NO. 77-306,574, FILED 10-17-2007.

FIRST USE 9-5-2007; IN COMMERCE 9-5-2007.

MATTHEW EINSTEIN, EXAMINING ATTORNEY

Int. Cls.: 30 and 32

Prior U.S. Cls.: 45, 46 and 48

United States Patent and Trademark Office

Reg. No. 3,475,350

Registered July 29, 2008

**TRADEMARK
PRINCIPAL REGISTER**

RAMOS FAMILY RECIPES

AZTECA RESTAURANT ENTERPRISES, INC.
(WASHINGTON CORPORATION)
133 SOUTHWEST 158TH STREET
SEATTLE, WA 98166

FOR: SALSA, IN CLASS 30 (U.S. CL. 46).

FIRST USE 4-17-2000; IN COMMERCE 4-17-2000.

FOR: NON-ALCOHOLIC MARGARITA MIX, IN
CLASS 32 (U.S. CLS. 45, 46 AND 48).

FIRST USE 4-17-2000; IN COMMERCE 4-17-2000.

THE MARK CONSISTS OF STANDARD CHAR-
ACTERS WITHOUT CLAIM TO ANY PARTICULAR
FONT, STYLE, SIZE, OR COLOR.

OWNER OF U.S. REG. NO. 2,590,021.

NO CLAIM IS MADE TO THE EXCLUSIVE
RIGHT TO USE "FAMILY RECIPES", APART FROM
THE MARK AS SHOWN.

SER. NO. 77-306,762, FILED 10-17-2007.

JOHN SCHUYLER YARD, EXAMINING ATTOR-
NEY

Int. Cl.: 41

Prior U.S. Cls.: 100, 101 and 107

United States Patent and Trademark Office

Reg. No. 3,475,351

Registered July 29, 2008

**SERVICE MARK
PRINCIPAL REGISTER**



GREENROOTS MEDIA, INC. (NEVADA CORPORATION)
5832 S SHERBOURNE DRIVE
LOS ANGELES, CA 90065

FOR: MULTIMEDIA ENTERTAINMENT SERVICES IN THE NATURE OF RECORDING, PRODUCTION AND POST-PRODUCTION SERVICES IN THE FIELDS OF MUSIC, VIDEO, AND FILMS, IN CLASS 41 (U.S. CLS. 100, 101 AND 107).

FIRST USE 9-20-2007; IN COMMERCE 9-20-2007.

THE COLOR(S) GREEN, BLACK, AND WHITE IS/ARE CLAIMED AS A FEATURE OF THE MARK.

THE MARK CONSISTS OF A SOLID GREEN LEAFLESS TREE WITH GREEN ROOTS AND WHITE DOTS AT THE TIPS OF THE BRANCHES. A CAPITAL LETTER G IS ON THE LEFT SIDE OF THE TREE AND A CAPITAL LETTER R ON THE RIGHT SIDE OF THE TREE. THE LETTERS ARE THE SAME COLOR GREEN AS THE TREE AND THE BACKGROUND COLOR IS BLACK. .

SER. NO. 77-306,831, FILED 10-17-2007.

AMY MCMENAMIN, EXAMINING ATTORNEY

Int. Cl.: 9

Prior U.S. Cls.: 21, 23, 26, 36 and 38

United States Patent and Trademark Office

Reg. No. 3,475,352

Registered July 29, 2008

**TRADEMARK
PRINCIPAL REGISTER**

Irrigation-Link

IRRIGATION-LINK, LLC (WASHINGTON LTD
LIAB CO)
1625 GRAYLYNN DRIVE
WALLA WALLA, WA 99362

FOR: CONTROL VALVES FOR REGULATING
THE FLOW OF GASES AND LIQUIDS; RADIO
TRANSMITTERS AND RECEIVERS FOR REMOTE
CONTROLS, RADIO CONTROLS; RADIO RECEI-
VERS; RADIO TRANSMITTERS; DEVICES FOR
WIRELESS RADIO TRANSMISSION, IN CLASS 9
(U.S. CLS. 21, 23, 26, 36 AND 38).

FIRST USE 7-26-2007; IN COMMERCE 7-26-2007.

THE MARK CONSISTS OF STANDARD CHAR-
ACTERS WITHOUT CLAIM TO ANY PARTICULAR
FONT, STYLE, SIZE, OR COLOR.

SER. NO. 77-306,919, FILED 10-18-2007.

ROBIN MITTLER, EXAMINING ATTORNEY

Int. Cls.: 25 and 35

Prior U.S. Cls.: 22, 39, 100, 101 and 102

United States Patent and Trademark Office

Reg. No. 3,475,353

Registered July 29, 2008

**TRADEMARK
SERVICE MARK
PRINCIPAL REGISTER**

Palmer Cash

OLIVER JACKSON INC. (IDAHO CORPORATION), DBA PALMERCASH
3208 N. LINDA VISTA PL.
BOISE, ID 83704

FOR: T-SHIRTS, IN CLASS 25 (U.S. CLS. 22 AND 39).

FIRST USE 9-11-2003; IN COMMERCE 9-26-2003.

FOR: ON-LINE RETAIL STORE SERVICES FEATURING CLOTHING; RETAIL CLOTHING STORES, IN CLASS 35 (U.S. CLS. 100, 101 AND 102).

FIRST USE 9-11-2003; IN COMMERCE 9-26-2003.

THE MARK CONSISTS OF STANDARD CHARACTERS WITHOUT CLAIM TO ANY PARTICULAR FONT, STYLE, SIZE, OR COLOR.

"PALMER CASH" DOES NOT IDENTIFY A LIVING INDIVIDUAL.

SER. NO. 77-307,200, FILED 10-18-2007.

MICHAEL ENGEL, EXAMINING ATTORNEY

Int. Cl.: 41

Prior U.S. Cls.: 100, 101 and 107

United States Patent and Trademark Office

Reg. No. 3,475,354

Registered July 29, 2008

**SERVICE MARK
PRINCIPAL REGISTER**

GILBERT BANKS FILMS

GILBERT BANKS FILMS, LLC (NEW YORK LTD
LIAB CO)
SUITE 10K
101-125 WEST 147 STREET
NEW YORK, NY 10039

FOR: PRODUCING MOTION PICTURE FILMS
AND SOUND RECORDINGS FOR COMMERCIAL
AND EDUCATIONAL USE, IN CLASS 41 (U.S. CLS.
100, 101 AND 107).

FIRST USE 6-30-2007; IN COMMERCE 9-1-2007.

THE MARK CONSISTS OF STANDARD CHAR-
ACTERS WITHOUT CLAIM TO ANY PARTICULAR
FONT, STYLE, SIZE, OR COLOR.

NO CLAIM IS MADE TO THE EXCLUSIVE
RIGHT TO USE "FILMS", APART FROM THE
MARK AS SHOWN.

THE NAME GILBERT BANKS IDENTIFIES A
LIVING INDIVIDUAL WHOSE CONSENT IS OF
RECORD.

SER. NO. 77-307,795, FILED 10-18-2007.

KATHERINE M. DUBRAY, EXAMINING ATTOR-
NEY

Prior U.S. Cl.: B

United States Patent and Trademark Office

Reg. No. 3,475,355

Registered July 29, 2008

**CERTIFICATION MARK
PRINCIPAL REGISTER**

GMA

NATIONAL ASSOCIATION OF MORTGAGE
BROKERS, INC. (FLORIDA CORPORATION)
7900 WESTPARK DRIVE SUITE T-309
MCLEAN, VA 22102

FOR: MORTGAGE BROKERAGE SERVICES, IN
CLASS B (U.S. CL. B).

FIRST USE 5-0-2007; IN COMMERCE 5-0-2007.

THE MARK CONSISTS OF STANDARD CHAR-
ACTERS WITHOUT CLAIM TO ANY PARTICULAR
FONT, STYLE, SIZE, OR COLOR.

THE CERTIFICATION MARK, AS USED BY
AUTHORIZED PERSONS, CERTIFIES THAT SUCH
PERSONS MEET THE STANDARDS OF EDUCA-
TION AND KNOWLEDGE OF THE PRINCIPLES,
PRACTICES, PRODUCTS, AND TRENDS IN THE
MORTGAGE PROFESSION, AND ITS RELATED
DISCIPLINES AND LAWS, AS ESTABLISHED BY
THE CERTIFIER, FOR PERSONS RELATIVELY
NEW TO THE PROFESSION.

SER. NO. 77-308,652, FILED 10-19-2007.

MARK SPARACINO, EXAMINING ATTORNEY

Int. Cl.: 43

Prior U.S. Cls.: 100 and 101

United States Patent and Trademark Office

Reg. No. 3,475,356

Registered July 29, 2008

**SERVICE MARK
PRINCIPAL REGISTER**

JIM'S CAFÉ AND COFFEE BAR

HASSLOCHER ENTERPRISES, INC. (TEXAS
CORPORATION)
8520 CROWNHILL BOULEVARD
SAN ANTONIO, TX 78209

FOR: RESTAURANT AND BAR SERVICES, IN
CLASS 43 (U.S. CLS. 100 AND 101).

FIRST USE 5-5-2005; IN COMMERCE 5-5-2005.

THE MARK CONSISTS OF STANDARD CHAR-
ACTERS WITHOUT CLAIM TO ANY PARTICULAR
FONT, STYLE, SIZE, OR COLOR.

OWNER OF U.S. REG. NOS. 1,162,330, 1,164,122
AND OTHERS.

NO CLAIM IS MADE TO THE EXCLUSIVE
RIGHT TO USE "CAFE AND COFFEE BAR", APART
FROM THE MARK AS SHOWN.

SER. NO. 77-308,773, FILED 10-19-2007.

STEPHEN AQUILA, EXAMINING ATTORNEY

Int. Cls.: 25 and 45

Prior U.S. Cls.: 22, 39, 100 and 101

United States Patent and Trademark Office

Reg. No. 3,475,357

Registered July 29, 2008

TRADEMARK
SERVICE MARK
PRINCIPAL REGISTER

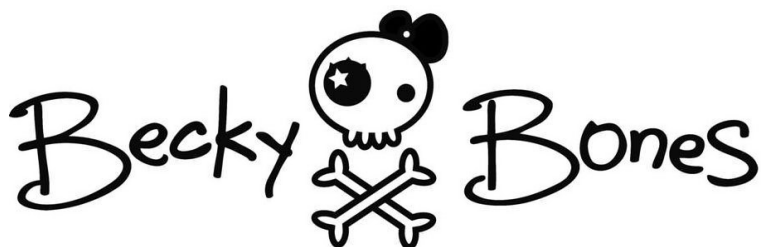

BECKY BONES, LLC (CALIFORNIA LTD LIAB
CO)
PO BOX 504054
SAN DIEGO, CA 921504050

FOR: CLOTHING, NAMELY, SHIRTS, PANTS,
JACKETS, TANK TOPS, SHORTS, SWEATSHIRTS,
SWEATPANTS, SWEATERS, SWEAT BANDS,
SOCKS, BATHING SUITS, FOOTWEAR, SHOES,
SNEAKERS, BOOTS, SNOWBOARD BOOTS, SAN-
DALS, HEADWEAR, HATS, BEANIES, AND SUN
VISORS, IN CLASS 25 (U.S. CLS. 22 AND 39).

FIRST USE 10-15-2007; IN COMMERCE 10-15-2007.

FOR: LICENSING OF CLOTHING, NAMELY,
SHIRTS, PANTS, JACKETS, TANK TOPS, SHORTS,
SWEATSHIRTS, SWEATPANTS, SWEATERS,
SWEAT BANDS, SOCKS, BATHING SUITS, FOOT-
WEAR, SHOES, SNEAKERS, BOOTS, SNOWBOARD
BOOTS, SANDALS, HEADWEAR, HATS, BEANIES,

SUN VISORS STICKERS, DOLLS, CARTOONS,
BOOKS, VIDEO GAMES, KEY CHAINS, JEWELRY,
PURSES, BAGS, BACKPACKS, VIRTUAL CLOTH-
ING AND HAIR ACCESSORIES, IN CLASS 45 (U.S.
CLS. 100 AND 101).

FIRST USE 10-15-2007; IN COMMERCE 10-15-2007.

THE MARK CONSISTS OF THE WORDS 'BECKY
BONES' SEPARATED BY A SKULL AND CROSS
BONES. THE SKULL'S RIGHT EYE IS A SMALL
CIRCLE AND THE LEFT EYE IS A LARGER
CIRCLE WITH A WHITE STAR IN THE MIDDLE.
A BOW SITS ON TOP OF THE SKULL SLIGHTLY TO
THE RIGHT.

SER. NO. 77-309,063, FILED 10-19-2007.

JANICE KIM, EXAMINING ATTORNEY

Int. Cl.: 41

Prior U.S. Cls.: 100, 101 and 107

United States Patent and Trademark Office

Reg. No. 3,475,358

Registered July 29, 2008

**SERVICE MARK
PRINCIPAL REGISTER**

ROCSTA TV

UPFLITE MUSIC LLC (FLORIDA LTD LIAB CO),
DBA MARK SHINE
17021 SW 64 CT.
FT. LAUDERDALE, FL 33331

FOR: ENTERTAINMENT IN THE NATURE OF LIVE COMEDY, MUSIC, PERFORMING ARTS AND HISTORY PERFORMANCES; ENTERTAINMENT SERVICES, NAMELY, AN ON-GOING SERIES FEATURING COMEDY, MUSIC, PERFORMING ARTS AND HISTORY PROVIDED THROUGH INTERNET AND CABLE NETWORKS; ENTERTAINMENT SERVICES, NAMELY, PLANNING AND CONDUCTING A SERIES OF FILM FESTIVALS; MUSIC SELECTION SERVICES FOR USE IN TV, FILM, RADIO AND VIDEO GAMES; PROVISION OF NON-DOWNLOADABLE FILMS AND TV PROGRAMMES VIA A VIDEO-ON-DEMAND SERVICE, IN CLASS 41 (U.S. CLS. 100, 101 AND 107).

FIRST USE 7-9-2007; IN COMMERCE 9-13-2007.

THE MARK CONSISTS OF STANDARD CHARACTERS WITHOUT CLAIM TO ANY PARTICULAR FONT, STYLE, SIZE, OR COLOR.

NO CLAIM IS MADE TO THE EXCLUSIVE RIGHT TO USE "TV", APART FROM THE MARK AS SHOWN.

THE FOREIGN WORDING IN THE MARK TRANSLATES INTO ENGLISH AS N/A.

SER. NO. 77-309,178, FILED 10-20-2007.

KIMBERLY FRYE, EXAMINING ATTORNEY

Int. Cl.: 14

Prior U.S. Cls.: 2, 27, 28 and 50

United States Patent and Trademark Office

Reg. No. 3,475,359

Registered July 29, 2008

**TRADEMARK
PRINCIPAL REGISTER**

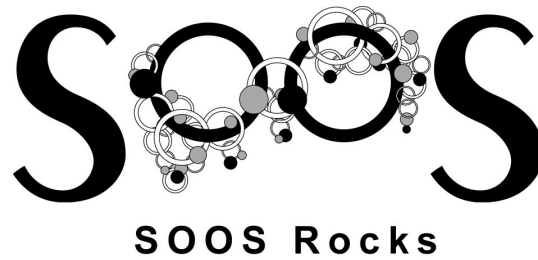

1644085 ONTARIO INC. (CANADA CORPORATION), DBA SOOS ROCKS
599 COLLEGE ST. #2
TORONTO, CANADA M6G1B5

THE MARK CONSISTS IN PART OF JEWELRY RINGS DRAPED FROM THE "OO" IN THE WORD "SOOS".

FOR: COSTUME JEWELRY, IN CLASS 14 (U.S. CLS. 2, 27, 28 AND 50).

SER. NO. 77-309,246, FILED 10-20-2007.

FIRST USE 1-1-2005; IN COMMERCE 1-1-2005.

HANNO RITTNER, EXAMINING ATTORNEY

Int. Cl.: 20

Prior U.S. Cls.: 2, 13, 22, 25, 32 and 50

United States Patent and Trademark Office

Reg. No. 3,475,360

Registered July 29, 2008

TRADEMARK
PRINCIPAL REGISTER



HEPPER, LLC (VERMONT CORPORATION),
DBA HEPPER
7 LAWSON LANE
BURLINGTON, VT 05401

FOR: BEDS FOR HOUSEHOLD PETS; PET FURNITURE; PORTABLE BEDS FOR PETS, IN CLASS 20 (U.S. CLS. 2, 13, 22, 25, 32 AND 50).

FIRST USE 8-0-2007; IN COMMERCE 10-1-2007.

THE MARK CONSISTS OF THE WORD "HEPPER" IN STYLIZED FONT BELOW A STYLIZED DESIGN OF AN ANIMAL'S FACE WEARING A CROWN SURROUNDED BY AN OUTLINE IN THE

SHAPE OF A SHIELD. THE STYLIZED DESIGN OF THE ANIMAL'S FACE CONSISTS OF TWO QUARTER CIRCLES; WITHIN EACH QUARTER CIRCLE IS A POINTED OVAL SHAPE; THE TWO QUARTER CIRCLES ARE SEPARATED BY AN ARROW POINTING DOWNWARDS; ABOVE THE LEFT QUARTER CIRCLE THERE IS A TRIANGLE; ABOVE THE RIGHT QUARTER CIRCLE THERE IS A SMALLER QUARTER CIRCLE; THERE IS A CROWN IN THE MIDDLE ABOVE THE TWO QUARTER CIRCLES.

SER. NO. 77-309,405, FILED 10-21-2007.

EMILY CHUO, EXAMINING ATTORNEY

Prior U.S. Cl.: B

United States Patent and Trademark Office

Reg. No. 3,475,361

Registered July 29, 2008

**CERTIFICATION MARK
PRINCIPAL REGISTER**

WARD'S 50

WARD FINANCIAL GROUP, INC. (OHIO CORPORATION)
11500 NORTHLAKE DRIVE, SUITE 305
CINCINNATI, OH 452491662

FOR: INSURANCE CARRIER SERVICES IN THE NATURE OF LIFE-HEALTH AND PROPERTY-CASUALTY INSURANCE, IN CLASS B (U.S. CL. B).

FIRST USE 12-31-1995; IN COMMERCE 12-31-1995.

THE MARK CONSISTS OF STANDARD CHARACTERS WITHOUT CLAIM TO ANY PARTICULAR FONT, STYLE, SIZE, OR COLOR.

OWNER OF U.S. REG. NOS. 3,271,017, 3,278,506 AND OTHERS.

NO CLAIM IS MADE TO THE EXCLUSIVE RIGHT TO USE "50", APART FROM THE MARK AS SHOWN.

THE CERTIFICATION MARK, AS USED BY AUTHORIZED PERSONS, CERTIFIES THAT THE LIFE-HEALTH AND PROPERTY-CASUALTY INSURANCE COMPANIES CERTIFIED MEET CERTAIN FINANCIAL AND OTHER PERFORMANCE STANDARDS SET BY THE CERTIFIER .

SER. NO. 77-309,626, FILED 10-22-2007.

DAVID COLLIER, EXAMINING ATTORNEY

Prior U.S. Cl.: B

United States Patent and Trademark Office

Reg. No. 3,475,362

Registered July 29, 2008

CERTIFICATION MARK
PRINCIPAL REGISTER



WARD FINANCIAL GROUP, INC. (OHIO CORPORATION)
11500 NORTHLAKE DRIVE, SUITE 305
CINCINNATI, OH 452491662

FOR: INSURANCE CARRIER SERVICES IN THE NATURE OF LIFE-HEALTH AND PROPERTY-CASUALTY INSURANCE, IN CLASS B (U.S. CL. B).

FIRST USE 12-31-1995; IN COMMERCE 12-31-1995.

OWNER OF U.S. REG. NOS. 3,271,017, 3,278,506 AND OTHERS.

NO CLAIM IS MADE TO THE EXCLUSIVE RIGHT TO USE "50" AND "SAFETY CONSISTENCY

PERFORMANCE", APART FROM THE MARK AS SHOWN.

THE MARK CONSISTS OF THE WORDS "WARD'S" AND "SAFETY. CONSISTENCY. PERFORMANCE." ENCIRCLING THE NUMBER "50".

THE CERTIFICATION MARK, AS USED BY AUTHORIZED PERSONS, CERTIFIES THAT THE LIFE-HEALTH AND PROPERTY-CASUALTY INSURANCE COMPANIES CERTIFIED MEET CERTAIN FINANCIAL AND OTHER PERFORMANCE STANDARDS SET BY THE CERTIFIER .

SER. NO. 77-309,633, FILED 10-22-2007.

DAVID COLLIER, EXAMINING ATTORNEY

Int. Cl.: 41

Prior U.S. Cls.: 100, 101 and 107

United States Patent and Trademark Office

Reg. No. 3,475,363

Registered July 29, 2008

**SERVICE MARK
PRINCIPAL REGISTER**

Mighty Mommies

CALABRESE-GUZMAN, AUTUMN (UNITED STATES INDIVIDUAL)
#102
12151 MOORPARK ST.
STUDIO CITY, CA 91604

FOR: EDUCATION SERVICES, NAMELY, PROVIDING CLASSES IN THE FIELD OF FITNESS FOR CURRENT AND EXPECTANT MOTHERS; PHYSICAL FITNESS INSTRUCTION , IN CLASS 41 (U.S. CLS. 100, 101 AND 107).

FIRST USE 8-1-2007; IN COMMERCE 8-1-2007.

THE MARK CONSISTS OF STANDARD CHARACTERS WITHOUT CLAIM TO ANY PARTICULAR FONT, STYLE, SIZE, OR COLOR.

NO CLAIM IS MADE TO THE EXCLUSIVE RIGHT TO USE "MOMMIES", APART FROM THE MARK AS SHOWN.

SER. NO. 77-309,676, FILED 10-22-2007.

NELSON SNYDER, EXAMINING ATTORNEY

Int. Cl.: 5

Prior U.S. Cls.: 6, 18, 44, 46, 51 and 52

United States Patent and Trademark Office

Reg. No. 3,475,364

Registered July 29, 2008

**TRADEMARK
PRINCIPAL REGISTER**



PSS WORLD MEDICAL, INC. (FLORIDA CORPORATION)
4345 SOUTHPOINT BOULEVARD
JACKSONVILLE, FL 32216

FOR: WOUND DRESSINGS; MEDICAL CLEANSERS FOR SKIN AND WOUNDS, IN CLASS 5 (U.S. CLS. 6, 18, 44, 46, 51 AND 52).

FIRST USE 2-28-2007; IN COMMERCE 2-28-2007.

OWNER OF U.S. REG. NO. 3,362,945.

THE COLOR(S) RED, YELLOW, GREEN, PURPLE AND BLUE IS/ARE CLAIMED AS A FEATURE OF THE MARK.

THE MARK CONSISTS OF ONE RED TRIANGLE, ONE YELLOW TRIANGLE, ONE GREEN TRIANGLE AND ONE PURPLE TRIANGLE ALL THE SAME SIZE ABOVE THE PHRASE "REPARA", WHICH IS IN BLUE CAPITAL LETTERS.

THE FOREIGN WORDING IN THE MARK TRANSLATES INTO ENGLISH AS REPAIR.

SER. NO. 77-309,861, FILED 10-22-2007.

ROBIN MITTLER, EXAMINING ATTORNEY

Int. Cl.: 9

Prior U.S. Cls.: 21, 23, 26, 36 and 38

Reg. No. 3,475,365

United States Patent and Trademark Office

Registered July 29, 2008

**TRADEMARK
PRINCIPAL REGISTER**

PERFECT VOICE OCTET

TELECO, INC. (SOUTH CAROLINA CORPORATION)
430 WOODRUFF ROAD, SUITE 300
GREENVILLE, SC 29607

FOR: TELEPHONE SYSTEMS COMPRISED OF COMPUTER HARDWARE AND SOFTWARE THAT ALLOWS FOR VOICE MAIL, CALL ROUTING, MESSAGE FORWARDING, CONVERSATION RECORDING, GREETINGS, MESSAGING AND ANNOUNCEMENTS, AND PAGING, IN CLASS 9 (U.S. CLS. 21, 23, 26, 36 AND 38).

FIRST USE 10-3-2007; IN COMMERCE 10-3-2007.

THE MARK CONSISTS OF STANDARD CHARACTERS WITHOUT CLAIM TO ANY PARTICULAR FONT, STYLE, SIZE, OR COLOR.

OWNER OF U.S. REG. NOS. 1,883,430, 3,170,434 AND OTHERS.

NO CLAIM IS MADE TO THE EXCLUSIVE RIGHT TO USE "VOICE", APART FROM THE MARK AS SHOWN.

SER. NO. 77-310,027, FILED 10-22-2007.

KYLE PEETE, EXAMINING ATTORNEY

Int. Cl.: 9

Prior U.S. Cls.: 21, 23, 26, 36 and 38

Reg. No. 3,475,366

United States Patent and Trademark Office

Registered July 29, 2008

**TRADEMARK
PRINCIPAL REGISTER**

PERFECT VOICE TIS16 SERIES3

TELECO, INC. (SOUTH CAROLINA CORPORATION)
430 WOODRUFF ROAD, SUITE 300
GREENVILLE, SC 29607

FOR: TELEPHONE SYSTEMS COMPRISED OF COMPUTER HARDWARE AND SOFTWARE THAT ALLOWS FOR VOICE MAIL, CALL ROUTING, MESSAGE FORWARDING, CONVERSATION RECORDING, GREETINGS, MESSAGING AND ANNOUNCEMENTS, AND PAGING, IN CLASS 9 (U.S. CLS. 21, 23, 26, 36 AND 38).

FIRST USE 9-18-2007; IN COMMERCE 9-18-2007.

THE MARK CONSISTS OF STANDARD CHARACTERS WITHOUT CLAIM TO ANY PARTICULAR FONT, STYLE, SIZE, OR COLOR.

OWNER OF U.S. REG. NOS. 1,883,430, 3,170,434 AND OTHERS.

NO CLAIM IS MADE TO THE EXCLUSIVE RIGHT TO USE "VOICE", APART FROM THE MARK AS SHOWN.

SER. NO. 77-310,029, FILED 10-22-2007.

KYLE PEETE, EXAMINING ATTORNEY

Int. Cl.: 9

Prior U.S. Cls.: 21, 23, 26, 36 and 38

Reg. No. 3,475,367

United States Patent and Trademark Office

Registered July 29, 2008

**TRADEMARK
PRINCIPAL REGISTER**

PERFECT VOICE TIS16 SERIES2

TELECO, INC. (SOUTH CAROLINA CORPORATION)
430 WOODRUFF ROAD, SUITE 300
GREENVILLE, SC 29607

FOR: TELEPHONE SYSTEMS COMPRISED OF COMPUTER HARDWARE AND SOFTWARE THAT ALLOWS FOR VOICE MAIL, CALL ROUTING, MESSAGE FORWARDING, CONVERSATION RECORDING, GREETINGS, MESSAGING AND ANNOUNCEMENTS, AND PAGING, IN CLASS 9 (U.S. CLS. 21, 23, 26, 36 AND 38).

FIRST USE 9-4-2007; IN COMMERCE 9-4-2007.

THE MARK CONSISTS OF STANDARD CHARACTERS WITHOUT CLAIM TO ANY PARTICULAR FONT, STYLE, SIZE, OR COLOR.

OWNER OF U.S. REG. NOS. 1,883,430, 3,170,434 AND OTHERS.

NO CLAIM IS MADE TO THE EXCLUSIVE RIGHT TO USE "VOICE", APART FROM THE MARK AS SHOWN.

SER. NO. 77-310,031, FILED 10-22-2007.

KYLE PEETE, EXAMINING ATTORNEY

Int. Cl.: 36

Prior U.S. Cls.: 100, 101 and 102

United States Patent and Trademark Office

Reg. No. 3,475,368

Registered July 29, 2008

**SERVICE MARK
PRINCIPAL REGISTER**



INTERNATIONAL SPECIALTY INSURANCE
INC. (NORTH CAROLINA CORPORATION)
P.O. BOX 609
SPARTA, NC 286750609

FOR: INSURANCE SERVICES, NAMELY,
BROKERAGE AND UNDERWRITING OF LIFE,
HEALTH, ACCIDENT AND DISABILITY INSUR-
ANCE, IN CLASS 36 (U.S. CLS. 100, 101 AND 102).

FIRST USE 2-1-2003; IN COMMERCE 2-1-2003.

NO CLAIM IS MADE TO THE EXCLUSIVE
RIGHT TO USE "INTERNATIONAL SPECIALTY
INSURANCE", APART FROM THE MARK AS
SHOWN.

THE MARK CONSISTS OF THE LETTERS "ISI"
SHOWN WITH THE WORD INTERNATIONAL UN-
DER THE ISI AND THE WORDS SPECIALTY IN-
SURANCE SHOWN UNDER THE WORD
"INTERNATIONAL"; A SHAPE CONSISTING OF A
SPHERE WITH A RING AROUND THE SPHERE
AND THREE TRIANGLES SHOWN ON THE TOP
RIGHT SIDE OF THE SPHERE AND FOUR TRIAN-
GLES SHOWN ON THE BOTTOM LEFT SIDE OF
THE SPHERE; THE DESIGN IS LOCATED NEXT TO
THE WORDS " ISI INTERNATIONAL SPECIALTY
INSURANCE".

SER. NO. 77-310,158, FILED 10-22-2007.

ALEX KEAM, EXAMINING ATTORNEY

Int. Cl.: 45

Prior U.S. Cls.: 100 and 101

United States Patent and Trademark Office

Reg. No. 3,475,369

Registered July 29, 2008

**SERVICE MARK
PRINCIPAL REGISTER**

KERN ATTORNEY SERVICE

KERN LEGAL SERVICES, INC. (CALIFORNIA CORPORATION)
1614 W. TEMPLE ST.
LOS ANGELES, CA 90026

FOR: LITIGATION SUPPORT SERVICES; SERVICE OF PROCESS; PUBLIC DOCUMENT FILING SERVICES; ELECTRONIC PUBLIC DOCUMENT FILING SERVICES; PUBLIC DOCUMENT FILING SERVICES BY FAX; COURT PUBLIC DOCUMENT FILING SERVICES; PRIVATE INVESTIGATION SERVICES; PERSONAL BACKGROUND INVESTIGATION; INVESTIGATION OF ASSETS, CREDIT REPORTS; BACKGROUND CHECKS; PRE-EMPLOYMENT CHECKS; LEGAL DOCUMENT PREPARATION SERVICES, IN CLASS 45 (U.S. CLS. 100 AND 101).

FIRST USE 5-14-1993; IN COMMERCE 5-14-1993.

THE MARK CONSISTS OF STANDARD CHARACTERS WITHOUT CLAIM TO ANY PARTICULAR FONT, STYLE, SIZE, OR COLOR.

NO CLAIM IS MADE TO THE EXCLUSIVE RIGHT TO USE "ATTORNEY SERVICE" , APART FROM THE MARK AS SHOWN.

SEC. 2(F).

SER. NO. 77-310,180, FILED 10-22-2007.

BARNEY CHARLON, EXAMINING ATTORNEY

Int. Cls.: 35 and 45

Prior U.S. Cls.: 100, 101 and 102

United States Patent and Trademark Office

Reg. No. 3,475,370

Registered July 29, 2008

**SERVICE MARK
PRINCIPAL REGISTER**



KERN LEGAL SERVICES, INC. (CALIFORNIA CORPORATION)
1614 W. TEMPLE ST.
LOS ANGELES, CA 90026

FOR: DOCUMENT REPRODUCTION; DISCOVERY DOCUMENT REPRODUCTION SERVICES, IN CLASS 35 (U.S. CLS. 100, 101 AND 102).

FIRST USE 2-11-2004; IN COMMERCE 2-11-2004.

FOR: LITIGATION SUPPORT SERVICES; SERVICE OF PROCESS; PUBLIC DOCUMENT FILING SERVICES; ELECTRONIC PUBLIC DOCUMENT FILING SERVICES; PUBLIC DOCUMENT FILING SERVICES BY FAX; COURT PUBLIC DOCUMENT FILING SERVICES; PRIVATE INVESTIGATION SERVICES; PERSONAL BACKGROUND INVESTI-

GATION; INVESTIGATION OF ASSETS, CREDIT REPORTS; BACKGROUND CHECKS; PRE-EMPLOYMENT CHECKS; LEGAL DOCUMENT PREPARATION SERVICES, IN CLASS 45 (U.S. CLS. 100 AND 101).

FIRST USE 2-11-2004; IN COMMERCE 2-11-2004.

NO CLAIM IS MADE TO THE EXCLUSIVE RIGHT TO USE THE DESIGN OF THE SCALES OF JUSTICE AND "LEGAL SERVICES", APART FROM THE MARK AS SHOWN.

SER. NO. 77-310,211, FILED 10-22-2007.

BARNEY CHARLON, EXAMINING ATTORNEY

Int. Cls.: 1 and 30

Prior U.S. Cls.: 1, 5, 6, 10, 26 and 46

United States Patent and Trademark Office

Reg. No. 3,475,371

Registered July 29, 2008

**TRADEMARK
PRINCIPAL REGISTER**

GLYSTAR

CORN PRODUCTS INTERNATIONAL, INC. (DE-
LAWARE CORPORATION)

5 WESTBROOK CORPORATE CENTER

WESTCHESTER, IL 60154

FOR: BLENDS OF GLYCERIN AND POLYOLS
FOR USE AS A GLYCERIN REPLACEMENT FOR
INDUSTRIAL USE, IN CLASS 1 (U.S. CLS. 1, 5, 6, 10,
26 AND 46).

FIRST USE 6-30-2000; IN COMMERCE 6-30-2000.

FOR: BLENDS OF GLYCERIN AND POLYOLS
FOR USE AS A GLYCERIN REPLACEMENT IN
FOOD PRODUCTS, IN CLASS 30 (U.S. CL. 46).

FIRST USE 6-30-2000; IN COMMERCE 6-30-2000.

THE MARK CONSISTS OF STANDARD CHAR-
ACTERS WITHOUT CLAIM TO ANY PARTICULAR
FONT, STYLE, SIZE, OR COLOR.

SER. NO. 77-310,572, FILED 10-23-2007.

ELLEN PERKINS, EXAMINING ATTORNEY

Int. Cl.: 36

Prior U.S. Cls.: 100, 101 and 102

United States Patent and Trademark Office

Reg. No. 3,475,372

Registered July 29, 2008

**SERVICE MARK
PRINCIPAL REGISTER**



RIDER INSURANCE COMPANY (NEW JERSEY CORPORATION)
120 MOUNTAIN AVENUE
SPRINGFIELD, NJ 07081

FOR: INSURANCE SERVICES, NAMELY, WRITING AND PROVIDING PROPERTY AND CASUALTY INSURANCE POLICIES, IN CLASS 36 (U.S. CLS. 100, 101 AND 102).

FIRST USE 12-1-2005; IN COMMERCE 12-1-2005.

THE MARK CONSISTS OF A LINE ARC WHICH IS A SEGMENT OF A CIRCLE WHICH TERMINATES IN A PORTION OF A CHORD OF THE ARC SUBTENDED BY THE CIRCULAR SEGMENT. A PERSPECTIVE IMAGE OF A MOTORCYCLE IS POSITIONED CENTRALLY WITHIN THE ARC AND CHORD.

SER. NO. 77-310,806, FILED 10-23-2007.

KIMBERLY PERRY, EXAMINING ATTORNEY

Int. Cl.: 36

Prior U.S. Cls.: 100, 101 and 102

United States Patent and Trademark Office

Reg. No. 3,475,373

Registered July 29, 2008

**SERVICE MARK
PRINCIPAL REGISTER**



MUSCULAR DYSTROPHY ASSOCIATION, INC.
(NEW YORK NON-PROFIT CORPORATION)
3300 EAST SUNRISE DRIVE
TUCSON, AZ 85718

FOR: CHARITABLE FUNDRAISING SERVICES
FOR BASIC AND APPLIED RESEARCH INTO NEU-
ROMUSCULAR DISORDERS AND FOR FUNDING
SERVICES TO PERSONS AFFLICTED BY SUCH
DISORDERS, IN CLASS 36 (U.S. CLS. 100, 101 AND
102).

FIRST USE 8-0-2007; IN COMMERCE 8-0-2007.

OWNER OF U.S. REG. NOS. 1,678,809, 2,895,111
AND OTHERS.

SER. NO. 77-310,946, FILED 10-23-2007.

AMY ALFIERI, EXAMINING ATTORNEY

Int. Cl.: 9

Prior U.S. Cls.: 21, 23, 26, 36 and 38

United States Patent and Trademark Office

Reg. No. 3,475,374

Registered July 29, 2008

**TRADEMARK
PRINCIPAL REGISTER**

GenTax

FAST ENTERPRISES LLC (NEW YORK LTD
LIAB CO)
SUITE 1500
6400 SOUTH FIDDLER'S GREEN CIRCLE
GREENWOOD VILLAGE, CO 80111

FOR: COMPUTER SOFTWARE FOR DATABASE
MANAGEMENT TO BE SOLD TO GOVERNMENTAL
AGENCIES FOR THE PURPOSE OF ADMINIS-
TERING TAX ADMINISTRATIVE FUNCTIONS
INCLUDING BUT NOT LIMITED TO, TAXPAYER
REGISTRATION, TAX PAYMENTS AND RE-
FUNDS, TAX RETURNS, BILLING, NOTICES, LET-
TERS, COLLECTIONS, AUDITS, TAXPAYER
ACCOUNTS, WORK FLOW, DOCUMENT MAN-

AGEMENT, SECURITY AND CONFIDENTIALITY
OF TAXPAYER INFORMATION AND REPORTS, IN
CLASS 9 (U.S. CLS. 21, 23, 26, 36 AND 38).

FIRST USE 10-5-1998; IN COMMERCE 10-9-1998.

THE MARK CONSISTS OF STANDARD CHAR-
ACTERS WITHOUT CLAIM TO ANY PARTICULAR
FONT, STYLE, SIZE, OR COLOR.

SER. NO. 77-311,220, FILED S.R. 10-23-2007 AM.
P.R. 3-12-2008.

SONYA STEPHENS, EXAMINING ATTORNEY

Int. Cl.: 41

Prior U.S. Cls.: 100, 101 and 107

United States Patent and Trademark Office

Reg. No. 3,475,375

Registered July 29, 2008

SERVICE MARK
PRINCIPAL REGISTER

The logo for Blue Chip Casino Hotel features the words "Blue Chip" in a large, elegant, cursive script. Below "Blue Chip", the words "CASINO HOTEL" are written in a smaller, clean, sans-serif, all-caps font. A thin, horizontal wavy line is positioned underneath the words "CASINO HOTEL".

BOYD GAMING CORPORATION (NEVADA CORPORATION)

4TH FLOOR

6465 S. RAINBOW BLVD.

LAS VEGAS, NV 89118

FOR: CASINO SERVICES; ENTERTAINMENT SERVICES IN THE NATURE OF LIVE PERFORMANCE BY MUSICAL GROUPS AND VOCALISTS, LIVE COMEDY SHOWS, LIVE THEATRICAL PRODUCTIONS, IN CLASS 41 (U.S. CLS. 100, 101 AND 107).

FIRST USE 2-12-2007; IN COMMERCE 2-12-2007.

OWNER OF U.S. REG. NOS. 2,639,237, 2,899,139 AND OTHERS.

NO CLAIM IS MADE TO THE EXCLUSIVE RIGHT TO USE "CASINO HOTEL", APART FROM THE MARK AS SHOWN.

THE MARK CONSISTS OF THE STYLIZED WORDS "BLUE CHIP" WRITTEN ABOVE THE WORDS "CASINO HOTEL", WITH A BROKEN WAVE DESIGN UNDER "CASINO HOTEL".

SER. NO. 77-311,246, FILED 10-23-2007.

RON FAIRBANKS, EXAMINING ATTORNEY

Int. Cl.: 9

Prior U.S. Cls.: 21, 23, 26, 36 and 38

Reg. No. 3,475,376

United States Patent and Trademark Office

Registered July 29, 2008

**TRADEMARK
PRINCIPAL REGISTER**

Precis

QUALITY VISION INTERNATIONAL, INC. (NEW
YORK CORPORATION)
850 HUDSON AVE.
ROCHESTER, NY 14621

THE MARK CONSISTS OF STANDARD CHAR-
ACTERS WITHOUT CLAIM TO ANY PARTICULAR
FONT, STYLE, SIZE, OR COLOR.

FOR: VIDEO MICROSCOPES AND SOFTWARE
FOR USE IN INSPECTION AND MEASUREMENT
OF INDUSTRIAL COMPONENTS, IN CLASS 9 (U.S.
CLS. 21, 23, 26, 36 AND 38).

SER. NO. 77-311,792, FILED 10-24-2007.

FIRST USE 2-0-1990; IN COMMERCE 2-0-1990.

GINA HAYES, EXAMINING ATTORNEY

Int. Cl.: 14

Prior U.S. Cls.: 2, 27, 28 and 50

United States Patent and Trademark Office

Reg. No. 3,475,377

Registered July 29, 2008

**TRADEMARK
PRINCIPAL REGISTER**

BEASTY BLING

NOTO, KATHERINE (UNITED STATES INDIVIDUAL)
225 WEST 94TH STREET, APT 15B
NEW YORK, NY 10025

FOR: COSTUME JEWELRY; GEMSTONE JEWELRY; JEWELRY CHAINS; PET JEWELRY; JEWELRY BOXES NOT OF METAL; JEWELRY CASES NOT OF PRECIOUS METAL, IN CLASS 14 (U.S. CLS. 2, 27, 28 AND 50).

FIRST USE 5-9-2005; IN COMMERCE 5-9-2005.

THE MARK CONSISTS OF STANDARD CHARACTERS WITHOUT CLAIM TO ANY PARTICULAR FONT, STYLE, SIZE, OR COLOR.

NO CLAIM IS MADE TO THE EXCLUSIVE RIGHT TO USE "BLING", APART FROM THE MARK AS SHOWN.

SER. NO. 77-311,861, FILED 10-24-2007.

KATINA MISTER, EXAMINING ATTORNEY

Int. Cl.: 9

Prior U.S. Cls.: 21, 23, 26, 36 and 38

United States Patent and Trademark Office

Reg. No. 3,475,378

Registered July 29, 2008

**TRADEMARK
PRINCIPAL REGISTER**

DIVER-DXD

VAN ESSEN INSTRUMENTS B.V. (NETHER-
LANDS LTD LIAB CO)
DELFTTECHPARK 20
DELFT, NETHERLANDS 2628XH

FOR: APPARATUS FOR READING OUT, PRO-
CESSING AND TRANSMITTING OF DATA; APPA-
RATUS FOR RECEIVING AND SENDING OF
DATA; ELECTRICAL CABLES, IN CLASS 9 (U.S.
CLS. 21, 23, 26, 36 AND 38).

THE MARK CONSISTS OF STANDARD CHAR-
ACTERS WITHOUT CLAIM TO ANY PARTICULAR
FONT, STYLE, SIZE, OR COLOR.

PRIORITY CLAIMED UNDER SEC. 44(D) ON
BENELUX APPLICATION NO. 1139323, FILED 7-13-
2007, REG. NO. 826973, DATED 10-5-2007, EXPIRES 7-
13-2017.

OWNER OF U.S. REG. NOS. 3,024,970, 3,315,594
AND OTHERS.

SER. NO. 77-311,873, FILED 10-24-2007.

PAM WILLIS, EXAMINING ATTORNEY

Int. Cl.: 9

Prior U.S. Cls.: 21, 23, 26, 36 and 38

United States Patent and Trademark Office

Reg. No. 3,475,379

Registered July 29, 2008

**TRADEMARK
PRINCIPAL REGISTER**

DIVER-OFFICE

VAN ESSEN INSTRUMENTS B.V. (NETHER-
LANDS LTD LIAB CO)
DELFTTECHPARK 20
DELFT, NETHERLANDS 2628XH

FOR: COMPUTER SOFTWARE FOR MEASUR-
ING AND PROCESSING DATA RELATIVE TO
WATER, IN CLASS 9 (U.S. CLS. 21, 23, 26, 36 AND 38).

THE MARK CONSISTS OF STANDARD CHAR-
ACTERS WITHOUT CLAIM TO ANY PARTICULAR
FONT, STYLE, SIZE, OR COLOR.

PRIORITY CLAIMED UNDER SEC. 44(D) ON
BENELUX APPLICATION NO. 1139325, FILED 7-13-
2007, REG. NO. 826972, DATED 10-5-2007, EXPIRES 7-
13-2017.

OWNER OF U.S. REG. NOS. 3,024,970, 3,315,594
AND OTHERS.

SER. NO. 77-311,997, FILED 10-24-2007.

PAM WILLIS, EXAMINING ATTORNEY

Int. Cls.: 16 and 41

Prior U.S. Cls.: 2, 5, 22, 23, 29, 37, 38, 50, 100, 101 and 107

Reg. No. 3,475,380

United States Patent and Trademark Office

Registered July 29, 2008

**TRADEMARK
SERVICE MARK
PRINCIPAL REGISTER**

ART AT YOUR FINGERTIPS

PALOS VERDES ART CENTER (CALIFORNIA CORPORATION)
5504 WEST CRESTRIDGE ROAD
RANCHO PALOS VERDES, CA 90275

FOR: PRINTED TEACHING MATERIALS IN THE FIELD OF ART, IN CLASS 16 (U.S. CLS. 2, 5, 22, 23, 29, 37, 38 AND 50).

FIRST USE 9-30-1976; IN COMMERCE 3-31-1987.

FOR: EDUCATIONAL SERVICES, NAMELY, CONDUCTING COURSES IN THE FIELD OF ART AND DISTRIBUTION OF COURSE MATERIAL IN CONNECTION THEREWITH, IN CLASS 41 (U.S. CLS. 100, 101 AND 107).

FIRST USE 9-30-1976; IN COMMERCE 3-31-1987.

THE MARK CONSISTS OF STANDARD CHARACTERS WITHOUT CLAIM TO ANY PARTICULAR FONT, STYLE, SIZE, OR COLOR.

NO CLAIM IS MADE TO THE EXCLUSIVE RIGHT TO USE "ART", APART FROM THE MARK AS SHOWN.

SER. NO. 77-312,145, FILED 10-24-2007.

PAUL MORENO, EXAMINING ATTORNEY

Int. Cl.: 35

Prior U.S. Cls.: 100, 101 and 102

United States Patent and Trademark Office

Reg. No. 3,475,381

Registered July 29, 2008

**SERVICE MARK
PRINCIPAL REGISTER**

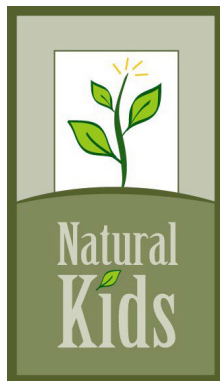

LEWIS, DONNA DOLEMAN (UNITED STATES
INDIVIDUAL)
8830 LAKEWAY COURT
YPSILANTI TOWNSHIP, MI 48197

WHITE, AND YELLOW IS/ARE CLAIMED AS A
FEATURE OF THE MARK.

FOR: BUSINESS MARKETING SERVICES,
NAMELY, PROVIDING MARKETING CONSULTA-
TION TO SCHOOLS AND BUSINESS ENTITIES
REGARDING THEIR USE OF ECO-FRIENDLY PO-
LICIES, PROCEDURES, CURRICULA, AND PRO-
DUCTS, IN CLASS 35 (U.S. CLS. 100, 101 AND 102).

FIRST USE 10-9-2006; IN COMMERCE 9-9-2007.

NO CLAIM IS MADE TO THE EXCLUSIVE
RIGHT TO USE "KIDS", APART FROM THE MARK
AS SHOWN.

THE COLOR(S) ARMY GREEN, FOREST GREEN,
LIME GREEN, PEA GREEN, MUTED GREEN,

THE MARK CONSISTS OF VERTICAL BOX OUT-
LINED IN ARMY GREEN DIVIDED BY AN ARMY
GREEN ARC, UPON WHICH SITS A FOREST
GREEN SAPLING WITH LIME GREEN LEAVES
AND A YELLOW TOP SURROUNDED BY A WHITE
BOX WITHIN A MUTED GREEN BORDER. UNDER
THE FOREST GREEN ARC, THE STYLIZED WORD
"NATURAL" ABOVE THE SYLIZED WORD "KIDS"
WITH A LIME GREEN LEAF AS THE DOT IN THE
"I".

SER. NO. 77-312,361, FILED 10-24-2007.

DORITT L. CARROLL, EXAMINING ATTORNEY

Int. Cl.: 35

Prior U.S. Cls.: 100, 101 and 102

United States Patent and Trademark Office

Reg. No. 3,475,382

Registered July 29, 2008

**SERVICE MARK
PRINCIPAL REGISTER**



ATL PEACHES (GEORGIA JOINT VENTURE)
4794 SHALLOW RIDGE ROAD
KENNESAW, GA 30144

FOR: ADVERTISING SERVICES, PUBLIC RELATIONS AND MARKETING SERVICES, NAMELY, PROMOTING AND MARKETING THE GOODS AND SERVICES OF OTHERS THROUGH ALL PUBLIC COMMUNICATION MEANS; ADVERTISING, INCLUDING PROMOTION RELATING TO THE SALE OF ARTICLES AND SERVICES FOR THIRD PARTIES BY THE TRANSMISSION OF ADVERTISING MATERIAL AND THE DISSEMINATION OF ADVERTISING MESSAGES ON COMPUTER NETWORKS; ADVERTISING, MARKETING AND PROMOTION SERVICES; ADVERTISING, MARKETING AND PROMOTIONAL SERVICES FOR AUTOMOTIVE DEALERSHIPS; ADVERTISING, PROMOTION AND MARKETING SERVICES IN THE NATURE OF E-MAIL BLAST CAMPAIGNS FOR OTHERS; ARRANGING AND CONDUCTING MARKETING PROMOTIONAL EVENTS FOR OTHERS; ASSOCIATION SERVICES, NAMELY, PROMOTING DIVERSITY IN THE RESTAURANT AND HOTEL INDUSTRIES ON BEHALF OF EMPLOYEES, VENDORS, MANAGEMENT, AND OWNERS; CHAMBER OF COMMERCE SERVICES, NAMELY, PROMOTING BUSINESS AND TOURISM IN THE ATLANTA, GEORGIA AREA; CONTESTS AND INCENTIVE AWARD PROGRAMS TO PROMOTE THE SALE OF PRODUCTS AND SERVICES OF OTHERS; DEVELOPING PROMOTIONAL CAMPAIGNS FOR BUSINESS; ADVERTISING AGENCIES, NAMELY, PROMOTING THE SERVICES OF BUSINESS THROUGH THE DISTRIBUTION OF PRINTED AND AUDIO PROMOTIONAL MATERIALS AND

BY RENDERING SALES PROMOTION ADVICE; ADVERTISING AND BUSINESS SERVICES, NAMELY SECURING AIRTIME ON ALL FORMS OF MEDIA COMMUNICATIONS STATIONS, SYSTEMS, NETWORKS, AND SERVICES FOR THE PURPOSE OF PROMOTING THE GOODS AND SERVICES OF OTHERS; ADVERTISING AND PROMOTION SERVICES AND RELATED CONSULTING; ADVERTISING AND PROMOTIONAL SERVICES; ADVERTISING AND PUBLICITY SERVICES, NAMELY, PROMOTING THE GOODS, SERVICES, BRAND IDENTITY AND COMMERCIAL INFORMATION AND NEWS OF THIRD PARTIES THROUGH PRINT, AUDIO, VIDEO, DIGITAL AND ON-LINE MEDIUM; ADVERTISING PARTICULARLY SERVICES FOR THE PROMOTION OF GOODS; ADVERTISING SERVICES, NAMELY, PROMOTING AND MARKETING THE GOODS AND SERVICES OF OTHERS THROUGH ALL PUBLIC COMMUNICATION MEANS; ADVERTISING SERVICES, NAMELY, PROMOTING THE FOOD AND WINE OF OTHERS; ADVERTISING SERVICES, NAMELY, PROMOTING THE GIFT CARDS OF OTHERS; ENTERTAINMENT MARKETING SERVICES, NAMELY, MARKETING, PROMOTION AND ADVERTISING FOR INDEPENDENT RECORDING ARTISTS; MODELING FOR ADVERTISING OR SALES PROMOTION; MODELING SERVICES FOR ADVERTISING OR SALES PROMOTION; ORGANIZATION OF PROMOTIONS USING AUDIOVISUAL MEDIA; PREPARING PROMOTIONAL AND MERCHANDISING MATERIAL FOR OTHERS; PRODUCING PROMOTIONAL VIDEOTAPES, VIDEO DISCS, AND AUDIO VISUAL RECORDINGS; PROMOTING SPORTS COMPETITIONS AND/OR EVENTS OF OTHERS; PROMOTING THE CON-

CERTS OF OTHERS; PROMOTING THE ECONOMIC DEVELOPMENT IN THE ATLANTA, GEORGIA AREA; PROMOTING THE GOODS AND SERVICES OF OTHERS BY ARRANGING FOR SPONSORS TO AFFILIATE THEIR GOODS AND SERVICES WITH AN AWARDS PROGRAM, A SPORTS COMPETITION AND SPORTING ACTIVITIES; PROMOTING THE GOODS AND SERVICES OF OTHERS BY DISTRIBUTING ADVERTISING MATERIALS THROUGH A VARIETY OF METHODS; PROMOTING THE GOODS AND SERVICES OF OTHERS BY PROVIDING A WEBSITE FEATURING COUPONS, REBATES, PRICE-COMPARISON INFORMATION, PRODUCT REVIEWS, LINKS TO THE RETAIL WEBSITES OF OTHERS, AND DISCOUNT INFORMATION; PROMOTING THE GOODS AND SERVICES OF OTHERS BY PROVIDING HYPERTEXT LINKS TO THE WEB SITES OF OTHERS; PROMOTING THE GOODS AND SERVICES OF OTHERS THROUGH THE DISTRIBUTION OF DISCOUNT CARDS; PROMOTING THE GOODS AND SERVICES OF OTHERS VIA A GLOBAL COMPUTER NETWORK; PROMOTING THE PARTIES AND SPECIAL EVENTS OF OTHERS; PROMOTING, ADVERTISING AND MARKETING OF THE ON-LINE WEBSITES OF OTHERS; PROMOTION AND MARKETING SERVICES AND RELATED CONSULTING; PROMOTION OF BUSINESS OPPORTUNITIES; PROMOTION USING AUDIOVISUAL MEDIA; PROMOTION, ADVERTISING AND MARKETING OF ON-LINE WEBSITES; PROMOTIONAL SERVICES, NAMELY PROMOTING THE CHARITIES OF OTHERS; PROVIDING A LIVE FORUM

FOR COMPANIES TO SHOWCASE, DISPLAY, DEMONSTRATE AND PROMOTE NEW AND INNOVATIVE IDEAS, PRODUCTS AND SERVICES IN THE CONVENTION/MEETING MANAGEMENT ARENA; PROVIDING MARKETING AND PROMOTION OF SPECIAL EVENTS; SALES PROMOTION FOR OTHERS PROVIDED THROUGH THE DISTRIBUTION AND THE ADMINISTRATION OF PRIVILEGED USER CARDS; SALES PROMOTION SERVICES, IN CLASS 35 (U.S. CLS. 100, 101 AND 102).

FIRST USE 5-19-2007; IN COMMERCE 5-19-2007.

NO CLAIM IS MADE TO THE EXCLUSIVE RIGHT TO USE "ATL PEACHES", APART FROM THE MARK AS SHOWN.

THE COLOR(S) PEACH, WHITE AND LIGHT GREEN IS/ARE CLAIMED AS A FEATURE OF THE MARK.

THE MARK CONSISTS OF A PEACH WITH BITE MARK IN THE UPPER RIGHT AND LEAF ON THE TOP. THE OUTLINE OF THE PEACH IS THE COLOR PEACH AND THE CENTER IS WHITE. THE LEAF IS GREEN. THE WORDS ARE WHITE OUTLINED IN PEACH.

SER. NO. 77-312,863, FILED 10-25-2007.

G. MAYERSCHOFF, EXAMINING ATTORNEY

Int. Cl.: 41

Prior U.S. Cls.: 100, 101 and 107

United States Patent and Trademark Office

Reg. No. 3,475,383

Registered July 29, 2008

**SERVICE MARK
PRINCIPAL REGISTER**

Little Flowers and Friends

ARCIERI, MARIANNE (UNITED STATES INDIVIDUAL)
27 WHITE SISTERS WAY
CANTON, MA 020212048

FOR: EDUCATION SERVICES, NAMELY, PROVIDING CLASSES, SEMINARS, AND WORKSHOPS IN THE FIELDS OF MUSIC, DANCE, ARTS, CRAFTS, EXERCISE, FITNESS, SELF-ESTEEM, SELF-LOVE, AND SOCIAL ACCEPTANCE FOR SPECIAL NEEDS CHILDREN AND COMPASSIONATE FRIENDS, IN CLASS 41 (U.S. CLS. 100, 101 AND 107).

FIRST USE 1-0-2004; IN COMMERCE 1-0-2004.

THE MARK CONSISTS OF STANDARD CHARACTERS WITHOUT CLAIM TO ANY PARTICULAR FONT, STYLE, SIZE, OR COLOR.

NO CLAIM IS MADE TO THE EXCLUSIVE RIGHT TO USE "FRIENDS", APART FROM THE MARK AS SHOWN.

SER. NO. 77-313,094, FILED 10-25-2007.

STEVEN R. FINE, EXAMINING ATTORNEY

Int. Cl.: 7

Prior U.S. Cls.: 13, 19, 21, 23, 31, 34 and 35

United States Patent and Trademark Office

Reg. No. 3,475,384

Registered July 29, 2008

**TRADEMARK
PRINCIPAL REGISTER**



red brilliant

BSH BOSCH UND SIEMENS HAUSGERAETE
GMBH (FED REP GERMANY CORPORATION)
CARL-WERY-STRASSE 34
MUNICH, FED REP GERMANY 81739

PRIORITY CLAIMED UNDER SEC. 44(D) ON FED
REP GERMANY APPLICATION NO. 30733325.6/0,
FILED 5-22-2007, REG. NO. 30733325, DATED 7-17-
2007, EXPIRES 5-31-2017.

FOR: HOUSEHOLD AND KITCHEN MACHINES
AND EQUIPMENT, NAMELY, ELECTRIC KITCH-
EN MACHINES AND EQUIPMENT, NAMELY, VA-
CUUM CLEANERS; STRUCTURAL PARTS OF ALL
AFOREMENTIONED GOODS, IN CLASS 7 (U.S. CLS.
13, 19, 21, 23, 31, 34 AND 35).

SER. NO. 77-313,274, FILED 10-25-2007.

JASON BLAIR, EXAMINING ATTORNEY

Int. Cl.: 35

Prior U.S. Cls.: 100, 101 and 102

United States Patent and Trademark Office

Reg. No. 3,475,385

Registered July 29, 2008

**SERVICE MARK
PRINCIPAL REGISTER**

MartiCons

MARTINDALE CONSULTANTS, INC. (OKLAHOMA CORPORATION)
4242 N. MERIDIAN
OKLAHOMA CITY, OK 73112

FOR: AUDITING, CONSULTING, BOOKKEEPING AND TEMPORARY PLACEMENT SERVICES, NAMELY, IN THE ACCOUNTING SECTOR OF THE OIL AND GAS INDUSTRY, IN CLASS 35 (U.S. CLS. 100, 101 AND 102).

FIRST USE 3-1-2003; IN COMMERCE 3-1-2003.

THE MARK CONSISTS OF STANDARD CHARACTERS WITHOUT CLAIM TO ANY PARTICULAR FONT, STYLE, SIZE, OR COLOR.

SER. NO. 77-313,481, FILED 10-25-2007.

JILL C. ALT, EXAMINING ATTORNEY

Int. Cl.: 9

Prior U.S. Cls.: 21, 23, 26, 36 and 38

Reg. No. 3,475,386

United States Patent and Trademark Office

Registered July 29, 2008

**TRADEMARK
PRINCIPAL REGISTER**

USTEST

SOUTHWEST ENVIRONMENTAL SERVICES,
INC. (ARIZONA CORPORATION)
13901 N. 73RD ST., SUITE 203
SCOTTSDALE, AZ 85260

THE MARK CONSISTS OF STANDARD CHAR-
ACTERS WITHOUT CLAIM TO ANY PARTICULAR
FONT, STYLE, SIZE, OR COLOR.

FOR: COMPUTERIZED TANK TIGHTNESS
TESTING SYSTEM, COMPRISED OF AN ELECTON-
IC PROBE AND PROCESSOR, USED FOR UNDER-
GROUND STORAGE TANKS TO DETECT LEAKS
AND REPORT FUEL INVENTORY, IN CLASS 9 (U.S.
CLS. 21, 23, 26, 36 AND 38).

SEC. 2(F).

SER. NO. 77-313,505, FILED 10-25-2007.

FIRST USE 10-19-1990; IN COMMERCE 10-19-1990.

CHARLES L. JENKINS, EXAMINING ATTORNEY

Int. Cl.: 35

Prior U.S. Cls.: 100, 101 and 102

United States Patent and Trademark Office

Reg. No. 3,475,387

Registered July 29, 2008

**SERVICE MARK
PRINCIPAL REGISTER**

iLUXCARS

FM ORANGE COUNTY (CALIFORNIA LTD
LIAB CO)
1470 DALE WAY
COSTA MESA, CA 92626

FOR: INTERNET-BASED WHOLESALE SERVICES FOR CAR DEALERS IN WHICH ONE DEALER POSTS AUTOMOBILES TO BE SOLD AT WHOLESALE TO OTHER DEALERS, WITH ALL TRANSACTIONS PERFORMED VIA THE INTERNET; PROVIDING INFORMATION ABOUT AUTOMOBILES FOR SALE BY MEANS OF THE INTERNET, IN CLASS 35 (U.S. CLS. 100, 101 AND 102).

FIRST USE 8-9-2005; IN COMMERCE 8-9-2005.

THE MARK CONSISTS OF STANDARD CHARACTERS WITHOUT CLAIM TO ANY PARTICULAR FONT, STYLE, SIZE, OR COLOR.

SER. NO. 77-313,601, FILED 10-25-2007.

STEPHEN AQUILA, EXAMINING ATTORNEY

Int. Cl.: 35

Prior U.S. Cls.: 100, 101 and 102

United States Patent and Trademark Office

Reg. No. 3,475,388

Registered July 29, 2008

**SERVICE MARK
PRINCIPAL REGISTER**

 LUXCARS

FM ORANGE COUNTY (CALIFORNIA LTD
LIAB CO)
1470 DALE WAY
COSTA MESA, CA 92626

FOR: INTERNET-BASED WHOLESALE SERVICES FOR CAR DEALERS IN WHICH ONE DEALER POSTS AUTOMOBILES TO BE SOLD AT WHOLESALE TO OTHER DEALERS, WITH ALL TRANSACTIONS PERFORMED VIA THE INTERNET; PROVIDING INFORMATION ABOUT AUTOMOBILES FOR SALE BY MEANS OF THE INTERNET, IN CLASS 35 (U.S. CLS. 100, 101 AND 102).

FIRST USE 8-9-2005; IN COMMERCE 8-9-2005.

THE MARK CONSISTS OF A STYLIZED LOWER CASE LETTER "I" ENCLOSED IN A CIRCLE, WITH THE BASE OF THE LETTER "I" MERGING WITH THE CIRCLE, FOLLOWED BY THE REMAINING LITERAL ELEMENTS OF THE MARK, "LUXCARS", IN ALL UPPER CASE LETTERS.

SER. NO. 77-313,659, FILED 10-25-2007.

STEPHEN AQUILA, EXAMINING ATTORNEY

Int. Cl.: 9

Prior U.S. Cls.: 21, 23, 26, 36 and 38

Reg. No. 3,475,389

United States Patent and Trademark Office

Registered July 29, 2008

**TRADEMARK
PRINCIPAL REGISTER**

SUCCESS BY DESIGN

STANDARD MICROSYSTEMS CORPORATION
(DELAWARE CORPORATION)
80 ARKAY DRIVE
HAUPPAUGE, NY 11788

FOR: INTEGRATED CIRCUITS; COMPUTER
HARDWARE, NAMELY, HUBS AND BASE STA-
TIONS; AND COMPUTER SOFTWARE, NAMELY,
DEVICE DRIVER SOFTWARE, SOFTWARE FOR
USE IN FACILITATING DATA COMMUNICATION
AND EXCHANGE, AND SOFTWARE FOR USE IN
CONNECTION WITH INTEGRATED CIRCUITS, IN
CLASS 9 (U.S. CLS. 21, 23, 26, 36 AND 38).

FIRST USE 12-26-2003; IN COMMERCE 4-26-2004.

THE MARK CONSISTS OF STANDARD CHAR-
ACTERS WITHOUT CLAIM TO ANY PARTICULAR
FONT, STYLE, SIZE, OR COLOR.

OWNER OF U.S. REG. NO. 3,110,149.

SER. NO. 77-313,753, FILED 10-25-2007.

PAUL MORENO, EXAMINING ATTORNEY

Int. Cl.: 17

Prior U.S. Cls.: 1, 5, 12, 13, 35 and 50

United States Patent and Trademark Office

Reg. No. 3,475,390

Registered July 29, 2008

**TRADEMARK
PRINCIPAL REGISTER**

Microbisan

LENDELL MANUFACTURING, INC. (MICHIGAN CORPORATION)
5301 S. GRAHAM ROAD
SAINT CHARLES, MI 48655

THE MARK CONSISTS OF STANDARD CHARACTERS WITHOUT CLAIM TO ANY PARTICULAR FONT, STYLE, SIZE, OR COLOR.

FOR: OPEN CELL FOAM IN ROLL FORM, IN CLASS 17 (U.S. CLS. 1, 5, 12, 13, 35 AND 50).

SER. NO. 77-313,754, FILED 10-25-2007.

FIRST USE 7-2-2002; IN COMMERCE 7-2-2002.

DAVID COLLIER, EXAMINING ATTORNEY

Int. Cl.: 36

Prior U.S. Cls.: 100, 101 and 102

United States Patent and Trademark Office

Reg. No. 3,475,391

Registered July 29, 2008

**SERVICE MARK
PRINCIPAL REGISTER**

LOCK-UP

MUSCULAR DYSTROPHY ASSOCIATION, INC.
(NEW YORK NON-PROFIT CORPORATION)
3300 EAST SUNRISE DRIVE
TUCSON, AZ 85718

THE MARK CONSISTS OF STANDARD CHAR-
ACTERS WITHOUT CLAIM TO ANY PARTICULAR
FONT, STYLE, SIZE, OR COLOR.

FOR: CHARITABLE FUNDRAISING SERVICES,
IN CLASS 36 (U.S. CLS. 100, 101 AND 102).

SER. NO. 77-313,818, FILED 10-25-2007.

FIRST USE 1-31-1990; IN COMMERCE 1-31-1990.

AMY ALFIERI, EXAMINING ATTORNEY

Int. Cl.: 9

Prior U.S. Cls.: 21, 23, 26, 36 and 38

Reg. No. 3,475,392

United States Patent and Trademark Office

Registered July 29, 2008

**TRADEMARK
PRINCIPAL REGISTER**

NOHO SOFTWARE

DAVID GRANT, INC. (CALIFORNIA CORPORATION)
SUITE 320
13245 RIVERSIDE DRIVE
SHERMAN OAKS, CA 91423

FOR: CHILD CARE ADMINISTRATION SOFTWARE FOR MANAGING CASELOADS, TRACKING ATTENDANCE, MAINTAINING WAITING LISTS AND CONDUCTING CHILD CARE RESOURCE AND REFERRAL ACTIVITIES, IN CLASS 9 (U.S. CLS. 21, 23, 26, 36 AND 38).

FIRST USE 6-1-1997; IN COMMERCE 6-1-1997.

THE MARK CONSISTS OF STANDARD CHARACTERS WITHOUT CLAIM TO ANY PARTICULAR FONT, STYLE, SIZE, OR COLOR.

NO CLAIM IS MADE TO THE EXCLUSIVE RIGHT TO USE "SOFTWARE", APART FROM THE MARK AS SHOWN.

SEC. 2(F).

SER. NO. 77-313,958, FILED 10-25-2007.

MARK RADEMACHER, EXAMINING ATTORNEY

Int. Cl.: 35

Prior U.S. Cls.: 100, 101 and 102

United States Patent and Trademark Office

Reg. No. 3,475,393

Registered July 29, 2008

**SERVICE MARK
PRINCIPAL REGISTER**



AMERICAN ASSOCIATION OF NATURAL
HORSEMEN (IOWA CORPORATION)
2609 XENIA AVENUE
SOMERS, IA 50586

FOR: PROMOTING AWARENESS OF THE NEED
FOR TRAINING HORSES USING NATURAL TECH-
NIQUES AND METHODS, NAMELY, TOUCH, PO-
SITIVE REINFORCEMENT, AND TRUST, IN CLASS
35 (U.S. CLS. 100, 101 AND 102).

FIRST USE 9-18-2007; IN COMMERCE 9-18-2007.

NO CLAIM IS MADE TO THE EXCLUSIVE
RIGHT TO USE "AMERICAN ASSOCIATION OF
NATURAL HORSEMEN", APART FROM THE
MARK AS SHOWN.

SER. NO. 77-314,174, FILED 10-26-2007.

MARK RADEMACHER, EXAMINING ATTORNEY

Int. Cl.: 41

Prior U.S. Cls.: 100, 101 and 107

United States Patent and Trademark Office

Reg. No. 3,475,394

Registered July 29, 2008

**SERVICE MARK
PRINCIPAL REGISTER**

Real Raise

HUBBARD, DAVID N (UNITED STATES INDIVIDUAL)
10599 RIDGECREST CIRCLE
HIGHLANDS RANCH, CO 80129

FOR: EDUCATIONAL AND ENTERTAINMENT SERVICES, NAMELY, A CONTINUING PROGRAM ABOUT CAREER DEVELOPMENT ACCESSIBLE BY RADIO, TELEVISION, SATELLITE, AUDIO, VIDEO AND COMPUTER NETWORKS, IN CLASS 41 (U.S. CLS. 100, 101 AND 107).

FIRST USE 10-15-2007; IN COMMERCE 10-15-2007.

THE MARK CONSISTS OF STANDARD CHARACTERS WITHOUT CLAIM TO ANY PARTICULAR FONT, STYLE, SIZE, OR COLOR.

NO CLAIM IS MADE TO THE EXCLUSIVE RIGHT TO USE "RAISE", APART FROM THE MARK AS SHOWN.

SER. NO. 77-314,579, FILED 10-26-2007.

ALICE BENMAMAN, EXAMINING ATTORNEY

Int. Cl.: 3

Prior U.S. Cls.: 1, 4, 6, 50, 51 and 52

United States Patent and Trademark Office

Reg. No. 3,475,395

Registered July 29, 2008

**TRADEMARK
PRINCIPAL REGISTER**

SUN LAB

IN GEAR FASHIONS, INC. (FLORIDA CORPORATION)
16085 NW 52ND AVE
MIAMI, FL 33014

FOR: AFTER SUN CREAMS; AFTER-SUN LOTIONS; AFTER-SUN OILS; SUN BLOCK PREPARATIONS; SUN CARE LOTIONS; SUN SCREEN PREPARATIONS; SUN TAN GEL; SUN TAN LOTION; SUN TAN OIL, IN CLASS 3 (U.S. CLS. 1, 4, 6, 50, 51 AND 52).

FIRST USE 3-6-2008; IN COMMERCE 3-6-2008.

THE MARK CONSISTS OF STANDARD CHARACTERS WITHOUT CLAIM TO ANY PARTICULAR FONT, STYLE, SIZE, OR COLOR.

NO CLAIM IS MADE TO THE EXCLUSIVE RIGHT TO USE "SUN", APART FROM THE MARK AS SHOWN.

SER. NO. 77-314,976, FILED 10-26-2007.

KEVIN DINALLO, EXAMINING ATTORNEY

Int. Cl.: 42

Prior U.S. Cls.: 100 and 101

United States Patent and Trademark Office

Reg. No. 3,475,396

Registered July 29, 2008

**SERVICE MARK
PRINCIPAL REGISTER**

SOCIALCAST

EVENT ROBOT, INC. (DELAWARE CORPORATION)
SUITE 120
9891 IRVINE CENTER DRIVE
IRVINE, CA 92618

THE MARK CONSISTS OF STANDARD CHARACTERS WITHOUT CLAIM TO ANY PARTICULAR FONT, STYLE, SIZE, OR COLOR.

FOR: APPLICATION SERVICE PROVIDER (ASP), NAMELY, HOSTING COMPUTER SOFTWARE APPLICATIONS OF OTHERS, IN CLASS 42 (U.S. CLS. 100 AND 101).

SER. NO. 77-315,028, FILED 10-26-2007.

FIRST USE 11-18-2004; IN COMMERCE 3-1-2005.

KATHERINE CONNOLLY, EXAMINING ATTORNEY

Int. Cl.: 41

Prior U.S. Cls.: 100, 101 and 107

United States Patent and Trademark Office

Reg. No. 3,475,397

Registered July 29, 2008

**SERVICE MARK
PRINCIPAL REGISTER**



ROSE, DOUGLAS E. (UNITED STATES INDIVIDUAL)
4 N. HOUSTON LANE
LODI, CA 95240

FOR: ARRANGING AND CONDUCTING ENTERTAINMENT EXHIBITIONS IN THE FIELD OF AUTOMOBILE RACING, IN CLASS 41 (U.S. CLS. 100, 101 AND 107).

FIRST USE 2-13-2007; IN COMMERCE 3-3-2007.

THE COLOR(S) YELLOW, BLACK AND RED IS/ARE CLAIMED AS A FEATURE OF THE MARK.

THE MARK CONSISTS OF SOLID YELLOW LETTERING OUTLINED WITH BLACK AGAINST A SOLID RED BACKGROUND.

SER. NO. 77-315,051, FILED 10-26-2007.

KATHRYN COWARD, EXAMINING ATTORNEY

Int. Cl.: 42

Prior U.S. Cls.: 100 and 101

United States Patent and Trademark Office

Reg. No. 3,475,398

Registered July 29, 2008

**SERVICE MARK
PRINCIPAL REGISTER**

TAXOLOGY SOLUTIONS, LLC

TAXOLOGY SOLUTIONS, LLC (DELAWARE
LTD LIAB CO)
38 BUCHANAN ROAD
SALEM, MA 01970

FOR: PROVIDING TEMPORARY USE OF ON-
LINE NON-DOWNLOADABLE SOFTWARE FOR
PURPOSES OF CALCULATING SALES AND USE
TAX LIABILITIES AND FOR CREATING SALES
AND USE TAX LIABILITY REPORTS , IN CLASS 42
(U.S. CLS. 100 AND 101).

FIRST USE 8-30-2007; IN COMMERCE 8-30-2007.

THE MARK CONSISTS OF STANDARD CHAR-
ACTERS WITHOUT CLAIM TO ANY PARTICULAR
FONT, STYLE, SIZE, OR COLOR.

NO CLAIM IS MADE TO THE EXCLUSIVE
RIGHT TO USE "SOLUTIONS, LLC", APART FROM
THE MARK AS SHOWN.

SER. NO. 77-315,123, FILED 10-26-2007.

MARK RADEMACHER, EXAMINING ATTORNEY

Int. Cl.: 41

Prior U.S. Cls.: 100, 101 and 107

United States Patent and Trademark Office

Reg. No. 3,475,399

Registered July 29, 2008

**SERVICE MARK
PRINCIPAL REGISTER**

VENOMGIRLS

VENOM ENTERPRISES, LLC (NEVADA LTD
LIAB CO)
3415 RAWHIDE STREET
LAS VEGAS, NV 89120

FOR: ENTERTAINMENT SERVICES, NAMELY,
PROVIDING A WEBSITE FEATURING PHOTO-
GRAPHIC, AUDIO, VIDEO AND PROSE PRESEN-
TATIONS FEATURING ADULT MATERIAL, IN
CLASS 41 (U.S. CLS. 100, 101 AND 107).

FIRST USE 6-4-2006; IN COMMERCE 6-4-2006.

THE MARK CONSISTS OF STANDARD CHAR-
ACTERS WITHOUT CLAIM TO ANY PARTICULAR
FONT, STYLE, SIZE, OR COLOR.

SER. NO. 77-316,517, FILED S.R. 10-30-2007 AM.
P.R. 10-30-2007.

HEATHER THOMPSON, EXAMINING ATTORNEY

Int. Cl.: 9

Prior U.S. Cls.: 21, 23, 26, 36 and 38

Reg. No. 3,475,400

United States Patent and Trademark Office

Registered July 29, 2008

**TRADEMARK
PRINCIPAL REGISTER**

eSight

HAWKESBURY CONSULTING LIMITED (UNITED KINGDOM LTD LIAB CO)
5 CARISBROOKE COURT, BUCKINGWAY BUS PARK
SWAVESEY, CAMBRIDGE, ENGLAND CB244UQ

FOR: COMPUTER SOFTWARE FOR THE COLLECTION, MONITORING AND TARGETING OF ENERGY DATA, TO PREPARE REPORTS BASED THEREON, AND TO PRODUCE ENERGY BILLING DATA, IN CLASS 9 (U.S. CLS. 21, 23, 26, 36 AND 38).

THE MARK CONSISTS OF STANDARD CHARACTERS WITHOUT CLAIM TO ANY PARTICULAR FONT, STYLE, SIZE, OR COLOR.

OWNER OF ENGLAND REG. NO. 2354059, DATED 1-22-2004, EXPIRES 1-22-2014.

SER. NO. 77-316,531, FILED 10-30-2007.

JAMES A. RAUEN, EXAMINING ATTORNEY

Int. Cl.: 25

Prior U.S. Cls.: 22 and 39

United States Patent and Trademark Office

Reg. No. 3,475,401

Registered July 29, 2008

**TRADEMARK
PRINCIPAL REGISTER**

ERIKA RAE

ERIKA R.SCHUSTER (UNITED STATES INDIVIDUAL)
C/O SCOTT J. SCHUSTER
283 WASHINGTON AVENUE
ALBANY, NY 12206

THE NAME(S), PORTRAIT(S), AND/OR SIGNATURE(S) SHOWN IN THE MARK IDENTIFIES "ERIKA R. SCHUSTER", A LIVING INDIVIDUAL, WHOSE CONSENT(S) TO REGISTER IS SUBMITTED."

FOR: TOPS, IN CLASS 25 (U.S. CLS. 22 AND 39).

FIRST USE 9-29-2005; IN COMMERCE 9-29-2005.

SER. NO. 77-316,569, FILED 10-30-2007.

THE MARK CONSISTS OF STANDARD CHARACTERS WITHOUT CLAIM TO ANY PARTICULAR FONT, STYLE, SIZE, OR COLOR.

MICHAEL KEATING, EXAMINING ATTORNEY

Int. Cl.: 32

Prior U.S. Cls.: 45, 46 and 48

United States Patent and Trademark Office

Reg. No. 3,475,402

Registered July 29, 2008

**TRADEMARK
PRINCIPAL REGISTER**

MEXICO VIA PACIFICO

CERVECERIA DEL PACIFICO, S.A. DE C.V.
(MEXICO CORPORATION)
CALZADA GABRIEL LEYVA Y MELCHOR OCAM-
PO
S/N COL. CENTRO
MAZATLAN, SINALOA, C.P, MEXICO 82000

FOR: BEER, IN CLASS 32 (U.S. CLS. 45, 46 AND 48).

FIRST USE 1-0-2004; IN COMMERCE 1-0-2004.

THE MARK CONSISTS OF STANDARD CHAR-
ACTERS WITHOUT CLAIM TO ANY PARTICULAR
FONT, STYLE, SIZE, OR COLOR.

OWNER OF U.S. REG. NOS. 1,336,171, 2,885,751
AND OTHERS.

NO CLAIM IS MADE TO THE EXCLUSIVE
RIGHT TO USE "MEXICO", APART FROM THE
MARK AS SHOWN.

THE FOREIGN WORDING IN THE MARK
TRANSLATES INTO ENGLISH AS PACIFIC.

SER. NO. 77-317,242, FILED 10-30-2007.

DOMINICK J. SALEMI, EXAMINING ATTORNEY

Int. Cl.: 31

Prior U.S. Cls.: 1 and 46

United States Patent and Trademark Office

Reg. No. 3,475,403

Registered July 29, 2008

**TRADEMARK
PRINCIPAL REGISTER**

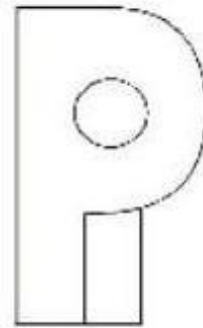

Protein, Inc.

T.L. MONTGOMERY & ASSOCIATES, INC. (CALIFORNIA CORPORATION)
2833 LEONIS BLVD. #205
VERNON, CA 90058

FOR: ANIMAL FEED, NAMELY, PET FOOD CONTAINING PROTEIN MADE FROM ANIMAL BY PRODUCTS, IN CLASS 31 (U.S. CLS. 1 AND 46).

FIRST USE 1-1-2008; IN COMMERCE 1-1-2008.

NO CLAIM IS MADE TO THE EXCLUSIVE RIGHT TO USE "PROTEIN, INC.", APART FROM THE MARK AS SHOWN.

THE MARK CONSISTS OF THE LETTERS "PI" ABOVE THE WORDS "PROTEIN, INC.".

SER. NO. 77-317,477, FILED 10-30-2007.

JUSTINE D. PARKER, EXAMINING ATTORNEY

Int. Cls.: 10, 11, 12, 20 and 40

**Prior U.S. Cls.: 2, 13, 19, 21, 22, 23, 25, 26, 31, 32, 34,
35, 39, 44, 50, 100, 103 and 106**

Reg. No. 3,475,404

United States Patent and Trademark Office

Registered July 29, 2008

**TRADEMARK
SERVICE MARK
PRINCIPAL REGISTER**

PEDIGO

PEDIGO PRODUCTS, INC. (CALIFORNIA CORPORATION)
4000 SE COLUMBIA WAY
VANCOUVER, WA 98661

FOR: STRETCHERS; IV STANDS; STAINLESS STEEL MEDICAL EXAMINATION AND OPERATING TABLES; MAYO STANDS; INFUSION PUMP STANDS, IN CLASS 10 (U.S. CLS. 26, 39 AND 44).

FIRST USE 0-0-1950; IN COMMERCE 0-0-1950.

FOR: BLANKET AND FLUID WARMING CABINETS, IN CLASS 11 (U.S. CLS. 13, 21, 23, 31 AND 34).

FIRST USE 1-0-1999; IN COMMERCE 1-0-1999.

FOR: HOSPITAL CARTS; MEDICAL CARTS; UTILITY CARTS; SUPPLY CARTS, IN CLASS 12 (U.S. CLS. 19, 21, 23, 31, 35 AND 44).

FIRST USE 0-0-1950; IN COMMERCE 0-0-1950.

FOR: CRIBS; BASINETS; HAMPERS; FOOT-STOOLS; CABINETS; WORK TABLES; MEDICAL INSTRUMENT ASSEMBLY TABLES; TABLES; STOOLS, IN CLASS 20 (U.S. CLS. 2, 13, 22, 25, 32 AND 50).

FIRST USE 0-0-1947; IN COMMERCE 0-0-1947.

FOR: CUSTOM MANUFACTURE OF MEDICAL SUPPLIES AND DEVICES, IN CLASS 40 (U.S. CLS. 100, 103 AND 106).

FIRST USE 0-0-1947; IN COMMERCE 0-0-1947.

THE MARK CONSISTS OF STANDARD CHARACTERS WITHOUT CLAIM TO ANY PARTICULAR FONT, STYLE, SIZE, OR COLOR.

SEC. 2(F).

SER. NO. 77-317,769, FILED 10-31-2007.

KAPIL BHANOT, EXAMINING ATTORNEY

Int. Cl.: 36

Prior U.S. Cls.: 100, 101 and 102

United States Patent and Trademark Office

Reg. No. 3,475,405

Registered July 29, 2008

**SERVICE MARK
PRINCIPAL REGISTER**

FREEDOM COMP

TRIVANTUS, INC. (NEW HAMPSHIRE COR-
PORATION)
20 MARKET STREET
MANCHESTER, NH 03101

FOR: WORKERS' COMPENSATION PREMIUM
PAYMENT PROCESSING SERVICES, IN CLASS 36
(U.S. CLS. 100, 101 AND 102).

FIRST USE 10-15-2007; IN COMMERCE 10-15-2007.

THE MARK CONSISTS OF STANDARD CHAR-
ACTERS WITHOUT CLAIM TO ANY PARTICULAR
FONT, STYLE, SIZE, OR COLOR.

NO CLAIM IS MADE TO THE EXCLUSIVE
RIGHT TO USE "COMP", APART FROM THE
MARK AS SHOWN.

SER. NO. 77-317,805, FILED 10-31-2007.

HOWARD SMIGA, EXAMINING ATTORNEY

Int. Cl.: 36

Prior U.S. Cls.: 100, 101 and 102

United States Patent and Trademark Office

Reg. No. 3,475,406

Registered July 29, 2008

**SERVICE MARK
PRINCIPAL REGISTER**

**WORKERS' COMPENSATION ON
DEMAND, ON TARGET**

TRIVANTUS, INC. (NEW HAMPSHIRE COR-
PORATION)
20 MARKET STREET
MANCHESTER, NH 03101

THE MARK CONSISTS OF STANDARD CHAR-
ACTERS WITHOUT CLAIM TO ANY PARTICULAR
FONT, STYLE, SIZE, OR COLOR.

FOR: WORKERS' COMPENSATION PREMIUM
PAYMENT PROCESSING SERVICES, IN CLASS 36
(U.S. CLS. 100, 101 AND 102).

SER. NO. 77-317,831, FILED 10-31-2007.

FIRST USE 10-15-2007; IN COMMERCE 10-15-2007.

HOWARD SMIGA, EXAMINING ATTORNEY

Int. Cl.: 35

Prior U.S. Cls.: 100, 101 and 102

United States Patent and Trademark Office

Reg. No. 3,475,407

Registered July 29, 2008

**SERVICE MARK
PRINCIPAL REGISTER**

Art Latitudes

DAVID CURRY (FLORIDA SOLE PROPRIETOR-
SHIP), DBA DESIGN LATITUDES
161 NE 106TH STREET
MIAMI SHORES, FL 331382036

FOR: ONLINE ORDERING, CATALOG MAIL
ORDER, RETAIL STORE, AND GALLERY SERVI-
CES IN THE FIELDS OF ART, ART WORKS,
FURNITURE, HOUSEWARES, AND RELATED
GIFTS, AND CONSULTING, INFORMATION AND
ADVISORY SERVICES RELATED THERETO, IN
CLASS 35 (U.S. CLS. 100, 101 AND 102).

FIRST USE 1-20-2000; IN COMMERCE 1-20-2000.

THE MARK CONSISTS OF STANDARD CHAR-
ACTERS WITHOUT CLAIM TO ANY PARTICULAR
FONT, STYLE, SIZE, OR COLOR.

NO CLAIM IS MADE TO THE EXCLUSIVE
RIGHT TO USE "ART", APART FROM THE MARK
AS SHOWN.

SER. NO. 77-317,928, FILED 10-31-2007.

MARY BOAGNI, EXAMINING ATTORNEY

Int. Cl.: 6

Prior U.S. Cls.: 2, 12, 13, 14, 23, 25 and 50

United States Patent and Trademark Office

Reg. No. 3,475,408

Registered July 29, 2008

**TRADEMARK
PRINCIPAL REGISTER**



BEAR INTERLOCKERS, LLC (CALIFORNIA LTD
LIAB CO)
5039 COLE ROAD
MARIPOSA, CA 95338

FIRST USE 2-15-2007; IN COMMERCE 2-15-2007.

SER. NO. 77-318,045, FILED 10-31-2007.

FOR: METAL COUPLINGS FOR USE WITH CON-
CRETE BLOCKS, IN CLASS 6 (U.S. CLS. 2, 12, 13, 14,
23, 25 AND 50).

APRIL ROACH, EXAMINING ATTORNEY

Int. Cls.: 3 and 21

**Prior U.S. Cls.: 1, 2, 4, 6, 13, 23, 29, 30, 33, 40, 50, 51
and 52**

Reg. No. 3,475,409

United States Patent and Trademark Office

Registered July 29, 2008

**TRADEMARK
PRINCIPAL REGISTER**

JOHN MASTERS ORGANICS

JOHN MASTERS ORGANIC HAIR CARE, INC.
(NEW YORK CORPORATION)
77 SULLIVAN STREET
NEW YORK, NY 10012

FOR: HAIR WASH PRODUCTS, NAMELY, HAIR SHAMPOOS, HAIR CONDITIONERS, ENABLING COMBINING HAIR THINNING PRODUCTS, NAMELY, CREAMS, PRODUCTS FOR LIGHTENING HAIR COLOR, NAMELY, DYES, SCALP CARE PRODUCTS, NAMELY, NON-MEDICATED SCALP TREATMENT CREAMS, HAIR STYLING PREPARATIONS FOR INCREASING HAIR VOLUME, HAIR NUTRITIONAL SUPPLEMENTS, NAMELY, OILS FOR HAIR CONDITIONING, HAIR GELS, HAIR COLORS, PRODUCTS IMPROVING HAIR TEXTURE, NAMELY, HAIR CONDITIONERS, HAIR RESTORATION PRODUCTS, NAMELY, HAIR CREAMS, HAIR RESTORATION SHAMPOOS, HAIR POLISHES, NAMELY, POMADES, FACIAL CLEANSING FOAMS, FACIAL EXFOLIATING CLEANSERS, FACIAL CLEANSING CREAMS, SKIN MOISTURIZING SPRAY TONICS, FACE AND SKIN MOISTURIZING SPRAYS, DAILY ANTI-OXIDANT SKIN MOISTURIZING CREAMS, SKIN MOISTURIZING YOGURT CREAMS FOR COSMETIC USE, FACIAL ANTI-AGING COSMETIC YOGURTS CREAMS, MOISTURIZING SKIN MASKS, SKIN CLEANSING MASKS, STRENGTHENING GELS FOR SKIN SURROUNDING THE EYES, SOAPS, BODY MILK, BODY WASHES, LIP-CARE PRODUCTS AND LIP COSMETICS WITH CALMING EFFECT, NAMELY, NON-MEDICATED LIP CARE

PREPARATIONS AND LIP BALM, IN CLASS 3 (U.S. CLS. 1, 4, 6, 50, 51 AND 52).

FIRST USE 12-31-1992; IN COMMERCE 12-31-1992.

FOR: HAIR BRUSHES, IONIC HAIR BRUSHES, IN CLASS 21 (U.S. CLS. 2, 13, 23, 29, 30, 33, 40 AND 50).

FIRST USE 12-31-1992; IN COMMERCE 12-31-1992.

THE MARK CONSISTS OF STANDARD CHARACTERS WITHOUT CLAIM TO ANY PARTICULAR FONT, STYLE, SIZE, OR COLOR.

PRIORITY CLAIMED UNDER SEC. 44(D) ON REPUBLIC OF KOREA APPLICATION NO. 2007-43202, FILED 8-14-2007.

OWNER OF U.S. REG. NO. 2,127,279.

NO CLAIM IS MADE TO THE EXCLUSIVE RIGHT TO USE "ORGANICS", APART FROM THE MARK AS SHOWN.

THE NAME(S), PORTRAIT(S), AND/OR SIGNATURE(S) SHOWN IN THE MARK IDENTIFIES "JOHN MASTERS", WHOSE CONSENT(S) TO REGISTER IS SUBMITTED.

SER. NO. 77-318,358, FILED 10-31-2007.

ANTHONY RINKER, EXAMINING ATTORNEY

Int. Cl.: 6

Prior U.S. Cls.: 2, 12, 13, 14, 23, 25 and 50

United States Patent and Trademark Office

Reg. No. 3,475,410

Registered July 29, 2008

**TRADEMARK
PRINCIPAL REGISTER**



BEAR INTERLOCKERS, LLC (CALIFORNIA LTD
LIAB CO)
5039 COLE ROAD
MARIPOSA, CA 95338

FIRST USE 2-15-2007; IN COMMERCE 2-15-2007.

SER. NO. 77-318,364, FILED 10-31-2007.

FOR: METAL COUPLINGS FOR USE WITH CON-
CRETE BLOCKS, IN CLASS 6 (U.S. CLS. 2, 12, 13, 14,
23, 25 AND 50).

APRIL ROACH, EXAMINING ATTORNEY

Int. Cl.: 9

Prior U.S. Cls.: 21, 23, 26, 36 and 38

United States Patent and Trademark Office

Reg. No. 3,475,411

Registered July 29, 2008

**TRADEMARK
PRINCIPAL REGISTER**

SHIVELY LABS

HOWELL LABORATORIES, INC. (MAINE CORPORATION)
P.O. BOX 389
BRIDGTON, ME 04009

FOR: COMBINERS FOR COMBINING RADIO FREQUENCY SIGNALS, FILTERS FOR FILTERING RADIO FREQUENCY SIGNALS, COAXIAL TRANSMISSION LINE AND COMPONENTS AND ACCESSORIES THEREFOR, NAMELY, DIRECTIONAL COUPLERS, HANGERS, PATCH PANELS, COAXIAL SWITCHES, SPOOLS, ELBOWS, TEES, ADAPTERS, FLANGES, GAS STOPS, ANCHOR CONNECTOR ASSEMBLIES, PRESSURE CAPS, O-RINGS, HARDWARE KITS AND HOSE CLAMPS, CONNECTORS, POWER DIVIDERS, HARMONIC FILTERS, ISOCOUPERS, HYBRIDS, FIELD FLANGE KITS, FLANGES AND CUT-OFF GUIDES; COMPONENTS AND ACCESSORIES FOR COMBINERS FOR COMBINING RADIO FREQUENCY SIGNALS AND FILTERS FOR FILTERING RADIO

FREQUENCY SIGNALS, NAMELY GROUP DELAY EQUALIZERS , IN CLASS 9 (U.S. CLS. 21, 23, 26, 36 AND 38).

FIRST USE 0-0-1983; IN COMMERCE 0-0-1983.

THE MARK CONSISTS OF STANDARD CHARACTERS WITHOUT CLAIM TO ANY PARTICULAR FONT, STYLE, SIZE, OR COLOR.

OWNER OF U.S. REG. NO. 2,142,314.

NO CLAIM IS MADE TO THE EXCLUSIVE RIGHT TO USE "LABS", APART FROM THE MARK AS SHOWN.

SER. NO. 77-318,464, FILED 10-31-2007.

JAMES A. RAUEN, EXAMINING ATTORNEY

Int. Cl.: 35

Prior U.S. Cls.: 100, 101 and 102

United States Patent and Trademark Office

Reg. No. 3,475,412

Registered July 29, 2008

**SERVICE MARK
PRINCIPAL REGISTER**



A.V. PROMOTORA, S.A. DE C.V. (MEXICO CORPORATION)
COL. OBISPADO CERRO DE PICACHOS #770
CERRO DE PICACHOS #70
MONTERREY, MEXICO 64060

FOR: ADVERTISING AND ADVERTISEMENT FOR OTHERS; COMMERCIAL BUSINESS MANAGEMENT IN THE FIELD OF SHOPPING CENTERS AND SHOPPING MALLS; COMMERCIAL ADMINISTRATION AND OFFICE WORK, IN CLASS 35 (U.S. CLS. 100, 101 AND 102).

OWNER OF MEXICO REG. NO. 742390, DATED 4-9-2002, EXPIRES 10-11-2011.

NO CLAIM IS MADE TO THE EXCLUSIVE RIGHT TO USE "CENTRO COMERCIAL", APART FROM THE MARK AS SHOWN.

THE COLOR(S) BLUE, GREEN AND WHITE IS/ARE CLAIMED AS A FEATURE OF THE MARK.

THE MARK CONSISTS OF THE DRAWING OF A WHITE PATHWAY INSIDE A FANCIFUL SQUARE-SHAPED BACKGROUND, WHOSE SURROUNDINGS ARE BLUE ABOVE THE HORIZON AND GREEN BELOW IT. BELOW THE DESIGN APPEARS THE WORD "SENDERO" IN LOWER CASE BLUE LETTERS, BELOW IT A THIN GREEN HORIZONTAL LINE, AND BENEATH THE LINE THE WORDS "CENTRO COMERCIAL" IN SMALLER CAPITAL BLUE LETTERS.

THE FOREIGN WORDING IN THE MARK TRANSLATES INTO ENGLISH AS PATHWAY COMMERCIAL CENTER.

SER. NO. 77-318,690, FILED 11-1-2007.

ELISSA GARBER KON, EXAMINING ATTORNEY

Int. Cl.: 2

Prior U.S. Cls.: 6, 11 and 16

United States Patent and Trademark Office

Reg. No. 3,475,413

Registered July 29, 2008

**TRADEMARK
PRINCIPAL REGISTER**

 **RUST-OLEUM**

RUST-OLEUM BRANDS COMPANY (DELA-
WARE CORPORATION)
LEGAL DEPT.
11 HAWTHORN PARKWAY
VERNON HILLS, IL 60061

FOR: HOUSEMARK FOR PAINTS AND COAT-
ING LINES, IN CLASS 2 (U.S. CLS. 6, 11 AND 16).

FIRST USE 12-31-2003; IN COMMERCE 12-31-2003.

OWNER OF U.S. REG. NOS. 837,788, 1,363,979 AND
OTHERS.

THE MARK CONSISTS OF FOUR SQUARES AND
STYLIZED LETTERING.

SER. NO. 77-318,832, FILED 11-1-2007.

HOWARD B. LEVINE, EXAMINING ATTORNEY

Int. Cl.: 41

Prior U.S. Cls.: 100, 101 and 107

United States Patent and Trademark Office

Reg. No. 3,475,414

Registered July 29, 2008

**SERVICE MARK
PRINCIPAL REGISTER**

EVM WORLD

PMI COLLEGE OF PERFORMANCE MANAGE-
MENT (VIRGINIA CORPORATION)
SUITE 320
101 SOUTH WHITING STREET
ALEXANDRIA, VA 22304

FOR: EDUCATION SERVICES, NAMELY, PRO-
VIDING SEMINARS IN THE FIELD OF PROJECT
MANAGEMENT, IN CLASS 41 (U.S. CLS. 100, 101
AND 107).

FIRST USE 5-1-2006; IN COMMERCE 5-1-2006.

THE MARK CONSISTS OF STANDARD CHAR-
ACTERS WITHOUT CLAIM TO ANY PARTICULAR
FONT, STYLE, SIZE, OR COLOR.

NO CLAIM IS MADE TO THE EXCLUSIVE
RIGHT TO USE "EVM", APART FROM THE MARK
AS SHOWN.

SER. NO. 77-318,931, FILED 11-1-2007.

ANDREA BUTLER, EXAMINING ATTORNEY

Int. Cl.: 11

Prior U.S. Cls.: 13, 21, 23, 31 and 34

United States Patent and Trademark Office

Reg. No. 3,475,415

Registered July 29, 2008

**TRADEMARK
PRINCIPAL REGISTER**

THERMOJET

LUBRICATION SYSTEMS COMPANY OF TEXAS,
LLC (TEXAS LTD LIAB CO)
1740 STEBBINS DRIVE
HOUSTON, TX 77043

FOR: OIL PURIFYING UNITS FOR COMMERCIAL,
INDUSTRIAL AND DOMESTIC USE, IN
CLASS 11 (U.S. CLS. 13, 21, 23, 31 AND 34).

FIRST USE 3-5-1994; IN COMMERCE 3-5-1994.

THE MARK CONSISTS OF STANDARD CHARACTERS
WITHOUT CLAIM TO ANY PARTICULAR
FONT, STYLE, SIZE, OR COLOR.

OWNER OF U.S. REG. NO. 1,927,962.

SER. NO. 77-318,949, FILED 11-1-2007.

NAAKWAMA ANKRAH, EXAMINING ATTORNEY

Int. Cl.: 41

Prior U.S. Cls.: 100, 101 and 107

United States Patent and Trademark Office

Reg. No. 3,475,416

Registered July 29, 2008

**SERVICE MARK
PRINCIPAL REGISTER**

**THE LIES THAT BIND - THE
LEGACY OF THE LOCKS**

ANNESHIA D. FREEMAN (UNITED STATES
INDIVIDUAL)
APT. 18
3466 WOODWARD
WYOMING, MI 49509

FOR: TRAINING IN THE FIELD OF COGNITIVE RESTRUCTURING AND RE-SOCIALIZATION FOR INDIVIDUALS AND GROUPS; PROVIDING MENTORING AND CONDUCTING WORKSHOPS IN THE FIELD OF NEW AND DIFFERENT SET OF THINKING PATTERNS, ATTITUDES, VALUES, AND BEHAVIORS FROM THOSE IN ONE'S BACKGROUND OR PREVIOUS HISTORY; EDUCATIONAL SERVICES, NAMELY, CONDUCTING TRAINING WORKSHOPS IN THE FIELD OF COGNITIVE RESTRUCTURING AND RE-SOCIALIZATION REGARDING NEW AND DIFFERENT SET OF THINKING PATTERNS, ATTITUDES, VALUES, AND BEHAVIORS FROM THOSE IN ONE'S BACKGROUND OR PREVIOUS HISTORY AND DISTRIBUTING COURSE MATERIALS, PROGRAM GUIDES AND MANUALS, BROCHURES, AND PRESENTATION HANDOUTS IN CONNECTION

THEREWITH; EDUCATIONAL SERVICES FOR INDIVIDUALS AND GROUPS, NAMELY, CONDUCTING SEMINARS AND CONFERENCES IN THE FIELD OF COGNITIVE RESTRUCTURING AND RE-SOCIALIZATION REGARDING THE NEED FOR AND BENEFITS OF, AND PROVIDING INFORMATION ON, PROGRAMS FOR COGNITIVE RESTRUCTURING AND RE-SOCIALIZATION EDUCATION REGARDING NEW AND DIFFERENT SET OF THINKING PATTERNS, ATTITUDES, VALUES, AND BEHAVIORS FROM THOSE IN ONE'S BACKGROUND OR PREVIOUS HISTORY, IN CLASS 41 (U.S. CLS. 100, 101 AND 107).

FIRST USE 5-14-2007; IN COMMERCE 6-19-2007.

THE MARK CONSISTS OF STANDARD CHARACTERS WITHOUT CLAIM TO ANY PARTICULAR FONT, STYLE, SIZE, OR COLOR.

SER. NO. 77-319,097, FILED 11-1-2007.

KAPIL BHANOT, EXAMINING ATTORNEY

Int. Cl.: 41

Prior U.S. Cls.: 100, 101 and 107

United States Patent and Trademark Office

Reg. No. 3,475,417

Registered July 29, 2008

**SERVICE MARK
PRINCIPAL REGISTER**

THE LIES THAT BIND

FREEMAN, ANNESHIA D. (UNITED STATES
INDIVIDUAL)
APT. 18
3466 WOODWARD
WYOMING, MI 49509

FOR: TRAINING IN THE FIELD OF COGNITIVE RESTRUCTURING AND RE-SOCIALIZATION FOR INDIVIDUALS AND GROUPS; PROVIDING MENTORING AND CONDUCTING WORKSHOPS IN THE FIELD OF NEW AND DIFFERENT SET OF THINKING PATTERNS, ATTITUDES, VALUES, AND BEHAVIORS FROM THOSE IN ONE'S BACKGROUND OR PREVIOUS HISTORY; EDUCATIONAL SERVICES, NAMELY, CONDUCTING TRAINING WORKSHOPS IN THE FIELD OF COGNITIVE RESTRUCTURING AND RE-SOCIALIZATION REGARDING NEW AND DIFFERENT SET OF THINKING PATTERNS, ATTITUDES, VALUES, AND BEHAVIORS FROM THOSE IN ONE'S BACKGROUND OR PREVIOUS HISTORY AND DISTRIBUTING COURSE MATERIALS, PROGRAM GUIDES AND MANUALS, BROCHURES, AND PRESENTATION HANDOUTS IN CONNECTION

THEREWITH; EDUCATIONAL SERVICES FOR INDIVIDUALS AND GROUPS, NAMELY, CONDUCTING SEMINARS AND CONFERENCES IN THE FIELD OF COGNITIVE RESTRUCTURING AND RE-SOCIALIZATION REGARDING THE NEED FOR AND BENEFITS OF, AND PROVIDING INFORMATION ON, PROGRAMS FOR COGNITIVE RESTRUCTURING AND RE-SOCIALIZATION EDUCATION REGARDING NEW AND DIFFERENT SET OF THINKING PATTERNS, ATTITUDES, VALUES, AND BEHAVIORS FROM THOSE IN ONE'S BACKGROUND OR PREVIOUS HISTORY, IN CLASS 41 (U.S. CLS. 100, 101 AND 107).

FIRST USE 5-14-2007; IN COMMERCE 6-19-2007.

THE MARK CONSISTS OF STANDARD CHARACTERS WITHOUT CLAIM TO ANY PARTICULAR FONT, STYLE, SIZE, OR COLOR.

SER. NO. 77-319,146, FILED 11-1-2007.

KAPIL BHANOT, EXAMINING ATTORNEY

Int. Cl.: 28

Prior U.S. Cls.: 22, 23, 38 and 50

Reg. No. 3,475,418

United States Patent and Trademark Office

Registered July 29, 2008

TRADEMARK
PRINCIPAL REGISTER

fullKiltPoker
We've Got The Nuts .COM

GRIFFARD, ROBERT (UNITED STATES INDIVIDUAL)
4622 N. LANCER AVE
BOISE, ID 83713

FOR: PLAYING CARD GAME SET COMPRISED OF PLAYING CARDS, POKER CHIPS, PEANUT SHAPED HOLDERS FOR CARDS, BAGS TO HOLD THE CARD HOLDERS, STRESS RELIEF BALLS FOR HAND EXERCISING , IN CLASS 28 (U.S. CLS. 22, 23, 38 AND 50).

FIRST USE 7-5-2005; IN COMMERCE 7-5-2005.

THE MARK CONSISTS OF THE WORDS "FULL-KILTPOKER.COM WE'VE GOT THE NUTS" IN STYLIZED TEXT.

SER. NO. 77-320,000, FILED 11-2-2007.

PAM WILLIS, EXAMINING ATTORNEY

Int. Cl.: 38

Prior U.S. Cls.: 100, 101 and 104

United States Patent and Trademark Office

Reg. No. 3,475,419

Registered July 29, 2008

**SERVICE MARK
PRINCIPAL REGISTER**



NETWORK FOUNDATION TECHNOLOGIES,
LLC (CALIFORNIA LTD LIAB CO)
SUITE 2062
10250 CONSTELLATION BOULEVARD
CENTURY CITY, CA 90067

FOR: ONLINE STREAMING OF AUDIO AND
VIDEO MATERIAL, ENABLING WEBCASTING

SERVICES FOR OTHERS, IN CLASS 38 (U.S. CLS.
100, 101 AND 104).

FIRST USE 2-0-2005; IN COMMERCE 2-0-2005.

SER. NO. 77-320,258, FILED 11-2-2007.

YAT SYE, LEE, EXAMINING ATTORNEY

Int. Cl.: 36

Prior U.S. Cls.: 100, 101 and 102

United States Patent and Trademark Office

Reg. No. 3,475,420

Registered July 29, 2008

**SERVICE MARK
PRINCIPAL REGISTER**



CREDIT UNION STRATEGIC PARTNERS, INC.
(COLORADO CORPORATION)
4905 W. 60TH AVENUE
ARVADA, CO 80003

FOR: PROVIDING INFORMATION AND ADVICE
IN THE FIELD OF PERSONAL FINANCE AND
CREDIT UNION SERVICES, IN CLASS 36 (U.S.
CLS. 100, 101 AND 102).

FIRST USE 5-31-2007; IN COMMERCE 5-31-2007.

NO CLAIM IS MADE TO THE EXCLUSIVE
RIGHT TO USE "CREDITUNIONFACTS.COM",
APART FROM THE MARK AS SHOWN.

THE COLOR(S) GREEN, BLUE AND WHITE IS/
ARE CLAIMED AS A FEATURE OF THE MARK.

THE MARK CONSISTS OF A HUMAN FIGURE
LEANING ON FOUR RECTANGLES WHICH CON-
TAIN THE WORDS "CREDIT", "UNION", "FACTS",
AND ".COM". THE COLOR BLUE APPEARS IN THE
BACKGROUND OF THE SQUARE IN THE DESIGN,
AND IN THE WORDING "CREDIT UNION FACTS.-
COM"; THE COLOR GREEN APPEARS IN THE
RECTANGLES THAT SURROUND THE WORDING
"CREDIT UNION FACTS.COM"; AND THE COLOR
WHITE APPEARS IN THE HUMAN FIGURE
SHOWN IN THE MARK.

SER. NO. 77-320,311, FILED 11-2-2007.

SHAUNIA CARLYLE, EXAMINING ATTORNEY

Int. Cl.: 25

Prior U.S. Cls.: 22 and 39

United States Patent and Trademark Office

Reg. No. 3,475,421

Registered July 29, 2008

**TRADEMARK
PRINCIPAL REGISTER**

The logo for "Rainbow Steps" features the word "Rainbow" in a blue, rounded font. The letter "o" is replaced by a yellow sun with rays. Above the "o" is a small rainbow. The word "Steps" is in the same blue font to the right.

RAINBOW STEPS LLC (MARYLAND LTD LIAB
CO), DBA RAINBOW STEPS
9701 MACARTHUR BLVD.
BETHESDA, MD 20817

FOR: FOOTWEAR, IN CLASS 25 (U.S. CLS. 22 AND
39).

FIRST USE 10-1-2007; IN COMMERCE 10-1-2007.

NO CLAIM IS MADE TO THE EXCLUSIVE
RIGHT TO USE "RAINBOW STEPS" , APART FROM
THE MARK AS SHOWN.

THE COLOR(S) BLUE, YELLOW, AND RED IS/
ARE CLAIMED AS A FEATURE OF THE MARK.

THE MARK CONSISTS OF THE LETTERING
"RAINB" AND "W" AND WORD "STEPS" IN BLUE
WITH A YELLOW SUN AND A RAINBOW DESIGN
FEATURING THE COLORS YELLOW, BLUE AND
RED.

SER. NO. 77-320,435, FILED 11-2-2007.

LOURDES AYALA, EXAMINING ATTORNEY

Int. Cl.: 41

Prior U.S. Cls.: 100, 101 and 107

United States Patent and Trademark Office

Reg. No. 3,475,422

Registered July 29, 2008

**SERVICE MARK
PRINCIPAL REGISTER**

GET LUCKY ON PURPOSE

EPSTEIN, JEFFREY H (UNITED STATES INDIVIDUAL)
2531 WINDSOR LANE
NORTHBROOK, IL 60062

FOR: EDUCATION SERVICES, NAMELY, PROVIDING SEMINARS AND PROGRAMS IN THE FIELD OF LIFE COACHING, MOTIVATION, AND SELF-IMPROVEMENT, IN CLASS 41 (U.S. CLS. 100, 101 AND 107).

FIRST USE 4-1-2001; IN COMMERCE 4-1-2001.

THE MARK CONSISTS OF STANDARD CHARACTERS WITHOUT CLAIM TO ANY PARTICULAR FONT, STYLE, SIZE, OR COLOR.

SER. NO. 77-320,642, FILED 11-2-2007.

MICHELLE DUBOIS, EXAMINING ATTORNEY

Int. Cl.: 41

Prior U.S. Cls.: 100, 101 and 107

United States Patent and Trademark Office

Reg. No. 3,475,423

Registered July 29, 2008

**SERVICE MARK
PRINCIPAL REGISTER**

BRIGHT TOWN

TCP, INC. (DELAWARE CORPORATION)
325 CAMPUS DRIVE
AURORA, OH 44202

FIRST USE 8-22-2007; IN COMMERCE 8-22-2007.

FOR: PRESENTATION OF LIVE SHOW PERFORMANCES IN THE NATURE OF CHILDREN'S SHOWS THAT PROMOTE AWARENESS OF GLOBAL WARMING AND BENEFITS OF ENERGY SAVING FLUORESCENT LIGHTING , IN CLASS 41 (U.S. CLS. 100, 101 AND 107).

THE MARK CONSISTS OF STANDARD CHARACTERS WITHOUT CLAIM TO ANY PARTICULAR FONT, STYLE, SIZE, OR COLOR.

SER. NO. 77-320,730, FILED 11-3-2007.

COLLEEN KEARNEY, EXAMINING ATTORNEY

Int. Cl.: 3

Prior U.S. Cls.: 1, 4, 6, 50, 51 and 52

United States Patent and Trademark Office

Reg. No. 3,475,424

Registered July 29, 2008

**TRADEMARK
PRINCIPAL REGISTER**

VANDANA

PIECE OF INDIA, INC. (NEW JERSEY CORPORATION)
126 CHARLES STREET
SOMERSET, NJ 08873

THE MARK CONSISTS OF STANDARD CHARACTERS WITHOUT CLAIM TO ANY PARTICULAR FONT, STYLE, SIZE, OR COLOR.

FOR: INCENSE STICKS, IN CLASS 3 (U.S. CLS. 1, 4, 6, 50, 51 AND 52).

SER. NO. 77-320,803, FILED 11-3-2007.

FIRST USE 5-10-1999; IN COMMERCE 5-10-1999.

WILLIAM ROSSMAN, EXAMINING ATTORNEY

Int. Cl.: 25

Prior U.S. Cls.: 22 and 39

United States Patent and Trademark Office

Reg. No. 3,475,425

Registered July 29, 2008

**TRADEMARK
PRINCIPAL REGISTER**



DEFANTI, MARK (UNITED STATES INDIVIDUAL)
4 MASSACHUSETTS AVE
BARRINGTON, RI 02806

FOR: NIGHT SHIRTS; SHIRTS; SHORT-SLEEVED OR LONG-SLEEVED T-SHIRTS; SLEEP SHIRTS; SPORT SHIRTS; T-SHIRTS; DENIMS; LOUNGE PANTS; PANTS; SWEAT PANTS; SKIRTS AND DRESSES; HATS; HEADWEAR; JACKETS; JEANS; LINGERIE; LOUNGEWEAR; SWIM WEAR; SLEEPWEAR; CROP TOPS; HALTER TOPS; MUSCLE TOPS; TANK-TOPS; UNDERGARMENTS, IN CLASS 25 (U.S. CLS. 22 AND 39).

FIRST USE 4-1-2004; IN COMMERCE 4-1-2004.

OWNER OF U.S. REG. NO. 2,903,807.

THE MARK CONSISTS OF ONE "S" FACING FORWARD CONNECTED TO ANOTHER "S" FACING REVERSE SO THAT THE TWO "S" CHARACTERS FORM A HEART IN THE MIDDLE WHERE THEY MEET AND THE WORDING "SEX SYMBOL" DIRECTLY BELOW THE "SS" DESIGN.

SER. NO. 77-320,842, FILED 11-4-2007.

ASMAT KHAN, EXAMINING ATTORNEY

Int. Cl.: 5

Prior U.S. Cls.: 6, 18, 44, 46, 51 and 52

United States Patent and Trademark Office

Reg. No. 3,475,426

Registered July 29, 2008

**TRADEMARK
PRINCIPAL REGISTER**

fruitslim

DREAMPAK (VIRGINIA LTD LIAB CO)
4717 EISENHOWER AVE
ALEXANDRIA, VA 22304

THE MARK CONSISTS OF STANDARD CHAR-
ACTERS WITHOUT CLAIM TO ANY PARTICULAR
FONT, STYLE, SIZE, OR COLOR.

FOR: DIETARY AND NUTRITIONAL SUPPLE-
MENTS, IN CLASS 5 (U.S. CLS. 6, 18, 44, 46, 51 AND
52).

SER. NO. 77-321,259, FILED 11-5-2007.

FIRST USE 10-5-2007; IN COMMERCE 11-5-2007.

LINDA LAVACHE, EXAMINING ATTORNEY

Int. Cl.: 41

Prior U.S. Cls.: 100, 101 and 107

United States Patent and Trademark Office

Reg. No. 3,475,427

Registered July 29, 2008

**SERVICE MARK
PRINCIPAL REGISTER**

THE CHOICE

ARCHER'S CHOICE MEDIA, INC. (ILLINOIS
CORPORATION)
31570 WILLOW ROAD
LANARK, IL 61046

FOR: PRODUCTION OF DVDS, VIDEOTAPES
AND TELEVISION PROGRAMS FEATURING
HUNTING ADVENTURES, INFORMATION AND
ENTERTAINMENT ABOUT HUNTING AND
SHOOTING, IN CLASS 41 (U.S. CLS. 100, 101 AND
107).

FIRST USE 7-1-2005; IN COMMERCE 1-1-2006.

THE MARK CONSISTS OF STANDARD CHAR-
ACTERS WITHOUT CLAIM TO ANY PARTICULAR
FONT, STYLE, SIZE, OR COLOR.

SER. NO. 77-321,413, FILED 11-5-2007.

KIMBERLY PERRY, EXAMINING ATTORNEY

Int. Cl.: 16

Prior U.S. Cls.: 2, 5, 22, 23, 29, 37, 38 and 50

Reg. No. 3,475,428

United States Patent and Trademark Office

Registered July 29, 2008

**TRADEMARK
PRINCIPAL REGISTER**

CONTRACTOR BEWARE

CULVERCO, LLC (MASSACHUSETTS LTD LIAB
CO), DBA CULVER COMPANY
104 BRIDGE ROAD
SALISBURY, MA 01952

FOR: EDUCATIONAL PUBLICATIONS, NAME-
LY, EDUCATIONAL LEARNING CARDS, FLASH
CARDS, ACTIVITY CARDS, WORKBOOKS, TEXT-
BOOKS, ACTIVITY BOOKS, STORY BOOKS, PUZ-
ZLE BOOKS, PUZZLES, TEACHER GUIDES,
MANUALS, POSTERS, EDUCATIONAL CARD
GAMES AND EDUCATIONAL BOOKLETS IN THE
FIELD OF ELECTRICAL AND NATURAL GAS
SAFETY, IN CLASS 16 (U.S. CLS. 2, 5, 22, 23, 29, 37,
38 AND 50).

FIRST USE 9-16-1996; IN COMMERCE 9-16-1996.

THE MARK CONSISTS OF STANDARD CHAR-
ACTERS WITHOUT CLAIM TO ANY PARTICULAR
FONT, STYLE, SIZE, OR COLOR.

NO CLAIM IS MADE TO THE EXCLUSIVE
RIGHT TO USE "CONTRACTOR", APART FROM
THE MARK AS SHOWN.

SER. NO. 77-321,506, FILED 11-5-2007.

STEVEN R. FINE, EXAMINING ATTORNEY

Int. Cl.: 41

Prior U.S. Cls.: 100, 101 and 107

United States Patent and Trademark Office

Reg. No. 3,475,429

Registered July 29, 2008

**SERVICE MARK
PRINCIPAL REGISTER**

Newport Pleasure Play

LORILLARD LICENSING COMPANY, LLC
(NORTH CAROLINA LTD LIAB CO)
1601 WACHOVIA TOWER, 300 N. GREENE ST.
GREENSBORO, NC 27401

OWNER OF U.S. REG. NOS. 2,711,321, 3,052,558
AND OTHERS.

FOR: ENTERTAINMENT SERVICES, NAMELY,
PROVIDING ON-LINE COMPUTER GAMES, IN
CLASS 41 (U.S. CLS. 100, 101 AND 107).

NO CLAIM IS MADE TO THE EXCLUSIVE
RIGHT TO USE PLAY, APART FROM THE MARK
AS SHOWN.

FIRST USE 11-1-2007; IN COMMERCE 11-1-2007.

SER. NO. 77-321,511, FILED 11-5-2007.

THE MARK CONSISTS OF STANDARD CHAR-
ACTERS WITHOUT CLAIM TO ANY PARTICULAR
FONT, STYLE, SIZE, OR COLOR.

STEVEN R. FINE, EXAMINING ATTORNEY

Int. Cl.: 30

Prior U.S. Cl.: 46

United States Patent and Trademark Office

Reg. No. 3,475,430

Registered July 29, 2008

**TRADEMARK
PRINCIPAL REGISTER**

AL BOHSALI

البحصلي

AL BOHSALI (LEBANON CORPORATION)
PO BOX 11-5262
BEIRUT, LEBANON

FOR: COFFEE BEANS, TEA, CACAO, SUGAR,
RICE, TAPIOCA, SAGO, ARTIFICIAL COFFEE,
FLOUR, PIES, CANDIES, HONEY OF BEES, BLACK
HONEY, YEAST AND BAKING POWDER, SALT,
MUSTARD, VINEGAR, PEPPER AND SPICE, ICE, IN
CLASS 30 (U.S. CL. 46).

OWNER OF LEBANON REG. NO. 112941, DATED
9-24-2007, EXPIRES 9-24-2022.

THE NAME(S), PORTRAIT(S), AND/OR SIGNA-
TURE(S) SHOWN IN THE MARK DOES NOT IDEN-
TIFY A PARTICULAR LIVING INDIVIDUAL.

THE MARK CONSISTS OF "AL BOHSALI" IN
ENGLISH AND ARABIC.

SER. NO. 77-321,745, FILED 11-5-2007.

CAROLYN GRAY, EXAMINING ATTORNEY

Int. Cl.: 9

Prior U.S. Cls.: 21, 23, 26, 36 and 38

United States Patent and Trademark Office

Reg. No. 3,475,431

Registered July 29, 2008

**TRADEMARK
PRINCIPAL REGISTER**

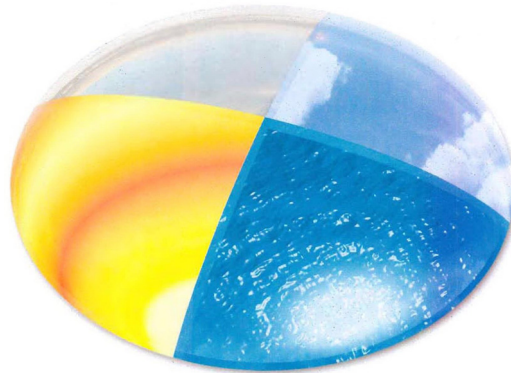

JOHNSON & JOHNSON (NEW JERSEY CORPORATION)
ONE JOHNSON & JOHNSON PLAZA
NEW BRUNSWICK, NJ 089337001

FOR: CONTACT LENSES, IN CLASS 9 (U.S. CLS. 21, 23, 26, 36 AND 38).

FIRST USE 2-0-2006; IN COMMERCE 2-0-2006.

THE COLOR(S) BLUE, AQUA, GREY, YELLOW AND RED IS/ARE CLAIMED AS A FEATURE OF THE MARK.

THE MARK CONSISTS OF A PICTURE OF A CONTACT LENS DIVIDED IN QUARTERS COLORED IN BLUE, AQUA, GREY AND YELLOW WITH RED HUES.

SER. NO. 77-322,184, FILED 11-6-2007.

BRIAN NEVILLE, EXAMINING ATTORNEY

Int. Cl.: 36

Prior U.S. Cls.: 100, 101 and 102

United States Patent and Trademark Office

Reg. No. 3,475,432

Registered July 29, 2008

SERVICE MARK
PRINCIPAL REGISTER

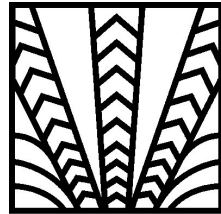

THE SHOPS AT
BOCA
CENTER

485 PROPERTIES, LLC (DELAWARE LTD LIAB
CO)
8500 ANDREW CARNEGIE BOULEVARD - C3-08
C/O TEACHERS INSURANCE & ANNUITY ASSOC.
CHARLOTTE, NC 28262

FOR: SHOPPING CENTER AND MIXED-USE
DEVELOPMENT SERVICES, NAMELY, RENTAL
OF SHOPPING CENTER SPACE , IN CLASS 36 (U.S.
CLS. 100, 101 AND 102).

FIRST USE 12-0-1999; IN COMMERCE 12-0-1999.

NO CLAIM IS MADE TO THE EXCLUSIVE
RIGHT TO USE "THE SHOPS AT" AND "CENTER",
APART FROM THE MARK AS SHOWN.

THE MARK CONSISTS OF A SQUARE WITH A
STYLIZED DESIGN IN THE SQUARE, WITH THE
WORDS "THE SHOPS AT BOCA CENTER" UNDER-
NEATH THE SQUARE.

SEC. 2(F) AS TO "BOCA".

SER. NO. 77-322,185, FILED 11-6-2007.

GINA HAYES, EXAMINING ATTORNEY

Int. Cl.: 35

Prior U.S. Cls.: 100, 101 and 102

United States Patent and Trademark Office

Reg. No. 3,475,433

Registered July 29, 2008

**SERVICE MARK
PRINCIPAL REGISTER**



**8POINT
PROMOTIONS**

PATRICK T. DRISCOLL (MICHIGAN LTD LIAB
CO), DBA 8 POINT PROMOTIONS
2231 EAST HILLS DRIVE
NEW ERA, MI 49446

FOR: PROMOTIONS AND MARKETING SERVI-
CES AND RELATED CONSULTING, IN CLASS 35
(U.S. CLS. 100, 101 AND 102).

FIRST USE 11-1-2007; IN COMMERCE 11-1-2007.

NO CLAIM IS MADE TO THE EXCLUSIVE
RIGHT TO USE "PROMOTIONS", APART FROM
THE MARK AS SHOWN.

THE COLOR(S) GREEN AND BLUE IS/ARE
CLAIMED AS A FEATURE OF THE MARK.

THE MARK CONSISTS OF THE GREEN NUM-
BER EIGHT WITH AN ARROW LEADING FROM
THE NUMBER'S OUTER EDGE TO ITS CENTER
HOLES, THE TOP ARROW POINTING UPWARD
AND THE BOTTOM DOWNWARD; CENTERED
ABOVE THE BLUE WORDS "8 POINT PROMO-
TIONS" WHICH ARE WRITTEN IN TWO LINES,
"PROMOTIONS" BEING THE SECOND LINE.

SER. NO. 77-322,205, FILED 11-6-2007.

GRETTA YAO, EXAMINING ATTORNEY

Int. Cl.: 41

Prior U.S. Cls.: 100, 101 and 107

United States Patent and Trademark Office

Reg. No. 3,475,434

Registered July 29, 2008

**SERVICE MARK
PRINCIPAL REGISTER**



LORILLARD LICENSING COMPANY, LLC
(NORTH CAROLINA LTD LIAB CO)
1601 WACHOVIA TOWER, 300 N. GREENE ST.
GREENSBORO, NC 27401

FOR: ENTERTAINMENT SERVICES, NAMELY,
PROVIDING ON-LINE COMPUTER GAMES, IN
CLASS 41 (U.S. CLS. 100, 101 AND 107).

FIRST USE 11-1-2007; IN COMMERCE 11-1-2007.

OWNER OF U.S. REG. NOS. 2,711,321, 3,052,558
AND OTHERS.

NO CLAIM IS MADE TO THE EXCLUSIVE
RIGHT TO USE "PLAY", APART FROM THE MARK
AS SHOWN.

THE COLOR(S) YELLOW AND ORANGE IS/ARE
CLAIMED AS A FEATURE OF THE MARK.

THE MARK CONSISTS OF A YELLOW OVAL
SHAPE WITH THE WORDS "NEWPORT PLEASURE
PLAY" WRITTEN IN ORANGE ON AND INSIDE
THE OVAL SHAPE.

SER. NO. 77-322,293, FILED 11-6-2007.

STEVEN R. FINE, EXAMINING ATTORNEY

Int. Cls.: 9 and 35

Prior U.S. Cls.: 21, 23, 26, 36, 38, 100, 101 and 102

Reg. No. 3,475,435

United States Patent and Trademark Office

Registered July 29, 2008

**TRADEMARK
SERVICE MARK
PRINCIPAL REGISTER**

WINESMART

MEADOR, WILLIAM R. (UNITED STATES INDIVIDUAL)

2031 MILLVILLE SHANDON RD.
HAMILTON, OH 45013 AND

FISHWICK, STEPHEN K. (UNITED STATES INDIVIDUAL), DBA STEVE FISHWICK ENTERPRISES, WINE CELLAR SYSTEMS

6434 CANASTOTA DR.
HAMILTON, OH 45011

FOR: CLIMATE CONTROL SYSTEMS CONSISTING OF DIGITAL THERMOSTATS FOR COOLING EQUIPMENT, AND A PROGRAMMABLE LOGIC CONTROLLER (PLC) WITH INPUT AND OUTPUT FEATURES FOR TEMPERATURE AND HUMIDITY, WHICH WORKS WITH A REMOTE DIGITAL READ OUT CONTROLLER; CLIMATE CONTROL SYSTEMS CONSISTING OF DIGITAL THERMOSTATS, AIR CONDITIONING, HEATING, VENTILATION AND DRYING CONTROL DEVICES; ELECTRIC AND ELECTRONIC CIRCUITS; ELECTRIC CONTROL DEVICES FOR HEATING AND ENERGY MANAGEMENT; ELECTRIC CONTROL PANELS; ELECTRICAL CONTROLLERS; ELECTRICAL CONTROLLING DEVICES; HOME AND OF-

FICE AUTOMATION SYSTEMS COMPRISING WIRELESS AND WIRED CONTROLLERS, CONTROLLED DEVICES, AND SOFTWARE FOR LIGHTING, HVAC, SECURITY, SAFETY AND OTHER HOME AND OFFICE MONITORING AND CONTROL APPLICATIONS, IN CLASS 9 (U.S. CLS. 21, 23, 26, 36 AND 38).

FIRST USE 6-1-2003; IN COMMERCE 9-1-2005.

FOR: DISTRIBUTORSHIPS IN THE FIELD OF CLIMATE CONTROL SYSTEMS, IN CLASS 35 (U.S. CLS. 100, 101 AND 102).

FIRST USE 6-1-2003; IN COMMERCE 9-1-2005.

THE MARK CONSISTS OF STANDARD CHARACTERS WITHOUT CLAIM TO ANY PARTICULAR FONT, STYLE, SIZE, OR COLOR.

SER. NO. 77-322,443, FILED 11-6-2007.

SUSAN LESLIE DUBOIS, EXAMINING ATTORNEY

Int. Cl.: 9

Prior U.S. Cls.: 21, 23, 26, 36 and 38

Reg. No. 3,475,436

United States Patent and Trademark Office

Registered July 29, 2008

**TRADEMARK
PRINCIPAL REGISTER**

PVAN Ultra

MILLAR INSTRUMENTS, INC. (TEXAS CORPORATION)
6001-A GULF FREEWAY
HOUSTON, TX 77023

THE MARK CONSISTS OF STANDARD CHARACTERS WITHOUT CLAIM TO ANY PARTICULAR FONT, STYLE, SIZE, OR COLOR.

FOR: MEDICAL SOFTWARE FOR CALCULATING AND GRAPHICALLY DISPLAYING HEMODYNAMIC PARAMETERS FOR CARDIAC ANALYSIS, IN CLASS 9 (U.S. CLS. 21, 23, 26, 36 AND 38).

SER. NO. 77-322,790, FILED 11-6-2007.

FIRST USE 5-31-2007; IN COMMERCE 5-31-2007.

EDWARD NELSON, EXAMINING ATTORNEY

Int. Cl.: 39

Prior U.S. Cls.: 100 and 105

United States Patent and Trademark Office

Reg. No. 3,475,437

Registered July 29, 2008

**SERVICE MARK
PRINCIPAL REGISTER**

AZ TRASH GUYS

TRASH & DEMO ENTERPRISES LLC (NEVADA
LTD LIAB CO)
STE 103 PMB 283
14835 E. SHEA BLVD.
FOUNTAIN HILLS, AZ 852685939

FOR: GARBAGE AND JUNK REMOVAL, IN
CLASS 39 (U.S. CLS. 100 AND 105).

FIRST USE 2-2-2007; IN COMMERCE 2-2-2007.

THE MARK CONSISTS OF STANDARD CHAR-
ACTERS WITHOUT CLAIM TO ANY PARTICULAR
FONT, STYLE, SIZE, OR COLOR.

NO CLAIM IS MADE TO THE EXCLUSIVE
RIGHT TO USE "TRASH", APART FROM THE
MARK AS SHOWN.

SER. NO. 77-322,818, FILED 11-6-2007.

ANDREA SAUNDERS, EXAMINING ATTORNEY

Int. Cl.: 41

Prior U.S. Cls.: 100, 101 and 107

United States Patent and Trademark Office

Reg. No. 3,475,438

Registered July 29, 2008

SERVICE MARK
PRINCIPAL REGISTER



ALABAMA TREASURE FOREST ASSOCIATION
(ALABAMA NON-PROFIT EDUCATIONAL
CORPORATION)

C/O UNIVERSITY OF MOBILE

5735 COLLEGE PARKWAY

MOBILE, AL 366132842

FOR: EDUCATIONAL AND TRAINING SERVICES, NAMELY, PROVIDING CLASSES, WORKSHOPS, AND OTHER INSTRUCTION IN LAND AND FOREST MANAGEMENT PRACTICES, IN CLASS 41 (U.S. CLS. 100, 101 AND 107).

FIRST USE 12-31-1999; IN COMMERCE 12-31-1999.

NO CLAIM IS MADE TO THE EXCLUSIVE RIGHT TO USE "FOREST", APART FROM THE MARK AS SHOWN.

THE MARK CONSISTS OF THE WORDS "TEAM TREASURE FOREST" ON THE TOP OF A CIRCULAR SHAPE, WITH AN ACORN SHAPE AND STAR AND STRIPE DESIGN INSIDE THE CIRCULAR SHAPE, AND TWO RIBBON SHAPES FLOWING OUT FROM BOTH SIDES OF THE ACORN SHAPE AND STAR AND STRIPE DESIGN, AND THE LETTERS "ATFA" ON THE BOTTOM OF THE CIRCULAR SHAPE.

SER. NO. 77-322,882, FILED 11-6-2007.

DORITT L. CARROLL, EXAMINING ATTORNEY

Int. Cl.: 11

Prior U.S. Cls.: 13, 21, 23, 31 and 34

United States Patent and Trademark Office

Reg. No. 3,475,439

Registered July 29, 2008

**TRADEMARK
PRINCIPAL REGISTER**

Aquip

STORMWATERX LLC (OREGON LTD LIAB CO)
122 SE 27TH AVENUE
PORTLAND, OR 97214

THE MARK CONSISTS OF STANDARD CHAR-
ACTERS WITHOUT CLAIM TO ANY PARTICULAR
FONT, STYLE, SIZE, OR COLOR.

FOR: WATER FILTERING UNITS FOR INDUS-
TRIAL AND COMMERCIAL USE, IN CLASS 11 (U.S.
CLS. 13, 21, 23, 31 AND 34).

SER. NO. 77-322,980, FILED 11-6-2007.

FIRST USE 11-30-2007; IN COMMERCE 12-4-2007.

MARY MUNSON, EXAMINING ATTORNEY

Int. Cl.: 30

Prior U.S. Cl.: 46

United States Patent and Trademark Office

Reg. No. 3,475,440

Registered July 29, 2008

TRADEMARK
PRINCIPAL REGISTER



ORTIZ-JÁUREGUI, J. ANGEL (MEXICO INDIVIDUAL)
SALVATIERRA #612, COLONIA INDUSTRIAL
LEÓN, MEXICO 37340

FOR: ICE CREAM POWDER; ICE CREAM MIX;
STARCH-BASED BINDING AGENTS FOR ICE
CREAM; SORBET, NAMELY, SORBET BASE, SORBET
POWDER AND SORBET MIX, IN CLASS 30 (U.S.
CL. 46).

FIRST USE 7-20-1994; IN COMMERCE 3-31-2005.

NO CLAIM IS MADE TO THE EXCLUSIVE
RIGHT TO USE "BASE PARA HELADOS", APART
FROM THE MARK AS SHOWN.

THE FOREIGN WORDING IN THE MARK
TRANSLATES INTO ENGLISH AS ICE CREAM
BASE THE ITALIAN LADY.

SER. NO. 77-323,200, FILED 11-7-2007.

SUSAN STIGLITZ, EXAMINING ATTORNEY

Int. Cl.: 12

Prior U.S. Cls.: 19, 21, 23, 31, 35 and 44

United States Patent and Trademark Office

Reg. No. 3,475,441

Registered July 29, 2008

**TRADEMARK
PRINCIPAL REGISTER**

C-Shade

C-WORTHY CORP. (FLORIDA CORPORATION)
241 SW 5TH COURT
POMPANNO BEACH, FL 33060

THE MARK CONSISTS OF STANDARD CHARACTERS WITHOUT CLAIM TO ANY PARTICULAR FONT, STYLE, SIZE, OR COLOR.

FOR: RECREATIONAL VEHICLE ACCESSORIES, NAMELY, SUN AWNINGS FOR BOATS WHICH ARE DESIGNED FOR RAPID SET UP AND BREAK-DOWN, IN CLASS 12 (U.S. CLS. 19, 21, 23, 31, 35 AND 44).

SER. NO. 77-323,364, FILED 11-7-2007.

FIRST USE 8-1-2007; IN COMMERCE 8-1-2007.

JACQUELINE A. LAVINE, EXAMINING ATTORNEY

Int. Cl.: 41

Prior U.S. Cls.: 100, 101 and 107

United States Patent and Trademark Office

Reg. No. 3,475,442

Registered July 29, 2008

**SERVICE MARK
PRINCIPAL REGISTER**

PLTW

PROJECT LEAD THE WAY, INC. (NEW YORK CORPORATION)
747 PIERCE ROAD
CLIFTON PARK, NY 12065

FOR: COMPREHENSIVE PROGRAM PROVIDING ADVANCED TECHNOLOGY AND SCIENCE-BASED CURRICULA AND EDUCATION TRAINING TO SECONDARY SCHOOL TEACHERS IN ORDER TO OFFER MORE ADVANCED TECHNICAL TRAINING IN PRE-ENGINEERING, INFORMATIONAL SYSTEMS AND OTHER TECHNOLOGY AREAS TO SECONDARY SCHOOL STUDENTS TO PREPARE THEM FOR POST-SEC-

ONDARY EDUCATION IN THESE FIELDS, IN CLASS 41 (U.S. CLS. 100, 101 AND 107).

FIRST USE 4-8-1996; IN COMMERCE 7-10-1997.

THE MARK CONSISTS OF STANDARD CHARACTERS WITHOUT CLAIM TO ANY PARTICULAR FONT, STYLE, SIZE, OR COLOR.

OWNER OF U.S. REG. NO. 2,221,969.

SER. NO. 77-323,415, FILED 11-7-2007.

TEJBIR SINGH, EXAMINING ATTORNEY

Int. Cl.: 30

Prior U.S. Cl.: 46

United States Patent and Trademark Office

Reg. No. 3,475,443

Registered July 29, 2008

**TRADEMARK
PRINCIPAL REGISTER**

SHARING PACK

SNIKIDDY, LLC (MARYLAND LTD LIAB CO)
5219 FARRINGTON ROAD
BETHESDA, MD 20816

FOR: ORGANIC SALTY FLAVORED CORN
PUFFS AND ORGANIC BAKED COOKIES FOR
CHILDREN, IN CLASS 30 (U.S. CL. 46).

FIRST USE 10-31-2006; IN COMMERCE 10-31-2006.

THE MARK CONSISTS OF STANDARD CHAR-
ACTERS WITHOUT CLAIM TO ANY PARTICULAR
FONT, STYLE, SIZE, OR COLOR.

NO CLAIM IS MADE TO THE EXCLUSIVE
RIGHT TO USE "PACK", APART FROM THE MARK
AS SHOWN.

SER. NO. 77-323,443, FILED 11-7-2007.

HENRY S. ZAK, EXAMINING ATTORNEY

Int. Cl.: 16

Prior U.S. Cls.: 2, 5, 22, 23, 29, 37, 38 and 50

United States Patent and Trademark Office

Reg. No. 3,475,444

Registered July 29, 2008

**TRADEMARK
PRINCIPAL REGISTER**

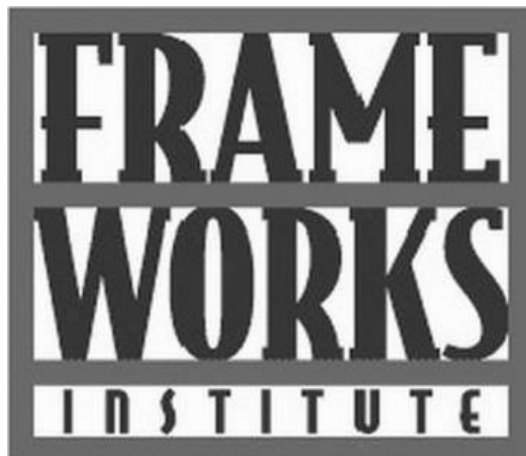

THE FRAMEWORKS INSTITUTE (DELAWARE
NON-PROFIT CORPORATION)
9TH FLOOR
1776 I STREET NW
WASHINGTON, DC 20006

FOR: PRINTED PUBLICATIONS, NAMELY,
BOOKS, NEWSLETTERS, REPORTS, BOOKLETS,
MANUALS, BROCHURES AND PAMPHLETS IN
THE FIELD OF COMMUNICATIONS, EDUCATION,
PUBLIC POLICY AND SOCIAL AND COGNITIVE
SCIENCES, IN CLASS 16 (U.S. CLS. 2, 5, 22, 23, 29, 37,
38 AND 50).

FIRST USE 9-0-1999; IN COMMERCE 9-0-1999.

NO CLAIM IS MADE TO THE EXCLUSIVE
RIGHT TO USE "INSTITUTE", APART FROM THE
MARK AS SHOWN.

THE MARK CONSISTS OF THE STYLIZED
WORDING "FRAME WORKS INSTITUTE".

SER. NO. 77-323,559, FILED 11-7-2007.

KATHLEEN LORENZO, EXAMINING ATTORNEY

Int. Cl.: 9

Prior U.S. Cls.: 21, 23, 26, 36 and 38

United States Patent and Trademark Office

Reg. No. 3,475,445

Registered July 29, 2008

**TRADEMARK
PRINCIPAL REGISTER**

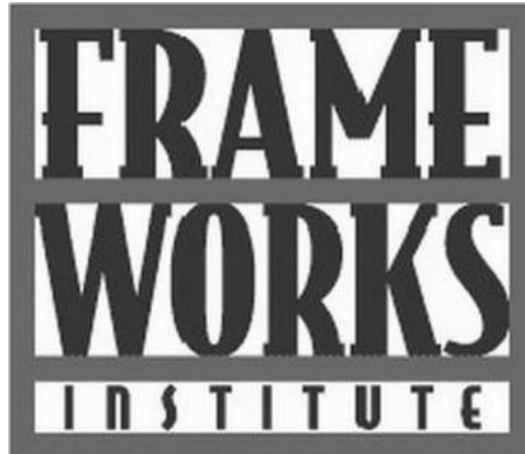

THE FRAMEWORKS INSTITUTE (DELAWARE
NON-PROFIT CORPORATION)

9TH FLOOR
1776 I STREET NW
WASHINGTON, DC 20006

FOR: PRE-RECORDED DIGITAL MEDIA, NAME-
LY, CD-ROMS, DVDS, CASSETTES, TAPES AND
DISCS FEATURING MATERIAL IN THE FIELD OF
COMMUNICATIONS, EDUCATION, MESSAGE DE-
VELOPMENT, PUBLIC POLICY, AND SOCIAL AND
COGNITIVE SCIENCES, IN CLASS 9 (U.S. CLS. 21, 23,
26, 36 AND 38).

FIRST USE 3-0-2001; IN COMMERCE 3-0-2001.

NO CLAIM IS MADE TO THE EXCLUSIVE
RIGHT TO USE "INSTITUTE", APART FROM THE
MARK AS SHOWN.

THE MARK CONSISTS OF THE STYLIZED
WORDING "FRAME WORKS INSTITUTE".

SER. NO. 77-323,579, FILED 11-7-2007.

KATHLEEN LORENZO, EXAMINING ATTORNEY

Int. Cl.: 42

Prior U.S. Cls.: 100 and 101

United States Patent and Trademark Office

Reg. No. 3,475,446

Registered July 29, 2008

**SERVICE MARK
PRINCIPAL REGISTER**

WESTAT

WESTAT, INC. (DELAWARE CORPORATION)
1650 RESEARCH BOULEVARD
ROCKVILLE, MD 208503129

FOR: PROVIDING ON-LINE NON-DOWNLOAD-
ABLE SOFTWARE FOR COLLECTION, STATISTI-
CAL ANALYSIS, AND REPORTING OF DATA, IN
CLASS 42 (U.S. CLS. 100 AND 101).

FIRST USE 11-1-2003; IN COMMERCE 11-1-2003.

THE MARK CONSISTS OF STANDARD CHAR-
ACTERS WITHOUT CLAIM TO ANY PARTICULAR
FONT, STYLE, SIZE, OR COLOR.

OWNER OF U.S. REG. NOS. 2,513,848 AND
3,293,397.

SER. NO. 77-323,642, FILED 11-7-2007.

FRED CARL, EXAMINING ATTORNEY

Int. Cl.: 25

Prior U.S. Cls.: 22 and 39

United States Patent and Trademark Office

Reg. No. 3,475,447

Registered July 29, 2008

**TRADEMARK
PRINCIPAL REGISTER**

ALFRED ANGELO SAPPHIRE

ALFRED ANGELO, INC. (PENNSYLVANIA CORPORATION)
SUITE 110 1301 VIRGINIA DRIVE
FT. WASHINGTON, PA 19034

FOR: WEDDING GOWNS, IN CLASS 25 (U.S. CLS. 22 AND 39).

FIRST USE 6-19-2007; IN COMMERCE 6-19-2007.

THE MARK CONSISTS OF STANDARD CHARACTERS WITHOUT CLAIM TO ANY PARTICULAR FONT, STYLE, SIZE, OR COLOR.

OWNER OF U.S. REG. NOS. 1,365,681, 3,372,495 AND OTHERS.

THE NAME(S), PORTRAIT(S), AND/OR SIGNATURE(S) SHOWN IN THE MARK DOES NOT IDENTIFY A PARTICULAR LIVING INDIVIDUAL.

SER. NO. 77-323,757, FILED 11-7-2007.

STEVEN PEREZ, EXAMINING ATTORNEY

Int. Cls.: 20, 40 and 42

Prior U.S. Cls.: 2, 13, 22, 25, 32, 50, 100, 101, 103 and 106

United States Patent and Trademark Office

Reg. No. 3,475,448

Registered July 29, 2008

**TRADEMARK
SERVICE MARK
PRINCIPAL REGISTER**

**STARMARK
C A B I N E T R Y**

NORCRAFT COMPANIES, L.P. (DELAWARE
LIMITED PARTNERSHIP)
SUITE 100
3020 DENMARK AVENUE
EAGAN, MN 55121

FOR: KITCHEN AND BATHROOM CABINETS,
IN CLASS 20 (U.S. CLS. 2, 13, 22, 25, 32 AND 50).

FIRST USE 10-0-2007; IN COMMERCE 10-0-2007.

FOR: CUSTOM MANUFACTURE OF CABINET-
RY, IN CLASS 40 (U.S. CLS. 100, 103 AND 106).

FIRST USE 10-0-2007; IN COMMERCE 10-0-2007.

FOR: DESIGN CONSULTING SERVICES IN THE
FIELD OF RESIDENTIAL CABINETRY, IN CLASS
42 (U.S. CLS. 100 AND 101).

FIRST USE 10-0-2007; IN COMMERCE 10-0-2007.

OWNER OF U.S. REG. NO. 1,162,775.

NO CLAIM IS MADE TO THE EXCLUSIVE
RIGHT TO USE "CABINETRY", APART FROM
THE MARK AS SHOWN.

SER. NO. 77-323,955, FILED 11-7-2007.

TOBY BULLOFF, EXAMINING ATTORNEY

Int. Cl.: 35

Prior U.S. Cls.: 100, 101 and 102

United States Patent and Trademark Office

Reg. No. 3,475,449

Registered July 29, 2008

**SERVICE MARK
PRINCIPAL REGISTER**

ewreckers

SOUL, SABAG (AUSTRALIA INDIVIDUAL)
3 CAHILL ST
BELLINGEN, AUSTRALIA 2454

FOR: ON-LINE RETAIL STORE SERVICES FEATURING AUTOMOBILES, AIRPLANES, LAND VEHICLES, BOATS, AND PARTS FOR AUTOMOBILES, AIRPLANES, LAND VEHICLES AND BOATS; ON-LINE RETAIL STORE SERVICES FEATURING FARM MACHINERY, GARDEN MACHINERY, APPLIANCES, AND PARTS FOR FARM MACHINERY,

GARDEN MACHINERY, AND APPLIANCES, IN CLASS 35 (U.S. CLS. 100, 101 AND 102).

FIRST USE 11-4-2005; IN COMMERCE 11-4-2005.

THE MARK CONSISTS OF STANDARD CHARACTERS WITHOUT CLAIM TO ANY PARTICULAR FONT, STYLE, SIZE, OR COLOR.

SER. NO. 77-324,223, FILED 11-7-2007.

MICHAEL GAAFAR, EXAMINING ATTORNEY

Int. Cl.: 45

Prior U.S. Cls.: 100 and 101

United States Patent and Trademark Office

Reg. No. 3,475,450

Registered July 29, 2008

**SERVICE MARK
PRINCIPAL REGISTER**

**GEORGIA LEGAL SERVICES
PROGRAM**

GEORGIA LEGAL SERVICES PROGRAM, INC.
(GEORGIA NON-PROFIT ORGANIZATION)
104 MARIETTA STREET, NW, SUITE 250
ATLANTA, GA 30303

NO CLAIM IS MADE TO THE EXCLUSIVE
RIGHT TO USE "LEGAL SERVICES PROGRAM",
APART FROM THE MARK AS SHOWN.

FOR: LEGAL SERVICES, IN CLASS 45 (U.S. CLS.
100 AND 101).

SEC. 2(F).

FIRST USE 0-0-1971; IN COMMERCE 0-0-1971.

SER. NO. 77-324,403, FILED 11-8-2007.

THE MARK CONSISTS OF STANDARD CHAR-
ACTERS WITHOUT CLAIM TO ANY PARTICULAR
FONT, STYLE, SIZE, OR COLOR.

KHANH LE, EXAMINING ATTORNEY

Int. Cl.: 9

Prior U.S. Cls.: 21, 23, 26, 36 and 38

United States Patent and Trademark Office

Reg. No. 3,475,451

Registered July 29, 2008

**TRADEMARK
PRINCIPAL REGISTER**

FIREROCK TECHNOLOGY

FIREROCK TECHNOLOGY (DELAWARE CORPORATION)
SUITE 103-286
14835 EAST SHEA BLVD.
FOUNTAIN HILLS, AZ 85268

FOR: COMPUTER HARDWARE AND COMPUTER SOFTWARE FOR DATA MANAGEMENT, ENCRYPTION AND DECRYPTION; COMPUTER SOFTWARE FOR DATA INTEGRATION AND SECURITY, NAMELY, INTEGRATION ALONG WITH ENCRYPTION/ DECRYPTION OF DATA FILES, DATA BLOCKS, TEXT, AUDIO, GRAPHICS, STILL IMAGES, AND MOVING PICTURES; COMPUTER HARDWARE AND SOFTWARE FOR DATA SHARING AND SECURE STORAGE, NAMELY, SECURING AND PROVIDING ACCESS DATA ACROSS A NETWORK OF STORAGE DEVICES AND COMPUTER SYSTEMS; COMPUTER SOFTWARE AND HARDWARE FOR IMPROVING DATA ACCESS TIMES AND ENCRYPTING/DECRYPTING DATA STORED ACROSS A NETWORK OF STORAGE

DEVICES AND COMPUTER SYSTEMS; COMPUTER SOFTWARE AND HARDWARE FOR VERIFYING AUTHENTICITY AND RELIABILITY OF THE DATA STORED ACROSS A NETWORK OF STORAGE DEVICES AND COMPUTER SYSTEMS, IN CLASS 9 (U.S. CLS. 21, 23, 26, 36 AND 38).

FIRST USE 2-1-2007; IN COMMERCE 6-14-2007.

THE MARK CONSISTS OF STANDARD CHARACTERS WITHOUT CLAIM TO ANY PARTICULAR FONT, STYLE, SIZE, OR COLOR.

NO CLAIM IS MADE TO THE EXCLUSIVE RIGHT TO USE "TECHNOLOGY", APART FROM THE MARK AS SHOWN.

SER. NO. 77-324,501, FILED 11-8-2007.

JAMES A. RAUEN, EXAMINING ATTORNEY

Int. Cl.: 7

Prior U.S. Cls.: 13, 19, 21, 23, 31, 34 and 35

United States Patent and Trademark Office

Reg. No. 3,475,452

Registered July 29, 2008

**TRADEMARK
PRINCIPAL REGISTER**



JET EDGE (MINNESOTA CORPORATION), DBA
JET EDGE

12070 43RD ST. N.E.

ST. MICHAEL, MN 55376

FOR: INTENSIFIER PUMP FOR WATERJET AND
ABRASIVE WATERJET CUTTING MACHINES, IN
CLASS 7 (U.S. CLS. 13, 19, 21, 23, 31, 34 AND 35).

FIRST USE 11-8-2007; IN COMMERCE 11-8-2007.

THE COLOR(S) BLUE, BLACK AND PURPLE IS/
ARE CLAIMED AS A FEATURE OF THE MARK.

THE COLOR BLUE APPEARS IN THE LETTER
"X" OF THE WORD "XSTREAM", IN THE OUT-
LINING OF THE WORD "STREAM", AND IN POR-
TIONS OF THE TERM "XP90-100"; THE COLOR
BLACK APPEARS IN THE WORD "STREAM" AND
IN THE OUTLINING OF THE LETTER "X" AND
OUTLINING OF THE TERM "XP90-100"; AND THE
COLOR PURPLE APPEARS IN THE TIP OF THE
UPPER RIGHT CORNER OF THE LETTER "X" OF
THE WORD "XSTREAM" AND IN PORTIONS OF
THE TERM "XP90-100" OF THE MARK.

SER. NO. 77-324,803, FILED 11-8-2007.

ANDREW RHIM, EXAMINING ATTORNEY

Int. Cl.: 39

Prior U.S. Cls.: 100 and 105

United States Patent and Trademark Office

Reg. No. 3,475,453

Registered July 29, 2008

**SERVICE MARK
PRINCIPAL REGISTER**

SAN JOAQUIN

NATIONAL RAILROAD PASSENGER COR-
PORATION (D.C. CORPORATION)

60 MASSACHUSETTS AVE, N.E.

WASHINGTON, DC 20002

FOR: RAILROAD TRANSPORTATION SERVI-
CES, IN CLASS 39 (U.S. CLS. 100 AND 105).

FIRST USE 3-1-1974; IN COMMERCE 3-1-1974.

THE MARK CONSISTS OF STANDARD CHAR-
ACTERS WITHOUT CLAIM TO ANY PARTICULAR
FONT, STYLE, SIZE, OR COLOR.

OWNER OF U.S. REG. NO. 3,069,916.

SEC. 2(F).

SER. NO. 77-324,999, FILED 11-8-2007.

JESSICA A. POWERS, EXAMINING ATTORNEY

Int. Cl.: 41

Prior U.S. Cls.: 100, 101 and 107

United States Patent and Trademark Office

Reg. No. 3,475,454

Registered July 29, 2008

**SERVICE MARK
PRINCIPAL REGISTER**



COLLISION STUDIOS, INC (CALIFORNIA CORPORATION)
1235 ELECTRIC AVENUE
VENICE, CA 90291

FOR: MULTIMEDIA ENTERTAINMENT SOFTWARE PRODUCTION SERVICES, IN CLASS 41 (U.S. CLS. 100, 101 AND 107).

FIRST USE 1-1-2007; IN COMMERCE 1-1-2007.

OWNER OF U.S. REG. NO. 3,292,162.

NO CLAIM IS MADE TO THE EXCLUSIVE RIGHT TO USE "STUDIOS", APART FROM THE MARK AS SHOWN.

THE COLOR(S) BLACK, WHITE, GRAY, ORANGE, AND YELLOW IS/ARE CLAIMED AS A FEATURE OF THE MARK.

THE MARK CONSISTS OF A WHITE BACKGROUND WITH THE WORD "COLLISION" IN BLACK LETTERS WITH GRAY OUTLINE; THE SECOND "O" IN THE WORD HAS A LARGER OUTER DIAMETER THAN THE FIRST "O"; THE SECOND "O" HAS AN ORANGE AND YELLOW SUN INSIDE IT; THE SUN HAS THREE SUNSPOTS INSIDE AND ONE OVERLAPPING; THE SECOND "O" ALSO HAS THREE BLACK SPOTS BURSTING FROM ITS PERIPHERY; THE WORD "STUDIOS" APPEARS IN GRAY LETTERS BENEATH THE WORD "COLLISION".

SER. NO. 77-325,106, FILED 11-8-2007.

JOHN DALIER, EXAMINING ATTORNEY

Int. Cl.: 5

Prior U.S. Cls.: 6, 18, 44, 46, 51 and 52

United States Patent and Trademark Office

Reg. No. 3,475,455

Registered July 29, 2008

**TRADEMARK
PRINCIPAL REGISTER**

MAX

FERRIS PHARMACEUTICALS INC. (ILLINOIS
CORPORATION)
16W300 83RD STREET
BURR RIDGE, IL 605275848

FOR: FOAM BANDAGES AND WOUND DRES-
SINGS USED ON EXPOSED OR OPEN WOUNDS, IN
CLASS 5 (U.S. CLS. 6, 18, 44, 46, 51 AND 52).

FIRST USE 4-0-2002; IN COMMERCE 6-25-2002.

THE MARK CONSISTS OF STANDARD CHAR-
ACTERS WITHOUT CLAIM TO ANY PARTICULAR
FONT, STYLE, SIZE, OR COLOR.

OWNER OF U.S. REG. NO. 3,226,019.

SER. NO. 77-325,156, FILED 11-8-2007.

MICHAEL TANNER, EXAMINING ATTORNEY

Int. Cl.: 36

Prior U.S. Cls.: 100, 101 and 102

United States Patent and Trademark Office

Reg. No. 3,475,456

Registered July 29, 2008

**SERVICE MARK
PRINCIPAL REGISTER**

**ACE RECREATIONAL MARINE
INSURANCE**

ACE LIMITED (CAYMAN ISLANDS CORPORATION)
17 WOODBOURNE AVENUE
ACE GLOBAL HEADQUARTERS
HAMILTON, BERMUDA 08

FOR: INSURANCE SERVICES, NAMELY, UNDERWRITING, CLAIMS ADMINISTRATION, ADJUSTMENT AND PROCESSING SERVICES, LOSS CONTROL SERVICES, BROKERAGE SERVICES, SUBROGATION AND ACTUARIAL SERVICES, ALL IN THE FIELD OF MARINE INSURANCE, IN CLASS 36 (U.S. CLS. 100, 101 AND 102).

FIRST USE 10-25-2007; IN COMMERCE 10-25-2007.

THE MARK CONSISTS OF STANDARD CHARACTERS WITHOUT CLAIM TO ANY PARTICULAR FONT, STYLE, SIZE, OR COLOR.

OWNER OF U.S. REG. NOS. 3,177,329 AND 3,207,350.

NO CLAIM IS MADE TO THE EXCLUSIVE RIGHT TO USE "RECREATIONAL MARINE INSURANCE", APART FROM THE MARK AS SHOWN.

SER. NO. 77-325,246, FILED 11-8-2007.

SAIMA MAKHDOOM, EXAMINING ATTORNEY

Int. Cl.: 42

Prior U.S. Cls.: 100 and 101

United States Patent and Trademark Office

Reg. No. 3,475,457

Registered July 29, 2008

**SERVICE MARK
PRINCIPAL REGISTER**

MORTGAGEDASHBOARD

VUECENTRIC, INC. (DELAWARE CORPORATION)
9390 RESEARCH BLVD
SUITE 440
AUSTIN, TX 78759

FOR: PROVIDING TEMPORARY USE OF ON-LINE NON-DOWNLOADABLE LOAN ORIGINATION SOFTWARE FOR PREPARING LOAN ORIGINATION DOCUMENTS AND MANAGEMENT OF LOAN ORIGINATION DOCUMENTS , IN CLASS 42 (U.S. CLS. 100 AND 101).

FIRST USE 10-1-2002; IN COMMERCE 10-1-2002.

THE MARK CONSISTS OF STANDARD CHARACTERS WITHOUT CLAIM TO ANY PARTICULAR FONT, STYLE, SIZE, OR COLOR.

SEC. 2(F).

SER. NO. 77-325,292, FILED 11-8-2007.

CYNTHIA SLOAN, EXAMINING ATTORNEY

Int. Cl.: 30

Prior U.S. Cl.: 46

United States Patent and Trademark Office

Reg. No. 3,475,458

Registered July 29, 2008

**TRADEMARK
PRINCIPAL REGISTER**

Ustad Banne Nawab's

DECCAN TRADERS PVT. LTD. (ILLINOIS CORPORATION)

26 COLONIAL CT

STREAMWOOD, IL 60107

FOR: BAKING SPICES; CINNAMON POWDER; CLOVE POWDER; CURRY; CURRY POWDER; GINGER; HOT PEPPER POWDER; PEPPER; PEPPER POWDER; SPICE BLENDS; SPICE RUBS; SPICES, IN CLASS 30 (U.S. CL. 46).

FIRST USE 9-1-2003; IN COMMERCE 3-18-2004.

THE MARK CONSISTS OF STANDARD CHARACTERS WITHOUT CLAIM TO ANY PARTICULAR FONT, STYLE, SIZE, OR COLOR.

THE NAME(S), PORTRAIT(S), AND/OR SIGNATURE(S) SHOWN IN THE MARK DOES NOT IDENTIFY A PARTICULAR LIVING INDIVIDUAL.

THE FOREIGN WORDING IN THE MARK TRANSLATES INTO ENGLISH AS ROYAL CHEF.

SER. NO. 77-325,370, FILED 11-8-2007.

MICHAEL KEATING, EXAMINING ATTORNEY

Int. Cl.: 16

Prior U.S. Cls.: 2, 5, 22, 23, 29, 37, 38 and 50

United States Patent and Trademark Office

Reg. No. 3,475,459

Registered July 29, 2008

**TRADEMARK
PRINCIPAL REGISTER**

FIRST RESPONDER BEWARE

CULVERCO, LLC (MASSACHUSETTS LTD LIAB
CO), DBA CULVER COMPANY, INC.
104 BRIDGE RD
SALISBURY, MA 01952

FOR: EDUCATIONAL PUBLICATIONS, NAME-
LY, EDUCATIONAL LEARNING CARDS, FLASH
CARDS, ACTIVITY CARDS, WORKBOOKS, TEXT-
BOOKS, ACTIVITY BOOKS, STORY BOOKS, PUZ-
ZLE BOOKS, PUZZLES, TEACHER GUIDES,
MANUALS, POSTERS, EDUCATIONAL CARD
GAMES AND EDUCATIONAL BOOKLETS IN THE
FIELD OF ELECTRICAL AND NATURAL GAS
SAFETY, IN CLASS 16 (U.S. CLS. 2, 5, 22, 23, 29, 37,
38 AND 50).

FIRST USE 6-9-1997; IN COMMERCE 6-9-1997.

THE MARK CONSISTS OF STANDARD CHAR-
ACTERS WITHOUT CLAIM TO ANY PARTICULAR
FONT, STYLE, SIZE, OR COLOR.

NO CLAIM IS MADE TO THE EXCLUSIVE
RIGHT TO USE "FIRST RESPONDER", APART
FROM THE MARK AS SHOWN.

SER. NO. 77-325,612, FILED 11-9-2007.

STEVEN R. FINE, EXAMINING ATTORNEY

Int. Cl.: 41

Prior U.S. Cls.: 100, 101 and 107

United States Patent and Trademark Office

Reg. No. 3,475,460

Registered July 29, 2008

**SERVICE MARK
PRINCIPAL REGISTER**

PREMIOS BRILLANTES

THE JEFFREY GROUP LLC (FLORIDA LTD
LIAB CO)

ATTN: JEFFREY SHARLACH

1111 LINCOLN ROAD – SUITE 800

MIAMI BEACH, FL 33139

FOR: AWARDS PROGRAM FOR MAJOR COR-
PORATIONS AND INDIVIDUALS WHO HAVE
MADE SIGNIFICANT CHARITABLE CONTRIBU-
TIONS, IN CLASS 41 (U.S. CLS. 100, 101 AND 107).

FIRST USE 7-2-2007; IN COMMERCE 7-2-2007.

THE MARK CONSISTS OF STANDARD CHAR-
ACTERS WITHOUT CLAIM TO ANY PARTICULAR
FONT, STYLE, SIZE, OR COLOR.

NO CLAIM IS MADE TO THE EXCLUSIVE
RIGHT TO USE "PREMIOS", APART FROM THE
MARK AS SHOWN.

THE ENGLISH TRANSLATION OF "PREMIOS
BRILLANTES" IS SHINING AWARDS.

SER. NO. 77-325,767, FILED 11-9-2007.

MICHELLE DUBOIS, EXAMINING ATTORNEY

Int. Cl.: 41

Prior U.S. Cls.: 100, 101 and 107

United States Patent and Trademark Office

Reg. No. 3,475,461

Registered July 29, 2008

SERVICE MARK
PRINCIPAL REGISTER



AMERICAN BUSINESS COLLEGE (CALIFORNIA CORPORATION)
SUITE 108
1635 LAKE SAN MARCOS DRIVE
SAN MARCOS, CA 92078

FOR: EDUCATIONAL SERVICES IN THE NATURE OF A BUSINESS SCHOOL, IN CLASS 41 (U.S. CLS. 100, 101 AND 107).

FIRST USE 6-1-2007; IN COMMERCE 6-1-2007.

NO CLAIM IS MADE TO THE EXCLUSIVE RIGHT TO USE "AMERICAN BUSINESS COLLEGE ESTABLISHED 2005", APART FROM THE MARK AS SHOWN.

THE COLOR(S) DARK BLUE IS/ARE CLAIMED AS A FEATURE OF THE MARK.

THE MARK CONSISTS OF A CIRCLE WITH QUARTER QUADRANT SECTIONS, IN THE TOP LEFT QUADRANT A CALCULATOR AND LEDGER BOOK, IN THE TOP RIGHT QUADRANT A STARS AND STRIPES SHIELD, IN THE LOWER LEFT QUADRANT AN ABACUS, IN THE LOWER RIGHT QUADRANT A MAGNIFYING GLASS, LEDGER, AND INDUSTRIAL BUILDINGS, TEXT ARCHING OVER THE TOP OF THE CIRCLE READING "AMERICAN BUSINESS COLLEGE" IN 20PT OLD ENGLISH FONT, TEXT CURVING UNDER THE CIRCLE READING "ESTABLISHED 2005" IN 16PT OLD ENGLISH FONT, THE TWO TEXTS SEPARATED BY TWO FIVE-POINTED STARS, ALL IN DARK BLUE.

SER. NO. 77-325,873, FILED 11-9-2007.

GEOFFREY FOSDICK, EXAMINING ATTORNEY

Int. Cl.: 21

Prior U.S. Cls.: 2, 13, 23, 29, 30, 33, 40 and 50

United States Patent and Trademark Office

Reg. No. 3,475,462

Registered July 29, 2008

**TRADEMARK
PRINCIPAL REGISTER**

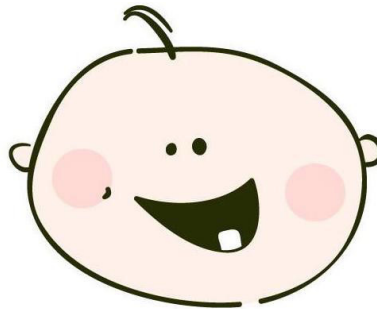

KORN, JONATHAN (UNITED STATES INDIVIDUAL)
35 CATHERINE DRIVE
ROCKY HILL, CT 06067 AND
LO, GRACE (CANADA INDIVIDUAL)
35 CATHERINE DRIVE
ROCKY HILL, CT 06067

FOR: ORAL HYGIENE DEVICES, NAMELY, INTERDENTAL CLEANERS SIZED FOR USE WITH INFANTS, IN CLASS 21 (U.S. CLS. 2, 13, 23, 29, 30, 33, 40 AND 50).

FIRST USE 11-1-2007; IN COMMERCE 11-1-2007.

THE COLOR(S) PINK, WHITE AND BLACK IS/ARE CLAIMED AS A FEATURE OF THE MARK.

THE MARK CONSISTS OF A BABY'S HEAD IN WHITE WITH BLACK OUTLINING, BLACK DIMPLE, PINK CHEEKS, BLACK EYES, BLACK MOUTH WITH WHITE TOOTH, AND BLACK HAIR.

SER. NO. 77-325,972, FILED 11-9-2007.

CHRISTINE COOPER, EXAMINING ATTORNEY

Int. Cl.: 41

Prior U.S. Cls.: 100, 101 and 107

United States Patent and Trademark Office

Reg. No. 3,475,463

Registered July 29, 2008

**SERVICE MARK
PRINCIPAL REGISTER**

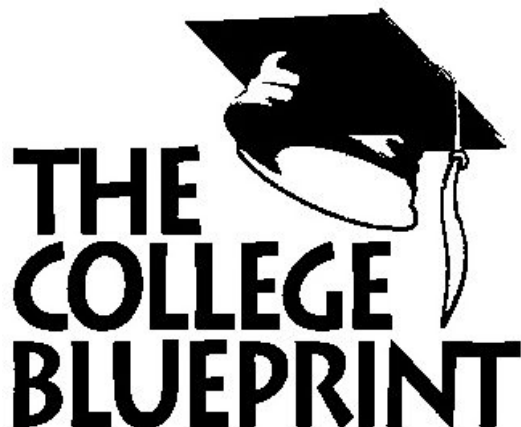

KERCHNER, JAN (UNITED STATES INDIVIDUAL)
23 LONGSHORE
IRVINE, CA 92614

FOR: EDUCATIONAL SERVICES, NAMELY, COLLEGE COUNSELING AND PREPARATION IN THE NATURE OF TUTORING IN THE FIELD OF STANDARDIZED TEST PREPARATION, MIDDLE AND HIGH SCHOOL PLACEMENT, COLLEGE ADMISSIONS COUNSELING AND ACADEMIC COACHING, IN CLASS 41 (U.S. CLS. 100, 101 AND 107).

FIRST USE 2-0-2002; IN COMMERCE 2-0-2002.

NO CLAIM IS MADE TO THE EXCLUSIVE RIGHT TO USE "COLLEGE", APART FROM THE MARK AS SHOWN.

THE MARK CONSISTS OF CONSIST OF STYLIZED TEXT "THE COLLEGE BLUEPRINT" WITH A LOGO OF A CAP AND TASSEL.

SER. NO. 77-326,481, FILED 11-9-2007.

FLORENTINA BLANDU, EXAMINING ATTORNEY

Int. Cl.: 9

Prior U.S. Cls.: 21, 23, 26, 36 and 38

United States Patent and Trademark Office

Reg. No. 3,475,464

Registered July 29, 2008

**TRADEMARK
PRINCIPAL REGISTER**



MURRAY, SKERRETT & ASSOCIATES INC. (CANADA CORPORATION)
SUITE 101
111 ILSLEY AVE.
DARTMOUTH, CANADA B3B1S8

FOR: COMPUTER PROGRAMMES FOR DOCUMENT MANAGEMENT, IN CLASS 9 (U.S. CLS. 21, 23, 26, 36 AND 38).

FIRST USE 3-14-2007; IN COMMERCE 7-14-2007.

THE COLOR(S) RED, AND BLUE IS/ARE CLAIMED AS A FEATURE OF THE MARK.

THE COLOR BLUE APPEARS IN THE OUTER CIRCLE WHICH CONSISTS OF FOUR (4) QUADRANTS AND IN THE TERM "DOC"; THE COLOR RED APPEARS IN THE INNER SOLID CIRCLE AND IN THE TERM "ITT"; AND THE BACKGROUND OF THE MARK IS TRANSPARENT.

SER. NO. 77-326,556, FILED 11-10-2007.

BILL DAWE, EXAMINING ATTORNEY

Int. Cl.: 41

Prior U.S. Cls.: 100, 101 and 107

United States Patent and Trademark Office

Reg. No. 3,475,465

Registered July 29, 2008

**SERVICE MARK
PRINCIPAL REGISTER**

X PLANE

MICHELL, PETER JEFFERY (UNITED STATES
INDIVIDUAL)
APT. 3L
144 RICHARDSON ST.
BROOKLYN, NY 11211

THE MARK CONSISTS OF STANDARD CHAR-
ACTERS WITHOUT CLAIM TO ANY PARTICULAR
FONT, STYLE, SIZE, OR COLOR.

FOR: ENTERTAINMENT, NAMELY, LIVE PER-
FORMANCES BY A MUSICAL BAND, IN CLASS 41
(U.S. CLS. 100, 101 AND 107).

SER. NO. 77-326,580, FILED 11-10-2007.

FIRST USE 12-6-2004; IN COMMERCE 11-9-2007.

LINDA M. KING, EXAMINING ATTORNEY

Int. Cl.: 9

Prior U.S. Cls.: 21, 23, 26, 36 and 38

Reg. No. 3,475,466

United States Patent and Trademark Office

Registered July 29, 2008

**TRADEMARK
PRINCIPAL REGISTER**

PRINT2POSTAL

STRONGHORSE, INC. (FLORIDA CORPORATION)
7746 CRESCENT PALM DR
WESLEY CHAPEL, FL 33545

FIRST USE 5-1-2007; IN COMMERCE 11-1-2007.

FOR: COMPUTER SOFTWARE FOR PREPARING DOCUMENTS FOR POSTAL MAIL THAT MAY BE DOWNLOADED FROM A GLOBAL COMPUTER NETWORK; COMPUTER SOFTWARE FOR PREPARING DOCUMENTS FOR POSTAL MAIL THAT MAY BE DOWNLOADED FROM A GLOBAL COMPUTER NETWORK, IN CLASS 9 (U.S. CLS. 21, 23, 26, 36 AND 38).

THE MARK CONSISTS OF STANDARD CHARACTERS WITHOUT CLAIM TO ANY PARTICULAR FONT, STYLE, SIZE, OR COLOR.

SER. NO. 77-326,714, FILED 11-11-2007.

NAAKWAMA ANKRAH, EXAMINING ATTORNEY

Int. Cl.: 33

Prior U.S. Cls.: 47 and 49

United States Patent and Trademark Office

Reg. No. 3,475,467

Registered July 29, 2008

**TRADEMARK
PRINCIPAL REGISTER**

ROTARI TALENTO

MEZZACORONA SCA (ITALY SOCIETA COOP-
ERATIVA (SC))
VIA DEL TEROLDEGO 1
MEZZOCORONA, ITALY 38016

FOR: APERITIF WINES; APERITIFS WITH A
WINE BASE; COOKING WINE; FRUIT WINE;
GRAPE WINE; KITS FOR MAKING WINE; NATUR-
AL SPARKLING WINES; PORT WINES; PREPARED
WINE COCKTAILS; RED WINE; SPARKLING
FRUIT WINE; SPARKLING GRAPE WINE; SPARK-
LING WINES; STRAWBERRY WINE; SWEET
WINES; TABLE WINES; TONIC SWEET GRAPE
WINE CONTAINING EXTRACTS FROM GINSENG
AND CONCHONA BARK (NINJIN-KINATETSU
WINE); WHITE WINE; WINE; WINE COOLERS;
WINE PUNCH; WINE PUNCHES; WINES, IN CLASS
33 (U.S. CLS. 47 AND 49).

FIRST USE 11-10-2007; IN COMMERCE 11-10-2007.

THE MARK CONSISTS OF STANDARD CHAR-
ACTERS WITHOUT CLAIM TO ANY PARTICULAR
FONT, STYLE, SIZE, OR COLOR.

OWNER OF U.S. REG. NO. 2,878,083.

THE FOREIGN WORDING IN THE MARK
TRANSLATES INTO ENGLISH AS "ROTARI" IS
AN ANCIENT ITALIAN KING, "TALENTO" IS LIKE
THE ART OF PRODUCING.

SER. NO. 77-326,842, FILED 11-12-2007.

NAPOLEON SHARMA, EXAMINING ATTORNEY

Int. Cls.: 35 and 36

Prior U.S. Cls.: 100, 101 and 102

United States Patent and Trademark Office

Reg. No. 3,475,468

Registered July 29, 2008

**SERVICE MARK
PRINCIPAL REGISTER**

TIMEBUYER

TIMEBUYER, INC. (NEW YORK CORPORATION)
113-119 EAST BRIDGE STREET
OSWEGO, NY 13126

FOR: AUTOMOBILE DEALERSHIPS, IN CLASS 35
(U.S. CLS. 100, 101 AND 102).

FIRST USE 1-18-2005; IN COMMERCE 1-18-2005.

FOR: FINANCING RELATING TO AUTOMOBILES, IN CLASS 36 (U.S. CLS. 100, 101 AND 102).

FIRST USE 1-18-2005; IN COMMERCE 1-18-2005.

THE MARK CONSISTS OF STANDARD CHARACTERS WITHOUT CLAIM TO ANY PARTICULAR FONT, STYLE, SIZE, OR COLOR.

SER. NO. 77-326,920, FILED 11-12-2007.

LOURDES AYALA, EXAMINING ATTORNEY

Int. Cl.: 36

Prior U.S. Cls.: 100, 101 and 102

United States Patent and Trademark Office

Reg. No. 3,475,469

Registered July 29, 2008

**SERVICE MARK
PRINCIPAL REGISTER**



PENSION SERVICES, INC. (FLORIDA CORPORATION)
SUITE 405
7700 N KENDALL DRIVE
MIAMI, FL 33156

FOR: ADMINISTRATION OF EMPLOYEE PENSION PLANS, IN CLASS 36 (U.S. CLS. 100, 101 AND 102).

FIRST USE 8-5-2007; IN COMMERCE 8-21-2007.

NO CLAIM IS MADE TO THE EXCLUSIVE RIGHT TO USE "PENSION SERVICES INC.", APART FROM THE MARK AS SHOWN.

THE MARK CONSISTS OF THE WORDS "PENSION SERVICES INC. DESIGNING RETIREMENT PLANS FOR MAXIMIZED CONTRIBUTIONS" AND IN THE BACKGROUND "PSI" IN STYLIZED FORM.

SER. NO. 77-326,925, FILED 11-12-2007.

STEVEN PEREZ, EXAMINING ATTORNEY

Int. Cl.: 41

Prior U.S. Cls.: 100, 101 and 107

United States Patent and Trademark Office

Reg. No. 3,475,470

Registered July 29, 2008

**SERVICE MARK
PRINCIPAL REGISTER**

CHORUS PRO MUSICA

CHORUS PRO MUSICA, INCORPORATED (MAS-
SACHUSETTS CORPORATION)
645 BOYLSTON STREET
BOSTON, MA 02116

FOR: ENTERTAINMENT SERVICES IN THE
NATURE OF LIVE MUSICAL PERFORMANCES,
IN CLASS 41 (U.S. CLS. 100, 101 AND 107).

FIRST USE 6-22-1959; IN COMMERCE 6-22-1959.

THE MARK CONSISTS OF STANDARD CHAR-
ACTERS WITHOUT CLAIM TO ANY PARTICULAR
FONT, STYLE, SIZE, OR COLOR.

NO CLAIM IS MADE TO THE EXCLUSIVE
RIGHT TO USE "CHORUS", APART FROM THE
MARK AS SHOWN.

SER. NO. 77-326,954, FILED 11-12-2007.

GILBERT SWIFT, EXAMINING ATTORNEY

Int. Cl.: 36

Prior U.S. Cls.: 100, 101 and 102

United States Patent and Trademark Office

Reg. No. 3,475,471

Registered July 29, 2008

SERVICE MARK
PRINCIPAL REGISTER

G the Real Estate 
Group

THE REAL ESTATE GROUP, LLC (VIRGINIA
LTD LIAB CO)
SUITE F
1112 EDEN WAY NORTH
CHESAPEAKE, VA 23320

FIRST USE 5-29-2003; IN COMMERCE 7-1-2003.

NO CLAIM IS MADE TO THE EXCLUSIVE
RIGHT TO USE "REAL ESTATE GROUP" , APART
FROM THE MARK AS SHOWN.

FOR: PROVIDING INFORMATION IN THE
FIELD OF REAL ESTATE VIA THE INTERNET;
PROVIDING REAL ESTATE LISTINGS AND REAL
ESTATE INFORMATION VIA THE INTERNET;
REAL ESTATE ACQUISITION SERVICES; REAL
ESTATE AGENCIES; REAL ESTATE BROKERAGE;
REAL ESTATE CONSULTANCY; REAL ESTATE
CONSULTATION; REAL ESTATE LISTING; REAL
ESTATE MANAGEMENT; REAL ESTATE MAN-
AGEMENT CONSULTATION; REAL ESTATE MUL-
TIPLE LISTING SERVICES; REAL ESTATE
PROCUREMENT FOR OTHERS; REAL ESTATE
VALUATION SERVICES; REAL ESTATE VALUA-
TIONS, IN CLASS 36 (U.S. CLS. 100, 101 AND 102).

THE MARK CONSISTS OF THE WORDS "THE
REAL ESTATE" APPEAR ABOVE THE LETTERS
"ROUP" FROM THE WORD "GROUP"; THE "G"
FROM THE WORD "GROUP" APPEARS TO THE
LEFT OF THE WORDS "THE REAL ESTATE" AND
THE LETTERS "ROUP"; THE MARK ALSO IN-
CLUDES A SYMBOL APPEARING TO THE RIGHT
OF THE WORDS "THE REAL ESTATE".

SER. NO. 77-327,136, FILED 11-12-2007.

DOMINICK J. SALEMI, EXAMINING ATTORNEY

Int. Cl.: 36

Prior U.S. Cls.: 100, 101 and 102

United States Patent and Trademark Office

Reg. No. 3,475,472

Registered July 29, 2008

SERVICE MARK
PRINCIPAL REGISTER

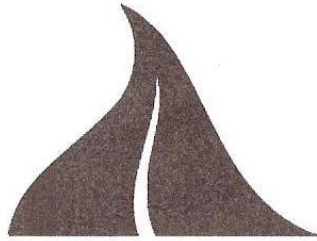

ALLEN LAWRENCE
& ASSOCIATES, INC.

Insurance Brokers

ALLEN LAWRENCE & ASSOCIATES, INC. (CALIFORNIA CORPORATION)
7033 OWENSMOUTH AVENUE
CANOGA PARK, CA 91303

FOR: INSURANCE BROKERAGE; INSURANCE CONSULTATION; INSURANCE SERVICES IN THE NATURE OF LOSS CONTROL MANAGEMENT FOR OTHERS; INSURANCE UNDERWRITING CONSULTATION; PROVIDING INFORMATION IN INSURANCE MATTERS; FINANCIAL EVALUATION FOR INSURANCE PURPOSES; FINANCIAL RISK MANAGEMENT CONSULTATION, IN CLASS 36 (U.S. CLS. 100, 101 AND 102).

FIRST USE 7-1-1972; IN COMMERCE 7-1-1972.

NO CLAIM IS MADE TO THE EXCLUSIVE RIGHT TO USE "ASSOCIATES, INC." AND "INSUR-

ANCE BROKERS", APART FROM THE MARK AS SHOWN.

THE NAME(S), PORTRAIT(S), AND/OR SIGNATURE(S) SHOWN IN THE MARK IDENTIFIES "ALLEN LAWRENCE", WHOSE CONSENT(S) TO REGISTER IS MADE OF RECORD.

THE MARK CONSISTS OF A TRIANGLE WITH TWO (2) CURVED SIDES AND BOTTOM SIDE THAT IS BROKEN IN THE MIDDLE WITH THE BREAK BECOMING A CURVED LINE EXTENDING UP, INTO THE TRIANGLE. BELOW THE TRIANGLE IS THE LITERAL ELEMENT OF THE MARK.

SER. NO. 77-327,202, FILED 11-12-2007.

MARK SPARACINO, EXAMINING ATTORNEY

Int. Cls.: 35 and 36

Prior U.S. Cls.: 100, 101 and 102

United States Patent and Trademark Office

Reg. No. 3,475,473

Registered July 29, 2008

**SERVICE MARK
PRINCIPAL REGISTER**



HOTEL & LEISURE ADVISORS, LLC (OHIO LTD
LIAB CO)
SUITE 420
14805 DETROIT AVENUE
CLEVELAND, OH 441073921

FOR: BUSINESS APPRAISALS, ALL IN THE
FIELD OF HOTELS, OUTDOOR AND INDOOR
WATERPARKS, AMUSEMENT PARKS, RESORTS,
CONFERENCE AND CONVENTION CENTERS,
GOLF COURSES, RESTAURANTS AND OTHER
LEISURE REAL ESTATE; MARKET RESEARCH
AND ANALYSIS AND BUSINESS CONSULTING
ALL IN THE FIELD OF HOTELS, OUTDOOR AND
INDOOR WATERPARKS, AMUSEMENT PARKS,
RESORTS, CONFERENCE AND CONVENTION
CENTERS, GOLF COURSES, RESTAURANTS AND
OTHER LEISURE REAL ESTATE, IN CLASS 35 (U.S.
CLS. 100, 101 AND 102).

FIRST USE 10-1-2005; IN COMMERCE 10-1-2005.

FOR: REAL ESTATE APPRAISALS, ALL IN THE
FIELD OF HOTELS, OUTDOOR AND INDOOR
WATERPARKS, AMUSEMENT PARKS, RESORTS,
CONFERENCE AND CONVENTION CENTERS,
GOLF COURSES, RESTAURANTS AND OTHER
LEISURE REAL ESTATE, IN CLASS 36 (U.S. CLS.
100, 101 AND 102).

FIRST USE 10-1-2005; IN COMMERCE 10-1-2005.

THE MARK CONSISTS OF A WAVY LINE UN-
DERNEATH THE LETTERS.

SER. NO. 77-327,255, FILED 11-12-2007.

FRED MANDIR, EXAMINING ATTORNEY

Int. Cl.: 19

Prior U.S. Cls.: 1, 12, 33 and 50

United States Patent and Trademark Office

Reg. No. 3,475,474

Registered July 29, 2008

**TRADEMARK
PRINCIPAL REGISTER**

VESCOVI

SAROYAN LUMBER COMPANY, INC. (CALI-
FORNIA CORPORATION)
6230 SO. ALAMEDA ST.
HUNTINGTON PARK, CA 90255

FOR: FLOOR BOARDS, WOODEN FLOORING,
HARDWOOD FLOORING; NON-METAL ARCHI-
TECTURAL MOULDINGS AND FINISH TRIM, IN
CLASS 19 (U.S. CLS. 1, 12, 33 AND 50).

FIRST USE 11-8-2007; IN COMMERCE 11-8-2007.

THE MARK CONSISTS OF STANDARD CHAR-
ACTERS WITHOUT CLAIM TO ANY PARTICULAR
FONT, STYLE, SIZE, OR COLOR.

"THE FOREIGN WORDING IN THE MARK
TRANSLATES INTO ENGLISH AS BISHOPS".

SER. NO. 77-327,382, FILED 11-12-2007.

DEIRDRE ROBERTSON, EXAMINING ATTORNEY

Int. Cl.: 3

Prior U.S. Cls.: 1, 4, 6, 50, 51 and 52

United States Patent and Trademark Office

Reg. No. 3,475,475

Registered July 29, 2008

TRADEMARK
PRINCIPAL REGISTER



MOBU, L.L.P. (OKLAHOMA LIMITED PART-
NERSHIP)
7646 NORTH WESTERN
OKLAHOMA CITY, OK 73116

THE MARK CONSISTS OF THE LOWERCASE
STYLIZED CURSIVE WORDS "SHA LINER" SEPA-
RATED BY A STYLIZED DOT.

FOR: EYE LINER; EYE MAKE-UP; EYELINER;
EYELINERS; EYES MAKE-UP, IN CLASS 3 (U.S.
CLS. 1, 4, 6, 50, 51 AND 52).

SER. NO. 77-327,420, FILED 11-12-2007.

FIRST USE 11-1-2007; IN COMMERCE 11-1-2007.

ALEX KEAM, EXAMINING ATTORNEY

Int. Cl.: 19

Prior U.S. Cls.: 1, 12, 33 and 50

United States Patent and Trademark Office

Reg. No. 3,475,476

Registered July 29, 2008

**TRADEMARK
PRINCIPAL REGISTER**

BRUCIA

SAROYAN LUMBER COMPANY, INC. (CALI-
FORNIA CORPORATION)
6230 SO. ALAMEDA ST.
HUNTINGTON PARK, CA 90255

FOR: FLOOR BOARDS, WOODEN FLOORING,
HARDWOOD FLOORING; NON-METAL ARCHI-
TECTURAL MOULDINGS AND FINISH TRIM, IN
CLASS 19 (U.S. CLS. 1, 12, 33 AND 50).

FIRST USE 11-8-2007; IN COMMERCE 11-8-2007.

THE MARK CONSISTS OF STANDARD CHAR-
ACTERS WITHOUT CLAIM TO ANY PARTICULAR
FONT, STYLE, SIZE, OR COLOR.

"THE FOREIGN WORDING IN THE MARK
TRANSLATES INTO ENGLISH AS IT BURNS."

SER. NO. 77-327,425, FILED 11-12-2007.

DEIRDRE ROBERTSON, EXAMINING ATTORNEY

Int. Cl.: 19

Prior U.S. Cls.: 1, 12, 33 and 50

United States Patent and Trademark Office

Reg. No. 3,475,477

Registered July 29, 2008

**TRADEMARK
PRINCIPAL REGISTER**

TROVATO

SAROYAN LUMBER COMPANY, INC. (CALI-
FORNIA CORPORATION)
6230 SO. ALAMEDA ST.
HUNTINGTON PARK, CA 90255

FOR: FLOOR BOARDS, WOODEN FLOORING,
HARDWOOD FLOORING; NON-METAL ARCHI-
TECTURAL MOULDINGS AND FINISH TRIM, IN
CLASS 19 (U.S. CLS. 1, 12, 33 AND 50).

FIRST USE 11-8-2007; IN COMMERCE 11-8-2007.

THE MARK CONSISTS OF STANDARD CHAR-
ACTERS WITHOUT CLAIM TO ANY PARTICULAR
FONT, STYLE, SIZE, OR COLOR.

"THE FOREIGN WORDING IN THE MARK
TRANSLATES INTO ENGLISH AS FOUND."

SER. NO. 77-327,475, FILED 11-12-2007.

DEIRDRE ROBERTSON, EXAMINING ATTORNEY

Int. Cl.: 42

Prior U.S. Cls.: 100 and 101

United States Patent and Trademark Office

Reg. No. 3,475,478

Registered July 29, 2008

SERVICE MARK
PRINCIPAL REGISTER



alita pharmaceuticals, inc.

ALITA PHARMACEUTICALS, INC. (DELAWARE
CORPORATION)
SUITE 420
100 MATSONFORD ROAD
RADNOR, PA 19087

FOR: RESEARCH SERVICES RELATING TO THE
DEVELOPMENT AND TESTING OF NEW PHAR-
MACEUTICALS; DEVELOPMENT OF PHARMA-
CEUTICAL PREPARATIONS; EVALUATION AND
TESTING OF PHARMACEUTICAL PRODUCTS; RE-
SEARCH AND DEVELOPMENT IN THE PHARMA-
CEUTICAL FIELD; SCIENTIFIC INVESTIGATIONS

FOR MEDICAL PURPOSES, IN CLASS 42 (U.S. CLS.
100 AND 101).

FIRST USE 11-2-2007; IN COMMERCE 11-2-2007.

NO CLAIM IS MADE TO THE EXCLUSIVE
RIGHT TO USE "PHARMACEUTICALS, INC.",
APART FROM THE MARK AS SHOWN.

SER. NO. 77-327,496, FILED 11-12-2007.

DAYNA BROWNE, EXAMINING ATTORNEY

Int. Cl.: 19

Prior U.S. Cls.: 1, 12, 33 and 50

United States Patent and Trademark Office

Reg. No. 3,475,479

Registered July 29, 2008

**TRADEMARK
PRINCIPAL REGISTER**

POSITANO

SAROYAN LUMBER COMPANY, INC. (CALI-
FORNIA CORPORATION)
6230 SO. ALAMEDA ST.
HUNTINGTON PARK, CA 90255

THE MARK CONSISTS OF STANDARD CHAR-
ACTERS WITHOUT CLAIM TO ANY PARTICULAR
FONT, STYLE, SIZE, OR COLOR.

FOR: FLOOR BOARDS, WOODEN FLOORING,
HARDWOOD FLOORING; NON-METAL ARCHI-
TECTURAL MOULDINGS AND FINISH TRIM, IN
CLASS 19 (U.S. CLS. 1, 12, 33 AND 50).

SER. NO. 77-327,504, FILED 11-12-2007.

FIRST USE 11-8-2007; IN COMMERCE 11-8-2007.

DEIRDRE ROBERTSON, EXAMINING ATTORNEY

Int. Cl.: 19

Prior U.S. Cls.: 1, 12, 33 and 50

United States Patent and Trademark Office

Reg. No. 3,475,480

Registered July 29, 2008

**TRADEMARK
PRINCIPAL REGISTER**

DONATO

SAROYAN LUMBER COMPANY, INC. (CALI-
FORNIA CORPORATION)
6230 SO. ALAMEDA ST.
HUNTINGTON PARK, CA 90255

FOR: FLOOR BOARDS, WOODEN FLOORING,
HARDWOOD FLOORING; NON-METAL ARCHI-
TECTURAL MOULDINGS AND FINISH TRIM, IN
CLASS 19 (U.S. CLS. 1, 12, 33 AND 50).

FIRST USE 11-8-2007; IN COMMERCE 11-8-2007.

THE MARK CONSISTS OF STANDARD CHAR-
ACTERS WITHOUT CLAIM TO ANY PARTICULAR
FONT, STYLE, SIZE, OR COLOR.

THE ENGLISH TRANSLATION OF "DONATO"
IN THE MARK MEANS "PRESENTED, BESTOWED
UPON, OR GIVEN".

SER. NO. 77-327,523, FILED 11-12-2007.

JEAN IM, EXAMINING ATTORNEY

Int. Cl.: 36

Prior U.S. Cls.: 100, 101 and 102

United States Patent and Trademark Office

Reg. No. 3,475,481

Registered July 29, 2008

**SERVICE MARK
PRINCIPAL REGISTER**

LiveREZ

LIVEREZ, INC. (IDAHO CORPORATION)
1300 E. STATE STREET
SUITE #102
BOISE, ID 83616

THE MARK CONSISTS OF STANDARD CHAR-
ACTERS WITHOUT CLAIM TO ANY PARTICULAR
FONT, STYLE, SIZE, OR COLOR.

FOR: REAL ESTATE SERVICES, NAMELY, REN-
TAL OF VACATION HOMES, CONDOMINIUMS,
CABINS AND VILLAS, IN CLASS 36 (U.S. CLS. 100,
101 AND 102).

SER. NO. 77-327,536, FILED S.R. 11-12-2007 AM.
P.R. 3-13-2008.

FIRST USE 6-1-2007; IN COMMERCE 6-1-2007.

STEVEN JACKSON, EXAMINING ATTORNEY

Int. Cls.: 35 and 37

Prior U.S. Cls.: 100, 101, 102, 103 and 106

United States Patent and Trademark Office

Reg. No. 3,475,482

Registered July 29, 2008

**SERVICE MARK
PRINCIPAL REGISTER**



MACOSER

MACOSER, INC. (NORTH CAROLINA CORPORATION)
2747 INTERSTATE STREET
CHARLOTTE, NC 28208

FOR: DISTRIBUTORSHIP SERVICES IN THE FIELD OF INDUSTRIAL MACHINERY; NAMELY, INDUSTRIAL WOODWORKING, METAL WORKING AND AUTOMATION MACHINERY AND PARTS AND ACCESSORIES THEREFOR, IN CLASS 35 (U.S. CLS. 100, 101 AND 102).

FIRST USE 11-5-2007; IN COMMERCE 11-5-2007.

FOR: REPAIR OF INDUSTRIAL MACHINERY, IN CLASS 37 (U.S. CLS. 100, 103 AND 106).

FIRST USE 11-1-2007; IN COMMERCE 11-1-2007.

THE MARK CONSISTS OF A STYLIZED LOWER CASE "M" HAVING THE GRAPHIC REPRESENTATION OF AN ARROW RUNNING THROUGH THE LETTER POSITIONED AT AN ANGLE OVER THE TERM "MACOSER" WHICH APPEARS IN STYLIZED LETTERING.

SER. NO. 77-327,838, FILED 11-13-2007.

WILLIAM P. SHANAHAN, EXAMINING ATTORNEY

Int. Cl.: 28

Prior U.S. Cls.: 22, 23, 38 and 50

United States Patent and Trademark Office

Reg. No. 3,475,483

Registered July 29, 2008

**TRADEMARK
PRINCIPAL REGISTER**

FRIENDS LAUGH TOGETHER

JOHN SWEIGART ENTERPRISES, LLC (UTAH
LTD LIAB CO)
715 SUMMIT DRIVE
SMITHFIELD, UT 84335

THE MARK CONSISTS OF STANDARD CHAR-
ACTERS WITHOUT CLAIM TO ANY PARTICULAR
FONT, STYLE, SIZE, OR COLOR.

FOR: AN ILLUMINATED TOY WAND THAT
YOU PASS OVER FOOD TO GIVE THE APPEAR-
ANCE OF ELIMINATING CALORIES, IN CLASS 28
(U.S. CLS. 22, 23, 38 AND 50).

SER. NO. 77-327,995, FILED 11-13-2007.

FIRST USE 9-1-2007; IN COMMERCE 10-22-2007.

NAAKWAMA ANKRAH, EXAMINING ATTORNEY

Int. Cl.: 41

Prior U.S. Cls.: 100, 101 and 107

United States Patent and Trademark Office

Reg. No. 3,475,484

Registered July 29, 2008

**SERVICE MARK
PRINCIPAL REGISTER**

THE TIMERNATOR

COOLMATH.COM, INC. (CALIFORNIA CORPORATION)
2973 FAIRVIEW ROAD
COSTA MESA, CA 92626

FOR: COMPUTER SERVICES, NAMELY, PROVIDING A WEBSITE FEATURING INFORMATION, PROBLEMS, EXAMPLES AND CALCULATIONS IN THE FIELD OF MATHEMATICS EDUCATION; NON-DOWNLOADABLE COMPUTER GAME SOFTWARE, NAMELY, A TIMED ONLINE COMPUTER GAME TO DETERMINE HOW MANY MATH PROBLEMS CAN BE COMPLETED CORRECTLY IN A

SPECIFIED AMOUNT OF TIME, IN CLASS 41 (U.S. CLS. 100, 101 AND 107).

FIRST USE 9-1-2006; IN COMMERCE 9-1-2006.

THE MARK CONSISTS OF STANDARD CHARACTERS WITHOUT CLAIM TO ANY PARTICULAR FONT, STYLE, SIZE, OR COLOR.

SER. NO. 77-328,673, FILED 11-13-2007.

SKYE YOUNG, EXAMINING ATTORNEY

Int. Cl.: 39

Prior U.S. Cls.: 100 and 105

United States Patent and Trademark Office

Reg. No. 3,475,485

Registered July 29, 2008

**SERVICE MARK
PRINCIPAL REGISTER**



HAULING PROS, INC. (CALIFORNIA CORPORATION)
P.O. BOX 4033
WALNUT CREEK, CA 94596

FOR: JUNK HAULING AND REMOVAL SERVICES, IN CLASS 39 (U.S. CLS. 100 AND 105).

FIRST USE 9-1-2001; IN COMMERCE 9-1-2001.

NO CLAIM IS MADE TO THE EXCLUSIVE RIGHT TO USE "HAULING PROS", APART FROM THE MARK AS SHOWN.

THE MARK CONSISTS OF A CITY SCAPE BACKGROUND WITH THE STYLIZED TEXT "HAULING PROS WE'RE TAKING JUNK TO THE NEXT LEVEL"; THE "O" IN "PROS" HAS AN ABSTRACT OBJECT ABOVE IT, AND THERE ARE TWO SOLID RECTANGLES (ONE TO THE LEFT OF THE "W" IN "WE" AND THE OTHER BENEATH THE "S" IN "PROS").

SER. NO. 77-328,756, FILED 11-13-2007.

NAAKWAMA ANKRAH, EXAMINING ATTORNEY

Int. Cl.: 35

Prior U.S. Cls.: 100, 101 and 102

United States Patent and Trademark Office

Reg. No. 3,475,486

Registered July 29, 2008

**SERVICE MARK
PRINCIPAL REGISTER**

Winsome Treasures

JAGLOWSKI, RITA (UNITED STATES INDIVIDUAL)
50 DAMREN ROAD
DERRY, NH 03038

FOR: ON-LINE RETAIL STORE SERVICES FEATURING HANDMADE GLASS WIND CHIMES, VINTAGE CLOTHING, NAMELY, DRESSES, HATS, GLOVES AND HANDBAGS, ANTIQUE LACE NAMELY TABLE CLOTHS, NAPKINS, DOILIES AND RUNNERS, HANDMADE WRITING JOURNALS, VINTAGE DOLLS, NAMELY, CLOTH AND COLLECTABLE NAME BRAND DOLLS, AND NATURAL SKINCARE PRODUCTS, NAMELY, LIP BALM AND SOLID PERFUME, IN CLASS 35 (U.S. CLS. 100, 101 AND 102).

FIRST USE 6-27-2005; IN COMMERCE 6-27-2005.

THE MARK CONSISTS OF STANDARD CHARACTERS WITHOUT CLAIM TO ANY PARTICULAR FONT, STYLE, SIZE, OR COLOR.

NO CLAIM IS MADE TO THE EXCLUSIVE RIGHT TO USE "TREASURES", APART FROM THE MARK AS SHOWN.

SER. NO. 77-328,759, FILED 11-13-2007.

NAAKWAMA ANKRAH, EXAMINING ATTORNEY

Int. Cl.: 41

Prior U.S. Cls.: 100, 101 and 107

United States Patent and Trademark Office

Reg. No. 3,475,487

Registered July 29, 2008

**SERVICE MARK
PRINCIPAL REGISTER**



NINE STEPS TO EMPOWERMENT PROCESS
(N'S.T.E.P.) (WASHINGTON SOLE PROPRIETORSHIP)
P.O. BOX 58994
RENTON, WA 98058

FOR: EDUCATIONAL SERVICES, NAMELY, CLASSES, SEMINARS, WORKSHOPS, CORRESPONDENCE COURSES IN THE FIELD OF GANG VIOLENCE PREVENTION AND DISTRIBUTING SELF HELP COURSE MATERIAL THEREWITH, IN CLASS 41 (U.S. CLS. 100, 101 AND 107).

FIRST USE 9-1-2007; IN COMMERCE 10-1-2007.

THE COLOR(S) BLUE, BLACK RED, AND WHITE IS/ARE CLAIMED AS A FEATURE OF THE MARK.

THE MARK CONSISTS OF A FIVE POINT CROWN IN 3D, FIRST PRONG IS FRONTAL & BLUE WITH LETTER "N" ON TIP, 2ND PRONG IS

REAR AND RED WITH LETTER "S" ON TIP, 3RD PRONG IS FRONTAL & BLACK WITH LETTER "T" ON TIP, 4TH PRONG IS REAR AND BLUE WITH LETTER "E" ON TIP, 5TH PRONG IS FRONTAL AND RED WITH LETTER "P" ON TIP. EACH PRONG COLOR HOLDS BANDANA DESIGN DETAILS IN WHITE. HEAD RIM OF CROWN INCLUDES BLACK BANDANA DESIGN IN ROW BORDERED BY WHITE AND ROPE DESIGN IN FRONT AND BACK. BELOW THAT RIM INCLUDES WORDS "CHANGING GANG BEHAVIOR" ON FRONT OF RIM ALL IN BLUE, BLACK AND RED CAPITAL LETTERS AND ON BACK OF RIM ALL IN BLUE, BLACK AND RED CAPITAL LETTERS ARE THE WORDS "FROM THE INSIDE OUT". BLACK IS SHADOWED BETWEEN FRONT AND BACK OF RIM.

SER. NO. 77-328,782, FILED 11-13-2007.

GINA HAYES, EXAMINING ATTORNEY

Int. Cl.: 6

Prior U.S. Cls.: 2, 12, 13, 14, 23, 25 and 50

Reg. No. 3,475,488

United States Patent and Trademark Office

Registered July 29, 2008

**TRADEMARK
PRINCIPAL REGISTER**

COUNTYLINE

TRACTOR SUPPLY CO. OF TEXAS, LP (TEXAS
LIMITED PARTNERSHIP)
200 POWELL PLACE
BRENTWOOD, TN 37027

FOR: LIVESTOCK, FARM AND RANCH EQUIP-
MENT, NAMELY, METAL GATES AND FENCING,
SOLD SEPARATELY AND AS PART OF LIVE-
STOCK HANDLING SYSTEMS COMPRISED OF
CHUTES, PENS AND ALLEYS, IN CLASS 6 (U.S.
CLS. 2, 12, 13, 14, 23, 25 AND 50).

FIRST USE 8-4-2007; IN COMMERCE 8-4-2007.

THE MARK CONSISTS OF STANDARD CHAR-
ACTERS WITHOUT CLAIM TO ANY PARTICULAR
FONT, STYLE, SIZE, OR COLOR.

SER. NO. 77-329,169, FILED 11-14-2007.

H. M. FISHER, EXAMINING ATTORNEY

Int. Cl.: 11

Prior U.S. Cls.: 13, 21, 23, 31 and 34

Reg. No. 3,475,489

United States Patent and Trademark Office

Registered July 29, 2008

**TRADEMARK
PRINCIPAL REGISTER**

BETTERFILTER

HARMSCO, INC. (FLORIDA CORPORATION)
7169 49TH TERRACE NORTH
WEST PALM BEACH, FL 33407

FOR: SWIMMING POOL WATER CLEANING
AND FILTERING UNITS, IN CLASS 11 (U.S. CLS.
13, 21, 23, 31 AND 34).

FIRST USE 3-13-1973; IN COMMERCE 3-13-1973.

THE MARK CONSISTS OF STANDARD CHAR-
ACTERS WITHOUT CLAIM TO ANY PARTICULAR
FONT, STYLE, SIZE, OR COLOR.

SEC. 2(F).

SER. NO. 77-329,271, FILED 11-14-2007.

ALICE SUE CARRUTHERS, EXAMINING ATTOR-
NEY

Int. Cls.: 16 and 20

Prior U.S. Cls.: 2, 5, 13, 22, 23, 25, 29, 32, 37, 38 and 50

United States Patent and Trademark Office

Reg. No. 3,475,490

Registered July 29, 2008

**TRADEMARK
PRINCIPAL REGISTER**

WALLABY MATES

GBS CORP. (OHIO CORPORATION)
7233 FREEDOM AVENUE, NW
NORTH CANTON, OH 44720

FOR: DRY ERASE WRITING BOARDS AND
WRITING SURFACES HAVING A PRESSURE SEN-
SITIVE ADHESIVE SIDE FOR SECURING TO A
SURFACE, IN CLASS 16 (U.S. CLS. 2, 5, 22, 23, 29, 37,
38 AND 50).

FIRST USE 10-31-2007; IN COMMERCE 10-31-2007.

FOR: PICTURE AND PHOTOGRAPH FRAMES
MADE WITH A PRESSURE SENSITIVE ADHESIVE

SIDE FOR SECURING TO A SURFACE, IN CLASS 20
(U.S. CLS. 2, 13, 22, 25, 32 AND 50).

FIRST USE 10-31-2007; IN COMMERCE 10-31-2007.

THE MARK CONSISTS OF STANDARD CHAR-
ACTERS WITHOUT CLAIM TO ANY PARTICULAR
FONT, STYLE, SIZE, OR COLOR.

SER. NO. 77-329,445, FILED 11-14-2007.

SKYE YOUNG, EXAMINING ATTORNEY

Int. Cl.: 6

Prior U.S. Cls.: 2, 12, 13, 14, 23, 25 and 50

United States Patent and Trademark Office

Reg. No. 3,475,491

Registered July 29, 2008

**TRADEMARK
PRINCIPAL REGISTER**



TRACTOR SUPPLY CO. OF TEXAS, LP (TEXAS
LIMITED PARTNERSHIP)
200 POWELL PLACE
BRENTWOOD, TN 37027

FOR: LIVESTOCK, FARM AND RANCH EQUIP-
MENT, NAMELY, METAL GATES AND FENCING,
SOLD SEPARATELY AND AS PART OF LIVE-
STOCK HANDLING SYSTEMS COMPRISED OF
CHUTES, PENS AND ALLEYS, IN CLASS 6 (U.S.
CLS. 2, 12, 13, 14, 23, 25 AND 50).

FIRST USE 8-4-2007; IN COMMERCE 8-4-2007.

THE MARK CONSISTS OF A FIVE-POINTED
STAR IMPOSED ON A TRIANGLE, BOTH OF
WHICH ARE INSIDE A POLYGON.

SER. NO. 77-329,519, FILED 11-14-2007.

H. M. FISHER, EXAMINING ATTORNEY

Int. Cl.: 5

Prior U.S. Cls.: 6, 18, 44, 46, 51 and 52

United States Patent and Trademark Office

Reg. No. 3,475,492

Registered July 29, 2008

**TRADEMARK
PRINCIPAL REGISTER**

SERENADE

AGRAQUEST, INC. (CALIFORNIA CORPORATION)
1540 DREW AVENUE
DAVIS, CA 95618

FOR: PESTICIDES, IN CLASS 5 (U.S. CLS. 6, 18, 44,
46, 51 AND 52).

FIRST USE 6-28-2000; IN COMMERCE 6-28-2000.

THE MARK CONSISTS OF STANDARD CHARACTERS WITHOUT CLAIM TO ANY PARTICULAR FONT, STYLE, SIZE, OR COLOR.

OWNER OF U.S. REG. NO. 2,417,828.

SER. NO. 77-329,529, FILED 11-14-2007.

NAAKWAMA ANKRAH, EXAMINING ATTORNEY

Int. Cl.: 35

Prior U.S. Cls.: 100, 101 and 102

United States Patent and Trademark Office

Reg. No. 3,475,493

Registered July 29, 2008

**SERVICE MARK
PRINCIPAL REGISTER**



GOLDEN FLAMINGO, LLC (NEW YORK LTD
LIAB CO)
1037 BRIGHTON BEACH AVENUE
BROOKLYN, NY 11235

FOR: ADVERTISING AND MARKETING; ADVISORY AND CONSULTANCY SERVICES RELATING TO EXPORT, EXPORT SERVICES, EXPORT PROMOTION INFORMATION AND SERVICES; ADVISORY SERVICES RELATING TO BUSINESS MANAGEMENT AND BUSINESS OPERATIONS; ARRANGING AND CONDUCTING TRADE SHOWS IN THE FIELD OF JEWELRY, PRECIOUS STONES, PEARLS, WATCHES AND CLOCKS; ASSISTANCE IN BUSINESS MANAGEMENT AND PRODUCT COMMERCIALIZATION, WITHIN THE FRAMEWORK OF A FRANCHISE CONTRACT; ASSISTANCE IN FRANCHISED COMMERCIAL BUSINESS MANAGEMENT; ASSISTANCE IN MANAGEMENT OF BUSINESS ACTIVITIES; ASSISTANCE TO INDUSTRIAL OR COMMERCIAL ENTERPRISES IN THE RUNNING OF THEIR BUSINESS; ASSISTANCE WITH BUSINESS MANAGEMENT AND PLANNING; BUSINESS ADMINISTRATION AND MANAGEMENT; BUSINESS ADMINISTRATION AND OFFICE WORK; BUSINESS CONSULTATION; COOPERATIVE ADVERTISING AND MARKETING; CUSTOMER RELATIONSHIP MANAGEMENT; FOREIGN TRADE INFORMATION AND CONSULTATION; FRANCHISE SERVICES, NAMELY, OFFERING TECHNICAL AND BUSINESS MANAGEMENT ASSISTANCE IN THE ESTABLISHMENT AND OPERATION OF JEWELRY RETAIL; FRANCHISING, NAMELY, CONSULTATION AND ASSISTANCE IN BUSINESS MANAGEMENT, ORGANIZATION AND PROMOTION; FRANCHISING, NAMELY, OFFERING TECHNICAL ASSISTANCE IN THE ESTABLISHMENT AND/OR OPERATION OF JEWELRY RE-

TAIL; GENERAL BUSINESS MERCHANDISING SERVICES, NAMELY, MARKETING; INVENTORY MANAGEMENT IN THE FIELD OF JEWELRY, PRECIOUS STONES, PEARLS, WATCHES AND CLOCKS; INVOICING SERVICES IN THE FIELD OF WHOLESALE AND RETAIL JEWELRY; MANUFACTURER REPRESENTATIVES IN THE FIELD OF JEWELRY, PRECIOUS STONES, PEARLS, WATCHES AND CLOCKS; MARKETING CONSULTING; ON-LINE RETAIL STORE SERVICES FEATURING JEWELRY, PRECIOUS STONES, PEARLS, WATCHES AND CLOCKS; ON-LINE SERVICES, NAMELY, ORDERING AND INVENTORY MONITORING FOR JEWELRY, PRECIOUS STONES, PEARLS, WATCHES AND CLOCKS; OPERATING AN ONLINE SHOPPING SITE IN THE FIELD OF JEWELRY, PRECIOUS STONES, PEARLS, WATCHES AND CLOCKS; ORGANISATION OF INTERNET AUCTIONS; ORGANIZATIONAL SERVICES FOR BUSINESS PURPOSES; PREPARING AND PLACING OF ADVERTISEMENTS; POST-PRODUCTION EDITING SERVICES FOR VIDEO AND AUDIO COMMERCIALS; PREPARATION AND PRESENTATION OF BUSINESS PROSPECTUSES; PREPARATION AND REALIZATION OF MEDIA AND ADVERTISING PLANS AND CONCEPTS; PREPARING AUDIO-VISUAL DISPLAYS IN THE FIELD OF JEWELRY, PRECIOUS STONES, PEARLS, WATCHES AND CLOCKS; PREPARING AUDIO-VISUAL PRESENTATIONS FOR USE IN ADVERTISING; PRODUCT DEMONSTRATION; PRODUCT MERCHANDISING; PRODUCTION AND DISTRIBUTION OF RADIO AND TELEVISION COMMERCIALS; PROMOTING THE GOODS AND SERVICES OF OTHERS BY DISTRIBUTING ADVERTISING MATERIALS THROUGH A VARIETY OF METHODS; PROMOTION OF BUSINESS OPPORTUNITIES; PROMOTION USING AUDIOVISUAL MEDIA; PROVIDING AN ON-LINE SHOWROOM

FOR THE GOODS OF OTHERS IN THE FIELD OF JEWELRY, PRECIOUS STONES, PEARLS, WATCHES AND CLOCKS; PROVIDING HOME SHOPPING SERVICES IN THE FIELD OF JEWELRY, PRECIOUS STONES, PEARLS, WATCHES AND CLOCKS BY MEANS OF TELEVISION; RETAIL GIFT SHOPS; RETAIL JEWELRY STORES; RETAIL STORE SERVICES FEATURING JEWELRY AND WATCHES MANUFACTURED AND/OR EXPORTED FROM THE COUNTRIES OF FORMER SOVIET UNION; RETAIL STORE SERVICES IN THE FIELD OF JEWELRY, PRECIOUS STONES, PEARLS, WATCHES AND CLOCKS FEATURING A BONUS INCENTIVE PROGRAM FOR CUSTOMERS; RETAIL STORE SERVICES IN THE FIELD OF JEWELRY, PRECIOUS STONES, PEARLS, WATCHES AND CLOCKS THAT CAN BE PURCHASED UNDER A RENT-TO-OWN CONTRACT; RETAIL STORE SERVICES, AVAILABLE THROUGH COMPUTER COMMUNICATIONS AND INTERACTIVE TELEVISION, FEATURING JEWELRY, PRECIOUS STONES, PEARLS, WATCHES AND CLOCKS; RETAIL STORES FEATURING JEWELRY AND WATCHES MANUFACTURED AND/OR EXPORTED FROM THE COUNTRIES OF FORMER SOVIET UNION; RETAIL JEWELRY, PRECIOUS STONES, PEARLS, WATCHES AND CLOCKS STORES; SHOP WINDOW DISPLAY ARRANGEMENT SERVICES; SUPPLY CHAIN MANAGEMENT SERVICES; TESTING TO DETERMINE EMPLOYMENT SKILLS; VENDING IN THE FIELD OF JEWELRY AND WATCHES; WHOLESALE DISTRIBUTORSHIPS

FEATURING JEWELRY, PRECIOUS STONES, PEARLS, WATCHES AND CLOCKS; WHOLESALE ORDERING SERVICES IN THE FIELD OF JEWELRY, PRECIOUS STONES, PEARLS, WATCHES AND CLOCKS; WHOLESALE STORES FEATURING JEWELRY, PRECIOUS STONES, PEARLS, WATCHES AND CLOCKS; WINDOW DISPLAY ARRANGEMENT SERVICES, IN CLASS 35 (U.S. CLS. 100, 101 AND 102).

FIRST USE 12-15-2004; IN COMMERCE 12-15-2004.

THE MARK CONSISTS OF COMBINATION OF ENGLISH WORDS "GOLDEN FLAMINGO" AND COMBINATION OF RUSSIAN WORDS WITH THE SAME MEANING & DESIGN WITH "FLAMINGO" BIRD LOOKING BACK AND FACETED CRYSTAL BETWEEN IT BEAK AND BODY.

THE FOREIGN WORDING IN THE MARK TRANSLATES INTO ENGLISH AS "GOLDEN FLAMINGO".

THE NON-LATIN CHARACTER(S) IN THE MARK TRANSLITERATE INTO ZOLOTOY FLAMINGO, AND THIS MEANS GOLDEN FLAMINGO IN ENGLISH.

SER. NO. 77-329,561, FILED 11-14-2007.

ALICE BENMAMAN, EXAMINING ATTORNEY

Int. Cl.: 35

Prior U.S. Cls.: 100, 101 and 102

United States Patent and Trademark Office

Reg. No. 3,475,494

Registered July 29, 2008

**SERVICE MARK
PRINCIPAL REGISTER**

**SIGNAL BEHAVIORAL HEALTH
NETWORK**

SIGNAL BEHAVIORAL HEALTH NETWORK
(COLORADO CORPORATION)
1391 SPEER BLVD
SUITE 300
DENVER, CO 80204

FOR: ADMINISTRATIVE SERVICES, NAMELY,
MANAGEMENT AND COORDINATION OF A NET-
WORK OF SERVICE PROVIDERS AND PAYORS IN
THE FIELD OF CHEMICAL DEPENDENCY AND
RELATED BEHAVIORAL HEALTH SERVICES, IN
ORDER TO MATCH SERVICES TO CONSUMERS IN
A TIMELY AND COST-EFFECTIVE MANNER, IN
CLASS 35 (U.S. CLS. 100, 101 AND 102).

FIRST USE 8-1-1996; IN COMMERCE 7-1-1997.

THE MARK CONSISTS OF STANDARD CHAR-
ACTERS WITHOUT CLAIM TO ANY PARTICULAR
FONT, STYLE, SIZE, OR COLOR.

NO CLAIM IS MADE TO THE EXCLUSIVE
RIGHT TO USE "BEHAVIORAL HEALTH NET-
WORK", APART FROM THE MARK AS SHOWN.

SER. NO. 77-329,697, FILED 11-14-2007.

TRACY CROSS, EXAMINING ATTORNEY

Int. Cls.: 14 and 26

Prior U.S. Cls.: 2, 27, 28, 37, 39, 40, 42 and 50

United States Patent and Trademark Office

Reg. No. 3,475,495

Registered July 29, 2008

**TRADEMARK
PRINCIPAL REGISTER**

ICING BY CLAIRE'S

CBI DISTRIBUTING CORP. (DELAWARE CORPORATION)
CORPORATION TRUST CENTER
1209 ORANGE STREET
WILMINGTON, DE 19801

FOR: JEWELRY NAMELY, EARRINGS, NECKLACES, RINGS, BRACELETS, AND ORNAMENTAL PINS, IN CLASS 14 (U.S. CLS. 2, 27, 28 AND 50).

FIRST USE 10-0-2001; IN COMMERCE 10-0-2001.

FOR: HAIR ORNAMENTS, IN CLASS 26 (U.S. CLS. 37, 39, 40, 42 AND 50).

FIRST USE 10-0-2001; IN COMMERCE 10-0-2001.

THE MARK CONSISTS OF STANDARD CHARACTERS WITHOUT CLAIM TO ANY PARTICULAR FONT, STYLE, SIZE, OR COLOR.

OWNER OF U.S. REG. NOS. 1,466,727, 3,050,863 AND OTHERS.

SER. NO. 77-329,708, FILED 11-14-2007.

TRACY CROSS, EXAMINING ATTORNEY

Int. Cl.: 36

Prior U.S. Cls.: 100, 101 and 102

United States Patent and Trademark Office

Reg. No. 3,475,496

Registered July 29, 2008

SERVICE MARK
PRINCIPAL REGISTER



TENPOINT INSURANCE SOLUTIONS, LLC
(OHIO LTD LIAB CO)
ATTN: BRAD JOHNNSTON
400 TECHNECENTER DRIVE, SUITE 402
MILFORD, OH 45150

FOR: CLAIMS ADJUSTMENT IN THE FIELD OF INSURANCE; ELECTRONIC PROCESSING OF INSURANCE CLAIMS AND PAYMENT DATA; INSURANCE ADMINISTRATION; INSURANCE CLAIMS ADMINISTRATION; INSURANCE CLAIMS PROCESSING; INSURANCE CONSULTATION; INSURANCE SUBROGATION; INSURANCE SUBROGATION AND SALVAGE; PROVIDING INFORMATION IN INSURANCE MATTERS, IN CLASS 36 (U.S. CLS. 100, 101 AND 102).

FIRST USE 9-11-2007; IN COMMERCE 10-22-2007.

NO CLAIM IS MADE TO THE EXCLUSIVE RIGHT TO USE "INSURANCE", APART FROM THE MARK AS SHOWN.

THE COLOR(S) GREY, MAROON AND WHITE IS/ARE CLAIMED AS A FEATURE OF THE MARK.

THE MARK CONSISTS OF THE WORD "TENPOINT" IN LARGE, MAROON PRINT OVER THE WORDS "INSURANCE SOLUTIONS" IN A SMALLER, MAROON PRINT. THE WORDS "DRIVEN BY EXPERIENCE" IN SMALLER, GREY ITALICS PRINT ARE LOCATED BELOW, AND SEPARATED BY A HORIZONTAL GREY LINE FROM THE TEXT "INSURANCE SOLUTIONS". TO THE LEFT OF ALL OF THE TEXT IS A GREY SQUARE WITH A WHITE LINE PERFORMING A SQUARE SPIRAL FROM LOWER RIGHT CORNER TO THE CENTER OF THE GREY SQUARE IN FOUR LAPS. A WHITE AND GREY LINE STARTS AT THE TERMINUS OF THE SPIRAL LINE AND TRAVELS ON A DIAGONAL THROUGH THE UPPER RIGHT CORNER OF THE GREY SQUARE ENDING IN A GREY ARROW POINT OUTSIDE THE SQUARE.

THE WORDING "TENPOINT" HAS NO MEANING IN A FOREIGN LANGUAGE.

SER. NO. 77-329,921, FILED 11-14-2007.

STEVEN R. FINE, EXAMINING ATTORNEY

Int. Cl.: 41

Prior U.S. Cls.: 100, 101 and 107

United States Patent and Trademark Office

Reg. No. 3,475,497

Registered July 29, 2008

**SERVICE MARK
PRINCIPAL REGISTER**



UTTARA YOGA STUDIO, LLC (VIRGINIA LTD
LIAB CO)
3956 WINDING WAY ROAD
ROANOKE, VA 24015

FOR: YOGA INSTRUCTION, IN CLASS 41 (U.S.
CLS. 100, 101 AND 107).

FIRST USE 9-14-2007; IN COMMERCE 9-14-2007.

NO CLAIM IS MADE TO THE EXCLUSIVE
RIGHT TO USE "YOGA STUDIO", APART FROM
THE MARK AS SHOWN.

THE MARK CONSISTS OF A STYLIZED DRAW-
ING OF A WOMAN SEATED IN A LOTUS POSE ON
A LOTUS BLOSSOM WITH HER HANDS IN A
MUDRA (I.E., ONE HAND CUPPED AND THE
OTHER RAISED WITH THE THUMB AND INDEX

FINGER TOUCHING AND THE REMAINING FIN-
GERS UP). TO THE BOTTOM, LEFT AND RIGHT OF
THE WOMAN ARE CURLING LINES AND SIX
CIRCLES OF VARYING SIZES. BENEATH THE
CURLING LINES ARE THE WORDS "UTTARA"
AND "YOGA STUDIO" WITH THE WORD "UT-
TARA" IN A STYLIZED LOWER-CASE FONT AND
THE WORDS "YOGA STUDIO" ALL IN UPPER-
CASE LETTERS. A CIRCLE IS PLACED ON EITHER
SIDE OF THE WORDS "YOGA STUDIO".

THE FOREIGN WORDING IN THE MARK
TRANSLATES INTO ENGLISH AS "ABOVE, BE-
YOND OR THAT WHICH TRANSCENDS".

SER. NO. 77-330,370, FILED 11-15-2007.

STEVEN PEREZ, EXAMINING ATTORNEY

Int. Cl.: 9

Prior U.S. Cls.: 21, 23, 26, 36 and 38

United States Patent and Trademark Office

Reg. No. 3,475,498

Registered July 29, 2008

**TRADEMARK
PRINCIPAL REGISTER**

E911 MANAGER

RED SKY TECHNOLOGIES, INC. (ILLINOIS
CORPORATION)
SUITE 300
925 WEST CHICAGO AVENUE
CHICAGO, IL 60602

FOR: COMPUTER SOFTWARE USED TO MAN-
AGE STORE AND DELIVER ENHANCED EMER-
G E N C Y T E L E C O M M U N I C A T I O N S
INFORMATION, IN CLASS 9 (U.S. CLS. 21, 23, 26,
36 AND 38).

FIRST USE 9-1-2001; IN COMMERCE 9-1-2001.

THE MARK CONSISTS OF STANDARD CHAR-
ACTERS WITHOUT CLAIM TO ANY PARTICULAR
FONT, STYLE, SIZE, OR COLOR.

OWNER OF U.S. REG. NO. 2,678,514.

SEC. 2(F).

SER. NO. 77-330,552, FILED 11-15-2007.

KATHY DE JONGE, EXAMINING ATTORNEY

Int. Cl.: 35

Prior U.S. Cls.: 100, 101 and 102

United States Patent and Trademark Office

Reg. No. 3,475,499

Registered July 29, 2008

**SERVICE MARK
PRINCIPAL REGISTER**

**Family Child Care Policy
Advisory Committee**

SILVERMAN, JOSEPH S (UNITED STATES INDIVIDUAL)
11923 BRENTWOOD GROVE DRIVE
LOS ANGELES, CA 90049

FOR: PROMOTION OF FINANCIAL AND INSURANCE SERVICES ON BEHALF OF THIRD PARTIES, NAMELY, REGULATED PROVIDERS OF CHILD CARE; LOBBYING SERVICES, NAMELY, PROMOTING THE INTERESTS OF REGULATED PROVIDERS OF CHILD CARE IN THE FIELDS OF LEGISLATION AND REGULATION, IN CLASS 35 (U.S. CLS. 100, 101 AND 102).

FIRST USE 6-14-1990; IN COMMERCE 6-14-1990.

THE MARK CONSISTS OF STANDARD CHARACTERS WITHOUT CLAIM TO ANY PARTICULAR FONT, STYLE, SIZE, OR COLOR.

NO CLAIM IS MADE TO THE EXCLUSIVE RIGHT TO USE "COMMITTEE", APART FROM THE MARK AS SHOWN.

SEC. 2(F).

SER. NO. 77-330,756, FILED 11-15-2007.

VIVIAN MICZNIK FIRST, EXAMINING ATTORNEY

Int. Cl.: 21

Prior U.S. Cls.: 2, 13, 23, 29, 30, 33, 40 and 50

United States Patent and Trademark Office

Reg. No. 3,475,500

Registered July 29, 2008

**TRADEMARK
PRINCIPAL REGISTER**

SPRAY ALERT

IMPACT PRODUCTS LLC (DELAWARE LTD
LIAB CO)
2840 CENTENNIAL ROAD
TOLEDO, OH 43617

FOR: SOAP DISPENSERS; EMPTY SPRAY BOT-
TLES, IN CLASS 21 (U.S. CLS. 2, 13, 23, 29, 30, 33, 40
AND 50).

FIRST USE 1-1-1994; IN COMMERCE 1-1-1994.

THE MARK CONSISTS OF STANDARD CHAR-
ACTERS WITHOUT CLAIM TO ANY PARTICULAR
FONT, STYLE, SIZE, OR COLOR.

NO CLAIM IS MADE TO THE EXCLUSIVE
RIGHT TO USE "SPRAY", APART FROM THE
MARK AS SHOWN.

SER. NO. 77-330,757, FILED 11-15-2007.

TRACY CROSS, EXAMINING ATTORNEY

Int. Cl.: 35

Prior U.S. Cls.: 100, 101 and 102

United States Patent and Trademark Office

Reg. No. 3,475,501

Registered July 29, 2008

**SERVICE MARK
PRINCIPAL REGISTER**



MEDIALOGIC, INC. (TEXAS CORPORATION)
3320 BERING DRIVE
HOUSTON, TX 77057

FOR: PROVIDING A SECURED ACCESS DATA-BASE VIA THE INTERNET THROUGH WHICH DOCUMENTS AND IMAGES CAN BE VIEWED, COPIED, AND PRINTED FOR PURPOSES OF CONDUCTING CORPORATE TRANSACTIONS , IN CLASS 35 (U.S. CLS. 100, 101 AND 102).

FIRST USE 6-4-2007; IN COMMERCE 6-4-2007.

NO CLAIM IS MADE TO THE EXCLUSIVE RIGHT TO USE "PLANROOM", APART FROM THE MARK AS SHOWN.

THE COLOR(S) GREEN, AND WHITE IS/ARE CLAIMED AS A FEATURE OF THE MARK.

THE MARK CONSISTS OF THE WORD "PLAN-ROOM" IN WHITE WITH 2 GREEN LEAVES AND ONE GREEN AND WHITE LEAF EXTENDING FROM THE LETTER "L". THE BACKGROUND IS BROWN.

SER. NO. 77-330,779, FILED S.R. 11-15-2007 AM.
P.R. 3-2-2008.

PRISCILLA MILTON, EXAMINING ATTORNEY

Int. Cl.: 36

Prior U.S. Cls.: 100, 101 and 102

United States Patent and Trademark Office

Reg. No. 3,475,502

Registered July 29, 2008

**SERVICE MARK
PRINCIPAL REGISTER**

TieCare International, Inc.

GLOBAL BENEFITS GROUP, INC. (DELAWARE
CORPORATION)
27092 BURBANK BLVD
FOOTHILL RANCH, CA 92610

FOR: INSURANCE UNDERWRITING SERVICES
FOR ALL TYPES OF INSURANCE, IN CLASS 36
(U.S. CLS. 100, 101 AND 102).

FIRST USE 9-1-1993; IN COMMERCE 9-1-1993.

THE MARK CONSISTS OF STANDARD CHAR-
ACTERS WITHOUT CLAIM TO ANY PARTICULAR
FONT, STYLE, SIZE, OR COLOR.

NO CLAIM IS MADE TO THE EXCLUSIVE
RIGHT TO USE "INTERNATIONAL, INC.", APART
FROM THE MARK AS SHOWN.

SER. NO. 77-330,876, FILED 11-15-2007.

CHERYL CLAYTON, EXAMINING ATTORNEY

Int. Cl.: 6

Prior U.S. Cls.: 2, 12, 13, 14, 23, 25 and 50

United States Patent and Trademark Office

Reg. No. 3,475,503

Registered July 29, 2008

**TRADEMARK
PRINCIPAL REGISTER**



WEDGCOR, INC. (WYOMING CORPORATION)
6800 E. HAMPDEN AVENUE
DENVER, CO 80224

THE MARK CONSISTS OF A FANCIFUL REPRESENTATION OF THE LETTER "W".

FOR: STEEL BUILDINGS AND STRUCTURAL COMPONENTS THEREOF, IN CLASS 6 (U.S. CLS. 2, 12, 13, 14, 23, 25 AND 50).

SER. NO. 77-330,895, FILED 11-15-2007.

FIRST USE 11-15-1984; IN COMMERCE 11-15-1984.

CHERYL CLAYTON, EXAMINING ATTORNEY

Int. Cl.: 3

Prior U.S. Cls.: 1, 4, 6, 50, 51 and 52

Reg. No. 3,475,504

United States Patent and Trademark Office

Registered July 29, 2008

**TRADEMARK
PRINCIPAL REGISTER**

**CIRA
PLUS**

WEBSTER ENTERPRISES, INC. (TENNESSEE
CORPORATION), DBA CIRRUS HAIR CEN-
TERS
1012 S. YATES
MEMPHIS, TN 38119

FOR: HAIR CONDITIONER; HAIR SHAMPOOS
AND CONDITIONERS; HAIR GELS; HAIR SPRAYS;
HAIR STYLING PREPARATIONS, IN CLASS 3 (U.S.
CLS. 1, 4, 6, 50, 51 AND 52).

FIRST USE 6-30-2007; IN COMMERCE 6-30-2007.

THE MARK CONSISTS OF STANDARD CHAR-
ACTERS WITHOUT CLAIM TO ANY PARTICULAR
FONT, STYLE, SIZE, OR COLOR.

SER. NO. 77-330,925, FILED 11-15-2007.

GEORGIA CARTY, EXAMINING ATTORNEY

Int. Cl.: 39

Prior U.S. Cls.: 100 and 105

United States Patent and Trademark Office

Reg. No. 3,475,505

Registered July 29, 2008

**SERVICE MARK
PRINCIPAL REGISTER**



CUMBRES & TOLTEC SCENIC RAILROAD COM-
MISSION (COLORADO BI-STATE AGENCY
CO/NM)

PO BOX 561
5250 STATE HWY 285
ANTONITO, CO 81120

FOR: RAILROAD TRANSPORTATION SERVI-
CES, IN CLASS 39 (U.S. CLS. 100 AND 105).

FIRST USE 10-1-2007; IN COMMERCE 10-1-2007.

NO CLAIM IS MADE TO THE EXCLUSIVE
RIGHT TO USE THE REPRESENTATION OF THE
COLORADO AND NEW MEXICO FLAGS AND
SCENIC RAILROAD, APART FROM THE MARK
AS SHOWN.

THE COLOR(S) RED, WHITE, BLUE, YELLOW,
BLACK AND SILVER IS/ARE CLAIMED AS A
FEATURE OF THE MARK.

THE MARK CONSISTS OF COLORADO FLAG
WITH BARS TOP AND BOTTOM, WHITE BAR IN
CENTER WITH "C" AND YELLOW CIRCLE
INSIDE "C"; NEW MEXICO FLAG WITH YELLOW
BACKGROUND AND RED + IN THE CENTER;
CIRCLE WITH BLUE SKY AND WHITE SNOW
CAPPED MOUNTAINS; STEAM LOCOMOTIVE IN
FOREGROUND WITH BLACK AND SILVER.

SER. NO. 77-331,491, FILED 11-16-2007.

CHERYL CLAYTON, EXAMINING ATTORNEY

Int. Cl.: 45

Prior U.S. Cls.: 100 and 101

United States Patent and Trademark Office

Reg. No. 3,475,506

Registered July 29, 2008

**SERVICE MARK
PRINCIPAL REGISTER**

HALF HOUR PRINCIPLE

SAFE (MARYLAND CORPORATION)
6 TIDINGS ON THE BAY
ANNAPOLIS, MD 20401

FOR: PERSONAL SECURITY CONSULTATION;
SECURITY SERVICES, NAMELY, PROVIDING SE-
CURITY ASSESSMENTS OF PHYSICAL LOCA-
TIONS, INFORMATION SYSTEMS, AND
WORKING ENVIRONMENTS; SECURITY SERVI-
CES, NAMELY, THREAT SIMULATION VULNER-
ABILITY ANALYSIS AND MITIGATION AND

EMERGENCY AND CRISIS RESPONSE, IN CLASS
45 (U.S. CLS. 100 AND 101).

FIRST USE 6-1-2002; IN COMMERCE 6-1-2002.

THE MARK CONSISTS OF STANDARD CHAR-
ACTERS WITHOUT CLAIM TO ANY PARTICULAR
FONT, STYLE, SIZE, OR COLOR.

SER. NO. 77-331,507, FILED 11-16-2007.

CHERYL CLAYTON, EXAMINING ATTORNEY

Int. Cls.: 16 and 41

Prior U.S. Cls.: 2, 5, 22, 23, 29, 37, 38, 50, 100, 101 and 107

Reg. No. 3,475,507

United States Patent and Trademark Office

Registered July 29, 2008

**TRADEMARK
SERVICE MARK
PRINCIPAL REGISTER**

Advanced Placement

COLLEGE ENTRANCE EXAMINATION BOARD
(NEW YORK NOT-FOR-PROFIT MEMBERSHIP
ASSOCIATION), DBA THE COLLEGE BOARD
LEGAL DEPARTMENT
45 COLUMBUS AVE
NEW YORK, NY 10023

FOR: PRINTED EDUCATIONAL MATERIAL,
NAMELY, TEACHING TILES; PRINTED INSTRUC-
TIONAL, EDUCATIONAL, AND TEACHING MA-
TERIALS IN THE FIELD OF SECONDARY
EDUCATION; PRINTED PRODUCTS, NAMELY,
LISTS FEATURING TESTS, TEST BOOKLETS, PER-
IODICAL BULLETINS AND BROCHURES PROVID-
ING INFORMATION AND GUIDANCE FOR
SCHOOLS, UNIVERSITIES, TEACHERS, AND STU-
DENTS REGARDING EXAMINATIONS IN SEC-
ONDARY SCHOOLS, IN CLASS 16 (U.S. CLS. 2, 5,
22, 23, 29, 37, 38 AND 50).

FIRST USE 10-0-1955; IN COMMERCE 10-0-1955.

FOR: EDUCATIONAL SERVICES, NAMELY,
PREPARING AND PROVIDING CURRICULAR MA-
TERIALS AND COURSE DESCRIPTIONS FOR SEC-

ONDARY SCHOOLS AND CONDUCTING
EXAMINATIONS BASED ON THE COURSE DE-
SCRIPTIONS FOR A PROGRAM IN WHICH HIGH
SCHOOL STUDENTS COMPLETE COLLEGE-LE-
VEL STUDIES WHILE THEY ARE STILL IN SEC-
ONDARY SCHOOL AND RECEIVE COLLEGE
RECOGNITION THEREFOR, IN CLASS 41 (U.S.
CLS. 100, 101 AND 107).

FIRST USE 10-0-1955; IN COMMERCE 10-0-1955.

THE MARK CONSISTS OF STANDARD CHAR-
ACTERS WITHOUT CLAIM TO ANY PARTICULAR
FONT, STYLE, SIZE, OR COLOR.

OWNER OF U.S. REG. NOS. 1,069,138, 3,316,868
AND OTHERS.

SEC. 2(F).

SER. NO. 77-331,889, FILED 11-16-2007.

MARY ROSSMAN, EXAMINING ATTORNEY

Int. Cl.: 9

Prior U.S. Cls.: 21, 23, 26, 36 and 38

United States Patent and Trademark Office

Reg. No. 3,475,508

Registered July 29, 2008

**TRADEMARK
PRINCIPAL REGISTER**

SOURCE IMAGING GONIOMETER

RADIANT IMAGING, INC. (WASHINGTON CORPORATION)
15321 MAIN STREET NE, SUITE 310
DUVALL, WA 98019

FOR: PHOTOMETRIC TOOL, NAMELY, A CAMERA SYSTEM COMPRISING LENSES, IMAGING SENSORS, AND DIGITIZERS, AND AUTOMATION HARDWARE, NAMELY, AUTOMATED MECHANICAL POSITIONERS, AND INTEGRATED SOFTWARE-BASED CONTROLS TO MEASURE AND ANALYZE LIGHT SOURCES; MACHINE AND INTEGRATED COMPUTER SOFTWARE, NAMELY, A CAMERA SYSTEM COMPRISING LENSES, IMAGING SENSORS, AND DIGITIZERS, AND AUTOMATION HARDWARE, NAMELY, AUTOMATED MECHANICAL POSITIONERS, AND INTEGRATED SOFTWARE-BASED CONTROLS FOR CHARACTERIZING AND MAPPING BOTH THE SPATIAL

AND ANGULAR DISTRIBUTION OF LIGHT RADIATING FROM LIGHT SOURCES, IN CLASS 9 (U.S. CLS. 21, 23, 26, 36 AND 38).

FIRST USE 7-17-2000; IN COMMERCE 7-17-2000.

THE MARK CONSISTS OF STANDARD CHARACTERS WITHOUT CLAIM TO ANY PARTICULAR FONT, STYLE, SIZE, OR COLOR.

NO CLAIM IS MADE TO THE EXCLUSIVE RIGHT TO USE "IMAGING GONIOMETER", APART FROM THE MARK AS SHOWN.

SER. NO. 77-332,149, FILED 11-16-2007.

SUZANNE BLANE, EXAMINING ATTORNEY

Int. Cl.: 28

Prior U.S. Cls.: 22, 23, 38 and 50

United States Patent and Trademark Office

Reg. No. 3,475,509

Registered July 29, 2008

**TRADEMARK
PRINCIPAL REGISTER**

Buzz Baby KS

K.S. TOYS LTD. (HONG KONG LTD LIAB CO)
RM 312-315, PENINSULA CENTRE 67 MODY RD.
T.S.T. EAST, KOWLOON, HONG KONG

OWNER OF U.S. REG. NO. 3,055,966.

FOR: ELECTRIC ACTION TOYS; ELECTRONIC
ACTION TOYS; MECHANICAL ACTION TOYS, IN
CLASS 28 (U.S. CLS. 22, 23, 38 AND 50).

NO CLAIM IS MADE TO THE EXCLUSIVE
RIGHT TO USE "BABY", APART FROM THE MARK
AS SHOWN.

FIRST USE 9-15-2007; IN COMMERCE 9-15-2007.

SER. NO. 77-332,248, FILED 11-17-2007.

THE MARK CONSISTS OF STANDARD CHAR-
ACTERS WITHOUT CLAIM TO ANY PARTICULAR
FONT, STYLE, SIZE, OR COLOR.

DAVID MILLER, EXAMINING ATTORNEY

Int. Cl.: 35

Prior U.S. Cls.: 100, 101 and 102

United States Patent and Trademark Office

Reg. No. 3,475,510

Registered July 29, 2008

**SERVICE MARK
PRINCIPAL REGISTER**



CUSTOMER FEEDBACK

Seeing your business through the customers' eyes.

CUSTOMER FEEDBACK, LLC (WASHINGTON
LTD LIAB CO)
6250 160TH AVE. SE
BELLEVUE, WA 980065624

FOR: EXPERT EVALUATIONS AND REPORTS
RELATING TO BUSINESS MATTERS; SHOPPING
BY RESEARCHERS WHO POSE AS CUSTOMERS TO
EVALUATE THE QUALITY OF SERVICE DELIV-
ERED, IN CLASS 35 (U.S. CLS. 100, 101 AND 102).

FIRST USE 9-24-1996; IN COMMERCE 9-24-1996.

NO CLAIM IS MADE TO THE EXCLUSIVE
RIGHT TO USE "CUSTOMER FEEDBACK", APART
FROM THE MARK AS SHOWN.

THE MARK CONSISTS OF AN ABSTRACT DE-
SIGN WITH THE STYLIZED WORDS "CUSTOMER
FEEDBACK SEEING YOUR BUSINESS THROUGH
THE CUSTOMERS' EYES." TO THE RIGHT OF IT.

SER. NO. 77-332,961, FILED 11-19-2007.

DOMINIC J. FERRAIUOLO, EXAMINING ATTOR-
NEY

Int. Cls.: 16, 20 and 40

**Prior U.S. Cls.: 2, 5, 13, 22, 23, 25, 29, 32, 37, 38, 50,
100, 103 and 106**

Reg. No. 3,475,511

United States Patent and Trademark Office

Registered July 29, 2008

**TRADEMARK
SERVICE MARK
PRINCIPAL REGISTER**



DRG TECHNOLOGIES, INC. (ARIZONA CORPORATION)
300 EAST 4TH STREET
SAFFORD, AZ 85546

FOR: ADDRESS LABELS, ADHESIVE LABELS, BAR CODE LABELS, BLANK OR PARTIALLY PRINTED PAPER LABELS, PAPER LABELS, PRINTED NOVELTY WINE LABELS, PRINTED PAPER LABELS AND SHIPPING LABELS, IN CLASS 16 (U.S. CLS. 2, 5, 22, 23, 29, 37, 38 AND 50).

FIRST USE 7-27-2007; IN COMMERCE 7-27-2007.

FOR: BLANK PLASTIC ADHESIVE LABELS AND PLASTIC LABELS, IN CLASS 20 (U.S. CLS. 2, 13, 22, 25, 32 AND 50).

FIRST USE 7-27-2007; IN COMMERCE 7-27-2007.

FOR: PRINTING SERVICES, IN CLASS 40 (U.S. CLS. 100, 103 AND 106).

FIRST USE 7-27-2007; IN COMMERCE 7-27-2007.

NO CLAIM IS MADE TO THE EXCLUSIVE RIGHT TO USE "HELLO LABELS", APART FROM THE MARK AS SHOWN.

THE MARK CONSISTS OF RECTANGULAR BOX CONTAINING THE WORDS "HELLOLABELS".

SER. NO. 77-333,069, FILED 11-19-2007.

JAMES A. RAUEN, EXAMINING ATTORNEY

Int. Cl.: 3

Prior U.S. Cls.: 1, 4, 6, 50, 51 and 52

United States Patent and Trademark Office

Reg. No. 3,475,512

Registered July 29, 2008

**TRADEMARK
PRINCIPAL REGISTER**

SCENTS AND SENSES

COTY BV (NETHERLANDS BESLOTEN VEN-
NOOTSCHAP (B.V.))
OUDEWEG 147
CC HAARLEM, NETHERLANDS 2031

FOR: TOILET SOAPS; PERFUMERY; ESSENTIAL
OILS; COSMETICS, AND HAIR LOTIONS, IN CLASS
3 (U.S. CLS. 1, 4, 6, 50, 51 AND 52).

THE MARK CONSISTS OF STANDARD CHAR-
ACTERS WITHOUT CLAIM TO ANY PARTICULAR
FONT, STYLE, SIZE, OR COLOR.

OWNER OF BENELUX REG. NO. 0668844, DATED
7-31-2000, EXPIRES 7-31-2010.

OWNER OF U.S. REG. NO. 2,639,587.

SER. NO. 77-333,186, FILED 11-19-2007.

CHRISTOPHER BUONGIORNO, EXAMINING AT-
TORNEY

Int. Cl.: 35

Prior U.S. Cls.: 100, 101 and 102

United States Patent and Trademark Office

Reg. No. 3,475,513

Registered July 29, 2008

**SERVICE MARK
PRINCIPAL REGISTER**

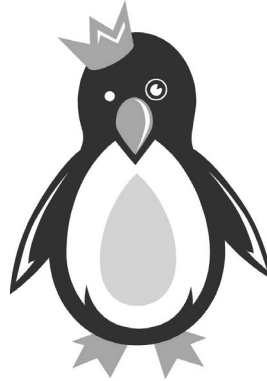

THE ICE BOX - COOL STUFF, LLC (GEORGIA
LTD LIAB CO)
700 LAKE AVE.
ATLANTA, GA 30307

FOR: WHOLESALE DISTRIBUTORSHIP OF PRO-
MOTIONAL AND BRANDED PRODUCTS BEAR-
ING THE TRADEMARKS, LOGOS, AND ORIGINAL
AND/OR THIRD PARTY ARTWORK OF OTHERS,
IN CLASS 35 (U.S. CLS. 100, 101 AND 102).

FIRST USE 6-30-2001; IN COMMERCE 6-30-2001.

THE MARK IS COMPRISED OF A STYLIZED
PENGUIN WITH A SHADED CROWN ON ITS
HEAD, A SHADED BEAK WITH AN UN-SHADED
CURVED LINE, A SHADED OVAL WITH A POIN-
TED TIP AT THE TOP IN THE CENTER OF THE
PENGUIN AND SHADED WEBBED FEET.

SER. NO. 77-333,315, FILED 11-19-2007.

ODESSA BIBBINS, EXAMINING ATTORNEY

Int. Cl.: 2

Prior U.S. Cls.: 6, 11 and 16

United States Patent and Trademark Office

Reg. No. 3,475,514

Registered July 29, 2008

**TRADEMARK
PRINCIPAL REGISTER**

Neo Megilp

GAMBLIN HOLDINGS, LLC (OREGON LTD
LIAB CO), DBA GAMBLIN ARTISTS COLORS
CO.

1000 SW BROADWAY, SUITE 1010
PORTLAND, OR 97205

FOR: GEL USED AS AN OIL PAINTING MEDIUM
TO DECREASE THE VISCOSITY OF OIL COLORS,
IN CLASS 2 (U.S. CLS. 6, 11 AND 16).

FIRST USE 4-1-2002; IN COMMERCE 4-1-2002.

THE MARK CONSISTS OF STANDARD CHAR-
ACTERS WITHOUT CLAIM TO ANY PARTICULAR
FONT, STYLE, SIZE, OR COLOR.

NO CLAIM IS MADE TO THE EXCLUSIVE
RIGHT TO USE "MEGILP", APART FROM THE
MARK AS SHOWN.

SER. NO. 77-333,436, FILED 11-19-2007.

ELLEN B. AWRICH, EXAMINING ATTORNEY

Int. Cl.: 41

Prior U.S. Cls.: 100, 101 and 107

United States Patent and Trademark Office

Reg. No. 3,475,515

Registered July 29, 2008

**SERVICE MARK
PRINCIPAL REGISTER**

Sign  **Language
SPECIALISTS**

SIGN LANGUAGE SPECIALISTS (MISSOURI CORPORATION)
471 SW WARD ROAD
LEES SUMMIT,, MO 64081

FOR: EDUCATIONAL SERVICES, NAMELY, PROVIDING CLASSES, SEMINARS, AND WORKSHOPS IN THE FIELDS OF SIGN LANGUAGE AND SIGN LANGUAGE INTERPRETING TO THE DEAF AND HEARING COMMUNITY; EDUCATIONAL SERVICES, NAMELY, CONDUCTING INFORMAL ON-LINE PROGRAMS IN THE FIELDS OF SIGN LANGUAGE AND SIGN LANGUAGE INTERPRETING TO THE DEAF AND HEARING COMMUNITY, AND PRINTABLE MATERIALS DISTRIBUTED THEREWITH; SIGN LANGUAGE INTERPRETATION, IN CLASS 41 (U.S. CLS. 100, 101 AND 107).

FIRST USE 8-0-2005; IN COMMERCE 8-0-2005.

NO CLAIM IS MADE TO THE EXCLUSIVE RIGHT TO USE "SIGN LANGUAGE SPECIALISTS", APART FROM THE MARK AS SHOWN.

THE MARK CONSISTS OF THE LETTER "L" REVERSED FROM A BLACK CIRCLE BETWEEN TWO STYLIZED LETTERS "S" WITH THE WORD "SIGN" PRECEEDING THE DESIGN AND THE WORD "LANGUAGE SPECIALISTS" STACKED AFTER THE DESIGN.

SER. NO. 77-333,529, FILED 11-19-2007.

ESTHER A. BORSUK, EXAMINING ATTORNEY

Int. Cl.: 35

Prior U.S. Cls.: 100, 101 and 102

United States Patent and Trademark Office

Reg. No. 3,475,516

Registered July 29, 2008

**SERVICE MARK
PRINCIPAL REGISTER**



L. KNIFE & SON, INC. (MASSACHUSETTS CORPORATION)
35 ELDER AVE
KINGSTON, MA 02364

FOR: PROMOTING THE GOODS AND SERVICES OF OTHERS VIA A GLOBAL COMPUTER NETWORK; PROVIDING AN ONLINE DIRECTORY INFORMATION SERVICE FEATURING INFORMATION REGARDING BEER AND BREWERS; PUBLICITY AND SALES PROMOTION SERVICES, IN CLASS 35 (U.S. CLS. 100, 101 AND 102).

FIRST USE 9-25-2007; IN COMMERCE 9-25-2007.

NO CLAIM IS MADE TO THE EXCLUSIVE RIGHT TO USE "GREATBREWERS.COM", APART FROM THE MARK AS SHOWN.

THE COLOR(S) CREAM, DARK BROWN, GRAY, BLACK AND WHITE IS/ARE CLAIMED AS A FEATURE OF THE MARK.

THE MARK CONSISTS OF A GLASS OF BEER TO THE LEFT OF THE WORDS "GREATBREWERS.COM" WITHIN A BROWN RECTANGLE BORDERED IN GRAY WITH "GREAT" AND ".COM" STACKED ON TOP OF "BREWERS". THE GLASS OF BEER HAS A CREAM COLORED FOAM HEAD AND DARK BROWN ALE WITH THE STEM OF THE GLASS IN WHITE. THE GLASS IS OUTLINED IN BLACK. THE WORD "GREAT" APPEARS IN CREAM, THE WORD "BREWERS" IN WHITE AND ".COM" IN GRAY.

SER. NO. 77-333,814, FILED 11-20-2007.

PAULA MAHONEY, EXAMINING ATTORNEY

Int. Cl.: 35

Prior U.S. Cls.: 100, 101 and 102

United States Patent and Trademark Office

Reg. No. 3,475,517

Registered July 29, 2008

**SERVICE MARK
PRINCIPAL REGISTER**



L. KNIFE & SON, INC. (MASSACHUSETTS CORPORATION)
35 ELDER AVE
KINGSTON, MA 02364

FOR: PROMOTING THE GOODS AND SERVICES OF OTHERS VIA A GLOBAL COMPUTER NETWORK; PROVIDING AN ONLINE DIRECTORY INFORMATION SERVICE FEATURING INFORMATION REGARDING BEER AND BREWERS; PUBLICITY AND SALES PROMOTION SERVICES, IN CLASS 35 (U.S. CLS. 100, 101 AND 102).

FIRST USE 9-25-2007; IN COMMERCE 9-25-2007.

NO CLAIM IS MADE TO THE EXCLUSIVE RIGHT TO USE "GREATBREWERS.COM", APART FROM THE MARK AS SHOWN.

THE COLOR(S) CREAM, DARK BROWN, GRAY, BLACK AND WHITE IS/ARE CLAIMED AS A FEATURE OF THE MARK.

THE MARK CONSISTS OF A GLASS OF BEER TO THE LEFT OF THE WORDS "GREATBREWERS.COM" WITHIN A BROWN RECTANGLE BORDERED IN GRAY WITH A GLASS OF BEER LOCATED BETWEEN THE WORDS "GREAT" AND "BREWERS.COM" AND WITH ".COM" APPEARING VERTICAL. THE GLASS OF BEER HAS A CREAM COLORED FOAM HEAD AND DARK BROWN ALE WITH THE STEM OF THE GLASS IN WHITE. THE GLASS IS OUTLINED IN BLACK. THE WORD "GREAT" APPEARS IN CREAM, THE WORD "BREWERS" IN WHITE AND ".COM" IN GRAY.

SER. NO. 77-333,825, FILED 11-20-2007.

PAULA MAHONEY, EXAMINING ATTORNEY

Int. Cl.: 9

Prior U.S. Cls.: 21, 23, 26, 36 and 38

United States Patent and Trademark Office

Reg. No. 3,475,518

Registered July 29, 2008

**TRADEMARK
PRINCIPAL REGISTER**

demandbridge

DEMAND BRIDGE, LLC (MARYLAND LTD
LIAB CO)
10830 GILROY ROAD
COCKEYSVILLE, MD 21031

FOR: COMPUTER SOFTWARE PLATFORMS
FOR ACCOUNTING, OPERATIONS AND PRODUC-
TION MANAGEMENT, INVENTORY CONTROL,
MARKETING, PROMOTION, AND ELECTRONIC
PROCUREMENT IN THE PRINT DISTRIBUTION
INDUSTRY, IN CLASS 9 (U.S. CLS. 21, 23, 26, 36 AND
38).

FIRST USE 10-17-2007; IN COMMERCE 10-17-2007.

THE MARK CONSISTS OF STANDARD CHAR-
ACTERS WITHOUT CLAIM TO ANY PARTICULAR
FONT, STYLE, SIZE, OR COLOR.

SER. NO. 77-333,902, FILED 11-20-2007.

ROBIN CHOSID, EXAMINING ATTORNEY

Int. Cl.: 7

Prior U.S. Cls.: 13, 19, 21, 23, 31, 34 and 35

United States Patent and Trademark Office

Reg. No. 3,475,519

Registered July 29, 2008

**TRADEMARK
PRINCIPAL REGISTER**

Auxxilia

BSH BOSCH UND SIEMENS HAUSGERAETE
GMBH (FED REP GERMANY CORPORA-
TION)

CARL-WERY-STRASSE 34

MUNICH, FED REP GERMANY 81739

FOR: HOUSEHOLD AND KITCHEN MACHINES
AND EQUIPMENT, NAMELY, VACUUM CLEA-
NERS; STRUCTURAL PARTS OF ALL AFOREMEN-
TIONED GOODS, IN CLASS 7 (U.S. CLS. 13, 19, 21, 23,
31, 34 AND 35).

THE MARK CONSISTS OF STANDARD CHAR-
ACTERS WITHOUT CLAIM TO ANY PARTICULAR
FONT, STYLE, SIZE, OR COLOR.

PRIORITY CLAIMED UNDER SEC. 44(D) ON FED
REP GERMANY APPLICATION NO. 30733331.0/0,
FILED 5-22-2007, REG. NO. 30733331, DATED 7-17-
2007, EXPIRES 5-31-2017.

SER. NO. 77-334,053, FILED 11-20-2007.

JASON BLAIR, EXAMINING ATTORNEY

Int. Cl.: 7

Prior U.S. Cls.: 13, 19, 21, 23, 31, 34 and 35

United States Patent and Trademark Office

Reg. No. 3,475,520

Registered July 29, 2008

**TRADEMARK
PRINCIPAL REGISTER**

Axxilia

BSH BOSCH UND SIEMENS HAUSGERAETE
GMBH (FED REP GERMANY CORPORA-
TION)

CARL-WERY-STRASSE 34

MUNICH, FED REP GERMANY 81739

FOR: HOUSEHOLD AND KITCHEN MACHINES
AND EQUIPMENT, NAMELY, VACUUM CLEA-
NERS; STRUCTURAL PARTS OF ALL AFOREMEN-
TIONED GOODS, IN CLASS 7 (U.S. CLS. 13, 19, 21, 23,
31, 34 AND 35).

THE MARK CONSISTS OF STANDARD CHAR-
ACTERS WITHOUT CLAIM TO ANY PARTICULAR
FONT, STYLE, SIZE, OR COLOR.

PRIORITY CLAIMED UNDER SEC. 44(D) ON FED
REP GERMANY APPLICATION NO. 30733332.9/0,
FILED 5-22-2007, REG. NO. 30733332, DATED 7-17-
2007, EXPIRES 5-31-2017.

SER. NO. 77-334,070, FILED 11-20-2007.

JASON BLAIR, EXAMINING ATTORNEY

Int. Cl.: 28

Prior U.S. Cls.: 22, 23, 38 and 50

United States Patent and Trademark Office

Reg. No. 3,475,521

Registered July 29, 2008

**TRADEMARK
PRINCIPAL REGISTER**

Grand Challenge Golf

FLORES, GEORGE J. (UNITED STATES INDIVIDUAL)

1523 W GRAMERCY PL

SAN ANTONIO, TX 78201

FOR: CARD GAMES; PLAYING CARDS, IN CLASS 28 (U.S. CLS. 22, 23, 38 AND 50).

FIRST USE 11-30-2004; IN COMMERCE 9-19-2006.

THE MARK CONSISTS OF STANDARD CHARACTERS WITHOUT CLAIM TO ANY PARTICULAR FONT, STYLE, SIZE, OR COLOR.

NO CLAIM IS MADE TO THE EXCLUSIVE RIGHT TO USE "GOLF", APART FROM THE MARK AS SHOWN.

SER. NO. 77-334,296, FILED 11-20-2007.

TASHIA BUNCH, EXAMINING ATTORNEY

Int. Cl.: 35

Prior U.S. Cls.: 100, 101 and 102

United States Patent and Trademark Office

Reg. No. 3,475,522

Registered July 29, 2008

**SERVICE MARK
PRINCIPAL REGISTER**



**LEARN TO
BREW**

LEARN TO BREW LLC (OKLAHOMA LTD LIAB
CO), DBA LEARN TO BREW
2307 SOUTH INTERSTATE 35 FRONTAGE ROAD
MOORE, OK 731604221

FOR: RETAIL STORES FEATURING HOME
BREWING EQUIPMENT, IN CLASS 35 (U.S. CLS.
100, 101 AND 102).

FIRST USE 7-1-2007; IN COMMERCE 7-10-2007.

NO CLAIM IS MADE TO THE EXCLUSIVE
RIGHT TO USE "LEARN TO BREW", APART FROM
THE MARK AS SHOWN.

THE MARK CONSISTS OF THE LETTERS "L T B"
ARRANGED AS IF A GLASS MUG. THE LETTERS
ARE ENCIRCLED WITH A BLACK CIRCLE.

SER. NO. 77-334,471, FILED 11-20-2007.

MICHAEL KEATING, EXAMINING ATTORNEY

Int. Cl.: 11

Prior U.S. Cls.: 13, 21, 23, 31 and 34

Reg. No. 3,475,523

United States Patent and Trademark Office

Registered July 29, 2008

**TRADEMARK
PRINCIPAL REGISTER**



CLAPP, RV (UNITED STATES INDIVIDUAL)
805 CENTRAL AVENUE, SUITE 306
FORT DODGE, IA 505013954

FIRST USE 12-31-1999; IN COMMERCE 12-31-1999.

FOR: ROOFTOP GREASE CONTAINMENT SYSTEM COMPRISING AN EXHAUST FAN, GREASE DEFLECTOR, AND FILTER FOR TRAPPING GREASE VENTED FROM ROOFTOP EXHAUST FANS FOR COOKING AREAS WITHIN THE BUILDING, IN CLASS 11 (U.S. CLS. 13, 21, 23, 31 AND 34).

NO CLAIM IS MADE TO THE EXCLUSIVE RIGHT TO USE "EXHAUST GREASE INHIBITION SYSTEM", APART FROM THE MARK AS SHOWN.

SER. NO. 77-334,512, FILED 11-20-2007.

HOWARD SMIGA, EXAMINING ATTORNEY

Int. Cl.: 36

Prior U.S. Cls.: 100, 101 and 102

United States Patent and Trademark Office

Reg. No. 3,475,524

Registered July 29, 2008

**SERVICE MARK
PRINCIPAL REGISTER**

WORK BANK LIVE

HARRIS NATIONAL ASSOCIATION (UNITED STATES NATIONAL BANKING ASSOCIATION)

#21E

111 W. MONROE ST.
CHICAGO, IL 60697

FOR: BANKING, IN CLASS 36 (U.S. CLS. 100, 101 AND 102).

FIRST USE 11-20-2007; IN COMMERCE 11-20-2007.

THE MARK CONSISTS OF STANDARD CHARACTERS WITHOUT CLAIM TO ANY PARTICULAR FONT, STYLE, SIZE, OR COLOR.

NO CLAIM IS MADE TO THE EXCLUSIVE RIGHT TO USE "BANK", APART FROM THE MARK AS SHOWN.

SER. NO. 77-334,523, FILED 11-20-2007.

SUE LAWRENCE, EXAMINING ATTORNEY

Int. Cl.: 11

Prior U.S. Cls.: 13, 21, 23, 31 and 34

United States Patent and Trademark Office

Reg. No. 3,475,525

Registered July 29, 2008

**TRADEMARK
PRINCIPAL REGISTER**

THE LOW COUNTRY COOKER

SIKES COOKERS AND GRILLS, INC. (GEORGIA CORPORATION)

337 COMMERCE LOOP

VIDALIA, GA 30474

FOR: GAS COOKERS, IN CLASS 11 (U.S. CLS. 13, 21, 23, 31 AND 34).

FIRST USE 10-1-2007; IN COMMERCE 10-1-2007.

THE MARK CONSISTS OF STANDARD CHARACTERS WITHOUT CLAIM TO ANY PARTICULAR FONT, STYLE, SIZE, OR COLOR.

NO CLAIM IS MADE TO THE EXCLUSIVE RIGHT TO USE "COOKER", APART FROM THE MARK AS SHOWN.

SER. NO. 77-334,536, FILED 11-20-2007.

MARK T. MULLEN, EXAMINING ATTORNEY

Int. Cl.: 35

Prior U.S. Cls.: 100, 101 and 102

United States Patent and Trademark Office

Reg. No. 3,475,526

Registered July 29, 2008

SERVICE MARK
PRINCIPAL REGISTER



OMP, INC. (DELAWARE CORPORATION)
310 GOLDEN SHORE
LONG BEACH, CA 90802

FOR: SALES PROMOTION SERVICES, IN CLASS
35 (U.S. CLS. 100, 101 AND 102).

FIRST USE 10-11-2007; IN COMMERCE 10-11-2007.

OWNER OF U.S. REG. NOS. 2,203,028, 2,838,565
AND OTHERS.

NO CLAIM IS MADE TO THE EXCLUSIVE
RIGHT TO USE "DOLLARS", APART FROM THE
MARK AS SHOWN.

THE MARK CONSISTS OF A DOLLAR SIGN AND
THE WORDS "OBAGI DOLLARS".

SER. NO. 77-334,948, FILED 11-21-2007.

MARY ROSSMAN, EXAMINING ATTORNEY

Int. Cl.: 43

Prior U.S. Cls.: 100 and 101

United States Patent and Trademark Office

Reg. No. 3,475,527

Registered July 29, 2008

SERVICE MARK
PRINCIPAL REGISTER



THOMAS AND KING, INC. (SOUTH CAROLINA
CORPORATION)
STE 101
249 EAST MAIN
LEXINGTON, KY 40507

THE MARK CONSISTS OF THE WORDS "THE
PERFECT BEER" WITH THE WORDS "THE" AND
"BEER" ENCLOSED IN A CIRCLE DESIGN, AND
THE WORD "PERFECT" SUPERIMPOSED IN A
BANNER DESIGN.

FOR: RESTAURANT AND BAR SERVICES, IN
CLASS 43 (U.S. CLS. 100 AND 101).

FIRST USE 10-4-2007; IN COMMERCE 10-4-2007.

SER. NO. 77-334,960, FILED 11-21-2007.

NO CLAIM IS MADE TO THE EXCLUSIVE
RIGHT TO USE "THE PERFECT BEER", APART
FROM THE MARK AS SHOWN.

CHERYL CLAYTON, EXAMINING ATTORNEY

Int. Cl.: 5

Prior U.S. Cls.: 6, 18, 44, 46, 51 and 52

United States Patent and Trademark Office

Reg. No. 3,475,528

Registered July 29, 2008

TRADEMARK
PRINCIPAL REGISTER



HILL, MIKE (UNITED STATES INDIVIDUAL)
13911 E. STATE HWY 66
ARCADIA, OK 73007

FOR: TOPICAL ANALGESICS, IN CLASS 5 (U.S.
CLS. 6, 18, 44, 46, 51 AND 52).

FIRST USE 11-0-2006; IN COMMERCE 11-0-2006.

NO CLAIM IS MADE TO THE EXCLUSIVE
RIGHT TO USE "OTC" , APART FROM THE MARK
AS SHOWN.

THE MARK CONSISTS OF THE WORDS "PAIN-
WORXS OTC" WITH THE LETTERS "OTC" AP-
PEARING PERPENDICULAR TO "PAINWORXS"
AND WITH THE "O" OF "OTC" APPROXIMATELY
BELOW THE "S" OF "PAINWORXS". IN ADDITION,
THE "X" OF "PAINWORX" IS FORMED BY CROSS-
ING AN EXTENSION OF THE "R" TO FORM "RX",
THE COMMON ABBREVIATION FOR "PRESCRIP-
TION".

SER. NO. 77-335,320, FILED 11-21-2007.

ADA HAN, EXAMINING ATTORNEY

Int. Cls.: 40 and 42

Prior U.S. Cls.: 100, 101, 103 and 106

United States Patent and Trademark Office

Reg. No. 3,475,529

Registered July 29, 2008

**SERVICE MARK
PRINCIPAL REGISTER**

**DESIGNS BROUGHT TO LIFE IN
WOOD**

BARSANTI WOODWORK CORPORATION (ILLINOIS CORPORATION)
3838 W. 51ST STREET
CHICAGO, IL 60632

FOR: CUSTOM MANUFACTURE OF ARCHITECTURAL WOODWORK FOR RESIDENTIAL, INSTITUTIONAL, COMMERCIAL AND INDUSTRIAL USE, IN CLASS 40 (U.S. CLS. 100, 103 AND 106).

FIRST USE 9-30-2000; IN COMMERCE 4-30-2002.

FOR: DESIGN OF CUSTOM ARCHITECTURAL WOODWORK FOR RESIDENTIAL, INSTITUTION-

AL, COMMERCIAL AND INDUSTRIAL USE, IN CLASS 42 (U.S. CLS. 100 AND 101).

FIRST USE 9-30-2000; IN COMMERCE 4-30-2002.

THE MARK CONSISTS OF STANDARD CHARACTERS WITHOUT CLAIM TO ANY PARTICULAR FONT, STYLE, SIZE, OR COLOR.

SER. NO. 77-335,469, FILED 11-21-2007.

RICHARD A. STRASER, EXAMINING ATTORNEY

Int. Cl.: 8

Prior U.S. Cls.: 23, 28 and 44

Reg. No. 3,475,530

United States Patent and Trademark Office

Registered July 29, 2008

**TRADEMARK
PRINCIPAL REGISTER**

STALLBOOGER

MR. DANIEL BURKS. (UNITED STATES INDIVIDUAL), DBA STALLBOOGER ALUMINUM PITCHFORKS
109 PARKER CIRCLE
SHELBYVILLE, TN 37160

THE MARK CONSISTS OF STANDARD CHARACTERS WITHOUT CLAIM TO ANY PARTICULAR FONT, STYLE, SIZE, OR COLOR.

FOR: PITCHFORKS, IN CLASS 8 (U.S. CLS. 23, 28 AND 44).

SER. NO. 77-335,472, FILED 11-21-2007.

FIRST USE 1-31-2008; IN COMMERCE 1-31-2008.

MICHAEL LITZAU, EXAMINING ATTORNEY

Int. Cl.: 36

Prior U.S. Cls.: 100, 101 and 102

United States Patent and Trademark Office

Reg. No. 3,475,531

Registered July 29, 2008

**SERVICE MARK
PRINCIPAL REGISTER**

RENAISSANCE INSTITUTIONAL
EQUITIES FUND

RENAISSANCE TECHNOLOGIES, LLC (DELA-
WARE LTD LIAB CO)
800 THIRD AVENUE
NEW YORK, NY 10022

FOR: FINANCIAL SERVICES, NAMELY, HEDGE
FUND MANAGEMENT, IN CLASS 36 (U.S. CLS. 100,
101 AND 102).

FIRST USE 6-29-2005; IN COMMERCE 7-7-2005.

THE MARK CONSISTS OF STANDARD CHAR-
ACTERS WITHOUT CLAIM TO ANY PARTICULAR
FONT, STYLE, SIZE, OR COLOR.

NO CLAIM IS MADE TO THE EXCLUSIVE
RIGHT TO USE "INSTITUTIONAL EQUITIES FUND
", APART FROM THE MARK AS SHOWN.

SER. NO. 77-335,505, FILED 11-21-2007.

THOMAS MANOR, EXAMINING ATTORNEY

Int. Cl.: 9

Prior U.S. Cls.: 21, 23, 26, 36 and 38

Reg. No. 3,475,532

United States Patent and Trademark Office

Registered July 29, 2008

**TRADEMARK
PRINCIPAL REGISTER**

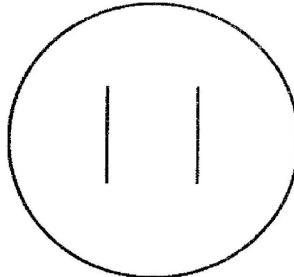

Labelless

LABELLESS, L.L.C. (MINNESOTA CORPORATION)
42563 168TH STREET
CLARK, SD 57225

THE MARK CONSISTS OF A CIRCLE CONTAINING TWO VERTICAL LINES AND THE WORD "LABELLESS" UNDER THE CIRCLE.

FOR: CDS, RECORDS AND TAPES FOR RECORDED MUSIC, IN CLASS 9 (U.S. CLS. 21, 23, 26, 36 AND 38).

SER. NO. 77-335,539, FILED 11-21-2007.

FIRST USE 1-6-2005; IN COMMERCE 1-6-2005.

ALLISON HOLTZ, EXAMINING ATTORNEY

Int. Cl.: 9

Prior U.S. Cls.: 21, 23, 26, 36 and 38

Reg. No. 3,475,533

United States Patent and Trademark Office

Registered July 29, 2008

**TRADEMARK
PRINCIPAL REGISTER**

FUTUREDRAW

LAW AND LEGAL PROPRIETARY LIMITED
(AUSTRALIA CORPORATION)
24 MARRIOT RD
KEILOR DOWNS, AUSTRALIA 3038

THE MARK CONSISTS OF STANDARD CHAR-
ACTERS WITHOUT CLAIM TO ANY PARTICULAR
FONT, STYLE, SIZE, OR COLOR.

FOR: COMPUTER GRAPHICS SOFTWARE, IN
CLASS 9 (U.S. CLS. 21, 23, 26, 36 AND 38).

SER. NO. 77-335,882, FILED 11-23-2007.

FIRST USE 6-1-1997; IN COMMERCE 1-9-2001.

KATHERINE CHANG, EXAMINING ATTORNEY

Int. Cl.: 14

Prior U.S. Cls.: 2, 27, 28 and 50

United States Patent and Trademark Office

Reg. No. 3,475,534

Registered July 29, 2008

**TRADEMARK
PRINCIPAL REGISTER**

ZALORA

CHIPPENDALE COLLECTION, INC. (VIRGINIA CORPORATION), DBA CCI BRANDS
13101 ASHLAND ROAD
ASHLAND, VA 23005

FOR: JEWELRY, IN CLASS 14 (U.S. CLS. 2, 27, 28 AND 50).

FIRST USE 8-17-2007; IN COMMERCE 8-17-2007.

THE MARK CONSISTS OF STANDARD CHARACTERS WITHOUT CLAIM TO ANY PARTICULAR FONT, STYLE, SIZE, OR COLOR.

"ZALORA" HAS NO MEANING IN A FOREIGN LANGUAGE.

SER. NO. 77-335,982, FILED 11-23-2007.

JOHN DALIER, EXAMINING ATTORNEY

Int. Cl.: 35

Prior U.S. Cls.: 100, 101 and 102

United States Patent and Trademark Office

Reg. No. 3,475,535

Registered July 29, 2008

**SERVICE MARK
PRINCIPAL REGISTER**



HONSU INC. (CALIFORNIA CORPORATION)
1025 N MOUNTAIN
ONTARIO, CA 91762

FOR: RETAIL STORE SERVICES FEATURING POWERSPORTS, NAMELY, MOTORCYCLES, BOATS, WATERCRAFT, MOTORHOMES, TRAILERS, ATVS, UTVS, MOTORCYCLE GEAR AND ACCESSORIES, IN CLASS 35 (U.S. CLS. 100, 101 AND 102).

FIRST USE 6-15-1993; IN COMMERCE 6-15-1993.

NO CLAIM IS MADE TO THE EXCLUSIVE RIGHT TO USE "MOTORSPORTS", APART FROM THE MARK AS SHOWN.

THE MARK CONSISTS OF AN OUTLINE OF A MOUNTAIN WITH THE WORDS "MOUNTAIN MOTORSPORTS" UNDERNEATH THE MOUNTAIN.

SER. NO. 77-336,090, FILED 11-23-2007.

JENNIFER MARTIN, EXAMINING ATTORNEY

Int. Cl.: 38

Prior U.S. Cls.: 100, 101 and 104

United States Patent and Trademark Office

Reg. No. 3,475,536

Registered July 29, 2008

**SERVICE MARK
PRINCIPAL REGISTER**

streamii

STREAMII, LLC (MARYLAND LTD LIAB CO)
APT 302
526 W UNIVERSITY PKWY
BALTIMORE, MD 21210

THE MARK CONSISTS OF STANDARD CHAR-
ACTERS WITHOUT CLAIM TO ANY PARTICULAR
FONT, STYLE, SIZE, OR COLOR.

FOR: WEB MESSAGING, IN CLASS 38 (U.S. CLS.
100, 101 AND 104).

SER. NO. 77-336,153, FILED 11-24-2007.

FIRST USE 4-10-2007; IN COMMERCE 11-24-2007.

MONIQUE MILLER, EXAMINING ATTORNEY

Int. Cl.: 44

Prior U.S. Cls.: 100 and 101

United States Patent and Trademark Office

Reg. No. 3,475,537

Registered July 29, 2008

**SERVICE MARK
PRINCIPAL REGISTER**



HIDDEN SPRINGS LANDSCAPE & DESIGN LLC
(WASHINGTON LTD LIAB CO)
P.O. BOX 158
SILVANA, WA 98287

FOR: LANDSCAPE GARDENING, IN CLASS 44
(U.S. CLS. 100 AND 101).

FIRST USE 2-14-2004; IN COMMERCE 2-14-2004.

NO CLAIM IS MADE TO THE EXCLUSIVE
RIGHT TO USE "LANDSCAPE & DESIGN", APART
FROM THE MARK AS SHOWN.

THE COLOR(S) LIGHT GREEN, BLUE, WHITE,
AND DARK GREEN IS/ARE CLAIMED AS A FEAT-
TURE OF THE MARK.

THE MARK CONSISTS OF A LEAF SPLIT INTO
TWO HALVES, A TOP AND BOTTOM. THE TOP
HALF OF THE LEAF HAS A BLUE EDGE ON THE
LOWER MARGIN. THE TOP HALF OF THE LEAF IS
LIGHT GREEN AND THE BOTTOM HALF OF THE
LEAF IS DARK GREEN. THE COLOR WHITE
SEPARATES THE TOP HALF OF THE LEAF FROM
THE BOTTOM HALF. THE WORDING "HIDDEN
SPRINGS" IS IN DARK GREEN. THE WORDING
"LANDSCAPE & DESIGN" IS IN BLUE.

SER. NO. 77-336,176, FILED 11-24-2007.

MONIQUE MILLER, EXAMINING ATTORNEY

Int. Cl.: 36

Prior U.S. Cls.: 100, 101 and 102

United States Patent and Trademark Office

Reg. No. 3,475,538

Registered July 29, 2008

**SERVICE MARK
PRINCIPAL REGISTER**



KEATS & CO. REAL ESTATE, LLC (VIRGINIA
LTD LIAB CO)
8860 COLUMBIA 100 PKWY, STE. 304
COLUMBIA, MD 21045

FOR: LEASING OF REAL ESTATE; LEASING OF REAL PROPERTY; PROVIDING INFORMATION IN THE FIELD OF REAL ESTATE BY MEANS OF LINKING THE WEB SITE TO OTHER WEB SITES FEATURING REAL ESTATE INFORMATION; PROVIDING INFORMATION IN THE FIELD OF REAL ESTATE VIA THE INTERNET; PROVIDING REAL ESTATE LISTINGS AND REAL ESTATE INFORMATION VIA THE INTERNET; REAL ESTATE AGENCIES; REAL ESTATE BROKERAGE; REAL ESTATE CONSULTANCY; REAL ESTATE CONSULTATION; REAL ESTATE LISTING; REAL ESTATE MANAGEMENT; REAL ESTATE MULTIPLE LISTING SERVICES; REAL ESTATE SERVICES IN THE FORM OF PROVIDING PHYSICAL ACCESS TO AVAILABLE PROPERTIES VIA A REMOTE CALL-IN LOCKING DEVICE; REAL ESTATE VALUATION SERVICES;

REAL ESTATE VALUATIONS, IN CLASS 36 (U.S. CLS. 100, 101 AND 102).

FIRST USE 5-6-2005; IN COMMERCE 8-10-2005.

NO CLAIM IS MADE TO THE EXCLUSIVE RIGHT TO USE "& CO." AND "REAL ESTATE, LLC", APART FROM THE MARK AS SHOWN.

THE COLOR(S) BLUE, WHITE AND RED IS/ARE CLAIMED AS A FEATURE OF THE MARK.

THE MARK CONSISTS OF A LARGER BLUE RECTANGLE CONTAINING THE WORDS "KEATS & CO. REAL ESTATE, LLC" IN WHITE LETTERS PLACED OVER A SMALLER RED RECTANGLE. A WHITE BAR SEPARATES THE TWO RECTANGLES.

SER. NO. 77-336,339, FILED 11-26-2007.

LINDSEY RUBIN, EXAMINING ATTORNEY

Int. Cls.: 25 and 28

Prior U.S. Cls.: 22, 23, 38, 39 and 50

United States Patent and Trademark Office

Reg. No. 3,475,539

Registered July 29, 2008

**TRADEMARK
PRINCIPAL REGISTER**



GANGSTA SURF (AUSTRALIA SOLE PROPRIETORSHIP)
241 ST TROPEZ, 27 ORCHID AVENUE
SURFERS PARADISE, AUSTRALIA 4217

FOR: T-SHIRTS, BOARD SHORTS, SWIMWEAR, BEACH WEAR, IN CLASS 25 (U.S. CLS. 22 AND 39).

FIRST USE 1-1-2003; IN COMMERCE 1-1-2004.

FOR: SURFBOARDS, SURFBOARD ACCESSORIES, NAMELY, SURFBOARD WAX, SURFBOARD LEASHES, SURFBOARD FINS, IN CLASS 28 (U.S. CLS. 22, 23, 38 AND 50).

FIRST USE 1-1-2003; IN COMMERCE 1-1-2004.

NO CLAIM IS MADE TO THE EXCLUSIVE RIGHT TO USE "SURF", APART FROM THE MARK AS SHOWN.

THE MARK CONSISTS OF TWO STYLIZED FEMALES OVER ONE HORIZONTAL AND ONE VERTICAL CROSS BAR WITHIN A CIRCLE WITH WORD "GANGSTA" IN CURVED SHAPE AT TOP OF THE CIRCLE AND THE WORD "SURF" IN HORIZONTAL SHAPE AT FOOT.

SER. NO. 77-336,343, FILED 11-26-2007.

WILLIAM P. SHANAHAN, EXAMINING ATTORNEY

Int. Cls.: 3 and 37

Prior U.S. Cls.: 1, 4, 6, 50, 51, 52, 100, 103 and 106

United States Patent and Trademark Office

Reg. No. 3,475,540

Registered July 29, 2008

**TRADEMARK
SERVICE MARK
PRINCIPAL REGISTER**

SERV-U

SERV-U #1 CARPET & UPHOLSTERY CLEAN-
ING, INC. (FLORIDA CORPORATION)
6387 PIEDMONT DR.
SPRING HILL, FL 346063829

FOR: CARPET CLEANERS; UPHOLSTERY CLEANERS, IN CLASS 3 (U.S. CLS. 1, 4, 6, 50, 51 AND 52).

FIRST USE 1-1-1995; IN COMMERCE 1-1-1995.

FOR: CARPET CLEANING, IN CLASS 37 (U.S. CLS. 100, 103 AND 106).

FIRST USE 1-1-1995; IN COMMERCE 1-1-1995.

THE MARK CONSISTS OF STANDARD CHARACTERS WITHOUT CLAIM TO ANY PARTICULAR FONT, STYLE, SIZE, OR COLOR.

SER. NO. 77-336,355, FILED S.R. 11-26-2007 AM.
P.R. 3-26-2008.

MARCIE MILONE, EXAMINING ATTORNEY

Int. Cl.: 37

Prior U.S. Cls.: 100, 103 and 106

Reg. No. 3,475,541

United States Patent and Trademark Office

Registered July 29, 2008

**SERVICE MARK
PRINCIPAL REGISTER**

WE UNDERSTAND THAT WE ARE
WORKING IN YOUR HOME, NOT
THAT YOU ARE LIVING IN OUR
CONSTRUCTION SITE

DENDER, RANDALL E. (UNITED STATES IN-
DIVIDUAL)
2049 WAHALAW NENE
TALLAHASSEE, FL 32301 AND
DENDER, PEGGY (UNITED STATES INDIVIDUAL)
2049 WAHALAW NENE
TALLAHASSEE, FL 32301

FIRST USE 7-0-2007; IN COMMERCE 7-0-2007.

THE MARK CONSISTS OF STANDARD CHAR-
ACTERS WITHOUT CLAIM TO ANY PARTICULAR
FONT, STYLE, SIZE, OR COLOR.

SER. NO. 77-336,449, FILED 11-26-2007.

FOR: BUILDING REMODELING SERVICES, IN
CLASS 37 (U.S. CLS. 100, 103 AND 106).

CORY BOONE, EXAMINING ATTORNEY

Int. Cl.: 36

Prior U.S. Cls.: 100, 101 and 102

United States Patent and Trademark Office

Reg. No. 3,475,542

Registered July 29, 2008

**SERVICE MARK
PRINCIPAL REGISTER**

COMBINED FEDERAL CAMPAIGN

U.S. OFFICE OF PERSONNEL MANAGEMENT
(UNITED STATES AGENCY OF THE UNITED
STATES GOVERNMENT)

OFFICE OF THE GENERAL COUNSEL

1900 E STREET NW

WASHINGTON, DC 20415

FOR: CHARITABLE FUND RAISING PROGRAM
WITHIN THE FEDERAL GOVERNMENT, IN CLASS
36 (U.S. CLS. 100, 101 AND 102).

FIRST USE 0-0-1964; IN COMMERCE 0-0-1964.

THE MARK CONSISTS OF STANDARD CHAR-
ACTERS WITHOUT CLAIM TO ANY PARTICULAR
FONT, STYLE, SIZE, OR COLOR.

NO CLAIM IS MADE TO THE EXCLUSIVE
RIGHT TO USE "CAMPAIGN", APART FROM THE
MARK AS SHOWN.

SEC. 2(F).

SER. NO. 77-336,681, FILED 11-26-2007.

JENNY PARK, EXAMINING ATTORNEY

Int. Cl.: 41

Prior U.S. Cls.: 100, 101 and 107

United States Patent and Trademark Office

Reg. No. 3,475,543

Registered July 29, 2008

**SERVICE MARK
PRINCIPAL REGISTER**

versionist

REM PRODUCTIONS LTD. (NEW YORK CORPORATION)
SUITE GRA
54 RIVERSIDE DRIVE
NEW YORK, NY 10024

FOR: ENTERTAINMENT SERVICES, NAMELY, PROVIDING PRERECORDED MUSIC, INFORMATION IN THE FIELD OF MUSIC, AND COMMENTARY AND ARTICLES ABOUT MUSIC, ALL ONLINE VIA A GLOBAL COMPUTER NETWORK, IN CLASS 41 (U.S. CLS. 100, 101 AND 107).

FIRST USE 1-1-2000; IN COMMERCE 1-1-2000.

THE MARK CONSISTS OF STANDARD CHARACTERS WITHOUT CLAIM TO ANY PARTICULAR FONT, STYLE, SIZE, OR COLOR.

SER. NO. 77-337,259, FILED 11-26-2007.

RAUL CORDOVA, EXAMINING ATTORNEY

Int. Cl.: 36

Prior U.S. Cls.: 100, 101 and 102

United States Patent and Trademark Office

Reg. No. 3,475,544

Registered July 29, 2008

**SERVICE MARK
PRINCIPAL REGISTER**

Green Desk

MCKELVEY, MIGUEL ANGEL (UNITED STATES
INDIVIDUAL)
110 LIVINGSTON ST APT 10J
BROOKLYN, NY 11201

FOR: LEASING OF OFFICE SPACE; RENTAL OF
OFFICE SPACE, IN CLASS 36 (U.S. CLS. 100, 101 AND
102).

FIRST USE 9-22-2007; IN COMMERCE 9-24-2007.

THE MARK CONSISTS OF STANDARD CHAR-
ACTERS WITHOUT CLAIM TO ANY PARTICULAR
FONT, STYLE, SIZE, OR COLOR.

NO CLAIM IS MADE TO THE EXCLUSIVE
RIGHT TO USE "GREEN", APART FROM THE
MARK AS SHOWN.

SER. NO. 77-337,286, FILED 11-27-2007.

HOWARD SMIGA, EXAMINING ATTORNEY

Int. Cl.: 35

Prior U.S. Cls.: 100, 101 and 102

United States Patent and Trademark Office

Reg. No. 3,475,545

Registered July 29, 2008

SERVICE MARK
PRINCIPAL REGISTER



ASCERTA HEALTH STAFFING, INC. (MARY-
LAND CORPORATION)
SUITE 501
11350 MCCORMICK ROAD
HUNT VALLEY, MD 21031

FOR: PROVIDE TEMPORARY AND PERMA-
NENT STAFFING FOR THE HEALTH SERVICES
INDUSTRY, NAMELY, HOSPITALS, NURSING
HOMES AND CONTINUING CARE FACILITIES ,
IN CLASS 35 (U.S. CLS. 100, 101 AND 102).

FIRST USE 6-26-2007; IN COMMERCE 6-26-2007.

NO CLAIM IS MADE TO THE EXCLUSIVE
RIGHT TO USE "HEALTH STAFFING", APART
FROM THE MARK AS SHOWN.

THE COLOR(S) BLUE AND RED IS/ARE
CLAIMED AS A FEATURE OF THE MARK.

THE MARK CONSISTS OF THE WORDS "ASCER-
TA HEALTH STAFFING" IN RED LETTERS WITH
BLUE LINES ABOVE AND BELOW THE WORDS,
FOLLOWED BY AN ARTISTIC FIGURE OF A
PERSON APPEARING IN BLUE WITH A BLUE-
LINED HEAD.

SER. NO. 77-337,327, FILED 11-27-2007.

TINA KUAN, EXAMINING ATTORNEY

Int. Cl.: 41

Prior U.S. Cls.: 100, 101 and 107

United States Patent and Trademark Office

Reg. No. 3,475,546

Registered July 29, 2008

SERVICE MARK
PRINCIPAL REGISTER



SANDT III, RAYMOND (GEORGIA CORPORATION)
1856 HOLSTEN DRIVE
JONESBORO, GA 30236

FOR: MARTIAL ARTS INSTRUCTION; OPERATING OF MARTIAL ARTS' SCHOOLS, IN CLASS 41 (U.S. CLS. 100, 101 AND 107).

FIRST USE 5-23-2003; IN COMMERCE 5-23-2003.

NO CLAIM IS MADE TO THE EXCLUSIVE RIGHT TO USE "MARTIAL ARTS" AND "DOJO", APART FROM THE MARK AS SHOWN.

THE MARK CONSISTS OF STYLIZED OAK LEAF IN CENTER WITH WORDS "KASHIWA DOJO STRENGTH THRU MARTIAL ARTS" IN CIRCULAR BORDER.

THE FOREIGN WORDING IN THE MARK TRANSLATES INTO ENGLISH AS "OAK".

SER. NO. 77-337,410, FILED 11-27-2007.

MARGERY A. TIERNEY, EXAMINING ATTORNEY

Int. Cl.: 45

Prior U.S. Cls.: 100 and 101

United States Patent and Trademark Office

Reg. No. 3,475,547

Registered July 29, 2008

**SERVICE MARK
PRINCIPAL REGISTER**

Vital Justice

MARC KING, PH.D. (UNITED STATES INDIVIDUAL)
819 ARAPAHO RD., SUITE 24B
RICHARDSON, TX 75080

THE MARK CONSISTS OF STANDARD CHARACTERS WITHOUT CLAIM TO ANY PARTICULAR FONT, STYLE, SIZE, OR COLOR.

FOR: LITIGATION CONSULTANCY, IN CLASS 45 (U.S. CLS. 100 AND 101).

SER. NO. 77-337,769, FILED 11-27-2007.

FIRST USE 10-11-2007; IN COMMERCE 10-11-2007.

TARAH HARDY, EXAMINING ATTORNEY

Int. Cl.: 35

Prior U.S. Cls.: 100, 101 and 102

United States Patent and Trademark Office

Reg. No. 3,475,548

Registered July 29, 2008

**SERVICE MARK
PRINCIPAL REGISTER**

MY PIZZA SUPPLIER

ALPHA FOODS CO., INC. (TEXAS CORPORATION)
8209 DUNLOP ST.
HOUSTON, TX 77047

FOR: WHOLESALE STORES FEATURING FOOD AND RELATED ITEMS; WHOLESALE ORDER SERVICES IN THE FIELD OF FOOD AND RELATED ITEMS; DISTRIBUTORSHIP SERVICES IN THE FIELD OF FOOD AND RELATED ITEMS TO EATING ESTABLISHMENTS, IN CLASS 35 (U.S. CLS. 100, 101 AND 102).

FIRST USE 12-31-1994; IN COMMERCE 12-31-1994.

THE MARK CONSISTS OF STANDARD CHARACTERS WITHOUT CLAIM TO ANY PARTICULAR FONT, STYLE, SIZE, OR COLOR.

NO CLAIM IS MADE TO THE EXCLUSIVE RIGHT TO USE "PIZZA SUPPLIER", APART FROM THE MARK AS SHOWN.

SEC. 2(F).

SER. NO. 77-337,838, FILED 11-27-2007.

JULIE GUTTADAURO, EXAMINING ATTORNEY

Int. Cl.: 35

Prior U.S. Cls.: 100, 101 and 102

United States Patent and Trademark Office

Reg. No. 3,475,549

Registered July 29, 2008

**SERVICE MARK
PRINCIPAL REGISTER**

RELAY NETWORKS

RELAY NETWORKS, INC. (MINNESOTA CORPORATION)
18399 MINNETONKA BLVD
DEEPHAVEN, MN 55391

FOR: RETAIL STORE SERVICES FEATURING NEW AND PRE-OWNED COMPUTER NETWORK HARDWARE; ON-LINE RETAIL STORE SERVICES FEATURING NEW AND PRE-OWNED COMPUTER NETWORK HARDWARE, IN CLASS 35 (U.S. CLS. 100, 101 AND 102).

FIRST USE 11-1-2005; IN COMMERCE 11-1-2005.

THE MARK CONSISTS OF STANDARD CHARACTERS WITHOUT CLAIM TO ANY PARTICULAR FONT, STYLE, SIZE, OR COLOR.

NO CLAIM IS MADE TO THE EXCLUSIVE RIGHT TO USE "NETWORKS", APART FROM THE MARK AS SHOWN.

SER. NO. 77-337,970, FILED 11-27-2007.

JENNY PARK, EXAMINING ATTORNEY

Int. Cl.: 9

Prior U.S. Cls.: 21, 23, 26, 36 and 38

Reg. No. 3,475,550

United States Patent and Trademark Office

Registered July 29, 2008

**TRADEMARK
PRINCIPAL REGISTER**

H2-3

LARRY HORSLEY & CO., INC. (GEORGIA CORPORATION)
4333 LYNWOOD CT
DOUGLASVILLE, GA 301343978

THE MARK CONSISTS OF STANDARD CHARACTERS WITHOUT CLAIM TO ANY PARTICULAR FONT, STYLE, SIZE, OR COLOR.

FOR: MOUNTING BRACKETS SPECIALLY ADAPTED FOR ELECTRICAL OUTLETS AND SWITCHES, IN CLASS 9 (U.S. CLS. 21, 23, 26, 36 AND 38).

SER. NO. 77-337,979, FILED 11-27-2007.

FIRST USE 1-1-1984; IN COMMERCE 1-1-1984.

COLLEEN DOMBROW, EXAMINING ATTORNEY

Int. Cl.: 35

Prior U.S. Cls.: 100, 101 and 102

United States Patent and Trademark Office

Reg. No. 3,475,551

Registered July 29, 2008

**SERVICE MARK
PRINCIPAL REGISTER**



RELAY NETWORKS, INC. (MINNESOTA CORPORATION)
18399 MINNETONKA BLVD
DEEPHAVEN, MN 55391

THE COLOR(S) BLACK, WHITE AND BLUE IS/ARE CLAIMED AS A FEATURE OF THE MARK.

FOR: RETAIL STORE SERVICES FEATURING NEW AND PRE-OWNED COMPUTER NETWORK HARDWARE; ON-LINE RETAIL STORE SERVICES FEATURING NEW AND PRE-OWNED COMPUTER NETWORK HARDWARE, IN CLASS 35 (U.S. CLS. 100, 101 AND 102).

THE MARK CONSISTS OF THE WORD "RELAY" IN BLOCK WHITE LETTERING WITH THE BLACK OUTLINE ABOVE THE WORD "NETWORKS" IN BLACK AND THE INVERTED BLUE CURVE SWOOSH APPEARING BEHIND THE WORDING "RELAY".

FIRST USE 11-1-2005; IN COMMERCE 11-1-2005.

SER. NO. 77-338,018, FILED 11-27-2007.

NO CLAIM IS MADE TO THE EXCLUSIVE RIGHT TO USE "NETWORKS", APART FROM THE MARK AS SHOWN.

JENNY PARK, EXAMINING ATTORNEY

Int. Cl.: 9

Prior U.S. Cls.: 21, 23, 26, 36 and 38

Reg. No. 3,475,552

United States Patent and Trademark Office

Registered July 29, 2008

**TRADEMARK
PRINCIPAL REGISTER**

HS3

LARRY HORSLEY & CO., INC. (GEORGIA CORPORATION)
4333 LYNWOOD CT
DOUGLASVILLE, GA 301343978

THE MARK CONSISTS OF STANDARD CHARACTERS WITHOUT CLAIM TO ANY PARTICULAR FONT, STYLE, SIZE, OR COLOR.

FOR: MOUNTING BRACKETS SPECIALLY ADAPTED FOR ELECTRICAL OUTLETS AND SWITCHES, IN CLASS 9 (U.S. CLS. 21, 23, 26, 36 AND 38).

SER. NO. 77-338,033, FILED 11-27-2007.

FIRST USE 1-1-1987; IN COMMERCE 1-1-1987.

COLLEEN DOMBROW, EXAMINING ATTORNEY

Int. Cl.: 35

Prior U.S. Cls.: 100, 101 and 102

United States Patent and Trademark Office

Reg. No. 3,475,553

Registered July 29, 2008

**SERVICE MARK
PRINCIPAL REGISTER**

"Winning Customer Value"

DAVID ELMO LLC (OHIO LTD LIAB CO)
5000 ALPINE ROSE COURT
DAYTON, OH 45458

THE MARK CONSISTS OF STANDARD CHAR-
ACTERS WITHOUT CLAIM TO ANY PARTICULAR
FONT, STYLE, SIZE, OR COLOR.

FOR: BUSINESS CONSULTATION AND MAN-
AGEMENT REGARDING MARKETING ACTIV-
ITIES AND LAUNCHING OF NEW PRODUCTS, IN
CLASS 35 (U.S. CLS. 100, 101 AND 102).

SER. NO. 77-338,122, FILED 11-27-2007.

FIRST USE 1-30-2007; IN COMMERCE 2-2-2007.

GENE MACIOL, EXAMINING ATTORNEY

Int. Cl.: 20

Prior U.S. Cls.: 2, 13, 22, 25, 32 and 50

United States Patent and Trademark Office

Reg. No. 3,475,554

Registered July 29, 2008

**TRADEMARK
PRINCIPAL REGISTER**



JAKEN CO., INC. (CALIFORNIA CORPORATION)
6842 WALKER STREET
LA PALMA, CA 90623

FOR: SHELVING AND COMPONENT PARTS THEREOF, NAMELY SHELVES AND BRACKETS SOLD AS A UNIT; STORAGE RACKS; WORKBENCHES, IN CLASS 20 (U.S. CLS. 2, 13, 22, 25, 32 AND 50).

FIRST USE 1-2-1988; IN COMMERCE 1-2-1988.

THE MARK CONSISTS OF STYLIZED J PLUS WORD JAKEN.

SER. NO. 77-338,131, FILED 11-27-2007.

GENE MACIOL, EXAMINING ATTORNEY

Int. Cl.: 35

Prior U.S. Cls.: 100, 101 and 102

United States Patent and Trademark Office

Reg. No. 3,475,555

Registered July 29, 2008

**SERVICE MARK
PRINCIPAL REGISTER**



HOMEMED PHARMACY, LLC (WYOMING LTD
LIAB CO)
6210 TECHNOLOGY CENTER DRIVE
INDIANAPOLIS, IN 46278

FOR: RETAIL PHARMACY SERVICES VIA MAIL
ORDER AND INTERNET, IN CLASS 35 (U.S. CLS.
100, 101 AND 102).

FIRST USE 1-1-2005; IN COMMERCE 1-1-2005.

OWNER OF U.S. REG. NOS. 2,796,919 AND
2,799,828.

NO CLAIM IS MADE TO THE EXCLUSIVE
RIGHT TO USE "MED", APART FROM THE MARK
AS SHOWN.

SER. NO. 77-338,158, FILED 11-27-2007.

KRISTINA MORRIS, EXAMINING ATTORNEY

Int. Cl.: 9

Prior U.S. Cls.: 21, 23, 26, 36 and 38

Reg. No. 3,475,556

United States Patent and Trademark Office

Registered July 29, 2008

**TRADEMARK
PRINCIPAL REGISTER**

H4

LARRY HORSLEY & CO., INC. (GEORGIA CORPORATION)
4333 LYNWOOD CT.
DOUGLASVILLE, GA 301343978

THE MARK CONSISTS OF STANDARD CHARACTERS WITHOUT CLAIM TO ANY PARTICULAR FONT, STYLE, SIZE, OR COLOR.

FOR: MOUNTING BRACKETS SPECIALLY ADAPTED FOR ELECTRICAL OUTLETS AND SWITCHES, IN CLASS 9 (U.S. CLS. 21, 23, 26, 36 AND 38).

SER. NO. 77-338,490, FILED 11-28-2007.

FIRST USE 1-5-1982; IN COMMERCE 5-13-1982.

COLLEEN DOMBROW, EXAMINING ATTORNEY

Int. Cl.: 9

Prior U.S. Cls.: 21, 23, 26, 36 and 38

United States Patent and Trademark Office

Reg. No. 3,475,557

Registered July 29, 2008

**TRADEMARK
PRINCIPAL REGISTER**

The logo for LexiCast features the word "LexiCast" in a bold, italicized, sans-serif font. A thick, black, curved line arches over the letters "Lexi", starting from the left and ending above the "i".

XORBIT, INC. (MARYLAND CORPORATION)
SUITE 190
8945 GUILFORD ROAD
COLUMBIA, MD 21046

FOR: COMPUTER SOFTWARE FOR THE CREA-
TION AND TRANSMISSION OF CLOSED CAPTION
DATA FOR TELEPHONE AND VIDEO, IN CLASS 9
(U.S. CLS. 21, 23, 26, 36 AND 38).

FIRST USE 4-28-2006; IN COMMERCE 4-28-2006.

THE MARK CONSISTS OF THE WORD "LEXI-
CAST" WITH A CURVED LINE DESIGN EXTEND-
ING ABOVE THE LETTERS "LEX".

SER. NO. 77-338,562, FILED 11-28-2007.

GENE MACIOL, EXAMINING ATTORNEY

Int. Cl.: 14

Prior U.S. Cls.: 2, 27, 28 and 50

United States Patent and Trademark Office

Reg. No. 3,475,558

Registered July 29, 2008

**TRADEMARK
PRINCIPAL REGISTER**

A COMPLAINT FREE WORLD.ORG

LAMPLIGHTER, INC. (MISSOURI CORPORATION)
15607 NE 174TH STREET
HOLT, MO 64048

THE MARK CONSISTS OF STANDARD CHARACTERS WITHOUT CLAIM TO ANY PARTICULAR FONT, STYLE, SIZE, OR COLOR.

FOR: RUBBER OR SILICON WRISTBANDS IN THE NATURE OF A BRACELET, IN CLASS 14 (U.S. CLS. 2, 27, 28 AND 50).

SER. NO. 77-338,565, FILED 11-28-2007.

FIRST USE 7-23-2006; IN COMMERCE 11-1-2006.

BENJAMIN OKEKE, EXAMINING ATTORNEY

Int. Cl.: 22

Prior U.S. Cls.: 1, 2, 7, 19, 22, 42 and 50

Reg. No. 3,475,559

United States Patent and Trademark Office

Registered July 29, 2008

**TRADEMARK
PRINCIPAL REGISTER**

WET HAPPENED?

BIRD, JAMIE (UNITED STATES INDIVIDUAL)
5749 PINEKNOLL
KENTWOOD, MI 49508

THE MARK CONSISTS OF STANDARD CHAR-
ACTERS WITHOUT CLAIM TO ANY PARTICULAR
FONT, STYLE, SIZE, OR COLOR.

FOR: WASHABLE, ZIPPERED BAG LINED WITH
POLYURETHANE LAMINATE FOR STORING WET
ITEMS, IN CLASS 22 (U.S. CLS. 1, 2, 7, 19, 22, 42 AND
50).

SEC. 2(F).

SER. NO. 77-338,626, FILED 11-28-2007.

FIRST USE 11-15-2006; IN COMMERCE 11-15-2006.

WENDY JUN, EXAMINING ATTORNEY

Int. Cl.: 9

Prior U.S. Cls.: 21, 23, 26, 36 and 38

United States Patent and Trademark Office

Reg. No. 3,475,560

Registered July 29, 2008

**TRADEMARK
PRINCIPAL REGISTER**

H6

LARRY HORSLEY & CO., INC. (GEORGIA CORPORATION)
4333 LYNWOOD CT.
DOUGLASVILLE, GA 301343978

THE MARK CONSISTS OF STANDARD CHARACTERS WITHOUT CLAIM TO ANY PARTICULAR FONT, STYLE, SIZE, OR COLOR.

FOR: MOUNTING BRACKETS SPECIALLY ADAPTED FOR ELECTRICAL OUTLETS AND SWITCHES, IN CLASS 9 (U.S. CLS. 21, 23, 26, 36 AND 38).

SER. NO. 77-338,715, FILED 11-28-2007.

FIRST USE 1-11-1988; IN COMMERCE 1-11-1988.

COLLEEN DOMBROW, EXAMINING ATTORNEY

Int. Cl.: 41

Prior U.S. Cls.: 100, 101 and 107

United States Patent and Trademark Office

Reg. No. 3,475,561

Registered July 29, 2008

**SERVICE MARK
PRINCIPAL REGISTER**

PRINCE WILLIAM SYMPHONY
ORCHESTRA

PRINCE WILLIAM SYMPHONY ORCHESTRA,
INC. (VIRGINIA CORPORATION)

SUITE 305

8665 SUDLEY ROAD

MANASSAS, VA 20110

FOR: ENTERTAINMENT, NAMELY, LIVE MU-
SIC CONCERTS, IN CLASS 41 (U.S. CLS. 100, 101
AND 107).

FIRST USE 0-0-1972; IN COMMERCE 0-0-1972.

THE MARK CONSISTS OF STANDARD CHAR-
ACTERS WITHOUT CLAIM TO ANY PARTICULAR
FONT, STYLE, SIZE, OR COLOR.

NO CLAIM IS MADE TO THE EXCLUSIVE
RIGHT TO USE "SYMPHONY ORCHESTRA",
APART FROM THE MARK AS SHOWN.

SEC. 2(F).

SER. NO. 77-338,763, FILED 11-28-2007.

TASHIA BUNCH, EXAMINING ATTORNEY

Int. Cl.: 39

Prior U.S. Cls.: 100 and 105

United States Patent and Trademark Office

Reg. No. 3,475,562

Registered July 29, 2008

**SERVICE MARK
PRINCIPAL REGISTER**

FIRST WING

EAGLE CREEK AVIATION SERVICES, INC. (IN-
DIANA CORPORATION)
4101 DANDY TRAIL
INDIANAPOLIS, IN 46254

FOR: AIRCRAFT MANAGEMENT SERVICES,
NAMELY, FLIGHT PLANNING AND SCHEDUL-
ING, AIRPLANE PILOTING SERVICES, AND AIR-
PLANE CHARTERING SERVICES, IN CLASS 39
(U.S. CLS. 100 AND 105).

FIRST USE 6-19-1995; IN COMMERCE 6-19-1995.

THE MARK CONSISTS OF STANDARD CHAR-
ACTERS WITHOUT CLAIM TO ANY PARTICULAR
FONT, STYLE, SIZE, OR COLOR.

SER. NO. 77-338,960, FILED 11-28-2007.

MATTHEW MCDOWELL, EXAMINING ATTOR-
NEY

Int. Cl.: 28

Prior U.S. Cls.: 22, 23, 38 and 50

United States Patent and Trademark Office

Reg. No. 3,475,563

Registered July 29, 2008

**TRADEMARK
PRINCIPAL REGISTER**

HEXAGONOES

DELTA EDUCATION, INC. (NEW HAMPSHIRE
CORPORATION)
80 NORTHWEST BLVD.
NASHUA, NH 03063

THE MARK CONSISTS OF STANDARD CHAR-
ACTERS WITHOUT CLAIM TO ANY PARTICULAR
FONT, STYLE, SIZE, OR COLOR.

FOR: EDUCATIONAL GAME, NAMELY, A
GAME IN THE NATURE OF DOMINOES USED
FOR TEACHING MATHEMATICAL CONCEPTS, IN
CLASS 28 (U.S. CLS. 22, 23, 38 AND 50).

SER. NO. 77-339,063, FILED 11-28-2007.

FIRST USE 0-0-2003; IN COMMERCE 0-0-2003.

EMILY CHUO, EXAMINING ATTORNEY

Int. Cl.: 43

Prior U.S. Cls.: 100 and 101

United States Patent and Trademark Office

Reg. No. 3,475,564

Registered July 29, 2008

**SERVICE MARK
PRINCIPAL REGISTER**

King of the Fat Sandwich

ARE YOU HUNGRY LLC (PENNSYLVANIA LTD
LIAB CO)

111 SOWERS STREET

STATE COLLEGE, PA 16801

FOR: RESTAURANTS, IN CLASS 43 (U.S. CLS. 100
AND 101).

FIRST USE 1-15-2006; IN COMMERCE 1-15-2006.

THE MARK CONSISTS OF STANDARD CHAR-
ACTERS WITHOUT CLAIM TO ANY PARTICULAR
FONT, STYLE, SIZE, OR COLOR.

NO CLAIM IS MADE TO THE EXCLUSIVE
RIGHT TO USE "SANDWICH", APART FROM THE
MARK AS SHOWN.

SER. NO. 77-339,089, FILED 11-28-2007.

JAY FLOWERS, EXAMINING ATTORNEY

Int. Cl.: 9

Prior U.S. Cls.: 21, 23, 26, 36 and 38

Reg. No. 3,475,565

United States Patent and Trademark Office

Registered July 29, 2008

**TRADEMARK
PRINCIPAL REGISTER**



XSENSE CONNECTIVITY INC. (CALIFORNIA CORPORATION)
857 HINCKLEY ROAD
BURLINGAME, CA 94010

THE MARK CONSISTS OF THE WORD "MAC-SENSE" WITH A STYLIZED "M" ACCOMPANIED BY THREE ADDITIONAL ROTATED "M"'S FORMING AN OPEN SQUARE ABOVE THE INITIAL "M".

FOR: COMPUTER HARDWARE, NAMELY, NETWORK PERIPHERALS FOR COMPUTERS AND COMPUTER HARDWARE FOR NETWORKING APPLICATIONS, IN CLASS 9 (U.S. CLS. 21, 23, 26, 36 AND 38).

SER. NO. 77-339,099, FILED 11-28-2007.

FIRST USE 4-0-1998; IN COMMERCE 4-0-1998.

SAIMA MAKHDOOM, EXAMINING ATTORNEY

Int. Cls.: 9, 16 and 41

**Prior U.S. Cls.: 2, 5, 21, 22, 23, 26, 29, 36, 37, 38, 50,
100, 101 and 107**

Reg. No. 3,475,566

United States Patent and Trademark Office

Registered July 29, 2008

**TRADEMARK
SERVICE MARK
PRINCIPAL REGISTER**

10x Mind Expander

THE STRATEGIC COACH INC. (CANADA CORPORATION)
SUITE #201
33 FRASER AVE.
TORONTO, CANADA M6K3J9

FOR: ELECTRONIC PUBLICATIONS, NAMELY, MANUALS, STUDY GUIDES, DISCUSSION GUIDES, BOOKS AND NEWSLETTERS FEATURING PRESENTATIONS AND INSTRUCTION IN THE FIELD OF PROFESSIONAL AND PERSONAL DEVELOPMENT, RECORDED ON COMPACT DISCS AND RECORDED ON COMPUTER MEDIA, IN CLASS 9 (U.S. CLS. 21, 23, 26, 36 AND 38).

FIRST USE 1-1-1998; IN COMMERCE 1-1-1998.

FOR: EDUCATIONAL PUBLICATIONS, NAMELY, MANUALS, STUDY GUIDES, DISCUSSION GUIDES, BOOKS AND NEWSLETTERS IN THE FIELDS OF PROFESSIONAL AND PERSONAL DE-

VELOPMENT, IN CLASS 16 (U.S. CLS. 2, 5, 22, 23, 29, 37, 38 AND 50).

FIRST USE 1-1-1998; IN COMMERCE 1-1-1998.

FOR: EDUCATION SERVICES, NAMELY, PROVIDING AND CONDUCTING SEMINARS, WORKSHOPS AND GROUP-STUDY INSTRUCTIONAL COURSES IN THE FIELD OF PERSONAL AND PROFESSIONAL DEVELOPMENT, IN CLASS 41 (U.S. CLS. 100, 101 AND 107).

FIRST USE 1-1-1998; IN COMMERCE 1-1-1998.

THE MARK CONSISTS OF STANDARD CHARACTERS WITHOUT CLAIM TO ANY PARTICULAR FONT, STYLE, SIZE, OR COLOR.

SER. NO. 77-339,166, FILED 11-28-2007.

RENEE SERVANCE, EXAMINING ATTORNEY

Int. Cl.: 41

Prior U.S. Cls.: 100, 101 and 107

United States Patent and Trademark Office

Reg. No. 3,475,567

Registered July 29, 2008

**SERVICE MARK
PRINCIPAL REGISTER**

Living Legends of Aviation

CENTENNIAL JOURNAL PUBLISHING OF CO,
LLC (COLORADO LTD LIAB CO)
SUITE 210, J-12
13000 E CONTROL TOWER RD
ENGLEWOOD, CO 80112

FOR: EDUCATIONAL SERVICES, NAMELY,
PROVIDING INCENTIVES TO PEOPLE TO DEMON-
STRATE EXCELLENCE IN THE FIELD OF AVIA-
TION THROUGH ISSUANCE OF AWARDS, IN
CLASS 41 (U.S. CLS. 100, 101 AND 107).

FIRST USE 1-15-2003; IN COMMERCE 1-15-2003.

THE MARK CONSISTS OF STANDARD CHAR-
ACTERS WITHOUT CLAIM TO ANY PARTICULAR
FONT, STYLE, SIZE, OR COLOR.

NO CLAIM IS MADE TO THE EXCLUSIVE
RIGHT TO USE "AVIATION", APART FROM THE
MARK AS SHOWN.

SER. NO. 77-339,322, FILED 11-28-2007.

MICHAEL ENGEL, EXAMINING ATTORNEY

Int. Cl.: 42

Prior U.S. Cls.: 100 and 101

United States Patent and Trademark Office

Reg. No. 3,475,568

Registered July 29, 2008

**SERVICE MARK
PRINCIPAL REGISTER**



VECTOR PLANNING & SERVICES, INC. (VIRGINIA CORPORATION)

ATTN: VINH VO

591 CAMINO DE LA REINA, SUITE 1210

SAN DIEGO, CA 91913

FOR: ACCREDITATION SERVICES, NAMELY, SETTING AND PROVIDING STANDARDS FOR COMPUTER SYSTEMS FOR THE PURPOSE OF ACCREDITATION; BACK-UP SERVICES FOR COMPUTER HARD DRIVE DATA; COMPUTER CONSULTATION; COMPUTER CONSULTATION IN THE FIELD OF COMPUTER SECURITY; COMPUTER DIAGNOSTIC SERVICES; COMPUTER DISASTER RECOVERY PLANNING; COMPUTER MONITORING SERVICE WHICH TRACKS HARDWARE PERFORMANCE AND PROCESSES AND SENDS OUT HISTORICAL REPORTS AND ALERTS; COMPUTER NETWORK DESIGN FOR OTHERS; COMPUTER PROJECT MANAGEMENT SERVICES; COMPUTER SECURITY SERVICE, NAMELY, HARD DRIVE ERASURE; COMPUTER SECURITY SERVICE, NAMELY, RESTRICTING ACCESS TO AND BY COMPUTER NETWORKS TO AND OF UNDESIRED WEB SITES, MEDIA AND INDIVIDUALS AND FACILITIES; COMPUTER SERVICE, NAMELY, ACTING AS AN APPLICATION SERVICE PROVIDER IN THE FIELD OF KNOWLEDGE MANAGEMENT TO HOST COMPUTER APPLICATION SOFTWARE FOR CREATING SEARCHABLE DATABASES OF INFORMATION AND DATA; COMPUTER SERVICE, NAMELY, ACTING AS AN APPLICATION SERVICE PROVIDER IN THE FIELD OF KNOWLEDGE MANAGEMENT TO HOST COMPUTER APPLICATION SOFTWARE FOR SEARCHING AND RETRIEVING INFORMATION FROM DATABASES AND COMPUTER NETWORKS; COMPUTER SERVICE, NAMELY, ACTING AS AN APPLICATION SERVICE PROVIDER IN THE FIELD

OF KNOWLEDGE MANAGEMENT TO HOST COMPUTER APPLICATION SOFTWARE FOR THE COLLECTION, EDITING, ORGANIZING, MODIFYING, BOOK MARKING, TRANSMISSION, STORAGE AND SHARING OF DATA AND INFORMATION; COMPUTER SERVICES, NAMELY, COMPUTER SYSTEM ADMINISTRATION FOR OTHERS; COMPUTER SERVICES, NAMELY, DATA RECOVERY SERVICES; COMPUTER SERVICES, NAMELY, FILTERING OF UNWANTED E-MAILS; COMPUTER SERVICES, NAMELY, MANAGING WEB SITES FOR OTHERS; COMPUTER SERVICES, NAMELY, REMOTE AND ON-SITE MANAGEMENT OF ELECTRONIC MESSAGING SYSTEMS AND APPLICATIONS FOR OTHERS; COMPUTER SERVICES, NAMELY, REMOTE MANAGEMENT OF COMPUTER APPLICATIONS FOR OTHERS; COMPUTER SYSTEMS ANALYSIS; COMPUTER VIRUS PROTECTION SERVICES; CONSULTATION SERVICES IN THE FIELDS OF SELECTION, IMPLEMENTATION AND USE OF COMPUTER HARDWARE AND SOFTWARE SYSTEMS FOR OTHERS; CONSULTING SERVICES IN THE FIELD OF DESIGN, SELECTION, IMPLEMENTATION AND USE OF COMPUTER HARDWARE AND SOFTWARE SYSTEMS FOR OTHERS; CREATING OR MAINTAINING WEB SITES FOR OTHERS; CREATION AND MAINTENANCE OF WEB SITES FOR OTHERS; DATA MINING; DATA WAREHOUSING; DATABASE DEVELOPMENT SERVICES; DESIGN AND TESTING FOR NEW PRODUCT DEVELOPMENT; DESIGN AND TESTING OF NEW PRODUCTS FOR OTHERS; DESIGN FOR OTHERS IN THE FIELD OF COMPUTER NETWORKS, SOFTWARE, AND ENGINEERING FOR INFORMATION TECHNOLOGY; DESIGN OF HOME PAGES; DESIGN OF HOME PAGES, COMPUTER SOFTWARE AND WEB SITES; DESIGN OF HOMEPAGES AND WEB-SITES; DESIGN OF HOMEPAGES AND WEBSITES; DEVEL-

OPMENT, DESIGN AND UPDATING OF HOME PAGES; DEVELOPMENT, UPDATING AND MAINTENANCE OF SOFTWARE AND DATA BASES; E-MAIL SYSTEM DESIGN AND IMPLEMENTATION FOR OTHERS; INFORMATION TECHNOLOGY CONSULTATION; PLANNING, DEVELOPMENT AND TECHNICAL SUPPORT OF ELECTRONIC COMMUNICATIONS NETWORKS; PROVIDING PLANNING AND ENGINEERING SERVICES IN THE FIELD OF INFORMATION AND COMMUNICATIONS NETWORKS; PROVIDING QUALITY ASSURANCE SERVICES IN THE FIELD OF INFORMATION TECHNOLOGY; TECHNOLOGICAL CONSULTATION IN THE TECHNOLOGY FIELD OF INFORMATION TECHNOLOGY; TECHNOLOGY CONSULTATION IN THE FIELD OF INFORMATION TECHNOLOGY; ENGINEERING SERVICES, NAMELY, ENGINEERING FOR INFORMATION TECHNOLOGY; INTEGRATION OF COM-

PUTER SYSTEMS AND NETWORKS; DESIGN AND DEVELOPMENT OF NETWORKS; TECHNICAL SUPPORT, NAMELY, MONITORING OF NETWORK SYSTEMS, IN CLASS 42 (U.S. CLS. 100 AND 101).

FIRST USE 9-20-1997; IN COMMERCE 9-20-1997.

THE COLOR(S) RED AND BLUE IS/ARE CLAIMED AS A FEATURE OF THE MARK.

THE MARK CONSISTS OF A STYLIZED LETTER "V" IN BLUE ENCIRCLED BY A DESIGN OVAL IN RED.

SER. NO. 77-339,347, FILED 11-28-2007.

MARY MUNSON, EXAMINING ATTORNEY

Int. Cl.: 43

Prior U.S. Cls.: 100 and 101

United States Patent and Trademark Office

Reg. No. 3,475,569

Registered July 29, 2008

**SERVICE MARK
PRINCIPAL REGISTER**

ZERZA

M & R MEDITERRANEAN CORP. (NEW YORK CORPORATION)
304 EAST 6TH STREET
NEW YORK, NY 10003

THE MARK CONSISTS OF STANDARD CHARACTERS WITHOUT CLAIM TO ANY PARTICULAR FONT, STYLE, SIZE, OR COLOR.

FOR: RESTAURANT, BAR AND CATERING SERVICES; DINING SERVICES WITH ACCOMPANYING LIVE ENTERTAINMENT, IN CLASS 43 (U.S. CLS. 100 AND 101).

SER. NO. 77-339,915, FILED 11-29-2007.

FIRST USE 6-0-2003; IN COMMERCE 6-0-2003.

JEFF DEFORD, EXAMINING ATTORNEY

Int. Cl.: 42

Prior U.S. Cls.: 100 and 101

United States Patent and Trademark Office

Reg. No. 3,475,570

Registered July 29, 2008

**SERVICE MARK
PRINCIPAL REGISTER**



PHENOMBLUE LLC (NEBRASKA LTD LIAB CO)
2626 HARNEY STREET
OMAHA, NE 68131

FOR: DESIGN AND DEVELOPMENT OF COM-
PUTER GRAPHICS, ANIMATION AND SOFTWARE
FOR OTHERS, IN CLASS 42 (U.S. CLS. 100 AND 101).

FIRST USE 3-26-2004; IN COMMERCE 3-26-2004.

THE MARK CONSISTS OF A SMALL LETTER "P"
WITH TWO DOTS IN THE MIDDLE OF THE "P"
AND A VERTICAL LINE BEFORE THE WORD
"PHENOMBLUE".

SER. NO. 77-339,916, FILED 11-29-2007.

JEFF DEFORD, EXAMINING ATTORNEY

Int. Cls.: 35 and 36

Prior U.S. Cls.: 100, 101 and 102

United States Patent and Trademark Office

Reg. No. 3,475,571

Registered July 29, 2008

**SERVICE MARK
PRINCIPAL REGISTER**



FRANCHISE SOLUTIONS, LLC (ARIZONA LTD
LIAB CO)
4340 EAST TAURUS PLACE
CHANDLER, AZ 85249

FOR: BUSINESS APPRAISALS; BUSINESS AP-
PRAISALS AND EVALUATIONS IN BUSINESS
MATTERS; BUSINESS CONSULTATION; BUSINESS
CONSULTATION SERVICES; BUSINESS CONSULT-
ING AND INFORMATION SERVICES; BUSINESS
NETWORKING; BUSINESS ORGANIZATION AD-
VICE; BUSINESS ORGANIZATION CONSULTING;
BUSINESS ORGANIZATIONAL CONSULTATION;
BUSINESS SERVICES, NAMELY, MATCHING PO-
TENTIAL PRIVATE INVESTORS WITH ENTREPRE-
NEURS NEEDING FUNDING; PROMOTION OF
BUSINESS OPPORTUNITIES; PROVIDING LIST-
INGS OF BUSINESSES FOR SALE, IN CLASS 35
(U.S. CLS. 100, 101 AND 102).

FIRST USE 6-4-2006; IN COMMERCE 6-4-2006.

FOR: BROKERAGE IN THE FIELD OF BUYING
AND SELLING BUSINESSES; BUSINESS BROKER-
AGE, IN CLASS 36 (U.S. CLS. 100, 101 AND 102).

FIRST USE 6-4-2006; IN COMMERCE 6-4-2006.

NO CLAIM IS MADE TO THE EXCLUSIVE
RIGHT TO USE "ASSOCIATES", APART FROM
THE MARK AS SHOWN.

THE COLOR(S) PURPLE, WHITE AND GREEN IS/
ARE CLAIMED AS A FEATURE OF THE MARK.

THE MARK CONSISTS OF A RAISED PURPLE
SPLASH WITH THE LOWER CASE LETTERS "E",
"A", "T", IN THE MIDDLE IN WHITE; THE LOWER
CASE LETTER "Z" IN GREEN TO THE RIGHT OF
THE PURPLE SPLASH; A WHITE "PLUS" SIGN IN
THE LOWER RIGHT CORNER OF THE PURPLE
SPLASH; THE WORDING "ASSOCIATES" IN ALL
LOWER CASE IN GREEN, TO THE LOWER RIGHT
UNDER THE PURPLE SPLASH.

SER. NO. 77-340,081, FILED 11-29-2007.

MARGERY A. TIERNEY, EXAMINING ATTORNEY

Int. Cl.: 36

Prior U.S. Cls.: 100, 101 and 102

United States Patent and Trademark Office

Reg. No. 3,475,572

Registered July 29, 2008

**SERVICE MARK
PRINCIPAL REGISTER**

RAINFOREST2REEF

RAINFOREST2REEF (DELAWARE NON-PROFIT
ORGANIZATION)
P.O. BOX 735
TAHOE CITY, CA 96145

FOR: CHARITABLE FUNDRAISING SERVICES
IN THE FIELD OF ECOSYSTEM CONSERVATION;
PROVIDING FINANCIAL ASSISTANCE FOR
CREATING ECOLOGICALLY BENEFICIAL ECO-
NOMIC ACTIVITIES, IN CLASS 36 (U.S. CLS. 100,
101 AND 102).

FIRST USE 7-25-2007; IN COMMERCE 7-25-2007.

THE MARK CONSISTS OF STANDARD CHAR-
ACTERS WITHOUT CLAIM TO ANY PARTICULAR
FONT, STYLE, SIZE, OR COLOR.

SER. NO. 77-340,125, FILED 11-29-2007.

KAREN M. STRZYZ, EXAMINING ATTORNEY

Int. Cl.: 36

Prior U.S. Cls.: 100, 101 and 102

United States Patent and Trademark Office

Reg. No. 3,475,573

Registered July 29, 2008

**SERVICE MARK
PRINCIPAL REGISTER**

**Special Situation
Financing for Commercial
Real Estate**

WINTER & COMPANY (NEW YORK CORPORATION)
149 MADISON AVENUE
SUITE 701
NEW YORK, NY 10016

FOR: FINANCIAL SERVICES, NAMELY, MORTGAGE LENDING AND REAL ESTATE INVESTMENT SERVICES, IN CLASS 36 (U.S. CLS. 100, 101 AND 102).

FIRST USE 2-1-2006; IN COMMERCE 2-1-2006.

THE MARK CONSISTS OF STANDARD CHARACTERS WITHOUT CLAIM TO ANY PARTICULAR FONT, STYLE, SIZE, OR COLOR.

NO CLAIM IS MADE TO THE EXCLUSIVE RIGHT TO USE "FINANCING FOR COMMERCIAL REAL ESTATE", APART FROM THE MARK AS SHOWN.

SER. NO. 77-340,827, FILED 11-30-2007.

SHAUNIA CARLYLE, EXAMINING ATTORNEY

Int. Cl.: 5

Prior U.S. Cls.: 6, 18, 44, 46, 51 and 52

United States Patent and Trademark Office

Reg. No. 3,475,574

Registered July 29, 2008

**TRADEMARK
PRINCIPAL REGISTER**

Fermental
MAX

ESI S.P.A. (ITALY CORPORATION)
PIAZZA VELASCA 5
MILAN, ITALY 20122

FOR: DIETARY SUPPLEMENTS, IN CLASS 5 (U.S.
CLS. 6, 18, 44, 46, 51 AND 52).

FIRST USE 5-4-2001; IN COMMERCE 5-4-2001.

NO CLAIM IS MADE TO THE EXCLUSIVE
RIGHT TO USE "MAX" , APART FROM THE MARK
AS SHOWN.

THE MARK CONSISTS OF CONSIST OF STY-
LIZED TEXT "FERMENTAL MAX".

SER. NO. 77-340,974, FILED 11-30-2007.

JOHN DALIER, EXAMINING ATTORNEY

Int. Cl.: 1

Prior U.S. Cls.: 1, 5, 6, 10, 26 and 46

United States Patent and Trademark Office

Reg. No. 3,475,575

Registered July 29, 2008

TRADEMARK
PRINCIPAL REGISTER

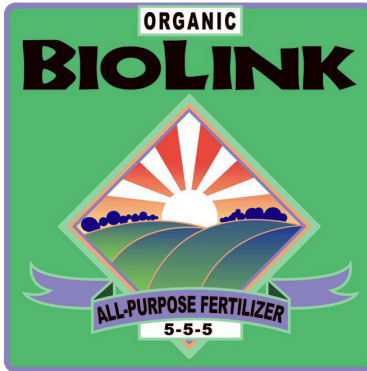

WESTBRIDGE AGRICULTURAL PRODUCTS
(CALIFORNIA CORPORATION)
1260 AVENIDA CHELSEA
VISTA, CA 92081

FOR: ORGANIC FERTILIZER, SOIL CONDITIONER AND PLANT FOOD FOR VEGETABLES, FRUIT TREES AND VINES, FLOWERING AND ORNAMENTAL TREES AND SHRUBS, FLOWERS, CONTAINERIZED PLANTS, LAWNS AND TURF, IN CLASS 1 (U.S. CLS. 1, 5, 6, 10, 26 AND 46).

FIRST USE 8-14-2002; IN COMMERCE 8-14-2002.

OWNER OF U.S. REG. NO. 1,936,121.

NO CLAIM IS MADE TO THE EXCLUSIVE RIGHT TO USE "ORGANIC" OR "ALL PURPOSE FERTILIZER 5-5-5", APART FROM THE MARK AS SHOWN.

THE COLOR(S) WHITE, BLACK, GREEN, LIGHT GREEN, PURPLE, RED, ORANGE, AND BLUE IS/ARE CLAIMED AS A FEATURE OF THE MARK.

THE MARK CONSISTS OF THE WORDS AND NUMBERS "ORGANIC BIOLINK", "ALL-PURPOSE FERTILIZER 5-5-5" AND OTHER DESIGNS SURROUNDED BY A SQUARE BORDER. THE SQUARE BORDER IN THE MARK IS IN THE COLOR PURPLE. THE BACKGROUND WITHIN THE SQUARE DESIGN IS IN THE COLOR GREEN. THE COLOR

BLACK APPEARS IN THE WORDS AND NUMBERS "ORGANIC BIOLINK", "ALL-PURPOSE FERTILIZER 5-5-5". THE WORD "ORGANIC" APPEARS WITHIN A WHITE RECTANGLE AT THE TOP OF THE SQUARE BORDER OUTLINED IN THE COLOR LIGHT GREEN. THE WORD "BIOLINK" APPEARS IN ZORBA FONT UNDER THE WHITE RECTANGLE. THE DIAMOND DESIGN WITHIN THE SQUARE BORDER, UNDER THE WORD "BIOLINK", CONSISTS OF AN OUTERMOST OUTLINE IN THE COLOR LIGHT GREEN, WITHIN WHICH IS AN OUTLINE IN ORANGE FOLLOWED BY AN OUTLINE IN BLUE. THE INSIDE OF THE DIAMOND DESIGN CONSISTS OF A WHITE SUN WITH WHITE RAYS ON A BACKGROUND SHADED IN THE COLOR RED AT THE TOP AND ORANGE AT THE BOTTOM; BLUE TREES; AND A FIELD SHADED IN THE COLOR BLUE AT THE TOP AND GREEN AT THE BOTTOM, OUTLINED IN THE COLOR ORANGE. A BANNER APPEARS ACROSS THE BOTTOM OF THE DIAMOND DESIGN OUTLINED IN THE COLOR LIGHT GREEN WITH A PURPLE BACKGROUND. THE WORDS "ALL-PURPOSE FERTILIZER" APPEAR IN ARIAL BLACK FONT WITHIN THE BANNER. THE NUMBERS "5-5-5" APPEAR IN ARIAL BLACK FONT WITHIN A WHITE RECTANGLE OUTLINED IN THE COLOR LIGHT GREEN LOCATED UNDER THE BANNER.

SER. NO. 77-341,011, FILED 11-30-2007.

THEODORE MCBRIDE, EXAMINING ATTORNEY

Int. Cl.: 38

Prior U.S. Cls.: 100, 101 and 104

United States Patent and Trademark Office

Reg. No. 3,475,576

Registered July 29, 2008

**SERVICE MARK
PRINCIPAL REGISTER**

MR. PREPAID

MR. PREPAID, INC. (FLORIDA CORPORATION)
5TH FLOOR
300 71ST STREET
MIAMI BEACH, FL 33141

FOR: TELECOMMUNICATION SERVICES,
NAMELY, CELLULAR TELEPHONE AND WIRE-
LESS COMMUNICATIONS SERVICES PROVIDED
VIA PREPAID AND POSTPAID CELLULAR TELE-
PHONES AND PREPAID AND POSTPAID AIRTIME
TELEPHONE CALLING CARD SERVICES, ACCES-
SING BILL PAYMENT, AVAILABLE WIRELESS
PHONE TIME, AND OBTAINING PIN RELOADS;
ELECTRONIC AND DIGITAL TRANSMISSION OF
VOICE, DATA, INFORMATION, IMAGES, SIGNALS

AND MESSAGES, IN CLASS 38 (U.S. CLS. 100, 101
AND 104).

FIRST USE 12-31-1998; IN COMMERCE 12-31-1998.

THE MARK CONSISTS OF STANDARD CHAR-
ACTERS WITHOUT CLAIM TO ANY PARTICULAR
FONT, STYLE, SIZE, OR COLOR.

NO CLAIM IS MADE TO THE EXCLUSIVE
RIGHT TO USE "PREPAID" , APART FROM THE
MARK AS SHOWN.

SER. NO. 77-341,032, FILED 11-30-2007.

TRICIA SONNEBORN, EXAMINING ATTORNEY

Int. Cl.: 42

Prior U.S. Cls.: 100 and 101

United States Patent and Trademark Office

Reg. No. 3,475,577

Registered July 29, 2008

**SERVICE MARK
PRINCIPAL REGISTER**

TradeStone

TRADESTONE SOFTWARE, INC. (DELAWARE CORPORATION)
17 ROGERS STREET
GLOUCESTER, MA 01930

FOR: COMPUTER SOFTWARE DESIGN, COMPUTER PROGRAMMING, OR MAINTENANCE OF COMPUTER SOFTWARE; COMPUTER SOFTWARE DEVELOPMENT; TECHNICAL SUPPORT SERVICES, NAMELY, TROUBLESHOOTING OF COMPUTER SOFTWARE PROBLEMS; MAINTENANCE OF COMPUTER SOFTWARE; DESIGN, DEVELOP-

MENT AND IMPLEMENTATION OF SOFTWARE, IN CLASS 42 (U.S. CLS. 100 AND 101).

FIRST USE 3-21-2001; IN COMMERCE 3-21-2003.

THE MARK CONSISTS OF STANDARD CHARACTERS WITHOUT CLAIM TO ANY PARTICULAR FONT, STYLE, SIZE, OR COLOR.

SER. NO. 77-341,063, FILED 11-30-2007.

KYLE PEETE, EXAMINING ATTORNEY

Int. Cls.: 9 and 35

Prior U.S. Cls.: 21, 23, 26, 36, 38, 100, 101 and 102

United States Patent and Trademark Office

Reg. No. 3,475,578

Registered July 29, 2008

**TRADEMARK
SERVICE MARK
PRINCIPAL REGISTER**

FASTPATH

NATHAN ASSOCIATES INC. (DELAWARE CORPORATION)

SUITE 1200

2101 WILSON BOULEVARD

ARLINGTON, VA 22201 AND

SOPHIA YU CONSULTING, INC. (VIRGINIA CORPORATION)

SUITE 304

7661 PROVINCIAL DRIVE

MCLEAN, VA 22102

FOR: COMPUTER SOFTWARE FOR MANAGING, ANALYZING, AND AUDITING LOGISTICS, REVERSE LOGISTICS, TRANSPORT, SUPPLY CHAIN SERVICES, SUPPLY CHAIN VISIBILITY AND SYNCHRONIZATION, SUPPLY AND DEMAND FORECASTING AND PRODUCT DISTRIBUTION PROCESSES FOR OTHERS, OPERATING AND USER INSTRUCTIONS STORED IN DIGITAL FORM FOR COMPUTERS AND COMPUTER SOFTWARE, IN PARTICULAR ON FLOPPY DISKS OR CD-ROM, IN CLASS 9 (U.S. CLS. 21, 23, 26, 36 AND 38).

FIRST USE 9-22-2005; IN COMMERCE 9-27-2005.

FOR: BUSINESS MANAGEMENT AND CONSULTING SERVICES, NAMELY, MANAGING, ANALYZING, AND AUDITING LOGISTICS, REVERSE LOGISTICS, TRANSPORT, SUPPLY CHAIN SERVICES, SUPPLY CHAIN VISIBILITY AND SYNCHRONIZATION, SUPPLY AND DEMAND FORECASTING AND PRODUCT DISTRIBUTION PROCESSES FOR OTHERS, IN CLASS 35 (U.S. CLS. 100, 101 AND 102).

FIRST USE 9-22-2005; IN COMMERCE 9-27-2005.

THE MARK CONSISTS OF STANDARD CHARACTERS WITHOUT CLAIM TO ANY PARTICULAR FONT, STYLE, SIZE, OR COLOR.

SER. NO. 77-341,189, FILED 11-30-2007.

JIM RINGLE, EXAMINING ATTORNEY

Int. Cl.: 16

Prior U.S. Cls.: 2, 5, 22, 23, 29, 37, 38 and 50

United States Patent and Trademark Office

Reg. No. 3,475,579

Registered July 29, 2008

**TRADEMARK
PRINCIPAL REGISTER**

CRAYO-CRAZE

LIQUI-MARK CORP. (NEW YORK CORPORATION)
30 DAVIDS DRIVE
HAUPPAUGE, NY 11788

FOR: CRAYONS, NAMELY, A DRAWING AND COLORING IMPLEMENT COMPRISING MULTIPLE CRAYONS CONNECTED IN A WHEEL-LIKE MANNER AT A CENTRAL HUB, IN CLASS 16 (U.S. CLS. 2, 5, 22, 23, 29, 37, 38 AND 50).

FIRST USE 6-15-2007; IN COMMERCE 6-15-2007.

THE MARK CONSISTS OF STANDARD CHARACTERS WITHOUT CLAIM TO ANY PARTICULAR FONT, STYLE, SIZE, OR COLOR.

SER. NO. 77-341,273, FILED 11-30-2007.

STEVEN PEREZ, EXAMINING ATTORNEY

Int. Cl.: 10

Prior U.S. Cls.: 26, 39 and 44

Reg. No. 3,475,580

United States Patent and Trademark Office

Registered July 29, 2008

**TRADEMARK
PRINCIPAL REGISTER**

ANCHI CRYSTALS

PRECIOUS OFFERING MINERAL EXCHANGE,
INC. (COLORADO CORPORATION)
200 ALDER LANE
BOULDER, CO 80304

FOR: CRYSTALS USED FOR THERAPEUTIC
BALANCE AND WELLNESS, IN CLASS 10 (U.S.
CLS. 26, 39 AND 44).

FIRST USE 6-25-2007; IN COMMERCE 6-25-2007.

THE MARK CONSISTS OF STANDARD CHAR-
ACTERS WITHOUT CLAIM TO ANY PARTICULAR
FONT, STYLE, SIZE, OR COLOR.

NO CLAIM IS MADE TO THE EXCLUSIVE
RIGHT TO USE "CRYSTALS", APART FROM THE
MARK AS SHOWN.

SER. NO. 77-341,454, FILED 11-30-2007.

ALICE BENMAMAN, EXAMINING ATTORNEY

Int. Cl.: 40

Prior U.S. Cls.: 100, 103 and 106

United States Patent and Trademark Office

Reg. No. 3,475,581

Registered July 29, 2008

**SERVICE MARK
PRINCIPAL REGISTER**



MCC RECYCLING SERVICES, LLC (NEW JERSEY LTD LIAB CO)
PO BOX 391
CRANBURY, NJ 08512

FOR: RECYCLING, IN CLASS 40 (U.S. CLS. 100, 103 AND 106).

FIRST USE 11-1-2007; IN COMMERCE 11-1-2007.

NO CLAIM IS MADE TO THE EXCLUSIVE RIGHT TO USE "RECYCLING" AND "SINGLE SOURCE RECYCLING SOLUTIONS", APART FROM THE MARK AS SHOWN.

THE COLOR(S) WHITE, BLUE, CYAN & GREEN IS/ARE CLAIMED AS A FEATURE OF THE MARK.

THE MARK CONSISTS OF A GREEN GLOBE WITH "MCC" WRITTEN IN BLUE WITH WHITE CONTINENTS, "RE" WRITTEN IN CYAN, "CYCLING" WRITTEN IN GREEN, SINGLE SOURCE RECYCLING SOLUTIONS WRITTEN IN BLUE.

SER. NO. 77-341,465, FILED 11-30-2007.

MARTHA SANTOMARTINO, EXAMINING ATTORNEY

Int. Cl.: 26

Prior U.S. Cls.: 37, 39, 40, 42 and 50

United States Patent and Trademark Office

Reg. No. 3,475,582

Registered July 29, 2008

**TRADEMARK
PRINCIPAL REGISTER**

HAIR CLIPPERS WITH GRIPPERS

RIBBIES, INC. (OKLAHOMA CORPORATION)
1612 REDTAIL HAWK
EDMOND, OK 73003

FOR: HAIR CLIPPERS; HAIR CLIPPERS AND HOLDERS
THEREFORE SOLD AS A UNIT, IN CLASS 26 (U.S.
CLS. 37, 39, 40, 42 AND 50).

FIRST USE 10-21-2007; IN COMMERCE 10-21-2007.

THE MARK CONSISTS OF STANDARD CHAR-
ACTERS WITHOUT CLAIM TO ANY PARTICULAR
FONT, STYLE, SIZE, OR COLOR.

NO CLAIM IS MADE TO THE EXCLUSIVE
RIGHT TO USE "HAIR", APART FROM THE MARK
AS SHOWN.

SER. NO. 77-341,593, FILED 11-30-2007.

WON TEAK OH, EXAMINING ATTORNEY

Int. Cl.: 26

Prior U.S. Cls.: 37, 39, 40, 42 and 50

United States Patent and Trademark Office

Reg. No. 3,475,583

Registered July 29, 2008

**TRADEMARK
PRINCIPAL REGISTER**

RIBBIES HAIR CLIPPES

RIBBIES, INC. (OKLAHOMA CORPORATION)
1612 REDTAIL HAWK
EDMOND, OK 73003

FOR: HAIR CLIPS; HAIR CLIPS AND HOLDERS
THEREFORE SOLD AS A UNIT, IN CLASS 26 (U.S.
CLS. 37, 39, 40, 42 AND 50).

FIRST USE 11-1-2006; IN COMMERCE 11-1-2006.

THE MARK CONSISTS OF STANDARD CHAR-
ACTERS WITHOUT CLAIM TO ANY PARTICULAR
FONT, STYLE, SIZE, OR COLOR.

NO CLAIM IS MADE TO THE EXCLUSIVE
RIGHT TO USE "HAIR", APART FROM THE MARK
AS SHOWN.

SER. NO. 77-341,607, FILED 11-30-2007.

WON TEAK OH, EXAMINING ATTORNEY

Int. Cl.: 45

Prior U.S. Cls.: 100 and 101

United States Patent and Trademark Office

Reg. No. 3,475,584

Registered July 29, 2008

SERVICE MARK
PRINCIPAL REGISTER



GREGORY POINSON (FLORIDA SOLE PROPRIETORSHIP), DBA PETZIBIT.COM
5517 NW 59TH PL
TAMARAC, FL 33319

FOR: PROVIDING A WEBSITE FEATURING LISTINGS AND PHOTOGRAPHS OF PETS AVAILABLE FOR ADOPTION AND RELATED INFORMATION CONCERNING PET ADOPTION, IN CLASS 45 (U.S. CLS. 100 AND 101).

FIRST USE 10-30-2007; IN COMMERCE 10-30-2007.

THE COLOR(S) BLUE, GREEN AND WHITE IS/ARE CLAIMED AS A FEATURE OF THE MARK.

THE MARK CONSISTS OF FOUR IDENTICAL GREEN SQUARES ARRANGED IN A SQUARE POSITION TWO ON TOP OF THE OTHER TWO. THE TOP LEFT QUADRANT HAS A WHITE HEART

WITH A SOLID BLUE BORDER AFFIXED IN THE MIDDLE. THE TOP RIGHT QUADRANT HAS AN UPSIDE DOWN WHITE TRIANGLE WITH A SOLID BLUE BORDER WITH THREE SOLID BLUE SLANTED BARS ON EITHER SIDE WHICH RESEMBLES A CAT'S WHISKERS. THE LOWER LEFT QUADRANT HAS A SOLID GREEN CIRCLE OUTLINED IN BLUE WITH A TONGUE ATTACHED MADE TO LOOK LIKE THE OUTLINE OF A CARTOON DOG'S FACE. THE LOWER RIGHT QUADRANT HAS A WHITE HEART WITH A SOLID BLUE BORDER AFFIXED IN THE MIDDLE. TO THE RIGHT OF THE LOWER RIGHT QUADRANT SQUARE IS THE WORDS "PETZIBIT" IN BLUE FOLLOWED BY ".COM" IN GREEN.

SER. NO. 77-341,625, FILED 11-30-2007.

ALYSSA PALADINO, EXAMINING ATTORNEY

Int. Cl.: 45

Prior U.S. Cls.: 100 and 101

United States Patent and Trademark Office

Reg. No. 3,475,585

Registered July 29, 2008

**SERVICE MARK
PRINCIPAL REGISTER**

Real People. Real Names.

CLASSMATES ONLINE, INC. (WASHINGTON CORPORATION)
2001 LIND AVENUE SW, STE. 500
RENTON, WA 98057

FOR: INTERNET BASED DATING, INTRODUCTION AND SOCIAL NETWORKING SERVICES, IN CLASS 45 (U.S. CLS. 100 AND 101).

FIRST USE 8-1-2007; IN COMMERCE 8-1-2007.

THE MARK CONSISTS OF STANDARD CHARACTERS WITHOUT CLAIM TO ANY PARTICULAR FONT, STYLE, SIZE, OR COLOR.

OWNER OF U.S. REG. NO. 3,256,093.

SER. NO. 77-341,718, FILED 11-30-2007.

MARY ROSSMAN, EXAMINING ATTORNEY

Int. Cls.: 10 and 28

Prior U.S. Cls.: 22, 23, 26, 38, 39, 44 and 50

United States Patent and Trademark Office

Reg. No. 3,475,586

Registered July 29, 2008

**TRADEMARK
PRINCIPAL REGISTER**

The logo consists of a stylized lowercase letter 'i' inside a square frame, followed by the word 'SHAPE' in a bold, sans-serif font.

TONIC FITNESS TECHNOLOGY, INC. (TAIWAN CORPORATION)
1F, NO. 462-7, CHUNG-SHAN RD.
HSI-KANG VILLAGE, HSI-KANG HSIANG
TAINAN HSIEN, TAIWAN

FOR: APPARATUS FOR ACUPRESSURE THERAPY; APPARATUS FOR CELLULITE TREATMENT, REDUCTION AND ELIMINATION; APPARATUS FOR DISPENSING NON-MEDICAL OXYGEN AND AROMATHERAPY THAT ALSO UTILIZES LIGHT, SOUND, AND VIBRATION FOR RELAXATION THERAPY; APPARATUS FOR PHYSICAL TRAINING FOR MEDICAL USE; APPARATUS FOR TAKING BLOOD; APPARATUS FOR TAKING BLOOD SAMPLES; ELECTRIC FOOT SPA MASSAGERS; ELECTRIC MASSAGE APPARATUS FOR HOUSEHOLD USE; ELECTRIC MASSAGE APPLIANCES, NAMELY, ELECTRIC VIBRATING MASSAGER; EXERCISE MACHINES FOR THERAPEUTIC PURPOSES; FORCE AND MOTION TESTING APPARATUS FOR PHYSICAL REHABILITATION; HIGH FREQUENCY ELECTROMAGNETIC THERAPY APPARATUS; LOW FREQUENCY ELECTRIC THERAPY APPARATUS; ELECTRIC OR NON-ELECTRIC MASSAGE APPARATUS; MASSAGE APPARATUS FOR MEDICAL PURPOSES; MASSAGERS IN THE NATURE OF ELECTROMECHANICAL MASSAGE MECHANISM FOR USE IN MASSAGE APPARATUS; MASSAGING APPARATUS FOR PERSONAL USE, IN CLASS 10 (U.S. CLS. 26, 39 AND 44).

FIRST USE 11-1-2007; IN COMMERCE 11-1-2007.

FOR: AEROBIC STEP MACHINES; AEROBIC STEPS; ATHLETIC EQUIPMENT, NAMELY, TRAINING DEVICES TO BE WORN ON THE BODY FOR SUPPORT; ATHLETIC SPORTING GOODS, NAMELY, ATHLETIC WRIST AND JOINT SUPPORTS; ATHLETIC SUPPORTERS; EXERCISE BENCHES; EXERCISE DOORWAY GYM BARS; EXERCISE EQUIPMENT, NAMELY, CHEST EXPANDERS; EXERCISE MACHINES; EXERCISE PLATFORMS; GYMNASTIC APPARATUS; VIBRATING APPARATUS USED IN FITNESS AND EXERCISE PROGRAMS TO STIMULATE MUSCLES AND INCREASE STRENGTH AND PHYSICAL PERFORMANCE, IN CLASS 28 (U.S. CLS. 22, 23, 38 AND 50).

FIRST USE 11-1-2007; IN COMMERCE 11-1-2007.

THE MARK CONSISTS OF THE STYLIZED LETTER "I" POSITIONED WITHIN A RECTANGULAR CONTOUR ADJACENT THE STYLIZED WORD "SHAPE".

SER. NO. 77-341,850, FILED 12-1-2007.

THOMAS MANOR, EXAMINING ATTORNEY

Int. Cl.: 3

Prior U.S. Cls.: 1, 4, 6, 50, 51 and 52

United States Patent and Trademark Office

Reg. No. 3,475,587

Registered July 29, 2008

**TRADEMARK
PRINCIPAL REGISTER**

RAADO

FRANCE COSMETICS (NEW JERSEY CORPORATION)

2

318 SAINT PAULS AVENUE
JERSEY CITY, NJ 07306

FOR: BODY AND BEAUTY CARE COSMETICS; COCOA BUTTER FOR COSMETIC PURPOSES; COSMETIC CREAMS FOR SKIN CARE; COSMETIC SOAPS; FACE CREAMS FOR COSMETIC USE; LOTIONS FOR COSMETIC PURPOSES; SKIN AND BODY TOPICAL LOTIONS, CREAMS AND OILS FOR COSMETIC USE; OILS FOR COSMETIC PURPOSES; HAIR CARE CREAMS; HAIR CARE LOTIONS; HAIR CONDITIONER; HAIR CREAMS;

HAIR LOTION; HAIR SHAMPOOS AND CONDITIONERS; OILS FOR HAIR CONDITIONING, IN CLASS 3 (U.S. CLS. 1, 4, 6, 50, 51 AND 52).

FIRST USE 10-7-2007; IN COMMERCE 10-15-2007.

THE MARK CONSISTS OF STANDARD CHARACTERS WITHOUT CLAIM TO ANY PARTICULAR FONT, STYLE, SIZE, OR COLOR.

SER. NO. 77-341,882, FILED 12-1-2007.

ANNE MADDEN, EXAMINING ATTORNEY

Int. Cl.: 45

Prior U.S. Cls.: 100 and 101

United States Patent and Trademark Office

Reg. No. 3,475,588

Registered July 29, 2008

SERVICE MARK
PRINCIPAL REGISTER

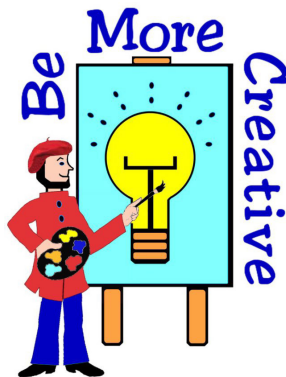

BAER, FRANKLIN C. (VIRGINIA SOLE PROPRIETORSHIP)
326 7TH ST.
HARRISONBURG, VA 22802

FOR: PROVIDING INFORMATION ON TECHNIQUES FOR IMPROVING PERSONAL CREATIVITY, IN CLASS 45 (U.S. CLS. 100 AND 101).

FIRST USE 0-0-1990; IN COMMERCE 0-0-1992.

THE COLOR(S) BEIGE, RED, DARK BLUE, SKY BLUE, BRIGHT YELLOW, LIGHT BROWN AND BLACK IS/ARE CLAIMED AS A FEATURE OF THE MARK.

THE MARK CONSISTS OF A BLACK BEARDED ARTIST WEARING BLACK SHOES, BLUE PANTS,

RED SMOCK AND RED BERET, WITH A BEIGE FACE AND HANDS, HOLDING A BLACK PAINTING PALETTE WITH BLUE, YELLOW, RED, LIGHT BROWN, AND SKY BLUE PAINT, IN HIS RIGHT HAND AND A BLACK PAINT BRUSH IN HIS LEFT HAND WHILE PAINTING A PICTURE OF A LARGE YELLOW AND BLACK LIGHT BULB WITH A LIGHT BROWN SCREW BASE RADIATING BLACK CREATIVE ENERGY AGAINST A SKY BLUE BACKGROUND CANVAS SITTING ON A LIGHT BROWN EASEL, ALL EDGED IN BLACK AND BORDERED ON THREE SIDES BY THE WORDS "BE MORE CREATIVE" IN DARK BLUE.

SER. NO. 77-341,941, FILED 12-1-2007.

TRACY CROSS, EXAMINING ATTORNEY

Int. Cl.: 45

Prior U.S. Cls.: 100 and 101

United States Patent and Trademark Office

Reg. No. 3,475,589

Registered July 29, 2008

SERVICE MARK
PRINCIPAL REGISTER

Creative Quotations



BAER, FRANKLIN C. (VIRGINIA SOLE PROPRIETORSHIP)
326 7TH ST.
HARRISONBURG, VA 22802

FOR: PROVIDING INFORMATION ON TECHNIQUES FOR IMPROVING PERSONAL CREATIVITY, IN CLASS 45 (U.S. CLS. 100 AND 101).

FIRST USE 0-0-1994; IN COMMERCE 0-0-1996.

NO CLAIM IS MADE TO THE EXCLUSIVE RIGHT TO USE "CREATIVE QUOTATIONS", APART FROM THE MARK AS SHOWN.

THE COLOR(S) GREEN, LIGHT YELLOW, BRIGHT YELLOW, RED, LIGHT BLUE, LIGHT PURPLE, LIGHT BROWN, DARK BROWN, AND BLACK IS/ARE CLAIMED AS A FEATURE OF THE MARK.

THE MARK CONSISTS OF A GRAPHIC COMPI- LATION REPRESENTING FIVE COMPONENTS/

QUOTATIONS OF THE CREATIVE PROCESS, I.E., "FORAGING" IN BLACK BELOW THREE BOOKS ON A SHELF LIGHT BROWN SHELF. THE BOOKS HAVE THE WORDS "BIBLE" IN BLACK ON A LIGHT PURPLE BOOK, "SCIENCE" IN BLACK ON A BRIGHT YELLOW BOOK, AND "ART" IN BLACK ON A BLUE AND RED BOOK. THE WORD "REFLECTING" IN BLACK BELOW A GREEN TREE WITH RED APPLES AND A DARK BROWN TRUNK. THE WORD "ADOPTING" IN BLACK BELOW A BRIGHT YELLOW, BLACK AND LIGHT BLUE LIGHT BULB ON A RED AND BLACK STAR BACKGROUND. THE WORD "NURTURING" IN BLACK BELOW IMPROVING BAR GRAPH AND ARROW IN GREEN, BRIGHT YELLOW, BLUE AND RED. THE WORDS "KNUCKLING DOWN" IN BLACK BELOW THE HEAD OF A LIGHT YELLOW AND BLACK BULLDOG. THE WORDS "CREATIVE QUOTATIONS" APPEAR IN RED.

SER. NO. 77-341,947, FILED 12-2-2007.

TRACY CROSS, EXAMINING ATTORNEY

Int. Cl.: 35

Prior U.S. Cls.: 100, 101 and 102

United States Patent and Trademark Office

Reg. No. 3,475,590

Registered July 29, 2008

**SERVICE MARK
PRINCIPAL REGISTER**



NEW ENGLAND BUSINESS BROKERS ASSOCIATION, INC. (MASSACHUSETTS CORPORATION)

P.O. BOX 3236

WORCESTER, MA 016133236

FOR: BUSINESS INFORMATION SERVICES IN THE NATURE OF EXCHANGE OF INFORMATION FOR THOSE ENGAGED IN THE BUSINESS TRANSFER INDUSTRY , IN CLASS 35 (U.S. CLS. 100, 101 AND 102).

FIRST USE 1-1-1987; IN COMMERCE 1-1-1987.

NO CLAIM IS MADE TO THE EXCLUSIVE RIGHT TO USE "NEW ENGLAND BUSINESS BROKERS ASSOCIATION", APART FROM THE MARK AS SHOWN.

"THE COLOR(S) BLUE AND WHITE IS/ARE CLAIMED AS A FEATURE OF THE MARK."

"THE MARK CONSISTS OF THE CAPITAL LETTERS "NEBBA", WITH THE LETTER "A" COMPRISING ONE TRIANGULAR-SHAPED SECTION OF A SIX-SIDED GEOMETRIC FIGURE. UNDER "NEBBA" ARE THE WORDS "NEW ENGLAND BUSINESS BROKERS ASSOCIATION". THE LETTERS "NEBBA" ARE BLUE, AND THE SIX-SIDED GEOMETRIC FIGURE IS BLUE WITH STRAIGHT DOUBLE WHITE LINES SEPARATING THE TRIANGULAR-SHAPED SECTIONS."

SER. NO. 77-341,999, FILED 12-2-2007.

KEVON CHISOLM, EXAMINING ATTORNEY

Int. Cl.: 37

Prior U.S. Cls.: 100, 103 and 106

United States Patent and Trademark Office

Reg. No. 3,475,591

Registered July 29, 2008

**SERVICE MARK
PRINCIPAL REGISTER**

Build With Stone

HARTLEY, LATONA D (NORTH CAROLINA CORPORATION), DBA NATURAL STONE COMPANY INC
7474 CONCORD CHURCH RD
LEWISVILLE, NC 27023

THE NAME(S), PORTRAIT(S), AND/OR SIGNATURE(S) SHOWN IN THE MARK DOES NOT IDENTIFY A PARTICULAR LIVING INDIVIDUAL.

FOR: MASONRY SERVICES, IN CLASS 37 (U.S. CLS. 100, 103 AND 106).

SEC. 2(F).

FIRST USE 7-1-1991; IN COMMERCE 7-1-1991.

SER. NO. 77-342,125, FILED 12-3-2007.

THE MARK CONSISTS OF STANDARD CHARACTERS WITHOUT CLAIM TO ANY PARTICULAR FONT, STYLE, SIZE, OR COLOR.

SHAUNIA CARLYLE, EXAMINING ATTORNEY

Int. Cl.: 14

Prior U.S. Cls.: 2, 27, 28 and 50

United States Patent and Trademark Office

Reg. No. 3,475,592

Registered July 29, 2008

TRADEMARK
PRINCIPAL REGISTER



ABINGDON LLC (NEVADA LTD LIAB CO)
2596 WELLESLEY AVE.
LOS ANGELES, CA 90064

FOR: JEWELRY; WATCHES, IN CLASS 14 (U.S.
CLS. 2, 27, 28 AND 50).

FIRST USE 12-18-2006; IN COMMERCE 7-1-2007.

NO CLAIM IS MADE TO THE EXCLUSIVE
RIGHT TO USE "WATCHES" , APART FROM THE
MARK AS SHOWN.

THE MARK CONSISTS OF THE STYLIZED
WORDS "A ABINGDON WATCHES". THE LETTER
"A" HAS AN AIRPLANE GRAPHIC BEHIND IT.

SER. NO. 77-342,423, FILED 12-3-2007.

MARGARET POWER, EXAMINING ATTORNEY

Int. Cl.: 36

Prior U.S. Cls.: 100, 101 and 102

United States Patent and Trademark Office

Reg. No. 3,475,593

Registered July 29, 2008

**SERVICE MARK
PRINCIPAL REGISTER**

**The "new math" of
retirement**

AMERICAN FUNDS DISTRIBUTORS, INC. (CALIFORNIA CORPORATION)
ATTN: MICHELE Y. YANG
333 SOUTH HOPE ST., 55TH FLOOR
LOS ANGELES, CA 90071

FOR: FINANCIAL SERVICES, NAMELY, FINANCIAL ANALYSIS, EVALUATION AND CONSULTATION; INVESTMENT MANAGEMENT AND ADVICE; MUTUAL FUND INVESTMENT MANAGEMENT AND DISTRIBUTION; ANNUITY SERVICES, NAMELY, INVESTMENT MANAGEMENT AND DISTRIBUTION OF VARIABLE ANNUITIES; FIDUCIARY SERVICES, NAMELY, SERVING AS TRUSTEE FOR DIRECTED AND DISCRETIONARY TRUST ACCOUNTS; ESTATE PLANNING; AND ADMINISTRATION OF EMPLOYEE BENEFIT, PENSION AND RETIREMENT PLANS IN CONNECTION

THEREWITH, IN CLASS 36 (U.S. CLS. 100, 101 AND 102).

FIRST USE 2-2-2007; IN COMMERCE 2-2-2007.

THE MARK CONSISTS OF STANDARD CHARACTERS WITHOUT CLAIM TO ANY PARTICULAR FONT, STYLE, SIZE, OR COLOR.

NO CLAIM IS MADE TO THE EXCLUSIVE RIGHT TO USE "RETIREMENT", APART FROM THE MARK AS SHOWN.

SER. NO. 77-342,474, FILED 12-3-2007.

MICHAEL WEBSTER, EXAMINING ATTORNEY

Int. Cl.: 45

Prior U.S. Cls.: 100 and 101

United States Patent and Trademark Office

Reg. No. 3,475,594

Registered July 29, 2008

SERVICE MARK
PRINCIPAL REGISTER



CONCIERGE BY THE SEA, INC. (DELAWARE CORPORATION)

36269 TARPON DRIVE
LEWES, DE 19958

FOR: PERSONAL CONCIERGE SERVICES FOR OTHERS, COMPRISING MAKING REQUESTED PERSONAL ARRANGEMENT AND RESERVATIONS, RUNNING ERRANDS AND PROVIDING CUSTOMER SPECIFIC INFORMATION TO MEET INDIVIDUAL NEEDS, ALL RENDERED IN RESIDENTIAL COMPLEXES AND HOMES, IN CLASS 45 (U.S. CLS. 100 AND 101).

FIRST USE 2-1-2007; IN COMMERCE 3-1-2007.

NO CLAIM IS MADE TO THE EXCLUSIVE RIGHT TO USE "CONCIERGE", APART FROM THE MARK AS SHOWN.

THE STIPPLING IS FOR SHADING PURPOSES ONLY.

THE MARK CONSISTS OF AN ADIRONDACK CHAIR UNDER UMBRELLA WITH "CONCIERGE BY THE SEA" OVER IT. "CONCIERGE" IS IN STYLIZED FONT AND "BY THE SEA" IS ALL CAPITAL LETTERS.

SER. NO. 77-342,837, FILED 12-3-2007.

ELLEN PERKINS, EXAMINING ATTORNEY

Int. Cl.: 30

Prior U.S. Cl.: 46

United States Patent and Trademark Office

Reg. No. 3,475,595

Registered July 29, 2008

**TRADEMARK
PRINCIPAL REGISTER**

Chia Goodness

RUTH'S HEMP FOODS, INC. (CANADA CORPORATION)

BOX 73, STN. P

TORONTO, CANADA

FOR: BREAKFAST CEREALS, IN CLASS 30 (U.S. CL. 46).

FIRST USE 6-1-2007; IN COMMERCE 9-23-2007.

THE MARK CONSISTS OF STANDARD CHARACTERS WITHOUT CLAIM TO ANY PARTICULAR FONT, STYLE, SIZE, OR COLOR.

NO CLAIM IS MADE TO THE EXCLUSIVE RIGHT TO USE "CHIA", APART FROM THE MARK AS SHOWN.

SER. NO. 77-342,956, FILED 12-3-2007.

ELLEN PERKINS, EXAMINING ATTORNEY

Int. Cl.: 25

Prior U.S. Cls.: 22 and 39

United States Patent and Trademark Office

Reg. No. 3,475,596

Registered July 29, 2008

**TRADEMARK
PRINCIPAL REGISTER**

My PASSIONE

ENVISION, INC. (CALIFORNIA CORPORATION)
1543 NEWTON STREET
LOS ANGELES, CA 90021

FOR: CHILDREN'S CLOTHING, NAMELY,
DRESSES, PANTS, TOPS, SKIRTS, JACKETS, COATS
AND FASHION ACCESSORIES, NAMELY, BELTS,
SCARVES AND SHAWLS, IN CLASS 25 (U.S. CLS. 22
AND 39).

FIRST USE 2-1-2007; IN COMMERCE 2-1-2007.

THE MARK CONSISTS OF STANDARD CHAR-
ACTERS WITHOUT CLAIM TO ANY PARTICULAR
FONT, STYLE, SIZE, OR COLOR.

THE FOREIGN WORDING IN THE MARK
TRANSLATES INTO ENGLISH AS PASSION.

SER. NO. 77-343,104, FILED 12-4-2007.

SAIMA MAKHDOOM, EXAMINING ATTORNEY

Int. Cl.: 35

Prior U.S. Cls.: 100, 101 and 102

United States Patent and Trademark Office

Reg. No. 3,475,597

Registered July 29, 2008

**SERVICE MARK
PRINCIPAL REGISTER**

LOGISTICSEQUITY

LOGISTICSEQUITY, LLC (ILLINOIS LTD LIAB
CO)
SUITE 124-107
3108 STATE ROUTE 59
NAPERVILLE, IL 605648021

FOR: BUSINESS CONSULTING SERVICES FOR
LOGISTICS AND SHIPPING COMPANIES IN THE
NATURE OF INCREASING COMPANY VALUE,
APPRAISING COMPANY VALUE, SUCCESSION
PLANNING AND DUE DILIGENCE FOR MER-
GERS AND ACQUISITIONS, IN CLASS 35 (U.S.
CLS. 100, 101 AND 102).

FIRST USE 11-26-2007; IN COMMERCE 11-26-2007.

THE MARK CONSISTS OF STANDARD CHAR-
ACTERS WITHOUT CLAIM TO ANY PARTICULAR
FONT, STYLE, SIZE, OR COLOR.

SER. NO. 77-343,158, FILED 12-4-2007.

HEATHER SAPP, EXAMINING ATTORNEY

Int. Cl.: 45

Prior U.S. Cls.: 100 and 101

United States Patent and Trademark Office

Reg. No. 3,475,598

Registered July 29, 2008

**SERVICE MARK
PRINCIPAL REGISTER**

MEN HAVE RIGHTS TOO!

CRAIG A. CANDELORE (UNITED STATES IN-
DIVIDUAL), DBA MEN'S LEGAL CENTER
940 "C" ST.
SAN DIEGO, CA 92101

THE MARK CONSISTS OF STANDARD CHAR-
ACTERS WITHOUT CLAIM TO ANY PARTICULAR
FONT, STYLE, SIZE, OR COLOR.

FOR: LEGAL SERVICES, IN CLASS 45 (U.S. CLS.
100 AND 101).

SER. NO. 77-343,469, FILED 12-4-2007.

FIRST USE 1-1-1999; IN COMMERCE 1-1-1999.

MICHAEL KAZAZIAN, EXAMINING ATTORNEY

Int. Cl.: 35

Prior U.S. Cls.: 100, 101 and 102

United States Patent and Trademark Office

Reg. No. 3,475,599

Registered July 29, 2008

**SERVICE MARK
PRINCIPAL REGISTER**



MAXIM HEALTHCARE SERVICES, INC. (MARY-
LAND CORPORATION)
7227 LEE DEFOREST DRIVE
COLUMBIA, MD 21046

FOR: ADMINISTRATIVE STAFFING SERVICES
IN THE FIELD OF HEALTHCARE, IN CLASS 35
(U.S. CLS. 100, 101 AND 102).

FIRST USE 12-1-2007; IN COMMERCE 12-1-2007.

OWNER OF U.S. REG. NOS. 2,538,008, 2,749,961
AND OTHERS.

NO CLAIM IS MADE TO THE EXCLUSIVE
RIGHT TO USE "STAFFING SOLUTIONS" AND
"ADMINISTRATIVE STAFFING", APART FROM
THE MARK AS SHOWN.

SER. NO. 77-343,499, FILED 12-4-2007.

JAMES LOVELACE, EXAMINING ATTORNEY

Int. Cl.: 41

Prior U.S. Cls.: 100, 101 and 107

United States Patent and Trademark Office

Reg. No. 3,475,600

Registered July 29, 2008

**SERVICE MARK
PRINCIPAL REGISTER**

Tuned In

PRAGMATIC MARKETING, INC. (ARIZONA CORPORATION)
8910 EAST RAINTREE DRIVE
SCOTTSDALE, AZ 85260

FOR: EDUCATION SERVICES, NAMELY, PROVIDING LIVE AND ON-LINE CLASSES, SEMINARS AND WORKSHOPS IN THE FIELD OF CREATING MARKET-DRIVEN BUSINESSES, IN CLASS 41 (U.S. CLS. 100, 101 AND 107).

FIRST USE 8-0-2007; IN COMMERCE 10-1-2007.

THE MARK CONSISTS OF STANDARD CHARACTERS WITHOUT CLAIM TO ANY PARTICULAR FONT, STYLE, SIZE, OR COLOR.

SER. NO. 77-343,508, FILED 12-4-2007.

MARIA-VICTORIA SUAREZ, EXAMINING ATTORNEY

Int. Cl.: 31

Prior U.S. Cls.: 1 and 46

United States Patent and Trademark Office

Reg. No. 3,475,601

Registered July 29, 2008

TRADEMARK
PRINCIPAL REGISTER

ROSALIND

DAVID AUSTIN ROSES LTD (GREAT BRITAIN
CORPORATION)
BOWLING GREEN LANE, ALBRIGHTON
WOLVERHAMPTON, GREAT BRITAIN WV73HB

FOR: LIVE ROSE PLANTS, IN CLASS 31 (U.S. CLS.
1 AND 46).

FIRST USE 11-0-2005; IN COMMERCE 11-16-2005.

THE MARK CONSISTS OF STANDARD CHAR-
ACTERS WITHOUT CLAIM TO ANY PARTICULAR
FONT, STYLE, SIZE, OR COLOR.

OWNER OF U.S. REG. NO. 2,387,828.

SER. NO. 77-343,510, FILED 12-4-2007.

MARIA-VICTORIA SUAREZ, EXAMINING ATTOR-
NEY

Int. Cls.: 35 and 37

Prior U.S. Cls.: 100, 101, 102, 103 and 106

United States Patent and Trademark Office

Reg. No. 3,475,602

Registered July 29, 2008

**SERVICE MARK
PRINCIPAL REGISTER**

**EAGLE CREEK AVIATION
SERVICES**

EAGLE CREEK AVIATION SERVICES, INC. (INDIANA CORPORATION)
4101 DANDY TRAIL
INDIANAPOLIS, IN 46254

FOR: RETAIL STORE SERVICES FEATURING AIRPLANES; BUSINESS MANAGEMENT SERVICES, NAMELY, AIRCRAFT MANAGEMENT FOR OTHERS IN THE NATURE OF MANAGING AND ARRANGING AIRCRAFT OPERATIONS FOR OTHERS, IN CLASS 35 (U.S. CLS. 100, 101 AND 102).

FIRST USE 6-3-1983; IN COMMERCE 6-3-1983.

FOR: AIRCRAFT MAINTENANCE AND REPAIR; AIRCRAFT REFURBISHMENT; AIRCRAFT FUELING SERVICES, IN CLASS 37 (U.S. CLS. 100, 103 AND 106).

FIRST USE 6-3-1983; IN COMMERCE 6-3-1983.

THE MARK CONSISTS OF STANDARD CHARACTERS WITHOUT CLAIM TO ANY PARTICULAR FONT, STYLE, SIZE, OR COLOR.

NO CLAIM IS MADE TO THE EXCLUSIVE RIGHT TO USE "AVIATION SERVICES" , APART FROM THE MARK AS SHOWN.

SEC. 2(F).

SER. NO. 77-343,548, FILED 12-4-2007.

MATTHEW MCDOWELL, EXAMINING ATTORNEY

Int. Cls.: 35 and 37

Prior U.S. Cls.: 100, 101, 102, 103 and 106

United States Patent and Trademark Office

Reg. No. 3,475,603

Registered July 29, 2008

**SERVICE MARK
PRINCIPAL REGISTER**



EAGLE CREEK AVIATION SERVICES, INC. (INDIANA CORPORATION)
4101 DANDY TRAIL
INDIANAPOLIS, IN 46254

FOR: RETAIL STORE SERVICES FEATURING AIRPLANES; BUSINESS MANAGEMENT SERVICES, NAMELY, AIRCRAFT MANAGEMENT FOR OTHERS IN THE NATURE OF MANAGING AND ARRANGING AIRCRAFT OPERATIONS FOR OTHERS, IN CLASS 35 (U.S. CLS. 100, 101 AND 102).

FIRST USE 1-31-2006; IN COMMERCE 1-31-2006.

FOR: AIRCRAFT MAINTENANCE AND REPAIR; AIRCRAFT REFURBISHMENT; AIRCRAFT FUEL-

ING SERVICES, IN CLASS 37 (U.S. CLS. 100, 103 AND 106).

FIRST USE 1-31-2006; IN COMMERCE 1-31-2006.

THE MARK CONSISTS OF A CIRCLE WITH AN AIRPLANE FLYING OUT THE RIGHT SIDE LEAVING A TRAIL THAT FORMS THE LETTER "E".

SER. NO. 77-343,556, FILED 12-4-2007.

MATTHEW MCDOWELL, EXAMINING ATTORNEY

Int. Cl.: 39

Prior U.S. Cls.: 100 and 105

United States Patent and Trademark Office

Reg. No. 3,475,604

Registered July 29, 2008

**SERVICE MARK
PRINCIPAL REGISTER**

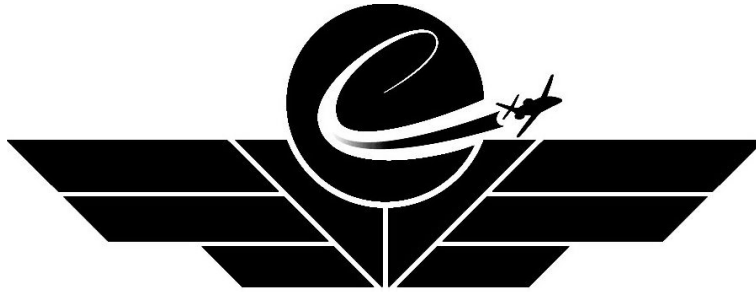

EAGLE CREEK AVIATION SERVICES, INC. (IN-
DIANA CORPORATION)
4101 DANDY TRAIL
INDIANAPOLIS, IN 46254

FOR: AIRCRAFT MANAGEMENT SERVICES,
NAMELY, FLIGHT PLANNING AND SCHEDUL-
ING, AIRPLANE PILOTING SERVICES, AND AIR-
PLANE CHARTERING SERVICES, IN CLASS 39
(U.S. CLS. 100 AND 105).

FIRST USE 3-30-2006; IN COMMERCE 3-30-2006.

THE MARK CONSISTS OF FLIGHT WINGS WITH
A CIRCLE RISING OUT OF THE TOP CENTER AND
AN AIRPLANE FLYING OUT OF THE RIGHT SIDE
OF THE CIRCLE, LEAVING A TRAIL THAT FORMS
THE LETTER "E".

SER. NO. 77-343,564, FILED 12-4-2007.

MATTHEW MCDOWELL, EXAMINING ATTOR-
NEY

Int. Cl.: 39

Prior U.S. Cls.: 100 and 105

United States Patent and Trademark Office

Reg. No. 3,475,605

Registered July 29, 2008

**SERVICE MARK
PRINCIPAL REGISTER**

WORK CHARTER, NOT HARDER.

EAGLE CREEK AVIATION SERVICES, INC. (INDIANA CORPORATION)
4101 DANDY TRAIL
INDIANAPOLIS, IN 46254

FOR: AIRCRAFT MANAGEMENT SERVICES, NAMELY, FLIGHT PLANNING AND SCHEDULING, AIRPLANE PILOTING SERVICES, AND AIRPLANE CHARTERING SERVICES, IN CLASS 39 (U.S. CLS. 100 AND 105).

FIRST USE 7-30-2006; IN COMMERCE 7-30-2006.

THE MARK CONSISTS OF STANDARD CHARACTERS WITHOUT CLAIM TO ANY PARTICULAR FONT, STYLE, SIZE, OR COLOR.

NO CLAIM IS MADE TO THE EXCLUSIVE RIGHT TO USE "CHARTER", APART FROM THE MARK AS SHOWN.

SER. NO. 77-343,576, FILED 12-4-2007.

MATTHEW MCDOWELL, EXAMINING ATTORNEY

Int. Cl.: 11

Prior U.S. Cls.: 13, 21, 23, 31 and 34

United States Patent and Trademark Office

Reg. No. 3,475,606

Registered July 29, 2008

**TRADEMARK
PRINCIPAL REGISTER**

TURNSTYLE

WCM INDUSTRIES, INC. (COLORADO CORPORATION)
2121 WAYNOKA ROAD
COLORADO SPRINGS, CO 80915

THE MARK CONSISTS OF STANDARD CHARACTERS WITHOUT CLAIM TO ANY PARTICULAR FONT, STYLE, SIZE, OR COLOR.

FOR: PLUMBING FITTINGS, NAMELY, DRAINS,
IN CLASS 11 (U.S. CLS. 13, 21, 23, 31 AND 34).

SER. NO. 77-343,706, FILED 12-4-2007.

FIRST USE 10-0-1999; IN COMMERCE 10-0-1999.

KHANH LE, EXAMINING ATTORNEY

Int. Cl.: 44

Prior U.S. Cls.: 100 and 101

United States Patent and Trademark Office

Reg. No. 3,475,607

Registered July 29, 2008

**SERVICE MARK
PRINCIPAL REGISTER**

**BE UNFORGETTABLE
OWN YOUR BEAUTY**

JS ART & TRADE CO., INC. (NEW YORK
CORPORATION)
79 SOUTH BROADWAY
NYACK, NY 10960

FOR: BEAUTY CARE SERVICES FOR WOMEN,
NAMELY, MAKE-UP ARTIST SERVICES, IN CLASS
44 (U.S. CLS. 100 AND 101).

FIRST USE 8-30-2007; IN COMMERCE 8-30-2007.

THE MARK CONSISTS OF STANDARD CHAR-
ACTERS WITHOUT CLAIM TO ANY PARTICULAR
FONT, STYLE, SIZE, OR COLOR.

NO CLAIM IS MADE TO THE EXCLUSIVE
RIGHT TO USE "BEAUTY", APART FROM THE
MARK AS SHOWN.

SER. NO. 77-343,886, FILED 12-4-2007.

TINA KUAN, EXAMINING ATTORNEY

Int. Cl.: 9

Prior U.S. Cls.: 21, 23, 26, 36 and 38

Reg. No. 3,475,608

United States Patent and Trademark Office

Registered July 29, 2008

**TRADEMARK
PRINCIPAL REGISTER**

GEMINI

MPI SYSTEMS, INC. (CONNECTICUT CORPORATION)
28 POWDER HORN HILL ROAD
WILTON, CT 06897

FOR: COMPUTER SOFTWARE FOR USE IN THE JEWELRY INDUSTRY ON DISK OR DOWNLOADABLE FOR JEWELRY RETAIL STORE MANAGEMENT, FOR FINISHED JEWELRY AND JEWELRY COMPONENT WHOLESALE MANAGEMENT, AND/OR FOR MANUFACTURING CONTROLS OF JEWELRY PRODUCTS, FOR USE IN INVENTORY CONTROL OF FINISHED GOODS, COMPONENTS, LOOSE DIAMONDS, PEARLS AND STONES, GIFTWARE, FOR TRACKING ITEMS BY QUANTITY AND WEIGHT AND METAL TYPE, IN MULTIPLE LOCATIONS WITHIN ONE STORE OR LOCATION, FOR PHYSICAL INVENTORY RECONCILIATION, FOR PURCHASING CAPABILITIES, FOR CONSTRUCTING ITEMS FROM EXISTING PIECE OR COMPONENTS, FOR GENERATING PACKING SLIPS, FOR ITEM COSTING AND PRICING, CUSTOMER SPECIFIC PRICING, FOR INVOICING AND CREDIT ISSUANCE, FOR MANUFACTURING ORDER TRACKING AND ROUTING, FOR DIAMOND PARCEL MANAGEMENT, FOR SPECIAL ORDER AND WORK ORDER AND REPAIR ORDER MANAGEMENT, FOR JEWELRY APPRAISALS, FOR GENERATING AND TRACKING MEMORANDA FOR CONSIGNMENTS, FOR ORGANIZING AND MAINTAINING A GIFT REGISTRY, FOR GIFT CARDS AND VOUCHERS, FOR COMPILING AND

UPDATING MAILING LISTS AND PRINTING LABELS, FOR CUSTOMER AND VENDOR CONTACT MANAGEMENT, FOR CREATING JOB BAGS INCLUDING BAR CODING AND IMAGING, FOR WORK IN PROCESS MANAGEMENT OF MATERIALS AND LABOR, FOR CREATING A BILL OF MATERIALS, FOR THE ABILITY TO USE IMAGING THROUGHOUT THE SYSTEM, FOR POINT OF SALE FEATURES INCLUDING GENERATING CHOICES OF SALES RECEIPTS, FOR REGISTERING SALES COMMISSIONS, FOR THE ABILITY TO ACCEPT DIFFERENT TYPES OF TENDERS, FOR INTEGRATED CREDIT CARDS, FOR LAYAWAYS, FOR GENERATING BAR CODE TAGS, FOR ACTIVE REPORTING CAPABILITIES, FOR INTERFACE TO ACCOUNTING CHOICES, FOR USE IN ONE OR CONNECTED MULTIPLE LOCATIONS FOR RETAIL, WHOLESALE, AND MANUFACTURING FACILITIES, IN CLASS 9 (U.S. CLS. 21, 23, 26, 36 AND 38).

FIRST USE 11-13-2007; IN COMMERCE 11-13-2007.

THE MARK CONSISTS OF STANDARD CHARACTERS WITHOUT CLAIM TO ANY PARTICULAR FONT, STYLE, SIZE, OR COLOR.

SER. NO. 77-343,889, FILED 12-4-2007.

ALICE BENMAMAN, EXAMINING ATTORNEY

Int. Cl.: 44

Prior U.S. Cls.: 100 and 101

United States Patent and Trademark Office

Reg. No. 3,475,609

Registered July 29, 2008

SERVICE MARK
PRINCIPAL REGISTER



CHAPMAN, TRISHA L (UNITED STATES INDIVIDUAL)
121 LYONS LANE
MILTON, NY 12547

NO CLAIM IS MADE TO THE EXCLUSIVE RIGHT TO USE "MASSAGE FOR HEALTH", APART FROM THE MARK AS SHOWN.

FOR: MASSAGE AND THERAPEUTIC SHIATSU MASSAGE, IN CLASS 44 (U.S. CLS. 100 AND 101).

SER. NO. 77-343,904, FILED 12-4-2007.

FIRST USE 5-5-1994; IN COMMERCE 5-5-1994.

TINA KUAN, EXAMINING ATTORNEY

Int. Cl.: 35

Prior U.S. Cls.: 100, 101 and 102

United States Patent and Trademark Office

Reg. No. 3,475,610

Registered July 29, 2008

**SERVICE MARK
PRINCIPAL REGISTER**



WEB2WEB MARKETING, INC. (DELAWARE CORPORATION), DBA ACTEVA.COM
60 SPEAR STREET, 9TH FLOOR
SAN FRANCISCO, CA 94105 AND
WEB2WEB MARKETING, INC. (DELAWARE CORPORATION), DBA ACTEVA.COM
60 SPEAR STREET, 9TH FLOOR
SAN FRANCISCO, CA 94105

FOR: PROVIDING ON-LINE REGISTRATION SERVICES FOR BUSINESS EVENTS, SOCIAL EVENTS AND INSTRUCTIONAL CLASSES, IN CLASS 35 (U.S. CLS. 100, 101 AND 102).

FIRST USE 5-29-2007; IN COMMERCE 7-24-2007.

OWNER OF U.S. REG. NO. 2,904,886.

THE MARK CONSISTS OF THE WORDS "ACTEVA RSVP INVITE YOUR WORLD". THE TERMS "ACTEVA RSVP" APPEAR ON THE TOP LINE OF THE MARK, WITH THE TERM "RSVP" ENCAPSULATED IN A RECTANGULAR DESIGN WHICH IS STYLIZED TO SIMULATE A CARD TENT. THE TERMS "INVITE YOUR WORLD". ARE BELOW THE TERM "ACTEVA".

SER. NO. 77-344,083, FILED 12-4-2007.

PAULA MAHONEY, EXAMINING ATTORNEY

Int. Cl.: 43

Prior U.S. Cls.: 100 and 101

United States Patent and Trademark Office

Reg. No. 3,475,611

Registered July 29, 2008

SERVICE MARK
PRINCIPAL REGISTER



S.S.M., INC. (TEXAS CORPORATION)
3602 ADVOCATE COURT
JARRETTSVILLE, MD 21084

FOR: PROVIDING ASSISTANCE TO SENIOR CITIZENS SEEKING TO DETERMINE ASSISTED LIVING FACILITIES APPROPRIATE FOR THEIR NEEDS, IN CLASS 43 (U.S. CLS. 100 AND 101).

FIRST USE 1-1-2007; IN COMMERCE 1-1-2007.

NO CLAIM IS MADE TO THE EXCLUSIVE RIGHT TO USE "SENIORS", APART FROM THE MARK AS SHOWN.

THE COLOR(S) YELLOW, GREEN, PURPLE AND BROWN IS/ARE CLAIMED AS A FEATURE OF THE MARK.

THE MARK CONSISTS OF A RECTANGULAR BORDER. WITHIN THE BORDER ON THE LEFT HAND SIDE IS A DRAWING OF A HOME, IN BROWN, WITH A CHIMNEY AND A SIDEWALK LEADING TO THE FRONT DOOR. TO THE LEFT OF THE DRAWING OF THE HOME IS THE SUN IN THE COLOR YELLOW, EMERGING FROM BEHIND THE HOME, BUT NOT IN FULL VIEW. TO THE RIGHT OF THE HOME ARE THE WORDS "NEW" AND "HORIZONS" IN GREEN AND IN CAPITAL LETTERS. BENEATH THE WORDS "NEW" AND "HORIZONS" ARE THE WORDS "FOR" AND "SENIORS", PURPLE AND IN A SMALLER FONT THAN THE WORDS "NEW" AND "HORIZONS". THE WORD "FOR" IS IN LOWER CASE LETTERS, AND THE WORD "SENIORS" IS IN CAPITAL LETTERS.

SER. NO. 77-344,249, FILED 12-5-2007.

CAROLYN GRAY, EXAMINING ATTORNEY

Int. Cl.: 35

Prior U.S. Cls.: 100, 101 and 102

United States Patent and Trademark Office

Reg. No. 3,475,612

Registered July 29, 2008

**SERVICE MARK
PRINCIPAL REGISTER**

TECHNOLOGY @ YOUR PACE

CABLEXPRESS CORPORATION (NEW YORK CORPORATION), DBA D/B/A CXTEC
P.O. BOX 4799
SYRACUSE, NY 132214799

FOR: BUSINESS EVALUATION OF CUSTOMERS' CURRENT AND FUTURE NEEDS FOR NEW OR REFURBISHED TECHNOLOGY HARDWARE; BUSINESS CONSULTATION IN THE FIELD OF COMPUTER HARDWARE EXPENSE MANAGEMENT; RETAIL DISTRIBUTORSHIPS FEATURING TECHNOLOGY HARDWARE, NAMELY, CABLES, MAINFRAME DATA CENTERS, COMPUTER PRODUCTS, CONNECTORS, WIRING SYSTEMS, STORAGE PRODUCTS, NETWORK, VOICE, AND

COMMUNICATION EQUIPMENT, IN CLASS 35 (U.S. CLS. 100, 101 AND 102).

FIRST USE 10-18-2007; IN COMMERCE 10-18-2007.

THE MARK CONSISTS OF STANDARD CHARACTERS WITHOUT CLAIM TO ANY PARTICULAR FONT, STYLE, SIZE, OR COLOR.

OWNER OF U.S. REG. NO. 2,871,703.

SER. NO. 77-344,276, FILED 12-5-2007.

RONALD AIKENS, EXAMINING ATTORNEY

Int. Cl.: 42

Prior U.S. Cls.: 100 and 101

United States Patent and Trademark Office

Reg. No. 3,475,613

Registered July 29, 2008

**SERVICE MARK
PRINCIPAL REGISTER**



SINCERA
CONSULTING

SINCERA CONSULTING, LLC (NEW HAMPSHIRE LTD LIAB CO)
03735 DOHM DR.
CHARLEVOIX, MI 49720

FOR: COMPUTER SOFTWARE DESIGN, COMPUTER PROGRAMMING, OR MAINTENANCE OF COMPUTER SOFTWARE, IN CLASS 42 (U.S. CLS. 100 AND 101).

FIRST USE 7-15-2004; IN COMMERCE 7-15-2004.

NO CLAIM IS MADE TO THE EXCLUSIVE RIGHT TO USE "CONSULTING", APART FROM THE MARK AS SHOWN.

THE MARK CONSISTS OF A TWO-HANDLED VASE WITH THE LETTER "S" INSCRIBED IN FRONT OVER THE LITERAL ELEMENT OF THE MARK.

THE FOREIGN WORDING IN THE MARK TRANSLATES INTO ENGLISH AS "SINCERE".

SER. NO. 77-344,285, FILED 12-5-2007.

KEVIN DINALLO, EXAMINING ATTORNEY

Int. Cl.: 3

Prior U.S. Cls.: 1, 4, 6, 50, 51 and 52

United States Patent and Trademark Office

Reg. No. 3,475,614

Registered July 29, 2008

**TRADEMARK
PRINCIPAL REGISTER**

IMMUNISTE

L'OREAL (FRANCE SOCIÉTÉ ANONYME (SA))
14 RUE ROYALE
PARIS, FRANCE 75008

FOR: PERFUME, TOILET WATER; BATH AND SHOWER GELS AND SALTS NOT FOR MEDICAL PURPOSE; TOILET SOAPS, BODY DEODORANTS; COSMETICS, NAMELY, CREAMS, MILKS, LOTIONS, GELS AND POWDERS FOR THE FACE, THE BODY AND THE HANDS; NON-MEDICATED SUN CARE PREPARATIONS; MAKEUP PREPARATIONS; SHAMPOOS; GELS, SPRAYS, MOUSSES, BALMS, CREAM, SERUMS AND WAX FOR THE HAIR STYLING AND HAIR CARE; HAIR LACQUERS; HAIR COLOURING AND HAIR DECOLORANT PREPARATIONS; PERMANENT WAVING AND CURLING PREPARATIONS; ESSENTIAL OILS

FOR PERSONAL USE, IN CLASS 3 (U.S. CLS. 1, 4, 6, 50, 51 AND 52).

THE MARK CONSISTS OF STANDARD CHARACTERS WITHOUT CLAIM TO ANY PARTICULAR FONT, STYLE, SIZE, OR COLOR.

PRIORITY CLAIMED UNDER SEC. 44(D) ON FRANCE APPLICATION NO. 073507519, FILED 6-19-2007, REG. NO. 073507519, DATED 6-19-2007, EXPIRES 6-19-2017.

THERE IS NO ENGLISH TRANSLATION OF "IMMUNISTE".

SER. NO. 77-344,325, FILED 12-5-2007.

DAVID ELTON, EXAMINING ATTORNEY

Int. Cl.: 36

Prior U.S. Cls.: 100, 101 and 102

United States Patent and Trademark Office

Reg. No. 3,475,615

Registered July 29, 2008

**SERVICE MARK
PRINCIPAL REGISTER**



ORIGEN FINANCIAL, INC. (VIRGINIA CORPORATION)
27777 FRANKLIN RD., SUITE 1700
SOUTHFIELD, MI 48034

FOR: FINANCING SERVICES; INSURANCE AGENCIES; INSURANCE BROKERAGE, IN CLASS 36 (U.S. CLS. 100, 101 AND 102).

FIRST USE 2-1-2001; IN COMMERCE 2-15-2001.

OWNER OF U.S. REG. NOS. 2,544,858 AND 2,544,859.

THE COLOR(S) BLUE AND GOLD IS/ARE CLAIMED AS A FEATURE OF THE MARK.

THE MARK CONSISTS OF AN OVAL BROKEN IN THE MIDDLE VERTICALLY WHERE THE RIGHT HALF OF THE OVAL IS GOLD AND THE LEFT HALF OF THE OVAL IS BLUE, ABOVE THE WORD "ORIGEN" IN BLUE, ABOVE THE WORDS "WE START WITH YOU." ALSO IN BLUE.

SER. NO. 77-344,384, FILED 12-5-2007.

KATHERINE M. DUBRAY, EXAMINING ATTORNEY

Int. Cls.: 35 and 41

Prior U.S. Cls.: 100, 101, 102 and 107

United States Patent and Trademark Office

Reg. No. 3,475,616

Registered July 29, 2008

**SERVICE MARK
PRINCIPAL REGISTER**

**New Jersey Alliance For
Action**

NEW JERSEY ALLIANCE FOR ACTION, INC.
(NEW JERSEY NON-PROFIT CORPORATION)
RARITAN PLAZA II, RARITAN CENTER
FIELDCREST AVENUE
EDISON, NJ 088186438

FOR: NON-PARTISAN ADVOCACY SERVICES, NAMELY, PROMOTING PUBLIC AWARENESS OF AND MOBILIZING PUBLIC SUPPORT FOR ROAD, BRIDGE AND RAIL IMPROVEMENTS, WATER PROJECTS, SCHOOL CONSTRUCTION, AVIATION ENHANCEMENTS, SHORE PRESERVATION, BUSINESS EXPANSION, ENVIRONMENTAL PROTECTION, GENERAL ECONOMIC DEVELOPMENT AND INFRASTRUCTURE ISSUES, IN CLASS 35 (U.S. CLS. 100, 101 AND 102).

FIRST USE 6-1-1974; IN COMMERCE 6-1-1974.

FOR: EDUCATIONAL SERVICES, NAMELY, CONDUCTING CLASSES, SEMINARS, WORKSHOPS, DEBATES, AND CONFERENCES TO INCREASE PUBLIC AWARENESS AND UNDERSTANDING OF PROGRAMS AND POLICIES THAT STIMULATE PRIVATE SECTOR BUSINESS DEVELOPMENT AND EMPLOYMENT OPPORTUNITIES WHILE ALSO STRENGTHENING

GOVERNMENT FINANCES AND CAPITAL ASSETS, AND MOBILIZING PUBLIC SUPPORT FOR ROAD, BRIDGE AND RAIL IMPROVEMENTS, WATER PROJECTS, SCHOOL CONSTRUCTION, AVIATION ENHANCEMENTS, SHORE PRESERVATION, BUSINESS EXPANSION, ENVIRONMENTAL PROTECTION AND OTHER KEY PUBLIC INFRASTRUCTURE INVESTMENTS, AND DISTRIBUTION OF PRINTED MATERIALS IN CONNECTION THEREWITH, IN CLASS 41 (U.S. CLS. 100, 101 AND 107).

FIRST USE 6-1-1974; IN COMMERCE 6-1-1974.

THE MARK CONSISTS OF STANDARD CHARACTERS WITHOUT CLAIM TO ANY PARTICULAR FONT, STYLE, SIZE, OR COLOR.

NO CLAIM IS MADE TO THE EXCLUSIVE RIGHT TO USE "NEW JERSEY", APART FROM THE MARK AS SHOWN.

SER. NO. 77-344,416, FILED 12-5-2007.

PAULA MAHONEY, EXAMINING ATTORNEY

Int. Cl.: 44

Prior U.S. Cls.: 100 and 101

United States Patent and Trademark Office

Reg. No. 3,475,617

Registered July 29, 2008

**SERVICE MARK
PRINCIPAL REGISTER**



FITZGERALD, LEE (UNITED STATES INDIVIDUAL)

424 MAPLELAWN DR.

PLANO, TX 75075

FOR: DENTIST SERVICES, IN CLASS 44 (U.S. CLS. 100 AND 101).

FIRST USE 8-1-2005; IN COMMERCE 8-1-2005.

NO CLAIM IS MADE TO THE EXCLUSIVE RIGHT TO USE "DENTAL CENTER" , APART FROM THE MARK AS SHOWN.

THE MARK CONSISTS OF A STYLIZED MOUTH SMILING.

SER. NO. 77-344,995, FILED 12-5-2007.

ANNE MADDEN, EXAMINING ATTORNEY

Int. Cl.: 35

Prior U.S. Cls.: 100, 101 and 102

United States Patent and Trademark Office

Reg. No. 3,475,618

Registered July 29, 2008

**SERVICE MARK
PRINCIPAL REGISTER**

ALARE

ALARE CAPITAL PARTNERS, LLC (DELAWARE
LTD LIAB CO)
14861 NORTH SCOTTSDALE ROAD, SUITE 105
SCOTTSDALE, AZ 85254

FOR: PROVIDING BUSINESS MANAGEMENT INFORMATION IN CONNECTION WITH CONSULTING AND ADVISORY SERVICES IN THE FIELD OF STRATEGIC PLANNING; BUSINESS CONSULTATION AND MANAGEMENT REGARDING MARKETING ACTIVITIES AND LAUNCHING OF NEW PRODUCTS; BUSINESS MANAGEMENT CONSULTING WITH RELATION TO STRATEGY, MARKETING, PRODUCTION, PERSONNEL AND RETAIL SALE MATTERS; BUSINESS MARKETING CONSULTING SERVICES; BUSINESS MANAGEMENT CONSULTANCY AS WELL AS DEVELOPMENT OF PROCESSES FOR THE ANALYSIS AND THE IMPLEMENTATION OF STRATEGY PLANS AND MANAGEMENT PROJECTS; BUSINESS DEVELOPMENT SERVICES, NAMELY, PROVIDING START-UP SUPPORT FOR BUSINESSES OF OTHERS; CONSULTANCY SERVICES REGARDING BUSINESS STRATEGIES; NEW BUSINESS VEN-

TURE DEVELOPMENT AND FORMATION CONSULTING SERVICES; DEVELOPMENT OF MARKETING STRATEGIES AND CONCEPTS; PROVIDING ORGANIZATIONAL DEVELOPMENT CONSULTING SERVICES; CORPORATE MANAGEMENT ASSISTANCE, IN CLASS 35 (U.S. CLS. 100, 101 AND 102).

FIRST USE 5-28-2006; IN COMMERCE 5-28-2006.

THE MARK CONSISTS OF STANDARD CHARACTERS WITHOUT CLAIM TO ANY PARTICULAR FONT, STYLE, SIZE, OR COLOR.

OWNER OF U.S. REG. NO. 3,396,059.

THE FOREIGN WORDING IN THE MARK TRANSLATES INTO ENGLISH AS WING.

SER. NO. 77-345,211, FILED 12-5-2007.

RONALD AIKENS, EXAMINING ATTORNEY

Int. Cl.: 41

Prior U.S. Cls.: 100, 101 and 107

United States Patent and Trademark Office

Reg. No. 3,475,619

Registered July 29, 2008

**SERVICE MARK
PRINCIPAL REGISTER**

Losers of the Year

BARKDULL, JOSHUA C. (UNITED STATES INDIVIDUAL)

11022 PAWNEE ROAD

APPLE VALLEY, CA 92308 AND

BARKDULL, JASON R. (UNITED STATES INDIVIDUAL)

11022 PAWNEE ROAD

APPLE VALLEY, CA 92308 AND

BARKDULL, JEREMY B. (UNITED STATES INDIVIDUAL)

11022 PAWNEE ROAD

APPLE VALLEY, CA 92308 AND

BARKDULL, JUSTIN K. (UNITED STATES INDIVIDUAL)

11022 PAWNEE ROAD

APPLE VALLEY, CA 92308

FOR: ENTERTAINMENT IN THE NATURE OF VISUAL AND AUDIO PERFORMANCES, NAMELY, MUSICAL BAND, ROCK GROUP, GYMNASTIC, DANCE, AND BALLET PERFORMANCES, IN CLASS 41 (U.S. CLS. 100, 101 AND 107).

FIRST USE 7-28-2003; IN COMMERCE 7-28-2003.

THE MARK CONSISTS OF STANDARD CHARACTERS WITHOUT CLAIM TO ANY PARTICULAR FONT, STYLE, SIZE, OR COLOR.

SER. NO. 77-345,261, FILED 12-5-2007.

HEATHER SAPP, EXAMINING ATTORNEY

Int. Cl.: 20

Prior U.S. Cls.: 2, 13, 22, 25, 32 and 50

Reg. No. 3,475,620

United States Patent and Trademark Office

Registered July 29, 2008

**TRADEMARK
PRINCIPAL REGISTER**

BUMPER BED

SCHOGGI, INC. (MONTANA CORPORATION)
32050 EAST FRONTAGE ROAD
BOZEMAN, MT 59715

FOR: BEDS FOR HOUSEHOLD PETS, IN CLASS
20 (U.S. CLS. 2, 13, 22, 25, 32 AND 50).

FIRST USE 7-23-2002; IN COMMERCE 7-23-2002.

THE MARK CONSISTS OF STANDARD CHAR-
ACTERS WITHOUT CLAIM TO ANY PARTICULAR
FONT, STYLE, SIZE, OR COLOR.

NO CLAIM IS MADE TO THE EXCLUSIVE
RIGHT TO USE "BED", APART FROM THE MARK
AS SHOWN.

SER. NO. 77-345,267, FILED 12-5-2007.

HEATHER SAPP, EXAMINING ATTORNEY

Int. Cl.: 42

Prior U.S. Cls.: 100 and 101

United States Patent and Trademark Office

Reg. No. 3,475,621

Registered July 29, 2008

**SERVICE MARK
PRINCIPAL REGISTER**

**ENGINEERING TECHNOLOGY TO
GROW YOUR BUSINESS**

THE JMOR CONNECTION, INC. (NEW JERSEY
CORPORATION)
BLDG F
115 RT 46 WEST
MOUNTAIN LAKES, NJ 07046

FOR: TECHNICAL SUPPORT SERVICES, NAME-
LY, ON-SITE AND REMOTE TROUBLESHOOTING
OF COMPUTER HARDWARE AND SOFTWARE
PROBLEMS, COMPUTER SYSTEM RELOCATION,
TECHNOLOGY RECOMMENDATION IN THE
NATURE OF SELECTION OF COMPUTER HARD-
WARE AND SOFTWARE SYSTEMS, AND DATA
RECOVERY SERVICES; SOFTWARE INSTALLA-
TION; COMPUTER SECURITY SERVICES, NAME-
LY, HARD DRIVE ERASURE AND HARD DRIVE
DISPOSAL; BACK-UP SERVICES FOR COMPUTER
HARD DRIVE DATA; COMPUTER PROJECT MAN-
AGEMENT SERVICES; COMPUTER PROGRAM-

MING; CONSULTATION IN THE FIELD OF
TECHNOLOGY SUPPORT, COMPUTER SECURITY,
COMPUTER SYSTEM RELOCATION, TECHNOLO-
GY RECOMMENDATION IN THE NATURE OF
SELECTION OF COMPUTER HARDWARE AND
SOFTWARE SYSTEMS, AND DATA RECOVERY
SERVICES, IN CLASS 42 (U.S. CLS. 100 AND 101).

FIRST USE 1-1-2006; IN COMMERCE 1-1-2006.

THE MARK CONSISTS OF STANDARD CHAR-
ACTERS WITHOUT CLAIM TO ANY PARTICULAR
FONT, STYLE, SIZE, OR COLOR.

SER. NO. 77-345,393, FILED 12-6-2007.

SHANNON TWOHIG, EXAMINING ATTORNEY

Int. Cl.: 41

Prior U.S. Cls.: 100, 101 and 107

United States Patent and Trademark Office

Reg. No. 3,475,622

Registered July 29, 2008

SERVICE MARK
PRINCIPAL REGISTER



HARPER'S EMBRACE LIFESAVER PROGRAM
(TEXAS CORPORATION)

6243 I.H.-10 WEST, SUITE 480

SAN ANTONIO, TX 78201

FOR: TEACHING CARDIOPULMONARY RESUS-
CITATION CLASSES, IN CLASS 41 (U.S. CLS. 100, 101
AND 107).

FIRST USE 12-1-2004; IN COMMERCE 4-1-2005.

NO CLAIM IS MADE TO THE EXCLUSIVE
RIGHT TO USE "LIFESAVER PROGRAM", APART
FROM THE MARK AS SHOWN.

THE MARK CONSISTS OF THE WORDS "HAR-
PER'S EMBRACE LIFESAVER PROGRAM", ITS
ACRONYM "H.E.L.P." AND AN ELEPHANT HOLD-
ING A HEART.

SER. NO. 77-345,438, FILED 12-6-2007.

KHANH LE, EXAMINING ATTORNEY

Int. Cl.: 35

Prior U.S. Cls.: 100, 101 and 102

United States Patent and Trademark Office

Reg. No. 3,475,623

Registered July 29, 2008

**SERVICE MARK
PRINCIPAL REGISTER**

LA ESPERANZA BAKERY

LA ESPERANZA, INC. (GEORGIA CORPORATION)
504 MOSEDALE DRIVE
DALTON, GA 30721

FOR: RETAIL BAKERY SHOPS, IN CLASS 35 (U.S. CLS. 100, 101 AND 102).

FIRST USE 6-0-2000; IN COMMERCE 6-0-2000.

THE MARK CONSISTS OF STANDARD CHARACTERS WITHOUT CLAIM TO ANY PARTICULAR FONT, STYLE, SIZE, OR COLOR.

OWNER OF U.S. REG. NO. 3,334,817.

NO CLAIM IS MADE TO THE EXCLUSIVE RIGHT TO USE "BAKERY", APART FROM THE MARK AS SHOWN.

THE FOREIGN WORDING IN THE MARK TRANSLATES INTO ENGLISH AS THE HOPE.

SER. NO. 77-345,488, FILED 12-6-2007.

ELLEN B. AWRICH, EXAMINING ATTORNEY

Int. Cl.: 12

Prior U.S. Cls.: 19, 21, 23, 31, 35 and 44

Reg. No. 3,475,624

United States Patent and Trademark Office

Registered July 29, 2008

**TRADEMARK
PRINCIPAL REGISTER**

ExerTrike

EXERCAR, LLC (TENNESSEE LTD LIAB CO)
P.O. BOX 231
ERIN, TN 37061

THE MARK CONSISTS OF STANDARD CHARACTERS WITHOUT CLAIM TO ANY PARTICULAR FONT, STYLE, SIZE, OR COLOR.

FOR: HUMAN-ELECTRIC HYBRID AND HUMAN-ELECTRIC-GAS TRI-HYBRID LAND VEHICLES, IN CLASS 12 (U.S. CLS. 19, 21, 23, 31, 35 AND 44).

SER. NO. 77-345,496, FILED 12-6-2007.

FIRST USE 3-21-2007; IN COMMERCE 5-11-2007.

KATHRYN COWARD, EXAMINING ATTORNEY

Int. Cl.: 44

Prior U.S. Cls.: 100 and 101

United States Patent and Trademark Office

Reg. No. 3,475,625

Registered July 29, 2008

**SERVICE MARK
PRINCIPAL REGISTER**

MATURE ASSESSMENT

HOOPER HOLMES, INC. (NEW YORK COR-
PORATION)
170 MT. AIRY ROAD
BASKING RIDGE, NJ 07920

FOR: MEDICAL TESTING SERVICES FOR USE
WITH RESPECT TO INSURANCE UNDERWRITING
AND RISK ASSESSMENT, IN CLASS 44 (U.S. CLS.
100 AND 101).

FIRST USE 10-19-2007; IN COMMERCE 10-19-2007.

THE MARK CONSISTS OF STANDARD CHAR-
ACTERS WITHOUT CLAIM TO ANY PARTICULAR
FONT, STYLE, SIZE, OR COLOR.

NO CLAIM IS MADE TO THE EXCLUSIVE
RIGHT TO USE "ASSESSMENT", APART FROM
THE MARK AS SHOWN.

SER. NO. 77-345,652, FILED 12-6-2007.

AMY HELLA, EXAMINING ATTORNEY

Int. Cl.: 37

Prior U.S. Cls.: 100, 103 and 106

United States Patent and Trademark Office

Reg. No. 3,475,626

Registered July 29, 2008

SERVICE MARK
PRINCIPAL REGISTER

The logo for Brandon Electric, Inc. features the word "Brandon" in a stylized, cursive script font. Below "Brandon" is a thick, black lightning bolt graphic. Underneath the lightning bolt, the words "Electric, Inc." are written in a bold, sans-serif font.

BRANDON ELECTRIC, INC. (FLORIDA CORPORATION)

P. O. BOX 358

DOVER, FL 33527

FOR: ELECTRICAL CONTRACTING SERVICES FOR COMMERCIAL AND RESIDENTIAL STRUCTURES, IN CLASS 37 (U.S. CLS. 100, 103 AND 106).

FIRST USE 2-8-1996; IN COMMERCE 2-8-1996.

NO CLAIM IS MADE TO THE EXCLUSIVE RIGHT TO USE "BRANDON ELECTRIC, INC.", APART FROM THE MARK AS SHOWN.

THE MARK CONSISTS OF THE WORDING "BRANDON" AND "ELECTRIC, INC." APPEARING ABOVE AND BELOW, RESPECTIVELY, A FANCIFUL LIGHTNING BOLT DESIGN.

SER. NO. 77-345,728, FILED 12-6-2007.

JAY BESCH, EXAMINING ATTORNEY

Int. Cl.: 39

Prior U.S. Cls.: 100 and 105

United States Patent and Trademark Office

Reg. No. 3,475,627

Registered July 29, 2008

**SERVICE MARK
PRINCIPAL REGISTER**



346 NW 29TH STREET, LLC (FLORIDA LTD
LIAB CO)
9101 NW 7TH AVENUE
MIAMI, FL 33150

FOR: PROVIDING SELF-STORAGE FACILITIES
FOR OTHERS, IN CLASS 39 (U.S. CLS. 100 AND 105).

FIRST USE 2-0-2008; IN COMMERCE 2-0-2008.

THE MARK CONSISTS OF STYLIZED LOCK
WITH KEYHOLE, ALL ABOVE THE WORD "MU-
SEO".

THE FOREIGN WORDING IN THE MARK
TRANSLATES INTO ENGLISH AS MUSEUM.

SER. NO. 77-345,849, FILED 12-6-2007.

ARETHA SOMERVILLE, EXAMINING ATTORNEY

Int. Cl.: 20

Prior U.S. Cls.: 2, 13, 22, 25, 32 and 50

United States Patent and Trademark Office

Reg. No. 3,475,628

Registered July 29, 2008

**TRADEMARK
PRINCIPAL REGISTER**

REAR GEAR

REAR GEAR INC. (CALIFORNIA CORPORATION)
3374 WALTON WAY
SAN JOSE, CA 95117

FOR: CUSHION ATTACHABLE TO A PERSON AND COMPACTLY CONTAINED IN AND ATTACHED TO A POUCH WHILE NOT IN USE AND DEPLOYABLE FROM POUCH WHILE REMAINING ATTACHED THERETO AND EXTENDABLE FOR COVERING AN AREA ON WHICH THE WEARER SITS, IN CLASS 20 (U.S. CLS. 2, 13, 22, 25, 32 AND 50).

FIRST USE 2-18-2007; IN COMMERCE 9-22-2007.

THE MARK CONSISTS OF STANDARD CHARACTERS WITHOUT CLAIM TO ANY PARTICULAR FONT, STYLE, SIZE, OR COLOR.

SER. NO. 77-345,856, FILED 12-6-2007.

COLLEEN KEARNEY, EXAMINING ATTORNEY

Int. Cl.: 39

Prior U.S. Cls.: 100 and 105

United States Patent and Trademark Office

Reg. No. 3,475,629

Registered July 29, 2008

**SERVICE MARK
PRINCIPAL REGISTER**

MUSEO

346 NW 29TH STREET, LLC (FLORIDA LTD
LIAB CO)
9101 NW 7TH AVENUE
MIAMI, FL 33150

FOR: PROVIDING SELF-STORAGE FACILITIES
FOR OTHERS, IN CLASS 39 (U.S. CLS. 100 AND 105).

FIRST USE 2-0-2008; IN COMMERCE 2-0-2008.

THE MARK CONSISTS OF STANDARD CHAR-
ACTERS WITHOUT CLAIM TO ANY PARTICULAR
FONT, STYLE, SIZE, OR COLOR.

THE FOREIGN WORDING IN THE MARK
TRANSLATES INTO ENGLISH AS MUSEUM.

SER. NO. 77-345,879, FILED 12-6-2007.

ARETHA SOMERVILLE, EXAMINING ATTORNEY

Int. Cl.: 45

Prior U.S. Cls.: 100 and 101

United States Patent and Trademark Office

Reg. No. 3,475,630

Registered July 29, 2008

**SERVICE MARK
PRINCIPAL REGISTER**

**The 360 Second Word
"6 minutes with God"**

MCCRIMMON, MICHAEL L. (GEORGIA CORPORATION), DBA 360 GLOBAL MINISTRIES INC.
437 CREEKVIEW LANE
COLLEGE PARK, GA 30349

FOR: PROVIDING ON-LINE INFORMATION IN THE FIELD OF SPIRITUALITY, SELF-HELP, AND PERSONAL EMPOWERMENT SUBJECT MATTERS, IN CLASS 45 (U.S. CLS. 100 AND 101).

FIRST USE 9-1-2005; IN COMMERCE 1-1-2006.

THE MARK CONSISTS OF STANDARD CHARACTERS WITHOUT CLAIM TO ANY PARTICULAR FONT, STYLE, SIZE, OR COLOR.

SER. NO. 77-345,910, FILED 12-6-2007.

CHERYL CLAYTON, EXAMINING ATTORNEY

Int. Cl.: 16

Prior U.S. Cls.: 2, 5, 22, 23, 29, 37, 38 and 50

United States Patent and Trademark Office

Reg. No. 3,475,631

Registered July 29, 2008

**TRADEMARK
PRINCIPAL REGISTER**

HOLIDAY HOUSE

HOLIDAY HOUSE, INC. (NEW YORK CORPORATION)
425 MADISON AVENUE
NEW YORK, NY 10017

FOR: CHILDREN'S BOOKS; SERIES OF FICTION AND NON-FICTION BOOKS ON A VARIETY OF TOPICS FOR YOUNG ADULTS, IN CLASS 16 (U.S. CLS. 2, 5, 22, 23, 29, 37, 38 AND 50).

FIRST USE 0-0-1935; IN COMMERCE 0-0-1935.

THE MARK CONSISTS OF STANDARD CHARACTERS WITHOUT CLAIM TO ANY PARTICULAR FONT, STYLE, SIZE, OR COLOR.

NO CLAIM IS MADE TO THE EXCLUSIVE RIGHT TO USE "HOUSE", APART FROM THE MARK AS SHOWN.

SER. NO. 77-345,941, FILED 12-6-2007.

DAVID YONTEF, EXAMINING ATTORNEY

Int. Cl.: 35

Prior U.S. Cls.: 100, 101 and 102

United States Patent and Trademark Office

Reg. No. 3,475,632

Registered July 29, 2008

**SERVICE MARK
PRINCIPAL REGISTER**

SEOWHAT

SEVEN, CATHERINE (UNITED STATES INDIVIDUAL)
6581 BISHOP DRIVE
HUNTINGTON BEACH, CA 92647

FIRST USE 5-1-2006; IN COMMERCE 5-1-2006.

FOR: PROMOTING THE GOODS, SERVICES, WEB PRESENCES, AND WEBSITE INTERNET RANKINGS OF OTHERS THROUGH SEARCH ENGINE OPTIMIZATION ACTIVITIES AND REPORTING, INTERNET MARKETING, AND SEARCH ENGINE MARKETING, IN CLASS 35 (U.S. CLS. 100, 101 AND 102).

THE MARK CONSISTS OF STANDARD CHARACTERS WITHOUT CLAIM TO ANY PARTICULAR FONT, STYLE, SIZE, OR COLOR.

SER. NO. 77-346,032, FILED 12-6-2007.

ESTHER BELENKER, EXAMINING ATTORNEY

Int. Cl.: 36

Prior U.S. Cls.: 100, 101 and 102

United States Patent and Trademark Office

Reg. No. 3,475,633

Registered July 29, 2008

**SERVICE MARK
PRINCIPAL REGISTER**



The Michael & JJ
Heart Club Foundation

SACCO, JOSEPHINE (UNITED STATES INDIVIDUAL)
UNIT 1001
80 BROAD STREET
BOSTON, MA 02110

THE MARK CONSISTS OF A STYLIZED REPRESENTATION OF A HEART FORMED FROM A FINGER PRINT NEXT TO THE WORDS "THE MICHAEL AND JJ HEART CLUB FOUNDATION".

FOR: CHARITABLE FUNDRAISING SERVICES,
IN CLASS 36 (U.S. CLS. 100, 101 AND 102).

SER. NO. 77-346,060, FILED 12-6-2007.

FIRST USE 5-0-2007; IN COMMERCE 5-0-2007.

NO CLAIM IS MADE TO THE EXCLUSIVE RIGHT TO USE "CLUB FOUNDATION", APART FROM THE MARK AS SHOWN.

DOMINIC J. FERRAIUOLO, EXAMINING ATTORNEY

Int. Cl.: 41

Prior U.S. Cls.: 100, 101 and 107

United States Patent and Trademark Office

Reg. No. 3,475,634

Registered July 29, 2008

**SERVICE MARK
PRINCIPAL REGISTER**

The Power To Change

SKY U, LLC (NEW YORK LTD LIAB CO)
105 CHAMBERS STREET, 3RD FLR
NEW YORK, NY 10007

FOR: EDUCATIONAL SERVICES, NAMELY,
CONDUCTING ONGOING CHILDRENS' SEMI-
NARS, CLASSES, AND COURSES IN THE FIELD
OF MOTIVATION AND EMPOWERMENT FOR
CHILDREN IN ORGANIZATION, PERSONAL DE-
VELOPMENT, AND THE REALIZATION OF THEIR
GOALS, IN CLASS 41 (U.S. CLS. 100, 101 AND 107).

FIRST USE 2-16-2005; IN COMMERCE 2-16-2005.

THE MARK CONSISTS OF STANDARD CHAR-
ACTERS WITHOUT CLAIM TO ANY PARTICULAR
FONT, STYLE, SIZE, OR COLOR.

SER. NO. 77-346,101, FILED 12-6-2007.

DOMINIC J. FERRAIUOLO, EXAMINING ATTOR-
NEY

Int. Cl.: 42

Prior U.S. Cls.: 100 and 101

United States Patent and Trademark Office

Reg. No. 3,475,635

Registered July 29, 2008

**SERVICE MARK
PRINCIPAL REGISTER**

ASK4

ASK TECHNOLOGY SOLUTIONS, INC. (NEW YORK CORPORATION)
P.O. BOX 326
381 SUNRISE HIGHWAY
LYNBROOK, NY 11563

FOR: CONSULTING SERVICES IN THE FIELD OF DESIGN, SELECTION, IMPLEMENTATION AND USE OF COMPUTER HARDWARE AND SOFTWARE SYSTEMS FOR OTHERS; INFORMATION TECHNOLOGY CONSULTATION; COMPUTER CONSULTATION; COMPUTER PROGRAMMING; HOSTING THE WEB SITES OF OTHERS ON A COMPUTER SERVER FOR A GLOBAL COMPUTER NETWORK; COMPUTER SECURITY SERVICE, NAMELY, RESTRICTING ACCESS TO AND BY COMPUTER NETWORKS TO AND OF UNDESIREED WEB SITES, MEDIA AND INDIVIDUALS AND FACILITIES; REPAIR OF COMPUTER SOFTWARE; TECHNICAL SUPPORT SERVICES, NAMELY, TROUBLESHOOTING OF COMPUTER SOFTWARE PROBLEMS; COMPUTER CONSULTA-

TION IN THE FIELD OF COMPUTER SECURITY AND NETWORK SECURITY; COMPUTER NETWORK DESIGN AND COMPUTER SOFTWARE DESIGN FOR SURVEILLANCE AND INVESTIGATION OF OTHERS; COMPUTER CONSULTATION IN THE FIELD OF NETWORK SURVEILLANCE AND INVESTIGATION; COMPUTER AND NETWORK SURVEILLANCE AND INVESTIGATION SERVICES, IN CLASS 42 (U.S. CLS. 100 AND 101).

FIRST USE 12-3-2007; IN COMMERCE 12-3-2007.

THE MARK CONSISTS OF STANDARD CHARACTERS WITHOUT CLAIM TO ANY PARTICULAR FONT, STYLE, SIZE, OR COLOR.

OWNER OF U.S. REG. NO. 3,375,340.

SER. NO. 77-346,257, FILED 12-6-2007.

MAUREEN DALL, EXAMINING ATTORNEY

Int. Cl.: 41

Prior U.S. Cls.: 100, 101 and 107

United States Patent and Trademark Office

Reg. No. 3,475,636

Registered July 29, 2008

**SERVICE MARK
PRINCIPAL REGISTER**

Shakshuka

RACHEL ROSENBERG (UNITED STATES INDIVIDUAL)

3022 MOON HILL DR.

NORTHBROOK, IL 60062 AND

CHARLES ROSENBERG (UNITED STATES INDIVIDUAL)

3022 MOON HILL DR.

NORTHBROOK, IL 60062 AND

STEVE YASTROW (UNITED STATES INDIVIDUAL)

716 DIMMEYDALE DR

DEERFIELD, IL 60015

FOR: ENTERTAINMENT, NAMELY, LIVE MUSIC CONCERTS AND PERFORMANCES BY A MUSICAL GROUP, AND A PERFORMANCE WEBSITE ON A GLOBAL COMPUTER NETWORK FEATURING INFORMATION ON THE MUSICAL GROUP AND ITS MUSICAL PERFORMANCES, MUSIC

AND VIDEO SAMPLE CLIPS, PICTURES, TOUR INFORMATION, BIOGRAPHIES AND PERSONAL APPEARANCES, IN CLASS 41 (U.S. CLS. 100, 101 AND 107).

FIRST USE 3-1-1995; IN COMMERCE 5-5-1995.

THE MARK CONSISTS OF STANDARD CHARACTERS WITHOUT CLAIM TO ANY PARTICULAR FONT, STYLE, SIZE, OR COLOR.

THE WORDING "SHAKSHUKA" HAS NO ENGLISH TRANSLATION.

SER. NO. 77-346,302, FILED 12-7-2007.

LINDA E. BLOHM, EXAMINING ATTORNEY

Int. Cls.: 35 and 36

Prior U.S. Cls.: 100, 101 and 102

United States Patent and Trademark Office

Reg. No. 3,475,637

Registered July 29, 2008

**SERVICE MARK
PRINCIPAL REGISTER**

PREQUENCE

RODIN, MOSES (UNITED STATES INDIVIDUAL)
1259 CONSERVANCY DRIVE
TALLAHASSEE, FL 32312

FOR: REAL ESTATE ADVERTISING SERVICES,
IN CLASS 35 (U.S. CLS. 100, 101 AND 102).

FIRST USE 6-27-2007; IN COMMERCE 6-27-2007.

FOR: PROVIDING INFORMATION AND LIST-
INGS IN THE FIELD OF REAL ESTATE VIA A CELL
PHONE, IN CLASS 36 (U.S. CLS. 100, 101 AND 102).

FIRST USE 6-27-2007; IN COMMERCE 6-27-2007.

THE MARK CONSISTS OF STANDARD CHAR-
ACTERS WITHOUT CLAIM TO ANY PARTICULAR
FONT, STYLE, SIZE, OR COLOR.

SER. NO. 77-346,368, FILED 12-7-2007.

CORY BOONE, EXAMINING ATTORNEY

Int. Cl.: 41

Prior U.S. Cls.: 100, 101 and 107

United States Patent and Trademark Office

Reg. No. 3,475,638

Registered July 29, 2008

**SERVICE MARK
PRINCIPAL REGISTER**

Blue Persuasion

PATTERSON, MALA (UNITED STATES INDIVIDUAL)
900 KYLE RD NE
HARTSELLE, AL 356402081

FOR: ENTERTAINMENT IN THE NATURE OF VISUAL AND AUDIO PERFORMANCES, NAMELY, MUSICAL BAND, ROCK GROUP, GYMNASTIC, DANCE, AND BALLET PERFORMANCES, IN CLASS 41 (U.S. CLS. 100, 101 AND 107).

FIRST USE 11-0-1998; IN COMMERCE 11-0-1998.

THE MARK CONSISTS OF STANDARD CHARACTERS WITHOUT CLAIM TO ANY PARTICULAR FONT, STYLE, SIZE, OR COLOR.

SER. NO. 77-346,541, FILED 12-7-2007.

REBECCA EISINGER, EXAMINING ATTORNEY

Int. Cl.: 36

Prior U.S. Cls.: 100, 101 and 102

United States Patent and Trademark Office

Reg. No. 3,475,639

Registered July 29, 2008

**SERVICE MARK
PRINCIPAL REGISTER**



PROFESSIONAL INSURANCE ELITE AGENCY,
LLC (TEXAS LTD LIAB CO), DBA PROFES-
SIONAL INSURANCE ELITE

615 CUTLASS
AUSTIN, TX 78734

FOR: INSURANCE AGENCIES, IN CLASS 36 (U.S.
CLS. 100, 101 AND 102).

FIRST USE 11-26-2007; IN COMMERCE 12-1-2007.

NO CLAIM IS MADE TO THE EXCLUSIVE
RIGHT TO USE "PROFESSIONAL INSURANCE",
APART FROM THE MARK AS SHOWN.

THE COLOR(S) BLACK, BURGUNDY, AND
GRAY IS/ARE CLAIMED AS A FEATURE OF THE
MARK.

THE MARK CONSISTS OF IN THE UPPER RIGHT
HAND, THERE IS A BLACK IMAGE OF A PIE.
THERE IS A BURGUNDY PIECE OF THE PIE
PULLED OUT FROM THE PIE AND IN GRAY IS
PIE. UNDER THIS ARE THE WORDS "PROFES-
SIONAL INSURANCE ELITE".

SER. NO. 77-346,571, FILED 12-7-2007.

ESTHER A. BORSUK, EXAMINING ATTORNEY

Int. Cls.: 43 and 44

Prior U.S. Cls.: 100 and 101

United States Patent and Trademark Office

Reg. No. 3,475,640

Registered July 29, 2008

**SERVICE MARK
PRINCIPAL REGISTER**



COMFORTCARE SENIOR LIVING CONSULTANTS, LLC (ARIZONA LTD LIAB CO)
2180 E. BALBOA DR.
TEMPE, AZ 852824007

FOR: CONSULTING SERVICES IN THE NATURE OF PROVIDING ASSISTANCE TO SENIOR CITIZENS SEEKING TO DETERMINE THE ASSISTED LIVING FACILITIES AND SENIOR CONGREGATE LIVING FACILITIES APPROPRIATE FOR THEIR NEEDS, IN CLASS 43 (U.S. CLS. 100 AND 101).

FIRST USE 11-1-2007; IN COMMERCE 11-1-2007.

FOR: CONSULTING SERVICES IN THE NATURE OF PROVIDING ASSISTANCE TO SENIOR CITIZENS SEEKING TO DETERMINE THE LONG-TERM CARE FACILITIES AND SKILLED NURSING FACILITIES APPROPRIATE FOR THEIR NEEDS, IN CLASS 44 (U.S. CLS. 100 AND 101).

FIRST USE 11-1-2007; IN COMMERCE 11-1-2007.

NO CLAIM IS MADE TO THE EXCLUSIVE RIGHT TO USE "SENIOR LIVING CONSULTANTS", APART FROM THE MARK AS SHOWN.

THE COLOR(S) DARK BLUE, MEDIUM BLUE, WHITE, AND RED IS/ARE CLAIMED AS A FEATURE OF THE MARK.

THE MARK CONSISTS OF A STYLIZED HOUSE OUTLINED IN DARK BLUE WITH A WHITE INTERIOR AND A RED CURVED LINE REPRESENTING THE GROUND, TWO STYLIZED PERSONS WITH THE ONE ON THE LEFT APPEARING IN DARK BLUE AND THE ONE ON THE RIGHT IN MEDIUM BLUE, AND THE DARK BLUE WORDING "COMFORTCARE SENIOR LIVING CONSULTANTS" APPEARING TO THE RIGHT OF IT ALL.

SER. NO. 77-346,631, FILED 12-7-2007.

RONALD MCMORROW, EXAMINING ATTORNEY

Int. Cl.: 30

Prior U.S. Cl.: 46

United States Patent and Trademark Office

Reg. No. 3,475,641

Registered July 29, 2008

**TRADEMARK
PRINCIPAL REGISTER**

MASHUGA COOKIES

TORN RANCH, INC. (CALIFORNIA CORPORATION)
23-B PIMENTEL COURT
NOVATO, CA 94949

FOR: COOKIES, IN CLASS 30 (U.S. CL. 46).

FIRST USE 4-0-1996; IN COMMERCE 4-0-1996.

THE MARK CONSISTS OF STANDARD CHARACTERS WITHOUT CLAIM TO ANY PARTICULAR FONT, STYLE, SIZE, OR COLOR.

OWNER OF U.S. REG. NOS. 2,027,324 AND 2,125,716.

NO CLAIM IS MADE TO THE EXCLUSIVE RIGHT TO USE "COOKIES", APART FROM THE MARK AS SHOWN.

SER. NO. 77-346,680, FILED 12-7-2007.

NORA BUCHANAN WILL, EXAMINING ATTORNEY

Int. Cl.: 25

Prior U.S. Cls.: 22 and 39

United States Patent and Trademark Office

Reg. No. 3,475,642

Registered July 29, 2008

TRADEMARK
PRINCIPAL REGISTER



WEINER, BENJAMIN (UNITED STATES INDIVIDUAL)
720 GUERRERO ST
SAN FRANCISCO, CA 94110

FOR: T-SHIRTS; HATS; HOODS, IN CLASS 25 (U.S. CLS. 22 AND 39).

FIRST USE 11-1-2005; IN COMMERCE 11-1-2005.

THE NAME "BENNY GOLD" IS THE NICKNAME OF BENJAMIN WEINER, WHOSE CONSENT IS OF RECORD.

THE MARK CONSISTS OF "BENNY GOLD" SIGNATURE SCRIPT LOGO WITH A PAPER AIRPLANE FLYING FLIGHT PATTERN CREATING THE SCRIPT.

SER. NO. 77-346,798, FILED 12-7-2007.

DAVID ELTON, EXAMINING ATTORNEY

Int. Cl.: 36

Prior U.S. Cls.: 100, 101 and 102

United States Patent and Trademark Office

Reg. No. 3,475,643

Registered July 29, 2008

**SERVICE MARK
PRINCIPAL REGISTER**

403bComply

CALIFORNIA STATE TEACHERS' RETIREMENT
SYSTEM (CALIFORNIA STATE AGENCY)
MS-3
7667 FOLSOM BOULEVARD
SACRAMENTO, CA 95826

THE MARK CONSISTS OF STANDARD CHAR-
ACTERS WITHOUT CLAIM TO ANY PARTICULAR
FONT, STYLE, SIZE, OR COLOR.

FOR: ADMINISTRATION OF EMPLOYEE PEN-
SION PLANS, IN CLASS 36 (U.S. CLS. 100, 101 AND
102).

SER. NO. 77-346,802, FILED 12-7-2007.

FIRST USE 8-20-2007; IN COMMERCE 8-20-2007.

DAVID ELTON, EXAMINING ATTORNEY

Int. Cl.: 36

Prior U.S. Cls.: 100, 101 and 102

United States Patent and Trademark Office

Reg. No. 3,475,644

Registered July 29, 2008

**SERVICE MARK
PRINCIPAL REGISTER**

**A Proud Past With A Solid
Future**

GERMANIA INSURANCE (TEXAS CORPORATION)
P.O. BOX 645
BRENHAM, TX 77834

THE MARK CONSISTS OF STANDARD CHARACTERS WITHOUT CLAIM TO ANY PARTICULAR FONT, STYLE, SIZE, OR COLOR.

FOR: INSURANCE SERVICES, NAMELY, WRITING PROPERTY AND CASUALTY INSURANCE, IN CLASS 36 (U.S. CLS. 100, 101 AND 102).

SER. NO. 77-346,807, FILED 12-7-2007.

FIRST USE 8-25-1996; IN COMMERCE 8-25-1996.

ANGELA GAW, EXAMINING ATTORNEY

Int. Cl.: 37

Prior U.S. Cls.: 100, 103 and 106

United States Patent and Trademark Office

Reg. No. 3,475,645

Registered July 29, 2008

SERVICE MARK
PRINCIPAL REGISTER



TEAM TORQUE INC. (NORTH DAKOTA CORPORATION)
1231 PARK AVE
BISMARCK, ND 58504

FOR: CALIBRATION LAB SERVICES, NAMELY, REPAIR AND MAINTENANCE OF CALIBRATED TORQUE TOOLS, IN CLASS 37 (U.S. CLS. 100, 103 AND 106).

FIRST USE 4-27-1998; IN COMMERCE 4-27-1998.

OWNER OF U.S. REG. NO. 3,247,131.

NO CLAIM IS MADE TO THE EXCLUSIVE RIGHT TO USE "TORQUE INC.", APART FROM THE MARK AS SHOWN.

THE COLOR(S) RED, PINK, YELLOW, SILVER, BLACK, AND WHITE IS/ARE CLAIMED AS A FEATURE OF THE MARK.

THE MARK CONSISTS OF THE WORDS "TEAM TORQUE INC." IN GRADIENT SHADES OF RED, PINK AND YELLOW, WITH A WRENCH GRAPHIC REPLACING THE "Q" AND UNIQUE FONTS. THE LETTERING OF ALL THE WORDING AND THE DESIGN OF THE WRENCH ARE OUTLINED IN BLACK. THE WRENCH IS SILVER AND WHITE. THE MARK BACKGROUND IS WHITE.

SER. NO. 77-346,825, FILED 12-7-2007.

H. M. FISHER, EXAMINING ATTORNEY

Int. Cls.: 1 and 3

Prior U.S. Cls.: 1, 4, 5, 6, 10, 26, 46, 50, 51 and 52

United States Patent and Trademark Office

Reg. No. 3,475,646

Registered July 29, 2008

**TRADEMARK
PRINCIPAL REGISTER**

SEM

SEM PRODUCTS, INC. (NORTH CAROLINA CORPORATION)
651 MICHAEL WYLIE DRIVE
CHARLOTTE, NC 28217

FOR: ADHESIVES FOR MOTOR AND MARINE VEHICLES, AFTERMARKET MOTOR AND MARINE VEHICLE USE, INDUSTRIAL USE AND GENERAL INDUSTRIAL USE, IN CLASS 1 (U.S. CLS. 1, 5, 6, 10, 26 AND 46).

FIRST USE 1-15-1986; IN COMMERCE 1-15-1986.

FOR: CLEANERS FOR MOTOR VEHICLES, AFTERMARKET MOTOR AND MARINE VEHICLE

USE, INDUSTRIAL USE, AND GENERAL PURPOSE USE, IN CLASS 3 (U.S. CLS. 1, 4, 6, 50, 51 AND 52).

FIRST USE 1-15-1980; IN COMMERCE 1-15-1980.

THE MARK CONSISTS OF STANDARD CHARACTERS WITHOUT CLAIM TO ANY PARTICULAR FONT, STYLE, SIZE, OR COLOR.

OWNER OF U.S. REG. NO. 2,290,220.

SER. NO. 77-346,852, FILED 12-7-2007.

JUDITH HELFMAN, EXAMINING ATTORNEY

Int. Cl.: 15

Prior U.S. Cls.: 2, 21 and 36

United States Patent and Trademark Office

Reg. No. 3,475,647

Registered July 29, 2008

TRADEMARK
PRINCIPAL REGISTER

micro•flex 
guitar strings by james d'aquisto II

D'AQUISTO II, JAMES (UNITED STATES INDIVIDUAL)
4998 CAMBRIDGE BLVD
PALM HARBOR, FL 34685

FOR: GUITAR STRINGS; STRINGS FOR WESTERN MUSICAL INSTRUMENTS, IN CLASS 15 (U.S. CLS. 2, 21 AND 36).

FIRST USE 11-28-2007; IN COMMERCE 11-28-2007.

OWNER OF U.S. REG. NOS. 1,548,224 AND 1,549,077.

NO CLAIM IS MADE TO THE EXCLUSIVE RIGHT TO USE "GUITAR STRINGS", APART FROM THE MARK AS SHOWN.

SER. NO. 77-346,883, FILED 12-7-2007.

ALICIA COLLINS, EXAMINING ATTORNEY

Int. Cl.: 35

Prior U.S. Cls.: 100, 101 and 102

United States Patent and Trademark Office

Reg. No. 3,475,648

Registered July 29, 2008

**SERVICE MARK
PRINCIPAL REGISTER**

GRANQUARTZ

GRANQUARTZ HOLDINGS, LLC (DELAWARE
LTD LIAB CO)
P.O. BOX 2206
TUCKER, GA 30085

FOR: DISTRIBUTORSHIP SERVICES IN THE
FIELD OF STONE WORKING TOOLS, STONE
WORKING MACHINES AND ACCESSORIES
THEREFOR, IN CLASS 35 (U.S. CLS. 100, 101 AND
102).

FIRST USE 0-0-1972; IN COMMERCE 0-0-1972.

THE MARK CONSISTS OF STANDARD CHAR-
ACTERS WITHOUT CLAIM TO ANY PARTICULAR
FONT, STYLE, SIZE, OR COLOR.

SER. NO. 77-346,900, FILED 12-7-2007.

BRIAN PINO, EXAMINING ATTORNEY

Int. Cl.: 36

Prior U.S. Cls.: 100, 101 and 102

United States Patent and Trademark Office

Reg. No. 3,475,649

Registered July 29, 2008

**SERVICE MARK
PRINCIPAL REGISTER**

The Insurance Texans Trust

GERMANIA INSURANCE (TEXAS CORPORATION)
P.O. BOX 645
BRENHAM, TX 77834

FOR: INSURANCE SERVICES, NAMELY, WRITING PROPERTY AND CASUALTY INSURANCE, IN CLASS 36 (U.S. CLS. 100, 101 AND 102).

FIRST USE 2-1-2004; IN COMMERCE 2-1-2004.

THE MARK CONSISTS OF STANDARD CHARACTERS WITHOUT CLAIM TO ANY PARTICULAR FONT, STYLE, SIZE, OR COLOR.

SER. NO. 77-346,932, FILED 12-7-2007.

ANGELA GAW, EXAMINING ATTORNEY

Int. Cl.: 9

Prior U.S. Cls.: 21, 23, 26, 36 and 38

Reg. No. 3,475,650

United States Patent and Trademark Office

Registered July 29, 2008

**TRADEMARK
PRINCIPAL REGISTER**

Kharma Noir

VITAS, CHRISTOPHER A. (UNITED STATES INDIVIDUAL), DBA KELTIK KHARMA MUSIC
2146 FORT STOCKTON DRIVE
SAN DIEGO, CA 921031500

FIRST USE 11-27-2007; IN COMMERCE 11-27-2007.

FOR: MUSICAL VIDEO RECORDINGS; AUDIO RECORDINGS FEATURING MUSIC; MUSICAL SOUND RECORDINGS; SOUND RECORDINGS FEATURING MUSIC; VIDEO RECORDINGS FEATURING MUSIC; DOWNLOADABLE MUSICAL SOUND RECORDINGS; AUDIO AND VIDEO RECORDINGS FEATURING MUSIC, IN CLASS 9 (U.S. CLS. 21, 23, 26, 36 AND 38).

THE MARK CONSISTS OF STANDARD CHARACTERS WITHOUT CLAIM TO ANY PARTICULAR FONT, STYLE, SIZE, OR COLOR.

SER. NO. 77-346,933, FILED 12-7-2007.

CHERYL CLAYTON, EXAMINING ATTORNEY

Int. Cl.: 36

Prior U.S. Cls.: 100, 101 and 102

United States Patent and Trademark Office

Reg. No. 3,475,651

Registered July 29, 2008

**SERVICE MARK
PRINCIPAL REGISTER**



GERMANIA INSURANCE (TEXAS CORPORATION)
P.O. BOX 645
BRENHAM, TX 77834

FOR: INSURANCE SERVICES, NAMELY, WRITING PROPERTY AND CASUALTY INSURANCE, IN CLASS 36 (U.S. CLS. 100, 101 AND 102).

FIRST USE 12-9-2005; IN COMMERCE 12-9-2005.

NO CLAIM IS MADE TO THE EXCLUSIVE RIGHT TO USE "INSURANCE" AND THE REPRESENTATION OF TEXAS, APART FROM THE MARK AS SHOWN.

SENTATION OF TEXAS, APART FROM THE MARK AS SHOWN.

THE MARK CONSISTS OF AN IMAGE OF THE STATE OF TEXAS WITH A SUPERIMPOSED IMAGE OF A HANDSHAKE, ACCOMPANIED AT THE RIGHT BY THE WORDS "GERMANIA INSURANCE".

SER. NO. 77-346,961, FILED 12-7-2007.

ANGELA GAW, EXAMINING ATTORNEY

Int. Cl.: 9

Prior U.S. Cls.: 21, 23, 26, 36 and 38

Reg. No. 3,475,652

United States Patent and Trademark Office

Registered July 29, 2008

**TRADEMARK
PRINCIPAL REGISTER**

ProMeter

FERTILE EARTH CORPORTATION (NEVADA
CORPORATION)
9384 SOUTH 670 WEST
SANDY, UT 84070

THE MARK CONSISTS OF STANDARD CHAR-
ACTERS WITHOUT CLAIM TO ANY PARTICULAR
FONT, STYLE, SIZE, OR COLOR.

FOR: ELECTRICAL CONTROLS FOR IRRIGA-
TION SPRINKLER SYSTEMS, IN CLASS 9 (U.S. CLS.
21, 23, 26, 36 AND 38).

SER. NO. 77-347,000, FILED 12-7-2007.

FIRST USE 8-1-2007; IN COMMERCE 8-1-2007.

THOMAS MANOR, EXAMINING ATTORNEY

Int. Cl.: 5

Prior U.S. Cls.: 6, 18, 44, 46, 51 and 52

United States Patent and Trademark Office

Reg. No. 3,475,653

Registered July 29, 2008

**TRADEMARK
PRINCIPAL REGISTER**

NatureShield

FERTILE EARTH CORPORATION (NEVADA
CORPORATION)
9384 SOUTH 670 WEST
SANDY, UT 84070

THE MARK CONSISTS OF STANDARD CHAR-
ACTERS WITHOUT CLAIM TO ANY PARTICULAR
FONT, STYLE, SIZE, OR COLOR.

FOR: DOMESTIC PESTICIDES, IN CLASS 5 (U.S.
CLS. 6, 18, 44, 46, 51 AND 52).

SER. NO. 77-347,092, FILED 12-7-2007.

FIRST USE 10-1-2007; IN COMMERCE 10-1-2007.

THOMAS MANOR, EXAMINING ATTORNEY

Int. Cl.: 36

Prior U.S. Cls.: 100, 101 and 102

United States Patent and Trademark Office

Reg. No. 3,475,654

Registered July 29, 2008

**SERVICE MARK
PRINCIPAL REGISTER**

SPECIE CAPITAL

SPECIE CAPITAL, LLC (IOWA LTD LIAB CO)
5870 MERLE HAY ROAD, P.O. #72
JOHNSTON, IA 50131

FOR: FINANCIAL SERVICES, NAMELY, EQUIP-
MENT LEASE FINANCING, IN CLASS 36 (U.S. CLS.
100, 101 AND 102).

FIRST USE 6-22-2006; IN COMMERCE 10-3-2006.

THE MARK CONSISTS OF STANDARD CHAR-
ACTERS WITHOUT CLAIM TO ANY PARTICULAR
FONT, STYLE, SIZE, OR COLOR.

NO CLAIM IS MADE TO THE EXCLUSIVE
RIGHT TO USE "CAPITAL", APART FROM THE
MARK AS SHOWN.

SER. NO. 77-347,113, FILED 12-7-2007.

ANDREA SAUNDERS, EXAMINING ATTORNEY

Int. Cl.: 42

Prior U.S. Cls.: 100 and 101

United States Patent and Trademark Office

Reg. No. 3,475,655

Registered July 29, 2008

**SERVICE MARK
PRINCIPAL REGISTER**

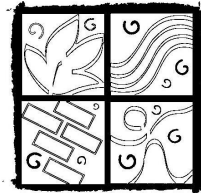

OUTSIDE
PRODUCTIONS, INC.
A LANDSCAPE
ARCHITECTURAL
DESIGN STUDIO

OUTSIDE PRODUCTIONS, INC. (FLORIDA COR-
PORATION)
SUITE 102
25241 ELEMENTARY WAY
BONITA SPRINGS, FL 34135

NO CLAIM IS MADE TO THE EXCLUSIVE
RIGHT TO USE "INC." AND "A LANDSCAPE
ARCHITECTURAL DESIGN STUDIO", APART
FROM THE MARK AS SHOWN.

FOR: LANDSCAPE ARCHITECTURAL DESIGN,
IN CLASS 42 (U.S. CLS. 100 AND 101).

SER. NO. 77-347,116, FILED 12-7-2007.

FIRST USE 5-0-2000; IN COMMERCE 5-0-2000.

APRIL ROACH, EXAMINING ATTORNEY

Int. Cl.: 36

Prior U.S. Cls.: 100, 101 and 102

United States Patent and Trademark Office

Reg. No. 3,475,656

Registered July 29, 2008

**SERVICE MARK
PRINCIPAL REGISTER**



SPECIE CAPITAL, LLC (IOWA LTD LIAB CO)
5870 MERLE HAY ROAD, P.O. #72
JOHNSTON, IA 50131

FOR: FINANCIAL SERVICES, NAMELY, EQUIP-
MENT LEASE FINANCING, IN CLASS 36 (U.S. CLS.
100, 101 AND 102).

FIRST USE 6-22-2006; IN COMMERCE 10-3-2006.

NO CLAIM IS MADE TO THE EXCLUSIVE
RIGHT TO USE "CAPITAL", APART FROM THE
MARK AS SHOWN.

THE COLOR(S) GOLD, BLUE AND WHITE IS/
ARE CLAIMED AS A FEATURE OF THE MARK.

THE COLOR GOLD APPEARS IN THE ISO-
SCELES TRAPEZOID, THE COLOR WHITE AP-
PEARS ON THE WORD "SPECIE" IN CAPITAL
LETTERS INSIDE THE TRAPEZOID, AND THE
COLOR BLUE APPEARS ON THE WORD "CAPI-
TAL" IN CAPITAL LETTERS BELOW THE TRAPE-
ZOID.

SER. NO. 77-347,118, FILED 12-7-2007.

ANDREA SAUNDERS, EXAMINING ATTORNEY

Int. Cl.: 28

Prior U.S. Cls.: 22, 23, 38 and 50

Reg. No. 3,475,657

United States Patent and Trademark Office

Registered July 29, 2008

**TRADEMARK
PRINCIPAL REGISTER**

LITTLE KUNG FU FIGHTER

LITTLE KUNG FU FIGHTERS (CALIFORNIA CORPORATION), DBA JIL INTERNATIONAL, INC.

7411 RAINBOW DR., SUITE 14
CUPERTINO, CA 95014

THE MARK CONSISTS OF STANDARD CHARACTERS WITHOUT CLAIM TO ANY PARTICULAR FONT, STYLE, SIZE, OR COLOR.

FOR: PLASTIC TOY CHARACTERS WITH BATTERY OPERATED ANIMATION MECHANISMS, IN CLASS 28 (U.S. CLS. 22, 23, 38 AND 50).

SER. NO. 77-347,162, FILED 12-7-2007.

FIRST USE 6-15-2007; IN COMMERCE 8-19-2007.

TOBY BULLOFF, EXAMINING ATTORNEY

Int. Cl.: 41

Prior U.S. Cls.: 100, 101 and 107

United States Patent and Trademark Office

Reg. No. 3,475,658

Registered July 29, 2008

**SERVICE MARK
PRINCIPAL REGISTER**

Anew Educational Services

ANEW EDUCATIONAL SERVICES, LLC (OHIO
LTD LIAB CO)
10910 PASADENA AVE
CLEVELAND, OH 44108

FOR: EDUCATIONAL SERVICES, NAMELY, THE
OFFERING OF WEB BASED AND CLASSROOM
TRAINING FOR CERTIFICATION OF TEACHERS
AND CONTINUING EDUCATION FOR TEACHERS
AND PRINCIPALS , IN CLASS 41 (U.S. CLS. 100, 101
AND 107).

FIRST USE 7-20-2007; IN COMMERCE 7-20-2007.

THE MARK CONSISTS OF STANDARD CHAR-
ACTERS WITHOUT CLAIM TO ANY PARTICULAR
FONT, STYLE, SIZE, OR COLOR.

NO CLAIM IS MADE TO THE EXCLUSIVE
RIGHT TO USE "EDUCATIONAL SERVICES",
APART FROM THE MARK AS SHOWN.

SER. NO. 77-347,168, FILED 12-7-2007.

MICHAEL WIENER, EXAMINING ATTORNEY

Int. Cl.: 7

Prior U.S. Cls.: 13, 19, 21, 23, 31, 34 and 35

United States Patent and Trademark Office

Reg. No. 3,475,659

Registered July 29, 2008

**TRADEMARK
PRINCIPAL REGISTER**

Multiport Drive Shower

SIMREK CORP. (NEW YORK CORPORATION)
137 PACER DRIVE
HENRIETTA, NY 14467

FOR: EXTERNAL, STERN DRIVE COOLING SYSTEM FOR BOATS COMPRISED OF TUBULAR PICK-UP AND DUMP PORTS FOR MARINE USE, IN CLASS 7 (U.S. CLS. 13, 19, 21, 23, 31, 34 AND 35).

FIRST USE 3-0-1997; IN COMMERCE 3-0-1997.

THE MARK CONSISTS OF STANDARD CHARACTERS WITHOUT CLAIM TO ANY PARTICULAR FONT, STYLE, SIZE, OR COLOR.

NO CLAIM IS MADE TO THE EXCLUSIVE RIGHT TO USE "DRIVE SHOWER", APART FROM THE MARK AS SHOWN.

SEC. 2(F).

SER. NO. 77-347,193, FILED 12-7-2007.

REBECCA GILBERT, EXAMINING ATTORNEY

Int. Cl.: 41

Prior U.S. Cls.: 100, 101 and 107

United States Patent and Trademark Office

Reg. No. 3,475,660

Registered July 29, 2008

**SERVICE MARK
PRINCIPAL REGISTER**



ALTER, PETER (UNITED STATES INDIVIDUAL)
1 KGB BETHANY
SAINT JOHN, US VIRGIN ISLANDS 00831

FOR: ENTERTAINMENT IN THE NATURE OF
RUNNING RACES, IN CLASS 41 (U.S. CLS. 100, 101
AND 107).

FIRST USE 2-1-1997; IN COMMERCE 2-22-1997.

NO CLAIM IS MADE TO THE EXCLUSIVE
RIGHT TO USE "8", "MILES" AND THE MAP OF

THE ISLAND OF SAINT JOHN U.S. VIRGIN IS-
LANDS, APART FROM THE MARK AS SHOWN.

THE MARK CONSISTS OF AN OUTLINE OF THE
ISLAND OF SAINT JOHN US VIRGIN ISLANDS
SHOWING ROUTE 10 AS A ROAD. THERE ARE
THREE STICK FIGURES RUNNING FROM LEFT
TO RIGHT ACROSS THE ISLAND.

SER. NO. 77-347,293, FILED 12-7-2007.

MARILYN IZZI, EXAMINING ATTORNEY

Int. Cl.: 7

Prior U.S. Cls.: 13, 19, 21, 23, 31, 34 and 35

United States Patent and Trademark Office

Reg. No. 3,475,661

Registered July 29, 2008

**TRADEMARK
PRINCIPAL REGISTER**

Halo

SIMREK CORP. (NEW YORK CORPORATION)
137 PACER DRIVE
HENRIETTA, NY 14467

THE MARK CONSISTS OF STANDARD CHARACTERS WITHOUT CLAIM TO ANY PARTICULAR FONT, STYLE, SIZE, OR COLOR.

FOR: EXTERNAL, STERN DRIVE COOLING SYSTEM FOR BOATS COMPRISED OF TUBULAR PICK-UP AND DUMP PORTS FOR MARINE USE, IN CLASS 7 (U.S. CLS. 13, 19, 21, 23, 31, 34 AND 35).

SER. NO. 77-347,350, FILED 12-8-2007.

FIRST USE 0-0-2000; IN COMMERCE 0-0-2000.

REBECCA GILBERT, EXAMINING ATTORNEY

Int. Cl.: 9

Prior U.S. Cls.: 21, 23, 26, 36 and 38

Reg. No. 3,475,662

United States Patent and Trademark Office

Registered July 29, 2008

**TRADEMARK
PRINCIPAL REGISTER**

USAmplate

USAMP PRODUCTS LLC (NEW HAMPSHIRE
LTD LIAB CO)
100 GLENGARRY DRIVE
STRATHAM, NH 03855

THE MARK CONSISTS OF STANDARD CHAR-
ACTERS WITHOUT CLAIM TO ANY PARTICULAR
FONT, STYLE, SIZE, OR COLOR.

FOR: GUITAR AMPLIFIER ACCESSORY, NAME-
LY, A FITTED FACE PLATE TO AFFIX TO AN
AMPLIFIER FOR USE WITH ELECTRIC GUITARS,
IN CLASS 9 (U.S. CLS. 21, 23, 26, 36 AND 38).

SER. NO. 77-347,374, FILED 12-8-2007.

FIRST USE 11-1-2001; IN COMMERCE 11-1-2007.

JAY FLOWERS, EXAMINING ATTORNEY

Int. Cls.: 29 and 30

Prior U.S. Cl.: 46

United States Patent and Trademark Office

Reg. No. 3,475,663

Registered July 29, 2008

TRADEMARK
PRINCIPAL REGISTER

GREAT EASTERN SUN

GREAT EASTERN SUN TRADING CO., INC.
(NORTH CAROLINA CORPORATION)
92 MCINSTOSH ROAD
ASHEVILLE, NC 28802

FOR: SALAD OIL; SESAME OIL; EDIBLE OILS;
PICKLED VEGETABLES; DRIED VEGETABLES;
PROCESSED VEGETABLES; VEGETABLE OILS;
DRIED EDIBLE SEAWEED (HOSHI-WAKAME);
DRIED FLAKES OF LAVER FOR SPRINKLING
ON RICE IN HOT WATER (OCHAZUKE-NORI);
SHEETS OF DRIED LAVER (HOSHI-NORI); IN-
STANT OR PRE-COOKED MISO SOUP; SOUPS;
PROCESSED MUSHROOMS; VEGETABLE PASTE,
IN CLASS 29 (U.S. CL. 46).

FIRST USE 5-0-1984; IN COMMERCE 5-0-1984.

FOR: INSTANT NOODLES; INSTANT SOBA NOO-
DLES; INSTANT UDON NOODLES; NOODLES;
NOODLES AND SAUCE MIXES COMBINED IN

UNITARY PACKAGES; NOODLES AND SEASON-
ING MIXES COMBINED IN UNITARY PACKAGES;
RICE NOODLES; VINEGAR; GREEN TEA; HERB
TEA; JAPANESE GREEN TEA; TEA; BLACK TEA;
FRUIT TEAS; SAUCES; SOY SAUCE; CANDY; SU-
GAR; TABLE SYRUP; MALT EXTRACTS FOR
FOOD; SWEET POUNDED RICE CAKES (MOCHI-
GASHI); SALAD DRESSING; SALT; PRESERVED
GINGER; MISO BEAN PASTE; CRACKERS, IN
CLASS 30 (U.S. CL. 46).

FIRST USE 5-0-1984; IN COMMERCE 5-0-1984.

THE MARK CONSISTS OF STANDARD CHAR-
ACTERS WITHOUT CLAIM TO ANY PARTICULAR
FONT, STYLE, SIZE, OR COLOR.

SER. NO. 77-347,406, FILED 12-8-2007.

LINDA MICKLEBURGH, EXAMINING ATTORNEY

Int. Cl.: 16

Prior U.S. Cls.: 2, 5, 22, 23, 29, 37, 38 and 50

United States Patent and Trademark Office

Reg. No. 3,475,664

Registered July 29, 2008

**TRADEMARK
PRINCIPAL REGISTER**

Cap Trapper

REBECCA DAVIDSON (UNITED STATES INDIVIDUAL)
250 N. 890 E
OREM, UT 84097

FOR: DESK STANDS AND HOLDERS FOR PENS, PENCILS, AND INK; PEN AND PENCIL CASES; PEN AND PENCIL CASES AND BOXES; PEN AND PENCIL HOLDERS; PEN CASES, IN CLASS 16 (U.S. CLS. 2, 5, 22, 23, 29, 37, 38 AND 50).

FIRST USE 12-1-2007; IN COMMERCE 12-1-2007.

THE MARK CONSISTS OF STANDARD CHARACTERS WITHOUT CLAIM TO ANY PARTICULAR FONT, STYLE, SIZE, OR COLOR.

SER. NO. 77-347,419, FILED 12-8-2007.

GEOFFREY FOSDICK, EXAMINING ATTORNEY

Int. Cl.: 45

Prior U.S. Cls.: 100 and 101

United States Patent and Trademark Office

Reg. No. 3,475,665

Registered July 29, 2008

**SERVICE MARK
PRINCIPAL REGISTER**



BRANDON VAN SCHAIK (UNITED STATES IN-
DIVIDUAL), DBA ONEGEN
5389 UNIVERSITY DR
SANTA BARBARA, CA 93111

FOR: PROVIDING ON-LINE INFORMATION IN
THE FIELD OF SPIRITUALITY, SELF-HELP, AND
PERSONAL EMPOWERMENT SUBJECT MATTERS,
IN CLASS 45 (U.S. CLS. 100 AND 101).

FIRST USE 7-11-2007; IN COMMERCE 12-7-2007.

THE COLOR(S) BLUE, GREY/SILVER, BLACK IS/
ARE CLAIMED AS A FEATURE OF THE MARK.

THE MARK CONSISTS OF "ONE" (MEDIUM
BLUE) "GEN" (LIGHT BLUE), ALSO SILVER-
BLACK COLORED PERSON WITH "EMPOWERED"
ARMS RAISED TO THE SKY.."

SER. NO. 77-347,437, FILED 12-8-2007.

PAM WILLIS, EXAMINING ATTORNEY

Int. Cl.: 9

Prior U.S. Cls.: 21, 23, 26, 36 and 38

United States Patent and Trademark Office

Reg. No. 3,475,666

Registered July 29, 2008

**TRADEMARK
PRINCIPAL REGISTER**



JAMES G. SKAFISH (INDIANA SOLE PROPRIETORSHIP)
4141 INDIANAPOLIS BLVD.
EAST CHICAGO, IN 46312

FOR: DIGITAL MATERIALS, NAMELY, CDS, DVDS AND DIGITAL DOWNLOADS FEATURING MUSICAL PERFORMANCES, IN CLASS 9 (U.S. CLS. 21, 23, 26, 36 AND 38).

FIRST USE 5-15-2006; IN COMMERCE 5-15-2006.

NO CLAIM IS MADE TO THE EXCLUSIVE RIGHT TO USE "RECORDS", APART FROM THE MARK AS SHOWN.

THE COLOR(S) MAROON, BLUE, ORANGE, LIGHT BROWN, GRAY IS/ARE CLAIMED AS A FEATURE OF THE MARK.

THE MARK CONSISTS OF IMAGE OF A WITCH WEARING ORANGE/MAROON CLOAK, BLUE NECK SCARF AND GRAY BOOTS AND HEAD SCARF, HOLDING A LIGHT BROWN SACK, RIDING A BROOMSTICK, WITH THE WORDS "LA BEFANA RECORDS" UNDERNEATH THE IMAGE.

THE FOREIGN WORDING IN THE MARK TRANSLATES INTO ENGLISH AS MYTHICAL ITALIAN CHRISTMAS WITCH.

SER. NO. 77-347,442, FILED 12-8-2007.

PAM WILLIS, EXAMINING ATTORNEY

Int. Cl.: 41

Prior U.S. Cls.: 100, 101 and 107

United States Patent and Trademark Office

Reg. No. 3,475,667

Registered July 29, 2008

**SERVICE MARK
PRINCIPAL REGISTER**

HYPE MACHINE

THE HYPE MACHINE INC (DELAWARE CORPORATION)
2165 BRIGHAM STREET #3F
BROOKLYN, NY 11229

FOR: PROVIDING A WEBSITE FEATURING THE AGGREGATION OF MUSIC FROM VARIOUS WEBSITES ACROSS THE INTERNET AND OTHER RELATED SUBJECT MATTER IN THE NATURE OF MUSIC REVIEWS AND MUSIC NEWS AND INFORMATION, IN CLASS 41 (U.S. CLS. 100, 101 AND 107).

FIRST USE 4-25-2005; IN COMMERCE 4-25-2005.

THE MARK CONSISTS OF STANDARD CHARACTERS WITHOUT CLAIM TO ANY PARTICULAR FONT, STYLE, SIZE, OR COLOR.

SER. NO. 77-347,522, FILED 12-9-2007.

EMILY CARLSEN, EXAMINING ATTORNEY

Int. Cl.: 9

Prior U.S. Cls.: 21, 23, 26, 36 and 38

Reg. No. 3,475,668

United States Patent and Trademark Office

Registered July 29, 2008

**TRADEMARK
PRINCIPAL REGISTER**

AIS WatchMate

VESPER MARINE LIMITED (NEW ZEALAND
CORPORATION)
PO BOX 91164 AMSC
AUCKLAND, NEW ZEALAND 1142

FOR: ELECTRONIC DISPLAY APPARATUS FOR
VESSEL COLLISION AVOIDANCE UTILIZING UNI-
VERSAL SHIPBORNE AUTOMATIC IDENTIFICA-
TION SYSTEM (AIS), IN CLASS 9 (U.S. CLS. 21, 23, 26,
36 AND 38).

FIRST USE 2-27-2008; IN COMMERCE 2-27-2008.

THE MARK CONSISTS OF STANDARD CHAR-
ACTERS WITHOUT CLAIM TO ANY PARTICULAR
FONT, STYLE, SIZE, OR COLOR.

NO CLAIM IS MADE TO THE EXCLUSIVE
RIGHT TO USE "AIS", APART FROM THE MARK
AS SHOWN.

SER. NO. 77-347,530, FILED 12-9-2007.

EMILY CARLSEN, EXAMINING ATTORNEY

Int. Cl.: 16

Prior U.S. Cls.: 2, 5, 22, 23, 29, 37, 38 and 50

Reg. No. 3,475,669

United States Patent and Trademark Office

Registered July 29, 2008

**TRADEMARK
PRINCIPAL REGISTER**

Braking News

DURABRAKE CO., LLC (CALIFORNIA LTD
LIAB CO)

PO BOX 1480

LOS ALTOS, CA 94023

FOR: NEWS BULLETINS, IN CLASS 16 (U.S. CLS.
2, 5, 22, 23, 29, 37, 38 AND 50).

FIRST USE 12-1-2001; IN COMMERCE 12-1-2001.

THE MARK CONSISTS OF STANDARD CHAR-
ACTERS WITHOUT CLAIM TO ANY PARTICULAR
FONT, STYLE, SIZE, OR COLOR.

NO CLAIM IS MADE TO THE EXCLUSIVE
RIGHT TO USE "NEWS", APART FROM THE
MARK AS SHOWN.

SER. NO. 77-347,546, FILED 12-9-2007.

GEOFFREY FOSDICK, EXAMINING ATTORNEY

Int. Cl.: 41

Prior U.S. Cls.: 100, 101 and 107

United States Patent and Trademark Office

Reg. No. 3,475,670

Registered July 29, 2008

**SERVICE MARK
PRINCIPAL REGISTER**

LIL' SPEEDIE

CLARK, TIMOTHY ALLEN (UNITED STATES
INDIVIDUAL)
104 PONCA DRIVE
MAUMELLE, AR 72113

FOR: ENTERTAINMENT SERVICES IN THE
NATURE OF LIVE MUSICAL, DANCE AND ACT-
ING PERFORMANCES; ENTERTAINMENT SERVI-
CES, NAMELY, PROVIDING A WEB SITE
FEATURING MUSICAL PERFORMANCES, MUSI-
CAL VIDEOS, RELATED FILM CLIPS, PHOTO-
GRAPHS, AND OTHER MULTIMEDIA

MATERIALS, IN CLASS 41 (U.S. CLS. 100, 101 AND
107).

FIRST USE 1-1-2002; IN COMMERCE 1-1-2005.

THE MARK CONSISTS OF STANDARD CHAR-
ACTERS WITHOUT CLAIM TO ANY PARTICULAR
FONT, STYLE, SIZE, OR COLOR.

SER. NO. 77-347,594, FILED 12-9-2007.

SKYE YOUNG, EXAMINING ATTORNEY

Int. Cl.: 31

Prior U.S. Cls.: 1 and 46

United States Patent and Trademark Office

Reg. No. 3,475,671

Registered July 29, 2008

**TRADEMARK
PRINCIPAL REGISTER**

BLUE SKY FARMS

BLUE SKY ORGANIC FARMS, INC. (ARIZONA
CORPORATION)
4762 NORTH 189TH AVENUE
LITCHFIELD PARK, AZ 85340

FOR: FRESH LETTUCES AND BABY VEGETA-
BLES, IN CLASS 31 (U.S. CLS. 1 AND 46).

FIRST USE 12-1-1994; IN COMMERCE 12-1-1994.

THE MARK CONSISTS OF STANDARD CHAR-
ACTERS WITHOUT CLAIM TO ANY PARTICULAR
FONT, STYLE, SIZE, OR COLOR.

NO CLAIM IS MADE TO THE EXCLUSIVE
RIGHT TO USE "FARMS", APART FROM THE
MARK AS SHOWN.

SER. NO. 77-347,680, FILED 12-10-2007.

SAMUEL E. SHARPER JR., EXAMINING ATTOR-
NEY

Int. Cl.: 39

Prior U.S. Cls.: 100 and 105

United States Patent and Trademark Office

Reg. No. 3,475,672

Registered July 29, 2008

**SERVICE MARK
PRINCIPAL REGISTER**

QUICK N EASY MOVING

PETERSON, ROBERT (UNITED STATES INDIVIDUAL)

6505 WEST PARK BLVD SUITE 306 PMB 377

PLANO, TX 75093

FOR: FURNITURE MOVING; MOVING VAN SERVICES, IN CLASS 39 (U.S. CLS. 100 AND 105).

FIRST USE 11-30-2007; IN COMMERCE 11-30-2007.

THE MARK CONSISTS OF STANDARD CHARACTERS WITHOUT CLAIM TO ANY PARTICULAR FONT, STYLE, SIZE, OR COLOR.

NO CLAIM IS MADE TO THE EXCLUSIVE RIGHT TO USE "MOVING", APART FROM THE MARK AS SHOWN.

SER. NO. 77-347,724, FILED 12-10-2007.

ESTHER A. BORSUK, EXAMINING ATTORNEY

Int. Cl.: 36

Prior U.S. Cls.: 100, 101 and 102

United States Patent and Trademark Office

Reg. No. 3,475,673

Registered July 29, 2008

SERVICE MARK
PRINCIPAL REGISTER



WISLAR WEALTH MANAGEMENT (NEW JERSEY LTD LIAB CO)
344 NASSAU STREET
PRINCETON, NJ 08540

FOR: FINANCIAL PLANNING, FINANCIAL MANAGEMENT AND FINANCIAL CONSULTATION SERVICES, IN CLASS 36 (U.S. CLS. 100, 101 AND 102).

FIRST USE 6-20-2007; IN COMMERCE 6-20-2007.

NO CLAIM IS MADE TO THE EXCLUSIVE RIGHT TO USE "WEALTH MANAGEMENT,

L.L.C." AND "OPTIMUM WEALTH & LIFE STRATEGIES", APART FROM THE MARK AS SHOWN.

THE MARK CONSISTS OF STYLIZED TEXT "W WISLAR WEALTH MANAGEMENT, LLC OPTIMUM WEALTH & LIFE STRATEGIES" WITH THE TEXT "W" IN A CIRCLE.

SER. NO. 77-347,907, FILED 12-10-2007.

MARGERY A. TIERNEY, EXAMINING ATTORNEY

Int. Cl.: 37

Prior U.S. Cls.: 100, 103 and 106

United States Patent and Trademark Office

Reg. No. 3,475,674

Registered July 29, 2008

**SERVICE MARK
PRINCIPAL REGISTER**

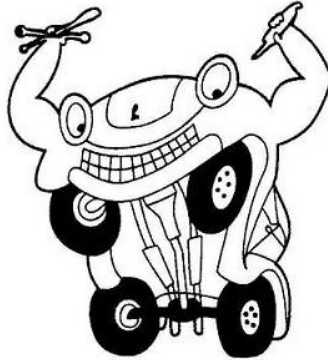

MIGHTY ASSOCIATES INC. (OHIO CORPORATION)
290 SOUTH PROSPECT STREET
MEDINA, OH 44256

FOR: AUTOMOBILE AND TRUCK REPAIR AND
MAINTENANCE, IN CLASS 37 (U.S. CLS. 100, 103
AND 106).

FIRST USE 4-30-1989; IN COMMERCE 6-30-1990.

THE MARK CONSISTS OF THE PERSONIFICATION
OF A CAR ON ITS REAR TIRES WITH ARMS
WAIVING TOOLS.

SER. NO. 77-347,908, FILED 12-10-2007.

MARGERY A. TIERNEY, EXAMINING ATTORNEY

Int. Cl.: 35

Prior U.S. Cls.: 100, 101 and 102

United States Patent and Trademark Office

Reg. No. 3,475,675

Registered July 29, 2008

**SERVICE MARK
PRINCIPAL REGISTER**

onwithyourshow

ON WITH YOUR SHOW, LLC (NEW YORK LTD
LIAB CO)

2 DUSENBERRY ROAD
BRONXVILLE, NY 10708

FOR: PROVIDING CONSUMER INFORMATION
SERVICES AND MAKING REFERRALS IN THE
FIELD OF ENTERTAINMENT SERVICES FOR PRO-
DUCTS, SERVICES, EVENTS, ACTIVITIES, FACIL-
ITIES AND LOCATIONS, IN CLASS 35 (U.S. CLS. 100,
101 AND 102).

FIRST USE 9-1-2007; IN COMMERCE 9-1-2007.

THE COLOR(S) LIME, BLUE, TEAL, ORANGE IS/
ARE CLAIMED AS A FEATURE OF THE MARK.

THE MARK CONSISTS OF THE WORD "ON" IS
LIME GREEN, THE WORD "WITH" IS BLUE, THE
WORD "YOUR" IS TEAL GREEN, THE WORD
"SHOW" IS BLUE, THE THREE STARS ABOVE
THE WORD "SHOW" ARE ORANGE, THE LETTER
O IN "SHOW" IS FILLED LIME GREEN.

SER. NO. 77-347,915, FILED 12-10-2007.

MARGERY A. TIERNEY, EXAMINING ATTORNEY

Int. Cl.: 1

Prior U.S. Cls.: 1, 5, 6, 10, 26 and 46

United States Patent and Trademark Office

Reg. No. 3,475,676

Registered July 29, 2008

**TRADEMARK
PRINCIPAL REGISTER**

Sun Caps

MITCHNICK, MARK A. (UNITED STATES INDIVIDUAL), DBA PARTICLE SCIENCES
3894 COURTNEY STREET, SUITE 180
BETHLEHEM, PA 18017

FOR: CHEMICALS FOR USE IN THE MANUFACTURE OF ENCAPSULATED COSMETICS, SUN BLOCKS, BODY LOTIONS, PLASTICS, PHARMACEUTICALS, ADHESIVES, AGRICULTURAL PRODUCTS SUCH AS PESTICIDES AND INSECT REPELLENTS, IN CLASS 1 (U.S. CLS. 1, 5, 6, 10, 26 AND 46).

FIRST USE 1-1-1996; IN COMMERCE 1-1-1996.

THE MARK CONSISTS OF STANDARD CHARACTERS WITHOUT CLAIM TO ANY PARTICULAR FONT, STYLE, SIZE, OR COLOR.

NO CLAIM IS MADE TO THE EXCLUSIVE RIGHT TO USE "SUN", APART FROM THE MARK AS SHOWN.

SER. NO. 77-347,916, FILED 12-10-2007.

LEIGH LOWRY, EXAMINING ATTORNEY

Int. Cl.: 43

Prior U.S. Cls.: 100 and 101

United States Patent and Trademark Office

Reg. No. 3,475,677

Registered July 29, 2008

**SERVICE MARK
PRINCIPAL REGISTER**



ROUNDZ (MARYLAND LTD LIAB CO)
1009 SHIRE CT
CROFTON, MD 21114

FOR: CATERING, IN CLASS 43 (U.S. CLS. 100
AND 101).

FIRST USE 7-5-2004; IN COMMERCE 9-5-2004.

THE MARK CONSISTS OF A STYLIZED 'O' WITH
AN OVERLAY OF A 'Z' IN THE LOWER RIGHT
CORNER OF THE 'O'. THIS IS AN ATTEMPT TO
CREATE THE VISUAL WORD ROUNDS. AFTER
THE STYLIZED 'O' AND 'Z' THE WORD ROUNDS
APPEARS.

SER. NO. 77-347,926, FILED 12-10-2007.

SKYE YOUNG, EXAMINING ATTORNEY

Int. Cl.: 36

Prior U.S. Cls.: 100, 101 and 102

United States Patent and Trademark Office

Reg. No. 3,475,678

Registered July 29, 2008

**SERVICE MARK
PRINCIPAL REGISTER**

ROOF ADVISORY GROUP, INC.

ROOF ADVISORY GROUP, INC. (PENNSYLVANIA CORPORATION)

507 NORTH FRONT STREET

HARRISBURG, PA 17101

FOR: FINANCIAL PLANNING AND INVESTMENT ADVISORY SERVICES, IN CLASS 36 (U.S. CLS. 100, 101 AND 102).

FIRST USE 1-20-1998; IN COMMERCE 1-20-1998.

THE MARK CONSISTS OF STANDARD CHARACTERS WITHOUT CLAIM TO ANY PARTICULAR FONT, STYLE, SIZE, OR COLOR.

NO CLAIM IS MADE TO THE EXCLUSIVE RIGHT TO USE "ADVISORY GROUP, INC.", APART FROM THE MARK AS SHOWN.

SER. NO. 77-347,938, FILED 12-10-2007.

JOHN SCHUYLER YARD, EXAMINING ATTORNEY

Int. Cl.: 20

Prior U.S. Cls.: 2, 13, 22, 25, 32 and 50

United States Patent and Trademark Office

Reg. No. 3,475,679

Registered July 29, 2008

**TRADEMARK
PRINCIPAL REGISTER**

TORTUGA OUTDOOR

TRUE BLUE OVERSEAS, INC. (GEORGIA CORPORATION)

190 ETOWAH INDUSTRIAL COURT

CANTON, GA 30326

FOR: FURNITURE, IN CLASS 20 (U.S. CLS. 2, 13, 22, 25, 32 AND 50).

FIRST USE 3-15-2007; IN COMMERCE 3-15-2007.

THE MARK CONSISTS OF STANDARD CHARACTERS WITHOUT CLAIM TO ANY PARTICULAR FONT, STYLE, SIZE, OR COLOR.

NO CLAIM IS MADE TO THE EXCLUSIVE RIGHT TO USE "OUTDOOR", APART FROM THE MARK AS SHOWN.

SER. NO. 77-347,958, FILED 12-10-2007.

RAUL CORDOVA, EXAMINING ATTORNEY

Int. Cl.: 33

Prior U.S. Cls.: 47 and 49

United States Patent and Trademark Office

Reg. No. 3,475,680

Registered July 29, 2008

**TRADEMARK
PRINCIPAL REGISTER**

POSTO BELLO

WI, INC. (SOUTH CAROLINA CORPORATION)
SUITE 102, PMB #271
4279 ROSWELL ROAD
ATLANTA, GA 30342

THE MARK CONSISTS OF STANDARD CHARACTERS WITHOUT CLAIM TO ANY PARTICULAR FONT, STYLE, SIZE, OR COLOR.

THE FOREIGN WORDING IN THE MARK TRANSLATES INTO ENGLISH AS "BEAUTIFUL PLACE".

FOR: WINES, IN CLASS 33 (U.S. CLS. 47 AND 49).

SER. NO. 77-348,024, FILED 12-10-2007.

FIRST USE 10-5-2007; IN COMMERCE 10-5-2007.

CHARISMA HAMPTON, EXAMINING ATTORNEY

Int. Cl.: 33

Prior U.S. Cls.: 47 and 49

United States Patent and Trademark Office

Reg. No. 3,475,681

Registered July 29, 2008

**TRADEMARK
PRINCIPAL REGISTER**

LUNA NUDA

WI, INC. (SOUTH CAROLINA CORPORATION)
SUITE 102, PMB #271
4279 ROSWELL ROAD
ATLANTA, GA 30342

THE MARK CONSISTS OF STANDARD CHARACTERS WITHOUT CLAIM TO ANY PARTICULAR FONT, STYLE, SIZE, OR COLOR.

THE ENGLISH TRANSLATION OF THE SPANISH WORDING "LUNA NUDA" IN THE MARK IS "NAKED MOON".

FOR: WINES, IN CLASS 33 (U.S. CLS. 47 AND 49).

SER. NO. 77-348,053, FILED 12-10-2007.

FIRST USE 10-5-2007; IN COMMERCE 10-5-2007.

CHARISMA HAMPTON, EXAMINING ATTORNEY

Int. Cl.: 37

Prior U.S. Cls.: 100, 103 and 106

Reg. No. 3,475,682

United States Patent and Trademark Office

Registered July 29, 2008

**SERVICE MARK
PRINCIPAL REGISTER**



TRUTECH, INC. (GEORGIA CORPORATION)
1801 ROSWELL ROAD, NE
MARIETTA, GA 30062

FOR: PEST, WILDLIFE, ANIMAL AND BIRD
CONTROL SERVICES, IN CLASS 37 (U.S. CLS. 100,
103 AND 106).

FIRST USE 8-22-2007; IN COMMERCE 8-22-2007.

OWNER OF U.S. REG. NO. 3,023,338.

THE MARK CONSISTS OF THE WORDS "TRU
PEACE OF MIND GUARANTEE TRUTECH WILL
SOLVE THE PROBLEM WHATEVER IT TAKES!"
ENCLOSED IN A SHIELD.

SER. NO. 77-348,081, FILED 12-10-2007.

JENNIFER HETU, EXAMINING ATTORNEY

Int. Cl.: 35

Prior U.S. Cls.: 100, 101 and 102

United States Patent and Trademark Office

Reg. No. 3,475,683

Registered July 29, 2008

**SERVICE MARK
PRINCIPAL REGISTER**



DBPERFMAN, LLC (CALIFORNIA LTD LIAB
CO)
1271 AVENDIA LAS BRISAS
SAN JOSE, CA 95131

FOR: DATABASE MANAGEMENT, IN CLASS 35
(U.S. CLS. 100, 101 AND 102).

FIRST USE 9-1-2004; IN COMMERCE 9-1-2004.

NO CLAIM IS MADE TO THE EXCLUSIVE
RIGHT TO USE "DATABASE PERFORMANCE
MANAGEMENT CONSULTING", APART FROM
THE MARK AS SHOWN.

THE COLOR(S) DARK BLUE, BLACK IS/ARE
CLAIMED AS A FEATURE OF THE MARK.

THE MARK CONSISTS OF DARK BLUE PERSON
WITH A SEQUENCE OF DARK BLUE TRIANGLES
IN THE SHAPE OF AN ARCH ABOVE THE PERSON,
STYLIZED DARK BLUE LETTERS IN UPPER CASE
"DBP", DARK BLUE LOWER CASE LETTERS
"ERF", DARK BLUE UPPER CASE LETTER "M",
AND DARK BLUE LOWER CASE LETTERS "AN";
IN BLACK LETTERS "DATABASE PERFORMANCE
MANAGEMENT CONSULTING" ON ALL WHITE
BACKGROUND WITH DARK BLUE BORDER.

SER. NO. 77-348,111, FILED 12-10-2007.

KEVON CHISOLM, EXAMINING ATTORNEY

Int. Cl.: 14

Prior U.S. Cls.: 2, 27, 28 and 50

United States Patent and Trademark Office

Reg. No. 3,475,684

Registered July 29, 2008

**TRADEMARK
PRINCIPAL REGISTER**

PeaceDog

SIBLEY, ALENE HALVERSON (UNITED STATES
INDIVIDUAL)
P.O. BOX 1071
CENTERVILLE, MA 02632

THE MARK CONSISTS OF STANDARD CHAR-
ACTERS WITHOUT CLAIM TO ANY PARTICULAR
FONT, STYLE, SIZE, OR COLOR.

FOR: BRACELETS; CHARITY BRACELETS, IN
CLASS 14 (U.S. CLS. 2, 27, 28 AND 50).

SER. NO. 77-348,120, FILED 12-10-2007.

FIRST USE 11-20-2007; IN COMMERCE 11-20-2007.

JULIE WATSON, EXAMINING ATTORNEY

Int. Cl.: 39

Prior U.S. Cls.: 100 and 105

United States Patent and Trademark Office

Reg. No. 3,475,685

Registered July 29, 2008

**SERVICE MARK
PRINCIPAL REGISTER**

ACTION DELIVERY

ACTION DELIVERY, INC. (MISSOURI CORPORATION)
3612 GARRDNER
KANSAS CITY, MO 64120

FOR: DELIVERY OF GOODS AND DOCUMENTS
AND COURIER SERVICES, IN CLASS 39 (U.S. CLS.
100 AND 105).

FIRST USE 11-8-1983; IN COMMERCE 11-8-1983.

THE MARK CONSISTS OF STANDARD CHARACTERS WITHOUT CLAIM TO ANY PARTICULAR FONT, STYLE, SIZE, OR COLOR.

NO CLAIM IS MADE TO THE EXCLUSIVE RIGHT TO USE "DELIVERY", APART FROM THE MARK AS SHOWN.

SER. NO. 77-348,135, FILED 12-10-2007.

JILL C. ALT, EXAMINING ATTORNEY

Int. Cl.: 44

Prior U.S. Cls.: 100 and 101

United States Patent and Trademark Office

Reg. No. 3,475,686

Registered July 29, 2008

**SERVICE MARK
PRINCIPAL REGISTER**

**TRUST YOUR LEGS TO A
VASCULAR SURGEON**

HARBIN CLINIC, LLC (GEORGIA LTD LIAB CO)
1825 MARTHA BERRY BLVD NW
ROME, GA 30165

THE MARK CONSISTS OF STANDARD CHAR-
ACTERS WITHOUT CLAIM TO ANY PARTICULAR
FONT, STYLE, SIZE, OR COLOR.

FOR: MEDICAL SERVICES, IN CLASS 44 (U.S.
CLS. 100 AND 101).

SER. NO. 77-348,156, FILED 12-10-2007.

FIRST USE 2-0-2006; IN COMMERCE 2-0-2006.

ANNE MADDEN, EXAMINING ATTORNEY

Int. Cl.: 39

Prior U.S. Cls.: 100 and 105

United States Patent and Trademark Office

Reg. No. 3,475,687

Registered July 29, 2008

**SERVICE MARK
PRINCIPAL REGISTER**

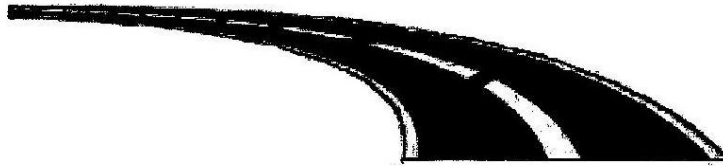

MEARS DESTINATION SERVICES, INC. (FLORIDA CORPORATION)
324 WEST GORE STREET
ORLANDO, FL 32806

FOR: PASSENGER GROUND TRANSPORTATION BY MOTOR COACHES, IN CLASS 39 (U.S. CLS. 100 AND 105).

FIRST USE 3-0-2007; IN COMMERCE 3-0-2007.

OWNER OF U.S. REG. NO. 3,125,411.

THE MARK CONSISTS OF A FANCIFUL DESIGN OF A LEFT-CURVED ROADWAY.

SEC. 2(F).

SER. NO. 77-348,267, FILED 12-10-2007.

PAUL CROWLEY, EXAMINING ATTORNEY

Int. Cl.: 39

Prior U.S. Cls.: 100 and 105

United States Patent and Trademark Office

Reg. No. 3,475,688

Registered July 29, 2008

**SERVICE MARK
PRINCIPAL REGISTER**



MEARS DESTINATION SERVICES, INC. (FLOR-
IDA CORPORATION)
324 WEST GORE STREET
ORLANDO, FL 32806

FOR: PASSENGER GROUND TRANSPORTA-
TION BY MOTOR COACHES, IN CLASS 39 (U.S.
CLS. 100 AND 105).

FIRST USE 3-0-2007; IN COMMERCE 3-0-2007.

OWNER OF U.S. REG. NO. 3,125,411.

THE MARK CONSISTS OF A FANCIFUL DESIGN
OF A RIGHT-CURVED ROADWAY.

SEC. 2(F).

SER. NO. 77-348,280, FILED 12-10-2007.

PAUL CROWLEY, EXAMINING ATTORNEY

Int. Cl.: 9

Prior U.S. Cls.: 21, 23, 26, 36 and 38

Reg. No. 3,475,689

United States Patent and Trademark Office

Registered July 29, 2008

**TRADEMARK
PRINCIPAL REGISTER**

SAFETMARK

SAFETSCRIBE LLC (TEXAS LTD LIAB CO)
6404 CUESTA TRAIL
AUSTIN, TX 78730

FIRST USE 9-21-2007; IN COMMERCE 10-1-2007.

FOR: A PRINTED SENSOR THAT CHANGES
COLOR TO VISUALLY INDICATE EXPOSURE TO
SELECTED ENVIRONMENTAL CONDITIONS,
SUCH AS TEMPERATURE, HUMIDITY, RADIA-
TION, IN CLASS 9 (U.S. CLS. 21, 23, 26, 36 AND 38).

THE MARK CONSISTS OF STANDARD CHAR-
ACTERS WITHOUT CLAIM TO ANY PARTICULAR
FONT, STYLE, SIZE, OR COLOR.

SER. NO. 77-348,362, FILED 12-10-2007.

ALLISON HOLTZ, EXAMINING ATTORNEY

Int. Cl.: 45

Prior U.S. Cls.: 100 and 101

United States Patent and Trademark Office

Reg. No. 3,475,690

Registered July 29, 2008

**SERVICE MARK
PRINCIPAL REGISTER**

WE SECURE AMERICA

WSA GROUP, INC. (CALIFORNIA CORPORATION)

10311 S. LA CIENEGA BOULEVARD

LOS ANGELES, CA 90045

FOR: SECURITY GUARD SERVICES, IN CLASS
45 (U.S. CLS. 100 AND 101).

FIRST USE 11-0-2007; IN COMMERCE 11-0-2007.

THE MARK CONSISTS OF STANDARD CHARACTERS WITHOUT CLAIM TO ANY PARTICULAR FONT, STYLE, SIZE, OR COLOR.

NO CLAIM IS MADE TO THE EXCLUSIVE RIGHT TO USE "AMERICA", APART FROM THE MARK AS SHOWN.

SER. NO. 77-348,365, FILED 12-10-2007.

SHAUNIA CARLYLE, EXAMINING ATTORNEY

Int. Cl.: 5

Prior U.S. Cls.: 6, 18, 44, 46, 51 and 52

Reg. No. 3,475,691

United States Patent and Trademark Office

Registered July 29, 2008

**TRADEMARK
PRINCIPAL REGISTER**

Bio-Kult

CAMBRIDGE BIOCEUTICALS LIMITED (UNI-
TED KINGDOM CORPORATION)
38, PADDOCK STREET
SOHAM, CAMBRIDGESHIRE, UNITED KINGDOM
CB75JB

FOR: FOOD BASED NUTRITIONAL PRODUCTS,
NAMELY, NUTRITIONAL SUPPLEMENTS IN TA-
BLET, CAPSULE, CAPLET, LIQUID, FOOD BAR,
AND POWDER FORM , IN CLASS 5 (U.S. CLS. 6, 18,
44, 46, 51 AND 52).

FIRST USE 1-20-2001; IN COMMERCE 1-20-2001.

THE MARK CONSISTS OF STANDARD CHAR-
ACTERS WITHOUT CLAIM TO ANY PARTICULAR
FONT, STYLE, SIZE, OR COLOR.

SER. NO. 77-348,370, FILED 12-10-2007.

WILLIAM VERHOSEK, EXAMINING ATTORNEY

Int. Cl.: 2

Prior U.S. Cls.: 6, 11 and 16

United States Patent and Trademark Office

Reg. No. 3,475,692

Registered July 29, 2008

**TRADEMARK
PRINCIPAL REGISTER**



CHOI, LAWRENCE HONGJOON (UNITED STATES INDIVIDUAL)
1543 W. OLYMPIC BLVD., SUITE P-1
LOS ANGELES, CA 90015

FOR: HOUSE PAINT; INTERIOR PAINT; PAINTS; PAINTS AND COATINGS, IN CLASS 2 (U.S. CLS. 6, 11 AND 16).

FIRST USE 3-1-2007; IN COMMERCE 4-1-2007.

THE COLOR(S) GREEN, ORANGE, BLUE, GREY AND WHITE IS/ARE CLAIMED AS A FEATURE OF THE MARK.

THE COLOR GREEN APPEARS IN THE LETTER "E" AND THE LEAF DESIGN; THE COLOR ORANGE APPEARS IN THE LETTER "C"; THE COLOR BLUE APPEARS IN THE LETTER "O"; THE COLOR GRAY APPEARS IN THE WORD "TREND" AND IN THE SHADOW BACKGROUND OF THE ENTIRE MARK; AND THE COLOR WHITE APPEARS IN THE OUTLINE OF THE WORD "TREND".

SER. NO. 77-348,440, FILED 12-10-2007.

ALEXANDER L. POWERS, EXAMINING ATTORNEY

Int. Cl.: 41

Prior U.S. Cls.: 100, 101 and 107

United States Patent and Trademark Office

Reg. No. 3,475,693

Registered July 29, 2008

SERVICE MARK
PRINCIPAL REGISTER



WEAPONS 9, LLC (NEW JERSEY LTD LIAB CO)
27 AMARYLLIS LANE
LUMBERTON, NJ 08048

FOR: INSTRUCTION IN THE FIELD OF MAR-
TIAL ARTS SPECIFICALLY MUAY THAI KICK-
BOXING, IN CLASS 41 (U.S. CLS. 100, 101 AND 107).

FIRST USE 8-1-2006; IN COMMERCE 9-0-2006.

NO CLAIM IS MADE TO THE EXCLUSIVE
RIGHT TO USE "MUAY THAI", APART FROM
THE MARK AS SHOWN.

THE ENGLISH TRANSLATION OF "MUAY
THAI" IS THAI BOXING.

SER. NO. 77-348,458, FILED 12-10-2007.

LINDSEY RUBIN, EXAMINING ATTORNEY

Int. Cl.: 35

Prior U.S. Cls.: 100, 101 and 102

United States Patent and Trademark Office

Reg. No. 3,475,694

Registered July 29, 2008

**SERVICE MARK
PRINCIPAL REGISTER**



REINHART FOODSERVICE, L.L.C. (DELAWARE
LTD LIAB CO)
1500 ST. JAMES STREET
LA CROSSE, WI 54602

FOR: DISTRIBUTORSHIP SERVICES IN THE
FIELD OF FOOD, FOOD SERVICE EQUIPMENT,
AND SUPPLIES FOR RESTAURANTS AND INSTI-
TUTIONAL FEEDING ESTABLISHMENTS, IN
CLASS 35 (U.S. CLS. 100, 101 AND 102).

FIRST USE 7-20-2005; IN COMMERCE 7-20-2005.

OWNER OF U.S. REG. NOS. 2,108,531, 2,823,379
AND OTHERS.

NO CLAIM IS MADE TO THE EXCLUSIVE
RIGHT TO USE "FOODSERVICE", APART FROM
THE MARK AS SHOWN.

SER. NO. 77-348,509, FILED 12-10-2007.

ANDREW RHIM, EXAMINING ATTORNEY

Int. Cl.: 41

Prior U.S. Cls.: 100, 101 and 107

United States Patent and Trademark Office

Reg. No. 3,475,695

Registered July 29, 2008

**SERVICE MARK
PRINCIPAL REGISTER**

**Mindfulness-Based Stress
Reduction**

KABAT-ZINN, JON (UNITED STATES INDIVIDUAL)
PO 547
LEXINGTON, MA 02421

FOR: EDUCATIONAL SERVICES, NAMELY, PROVIDING SEMINARS IN THE FIELDS OF STRESS REDUCTION TECHNIQUES, IN CLASS 41 (U.S. CLS. 100, 101 AND 107).

FIRST USE 12-31-1995; IN COMMERCE 12-31-1995.

THE MARK CONSISTS OF STANDARD CHARACTERS WITHOUT CLAIM TO ANY PARTICULAR FONT, STYLE, SIZE, OR COLOR.

SEC. 2(F).

SER. NO. 77-348,634, FILED 12-11-2007.

YAT SYE, LEE, EXAMINING ATTORNEY

Int. Cls.: 39 and 44

Prior U.S. Cls.: 100, 101 and 105

United States Patent and Trademark Office

Reg. No. 3,475,696

Registered July 29, 2008

SERVICE MARK
PRINCIPAL REGISTER



ONE WORLD UNITED INC. (NEW YORK CORPORATION)
6619 THIRTEENTH AVENUE
BROOKLYN, NY 11219

FOR: MEDICAL TOURISM SERVICES, NAMELY, MAKING TRANSPORTATION RESERVATIONS AND BOOKINGS FOR TRAVEL TO ANOTHER COUNTRY IN ORDER TO OBTAIN HEALTH CARE, IN CLASS 39 (U.S. CLS. 100 AND 105).

FIRST USE 7-1-2007; IN COMMERCE 7-1-2007.

FOR: MATERNAL SURROGACY SERVICES; HUMAN EGG DONATION SERVICES, IN CLASS 44 (U.S. CLS. 100 AND 101).

FIRST USE 7-1-2007; IN COMMERCE 7-1-2007.

NO CLAIM IS MADE TO THE EXCLUSIVE RIGHT TO USE "FAMILY", APART FROM THE MARK AS SHOWN.

THE COLOR(S) BLACK, RED, GREY AND WHITE IS/ARE CLAIMED AS A FEATURE OF THE MARK.

THE MARK CONSISTS OF A STYLIZED DESIGN OF BLACK, RED AND GREY LINES REPRESENTING A WOMAN HOLDING A CHILD IN HER HANDS, OVER THE WORD "PROACTIVE" IN BLACK AND THE WORDS "FAMILY SOLUTIONS" IN RED, AND BELOW THE WORDS "CONTROL" IN BLACK "YOUR" IN RED AND "DESTINY" IN BLACK, OVER A WHITE BACKGROUND.

SER. NO. 77-348,752, FILED 12-11-2007.

B. PARADEWELAI, EXAMINING ATTORNEY

Int. Cl.: 30

Prior U.S. Cl.: 46

United States Patent and Trademark Office

Reg. No. 3,475,697

Registered July 29, 2008

**TRADEMARK
PRINCIPAL REGISTER**

BIG TEXAS

CLOVERHILL PASTRY-VEND CORPORATION
(ILLINOIS CORPORATION)
2035 N. NARRAGANSETT AVE.
CHICAGO, IL 60639

FOR: BAKERY PRODUCTS, NAMELY, SWEET
BAKERY GOODS, IN CLASS 30 (U.S. CL. 46).

FIRST USE 6-0-1993; IN COMMERCE 6-0-1993.

THE MARK CONSISTS OF STANDARD CHAR-
ACTERS WITHOUT CLAIM TO ANY PARTICULAR
FONT, STYLE, SIZE, OR COLOR.

OWNER OF U.S. REG. NOS. 2,235,589 AND
3,271,078.

SER. NO. 77-348,775, FILED 12-11-2007.

TINA L. SNAPP, EXAMINING ATTORNEY

Int. Cl.: 9

Prior U.S. Cls.: 21, 23, 26, 36 and 38

Reg. No. 3,475,698

United States Patent and Trademark Office

Registered July 29, 2008

**TRADEMARK
PRINCIPAL REGISTER**

PON  ext

ALPHION CORPORATION (DELAWARE CORPORATION)
BUILDING 1A, SUITE 1
196 PRINCETON HIGHTSTOWN ROAD
PRINCETON JUNCTION, NJ 08550

FOR: TELECOMMUNICATIONS EQUIPMENT, NAMELY, AN INTEGRATED PHOTONIC SYSTEM COMPRISING OPTICAL SWITCHES, ROUTERS AND SEMICONDUCTOR OPTICAL AMPLIFIERS TO ALLOW THE CONVERGENCE OF VOICE, DATA AND VIDEO COMMUNICATIONS IN A UNIFIED PLATFORM ACROSS MULTIPLE NETWORK INFRASTRUCTURES AND COMMUNICATIONS

PROTOCOLS, IN CLASS 9 (U.S. CLS. 21, 23, 26, 36 AND 38).

FIRST USE 6-19-2007; IN COMMERCE 6-19-2007.

NO CLAIM IS MADE TO THE EXCLUSIVE RIGHT TO USE "PON" AND "EXT", APART FROM THE MARK AS SHOWN.

SER. NO. 77-348,803, FILED 12-11-2007.

ALICE SUE CARRUTHERS, EXAMINING ATTORNEY

Int. Cl.: 42

Prior U.S. Cls.: 100 and 101

United States Patent and Trademark Office

Reg. No. 3,475,699

Registered July 29, 2008

**SERVICE MARK
PRINCIPAL REGISTER**

TipTopWebsite.com

TIPTOPWEBSITE.COM, LLC (FLORIDA LTD
LIAB CO)
#258
2023 N. ATLANTIC AVE.
COCOA BEACH, FL 32931

THE MARK CONSISTS OF STANDARD CHAR-
ACTERS WITHOUT CLAIM TO ANY PARTICULAR
FONT, STYLE, SIZE, OR COLOR.

FOR: DESIGN OF HOMEPAGES AND WEBSITES;
WEB SITE HOSTING SERVICES, IN CLASS 42 (U.S.
CLS. 100 AND 101).

SER. NO. 77-348,839, FILED 12-11-2007.

FIRST USE 7-14-2005; IN COMMERCE 7-14-2005.

BRIAN NEVILLE, EXAMINING ATTORNEY

Int. Cl.: 29

Prior U.S. Cl.: 46

United States Patent and Trademark Office

Reg. No. 3,475,700

Registered July 29, 2008

**TRADEMARK
PRINCIPAL REGISTER**

NU-TRES

EMPACADORA BONNACARNE, S.A. DE C.V.
(MEXICO CORPORATION)
CARR LA PIEDAD-MANUEL DOBLADO KM 1
SANTA ANNA PACUECO, MEXICO 36910

FOR: MEAT, FISH, POULTRY AND GAME;
MEAT, FISH, POULTRY AND GAME PRESERVES;
PROCESSED MEAT, NAMELY, HAM, TURKEY,
LAMB, VEAL, SAUSAGES, CHORIZO, MORTADE-
LA, SALAMI, BACON, PASTRAMI; PRESERVED
MEATS AND SAUSAGES; MEAT, FISH, FRUIT
AND VEGETABLE PRESERVES; PROCESSED VE-
GETABLES AND FRUITS, IN CLASS 29 (U.S. CL. 46).

FIRST USE 10-15-2007; IN COMMERCE 10-15-2007.

THE MARK CONSISTS OF STANDARD CHAR-
ACTERS WITHOUT CLAIM TO ANY PARTICULAR
FONT, STYLE, SIZE, OR COLOR.

THE ENGLISH TRANSLATION OF THE WORD
"TRES" IN THE MARK IS "3".

SER. NO. 77-348,844, FILED 12-11-2007.

BRIAN NEVILLE, EXAMINING ATTORNEY

Int. Cl.: 9

Prior U.S. Cls.: 21, 23, 26, 36 and 38

Reg. No. 3,475,701

United States Patent and Trademark Office

Registered July 29, 2008

**TRADEMARK
PRINCIPAL REGISTER**

HIPSERV

AXENTRA CORPORATION (CANADA CORPORATION)
377 DALHOUSIE STREET, SUITE 210
OTTAWA, CANADA K1N9N8

FOR: COMPUTER SOFTWARE, NAMELY OPERATING SYSTEM PROGRAMS FOR STORAGE AND FILE SHARING OF DATA, DOCUMENTS, FILES, DIGITAL PHOTOGRAPHS, DIGITAL VIDEO AND OTHER DIGITAL CONTENT; COMPUTER SOFTWARE FOR STREAMING AUDIO AND VIDEO CONTENT TO A VARIETY OF NETWORK DEVICES, NAMELY, PERSONAL COMPUTERS, NETWORKED DIGITAL MEDIA PLAYERS (DMP'S), MOBILE PHONES, PERSONAL DIGITAL ASSISTANTS (PDA'S), AND STAND-ALONE HARDWARE DECODERS; MICROPROCESSOR-BASED, WEB

AND FILE SERVERS; COMMUNICATIONS SERVERS; COMPUTER SERVERS; COMPUTER SOFTWARE FOR CONTROLLING AND MANAGING ACCESS SERVER APPLICATIONS; NETWORK ACCESS SERVER OPERATING SOFTWARE, IN CLASS 9 (U.S. CLS. 21, 23, 26, 36 AND 38).

FIRST USE 5-1-2005; IN COMMERCE 5-1-2005.

THE MARK CONSISTS OF STANDARD CHARACTERS WITHOUT CLAIM TO ANY PARTICULAR FONT, STYLE, SIZE, OR COLOR.

SER. NO. 77-348,860, FILED 12-11-2007.

SUSAN RICHARDS, EXAMINING ATTORNEY

Int. Cl.: 9

Prior U.S. Cls.: 21, 23, 26, 36 and 38

Reg. No. 3,475,702

United States Patent and Trademark Office

Registered July 29, 2008

**TRADEMARK
PRINCIPAL REGISTER**

NTX

GNEUSS, INC. (NORTH CAROLINA CORPORATION)
921A MATTHEWS-MINT HILL ROAD
MATTHEWS, NC 28105

THE MARK CONSISTS OF STANDARD CHARACTERS WITHOUT CLAIM TO ANY PARTICULAR FONT, STYLE, SIZE, OR COLOR.

FOR: PRESSURE SENSORS, PRESSURE TRANSDUCERS, PRESSURE TRANSMITTERS, IN CLASS 9 (U.S. CLS. 21, 23, 26, 36 AND 38).

SER. NO. 77-348,889, FILED 12-11-2007.

FIRST USE 10-15-2007; IN COMMERCE 10-15-2007.

YAT SYE, LEE, EXAMINING ATTORNEY

Int. Cl.: 11

Prior U.S. Cls.: 13, 21, 23, 31 and 34

Reg. No. 3,475,703

United States Patent and Trademark Office

Registered July 29, 2008

**TRADEMARK
PRINCIPAL REGISTER**

QUARTZ CURVE

RAB LIGHTING INC. (NEW YORK CORPORATION)
170 LUDLOW AVENUE
NORTHVALE, NJ 07647

FOR: ELECTRIC LAMPS; ELECTRIC LIGHTING
FIXTURES; ELECTRIC LUMINAIRES, IN CLASS 11
(U.S. CLS. 13, 21, 23, 31 AND 34).

FIRST USE 2-29-2000; IN COMMERCE 2-29-2000.

THE MARK CONSISTS OF STANDARD CHARACTERS WITHOUT CLAIM TO ANY PARTICULAR FONT, STYLE, SIZE, OR COLOR.

NO CLAIM IS MADE TO THE EXCLUSIVE RIGHT TO USE "QUARTZ", APART FROM THE MARK AS SHOWN.

SER. NO. 77-348,900, FILED 12-11-2007.

LINDA MICKLEBURGH, EXAMINING ATTORNEY

Int. Cl.: 39

Prior U.S. Cls.: 100 and 105

United States Patent and Trademark Office

Reg. No. 3,475,704

Registered July 29, 2008

**SERVICE MARK
PRINCIPAL REGISTER**

**USA CONSOLIDATED TRAVEL
GROUP**

USA CONSOLIDATED TRAVEL GROUP (CALI-
FORNIA LTD LIAB CO)
5080 ROBERT J. MATHEWS PARKWAY
EL DORADO HILLS, CA 95762

FOR: TRAVEL AGENCY SERVICES, NAMELY,
ARRANGING TRAVEL RESERVATION AND
BOOKING TOURS FOR GROUPS, IN CLASS 39
(U.S. CLS. 100 AND 105).

FIRST USE 6-26-1988; IN COMMERCE 6-26-1988.

THE MARK CONSISTS OF STANDARD CHAR-
ACTERS WITHOUT CLAIM TO ANY PARTICULAR
FONT, STYLE, SIZE, OR COLOR.

OWNER OF U.S. REG. NO. 2,458,870.

NO CLAIM IS MADE TO THE EXCLUSIVE
RIGHT TO USE "TRAVEL GROUP", APART FROM
THE MARK AS SHOWN.

SEC. 2(F).

SER. NO. 77-348,953, FILED 12-11-2007.

B. PARADEWELAI, EXAMINING ATTORNEY

Int. Cl.: 41

Prior U.S. Cls.: 100, 101 and 107

United States Patent and Trademark Office

Reg. No. 3,475,705

Registered July 29, 2008

**SERVICE MARK
PRINCIPAL REGISTER**

Dance Camp at Sea

E. L. WOODCOCK TRUST UNDER AGREEMENT
(NORTH CAROLINA TRUST)
2021 WATERSTONE LANE
HIGH POINT, NC 27265

FOR: DANCE EVENTS; DANCE INSTRUCTION;
DANCE INSTRUCTION FOR CHILDREN; DANCE
SCHOOLS; ORGANIZATION OF DANCING
EVENTS; PROVIDING DANCE HALLS; RECREA-
TIONAL CAMPS; TRAINING OF DANCE INSTRUC-
TORS, IN CLASS 41 (U.S. CLS. 100, 101 AND 107).

FIRST USE 6-15-2004; IN COMMERCE 1-1-2005.

THE MARK CONSISTS OF STANDARD CHAR-
ACTERS WITHOUT CLAIM TO ANY PARTICULAR
FONT, STYLE, SIZE, OR COLOR.

SEC. 2(F).

SER. NO. 77-348,958, FILED 12-11-2007.

SUE LAWRENCE, EXAMINING ATTORNEY

Int. Cl.: 9

Prior U.S. Cls.: 21, 23, 26, 36 and 38

Reg. No. 3,475,706

United States Patent and Trademark Office

Registered July 29, 2008

**TRADEMARK
PRINCIPAL REGISTER**

modelogix

WINESTIMATOR, INC. (WASHINGTON CORPORATION)
7425 WEST MERCER WAY
MERCER ISLAND, WA 98040

FOR: COMPUTER SOFTWARE FOR THE COLLECTION, EDITING, ORGANIZING, MODIFYING, BOOK MARKING, TRANSMISSION, STORAGE AND SHARING OF DATA AND INFORMATION, IN CLASS 9 (U.S. CLS. 21, 23, 26, 36 AND 38).

FIRST USE 12-5-2007; IN COMMERCE 12-10-2007.

THE MARK CONSISTS OF STANDARD CHARACTERS WITHOUT CLAIM TO ANY PARTICULAR FONT, STYLE, SIZE, OR COLOR.

SER. NO. 77-349,000, FILED 12-11-2007.

JUDITH HELFMAN, EXAMINING ATTORNEY

Int. Cl.: 40

Prior U.S. Cls.: 100, 103 and 106

United States Patent and Trademark Office

Reg. No. 3,475,707

Registered July 29, 2008

**SERVICE MARK
PRINCIPAL REGISTER**

BEAMALLOY

BEAMALLOY TECHNOLOGIES, LLC (OHIO LTD
LIAB CO)
8270 ESTATES PARKWAY
PLAIN CITY, OH 43064

THE MARK CONSISTS OF STANDARD CHAR-
ACTERS WITHOUT CLAIM TO ANY PARTICULAR
FONT, STYLE, SIZE, OR COLOR.

FOR: METAL TREATMENT, IN CLASS 40 (U.S.
CLS. 100, 103 AND 106).

SER. NO. 77-349,007, FILED 12-11-2007.

FIRST USE 4-8-1983; IN COMMERCE 5-23-1983.

EMILY CARLSEN, EXAMINING ATTORNEY

Int. Cl.: 41

Prior U.S. Cls.: 100, 101 and 107

United States Patent and Trademark Office

Reg. No. 3,475,708

Registered July 29, 2008

**SERVICE MARK
PRINCIPAL REGISTER**



GREEN BAY PACKERS, INC. (WISCONSIN CORPORATION)
1265 LOMBARDI AVENUE
GREEN BAY, WI 54303

FOR: FAN CLUBS, IN CLASS 41 (U.S. CLS. 100, 101 AND 107).

FIRST USE 7-20-2007; IN COMMERCE 7-20-2007.

OWNER OF U.S. REG. NOS. 1,107,558, 1,850,663, AND 3,258,812.

THE COLOR(S) GREEN, GOLD, BLACK, WHITE AND GRAY IS/ARE CLAIMED AS A FEATURE OF THE MARK.

THE MARK CONSISTS OF A SHIELD, THE LEFT HALF BEING GREEN AND THE RIGHT HALF BEING GOLD, CONTAINING THE LETTER "G" AND THE WORD "FORCE" IN A BANNER UNDER THE "G". THE LETTER "G" IS WHITE ON TOP OF A BLACK OVAL. THE WORD "FORCE" IS IN BLACK LETTERS WITH WHITE AND GRAY BORDERS ON TOP OF A WHITE RECTANGLE WITH A BLACK OUTLINE. THE SHIELD IS OUTLINED IN BLACK WITH THREE BLACK BENT LINES ON EACH SIDE OF THE SHIELD.

SER. NO. 77-349,053, FILED 12-11-2007.

NORA BUCHANAN WILL, EXAMINING ATTORNEY

Int. Cl.: 35

Prior U.S. Cls.: 100, 101 and 102

United States Patent and Trademark Office

Reg. No. 3,475,709

Registered July 29, 2008

**SERVICE MARK
PRINCIPAL REGISTER**



PERFORMANCE DONE QUICKLY (OHIO CORPORATION), DBA MEMPHIS SURPLUS
1914 CLARK AVENUE
CLEVELAND, OH 44109

FOR: DISCOUNT SURPLUS STORES IN THE FIELDS OF AUTO PARTS, INDUSTRIAL TOOLS AND HARDWARE, ELECTRICAL PARTS FOR ELECTRICIANS AND HOBBYISTS, AND INDUSTRIAL EQUIPMENT PARTS IN THE FIELDS OF MAINTENANCE, PRINTING, PACKAGING, AND MACHINING; RETAIL DEPARTMENT STORES, IN CLASS 35 (U.S. CLS. 100, 101 AND 102).

FIRST USE 4-20-2007; IN COMMERCE 4-20-2007.

NO CLAIM IS MADE TO THE EXCLUSIVE RIGHT TO USE "SURPLUS" AND "AUTO, INDUS-

TRIAL & ELECTRICAL SURPLUS", APART FROM THE MARK AS SHOWN.

THE COLOR(S) BLACK, YELLOW AND WHITE IS/ARE CLAIMED AS A FEATURE OF THE MARK.

THE MARK CONSISTS OF A YELLOW OVAL CONTAINING THE WORDS "MEMPHIS SURPLUS" IN BLACK. A BLACK INCOMPLETE OVAL BORDERS THE BOTTOM AND THE LEFT SIDE OF THE YELLOW OVAL. THIS INCOMPLETE OVAL CONTAINS THE WORDS "AUTO, INDUSTRIAL & ELECTRICAL SURPLUS" IN WHITE.

SER. NO. 77-349,099, FILED 12-11-2007.

BRIAN PINO, EXAMINING ATTORNEY

Int. Cl.: 35

Prior U.S. Cls.: 100, 101 and 102

United States Patent and Trademark Office

Reg. No. 3,475,710

Registered July 29, 2008

**SERVICE MARK
PRINCIPAL REGISTER**



THE NATIONAL OSTEOPOROSIS FOUNDATION
(MISSOURI NON-PROFIT CORPORATION)
1232 22ND STREET, N.W.
WASHINGTON, DC 200371292

FOR: PROMOTING PUBLIC AWARENESS
ABOUT OSTEOPOROSIS, BONE HEALTH, AND
WOMEN'S HEALTH ISSUES TO THE PUBLIC, PA-
TIENTS, AND HEALTH CARE PROFESSIONALS, IN
CLASS 35 (U.S. CLS. 100, 101 AND 102).

FIRST USE 12-6-2007; IN COMMERCE 12-6-2007.

OWNER OF U.S. REG. NOS. 1,801,215, 2,206,436,
AND 3,164,972.

NO CLAIM IS MADE TO THE EXCLUSIVE
RIGHT TO USE "NATIONAL OSTEOPOROSIS
FOUNDATION", APART FROM THE MARK AS
SHOWN.

THE MARK CONSISTS OF THE WORDS
"FRIEND OF THE NATIONAL OSTEOPOROSIS
FOUNDATION" TO THE LEFT OF A STYLIZED
HUMAN BEING WITH WAVES EMANATING
FROM THE LEFT OF THE FIGURE.

SER. NO. 77-349,128, FILED 12-11-2007.

CARYN GLASSER, EXAMINING ATTORNEY

Int. Cl.: 35

Prior U.S. Cls.: 100, 101 and 102

United States Patent and Trademark Office

Reg. No. 3,475,711

Registered July 29, 2008

**SERVICE MARK
PRINCIPAL REGISTER**



THE NATIONAL OSTEOPOROSIS FOUNDATION
(MISSOURI NON-PROFIT CORPORATION)
1232 22ND STREET, N.W.
WASHINGTON, DC 200371292

FOR: PROMOTING PUBLIC AWARENESS ABOUT OSTEOPOROSIS, BONE HEALTH, AND WOMEN'S HEALTH ISSUES TO THE PUBLIC, PATIENTS, AND HEALTH CARE PROFESSIONALS, IN CLASS 35 (U.S. CLS. 100, 101 AND 102).

FIRST USE 12-6-2007; IN COMMERCE 12-6-2007.

OWNER OF U.S. REG. NOS. 1,801,215, 2,206,436, AND 3,164,972.

NO CLAIM IS MADE TO THE EXCLUSIVE RIGHT TO USE "NATIONAL OSTEOPOROSIS FOUNDATION", APART FROM THE MARK AS SHOWN.

THE MARK CONSISTS OF THE WORDS "FRIEND OF THE NATIONAL OSTEOPOROSIS FOUNDATION" ABOVE A STYLIZED TOP HALF OF A HUMAN BEING WITH WAVES EMANATING FROM THE FIGURE.

SER. NO. 77-349,152, FILED 12-11-2007.

CARYN GLASSER, EXAMINING ATTORNEY

Int. Cl.: 13

Prior U.S. Cls.: 2 and 9

United States Patent and Trademark Office

Reg. No. 3,475,712

Registered July 29, 2008

**TRADEMARK
PRINCIPAL REGISTER**



MACE SECURITY INTERNATIONAL, INC. (DE-
LAWARE CORPORATION)
160 BENMONT AVENUE
BENNINGTON, VT 052011893

OWNER OF U.S. REG. NOS. 2,909,279, 3,389,556,
AND 3,389,592.

FOR: PERSONAL DEFENSE SPRAY DEVICES, IN
CLASS 13 (U.S. CLS. 2 AND 9).

SER. NO. 77-349,167, FILED 12-11-2007.

FIRST USE 5-15-2007; IN COMMERCE 5-15-2007.

WILLIAM VERHOSEK, EXAMINING ATTORNEY

Int. Cl.: 22

Prior U.S. Cls.: 1, 2, 7, 19, 22, 42 and 50

United States Patent and Trademark Office

Reg. No. 3,475,713

Registered July 29, 2008

**TRADEMARK
PRINCIPAL REGISTER**

The logo for "ARMOR SCREEN" features the word "ARMOR" in a large, bold, serif font above the word "SCREEN" in a similar font. The letter "O" in "ARMOR" is replaced by a stylized, grey, three-bladed wind whirl or turbine icon.

ARMOR SCREEN CORP. (FLORIDA CORPORATION)
2001-H NORTH CONGRESS AVENUE
RIVIERA BEACH, FL 33404

FOR: FLEXIBLE PROTECTIVE WIND ABATEMENT SYSTEMS COMPRISED OF WIND PERMEABLE SYNTHETIC FABRIC AND ANCHORING HARDWARE THEREFOR, IN CLASS 22 (U.S. CLS. 1, 2, 7, 19, 22, 42 AND 50).

FIRST USE 10-0-2000; IN COMMERCE 10-0-2000.

OWNER OF U.S. REG. NO. 2,526,732.

NO CLAIM IS MADE TO THE EXCLUSIVE RIGHT TO USE "SCREEN", APART FROM THE MARK AS SHOWN.

THE MARK CONSISTS OF THE WORD "ARMOR" ABOVE THE WORD "SCREEN" WITH THE LETTER "O" IN "ARMOR" BEING REPLACED BY A DESIGNED IMAGE OF A WIND WHIRL .

SER. NO. 77-349,213, FILED 12-11-2007.

LEIGH CAROLINE CASE, EXAMINING ATTORNEY

Int. Cl.: 25

Prior U.S. Cls.: 22 and 39

United States Patent and Trademark Office

Reg. No. 3,475,714

Registered July 29, 2008

TRADEMARK
PRINCIPAL REGISTER

Ribbon

ROLDAN, STEPHANIE (UNITED STATES INDIVIDUAL)
18132 COACHMANS ROAD
GERMANTOWN, MD 20874

FOR: FULL LINE OF APPAREL, NAMELY, DRESS SHIRTS, OXFORD SHIRTS, POLO SHIRTS, WOVEN SHIRTS, GOLF SHIRTS, T-SHIRTS, SWEAT SHIRTS, PULLOVERS, TANK TOPS, SWEATERS, JERSEYS, TURTLE-NECKS, SHORTS, SWEAT-PANTS, WARM-UP SUITS, BLAZERS, COATS, SPORT COATS, RAINCOATS, PANTS, JEANS, SKIRTS, MINISKIRTS, SUITS, OVERALLS, VESTS, WIND SHIRTS, JACKETS, PONCHOS, SWIMWEAR, BIKINIS, SWIM TRUNKS, OVERCOATS, RAINWEAR, WIND RESISTANT JACKETS, SLEEPWEAR, ROBES, UNDERWEAR, LINGERIE, BOXER SHORTS, BELTS, TIES, SCARVES, HEADBANDS, EAR MUFFS, WRISTBANDS, BATHROBES, PAJAMAS, CLOTH BIBS, TIES, HOSIERY, SOCK SUSPENDERS, FOOTWEAR AND HEADWEAR IN THE NATURE OF HATS, WOOL HATS, CAPS, VISORS, HOSIERY, SHOES, BOOTS, SNEAKERS, BEACH

SHOES, SANDALS, SLIPPERS, ANORAKS, JUMPERS, PANTS, BLOUSES, KNIT TOPS, WOVEN TOPS, HALTER TOPS, DRESSES, GOWNS, SLACKS, JEANS, TROUSERS, GLOVES, SCARVES, SOCKS, LEGGINGS, NIGHTGOWNS, BRAS, PANTIES, BRIEFS, SUPPORT FOUNDATION GARMENTS AND SHAPE WEAR IN THE NATURE OF GIRDLES, SLIPS, CAMISOLES, SUSPENDERS, IN CLASS 25 (U.S. CLS. 22 AND 39).

FIRST USE 6-1-2007; IN COMMERCE 6-1-2007.

THE MARK CONSISTS OF STANDARD CHARACTERS WITHOUT CLAIM TO ANY PARTICULAR FONT, STYLE, SIZE, OR COLOR.

OWNER OF U.S. REG. NO. 3,386,702.

SER. NO. 77-349,253, FILED 12-11-2007.

KAELIE KUNG, EXAMINING ATTORNEY

Int. Cl.: 43

Prior U.S. Cls.: 100 and 101

United States Patent and Trademark Office

Reg. No. 3,475,715

Registered July 29, 2008

**SERVICE MARK
PRINCIPAL REGISTER**

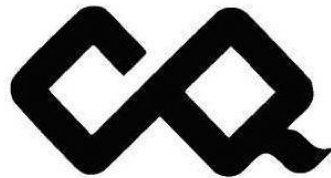

CLUB QUARTERS FRANCHISE NETWORK LLC
(DELAWARE LTD LIAB CO)
585 OLD STAMFORD ROAD
NEW CANAAN, CT 06840

OWNER OF U.S. REG. NO. 1,912,820.

FOR: LIMITED ACCESS AND PRIVATE HOTEL
SERVICES FOR CORPORATE AND BUSINESS
MEMBERS AND REGULAR BUSINESS VISITORS,
IN CLASS 43 (U.S. CLS. 100 AND 101).

THE MARK CONSISTS OF THE LETTERS "CQ"
IN A STYLIZED FORM.

SER. NO. 77-349,258, FILED 12-11-2007.

FIRST USE 1-1-1991; IN COMMERCE 1-1-1991.

KAELIE KUNG, EXAMINING ATTORNEY

Int. Cl.: 41

Prior U.S. Cls.: 100, 101 and 107

United States Patent and Trademark Office

Reg. No. 3,475,716

Registered July 29, 2008

**SERVICE MARK
PRINCIPAL REGISTER**

**VOICES IN MY HEAD
PRODUCTIONS**

LEDOUX, GEORGE (UNITED STATES INDIVIDUAL)
830 BAY ROAD
BELCHERTOWN, MA 01007

FOR: AUDIO PRODUCTION SERVICES, NAME-
LY, VOICE-OVERS, NARRATION, AUDIO BOOK
PRODUCING AND EDITING FOR ENTERTAIN-
MENT OR EDUCATIONAL PURPOSES, IN CLASS 41
(U.S. CLS. 100, 101 AND 107).

FIRST USE 6-6-1995; IN COMMERCE 6-6-1995.

THE MARK CONSISTS OF STANDARD CHAR-
ACTERS WITHOUT CLAIM TO ANY PARTICULAR
FONT, STYLE, SIZE, OR COLOR.

NO CLAIM IS MADE TO THE EXCLUSIVE
RIGHT TO USE "PRODUCTIONS", APART FROM
THE MARK AS SHOWN.

SER. NO. 77-349,329, FILED 12-11-2007.

JANICE L. MCMORROW, EXAMINING ATTOR-
NEY

Int. Cl.: 9

Prior U.S. Cls.: 21, 23, 26, 36 and 38

United States Patent and Trademark Office

Reg. No. 3,475,717

Registered July 29, 2008

**TRADEMARK
PRINCIPAL REGISTER**

Sabrent

NEXARK (CALIFORNIA CORPORATION)
137 N HUDSON AVE
INDUSTRY, CA 91744

FOR: COMPUTER HARDWARE AND COMPUTER PERIPHERALS, IN CLASS 9 (U.S. CLS. 21, 23, 26, 36 AND 38).

FIRST USE 1-1-2004; IN COMMERCE 1-1-2005.

THE MARK CONSISTS OF STANDARD CHARACTERS WITHOUT CLAIM TO ANY PARTICULAR FONT, STYLE, SIZE, OR COLOR.

SER. NO. 77-349,330, FILED 12-11-2007.

JANICE L. MCMORROW, EXAMINING ATTORNEY

Int. Cl.: 35

Prior U.S. Cls.: 100, 101 and 102

United States Patent and Trademark Office

Reg. No. 3,475,718

Registered July 29, 2008

**SERVICE MARK
PRINCIPAL REGISTER**

Marden's

MARDEN'S (MAINE CORPORATION)
184 COLLEGE AVE.
WATERVILLE, ME 04901

FOR: RETAIL DISCOUNT STORE SERVICES IN
THE FIELD OF GENERAL CONSUMER MER-
CHANDISE, IN CLASS 35 (U.S. CLS. 100, 101 AND
102).

FIRST USE 11-1-1976; IN COMMERCE 11-1-1976.

THE MARK CONSISTS OF STANDARD CHAR-
ACTERS WITHOUT CLAIM TO ANY PARTICULAR
FONT, STYLE, SIZE, OR COLOR.

SEC. 2(F).

SER. NO. 77-349,373, FILED 12-11-2007.

MICHAEL WIENER, EXAMINING ATTORNEY

Int. Cl.: 35

Prior U.S. Cls.: 100, 101 and 102

United States Patent and Trademark Office

Reg. No. 3,475,719

Registered July 29, 2008

**SERVICE MARK
PRINCIPAL REGISTER**

Marden's of Maine

MARDEN'S (MAINE CORPORATION)
184 COLLEGE AVE.
WATERVILLE, ME 04901

FOR: RETAIL DISCOUNT STORE SERVICES IN
THE FIELD OF GENERAL CONSUMER MER-
CHANDISE, IN CLASS 35 (U.S. CLS. 100, 101 AND
102).

FIRST USE 11-1-1976; IN COMMERCE 11-1-1976.

THE MARK CONSISTS OF STANDARD CHAR-
ACTERS WITHOUT CLAIM TO ANY PARTICULAR
FONT, STYLE, SIZE, OR COLOR.

SEC. 2(F).

SER. NO. 77-349,413, FILED 12-11-2007.

MICHAEL WIENER, EXAMINING ATTORNEY

Int. Cl.: 45

Prior U.S. Cls.: 100 and 101

United States Patent and Trademark Office

Reg. No. 3,475,720

Registered July 29, 2008

**SERVICE MARK
PRINCIPAL REGISTER**



ST. JUDE ROMAN CATHOLIC CONGREGATION
OF PEORIA, ILLINOIS (ILLINOIS CORPORATION), DBA ST. JUDE PARISH
10811 N. KNOXVILLE AVE
PEORIA, IL 61615

FOR: RELIGIOUS MASS INTENTIONS SERVICES, NAMELY, PROVIDING FOR THE ARRANGEMENT OF MASS INTENTIONS FOR THE DECEASED AND OR LIVING, IN CLASS 45 (U.S. CLS. 100 AND 101).

FIRST USE 12-1-2007; IN COMMERCE 12-1-2007.

NO CLAIM IS MADE TO THE EXCLUSIVE RIGHT TO USE "PARISH", APART FROM THE MARK AS SHOWN.

THE COLOR(S) BLACK, WHITE AND RED IS/ ARE CLAIMED AS A FEATURE OF THE MARK.

THE MARK CONSISTS OF TWO HANDS, THE RIGHT ONE BLACK AND THE LEFT ONE WHITE FORMING THE SHAPE OF A CUP WITH THE WORDS, "ST. JUDE PARISH" UNDERLINED AT THE BOTTOM IN BLACK DENOTING THE BASE OF THE CUP WITH A RED FLAME CONTAINING A WHITE CIRCLE WITH A BLACK CROSS SHAPE CONTAINED THEREIN.

SER. NO. 77-349,433, FILED 12-11-2007.

ALICE BENMAMAN, EXAMINING ATTORNEY

Int. Cls.: 16 and 41

Prior U.S. Cls.: 2, 5, 22, 23, 29, 37, 38, 50, 100, 101 and 107

Reg. No. 3,475,721

United States Patent and Trademark Office

Registered July 29, 2008

**TRADEMARK
SERVICE MARK
PRINCIPAL REGISTER**



BOARD OF REGENTS OF THE UNIVERSITY OF WISCONSIN SYSTEM (WISCONSIN CORPORATION)

361 BASCOM HALL 500 LINCOLN DRIVE
MADISON, WI 53706

FOR: PRINTED MATERIALS, NAMELY, A SERIES OF STANDARDIZED ACHIEVEMENT TESTS TO ASSESS THE ENGLISH LANGUAGE PROFICIENCY AND ACADEMIC CONTENT KNOWLEDGE OF LIMITED ENGLISH PROFICIENT STUDENTS IN PRE-KINDERGARTEN THROUGH GRADE 12 CONSISTING OF TEST BOOKLETS, ANSWER SHEETS, TECHNICAL GUIDES, REVIEW'S EDITIONS, CLASS MANAGEMENT GUIDES, EXAMINER'S MANUALS, NORMS BOOKLETS AND SCORE REPORTS; PRINTED INSTRUCTIONAL AND TEACHING MATERIALS, BOOKLETS, NEWSLETTERS, TRAINING MANUALS, BROCHURES, REPORTS, WORKBOOKS, WORKSHEETS, TECHNICAL GUIDES IN THE FIELDS OF CLASSROOM INSTRUCTION OF ENGLISH LANGUAGE LEARNERS AND CLASSROOM ASSESSMENT OF LIMITED ENGLISH PROFICIENT STUDENTS; PRINTED MATERIALS, NAMELY, BOOKLETS, WORKSHEETS, HANDOUTS, WORKBOOKS, TECHNICAL GUIDES AND BROCHURES IN THE FIELD OF ENGLISH SPEAKING, LISTENING, READING AND WRITING PROFICIENCY STANDARDS, IN CLASS 16 (U.S. CLS. 2, 5, 22, 23, 29, 37, 38 AND 50).

FIRST USE 5-9-2007; IN COMMERCE 8-31-2007.

FOR: EDUCATIONAL SERVICES, NAMELY, PREPARING, ADMINISTERING, AND SCORING STANDARDIZED TESTS; EDUCATIONAL TESTING, NAMELY, ACADEMIC CONTENT AND ENG-

LISH LANGUAGE PROFICIENCY TESTING OF PRE-KINDERGARTEN THROUGH GRADE 12 STUDENTS; DEVELOPING CURRICULUM FOR OTHERS IN THE FIELD OF ENGLISH LANGUAGE LEARNING; EDUCATIONAL ASSESSMENT; DEVELOPING EDUCATIONAL MANUALS FOR OTHERS IN THE FIELD OF ENGLISH LANGUAGE LEARNING; EDUCATIONAL SERVICES, NAMELY, DEVELOPING, ARRANGING, AND CONDUCTING EDUCATIONAL CONFERENCES AND PROGRAMS AND PROVIDING COURSES OF INSTRUCTION IN THE FIELD OF ENGLISH LANGUAGE LEARNING; EDUCATIONAL SERVICES, NAMELY, OFFERING OF ASSESSMENTS AND SURVEYS IN THE FIELD OF EDUCATOR TRAINING AND PERFORMANCE FOR THE PURPOSE OF IMPROVING TEACHING PROCEDURES; EDUCATIONAL SERVICES, NAMELY, CONDUCTING SEMINARS, WORKSHOPS, CONFERENCES, COURSES AND PROFESSIONAL DEVELOPMENT TRAINING PROGRAMS FOR TEACHERS, ADMINISTRATORS AND EDUCATION PERSONNEL IN THE FIELDS OF CLASSROOM INSTRUCTION FOR ENGLISH LANGUAGE LEARNERS AND CLASSROOM ASSESSMENT OF LIMITED ENGLISH PROFICIENT STUDENTS; EDUCATIONAL RESEARCH SERVICES IN THE FIELD OF ALIGNMENT ANALYSIS OF TEACHER PROFESSIONAL DEVELOPMENT ACTIVITIES, CURRICULA AND INSTRUCTION, EDUCATIONAL PROGRAMS, ENGLISH PROFICIENCY STANDARDS, AND ASSESSMENTS WITH ACADEMIC CONTENT AND ACHIEVEMENT STANDARDS; EDUCATIONAL RESEARCH SERVICES IN THE FIELD OF THE IDENTIFICATION AND ASSESSMENT OF EDUCATION PRACTICES, STRATEGIES, CURRICULUM, PROGRAMS AND MEASURABLE ACHIEVEMENT OBJECTIVES FOR THE ENGLISH LANGUAGE ACQUISITION AND ACADEMIC

ACHIEVEMENT OF LIMITED ENGLISH PROFICIENT STUDENTS , IN CLASS 41 (U.S. CLS. 100, 101 AND 107).

FIRST USE 5-9-2007; IN COMMERCE 5-9-2007.

NO CLAIM IS MADE TO THE EXCLUSIVE RIGHT TO USE "CONSORTIUM", APART FROM THE MARK AS SHOWN.

THE MARK CONSISTS OF THE WORDS "WIDA CONSORTIUM" IN STYLIZED FONT, WITH A CIRCULAR REPRESENTATION OF THE EARTH ABOVE THE LETTER "I" IN "WIDA".

SER. NO. 77-349,448, FILED 12-11-2007.

WENDY GOODMAN, EXAMINING ATTORNEY

Int. Cl.: 41

Prior U.S. Cls.: 100, 101 and 107

United States Patent and Trademark Office

Reg. No. 3,475,722

Registered July 29, 2008

**SERVICE MARK
PRINCIPAL REGISTER**

WIDA

BOARD OF REGENTS OF THE UNIVERSITY OF
WISCONSIN SYSTEM (WISCONSIN COR-
PORATION)
361 BASCOM HALL 500 LINCOLN DRIVE
MADISON, WI 53706

FOR: EDUCATIONAL SERVICES, NAMELY, PREPARING, ADMINISTERING, AND SCORING STANDARDIZED TESTS; EDUCATIONAL TESTING, NAMELY, ACADEMIC CONTENT AND ENGLISH LANGUAGE PROFICIENCY TESTING OF PRE-KINDERGARTEN THROUGH GRADE 12 STUDENTS; DEVELOPING CURRICULUM FOR OTHERS IN THE FIELD OF ENGLISH LANGUAGE LEARNING; EDUCATIONAL ASSESSMENT; DEVELOPING EDUCATIONAL MANUALS FOR OTHERS IN THE FIELD OF ENGLISH LANGUAGE LEARNING; EDUCATIONAL SERVICES, NAMELY, DEVELOPING, ARRANGING, AND CONDUCTING EDUCATIONAL CONFERENCES AND PROGRAMS AND PROVIDING COURSES OF INSTRUCTION IN THE FIELD OF ENGLISH LANGUAGE LEARNING; EDUCATIONAL SERVICES, NAMELY, OFFERING OF ASSESSMENTS AND SURVEYS IN THE FIELD OF EDUCATOR TRAINING AND PERFORMANCE FOR THE PURPOSE OF IMPROVING TEACHING PROCEDURES; EDUCATIONAL SERVICES, NAMELY, CONDUCTING SEMINARS, WORKSHOPS, CONFERENCES, COURSES AND PROFESSIONAL DEVELOPMENT TRAINING PROGRAMS FOR TEACHERS, ADMINISTRATORS AND EDUCA-

TION PERSONNEL IN THE FIELDS OF CLASSROOM INSTRUCTION FOR ENGLISH LANGUAGE LEARNERS AND CLASSROOM ASSESSMENT OF LIMITED ENGLISH PROFICIENT STUDENTS; EDUCATIONAL RESEARCH SERVICES IN THE FIELD OF ALIGNMENT ANALYSIS OF TEACHER PROFESSIONAL DEVELOPMENT ACTIVITIES, CURRICULA AND INSTRUCTION, EDUCATIONAL PROGRAMS, ENGLISH PROFICIENCY STANDARDS, AND ASSESSMENTS WITH ACADEMIC CONTENT AND ACHIEVEMENT STANDARDS; EDUCATIONAL RESEARCH SERVICES IN THE FIELD OF THE IDENTIFICATION AND ASSESSMENT OF EDUCATION PRACTICES, STRATEGIES, CURRICULUM, PROGRAMS AND MEASURABLE ACHIEVEMENT OBJECTIVES FOR THE ENGLISH LANGUAGE ACQUISITION AND ACADEMIC ACHIEVEMENT OF LIMITED ENGLISH PROFICIENT STUDENTS , IN CLASS 41 (U.S. CLS. 100, 101 AND 107).

FIRST USE 12-31-2003; IN COMMERCE 3-12-2004.

THE MARK CONSISTS OF STANDARD CHARACTERS WITHOUT CLAIM TO ANY PARTICULAR FONT, STYLE, SIZE, OR COLOR.

SER. NO. 77-349,461, FILED 12-11-2007.

WENDY GOODMAN, EXAMINING ATTORNEY

Int. Cl.: 26

Prior U.S. Cls.: 37, 39, 40, 42 and 50

United States Patent and Trademark Office

Reg. No. 3,475,723

Registered July 29, 2008

**TRADEMARK
PRINCIPAL REGISTER**

CREA/CLIP

INNOV8 LLC (HAWAII LTD LIAB CO)
APT. 1001
2211 ALA WAI BOULEVARD
HONOLULU, HI 96815

FOR: HAIR CUTTING GUIDES IN THE NATURE
OF A DEVICE CLAMPED TO HAIR PROVIDING AN
EDGE TO GUIDE A HAIR CUTTING INSTRUMENT
ACROSS THE HAIR, IN CLASS 26 (U.S. CLS. 37, 39,
40, 42 AND 50).

FIRST USE 8-17-2007; IN COMMERCE 8-17-2007.

THE MARK CONSISTS OF "CREA", WHEREIN
THE "A" IS PARTIAL; AND "CLIP", WHEREIN THE
"CLIP" IS POSITIONED CLOSE TO "CREA".

SER. NO. 77-349,514, FILED 12-11-2007.

DANIEL BRODY, EXAMINING ATTORNEY

Int. Cl.: 42

Prior U.S. Cls.: 100 and 101

United States Patent and Trademark Office

Reg. No. 3,475,724

Registered July 29, 2008

**SERVICE MARK
PRINCIPAL REGISTER**

SDN

SOUTH DAKOTA NETWORK, LLC (SOUTH DAKOTA LTD LIAB CO)
2900 W. 10TH ST.
SIOUX FALLS, SD 57104

FOR: DESIGN AND CONFIGURATION OF DATA NETWORKS CONSISTING OF COMPUTERS, ROUTERS, SWITCHES, VIDEO CONFERENCING EQUIPMENT, PRINTERS, SERVERS, STORAGE AREA NETWORKS AND FIREWALLS; TECHNICAL SUPPORT SERVICES, NAMELY, TROUBLESHOOTING OF COMPUTER HARDWARE AND SOFTWARE PROBLEMS INCLUDING COMPUTERS, ROUTERS, SWITCHES, VIDEO CONFERENCING EQUIPMENT, PRINTERS, SERVERS, STORAGE AREA NETWORKS AND FIREWALLS; TECHNICAL SUPPORT, NAMELY, MONITORING OF DATA NETWORK SYSTEMS CONSISTING OF

COMPUTERS, ROUTERS, SWITCHES, VIDEO CONFERENCING EQUIPMENT, PRINTERS, SERVERS, STORAGE AREA NETWORKS AND FIREWALLS, IN CLASS 42 (U.S. CLS. 100 AND 101).

FIRST USE 0-0-2002; IN COMMERCE 0-0-2002.

THE MARK CONSISTS OF STANDARD CHARACTERS WITHOUT CLAIM TO ANY PARTICULAR FONT, STYLE, SIZE, OR COLOR.

OWNER OF U.S. REG. NO. 3,289,788.

SER. NO. 77-349,719, FILED 12-12-2007.

PAUL E. FAHRENKOPF, EXAMINING ATTORNEY

Int. Cl.: 35

Prior U.S. Cls.: 100, 101 and 102

United States Patent and Trademark Office

Reg. No. 3,475,725

Registered July 29, 2008

**SERVICE MARK
PRINCIPAL REGISTER**

**Marden's Surplus and
Salvage**

MARDEN'S (MAINE CORPORATION)
184 COLLEGE AVE.
WATERVILLE, ME 04901

FOR: RETAIL DISCOUNT STORE SERVICES IN
THE FIELD OF GENERAL CONSUMER MER-
CHANDISE, IN CLASS 35 (U.S. CLS. 100, 101 AND
102).

FIRST USE 11-1-1976; IN COMMERCE 11-1-1976.

THE MARK CONSISTS OF STANDARD CHAR-
ACTERS WITHOUT CLAIM TO ANY PARTICULAR
FONT, STYLE, SIZE, OR COLOR.

SEC. 2(F).

SER. NO. 77-349,725, FILED 12-12-2007.

MICHAEL WIENER, EXAMINING ATTORNEY

Int. Cl.: 41

Prior U.S. Cls.: 100, 101 and 107

United States Patent and Trademark Office

Reg. No. 3,475,726

Registered July 29, 2008

**SERVICE MARK
PRINCIPAL REGISTER**



SMARTER TRAVEL MEDIA LLC (NEVADA LTD
LIAB CO)
465 MEDFORD STREET, SUITE 400
BOSTON, MA 02129

FOR: PROVIDING ONLINE PUBLICATIONS IN
THE NATURE OF COLUMNS AND NEWSLETTERS
REGARDING TRAVEL AND CONTAINING TRA-
VEL INFORMATION, AND ADVICE AND UP-
DATES ON TRAVEL, ACCOMMODATIONS,
BOOKING AND TRANSPORTATION, IN CLASS 41
(U.S. CLS. 100, 101 AND 107).

FIRST USE 4-19-2007; IN COMMERCE 4-19-2007.

THE MARK CONSISTS OF THE SILHOUETTE OF
A MAN WEARING A FEDORA HAT IN A RECTAN-
GLE BACKGROUND.

SER. NO. 77-349,726, FILED 12-12-2007.

ANDREA K. NADELMAN, EXAMINING ATTOR-
NEY

Int. Cl.: 35

Prior U.S. Cls.: 100, 101 and 102

United States Patent and Trademark Office

Reg. No. 3,475,727

Registered July 29, 2008

**SERVICE MARK
PRINCIPAL REGISTER**

Marden's Salvage

MARDEN'S (MAINE CORPORATION)
184 COLLEGE AVE.
WATERVILLE, ME 04901

FOR: RETAIL DISCOUNT STORE SERVICES IN
THE FIELD OF GENERAL CONSUMER MER-
CHANDISE, IN CLASS 35 (U.S. CLS. 100, 101 AND
102).

FIRST USE 11-1-1976; IN COMMERCE 11-1-1976.

THE MARK CONSISTS OF STANDARD CHAR-
ACTERS WITHOUT CLAIM TO ANY PARTICULAR
FONT, STYLE, SIZE, OR COLOR.

SEC. 2(F).

SER. NO. 77-349,733, FILED 12-12-2007.

MICHAEL WIENER, EXAMINING ATTORNEY

Int. Cl.: 35

Prior U.S. Cls.: 100, 101 and 102

United States Patent and Trademark Office

Reg. No. 3,475,728

Registered July 29, 2008

**SERVICE MARK
PRINCIPAL REGISTER**

Marden's Surplus

MARDEN'S (MAINE CORPORATION)
184 COLLEGE AVE.
WATERVILLE, ME 04901

FOR: RETAIL DISCOUNT STORE SERVICES IN
THE FIELD OF GENERAL CONSUMER MER-
CHANDISE, IN CLASS 35 (U.S. CLS. 100, 101 AND
102).

FIRST USE 11-1-1976; IN COMMERCE 11-1-1976.

THE MARK CONSISTS OF STANDARD CHAR-
ACTERS WITHOUT CLAIM TO ANY PARTICULAR
FONT, STYLE, SIZE, OR COLOR.

SEC. 2(F).

SER. NO. 77-349,737, FILED 12-12-2007.

MICHAEL WIENER, EXAMINING ATTORNEY

Int. Cl.: 45

Prior U.S. Cls.: 100 and 101

United States Patent and Trademark Office

Reg. No. 3,475,729

Registered July 29, 2008

**SERVICE MARK
PRINCIPAL REGISTER**

SDN

SOUTH DAKOTA NETWORK, LLC (SOUTH DAKOTA LTD LIAB CO)
2900 W. 10TH ST.
SIOUX FALLS, SD 57104

FOR: MONITORING OF COMPUTER SYSTEMS FOR SECURITY PURPOSES, NAMELY, NETWORK INTRUSION DETECTION SERVICES, IN CLASS 45 (U.S. CLS. 100 AND 101).

FIRST USE 0-0-2002; IN COMMERCE 0-0-2002.

THE MARK CONSISTS OF STANDARD CHARACTERS WITHOUT CLAIM TO ANY PARTICULAR FONT, STYLE, SIZE, OR COLOR.

OWNER OF U.S. REG. NO. 3,289,788.

SER. NO. 77-349,739, FILED 12-12-2007.

PAUL E. FAHRENKOPF, EXAMINING ATTORNEY

Int. Cl.: 35

Prior U.S. Cls.: 100, 101 and 102

United States Patent and Trademark Office

Reg. No. 3,475,730

Registered July 29, 2008

**SERVICE MARK
PRINCIPAL REGISTER**

Marden's Discount

MARDEN'S (MAINE CORPORATION)
184 COLLEGE AVE.
WATERVILLE, ME 04901

FOR: RETAIL DISCOUNT STORE SERVICES IN
THE FIELD OF GENERAL CONSUMER MER-
CHANDISE, IN CLASS 35 (U.S. CLS. 100, 101 AND
102).

FIRST USE 11-1-1976; IN COMMERCE 11-1-1976.

THE MARK CONSISTS OF STANDARD CHAR-
ACTERS WITHOUT CLAIM TO ANY PARTICULAR
FONT, STYLE, SIZE, OR COLOR.

SEC. 2(F).

SER. NO. 77-349,748, FILED 12-12-2007.

MICHAEL WIENER, EXAMINING ATTORNEY

Int. Cl.: 36

Prior U.S. Cls.: 100, 101 and 102

United States Patent and Trademark Office

Reg. No. 3,475,731

Registered July 29, 2008

**SERVICE MARK
PRINCIPAL REGISTER**

Flavor of Jazz

CLEARWATER JAZZ HOLIDAY FOUNDATION,
INC. (FLORIDA CORPORATION)
SUITE 1
1130 CLEVELAND STREET
CLEARWATER, FL 33755

FOR: CHARITABLE FUND RAISING SERVICES
BY MEANS OF AN ENTERTAINMENT EVENT;
CHARITABLE FUND RAISING SERVICES BY
MEANS OF MUSICAL CONCERTS , IN CLASS 36
(U.S. CLS. 100, 101 AND 102).

FIRST USE 5-1-2006; IN COMMERCE 5-1-2006.

THE MARK CONSISTS OF STANDARD CHAR-
ACTERS WITHOUT CLAIM TO ANY PARTICULAR
FONT, STYLE, SIZE, OR COLOR.

NO CLAIM IS MADE TO THE EXCLUSIVE
RIGHT TO USE "JAZZ", APART FROM THE MARK
AS SHOWN.

SER. NO. 77-349,749, FILED 12-12-2007.

PAUL CROWLEY, EXAMINING ATTORNEY

Int. Cl.: 16

Prior U.S. Cls.: 2, 5, 22, 23, 29, 37, 38 and 50

Reg. No. 3,475,732

United States Patent and Trademark Office

Registered July 29, 2008

**TRADEMARK
PRINCIPAL REGISTER**

PAPA

MITA, JAFOR (BANGLADESH INDIVIDUAL)
1C
44-05 MACNISH ST
ELMHURST, NY 11373

THE MARK CONSISTS OF STANDARD CHAR-
ACTERS WITHOUT CLAIM TO ANY PARTICULAR
FONT, STYLE, SIZE, OR COLOR.

FOR: PRE-PAID TELEPHONE CALLING CARDS,
NOT MAGNETICALLY ENCODED, IN CLASS 16
(U.S. CLS. 2, 5, 22, 23, 29, 37, 38 AND 50).

SER. NO. 77-349,757, FILED 12-12-2007.

FIRST USE 8-0-2004; IN COMMERCE 8-0-2004.

ROBIN CHOSID, EXAMINING ATTORNEY

Int. Cl.: 35

Prior U.S. Cls.: 100, 101 and 102

United States Patent and Trademark Office

Reg. No. 3,475,733

Registered July 29, 2008

**SERVICE MARK
PRINCIPAL REGISTER**

**Where the elite meet and
the misers mingle**

MARDEN'S (MAINE CORPORATION)
184 COLLEGE AVE.
WATERVILLE, ME 04901

FOR: RETAIL DISCOUNT STORE SERVICES IN
THE FIELD OF GENERAL CONSUMER MER-
CHANDISE, IN CLASS 35 (U.S. CLS. 100, 101 AND
102).

FIRST USE 11-1-1976; IN COMMERCE 11-1-1976.

THE MARK CONSISTS OF STANDARD CHAR-
ACTERS WITHOUT CLAIM TO ANY PARTICULAR
FONT, STYLE, SIZE, OR COLOR.

SEC. 2(F).

SER. NO. 77-349,758, FILED 12-12-2007.

MICHAEL WIENER, EXAMINING ATTORNEY

Int. Cl.: 12

Prior U.S. Cls.: 19, 21, 23, 31, 35 and 44

United States Patent and Trademark Office

Reg. No. 3,475,734

Registered July 29, 2008

**TRADEMARK
PRINCIPAL REGISTER**

POWRALL

ALBRECHT, ALLAN J (UNITED STATES INDIVIDUAL)
8325 ENTERPRISE DRIVE
WAUSAU, WI 54401

THE MARK CONSISTS OF STANDARD CHARACTERS WITHOUT CLAIM TO ANY PARTICULAR FONT, STYLE, SIZE, OR COLOR.

FOR: TRAILERS, IN CLASS 12 (U.S. CLS. 19, 21, 23, 31, 35 AND 44).

SER. NO. 77-349,763, FILED 12-12-2007.

FIRST USE 2-20-2007; IN COMMERCE 8-0-2007.

SHAUNIA CARLYLE, EXAMINING ATTORNEY

Int. Cl.: 35

Prior U.S. Cls.: 100, 101 and 102

United States Patent and Trademark Office

Reg. No. 3,475,735

Registered July 29, 2008

**SERVICE MARK
PRINCIPAL REGISTER**

**we sell anything we don't
have to feed**

MARDEN'S (MAINE CORPORATION)
184 COLLEGE AVE.
WATERVILLE, ME 04901

FOR: RETAIL DISCOUNT STORE SERVICES IN
THE FIELD OF GENERAL CONSUMER MER-
CHANDISE, IN CLASS 35 (U.S. CLS. 100, 101 AND
102).

FIRST USE 11-1-1976; IN COMMERCE 11-1-1976.

THE MARK CONSISTS OF STANDARD CHAR-
ACTERS WITHOUT CLAIM TO ANY PARTICULAR
FONT, STYLE, SIZE, OR COLOR.

SEC. 2(F).

SER. NO. 77-349,768, FILED 12-12-2007.

INGA ERVIN, EXAMINING ATTORNEY

Int. Cl.: 16

Prior U.S. Cls.: 2, 5, 22, 23, 29, 37, 38 and 50

United States Patent and Trademark Office

Reg. No. 3,475,736

Registered July 29, 2008

**TRADEMARK
PRINCIPAL REGISTER**

CHIEF JUSTICE NY

MITA, JAFOR (BANGLADESH INDIVIDUAL)
1 C
44-05 MACNISH ST
ELMHURST, NY 11373

FOR: PRE-PAID TELEPHONE CALLING CARDS,
NOT MAGNETICALLY ENCODED, IN CLASS 16
(U.S. CLS. 2, 5, 22, 23, 29, 37, 38 AND 50).

FIRST USE 6-0-2007; IN COMMERCE 7-0-2007.

THE MARK CONSISTS OF STANDARD CHAR-
ACTERS WITHOUT CLAIM TO ANY PARTICULAR
FONT, STYLE, SIZE, OR COLOR.

NO CLAIM IS MADE TO THE EXCLUSIVE
RIGHT TO USE "NY", APART FROM THE MARK
AS SHOWN.

SER. NO. 77-349,773, FILED 12-12-2007.

ROBIN CHOSID, EXAMINING ATTORNEY

Int. Cls.: 35 and 36

Prior U.S. Cls.: 100, 101 and 102

United States Patent and Trademark Office

Reg. No. 3,475,737

Registered July 29, 2008

**SERVICE MARK
PRINCIPAL REGISTER**



LUMEN FINANCIAL GROUP, INC. (MARY-
LAND CORPORATION)
SUITE 2700
111 S. CALVERT STREET
BALTIMORE, MD 21202

FOR: ASSISTANCE, ADVISORY SERVICES AND
CONSULTANCY WITH REGARD TO BUSINESS
PLANNING, BUSINESS ANALYSIS, BUSINESS
MANAGEMENT, AND BUSINESS ORGANIZA-
TION; BUSINESS ACQUISITION AND MERGER
CONSULTATION; BUSINESS ADMINISTRATION
CONSULTANCY; BUSINESS CONSULTATION;
BUSINESS PLANNING; BUSINESS SUCCESSION
PLANNING, IN CLASS 35 (U.S. CLS. 100, 101 AND
102).

FIRST USE 2-28-2007; IN COMMERCE 2-28-2007.

FOR: BUSINESS FINANCE PROCUREMENT SER-
VICES; FINANCIAL ANALYSIS AND CONSULTA-
TION; FINANCIAL CONSULTATION; FINANCIAL
CONSULTING; FINANCIAL LOAN CONSULTA-
TION; FINANCIAL PLANNING CONSULTATION;
MORTGAGE PROCUREMENT FOR OTHERS, IN
CLASS 36 (U.S. CLS. 100, 101 AND 102).

FIRST USE 2-28-2007; IN COMMERCE 2-28-2007.

NO CLAIM IS MADE TO THE EXCLUSIVE
RIGHT TO USE "FINANCIAL", APART FROM
THE MARK AS SHOWN.

THE COLOR(S) GREEN AND BLUE IS/ARE
CLAIMED AS A FEATURE OF THE MARK.

THE MARK CONSISTS OF THE WORDS LUMEN
FINANCIAL WITH THE LETTER "C" IN "FINAN-
CIAL" FORMING THE BODY OF A LIGHT BULB.
THE LETTER "C" IN "FINANCIAL" IS TOPPED BY
A THREE (3) PRONG HALO AND HAS A BASE
RESEMBLING THAT OF A LIGHT BULB. A SMALL
CAPITAL "L" APPEARS IN THE MIDDLE OF THE
LIGHT BULB. THE WORD "LUMEN" IS GREEN,
THE WORD, "FINANCIAL" IS BLUE, AND THE
HALO, "L" AND BASE OF THE LIGHT BULB ARE
GREEN.

SER. NO. 77-349,785, FILED 12-12-2007.

SANJEEV VOHRA, EXAMINING ATTORNEY

Int. Cls.: 36, 39 and 41

Prior U.S. Cls.: 100, 101, 102, 105 and 107

United States Patent and Trademark Office

Reg. No. 3,475,738

Registered July 29, 2008

**SERVICE MARK
PRINCIPAL REGISTER**

Experience the Boating Life!

SOUTHWEST FLORIDA YACHTS, INC. (FLORIDA CORPORATION)
3444 MARINATOWN LANE, NW
NORTH FORT MYERS, FL 33903

FOR: YACHT BROKERAGE, IN CLASS 36 (U.S. CLS. 100, 101 AND 102).

FIRST USE 8-25-2007; IN COMMERCE 8-25-2007.

FOR: BOAT CHARTERING, IN CLASS 39 (U.S. CLS. 100 AND 105).

FIRST USE 8-25-2007; IN COMMERCE 8-25-2007.

FOR: EDUCATION SERVICES, NAMELY, PROVIDING CLASSES AND COURSES OF INSTRU-

TION IN THE FIELDS OF SAILING AND POWER BOATING, IN CLASS 41 (U.S. CLS. 100, 101 AND 107).

FIRST USE 8-25-2007; IN COMMERCE 8-25-2007.

NO CLAIM IS MADE TO THE EXCLUSIVE RIGHT TO USE "BOATING", APART FROM THE MARK AS SHOWN.

THE MARK CONSISTS OF THE EXPRESSION "EXPERIENCE THE BOATING LIFE!" IN SCRIPT TYPEFACE, WITH A WAVE DESIGN BENEATH THE EXPRESSION.

SER. NO. 77-349,788, FILED 12-12-2007.

SANJEEV VOHRA, EXAMINING ATTORNEY

Int. Cl.: 25

Prior U.S. Cls.: 22 and 39

United States Patent and Trademark Office

Reg. No. 3,475,739

Registered July 29, 2008

**TRADEMARK
PRINCIPAL REGISTER**

**A MOTHER OF SONS.....
SETTLES FOR CRUMBS**

GALANTE, NICOLE R. (UNITED STATES INDIVIDUAL)
6255 TIMBERLAKE WAY
DELRAY BEACH, FL 33484

THE MARK CONSISTS OF STANDARD CHARACTERS WITHOUT CLAIM TO ANY PARTICULAR FONT, STYLE, SIZE, OR COLOR.

FOR: CLOTHING, NAMELY, T-SHIRTS, BLOUSES, SKIRTS, SHORTS, PANTS, DRESSES, AND HEADGEAR, NAMELY, HATS, CAPS, SCARVES, IN CLASS 25 (U.S. CLS. 22 AND 39).

SER. NO. 77-349,792, FILED 12-12-2007.

FIRST USE 11-4-2007; IN COMMERCE 11-14-2007.

RICHARD A. STRASER, EXAMINING ATTORNEY

Int. Cl.: 43

Prior U.S. Cls.: 100 and 101

United States Patent and Trademark Office

Reg. No. 3,475,740

Registered July 29, 2008

**SERVICE MARK
PRINCIPAL REGISTER**

DON'T THINK JUST DRINK!

THECORNERBAR, LLC (ILLINOIS LTD LIAB
CO)
201 DES PLAINES
FOREST PARK, IL 60130

THE MARK CONSISTS OF STANDARD CHAR-
ACTERS WITHOUT CLAIM TO ANY PARTICULAR
FONT, STYLE, SIZE, OR COLOR.

FOR: BAR SERVICES, IN CLASS 43 (U.S. CLS. 100
AND 101).

SER. NO. 77-349,798, FILED 12-12-2007.

FIRST USE 1-1-2007; IN COMMERCE 1-1-2007.

MARK SPARACINO, EXAMINING ATTORNEY

Int. Cl.: 9

Prior U.S. Cls.: 21, 23, 26, 36 and 38

United States Patent and Trademark Office

Reg. No. 3,475,741

Registered July 29, 2008

**TRADEMARK
PRINCIPAL REGISTER**

STACOSINE

STACO ENERGY PRODUCTS CO. (OHIO CORPORATION)
301 GADDIS BLVD.
DAYTON, OH 45403

FOR: POWER LINE CONDITIONERS, IN CLASS 9
(U.S. CLS. 21, 23, 26, 36 AND 38).

FIRST USE 4-0-2006; IN COMMERCE 4-0-2006.

THE MARK CONSISTS OF STANDARD CHARACTERS WITHOUT CLAIM TO ANY PARTICULAR FONT, STYLE, SIZE, OR COLOR.

OWNER OF U.S. REG. NOS. 2,531,995 AND 3,112,450.

SER. NO. 77-349,834, FILED 12-12-2007.

GILBERT SWIFT, EXAMINING ATTORNEY

Int. Cl.: 28

Prior U.S. Cls.: 22, 23, 38 and 50

United States Patent and Trademark Office

Reg. No. 3,475,742

Registered July 29, 2008

**TRADEMARK
PRINCIPAL REGISTER**

3 DAY HARVEST

ENVIRONMENTAL SCIENCE TECHNOLOGIES,
LLC (DELAWARE LTD LIAB CO)
205 FAIR AVENUE
WINNSBORO, LA 71295

THE MARK CONSISTS OF STANDARD CHAR-
ACTERS WITHOUT CLAIM TO ANY PARTICULAR
FONT, STYLE, SIZE, OR COLOR.

FOR: SCENT ATTRACTANTS FOR HUNTING
GAME, IN CLASS 28 (U.S. CLS. 22, 23, 38 AND 50).

SER. NO. 77-349,850, FILED 12-12-2007.

FIRST USE 6-0-2005; IN COMMERCE 6-0-2005.

TAMARA FRAZIER, EXAMINING ATTORNEY

Int. Cl.: 41

Prior U.S. Cls.: 100, 101 and 107

United States Patent and Trademark Office

Reg. No. 3,475,743

Registered July 29, 2008

**SERVICE MARK
PRINCIPAL REGISTER**



PIANOONE LLC (COLORADO LTD LIAB CO)
9693 LAS COLINAS DRIVE
LITTLETON, CO 801244201

THE COLOR(S) PURPLE IS/ARE CLAIMED AS A
FEATURE OF THE MARK.

FOR: EDUCATIONAL SERVICES, NAMELY,
CONDUCTING INTERACTIVE GROUP PRO-
GRAMS THAT EDUCATE AND ENTERTAIN AND
FEATURE MUSIC, SPEAKING AND GROUP DIS-
CUSSIONS RELATING TO LEADERSHIP, INTER-
PERSONAL SKILLS AND PERSONAL AND
PROFESSIONAL DEVELOPMENT FOR LEADERS,
MANAGERS AND PROFESSIONALS, IN CLASS 41
(U.S. CLS. 100, 101 AND 107).

THE MARK CONSISTS OF THREE PURPLE
SEMI-CIRCLES WITHIN EACH OTHER TO THE
LEFT OF THE PURPLE COLORED WORDS "IN-
SPIRE! IMAGINE! INNOVATE!".

SER. NO. 77-349,867, FILED 12-12-2007.

FIRST USE 12-21-2007; IN COMMERCE 12-21-2007.

MARK PILARO, EXAMINING ATTORNEY

Int. Cl.: 35

Prior U.S. Cls.: 100, 101 and 102

United States Patent and Trademark Office

Reg. No. 3,475,744

Registered July 29, 2008

**SERVICE MARK
PRINCIPAL REGISTER**

Dux Marketing

ANDJOE, INC. (FLORIDA CORPORATION), DBA
DUX MARKETING
2520 SOUTH DIXIE HIGHWAY
MIAMI, FL 33133

FOR: ADVERTISING AGENCY SPECIALIZING IN THE DESIGN AND EXECUTION OF WORD OF MOUTH, VIRAL, BUZZ AND EXPERIENTIAL MARKETING PROGRAMS; ADVERTISING AND MARKETING; ADVERTISING SERVICES, NAMELY, PROMOTING AND MARKETING THE GOODS AND SERVICES OF OTHERS THROUGH ALL PUBLIC COMMUNICATION MEANS; ADVERTISING SERVICES, PUBLIC RELATIONS AND MARKETING SERVICES, NAMELY, PROMOTING AND MARKETING THE GOODS AND SERVICES OF OTHERS THROUGH ALL PUBLIC COMMUNICATION MEANS; ADVERTISING, MARKETING AND PROMOTION SERVICES; ADVERTISING, MARKETING AND PROMOTIONAL SERVICES FOR AUTOMOTIVE DEALERSHIPS; ADVERTISING, PROMOTION AND MARKETING SERVICES IN THE NATURE OF E-MAIL BLAST CAMPAIGNS FOR OTHERS; ADVICE CONCERNING CHEMICAL PRODUCT MARKETING; ADVICE IN THE FIELD OF BUSINESS MANAGEMENT AND MARKETING; ANALYZING AND COMPILING DATA FOR MEASURING THE PERFORMANCE OF FINANCIAL MARKETS; ARRANGING AND CONDUCTING MARKETING PROMOTIONAL EVENTS FOR OTHERS; BUSINESS ADVICE AND ANALYSIS OF MARKETS; BUSINESS CONSULTATION AND MANAGEMENT REGARDING MARKETING ACTIVITIES AND LAUNCHING OF NEW PRODUCTS; BUSINESS MANAGEMENT AND CONSULTING SERVICES FOR THE HEALTH CARE INDUSTRY, NAMELY, CUSTOMER SERVICE, ACCOUNTING SERVICES, AND WEB-BASED ADVERTISING AND MARKETING SERVICES; BUSINESS MANAGEMENT CONSULTING WITH RELATION TO STRATEGY, FINANCING, MARKETING, PRODUCTION, PERSONNEL AND SALE MATTERS FOR COMPANIES INVOLVED WITH THIN FILM AND NANO TECHNOLOGIES AND PLASMA PROCESSES; BUSINESS MANAGEMENT CONSULTING WITH RELATION TO STRATEGY, MARKETING, PRODUCTION, PERSONNEL AND RETAIL SALE MATTERS; BUSINESS MARKETING AND DIRECT MAIL CONSULTING SERVICES; BUSINESS MARKETING CONSULTING SERVICES; BUSINESS MARKETING CONSULTING SERVICES TO CHILD-CARE ORGANIZATIONS; BUSINESS MARKETING SERVICES; COMMERCIAL INFORMATION AGENCIES; CONDUCTING BUSINESS AND MARKET RESEARCH SURVEYS; CONDUCTING MARKET RESEARCH STUDIES; COOPERATIVE ADVERTISING AND MARKETING; COOPERATIVE ADVERTISING AND MARKETING SERVICES BY WAY OF SOLICITATION, CUSTOMER SERVICE AND PROVIDING MARKETING INFORMATION VIA WEBSITES ON A GLOBAL COMPUTER NETWORK; CREATION OF MARKETING TOOLS DESIGNED TO INCREASE A CLIENT COMPANY'S KNOWLEDGE OF CUSTOMER NEEDS, AND ITS COMPETITORS' PRODUCTS AND SERVICES, PRICING, ADVERTISING STRATEGY AND SALES STRATEGY; CREATIVE MARKETING DESIGN SERVICES; CUSTOM WRITING SERVICES COMPRISING PUBLIC RELATIONS AND MARKETING MATERIALS FOR THE AUDIO, VIDEO AND TECHNOLOGY INDUSTRIES; DEVELOPMENT OF MARKETING STRATEGIES AND CONCEPTS; DIRECT MARKETING ADVERTISING FOR OTHERS; DIRECT MARKETING CONSULTING SERVICES; DIRECT MARKETING SERVICES; ENTERTAINMENT MARKETING SERVICES, NAMELY, MARKETING, PROMOTION AND ADVERTISING FOR INDEPENDENT RECORDING ARTISTS; FLEA MARKETS; GENERAL BUSINESS MERCHANDISING SERVICES, NAMELY, MARKETING; GRAIN MARKET ANALYSIS; IMPLEMENTATION AND FOLLOW-UP OF ADVICE IN THE FIELDS OF MARKETING; INFORMATION OR ENQUIRIES ON BUSINESS AND MARKETING; MARKET ANALYSIS; MARKET MA-

NIPULATION, RESEARCH AND ANALYSIS, WHETHER OR NOT VIA THE INTERNET; MARKET OPINION POLLING STUDIES; MARKET REPORTS AND STUDIES; MARKET RESEARCH; MARKET RESEARCH CONSULTATION; MARKET RESEARCH SERVICES; MARKET RESEARCH STUDIES; MARKET SEGMENTATION CONSULTATION; MARKET STUDY AND ANALYSIS OF MARKET STUDIES; MARKETING AND ADVERTISING SERVICES FOR AUTOMOBILE DEALERSHIPS; MARKETING CONSULTING; MARKETING PLAN DEVELOPMENT; MARKETING SERVICES IN THE FIELD OF PLANNED-GIVING FOR NON-PROFIT AND CHARITABLE ORGANIZATIONS; MARKETING SERVICES, NAMELY, PROVIDING INFORMATIONAL WEB PAGES DESIGNED TO GENERATE SALES TRAFFIC VIA HYPERLINKS TO OTHER WEB SITES; MARKETING, PROMOTIONAL AND ADVERTISING SERVICES PROVIDED BY MOBILE TELEPHONE CONNECTIONS; MEDIA PLANNING, NAMELY, ADVISING THE CLIENT ON THE CORRECT TIMES AND STATIONS TO ADVERTISE BASED ON MEDIA ANALYSIS OF THE MARKET FOR THAT MEDIA; MULTI-LEVEL MARKETING BUSINESS SERVICES; ON-LINE ADVERTISING AND MARKETING SERVICES; OUTSOURCING IN THE FIELD OF SALES AND MARKETING OF COMPUTER SOFTWARE; PROMOTING, ADVERTISING AND MARKETING OF THE ON-LINE WEBSITES OF OTHERS; PROMOTION AND MARKETING SERVICES AND RELATED CONSULTING; PROMOTION, ADVERTISING AND MARKETING OF ON-LINE WEBSITES; PROVIDING A WEBSITE THAT FEATURES AN ONLINE MARKET FOR USERS TO LIST OFFERED OR WANTED PERSONAL AND BUSINESS ASSETS AND SKILLS FOR HIRE, RENT, SALE OR AUCTION TRANSACTED ON THE BASIS OF PREDEFINED PERFORMANCE AND CLOSING TERMS AND CONDITIONS; PROVIDING ADVERTISING, MARKETING AND PROMOTIONAL SERVICES FOR THE

PHARMACEUTICAL AND MEDICAL INDUSTRY; PROVIDING ADVERTISING, MARKETING AND PROMOTIONAL SERVICES FOR THE PHARMACEUTICAL AND MEDICAL PRODUCTS OF OTHERS; PROVIDING BUSINESS MARKETING INFORMATION; PROVIDING FINANCIAL INDICES OF SELECT BONDS TO ENABLE CONSUMERS TO EVALUATE INVESTMENTS AND MARKET TRENDS IN THE BOND MARKET; PROVIDING INFORMATION IN THE FIELD OF MARKETING AND ON-LINE MARKETING MEDIA VIA THE INTERNET; PROVIDING MARKETING AND PROMOTION OF SPECIAL EVENTS; PROVIDING PROMOTIONAL MARKETING SERVICES TO BUSINESSES IN THE BROADBAND AND MEDIA INDUSTRIES; REAL ESTATE MARKETING SERVICES, NAMELY, ONLINE SERVICES FEATURING THE PROMOTION OF RESIDENTIAL NEW CONSTRUCTION, WHICH ALSO CONTAINS BACK OFFICE SOLUTIONS FOR BUILDERS; REAL ESTATE MARKETING SERVICES, NAMELY, ON-LINE SERVICES FEATURING TOURS OF RESIDENTIAL AND COMMERCIAL REAL ESTATE; RENTAL OF ALL PUBLICITY AND MARKETING PRESENTATION MATERIALS; STATISTICAL EVALUATIONS OF MARKETING DATA, IN CLASS 35 (U.S. CLS. 100, 101 AND 102).

FIRST USE 1-1-2007; IN COMMERCE 1-1-2007.

THE MARK CONSISTS OF STANDARD CHARACTERS WITHOUT CLAIM TO ANY PARTICULAR FONT, STYLE, SIZE, OR COLOR.

NO CLAIM IS MADE TO THE EXCLUSIVE RIGHT TO USE "MARKETING" , APART FROM THE MARK AS SHOWN.

SER. NO. 77-349,873, FILED 12-12-2007.

MARK PILARO, EXAMINING ATTORNEY

Int. Cl.: 29

Prior U.S. Cl.: 46

United States Patent and Trademark Office

Reg. No. 3,475,745

Registered July 29, 2008

**TRADEMARK
PRINCIPAL REGISTER**



HARBOR SEAFOOD, INC. (NEW YORK CORPORATION)
969 LAKEVILLE ROAD
NEW HYDE PARK, NY 11040

THE MARK CONSISTS OF THE ELEMENT "WAKEFIELD" IN STYLIZED TYPEFACE ACROSS A PARTIAL CIRCLE.

FOR: FRESH AND FROZEN SHELLFISH AND IMITATION CRAB MEAT, IN CLASS 29 (U.S. CL. 46).

SER. NO. 77-349,890, FILED 12-12-2007.

FIRST USE 2-12-1979; IN COMMERCE 2-12-1979.

SUE LAWRENCE, EXAMINING ATTORNEY

Int. Cl.: 45

Prior U.S. Cls.: 100 and 101

United States Patent and Trademark Office

Reg. No. 3,475,746

Registered July 29, 2008

**SERVICE MARK
PRINCIPAL REGISTER**

Transforming Truth

TRANSFORMING TRUTH INC. (GEORGIA CORPORATION)
2249 HWY. 120
DULUTH, GA 30097

THE MARK CONSISTS OF STANDARD CHARACTERS WITHOUT CLAIM TO ANY PARTICULAR FONT, STYLE, SIZE, OR COLOR.

FOR: MINISTERIAL SERVICES, IN CLASS 45 (U.S. CLS. 100 AND 101).

SER. NO. 77-349,901, FILED 12-12-2007.

FIRST USE 1-1-2005; IN COMMERCE 3-1-2007.

BERNICE MIDDLETON, EXAMINING ATTORNEY

Int. Cl.: 35

Prior U.S. Cls.: 100, 101 and 102

United States Patent and Trademark Office

Reg. No. 3,475,747

Registered July 29, 2008

**SERVICE MARK
PRINCIPAL REGISTER**

SUNPLAY

SUNPLAY POOLS AND SPAS SUPERSTORE
(OHIO CORPORATION)
5690 S HARRISON BLVD
SOUTH OGDEN, UT 84403

THE MARK CONSISTS OF STANDARD CHAR-
ACTERS WITHOUT CLAIM TO ANY PARTICULAR
FONT, STYLE, SIZE, OR COLOR.

FOR: RETAIL STORE SERVICES FEATURING
POOL AND SPA CHEMICALS, PARTS, MAINTEN-
ANCE EQUIPMENT, IN CLASS 35 (U.S. CLS. 100,
101 AND 102).

SER. NO. 77-349,920, FILED 12-12-2007.

FIRST USE 1-0-1968; IN COMMERCE 1-0-1968.

HOWARD FRIEDMAN, EXAMINING ATTORNEY

Int. Cls.: 40 and 42

Prior U.S. Cls.: 100, 101, 103 and 106

United States Patent and Trademark Office

Reg. No. 3,475,748

Registered July 29, 2008

**SERVICE MARK
PRINCIPAL REGISTER**



THE GRAPHIC COW CO. (SOUTH CAROLINA CORPORATION), DBA THE GRAPHIC COW GRAPHIC DESIGN & SCREENPRINTING CO.
119 W. FRONT STEET
LIBERTY, SC 29657

FOR: IMPRINTING MESSAGES ON T-SHIRTS, IN CLASS 40 (U.S. CLS. 100, 103 AND 106).

FIRST USE 11-1-1993; IN COMMERCE 8-20-1994.

FOR: GRAPHIC ART DESIGN; GRAPHIC DESIGN; GRAPHIC DESIGN SERVICES, IN CLASS 42 (U.S. CLS. 100 AND 101).

FIRST USE 11-1-1993; IN COMMERCE 8-20-1994.

OWNER OF U.S. REG. NO. 2,132,213.

THE COLOR(S) BLUE, WHITE IS/ARE CLAIMED AS A FEATURE OF THE MARK.

THE COLOR BLUE APPEARS IN RECTANGULAR DESIGN AROUND THE MARK, PART OF THE COW'S EARS, FACE, CHEST AND FEET; THE COLOR WHITE APPEARS IN PART OF THE COW'S EARS, FACE, CHEST AND FEET AND THE DESK DESIGN.

SER. NO. 77-349,932, FILED 12-12-2007.

MARGERY A. TIERNEY, EXAMINING ATTORNEY

Int. Cl.: 25

Prior U.S. Cls.: 22 and 39

United States Patent and Trademark Office

Reg. No. 3,475,749

Registered July 29, 2008

**TRADEMARK
PRINCIPAL REGISTER**

VINTAGE CHROME

1812 CLOTHING CORPORATION (NEW YORK
CORPORATION)
1330 BROADWAY
HEWLETT, NY 11557

FOR: CLOTHING, NAMELY, TEE-SHIRTS, TANK
TOPS, SWEATSHIRTS, SWEATPANTS, SKIRTS,
JACKETS, BLAZERS, COATS, DRESSES, BATHING
SUITS, BELTS, HATS, SCARVES, JEANS AND SANDALS , IN CLASS 25 (U.S. CLS. 22 AND 39).

FIRST USE 7-1-2007; IN COMMERCE 7-1-2007.

THE MARK CONSISTS OF STANDARD CHARACTERS WITHOUT CLAIM TO ANY PARTICULAR FONT, STYLE, SIZE, OR COLOR.

SER. NO. 77-349,933, FILED 12-12-2007.

MARGERY A. TIERNEY, EXAMINING ATTORNEY

Int. Cl.: 7

Prior U.S. Cls.: 13, 19, 21, 23, 31, 34 and 35

United States Patent and Trademark Office

Reg. No. 3,475,750

Registered July 29, 2008

**TRADEMARK
PRINCIPAL REGISTER**

Pro-Torque

PERFORMANCE DEVICES, INC. (CALIFORNIA
CORPORATION)
P.O. BOX 1043
SOULSBYVILLE, CA 95372

THE MARK CONSISTS OF STANDARD CHAR-
ACTERS WITHOUT CLAIM TO ANY PARTICULAR
FONT, STYLE, SIZE, OR COLOR.

FOR: SERVO MOTORS; ALTERNATING CUR-
RENT SERVO MOTORS, IN CLASS 7 (U.S. CLS. 13,
19, 21, 23, 31, 34 AND 35).

SER. NO. 77-349,945, FILED 12-12-2007.

FIRST USE 11-26-2007; IN COMMERCE 11-28-2007.

ARETHA SOMERVILLE, EXAMINING ATTORNEY

Int. Cl.: 12

Prior U.S. Cls.: 19, 21, 23, 31, 35 and 44

Reg. No. 3,475,751

United States Patent and Trademark Office

Registered July 29, 2008

**TRADEMARK
PRINCIPAL REGISTER**

ZIMMER

ZIMMER NEO-CLASSIC MOTOR CAR COMPAN-
NY (NEW YORK CORPORATION)

1415 W. GENESEE STREET

SYRACUSE, NY 13204

FOR: MOTOR CAR AND STRUCTURAL COM-
PONENTS THEREOF, IN CLASS 12 (U.S. CLS. 19, 21,
23, 31, 35 AND 44).

FIRST USE 11-0-1997; IN COMMERCE 11-0-1997.

THE MARK CONSISTS OF STANDARD CHAR-
ACTERS WITHOUT CLAIM TO ANY PARTICULAR
FONT, STYLE, SIZE, OR COLOR.

OWNER OF U.S. REG. NOS. 2,480,221 AND
2,560,705.

SEC. 2(F).

SER. NO. 77-350,002, FILED 12-12-2007.

DANIEL CAPSHAW, EXAMINING ATTORNEY

Int. Cl.: 28

Prior U.S. Cls.: 22, 23, 38 and 50

United States Patent and Trademark Office

Reg. No. 3,475,752

Registered July 29, 2008

**TRADEMARK
PRINCIPAL REGISTER**

THE ARM SHAPER

DYNAFLEX INTERNATIONAL, INC. (CALIFORNIA CORPORATION)
1144 N GROVE ST
ANAHEIM, CA 92806

FOR: EXERCISE WRIST WEIGHTS; WRIST AND ANKLE WEIGHTS FOR EXERCISE; BODY-TRAINING APPARATUS; EXERCISE WEIGHTS, IN CLASS 28 (U.S. CLS. 22, 23, 38 AND 50).

FIRST USE 12-12-2007; IN COMMERCE 12-12-2007.

THE MARK CONSISTS OF STANDARD CHARACTERS WITHOUT CLAIM TO ANY PARTICULAR FONT, STYLE, SIZE, OR COLOR.

NO CLAIM IS MADE TO THE EXCLUSIVE RIGHT TO USE "ARM", APART FROM THE MARK AS SHOWN.

SER. NO. 77-350,012, FILED 12-12-2007.

BERYL GARDNER, EXAMINING ATTORNEY

Int. Cl.: 16

Prior U.S. Cls.: 2, 5, 22, 23, 29, 37, 38 and 50

United States Patent and Trademark Office

Reg. No. 3,475,753

Registered July 29, 2008

**TRADEMARK
PRINCIPAL REGISTER**

OTC BEAUTY MAGAZINE

JINNY BEAUTY SUPPLY CO., INC. (GEORGIA CORPORATION)
3587 OAKCLIFF ROAD
DORAVILLE, GA 30340

FOR: MAGAZINES FEATURING BUSINESS MANAGEMENT OF RETAILERS IN BEAUTY INDUSTRY, TRENDS IN BEAUTY INDUSTRY, PRODUCT REVIEWS, AND INFORMATION ABOUT BEAUTY CARE PRODUCTS, IN CLASS 16 (U.S. CLS. 2, 5, 22, 23, 29, 37, 38 AND 50).

FIRST USE 1-0-2001; IN COMMERCE 1-0-2001.

THE MARK CONSISTS OF STANDARD CHARACTERS WITHOUT CLAIM TO ANY PARTICULAR FONT, STYLE, SIZE, OR COLOR.

NO CLAIM IS MADE TO THE EXCLUSIVE RIGHT TO USE "BEAUTY MAGAZINE", APART FROM THE MARK AS SHOWN.

SER. NO. 77-350,021, FILED 12-12-2007.

JEFFERY COWARD, EXAMINING ATTORNEY

Int. Cl.: 35

Prior U.S. Cls.: 100, 101 and 102

United States Patent and Trademark Office

Reg. No. 3,475,754

Registered July 29, 2008

**SERVICE MARK
PRINCIPAL REGISTER**

WHAT THE DEVIL IS THIS?

CUSHMAN FRUIT COMPANY, INC. (FLORIDA
CORPORATION)
3325 FOREST HILL BLVD
WEST PALM BEACH, FL 33406

THE MARK CONSISTS OF STANDARD CHAR-
ACTERS WITHOUT CLAIM TO ANY PARTICULAR
FONT, STYLE, SIZE, OR COLOR.

FOR: ON-LINE ORDERING SERVICES FEATUR-
ING FRESH CITRUS FRUITS, IN CLASS 35 (U.S.
CLS. 100, 101 AND 102).

SER. NO. 77-350,037, FILED 12-12-2007.

FIRST USE 6-13-2006; IN COMMERCE 6-13-2006.

ANNE E. GUSTASON, EXAMINING ATTORNEY

Int. Cl.: 35

Prior U.S. Cls.: 100, 101 and 102

United States Patent and Trademark Office

Reg. No. 3,475,755

Registered July 29, 2008

**SERVICE MARK
PRINCIPAL REGISTER**

**SNOW BLOWERS
DIRECT**

POWER EQUIPMENT DIRECT, INC. (DELA-
WARE CORPORATION)
600 TERRITORIAL DRIVE, SUITE B
BOLLINGBROOK, IL 60440

FOR: ONLINE RETAIL STORE SERVICES FEATURING POWER EQUIPMENT PRODUCTS, IN CLASS 35 (U.S. CLS. 100, 101 AND 102).

FIRST USE 10-15-2007; IN COMMERCE 10-15-2007.

NO CLAIM IS MADE TO THE EXCLUSIVE RIGHT TO USE "SNOW BLOWERS DIRECT", APART FROM THE MARK AS SHOWN.

THE MARK CONSISTS OF THE TERMS "SNOW BLOWERS DIRECT" IN A STYLIZED LOGO WITH AN ARROW.

SER. NO. 77-350,043, FILED 12-12-2007.

JASON TURNER, EXAMINING ATTORNEY

Int. Cl.: 42

Prior U.S. Cls.: 100 and 101

United States Patent and Trademark Office

Reg. No. 3,475,756

Registered July 29, 2008

**SERVICE MARK
PRINCIPAL REGISTER**

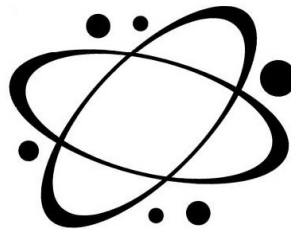

ATOMIC LABS, INC. (DELAWARE CORPORATION)
812 W DANA STREET
MOUNTAIN VIEW, CA 94301

THE MARK CONSISTS OF ATOMIC PARTICLE DESIGN.

FOR: COMPUTER SOFTWARE RESEARCH, DESIGN, AND DEVELOPMENT, IN CLASS 42 (U.S. CLS. 100 AND 101).

SER. NO. 77-350,052, FILED 12-12-2007.

FIRST USE 8-11-2007; IN COMMERCE 8-11-2007.

LANA PHAM, EXAMINING ATTORNEY

Int. Cl.: 36

Prior U.S. Cls.: 100, 101 and 102

United States Patent and Trademark Office

Reg. No. 3,475,757

Registered July 29, 2008

**SERVICE MARK
PRINCIPAL REGISTER**

Jeanie C. Linders Fund

JEANIE C. LINDERS FUND, INC. (FLORIDA
CORPORATION)
SUITE 1
1069 W. MORSE BOULEVARD
WINTER PARK, FL 32789

FOR: CHARITABLE FUND RAISING SERVICES;
PROVIDING GRANTS TO WOMEN'S CHARITABLE
ORGANIZATIONS, IN CLASS 36 (U.S. CLS. 100, 101
AND 102).

FIRST USE 9-10-2007; IN COMMERCE 9-10-2007.

THE MARK CONSISTS OF STANDARD CHAR-
ACTERS WITHOUT CLAIM TO ANY PARTICULAR
FONT, STYLE, SIZE, OR COLOR.

NO CLAIM IS MADE TO THE EXCLUSIVE
RIGHT TO USE "FUND", APART FROM THE
MARK AS SHOWN.

THE NAME(S), PORTRAIT(S), AND/OR SIGNA-
TURE(S) SHOWN IN THE MARK IDENTIFIES
"JEANIE C. LINDERS", WHOSE CONSENT(S) TO
REGISTER IS MADE OF RECORD.

SER. NO. 77-350,075, FILED 12-12-2007.

EUGENIA MARTIN, EXAMINING ATTORNEY

Int. Cl.: 41

Prior U.S. Cls.: 100, 101 and 107

United States Patent and Trademark Office

Reg. No. 3,475,758

Registered July 29, 2008

**SERVICE MARK
PRINCIPAL REGISTER**



TRINITY SPORTS & ENTERTAINMENT GROUP,
INC. (FLORIDA CORPORATION)
SUITE 1500
101 N.E. THIRD AVENUE
FORT LAUDERDALE, FL 33301

FOR: BASKETBALL CAMPS; ENTERTAINMENT IN THE NATURE OF AN ON-GOING SPECIAL VARIETY, NEWS, MUSIC OR COMEDY SHOW FEATURING SPORTS COMMENTARY BROADCAST OVER TELEVISION, SATELLITE, AUDIO, AND VIDEO MEDIA; ENTERTAINMENT IN THE NATURE OF BASKETBALL GAMES; ENTERTAINMENT IN THE NATURE OF DANCE PERFORMANCES; ENTERTAINMENT IN THE NATURE OF LIVE PERFORMANCES BY MUSICIANS, MUSICAL PERFORMERS; ENTERTAINMENT, NAMELY, LIVE PERFORMANCES BY A MUSICAL BAND; ENTERTAINMENT, NAMELY, LIVE MUSIC CONCERTS; ENTERTAINMENT, NAMELY, LIVE PERFORMANCES BY MUSICAL BANDS, IN CLASS 41 (U.S. CLS. 100, 101 AND 107).

FIRST USE 6-1-2007; IN COMMERCE 9-1-2007.

NO CLAIM IS MADE TO THE EXCLUSIVE RIGHT TO USE "EAST KENTUCKY", APART FROM THE MARK AS SHOWN.

THE COLOR(S) BLACK, WHITE, GRAY AND ORANGE IS/ARE CLAIMED AS A FEATURE OF THE MARK.

THE MARK CONSISTS OF A MALE FIGURE WITH A CONSTRUCTION OR MINING TYPE OF HAT WITH A BASKETBALL IN THE BACKGROUND AND THE WORDS, "EAST KENTUCKY MINERS" ACROSS THE CHEST OF THE MALE FIGURE. THE BASKETBALL IS ORANGE WITH BLACK STRIPES. THE MALE FIGURE IS GRAY WITH BLACK SHADING ON HIS FACE AND BODY. THE HAT IS GRAY WITH WHITE LIGHT AND THE WORDS "EAST KENTUCKY" ARE IN WHITE AND THE WORD "MINERS" IS IN GRAY BOLD TYPE.

SER. NO. 77-350,076, FILED 12-12-2007.

SAMUEL E. SHARPER JR., EXAMINING ATTORNEY

Int. Cl.: 44

Prior U.S. Cls.: 100 and 101

United States Patent and Trademark Office

Reg. No. 3,475,759

Registered July 29, 2008

**SERVICE MARK
PRINCIPAL REGISTER**

**BREEDING TOMORROW'S
CHAMPIONS TODAY**

STABLE OF DREAMS, LLC (MISSOURI LTD
LIAB CO)
6050 E. PALOMINO LANE
ROGERSVILLE, MO 65742

THE MARK CONSISTS OF STANDARD CHAR-
ACTERS WITHOUT CLAIM TO ANY PARTICULAR
FONT, STYLE, SIZE, OR COLOR.

FOR: HORSE FARMS, IN CLASS 44 (U.S. CLS. 100
AND 101).

SER. NO. 77-350,082, FILED 12-12-2007.

FIRST USE 0-0-2002; IN COMMERCE 0-0-2002.

JEFFERY COWARD, EXAMINING ATTORNEY

Int. Cls.: 35, 36, 41 and 45

Prior U.S. Cls.: 100, 101, 102 and 107

United States Patent and Trademark Office

Reg. No. 3,475,760

Registered July 29, 2008

**SERVICE MARK
PRINCIPAL REGISTER**



ABRAXAS CORPORATION (VIRGINIA CORPORATION)
6845 ELM STREET, SUITE 310
MCLEAN, VA 22101

FOR: CONSULTING SERVICES REGARDING BUSINESS STRATEGIES, MARKET INTELLIGENCE SERVICES, NAMELY, MARKET RESEARCH AND ANALYSIS SERVICES; POLITICAL CONSULTANCY SERVICES, NAMELY, ASSESSING POLITICAL CLIMATES; ECONOMIC FORECASTING AND ANALYSIS; BUSINESS RISK MANAGEMENT SERVICES, IN CLASS 35 (U.S. CLS. 100, 101 AND 102).

FIRST USE 3-1-2002; IN COMMERCE 3-1-2003.

FOR: FINANCIAL DOMESTIC AND INTERNATIONAL DUE DILIGENCE SERVICES; FINANCIAL RISK MANAGEMENT SERVICES, IN CLASS 36 (U.S. CLS. 100, 101 AND 102).

FIRST USE 3-1-2002; IN COMMERCE 3-1-2003.

FOR: TRAINING SERVICES IN THE FIELD OF DECEPTION DETECTION, INFORMATION ELICITATION AND INTERVIEWING STRATEGIES; CONDUCTING WORKSHOPS AND SEMINARS IN THE FIELD OF OVERSEAS SECURITY AWARENESS, IN CLASS 41 (U.S. CLS. 100, 101 AND 107).

TATION AND INTERVIEWING STRATEGIES; CONDUCTING WORKSHOPS AND SEMINARS IN THE FIELD OF OVERSEAS SECURITY AWARENESS, IN CLASS 41 (U.S. CLS. 100, 101 AND 107).

FIRST USE 3-1-2002; IN COMMERCE 3-1-2003.

FOR: CONSULTING SERVICES IN THE FIELD OF NATIONAL SECURITY, IN CLASS 45 (U.S. CLS. 100 AND 101).

FIRST USE 3-1-2002; IN COMMERCE 3-1-2003.

THE COLOR(S) GRAY (PMS 877) AND BLUE (PMS 288) IS/ARE CLAIMED AS A FEATURE OF THE MARK.

THE MARK CONSISTS OF A GRAY "A" IN ORIGGARMOND BT FONT WITH A PARTIAL BLUE BACKGROUND.

SER. NO. 77-350,086, FILED 12-12-2007.

ZHALEH DELANEY, EXAMINING ATTORNEY

Int. Cl.: 35

Prior U.S. Cls.: 100, 101 and 102

United States Patent and Trademark Office

Reg. No. 3,475,761

Registered July 29, 2008

**SERVICE MARK
PRINCIPAL REGISTER**

**Family Hydroponics and
Organics**

FAMILY HYDROPONICS AND ORGANICS
FRANCHISING, INC. (CALIFORNIA COR-
PORATION)
7190 HIGHWAY 20
SMARTVILLE, CA 95977

FOR: FRANCHISING, NAMELY, OFFERING
TECHNICAL ASSISTANCE IN THE ESTABLISH-
MENT AND/OR OPERATION OF RETAIL STORES
SELLING EQUIPMENT AND SUPPLIES FOR HY-
DROPONIC AND ORGANIC FARMING AND GAR-
DENING, IN CLASS 35 (U.S. CLS. 100, 101 AND 102).

FIRST USE 1-31-2006; IN COMMERCE 1-31-2006.

THE MARK CONSISTS OF STANDARD CHAR-
ACTERS WITHOUT CLAIM TO ANY PARTICULAR
FONT, STYLE, SIZE, OR COLOR.

NO CLAIM IS MADE TO THE EXCLUSIVE
RIGHT TO USE "HYDROPONICS AND ORGAN-
ICS", APART FROM THE MARK AS SHOWN.

SER. NO. 77-350,102, FILED 12-12-2007.

ARETHA SOMERVILLE, EXAMINING ATTORNEY

Int. Cls.: 35 and 38

Prior U.S. Cls.: 100, 101, 102 and 104

United States Patent and Trademark Office

Reg. No. 3,475,762

Registered July 29, 2008

**SERVICE MARK
PRINCIPAL REGISTER**

IN-CALL MEDIA

VOODOOVOX, INC. (DELAWARE CORPORATION)
1321 MASS MOCA WAY
NORTH ADAMS, MA 01247

FOR: ADVERTISING SERVICES; INTERACTIVE ADVERTISING SERVICES FOR OTHERS VIA TELEPHONES AND OTHER PERSONAL DIGITAL EQUIPMENT; BUSINESS MARKETING SERVICES; ADVERTISING AND MARKETING CONSULTATION SERVICES; DEVELOPMENT FOR OTHERS OF ADVERTISING CAMPAIGNS TRANSMITTED VIA TELEPHONE, IN CLASS 35 (U.S. CLS. 100, 101 AND 102).

FIRST USE 5-0-2007; IN COMMERCE 5-0-2007.

FOR: TELECOMMUNICATION SERVICES, NAMELY, INTERNET TELEPHONY SERVICES;

MOBILE TELEPHONY SERVICES; VOICE AND TEXT MESSAGING SERVICES; PROVIDING BROADCAST OF INTERACTIVE AUDIO CONTENT, IN CLASS 38 (U.S. CLS. 100, 101 AND 104).

FIRST USE 5-0-2007; IN COMMERCE 5-0-2007.

THE MARK CONSISTS OF STANDARD CHARACTERS WITHOUT CLAIM TO ANY PARTICULAR FONT, STYLE, SIZE, OR COLOR.

NO CLAIM IS MADE TO THE EXCLUSIVE RIGHT TO USE "MEDIA", APART FROM THE MARK AS SHOWN.

SER. NO. 77-350,103, FILED 12-12-2007.

KAREN SEVERSON, EXAMINING ATTORNEY

Int. Cl.: 35

Prior U.S. Cls.: 100, 101 and 102

United States Patent and Trademark Office

Reg. No. 3,475,763

Registered July 29, 2008

**SERVICE MARK
PRINCIPAL REGISTER**

venturous moms

BITTNER, TERRI (WISCONSIN LTD LIAB CO)
120 ASHBROOKE PLACE
NEENAH, WI 54956

THE MARK CONSISTS OF STANDARD CHAR-
ACTERS WITHOUT CLAIM TO ANY PARTICULAR
FONT, STYLE, SIZE, OR COLOR.

FOR: BUSINESS NETWORKING, IN CLASS 35
(U.S. CLS. 100, 101 AND 102).

SER. NO. 77-350,108, FILED 12-12-2007.

FIRST USE 11-4-2007; IN COMMERCE 12-5-2007.

CAROL SPILS, EXAMINING ATTORNEY

Int. Cl.: 30

Prior U.S. Cl.: 46

United States Patent and Trademark Office

Reg. No. 3,475,764

Registered July 29, 2008

**TRADEMARK
PRINCIPAL REGISTER**

CRAZY BUBBLE TEA

HYBRID GROUP, INC., THE (GEORGIA CORPORATION)
2889 KNOB HILL DRIVE SE
ATLANTA, GA 303394202

FOR: MIXES IN THE NATURE OF CONCENTRATES, SYRUPS OR POWDERS USED IN THE PREPARATION OF TEA BASED BEVERAGES, IN CLASS 30 (U.S. CL. 46).

FIRST USE 10-0-2002; IN COMMERCE 10-0-2002.

THE MARK CONSISTS OF STANDARD CHARACTERS WITHOUT CLAIM TO ANY PARTICULAR FONT, STYLE, SIZE, OR COLOR.

NO CLAIM IS MADE TO THE EXCLUSIVE RIGHT TO USE "BUBBLE TEA", APART FROM THE MARK AS SHOWN.

SER. NO. 77-350,136, FILED 12-12-2007.

KAREN SEVERSON, EXAMINING ATTORNEY

Int. Cls.: 38 and 41

Prior U.S. Cls.: 100, 101, 104 and 107

United States Patent and Trademark Office

Reg. No. 3,475,765

Registered July 29, 2008

**SERVICE MARK
PRINCIPAL REGISTER**

V-ME

V-ME MEDIA, INC. (DELAWARE CORPORATION)
450 WEST 33RD STREET
NEW YORK, NY 10001

FOR: TELEVISION BROADCASTING; CABLE TELEVISION BROADCASTING; SATELLITE TELEVISION BROADCASTING; BROADCASTING PROGRAMS VIA THE INTERNET AND WIRELESS COMMUNICATION DEVICES; RADIO BROADCASTING SERVICES AND INTERNET BROADCASTING SERVICES, NAMELY, STREAMING OF AUDIO MATERIAL ON THE INTERNET, IN CLASS 38 (U.S. CLS. 100, 101 AND 104).

FIRST USE 3-5-2007; IN COMMERCE 3-5-2007.

FOR: EDUCATION AND ENTERTAINMENT SERVICES, NAMELY, PRODUCTION AND DISTRIBUTION OF MOTION PICTURES, TELEVISED DOCUMENTARIES, NEWS SHOWS, PUBLIC AFFAIRS SHOWS AND SPORTING EVENTS SHOWS BROADCAST OVER TELEVISION, CABLE, SATELLITE, THE INTERNET AND WIRELESS COMMUNICA-

TION DEVICES; EDUCATION AND ENTERTAINMENT IN THE NATURE OF TELEVISION COMEDY, MUSICAL AND DRAMATIC SERIES BROADCAST OVER TELEVISION, CABLE, SATELLITE, THE INTERNET AND WIRELESS COMMUNICATION DEVICES; PROVIDING INFORMATION IN THE FIELD OF CURRENT EVENT NEWS, TELEVISION ENTERTAINMENT AND SOCIAL AND POLITICAL PUBLIC AFFAIRS TELEVISION PROGRAMS VIA THE INTERNET AND WIRELESS COMMUNICATION DEVICES; TELEVISION PRODUCTION SERVICES, IN CLASS 41 (U.S. CLS. 100, 101 AND 107).

FIRST USE 3-5-2007; IN COMMERCE 3-5-2007.

THE MARK CONSISTS OF STANDARD CHARACTERS WITHOUT CLAIM TO ANY PARTICULAR FONT, STYLE, SIZE, OR COLOR.

SER. NO. 77-350,143, FILED 12-12-2007.

MARK PILARO, EXAMINING ATTORNEY

Int. Cls.: 35 and 38

Prior U.S. Cls.: 100, 101, 102 and 104

United States Patent and Trademark Office

Reg. No. 3,475,766

Registered July 29, 2008

**SERVICE MARK
PRINCIPAL REGISTER**

IN-CALL ADVERTISING

VOODOOVOX, INC. (DELAWARE CORPORATION)
132 MASS MOCA WAY
NORTH ADAMS, MA 01247

FOR: ADVERTISING SERVICES; INTERACTIVE ADVERTISING SERVICES FOR OTHERS VIA TELEPHONES AND OTHER PERSONAL DIGITAL EQUIPMENT; BUSINESS MARKETING SERVICES; ADVERTISING AND MARKETING CONSULTATION SERVICES; DEVELOPMENT FOR OTHERS OF ADVERTISING CAMPAIGNS TRANSMITTED VIA TELEPHONE, IN CLASS 35 (U.S. CLS. 100, 101 AND 102).

FIRST USE 1-0-2007; IN COMMERCE 1-0-2007.

FOR: TELECOMMUNICATION SERVICES, NAMELY, INTERNET TELEPHONY SERVICES;

MOBILE TELEPHONY SERVICES; VOICE AND TEXT MESSAGING SERVICES; PROVIDING BROADCAST OF INTERACTIVE AUDIO CONTENT, IN CLASS 38 (U.S. CLS. 100, 101 AND 104).

FIRST USE 1-0-2007; IN COMMERCE 1-0-2007.

THE MARK CONSISTS OF STANDARD CHARACTERS WITHOUT CLAIM TO ANY PARTICULAR FONT, STYLE, SIZE, OR COLOR.

NO CLAIM IS MADE TO THE EXCLUSIVE RIGHT TO USE "ADVERTISING", APART FROM THE MARK AS SHOWN.

SER. NO. 77-350,146, FILED 12-12-2007.

KAREN SEVERSON, EXAMINING ATTORNEY

Int. Cl.: 35

Prior U.S. Cls.: 100, 101 and 102

United States Patent and Trademark Office

Reg. No. 3,475,767

Registered July 29, 2008

**SERVICE MARK
PRINCIPAL REGISTER**

ASP

BOARD OF CERTIFIED SAFETY PROFESSIONALS, INC. (ILLINOIS CORPORATION)
208 BURWASH AVENUE
SAVOY, IL 61874

THE MARK CONSISTS OF STANDARD CHARACTERS WITHOUT CLAIM TO ANY PARTICULAR FONT, STYLE, SIZE, OR COLOR.

FOR: TESTING, ANALYSIS AND EVALUATION OF INDIVIDUALS WORKING IN THE FIELD OF SAFETY TO DETERMINE PROFESSIONAL COMPETENCY, IN CLASS 35 (U.S. CLS. 100, 101 AND 102).

SER. NO. 77-350,148, FILED 12-12-2007.

FIRST USE 9-1-1978; IN COMMERCE 9-1-1978.

PAUL F. GAST, EXAMINING ATTORNEY

Int. Cl.: 39

Prior U.S. Cls.: 100 and 105

United States Patent and Trademark Office

Reg. No. 3,475,768

Registered July 29, 2008

**SERVICE MARK
PRINCIPAL REGISTER**



METROPOLITAN TRANSIT AUTHORITY OF
HARRIS COUNTY, TEXAS (TEXAS POLITICAL
SUBDIVISION OF THE STATE OF
TEXAS)
1900 MAIN STREET
HOUSTON, TX 77002

FOR: TRANSPORTATION OF PASSENGERS
AND/OR GOODS BY BUS AND RAIL, IN CLASS 39
(U.S. CLS. 100 AND 105).

FIRST USE 12-3-2007; IN COMMERCE 12-3-2007.

OWNER OF U.S. REG. NOS. 3,355,355 AND
3,364,635.

NO CLAIM IS MADE TO THE EXCLUSIVE
RIGHT TO USE "METRO", APART FROM THE
MARK AS SHOWN.

THE COLOR(S) RED, BLUE AND BLACK IS/ARE
CLAIMED AS A FEATURE OF THE MARK.

THE MARK CONSISTS OF THE WORDING "ME-
TRO GOING PLACES" IN BLACK. TO THE RIGHT
OF THE WORDING IS A SERIES OF BARS THAT
FORM A STYLIZED TRAPEZOID, THE LEFT SIDE
OF WHICH APPEARS IN RED AND THE RIGHT
SIDE OF WHICH APPEARS IN BLUE. THE COLOR
WHITE CONSTITUTES BACKGROUND AND IS
NOT A PART OF THE MARK.

SER. NO. 77-350,160, FILED 12-12-2007.

KAREN SEVERSON, EXAMINING ATTORNEY

Int. Cls.: 38 and 41

Prior U.S. Cls.: 100, 101, 104 and 107

United States Patent and Trademark Office

Reg. No. 3,475,769

Registered July 29, 2008

**SERVICE MARK
PRINCIPAL REGISTER**

V ME

V-ME MEDIA, INC. (DELAWARE CORPORATION)
450 WEST 33RD STREET
NEW YORK, NY 10001

FOR: TELEVISION BROADCASTING; CABLE TELEVISION BROADCASTING; SATELLITE TELEVISION BROADCASTING; BROADCASTING PROGRAMS VIA THE INTERNET AND WIRELESS COMMUNICATION DEVICES; RADIO BROADCASTING SERVICES AND INTERNET BROADCASTING SERVICES, NAMELY, STREAMING OF AUDIO MATERIAL ON THE INTERNET, IN CLASS 38 (U.S. CLS. 100, 101 AND 104).

FIRST USE 3-5-2007; IN COMMERCE 3-5-2007.

FOR: EDUCATION AND ENTERTAINMENT SERVICES, NAMELY, PRODUCTION AND DISTRIBUTION OF MOTION PICTURES, TELEVISED DOCUMENTARIES, NEWS SHOWS, PUBLIC AFFAIRS SHOWS AND SPORTING EVENTS SHOWS BROADCAST OVER TELEVISION, CABLE, SATELLITE, THE INTERNET AND WIRELESS COMMUNICA-

TION DEVICES; EDUCATION AND ENTERTAINMENT IN THE NATURE OF TELEVISION COMEDY, MUSICAL AND DRAMATIC SERIES BROADCAST OVER TELEVISION, CABLE, SATELLITE, THE INTERNET AND WIRELESS COMMUNICATION DEVICES; PROVIDING INFORMATION IN THE FIELD OF CURRENT EVENT NEWS, TELEVISION ENTERTAINMENT AND SOCIAL AND POLITICAL PUBLIC AFFAIRS TELEVISION PROGRAMS VIA THE INTERNET AND WIRELESS COMMUNICATION DEVICES; TELEVISION PRODUCTION SERVICES, IN CLASS 41 (U.S. CLS. 100, 101 AND 107).

FIRST USE 3-5-2007; IN COMMERCE 3-5-2007.

THE MARK CONSISTS OF STANDARD CHARACTERS WITHOUT CLAIM TO ANY PARTICULAR FONT, STYLE, SIZE, OR COLOR.

SER. NO. 77-350,167, FILED 12-12-2007.

MARK PILARO, EXAMINING ATTORNEY

Int. Cl.: 35

Prior U.S. Cls.: 100, 101 and 102

United States Patent and Trademark Office

Reg. No. 3,475,770

Registered July 29, 2008

**SERVICE MARK
PRINCIPAL REGISTER**

INFINITE CAR PARTS

DESIGN SYSTEMS SOLUTIONS INC. (COLOR-
ADO CORPORATION)
9695 WEST 44TH AVENUE
WHEAT RIDGE, CO 80033

FOR: DISTRIBUTORSHIP SERVICES IN THE
FIELD OF AUTOMOTIVE PARTS AND ACCESSOR-
IES, IN CLASS 35 (U.S. CLS. 100, 101 AND 102).

FIRST USE 12-12-2007; IN COMMERCE 12-12-2007.

THE MARK CONSISTS OF STANDARD CHAR-
ACTERS WITHOUT CLAIM TO ANY PARTICULAR
FONT, STYLE, SIZE, OR COLOR.

NO CLAIM IS MADE TO THE EXCLUSIVE
RIGHT TO USE "CAR PARTS", APART FROM THE
MARK AS SHOWN.

SER. NO. 77-350,168, FILED 12-12-2007.

APRIL ROACH, EXAMINING ATTORNEY

Int. Cl.: 5

Prior U.S. Cls.: 6, 18, 44, 46, 51 and 52

United States Patent and Trademark Office

Reg. No. 3,475,771

Registered July 29, 2008

**TRADEMARK
PRINCIPAL REGISTER**

COMFORT LIFE

EMPRESAS CMPC S.A. (CHILE CORPORATION)

AGUSTINAS N. 1343, PISO 8

SANTIAGO, CHILE

FOR: PRODUCTS, NAMELY, DIAPERS FOR
ADULTS, IN CLASS 5 (U.S. CLS. 6, 18, 44, 46, 51
AND 52).

THE MARK CONSISTS OF STANDARD CHAR-
ACTERS WITHOUT CLAIM TO ANY PARTICULAR
FONT, STYLE, SIZE, OR COLOR.

OWNER OF CHILE REG. NO. 776,487, DATED 4-
10-2007, EXPIRES 1-3-2017.

SER. NO. 77-350,178, FILED 12-12-2007.

SANI KHOURI, EXAMINING ATTORNEY

Int. Cl.: 7

Prior U.S. Cls.: 13, 19, 21, 23, 31, 34 and 35

United States Patent and Trademark Office

Reg. No. 3,475,772

Registered July 29, 2008

**TRADEMARK
PRINCIPAL REGISTER**

CNC SHARK

NEXT WAVE AUTOMATION, LLC (OHIO LTD
LIAB CO)

2675 CUMBERLAND RD

BERKLEY, MI 48072

FOR: POWER TOOLS, NAMELY, ROUTERS, IN
CLASS 7 (U.S. CLS. 13, 19, 21, 23, 31, 34 AND 35).

FIRST USE 1-17-2007; IN COMMERCE 1-17-2007.

THE MARK CONSISTS OF STANDARD CHAR-
ACTERS WITHOUT CLAIM TO ANY PARTICULAR
FONT, STYLE, SIZE, OR COLOR.

NO CLAIM IS MADE TO THE EXCLUSIVE
RIGHT TO USE "CNC", APART FROM THE MARK
AS SHOWN.

SER. NO. 77-350,190, FILED 12-12-2007.

TINA L. SNAPP, EXAMINING ATTORNEY

Int. Cl.: 41

Prior U.S. Cls.: 100, 101 and 107

United States Patent and Trademark Office

Reg. No. 3,475,773

Registered July 29, 2008

**SERVICE MARK
PRINCIPAL REGISTER**

LEXI LOVE

LEXI LOVE ENTERTAINMENT INC (CALIFORNIA CORPORATION)
2261 MARKET ST. #328
SAN FRANCISCO, CA 94114

FOR: ENTERTAINMENT SERVICES, NAMELY, PROVIDING A WEBSITE FEATURING PHOTOGRAPHIC, AUDIO, VIDEO AND PROSE PRESENTATIONS FEATURING ADULT CONTENT; ENTERTAINMENT SERVICES, NAMELY, LIVE, TELEVISED AND MOVIE APPEARANCES BY A PROFESSIONAL ENTERTAINER; ENTERTAINMENT SERVICES, NAMELY, PERSONAL APPEAR-

ANCES BY A ADULT FILM STAR, IN CLASS 41 (U.S. CLS. 100, 101 AND 107).

FIRST USE 8-16-2004; IN COMMERCE 8-16-2004.

THE MARK CONSISTS OF STANDARD CHARACTERS WITHOUT CLAIM TO ANY PARTICULAR FONT, STYLE, SIZE, OR COLOR.

SER. NO. 77-350,200, FILED 12-12-2007.

LINDA MICKLEBURGH, EXAMINING ATTORNEY

Int. Cl.: 35

Prior U.S. Cls.: 100, 101 and 102

United States Patent and Trademark Office

Reg. No. 3,475,774

Registered July 29, 2008

**SERVICE MARK
PRINCIPAL REGISTER**

Family Hydroponics

FAMILY HYDROPONICS AND ORGANICS
FRANCHISING, INC. (CALIFORNIA COR-
PORATION)
7190 HIGHWAY 20
SMARTVILLE, CA 95977

FOR: FRANCHISING, NAMELY, OFFERING
TECHNICAL ASSISTANCE IN THE ESTABLISH-
MENT AND/OR OPERATION OF RETAIL STORES
SELLING EQUIPMENT AND SUPPLIES FOR HY-
DROPONIC AND ORGANIC FARMING AND GAR-
DENING; PROCURING OF CONTRACTS FOR THE
PURCHASE AND SALE OF GOODS, IN CLASS 35
(U.S. CLS. 100, 101 AND 102).

FIRST USE 1-31-2006; IN COMMERCE 1-31-2006.

THE MARK CONSISTS OF STANDARD CHAR-
ACTERS WITHOUT CLAIM TO ANY PARTICULAR
FONT, STYLE, SIZE, OR COLOR.

NO CLAIM IS MADE TO THE EXCLUSIVE
RIGHT TO USE "HYDROPONICS", APART FROM
THE MARK AS SHOWN.

SER. NO. 77-350,215, FILED 12-12-2007.

ARETHA SOMERVILLE, EXAMINING ATTORNEY

Int. Cl.: 35

Prior U.S. Cls.: 100, 101 and 102

United States Patent and Trademark Office

Reg. No. 3,475,775

Registered July 29, 2008

**SERVICE MARK
PRINCIPAL REGISTER**

BLUEGREEN ALLIANCE

UNITED STEEL, PAPER AND FORESTRY, RUBBER, MANUFACTURING, ENERGY, ALLIED INDUSTRIAL AND SERVICE WORKERS INTERNATIONAL UNION AFL-CIO.CLC (PENNSYLVANIA ASSOCIATION (UNINCORPORATED))

5 GATEWAY CENTER
PITTSBURGH, PA 152221214

FOR: PROMOTING PUBLIC AWARENESS OF THE NEED FOR ENVIRONMENTAL PROTECTION, CONSERVATION OF NATURAL RESOURCES, SUSTAINABLE ENERGY AND DEVELOPMENT, JOB CREATION AND PUBLIC HEALTH AND SAFETY, IN CLASS 35 (U.S. CLS. 100, 101 AND 102).

FIRST USE 6-7-2006; IN COMMERCE 6-30-2006.

THE MARK CONSISTS OF STANDARD CHARACTERS WITHOUT CLAIM TO ANY PARTICULAR FONT, STYLE, SIZE, OR COLOR.

NO CLAIM IS MADE TO THE EXCLUSIVE RIGHT TO USE "ALLIANCE", APART FROM THE MARK AS SHOWN.

SER. NO. 77-350,252, FILED 12-12-2007.

HANNO RITTNER, EXAMINING ATTORNEY

Int. Cls.: 14 and 35

Prior U.S. Cls.: 2, 27, 28, 50, 100, 101 and 102

United States Patent and Trademark Office

Reg. No. 3,475,776

Registered July 29, 2008

TRADEMARK
SERVICE MARK
PRINCIPAL REGISTER



GIANCARLO DESIGNS, INC. (FLORIDA CORPORATION)
SUITE 226
36 NE 1ST
MIAMI, FL 33132

FOR: JEWELRY, IN CLASS 14 (U.S. CLS. 2, 27, 28 AND 50).

FIRST USE 11-30-1992; IN COMMERCE 12-31-1992.

FOR: RETAIL JEWELRY STORES , IN CLASS 35 (U.S. CLS. 100, 101 AND 102).

FIRST USE 11-30-1992; IN COMMERCE 12-31-1992.

NO CLAIM IS MADE TO THE EXCLUSIVE RIGHT TO USE "JEWELRY DESIGNS", APART FROM THE MARK AS SHOWN.

THE NAME(S), PORTRAIT(S), AND/OR SIGNATURE(S) SHOWN IN THE MARK DOES NOT IDENTIFY A PARTICULAR LIVING INDIVIDUAL.

SER. NO. 77-350,260, FILED 12-12-2007.

HANNO RITTNER, EXAMINING ATTORNEY

Int. Cl.: 18

Prior U.S. Cls.: 1, 2, 3, 22 and 41

Reg. No. 3,475,777

United States Patent and Trademark Office

Registered July 29, 2008

**TRADEMARK
PRINCIPAL REGISTER**

CIMARRON BONDED LEATHER

FIBERMARK NORTH AMERICA, INC. (DELA-
WARE CORPORATION)
161 WELLINGTON ROAD
BRATTLEBORO, VT 05301

FOR: SEMI-WORKED BONDED LEATHER,
SOLD IN BULK, CONSISTING OF FIBERS OF
LEATHER, HELD TOGETHER BY A BINDER OR
GLUING AGENT FOR USE IN FURTHER MANU-
FACTURE, IN CLASS 18 (U.S. CLS. 1, 2, 3, 22 AND 41).

FIRST USE 4-15-1994; IN COMMERCE 4-15-1994.

THE MARK CONSISTS OF STANDARD CHAR-
ACTERS WITHOUT CLAIM TO ANY PARTICULAR
FONT, STYLE, SIZE, OR COLOR.

NO CLAIM IS MADE TO THE EXCLUSIVE
RIGHT TO USE "BONDED LEATHER", APART
FROM THE MARK AS SHOWN.

SER. NO. 77-350,335, FILED 12-12-2007.

ALYSSA PALADINO, EXAMINING ATTORNEY

Int. Cl.: 9

Prior U.S. Cls.: 21, 23, 26, 36 and 38

Reg. No. 3,475,778

United States Patent and Trademark Office

Registered July 29, 2008

**TRADEMARK
PRINCIPAL REGISTER**

HOUSE OF LIGHT RECORDINGS

HOUSE OF LIGHT RECORDINGS, LLC (CALIFORNIA LTD LIAB CO)
3595 GRANDVIEW BLVD.
LOS ANGELES, CA 90066

FOR: A SERIES OF SOUND AND AUDIO-VISUAL RECORDINGS EMBODIED ON PHONORECORDS, NAMELY, VINYL DISCS, CASSETTES TAPES, DIGITAL COMPACT DISCS, ENHANCED CDS, CD-PLUS, CD-ROMS, DVDS, PRE-RECORDED VIDEO CASSETTES AND VIDEO DISCS, AND DIGITAL MEDIA FILES, ALL FEATURING MUSIC AND/OR AUDIO VISUAL ENTERTAINMENT, IN CLASS 9 (U.S. CLS. 21, 23, 26, 36 AND 38).

FIRST USE 11-29-2007; IN COMMERCE 11-29-2007.

THE MARK CONSISTS OF STANDARD CHARACTERS WITHOUT CLAIM TO ANY PARTICULAR FONT, STYLE, SIZE, OR COLOR.

NO CLAIM IS MADE TO THE EXCLUSIVE RIGHT TO USE "RECORDINGS", APART FROM THE MARK AS SHOWN.

SER. NO. 77-350,370, FILED 12-12-2007.

CAROLYN GRAY, EXAMINING ATTORNEY

Int. Cl.: 30

Prior U.S. Cl.: 46

United States Patent and Trademark Office

Reg. No. 3,475,779

Registered July 29, 2008

**TRADEMARK
PRINCIPAL REGISTER**

Magical Lollipop Seeds

LISA DENISON (MARYLAND LTD LIAB CO)
321 ALDERWOOD DRIVE
GAITHERSBURG, MD 20878

NO CLAIM IS MADE TO THE EXCLUSIVE
RIGHT TO USE "LOLLIPOP", APART FROM THE
MARK AS SHOWN.

FOR: LOLLIPOPS, IN CLASS 30 (U.S. CL. 46).

FIRST USE 4-13-2004; IN COMMERCE 12-5-2007.

SER. NO. 77-350,376, FILED 12-12-2007.

THE MARK CONSISTS OF STANDARD CHAR-
ACTERS WITHOUT CLAIM TO ANY PARTICULAR
FONT, STYLE, SIZE, OR COLOR.

CAROLYN GRAY, EXAMINING ATTORNEY

Int. Cl.: 35

Prior U.S. Cls.: 100, 101 and 102

United States Patent and Trademark Office

Reg. No. 3,475,780

Registered July 29, 2008

**SERVICE MARK
PRINCIPAL REGISTER**

GREAT SLEEP FOR LESS

HARLEM FURNITURE, INC. (ILLINOIS CORPORATION)
1000-46 ROHLWING ROAD
LOMBARD, IL 60148

THE MARK CONSISTS OF STANDARD CHARACTERS WITHOUT CLAIM TO ANY PARTICULAR FONT, STYLE, SIZE, OR COLOR.

FOR: RETAIL FURNITURE STORE SERVICES, IN CLASS 35 (U.S. CLS. 100, 101 AND 102).

SER. NO. 77-350,418, FILED 12-12-2007.

FIRST USE 11-23-2007; IN COMMERCE 11-23-2007.

LINDA ORNDORFF, EXAMINING ATTORNEY

Int. Cl.: 45

Prior U.S. Cls.: 100 and 101

United States Patent and Trademark Office

Reg. No. 3,475,781

Registered July 29, 2008

**SERVICE MARK
PRINCIPAL REGISTER**

Be There.

SMARTVUE CORPORATION (DELAWARE CORPORATION)
SUITE 400
102 WOODMONT BOULEVARD
NASHVILLE, TN 37205

FOR: PROVIDING RECONNAISSANCE AND SURVEILLANCE SERVICES, IN CLASS 45 (U.S. CLS. 100 AND 101).

FIRST USE 12-12-2007; IN COMMERCE 12-12-2007.

THE MARK CONSISTS OF THE ENGLISH LANGUAGE WORDS "BE THERE" PLUS A PERIOD FOR PUNCTUATION.

SER. NO. 77-350,447, FILED 12-12-2007.

ZHALEH DELANEY, EXAMINING ATTORNEY

Int. Cl.: 25

Prior U.S. Cls.: 22 and 39

United States Patent and Trademark Office

Reg. No. 3,475,782

Registered July 29, 2008

**TRADEMARK
PRINCIPAL REGISTER**

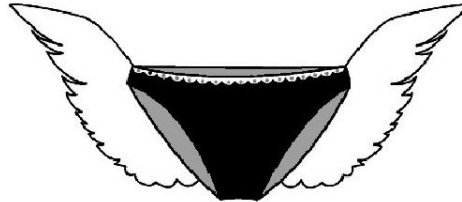

PASSPORT PANTIES, LLC (NEW YORK LTD
LIAB CO)
6243 DOLIVER
HOUSTON, TX 77057

THE MARK CONSISTS OF A LADIES' PANTY
WHICH IS TRIMMED WITH SCALLOPED LACE AT
THE TOP AND COMING FROM THE SIDES OF THE
PANTY ARE A PAIR OF WINGS.

FOR: LINGERIE; LOUNGEWEAR; ROBES; PAJA-
MAS; SWEAT SUITS; PANTIES; BRAS; CAMISOLES;
SLIPS; TANK TOPS, IN CLASS 25 (U.S. CLS. 22 AND
39).

SER. NO. 77-350,453, FILED 12-12-2007.

FIRST USE 7-31-2005; IN COMMERCE 7-31-2005.

JORDAN BAKER, EXAMINING ATTORNEY

Int. Cl.: 42

Prior U.S. Cls.: 100 and 101

United States Patent and Trademark Office

Reg. No. 3,475,783

Registered July 29, 2008

**SERVICE MARK
PRINCIPAL REGISTER**

Incrementor

INCREMENT MENTORING GROUP LLC (NEW YORK LTD LIAB CO), DBA INCREMENTOR
29 HUNTVILLE ROAD
KATONAH, NY 10536

FOR: COMPUTER PROJECT MANAGEMENT SERVICES; INFORMATION TECHNOLOGY CONSULTATION; ADVISORY SERVICES IN THE FIELD OF PRODUCT DEVELOPMENT AND QUALITY IMPROVEMENT OF SOFTWARE, IN CLASS 42 (U.S. CLS. 100 AND 101).

FIRST USE 11-1-2007; IN COMMERCE 11-1-2007.

THE MARK CONSISTS OF STANDARD CHARACTERS WITHOUT CLAIM TO ANY PARTICULAR FONT, STYLE, SIZE, OR COLOR.

SER. NO. 77-350,505, FILED 12-12-2007.

LINDA LAVACHE, EXAMINING ATTORNEY

Int. Cl.: 37

Prior U.S. Cls.: 100, 103 and 106

United States Patent and Trademark Office

Reg. No. 3,475,784

Registered July 29, 2008

**SERVICE MARK
PRINCIPAL REGISTER**



SHOWTIME AUTOMOTIVE, INC. (MARYLAND CORPORATION), DBA ATOMIC AUTOSPORTS

1211 TAFT STREET
ROCKVILLE, MD 20850

FOR: AUTOMOBILE CUSTOMIZATION SERVICES; REPAIR AND MAINTENANCE OF VEHICLES; INSTALLATION, MAINTENANCE AND REPAIR OF AUTOMOBILES; RESTORATION IN THE FIELD OF RACE CARS, STREET RODS AND SHOW CARS; AUTOMOBILE REPAIR AND MAINTENANCE; REBUILDING OF AUTOMOBILE ENGINES; REPAIR OF AUTOMOBILES, IN CLASS 37 (U.S. CLS. 100, 103 AND 106).

FIRST USE 1-24-2006; IN COMMERCE 1-24-2006.

NO CLAIM IS MADE TO THE EXCLUSIVE RIGHT TO USE "AUTOSPORTS", APART FROM THE MARK AS SHOWN.

THE MARK CONSISTS OF THE WORD "ATOMIC" IN LARGE, BOLD STYLIZED LETTERS WITH THE WORD "AUTOSPORTS" BELOW IN SMALL CAPITAL LETTERS WITH BOTH WORDS RIGHT JUSTIFIED IN THE CENTER OF AN ATOMIC ENERGY SYMBOL COMPRISED OF THREE ELONGATED CIRCLES ON A 45 DEGREE AXIS, 90 DEGREE AXIS, AND 135 DEGREE AXIS WITH ONE SMALL CIRCLE REPRESENTING AN ATOM LOCATED ON EACH OF THE THREE ELONGATED CIRCLES.

SER. NO. 77-350,513, FILED 12-12-2007.

MORGAN WYNNE, EXAMINING ATTORNEY

Int. Cl.: 5

Prior U.S. Cls.: 6, 18, 44, 46, 51 and 52

Reg. No. 3,475,785

United States Patent and Trademark Office

Registered July 29, 2008

**TRADEMARK
PRINCIPAL REGISTER**

ODORGO

SERVICEMASTER BRANDS L.L.C. (DELAWARE
LTD LIAB CO)
100 BANK STREET
BURLINGTON, VT 05401

FOR: ODOR NEUTRALIZING PREPARATIONS
FOR USE ON TEXTILE MATERIALS, FLOORING,
FURNITURE, HARD SURFACES, WALLS, VEHI-
CLES, HOMES, OFFICES, SCHOOLS, LAUNDRY,
CLOTHING, HANDICAP EQUIPMENT, DISASTER
CLEAN-UP SITES, HEALTHCARE FACILITIES,
BUILDINGS, RESTAURANTS, BARS AND TA-
VERNS, KITCHENS, REFRIGERATORS, PORTA-
BLE TOILETS, RESTROOMS, BATHROOMS,
MEDICAL AND VETERINARY OFFICES, ANIMAL
CARE FACILITIES, DESIGNATED SMOKING
AREAS, COMMERCIAL BUILDINGS, LOCKER

ROOMS, HEALTH CLUBS, GARBAGE CANS AND
WASTE DISPOSAL AREAS, FOR AIRBORNE
ODORS, AND FOR GENERAL INDUSTRIAL, COM-
MERCIAL AND RESIDENTIAL USE, IN CLASS 5
(U.S. CLS. 6, 18, 44, 46, 51 AND 52).

FIRST USE 5-6-1977; IN COMMERCE 5-6-1977.

THE MARK CONSISTS OF STANDARD CHAR-
ACTERS WITHOUT CLAIM TO ANY PARTICULAR
FONT, STYLE, SIZE, OR COLOR.

SER. NO. 77-350,556, FILED 12-12-2007.

TINA L. SNAPP, EXAMINING ATTORNEY

Int. Cl.: 35

Prior U.S. Cls.: 100, 101 and 102

United States Patent and Trademark Office

Reg. No. 3,475,786

Registered July 29, 2008

**SERVICE MARK
PRINCIPAL REGISTER**

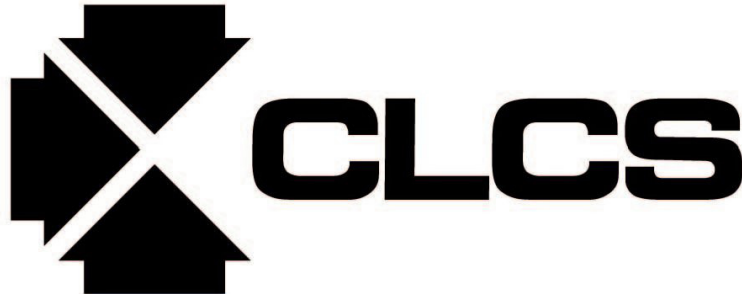

COUNCIL ON CERTIFICATION OF HEALTH,
ENVIRONMENTAL AND SAFETY TECHNOLOGISTS
(ILLINOIS JOINT VENTURE)
208 BURWASH AVENUE
SAVOY, IL 61874

FOR: TESTING, ANALYSIS AND EVALUATION
OF INDIVIDUALS WORKING IN LOSS MANAGE-
MENT FOR INSURANCE COMPANIES FOR THE
PURPOSE OF CERTIFICATION OF COMPETENCY

IN THE LOSS MANAGEMENT PRACTICE, IN
CLASS 35 (U.S. CLS. 100, 101 AND 102).

FIRST USE 12-1-2007; IN COMMERCE 12-1-2007.

SER. NO. 77-350,572, FILED 12-12-2007.

KATHRYN COWARD, EXAMINING ATTORNEY

Int. Cl.: 7

Prior U.S. Cls.: 13, 19, 21, 23, 31, 34 and 35

Reg. No. 3,475,787

United States Patent and Trademark Office

Registered July 29, 2008

**TRADEMARK
PRINCIPAL REGISTER**

CHOICE FUEL

IMPCO TECHNOLOGIES, INC. (CALIFORNIA CORPORATION)
3030 SOUTH SUSAN STREET
SANTA ANA, CA 92704

FOR: FUEL SYSTEM CONSISTING OF A CARBURETOR, REGULATOR AND FUEL SHUT-OFF VALVE FOR USE WITH POWER GENERATORS AND LAND VEHICLE ENGINES , IN CLASS 7 (U.S. CLS. 13, 19, 21, 23, 31, 34 AND 35).

FIRST USE 7-1-2001; IN COMMERCE 7-1-2001.

THE MARK CONSISTS OF STANDARD CHARACTERS WITHOUT CLAIM TO ANY PARTICULAR FONT, STYLE, SIZE, OR COLOR.

NO CLAIM IS MADE TO THE EXCLUSIVE RIGHT TO USE "FUEL", APART FROM THE MARK AS SHOWN.

SER. NO. 77-350,606, FILED 12-12-2007.

ALYSSA PALADINO, EXAMINING ATTORNEY

Int. Cl.: 41

Prior U.S. Cls.: 100, 101 and 107

United States Patent and Trademark Office

Reg. No. 3,475,788

Registered July 29, 2008

**SERVICE MARK
PRINCIPAL REGISTER**

PARK(ing) Day

REBAR GROUP, INC. (CALIFORNIA CORPORATION)
PO BOX 9234
BERKELEY, CA 947090234

FOR: ART EXHIBITIONS, NAMELY, A ONE DAY GLOBAL ART EVENT WHERE METERED PARKING SPACES ARE TRANSFORMED INTO TEMPORARY PUBLIC PARKS, IN CLASS 41 (U.S. CLS. 100, 101 AND 107).

FIRST USE 11-16-2005; IN COMMERCE 11-16-2005.

THE MARK CONSISTS OF STANDARD CHARACTERS WITHOUT CLAIM TO ANY PARTICULAR FONT, STYLE, SIZE, OR COLOR.

SER. NO. 77-350,626, FILED 12-12-2007.

GIANCARLO CASTRO, EXAMINING ATTORNEY

Int. Cl.: 41

Prior U.S. Cls.: 100, 101 and 107

United States Patent and Trademark Office

Reg. No. 3,475,789

Registered July 29, 2008

**SERVICE MARK
PRINCIPAL REGISTER**

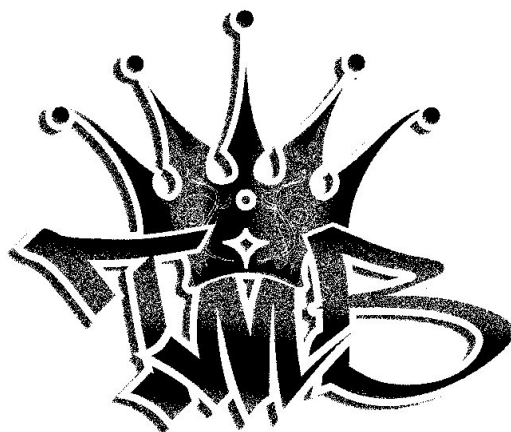

VERNON INDUSTRIES INCORPORATED (DE-
LAWARE CORPORATION)

#310

621 SOUTH GRAMERCY PL.
LOS ANGELES, CA 90005

FOR: ENTERTAINMENT SERVICES, NAMELY,
RECORD PRODUCTION, AUDIO RECORDING
AND PRODUCTION, MUSIC PRODUCTION SER-
VICES, LIVE MUSIC CONCERTS, LIVE MUSIC
PERFORMANCES, PERSONAL APPEARANCES BY
A CELEBRITY; LIVE, TELEVISED AND MOVIE
APPEARANCES BY A PROFESSIONAL ENTERTAI-
NER OR GROUP, IN CLASS 41 (U.S. CLS. 100, 101
AND 107).

FIRST USE 10-15-2007; IN COMMERCE 11-1-2007.

THE STIPPLING IS FOR SHADING PURPOSES
ONLY.

THE NAME "TMB" IDENTIFIES A LIVING IN-
DIVIDUAL MUSICAL PERFORMER "TRACY
GLEASON" WHOSE CONSENT IS OF RECORD.

THE MARK CONSISTS OF STYLIZED DESIGN
OF THE LETTERS "TMB" WITH A CROWN ON THE
"M".

SER. NO. 77-350,700, FILED 12-12-2007.

PAULA MAHONEY, EXAMINING ATTORNEY

Int. Cl.: 30

Prior U.S. Cl.: 46

United States Patent and Trademark Office

Reg. No. 3,475,790

Registered July 29, 2008

TRADEMARK
PRINCIPAL REGISTER



ROMARSI LLC (NEW JERSEY LTD LIAB CO)
17 BUTTEL DRIVE
CLIFTON, NJ 07013

THE MARK CONSISTS OF STYLIZED TEXT OF
"ROMARSI PESTO TO GO" IN BETWEEN TO PIL-
LARS WITH VINES ON THEM.

FOR: PESTO SAUCE, IN CLASS 30 (U.S. CL. 46).

SER. NO. 77-350,707, FILED 12-12-2007.

FIRST USE 10-1-2007; IN COMMERCE 10-1-2007.

NO CLAIM IS MADE TO THE EXCLUSIVE
RIGHT TO USE "PESTO", APART FROM THE
MARK AS SHOWN.

LEIGH CAROLINE CASE, EXAMINING ATTOR-
NEY

Int. Cl.: 5

Prior U.S. Cls.: 6, 18, 44, 46, 51 and 52

Reg. No. 3,475,791

United States Patent and Trademark Office

Registered July 29, 2008

**TRADEMARK
PRINCIPAL REGISTER**

PRO KIDS

WILLIAM, WINTER (UNITED STATES INDIVIDUAL)
26911 TERRI DRIVE
CANYON COUNTY, CA 91351 AND
TAYLOR, MICHAEL (UNITED STATES INDIVIDUAL)
26911 TERRI DRIVE
CANYON COUNTY, CA 91351

THE MARK CONSISTS OF STANDARD CHARACTERS WITHOUT CLAIM TO ANY PARTICULAR FONT, STYLE, SIZE, OR COLOR.

NO CLAIM IS MADE TO THE EXCLUSIVE RIGHT TO USE "KIDS", APART FROM THE MARK AS SHOWN.

FOR: HEALTHY, VITAMIN-FORTIFIED BEVERAGES FOR CHILDREN , IN CLASS 5 (U.S. CLS. 6, 18, 44, 46, 51 AND 52).

SER. NO. 77-350,801, FILED 12-13-2007.

FIRST USE 12-12-2007; IN COMMERCE 12-12-2007.

ANDREW RHIM, EXAMINING ATTORNEY

Int. Cl.: 29

Prior U.S. Cl.: 46

United States Patent and Trademark Office

Reg. No. 3,475,792

Registered July 29, 2008

**TRADEMARK
PRINCIPAL REGISTER**

TASTE

COE LICENSING COMPANY, INC. (VIRGINIA CORPORATION)
837 BOBOLINK DRIVE
VIRGINIA BEACH, VA 23451

FOR: MEATS, CHEESES, JELLIES, JAMS, DRIED FRUITS, DRIED VEGETABLES, FRUIT PRESERVES, PICKLES, CANDIED FRUIT, CANDIED NUTS, CHEESE SPREADS, COLESLAW, DIPS, FOOD PACKAGE COMBINATIONS CONSISTING PRIMARILY OF CHEESE, MEAT, NUTS OR PROCESSED FRUIT, JELLIES, PROCESSED NUTS, AND ROASTED NUTS, IN CLASS 29 (U.S. CL. 46).

FIRST USE 11-1-2007; IN COMMERCE 11-1-2007.

THE MARK CONSISTS OF STANDARD CHARACTERS WITHOUT CLAIM TO ANY PARTICULAR FONT, STYLE, SIZE, OR COLOR.

OWNER OF U.S. REG. NOS. 2,895,029, 2,910,059, AND 2,937,391.

SER. NO. 77-350,809, FILED 12-13-2007.

CAROL SPILS, EXAMINING ATTORNEY

Int. Cl.: 30

Prior U.S. Cl.: 46

United States Patent and Trademark Office

Reg. No. 3,475,793

Registered July 29, 2008

**TRADEMARK
PRINCIPAL REGISTER**

TASTE

COE LICENSING COMPANY, INC. (VIRGINIA CORPORATION)
837 BOBOLINK DRIVE
VIRGINIA BEACH, VA 23451

FOR: BAKED GOODS, NAMELY, BREAD, CAKES, BISCUITS, COOKIES, PASTRIES, CHOCOLATE COVERED NUTS, CORN CHIPS, CRACKERS, PASTA SALAD, DELI SANDWICHES, COFFEE, TEA, SPICES, SALAD DRESSING AND SAUCES EXCLUDING APPLESAUCE AND CRANBERRY SAUCE, IN CLASS 30 (U.S. CL. 46).

FIRST USE 11-1-2007; IN COMMERCE 11-1-2007.

THE MARK CONSISTS OF STANDARD CHARACTERS WITHOUT CLAIM TO ANY PARTICULAR FONT, STYLE, SIZE, OR COLOR.

OWNER OF U.S. REG. NOS. 2,895,029, 2,910,059, AND 2,937,391.

SER. NO. 77-350,811, FILED 12-13-2007.

CAROL SPILS, EXAMINING ATTORNEY

Int. Cl.: 35

Prior U.S. Cls.: 100, 101 and 102

United States Patent and Trademark Office

Reg. No. 3,475,794

Registered July 29, 2008

**SERVICE MARK
PRINCIPAL REGISTER**

TASTE

COE LICENSING COMPANY, INC. (VIRGINIA CORPORATION)
837 BOBOLINK DRIVE
VIRGINIA BEACH, VA 23451

FOR: RETAIL STORE SERVICES FEATURING FOOD PRODUCTS AND WINE; MAIL ORDER SERVICES FEATURING FOOD PRODUCTS AND WINE; ON-LINE RETAIL STORE SERVICES FEATURING FOOD PRODUCTS AND WINE, IN CLASS 35 (U.S. CLS. 100, 101 AND 102).

FIRST USE 11-1-2007; IN COMMERCE 11-1-2007.

THE MARK CONSISTS OF STANDARD CHARACTERS WITHOUT CLAIM TO ANY PARTICULAR FONT, STYLE, SIZE, OR COLOR.

OWNER OF U.S. REG. NOS. 2,895,029, 2,910,059, AND 2,937,391.

SER. NO. 77-350,812, FILED 12-13-2007.

CAROL SPILS, EXAMINING ATTORNEY

Int. Cl.: 45

Prior U.S. Cls.: 100 and 101

United States Patent and Trademark Office

Reg. No. 3,475,795

Registered July 29, 2008

**SERVICE MARK
PRINCIPAL REGISTER**

SECURE US

SECURE US (WEST VIRGINIA CORPORATION)
330 SCOTT AVENUE
MORGANTOWN, WV 26508

FOR: MONITORING ALARMS; MONITORING
BURGLAR AND SECURITY ALARMS; MONITOR-
ING FIRE ALARMS, IN CLASS 45 (U.S. CLS. 100
AND 101).

FIRST USE 1-0-1994; IN COMMERCE 1-0-1994.

THE MARK CONSISTS OF STANDARD CHAR-
ACTERS WITHOUT CLAIM TO ANY PARTICULAR
FONT, STYLE, SIZE, OR COLOR.

NO CLAIM IS MADE TO THE EXCLUSIVE
RIGHT TO USE "SECURE", APART FROM THE
MARK AS SHOWN.

SER. NO. 77-350,831, FILED 12-13-2007.

MICHAEL GAAFAR, EXAMINING ATTORNEY

Int. Cl.: 44

Prior U.S. Cls.: 100 and 101

United States Patent and Trademark Office

Reg. No. 3,475,796

Registered July 29, 2008

**SERVICE MARK
PRINCIPAL REGISTER**



VALLEY CASE MANAGEMENT & CONSULTING
SERVICES, LLC (VIRGINIA LTD LIAB CO)

3454 PEAKS VIEW CIRCLE

MCGAHEYSVILLE, VA 22840

FOR: MEDICAL SERVICES; MOBILE MEDICAL
CLINICS; MEDICAL CONSULTATION SERVICES;
MEDICAL ASSISTANCE SERVICES; PROVIDING
MEDICAL INFORMATION; DRUG TESTING FOR
SUBSTANCE ABUSE; MEDICAL TESTING; AND
CONSULTING SERVICES IN THE FIELD OF
HEALTH AND WELLNESS, IN CLASS 44 (U.S. CLS.
100 AND 101).

FIRST USE 0-0-2006; IN COMMERCE 0-0-2006.

NO CLAIM IS MADE TO THE EXCLUSIVE
RIGHT TO USE DEPICTION OF A CROSS, APART
FROM THE MARK AS SHOWN.

THE COLOR(S) RED AND WHITE IS/ARE
CLAIMED AS A FEATURE OF THE MARK.

THE COLOR RED APPEARS IN THE SQUARE, IN
THE DEPICTION OF A HELMET AND IN THE
LETTERS "VCM". THE COLOR WHITE APPEARS IN
THE DEPICTION OF THE CROSS AND IN THE
HELMET.

SER. NO. 77-350,843, FILED 12-13-2007.

EVELYN BRADLEY, EXAMINING ATTORNEY

Int. Cls.: 35 and 42

Prior U.S. Cls.: 100, 101 and 102

United States Patent and Trademark Office

Reg. No. 3,475,797

Registered July 29, 2008

**SERVICE MARK
PRINCIPAL REGISTER**

TWO-IN-A-BOX

COGNIZANT TECHNOLOGY SOLUTIONS U.S.
CORPORATION (DELAWARE CORPORATION)

500 GLENPOINTE CENTER WEST
TEANECK, NJ 07666

FOR: BUSINESS MANAGEMENT, CONSULTING
AND ADVISORY SERVICES, IN CLASS 35 (U.S. CLS.
100, 101 AND 102).

FIRST USE 9-30-2006; IN COMMERCE 9-30-2006.

FOR: COMPUTER SOFTWARE AND HARD-
WARE CONSULTING SERVICES, IN CLASS 42
(U.S. CLS. 100 AND 101).

FIRST USE 9-30-2006; IN COMMERCE 9-30-2006.

THE MARK CONSISTS OF STANDARD CHAR-
ACTERS WITHOUT CLAIM TO ANY PARTICULAR
FONT, STYLE, SIZE, OR COLOR.

SER. NO. 77-350,852, FILED 12-13-2007.

SANJEEV VOHRA, EXAMINING ATTORNEY

Int. Cl.: 41

Prior U.S. Cls.: 100, 101 and 107

United States Patent and Trademark Office

Reg. No. 3,475,798

Registered July 29, 2008

**SERVICE MARK
PRINCIPAL REGISTER**

East Kentucky Miners

TRINITY SPORTS & ENTERTAINMENT GROUP,
INC. (FLORIDA CORPORATION)
SUITE 1500
101 N.E. THIRD AVENUE
FORT LAUDERDALE, FL 33301

FOR: BASKETBALL CAMPS; ENTERTAINMENT IN THE NATURE OF BASKETBALL GAMES; ENTERTAINMENT IN THE NATURE OF DANCE PERFORMANCES; ENTERTAINMENT IN THE NATURE OF LIVE PERFORMANCES BY SINGERS, DANCERS, MUSICAL GROUPS; ENTERTAINMENT, NAMELY, LIVE PERFORMANCES BY A MUSICAL BAND; ENTERTAINMENT SERVICES, NAMELY, LIVE, TELEVISED AND MOVIE APPEARANCES BY A PROFESSIONAL ENTERTAINER; ENTERTAINMENT SERVICES, NAMELY, AN ON-GOING SERIES FEATURING SPORTS COMMENTARY PROVIDED THROUGH CABLE, TELEVISION AND GLOBAL COMPUTER NETWORK; ENTERTAINMENT SERVICES, NAMELY, PROVIDING A TELEVISION PROGRAM IN THE FIELD OF

NEWS COMMENTARY VIA A GLOBAL COMPUTER NETWORK; ENTERTAINMENT, NAMELY, LIVE MUSIC CONCERTS; ENTERTAINMENT, NAMELY, LIVE PERFORMANCES BY MUSICAL BANDS, IN CLASS 41 (U.S. CLS. 100, 101 AND 107).

FIRST USE 6-1-2007; IN COMMERCE 9-1-2007.

THE MARK CONSISTS OF STANDARD CHARACTERS WITHOUT CLAIM TO ANY PARTICULAR FONT, STYLE, SIZE, OR COLOR.

NO CLAIM IS MADE TO THE EXCLUSIVE RIGHT TO USE "EAST KENTUCKY", APART FROM THE MARK AS SHOWN.

SER. NO. 77-350,884, FILED 12-13-2007.

SAMUEL E. SHARPER JR., EXAMINING ATTORNEY

Int. Cl.: 9

Prior U.S. Cls.: 21, 23, 26, 36 and 38

Reg. No. 3,475,799

United States Patent and Trademark Office

Registered July 29, 2008

**TRADEMARK
PRINCIPAL REGISTER**

SOLARA

PYRAMEX SAFETY PRODUCTS, LLC (TENNESSEE LTD LIAB CO)
281-A MOORE LANE
COLLIERVILLE, TN 38017

THE MARK CONSISTS OF STANDARD CHARACTERS WITHOUT CLAIM TO ANY PARTICULAR FONT, STYLE, SIZE, OR COLOR.

FOR: PROTECTIVE EYEGASSES, IN CLASS 9 (U.S. CLS. 21, 23, 26, 36 AND 38).

SER. NO. 77-350,918, FILED 12-13-2007.

FIRST USE 6-1-2006; IN COMMERCE 6-1-2006.

H. M. FISHER, EXAMINING ATTORNEY

Int. Cl.: 35

Prior U.S. Cls.: 100, 101 and 102

United States Patent and Trademark Office

Reg. No. 3,475,800

Registered July 29, 2008

**SERVICE MARK
PRINCIPAL REGISTER**

ICONIC FINDS

M2L, INC. (NEW YORK CORPORATION)
215 EAST 58TH STREET
NEW YORK, NY 10022

FOR: WHOLESALE AND RETAIL STORE SERVICES IN THE FIELD OF FURNITURE, BEDDING, LAMPS AND HOME FURNISHINGS, IN CLASS 35 (U.S. CLS. 100, 101 AND 102).

FIRST USE 9-1-2007; IN COMMERCE 9-1-2007.

THE MARK CONSISTS OF STANDARD CHARACTERS WITHOUT CLAIM TO ANY PARTICULAR FONT, STYLE, SIZE, OR COLOR.

SER. NO. 77-350,990, FILED 12-13-2007.

REBECCA POVARCHUK, EXAMINING ATTORNEY

Int. Cl.: 35

Prior U.S. Cls.: 100, 101 and 102

United States Patent and Trademark Office

Reg. No. 3,475,801

Registered July 29, 2008

**SERVICE MARK
PRINCIPAL REGISTER**

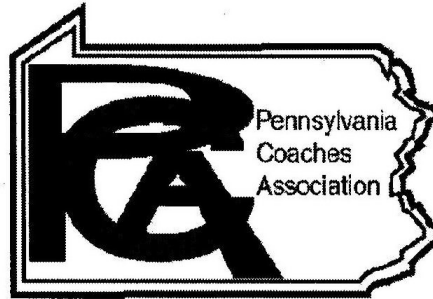

PENNSYLVANIA INTERSCHOLASTIC ATHLETIC ASSOCIATION, INC. (PENNSYLVANIA CORPORATION)
550 GETTYSBURG ROAD
MECHANICSBURG, PA 17055

FOR: ASSOCIATION SERVICES, NAMELY, PROMOTING THE INTERESTS OF COACHES OF INTERSCHOLASTIC ATHLETIC COMPETITIONS, IN CLASS 35 (U.S. CLS. 100, 101 AND 102).

FIRST USE 7-1-2001; IN COMMERCE 7-1-2001.

NO CLAIM IS MADE TO THE EXCLUSIVE RIGHT TO USE "PENNSYLVANIA COACHES AS-

SOCIATION" AND THE DESIGN REPRESENTATION OF THE STATE OF PENNSYLVANIA, APART FROM THE MARK AS SHOWN.

THE MARK CONSISTS OF THE LETTERS "PCA" AND THE WORDS "PENNSYLVANIA COACHES ASSOCIATION" INSIDE A DOUBLE OUTLINE OF THE STATE OF PENNSYLVANIA.

SER. NO. 77-350,994, FILED 12-13-2007.

JESSICA A. POWERS, EXAMINING ATTORNEY

Int. Cl.: 25

Prior U.S. Cls.: 22 and 39

United States Patent and Trademark Office

Reg. No. 3,475,802

Registered July 29, 2008

**TRADEMARK
PRINCIPAL REGISTER**

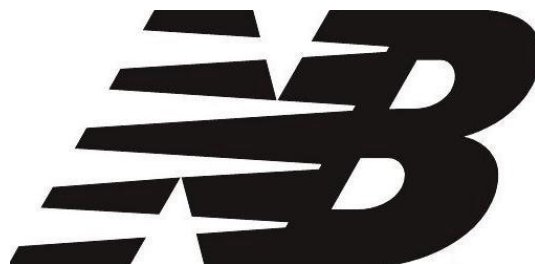

NEW BALANCE ATHLETIC SHOE INC. (MASSACHUSETTS CORPORATION)
20 GUEST STREET
BOSTON, MA 02135

FOR: BASKETBALL SNEAKERS; SNEAKERS; BUTTON-FRONT ALOHA SHIRTS; CAMP SHIRTS; DRESS SHIRTS; GOLF SHIRTS; KNIT SHIRTS; LONG-SLEEVED SHIRTS; NIGHT SHIRTS; OPEN-NECKED SHIRTS; POLO SHIRTS; RUGBY SHIRTS; SHIRTS; SHORT-SLEEVED OR LONG-SLEEVED T-SHIRTS; SHORT-SLEEVED SHIRTS; SPORT SHIRTS; SPORTS SHIRTS; SPORTS SHIRTS WITH SHORT SLEEVES; SWEAT SHIRTS; T-SHIRTS; TEE SHIRTS; TRIATHLON CLOTHING, NAMELY, TRIATHLON TIGHTS, TRIATHLON SHORTS, TRIATHLON SINGLET, TRIATHLON SHIRTS, TRIATHLON SUITS; WIND SHIRTS; YOGA SHIRTS; BERMUDA SHORTS; BOARD SHORTS; BOXER SHORTS; FLEECE SHORTS; GYM SHORTS; PANTIES, SHORTS AND BRIEFS; RUGBY SHORTS; SHORT

TROUSERS; UNDERWEAR, NAMELY, BOY SHORTS; WALKING SHORTS; CAPRI PANTS; CARGO PANTS; JOGGING PANTS; LOUNGE PANTS; PANTS; SKI PANTS; SNOW PANTS; STRETCH PANTS; SWEAT PANTS; TRACK PANTS; WATER-PROOF JACKETS AND PANTS; WIND PANTS; YOGA PANTS; JACKETS; LIGHT-REFLECTING JACKETS; MEN AND WOMEN JACKETS, COATS, TROUSERS, VESTS; RAIN JACKETS; SKI JACKETS; SPORTS JACKETS; WIND-JACKETS; ATHLETIC SHOES, IN CLASS 25 (U.S. CLS. 22 AND 39).

FIRST USE 1-1-2007; IN COMMERCE 1-2-2007.

THE MARK CONSISTS OF "NB".

SER. NO. 77-350,997, FILED 12-13-2007.

EUGENIA MARTIN, EXAMINING ATTORNEY

Int. Cl.: 35

Prior U.S. Cls.: 100, 101 and 102

United States Patent and Trademark Office

Reg. No. 3,475,803

Registered July 29, 2008

**SERVICE MARK
PRINCIPAL REGISTER**

bidabing

BIDABING CORPORATION (FLORIDA CORPORATION)
15580 PALMETTO CLUB DR.
MIAMI, FL 33157

FOR: ADVERTISING SERVICES, NAMELY, PROMOTING AND MARKETING THE GOODS AND SERVICES OF OTHERS THROUGH ALL PUBLIC COMMUNICATION MEANS; ON-LINE ADVERTISING AND MARKETING SERVICES; PROVIDING A WEBSITE THAT FEATURES AN ONLINE MARKET FOR USERS TO LIST OFFERED OR WANTED PERSONAL AND BUSINESS ASSETS AND SKILLS FOR HIRE, RENT, SALE OR AUCTION TRANSACTED ON THE BASIS OF PREDEFINED PERFORMANCE AND CLOSING TERMS AND CONDITIONS; REAL ESTATE MARKETING SERVICES, NAMELY, ON-LINE SERVICES FEATUR-

ING TOURS OF RESIDENTIAL AND COMMERCIAL REAL ESTATE; ON-LINE TRADING SERVICES IN WHICH SELLER POSTS PRODUCTS TO BE AUCTIONED AND BIDDING IS DONE VIA THE INTERNET; REAL ESTATE AUCTIONS , IN CLASS 35 (U.S. CLS. 100, 101 AND 102).

FIRST USE 10-1-2007; IN COMMERCE 10-1-2007.

THE MARK CONSISTS OF STANDARD CHARACTERS WITHOUT CLAIM TO ANY PARTICULAR FONT, STYLE, SIZE, OR COLOR.

SER. NO. 77-351,004, FILED 12-13-2007.

JAY FLOWERS, EXAMINING ATTORNEY

Int. Cl.: 29

Prior U.S. Cl.: 46

United States Patent and Trademark Office

Reg. No. 3,475,804

Registered July 29, 2008

**TRADEMARK
PRINCIPAL REGISTER**



FISCALINI CHEESE CO., LLC (CALIFORNIA
LTD LIAB CO)
7231 COVERT ROAD
MODESTO, CA 95358

FOR: CHEESE; CHEESE FOOD; CHEESE
SPREADS; FOOD PACKAGE COMBINATIONS
CONSISTING PRIMARILY OF CHEESE, MEAT
AND/OR PROCESSED FRUIT; FRESH UNRIPENED
CHEESES; MOLD-RIPENED CHEESE , IN CLASS 29
(U.S. CL. 46).

FIRST USE 12-1-2006; IN COMMERCE 12-1-2006.

THE MARK CONSISTS OF AN INVERTED RAIN-
DROP-SHAPED LABEL WITH A PICTURE OF A
CHURCH WITH A MOUNTAIN RANGE IN THE
BACKGROUND.

SER. NO. 77-351,020, FILED 12-13-2007.

INGRID C. EULIN, EXAMINING ATTORNEY

Int. Cl.: 5

Prior U.S. Cls.: 6, 18, 44, 46, 51 and 52

Reg. No. 3,475,805

United States Patent and Trademark Office

Registered July 29, 2008

**TRADEMARK
PRINCIPAL REGISTER**

SLEEP1

NUTRITION 53, INC. (CALIFORNIA CORPORATION)
3706 MT. DIABLO BLVD SUITE 300
LAFAYETTE, CA 94549

THE MARK CONSISTS OF STANDARD CHARACTERS WITHOUT CLAIM TO ANY PARTICULAR FONT, STYLE, SIZE, OR COLOR.

FOR: MEAL REPLACEMENT AND DIETARY SUPPLEMENT DRINK MIXES; DIETARY SUPPLEMENTS, IN CLASS 5 (U.S. CLS. 6, 18, 44, 46, 51 AND 52).

SER. NO. 77-351,051, FILED 12-13-2007.

FIRST USE 8-1-2006; IN COMMERCE 11-11-2006.

KATHRYN COWARD, EXAMINING ATTORNEY

Int. Cl.: 42

Prior U.S. Cls.: 100 and 101

United States Patent and Trademark Office

Reg. No. 3,475,806

Registered July 29, 2008

**SERVICE MARK
PRINCIPAL REGISTER**

ThreePointOffice

THREEPOINTOFFICE (NEW YORK LTD LIAB
CO)
19 WESTMINSTER CT SO
NESCONSET, NY 11767

FOR: PROVIDING ON-LINE NON-DOWNLOAD-
ABLE SOFTWARE FOR REAL ESTATE OFFICES
AND CORPORATIONS TO MANAGE ASPECTS OF
THEIR OFFICE OPERATION IN THE NATURE OF
LISTINGS, SHOWINGS, LEADS, COMMISSIONS,
CLOSINGS, AND CONTACTS, IN CLASS 42 (U.S.
CLS. 100 AND 101).

FIRST USE 6-1-2007; IN COMMERCE 6-1-2007.

THE MARK CONSISTS OF STANDARD CHAR-
ACTERS WITHOUT CLAIM TO ANY PARTICULAR
FONT, STYLE, SIZE, OR COLOR.

SER. NO. 77-351,063, FILED 12-13-2007.

B. PARADEWELAI, EXAMINING ATTORNEY

Int. Cl.: 20

Prior U.S. Cls.: 2, 13, 22, 25, 32 and 50

United States Patent and Trademark Office

Reg. No. 3,475,807

Registered July 29, 2008

**TRADEMARK
PRINCIPAL REGISTER**



OENEO BOUCHAGE (FRANCE CORPORATION)
ESPACE TECH ULRICH
CERET, FRANCE F-66400

FOR: CORKS FOR BOTTLES, IN CLASS 20 (U.S.
CLS. 2, 13, 22, 25, 32 AND 50).

FIRST USE 6-0-2007; IN COMMERCE 6-0-2007.

OWNER OF U.S. REG. NO. 3,158,918.

THE MARK CONSISTS OF THE WORD "DIAM"
WITH AN ARC ABOVE AND BELOW THE WORD.

SER. NO. 77-351,074, FILED 12-13-2007.

JUDITH HELFMAN, EXAMINING ATTORNEY

Int. Cl.: 14

Prior U.S. Cls.: 2, 27, 28 and 50

United States Patent and Trademark Office

Reg. No. 3,475,808

Registered July 29, 2008

**TRADEMARK
PRINCIPAL REGISTER**

CRYSTAZZI

COUSIN CORPORATION OF AMERICA (FLOR-
IDA CORPORATION)
12333 ENTERPRISE BLVD
LARGO, FL 33773

FOR: JEWELRY, IMITATION JEWELRY AND
COSTUME JEWELRY AND PARTS THEREOF,
NAMELY, GLASS BEADS, METAL BEADS, PLAS-
TIC BEADS, STONE BEADS, CORAL BEADS, SHELL
BEADS, CERAMIC BEADS, STRINGS OF BEADS,
PEARL BEADS, RHINESTONES, DECORATIVE
CHAIN, ORNAMENTAL PINS, BRACELETS,

CHARMS, CHAINS, AND JEWELRY FINDINGS,
IN CLASS 14 (U.S. CLS. 2, 27, 28 AND 50).

FIRST USE 12-3-2007; IN COMMERCE 12-3-2007.

THE MARK CONSISTS OF STANDARD CHAR-
ACTERS WITHOUT CLAIM TO ANY PARTICULAR
FONT, STYLE, SIZE, OR COLOR.

SER. NO. 77-351,095, FILED 12-13-2007.

BARBARA RUTLAND, EXAMINING ATTORNEY

Int. Cl.: 11

Prior U.S. Cls.: 13, 21, 23, 31 and 34

United States Patent and Trademark Office

Reg. No. 3,475,809

Registered July 29, 2008

**TRADEMARK
PRINCIPAL REGISTER**

TES

BRIDGEWATER, INC. (UTAH CORPORATION)
4282 SOUTH 590 WEST
SALT LAKE CITY, UT 84123

THE MARK CONSISTS OF STANDARD CHAR-
ACTERS WITHOUT CLAIM TO ANY PARTICULAR
FONT, STYLE, SIZE, OR COLOR.

FOR: DRYERS FOR USE IN RESTORATION
AFTER WATER AND SEWER DAMAGE, IN CLASS
11 (U.S. CLS. 13, 21, 23, 31 AND 34).

SER. NO. 77-351,096, FILED 12-13-2007.

FIRST USE 10-31-2005; IN COMMERCE 10-31-2005.

BARBARA RUTLAND, EXAMINING ATTORNEY

Int. Cl.: 7

Prior U.S. Cls.: 13, 19, 21, 23, 31, 34 and 35

United States Patent and Trademark Office

Reg. No. 3,475,810

Registered July 29, 2008

**TRADEMARK
PRINCIPAL REGISTER**

GS 10

BSH BOSCH UND SIEMENS HAUSGERAETE
GMBH (FED REP GERMANY CORPORATION)
CARL-WERY-STRASSE 34
MUNICH, FED REP GERMANY 81739

FOR: HOUSEHOLD AND KITCHEN MACHINES
AND EQUIPMENT, NAMELY, ELECTRIC KITCHEN
MACHINES AND EQUIPMENT, NAMELY, VACUUM
CLEANERS; STRUCTURAL PARTS OF ALL
AFOREMENTIONED GOODS, IN CLASS 7 (U.S. CLS.
13, 19, 21, 23, 31, 34 AND 35).

THE MARK CONSISTS OF STANDARD CHARACTERS
WITHOUT CLAIM TO ANY PARTICULAR
FONT, STYLE, SIZE, OR COLOR.

PRIORITY CLAIMED UNDER SEC. 44(D) ON FED
REP GERMANY APPLICATION NO. 30744389.2/0,
FILED 7-6-2007, REG. NO. 30744389, DATED 10-5-
2007, EXPIRES 7-31-2017.

SER. NO. 77-351,099, FILED 12-13-2007.

JASON BLAIR, EXAMINING ATTORNEY

Int. Cl.: 36

Prior U.S. Cls.: 100, 101 and 102

United States Patent and Trademark Office

Reg. No. 3,475,811

Registered July 29, 2008

**SERVICE MARK
PRINCIPAL REGISTER**

FREEDOM WEEKEND ALOFT

FREEDOM WEEKEND ALOFT, INC. (SOUTH
CAROLINA CORPORATION)
419 S.E. MAIN ST., SUITE 400
SIMPSONVILLE, SC 29681

FOR: CHARITABLE FUND RAISING SERVICES
BY MEANS OF AN ENTERTAINMENT EVENT, IN
CLASS 36 (U.S. CLS. 100, 101 AND 102).

FIRST USE 5-31-1985; IN COMMERCE 5-31-1985.

THE MARK CONSISTS OF STANDARD CHAR-
ACTERS WITHOUT CLAIM TO ANY PARTICULAR
FONT, STYLE, SIZE, OR COLOR.

OWNER OF U.S. REG. NO. 1,471,726.

SER. NO. 77-351,105, FILED 12-13-2007.

MONIQUE MILLER, EXAMINING ATTORNEY

Int. Cl.: 42

Prior U.S. Cls.: 100 and 101

United States Patent and Trademark Office

Reg. No. 3,475,812

Registered July 29, 2008

**SERVICE MARK
PRINCIPAL REGISTER**

PARENTLY

BABYNAMES.COM LLC (CALIFORNIA LTD
LIAB CO)
2355 WESTWOOD BLVD., #133
LOS ANGELES, CA 90064

FOR: COMPUTER SERVICES, NAMELY, PROVIDING TEMPORARY USE OF ON-LINE NON-DOWNLOADABLE SOFTWARE FOR MANAGING FAMILY INFORMATION FEATURING A PREGNANCY JOURNAL, CHILDREN'S INFORMATION, SHAREABLE BABY BOOKS, FAMILY CALENDAR, BIRTH PLAN BUILDER, BABYSITTER INSTRUCTIONS, DOCTOR VISIT CATALOG AND MEDICAL RECORDS, AND UNIVERSAL GIFT REGISTRY; PROVIDING A WEB SITE FEATURING TEMPORARY USE OF NON-DOWNLOADABLE SOFTWARE ALLOWING WEB SITE USERS TO UPLOAD FAMILY INFORMATION FEATURING A PREGNAN-

CY JOURNAL, CHILDREN'S INFORMATION, SHAREABLE BABY BOOKS, FAMILY CALENDAR, BIRTH PLAN BUILDER, BABYSITTER INSTRUCTIONS, DOCTOR VISIT CATALOG AND MEDICAL RECORDS, AND UNIVERSAL GIFT REGISTRY, IN CLASS 42 (U.S. CLS. 100 AND 101).

FIRST USE 12-20-2005; IN COMMERCE 12-20-2005.

THE MARK CONSISTS OF STANDARD CHARACTERS WITHOUT CLAIM TO ANY PARTICULAR FONT, STYLE, SIZE, OR COLOR.

SER. NO. 77-351,118, FILED 12-13-2007.

MONIQUE MILLER, EXAMINING ATTORNEY

Int. Cl.: 19

Prior U.S. Cls.: 1, 12, 33 and 50

United States Patent and Trademark Office

Reg. No. 3,475,813

Registered July 29, 2008

**TRADEMARK
PRINCIPAL REGISTER**

COUNTY STONE

COUNTY MATERIALS CORPORATION (WIS-
CONSIN CORPORATION)
205 NORTH STREET
MARATHON, WI 54448

FOR: CONCRETE MASONRY UNITS, NAMELY,
DECORATIVE MASONRY BLOCKS, IN CLASS 19
(U.S. CLS. 1, 12, 33 AND 50).

FIRST USE 8-0-2000; IN COMMERCE 8-0-2000.

THE MARK CONSISTS OF STANDARD CHAR-
ACTERS WITHOUT CLAIM TO ANY PARTICULAR
FONT, STYLE, SIZE, OR COLOR.

OWNER OF U.S. REG. NO. 2,140,330.

NO CLAIM IS MADE TO THE EXCLUSIVE
RIGHT TO USE "STONE", APART FROM THE
MARK AS SHOWN.

SER. NO. 77-351,122, FILED 12-13-2007.

ALLISON SCHRODY, EXAMINING ATTORNEY

Int. Cl.: 7

Prior U.S. Cls.: 13, 19, 21, 23, 31, 34 and 35

United States Patent and Trademark Office

Reg. No. 3,475,814

Registered July 29, 2008

**TRADEMARK
PRINCIPAL REGISTER**

GS 30

BSH BOSCH UND SIEMENS HAUSGERAETE
GMBH (FED REP GERMANY CORPORATION)
CARL-WERY-STRASSE 34
MUNICH, FED REP GERMANY 81739

FOR: HOUSEHOLD AND KITCHEN MACHINES
AND EQUIPMENT, NAMELY, ELECTRIC KITCHEN
MACHINES AND EQUIPMENT, NAMELY, VACUUM
CLEANERS; STRUCTURAL PARTS OF ALL
AFOREMENTIONED GOODS, IN CLASS 7 (U.S. CLS.
13, 19, 21, 23, 31, 34 AND 35).

THE MARK CONSISTS OF STANDARD CHARACTERS
WITHOUT CLAIM TO ANY PARTICULAR
FONT, STYLE, SIZE, OR COLOR.

PRIORITY CLAIMED UNDER SEC. 44(D) ON FED
REP GERMANY APPLICATION NO. 30744391.4/0,
FILED 7-6-2007, REG. NO. 30744391, DATED 10-5-
2007, EXPIRES 7-31-2017.

SER. NO. 77-351,132, FILED 12-13-2007.

JASON BLAIR, EXAMINING ATTORNEY

Int. Cl.: 19

Prior U.S. Cls.: 1, 12, 33 and 50

United States Patent and Trademark Office

Reg. No. 3,475,815

Registered July 29, 2008

**TRADEMARK
PRINCIPAL REGISTER**

H2O PRO PAVERS

COUNTY MATERIALS CORPORATION (WIS-
CONSIN CORPORATION)

205 NORTH STREET

MARATHON, WI 54448

FOR: PERMEABLE PAVERS, IN CLASS 19 (U.S.
CLS. 1, 12, 33 AND 50).

FIRST USE 12-1-2007; IN COMMERCE 12-1-2007.

THE MARK CONSISTS OF STANDARD CHAR-
ACTERS WITHOUT CLAIM TO ANY PARTICULAR
FONT, STYLE, SIZE, OR COLOR.

NO CLAIM IS MADE TO THE EXCLUSIVE
RIGHT TO USE "PAVERS", APART FROM THE
MARK AS SHOWN.

SER. NO. 77-351,149, FILED 12-13-2007.

ALLISON SCHRODY, EXAMINING ATTORNEY

Int. Cl.: 19

Prior U.S. Cls.: 1, 12, 33 and 50

Reg. No. 3,475,816

United States Patent and Trademark Office

Registered July 29, 2008

**TRADEMARK
PRINCIPAL REGISTER**



COUNTY MATERIALS CORPORATION (WIS-
CONSIN CORPORATION)

205 NORTH STREET

MARATHON, WI 54448

FOR: PERMEABLE PAVERS, IN CLASS 19 (U.S.
CLS. 1, 12, 33 AND 50).

FIRST USE 12-1-2007; IN COMMERCE 12-1-2007.

NO CLAIM IS MADE TO THE EXCLUSIVE
RIGHT TO USE "PAVERS" , APART FROM THE
MARK AS SHOWN.

THE MARK CONSISTS OF "H2O" IN A RAIN-
DROP WITH "PRO PAVERS" IN A RECTANGLE
BEHIND.

SER. NO. 77-351,156, FILED 12-13-2007.

ALLISON SCHRODY, EXAMINING ATTORNEY

Int. Cl.: 24

Prior U.S. Cls.: 42 and 50

United States Patent and Trademark Office

Reg. No. 3,475,817

Registered July 29, 2008

**TRADEMARK
PRINCIPAL REGISTER**

SOMERSET

PRL USA HOLDINGS, INC. (DELAWARE CORPORATION)
103 FOULK ROAD
WILMINGTON, DE 19803

THE MARK CONSISTS OF STANDARD CHARACTERS WITHOUT CLAIM TO ANY PARTICULAR FONT, STYLE, SIZE, OR COLOR.

FOR: BED LINEN, IN CLASS 24 (U.S. CLS. 42 AND 50).

SER. NO. 77-351,167, FILED 12-13-2007.

FIRST USE 3-31-2007; IN COMMERCE 3-31-2007.

ANNE MADDEN, EXAMINING ATTORNEY

SONS INTERESTED IN AND INVOLVED WITH MUSIC AND THE MUSIC INDUSTRY; DIGITAL MEDIA, NAMELY, DVDS, DOWNLOADABLE AUDIO FILES, AND DOWNLOADABLE VIDEO FILES FEATURING EDUCATIONAL AND TRAINING MATERIALS IN THE FIELD OF MUSICAL INSTRUMENT CARE AND USE, RECORDING AND SOUND EQUIPMENT OPERATION, THE USE OF MUSIC RECORDING SOFTWARE, THE PERFORMANCE OF MUSIC, AND BUSINESS, FOR PERSONS INTERESTED IN AND INVOLVED WITH MUSIC AND THE MUSIC INDUSTRY; DOWNLOADABLE ELECTRONIC EDUCATIONAL PUBLICATIONS IN THE NATURE OF MANUALS AND GUIDE BOOKS IN THE FIELD OF MUSICAL INSTRUMENT CARE AND USE, RECORDING AND SOUND EQUIPMENT OPERATION, THE USE OF MUSIC RECORDING SOFTWARE, THE PERFORMANCE OF MUSIC, AND BUSINESS, FOR PERSONS INTERESTED IN AND INVOLVED WITH MUSIC AND THE MUSIC INDUSTRY; DOWNLOADABLE EDUCATIONAL PODCASTS IN THE FIELD OF MUSICAL INSTRUMENT CARE AND USE, RECORDING AND SOUND EQUIPMENT OP-

ERATION, THE USE OF MUSIC RECORDING SOFTWARE, THE PERFORMANCE OF MUSIC, AND BUSINESS, FOR PERSONS INTERESTED IN AND INVOLVED WITH MUSIC AND THE MUSIC INDUSTRY; DOWNLOADABLE EDUCATIONAL WEBCASTS IN THE FIELD OF MUSICAL INSTRUMENT CARE AND USE, RECORDING AND SOUND EQUIPMENT OPERATION, THE USE OF MUSIC RECORDING SOFTWARE, THE PERFORMANCE OF MUSIC, AND BUSINESS, FOR PERSONS INTERESTED IN AND INVOLVED WITH MUSIC AND THE MUSIC INDUSTRY, IN CLASS 9 (U.S. CLS. 21, 23, 26, 36 AND 38).

FIRST USE 8-1-2007; IN COMMERCE 8-1-2007.

THE MARK CONSISTS OF STANDARD CHARACTERS WITHOUT CLAIM TO ANY PARTICULAR FONT, STYLE, SIZE, OR COLOR.

SER. NO. 77-351,217, FILED 12-13-2007.

MICHAEL GAAFAR, EXAMINING ATTORNEY

Int. Cl.: 12

Prior U.S. Cls.: 19, 21, 23, 31, 35 and 44

Reg. No. 3,475,819

United States Patent and Trademark Office

Registered July 29, 2008

**TRADEMARK
PRINCIPAL REGISTER**



BONITEAU, XAVIER (FRANCE INDIVIDUAL)
LA PETITE CATONNIERE
22 ROUTE DE SAINT-MARTIN
SAINT MARTIN LA PLAINE, FRANCE 42800

FOR: ELECTRIC VEHICLES FOR LOCOMOTION
BY LAND, IN CLASS 12 (U.S. CLS. 19, 21, 23, 31, 35
AND 44).

OWNER OF ERPN CMNTY TM OFC REG. NO.
003568177, DATED 5-4-2005, EXPIRES 12-2-2013.

NO CLAIM IS MADE TO THE EXCLUSIVE
RIGHT TO USE "ELECTRIC CAR", APART FROM
THE MARK AS SHOWN.

THE MARK CONSISTS OF A STYLIZED "T" AND
THE WORD "TENDER" UNDER WHICH IS THE
PHRASE "ELECTRIC CAR".

SER. NO. 77-351,222, FILED 12-13-2007.

DAWN FELDMAN, EXAMINING ATTORNEY

Int. Cl.: 39

Prior U.S. Cls.: 100 and 105

United States Patent and Trademark Office

Reg. No. 3,475,820

Registered July 29, 2008

**SERVICE MARK
PRINCIPAL REGISTER**

Grape Therapy

S.U.V. TOURS, LLC (WASHINGTON LTD LIAB
CO)
6900 W. 6TH AVENUE
KENNEWICK, WA 99336

THE MARK CONSISTS OF STANDARD CHAR-
ACTERS WITHOUT CLAIM TO ANY PARTICULAR
FONT, STYLE, SIZE, OR COLOR.

FOR: WINE TASTING TOUR SERVICES, IN
CLASS 39 (U.S. CLS. 100 AND 105).

SER. NO. 77-351,280, FILED 12-13-2007.

FIRST USE 1-1-2007; IN COMMERCE 1-1-2007.

GENE MACIOL, EXAMINING ATTORNEY

Int. Cls.: 3, 4 and 11

Prior U.S. Cls.: 1, 4, 6, 13, 15, 21, 23, 31, 34, 50, 51 and 52

United States Patent and Trademark Office

Reg. No. 3,475,821

Registered July 29, 2008

**TRADEMARK
PRINCIPAL REGISTER**

ASIAN SPICE

MANAGING TRUSTEE OF PIER 1 SERVICES
COMPANY (DELAWARE STATUTORY
TRUST)

100 PIER 1 PLACE
FORT WORTH, TX 76102

FOR: SCENTED ROOM SPRAYS; INCENSE, IN
CLASS 3 (U.S. CLS. 1, 4, 6, 50, 51 AND 52).

FIRST USE 8-1-2007; IN COMMERCE 8-1-2007.

FOR: CANDLES, IN CLASS 4 (U.S. CLS. 1, 6 AND
15).

FIRST USE 1-1-1999; IN COMMERCE 1-1-1999.

FOR: DIFFUSERS FOR EMITTING SCENT, IN
CLASS 11 (U.S. CLS. 13, 21, 23, 31 AND 34).

FIRST USE 8-1-2007; IN COMMERCE 8-1-2007.

THE MARK CONSISTS OF STANDARD CHAR-
ACTERS WITHOUT CLAIM TO ANY PARTICULAR
FONT, STYLE, SIZE, OR COLOR.

NO CLAIM IS MADE TO THE EXCLUSIVE
RIGHT TO USE "SPICE", APART FROM THE MARK
AS SHOWN.

SER. NO. 77-351,311, FILED 12-13-2007.

KELLY MCCOY, EXAMINING ATTORNEY

Int. Cl.: 3

Prior U.S. Cls.: 1, 4, 6, 50, 51 and 52

United States Patent and Trademark Office

Reg. No. 3,475,822

Registered July 29, 2008

**TRADEMARK
PRINCIPAL REGISTER**

**X-TENSO
MOISTURIST**

L'OREAL (FRANCE SOCIÉTÉ ANONYME (SA))
14 RUE ROYALE
PARIS, FRANCE 75008

FOR: SHAMPOOS; GELS, SPRAYS, MOUSSES,
BALMS FOR THE HAIR STYLING AND HAIR
CARE; HAIR LACQUERS; HAIR COLOURING
AND HAIR DECOLORANT PREPARATIONS; PER-
MANENT HAIR WAVING AND HAIR CURLING
PREPARATIONS; HAIR STRAIGHTENING PRE-
PARATIONS; ESSENTIAL OILS FOR PERSONAL
USE, IN CLASS 3 (U.S. CLS. 1, 4, 6, 50, 51 AND 52).

THE MARK CONSISTS OF STANDARD CHAR-
ACTERS WITHOUT CLAIM TO ANY PARTICULAR
FONT, STYLE, SIZE, OR COLOR.

PRIORITY CLAIMED UNDER SEC. 44(D) ON
FRANCE APPLICATION NO. 073510172, FILED 6-
29-2007, REG. NO. 073510172, DATED 6-29-2007, EX-
PIRES 6-29-2017.

OWNER OF U.S. REG. NO. 2,289,017.

SER. NO. 77-351,343, FILED 12-13-2007.

DAVID ELTON, EXAMINING ATTORNEY

Int. Cl.: 36

Prior U.S. Cls.: 100, 101 and 102

United States Patent and Trademark Office

Reg. No. 3,475,823

Registered July 29, 2008

**SERVICE MARK
PRINCIPAL REGISTER**

HARLEYSVILLE NATIONAL BANK

HARLEYSVILLE NATIONAL CORPORATION
(PENNSYLVANIA CORPORATION)
483 MAIN STREET
HARLEYSVILLE, PA 19438

FOR: BANKING, IN CLASS 36 (U.S. CLS. 100, 101
AND 102).

FIRST USE 8-1-2004; IN COMMERCE 8-1-2004.

THE MARK CONSISTS OF STANDARD CHAR-
ACTERS WITHOUT CLAIM TO ANY PARTICULAR
FONT, STYLE, SIZE, OR COLOR.

OWNER OF U.S. REG. NOS. 2,606,826, 3,045,348,
AND 3,049,625.

NO CLAIM IS MADE TO THE EXCLUSIVE
RIGHT TO USE "NATIONAL BANK", APART
FROM THE MARK AS SHOWN.

SEC. 2(F).

SER. NO. 77-351,365, FILED 12-13-2007.

TOBY BULLOFF, EXAMINING ATTORNEY

Int. Cl.: 35

Prior U.S. Cls.: 100, 101 and 102

United States Patent and Trademark Office

Reg. No. 3,475,824

Registered July 29, 2008

SERVICE MARK
PRINCIPAL REGISTER

On Assignment

ON ASSIGNMENT, INC. (DELAWARE CORPORATION)
26651 WEST AGOURA ROAD
CALABASAS, CA 91302

FOR: TEMPORARY EMPLOYMENT AGENCY SERVICES, IN CLASS 35 (U.S. CLS. 100, 101 AND 102).

FIRST USE 9-0-1992; IN COMMERCE 9-0-1992.

OWNER OF U.S. REG. NO. 2,349,235.

SEC. 2(F).

SER. NO. 77-351,370, FILED 12-13-2007.

TOBY BULLOFF, EXAMINING ATTORNEY

Int. Cls.: 17 and 19

Prior U.S. Cls.: 1, 5, 12, 13, 33, 35 and 50

United States Patent and Trademark Office

Reg. No. 3,475,825

Registered July 29, 2008

**TRADEMARK
PRINCIPAL REGISTER**

Wavistrong

FUTURE PIPE HOLDINGS, INC. (DELAWARE CORPORATION)
816 CONNECTICUT AVENUE, N.W., SUITE 600
WASHINGTON, DC 20006

FOR: NON-METALLIC FLEXIBLE PIPES AND STRUCTURAL COMPONENTS THEREOF USED FOR WATER, SEWAGE, OIL, AND GAS INDUSTRIAL APPLICATIONS, IN CLASS 17 (U.S. CLS. 1, 5, 12, 13, 35 AND 50).

FIRST USE 12-31-1974; IN COMMERCE 12-31-1974.

FOR: NON-METALLIC, NON-FLEXIBLE PIPES AND STRUCTURAL COMPONENTS THEREOF

USED FOR WATER, SEWAGE, OIL, AND GAS INDUSTRIAL APPLICATIONS, IN CLASS 19 (U.S. CLS. 1, 12, 33 AND 50).

FIRST USE 12-31-1974; IN COMMERCE 12-31-1974.

THE MARK CONSISTS OF STANDARD CHARACTERS WITHOUT CLAIM TO ANY PARTICULAR FONT, STYLE, SIZE, OR COLOR.

SER. NO. 77-351,373, FILED 12-13-2007.

ZHALEH DELANEY, EXAMINING ATTORNEY

Int. Cl.: 40

Prior U.S. Cls.: 100, 103 and 106

United States Patent and Trademark Office

Reg. No. 3,475,826

Registered July 29, 2008

**SERVICE MARK
PRINCIPAL REGISTER**

**INNOVATIVE SURGICAL
PRODUCTS**

ISSAC MEDICAL, INC. (CALIFORNIA CORPORATION)
2761 WALNUT AVENUE
TUSTIN, CA 92780

NO CLAIM IS MADE TO THE EXCLUSIVE RIGHT TO USE "SURGICAL PRODUCTS", APART FROM THE MARK AS SHOWN.

FOR: CONTRACT MEDICAL DEVICE MANUFACTURING, IN CLASS 40 (U.S. CLS. 100, 103 AND 106).

SEC. 2(F).

FIRST USE 2-23-1998; IN COMMERCE 2-23-1998.

SER. NO. 77-351,382, FILED 12-13-2007.

THE MARK CONSISTS OF STANDARD CHARACTERS WITHOUT CLAIM TO ANY PARTICULAR FONT, STYLE, SIZE, OR COLOR.

KATHRYN COWARD, EXAMINING ATTORNEY

Int. Cl.: 11

Prior U.S. Cls.: 13, 21, 23, 31 and 34

United States Patent and Trademark Office

Reg. No. 3,475,827

Registered July 29, 2008

**TRADEMARK
PRINCIPAL REGISTER**

AQUASCAPE

WATER PIK, INC. (COLORADO CORPORATION)
1730 EAST PROSPECT ROAD
FORT COLLINS, CO 805530001

THE MARK CONSISTS OF STANDARD CHAR-
ACTERS WITHOUT CLAIM TO ANY PARTICULAR
FONT, STYLE, SIZE, OR COLOR.

FOR: SHOWERHEADS AND COMPONENTS
THEREOF, IN CLASS 11 (U.S. CLS. 13, 21, 23, 31
AND 34).

SER. NO. 77-351,411, FILED 12-13-2007.

FIRST USE 9-7-2005; IN COMMERCE 9-7-2005.

MORGAN WYNNE, EXAMINING ATTORNEY

Int. Cl.: 11

Prior U.S. Cls.: 13, 21, 23, 31 and 34

Reg. No. 3,475,828

United States Patent and Trademark Office

Registered July 29, 2008

**TRADEMARK
PRINCIPAL REGISTER**

AirScape

HVACQUICK.COM INC. (CALIFORNIA CORPORATION)
1585 N. 4TH STREET, SUITE BB
SAN JOSE, CA 95112

THE MARK CONSISTS OF STANDARD CHARACTERS WITHOUT CLAIM TO ANY PARTICULAR FONT, STYLE, SIZE, OR COLOR.

FOR: VENTILATING EXHAUST FANS, IN CLASS 11 (U.S. CLS. 13, 21, 23, 31 AND 34).

SER. NO. 77-351,438, FILED 12-13-2007.

FIRST USE 4-1-2005; IN COMMERCE 4-1-2005.

MELISSA VALLILLO, EXAMINING ATTORNEY

Int. Cl.: 40

Prior U.S. Cls.: 100, 103 and 106

United States Patent and Trademark Office

Reg. No. 3,475,829

Registered July 29, 2008

**SERVICE MARK
PRINCIPAL REGISTER**

**SPECIALTY SILICONE
FABRICATORS**

ISSAC MEDICAL, INC. (CALIFORNIA CORPORATION)

2761 WALNUT AVENUE

TUSTIN, CA 92780

FOR: MEDICAL DEVICE MANUFACTURER OF CUSTOM SILICONE COMPONENTS FOR THE MEDICAL DEVICE INDUSTRY, IN CLASS 40 (U.S. CLS. 100, 103 AND 106).

FIRST USE 10-4-1984; IN COMMERCE 10-4-1984.

THE MARK CONSISTS OF STANDARD CHARACTERS WITHOUT CLAIM TO ANY PARTICULAR FONT, STYLE, SIZE, OR COLOR.

NO CLAIM IS MADE TO THE EXCLUSIVE RIGHT TO USE "FABRICATORS", APART FROM THE MARK AS SHOWN.

SEC. 2(F).

SER. NO. 77-351,450, FILED 12-13-2007.

KATHRYN COWARD, EXAMINING ATTORNEY

Int. Cl.: 41

Prior U.S. Cls.: 100, 101 and 107

United States Patent and Trademark Office

Reg. No. 3,475,830

Registered July 29, 2008

SERVICE MARK
PRINCIPAL REGISTER

"GET TOUGH"
Men's Ministry

COWBOY CHURCH, INC. (TEXAS NON-PROFIT CORPORATION)
8827 S. WASHINGTON ST.
AMARILLO, TX 79118

FOR: EDUCATION SERVICES, NAMELY, PROVIDING CLASSES, SEMINARS, WORKSHOPS, TUTORING, AND MENTORING IN THE FIELDS OF CHRISTIAN TEACHING, CHRISTIAN LIVING, RELIGIOUS THEOLOGY, AND DISTRIBUTING COURSE MATERIAL IN THE NATURE OF BROCHURES AND BIBLE STUDY MATERIAL IN CONNECTION THEREWITH; EDUCATIONAL AND ENTERTAINMENT SERVICES, NAMELY, PROVIDING MOTIVATIONAL AND EDUCATIONAL SPEAKERS; EDUCATIONAL SERVICES, NAMELY, CONDUCTING INFORMAL PROGRAMS IN THE FIELDS OF RELIGIOUS STUDIES, IN CLASS 41 (U.S. CLS. 100, 101 AND 107).

FIRST USE 11-1-2003; IN COMMERCE 11-1-2003.

NO CLAIM IS MADE TO THE EXCLUSIVE RIGHT TO USE "MEN'S MINISTRY", APART FROM THE MARK AS SHOWN.

THE MARK CONSISTS OF THE WORDS "GET TOUGH" IN STYLIZED FORM WITH THE WORDING "MEN'S MINISTRY" CENTERED BELOW IT. "GET TOUGH" APPEARS IN A CURVED MANNER IN ALL CAPITAL LETTERS WITH SHADOWS BEHIND THE LETTERS HAVING A TEXTURED TWO-DIMENSIONAL APPEARANCE.

SER. NO. 77-351,455, FILED 12-13-2007.

ZHALEH DELANEY, EXAMINING ATTORNEY

Int. Cls.: 3, 4 and 11

Prior U.S. Cls.: 1, 4, 6, 13, 15, 21, 23, 31, 34, 50, 51 and 52

United States Patent and Trademark Office

Reg. No. 3,475,831

Registered July 29, 2008

**TRADEMARK
PRINCIPAL REGISTER**

CRISP BAMBOO

MANAGING TRUSTEE OF PIER 1 SERVICES
COMPANY (DELAWARE STATUTORY
TRUST)

100 PIER 1 PLACE
FORT WORTH, TX 76102

FOR: SCENTED ROOM SPRAYS, IN CLASS 3 (U.S.
CLS. 1, 4, 6, 50, 51 AND 52).

FIRST USE 5-1-2007; IN COMMERCE 5-1-2007.

FOR: CANDLES, IN CLASS 4 (U.S. CLS. 1, 6 AND
15).

FIRST USE 2-1-2007; IN COMMERCE 2-1-2007.

FOR: DIFFUSERS FOR EMITTING SCENT, IN
CLASS 11 (U.S. CLS. 13, 21, 23, 31 AND 34).

FIRST USE 5-1-2007; IN COMMERCE 5-1-2007.

THE MARK CONSISTS OF STANDARD CHAR-
ACTERS WITHOUT CLAIM TO ANY PARTICULAR
FONT, STYLE, SIZE, OR COLOR.

NO CLAIM IS MADE TO THE EXCLUSIVE
RIGHT TO USE "BAMBOO", APART FROM THE
MARK AS SHOWN.

SER. NO. 77-351,459, FILED 12-13-2007.

KELLY MCCOY, EXAMINING ATTORNEY

Int. Cl.: 43

Prior U.S. Cls.: 100 and 101

United States Patent and Trademark Office

Reg. No. 3,475,832

Registered July 29, 2008

SERVICE MARK
PRINCIPAL REGISTER



SODEXHO OPERATIONS, LLC (DELAWARE
LTD LIAB CO)
9801 WASHINGTONIAN BOULEVARD
GAITHERSBURG, MD 20878

FOR: SERVING FOOD AND DRINKS; CON-
TRACT FOOD SERVICES, IN CLASS 43 (U.S. CLS.
100 AND 101).

FIRST USE 8-0-2003; IN COMMERCE 8-0-2003.

OWNER OF U.S. REG. NO. 2,619,067.

NO CLAIM IS MADE TO THE EXCLUSIVE
RIGHT TO USE "FAR EAST FUSION" AND "ASIAN
CUISINE", APART FROM THE MARK AS SHOWN.

THE MARK CONSISTS OF THE WORDING "FAR
EAST FUSION CREATIVE ASIAN CUISINE" AND
THE DESIGN OF A TREE ON A RECTANGULAR
BACKGROUND.

SER. NO. 77-351,480, FILED 12-13-2007.

BARBARA GAYNOR, EXAMINING ATTORNEY

Int. Cls.: 3, 4 and 11

Prior U.S. Cls.: 1, 4, 6, 13, 15, 21, 23, 31, 34, 50, 51 and 52

United States Patent and Trademark Office

Reg. No. 3,475,833

Registered July 29, 2008

**TRADEMARK
PRINCIPAL REGISTER**

FIRST RAIN

MANAGING TRUSTEE OF PIER 1 SERVICES
COMPANY (DELAWARE STATUTORY
TRUST)
100 PIER 1 PLACE
FORT WORTH, TX 76102

FOR: SCENTED ROOM SPRAYS, IN CLASS 3 (U.S.
CLS. 1, 4, 6, 50, 51 AND 52).

FIRST USE 8-1-2007; IN COMMERCE 8-1-2007.

FOR: CANDLES, IN CLASS 4 (U.S. CLS. 1, 6 AND
15).

FIRST USE 1-1-1999; IN COMMERCE 1-1-1999.

FOR: DIFFUSERS FOR EMITTING SCENT, IN
CLASS 11 (U.S. CLS. 13, 21, 23, 31 AND 34).

FIRST USE 8-1-2007; IN COMMERCE 8-1-2007.

THE MARK CONSISTS OF STANDARD CHAR-
ACTERS WITHOUT CLAIM TO ANY PARTICULAR
FONT, STYLE, SIZE, OR COLOR.

SER. NO. 77-351,483, FILED 12-13-2007.

KELLY MCCOY, EXAMINING ATTORNEY

Int. Cl.: 42

Prior U.S. Cls.: 100 and 101

United States Patent and Trademark Office

Reg. No. 3,475,834

Registered July 29, 2008

**SERVICE MARK
PRINCIPAL REGISTER**



NEWPORT MEDIA, INC. (CALIFORNIA CORPORATION)
SUITE 125
25371 COMMERCENTRE DRIVE
LAKE FOREST, CA 92630

FOR: COMPUTER HARDWARE DEVELOPMENT; CUSTOMIZATION OF COMPUTER HARDWARE AND SOFTWARE; DESIGN OF COMPUTER HARDWARE, INTEGRATED CIRCUITS, COMMUNICATIONS HARDWARE AND SOFTWARE AND COMPUTER NETWORKS FOR OTHERS; TECHNOLOGICAL CONSULTATION IN THE TECHNOLOGY FIELD OF REAL-TIME RECONFIGURABLE WIRELESS COMMUNICATION HANDSETS AND NETWORK EQUIPMENT FOR USE IN WIDEBAND COMMUNICATIONS; DESIGN FOR OTHERS OF INTEGRATED CIRCUITS AND INTEGRATED CIRCUIT CORES FOR USE IN WIRELESS COMMUNICATIONS AND WIRELESS COMMUNICATION

EQUIPMENT AND APPARATI AND DIGITAL SIGNAL PROCESSORS (DSP); RENTAL OF MEASURING APPARATUS; PROVIDING PLANNING AND ENGINEERING SERVICES IN THE FIELD OF INFORMATION AND COMMUNICATIONS NETWORKS, IN CLASS 42 (U.S. CLS. 100 AND 101).

FIRST USE 8-15-2007; IN COMMERCE 8-15-2007.

THE MARK CONSISTS OF THE LETTER "N" WITHIN A ROUNDED RECTANGLE FOLLOWED BY THE LETTER "M" WITHIN A ROUNDED RECTANGLE FOLLOWED BY THE LETTER "I" WITHIN A ROUNDED RECTANGLE SUCH THAT THE THREE RECTANGLES TOUCH.

SER. NO. 77-351,487, FILED 12-13-2007.

MORGAN WYNNE, EXAMINING ATTORNEY

Int. Cls.: 14, 16 and 25

Prior U.S. Cls.: 2, 5, 22, 23, 27, 28, 29, 37, 38, 39 and 50

Reg. No. 3,475,835

United States Patent and Trademark Office

Registered July 29, 2008

**TRADEMARK
PRINCIPAL REGISTER**

AFSCME

AMERICAN FEDERATION OF STATE, COUNTY
AND MUNICIPAL EMPLOYEES (D.C. UNINC.
ASSOCIATION)
1625 L STREET, N.W.
WASHINGTON, DC 20036

FOR: LAPEL PINS, IN CLASS 14 (U.S. CLS. 2, 27, 28
AND 50).

FIRST USE 1-31-1940; IN COMMERCE 1-31-1940.

FOR: PENS, IN CLASS 16 (U.S. CLS. 2, 5, 22, 23, 29,
37, 38 AND 50).

FIRST USE 1-31-1940; IN COMMERCE 1-31-1940.

FOR: T-SHIRTS, IN CLASS 25 (U.S. CLS. 22 AND
39).

FIRST USE 1-31-1940; IN COMMERCE 1-31-1940.

THE MARK CONSISTS OF STANDARD CHAR-
ACTERS WITHOUT CLAIM TO ANY PARTICULAR
FONT, STYLE, SIZE, OR COLOR.

OWNER OF U.S. REG. NOS. 1,136,470, 2,308,888
AND OTHERS.

SER. NO. 77-351,514, FILED 12-13-2007.

KELLY BOULTON, EXAMINING ATTORNEY

Int. Cl.: 37

Prior U.S. Cls.: 100, 103 and 106

United States Patent and Trademark Office

Reg. No. 3,475,836

Registered July 29, 2008

**SERVICE MARK
PRINCIPAL REGISTER**

**Westfield Gage Company
Overhaul and Repair**

WGI (DELAWARE CORPORATION), DBA WEST-
FIELD GAGE COMPANY OVERHAUL AND
REPAIR

34 HUDSON DRIVE

SOUTHWICK, MA 010771130

FOR: AIRCRAFT REPAIR AND MAINTENANCE,
IN CLASS 37 (U.S. CLS. 100, 103 AND 106).

FIRST USE 1-1-1990; IN COMMERCE 1-1-1990.

THE MARK CONSISTS OF STANDARD CHAR-
ACTERS WITHOUT CLAIM TO ANY PARTICULAR
FONT, STYLE, SIZE, OR COLOR.

NO CLAIM IS MADE TO THE EXCLUSIVE
RIGHT TO USE "GAGE COMPANY OVERHAUL
AND REPAIR", APART FROM THE MARK AS
SHOWN.

SER. NO. 77-351,569, FILED 12-13-2007.

REGINA DRUMMOND, EXAMINING ATTORNEY

Int. Cls.: 40 and 42

Prior U.S. Cls.: 100, 101, 103 and 106

United States Patent and Trademark Office

Reg. No. 3,475,837

Registered July 29, 2008

**SERVICE MARK
PRINCIPAL REGISTER**

SHELTERCRAFT

SHELTERCRAFT INC (CALIFORNIA CORPORATION)
1321 ALAMEDA STREET
WILMINGTON, CA 90744

FOR: CUSTOM MANUFACTURE OF KIT HOMES, CABINETS, FURNITURE AND MILLWORK FOR RESIDENTIAL AND COMMERCIAL APPLICATIONS, IN CLASS 40 (U.S. CLS. 100, 103 AND 106).

FIRST USE 1-1-2002; IN COMMERCE 1-1-2002.

FOR: DESIGN FOR OTHERS IN THE FIELD OF KIT HOMES, CABINETS, FURNITURE AND

MILLWORK FOR RESIDENTIAL AND COMMERCIAL APPLICATIONS, IN CLASS 42 (U.S. CLS. 100 AND 101).

FIRST USE 1-1-2002; IN COMMERCE 1-1-2002.

THE MARK CONSISTS OF STANDARD CHARACTERS WITHOUT CLAIM TO ANY PARTICULAR FONT, STYLE, SIZE, OR COLOR.

SER. NO. 77-351,600, FILED 12-13-2007.

HEATHER THOMPSON, EXAMINING ATTORNEY

Int. Cl.: 41

Prior U.S. Cls.: 100, 101 and 107

Reg. No. 3,475,838

United States Patent and Trademark Office

Registered July 29, 2008

**SERVICE MARK
PRINCIPAL REGISTER**

ARTS

NATIONAL RETAIL FEDERATION, INC. (NEW
YORK NON-PROFIT CORPORATION)
325 7TH STREET, N.W., SUITE 1100
LIBERTY PLACE
WASHINGTON, DC 20004

FOR: EDUCATIONAL SERVICES, NAMELY,
CONDUCTING CLASSES, CONFERENCES, SEMI-
NARS, AND WORKSHOPS IN THE FIELD OF THE
RETAIL TRADE AND DISTRIBUTION OF COURSE
MATERIAL IN CONNECTION THEREWITH, IN
CLASS 41 (U.S. CLS. 100, 101 AND 107).

FIRST USE 2-0-1999; IN COMMERCE 2-0-1999.

THE MARK CONSISTS OF STANDARD CHAR-
ACTERS WITHOUT CLAIM TO ANY PARTICULAR
FONT, STYLE, SIZE, OR COLOR.

OWNER OF U.S. REG. NOS. 2,338,756, 2,543,938
AND OTHERS.

SER. NO. 77-351,629, FILED 12-13-2007.

CAROL SPILS, EXAMINING ATTORNEY

Int. Cl.: 17

Prior U.S. Cls.: 1, 5, 12, 13, 35 and 50

United States Patent and Trademark Office

Reg. No. 3,475,839

Registered July 29, 2008

**TRADEMARK
PRINCIPAL REGISTER**

Encapso

SMOOTH-ON, INC. (PENNSYLVANIA CORPORATION)
2000 SAINT JOHN ST
EASTON, PA 18042

THE MARK CONSISTS OF STANDARD CHARACTERS WITHOUT CLAIM TO ANY PARTICULAR FONT, STYLE, SIZE, OR COLOR.

FOR: CLEAR TWO COMPONENT SILICONE RUBBER USED TO ENCAPSULATE SILK FLOWERS AND OTHER MATERIALS, IN CLASS 17 (U.S. CLS. 1, 5, 12, 13, 35 AND 50).

SER. NO. 77-351,632, FILED 12-13-2007.

FIRST USE 11-0-2007; IN COMMERCE 11-0-2007.

SUZANNE BLANE, EXAMINING ATTORNEY

Int. Cl.: 41

Prior U.S. Cls.: 100, 101 and 107

United States Patent and Trademark Office

Reg. No. 3,475,840

Registered July 29, 2008

**SERVICE MARK
PRINCIPAL REGISTER**

CAROLINA TERRITORY

TALTON, JUSTIN R. (UNITED STATES INDIVIDUAL)

P.O. BOX 1384

BOONE, NC 28607

FOR: ENTERTAINMENT, NAMELY, PRODUCTION OF AND DEVELOPMENT OF LIVE-ACTION PERFORMANCES, IN CLASS 41 (U.S. CLS. 100, 101 AND 107).

FIRST USE 11-0-1999; IN COMMERCE 10-12-2001.

THE MARK CONSISTS OF STANDARD CHARACTERS WITHOUT CLAIM TO ANY PARTICULAR FONT, STYLE, SIZE, OR COLOR.

OWNER OF U.S. REG. NO. 2,884,555.

NO CLAIM IS MADE TO THE EXCLUSIVE RIGHT TO USE "CAROLINA", APART FROM THE MARK AS SHOWN.

SER. NO. 77-351,645, FILED 12-13-2007.

PRISCILLA MILTON, EXAMINING ATTORNEY

Int. Cl.: 41

Prior U.S. Cls.: 100, 101 and 107

United States Patent and Trademark Office

Reg. No. 3,475,841

Registered July 29, 2008

**SERVICE MARK
PRINCIPAL REGISTER**

ARTS

NATIONAL RETAIL FEDERATION, INC. (NEW
YORK NON-PROFIT CORPORATION)
325 7TH STREET, N.W., SUITE 1100
LIBERTY PLACE
WASHINGTON, DC 20004

FOR: EDUCATIONAL SERVICES, NAMELY,
CONDUCTING CLASSES, CONFERENCES, SEMI-
NARS, AND WORKSHOPS IN THE FIELD OF THE
RETAIL TRADE AND DISTRIBUTION OF COURSE
MATERIAL IN CONNECTION THEREWITH, IN
CLASS 41 (U.S. CLS. 100, 101 AND 107).

FIRST USE 2-0-1999; IN COMMERCE 2-0-1999.

OWNER OF U.S. REG. NOS. 2,338,756, 2,543,938
AND OTHERS.

THE MARK CONSISTS OF THE WORD "ARTS"
WITH A CURVED LINE THROUGH THOSE
WORDS.

SER. NO. 77-351,663, FILED 12-13-2007.

CAROL SPILS, EXAMINING ATTORNEY

Int. Cl.: 21

Prior U.S. Cls.: 2, 13, 23, 29, 30, 33, 40 and 50

United States Patent and Trademark Office

Reg. No. 3,475,842

Registered July 29, 2008

**TRADEMARK
PRINCIPAL REGISTER**

HANDY MIX

CORPORATE EXPRESS US INC. (COLORADO
CORPORATION)
ONE ENVIRONMENTAL WAY
BROOMFIELD, CO 80021

FOR: DISPENSERS FOR CLEANING AND DISIN-
FECTING PRODUCTS, IN CLASS 21 (U.S. CLS. 2, 13,
23, 29, 30, 33, 40 AND 50).

FIRST USE 1-0-2004; IN COMMERCE 1-0-2004.

THE MARK CONSISTS OF STANDARD CHAR-
ACTERS WITHOUT CLAIM TO ANY PARTICULAR
FONT, STYLE, SIZE, OR COLOR.

NO CLAIM IS MADE TO THE EXCLUSIVE
RIGHT TO USE "MIX", APART FROM THE MARK
AS SHOWN.

SER. NO. 77-351,719, FILED 12-13-2007.

TAMARA FRAZIER, EXAMINING ATTORNEY

Int. Cl.: 25

Prior U.S. Cls.: 22 and 39

United States Patent and Trademark Office

Reg. No. 3,475,843

Registered July 29, 2008

**TRADEMARK
PRINCIPAL REGISTER**

PHRESHLA

JEFFREY BUTSCHER (UNITED STATES INDIVIDUAL)
P.O. BOX 2345
MANHATTAN BEACH, CA 90267

FOR: HOODS; BELTS; CAPS; JERSEYS; LEATHER BELTS; SWADDLING CLOTHES; TIES; TOPS; WRAPS; CLOTHING, NAMELY, WRAP-AROUNDS; CORSETS; DUSTERS; SHOULDER WRAPS, IN CLASS 25 (U.S. CLS. 22 AND 39).

FIRST USE 12-1-2007; IN COMMERCE 12-10-2007.

THE MARK CONSISTS OF STANDARD CHARACTERS WITHOUT CLAIM TO ANY PARTICULAR FONT, STYLE, SIZE, OR COLOR.

SER. NO. 77-351,728, FILED 12-13-2007.

NAAKWAMA ANKRAH, EXAMINING ATTORNEY

Int. Cl.: 3

Prior U.S. Cls.: 1, 4, 6, 50, 51 and 52

Reg. No. 3,475,844

United States Patent and Trademark Office

Registered July 29, 2008

**TRADEMARK
PRINCIPAL REGISTER**

NANOCOLOR

GROSE, TRICIA (UNITED STATES INDIVIDUAL)

SUITE A

630 AIRPARK ROAD

NAPA, CA 94558 AND

MURPHY, EMALIE G. (UNITED STATES INDIVIDUAL)

1601 K STREET NW

WASHINGTON, DC 20006

FOR: HAIR CARE PREPARATIONS; HAIR DYES; HAIR GELS; HAIR CONDITIONERS , IN CLASS 3 (U.S. CLS. 1, 4, 6, 50, 51 AND 52).

FIRST USE 5-30-2006; IN COMMERCE 5-30-2006.

THE MARK CONSISTS OF STANDARD CHARACTERS WITHOUT CLAIM TO ANY PARTICULAR FONT, STYLE, SIZE, OR COLOR.

SER. NO. 77-351,748, FILED 12-13-2007.

KELLY BOULTON, EXAMINING ATTORNEY

Int. Cl.: 9

Prior U.S. Cls.: 21, 23, 26, 36 and 38

Reg. No. 3,475,845

United States Patent and Trademark Office

Registered July 29, 2008

**TRADEMARK
PRINCIPAL REGISTER**

AEGIS

NETIQ CORPORATION (DELAWARE CORPORATION)
1500 DEXTER AVENUE NORTH
SEATTLE, WA 98109

FIRST USE 10-25-2007; IN COMMERCE 10-25-2007.

FOR: COMPUTER SOFTWARE FOR COORDINATING AND CONNECTING INFORMATION TECHNOLOGY MANAGEMENT PRODUCTS AND MODELING, MEASURING, MANAGING AND AUTOMATING INFORMATION TECHNOLOGY PROCESSES; INSTRUCTION MANUALS SOLD AS A UNIT THEREWITH, IN CLASS 9 (U.S. CLS. 21, 23, 26, 36 AND 38).

THE MARK CONSISTS OF STANDARD CHARACTERS WITHOUT CLAIM TO ANY PARTICULAR FONT, STYLE, SIZE, OR COLOR.

SER. NO. 77-351,762, FILED 12-13-2007.

JIM RINGLE, EXAMINING ATTORNEY

Int. Cl.: 9

Prior U.S. Cls.: 21, 23, 26, 36 and 38

Reg. No. 3,475,846

United States Patent and Trademark Office

Registered July 29, 2008

**TRADEMARK
PRINCIPAL REGISTER**

IBOX

UVP, LLC (CALIFORNIA LTD LIAB CO)
2066 WEST 11TH STREET
UPLAND, CA 91786

THE MARK CONSISTS OF STANDARD CHARACTERS WITHOUT CLAIM TO ANY PARTICULAR FONT, STYLE, SIZE, OR COLOR.

FOR: A IMAGING SYSTEM COMPRISED OF CAMERAS USED TO OBTAIN IMAGES OF LABORATORY SAMPLES, IN CLASS 9 (U.S. CLS. 21, 23, 26, 36 AND 38).

SER. NO. 77-351,808, FILED 12-13-2007.

FIRST USE 12-13-2007; IN COMMERCE 12-13-2007.

KATINA MISTER, EXAMINING ATTORNEY

Int. Cl.: 44

Prior U.S. Cls.: 100 and 101

United States Patent and Trademark Office

Reg. No. 3,475,847

Registered July 29, 2008

**SERVICE MARK
PRINCIPAL REGISTER**

AQUAPLAY

SHEAR, WARREN K. (UNITED STATES INDIVIDUAL)
222 LUAKAHA CIRCLE
KIHEI, HI 96753

FOR: CREATIVE ARTS THERAPIES IN WATER FOR INDIVIDUALS AND GROUPS, NAMELY, MENTAL HEALTH COUNSELING, PHYSICAL THERAPY AND MASSAGE THERAPY IN WATER USING THE ARTS AS A MEDIUM , IN CLASS 44 (U.S. CLS. 100 AND 101).

FIRST USE 12-11-2007; IN COMMERCE 12-11-2007.

THE MARK CONSISTS OF STANDARD CHARACTERS WITHOUT CLAIM TO ANY PARTICULAR FONT, STYLE, SIZE, OR COLOR.

SER. NO. 77-351,827, FILED 12-13-2007.

KELLY BOULTON, EXAMINING ATTORNEY

Int. Cl.: 35

Prior U.S. Cls.: 100, 101 and 102

United States Patent and Trademark Office

Reg. No. 3,475,848

Registered July 29, 2008

**SERVICE MARK
PRINCIPAL REGISTER**



STAFF RESOURCES, INC. (CALIFORNIA CORPORATION)
SUITE A
870 MANZANITA COURT
CHICO, CA 95926

FOR: PROFESSIONAL EMPLOYER SERVICES, NAMELY, HUMAN RESOURCES MANAGEMENT, PAYROLL PROCESSING SERVICES, AND BUSINESS RISK MANAGEMENT, IN CLASS 35 (U.S. CLS. 100, 101 AND 102).

FIRST USE 1-2-1999; IN COMMERCE 1-2-1999.

NO CLAIM IS MADE TO THE EXCLUSIVE RIGHT TO USE "STAFF RESOURCES, INC." AND "HUMAN RESOURCE SPECIALISTS", APART FROM THE MARK AS SHOWN.

SER. NO. 77-351,846, FILED 12-13-2007.

LINDA LAVACHE, EXAMINING ATTORNEY

Int. Cl.: 25

Prior U.S. Cls.: 22 and 39

United States Patent and Trademark Office

Reg. No. 3,475,849

Registered July 29, 2008

**TRADEMARK
PRINCIPAL REGISTER**

LOVE HEAD

HEADBLADE COMPANY, LLC (CALIFORNIA
LTD LIAB CO)
3623 EASTHAM DRIVE
CULVER CITY, CA 90232

FOR: T-SHIRTS; SWEAT SHIRTS; HATS, IN
CLASS 25 (U.S. CLS. 22 AND 39).

FIRST USE 3-0-2006; IN COMMERCE 3-0-2006.

THE MARK CONSISTS OF STANDARD CHAR-
ACTERS WITHOUT CLAIM TO ANY PARTICULAR
FONT, STYLE, SIZE, OR COLOR.

OWNER OF U.S. REG. NO. 3,062,992.

SER. NO. 77-351,856, FILED 12-13-2007.

MATTHEW MCDOWELL, EXAMINING ATTOR-
NEY

Int. Cl.: 35

Prior U.S. Cls.: 100, 101 and 102

United States Patent and Trademark Office

Reg. No. 3,475,850

Registered July 29, 2008

**SERVICE MARK
PRINCIPAL REGISTER**

SHILOH RIFLE

POWDER RIVER RIFLE COMPANY, INC. (MON-
TANA CORPORATION)
PO BOX 279
BIG TIMBER, MT 59011

FOR: ONLINE RETAIL STORE SERVICES FEATURING RIFLES; FIREARM SIGHTS; FIREARM SIGHT CADDIES; FIREARM SCOPES; FIREARM SCOPE MOUNTS; BLOW TUBES; WIND CHARTS; SHOOTING MATS; SHOOTING STICKS; RIFLE SLINGS; GUN STANDS; CARTRIDGE BELTS; SIGHT SACKS; SCOREBOOKS FOR USE IN TARGET SHOOTING; SPOTTING BOARDS FOR USE IN TARGET SHOOTING; CLEANING SUPPLIES, NAMELY, GUN CLEANING PATCHES, GUN SOLVENTS, GUN OIL, GUN CLEANING CLOTHS, CLEANER FOR BRASS CARTRIDGES, CERAMIC MEDIA AND TUMBLER USED FOR CLEANING BRASS, GUN CLEANING ROD, GUN GLOW USED FOR CLEANING WOOD AND OUTER PARTS OF A GUN; RELOADING EQUIPMENT, NAMELY, POWDER MEASURES, LUBRICANT/SIZER, RELOADING PRESSES, SEATER PRESSES, INLINE DIES, RELOADING DIES, DROP TUBES, PLASTIC AND FIBER WADS, BULLET LUBES, RELOADING

BLOCKS, DE-PRIMING TOOLS, AND PAPER CARTRIDGE KITS FOR PERCUSSION RIFLES; CLOTHING, NAMELY, T-SHIRTS, SWEATSHIRTS, CAPS, COATS, VESTS, SHIRTS; BELT BUCKLES; BOOKS RELATING TO FIREARMS AND HUNTING; DVDS AND CDS RELATING TO HUNTING THEMES; MUGS; COASTERS; POSTERS; CALENDARS; MOUSE PADS, IN CLASS 35 (U.S. CLS. 100, 101 AND 102).

FIRST USE 12-3-2007; IN COMMERCE 12-3-2007.

THE MARK CONSISTS OF STANDARD CHARACTERS WITHOUT CLAIM TO ANY PARTICULAR FONT, STYLE, SIZE, OR COLOR.

NO CLAIM IS MADE TO THE EXCLUSIVE RIGHT TO USE "RIFLE", APART FROM THE MARK AS SHOWN.

SER. NO. 77-351,895, FILED 12-13-2007.

DOMINICK J. SALEMI, EXAMINING ATTORNEY

Int. Cl.: 30

Prior U.S. Cl.: 46

United States Patent and Trademark Office

Reg. No. 3,475,851

Registered July 29, 2008

**TRADEMARK
PRINCIPAL REGISTER**

DKAÑA

PROCANE LLC (NEW JERSEY LTD LIAB CO)
44 CENTER GROVE RD APT Q-30
RANDOLPH, NJ 07869

FOR: BROWN SUGAR; NATURAL BROWN SUGAR; PANELA; PRODUCTS MADE FROM DRIED RAW CANE JUICE, NAMELY, DRIED CANE JUICE CONFECTIONS IN THE FORM OF CUBES, CIRCULAR BLOCKS, AND TRIANGULAR BLOCKS, AND DRIED CANE JUICE GRANULES AND POWDER, IN CLASS 30 (U.S. CL. 46).

FIRST USE 12-12-2007; IN COMMERCE 12-12-2007.

THE MARK CONSISTS OF STANDARD CHARACTERS WITHOUT CLAIM TO ANY PARTICULAR FONT, STYLE, SIZE, OR COLOR.

SER. NO. 77-351,927, FILED 12-14-2007.

WILLIAM P. SHANAHAN, EXAMINING ATTORNEY

Int. Cl.: 35

Prior U.S. Cls.: 100, 101 and 102

United States Patent and Trademark Office

Reg. No. 3,475,852

Registered July 29, 2008

**SERVICE MARK
PRINCIPAL REGISTER**

Beef STAR

MIDWEST MICROSYSTEMS L.L.C. (NEBRASKA
LTD LIAB CO)
SUITE 7
3100 O STREET
LINCOLN, NE 68510

FIRST USE 8-13-2001; IN COMMERCE 11-8-2005.

NO CLAIM IS MADE TO THE EXCLUSIVE
RIGHT TO USE "BEEF", APART FROM THE MARK
AS SHOWN.

FOR: DATABASE MANAGEMENT SERVICES
FOR TRACKING AND REPORTING AGE SOURCE
AND OTHER CHARACTERISTICS OF BEEF CAT-
TLE, IN CLASS 35 (U.S. CLS. 100, 101 AND 102).

SER. NO. 77-351,939, FILED 12-14-2007.

WENDY GOODMAN, EXAMINING ATTORNEY

Int. Cl.: 36

Prior U.S. Cls.: 100, 101 and 102

United States Patent and Trademark Office

Reg. No. 3,475,853

Registered July 29, 2008

**SERVICE MARK
PRINCIPAL REGISTER**

Love Shouldn't Hurt

ROBERT, JILL SORENSEN (UNITED STATES
INDIVIDUAL)
1127 BELLVIEW ROAD
MCLEAN, VA 22101 AND
MASRI, CHERYL DAVIS (UNITED STATES INDIVI-
DUAL)
1901 24TH STREET, N.W.
WASHINGTON, D.C., DC 20008

FIRST USE 11-1-2007; IN COMMERCE 11-1-2007.

THE MARK CONSISTS OF STANDARD CHAR-
ACTERS WITHOUT CLAIM TO ANY PARTICULAR
FONT, STYLE, SIZE, OR COLOR.

FOR: CHARITABLE FUND RAISING IN THE
NATURE OF FUND RAISING PROGRAMS TO
COMBAT DOMESTIC VIOLENCE, IN CLASS 36
(U.S. CLS. 100, 101 AND 102).

SER. NO. 77-351,986, FILED 12-14-2007.

PAULA MAHONEY, EXAMINING ATTORNEY

Int. Cl.: 28

Prior U.S. Cls.: 22, 23, 38 and 50

United States Patent and Trademark Office

Reg. No. 3,475,854

Registered July 29, 2008

**TRADEMARK
PRINCIPAL REGISTER**

WONDERLIT

SOUTHEAST OASIS POOLS, INC. (NORTH CAROLINA CORPORATION)
11729 CAROLINA PLACE PARKWAY
PINEVILLE, NC 28134

THE MARK CONSISTS OF STANDARD CHARACTERS WITHOUT CLAIM TO ANY PARTICULAR FONT, STYLE, SIZE, OR COLOR.

FOR: ARTIFICIAL CHRISTMAS TREES WITH PRE-ATTACHED DECORATIVE LIGHTING, IN CLASS 28 (U.S. CLS. 22, 23, 38 AND 50).

SER. NO. 77-352,067, FILED 12-14-2007.

FIRST USE 9-24-2007; IN COMMERCE 9-24-2007.

APRIL ROACH, EXAMINING ATTORNEY

Int. Cl.: 35

Prior U.S. Cls.: 100, 101 and 102

United States Patent and Trademark Office

Reg. No. 3,475,855

Registered July 29, 2008

**SERVICE MARK
PRINCIPAL REGISTER**

1543AD

1543AD, LLC (MINNESOTA LTD LIAB CO)
SUITE 200
219 NO. 2ND STREET
MINNEAPOLIS, MN 55401

FOR: BUSINESS CONSULTING SERVICES RE-
LATING TO TECHNOLOGY, INCLUDING VEN-
DOR MANAGEMENT, HUMAN RESOURCES AND
SOFTWARE DEVELOPMENT, IN CLASS 35 (U.S.
CLS. 100, 101 AND 102).

FIRST USE 11-1-2002; IN COMMERCE 11-1-2002.

THE MARK CONSISTS OF STANDARD CHAR-
ACTERS WITHOUT CLAIM TO ANY PARTICULAR
FONT, STYLE, SIZE, OR COLOR.

SER. NO. 77-352,087, FILED 12-14-2007.

JUDITH HELFMAN, EXAMINING ATTORNEY

Int. Cl.: 41

Prior U.S. Cls.: 100, 101 and 107

United States Patent and Trademark Office

Reg. No. 3,475,856

Registered July 29, 2008

**SERVICE MARK
PRINCIPAL REGISTER**

INTEGRAL MEDIA

INTEGRAL MEDIA (FLORIDA LTD LIAB CO)
910 WEST AVE SUITE 1106
MIAMI BEACH, FL 33139

FOR: MULTIMEDIA ENTERTAINMENT SERVICES IN THE NATURE OF RECORDING, PRODUCTION AND POST-PRODUCTION SERVICES IN THE FIELDS OF MUSIC, VIDEO, AND FILMS; MULTIMEDIA PUBLISHING OF BOOKS, MAGAZINES, JOURNALS, SOFTWARE, GAMES, MUSIC, AND ELECTRONIC PUBLICATIONS; PRODUCTION AND DISTRIBUTION OF TELEVISION SHOWS AND MOVIES; MEDIA PRODUCTION LOCATION SCOUTING SERVICES FOR ENTERTAINMENT PURPOSES; EDUCATIONAL AND ENTERTAINMENT SERVICES, NAMELY, A CONTINUING PROGRAM ABOUT COMMUNITY EVENTS, EDUCATIONAL RESOURCES, HEALTH, FASHION, FINANCE, LEISURE ACTIVITIES AND NEWS ACCESSIBLE BY RADIO, TELEVISION, SATELLITE, AUDIO, VIDEO AND COMPUTER NETWORKS; PROVIDING A WEB SITE WHERE USERS CAN POST RATINGS, REVIEWS AND RECOMMENDATIONS ON EVENTS AND ACTIVITIES IN THE FIELD OF ENTERTAINMENT AND EDUCATION; MUSIC SELECTION SERVICES FOR USE IN TELEVISION, FILM, RADIO AND VIDEO GAMES; ENTERTAINMENT IN THE NATURE OF LIVE PERFORMANCES BY ACTORS AND MUSICIANS;

EDUCATIONAL AND ENTERTAINMENT SERVICES, NAMELY, PROVIDING EDUCATIONAL SPEAKERS; ENTERTAINMENT, NAMELY LIVE MUSIC CONCERTS; SPECIAL EVENT PLANNING; CONDUCTING WORKSHOPS AND SEMINARS IN PERSONAL AWARENESS; PROVIDING ADVICE AND INFORMATION IN THE FIELD OF EDUCATIONAL AND ENTERTAINMENT ACTIVITIES AND EVENTS FOR CHILDREN; PROVIDING ASSISTANCE, PERSONAL TRAINING AND PHYSICAL FITNESS CONSULTATION TO INDIVIDUALS TO HELP THEM MAKE PHYSICAL FITNESS, STRENGTH, CONDITIONING, AND EXERCISE IMPROVEMENT IN THEIR DAILY LIVING, IN CLASS 41 (U.S. CLS. 100, 101 AND 107).

FIRST USE 9-15-2007; IN COMMERCE 9-15-2007.

THE MARK CONSISTS OF STANDARD CHARACTERS WITHOUT CLAIM TO ANY PARTICULAR FONT, STYLE, SIZE, OR COLOR.

NO CLAIM IS MADE TO THE EXCLUSIVE RIGHT TO USE "MEDIA", APART FROM THE MARK AS SHOWN.

SER. NO. 77-352,095, FILED 12-14-2007.

EVELYN BRADLEY, EXAMINING ATTORNEY

Int. Cl.: 9

Prior U.S. Cls.: 21, 23, 26, 36 and 38

United States Patent and Trademark Office

Reg. No. 3,475,857

Registered July 29, 2008

**TRADEMARK
PRINCIPAL REGISTER**

CODESTREET

CODESTREET, LLC (NEW YORK LTD LIAB CO)
9TH FLOOR
11 WEST 42ND STREET
NEW YORK, NY 10036

THE MARK CONSISTS OF STANDARD CHARACTERS WITHOUT CLAIM TO ANY PARTICULAR FONT, STYLE, SIZE, OR COLOR.

FOR: COMPUTER PROGRAMS FOR GATHERING, REVIEWING, AND ANALYZING FINANCIAL DATA, IN CLASS 9 (U.S. CLS. 21, 23, 26, 36 AND 38).

SER. NO. 77-352,123, FILED 12-14-2007.

FIRST USE 8-1-2003; IN COMMERCE 8-1-2003.

ESTHER BELENKER, EXAMINING ATTORNEY

Int. Cl.: 35

Prior U.S. Cls.: 100, 101 and 102

United States Patent and Trademark Office

Reg. No. 3,475,858

Registered July 29, 2008

**SERVICE MARK
PRINCIPAL REGISTER**

Printbrat

WOLF-ROBIN, JULIETTE (UNITED STATES IN-
DIVIDUAL)
#12-B
425 W. 23RD ST.
NEW YORK, NY 10011

THE MARK CONSISTS OF STANDARD CHAR-
ACTERS WITHOUT CLAIM TO ANY PARTICULAR
FONT, STYLE, SIZE, OR COLOR.

FOR: ADVERTISING AND PROMOTION SERVI-
CES AND RELATED CONSULTING, IN CLASS 35
(U.S. CLS. 100, 101 AND 102).

SER. NO. 77-352,194, FILED 12-14-2007.

FIRST USE 7-5-2005; IN COMMERCE 4-1-2007.

PAUL MORENO, EXAMINING ATTORNEY

Int. Cls.: 9 and 42

Prior U.S. Cls.: 21, 23, 26, 36, 38, 100 and 101

United States Patent and Trademark Office

Reg. No. 3,475,859

Registered July 29, 2008

**TRADEMARK
SERVICE MARK
PRINCIPAL REGISTER**

CIMARRON

FUSION GEOPHYSICAL, LLC (OKLAHOMA LTD
LIAB CO)
1818 W. LINDSEY, SUITE A105
NORMAN, OK 73069

FOR: DATA PROCESSING SOFTWARE, NAME-
LY, GEOPHYSICAL PROCESSING SOFTWARE FOR
ANALYSIS AND CORRECTION OF FIELD GEOME-
TRIES AND ANALYSIS OF STATICS FOR SEISMIC
PROCESSING FOR USE IN THE OIL AND GAS
INDUSTRY, IN CLASS 9 (U.S. CLS. 21, 23, 26, 36 AND
38).

FIRST USE 7-31-2007; IN COMMERCE 9-27-2007.

FOR: ANALYSIS SERVICES FOR OIL FIELD
EXPLORATION, NAMELY, PROCESSING SEISMIC

DATA INCLUDING THE ANALYSIS AND COR-
RECTION OF FIELD GEOMETRIES AND ANALY-
SIS OF STATICS FOR SEISMIC PROCESSING, IN
CLASS 42 (U.S. CLS. 100 AND 101).

FIRST USE 7-31-2007; IN COMMERCE 9-27-2007.

THE MARK CONSISTS OF STANDARD CHAR-
ACTERS WITHOUT CLAIM TO ANY PARTICULAR
FONT, STYLE, SIZE, OR COLOR.

SER. NO. 77-352,214, FILED 12-14-2007.

PRISCILLA MILTON, EXAMINING ATTORNEY

Int. Cl.: 36

Prior U.S. Cls.: 100, 101 and 102

United States Patent and Trademark Office

Reg. No. 3,475,860

Registered July 29, 2008

**SERVICE MARK
PRINCIPAL REGISTER**

WCG

WCG MANAGEMENT, L.P. (DELAWARE LIMITED PARTNERSHIP)
2 WORLD FINANCIAL CENTER, SOUTH TOWER
225 LIBERTY STREET
NEW YORK, NY 10281

FOR: FINANCIAL SERVICES, NAMELY, INVESTMENT MANAGEMENT AND ADVISORY SERVICES; HEDGE FUND INVESTMENT SERVICES; INVESTMENT OF FUNDS FOR OTHERS, IN CLASS 36 (U.S. CLS. 100, 101 AND 102).

FIRST USE 8-6-2007; IN COMMERCE 8-6-2007.

THE MARK CONSISTS OF STANDARD CHARACTERS WITHOUT CLAIM TO ANY PARTICULAR FONT, STYLE, SIZE, OR COLOR.

SER. NO. 77-352,219, FILED 12-14-2007.

STEPHEN AQUILA, EXAMINING ATTORNEY

Int. Cl.: 38

Prior U.S. Cls.: 100, 101 and 104

United States Patent and Trademark Office

Reg. No. 3,475,861

Registered July 29, 2008

**SERVICE MARK
PRINCIPAL REGISTER**

Broad-Connect

BROAD-CONNECT TELECOM LLC (NEW YORK
LTD LIAB CO)
221 COMMERCE DRIVE
AMHERST, NY 14228

FOR: VOICE OVER INTERNET PROTOCOL (VOIP) SERVICES; ELECTRONIC VOICE MESSAGING, NAMELY, THE RECORDING AND SUBSEQUENT TRANSMISSION OF VOICE MESSAGES BY TELEPHONE; PROVIDING VOICE COMMUNICATION SERVICES VIA THE INTERNET; VOICE MAIL SERVICES; VOICE OVER IP SERVICES; INTERNATIONAL TELEPHONE SERVICES; INTERSTATE TELEPHONE SERVICES; INTRASTATE TELEPHONE SERVICES; LOCAL AND LONG DISTANCE TELEPHONE SERVICES; PROVIDING TELEPHONE

CONFERENCING SERVICES; TELEPHONE COMMUNICATION SERVICES; TELEPHONE VOICE MESSAGING SERVICES; PBX DIALING SERVICES, IN CLASS 38 (U.S. CLS. 100, 101 AND 104).

FIRST USE 8-8-2007; IN COMMERCE 10-1-2007.

THE MARK CONSISTS OF STANDARD CHARACTERS WITHOUT CLAIM TO ANY PARTICULAR FONT, STYLE, SIZE, OR COLOR.

SER. NO. 77-352,253, FILED 12-14-2007.

PAM WILLIS, EXAMINING ATTORNEY

Int. Cl.: 38

Prior U.S. Cls.: 100, 101 and 104

United States Patent and Trademark Office

Reg. No. 3,475,862

Registered July 29, 2008

**SERVICE MARK
PRINCIPAL REGISTER**



BROAD-CONNECT TELECOM LLC (NEW YORK
LTD LIAB CO)
221 COMMERCE DRIVE
AMHERST, NY 14228

FOR: ELECTRONIC VOICE MESSAGING, NAME-
LY, THE RECORDING AND SUBSEQUENT TRANS-
MISSION OF VOICE MESSAGES BY TELEPHONE;
PROVIDING VOICE COMMUNICATION SERVICES
VIA THE INTERNET; TELEPHONE VOICE MESSA-
GING SERVICES; VOICE MAIL SERVICES; VOICE
OVER IP SERVICES; VOICE OVER INTERNET
PROTOCOL (VOIP) SERVICES; COMMUNICA-
TIONS BY TELEPHONE; FIXED AND MOBILE
TELEPHONE SERVICES; INTERNATIONAL TELE-
PHONE SERVICES; INTERSTATE TELEPHONE
SERVICES; INTRASTATE TELEPHONE SERVICES;
LOCAL AND LONG DISTANCE TELEPHONE SER-
VICES; LONG DISTANCE TELEPHONE COMMU-
NICATION SERVICES; PROVIDING TELEPHONE

CONFERENCING SERVICES; TELEPHONE COM-
MUNICATION SERVICES; PBX DIALING SERVI-
CES , IN CLASS 38 (U.S. CLS. 100, 101 AND 104).

FIRST USE 8-8-2007; IN COMMERCE 10-1-2007.

THE MARK CONSISTS OF A CIRCLE FORMED
FROM TWO TAPERED ARCS WITHIN WHICH THE
FIRST PART OF THE LITERAL ELEMENT
"BROAD" (STYLIZED, ITALIC CAPITAL LETTERS)
IS FRAMED AFTER THE WORD BY AN OPEN
TRIANGLE RESEMBLING TWO, CONNECTED
BARBELLS, AND BENEATH WHICH WORD THE
LITERAL ELEMENT "CONNECT" (STYLIZED, ITA-
LIC CAPITAL LETTERS) IS FRAMED BEFORE THE
WORD BY A RECIPROCAL OPEN TRIANGLE.

SER. NO. 77-352,296, FILED 12-14-2007.

PAM WILLIS, EXAMINING ATTORNEY

Int. Cl.: 14

Prior U.S. Cls.: 2, 27, 28 and 50

United States Patent and Trademark Office

Reg. No. 3,475,863

Registered July 29, 2008

**TRADEMARK
PRINCIPAL REGISTER**



MARIA EWING ESTRADA (CALIFORNIA PART-
NERSHIP), DBA LOCKETSHIP
2390 CRENSHAW BLVD #181
TORRANCE, CA 90501

FOR: JEWELRY, IN CLASS 14 (U.S. CLS. 2, 27, 28
AND 50).

FIRST USE 10-0-2007; IN COMMERCE 12-0-2007.

THE MARK CONSISTS OF A DOME SHAPED
ROCKETSHIP WITH 2 FINS, 1 ON EACH BOTTOM
CORNER. INSIDE THE WINDOW OF THE ROCK-

ETSHIP, THERE IS A RACCOON WITH A HEART
SHAPED NOSE WEARING AN ASTRONAUT HEL-
MET. JUST BELOW THE WINDOW, THE WORD,
"LOCKETSHIP" IS WRITTEN ACROSS THE ROCK-
ETSHIP. BELOW THE WORDING, THERE ARE 3
STARS. THERE ARE 2 PIECES OF TRIM OUTSIDE
OF THE OUTER STARS THAT HANG JUST BELOW
THE BOTTOM OF THE ROCKETSHIP.

SER. NO. 77-352,299, FILED 12-14-2007.

PAM WILLIS, EXAMINING ATTORNEY

Int. Cl.: 36

Prior U.S. Cls.: 100, 101 and 102

United States Patent and Trademark Office

Reg. No. 3,475,864

Registered July 29, 2008

**SERVICE MARK
PRINCIPAL REGISTER**



DIVERSICORP
FINANCIAL GROUP

DIVERSICORP FINANCIAL GROUP (CALIFORNIA LTD LIAB CO)
15788 AMSTON CT.
CHINO HILLS, CA 91709

FOR: FINANCING SERVICES; LEASE-PURCHASE FINANCING, IN CLASS 36 (U.S. CLS. 100, 101 AND 102).

FIRST USE 5-4-2007; IN COMMERCE 5-4-2007.

NO CLAIM IS MADE TO THE EXCLUSIVE RIGHT TO USE "FINANCIAL GROUP", APART FROM THE MARK AS SHOWN.

THE STIPLING IS FOR SHADING PURPOSES ONLY.

THE MARK CONSISTS OF A SHADED SQUARE WITH ROUNDED EDGES, DIVIDED IN THREE SECTIONS, TO THE LEFT OF THE STYLIZED TEXT "DIVERSICORP FINANCIAL GROUP".

SER. NO. 77-352,318, FILED 12-14-2007.

BRIAN CALLAGHAN, EXAMINING ATTORNEY

Int. Cl.: 21

Prior U.S. Cls.: 2, 13, 23, 29, 30, 33, 40 and 50

Reg. No. 3,475,865

United States Patent and Trademark Office

Registered July 29, 2008

**TRADEMARK
PRINCIPAL REGISTER**

VIBRANTMOP

COLUMBIA INSURANCE COMPANY (NEBRASKA CORPORATION)
3024 HARNEY STREET
OMAHA, NE 68131

FOR: MANUALLY OPERATED FLOOR CLEANING DEVICE, CONSISTING OF A MOP AND CLEANING PADS FOR HOUSEHOLD PURPOSES FOR USE BY INDIVIDUALS, IN CLASS 21 (U.S. CLS. 2, 13, 23, 29, 30, 33, 40 AND 50).

FIRST USE 6-30-2007; IN COMMERCE 6-30-2007.

THE MARK CONSISTS OF STANDARD CHARACTERS WITHOUT CLAIM TO ANY PARTICULAR FONT, STYLE, SIZE, OR COLOR.

SER. NO. 77-352,336, FILED 12-14-2007.

CHERYL CLAYTON, EXAMINING ATTORNEY

Int. Cl.: 14

Prior U.S. Cls.: 2, 27, 28 and 50

United States Patent and Trademark Office

Reg. No. 3,475,866

Registered July 29, 2008

**TRADEMARK
PRINCIPAL REGISTER**

**Tresors des Filles Girls
Treasures**

LICKITY SPLIT DESIGNS INC. (CALIFORNIA
CORPORATION)

1539 SPRINGHAVEN WAY

LODI, CA 95242

FOR: JEWELRY, IN CLASS 14 (U.S. CLS. 2, 27, 28
AND 50).

FIRST USE 5-0-2006; IN COMMERCE 5-0-2006.

THE MARK CONSISTS OF STANDARD CHAR-
ACTERS WITHOUT CLAIM TO ANY PARTICULAR
FONT, STYLE, SIZE, OR COLOR.

THE FOREIGN WORDING IN THE MARK
TRANSLATES INTO ENGLISH AS "GIRLS TREAS-
URES".

SER. NO. 77-352,350, FILED 12-14-2007.

GINA HAYES, EXAMINING ATTORNEY

Int. Cl.: 41

Prior U.S. Cls.: 100, 101 and 107

United States Patent and Trademark Office

Reg. No. 3,475,867

Registered July 29, 2008

**SERVICE MARK
PRINCIPAL REGISTER**

ROLF MOVEMENT

ROLF INSTITUTE OF STRUCTURAL INTEGRATION, THE (CALIFORNIA NON-PROFIT CORPORATION)
5055 CHAPARRAL COURT, SUITE 103
BOULDER, CO 80301

FOR: EDUCATIONAL SERVICES, NAMELY, CONDUCTING CLASSES, SEMINARS, COURSES, WORKSHOPS IN THE FIELD OF BODYWORK, STRUCTURAL INTEGRATION, BREATHING, STRUCTURAL PATTERNS AND DISTRIBUTING COURSE MATERIALS THEREWITH; DEVELOPMENT AND DISSEMINATION OF EDUCATIONAL MATERIALS OF OTHERS IN THE FIELD OF BODYWORK, STRUCTURAL INTEGRATION, BREATHING, STRUCTURAL PATTERNS; TRAINING

PERSONS IN A TECHNIQUE OF BODYWORK, STRUCTURAL INTEGRATION, BREATHING AND STRUCTURAL PATTERNS, IN CLASS 41 (U.S. CLS. 100, 101 AND 107).

FIRST USE 0-0-1997; IN COMMERCE 0-0-1997.

THE MARK CONSISTS OF STANDARD CHARACTERS WITHOUT CLAIM TO ANY PARTICULAR FONT, STYLE, SIZE, OR COLOR.

SER. NO. 77-352,361, FILED 12-14-2007.

GINA HAYES, EXAMINING ATTORNEY

Int. Cl.: 36

Prior U.S. Cls.: 100, 101 and 102

United States Patent and Trademark Office

Reg. No. 3,475,868

Registered July 29, 2008

**SERVICE MARK
PRINCIPAL REGISTER**

THE BROOM FACTORY

HARBOR ENTERPRISE CENTER LLC (MARY-
LAND LTD LIAB CO)
MS 14 - SUITE 120
3500 BOSTON STREET
BALTIMORE, MD 21224

FOR: BUILDING LEASING; BUILDING MAN-
AGEMENT, IN CLASS 36 (U.S. CLS. 100, 101 AND
102).

FIRST USE 1-1-1907; IN COMMERCE 6-1-1992.

THE MARK CONSISTS OF STANDARD CHAR-
ACTERS WITHOUT CLAIM TO ANY PARTICULAR
FONT, STYLE, SIZE, OR COLOR.

SER. NO. 77-352,366, FILED 12-14-2007.

GINA HAYES, EXAMINING ATTORNEY

Int. Cl.: 39

Prior U.S. Cls.: 100 and 105

United States Patent and Trademark Office

Reg. No. 3,475,869

Registered July 29, 2008

**SERVICE MARK
PRINCIPAL REGISTER**

EJ&E Railway

EJ&E WEST COMPANY (ILLINOIS CORPORATION)
ROOM 1500
600 GRANT STREET
PITTSBURGH, PA 152192800

FOR: RAILWAY TRANSPORT, IN CLASS 39 (U.S. CLS. 100 AND 105).

FIRST USE 4-1-1901; IN COMMERCE 4-1-1901.

THE MARK CONSISTS OF STANDARD CHARACTERS WITHOUT CLAIM TO ANY PARTICULAR FONT, STYLE, SIZE, OR COLOR.

NO CLAIM IS MADE TO THE EXCLUSIVE RIGHT TO USE "RAILWAY", APART FROM THE MARK AS SHOWN.

SER. NO. 77-352,379, FILED 12-14-2007.

JASON TURNER, EXAMINING ATTORNEY

Int. Cls.: 35 and 37

Prior U.S. Cls.: 100, 101, 102, 103 and 106

United States Patent and Trademark Office

Reg. No. 3,475,870

Registered July 29, 2008

**SERVICE MARK
PRINCIPAL REGISTER**



ULTIMATE GUTTER GUARD BY SOUTHERN
(GEORGIA LTD LIAB CO)
6350 REGENCY PARKWAY, SUITE 520
NORCROSS, GA 30071

FOR: RETAIL STORE SERVICES FEATURING
METAL HOODED GUTTERS, IN CLASS 35 (U.S.
CLS. 100, 101 AND 102).

FIRST USE 10-2-2007; IN COMMERCE 11-26-2007.

FOR: INSTALLATION OF GUTTERS, IN CLASS
37 (U.S. CLS. 100, 103 AND 106).

FIRST USE 10-2-2007; IN COMMERCE 11-26-2007.

NO CLAIM IS MADE TO THE EXCLUSIVE
RIGHT TO USE "ULTIMATE GUTTER GUARD",
APART FROM THE MARK AS SHOWN.

THE MARK CONSISTS OF WORDS UNDER-
LINED BY BOTTOM OF "GUTTER" ILLUSTRATION
AND TOPPED WITH A "GUTTER" COVER
ILLUSTRATION.

SER. NO. 77-352,412, FILED 12-14-2007.

RENEE MCCRAY, EXAMINING ATTORNEY

Int. Cl.: 39

Prior U.S. Cls.: 100 and 105

United States Patent and Trademark Office

Reg. No. 3,475,871

Registered July 29, 2008

**SERVICE MARK
PRINCIPAL REGISTER**

PackMy Dorm

WEST COAST STORAGE LLC (DELAWARE LTD
LIAB CO)
2742 OTTOWA AVE.
DAVIS, CA 95616

FOR: MOVING AND STORAGE OF FURNITURE,
CLOTHING, BOOKS, ELECTRONIC EQUIPMENT
AND OTHER HOUSEHOLD GOODS, IN CLASS 39
(U.S. CLS. 100 AND 105).

FIRST USE 3-2-2007; IN COMMERCE 3-2-2007.

THE MARK CONSISTS OF STANDARD CHAR-
ACTERS WITHOUT CLAIM TO ANY PARTICULAR
FONT, STYLE, SIZE, OR COLOR.

NO CLAIM IS MADE TO THE EXCLUSIVE
RIGHT TO USE "DORM", APART FROM THE
MARK AS SHOWN.

SER. NO. 77-352,439, FILED 12-14-2007.

MATTHEW MCDOWELL, EXAMINING ATTOR-
NEY

Int. Cls.: 9 and 16

Prior U.S. Cls.: 2, 5, 21, 22, 23, 26, 29, 36, 37, 38 and 50

Reg. No. 3,475,872

United States Patent and Trademark Office

Registered July 29, 2008

**TRADEMARK
PRINCIPAL REGISTER**

LabPaq

HANDS-ON LABS, INC. (COLORADO CORPORATION), DBA F/K/A AT HOME SCIENCE, INC.
3203 W. HAMPDEN AVE.
SHERIDAN, CO 80110

FOR: SCIENTIFIC EDUCATIONAL KITS COMPRISED OF INSTRUCTIONAL USER LAB MANUALS SOLD AS A UNIT THEREWITH, SAFETY GOGGLES, TEST TUBES, TEST TUBE BRUSHES, TEST TUBE STAND, MICRO PIPETS, VIALS, AND PACKETS OF CHEMICALS, MAGNIFIERS, PH, LEAD AND LITMUS TEST PAPERS, FILTER PAPERS, PETRI DISHES, BEAKERS, PLASTIC AND COPPER TUBING FOR USE WITH TEST TUBES, REACTION PLATES, MICROSCOPES, MULTIMETERS, SCALES, THERMOMETERS, TIMERS FOR EXPERIMENTS, PROTRACTORS, RULERS, GRADUATED CYLINDERS, AND COLLECTIONS OF THESE ITEMS INTENDED FOR USE IN A HOME AS WELL AS FORMAL LABORATORY, AND RELATED TO THE STUDY OF ALL FIELDS AND

BRANCHES OF SCIENCE, NAMELY, CHEMISTRY, BIOLOGY, PHYSICS, GEOLOGY, METEOROLOGY, AND ECOLOGY, IN CLASS 9 (U.S. CLS. 21, 23, 26, 36 AND 38).

FIRST USE 9-21-2007; IN COMMERCE 9-21-2007.

FOR: EDUCATIONAL INSTRUCTIONAL MANUALS IN THE FIELD OF SCIENCE, IN CLASS 16 (U.S. CLS. 2, 5, 22, 23, 29, 37, 38 AND 50).

FIRST USE 9-21-2007; IN COMMERCE 9-21-2007.

THE MARK CONSISTS OF STANDARD CHARACTERS WITHOUT CLAIM TO ANY PARTICULAR FONT, STYLE, SIZE, OR COLOR.

SER. NO. 77-352,504, FILED 12-14-2007.

EDWARD FENNESSY, EXAMINING ATTORNEY

Int. Cl.: 5

Prior U.S. Cls.: 6, 18, 44, 46, 51 and 52

United States Patent and Trademark Office

Reg. No. 3,475,873

Registered July 29, 2008

**TRADEMARK
PRINCIPAL REGISTER**

Nutrapreventives

COASTSDIDE BIO RESOURCES (MAINE CORPORATION)
P.O. BOX 151
13 ATLANTIC AVE
STONINGTON, ME 04681

FOR: DIETARY SUPPLEMENTS FOR HUMAN CONSUMPTION; DIETARY SUPPLEMENTS FOR ANIMALS, IN CLASS 5 (U.S. CLS. 6, 18, 44, 46, 51 AND 52).

FIRST USE 12-30-2004; IN COMMERCE 12-6-2007.

THE MARK CONSISTS OF STANDARD CHARACTERS WITHOUT CLAIM TO ANY PARTICULAR FONT, STYLE, SIZE, OR COLOR.

SER. NO. 77-352,530, FILED 12-14-2007.

KARANENDRA S. CHHINA, EXAMINING ATTORNEY

Int. Cl.: 44

Prior U.S. Cls.: 100 and 101

United States Patent and Trademark Office

Reg. No. 3,475,874

Registered July 29, 2008

**SERVICE MARK
PRINCIPAL REGISTER**



BAPTIST HEALTH CARE CORPORATION
(FLORIDA CORPORATION)
SUITE 320
1717 NORTH "E" STREET
PENSACOLA, FL 32501

FOR: HEALTHCARE, IN CLASS 44 (U.S. CLS. 100
AND 101).

FIRST USE 10-1-2004; IN COMMERCE 11-19-2004.

NO CLAIM IS MADE TO THE EXCLUSIVE
RIGHT TO USE "INSTITUTE," "ORTHOPAEDICS,"
AND "SPORTS MEDICINE", APART FROM THE
MARK AS SHOWN.

THE COLOR(S) BLUE AND GREY IS/ARE
CLAIMED AS A FEATURE OF THE MARK.

THE MARK CONSISTS OF A CAPITAL LETTER
"A" IN BLUE WITH A BLUE AND GREY LINE
THROUGH THE "A", UNDERNEATH WHICH IS
THE WORD "ANDREWS" IN ALL CAPITAL GREY
FONT, UNDERNEATH WHICH IS THE WORD
"INSTITUTE" IN ALL CAPITAL GREY FONT, UN-
DERNEATH WHICH IS A DOUBLE BLUE LINE,
UNDERNEATH WHICH IS THE PHRASE "ORTHO-
PAEDICS & SPORTS MEDICINE" IN ALL CAPITAL
GREY FONT.

SER. NO. 77-352,532, FILED 12-14-2007.

KARANENDRA S. CHHINA, EXAMINING ATTOR-
NEY

Int. Cls.: 9 and 16

Prior U.S. Cls.: 2, 5, 21, 22, 23, 26, 29, 36, 37, 38 and 50

United States Patent and Trademark Office

Reg. No. 3,475,875

Registered July 29, 2008

**TRADEMARK
PRINCIPAL REGISTER**

**ORDINARY WOMAN /
EXTRAORDINARY GOD**

TAGGART, SUSAN MISTY (UNITED STATES
INDIVIDUAL)
13523 W POST DRIVE
SURPRISE, AZ 85374

FOR: DOWNLOADABLE MP3 FILES, MP3 RE-
CORDINGS, ONLINE DISCUSSION BOARDS, WEB-
CASTS AND PODCASTS FEATURING MUSIC,
AUDIO BOOKS AND NEWS BROADCASTS; ELEC-
TRONIC PUBLICATIONS, NAMELY, NEWSLET-
TERS, WORKBOOKS, BOOKS AND MANUALS
FEATURING FICTIONAL, INSPIRATIONAL AND
RELIGIOUS CONTENT AND MUSIC RECORDED
ON COMPUTER MEDIA, IN CLASS 9 (U.S. CLS. 21,
23, 26, 36 AND 38).

FIRST USE 1-1-1998; IN COMMERCE 1-1-1998.

FOR: A SERIES OF BOOKS AND WRITTEN
ARTICLES IN THE FIELD OF RELIGION; A SERIES
OF BOOKS, WRITTEN ARTICLES, HANDOUTS
AND WORKSHEETS IN THE FIELD OF RELIGION,
IN CLASS 16 (U.S. CLS. 2, 5, 22, 23, 29, 37, 38 AND 50).

FIRST USE 1-1-1998; IN COMMERCE 1-1-1998.

THE MARK CONSISTS OF STANDARD CHAR-
ACTERS WITHOUT CLAIM TO ANY PARTICULAR
FONT, STYLE, SIZE, OR COLOR.

SER. NO. 77-352,535, FILED 12-14-2007.

KARANENDRA S. CHHINA, EXAMINING ATTOR-
NEY

Int. Cl.: 35

Prior U.S. Cls.: 100, 101 and 102

United States Patent and Trademark Office

Reg. No. 3,475,876

Registered July 29, 2008

**SERVICE MARK
PRINCIPAL REGISTER**

LISTMIGHTY

MITRYA SHOPPING, LLC (INDIANA LTD LIAB
CO)
1040 WOODLAWN ROAD
GLENVIEW, IL 60035

FOR: ADVERTISING AND COMMERCIAL INFORMATION SERVICES, VIA THE INTERNET; ADVERTISING AND MARKETING; ADVERTISING AND PUBLICITY SERVICES, NAMELY, PROMOTING THE GOODS, SERVICES, BRAND IDENTITY AND COMMERCIAL INFORMATION AND NEWS OF THIRD PARTIES THROUGH PRINT, AUDIO, VIDEO, DIGITAL AND ON-LINE MEDIUM; ADVERTISING BY TRANSMISSION OF ON-LINE PUBLICITY FOR THIRD PARTIES THROUGH ELECTRONIC COMMUNICATIONS NETWORKS; ADVERTISING SERVICES, FOR THIRD PARTIES, IN CONNECTION WITH THE COMMERCIALIZATION AND SALE OF PERFUMERY AND COSMETIC ARTICLES, PRODUCTS FOR HOUSEHOLD PURPOSES, OPTICAL PRODUCTS, CLOCKS AND TIMEPIECES, JEWELLERY, FURNISHING ARTICLES; ADVERTISING SERVICES, NAMELY, PROMOTING AND MARKETING THE GOODS AND SERVICES OF OTHERS THROUGH ALL PUBLIC COMMUNICATION MEANS; ADVERTISING SERVICES, NAMELY, PROMOTING THE FOOD AND WINE OF OTHERS; ADVERTISING VIA ELECTRONIC MEDIA AND SPECIFICALLY THE INTERNET; COMPUTERIZED ON-LINE GIFT ORDERING SERVICE WHICH MATCHES THE GIFT GIVER'S REQUIREMENTS WITH THE GIFT RECIPIENT'S WANTS AND NEEDS; COMPUTERIZED ON-LINE ORDERING FEATURING GENERAL MERCHANDISE AND GENERAL CONSUMER GOODS; COMPUTERIZED ON-LINE RETAIL STORE SERVICES IN THE FIELD OF CONSUMER GOODS; CUSTOMER LOYALTY SERVICES AND CUSTOMER CLUB SERVICES, FOR COMMERCIAL, PROMOTIONAL AND/OR ADVERTISING PURPOSES; DISSEMINATION OF ADVERTISING FOR OTHERS VIA AN ON-LINE COMMUNICATIONS NETWORK ON THE

INTERNET; DISSEMINATION OF ADVERTISING FOR OTHERS VIA THE INTERNET; ON-LINE ADVERTISING AND MARKETING SERVICES; ON-LINE ADVERTISING ON COMPUTER COMMUNICATION NETWORKS; ON-LINE ORDERING SERVICES FEATURING CONSUMER GOODS; ON-LINE RETAIL STORE SERVICES FEATURING CONSUMER GOODS; ON-LINE SERVICES, NAMELY, ORDERING AND INVENTORY MONITORING FOR CONSUMER GOODS; PROMOTING THE GOODS AND SERVICES OF OTHERS THROUGH ON-LINE ORDERING AND CATALOGING OF THOSE GOODS AND SERVICES; PROMOTING THE GOODS OF OTHERS BY MEANS OF ON-LINE REAL TIME PRESENTATION FOR INSPECTION, VIEWING OR SHOWING OF CONSUMER GOODS; PROMOTING, ADVERTISING AND MARKETING OF THE ON-LINE WEBSITES OF OTHERS; PROMOTION, ADVERTISING AND MARKETING OF ON-LINE WEBSITES; PROVIDING A SEARCHABLE ONLINE ADVERTISING GUIDE FEATURING THE GOODS AND SERVICES OF OTHER ON-LINE VENDORS ON THE INTERNET; PROVIDING A WEB SITE WHICH FEATURES ADVERTISEMENTS FOR THE GOODS AND SERVICES OF OTHERS ON A GLOBAL COMPUTER NETWORK; PROVIDING AN ON-LINE COMMERCIAL INFORMATION DIRECTORY ON THE INTERNET; PROVIDING AN ON-LINE SHOWROOM FOR THE GOODS OF OTHERS IN THE FIELD OF CONSUMER GOODS; PROVIDING ON-LINE DIRECTORY INFORMATION SERVICES ALSO FEATURING HYPERLINKS TO OTHER WEB SITES, IN CLASS 35 (U.S. CLS. 100, 101 AND 102).

FIRST USE 9-1-2007; IN COMMERCE 9-1-2007.

THE MARK CONSISTS OF STANDARD CHARACTERS WITHOUT CLAIM TO ANY PARTICULAR FONT, STYLE, SIZE, OR COLOR.

SER. NO. 77-352,561, FILED 12-14-2007.

MONIQUE MILLER, EXAMINING ATTORNEY

Int. Cls.: 16 and 41

Prior U.S. Cls.: 2, 5, 22, 23, 29, 37, 38, 50, 100, 101 and 107

Reg. No. 3,475,877

United States Patent and Trademark Office

Registered July 29, 2008

**TRADEMARK
SERVICE MARK
PRINCIPAL REGISTER**

Power Electronics Technology

PENTON BUSINESS MEDIA, INC. (DELAWARE CORPORATION)
4TH FLOOR
249 WEST 17TH STREET
NEW YORK, NY 10011

FOR: MAGAZINES FEATURING INFORMATION IN THE FIELD OF ELECTRONICS AND THE ELECTRONICS INDUSTRY; NEWSLETTERS IN THE FIELD OF ELECTRONICS AND THE ELECTRONICS INDUSTRY; GUIDE BOOKS FEATURING INFORMATION IN THE FIELD OF ELECTRONICS AND THE ELECTRONICS INDUSTRY, IN CLASS 16 (U.S. CLS. 2, 5, 22, 23, 29, 37, 38 AND 50).

FIRST USE 10-0-2001; IN COMMERCE 10-0-2001.

FOR: PROVIDING ON-LINE PUBLICATIONS IN THE NATURE OF MAGAZINES, GUIDES, AND NEWSLETTERS IN THE FIELD OF ELECTRONICS AND THE ELECTRONICS INDUSTRY; PROVIDING NEWSLETTERS IN THE FIELD OF ELECTRONICS

AND THE ELECTRONICS INDUSTRY VIA E-MAIL , IN CLASS 41 (U.S. CLS. 100, 101 AND 107).

FIRST USE 10-0-2001; IN COMMERCE 10-0-2001.

THE MARK CONSISTS OF STANDARD CHARACTERS WITHOUT CLAIM TO ANY PARTICULAR FONT, STYLE, SIZE, OR COLOR.

OWNER OF U.S. REG. NO. 2,657,368.

NO CLAIM IS MADE TO THE EXCLUSIVE RIGHT TO USE "ELECTRONICS", APART FROM THE MARK AS SHOWN.

SEC. 2(F).

SER. NO. 77-352,580, FILED 12-14-2007.

MICHAEL ENGEL, EXAMINING ATTORNEY

Int. Cl.: 30

Prior U.S. Cl.: 46

United States Patent and Trademark Office

Reg. No. 3,475,878

Registered July 29, 2008

**TRADEMARK
PRINCIPAL REGISTER**

ESCARGOT

PALM BEACH CONFECTIONS, INC. (FLORIDA
CORPORATION)
SUITE G
2875 CONGRESS AVENUE
DELRAY BEACH, FL 33445

THE MARK CONSISTS OF STANDARD CHAR-
ACTERS WITHOUT CLAIM TO ANY PARTICULAR
FONT, STYLE, SIZE, OR COLOR.

FOR: CANDIES MADE OF CHOCOLATE, CARA-
MEL, AND MARSHMALLOW, IN CLASS 30 (U.S. CL.
46).

SER. NO. 77-352,638, FILED 12-14-2007.

FIRST USE 0-0-1982; IN COMMERCE 0-0-1982.

GINA FINK, EXAMINING ATTORNEY

Int. Cl.: 41

Prior U.S. Cls.: 100, 101 and 107

United States Patent and Trademark Office

Reg. No. 3,475,879

Registered July 29, 2008

**SERVICE MARK
PRINCIPAL REGISTER**

USNLE

PARKER, JASON W. (UNITED STATES INDIVIDUAL)
2920 CORTEZ AVENUE
IDAHO FALLS, ID 83404

FOR: PREPARING, DEVELOPING, ADMINISTERING AND SCORING EXAMINATIONS OF STANDARDIZED TESTS IN THE FIELD OF NATUROPATHIC MEDICINE AND NATUROPATHY, IN CLASS 41 (U.S. CLS. 100, 101 AND 107).

FIRST USE 12-1-2007; IN COMMERCE 12-1-2007.

THE MARK CONSISTS OF STANDARD CHARACTERS WITHOUT CLAIM TO ANY PARTICULAR FONT, STYLE, SIZE, OR COLOR.

SER. NO. 77-352,652, FILED 12-14-2007.

LINDA ESTRADA, EXAMINING ATTORNEY

Int. Cls.: 9 and 25

Prior U.S. Cls.: 21, 22, 23, 26, 36, 38 and 39

United States Patent and Trademark Office

Reg. No. 3,475,880

Registered July 29, 2008

**TRADEMARK
PRINCIPAL REGISTER**

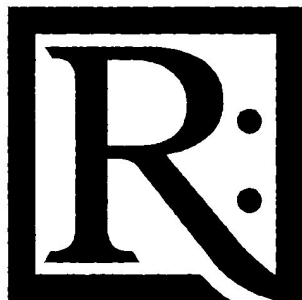

RESOLVED:

GRACE COMMUNITY CHURCH OF THE VAL-
LEY (CALIFORNIA CORPORATION)
13248 ROSCOE BLVD.
SUN VALLEY, CA 91352

FOR: DIGITAL MEDIA, NAMELY, PRE RECOR-
DED CDS FEATURING MUSIC, IN CLASS 9 (U.S.
CLS. 21, 23, 26, 36 AND 38).

FIRST USE 9-1-2004; IN COMMERCE 9-1-2004.

FOR: T-SHIRTS, LONG SLEEVED T-SHIRTS,
HOODED ZIPPERED SWEAT SHIRTS, SWEAT

SHIRTS, LOUNGE WEAR, TOPS, AND HATS, IN
CLASS 25 (U.S. CLS. 22 AND 39).

FIRST USE 9-1-2004; IN COMMERCE 9-1-2004.

THE MARK CONSISTS OF A BOX DESIGN
INCLUDING A CAPITAL "R" AND A COLON,
AND THE STYLIZED TEXT "RESOLVED".

SER. NO. 77-352,684, FILED 12-14-2007.

REGINA DRUMMOND, EXAMINING ATTORNEY

Int. Cl.: 3

Prior U.S. Cls.: 1, 4, 6, 50, 51 and 52

Reg. No. 3,475,881

United States Patent and Trademark Office

Registered July 29, 2008

**TRADEMARK
PRINCIPAL REGISTER**

Citrol



SCHAEFFER MFG. CO. (MISSOURI CORPORATION)
102 BARTON STREET
ST. LOUIS, MO 63104

THE MARK CONSISTS OF A DESIGN THAT IS A DEPICTION, WITHIN THE LETTER "O", OF A CROSS SECTION OF AN ORANGE.

FOR: DEGREASING PREPARATIONS FOR USE AS A SURFACE CLEANER FOR COMMERCIAL, INDUSTRIAL AND DOMESTIC USE, IN CLASS 3 (U.S. CLS. 1, 4, 6, 50, 51 AND 52).

SER. NO. 77-352,719, FILED 12-14-2007.

FIRST USE 6-0-1990; IN COMMERCE 6-0-1990.

PATRICIA EVANKO, EXAMINING ATTORNEY

Int. Cl.: 41

Prior U.S. Cls.: 100, 101 and 107

United States Patent and Trademark Office

Reg. No. 3,475,882

Registered July 29, 2008

**SERVICE MARK
PRINCIPAL REGISTER**

CRAB CITY CLASSIC

TEAM MELO, LLC (MARYLAND LTD LIAB CO)
4103 OAKFORD AVE.
BALTIMORE, MD 21215

FOR: CONDUCTING ENTERTAINMENT EXHIBITIONS IN THE NATURE OF BASKETBALL GAMES, IN CLASS 41 (U.S. CLS. 100, 101 AND 107).

FIRST USE 1-5-2007; IN COMMERCE 1-5-2007.

THE MARK CONSISTS OF STANDARD CHARACTERS WITHOUT CLAIM TO ANY PARTICULAR FONT, STYLE, SIZE, OR COLOR.

NO CLAIM IS MADE TO THE EXCLUSIVE RIGHT TO USE "CLASSIC", APART FROM THE MARK AS SHOWN.

SER. NO. 77-352,721, FILED 12-14-2007.

PATRICIA EVANKO, EXAMINING ATTORNEY

Int. Cl.: 41

Prior U.S. Cls.: 100, 101 and 107

United States Patent and Trademark Office

Reg. No. 3,475,883

Registered July 29, 2008

**SERVICE MARK
PRINCIPAL REGISTER**

SPECTRUM

CERAMIC TILE DISTRIBUTORS ASSOCIATION
(ILLINOIS NON-PROFIT CORPORATION)
BUILDING C, SUITE 312
800 ROOSEVELT ROAD
GLEN ELLYN, IL 60137

FOR: PROVIDING RECOGNITION AND INCENTIVES BY THE WAY OF AWARDS TO DEMONSTRATE CREATIVE EXCELLENCE IN THE USE AND INSTALLATION OF CERAMIC TILE, IN CLASS 41 (U.S. CLS. 100, 101 AND 107).

FIRST USE 9-0-1984; IN COMMERCE 9-0-1984.

THE MARK CONSISTS OF STANDARD CHARACTERS WITHOUT CLAIM TO ANY PARTICULAR FONT, STYLE, SIZE, OR COLOR.

OWNER OF U.S. REG. NOS. 1,463,957 AND 1,688,184.

SER. NO. 77-352,752, FILED 12-14-2007.

SKYE YOUNG, EXAMINING ATTORNEY

Int. Cl.: 9

Prior U.S. Cls.: 21, 23, 26, 36 and 38

United States Patent and Trademark Office

Reg. No. 3,475,884

Registered July 29, 2008

**TRADEMARK
PRINCIPAL REGISTER**

EPROCLOCK

SPECTRALINEAR INC. (DELAWARE CORPORATION)

#2200

2200 LAURELWOOD ROAD

SANTA CLARA, CA 95054

THE MARK CONSISTS OF STANDARD CHARACTERS WITHOUT CLAIM TO ANY PARTICULAR FONT, STYLE, SIZE, OR COLOR.

FOR: ELECTRONIC INTEGRATED CIRCUITS, IN CLASS 9 (U.S. CLS. 21, 23, 26, 36 AND 38).

SER. NO. 77-352,767, FILED 12-14-2007.

FIRST USE 12-0-2005; IN COMMERCE 12-0-2005.

COLLEEN KEARNEY, EXAMINING ATTORNEY

Int. Cl.: 39

Prior U.S. Cls.: 100 and 105

United States Patent and Trademark Office

Reg. No. 3,475,885

Registered July 29, 2008

**SERVICE MARK
PRINCIPAL REGISTER**



EJ&E WEST COMPANY (ILLINOIS CORPORATION)
ROOM 1500
600 GRANT STREET
PITTSBURGH, PA 152192800

FOR: RAILWAY TRANSPORT, IN CLASS 39 (U.S. CLS. 100 AND 105).

FIRST USE 12-26-1991; IN COMMERCE 12-26-1991.

NO CLAIM IS MADE TO THE EXCLUSIVE RIGHT TO USE "RAILWAY", APART FROM THE MARK AS SHOWN.

THE COLOR(S) GREEN AND ORANGE IS/ARE CLAIMED AS A FEATURE OF THE MARK.

THE MARK CONSISTS OF THE WORDS "EJ&E RAILWAY" IN GREEN LETTERING AND ENCIRCLING A SOLID GREEN DISC UPON WHICH IS SITUATED AN ORANGE LETTER "J".

SER. NO. 77-352,769, FILED 12-14-2007.

JASON TURNER, EXAMINING ATTORNEY

Int. Cl.: 9

Prior U.S. Cls.: 21, 23, 26, 36 and 38

Reg. No. 3,475,886

United States Patent and Trademark Office

Registered July 29, 2008

**TRADEMARK
PRINCIPAL REGISTER**

**RAD-X MEDICAL POWER
FILTRATION SYSTEM**

APPLIED POWER QUALITY SOLUTIONS, L.L.C.
(ARIZONA LTD LIAB CO)
P.O. BOX 14915
SCOTTSDALE, AZ 852674915

FOR: ELECTRICAL POWER FILTER WITH
TRANSIENT VOLTAGE SURGE SUPPRESSION
FOR MEDICAL USE, IN CLASS 9 (U.S. CLS. 21, 23,
26, 36 AND 38).

FIRST USE 3-30-2005; IN COMMERCE 3-30-2005.

THE MARK CONSISTS OF STANDARD CHAR-
ACTERS WITHOUT CLAIM TO ANY PARTICULAR
FONT, STYLE, SIZE, OR COLOR.

NO CLAIM IS MADE TO THE EXCLUSIVE
RIGHT TO USE "MEDICAL POWER FILTRATION
SYSTEM", APART FROM THE MARK AS SHOWN.

SER. NO. 77-352,784, FILED 12-14-2007.

PATRICIA EVANKO, EXAMINING ATTORNEY

Int. Cl.: 41

Prior U.S. Cls.: 100, 101 and 107

United States Patent and Trademark Office

Reg. No. 3,475,887

Registered July 29, 2008

**SERVICE MARK
PRINCIPAL REGISTER**

Sackcloth & Ashes

ALISON J LYON AND ERIK SIGUENZA PART-
NERSHIPS, THE (UTAH PARTNERSHIP)
1246 N. CLEAVER ST. #2
CHICAGO, IL 60622

THE MARK CONSISTS OF STANDARD CHAR-
ACTERS WITHOUT CLAIM TO ANY PARTICULAR
FONT, STYLE, SIZE, OR COLOR.

FOR: ENTERTAINMENT, NAMELY, LIVE PER-
FORMANCES BY MUSICAL BANDS, IN CLASS 41
(U.S. CLS. 100, 101 AND 107).

SER. NO. 77-352,800, FILED 12-14-2007.

FIRST USE 8-26-2006; IN COMMERCE 8-26-2006.

LEIGH LOWRY, EXAMINING ATTORNEY

Int. Cl.: 25

Prior U.S. Cls.: 22 and 39

United States Patent and Trademark Office

Reg. No. 3,475,888

Registered July 29, 2008

**TRADEMARK
PRINCIPAL REGISTER**

THE LEGENDARY QUALITY OF
BVD

THE B.V.D. LICENSING CORPORATION (DELA-
WARE CORPORATION)
LEGAL DEPARTMENT
1 FRUIT OF THE LOOM DRIVE
BOWLING GREEN, KY 42103

FOR: T-SHIRTS; BRIEFS; UNDERWEAR, IN
CLASS 25 (U.S. CLS. 22 AND 39).

FIRST USE 2-13-2004; IN COMMERCE 2-13-2004.

THE MARK CONSISTS OF STANDARD CHAR-
ACTERS WITHOUT CLAIM TO ANY PARTICULAR
FONT, STYLE, SIZE, OR COLOR.

OWNER OF U.S. REG. NOS. 367,184, 1,464,625 AND
OTHERS.

SER. NO. 77-352,812, FILED 12-14-2007.

LEIGH LOWRY, EXAMINING ATTORNEY

Int. Cl.: 41

Prior U.S. Cls.: 100, 101 and 107

United States Patent and Trademark Office

Reg. No. 3,475,889

Registered July 29, 2008

SERVICE MARK
PRINCIPAL REGISTER



WHITWORTH UNIVERSITY (WASHINGTON
NON-PROFIT CORPORATION)
300 W. HAWTHORNE ROAD
SPOKANE, WA 99251

FOR: PROVIDING COURSES OF INSTRUCTION AT THE COLLEGE AND POST-GRADUATE LEVELS AND FACILITIES THEREFORE; PROVIDING COURSES IN CONTINUING AND COMMUNITY EDUCATIONAL PROGRAMS AND FACILITIES THEREFORE; ARRANGING, CONDUCTING AND SPONSORING COLLEGE SPORTING EVENTS, LECTURES, THEATRE, MUSIC AND CULTURAL ACTIVITIES AND PROVIDING FACILITIES THEREFORE; DEVELOPMENT AND DISSEMINATION OF COLLEGE EDUCATIONAL MATERIALS; LIBRARY SERVICES; PROVIDING INFORMATION ONLINE RELATING TO COLLEGE PROGRAMS, ATHLETICS AND CULTURAL EVENTS; ARRANGING AND CONDUCTING ATHLETIC COMPETITIONS; ARRANGING AND CONDUCTING EDUCATIONAL CONFERENCES; ARRANGING AND CONDUCTING OF CONCERTS; ARRANGING PROFESSIONAL WORKSHOP AND TRAINING COURSES; DEVELOPMENT AND DISSEMINATION OF EDUCATIONAL MATERIALS OF OTHERS IN THE FIELD OF UNDERGRADUATE COURSES; EDUCATIONAL SERVICES, NAMELY, PROVIDING COURSES OF INSTRUCTION AT THE COLLEGE AND POST-GRADUATE LEVEL AND DISTRIBUTION OF COURSE MATERIAL IN CONNECTION THEREWITH; ENTERTAINMENT IN THE NATURE OF BASEBALL, BASKETBALL, CROSS COUNTRY,

FOOTBALL, GOLF, SOCCER, SOFTBALL, SWIMMING, TENNIS, TRACK AND FIELD OR VOLLEYBALL GAMES; INFORMATION RELATING TO COLLEGE EDUCATION AND ENTERTAINMENT, PROVIDED ON-LINE FROM A COMPUTER DATABASE OR THE INTERNET; PLANNING ARRANGEMENT OF SHOWING MOVIES, SHOWS, PLAYS OR MUSICAL PERFORMANCES; PROVIDING A WEBSITE FEATURING COLLEGE AND POST GRADUATE LEVEL EDUCATION, COLLEGE SPORTS, COLLEGE ENTERTAINMENT, AND RELATED COLLEGE EVENTS; PROVIDING A WEBSITE THAT FEATURES INFORMATION ON ATTENDING COLLEGE AND UNIVERSITY WITH AN EMPHASIS ON NEWLY ENROLLED STUDENTS, IN CLASS 41 (U.S. CLS. 100, 101 AND 107).

FIRST USE 7-15-2007; IN COMMERCE 8-1-2007.

NO CLAIM IS MADE TO THE EXCLUSIVE RIGHT TO USE "UNIVERSITY" AND "1890", APART FROM THE MARK AS SHOWN.

THE MARK CONSISTS OF A CIRCULAR LOGO WITH "WHITWORTH UNIVERSITY" AS A BORDER AND A BOOK AND TORCH IN THE MIDDLE WITH A BANNER STATING "1890".

SER. NO. 77-352,833, FILED 12-14-2007.

KATINA MISTER, EXAMINING ATTORNEY

Int. Cls.: 9, 42 and 45

Prior U.S. Cls.: 21, 23, 26, 36, 38, 100 and 101

United States Patent and Trademark Office

Reg. No. 3,475,890

Registered July 29, 2008

**TRADEMARK
SERVICE MARK
PRINCIPAL REGISTER**



IOVATION INC. (DELAWARE CORPORATION)
SUITE 3200
111 SW FIFTH AVENUE
PORTLAND, OR 97204

FOR: COMPUTER SOFTWARE FOR THE DETECTION AND PREVENTION OF ONLINE FRAUD AND ABUSE, AND FOR DEVICE AND ACCOUNT IDENTIFICATION AND AUTHENTICATION, IN CLASS 9 (U.S. CLS. 21, 23, 26, 36 AND 38).

FIRST USE 5-15-2004; IN COMMERCE 5-15-2004.

FOR: PROVIDING ONLINE NON-DOWNLOADABLE SOFTWARE FOR USE IN THE DETECTION AND PREVENTION OF ONLINE FRAUD AND ABUSE, AND FOR DEVICE AND ACCOUNT AUTHENTICATION; CONSULTING SERVICES IN THE FIELD OF COMPUTER, NETWORK AND ONLINE SECURITY AND FRAUD MANAGEMENT, IN CLASS 42 (U.S. CLS. 100 AND 101).

FIRST USE 5-15-2004; IN COMMERCE 5-15-2004.

FOR: IDENTIFICATION VERIFICATION SERVICES, NAMELY, PROVIDING AUTHENTICATION OF ACCOUNT AND DEVICE INFORMATION; PROVIDING USER AND DEVICE AUTHENTICATION SERVICES FOR ONLINE TRANSACTIONS, ACCOUNT ACCESS AND E-COMMERCE TRANSACTIONS, IN CLASS 45 (U.S. CLS. 100 AND 101).

FIRST USE 5-15-2004; IN COMMERCE 5-15-2004.

THE MARK CONSISTS OF A STYLIZED DESIGN OF A KEYHOLE.

SER. NO. 77-352,837, FILED 12-14-2007.

PETER B. BROMAGHIM, EXAMINING ATTORNEY

Int. Cl.: 45

Prior U.S. Cls.: 100 and 101

United States Patent and Trademark Office

Reg. No. 3,475,891

Registered July 29, 2008

**SERVICE MARK
PRINCIPAL REGISTER**

NMG Resolutions

THE NEIMAN MARCUS GROUP, INC. (DELA-
WARE CORPORATION)

1618 MAIN STREET

DALLAS, TX 75201

FOR: ALTERNATIVE DISPUTE RESOLUTION, IN
CLASS 45 (U.S. CLS. 100 AND 101).

FIRST USE 8-1-2007; IN COMMERCE 8-1-2007.

THE MARK CONSISTS OF STANDARD CHAR-
ACTERS WITHOUT CLAIM TO ANY PARTICULAR
FONT, STYLE, SIZE, OR COLOR.

NO CLAIM IS MADE TO THE EXCLUSIVE
RIGHT TO USE "RESOLUTIONS", APART FROM
THE MARK AS SHOWN.

SER. NO. 77-352,859, FILED 12-14-2007.

LEIGH LOWRY, EXAMINING ATTORNEY

Int. Cls.: 9 and 16

Prior U.S. Cls.: 2, 5, 21, 22, 23, 26, 29, 36, 37, 38 and 50

Reg. No. 3,475,892

United States Patent and Trademark Office

Registered July 29, 2008

**TRADEMARK
PRINCIPAL REGISTER**



HANDS-ON LABS, INC. (COLORADO CORPORATION), DBA F/K/A AT HOME SCIENCE, INC.
3203 W. HAMPDEN AVE.
SHERIDAN, CO 80110

FOR: SCIENTIFIC EDUCATIONAL KITS COMPRISED OF INSTRUCTIONAL USER LAB MANUALS SOLD AS A UNIT THEREWITH, SAFETY GOGGLES, TEST TUBES, TEST TUBE BRUSHES, TEST TUBE STAND, MICRO PIPETS, VIALS, AND PACKETS OF CHEMICALS, MAGNIFIERS, PH, LEAD AND LITMUS TEST PAPERS, FILTER PAPERS, PETRI DISHES, BEAKERS, PLASTIC AND COPPER TUBING FOR USE WITH TEST TUBES, REACTION PLATES, MICROSCOPES, MULTIMETERS, SCALES, THERMOMETERS, TIMERS FOR EXPERIMENTS, PROTRACTORS, RULERS, GRADUATED CYLINDERS, AND COLLECTIONS OF THESE ITEMS INTENDED FOR USE IN A HOME AS WELL AS FORMAL LABORATORY, AND RELATED TO THE STUDY OF ALL FIELDS AND BRANCHES OF SCIENCE, NAMELY, CHEMISTRY, BIOLOGY, PHYSICS, GEOLOGY, METEOROLOGY, AND ECOLOGY, IN CLASS 9 (U.S. CLS. 21, 23, 26, 36 AND 38).

FIRST USE 9-21-2007; IN COMMERCE 9-21-2007.

FOR: EDUCATIONAL INSTRUCTIONAL MANUALS IN THE FIELD OF SCIENCE, IN CLASS 16 (U.S. CLS. 2, 5, 22, 23, 29, 37, 38 AND 50).

FIRST USE 9-21-2007; IN COMMERCE 9-21-2007.

THE COLOR(S) ORANGE AND BLUE IS/ARE CLAIMED AS A FEATURE OF THE MARK.

THE MARK CONSISTS OF THE WORD "LAB" IN CAPITAL LETTERS IN BLUE IMMEDIATELY FOLLOWED BY THE WORD "PAQ" IN CAPITAL LETTERS IN ORANGE WITH THE SLOGAN "THE BEST WAY TO LEARN SCIENCE" IN BLUE DIRECTLY BELOW THE WORD "LABPAQ". A FROG IS TO THE RIGHT OF THE WORD "LABPAQ" SURROUNDED BY A BROKEN OVAL IN BLUE AND ORANGE.

SER. NO. 77-352,915, FILED 12-14-2007.

EDWARD FENNESSY, EXAMINING ATTORNEY

Int. Cls.: 35 and 42

Prior U.S. Cls.: 100, 101 and 102

United States Patent and Trademark Office

Reg. No. 3,475,893

Registered July 29, 2008

**SERVICE MARK
PRINCIPAL REGISTER**

OK-DOWNLOAD

FIZZKICKS, LLC (PENNSYLVANIA LTD LIAB
CO)
7562 PENN DRIVE, SUITE 100
ALLENTOWN, PA 18106

FOR: ON-LINE RETAIL STORE SERVICES FEATURING DOWNLOADABLE PRE-RECORDED MUSIC AND VIDEO; PREPARATION OF CUSTOM OR NON-CUSTOM ADVERTISING FOR BUSINESSES FOR DISSEMINATION VIA THE WEB, CD OR DVD FOR OPTIONAL UPLOAD OR DOWNLOAD TO A COMPUTER; ADVERTISING AND PUBLICITY SERVICES, NAMELY, PROMOTING THE GOODS, SERVICES, BRAND IDENTITY AND COMMERCIAL INFORMATION AND NEWS OF THIRD PARTIES THROUGH PRINT, AUDIO, VIDEO, DIGITAL AND ON-LINE MEDIUM; PROVIDING A WEB-BASED SERVICE THAT ENABLES INDIVIDUALS TO MANAGE THE PRODUCTION AND PUBLICATION OF ELECTRONIC BOOKS AND RELATED DIGITAL CONTENT AND OFFER THEM FOR SALE TO THE GENERAL PUBLIC, IN CLASS 35 (U.S. CLS. 100, 101 AND 102).

FIRST USE 6-22-2006; IN COMMERCE 6-22-2006.

FOR: PROVIDING A WEBSITE FEATURING TEMPORARY USE OF NONDOWNLOADABLE SOFTWARE ALLOWING WEBSITE USERS TO UPLOAD ONLINE VIDEOS FOR SHARING WITH OTHERS FOR ENTERTAINMENT PURPOSES; PROVIDING A WEBSITE THAT GIVES COMPUTER USERS THE ABILITY TO UPLOAD, EXCHANGE AND SHARE PHOTOS, VIDEOS AND VIDEO LOGS; PROVIDING COMPUTER PROGRAMMING SERVICES TO CUSTOMERS THAT ENABLES THEM TO PROVIDE VIDEO AND AUDIO CONTENT ON THEIR WEBSITES , IN CLASS 42 (U.S. CLS. 100 AND 101).

FIRST USE 6-22-2006; IN COMMERCE 6-22-2006.

THE MARK CONSISTS OF STANDARD CHARACTERS WITHOUT CLAIM TO ANY PARTICULAR FONT, STYLE, SIZE, OR COLOR.

SER. NO. 77-352,928, FILED 12-14-2007.

DAYNA BROWNE, EXAMINING ATTORNEY

Int. Cl.: 33

Prior U.S. Cls.: 47 and 49

United States Patent and Trademark Office

Reg. No. 3,475,894

Registered July 29, 2008

**TRADEMARK
PRINCIPAL REGISTER**

MY SISTERS MY FRIENDS

CANYON'S EDGE WINERY LLC (WASHINGTON
LTD LIAB CO)
1130 HALE ROAD
MABTON, WA 98935

THE MARK CONSISTS OF STANDARD CHAR-
ACTERS WITHOUT CLAIM TO ANY PARTICULAR
FONT, STYLE, SIZE, OR COLOR.

FOR: WINE, IN CLASS 33 (U.S. CLS. 47 AND 49).

SER. NO. 77-352,937, FILED 12-14-2007.

FIRST USE 1-0-2007; IN COMMERCE 1-0-2007.

SUNG IN, EXAMINING ATTORNEY

Int. Cl.: 9

Prior U.S. Cls.: 21, 23, 26, 36 and 38

Reg. No. 3,475,895

United States Patent and Trademark Office

Registered July 29, 2008

**TRADEMARK
PRINCIPAL REGISTER**

The logo for McCain features a stylized sunburst icon on the left, composed of several diagonal lines radiating from a central point. To the right of the icon, the word "McCain" is written in a bold, sans-serif font. The letter "M" is particularly large and prominent, with the sunburst lines appearing to pass through it.

MCCAIN, INC. (CALIFORNIA CORPORATION)
2365 OAK RIDGE WAY
VISTA, CA 92081

FIRST USE 1-1-2006; IN COMMERCE 1-1-2006.

OWNER OF U.S. REG. NO. 1,682,756.

FOR: TRAFFIC SIGNAL AND CONTROL EQUIPMENT, NAMELY, TRAFFIC LIGHTS, TRAFFIC-LIGHT APPARATUS, SIGNAL CONTROLLERS, TRAFFIC SIGNAL CABINETS, LUMINOUS OR MECHANICAL ROAD SIGNS, AND COMPUTER SOFTWARE FOR TRAFFIC-RELATED CONTROLLERS AND APPLICATIONS, IN CLASS 9 (U.S. CLS. 21, 23, 26, 36 AND 38).

THE MARK CONSISTS OF A SUNBURST DESIGN IN FRONT OF THE WORD "MCCAIN", WITH ONE RAY OF THE SUNBURST PENETRATING THE FIRST THREE LETTERS.

SER. NO. 77-352,962, FILED 12-14-2007.

MICHAEL WEBSTER, EXAMINING ATTORNEY

Int. Cl.: 9

Prior U.S. Cls.: 21, 23, 26, 36 and 38

Reg. No. 3,475,896

United States Patent and Trademark Office

Registered July 29, 2008

**TRADEMARK
PRINCIPAL REGISTER**

CRAZY BALL BINGO

CAPITAL BINGO, INC. (CALIFORNIA CORPORATION)
SUITE 400-B
6630 SIERRA COLLEGE BOULEVARD
ROCKLIN, CA 95677

FOR: GAMING MACHINES, NAMELY, ELECTRONIC SLOT AND BINGO MACHINES, IN CLASS 9 (U.S. CLS. 21, 23, 26, 36 AND 38).

FIRST USE 6-1-2007; IN COMMERCE 6-1-2007.

THE MARK CONSISTS OF STANDARD CHARACTERS WITHOUT CLAIM TO ANY PARTICULAR FONT, STYLE, SIZE, OR COLOR.

NO CLAIM IS MADE TO THE EXCLUSIVE RIGHT TO USE "BINGO", APART FROM THE MARK AS SHOWN.

SER. NO. 77-352,971, FILED 12-14-2007.

SANJEEV VOHRA, EXAMINING ATTORNEY

Int. Cl.: 35

Prior U.S. Cls.: 100, 101 and 102

United States Patent and Trademark Office

Reg. No. 3,475,897

Registered July 29, 2008

**SERVICE MARK
PRINCIPAL REGISTER**

CareerShip

MAPPING YOUR FUTURE, INC. (SOUTH DA-
KOTA NON-PROFIT CORPORATION)
301 SUNDANCE PARKWAY
ROUND ROCK, TX 78681

THE MARK CONSISTS OF STANDARD CHAR-
ACTERS WITHOUT CLAIM TO ANY PARTICULAR
FONT, STYLE, SIZE, OR COLOR.

FOR: PROVIDING CAREER INFORMATION, IN
CLASS 35 (U.S. CLS. 100, 101 AND 102).

SER. NO. 77-353,035, FILED 12-15-2007.

FIRST USE 0-0-1999; IN COMMERCE 0-0-1999.

LA TONIA FISHER, EXAMINING ATTORNEY

Int. Cl.: 36

Prior U.S. Cls.: 100, 101 and 102

United States Patent and Trademark Office

Reg. No. 3,475,898

Registered July 29, 2008

**SERVICE MARK
PRINCIPAL REGISTER**

LAKEVIEW OF CULPEPER

LAKEVIEW OF CULPEPER HOMEOWNERS ASSOCIATION, INC. (VIRGINIA CORPORATION)

C/O VALUE PROPERTIES
39 GARRETT ST.
WARRENTON, VA 20186

FOR: HOMEOWNERS ASSOCIATION SERVICES, NAMELY, REAL ESTATE MANAGEMENT OF COMMON GROUNDS AND RESIDENTIAL COMMUNITY AMENITIES, IN CLASS 36 (U.S. CLS. 100, 101 AND 102).

FIRST USE 4-8-2002; IN COMMERCE 4-0-2004.

THE MARK CONSISTS OF STANDARD CHARACTERS WITHOUT CLAIM TO ANY PARTICULAR FONT, STYLE, SIZE, OR COLOR.

SER. NO. 77-353,040, FILED 12-15-2007.

KAELIE KUNG, EXAMINING ATTORNEY

Int. Cl.: 35

Prior U.S. Cls.: 100, 101 and 102

United States Patent and Trademark Office

Reg. No. 3,475,899

Registered July 29, 2008

**SERVICE MARK
PRINCIPAL REGISTER**



TICTOC (SOUTH CAROLINA SOLE PROPRIETORSHIP)
2523 TRAMMEL ROAD
WOODRUFF, SC 29388

FOR: BUSINESS CONSULTING AND INFORMATION SERVICES; BUSINESS ORGANIZATION AND OPERATION CONSULTANCY, IN CLASS 35 (U.S. CLS. 100, 101 AND 102).

FIRST USE 11-15-2007; IN COMMERCE 11-24-2007.

THE COLOR(S) GOLD AND PURPLE IS/ARE CLAIMED AS A FEATURE OF THE MARK.

THE MARK CONSISTS OF PURPLE HORIZONTAL WAVES WITH GOLD VERTICAL WAVES OVERLAPPING EACH OTHER. THE WORDS, "TICTOC "TECHNOLOGY NEVER SLEEPS"", ARE GOLD.

SER. NO. 77-353,064, FILED 12-15-2007.

ROBIN CHOSID, EXAMINING ATTORNEY

Int. Cl.: 35

Prior U.S. Cls.: 100, 101 and 102

United States Patent and Trademark Office

Reg. No. 3,475,900

Registered July 29, 2008

**SERVICE MARK
PRINCIPAL REGISTER**

**Royal delicacies at
peasant prices!**

IVA FOODS, INC (MASSACHUSETTS CORPORATION), DBA FESTIVE FOODS, INC
424 CAMBRIDGE ST.
ALLSTON, MA 02134

THE MARK CONSISTS OF STANDARD CHARACTERS WITHOUT CLAIM TO ANY PARTICULAR FONT, STYLE, SIZE, OR COLOR.

FOR: RETAIL GROCERY STORES, IN CLASS 35 (U.S. CLS. 100, 101 AND 102).

SER. NO. 77-353,077, FILED 12-15-2007.

FIRST USE 10-15-1987; IN COMMERCE 10-15-1987.

KELLY MCCOY, EXAMINING ATTORNEY

Int. Cl.: 36

Prior U.S. Cls.: 100, 101 and 102

United States Patent and Trademark Office

Reg. No. 3,475,901

Registered July 29, 2008

**SERVICE MARK
PRINCIPAL REGISTER**



CALACOMO, INC (PENNSYLVANIA CORPORATION), DBA ENTERPRISE APPRAISAL CO.
SUITE 206
487 DEVON PARK DRIVE
WAYNE, PA 19087

FOR: FINANCIAL VALUATION OF PERSONAL PROPERTY AND REAL ESTATE, IN CLASS 36 (U.S. CLS. 100, 101 AND 102).

FIRST USE 12-3-2007; IN COMMERCE 12-3-2007.

THE COLOR(S) BLUE AND GRAY AND SHADES THEREOF IS/ARE CLAIMED AS A FEATURE OF THE MARK.

THE MARK CONSISTS OF A FLOWING "E" (FOR ENTERPRISE APPRAISAL), WITH SWOOSH FROM BLUE TO GRAY TO GIVE THREE DIMENSIONAL EFFECT.

SER. NO. 77-353,087, FILED 12-15-2007.

JOHN KELLY, EXAMINING ATTORNEY

Int. Cl.: 39

Prior U.S. Cls.: 100 and 105

United States Patent and Trademark Office

Reg. No. 3,475,902

Registered July 29, 2008

**SERVICE MARK
PRINCIPAL REGISTER**

Drink Wine? Live It!

TOP HAT MARKETING, LLC (COLORADO LTD
LIAB CO), DBA WINE TOURS OF THE
WORLD
BUILDING E, SUITE 103
88 INVERNESS CIRCLE EAST
ENGLEWOOD, CO 80112

FOR: ARRANGING TRAVEL TOURS; COORDI-
NATING TRAVEL ARRANGEMENTS FOR INDIVI-
DUALS AND FOR GROUPS; ORGANISATION OF
TRAVEL; ORGANIZATION OF EXCURSIONS,
SIGHTSEEING TOURS, HOLIDAYS, TOURS AND
TRAVEL; PROVISION OF TRAVEL INFORMATION;
TRAVEL AGENCY SERVICES, NAMELY, MAKING
RESERVATIONS AND BOOKINGS FOR TRANS-

PORTATION; TRAVEL AND TOUR INFORMATION
SERVICE; TRAVEL BOOKING AGENCIES; TRAVEL
GUIDE AND TRAVEL INFORMATION SERVICES,
IN CLASS 39 (U.S. CLS. 100 AND 105).

FIRST USE 2-1-2007; IN COMMERCE 4-1-2007.

THE MARK CONSISTS OF STANDARD CHAR-
ACTERS WITHOUT CLAIM TO ANY PARTICULAR
FONT, STYLE, SIZE, OR COLOR.

SER. NO. 77-353,090, FILED 12-15-2007.

JOHN KELLY, EXAMINING ATTORNEY

Int. Cl.: 16

Prior U.S. Cls.: 2, 5, 22, 23, 29, 37, 38 and 50

United States Patent and Trademark Office

Reg. No. 3,475,903

Registered July 29, 2008

**TRADEMARK
PRINCIPAL REGISTER**

GRASS & GRAIN

AG PRESS, INC. (KANSAS CORPORATION)
1531 YUMA STREET
MANHATTAN, KS 66502

THE MARK CONSISTS OF STANDARD CHAR-
ACTERS WITHOUT CLAIM TO ANY PARTICULAR
FONT, STYLE, SIZE, OR COLOR.

FOR: NEWSPAPER IN THE FIELD OF FARMING,
RANCHING AND AGRI-BUSINESS, IN CLASS 16
(U.S. CLS. 2, 5, 22, 23, 29, 37, 38 AND 50).

SER. NO. 77-353,098, FILED 12-15-2007.

FIRST USE 3-31-1954; IN COMMERCE 3-31-1954.

MARK RADEMACHER, EXAMINING ATTORNEY

Int. Cl.: 7

Prior U.S. Cls.: 13, 19, 21, 23, 31, 34 and 35

United States Patent and Trademark Office

Reg. No. 3,475,904

Registered July 29, 2008

**TRADEMARK
PRINCIPAL REGISTER**

TSD Crane & Rigging

PRESLEY SANDY LEBZAN (TEXAS SOLE PROPRIETORSHIP)
2810 S. COUNTRY CLUB RD
GARLAND, TX 75043

FOR: CABLE CRANES; CRANES; CRAWLER CRANES; FIXED AND MOBILE CRANES; FLOATING CRANES; GANTRY CRANES; JIB CRANES; LATTICE MAST CRANES; LOCOMOTIVE CRANES; MARINE MOUNTED DOCK CRANES; MOBILE CRANES; MOBILE DOCK CRANES; OVERHEAD TRAVELLING CRANES; TOWER CRANES; TRUCK CRANES; UNLOADING CRANES, IN CLASS 7 (U.S. CLS. 13, 19, 21, 23, 31, 34 AND 35).

FIRST USE 10-1-2007; IN COMMERCE 10-1-2007.

THE MARK CONSISTS OF STANDARD CHARACTERS WITHOUT CLAIM TO ANY PARTICULAR FONT, STYLE, SIZE, OR COLOR.

NO CLAIM IS MADE TO THE EXCLUSIVE RIGHT TO USE "CRANE & RIGGING", APART FROM THE MARK AS SHOWN.

SER. NO. 77-353,136, FILED 12-15-2007.

ESTHER BELENKER, EXAMINING ATTORNEY

Int. Cl.: 44

Prior U.S. Cls.: 100 and 101

United States Patent and Trademark Office

Reg. No. 3,475,905

Registered July 29, 2008

**SERVICE MARK
PRINCIPAL REGISTER**

GARTH FISHER, M.D.

GARTH FISHER SKIN CARE, LLC (CALIFORNIA LTD LIAB CO)
SUITE 222
120 SOUTH SPAULDING DRIVE
BEVERLY HILLS, CA 90212

FOR: COSMETIC AND PLASTIC SURGERY, IN CLASS 44 (U.S. CLS. 100 AND 101).

FIRST USE 7-1-1991; IN COMMERCE 7-1-1991.

THE MARK CONSISTS OF STANDARD CHARACTERS WITHOUT CLAIM TO ANY PARTICULAR FONT, STYLE, SIZE, OR COLOR.

NO CLAIM IS MADE TO THE EXCLUSIVE RIGHT TO USE "M.D.", APART FROM THE MARK AS SHOWN.

THE NAME(S), PORTRAIT(S), AND/OR SIGNATURE(S) SHOWN IN THE MARK IDENTIFIES "GARTH FISHER", WHOSE CONSENT(S) TO REGISTER IS MADE OF RECORD.

SER. NO. 77-353,138, FILED 12-15-2007.

PAUL MORENO, EXAMINING ATTORNEY

Int. Cl.: 35

Prior U.S. Cls.: 100, 101 and 102

United States Patent and Trademark Office

Reg. No. 3,475,906

Registered July 29, 2008

**SERVICE MARK
PRINCIPAL REGISTER**

JAK

KOSCHITZKI, JOSEPH A. (UNITED STATES IN-
DIVIDUAL)
1180 CALLE PECOS
THOUSAND OAKS, CA 91360

THE MARK CONSISTS OF STANDARD CHAR-
ACTERS WITHOUT CLAIM TO ANY PARTICULAR
FONT, STYLE, SIZE, OR COLOR.

FOR: RETAIL STORE AND ONLINE RETAIL
STORE SERVICES FEATURING SILVER ITEMS
AND ANTIQUE AND COLLECTIBLE SILVER
ITEMS, IN CLASS 35 (U.S. CLS. 100, 101 AND 102).

SER. NO. 77-353,140, FILED 12-15-2007.

FIRST USE 7-1-2005; IN COMMERCE 2-15-2006.

ESTHER BELENKER, EXAMINING ATTORNEY

Int. Cl.: 40

Prior U.S. Cls.: 100, 103 and 106

United States Patent and Trademark Office

Reg. No. 3,475,907

Registered July 29, 2008

**SERVICE MARK
PRINCIPAL REGISTER**

Dry It Fearlessly

RASMUSSEN, RYAN C (UNITED STATES INDIVIDUAL)
38346 N. AMY LN.
QUEEN CREEK, AZ 85240

THE MARK CONSISTS OF STANDARD CHARACTERS WITHOUT CLAIM TO ANY PARTICULAR FONT, STYLE, SIZE, OR COLOR.

FOR: RENTAL OF INDOOR CLIMATE CONTROL EQUIPMENT, IN CLASS 40 (U.S. CLS. 100, 103 AND 106).

SER. NO. 77-353,148, FILED 12-15-2007.

FIRST USE 10-17-2007; IN COMMERCE 10-19-2007.

ALEXANDER L. POWERS, EXAMINING ATTORNEY

Int. Cl.: 31

Prior U.S. Cls.: 1 and 46

United States Patent and Trademark Office

Reg. No. 3,475,908

Registered July 29, 2008

TRADEMARK
PRINCIPAL REGISTER



GARCIA, VICTOR (ALASKA SOLE PROPRIETORSHIP), DBA ISLAND SISTERS ENTERPRISES
413 7TH AVE APT #9
JUNEAU, AK 99801

FOR: CATNIP, IN CLASS 31 (U.S. CLS. 1 AND 46).

FIRST USE 7-31-2007; IN COMMERCE 7-31-2007.

NO CLAIM IS MADE TO THE EXCLUSIVE RIGHT TO USE "ENTERPRISES" , APART FROM THE MARK AS SHOWN.

THE COLOR(S) BLACK, BLUE, GREEN, BROWN, WHITE AND GRAY IS/ARE CLAIMED AS A FEATURE OF THE MARK.

THE MARK CONSISTS OF FOUR PALM TREES THAT HAVE BROWN STALKS AND GREEN FRONTS IN FRONT OF A GREEN RIDGE WITH BLUE SKY. THE PALM TREES ARE IN A CIRCLE, WITH THE WORDS "ISLAND SISTERS ENTERPRISES" AROUND THE CIRCLE. THE WORDS ARE IN BLUE. THE CIRCLE IS DELINEATED BY A WHITE LINE IN BETWEEN THE LOGO AND THE WORDS. THE COLOR GRAY APPEARS AS SHADOWING IN THE MARK.

SER. NO. 77-353,165, FILED 12-16-2007.

SKYE YOUNG, EXAMINING ATTORNEY

Int. Cl.: 24

Prior U.S. Cls.: 42 and 50

United States Patent and Trademark Office

Reg. No. 3,475,909

Registered July 29, 2008

**TRADEMARK
PRINCIPAL REGISTER**

Magnolia Tapestry Project

MAGNOLIA EDITIONS, INC. (CALIFORNIA
CORPORATION)

2527 MAGNOLIA STREET

OAKLAND, CA 94607

FOR: TAPESTRIES OF TEXTILE, IN CLASS 24
(U.S. CLS. 42 AND 50).

FIRST USE 2-0-2003; IN COMMERCE 2-0-2003.

THE MARK CONSISTS OF STANDARD CHAR-
ACTERS WITHOUT CLAIM TO ANY PARTICULAR
FONT, STYLE, SIZE, OR COLOR.

NO CLAIM IS MADE TO THE EXCLUSIVE
RIGHT TO USE "TAPESTRY PROJECT", APART
FROM THE MARK AS SHOWN.

SER. NO. 77-353,170, FILED 12-16-2007.

ASMAT KHAN, EXAMINING ATTORNEY

Int. Cl.: 43

Prior U.S. Cls.: 100 and 101

United States Patent and Trademark Office

Reg. No. 3,475,910

Registered July 29, 2008

**SERVICE MARK
PRINCIPAL REGISTER**

MAUI MIKE'S

MAUI MIKE'S, INC. (HAWAII CORPORATION),
DBA MAUI MIKE'S FIRE-ROASTED CHICK-
EN
P.O. BOX 327
HALEIWA, HI 96712

FOR: RESTAURANTS, IN CLASS 43 (U.S. CLS. 100
AND 101).

FIRST USE 3-19-2003; IN COMMERCE 2-11-2005.

THE MARK CONSISTS OF STANDARD CHAR-
ACTERS WITHOUT CLAIM TO ANY PARTICULAR
FONT, STYLE, SIZE, OR COLOR.

OWNER OF U.S. REG. NO. 3,258,450.

NO CLAIM IS MADE TO THE EXCLUSIVE
RIGHT TO USE "MAUI", APART FROM THE MARK
AS SHOWN.

SER. NO. 77-353,171, FILED 12-16-2007.

ASMAT KHAN, EXAMINING ATTORNEY

Int. Cl.: 30

Prior U.S. Cl.: 46

United States Patent and Trademark Office

Reg. No. 3,475,911

Registered July 29, 2008

**TRADEMARK
PRINCIPAL REGISTER**

MAUI WOWIE

MAUI MIKE'S, INC. (HAWAII CORPORATION),
DBA MAUI MIKE'S FIRE-ROASTED CHICK-
EN

P.O. BOX 327

HALEIWA, HI 96712

FOR: SANDWICHES, IN CLASS 30 (U.S. CL. 46).

FIRST USE 2-11-2005; IN COMMERCE 2-11-2005.

THE MARK CONSISTS OF STANDARD CHAR-
ACTERS WITHOUT CLAIM TO ANY PARTICULAR
FONT, STYLE, SIZE, OR COLOR.

NO CLAIM IS MADE TO THE EXCLUSIVE
RIGHT TO USE "MAUI", APART FROM THE MARK
AS SHOWN.

SER. NO. 77-353,173, FILED 12-16-2007.

ASMAT KHAN, EXAMINING ATTORNEY

Int. Cl.: 41

Prior U.S. Cls.: 100, 101 and 107

United States Patent and Trademark Office

Reg. No. 3,475,912

Registered July 29, 2008

**SERVICE MARK
PRINCIPAL REGISTER**

**Making memories out of
moments!**

TRIPP HARRINGTON PHOTOGRAPHY, LLC.
(NORTH CAROLINA LTD LIAB CO), DBA
AMAZING LOVE STUDIOS
SUITE 120
3540 CLEMMONS ROAD
CLEMMONS, NC 27012

FOR: PHOTOGRAPHY SERVICES, IN CLASS 41
(U.S. CLS. 100, 101 AND 107).

FIRST USE 10-26-2007; IN COMMERCE 10-26-2007.

THE MARK CONSISTS OF STANDARD CHAR-
ACTERS WITHOUT CLAIM TO ANY PARTICULAR
FONT, STYLE, SIZE, OR COLOR.

SER. NO. 77-353,197, FILED 12-16-2007.

JULIE GUTTADAURO, EXAMINING ATTORNEY

Int. Cl.: 36

Prior U.S. Cls.: 100, 101 and 102

United States Patent and Trademark Office

Reg. No. 3,475,913

Registered July 29, 2008

**SERVICE MARK
PRINCIPAL REGISTER**

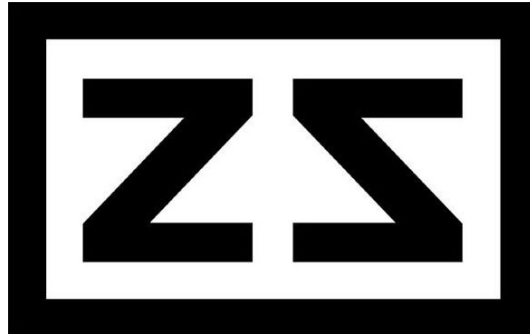

ZOMBIE SQUAD, INC. (MISSOURI CORPORATION)
4045 OLEATHA
ST. LOUIS, MO 63116

THE MARK CONSISTS OF A RECTANGLE CONTAINING THE LETTERS "Z" AND "S" IN A STYLIZED FONT.

FOR: CHARITABLE FUND RAISING SERVICES BY MEANS OF AN ENTERTAINMENT EVENT, IN CLASS 36 (U.S. CLS. 100, 101 AND 102).

SER. NO. 77-353,210, FILED 12-16-2007.

FIRST USE 3-1-2004; IN COMMERCE 3-1-2004.

ANGELA M. MICHELI, EXAMINING ATTORNEY

Int. Cl.: 31

Prior U.S. Cls.: 1 and 46

United States Patent and Trademark Office

Reg. No. 3,475,914

Registered July 29, 2008

**TRADEMARK
PRINCIPAL REGISTER**

Potterosa

POTTER, JEFFERY J (UNITED STATES INDIVIDUAL)
28055 310TH ST.
REDWOOD FALLS, MN 56283

THE MARK CONSISTS OF STANDARD CHARACTERS WITHOUT CLAIM TO ANY PARTICULAR FONT, STYLE, SIZE, OR COLOR.

FOR: LIVESTOCK, NAMELY, CATTLE, IN CLASS 31 (U.S. CLS. 1 AND 46).

SER. NO. 77-353,211, FILED 12-16-2007.

FIRST USE 1-1-1977; IN COMMERCE 1-1-1977.

ANGELA M. MICHELI, EXAMINING ATTORNEY

Int. Cl.: 36

Prior U.S. Cls.: 100, 101 and 102

United States Patent and Trademark Office

Reg. No. 3,475,915

Registered July 29, 2008

**SERVICE MARK
PRINCIPAL REGISTER**

SELL FOR A CAUSE

DEPENA, BOLIVAR J. (UNITED STATES INDIVIDUAL)
SUITE 205
5150 BROADWAY
SAN ANTONIO, TX 78209

THE MARK CONSISTS OF STANDARD CHARACTERS WITHOUT CLAIM TO ANY PARTICULAR FONT, STYLE, SIZE, OR COLOR.

FOR: REAL ESTATE AGENCIES, IN CLASS 36 (U.S. CLS. 100, 101 AND 102).

SER. NO. 77-353,242, FILED 12-16-2007.

FIRST USE 12-1-2007; IN COMMERCE 12-12-2007.

ANGELA M. MICHELI, EXAMINING ATTORNEY

Int. Cl.: 41

Prior U.S. Cls.: 100, 101 and 107

United States Patent and Trademark Office

Reg. No. 3,475,916

Registered July 29, 2008

**SERVICE MARK
PRINCIPAL REGISTER**

Seviin Li

LEE, TELISHA MARIE (UNITED STATES INDIVIDUAL)
4402 KARENANN CT.
FLORISSANT, MO 63034

FOR: ENTERTAINMENT IN THE NATURE OF LIVE MUSIC AND DRAMA PERFORMANCES, IN CLASS 41 (U.S. CLS. 100, 101 AND 107).

FIRST USE 5-1-2001; IN COMMERCE 5-1-2001.

THE MARK CONSISTS OF STANDARD CHARACTERS WITHOUT CLAIM TO ANY PARTICULAR FONT, STYLE, SIZE, OR COLOR.

THE NAME "SEVIIN LI" IDENTIFIES A LIVING INDIVIDUAL WHOSE CONSENT IS OF RECORD.

SER. NO. 77-353,249, FILED 12-16-2007.

ANGELA M. MICHELI, EXAMINING ATTORNEY

Int. Cl.: 41

Prior U.S. Cls.: 100, 101 and 107

United States Patent and Trademark Office

Reg. No. 3,475,917

Registered July 29, 2008

**SERVICE MARK
PRINCIPAL REGISTER**



MINDJOLT, INC. (NEVADA CORPORATION)
2550 E DESERT INN RD 448
LAS VEGAS, NV 89121

FOR: ENTERTAINMENT SERVICES, NAMELY,
PROVIDING ON-LINE COMPUTER GAMES, IN
CLASS 41 (U.S. CLS. 100, 101 AND 107).

FIRST USE 9-16-2007; IN COMMERCE 9-16-2007.

THE COLOR(S) GREY, RED, AND YELLOW IS/
ARE CLAIMED AS A FEATURE OF THE MARK.

THE MARK CONSISTS OF A RED OVAL OUT-
LINED WITH A JAGGED EDGED YELLOW BOR-
DER REMINISCENT OF THE EDGE OF A BOTTLE
CAP AND IN THE CENTER A YELLOW LIGHT-
NING BOLT WITH "MIND" IN ALL GREY CAPS ON
THE LEFT SIDE OF THE LIGHTNING BOLT AND
"JOLT" IN ALL GREY CAPS TO THE RIGHT OF
THE LIGHTING BOLD AND "COM" AT THE TIP OF
THE LIGHTNING BOLT.

SER. NO. 77-353,252, FILED 12-16-2007.

ANGELA M. MICHELI, EXAMINING ATTORNEY

Int. Cl.: 9

Prior U.S. Cls.: 21, 23, 26, 36 and 38

United States Patent and Trademark Office

Reg. No. 3,475,918

Registered July 29, 2008

**TRADEMARK
PRINCIPAL REGISTER**



CRAVENS & ASSOCIATES INC. (IDAHO CORPORATION)
2909 N ROAD 64
PASCO, WA 99301

FOR: COMPUTER SOFTWARE FOR RETIREMENT PLANNING AND ANALYSIS, IN THE FIELD OF RETIREMENT PLANNING; DOWNLOADABLE COMPUTER SOFTWARE FOR RETIREMENT PLANNING AND ANALYSIS, IN THE FIELD OF RETIREMENT PLANNING, IN CLASS 9 (U.S. CLS. 21, 23, 26, 36 AND 38).

FIRST USE 11-0-2007; IN COMMERCE 11-0-2007.

NO CLAIM IS MADE TO THE EXCLUSIVE RIGHT TO USE "RETIREMENT ANALYZER", APART FROM THE MARK AS SHOWN.

THE COLOR(S) BLUE, WHITE, YELLOW AND ORANGE IS/ARE CLAIMED AS A FEATURE OF THE MARK.

THE MARK CONSISTS OF AN ORANGE AND YELLOW CIRCULAR DESIGN, WITH THE TERMS "RETIREMENT ANALYZER" IN WHITE SUPERIMPOSED IN PART OVER THE DESIGN AND THE WORDING AND DESIGN ON A BLUE BACKGROUND.

SER. NO. 77-353,256, FILED 12-16-2007.

ANGELA M. MICHELI, EXAMINING ATTORNEY

Int. Cls.: 9 and 41

Prior U.S. Cls.: 21, 23, 26, 36, 38, 100, 101 and 107

United States Patent and Trademark Office

Reg. No. 3,475,919

Registered July 29, 2008

**TRADEMARK
SERVICE MARK
PRINCIPAL REGISTER**

SADIKI

BUCKLEY, HENRY GLASFORD (JAMAICA IN-
DIVIDUAL)
P.O. BOX 181
PARSIPPANY, NJ 070540181

FOR: COMPACT DISCS FEATURING MUSICAL
SOUND RECORDINGS AND VISUAL RECORD-
INGS FEATURING MUSIC, IN CLASS 9 (U.S. CLS.
21, 23, 26, 36 AND 38).

FIRST USE 9-28-2001; IN COMMERCE 9-28-2001.

FOR: ENTERTAINMENT IN THE NATURE OF
LIVE MUSICAL PERFORMANCES BY A PERFOR-
MER OR GROUP, IN CLASS 41 (U.S. CLS. 100, 101
AND 107).

FIRST USE 9-28-2001; IN COMMERCE 9-28-2001.

THE MARK CONSISTS OF STANDARD CHAR-
ACTERS WITHOUT CLAIM TO ANY PARTICULAR
FONT, STYLE, SIZE, OR COLOR.

THE NAME "SADIKI" IDENTIFIES A LIVING
INDIVIDUAL WHOSE CONSENT IS OF RECORD.

SER. NO. 77-353,259, FILED 12-16-2007.

ANGELA M. MICHELI, EXAMINING ATTORNEY

Int. Cl.: 25

Prior U.S. Cls.: 22 and 39

United States Patent and Trademark Office

Reg. No. 3,475,920

Registered July 29, 2008

TRADEMARK
PRINCIPAL REGISTER



LOMBARD, CHRIS (UNITED STATES INDIVIDUAL), DBA RVR WARE
916 PEPPER AVENUE
RICHMOND, VA 23226

FOR: BATHING SUITS; BIKINIS; HATS; HEADGEAR, NAMELY, HATS, CAPS; LONG SLEEVED VESTS; MEN AND WOMEN JACKETS, COATS, TROUSERS, VESTS; RUGBY SHIRTS; SHIRTS; SHORT-SLEEVED OR LONG-SLEEVED T-SHIRTS; SPORT SHIRTS; SWEAT SHIRTS; TEE SHIRTS; VESTS; BELTS; BATHING TRUNKS; JACKETS; RAINPROOF JACKETS; SHORT-SLEEVED SHIRTS; TIES; BOW TIES; GLOVES; GOLF SHIRTS; POLO SHIRTS; REVERSIBLE JACKETS; SHELL JACKETS; SLEEVED OR SLEEVELESS JACKETS; SMALL HATS; SPORTS JACKETS; WATERPROOF JACKETS AND PANTS; WIND RESISTANT JACKETS; WIND VESTS; WIND-JACKETS; ATHLETIC FOOTWEAR;

FLIP FLOPS; FOOTWEAR; PANTS, IN CLASS 25 (U.S. CLS. 22 AND 39).

FIRST USE 11-15-2007; IN COMMERCE 12-5-2007.

NO CLAIM IS MADE TO THE EXCLUSIVE RIGHT TO USE "WARE", APART FROM THE MARK AS SHOWN.

THE MARK CONSISTS OF STYLIZED LETTERS "R", "V", AND REVERSE "R", FOLLOWED BY "WARE", STYLIZED LETTERS "W" "A" "R" AND "E".

SER. NO. 77-353,260, FILED 12-16-2007.

ANGELA M. MICHELI, EXAMINING ATTORNEY

Int. Cl.: 28

Prior U.S. Cls.: 22, 23, 38 and 50

United States Patent and Trademark Office

Reg. No. 3,475,921

Registered July 29, 2008

**TRADEMARK
PRINCIPAL REGISTER**

Sunny Patch

CALLAWAY & KIRK COMPANY LLC (DELA-
WARE LTD LIAB CO)
19 FULTON STREET
NEW YORK, NY 10038

THE MARK CONSISTS OF STANDARD CHAR-
ACTERS WITHOUT CLAIM TO ANY PARTICULAR
FONT, STYLE, SIZE, OR COLOR.

FOR: TOYS, NAMELY, JUMP ROPES, BENDABLE
TOYS, DISC TOSS TOYS, PLAY TENTS, PLAY
TUNNELS, HOPSCOTCH, AND PADDLE BALL
GAMES, IN CLASS 28 (U.S. CLS. 22, 23, 38 AND 50).

SER. NO. 77-353,262, FILED 12-16-2007.

FIRST USE 10-1-2007; IN COMMERCE 10-1-2007.

ANGELA M. MICHELI, EXAMINING ATTORNEY

Int. Cl.: 32

Prior U.S. Cls.: 45, 46 and 48

Reg. No. 3,475,922

United States Patent and Trademark Office

Registered July 29, 2008

**TRADEMARK
PRINCIPAL REGISTER**

RALPH & CHARLIE'S

RALPH & CHARLIE'S BEVERAGE CORP. (NEW
YORK CORPORATION)
169 GARDNER AVE
BROOKLYN, NY 11237

THE MARK CONSISTS OF STANDARD CHAR-
ACTERS WITHOUT CLAIM TO ANY PARTICULAR
FONT, STYLE, SIZE, OR COLOR.

FOR: VEGETABLE JUICES, IN CLASS 32 (U.S.
CLS. 45, 46 AND 48).

SER. NO. 77-353,268, FILED 12-16-2007.

FIRST USE 11-0-2007; IN COMMERCE 11-0-2007.

ANGELA M. MICHELI, EXAMINING ATTORNEY

Int. Cl.: 32

Prior U.S. Cls.: 45, 46 and 48

United States Patent and Trademark Office

Reg. No. 3,475,923

Registered July 29, 2008

**TRADEMARK
PRINCIPAL REGISTER**

SITRUS STUNNER

LOUD BEVERAGE CORPORATION (NEW YORK CORPORATION)
431 CEDAR DRIVE WEST
BRIARCLIFF MANOR, NY 10510

FOR: APPLE JUICE BEVERAGES; FRUIT BEVERAGES; FRUIT CONCENTRATES AND PUREES USED AS INGREDIENTS OF BEVERAGES; FRUIT-FLAVORED BEVERAGES; FRUIT-FLAVOURED BEVERAGES; ISOTONIC BEVERAGES; NON-ALCOHOLIC BEVERAGES CONTAINING FRUIT JUICES; NON-ALCOHOLIC BEVERAGES, NAMELY, CARBONATED BEVERAGES; NON-ALCOHOLIC FRUIT EXTRACTS USED IN THE PREPARATION OF BEVERAGES; NON-ALCOHOLIC FRUIT JUICE BEVERAGES; POWDERS USED IN THE PREPARATION OF ISOTONIC SPORTS DRINKS AND SPORTS BEVERAGES; PREPARATIONS FOR MAKING BEVERAGES, FRUIT DRINKS, CARBONATED BEV-

ERAGES, ENERGY DRINKS; SYRUPS FOR BEVERAGES; SYRUPS FOR MAKING BEVERAGES, IN CLASS 32 (U.S. CLS. 45, 46 AND 48).

FIRST USE 1-3-2007; IN COMMERCE 5-7-2007.

THE MARK CONSISTS OF STANDARD CHARACTERS WITHOUT CLAIM TO ANY PARTICULAR FONT, STYLE, SIZE, OR COLOR.

NO CLAIM IS MADE TO THE EXCLUSIVE RIGHT TO USE "CITRUS", APART FROM THE MARK AS SHOWN.

SER. NO. 77-353,270, FILED 12-16-2007.

ANGELA M. MICHELI, EXAMINING ATTORNEY

Int. Cl.: 41

Prior U.S. Cls.: 100, 101 and 107

United States Patent and Trademark Office

Reg. No. 3,475,924

Registered July 29, 2008

**SERVICE MARK
PRINCIPAL REGISTER**

S.L.A.M.M.A.

CORCORAN, PETER A. (UNITED STATES INDIVIDUAL)
4052 SHASTA DAM BLVD
SHASTA LAKE, CA 96019 AND
HARRIS, SHIHAN JOHN (UNITED STATES INDIVIDUAL)
4052 SHASTA DAM BLVD
SHASTA LAKE, CA 96019

FOR: MARTIAL ARTS INSTRUCTION; OPERATING OF MARTIAL ARTS' SCHOOLS; KARATE INSTRUCTION; TRAINING SERVICES IN THE FIELD OF BOXING, KICKBOXING, JAPANESE JUI-JITSU, WEAPONS TRAINING, AND PERSONAL

PROTECTION, IN CLASS 41 (U.S. CLS. 100, 101 AND 107).

FIRST USE 11-0-2007; IN COMMERCE 11-0-2007.

THE MARK CONSISTS OF STANDARD CHARACTERS WITHOUT CLAIM TO ANY PARTICULAR FONT, STYLE, SIZE, OR COLOR.

SER. NO. 77-353,273, FILED 12-16-2007.

PAUL E. FAHRENKOPF, EXAMINING ATTORNEY

Int. Cl.: 25

Prior U.S. Cls.: 22 and 39

United States Patent and Trademark Office

Reg. No. 3,475,925

Registered July 29, 2008

**TRADEMARK
PRINCIPAL REGISTER**

S.L.A.M.M.A.

CORCORAN, PETER A. (UNITED STATES INDIVIDUAL)
4052 SHASTA DAM BLVD
SHASTA LAKE, CA 96019 AND
HARRIS, SHIHAN JOHN (UNITED STATES INDIVIDUAL)
4052 SHASTA DAM BLVD
SHASTA LAKE, CA 96019

FOR: SHIRTS; HATS; GLOVES; JACKETS; PANTS;
SHORTS; MARTIAL ARTS UNIFORMS , IN CLASS
25 (U.S. CLS. 22 AND 39).

FIRST USE 11-0-2007; IN COMMERCE 11-0-2007.

THE MARK CONSISTS OF STANDARD CHARACTERS WITHOUT CLAIM TO ANY PARTICULAR FONT, STYLE, SIZE, OR COLOR.

SER. NO. 77-353,275, FILED 12-16-2007.

PAUL E. FAHRENKOPF, EXAMINING ATTORNEY

Int. Cl.: 35

Prior U.S. Cls.: 100, 101 and 102

United States Patent and Trademark Office

Reg. No. 3,475,926

Registered July 29, 2008

SERVICE MARK
PRINCIPAL REGISTER



CANYON PUBLISHING INC. (ARIZONA CORPORATION)
SUITE 102
1948 MESQUITE AVE.
LAKE HAVASU, AZ 86403

FOR: ADVERTISING AND PUBLICITY SERVICES, NAMELY, PROMOTING THE GOODS, SERVICES, BRAND IDENTITY AND COMMERCIAL INFORMATION AND NEWS OF THIRD PARTIES THROUGH PRINT, AUDIO, VIDEO, DIGITAL AND ON-LINE MEDIUM; COMMERCIAL INFORMATION AND DIRECTORY AGENCY; ON-LINE BUSINESS DIRECTORIES FEATURING LOCAL COMMUNITY AND GOVERNMENT INFORMATION AND SERVICES; PROVIDING AN ON-LINE COMMERCIAL INFORMATION DIRECTORY ON THE INTERNET; PROVIDING ON-LINE DIREC-

TORY INFORMATION SERVICES ALSO FEATURING HYPERLINKS TO OTHER WEB SITES, IN CLASS 35 (U.S. CLS. 100, 101 AND 102).

FIRST USE 3-23-2007; IN COMMERCE 3-23-2007.

NO CLAIM IS MADE TO THE EXCLUSIVE RIGHT TO USE "LAKE HAVASU PHONE BOOK", APART FROM THE MARK AS SHOWN.

THE MARK CONSISTS OF A QUAIL POSITIONED ADJACENT THE WORDS "LAKE HAVASU PHONE BOOK".

SER. NO. 77-353,287, FILED 12-16-2007.

ANDREA HACK, EXAMINING ATTORNEY

Int. Cl.: 25

Prior U.S. Cls.: 22 and 39

United States Patent and Trademark Office

Reg. No. 3,475,927

Registered July 29, 2008

**TRADEMARK
PRINCIPAL REGISTER**

MOTO-BOY

TAIAN DONGSHENG CLOTHING CO., LIMITED
(HONG KONG CORPORATION)
HI-TECH DEVELOPMENT ZONE, TAIAN,
EAST PART OF CHUANGYE STREET,
SHANGDONG,, CHINA 00000

FOR: BELTS; COATS FOR MEN AND WOMEN;
GLOVES; JACKETS; JEANS; JERSEYS; LEATHER
JACKETS; LEATHER PANTS; LIGHT-REFLECTING
JACKETS; MEN AND WOMEN JACKETS, COATS,
TROUSERS, VESTS; MOTORCYCLE GLOVES; MO-
TORCYCLIST BOOTS; RAIN SUITS; SHORT-
SLEEVED OR LONG-SLEEVED T-SHIRTS; SKI
GLOVES; SKI JACKETS; SKI WEAR; SPORT COATS;

SPORTS JACKETS; TROUSERS, IN CLASS 25 (U.S.
CLS. 22 AND 39).

FIRST USE 9-8-2005; IN COMMERCE 9-8-2005.

THE MARK CONSISTS OF STANDARD CHAR-
ACTERS WITHOUT CLAIM TO ANY PARTICULAR
FONT, STYLE, SIZE, OR COLOR.

SER. NO. 77-353,325, FILED 12-17-2007.

BRIAN NEVILLE, EXAMINING ATTORNEY

Int. Cls.: 36 and 37

Prior U.S. Cls.: 100, 101, 102, 103 and 106

United States Patent and Trademark Office

Reg. No. 3,475,928

Registered July 29, 2008

**SERVICE MARK
PRINCIPAL REGISTER**



TIMBERSTONE GROUP, INC. (OHIO CORPORATION)
1630 TIMBERWOLF DRIVE
HOLLAND, OH 43528

FOR: REAL ESTATE MANAGEMENT, IN CLASS 36 (U.S. CLS. 100, 101 AND 102).

FIRST USE 5-1-2005; IN COMMERCE 11-0-2005.

FOR: BUILDING CONSTRUCTION SERVICES; CONSTRUCTION MANAGEMENT; REAL ESTATE DEVELOPMENT, IN CLASS 37 (U.S. CLS. 100, 103 AND 106).

FIRST USE 5-1-2005; IN COMMERCE 11-0-2005.

NO CLAIM IS MADE TO THE EXCLUSIVE RIGHT TO USE "GROUP", APART FROM THE MARK AS SHOWN.

THE COLOR(S) BLUE, BLACK AND WHITE IS/ ARE CLAIMED AS A FEATURE OF THE MARK.

THE MARK CONSISTS OF THE WORD "TIMBERSTONE" IN BLUE, THE WORD "GROUP" IN BLACK AND THE LETTER "T" IN WHITE. IN THE BACKGROUND OF THE "T", TWO DIAGONAL SQUARES ARE BLUE; TWO DIAGONAL SQUARES ARE BLACK. THE SQUARES ARE SEPARATED BY WHITE LINES AND BORDERED BY A WHITE BORDER.

SER. NO. 77-353,335, FILED 12-17-2007.

ALYSSA PALADINO, EXAMINING ATTORNEY

Int. Cls.: 36 and 37

Prior U.S. Cls.: 100, 101, 102, 103 and 106

United States Patent and Trademark Office

Reg. No. 3,475,929

Registered July 29, 2008

**SERVICE MARK
PRINCIPAL REGISTER**

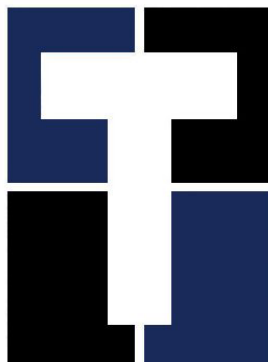

TIMBERSTONE GROUP, INC. (OHIO CORPORATION)
1630 TIMBERWOLF DRIVE
HOLLAND, OH 43528

FOR: REAL ESTATE MANAGEMENT, IN CLASS 36 (U.S. CLS. 100, 101 AND 102).

FIRST USE 5-1-2005; IN COMMERCE 11-0-2005.

FOR: BUILDING CONSTRUCTION SERVICES; CONSTRUCTION MANAGEMENT; REAL ESTATE DEVELOPMENT, IN CLASS 37 (U.S. CLS. 100, 103 AND 106).

FIRST USE 5-1-2005; IN COMMERCE 11-0-2005.

THE COLOR(S) WHITE, BLACK AND BLUE IS/ ARE CLAIMED AS A FEATURE OF THE MARK.

THE MARK CONSISTS OF THE LETTER "T" IN WHITE ON A BACKGROUND OF TWO BLUE DIAGONAL SQUARES AND TWO BLACK DIAGONAL SQUARES. THE SQUARES ARE SEPARATED BY WHITE LINES AND BORDERED BY A WHITE BORDER.

SER. NO. 77-353,350, FILED 12-17-2007.

ALYSSA PALADINO, EXAMINING ATTORNEY

Int. Cl.: 35

Prior U.S. Cls.: 100, 101 and 102

United States Patent and Trademark Office

Reg. No. 3,475,930

Registered July 29, 2008

**SERVICE MARK
PRINCIPAL REGISTER**



BALTIMORE AREA CONVENTION AND VISITORS ASSOCIATION, INC. (MARYLAND NON-STOCK CORPORATION)

100 LIGHT STREET
BALTIMORE, MD 21202

FOR: PROMOTING BUSINESS AND TOURISM IN THE BALTIMORE METROPOLITAN AREA; ASSOCIATION SERVICES, NAMELY, PROMOTING THE INTERESTS OF BALTIMORE AREA BUSINESSES THAT BENEFIT FROM THE MEETING, CONVENTION, AND TOURISM INDUSTRIES; ADVERTISING, MARKETING AND PROMOTION SERVICES, IN CLASS 35 (U.S. CLS. 100, 101 AND 102).

FIRST USE 5-26-2006; IN COMMERCE 5-26-2006.

THE MARK CONSISTS OF MULTI-ICON LOGO FEATURING MUSICAL NOTE, BIRD, MUG, CRAB, STAR, SHOPPING BAG, SAILBOAT, GUITAR, ICE CREAM CONE, DINOSAUR, FORK, TEACUP, SHARK, AND BASEBALL CAP.

SER. NO. 77-353,365, FILED 12-17-2007.

STEPHEN AQUILA, EXAMINING ATTORNEY

Int. Cl.: 39

Prior U.S. Cls.: 100 and 105

United States Patent and Trademark Office

Reg. No. 3,475,931

Registered July 29, 2008

**SERVICE MARK
PRINCIPAL REGISTER**



BALTIMORE AREA CONVENTION AND VISITORS ASSOCIATION, INC. (MARYLAND NON-STOCK CORPORATION)
100 LIGHT STREET
BALTIMORE, MD 21202

FOR: ARRANGING TRAVEL TOURS; TRAVEL AND TOUR INFORMATION SERVICE; TRAVEL AND TOUR TICKET RESERVATION SERVICE, IN CLASS 39 (U.S. CLS. 100 AND 105).

FIRST USE 5-26-2006; IN COMMERCE 5-26-2006.

THE MARK CONSISTS OF MULTI-ICON LOGO FEATURING MUSICAL NOTE, BIRD, MUG, CRAB, STAR, SHOPPING BAG, SAILBOAT, GUITAR, ICE CREAM CONE, DINOSAUR, FORK, TEACUP, SHARK, AND BASEBALL CAP.

SER. NO. 77-353,371, FILED 12-17-2007.

STEPHEN AQUILA, EXAMINING ATTORNEY

Int. Cl.: 43

Prior U.S. Cls.: 100 and 101

United States Patent and Trademark Office

Reg. No. 3,475,932

Registered July 29, 2008

**SERVICE MARK
PRINCIPAL REGISTER**



BALTIMORE AREA CONVENTION AND VISITORS ASSOCIATION, INC. (MARYLAND NON-STOCK CORPORATION)
100 LIGHT STREET
BALTIMORE, MD 21202

FOR: RESTAURANT AND BAR SERVICES; SERVING FOOD AND DRINKS; HOTELS; PROVIDING TEMPORARY ACCOMMODATION; PROVIDING TRAVEL LODGING INFORMATION SERVICES AND TRAVEL LODGING BOOKING AGENCY SERVICES FOR TRAVELERS, IN CLASS 43 (U.S. CLS. 100 AND 101).

FIRST USE 5-26-2006; IN COMMERCE 5-26-2006.

THE MARK CONSISTS OF MULTI-ICON LOGO FEATURING MUSICAL NOTE, BIRD, MUG, CRAB, STAR, SHOPPING BAG, SAILBOAT, GUITAR, ICE CREAM CONE, DINOSAUR, FORK, TEACUP, SHARK, AND BASEBALL CAP.

SER. NO. 77-353,381, FILED 12-17-2007.

STEPHEN AQUILA, EXAMINING ATTORNEY

Int. Cl.: 42

Prior U.S. Cls.: 100 and 101

United States Patent and Trademark Office

Reg. No. 3,475,933

Registered July 29, 2008

**SERVICE MARK
PRINCIPAL REGISTER**

RedZebra Mobile

REDZEBRA MOBILE LIMITED (UNITED KING-
DOM LTD LIAB CO)
10 BURNT HILL WAY
FARNHAM, UNITED KINGDOM GU104RN

FOR: PROVISION OF ONLINE NON-DOWN-
LOADABLE COMPUTER SOFTWARE TO EN-
HANCE THE AUDIO-VISUAL CAPABILITIES OF
MULTIMEDIA APPLICATIONS, NAMELY, FOR
THE INTEGRATION OF TEXT, AUDIO, GRAPHICS,
STILL IMAGES AND MOVING PICTURES, IN
CLASS 42 (U.S. CLS. 100 AND 101).

FIRST USE 7-1-2006; IN COMMERCE 7-1-2007.

THE MARK CONSISTS OF STANDARD CHAR-
ACTERS WITHOUT CLAIM TO ANY PARTICULAR
FONT, STYLE, SIZE, OR COLOR.

NO CLAIM IS MADE TO THE EXCLUSIVE
RIGHT TO USE "MOBILE", APART FROM THE
MARK AS SHOWN.

SER. NO. 77-353,387, FILED 12-17-2007.

MARK PILARO, EXAMINING ATTORNEY

Int. Cl.: 29

Prior U.S. Cl.: 46

United States Patent and Trademark Office

Reg. No. 3,475,934

Registered July 29, 2008

**TRADEMARK
PRINCIPAL REGISTER**

PETE & GERRY'S

PETE AND GERRY'S ORGANICS, LLC (NEW
HAMPSHIRE LTD LIAB CO)
140 BUFFUM ROAD
MONROE, NH 03771

FOR: EGGS, IN CLASS 29 (U.S. CL. 46).

FIRST USE 9-16-1996; IN COMMERCE 9-16-1996.

THE MARK CONSISTS OF STANDARD CHAR-
ACTERS WITHOUT CLAIM TO ANY PARTICULAR
FONT, STYLE, SIZE, OR COLOR.

OWNER OF U.S. REG. NO. 2,149,454.

SER. NO. 77-353,414, FILED 12-17-2007.

JOHN DALIER, EXAMINING ATTORNEY

Int. Cls.: 41 and 42

Prior U.S. Cls.: 100, 101 and 107

United States Patent and Trademark Office

Reg. No. 3,475,935

Registered July 29, 2008

**SERVICE MARK
PRINCIPAL REGISTER**

URAC

URAC (D.C. NON-PROFIT CORPORATION)
SUITE 400
1220 L STREET, N.W.
WASHINGTON, DC 20005

FOR: EDUCATIONAL SERVICES, NAMELY, WORKSHOPS AND SEMINARS REGARDING QUALITY MANGEMENT FOR MANAGED HEALTH CARE ORGANIZATIONS AND HEALTH CARE PROFESSIONALS, IN CLASS 41 (U.S. CLS. 100, 101 AND 107).

FIRST USE 2-14-1990; IN COMMERCE 3-1-1990.

FOR: ACCREDITATION AND CERTIFICATION SERVICES, NAMELY, ANALYSIS AND EVALUA-

TION OF THE QUALITY AND EFFICIENCY OF MANAGED HEALTH CARE PLANS FOR THE PURPOSE OF ACCREDITATION AND CERTIFICATION, IN CLASS 42 (U.S. CLS. 100 AND 101).

FIRST USE 2-14-1990; IN COMMERCE 3-1-1990.

THE MARK CONSISTS OF STANDARD CHARACTERS WITHOUT CLAIM TO ANY PARTICULAR FONT, STYLE, SIZE, OR COLOR.

OWNER OF U.S. REG. NO. 3,308,393.

SER. NO. 77-353,416, FILED 12-17-2007.

ANN E. SAPPENFIELD, EXAMINING ATTORNEY

Int. Cl.: 45

Prior U.S. Cls.: 100 and 101

United States Patent and Trademark Office

Reg. No. 3,475,936

Registered July 29, 2008

**SERVICE MARK
PRINCIPAL REGISTER**

**PROTECTING WHAT'S
IMPORTANT TO YOU**

MASTER SECURITY COMPANY LLC (MARY-
LAND LTD LIAB CO)
10944-D BEAVER DAM ROAD
HUNT VALLEY, MD 21030

FOR: SECURITY CONSULTANCY; SECURITY
GUARD SERVICES; SECURITY GUARDING FOR
FACILITIES; SECURITY SERVICES, NAMELY,
PROVIDING SECURITY ASSESSMENTS OF PHYSI-
CAL LOCATIONS, INFORMATION SYSTEMS, AND
WORKING ENVIRONMENTS, IN CLASS 45 (U.S.
CLS. 100 AND 101).

FIRST USE 11-17-2006; IN COMMERCE 11-17-2006.

THE MARK CONSISTS OF STANDARD CHAR-
ACTERS WITHOUT CLAIM TO ANY PARTICULAR
FONT, STYLE, SIZE, OR COLOR.

SER. NO. 77-353,421, FILED 12-17-2007.

JEFFERY COWARD, EXAMINING ATTORNEY

Int. Cl.: 41

Prior U.S. Cls.: 100, 101 and 107

United States Patent and Trademark Office

Reg. No. 3,475,937

Registered July 29, 2008

**SERVICE MARK
PRINCIPAL REGISTER**

KOSMIC GODDESS

DE LOS SANTOS, JENIFFER (UNITED STATES
INDIVIDUAL)
215 WALDO PLACE
ENGLEWOOD, NJ 07631

THE MARK CONSISTS OF STANDARD CHAR-
ACTERS WITHOUT CLAIM TO ANY PARTICULAR
FONT, STYLE, SIZE, OR COLOR.

FOR: ENTERTAINMENT SERVICES, NAMELY,
PERSONAL APPEARANCES BY A MUSICIAN, IN
CLASS 41 (U.S. CLS. 100, 101 AND 107).

SER. NO. 77-353,425, FILED 12-17-2007.

FIRST USE 8-15-2004; IN COMMERCE 10-2-2004.

MARGERY A. TIERNEY, EXAMINING ATTORNEY

Int. Cl.: 29

Prior U.S. Cl.: 46

United States Patent and Trademark Office

Reg. No. 3,475,938

Registered July 29, 2008

**TRADEMARK
PRINCIPAL REGISTER**

PETE & GERRY'S ORGANIC EGGS

PETE AND GERRY'S ORGANICS, LLC (NEW
HAMPSHIRE LTD LIAB CO)
140 BUFFUM ROAD
MONROE, NH 03771

FOR: ORGANIC EGGS, IN CLASS 29 (U.S. CL. 46).

FIRST USE 9-16-1996; IN COMMERCE 9-16-1996.

THE MARK CONSISTS OF STANDARD CHAR-
ACTERS WITHOUT CLAIM TO ANY PARTICULAR
FONT, STYLE, SIZE, OR COLOR.

OWNER OF U.S. REG. NO. 2,149,454.

NO CLAIM IS MADE TO THE EXCLUSIVE
RIGHT TO USE "ORGANIC EGGS", APART FROM
THE MARK AS SHOWN.

SER. NO. 77-353,434, FILED 12-17-2007.

JOHN DALIER, EXAMINING ATTORNEY

Int. Cl.: 1

Prior U.S. Cls.: 1, 5, 6, 10, 26 and 46

Reg. No. 3,475,939

United States Patent and Trademark Office

Registered July 29, 2008

**TRADEMARK
PRINCIPAL REGISTER**

DC UPREGULEX

DISTINCTIVE COSMETICS INGREDIENTS, LLC
(NEW JERSEY LTD LIAB CO)
2259 SOUTH CLINTON AVENUE
SOUTH PLAINFIELD, NJ 07080

THE MARK CONSISTS OF STANDARD CHARACTERS WITHOUT CLAIM TO ANY PARTICULAR FONT, STYLE, SIZE, OR COLOR.

FOR: CHEMICAL ACTIVITIES FOR USE IN THE MANUFACTURE OF PERSONAL CARE PRODUCTS AND COSMETICS, IN CLASS 1 (U.S. CLS. 1, 5, 6, 10, 26 AND 46).

SER. NO. 77-353,436, FILED 12-17-2007.

FIRST USE 11-15-2006; IN COMMERCE 11-15-2006.

LINDA MICKLEBURGH, EXAMINING ATTORNEY

Int. Cl.: 42

Prior U.S. Cls.: 100 and 101

United States Patent and Trademark Office

Reg. No. 3,475,940

Registered July 29, 2008

**SERVICE MARK
PRINCIPAL REGISTER**

SOURCEPOINT

AIRS HUMAN CAPITAL SOLUTIONS, INC.
(NEW HAMPSHIRE CORPORATION)
58 FOGG FARM ROAD
WHITE RIVER JUNCTION, VT 05001

FOR: PROVIDING TEMPORARY USE OF ON-
LINE NON-DOWNLOADABLE SOFTWARE FOR
SEARCHING THE INTERNET IN THE FIELD OF
EMPLOYMENT RECRUITMENT , IN CLASS 42 (U.S.
CLS. 100 AND 101).

FIRST USE 7-17-2006; IN COMMERCE 7-17-2006.

THE MARK CONSISTS OF STANDARD CHAR-
ACTERS WITHOUT CLAIM TO ANY PARTICULAR
FONT, STYLE, SIZE, OR COLOR.

SER. NO. 77-353,438, FILED 12-17-2007.

MARGERY A. TIERNEY, EXAMINING ATTORNEY

Int. Cl.: 42

Prior U.S. Cls.: 100 and 101

United States Patent and Trademark Office

Reg. No. 3,475,941

Registered July 29, 2008

**SERVICE MARK
PRINCIPAL REGISTER**

**ROCK PROPERTIES IN REAL
TIME**

INGRAIN INC. (TEXAS CORPORATION)
3733 WESTHEIMER ROAD
HOUSTON, TX 77027

FOR: TECHNICAL CONSULTATION, ANALYSIS, AND MEASUREMENTS OF GEOPHYSICAL PROPERTIES OF ROCKS, MINERALS, SANDS, SOILS AND SUBSOILS FOR THE ENERGY, PETROLEUM, OIL AND GAS INDUSTRIES; AND CONDUCTING STUDIES, RESEARCH, VIRTUAL EXPERIMENTATION, COMPUTER SIMULATIONS, MAGNETIC RESONANCE IMAGING AND ANALYSIS, AND COMPUTED TOMOGRAPHY SCANS, IMAGING AND ANALYSIS OF GEOPHYSICAL PROPERTIES

OF ROCKS, MINERALS, SANDS, SOILS AND SUBSOILS FOR THE ENERGY, PETROLEUM, OIL AND GAS INDUSTRIES, IN CLASS 42 (U.S. CLS. 100 AND 101).

FIRST USE 8-0-2007; IN COMMERCE 8-0-2007.

THE MARK CONSISTS OF STANDARD CHARACTERS WITHOUT CLAIM TO ANY PARTICULAR FONT, STYLE, SIZE, OR COLOR.

SER. NO. 77-353,448, FILED 12-17-2007.

KEVON CHISOLM, EXAMINING ATTORNEY

Int. Cl.: 42

Prior U.S. Cls.: 100 and 101

United States Patent and Trademark Office

Reg. No. 3,475,942

Registered July 29, 2008

**SERVICE MARK
PRINCIPAL REGISTER**

INGRAIN

INGRAIN INC. (TEXAS CORPORATION)
3733 WESTHEIMER ROAD
HOUSTON, TX 77027

FOR: TECHNICAL CONSULTATION, ANALYSIS, AND MEASUREMENTS OF GEOPHYSICAL PROPERTIES OF ROCKS, MINERALS, SANDS, SOILS AND SUBSOILS FOR THE ENERGY, PETROLEUM, OIL AND GAS INDUSTRIES; AND CONDUCTING STUDIES, RESEARCH, VIRTUAL EXPERIMENTATION, COMPUTER SIMULATIONS, MAGNETIC RESONANCE IMAGING AND ANALYSIS, AND COMPUTED TOMOGRAPHY SCANS, IMAGING AND ANALYSIS OF GEOPHYSICAL PROPERTIES

OF ROCKS, MINERALS, SANDS, SOILS AND SUBSOILS FOR THE ENERGY, PETROLEUM, OIL AND GAS INDUSTRIES, IN CLASS 42 (U.S. CLS. 100 AND 101).

FIRST USE 8-0-2007; IN COMMERCE 8-0-2007.

THE MARK CONSISTS OF STANDARD CHARACTERS WITHOUT CLAIM TO ANY PARTICULAR FONT, STYLE, SIZE, OR COLOR.

SER. NO. 77-353,456, FILED 12-17-2007.

KEVON CHISOLM, EXAMINING ATTORNEY

Int. Cls.: 1, 5 and 42

**Prior U.S. Cls.: 1, 5, 6, 10, 18, 26, 44, 46, 51, 52, 100
and 101**

Reg. No. 3,475,943

United States Patent and Trademark Office

Registered July 29, 2008

**TRADEMARK
SERVICE MARK
PRINCIPAL REGISTER**

HESylation

FRESENIUS KABI AG (FED REP GERMANY
AKTIENGESELLSCHAFT)
FRIEDRICHSTR. 2-6
FRANKFURT AM MAIN, FED REP GERMANY
60323

FOR: CHEMICALS USED IN INDUSTRY AND
SCIENCE, IN CLASS 1 (U.S. CLS. 1, 5, 6, 10, 26 AND
46).

FOR: PHARMACEUTICAL PREPARATIONS FOR
PROLONGATION OF PLASMA CIRCULATION OF
PHARMACEUTICAL SUBSTANCES; PHARMACEU-
TICAL PREPARATIONS FOR INFUSION THER-
APY; PHARMACEUTICAL PREPARATIONS FOR
CLINICAL NUTRITION; VETERINARY PREPARA-
TIONS FOR PROLONGATION OF PLASMA CIRCU-
LATION OF PHARMACEUTICAL SUBSTANCES;
VETERINARY PREPARATIONS FOR INFUSION
THERAPY; VETERINARY PREPARATIONS FOR
CLINICAL NUTRITION; DIETETIC FOOD ADAP-
TED FOR MEDICAL USE; PLASTERS FOR MEDI-
CAL PURPOSES; MATERIALS FOR DRESSINGS,
NAMELY, GAUZE AND BANDAGES; DISINFEC-
TANTS FOR HYGIENIC PURPOSES AND MEDICAL
INSTRUMENTS, IN CLASS 5 (U.S. CLS. 6, 18, 44, 46, 51
AND 52).

FOR: SCIENTIFIC RESEARCH; TECHNOLOGI-
CAL SERVICES, NAMELY, SYNTHESIS OF CHEMI-
CAL SUBSTANCES AND PHARMACEUTICALLY
ACTIVE SUBSTANCES AND OF THEIR PRECUR-
SORS; RESEARCH IN THE FIELD OF CHEMISTRY,
PHARMACY AND PHARMACOLOGY; MOLECU-
LAR DESIGN OF PHARMACEUTICALLY ACTIVE
SUBSTANCES AND THEIR PRECURSORS; CHEMI-
CAL ANALYSIS; PRODUCT RESEARCH, IN CLASS
42 (U.S. CLS. 100 AND 101).

THE MARK CONSISTS OF STANDARD CHAR-
ACTERS WITHOUT CLAIM TO ANY PARTICULAR
FONT, STYLE, SIZE, OR COLOR.

OWNER OF FED REP GERMANY REG. NO.
30743570, DATED 9-7-2007, EXPIRES 7-31-2017.

OWNER OF U.S. REG. NO. 3,076,840.

SER. NO. 77-353,458, FILED 12-17-2007.

KEVON CHISOLM, EXAMINING ATTORNEY

Int. Cl.: 9

Prior U.S. Cls.: 21, 23, 26, 36 and 38

United States Patent and Trademark Office

Reg. No. 3,475,944

Registered July 29, 2008

**TRADEMARK
PRINCIPAL REGISTER**

TRUESHIP

TRUESHIP (ARIZONA LTD LIAB CO)
8449 E EDGEMONT AVE
SCOTTSDALE, AZ 85257

THE MARK CONSISTS OF STANDARD CHAR-
ACTERS WITHOUT CLAIM TO ANY PARTICULAR
FONT, STYLE, SIZE, OR COLOR.

FOR: SOFTWARE FOR ORGANIZING ORDER-
ING AND MAILING INFORMATION AND FOR
THE CREATION OF SHIPPING LABELS, IN CLASS 9
(U.S. CLS. 21, 23, 26, 36 AND 38).

SER. NO. 77-353,463, FILED 12-17-2007.

FIRST USE 12-31-2002; IN COMMERCE 12-31-2002.

KEVON CHISOLM, EXAMINING ATTORNEY

Int. Cl.: 36

Prior U.S. Cls.: 100, 101 and 102

United States Patent and Trademark Office

Reg. No. 3,475,945

Registered July 29, 2008

SERVICE MARK
PRINCIPAL REGISTER

DIAMOND HILL
investments

DIAMOND HILL INVESTMENT GROUP, INC.
(OHIO CORPORATION)
SUITE 200
325 JOHN H. MCCONNELL BOULEVARD
COLUMBUS, OH 43215

FOR: MUTUAL FUND INVESTMENT SERVICES;
INVESTMENT MANAGEMENT; INVESTMENT AD-
VISORY SERVICES, IN CLASS 36 (U.S. CLS. 100, 101
AND 102).

FIRST USE 5-0-2004; IN COMMERCE 5-0-2004.

NO CLAIM IS MADE TO THE EXCLUSIVE
RIGHT TO USE "INVESTMENTS", APART FROM
THE MARK AS SHOWN.

THE MARK CONSISTS OF THE WORDS "DIA-
MOND HILL INVESTMENTS" WITH A DIAMOND
DESIGN FORMING A STYLIZED LETTER "A" IN
THE WORD "DIAMOND" AND A STYLIZED LET-
TER "V" IN THE WORD "INVESTMENTS". A HOR-
IZONTAL LINE APPEARS UNDER THE WORDS
"DIAMOND HILL" AND ABOVE THE WORD "IN-
VESTMENTS". THE HORIZONTAL LINE DOES
NOT BISECT THE DIAMOND DESIGN.

SER. NO. 77-353,513, FILED 12-17-2007.

JENNIFER DIXON, EXAMINING ATTORNEY

Int. Cl.: 36

Prior U.S. Cls.: 100, 101 and 102

United States Patent and Trademark Office

Reg. No. 3,475,946

Registered July 29, 2008

**SERVICE MARK
PRINCIPAL REGISTER**

INVEST WITH US.

DIAMOND HILL INVESTMENT GROUP, INC.
(OHIO CORPORATION)
SUITE 200
325 JOHN H. MCCONNELL BOULEVARD
COLUMBUS, OH 43215

FOR: MUTUAL FUND INVESTMENT SERVICES;
INVESTMENT MANAGEMENT; INVESTMENT AD-
VISORY SERVICES, IN CLASS 36 (U.S. CLS. 100, 101
AND 102).

FIRST USE 9-0-2004; IN COMMERCE 9-0-2004.

THE MARK CONSISTS OF STANDARD CHAR-
ACTERS WITHOUT CLAIM TO ANY PARTICULAR
FONT, STYLE, SIZE, OR COLOR.

SER. NO. 77-353,532, FILED 12-17-2007.

JENNIFER DIXON, EXAMINING ATTORNEY

Int. Cl.: 36

Prior U.S. Cls.: 100, 101 and 102

United States Patent and Trademark Office

Reg. No. 3,475,947

Registered July 29, 2008

**SERVICE MARK
PRINCIPAL REGISTER**

DIAMOND HILL

DIAMOND HILL INVESTMENT GROUP, INC.
(OHIO CORPORATION)
SUITE 200
325 JOHN H. MCCONNELL BOULEVARD
COLUMBUS, OH 43215

FOR: MUTUAL FUND INVESTMENT SERVICES;
INVESTMENT MANAGEMENT; INVESTMENT AD-
VISORY SERVICES, IN CLASS 36 (U.S. CLS. 100, 101
AND 102).

FIRST USE 10-0-2000; IN COMMERCE 10-0-2000.

THE MARK CONSISTS OF STANDARD CHAR-
ACTERS WITHOUT CLAIM TO ANY PARTICULAR
FONT, STYLE, SIZE, OR COLOR.

SER. NO. 77-353,535, FILED 12-17-2007.

JENNIFER DIXON, EXAMINING ATTORNEY

Int. Cl.: 36

Prior U.S. Cls.: 100, 101 and 102

United States Patent and Trademark Office

Reg. No. 3,475,948

Registered July 29, 2008

SERVICE MARK
PRINCIPAL REGISTER



DIAMOND HILL INVESTMENT GROUP, INC.
(OHIO CORPORATION)
SUITE 200
325 JOHN H. MCCONNELL BOULEVARD
COLUMBUS, OH 43215

FOR: MUTUAL FUND INVESTMENT SERVICES,
IN CLASS 36 (U.S. CLS. 100, 101 AND 102).

FIRST USE 4-30-2004; IN COMMERCE 4-30-2004.

NO CLAIM IS MADE TO THE EXCLUSIVE
RIGHT TO USE "FUNDS", APART FROM THE
MARK AS SHOWN.

THE MARK CONSISTS OF THE WORDS "DIAMOND HILL FUNDS" WITH A DIAMOND DESIGN FORMING A STYLIZED LETTER "A" IN THE WORD "DIAMOND" AND A HORIZONTAL LINE UNDER THE WORDS "DIAMOND HILL". THE WORD "FUNDS" APPEARS IN LOWERCASE LETTERS BELOW THE HORIZONTAL LINE AND UNDER THE WORD "HILL".

SER. NO. 77-353,536, FILED 12-17-2007.

JENNIFER DIXON, EXAMINING ATTORNEY

Int. Cl.: 37

Prior U.S. Cls.: 100, 103 and 106

United States Patent and Trademark Office

Reg. No. 3,475,949

Registered July 29, 2008

**SERVICE MARK
PRINCIPAL REGISTER**

PPCI

POINT TO POINT COMMUNICATIONS INC.
(DELAWARE CORPORATION)
6401 HARNEY ROAD, SUITE A
TAMPA, FL 33610

THE MARK CONSISTS OF STANDARD CHAR-
ACTERS WITHOUT CLAIM TO ANY PARTICULAR
FONT, STYLE, SIZE, OR COLOR.

FOR: INSTALLATION, MAINTENANCE AND
REPAIR OF TELECOMMUNICATION SYSTEMS,
IN CLASS 37 (U.S. CLS. 100, 103 AND 106).

SER. NO. 77-353,538, FILED 12-17-2007.

FIRST USE 9-17-1985; IN COMMERCE 9-17-1985.

ANNE MADDEN, EXAMINING ATTORNEY

Int. Cls.: 25 and 41

Prior U.S. Cls.: 22, 39, 100, 101 and 107

United States Patent and Trademark Office

Reg. No. 3,475,950

Registered July 29, 2008

**TRADEMARK
SERVICE MARK
PRINCIPAL REGISTER**



CURL SWIMMING SERVICES UNLIMITED, INCORPORATED (VIRGINIA CORPORATION)
P.O. BOX 359
DAMASCUS, MD 20872

FOR: SWIM WEAR; SWIM CAPS; SWIM TRUNKS; CLOTHING, NAMELY, SHORT-SLEEVED AND LONG-SLEEVED T-SHIRTS, SWEAT SHIRTS, AND SPORT SHIRTS, IN CLASS 25 (U.S. CLS. 22 AND 39).

FIRST USE 12-0-1983; IN COMMERCE 12-0-1983.

FOR: PROVIDING INSTRUCTION AND COACHING IN RECREATIONAL AND COMPETITIVE SWIMMING FOR PERSONS OF ALL AGES AND SKILL LEVELS; ORGANIZING AND CONDUCTING SPORTING EVENTS, NAMELY, SWIMMING COMPETITIONS AND MEETS; PROVIDING SWIMMING FACILITIES, IN CLASS 41 (U.S. CLS. 100, 101 AND 107).

FIRST USE 12-0-1983; IN COMMERCE 12-0-1983.

NO CLAIM IS MADE TO THE EXCLUSIVE RIGHT TO USE "SWIM CLUB", APART FROM THE MARK AS SHOWN.

THE MARK CONSISTS OF WAVES APPEAR OVER AN IMAGE WITH "CURL BURKE SWIM CLUB" IN BLOCK LETTERS APPEARING UNDERNEATH.

SEC. 2(F) AS TO "BURKE".

SER. NO. 77-353,574, FILED 12-17-2007.

LINDA M. KING, EXAMINING ATTORNEY

Int. Cl.: 12

Prior U.S. Cls.: 19, 21, 23, 31, 35 and 44

Reg. No. 3,475,951

United States Patent and Trademark Office

Registered July 29, 2008

**TRADEMARK
PRINCIPAL REGISTER**

g-Bar

CHRIS ALSTON'S CHASSISWORKS, INC. (CALIFORNIA CORPORATION), AKA TOTAL CONTROL PRODUCTS
8661 YOUNGER CREEK DRIVE
SACRAMENTO, CA 95828

FIRST USE 5-1-2006; IN COMMERCE 5-1-2006.

THE MARK CONSISTS OF STANDARD CHARACTERS WITHOUT CLAIM TO ANY PARTICULAR FONT, STYLE, SIZE, OR COLOR.

FOR: SUSPENSION SYSTEMS FOR AUTOMOBILES; LAND VEHICLE SUSPENSION PARTS, NAMELY, TORSION/SWAY BARS , IN CLASS 12 (U.S. CLS. 19, 21, 23, 31, 35 AND 44).

SER. NO. 77-353,590, FILED 12-17-2007.

MICHAEL ENGEL, EXAMINING ATTORNEY

Int. Cls.: 16 and 35

Prior U.S. Cls.: 2, 5, 22, 23, 29, 37, 38, 50, 100, 101 and 102

Reg. No. 3,475,952

United States Patent and Trademark Office

Registered July 29, 2008

**TRADEMARK
SERVICE MARK
PRINCIPAL REGISTER**

Transformation Tips

JODY ALYN (COLORADO SOLE PROPRIETORSHIP), DBA JODY ALYN CONSULTING
2502 ANDROMEDA DRIVE
COLORADO SPRINGS, CO 80906

FOR: A SERIES OF BOOKS, WRITTEN ARTICLES, HANDOUTS AND WORKSHEETS IN THE FIELD OF DIVERSITY , IN CLASS 16 (U.S. CLS. 2, 5, 22, 23, 29, 37, 38 AND 50).

FIRST USE 10-1-2004; IN COMMERCE 12-15-2004.

FOR: BUSINESS MANAGEMENT CONSULTING AND ADVISORY SERVICES; CONSULTANCY SERVICES REGARDING BUSINESS STRATEGIES; BUSINESS ORGANIZATION AND MANAGEMENT CONSULTING; BUSINESS ORGANIZATIONAL CONSULTATION; BUSINESS MANAGEMENT CONSULTATION; BUSINESS MANAGEMENT CONSULTATION IN THE FIELD OF EXECUTIVE AND LEADERSHIP DEVELOPMENT; BUSINESS MANAGEMENT CONSULTING; BUSINESS MANAGEMENT CONSULTING WITH RELATION TO STRATEGY, MARKETING, PRODUCTION, PERSONNEL AND RETAIL SALE MATTERS; BUSINESS MANAGEMENT INFORMATION ON A WIDE VARIETY OF TOPICS TO SERVICE PROVIDING

PROFESSIONALS; BUSINESS MANAGEMENT OF THE NONPROFIT CORPORATIONS AND TRADE ASSOCIATIONS OF OTHERS; BUSINESS CONSULTING, MANAGEMENT, PLANNING AND SUPERVISION; BUSINESS MANAGEMENT AND ADVICE; BUSINESS MANAGEMENT AND CONSULTATION; BUSINESS MANAGEMENT AND CONSULTATION IN THE FIELD OF DIVERSITY; BUSINESS MANAGEMENT CONSULTANCY AND ADVISORY SERVICES; BUSINESS MANAGEMENT CONSULTANCY SERVICES, IN CLASS 35 (U.S. CLS. 100, 101 AND 102).

FIRST USE 10-1-2004; IN COMMERCE 12-15-2004.

THE MARK CONSISTS OF STANDARD CHARACTERS WITHOUT CLAIM TO ANY PARTICULAR FONT, STYLE, SIZE, OR COLOR.

NO CLAIM IS MADE TO THE EXCLUSIVE RIGHT TO USE "TIPS", APART FROM THE MARK AS SHOWN.

SER. NO. 77-353,616, FILED 12-17-2007.

MATTHEW EINSTEIN, EXAMINING ATTORNEY

Int. Cl.: 41

Prior U.S. Cls.: 100, 101 and 107

United States Patent and Trademark Office

Reg. No. 3,475,953

Registered July 29, 2008

**SERVICE MARK
PRINCIPAL REGISTER**

CUBU

CURL SWIMMING SERVICES UNLIMITED, INCORPORATED (VIRGINIA CORPORATION)
P.O. BOX 359
DAMASCUS, MD 20872

FOR: PROVIDING INSTRUCTION AND COACHING IN RECREATIONAL AND COMPETITIVE SWIMMING FOR PERSONS OF ALL AGES AND SKILL LEVELS; ORGANIZING AND CONDUCTING SPORTING EVENTS, NAMELY, SWIMMING COMPETITIONS AND MEETS; PROVIDING SWIMMING FACILITIES, IN CLASS 41 (U.S. CLS. 100, 101 AND 107).

FIRST USE 12-0-1983; IN COMMERCE 12-0-1983.

THE MARK CONSISTS OF STANDARD CHARACTERS WITHOUT CLAIM TO ANY PARTICULAR FONT, STYLE, SIZE, OR COLOR.

SER. NO. 77-353,618, FILED 12-17-2007.

LINDA M. KING, EXAMINING ATTORNEY

Int. Cl.: 19

Prior U.S. Cls.: 1, 12, 33 and 50

United States Patent and Trademark Office

Reg. No. 3,475,954

Registered July 29, 2008

**TRADEMARK
PRINCIPAL REGISTER**

BIOLIME

BIOLIME, LLC (OREGON LTD LIAB CO)
16869 SW 65TH AVE.
LAKE OSWEGO, OR 97035

THE MARK CONSISTS OF STANDARD CHAR-
ACTERS WITHOUT CLAIM TO ANY PARTICULAR
FONT, STYLE, SIZE, OR COLOR.

FOR: PLASTER, IN CLASS 19 (U.S. CLS. 1, 12, 33
AND 50).

SER. NO. 77-353,623, FILED 12-17-2007.

FIRST USE 12-14-2007; IN COMMERCE 12-14-2007.

ARETHA SOMERVILLE, EXAMINING ATTORNEY

Int. Cl.: 36

Prior U.S. Cls.: 100, 101 and 102

United States Patent and Trademark Office

Reg. No. 3,475,955

Registered July 29, 2008

**SERVICE MARK
PRINCIPAL REGISTER**

ROBINSWOOD

ROBINSWOOD FINANCIAL, LLC (WASHINGTON LTD LIAB CO)
BUILDING 5000, 4TH FLOOR
5400 CARILLON POINT
KIRKLAND, WA 98033

FOR: FINANCIAL ADVICE AND CONSULTANCY SERVICES; FINANCIAL PLANNING FOR RETIREMENT; FINANCIAL PORTFOLIO MANAGEMENT; INVESTMENT ADVICE AND CONSULTATION; ESTATE AND WEALTH PRESERVATION PLANNING; COLLEGE EDUCATION FUND PLANNING; AND INVESTMENT SERVICES, NAMELY, PROVIDING INFORMATION AND CON-

SULTATION FOR DIVERSIFICATION AND ASSET ALLOCATION STRATEGIES, IN CLASS 36 (U.S. CLS. 100, 101 AND 102).

FIRST USE 2-7-2007; IN COMMERCE 2-7-2007.

THE MARK CONSISTS OF STANDARD CHARACTERS WITHOUT CLAIM TO ANY PARTICULAR FONT, STYLE, SIZE, OR COLOR.

SER. NO. 77-353,632, FILED 12-17-2007.

JESSICA A. POWERS, EXAMINING ATTORNEY

Int. Cl.: 9

Prior U.S. Cls.: 21, 23, 26, 36 and 38

Reg. No. 3,475,956

United States Patent and Trademark Office

Registered July 29, 2008

**TRADEMARK
PRINCIPAL REGISTER**

MIRASOL

QUALCOMM MEMS TECHNOLOGIES, INC. (DE-
LAWARE CORPORATION)
PATENT & TRADEMARK DEPT.
5775 MOREHOUSE DRIVE
SAN DIEGO, CA 921211714

FOR: MICROELECTROMECHANICAL SYSTEMS
DEVICES, NAMELY, FLAT PANEL DISPLAY
SCREENS, IN CLASS 9 (U.S. CLS. 21, 23, 26, 36 AND
38).

FIRST USE 12-7-2007; IN COMMERCE 12-7-2007.

THE MARK CONSISTS OF STANDARD CHAR-
ACTERS WITHOUT CLAIM TO ANY PARTICULAR
FONT, STYLE, SIZE, OR COLOR.

THE FOREIGN WORDING IN THE MARK
TRANSLATES INTO ENGLISH AS SUNFLOWER.

SER. NO. 77-353,665, FILED 12-17-2007.

LINDA MICKLEBURGH, EXAMINING ATTORNEY

Int. Cl.: 13

Prior U.S. Cls.: 2 and 9

United States Patent and Trademark Office

Reg. No. 3,475,957

Registered July 29, 2008

**TRADEMARK
PRINCIPAL REGISTER**

YOU ARE NOT ALONE!

ARMOR ACCESSORIES, INC. (DELAWARE CORPORATION)
13386 INTERNATIONAL PARKWAY
JACKSONVILLE, FL 32218

THE MARK CONSISTS OF STANDARD CHARACTERS WITHOUT CLAIM TO ANY PARTICULAR FONT, STYLE, SIZE, OR COLOR.

FOR: PERSONAL DEFENSE SPRAYS, IN CLASS 13 (U.S. CLS. 2 AND 9).

SER. NO. 77-353,670, FILED 12-17-2007.

FIRST USE 9-15-2007; IN COMMERCE 9-15-2007.

JIM RINGLE, EXAMINING ATTORNEY

Int. Cl.: 36

Prior U.S. Cls.: 100, 101 and 102

United States Patent and Trademark Office

Reg. No. 3,475,958

Registered July 29, 2008

**SERVICE MARK
PRINCIPAL REGISTER**

OCEAN BANK

OCEAN BANK (NEW HAMPSHIRE CHARTERED
BANK)

325 STATE STREET

PORTSMOUTH, NH 03801

FOR: BANKING SERVICES, IN CLASS 36 (U.S.
CLS. 100, 101 AND 102).

FIRST USE 0-0-1854; IN COMMERCE 0-0-1854.

THE MARK CONSISTS OF STANDARD CHAR-
ACTERS WITHOUT CLAIM TO ANY PARTICULAR
FONT, STYLE, SIZE, OR COLOR.

NO CLAIM IS MADE TO THE EXCLUSIVE
RIGHT TO USE "BANK", APART FROM THE
MARK AS SHOWN.

SER. NO. 77-353,671, FILED 12-17-2007.

LINDA M. KING, EXAMINING ATTORNEY

Int. Cl.: 10

Prior U.S. Cls.: 26, 39 and 44

United States Patent and Trademark Office

Reg. No. 3,475,959

Registered July 29, 2008

**TRADEMARK
PRINCIPAL REGISTER**

STARION INSTRUMENTS

STARION INSTRUMENTS CORPORATION (CALIFORNIA CORPORATION)
775 PALOMAR AVENUE
SUNNYVALE, CA 94085

FOR: SURGICAL DEVICES, NAMELY, GRASPERS, FORCEPS, ABLATION PROBES, LIGATING SHEARS, TISSUE CUTTING AND SEALING SYSTEMS COMPRISED OF THERMAL CAUTERY DEVICES, POWER SUPPLIES AND BATTERIES THEREFOR, AND ACCESSORIES THEREFOR, THERMAL ABLATION PROBES ADAPTED FOR TURBINATE ABLATION, THERMAL ABLATION SYSTEMS COMPRISED OF THERMAL ABLATION PROBES ADAPTED FOR TURBINATE ABLATION, POWER SUPPLIES AND BATTERIES THEREFOR, SURGICAL INSTRUMENTS FOR USE IN TURBINATE REDUCTION PROCEDURES, SURGICAL IN-

STRUMENTS FOR USE IN OTOLARYNGOLOGICAL PROCEDURES, IN CLASS 10 (U.S. CLS. 26, 39 AND 44).

FIRST USE 12-3-1999; IN COMMERCE 12-3-1999.

THE MARK CONSISTS OF STANDARD CHARACTERS WITHOUT CLAIM TO ANY PARTICULAR FONT, STYLE, SIZE, OR COLOR.

NO CLAIM IS MADE TO THE EXCLUSIVE RIGHT TO USE "INSTRUMENTS", APART FROM THE MARK AS SHOWN.

SER. NO. 77-353,684, FILED 12-17-2007.

LINDA M. KING, EXAMINING ATTORNEY

Int. Cl.: 26

Prior U.S. Cls.: 37, 39, 40, 42 and 50

United States Patent and Trademark Office

Reg. No. 3,475,960

Registered July 29, 2008

**TRADEMARK
PRINCIPAL REGISTER**

PRINCESS

EASTERN WIG & HAIR COMPANY, L.L.C. (MI-
CHIGAN LTD LIAB CO)
1400 WOODWARD AVENUE
DETROIT, MI 48226

THE MARK CONSISTS OF STANDARD CHAR-
ACTERS WITHOUT CLAIM TO ANY PARTICULAR
FONT, STYLE, SIZE, OR COLOR.

FOR: HAIR EXTENSIONS, IN CLASS 26 (U.S. CLS.
37, 39, 40, 42 AND 50).

SER. NO. 77-353,696, FILED 12-17-2007.

FIRST USE 1-1-1999; IN COMMERCE 1-1-1999.

ELISSA GARBER KON, EXAMINING ATTORNEY

Int. Cl.: 14

Prior U.S. Cls.: 2, 27, 28 and 50

United States Patent and Trademark Office

Reg. No. 3,475,961

Registered July 29, 2008

**TRADEMARK
PRINCIPAL REGISTER**



WHITEFLASH.COM, INC. (TEXAS CORPORATION)
6222 RICHMOND AVENUE
HOUSTON, TX 77057

FIRST USE 8-0-2006; IN COMMERCE 8-0-2006.

FOR: JEWELRY; DIAMONDS; PRECIOUS STONES; JEWELRY MADE OF PRECIOUS STONES; RINGS BEING JEWELRY, IN CLASS 14 (U.S. CLS. 2, 27, 28 AND 50).

SER. NO. 77-353,697, FILED 12-17-2007.

LANA PHAM, EXAMINING ATTORNEY

Int. Cl.: 24

Prior U.S. Cls.: 42 and 50

United States Patent and Trademark Office

Reg. No. 3,475,962

Registered July 29, 2008

TRADEMARK
PRINCIPAL REGISTER



SHAYLA M. POPE (TEXAS SOLE PROPRIETOR-
SHIP)
124 RINEHARDT
HUTTO, TX 78634

FIRST USE 3-1-2007; IN COMMERCE 7-25-2007.

THE MARK CONSISTS OF THE WORDS "LAZY
LAMBS" AND THE DESIGN OF A LAMB.

FOR: BED BLANKETS; BLANKET THROWS;
CHILDREN'S BLANKETS; RECEIVING BLANKETS;
BED SHEETS; BED SKIRTS; CRIB BUMPERS; PIL-
LOW CASES; PILLOW COVERS; PILLOW SHAMS;
BURP CLOTHS, IN CLASS 24 (U.S. CLS. 42 AND 50).

SER. NO. 77-353,710, FILED 12-17-2007.

TOBY BULLOFF, EXAMINING ATTORNEY

Int. Cl.: 36

Prior U.S. Cls.: 100, 101 and 102

United States Patent and Trademark Office

Reg. No. 3,475,963

Registered July 29, 2008

SERVICE MARK
PRINCIPAL REGISTER



OCEAN BANK (NEW HAMPSHIRE CHARTERED
BANK)
325 STATE STREET
PORTSMOUTH, NH 03801

FOR: BANKING SERVICES, IN CLASS 36 (U.S.
CLS. 100, 101 AND 102).

FIRST USE 6-29-2007; IN COMMERCE 6-29-2007.

NO CLAIM IS MADE TO THE EXCLUSIVE
RIGHT TO USE "BANK" , APART FROM THE
MARK AS SHOWN.

THE MARK CONSISTS OF THE WORDS "OCEAN
BANK" IN STYLIZED LETTERS.

SER. NO. 77-353,711, FILED 12-17-2007.

LINDA M. KING, EXAMINING ATTORNEY

Int. Cl.: 42

Prior U.S. Cls.: 100 and 101

United States Patent and Trademark Office

Reg. No. 3,475,964

Registered July 29, 2008

**SERVICE MARK
PRINCIPAL REGISTER**



MCDERMOTT, PATRICK (UNITED STATES IN-
DIVIDUAL)
12244 E. PALOMINO RD.
SCOTTSDALE, AZ 85259

FIRST USE 3-18-2005; IN COMMERCE 5-6-2005.

FOR: COMPUTER SOFTWARE DESIGN, COM-
PUTER PROGRAMMING, OR MAINTENANCE OF
COMPUTER SOFTWARE, IN CLASS 42 (U.S. CLS.
100 AND 101).

SER. NO. 77-353,712, FILED 12-17-2007.

KATHRYN COWARD, EXAMINING ATTORNEY

Int. Cl.: 14

Prior U.S. Cls.: 2, 27, 28 and 50

United States Patent and Trademark Office

Reg. No. 3,475,965

Registered July 29, 2008

**TRADEMARK
PRINCIPAL REGISTER**

**Rhonda Faber Green For
Green**

RHONDA FABER GREEN DESIGNS, LLC (CALI-
FORNIA LTD LIAB CO)
PENTHOUSE
332 N. RODEO DR
BEVERLY HILLS, CA 90210

FOR: DIAMOND JEWELRY, IN CLASS 14 (U.S.
CLS. 2, 27, 28 AND 50).

FIRST USE 11-14-2007; IN COMMERCE 11-14-2007.

THE MARK CONSISTS OF STANDARD CHAR-
ACTERS WITHOUT CLAIM TO ANY PARTICULAR
FONT, STYLE, SIZE, OR COLOR.

OWNER OF U.S. REG. NOS. 2,905,953 AND
2,907,928.

THE NAME "RHONDA FABER GREEN" IDEN-
TIFIES A LIVING INDIVIDUAL WHOSE CONSENT
IS OF RECORD.

SER. NO. 77-353,717, FILED 12-17-2007.

KATHLEEN LORENZO, EXAMINING ATTORNEY

Int. Cls.: 35 and 41

Prior U.S. Cls.: 100, 101, 102 and 107

United States Patent and Trademark Office

Reg. No. 3,475,966

Registered July 29, 2008

**SERVICE MARK
PRINCIPAL REGISTER**

BUILD YOUR FIRM

BUILD YOUR FIRM, INC. (NEW YORK CORPORATION)
245 SAW MILL RIVER ROAD, SUITE 106
HAWTHORNE, NY 10532

FOR: BUSINESS MANAGEMENT, CONSULTING AND MARKETING SERVICES, IN CLASS 35 (U.S. CLS. 100, 101 AND 102).

FIRST USE 2-15-2003; IN COMMERCE 3-27-2003.

FOR: TRAINING COURSES, WORKSHOPS AND SEMINARS IN BUSINESS DEVELOPMENT, NAME-
LY, ADVERTISING, TIME MANAGEMENT, CLI-

ENT RELATIONS AND PROMOTION AND MARKETING OF BUSINESSES, IN CLASS 41 (U.S. CLS. 100, 101 AND 107).

FIRST USE 2-15-2003; IN COMMERCE 3-27-2003.

THE MARK CONSISTS OF STANDARD CHARACTERS WITHOUT CLAIM TO ANY PARTICULAR FONT, STYLE, SIZE, OR COLOR.

SER. NO. 77-353,733, FILED 12-17-2007.

ANDREA BUTLER, EXAMINING ATTORNEY

Int. Cl.: 12

Prior U.S. Cls.: 19, 21, 23, 31, 35 and 44

Reg. No. 3,475,967

United States Patent and Trademark Office

Registered July 29, 2008

**TRADEMARK
PRINCIPAL REGISTER**

DRAGONFLY

DRAGONFLY BOATWORKS LLC (FLORIDA
LTD LIAB CO)
2625 CARISSA DRIVE
4575 N. US 1 STE 10 VERO BEACH, FL 32960
VERO BEACH, FL 32967

FOR: BOAT HULLS; BOATS; BOATS AND
STRUCTURAL PARTS THEREFOR; FISHING
BOATS; STRUCTURAL PARTS FOR BOATS; VES-
SELS; JON BOATS; KAYAK-LIKE BOATS, IN CLASS
12 (U.S. CLS. 19, 21, 23, 31, 35 AND 44).

FIRST USE 5-15-2007; IN COMMERCE 5-15-2007.

THE MARK CONSISTS OF STANDARD CHAR-
ACTERS WITHOUT CLAIM TO ANY PARTICULAR
FONT, STYLE, SIZE, OR COLOR.

SER. NO. 77-353,737, FILED 12-17-2007.

KARANENDRA S. CHHINA, EXAMINING ATTOR-
NEY

Int. Cl.: 4

Prior U.S. Cls.: 1, 6 and 15

United States Patent and Trademark Office

Reg. No. 3,475,968

Registered July 29, 2008

**TRADEMARK
PRINCIPAL REGISTER**

AIRREX LUBE

MINING AUGER & TOOL WORKS, INC. (MINNESOTA CORPORATION)

557 STINSON STREET

ST. PAUL, MN 55117

FOR: LUBRICANTS FOR PNEUMATIC TOOLS,
IN CLASS 4 (U.S. CLS. 1, 6 AND 15).

FIRST USE 8-31-1989; IN COMMERCE 8-31-1989.

THE MARK CONSISTS OF STANDARD CHARACTERS WITHOUT CLAIM TO ANY PARTICULAR FONT, STYLE, SIZE, OR COLOR.

NO CLAIM IS MADE TO THE EXCLUSIVE RIGHT TO USE "LUBE", APART FROM THE MARK AS SHOWN.

SER. NO. 77-353,739, FILED 12-17-2007.

JUDITH HELFMAN, EXAMINING ATTORNEY

Int. Cl.: 1

Prior U.S. Cls.: 1, 5, 6, 10, 26 and 46

Reg. No. 3,475,969

United States Patent and Trademark Office

Registered July 29, 2008

**TRADEMARK
PRINCIPAL REGISTER**

AIRREX ICE-OUT

MINING AUGER & TOOL WORKS, INC. (MIN-
NESOTA CORPORATION)
557 STINSON STREET
ST. PAUL, MN 55117

THE MARK CONSISTS OF STANDARD CHAR-
ACTERS WITHOUT CLAIM TO ANY PARTICULAR
FONT, STYLE, SIZE, OR COLOR.

FOR: DEICING AGENTS FOR AIR SUPPLY
LINES OF PNEUMATIC TOOLS, IN CLASS 1 (U.S.
CLS. 1, 5, 6, 10, 26 AND 46).

SER. NO. 77-353,787, FILED 12-17-2007.

FIRST USE 9-30-1988; IN COMMERCE 9-30-1988.

JUDITH HELFMAN, EXAMINING ATTORNEY

Int. Cl.: 3

Prior U.S. Cls.: 1, 4, 6, 50, 51 and 52

United States Patent and Trademark Office

Reg. No. 3,475,970

Registered July 29, 2008

**TRADEMARK
PRINCIPAL REGISTER**

SkinCandescence

FLAGEOLI, LTD. (NEVADA LTD LIAB CO)
7310 SMOKE RANCH RD. SUITE "1"
LAS VEGAS, NV 89128

THE MARK CONSISTS OF STANDARD CHAR-
ACTERS WITHOUT CLAIM TO ANY PARTICULAR
FONT, STYLE, SIZE, OR COLOR.

FOR: SKIN CARE PRODUCTS, NAMELY, NON-
MEDICATED SKIN SERUM, IN CLASS 3 (U.S. CLS.
1, 4, 6, 50, 51 AND 52).

SER. NO. 77-353,792, FILED 12-17-2007.

FIRST USE 11-15-2007; IN COMMERCE 11-15-2007.

MICHAEL TANNER, EXAMINING ATTORNEY

Int. Cls.: 35 and 37

Prior U.S. Cls.: 100, 101, 102, 103 and 106

United States Patent and Trademark Office

Reg. No. 3,475,971

Registered July 29, 2008

**SERVICE MARK
PRINCIPAL REGISTER**

YALE APPLIANCE + LIGHTING

YALE APPLIANCE AND LIGHTING, INC. (MAS-
SACHUSETTS CORPORATION)
296 FREEPORT STREET
BOSTON, MA 02122

FOR: RETAIL STORE SERVICES FEATURING
APPLIANCES, LIGHTING PRODUCTS, LIGHTING
ACCESSORIES, AND LIGHT BULBS; ONLINE RE-
TAIL STORE SERVICES FEATURING APPLIAN-
CES, LIGHTING PRODUCTS, LIGHTING
ACCESSORIES, LIGHT BULBS, CEILING AND
BATHROOM FANS, VACUUM CLEANERS, FAU-
CETS, SINKS, GARBAGE DISPOSALS, WATER FIL-
TRATION SYSTEMS, AND SOAP DISPENSERS, IN
CLASS 35 (U.S. CLS. 100, 101 AND 102).

FIRST USE 0-0-1923; IN COMMERCE 0-0-1923.

FOR: INSTALLATION, MAINTENANCE AND
REPAIR OF APPLIANCES, LIGHTING PRODUCTS,
LIGHTING ACCESSORIES, AND LIGHT BULBS, IN
CLASS 37 (U.S. CLS. 100, 103 AND 106).

FIRST USE 0-0-1923; IN COMMERCE 0-0-1923.

THE MARK CONSISTS OF STANDARD CHAR-
ACTERS WITHOUT CLAIM TO ANY PARTICULAR
FONT, STYLE, SIZE, OR COLOR.

NO CLAIM IS MADE TO THE EXCLUSIVE
RIGHT TO USE "APPLIANCE" AND "LIGHTING",
APART FROM THE MARK AS SHOWN.

SER. NO. 77-353,798, FILED 12-17-2007.

DEIRDRE ROBERTSON, EXAMINING ATTORNEY

Int. Cl.: 36

Prior U.S. Cls.: 100, 101 and 102

United States Patent and Trademark Office

Reg. No. 3,475,972

Registered July 29, 2008

**SERVICE MARK
PRINCIPAL REGISTER**

EXPEDITIONS

AMERICAN EXPRESS INCENTIVE SERVICES
(MISSOURI CORPORATION)
1309 NORTH HIGHWAY DRIVE
FENTON, MO 63099

THE MARK CONSISTS OF STANDARD CHAR-
ACTERS WITHOUT CLAIM TO ANY PARTICULAR
FONT, STYLE, SIZE, OR COLOR.

FOR: ISSUING STORED VALUE CARDS, IN
CLASS 36 (U.S. CLS. 100, 101 AND 102).

SER. NO. 77-353,803, FILED 12-17-2007.

FIRST USE 12-0-2006; IN COMMERCE 12-0-2006.

APRIL ROACH, EXAMINING ATTORNEY

Int. Cl.: 41

Prior U.S. Cls.: 100, 101 and 107

United States Patent and Trademark Office

Reg. No. 3,475,973

Registered July 29, 2008

**SERVICE MARK
PRINCIPAL REGISTER**

CKSOLUTIONS

CK SOLUTIONS, INC. (OKLAHOMA CORPORATION)
3326 FOX HILL TERRACE
EDMOND, OK 73034

THE MARK CONSISTS OF STANDARD CHARACTERS WITHOUT CLAIM TO ANY PARTICULAR FONT, STYLE, SIZE, OR COLOR.

FOR: EDUCATIONAL SERVICES, NAMELY, CLASSES AND TRAINING IN MEDICAL RADIO THERAPY, IN CLASS 41 (U.S. CLS. 100, 101 AND 107).

SER. NO. 77-353,822, FILED 12-17-2007.

FIRST USE 10-4-2007; IN COMMERCE 10-4-2007.

MICHAEL KEATING, EXAMINING ATTORNEY

Int. Cl.: 42

Prior U.S. Cls.: 100 and 101

United States Patent and Trademark Office

Reg. No. 3,475,974

Registered July 29, 2008

**SERVICE MARK
PRINCIPAL REGISTER**

RJE

RJE TELECOM, LLC (DELAWARE LTD LIAB
CO)
SUITE 100
7290 COLLEGE PARKWAY
FORT MYERS, FL 33907

THE MARK CONSISTS OF STANDARD CHAR-
ACTERS WITHOUT CLAIM TO ANY PARTICULAR
FONT, STYLE, SIZE, OR COLOR.

FOR: ENGINEERING SERVICES, NAMELY, EN-
GINEERING FOR THE TELECOMMUNICATIONS
INDUSTRY, IN CLASS 42 (U.S. CLS. 100 AND 101).

SER. NO. 77-353,834, FILED 12-17-2007.

FIRST USE 12-31-1982; IN COMMERCE 12-31-1982.

LANA PHAM, EXAMINING ATTORNEY

Int. Cls.: 16 and 41

Prior U.S. Cls.: 2, 5, 22, 23, 29, 37, 38, 50, 100, 101 and 107

United States Patent and Trademark Office

Reg. No. 3,475,975

Registered July 29, 2008

**TRADEMARK
SERVICE MARK
PRINCIPAL REGISTER**

Eliza

BELLESA, SUMMER (UNITED STATES INDIVIDUAL)
3033 BAGLEY AVENUE
LOS ANGELES, CA 90034

FOR: MAGAZINES FEATURING FASHION, STYLE, BEAUTY, REVIEWS, TRAVEL, AND FOOD, IN CLASS 16 (U.S. CLS. 2, 5, 22, 23, 29, 37, 38 AND 50).

FIRST USE 4-1-2007; IN COMMERCE 6-23-2007.

FOR: ON-LINE PUBLICATION OF MAGAZINES FEATURING FASHION, STYLE, BEAUTY, RE-

VIEWS, TRAVEL, AND FOOD, IN CLASS 41 (U.S. CLS. 100, 101 AND 107).

FIRST USE 4-1-2007; IN COMMERCE 4-1-2007.

THE MARK CONSISTS OF STANDARD CHARACTERS WITHOUT CLAIM TO ANY PARTICULAR FONT, STYLE, SIZE, OR COLOR.

SER. NO. 77-353,836, FILED 12-17-2007.

LANA PHAM, EXAMINING ATTORNEY

Int. Cl.: 35

Prior U.S. Cls.: 100, 101 and 102

United States Patent and Trademark Office

Reg. No. 3,475,976

Registered July 29, 2008

**SERVICE MARK
PRINCIPAL REGISTER**

Mafit Solutions

MAFIT SOLUTIONS, LLC (GEORGIA LTD LIAB
CO)
SUITE 322
2020 HOWELL MILL RD.
ATLANTA, GA 30318

FOR: CAREER PLACEMENT; EMPLOYMENT
HIRING, RECRUITING, PLACEMENT, STAFFING
AND CAREER NETWORKING SERVICES; EXECU-
TIVE SEARCH AND PLACEMENT SERVICES; JOB
AND PERSONNEL PLACEMENT; JOB PLACE-
MENT; PERSONNEL PLACEMENT AND RECRUIT-
MENT, IN CLASS 35 (U.S. CLS. 100, 101 AND 102).

FIRST USE 10-16-2007; IN COMMERCE 10-16-2007.

THE MARK CONSISTS OF STANDARD CHAR-
ACTERS WITHOUT CLAIM TO ANY PARTICULAR
FONT, STYLE, SIZE, OR COLOR.

NO CLAIM IS MADE TO THE EXCLUSIVE
RIGHT TO USE "SOLUTIONS", APART FROM
THE MARK AS SHOWN.

SER. NO. 77-353,842, FILED 12-17-2007.

BRENDAN MCCAULEY, EXAMINING ATTORNEY

Int. Cl.: 35

Prior U.S. Cls.: 100, 101 and 102

United States Patent and Trademark Office

Reg. No. 3,475,977

Registered July 29, 2008

**SERVICE MARK
PRINCIPAL REGISTER**

The All Cities Resource
Group is the place where
you learn How to
Network... Make Money...
and Gain New Friends

ALL CITIES RESOURCE GROUP (CALIFORNIA
CORPORATION)
929 HOWARD STREET
MARINA DEL REY, CA 90292

FOR: BUSINESS NETWORKING, NAMELY, OR-
GANIZING AND CONDUCTING MEETINGS OF
BUSINESS PROFESSIONALS, IN CLASS 35 (U.S.
CLS. 100, 101 AND 102).

FIRST USE 1-1-2007; IN COMMERCE 1-1-2007.

THE MARK CONSISTS OF STANDARD CHAR-
ACTERS WITHOUT CLAIM TO ANY PARTICULAR
FONT, STYLE, SIZE, OR COLOR.

OWNER OF U.S. REG. NO. 2,046,325.

SER. NO. 77-353,851, FILED 12-17-2007.

HEATHER THOMPSON, EXAMINING ATTORNEY

Int. Cl.: 44

Prior U.S. Cls.: 100 and 101

United States Patent and Trademark Office

Reg. No. 3,475,978

Registered July 29, 2008

SERVICE MARK
PRINCIPAL REGISTER

Pet Esthé

MERRY DO BEAUTY PRODUCTS CO. LTD.
(JAPAN CORPORATION)
NO.2-23-24, HYAKUNIN-CHO, SHINJUKU-KU
TOKYO, JAPAN

FOR: BEAUTY SALON FOR PETS, PET GROOM-
ING, IN CLASS 44 (U.S. CLS. 100 AND 101).

FIRST USE 7-4-1997; IN COMMERCE 1-6-2007.

OWNER OF U.S. REG. NO. 3,021,705.

NO CLAIM IS MADE TO THE EXCLUSIVE
RIGHT TO USE "PET", APART FROM THE MARK
AS SHOWN.

SER. NO. 77-353,852, FILED 12-17-2007.

HEATHER THOMPSON, EXAMINING ATTORNEY

Int. Cl.: 35

Prior U.S. Cls.: 100, 101 and 102

United States Patent and Trademark Office

Reg. No. 3,475,979

Registered July 29, 2008

**SERVICE MARK
PRINCIPAL REGISTER**



SEALTECH CORPORATION (LOUISIANA CORPORATION)

283-D CAHABA VALLEY PARKWAY NORTH

PELHAM, AL 35124

FOR: WHOLESALE DISTRIBUTORSHIPS FEATURING OUTBOARD MARINE PARTS, IN CLASS 35 (U.S. CLS. 100, 101 AND 102).

FIRST USE 11-9-2006; IN COMMERCE 11-9-2006.

THE COLOR(S) RED AND BLUE IS/ARE CLAIMED AS A FEATURE OF THE MARK.

THE MARK CONSISTS OF A RED BALL INSIDE A BLUE GEAR WITH A BLUE WAVY LINE ACROSS AND THE LETTERS "EMP" IN BLUE UNDERNEATH.

SER. NO. 77-353,856, FILED 12-17-2007.

HEATHER THOMPSON, EXAMINING ATTORNEY

Int. Cl.: 5

Prior U.S. Cls.: 6, 18, 44, 46, 51 and 52

Reg. No. 3,475,980

United States Patent and Trademark Office

Registered July 29, 2008

**TRADEMARK
PRINCIPAL REGISTER**

CONTRE VIR

SWISS PACIFIC GROUP, LTD. (UNITED KING-
DOM CORPORATION)
601 UNIVERSITY AVE. STE. 278
SACRAMENTO, CA 95825

THE MARK CONSISTS OF STANDARD CHAR-
ACTERS WITHOUT CLAIM TO ANY PARTICULAR
FONT, STYLE, SIZE, OR COLOR.

FOR: VACCINES, IN CLASS 5 (U.S. CLS. 6, 18, 44,
46, 51 AND 52).

SER. NO. 77-353,859, FILED 12-17-2007.

FIRST USE 7-3-1993; IN COMMERCE 3-8-1994.

MICHAEL TANNER, EXAMINING ATTORNEY

Int. Cl.: 41

Prior U.S. Cls.: 100, 101 and 107

United States Patent and Trademark Office

Reg. No. 3,475,981

Registered July 29, 2008

**SERVICE MARK
PRINCIPAL REGISTER**

FIXER

RIKER HILL RECORDS, LLC (DELAWARE LTD
LIAB CO)
SUITE 1600
90 PARK AVENUE
NEW YORK, NY 10016

FOR: ENTERTAINMENT SERVICES IN THE
NATURE OF LIVE MUSICAL PERFORMANCES
BY A PERFORMER OR GROUP, IN CLASS 41 (U.S.
CLS. 100, 101 AND 107).

FIRST USE 6-2-2002; IN COMMERCE 6-2-2002.

THE MARK CONSISTS OF STANDARD CHAR-
ACTERS WITHOUT CLAIM TO ANY PARTICULAR
FONT, STYLE, SIZE, OR COLOR.

SER. NO. 77-353,888, FILED 12-17-2007.

JENNY PARK, EXAMINING ATTORNEY

Int. Cl.: 35

Prior U.S. Cls.: 100, 101 and 102

United States Patent and Trademark Office

Reg. No. 3,475,982

Registered July 29, 2008

SERVICE MARK
PRINCIPAL REGISTER



LEADERSHIP SOLUTIONS, INC. (MINNESOTA CORPORATION)

4716 MINNETONKA BLVD
ST. LOUIS PARK, MN 55416

FOR: BUSINESS LEADERSHIP DEVELOPMENT; BUSINESS MANAGEMENT CONSULTATION IN THE FIELD OF EXECUTIVE AND LEADERSHIP DEVELOPMENT; PROMOTING PUBLIC INTEREST IN EDUCATION, RECOGNITION, CAREER ADVANCEMENT, AND LEADERSHIP FOR ELITE MANAGERS AND EXECUTIVES IN CORPORATIONS AND PROFESSIONAL SERVICE FIRMS, IN CLASS 35 (U.S. CLS. 100, 101 AND 102).

FIRST USE 1-1-2006; IN COMMERCE 1-1-2006.

NO CLAIM IS MADE TO THE EXCLUSIVE RIGHT TO USE "LEADERSHIP", APART FROM THE MARK AS SHOWN.

THE COLOR(S) BLUE, WHITE AND BLACK IS/ ARE CLAIMED AS A FEATURE OF THE MARK.

THE MARK CONSISTS OF THE LITERAL ELEMENTS "THE LEADERSHIP COMMONWEALTH" AND THE LETTERS "I", "U", "P" AND "E" IN STYLIZED LETTERING AND INTEGRATED DESIGN. THE LITERAL ELEMENTS APPEAR IN BLACK, WITH "THE LEADERSHIP" APPEARING ABOVE THE DESIGN AND "COMMONWEALTH" APPEARING BELOW. THE DESIGN IS A FANCIFUL REPRESENTATION OF A COMPASS, WITH THE LETTER "I" APPEARING AS THE TOP DIRECTIONAL POINT, "U" APPEARING AS THE RIGHT POINT, "P" APPEARING AS THE BOTTOM POINT, AND "E" APPEARING AS THE LEFT POINT. THE OUTER CIRCULAR RIM OF THE COMPASS APPEARS IN BLUE AND WHITE, WITH A BLUE OUTER CIRCLE AND A WHITE INNER CIRCLE, WITH TWO INTERSECTING BLUE LINES FORMING THE FACE OF THE COMPASS AND THE BLUE COMPASS DIAL HAND, WHICH POINTS SLIGHTLY TO THE RIGHT OF THE LETTER "I".

SER. NO. 77-353,893, FILED 12-17-2007.

JUDITH HELFMAN, EXAMINING ATTORNEY

Int. Cl.: 35

Prior U.S. Cls.: 100, 101 and 102

United States Patent and Trademark Office

Reg. No. 3,475,983

Registered July 29, 2008

**SERVICE MARK
PRINCIPAL REGISTER**

Daufuskie360

DAUFUSKIE 360 (NEVADA CORPORATION)
PO BOX 27740
LAS VEGAS, NV 89126

FIRST USE 8-14-2007; IN COMMERCE 8-14-2007.

FOR: PROVIDING INFORMATION VIA THE INTERNET ABOUT AND MAKING REFERRALS IN THE FIELD OF CONSUMER PRODUCTS AND SERVICES FOR RETAIL SERVICES CONCERNING PRODUCTS, SERVICES, EVENTS, ACTIVITIES, ATTRACTIONS AND FACILITIES IN PARTICULAR GEOGRAPHIC LOCATIONS, IN CLASS 35 (U.S. CLS. 100, 101 AND 102).

THE MARK CONSISTS OF STANDARD CHARACTERS WITHOUT CLAIM TO ANY PARTICULAR FONT, STYLE, SIZE, OR COLOR.

SER. NO. 77-353,896, FILED 12-17-2007.

ELISSA GARBER KON, EXAMINING ATTORNEY

Int. Cl.: 30

Prior U.S. Cl.: 46

United States Patent and Trademark Office

Reg. No. 3,475,984

Registered July 29, 2008

**TRADEMARK
PRINCIPAL REGISTER**

Magic Dust

MILLS, JAMES MICHAEL (UNITED STATES IN-
DIVIDUAL)
PO BOX 382
MURPHYSBORO, IL 62966 AND
TUNNICLIFFE, AMY MILLS (UNITED STATES
INDIVIDUAL)
PO BOX 382
MURPHYSBORO, IL 62966

FOR: BARBECUE DRY RUB, IN CLASS 30 (U.S.
CL. 46).

FIRST USE 1-5-1989; IN COMMERCE 3-26-1989.

THE MARK CONSISTS OF STANDARD CHAR-
ACTERS WITHOUT CLAIM TO ANY PARTICULAR
FONT, STYLE, SIZE, OR COLOR.

SER. NO. 77-353,898, FILED 12-17-2007.

ROBERT LAVACHE, EXAMINING ATTORNEY

Int. Cl.: 25

Prior U.S. Cls.: 22 and 39

United States Patent and Trademark Office

Reg. No. 3,475,985

Registered July 29, 2008

**TRADEMARK
PRINCIPAL REGISTER**

compai

COMPAI DESIGN STUDIO INC. (NEW YORK
CORPORATION), DBA COMPAI
312 GRAND STREET
BROOKLYN, NY 11211

THE MARK CONSISTS OF STANDARD CHAR-
ACTERS WITHOUT CLAIM TO ANY PARTICULAR
FONT, STYLE, SIZE, OR COLOR.

FOR: BOTTOMS; TOPS; DRESSES, IN CLASS 25
(U.S. CLS. 22 AND 39).

SER. NO. 77-353,911, FILED 12-17-2007.

FIRST USE 7-1-2002; IN COMMERCE 7-1-2002.

STEVEN R. FINE, EXAMINING ATTORNEY

Int. Cl.: 35

Prior U.S. Cls.: 100, 101 and 102

United States Patent and Trademark Office

Reg. No. 3,475,986

Registered July 29, 2008

**SERVICE MARK
PRINCIPAL REGISTER**

Management House

SHERMAN, VERNON CLAYTON (ILLINOIS CORPORATION), DBA MANAGEMENT HOUSE, DIVISION OF BETA GROUP, LTD
PO BOX 2708, 36422 SIDEWINDER RD
CAREFREE, AZ 853777028

FOR: BUSINESS ORGANIZATION AND MANAGEMENT CONSULTING, IN CLASS 35 (U.S. CLS. 100, 101 AND 102).

FIRST USE 1-1-1979; IN COMMERCE 1-1-1979.

THE MARK CONSISTS OF STANDARD CHARACTERS WITHOUT CLAIM TO ANY PARTICULAR FONT, STYLE, SIZE, OR COLOR.

NO CLAIM IS MADE TO THE EXCLUSIVE RIGHT TO USE "MANAGEMENT", APART FROM THE MARK AS SHOWN.

SER. NO. 77-353,919, FILED 12-17-2007.

PAULA MAHONEY, EXAMINING ATTORNEY

Int. Cl.: 35

Prior U.S. Cls.: 100, 101 and 102

United States Patent and Trademark Office

Reg. No. 3,475,987

Registered July 29, 2008

**SERVICE MARK
PRINCIPAL REGISTER**

GoMobile Advertising

GOMOBILE ADVERTISING, LLC (WASHINGTON LTD LIAB CO)
6805 S. 220TH STREET
KENT, WA 98032

FOR: ADVERTISING, MARKETING AND PUBLIC RELATIONS SERVICES, NAMELY, PROVIDING ADVERTISING SPACE ON MOBILE VEHICLES INCLUDING TRUCKS, SEGWAYS AND SCOOTERS, IN CLASS 35 (U.S. CLS. 100, 101 AND 102).

FIRST USE 8-26-2005; IN COMMERCE 8-26-2005.

THE MARK CONSISTS OF STANDARD CHARACTERS WITHOUT CLAIM TO ANY PARTICULAR FONT, STYLE, SIZE, OR COLOR.

NO CLAIM IS MADE TO THE EXCLUSIVE RIGHT TO USE "ADVERTISING", APART FROM THE MARK AS SHOWN.

SER. NO. 77-353,959, FILED 12-17-2007.

LINDA M. KING, EXAMINING ATTORNEY

Int. Cl.: 35

Prior U.S. Cls.: 100, 101 and 102

United States Patent and Trademark Office

Reg. No. 3,475,988

Registered July 29, 2008

**SERVICE MARK
PRINCIPAL REGISTER**

GoMobile

GOMOBILE ADVERTISING, LLC (WASHINGTON LTD LIAB CO)
6805 S. 220TH STREET
KENT, WA 98032

FOR: ADVERTISING, MARKETING AND PUBLIC RELATIONS SERVICES, NAMELY, PROVIDING ADVERTISING SPACE ON MOBILE VEHICLES INCLUDING TRUCKS, SEGWAYS AND SCOOTERS, IN CLASS 35 (U.S. CLS. 100, 101 AND 102).

FIRST USE 8-26-2005; IN COMMERCE 8-26-2005.

THE MARK CONSISTS OF STANDARD CHARACTERS WITHOUT CLAIM TO ANY PARTICULAR FONT, STYLE, SIZE, OR COLOR.

SER. NO. 77-353,984, FILED 12-17-2007.

LINDA M. KING, EXAMINING ATTORNEY

Int. Cl.: 41

Prior U.S. Cls.: 100, 101 and 107

United States Patent and Trademark Office

Reg. No. 3,475,989

Registered July 29, 2008

**SERVICE MARK
PRINCIPAL REGISTER**

PUBLISHINGGOLD.COM

CAREER ADVANCEMENT CENTER, INC. (NEW
YORK CORPORATION)
PO BOX 758
ARMONK, NY 105040758

THE MARK CONSISTS OF STANDARD CHAR-
ACTERS WITHOUT CLAIM TO ANY PARTICULAR
FONT, STYLE, SIZE, OR COLOR.

FOR: PROVIDING A WEBSITE FEATURING IN-
FORMATION ON PUBLISHING AND COPY WRIT-
ING, IN CLASS 41 (U.S. CLS. 100, 101 AND 107).

SER. NO. 77-354,026, FILED 12-17-2007.

FIRST USE 7-31-2002; IN COMMERCE 7-31-2002.

JAMES A. RAUEN, EXAMINING ATTORNEY

Int. Cl.: 41

Prior U.S. Cls.: 100, 101 and 107

United States Patent and Trademark Office

Reg. No. 3,475,990

Registered July 29, 2008

**SERVICE MARK
PRINCIPAL REGISTER**

THE REVENUE MINER

CAREER ADVANCEMENT CENTER, INC. (NEW
YORK CORPORATION)
PO BOX 758
ARMONK, NY 105040758

FOR: ON-LINE JOURNALS, NAMELY, BLOGS
FEATURING INFORMATION ON BUSINESS
GROWTH AND EXPANSION; EDUCATIONAL SER-
VICES, NAMELY, PROVIDING CLASSES, SEMI-
NARS, CONFERENCES AND WORKSHOPS IN
THE FIELD OF BUSINESS GROWTH AND EXPAN-
SION AND DISTRIBUTION OF COURSE MATERI-
ALS IN CONNECTION THEREWITH, IN CLASS 41
(U.S. CLS. 100, 101 AND 107).

FIRST USE 10-7-2007; IN COMMERCE 10-7-2007.

THE MARK CONSISTS OF STANDARD CHAR-
ACTERS WITHOUT CLAIM TO ANY PARTICULAR
FONT, STYLE, SIZE, OR COLOR.

NO CLAIM IS MADE TO THE EXCLUSIVE
RIGHT TO USE "REVENUE", APART FROM THE
MARK AS SHOWN.

SER. NO. 77-354,037, FILED 12-17-2007.

JAMES A. RAUEN, EXAMINING ATTORNEY

Int. Cl.: 9

Prior U.S. Cls.: 21, 23, 26, 36 and 38

Reg. No. 3,475,991

United States Patent and Trademark Office

Registered July 29, 2008

**TRADEMARK
PRINCIPAL REGISTER**

FOLDERSEAL

SURETY, LLC (DELAWARE LTD LIAB CO)
12020 SUNRISE VALLEY DRIVE, SUITE 250
RESTON, VA 20191

THE MARK CONSISTS OF STANDARD CHAR-
ACTERS WITHOUT CLAIM TO ANY PARTICULAR
FONT, STYLE, SIZE, OR COLOR.

FOR: COMPUTER SOFTWARE USED TO PRO-
TECT AND AUTHENTICATE ELECTRONIC DATA
AND RECORDS, IN CLASS 9 (U.S. CLS. 21, 23, 26, 36
AND 38).

SER. NO. 77-354,042, FILED 12-17-2007.

FIRST USE 12-11-2007; IN COMMERCE 12-11-2007.

MICHAEL WIENER, EXAMINING ATTORNEY

Int. Cl.: 41

Prior U.S. Cls.: 100, 101 and 107

United States Patent and Trademark Office

Reg. No. 3,475,992

Registered July 29, 2008

**SERVICE MARK
PRINCIPAL REGISTER**

**Add Volumes to a Child's
Future**

TURN THE PAGE INC. (ILLINOIS CORPORATION)
442 SIGNAL HILL RD.
NORTH BARRINGTON, IL 60010

FOR: LITERACY PROGRAM THAT PROVIDES BOTH NEW AND SLIGHTLY USED BOOKS TO UNDERFUNDED PUBLIC AND SCHOOL LIBRARIES, NEW AND USED BOOKS ARE ACCEPTED TO DISTRIBUTE AS WELL AS CASH DONATIONS TO PURCHASE BOOKS, IN CLASS 41 (U.S. CLS. 100, 101 AND 107).

FIRST USE 10-15-2007; IN COMMERCE 10-15-2007.

THE MARK CONSISTS OF STANDARD CHARACTERS WITHOUT CLAIM TO ANY PARTICULAR FONT, STYLE, SIZE, OR COLOR.

SER. NO. 77-354,044, FILED 12-17-2007.

DORITT L. CARROLL, EXAMINING ATTORNEY

Int. Cl.: 36

Prior U.S. Cls.: 100, 101 and 102

United States Patent and Trademark Office

Reg. No. 3,475,993

Registered July 29, 2008

**SERVICE MARK
PRINCIPAL REGISTER**

WRAP-UP RESOURCES, LLC

WRAP-UP RESOURCES, LLC (CALIFORNIA LTD
LIAB CO)
SUITE 1110
555 MONTGOMERY STREET
SAN FRANCISCO, CA 94111

FOR: INSURANCE ADMINISTRATION, IN
CLASS 36 (U.S. CLS. 100, 101 AND 102).

FIRST USE 9-15-2004; IN COMMERCE 9-15-2004.

THE MARK CONSISTS OF STANDARD CHAR-
ACTERS WITHOUT CLAIM TO ANY PARTICULAR
FONT, STYLE, SIZE, OR COLOR.

NO CLAIM IS MADE TO THE EXCLUSIVE
RIGHT TO USE "RESOURCES, LLC", APART FROM
THE MARK AS SHOWN.

SER. NO. 77-354,068, FILED 12-17-2007.

JENNY PARK, EXAMINING ATTORNEY

Int. Cl.: 35

Prior U.S. Cls.: 100, 101 and 102

United States Patent and Trademark Office

Reg. No. 3,475,994

Registered July 29, 2008

**SERVICE MARK
PRINCIPAL REGISTER**

**Winning With Process
Thinking**

LOWERY-JACKSON, ALFREDDA R. (UNITED STATES INDIVIDUAL)
4595 REGENCY TRACE, SW
ATLANTA, GA 30331

FOR: BUSINESS ADMINISTRATION CONSULTANCY; BUSINESS CONSULTATION; BUSINESS CONSULTATION AND MANAGEMENT REGARDING MARKETING ACTIVITIES AND LAUNCHING OF NEW PRODUCTS; BUSINESS CONSULTATION SERVICES; BUSINESS CONSULTATION SERVICES TO ASSIST NON-PROFIT ORGANIZATIONS IN PLANNING, MANAGING, AND CONDUCTING FUND RAISING ACTIVITIES VIA A GLOBAL COMPUTER NETWORK; MANAGEMENT AND BUSINESS CONSULTING SERVICES IN THE FIELD OF TRAINING AND RECRUITMENT; MANAGEMENT AND BUSINESS CONSULTING SERVICES IN THE

FIELD OF PROCESS MANAGEMENT; NEW BUSINESS VENTURE DEVELOPMENT AND FORMATION CONSULTING SERVICES; PERSONNEL CONSULTANCY; PROFESSIONAL BUSINESS CONSULTATION; PROFESSIONAL BUSINESS CONSULTING, IN CLASS 35 (U.S. CLS. 100, 101 AND 102).

FIRST USE 10-29-2007; IN COMMERCE 10-29-2007.

THE MARK CONSISTS OF STANDARD CHARACTERS WITHOUT CLAIM TO ANY PARTICULAR FONT, STYLE, SIZE, OR COLOR.

SER. NO. 77-354,099, FILED 12-17-2007.

HOWARD SMIGA, EXAMINING ATTORNEY

Prior U.S. Cl.: B

United States Patent and Trademark Office

Reg. No. 3,475,995

Registered July 29, 2008

**CERTIFICATION MARK
PRINCIPAL REGISTER**

COLLABORATIVE MEDIATOR

PHOENIX STRATEGIES, INC. (COLORADO CORPORATION)

6855 OAK VALLEY LANE

COLORADO SPRINGS, CO 80919

FOR: LEGAL SERVICES, NAMELY, MEDIATION, IN CLASS B (U.S. CL. B).

FIRST USE 8-16-2007; IN COMMERCE 8-16-2007.

THE MARK CONSISTS OF STANDARD CHARACTERS WITHOUT CLAIM TO ANY PARTICULAR FONT, STYLE, SIZE, OR COLOR.

NO CLAIM IS MADE TO THE EXCLUSIVE RIGHT TO USE "MEDIATOR", APART FROM THE MARK AS SHOWN.

THE CERTIFICATION MARK, AS USED BY AUTHORIZED PERSONS, CERTIFIES THAT THE SERVICES PROVIDED HAVE BEEN PERFORMED BY A PERSON MEETING THE STANDARDS AND TESTS OF COMPETENCY, SKILL, EXPERIENCE, AND KNOWLEDGE SET BY THE CERTIFIER IN THE FIELD OF LEGAL MEDIATION.

SER. NO. 77-354,103, FILED 12-17-2007.

CAROLYN GRAY, EXAMINING ATTORNEY

Int. Cl.: 25

Prior U.S. Cls.: 22 and 39

United States Patent and Trademark Office

Reg. No. 3,475,996

Registered July 29, 2008

**TRADEMARK
PRINCIPAL REGISTER**

BAD PEOPLE

SCHACHLE, MATTHEW H. (UNITED STATES
INDIVIDUAL)
300 SKYLOOP DR
AUSTIN, TX 78745 AND
GUZMAN, SEAN M. (UNITED STATES INDIVI-
DUAL)
300 SKYLOOP DR
AUSTIN, TX 78745

FIRST USE 10-6-2007; IN COMMERCE 10-6-2007.

THE MARK CONSISTS OF STANDARD CHAR-
ACTERS WITHOUT CLAIM TO ANY PARTICULAR
FONT, STYLE, SIZE, OR COLOR.

SER. NO. 77-354,245, FILED 12-17-2007.

FOR: SHIRTS; TOPS, IN CLASS 25 (U.S. CLS. 22
AND 39).

SKYE YOUNG, EXAMINING ATTORNEY

Int. Cl.: 31

Prior U.S. Cls.: 1 and 46

United States Patent and Trademark Office

Reg. No. 3,475,997

Registered July 29, 2008

**TRADEMARK
PRINCIPAL REGISTER**

MYCOGROW

STAMETS, PAUL (UNITED STATES INDIVIDUAL)
P.O. BOX 7634
OLYMPIA, WA 98507

THE MARK CONSISTS OF STANDARD CHARACTERS WITHOUT CLAIM TO ANY PARTICULAR FONT, STYLE, SIZE, OR COLOR.

FOR: SPORES OF BENEFICIAL FUNGI, IN CLASS 31 (U.S. CLS. 1 AND 46).

SER. NO. 77-354,256, FILED 12-18-2007.

FIRST USE 11-30-2001; IN COMMERCE 11-30-2001.

CAROLYN GRAY, EXAMINING ATTORNEY

Int. Cls.: 39 and 41

Prior U.S. Cls.: 100, 101, 105 and 107

United States Patent and Trademark Office

Reg. No. 3,475,998

Registered July 29, 2008

**SERVICE MARK
PRINCIPAL REGISTER**

FISHIN' WITH A MISSION

NOLTE, BENJAMIN JEFFREY (UNITED STATES
INDIVIDUAL)
415 NORTH 800 EAST
LINDON, UT 84042

FOR: TOUR GUIDE SERVICES, IN CLASS 39 (U.S.
CLS. 100 AND 105).

FIRST USE 10-26-2007; IN COMMERCE 12-17-2007.

FOR: FISHING GUIDE SERVICES , IN CLASS 41
(U.S. CLS. 100, 101 AND 107).

FIRST USE 10-26-2007; IN COMMERCE 12-17-2007.

THE MARK CONSISTS OF STANDARD CHAR-
ACTERS WITHOUT CLAIM TO ANY PARTICULAR
FONT, STYLE, SIZE, OR COLOR.

SER. NO. 77-354,265, FILED 12-18-2007.

LAURA HAMMEL, EXAMINING ATTORNEY

Int. Cl.: 30

Prior U.S. Cl.: 46

United States Patent and Trademark Office

Reg. No. 3,475,999

Registered July 29, 2008

**TRADEMARK
PRINCIPAL REGISTER**

Vivaccino

CHOCOGLATIER, LLC (DELAWARE LTD LIAB
CO)
8408 BIG TIMBER
AUSTIN, TX 78735

FOR: COFFEE AND ESPRESSO BEVERAGES,
COFFEE AND ESPRESSO BASED BEVERAGES,
MILKSHAKES, ICE CREAM, GELATO, SHERBERT,
SORBET, FLAVORED ICES AND FROZEN CON-
FECTIONS, CHOCOLATE, COCOA , IN CLASS 30
(U.S. CL. 46).

FIRST USE 2-1-2007; IN COMMERCE 12-1-2007.

THE MARK CONSISTS OF STANDARD CHAR-
ACTERS WITHOUT CLAIM TO ANY PARTICULAR
FONT, STYLE, SIZE, OR COLOR.

SER. NO. 77-354,269, FILED 12-18-2007.

STEPHEN AQUILA, EXAMINING ATTORNEY

Int. Cl.: 43

Prior U.S. Cls.: 100 and 101

United States Patent and Trademark Office

Reg. No. 3,476,000

Registered July 29, 2008

**SERVICE MARK
PRINCIPAL REGISTER**

ChocoParties

CHOCOGELATIER, LLC (DELAWARE LTD LIAB
CO)
8408 BIG TIMBER DR
AUSTIN, TX 78735

THE MARK CONSISTS OF STANDARD CHAR-
ACTERS WITHOUT CLAIM TO ANY PARTICULAR
FONT, STYLE, SIZE, OR COLOR.

FOR: SERVICES FOR PROVIDING FOOD AND
DRINK, NAMELY, RESTAURANT SERVICES, SER-
VING FOOD AND DRINKS; CATERING SERVICES,
IN CLASS 43 (U.S. CLS. 100 AND 101).

SER. NO. 77-354,270, FILED 12-18-2007.

FIRST USE 2-1-2007; IN COMMERCE 12-1-2007.

STEPHEN AQUILA, EXAMINING ATTORNEY

Int. Cl.: 28

Prior U.S. Cls.: 22, 23, 38 and 50

United States Patent and Trademark Office

Reg. No. 3,476,001

Registered July 29, 2008

**TRADEMARK
PRINCIPAL REGISTER**

SHADWING

WINGMAN LURES, LLC (GEORGIA LTD LIAB
CO)
P.O. BOX 492
ALPHARETTA, GA 300090492

THE MARK CONSISTS OF STANDARD CHAR-
ACTERS WITHOUT CLAIM TO ANY PARTICULAR
FONT, STYLE, SIZE, OR COLOR.

FOR: ARTIFICIAL FISHING LURES, IN CLASS 28
(U.S. CLS. 22, 23, 38 AND 50).

SER. NO. 77-354,373, FILED 12-18-2007.

FIRST USE 11-20-2007; IN COMMERCE 11-20-2007.

DAVID COLLIER, EXAMINING ATTORNEY

Int. Cl.: 4

Prior U.S. Cls.: 1, 6 and 15

United States Patent and Trademark Office

Reg. No. 3,476,002

Registered July 29, 2008

**TRADEMARK
PRINCIPAL REGISTER**

WOOD CHUCK

HICKS OIL & HICKSGAS, INC. (INDIANA COR-
PORATION)
P.O. BOX 94
204 N. ROUTE 54
ROBERTS, IL 60962

THE MARK CONSISTS OF STANDARD CHAR-
ACTERS WITHOUT CLAIM TO ANY PARTICULAR
FONT, STYLE, SIZE, OR COLOR.

FOR: CHAINSAW BAR AND CHAIN OIL, IN
CLASS 4 (U.S. CLS. 1, 6 AND 15).

SER. NO. 77-354,374, FILED 12-18-2007.

FIRST USE 0-0-1988; IN COMMERCE 0-0-1988.

HEATHER THOMPSON, EXAMINING ATTORNEY

Int. Cl.: 41

Prior U.S. Cls.: 100, 101 and 107

United States Patent and Trademark Office

Reg. No. 3,476,003

Registered July 29, 2008

**SERVICE MARK
PRINCIPAL REGISTER**

EHSASSIST

THE BUREAU OF NATIONAL AFFAIRS, INC.
(DELAWARE CORPORATION)
ROOM 11211
1801 S. BELL STREET
ARLINGTON, VA 22202

FOR: PROVIDING ONLINE PUBLICATIONS IN
THE NATURE OF REPORTS, NEWSLETTERS, AND
GUIDES FEATURING LEGAL ANALYSIS, NEWS,
INFORMATION, AND DEVELOPMENTS, JUDI-
CIAL OPINIONS, REGULATORY, AGENCY, AND
LEGISLATIVE MATERIALS, AND FORMS IN THE
FIELD OF ENVIRONMENT, HEALTH, AND SAFE-

TY LEGISLATION, REGULATION, AND POLICY,
IN CLASS 41 (U.S. CLS. 100, 101 AND 107).

FIRST USE 9-0-2003; IN COMMERCE 9-0-2003.

THE MARK CONSISTS OF STANDARD CHAR-
ACTERS WITHOUT CLAIM TO ANY PARTICULAR
FONT, STYLE, SIZE, OR COLOR.

SER. NO. 77-354,375, FILED 12-18-2007.

DORITT L. CARROLL, EXAMINING ATTORNEY

Int. Cl.: 19

Prior U.S. Cls.: 1, 12, 33 and 50

United States Patent and Trademark Office

Reg. No. 3,476,004

Registered July 29, 2008

**TRADEMARK
PRINCIPAL REGISTER**



LUMBER LIQUIDATORS, INC. (MASSACHU-
SETTS CORPORATION)
3000 JOHN DEERE ROAD
TOANO, VA 23168

THE MARK CONSISTS OF THE WORDS "BUIL-
DER'S PRIDE BY DURA-WOOD" WITH RIBBON-
STYLE LINES.

FOR: WOODEN FLOORING, IN CLASS 19 (U.S.
CLS. 1, 12, 33 AND 50).

SER. NO. 77-354,384, FILED 12-18-2007.

FIRST USE 1-1-2006; IN COMMERCE 1-1-2006.

OWNER OF U.S. REG. NO. 3,297,153.

DAVID COLLIER, EXAMINING ATTORNEY

Int. Cls.: 37 and 39

Prior U.S. Cls.: 100, 103, 105 and 106

United States Patent and Trademark Office

Reg. No. 3,476,005

Registered July 29, 2008

**SERVICE MARK
PRINCIPAL REGISTER**

NATIONAL TRUCKPORTS

ROYALTON REAL ESTATE CAPITAL, LLC (DE-
LAWARE LTD LIAB CO)
SUITE 750
5949 SHERRY LANE
DALLAS, TX 75225

FOR: TRUCK STOP SERVICES, NAMELY, VEHI-
CLE MAINTENANCE AND REPAIR SERVICES;
TRUCK WASHING SERVICES, IN CLASS 37 (U.S.
CLS. 100, 103 AND 106).

FIRST USE 8-23-2007; IN COMMERCE 8-23-2007.

FOR: TRAILER STORAGE SERVICES, IN CLASS
39 (U.S. CLS. 100 AND 105).

FIRST USE 8-23-2007; IN COMMERCE 8-23-2007.

THE MARK CONSISTS OF STANDARD CHAR-
ACTERS WITHOUT CLAIM TO ANY PARTICULAR
FONT, STYLE, SIZE, OR COLOR.

NO CLAIM IS MADE TO THE EXCLUSIVE
RIGHT TO USE "NATIONAL", APART FROM THE
MARK AS SHOWN.

SER. NO. 77-354,390, FILED 12-18-2007.

LINDA M. KING, EXAMINING ATTORNEY

Int. Cls.: 9 and 35

Prior U.S. Cls.: 21, 23, 26, 36, 38, 100, 101 and 102

United States Patent and Trademark Office

Reg. No. 3,476,006

Registered July 29, 2008

**TRADEMARK
SERVICE MARK
PRINCIPAL REGISTER**

BUSINESS REARVIEW MIRROR

CDW CORPORATION (ILLINOIS CORPORATION)

200 NORTH MILWAUKEE AVENUE

VERNON HILLS, IL 60061

FOR: PROVIDING DOWNLOADABLE REPORTS, NAMELY, DOWNLOADABLE AND PRINTABLE REPORTS CONTAINING SURVEY RESULTS AND ANALYSIS RELATING TO THE GROWTH AND SUCCESS OF SMALL BUSINESSES AND THE USE OF COMPUTER HARDWARE, SOFTWARE, SERVICES AND SOLUTIONS AND INFORMATION TECHNOLOGY BY BUSINESSES, IN CLASS 9 (U.S. CLS. 21, 23, 26, 36 AND 38).

FIRST USE 8-20-2007; IN COMMERCE 8-20-2007.

FOR: CONDUCTING MARKET RESEARCH SURVEYS AND PROVIDING ANALYSIS RELATING TO THE GROWTH AND SUCCESS OF SMALL BUSINESSES AND THE USE OF COMPUTER HARDWARE, SOFTWARE, SERVICES AND SOLUTIONS AND INFORMATION TECHNOLOGY BY BUSINESSES, IN CLASS 35 (U.S. CLS. 100, 101 AND 102).

FIRST USE 8-20-2007; IN COMMERCE 8-20-2007.

THE MARK CONSISTS OF STANDARD CHARACTERS WITHOUT CLAIM TO ANY PARTICULAR FONT, STYLE, SIZE, OR COLOR.

SER. NO. 77-354,440, FILED 12-18-2007.

PATRICIA EVANKO, EXAMINING ATTORNEY

Int. Cl.: 18

Prior U.S. Cls.: 1, 2, 3, 22 and 41

United States Patent and Trademark Office

Reg. No. 3,476,007

Registered July 29, 2008

**TRADEMARK
PRINCIPAL REGISTER**

CACHE IT & STASH IT

DAVE MASSIE, INC. (NORTH CAROLINA CORPORATION)
157 SCARLET DRIVE
FLETCHER, NC 28732

THE MARK CONSISTS OF STANDARD CHARACTERS WITHOUT CLAIM TO ANY PARTICULAR FONT, STYLE, SIZE, OR COLOR.

FOR: POUCHES USED AS ALL-PURPOSE CARRYING BAGS AND ALL PURPOSE SPORT AND TRAVEL BAGS, IN CLASS 18 (U.S. CLS. 1, 2, 3, 22 AND 41).

SER. NO. 77-354,451, FILED 12-18-2007.

FIRST USE 8-22-2007; IN COMMERCE 8-22-2007.

VERNA BETH RIRIE, EXAMINING ATTORNEY

Int. Cl.: 7

Prior U.S. Cls.: 13, 19, 21, 23, 31, 34 and 35

United States Patent and Trademark Office

Reg. No. 3,476,008

Registered July 29, 2008

TRADEMARK
PRINCIPAL REGISTER

The image shows the word "Aaladin" written in a highly stylized, cursive script. The letters are interconnected and have a slight shadow effect, giving it a three-dimensional appearance. The 'A' is particularly large and prominent.

AALADIN INDUSTRIES, INC. (SOUTH DAKOTA CORPORATION)
32584 477TH AVENUE
ELK POINT, SD 57025

FOR: PRESSURE WASHING MACHINES, PRESSURE WASHERS, AND WASHING MACHINES FOR MACHINE PARTS, IN CLASS 7 (U.S. CLS. 13, 19, 21, 23, 31, 34 AND 35).

FIRST USE 0-0-1993; IN COMMERCE 0-0-1993.

OWNER OF U.S. REG. NO. 2,507,063.

THE MARK CONSISTS OF THE STYLIZED REPRESENTATION OF THE WORD "AALADIN".

THE WORDING "AALADIN" HAS NO MEANING IN A FOREIGN LANGUAGE.

SER. NO. 77-354,455, FILED 12-18-2007.

ANDREW RHIM, EXAMINING ATTORNEY

Int. Cl.: 28

Prior U.S. Cls.: 22, 23, 38 and 50

United States Patent and Trademark Office

Reg. No. 3,476,009

Registered July 29, 2008

**TRADEMARK
PRINCIPAL REGISTER**

FORCE TRAINING KIT

FITNESS ANYWHERE, INC. (CALIFORNIA CORPORATION)
1660 PACIFIC AVENUE
SAN FRANCISCO, CA 94109

FOR: MANUALLY OPERATED EXERCISE EQUIPMENT, AND INSTRUCTIONAL MATERIAL SOLD TOGETHER THEREWITH AS A UNIT, IN CLASS 28 (U.S. CLS. 22, 23, 38 AND 50).

FIRST USE 10-10-2005; IN COMMERCE 10-10-2005.

THE MARK CONSISTS OF STANDARD CHARACTERS WITHOUT CLAIM TO ANY PARTICULAR FONT, STYLE, SIZE, OR COLOR.

NO CLAIM IS MADE TO THE EXCLUSIVE RIGHT TO USE "TRAINING KIT", APART FROM THE MARK AS SHOWN.

SER. NO. 77-354,458, FILED 12-18-2007.

PATRICIA EVANKO, EXAMINING ATTORNEY

Int. Cl.: 35

Prior U.S. Cls.: 100, 101 and 102

United States Patent and Trademark Office

Reg. No. 3,476,010

Registered July 29, 2008

**SERVICE MARK
PRINCIPAL REGISTER**

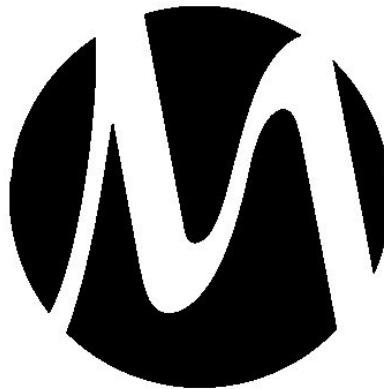

MENDOCINO COUNTY LODGING ASSOCIATION (CALIFORNIA NON PROFIT ASSOCIATION)
PO BOX 550
LITTLE RIVER, CA 95456

THE MARK CONSISTS OF A CIRCLE WITH THE LETTER "M" IN THE FORM OF A WAVEY MOUNTAIN IMPOSED ON IT. THE "M" REFERS TO THE COUNTY OF MENDOCINO, CA.

FOR: PROMOTING TOURISM IN MENDOCINO COUNTY, IN CLASS 35 (U.S. CLS. 100, 101 AND 102).

SER. NO. 77-354,460, FILED 12-18-2007.

FIRST USE 10-1-2006; IN COMMERCE 10-1-2006.

ANNE E. GUSTASON, EXAMINING ATTORNEY

Int. Cl.: 18

Prior U.S. Cls.: 1, 2, 3, 22 and 41

United States Patent and Trademark Office

Reg. No. 3,476,011

Registered July 29, 2008

**TRADEMARK
PRINCIPAL REGISTER**

BRIANNA

LUNDEEN, BRIANNA (UNITED STATES INDIVIDUAL)
400 MILLS AVENUE, SUITE 212
GREENVILLE, SC 29605

THE MARK CONSISTS OF STANDARD CHARACTERS WITHOUT CLAIM TO ANY PARTICULAR FONT, STYLE, SIZE, OR COLOR.

FOR: HANDBAGS, IN CLASS 18 (U.S. CLS. 1, 2, 3, 22 AND 41).

SER. NO. 77-354,465, FILED 12-18-2007.

FIRST USE 4-0-2007; IN COMMERCE 7-14-2007.

LESLEY LAMOTHE, EXAMINING ATTORNEY

Int. Cl.: 35

Prior U.S. Cls.: 100, 101 and 102

United States Patent and Trademark Office

Reg. No. 3,476,012

Registered July 29, 2008

**SERVICE MARK
PRINCIPAL REGISTER**



O'REILLY AUTOMOTIVE, INC. (MISSOURI CORPORATION)
233 SOUTH PATTERSON
SPRINGFIELD, MO 65802

FOR: RETAIL STORE SERVICES AND WHOLESALE DISTRIBUTORSHIP SERVICES IN THE FIELD OF AUTOMOTIVE PAINT, SUPPLIES, AND EQUIPMENT FOR AUTOBODY REPAIR AND REFINISHING, IN CLASS 35 (U.S. CLS. 100, 101 AND 102).

FIRST USE 3-0-2001; IN COMMERCE 3-0-2001.

OWNER OF U.S. REG. NOS. 1,699,577 AND 1,896,667.

NO CLAIM IS MADE TO THE EXCLUSIVE RIGHT TO USE "AUTO COLOR" AND "PROFESSIONAL PAINT", APART FROM THE MARK AS SHOWN.

THE MARK CONSISTS OF THE WORD "O'REILLY" IN STYLIZED FONT, WITH A SHAMROCK INSIDE THE "O", AND THE WORDS "AUTO COLOR" OVER A RECTANGULAR BOX IN WHICH THE WORDS "PROFESSIONAL PAINT PEOPLE" ARE DISPLAYED.

SER. NO. 77-354,493, FILED 12-18-2007.

MORGAN WYNNE, EXAMINING ATTORNEY

Int. Cl.: 41

Prior U.S. Cls.: 100, 101 and 107

United States Patent and Trademark Office

Reg. No. 3,476,013

Registered July 29, 2008

**SERVICE MARK
PRINCIPAL REGISTER**

CARROTS N NUGGETS

CARROTS N NUGGETS (NEW YORK LTD LIAB
CO)
168 TAMMS ROAD
MIDDLETOWN, NY 10941

FOR: ENTERTAINMENT SERVICES, NAMELY,
PROVIDING A WEBSITE FEATURING PHOTO-
GRAPHIC, AUDIO, VIDEO AND PROSE PRESEN-
TATIONS FEATURING HORSEMANSHIP, IN
CLASS 41 (U.S. CLS. 100, 101 AND 107).

FIRST USE 10-1-2007; IN COMMERCE 10-1-2007.

THE MARK CONSISTS OF STANDARD CHAR-
ACTERS WITHOUT CLAIM TO ANY PARTICULAR
FONT, STYLE, SIZE, OR COLOR.

SER. NO. 77-354,501, FILED 12-18-2007.

MARY MUNSON, EXAMINING ATTORNEY

Int. Cl.: 14

Prior U.S. Cls.: 2, 27, 28 and 50

United States Patent and Trademark Office

Reg. No. 3,476,014

Registered July 29, 2008

**TRADEMARK
PRINCIPAL REGISTER**

PURELY SILVER

ERWIN PEARL, INC. (NEW YORK CORPORATION)
389 FIFTH AVE.
NEW YORK, NY 10016

FOR: JEWELRY MADE WHOLLY OR IN PART
OF SILVER, IN CLASS 14 (U.S. CLS. 2, 27, 28 AND 50).

FIRST USE 8-6-1997; IN COMMERCE 8-6-1997.

THE MARK CONSISTS OF STANDARD CHARACTERS WITHOUT CLAIM TO ANY PARTICULAR FONT, STYLE, SIZE, OR COLOR.

OWNER OF U.S. REG. NO. 2,127,901.

NO CLAIM IS MADE TO THE EXCLUSIVE RIGHT TO USE "SILVER", APART FROM THE MARK AS SHOWN.

SEC. 2(F).

SER. NO. 77-354,515, FILED 12-18-2007.

AHSEN KHAN, EXAMINING ATTORNEY

Int. Cl.: 35

Prior U.S. Cls.: 100, 101 and 102

United States Patent and Trademark Office

Reg. No. 3,476,015

Registered July 29, 2008

**SERVICE MARK
PRINCIPAL REGISTER**

Trees 'n Bees, Inc.

TREES 'N BEES, INC. (WASHINGTON COR-
PORATION)
PO BOX 1796
AUBURN, WA 98071

FOR: RETAIL STORE SERVICES FEATURING
BEEKEEPING SUPPLIES AND CHRISTMAS TREES,
IN CLASS 35 (U.S. CLS. 100, 101 AND 102).

FIRST USE 6-1-1992; IN COMMERCE 6-1-1992.

THE MARK CONSISTS OF STANDARD CHAR-
ACTERS WITHOUT CLAIM TO ANY PARTICULAR
FONT, STYLE, SIZE, OR COLOR.

NO CLAIM IS MADE TO THE EXCLUSIVE
RIGHT TO USE "INC.", APART FROM THE MARK
AS SHOWN.

SER. NO. 77-354,527, FILED 12-18-2007.

IRA J. GOODSaid, EXAMINING ATTORNEY

Int. Cl.: 7

Prior U.S. Cls.: 13, 19, 21, 23, 31, 34 and 35

United States Patent and Trademark Office

Reg. No. 3,476,016

Registered July 29, 2008

**TRADEMARK
PRINCIPAL REGISTER**

LINCOLN

BOYDCO SPECIALTY FABRICATION, LLC (CA-
LIFORNIA LTD LIAB CO)
P.O. BOX 469
WILTON, CA 95693

FOR: ASPHALT PAVING MACHINES, NAMELY,
ASPHALT WINDROW ELEVATORS, AND AS-
PHALT FRAGMENTING AND RE-MIXING MA-
CHINES, IN CLASS 7 (U.S. CLS. 13, 19, 21, 23, 31, 34
AND 35).

FIRST USE 5-8-1985; IN COMMERCE 5-8-1985.

THE MARK CONSISTS OF STANDARD CHAR-
ACTERS WITHOUT CLAIM TO ANY PARTICULAR
FONT, STYLE, SIZE, OR COLOR.

SER. NO. 77-354,535, FILED 12-18-2007.

IRA J. GOODSaid, EXAMINING ATTORNEY

Int. Cl.: 41

Prior U.S. Cls.: 100, 101 and 107

United States Patent and Trademark Office

Reg. No. 3,476,017

Registered July 29, 2008

SERVICE MARK
PRINCIPAL REGISTER



ARMSTRONG INVESTMENTS, LLC (COLORADO LTD LIAB CO)
2363 E. MISSION RD.
FALLBROOK, CA 92028

FOR: PRODUCTION OF VIDEO DISCS, VIDEO CASSETTES AND DIGITAL PHOTOGRAPHS FEATURING 2D/3D/4D PRENATAL ULTRASOUND IMAGES, IN CLASS 41 (U.S. CLS. 100, 101 AND 107).

FIRST USE 9-1-2004; IN COMMERCE 9-1-2004.

THE COLOR(S) BLUE AND GRAY IS/ARE CLAIMED AS A FEATURE OF THE MARK.

THE MARK CONSISTS OF THE WORDS "THE ULTRASOUND EXPERIENCE" IN STYLIZED FONT, WHERE THE "S" IN "ULTRASOUND" IS BLUE AND REPRESENTS A FEMALE FIGURE AND THE REMAINING LETTERS ARE GRAY. THE "S" IS ENCLOSED BY A GRAY CIRCLE. THE WORDS "THE" AND "EXPERIENCE" ARE BLUE.

SER. NO. 77-354,548, FILED 12-18-2007.

JAMES A. RAUEN, EXAMINING ATTORNEY

Int. Cl.: 12

Prior U.S. Cls.: 19, 21, 23, 31, 35 and 44

United States Patent and Trademark Office

Reg. No. 3,476,018

Registered July 29, 2008

**TRADEMARK
PRINCIPAL REGISTER**

ULTRALITE

DOWCO, INC. (WISCONSIN CORPORATION)
4230 CLIPPER DRIVE
MANITOWOC, WI 54220

THE MARK CONSISTS OF STANDARD CHAR-
ACTERS WITHOUT CLAIM TO ANY PARTICULAR
FONT, STYLE, SIZE, OR COLOR.

FOR: FITTED MOTORCYCLE COVERS, IN
CLASS 12 (U.S. CLS. 19, 21, 23, 31, 35 AND 44).

SER. NO. 77-354,565, FILED 12-18-2007.

FIRST USE 1-1-2004; IN COMMERCE 1-1-2004.

MATTHEW EINSTEIN, EXAMINING ATTORNEY

Int. Cl.: 12

Prior U.S. Cls.: 19, 21, 23, 31, 35 and 44

United States Patent and Trademark Office

Reg. No. 3,476,019

Registered July 29, 2008

**TRADEMARK
PRINCIPAL REGISTER**

TRAVELER

DOWCO, INC. (WISCONSIN CORPORATION)
4230 CLIPPER DRIVE
MANITOWOC, WI 54220

THE MARK CONSISTS OF STANDARD CHAR-
ACTERS WITHOUT CLAIM TO ANY PARTICULAR
FONT, STYLE, SIZE, OR COLOR.

FOR: FITTED MOTORCYCLE COVERS, IN
CLASS 12 (U.S. CLS. 19, 21, 23, 31, 35 AND 44).

SER. NO. 77-354,571, FILED 12-18-2007.

FIRST USE 1-1-2004; IN COMMERCE 1-1-2004.

MATTHEW EINSTEIN, EXAMINING ATTORNEY

Int. Cl.: 42

Prior U.S. Cls.: 100 and 101

United States Patent and Trademark Office

Reg. No. 3,476,020

Registered July 29, 2008

**SERVICE MARK
PRINCIPAL REGISTER**

compelling web experiences

SITECORE CORPORATION DANMARK (DEN-
MARK CORPORATION)
MELDAHLSGADE 5, 4.
DENMARK, DENMARK 1613

FOR: WEBSITE DESIGN, CONSULTING, INTE-
GRATION, IMPLEMENTATION, SERVICE AND SUP-
PORT, FOR OTHERS, IN CLASS 42 (U.S. CLS. 100
AND 101).

FIRST USE 9-3-2007; IN COMMERCE 9-3-2007.

THE MARK CONSISTS OF STANDARD CHAR-
ACTERS WITHOUT CLAIM TO ANY PARTICULAR
FONT, STYLE, SIZE, OR COLOR.

SER. NO. 77-354,632, FILED 12-18-2007.

KAPIL BHANOT, EXAMINING ATTORNEY

Int. Cl.: 9

Prior U.S. Cls.: 21, 23, 26, 36 and 38

United States Patent and Trademark Office

Reg. No. 3,476,021

Registered July 29, 2008

**TRADEMARK
PRINCIPAL REGISTER**

compelling web experiences

SITECORE DANMARK (DENMARK CORPORATION)
MELDAHLSGADE 5, 4.
1613 COPENHAGEN V, DENMARK 1613

FOR: COMPUTER SOFTWARE FOR MANAGING ONLINE CONTENT, COMPUTER SOFTWARE FOR EDITING AND MANAGING THE INFORMATION CONTAINED ON THE INTERNET, INTRANET, AND EXTRANET SITES, AND COMPUTER SOFTWARE FOR DEVELOPMENT OF INTERNET APPLICATIONS, IN CLASS 9 (U.S. CLS. 21, 23, 26, 36 AND 38).

FIRST USE 9-3-2007; IN COMMERCE 9-3-2007.

THE MARK CONSISTS OF STANDARD CHARACTERS WITHOUT CLAIM TO ANY PARTICULAR FONT, STYLE, SIZE, OR COLOR.

SER. NO. 77-354,646, FILED 12-18-2007.

KAPIL BHANOT, EXAMINING ATTORNEY

Int. Cl.: 11

Prior U.S. Cls.: 13, 21, 23, 31 and 34

United States Patent and Trademark Office

Reg. No. 3,476,022

Registered July 29, 2008

**TRADEMARK
PRINCIPAL REGISTER**

The logo for 'Aaladin' is written in a fluid, cursive script. The letters are interconnected, with a prominent 'A' at the start and a long, sweeping tail on the 'n'. The overall appearance is that of a handwritten signature or a calligraphic brand mark.

AALADIN INDUSTRIES, INC. (SOUTH DAKOTA CORPORATION)
32584 477TH AVENUE
ELK POINT, SD 57025

FOR: HOT WATER HEATERS AND WASTE OIL HEATERS, IN CLASS 11 (U.S. CLS. 13, 21, 23, 31 AND 34).

FIRST USE 0-0-1993; IN COMMERCE 0-0-1993.

OWNER OF U.S. REG. NO. 2,507,063.

THE MARK CONSISTS OF THE STYLIZED REPRESENTATION OF "AALADIN".

THE WORDING "AALADIN" HAS NO MEANING IN A FOREIGN LANGUAGE.

SER. NO. 77-354,677, FILED 12-18-2007.

ANDREW RHIM, EXAMINING ATTORNEY

Int. Cls.: 25 and 41

Prior U.S. Cls.: 22, 39, 100, 101 and 107

United States Patent and Trademark Office

Reg. No. 3,476,023

Registered July 29, 2008

**TRADEMARK
SERVICE MARK
PRINCIPAL REGISTER**

YBE'S

YBE'S, LLC (NEW JERSEY LTD LIAB CO)
130 BALDWIN AVE.
JERSEY CITY, NJ 07304

FIRST USE 1-1-2007; IN COMMERCE 1-1-2007.

FOR: CLOTHING, NAMELY, T-SHIRTS, IN
CLASS 25 (U.S. CLS. 22 AND 39).

THE MARK CONSISTS OF STANDARD CHAR-
ACTERS WITHOUT CLAIM TO ANY PARTICULAR
FONT, STYLE, SIZE, OR COLOR.

FIRST USE 4-1-2007; IN COMMERCE 4-1-2007.

SER. NO. 77-354,680, FILED 12-18-2007.

FOR: AUDIO RECORDING AND PRODUCTION,
IN CLASS 41 (U.S. CLS. 100, 101 AND 107).

ANDREW RHIM, EXAMINING ATTORNEY

Int. Cl.: 45

Prior U.S. Cls.: 100 and 101

United States Patent and Trademark Office

Reg. No. 3,476,024

Registered July 29, 2008

**SERVICE MARK
PRINCIPAL REGISTER**

Angel Salon

PAIST, JANET A (UNITED STATES INDIVIDUAL)
56 SEVENTH AVENUE #11-H
NEW YORK, NY 10011

FOR: PROVIDING BOTH IN-PERSON AND ONLINE HOLISTIC SPIRITUAL COUNSELING SERVICES, IN CLASS 45 (U.S. CLS. 100 AND 101).

FIRST USE 12-1-2007; IN COMMERCE 12-8-2007.

THE MARK CONSISTS OF STANDARD CHARACTERS WITHOUT CLAIM TO ANY PARTICULAR FONT, STYLE, SIZE, OR COLOR.

SER. NO. 77-354,692, FILED 12-18-2007.

BRIAN NEVILLE, EXAMINING ATTORNEY

Int. Cl.: 7

Prior U.S. Cls.: 13, 19, 21, 23, 31, 34 and 35

United States Patent and Trademark Office

Reg. No. 3,476,025

Registered July 29, 2008

**TRADEMARK
PRINCIPAL REGISTER**

Stinger

NOVATEK INTERNATIONAL, INC. (UTAH CORPORATION)
2185 SOUTH LARSEN PARKWAY
PROVO, UT 84606

FOR: WEARS CAP FOR USE IN AUTOMATED MACHINERY NAMELY PULVERIZES AND CONVEYERS, IN CLASS 7 (U.S. CLS. 13, 19, 21, 23, 31, 34 AND 35).

FIRST USE 1-1-2007; IN COMMERCE 1-1-2007.

THE MARK CONSISTS OF STANDARD CHARACTERS WITHOUT CLAIM TO ANY PARTICULAR FONT, STYLE, SIZE, OR COLOR.

SER. NO. 77-354,693, FILED 12-18-2007.

BRIAN NEVILLE, EXAMINING ATTORNEY

Int. Cls.: 39 and 43

Prior U.S. Cls.: 100, 101 and 105

United States Patent and Trademark Office

Reg. No. 3,476,026

Registered July 29, 2008

**SERVICE MARK
PRINCIPAL REGISTER**

PIECE OUT

PIECE, L.L.C. (ILLINOIS LTD LIAB CO)
2630 NORTH DAYTON, COACH HOUSE
CHICAGO, IL 60614

FOR: DELIVERY OF FOOD BY RESTAURANTS,
IN CLASS 39 (U.S. CLS. 100 AND 105).

FIRST USE 12-12-2007; IN COMMERCE 12-12-2007.

FOR: TAKE-OUT RESTAURANT SERVICES , IN
CLASS 43 (U.S. CLS. 100 AND 101).

FIRST USE 12-12-2007; IN COMMERCE 12-12-2007.

THE MARK CONSISTS OF STANDARD CHAR-
ACTERS WITHOUT CLAIM TO ANY PARTICULAR
FONT, STYLE, SIZE, OR COLOR.

OWNER OF U.S. REG. NOS. 2,560,008 AND
2,702,474.

SER. NO. 77-354,707, FILED 12-18-2007.

MICHELE SWAIN, EXAMINING ATTORNEY

Int. Cls.: 9, 14, 20, 21, 22, 24 and 25

Prior U.S. Cls.: 1, 2, 7, 13, 19, 21, 22, 23, 25, 26, 27, 28, 29, 30, 32, 33, 36, 38, 39, 40, 42 and 50

Reg. No. 3,476,027

United States Patent and Trademark Office

Registered July 29, 2008

**TRADEMARK
PRINCIPAL REGISTER**



AMERICAN FEDERATION OF STATE, COUNTY
AND MUNICIPAL EMPLOYEES (D.C. UNINC.
ASSOCIATION)
1625 L STREET, N.W.
WASHINGTON, DC 20036

FOR: MOUSEPADS , IN CLASS 9 (U.S. CLS. 21, 23,
26, 36 AND 38).

FIRST USE 6-30-2007; IN COMMERCE 6-30-2007.

FOR: LAPEL PINS, IN CLASS 14 (U.S. CLS. 2, 27, 28
AND 50).

FIRST USE 6-30-2007; IN COMMERCE 6-30-2007.

FOR: PLASTIC KEY RINGS, IN CLASS 20 (U.S.
CLS. 2, 13, 22, 25, 32 AND 50).

FIRST USE 6-30-2007; IN COMMERCE 6-30-2007.

FOR: PORTABLE COOLERS, THERMAL INSU-
LATED BAGS FOR FOOD OR BEVERAGES AND
CERAMIC MUGS, IN CLASS 21 (U.S. CLS. 2, 13, 23,
29, 30, 33, 40 AND 50).

FIRST USE 6-30-2007; IN COMMERCE 6-30-2007.

FOR: LANYARDS FOR HOLDING EYEGLASSES,
BADGES AND KEYS, IN CLASS 22 (U.S. CLS. 1, 2, 7,
19, 22, 42 AND 50).

FIRST USE 6-30-2007; IN COMMERCE 6-30-2007.

FOR: CLOTH BANNERS, IN CLASS 24 (U.S. CLS.
42 AND 50).

FIRST USE 6-30-2007; IN COMMERCE 6-30-2007.

FOR: T-SHIRTS AND CAPS, IN CLASS 25 (U.S.
CLS. 22 AND 39).

FIRST USE 6-30-2007; IN COMMERCE 6-30-2007.

OWNER OF U.S. REG. NOS. 1,136,470, 2,308,888
AND OTHERS.

THE MARK CONSISTS OF THE ACRONYM
"AFSCME" UNDERNEATH THREE CURVED
LINES AND A FIVE-POINT STAR.

SER. NO. 77-354,744, FILED 12-18-2007.

KELLY BOULTON, EXAMINING ATTORNEY

Int. Cl.: 3

Prior U.S. Cls.: 1, 4, 6, 50, 51 and 52

Reg. No. 3,476,028

United States Patent and Trademark Office

Registered July 29, 2008

**TRADEMARK
PRINCIPAL REGISTER**

FRENCH KISS

HAROLD KATZ (UNITED STATES INDIVIDUAL)
750 N. HIGHLAND AVENUE
LOS ANGELES, CA 90038

THE MARK CONSISTS OF STANDARD CHARACTERS WITHOUT CLAIM TO ANY PARTICULAR FONT, STYLE, SIZE, OR COLOR.

FOR: BREATH FRESHENING CONFECTIONARY, NAMELY, GUM; DENTIFRICES IN THE FORM OF CHEWING GUM, IN CLASS 3 (U.S. CLS. 1, 4, 6, 50, 51 AND 52).

SER. NO. 77-354,786, FILED 12-18-2007.

FIRST USE 9-30-2005; IN COMMERCE 11-16-2005.

JASON BLAIR, EXAMINING ATTORNEY

Int. Cl.: 41

Prior U.S. Cls.: 100, 101 and 107

United States Patent and Trademark Office

Reg. No. 3,476,029

Registered July 29, 2008

**SERVICE MARK
PRINCIPAL REGISTER**

PSO

WMG PSO LLC (DELAWARE LTD LIAB CO)
12100 W. OLYMPIC BLVD., SUITE 400
LOS ANGELES, CA 90064

FOR: ELECTRONIC PUBLISHING SERVICES, NAMELY, PUBLICATION OF TEXT AND GRAPHIC WORKS OF OTHERS ON THE WORLD WIDE WEB FEATURING HIGH SCHOOL ATHLETICS; ENTERTAINMENT SERVICES, NAMELY, PROVIDING A WEBSITE FEATURING, PHOTOGRAPHIC, AUDIO, VIDEO AND PROSE PRESENTATIONS FEATURING HIGH SCHOOL ATHLETICS; ON-LINE JOURNALS, NAMELY, BLOGS FEATURING HIGH SCHOOL ATHLETICS; PUBLICATIONS OF THE

EDITORIAL CONTENT RELATING TO HIGH SCHOOL ATHLETICS OF SITES ACCESSIBLE VIA A GLOBAL COMPUTER NETWORK, IN CLASS 41 (U.S. CLS. 100, 101 AND 107).

FIRST USE 1-1-2007; IN COMMERCE 1-1-2007.

THE MARK CONSISTS OF STANDARD CHARACTERS WITHOUT CLAIM TO ANY PARTICULAR FONT, STYLE, SIZE, OR COLOR.

SER. NO. 77-354,789, FILED 12-18-2007.

ALICE BENMAMAN, EXAMINING ATTORNEY

Int. Cl.: 5

Prior U.S. Cls.: 6, 18, 44, 46, 51 and 52

Reg. No. 3,476,030

United States Patent and Trademark Office

Registered July 29, 2008

**TRADEMARK
PRINCIPAL REGISTER**

RESCUE DETOX

APPLIED SCIENCES LLC (ARIZONA LTD LIAB
CO)
15111 N. HAYDEN ROAD SUITE 160-327
SCOTTSDALE, AZ 85260

FOR: DIETARY AND NUTRITIONAL SUPPLE-
MENTS; DIETARY FOOD SUPPLEMENTS, IN
CLASS 5 (U.S. CLS. 6, 18, 44, 46, 51 AND 52).

FIRST USE 8-0-2007; IN COMMERCE 11-0-2007.

THE MARK CONSISTS OF STANDARD CHAR-
ACTERS WITHOUT CLAIM TO ANY PARTICULAR
FONT, STYLE, SIZE, OR COLOR.

NO CLAIM IS MADE TO THE EXCLUSIVE
RIGHT TO USE "DETOX", APART FROM THE
MARK AS SHOWN.

SER. NO. 77-354,827, FILED 12-18-2007.

PAUL F. GAST, EXAMINING ATTORNEY

Int. Cl.: 5

Prior U.S. Cls.: 6, 18, 44, 46, 51 and 52

Reg. No. 3,476,031

United States Patent and Trademark Office

Registered July 29, 2008

**TRADEMARK
PRINCIPAL REGISTER**

RESCUE CLEAN

APPLIED SCIENCES LLC (ARIZONA LTD LIAB
CO)
15111 N. HAYDEN ROAD SUITE 160-327
SCOTTSDALE, AZ 85260

FOR: DIETARY AND NUTRITIONAL SUPPLE-
MENTS; DIETARY FOOD SUPPLEMENTS, IN
CLASS 5 (U.S. CLS. 6, 18, 44, 46, 51 AND 52).

FIRST USE 8-0-2007; IN COMMERCE 11-0-2007.

THE MARK CONSISTS OF STANDARD CHAR-
ACTERS WITHOUT CLAIM TO ANY PARTICULAR
FONT, STYLE, SIZE, OR COLOR.

NO CLAIM IS MADE TO THE EXCLUSIVE
RIGHT TO USE "CLEAN", APART FROM THE
MARK AS SHOWN.

SER. NO. 77-354,843, FILED 12-18-2007.

PAUL F. GAST, EXAMINING ATTORNEY

Int. Cl.: 3

Prior U.S. Cls.: 1, 4, 6, 50, 51 and 52

Reg. No. 3,476,032

United States Patent and Trademark Office

Registered July 29, 2008

**TRADEMARK
PRINCIPAL REGISTER**

GUY

HAROLD KATZ (UNITED STATES INDIVIDUAL)
750 N. HIGHLAND AVENUE
LOS ANGELES, CA 90038

THE MARK CONSISTS OF STANDARD CHARACTERS WITHOUT CLAIM TO ANY PARTICULAR FONT, STYLE, SIZE, OR COLOR.

FOR: BREATH FRESHENING CONFECTIONARY, NAMELY, GUM; DENTIFRICES IN THE FORM OF CHEWING GUM, IN CLASS 3 (U.S. CLS. 1, 4, 6, 50, 51 AND 52).

SER. NO. 77-354,845, FILED 12-18-2007.

FIRST USE 9-30-2005; IN COMMERCE 11-16-2005.

JASON BLAIR, EXAMINING ATTORNEY

Int. Cl.: 9

Prior U.S. Cls.: 21, 23, 26, 36 and 38

United States Patent and Trademark Office

Reg. No. 3,476,033

Registered July 29, 2008

**TRADEMARK
PRINCIPAL REGISTER**

STORM FLEX

STORM PRODUCTS CO. (CALIFORNIA CORPORATION)
10221 WERCH DRIVE
WOODRIDGE, IL 60517

THE MARK CONSISTS OF STANDARD CHARACTERS WITHOUT CLAIM TO ANY PARTICULAR FONT, STYLE, SIZE, OR COLOR.

FOR: COAXIAL CABLES FOR MICROWAVE TRANSMISSIONS, IN CLASS 9 (U.S. CLS. 21, 23, 26, 36 AND 38).

SER. NO. 77-354,862, FILED 12-18-2007.

FIRST USE 7-31-2003; IN COMMERCE 7-31-2003.

PAUL F. GAST, EXAMINING ATTORNEY

Int. Cl.: 35

Prior U.S. Cls.: 100, 101 and 102

United States Patent and Trademark Office

Reg. No. 3,476,034

Registered July 29, 2008

**SERVICE MARK
PRINCIPAL REGISTER**

LicenseSure

REDVECTOR.COM, INC. (FLORIDA CORPORATION)
4890 W KENNEDY BLVD SUITE 740
TAMPA, FL 33609

FOR: PREPARATION, RENEWAL, RECORDATION, MANAGEMENT, AND CENTRALIZATION OF EDUCATION RECORDS, CONTINUING EDUCATION, PROFESSIONAL LICENSES, AND/OR ORGANIZATIONAL MEMBERSHIPS HELD BY INDIVIDUALS TO PRACTICE TRADES AND TO MANAGE AND BUILD CAREERS, IN CLASS 35 (U.S. CLS. 100, 101 AND 102).

FIRST USE 5-1-2007; IN COMMERCE 5-1-2007.

THE MARK CONSISTS OF STANDARD CHARACTERS WITHOUT CLAIM TO ANY PARTICULAR FONT, STYLE, SIZE, OR COLOR.

SER. NO. 77-354,868, FILED 12-18-2007.

KARANENDRA S. CHHINA, EXAMINING ATTORNEY

Int. Cl.: 9

Prior U.S. Cls.: 21, 23, 26, 36 and 38

United States Patent and Trademark Office

Reg. No. 3,476,035

Registered July 29, 2008

**TRADEMARK
PRINCIPAL REGISTER**

JMFA FRAUDMANAGER

JOHN M. FLOYD & ASSOCIATES, INC. (TEXAS CORPORATION)
125 N. BURNET
BAYTOWN, TX 77520

OWNER OF U.S. REG. NOS. 2,985,537, 3,191,658 AND OTHERS.

FOR: COMPUTER SOFTWARE FOR FINANCIAL INSTITUTION TRANSACTIONAL RISKS ANALYSIS, IN CLASS 9 (U.S. CLS. 21, 23, 26, 36 AND 38).

NO CLAIM IS MADE TO THE EXCLUSIVE RIGHT TO USE "FRAUD MANAGER", APART FROM THE MARK AS SHOWN.

FIRST USE 6-7-2007; IN COMMERCE 6-7-2007.

SER. NO. 77-354,870, FILED 12-18-2007.

THE MARK CONSISTS OF STANDARD CHARACTERS WITHOUT CLAIM TO ANY PARTICULAR FONT, STYLE, SIZE, OR COLOR.

KARANENDRA S. CHHINA, EXAMINING ATTORNEY

Int. Cl.: 35

Prior U.S. Cls.: 100, 101 and 102

United States Patent and Trademark Office

Reg. No. 3,476,036

Registered July 29, 2008

**SERVICE MARK
PRINCIPAL REGISTER**

WEE SOLES

WEE SOLES (CALIFORNIA PARTNERSHIP)
STE. E
3827 SUNSET BLVD.
LOS ANGELES, CA 90026

FOR: ON-LINE RETAIL STORE SERVICES FEATURING CHILDREN'S FOOTWEAR; RETAIL CONSIGNMENT STORES IN THE FIELD OF CHILDREN'S FOOTWEAR, IN CLASS 35 (U.S. CLS. 100, 101 AND 102).

FIRST USE 1-1-2006; IN COMMERCE 1-1-2006.

THE MARK CONSISTS OF STANDARD CHARACTERS WITHOUT CLAIM TO ANY PARTICULAR FONT, STYLE, SIZE, OR COLOR.

NO CLAIM IS MADE TO THE EXCLUSIVE RIGHT TO USE "SOLES", APART FROM THE MARK AS SHOWN.

SER. NO. 77-354,896, FILED 12-18-2007.

VIVIAN MICZNIK FIRST, EXAMINING ATTORNEY

Int. Cl.: 35

Prior U.S. Cls.: 100, 101 and 102

United States Patent and Trademark Office

Reg. No. 3,476,037

Registered July 29, 2008

**SERVICE MARK
PRINCIPAL REGISTER**

Surropa

NACO USA LLC (FLORIDA LTD LIAB CO)
14 NE 1ST AVE., SUITE 400
MIAMI, FL 33132

FOR: COMPUTERIZED ON-LINE RETAIL STORE
SERVICES IN THE FIELD OF CLOTHING AND
ACCESSORIES; RETAIL APPAREL STORES, IN
CLASS 35 (U.S. CLS. 100, 101 AND 102).

FIRST USE 12-1-2006; IN COMMERCE 12-21-2006.

THE MARK CONSISTS OF STANDARD CHAR-
ACTERS WITHOUT CLAIM TO ANY PARTICULAR
FONT, STYLE, SIZE, OR COLOR.

SER. NO. 77-354,900, FILED 12-18-2007.

VIVIAN MICZNIK FIRST, EXAMINING ATTOR-
NEY

Int. Cl.: 16

Prior U.S. Cls.: 2, 5, 22, 23, 29, 37, 38 and 50

United States Patent and Trademark Office

Reg. No. 3,476,038

Registered July 29, 2008

**TRADEMARK
PRINCIPAL REGISTER**

**FOR A BETTER FINISH, START
WITH HYDE.**

HYDE TOOLS, INC. (MASSACHUSETTS CORPORATION)
54 EASTFORD ROAD
SOUTHBRIDGE, MA 01550

FOR: PAINT BRUSHES; PASTE BRUSHES; SMOOTHING BRUSHES; TEXTURE BRUSHES; PAINT TRAYS; PAPER DROP CLOTHS, SASH PAINTING BRUSHES; T-SQUARES, STRAIGHT EDGES; PAINT APPLICATOR ROLLERS; PAINT ROLLER FRAMES; PAINT STIRRERS; SERIES OF INSTRUCTION BOOKS IN THE FIELDS OF PAINTING, WALL COVERING, MASONRY, CERAMIC TILE WORK AND FLOOR COVERING; PAINT ROLLERS WITH CLAMPS FOR ATTACHMENT TO

EXTENSION TUBES, IN CLASS 16 (U.S. CLS. 2, 5, 22, 23, 29, 37, 38 AND 50).

FIRST USE 3-25-2005; IN COMMERCE 3-25-2005.

THE MARK CONSISTS OF STANDARD CHARACTERS WITHOUT CLAIM TO ANY PARTICULAR FONT, STYLE, SIZE, OR COLOR.

OWNER OF U.S. REG. NOS. 575,371, 1,955,677 AND OTHERS.

SER. NO. 77-354,901, FILED 12-18-2007.

PRISCILLA MILTON, EXAMINING ATTORNEY

Int. Cl.: 6

Prior U.S. Cls.: 2, 12, 13, 14, 23, 25 and 50

Reg. No. 3,476,039

United States Patent and Trademark Office

Registered July 29, 2008

**TRADEMARK
PRINCIPAL REGISTER**

TITWELD

DIRECT METALS COMPANY, LLC (GEORGIA
LTD LIAB CO)
1200 CHASTAIN ROAD, NO. 201
KENNESAW, GA 301445586

THE MARK CONSISTS OF STANDARD CHAR-
ACTERS WITHOUT CLAIM TO ANY PARTICULAR
FONT, STYLE, SIZE, OR COLOR.

FOR: METAL GRATINGS, IN CLASS 6 (U.S. CLS.
2, 12, 13, 14, 23, 25 AND 50).

SER. NO. 77-354,910, FILED 12-18-2007.

FIRST USE 8-27-2007; IN COMMERCE 10-26-2007.

ASMAT KHAN, EXAMINING ATTORNEY

Int. Cl.: 41

Prior U.S. Cls.: 100, 101 and 107

United States Patent and Trademark Office

Reg. No. 3,476,040

Registered July 29, 2008

**SERVICE MARK
PRINCIPAL REGISTER**



CIRCLE TOWARD WHOLENESS (VIRGINIA CORPORATION)
1707 GINGER LANE
BLACKSBURG, VA 24060

FOR: EDUCATIONAL SERVICES, NAMELY, DEVELOPING, ARRANGING, AND CONDUCTING EDUCATIONAL CONFERENCES AND PROGRAMS AND PROVIDING COURSES OF INSTRUCTION IN THE FIELD OF INNOVATIVE PROGRAMMING FOR INNER PEACE, IN CLASS 41 (U.S. CLS. 100, 101 AND 107).

FIRST USE 10-1-2006; IN COMMERCE 11-16-2006.

THE COLOR(S) BLUE, ORANGE, GREEN, AND YELLOW IS/ARE CLAIMED AS A FEATURE OF THE MARK.

THE MARK CONSISTS OF ONE BLUE CIRCLE, ONE ORANGE CIRCLE, ONE GREEN CIRCLE AND ONE YELLOW CIRCLE THAT MEET IN THE CENTER TO FORM A HEART. EACH CIRCLE DOES NOT CLOSE COMPLETELY, THE COLOR FADES SO THERE IS A PARTIAL OPENING IN EACH. THE WORDS CIRCLE TOWARD WHOLENESS ARE ORANGE AND EXTEND HORIZONTALLY TO THE RIGHT AND FROM THE CENTER OF THE MARK.

SER. NO. 77-354,913, FILED 12-18-2007.

ASMAT KHAN, EXAMINING ATTORNEY

Int. Cl.: 35

Prior U.S. Cls.: 100, 101 and 102

United States Patent and Trademark Office

Reg. No. 3,476,041

Registered July 29, 2008

**SERVICE MARK
PRINCIPAL REGISTER**

UCEA

UNIVERSITY CONTINUING EDUCATION ASSO-
CIATION (D.C. NON-PROFIT ASSOCIATION)
SUITE 615
ONE DUPONT CIRCLE
WASHINGTON, DC 20036

THE MARK CONSISTS OF STANDARD CHAR-
ACTERS WITHOUT CLAIM TO ANY PARTICULAR
FONT, STYLE, SIZE, OR COLOR.

FOR: ASSOCIATION SERVICES, NAMELY, PRO-
MOTING THE INTERESTS OF CONTINUING EDU-
CATION, IN CLASS 35 (U.S. CLS. 100, 101 AND 102).

SER. NO. 77-354,919, FILED 12-18-2007.

FIRST USE 12-0-1996; IN COMMERCE 12-0-1996.

ANN E. SAPPENFIELD, EXAMINING ATTORNEY

Int. Cls.: 9 and 16

Prior U.S. Cls.: 2, 5, 21, 22, 23, 26, 29, 36, 37, 38 and 50

Reg. No. 3,476,042

United States Patent and Trademark Office

Registered July 29, 2008

**TRADEMARK
PRINCIPAL REGISTER**

BLUEGRASS BREAKDOWN

CALIFORNIA BLUEGRASS ASSOCIATION (CALIFORNIA CORPORATION)
640 MCKENZIE DR.
DIXON, CA 95620

FOR: PROVIDING DOWNLOADABLE ELECTRONIC NEWSLETTERS IN THE FIELD OF BLUEGRASS, OLD-TIME, GOSPEL AND RELATED ACOUSTIC MUSIC, IN CLASS 9 (U.S. CLS. 21, 23, 26, 36 AND 38).

FIRST USE 6-1-1975; IN COMMERCE 6-1-1975.

FOR: NEWSLETTERS IN THE FIELD OF BLUEGRASS, OLD-TIME, GOSPEL AND RELATED ACOUSTIC MUSIC, IN CLASS 16 (U.S. CLS. 2, 5, 22, 23, 29, 37, 38 AND 50).

FIRST USE 6-1-1975; IN COMMERCE 6-1-1975.

THE MARK CONSISTS OF STANDARD CHARACTERS WITHOUT CLAIM TO ANY PARTICULAR FONT, STYLE, SIZE, OR COLOR.

NO CLAIM IS MADE TO THE EXCLUSIVE RIGHT TO USE "BLUEGRASS", APART FROM THE MARK AS SHOWN.

SER. NO. 77-354,930, FILED 12-18-2007.

YONG KIM, EXAMINING ATTORNEY

Int. Cl.: 7

Prior U.S. Cls.: 13, 19, 21, 23, 31, 34 and 35

Reg. No. 3,476,043

United States Patent and Trademark Office

Registered July 29, 2008

**TRADEMARK
PRINCIPAL REGISTER**

B-LOC

FENNER U.S., INC. (DELAWARE CORPORATION)
SUITE 200
103 FOULK ROAD
WILMINGTON, DE 19803

THE MARK CONSISTS OF STANDARD CHARACTERS WITHOUT CLAIM TO ANY PARTICULAR FONT, STYLE, SIZE, OR COLOR.

FOR: MACHINE PARTS, NAMELY, KEYLESS BUSHINGS, IN CLASS 7 (U.S. CLS. 13, 19, 21, 23, 31, 34 AND 35).

SER. NO. 77-354,936, FILED 12-18-2007.

FIRST USE 11-26-1993; IN COMMERCE 11-26-1993.

HEATHER THOMPSON, EXAMINING ATTORNEY

Int. Cl.: 10

Prior U.S. Cls.: 26, 39 and 44

United States Patent and Trademark Office

Reg. No. 3,476,044

Registered July 29, 2008

**TRADEMARK
PRINCIPAL REGISTER**

**SIMPL IMPLANT ABUTMENT
SYSTEM**

DENTACO CORP. (NEW YORK CORPORATION)
275 SOUTH MAIN STREET
FREEPORT, NY 11520

FOR: DENTAL PROSTHESES, IN CLASS 10 (U.S.
CLS. 26, 39 AND 44).

FIRST USE 6-1-2005; IN COMMERCE 6-1-2005.

THE MARK CONSISTS OF STANDARD CHAR-
ACTERS WITHOUT CLAIM TO ANY PARTICULAR
FONT, STYLE, SIZE, OR COLOR.

NO CLAIM IS MADE TO THE EXCLUSIVE
RIGHT TO USE "IMPLANT ABUTMENT SYSTEM",
APART FROM THE MARK AS SHOWN.

SER. NO. 77-354,960, FILED 12-18-2007.

KATINA MISTER, EXAMINING ATTORNEY

Int. Cl.: 35

Prior U.S. Cls.: 100, 101 and 102

United States Patent and Trademark Office

Reg. No. 3,476,045

Registered July 29, 2008

**SERVICE MARK
PRINCIPAL REGISTER**

BOARD ANALYST

THE CORPORATE LIBRARY, LLC (MAINE LTD
LIAB CO)
45 EXCHANGE STREET
PORTLAND, ME 04101

FOR: BUSINESS RESEARCH SERVICES IN THE
FIELD OF CORPORATE INFORMATION PROVI-
DED VIA A GLOBAL COMPUTER NETWORK, IN
CLASS 35 (U.S. CLS. 100, 101 AND 102).

FIRST USE 7-0-2001; IN COMMERCE 7-0-2002.

THE MARK CONSISTS OF STANDARD CHAR-
ACTERS WITHOUT CLAIM TO ANY PARTICULAR
FONT, STYLE, SIZE, OR COLOR.

OWNER OF U.S. REG. NO. 2,807,553.

SEC. 2(F).

SER. NO. 77-354,962, FILED 12-18-2007.

ELLEN PERKINS, EXAMINING ATTORNEY

Int. Cl.: 35

Prior U.S. Cls.: 100, 101 and 102

United States Patent and Trademark Office

Reg. No. 3,476,046

Registered July 29, 2008

**SERVICE MARK
PRINCIPAL REGISTER**

standout.

STANDOUT, LLC (SOUTH CAROLINA LTD LIAB
CO)
2840 SHOP ROAD
COLUMBIA, SC 29209

THE MARK CONSISTS OF THE WORD "STAND-
OUT" WRITTEN IN LOWER CASE FOLLOWED BY
A PERIOD.

FOR: BUSINESS MARKETING CONSULTING
SERVICES, IN CLASS 35 (U.S. CLS. 100, 101 AND 102).

SER. NO. 77-354,976, FILED 12-18-2007.

FIRST USE 6-1-2006; IN COMMERCE 6-1-2006.

YONG KIM, EXAMINING ATTORNEY

Int. Cl.: 7

Prior U.S. Cls.: 13, 19, 21, 23, 31, 34 and 35

United States Patent and Trademark Office

Reg. No. 3,476,047

Registered July 29, 2008

**TRADEMARK
PRINCIPAL REGISTER**

**FOR A BETTER FINISH, START
WITH HYDE.**

HYDE TOOLS, INC. (MASSACHUSETTS CORPORATION)
54 EASTFORD ROAD
SOUTHBRIDGE, MA 01550

FOR: PAINT SPRAY GUNS, PAINT SPRAY GUN MOUNTS, EXTENSIONS FOR POWER TOOLS, AND REMOTE VALVE ACTUATORS, HYDRAULIC REMOTE VALVE ACTUATORS AND PNEUMATIC REMOTE VALVE ACTUATORS; EXTENSIONS FOR POWER TOOLS, NAMELY, EXTENSION POLES, EXTENSION POLES OF ADJUSTABLE LENGTH, EXTENSION POLES WITH TRIGGER MECHANISM ON THE HANDLE END FOR REMOTELY ACTUATING ATTACHED TRIGGER INITIATED DEVICE, SPRAY TIP EXTENSIONS, SPRAY TIP EXTENSIONS WITH SLIDE MECHANISM FOR MANUAL CONTROL OF TIP ANGLE; SPRAY GUNS WITH HOPPERS FOR SPRAYING TEXTURE AND COATINGS; WANDS FOR HIGH PRESSURE WASHERS; SANDING TOOLS CONSISTING OF SANDING HEAD, CLAMPS AND TUBES FOR ATTACHMENT TO A COMMERCIAL OR SHOP VACUUM; TUBES AND HOSES FOR COMMERCIAL AND SHOP VA-

CUUMS; BLADES FOR POWER SAWS; POWER-DRIVEN MIXERS FOR USE WITH ELECTRIC DRILLS; POWER-DRIVEN DRYWALL COMPOUND, PAINT COATING AND SEALER MIXERS FOR MIXING DRYWALL COMPOUND PAINT COATINGS AND SEALERS; PAINT BRUSH AND ROLLER MANUAL CENTRIFUGAL FORCE CLEANING MACHINES, IN CLASS 7 (U.S. CLS. 13, 19, 21, 23, 31, 34 AND 35).

FIRST USE 1-3-2005; IN COMMERCE 1-3-2005.

THE MARK CONSISTS OF STANDARD CHARACTERS WITHOUT CLAIM TO ANY PARTICULAR FONT, STYLE, SIZE, OR COLOR.

OWNER OF U.S. REG. NOS. 575,371, 1,244,984, AND 1,955,677.

SER. NO. 77-354,992, FILED 12-18-2007.

PRISCILLA MILTON, EXAMINING ATTORNEY

Int. Cl.: 35

Prior U.S. Cls.: 100, 101 and 102

United States Patent and Trademark Office

Reg. No. 3,476,048

Registered July 29, 2008

**SERVICE MARK
PRINCIPAL REGISTER**

iPlanIt

IPLANIT, LLC (COLORADO LTD LIAB CO)
1332 CUMBERLAND DRIVE
LONGMONT, CO 80501

THE MARK CONSISTS OF STANDARD CHAR-
ACTERS WITHOUT CLAIM TO ANY PARTICULAR
FONT, STYLE, SIZE, OR COLOR.

FOR: ARRANGING AND CONDUCTING BUSI-
NESS CONFERENCES, IN CLASS 35 (U.S. CLS. 100,
101 AND 102).

SER. NO. 77-354,998, FILED 12-18-2007.

FIRST USE 2-8-2005; IN COMMERCE 2-8-2005.

ANN E. SAPPENFIELD, EXAMINING ATTORNEY

Int. Cl.: 35

Prior U.S. Cls.: 100, 101 and 102

United States Patent and Trademark Office

Reg. No. 3,476,049

Registered July 29, 2008

**SERVICE MARK
PRINCIPAL REGISTER**

PROTELUS

PROTELUS (WASHINGTON CORPORATION)
SUITE 320
11000 NE 33RD PLACE
BELLEVUE, WA 98004

FOR: BUSINESS MARKETING SERVICES,
NAMELY, DATA AGGREGATION AND DIGITAL
MARKETING, IN CLASS 35 (U.S. CLS. 100, 101 AND
102).

FIRST USE 12-0-2005; IN COMMERCE 12-0-2005.

THE MARK CONSISTS OF STANDARD CHAR-
ACTERS WITHOUT CLAIM TO ANY PARTICULAR
FONT, STYLE, SIZE, OR COLOR.

SER. NO. 77-355,000, FILED 12-18-2007.

MARY ROSSMAN, EXAMINING ATTORNEY

Int. Cl.: 40

Prior U.S. Cls.: 100, 103 and 106

United States Patent and Trademark Office

Reg. No. 3,476,050

Registered July 29, 2008

**SERVICE MARK
PRINCIPAL REGISTER**

WGI

WGI (DELAWARE CORPORATION), DBA WEST-
FIELD GAGE COMPANY OVERHAUL & RE-
PAIR
34 HUDSON DRIVE
SOUTHWICK, MA 010771130

FOR: MANUFACTURING SERVICES FOR OTHERS IN THE FIELD OF PRECISION AEROSPACE PARTS, IN CLASS 40 (U.S. CLS. 100, 103 AND 106).

FIRST USE 1-1-2000; IN COMMERCE 1-1-2000.

THE MARK CONSISTS OF STANDARD CHARACTERS WITHOUT CLAIM TO ANY PARTICULAR FONT, STYLE, SIZE, OR COLOR.

SER. NO. 77-355,017, FILED 12-18-2007.

DEZMONA MIZELLE, EXAMINING ATTORNEY

Int. Cl.: 2

Prior U.S. Cls.: 6, 11 and 16

United States Patent and Trademark Office

Reg. No. 3,476,051

Registered July 29, 2008

**TRADEMARK
PRINCIPAL REGISTER**

EPOXY-CRETE

CROSSFIELD PRODUCTS CORPORATION (CALIFORNIA CORPORATION)
3000 E. HARCOURT STREET
RANCHO DOMINGUEZ, CA 90221

FOR: COATINGS FOR USE ON CONCRETE SURFACES FOR INHIBITING CORROSION, INSULATING, WATERPROOFING AND DECORATION, IN CLASS 2 (U.S. CLS. 6, 11 AND 16).

FIRST USE 8-8-2007; IN COMMERCE 8-8-2007.

THE MARK CONSISTS OF STANDARD CHARACTERS WITHOUT CLAIM TO ANY PARTICULAR FONT, STYLE, SIZE, OR COLOR.

SER. NO. 77-355,028, FILED 12-18-2007.

LINDA ESTRADA, EXAMINING ATTORNEY

Int. Cl.: 20

Prior U.S. Cls.: 2, 13, 22, 25, 32 and 50

United States Patent and Trademark Office

Reg. No. 3,476,052

Registered July 29, 2008

**TRADEMARK
PRINCIPAL REGISTER**

TOUCHMOTION

BERKLINE, LLC (DELAWARE LTD LIAB CO)
ONE BERKLINE DRIVE
MORRISTOWN, TN 37813

FOR: UPHOLSTERED FURNITURE, IN CLASS 20
(U.S. CLS. 2, 13, 22, 25, 32 AND 50).

FIRST USE 1-6-1987; IN COMMERCE 1-6-1987.

THE MARK CONSISTS OF STANDARD CHAR-
ACTERS WITHOUT CLAIM TO ANY PARTICULAR
FONT, STYLE, SIZE, OR COLOR.

OWNER OF U.S. REG. NO. 1,461,937.

SER. NO. 77-355,033, FILED 12-18-2007.

MATTHEW MCDOWELL, EXAMINING ATTOR-
NEY

Int. Cls.: 35, 39, 40 and 42

Prior U.S. Cls.: 100, 101, 102, 103, 105 and 106

United States Patent and Trademark Office

Reg. No. 3,476,053

Registered July 29, 2008

**SERVICE MARK
PRINCIPAL REGISTER**

Southwest Water Company

SOUTHWEST WATER COMPANY (DELAWARE CORPORATION)
SUITE 2900
624 SOUTH GRAND AVENUE
LOS ANGELES, CA 90017

FOR: MANAGEMENT OF WASTE WATER COLLECTION SYSTEMS FOR OTHERS, IN CLASS 35 (U.S. CLS. 100, 101 AND 102).

FIRST USE 1-1-1957; IN COMMERCE 1-1-1957.

FOR: WATER SUPPLY; WATER SUPPLY AND DISTRIBUTION SERVICES, IN CLASS 39 (U.S. CLS. 100 AND 105).

FIRST USE 1-1-1957; IN COMMERCE 1-1-1957.

FOR: TREATMENT OF WASTE WATER; WASTE WATER REPROCESSING; WATER TREATMENT; WATER TREATMENT AND PURIFICATION, IN CLASS 40 (U.S. CLS. 100, 103 AND 106).

FIRST USE 1-1-1957; IN COMMERCE 1-1-1957.

FOR: ENGINEERING SERVICES FOR THE CONSTRUCTION OF WATER TREATMENT AND PURIFICATION PLANTS, SOLID WASTE TREATMENT PLANTS AND OTHER MUNICIPAL INFRASTRUCTURE FACILITIES; TECHNICAL MONITORING SERVICES FOR CONDITIONS OF WATER; WATER METER READING AND DATA ANALYSIS; WATER QUALITY CONTROL SERVICES, IN CLASS 42 (U.S. CLS. 100 AND 101).

FIRST USE 1-1-1957; IN COMMERCE 1-1-1957.

THE MARK CONSISTS OF STANDARD CHARACTERS WITHOUT CLAIM TO ANY PARTICULAR FONT, STYLE, SIZE, OR COLOR.

NO CLAIM IS MADE TO THE EXCLUSIVE RIGHT TO USE "WATER COMPANY", APART FROM THE MARK AS SHOWN.

SEC. 2(F).

SER. NO. 77-355,034, FILED 12-18-2007.

JOHN KELLY, EXAMINING ATTORNEY

Int. Cls.: 30 and 43

Prior U.S. Cls.: 46, 100 and 101

United States Patent and Trademark Office

Reg. No. 3,476,054

Registered July 29, 2008

**TRADEMARK
SERVICE MARK
PRINCIPAL REGISTER**

A PIZZA YOU CAN'T REFUSE

GODFATHER'S PIZZA, INC. (NEBRASKA CORPORATION)
2808 N. 108TH STREET
OMAHA, NE 68164

FOR: PIZZA PREPARED FOR CONSUMPTION ON OR OFF THE PREMISES, IN CLASS 30 (U.S. CL. 46).

FIRST USE 1-9-1979; IN COMMERCE 1-9-1979.

FOR: RESTAURANT SERVICES, IN CLASS 43 (U.S. CLS. 100 AND 101).

FIRST USE 1-9-1979; IN COMMERCE 1-9-1979.

THE MARK CONSISTS OF STANDARD CHARACTERS WITHOUT CLAIM TO ANY PARTICULAR FONT, STYLE, SIZE, OR COLOR.

SER. NO. 77-355,043, FILED 12-18-2007.

JENNIFER VASQUEZ, EXAMINING ATTORNEY

Int. Cl.: 36

Prior U.S. Cls.: 100, 101 and 102

United States Patent and Trademark Office

Reg. No. 3,476,055

Registered July 29, 2008

SERVICE MARK
PRINCIPAL REGISTER

Benefits
for you

FLUOR CORPORATION (DELAWARE CORPORATION)
3 POLARIS WAY
ALISO VIEJO, CA 92698

FOR: HUMAN RESOURCE SERVICES, NAMELY, ADMINISTRATION OF EMPLOYEE BENEFITS PLANS AND ADMINISTRATION OF EMPLOYEE RETIREMENT PLANS, PROVIDING INFORMATION RELATING TO HEALTH AND DISABILITY INSURANCE AND MEDICAL BENEFITS PROVIDERS, PROVIDING INFORMATION IN THE FIELDS OF EMPLOYEE BENEFIT PLAN MANAGEMENT AND EMPLOYEE RETIREMENT PLANS, DIRECTLY AND VIA THE INTERNET, IN CLASS 36 (U.S. CLS. 100, 101 AND 102).

FIRST USE 10-31-2003; IN COMMERCE 10-31-2003.

THE MARK CONSISTS OF THE WORD "BENEFITS" IS CAPITALIZED AND IS ABOVE THE WORDS "FOR YOU". THE WORD "FOR" IS IN LOWER CASE AND TO THE LEFT OF THE WORD "YOU" WHICH IS ALSO IN LOWER CASE AND BOLDED. THE WORDS "FOR YOU" ARE UNDERLINED.

SER. NO. 77-355,049, FILED 12-18-2007.

KYLE PEETE, EXAMINING ATTORNEY

Int. Cl.: 33

Prior U.S. Cls.: 47 and 49

United States Patent and Trademark Office

Reg. No. 3,476,056

Registered July 29, 2008

**TRADEMARK
PRINCIPAL REGISTER**

PROXIMUS

ADEGA, LLC (COLORADO LTD LIAB CO)
406
1449 WYNKOOP ST
DENVER, CO 80202

FOR: TEQUILA, IN CLASS 33 (U.S. CLS. 47 AND
49).

FIRST USE 8-1-2007; IN COMMERCE 8-1-2007.

THE MARK CONSISTS OF STANDARD CHAR-
ACTERS WITHOUT CLAIM TO ANY PARTICULAR
FONT, STYLE, SIZE, OR COLOR.

SER. NO. 77-355,058, FILED 12-18-2007.

DOMINIC J. FERRAIUOLO, EXAMINING ATTOR-
NEY

Int. Cl.: 5

Prior U.S. Cls.: 6, 18, 44, 46, 51 and 52

United States Patent and Trademark Office

Reg. No. 3,476,057

Registered July 29, 2008

**TRADEMARK
PRINCIPAL REGISTER**

Dakota Gold

POET INVESTMENTS, INC. (SOUTH DAKOTA
CORPORATION)
4615 N. LEWIS AVENUE
SIOUX FALLS, SD 57104

FOR: ANIMAL FEED SUPPLEMENTS, IN CLASS
5 (U.S. CLS. 6, 18, 44, 46, 51 AND 52).

FIRST USE 0-0-1993; IN COMMERCE 0-0-1993.

THE MARK CONSISTS OF STANDARD CHAR-
ACTERS WITHOUT CLAIM TO ANY PARTICULAR
FONT, STYLE, SIZE, OR COLOR.

OWNER OF U.S. REG. NO. 1,994,116.

SER. NO. 77-355,066, FILED 12-18-2007.

LESLEY LAMOTHE, EXAMINING ATTORNEY

Int. Cl.: 41

Prior U.S. Cls.: 100, 101 and 107

United States Patent and Trademark Office

Reg. No. 3,476,058

Registered July 29, 2008

**SERVICE MARK
PRINCIPAL REGISTER**



J.J. BUCKLEY, LLC (CALIFORNIA LTD LIAB
CO)
SUITE D
7305 EDGEWATER DRIVE
OAKLAND, CA 94621

FOR: ON-LINE JOURNALS, NAMELY, BLOGS
FEATURING WINE-RELATED TOPICS; PROVID-
ING NEWSLETTERS IN THE FIELD OF WINE VIA
E-MAIL; ENTERTAINMENT SERVICES, NAMELY,
PROVIDING A WEB SITE FEATURING FILM
CLIPS, PHOTOGRAPHS, AND OTHER MULTIME-
DIA MATERIALS; ENTERTAINMENT SERVICES,
NAMELY, PROVIDING ON-LINE REVIEWS OF
WINES; PUBLISHING OF REVIEWS; ENTERTAIN-
MENT SERVICES, NAMELY, WINE TASTINGS;
EDUCATION SERVICES, NAMELY, PROVIDING
EDUCATION IN THE FIELD OF WINE, IN CLASS
41 (U.S. CLS. 100, 101 AND 107).

FIRST USE 11-30-2006; IN COMMERCE 11-30-2006.

NO CLAIM IS MADE TO THE EXCLUSIVE
RIGHT TO USE "FINE WINES", APART FROM
THE MARK AS SHOWN.

THE MARK CONSISTS OF AN OVAL-SHAPED
BACKGROUND, WITH A SHIELD THAT CON-
TAINS FOUR CHARGES, WITH THE WORDS "J.J.
BUCKLEY FINE WINES" IMPRINTED OVER THE
SHIELD.

SER. NO. 77-355,071, FILED 12-18-2007.

AISHA CLARKE, EXAMINING ATTORNEY

Int. Cl.: 37

Prior U.S. Cls.: 100, 103 and 106

United States Patent and Trademark Office

Reg. No. 3,476,059

Registered July 29, 2008

**SERVICE MARK
PRINCIPAL REGISTER**

CAR BAR  INTERNATIONAL

CAR BAR INTERNATIONAL, INC. (ARIZONA CORPORATION)
333 CIRCLE P DRIVE
PRESCOTT, AZ 86303

FOR: AUTOMOBILE GLASS REPAIR AND REPLACEMENT SERVICES, IN CLASS 37 (U.S. CLS. 100, 103 AND 106).

FIRST USE 3-4-2003; IN COMMERCE 3-4-2003.

NO CLAIM IS MADE TO THE EXCLUSIVE RIGHT TO USE "INTERNATIONAL", APART FROM THE MARK AS SHOWN.

THE MARK CONSISTS OF THREE COLOR BARS IN BETWEEN THE WORDS "CAR BAR" AND THE WORD "INTERNATIONAL".

SER. NO. 77-355,091, FILED 12-18-2007.

MARCIE MILONE, EXAMINING ATTORNEY

Int. Cl.: 9

Prior U.S. Cls.: 21, 23, 26, 36 and 38

Reg. No. 3,476,060

United States Patent and Trademark Office

Registered July 29, 2008

**TRADEMARK
PRINCIPAL REGISTER**



J.J. BUCKLEY, LLC (CALIFORNIA LTD LIAB
CO)
SUITE D
7305 EDGEWATER DRIVE
OAKLAND, CA 94621

FOR: TEMPORARILY DOWNLOADABLE MUL-
TIMEDIA FILES CONTAINING ARTWORK, TEXT,
AUDIO, VIDEO AND INTERNET WEB LINKS RE-
LATED TO WINE, IN CLASS 9 (U.S. CLS. 21, 23, 26, 36
AND 38).

FIRST USE 6-30-2005; IN COMMERCE 9-30-2006.

NO CLAIM IS MADE TO THE EXCLUSIVE
RIGHT TO USE "FINE WINES", APART FROM
THE MARK AS SHOWN.

THE MARK CONSISTS OF AN OVAL-SHAPED
BACKGROUND, WITH A SHIELD THAT CON-
TAINS FOUR CHARGES, WITH THE WORDS " J.J.
BUCKLEY FINE WINES" IMPRINTED OVER THE
SHIELD.

SER. NO. 77-355,110, FILED 12-18-2007.

AISHA CLARKE, EXAMINING ATTORNEY

Int. Cl.: 35

Prior U.S. Cls.: 100, 101 and 102

United States Patent and Trademark Office

Reg. No. 3,476,061

Registered July 29, 2008

**SERVICE MARK
PRINCIPAL REGISTER**

SPREAD THE GOOD LIFE

PAUL RISCALLA (UNITED STATES INDIVIDUAL)

#115

70 PALATINE

IRVINE, CA 92612

FOR: COMPUTERIZED ON-LINE RETAIL STORE SERVICES IN THE FIELD OF CLOTHING; ON-LINE RETAIL STORE SERVICES FEATURING CLOTHING; RETAIL APPAREL STORES; RETAIL CLOTHING BOUTIQUES; RETAIL CLOTHING STORES, IN CLASS 35 (U.S. CLS. 100, 101 AND 102).

FIRST USE 12-5-2007; IN COMMERCE 12-5-2007.

THE MARK CONSISTS OF STANDARD CHARACTERS WITHOUT CLAIM TO ANY PARTICULAR FONT, STYLE, SIZE, OR COLOR.

SER. NO. 77-355,116, FILED 12-18-2007.

SAMUEL E. SHARPER JR., EXAMINING ATTORNEY

Int. Cl.: 11

Prior U.S. Cls.: 13, 21, 23, 31 and 34

Reg. No. 3,476,062

United States Patent and Trademark Office

Registered July 29, 2008

**TRADEMARK
PRINCIPAL REGISTER**

Glowwisp

GLOWWISP, LLC (TEXAS LTD LIAB CO)
1844 RED ROCK DR
ROUND ROCK, TX 78665

THE MARK CONSISTS OF STANDARD CHAR-
ACTERS WITHOUT CLAIM TO ANY PARTICULAR
FONT, STYLE, SIZE, OR COLOR.

FOR: FLASHING STROBE LIGHT APPARATUS,
IN CLASS 11 (U.S. CLS. 13, 21, 23, 31 AND 34).

SER. NO. 77-355,131, FILED 12-18-2007.

FIRST USE 11-30-2007; IN COMMERCE 11-30-2007.

ROBIN CHOSID, EXAMINING ATTORNEY

Int. Cl.: 44

Prior U.S. Cls.: 100 and 101

United States Patent and Trademark Office

Reg. No. 3,476,063

Registered July 29, 2008

**SERVICE MARK
PRINCIPAL REGISTER**

**The Future of Healthcare
is Here**

TRANS4MED, PLLC (ARIZONA LTD LIAB CO),
DBA UCR HEALTH CENTERS
2815 S ALMA SCHOOL RD. STE. 7
CHANDLER, AZ 85286

FOR: ACUPUNCTURE SERVICES; AMBULANT
MEDICAL CARE; AROMATHERAPY SERVICES;
BODY WAXING SERVICES; COSMETICIAN SERVI-
CES; FACIAL TREATMENT SERVICES, NAMELY,
COSMETIC PEELS; HEALTH CARE SERVICES,
NAMELY, WELLNESS PROGRAMS; HEALTH SPA
SERVICES, NAMELY, COSMETIC BODY CARE
SERVICES; MEDICAL CLINICS; MEDICAL SERVI-
CES, NAMELY, PRE-EMPLOYMENT DRUG
SCREENING; NON-INVASIVE COSMETIC MEDI-
CAL PROCEDURES; OCCUPATIONAL THERAPY

SERVICES; PHYSICIAN SERVICES; PREPARATION
AND DISPENSING OF MEDICATIONS; PROVID-
ING LASER THERAPY FOR TREATING MEDICAL
CONDITIONS; URGENT MEDICAL CARE CEN-
TERS, IN CLASS 44 (U.S. CLS. 100 AND 101).

FIRST USE 11-23-2005; IN COMMERCE 11-23-2005.

THE MARK CONSISTS OF STANDARD CHAR-
ACTERS WITHOUT CLAIM TO ANY PARTICULAR
FONT, STYLE, SIZE, OR COLOR.

SER. NO. 77-355,138, FILED 12-18-2007.

CHRISIE B. KING, EXAMINING ATTORNEY

Int. Cl.: 41

Prior U.S. Cls.: 100, 101 and 107

United States Patent and Trademark Office

Reg. No. 3,476,064

Registered July 29, 2008

**SERVICE MARK
PRINCIPAL REGISTER**

IT'S ABOUT WE

MOS ENTERPRISES, INC. (CALIFORNIA CORPORATION)
3110 MAIN STREET, SUITE 300
SANTA MONICA, CA 90405

FOR: EDUCATIONAL SERVICES, NAMELY, CONDUCTING CONFERENCES IN THE FIELD OF NEWS AND INFORMATION OF INTEREST TO WOMEN RELATED TO INVESTMENT, PERSONAL FINANCE, HEALTH, SPIRITUALITY, LEADERSHIP, COMMUNITY SERVICE, ACTIVISM, CAREER, ENVIRONMENTAL AWARENESS, PERSONAL GROWTH, AND EMPOWERMENT, IN CLASS 41 (U.S. CLS. 100, 101 AND 107).

FIRST USE 10-23-2007; IN COMMERCE 10-23-2007.

THE MARK CONSISTS OF STANDARD CHARACTERS WITHOUT CLAIM TO ANY PARTICULAR FONT, STYLE, SIZE, OR COLOR.

SER. NO. 77-355,144, FILED 12-18-2007.

AMOS T. MATTHEWS, JR., EXAMINING ATTORNEY

Int. Cls.: 16 and 44

Prior U.S. Cls.: 2, 5, 22, 23, 29, 37, 38, 50, 100 and 101

United States Patent and Trademark Office

Reg. No. 3,476,065

Registered July 29, 2008

**TRADEMARK
SERVICE MARK
PRINCIPAL REGISTER**

**TREAT NOW, BECAUSE EVERY
DAY COUNTS**

EISAI INC. (DELAWARE CORPORATION)
100 TICE BLVD.
WOODCLIFF LAKE, NJ 07677

FOR: PRINTED MATERIALS, NAMELY, INFORMATIONAL BOOKLETS, BROCHURES, PAMPHLETS, LEAFLETS, FOLDERS, INSERTS, AND SCREENING TOOLS ON THE TOPIC OF AGING, DEMENTIA AND ALZHEIMER'S DISEASE AND MEDICATIONS FOR THE TREATMENT OF ALZHEIMER'S DISEASE AND DEMENTIA, IN CLASS 16 (U.S. CLS. 2, 5, 22, 23, 29, 37, 38 AND 50).

FIRST USE 9-0-2007; IN COMMERCE 9-0-2007.

FOR: MEDICAL INFORMATION SERVICES, NAMELY, PROVIDING INFORMATION RELATED

TO AGING, DEMENTIA AND ALZHEIMER'S DISEASE, THE DIAGNOSIS, TREATMENT AND MANAGEMENT OF ALZHEIMER'S DISEASE AND DEMENTIA, AND MEDICATIONS FOR THE TREATMENT OF ALZHEIMER'S DISEASE AND DEMENTIA, IN CLASS 44 (U.S. CLS. 100 AND 101).

FIRST USE 9-0-2007; IN COMMERCE 9-0-2007.

THE MARK CONSISTS OF STANDARD CHARACTERS WITHOUT CLAIM TO ANY PARTICULAR FONT, STYLE, SIZE, OR COLOR.

SER. NO. 77-355,149, FILED 12-18-2007.

GEOFFREY FOSDICK, EXAMINING ATTORNEY

Int. Cl.: 9

Prior U.S. Cls.: 21, 23, 26, 36 and 38

Reg. No. 3,476,066

United States Patent and Trademark Office

Registered July 29, 2008

**TRADEMARK
PRINCIPAL REGISTER**

U-VIEWER

COSTA, MARCUS (BRAZIL INDIVIDUAL)
1314 WATERFORD FALLS AVE.
LAS VEGAS, NV 89123

FOR: APPARATUS COMPRISED OF A PROPRIETARY DESKTOP DESIGNED COMPUTER MODULE WITH A TOUCH SCREEN MONITOR AND BAR CODE SCANNER THAT ENABLES THE VISUALIZATION OF THE WINNING RESULT OF PRINTED PAPER PULL TABS, LOTTERY TICKETS AND SCRATCH TICKETS BY SCANNING A BAR

CODE ASSOCIATED WITH THE GAME ELEMENT, IN CLASS 9 (U.S. CLS. 21, 23, 26, 36 AND 38).

FIRST USE 4-13-2007; IN COMMERCE 11-20-2007.

THE MARK CONSISTS OF STANDARD CHARACTERS WITHOUT CLAIM TO ANY PARTICULAR FONT, STYLE, SIZE, OR COLOR.

SER. NO. 77-355,163, FILED 12-18-2007.

ROBIN CHOSID, EXAMINING ATTORNEY

Int. Cl.: 40

Prior U.S. Cls.: 100, 103 and 106

United States Patent and Trademark Office

Reg. No. 3,476,067

Registered July 29, 2008

**SERVICE MARK
PRINCIPAL REGISTER**



WGI INC. (DELAWARE CORPORATION), DBA
WESTFIELD GAGE COMPANY OVERHAUL &
REPAIR
34 HUDSON DRIVE
SOUTHWICK, MA 010771130

FOR: MANUFACTURING SERVICES FOR OTHERS IN THE FIELD OF PRECISION AEROSPACE PARTS, IN CLASS 40 (U.S. CLS. 100, 103 AND 106).

FIRST USE 1-1-1990; IN COMMERCE 1-1-1990.

THE MARK CONSISTS OF STYLIZED TEXT OF "WGI".

SER. NO. 77-355,175, FILED 12-18-2007.

DEZMONA MIZELLE, EXAMINING ATTORNEY

Int. Cl.: 45

Prior U.S. Cls.: 100 and 101

United States Patent and Trademark Office

Reg. No. 3,476,068

Registered July 29, 2008

**SERVICE MARK
PRINCIPAL REGISTER**

MATT'S LITTLE BLACK BOOK

MATT'S LITTLE BLACK BOOK, INC. (NEW
JERSEY CORPORATION)
218 BEACH DRIVE
SEASIDE PARK, NJ 08752

FOR: MATCHMAKING SERVICES; PERSONAL
IMAGE CONSULTING SERVICES; PERSONAL
LIFESTYLE CONSULTING SERVICES, IN CLASS
45 (U.S. CLS. 100 AND 101).

FIRST USE 9-1-2004; IN COMMERCE 1-1-2005.

THE MARK CONSISTS OF STANDARD CHAR-
ACTERS WITHOUT CLAIM TO ANY PARTICULAR
FONT, STYLE, SIZE, OR COLOR.

SER. NO. 77-355,194, FILED 12-18-2007.

JEFFERY COWARD, EXAMINING ATTORNEY

Int. Cl.: 35

Prior U.S. Cls.: 100, 101 and 102

United States Patent and Trademark Office

Reg. No. 3,476,069

Registered July 29, 2008

**SERVICE MARK
PRINCIPAL REGISTER**



YELLOW PAGES NATIONWIDE, INC. (NEVADA CORPORATION)

#140

3565 LAS VEGAS BLVD. SOUTH
LAS VEGAS, NV 89109

FOR: PROVIDING AN ONLINE DIRECTORY INFORMATION SERVICE FEATURING INFORMATION REGARDING LOCAL BUSINESSES IN CITIES ACROSS THE UNITED STATES INCLUDING ADDRESSES, PHONE NUMBERS, MAPS, LINKS, AND IMAGES RELEVANT TO THE BUSINESSES, IN CLASS 35 (U.S. CLS. 100, 101 AND 102).

FIRST USE 4-10-2002; IN COMMERCE 4-10-2002.

THE MARK CONSISTS OF THE WORDING AND/OR LETTERS "GETYP", APPEARS WITH AN IMAGE IN AN OPEN BOOK, COMPUTER MOUSE AND BUILDINGS OUTLINE TO FORM THE IMAGE OF A CITY SKYLINE.

SER. NO. 77-355,199, FILED 12-18-2007.

JILL C. ALT, EXAMINING ATTORNEY

Int. Cl.: 42

Prior U.S. Cls.: 100 and 101

United States Patent and Trademark Office

Reg. No. 3,476,070

Registered July 29, 2008

**SERVICE MARK
PRINCIPAL REGISTER**



MARK WARRINGTON-READ (UNITED KING-
DOM INDIVIDUAL)
2900 DELK RD, STE 700 # 252
MARIETTA, GA 30067

FOR: COMPUTER CONSULTATION IN THE
FIELD OF COMPUTER SECURITY; COMPUTER
DIAGNOSTIC SERVICES; COMPUTER NETWORK
DESIGN FOR OTHERS; COMPUTER SERVICES,
NAMELY, COMPUTER SYSTEM ADMINISTRA-
TION FOR OTHERS; COMPUTER SERVICES,
NAMELY, DESIGNING AND IMPLEMENTING
WEB SITES FOR OTHERS; COMPUTER SERVICES,
NAMELY, MANAGING WEB SITES FOR OTHERS;
COMPUTER SERVICES, NAMELY, REMOTE AND
ON-SITE MANAGEMENT OF ELECTRONIC MES-
SAGING SYSTEMS AND APPLICATIONS FOR OTH-
ERS; COMPUTER SOFTWARE CONSULTATION;

COMPUTER SYSTEMS ANALYSIS, IN CLASS 42
(U.S. CLS. 100 AND 101).

FIRST USE 2-1-2006; IN COMMERCE 2-1-2006.

NO CLAIM IS MADE TO THE EXCLUSIVE
RIGHT TO USE "NETWORK CONSULTANTS" ,
APART FROM THE MARK AS SHOWN.

THE MARK CONSISTS OF THE LETTERS "WNC"
NEXT TO AN OAK TREE, ALL LOCATED ABOVE A
SHADED SECTION CONTAINING THE UNDER-
LINED WORDS "WARRINGTON NETWORK CON-
SULTANTS".

SER. NO. 77-355,207, FILED 12-18-2007.

CHRISIE B. KING, EXAMINING ATTORNEY

Int. Cl.: 37

Prior U.S. Cls.: 100, 103 and 106

United States Patent and Trademark Office

Reg. No. 3,476,071

Registered July 29, 2008

SERVICE MARK
PRINCIPAL REGISTER

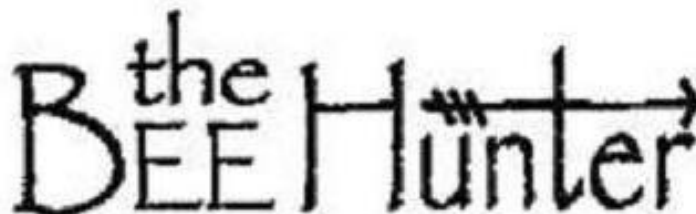
The logo features the words "The Bee Hunter" in a stylized, hand-drawn font. The word "The" is in a smaller, cursive script above the word "BEE". "BEE" is in large, bold, block letters. "Hunter" is in a similar block font, but the letter "T" is crossed by a horizontal arrow pointing to the right.

BEECON, INC. (PENNSYLVANIA CORPORATION)

1275 PENN AVE

PITTSBURGH, PA 15221

FOR: PEST EXTERMINATION OTHER THAN FOR AGRICULTURAL PURPOSES, IN CLASS 37 (U.S. CLS. 100, 103 AND 106).

FIRST USE 3-1-2007; IN COMMERCE 3-1-2007.

NO CLAIM IS MADE TO THE EXCLUSIVE RIGHT TO USE "BEE", APART FROM THE MARK AS SHOWN.

THE MARK CONSISTS OF THE WORDS "THE BEE HUNTER" WITH THE "T" IN HUNTER CROSSED WITH AN ARROW.

SER. NO. 77-355,249, FILED 12-18-2007.

ANTHONY RINKER, EXAMINING ATTORNEY

Int. Cl.: 35

Prior U.S. Cls.: 100, 101 and 102

United States Patent and Trademark Office

Reg. No. 3,476,072

Registered July 29, 2008

**SERVICE MARK
PRINCIPAL REGISTER**



SNOWCOVERED INCORPORATED (TENNESSEE CORPORATION)
3815 HIGHWAY 79 N STE B
PARIS, TN 38242

FOR: OPERATING ON-LINE MARKETPLACES FEATURING SOFTWARE AND SOFTWARE PRODUCTS; OPERATING ON-LINE MARKETPLACES FOR SELLERS OF GOODS AND/OR SERVICES, IN CLASS 35 (U.S. CLS. 100, 101 AND 102).

FIRST USE 11-30-2007; IN COMMERCE 11-30-2007.

THE COLOR(S) BLUE AND WHITE IS/ARE CLAIMED AS A FEATURE OF THE MARK.

THE MARK CONSISTS OF AN IMAGE OF BLUE AND WHITE SNOW-COVERED MOUNTAINS INTERTWINED WITH THE WORDING "SNOWCOVERED" APPEARING IN BLUE AND WHITE

SER. NO. 77-355,254, FILED 12-18-2007.

ANTHONY RINKER, EXAMINING ATTORNEY

Int. Cl.: 41

Prior U.S. Cls.: 100, 101 and 107

United States Patent and Trademark Office

Reg. No. 3,476,073

Registered July 29, 2008

**SERVICE MARK
PRINCIPAL REGISTER**

Rogues & Wenches

ROGUES & WENCHES, A DE FACTO PARTNER-
SHIP (ALASKA PARTNERSHIP)
P. O. BOX 232013
ANCHORAGE, AK 995232013

FOR: ENTERTAINMENT, NAMELY, LIVE PER-
FORMANCES BY MUSICAL BANDS, IN CLASS 41
(U.S. CLS. 100, 101 AND 107).

FIRST USE 7-6-2003; IN COMMERCE 1-6-2004.

THE MARK CONSISTS OF STANDARD CHAR-
ACTERS WITHOUT CLAIM TO ANY PARTICULAR
FONT, STYLE, SIZE, OR COLOR.

SER. NO. 77-355,264, FILED 12-18-2007.

VERNA BETH RIRIE, EXAMINING ATTORNEY

Int. Cl.: 9

Prior U.S. Cls.: 21, 23, 26, 36 and 38

Reg. No. 3,476,074

United States Patent and Trademark Office

Registered July 29, 2008

**TRADEMARK
PRINCIPAL REGISTER**

The logo for ARKITIO features the word "ARKITIO" in a bold, sans-serif font. The letter "A" is stylized with a horizontal line extending to the left, ending in a small arrowhead pointing towards the left.

MACPOWER & TYTECH TECHNOLOGY CO.,
LTD. (TAIWAN LTD LIAB CO)
8F, NO. 52, MING-QUAN RD.
HSIN-TIEN CITY
TAIPEI HSIEN, TAIWAN

FOR: AMUSEMENT APPARATUS ADAPTED
FOR USE WITH TELEVISION RECEIVERS ONLY;
AUDIO-VIDEO RECEIVERS; COMPUTER GAME
SOFTWARE; COMPUTER PERIPHERAL DEVICES;
COMPUTER DISC DRIVES; INTERFACES FOR
COMPUTERS; BLANK MAGNETIC DATA CARRI-
ERS; APPARATUS FOR RECORDING, TRANSMIS-
SION, PROCESSING AND REPRODUCTION OF

SOUND, IMAGES OR DATA; ELECTRONIC CARD
READERS; WIRELESS TELEPHONY APPARATUS,
IN CLASS 9 (U.S. CLS. 21, 23, 26, 36 AND 38).

FIRST USE 6-23-2004; IN COMMERCE 6-23-2004.

THE MARK CONSISTS OF THE WORD "ARKI-
TIO".

SER. NO. 77-355,296, FILED 12-19-2007.

CHARLES L. JENKINS, EXAMINING ATTORNEY

Int. Cls.: 9 and 11

Prior U.S. Cls.: 13, 21, 23, 26, 31, 34, 36 and 38

United States Patent and Trademark Office

Reg. No. 3,476,075

Registered July 29, 2008

**TRADEMARK
PRINCIPAL REGISTER**



RAB LIGHTING, INC. (NEW YORK CORPORATION)
170 LUDLOW AVENUE
NORTHVALE, NJ 07647

FOR: ELECTRICAL EQUIPMENT, NAMELY, JUNCTION BOXES, OUTLET BOXES, COVER PLATES, PLUGS FOR LIGHTING FIXTURES, IN CLASS 9 (U.S. CLS. 21, 23, 26, 36 AND 38).

FIRST USE 0-0-1950; IN COMMERCE 0-0-1950.

FOR: ELECTRIC LIGHTING FIXTURES AND PARTS THEREOF; ELECTRICAL EQUIPMENT,

NAMELY, INDOOR AND OUTDOOR MOTION-ACTIVATED LIGHTING FIXTURES WITH EXPLOSIONPROOF, VAPORPROOF, WEATHERPROOF AND VANDALPROOF FEATURES, IN CLASS 11 (U.S. CLS. 13, 21, 23, 31 AND 34).

FIRST USE 0-0-1950; IN COMMERCE 0-0-1950.

SER. NO. 77-355,334, FILED 12-19-2007.

ALICE BENMAMAN, EXAMINING ATTORNEY

Int. Cl.: 25

Prior U.S. Cls.: 22 and 39

United States Patent and Trademark Office

Reg. No. 3,476,076

Registered July 29, 2008

**TRADEMARK
PRINCIPAL REGISTER**

HYDRA SWIM

HYDRA SWIMWEAR, INC. (CALIFORNIA CORPORATION)

8581 SANTA MONICA BOULEVARD, SUITE 485

LOS ANGELES, CA 90068

FOR: BATHING SUITS, IN CLASS 25 (U.S. CLS. 22 AND 39).

FIRST USE 7-1-2007; IN COMMERCE 7-1-2007.

THE MARK CONSISTS OF STANDARD CHARACTERS WITHOUT CLAIM TO ANY PARTICULAR FONT, STYLE, SIZE, OR COLOR.

NO CLAIM IS MADE TO THE EXCLUSIVE RIGHT TO USE "SWIM", APART FROM THE MARK AS SHOWN.

SER. NO. 77-355,336, FILED 12-19-2007.

ALICE BENMAMAN, EXAMINING ATTORNEY

Int. Cl.: 18

Prior U.S. Cls.: 1, 2, 3, 22 and 41

Reg. No. 3,476,077

United States Patent and Trademark Office

Registered July 29, 2008

**TRADEMARK
PRINCIPAL REGISTER**



FTI CORPORATION LIMITED (HONG KONG CORPORATION)
33 CANTON RD FLAT/RM 901 9/F
TOWER 1 CHINA HONG KONG CITY
TSIM SHA TSUI, KL, HONG KONG

FOR: BOOK BAGS; SHOULDER BAGS; COIN PURSES; LUGGAGE; ALL PURPOSE SPORT BAGS; TOTE BAGS; LEATHER SUITCASES; GARMENT BAGS FOR TRAVEL; OVERNIGHT CASES; BACKPACKS; BRIEFCASES; HANDBAGS; PARASOLS; POCKET WALLETS; TEXTILE SHOPPING BAGS; SUITCASES; TRAVELING BAGS; LUGGAGE, NAMELY, TRUNKS; UMBRELLAS; CANES; FUR; LEATHER FOR FURNITURE; IMITATION LEA-

THER; LEATHER POUCHES; SCHOOL BAGS; SLING BAGS FOR CARRYING INFANTS; UMBRELLA COVERS; VALISES; SHOPPING BAGS WITH WHEELS ATTACHED, IN CLASS 18 (U.S. CLS. 1, 2, 3, 22 AND 41).

FIRST USE 6-30-2006; IN COMMERCE 5-31-2007.

THE MARK CONSISTS OF A GLOBE WITH THE LETTERS "EFT".

SER. NO. 77-355,410, FILED 12-19-2007.

TINA BROWN, EXAMINING ATTORNEY

Int. Cl.: 35

Prior U.S. Cls.: 100, 101 and 102

United States Patent and Trademark Office

Reg. No. 3,476,078

Registered July 29, 2008

**SERVICE MARK
PRINCIPAL REGISTER**



CITIZENS FOR CIVIL DISCOURSE (D.C. CORPORATION)

2019 Q STREET, NW

WASHINGTON, DC 20009

FOR: PROVIDING FREE ON-LINE REGISTRATION SERVICES THAT ALLOW ALL VOTERS IN THE UNITED STATES TO REGISTER THEIR TELEPHONE NUMBER IN ORDER TO HAVE POLITICIANS STOP CALLING THEM AT HOME, IN CLASS 35 (U.S. CLS. 100, 101 AND 102).

FIRST USE 10-24-2007; IN COMMERCE 10-24-2007.

NO CLAIM IS MADE TO THE EXCLUSIVE RIGHT TO USE "NATIONAL POLITICAL DO NOT CONTACT REGISTRY", APART FROM THE MARK AS SHOWN.

THE MARK CONSISTS OF A UNIVERSAL STOP MARK WITH A GRAPHIC OF A US POLITICIAN AND A PHONE WITH THE TEXT "NATIONAL POLITICAL DO NOT CONTACT REGISTRY" GOING AROUND IT.

SER. NO. 77-355,443, FILED 12-19-2007.

MARY ROSSMAN, EXAMINING ATTORNEY

Int. Cl.: 18

Prior U.S. Cls.: 1, 2, 3, 22 and 41

United States Patent and Trademark Office

Reg. No. 3,476,079

Registered July 29, 2008

**TRADEMARK
PRINCIPAL REGISTER**

ECOTECH

FTI CORPORATION LIMITED (HONG KONG CORPORATION)
33 CANTON RD FLAT/RM 901 9/F
TOWER 1 CHINA HONG KONG CITY
TSIM SHA TSUI, KL, HONG KONG

FOR: BOOK BAGS; SHOULDER BAGS; COIN PURSES; LUGGAGE; ALL PURPOSE SPORT BAGS; TOTE BAGS; LEATHER SUITCASES; GARMENT BAGS FOR TRAVEL; OVERNIGHT CASES; BACK-PACKS; BRIEFCASES; HANDBAGS; PARASOLS; POCKET WALLETS; TEXTILE SHOPPING BAGS; SUITCASES; TRAVELING BAGS; LUGGAGE, NAMELY, TRUNKS; UMBRELLAS; CANES; FUR; LEATHER FOR FURNITURE; IMITATION LEATHER; LEATHER POUCHES; SCHOOL BAGS; SLING BAGS FOR CARRYING INFANTS; UMBRELLA COVERS; VALISES; SHOPPING BAGS

WITH WHEELS ATTACHED, IN CLASS 18 (U.S. CLS. 1, 2, 3, 22 AND 41).

FIRST USE 6-30-2006; IN COMMERCE 5-31-2007.

THE COLOR(S) GREEN IS/ARE CLAIMED AS A FEATURE OF THE MARK.

THE MARK CONSISTS OF THE WORDS "ECOTECH" IN CAPITAL LETTERS IN STYLIZED FORM IN THE COLOR GREEN.

SER. NO. 77-355,445, FILED 12-19-2007.

TINA BROWN, EXAMINING ATTORNEY

Int. Cl.: 35

Prior U.S. Cls.: 100, 101 and 102

United States Patent and Trademark Office

Reg. No. 3,476,080

Registered July 29, 2008

SERVICE MARK
PRINCIPAL REGISTER



MORGAN ADVISORY GROUP, LLC (CALIFORNIA LTD LIAB CO)
451 LOS GATOS BLVD. STE. 103
LOS GATOS, CA 95032

FOR: MANAGEMENT OF PROFESSIONAL ATHLETES, IN CLASS 35 (U.S. CLS. 100, 101 AND 102).

FIRST USE 1-1-2004; IN COMMERCE 1-1-2004.

NO CLAIM IS MADE TO THE EXCLUSIVE RIGHT TO USE "ADVISORY GROUP", APART FROM THE MARK AS SHOWN.

THE NAME "MAG MORGAN" DOES NOT IDENTIFY A LIVING INDIVIDUAL.

THE COLOR(S) BLUE, WHITE, BLACK IS/ARE CLAIMED AS A FEATURE OF THE MARK.

THE MARK CONSISTS OF THE WHITE LETTERS "M" "A" AND "G," EACH SET WITHIN A GRADIENT BLUE BLOCK (FOR A TOTAL OF THREE BLOCKS), ABOVE BLACK TEXT READING "MORGAN" IN ALL CAPITAL LETTERS WITH A BLUE VERTICAL LINE ON EACH SIDE OF THE WORDING "MORGAN" FOLLOWED WITH THE SCRIPT "ADVISORY GROUP," IN BLUE.

SER. NO. 77-355,457, FILED 12-19-2007.

RUDY R. SINGLETON, EXAMINING ATTORNEY

Int. Cl.: 18

Prior U.S. Cls.: 1, 2, 3, 22 and 41

Reg. No. 3,476,081

United States Patent and Trademark Office

Registered July 29, 2008

**TRADEMARK
PRINCIPAL REGISTER**

revo

FTI CORPORATION LIMITED (HONG KONG CORPORATION)
33 CANTON RD FLAT/RM 901 9/F
TOWER 1 CHINA HONG KONG CITY
TSIM SHA TSUI, KL, HONG KONG

FOR: BOOK BAGS; SHOULDER BAGS; COIN PURSES; LUGGAGE; ALL PURPOSE SPORT BAGS; TOTE BAGS; LEATHER SUITCASES; GARMENT BAGS FOR TRAVEL; OVERNIGHT CASES; BACK-PACKS; BRIEFCASES; HANDBAGS; PARASOLS; POCKET WALLETS; TEXTILE SHOPPING BAGS; SUITCASES; TRAVELING BAGS; LUGGAGE, NAMELY, TRUNKS; UMBRELLAS; CANES; FUR; LEATHER FOR FURNITURE; IMITATION LEATHER; LEATHER POUCHES; SCHOOL BAGS; SLING BAGS FOR CARRYING INFANTS; UMBRELLA COVERS; VALISES; SHOPPING BAGS

WITH WHEELS ATTACHED, IN CLASS 18 (U.S. CLS. 1, 2, 3, 22 AND 41).

FIRST USE 6-30-2006; IN COMMERCE 5-31-2007.

OWNER OF U.S. REG. NO. 3,224,978.

THE MARK CONSISTS OF THE WORD "REVO" IN STYLIZED FORM.

THE WORD "REVO" HAS NO MEANING IN A FOREIGN LANGUAGE.

SER. NO. 77-355,473, FILED 12-19-2007.

TINA BROWN, EXAMINING ATTORNEY

Int. Cl.: 18

Prior U.S. Cls.: 1, 2, 3, 22 and 41

United States Patent and Trademark Office

Reg. No. 3,476,082

Registered July 29, 2008

**TRADEMARK
PRINCIPAL REGISTER**



FTI CORPORATION LIMITED (HONG KONG CORPORATION)
33 CANTON RD FLAT/RM 901 9/F
TOWER 1 CHINA HONG KONG CITY
TSIM SHA TSUI, KL, HONG KONG

FOR: BOOK BAGS; SHOULDER BAGS; COIN PURSES; LUGGAGE; ALL PURPOSE SPORT BAGS; TOTE BAGS; LEATHER SUITCASES; GARMENT BAGS FOR TRAVEL; OVERNIGHT CASES; BACK-PACKS; BRIEFCASES; HANDBAGS; PARASOLS; POCKET WALLETS; TEXTILE SHOPPING BAGS; SUITCASES; TRAVELING BAGS; LUGGAGE, NAMELY, TRUNKS; UMBRELLAS; CANES; FUR; LEATHER FOR FURNITURE; IMITATION LEATHER; LEATHER POUCHES; SCHOOL BAGS; SLING BAGS FOR CARRYING INFANTS; UMBRELLA COVERS; VALISES; SHOPPING BAGS

WITH WHEELS ATTACHED, IN CLASS 18 (U.S. CLS. 1, 2, 3, 22 AND 41).

FIRST USE 6-30-2006; IN COMMERCE 5-31-2007.

OWNER OF U.S. REG. NO. 3,224,978.

THE MARK CONSISTS OF THE WORD "REVO" IN STYLIZED FORM, WITH THE LETTERS "RE" ABOVE THE LETTERS "VO".

THE WORD "REVO" HAS NO MEANING IN A FOREIGN LANGUAGE.

SER. NO. 77-355,492, FILED 12-19-2007.

TINA BROWN, EXAMINING ATTORNEY

Int. Cl.: 35

Prior U.S. Cls.: 100, 101 and 102

United States Patent and Trademark Office

Reg. No. 3,476,083

Registered July 29, 2008

**SERVICE MARK
PRINCIPAL REGISTER**



ADRIANE SHELLEY (UNITED STATES INDIVIDUAL), DBA SWANKY BOUTIQUE
10203 TWO NOTCH RD.
COLUMBIA, SC 29229

THE MARK CONSISTS OF THE STYLIZED WORDS "SWANKY BOUTIQUE" WITH A DESIGN FEATURING THE UPPER TORSO OF A FEMALE INCORPORATED INTO THE LETTER "W".

FOR: RETAIL CLOTHING STORES, IN CLASS 35 (U.S. CLS. 100, 101 AND 102).

FIRST USE 3-1-2004; IN COMMERCE 8-0-2004.

SER. NO. 77-355,506, FILED 12-19-2007.

NO CLAIM IS MADE TO THE EXCLUSIVE RIGHT TO USE "BOUTIQUE", APART FROM THE MARK AS SHOWN.

RUDY R. SINGLETON, EXAMINING ATTORNEY

Int. Cl.: 42

Prior U.S. Cls.: 100 and 101

United States Patent and Trademark Office

Reg. No. 3,476,084

Registered July 29, 2008

**SERVICE MARK
PRINCIPAL REGISTER**

The Elevation of Wine

LAKE COUNTY DISTRICT 2 LOCAL WINE-
GRAPE COMMISSION (CALIFORNIA STATE
AGENCY)
P.O. BOX 877
LAKEPORT, CA 95453

THE MARK CONSISTS OF STANDARD CHAR-
ACTERS WITHOUT CLAIM TO ANY PARTICULAR
FONT, STYLE, SIZE, OR COLOR.

FOR: AGRICULTURAL RESEARCH, IN CLASS 42
(U.S. CLS. 100 AND 101).

SER. NO. 77-355,565, FILED 12-19-2007.

FIRST USE 1-22-2007; IN COMMERCE 1-22-2007.

DARRYL SPRUILL, EXAMINING ATTORNEY

Int. Cl.: 16

Prior U.S. Cls.: 2, 5, 22, 23, 29, 37, 38 and 50

United States Patent and Trademark Office

Reg. No. 3,476,085

Registered July 29, 2008

**TRADEMARK
PRINCIPAL REGISTER**

IDENT-A-KID

IDENT-A-KID SERVICES OF AMERICA, INC.
(FLORIDA CORPORATION)
2810 SCHERER DR., SUITE 100
ST. PETERSBURG, FL 33716

FOR: PRINTED CHILD IDENTIFICATION
CARDS, IN CLASS 16 (U.S. CLS. 2, 5, 22, 23, 29, 37,
38 AND 50).

FIRST USE 0-0-1986; IN COMMERCE 0-0-1986.

THE MARK CONSISTS OF STANDARD CHAR-
ACTERS WITHOUT CLAIM TO ANY PARTICULAR
FONT, STYLE, SIZE, OR COLOR.

OWNER OF U.S. REG. NO. 1,486,890.

SER. NO. 77-355,570, FILED 12-19-2007.

MARLENE BELL, EXAMINING ATTORNEY

Int. Cl.: 43

Prior U.S. Cls.: 100 and 101

United States Patent and Trademark Office

Reg. No. 3,476,086

Registered July 29, 2008

**SERVICE MARK
PRINCIPAL REGISTER**

STONE BROS.

STONE BROS. PIZZA LLC (OHIO LTD LIAB CO)
237 N. CENTRAL AVE.
UTICA, OH 43080

FOR: RESTAURANT SERVICES; RESTAURANTS
FEATURING HOME DELIVERY, IN CLASS 43 (U.S.
CLS. 100 AND 101).

FIRST USE 8-5-2002; IN COMMERCE 8-5-2002.

THE MARK CONSISTS OF STANDARD CHAR-
ACTERS WITHOUT CLAIM TO ANY PARTICULAR
FONT, STYLE, SIZE, OR COLOR.

NO CLAIM IS MADE TO THE EXCLUSIVE
RIGHT TO USE "BROS.", APART FROM THE MARK
AS SHOWN.

SER. NO. 77-355,588, FILED 12-19-2007.

SEAN CROWLEY, EXAMINING ATTORNEY

Int. Cl.: 42

Prior U.S. Cls.: 100 and 101

United States Patent and Trademark Office

Reg. No. 3,476,087

Registered July 29, 2008

**SERVICE MARK
PRINCIPAL REGISTER**

Gnostech

GNOSTECH INC. (PENNSYLVANIA CORPORATION)
SUITE 190
650 LOUIS DRIVE
WARMINSTER, PA 18974

THE MARK CONSISTS OF STANDARD CHARACTERS WITHOUT CLAIM TO ANY PARTICULAR FONT, STYLE, SIZE, OR COLOR.

FOR: COMPUTER CONSULTATION IN THE FIELD OF COMPUTER SECURITY, IN CLASS 42 (U.S. CLS. 100 AND 101).

SER. NO. 77-355,589, FILED 12-19-2007.

FIRST USE 9-20-1999; IN COMMERCE 9-20-1999.

WENDY GOODMAN, EXAMINING ATTORNEY

Int. Cl.: 35

Prior U.S. Cls.: 100, 101 and 102

United States Patent and Trademark Office

Reg. No. 3,476,088

Registered July 29, 2008

**SERVICE MARK
PRINCIPAL REGISTER**

PSI

POPULATION SERVICES INTERNATIONAL
(NORTH CAROLINA CORPORATION)
SUITE 600
1120 19TH STREET, NW
WASHINGTON, DC 20036

FOR: PROMOTING PUBLIC AWARENESS OF
HEALTH ISSUES BY APPLYING MARKETING
AND COMMUNICATIONS STRATEGIES TO EN-
COURAGE THE ADOPTION AND USE OF PRO-
DUCTS, SERVICES AND BEHAVIORS THAT
ENABLE PEOPLE TO LIVE HEALTHIER LIVES, IN
CLASS 35 (U.S. CLS. 100, 101 AND 102).

FIRST USE 1-22-1970; IN COMMERCE 1-0-1987.

THE MARK CONSISTS OF STANDARD CHAR-
ACTERS WITHOUT CLAIM TO ANY PARTICULAR
FONT, STYLE, SIZE, OR COLOR.

SER. NO. 77-355,594, FILED 12-19-2007.

ELISSA GARBER KON, EXAMINING ATTORNEY

Int. Cls.: 35 and 41

Prior U.S. Cls.: 100, 101, 102 and 107

United States Patent and Trademark Office

Reg. No. 3,476,089

Registered July 29, 2008

**SERVICE MARK
PRINCIPAL REGISTER**

**MANAGEMENT LEADERSHIP FOR
TOMORROW**

MANAGEMENT LEADERSHIP FOR TOMORROW (NEW YORK NON-PROFIT ORGANIZATION), DBA MLT
SUITE 200
224 WEST 35TH STREET
NEW YORK, NY 10001

FOR: EDUCATION LEADERSHIP DEVELOPMENT, IN CLASS 35 (U.S. CLS. 100, 101 AND 102).

FIRST USE 12-15-1997; IN COMMERCE 12-15-1997.

FOR: EDUCATION SERVICES, NAMELY, PROVIDING LIVE AND ONLINE CLASSES, SEMINARS, WORKSHOPS, COACHING IN THE FIELD OF BUSI-

NESS, CAREER PREPARATION, ACADEMIC COUNSELING, IN CLASS 41 (U.S. CLS. 100, 101 AND 107).

FIRST USE 12-15-1997; IN COMMERCE 12-15-1997.

THE MARK CONSISTS OF STANDARD CHARACTERS WITHOUT CLAIM TO ANY PARTICULAR FONT, STYLE, SIZE, OR COLOR.

SER. NO. 77-355,598, FILED 12-19-2007.

JUDITH HELFMAN, EXAMINING ATTORNEY

Int. Cls.: 35 and 41

Prior U.S. Cls.: 100, 101, 102 and 107

United States Patent and Trademark Office

Reg. No. 3,476,090

Registered July 29, 2008

**SERVICE MARK
PRINCIPAL REGISTER**

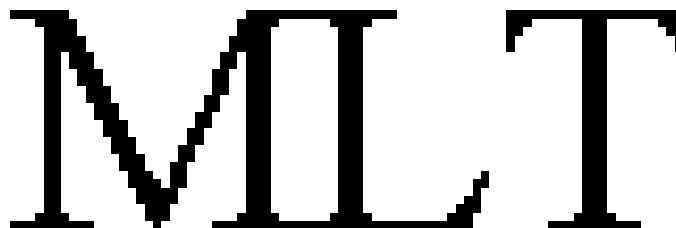

MANAGEMENT LEADERSHIP FOR TOMORROW (NEW YORK NON-PROFIT ORGANIZATION), DBA MLT
SUITE 200
224 WEST 35TH STREET
NEW YORK, NY 10001

FOR: EDUCATION LEADERSHIP DEVELOPMENT, IN CLASS 35 (U.S. CLS. 100, 101 AND 102).

FIRST USE 12-15-1997; IN COMMERCE 12-15-1997.

FOR: EDUCATION SERVICES, NAMELY, PROVIDING LIVE AND ONLINE CLASSES, SEMINARS, WORKSHOPS, COACHING IN THE FIELD OF BUSI-

NESS, CAREER PREPARATION, ACADEMIC COUNSELING, IN CLASS 41 (U.S. CLS. 100, 101 AND 107).

FIRST USE 12-15-1997; IN COMMERCE 12-15-1997.

THE MARK CONSISTS OF STANDARD CHARACTERS WITHOUT CLAIM TO ANY PARTICULAR FONT, STYLE, SIZE, OR COLOR.

SER. NO. 77-355,610, FILED 12-19-2007.

JUDITH HELFMAN, EXAMINING ATTORNEY

Int. Cl.: 14

Prior U.S. Cls.: 2, 27, 28 and 50

United States Patent and Trademark Office

Reg. No. 3,476,091

Registered July 29, 2008

**TRADEMARK
PRINCIPAL REGISTER**

IMAGES IN MOTION

THOUGHTWORKS LTD. (OHIO LTD LIAB CO)
3635 PERKIN AVE.
CLEVELAND, OH 44114

THE MARK CONSISTS OF STANDARD CHAR-
ACTERS WITHOUT CLAIM TO ANY PARTICULAR
FONT, STYLE, SIZE, OR COLOR.

FOR: CLOCKS, IN CLASS 14 (U.S. CLS. 2, 27, 28
AND 50).

SER. NO. 77-355,617, FILED 12-19-2007.

FIRST USE 11-0-2004; IN COMMERCE 11-0-2004.

DAVID HOFFMAN, EXAMINING ATTORNEY

Int. Cl.: 9

Prior U.S. Cls.: 21, 23, 26, 36 and 38

Reg. No. 3,476,092

United States Patent and Trademark Office

Registered July 29, 2008

**TRADEMARK
PRINCIPAL REGISTER**

BIG SPLASH GAMES

BIG SPLASH GAMES, LLC (DELAWARE LTD
LIAB CO)

2428 EAST 1ST STREET

TUCSON, AZ 85719

FOR: COMPUTER GAME PROGRAMS, IN CLASS
9 (U.S. CLS. 21, 23, 26, 36 AND 38).

FIRST USE 4-30-2007; IN COMMERCE 4-30-2007.

THE MARK CONSISTS OF STANDARD CHAR-
ACTERS WITHOUT CLAIM TO ANY PARTICULAR
FONT, STYLE, SIZE, OR COLOR.

NO CLAIM IS MADE TO THE EXCLUSIVE
RIGHT TO USE "GAMES", APART FROM THE
MARK AS SHOWN.

SER. NO. 77-355,653, FILED 12-19-2007.

DAVID HOFFMAN, EXAMINING ATTORNEY

Int. Cl.: 30

Prior U.S. Cl.: 46

United States Patent and Trademark Office

Reg. No. 3,476,093

Registered July 29, 2008

**TRADEMARK
PRINCIPAL REGISTER**

AU'SOME

AU'SOME, INC. (NEW JERSEY CORPORATION)
SUITE E, BUILDING A
2031 ROUTE 130
MONMOUTH JUNCTION, NJ 08852

FOR: CANDY, IN CLASS 30 (U.S. CL. 46).

FIRST USE 2-1-1998; IN COMMERCE 2-1-1998.

THE MARK CONSISTS OF STANDARD CHARACTERS WITHOUT CLAIM TO ANY PARTICULAR FONT, STYLE, SIZE, OR COLOR.

OWNER OF U.S. REG. NOS. 2,302,907 AND 3,149,290.

SER. NO. 77-355,658, FILED 12-19-2007.

HOWARD SMIGA, EXAMINING ATTORNEY

Int. Cl.: 9

Prior U.S. Cls.: 21, 23, 26, 36 and 38

Reg. No. 3,476,094

United States Patent and Trademark Office

Registered July 29, 2008

**TRADEMARK
PRINCIPAL REGISTER**

SKIP-AWAY

DIOTTE, DANIEL (CANADA INDIVIDUAL),
DBA VENMILL
660 DOUGLAS STREET
UXBRIDGE, MA 015692001

THE MARK CONSISTS OF STANDARD CHAR-
ACTERS WITHOUT CLAIM TO ANY PARTICULAR
FONT, STYLE, SIZE, OR COLOR.

FOR: BLANK DISCS FOR COMPUTERS; BLANK
OPTICAL DISCS; BLANK RECORDABLE OPTICAL
DISC; COMPUTER GAME DISCS; VIDEO GAME
DISCS, IN CLASS 9 (U.S. CLS. 21, 23, 26, 36 AND 38).

SER. NO. 77-355,664, FILED 12-19-2007.

FIRST USE 11-4-2005; IN COMMERCE 11-4-2005.

DAVID HOFFMAN, EXAMINING ATTORNEY

Int. Cl.: 5

Prior U.S. Cls.: 6, 18, 44, 46, 51 and 52

Reg. No. 3,476,095

United States Patent and Trademark Office

Registered July 29, 2008

**TRADEMARK
PRINCIPAL REGISTER**

LIFEQ10

1-800-HEALTHY.COM, INC. (DELAWARE CORPORATION)
834 WILSON DRIVE, SUITE B
RIDGELAND, MS 39157

THE MARK CONSISTS OF STANDARD CHARACTERS WITHOUT CLAIM TO ANY PARTICULAR FONT, STYLE, SIZE, OR COLOR.

FOR: DIETARY AND NUTRITIONAL SUPPLEMENTS, IN CLASS 5 (U.S. CLS. 6, 18, 44, 46, 51 AND 52).

SER. NO. 77-355,676, FILED 12-19-2007.

FIRST USE 1-19-2007; IN COMMERCE 1-19-2007.

CYNTHIA SLOAN, EXAMINING ATTORNEY

Prior U.S. Cl.: A

United States Patent and Trademark Office

Reg. No. 3,476,096

Registered July 29, 2008

CERTIFICATION MARK
PRINCIPAL REGISTER

MAINETAINER

AMERICAN MAINE-ANJOU ASSOCIATION (NE-
BRASKA NON-PROFIT CORPORATION)
204 MARSHALL ROAD
PLATTE CITY, MO 64079

FOR: LIVE ANIMALS, NAMELY, MAINE-ANJOU
CATTLE, IN CLASS A (U.S. CL. A).

FIRST USE 6-30-2003; IN COMMERCE 6-30-2003.

THE MARK CONSISTS OF STANDARD CHAR-
ACTERS WITHOUT CLAIM TO ANY PARTICULAR
FONT, STYLE, SIZE, OR COLOR.

THE CERTIFICATION MARK, AS USED BY
AUTHORIZED PERSONS, CERTIFIES AMERICAN
MAINE-ANJOU CATTLE BRED TO PARTICULAR
SPECIFICATIONS OF THE CERTIFIER.

SER. NO. 77-355,677, FILED 12-19-2007.

ANDREA SAUNDERS, EXAMINING ATTORNEY

Int. Cl.: 43

Prior U.S. Cls.: 100 and 101

United States Patent and Trademark Office

Reg. No. 3,476,097

Registered July 29, 2008

**SERVICE MARK
PRINCIPAL REGISTER**

COMME ÇA

B&O FOODART A.G. (SWITZERLAND COR-
PORATION)
KIRCHGASSE 6
FREINBACH, SWITZERLAND

FOR: RESTAURANT SERVICES; BAR SERVICES,
IN CLASS 43 (U.S. CLS. 100 AND 101).

FIRST USE 10-16-2007; IN COMMERCE 10-16-2007.

THE MARK CONSISTS OF STANDARD CHAR-
ACTERS WITHOUT CLAIM TO ANY PARTICULAR
FONT, STYLE, SIZE, OR COLOR.

THE FOREIGN WORDING IN THE MARK
TRANSLATES INTO ENGLISH AS "LIKE THAT".

SER. NO. 77-355,684, FILED 12-19-2007.

HOWARD SMIGA, EXAMINING ATTORNEY

Int. Cl.: 36

Prior U.S. Cls.: 100, 101 and 102

United States Patent and Trademark Office

Reg. No. 3,476,098

Registered July 29, 2008

**SERVICE MARK
PRINCIPAL REGISTER**

**PHYSICIAN ASSISTANT
FOUNDATION**

PHYSICIAN ASSISTANT FOUNDATION (VIRGINIA NON-PROFIT CORPORATION)
950 NORTH WASHINGTON STREET
ALEXANDRIA, VA 22314

FOR: PHILANTHROPIC SERVICES CONCERNING MONETARY DONATIONS AND CHARITABLE FUNDRAISING SERVICES TO ADVANCE KNOWLEDGE AND TO PROMOTE DELIVERY OF QUALITY HEALTH CARE, IN CLASS 36 (U.S. CLS. 100, 101 AND 102).

FIRST USE 7-18-1997; IN COMMERCE 7-20-1997.

THE MARK CONSISTS OF STANDARD CHARACTERS WITHOUT CLAIM TO ANY PARTICULAR FONT, STYLE, SIZE, OR COLOR.

NO CLAIM IS MADE TO THE EXCLUSIVE RIGHT TO USE "FOUNDATION", APART FROM THE MARK AS SHOWN.

SEC. 2(F).

SER. NO. 77-355,690, FILED 12-19-2007.

HOWARD SMIGA, EXAMINING ATTORNEY

Int. Cl.: 30

Prior U.S. Cl.: 46

United States Patent and Trademark Office

Reg. No. 3,476,099

Registered July 29, 2008

**TRADEMARK
PRINCIPAL REGISTER**



AU'SOME, INC. (NEW JERSEY CORPORATION)
SUITE E, BUILDING A
2031 ROUTE 130
MONMOUTH JUNCTION, NJ 08852

OWNER OF U.S. REG. NO. 2,302,907.

THE MARK CONSISTS OF AN OUTLINE
AROUND THE WORD AU'SOME.

FOR: CANDY, IN CLASS 30 (U.S. CL. 46).

SER. NO. 77-355,693, FILED 12-19-2007.

FIRST USE 2-1-1998; IN COMMERCE 2-1-1998.

HOWARD SMIGA, EXAMINING ATTORNEY

Int. Cl.: 4

Prior U.S. Cls.: 1, 6 and 15

United States Patent and Trademark Office

Reg. No. 3,476,100

Registered July 29, 2008

**TRADEMARK
PRINCIPAL REGISTER**

EMBERS

CHRISTMAS TREE SHOPS (MASSACHUSETTS
CORPORATION)
261 WHITE'S PATH
SOUTH YARMOUTH, MA 02664

THE MARK CONSISTS OF STANDARD CHAR-
ACTERS WITHOUT CLAIM TO ANY PARTICULAR
FONT, STYLE, SIZE, OR COLOR.

FOR: CANDLES, IN CLASS 4 (U.S. CLS. 1, 6 AND
15).

SER. NO. 77-355,702, FILED 12-19-2007.

FIRST USE 2-0-2004; IN COMMERCE 2-0-2004.

JEFFERY COWARD, EXAMINING ATTORNEY

Int. Cl.: 36

Prior U.S. Cls.: 100, 101 and 102

United States Patent and Trademark Office

Reg. No. 3,476,101

Registered July 29, 2008

**SERVICE MARK
PRINCIPAL REGISTER**

InSite Medical Properties

INSITE PROPERTIES, INC. (COLORADO CORPORATION)
252 CLAYTON STREET, FOURTH FLOOR
DENVER, CO 80206

FOR: MANAGEMENT AND LEASING OF MEDICAL AND HEALTHCARE REAL ESTATE, IN CLASS 36 (U.S. CLS. 100, 101 AND 102).

FIRST USE 8-0-2006; IN COMMERCE 8-0-2006.

THE MARK CONSISTS OF STANDARD CHARACTERS WITHOUT CLAIM TO ANY PARTICULAR FONT, STYLE, SIZE, OR COLOR.

NO CLAIM IS MADE TO THE EXCLUSIVE RIGHT TO USE "MEDICAL PROPERTIES", APART FROM THE MARK AS SHOWN.

SER. NO. 77-355,714, FILED 12-19-2007.

CHARISMA HAMPTON, EXAMINING ATTORNEY

Int. Cl.: 9

Prior U.S. Cls.: 21, 23, 26, 36 and 38

United States Patent and Trademark Office

Reg. No. 3,476,102

Registered July 29, 2008

**TRADEMARK
PRINCIPAL REGISTER**



BIG SPLASH GAMES, LLC (DELAWARE LTD
LIAB CO)
2428 EAST 1ST STREET
TUCSON, AZ 85719

THE MARK CONSISTS OF THE STYLIZED
WORDS "BIG SPLASH GAMES" ENCIRCLING A
JOVIAL, FAT HUMAN MALE WEARING A BATH-
ING SUIT AND DIVING THROUGH THE AIR.

FOR: COMPUTER GAME PROGRAMS, IN CLASS
9 (U.S. CLS. 21, 23, 26, 36 AND 38).

FIRST USE 4-30-2007; IN COMMERCE 4-30-2007.

SER. NO. 77-355,754, FILED 12-19-2007.

NO CLAIM IS MADE TO THE EXCLUSIVE
RIGHT TO USE "GAMES", APART FROM THE
MARK AS SHOWN.

DAVID HOFFMAN, EXAMINING ATTORNEY

Int. Cl.: 42

Prior U.S. Cls.: 100 and 101

United States Patent and Trademark Office

Reg. No. 3,476,103

Registered July 29, 2008

**SERVICE MARK
PRINCIPAL REGISTER**

WORDZE

MAD FROG PRODUCTIONS, INC. (VIRGINIA
CORPORATION)
725 JACKSON ST., SUITE 216
FREDERICKSBURG, VA 22401

THE MARK CONSISTS OF STANDARD CHAR-
ACTERS WITHOUT CLAIM TO ANY PARTICULAR
FONT, STYLE, SIZE, OR COLOR.

FOR: INTERNET KEYWORD RESEARCH SERVI-
CES; DATA MINING, IN CLASS 42 (U.S. CLS. 100
AND 101).

SER. NO. 77-355,778, FILED 12-19-2007.

FIRST USE 10-28-2006; IN COMMERCE 10-28-2006.

AISHA CLARKE, EXAMINING ATTORNEY

Int. Cls.: 35 and 36

Prior U.S. Cls.: 100, 101 and 102

United States Patent and Trademark Office

Reg. No. 3,476,104

Registered July 29, 2008

**SERVICE MARK
PRINCIPAL REGISTER**



USA TAX & INSURANCE SERVICES, INC.

USA TAX & INSURANCE SERVICES, INC.
(FLORIDA CORPORATION)
4114 WOODLANDS PKWY., SUITE 402
PALM HARBOR, FL 34685

FOR: TAX ADVISORY SERVICES; TAX AND TAXATION PLANNING, ADVICE, INFORMATION AND CONSULTANCY SERVICES; TAX CONSULTATION; TAX PREPARATION, IN CLASS 35 (U.S. CLS. 100, 101 AND 102).

FIRST USE 1-2-2003; IN COMMERCE 1-2-2003.

FOR: FINANCIAL ADMINISTRATION OF RETIREMENT PLANS; FINANCIAL PLANNING FOR RETIREMENT; PROVIDING A WEB SITE THAT ASSISTS FINANCIAL PROFESSIONALS IN THE MANAGEMENT OF RETIREMENT ACCOUNTS; PROVIDING INFORMATION AND ADVICE IN THE FIELD OF FINANCE, FINANCIAL INVESTMENTS, FINANCIAL VALUATIONS, AND THE FINANCIAL ASPECTS OF RETIREMENT; LIFE IN-

SURANCE BROKERAGE, IN CLASS 36 (U.S. CLS. 100, 101 AND 102).

FIRST USE 2-1-2003; IN COMMERCE 2-1-2003.

NO CLAIM IS MADE TO THE EXCLUSIVE RIGHT TO USE THE OUTLINE OF THE UNITED STATES AND "USA TAX & INSURANCE SERVICES, INC.", APART FROM THE MARK AS SHOWN.

THE COLOR(S) RED, WHITE AND BLUE IS/ARE CLAIMED AS A FEATURE OF THE MARK.

THE MARK CONSISTS OF RED WHITE AND BLUE FLAG SUPERIMPOSED ON A SILHOUETTE OF THE CONTINENTAL UNITED STATES MAP.

SER. NO. 77-355,791, FILED 12-19-2007.

AISHA CLARKE, EXAMINING ATTORNEY

Int. Cl.: 37

Prior U.S. Cls.: 100, 103 and 106

United States Patent and Trademark Office

Reg. No. 3,476,105

Registered July 29, 2008

**SERVICE MARK
PRINCIPAL REGISTER**



GEORGE M. RAYMOND CO. (CALIFORNIA CORPORATION)
520 WEST WALNUT AVENUE
ORANGE, CA 92868

FOR: BUILDING CONSTRUCTION SERVICES;
CONSULTING IN THE FIELD OF BUILDING CONSTRUCTION, IN CLASS 37 (U.S. CLS. 100, 103 AND 106).

FIRST USE 7-0-1992; IN COMMERCE 7-0-1992.

THE MARK CONSISTS OF THE WORD "RAYMOND" WITH A STYLIZED "R".

SER. NO. 77-355,813, FILED 12-19-2007.

PATRICIA EVANKO, EXAMINING ATTORNEY

Int. Cl.: 29

Prior U.S. Cl.: 46

United States Patent and Trademark Office

Reg. No. 3,476,106

Registered July 29, 2008

**TRADEMARK
PRINCIPAL REGISTER**

IVERNIA

THE IRISH DAIRY BOARD CO-OPERATIVE
LIMITED (IRELAND BODY CORPORATE)
GRATTAN HOUSE, MOUNT STREET LOWER
DUBLIN, IRELAND 2

THE MARK CONSISTS OF STANDARD CHAR-
ACTERS WITHOUT CLAIM TO ANY PARTICULAR
FONT, STYLE, SIZE, OR COLOR.

FOR: CHEESE, IN CLASS 29 (U.S. CL. 46).

SER. NO. 77-355,822, FILED 12-19-2007.

FIRST USE 0-0-1997; IN COMMERCE 9-30-2006.

AISHA CLARKE, EXAMINING ATTORNEY

Int. Cls.: 16 and 17

Prior U.S. Cls.: 1, 2, 5, 12, 13, 22, 23, 29, 35, 37, 38 and 50

Reg. No. 3,476,107

United States Patent and Trademark Office

Registered July 29, 2008

**TRADEMARK
PRINCIPAL REGISTER**

ECO-TITE

CURWOOD, INC. (DELAWARE CORPORATION)
2200 BADGER AVENUE
OSHKOSH, WI 54904

FOR: SHRINKABLE PLASTIC PACKAGING BAGS AND POUCHES FOR COMMERCIAL AND INDUSTRIAL USE; HEAT SHRINKABLE PLASTIC BAGS FOR PACKAGING FOOD; PLASTIC PACKAGING FILM AND PLASTIC BAGS FOR PACKAGING, IN CLASS 16 (U.S. CLS. 2, 5, 22, 23, 29, 37, 38 AND 50).

FIRST USE 12-12-2007; IN COMMERCE 12-12-2007.

FOR: PLASTIC FLEXIBLE PACKAGING FILM SOLD IN BULK TO INDUSTRIAL AND COMMER-

CIAL MANUFACTURERS; PLASTICS IN THE FORM OF SHEETS AND FILMS; PLASTIC FILMS USED AS PACKAGING FOR FOOD, IN CLASS 17 (U.S. CLS. 1, 5, 12, 13, 35 AND 50).

FIRST USE 12-12-2007; IN COMMERCE 12-12-2007.

THE MARK CONSISTS OF STANDARD CHARACTERS WITHOUT CLAIM TO ANY PARTICULAR FONT, STYLE, SIZE, OR COLOR.

SER. NO. 77-355,825, FILED 12-19-2007.

AISHA CLARKE, EXAMINING ATTORNEY

Int. Cl.: 37

Prior U.S. Cls.: 100, 103 and 106

United States Patent and Trademark Office

Reg. No. 3,476,108

Registered July 29, 2008

**SERVICE MARK
PRINCIPAL REGISTER**

WE BUILD THE THEME!

GEORGE M. RAYMOND CO. (CALIFORNIA
CORPORATION)
520 WEST WALNUT AVENUE
ORANGE, CA 92868

THE MARK CONSISTS OF STANDARD CHAR-
ACTERS WITHOUT CLAIM TO ANY PARTICULAR
FONT, STYLE, SIZE, OR COLOR.

FOR: BUILDING CONSTRUCTION SERVICES;
CONSULTING IN THE FIELD OF BUILDING CON-
STRUCTION, IN CLASS 37 (U.S. CLS. 100, 103 AND
106).

SER. NO. 77-355,827, FILED 12-19-2007.

FIRST USE 7-0-1992; IN COMMERCE 7-0-1992.

PATRICIA EVANKO, EXAMINING ATTORNEY

Int. Cl.: 16

Prior U.S. Cls.: 2, 5, 22, 23, 29, 37, 38 and 50

Reg. No. 3,476,109

United States Patent and Trademark Office

Registered July 29, 2008

**TRADEMARK
PRINCIPAL REGISTER**

THE ELEPHANT SANCTUARY

THE ELEPHANT SANCTUARY IN TENNESSEE
(TENNESSEE CORPORATION)
PO BOX 393
HOHENWALD, TN 38462

FOR: PHOTOGRAPHS, DECALS, CALENDARS,
PAINTINGS, POSTERS, NOTE CARDS, POSTAGE
STAMPS, BANK CHECKS, IN CLASS 16 (U.S. CLS. 2,
5, 22, 23, 29, 37, 38 AND 50).

FIRST USE 8-31-1996; IN COMMERCE 8-31-1996.

THE MARK CONSISTS OF STANDARD CHAR-
ACTERS WITHOUT CLAIM TO ANY PARTICULAR
FONT, STYLE, SIZE, OR COLOR.

OWNER OF U.S. REG. NO. 2,230,174.

SER. NO. 77-355,854, FILED 12-19-2007.

JENNIFER VASQUEZ, EXAMINING ATTORNEY

Int. Cl.: 31

Prior U.S. Cls.: 1 and 46

United States Patent and Trademark Office

Reg. No. 3,476,110

Registered July 29, 2008

**TRADEMARK
PRINCIPAL REGISTER**

DROOLING DOG GOURMET

DROOLING DOG GOURMET LLC (ILLINOIS
LTD LIAB CO)

421 WINDING CANYON WAY

ALGONQUIN, IL 60102

FOR: ANIMAL TREATS AND BISCUITS, IN
CLASS 31 (U.S. CLS. 1 AND 46).

FIRST USE 10-16-2007; IN COMMERCE 10-16-2007.

THE MARK CONSISTS OF STANDARD CHAR-
ACTERS WITHOUT CLAIM TO ANY PARTICULAR
FONT, STYLE, SIZE, OR COLOR.

NO CLAIM IS MADE TO THE EXCLUSIVE
RIGHT TO USE "DOG GOURMET", APART FROM
THE MARK AS SHOWN.

SER. NO. 77-355,892, FILED 12-19-2007.

SHAUNIA CARLYLE, EXAMINING ATTORNEY

Int. Cl.: 35

Prior U.S. Cls.: 100, 101 and 102

United States Patent and Trademark Office

Reg. No. 3,476,111

Registered July 29, 2008

**SERVICE MARK
PRINCIPAL REGISTER**

VisitErie

ERIE AREA CONVENTION AND VISITORS BU-
REAU (PENNSYLVANIA CORPORATION)
208 EAST BAYFRONT PARKWAY, SUITE 103
ERIE, PA 165072405

THE MARK CONSISTS OF STANDARD CHAR-
ACTERS WITHOUT CLAIM TO ANY PARTICULAR
FONT, STYLE, SIZE, OR COLOR.

FOR: ASSOCIATION SERVICES, NAMELY, PRO-
MOTING THE INTERESTS OF TOURISM, BUSI-
NESS, AND CONVENTIONS IN THE ERIE, PA
AREA, IN CLASS 35 (U.S. CLS. 100, 101 AND 102).

SER. NO. 77-355,897, FILED 12-19-2007.

FIRST USE 10-11-2007; IN COMMERCE 10-11-2007.

JENNIFER VASQUEZ, EXAMINING ATTORNEY

Int. Cl.: 44

Prior U.S. Cls.: 100 and 101

United States Patent and Trademark Office

Reg. No. 3,476,112

Registered July 29, 2008

**SERVICE MARK
PRINCIPAL REGISTER**

**"The Best Surgeon in The
Joint"**

HUMBERT, EDWARD (UNITED STATES INDIVIDUAL)
5657 SHADDELEE LN. W
FORT MYERS, FL 33919

THE MARK CONSISTS OF STANDARD CHARACTERS WITHOUT CLAIM TO ANY PARTICULAR FONT, STYLE, SIZE, OR COLOR.

FOR: ORTHOPEDIC SURGERY SERVICES SPECIALIZING IN JOINT REPLACEMENT, ARTHROSCOPY AND SPORTS MEDICINE, IN CLASS 44 (U.S. CLS. 100 AND 101).

SER. NO. 77-355,898, FILED 12-19-2007.

FIRST USE 1-1-2003; IN COMMERCE 1-1-2003.

CHARISMA HAMPTON, EXAMINING ATTORNEY

Int. Cls.: 35 and 37

Prior U.S. Cls.: 100, 101, 102, 103 and 106

United States Patent and Trademark Office

Reg. No. 3,476,113

Registered July 29, 2008

SERVICE MARK
PRINCIPAL REGISTER



PAGE, DONALD K. (UNITED STATES INDIVIDUAL)
13508 BATTLEWOOD COURT
CLIFTON, VA 20124

FOR: RETAIL STORE SERVICES FEATURING CONVENIENCE STORE ITEMS AND GASOLINE, IN CLASS 35 (U.S. CLS. 100, 101 AND 102).

FIRST USE 9-1-1986; IN COMMERCE 9-1-1986.

FOR: AUTOMOBILE REPAIR AND MAINTENANCE; AUTOMOBILE SERVICE STATION SERVICES, IN CLASS 37 (U.S. CLS. 100, 103 AND 106).

FIRST USE 9-1-1986; IN COMMERCE 9-1-1986.

NO CLAIM IS MADE TO THE EXCLUSIVE RIGHT TO USE "1983" OR "QUALITY AUTOMOTIVE SERVICE", APART FROM THE MARK AS SHOWN.

THE LINING IN THE DRAWING IS FOR SHADING PURPOSES ONLY.

THE MARK CONSISTS OF AN AUTOMOBILE ATOP A ROPE SET BETWEEN TWO LEAVES, ABOVE A SHIELD DEPICTING CROSSED WRENCHES WITH THE LETTER "W" ABOVE THEM, "S" TO THE LEFT, "C" TO THE RIGHT, AND "1983" BELOW. THE LEAVES ATTACHED BY THE ROPE ARE PARTS OF SETS OF HERALDIC LEAVES ON EACH SIDE OF THE SHIELD. A BANNER BELOW THE SHIELD HAS THE WORDING "QUALITY AUTOMOTIVE SERVICE".

SER. NO. 77-355,907, FILED 12-19-2007.

LYDIA BELZER, EXAMINING ATTORNEY

Int. Cl.: 37

Prior U.S. Cls.: 100, 103 and 106

United States Patent and Trademark Office

Reg. No. 3,476,114

Registered July 29, 2008

**SERVICE MARK
PRINCIPAL REGISTER**

CEDAR VALLEY EXTERIORS

CEDAR VALLEY EXTERIORS, INCORPORATED
(MINNESOTA CORPORATION)
1700 - 93RD LANE N.E.
BLAINE, MN 55449

FOR: CONSTRUCTION AND REPAIR OF BUILDINGS; GENERAL CONSTRUCTION CONTRACTING; SIDING INSTALLATION; ROOFING SERVICES; ROOFING REPAIR; ROOFING CONTRACTING; ROOFING INSTALLATION; GUTTER INSTALLATION; DAMAGE AND LOSS MITIGATION SERVICES, NAMELY, THE TEMPORARY WEATHERPROOFING OF OUTDOOR STRUCTURES DAMAGED BY WIND, RAIN, HAIL, SNOW, LIGHTNING, HURRICANES AND THE LIKE, IN CLASS 37 (U.S. CLS. 100, 103 AND 106).

FIRST USE 0-0-1998; IN COMMERCE 0-0-1998.

THE MARK CONSISTS OF STANDARD CHARACTERS WITHOUT CLAIM TO ANY PARTICULAR FONT, STYLE, SIZE, OR COLOR.

OWNER OF U.S. REG. NOS. 3,222,451 AND 3,279,965.

NO CLAIM IS MADE TO THE EXCLUSIVE RIGHT TO USE "EXTERIORS", APART FROM THE MARK AS SHOWN.

SER. NO. 77-355,935, FILED 12-19-2007.

TRACY WHITTAKER-BROWN, EXAMINING ATTORNEY

Int. Cls.: 3, 9, 14, 18 and 25

Prior U.S. Cls.: 1, 2, 3, 4, 6, 21, 22, 23, 26, 27, 28, 36,
38, 39, 41, 50, 51 and 52

Reg. No. 3,476,115

United States Patent and Trademark Office

Registered July 29, 2008

TRADEMARK
PRINCIPAL REGISTER

formfollowsfunction

CHRISTIAN, NATHANIEL (UNITED STATES IN-
DIVIDUAL)
NORTH PENTHOUSE 2D
535 WEST 23RD STREET
NEW YORK, NY 10011

FOR: COSMETICS, NAMELY, NIGHT AND DAY CREAM, CLEANING PREPARATIONS FOR THE FACE AND BODY, BATH FOAM, SHAVING FOAM, AFTERSHAVE, FOUNDATION MAKEUP, NAIL POLISH, PERSONAL DEODORANTS FOR MEN AND WOMEN, HAND AND BABY SOAP, HAIR SHAMPOO AND RINSES, HAIR SPRAY, TOOTH-PASTE AND FRAGRANCES, NAMELY, PERFUME, TOILET WATER AND ESSENTIAL OILS FOR PERSONAL USE FOR MEN AND WOMEN, ESSENTIAL OIL FOR USE IN MANUFACTURING COSMETICS, HAIR SHAMPOOS, ESSENTIAL OILS FOR PERSONAL USE, HAIR-LOTIONS, SKIN AND BODY SOAPS AND SKIN AND BODY TONERS AND NON-MEDICATED SKIN CARE PREPARATIONS, DENTIFRICES, IN CLASS 3 (U.S. CLS. 1, 4, 6, 50, 51 AND 52).

FIRST USE 1-1-1989; IN COMMERCE 1-1-1989.

FOR: LENSES FOR EYEGLASSES, SPECTACLES, SUNGLASSES, LENSES FOR SPECTACLES AND FOR SUNGLASSES, FRAMES FOR SPECTACLES AND FOR SUNGLASSES, SPECTACLES CASES, IN CLASS 9 (U.S. CLS. 21, 23, 26, 36 AND 38).

FIRST USE 6-1-1999; IN COMMERCE 6-1-1999.

FOR: PRECIOUS AND SEMI-PRECIOUS GEM-
STONES, HOROLOGICAL AND CHRONOMETRIC
INSTRUMENTS, NAMELY, WATCHES, CLOCKS

AND CHRONOMETERS, JEWELRY, IN CLASS 14
(U.S. CLS. 2, 27, 28 AND 50).

FIRST USE 6-1-1999; IN COMMERCE 6-1-1999.

FOR: HANDBAGS, WALLETS, LUGGAGE, AT-
TACHE CASES, TOTE BAGS, BRIEFCASES, ALL
PURPOSE SPORT BAGS, TRAVELLING TRUNKS
AND CARRY-ON BAGS, SHOULDER BAGS, GAR-
MENT BAGS FOR TRAVELLING, KEYCASES, UM-
BRELLAS, PARASOLS AND WALKING STICKS,
WHIPS, HARNESSSES AND SADDLERY, IN CLASS
18 (U.S. CLS. 1, 2, 3, 22 AND 41).

FIRST USE 6-1-1999; IN COMMERCE 6-1-1999.

FOR: CLOTHING, NAMELY, DRESSES, LINGER-
IE, UNDERWEAR, SUITS, SKIRTS, JACKETS,
PULLOVERS, BLOUSES, T-SHIRTS, SHOES, JACK-
ETS, CLOTHING TIES, SUSPENDERS, CLOTHING
CAPS, HATS, FUR JACKETS, FUR COATS, FUR
STOLES, HOSIERY, GLOVES, SCARVES, TROU-
SERS, SHORTS, FOOTWEAR, HEADWEAR, SPORTS
CLOTHING, NAMELY, TRACK SUITS, SWEAT-
SHIRTS, SWEATPANTS, SWIMWEAR, IN CLASS 25
(U.S. CLS. 22 AND 39).

FIRST USE 1-1-1989; IN COMMERCE 1-1-1989.

THE MARK CONSISTS OF THE LETTERS "FOR-
MFOLLOWSFUNCTION", WITH "FOLLOWS"
BEING SHOWN IN BOLDFACE TYPE.

SER. NO. 77-355,941, FILED 12-19-2007.

RUDY R. SINGLETON, EXAMINING ATTORNEY

Int. Cl.: 39

Prior U.S. Cls.: 100 and 105

United States Patent and Trademark Office

Reg. No. 3,476,116

Registered July 29, 2008

**SERVICE MARK
PRINCIPAL REGISTER**

U-PICK TOURS

PENNSYLVANIA DUTCH TOURIST BUREAU
(PENNSYLVANIA CORPORATION), DBA
PENNSYLVANIA DUTCH CONVENTION
AND VISITORS BUREAU
501 GREENFIELD ROAD
LANCASTER, PA 17601

FOR: ARRANGING OF TOURS, IN CLASS 39 (U.S.
CLS. 100 AND 105).

FIRST USE 7-0-2007; IN COMMERCE 7-0-2007.

THE MARK CONSISTS OF STANDARD CHAR-
ACTERS WITHOUT CLAIM TO ANY PARTICULAR
FONT, STYLE, SIZE, OR COLOR.

NO CLAIM IS MADE TO THE EXCLUSIVE
RIGHT TO USE "TOURS", APART FROM THE
MARK AS SHOWN.

SER. NO. 77-355,965, FILED 12-19-2007.

JESSICA A. POWERS, EXAMINING ATTORNEY

Int. Cl.: 9

Prior U.S. Cls.: 21, 23, 26, 36 and 38

United States Patent and Trademark Office

Reg. No. 3,476,117

Registered July 29, 2008

**TRADEMARK
PRINCIPAL REGISTER**

EASYPOWER

ESA NW, INC. (OREGON CORPORATION)
PO BOX 2110
CLACKAMAS, OR 97015

THE MARK CONSISTS OF STANDARD CHAR-
ACTERS WITHOUT CLAIM TO ANY PARTICULAR
FONT, STYLE, SIZE, OR COLOR.

FOR: COMPUTER SOFTWARE FOR ELECTRI-
CAL POWER SYSTEM ANALYSIS AND INSTRUC-
TION MANUALS SOLD AS A UNIT, IN CLASS 9
(U.S. CLS. 21, 23, 26, 36 AND 38).

SER. NO. 77-355,971, FILED 12-19-2007.

FIRST USE 9-12-1991; IN COMMERCE 10-17-1991.

JOHN GARTNER, EXAMINING ATTORNEY

Int. Cl.: 42

Prior U.S. Cls.: 100 and 101

United States Patent and Trademark Office

Reg. No. 3,476,118

Registered July 29, 2008

**SERVICE MARK
PRINCIPAL REGISTER**

Organomed

ORGANOMED CORPORATION (RHODE ISLAND CORPORATION)
11 GRANDVIEW AVE, UNIT 8
COVENTRY, RI 02816

FOR: MEDICAL AND SCIENTIFIC SERVICES;
CUSTOM SYNTHESIS IN THE NATURE OF PREPARING CHEMICAL COMPOUNDS FOR BIOMEDICAL RESEARCH, IN CLASS 42 (U.S. CLS. 100 AND 101).

FIRST USE 4-0-1991; IN COMMERCE 5-0-1994.

THE MARK CONSISTS OF STANDARD CHARACTERS WITHOUT CLAIM TO ANY PARTICULAR FONT, STYLE, SIZE, OR COLOR.

SER. NO. 77-355,988, FILED 12-19-2007.

BARBARA A. GOLD, EXAMINING ATTORNEY

Int. Cl.: 39

Prior U.S. Cls.: 100 and 105

United States Patent and Trademark Office

Reg. No. 3,476,119

Registered July 29, 2008

**SERVICE MARK
PRINCIPAL REGISTER**

ZIPSKINNY

NASH, MARK E. (UNITED STATES INDIVIDUAL)
1200 MAIN STREET, APT. 1105
DALLAS, TX 75202

THE MARK CONSISTS OF STANDARD CHARACTERS WITHOUT CLAIM TO ANY PARTICULAR FONT, STYLE, SIZE, OR COLOR.

FOR: PROVIDING A WEBSITE FEATURING INFORMATION IN THE FIELD OF POSTAL CODES, IN CLASS 39 (U.S. CLS. 100 AND 105).

SER. NO. 77-356,003, FILED 12-19-2007.

FIRST USE 1-12-2007; IN COMMERCE 1-12-2007.

CHARLOTTE CORWIN, EXAMINING ATTORNEY

Int. Cl.: 42

Prior U.S. Cls.: 100 and 101

United States Patent and Trademark Office

Reg. No. 3,476,120

Registered July 29, 2008

**SERVICE MARK
PRINCIPAL REGISTER**

TIS

TOTAL IMMERSION SOFTWARE, INC. (DELA-
WARE CORPORATION)
1080 MARINA VILLAGE PARKWAY, SUITE 205
ALAMEDA, CA 94501

FOR: COMPUTER SOFTWARE DESIGN AND
PROGRAMMING, IN CLASS 42 (U.S. CLS. 100 AND
101).

FIRST USE 1-4-2007; IN COMMERCE 1-4-2007.

THE MARK CONSISTS OF STANDARD CHAR-
ACTERS WITHOUT CLAIM TO ANY PARTICULAR
FONT, STYLE, SIZE, OR COLOR.

SER. NO. 77-356,016, FILED 12-19-2007.

REGINA DRUMMOND, EXAMINING ATTORNEY

Int. Cls.: 16 and 25

Prior U.S. Cls.: 2, 5, 22, 23, 29, 37, 38, 39 and 50

Reg. No. 3,476,121

United States Patent and Trademark Office

Registered July 29, 2008

**TRADEMARK
PRINCIPAL REGISTER**



AMERICAN FEDERATION OF STATE, COUNTY
AND MUNICIPAL EMPLOYEES (D.C. UNINC.
ASSOCIATION)

1625 L STREET, N.W.
WASHINGTON, DC 20036

FOR: STICKERS, IN CLASS 16 (U.S. CLS. 2, 5, 22,
23, 29, 37, 38 AND 50).

FIRST USE 1-31-1940; IN COMMERCE 1-31-1940.

FOR: T-SHIRTS, IN CLASS 25 (U.S. CLS. 22 AND
39).

FIRST USE 1-31-1940; IN COMMERCE 1-31-1940.

OWNER OF U.S. REG. NOS. 1,075,748 AND
2,334,848.

NO CLAIM IS MADE TO THE EXCLUSIVE
RIGHT TO USE "AFL-CIO", APART FROM THE
MARK AS SHOWN.

THE MARK CONSISTS OF THE WORDS "AMER-
ICAN FEDERATION STATE COUNTY MUNICIPAL
EMPLOYEES AFL-CIO" IN A CIRCLE SURROUND-
ING A TRIANGLE CONTAINING THE IMAGE OF A
BUILDING DOME.

SER. NO. 77-356,018, FILED 12-19-2007.

KELLY BOULTON, EXAMINING ATTORNEY

Int. Cl.: 41

Prior U.S. Cls.: 100, 101 and 107

United States Patent and Trademark Office

Reg. No. 3,476,122

Registered July 29, 2008

**SERVICE MARK
PRINCIPAL REGISTER**

Fair But Firm

CORTEZ, JOE (UNITED STATES INDIVIDUAL)
7065 W. ANN RD. #130-353
LAS VEGAS, NV 89130

FOR: EDUCATIONAL SERVICES, NAMELY,
CONDUCTING CLASSES, SEMINARS AND WORK-
SHOPS IN THE FIELD OF OFFICIATING BOXING
CONTESTS AND DISTRIBUTION OF COURSE MA-
TERIAL IN CONNECTION THEREWITH, IN CLASS
41 (U.S. CLS. 100, 101 AND 107).

FIRST USE 7-15-2002; IN COMMERCE 7-15-2002.

THE MARK CONSISTS OF STANDARD CHAR-
ACTERS WITHOUT CLAIM TO ANY PARTICULAR
FONT, STYLE, SIZE, OR COLOR.

SER. NO. 77-356,025, FILED 12-19-2007.

JOHN SCHUYLER YARD, EXAMINING ATTOR-
NEY

Int. Cl.: 45

Prior U.S. Cls.: 100 and 101

United States Patent and Trademark Office

Reg. No. 3,476,123

Registered July 29, 2008

**SERVICE MARK
PRINCIPAL REGISTER**



BRODY WILKINSON PC (CONNECTICUT CORPORATION)
2507 POST ROAD
SOUTHPORT, CT 06490

FOR: LEGAL SERVICES, IN CLASS 45 (U.S. CLS. 100 AND 101).

FIRST USE 8-31-2007; IN COMMERCE 8-31-2007.

THE MARK CONSISTS OF A SHADED RECTANGLE CONTAINING THE STYLIZED UPPERCASE LETTERS "B" AND "W" SEPARATED BY A SMALL DIAMOND SHAPE.

SER. NO. 77-356,028, FILED 12-19-2007.

JOHN SCHUYLER YARD, EXAMINING ATTORNEY

Int. Cl.: 42

Prior U.S. Cls.: 100 and 101

United States Patent and Trademark Office

Reg. No. 3,476,124

Registered July 29, 2008

**SERVICE MARK
PRINCIPAL REGISTER**

NIFTYSOFT

GONZALEZ, ADIEL (UNITED STATES INDIVIDUAL)
8530 SW 46 ST
MIAMI, FL 33155

THE MARK CONSISTS OF STANDARD CHARACTERS WITHOUT CLAIM TO ANY PARTICULAR FONT, STYLE, SIZE, OR COLOR.

FOR: DESIGN, DEVELOPMENT AND IMPLEMENTATION OF SOFTWARE, IN CLASS 42 (U.S. CLS. 100 AND 101).

SER. NO. 77-356,049, FILED 12-19-2007.

FIRST USE 12-1-2007; IN COMMERCE 12-1-2007.

KYLE PEETE, EXAMINING ATTORNEY

Int. Cl.: 41

Prior U.S. Cls.: 100, 101 and 107

United States Patent and Trademark Office

Reg. No. 3,476,125

Registered July 29, 2008

**SERVICE MARK
PRINCIPAL REGISTER**

**YES! Your Empowerment
Systems**

INSPIRED IMAGINATIONS, LLC (COLORADO
LTD LIAB CO)
3221 W. TORREYS PEAK DRIVE
SUPERIOR, CO 80027

FOR: EDUCATIONAL SERVICES, NAMELY,
CONDUCTING SEMINARS AND LECTURES ON
THE SUBJECT OF INSPIRATION, SELF-ESTEEM
AND PERSONAL DEVELOPMENT; TRAINING
AND TEACHING IN THE FIELD OF INSPIRATION,
SELF-ESTEEM AND PERSONAL DEVELOPMENT;
TRAINING AND TEACHING IN THE AREA OF
FAMILY AND ENTREPRENEURIAL DEVELOP-
MENT AND DISTRIBUTION OF COURSE MATERI-

AL IN CONNECTION THEREWITH, IN CLASS 41
(U.S. CLS. 100, 101 AND 107).

FIRST USE 11-1-2005; IN COMMERCE 12-1-2005.

THE MARK CONSISTS OF STANDARD CHAR-
ACTERS WITHOUT CLAIM TO ANY PARTICULAR
FONT, STYLE, SIZE, OR COLOR.

SER. NO. 77-356,067, FILED 12-19-2007.

BRIAN NEVILLE, EXAMINING ATTORNEY

Int. Cls.: 35 and 41

Prior U.S. Cls.: 100, 101, 102 and 107

Reg. No. 3,476,126

United States Patent and Trademark Office

Registered July 29, 2008

**SERVICE MARK
PRINCIPAL REGISTER**

ManageMyCE

REDVECTOR.COM, INC. (FLORIDA CORPORATION)
4890 W. KENNEDY BOULEVARD, SUITE 740
TAMPA, FL 33609

FOR: ONLINE CONTINUING EDUCATION DIRECTORY FOR PROVIDING PROFESSIONALS AN OUTLET TO FIND ONLINE COURSES AND TRAINING TO ADVANCE THEIR PROFESSIONAL GOALS AND TO SATISFY THEIR CONTINUING EDUCATION REQUIREMENTS WITH ONLINE COURSES AND TRAINING FOR ENGINEERS, ARCHITECTS, CONTRACTORS, INTERIOR DESIGNERS, LAND SURVEYORS, LANDSCAPE ARCHITECTS, BUILDING INSPECTORS, OTHER ARCHITECTURE ENGINEERING AND CONSTRUCTION PROFESSIONALS, AND HEALTHCARE PROFESSIONALS, NAMELY, NURSES, PHYSICAL THERAPISTS, OCCUPATIONAL THERAPISTS, SPEECH-LANGUAGE PATHOLOGISTS, CASE MANAGERS, AUDIOLOGISTS, CERTIFIED REHABILITATION NURSES, SOCIAL WORKERS, ACTIVITIES PROFESSIONALS, NURSING HOME ADMINISTRATORS, CERTIFIED COUNSELORS, AND DIETITIANS, IN CLASS 35 (U.S. CLS. 100, 101 AND 102).

FIRST USE 8-20-2007; IN COMMERCE 8-20-2007.

FOR: ONLINE CONTINUING EDUCATION PORTAL THAT PROVIDES INFORMATION TO PRO-

FESSIONALS TO FIND ONLINE COURSES AND TRAINING TO ADVANCE THEIR PROFESSIONAL GOALS AND TO SATISFY THEIR CONTINUING EDUCATION REQUIREMENTS WITH ONLINE COURSES AND TRAINING FOR ENGINEERS, ARCHITECTS, CONTRACTORS, INTERIOR DESIGNERS, LAND SURVEYORS, LANDSCAPE ARCHITECTS, BUILDING INSPECTORS, OTHER ARCHITECTURE ENGINEERING AND CONSTRUCTION PROFESSIONALS, AND HEALTHCARE PROFESSIONALS, NAMELY, NURSES, PHYSICAL THERAPISTS, OCCUPATIONAL THERAPISTS, SPEECH-LANGUAGE PATHOLOGISTS, CASE MANAGERS, AUDIOLOGISTS, CERTIFIED REHABILITATION NURSES, SOCIAL WORKERS, ACTIVITIES PROFESSIONALS, NURSING HOME ADMINISTRATORS, CERTIFIED COUNSELORS, AND DIETITIANS, IN CLASS 41 (U.S. CLS. 100, 101 AND 107).

FIRST USE 8-20-2007; IN COMMERCE 8-20-2007.

THE MARK CONSISTS OF STANDARD CHARACTERS WITHOUT CLAIM TO ANY PARTICULAR FONT, STYLE, SIZE, OR COLOR.

SER. NO. 77-356,076, FILED 12-19-2007.

KARANENDRA S. CHHINA, EXAMINING ATTORNEY

Int. Cl.: 40

Prior U.S. Cls.: 100, 103 and 106

United States Patent and Trademark Office

Reg. No. 3,476,127

Registered July 29, 2008

**SERVICE MARK
PRINCIPAL REGISTER**



DPM ENTERPRISES, INC. (TENNESSEE CORPORATION)
128 REGINAL PARK DRIVE
KINGSPORT, TN 37660

THE MARK CONSISTS OF A RECTANGLE AND
STYLIZED ARROW THROUGH THE RECTANGLE
WITH "OPT3" BESIDE THE RECTANGLE.

FOR: RECYCLING CARPET TILE, IN CLASS 40
(U.S. CLS. 100, 103 AND 106).

SER. NO. 77-356,085, FILED 12-19-2007.

FIRST USE 12-31-2003; IN COMMERCE 5-5-2004.

ANTHONY RINKER, EXAMINING ATTORNEY

Int. Cl.: 41

Prior U.S. Cls.: 100, 101 and 107

United States Patent and Trademark Office

Reg. No. 3,476,128

Registered July 29, 2008

**SERVICE MARK
PRINCIPAL REGISTER**

cheesegod

MONACO, JONATHAN J. (UNITED STATES IN-
DIVIDUAL)
1 GLADYS PL
HICKSVILLE, NY 11801

THE MARK CONSISTS OF STANDARD CHAR-
ACTERS WITHOUT CLAIM TO ANY PARTICULAR
FONT, STYLE, SIZE, OR COLOR.

FOR: ON-LINE JOURNALS, NAMELY, BLOGS
FEATURING SATIRE AND HUMOROUS STORIES
AND ENTRIES, IN CLASS 41 (U.S. CLS. 100, 101 AND
107).

SER. NO. 77-356,108, FILED 12-19-2007.

FIRST USE 5-2-1997; IN COMMERCE 5-2-1997.

LAURIE MAYES, EXAMINING ATTORNEY

Int. Cl.: 25

Prior U.S. Cls.: 22 and 39

United States Patent and Trademark Office

Reg. No. 3,476,129

Registered July 29, 2008

TRADEMARK
PRINCIPAL REGISTER



MARKS, TOYA (UNITED STATES INDIVIDUAL)
1710 ANN SCARLET CT
WOODBIDGE, VA 22191

FOR: BATHING SUITS; SHIRTS; SHOES; PANTS,
IN CLASS 25 (U.S. CLS. 22 AND 39).

FIRST USE 8-1-2007; IN COMMERCE 1-1-2008.

THE NAME "LIZ SCHANNETTE" DOES NOT
IDENTIFY A LIVING INDIVIDUAL.

THE MARK CONSISTS OF HANDWRITTEN
STYLE WORDS IN THE MIDDLE OF A CLOTHING
TAG IMAGE WITH A LADY SITTING ON THE
EDGE OF THE TAG. THE "E" OF SCHANNETTE
HAS A HEART AT ITS TIP.

SER. NO. 77-356,120, FILED 12-19-2007.

REBECCA GILBERT, EXAMINING ATTORNEY

Int. Cls.: 35 and 37

Prior U.S. Cls.: 100, 101, 102, 103 and 106

United States Patent and Trademark Office

Reg. No. 3,476,130

Registered July 29, 2008

**SERVICE MARK
PRINCIPAL REGISTER**



PAGE, DONALD K. (UNITED STATES INDIVIDUAL)
13508 BATTLEWOOD COURT
CLIFTON, VA 20124

FOR: RETAIL STORE SERVICES FEATURING CONVENIENCE STORE ITEMS AND GASOLINE, IN CLASS 35 (U.S. CLS. 100, 101 AND 102).

FIRST USE 12-31-1990; IN COMMERCE 12-31-1990.

FOR: AUTOMOBILE REPAIR AND MAINTENANCE; AUTOMOBILE SERVICE STATION SERVICES, IN CLASS 37 (U.S. CLS. 100, 103 AND 106).

FIRST USE 12-31-1990; IN COMMERCE 12-31-1990.

NO CLAIM IS MADE TO THE EXCLUSIVE RIGHT TO USE "1983" OR "QUALITY AUTOMOTIVE SERVICE", APART FROM THE MARK AS SHOWN.

THE COLOR(S) BLUE, GREEN, YELLOW, RED, ORANGE, AND BLACK IS/ARE CLAIMED AS A FEATURE OF THE MARK.

THE MARK CONSISTS OF A BLUE AUTOMOBILE, WITH BLACK OUTLINE AND FEATURES, ATOP A YELLOW AND ORANGE ROPE SET BETWEEN TWO GREEN LEAVES WITH BLACK OUTLINE AND FEATURES, ABOVE A SHIELD DEPICTING CROSSED YELLOW WRENCHES WITH THE LETTER W ABOVE THEM, S TO THE LEFT, C TO THE RIGHT, AND 1983 BELOW; ALL OF THE WORDING APPEARS IN BLACK. THE SHIELD IS BLUE IN THE CENTER, WITH A THICK RED OUTLINE ALL AROUND IT; THERE IS A BLACK OUTLINE BETWEEN THE BLUE AND RED AND AROUND THE RED. THE LEAVES ATTACHED BY THE ROPE AND PARTS OF SETS OF HERALDIC LEAVES, ALL IN GREEN WITH BLACK OUTLINE AND DETAILS, ON EACH SIDE OF THE SHIELD. BELOW THE SHIELD IS A YELLOW BANNER, OUTLINED IN BLACK, WITH THE WORDING "QUALITY AUTOMOTIVE SERVICE" IN BLACK.

SER. NO. 77-356,121, FILED 12-19-2007.

LYDIA BELZER, EXAMINING ATTORNEY

Int. Cl.: 35

Prior U.S. Cls.: 100, 101 and 102

United States Patent and Trademark Office

Reg. No. 3,476,131

Registered July 29, 2008

SERVICE MARK
PRINCIPAL REGISTER

INSPIRE
Rewards

CHRISTIAN SUPPLY SHOPPE, INC. (SOUTH
CAROLINA CORPORATION)
1600 JOHN B. WHITE, SR. BLVD
SPARTANBURG, SC 29301

FOR: CUSTOMER LOYALTY SERVICES AND
CUSTOMER CLUB SERVICES, FOR COMMERCIAL,
PROMOTIONAL AND/OR ADVERTISING PURPOSES,
IN CLASS 35 (U.S. CLS. 100, 101 AND 102).

FIRST USE 8-1-2005; IN COMMERCE 8-1-2005.

NO CLAIM IS MADE TO THE EXCLUSIVE
RIGHT TO USE "REWARDS", APART FROM THE
MARK AS SHOWN.

THE MARK CONSISTS OF STYLIZED TEXT OF
"INSPIRE REWARDS".

SER. NO. 77-356,132, FILED 12-19-2007.

FRED MANDIR, EXAMINING ATTORNEY

Int. Cl.: 39

Prior U.S. Cls.: 100 and 105

United States Patent and Trademark Office

Reg. No. 3,476,132

Registered July 29, 2008

**SERVICE MARK
PRINCIPAL REGISTER**

SAILABRATION

TEMPLETON TOURS, INC. (NORTH CAROLINA
CORPORATION)
170 MEADOWVIEW DR.
BOONE, NC 28607

THE MARK CONSISTS OF STANDARD CHAR-
ACTERS WITHOUT CLAIM TO ANY PARTICULAR
FONT, STYLE, SIZE, OR COLOR.

FOR: CONDUCTING CRUISE TOURS, IN CLASS
39 (U.S. CLS. 100 AND 105).

SER. NO. 77-356,141, FILED 12-19-2007.

FIRST USE 6-0-1996; IN COMMERCE 6-0-1996.

TINA BROWN, EXAMINING ATTORNEY

Int. Cl.: 39

Prior U.S. Cls.: 100 and 105

United States Patent and Trademark Office

Reg. No. 3,476,133

Registered July 29, 2008

**SERVICE MARK
PRINCIPAL REGISTER**

JUBILEE AT SEA

TEMPLETON TOURS, INC. (NORTH CAROLINA
CORPORATION)
170 MEADOWVIEW DR.
BOONE, NC 28607

THE MARK CONSISTS OF STANDARD CHAR-
ACTERS WITHOUT CLAIM TO ANY PARTICULAR
FONT, STYLE, SIZE, OR COLOR.

FOR: CONDUCTING CRUISE TOURS, IN CLASS
39 (U.S. CLS. 100 AND 105).

SER. NO. 77-356,171, FILED 12-19-2007.

FIRST USE 2-0-1998; IN COMMERCE 2-0-1998.

TINA BROWN, EXAMINING ATTORNEY

Int. Cl.: 5

Prior U.S. Cls.: 6, 18, 44, 46, 51 and 52

United States Patent and Trademark Office

Reg. No. 3,476,134

Registered July 29, 2008

**TRADEMARK
PRINCIPAL REGISTER**

SCENT MY RIDE

CAPITOL FOOD BROKERS, INC. (MISSISSIPPI
CORPORATION)
SUITE D
657 HWY 49S
RICHLAND, MS 39218

FOR: AIR DEODORIZER; CAR DEODORIZER;
DEODORIZERS FOR AUTOMOBILES; DEODORIZ-
ING PRODUCTS, NAMELY, ALL PURPOSE DEO-
DORIZER PREPARATIONS FOR HOUSEHOLD,
COMMERCIAL AND INDUSTRIAL USE; ROOM
DEODORIZING COMPOSITIONS, IN CLASS 5 (U.S.
CLS. 6, 18, 44, 46, 51 AND 52).

FIRST USE 1-1-2007; IN COMMERCE 1-1-2007.

THE MARK CONSISTS OF STANDARD CHAR-
ACTERS WITHOUT CLAIM TO ANY PARTICULAR
FONT, STYLE, SIZE, OR COLOR.

SER. NO. 77-356,200, FILED 12-19-2007.

JAY FLOWERS, EXAMINING ATTORNEY

Int. Cls.: 38 and 42

Prior U.S. Cls.: 100, 101 and 104

United States Patent and Trademark Office

Reg. No. 3,476,135

Registered July 29, 2008

**SERVICE MARK
PRINCIPAL REGISTER**

ABAQIS

NURSING HOME QUALITY, LLC (COLORADO
LTD LIAB CO)
SUITE 308
7600 E. ARAPAHOE ROAD
CENTENNIAL, CO 80112

FOR: PROVISION OF ACCESS TO DATA OR
DOCUMENTS STORED ELECTRONICALLY IN
CENTRAL FILES FOR REMOTE CONSULTATION
IN THE FIELD OF MEDICAL SERVICES, NAMELY,
NURSING HOME CARE, IN CLASS 38 (U.S. CLS. 100,
101 AND 104).

FIRST USE 8-15-2007; IN COMMERCE 8-15-2007.

FOR: PROVIDING ON-LINE, NON-DOWNLOAD-
ABLE SOFTWARE FOR USE IN PROVIDING QUAL-

ITY ASSURANCE AND QUALITY MANAGEMENT
SERVICES IN THE FIELD OF MEDICAL SERVICES,
NAMELY, NURSING HOME CARE, IN CLASS 42
(U.S. CLS. 100 AND 101).

FIRST USE 8-15-2007; IN COMMERCE 8-15-2007.

THE MARK CONSISTS OF STANDARD CHAR-
ACTERS WITHOUT CLAIM TO ANY PARTICULAR
FONT, STYLE, SIZE, OR COLOR.

SER. NO. 77-356,201, FILED 12-19-2007.

DEZMONA MIZELLE, EXAMINING ATTORNEY

Int. Cl.: 43

Prior U.S. Cls.: 100 and 101

United States Patent and Trademark Office

Reg. No. 3,476,136

Registered July 29, 2008

SERVICE MARK
PRINCIPAL REGISTER



AKINS, PATTI (UNITED STATES INDIVIDUAL)
442 W. B ST.
DRAIN, OR 97435

FOR: DRIVE-THRU COFFEE SHOP, IN CLASS 43
(U.S. CLS. 100 AND 101).

FIRST USE 3-10-2007; IN COMMERCE 9-10-2007.

NO CLAIM IS MADE TO THE EXCLUSIVE
RIGHT TO USE "GREAT COFFEE" , APART FROM
THE MARK AS SHOWN.

THE STIPLING IS FOR SHADING PURPOSES
ONLY.

THE MARK CONSISTS OF THE STYLIZED
WORDS "UNCLE JOHN'S" ARCHED OVER THE
TOP OF A MAN HOLDING A HOT CUP OF COFFEE.
BELOW THE MAN IS A BANNER WITH THE
STYLIZED WORDS "GREAT COFFEE". THERE IS
A FOREST BACKGROUND BEHIND THE MAN
HOLDING THE CUP.

SER. NO. 77-356,204, FILED 12-19-2007.

ANTHONY RINKER, EXAMINING ATTORNEY

Int. Cl.: 10

Prior U.S. Cls.: 26, 39 and 44

United States Patent and Trademark Office

Reg. No. 3,476,137

Registered July 29, 2008

**TRADEMARK
PRINCIPAL REGISTER**

KNOBBLE

PRESSURE POSITIVE CO., THE (PENNSYLVANIA CORPORATION)
128 OBERHOLTZER ROAD
GILBERTSVILLE, PA 19525

THE MARK CONSISTS OF STANDARD CHARACTERS WITHOUT CLAIM TO ANY PARTICULAR FONT, STYLE, SIZE, OR COLOR.

FOR: MASSAGE APPARATUS, IN CLASS 10 (U.S. CLS. 26, 39 AND 44).

SER. NO. 77-356,207, FILED 12-19-2007.

FIRST USE 12-17-1981; IN COMMERCE 12-17-1981.

ANTHONY RINKER, EXAMINING ATTORNEY

Int. Cl.: 20

Prior U.S. Cls.: 2, 13, 22, 25, 32 and 50

United States Patent and Trademark Office

Reg. No. 3,476,138

Registered July 29, 2008

**TRADEMARK
PRINCIPAL REGISTER**

'Dependable NOT Bendable'

NUFURN PTY LTD (AUSTRALIA LTD LIAB CO)
1/8 BLACKFRIAR PL
WETHERILL PARK, AUSTRALIA

THE MARK CONSISTS OF STANDARD CHAR-
ACTERS WITHOUT CLAIM TO ANY PARTICULAR
FONT, STYLE, SIZE, OR COLOR.

FOR: CHAIRS, IN CLASS 20 (U.S. CLS. 2, 13, 22, 25,
32 AND 50).

SER. NO. 77-356,305, FILED 12-19-2007.

FIRST USE 1-1-2007; IN COMMERCE 1-1-2007.

HOWARD B. LEVINE, EXAMINING ATTORNEY

Int. Cl.: 33

Prior U.S. Cls.: 47 and 49

United States Patent and Trademark Office

Reg. No. 3,476,139

Registered July 29, 2008

**TRADEMARK
PRINCIPAL REGISTER**

DOLCINO

CAPITELLO WINES LLC (OREGON LTD LIAB
CO)
P.O. BOX 11694
EUGENE, OR 97440

FOR: WINE, IN CLASS 33 (U.S. CLS. 47 AND 49).

FIRST USE 8-22-2005; IN COMMERCE 12-8-2005.

THE MARK CONSISTS OF STANDARD CHAR-
ACTERS WITHOUT CLAIM TO ANY PARTICULAR
FONT, STYLE, SIZE, OR COLOR.

SER. NO. 77-356,306, FILED 12-19-2007.

WILLIAM P. SHANAHAN, EXAMINING ATTOR-
NEY

Int. Cl.: 35

Prior U.S. Cls.: 100, 101 and 102

United States Patent and Trademark Office

Reg. No. 3,476,140

Registered July 29, 2008

**SERVICE MARK
PRINCIPAL REGISTER**

www.DHCcare.com

DHC CORPORATION (JAPAN CORPORATION)
2-7-1 MINAMI-AZABU
MINATO-KU, TOKYO, JAPAN 106

FOR: OPERATING AN ONLINE SHOPPING SITE
IN THE FIELD OF MAKEUP PRODUCTS, SKIN
CARE PRODUCTS, HAIR CARE PRODUCTS, PER-
SONAL GROOMING PRODUCTS, FOOD PRO-
DUCTS AND DIETARY SUPPLEMENTS , IN
CLASS 35 (U.S. CLS. 100, 101 AND 102).

FIRST USE 9-30-1997; IN COMMERCE 9-30-1997.

THE MARK CONSISTS OF STANDARD CHAR-
ACTERS WITHOUT CLAIM TO ANY PARTICULAR
FONT, STYLE, SIZE, OR COLOR.

OWNER OF U.S. REG. NOS. 2,188,062, 3,184,193
AND OTHERS.

SER. NO. 77-356,329, FILED 12-19-2007.

LINDA M. KING, EXAMINING ATTORNEY

Int. Cl.: 36

Prior U.S. Cls.: 100, 101 and 102

United States Patent and Trademark Office

Reg. No. 3,476,141

Registered July 29, 2008

**SERVICE MARK
PRINCIPAL REGISTER**

CHEERBUCKS

CHEERBUCKS (GEORGIA CORPORATION)
52 BECKY DR.
ROSSVILLE, GA 30741

THE MARK CONSISTS OF STANDARD CHAR-
ACTERS WITHOUT CLAIM TO ANY PARTICULAR
FONT, STYLE, SIZE, OR COLOR.

FOR: FUNDRAISING FOR CHEERLEADERS, IN
CLASS 36 (U.S. CLS. 100, 101 AND 102).

SER. NO. 77-356,361, FILED 12-19-2007.

FIRST USE 9-11-2006; IN COMMERCE 9-11-2006.

SUNG IN, EXAMINING ATTORNEY

Int. Cl.: 41

Prior U.S. Cls.: 100, 101 and 107

United States Patent and Trademark Office

Reg. No. 3,476,142

Registered July 29, 2008

**SERVICE MARK
PRINCIPAL REGISTER**

Polichicks

MEGAN COSBY (UNITED STATES INDIVIDUAL)
1107-E SPRING STREET SUITE 2F
SILVER SPRING, MD 20910

FOR: PROVIDING ONLINE INFORMATION AND NEWS IN THE FIELDS OF POLITICS, ENTERTAINMENT, POPULAR CULTURE, FASHION AND WOMEN'S LIFESTYLE, IN CLASS 41 (U.S. CLS. 100, 101 AND 107).

FIRST USE 8-10-2007; IN COMMERCE 8-10-2007.

THE MARK CONSISTS OF STANDARD CHARACTERS WITHOUT CLAIM TO ANY PARTICULAR FONT, STYLE, SIZE, OR COLOR.

SER. NO. 77-356,382, FILED 12-19-2007.

MATTHEW MCDOWELL, EXAMINING ATTORNEY

Int. Cl.: 35

Prior U.S. Cls.: 100, 101 and 102

United States Patent and Trademark Office

Reg. No. 3,476,143

Registered July 29, 2008

**SERVICE MARK
PRINCIPAL REGISTER**

Paw Country

BOLKEN, KELLY C (UNITED STATES INDIVIDUAL), DBA PAW COUNTRY
5652 LAKE MURRAY BLVD.
LA MESA, CA 91942

THE MARK CONSISTS OF STANDARD CHARACTERS WITHOUT CLAIM TO ANY PARTICULAR FONT, STYLE, SIZE, OR COLOR.

FOR: RETAIL PET STORES, IN CLASS 35 (U.S. CLS. 100, 101 AND 102).

SER. NO. 77-356,396, FILED 12-19-2007.

FIRST USE 12-1-2007; IN COMMERCE 12-1-2007.

DEIRDRE ROBERTSON, EXAMINING ATTORNEY

Int. Cl.: 35

Prior U.S. Cls.: 100, 101 and 102

United States Patent and Trademark Office

Reg. No. 3,476,144

Registered July 29, 2008

**SERVICE MARK
PRINCIPAL REGISTER**

POTOMACWAVE

POTOMACWAVE CONSULTING, INC. (WA-
SHINGTON CORPORATION)
704 17TH AVE WEST
KIRKLAND, WA 98033

THE MARK CONSISTS OF STANDARD CHAR-
ACTERS WITHOUT CLAIM TO ANY PARTICULAR
FONT, STYLE, SIZE, OR COLOR.

FOR: BUSINESS CONSULTATION SERVICES, IN
CLASS 35 (U.S. CLS. 100, 101 AND 102).

SER. NO. 77-356,407, FILED 12-19-2007.

FIRST USE 10-1-2007; IN COMMERCE 10-1-2007.

EUGENIA MARTIN, EXAMINING ATTORNEY

Int. Cl.: 42

Prior U.S. Cls.: 100 and 101

United States Patent and Trademark Office

Reg. No. 3,476,145

Registered July 29, 2008

**SERVICE MARK
PRINCIPAL REGISTER**

CENTRIDEA

BANDIREDDY, MADHU (UNITED STATES INDIVIDUAL)
138 CHARLES ST
SOMERSET, NJ 08873

FOR: INFORMATION TECHNOLOGY CONSULTATION; COMPUTER HARDWARE AND SOFTWARE CONSULTING SERVICES; CONSULTATION SERVICES IN THE FIELDS OF SELECTION, IMPLEMENTATION AND USE OF COMPUTER HARDWARE AND SOFTWARE SYSTEMS FOR OTHERS; CONSULTING SERVICES IN THE FIELD OF DESIGN, SELECTION, IMPLEMENTATION AND USE OF COMPUTER HARDWARE AND SOFTWARE SYSTEMS FOR OTHERS; TECHNOLOGICAL CONSULTATION IN THE TECHNOL-

OGY FIELD OF COMPUTER HARDWARE AND SOFTWARE SYSTEMS; DESIGN AND DEVELOPMENT OF COMPUTER HARDWARE AND SOFTWARE, IN CLASS 42 (U.S. CLS. 100 AND 101).

FIRST USE 12-12-2007; IN COMMERCE 12-12-2007.

THE MARK CONSISTS OF STANDARD CHARACTERS WITHOUT CLAIM TO ANY PARTICULAR FONT, STYLE, SIZE, OR COLOR.

SER. NO. 77-356,415, FILED 12-19-2007.

INGA ERVIN, EXAMINING ATTORNEY

Int. Cl.: 16

Prior U.S. Cls.: 2, 5, 22, 23, 29, 37, 38 and 50

Reg. No. 3,476,146

United States Patent and Trademark Office

Registered July 29, 2008

**TRADEMARK
PRINCIPAL REGISTER**

MEDICINE IN A FLASH

FRONTRUNNERS (CALIFORNIA SOLE PROPRIETORSHIP), DBA FRONTRUNNERS PUBLISHING; FRONTRUNNERS BOARD REVIEW
27292 RYAN DR
LAGUNA NIGUEL, CA 92677

FOR: EDUCATIONAL PUBLICATIONS, NAME-
LY, EDUCATIONAL LEARNING CARDS, FLASH
CARDS, ACTIVITY CARDS, WORKBOOKS, TEXT-
BOOKS, ACTIVITY BOOKS, STORY BOOKS, PUZ-
ZLE BOOKS, PUZZLES, TEACHER GUIDES,
MANUALS, POSTERS, EDUCATIONAL CARD
GAMES AND EDUCATIONAL BOOKLETS IN THE
FIELD OF MEDICINE; FLASH CARDS, IN CLASS 16
(U.S. CLS. 2, 5, 22, 23, 29, 37, 38 AND 50).

FIRST USE 3-5-2007; IN COMMERCE 3-5-2007.

THE MARK CONSISTS OF STANDARD CHAR-
ACTERS WITHOUT CLAIM TO ANY PARTICULAR
FONT, STYLE, SIZE, OR COLOR.

NO CLAIM IS MADE TO THE EXCLUSIVE
RIGHT TO USE "MEDICINE", APART FROM THE
MARK AS SHOWN.

SER. NO. 77-356,427, FILED 12-20-2007.

ANTHONY RINKER, EXAMINING ATTORNEY

Int. Cl.: 32

Prior U.S. Cls.: 45, 46 and 48

Reg. No. 3,476,147

United States Patent and Trademark Office

Registered July 29, 2008

**TRADEMARK
PRINCIPAL REGISTER**

Happy Bottom Riding Club

PANCHO BARNES ENTERPRISES, INC. (CALI-
FORNIA CORPORATION)
SUITE 106
1137 SECOND STREET
SANTA MONICA, CA 90403

THE MARK CONSISTS OF STANDARD CHAR-
ACTERS WITHOUT CLAIM TO ANY PARTICULAR
FONT, STYLE, SIZE, OR COLOR.

FOR: ENERGY DRINKS, IN CLASS 32 (U.S. CLS.
45, 46 AND 48).

SER. NO. 77-356,434, FILED 12-20-2007.

FIRST USE 12-18-2007; IN COMMERCE 12-18-2007.

ELLEN PERKINS, EXAMINING ATTORNEY

Int. Cl.: 13

Prior U.S. Cls.: 2 and 9

United States Patent and Trademark Office

Reg. No. 3,476,148

Registered July 29, 2008

**TRADEMARK
PRINCIPAL REGISTER**

PALM SWELL

ONO, TOSH B. (UNITED STATES INDIVIDUAL)
15612 DAWSON LANE
HUNTINGTON BEACH, CA 92647

THE MARK CONSISTS OF STANDARD CHAR-
ACTERS WITHOUT CLAIM TO ANY PARTICULAR
FONT, STYLE, SIZE, OR COLOR.

FOR: RECOIL PADS; FIREARM HAND GUARDS,
IN CLASS 13 (U.S. CLS. 2 AND 9).

SER. NO. 77-356,437, FILED 12-20-2007.

FIRST USE 3-13-2004; IN COMMERCE 3-13-2004.

ELLEN PERKINS, EXAMINING ATTORNEY

Int. Cl.: 9

Prior U.S. Cls.: 21, 23, 26, 36 and 38

Reg. No. 3,476,149

United States Patent and Trademark Office

Registered July 29, 2008

**TRADEMARK
PRINCIPAL REGISTER**

VA-Lab

BEIJING SHENG WANG ACOUSTIC-ELECTRIC
TECHNOLOGY CO., LTD (CHINA LTD LIAB
CO)
NO.1003, NORTH RING CENTER, #18 YUMIN RD
BEIJING 100029, CHINA

FOR: COMPUTER SOFTWARE TO CONTROL
AND IMPROVE COMPUTER AND AUDIO EQUIP-
MENT SOUND QUALITY , IN CLASS 9 (U.S. CLS. 21,
23, 26, 36 AND 38).

FIRST USE 1-1-2007; IN COMMERCE 1-1-2007.

THE MARK CONSISTS OF STANDARD CHAR-
ACTERS WITHOUT CLAIM TO ANY PARTICULAR
FONT, STYLE, SIZE, OR COLOR.

SER. NO. 77-356,441, FILED 12-20-2007.

TRACY WHITTAKER-BROWN, EXAMINING AT-
TORNEY

Int. Cl.: 5

Prior U.S. Cls.: 6, 18, 44, 46, 51 and 52

United States Patent and Trademark Office

Reg. No. 3,476,150

Registered July 29, 2008

**TRADEMARK
PRINCIPAL REGISTER**

JOINT DEFENSE

ELITE ATHLETE SALES, INC. (OREGON CORPORATION)
845 NE CLEVELAND AVE
GRESHAM, OR 97030

FOR: DIETARY AND NUTRITIONAL SUPPLEMENTS, IN CLASS 5 (U.S. CLS. 6, 18, 44, 46, 51 AND 52).

FIRST USE 10-1-1999; IN COMMERCE 10-1-1999.

THE MARK CONSISTS OF STANDARD CHARACTERS WITHOUT CLAIM TO ANY PARTICULAR FONT, STYLE, SIZE, OR COLOR.

NO CLAIM IS MADE TO THE EXCLUSIVE RIGHT TO USE "JOINT", APART FROM THE MARK AS SHOWN.

SER. NO. 77-356,444, FILED 12-20-2007.

NELSON SNYDER, EXAMINING ATTORNEY

Int. Cl.: 35

Prior U.S. Cls.: 100, 101 and 102

United States Patent and Trademark Office

Reg. No. 3,476,151

Registered July 29, 2008

**SERVICE MARK
PRINCIPAL REGISTER**

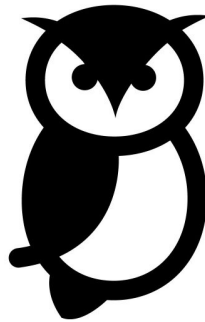

OWLNOTES.COM, LLC (CALIFORNIA LTD LIAB
CO)
PO BOX 27250
ANAHEIM, CA 92809

FOR: PROVIDING A WIDE RANGE OF CAREER,
JOB PLACEMENT, AND GENERAL BUSINESS IN-
FORMATION VIA A GLOBAL COMMUNICATION
INFORMATION NETWORK, IN CLASS 35 (U.S. CLS.
100, 101 AND 102).

FIRST USE 5-1-2006; IN COMMERCE 5-1-2006.

THE MARK CONSISTS OF A DESIGN OF AN
OWL.

SER. NO. 77-356,472, FILED 12-20-2007.

LESLIE RICHARDS, EXAMINING ATTORNEY

Int. Cl.: 41

Prior U.S. Cls.: 100, 101 and 107

United States Patent and Trademark Office

Reg. No. 3,476,152

Registered July 29, 2008

**SERVICE MARK
PRINCIPAL REGISTER**

WISDOM IN GOD'S COUNTRY

WYOMING CATHOLIC COLLEGE (WYOMING
NON-PROFIT CORPORATION)
163 LEEDY DRIVE
LANDER, WY 82520

FOR: EDUCATION SERVICES IN THE NATURE
OF COURSES AT THE UNIVERSITY LEVEL AND
DISTRIBUTION OF COURSE MATERIAL IN CON-
NECTION THEREWITH, IN CLASS 41 (U.S. CLS. 100,
101 AND 107).

FIRST USE 4-1-2005; IN COMMERCE 4-1-2005.

THE MARK CONSISTS OF STANDARD CHAR-
ACTERS WITHOUT CLAIM TO ANY PARTICULAR
FONT, STYLE, SIZE, OR COLOR.

SER. NO. 77-356,529, FILED 12-20-2007.

WILLIAM BRECKENFELD, EXAMINING ATTOR-
NEY

Int. Cl.: 35

Prior U.S. Cls.: 100, 101 and 102

United States Patent and Trademark Office

Reg. No. 3,476,153

Registered July 29, 2008

**SERVICE MARK
PRINCIPAL REGISTER**

Loyal Listening

EVA-TONE INC. (FLORIDA CORPORATION),
DBA EAGLE MARKETING, A DIVISION OF
EVATONE INC.
4801 ULMERTON ROAD
CLEARWATER, FL 33762

THE MARK CONSISTS OF STANDARD CHAR-
ACTERS WITHOUT CLAIM TO ANY PARTICULAR
FONT, STYLE, SIZE, OR COLOR.

FOR: ADVERTISING, MARKETING AND PRO-
MOTION SERVICES, IN CLASS 35 (U.S. CLS. 100, 101
AND 102).

SER. NO. 77-356,555, FILED 12-20-2007.

FIRST USE 11-6-2007; IN COMMERCE 12-14-2007.

JUDITH HELFMAN, EXAMINING ATTORNEY

Int. Cl.: 35

Prior U.S. Cls.: 100, 101 and 102

United States Patent and Trademark Office

Reg. No. 3,476,154

Registered July 29, 2008

**SERVICE MARK
PRINCIPAL REGISTER**

CAREVERTISER

HEALTHCARE NEWS NETWORK, LLC (FLORIDA LTD LIAB CO)
1625 SE 46TH STREET, SUITE 4A
CAPE CORAL, FL 33904

FOR: ADVERTISING SERVICES, NAMELY, PROVIDING ADVERTISING SPACE ON A TELEVISION NETWORK FEATURING HEALTH RELATED CONTENT; ADVERTISING SERVICES, NAMELY, PROVIDING A HEALTH-RELATED ADVERTISING SERVICE PROGRAM THAT BENEFITS NON-PROFIT ORGANIZATIONS, IN CLASS 35 (U.S. CLS. 100, 101 AND 102).

FIRST USE 9-19-2007; IN COMMERCE 9-19-2007.

THE MARK CONSISTS OF STANDARD CHARACTERS WITHOUT CLAIM TO ANY PARTICULAR FONT, STYLE, SIZE, OR COLOR.

SER. NO. 77-356,557, FILED 12-20-2007.

JUDITH HELFMAN, EXAMINING ATTORNEY

Int. Cl.: 35

Prior U.S. Cls.: 100, 101 and 102

United States Patent and Trademark Office

Reg. No. 3,476,155

Registered July 29, 2008

**SERVICE MARK
PRINCIPAL REGISTER**

Loyal Viewing

EVA-TONE INC. (FLORIDA CORPORATION),
DBA EAGLE MARKETING, A DIVISION OF
EVATONE INC.
4801 ULMERTON ROAD
CLEARWATER, FL 33762

THE MARK CONSISTS OF STANDARD CHAR-
ACTERS WITHOUT CLAIM TO ANY PARTICULAR
FONT, STYLE, SIZE, OR COLOR.

FOR: ADVERTISING, MARKETING AND PRO-
MOTION SERVICES, IN CLASS 35 (U.S. CLS. 100, 101
AND 102).

SER. NO. 77-356,569, FILED 12-20-2007.

FIRST USE 11-6-2007; IN COMMERCE 12-14-2007.

JUDITH HELFMAN, EXAMINING ATTORNEY

Int. Cl.: 27

Prior U.S. Cls.: 19, 20, 37, 42 and 50

United States Patent and Trademark Office

Reg. No. 3,476,156

Registered July 29, 2008

**TRADEMARK
PRINCIPAL REGISTER**

DURAMAT

DEFLECTO CORPORATION (DELAWARE COR-
PORATION)
11937 EXIT FIVE PARKWAY
FISHERS, IN 46038

THE MARK CONSISTS OF STANDARD CHAR-
ACTERS WITHOUT CLAIM TO ANY PARTICULAR
FONT, STYLE, SIZE, OR COLOR.

FOR: UNDER-CHAIR FLOOR PROTECTOR,
NAMELY, CHAIR MATS, IN CLASS 27 (U.S. CLS.
19, 20, 37, 42 AND 50).

SER. NO. 77-356,577, FILED 12-20-2007.

FIRST USE 12-31-1999; IN COMMERCE 12-31-1999.

MARY MUNSON, EXAMINING ATTORNEY

Int. Cl.: 11

Prior U.S. Cls.: 13, 21, 23, 31 and 34

Reg. No. 3,476,157

United States Patent and Trademark Office

Registered July 29, 2008

**TRADEMARK
PRINCIPAL REGISTER**

LCG SYSTEM

LC TRADING INTERNATIONAL CORP. (FLOR-
IDA CORPORATION), DBA LC CORP
5300 ADAMO DRIVE - SUITE A
TAMPA, FL 33615

FOR: PEDICURE SPAS IN THE NATURE OF
NON-PORTABLE FOOT BATHS WITH SUPERSO-
NIC WATER UNITS FOR PRODUCING BUBBLES
AND A MASSAGE CHAIR, SOLD TOGETHER AS A
UNIT, IN CLASS 11 (U.S. CLS. 13, 21, 23, 31 AND 34).

FIRST USE 3-21-2007; IN COMMERCE 3-21-2007.

THE MARK CONSISTS OF STANDARD CHAR-
ACTERS WITHOUT CLAIM TO ANY PARTICULAR
FONT, STYLE, SIZE, OR COLOR.

NO CLAIM IS MADE TO THE EXCLUSIVE
RIGHT TO USE "SYSTEM", APART FROM THE
MARK AS SHOWN.

SER. NO. 77-356,578, FILED 12-20-2007.

CYNTHIA SLOAN, EXAMINING ATTORNEY

Int. Cl.: 27

Prior U.S. Cls.: 19, 20, 37, 42 and 50

United States Patent and Trademark Office

Reg. No. 3,476,158

Registered July 29, 2008

**TRADEMARK
PRINCIPAL REGISTER**

ECONOMAT

DEFLECTO CORPORATION (DELAWARE COR-
PORATION)
11937 EXIT FIVE PARKWAY
FISHERS, IN 46038

THE MARK CONSISTS OF STANDARD CHAR-
ACTERS WITHOUT CLAIM TO ANY PARTICULAR
FONT, STYLE, SIZE, OR COLOR.

FOR: UNDER-CHAIR FLOOR PROTECTOR,
NAMELY, CHAIR MATS, IN CLASS 27 (U.S. CLS.
19, 20, 37, 42 AND 50).

SER. NO. 77-356,587, FILED 12-20-2007.

FIRST USE 12-31-1999; IN COMMERCE 12-31-1999.

MARY MUNSON, EXAMINING ATTORNEY

Int. Cl.: 28

Prior U.S. Cls.: 22, 23, 38 and 50

United States Patent and Trademark Office

Reg. No. 3,476,159

Registered July 29, 2008

**TRADEMARK
PRINCIPAL REGISTER**

TUFFTERRYS

A&R ALLIED ENTERPRISE INC. (NEW JERSEY
CORPORATION)
600 GRAND AVENUE
RIDGEFIELD, NJ 07657

THE MARK CONSISTS OF STANDARD CHAR-
ACTERS WITHOUT CLAIM TO ANY PARTICULAR
FONT, STYLE, SIZE, OR COLOR.

FOR: POLYPROPYLENE REINFORCED ICE
SKATE BLADE COVER, IN CLASS 28 (U.S. CLS. 22,
23, 38 AND 50).

SER. NO. 77-356,621, FILED 12-20-2007.

FIRST USE 1-2-2005; IN COMMERCE 1-2-2005.

MARY MUNSON, EXAMINING ATTORNEY

Int. Cl.: 27

Prior U.S. Cls.: 19, 20, 37, 42 and 50

United States Patent and Trademark Office

Reg. No. 3,476,160

Registered July 29, 2008

**TRADEMARK
PRINCIPAL REGISTER**

EXECUMAT

DEFLECTO CORPORATION (DELAWARE COR-
PORATION)
11937 EXIT FIVE PARKWAY
FISHERS, IN 46038

THE MARK CONSISTS OF STANDARD CHAR-
ACTERS WITHOUT CLAIM TO ANY PARTICULAR
FONT, STYLE, SIZE, OR COLOR.

FOR: UNDER-CHAIR FLOOR PROTECTOR,
NAMELY, CHAIR MATS, IN CLASS 27 (U.S. CLS.
19, 20, 37, 42 AND 50).

SER. NO. 77-356,636, FILED 12-20-2007.

FIRST USE 12-31-1999; IN COMMERCE 12-31-1999.

MARY MUNSON, EXAMINING ATTORNEY

Int. Cl.: 42

Prior U.S. Cls.: 100 and 101

United States Patent and Trademark Office

Reg. No. 3,476,161

Registered July 29, 2008

**SERVICE MARK
PRINCIPAL REGISTER**

**Track to Excellence
Quality Improvement for
the Railroad Industry**

MONTGOMERY QUALITY ENTERPRISES INTERNATIONAL, INC. (GEORGIA CORPORATION)

4035 DOLLAR CIRCLE
SUWANEE, GA 30024

FOR: PROVIDING QUALITY ASSURANCE SERVICES IN THE FIELD OF THE RAILROAD INDUSTRY, IN CLASS 42 (U.S. CLS. 100 AND 101).

FIRST USE 1-15-1997; IN COMMERCE 1-15-1997.

THE MARK CONSISTS OF STANDARD CHARACTERS WITHOUT CLAIM TO ANY PARTICULAR FONT, STYLE, SIZE, OR COLOR.

NO CLAIM IS MADE TO THE EXCLUSIVE RIGHT TO USE "QUALITY IMPROVEMENT FOR THE RAILROAD INDUSTRY", APART FROM THE MARK AS SHOWN.

SER. NO. 77-356,642, FILED 12-20-2007.

JEFFERY COWARD, EXAMINING ATTORNEY

Int. Cl.: 35

Prior U.S. Cls.: 100, 101 and 102

United States Patent and Trademark Office

Reg. No. 3,476,162

Registered July 29, 2008

**SERVICE MARK
PRINCIPAL REGISTER**

The Truckers Best Friend

TMT TRUCK PERMITTING INC. (KANSAS CORPORATION)
1100 S KANSAS AVENUE
LIBERAL, KS 67901

FOR: REGULATORY FUEL TAX AND DRIVER LOG AUDIT REPORTING FOR THE TRANSPORTATION INDUSTRY, IN CLASS 35 (U.S. CLS. 100, 101 AND 102).

FIRST USE 12-22-2000; IN COMMERCE 12-22-2000.

THE MARK CONSISTS OF STANDARD CHARACTERS WITHOUT CLAIM TO ANY PARTICULAR FONT, STYLE, SIZE, OR COLOR.

SER. NO. 77-356,676, FILED 12-20-2007.

EMILY CARLSEN, EXAMINING ATTORNEY

Int. Cl.: 36

Prior U.S. Cls.: 100, 101 and 102

United States Patent and Trademark Office

Reg. No. 3,476,163

Registered July 29, 2008

**SERVICE MARK
PRINCIPAL REGISTER**

TALARIS INSTITUTE

TALARIS RESEARCH INSTITUTE (WASHINGTON NON-PROFIT CORPORATION)

P.O. BOX 45040

SEATTLE, WA 98145

FOR: CHARITABLE FUND RAISING IN THE AREA OF RESEARCH AND STUDY REGARDING LEARNING, BEHAVIORAL DEVELOPMENT AND EARLY BRAIN DEVELOPMENT, IN CLASS 36 (U.S. CLS. 100, 101 AND 102).

FIRST USE 11-13-2007; IN COMMERCE 11-13-2007.

THE MARK CONSISTS OF STANDARD CHARACTERS WITHOUT CLAIM TO ANY PARTICULAR FONT, STYLE, SIZE, OR COLOR.

OWNER OF U.S. REG. NOS. 2,795,876, 2,948,862 AND OTHERS.

NO CLAIM IS MADE TO THE EXCLUSIVE RIGHT TO USE "INSTITUTE", APART FROM THE MARK AS SHOWN.

SER. NO. 77-356,688, FILED 12-20-2007.

MARTHA FROMM, EXAMINING ATTORNEY

Int. Cl.: 37

Prior U.S. Cls.: 100, 103 and 106

United States Patent and Trademark Office

Reg. No. 3,476,164

Registered July 29, 2008

**SERVICE MARK
PRINCIPAL REGISTER**

jani-green

JANI-GREEN LLC (SOUTH CAROLINA LTD
LIAB CO)
SUITE J
3305 RUTHERFORD ROAD
TAYLORS, SC 29687

FOR: JANITORIAL SERVICES, IN CLASS 37 (U.S.
CLS. 100, 103 AND 106).

FIRST USE 10-1-2007; IN COMMERCE 10-15-2007.

THE MARK CONSISTS OF STANDARD CHAR-
ACTERS WITHOUT CLAIM TO ANY PARTICULAR
FONT, STYLE, SIZE, OR COLOR.

SER. NO. 77-356,690, FILED 12-20-2007.

WILLIAM BRECKENFELD, EXAMINING ATTOR-
NEY

Int. Cl.: 16

Prior U.S. Cls.: 2, 5, 22, 23, 29, 37, 38 and 50

Reg. No. 3,476,165

United States Patent and Trademark Office

Registered July 29, 2008

**TRADEMARK
PRINCIPAL REGISTER**

LINEMARK

APPLETON PAPERS INC. (DELAWARE COR-
PORATION)
PO BOX 359
825 EAST WISCONSIN AVENUE
APPLETON, WI 54912

FOR: COATED PRINTING PAPERS AND PAPER-
LIKE SUBSTRATES, NAMELY, SECURITY PAPERS
FOR USE IN PRINTING DOCUMENTS, TAGS AND
LABELS IN INTERNATIONAL CLASS 16, IN CLASS
16 (U.S. CLS. 2, 5, 22, 23, 29, 37, 38 AND 50).

FIRST USE 12-10-2007; IN COMMERCE 12-10-2007.

THE MARK CONSISTS OF STANDARD CHAR-
ACTERS WITHOUT CLAIM TO ANY PARTICULAR
FONT, STYLE, SIZE, OR COLOR.

SER. NO. 77-356,691, FILED 12-20-2007.

AMY HELLA, EXAMINING ATTORNEY

Int. Cl.: 9

Prior U.S. Cls.: 21, 23, 26, 36 and 38

Reg. No. 3,476,166

United States Patent and Trademark Office

Registered July 29, 2008

**TRADEMARK
PRINCIPAL REGISTER**

dMProbate

COVINGTON, NORMAN (UNITED STATES INDIVIDUAL)

#207

16787 BEACH BLVD.

HUNTINGTON BEACH, CA 92647

FOR: COMPUTER SOFTWARE FOR ACCOUNTING USE BY ANY ENTITY WORKING WITH PROBATE MATTERS IN THE LEGAL, ACCOUNTING, SECRETARIAL, CLERICAL OR BOOKKEEPING PROFESSIONS, IN CLASS 9 (U.S. CLS. 21, 23, 26, 36 AND 38).

FIRST USE 8-15-2007; IN COMMERCE 9-1-2007.

THE MARK CONSISTS OF STANDARD CHARACTERS WITHOUT CLAIM TO ANY PARTICULAR FONT, STYLE, SIZE, OR COLOR.

SER. NO. 77-356,698, FILED 12-20-2007.

WILLIAM BRECKENFELD, EXAMINING ATTORNEY

Int. Cl.: 41

Prior U.S. Cls.: 100, 101 and 107

United States Patent and Trademark Office

Reg. No. 3,476,167

Registered July 29, 2008

**SERVICE MARK
PRINCIPAL REGISTER**

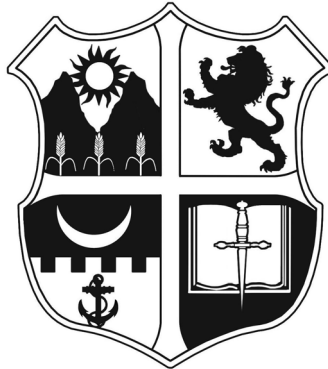

WYOMING CATHOLIC COLLEGE (WYOMING
NON-PROFIT CORPORATION)
163 LEEDY DRIVE
LANDER, WY 82520

FOR: EDUCATION SERVICES IN THE NATURE
OF COURSES AT THE UNIVERSITY LEVEL AND
DISTRIBUTION OF COURSE MATERIAL IN CON-
NECTION THEREWITH, IN CLASS 41 (U.S. CLS. 100,
101 AND 107).

FIRST USE 4-15-2006; IN COMMERCE 4-15-2006.

THE MARK CONSISTS OF A SHIELD DIVIDED
INTO FOUR SEPARATE SYMBOLS - THE MOUN-
TAIN, SUN AND WHEAT; LION STANDING ON ITS
HIND LEGS; CRESCENT MOON ON A WALL
OVERLOOKING AN ANCHOR CROSS; AND OPEN
BOOK WITH A SWORD WITHIN.

SER. NO. 77-356,699, FILED 12-20-2007.

WILLIAM BRECKENFELD, EXAMINING ATTOR-
NEY

Int. Cl.: 36

Prior U.S. Cls.: 100, 101 and 102

United States Patent and Trademark Office

Reg. No. 3,476,168

Registered July 29, 2008

**SERVICE MARK
PRINCIPAL REGISTER**

MorCap

MORCAP FUND ADVISORS, LLC (CALIFORNIA
LTD LIAB CO)
9TH FLOOR
2040 MAIN STREET
IRVINE, CA 92614

FOR: MORTGAGE FUND ADVISOR, MORT-
GAGE BANKING, LOAN ACQUISITION, MORT-
GAGE LOAN POOL SALES AND ACQUISITION,
FUND MANAGEMENT, IN CLASS 36 (U.S. CLS. 100,
101 AND 102).

FIRST USE 10-15-2007; IN COMMERCE 10-15-2007.

THE MARK CONSISTS OF STANDARD CHAR-
ACTERS WITHOUT CLAIM TO ANY PARTICULAR
FONT, STYLE, SIZE, OR COLOR.

SER. NO. 77-356,734, FILED 12-20-2007.

RONALD AIKENS, EXAMINING ATTORNEY

Int. Cl.: 25

Prior U.S. Cls.: 22 and 39

United States Patent and Trademark Office

Reg. No. 3,476,169

Registered July 29, 2008

**TRADEMARK
PRINCIPAL REGISTER**

Poogies

MARK SIELER AND ROBBIN SIELER (HUSBAND AND WIFE) (UNITED STATES INDIVIDUAL), DBA POOGIES
319 N. PENN STREET
ABERDEEN, SD 57401

THE MARK CONSISTS OF STANDARD CHARACTERS WITHOUT CLAIM TO ANY PARTICULAR FONT, STYLE, SIZE, OR COLOR.

FOR: LEG WARMERS, IN CLASS 25 (U.S. CLS. 22 AND 39).

SER. NO. 77-356,737, FILED 12-20-2007.

FIRST USE 0-0-2005; IN COMMERCE 0-0-2005.

RONALD AIKENS, EXAMINING ATTORNEY

Int. Cl.: 41

Prior U.S. Cls.: 100, 101 and 107

United States Patent and Trademark Office

Reg. No. 3,476,170

Registered July 29, 2008

**SERVICE MARK
PRINCIPAL REGISTER**

Remember Forever

REVERIE UNLIMITED LLC (TEXAS LTD LIAB
CO)
P.O. BOX 92225
AUSTIN, TX 78709

THE MARK CONSISTS OF STANDARD CHAR-
ACTERS WITHOUT CLAIM TO ANY PARTICULAR
FONT, STYLE, SIZE, OR COLOR.

FOR: PHOTOGRAPHY, IN CLASS 41 (U.S. CLS.
100, 101 AND 107).

SER. NO. 77-356,743, FILED 12-20-2007.

FIRST USE 1-1-2006; IN COMMERCE 1-1-2007.

EUGENIA MARTIN, EXAMINING ATTORNEY

Int. Cl.: 35

Prior U.S. Cls.: 100, 101 and 102

United States Patent and Trademark Office

Reg. No. 3,476,171

Registered July 29, 2008

**SERVICE MARK
PRINCIPAL REGISTER**

Fiderion

FIDERION GROUP, LLC (GEORGIA LTD LIAB
CO)
SUITE 2625
3280 PEACHTREE ROAD, NW
ATLANTA, GA 30305

THE MARK CONSISTS OF STANDARD CHAR-
ACTERS WITHOUT CLAIM TO ANY PARTICULAR
FONT, STYLE, SIZE, OR COLOR.

FOR: EXECUTIVE SEARCH AND PLACEMENT
SERVICES, IN CLASS 35 (U.S. CLS. 100, 101 AND 102).

SER. NO. 77-356,744, FILED 12-20-2007.

FIRST USE 3-19-2003; IN COMMERCE 3-19-2003.

SONYA STEPHENS, EXAMINING ATTORNEY

Int. Cl.: 37

Prior U.S. Cls.: 100, 103 and 106

United States Patent and Trademark Office

Reg. No. 3,476,172

Registered July 29, 2008

**SERVICE MARK
PRINCIPAL REGISTER**

Got Bees?

BEECON, INC. (PENNSYLVANIA CORPORATION)
1275 PENN AVE
PITTSBURGH, PA 15221

FOR: PEST EXTERMINATION OTHER THAN
FOR AGRICULTURAL PURPOSES, IN CLASS 37
(U.S. CLS. 100, 103 AND 106).

FIRST USE 5-1-2007; IN COMMERCE 5-1-2007.

THE MARK CONSISTS OF STANDARD CHARACTERS WITHOUT CLAIM TO ANY PARTICULAR FONT, STYLE, SIZE, OR COLOR.

NO CLAIM IS MADE TO THE EXCLUSIVE RIGHT TO USE "BEES", APART FROM THE MARK AS SHOWN.

SER. NO. 77-356,748, FILED 12-20-2007.

ANTHONY RINKER, EXAMINING ATTORNEY

Int. Cl.: 35

Prior U.S. Cls.: 100, 101 and 102

United States Patent and Trademark Office

Reg. No. 3,476,173

Registered July 29, 2008

**SERVICE MARK
PRINCIPAL REGISTER**

BUSINESSPATH

RICHARDSON, TERRY (UNITED STATES INDIVIDUAL)
733 LONGFELLOW ST.
TRACY, CA 95376

THE MARK CONSISTS OF STANDARD CHARACTERS WITHOUT CLAIM TO ANY PARTICULAR FONT, STYLE, SIZE, OR COLOR.

FOR: INTERNET ADVERTISING SERVICES, IN CLASS 35 (U.S. CLS. 100, 101 AND 102).

SER. NO. 77-356,751, FILED 12-20-2007.

FIRST USE 1-0-1997; IN COMMERCE 1-0-1997.

PRISCILLA MILTON, EXAMINING ATTORNEY

Int. Cl.: 5

Prior U.S. Cls.: 6, 18, 44, 46, 51 and 52

United States Patent and Trademark Office

Reg. No. 3,476,174

Registered July 29, 2008

**TRADEMARK
PRINCIPAL REGISTER**

CRYSHOCK

ELITE SPORTS PRODUCTS INC (FLORIDA CORPORATION)
405 S DALE MABRY HWY UNIT 330
TAMPA, FL 33609

THE MARK CONSISTS OF STANDARD CHARACTERS WITHOUT CLAIM TO ANY PARTICULAR FONT, STYLE, SIZE, OR COLOR.

FOR: NUTRITIONAL SUPPLEMENTS, IN CLASS 5 (U.S. CLS. 6, 18, 44, 46, 51 AND 52).

SER. NO. 77-356,752, FILED 12-20-2007.

FIRST USE 12-19-2007; IN COMMERCE 12-19-2007.

PRISCILLA MILTON, EXAMINING ATTORNEY

Int. Cl.: 41

Prior U.S. Cls.: 100, 101 and 107

United States Patent and Trademark Office

Reg. No. 3,476,175

Registered July 29, 2008

**SERVICE MARK
PRINCIPAL REGISTER**

SILVERSTEEL

SILVER, MARCUS (UNITED STATES INDIVIDUAL)
8613 FRANKLIN AVE.
LOS ANGELES, CA 90069

FOR: ENTERTAINMENT IN THE NATURE OF LIVE PERFORMANCES BY ROCK BAND; ENTERTAINMENT SERVICES, NAMELY, PERSONAL APPEARANCES BY A ROCK BAND; ENTERTAINMENT SERVICES, NAMELY, PROVIDING A WEB SITE FEATURING MUSICAL PERFORMANCES, MUSICAL VIDEOS, RELATED FILM CLIPS, PHOTOGRAPHS, AND OTHER MULTIMEDIA MATERIALS; ENTERTAINMENT, NAMELY,

LIVE MUSIC CONCERTS, IN CLASS 41 (U.S. CLS. 100, 101 AND 107).

FIRST USE 3-25-1999; IN COMMERCE 6-25-1999.

THE MARK CONSISTS OF STANDARD CHARACTERS WITHOUT CLAIM TO ANY PARTICULAR FONT, STYLE, SIZE, OR COLOR.

SER. NO. 77-356,782, FILED 12-20-2007.

JAY FLOWERS, EXAMINING ATTORNEY

Int. Cl.: 9

Prior U.S. Cls.: 21, 23, 26, 36 and 38

United States Patent and Trademark Office

Reg. No. 3,476,176

Registered July 29, 2008

**TRADEMARK
PRINCIPAL REGISTER**

READYSTATION

SOUTH WESTERN COMMUNICATIONS, INC.
(INDIANA CORPORATION)
4871 ROSEBUD LANE
NEWBURGH, IN 47630

FOR: BUILDING EMERGENCY MANAGEMENT AND CONTROL SYSTEMS, NAMELY, BIOMETRICALLY ACCESSED, BULLET RESISTANT COMMAND CENTERS DESIGNED AS THE FOCAL POINT INTENDED FOR USE BY BOTH ON-SITE PERSONNEL AND FIRST RESPONDERS IN EMERGENCY SITUATIONS, FEATURING APPARATUS FOR VOICE AND VIDEO COMMUNICATIONS, VIDEO SURVEILLANCE, ACCESS AND DOOR CONTROL, HVAC CONTROL, UTILITY SHUT-OFF, MASS NOTIFICATION, TOUCHSCREEN PA-

GING FUNCTIONS AND A SEPARATE, BIOMETRICALLY ACCESSED STORAGE AREA FOR SELF DEFENSE TOOLS, IN CLASS 9 (U.S. CLS. 21, 23, 26, 36 AND 38).

FIRST USE 12-4-2007; IN COMMERCE 12-4-2007.

THE MARK CONSISTS OF STANDARD CHARACTERS WITHOUT CLAIM TO ANY PARTICULAR FONT, STYLE, SIZE, OR COLOR.

SER. NO. 77-356,790, FILED 12-20-2007.

MELVIN AXILBUND, EXAMINING ATTORNEY

Int. Cl.: 25

Prior U.S. Cls.: 22 and 39

United States Patent and Trademark Office

Reg. No. 3,476,177

Registered July 29, 2008

**TRADEMARK
PRINCIPAL REGISTER**

ONE RACE WRYBB

ONE RACE - WRYBB, INC. (FLORIDA CORPORATION), DBA (FORMERLY) ONE RACE - RYBBW, INC
818 EAST WASHINGTON STREET
ORLANDO, FL 32801

FOR: T-SHIRTS; HATS, IN CLASS 25 (U.S. CLS. 22 AND 39).

FIRST USE 8-23-2006; IN COMMERCE 9-26-2006.

THE MARK CONSISTS OF STANDARD CHARACTERS WITHOUT CLAIM TO ANY PARTICULAR FONT, STYLE, SIZE, OR COLOR.

OWNER OF U.S. REG. NO. 3,086,397.

SER. NO. 77-356,795, FILED 12-20-2007.

EUGENIA MARTIN, EXAMINING ATTORNEY

Int. Cl.: 15

Prior U.S. Cls.: 2, 21 and 36

United States Patent and Trademark Office

Reg. No. 3,476,178

Registered July 29, 2008

**TRADEMARK
PRINCIPAL REGISTER**

LIQUICY

STANNARD, JOHN (UNITED STATES INDIVIDUAL)
2140 RANGE ROAD, UNIT C
CLEARWATER, FL 33765

THE MARK CONSISTS OF STANDARD CHARACTERS WITHOUT CLAIM TO ANY PARTICULAR FONT, STYLE, SIZE, OR COLOR.

FOR: CYMBALS, PERCUSSION INSTRUMENTS AND PERCUSSION BELLS, NAMELY, HAND BELLS, AGOGO BELLS, COWBELLS AND ORCHESTRAL BELLS, IN CLASS 15 (U.S. CLS. 2, 21 AND 36).

SER. NO. 77-356,797, FILED 12-20-2007.

FIRST USE 11-3-2007; IN COMMERCE 11-3-2007.

ANDREW RHIM, EXAMINING ATTORNEY

Int. Cl.: 9

Prior U.S. Cls.: 21, 23, 26, 36 and 38

United States Patent and Trademark Office

Reg. No. 3,476,179

Registered July 29, 2008

TRADEMARK
PRINCIPAL REGISTER

Express Gate

ASUSTEK COMPUTER INC. (TAIWAN CORPORATION)
4F, NO. 150, LI-TE RD
PEITOU, TAIPEI, TAIWAN

FOR: COMPUTER HARDWARE AND PERIPHERALS; PERSONAL COMPUTERS, NOTEBOOK COMPUTERS, COMPUTER MOTHERBOARDS, COMPUTER CHIPS; MEDIA PLAYERS, COMPUTER HARDWARE AND SOFTWARE FOR FACILITATING ACCESS TO THE INTERNET AND THE WORLD WIDE WEB, IN CLASS 9 (U.S. CLS. 21, 23, 26, 36 AND 38).

FIRST USE 10-22-2007; IN COMMERCE 10-22-2007.

THE MARK CONSISTS OF THE WORDS "EXPRESS GATE" IN A STYLIZED FONT.

SER. NO. 77-356,812, FILED 12-20-2007.

REBECCA POVARCHUK, EXAMINING ATTORNEY

Int. Cl.: 44

Prior U.S. Cls.: 100 and 101

United States Patent and Trademark Office

Reg. No. 3,476,180

Registered July 29, 2008

**SERVICE MARK
PRINCIPAL REGISTER**

MY DOCTOR LOVES ME

A. KO, M.D., INC. (CALIFORNIA CORPORATION)
2621 S. BRISTOL STREET #306
SANTA ANA, CA 92704

THE MARK CONSISTS OF STANDARD CHARACTERS WITHOUT CLAIM TO ANY PARTICULAR FONT, STYLE, SIZE, OR COLOR.

FOR: PHYSICIAN SERVICES; MEDICAL CLINICS, IN CLASS 44 (U.S. CLS. 100 AND 101).

SER. NO. 77-356,825, FILED 12-20-2007.

FIRST USE 12-16-2007; IN COMMERCE 12-16-2007.

BERYL GARDNER, EXAMINING ATTORNEY

Int. Cl.: 3

Prior U.S. Cls.: 1, 4, 6, 50, 51 and 52

United States Patent and Trademark Office

Reg. No. 3,476,181

Registered July 29, 2008

**TRADEMARK
PRINCIPAL REGISTER**

VESPORT

BIONOVIX, INC. (DELAWARE CORPORATION),
DBA BIOCARE DIRECT, INC.
16410 N 91ST STREET, SUITE 110
SCOTTSDALE, AZ 85260

FOR: COSMETIC CREAMS FOR SKIN CARE;
COSMETIC PREPARATIONS FOR SKIN RENEWAL;
SKIN CARE PREPARATIONS, NAMELY, BODY
BALM; SKIN CONDITIONERS; SKIN CREAMS;
SKIN EMOLLIENTS; SKIN LOTION; SKIN MOIST-
URIZER; SKIN TONERS; WRINKLE REMOVING
SKIN CARE PREPARATIONS; BODY AND BEAUTY
CARE COSMETICS; COSMETIC CREAMS; COS-
METIC PREPARATIONS; COSMETIC PREPARA-
TIONS AGAINST SUNBURN; COSMETIC
PREPARATIONS FOR BODY CARE; COSMETICS
AND COSMETIC PREPARATIONS; FACE CREAMS
FOR COSMETIC USE; LOTIONS FOR COSMETIC

PURPOSES; SKIN AND BODY TOPICAL LOTIONS,
CREAMS AND OILS FOR COSMETIC USE; AFTER
SUN CREAMS; AFTER-SUN LOTIONS; COSMETIC
SUN-PROTECTING PREPARATIONS; NON-MEDI-
CATED SUN CARE PREPARATIONS; SUN
CREAMS, IN CLASS 3 (U.S. CLS. 1, 4, 6, 50, 51 AND
52).

FIRST USE 12-10-2007; IN COMMERCE 12-20-2007.

THE MARK CONSISTS OF STANDARD CHAR-
ACTERS WITHOUT CLAIM TO ANY PARTICULAR
FONT, STYLE, SIZE, OR COLOR.

SER. NO. 77-356,828, FILED 12-20-2007.

BERYL GARDNER, EXAMINING ATTORNEY

Int. Cl.: 12

Prior U.S. Cls.: 19, 21, 23, 31, 35 and 44

United States Patent and Trademark Office

Reg. No. 3,476,182

Registered July 29, 2008

**TRADEMARK
PRINCIPAL REGISTER**

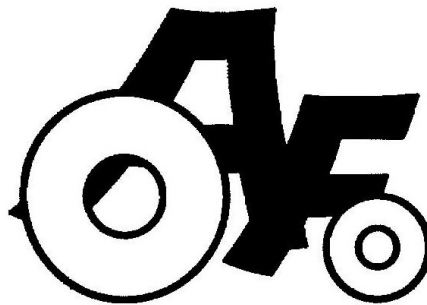

POLYMER ENTERPRISES, CORP. (DELAWARE
CORPORATION)
SUITE 1300
1105 N. MARKET STREET
WILMINGTON, DE 19801

FOR: TIRES, IN CLASS 12 (U.S. CLS. 19, 21, 23, 31,
35 AND 44).

FIRST USE 9-26-2003; IN COMMERCE 9-26-2003.

THE MARK CONSISTS OF LOGO.

SER. NO. 77-356,855, FILED 12-20-2007.

KEVON CHISOLM, EXAMINING ATTORNEY

Int. Cl.: 40

Prior U.S. Cls.: 100, 103 and 106

United States Patent and Trademark Office

Reg. No. 3,476,183

Registered July 29, 2008

**SERVICE MARK
PRINCIPAL REGISTER**

GREEN INK

SOUTHEASTERN PRINTING COMPANY, INC.
(FLORIDA CORPORATION)
P.O. BOX 2476
STUART, FL 34995

THE MARK CONSISTS OF STANDARD CHAR-
ACTERS WITHOUT CLAIM TO ANY PARTICULAR
FONT, STYLE, SIZE, OR COLOR.

FOR: PRINTING SERVICES, IN CLASS 40 (U.S.
CLS. 100, 103 AND 106).

SER. NO. 77-356,871, FILED 12-20-2007.

FIRST USE 12-20-2007; IN COMMERCE 12-20-2007.

KEVON CHISOLM, EXAMINING ATTORNEY

Int. Cl.: 45

Prior U.S. Cls.: 100 and 101

United States Patent and Trademark Office

Reg. No. 3,476,184

Registered July 29, 2008

**SERVICE MARK
PRINCIPAL REGISTER**

ImageClick

IMAGECLICK, INC. (CALIFORNIA CORPORATION)
SUITE M
212 TECHNOLOGY DR.
IRVINE, CA 92618

FOR: STOCK PHOTOGRAPHY SERVICES,
NAMELY, LEASING REPRODUCTION RIGHTS
OF PHOTOGRAPHS AND TRANSPARENCIES TO
OTHERS, IN CLASS 45 (U.S. CLS. 100 AND 101).

FIRST USE 8-25-2000; IN COMMERCE 8-25-2000.

THE MARK CONSISTS OF STANDARD CHARACTERS WITHOUT CLAIM TO ANY PARTICULAR FONT, STYLE, SIZE, OR COLOR.

SER. NO. 77-356,976, FILED 12-20-2007.

ARETHA SOMERVILLE, EXAMINING ATTORNEY

Int. Cl.: 9

Prior U.S. Cls.: 21, 23, 26, 36 and 38

United States Patent and Trademark Office

Reg. No. 3,476,185

Registered July 29, 2008

**TRADEMARK
PRINCIPAL REGISTER**

GUARDIAN

SCHWARTZCO, INC. (NEW YORK CORPORATION)
281 GRAND STREET, SUITE 2-F
NEW YORK, NY 10002

FOR: PRINTING FONTS THAT CAN BE DOWNLOADED PROVIDED BY MEANS OF ELECTRONIC TRANSMISSION; TYPEFACE FONTS RECORDED ON MAGNETIC MEDIA, IN CLASS 9 (U.S. CLS. 21, 23, 26, 36 AND 38).

FIRST USE 5-15-2004; IN COMMERCE 5-15-2004.

THE MARK CONSISTS OF STANDARD CHARACTERS WITHOUT CLAIM TO ANY PARTICULAR FONT, STYLE, SIZE, OR COLOR.

SER. NO. 77-356,980, FILED 12-20-2007.

TINA BROWN, EXAMINING ATTORNEY

Int. Cl.: 7

Prior U.S. Cls.: 13, 19, 21, 23, 31, 34 and 35

United States Patent and Trademark Office

Reg. No. 3,476,186

Registered July 29, 2008

**TRADEMARK
PRINCIPAL REGISTER**

FROGMILL

STREAMLINE AUTOMATION LTD. (CANADA
CORPORATION)
9192-52ND STREET S.E.
CALGARY, CANADA T2C5A9

FOR: MILLING CUTTERS; MILLING MA-
CHINES, IN CLASS 7 (U.S. CLS. 13, 19, 21, 23, 31, 34
AND 35).

FIRST USE 9-30-2006; IN COMMERCE 9-30-2006.

THE MARK CONSISTS OF STANDARD CHAR-
ACTERS WITHOUT CLAIM TO ANY PARTICULAR
FONT, STYLE, SIZE, OR COLOR.

OWNER OF U.S. REG. NO. 3,372,483.

SER. NO. 77-356,991, FILED 12-20-2007.

PAUL CROWLEY, EXAMINING ATTORNEY

Int. Cl.: 9

Prior U.S. Cls.: 21, 23, 26, 36 and 38

Reg. No. 3,476,187

United States Patent and Trademark Office

Registered July 29, 2008

**TRADEMARK
PRINCIPAL REGISTER**

NETWORK TWENTYONE

NETWORK TWENTYONE INTERNATIONAL,
INC. (NEVADA CORPORATION)
3550 CORPORATE WAY
SUITE C
DULUTH, GA 30096

FOR: PRE-RECORDED CDS AND DVDS ON
MOTIVATION, SUCCESS TECHNIQUES, LIFE,
BUILDING BUSINESSES, MEETING PEOPLE, AND
LEADERSHIP, IN CLASS 9 (U.S. CLS. 21, 23, 26, 36
AND 38).

FIRST USE 9-26-1997; IN COMMERCE 9-26-1997.

THE MARK CONSISTS OF STANDARD CHAR-
ACTERS WITHOUT CLAIM TO ANY PARTICULAR
FONT, STYLE, SIZE, OR COLOR.

OWNER OF U.S. REG. NOS. 1,734,470 AND
2,181,848.

SER. NO. 77-357,016, FILED 12-20-2007.

HENRY S. ZAK, EXAMINING ATTORNEY

Int. Cl.: 9

Prior U.S. Cls.: 21, 23, 26, 36 and 38

Reg. No. 3,476,188

United States Patent and Trademark Office

Registered July 29, 2008

**TRADEMARK
PRINCIPAL REGISTER**

MARIAN

SCHWARTZCO, INC. (NEW YORK CORPORATION)
281 GRAND STREET, SUITE 2-F
NEW YORK, NY 10002

THE MARK CONSISTS OF STANDARD CHARACTERS WITHOUT CLAIM TO ANY PARTICULAR FONT, STYLE, SIZE, OR COLOR.

FOR: DOWNLOADABLE PRINTING FONTS;
TYPEFACE FONTS RECORDED ON MAGNETIC
MEDIA, IN CLASS 9 (U.S. CLS. 21, 23, 26, 36 AND 38).

SER. NO. 77-357,034, FILED 12-20-2007.

FIRST USE 12-5-2007; IN COMMERCE 12-5-2007.

TINA BROWN, EXAMINING ATTORNEY

Int. Cl.: 6

Prior U.S. Cls.: 2, 12, 13, 14, 23, 25 and 50

Reg. No. 3,476,189

United States Patent and Trademark Office

Registered July 29, 2008

**TRADEMARK
PRINCIPAL REGISTER**



**BASS PRO TRADEMARKS, L.L.C. (MISSOURI
LTD LIAB CO)**

2500 EAST KEARNEY

SPRINGFIELD, MO 65898

**FOR: METAL GUN SAFES, IN CLASS 6 (U.S. CLS.
2, 12, 13, 14, 23, 25 AND 50).**

FIRST USE 6-0-2005; IN COMMERCE 6-0-2005.

**OWNER OF U.S. REG. NOS. 2,120,188 AND
3,015,509.**

**THE MARK CONSISTS OF AN ILLUSTRATION
OF A BUCK OVER THE WORDS "KING OF
BUCKS", IN STYLIZED FONT.**

SER. NO. 77-357,046, FILED 12-20-2007.

**SAMUEL E. SHARPER JR., EXAMINING ATTOR-
NEY**

Int. Cl.: 45

Prior U.S. Cls.: 100 and 101

United States Patent and Trademark Office

Reg. No. 3,476,190

Registered July 29, 2008

SERVICE MARK
PRINCIPAL REGISTER



THE DOMESTIC DIVAS LLC (TENNESSEE LTD
LIAB CO)
PMB 139
170-D EAST MAIN STREET
HENDERSONVILLE, TN 37075

FOR: PERSONAL CONCIERGE SERVICES FOR
OTHERS COMPRISING MAKING REQUESTED
PERSONAL ARRANGEMENTS AND RESERVA-
TIONS, RUNNING ERRANDS AND PROVIDING
CUSTOMER SPECIFIC INFORMATION TO MEET
INDIVIDUAL NEEDS, ALL RENDERED IN BUSI-
NESS ESTABLISHMENTS, OFFICE BUILDINGS,
HOTELS, RESIDENTIAL COMPLEXES AND
HOMES, IN CLASS 45 (U.S. CLS. 100 AND 101).

FIRST USE 10-1-2005; IN COMMERCE 11-1-2005.

THE MARK CONSISTS OF THE TEXT "DOMES-
TIC DIVAS" IN EDWARDIAN SCRIPT FONT. THE
STYLIZED MARK IS A LADY WITH A PONY TAIL.
ONE OF HER LEGS HAS A LEASH WITH A DOG
ATTACHED. SHE HAS A COMPUTER ON ONE
HAND, A SMOKING CASSEROLE DISH ON THE
OTHER AND A PHONE UP TO HER EAR. SHE ALSO
HAS A BRIEFCASE/PURSE FALLING FROM HER
SHOULDER.

SER. NO. 77-357,054, FILED 12-20-2007.

IRA J. GOODSaid, EXAMINING ATTORNEY

Int. Cl.: 41

Prior U.S. Cls.: 100, 101 and 107

United States Patent and Trademark Office

Reg. No. 3,476,191

Registered July 29, 2008

**SERVICE MARK
PRINCIPAL REGISTER**

CANINE KINSHIP

BRANDAU, ROBERT H. (UNITED STATES IN-
DIVIDUAL)
20 PIDGEON HILL ROAD
WANTAGE, NJ 074612729

FOR: DOG TRAINING SERVICES, IN CLASS 41
(U.S. CLS. 100, 101 AND 107).

FIRST USE 7-0-2006; IN COMMERCE 7-0-2006.

THE MARK CONSISTS OF STANDARD CHAR-
ACTERS WITHOUT CLAIM TO ANY PARTICULAR
FONT, STYLE, SIZE, OR COLOR.

OWNER OF U.S. REG. NOS. 3,138,401 AND
3,237,400.

NO CLAIM IS MADE TO THE EXCLUSIVE
RIGHT TO USE "CANINE", APART FROM THE
MARK AS SHOWN.

SER. NO. 77-357,063, FILED 12-20-2007.

DAVID HOFFMAN, EXAMINING ATTORNEY

Int. Cl.: 41

Prior U.S. Cls.: 100, 101 and 107

United States Patent and Trademark Office

Reg. No. 3,476,192

Registered July 29, 2008

**SERVICE MARK
PRINCIPAL REGISTER**

DANCING SUCCESS STARTS HERE

XPRESS INNOVATIONS, INC. (FLORIDA CORPORATION)
2022 NOLAN DRIVE
DUNEDIN, FL 34698

THE MARK CONSISTS OF STANDARD CHARACTERS WITHOUT CLAIM TO ANY PARTICULAR FONT, STYLE, SIZE, OR COLOR.

FOR: DANCE INSTRUCTION, IN CLASS 41 (U.S. CLS. 100, 101 AND 107).

SER. NO. 77-357,069, FILED 12-20-2007.

FIRST USE 6-4-2007; IN COMMERCE 6-4-2007.

MICHAEL KEATING, EXAMINING ATTORNEY

Int. Cl.: 1

Prior U.S. Cls.: 1, 5, 6, 10, 26 and 46

United States Patent and Trademark Office

Reg. No. 3,476,193

Registered July 29, 2008

**TRADEMARK
PRINCIPAL REGISTER**

ENDUROSOLV

AP TECH GROUP, INC. (OHIO CORPORATION)
6 KOVACH DRIVE, SUITE 612
CINCINNATI, OH 46215

THE MARK CONSISTS OF STANDARD CHAR-
ACTERS WITHOUT CLAIM TO ANY PARTICULAR
FONT, STYLE, SIZE, OR COLOR.

FOR: SOLID WATER TREATMENT CHEMICALS
FOR USE IN BOILERS AND COOLING TOWERS, IN
CLASS 1 (U.S. CLS. 1, 5, 6, 10, 26 AND 46).

SER. NO. 77-357,070, FILED 12-20-2007.

FIRST USE 10-15-2007; IN COMMERCE 10-15-2007.

LESLEY LAMOTHE, EXAMINING ATTORNEY

Int. Cl.: 20

Prior U.S. Cls.: 2, 13, 22, 25, 32 and 50

United States Patent and Trademark Office

Reg. No. 3,476,194

Registered July 29, 2008

**TRADEMARK
PRINCIPAL REGISTER**



BASS PRO TRADEMARKS, L.L.C. (MISSOURI
LTD LIAB CO)
2500 EAST KEARNEY
SPRINGFIELD, MO 65898

FOR: FURNITURE; SCULPTURES OF RESIN;
WORKS OF ART OF WOOD; FIREPLACE SCREENS;
FIREPLACE ACCESSORIES, NAMELY, FIREWOOD
STORAGE RACKS; DECORATIVE WALL MIR-
RORS; PICTURE FRAMES; NON-METAL GAR-
MENT HOOKS, IN CLASS 20 (U.S. CLS. 2, 13, 22, 25,
32 AND 50).

FIRST USE 8-0-2003; IN COMMERCE 8-0-2003.

OWNER OF U.S. REG. NOS. 2,120,188 AND
3,015,509.

THE MARK CONSISTS OF AN ILLUSTRATION
OF A BUCK OVER THE WORDS "KING OF BUCKS"
IN STYLIZED FONT.

SER. NO. 77-357,078, FILED 12-20-2007.

SAMUEL E. SHARPER JR., EXAMINING ATTOR-
NEY

Int. Cl.: 16

Prior U.S. Cls.: 2, 5, 22, 23, 29, 37, 38 and 50

United States Patent and Trademark Office

Reg. No. 3,476,195

Registered July 29, 2008

**TRADEMARK
PRINCIPAL REGISTER**

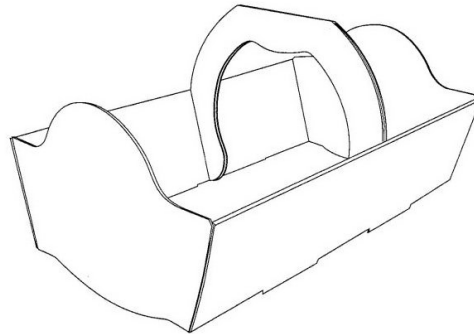

NETSKEYE, INC. (CALIFORNIA CORPORATION)
P.O. BOX 1349
AGOURA HILLS, CA 91376

FOR: CARDBOARD CONTAINERS, IN CLASS 16
(U.S. CLS. 2, 5, 22, 23, 29, 37, 38 AND 50).

FIRST USE 2-28-2000; IN COMMERCE 2-28-2000.

OWNER OF U.S. REG. NO. 2,652,914.

THE MARK CONSISTS OF THE CONFIGURATION OF A CARDBOARD CONTAINER USED AS A CRADLE FOR THE PLACEMENT AND CARRYING OF SOFT PLUSH TOYS.

SEC. 2(F).

SER. NO. 77-357,098, FILED 12-20-2007.

JAY FLOWERS, EXAMINING ATTORNEY

Int. Cl.: 25

Prior U.S. Cls.: 22 and 39

United States Patent and Trademark Office

Reg. No. 3,476,196

Registered July 29, 2008

**TRADEMARK
PRINCIPAL REGISTER**

RPNG

YO LATINO, INC. (FLORIDA CORPORATION)
818 EAST WASHINGTON STREET
ORLANDO, FL 32801

THE MARK CONSISTS OF STANDARD CHAR-
ACTERS WITHOUT CLAIM TO ANY PARTICULAR
FONT, STYLE, SIZE, OR COLOR.

FOR: T-SHIRTS; HATS, IN CLASS 25 (U.S. CLS. 22
AND 39).

SER. NO. 77-357,106, FILED 12-20-2007.

FIRST USE 6-13-2005; IN COMMERCE 6-13-2005.

HOWARD B. LEVINE, EXAMINING ATTORNEY

Int. Cl.: 44

Prior U.S. Cls.: 100 and 101

United States Patent and Trademark Office

Reg. No. 3,476,197

Registered July 29, 2008

**SERVICE MARK
PRINCIPAL REGISTER**

The Palm Beach Institute

PALM BEACH INSTITUTE, INC. (FLORIDA CORPORATION)
1017 N. OLIVE AVENUE
WEST PALM BEACH, FL 33401

FOR: ADDICTION TREATMENT SERVICES; DRUG TESTING FOR SUBSTANCE ABUSE; INFORMATION ABOUT PARENTING TOPICS, NAMELY, DRUG AND ALCOHOL AWARENESS; MEDICAL EVALUATION SERVICES, NAMELY, FUNCTIONAL ASSESSMENT PROGRAM FOR PATIENTS RECEIVING MEDICAL REHABILITATION SERVICES FOR PURPOSES OF GUIDING TREATMENT AND ASSESSING PROGRAM EFFECTIVENESS; REHABILITATION OF ALCOHOL ADDICTED PATIENTS; REHABILITATION OF DRUG ADDICTED PATIENTS; REHABILITATION OF NARCOTIC ADDICTED PATIENTS, IN CLASS 44 (U.S. CLS. 100 AND 101).

FIRST USE 1-1-1971; IN COMMERCE 1-1-1971.

THE MARK CONSISTS OF STANDARD CHARACTERS WITHOUT CLAIM TO ANY PARTICULAR FONT, STYLE, SIZE, OR COLOR.

NO CLAIM IS MADE TO THE EXCLUSIVE RIGHT TO USE "INSTITUTE", APART FROM THE MARK AS SHOWN.

SEC. 2(F).

SER. NO. 77-357,111, FILED 12-20-2007.

SARA THOMAS, EXAMINING ATTORNEY

Int. Cl.: 7

Prior U.S. Cls.: 13, 19, 21, 23, 31, 34 and 35

Reg. No. 3,476,198

United States Patent and Trademark Office

Registered July 29, 2008

**TRADEMARK
PRINCIPAL REGISTER**

UNIPRESS

UNIPRESS CORPORATION (FLORIDA CORPORATION)
3501 QUEEN PALM DRIVE
TAMPA, FL 33619

THE MARK CONSISTS OF STANDARD CHARACTERS WITHOUT CLAIM TO ANY PARTICULAR FONT, STYLE, SIZE, OR COLOR.

FOR: GARMENT PRESSES, IN CLASS 7 (U.S. CLS. 13, 19, 21, 23, 31, 34 AND 35).

SER. NO. 77-357,113, FILED 12-20-2007.

FIRST USE 9-7-1927; IN COMMERCE 9-7-1927.

LINDA MICKLEBURGH, EXAMINING ATTORNEY

Int. Cl.: 32

Prior U.S. Cls.: 45, 46 and 48

United States Patent and Trademark Office

Reg. No. 3,476,199

Registered July 29, 2008

**TRADEMARK
PRINCIPAL REGISTER**

Leisure

LEISURE BOY, LLC (WISCONSIN LTD LIAB CO)
W356N5318 LAKESHORE DRIVE
OCONOMOWOC, WI 53066

THE MARK CONSISTS OF STANDARD CHAR-
ACTERS WITHOUT CLAIM TO ANY PARTICULAR
FONT, STYLE, SIZE, OR COLOR.

FOR: BEER, IN CLASS 32 (U.S. CLS. 45, 46 AND 48).

SER. NO. 77-357,134, FILED 12-20-2007.

FIRST USE 12-14-2007; IN COMMERCE 12-14-2007.

EUGENIA MARTIN, EXAMINING ATTORNEY

Int. Cls.: 3 and 5

Prior U.S. Cls.: 1, 4, 6, 18, 44, 46, 50, 51 and 52

United States Patent and Trademark Office

Reg. No. 3,476,200

Registered July 29, 2008

**TRADEMARK
PRINCIPAL REGISTER**

EXOMEGA

PIERRE FABRE DERMOCOSMETIQUE
(FRANCE SOCIÉTÉ ANONYME (SA))

45, PLACE ABEL GANCE

BOULOGNE, FRANCE 92100

FOR: COSMETICS, NAMELY, SKIN CREAMS, IN
CLASS 3 (U.S. CLS. 1, 4, 6, 50, 51 AND 52).

FOR: DERMATOLOGICALS USEFUL FOR ATOP-
PY, IN CLASS 5 (U.S. CLS. 6, 18, 44, 46, 51 AND 52).

THE MARK CONSISTS OF STANDARD CHAR-
ACTERS WITHOUT CLAIM TO ANY PARTICULAR
FONT, STYLE, SIZE, OR COLOR.

OWNER OF FRANCE REG. NO. 93485229, DATED
9-17-1993, EXPIRES 9-17-2013.

OWNER OF U.S. REG. NO. 2,522,391.

SER. NO. 77-357,136, FILED 12-20-2007.

NICHOLAS ALTREE, EXAMINING ATTORNEY

Int. Cl.: 9

Prior U.S. Cls.: 21, 23, 26, 36 and 38

Reg. No. 3,476,201

United States Patent and Trademark Office

Registered July 29, 2008

**TRADEMARK
PRINCIPAL REGISTER**

PATTERSON EAGLESOFT

PATTERSON COMPANIES, INC. (MINNESOTA CORPORATION)
1031 MENDOTA HEIGHTS ROAD
SAINT PAUL, MN 55120

FOR: PRACTICE MANAGEMENT, CLINICAL, AND IMAGING SOFTWARE FOR DENTAL OFFICES TO MANAGE ALL FACETS OF THEIR BUSINESS, INCLUDING SCHEDULING, INSURANCE PROCESSING, TREATMENT PLANNING, PATIENT RECORD KEEPING, AND INSTRUCTIONAL MANUAL SOLD AS A UNIT, IN CLASS 9 (U.S. CLS. 21, 23, 26, 36 AND 38).

FIRST USE 8-1-2000; IN COMMERCE 8-1-2000.

THE MARK CONSISTS OF STANDARD CHARACTERS WITHOUT CLAIM TO ANY PARTICULAR FONT, STYLE, SIZE, OR COLOR.

OWNER OF U.S. REG. NOS. 2,009,398, 3,199,849 AND OTHERS.

SER. NO. 77-357,141, FILED 12-20-2007.

DAVID TAYLOR, EXAMINING ATTORNEY

Int. Cl.: 10

Prior U.S. Cls.: 26, 39 and 44

United States Patent and Trademark Office

Reg. No. 3,476,202

Registered July 29, 2008

**TRADEMARK
PRINCIPAL REGISTER**

VISI-PRO

EV3 ENDOVASCULAR, INC. (DELAWARE CORPORATION)
SUITE 100, 9600 - 54TH AVENUE NORTH
PLYMOUTH, MN 55442

THE MARK CONSISTS OF STANDARD CHARACTERS WITHOUT CLAIM TO ANY PARTICULAR FONT, STYLE, SIZE, OR COLOR.

FOR: MEDICAL DEVICES, NAMELY, BALLOON EXPANDABLE STENTS, IN CLASS 10 (U.S. CLS. 26, 39 AND 44).

SER. NO. 77-357,343, FILED 12-20-2007.

FIRST USE 10-9-2007; IN COMMERCE 10-9-2007.

SEAN CROWLEY, EXAMINING ATTORNEY

Int. Cl.: 32

Prior U.S. Cls.: 45, 46 and 48

United States Patent and Trademark Office

Reg. No. 3,476,203

Registered July 29, 2008

**TRADEMARK
PRINCIPAL REGISTER**

**SPORTEK HI PERFORMANCE
ENERGY DRINK**

HANASABZADEH, BENHOOR (UNITED STATES
INDIVIDUAL)

820 GLADYS AVE.

LOS ANGELES, CA 90021

FOR: ENERGY DRINKS, IN CLASS 32 (U.S. CLS.
45, 46 AND 48).

FIRST USE 12-11-2007; IN COMMERCE 12-11-2007.

THE MARK CONSISTS OF STANDARD CHAR-
ACTERS WITHOUT CLAIM TO ANY PARTICULAR
FONT, STYLE, SIZE, OR COLOR.

NO CLAIM IS MADE TO THE EXCLUSIVE
RIGHT TO USE "HI PERFORMANCE ENERGY
DRINK", APART FROM THE MARK AS SHOWN.

SER. NO. 77-357,351, FILED 12-20-2007.

DAVID TAYLOR, EXAMINING ATTORNEY

Int. Cl.: 44

Prior U.S. Cls.: 100 and 101

United States Patent and Trademark Office

Reg. No. 3,476,204

Registered July 29, 2008

**SERVICE MARK
PRINCIPAL REGISTER**

GREENS WITH ENVY

SPOSITO, JARED (UNITED STATES INDIVIDUAL)
5638 E 16TH AVE.
DENVER, CO 802201401

THE MARK CONSISTS OF STANDARD CHARACTERS WITHOUT CLAIM TO ANY PARTICULAR FONT, STYLE, SIZE, OR COLOR.

FOR: LANDSCAPE DESIGN, INCLUDING RESIDENTIAL PUTTING GREENS, IN CLASS 44 (U.S. CLS. 100 AND 101).

SER. NO. 77-357,356, FILED 12-20-2007.

FIRST USE 9-1-2005; IN COMMERCE 9-1-2005.

KHANH LE, EXAMINING ATTORNEY

Int. Cl.: 6

Prior U.S. Cls.: 2, 12, 13, 14, 23, 25 and 50

Reg. No. 3,476,205

United States Patent and Trademark Office

Registered July 29, 2008

**TRADEMARK
PRINCIPAL REGISTER**

SHELTER ONE

SHELTER ONE, INC. (OREGON CORPORATION)
5887 MONUMENT DRVIE
GRANTS PASS, OR 97526

FOR: METAL SHELTER STRUCTURES, IN
CLASS 6 (U.S. CLS. 2, 12, 13, 14, 23, 25 AND 50).

FIRST USE 9-0-1998; IN COMMERCE 9-0-1998.

THE MARK CONSISTS OF STANDARD CHAR-
ACTERS WITHOUT CLAIM TO ANY PARTICULAR
FONT, STYLE, SIZE, OR COLOR.

NO CLAIM IS MADE TO THE EXCLUSIVE
RIGHT TO USE "SHELTER", APART FROM THE
MARK AS SHOWN.

SER. NO. 77-357,360, FILED 12-20-2007.

KAREN BRACEY, EXAMINING ATTORNEY

Int. Cl.: 41

Prior U.S. Cls.: 100, 101 and 107

United States Patent and Trademark Office

Reg. No. 3,476,206

Registered July 29, 2008

SERVICE MARK
PRINCIPAL REGISTER



ATG LEGAL
EDUCATION

ATTORNEYS' TITLE GUARANTY FUND, INC.
(ILLINOIS CORPORATION)
2408 WINDSOR PLACE
CHAMPAIGN, IL 61826

FOR: EDUCATION SERVICES, NAMELY, PROVIDING EDUCATIONAL PROGRAMS IN THE FIELDS OF REAL ESTATE, TITLE INSURANCE, AND ESTATE PLANNING, IN CLASS 41 (U.S. CLS. 100, 101 AND 107).

FIRST USE 8-1-2007; IN COMMERCE 8-1-2007.

NO CLAIM IS MADE TO THE EXCLUSIVE RIGHT TO USE "LEGAL EDUCATION", APART FROM THE MARK AS SHOWN.

THE MARK CONSISTS OF A BOOK OVER THE WORDS "ATG LEGAL EDUCATION".

SER. NO. 77-357,362, FILED 12-20-2007.

HOWARD B. LEVINE, EXAMINING ATTORNEY

Int. Cl.: 35

Prior U.S. Cls.: 100, 101 and 102

United States Patent and Trademark Office

Reg. No. 3,476,207

Registered July 29, 2008

**SERVICE MARK
PRINCIPAL REGISTER**

MONKEY SEE, MONKEY DO!

MONKEY SEE, MONKEY DO! (TEXAS SOLE
PROPRIETORSHIP)
1712 S. CONGRESS AVENUE
AUSTIN, TX 78704

THE MARK CONSISTS OF STANDARD CHAR-
ACTERS WITHOUT CLAIM TO ANY PARTICULAR
FONT, STYLE, SIZE, OR COLOR.

FOR: RETAIL GIFT SHOPS, IN CLASS 35 (U.S.
CLS. 100, 101 AND 102).

SER. NO. 77-357,366, FILED 12-20-2007.

FIRST USE 3-3-2005; IN COMMERCE 7-6-2005.

EUGENIA MARTIN, EXAMINING ATTORNEY

Int. Cl.: 35

Prior U.S. Cls.: 100, 101 and 102

United States Patent and Trademark Office

Reg. No. 3,476,208

Registered July 29, 2008

**SERVICE MARK
PRINCIPAL REGISTER**

infonado

SCHAG, DANIEL STEVEN (UNITED STATES
INDIVIDUAL)
2118 WILSHIRE BLVD., #1000
SANTA MONICA, CA 90403

FOR: PROMOTION, ADVERTISING AND MAR-
KETING OF ON-LINE WEBSITES, IN CLASS 35 (U.S.
CLS. 100, 101 AND 102).

FIRST USE 6-6-2007; IN COMMERCE 6-19-2007.

THE MARK CONSISTS OF STANDARD CHAR-
ACTERS WITHOUT CLAIM TO ANY PARTICULAR
FONT, STYLE, SIZE, OR COLOR.

THE WORDING "INFONADO" HAS NO MEAN-
ING IN ENGLISH.

SER. NO. 77-357,396, FILED 12-20-2007.

ARETHA SOMERVILLE, EXAMINING ATTORNEY

Int. Cl.: 41

Prior U.S. Cls.: 100, 101 and 107

United States Patent and Trademark Office

Reg. No. 3,476,209

Registered July 29, 2008

**SERVICE MARK
PRINCIPAL REGISTER**

GODDESSES' FOOTBOY

CIARDULLO, MICHAEL L. (UNITED STATES
INDIVIDUAL)
123 S FIGUEROA ST APT 1231A
LOS ANGELES, CA 90012

THE MARK CONSISTS OF STANDARD CHAR-
ACTERS WITHOUT CLAIM TO ANY PARTICULAR
FONT, STYLE, SIZE, OR COLOR.

FOR: ENTERTAINMENT SERVICES, NAMELY,
PROVIDING A WEB SITE FEATURING ADULT-
THEMED PHOTOGRAPHS AND VIDEOS, IN CLASS
41 (U.S. CLS. 100, 101 AND 107).

SER. NO. 77-357,556, FILED 12-20-2007.

FIRST USE 1-0-2006; IN COMMERCE 1-0-2006.

JESSICA A. POWERS, EXAMINING ATTORNEY

Int. Cl.: 25

Prior U.S. Cls.: 22 and 39

United States Patent and Trademark Office

Reg. No. 3,476,210

Registered July 29, 2008

**TRADEMARK
PRINCIPAL REGISTER**



CHARMONÉ LLC (NEW YORK LTD LIAB CO)
8 COMMONWEALTH AVE
MASSAPEQUA, NY 11758

THE MARK CONSISTS OF THREE HEART
SHAPED LEAVES ON A STEM WITHIN A LARGE
"C".

FOR: SHOES AND FOOTWEAR INCLUDING
ORGANIC SHOES AND FOOTWEAR, IN CLASS 25
(U.S. CLS. 22 AND 39).

SER. NO. 77-357,587, FILED 12-21-2007.

FIRST USE 7-1-2005; IN COMMERCE 7-1-2005.

CYNTHIA SLOAN, EXAMINING ATTORNEY

Int. Cl.: 28

Prior U.S. Cls.: 22, 23, 38 and 50

Reg. No. 3,476,211

United States Patent and Trademark Office

Registered July 29, 2008

**TRADEMARK
PRINCIPAL REGISTER**

Dancing Buzz

K.S. TOYS LTD. (HONG KONG LTD LIAB CO)
RM 312-315, PENINSULA CENTRE 67 MODY RD.
T.S.T. EAST, KOWLOON, HONG KONG

THE MARK CONSISTS OF STANDARD CHAR-
ACTERS WITHOUT CLAIM TO ANY PARTICULAR
FONT, STYLE, SIZE, OR COLOR.

FOR: ELECTRONIC ACTION TOYS, IN CLASS 28
(U.S. CLS. 22, 23, 38 AND 50).

SER. NO. 77-357,655, FILED 12-21-2007.

FIRST USE 11-15-2007; IN COMMERCE 11-15-2007.

DAVID MILLER, EXAMINING ATTORNEY

Int. Cl.: 7

Prior U.S. Cls.: 13, 19, 21, 23, 31, 34 and 35

United States Patent and Trademark Office

Reg. No. 3,476,212

Registered July 29, 2008

TRADEMARK
PRINCIPAL REGISTER



SOLAR DEPOT, LLC (CALIFORNIA LTD LIAB
CO)
1240 HOLM ROAD
PETALUMA, CA 94954

FOR: SOLAR-POWERED ELECTRICITY GEN-
ERATORS, IN CLASS 7 (U.S. CLS. 13, 19, 21, 23, 31,
34 AND 35).

FIRST USE 6-0-2002; IN COMMERCE 6-0-2002.

NO CLAIM IS MADE TO THE EXCLUSIVE
RIGHT TO USE "SOLAR ELECTRIC GENERA-
TORS", APART FROM THE MARK AS SHOWN.

THE COLOR(S) WHITE, BLUE, YELLOW, OR-
ANGE, AND GREEN IS/ARE CLAIMED AS A
FEATURE OF THE MARK.

THE MARK CONSISTS OF THE COLOR WHITE
APPEARS IN THE WORDS "SOL-GEN SOLAR ELEC-
TRIC GENERATORS", THE COLORS YELLOW
AND ORANGE APPEAR IN THE CIRCLE DESIGN.
THE COLOR BLUE APPEARS IN THE LIGHTNING
DESIGN. THE BACKGROUND IS A GREEN OVAL.

SER. NO. 77-357,692, FILED 12-21-2007.

LEIGH LOWRY, EXAMINING ATTORNEY

Int. Cl.: 35

Prior U.S. Cls.: 100, 101 and 102

United States Patent and Trademark Office

Reg. No. 3,476,213

Registered July 29, 2008

**SERVICE MARK
PRINCIPAL REGISTER**

TARISIO

TARISIO AUCTIONS LLC (MASSACHUSETTS
LTD LIAB CO)
244 WEST 54TH STREET, 12TH FLOOR
NEW YORK, NY 10019

THE MARK CONSISTS OF STANDARD CHAR-
ACTERS WITHOUT CLAIM TO ANY PARTICULAR
FONT, STYLE, SIZE, OR COLOR.

FOR: ARRANGING AND CONDUCTING ON-
LINE AUCTIONS SALES OF MUSICAL INSTRU-
MENTS AND BOWS, IN CLASS 35 (U.S. CLS. 100, 101
AND 102).

SER. NO. 77-357,715, FILED 12-21-2007.

FIRST USE 11-5-1999; IN COMMERCE 11-5-1999.

DORITT L. CARROLL, EXAMINING ATTORNEY

Int. Cls.: 1 and 19

Prior U.S. Cls.: 1, 5, 6, 10, 12, 26, 33, 46 and 50

United States Patent and Trademark Office

Reg. No. 3,476,214

Registered July 29, 2008

**TRADEMARK
PRINCIPAL REGISTER**

BLUE DIAMOND

WALKER, ROGER H. (UNITED STATES INDIVIDUAL)
6430 S. 39TH WEST AVE.
TULSA, OK 74132

FOR: EPOXY FILLER MATERIAL FOR REPAIRING PIPELINES INTERNALLY OR EXTERNALLY, IN CLASS 1 (U.S. CLS. 1, 5, 6, 10, 26 AND 46).

FIRST USE 3-19-2007; IN COMMERCE 6-20-2007.

FOR: CARBON COMPOSITE WRAP MATERIAL FOR REPAIRING PIPELINES INTERNALLY OR EXTERNALLY, IN CLASS 19 (U.S. CLS. 1, 12, 33 AND 50).

FIRST USE 3-19-2007; IN COMMERCE 6-20-2007.

THE MARK CONSISTS OF STANDARD CHARACTERS WITHOUT CLAIM TO ANY PARTICULAR FONT, STYLE, SIZE, OR COLOR.

OWNER OF U.S. REG. NO. 3,322,311.

SER. NO. 77-357,719, FILED 12-21-2007.

DOMINIC J. FERRAIUOLO, EXAMINING ATTORNEY

Int. Cl.: 41

Prior U.S. Cls.: 100, 101 and 107

United States Patent and Trademark Office

Reg. No. 3,476,215

Registered July 29, 2008

**SERVICE MARK
PRINCIPAL REGISTER**



YANKEES ENTERTAINMENT AND SPORTS
NETWORK, LLC (DELAWARE LTD LIAB CO)
36TH FLOOR
405 LEXINGTON AVENUE
NEW YORK, NY 10174

FOR: PROVIDING A WEBSITE FEATURING INFORMATION ABOUT NEW YORK AND NEW JERSEY PROFESSIONAL BASEBALL AND BASKETBALL TEAMS, SPORTS LEAGUE TEAM STANDINGS, SPORTS LEAGUE PLAYER STATISTICS, AND GENERAL SPORTS-RELATED NEWS AND INFORMATION, IN CLASS 41 (U.S. CLS. 100, 101 AND 107).

FIRST USE 4-1-2005; IN COMMERCE 4-1-2005.

THE COLOR(S) WHITE, BLUE AND GREY IS/ARE CLAIMED AS A FEATURE OF THE MARK.

THE MARK CONSISTS OF THE WORD "YES" IN WHITE AND GREY WITHIN A GENERALLY RECTANGULAR FIELD IN BLUE, WITHIN A GREY FRAME WITH A BLACK SHADOW AROUND HALF THE FRAME.

SER. NO. 77-357,744, FILED 12-21-2007.

MATTHEW EINSTEIN, EXAMINING ATTORNEY

Int. Cl.: 36

Prior U.S. Cls.: 100, 101 and 102

United States Patent and Trademark Office

Reg. No. 3,476,216

Registered July 29, 2008

**SERVICE MARK
PRINCIPAL REGISTER**

EMBRACE THE CHANGE

LINCOLN INVESTMENT PLANNING, INC.
(PENNSYLVANIA CORPORATION)
218 GLENSIDE AVENUE
WYNCOTE, PA 19095

THE MARK CONSISTS OF STANDARD CHARACTERS WITHOUT CLAIM TO ANY PARTICULAR FONT, STYLE, SIZE, OR COLOR.

FOR: INVESTMENT CONSULTING AND MANAGEMENT SERVICES, NAMELY, ASSET ACQUISITION, CONSULTATION AND MANAGEMENT SERVICES, IN CLASS 36 (U.S. CLS. 100, 101 AND 102).

SER. NO. 77-357,751, FILED 12-21-2007.

FIRST USE 10-26-2007; IN COMMERCE 10-26-2007.

ELI HELLMAN, EXAMINING ATTORNEY

Int. Cl.: 41

Prior U.S. Cls.: 100, 101 and 107

United States Patent and Trademark Office

Reg. No. 3,476,217

Registered July 29, 2008

**SERVICE MARK
PRINCIPAL REGISTER**



INSTITUTE FOR FACIAL ESTHETICS (PENN-
SYLVANIA NON-PROFIT CORPORATION)
SUITE 201
467 PENNSYLVANIA AVE.
FORT WASHINGTON, PA 19034

FOR: EDUCATIONAL SERVICES, NAMELY,
CONDUCTING COURSES OF INSTRUCTION,
CLASSES, SEMINARS, WORKSHOPS, FORUMS
AND SYMPOSIA ABOUT DENTAL EXAMINATION,
DENTAL IMPLANTS AND DENTAL IMPLANT
TREATMENTS FOR DENTAL PROFESSIONALS
AND THE GENERAL PUBLIC, IN CLASS 41 (U.S.
CLS. 100, 101 AND 107).

FIRST USE 5-14-2007; IN COMMERCE 5-14-2007.

NO CLAIM IS MADE TO THE EXCLUSIVE
RIGHT TO USE "THE INSTITUTE FOR FACIAL
ESTHETICS", APART FROM THE MARK AS
SHOWN.

THE MARK CONSISTS OF AN IMAGE TO THE
LEFT CONSISTING OF TRIANGLES AND LINES
AND THE WORDS "THE INSTITUTE FOR FACIAL
ESTHETICS" TO THE RIGHT OF THE IMAGE.

SER. NO. 77-357,753, FILED 12-21-2007.

PAM WILLIS, EXAMINING ATTORNEY

Int. Cl.: 41

Prior U.S. Cls.: 100, 101 and 107

United States Patent and Trademark Office

Reg. No. 3,476,218

Registered July 29, 2008

**SERVICE MARK
PRINCIPAL REGISTER**

PIEROGI FEST

WHITING-ROBERTSDALE CHAMBER OF COM-
MERCE (INDIANA NON-PROFIT CORPORA-
TION)
1442 119TH STREET
WHITING, IN 46394

FOR: ENTERTAINMENT SERVICES IN THE
NATURE OF ORGANIZING AND PROMOTING
AN ANNUAL FESTIVAL AND PARADE THAT
EMPHASIZES POLISH ETHNICITY , IN CLASS 41
(U.S. CLS. 100, 101 AND 107).

FIRST USE 7-22-1994; IN COMMERCE 7-22-1994.

THE MARK CONSISTS OF STANDARD CHAR-
ACTERS WITHOUT CLAIM TO ANY PARTICULAR
FONT, STYLE, SIZE, OR COLOR.

NO CLAIM IS MADE TO THE EXCLUSIVE
RIGHT TO USE "FEST", APART FROM THE MARK
AS SHOWN.

SER. NO. 77-357,761, FILED 12-21-2007.

JENNIFER MARTIN, EXAMINING ATTORNEY

Int. Cls.: 16 and 36

Prior U.S. Cls.: 2, 5, 22, 23, 29, 37, 38, 50, 100, 101 and 102

United States Patent and Trademark Office

Reg. No. 3,476,219

Registered July 29, 2008

**TRADEMARK
SERVICE MARK
PRINCIPAL REGISTER**

LIFE BLOSSOMS

CAYMAN SHORES DEVELOPMENT LIMITED
(CAYMAN ISLANDS CORPORATION)
C/O FORESHORE CORPORATE SERVICES, LTD.
4TH/F, QUEENSGATE HOUSE, 113 CHURCH ST.
GEORGE TOWN, CAYMAN ISLANDS KY1-1104

FOR: NEWSLETTERS ON THE SUBJECT OF
MULTI-USE REAL ESTATE DEVELOPMENT COM-
PLEXES AND PROJECTS, IN CLASS 16 (U.S. CLS. 2,
5, 22, 23, 29, 37, 38 AND 50).

FIRST USE 6-30-2007; IN COMMERCE 6-30-2007.

FOR: PROVIDING INFORMATION VIA THE IN-
TERNET RELATING TO MULTI-USE REAL ES-

TATE DEVELOPMENT COMPLEXES AND
PROJECTS, IN CLASS 36 (U.S. CLS. 100, 101 AND 102).

FIRST USE 5-31-2005; IN COMMERCE 5-31-2005.

THE MARK CONSISTS OF STANDARD CHAR-
ACTERS WITHOUT CLAIM TO ANY PARTICULAR
FONT, STYLE, SIZE, OR COLOR.

SER. NO. 77-357,783, FILED 12-21-2007.

MARK SPARACINO, EXAMINING ATTORNEY

Int. Cl.: 5

Prior U.S. Cls.: 6, 18, 44, 46, 51 and 52

United States Patent and Trademark Office

Reg. No. 3,476,220

Registered July 29, 2008

**TRADEMARK
PRINCIPAL REGISTER**

KAMAGRA

AJANTA PHARMA LTD (INDIA CORPORATION)

AJANTA HOUSE, CHARKOP, KANDIVLI (W)

MUMBAI, INDIA 400-067

FOR: PHARMACEUTICAL FOR THE TREAT-
MENT OF ERECTILE DYSFUNCTION, IN CLASS 5
(U.S. CLS. 6, 18, 44, 46, 51 AND 52).

THE MARK CONSISTS OF STANDARD CHAR-
ACTERS WITHOUT CLAIM TO ANY PARTICULAR
FONT, STYLE, SIZE, OR COLOR.

OWNER OF INDIA REG. NO. 1203287INCLA,
DATED 6-3-2003, EXPIRES 6-3-2013.

SER. NO. 77-357,786, FILED 12-21-2007.

MARK SPARACINO, EXAMINING ATTORNEY

Int. Cl.: 35

Prior U.S. Cls.: 100, 101 and 102

United States Patent and Trademark Office

Reg. No. 3,476,221

Registered July 29, 2008

**SERVICE MARK
PRINCIPAL REGISTER**

GREATER YIELD

GREATER-YIELD, LTD. (TEXAS LIMITED
PARTNERSHIP)
SUITE 500
15851 N. DALLAS PARKWAY
ADDISON, TX 75001

FOR: BUSINESS PURCHASING CONSULTATION
SERVICES, NAMELY, THE PURCHASING OF BUSI-
NESS AND OFFICE PRODUCTS, IN CLASS 35 (U.S.
CLS. 100, 101 AND 102).

FIRST USE 10-1-1999; IN COMMERCE 10-1-1999.

THE MARK CONSISTS OF STANDARD CHAR-
ACTERS WITHOUT CLAIM TO ANY PARTICULAR
FONT, STYLE, SIZE, OR COLOR.

OWNER OF U.S. REG. NO. 2,524,991.

SER. NO. 77-357,789, FILED 12-21-2007.

MARK SPARACINO, EXAMINING ATTORNEY

Int. Cl.: 36

Prior U.S. Cls.: 100, 101 and 102

United States Patent and Trademark Office

Reg. No. 3,476,222

Registered July 29, 2008

**SERVICE MARK
PRINCIPAL REGISTER**

Shoregate

THE SLOSBURG COMPANY (NEBRASKA CORPORATION)
10040 REGENCY CIRCLE, SUITE 200
OMAHA, NE 68114

THE MARK CONSISTS OF STANDARD CHARACTERS WITHOUT CLAIM TO ANY PARTICULAR FONT, STYLE, SIZE, OR COLOR.

FOR: EQUITY CAPITAL INVESTMENT; FUNDS INVESTMENT, IN CLASS 36 (U.S. CLS. 100, 101 AND 102).

SER. NO. 77-357,808, FILED 12-21-2007.

FIRST USE 7-9-2002; IN COMMERCE 7-9-2002.

LINDSEY RUBIN, EXAMINING ATTORNEY

Int. Cl.: 35

Prior U.S. Cls.: 100, 101 and 102

United States Patent and Trademark Office

Reg. No. 3,476,223

Registered July 29, 2008

SERVICE MARK
PRINCIPAL REGISTER



THE 67 LIQUOR SHOP, INC. (NEW YORK CORPORATION)
179 COLUMBUS AVENUE
NEW YORK, NY 10023

FOR: ON-LINE RETAIL STORE SERVICES FEATURING WINES, LIQUORS, SPIRITS AND ALCOHOLIC BEVERAGES; RETAIL SHOPS FEATURING WINES, LIQUORS, SPIRITS AND ALCOHOLIC BEVERAGES; RETAIL STORE SERVICES FEATURING WINES, LIQUORS, SPIRITS AND ALCOHOLIC BEVERAGES; RETAIL STORES FEATURING WINES, LIQUORS, SPIRITS AND ALCOHOLIC BEVERAGES; RETAIL WINES, LIQUORS, SPIRITS AND ALCOHOLIC BEVERAGES STORES; MAIL ORDER SERVICES FEATURING WINES, LIQUORS, SPIRITS AND ALCOHOLIC BEVERAGES, IN CLASS 35 (U.S. CLS. 100, 101 AND 102).

FIRST USE 10-31-2005; IN COMMERCE 10-31-2005.

OWNER OF U.S. REG. NO. 2,332,391.

NO CLAIM IS MADE TO THE EXCLUSIVE RIGHT TO USE "WINE" , APART FROM THE MARK AS SHOWN.

THE MARK CONSISTS OF FANCIFUL DEPICTION OF CLUSTER OF GRAPES WITH WORDS "67 WINE".

SER. NO. 77-357,850, FILED 12-21-2007.

AMY ALFIERI, EXAMINING ATTORNEY

Int. Cl.: 41

Prior U.S. Cls.: 100, 101 and 107

United States Patent and Trademark Office

Reg. No. 3,476,224

Registered July 29, 2008

**SERVICE MARK
PRINCIPAL REGISTER**

**KNOWLEDGE CENTRAL TO
SECURING YOUR WORLD**

DAVID G. MAJOR ASSOCIATES, INC. (VIRGINIA CORPORATION)
5650 GENERAL WASHINGTON DR.
ALEXANDRIA, VA 22312

FOR: EDUCATIONAL AND TRAINING SERVICES, NAMELY, CONDUCTING CLASSES, SEMINARS, TRAINING AND WORKSHOPS AND EDUCATIONAL RESEARCH IN THE FIELD OF COUNTERINTELLIGENCE, IN CLASS 41 (U.S. CLS. 100, 101 AND 107).

FIRST USE 11-0-2007; IN COMMERCE 11-0-2007.

THE MARK CONSISTS OF STANDARD CHARACTERS WITHOUT CLAIM TO ANY PARTICULAR FONT, STYLE, SIZE, OR COLOR.

SER. NO. 77-357,862, FILED 12-21-2007.

CHRIS WELLS, EXAMINING ATTORNEY

Int. Cl.: 35

Prior U.S. Cls.: 100, 101 and 102

United States Patent and Trademark Office

Reg. No. 3,476,225

Registered July 29, 2008

**SERVICE MARK
PRINCIPAL REGISTER**



OXFORD PUBLISHING, INC. (MISSISSIPPI CORPORATION)
307 WEST JACKSON AVENUE
OXFORD, MS 38655

FOR: ARRANGING AND CONDUCTING TRADE SHOWS AND CONVENTIONS FOR MEMBERS OF THE HOSPITALITY INDUSTRY; DISSEMINATING MARKETING MATERIALS TO EXHIBITORS AND ATTENDEES AT TRADE SHOWS AND CONVENTIONS ARRANGED BY OTHERS, IN CLASS 35 (U.S. CLS. 100, 101 AND 102).

FIRST USE 8-1-2007; IN COMMERCE 8-1-2007.

THE MARK CONSISTS OF A SERIES OF FOUR BOXES CONTAINING (IN ORDER): A COCKTAIL GLASS, A CHEF'S HAT, A SERVICE BELL, AND A STEAMING MUG.

SER. NO. 77-357,863, FILED 12-21-2007.

CHRIS WELLS, EXAMINING ATTORNEY

Int. Cl.: 43

Prior U.S. Cls.: 100 and 101

United States Patent and Trademark Office

Reg. No. 3,476,226

Registered July 29, 2008

**SERVICE MARK
PRINCIPAL REGISTER**

STEVE'S FAMOUS DINER

CHRISTOMELI, INC. (FLORIDA CORPORATION)

1584 SOUTH NOVA ROAD

DAYTONA BEACH, FL 32114

FOR: RESTAURANT SERVICES, IN CLASS 43
(U.S. CLS. 100 AND 101).

FIRST USE 8-28-1986; IN COMMERCE 8-28-1986.

THE MARK CONSISTS OF STANDARD CHARACTERS WITHOUT CLAIM TO ANY PARTICULAR FONT, STYLE, SIZE, OR COLOR.

NO CLAIM IS MADE TO THE EXCLUSIVE RIGHT TO USE "FAMOUS DINER", APART FROM THE MARK AS SHOWN.

SER. NO. 77-357,871, FILED 12-21-2007.

ELI HELLMAN, EXAMINING ATTORNEY

Int. Cl.: 36

Prior U.S. Cls.: 100, 101 and 102

United States Patent and Trademark Office

Reg. No. 3,476,227

Registered July 29, 2008

**SERVICE MARK
PRINCIPAL REGISTER**

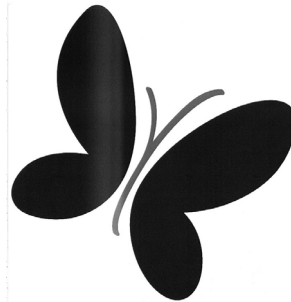

CHILDREN'S CANCER RESEARCH FUND (MIN-
NESOTA NON-PROFIT ORGANIZATION)
7801 EAST BUSH LAKE ROAD
MINNEAPOLIS, MN 55439

FOR: CHARITABLE FUND RAISING SERVICES,
IN CLASS 36 (U.S. CLS. 100, 101 AND 102).

FIRST USE 9-5-2007; IN COMMERCE 9-5-2007.

OWNER OF U.S. REG. NO. 2,680,859.

THE MARK CONSISTS OF STYLIZED BUTTER-
FLY.

SER. NO. 77-357,885, FILED 12-21-2007.

EUGENIA MARTIN, EXAMINING ATTORNEY

Int. Cl.: 9

Prior U.S. Cls.: 21, 23, 26, 36 and 38

Reg. No. 3,476,228

United States Patent and Trademark Office

Registered July 29, 2008

**TRADEMARK
PRINCIPAL REGISTER**

STINKABOO

WILLIAMS, TERRANCE (UNITED STATES IN-
DIVIDUAL)
P.O. BOX 11212
KILLEEN, TX 76547

THE MARK CONSISTS OF STANDARD CHAR-
ACTERS WITHOUT CLAIM TO ANY PARTICULAR
FONT, STYLE, SIZE, OR COLOR.

FOR: MUSICAL SOUND RECORDINGS, IN
CLASS 9 (U.S. CLS. 21, 23, 26, 36 AND 38).

SER. NO. 77-357,886, FILED 12-21-2007.

FIRST USE 0-0-2004; IN COMMERCE 0-0-2004.

LINDSEY RUBIN, EXAMINING ATTORNEY

Int. Cl.: 41

Prior U.S. Cls.: 100, 101 and 107

United States Patent and Trademark Office

Reg. No. 3,476,229

Registered July 29, 2008

**SERVICE MARK
PRINCIPAL REGISTER**

DEMOCRACY NOW!

GOODMAN, AMY (UNITED STATES INDIVIDUAL)
C/O FROSS ZELNICK LEHRMAN & ZISSU, P.C.
866 UNITED NATIONS PLAZA
NEW YORK, NY 10017

FOR: ONGOING TELEVISION NEWS PROGRAM; ONGOING RADIO NEWS MAGAZINE PROGRAM; PROVIDING A WEBSITE FEATURING INFORMATION IN THE NATURE OF NEWS, CURRENT EVENTS AND COMMENTARY; NEWS REPORTING SERVICES; PROVIDING NEWS IN THE NATURE OF CURRENT EVENT REPORTING; EDUCATIONAL AND ENTERTAINMENT SERVICES, NAMELY, A CONTINUING PROGRAM ABOUT NEWS AND CURRENT EVENTS ACCESSIBLE BY RADIO, TELEVISION, SATELLITE, COMPUTER NETWORKS

AND PODCASTS, IN CLASS 41 (U.S. CLS. 100, 101 AND 107).

FIRST USE 2-19-1996; IN COMMERCE 2-19-1996.

THE MARK CONSISTS OF STANDARD CHARACTERS WITHOUT CLAIM TO ANY PARTICULAR FONT, STYLE, SIZE, OR COLOR.

OWNER OF U.S. REG. NOS. 2,522,579 AND 2,620,586.

SER. NO. 77-357,897, FILED 12-21-2007.

MATTHEW EINSTEIN, EXAMINING ATTORNEY

Int. Cl.: 5

Prior U.S. Cls.: 6, 18, 44, 46, 51 and 52

Reg. No. 3,476,230

United States Patent and Trademark Office

Registered July 29, 2008

**TRADEMARK
PRINCIPAL REGISTER**

FAST RESPONSE

VITAMIN RESEARCH PRODUCTS, INC. (NEVADA CORPORATION)
4610 ARROWHEAD DR.
CARSON CITY, NV 897062017

THE MARK CONSISTS OF STANDARD CHARACTERS WITHOUT CLAIM TO ANY PARTICULAR FONT, STYLE, SIZE, OR COLOR.

FOR: DIETARY SUPPLEMENTS, IN CLASS 5 (U.S. CLS. 6, 18, 44, 46, 51 AND 52).

SER. NO. 77-357,913, FILED 12-21-2007.

FIRST USE 12-1-2007; IN COMMERCE 12-1-2007.

AMY GEARIN, EXAMINING ATTORNEY

Int. Cl.: 41

Prior U.S. Cls.: 100, 101 and 107

United States Patent and Trademark Office

Reg. No. 3,476,231

Registered July 29, 2008

**SERVICE MARK
PRINCIPAL REGISTER**

Soul Quest

LAUREN D. BLOOM (UNITED STATES INDIVIDUAL)
1641 VINE STREET #3
DENVER, CO 80206

THE MARK CONSISTS OF STANDARD CHARACTERS WITHOUT CLAIM TO ANY PARTICULAR FONT, STYLE, SIZE, OR COLOR.

FOR: LIFE COACHING SERVICES IN THE FIELD OF LIFE, CAREER, AND CREATIVITY, IN CLASS 41 (U.S. CLS. 100, 101 AND 107).

SER. NO. 77-357,935, FILED 12-21-2007.

FIRST USE 10-31-2004; IN COMMERCE 10-31-2004.

PATRICIA EVANKO, EXAMINING ATTORNEY

Int. Cl.: 12

Prior U.S. Cls.: 19, 21, 23, 31, 35 and 44

United States Patent and Trademark Office

Reg. No. 3,476,232

Registered July 29, 2008

**TRADEMARK
PRINCIPAL REGISTER**

SUREFIT

ELEGANT USA, LLC (NEW JERSEY LTD LIAB
CO)
100 BOMONT PLACE
TOTOWA, NJ 07512

THE MARK CONSISTS OF STANDARD CHAR-
ACTERS WITHOUT CLAIM TO ANY PARTICULAR
FONT, STYLE, SIZE, OR COLOR.

FOR: VEHICLE SEAT COVERS, IN CLASS 12 (U.S.
CLS. 19, 21, 23, 31, 35 AND 44).

SER. NO. 77-357,983, FILED 12-21-2007.

FIRST USE 1-1-1917; IN COMMERCE 1-1-1917.

VERNA BETH RIRIE, EXAMINING ATTORNEY

Int. Cl.: 35

Prior U.S. Cls.: 100, 101 and 102

United States Patent and Trademark Office

Reg. No. 3,476,233

Registered July 29, 2008

**SERVICE MARK
PRINCIPAL REGISTER**

TOONS4BIZ

THOMPSON, DAVID (UNITED STATES INDIVIDUAL)
306 SE 291 HIGHWAY
LEES SUMMIT, MO 64063

FOR: ADVERTISING SERVICES, NAMELY, CREATING CORPORATE AND BRAND IDENTITY FOR OTHERS, IN CLASS 35 (U.S. CLS. 100, 101 AND 102).

FIRST USE 6-1-2004; IN COMMERCE 6-1-2004.

THE MARK CONSISTS OF THE STYLIZED WORDS "TOONS4BIZ".

SER. NO. 77-357,997, FILED 12-21-2007.

JENNIFER HETU, EXAMINING ATTORNEY

Int. Cl.: 3

Prior U.S. Cls.: 1, 4, 6, 50, 51 and 52

United States Patent and Trademark Office

Reg. No. 3,476,234

Registered July 29, 2008

**TRADEMARK
PRINCIPAL REGISTER**

PerioPro

FARRAGO LABS (CANADA PARTNERSHIP)
13807 NASH DRIVE
COLDSTREAM,, CANADA V181X9

THE MARK CONSISTS OF STANDARD CHAR-
ACTERS WITHOUT CLAIM TO ANY PARTICULAR
FONT, STYLE, SIZE, OR COLOR.

FOR: NON-MEDICATED DENTAL RINSE; NON-
MEDICATED MOUTH RINSE; NON-MEDICATED
MOUTH WASH AND RINSE, IN CLASS 3 (U.S. CLS.
1, 4, 6, 50, 51 AND 52).

SER. NO. 77-358,042, FILED 12-21-2007.

FIRST USE 6-0-2007; IN COMMERCE 6-0-2007.

DOMINICK J. SALEMI, EXAMINING ATTORNEY

Int. Cl.: 35

Prior U.S. Cls.: 100, 101 and 102

United States Patent and Trademark Office

Reg. No. 3,476,235

Registered July 29, 2008

**SERVICE MARK
PRINCIPAL REGISTER**



RETAILMANIA, INC (FLORIDA CORPORATION)
9250 S.W. 40TH ST.
MIAMI, FL 33165

FOR: RETAIL CLOTHING STORES, IN CLASS 35
(U.S. CLS. 100, 101 AND 102).

FIRST USE 10-10-2004; IN COMMERCE 10-10-2004.

THE MARK CONSISTS OF AN IMAGE OF A
WOMAN ON HER KNEES. THE STYLIZED WORD

"PLAYTHINGS" IS LOCATED ACROSS THE WO-
MANS WAIST. THERE IS AN OUTLINE OF A STAR
IN THE BACKGROUND. THE STAR BACK-
GROUND IS LOCATED ON THE TORSO AND
HEAD OF THE WOMAN.

SER. NO. 77-358,048, FILED 12-21-2007.

DOMINICK J. SALEMI, EXAMINING ATTORNEY

Int. Cl.: 42

Prior U.S. Cls.: 100 and 101

United States Patent and Trademark Office

Reg. No. 3,476,236

Registered July 29, 2008

**SERVICE MARK
PRINCIPAL REGISTER**

Cmagik

CMAGIK (FLORIDA LTD LIAB CO)
581 ROUNTREE DRIVE
LONGBOAT KEY, FL 342282618

FOR: CONSULTING SERVICES IN THE FIELD OF DESIGN, SELECTION, IMPLEMENTATION AND USE OF COMPUTER HARDWARE AND SOFTWARE SYSTEMS FOR OTHERS; DESIGN OF HOMEPAGES AND WEBSITES , IN CLASS 42 (U.S. CLS. 100 AND 101).

FIRST USE 10-14-1998; IN COMMERCE 1-1-1999.

THE MARK CONSISTS OF STANDARD CHARACTERS WITHOUT CLAIM TO ANY PARTICULAR FONT, STYLE, SIZE, OR COLOR.

SER. NO. 77-358,049, FILED 12-21-2007.

DOMINICK J. SALEMI, EXAMINING ATTORNEY

Int. Cl.: 41

Prior U.S. Cls.: 100, 101 and 107

United States Patent and Trademark Office

Reg. No. 3,476,237

Registered July 29, 2008

**SERVICE MARK
PRINCIPAL REGISTER**

Plays well with others.

KASIDIE ENTERTAINMENT, LLC (COLORADO
LTD LIAB CO), DBA KASIDIE MAGAZINE
8007 E. 24TH AVE.
DENVER, CO 80238

FOR: ENTERTAINMENT SERVICES, NAMELY,
CONDUCTING PARTIES FOR THE PURPOSE OF
DATING AND SOCIAL INTRODUCTION FOR
ADULTS, IN CLASS 41 (U.S. CLS. 100, 101 AND 107).

FIRST USE 9-15-2007; IN COMMERCE 12-7-2007.

THE MARK CONSISTS OF STANDARD CHAR-
ACTERS WITHOUT CLAIM TO ANY PARTICULAR
FONT, STYLE, SIZE, OR COLOR.

SER. NO. 77-358,051, FILED 12-21-2007.

DOMINICK J. SALEMI, EXAMINING ATTORNEY

Int. Cl.: 9

Prior U.S. Cls.: 21, 23, 26, 36 and 38

Reg. No. 3,476,238

United States Patent and Trademark Office

Registered July 29, 2008

**TRADEMARK
PRINCIPAL REGISTER**

tealic

NEWTOUCH DIGITAL MEDIA (FLORIDA CORPORATION)
15-236 PARADISE PLAZA
SARASOTA, FL 34240

FOR: ELECTRONIC PUBLICATIONS, NAMELY, NEWSPAPER FEATURING ARTICLES, TEACHING RESOURCES, JOB AND APARTMENT LISTINGS FOR THOSE WHO WISH TO TEACH AND LIVE IN CHINA RECORDED ON COMPUTER MEDIA, IN CLASS 9 (U.S. CLS. 21, 23, 26, 36 AND 38).

FIRST USE 5-18-2001; IN COMMERCE 5-18-2001.

THE MARK CONSISTS OF STANDARD CHARACTERS WITHOUT CLAIM TO ANY PARTICULAR FONT, STYLE, SIZE, OR COLOR.

SER. NO. 77-358,053, FILED 12-21-2007.

DOMINICK J. SALEMI, EXAMINING ATTORNEY

Int. Cl.: 9

Prior U.S. Cls.: 21, 23, 26, 36 and 38

Reg. No. 3,476,239

United States Patent and Trademark Office

Registered July 29, 2008

**TRADEMARK
PRINCIPAL REGISTER**

tealit

NEWTOUCH DIGITAL MEDIA (FLORIDA CORPORATION)
15-236 PARADISE PLAZA
SARASOTA, FL 34240

FOR: ELECTRONIC PUBLICATIONS, NAMELY, NEWSPAPER FEATURING ARTICLES, TEACHING RESOURCES, JOB AND APARTMENT LISTINGS FOR THOSE WHO WISH TO TEACH AND LIVE IN TAIWAN RECORDED ON COMPUTER MEDIA, IN CLASS 9 (U.S. CLS. 21, 23, 26, 36 AND 38).

FIRST USE 12-31-1999; IN COMMERCE 12-31-1999.

THE MARK CONSISTS OF STANDARD CHARACTERS WITHOUT CLAIM TO ANY PARTICULAR FONT, STYLE, SIZE, OR COLOR.

SER. NO. 77-358,058, FILED 12-21-2007.

DOMINICK J. SALEMI, EXAMINING ATTORNEY

Int. Cl.: 41

Prior U.S. Cls.: 100, 101 and 107

United States Patent and Trademark Office

Reg. No. 3,476,240

Registered July 29, 2008

**SERVICE MARK
PRINCIPAL REGISTER**

INSPIRATION CELEBRATION

MCDONALD'S CORPORATION (DELAWARE
CORPORATION)
ONE MCDONALD'S PLAZA
OAK BROOK, IL 60523

FOR: ENTERTAINMENT SERVICES, NAMELY,
ARRANGING AND CONDUCTING GOSPEL MU-
SIC COMPETITIONS AND LIVE CONCERT PER-
FORMANCES, IN CLASS 41 (U.S. CLS. 100, 101 AND
107).

FIRST USE 1-30-2007; IN COMMERCE 1-30-2007.

THE MARK CONSISTS OF STANDARD CHAR-
ACTERS WITHOUT CLAIM TO ANY PARTICULAR
FONT, STYLE, SIZE, OR COLOR.

SER. NO. 77-358,069, FILED 12-21-2007.

HOWARD SMIGA, EXAMINING ATTORNEY

Int. Cl.: 41

Prior U.S. Cls.: 100, 101 and 107

United States Patent and Trademark Office

Reg. No. 3,476,241

Registered July 29, 2008

**SERVICE MARK
PRINCIPAL REGISTER**



DALLAS PATRIOTS, INC. (VIRGINIA CORPORATION)
1803 PARK MEADOW LANE
RICHARDSON, TX 75081

FOR: AMATEUR YOUTH BASEBALL SERVICES, NAMELY, ORGANIZING, PROVIDING, AND MANAGING YOUTH BASEBALL ACTIVITIES, IN CLASS 41 (U.S. CLS. 100, 101 AND 107).

FIRST USE 7-1-2003; IN COMMERCE 7-1-2003.

THE COLOR(S) RED AND WHITE IS/ARE CLAIMED AS A FEATURE OF THE MARK.

THE MARK CONSISTS OF THE LETTER "D" IN RED WITH A WHITE OUTLINE AND THE LETTER "P" ALSO IN RED WITH A WHITE OUTLINE OVERLAYING THE LETTER "D" .

SER. NO. 77-358,073, FILED 12-21-2007.

WARREN L. OLANDRIA, EXAMINING ATTORNEY

Int. Cl.: 42

Prior U.S. Cls.: 100 and 101

United States Patent and Trademark Office

Reg. No. 3,476,242

Registered July 29, 2008

**SERVICE MARK
PRINCIPAL REGISTER**

REALDIALOG

ASTUTE, INC. (OHIO CORPORATION)
SUITE 150
2400 CORPORATE EXCHANGE DRIVE
COLUMBUS, OH 43231

FOR: ON-LINE NON-DOWNLOADABLE SOFTWARE FOR PROVIDING TEXT-BASED ANSWERS TO QUESTIONS AND INFORMATION DERIVED FROM LINGUISTIC ANALYSIS OF DATA AND DOCUMENTS VIA A NATURAL LANGUAGE AUTOMATED ATTENDANT IN THE FIELD OF CUSTOMER AND EMPLOYEE RELATIONS, SERVICE AND CARE, IN CLASS 42 (U.S. CLS. 100 AND 101).

FIRST USE 9-9-2002; IN COMMERCE 9-9-2002.

THE MARK CONSISTS OF STANDARD CHARACTERS WITHOUT CLAIM TO ANY PARTICULAR FONT, STYLE, SIZE, OR COLOR.

OWNER OF U.S. REG. NO. 2,957,435.

SER. NO. 77-358,214, FILED 12-21-2007.

LINDA E. BLOHM, EXAMINING ATTORNEY

Int. Cl.: 41

Prior U.S. Cls.: 100, 101 and 107

United States Patent and Trademark Office

Reg. No. 3,476,243

Registered July 29, 2008

SERVICE MARK
PRINCIPAL REGISTER



MYSPACE INC. (DELAWARE CORPORATION)
407 N. MAPLE DRIVE
BEVERLY HILLS, CA 90210

PUTER NETWORK AND WIRELESS COMMUNI-
CATION DEVICES, IN CLASS 41 (U.S. CLS. 100, 101
AND 107).

FOR: PROVIDING ON-LINE INFORMATION IN
THE FIELD OF MUSIC, MUSICAL ARTISTS AND
MUSICAL PERFORMANCES VIA THE INTERNET;
ENTERTAINMENT SERVICES IN THE NATURE OF
AUDIO VISUAL PERFORMANCES AND MUSICAL
SHOWS TRANSMITTED VIA THE GLOBAL COM-

FIRST USE 9-27-2007; IN COMMERCE 9-27-2007.

SER. NO. 77-358,226, FILED 12-21-2007.

NICHOLAS ALTREE, EXAMINING ATTORNEY

Int. Cl.: 42

Prior U.S. Cls.: 100 and 101

United States Patent and Trademark Office

Reg. No. 3,476,244

Registered July 29, 2008

**SERVICE MARK
PRINCIPAL REGISTER**



MYSPLACE INC. (DELAWARE CORPORATION)
407 N. MAPLE DRIVE
BEVERLY HILLS, CA 90210

FOR: COMPUTER SERVICES, NAMELY, HOST-
ING ON-LINE WEB FACILITIES FOR OTHERS FOR
ORGANIZING AND CONDUCTING ON-LINE

MEETINGS, GATHERINGS AND INTERACTIVE
DISCUSSIONS, IN CLASS 42 (U.S. CLS. 100 AND 101).

FIRST USE 9-27-2007; IN COMMERCE 9-27-2007.

SER. NO. 77-358,237, FILED 12-21-2007.

NICHOLAS ALTREE, EXAMINING ATTORNEY

Int. Cl.: 37

Prior U.S. Cls.: 100, 103 and 106

United States Patent and Trademark Office

Reg. No. 3,476,245

Registered July 29, 2008

**SERVICE MARK
PRINCIPAL REGISTER**

BACK TO BLACK

BACK TO BLACK DRIVEWAY SEALCOATING,
INC. (MINNESOTA CORPORATION)
15183 FREELAND AVE. N.
HUGO, MN 55038

THE MARK CONSISTS OF STANDARD CHAR-
ACTERS WITHOUT CLAIM TO ANY PARTICULAR
FONT, STYLE, SIZE, OR COLOR.

FOR: ASPHALT AND PAVEMENT SEALCOAT-
ING, CRACK FILLING, PATCHING, LINE STRIP-
ING, PAVING AND RESURFACING, IN CLASS 37
(U.S. CLS. 100, 103 AND 106).

SER. NO. 77-358,307, FILED 12-21-2007.

FIRST USE 4-30-2007; IN COMMERCE 4-30-2007.

LESLEY LAMOTHE, EXAMINING ATTORNEY

Int. Cl.: 42

Prior U.S. Cls.: 100 and 101

United States Patent and Trademark Office

Reg. No. 3,476,246

Registered July 29, 2008

**SERVICE MARK
PRINCIPAL REGISTER**

DISBURS-ALL

DISBURS-ALL, L.L.C. (MISSOURI LTD LIAB CO)
1795 CLARKSON ROAD, SUITE 310
CHESTERFIELD, MO 63017

FIRST USE 1-1-2000; IN COMMERCE 1-1-2000.

FOR: PROVIDING TEMPORARY USE OF ON-LINE NON-DOWNLOADABLE SOFTWARE TO PROVIDE AUTOMATED TRACKING, IMPLEMENTATION AND MANAGEMENT OF DISBURSING TRANSACTIONS MADE BY LENDERS, CONTRACTORS, BUILDERS, PROJECTS, AND REAL PROPERTY DEVELOPMENT, IN CLASS 42 (U.S. CLS. 100 AND 101).

THE MARK CONSISTS OF STANDARD CHARACTERS WITHOUT CLAIM TO ANY PARTICULAR FONT, STYLE, SIZE, OR COLOR.

SER. NO. 77-358,333, FILED 12-21-2007.

BARNEY CHARLON, EXAMINING ATTORNEY

Int. Cls.: 42 and 45

Prior U.S. Cls.: 100 and 101

United States Patent and Trademark Office

Reg. No. 3,476,247

Registered July 29, 2008

**SERVICE MARK
PRINCIPAL REGISTER**

ACCOUNTLOCK

IOVATION INC. (DELAWARE CORPORATION)
SUITE 3200
111 SW FIFTH AVENUE
PORTLAND, OR 97204

FOR: PROVIDING ONLINE NON-DOWNLOADABLE SOFTWARE FOR USE IN THE DETECTION AND PREVENTION OF ONLINE FRAUD, FOR CONTROLLING ONLINE ACCOUNT ACCESS, AND FOR DEVICE IDENTIFICATION AND AUTHENTICATION, IN CLASS 42 (U.S. CLS. 100 AND 101).

FIRST USE 6-15-2005; IN COMMERCE 6-15-2005.

FOR: IDENTIFICATION VERIFICATION SERVICES, NAMELY, PROVIDING AUTHENTICATION

OF ACCOUNT AND DEVICE INFORMATION; PROVIDING USER AND DEVICE AUTHENTICATION SERVICES FOR ONLINE ACCOUNT ACCESS AND E-COMMERCE TRANSACTIONS, IN CLASS 45 (U.S. CLS. 100 AND 101).

FIRST USE 6-15-2005; IN COMMERCE 6-15-2005.

THE MARK CONSISTS OF STANDARD CHARACTERS WITHOUT CLAIM TO ANY PARTICULAR FONT, STYLE, SIZE, OR COLOR.

SER. NO. 77-358,345, FILED 12-21-2007.

PETER B. BROMAGHIM, EXAMINING ATTORNEY

Int. Cls.: 9, 42 and 45

Prior U.S. Cls.: 21, 23, 26, 36, 38, 100 and 101

United States Patent and Trademark Office

Reg. No. 3,476,248

Registered July 29, 2008

**TRADEMARK
SERVICE MARK
PRINCIPAL REGISTER**

REPUTATION IS EVERYTHING

IOVATION INC. (DELAWARE CORPORATION)
SUITE 3200
111 SW FIFTH AVENUE
PORTLAND, OR 97204

FOR: COMPUTER SOFTWARE FOR THE DETECTION AND PREVENTION OF ONLINE FRAUD AND ABUSE, AND FOR DEVICE AND ACCOUNT IDENTIFICATION AND AUTHENTICATION, IN CLASS 9 (U.S. CLS. 21, 23, 26, 36 AND 38).

FIRST USE 6-13-2005; IN COMMERCE 6-13-2005.

FOR: PROVIDING ONLINE NON-DOWNLOADABLE SOFTWARE FOR USE IN THE DETECTION AND PREVENTION OF ONLINE FRAUD AND ABUSE, AND FOR DEVICE AND ACCOUNT AUTHENTICATION; CONSULTING SERVICES IN THE FIELD OF COMPUTER, NETWORK AND ONLINE SECURITY AND FRAUD MANAGEMENT, IN CLASS 42 (U.S. CLS. 100 AND 101).

FIRST USE 6-13-2005; IN COMMERCE 6-13-2005.

FOR: IDENTIFICATION VERIFICATION SERVICES, NAMELY, PROVIDING AUTHENTICATION OF ACCOUNT AND DEVICE INFORMATION; PROVIDING USER AND DEVICE AUTHENTICATION SERVICES FOR ONLINE TRANSACTIONS, ACCOUNT ACCESS AND E-COMMERCE TRANSACTIONS, IN CLASS 45 (U.S. CLS. 100 AND 101).

FIRST USE 6-13-2005; IN COMMERCE 6-13-2005.

THE MARK CONSISTS OF STANDARD CHARACTERS WITHOUT CLAIM TO ANY PARTICULAR FONT, STYLE, SIZE, OR COLOR.

SER. NO. 77-358,363, FILED 12-21-2007.

PETER B. BROMAGHIM, EXAMINING ATTORNEY

Int. Cl.: 35

Prior U.S. Cls.: 100, 101 and 102

United States Patent and Trademark Office

Reg. No. 3,476,249

Registered July 29, 2008

**SERVICE MARK
PRINCIPAL REGISTER**



DELAWARE ENTITY SERVICES LLC (DELA-
WARE LTD LIAB CO)
1007 NORTH ORANGE STREET, 9TH FLOOR
WILMINGTON, DE 19801

FOR: BUSINESS SERVICES, NAMELY, ASSIST-
ING OTHERS IN THE ESTABLISHMENT OF BUSI-
NESS ENTITIES; BUSINESS ORGANIZATION AND
OPERATION CONSULTANCY; COMMERCIAL RE-
GISTERED AGENT SERVICES; INFORMATION
SERVICES RELATING TO BUSINESS MATTERS;
NEW BUSINESS VENTURE DEVELOPMENT AND
FORMATION CONSULTING SERVICES; FINAN-
CING STATEMENT PREPARATION AND ANALY-
SIS FOR BUSINESSES, IN CLASS 35 (U.S. CLS. 100,
101 AND 102).

FIRST USE 4-15-2007; IN COMMERCE 4-15-2007.

NO CLAIM IS MADE TO THE EXCLUSIVE
RIGHT TO USE "DELAWARE ENTITY SERVICES
LLC", APART FROM THE MARK AS SHOWN.

THE MARK CONSISTS OF THREE DIAGONAL
LINES TO THE LEFT OF THE LITERAL ELEMENT.

SER. NO. 77-358,371, FILED 12-21-2007.

RICHARD A. STRASER, EXAMINING ATTORNEY

Int. Cl.: 13

Prior U.S. Cls.: 2 and 9

United States Patent and Trademark Office

Reg. No. 3,476,250

Registered July 29, 2008

**TRADEMARK
PRINCIPAL REGISTER**



SEE, MICHAEL (UNITED STATES INDIVIDUAL)
6431 N. TAOS ROAD
SCOTT CITY, KS 67871

FOR: FIREARMS, NAMELY, GUN PARTS INCLUDING GUN CHOKES AND GUN BARRELS, IN CLASS 13 (U.S. CLS. 2 AND 9).

FIRST USE 12-31-1994; IN COMMERCE 12-31-1994.

OWNER OF U.S. REG. NO. 2,683,547.

THE MARK CONSISTS OF THE WORD "PATTERNMASTER" IN BLOCK LETTERS SUPERIMPOSED OVER A CIRCLE WHICH IS SUPERIMPOSED OVER AN ELLIPSE; A NUMBER OF DOTS ARE RANDOMLY SCATTERED THROUGHOUT THE CIRCLE.

SER. NO. 77-358,375, FILED 12-21-2007.

SANI KHOURI, EXAMINING ATTORNEY

Int. Cl.: 36

Prior U.S. Cls.: 100, 101 and 102

United States Patent and Trademark Office

Reg. No. 3,476,251

Registered July 29, 2008

**SERVICE MARK
PRINCIPAL REGISTER**

AUTOPDAP

UNITED AIR LINES, INC. (DELAWARE COR-
PORATION)
P.O. BOX 66100
CHICAGO, IL 60666

THE MARK CONSISTS OF STANDARD CHAR-
ACTERS WITHOUT CLAIM TO ANY PARTICULAR
FONT, STYLE, SIZE, OR COLOR.

FOR: FINANCIAL SERVICES, NAMELY, PRO-
VIDING FUND INVESTMENT SERVICES, IN CLASS
36 (U.S. CLS. 100, 101 AND 102).

SER. NO. 77-358,393, FILED 12-21-2007.

FIRST USE 10-10-2007; IN COMMERCE 10-10-2007.

DANIEL CAPSHAW, EXAMINING ATTORNEY

Int. Cl.: 37

Prior U.S. Cls.: 100, 103 and 106

United States Patent and Trademark Office

Reg. No. 3,476,252

Registered July 29, 2008

**SERVICE MARK
PRINCIPAL REGISTER**



MANHEIM AUCTIONS, INC. (DELAWARE CORPORATION)
6205 PEACHTREE DUNWOODY ROAD
ATLANTA, GA 30328

FOR: VEHICLE RESTORATION SERVICES, IN CLASS 37 (U.S. CLS. 100, 103 AND 106).

FIRST USE 5-20-2007; IN COMMERCE 5-20-2007.

THE COLOR(S) RED, YELLOW, PEACH, TAN, GREY, BLACK AND WHITE IS/ARE CLAIMED AS A FEATURE OF THE MARK.

THE MARK CONSISTS OF A CHARACTER DESIGN OF A MAN THROWING A TIRE RIM WITH HIS RIGHT ARM ACROSS HIS CHEST, LEFT LEG BENT, AND RIGHT ARM TUCKED BY HIS WAIST AND HAND IN A FIST, WITH THE TIRE RIM IN THE AIR WITH THROW MARKS GIVING THE APPEARANCE THE TIRE RIM HAS JUST BEEN

THROWN INTO THE AIR. THE MAN IS WEARING BLACK SUNGLASSES, A RED LONG JACKET WITH A YELLOW CAPITAL LETTER "M" WITH BLACK SHADING INSIDE CONSECUTIVE BLACK AND YELLOW CIRCLES ON THE RIGHT SHOULDER, A GREY JUMPSUIT WITH YELLOW AND BLACK DETAIL, GREY BELT WITH A BELT BUCKLE CONSISTING OF A YELLOW CAPITAL LETTER "M" WITH BLACK SHADING INSIDE CONSECUTIVE BLACK AND YELLOW CIRCLES AND THREE GREY TIRE RIMS ATTACHED TO THE BELT, YELLOW KNEE HIGH BOOTS AND KNEE PADS WITH GREY SHADING AND BLACK OUTLINING. THE MAN'S HAIR IS THE COLOR BLACK, FACE IS THE COLOR PEACH WITH TAN SHADING AND BLACK OUTLINING AND WHITE MOUTH.

SER. NO. 77-358,394, FILED 12-21-2007.

DAVID TAYLOR, EXAMINING ATTORNEY

Int. Cl.: 37

Prior U.S. Cls.: 100, 103 and 106

United States Patent and Trademark Office

Reg. No. 3,476,253

Registered July 29, 2008

**SERVICE MARK
PRINCIPAL REGISTER**



MANHEIM AUCTIONS, INC. (DELAWARE CORPORATION)
6205 PEACHTREE DUNWOODY ROAD
ATLANTA, GA 30328

FOR: VEHICLE RESTORATION SERVICES, IN CLASS 37 (U.S. CLS. 100, 103 AND 106).

FIRST USE 5-20-2007; IN COMMERCE 5-20-2007.

THE COLOR(S) DARK BLUE, LIGHT BLUE, ORANGE, BROWN, GREY, BLACK AND WHITE IS/ARE CLAIMED AS A FEATURE OF THE MARK.

THE MARK CONSISTS OF A CHARACTER DESIGN OF A MAN RUNNING WITH HIS RIGHT ARM RAISED ABOVE HIS HEAD, HAND IN A FIST, AND A CAR DOOR ATTACHED TO HIS WRIST.

THE MAN'S FACE, CHEST AND ARMS ARE IN THE COLOR LIGHT BLUE WITH BLACK DETAIL AND SHADING, GREY WRIST BANDS ON EACH WRIST AND AN ORANGE AND BROWN CAR DOOR WITH A GREY, BLACK AND WHITE WINDOW ATTACHED TO THE WRIST OF THE RIGHT ARM WHICH IS RAISED OVERHEAD. THE MAN IS WEARING AN ORANGE TANK TOP AND BANDANA WITH A YELLOW CAPITAL LETTER "M" WITH BLACK SHADING INSIDE CONSECUTIVE BLACK AND YELLOW CIRCLES, DARK BLUE PANTS WITH BLACK SHADING AND YELLOW BOOTS WITH GREY AND BLACK SHADING.

SER. NO. 77-358,396, FILED 12-21-2007.

DAVID TAYLOR, EXAMINING ATTORNEY

Int. Cl.: 16

Prior U.S. Cls.: 2, 5, 22, 23, 29, 37, 38 and 50

Reg. No. 3,476,254

United States Patent and Trademark Office

Registered July 29, 2008

**TRADEMARK
PRINCIPAL REGISTER**

**THE
TABLET**

THE TABLET PUBLISHING CO., LTD. (UNITED
KINGDOM CORPORATION)
CLIFTON WALK
1 KING STREET CLOISTERS
LONDON, ENGLAND W60QZ

FOR: CATHOLIC JOURNAL CONTAINING RE-
LIGIOUS ARTICLES, NEWS AND DISCUSSIONS, IN
CLASS 16 (U.S. CLS. 2, 5, 22, 23, 29, 37, 38 AND 50).

FIRST USE 3-31-2006; IN COMMERCE 3-31-2006.

OWNER OF U.S. REG. NO. 2,094,508.

THE COLOR(S) RED IS/ARE CLAIMED AS A
FEATURE OF THE MARK.

THE MARK CONSISTS OF "THE" PRESENTED IN
A HORIZONTAL LINE POSITIONED ABOVE "TA-
BLET"; "TABLET" IS GREATER IN SIZE THAN
"THE"; BOTH TERMS ARE PRESENTED IN RED.

SER. NO. 77-358,397, FILED 12-21-2007.

IRA J. GOODSaid, EXAMINING ATTORNEY

Int. Cl.: 37

Prior U.S. Cls.: 100, 103 and 106

United States Patent and Trademark Office

Reg. No. 3,476,255

Registered July 29, 2008

**SERVICE MARK
PRINCIPAL REGISTER**



MANHEIM AUCTIONS, INC. (DELAWARE CORPORATION)
6205 PEACHTREE DUNWOODY ROAD
ATLANTA, GA 30328

FOR: VEHICLE RESTORATION SERVICES, IN CLASS 37 (U.S. CLS. 100, 103 AND 106).

FIRST USE 5-20-2007; IN COMMERCE 5-20-2007.

THE COLOR(S) DARK BLUE, LIGHT BLUE, GREEN, RED, YELLOW, PEACH, TAN, GREY, BLACK AND WHITE IS/ARE CLAIMED AS A FEATURE OF THE MARK.

THE MARK CONSISTS OF A CHARACTER DESIGN OF A WOMAN RUNNING WITH HER RIGHT ARM RAISED ABOVE HER HEAD, HAND IN A FIST, WITH A SPRAY GUN ATTACHED TO HER WRIST. THE WOMAN IS WEARING A BLACK MASK, A CROPPED GREEN, YELLOW AND GREY SHIRT WITH A YELLOW CAPITAL LETTER "M"

WITH BLACK SHADING INSIDE CONSECUTIVE BLACK AND YELLOW CIRCLES ON THE CHEST, GREEN GLOVES WITH YELLOW TRIM AND BLACK OUTLINING, GREY WRIST BANDS AND A GREY SPRAY GUN WITH BLACK OUTLINING ON THE RIGHT ARM, GREY PANTS WITH A YELLOW STRIPE, YELLOW BELT WITH A BELT BUCKLE CONSISTING OF A YELLOW CAPITAL LETTER "M" WITH BLACK SHADING INSIDE CONSECUTIVE BLACK AND YELLOW CIRCLES AND TWO YELLOW BELT LOOPS WITH BLACK OUTLINING, AND GREEN BOOTS WITH YELLOW TRIM AND BLACK OUTLINING. THE WOMAN'S HAIR IS LIGHT BLUE AND DARK BLUE WITH BLACK DETAILING, FACE IS THE COLOR PEACH WITH TAN SHADING AND BLACK OUTLINING, RED LIPS, WHITE MOUTH AND EYES.

SER. NO. 77-358,403, FILED 12-21-2007.

DAVID TAYLOR, EXAMINING ATTORNEY

Int. Cl.: 37

Prior U.S. Cls.: 100, 103 and 106

United States Patent and Trademark Office

Reg. No. 3,476,256

Registered July 29, 2008

**SERVICE MARK
PRINCIPAL REGISTER**



MANHEIM AUCTIONS, INC. (DELAWARE CORPORATION)
6205 PEACHTREE DUNWOODY ROAD
ATLANTA, GA 30328

FOR: VEHICLE RESTORATION SERVICES, IN CLASS 37 (U.S. CLS. 100, 103 AND 106).

FIRST USE 5-20-2007; IN COMMERCE 5-20-2007.

THE COLOR(S) BROWN, BLUE, LIGHT BLUE, RED, ORANGE, YELLOW, DARK GREY, GREY, LIGHT GREY, BLACK AND WHITE IS/ARE CLAIMED AS A FEATURE OF THE MARK.

THE MARK CONSISTS OF A CHARACTER DESIGN OF A MAN CHARGING FORWARD WITH RIGHT ARM EXTENDED, HAND IN A FIST, AND LEFT ARM SWUNG BACK. THE MAN IS WEARING A GREY HELMET WITH A YELLOW CAPITAL

LETTER "M" WITH BLACK SHADING INSIDE CONSECUTIVE BLACK AND YELLOW CIRCLES ON THE FOREHEAD, BLACK AND DARK GREY SHADING AND DETAIL, GREY CHEST ARMOR WITH BLUE DETAIL, DARK AND LIGHT GREY SHADING AND BLACK OUTLINING, GREY GLOVES WITH DARK AND LIGHT GREY SHADING AND BLACK OUTLINING, GREY BOOTS WITH BLUE DETAIL, DARK AND LIGHT GREY SHADING, BLACK DETAIL AND OUTLINING, AND A BLUE WITH LIGHT BLUE DETAILED BODY SUIT. THE MAN'S FACE IS BROWN WITH BLACK SHADING AND DETAIL, WHITE MOUTH AND EYES. BEHIND THE MAN'S LOWER BODY AND LEGS IS AN EXPLOSIVE SHAPE IN THE COLORS RED, ORANGE AND YELLOW.

SER. NO. 77-358,407, FILED 12-21-2007.

DAVID TAYLOR, EXAMINING ATTORNEY

Int. Cl.: 36

Prior U.S. Cls.: 100, 101 and 102

United States Patent and Trademark Office

Reg. No. 3,476,257

Registered July 29, 2008

**SERVICE MARK
PRINCIPAL REGISTER**

CITIZENS SECURITY BANK

MABREY BANCORPORATION, INC. (OKLAHOMA CORPORATION)
POST OFFICE BOX 1117
OKMULGEE, OK 74447

FOR: BANKING AND FINANCING SERVICES,
IN CLASS 36 (U.S. CLS. 100, 101 AND 102).

FIRST USE 6-6-1973; IN COMMERCE 6-6-1973.

THE MARK CONSISTS OF STANDARD CHARACTERS WITHOUT CLAIM TO ANY PARTICULAR FONT, STYLE, SIZE, OR COLOR.

OWNER OF U.S. REG. NO. 2,189,331.

NO CLAIM IS MADE TO THE EXCLUSIVE RIGHT TO USE "BANK", APART FROM THE MARK AS SHOWN.

SER. NO. 77-358,434, FILED 12-21-2007.

TOBY BULLOFF, EXAMINING ATTORNEY

Int. Cl.: 45

Prior U.S. Cls.: 100 and 101

United States Patent and Trademark Office

Reg. No. 3,476,258

Registered July 29, 2008

**SERVICE MARK
PRINCIPAL REGISTER**

ORANGE LEGAL TECHNOLOGIES

ORANGE LEGAL TECHNOLOGIES, LLC (CALIFORNIA LTD LIAB CO)

500 SANSOME STREET, SUITE 503

SAN FRANCISCO, CA 94111

FOR: LITIGATION SUPPORT SERVICES, IN CLASS 45 (U.S. CLS. 100 AND 101).

FIRST USE 11-24-2007; IN COMMERCE 11-24-2007.

THE MARK CONSISTS OF STANDARD CHARACTERS WITHOUT CLAIM TO ANY PARTICULAR FONT, STYLE, SIZE, OR COLOR.

NO CLAIM IS MADE TO THE EXCLUSIVE RIGHT TO USE "LEGAL TECHNOLOGIES", APART FROM THE MARK AS SHOWN.

SER. NO. 77-358,457, FILED 12-21-2007.

DANNEAN HETZEL, EXAMINING ATTORNEY

Int. Cl.: 38

Prior U.S. Cls.: 100, 101 and 104

United States Patent and Trademark Office

Reg. No. 3,476,259

Registered July 29, 2008

**SERVICE MARK
PRINCIPAL REGISTER**

TV FOR A BETTER YOU

SKY ANGEL U.S., LLC (FLORIDA LTD LIAB CO)
SUITE 290
3050 N. HORSESHOE DRIVE
NAPLES, FL 34104

FOR: PROVIDING TELEVISION BROADCAST
VIA IPTV, NAMELY, DELIVERING TELEVISION
SERVICE VIA THE INTERNET, IN CLASS 38 (U.S.
CLS. 100, 101 AND 104).

FIRST USE 9-30-2007; IN COMMERCE 9-30-2007.

THE MARK CONSISTS OF STANDARD CHAR-
ACTERS WITHOUT CLAIM TO ANY PARTICULAR
FONT, STYLE, SIZE, OR COLOR.

SER. NO. 77-358,478, FILED 12-21-2007.

HOWARD B. LEVINE, EXAMINING ATTORNEY

Int. Cl.: 9

Prior U.S. Cls.: 21, 23, 26, 36 and 38

Reg. No. 3,476,260

United States Patent and Trademark Office

Registered July 29, 2008

**TRADEMARK
PRINCIPAL REGISTER**

IntelliAg

DICKEY-JOHN CORPORATION (DELAWARE
CORPORATION)
5200 DICKEY-JOHN ROAD
AUBURN, IL 62615

FOR: HARDWARE AND SOFTWARE, NAMELY,
MONITOR, CONTROL MODULES AND SOFT-
WARE FOR CONTROLLING AND MONITORING
SEED RATES AND FERTILIZER APPLICATION
CONTROL ON PLANTERS, GRAIN DRILLS, OR
AIR CARTS, IN CLASS 9 (U.S. CLS. 21, 23, 26, 36 AND
38).

FIRST USE 3-1-2006; IN COMMERCE 3-1-2006.

THE MARK CONSISTS OF STANDARD CHAR-
ACTERS WITHOUT CLAIM TO ANY PARTICULAR
FONT, STYLE, SIZE, OR COLOR.

SER. NO. 77-358,481, FILED 12-21-2007.

MATTHEW EINSTEIN, EXAMINING ATTORNEY

Int. Cl.: 41

Prior U.S. Cls.: 100, 101 and 107

United States Patent and Trademark Office

Reg. No. 3,476,261

Registered July 29, 2008

**SERVICE MARK
PRINCIPAL REGISTER**

SALESOLOGY

SALESOLOGY, INC. (TEXAS CORPORATION)
2012 DILLON CT.
FLOWER MOUND, TX 75028

FOR: TRAINING SERVICES IN THE FIELD OF
SALES, IN CLASS 41 (U.S. CLS. 100, 101 AND 107).

FIRST USE 11-0-1995; IN COMMERCE 11-0-1995.

THE MARK CONSISTS OF STANDARD CHAR-
ACTERS WITHOUT CLAIM TO ANY PARTICULAR
FONT, STYLE, SIZE, OR COLOR.

SER. NO. 77-358,541, FILED 12-21-2007.

SANJEEV VOHRA, EXAMINING ATTORNEY

Int. Cl.: 35

Prior U.S. Cls.: 100, 101 and 102

United States Patent and Trademark Office

Reg. No. 3,476,262

Registered July 29, 2008

**SERVICE MARK
PRINCIPAL REGISTER**



UTAH TECHNOLOGY COUNCIL (UTAH NON-
PROFIT ORGANIZATION)
2855 EAST COTTONWOOD PARKWAY, SUITE 110
SALT LAKE CITY, UT 84121

FOR: ASSOCIATION SERVICES, NAMELY PRO-
MOTING THE INTERESTS OF TECHNOLOGY,
HIGH-TECH AND THE LIFE SCIENCES, IN CLASS
35 (U.S. CLS. 100, 101 AND 102).

FIRST USE 7-27-2007; IN COMMERCE 7-27-2007.

THE MARK CONSISTS OF A CIRCLE WITH A
LARGE LETTER "U" IN THE MIDDLE ENCIRCLED
BY ANOTHER THIN CIRCLE.

SER. NO. 77-358,542, FILED 12-21-2007.

DORITT L. CARROLL, EXAMINING ATTORNEY

Int. Cl.: 36

Prior U.S. Cls.: 100, 101 and 102

United States Patent and Trademark Office

Reg. No. 3,476,263

Registered July 29, 2008

**SERVICE MARK
PRINCIPAL REGISTER**

Rental-Assist

RENTAL PROPERTY RESOURCES, LLC (FLOR-
IDA LTD LIAB CO)
1045 RUGGLESTONE WAY
DULUTH, GA 30097

FOR: REAL ESTATE RENTAL SERVICES, NAME-
LY, RENTAL OF RESIDENTIAL HOUSING; REAL
ESTATE SERVICES, NAMELY, RENTAL OF VACA-
TION HOMES, CONDOMINIUMS, CABINS, AND
VILLAS USING PAY PER CLICK ADVERTISING ON
A GLOBAL COMPUTER NETWORK, IN CLASS 36
(U.S. CLS. 100, 101 AND 102).

FIRST USE 5-13-2007; IN COMMERCE 7-17-2007.

THE MARK CONSISTS OF STANDARD CHAR-
ACTERS WITHOUT CLAIM TO ANY PARTICULAR
FONT, STYLE, SIZE, OR COLOR.

SER. NO. 77-358,560, FILED 12-21-2007.

LEIGH CAROLINE CASE, EXAMINING ATTOR-
NEY

Int. Cl.: 35

Prior U.S. Cls.: 100, 101 and 102

United States Patent and Trademark Office

Reg. No. 3,476,264

Registered July 29, 2008

**SERVICE MARK
PRINCIPAL REGISTER**



LA CHOCOLATIERRA LIMITED (NEW YORK CORPORATION)
710 WEST 190TH STREET, SUITE D
NEW YORK, NY 10040

FOR: ON-LINE RETAIL STORE SERVICES FEATURING THE SALE AND DISTRIBUTION OF CHOCOLATE AND CHOCOLATE DERIVED PRODUCTS, INCLUDING CHOCOLATE TRUFFLES AND BONBONS, CHOCOLATE CONFECTIONERY, CHOCOLATE BARS, CACAO, CACAO NIBS, CACAO-BASED PRODUCTS, CACAO-BASED BEVERAGES, CACAO-BASED FOOD ITEMS, CHOCOLATE NOVELTY ITEMS, HOT CHOCOLATE, HOT COCOA, COOKIES, CAKES, CANDY, PAS-

TRIES, SAVORY SNACKS, CONFECTIONERY, HOT/COLD BEVERAGES, DESSERTS, SAUCES, COFFEE AND COFFEE-BASED BEVERAGES AND PRODUCTS, TEA, TEA-BASED BEVERAGES, IN CLASS 35 (U.S. CLS. 100, 101 AND 102).

FIRST USE 12-1-2007; IN COMMERCE 12-1-2007.

THE MARK CONSISTS A STYLIZED LETTER "C".

SER. NO. 77-358,576, FILED 12-21-2007.

LINDA MICKLEBURGH, EXAMINING ATTORNEY

Int. Cl.: 33

Prior U.S. Cls.: 47 and 49

United States Patent and Trademark Office

Reg. No. 3,476,265

Registered July 29, 2008

**TRADEMARK
PRINCIPAL REGISTER**

WineNik

WINENIK LLC (WASHINGTON LTD LIAB CO)
11524 28TH STREET COURT NW
GIG HARBOR, WA 98335

THE MARK CONSISTS OF STANDARD CHAR-
ACTERS WITHOUT CLAIM TO ANY PARTICULAR
FONT, STYLE, SIZE, OR COLOR.

FOR: WINE, IN CLASS 33 (U.S. CLS. 47 AND 49).

SER. NO. 77-358,580, FILED 12-21-2007.

FIRST USE 11-13-2007; IN COMMERCE 11-13-2007.

LINDSEY RUBIN, EXAMINING ATTORNEY

Int. Cls.: 13 and 35

Prior U.S. Cls.: 2, 9, 100, 101 and 102

United States Patent and Trademark Office

Reg. No. 3,476,266

Registered July 29, 2008

**TRADEMARK
SERVICE MARK
PRINCIPAL REGISTER**



TREADCARE, INC. (VIRGINIA CORPORATION)
40749 BEACHNUT RD.
LEESBURG, VA 20175

FOR: BENGAL LIGHTS; DETONATING FIREWORKS; FIREWORK FOUNTAINS; FIREWORKS; FIREWORKS; FIREWORKS BODIES; FIREWORKS IN SHELL FORMS; FIREWORKS NAMELY, SPARKLERS; POWDERS WHICH BURN WITH COLOR FLAMES FOR PYROTECHNICAL PURPOSES; PROPELLING PYROTECHNIC MIXTURES FOR AMMUNITION AND ROCKET ENGINES; PYROTECHNIC CHARGES; PYROTECHNIC MISSILES; PYROTECHNICS; SHAPES WHICH BURN WITH COLOR FLAMES FOR PYROTECHNICAL PURPOSES; FIRECRACKERS; SMOKE PROJECTILES; DEVICES FOR LAUNCHING SIGNAL ROCKETS AND ILLUMINATION ROCKETS, IN CLASS 13 (U.S. CLS. 2 AND 9).

FIRST USE 4-1-2000; IN COMMERCE 6-1-2006.

FOR: ON-LINE RETAIL STORE SERVICES FEATURING FIREWORKS, PYROTECHNICS, NOISEMAKERS, SPARKLERS, AND RELATED SUPPLIES; RETAIL STORE SERVICES FEATURING FIREWORKS, PYROTECHNICS, NOISEMAKERS, SPARKLERS, AND RELATED SUPPLIES; WHOLE-

SALE DISTRIBUTORSHIPS FEATURING FIREWORKS, PYROTECHNICS, NOISEMAKERS, SPARKLERS, AND RELATED SUPPLIES; WHOLESALE STORES FEATURING FIREWORKS, PYROTECHNICS, NOISEMAKERS, SPARKLERS, AND RELATED SUPPLIES, IN CLASS 35 (U.S. CLS. 100, 101 AND 102).

FIRST USE 4-1-2000; IN COMMERCE 6-1-2001.

THE STIPPLING IS FOR SHADING PURPOSES ONLY.

THE MARK CONSISTS OF A CARTOON-ISH MAN, A WESTERN OR MINER-TYPE CHARACTER, WITH A MOUSTACHE, WEARING A LARGE COWBOY HAT AND HANDKERCHIEF, HAVING AN EXPRESSION OF SURPRISE AND TERROR ON HIS FACE, WHO IS ON TOP OF TWO LIT STICKS OF DYNAMITE THAT ARE IN THE PROCESS OF EXPLODING. THE EXPLOSION CREATES A CLOUD OF SMOKE AROUND WHERE THE CARTOON-ISH MAN MEETS THE DYNAMITE STICKS.

SER. NO. 77-358,598, FILED 12-21-2007.

TOBY BULLOFF, EXAMINING ATTORNEY

Int. Cl.: 35

Prior U.S. Cls.: 100, 101 and 102

United States Patent and Trademark Office

Reg. No. 3,476,267

Registered July 29, 2008

**SERVICE MARK
PRINCIPAL REGISTER**

GOGOBEANS

GOGOBEANS HOLDINGS, LLC (WASHINGTON
LTD LIAB CO)
920 5TH AVENUE N. #7
SEATTLE, WA 98109

FOR: PROMOTING THE GOODS AND SERVICES
OF OTHERS BY DISTRIBUTING ADVERTISING
MATERIALS, PROMOTIONAL OFFERS, AND
COMMERCIAL INFORMATION RELATING TO
SUCH GOODS AND SERVICES THROUGH MOBILE
TELEPHONES AND THE INTERNET; PROVIDING
CONSUMER INFORMATION ABOUT THE GOODS
AND SERVICES OF OTHERS VIA MOBILE TELE-
PHONES AND THE INTERNET; INCENTIVE

AWARD PROGRAMS TO PROMOTE THE SALE
OF GOODS AND SERVICES OF OTHERS, IN CLASS
35 (U.S. CLS. 100, 101 AND 102).

FIRST USE 5-1-2007; IN COMMERCE 5-1-2007.

THE MARK CONSISTS OF STANDARD CHAR-
ACTERS WITHOUT CLAIM TO ANY PARTICULAR
FONT, STYLE, SIZE, OR COLOR.

SER. NO. 77-358,602, FILED 12-21-2007.

JOHN E. MICHOS, EXAMINING ATTORNEY

Int. Cl.: 9

Prior U.S. Cls.: 21, 23, 26, 36 and 38

United States Patent and Trademark Office

Reg. No. 3,476,268

Registered July 29, 2008

**TRADEMARK
PRINCIPAL REGISTER**

CM3BATCH

FIRE PROGRAM SOLUTIONS, LLC (OREGON
LTD LIAB CO)
17067 HOOD COURT
SANDY, OR 97055 AND
CALVIN, MICHAEL (UNITED STATES INDIVI-
DUAL)
P.O. BOX 627
STELLENBOSCH, SOUTH AFRICA 7599

FOR: COMPUTER SOFTWARE USED IN FOREST
FIRE MANAGEMENT, NAMELY, COMPUTER
SOFTWARE THAT FACILITATES THE CALCULA-
TION OF THE AMOUNT OF WOOD AND FOLIAGE

IN TREE CANOPIES, IN CLASS 9 (U.S. CLS. 21, 23, 26,
36 AND 38).

FIRST USE 9-1-2006; IN COMMERCE 9-1-2006.

THE MARK CONSISTS OF STANDARD CHAR-
ACTERS WITHOUT CLAIM TO ANY PARTICULAR
FONT, STYLE, SIZE, OR COLOR.

SER. NO. 77-358,615, FILED 12-21-2007.

SARA THOMAS, EXAMINING ATTORNEY

Int. Cl.: 38

Prior U.S. Cls.: 100, 101 and 104

United States Patent and Trademark Office

Reg. No. 3,476,269

Registered July 29, 2008

**SERVICE MARK
PRINCIPAL REGISTER**

GOGOBEANS

GOGOBEANS HOLDINGS, LLC (WASHINGTON
LTD LIAB CO)
920 5TH AVENUE N. #7
SEATTLE, WA 98109

FOR: WIRELESS COMMUNICATIONS SERVICES, NAMELY, TRANSMISSION OF TEXT AND MULTIMEDIA MESSAGES TO MOBILE TELEPHONES; PROVIDING ON-LINE CHAT ROOMS AND ELECTRONIC BULLETIN BOARDS FOR TRANSMISSION OF MESSAGES AMONG USERS IN THE FIELD OF GENERAL INTEREST; PROVID-

ING EMAIL AND INSTANT MESSAGING SERVICES, IN CLASS 38 (U.S. CLS. 100, 101 AND 104).

FIRST USE 5-1-2007; IN COMMERCE 5-1-2007.

THE MARK CONSISTS OF STANDARD CHARACTERS WITHOUT CLAIM TO ANY PARTICULAR FONT, STYLE, SIZE, OR COLOR.

SER. NO. 77-358,618, FILED 12-21-2007.

JOHN E. MICHOS, EXAMINING ATTORNEY

Int. Cl.: 42

Prior U.S. Cls.: 100 and 101

United States Patent and Trademark Office

Reg. No. 3,476,270

Registered July 29, 2008

**SERVICE MARK
PRINCIPAL REGISTER**

GOGOBEANS

GOGOBEANS HOLDINGS, LLC (WASHINGTON
LTD LIAB CO)
920 5TH AVENUE N. #7
SEATTLE, WA 98109

FOR: COMPUTER SERVICES, NAMELY, HOST-
ING ONLINE WEB FACILITIES FOR OTHERS FOR
ORGANIZING AND CONDUCTING ONLINE
MEETINGS, GATHERINGS, AND INTERACTIVE
DISCUSSIONS; AND COMPUTER SERVICES IN
THE NATURE OF CUSTOMIZED WEB PAGES
FEATURING USER-DEFINED INFORMATION,

PERSONAL PROFILES, BLOGS, AND INFORMA-
TION, IN CLASS 42 (U.S. CLS. 100 AND 101).

FIRST USE 5-1-2007; IN COMMERCE 5-1-2007.

THE MARK CONSISTS OF STANDARD CHAR-
ACTERS WITHOUT CLAIM TO ANY PARTICULAR
FONT, STYLE, SIZE, OR COLOR.

SER. NO. 77-358,620, FILED 12-21-2007.

JOHN E. MICHOS, EXAMINING ATTORNEY

Int. Cl.: 41

Prior U.S. Cls.: 100, 101 and 107

United States Patent and Trademark Office

Reg. No. 3,476,271

Registered July 29, 2008

**SERVICE MARK
PRINCIPAL REGISTER**

Ultra Fantasy Football

SLICKHEAD STUDIOS, INC. (TEXAS CORPORATION)
18706 ISLANDBREEZE DR
SPRING, TX 773794046

FOR: ENTERTAINMENT SERVICES IN THE NATURE OF FANTASY FOOTBALL LEAGUES, IN CLASS 41 (U.S. CLS. 100, 101 AND 107).

FIRST USE 1-1-2007; IN COMMERCE 1-1-2007.

THE MARK CONSISTS OF STANDARD CHARACTERS WITHOUT CLAIM TO ANY PARTICULAR FONT, STYLE, SIZE, OR COLOR.

NO CLAIM IS MADE TO THE EXCLUSIVE RIGHT TO USE "FANTASY FOOTBALL", APART FROM THE MARK AS SHOWN.

SER. NO. 77-358,637, FILED 12-21-2007.

KEVIN CORWIN, EXAMINING ATTORNEY

Int. Cl.: 25

Prior U.S. Cls.: 22 and 39

United States Patent and Trademark Office

Reg. No. 3,476,272

Registered July 29, 2008

**TRADEMARK
PRINCIPAL REGISTER**

H L Walson

HU, JINMING (CHINA INDIVIDUAL)

31500 1ST AVE S., APT. 10-104

FEDERAL WAY, WA 98003

FOR: SHIRTS, SWEATERS, JACKETS, PANTS,
BELTS AND HATS, IN CLASS 25 (U.S. CLS. 22 AND
39).

FIRST USE 10-7-2007; IN COMMERCE 11-17-2007.

THE MARK CONSISTS OF STANDARD CHAR-
ACTERS WITHOUT CLAIM TO ANY PARTICULAR
FONT, STYLE, SIZE, OR COLOR.

THE NAME(S), PORTRAIT(S), AND/OR SIGNA-
TURE(S) SHOWN IN THE MARK DOES NOT IDENTI-
FY A PARTICULAR LIVING INDIVIDUAL.

SER. NO. 77-358,648, FILED 12-21-2007.

SAMUEL E. SHARPER JR., EXAMINING ATTOR-
NEY

Int. Cl.: 35

Prior U.S. Cls.: 100, 101 and 102

United States Patent and Trademark Office

Reg. No. 3,476,273

Registered July 29, 2008

**SERVICE MARK
PRINCIPAL REGISTER**

Whatever Lola Wants

WHATEVER LOLA WANTS, INC. (CALIFORNIA CORPORATION)
834 N. LA BREA AVENUE
LOS ANGELES, CA 90038

FOR: RETAIL STORES FEATURING WOMEN'S AND MEN'S ACCESSORIES, LINGERIE, AND SWIM WEAR, IN CLASS 35 (U.S. CLS. 100, 101 AND 102).

FIRST USE 5-22-2007; IN COMMERCE 5-22-2007.

THE MARK CONSISTS OF STANDARD CHARACTERS WITHOUT CLAIM TO ANY PARTICULAR FONT, STYLE, SIZE, OR COLOR.

SER. NO. 77-358,654, FILED 12-21-2007.

SAMUEL E. SHARPER JR., EXAMINING ATTORNEY

Int. Cl.: 25

Prior U.S. Cls.: 22 and 39

United States Patent and Trademark Office

Reg. No. 3,476,274

Registered July 29, 2008

**TRADEMARK
PRINCIPAL REGISTER**



HU, JINMING (CHINA INDIVIDUAL)
APT. 10-104
31500 1ST AVE S.
FEDERAL WAY, WA 98003

FOR: SHIRTS, SWEATERS, JACKETS, PANTS,
HATS, BELTS, IN CLASS 25 (U.S. CLS. 22 AND 39).

FIRST USE 10-7-2007; IN COMMERCE 11-17-2007.

THE MARK CONSISTS OF STYLIZED DEER
HEAD, FULL FRONTAL VIEW, WITH ANTLERS.

SER. NO. 77-358,657, FILED 12-21-2007.

SAMUEL E. SHARPER JR., EXAMINING ATTOR-
NEY

Int. Cl.: 9

Prior U.S. Cls.: 21, 23, 26, 36 and 38

Reg. No. 3,476,275

United States Patent and Trademark Office

Registered July 29, 2008

**TRADEMARK
PRINCIPAL REGISTER**

EPU

ASUSTEK COMPUTER INC. (TAIWAN CORPORATION)
4F, NO. 150, LI-TE RD.
PEITOU, TAIPEI, TAIWAN

THE MARK CONSISTS OF STANDARD CHARACTERS WITHOUT CLAIM TO ANY PARTICULAR FONT, STYLE, SIZE, OR COLOR.

FOR: COMPUTER GRAPHICS BOARDS, COMPUTER VIDEO CARDS, COMPUTER AUDIO CARDS, COMPUTER CHIPS, SEMI CONDUCTOR CHIPS, COMPUTER MOTHERBOARDS, SILICON CHIPS, IN CLASS 9 (U.S. CLS. 21, 23, 26, 36 AND 38).

SER. NO. 77-358,658, FILED 12-21-2007.

FIRST USE 9-24-2007; IN COMMERCE 10-10-2007.

REBECCA POVARCHUK, EXAMINING ATTORNEY

Int. Cl.: 9

Prior U.S. Cls.: 21, 23, 26, 36 and 38

United States Patent and Trademark Office

Reg. No. 3,476,276

Registered July 29, 2008

**TRADEMARK
PRINCIPAL REGISTER**

BUILD-A-LOT

HIPSOFT, LLC (WASHINGTON LTD LIAB CO)
SUITE #203
8275 166TH AVE. NE
REDMOND, WA 98052

FOR: VIDEO AND COMPUTER GAME PRO-
GRAMS, IN CLASS 9 (U.S. CLS. 21, 23, 26, 36 AND 38).

FIRST USE 7-15-2007; IN COMMERCE 9-8-2007.

THE MARK CONSISTS OF STANDARD CHAR-
ACTERS WITHOUT CLAIM TO ANY PARTICULAR
FONT, STYLE, SIZE, OR COLOR.

SER. NO. 77-358,696, FILED 12-21-2007.

KARANENDRA S. CHHINA, EXAMINING ATTOR-
NEY

Int. Cl.: 45

Prior U.S. Cls.: 100 and 101

United States Patent and Trademark Office

Reg. No. 3,476,277

Registered July 29, 2008

**SERVICE MARK
PRINCIPAL REGISTER**

ZOOSK

ZOOSK, INC. (DELAWARE CORPORATION)
39300 CIVIC CENTER DRIVE, #210
FREMONT, CA 94538

THE MARK CONSISTS OF STANDARD CHAR-
ACTERS WITHOUT CLAIM TO ANY PARTICULAR
FONT, STYLE, SIZE, OR COLOR.

FOR: ONLINE SOCIAL NETWORKING SERVI-
CES, IN CLASS 45 (U.S. CLS. 100 AND 101).

SER. NO. 77-358,727, FILED 12-21-2007.

FIRST USE 12-21-2007; IN COMMERCE 12-21-2007.

HEATHER THOMPSON, EXAMINING ATTORNEY

Int. Cl.: 35

Prior U.S. Cls.: 100, 101 and 102

United States Patent and Trademark Office

Reg. No. 3,476,278

Registered July 29, 2008

**SERVICE MARK
PRINCIPAL REGISTER**



L. SARCONE & SON, INC. (PENNSYLVANIA CORPORATION)
756-58 SOUTH 9TH STREET
PHILADELPHIA, PA 19147

FOR: RETAIL DELICATESSEN SERVICES; RETAIL SHOPS FEATURING BAKED GOODS, IN CLASS 35 (U.S. CLS. 100, 101 AND 102).

FIRST USE 12-0-2007; IN COMMERCE 12-0-2007.

OWNER OF U.S. REG. NO. 3,192,131.

NO CLAIM IS MADE TO THE EXCLUSIVE RIGHT TO USE "DELI", APART FROM THE MARK AS SHOWN.

THE MARK CONSISTS OF A FRUIT-FILLED CORNUCOPIA DESIGN AND THE WORDS "SARCONE'S DELI".

SER. NO. 77-358,729, FILED 12-21-2007.

HEATHER THOMPSON, EXAMINING ATTORNEY

Int. Cl.: 35

Prior U.S. Cls.: 100, 101 and 102

United States Patent and Trademark Office

Reg. No. 3,476,279

Registered July 29, 2008

**SERVICE MARK
PRINCIPAL REGISTER**

PINCOFFS

MAURICE PINCOFFS COMPANY, INC. (TEXAS
CORPORATION)
SUITE 510
2180 NORTH LOOP WEST
HOUSTON, TX 77018

FOR: DISTRIBUTORSHIP SERVICES IN THE
FIELD OF METALS, STEEL-RELATED PRODUCTS,
METAL-RELATED PRODUCTS, AND OTHER COM-
MODITIES; EXPORT AND IMPORT SERVICES IN
THE FIELD OF METALS, STEEL-RELATED PRO-
DUCTS, METAL-RELATED PRODUCTS, AND
OTHER COMMODITIES; EXPORT AND IMPORT
OF GOODS FOR OTHERS; SALES AGENCY SERVI-
CES FOR OTHERS; MARKETING SERVICES IN
THE FIELD OF METALS, METAL-RELATED PRO-
DUCTS, AND OTHER COMMODITIES; PROCURE-
MENT, NAMELY, PURCHASING OF METALS,
METAL-RELATED PRODUCTS, AND OTHER COM-

MODITIES FOR OTHERS, IN CLASS 35 (U.S. CLS.
100, 101 AND 102).

FIRST USE 12-31-1905; IN COMMERCE 12-31-1905.

THE MARK CONSISTS OF STANDARD CHAR-
ACTERS WITHOUT CLAIM TO ANY PARTICULAR
FONT, STYLE, SIZE, OR COLOR.

THE NAME(S), PORTRAIT(S), AND/OR SIGNA-
TURE(S) SHOWN IN THE MARK DOES NOT IDEN-
TIFY A PARTICULAR LIVING INDIVIDUAL.

SEC. 2(F).

SER. NO. 77-358,731, FILED 12-21-2007.

MARY ROSSMAN, EXAMINING ATTORNEY

Int. Cl.: 35

Prior U.S. Cls.: 100, 101 and 102

United States Patent and Trademark Office

Reg. No. 3,476,280

Registered July 29, 2008

**SERVICE MARK
PRINCIPAL REGISTER**

**MAURICE PINCOFFS COMPANY,
INC.**

MAURICE PINCOFFS COMPANY, INC. (TEXAS
CORPORATION)
SUITE 510
2180 NORTH LOOP WEST
HOUSTON, TX 77018

FOR: DISTRIBUTORSHIP SERVICES IN THE
FIELD OF METALS, STEEL-RELATED PRODUCTS,
METAL-RELATED PRODUCTS, AND OTHER COM-
MODITIES; EXPORT AND IMPORT SERVICES IN
THE FIELD OF METALS, STEEL-RELATED PRO-
DUCTS, METAL-RELATED PRODUCTS, AND
OTHER COMMODITIES; EXPORT AND IMPORT
OF GOODS FOR OTHERS; SALES AGENCY SERVI-
CES FOR OTHERS; MARKETING SERVICES IN
THE FIELD OF METALS, METAL-RELATED PRO-
DUCTS, AND OTHER COMMODITIES; PROCURE-
MENT, NAMELY, PURCHASING OF METALS,
METAL-RELATED PRODUCTS, AND OTHER COM-
MODITIES FOR OTHERS, IN CLASS 35 (U.S. CLS.
100, 101 AND 102).

FIRST USE 12-31-1905; IN COMMERCE 12-31-1905.

THE MARK CONSISTS OF STANDARD CHAR-
ACTERS WITHOUT CLAIM TO ANY PARTICULAR
FONT, STYLE, SIZE, OR COLOR.

NO CLAIM IS MADE TO THE EXCLUSIVE
RIGHT TO USE "COMPANY, INC.", APART FROM
THE MARK AS SHOWN.

THE NAME(S), PORTRAIT(S), AND/OR SIGNA-
TURE(S) SHOWN IN THE MARK DOES NOT IDEN-
TIFY A PARTICULAR LIVING INDIVIDUAL.

SER. NO. 77-358,733, FILED 12-21-2007.

MARY ROSSMAN, EXAMINING ATTORNEY

Int. Cl.: 25

Prior U.S. Cls.: 22 and 39

United States Patent and Trademark Office

Reg. No. 3,476,281

Registered July 29, 2008

TRADEMARK
PRINCIPAL REGISTER



MUÑIZ, ALICIA JORGELINA (ARGENTINA IN-
DIVIDUAL)
ARENALES 1239 PISO 30. DEPTO "M"
BUENOS AIRES, ARGENTINA

FOR: SHOES; FOOTWEAR, IN CLASS 25 (U.S. CLS.
22 AND 39).

FIRST USE 10-1-2003; IN COMMERCE 2-10-2006.

NO CLAIM IS MADE TO THE EXCLUSIVE
RIGHT TO USE "BUENOS AIRES", APART FROM
THE MARK AS SHOWN.

THE MARK CONSISTS OF A CIRCULAR AB-
STRACT DESIGN SIMILAR TO A FINGERPRINT
BELOW OF WHICH APPEAR THE WORDS
"COMME IL FAUT BUENOS AIRES" IN STYLIZED
LETTERS.

THE FOREIGN WORDING IN THE MARK
TRANSLATES INTO ENGLISH AS AS IT SHOULD
BE BUENOS AIRES.

SER. NO. 77-358,759, FILED 12-22-2007.

DAVID HOFFMAN, EXAMINING ATTORNEY

Int. Cl.: 7

Prior U.S. Cls.: 13, 19, 21, 23, 31, 34 and 35

Reg. No. 3,476,282

United States Patent and Trademark Office

Registered July 29, 2008

**TRADEMARK
PRINCIPAL REGISTER**



FOSHAN NANHAI DONGFANG CARTON MACHINERY CO., LTD. (CHINA LTD LIAB CO)
SHISHAN TECHNICAL INDUSTRIAL ZONE
SHISHAN ROAD NORTH, NANHAI DISTRICT
FOSHAN CITY, CHINA

FOR: WRAPPING MACHINES; TYPESETTING MACHINES; PHOTOTYPESETTING OR COMPOSING MACHINES; MACHINE PARTS, NAMELY, CYLINDERS; PACKAGING MACHINES; ELECTRIC PUMPS; SHEAF-BINDING MACHINES; PACKING MACHINES; EMBOSsing MACHINES; MACHINE-OPERATED PLATFORMS FOR STORING PAPER IN PRINTING PRESSES DURING THE PRINTING PROCESS; PAPER BAG MAKING MACHINES; PAPER CALENDERING MACHINES; PAPER COATING MACHINES; PAPER CUTTING MACHINES; PAPER REELING MACHINES; PAPER SHREDDING MACHINES; PRESS FABRIC FOR PAPER MAKING MACHINES; SHREDDING MACHINES;

FLEXOGRAPHIC PRINTING MACHINES; INKING APPARATUS FOR PRINTING BLOCKS; INTAGLIO PRINTING MACHINES; PHOTOGRAVURE PRINTING PRESSES; PLANOGRAPHIC PRINTING MACHINES; PRINTING MACHINES FOR COMMERCIAL OR INDUSTRIAL USE; PRINTING PLATES; PRINTING PRESSES; PRINTING PRESSES FOR CERAMIC MATERIAL; ROLLERS FOR ROTARY PRINTING MACHINES, IN CLASS 7 (U.S. CLS. 13, 19, 21, 23, 31, 34 AND 35).

FIRST USE 1-14-1998; IN COMMERCE 3-31-2006.

THE MARK CONSISTS OF ITALICIZED AND CAPITALIZED LETTER D.

SER. NO. 77-358,778, FILED 12-22-2007.

BARBARA GAYNOR, EXAMINING ATTORNEY

Int. Cl.: 44

Prior U.S. Cls.: 100 and 101

United States Patent and Trademark Office

Reg. No. 3,476,283

Registered July 29, 2008

**SERVICE MARK
PRINCIPAL REGISTER**



CHALIKIAN CHIROPRACTIC CORPORATION
(CALIFORNIA CORPORATION), DBA CALI-
FORNIA CHIROPRACTIC CARE

SUITE 619

16 N. MARENGO AVENUE

PASADENA, CA 91101

FOR: CHIROPRACTIC SERVICES; PHYSICAL
THERAPY; BODYWORK THERAPY, IN CLASS 44
(U.S. CLS. 100 AND 101).

FIRST USE 5-1-2006; IN COMMERCE 5-1-2006.

NO CLAIM IS MADE TO THE EXCLUSIVE
RIGHT TO USE "CALIFORNIA CHIROPRACTIC
CARE", APART FROM THE MARK AS SHOWN.

THE MARK CONSISTS OF THREE (3) STYLIZED
LETTER "C"S IN A PARTIALLY SHADED CIRCLE
WITH THE WORDS "CALIFORNIA CHIROPRACTIC
CARE" TO THE RIGHT.

SER. NO. 77-358,864, FILED 12-22-2007.

MATTHEW MCDOWELL, EXAMINING ATTOR-
NEY

Int. Cl.: 37

Prior U.S. Cls.: 100, 103 and 106

United States Patent and Trademark Office

Reg. No. 3,476,284

Registered July 29, 2008

**SERVICE MARK
PRINCIPAL REGISTER**

CLEANING THE ITEMS YOU
CARE ABOUT THE MOST ...FOR
OVER 100 YEARS

PENINO FRENCH LAUNDRY & CLEANERS,
INC. (CALIFORNIA CORPORATION)
101 SOUTH MAPLE AVE.
SOUTH SAN FRANCISCO, CA 94080

THE MARK CONSISTS OF STANDARD CHAR-
ACTERS WITHOUT CLAIM TO ANY PARTICULAR
FONT, STYLE, SIZE, OR COLOR.

FOR: DRY CLEANING; LAUNDRY SERVICES,
IN CLASS 37 (U.S. CLS. 100, 103 AND 106).

SER. NO. 77-358,881, FILED 12-23-2007.

FIRST USE 1-0-2005; IN COMMERCE 1-0-2005.

NELSON SNYDER, EXAMINING ATTORNEY

Int. Cl.: 41

Prior U.S. Cls.: 100, 101 and 107

United States Patent and Trademark Office

Reg. No. 3,476,285

Registered July 29, 2008

**SERVICE MARK
PRINCIPAL REGISTER**

My Encore Career

HAN, PETER (UNITED STATES INDIVIDUAL)
2429 CHANTILLY LANE
CONROE, TX 773843625 AND
FERNANDEZ, MARIA E. (UNITED STATES INDIVIDUAL)
2429 CHANTILLY LANE
CONROE, TX 773843625

FOR: EDUCATIONAL SERVICES, NAMELY, CONDUCTING CLASSES, SEMINARS, WORKSHOPS, CONFERENCES, MENTORING, AND COACHING IN THE FIELD OF CREATING NEW CAREERS FOR THOSE OVER FORTY YEARS OF AGE FOCUSED ON PUBLIC SERVICE AND SOCIAL PHILANTHROPY AND DISTRIBUTION OF

COURSE MATERIAL IN CONNECTION THEREWITH, IN CLASS 41 (U.S. CLS. 100, 101 AND 107).

FIRST USE 2-14-2007; IN COMMERCE 2-14-2007.

THE MARK CONSISTS OF STANDARD CHARACTERS WITHOUT CLAIM TO ANY PARTICULAR FONT, STYLE, SIZE, OR COLOR.

NO CLAIM IS MADE TO THE EXCLUSIVE RIGHT TO USE "CAREER" , APART FROM THE MARK AS SHOWN.

SER. NO. 77-358,902, FILED 12-23-2007.

WENDY GOODMAN, EXAMINING ATTORNEY

Int. Cls.: 42 and 45

Prior U.S. Cls.: 100 and 101

United States Patent and Trademark Office

Reg. No. 3,476,286

Registered July 29, 2008

**SERVICE MARK
PRINCIPAL REGISTER**

**Lock-in success. Because
information travels...**

ECLIPSECURITY, LLC (ILLINOIS LTD LIAB CO)
1278 BARCLAY BOULEVARD
BUFFALO GROVE, IL 60089

FOR: COMPUTER CONSULTATION IN THE
FIELD OF COMPUTER SECURITY; CONSULTA-
TION SERVICES IN THE FIELDS OF SELECTION,
IMPLEMENTATION AND USE OF COMPUTER
HARDWARE AND SOFTWARE SYSTEMS FOR
OTHERS, IN CLASS 42 (U.S. CLS. 100 AND 101).

FIRST USE 9-20-2007; IN COMMERCE 9-20-2007.

FOR: CONSULTING AND LEGAL SERVICES IN
THE FIELD OF PRIVACY AND SECURITY LAWS,

REGULATIONS, AND REQUIREMENTS; SECUR-
ITY SERVICES, NAMELY, PROVIDING SECURITY
ASSESSMENTS OF PHYSICAL LOCATIONS, IN-
FORMATION SYSTEMS, AND WORKING ENVIR-
ONMENTS, IN CLASS 45 (U.S. CLS. 100 AND 101).

FIRST USE 9-20-2007; IN COMMERCE 9-20-2007.

THE MARK CONSISTS OF STANDARD CHAR-
ACTERS WITHOUT CLAIM TO ANY PARTICULAR
FONT, STYLE, SIZE, OR COLOR.

SER. NO. 77-358,922, FILED 12-23-2007.

C. DIONNE CLYBURN, EXAMINING ATTORNEY

Int. Cl.: 16

Prior U.S. Cls.: 2, 5, 22, 23, 29, 37, 38 and 50

United States Patent and Trademark Office

Reg. No. 3,476,287

Registered July 29, 2008

**TRADEMARK
PRINCIPAL REGISTER**

DRIVING REFLECTIONS

Inspiration for the Road!

GET IT IN YOUR SOUL, INC. (MINNESOTA CORPORATION)
8360 XYLON CIRCLE
BLOOMINGTON, MN 55438

FOR: MOTIVATIONAL CARDS; PRINTED INFORMATIONAL CARDS IN THE FIELD OF RETAIL GIFTS AND NOVELTY MERCHANDISE INCLUDING CARD HOLDER SPECIFICALLY ADAPTED THEREFOR AND AFFIXABLE TO AN AUTOMOBILE DASHBOARD FEATURING SAYINGS AFFIRMATIONS AND MOTIVATIONAL MESSAGES, IN CLASS 16 (U.S. CLS. 2, 5, 22, 23, 29, 37, 38 AND 50).

FIRST USE 10-15-2007; IN COMMERCE 12-17-2007.

OWNER OF U.S. REG. NO. 3,280,009.

THE MARK CONSISTS OF TWO LINES OF TEXT WITH THE FIRST LINE BEING THE WORDS

"DRIVING REFLECTIONS", THE SECOND LINE BEING "INSPIRATION FOR THE ROAD!", IN THE FONT ITC CONDUIT. THE WORD "DRIVING" IS IN ALL CAPS, BLACK LETTERS ON A WHITE BACKGROUND OUTLINED IN A THIN BLACK BORDER THAT CONNECTS HORIZONTALLY TO THE NEXT WORD, "REFLECTIONS", WHICH IS IN ALL CAPS, WHITE LETTERS ON A BLACK BACKGROUND, CREATING A RECTANGLE OF THE TWO WORDS. UNDER "DRIVING REFLECTIONS", THE SENTENCE: "INSPIRATION FOR THE ROAD!" IS IN BLACK TYPE, SMALLER ITC CONDUIT FONT, UPPER AND LOWER CASE, AND CENTERED UNDER THE "DRIVING REFLECTIONS" RECTANGLE, BETWEEN THE LETTERS "I" AND "T".

SER. NO. 77-358,925, FILED 12-23-2007.

C. DIONNE CLYBURN, EXAMINING ATTORNEY

Int. Cl.: 41

Prior U.S. Cls.: 100, 101 and 107

United States Patent and Trademark Office

Reg. No. 3,476,288

Registered July 29, 2008

**SERVICE MARK
PRINCIPAL REGISTER**

**Famous for capturing the
individuality and charm of
adults and children**

STUDIO GROUP INCORPORATED (MARYLAND
CORPORATION), DBA BROOKS GLOGAU
PHOTOGRAPHERS
5110 RIDGEFIELD RD # 208
BETHESDA, MD 20816

THE MARK CONSISTS OF STANDARD CHAR-
ACTERS WITHOUT CLAIM TO ANY PARTICULAR
FONT, STYLE, SIZE, OR COLOR.

FOR: PHOTOGRAPHY; PHOTOGRAPHY SERVI-
CES; PORTRAIT PHOTOGRAPHY, IN CLASS 41
(U.S. CLS. 100, 101 AND 107).

SER. NO. 77-358,996, FILED 12-24-2007.

FIRST USE 0-0-1975; IN COMMERCE 1-1-2005.

NELSON SNYDER, EXAMINING ATTORNEY

Int. Cl.: 25

Prior U.S. Cls.: 22 and 39

United States Patent and Trademark Office

Reg. No. 3,476,289

Registered July 29, 2008

**TRADEMARK
PRINCIPAL REGISTER**



SOLPATCH, INC. (FLORIDA CORPORATION)
17621 CIRCLE POND COURT
BOCA RATON, FL 33496

FOR: MEN'S, WOMEN'S AND CHILDREN'S
CLOTHING, NAMELY, T-SHIRTS, SWEAT SHIRTS,
SWEAT PANTS, HATS AND PANTS, IN CLASS 25
(U.S. CLS. 22 AND 39).

FIRST USE 3-19-2007; IN COMMERCE 3-19-2007.

THE COLOR(S) RED AND GREY IS/ARE
CLAIMED AS A FEATURE OF THE MARK.

THE MARK CONSISTS OF THE WORD "SOL-
PATCH" IN A CAPITALIZED STYLIZED FONT
WITH THE TAGLINE (THE "TAGLINE") "YOUR
MESSAGE YOUR MARK" LOCATED BELOW
WORD THE "SOLPATCH" WITH A STYLIZED "X"
IN BETWEEN THE WORDS "MESSAGE" AND
"YOUR" OF THE TAGLINE. THE WORK "SOL-
PATCH" AND THE STYLIZED "X" IN THE TAG-
LINE ARE A RED COLOR AND THE PHRASE
"YOUR MESSAGE YOUR MARK" IN THE TAG-
LINE IS A GREY COLOR .

SER. NO. 77-359,022, FILED 12-24-2007.

ELISSA GARBER KON, EXAMINING ATTORNEY

Int. Cl.: 41

Prior U.S. Cls.: 100, 101 and 107

United States Patent and Trademark Office

Reg. No. 3,476,290

Registered July 29, 2008

SERVICE MARK
PRINCIPAL REGISTER



ELLA FITNESS HOLDINGS, INC. (RHODE ISLAND CORPORATION), DBA LUXE FITNESS CLUBS

115 GRANITE STREET
WESTERLY, RI 02891

FOR: HEALTH CLUB SERVICES, NAMELY, PROVIDING INSTRUCTION AND EQUIPMENT IN THE FIELD OF PHYSICAL EXERCISE, IN CLASS 41 (U.S. CLS. 100, 101 AND 107).

FIRST USE 12-5-2007; IN COMMERCE 12-5-2007.

NO CLAIM IS MADE TO THE EXCLUSIVE RIGHT TO USE "FITNESS CLUBS", APART FROM THE MARK AS SHOWN.

THE COLOR(S) MAROON, GRAY AND SILVER IS/ARE CLAIMED AS A FEATURE OF THE MARK.

THE MARK CONSISTS OF THE WORD "LUXE" IN LARGE, ALL CAPITAL LETTERS, MAROON IN COLOR, EXCEPT THE "X", WHICH IS GRAY IN COLOR, BELOW WHICH APPEAR THE WORDS "FITNESS CLUBS", INITIAL CAPITALS ONLY, IN A SMALLER FONT AND MAROON IN COLOR, ALL OF WHICH IS SET FORTH WITHIN A SILVER OVAL WITH A MAROON BORDER AND A GRAY SHADOW TO THE BOTTOM AND RIGHT SIDE OF THE OVAL.

SER. NO. 77-359,036, FILED 12-24-2007.

KARANENDRA S. CHHINA, EXAMINING ATTORNEY

Int. Cl.: 21

Prior U.S. Cls.: 2, 13, 23, 29, 30, 33, 40 and 50

United States Patent and Trademark Office

Reg. No. 3,476,291

Registered July 29, 2008

**TRADEMARK
PRINCIPAL REGISTER**

NESIUM

CANTINA ARREDO S.R.L. (ITALY LTD LIAB
CO)
VIA F. SEVERI 6/8
CAMPODARSEGO (PADOVA), ITALY

FOR: GLASS BEVERAGWARE; BEVERAGE
GLASSWARE; DRINKING GLASSES; WATER
GLASSES; SPIRIT GLASSES; SOFT DRINK GLAS-
SES; WINE GLASSES; SPARKLING WINE GLASSES;
CHAMPAGNE GLASSES; TALL NARROW WINE
GLASSES, NAMELY, FLUTES; GLASS MUGS; BEER
MUGS; PILSNER DRINKING GLASSES; SHOT
GLASSES; GOBLETS; GLASS TUMBLERS; GLASS
CUPS; GLASS JUGS; DECANTERS; GLASS DECAN-
TERS; GLASS CARAFES; GLASS BOWLS FOR

WINE, IN CLASS 21 (U.S. CLS. 2, 13, 23, 29, 30, 33, 40
AND 50).

FIRST USE 12-31-2005; IN COMMERCE 12-31-2005.

THE MARK CONSISTS OF STANDARD CHAR-
ACTERS WITHOUT CLAIM TO ANY PARTICULAR
FONT, STYLE, SIZE, OR COLOR.

SER. NO. 77-359,046, FILED 12-24-2007.

ALEXANDER L. POWERS, EXAMINING ATTOR-
NEY

Int. Cl.: 40

Prior U.S. Cls.: 100, 103 and 106

United States Patent and Trademark Office

Reg. No. 3,476,292

Registered July 29, 2008

**SERVICE MARK
PRINCIPAL REGISTER**

BUILD YOUR DREAM

LATEX FOAM INTERNATIONAL HOLDINGS,
INC. (CONNECTICUT CORPORATION)
510 RIVER ROAD
SHELTON, CT 06484

THE MARK CONSISTS OF STANDARD CHAR-
ACTERS WITHOUT CLAIM TO ANY PARTICULAR
FONT, STYLE, SIZE, OR COLOR.

FOR: MANUFACTURE OF LATEX FOAM PIL-
LOWS, MATTRESSES AND MATTRESS TOPPERS
TO ORDER AND/OR SPECIFICATION OF OTHERS,
IN CLASS 40 (U.S. CLS. 100, 103 AND 106).

SER. NO. 77-359,047, FILED 12-24-2007.

FIRST USE 7-23-2007; IN COMMERCE 7-23-2007.

LANA PHAM, EXAMINING ATTORNEY

Int. Cl.: 17

Prior U.S. Cls.: 1, 5, 12, 13, 35 and 50

United States Patent and Trademark Office

Reg. No. 3,476,293

Registered July 29, 2008

**TRADEMARK
PRINCIPAL REGISTER**

DAMPLIFIER

SECOND SKIN AUDIO, LLC (ARIZONA LTD
LIAB CO)
SUITE 3
3611 W. CAMBRIDGE AVENUE
PHOENIX, AZ 85009

FOR: SOUND AND VIBRATION ABSORBING
UNDERLAYMENT FOR AUTOMOBILES IN THE
NATURE OF ACOUSTICAL INSULATION BARRI-
ERS, IN CLASS 17 (U.S. CLS. 1, 5, 12, 13, 35 AND 50).

FIRST USE 11-23-2002; IN COMMERCE 11-30-2002.

THE MARK CONSISTS OF STANDARD CHAR-
ACTERS WITHOUT CLAIM TO ANY PARTICULAR
FONT, STYLE, SIZE, OR COLOR.

SER. NO. 77-359,051, FILED 12-24-2007.

MATTHEW MCDOWELL, EXAMINING ATTOR-
NEY

Int. Cl.: 5

Prior U.S. Cls.: 6, 18, 44, 46, 51 and 52

Reg. No. 3,476,294

United States Patent and Trademark Office

Registered July 29, 2008

**TRADEMARK
PRINCIPAL REGISTER**

LEAN1

NUTRITION 53, INC. (CALIFORNIA CORPORATION)
3706 MT. DIABLO BLVD SUITE 300
LAFAYETTE, CA 94549

THE MARK CONSISTS OF STANDARD CHARACTERS WITHOUT CLAIM TO ANY PARTICULAR FONT, STYLE, SIZE, OR COLOR.

FOR: DIETARY DRINK MIX FOR USE AS A MEAL REPLACEMENT; DIETARY SUPPLEMENTAL DRINKS; DIETARY SUPPLEMENTS, IN CLASS 5 (U.S. CLS. 6, 18, 44, 46, 51 AND 52).

SER. NO. 77-359,073, FILED 12-24-2007.

FIRST USE 8-1-2006; IN COMMERCE 11-11-2006.

KATHRYN COWARD, EXAMINING ATTORNEY

Int. Cl.: 5

Prior U.S. Cls.: 6, 18, 44, 46, 51 and 52

United States Patent and Trademark Office

Reg. No. 3,476,295

Registered July 29, 2008

**TRADEMARK
PRINCIPAL REGISTER**

THERMOPHORIC

SPECTRA FORCE RESEARCH, LLC (CALIFORNIA LTD LIAB CO)
18742 VIA SIENA
IRVINE, CA 92603

THE MARK CONSISTS OF STANDARD CHARACTERS WITHOUT CLAIM TO ANY PARTICULAR FONT, STYLE, SIZE, OR COLOR.

FOR: DIETARY AND NUTRITIONAL SUPPLEMENTS, IN CLASS 5 (U.S. CLS. 6, 18, 44, 46, 51 AND 52).

SER. NO. 77-359,089, FILED 12-24-2007.

FIRST USE 11-1-2006; IN COMMERCE 11-1-2006.

KEVON CHISOLM, EXAMINING ATTORNEY

Int. Cls.: 29 and 30

Prior U.S. Cl.: 46

United States Patent and Trademark Office

Reg. No. 3,476,296

Registered July 29, 2008

**TRADEMARK
PRINCIPAL REGISTER**

KIMBERLEY

CALIFORNIA CONCENTRATE CO. (CALIFORNIA CORPORATION), DBA KIMBERLEY WINE VINEGAR WORKS
18678 N. HIGHWAY 99
ACAMPO, CA 95220

FIRST USE 10-0-1979; IN COMMERCE 10-0-1979.

THE MARK CONSISTS OF STANDARD CHARACTERS WITHOUT CLAIM TO ANY PARTICULAR FONT, STYLE, SIZE, OR COLOR.

FOR: OLIVE OIL, IN CLASS 29 (U.S. CL. 46).

SER. NO. 77-359,098, FILED 12-24-2007.

FIRST USE 10-0-1979; IN COMMERCE 10-0-1979.

FOR: WINE VINEGAR, IN CLASS 30 (U.S. CL. 46).

ESTHER BELENKER, EXAMINING ATTORNEY

Int. Cl.: 3

Prior U.S. Cls.: 1, 4, 6, 50, 51 and 52

United States Patent and Trademark Office

Reg. No. 3,476,297

Registered July 29, 2008

**TRADEMARK
PRINCIPAL REGISTER**

COMBAT-READY

DAMELIO, SARA M (DELAWARE LTD LIAB CO)
1900 LYTTONSVILLE RD. #1210
SILVER SPRING, MD 20910

FIRST USE 10-31-2001; IN COMMERCE 10-31-2001.

THE MARK CONSISTS OF "COMBAT-READY".

FOR: SKIN, NAMELY, FACE AND BODY, CARE
PRODUCTS, NAMELY, SKIN BALM, LIP BALM,
SHAMPOO, CONDITIONER, CLEANSER, TONER,
SHAVING CREAM, SOAP, IN CLASS 3 (U.S. CLS. 1, 4,
6, 50, 51 AND 52).

SER. NO. 77-359,113, FILED 12-24-2007.

SKYE YOUNG, EXAMINING ATTORNEY

Int. Cls.: 29 and 30

Prior U.S. Cl.: 46

United States Patent and Trademark Office

Reg. No. 3,476,298

Registered July 29, 2008

**TRADEMARK
PRINCIPAL REGISTER**



OLÉ MEXICAN FOODS, INC. (GEORGIA CORPORATION)
6585 CRESCENT DRIVE
NORCROSS, GA 30071

THE COLOR(S) WHITE, GREEN, AND BROWN IS/ARE CLAIMED AS A FEATURE OF THE MARK.

FOR: MEXICAN STYLE FOOD PRODUCTS, NAMELY, YOGURT BASED BEVERAGES, IN CLASS 29 (U.S. CL. 46).

THE MARK CONSISTS OF THE PHRASE "XTREME WELLNESS!" IN WHITE LETTERS ON A GREEN BACKGROUND WITH A BROWN OUTLINE AROUND THE LETTERS AND THE GREEN BACKGROUND.

FIRST USE 12-0-2007; IN COMMERCE 12-0-2007.

FOR: MEXICAN STYLE FOOD PRODUCTS, NAMELY, TORTILLAS, IN CLASS 30 (U.S. CL. 46).

SER. NO. 77-359,116, FILED 12-24-2007.

FIRST USE 1-0-2008; IN COMMERCE 1-0-2008.

SKYE YOUNG, EXAMINING ATTORNEY

Int. Cl.: 14

Prior U.S. Cls.: 2, 27, 28 and 50

United States Patent and Trademark Office

Reg. No. 3,476,299

Registered July 29, 2008

**TRADEMARK
PRINCIPAL REGISTER**

It's a Bead-a-ful Life

KAREN HAWES (UNITED STATES INDIVIDUAL)
13650 WILLOW BRIDGE DRIVE
NORTH FORT MYERS, FL 33903

FOR: BEADS FOR USE IN THE MANUFACTURE OF JEWELRY; BRACELETS; CHARMS; COSTUME JEWELRY; GEMSTONE JEWELRY; IDENTIFICATION BRACELETS; JEWELRY; JEWELRY CHAINS; JEWELRY FOR THE HEAD; JEWELRY, NAMELY, CROSSES; RINGS, IN CLASS 14 (U.S. CLS. 2, 27, 28 AND 50).

FIRST USE 4-22-2007; IN COMMERCE 5-5-2007.

THE MARK CONSISTS OF STANDARD CHARACTERS WITHOUT CLAIM TO ANY PARTICULAR FONT, STYLE, SIZE, OR COLOR.

SER. NO. 77-359,119, FILED 12-24-2007.

JEFFERY COWARD, EXAMINING ATTORNEY

Int. Cl.: 42

Prior U.S. Cls.: 100 and 101

United States Patent and Trademark Office

Reg. No. 3,476,300

Registered July 29, 2008

**SERVICE MARK
PRINCIPAL REGISTER**

CONSILIUM DESIGN

CONSILIUM DESIGN, INC. (COLORADO CORPORATION)
7353 SOUTH ALTON WAY, SUITE 135
CENTENNIAL, CO 80112

FOR: LANDSCAPE ARCHITECTURAL DESIGN AND LAND USE PLANNING SERVICES, IN CLASS 42 (U.S. CLS. 100 AND 101).

FIRST USE 8-5-2005; IN COMMERCE 8-5-2005.

THE MARK CONSISTS OF STANDARD CHARACTERS WITHOUT CLAIM TO ANY PARTICULAR FONT, STYLE, SIZE, OR COLOR.

NO CLAIM IS MADE TO THE EXCLUSIVE RIGHT TO USE "DESIGN", APART FROM THE MARK AS SHOWN.

SER. NO. 77-359,130, FILED 12-24-2007.

SUNG IN, EXAMINING ATTORNEY

Int. Cl.: 41

Prior U.S. Cls.: 100, 101 and 107

United States Patent and Trademark Office

Reg. No. 3,476,301

Registered July 29, 2008

**SERVICE MARK
PRINCIPAL REGISTER**

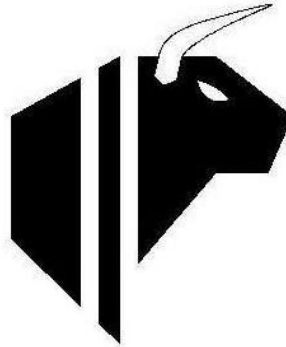

IBEROVOX COMMUNICATIONS, INC. (CONNECTICUT CORPORATION)
SUITE 101
3 MAYRAND WAY
WINDSOR LOCKS, CT 06096

FOR: LANGUAGE TRANSLATION; TRANSLATION SERVICES; LANGUAGE INTERPRETATION; LANGUAGE INTERPRETING; PROVIDING VOICE OVERS FOR TAPES, RECORDS AND OTHER RECORDED MEDIA, IN CLASS 41 (U.S. CLS. 100, 101 AND 107).

THE MARK CONSISTS OF OX/BULL FACING TOWARDS THE RIGHT, HORNS POINTING FORWARD, WITH TWO VERTICAL LINES CUTTING THROUGH THE NECK OF THE OX/BULL, THE LEFT LINE BEING OF SMALLER WIDTH THE THE RIGHT LINE..

SER. NO. 77-359,200, FILED 12-25-2007.

FIRST USE 7-31-2007; IN COMMERCE 7-31-2007.

PATRICIA EVANKO, EXAMINING ATTORNEY

Int. Cl.: 15

Prior U.S. Cls.: 2, 21 and 36

United States Patent and Trademark Office

Reg. No. 3,476,302

Registered July 29, 2008

TRADEMARK
PRINCIPAL REGISTER



NICEWONGER, MARK RANDAL (UNITED STATES INDIVIDUAL), DBA PHOENIX MUSICAL INSTRUMENTS
5960 FREEDOM BLVD.
APTOS, CA 95003

FOR: WOODWIND INSTRUMENTS, IN CLASS 15 (U.S. CLS. 2, 21 AND 36).

FIRST USE 7-1-2007; IN COMMERCE 9-4-2007.

THE MARK CONSISTS OF THE STYLIZED FONT FOR THE LITERAL ELEMENT "WINDSONG".

SER. NO. 77-359,210, FILED 12-26-2007.

WENDY GOODMAN, EXAMINING ATTORNEY

Int. Cls.: 9 and 16

Prior U.S. Cls.: 2, 5, 21, 22, 23, 26, 29, 36, 37, 38 and 50

United States Patent and Trademark Office

Reg. No. 3,476,303

Registered July 29, 2008

**TRADEMARK
PRINCIPAL REGISTER**

PSORIASIS SKINSIGHTS

NATIONAL PSORIASIS FOUNDATION (ORE-
GON CORPORATION)
SUITE 300
6600 S.W. 92ND AVENUE
PORTLAND, OR 97223

FOR: DOWNLOADABLE ELECTRONIC NEWS-
LETTER IN THE FIELD OF PSORIASIS AND PSOR-
IATIC ARTHRITIS, IN CLASS 9 (U.S. CLS. 21, 23, 26,
36 AND 38).

FIRST USE 1-31-2007; IN COMMERCE 1-31-2007.

FOR: NEWSLETTER IN THE FIELD OF PSORIA-
SIS AND PSORIATIC ARTHRITIS, IN CLASS 16 (U.S.
CLS. 2, 5, 22, 23, 29, 37, 38 AND 50).

FIRST USE 1-31-2007; IN COMMERCE 1-31-2007.

THE MARK CONSISTS OF STANDARD CHAR-
ACTERS WITHOUT CLAIM TO ANY PARTICULAR
FONT, STYLE, SIZE, OR COLOR.

NO CLAIM IS MADE TO THE EXCLUSIVE
RIGHT TO USE "PSORIASIS", APART FROM THE
MARK AS SHOWN.

SER. NO. 77-359,310, FILED 12-26-2007.

DAVID I, EXAMINING ATTORNEY

Int. Cl.: 35

Prior U.S. Cls.: 100, 101 and 102

United States Patent and Trademark Office

Reg. No. 3,476,304

Registered July 29, 2008

**SERVICE MARK
PRINCIPAL REGISTER**



MAJDPEZESHKI, SAYEH (IRAN INDIVIDUAL)
24646 VISTA CERRITOS
CALABASAS, CA 91302

FIRST USE 9-1-2007; IN COMMERCE 9-1-2007.

SER. NO. 77-359,345, FILED 12-26-2007.

FOR: BUSINESS NETWORKING, IN CLASS 35
(U.S. CLS. 100, 101 AND 102).

COLLEEN KEARNEY, EXAMINING ATTORNEY

Int. Cl.: 30

Prior U.S. Cl.: 46

United States Patent and Trademark Office

Reg. No. 3,476,305

Registered July 29, 2008

**TRADEMARK
PRINCIPAL REGISTER**



MITIDIERI, MONICA (UNITED STATES INDIVIDUAL)

3611 THORNAPPLE RIVER DR SE
GRAND RAPIDS, MI 49546

FOR: COOKIES, IN CLASS 30 (U.S. CL. 46).

FIRST USE 12-15-2002; IN COMMERCE 12-15-2002.

THE STIPPLING IS FOR SHADING PURPOSES ONLY.

THE MARK CONSISTS OF STYLIZED TEXT OF "M MBGC".

SER. NO. 77-359,357, FILED 12-26-2007.

MARK PILARO, EXAMINING ATTORNEY

Int. Cl.: 16

Prior U.S. Cls.: 2, 5, 22, 23, 29, 37, 38 and 50

Reg. No. 3,476,306

United States Patent and Trademark Office

Registered July 29, 2008

**TRADEMARK
PRINCIPAL REGISTER**

RATTLE-N-ROLL

LOYKO, ANDREA (UNITED STATES INDIVIDUAL), DBA RATTLE-N-ROLL
3743 RACINE ROAD
SAN DIEGO, CA 92115 AND
LOYKO, RYAN (UNITED STATES INDIVIDUAL),
DBA RATTLE-N-ROLL
3743 RACINE ROAD
SAN DIEGO, CA 92115

FIRST USE 7-1-2005; IN COMMERCE 4-30-2006.

THE MARK CONSISTS OF STANDARD CHARACTERS WITHOUT CLAIM TO ANY PARTICULAR FONT, STYLE, SIZE, OR COLOR.

SER. NO. 77-359,367, FILED 12-26-2007.

FOR: GREETING CARDS; HOLIDAY CARDS;
INVITATION CARDS; ANNOUNCEMENT CARDS;
CARDS BEARING UNIVERSAL GREETINGS, IN
CLASS 16 (U.S. CLS. 2, 5, 22, 23, 29, 37, 38 AND 50).

LEIGH CAROLINE CASE, EXAMINING ATTORNEY

Int. Cl.: 17

Prior U.S. Cls.: 1, 5, 12, 13, 35 and 50

United States Patent and Trademark Office

Reg. No. 3,476,307

Registered July 29, 2008

**TRADEMARK
PRINCIPAL REGISTER**

ColorGrip

FLOW SMART INC. (DELAWARE CORPORATION)
103 DAVIS DRIVE
SEAFORD, DE 19973

FOR: PIPE GASKETS, IN CLASS 17 (U.S. CLS. 1, 5,
12, 13, 35 AND 50).

FIRST USE 8-1-2005; IN COMMERCE 12-1-2005.

THE MARK CONSISTS OF STANDARD CHARACTERS WITHOUT CLAIM TO ANY PARTICULAR FONT, STYLE, SIZE, OR COLOR.

SER. NO. 77-359,368, FILED 12-26-2007.

KATHERINE E. HALMEN, EXAMINING ATTORNEY

Int. Cl.: 16

Prior U.S. Cls.: 2, 5, 22, 23, 29, 37, 38 and 50

United States Patent and Trademark Office

Reg. No. 3,476,308

Registered July 29, 2008

**TRADEMARK
PRINCIPAL REGISTER**



LOYKO, ANDREA (UNITED STATES INDIVIDUAL), DBA RATTLE-N-ROLL
3743 RACINE ROAD
SAN DIEGO, CA 92115 AND
LOYKO, RYAN (UNITED STATES INDIVIDUAL),
DBA RATTLE-N-ROLL
3743 RACINE ROAD
SAN DIEGO, CA 92115

FIRST USE 7-1-2005; IN COMMERCE 4-30-2006.

THE MARK CONSISTS OF A FIST HOLDING UP A BABY RATTLE ALONG WITH THE WORDS "RATTLE-N-ROLL", ALL ENCLOSED IN BLACK OUTLINE.

FOR: ANNOUNCEMENT CARDS; GREETING CARDS; HOLIDAY CARDS; INVITATION CARDS; CARDS BEARING UNIVERSAL GREETINGS, IN CLASS 16 (U.S. CLS. 2, 5, 22, 23, 29, 37, 38 AND 50).

SER. NO. 77-359,387, FILED 12-26-2007.

LEIGH CAROLINE CASE, EXAMINING ATTORNEY

Int. Cl.: 35

Prior U.S. Cls.: 100, 101 and 102

United States Patent and Trademark Office

Reg. No. 3,476,309

Registered July 29, 2008

**SERVICE MARK
PRINCIPAL REGISTER**

ROADTRUCKER

ODDO, FRANK J. (UNITED STATES INDIVIDUAL)
8312 SIDBURY ROAD
WILMINGTON, NC 28411

FOR: ONLINE RETAIL/WHOLESALE STORE FEATURING SPECIALTY ITEMS FOR TRUCKERS AND OTHER VEHICLE USERS, 12 VOLT APPLIANCES, ELECTRONICS, SECURITY AND SAFETY EQUIPMENT, TRAVEL GIFTS, CHROME STACKS, LED TRAILER LIGHTS, MUDFLAP BRACKETS, LOGBOOKS AND TRUCK ACCESSORIES, IN CLASS 35 (U.S. CLS. 100, 101 AND 102).

FIRST USE 8-1-2003; IN COMMERCE 8-1-2003.

THE MARK CONSISTS OF STANDARD CHARACTERS WITHOUT CLAIM TO ANY PARTICULAR FONT, STYLE, SIZE, OR COLOR.

SER. NO. 77-359,422, FILED 12-26-2007.

ELISSA GARBER KON, EXAMINING ATTORNEY

Int. Cl.: 41

Prior U.S. Cls.: 100, 101 and 107

United States Patent and Trademark Office

Reg. No. 3,476,310

Registered July 29, 2008

**SERVICE MARK
PRINCIPAL REGISTER**

Quote-Along

ALAMO DOWNTOWN, INC. (TEXAS CORPORATION)
1120 S. LAMAR BLVD.
AUSTIN, TX 78704

THE MARK CONSISTS OF STANDARD CHARACTERS WITHOUT CLAIM TO ANY PARTICULAR FONT, STYLE, SIZE, OR COLOR.

FOR: ENTERTAINMENT SERVICES, NAMELY, CINEMA THEATER SERVICES, IN CLASS 41 (U.S. CLS. 100, 101 AND 107).

SER. NO. 77-359,436, FILED 12-26-2007.

FIRST USE 5-11-2007; IN COMMERCE 5-11-2007.

JIM RINGLE, EXAMINING ATTORNEY

Int. Cl.: 5

Prior U.S. Cls.: 6, 18, 44, 46, 51 and 52

Reg. No. 3,476,311

United States Patent and Trademark Office

Registered July 29, 2008

**TRADEMARK
PRINCIPAL REGISTER**

NanaCea

NANA PATRICIA MCPEAK (UNITED STATES
INDIVIDUAL)
100 ROCK LANE
EL DORADO HILLS, CA 95762

THE MARK CONSISTS OF STANDARD CHAR-
ACTERS WITHOUT CLAIM TO ANY PARTICULAR
FONT, STYLE, SIZE, OR COLOR.

FOR: DIETARY AND NUTRITIONAL SUPPLE-
MENTS, IN CLASS 5 (U.S. CLS. 6, 18, 44, 46, 51 AND
52).

SER. NO. 77-359,456, FILED 12-26-2007.

FIRST USE 11-1-2007; IN COMMERCE 11-1-2007.

HOWARD B. LEVINE, EXAMINING ATTORNEY

Int. Cl.: 9

Prior U.S. Cls.: 21, 23, 26, 36 and 38

United States Patent and Trademark Office

Reg. No. 3,476,312

Registered July 29, 2008

**TRADEMARK
PRINCIPAL REGISTER**

TREBLE DAMAGE

JON RUBERTS (UNITED STATES INDIVIDUAL)
320 OSAGE LANE
NAPERVILLE, IL 60540

THE MARK CONSISTS OF STANDARD CHAR-
ACTERS WITHOUT CLAIM TO ANY PARTICULAR
FONT, STYLE, SIZE, OR COLOR.

FOR: A SERIES OF PRERECORDED MUSIC ON
CASSETTES, COMPACT DISCS AND MP3S, IN
CLASS 9 (U.S. CLS. 21, 23, 26, 36 AND 38).

SER. NO. 77-359,461, FILED 12-26-2007.

FIRST USE 7-18-1994; IN COMMERCE 7-18-1994.

KEVON CHISOLM, EXAMINING ATTORNEY

Int. Cl.: 25

Prior U.S. Cls.: 22 and 39

United States Patent and Trademark Office

Reg. No. 3,476,313

Registered July 29, 2008

TRADEMARK
PRINCIPAL REGISTER



LOMBARD, CHRIS (UNITED STATES INDIVIDUAL)
916 PEPPER AVENUE
RICHMOND, VA 23226

FOR: ATHLETIC FOOTWEAR; BATHING SUITS; BATHING TRUNKS; BEACH FOOTWEAR; BELTS; BIKINIS; BOW TIES; CAPS; FLEECE VESTS; FLIP FLOPS; GOLF SHIRTS; HATS; HEADGEAR, NAMELY, HATS, CAPS; JACKETS; LONG SLEEVED VESTS; LONG-SLEEVED SHIRTS; PANTS; POLO SHIRTS; RAINPROOF JACKETS; REVERSIBLE JACKETS; RUGBY SHIRTS; SHIRTS; SHORT-SLEEVED OR LONG-SLEEVED T-SHIRTS; SHORT-SLEEVED SHIRTS; SHORTS; SPORT SHIRTS; SWIM TRUNKS; T-SHIRTS; TEE SHIRTS; TIES; VESTS; MEN AND WOMEN JACKETS, COATS, TROUSERS, VESTS; GLOVES; SWEAT SHIRTS; SLEEVED OR SLEEVELESS JACKETS; SHELL JACKETS; SMALL HATS; SPORTS JACKETS; WATERPROOF JACKETS AND PANTS; WIND RESISTANT JACKETS; WIND VESTS; WIND-JACKETS; FOOTWEAR, IN CLASS 25 (U.S. CLS. 22 AND 39).

FIRST USE 11-15-2007; IN COMMERCE 12-5-2007.

THE MARK CONSISTS OF STYLIZED DRAWING IN THE FORM OF A FISH, CONSISTING OF A STYLIZED LETTER "G" IN THE FORM OF A FISHHEAD WITH AN EYE CONTAINED IN THE AREA OF THE STYLIZED "G", FOLLOWED BY THE STYLIZED LETTERS "T", "O", "W", "N", WITH THE TOP OF THE CAPITAL "T" DRAWN OVER THE LOWER-CASE LETTERS "O", "W", AND "N", AND A STYLIZED DRAWING OF A FISH TAIL THAT FOLLOWS DIRECTLY BEHIND THE COMBINED STYLIZED DRAWING AND LETTERS, THE CENTER OF SAID TAIL BEGINNING DIRECTLY BEHIND A SMALL GAP AT THE END OF THE TOP OF THE "T", THE BOTTOM PORTION OF WHICH BEGINS DIRECTLY BEHIND THE N, AND THE TOP PORTION OF WHICH BEGINS HALFWAY ABOVE THE END OF THE TOP OF THE "T" IN THE AREA OF THE DRAWING.

SER. NO. 77-359,484, FILED 12-26-2007.

ANGELA M. MICHELI, EXAMINING ATTORNEY

Int. Cl.: 5

Prior U.S. Cls.: 6, 18, 44, 46, 51 and 52

United States Patent and Trademark Office

Reg. No. 3,476,314

Registered July 29, 2008

**TRADEMARK
PRINCIPAL REGISTER**

FiberCea

NANA PATRICIA MCPEAK (UNITED STATES
INDIVIDUAL)
100 ROCK LANE
EL DORADO HILLS, CA 95762

THE MARK CONSISTS OF STANDARD CHAR-
ACTERS WITHOUT CLAIM TO ANY PARTICULAR
FONT, STYLE, SIZE, OR COLOR.

FOR: DIETARY AND NUTRITIONAL SUPPLE-
MENTS, IN CLASS 5 (U.S. CLS. 6, 18, 44, 46, 51 AND
52).

SER. NO. 77-359,564, FILED 12-26-2007.

FIRST USE 1-11-2007; IN COMMERCE 1-11-2007.

HOWARD B. LEVINE, EXAMINING ATTORNEY

Int. Cl.: 31

Prior U.S. Cls.: 1 and 46

United States Patent and Trademark Office

Reg. No. 3,476,315

Registered July 29, 2008

**TRADEMARK
PRINCIPAL REGISTER**

BACKYARD BISTRO

ASLIN-FINCH COMPANY (WASHINGTON COR-
PORATION)
10424 WEST AERO ROAD
SPOKANE, WA 99224

THE MARK CONSISTS OF STANDARD CHAR-
ACTERS WITHOUT CLAIM TO ANY PARTICULAR
FONT, STYLE, SIZE, OR COLOR.

FOR: SMALL ANIMAL FEED, IN CLASS 31 (U.S.
CLS. 1 AND 46).

SER. NO. 77-359,566, FILED 12-26-2007.

FIRST USE 2-1-2007; IN COMMERCE 2-1-2007.

MARK PILARO, EXAMINING ATTORNEY

Int. Cl.: 35

Prior U.S. Cls.: 100, 101 and 102

United States Patent and Trademark Office

Reg. No. 3,476,316

Registered July 29, 2008

**SERVICE MARK
PRINCIPAL REGISTER**

GOOMZEE

GOOMZEE CORPORATION (MONTANA CORPORATION)
2344 W. KENT AVE.
MISSOULA, MT 59801

FOR: MARKETING AND ADVERTISING SERVICES FOR AUTOMOBILE DEALERSHIPS; MARKETING SERVICES, NAMELY, PROVIDING INFORMATIONAL WEB PAGES DESIGNED TO GENERATE SALES TRAFFIC VIA HYPERLINKS TO OTHER WEB SITES; MARKETING, PROMOTIONAL AND ADVERTISING SERVICES PROVIDED BY MOBILE TELEPHONE CONNECTIONS; MATCHING CONSUMERS WITH REAL ESTATE PROFESSIONALS IN THE FIELD OF REAL ESTATE SERVICES VIA COMPUTER NETWORK; DIRECT MARKETING ADVERTISING FOR OTHERS; GENERAL BUSINESS MERCHANDISING SERVICES, NAMELY, MARKETING; ADVERTISING SERVICES, PUBLIC RELATIONS AND MARKETING SERVICES, NAMELY, PROMOTING AND MARKETING THE GOODS AND SERVICES OF OTHERS

THROUGH ALL PUBLIC COMMUNICATION MEANS; ADVERTISING, INCLUDING PROMOTION RELATING TO THE SALE OF ARTICLES AND SERVICES FOR THIRD PARTIES BY THE TRANSMISSION OF ADVERTISING MATERIAL AND THE DISSEMINATION OF ADVERTISING MESSAGES ON COMPUTER NETWORKS, IN CLASS 35 (U.S. CLS. 100, 101 AND 102).

FIRST USE 5-1-2003; IN COMMERCE 9-1-2003.

THE MARK CONSISTS OF STANDARD CHARACTERS WITHOUT CLAIM TO ANY PARTICULAR FONT, STYLE, SIZE, OR COLOR.

THE WORDING "GOOMZEE" HAS NO MEANING IN A FOREIGN LANGUAGE.

SER. NO. 77-359,567, FILED 12-26-2007.

MARK PILARO, EXAMINING ATTORNEY

Int. Cl.: 5

Prior U.S. Cls.: 6, 18, 44, 46, 51 and 52

United States Patent and Trademark Office

Reg. No. 3,476,317

Registered July 29, 2008

**TRADEMARK
PRINCIPAL REGISTER**

DiaCea

NANA PATRICIA MCPEAK (UNITED STATES
INDIVIDUAL)
100 ROCK LANE
EL DORADO HILLS, CA 95762

THE MARK CONSISTS OF STANDARD CHAR-
ACTERS WITHOUT CLAIM TO ANY PARTICULAR
FONT, STYLE, SIZE, OR COLOR.

FOR: DIETARY AND NUTRITIONAL SUPPLE-
MENTS, IN CLASS 5 (U.S. CLS. 6, 18, 44, 46, 51 AND
52).

SER. NO. 77-359,586, FILED 12-26-2007.

FIRST USE 11-1-2007; IN COMMERCE 11-1-2007.

HOWARD B. LEVINE, EXAMINING ATTORNEY

Int. Cl.: 41

Prior U.S. Cls.: 100, 101 and 107

United States Patent and Trademark Office

Reg. No. 3,476,318

Registered July 29, 2008

**SERVICE MARK
PRINCIPAL REGISTER**

**WE MAKE LEARNING TO SAVE
LIVES EASY**

ASHI HOLDING COMPANY (DELAWARE CORPORATION)
PO BOX 21738
1450 WESTEC DRIVE
EUGENE, OR 97402

FOR: EDUCATIONAL SERVICES IN THE FIELD OF EMERGENCY MEDICAL RESPONSE, NAMELY, TRAINING BUSINESSES, ORGANIZATIONS, AND OTHER GROUPS TO IMPLEMENT EMERGENCY MEDICAL RESPONSE SERVICES, INCLUDING BASIC LIFE SUPPORT, INJURY MANAGEMENT, FIRST AID AND CARDIOPULMONARY RESUSCITATION (CPR), AND THE USE OF AUTOMATED

EXTERNAL DEFIBRILLATORS (AEDS), IN CLASS 41 (U.S. CLS. 100, 101 AND 107).

FIRST USE 7-0-2007; IN COMMERCE 7-0-2007.

THE MARK CONSISTS OF STANDARD CHARACTERS WITHOUT CLAIM TO ANY PARTICULAR FONT, STYLE, SIZE, OR COLOR.

SER. NO. 77-359,587, FILED 12-26-2007.

MARCIE MILONE, EXAMINING ATTORNEY

Int. Cl.: 5

Prior U.S. Cls.: 6, 18, 44, 46, 51 and 52

Reg. No. 3,476,319

United States Patent and Trademark Office

Registered July 29, 2008

**TRADEMARK
PRINCIPAL REGISTER**

LiverCea

NANA PATRICIA MCPEAK (UNITED STATES
INDIVIDUAL)
100 ROCK LANE
EL DORADO HILLS, CA 95762

THE MARK CONSISTS OF STANDARD CHAR-
ACTERS WITHOUT CLAIM TO ANY PARTICULAR
FONT, STYLE, SIZE, OR COLOR.

FOR: DIETARY AND NUTRITIONAL SUPPLE-
MENTS, IN CLASS 5 (U.S. CLS. 6, 18, 44, 46, 51 AND
52).

SER. NO. 77-359,596, FILED 12-26-2007.

FIRST USE 11-1-2007; IN COMMERCE 11-1-2007.

HOWARD B. LEVINE, EXAMINING ATTORNEY

Int. Cl.: 5

Prior U.S. Cls.: 6, 18, 44, 46, 51 and 52

Reg. No. 3,476,320

United States Patent and Trademark Office

Registered July 29, 2008

**TRADEMARK
PRINCIPAL REGISTER**

EARTH'S BOUNTY

MATRIX HEALTH PRODUCTS INC. (WASHING-
TON CORPORATION)
1101 NE 144TH ST #109
VANCOUVER, WA 98685

THE MARK CONSISTS OF STANDARD CHAR-
ACTERS WITHOUT CLAIM TO ANY PARTICULAR
FONT, STYLE, SIZE, OR COLOR.

FOR: DIETARY AND NUTRITIONAL SUPPLE-
MENTS, IN CLASS 5 (U.S. CLS. 6, 18, 44, 46, 51 AND
52).

SER. NO. 77-359,628, FILED 12-26-2007.

FIRST USE 6-1-1992; IN COMMERCE 6-1-1992.

MICHAEL WEBSTER, EXAMINING ATTORNEY

Int. Cl.: 5

Prior U.S. Cls.: 6, 18, 44, 46, 51 and 52

Reg. No. 3,476,321

United States Patent and Trademark Office

Registered July 29, 2008

**TRADEMARK
PRINCIPAL REGISTER**

ImmuneCea

NANA PATRICIA MCPEAK (UNITED STATES
INDIVIDUAL)
100 ROCK LANE
EL DORADO HILLS, CA 95762

THE MARK CONSISTS OF STANDARD CHAR-
ACTERS WITHOUT CLAIM TO ANY PARTICULAR
FONT, STYLE, SIZE, OR COLOR.

FOR: DIETARY AND NUTRITIONAL SUPPLE-
MENTS, IN CLASS 5 (U.S. CLS. 6, 18, 44, 46, 51 AND
52).

SER. NO. 77-359,632, FILED 12-26-2007.

FIRST USE 11-1-2007; IN COMMERCE 11-1-2007.

HOWARD B. LEVINE, EXAMINING ATTORNEY

Int. Cl.: 5

Prior U.S. Cls.: 6, 18, 44, 46, 51 and 52

Reg. No. 3,476,322

United States Patent and Trademark Office

Registered July 29, 2008

**TRADEMARK
PRINCIPAL REGISTER**

PROSTA-FORTE

MATRIX HEALTH PRODUCTS INC. (WASHING-
TON CORPORATION)
1101 NE 144TH ST. #109
VANCOUVER, WA 98685

THE MARK CONSISTS OF STANDARD CHAR-
ACTERS WITHOUT CLAIM TO ANY PARTICULAR
FONT, STYLE, SIZE, OR COLOR.

FOR: DIETARY AND NUTRITIONAL SUPPLE-
MENTS, IN CLASS 5 (U.S. CLS. 6, 18, 44, 46, 51 AND
52).

SER. NO. 77-359,655, FILED 12-26-2007.

FIRST USE 2-1-1994; IN COMMERCE 2-1-1994.

MICHAEL WEBSTER, EXAMINING ATTORNEY

Int. Cl.: 30

Prior U.S. Cl.: 46

United States Patent and Trademark Office

Reg. No. 3,476,323

Registered July 29, 2008

**TRADEMARK
PRINCIPAL REGISTER**

Beehavin' Apiary

ZURLINDEN, EVERETT V (UNITED STATES
INDIVIDUAL), DBA BEEHAVIN' APIARY
99 LAFAYETTE DRIVE
EAST GREENWICH, RI 02818

NO CLAIM IS MADE TO THE EXCLUSIVE
RIGHT TO USE "APIARY", APART FROM THE
MARK AS SHOWN.

FOR: HONEY, IN CLASS 30 (U.S. CL. 46).

SER. NO. 77-359,673, FILED 12-26-2007.

FIRST USE 7-1-2007; IN COMMERCE 11-15-2007.

THE MARK CONSISTS OF STANDARD CHAR-
ACTERS WITHOUT CLAIM TO ANY PARTICULAR
FONT, STYLE, SIZE, OR COLOR.

CIMMERIAN COLEMAN, EXAMINING ATTOR-
NEY

Int. Cl.: 5

Prior U.S. Cls.: 6, 18, 44, 46, 51 and 52

Reg. No. 3,476,324

United States Patent and Trademark Office

Registered July 29, 2008

**TRADEMARK
PRINCIPAL REGISTER**

WOMAN'S SELECT

MATRIX HEALTH PRODUCTS INC. (WASHINGTON CORPORATION)
1101 NE 144TH ST. #109
VANCOUVER, WA 98685

FOR: DIETARY AND NUTRITIONAL SUPPLEMENTS, IN CLASS 5 (U.S. CLS. 6, 18, 44, 46, 51 AND 52).

FIRST USE 7-5-1994; IN COMMERCE 7-5-1994.

THE MARK CONSISTS OF STANDARD CHARACTERS WITHOUT CLAIM TO ANY PARTICULAR FONT, STYLE, SIZE, OR COLOR.

NO CLAIM IS MADE TO THE EXCLUSIVE RIGHT TO USE "WOMAN'S", APART FROM THE MARK AS SHOWN.

SER. NO. 77-359,677, FILED 12-26-2007.

MICHAEL WEBSTER, EXAMINING ATTORNEY

Int. Cl.: 44

Prior U.S. Cls.: 100 and 101

United States Patent and Trademark Office

Reg. No. 3,476,325

Registered July 29, 2008

**SERVICE MARK
PRINCIPAL REGISTER**

natural**SS**

DULLES URGENT CARE CENTER, LLC (VIRGINIA LTD LIAB CO)
SUITE 100
42010 VILLAGE CENTER PLAZA
STONE RIDGE, VA 20105

FOR: CONSULTING TO INDIVIDUALS AND COMMUNITIES ENGAGED IN GROUP WEIGHT LOSS PROGRAMS; WEIGHT REDUCTION DIET PLANNING AND SUPERVISION; COUNSELING SERVICES IN THE FIELDS OF HEALTH, NUTRITION AND LIFESTYLE WELLNESS; DIETARY AND NUTRITIONAL GUIDANCE; FOOD NUTRITION CONSULTATION; NUTRITION COUNSELING; PROVIDING A WEBSITE FEATURING INFORMATION ON HEALTH AND NUTRITION; PROVIDING ASSISTANCE, FITNESS EVALUATION AND CONSULTATION TO INDIVIDUALS TO HELP THEM MAKE HEALTH, WELLNESS AND NUTRITIONAL CHANGES IN THEIR DAILY LIVING TO IMPROVE HEALTH; PROVIDING A WEBSITE FEATURING EDUCATIONAL INFORMATION RE-

GARDING NUTRITION AND GENETICS; HEALTH CARE SERVICES, NAMELY WELLNESS PROGRAMS, IN CLASS 44 (U.S. CLS. 100 AND 101).

FIRST USE 11-25-2007; IN COMMERCE 12-21-2007.

THE STIPPLING IS FOR SHADING PURPOSES ONLY.

THE MARK CONSISTS OF THE LOWERCASE LETTERS "NATURALOSS" WHICH GET PROGRESSIVELY THINNER FROM LEFT TO RIGHT, WITH THE 'N' BEING THE WIDEST LETTER AND THE FINAL 'S' BEING THE SKINNIEST. THE LOWERCASE LETTER 'O' IS REPLACED BY A CITRUS FRUIT SLICE, MOST CLOSELY RESEMBLING AN ORANGE..

SER. NO. 77-359,692, FILED 12-26-2007.

ELISSA GARBER KON, EXAMINING ATTORNEY

Int. Cl.: 33

Prior U.S. Cls.: 47 and 49

United States Patent and Trademark Office

Reg. No. 3,476,326

Registered July 29, 2008

**TRADEMARK
PRINCIPAL REGISTER**

RED BRANCH

FAUL, MICHAEL J. (UNITED STATES INDIVIDUAL)
1246 BIRCHWOOD DR.
SUNNYVALE, CA 94089

THE MARK CONSISTS OF STANDARD CHARACTERS WITHOUT CLAIM TO ANY PARTICULAR FONT, STYLE, SIZE, OR COLOR.

FOR: WINE, IN CLASS 33 (U.S. CLS. 47 AND 49).

SER. NO. 77-359,716, FILED 12-26-2007.

FIRST USE 6-10-2005; IN COMMERCE 6-10-2005.

AISHA CLARKE, EXAMINING ATTORNEY

Int. Cls.: 37 and 42

Prior U.S. Cls.: 100, 101, 103 and 106

United States Patent and Trademark Office

Reg. No. 3,476,327

Registered July 29, 2008

**SERVICE MARK
PRINCIPAL REGISTER**

Blue Skies Consulting

BLUE SKIES CONSULTING, LLC (NEW MEXICO
LTD LIAB CO)
100 BLUE SKIES DRIVE
BELEN, NM 87002

FOR: AIRCRAFT REPAIR AND MAINTENANCE;
FUELING SERVICES FOR AIRCRAFT; INFORMATION
WITH RELATION TO AIRCRAFT CON-
STRUCTION, REPAIR AND MAINTENANCE;
TECHNICAL SUPPORT SERVICES, NAMELY, PRO-
VIDING TECHNICAL ADVICE IN THE FIELD OF
AIRCRAFT ENGINE OVERHAUL AND REPAIR, IN
CLASS 37 (U.S. CLS. 100, 103 AND 106).

FIRST USE 1-1-1999; IN COMMERCE 1-1-1999.

FOR: PHOTOGRAMMETRY, IN CLASS 42 (U.S.
CLS. 100 AND 101).

FIRST USE 1-1-1999; IN COMMERCE 1-1-1999.

THE MARK CONSISTS OF STANDARD CHAR-
ACTERS WITHOUT CLAIM TO ANY PARTICULAR
FONT, STYLE, SIZE, OR COLOR.

NO CLAIM IS MADE TO THE EXCLUSIVE
RIGHT TO USE "CONSULTING", APART FROM
THE MARK AS SHOWN.

SER. NO. 77-359,721, FILED 12-26-2007.

AISHA CLARKE, EXAMINING ATTORNEY

Int. Cl.: 5

Prior U.S. Cls.: 6, 18, 44, 46, 51 and 52

United States Patent and Trademark Office

Reg. No. 3,476,328

Registered July 29, 2008

**TRADEMARK
PRINCIPAL REGISTER**

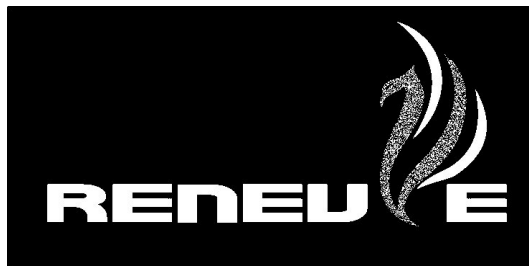

PHOENIX RESEARCH INSTITUTE, LLC (NEVA-
DA LTD LIAB CO)
#SP-D9
64625 PIERSON BLVD.
DESERT HOT SPRINGS, CA 92240

FOR: DIETARY SUPPLEMENTS, IN CLASS 5 (U.S.
CLS. 6, 18, 44, 46, 51 AND 52).

FIRST USE 7-27-2007; IN COMMERCE 7-27-2007.

THE STIPPLING IS FOR SHADING PURPOSES
ONLY.

THE MARK CONSISTS OF THE STYLIZED
WORD "RENEUE". THE LETTER "V" TRANS-
FORMS INTO A PHOENIX WITH FEATHERS
FORMING THE "V" SHAPE.

THE FOREIGN WORDING IN THE MARK
TRANSLATES INTO ENGLISH AS RENEW.

SER. NO. 77-359,726, FILED 12-26-2007.

AISHA CLARKE, EXAMINING ATTORNEY

Int. Cl.: 41

Prior U.S. Cls.: 100, 101 and 107

United States Patent and Trademark Office

Reg. No. 3,476,329

Registered July 29, 2008

SERVICE MARK
PRINCIPAL REGISTER



BOULDERDASH INDOOR ROCK CLIMBING
STUDIO, INC. (CALIFORNIA CORPORATION)
880-A HAMPSHIRE RD.
THOUSAND OAKS, CA 91361

FOR: RECREATIONAL SERVICES IN THE NATURE OF INDOOR ROCK CLIMBING FACILITIES, IN CLASS 41 (U.S. CLS. 100, 101 AND 107).

FIRST USE 8-31-2004; IN COMMERCE 8-31-2004.

NO CLAIM IS MADE TO THE EXCLUSIVE RIGHT TO USE "INDOOR ROCK CLIMBING", APART FROM THE MARK AS SHOWN.

THE STIPLING IS FOR SHADING PURPOSES ONLY.

THE MARK CONSISTS OF A SQUARE WITH AN OUTLINE OF A MONKEY WITH THE STYLIZED WORDS "BOULDERDASH INDOOR ROCK CLIMBING" TO THE RIGHT OF THE SQUARE.

SER. NO. 77-359,733, FILED 12-26-2007.

AISHA CLARKE, EXAMINING ATTORNEY

Int. Cl.: 40

Prior U.S. Cls.: 100, 103 and 106

United States Patent and Trademark Office

Reg. No. 3,476,330

Registered July 29, 2008

**SERVICE MARK
PRINCIPAL REGISTER**



JAKPRINTS INC. (OHIO CORPORATION)
3133 CHESTER AVE.
CLEVELAND, OH 44114

FOR: DESIGN PRINTING FOR OTHERS; DIGITAL ON-DEMAND PRINTING SERVICES OF BOOKS AND OTHER DOCUMENTS; IMPRINTING MESSAGES ON T-SHIRTS; LETTERPRESS PRINTING; OFFSET PRINTING; PATTERN PRINTING; PRINTING; PRINTING OF ADVERTISING MATTER; PRINTING OF BOOKS; PRINTING OF PATTERNS ON TEXTILES; SCREEN PRINTING; SILK SCREEN PRINTING; STATIONERY PRINTING

SERVICES; THERMOGRAPHIC PRINTING SERVICES, IN CLASS 40 (U.S. CLS. 100, 103 AND 106).

FIRST USE 1-1-1997; IN COMMERCE 1-1-1997.

THE MARK CONSISTS OF A SIMPLE BLOCK TEXT WITH A PICK UP JAK BETWEEN THE WORDS "JAK" (JAK GRAPHIC) "PRINTS".

SER. NO. 77-359,740, FILED 12-26-2007.

AISHA CLARKE, EXAMINING ATTORNEY

Int. Cl.: 42

Prior U.S. Cls.: 100 and 101

United States Patent and Trademark Office

Reg. No. 3,476,331

Registered July 29, 2008

**SERVICE MARK
PRINCIPAL REGISTER**



SHINER ENTERPRISES INC. (DELAWARE CORPORATION)
SUITE 478
826 ORANGE AVENUE
CORONADO, CA 92118

FOR: PROVIDING ONLINE NON-DOWNLOADABLE SOFTWARE TO ENABLE THE ORGANIZATION, COLLECTION, TRACKING AND MANAGEMENT OF MONEY FOR GROUP PAYMENTS OR FUNDRAISING AND TO FACILITATE THE PURCHASE OF SHARED GOODS AND/OR SERVICES, IN CLASS 42 (U.S. CLS. 100 AND 101).

FIRST USE 6-0-2007; IN COMMERCE 11-0-2007.

THE MARK CONSISTS OF A SET OF COINS THAT INITIATE OUT OF THE LETTER "I", ARCH OVER THE WORD, AND GO INTO THE LETTER "U".

SER. NO. 77-359,757, FILED 12-26-2007.

LEIGH CAROLINE CASE, EXAMINING ATTORNEY

Int. Cl.: 42

Prior U.S. Cls.: 100 and 101

United States Patent and Trademark Office

Reg. No. 3,476,332

Registered July 29, 2008

**SERVICE MARK
PRINCIPAL REGISTER**

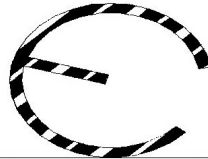

E-AutoCAD Design Solutions

E-AUTOCAD DESIGN SOLUTIONS (FLORIDA
LTD LIAB CO)
13447 DRAYTON DRIVE
SPRING HILL, FL 34609

FOR: DRAFTING SERVICES, IN CLASS 42 (U.S.
CLS. 100 AND 101).

FIRST USE 7-19-2007; IN COMMERCE 7-19-2007.

NO CLAIM IS MADE TO THE EXCLUSIVE
RIGHT TO USE "E-AUTOCAD DESIGN SOLU-
TIONS", APART FROM THE MARK AS SHOWN.

THE MARK CONSISTS OF A STYLIZED "E"
WITH THE WORDING "E-AUTOCAD DESIGN SO-
LUTIONS" BELOW THE STYLIZED "E".

SER. NO. 77-359,761, FILED 12-26-2007.

TAMARA FRAZIER, EXAMINING ATTORNEY

Int. Cl.: 5

Prior U.S. Cls.: 6, 18, 44, 46, 51 and 52

United States Patent and Trademark Office

Reg. No. 3,476,333

Registered July 29, 2008

**TRADEMARK
PRINCIPAL REGISTER**

MENO-SELECT

MATRIX HEALTH PRODUCTS INC. (WASHING-
TON CORPORATION)
1101 NE 144TH ST. #109
VANCOUVER, WA 98685

THE MARK CONSISTS OF STANDARD CHAR-
ACTERS WITHOUT CLAIM TO ANY PARTICULAR
FONT, STYLE, SIZE, OR COLOR.

FOR: DIETARY AND NUTRITIONAL SUPPLE-
MENTS, IN CLASS 5 (U.S. CLS. 6, 18, 44, 46, 51 AND
52).

SER. NO. 77-359,770, FILED 12-26-2007.

FIRST USE 7-28-1995; IN COMMERCE 7-28-1995.

MICHAEL WEBSTER, EXAMINING ATTORNEY

Int. Cl.: 35

Prior U.S. Cls.: 100, 101 and 102

United States Patent and Trademark Office

Reg. No. 3,476,334

Registered July 29, 2008

**SERVICE MARK
PRINCIPAL REGISTER**

AUDIOHIGH

SILVER, MICHAEL (UNITED STATES INDIVIDUAL)
165 MOFFETT BLVD
MOUNTAIN VIEW, CA 94043

THE MARK CONSISTS OF STYLIZED TEXT OF "AUDIO HIGH" WITH A TRIANGLE OVER THE "I" IN "AUDIO".

FOR: ON-LINE RETAIL STORE SERVICES FEATURING ELECTRONICS AND MEDIA; RETAIL STORE SERVICES FEATURING ELECTRONICS AND MEDIA, IN CLASS 35 (U.S. CLS. 100, 101 AND 102).

SER. NO. 77-359,776, FILED 12-26-2007.

FIRST USE 6-1-2003; IN COMMERCE 7-1-2003.

JACQUELINE A. LAVINE, EXAMINING ATTORNEY

Int. Cl.: 25

Prior U.S. Cls.: 22 and 39

United States Patent and Trademark Office

Reg. No. 3,476,335

Registered July 29, 2008

**TRADEMARK
PRINCIPAL REGISTER**

WRANGLER WORK WEAR

WRANGLER APPAREL CORP. (DELAWARE
CORPORATION)
3411 SILVERSIDE RD.
WILMINGTON, DE 19810

FOR: FOOTWEAR, NAMELY, SHOES AND
BOOTS, IN CLASS 25 (U.S. CLS. 22 AND 39).

FIRST USE 9-16-1998; IN COMMERCE 9-16-1998.

THE MARK CONSISTS OF STANDARD CHAR-
ACTERS WITHOUT CLAIM TO ANY PARTICULAR
FONT, STYLE, SIZE, OR COLOR.

OWNER OF U.S. REG. NOS. 809,323, 1,108,076 AND
OTHERS.

NO CLAIM IS MADE TO THE EXCLUSIVE
RIGHT TO USE "WORK WEAR", APART FROM
THE MARK AS SHOWN.

SER. NO. 77-359,860, FILED 12-27-2007.

WILLIAM BRECKENFELD, EXAMINING ATTOR-
NEY

Int. Cl.: 35

Prior U.S. Cls.: 100, 101 and 102

United States Patent and Trademark Office

Reg. No. 3,476,336

Registered July 29, 2008

**SERVICE MARK
PRINCIPAL REGISTER**

ZIPLINE

WILLIAMS, EDWARD R. III (UNITED STATES
INDIVIDUAL)
1391 DUBLIN ROAD
COLUMBUS, OH 43215

FOR: TRANSPORTATION LOGISTICS SERVICES,
NAMELY, ARRANGING THE TRANSPORTATION
OF GOODS FOR OTHERS, IN CLASS 35 (U.S. CLS.
100, 101 AND 102).

FIRST USE 6-6-2007; IN COMMERCE 6-6-2007.

THE MARK CONSISTS OF STANDARD CHAR-
ACTERS WITHOUT CLAIM TO ANY PARTICULAR
FONT, STYLE, SIZE, OR COLOR.

SER. NO. 77-359,873, FILED 12-27-2007.

WILLIAM BRECKENFELD, EXAMINING ATTOR-
NEY

Int. Cl.: 35

Prior U.S. Cls.: 100, 101 and 102

United States Patent and Trademark Office

Reg. No. 3,476,337

Registered July 29, 2008

**SERVICE MARK
PRINCIPAL REGISTER**

BULL COUTURE

ISAACSON, DEAN (UNITED STATES INDIVIDUAL)
P.O. BOX 9148
CALABASAS, CA 91373 AND
ISAACSON, MEGAN (UNITED STATES INDIVIDUAL)
P.O. BOX 9148
CALABASAS, CA 91373

FOR: RETAIL STORES FEATURING WOMEN'S CLOTHING AND SHOES, IN CLASS 35 (U.S. CLS. 100, 101 AND 102).

FIRST USE 8-11-2007; IN COMMERCE 8-11-2007.

THE MARK CONSISTS OF STANDARD CHARACTERS WITHOUT CLAIM TO ANY PARTICULAR FONT, STYLE, SIZE, OR COLOR.

NO CLAIM IS MADE TO THE EXCLUSIVE RIGHT TO USE "COUTURE", APART FROM THE MARK AS SHOWN.

SER. NO. 77-359,874, FILED 12-27-2007.

JENNIFER VASQUEZ, EXAMINING ATTORNEY

Int. Cl.: 35

Prior U.S. Cls.: 100, 101 and 102

United States Patent and Trademark Office

Reg. No. 3,476,338

Registered July 29, 2008

**SERVICE MARK
PRINCIPAL REGISTER**

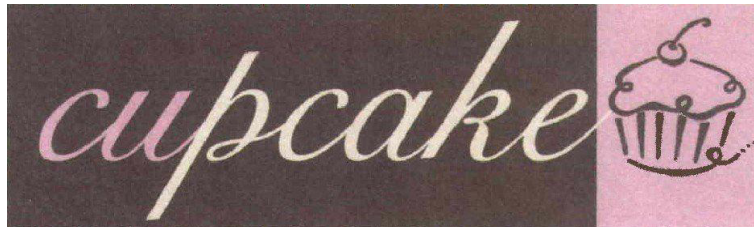

KGK ENTERPRISES, LLC (SOUTH CAROLINA
LTD LIAB CO)
433 KING STREET
CHARLESTON, SC 29403

FOR: ON-LINE RETAIL STORE SERVICES FEATURING BAKED GOODS; RETAIL BAKERY SHOPS, IN CLASS 35 (U.S. CLS. 100, 101 AND 102).

FIRST USE 1-31-2006; IN COMMERCE 1-31-2006.

NO CLAIM IS MADE TO THE EXCLUSIVE RIGHT TO USE "CUPCAKE", APART FROM THE MARK AS SHOWN.

THE COLOR(S) PINK, BEIGE AND BROWN IS/ ARE CLAIMED AS A FEATURE OF THE MARK.

THE MARK CONSISTS OF THE LITERAL ELEMENT WHERE THE TERM "CUPCAKE" APPEARS IN A BROWN BACKGROUND AND THE "CU" OF CUPCAKE APPEARS IN PINK, THE "P" OF CUPCAKE APPEARS IN BEIGE; THE BROWN CUPCAKE DESIGN APPEARS IN A PINK BACKGROUND.

SER. NO. 77-359,881, FILED 12-27-2007.

WILLIAM BRECKENFELD, EXAMINING ATTORNEY

Int. Cl.: 35

Prior U.S. Cls.: 100, 101 and 102

United States Patent and Trademark Office

Reg. No. 3,476,339

Registered July 29, 2008

**SERVICE MARK
PRINCIPAL REGISTER**



ISAACSON, DEAN (UNITED STATES INDIVIDUAL)
P.O. BOX 9148
CALABASAS, CA 91373 AND
ISAACSON, MEGAN (UNITED STATES INDIVIDUAL)
P.O. BOX 9148
CALABASAS, CA 91373

NO CLAIM IS MADE TO THE EXCLUSIVE RIGHT TO USE "COUTURE", APART FROM THE MARK AS SHOWN.

THE MARK CONSISTS OF THE WORDS "BULL COUTURE" & DESIGN OF A BULL.

FOR: RETAIL STORES FEATURING WOMEN'S CLOTHING AND SHOES, IN CLASS 35 (U.S. CLS. 100, 101 AND 102).

SER. NO. 77-359,896, FILED 12-27-2007.

FIRST USE 8-11-2007; IN COMMERCE 8-11-2007.

JENNIFER VASQUEZ, EXAMINING ATTORNEY

Int. Cl.: 35

Prior U.S. Cls.: 100, 101 and 102

United States Patent and Trademark Office

Reg. No. 3,476,340

Registered July 29, 2008

**SERVICE MARK
PRINCIPAL REGISTER**



THE FOUNDATION FOR EVANGELISM (TEN-
NESSEE CORPORATION)
P.O. BOX 985
125 NORTH LAKESHORE DRIVE
LAKE JUNALUSKA, NC 28745

FOR: ASSOCIATION SERVICES, NAMELY, PRO-
MOTING THE INTERESTS OF EVANGELISTS AND
EVANGELISM, IN CLASS 35 (U.S. CLS. 100, 101 AND
102).

FIRST USE 11-29-2007; IN COMMERCE 11-29-2007.

NO CLAIM IS MADE TO THE EXCLUSIVE
RIGHT TO USE THE IMAGE OF THE CROSS,
APART FROM THE MARK AS SHOWN.

THE COLOR(S) GREEN, BROWN, ORANGE AND
TAN IS/ARE CLAIMED AS A FEATURE OF THE
MARK.

THE MARK CONSISTS OF A BROWN CROSS AT
THE INTERSECTION OF TAN AND ORANGE REC-
TANGLES WITH DARK GREEN LEAVES ON THE
LEFT OF THE DESIGN.

SER. NO. 77-359,904, FILED 12-27-2007.

KARANENDRA S. CHHINA, EXAMINING ATTOR-
NEY

Int. Cl.: 41

Prior U.S. Cls.: 100, 101 and 107

United States Patent and Trademark Office

Reg. No. 3,476,341

Registered July 29, 2008

**SERVICE MARK
PRINCIPAL REGISTER**

ACL

CAPITAL OF TEXAS PUBLIC TELECOMMUNI-
CATIONS COUNCIL (TEXAS CORPORATION)
P.O. BOX 7158
AUSTIN, TX 78713

FOR: ENTERTAINMENT SERVICES IN THE
NATURE OF ON-GOING RADIO AND ON-GOING
TELEVISION PROGRAMS AND LIVE MUSIC CON-
CERTS; PRODUCTION AND DISTRIBUTION OF
RADIO, TELEVISION PROGRAMS AND TELE-
VISED MUSIC CONCERTS, IN CLASS 41 (U.S. CLS.
100, 101 AND 107).

FIRST USE 10-14-1974; IN COMMERCE 10-14-1974.

THE MARK CONSISTS OF STANDARD CHAR-
ACTERS WITHOUT CLAIM TO ANY PARTICULAR
FONT, STYLE, SIZE, OR COLOR.

OWNER OF U.S. REG. NOS. 1,579,521 AND
1,580,670.

SER. NO. 77-359,922, FILED 12-27-2007.

TRACY WHITTAKER-BROWN, EXAMINING AT-
TORNEY

Int. Cl.: 36

Prior U.S. Cls.: 100, 101 and 102

United States Patent and Trademark Office

Reg. No. 3,476,342

Registered July 29, 2008

**SERVICE MARK
PRINCIPAL REGISTER**

CHAMPIONS FOR HER

WOMEN FOR WOMEN, INC. (KENTUCKY COR-
PORATION)
SUITE 1110
325 WEST MAIN STREET
LOUISVILLE, KY 402024251

FOR: CHARITABLE FUND RAISING SERVICES,
IN CLASS 36 (U.S. CLS. 100, 101 AND 102).

FIRST USE 9-1-2006; IN COMMERCE 9-1-2006.

THE MARK CONSISTS OF STANDARD CHAR-
ACTERS WITHOUT CLAIM TO ANY PARTICULAR
FONT, STYLE, SIZE, OR COLOR.

SER. NO. 77-359,960, FILED 12-27-2007.

MARCIE MILONE, EXAMINING ATTORNEY

Int. Cl.: 39

Prior U.S. Cls.: 100 and 105

United States Patent and Trademark Office

Reg. No. 3,476,343

Registered July 29, 2008

**SERVICE MARK
PRINCIPAL REGISTER**



TRAVELSCREAM, INC. (COLORADO CORPORATION)

P.O. BOX 3851
AVON, CO 81620

FOR: TRAVEL INFORMATION SERVICES, IN CLASS 39 (U.S. CLS. 100 AND 105).

FIRST USE 7-0-2007; IN COMMERCE 7-0-2007.

NO CLAIM IS MADE TO THE EXCLUSIVE RIGHT TO USE ".COM", APART FROM THE MARK AS SHOWN.

THE COLOR(S) RED AND BLACK IS/ARE CLAIMED AS A FEATURE OF THE MARK.

THE MARK CONSISTS OF BLACK STICK FIGURE HOLDING A RED AND BLACK MEGAPHONE WITH A RED SWISH BELOW THE FIGURE AND THE LITERAL ELEMENTS "TRAVELSCREAM" IN BLACK AND ".COM" APPEARING IN RED TO RIGHT OF THE DESIGN.

SER. NO. 77-360,072, FILED 12-27-2007.

SUNG IN, EXAMINING ATTORNEY

Int. Cl.: 5

Prior U.S. Cls.: 6, 18, 44, 46, 51 and 52

United States Patent and Trademark Office

Reg. No. 3,476,344

Registered July 29, 2008

**TRADEMARK
PRINCIPAL REGISTER**

LONGEVITROL

MATRIX HEALTH PRODUCTS INC. (WASHING-
TON CORPORATION)
1101 NE 144TH ST. #109
VANCOUVER, WA 98685

THE MARK CONSISTS OF STANDARD CHAR-
ACTERS WITHOUT CLAIM TO ANY PARTICULAR
FONT, STYLE, SIZE, OR COLOR.

FOR: DIETARY AND NUTRITIONAL SUPPLE-
MENTS, IN CLASS 5 (U.S. CLS. 6, 18, 44, 46, 51 AND
52).

SER. NO. 77-360,123, FILED 12-27-2007.

FIRST USE 5-16-2000; IN COMMERCE 5-16-2000.

MICHAEL WEBSTER, EXAMINING ATTORNEY

Int. Cl.: 36

Prior U.S. Cls.: 100, 101 and 102

United States Patent and Trademark Office

Reg. No. 3,476,345

Registered July 29, 2008

**SERVICE MARK
PRINCIPAL REGISTER**

ASSEMBLY SQUARE

FEDERAL REALTY INVESTMENT TRUST
(MARYLAND REAL ESTATE INVESTMENT
TRUST)

1626 EAST JEFFERSON STREET
ROCKVILLE, MD 208524041

FOR: REAL ESTATE LEASING; REAL ESTATE
MANAGEMENT, IN CLASS 36 (U.S. CLS. 100, 101
AND 102).

FIRST USE 12-31-1981; IN COMMERCE 12-31-1981.

THE MARK CONSISTS OF STANDARD CHAR-
ACTERS WITHOUT CLAIM TO ANY PARTICULAR
FONT, STYLE, SIZE, OR COLOR.

NO CLAIM IS MADE TO THE EXCLUSIVE
RIGHT TO USE SQUARE, APART FROM THE
MARK AS SHOWN.

SER. NO. 77-360,128, FILED 12-27-2007.

ELLEN PERKINS, EXAMINING ATTORNEY

Int. Cl.: 9

Prior U.S. Cls.: 21, 23, 26, 36 and 38

Reg. No. 3,476,346

United States Patent and Trademark Office

Registered July 29, 2008

**TRADEMARK
PRINCIPAL REGISTER**

ALIEN SKIN SOFTWARE

ALIEN SKIN SOFTWARE, LLC (NORTH CAROLINA LTD LIAB CO)
SUITE 113
1111 HAYNES STREET
RALEIGH, NC 27604

FOR: COMPUTER SOFTWARE PROGRAMS AND APPLICATIONS FOR USE IN THE FIELD OF GRAPHIC ARTS, DIGITAL PHOTOGRAPHY, MULTIMEDIA DESIGN, AND VIDEO, NAMELY, COMPUTER SOFTWARE FOR THE CREATION OF SPECIAL EFFECTS AND FOR THE MODIFICATION, MANIPULATION AND ENHANCEMENT OF DIGITAL IMAGES AND VIDEO, IN CLASS 9 (U.S. CLS. 21, 23, 26, 36 AND 38).

FIRST USE 9-0-1993; IN COMMERCE 9-0-1993.

THE MARK CONSISTS OF STANDARD CHARACTERS WITHOUT CLAIM TO ANY PARTICULAR FONT, STYLE, SIZE, OR COLOR.

OWNER OF U.S. REG. NO. 2,851,052.

NO CLAIM IS MADE TO THE EXCLUSIVE RIGHT TO USE "SOFTWARE", APART FROM THE MARK AS SHOWN.

SER. NO. 77-360,163, FILED 12-27-2007.

SKYE YOUNG, EXAMINING ATTORNEY

Int. Cl.: 36

Prior U.S. Cls.: 100, 101 and 102

United States Patent and Trademark Office

Reg. No. 3,476,347

Registered July 29, 2008

**SERVICE MARK
PRINCIPAL REGISTER**

CHAMPIONS4HER

WOMEN FOR WOMEN, INC. (KENTUCKY COR-
PORATION)
SUITE 1110
325 WEST MAIN STREET
LOUISVILLE, KY 402024251

FOR: CHARITABLE FUND RAISING SERVICES,
IN CLASS 36 (U.S. CLS. 100, 101 AND 102).

FIRST USE 9-1-2006; IN COMMERCE 9-1-2006.

THE MARK CONSISTS OF STANDARD CHAR-
ACTERS WITHOUT CLAIM TO ANY PARTICULAR
FONT, STYLE, SIZE, OR COLOR.

SER. NO. 77-360,205, FILED 12-27-2007.

MARCIE MILONE, EXAMINING ATTORNEY

Int. Cl.: 41

Prior U.S. Cls.: 100, 101 and 107

United States Patent and Trademark Office

Reg. No. 3,476,348

Registered July 29, 2008

**SERVICE MARK
PRINCIPAL REGISTER**

BRISNET.COM

CHURCHILL DOWNS INCORPORATED (KEN-
TUCKY CORPORATION)
700 CENTRAL AVENUE
LOUISVILLE, KY 40208

FOR: PROVIDING NEWS AND INFORMATION
IN THE FIELD OF HORSE RACING AND HORSE
PEDIGREES VIA A GLOBAL COMPUTER NET-
WORK, IN CLASS 41 (U.S. CLS. 100, 101 AND 107).

FIRST USE 12-31-1996; IN COMMERCE 12-31-1996.

THE MARK CONSISTS OF STANDARD CHAR-
ACTERS WITHOUT CLAIM TO ANY PARTICULAR
FONT, STYLE, SIZE, OR COLOR.

SER. NO. 77-360,231, FILED 12-27-2007.

DARRYL SPRUILL, EXAMINING ATTORNEY

Int. Cl.: 41

Prior U.S. Cls.: 100, 101 and 107

United States Patent and Trademark Office

Reg. No. 3,476,349

Registered July 29, 2008

**SERVICE MARK
PRINCIPAL REGISTER**

LOS YONIC'S

ZAMACONA, JOSE MANUEL (MEXICO INDIVIDUAL)
7254 WIBLE ROAD
BAKERSFIELD, CA 93313

FOR: ENTERTAINMENT, NAMELY, LIVE PERFORMANCES BY A MUSICAL BAND, IN CLASS 41 (U.S. CLS. 100, 101 AND 107).

FIRST USE 10-1-1974; IN COMMERCE 2-12-1975.

THE MARK CONSISTS OF STANDARD CHARACTERS WITHOUT CLAIM TO ANY PARTICULAR FONT, STYLE, SIZE, OR COLOR.

THE FOREIGN WORDING IN THE MARK TRANSLATES INTO ENGLISH AS THE YONIC'S.

SER. NO. 77-360,267, FILED 12-27-2007.

RONALD AIKENS, EXAMINING ATTORNEY

Int. Cl.: 31

Prior U.S. Cls.: 1 and 46

United States Patent and Trademark Office

Reg. No. 3,476,350

Registered July 29, 2008

TRADEMARK
PRINCIPAL REGISTER



VERITAS V, LLC (CALIFORNIA LTD LIAB CO)
401 MONTEREY STREET, SUITE 201
SALINAS, CA 93901

FOR: ORGANIC FRESH VEGETABLES, IN CLASS
31 (U.S. CLS. 1 AND 46).

FIRST USE 6-0-2007; IN COMMERCE 6-0-2007.

NO CLAIM IS MADE TO THE EXCLUSIVE
RIGHT TO USE "GOOD FRESH VEGGIES", APART
FROM THE MARK AS SHOWN.

THE COLOR(S) RED, ORANGE, GREEN AND
BLACK IS/ARE CLAIMED AS A FEATURE OF THE
MARK.

THE MARK IS COMPRISED OF THE WORDING
"ORGANICGIRL" AND "GOOD FRESH VEGGIES"
AND THE DESIGN OF A TOMATO, CARROT AND
LETTUCE LEAF IN A RECTANGULAR BACK-

GROUND CARRIER WITH A SINGLE LINE DIS-
SECTING THE RECTANGLE BELOW THE
WORDING. THE COLOR RED APPEARS IN THE
TOMATO DESIGN AND IN THE WORDING
"GIRL". THE COLOR GREEN APPEARS IN THE
LEAF DESIGN AND ON THE LEAVES SHOWN ON
THE VEGETABLES. THE COLOR ORANGE AP-
PEARS IN THE CARROT DESIGN. THE COLOR
BLACK APPEARS IN THE WORDING "ORGANIC",
IN THE WORDING "GOOD FRESH VEGGIES", IN
THE OUTLINE OF THE VEGETABLES, IN THE
OUTLINE OF THE RECTANGLE, AND IN THE
DESIGN OF THE LINE. THE COLOR WHITE AP-
PEARS ON THE SHADING PART OF THE TOMATO.
THE WHITE AREA THAT COMPRISES THE BACK-
GROUND AREA OF THE MARK WITHIN THE
RECTANGLE IS INTENDED AS A TRANSPARENT
AREA AND IS NOT PART OF THE MARK.

SER. NO. 77-360,275, FILED 12-27-2007.

SHARON MEIER, EXAMINING ATTORNEY

Int. Cl.: 5

Prior U.S. Cls.: 6, 18, 44, 46, 51 and 52

United States Patent and Trademark Office

Reg. No. 3,476,351

Registered July 29, 2008

**TRADEMARK
PRINCIPAL REGISTER**

CANINE CARE

FREELIFE INTERNATIONAL HOLDINGS, LLC
(CONNECTICUT LTD LIAB CO)
SUITE 201
3925 E. BROADWAY
PHOENIX, AZ 85040

FOR: DIETARY SUPPLEMENTS FOR PETS, NUTRITIONAL SUPPLEMENTS FOR PETS, INGREDIENTS FOR USE AS DIETARY AND NUTRITIONAL DIETARY SUPPLEMENTS FOR PETS, HERBS AND HERBAL EXTRACTS FOR USE AS DIETARY SUPPLEMENTS FOR PETS, PLANTS ENZYMES FOR USE AS DIETARY SUPPLEMENTS FOR PETS, AND MINERALS FOR USE AS DIETARY SUPPLEMENTS FOR PETS, IN CLASS 5 (U.S. CLS. 6, 18, 44, 46, 51 AND 52).

FIRST USE 8-9-1999; IN COMMERCE 8-9-1999.

THE MARK CONSISTS OF STANDARD CHARACTERS WITHOUT CLAIM TO ANY PARTICULAR FONT, STYLE, SIZE, OR COLOR.

OWNER OF U.S. REG. NO. 2,528,677.

SEC. 2(F).

SER. NO. 77-360,294, FILED 12-27-2007.

MARY ROSSMAN, EXAMINING ATTORNEY

Int. Cl.: 1

Prior U.S. Cls.: 1, 5, 6, 10, 26 and 46

Reg. No. 3,476,352

United States Patent and Trademark Office

Registered July 29, 2008

**TRADEMARK
PRINCIPAL REGISTER**

Fatezzi Faux Wood

ACKUE INTERNATIONAL, LLC (FLORIDA LTD
LIAB CO)
587 DUNMAR CR
WINTER SPRINGS, FL 32708

FOR: SYNTHETIC RESINS FOR USE IN THE
MANUFACTURE OF PLASTIC MOLDING COM-
POUNDS, IN CLASS 1 (U.S. CLS. 1, 5, 6, 10, 26 AND
46).

FIRST USE 10-1-2007; IN COMMERCE 10-1-2007.

THE MARK CONSISTS OF STANDARD CHAR-
ACTERS WITHOUT CLAIM TO ANY PARTICULAR
FONT, STYLE, SIZE, OR COLOR.

NO CLAIM IS MADE TO THE EXCLUSIVE
RIGHT TO USE "FAUX WOOD", APART FROM
THE MARK AS SHOWN.

SER. NO. 77-360,296, FILED 12-27-2007.

MARY ROSSMAN, EXAMINING ATTORNEY

Int. Cl.: 30

Prior U.S. Cl.: 46

United States Patent and Trademark Office

Reg. No. 3,476,353

Registered July 29, 2008

**TRADEMARK
PRINCIPAL REGISTER**

ONE OF A KIND MADE ONE AT
A TIME

JUDY'S CANDY COMPANY (CALIFORNIA COR-
PORATION)
1225 8TH STREET
BERKELEY, CA 94710

FOR: CANDY, IN CLASS 30 (U.S. CL. 46).

FIRST USE 2-7-2001; IN COMMERCE 2-7-2001.

THE MARK CONSISTS OF STANDARD CHAR-
ACTERS WITHOUT CLAIM TO ANY PARTICULAR
FONT, STYLE, SIZE, OR COLOR.

OWNER OF U.S. REG. NO. 2,532,283.

SER. NO. 77-360,303, FILED 12-27-2007.

RONALD AIKENS, EXAMINING ATTORNEY

Int. Cl.: 20

Prior U.S. Cls.: 2, 13, 22, 25, 32 and 50

United States Patent and Trademark Office

Reg. No. 3,476,354

Registered July 29, 2008

**TRADEMARK
PRINCIPAL REGISTER**

STYLEX

STYLEX, INC. (NEW JERSEY CORPORATION)
P.O. BOX 5038
DELANCO, NJ 08075

THE MARK CONSISTS OF STANDARD CHAR-
ACTERS WITHOUT CLAIM TO ANY PARTICULAR
FONT, STYLE, SIZE, OR COLOR.

FOR: FURNITURE, NAMELY, CHAIRS AND
TABLES; FURNITURE, IN CLASS 20 (U.S. CLS. 2,
13, 22, 25, 32 AND 50).

SER. NO. 77-360,317, FILED 12-27-2007.

FIRST USE 0-0-1956; IN COMMERCE 0-0-1956.

RONALD AIKENS, EXAMINING ATTORNEY

Int. Cl.: 41

Prior U.S. Cls.: 100, 101 and 107

United States Patent and Trademark Office

Reg. No. 3,476,355

Registered July 29, 2008

**SERVICE MARK
PRINCIPAL REGISTER**



ZAMACONA, JOSE MANUEL (MEXICO INDIVIDUAL)
7254 WIBLE ROAD
BAKERSFIELD, CA 93313

FOR: ENTERTAINMENT NAMELY, LIVE PERFORMANCES BY A MUSICAL BAND, IN CLASS 41 (U.S. CLS. 100, 101 AND 107).

FIRST USE 10-1-1974; IN COMMERCE 2-12-1975.

THE MARK CONSISTS OF THE WORDS "LOS YONIC'S" WITH THE STYLIZED HEAD OF A BIRD.

THE FOREIGN WORDING IN THE MARK TRANSLATES INTO ENGLISH AS THE YONIC'S.

SER. NO. 77-360,318, FILED 12-27-2007.

RONALD AIKENS, EXAMINING ATTORNEY

Int. Cl.: 31

Prior U.S. Cls.: 1 and 46

United States Patent and Trademark Office

Reg. No. 3,476,356

Registered July 29, 2008

TRADEMARK
PRINCIPAL REGISTER

washed²

we washed it 2 times
so you don't have to

VERITAS V, LLC (CALIFORNIA LTD LIAB CO)
401 MONTEREY STREET, SUITE 201
SALINAS, CA 93901

FOR: FRESH VEGETABLES, IN CLASS 31 (U.S.
CLS. 1 AND 46).

FIRST USE 6-0-2007; IN COMMERCE 6-0-2007.

THE MARK CONSISTS OF THE WORD "WASHED", THE ROMAN NUMERAL "2" AND A LINE ABOVE THE PHRASE "WE WASHED IT 2 TIMES SO YOU DON'T HAVE TO".

SER. NO. 77-360,323, FILED 12-27-2007.

SHARON MEIER, EXAMINING ATTORNEY

Int. Cls.: 35, 36 and 42

Prior U.S. Cls.: 100, 101 and 102

United States Patent and Trademark Office

Reg. No. 3,476,357

Registered July 29, 2008

**SERVICE MARK
PRINCIPAL REGISTER**



CASS INFORMATION SYSTEMS, INC. (MISSOURI CORPORATION)
13001 HOLLENBERG DRIVE
BRIDGETON, MO 63044

FOR: PROVIDING INFORMATION SERVICES RELATING TO BUSINESS EXPENSE MANAGEMENT, IN CLASS 35 (U.S. CLS. 100, 101 AND 102).

FIRST USE 12-31-1976; IN COMMERCE 12-31-1976.

FOR: BANKING; BILL PAYMENT SERVICES, IN CLASS 36 (U.S. CLS. 100, 101 AND 102).

FIRST USE 12-31-1976; IN COMMERCE 12-31-1976.

FOR: APPLICATION SERVICE PROVIDER (ASP) FEATURING ONLINE NONDOWNLOADABLE SOFTWARE FOR ASSEMBLING, ORGANIZING, AND ANALYZING INFORMATION RELATING

TO FREIGHT AND TRANSPORTATION EXPENSE MANAGEMENT, IN CLASS 42 (U.S. CLS. 100 AND 101).

FIRST USE 6-0-2000; IN COMMERCE 6-0-2000.

OWNER OF U.S. REG. NOS. 1,665,200 AND 2,126,891.

THE MARK CONSISTS OF A DARK RECTANGLE WITH CURVED SIDES, CONTAINING THE LETTERS "CASS" PRINTED IN REVERSE TYPE AND WITH AN UNDERLINE THAT CURVES UPWARD.

SER. NO. 77-360,325, FILED 12-27-2007.

JOHN SCHUYLER YARD, EXAMINING ATTORNEY

Int. Cl.: 36

Prior U.S. Cls.: 100, 101 and 102

United States Patent and Trademark Office

Reg. No. 3,476,358

Registered July 29, 2008

**SERVICE MARK
PRINCIPAL REGISTER**



SHANNON & LUCHS INSURANCE AGENCY,
INC. (D.C. CORPORATION)
400 PROFESSIONAL DRIVE, SUITE 360
GAITHERSBURG, MD 20879

FIRST USE 6-20-2006; IN COMMERCE 6-20-2006.

SER. NO. 77-360,334, FILED 12-27-2007.

FOR: INSURANCE AGENCY, IN CLASS 36 (U.S.
CLS. 100, 101 AND 102).

KARANENDRA S. CHHINA, EXAMINING ATTOR-
NEY

Int. Cl.: 41

Prior U.S. Cls.: 100, 101 and 107

United States Patent and Trademark Office

Reg. No. 3,476,359

Registered July 29, 2008

**SERVICE MARK
PRINCIPAL REGISTER**

FINNISHING SCHOOL

FINLANDIA VODKA WORLDWIDE LTD. (FIN-
LAND CORPORATION)
PORKKALANKATU 24
HELSINKI, FINLAND 00180

FOR: EDUCATIONAL SERVICES, NAMELY,
PROVIDING CLASSES IN THE FIELD OF BAR-
TENDING AND VODKA APPRECIATION, IN
CLASS 41 (U.S. CLS. 100, 101 AND 107).

FIRST USE 9-30-2005; IN COMMERCE 9-30-2005.

THE MARK CONSISTS OF STANDARD CHAR-
ACTERS WITHOUT CLAIM TO ANY PARTICULAR
FONT, STYLE, SIZE, OR COLOR.

SER. NO. 77-360,359, FILED 12-27-2007.

JEFFERY COWARD, EXAMINING ATTORNEY

Int. Cl.: 20

Prior U.S. Cls.: 2, 13, 22, 25, 32 and 50

Reg. No. 3,476,360

United States Patent and Trademark Office

Registered July 29, 2008

**TRADEMARK
PRINCIPAL REGISTER**

VITEX

WERNER MEDIA PARTNERS, LLC (ILLINOIS
LTD LIAB CO), DBA NATURE'S SLEEP, LLC
10984 GOLDEN EAGLE COURT
PLANTATION, FL 33324

THE MARK CONSISTS OF STANDARD CHAR-
ACTERS WITHOUT CLAIM TO ANY PARTICULAR
FONT, STYLE, SIZE, OR COLOR.

FOR: PILLOWS, IN CLASS 20 (U.S. CLS. 2, 13, 22,
25, 32 AND 50).

SER. NO. 77-360,376, FILED 12-27-2007.

FIRST USE 8-1-2007; IN COMMERCE 8-1-2007.

KYLE PEETE, EXAMINING ATTORNEY

Int. Cl.: 41

Prior U.S. Cls.: 100, 101 and 107

United States Patent and Trademark Office

Reg. No. 3,476,361

Registered July 29, 2008

**SERVICE MARK
PRINCIPAL REGISTER**

MASTER OF VODKA

FINLANDIA VODKA WORLDWIDE LTD. (FIN-
LAND CORPORATION)
PORKKALANKATU 24
HELSINKI, FINLAND 00180

FOR: EDUCATIONAL SERVICES, NAMELY,
PROVIDING CLASSES IN THE FIELD OF BAR-
TENDING AND VODKA APPRECIATION, IN
CLASS 41 (U.S. CLS. 100, 101 AND 107).

FIRST USE 9-30-2005; IN COMMERCE 9-30-2005.

THE MARK CONSISTS OF STANDARD CHAR-
ACTERS WITHOUT CLAIM TO ANY PARTICULAR
FONT, STYLE, SIZE, OR COLOR.

SER. NO. 77-360,377, FILED 12-27-2007.

JEFFERY COWARD, EXAMINING ATTORNEY

Int. Cl.: 35

Prior U.S. Cls.: 100, 101 and 102

United States Patent and Trademark Office

Reg. No. 3,476,362

Registered July 29, 2008

**SERVICE MARK
PRINCIPAL REGISTER**

The logo for CLIKIO.COM is rendered in a bold, black, hand-drawn style. The word "CLIKIO" is written in large, thick letters, with the "i" having a dot. Below "CLIKIO", the word ".COM" is written in a smaller, similar font. The overall appearance is that of a casual, sketchy brand mark.

J MEDIA GROUP (FLORIDA LTD LIAB CO)
12931 SW 2 TER.
MIAMI, FL 33184

THE MARK CONSISTS OF THE STYLIZED
WORDS "CLIKIO .COM".

FOR: ON-LINE RETAIL STORE SERVICES FEATURING WATCHES, IN CLASS 35 (U.S. CLS. 100, 101 AND 102).

SER. NO. 77-360,392, FILED 12-27-2007.

FIRST USE 11-0-2007; IN COMMERCE 11-0-2007.

JEFFERY COWARD, EXAMINING ATTORNEY

Int. Cl.: 35

Prior U.S. Cls.: 100, 101 and 102

United States Patent and Trademark Office

Reg. No. 3,476,363

Registered July 29, 2008

SERVICE MARK
PRINCIPAL REGISTER

*wish*giving

LEE, VANESSA (UNITED STATES INDIVIDUAL)
3058 GALLOPING HILLS
CHINO HILLS, CA 91709

FOR: RETAIL STORE SERVICES FEATURING
JEWELRY AND GIFTS, IN CLASS 35 (U.S. CLS. 100,
101 AND 102).

FIRST USE 12-1-2006; IN COMMERCE 12-1-2006.

THE MARK CONSISTS OF THE WORD "WISH-
GIVING" BEING WRITTEN IN BOTH CALLIGRA-
PHY AND SERIF WRITING. "WISH" IS WRITTEN
IN CALLIGRAPHY AND "GIVING" IS WRITTEN IN
SERIF TEXT. BOTH WORDS ARE JOINED TOGE-
THER TO FORM ONE WORD.

SER. NO. 77-360,394, FILED 12-27-2007.

DAYNA BROWNE, EXAMINING ATTORNEY

Int. Cl.: 42

Prior U.S. Cls.: 100 and 101

United States Patent and Trademark Office

Reg. No. 3,476,364

Registered July 29, 2008

**SERVICE MARK
PRINCIPAL REGISTER**

ELEXTEK

ELEX TECHNOLOGIES, INC. (TEXAS CORPORATION)
2109 COLQUITT
HOUSTON, TX 77098

FOR: CONSULTING SERVICES IN THE FIELD OF DESIGN, SELECTION, IMPLEMENTATION AND USE OF COMPUTER HARDWARE AND SOFTWARE SYSTEMS FOR OTHERS, IN CLASS 42 (U.S. CLS. 100 AND 101).

FIRST USE 2-3-1999; IN COMMERCE 2-25-1999.

THE MARK CONSISTS OF STANDARD CHARACTERS WITHOUT CLAIM TO ANY PARTICULAR FONT, STYLE, SIZE, OR COLOR.

SER. NO. 77-360,398, FILED 12-27-2007.

YONG KIM, EXAMINING ATTORNEY

Int. Cl.: 35

Prior U.S. Cls.: 100, 101 and 102

United States Patent and Trademark Office

Reg. No. 3,476,365

Registered July 29, 2008

**SERVICE MARK
PRINCIPAL REGISTER**

NTRA ADVANTAGE

NATIONAL THOROUGHBRED RACING ASSO-
CIATION, INC. (DELAWARE CORPORATION)
2525 HARRODSBURG ROAD
LEXINGTON, KY 40504

FOR: ADVERTISING SERVICES, NAMELY, PRO-
MOTING AND MARKETING THE GOODS AND
SERVICES OF OTHERS THROUGH ALL PUBLIC
COMMUNICATIONS MEANS , IN CLASS 35 (U.S.
CLS. 100, 101 AND 102).

FIRST USE 11-12-2007; IN COMMERCE 11-12-2007.

THE MARK CONSISTS OF STANDARD CHAR-
ACTERS WITHOUT CLAIM TO ANY PARTICULAR
FONT, STYLE, SIZE, OR COLOR.

OWNER OF U.S. REG. NOS. 2,325,233 AND
2,334,296.

SER. NO. 77-360,421, FILED 12-27-2007.

BARBARA A. GOLD, EXAMINING ATTORNEY

Int. Cl.: 9

Prior U.S. Cls.: 21, 23, 26, 36 and 38

United States Patent and Trademark Office

Reg. No. 3,476,366

Registered July 29, 2008

**TRADEMARK
PRINCIPAL REGISTER**

SCREEN SHEPHERD

ELEX TECHNOLOGIES, INC. (TEXAS CORPORATION)
2109 COLQUITT
HOUSTON, TX 77098

THE MARK CONSISTS OF STANDARD CHARACTERS WITHOUT CLAIM TO ANY PARTICULAR FONT, STYLE, SIZE, OR COLOR.

FOR: COMPUTER SCREEN SAVER SOFTWARE,
IN CLASS 9 (U.S. CLS. 21, 23, 26, 36 AND 38).

SER. NO. 77-360,425, FILED 12-27-2007.

FIRST USE 2-5-2005; IN COMMERCE 8-30-2005.

YONG KIM, EXAMINING ATTORNEY

Int. Cls.: 9 and 41

Prior U.S. Cls.: 21, 23, 26, 36, 38, 100, 101 and 107

United States Patent and Trademark Office

Reg. No. 3,476,367

Registered July 29, 2008

**TRADEMARK
SERVICE MARK
PRINCIPAL REGISTER**

THE NATURAL ADVOCATE

COALITION FOR NATURAL HEALTH, INC.
(DELAWARE CORPORATION)
PMB 100-408
1220 L STREET NW
WASHINGTON, DC 20005

FOR: PROVIDING DOWNLOADABLE ELECTRO-
NIC NEWSLETTERS IN THE FIELD OF NATURO-
PATHY, NATURAL HEALTH AND HOLISTIC
NUTRITION, IN CLASS 9 (U.S. CLS. 21, 23, 26, 36
AND 38).

FIRST USE 0-0-2005; IN COMMERCE 0-0-2005.

FOR: PROVIDING NEWSLETTERS IN THE
FIELD OF NATUROPATHY, NATURAL HEALTH

AND HOLISTIC NUTRITION VIA E-MAIL, IN
CLASS 41 (U.S. CLS. 100, 101 AND 107).

FIRST USE 0-0-2005; IN COMMERCE 0-0-2005.

THE MARK CONSISTS OF STANDARD CHAR-
ACTERS WITHOUT CLAIM TO ANY PARTICULAR
FONT, STYLE, SIZE, OR COLOR.

OWNER OF U.S. REG. NO. 2,539,484.

SER. NO. 77-360,467, FILED 12-27-2007.

APRIL ROACH, EXAMINING ATTORNEY

Int. Cl.: 16

Prior U.S. Cls.: 2, 5, 22, 23, 29, 37, 38 and 50

United States Patent and Trademark Office

Reg. No. 3,476,368

Registered July 29, 2008

**TRADEMARK
PRINCIPAL REGISTER**

MEMOPIT

NANTOKA KANTOKA, LLC (NEW YORK LTD
LIAB CO)
RM. 1003
1230 AMSTERDAM AVE.
NEW YORK, NY 10027

THE MARK CONSISTS OF STANDARD CHAR-
ACTERS WITHOUT CLAIM TO ANY PARTICULAR
FONT, STYLE, SIZE, OR COLOR.

FOR: ADHESIVE MEMO HOLDER, IN CLASS 16
(U.S. CLS. 2, 5, 22, 23, 29, 37, 38 AND 50).

SER. NO. 77-360,517, FILED 12-27-2007.

FIRST USE 10-10-2006; IN COMMERCE 10-10-2006.

WANDA KAY PRICE, EXAMINING ATTORNEY

Int. Cl.: 42

Prior U.S. Cls.: 100 and 101

United States Patent and Trademark Office

Reg. No. 3,476,369

Registered July 29, 2008

**SERVICE MARK
PRINCIPAL REGISTER**

WEBVISIBLE

WEBVISIBLE, INC. (DELAWARE CORPORATION), FORMERLY SME GLOBAL SOLUTIONS, INC.
121 INNOVATION, SUITE 100
IRVINE, CA 92617

FOR: PROVIDING TEMPORARY USE OF ON-LINE NON-DOWNLOADABLE SOFTWARE FOR DISSEMINATION OF ADVERTISING FOR OTHERS, IN CLASS 42 (U.S. CLS. 100 AND 101).

FIRST USE 9-13-2005; IN COMMERCE 9-13-2005.

THE MARK CONSISTS OF STANDARD CHARACTERS WITHOUT CLAIM TO ANY PARTICULAR FONT, STYLE, SIZE, OR COLOR.

OWNER OF U.S. REG. NOS. 3,218,915 AND 3,262,710.

SER. NO. 77-360,543, FILED 12-27-2007.

MONIQUE MILLER, EXAMINING ATTORNEY

Int. Cl.: 35

Prior U.S. Cls.: 100, 101 and 102

United States Patent and Trademark Office

Reg. No. 3,476,370

Registered July 29, 2008

**SERVICE MARK
PRINCIPAL REGISTER**

Quick Buy House Guy

HOME RESCUE RESOURCES LLC (ARIZONA
LTD LIAB CO)
15602 N. 18TH ST.
PHOENIX, AZ 85022

THE MARK CONSISTS OF STANDARD CHAR-
ACTERS WITHOUT CLAIM TO ANY PARTICULAR
FONT, STYLE, SIZE, OR COLOR.

FOR: MATCHING CONSUMERS WITH REAL
ESTATE PROFESSIONALS IN THE FIELD OF REAL
ESTATE SERVICES VIA COMPUTER NETWORK,
IN CLASS 35 (U.S. CLS. 100, 101 AND 102).

SER. NO. 77-360,573, FILED 12-27-2007.

FIRST USE 7-7-2007; IN COMMERCE 7-7-2007.

BARBARA BROWN, EXAMINING ATTORNEY

Int. Cl.: 41

Prior U.S. Cls.: 100, 101 and 107

United States Patent and Trademark Office

Reg. No. 3,476,371

Registered July 29, 2008

**SERVICE MARK
PRINCIPAL REGISTER**

Write To Share

WRITE TO SHARE (TEXAS CHARITABLE CORPORATION)
7904 BRIGHTMAN LANE
AUSTIN, TX 78733

THE MARK CONSISTS OF STANDARD CHARACTERS WITHOUT CLAIM TO ANY PARTICULAR FONT, STYLE, SIZE, OR COLOR.

FOR: EDUCATION INFORMATION, IN CLASS 41 (U.S. CLS. 100, 101 AND 107).

SER. NO. 77-360,582, FILED 12-27-2007.

FIRST USE 6-14-2007; IN COMMERCE 6-14-2007.

WANDA KAY PRICE, EXAMINING ATTORNEY

Int. Cl.: 1

Prior U.S. Cls.: 1, 5, 6, 10, 26 and 46

Reg. No. 3,476,372

United States Patent and Trademark Office

Registered July 29, 2008

**TRADEMARK
PRINCIPAL REGISTER**

CEDAR GROVE

CEDAR GROVE COMPOSTING, INC. (WA-
SHINGTON CORPORATION)
9010 E. MARGINAL WAY SOUTH, SUITE 200
SEATTLE, WA 98108

THE MARK CONSISTS OF STANDARD CHAR-
ACTERS WITHOUT CLAIM TO ANY PARTICULAR
FONT, STYLE, SIZE, OR COLOR.

FOR: COMPOST; PLANTING SOIL; POTTING
SOIL; SOIL AMENDMENTS; MANURE; LOAM, IN
CLASS 1 (U.S. CLS. 1, 5, 6, 10, 26 AND 46).

SER. NO. 77-360,595, FILED 12-27-2007.

FIRST USE 2-1-1991; IN COMMERCE 2-1-1991.

JANET LEE, EXAMINING ATTORNEY

Int. Cl.: 20

Prior U.S. Cls.: 2, 13, 22, 25, 32 and 50

United States Patent and Trademark Office

Reg. No. 3,476,373

Registered July 29, 2008

**TRADEMARK
PRINCIPAL REGISTER**

GORILLA WRAP

RAPID RACK INDUSTRIES, INC. (CALIFORNIA
CORPORATION)
14421 BONELLI STREET
CITY OF INDUSTRY, CA 91746

FOR: LAMINATED SHELVING, IN CLASS 20 (U.S.
CLS. 2, 13, 22, 25, 32 AND 50).

FIRST USE 7-3-2006; IN COMMERCE 7-3-2006.

THE MARK CONSISTS OF STANDARD CHAR-
ACTERS WITHOUT CLAIM TO ANY PARTICULAR
FONT, STYLE, SIZE, OR COLOR.

OWNER OF U.S. REG. NOS. 2,422,507 AND
3,300,657.

SER. NO. 77-360,613, FILED 12-27-2007.

DORITT L. CARROLL, EXAMINING ATTORNEY

Int. Cl.: 28

Prior U.S. Cls.: 22, 23, 38 and 50

United States Patent and Trademark Office

Reg. No. 3,476,374

Registered July 29, 2008

**TRADEMARK
PRINCIPAL REGISTER**

JUST LIKE MINE

JOOVY HOLDING CO. (TEXAS CORPORATION)
2919 CANTON STREET
DALLAS, TX 752261604

FOR: MECHANICAL TOYS; NONELECTRONIC
TOY VEHICLES; NONRIDING TRANSPORTATION
TOYS; PUSH TOYS, IN CLASS 28 (U.S. CLS. 22, 23, 38
AND 50).

FIRST USE 2-12-2006; IN COMMERCE 7-15-2006.

THE MARK CONSISTS OF STANDARD CHAR-
ACTERS WITHOUT CLAIM TO ANY PARTICULAR
FONT, STYLE, SIZE, OR COLOR.

SER. NO. 77-360,649, FILED 12-28-2007.

ALICE SUE CARRUTHERS, EXAMINING ATTOR-
NEY

Int. Cl.: 3

Prior U.S. Cls.: 1, 4, 6, 50, 51 and 52

United States Patent and Trademark Office

Reg. No. 3,476,375

Registered July 29, 2008

**TRADEMARK
PRINCIPAL REGISTER**

**Wash until the light show
ends**

SOAP LABS, INC. (DELAWARE CORPORATION)
SUITE 200
1333 MCDERMOTT DR.
ALLEN, TX 75013

THE MARK CONSISTS OF STANDARD CHAR-
ACTERS WITHOUT CLAIM TO ANY PARTICULAR
FONT, STYLE, SIZE, OR COLOR.

FOR: SOAPS FOR PERSONAL USE, IN CLASS 3
(U.S. CLS. 1, 4, 6, 50, 51 AND 52).

SER. NO. 77-360,655, FILED 12-28-2007.

FIRST USE 11-5-2007; IN COMMERCE 11-5-2007.

BARNEY CHARLON, EXAMINING ATTORNEY

Int. Cl.: 41

Prior U.S. Cls.: 100, 101 and 107

United States Patent and Trademark Office

Reg. No. 3,476,376

Registered July 29, 2008

**SERVICE MARK
PRINCIPAL REGISTER**

a million smocks



OMENSON, RACHELLE, A (UNITED STATES
INDIVIDUAL)
210 LAKEVIEW DR.
COLLINGSWOOD, NJ 08108

THE MARK CONSISTS OF THE WORDS "A
MILLION SMOCKS" WITH A PICTURE OF A
SMOCK HANGING OFF OF THE LETTER "C".

FOR: PROVIDING EDUCATIONAL MENTOR-
ING SERVICES AND PROGRAMS IN THE FIELD
OF ART, IN CLASS 41 (U.S. CLS. 100, 101 AND 107).

SER. NO. 77-360,661, FILED 12-28-2007.

FIRST USE 11-1-2005; IN COMMERCE 11-1-2005.

DAVID HOFFMAN, EXAMINING ATTORNEY

Int. Cls.: 9, 42 and 45

Prior U.S. Cls.: 21, 23, 26, 36, 38, 100 and 101

United States Patent and Trademark Office

Reg. No. 3,476,377

Registered July 29, 2008

**TRADEMARK
SERVICE MARK
PRINCIPAL REGISTER**

The logo for Oberon features the word "Oberon" in a stylized, blue, serif font. A red, multi-pointed starburst or sunburst symbol is positioned above the letter "O".

OBERON ASSOCIATES, INC. (VIRGINIA CORPORATION)
SUITE 301
9700 CAPITAL COURT
MANASSAS, VA 20110

FOR: IRIS RECOGNITION SECURITY DEVICES; COMPUTER SOFTWARE, NAMELY, SOFTWARE DEVELOPMENT TOOLS FOR THE CREATION OF MOBILE INTERNET APPLICATIONS AND CLIENT INTERFACES, IN CLASS 9 (U.S. CLS. 21, 23, 26, 36 AND 38).

FIRST USE 1-15-2002; IN COMMERCE 1-15-2002.

FOR: DESIGN AND DEVELOPMENT OF COMPUTER HARDWARE AND SOFTWARE; DESIGN, DEVELOPMENT AND IMPLEMENTATION OF SOFTWARE; APPLICATION SERVICE PROVIDER, NAMELY, PROVIDING, HOSTING, MANAGING, DEVELOPING, AND MAINTAINING APPLICATIONS, SOFTWARE, WEBSITES, AND DATABASES IN THE FIELDS OF PERSONAL PRODUCTIVITY, WIRELESS COMMUNICATION, MOBILE INFORMATION ACCESS, AND REMOTE DATA MANAGE-

MENT FOR WIRELESS DELIVERY OF CONTENT TO HANDHELD COMPUTERS, LAPTOPS AND MOBILE ELECTRONIC DEVICES, IN CLASS 42 (U.S. CLS. 100 AND 101).

FIRST USE 1-15-2002; IN COMMERCE 1-15-2002.

FOR: PROVIDING INFORMATION CONCERNING HOMELAND SAFETY AND SECURITY ISSUES, IN CLASS 45 (U.S. CLS. 100 AND 101).

FIRST USE 1-15-2002; IN COMMERCE 1-15-2002.

THE COLOR(S) BLUE AND RED IS/ARE CLAIMED AS A FEATURE OF THE MARK.

THE MARK CONSISTS OF THE WORD "OBERON" IN BLUE PANTONE 294 AND A RED PANTONE 200 STAR AT THE TOP OF THE "O".

SER. NO. 77-360,695, FILED 12-28-2007.

ROBIN CHOSID, EXAMINING ATTORNEY

Int. Cl.: 35

Prior U.S. Cls.: 100, 101 and 102

United States Patent and Trademark Office

Reg. No. 3,476,378

Registered July 29, 2008

**SERVICE MARK
PRINCIPAL REGISTER**



BRIDGEVINE, INC. (DELAWARE CORPORATION)
2770 INDIAN RIVER BLVD, SUITE 501
VERO BEACH, FL 32960

THE COLOR(S) ORANGE, GREEN AND BLUE IS/
ARE CLAIMED AS A FEATURE OF THE MARK.

FOR: PROVIDING A WEBSITE THAT ENABLES
SMALL BUSINESSES AND CONSUMERS TO COM-
PARE PRICES AND TO PURCHASE SERVICES,
NAMELY, HIGH SPEED INTERNET, VOICE OVER
INTERNET PROTOCOL (VOIP), TELEVISION, MO-
BILE, MUSIC, SECURITY AND OTHER DIGITAL-
RELATED SERVICES, IN CLASS 35 (U.S. CLS. 100,
101 AND 102).

THE MARK CONSISTS OF AN ORANGE AND
GREEN BOX OUTLINED IN BLUE NEXT TO
"BRIDGE" IN GREEN WITH A BLUE DOT IN THE
MIDDLE OF THE "G" AND "VINE" IN ORANGE.

SER. NO. 77-360,710, FILED 12-28-2007.

FIRST USE 12-11-2007; IN COMMERCE 12-11-2007.

MONIQUE MILLER, EXAMINING ATTORNEY

Int. Cl.: 9

Prior U.S. Cls.: 21, 23, 26, 36 and 38

Reg. No. 3,476,379

United States Patent and Trademark Office

Registered July 29, 2008

**TRADEMARK
PRINCIPAL REGISTER**

DURAC

H-B INSTRUMENT COMPANY (PENNSYLVANIA CORPORATION)
102 WEST SEVENTH AVENUE
TRAPPE, PA 194260770

FOR: THERMOMETERS NOT FOR MEDICAL USE, IN CLASS 9 (U.S. CLS. 21, 23, 26, 36 AND 38).

FIRST USE 0-0-1967; IN COMMERCE 0-0-1967.

THE MARK CONSISTS OF STANDARD CHARACTERS WITHOUT CLAIM TO ANY PARTICULAR FONT, STYLE, SIZE, OR COLOR.

OWNER OF U.S. REG. NO. 1,300,294.

SER. NO. 77-360,735, FILED 12-28-2007.

BARNEY CHARLON, EXAMINING ATTORNEY

Int. Cl.: 36

Prior U.S. Cls.: 100, 101 and 102

United States Patent and Trademark Office

Reg. No. 3,476,380

Registered July 29, 2008

**SERVICE MARK
PRINCIPAL REGISTER**

**Making It Easy To Find
Your Way Home!**

EXACT TITLE SERVICES, LLC (FLORIDA LTD
LIAB CO)
137 S. RIDGEWOOD DRIVE
SEBRING, FL 33870

THE MARK CONSISTS OF STANDARD CHAR-
ACTERS WITHOUT CLAIM TO ANY PARTICULAR
FONT, STYLE, SIZE, OR COLOR.

FOR: TITLE INSURANCE SERVICES; REAL ES-
TATE SERVICES, NAMELY, CLOSING AND
ESCROW SERVICES, IN CLASS 36 (U.S. CLS. 100,
101 AND 102).

SER. NO. 77-360,741, FILED 12-28-2007.

FIRST USE 8-16-2005; IN COMMERCE 8-16-2005.

RONALD AIKENS, EXAMINING ATTORNEY

Int. Cl.: 35

Prior U.S. Cls.: 100, 101 and 102

United States Patent and Trademark Office

Reg. No. 3,476,381

Registered July 29, 2008

**SERVICE MARK
PRINCIPAL REGISTER**



LITTLE ELFS (CALIFORNIA LTD LIAB CO)
9000 CROW CANYON ROAD
DANVILLE, CA 94506

FOR: PROVIDING A WEB SITE WHERE USERS
CAN POST RATINGS, REVIEWS AND RECOMMEN-
DATIONS ON PRODUCTS AND SERVICES, IN
CLASS 35 (U.S. CLS. 100, 101 AND 102).

FIRST USE 9-7-2006; IN COMMERCE 4-10-2007.

THE MARK CONSISTS OF AN "ELF" HAT THAT
IS PLACED AT THE TOP OF THE "E" IN THE
SPELLING OF "LITTLE ELFS". ALSO, WE HAVE
THE TAG LINE ""CONNECTING OPPORTUNITIES
WITH SOLUTIONS"" IN QUOTATION UNDER THE
SPELLING OF "LITTLE ELFS".

SER. NO. 77-360,753, FILED 12-28-2007.

RONALD AIKENS, EXAMINING ATTORNEY

Int. Cl.: 41

Prior U.S. Cls.: 100, 101 and 107

United States Patent and Trademark Office

Reg. No. 3,476,382

Registered July 29, 2008

**SERVICE MARK
PRINCIPAL REGISTER**

BANGEMOUT

COHEN, BARRY (UNITED STATES INDIVIDUAL)
14 LYLE COURT
STATEN ISLAND, NY 10306

FOR: MULTIMEDIA ENTERTAINMENT SERVICES IN THE NATURE OF RECORDING, PRODUCTION AND POST-PRODUCTION SERVICES IN THE FIELDS OF MUSIC, VIDEO, AND FILMS, IN CLASS 41 (U.S. CLS. 100, 101 AND 107).

FIRST USE 1-1-1980; IN COMMERCE 1-1-1980.

THE MARK CONSISTS OF STANDARD CHARACTERS WITHOUT CLAIM TO ANY PARTICULAR FONT, STYLE, SIZE, OR COLOR.

SER. NO. 77-360,759, FILED 12-28-2007.

DAVID HOFFMAN, EXAMINING ATTORNEY

Int. Cl.: 36

Prior U.S. Cls.: 100, 101 and 102

United States Patent and Trademark Office

Reg. No. 3,476,383

Registered July 29, 2008

**SERVICE MARK
PRINCIPAL REGISTER**

I-BAIL 4U

ALWAYS AVAILABLE BAIL BONDS, INC.
(FLORIDA CORPORATION)
4707 140TH AVENUE NORTH, STE. 102
CLEARWATER, FL 33762

FOR: BAIL BONDING, IN CLASS 36 (U.S. CLS. 100,
101 AND 102).

FIRST USE 5-0-1997; IN COMMERCE 5-0-1997.

THE MARK CONSISTS OF STANDARD CHAR-
ACTERS WITHOUT CLAIM TO ANY PARTICULAR
FONT, STYLE, SIZE, OR COLOR.

SER. NO. 77-360,787, FILED 12-28-2007.

MARTHA SANTOMARTINO, EXAMINING ATTOR-
NEY

Int. Cl.: 30

Prior U.S. Cl.: 46

United States Patent and Trademark Office

Reg. No. 3,476,384

Registered July 29, 2008

**TRADEMARK
PRINCIPAL REGISTER**

LolliChocs

REIZIAN HOLMES, LEE (UNITED STATES IN-
DIVIDUAL)
1814 19TH STREET, NW
WASHINGTON, DC 20009

THE MARK CONSISTS OF STANDARD CHAR-
ACTERS WITHOUT CLAIM TO ANY PARTICULAR
FONT, STYLE, SIZE, OR COLOR.

FOR: CHOCOLATE; CHOCOLATE CANDIES;
LOLLIPOPS, IN CLASS 30 (U.S. CL. 46).

SER. NO. 77-360,844, FILED 12-28-2007.

FIRST USE 10-31-2007; IN COMMERCE 12-1-2007.

NELSON SNYDER, EXAMINING ATTORNEY

Int. Cl.: 36

Prior U.S. Cls.: 100, 101 and 102

United States Patent and Trademark Office

Reg. No. 3,476,385

Registered July 29, 2008

**SERVICE MARK
PRINCIPAL REGISTER**

cfid Investments

CFD INVESTMENTS, INC. (INDIANA CORPORATION)

2704 SOUTH GOYER

KOKOMO, IN 46902

FOR: BROKERAGE IN THE FIELD OF STOCKS, BONDS, VARIABLE ANNUITIES, LIMITED PARTNERSHIPS, VARIABLE LIFE INSURANCE, AND OPTIONS, IN CLASS 36 (U.S. CLS. 100, 101 AND 102).

FIRST USE 1-1-1990; IN COMMERCE 1-1-1990.

THE MARK CONSISTS OF STANDARD CHARACTERS WITHOUT CLAIM TO ANY PARTICULAR FONT, STYLE, SIZE, OR COLOR.

NO CLAIM IS MADE TO THE EXCLUSIVE RIGHT TO USE "INVESTEMENTS", APART FROM THE MARK AS SHOWN.

SEC. 2(F).

SER. NO. 77-360,849, FILED 12-28-2007.

CHERYL CLAYTON, EXAMINING ATTORNEY

Int. Cl.: 45

Prior U.S. Cls.: 100 and 101

United States Patent and Trademark Office

Reg. No. 3,476,386

Registered July 29, 2008

**SERVICE MARK
PRINCIPAL REGISTER**



The Adoption Consultancy

WITT ENTERPRISES, INC. (FLORIDA CORPORATION), DBA THE ADOPTION CONSULTANCY
SUITE 388
809 E. BLOOMINGDALE AVE.
BRANDON, FL 33511

FOR: ADOPTION COUNSELING, IN CLASS 45
(U.S. CLS. 100 AND 101).

FIRST USE 3-0-2006; IN COMMERCE 3-0-2006.

NO CLAIM IS MADE TO THE EXCLUSIVE RIGHT TO USE "THE ADOPTION CONSULTANCY", APART FROM THE MARK AS SHOWN.

THE MARK CONSISTS OF A MAN AND A WOMAN HOLDING A BABY IN A CIRCLE.

SER. NO. 77-360,879, FILED 12-28-2007.

SARA THOMAS, EXAMINING ATTORNEY

Int. Cl.: 42

Prior U.S. Cls.: 100 and 101

United States Patent and Trademark Office

Reg. No. 3,476,387

Registered July 29, 2008

**SERVICE MARK
PRINCIPAL REGISTER**

FrameChannel

FRAME MEDIA, INC. (DELAWARE CORPORATION)
SUITE 70
36 WASHINGTON STREET
WELLESLEY HILLS, MA 02481

FOR: COMPUTER SERVICES, NAMELY, PROVIDING ON-LINE NON-DOWNLOADABLE SOFTWARE FOR MULTIMEDIA CONTENT SELECTION, MANAGEMENT AND DELIVERY FOR USE ON WIRELESS DEVICES, IN CLASS 42 (U.S. CLS. 100 AND 101).

FIRST USE 1-15-2007; IN COMMERCE 1-15-2007.

THE MARK CONSISTS OF STANDARD CHARACTERS WITHOUT CLAIM TO ANY PARTICULAR FONT, STYLE, SIZE, OR COLOR.

SER. NO. 77-360,880, FILED 12-28-2007.

DANNEAN HETZEL, EXAMINING ATTORNEY

Int. Cl.: 36

Prior U.S. Cls.: 100, 101 and 102

United States Patent and Trademark Office

Reg. No. 3,476,388

Registered July 29, 2008

**SERVICE MARK
PRINCIPAL REGISTER**

SCHWAB STOCK LISTS

CHARLES SCHWAB & CO., INC. (CALIFORNIA
CORPORATION)
101 MONTGOMERY STREET
SAN FRANCISCO, CA 94104

FOR: PROVIDING FINANCIAL INFORMATION
AND ANALYSIS IN THE FIELD OF INVESTMENTS,
IN CLASS 36 (U.S. CLS. 100, 101 AND 102).

FIRST USE 11-11-2002; IN COMMERCE 11-11-2002.

THE MARK CONSISTS OF STANDARD CHAR-
ACTERS WITHOUT CLAIM TO ANY PARTICULAR
FONT, STYLE, SIZE, OR COLOR.

SEC. 2(F).

SER. NO. 77-360,902, FILED 12-28-2007.

AISHA CLARKE, EXAMINING ATTORNEY

Int. Cl.: 36

Prior U.S. Cls.: 100, 101 and 102

United States Patent and Trademark Office

Reg. No. 3,476,389

Registered July 29, 2008

**SERVICE MARK
PRINCIPAL REGISTER**

SCHWAB EQUITY RATINGS

CHARLES SCHWAB & CO., INC. (CALIFORNIA
CORPORATION)
101 MONTGOMERY STREET
SAN FRANCISCO, CA 94104

FOR: PROVIDING FINANCIAL INFORMATION
AND ANALYSIS IN THE FIELD OF INVESTMENTS,
IN CLASS 36 (U.S. CLS. 100, 101 AND 102).

FIRST USE 5-6-2002; IN COMMERCE 5-6-2002.

THE MARK CONSISTS OF STANDARD CHAR-
ACTERS WITHOUT CLAIM TO ANY PARTICULAR
FONT, STYLE, SIZE, OR COLOR.

SEC. 2(F).

SER. NO. 77-360,904, FILED 12-28-2007.

AISHA CLARKE, EXAMINING ATTORNEY

Int. Cl.: 33

Prior U.S. Cls.: 47 and 49

United States Patent and Trademark Office

Reg. No. 3,476,390

Registered July 29, 2008

**TRADEMARK
PRINCIPAL REGISTER**



MARGRIT ENTERPRISES INTERNATIONAL,
INC. (CALIFORNIA CORPORATION)
13152 RAYMER STREET E/F
NORTH HOLLYWOOD, CA 91605

THE MARK CONSISTS OF THE LETTER "M"
AND WORD "MARANI" IN A STYLIZED FORMAT
WITHIN A CIRCLE.

FOR: FLAVORED DISTILLED SPIRITS; VODKA,
IN CLASS 33 (U.S. CLS. 47 AND 49).

SER. NO. 77-360,917, FILED 12-28-2007.

FIRST USE 8-1-2002; IN COMMERCE 8-1-2002.

OWNER OF U.S. REG. NO. 2,922,839.

LANA PHAM, EXAMINING ATTORNEY

Int. Cl.: 41

Prior U.S. Cls.: 100, 101 and 107

United States Patent and Trademark Office

Reg. No. 3,476,391

Registered July 29, 2008

**SERVICE MARK
PRINCIPAL REGISTER**

IDENTIFY REALITY

JESTER, WILLIAM (UNITED STATES INDIVIDUAL)
P.O. BOX 101
BLACKSBURG, VA 24063

THE MARK CONSISTS OF STANDARD CHARACTERS WITHOUT CLAIM TO ANY PARTICULAR FONT, STYLE, SIZE, OR COLOR.

FOR: PROFESSIONAL COACHING SERVICES IN THE FIELD OF PERSONAL FULFILLMENT AND LEADERSHIP, IN CLASS 41 (U.S. CLS. 100, 101 AND 107).

SER. NO. 77-360,987, FILED 12-28-2007.

FIRST USE 7-16-2006; IN COMMERCE 7-16-2006.

WANDA KAY PRICE, EXAMINING ATTORNEY

Int. Cl.: 35

Prior U.S. Cls.: 100, 101 and 102

United States Patent and Trademark Office

Reg. No. 3,476,392

Registered July 29, 2008

**SERVICE MARK
PRINCIPAL REGISTER**



MT. CARMEL PHARMACY (NEW YORK CORPORATION)
705 E. 187TH STREET
BRONX, NY 10458

FOR: RETAIL PHARMACY SERVICES, IN CLASS
35 (U.S. CLS. 100, 101 AND 102).

FIRST USE 4-1-1964; IN COMMERCE 4-1-1964.

NO CLAIM IS MADE TO THE EXCLUSIVE
RIGHT TO USE "PHARMACY AND SURGICALS",
APART FROM THE MARK AS SHOWN.

THE STIPLING IS FOR SHADING PURPOSES
ONLY.

THE MARK CONSISTS OF FIVE SILHOUETTES
OF PEOPLE HOLDING HANDS WITH AN ARC
ABOVE THEIR HEADS. BELOW THE SILHOUETTES
ARE THE STYLIZED WORDS "MT CARMEL
PHARMACY AND SURGICALS".

SER. NO. 77-360,992, FILED 12-28-2007.

SANDRA MANIOS, EXAMINING ATTORNEY

Int. Cl.: 25

Prior U.S. Cls.: 22 and 39

United States Patent and Trademark Office

Reg. No. 3,476,393

Registered July 29, 2008

**TRADEMARK
PRINCIPAL REGISTER**

In the House Productions

IN THE HOUSE PRODUCTIONS (CALIFORNIA
SOLE PROPRIETORSHIP)
P.O. BOX 3569
MISSION VIEJO, CA 92690

THE MARK CONSISTS OF STANDARD CHAR-
ACTERS WITHOUT CLAIM TO ANY PARTICULAR
FONT, STYLE, SIZE, OR COLOR.

FOR: GOLF SHIRTS; SHIRTS; SHORT-SLEEVED
OR LONG-SLEEVED T-SHIRTS; SWEAT SHIRTS; T-
SHIRTS, IN CLASS 25 (U.S. CLS. 22 AND 39).

SER. NO. 77-361,023, FILED 12-28-2007.

FIRST USE 11-19-2006; IN COMMERCE 11-19-2006.

ANNE MADDEN, EXAMINING ATTORNEY

Int. Cl.: 41

Prior U.S. Cls.: 100, 101 and 107

United States Patent and Trademark Office

Reg. No. 3,476,394

Registered July 29, 2008

**SERVICE MARK
PRINCIPAL REGISTER**

HALF PAST MY SIN

ARIGONI, JASON (UNITED STATES INDIVIDUAL)
PO BOX 346
NORTH ADAMS, MA 01247

FOR: ENTERTAINMENT, NAMELY, LIVE PERFORMANCES BY A MUSICAL BAND; ENTERTAINMENT SERVICES, NAMELY, PERSONAL APPEARANCES BY A MUSICAL BAND; ENTERTAINMENT, NAMELY, LIVE MUSIC CONCERTS, IN CLASS 41 (U.S. CLS. 100, 101 AND 107).

FIRST USE 2-16-2006; IN COMMERCE 2-16-2006.

THE MARK CONSISTS OF STANDARD CHARACTERS WITHOUT CLAIM TO ANY PARTICULAR FONT, STYLE, SIZE, OR COLOR.

SER. NO. 77-361,030, FILED 12-28-2007.

HEATHER THOMPSON, EXAMINING ATTORNEY

Int. Cl.: 36

Prior U.S. Cls.: 100, 101 and 102

United States Patent and Trademark Office

Reg. No. 3,476,395

Registered July 29, 2008

SERVICE MARK
PRINCIPAL REGISTER



ORIGEN FINANCIAL, INC. (VIRGINIA CORPORATION)
27777 FRANKLIN RD., SUITE 1700
SOUTHFIELD, MI 48034

FOR: INSURANCE AGENCY AND BROKERAGE;
FINANCING SERVICES, IN CLASS 36 (U.S. CLS. 100,
101 AND 102).

FIRST USE 5-23-2005; IN COMMERCE 5-23-2005.

OWNER OF U.S. REG. NO. 2,544,859.

NO CLAIM IS MADE TO THE EXCLUSIVE
RIGHT TO USE "INSURANCE AGENCY, INC."
AND "COMPREHENSIVE COVERAGE", APART
FROM THE MARK AS SHOWN.

THE COLOR(S) BLUE, GOLD AND WHITE IS/
ARE CLAIMED AS A FEATURE OF THE MARK.

THE MARK CONSISTS OF THE LETTERS "OF"
WRITTEN IN BLUE ABOVE THE WORD "INSUR-
ANCE" WRITTEN IN GOLD ABOVE THE WORDS
"AGENCY, INC." WRITTEN IN BLUE INSIDE OF
AN OVAL BROKEN IN HALF VERTICALLY WITH
THE WORDS "CONVENIENCE FASTER FUNDING"
WRITTEN IN WHITE IN THE LEFT HALF OF THE
OVAL WHICH IS OTHERWISE BLUE AND THE
WORDS "COMPREHENSIVE COVERAGE" WRIT-
TEN IN WHITE ON THE RIGHT HALF OF THE
OVAL WHICH IS OTHERWISE GOLD.

SER. NO. 77-361,046, FILED 12-28-2007.

KATHERINE M. DUBRAY, EXAMINING ATTOR-
NEY

Int. Cl.: 16

Prior U.S. Cls.: 2, 5, 22, 23, 29, 37, 38 and 50

United States Patent and Trademark Office

Reg. No. 3,476,396

Registered July 29, 2008

**TRADEMARK
PRINCIPAL REGISTER**

SHOOTING ILLUSTRATED

NATIONAL RIFLE ASSOCIATION OF AMERICA
(NEW YORK CORPORATION)
11250 WAPLES MILL RD.
FAIRFAX, VA 220307400

FOR: MAGAZINE IN THE FIELD OF SHOOTING
SPORTS AND FIREARMS, IN CLASS 16 (U.S. CLS. 2,
5, 22, 23, 29, 37, 38 AND 50).

FIRST USE 12-31-2001; IN COMMERCE 12-31-2001.

THE MARK CONSISTS OF STANDARD CHAR-
ACTERS WITHOUT CLAIM TO ANY PARTICULAR
FONT, STYLE, SIZE, OR COLOR.

OWNER OF U.S. REG. NO. 2,657,384.

SEC. 2(F).

SER. NO. 77-361,054, FILED 12-28-2007.

MARCIE MILONE, EXAMINING ATTORNEY

Int. Cl.: 41

Prior U.S. Cls.: 100, 101 and 107

United States Patent and Trademark Office

Reg. No. 3,476,397

Registered July 29, 2008

**SERVICE MARK
PRINCIPAL REGISTER**



A-Z INVESTING CORP. (NEVADA CORPORATION)

5516 BOULDER HWY., STE 2F-914
LAS VEGAS, NV 89122

FOR: SPECIAL EVENT PLANNING, IN CLASS 41
(U.S. CLS. 100, 101 AND 107).

FIRST USE 1-1-1999; IN COMMERCE 1-1-1999.

NO CLAIM IS MADE TO THE EXCLUSIVE
RIGHT TO USE "EVENTS", APART FROM THE
MARK AS SHOWN.

THE COLOR(S) GREEN, LIGHT GREEN, PUR-
PLE, BLACK IS/ARE CLAIMED AS A FEATURE OF
THE MARK.

THE MARK CONSISTS OF RECTANGULAR DE-
SIGN OF A TICKET THAT IS COLORED WITH A
LIGHT GREEN IN THE LOWER RIGHT HAND
CORNER AND GRADUALLY DARKENS TO-
WARDS THE UPPER LEFT HAND CORNER. THE
WORDS "PARTY TIME" ARE IN THE CENTER OF
THE TICKET IN PURPLE LETTERS SURROUNDED
BY PURPLE BOX AND WITH THE WORD
"EVENTS" ALONG THE RIGHT AND LEFT BOR-
DERS OF THE TICKET IN PURPLE LETTERS. THE
GREEN SHADING CONTAINS GREEN 'SPECKL-
ING' WHICH IS PART OF THE MARK AND THERE
IS A BLACK SHADING BAR BELOW THE TICKET
TO GIVE THE APPEARANCE OF A 3-D OBJECT.

SER. NO. 77-361,076, FILED 12-28-2007.

PAULA MAHONEY, EXAMINING ATTORNEY

Int. Cls.: 35 and 42

Prior U.S. Cls.: 100, 101 and 102

United States Patent and Trademark Office

Reg. No. 3,476,398

Registered July 29, 2008

**SERVICE MARK
PRINCIPAL REGISTER**

UFOLLOWIT

TVIRTUAL (TEXAS LTD LIAB CO)
1101 S CAPITAL OF TX HWY, BLDG K STE 250
AUSTIN, TX 78746

FOR: COMPUTERIZED TRACKING AND TRACING OF PACKAGES, CARGO AND FREIGHT IN TRANSIT; INFORMATION MANAGEMENT SERVICES, NAMELY, SHIPMENT PROCESSING, PREPARING SHIPPING DOCUMENTS AND INVOICES, TRACKING DOCUMENTS, PACKAGES AND FREIGHT OVER COMPUTER NETWORKS AND THE INTERNET; MONITORING AND TRACKING OF PACKAGE, CARGO AND FREIGHT SHIPMENTS; PROVIDING ELECTRONIC TRACKING OF PACKAGES, CARGO AND FREIGHT INFORMATION TO OTHERS; PROVIDING TRACKING SERVICES AND INFORMATION CONCERNING TRACKING OF ASSETS IN TRANSIT, NAMELY, PACKAGES, CARGO, FREIGHT AND

DELIVERY CONTAINERS, IN CLASS 35 (U.S. CLS. 100, 101 AND 102).

FIRST USE 11-0-2007; IN COMMERCE 11-0-2007.

FOR: PROVIDING TEMPORARY USE OF NON-DOWNLOADABLE COMPUTER SOFTWARE FOR TRACKING PACKAGES AND FREIGHT OVER COMPUTER NETWORKS AND THE INTERNET, IN CLASS 42 (U.S. CLS. 100 AND 101).

FIRST USE 11-0-2007; IN COMMERCE 11-0-2007.

THE MARK CONSISTS OF STANDARD CHARACTERS WITHOUT CLAIM TO ANY PARTICULAR FONT, STYLE, SIZE, OR COLOR.

SER. NO. 77-361,101, FILED 12-28-2007.

KHANH LE, EXAMINING ATTORNEY

Int. Cl.: 41

Prior U.S. Cls.: 100, 101 and 107

United States Patent and Trademark Office

Reg. No. 3,476,399

Registered July 29, 2008

**SERVICE MARK
PRINCIPAL REGISTER**

**Your Ticket... to an
Unforgettable Event!**

A-Z INVESTING CORP. (NEVADA CORPORATION)
5516 BOULDER HWY., STE 2F-914
LAS VEGAS, NV 89122

THE MARK CONSISTS OF STANDARD CHARACTERS WITHOUT CLAIM TO ANY PARTICULAR FONT, STYLE, SIZE, OR COLOR.

FOR: SPECIAL EVENT PLANNING, IN CLASS 41 (U.S. CLS. 100, 101 AND 107).

SER. NO. 77-361,117, FILED 12-28-2007.

FIRST USE 1-1-1999; IN COMMERCE 1-1-1999.

PAULA MAHONEY, EXAMINING ATTORNEY

Int. Cl.: 39

Prior U.S. Cls.: 100 and 105

United States Patent and Trademark Office

Reg. No. 3,476,400

Registered July 29, 2008

**SERVICE MARK
PRINCIPAL REGISTER**

CLUB EDNA

EDNA VALLEY BRAND NAME, LLC (CALIFORNIA LTD LIAB CO)
4915 ORCUTT ROAD
SAN LUIS OBISPO, CA 93401

OWNER OF U.S. REG. NOS. 1,399,057 AND 3,335,118.

FOR: WINE CLUB SERVICES FEATURING PERIODIC SHIPMENTS OF WINE TO MEMBERS, IN CLASS 39 (U.S. CLS. 100 AND 105).

NO CLAIM IS MADE TO THE EXCLUSIVE RIGHT TO USE "CLUB", APART FROM THE MARK AS SHOWN.

FIRST USE 0-0-1999; IN COMMERCE 0-0-1999.

SER. NO. 77-361,118, FILED 12-28-2007.

THE MARK CONSISTS OF STANDARD CHARACTERS WITHOUT CLAIM TO ANY PARTICULAR FONT, STYLE, SIZE, OR COLOR.

MARCIE MILONE, EXAMINING ATTORNEY

Int. Cls.: 16, 28 and 41

Prior U.S. Cls.: 2, 5, 22, 23, 29, 37, 38, 50, 100, 101 and 107

Reg. No. 3,476,401

United States Patent and Trademark Office

Registered July 29, 2008

**TRADEMARK
SERVICE MARK
PRINCIPAL REGISTER**

WRONG RIGHTERS

URIBE, KERI R. (UNITED STATES INDIVIDUAL)
PO BOX 20370
NEW YORK, NY 10025

FOR: BOOK COVERS; BOOKMARKS; CALENDARS; CHILDREN'S ACTIVITY BOOKS; CHILDREN'S BOOKS; COLORING BOOKS; COMIC BOOKS; DIARIES; NOVELS; PHOTOGRAPHS; POSTERS; PRINTED EDUCATIONAL MATERIAL, NAMELY, TEACHING TILES; SCRAPBOOKS; TALKING CHILDREN'S BOOKS, IN CLASS 16 (U.S. CLS. 2, 5, 22, 23, 29, 37, 38 AND 50).

FIRST USE 3-10-1993; IN COMMERCE 2-14-2002.

FOR: BALLOONS; BATTERY OPERATED ACTION TOYS; BOARD GAMES; CARD GAMES; CHRISTMAS TREE ORNAMENTS WITH A MUSIC FEATURE; COLLECTABLE TOY FIGURES; DOLL ACCESSORIES; DOLL CLOTHING; DOLL HOUSES; DOLLS; ELECTRONIC LEARNING TOYS; MUSICAL TOYS; PLUSH TOYS; PUPPETS; PUZZLES; ROLLER SKATES; SPORT BALLS; STUFFED TOYS; TALKING TOYS; TOY ACTION FIGURES AND ACCESSORIES THEREFOR; TOY BUILDING BLOCKS; TOY SCOOTERS, IN CLASS 28 (U.S. CLS. 22, 23, 38 AND 50).

FIRST USE 3-10-1993; IN COMMERCE 2-14-2002.

FOR: ENTERTAINMENT IN THE NATURE OF LIVE PERFORMANCES BY A COSTUMED CHAR-

ACTER; ENTERTAINMENT IN THE NATURE OF ON-GOING TELEVISION PROGRAMS IN THE FIELD OF MUSICAL, COMEDY AND VARIETY; ENTERTAINMENT IN THE NATURE OF VISUAL AND AUDIO PERFORMANCES, AND MUSICAL, VARIETY, NEWS AND COMEDY SHOWS; ENTERTAINMENT SERVICES IN THE NATURE OF ON-GOING TELEVISION PROGRAMS IN THE FIELD OF CHILDREN'S ENTERTAINMENT; ENTERTAINMENT SERVICES, NAMELY, PROVIDING A WEB SITE FEATURING MUSICAL PERFORMANCES, MUSICAL VIDEOS, RELATED FILM CLIPS, PHOTOGRAPHS, AND OTHER MULTIMEDIA MATERIALS; ENTERTAINMENT SERVICES, NAMELY, PROVIDING ON-LINE COMPUTER GAMES; ENTERTAINMENT SERVICES, NAMELY, PROVIDING A TELEVISION PROGRAM IN THE FIELD OF MUSICAL, COMEDY AND VARIETY VIA A GLOBAL COMPUTER NETWORK, IN CLASS 41 (U.S. CLS. 100, 101 AND 107).

FIRST USE 3-10-1993; IN COMMERCE 2-14-2002.

THE MARK CONSISTS OF STANDARD CHARACTERS WITHOUT CLAIM TO ANY PARTICULAR FONT, STYLE, SIZE, OR COLOR.

SER. NO. 77-361,120, FILED 12-28-2007.

MARCIE MILONE, EXAMINING ATTORNEY

Int. Cl.: 41

Prior U.S. Cls.: 100, 101 and 107

United States Patent and Trademark Office

Reg. No. 3,476,402

Registered July 29, 2008

**SERVICE MARK
PRINCIPAL REGISTER**

Party Time Events

A-Z INVESTING CORP. (NEVADA CORPORATION)

5516 BOULDER HWY., STE 2F-914

LAS VEGAS, NV 89122

FOR: SPECIAL EVENT PLANNING, IN CLASS 41
(U.S. CLS. 100, 101 AND 107).

FIRST USE 1-1-1999; IN COMMERCE 1-1-1999.

THE MARK CONSISTS OF STANDARD CHARACTERS WITHOUT CLAIM TO ANY PARTICULAR FONT, STYLE, SIZE, OR COLOR.

NO CLAIM IS MADE TO THE EXCLUSIVE RIGHT TO USE "EVENTS", APART FROM THE MARK AS SHOWN.

SER. NO. 77-361,140, FILED 12-28-2007.

PAULA MAHONEY, EXAMINING ATTORNEY

Int. Cl.: 36

Prior U.S. Cls.: 100, 101 and 102

United States Patent and Trademark Office

Reg. No. 3,476,403

Registered July 29, 2008

SERVICE MARK
PRINCIPAL REGISTER



ORIGEN FINANCIAL, INC. (VIRGINIA CORPORATION)
27777 FRANKLIN RD., SUITE 1700
SOUTHFIELD, MI 48034

FOR: FACILITATING AND ARRANGING FOR THE FINANCING OF MANUFACTURED HOMES; FINANCING SERVICES; LOAN FINANCING, IN CLASS 36 (U.S. CLS. 100, 101 AND 102).

FIRST USE 5-23-2005; IN COMMERCE 5-23-2005.

OWNER OF U.S. REG. NO. 2,544,859.

NO CLAIM IS MADE TO THE EXCLUSIVE RIGHT TO USE "INVESTMENT", APART FROM THE MARK AS SHOWN.

THE COLOR(S) BLUE, GOLD AND WHITE IS/ARE CLAIMED AS A FEATURE OF THE MARK.

THE MARK CONSISTS OF THE WORD "ORIGEN" WRITTEN IN BLUE ABOVE THE WORD "RECOVERY" WRITTEN IN GOLD ABOVE THE WORD "REWARDS" WRITTEN IN BLUE INSIDE OF AN OVAL BROKEN IN HALF VERTICALLY WITH THE WORDS "INCOME" AND "ACCOUNTABILITY" WRITTEN IN WHITE IN THE LEFT HALF OF THE OVAL WHICH IS OTHERWISE BLUE AND THE WORDS "PARTNERSHIP" AND "INVESTMENT" WRITTEN IN WHITE ON THE RIGHT HALF OF THE OVAL WHICH IS OTHERWISE GOLD.

SER. NO. 77-361,150, FILED 12-28-2007.

KATHERINE M. DUBRAY, EXAMINING ATTORNEY

Int. Cl.: 36

Prior U.S. Cls.: 100, 101 and 102

United States Patent and Trademark Office

Reg. No. 3,476,404

Registered July 29, 2008

SERVICE MARK
PRINCIPAL REGISTER



ORIGEN FINANCIAL, INC. (VIRGINIA CORPORATION)
27777 FRANKLIN RD., SUITE 1700
SOUTHFIELD, MI 48034

FOR: FACILITATING AND ARRANGING FOR THE FINANCING OF MANUFACTURED HOMES; FINANCING SERVICES; LOAN FINANCING, IN CLASS 36 (U.S. CLS. 100, 101 AND 102).

FIRST USE 5-23-2005; IN COMMERCE 5-23-2005.

OWNER OF U.S. REG. NO. 2,544,859.

NO CLAIM IS MADE TO THE EXCLUSIVE RIGHT TO USE "ELITE", "ENHANCED SERVICE" AND "EXPANDED PROGRAMS AND PRODUCTS", APART FROM THE MARK AS SHOWN.

THE COLOR(S) BLUE, GOLD AND WHITE IS/ARE CLAIMED AS A FEATURE OF THE MARK.

THE MARK CONSISTS OF THE WORD "ORIGEN" WRITTEN IN BLUE ABOVE THE WORD "ELITE" WRITTEN IN GOLD INSIDE OF AN OVAL BROKEN IN HALF VERTICALLY WITH THE WORDS "PROGRAM ADVANTAGES" AND "ENHANCED SERVICE" WRITTEN IN WHITE IN THE LEFT HALF OF THE OVAL WHICH IS OTHERWISE BLUE AND THE WORDS "EXPANDED PROGRAMS AND PRODUCTS" WRITTEN IN WHITE IN THE RIGHT HALF OF THE OVAL WHICH IS OTHERWISE GOLD.

SER. NO. 77-361,152, FILED 12-28-2007.

KATHERINE M. DUBRAY, EXAMINING ATTORNEY

Int. Cl.: 3

Prior U.S. Cls.: 1, 4, 6, 50, 51 and 52

United States Patent and Trademark Office

Reg. No. 3,476,405

Registered July 29, 2008

**TRADEMARK
PRINCIPAL REGISTER**

BEACH BAG ELIXIR

REBECCA BACON (UNITED STATES INDIVIDUAL)
2596 ARMACOST AVENUE
LOS ANGELES, CA 90064

THE MARK CONSISTS OF STANDARD CHARACTERS WITHOUT CLAIM TO ANY PARTICULAR FONT, STYLE, SIZE, OR COLOR.

FOR: HAIR CARE PREPARATIONS AND HAIR STYLING PREPARATIONS, IN CLASS 3 (U.S. CLS. 1, 4, 6, 50, 51 AND 52).

SER. NO. 77-361,182, FILED 12-28-2007.

FIRST USE 3-31-2007; IN COMMERCE 4-30-2007.

LANA PHAM, EXAMINING ATTORNEY

Int. Cl.: 3

Prior U.S. Cls.: 1, 4, 6, 50, 51 and 52

United States Patent and Trademark Office

Reg. No. 3,476,406

Registered July 29, 2008

**TRADEMARK
PRINCIPAL REGISTER**

SPRAY IT DON'T SAY IT

REBECCA BACON (UNITED STATES INDIVIDUAL)
2596 ARMACOST AVENUE
LOS ANGELES, CA 90064

THE MARK CONSISTS OF STANDARD CHARACTERS WITHOUT CLAIM TO ANY PARTICULAR FONT, STYLE, SIZE, OR COLOR.

FOR: HAIR CARE PREPARATIONS AND HAIR STYLING PREPARATIONS, IN CLASS 3 (U.S. CLS. 1, 4, 6, 50, 51 AND 52).

SER. NO. 77-361,191, FILED 12-28-2007.

FIRST USE 7-31-2007; IN COMMERCE 12-27-2007.

LANA PHAM, EXAMINING ATTORNEY

Int. Cl.: 33

Prior U.S. Cls.: 47 and 49

United States Patent and Trademark Office

Reg. No. 3,476,407

Registered July 29, 2008

**TRADEMARK
PRINCIPAL REGISTER**

PEACEFUL RIVER

SAKEONE CORPORATION (OREGON COR-
PORATION)
820 ELM STREET
FOREST GROVE, OR 97116

FOR: SAKE, IN CLASS 33 (U.S. CLS. 47 AND 49).

FIRST USE 11-0-2005; IN COMMERCE 11-0-2005.

THE MARK CONSISTS OF STANDARD CHAR-
ACTERS WITHOUT CLAIM TO ANY PARTICULAR
FONT, STYLE, SIZE, OR COLOR.

SER. NO. 77-361,194, FILED 12-28-2007.

NANCY CLARKE, EXAMINING ATTORNEY

Int. Cl.: 35

Prior U.S. Cls.: 100, 101 and 102

United States Patent and Trademark Office

Reg. No. 3,476,408

Registered July 29, 2008

**SERVICE MARK
PRINCIPAL REGISTER**

BDA sports management

BILL A. DUFFY, INC. (CALIFORNIA CORPORATION), DBA BDA SPORTS MANAGEMENT
STE. A
822 ASHLEY LANE
WALNUT CREEK, CA 94596

FOR: MANAGEMENT OF PROFESSIONAL ATHLETES, IN CLASS 35 (U.S. CLS. 100, 101 AND 102).

FIRST USE 2-22-1999; IN COMMERCE 2-22-1999.

THE MARK CONSISTS OF STANDARD CHARACTERS WITHOUT CLAIM TO ANY PARTICULAR FONT, STYLE, SIZE, OR COLOR.

NO CLAIM IS MADE TO THE EXCLUSIVE RIGHT TO USE "SPORTS MANAGEMENT", APART FROM THE MARK AS SHOWN.

SER. NO. 77-361,236, FILED 12-28-2007.

LEIGH CAROLINE CASE, EXAMINING ATTORNEY

Int. Cl.: 7

Prior U.S. Cls.: 13, 19, 21, 23, 31, 34 and 35

United States Patent and Trademark Office

Reg. No. 3,476,409

Registered July 29, 2008

**TRADEMARK
PRINCIPAL REGISTER**

The logo for 'Exact' features the word in a bold, italicized, sans-serif font. The letter 'E' is significantly larger and more prominent than the other letters. A thick, black, curved underline starts under the 'E' and sweeps under the rest of the word.

EXACT CORP. (CALIFORNIA CORPORATION)
5143 BLUE GUM AVENUE
MODESTO, CA 95358

FIRST USE 2-15-2004; IN COMMERCE 4-1-2005.

FOR: HORTICULTURAL SWEEPERS, CONDI-
TIONERS, AND HARVESTERS, IN CLASS 7 (U.S.
CLS. 13, 19, 21, 23, 31, 34 AND 35).

SER. NO. 77-361,271, FILED 12-28-2007.

RONALD AIKENS, EXAMINING ATTORNEY

Int. Cl.: 41

Prior U.S. Cls.: 100, 101 and 107

United States Patent and Trademark Office

Reg. No. 3,476,410

Registered July 29, 2008

**SERVICE MARK
PRINCIPAL REGISTER**

**BIRDSONG AND THE
ECO-WONDERS**

PROCACCINI, CHERYL (UNITED STATES INDIVIDUAL)
1037 ORO STREET
LAGUNA BEACH, CA 92651

THE MARK CONSISTS OF STANDARD CHARACTERS WITHOUT CLAIM TO ANY PARTICULAR FONT, STYLE, SIZE, OR COLOR.

FOR: ENTERTAINMENT SERVICES, NAMELY, LIVE PERFORMANCES BY A MUSICAL GROUP, IN CLASS 41 (U.S. CLS. 100, 101 AND 107).

SER. NO. 77-361,272, FILED 12-28-2007.

FIRST USE 2-3-2007; IN COMMERCE 11-4-2007.

RONALD AIKENS, EXAMINING ATTORNEY

Int. Cl.: 25

Prior U.S. Cls.: 22 and 39

United States Patent and Trademark Office

Reg. No. 3,476,411

Registered July 29, 2008

**TRADEMARK
PRINCIPAL REGISTER**

ElevenFour

FREE SYSTEMS, LLC (CALIFORNIA LTD LIAB
CO)
550 W. 135TH STREET
LOS ANGELES, CA 90248

THE MARK CONSISTS OF STANDARD CHAR-
ACTERS WITHOUT CLAIM TO ANY PARTICULAR
FONT, STYLE, SIZE, OR COLOR.

FOR: SHIRTS; SKIRTS; SHORTS; JEANS; JACK-
ETS; T-SHIRTS; TROUSERS; PANTS; SWEATERS;
HEADWEAR; FOOTWEAR; BELTS; NECKWEAR;
SWEAT SHIRTS, IN CLASS 25 (U.S. CLS. 22 AND 39).

SER. NO. 77-361,285, FILED 12-28-2007.

FIRST USE 12-1-2007; IN COMMERCE 12-1-2007.

RONALD AIKENS, EXAMINING ATTORNEY

Int. Cl.: 41

Prior U.S. Cls.: 100, 101 and 107

United States Patent and Trademark Office

Reg. No. 3,476,412

Registered July 29, 2008

**SERVICE MARK
PRINCIPAL REGISTER**

DIRTBAGS

PARTIN, ANDREW (UNITED STATES INDIVIDUAL)
P.O. BOX 47
SEDALIA, NC 27342

THE MARK CONSISTS OF STANDARD CHARACTERS WITHOUT CLAIM TO ANY PARTICULAR FONT, STYLE, SIZE, OR COLOR.

FOR: ENTERTAINMENT IN THE NATURE OF BASEBALL GAMES, IN CLASS 41 (U.S. CLS. 100, 101 AND 107).

SER. NO. 77-361,311, FILED 12-28-2007.

FIRST USE 8-0-2004; IN COMMERCE 8-0-2004.

ZHALEH DELANEY, EXAMINING ATTORNEY

Int. Cl.: 41

Prior U.S. Cls.: 100, 101 and 107

United States Patent and Trademark Office

Reg. No. 3,476,413

Registered July 29, 2008

**SERVICE MARK
PRINCIPAL REGISTER**

DIRTBAG BASEBALL

PARTIN, ANDREW (UNITED STATES INDIVIDUAL)
P.O. BOX 47
SEDALIA, NC 27342

FOR: ENTERTAINMENT IN THE NATURE OF BASEBALL GAMES, IN CLASS 41 (U.S. CLS. 100, 101 AND 107).

FIRST USE 8-0-2004; IN COMMERCE 8-0-2004.

THE MARK CONSISTS OF STANDARD CHARACTERS WITHOUT CLAIM TO ANY PARTICULAR FONT, STYLE, SIZE, OR COLOR.

NO CLAIM IS MADE TO THE EXCLUSIVE RIGHT TO USE "BASEBALL", APART FROM THE MARK AS SHOWN.

SER. NO. 77-361,312, FILED 12-28-2007.

ZHALEH DELANEY, EXAMINING ATTORNEY

Int. Cl.: 25

Prior U.S. Cls.: 22 and 39

United States Patent and Trademark Office

Reg. No. 3,476,414

Registered July 29, 2008

**TRADEMARK
PRINCIPAL REGISTER**

**WALK IN PEACE
BUDDHA BOOTS**

AMANDA HAYLEY BEARD (AUSTRALIA INDIVIDUAL), DBA BUDDHA BOOTS
31265 BAILARD ROAD
MALIBU, CA 90265

NO CLAIM IS MADE TO THE EXCLUSIVE RIGHT TO USE "BOOTS", APART FROM THE MARK AS SHOWN.

FOR: BOOTS, IN CLASS 25 (U.S. CLS. 22 AND 39).

FIRST USE 11-27-2007; IN COMMERCE 12-1-2007.

SER. NO. 77-361,347, FILED 12-28-2007.

THE MARK CONSISTS OF STANDARD CHARACTERS WITHOUT CLAIM TO ANY PARTICULAR FONT, STYLE, SIZE, OR COLOR.

MARY ROSSMAN, EXAMINING ATTORNEY

Int. Cl.: 25

Prior U.S. Cls.: 22 and 39

United States Patent and Trademark Office

Reg. No. 3,476,415

Registered July 29, 2008

TRADEMARK
PRINCIPAL REGISTER



SONKING LLC (CALIFORNIA LTD LIAB CO)
4695 MACARTHUR COURT, SUITE 310
NEWPORT BEACH, CA 92660

FOR: GOLF SHIRTS; KNIT SHIRTS; LONG-SLEEVED SHIRTS; OPEN-NECKED SHIRTS; POLO SHIRTS; RUGBY SHIRTS; SHIRTS; SHORT-SLEEVED OR LONG-SLEEVED T-SHIRTS; SHORT-SLEEVED SHIRTS; SPORT SHIRTS; SPORTS SHIRTS WITH SHORT SLEEVES; SWEAT SHIRTS; WIND SHIRTS; HATS; JACKETS, IN CLASS 25 (U.S. CLS. 22 AND 39).

FIRST USE 3-18-2007; IN COMMERCE 9-28-2007.

THE MARK CONSISTS OF AN IMAGE OF A STYLIZED FISH CONSISTING OF TWO INTERSECTION ARCS WEARING A CROWN. THE LITERAL ELEMENT "SONKING" APPEARS BELOW THE IMAGE.

SER. NO. 77-361,360, FILED 12-28-2007.

GINA FINK, EXAMINING ATTORNEY

Int. Cl.: 5

Prior U.S. Cls.: 6, 18, 44, 46, 51 and 52

United States Patent and Trademark Office

Reg. No. 3,476,416

Registered July 29, 2008

**TRADEMARK
PRINCIPAL REGISTER**

Extagen

J3 LABS, LLC (ARIZONA LTD LIAB CO)
2122 W. LONE CACTUS DR., #1
PHOENIX, AZ 85027

FOR: HERBAL DIETARY SUPPLEMENT, IN
CLASS 5 (U.S. CLS. 6, 18, 44, 46, 51 AND 52).

FIRST USE 4-13-2000; IN COMMERCE 4-13-2000.

THE MARK CONSISTS OF STANDARD CHAR-
ACTERS WITHOUT CLAIM TO ANY PARTICULAR
FONT, STYLE, SIZE, OR COLOR.

OWNER OF U.S. REG. NO. 2,814,111.

SER. NO. 77-361,377, FILED 12-28-2007.

ANGELA GAW, EXAMINING ATTORNEY

Int. Cl.: 35

Prior U.S. Cls.: 100, 101 and 102

United States Patent and Trademark Office

Reg. No. 3,476,417

Registered July 29, 2008

**SERVICE MARK
PRINCIPAL REGISTER**

ALPHA & LEADER

USA CHINA LAW GROUP, INC. (DELAWARE CORPORATION), DBA ALPHA & LEADER US
22917 PACIFIC COAST HIGHWAY, SUITE 350
MALIBU, CA 90265

FOR: PROVIDING MARKETING AND PROMOTIONAL SERVICES, NAMELY, PROVIDING SERVICES TO INVESTORS, BUSINESSES AND LAW FIRMS TO ESTABLISH OR EXPAND THEIR PRESENCE IN THE PEOPLE'S REPUBLIC OF CHINA, IN CLASS 35 (U.S. CLS. 100, 101 AND 102).

FIRST USE 12-0-2007; IN COMMERCE 12-28-2007.

THE MARK CONSISTS OF STANDARD CHARACTERS WITHOUT CLAIM TO ANY PARTICULAR FONT, STYLE, SIZE, OR COLOR.

SER. NO. 77-361,391, FILED 12-28-2007.

NAAKWAMA ANKRAH, EXAMINING ATTORNEY

Int. Cl.: 10

Prior U.S. Cls.: 26, 39 and 44

United States Patent and Trademark Office

Reg. No. 3,476,418

Registered July 29, 2008

**TRADEMARK
PRINCIPAL REGISTER**

Stethocap

STETHOCAP, INC. (ILLINOIS CORPORATION)
3401 WELLINGTON CT.
ROLLING MEADOWS, IL 60008

THE MARK CONSISTS OF STANDARD CHAR-
ACTERS WITHOUT CLAIM TO ANY PARTICULAR
FONT, STYLE, SIZE, OR COLOR.

FOR: SANITIZATION UNITS FOR STETHO-
SCOPES, IN CLASS 10 (U.S. CLS. 26, 39 AND 44).

SER. NO. 77-361,407, FILED 12-28-2007.

FIRST USE 4-10-1998; IN COMMERCE 4-3-2003.

TRACY CROSS, EXAMINING ATTORNEY

Int. Cl.: 41

Prior U.S. Cls.: 100, 101 and 107

United States Patent and Trademark Office

Reg. No. 3,476,419

Registered July 29, 2008

**SERVICE MARK
PRINCIPAL REGISTER**

MusicMaster

MUSIC MASTER DISC JOCKEYS, INC. (GEORGIA CORPORATION)
2954 LEGISLATIVE LANE
BUFORD, GA 30519

FOR: DISC JOCKEYS FOR PARTIES AND SPECIAL EVENTS, IN CLASS 41 (U.S. CLS. 100, 101 AND 107).

FIRST USE 12-31-1989; IN COMMERCE 12-31-1989.

THE MARK CONSISTS OF STANDARD CHARACTERS WITHOUT CLAIM TO ANY PARTICULAR FONT, STYLE, SIZE, OR COLOR.

OWNER OF U.S. REG. NO. 2,597,386.

SER. NO. 77-361,411, FILED 12-28-2007.

EDWARD FENNESSY, EXAMINING ATTORNEY

Int. Cl.: 16

Prior U.S. Cls.: 2, 5, 22, 23, 29, 37, 38 and 50

United States Patent and Trademark Office

Reg. No. 3,476,420

Registered July 29, 2008

**TRADEMARK
PRINCIPAL REGISTER**

miniLUK

BEYOND123 LLC (DELAWARE LTD LIAB CO),
DBA LUK STORE
18 VARSITY BOULEVARD
EAST SETAUKET, NY 11733

THE MARK CONSISTS OF STANDARD CHAR-
ACTERS WITHOUT CLAIM TO ANY PARTICULAR
FONT, STYLE, SIZE, OR COLOR.

FOR: CHILDREN'S INTERACTIVE EDUCATION-
AL BOOKS, IN CLASS 16 (U.S. CLS. 2, 5, 22, 23, 29, 37,
38 AND 50).

SER. NO. 77-361,426, FILED 12-29-2007.

FIRST USE 6-2-2005; IN COMMERCE 10-25-2005.

HEATHER THOMPSON, EXAMINING ATTORNEY

Int. Cl.: 39

Prior U.S. Cls.: 100 and 105

United States Patent and Trademark Office

Reg. No. 3,476,421

Registered July 29, 2008

**SERVICE MARK
PRINCIPAL REGISTER**

CAQ

LIGHTNING JOE'S, INC. (PENNSYLVANIA CORPORATION)
802 FAR HILLS DRIVE
NEW FREEDOM, PA 17349

FOR: FREIGHT FORWARDING; FREIGHT FORWARDING SERVICES; GLOBAL TRANSPORTATION OF FREIGHT FOR OTHERS BY ALL AVAILABLE MEANS, IN CLASS 39 (U.S. CLS. 100 AND 105).

FIRST USE 4-7-2006; IN COMMERCE 4-7-2006.

THE MARK CONSISTS OF STANDARD CHARACTERS WITHOUT CLAIM TO ANY PARTICULAR FONT, STYLE, SIZE, OR COLOR.

SER. NO. 77-361,443, FILED 12-29-2007.

WANDA KAY PRICE, EXAMINING ATTORNEY

Int. Cl.: 35

Prior U.S. Cls.: 100, 101 and 102

United States Patent and Trademark Office

Reg. No. 3,476,422

Registered July 29, 2008

SERVICE MARK
PRINCIPAL REGISTER



FANTOM COMICS, LLC (D.C. LTD LIAB CO)
4500 WISCONSIN AVE. NW
WASHINGTON, DC 20016

FOR: RETAIL BOOK STORE SERVICES; RETAIL SHOPS FEATURING COMIC BOOKS, GRAPHIC NOVELS AND RELATED PRODUCTS; RETAIL STORE SERVICES FEATURING COMIC BOOKS, GRAPHIC NOVELS AND RELATED PRODUCTS; RETAIL STORE SERVICES IN THE FIELD OF COMIC BOOKS, GRAPHIC NOVELS AND RELATED PRODUCTS FEATURING A BONUS INCENTIVE PROGRAM FOR CUSTOMERS; RETAIL STORES FEATURING COMIC BOOKS, GRAPHIC NOVELS AND RELATED PRODUCTS; RETAIL COMIC BOOK AND GRAPHIC NOVEL STORES, IN CLASS 35 (U.S. CLS. 100, 101 AND 102).

FIRST USE 5-17-2005; IN COMMERCE 11-13-2005.

NO CLAIM IS MADE TO THE EXCLUSIVE RIGHT TO USE "COMICS", APART FROM THE MARK AS SHOWN.

THE MARK CONSISTS OF THE WORD "FANTOM" IN CAPITAL LETTERS WITH A BOLD BRUSHSTROKE STYLE WHERE THE APPEAR-

ANCE OF AN IRREGULAR PATTERN AS IF MADE BY A PAINTBRUSH IS VISIBLE AT THE ENDS OF CERTAIN LINES MAKING UP THE LETTERS; THE VERTICAL BRUSHSTROKE OF THE LEADING "F" AND THE RIGHTMOST BRUSHSTROKE OF THE CLOSING "M" IN THE WORD "FANTOM" ANGLED INWARD SO THAT THEY ARE CLOSER TO EACH OTHER AT THE BOTTOM THAN THEY ARE AT THE TOP, AND EXTENDING BELOW THE OTHER LETTERS IN THE WORD "FANTOM"; ALL OF THE BRUSHSTROKES IN THE WORD "FANTOM" AT VARYING ANGLES TO EACH OTHER; THE TOP HORIZONTAL BRUSHSTROKE OF THE LETTER "F" AND THE HORIZONTAL BRUSHSTROKE OF THE LETTER "T" IN THE WORD "FANTOM" EXTEND ABOVE OTHER LETTERS IN THE SAME WORD; THE WORD "COMICS" IN LOWERCASE LETTERS IN BOLD COMIC FONT BETWEEN THE EXTENDED PORTIONS OF THE LETTERS "F" & "M" FROM THE WORD "FANTOM", AND DIRECTLY BELOW THE OTHER LETTERS IN THE WORD "FANTOM".

SER. NO. 77-361,444, FILED 12-29-2007.

SKYE YOUNG, EXAMINING ATTORNEY

Int. Cl.: 35

Prior U.S. Cls.: 100, 101 and 102

United States Patent and Trademark Office

Reg. No. 3,476,423

Registered July 29, 2008

**SERVICE MARK
PRINCIPAL REGISTER**

FANTOM COMICS

FANTOM COMICS, LLC (D.C. LTD LIAB CO)
4500 WISCONSIN AVE. NW
WASHINGTON, DC 20016

FOR: RETAIL BOOK STORE SERVICES; RETAIL SHOPS FEATURING COMIC BOOKS, GRAPHIC NOVELS AND RELATED PRODUCTS; RETAIL STORE SERVICES FEATURING COMIC BOOKS, GRAPHIC NOVELS AND RELATED PRODUCTS; RETAIL STORE SERVICES IN THE FIELD OF COMIC BOOKS, GRAPHIC NOVELS AND RELATED PRODUCTS FEATURING A BONUS INCENTIVE PROGRAM FOR CUSTOMERS; RETAIL STORES FEATURING COMIC BOOKS, GRAPHIC NOVELS AND RELATED PRODUCTS; RETAIL CO-

MIC BOOK AND GRAPHIC NOVEL STORES, IN CLASS 35 (U.S. CLS. 100, 101 AND 102).

FIRST USE 5-17-2005; IN COMMERCE 11-13-2005.

THE MARK CONSISTS OF STANDARD CHARACTERS WITHOUT CLAIM TO ANY PARTICULAR FONT, STYLE, SIZE, OR COLOR.

NO CLAIM IS MADE TO THE EXCLUSIVE RIGHT TO USE "COMICS", APART FROM THE MARK AS SHOWN.

SER. NO. 77-361,452, FILED 12-29-2007.

SKYE YOUNG, EXAMINING ATTORNEY

Int. Cl.: 10

Prior U.S. Cls.: 26, 39 and 44

United States Patent and Trademark Office

Reg. No. 3,476,424

Registered July 29, 2008

**TRADEMARK
PRINCIPAL REGISTER**

SUPEREAGLE

EAGLEVISION, INC. (TENNESSEE CORPORATION)
8500 WOLF LAKE DRIVE, SUITE 110
MEMPHIS, TN 38133

THE MARK CONSISTS OF STANDARD CHARACTERS WITHOUT CLAIM TO ANY PARTICULAR FONT, STYLE, SIZE, OR COLOR.

FOR: MEDICAL DEVICES, NAMELY, PUNCTUM PLUGS, IN CLASS 10 (U.S. CLS. 26, 39 AND 44).

SER. NO. 77-361,471, FILED 12-29-2007.

FIRST USE 9-0-2004; IN COMMERCE 9-0-2004.

WANDA KAY PRICE, EXAMINING ATTORNEY

Int. Cl.: 25

Prior U.S. Cls.: 22 and 39

United States Patent and Trademark Office

Reg. No. 3,476,425

Registered July 29, 2008

**TRADEMARK
PRINCIPAL REGISTER**



CLASSIC KICKS, INC. (NEW YORK CORPORATION)
298 ELIZABETH STREET
NEW YORK, NY 10012

FOR: CLOTHING, NAMELY, T-SHIRTS, SHIRTS,
SWEATSHIRTS, JACKETS FOR MEN, WOMEN
AND CHILDREN, IN CLASS 25 (U.S. CLS. 22 AND
39).

FIRST USE 1-1-2005; IN COMMERCE 1-1-2005.

THE MARK CONSISTS OF FOUR RHOMBI AR-
RANGED TO CREATE A LARGER RHOMBUS
WITH A SLIGHT CURVATURE.

SER. NO. 77-361,475, FILED 12-29-2007.

CHERYL CLAYTON, EXAMINING ATTORNEY

Int. Cls.: 41 and 43

Prior U.S. Cls.: 100, 101 and 107

United States Patent and Trademark Office

Reg. No. 3,476,426

Registered July 29, 2008

**SERVICE MARK
PRINCIPAL REGISTER**

CENTURY BALLROOM

CENTURY BALLROOM, LLC (WASHINGTON
LTD LIAB CO)
915 EAST PINE STREET
SEATTLE, WA 98122

FOR: ENTERTAINMENT IN THE NATURE OF
DANCE PERFORMANCES; ENTERTAINMENT IN
THE NATURE OF VISUAL AND AUDIO PERFOR-
MANCES, NAMELY, MUSICAL BAND, ROCK
GROUP, GYMNASTIC, DANCE, AND BALLET PER-
FORMANCES; DANCE EVENTS; DANCE INSTRUC-
TION; ORGANIZATION OF DANCING EVENTS;
PROVIDING DANCE HALLS, IN CLASS 41 (U.S.
CLS. 100, 101 AND 107).

FIRST USE 3-1-1997; IN COMMERCE 3-1-1997.

FOR: CAFE AND RESTAURANT SERVICES, IN
CLASS 43 (U.S. CLS. 100 AND 101).

FIRST USE 3-1-1997; IN COMMERCE 3-1-1997.

THE MARK CONSISTS OF STANDARD CHAR-
ACTERS WITHOUT CLAIM TO ANY PARTICULAR
FONT, STYLE, SIZE, OR COLOR.

NO CLAIM IS MADE TO THE EXCLUSIVE
RIGHT TO USE "BALLROOM" , APART FROM
THE MARK AS SHOWN.

SER. NO. 77-361,482, FILED 12-29-2007.

WANDA KAY PRICE, EXAMINING ATTORNEY

Int. Cl.: 7

Prior U.S. Cls.: 13, 19, 21, 23, 31, 34 and 35

Reg. No. 3,476,427

United States Patent and Trademark Office

Registered July 29, 2008

**TRADEMARK
PRINCIPAL REGISTER**

Reach 'n Spray

DREW, FRANK MOREHEAD (UNITED STATES
INDIVIDUAL), DBA PRUNER'S PAL, INC.
3004 LOVELAND COVE
AUSTIN, TX 78746

THE MARK CONSISTS OF STANDARD CHAR-
ACTERS WITHOUT CLAIM TO ANY PARTICULAR
FONT, STYLE, SIZE, OR COLOR.

FOR: PAINT SPRAYERS, IN CLASS 7 (U.S. CLS. 13,
19, 21, 23, 31, 34 AND 35).

SER. NO. 77-361,506, FILED 12-29-2007.

FIRST USE 12-11-2007; IN COMMERCE 12-23-2007.

ARETHA SOMERVILLE, EXAMINING ATTORNEY

Int. Cl.: 25

Prior U.S. Cls.: 22 and 39

United States Patent and Trademark Office

Reg. No. 3,476,428

Registered July 29, 2008

**TRADEMARK
PRINCIPAL REGISTER**

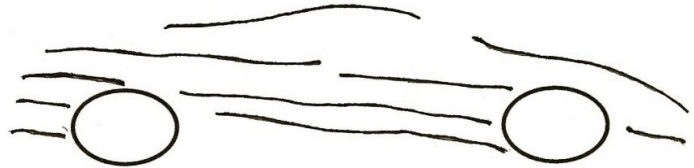

JORGENSEN, ION (UNITED STATES INDIVIDUAL)
30856 AGOURA RD, #H1
AGOURA HILLS, CA 91301

FOR: GOLF SHIRTS; POLO SHIRTS; SHORT-SLEEVED OR LONG-SLEEVED T-SHIRTS; T-SHIRTS; HATS, IN CLASS 25 (U.S. CLS. 22 AND 39).

FIRST USE 12-20-2007; IN COMMERCE 12-20-2007.

THE MARK CONSISTS OF IMAGE OF A CAR.

SER. NO. 77-361,533, FILED 12-29-2007.

KARANENDRA S. CHHINA, EXAMINING ATTORNEY

Int. Cl.: 35

Prior U.S. Cls.: 100, 101 and 102

United States Patent and Trademark Office

Reg. No. 3,476,429

Registered July 29, 2008

**SERVICE MARK
PRINCIPAL REGISTER**

VEGAS BADA BABES

WOLF, RAYMOND T. (UNITED STATES INDIVIDUAL), DBA RAY WOLF PRODUCTIONS
65 RYERSON AVE.
MANORVILLE, NY 11949

FOR: ADVERTISING SERVICES, NAMELY, PROMOTING AND MARKETING THE GOODS AND SERVICES OF OTHERS THROUGH ALL PUBLIC COMMUNICATION MEANS , IN CLASS 35 (U.S. CLS. 100, 101 AND 102).

FIRST USE 10-19-2007; IN COMMERCE 10-19-2007.

THE MARK CONSISTS OF STANDARD CHARACTERS WITHOUT CLAIM TO ANY PARTICULAR FONT, STYLE, SIZE, OR COLOR.

NO CLAIM IS MADE TO THE EXCLUSIVE RIGHT TO USE "VEGAS", APART FROM THE MARK AS SHOWN.

SER. NO. 77-361,539, FILED 12-29-2007.

HEATHER THOMPSON, EXAMINING ATTORNEY

Int. Cl.: 16

Prior U.S. Cls.: 2, 5, 22, 23, 29, 37, 38 and 50

Reg. No. 3,476,430

United States Patent and Trademark Office

Registered July 29, 2008

**TRADEMARK
PRINCIPAL REGISTER**



BEYOND123 LLC (DELAWARE LTD LIAB CO)
18 VARSITY BOULEVARD
EAST SETAUKET, NY 11733

FOR: EDUCATIONAL BOOKS FEATURING
CHILDREN'S INTELLECTUAL DEVELOPMENT,
IN CLASS 16 (U.S. CLS. 2, 5, 22, 23, 29, 37, 38 AND 50).

FIRST USE 6-1-2005; IN COMMERCE 6-30-2005.

THE COLOR(S) LIGHT GREEN, ORANGE AND
LIGHT BLUE IS/ARE CLAIMED AS A FEATURE OF
THE MARK.

THE MARK CONSISTS OF THE WORD "BE-
YOND" IN STYLIZED LIGHT GREEN LETTERS
WITH AN ORANGE CENTER FOR THE LETTER
"O" IN "BEYOND". THE STYLIZED NUMBERS "123"
APPEAR IN LIGHT BLUE

SER. NO. 77-361,542, FILED 12-29-2007.

HEATHER THOMPSON, EXAMINING ATTORNEY

Int. Cl.: 25

Prior U.S. Cls.: 22 and 39

United States Patent and Trademark Office

Reg. No. 3,476,431

Registered July 29, 2008

**TRADEMARK
PRINCIPAL REGISTER**

**MUSIC
IS A
LIFESTYLE**

COPLEY, TONY B (UNITED STATES INDIVIDUAL)
470 SPRING MEADOWS AVE.
DALLAS, GA 30157

FOR: SPORT SHIRTS; SPORTS JERSEYS AND BREECHES FOR SPORTS; SPORTS SHIRTS; SWEAT BANDS; SWEAT PANTS; SWEAT SHIRTS; T-SHIRTS; SKIRTS AND DRESSES; SKULL CAPS; BASEBALL CAPS; BEACH FOOTWEAR; BELTS; BERMUDA SHORTS; BOARD SHORTS; BOXER SHORTS; CAP VISORS; CAPS; CAPS WITH VISORS; CARGO PANTS; COATS FOR MEN AND WOMEN; FLIP FLOPS; FOOTWEAR; HEADBANDS AGAINST SWEATING; HEADGEAR, NAMELY, SKULL CAPS; HOODS; JACKETS; JERSEYS; LONG-SLEEVED

SHIRTS; SHORT-SLEEVED OR LONG-SLEEVED T-SHIRTS; SHORTS; SLEEVED OR SLEEVELESS JACKETS; TANK TOPS; TANK-TOPS; TEE SHIRTS; TIES; TOBOGGAN HATS, PANTS AND CAPS; WOOLLY HATS, IN CLASS 25 (U.S. CLS. 22 AND 39).

FIRST USE 6-9-2006; IN COMMERCE 12-29-2007.

THE MARK CONSISTS OF STANDARD CHARACTERS WITHOUT CLAIM TO ANY PARTICULAR FONT, STYLE, SIZE, OR COLOR.

SER. NO. 77-361,548, FILED 12-29-2007.

LESLEY LAMOTHE, EXAMINING ATTORNEY

Int. Cl.: 29

Prior U.S. Cl.: 46

United States Patent and Trademark Office

Reg. No. 3,476,432

Registered July 29, 2008

**TRADEMARK
PRINCIPAL REGISTER**

QUIROLA

QUIROLA ENTERPRISES LIMITED COMPANY
(FLORIDA LTD LIAB CO)
2853 EXECUTIVE PARK DRIVE - SUITE 105
WESTON, FL 33331

THE MARK CONSISTS OF STANDARD CHAR-
ACTERS WITHOUT CLAIM TO ANY PARTICULAR
FONT, STYLE, SIZE, OR COLOR.

FOR: FROZEN SEAFOOD, IN CLASS 29 (U.S. CL.
46).

SER. NO. 77-361,563, FILED 12-30-2007.

FIRST USE 9-1-1983; IN COMMERCE 9-1-1983.

MICHAEL KAZAZIAN, EXAMINING ATTORNEY

Int. Cl.: 11

Prior U.S. Cls.: 13, 21, 23, 31 and 34

United States Patent and Trademark Office

Reg. No. 3,476,433

Registered July 29, 2008

**TRADEMARK
PRINCIPAL REGISTER**

Moollona

YUAN, SHIQIANG (CHINA INDIVIDUAL)
MINGLIU ROAD, SHALANG, WEST D. ZONG-
CHAN
GUANGDONG, CHINA

FOR: CHANDELIERS; CEILING LIGHTS; ELEC-
TRIC LIGHTING FIXTURES, IN CLASS 11 (U.S. CLS.
13, 21, 23, 31 AND 34).

FIRST USE 10-18-2007; IN COMMERCE 10-18-2007.

THE MARK CONSISTS OF STANDARD CHAR-
ACTERS WITHOUT CLAIM TO ANY PARTICULAR
FONT, STYLE, SIZE, OR COLOR.

SER. NO. 77-361,564, FILED 12-30-2007.

MARIA-VICTORIA SUAREZ, EXAMINING ATTOR-
NEY

Int. Cl.: 11

Prior U.S. Cls.: 13, 21, 23, 31 and 34

United States Patent and Trademark Office

Reg. No. 3,476,434

Registered July 29, 2008

**TRADEMARK
PRINCIPAL REGISTER**

Kinglong

YUAN, SHIQIANG (CHINA INDIVIDUAL)
C/O E.HANSCOM, 7395 PORTAGE WAY
CARLSBAD, CA 92011

FOR: CHANDELIERS; CEILING LIGHTS; ELECTRIC LIGHTING FIXTURES; LIGHT DIFFUSERS; LIGHTING FIXTURES, IN CLASS 11 (U.S. CLS. 13, 21, 23, 31 AND 34).

FIRST USE 11-28-1997; IN COMMERCE 11-28-1997.

THE MARK CONSISTS OF STANDARD CHARACTERS WITHOUT CLAIM TO ANY PARTICULAR FONT, STYLE, SIZE, OR COLOR.

SER. NO. 77-361,567, FILED 12-30-2007.

MARIA-VICTORIA SUAREZ, EXAMINING ATTORNEY

Int. Cl.: 35

Prior U.S. Cls.: 100, 101 and 102

United States Patent and Trademark Office

Reg. No. 3,476,435

Registered July 29, 2008

**SERVICE MARK
PRINCIPAL REGISTER**

Market Motive

MARKET MOTIVE (CALIFORNIA CORPORATION)
450 ESTRELLA DRIVE
SCOTTS VALLEY, CA 95066

FOR: ADVERTISING, MARKETING AND PROMOTION SERVICES; PROVIDING INFORMATION IN THE FIELD OF MARKETING AND ON-LINE MARKETING MEDIA VIA THE INTERNET, IN CLASS 35 (U.S. CLS. 100, 101 AND 102).

FIRST USE 8-1-2007; IN COMMERCE 8-1-2007.

THE MARK CONSISTS OF STANDARD CHARACTERS WITHOUT CLAIM TO ANY PARTICULAR FONT, STYLE, SIZE, OR COLOR.

SER. NO. 77-361,579, FILED 12-30-2007.

CHARLES L. JENKINS, EXAMINING ATTORNEY

Int. Cl.: 41

Prior U.S. Cls.: 100, 101 and 107

United States Patent and Trademark Office

Reg. No. 3,476,436

Registered July 29, 2008

**SERVICE MARK
PRINCIPAL REGISTER**

2Hats

2HATS NETWORK LLC (NEW YORK LTD LIAB
CO)
14001C ST. GERMAIN DRIVE
SUITE 618
CENTERVILLE, VA 20121

FOR: CAREER COUNSELING; ARRANGING
AND CONDUCTING EDUCATIONAL CONFEREN-
CES; ARRANGING PROFESSIONAL WORKSHOP
AND TRAINING COURSES; CONDUCTING WORK-
SHOPS AND SEMINARS IN THE FIELDS OF CA-
REER MANAGEMENT AND DEVELOPMENT,
EMPLOYMENT, RECRUITING, BUSINESS MAN-
AGEMENT, BUSINESS DEVELOPMENT, NEGOTIA-
TION, TIME AND ENERGY MANAGEMENT,
WORK-LIFE BALANCE, LEADERSHIP DEVELOP-
MENT, AND WORKFORCE SKILLS; PROFESSION-

AL COACHING SERVICES IN THE FIELD OF
CAREER DEVELOPMENT, CAREER MANAGE-
MENT, AND ACHIEVING AND MAINTAINING
WORK-LIFE BALANCE, IN CLASS 41 (U.S. CLS.
100, 101 AND 107).

FIRST USE 1-15-2007; IN COMMERCE 1-15-2007.

THE MARK CONSISTS OF STANDARD CHAR-
ACTERS WITHOUT CLAIM TO ANY PARTICULAR
FONT, STYLE, SIZE, OR COLOR.

SER. NO. 77-361,598, FILED 12-30-2007.

JAMES STEIN, EXAMINING ATTORNEY

Int. Cl.: 36

Prior U.S. Cls.: 100, 101 and 102

United States Patent and Trademark Office

Reg. No. 3,476,437

Registered July 29, 2008

**SERVICE MARK
PRINCIPAL REGISTER**



CHILD FOUNDATION (OREGON NON-PROFIT CORPORATION)
P.O. BOX 1364
CLACKAMAS, OR 97015

FOR: CHARITABLE FUND RAISING, IN CLASS 36 (U.S. CLS. 100, 101 AND 102).

FIRST USE 5-18-1994; IN COMMERCE 5-18-1994.

NO CLAIM IS MADE TO THE EXCLUSIVE RIGHT TO USE "CHILD FOUNDATION", APART FROM THE MARK AS SHOWN.

THE MARK CONSISTS OF A PROFILE IMAGE OF A CHILD SUPERIMPOSED OVER A GLOBE WITH LONGITUDE AND LATITUDE LINES, WITH THE LITERAL ELEMENT "CHILD FOUNDATION" IMMEDIATELY BELOW.

SER. NO. 77-361,607, FILED 12-30-2007.

MARCIE MILONE, EXAMINING ATTORNEY

Int. Cl.: 42

Prior U.S. Cls.: 100 and 101

United States Patent and Trademark Office

Reg. No. 3,476,438

Registered July 29, 2008

**SERVICE MARK
PRINCIPAL REGISTER**

SEARCHWORM

SEARCH WORM LLC (MICHIGAN LTD LIAB
CO)
PO BOX 897
TROY, MI 48360

FOR: PROVIDING CUSTOMIZED ON-LINE WEB
PAGES FEATURING USER-DEFINED INFORMA-
TION, WHICH INCLUDES SEARCH ENGINES AND
ON-LINE WEB LINKS TO OTHER WEB SITES, IN
CLASS 42 (U.S. CLS. 100 AND 101).

FIRST USE 4-16-2006; IN COMMERCE 4-16-2006.

THE MARK CONSISTS OF STANDARD CHAR-
ACTERS WITHOUT CLAIM TO ANY PARTICULAR
FONT, STYLE, SIZE, OR COLOR.

SER. NO. 77-361,622, FILED 12-30-2007.

KARANENDRA S. CHHINA, EXAMINING ATTOR-
NEY

Int. Cl.: 44

Prior U.S. Cls.: 100 and 101

United States Patent and Trademark Office

Reg. No. 3,476,439

Registered July 29, 2008

**SERVICE MARK
PRINCIPAL REGISTER**

PRECISION NAILS

SCHRABECK, JAIME DEVON (UNITED STATES
INDIVIDUAL), DBA PRECISION NAILS

238 CROSSROADS BOULEVARD

CARMEL, CA 93923

FOR: NAIL CARE SALONS, IN CLASS 44 (U.S.
CLS. 100 AND 101).

FIRST USE 6-5-1992; IN COMMERCE 6-5-1992.

THE MARK CONSISTS OF STANDARD CHAR-
ACTERS WITHOUT CLAIM TO ANY PARTICULAR
FONT, STYLE, SIZE, OR COLOR.

NO CLAIM IS MADE TO THE EXCLUSIVE
RIGHT TO USE "NAILS", APART FROM THE
MARK AS SHOWN.

SER. NO. 77-361,626, FILED 12-30-2007.

SKYE YOUNG, EXAMINING ATTORNEY

Int. Cl.: 35

Prior U.S. Cls.: 100, 101 and 102

United States Patent and Trademark Office

Reg. No. 3,476,440

Registered July 29, 2008

**SERVICE MARK
PRINCIPAL REGISTER**

FAN'S BEST FRIEND!

HUNTER, BRIAN J. (UNITED STATES INDIVIDUAL)
1547 CEDAR MILLS DR.
CORDOVA, TN 38016

FOR: ON-LINE CONSIGNMENT SERVICES WHEREBY GOODS ARE RECEIVED ON CONSIGNMENT FOR AUCTION ON AN ONLINE AUCTION SITE; ON-LINE ORDERING SERVICES FEATURING VARIOUS EVENT TICKETS; ONLINE AUCTION BIDDING FOR OTHERS; ONLINE AUCTION SERVICES; OPERATING ON-LINE MARKETPLACES FOR SELLERS OF GOODS AND/OR SERVICES; ORDER FULFILLMENT SERVICES; PROMOTING SPORTS COMPETITIONS AND/OR EVENTS OF OTHERS; PROMOTING THE GOODS AND SERVICES OF OTHERS BY PROVIDING HYPERTEXT LINKS TO THE WEB SITES OF OTHERS; PROMOTING THE PARTIES AND SPECIAL EVENTS OF OTHERS; PROVIDING A WEB SITE WHEREBY

BUYERS OF GOODS OR SERVICES LOCATE AND RECEIVE QUOTATIONS FROM MULTIPLE COMPETITIVE SOURCES AND SELLERS OF GOODS OR SERVICES IDENTIFY AND BID ON MULTIPLE NEW SALES OPPORTUNITIES; PROVIDING SPACE AT A WEB SITE FOR THE ADVERTISEMENT OF THE GOODS AND SERVICES OF OTHERS, IN CLASS 35 (U.S. CLS. 100, 101 AND 102).

FIRST USE 11-1-2007; IN COMMERCE 2-14-2008.

THE MARK CONSISTS OF STANDARD CHARACTERS WITHOUT CLAIM TO ANY PARTICULAR FONT, STYLE, SIZE, OR COLOR.

SER. NO. 77-361,645, FILED 12-30-2007.

MARIA-VICTORIA SUAREZ, EXAMINING ATTORNEY

Int. Cl.: 27

Prior U.S. Cls.: 19, 20, 37, 42 and 50

Reg. No. 3,476,441

United States Patent and Trademark Office

Registered July 29, 2008

**TRADEMARK
PRINCIPAL REGISTER**

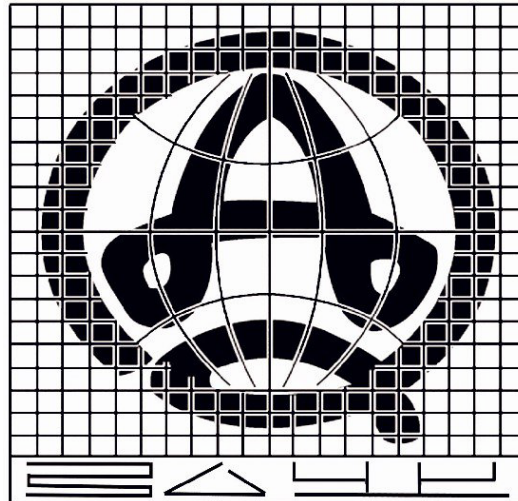

HEBEI HONGYE CARPET GROUP CO., LTD.
(CHINA CORPORATION)
SOUTH OF QIAN' AN CITY
HEBEI PROVINCE 064400, CHINA

THE NON-LATIN CHARACTERS IN THE MARK
TRANSLITERATE TO HONG AND YE AND THIS
MEANS TO EXPAND OR ACHIEVEMENT IN ENG-
LISH.

FOR: CARPETS; RUGS, IN CLASS 27 (U.S. CLS. 19,
20, 37, 42 AND 50).

SER. NO. 77-361,655, FILED 12-31-2007.

OWNER OF CHINA REG. NO. 3505046, DATED 1-
7-2005, EXPIRES 1-6-2015.

WENDY JUN, EXAMINING ATTORNEY

Int. Cl.: 30

Prior U.S. Cl.: 46

United States Patent and Trademark Office

Reg. No. 3,476,442

Registered July 29, 2008

**TRADEMARK
PRINCIPAL REGISTER**

LT's Hot Sauce

BRICK AND BRICK ENTERPRISES (NEW JERSEY LTD LIAB CO)
12 SOUTH PARK RD
TABERNACLE, NJ 08088

NO CLAIM IS MADE TO THE EXCLUSIVE RIGHT TO USE HOT SAUCE, APART FROM THE MARK AS SHOWN.

FOR: HOT SAUCE, IN CLASS 30 (U.S. CL. 46).

FIRST USE 1-1-1994; IN COMMERCE 4-5-2007.

SER. NO. 77-361,694, FILED 12-31-2007.

THE MARK CONSISTS OF STANDARD CHARACTERS WITHOUT CLAIM TO ANY PARTICULAR FONT, STYLE, SIZE, OR COLOR.

JOHN KELLY, EXAMINING ATTORNEY

Int. Cl.: 37

Prior U.S. Cls.: 100, 103 and 106

United States Patent and Trademark Office

Reg. No. 3,476,443

Registered July 29, 2008

**SERVICE MARK
PRINCIPAL REGISTER**

CLEAN SLATE

CLEANSLATE PRESSURE WASHING, INC.
(NORTH CAROLINA CORPORATION)
108 BAUERSFELD ST.
HAMLET, NC 28345

FOR: PRESSURE WASHING SERVICES, IN
CLASS 37 (U.S. CLS. 100, 103 AND 106).

FIRST USE 8-30-2006; IN COMMERCE 8-30-2006.

THE MARK CONSISTS OF STANDARD CHAR-
ACTERS WITHOUT CLAIM TO ANY PARTICULAR
FONT, STYLE, SIZE, OR COLOR.

SER. NO. 77-361,711, FILED 12-31-2007.

ALICE SUE CARRUTHERS, EXAMINING ATTOR-
NEY

Int. Cl.: 36

Prior U.S. Cls.: 100, 101 and 102

United States Patent and Trademark Office

Reg. No. 3,476,444

Registered July 29, 2008

**SERVICE MARK
PRINCIPAL REGISTER**

Kid Tough Promise

SHOPKO STORES OPERATING CO., LLC (DELA-
WARE LTD LIAB CO)
700 PILGRIM WAY
GREEN BAY, WI 54304

FOR: EXTENDED REPLACEMENT WARRANTY
SERVICES COVERING NEWBORN, INFANT, TOD-
DLER AND CHILDREN'S APPAREL, OUTERWEAR
AND ACCESSORIES, SLEEPWEAR, AND SWIM-
WEAR, IN CLASS 36 (U.S. CLS. 100, 101 AND 102).

FIRST USE 10-0-1996; IN COMMERCE 10-0-1996.

THE MARK CONSISTS OF STANDARD CHAR-
ACTERS WITHOUT CLAIM TO ANY PARTICULAR
FONT, STYLE, SIZE, OR COLOR.

OWNER OF U.S. REG. NO. 2,119,647.

SER. NO. 77-361,721, FILED 12-31-2007.

NORA BUCHANAN WILL, EXAMINING ATTOR-
NEY

Int. Cl.: 45

Prior U.S. Cls.: 100 and 101

United States Patent and Trademark Office

Reg. No. 3,476,445

Registered July 29, 2008

**SERVICE MARK
PRINCIPAL REGISTER**

**HARD WORK DESERVES
COMPENSATION**

PAMELA B. WALDORF (UNITED STATES INDIVIDUAL)
3128 EVONSHIRE LANE
DACULA, GA 30019

THE MARK CONSISTS OF STANDARD CHARACTERS WITHOUT CLAIM TO ANY PARTICULAR FONT, STYLE, SIZE, OR COLOR.

FOR: LEGAL SERVICES, IN CLASS 45 (U.S. CLS. 100 AND 101).

SER. NO. 77-361,722, FILED 12-31-2007.

FIRST USE 9-30-2007; IN COMMERCE 12-30-2007.

JASON TURNER, EXAMINING ATTORNEY

Int. Cl.: 37

Prior U.S. Cls.: 100, 103 and 106

United States Patent and Trademark Office

Reg. No. 3,476,446

Registered July 29, 2008

**SERVICE MARK
PRINCIPAL REGISTER**

SILVERMEAD

SILVER ENTERPRISES, INC. (NEW JERSEY CORPORATION)
100 CARDINAL WAY
FREEHOLD, NJ 07728

FOR: CONSTRUCTION OF MANUFACTURED HOME COMMUNITY, IN CLASS 37 (U.S. CLS. 100, 103 AND 106).

FIRST USE 10-31-1964; IN COMMERCE 10-31-1964.

THE MARK CONSISTS OF STANDARD CHARACTERS WITHOUT CLAIM TO ANY PARTICULAR FONT, STYLE, SIZE, OR COLOR.

SER. NO. 77-361,736, FILED 12-31-2007.

MARIA-VICTORIA SUAREZ, EXAMINING ATTORNEY

Int. Cl.: 42

Prior U.S. Cls.: 100 and 101

United States Patent and Trademark Office

Reg. No. 3,476,447

Registered July 29, 2008

**SERVICE MARK
PRINCIPAL REGISTER**

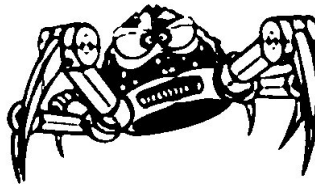

MONSTER CRAWLER, INC. (ILLINOIS CORPORATION)
1430 N. 7TH
MURPHYSBORO, IL 62966

FOR: COMPUTER SERVICES, NAMELY, PROVIDING SEARCH ENGINES FOR OBTAINING DATA ON A GLOBAL COMPUTER NETWORK, IN CLASS 42 (U.S. CLS. 100 AND 101).

FIRST USE 12-1-1999; IN COMMERCE 12-1-1999.

THE MARK CONSISTS OF A MECHANICAL CRAB WITH A MEAN FACE.

SER. NO. 77-361,790, FILED 12-31-2007.

EMILY CARLSEN, EXAMINING ATTORNEY

Int. Cls.: 9 and 16

Prior U.S. Cls.: 2, 5, 21, 22, 23, 26, 29, 36, 37, 38 and 50

Reg. No. 3,476,448

United States Patent and Trademark Office

Registered July 29, 2008

**TRADEMARK
PRINCIPAL REGISTER**

PERFECT ENOUGH

KING, LAURA (UNITED STATES INDIVIDUAL)
1375 N. KILLIAN DRIVE
LAKE PARK, FL 33403

FIRST USE 8-15-2007; IN COMMERCE 8-15-2007.

FOR: DIGITAL MEDIA, NAMELY, AUDIO CD'S
FEATURING SELF DEVELOPMENT TOOLS, IN
CLASS 9 (U.S. CLS. 21, 23, 26, 36 AND 38).

THE MARK CONSISTS OF STANDARD CHAR-
ACTERS WITHOUT CLAIM TO ANY PARTICULAR
FONT, STYLE, SIZE, OR COLOR.

FIRST USE 8-15-2007; IN COMMERCE 8-15-2007.

SER. NO. 77-361,799, FILED 12-31-2007.

FOR: A SERIES OF BOOKS IN THE FIELD OF
SELF DEVELOPMENT, IN CLASS 16 (U.S. CLS. 2, 5,
22, 23, 29, 37, 38 AND 50).

BARNEY CHARLON, EXAMINING ATTORNEY

Int. Cl.: 42

Prior U.S. Cls.: 100 and 101

United States Patent and Trademark Office

Reg. No. 3,476,449

Registered July 29, 2008

**SERVICE MARK
PRINCIPAL REGISTER**



MURDOCH CONSULTING, INC. (UTAH CORPORATION)
1394 N 910 E
AMERICAN FORK, UT 84003

FOR: TECHNOLOGY CONSULTATION IN THE
FIELD OF COMPUTER SOFTWARE, IN CLASS 42
(U.S. CLS. 100 AND 101).

FIRST USE 7-30-2005; IN COMMERCE 7-30-2005.

NO CLAIM IS MADE TO THE EXCLUSIVE
RIGHT TO USE "CONSULTING", APART FROM
THE MARK AS SHOWN.

SER. NO. 77-361,821, FILED 12-31-2007.

ALICE SUE CARRUTHERS, EXAMINING ATTORNEY

Int. Cl.: 5

Prior U.S. Cls.: 6, 18, 44, 46, 51 and 52

United States Patent and Trademark Office

Reg. No. 3,476,450

Registered July 29, 2008

**TRADEMARK
PRINCIPAL REGISTER**

Lipotrox

FOCUS USA, LLC (FLORIDA LTD LIAB CO)
P.O. BOX 9
DOVER, FL 33527

THE MARK CONSISTS OF STANDARD CHAR-
ACTERS WITHOUT CLAIM TO ANY PARTICULAR
FONT, STYLE, SIZE, OR COLOR.

FOR: NUTRITIONAL SUPPLEMENTS, IN CLASS
5 (U.S. CLS. 6, 18, 44, 46, 51 AND 52).

SER. NO. 77-361,824, FILED 12-31-2007.

FIRST USE 7-1-2007; IN COMMERCE 7-29-2007.

LANA PHAM, EXAMINING ATTORNEY

Int. Cl.: 44

Prior U.S. Cls.: 100 and 101

United States Patent and Trademark Office

Reg. No. 3,476,451

Registered July 29, 2008

**SERVICE MARK
PRINCIPAL REGISTER**

**HPI HEALTH PROFILE
INSTITUTE**

HEALTH PROFILE INSTITUTE, INC. (NEVADA
CORPORATION)
P.O. BOX 777178
HENDERSON, NV 89077

FOR: EMPLOYEE HEALTH PROGRAMS, NAME-
LY, PROVIDING HEALTH ASSESSMENTS TO IN-
DIVIDUALS AND COMPANIES, IN CLASS 44 (U.S.
CLS. 100 AND 101).

FIRST USE 4-24-2007; IN COMMERCE 5-1-2007.

THE MARK CONSISTS OF STANDARD CHAR-
ACTERS WITHOUT CLAIM TO ANY PARTICULAR
FONT, STYLE, SIZE, OR COLOR.

NO CLAIM IS MADE TO THE EXCLUSIVE
RIGHT TO USE "HEALTH PROFILE INSTITUTE",
APART FROM THE MARK AS SHOWN.

SER. NO. 77-361,838, FILED 12-31-2007.

EVELYN BRADLEY, EXAMINING ATTORNEY

Int. Cl.: 33

Prior U.S. Cls.: 47 and 49

United States Patent and Trademark Office

Reg. No. 3,476,452

Registered July 29, 2008

**TRADEMARK
PRINCIPAL REGISTER**

MOONSTONE

SAKEONE CORPORATION (OREGON COR-
PORATION)
820 ELM STREET
FOREST GROVE, OR 97116

FOR: SAKE, IN CLASS 33 (U.S. CLS. 47 AND 49).

FIRST USE 0-0-2000; IN COMMERCE 0-0-2000.

THE MARK CONSISTS OF STANDARD CHAR-
ACTERS WITHOUT CLAIM TO ANY PARTICULAR
FONT, STYLE, SIZE, OR COLOR.

SER. NO. 77-361,995, FILED 12-31-2007.

NANCY CLARKE, EXAMINING ATTORNEY

Int. Cl.: 41

Prior U.S. Cls.: 100, 101 and 107

United States Patent and Trademark Office

Reg. No. 3,476,453

Registered July 29, 2008

**SERVICE MARK
PRINCIPAL REGISTER**



NOAH'S ART, LLC (NORTH CAROLINA LTD
LIAB CO)
1371 WOODHURST DR
ROCK HILL, SC 29732

THE MARK CONSISTS OF THE TEXT "NOAH'S
ART" IN A SPLASH OF PAINT.

FOR: EDUCATION SERVICES, NAMELY, PRO-
VIDING CLASSES IN THE FIELD OF ART, IN
CLASS 41 (U.S. CLS. 100, 101 AND 107).

SER. NO. 77-362,125, FILED 12-31-2007.

FIRST USE 5-1-2001; IN COMMERCE 5-1-2001.

KELLEY WELLS, EXAMINING ATTORNEY

Int. Cl.: 36

Prior U.S. Cls.: 100, 101 and 102

United States Patent and Trademark Office

Reg. No. 3,476,454

Registered July 29, 2008

**SERVICE MARK
PRINCIPAL REGISTER**



MORCAP FUND ADVISORS, LLC (CALIFORNIA
LTD LIAB CO)
9TH FLOOR
2040 MAIN STREET
IRVINE, CA 92614

FOR: MORTGAGE BANKING; MORTGAGE
LOAN POOL SALES; INVESTMENT FUND MAN-
AGEMENT, IN CLASS 36 (U.S. CLS. 100, 101 AND
102).

FIRST USE 10-15-2007; IN COMMERCE 10-15-2007.

THE MARK CONSISTS OF A SQUARE WITH
TWO MOUNTAIN PEAKS. THE PEAK ON THE
RIGHT STANDS APPROXIMATELY 50% HIGHER
THAN THE LEFT PEAK. THE RIGHT PEAK IS
CHARACTERIZED BY A GRADIENT ON THE TOP
OF THE PEAK. THE WORD "MORCAP" APPEARS
BELOW THE MOUNTAIN PEAKS.

SER. NO. 77-362,472, FILED 1-2-2008.

RONALD AIKENS, EXAMINING ATTORNEY

Int. Cl.: 26

Prior U.S. Cls.: 37, 39, 40, 42 and 50

United States Patent and Trademark Office

Reg. No. 3,476,455

Registered July 29, 2008

**TRADEMARK
PRINCIPAL REGISTER**

Swanky Hairy Monsters

RIZEL, LAUREN BETH (UNITED STATES INDIVIDUAL)
1463 GRANADA PLACE
FAR ROCKAWAY, NY 11691

THE MARK CONSISTS OF STANDARD CHARACTERS WITHOUT CLAIM TO ANY PARTICULAR FONT, STYLE, SIZE, OR COLOR.

FOR: WIGS; HAIR PIECES AND WIGS, IN CLASS 26 (U.S. CLS. 37, 39, 40, 42 AND 50).

SER. NO. 77-362,519, FILED 1-2-2008.

FIRST USE 11-8-2007; IN COMMERCE 12-31-2007.

REGINA DRUMMOND, EXAMINING ATTORNEY

Int. Cls.: 37 and 42

Prior U.S. Cls.: 100, 101, 103 and 106

United States Patent and Trademark Office

Reg. No. 3,476,456

Registered July 29, 2008

**SERVICE MARK
PRINCIPAL REGISTER**

Lux Design Build

SWEINHAGEN, PAUL B. (UNITED STATES INDIVIDUAL)
4414 E. FLOWER ST.
PHOENIX, AZ 85018

FOR: GENERAL CONSTRUCTION CONTRACTING; REAL ESTATE DEVELOPMENT, IN CLASS 37 (U.S. CLS. 100, 103 AND 106).

FIRST USE 10-1-2004; IN COMMERCE 12-2-2004.

FOR: ARCHITECTURAL AND ENGINEERING SERVICES, IN CLASS 42 (U.S. CLS. 100 AND 101).

FIRST USE 10-1-2004; IN COMMERCE 12-2-2004.

THE MARK CONSISTS OF STANDARD CHARACTERS WITHOUT CLAIM TO ANY PARTICULAR FONT, STYLE, SIZE, OR COLOR.

NO CLAIM IS MADE TO THE EXCLUSIVE RIGHT TO USE "DESIGN BUILD", APART FROM THE MARK AS SHOWN.

SER. NO. 77-362,522, FILED 1-2-2008.

REGINA DRUMMOND, EXAMINING ATTORNEY

Int. Cl.: 35

Prior U.S. Cls.: 100, 101 and 102

United States Patent and Trademark Office

Reg. No. 3,476,457

Registered July 29, 2008

**SERVICE MARK
PRINCIPAL REGISTER**

THE SWEETEST WAY TO SEND A
SMILE

HOPE FAITH & GLUTTONY, INC. (NEW YORK
CORPORATION)
244 RIVERSIDE DRIVE, SUITE 4-E
NEW YORK, NY 10025

THE MARK CONSISTS OF STANDARD CHAR-
ACTERS WITHOUT CLAIM TO ANY PARTICULAR
FONT, STYLE, SIZE, OR COLOR.

FOR: ON-LINE RETAIL STORE SERVICES FEATURING BAKED GOODS, IN CLASS 35 (U.S. CLS. 100, 101 AND 102).

SER. NO. 77-362,524, FILED 1-2-2008.

FIRST USE 10-1-2007; IN COMMERCE 10-1-2007.

LESLEY LAMOTHE, EXAMINING ATTORNEY

Int. Cl.: 9

Prior U.S. Cls.: 21, 23, 26, 36 and 38

Reg. No. 3,476,458

United States Patent and Trademark Office

Registered July 29, 2008

**TRADEMARK
PRINCIPAL REGISTER**



ISTWORKS CORPORATION (DELAWARE CORPORATION)
30 NOON HILL AVENUE
NORFOLK, MA 02056

FOR: COMPUTER SOFTWARE FOR USE IN THE SAFEGUARDING OF DIGITAL FILES, INCLUDING AUDIO, VIDEO, TEXT, BINARY, STILL IMAGES, GRAPHICS AND MULTIMEDIA FILES, IN CLASS 9 (U.S. CLS. 21, 23, 26, 36 AND 38).

FIRST USE 12-21-2007; IN COMMERCE 12-21-2007.

THE COLOR(S) YELLOW, RED, BLUE, BLACK, WHITE, BROWN AND FLESH IS/ARE CLAIMED AS A FEATURE OF THE MARK.

THE MARK CONSISTS OF AN EYE DEPICTED IN WHITE, BLACK, BROWN AND FLESH, WITHIN A RED CIRCLE WITH A RED LINE THROUGH IT, ON A YELLOW RECTANGLE. THE WORDING "EYES OFF!" APPEARS IN BLUE ABOVE THE RED CIRCLE. THE YELLOW RECTANGLE IS OUTLINED IN BLACK.

SER. NO. 77-362,594, FILED 1-2-2008.

JAMES MACFARLANE, EXAMINING ATTORNEY

Int. Cl.: 17

Prior U.S. Cls.: 1, 5, 12, 13, 35 and 50

United States Patent and Trademark Office

Reg. No. 3,476,459

Registered July 29, 2008

**TRADEMARK
PRINCIPAL REGISTER**

PINK IS GREEN

OWENS CORNING INTELLECTUAL CAPITAL,
LLC (DELAWARE LTD LIAB CO)
ONE OWENS CORNING PARKWAY
TOLEDO, OH 43659

FOR: BUILDING INSULATION, IN CLASS 17 (U.S.
CLS. 1, 5, 12, 13, 35 AND 50).

FIRST USE 12-28-2007; IN COMMERCE 12-28-2007.

THE MARK CONSISTS OF STANDARD CHAR-
ACTERS WITHOUT CLAIM TO ANY PARTICULAR
FONT, STYLE, SIZE, OR COLOR.

OWNER OF U.S. REG. NOS. 1,439,132, 2,380,742
AND OTHERS.

SER. NO. 77-362,596, FILED 1-2-2008.

TINA L. SNAPP, EXAMINING ATTORNEY

Int. Cl.: 35

Prior U.S. Cls.: 100, 101 and 102

United States Patent and Trademark Office

Reg. No. 3,476,460

Registered July 29, 2008

**SERVICE MARK
PRINCIPAL REGISTER**

Think Smart!

GALLAGHER MARKETING, LLC (MASSACHU-
SETTS LTD LIAB CO), DBA THE GALLA-
GHER GROUP
5 MARKET SQUARE, SUITE 7
AMESBURY, MA 01913

FOR: MARKET RESEARCH SERVICES, IN CLASS
35 (U.S. CLS. 100, 101 AND 102).

FIRST USE 12-21-2007; IN COMMERCE 12-21-2007.

THE MARK CONSISTS OF STANDARD CHAR-
ACTERS WITHOUT CLAIM TO ANY PARTICULAR
FONT, STYLE, SIZE, OR COLOR.

SER. NO. 77-362,662, FILED 1-2-2008.

WILLIAM P. SHANAHAN, EXAMINING ATTOR-
NEY

Int. Cl.: 25

Prior U.S. Cls.: 22 and 39

United States Patent and Trademark Office

Reg. No. 3,476,461

Registered July 29, 2008

**TRADEMARK
PRINCIPAL REGISTER**

QUALITY . . . PLAIN & SIMPLE

LOKAR, INC. (TENNESSEE CORPORATION)
10924 MURDOCK DRIVE
KNOXVILLE, TN 37932

THE MARK CONSISTS OF STYLIZED LETTERING WITH SELECTED TERMS SEPARATED BY A STRING OF PERIODS.

FOR: CLOTHING, NAMELY, GOLF SHIRTS, T-SHIRTS AND HATS, IN CLASS 25 (U.S. CLS. 22 AND 39).

SER. NO. 77-362,691, FILED 1-2-2008.

FIRST USE 7-31-1996; IN COMMERCE 7-31-1996.

MARK RADEMACHER, EXAMINING ATTORNEY

Int. Cl.: 35

Prior U.S. Cls.: 100, 101 and 102

United States Patent and Trademark Office

Reg. No. 3,476,462

Registered July 29, 2008

**SERVICE MARK
PRINCIPAL REGISTER**

SUPPORTALEG

SUPPORTALEG, INC. (NORTH CAROLINA CORPORATION)
P.O. BOX 400
RANDLEMAN, NC 27317

THE MARK CONSISTS OF STANDARD CHARACTERS WITHOUT CLAIM TO ANY PARTICULAR FONT, STYLE, SIZE, OR COLOR.

FOR: ON-LINE RETAIL STORE SERVICES FEATURING FOOTWEAR AND HOSIERY, IN CLASS 35 (U.S. CLS. 100, 101 AND 102).

SER. NO. 77-362,736, FILED 1-2-2008.

FIRST USE 2-0-2007; IN COMMERCE 2-0-2007.

JAY FLOWERS, EXAMINING ATTORNEY

Int. Cl.: 40

Prior U.S. Cls.: 100, 103 and 106

United States Patent and Trademark Office

Reg. No. 3,476,463

Registered July 29, 2008

**SERVICE MARK
PRINCIPAL REGISTER**

kingsa

KINGSA INDUSTRIES (USA) INC. (TEXAS CORPORATION)
17497 VILLAGE GREEN DRIVE
HOUSTON, TX 77040

THE MARK CONSISTS OF STANDARD CHARACTERS WITHOUT CLAIM TO ANY PARTICULAR FONT, STYLE, SIZE, OR COLOR.

FOR: MANUFACTURING SERVICES FOR OTHERS IN THE FIELD OF OIL FIELD EQUIPMENT, IN CLASS 40 (U.S. CLS. 100, 103 AND 106).

SER. NO. 77-362,835, FILED 1-2-2008.

FIRST USE 4-12-1999; IN COMMERCE 4-12-1999.

DANNEAN HETZEL, EXAMINING ATTORNEY

Int. Cl.: 29

Prior U.S. Cl.: 46

United States Patent and Trademark Office

Reg. No. 3,476,464

Registered July 29, 2008

**TRADEMARK
PRINCIPAL REGISTER**



VOLPI

JOHN VOLPI & COMPANY, INC. (MISSOURI CORPORATION)

5263 NORTHRUP AVE.

ST. LOUIS, MO 63110

FOR: PROCESSED MEATS; CURED MEATS; DRIED MEATS, IN CLASS 29 (U.S. CL. 46).

FIRST USE 9-30-1995; IN COMMERCE 9-30-1995.

OWNER OF U.S. REG. NOS. 1,594,451 AND 1,972,600.

THE MARK CONSISTS OF THE WORD "VOLPI" WITH A STYLIZED SUN WITHIN THE LETTER "O".

SER. NO. 77-362,900, FILED 1-2-2008.

ANDREA K. NADELMAN, EXAMINING ATTORNEY

Int. Cl.: 3

Prior U.S. Cls.: 1, 4, 6, 50, 51 and 52

United States Patent and Trademark Office

Reg. No. 3,476,465

Registered July 29, 2008

**TRADEMARK
PRINCIPAL REGISTER**

DRY REMEDY

AVEDA CORPORATION (DELAWARE CORPORATION)
4000 PHEASANT RIDGE DRIVE
MINNEAPOLIS, MN 55449

FOR: HAIR CARE PREPARATIONS, IN CLASS 3
(U.S. CLS. 1, 4, 6, 50, 51 AND 52).

FIRST USE 12-31-1992; IN COMMERCE 12-31-1992.

THE MARK CONSISTS OF STANDARD CHARACTERS WITHOUT CLAIM TO ANY PARTICULAR FONT, STYLE, SIZE, OR COLOR.

OWNER OF U.S. REG. NOS. 3,273,469, 3,369,041
AND OTHERS.

NO CLAIM IS MADE TO THE EXCLUSIVE
RIGHT TO USE "DRY", APART FROM THE MARK
AS SHOWN.

SER. NO. 77-363,119, FILED 1-3-2008.

ALYSSA PALADINO, EXAMINING ATTORNEY

Int. Cl.: 35

Prior U.S. Cls.: 100, 101 and 102

United States Patent and Trademark Office

Reg. No. 3,476,466

Registered July 29, 2008

SERVICE MARK
PRINCIPAL REGISTER



WE
— *are* —
TEACHERS

WEARETEACHERS (TEXAS LTD LIAB CO)
SUITE 100
8015 SHOAL CREEK BLVD.
AUSTIN, TX 78757

FOR: ADVERTISING AND PUBLICITY SERVICES, NAMELY, PROMOTING THE GOODS, SERVICES, BRAND IDENTITY AND COMMERCIAL INFORMATION AND NEWS OF THIRD PARTIES THROUGH PRINT, AUDIO, VIDEO, DIGITAL AND ON-LINE MEDIUM, IN CLASS 35 (U.S. CLS. 100, 101 AND 102).

FIRST USE 5-1-2007; IN COMMERCE 11-15-2007.

THE MARK CONSISTS OF A CUBE WITH THREE SIDES VISIBLE THE SQUARE ON THE LEFT SIDE HAS A YIN YANG SYMBOL INSIDE, THE TOP SQUARE HAS A BOOK ITS PAGES OPENING SLIGHTLY INSIDE, THE RIGHT SQUARE HAS A MUSIC NOTE INSIDE, THE CUBE IS CENTER ALIGNED ABOVE THE TEXT "WE", THE "ARE" IS CENTER ALIGNED BELOW "WE" IN SMALLER ITALICIZED FONT IN THE MIDDLE OF A HORIZONTAL LINE, BELOW THE "ARE" AND HORIZONTAL LINE CENTER ALIGNED IS THE TEXT "TEACHERS".

SER. NO. 77-363,201, FILED 1-3-2008.

AISHA CLARKE, EXAMINING ATTORNEY

Int. Cl.: 30

Prior U.S. Cl.: 46

United States Patent and Trademark Office

Reg. No. 3,476,467

Registered July 29, 2008

**TRADEMARK
PRINCIPAL REGISTER**

PAMPA

TRANSNATIONAL FOODS, INC. (FLORIDA
CORPORATION)

1110 BRICKELL AVENUE, SUITE 808

MIAMI, FL 33131

FOR: FROSTINGS, IN CLASS 30 (U.S. CL. 46).

FIRST USE 10-2-2007; IN COMMERCE 10-2-2007.

THE MARK CONSISTS OF STANDARD CHAR-
ACTERS WITHOUT CLAIM TO ANY PARTICULAR
FONT, STYLE, SIZE, OR COLOR.

OWNER OF U.S. REG. NOS. 3,094,440, 3,193,405
AND OTHERS.

SER. NO. 77-363,211, FILED 1-3-2008.

SUZANNE BLANE, EXAMINING ATTORNEY

Int. Cl.: 41

Prior U.S. Cls.: 100, 101 and 107

United States Patent and Trademark Office

Reg. No. 3,476,468

Registered July 29, 2008

**SERVICE MARK
PRINCIPAL REGISTER**

MUD

MUD (CALIFORNIA PARTNERSHIP)
301 LENOX AVENUE, #202
OAKLAND, CA 94610

THE MARK CONSISTS OF STANDARD CHAR-
ACTERS WITHOUT CLAIM TO ANY PARTICULAR
FONT, STYLE, SIZE, OR COLOR.

FOR: ENTERTAINMENT, NAMELY, LIVE PER-
FORMANCES BY A MUSICAL BAND, IN CLASS 41
(U.S. CLS. 100, 101 AND 107).

SER. NO. 77-363,779, FILED 1-3-2008.

FIRST USE 12-15-1995; IN COMMERCE 12-15-1995.

JAY BESCH, EXAMINING ATTORNEY

Int. Cl.: 9

Prior U.S. Cls.: 21, 23, 26, 36 and 38

Reg. No. 3,476,469

United States Patent and Trademark Office

Registered July 29, 2008

**TRADEMARK
PRINCIPAL REGISTER**

EpiFlash

CANFIELD SCIENTIFIC, INC. (NEW JERSEY
CORPORATION)
253 PASSAIC AVENUE
FAIRFIELD, NJ 070042524

FOR: CAMERA FLASH, NAMELY, A LENS-
MOUNTED FLASH SYSTEM FOR USE IN VARIOUS
APPLICATIONS INCLUDING DERMOSCOPY,
CLINICAL PHOTOGRAPHY AND GENERAL USE,
IN CLASS 9 (U.S. CLS. 21, 23, 26, 36 AND 38).

FIRST USE 2-19-2005; IN COMMERCE 2-19-2005.

THE MARK CONSISTS OF STANDARD CHAR-
ACTERS WITHOUT CLAIM TO ANY PARTICULAR
FONT, STYLE, SIZE, OR COLOR.

SER. NO. 77-363,987, FILED 1-4-2008.

PAULA MAHONEY, EXAMINING ATTORNEY

Int. Cl.: 39

Prior U.S. Cls.: 100 and 105

United States Patent and Trademark Office

Reg. No. 3,476,470

Registered July 29, 2008

**SERVICE MARK
PRINCIPAL REGISTER**

REACH FOR THE SKIES

UNITED AIR LINES, INC. (DELAWARE COR-
PORATION)
P.O. BOX 66100
CHICAGO, IL 60666

THE MARK CONSISTS OF STANDARD CHAR-
ACTERS WITHOUT CLAIM TO ANY PARTICULAR
FONT, STYLE, SIZE, OR COLOR.

FOR: AIR TRANSPORTATION SERVICES, IN
CLASS 39 (U.S. CLS. 100 AND 105).

SER. NO. 77-364,009, FILED 1-4-2008.

FIRST USE 6-1-2000; IN COMMERCE 6-1-2000.

DANIEL CAPSHAW, EXAMINING ATTORNEY

Int. Cl.: 35

Prior U.S. Cls.: 100, 101 and 102

United States Patent and Trademark Office

Reg. No. 3,476,471

Registered July 29, 2008

**SERVICE MARK
PRINCIPAL REGISTER**



WEARETEACHERS (TEXAS LTD LIAB CO)
SUITE 100
8015 SHOAL CREEK BLVD.
AUSTIN, TX 78757

FOR: ADVERTISING AND PUBLICITY SERVICES, NAMELY, PROMOTING THE GOODS, SERVICES, BRAND IDENTITY AND COMMERCIAL INFORMATION AND NEWS OF THIRD PARTIES THROUGH PRINT, AUDIO, VIDEO, DIGITAL AND ON-LINE MEDIUM, IN CLASS 35 (U.S. CLS. 100, 101 AND 102).

FIRST USE 9-15-2007; IN COMMERCE 11-15-2007.

THE MARK CONSISTS OF AN IMAGE LEFT ALIGNED OF A PILLAR THAT RESEMBLES THE ROMAN STYLE, THE IMAGE IS ENCIRCLED BY A SQUARE WITH SMOOTH EDGES, TO THE RIGHT OF THE IMAGE IS THE TEXT "WAT ACADEMY" THE TEXT IS DIVIDED BY A HORIZONTAL LINE WITH "WAT" ON TOP AND "ACADEMY" BELOW, THE TEXT IS CENTER ALIGNED IN RELATION TO THE HORIZONTAL LINE.

SER. NO. 77-364,137, FILED 1-4-2008.

AISHA CLARKE, EXAMINING ATTORNEY

Int. Cl.: 35

Prior U.S. Cls.: 100, 101 and 102

United States Patent and Trademark Office

Reg. No. 3,476,472

Registered July 29, 2008

**SERVICE MARK
PRINCIPAL REGISTER**

HUNGER ALL-STARS

TYSON FOODS, INC. (DELAWARE CORPORATION)
2210 W. OAKLAWN DRIVE
SPRINGDALE, AR 72762

FOR: PROMOTING PUBLIC AWARENESS VIA THE INTERNET OF THE NEED FOR HUNGER RELIEF AND RECOGNIZING INDIVIDUALS AND ORGANIZATIONS FOR THEIR CONTRIBUTIONS, IN CLASS 35 (U.S. CLS. 100, 101 AND 102).

FIRST USE 12-15-2007; IN COMMERCE 12-15-2007.

THE MARK CONSISTS OF STANDARD CHARACTERS WITHOUT CLAIM TO ANY PARTICULAR FONT, STYLE, SIZE, OR COLOR.

NO CLAIM IS MADE TO THE EXCLUSIVE RIGHT TO USE "HUNGER", APART FROM THE MARK AS SHOWN.

SER. NO. 77-364,152, FILED 1-4-2008.

CORY BOONE, EXAMINING ATTORNEY

Int. Cl.: 35

Prior U.S. Cls.: 100, 101 and 102

United States Patent and Trademark Office

Reg. No. 3,476,473

Registered July 29, 2008

**SERVICE MARK
PRINCIPAL REGISTER**

MINDSPOT

MINDSPOT INC (FLORIDA CORPORATION)
8646 LAGO COURT
ORLANDO, FL 32836

THE MARK CONSISTS OF STANDARD CHARACTERS WITHOUT CLAIM TO ANY PARTICULAR FONT, STYLE, SIZE, OR COLOR.

FOR: CONDUCTING BUSINESS AND MARKET RESEARCH SURVEYS; MARKET RESEARCH; MARKET RESEARCH CONSULTATION; MARKET RESEARCH SERVICES; MARKET RESEARCH STUDIES, IN CLASS 35 (U.S. CLS. 100, 101 AND 102).

SER. NO. 77-364,275, FILED S.R. 1-4-2008 AM. P.R. 4-4-2008.

FIRST USE 8-31-2007; IN COMMERCE 8-31-2007.

LINDA E. BLOHM, EXAMINING ATTORNEY

Int. Cls.: 8, 9, 25 and 28

Prior U.S. Cls.: 21, 22, 23, 26, 28, 36, 38, 39, 44 and 50

United States Patent and Trademark Office

Reg. No. 3,476,474

Registered July 29, 2008

**TRADEMARK
PRINCIPAL REGISTER**

PROFISHCO

PRO FISH COMPANY. (PENNSYLVANIA CORPORATION)
4050 HERBERTSVILLE ROAD
WALL TOWNSHIP, NJ 08724

FOR: FISHING KNIVES; FISHING LINE CUTTERS; PLIERS, IN CLASS 8 (U.S. CLS. 23, 28 AND 44).

FIRST USE 1-2-2004; IN COMMERCE 1-2-2004.

FOR: SCALES, IN CLASS 9 (U.S. CLS. 21, 23, 26, 36 AND 38).

FIRST USE 1-2-2004; IN COMMERCE 1-2-2004.

FOR: HATS; SHIRTS, IN CLASS 25 (U.S. CLS. 22 AND 39).

FIRST USE 1-2-2004; IN COMMERCE 1-2-2004.

FOR: ARTIFICIAL FISHING LURES; FISH HOOKS; FISHING LURES, IN CLASS 28 (U.S. CLS. 22, 23, 38 AND 50).

FIRST USE 1-2-2004; IN COMMERCE 1-2-2004.

THE MARK CONSISTS OF STANDARD CHARACTERS WITHOUT CLAIM TO ANY PARTICULAR FONT, STYLE, SIZE, OR COLOR.

SER. NO. 77-364,441, FILED 1-4-2008.

TRICIA SONNEBORN, EXAMINING ATTORNEY

Int. Cl.: 41

Prior U.S. Cls.: 100, 101 and 107

United States Patent and Trademark Office

Reg. No. 3,476,475

Registered July 29, 2008

**SERVICE MARK
PRINCIPAL REGISTER**



FOUNDATION FOR NORTH AMERICAN WILD
SHEEP (IOWA CORPORATION)
720 ALLEN AVENUE
CODY, WY 82414

FOR: EDUCATIONAL SERVICES, NAMELY,
CONDUCTING EDUCATIONAL COMPETITIONS,
CONFERENCES, CONVENTIONS, SEMINARS
AND WORKSHOPS IN THE FIELD OF WILDLIFE
PRESERVATION, ANIMAL WELFARE, WILDLIFE
MANAGEMENT, CONSERVATION, HUNTING,
SPORTSMEN'S RIGHTS AND WILD SHEEP, WILD-
LIFE RESEARCH OPPORTUNITIES, BIOLOGICAL
STUDIES, WILD SHEEP TRANSPLANTS, LAND

ACQUISITION, AND PROVIDING EDUCATIONAL
MATERIALS THEREWITH, IN CLASS 41 (U.S. CLS.
100, 101 AND 107).

FIRST USE 2-6-2008; IN COMMERCE 2-6-2008.

THE MARK CONSISTS OF SKETCH OF A CHAD-
WICK RAM'S HEAD.

SER. NO. 77-364,578, FILED 1-4-2008.

RUSS HERMAN, EXAMINING ATTORNEY

Int. Cl.: 35

Prior U.S. Cls.: 100, 101 and 102

United States Patent and Trademark Office

Reg. No. 3,476,476

Registered July 29, 2008

**SERVICE MARK
PRINCIPAL REGISTER**

WE WANT YOUR DRAWERS

COLORLAB COSMETICS, INC. (ILLINOIS CORPORATION)
1112 5TH AVENUE
ROCKFORD, IL 61104

FOR: RETAIL STORE SERVICES FEATURING
CUSTOM BLENDING OF COSMETICS TO CUSTOMER SPECIFICATIONS, IN CLASS 35 (U.S. CLS. 100, 101 AND 102).

FIRST USE 10-1-2007; IN COMMERCE 12-8-2007.

THE MARK CONSISTS OF STANDARD CHARACTERS WITHOUT CLAIM TO ANY PARTICULAR FONT, STYLE, SIZE, OR COLOR.

SER. NO. 77-365,383, FILED 1-7-2008.

SAMUEL E. SHARPER JR., EXAMINING ATTORNEY

Int. Cl.: 38

Prior U.S. Cls.: 100, 101 and 104

United States Patent and Trademark Office

Reg. No. 3,476,477

Registered July 29, 2008

**SERVICE MARK
PRINCIPAL REGISTER**

SUBPASS

PROFESSIONAL EMPLOYER'S SERVICES
GROUP, LLC (MICHIGAN LTD LIAB CO),
DBA PROFESSIONAL EDUCATIONAL SERVI-
CES GROUP, LLC
P.O. BOX 50, SUITE D
6307 84TH STREET, SE
CALEDONIA, MI 49316

FOR: INTERNET SERVICE, NAMELY, PROVID-
ING ACCESS BY SCHOOL DISTRICTS AND REGIO-
NAL EDUCATIONAL SCHOOL AGENCIES TO
DATABASES FEATURING INFORMATION AND
DATA ON SUBSTITUTE TEACHERS, ADMINIS-

TRATIVE STAFF, AND SUPPORT STAFF FOR
SCHOOLS, IN CLASS 38 (U.S. CLS. 100, 101 AND 104).

FIRST USE 11-1-2006; IN COMMERCE 11-1-2006.

THE MARK CONSISTS OF STANDARD CHAR-
ACTERS WITHOUT CLAIM TO ANY PARTICULAR
FONT, STYLE, SIZE, OR COLOR.

SER. NO. 77-365,450, FILED 1-7-2008.

DAVID MILLER, EXAMINING ATTORNEY

Int. Cl.: 36

Prior U.S. Cls.: 100, 101 and 102

United States Patent and Trademark Office

Reg. No. 3,476,478

Registered July 29, 2008

**SERVICE MARK
PRINCIPAL REGISTER**



ASSEMBLY SQUARE

FEDERAL REALTY INVESTMENT TRUST
(MARYLAND REAL ESTATE INVESTMENT
TRUST)
1626 EAST JEFFERSON STREET
ROCKVILLE, MD 208524041

NO CLAIM IS MADE TO THE EXCLUSIVE
RIGHT TO USE "SQUARE", APART FROM THE
MARK AS SHOWN.

FOR: REAL ESTATE LEASING; REAL ESTATE
MANAGEMENT, IN CLASS 36 (U.S. CLS. 100, 101
AND 102).

SER. NO. 77-365,648, FILED 1-7-2008.

FIRST USE 12-17-2005; IN COMMERCE 12-17-2005.

ELLEN PERKINS, EXAMINING ATTORNEY

Int. Cl.: 35

Prior U.S. Cls.: 100, 101 and 102

United States Patent and Trademark Office

Reg. No. 3,476,479

Registered July 29, 2008

**SERVICE MARK
PRINCIPAL REGISTER**

The Uncommon Leader

SHERMAN, VERNON CLAYTON (ILLINOIS CORPORATION), DBA MANAGEMENT HOUSE, DIVISION OF BETA GROUP, LTD
PO BOX 2708, 36422 SIDEWINDER RD
CAREFREE, AZ 853777028

FOR: BUSINESS MANAGEMENT AND CONSULTATION; BUSINESS LEADERSHIP DEVELOPMENT, IN CLASS 35 (U.S. CLS. 100, 101 AND 102).

FIRST USE 1-1-1981; IN COMMERCE 1-1-1981.

THE MARK CONSISTS OF STANDARD CHARACTERS WITHOUT CLAIM TO ANY PARTICULAR FONT, STYLE, SIZE, OR COLOR.

NO CLAIM IS MADE TO THE EXCLUSIVE RIGHT TO USE "LEADER", APART FROM THE MARK AS SHOWN.

SER. NO. 77-366,450, FILED 1-8-2008.

PAULA MAHONEY, EXAMINING ATTORNEY

Int. Cl.: 16

Prior U.S. Cls.: 2, 5, 22, 23, 29, 37, 38 and 50

United States Patent and Trademark Office

Reg. No. 3,476,480

Registered July 29, 2008

**TRADEMARK
PRINCIPAL REGISTER**

FLOORED

COLUMBIA INSURANCE COMPANY (NEBRASKA CORPORATION)
3024 HARNEY STREET
OMAHA, NE 68131

THE MARK CONSISTS OF STANDARD CHARACTERS WITHOUT CLAIM TO ANY PARTICULAR FONT, STYLE, SIZE, OR COLOR.

FOR: MAGAZINES FEATURING FLOORING, IN CLASS 16 (U.S. CLS. 2, 5, 22, 23, 29, 37, 38 AND 50).

SER. NO. 77-366,451, FILED 1-8-2008.

FIRST USE 9-0-2005; IN COMMERCE 9-0-2005.

CHERYL CLAYTON, EXAMINING ATTORNEY

Int. Cl.: 36

Prior U.S. Cls.: 100, 101 and 102

United States Patent and Trademark Office

Reg. No. 3,476,481

Registered July 29, 2008

**SERVICE MARK
PRINCIPAL REGISTER**

EL PODER DE NOSOTROS

NEW MEXICO EDUCATORS FEDERAL CREDIT
UNION (UNITED STATES FEDERALLY
CHARTERED CREDIT UNION)

P.O. BOX 8530

ALBUQUERQUE, NM 87198

FOR: FINANCIAL SERVICES, NAMELY, COOP-
ERATIVE CREDIT UNIONS AND ONLINE BANK-
ING, IN CLASS 36 (U.S. CLS. 100, 101 AND 102).

FIRST USE 12-26-2007; IN COMMERCE 12-26-2007.

THE MARK CONSISTS OF STANDARD CHAR-
ACTERS WITHOUT CLAIM TO ANY PARTICULAR
FONT, STYLE, SIZE, OR COLOR.

THE FOREIGN WORDING IN THE MARK
TRANSLATES INTO ENGLISH AS THE POWER OF
WE.

SER. NO. 77-366,881, FILED 1-8-2008.

DEZMONA MIZELLE, EXAMINING ATTORNEY

Int. Cl.: 31

Prior U.S. Cls.: 1 and 46

United States Patent and Trademark Office

Reg. No. 3,476,482

Registered July 29, 2008

TRADEMARK
PRINCIPAL REGISTER

washed³

we washed it 3 times
so you don't have to

VERITAS V, LLC (CALIFORNIA LTD LIAB CO)
401 MONTEREY STREET, SUITE 201
SALINAS, CA 93901

FOR: FRESH VEGETABLES, IN CLASS 31 (U.S.
CLS. 1 AND 46).

FIRST USE 5-4-2007; IN COMMERCE 5-4-2007.

THE MARK CONSISTS OF THE WORD "WASHED", THE ROMAN NUMERAL "3" AND A LINE ABOVE THE PHRASE "WE WASHED IT 3 TIMES SO YOU DON'T HAVE TO".

SER. NO. 77-366,954, FILED 1-8-2008.

SHARON MEIER, EXAMINING ATTORNEY

Int. Cl.: 14

Prior U.S. Cls.: 2, 27, 28 and 50

United States Patent and Trademark Office

Reg. No. 3,476,483

Registered July 29, 2008

**TRADEMARK
PRINCIPAL REGISTER**

KONSTANTINO

KONSTANTINO PROPERTIES LLC (NEW YORK
LTD LIAB CO)
C/O DAVIDOFF MALITO & HUTCHER, LLP
605 THIRD AVENUE - 34 FLOOR
NEW YORK, NY 10158

THE MARK CONSISTS OF STANDARD CHAR-
ACTERS WITHOUT CLAIM TO ANY PARTICULAR
FONT, STYLE, SIZE, OR COLOR.

FOR: WATCHES AND JEWELRY, IN CLASS 14
(U.S. CLS. 2, 27, 28 AND 50).

SER. NO. 77-367,181, FILED 1-9-2008.

FIRST USE 1-1-1997; IN COMMERCE 1-1-1997.

LESLEY LAMOTHE, EXAMINING ATTORNEY

Int. Cl.: 18

Prior U.S. Cls.: 1, 2, 3, 22 and 41

Reg. No. 3,476,484

United States Patent and Trademark Office

Registered July 29, 2008

**TRADEMARK
PRINCIPAL REGISTER**

ECOTEX

FTI CORPORATION LIMITED (HONG KONG CORPORATION)
TOWER 1 CHINA HONG KONG CITY
33 CANTON RD. - FLAT/RM 901 9/F
TSIM SHA TSUI, KL, HONG KONG

FOR: BOOK BAGS; SHOULDER BAGS; COIN PURSES; LUGGAGE; ALL PURPOSE SPORT BAGS; TOTE BAGS; LEATHER SUITCASES; GARMENT BAGS FOR TRAVEL; OVERNIGHT CASES; BACKPACKS; BRIEFCASES; HANDBAGS; PARASOLS; POCKET WALLETS; TEXTILE SHOPPING BAGS; SUITCASES; TRAVELING BAGS; LUGGAGE, NAMELY, TRUNKS; UMBRELLAS; CANES; FUR; LEATHER FOR FURNITURE; IMITATION LEATHER; LEATHER POUCHES; SCHOOL BAGS; SLING BAGS FOR CARRYING INFANTS; UM-

BRELLA COVERS; VALISES; SHOPPING BAGS WITH WHEELS ATTACHED, IN CLASS 18 (U.S. CLS. 1, 2, 3, 22 AND 41).

FIRST USE 8-31-2006; IN COMMERCE 9-30-2007.

THE COLOR(S) GREEN IS/ARE CLAIMED AS A FEATURE OF THE MARK.

THE MARK CONSISTS OF THE WORD "ECOTEX" IN STYLIZED FORM IN THE COLOR GREEN.

SER. NO. 77-367,325, FILED 1-9-2008.

TINA BROWN, EXAMINING ATTORNEY

Int. Cl.: 9

Prior U.S. Cls.: 21, 23, 26, 36 and 38

United States Patent and Trademark Office

Reg. No. 3,476,485

Registered July 29, 2008

**TRADEMARK
PRINCIPAL REGISTER**

BAY STUDIO

BDSRCO, INC. (DELAWARE CORPORATION)
SUITE 202
103 FOULK ROAD
WILMINGTON, DE 19803

FOR: SUNGLASSES, IN CLASS 9 (U.S. CLS. 21, 23,
26, 36 AND 38).

FIRST USE 11-0-2005; IN COMMERCE 11-0-2005.

THE MARK CONSISTS OF STANDARD CHAR-
ACTERS WITHOUT CLAIM TO ANY PARTICULAR
FONT, STYLE, SIZE, OR COLOR.

OWNER OF U.S. REG. NOS. 2,195,245, 3,007,528,
AND 3,201,823.

SER. NO. 77-368,886, FILED 1-10-2008.

MICHAEL SOUDERS, EXAMINING ATTORNEY

Int. Cl.: 42

Prior U.S. Cls.: 100 and 101

United States Patent and Trademark Office

Reg. No. 3,476,486

Registered July 29, 2008

**SERVICE MARK
PRINCIPAL REGISTER**

SEARCHFUSION

TELEPATHY, INC. (D.C. CORPORATION)
3601 CONNECTICUT AVE. NW, SUITE L-7
WASHINGTON, DC 20008

FIRST USE 1-9-2006; IN COMMERCE 1-9-2006.

FOR: COMPUTER SERVICES, NAMELY, CREATING INDEXES OF INFORMATION, SITES, AND OTHER RESOURCES AVAILABLE ON COMPUTER NETWORKS; SEARCHING AND RETRIEVING INFORMATION, SITES, AND OTHER RESOURCES AVAILABLE ON COMPUTER NETWORKS FOR OTHERS, IN CLASS 42 (U.S. CLS. 100 AND 101).

THE MARK CONSISTS OF STANDARD CHARACTERS WITHOUT CLAIM TO ANY PARTICULAR FONT, STYLE, SIZE, OR COLOR.

SER. NO. 77-368,968, FILED 1-10-2008.

NELSON SNYDER, EXAMINING ATTORNEY

Int. Cl.: 9

Prior U.S. Cls.: 21, 23, 26, 36 and 38

Reg. No. 3,476,487

United States Patent and Trademark Office

Registered July 29, 2008

**TRADEMARK
PRINCIPAL REGISTER**

ART OF ALLOWING

HICKS, ESTHER (UNITED STATES INDIVIDUAL)
28800 OLD FREDERICKSBURG ROAD
BOERNE, TX 78015 AND
HICKS, JERRY (UNITED STATES INDIVIDUAL)
28880 OLD FREDERICKSBURG ROAD
BOURNE, TX 78015

FIRST USE 11-1-2000; IN COMMERCE 11-1-2000.

THE MARK CONSISTS OF STANDARD CHARACTERS WITHOUT CLAIM TO ANY PARTICULAR FONT, STYLE, SIZE, OR COLOR.

FOR: PRE-RECORDED CDS, DVDS, AUDIO-TAPES, AND AUDIO RECORDINGS FEATURING MUSIC AND SPOKEN WORDS IN THE FIELDS OF INSPIRATION, SELF-IMPROVEMENT, FINANCE, SPIRITUALITY AND PERSONAL EMPOWERMENT, IN CLASS 9 (U.S. CLS. 21, 23, 26, 36 AND 38).

SER. NO. 77-369,998, FILED 1-11-2008.

WILLIAM P. SHANAHAN, EXAMINING ATTORNEY

Int. Cl.: 44

Prior U.S. Cls.: 100 and 101

United States Patent and Trademark Office

Reg. No. 3,476,488

Registered July 29, 2008

**SERVICE MARK
PRINCIPAL REGISTER**

**"The Best Surgeons in The
Joint"**

HUMBERT, EDWARD (UNITED STATES INDIVIDUAL)
5657 SHADDELEE LANE WEST
FORT MYERS, FL 33919

FOR: MEDICAL SERVICES, NAMELY, ORTHOPEDIC SURGERY INCLUDING JOINT REPLACEMENT, ARTHROSCOPY, TRAUMA AND SPORTS MEDICINE, OR ANY SURGERY ON THE KNEE, HIP AND SHOULDER, IN CLASS 44 (U.S. CLS. 100 AND 101).

FIRST USE 1-1-2002; IN COMMERCE 1-1-2002.

THE MARK CONSISTS OF STANDARD CHARACTERS WITHOUT CLAIM TO ANY PARTICULAR FONT, STYLE, SIZE, OR COLOR.

SER. NO. 77-370,639, FILED 1-14-2008.

CHARISMA HAMPTON, EXAMINING ATTORNEY

Int. Cls.: 5 and 32

Prior U.S. Cls.: 6, 18, 44, 45, 46, 48, 51 and 52

United States Patent and Trademark Office

Reg. No. 3,476,489

Registered July 29, 2008

**TRADEMARK
PRINCIPAL REGISTER**

GoChi

FREELIFE INTERNATIONAL HOLDINGS, LLC
(CONNECTICUT LTD LIAB CO)
SUITE 201
3925 E. BROADWAY
PHOENIX, AZ 85040

FOR: NUTRITIONAL SUPPLEMENTS, DIETARY
SUPPLEMENTS AND LIQUID DIETARY SUPPLE-
MENTS; NUTRITIONALLY FORTIFIED FRUIT-
BASED BEVERAGES , IN CLASS 5 (U.S. CLS. 6, 18,
44, 46, 51 AND 52).

FIRST USE 1-9-2008; IN COMMERCE 1-9-2008.

FOR: SPORTS DRINKS, IN CLASS 32 (U.S. CLS. 45,
46 AND 48).

FIRST USE 1-9-2008; IN COMMERCE 1-9-2008.

THE MARK CONSISTS OF STYLIZED VERSION
OF GOCHI.

SER. NO. 77-370,834, FILED 1-14-2008.

MARTHA FROMM, EXAMINING ATTORNEY

Int. Cl.: 41

Prior U.S. Cls.: 100, 101 and 107

United States Patent and Trademark Office

Reg. No. 3,476,490

Registered July 29, 2008

**SERVICE MARK
PRINCIPAL REGISTER**

big ideas for small screens

D-DUB INC. (CALIFORNIA CORPORATION)
6239 BEN AVE.
NORTH HOLLYWOOD, CA 91606

FOR: MULTIMEDIA ENTERTAINMENT SERVICES IN THE NATURE OF RECORDING, PRODUCTION AND POST-PRODUCTION SERVICES IN THE FIELDS OF MUSIC, VIDEO, AND FILMS, IN CLASS 41 (U.S. CLS. 100, 101 AND 107).

FIRST USE 1-1-2006; IN COMMERCE 1-1-2006.

THE MARK CONSISTS OF STANDARD CHARACTERS WITHOUT CLAIM TO ANY PARTICULAR FONT, STYLE, SIZE, OR COLOR.

SER. NO. 77-371,426, FILED 1-14-2008.

AISHA CLARKE, EXAMINING ATTORNEY

Int. Cl.: 9

Prior U.S. Cls.: 21, 23, 26, 36 and 38

Reg. No. 3,476,491

United States Patent and Trademark Office

Registered July 29, 2008

**TRADEMARK
PRINCIPAL REGISTER**

**Teaching English and
Living in Taiwan**

NEWTOUCH DIGITAL MEDIA (FLORIDA CORPORATION)
15-236 PARADISE PLAZA
SARASOTA, FL 34239

THE MARK CONSISTS OF STANDARD CHARACTERS WITHOUT CLAIM TO ANY PARTICULAR FONT, STYLE, SIZE, OR COLOR.

FOR: ELECTRONIC PUBLICATIONS, NAMELY, NEWSPAPER FEATURING ARTICLES, TEACHING RESOURCES, JOB AND APARTMENT LISTINGS FOR THOSE WHO WISH TO TEACH AND LIVE IN TAIWAN RECORDED ON COMPUTER MEDIA, IN CLASS 9 (U.S. CLS. 21, 23, 26, 36 AND 38).

SEC. 2(F).

SER. NO. 77-371,555, FILED 1-14-2008.

FIRST USE 12-31-1999; IN COMMERCE 12-31-1999.

DOMINICK J. SALEMI, EXAMINING ATTORNEY

Int. Cl.: 5

Prior U.S. Cls.: 6, 18, 44, 46, 51 and 52

Reg. No. 3,476,492

United States Patent and Trademark Office

Registered July 29, 2008

**TRADEMARK
PRINCIPAL REGISTER**



BEIJING YUANDE BIO-MEDICAL ENGINEERING CO., LTD. (CHINA CORPORATION)
THE NO. 1 BUILDING
NO. 24 YONGCHANG NORTH ROAD
BEIJING, CHINA

FOR: VETERINARY PREPARATIONS, NAMELY, PAIN RELIEF MEDICATION; VETERINARY PREPARATIONS FOR TREATMENT OF INTESTINAL BACTERIA; VETERINARY PREPARATIONS, NAMELY, ANTIOXIDANTS; BIOCHEMICAL PREPARATIONS FOR MEDICAL OR VETERINARY PURPOSES; PREGNANCY TEST KITS FOR HOME USE; DIAGNOSTIC PREPARATIONS FOR MEDICAL OR VETERINARY PURPOSES; CHEMICAL

REAGENTS FOR MEDICAL OR VETERINARY PURPOSES, IN CLASS 5 (U.S. CLS. 6, 18, 44, 46, 51 AND 52).

FIRST USE 7-0-1999; IN COMMERCE 9-0-2006.

THE MARK CONSISTS OF AN INVENTED WORD "YDME" AND A DEVICE, AMONG WHICH THE LETTER "M" IS STYLIZED. THE DEVICE COMPRISES THREE STYLIZED CONCENTRIC CIRCLES.

SER. NO. 77-371,716, FILED 1-15-2008.

EDWARD FENNESSY, EXAMINING ATTORNEY

Int. Cl.: 43

Prior U.S. Cls.: 100 and 101

United States Patent and Trademark Office

Reg. No. 3,476,493

Registered July 29, 2008

**SERVICE MARK
PRINCIPAL REGISTER**

LEGACY CAFE

ANDERSON-MCQUEEN COMPANY (FLORIDA
CORPORATION)
2201 DR. M.L. KING ST. N.
SAINT PETERSBURG, FL 33704

FOR: CAFE SERVICES, NAMELY, PROVIDING
CAFE SERVICES IN A FUNERAL HOME ENVIR-
ONMENT, IN CLASS 43 (U.S. CLS. 100 AND 101).

FIRST USE 6-1-2007; IN COMMERCE 6-1-2007.

THE MARK CONSISTS OF STANDARD CHAR-
ACTERS WITHOUT CLAIM TO ANY PARTICULAR
FONT, STYLE, SIZE, OR COLOR.

NO CLAIM IS MADE TO THE EXCLUSIVE
RIGHT TO USE "CAFE", APART FROM THE MARK
AS SHOWN.

SER. NO. 77-371,759, FILED 1-15-2008.

SONYA STEPHENS, EXAMINING ATTORNEY

Int. Cl.: 33

Prior U.S. Cls.: 47 and 49

United States Patent and Trademark Office

Reg. No. 3,476,494

Registered July 29, 2008

**TRADEMARK
PRINCIPAL REGISTER**

WILLOW CREST

PRECEPT BRANDS LLC (WASHINGTON CORPORATION)
3534 BAGLEY AVENUE N.
SEATTLE, WA 98103 AND
SNIPE GAP VINEYARDS, INC. (WASHINGTON CORPORATION)
590 MERLOT DRIVE
PROSSER, WA 99350

FIRST USE 12-10-1995; IN COMMERCE 12-10-1995.

THE MARK CONSISTS OF STANDARD CHARACTERS WITHOUT CLAIM TO ANY PARTICULAR FONT, STYLE, SIZE, OR COLOR.

SER. NO. 77-371,811, FILED 1-15-2008.

FOR: WINE, IN CLASS 33 (U.S. CLS. 47 AND 49).

GINA FINK, EXAMINING ATTORNEY

Int. Cl.: 36

Prior U.S. Cls.: 100, 101 and 102

United States Patent and Trademark Office

Reg. No. 3,476,495

Registered July 29, 2008

**SERVICE MARK
PRINCIPAL REGISTER**

**YOUR ROCK FOR RETIREMENT
INCOME**

THE PRUDENTIAL INSURANCE COMPANY OF
AMERICA (NEW JERSEY CORPORATION)
751 BROAD STREET
NEWARK, NJ 07102

FOR: INSURANCE AND FINANCIAL SERVICES, NAMELY, INSURANCE UNDERWRITING, ADMINISTRATION AND AGENCY SERVICES IN THE FIELDS OF LIFE, DISABILITY AND LONG TERM CARE; PENSION FUND AND RETIREMENT PLAN MANAGEMENT SERVICES, NAMELY, INVESTMENT OF PENSION AND RETIREMENT FUNDS FOR OTHERS, AND ADMINISTRATION OF EMPLOYEE PENSION AND RETIREMENT PLANS; UNDERWRITING AND ADMINISTERING ANNUITIES, DEFINED CONTRIBUTION AND DEFINED BENEFIT PLANS; MUTUAL FUND BROKERAGE, DISTRIBUTION AND INVESTMENT SERVICES; INVESTMENT ADVISORY AND MANAGEMENT SERVICES; FINANCIAL SERVICES, NAMELY, ASSET MANAGEMENT SERVICES; FINANCIAL PLANNING SERVICES; INVESTMENT CONSULTATION SERVICES; INVESTMENT BROKERAGE SERVICES; SECURITIES BROKER-

AGE SERVICES; COMMODITIES BROKERAGE SERVICES; FINANCIAL AND ESTATE PLANNING SERVICES; PROVIDING FINANCIAL, INSURANCE, AND REAL ESTATE INFORMATION AND RESEARCH BY ELECTRONIC MEANS; REAL ESTATE BROKERAGE AND REAL ESTATE INVESTMENT SERVICES; RESEARCH SERVICES IN THE FIELDS OF FINANCE, INSURANCE AND REAL ESTATE, IN CLASS 36 (U.S. CLS. 100, 101 AND 102).

FIRST USE 1-16-2008; IN COMMERCE 1-16-2008.

THE MARK CONSISTS OF STANDARD CHARACTERS WITHOUT CLAIM TO ANY PARTICULAR FONT, STYLE, SIZE, OR COLOR.

NO CLAIM IS MADE TO THE EXCLUSIVE RIGHT TO USE "RETIREMENT INCOME", APART FROM THE MARK AS SHOWN.

SER. NO. 77-372,933, FILED 1-16-2008.

LA TONIA FISHER, EXAMINING ATTORNEY

Int. Cl.: 29

Prior U.S. Cl.: 46

United States Patent and Trademark Office

Reg. No. 3,476,496

Registered July 29, 2008

**TRADEMARK
PRINCIPAL REGISTER**

GLACIER POINT

SARTORI FOOD CORPORATION (WISCONSIN
CORPORATION)
107 PLEASANT VIEW ROAD, P.O. BOX 258
PLYMOUTH, WI 53073

THE MARK CONSISTS OF STANDARD CHAR-
ACTERS WITHOUT CLAIM TO ANY PARTICULAR
FONT, STYLE, SIZE, OR COLOR.

FOR: CHEESE, IN CLASS 29 (U.S. CL. 46).

SER. NO. 77-373,284, FILED 1-16-2008.

FIRST USE 12-0-2007; IN COMMERCE 12-0-2007.

ZHALEH DELANEY, EXAMINING ATTORNEY

Int. Cl.: 36

Prior U.S. Cls.: 100, 101 and 102

United States Patent and Trademark Office

Reg. No. 3,476,497

Registered July 29, 2008

**SERVICE MARK
PRINCIPAL REGISTER**



OMNI BROKERAGE, INC. (UTAH CORPORATION)
10542 SOUTH JORDAN GATEWAY, SUITE 330
SOUTH JORDAN, UT 84095

FOR: FINANCIAL AND INVESTMENT SERVICES; NAMELY, BROKERAGE AND MANAGEMENT IN THE FIELDS OF STOCKS, BONDS, OPTIONS, COMMODITIES, FUTURES AND OTHER SECURITIES, AND THE INVESTMENT OF FUNDS OF OTHERS; FINANCIAL CONSULTATION; REAL

ESTATE BROKERAGE, IN CLASS 36 (U.S. CLS. 100, 101 AND 102).

FIRST USE 4-0-2007; IN COMMERCE 4-0-2007.

THE MARK CONSISTS OF A SNOWFLAKE.

SER. NO. 77-373,715, FILED 1-16-2008.

EDWARD FENNESSY, EXAMINING ATTORNEY

Int. Cl.: 17

Prior U.S. Cls.: 1, 5, 12, 13, 35 and 50

United States Patent and Trademark Office

Reg. No. 3,476,498

Registered July 29, 2008

**TRADEMARK
PRINCIPAL REGISTER**

Biogreen

RELIEF-MART, INC. (CALIFORNIA CORPORATION)
755 LAKEFIELD RD., STE. H
WESTLAKE VILLAGE, CA 91361

FOR: POLYURETHANE FOAM FOR INCORPORATION INTO PILLOWS, MATTRESSES, MATTRESS TOPPERS, MATTRESS COVERS AND MATTRESS PADS, IN CLASS 17 (U.S. CLS. 1, 5, 12, 13, 35 AND 50).

FIRST USE 1-3-2008; IN COMMERCE 1-17-2008.

THE MARK CONSISTS OF STANDARD CHARACTERS WITHOUT CLAIM TO ANY PARTICULAR FONT, STYLE, SIZE, OR COLOR.

SER. NO. 77-374,839, FILED 1-18-2008.

DAVID TAYLOR, EXAMINING ATTORNEY

Int. Cl.: 9

Prior U.S. Cls.: 21, 23, 26, 36 and 38

Reg. No. 3,476,499

United States Patent and Trademark Office

Registered July 29, 2008

**TRADEMARK
PRINCIPAL REGISTER**

CLINICAL VISION VR

HS TM, LLC (DELAWARE LTD LIAB CO)
220 CONTINENTAL DRIVE, SUITE 115
NEWARK, DE 19713

FOR: VISUAL CLINICAL CHARTING APPLICATION MODULE USED WITH DENTIST AND PERIODONTIST PRACTICE MANAGEMENT SOFTWARE, IN CLASS 9 (U.S. CLS. 21, 23, 26, 36 AND 38).

FIRST USE 9-0-2005; IN COMMERCE 9-0-2005.

THE MARK CONSISTS OF STANDARD CHARACTERS WITHOUT CLAIM TO ANY PARTICULAR FONT, STYLE, SIZE, OR COLOR.

NO CLAIM IS MADE TO THE EXCLUSIVE RIGHT TO USE "VR", APART FROM THE MARK AS SHOWN.

SER. NO. 77-375,049, FILED 1-18-2008.

CHERYL CLAYTON, EXAMINING ATTORNEY

Int. Cl.: 21

Prior U.S. Cls.: 2, 13, 23, 29, 30, 33, 40 and 50

Reg. No. 3,476,500

United States Patent and Trademark Office

Registered July 29, 2008

**TRADEMARK
PRINCIPAL REGISTER**

MIGHTY GRIP

MUNCHKIN, INC. (DELAWARE CORPORATION)
16689 SCHOENBORN STREET
NORTH HILLS, CA 91343

FOR: DRINKING CUPS; TRAINING CUPS FOR
BABIES AND CHILDREN, IN CLASS 21 (U.S. CLS. 2,
13, 23, 29, 30, 33, 40 AND 50).

FIRST USE 12-21-2007; IN COMMERCE 1-17-2008.

THE MARK CONSISTS OF STANDARD CHARACTERS WITHOUT CLAIM TO ANY PARTICULAR FONT, STYLE, SIZE, OR COLOR.

NO CLAIM IS MADE TO THE EXCLUSIVE RIGHT TO USE "GRIP", APART FROM THE MARK AS SHOWN.

SER. NO. 77-375,300, FILED 1-18-2008.

CAROLYN CATALDO, EXAMINING ATTORNEY

Int. Cl.: 16

Prior U.S. Cls.: 2, 5, 22, 23, 29, 37, 38 and 50

United States Patent and Trademark Office

Reg. No. 3,476,501

Registered July 29, 2008

**TRADEMARK
PRINCIPAL REGISTER**

TEK WRITER

CRI 2000, L.P. (CALIFORNIA LIMITED PART-
NERSHIP)
SUITE 223
2245 SAN DIEGO AVENUE
SAN DIEGO, CA 92110

FOR: GEL ROLLER PENS, IN CLASS 16 (U.S. CLS.
2, 5, 22, 23, 29, 37, 38 AND 50).

FIRST USE 3-31-2006; IN COMMERCE 3-31-2006.

THE MARK CONSISTS OF STANDARD CHAR-
ACTERS WITHOUT CLAIM TO ANY PARTICULAR
FONT, STYLE, SIZE, OR COLOR.

OWNER OF U.S. REG. NO. 3,216,166.

SER. NO. 77-375,652, FILED 1-18-2008.

PAUL MORENO, EXAMINING ATTORNEY

Int. Cl.: 35

Prior U.S. Cls.: 100, 101 and 102

United States Patent and Trademark Office

Reg. No. 3,476,502

Registered July 29, 2008

**SERVICE MARK
PRINCIPAL REGISTER**



ERIE AREA CONVENTION AND VISITORS BU-
REAU (PENNSYLVANIA CORPORATION)
SUITE 103
208 EAST BAYFRONT PARKWAY
ERIE, PA 165072405

FOR: ASSOCIATION SERVICES, NAMELY, PRO-
MOTING THE INTERESTS OF TOURISM, BUSI-
NESS, AND CONVENTIONS IN THE ERIE, PA
AREA, IN CLASS 35 (U.S. CLS. 100, 101 AND 102).

FIRST USE 10-11-2007; IN COMMERCE 10-11-2007.

THE COLOR(S) YELLOW AND BLUE IS/ARE
CLAIMED AS A FEATURE OF THE MARK.

THE MARK CONSISTS OF A PARTIALLY OB-
SCURED OUTLINE OF A YELLOW SUN, THREE
BLUE WAVES UNDERNEATH THE SUN, A LAR-
GER BLUE BIRD PARTIALLY WITHIN THE SUN
AND A SMALL BLUE BIRD ABOVE THE SUN.

SER. NO. 77-375,964, FILED 1-19-2008.

JENNIFER VASQUEZ, EXAMINING ATTORNEY

Int. Cl.: 25

Prior U.S. Cls.: 22 and 39

United States Patent and Trademark Office

Reg. No. 3,476,503

Registered July 29, 2008

**TRADEMARK
PRINCIPAL REGISTER**

Underground Kingz

FREEMAN, BERNARD (UNITED STATES INDIVIDUAL)

TWO BALA PLAZA, SUITE #300

C/O BERNARD M. RESNICK, ESQ., P.C.

BALA CYNWYD, PA 19004

FOR: JERSEYS; SHORT-SLEEVED OR LONG-SLEEVED T-SHIRTS; SHORT-SLEEVED SHIRTS; SPORT SHIRTS; T-SHIRTS; TEE SHIRTS; LONG-SLEEVED SHIRTS; JACKETS; BASEBALL CAPS; HEADGEAR, NAMELY, BASEBALL AND KNIT CAPS, IN CLASS 25 (U.S. CLS. 22 AND 39).

FIRST USE 6-1-1991; IN COMMERCE 2-21-1992.

THE MARK CONSISTS OF STANDARD CHARACTERS WITHOUT CLAIM TO ANY PARTICULAR FONT, STYLE, SIZE, OR COLOR.

SER. NO. 77-376,175, FILED 1-20-2008.

ESTHER BELENKER, EXAMINING ATTORNEY

Int. Cl.: 25

Prior U.S. Cls.: 22 and 39

United States Patent and Trademark Office

Reg. No. 3,476,504

Registered July 29, 2008

**TRADEMARK
PRINCIPAL REGISTER**

UGK

FREEMAN, BERNARD (UNITED STATES INDIVIDUAL)
TWO BALA PLAZA, SUITE #300
C/O BERNARD M. RESNICK, ESQ., P.C.
BALA CYNWYD, PA 19004

FOR: JERSEYS; SHORT-SLEEVED OR LONG-SLEEVED T-SHIRTS; SHORT-SLEEVED SHIRTS; SPORT SHIRTS; T-SHIRTS; TEE SHIRTS; LONG-SLEEVED SHIRTS; BASEBALL CAPS; HEADGEAR, NAMELY, BASEBALL AND KNIT CAPS; JACKETS, IN CLASS 25 (U.S. CLS. 22 AND 39).

FIRST USE 6-1-1991; IN COMMERCE 2-21-1992.

THE MARK CONSISTS OF STANDARD CHARACTERS WITHOUT CLAIM TO ANY PARTICULAR FONT, STYLE, SIZE, OR COLOR.

SER. NO. 77-376,181, FILED 1-20-2008.

ESTHER BELENKER, EXAMINING ATTORNEY

Int. Cl.: 5

Prior U.S. Cls.: 6, 18, 44, 46, 51 and 52

Reg. No. 3,476,505

United States Patent and Trademark Office

Registered July 29, 2008

**TRADEMARK
PRINCIPAL REGISTER**

NanaCea Manna

NANA PATRICIA MCPEAK (UNITED STATES
INDIVIDUAL)
100 ROCK LANE
EL DORADO HILLS, CA 95762

THE MARK CONSISTS OF STANDARD CHAR-
ACTERS WITHOUT CLAIM TO ANY PARTICULAR
FONT, STYLE, SIZE, OR COLOR.

FOR: DIETARY AND NUTRITIONAL SUPPLE-
MENTS, IN CLASS 5 (U.S. CLS. 6, 18, 44, 46, 51 AND
52).

SER. NO. 77-377,939, FILED 1-22-2008.

FIRST USE 11-1-2007; IN COMMERCE 11-1-2007.

KHANH LE, EXAMINING ATTORNEY

Int. Cl.: 11

Prior U.S. Cls.: 13, 21, 23, 31 and 34

United States Patent and Trademark Office

Reg. No. 3,476,506

Registered July 29, 2008

**TRADEMARK
PRINCIPAL REGISTER**

SUPERB ENERGY MISER

CTB IP, INC. (DELAWARE CORPORATION)
SUITE 900
300 DELAWARE AVENUE
WILMINGTON, DE 19801

FOR: GRAIN DRYERS, IN CLASS 11 (U.S. CLS. 13,
21, 23, 31 AND 34).

FIRST USE 1-11-2008; IN COMMERCE 1-11-2008.

THE MARK CONSISTS OF STANDARD CHAR-
ACTERS WITHOUT CLAIM TO ANY PARTICULAR
FONT, STYLE, SIZE, OR COLOR.

OWNER OF U.S. REG. NOS. 1,100,667 AND
1,105,575.

SER. NO. 77-378,601, FILED 1-23-2008.

NELSON SNYDER, EXAMINING ATTORNEY

Int. Cl.: 25

Prior U.S. Cls.: 22 and 39

United States Patent and Trademark Office

Reg. No. 3,476,507

Registered July 29, 2008

**TRADEMARK
PRINCIPAL REGISTER**

GYPSY IN PINK

SUBLIMATION FACTORY, INC. (CALIFORNIA CORPORATION)
3400 S. MAIN STREET
LOS ANGELES, CA 90007

FOR: MEN'S AND WOMEN'S CLOTHING, NAMELY, JEANS, PANTS, TROUSERS, CAPRIS, LEGGINGS, SHORTS, OVERALLS, SKIRTS, DRESSES, TOPS, T-SHIRTS, TANK TOPS, SWEATSHIRTS, SWEAT PANTS, BLOUSES, SHIRTS, JACKETS, COATS, SWEATERS, VESTS, LINGERIE, CARDIGANS, SCARVES, SOCKS, UNDERWEAR, THERMAL UNDERWEAR AND SOCKS, NECKTIES, FOOTWEAR, HATS, CAPS, HEADWEAR, BOOTS,

SANDALS, AND BELTS, IN CLASS 25 (U.S. CLS. 22 AND 39).

FIRST USE 1-15-2008; IN COMMERCE 1-15-2008.

THE MARK CONSISTS OF STANDARD CHARACTERS WITHOUT CLAIM TO ANY PARTICULAR FONT, STYLE, SIZE, OR COLOR.

SER. NO. 77-378,972, FILED 1-23-2008.

COLLEEN DOMBROW, EXAMINING ATTORNEY

Int. Cl.: 3

Prior U.S. Cls.: 1, 4, 6, 50, 51 and 52

United States Patent and Trademark Office

Reg. No. 3,476,508

Registered July 29, 2008

**TRADEMARK
PRINCIPAL REGISTER**

QF2

MYCONE DENTAL SUPPLY CO., INC. (NEW
YORK CORPORATION)
616 HOLLYWOOD AVENUE
CHERRY HILL, NJ 08002

FOR: ABRASIVE PASTE; DENTIFRICES; NAIL
CARE PREPARATIONS; NAIL ENAMEL; NAIL
HARDENERS; NAIL POLISH; NAIL VARNISH FOR
COSMETIC PURPOSES; POLISHING PREPARA-
TIONS, IN CLASS 3 (U.S. CLS. 1, 4, 6, 50, 51 AND 52).

FIRST USE 3-1-2004; IN COMMERCE 3-1-2004.

THE MARK CONSISTS OF STANDARD CHAR-
ACTERS WITHOUT CLAIM TO ANY PARTICULAR
FONT, STYLE, SIZE, OR COLOR.

SER. NO. 77-379,194, FILED 1-24-2008.

YONG KIM, EXAMINING ATTORNEY

Int. Cl.: 7

Prior U.S. Cls.: 13, 19, 21, 23, 31, 34 and 35

Reg. No. 3,476,509

United States Patent and Trademark Office

Registered July 29, 2008

**TRADEMARK
PRINCIPAL REGISTER**



CANYON STREET CROSSING LIMITED LIABILITY COMPANY (COLORADO LTD LIAB CO)
SUITE 101
1470 WALNUT STREET
BOULDER, CO 80302

FIRST USE 8-0-2005; IN COMMERCE 8-0-2005.

OWNER OF U.S. REG. NOS. 726,468 AND 1,289,834.

FOR: EARTH ENGAGING, EARTH CUTTING AND EARTH PULVERIZING DISCS AND COULTER BLADES FOR PLOWS, HARROWS, AND LIKE AGRICULTURAL IMPLEMENTS, IN CLASS 7 (U.S. CLS. 13, 19, 21, 23, 31, 34 AND 35).

SER. NO. 77-379,950, FILED 1-24-2008.

APRIL ROACH, EXAMINING ATTORNEY

Int. Cl.: 31

Prior U.S. Cls.: 1 and 46

United States Patent and Trademark Office

Reg. No. 3,476,510

Registered July 29, 2008

**TRADEMARK
PRINCIPAL REGISTER**

N-Rich

REED MARICULTURE INC. (CALIFORNIA
CORPORATION)
511 PAMLAR AVE
SAN JOSE, CA 951284222

THE MARK CONSISTS OF STANDARD CHAR-
ACTERS WITHOUT CLAIM TO ANY PARTICULAR
FONT, STYLE, SIZE, OR COLOR.

FOR: FISH FOOD, IN CLASS 31 (U.S. CLS. 1 AND
46).

SER. NO. 77-379,951, FILED 1-24-2008.

FIRST USE 1-1-2008; IN COMMERCE 1-1-2008.

LYDIA BELZER, EXAMINING ATTORNEY

Int. Cl.: 3

Prior U.S. Cls.: 1, 4, 6, 50, 51 and 52

Reg. No. 3,476,511

United States Patent and Trademark Office

Registered July 29, 2008

**TRADEMARK
PRINCIPAL REGISTER**

GLASS KOTE

MYCONE DENTAL SUPPLY CO., INC. (NEW
YORK CORPORATION)
616 HOLLYWOOD AVENUE
CHERRY HILL, NJ 08002

FOR: ABRASIVE PASTE; DENTIFRICES; NAIL
CARE PREPARATIONS; NAIL ENAMEL; NAIL
HARDENERS; NAIL POLISH; NAIL VARNISH FOR
COSMETIC PURPOSES; POLISHING PREPARA-
TIONS, IN CLASS 3 (U.S. CLS. 1, 4, 6, 50, 51 AND 52).

FIRST USE 10-1-1996; IN COMMERCE 10-1-1996.

THE MARK CONSISTS OF STANDARD CHAR-
ACTERS WITHOUT CLAIM TO ANY PARTICULAR
FONT, STYLE, SIZE, OR COLOR.

NO CLAIM IS MADE TO THE EXCLUSIVE
RIGHT TO USE "COAT", APART FROM THE MARK
AS SHOWN.

SER. NO. 77-380,290, FILED 1-25-2008.

YONG KIM, EXAMINING ATTORNEY

Int. Cl.: 3

Prior U.S. Cls.: 1, 4, 6, 50, 51 and 52

Reg. No. 3,476,512

United States Patent and Trademark Office

Registered July 29, 2008

**TRADEMARK
PRINCIPAL REGISTER**

O-3 U.V. CURABLE TOP GEL

MYCONE DENTAL SUPPLY CO., INC. (NEW
YORK CORPORATION)
616 HOLLYWOOD AVENUE
CHERRY HILL, NJ 08002

FOR: ABRASIVE PASTE; DENTIFRICES; NAIL
CARE PREPARATIONS; NAIL ENAMEL; NAIL
HARDENERS; NAIL POLISH; NAIL VARNISH FOR
COSMETIC PURPOSES; POLISHING PREPARA-
TIONS, IN CLASS 3 (U.S. CLS. 1, 4, 6, 50, 51 AND 52).

FIRST USE 10-1-1996; IN COMMERCE 10-1-1996.

THE MARK CONSISTS OF STANDARD CHAR-
ACTERS WITHOUT CLAIM TO ANY PARTICULAR
FONT, STYLE, SIZE, OR COLOR.

NO CLAIM IS MADE TO THE EXCLUSIVE
RIGHT TO USE "U.V. CURABLE TOP GEL", APART
FROM THE MARK AS SHOWN.

SER. NO. 77-380,293, FILED 1-25-2008.

YONG KIM, EXAMINING ATTORNEY

Int. Cl.: 3

Prior U.S. Cls.: 1, 4, 6, 50, 51 and 52

United States Patent and Trademark Office

Reg. No. 3,476,513

Registered July 29, 2008

**TRADEMARK
PRINCIPAL REGISTER**

PROLINE CLEAR GEL

MYCONE DENTAL SUPPLY CO., INC. (NEW
YORK CORPORATION)
616 HOLLYWOOD AVENUE
CHERRY HILL, NJ 08002

FOR: ABRASIVE PASTE; DENTIFRICES; NAIL
CARE PREPARATIONS; NAIL ENAMEL; NAIL
HARDENERS; NAIL POLISH; NAIL VARNISH FOR
COSMETIC PURPOSES; POLISHING PREPARA-
TIONS FOR NAILS, IN CLASS 3 (U.S. CLS. 1, 4, 6,
50, 51 AND 52).

FIRST USE 1-1-2006; IN COMMERCE 1-1-2006.

THE MARK CONSISTS OF STANDARD CHAR-
ACTERS WITHOUT CLAIM TO ANY PARTICULAR
FONT, STYLE, SIZE, OR COLOR.

NO CLAIM IS MADE TO THE EXCLUSIVE
RIGHT TO USE "CLEAR GEL", APART FROM
THE MARK AS SHOWN.

SER. NO. 77-380,303, FILED 1-25-2008.

YONG KIM, EXAMINING ATTORNEY

Int. Cl.: 41

Prior U.S. Cls.: 100, 101 and 107

United States Patent and Trademark Office

Reg. No. 3,476,514

Registered July 29, 2008

**SERVICE MARK
PRINCIPAL REGISTER**

JUMP KIDS JUMP

CLARIAN HEALTH PARTNERS, INC. (INDIANA
CORPORATION)
P.O. BOX 1367
1520 N. SENATE BOULEVARD
INDIANAPOLIS, IN 46206

FOR: ORGANIZING AND CONDUCTING
YOUTH JUMP ROPE ACTIVITIES TO ENHANCE
THE PHYSICAL FITNESS OF YOUTHS, IN CLASS 41
(U.S. CLS. 100, 101 AND 107).

FIRST USE 8-4-2006; IN COMMERCE 8-4-2006.

THE MARK CONSISTS OF STANDARD CHAR-
ACTERS WITHOUT CLAIM TO ANY PARTICULAR
FONT, STYLE, SIZE, OR COLOR.

SER. NO. 77-380,813, FILED 1-25-2008.

EDWARD NELSON, EXAMINING ATTORNEY

Int. Cl.: 41

Prior U.S. Cls.: 100, 101 and 107

United States Patent and Trademark Office

Reg. No. 3,476,515

Registered July 29, 2008

**SERVICE MARK
PRINCIPAL REGISTER**

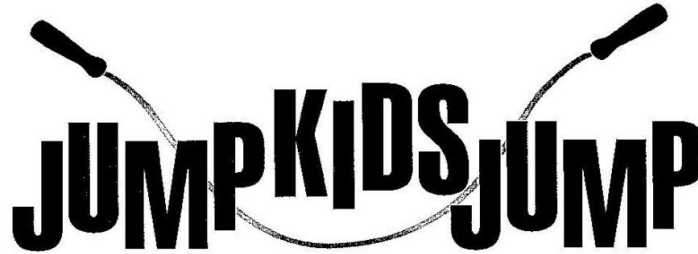

CLARIAN HEALTH PARTNERS, INC. (INDIANA CORPORATION)
P.O. BOX 1367
1520 N. SENATE BOULEVARD
INDIANAPOLIS, IN 46206

FIRST USE 1-21-2008; IN COMMERCE 1-21-2008.

THE MARK CONSISTS IN PART OF A STYLIZED "JUMP ROPE"

FOR: ORGANIZING AND CONDUCTING YOUTH JUMP ROPE ACTIVITIES TO ENHANCE THE PHYSICAL FITNESS OF YOUTHS, IN CLASS 41 (U.S. CLS. 100, 101 AND 107).

SER. NO. 77-380,853, FILED 1-25-2008.

EDWARD NELSON, EXAMINING ATTORNEY

Int. Cl.: 41

Prior U.S. Cls.: 100, 101 and 107

United States Patent and Trademark Office

Reg. No. 3,476,516

Registered July 29, 2008

**SERVICE MARK
PRINCIPAL REGISTER**

WATCH. LEARN. DO.

SMOOTH-ON, INC. (PENNSYLVANIA CORPORATION)
2000 ST. JOHN STREET
EASTON, PA 18042

FOR: CONDUCTING WORKSHOPS AND SEMINARS IN THE FIELD OF MOLD MAKING AND CASTING, IN CLASS 41 (U.S. CLS. 100, 101 AND 107).

FIRST USE 11-0-2007; IN COMMERCE 11-0-2007.

THE MARK CONSISTS OF STANDARD CHARACTERS WITHOUT CLAIM TO ANY PARTICULAR FONT, STYLE, SIZE, OR COLOR.

SER. NO. 77-380,977, FILED 1-25-2008.

SUZANNE BLANE, EXAMINING ATTORNEY

Int. Cl.: 33

Prior U.S. Cls.: 47 and 49

United States Patent and Trademark Office

Reg. No. 3,476,517

Registered July 29, 2008

TRADEMARK
PRINCIPAL REGISTER



CAPITELLO WINES LLC (OREGON LTD LIAB
CO)
P.O. BOX 11694
EUGENE, OR 97440

FOR: WINE, IN CLASS 33 (U.S. CLS. 47 AND 49).

FIRST USE 8-22-2005; IN COMMERCE 12-8-2005.

THE COLOR(S) ROYAL PURPLE, GOLD, CORN-
SILK BEIGE, AND WARM GREY IS/ARE CLAIMED
AS A FEATURE OF THE MARK.

THE MARK CONSISTS OF ROYAL PURPLE
DRAWING OF A MAN STANDING ON THE

GROUND LOOKING UP AT THREE WARM GREY
WINE BOTTLES FLOATING AMONG FIVE GOLD
STARS AND A GOLD WANING MOON ABOVE THE
WORD "CAPITELLO" IN STYLIZED ROYAL PUR-
PLE FONT, ALL TOGETHER ON A SQUARE CORN-
SILK BEIGE BACKGROUND WITHIN A THIN
GOLD SQUARE LINE ENCLOSED WITHIN A ROY-
AL PURPLE SQUARE FRAME. .

SER. NO. 77-381,209, FILED 1-25-2008.

WILLIAM P. SHANAHAN, EXAMINING ATTOR-
NEY

Int. Cl.: 28

Prior U.S. Cls.: 22, 23, 38 and 50

Reg. No. 3,476,518

United States Patent and Trademark Office

Registered July 29, 2008

**TRADEMARK
PRINCIPAL REGISTER**

DANBAR TOYS

DANBAR INTERNATIONAL LTD. (UNITED
KINGDOM CORPORATION)
BUSINESS CENTRE
DIXONS HILL ROAD UNIT 2 A1 (M)
WELHAM GREEN, UNITED KINGDOM AL97JE

FOR: REMOTE CONTROL TOYS, NAMELY, HE-
LICOPTERS, ROAD VEHICLES, AIR PLANES,
TANKS, UFOS, AND HELICOPTERS , IN CLASS 28
(U.S. CLS. 22, 23, 38 AND 50).

FIRST USE 10-17-2007; IN COMMERCE 10-17-2007.

THE MARK CONSISTS OF STANDARD CHAR-
ACTERS WITHOUT CLAIM TO ANY PARTICULAR
FONT, STYLE, SIZE, OR COLOR.

NO CLAIM IS MADE TO THE EXCLUSIVE
RIGHT TO USE "TOYS", APART FROM THE MARK
AS SHOWN.

SER. NO. 77-381,404, FILED 1-26-2008.

ANDREA K. NADELMAN, EXAMINING ATTOR-
NEY

Int. Cl.: 35

Prior U.S. Cls.: 100, 101 and 102

United States Patent and Trademark Office

Reg. No. 3,476,519

Registered July 29, 2008

**SERVICE MARK
PRINCIPAL REGISTER**



O'REILLY AUTOMOTIVE, INC. (MISSOURI CORPORATION)
233 SOUTH PATTERSON
SPRINGFIELD, MO 65802

FOR: RETAIL STORE SERVICES AND WHOLESALE DISTRIBUTORSHIP SERVICES IN THE FIELD OF AUTOMOTIVE PARTS AND ACCESSORIES, TOOLS AND EQUIPMENT, IN CLASS 35 (U.S. CLS. 100, 101 AND 102).

FIRST USE 3-31-2005; IN COMMERCE 3-31-2005.

THE MARK CONSISTS OF THE WORDS "TOOL" AND "BOX", IN STYLIZED FONT, WITH THE "X" IN "BOX" BEING LARGER THAN THE OTHER LETTERS, AND SUPERIMPOSED OVER A CIRCLE WITHIN A CIRCLE, ALL OF WHICH IS OUTLINED TO GIVE A SHADOW EFFECT.

SER. NO. 77-382,215, FILED 1-28-2008.

MORGAN WYNNE, EXAMINING ATTORNEY

Int. Cl.: 6

Prior U.S. Cls.: 2, 12, 13, 14, 23, 25 and 50

United States Patent and Trademark Office

Reg. No. 3,476,520

Registered July 29, 2008

**TRADEMARK
PRINCIPAL REGISTER**

**The Look You Want, The
Security You Need.**

SECUREUSA, INC. (GEORGIA CORPORATION)
SUITE 160
4250 KEITH BRIDGE ROAD
CUMMING, GA 30041

FOR: STEEL BARRIERS AND STEEL BOLLARDS
FOR PERIMETER PROTECTION THAT PREVENT
VEHICULAR INTRUSION, IN CLASS 6 (U.S. CLS. 2,
12, 13, 14, 23, 25 AND 50).

FIRST USE 8-31-2006; IN COMMERCE 8-31-2006.

THE MARK CONSISTS OF STANDARD CHAR-
ACTERS WITHOUT CLAIM TO ANY PARTICULAR
FONT, STYLE, SIZE, OR COLOR.

SER. NO. 77-382,307, FILED 1-28-2008.

NANCY CLARKE, EXAMINING ATTORNEY

Int. Cl.: 35

Prior U.S. Cls.: 100, 101 and 102

United States Patent and Trademark Office

Reg. No. 3,476,521

Registered July 29, 2008

**SERVICE MARK
PRINCIPAL REGISTER**

ULTIMATELY, CONNECTED

AMERICAN EXPRESS MARKETING & DEVELOPMENT CORP. (DELAWARE CORPORATION)
200 VESEY STREET
NEW YORK, NY 10285

THE MARK CONSISTS OF STANDARD CHARACTERS WITHOUT CLAIM TO ANY PARTICULAR FONT, STYLE, SIZE, OR COLOR.

FOR: ADVERTISING SERVICES, NAMELY, PROVIDING ADVERTISING SPACE IN A PERIODICAL, IN CLASS 35 (U.S. CLS. 100, 101 AND 102).

SER. NO. 77-382,818, FILED 1-29-2008.

FIRST USE 0-0-2005; IN COMMERCE 0-0-2005.

KEVON CHISOLM, EXAMINING ATTORNEY

Int. Cl.: 5

Prior U.S. Cls.: 6, 18, 44, 46, 51 and 52

Reg. No. 3,476,522

United States Patent and Trademark Office

Registered July 29, 2008

**TRADEMARK
PRINCIPAL REGISTER**



NATURAL ORGANICS INC. (NEW YORK CORPORATION)

548 BROADHOLLOW ROAD

MELVILLE, NY 117473708

FOR: DIETARY SUPPLEMENT, IN CLASS 5 (U.S. CLS. 6, 18, 44, 46, 51 AND 52).

FIRST USE 7-1-2007; IN COMMERCE 7-1-2007.

NO CLAIM IS MADE TO THE EXCLUSIVE RIGHT TO USE "PROTEIN", APART FROM THE MARK AS SHOWN.

THE MARK CONSISTS OF FANCIFUL THREE LEAF PLANT ILLUSTRATING SOY, RICE AND PEAS IN SEPARATE LEAVES.

SER. NO. 77-382,949, FILED 1-29-2008.

GIANCARLO CASTRO, EXAMINING ATTORNEY

Int. Cls.: 3 and 21

**Prior U.S. Cls.: 1, 2, 4, 6, 13, 23, 29, 30, 33, 40, 50, 51
and 52**

Reg. No. 3,476,523

United States Patent and Trademark Office

Registered July 29, 2008

**TRADEMARK
PRINCIPAL REGISTER**

WOOLITE

RECKITT BENCKISER INC. (DELAWARE COR-
PORATION)
399 INTERPACE PARKWAY
PARSIPPANY, NJ 07054

FOR: CLEANING PREPARATIONS FOR CAR-
PETS, RUGS AND UPHOLSTERY, IN CLASS 3 (U.S.
CLS. 1, 4, 6, 50, 51 AND 52).

FIRST USE 6-26-2006; IN COMMERCE 6-26-2006.

FOR: NON-ELECTRIC CLEANING DEVICE FOR
CARPETS, RUGS AND UPHOLSTERY IN THE
NATURE OF COMBINATION OF A COMB, SPONGE
AND BRUSH, IN CLASS 21 (U.S. CLS. 2, 13, 23, 29, 30,
33, 40 AND 50).

FIRST USE 6-26-2006; IN COMMERCE 6-26-2006.

THE MARK CONSISTS OF STANDARD CHAR-
ACTERS WITHOUT CLAIM TO ANY PARTICULAR
FONT, STYLE, SIZE, OR COLOR.

OWNER OF U.S. REG. NOS. 922,525, 1,948,852 AND
OTHERS.

SER. NO. 77-383,203, FILED 1-29-2008.

CHRISTINE COOPER, EXAMINING ATTORNEY

Int. Cl.: 18

Prior U.S. Cls.: 1, 2, 3, 22 and 41

United States Patent and Trademark Office

Reg. No. 3,476,524

Registered July 29, 2008

**TRADEMARK
PRINCIPAL REGISTER**

NATURALIZER

BROWN SHOE COMPANY, INC. (NEW YORK
CORPORATION)
8300 MARYLAND AVENUE
ST. LOUIS, MO 63105

FOR: HANDBAGS, PURSES, CARRY ALL BAGS,
TOTE BAGS, WALLETS, IN CLASS 18 (U.S. CLS. 1, 2,
3, 22 AND 41).

FIRST USE 12-31-1954; IN COMMERCE 12-31-1954.

THE MARK CONSISTS OF STANDARD CHAR-
ACTERS WITHOUT CLAIM TO ANY PARTICULAR
FONT, STYLE, SIZE, OR COLOR.

OWNER OF U.S. REG. NOS. 3,149,878, 3,236,960
AND OTHERS.

SER. NO. 77-383,520, FILED 1-29-2008.

ANNE FARRELL, EXAMINING ATTORNEY

Int. Cl.: 35

Prior U.S. Cls.: 100, 101 and 102

United States Patent and Trademark Office

Reg. No. 3,476,525

Registered July 29, 2008

**SERVICE MARK
PRINCIPAL REGISTER**

WHITEFLASH

WHITEFLASH.COM, INC. (TEXAS CORPORATION)
SUITE 700
6222 RICHMOND AVE.
HOUSTON, TX 77057

FOR: ONLINE RETAIL STORE SERVICES FEATURING DIAMONDS, PRECIOUS STONES, JEWELRY, JEWELRY MADE OF DIAMONDS, JEWELRY MADE OF PRECIOUS STONES, AND RINGS BEING JEWELRY, IN CLASS 35 (U.S. CLS. 100, 101 AND 102).

FIRST USE 12-31-2000; IN COMMERCE 12-31-2000.

THE MARK CONSISTS OF STANDARD CHARACTERS WITHOUT CLAIM TO ANY PARTICULAR FONT, STYLE, SIZE, OR COLOR.

OWNER OF U.S. REG. NO. 3,312,233.

SER. NO. 77-383,729, FILED 1-29-2008.

LANA PHAM, EXAMINING ATTORNEY

Int. Cl.: 28

Prior U.S. Cls.: 22, 23, 38 and 50

United States Patent and Trademark Office

Reg. No. 3,476,526

Registered July 29, 2008

**TRADEMARK
PRINCIPAL REGISTER**

**THE TOUGHEST BASKETBALL
SYSTEM ON THE PLANET**

SOP SERVICES, INC. (NEVADA CORPORATION)
2325-B RENAISSANCE DRIVE, SUITE 10
LAS VEGAS, NV 89119

FOR: BASKETBALL GOALS, IN CLASS 28 (U.S.
CLS. 22, 23, 38 AND 50).

FIRST USE 6-0-2000; IN COMMERCE 6-0-2000.

THE MARK CONSISTS OF STANDARD CHAR-
ACTERS WITHOUT CLAIM TO ANY PARTICULAR
FONT, STYLE, SIZE, OR COLOR.

NO CLAIM IS MADE TO THE EXCLUSIVE
RIGHT TO USE "BASKETBALL SYSTEM", APART
FROM THE MARK AS SHOWN.

SER. NO. 77-384,417, FILED 1-30-2008.

STEPHEN AQUILA, EXAMINING ATTORNEY

Int. Cl.: 14

Prior U.S. Cls.: 2, 27, 28 and 50

United States Patent and Trademark Office

Reg. No. 3,476,527

Registered July 29, 2008

**TRADEMARK
PRINCIPAL REGISTER**

BHWC

EIJ, INC. (CALIFORNIA CORPORATION)
227 S. BEVERLY DRIVE
BEVERLY HILLS, CA 91202

FOR: JEWELLERY AND WATCHES, IN CLASS 14
(U.S. CLS. 2, 27, 28 AND 50).

FIRST USE 1-15-1979; IN COMMERCE 1-15-1979.

THE MARK CONSISTS OF STANDARD CHAR-
ACTERS WITHOUT CLAIM TO ANY PARTICULAR
FONT, STYLE, SIZE, OR COLOR.

OWNER OF U.S. REG. NO. 2,797,095.

SER. NO. 77-384,880, FILED 1-30-2008.

MICHAEL KAZAZIAN, EXAMINING ATTORNEY

Int. Cl.: 40

Prior U.S. Cls.: 100, 103 and 106

United States Patent and Trademark Office

Reg. No. 3,476,528

Registered July 29, 2008

**SERVICE MARK
PRINCIPAL REGISTER**

Fresh Brewed Attitude

CALIFORNIA BREWING COMPANY INC. (CALIFORNIA CORPORATION)

5310 DOBERMAN LANE

ANDERSON, CA 96007

FOR: BREWERY SERVICES, IN CLASS 40 (U.S. CLS. 100, 103 AND 106).

FIRST USE 11-2-2007; IN COMMERCE 11-2-2007.

THE MARK CONSISTS OF STANDARD CHARACTERS WITHOUT CLAIM TO ANY PARTICULAR FONT, STYLE, SIZE, OR COLOR.

NO CLAIM IS MADE TO THE EXCLUSIVE RIGHT TO USE "FRESH BREWED", APART FROM THE MARK AS SHOWN.

SER. NO. 77-384,935, FILED 1-31-2008.

ARETHA SOMERVILLE, EXAMINING ATTORNEY

Int. Cl.: 3

Prior U.S. Cls.: 1, 4, 6, 50, 51 and 52

United States Patent and Trademark Office

Reg. No. 3,476,529

Registered July 29, 2008

**TRADEMARK
PRINCIPAL REGISTER**

SEXY SOLE-UTIONZ

FOOT PETALS LLC (CALIFORNIA LTD LIAB
CO)
SUITE 150
6615 PACIFIC COAST HIGHWAY
LONG BEACH, CA 90803

THE MARK CONSISTS OF STANDARD CHAR-
ACTERS WITHOUT CLAIM TO ANY PARTICULAR
FONT, STYLE, SIZE, OR COLOR.

FOR: SHOE POLISH, IN CLASS 3 (U.S. CLS. 1, 4, 6,
50, 51 AND 52).

SER. NO. 77-385,202, FILED 1-31-2008.

FIRST USE 10-12-2007; IN COMMERCE 10-12-2007.

JACLYN KIDWELL, EXAMINING ATTORNEY

Int. Cls.: 41 and 44

Prior U.S. Cls.: 100, 101 and 107

United States Patent and Trademark Office

Reg. No. 3,476,530

Registered July 29, 2008

**SERVICE MARK
PRINCIPAL REGISTER**



CLARITY WAY, INC. (PENNSYLVANIA CORPORATION)
3108 WEST MARKET STREET
YORK, PA 17404

FOR: EDUCATIONAL SERVICES, NAMELY, CONDUCTING CLASSES, SEMINARS, CONFERENCES AND WORKSHOPS IN THE FIELD OF COUNSELING, RECOGNIZING AND TREATING ADDICTIVE DISEASES, IN CLASS 41 (U.S. CLS. 100, 101 AND 107).

FIRST USE 12-13-2006; IN COMMERCE 11-8-2007.

FOR: PROVIDING COUNSELING AND REHABILITATIVE SERVICES FOR ALCOHOL AND OTHER DRUG DEPENDENT PATIENTS AND THEIR FAMILIES, IN CLASS 44 (U.S. CLS. 100 AND 101).

FIRST USE 12-13-2006; IN COMMERCE 11-8-2007.

NO CLAIM IS MADE TO THE EXCLUSIVE RIGHT TO USE "DRUG & ALCOHOL REHAB FACILITY", APART FROM THE MARK AS SHOWN.

THE MARK CONSISTS OF AN ARCHED SWISH ABOVE CAPITAL LETTERS "CW" EMBLAZONED BEHIND THE WORDS "CLARITY WAY DRUG & ALCOHOL REHAB FACILITY".

SER. NO. 77-385,476, FILED 1-31-2008.

YONG KIM, EXAMINING ATTORNEY

Int. Cl.: 36

Prior U.S. Cls.: 100, 101 and 102

United States Patent and Trademark Office

Reg. No. 3,476,531

Registered July 29, 2008

**SERVICE MARK
PRINCIPAL REGISTER**



MANHEIM FINANCIAL SERVICES

MANHEIM AUCTIONS, INC. (DELAWARE CORPORATION)
6205 PEACHTREE DUNWOODY ROAD
ATLANTA, GA 30328

FOR: AUTOMOBILE FINANCING SERVICES, IN CLASS 36 (U.S. CLS. 100, 101 AND 102).

FIRST USE 6-0-2007; IN COMMERCE 6-0-2007.

OWNER OF U.S. REG. NOS. 1,699,332, 3,201,964 AND OTHERS.

NO CLAIM IS MADE TO THE EXCLUSIVE RIGHT TO USE "FINANCIAL SERVICES", APART FROM THE MARK AS SHOWN.

THE COLOR(S) GOLD, BLUE, BROWN, WHITE AND BLACK IS/ARE CLAIMED AS A FEATURE OF THE MARK.

THE MARK CONSISTS OF A GOLD CAPITAL LETTER "M" OVER A BLUE CIRCULAR BACKGROUND AND WITHIN TWO GOLD OUTER RINGS. THE COLOR BROWN OUTLINES THE MARK. TO THE RIGHT OF THE "M" ARE LARGE BLOCK CAPITAL LETTERS "MAFS" IN THE COLOR WHITE. BEHIND THE CAPITAL LETTER "M" AND THE LARGE BLOCK CAPITAL LETTERS "MAFS" IS A BLUE RECTANGLE. CENTERED UNDERNEATH THE BLUE RECTANGLE ARE THE WORDS "MANHEIM FINANCIAL SERVICES" IN THE COLOR BLACK.

SER. NO. 77-386,173, FILED 2-1-2008.

DAVID TAYLOR, EXAMINING ATTORNEY

Int. Cls.: 6 and 11

Prior U.S. Cls.: 2, 12, 13, 14, 21, 23, 25, 31, 34 and 50

United States Patent and Trademark Office

Reg. No. 3,476,532

Registered July 29, 2008

**TRADEMARK
PRINCIPAL REGISTER**

EZPEX

RED-WHITE VALVE CORP. (CALIFORNIA CORPORATION)
20600 REGENCY LANE
LAKE FOREST, CA 92630

FOR: MANUALLY-OPERATED METAL VALVES FOR FLUID CONTROL, IN CLASS 6 (U.S. CLS. 2, 12, 13, 14, 23, 25 AND 50).

FIRST USE 2-20-2003; IN COMMERCE 2-20-2003.

FOR: PLUMBING FITTINGS, NAMELY, FLUID CONTROL VALVES FOR SHOWERS AND TUBS, IN CLASS 11 (U.S. CLS. 13, 21, 23, 31 AND 34).

FIRST USE 2-20-2003; IN COMMERCE 2-20-2003.

THE MARK CONSISTS OF STANDARD CHARACTERS WITHOUT CLAIM TO ANY PARTICULAR FONT, STYLE, SIZE, OR COLOR.

SER. NO. 77-386,177, FILED 2-1-2008.

HOWARD B. LEVINE, EXAMINING ATTORNEY

Int. Cl.: 29

Prior U.S. Cl.: 46

United States Patent and Trademark Office

Reg. No. 3,476,533

Registered July 29, 2008

**TRADEMARK
PRINCIPAL REGISTER**

HAPPY WINGS

HAPPY'S PIZZA COMPANY (MICHIGAN CORPORATION)
STE 607
29201 TELEGRAPH ROAD
SOUTHFIELD, MI 48034

FOR: CHICKEN WINGS FOR CONSUMPTION
ON OR OFF THE PREMISES, IN CLASS 29 (U.S. CL.
46).

FIRST USE 12-31-1993; IN COMMERCE 12-31-1993.

THE MARK CONSISTS OF STANDARD CHARACTERS WITHOUT CLAIM TO ANY PARTICULAR FONT, STYLE, SIZE, OR COLOR.

NO CLAIM IS MADE TO THE EXCLUSIVE RIGHT TO USE "WINGS", APART FROM THE MARK AS SHOWN.

SER. NO. 77-386,741, FILED 2-1-2008.

YONG KIM, EXAMINING ATTORNEY

Int. Cl.: 21

Prior U.S. Cls.: 2, 13, 23, 29, 30, 33, 40 and 50

Reg. No. 3,476,534

United States Patent and Trademark Office

Registered July 29, 2008

**TRADEMARK
PRINCIPAL REGISTER**



LEFT BRAIN ENTERPRISES, LLC (DELAWARE
LTD LIAB CO)
902 STUART ROAD
WILMINGTON, DE 19807

FIRST USE 12-0-2007; IN COMMERCE 12-0-2007.

THE MARK CONSISTS OF THE STYLIZED
WORDS "WISE-GLASS".

FOR: BEVERAGE GLASSWARE UPON WHICH
WORDING, MONOGRAMS, LOGOS OR DESIGNS
ARE ETCHED, IN CLASS 21 (U.S. CLS. 2, 13, 23, 29, 30,
33, 40 AND 50).

SER. NO. 77-387,281, FILED 2-3-2008.

ANGELA M. MICHELI, EXAMINING ATTORNEY

Int. Cls.: 3 and 5

Prior U.S. Cls.: 1, 4, 6, 18, 44, 46, 50, 51 and 52

Reg. No. 3,476,535

United States Patent and Trademark Office

Registered July 29, 2008

**TRADEMARK
PRINCIPAL REGISTER**

The logo consists of the word "Zao" in a bold, sans-serif font. The letter "Z" is significantly larger than the "ao". Above the "a" is a solid black diamond shape with a long, thin tail extending to the right, resembling a stylized arrow or a traditional Chinese brushstroke.

ANAZAOHEALTH CORPORATION (FLORIDA CORPORATION)

5710 HOOVER BLVD.

TAMPA, FL 33634

FOR: AFTER SUN CREAMS; AFTER-SUN LOTIONS; AGE RETARDANT GEL; AGE RETARDANT LOTION; AGE SPOT REDUCING CREAMS; ANTI-AGING CREAM; ANTI-AGING CREAMS; ANTI-FRECKLE CREAMS; ANTI-WRINKLE CREAM; ANTI-WRINKLE CREAMS; AROMATHERAPY CREAMS; AROMATHERAPY LOTIONS; ASTRINGENTS FOR COSMETIC PURPOSES; BEAUTY CREAMS; BEAUTY CREAMS FOR BODY CARE; BEAUTY GELS; BEAUTY LOTIONS; BEAUTY MASKS; BEAUTY MILKS; BEAUTY SERUMS; BLEACHING PREPARATIONS FOR COSMETIC PURPOSES; BODY AND BEAUTY CARE COSMETICS; BODY CREAM; BODY CREAM SOAP; BODY CREAMS; BODY LOTION; BODY LOTIONS; BODY MASK CREAM; BODY MASK LOTION; CLEANSING CREAMS; COLD CREAM; COLD CREAMS; COLORING PREPARATIONS FOR COSMETIC PURPOSES; COSMETIC CREAMS; COSMETIC CREAMS FOR SKIN CARE; COSMETIC OILS FOR THE EPIDERMIS; COSMETIC PREPARATIONS FOR BODY CARE; COSMETIC PREPARATIONS FOR SKIN RENEWAL; COSMETIC SOAPS; COSMETIC SUN-PROTECTING PREPARATIONS; COSMETICS; COSMETICS AND COSMETIC PREPARATIONS; COSMETICS AND MAKE-UP; COSMETICS, NAMELY, LIP PRIMER; COSMETICS, NAMELY, COMPACTS; COSMETICS, NAMELY, LIP REPAIRERS; CREAM SOAPS; CREAMS FOR CELLULITE REDUCTION; EXFOLIANT CREAMS; EYE CREAM; EYE GELS; EYE LOTIONS; FACE AND

BODY BEAUTY CREAMS; FACE AND BODY CREAMS; FACE AND BODY LOTIONS; FACE CREAMS; FACE CREAMS FOR COSMETIC USE; FACIAL BEAUTY MASKS; FACIAL CLEANSERS; FACIAL CLEANSING MILK; FACIAL CONCEALER; FACIAL CREAM; FACIAL CREAMS; FACIAL EMULSIONS; FACIAL LOTION; FACIAL MASKS; FACIAL SCRUBS; FACIAL WASHES; FAIR COMPLEXION CREAM; FOAM CLEANING PREPARATIONS; GEL EYE MASKS; LIP BALM; LIP BALM; LIP CREAM; LIP GLOSS; LIP LINER; LIQUID SOAP; LIQUID SOAPS; LIQUID SOAPS FOR HANDS AND FACE; LIQUID SOAPS FOR HANDS, FACE AND BODY; LOTIONS FOR CELLULITE REDUCTION; LOTIONS FOR COSMETIC PURPOSES; LOTIONS FOR FACE AND BODY CARE; MAKE UP REMOVING PREPARATIONS; MAKE-UP FOR THE FACE AND BODY; MAKE-UP PREPARATIONS; MOISTURIZING CREAMS; MOISTURIZING MILKS; NON-MEDICATED ACNE TREATMENT PREPARATIONS; NON-MEDICATED LIP CARE PREPARATIONS; NON-MEDICATED LIP PROTECTOR; NON-MEDICATED OINTMENTS FOR THE PREVENTION AND TREATMENT OF SUNBURN; NON-MEDICATED SKIN CARE PREPARATIONS; NON-MEDICATED SKIN CARE PREPARATIONS, NAMELY, CREAMS, LOTIONS, GELS, TONERS, CLEANSERS AND PEELS; NON-MEDICATED SKIN CREAMS; NON-MEDICATED STIMULATING LOTIONS FOR THE SKIN; NUTRITIONAL OILS FOR COSMETIC PURPOSES; RETINOL CREAM FOR COSMETIC PURPOSES; SKIN ABRASIVE PREPARATIONS; SKIN AND BODY TOPICAL LOTIONS, CREAMS AND OILS FOR COSMETIC USE; SKIN CARE PREPARATION, NAMELY, BODY POLISH; SKIN CARE PREPARATIONS, NAMELY, CHEMI-

CAL PEELS FOR SKIN; SKIN CARE PREPARATIONS, NAMELY, FRUIT ACID PEELS FOR SKIN; SKIN CARE PREPARATIONS, NAMELY, BODY BALM; SKIN CARE PRODUCTS, NAMELY, NON-MEDICATED SKIN SERUM; SKIN CLARIFIERS; SKIN CLEANSERS; SKIN CLEANSING CREAM; SKIN CLEANSING LOTION; SKIN CONDITIONERS; SKIN CREAM; SKIN CREAMS; SKIN CREAMS IN LIQUID AND IN SOLID FORM; SKIN CREAMS IN LIQUID AND SOLID; SKIN CREAMS IN LIQUID AND SOLID FORM; SKIN EMOLLIENTS; SKIN GELS FOR ACCELERATING, ENHANCING OR EXTENDING TANS; SKIN LIGHTENERS; SKIN LIGHTENING CREAMS; SKIN LOTION; SKIN LOTIONS; SKIN MASKS; SKIN MOISTURIZER; SKIN MOISTURIZER MASKS; SKIN SOAP; SKIN TEXTURIZERS; SKIN TONERS; SKIN WHITENING CREAMS; SKIN WHITENING PREPARATIONS; SOAP POWDER; SOAPS FOR BODY CARE; TONING LOTION, FOR THE FACE, BODY AND HANDS; VANISHING CREAM; WRINKLE REMOVING SKIN CARE PREPARATIONS; WRINKLE RESISTANT CREAM, IN CLASS 3 (U.S. CLS. 1, 4, 6, 50, 51 AND 52).

FIRST USE 11-6-2007; IN COMMERCE 12-13-2007.

FOR: ANAESTHETICS; ACNE MEDICATIONS; ACNE TREATMENT PREPARATIONS; ADRENAL HORMONE PREPARATIONS; ANALGESIC BALM; AMINO ACIDS FOR MEDICAL OR VETERINARY PURPOSES; AMINO ACIDS FOR NUTRITIONAL PURPOSES; ANDROGEN PREPARATIONS; ANESTHETICS FOR NON-SURGICAL USE; ASTRINGENTS; ASTRINGENTS FOR MEDICINAL PURPOSES; APPETITE SUPPRESSANTS; BIOLOGICAL PREPARATIONS FOR MEDICAL PURPOSES; BIOMEDICAL COMPOUNDS, NAMELY, PEPTIDE SUBSTRATES USED IN ANALYZING AND DETECTING CERTAIN TOXINS FOR CLINICAL OR MEDICAL LABORATORY USE; CALCIUM SUPPLEMENTS; DERMATOLOGICAL PHARMACEUTICAL PRODUCTS; DERMATOLOGICALS; DIET CAPSULES; DIET PILLS; DIETARY AND NUTRITIONAL SUPPLEMENTS; DIETARY SUPPLEMENTS; DIETARY SUPPLEMENTS FOR HUMAN CONSUMPTION; DRUG DELIVERY AGENTS CONSISTING OF COMPOUNDS THAT FACILITATE DELIVERY OF A WIDE RANGE OF PHARMACEUTICALS; GELS FOR USE AS PERSONAL LUBRICANT; GENERAL ANESTHETICS; GROUND FLAXSEED FIBER FOR USE AS A DIETARY SUPPLEMENT; HAIR GROWTH STIMULANTS; HEMORRHOID TREATMENT PREPARATIONS; HEMORRHOIDAL OINTMENTS; HERBAL SUPPLEMENTS; HERBS FOR MEDICINAL PURPOSES; HORMONES; HORMONES FOR MEDICAL PURPOSES; HUMAN GROWTH HORMONE; LOCAL ANESTHETICS; MEDICAL LUBRICANT, NAMELY, VAGINAL LUBRICANTS; MEDICATED LIP BALM; MEDICATED SKIN CARE PREPARATIONS; MEDICATED SKIN CARE PREPARATIONS, NAMELY, CREAMS, LOTIONS, GELS, TONERS, CLEANERS AND PEELS; MEDICINAL CREAMS FOR SKIN

CARE; MEDICINAL HERB EXTRACTS; MEDICINAL HERBAL EXTRACTS FOR MEDICAL PURPOSES; MIXED VITAMIN PREPARATIONS; MULTIVITAMIN PREPARATIONS; MULTIVITAMIN PREPARATIONS; NUTRACEUTICALS FOR USE AS A DIETARY SUPPLEMENT; NUTRITIONAL ADDITIVES FOR MEDICAL PURPOSES FOR USE IN FOODS AND DIETARY SUPPLEMENTS FOR HUMAN CONSUMPTION; NUTRITIONAL SUPPLEMENTS; NUTRITIONAL SUPPLEMENTS IN LOTION FORM SOLD AS A COMPONENT OF NUTRITIONAL SKIN CARE PRODUCTS; ORGASM CREAMS; PAIN RELIEF MEDICATION; PARAPHARMACEUTICAL PRODUCTS FOR USE IN DERMATOLOGY; PHARMACEUTICAL FOR THE TREATMENT OF ERECTILE DYSFUNCTION; PHARMACEUTICAL PREPARATIONS FOR SKIN CARE; PHARMACEUTICAL PREPARATIONS FOR THE TREATMENT OF HORMONAL DISORDERS AND THE PREVENTION OF OSTEOPOROSIS; PHARMACEUTICAL PREPARATIONS FOR TREATING SKIN DISORDERS; PHARMACEUTICAL PREPARATIONS FOR USE IN DERMATOLOGY; PHARMACEUTICAL PREPARATIONS FOR USE IN UROLOGY; PHARMACEUTICAL PREPARATIONS, NAMELY, APPETITE SUPPRESSANTS; PHARMACEUTICAL PRODUCTS AND PREPARATIONS TO PREVENT STRETCH MARKS; PHARMACEUTICAL SKIN LOTIONS; PHARMACEUTICALS FOR THE TREATMENT OF ERECTILE DYSFUNCTION; PHARMACEUTICALS, NAMELY, INDUCERS OF ERECTIONS; PLANT EXTRACTS FOR MEDICAL, VETERINARY AND PHARMACEUTICAL PURPOSES; POWDERED NUTRITIONAL SUPPLEMENT DRINK MIX; PREPARATIONS FOR CLEANSING THE SKIN FOR MEDICAL USE; PRODUCTS AND PREPARATIONS FOR CLEANSING THE SKIN FOR MEDICAL USE; STEROIDS; TOPICAL ANALGESICS; TOPICAL ANESTHETICS; VITAMIN B PREPARATIONS; VITAMIN C PREPARATIONS; VITAMIN D PREPARATIONS; VITAMIN AND MINERAL PREPARATIONS FOR MEDICAL USE; VITAMIN AND MINERAL SUPPLEMENTS; VITAMIN PREPARATIONS; VITAMIN SUPPLEMENTS; VITAMIN TABLETS; VITAMINS; VITAMINS AND VITAMIN PREPARATIONS; WITCH HAZEL, IN CLASS 5 (U.S. CLS. 6, 18, 44, 46, 51 AND 52).

FIRST USE 8-8-2007; IN COMMERCE 12-13-2007.

THE MARK CONSISTS OF A DIAMOND SHAPE WITH CURVED LINES LOCATED ABOVE THE LITERAL ELEMENT "A".

THE FOREIGN WORDING IN THE MARK TRANSLATES INTO ENGLISH AS LIVE OR TO LIVE.

SER. NO. 77-388,211, FILED 2-4-2008.

REBECCA GILBERT, EXAMINING ATTORNEY

Int. Cl.: 44

Prior U.S. Cls.: 100 and 101

United States Patent and Trademark Office

Reg. No. 3,476,536

Registered July 29, 2008

**SERVICE MARK
PRINCIPAL REGISTER**

Dental Wellness Center 

HEALTH CARE SERVICE CORPORATION (ILLINOIS CORPORATION)
300 EAST RANDOLPH STREET
CHICAGO, IL 60601

FOR: PROVIDING NEWS AND INFORMATION IN THE FIELD OF DENTAL HEALTH AND DENTAL CARE VIA THE INTERNET, IN CLASS 44 (U.S. CLS. 100 AND 101).

FIRST USE 12-21-2007; IN COMMERCE 12-21-2007.

NO CLAIM IS MADE TO THE EXCLUSIVE RIGHT TO USE "DENTAL WELLNESS CENTER", APART FROM THE MARK AS SHOWN.

THE LINING IS A FEATURE OF THE MARK AND DOES NOT INDICATE COLOR.

THE MARK CONSISTS OF THE WORDS "DENTAL WELLNESS CENTER" AND THE INITIALS "DWC" OVER AN OVAL SHAPE AND THE INITIALS "DWC" ALSO APPEARING IN A REFLECTION IN THE OVAL.

SER. NO. 77-388,846, FILED 2-5-2008.

EVELYN BRADLEY, EXAMINING ATTORNEY

Int. Cl.: 44

Prior U.S. Cls.: 100 and 101

United States Patent and Trademark Office

Reg. No. 3,476,537

Registered July 29, 2008

**SERVICE MARK
PRINCIPAL REGISTER**

DermaTrak

CANFIELD SCIENTIFIC, INC. (NEW JERSEY
CORPORATION)
253 PASSAIC AVENUE
FAIRFIELD, NJ 070042524

FOR: MEDICAL SKIN IMAGING SERVICES,
NAMELY, MEDICAL PHOTOGRAPHY, TOTAL
BODY PHOTOGRAPHY, AND MOLE MAPPING
FOR EARLY DETECTION OF SKIN CANCERS, IN
CLASS 44 (U.S. CLS. 100 AND 101).

FIRST USE 3-30-2004; IN COMMERCE 3-30-2004.

THE MARK CONSISTS OF STANDARD CHAR-
ACTERS WITHOUT CLAIM TO ANY PARTICULAR
FONT, STYLE, SIZE, OR COLOR.

SER. NO. 77-389,655, FILED 2-6-2008.

PAULA MAHONEY, EXAMINING ATTORNEY

Int. Cl.: 38

Prior U.S. Cls.: 100, 101 and 104

United States Patent and Trademark Office

Reg. No. 3,476,538

Registered July 29, 2008

**SERVICE MARK
PRINCIPAL REGISTER**

**FIRST TO HEAR. FIRST TO
KNOW.**

BONNEVILLE INTERNATIONAL CORPORA-
TION (UTAH CORPORATION)
BROADCAST HOUSE, 55 NORTH 300 WEST
SALT LAKE CITY, UT 84180

THE MARK CONSISTS OF STANDARD CHAR-
ACTERS WITHOUT CLAIM TO ANY PARTICULAR
FONT, STYLE, SIZE, OR COLOR.

FOR: COMMUNICATIONS SERVICES, NAMELY,
TRANSMITTING STREAMED SOUND AND
AUDIO-VISUAL RECORDINGS VIA THE INTER-
NET, IN CLASS 38 (U.S. CLS. 100, 101 AND 104).

SER. NO. 77-390,286, FILED 2-6-2008.

FIRST USE 12-31-2005; IN COMMERCE 12-31-2005.

BARNEY CHARLON, EXAMINING ATTORNEY

Int. Cl.: 20

Prior U.S. Cls.: 2, 13, 22, 25, 32 and 50

United States Patent and Trademark Office

Reg. No. 3,476,539

Registered July 29, 2008

**TRADEMARK
PRINCIPAL REGISTER**

Flow-Pedic

RELIEF-MART, INC. (CALIFORNIA CORPORATION)
755 LAKEFIELD RD., STE. H
WESTLAKE VILLAGE, CA 91361

THE MARK CONSISTS OF STANDARD CHARACTERS WITHOUT CLAIM TO ANY PARTICULAR FONT, STYLE, SIZE, OR COLOR.

FOR: MATTRESSES, IN CLASS 20 (U.S. CLS. 2, 13, 22, 25, 32 AND 50).

SER. NO. 77-390,770, FILED 2-7-2008.

FIRST USE 8-20-2006; IN COMMERCE 2-6-2008.

DAVID TAYLOR, EXAMINING ATTORNEY

Int. Cl.: 12

Prior U.S. Cls.: 19, 21, 23, 31, 35 and 44

United States Patent and Trademark Office

Reg. No. 3,476,540

Registered July 29, 2008

**TRADEMARK
PRINCIPAL REGISTER**



COLLINS BUS CORPORATION (KANSAS CORPORATION)
415 WEST SIXTH
SOUTH HUTCHINSON, KS 67505

FOR: BUSES, IN CLASS 12 (U.S. CLS. 19, 21, 23, 31, 35 AND 44).

FIRST USE 9-1-2007; IN COMMERCE 9-1-2007.

THE MARK CONSISTS OF A SERIES OF CURVED LINES WITHIN AN OVAL THAT REPRESENT A CURVED TWO LANE ROAD WITH A CENTER STRIPE.

SER. NO. 77-391,541, FILED 2-7-2008.

CHRISTOPHER BUONGIORNO, EXAMINING ATTORNEY

Int. Cls.: 29, 30 and 32

Prior U.S. Cls.: 45, 46 and 48

United States Patent and Trademark Office

Reg. No. 3,476,541

Registered July 29, 2008

**TRADEMARK
PRINCIPAL REGISTER**

MARKET DISTRICT

PHOENIX INTANGIBLES HOLDING COMPANY
(DELAWARE CORPORATION)
TWO GREENVILLE CROSSING
4005 KENNETT PIKE, SUITE 220
GREENVILLE, DE 19807

FOR: PROCESSED NUTS; DIPS; CHEESE
SPREADS; EDIBLE OILS FOR DIPPING; AND BRU-
SCHETTA TOPPINGS, IN CLASS 29 (U.S. CL. 46).

FIRST USE 9-9-2006; IN COMMERCE 9-9-2006.

FOR: CHOCOLATE; PRETZELS; CANDY; PEA-
NUT BRITTLES; CANDY MINTS; DRIED PASTA;
SPICES; MAPLE SYRUP; MUFFINS; CHEESECAKE;
CHOCOLATE COVERED PRETZELS AND TIRAMI-
SU, IN CLASS 30 (U.S. CL. 46).

FIRST USE 9-9-2006; IN COMMERCE 9-9-2006.

FOR: FRUIT JUICES, IN CLASS 32 (U.S. CLS. 45, 46
AND 48).

FIRST USE 11-10-2007; IN COMMERCE 11-10-2007.

THE MARK CONSISTS OF STANDARD CHAR-
ACTERS WITHOUT CLAIM TO ANY PARTICULAR
FONT, STYLE, SIZE, OR COLOR.

OWNER OF U.S. REG. NOS. 3,121,888, 3,245,588
AND OTHERS.

SER. NO. 77-391,926, FILED 2-8-2008.

INGRID C. EULIN, EXAMINING ATTORNEY

Int. Cls.: 29, 30 and 32

Prior U.S. Cls.: 45, 46 and 48

United States Patent and Trademark Office

Reg. No. 3,476,542

Registered July 29, 2008

**TRADEMARK
PRINCIPAL REGISTER**

GIANT EAGLE MARKET DISTRICT

PHOENIX INTANGIBLES HOLDING COMPANY
(DELAWARE CORPORATION)
TWO GREENVILLE CROSSING
4005 KENNETT PIKE, SUITE 220
GREENVILLE, DE 19807

FOR: PROCESSED NUTS; DIPS; CHEESE
SPREADS; EDIBLE OILS FOR DIPPING; AND BRU-
SCHETTA TOPPINGS, IN CLASS 29 (U.S. CL. 46).

FIRST USE 9-9-2006; IN COMMERCE 9-9-2006.

FOR: CHOCOLATE; PRETZELS; CANDY; PEA-
NUT BRITTLES; CANDY MINTS; DRIED PASTA;
SPICES; MAPLE SYRUP; MUFFINS; CHEESECAKE;
CHOCOLATE COVERED PRETZELS AND TIRAMI-
SU, IN CLASS 30 (U.S. CL. 46).

FIRST USE 9-9-2006; IN COMMERCE 9-9-2006.

FOR: FRUIT JUICES, IN CLASS 32 (U.S. CLS. 45, 46
AND 48).

FIRST USE 11-10-2007; IN COMMERCE 11-10-2007.

THE MARK CONSISTS OF STANDARD CHAR-
ACTERS WITHOUT CLAIM TO ANY PARTICULAR
FONT, STYLE, SIZE, OR COLOR.

OWNER OF U.S. REG. NOS. 3,168,744, 3,272,905
AND OTHERS.

SER. NO. 77-391,934, FILED 2-8-2008.

INGRID C. EULIN, EXAMINING ATTORNEY

Int. Cl.: 41

Prior U.S. Cls.: 100, 101 and 107

United States Patent and Trademark Office

Reg. No. 3,476,543

Registered July 29, 2008

**SERVICE MARK
PRINCIPAL REGISTER**

FRED CLAUS

WARNER BROS. ENTERTAINMENT INC. (DE-
LAWARE CORPORATION)
4000 WARNER BOULEVARD
BURBANK, CA 91522

FOR: ENTERTAINMENT SERVICES IN THE
NATURE OF DISTRIBUTION AND DISPLAY OF
LIVE-ACTION, COMEDY, DRAMA AND ANIMA-
TED MOTION PICTURE THEATRICAL FILMS;
INTERNET SERVICES PROVIDING INFORMA-
TION VIA AN ELECTRONIC GLOBAL COMMUNI-
CATIONS NETWORK IN THE FIELD OF
ENTERTAINMENT RELATING SPECIFICALLY TO
MOVIES, IN CLASS 41 (U.S. CLS. 100, 101 AND 107).

FIRST USE 9-9-2007; IN COMMERCE 9-9-2007.

THE MARK CONSISTS OF STANDARD CHAR-
ACTERS WITHOUT CLAIM TO ANY PARTICULAR
FONT, STYLE, SIZE, OR COLOR.

THE NAME "FRED CLAUS" DOES NOT IDENTI-
FY A LIVING INDIVIDUAL.

SER. NO. 77-392,321, FILED 2-8-2008.

AMY ALFIERI, EXAMINING ATTORNEY

Int. Cl.: 9

Prior U.S. Cls.: 21, 23, 26, 36 and 38

United States Patent and Trademark Office

Reg. No. 3,476,544

Registered July 29, 2008

**TRADEMARK
PRINCIPAL REGISTER**

SIGNATUNES

YAHOO! INC. (DELAWARE CORPORATION)
701 FIRST AVENUE
SUNNYVALE, CA 94089

THE MARK CONSISTS OF STANDARD CHAR-
ACTERS WITHOUT CLAIM TO ANY PARTICULAR
FONT, STYLE, SIZE, OR COLOR.

FOR: DOWNLOADABLE COMPUTER SOFT-
WARE FOR USE IN ELECTRONIC MESSAGING
AND CONTENT DELIVERY, IN CLASS 9 (U.S. CLS.
21, 23, 26, 36 AND 38).

SER. NO. 77-392,669, FILED 2-8-2008.

FIRST USE 7-5-2007; IN COMMERCE 7-5-2007.

LYDIA BELZER, EXAMINING ATTORNEY

Int. Cl.: 5

Prior U.S. Cls.: 6, 18, 44, 46, 51 and 52

United States Patent and Trademark Office

Reg. No. 3,476,545

Registered July 29, 2008

**TRADEMARK
PRINCIPAL REGISTER**



VETSCIENCE, LLC (TEXAS LTD LIAB CO)
SUITE 450
3102 MAPLE AVENUE
DALLAS, TX 75201

FOR: DIETARY SUPPLEMENTS FOR PETS, IN
CLASS 5 (U.S. CLS. 6, 18, 44, 46, 51 AND 52).

FIRST USE 11-0-2005; IN COMMERCE 4-25-2007.

NO CLAIM IS MADE TO THE EXCLUSIVE
RIGHT TO USE "VET", APART FROM THE MARK
AS SHOWN.

THE COLOR(S) RED AND WHITE IS/ARE
CLAIMED AS A FEATURE OF THE MARK.

THE MARK CONSISTS OF A HEART DEFINED
BY BUSH STROKES WITH THE WORD "VET" IN-
SIDE, BOTH IN THE COLOR RED AND ON A
WHITE BACKGROUND.

SER. NO. 77-392,848, FILED 2-8-2008.

PAUL CROWLEY, EXAMINING ATTORNEY

Int. Cl.: 31

Prior U.S. Cls.: 1 and 46

United States Patent and Trademark Office

Reg. No. 3,476,546

Registered July 29, 2008

**TRADEMARK
PRINCIPAL REGISTER**



VETSCIENCE, LLC (TEXAS LTD LIAB CO)
SUITE 450
3102 MAPLE AVENUE
DALLAS, TX 75201

FOR: PET FOOD; PET TREATS, IN CLASS 31 (U.S.
CLS. 1 AND 46).

FIRST USE 11-0-2005; IN COMMERCE 4-25-2007.

NO CLAIM IS MADE TO THE EXCLUSIVE
RIGHT TO USE "VET", APART FROM THE MARK
AS SHOWN.

THE COLOR(S) RED AND WHITE IS/ARE
CLAIMED AS A FEATURE OF THE MARK.

THE MARK CONSISTS OF A HEART DEFINED
BY BUSH STROKES WITH THE WORD "VET" IN-
SIDE, BOTH IN THE COLOR RED AND ON A
WHITE BACKGROUND.

SER. NO. 77-392,853, FILED 2-8-2008.

PAUL CROWLEY, EXAMINING ATTORNEY

Int. Cl.: 8

Prior U.S. Cls.: 23, 28 and 44

United States Patent and Trademark Office

Reg. No. 3,476,547

Registered July 29, 2008

**TRADEMARK
PRINCIPAL REGISTER**

LAREDO BOWIE

COLD STEEL, INC. (CALIFORNIA CORPORATION)

3036-A SEABORG AVENUE

VENTURA, CA 93003

FOR: SPORT KNIVES, IN CLASS 8 (U.S. CLS. 23, 28 AND 44).

FIRST USE 9-19-2002; IN COMMERCE 9-19-2002.

THE MARK CONSISTS OF STANDARD CHARACTERS WITHOUT CLAIM TO ANY PARTICULAR FONT, STYLE, SIZE, OR COLOR.

NO CLAIM IS MADE TO THE EXCLUSIVE RIGHT TO USE "BOWIE", APART FROM THE MARK AS SHOWN.

SER. NO. 77-392,908, FILED 2-8-2008.

GEORGE LORENZO, EXAMINING ATTORNEY

Int. Cl.: 32

Prior U.S. Cls.: 45, 46 and 48

Reg. No. 3,476,548

United States Patent and Trademark Office

Registered July 29, 2008

**TRADEMARK
PRINCIPAL REGISTER**

BE.GO.DO.

LEISURE BOY, LLC (WISCONSIN LTD LIAB CO)
W356N5318 LAKESHORE DRIVE
OCONOMOWOC, WI 53066

THE MARK CONSISTS OF STANDARD CHAR-
ACTERS WITHOUT CLAIM TO ANY PARTICULAR
FONT, STYLE, SIZE, OR COLOR.

FOR: BEER, IN CLASS 32 (U.S. CLS. 45, 46 AND 48).

SER. NO. 77-393,062, FILED 2-9-2008.

FIRST USE 12-14-2007; IN COMMERCE 12-14-2007.

EUGENIA MARTIN, EXAMINING ATTORNEY

Int. Cl.: 3

Prior U.S. Cls.: 1, 4, 6, 50, 51 and 52

United States Patent and Trademark Office

Reg. No. 3,476,549

Registered July 29, 2008

**TRADEMARK
PRINCIPAL REGISTER**

BriteScience

RODRIGUEZ, CARLOS ANDRES (UNITED STATES INDIVIDUAL)
2845 N.E. 185 STREET #906
AVENTURA, FL 33180

FOR: DENTAL BLEACHING GEL; TEETH CLEANING LOTIONS; TOOTH WHITENING CREAMS; TOOTH WHITENING GELS; TOOTH WHITENING PASTES; TOOTH WHITENING PREPARATIONS , IN CLASS 3 (U.S. CLS. 1, 4, 6, 50, 51 AND 52).

FIRST USE 12-21-2007; IN COMMERCE 1-7-2008.

THE MARK CONSISTS OF STANDARD CHARACTERS WITHOUT CLAIM TO ANY PARTICULAR FONT, STYLE, SIZE, OR COLOR.

SER. NO. 77-393,181, FILED 2-9-2008.

CHARLES L. JENKINS, EXAMINING ATTORNEY

Int. Cl.: 42

Prior U.S. Cls.: 100 and 101

United States Patent and Trademark Office

Reg. No. 3,476,550

Registered July 29, 2008

**SERVICE MARK
PRINCIPAL REGISTER**

HOOWAT

AOL LLC (DELAWARE LTD LIAB CO)
22000 AOL WAY
DULLES, VA 20166

FOR: PROVIDING A WEBSITE THAT GIVES
COMPUTER USERS THE ABILITY TO UPLOAD,
SHARE, AND DISPLAY PHOTOS AND TO FIND
CELEBRITY LOOK-ALIKES, IN CLASS 42 (U.S. CLS.
100 AND 101).

FIRST USE 7-0-2007; IN COMMERCE 7-0-2007.

THE MARK CONSISTS OF STANDARD CHAR-
ACTERS WITHOUT CLAIM TO ANY PARTICULAR
FONT, STYLE, SIZE, OR COLOR.

SER. NO. 77-394,463, FILED 2-12-2008.

CHERYL CLAYTON, EXAMINING ATTORNEY

Int. Cl.: 36

Prior U.S. Cls.: 100, 101 and 102

United States Patent and Trademark Office

Reg. No. 3,476,551

Registered July 29, 2008

**SERVICE MARK
PRINCIPAL REGISTER**

PINPOINT HOMEOWNERS

GRANGE MUTUAL CASUALTY COMPANY
(OHIO CORPORATION)

650 SOUTH FRONT STREET

COLUMBUS, OH 43206

FOR: INSURANCE UNDERWRITING SERVICES
IN THE FIELD OF HOMEOWNERS INSURANCE, IN
CLASS 36 (U.S. CLS. 100, 101 AND 102).

FIRST USE 2-5-2008; IN COMMERCE 2-5-2008.

THE MARK CONSISTS OF STANDARD CHAR-
ACTERS WITHOUT CLAIM TO ANY PARTICULAR
FONT, STYLE, SIZE, OR COLOR.

NO CLAIM IS MADE TO THE EXCLUSIVE
RIGHT TO USE "HOMEOWNERS", APART FROM
THE MARK AS SHOWN.

SER. NO. 77-394,623, FILED 2-12-2008.

KATHERINE M. DUBRAY, EXAMINING ATTOR-
NEY

Int. Cl.: 17

Prior U.S. Cls.: 1, 5, 12, 13, 35 and 50

United States Patent and Trademark Office

Reg. No. 3,476,552

Registered July 29, 2008

**TRADEMARK
PRINCIPAL REGISTER**

IMPAXX

THE DOW CHEMICAL COMPANY (DELAWARE
CORPORATION)
TRADEMARK & COPYRIGHT PRACTICE GROUP
2030 DOW CENTER
MIDLAND, MI 48674

FOR: POLYSTYRENE FOAM USED IN THE
MANUFACTURE OF STRUCTURAL COMPO-
NENTS OF AUTOMOBILES AND MARINE VES-
SELS, IN CLASS 17 (U.S. CLS. 1, 5, 12, 13, 35 AND 50).

FIRST USE 10-30-2006; IN COMMERCE 10-30-2006.

THE MARK CONSISTS OF STANDARD CHAR-
ACTERS WITHOUT CLAIM TO ANY PARTICULAR
FONT, STYLE, SIZE, OR COLOR.

OWNER OF U.S. REG. NO. 3,345,354.

SER. NO. 77-395,074, FILED 2-12-2008.

MICHELE SWAIN, EXAMINING ATTORNEY

Int. Cl.: 1

Prior U.S. Cls.: 1, 5, 6, 10, 26 and 46

United States Patent and Trademark Office

Reg. No. 3,476,553

Registered July 29, 2008

**TRADEMARK
PRINCIPAL REGISTER**

**Feed Them Once. Feed Them
Right.**

ENVIRO-SAFE LABORATORIES, INC. (FLORIDA
CORPORATION)
1579 BARBER ROAD
SARASOTA, FL 34240

THE MARK CONSISTS OF STANDARD CHAR-
ACTERS WITHOUT CLAIM TO ANY PARTICULAR
FONT, STYLE, SIZE, OR COLOR.

FOR: FERTILIZERS; PLANT FOOD, IN CLASS 1
(U.S. CLS. 1, 5, 6, 10, 26 AND 46).

SER. NO. 77-395,487, FILED 2-13-2008.

FIRST USE 2-1-2008; IN COMMERCE 2-1-2008.

BERNICE MIDDLETON, EXAMINING ATTORNEY

Int. Cl.: 42

Prior U.S. Cls.: 100 and 101

United States Patent and Trademark Office

Reg. No. 3,476,554

Registered July 29, 2008

**SERVICE MARK
PRINCIPAL REGISTER**

 SchwabSafe

CHARLES SCHWAB & CO., INC. (CALIFORNIA CORPORATION)
101 MONTGOMERY STREET
SAN FRANCISCO, CA 94104

FIRST USE 12-26-2007; IN COMMERCE 12-26-2007.

OWNER OF U.S. REG. NO. 2,706,554.

FOR: ON-LINE SECURITY SERVICES, NAMELY, PROVIDING SECURITY ASSURANCE FOR USER IDENTITY, FINANCIAL DATA, AND FINANCIAL TRANSACTIONS, IN CLASS 42 (U.S. CLS. 100 AND 101).

SER. NO. 77-395,851, FILED 2-13-2008.

AISHA CLARKE, EXAMINING ATTORNEY

Int. Cl.: 35

Prior U.S. Cls.: 100, 101 and 102

United States Patent and Trademark Office

Reg. No. 3,476,555

Registered July 29, 2008

**SERVICE MARK
PRINCIPAL REGISTER**

Think Market!

GALLAGHER MARKETING, LLC (MASSACHU-
SETTS LTD LIAB CO), DBA THE GALLA-
GHER GROUP
5 MARKET SQUARE, SUITE 7
AMESBURY, MA 01913

FOR: MARKET RESEARCH SERVICES, IN CLASS
35 (U.S. CLS. 100, 101 AND 102).

FIRST USE 12-21-2007; IN COMMERCE 12-21-2007.

THE MARK CONSISTS OF STANDARD CHAR-
ACTERS WITHOUT CLAIM TO ANY PARTICULAR
FONT, STYLE, SIZE, OR COLOR.

SER. NO. 77-396,197, FILED 2-13-2008.

WILLIAM P. SHANAHAN, EXAMINING ATTOR-
NEY

Int. Cl.: 2

Prior U.S. Cls.: 6, 11 and 16

United States Patent and Trademark Office

Reg. No. 3,476,556

Registered July 29, 2008

**TRADEMARK
PRINCIPAL REGISTER**

HOME STYLE

THE SHERWIN-WILLIAMS COMPANY (OHIO
CORPORATION)
101 PROSPECT AVENUE NW
CLEVELAND, OH 441151075

FOR: PAINTS, IN CLASS 2 (U.S. CLS. 6, 11 AND 16).

FIRST USE 6-9-2006; IN COMMERCE 6-9-2006.

THE MARK CONSISTS OF STANDARD CHAR-
ACTERS WITHOUT CLAIM TO ANY PARTICULAR
FONT, STYLE, SIZE, OR COLOR.

SER. NO. 77-396,768, FILED 2-14-2008.

WILLIAM BRECKENFELD, EXAMINING ATTOR-
NEY

Int. Cl.: 9

Prior U.S. Cls.: 21, 23, 26, 36 and 38

Reg. No. 3,476,557

United States Patent and Trademark Office

Registered July 29, 2008

**TRADEMARK
PRINCIPAL REGISTER**

GOODYEAR

THE GOODYEAR TIRE & RUBBER COMPANY
(OHIO CORPORATION)
DEPT. 823
1144 EAST MARKET STREET
AKRON, OH 443160001

THE MARK CONSISTS OF STANDARD CHAR-
ACTERS WITHOUT CLAIM TO ANY PARTICULAR
FONT, STYLE, SIZE, OR COLOR.

FOR: KNEE PADS FOR WORKERS, IN CLASS 9
(U.S. CLS. 21, 23, 26, 36 AND 38).

SER. NO. 77-397,386, FILED 2-14-2008.

FIRST USE 5-9-2007; IN COMMERCE 5-9-2007.

CHRISTINE COOPER, EXAMINING ATTORNEY

Int. Cl.: 21

Prior U.S. Cls.: 2, 13, 23, 29, 30, 33, 40 and 50

Reg. No. 3,476,558

United States Patent and Trademark Office

Registered July 29, 2008

**TRADEMARK
PRINCIPAL REGISTER**

GOODYEAR

THE GOODYEAR TIRE & RUBBER COMPANY
(OHIO CORPORATION)
DEPT. 823
1144 EAST MARKET STREET
AKRON, OH 443160001

THE MARK CONSISTS OF STANDARD CHAR-
ACTERS WITHOUT CLAIM TO ANY PARTICULAR
FONT, STYLE, SIZE, OR COLOR.

FOR: WORK GLOVES, IN CLASS 21 (U.S. CLS. 2,
13, 23, 29, 30, 33, 40 AND 50).

SER. NO. 77-397,392, FILED 2-14-2008.

FIRST USE 5-9-2007; IN COMMERCE 5-9-2007.

CHRISTINE COOPER, EXAMINING ATTORNEY

Int. Cl.: 27

Prior U.S. Cls.: 19, 20, 37, 42 and 50

Reg. No. 3,476,559

United States Patent and Trademark Office

Registered July 29, 2008

**TRADEMARK
PRINCIPAL REGISTER**

GOODYEAR

THE GOODYEAR TIRE & RUBBER COMPANY
(OHIO CORPORATION)
DEPT. 823
1144 EAST MARKET STREET
AKRON, OH 443160001

THE MARK CONSISTS OF STANDARD CHAR-
ACTERS WITHOUT CLAIM TO ANY PARTICULAR
FONT, STYLE, SIZE, OR COLOR.

FOR: FLOOR MATS, IN CLASS 27 (U.S. CLS. 19, 20,
37, 42 AND 50).

SER. NO. 77-397,405, FILED 2-14-2008.

FIRST USE 9-12-2006; IN COMMERCE 9-12-2006.

CHRISTINE COOPER, EXAMINING ATTORNEY

Int. Cl.: 8

Prior U.S. Cls.: 23, 28 and 44

Reg. No. 3,476,560

United States Patent and Trademark Office

Registered July 29, 2008

**TRADEMARK
PRINCIPAL REGISTER**

GOODYEAR

THE GOODYEAR TIRE & RUBBER COMPANY
(OHIO CORPORATION)
DEPT. 823
1144 EAST MARKET STREET
AKRON, OH 443160001

THE MARK CONSISTS OF STANDARD CHAR-
ACTERS WITHOUT CLAIM TO ANY PARTICULAR
FONT, STYLE, SIZE, OR COLOR.

FOR: HAND TOOLS, NAMELY, WRENCHES,
RATCHETS, SCREWDRIVERS AND PLIERS, IN
CLASS 8 (U.S. CLS. 23, 28 AND 44).

SER. NO. 77-397,437, FILED 2-14-2008.

FIRST USE 9-26-2005; IN COMMERCE 9-26-2005.

CHRISTINE COOPER, EXAMINING ATTORNEY

Int. Cl.: 5

Prior U.S. Cls.: 6, 18, 44, 46, 51 and 52

Reg. No. 3,476,561

United States Patent and Trademark Office

Registered July 29, 2008

**TRADEMARK
PRINCIPAL REGISTER**

LUNAR

BAYER AKTIENGESELLSCHAFT (FED REP
GERMANY AKTIENGESELLSCHAFT)
D-51368
LEVERKUSEN-BAYERWERK, FED REP GERMA-
NY

FOR: PREPARATIONS FOR KILLING WEEDS
AND DESTROYING VERMIN; INSECTICIDES,
HERBICIDES, FUNGICIDES, IN CLASS 5 (U.S. CLS.
6, 18, 44, 46, 51 AND 52).

THE MARK CONSISTS OF STANDARD CHAR-
ACTERS WITHOUT CLAIM TO ANY PARTICULAR
FONT, STYLE, SIZE, OR COLOR.

OWNER OF FED REP GERMANY REG. NO.
30126851, DATED 11-8-2001, EXPIRES 4-30-2011.

SER. NO. 77-397,440, FILED 2-14-2008.

KIMBERLY PERRY, EXAMINING ATTORNEY

Int. Cl.: 10

Prior U.S. Cls.: 26, 39 and 44

United States Patent and Trademark Office

Reg. No. 3,476,562

Registered July 29, 2008

**TRADEMARK
PRINCIPAL REGISTER**

TRI-COMFORT

SCHERING-PLOUGH HEALTHCARE PRO-
DUCTS, INC. (DELAWARE CORPORATION)
3030 JACKSON AVENUE
MEMPHIS, TN 38151

FOR: ORTHOTICS FOR FOOTWEAR; ORTHO-
TICS FOR FEET, IN CLASS 10 (U.S. CLS. 26, 39 AND
44).

FIRST USE 11-5-2002; IN COMMERCE 11-5-2002.

THE MARK CONSISTS OF STANDARD CHAR-
ACTERS WITHOUT CLAIM TO ANY PARTICULAR
FONT, STYLE, SIZE, OR COLOR.

OWNER OF U.S. REG. NOS. 2,378,311 AND
2,776,632.

SER. NO. 77-398,062, FILED 2-15-2008.

HEATHER THOMPSON, EXAMINING ATTORNEY

Int. Cl.: 17

Prior U.S. Cls.: 1, 5, 12, 13, 35 and 50

Reg. No. 3,476,563

United States Patent and Trademark Office

Registered July 29, 2008

**TRADEMARK
PRINCIPAL REGISTER**

VULCO

THE GATES CORPORATION (DELAWARE CORPORATION)

MS 10-A3

1551 WEWATTA STREET

DENVER, CO 80202

FOR: HOSES MADE PREDOMINANTLY OF RUBBER OR RUBBER-LIKE MATERIAL; NON-METALLIC COOLANT HOSE FOR VEHICULAR AND INDUSTRIAL APPLICATIONS; VEHICULAR RADIATOR COOLANT HOSE, IN CLASS 17 (U.S. CLS. 1, 5, 12, 13, 35 AND 50).

FIRST USE 12-31-1927; IN COMMERCE 12-31-1927.

THE MARK CONSISTS OF STANDARD CHARACTERS WITHOUT CLAIM TO ANY PARTICULAR FONT, STYLE, SIZE, OR COLOR.

OWNER OF U.S. REG. NO. 592,435.

SER. NO. 77-398,086, FILED 2-15-2008.

ERIN FALK, EXAMINING ATTORNEY

Int. Cls.: 16 and 41

Prior U.S. Cls.: 2, 5, 22, 23, 29, 37, 38, 50, 100, 101 and 107

Reg. No. 3,476,564

United States Patent and Trademark Office

Registered July 29, 2008

**TRADEMARK
SERVICE MARK
PRINCIPAL REGISTER**

SOUTHTOWNSTAR

THE SUN-TIMES COMPANY (DELAWARE CORPORATION)
350 NORTH ORLEANS STREET
CHICAGO, IL 60654

FOR: PRINT PUBLICATIONS, NAMELY, NEWSPAPERS, IN CLASS 16 (U.S. CLS. 2, 5, 22, 23, 29, 37, 38 AND 50).

FIRST USE 11-18-2007; IN COMMERCE 11-18-2007.

FOR: ONLINE PUBLICATION OF NEWSPAPERS, IN CLASS 41 (U.S. CLS. 100, 101 AND 107).

FIRST USE 11-18-2007; IN COMMERCE 11-18-2007.

THE MARK CONSISTS OF STANDARD CHARACTERS WITHOUT CLAIM TO ANY PARTICULAR FONT, STYLE, SIZE, OR COLOR.

SER. NO. 77-400,470, FILED 2-19-2008.

MICHAEL KEATING, EXAMINING ATTORNEY

Int. Cls.: 29, 30, 31 and 32

Prior U.S. Cls.: 1, 45, 46 and 48

United States Patent and Trademark Office

Reg. No. 3,476,565

Registered July 29, 2008

**TRADEMARK
PRINCIPAL REGISTER**



DOLE FOOD COMPANY, INC. (DELAWARE CORPORATION)
ONE DOLE DRIVE
WESTLAKE VILLAGE, CA 91362

FOR: CANNED OR BOTTLED FRUITS; CUT FRUITS; DRIED FRUITS; FROZEN FRUITS; PROCESSED VEGETABLES AND FRUITS; CUT VEGETABLES; VEGETABLE SALADS, IN CLASS 29 (U.S. CL. 46).

FIRST USE 7-28-1986; IN COMMERCE 7-28-1986.

FOR: FRUIT ICES; FROZEN DESSERT CONSISTING OF FRUIT AND CREAM OR CREAM SUBSTITUTES; COFFEE BEANS; GROUND COFFEE BEANS; CHOCOLATE AND CHOCOLATES; CHOCOLATE BARS, IN CLASS 30 (U.S. CL. 46).

FIRST USE 6-1-1985; IN COMMERCE 6-1-1985.

FOR: FRESH FRUIT AND VEGETABLES; CUT FLOWERS; LIVE FLOWER ARRANGEMENTS, IN CLASS 31 (U.S. CLS. 1 AND 46).

FIRST USE 10-10-1984; IN COMMERCE 10-10-1984.

FOR: AERATED FRUIT JUICES; FROZEN FRUIT BEVERAGES; FRUIT BEVERAGES; FRUIT CONCENTRATES AND PUREES USED AS INGREDIENTS OF BEVERAGES; FRUIT DRINKS AND JUICES; FRUIT JUICE BASES; FRUIT JUICE CONCENTRATES; NON-ALCOHOLIC BEVERAGES CONTAINING FRUIT JUICES, IN CLASS 32 (U.S. CLS. 45, 46 AND 48).

FIRST USE 5-31-1985; IN COMMERCE 5-31-1985.

OWNER OF U.S. REG. NOS. 1,334,608, 1,568,638 AND OTHERS.

THE MARK CONSISTS OF THE WORD "DOLE" WITH A SUN EMANATING FROM THE CENTER OF THE LETTER "O" AND A BAR BELOW AND EXTENDING THE LENGTH OF THE WORD.

SER. NO. 77-400,899, FILED 2-19-2008.

BARBARA BROWN, EXAMINING ATTORNEY

Int. Cl.: 33

Prior U.S. Cls.: 47 and 49

United States Patent and Trademark Office

Reg. No. 3,476,566

Registered July 29, 2008

**TRADEMARK
PRINCIPAL REGISTER**

ERUMIR

BODEGA CAN BONASTRE, S.L.U. (SPAIN CORPORATION)
FINCA CAN BONASTRE DE SANTA MAGDALENA
MASQUEFA (BARCELONA), SPAIN 08783

FOR: WINES, IN CLASS 33 (U.S. CLS. 47 AND 49).

FIRST USE 11-7-2007; IN COMMERCE 11-7-2007.

THE MARK CONSISTS OF STANDARD CHARACTERS WITHOUT CLAIM TO ANY PARTICULAR FONT, STYLE, SIZE, OR COLOR.

SER. NO. 77-401,654, FILED 2-20-2008.

RONALD AIKENS, EXAMINING ATTORNEY

Int. Cl.: 41

Prior U.S. Cls.: 100, 101 and 107

United States Patent and Trademark Office

Reg. No. 3,476,567

Registered July 29, 2008

**SERVICE MARK
PRINCIPAL REGISTER**

El Chulo de la Mañana

SPANISH BROADCASTING SYSTEM, INC (DE-
LAWARE CORPORATION)

2601 SOUTH BAYSHORE DRIVE, PENTHOUSE 2

COCONUT GROVE, FL 33133

FOR: ENTERTAINMENT SERVICES, NAMELY, A
CONTINUING SPANISH LANGUAGE RADIO PRO-
GRAM FEATURING MUSIC, TALK AND VARIETY,
IN CLASS 41 (U.S. CLS. 100, 101 AND 107).

FIRST USE 2-8-2008; IN COMMERCE 2-8-2008.

THE MARK CONSISTS OF STANDARD CHAR-
ACTERS WITHOUT CLAIM TO ANY PARTICULAR
FONT, STYLE, SIZE, OR COLOR.

OWNER OF U.S. REG. NO. 2,913,255.

THE FOREIGN WORDING IN THE MARK
TRANSLATES INTO ENGLISH AS "THE MORNING
HOT GUY".

SER. NO. 77-403,772, FILED 2-22-2008.

JENNIFER HETU, EXAMINING ATTORNEY

Int. Cl.: 3

Prior U.S. Cls.: 1, 4, 6, 50, 51 and 52

United States Patent and Trademark Office

Reg. No. 3,476,568

Registered July 29, 2008

**TRADEMARK
PRINCIPAL REGISTER**

SHERMAGIC

THE SHERWIN-WILLIAMS COMPANY (OHIO
CORPORATION)
101 PROSPECT AVENUE NW
CLEVELAND, OH 441151075

FOR: PAINT REMOVER, IN CLASS 3 (U.S. CLS. 1,
4, 6, 50, 51 AND 52).

FIRST USE 6-19-2007; IN COMMERCE 6-19-2007.

THE MARK CONSISTS OF STANDARD CHAR-
ACTERS WITHOUT CLAIM TO ANY PARTICULAR
FONT, STYLE, SIZE, OR COLOR.

SER. NO. 77-407,164, FILED 2-27-2008.

WILLIAM BRECKENFELD, EXAMINING ATTOR-
NEY

Int. Cl.: 38

Prior U.S. Cls.: 100, 101 and 104

United States Patent and Trademark Office

Reg. No. 3,476,569

Registered July 29, 2008

**SERVICE MARK
PRINCIPAL REGISTER**

COSMOPOLITAN TV

HEARST COMMUNICATIONS, INC. (DELA-
WARE CORPORATION)
959 EIGHTH AVENUE
NEW YORK, NY 10019

OWNER OF U.S. REG. NOS. 630,028, 2,518,660 AND
OTHERS.

FOR: TELEVISION BROADCASTING; BROAD-
CASTING OF TELEVISION PROGRAMMES, IN
CLASS 38 (U.S. CLS. 100, 101 AND 104).

NO CLAIM IS MADE TO THE EXCLUSIVE
RIGHT TO USE "TV", APART FROM THE MARK
AS SHOWN.

FIRST USE 2-14-2008; IN COMMERCE 2-14-2008.

SER. NO. 77-408,191, FILED 2-28-2008.

THE MARK CONSISTS OF STANDARD CHAR-
ACTERS WITHOUT CLAIM TO ANY PARTICULAR
FONT, STYLE, SIZE, OR COLOR.

JOHN E. MICHOS, EXAMINING ATTORNEY

Int. Cl.: 11

Prior U.S. Cls.: 13, 21, 23, 31 and 34

United States Patent and Trademark Office

Reg. No. 3,476,570

Registered July 29, 2008

**TRADEMARK
PRINCIPAL REGISTER**

CONAIR COMFORT TOUCH

CONAIR CORPORATION (DELAWARE CORPORATION)
ONE CUMMINGS POINT ROAD
STAMFORD, CT 06902

FOR: HAND-HELD ELECTRIC HAIR DRYERS,
IN CLASS 11 (U.S. CLS. 13, 21, 23, 31 AND 34).

FIRST USE 8-0-2007; IN COMMERCE 8-0-2007.

THE MARK CONSISTS OF STANDARD CHARACTERS WITHOUT CLAIM TO ANY PARTICULAR FONT, STYLE, SIZE, OR COLOR.

OWNER OF U.S. REG. NOS. 1,032,163 AND 1,824,319.

SER. NO. 77-411,310, FILED 3-3-2008.

SUSAN RICHARDS, EXAMINING ATTORNEY

Int. Cl.: 9

Prior U.S. Cls.: 21, 23, 26, 36 and 38

Reg. No. 3,476,571

United States Patent and Trademark Office

Registered July 29, 2008

**TRADEMARK
PRINCIPAL REGISTER**

XLR Processor

RMI CORPORATION (DELAWARE CORPORATION), DBA RAZA MICROELECTRONICS, INC.

LEGAL DEPARTMENT
18920 FORGE DRIVE
CUPERTINO, CA 95014

FOR: SEMICONDUCTOR CHIPS; SEMICONDUCTOR DEVICES; SEMICONDUCTORS; ELECTRONIC CHIPS FOR THE MANUFACTURER OF INTEGRATED CIRCUITS; ELECTRONIC INTEGRATED CIRCUITS; INTEGRATED CIRCUITS; INTEGRATED CIRCUITS AND INTEGRATED CIRCUIT CORES FOR USE IN WIRELESS COMMUNICATIONS AND WIRELESS COMMUNICATION EQUIPMENT AND APPARATI AND DIGITAL SIGNAL PROCESSORS

(DSP); LARGE SCALE INTEGRATED CIRCUITS, IN CLASS 9 (U.S. CLS. 21, 23, 26, 36 AND 38).

FIRST USE 6-23-2004; IN COMMERCE 12-3-2004.

THE MARK CONSISTS OF STANDARD CHARACTERS WITHOUT CLAIM TO ANY PARTICULAR FONT, STYLE, SIZE, OR COLOR.

NO CLAIM IS MADE TO THE EXCLUSIVE RIGHT TO USE "PROCESSOR", APART FROM THE MARK AS SHOWN.

SER. NO. 77-411,902, FILED 3-3-2008.

PATRICIA EVANKO, EXAMINING ATTORNEY

Int. Cl.: 35

Prior U.S. Cls.: 100, 101 and 102

United States Patent and Trademark Office

Reg. No. 3,476,572

Registered July 29, 2008

**SERVICE MARK
PRINCIPAL REGISTER**

PERFECT FIT BY CACIQUE

LANE BRYANT PURCHASING CORP. (OHIO
CORPORATION)
3344 MORSE CROSSING ROAD
COLUMBUS, OH 43219

FOR: RETAIL CLOTHING STORE SERVICES
FEATURING BRA FITTING SERVICES, IN CLASS
35 (U.S. CLS. 100, 101 AND 102).

FIRST USE 2-23-2006; IN COMMERCE 2-23-2006.

THE MARK CONSISTS OF STANDARD CHAR-
ACTERS WITHOUT CLAIM TO ANY PARTICULAR
FONT, STYLE, SIZE, OR COLOR.

OWNER OF U.S. REG. NOS. 1,566,672 AND
2,613,254.

NO CLAIM IS MADE TO THE EXCLUSIVE
RIGHT TO USE "PERFECT FIT", APART FROM
THE MARK AS SHOWN.

THE FOREIGN WORDING IN THE MARK
TRANSLATES INTO ENGLISH AS INDIAN CHIEF.

SER. NO. 77-412,893, FILED 3-4-2008.

KRISTIN DAHLING, EXAMINING ATTORNEY

Int. Cl.: 14

Prior U.S. Cls.: 2, 27, 28 and 50

United States Patent and Trademark Office

Reg. No. 3,476,573

Registered July 29, 2008

**TRADEMARK
PRINCIPAL REGISTER**

**Green For Green by Rhonda
Faber Green**

RHONDA FABER GREEN DESIGNS, LLC (CALI-
FORNIA LTD LIAB CO)
PENTHOUSE
332N RODEO DR
BEVERLY HILLS, CA 90210

FOR: DIAMOND JEWELRY, IN CLASS 14 (U.S.
CLS. 2, 27, 28 AND 50).

FIRST USE 11-15-2007; IN COMMERCE 11-15-2007.

THE MARK CONSISTS OF STANDARD CHAR-
ACTERS WITHOUT CLAIM TO ANY PARTICULAR
FONT, STYLE, SIZE, OR COLOR.

OWNER OF U.S. REG. NOS. 2,905,953 AND
2,907,928.

THE NAME "RHONDA FABER GREEN" IDEN-
TIFIES A LIVING INDIVIDUAL WHOSE CONSENT
IS OF RECORD.

SER. NO. 77-416,451, FILED 3-7-2008.

KATHLEEN LORENZO, EXAMINING ATTORNEY

Int. Cl.: 42

Prior U.S. Cls.: 100 and 101

United States Patent and Trademark Office

Reg. No. 3,476,574

Registered July 29, 2008

**SERVICE MARK
PRINCIPAL REGISTER**

Canaan Technology

CANAAN TECHNOLOGY, LLC (CONNECTICUT
LTD LIAB CO)
194 MAIN STREET
NORWALK, CT 06851 AND
FELTON, DAVID R (UNITED STATES INDIVI-
DUAL)
PO BOX 121
NORWALK, CT 06851

FOR: COMPUTER DIAGNOSTIC SERVICES;
COMPUTER NETWORK DESIGN FOR OTHERS;
CONSULTATION SERVICES IN THE FIELDS OF
SELECTION, IMPLEMENTATION AND USE OF
COMPUTER HARDWARE AND SOFTWARE SYS-
TEMS FOR OTHERS; CONSULTING SERVICES IN
THE FIELD OF DESIGN, SELECTION, IMPLEMEN-
TATION AND USE OF COMPUTER HARDWARE
AND SOFTWARE SYSTEMS FOR OTHERS; IN-
STALLATION OF COMPUTER SOFTWARE; RE-
PAIR OF COMPUTER SOFTWARE; REPAIR OF
DAMAGED COMPUTER PROGRAMS; TECHNICAL
SUPPORT SERVICES, NAMELY, TROUBLESHOOT-
ING OF COMPUTER HARDWARE AND SOFT-
WARE PROBLEMS; TECHNICAL SUPPORT

SERVICES, NAMELY, TROUBLESHOOTING OF
COMPUTER SOFTWARE PROBLEMS; TECHNICAL
SUPPORT SERVICES, NAMELY, TROUBLESHOOT-
ING OF INDUSTRIAL PROCESS CONTROL COM-
PUTER SOFTWARE PROBLEMS; TECHNICAL
SUPPORT, NAMELY, MONITORING OF NET-
WORK SYSTEMS, IN CLASS 42 (U.S. CLS. 100 AND
101).

FIRST USE 4-1-2002; IN COMMERCE 4-1-2002.

THE MARK CONSISTS OF STANDARD CHAR-
ACTERS WITHOUT CLAIM TO ANY PARTICULAR
FONT, STYLE, SIZE, OR COLOR.

NO CLAIM IS MADE TO THE EXCLUSIVE
RIGHT TO USE "TECHNOLOGY", APART FROM
THE MARK AS SHOWN.

SER. NO. 77-975,113, FILED 11-22-2006.

KELLY BOULTON, EXAMINING ATTORNEY

Int. Cl.: 9

Prior U.S. Cls.: 21, 23, 26, 36 and 38

Reg. No. 3,476,575

United States Patent and Trademark Office

Registered July 29, 2008

**TRADEMARK
PRINCIPAL REGISTER**

SPI

SOLAR POWER INDUSTRIES, INC. (DELAWARE
CORPORATION)
13 AIRPORT ROAD
BELLE VERNON, PA 15012

THE MARK CONSISTS OF STANDARD CHAR-
ACTERS WITHOUT CLAIM TO ANY PARTICULAR
FONT, STYLE, SIZE, OR COLOR.

FOR: SOLAR CELLS AND SOLAR CELL MOD-
ULES, IN CLASS 9 (U.S. CLS. 21, 23, 26, 36 AND 38).

SER. NO. 77-975,365, FILED 5-25-2007.

FIRST USE 4-6-2004; IN COMMERCE 4-6-2004.

JASON LOTT, EXAMINING ATTORNEY

Int. Cls.: 9, 29, 30, 32 and 36

**Prior U.S. Cls.: 21, 23, 26, 36, 38, 45, 46, 48, 100, 101
and 102**

Reg. No. 3,476,576

United States Patent and Trademark Office

Registered July 29, 2008

**TRADEMARK
SERVICE MARK
PRINCIPAL REGISTER**

BK

BURGER KING BRANDS, INC. (DELAWARE CORPORATION)
5505 BLUE LAGOON DRIVE
MIAMI, FL 33126

FOR: MAGNETICALLY ENCODED ELECTRONIC DEBIT AND STORED-VALUE CARDS FOR USE IN QUICK-SERVICE RESTAURANTS, IN CLASS 9 (U.S. CLS. 21, 23, 26, 36 AND 38).

FIRST USE 11-19-2006; IN COMMERCE 11-19-2006.

FOR: CHICKEN PIECES; FRENCH FRIED POTATOES, ONION RINGS AND GARDEN SALADS, IN CLASS 29 (U.S. CL. 46).

FIRST USE 5-10-2005; IN COMMERCE 5-10-2005.

FOR: SANDWICHES, HAMBURGER SANDWICHES; DESSERTS, NAMELY, PIES; COFFEE, CAFFEINE-FREE COFFEE, MILKSHAKES, IN CLASS 30 (U.S. CL. 46).

FIRST USE 4-17-2006; IN COMMERCE 4-17-2006.

FOR: SOFT DRINKS, IN CLASS 32 (U.S. CLS. 45, 46 AND 48).

FIRST USE 4-18-2006; IN COMMERCE 4-18-2006.

FOR: FINANCIAL SERVICES, NAMELY, ISSUING DEBIT AND STORED VALUE CARDS FOR USE IN QUICK-SERVICE RESTAURANTS, IN CLASS 36 (U.S. CLS. 100, 101 AND 102).

FIRST USE 11-19-2006; IN COMMERCE 11-19-2006.

THE MARK CONSISTS OF STANDARD CHARACTERS WITHOUT CLAIM TO ANY PARTICULAR FONT, STYLE, SIZE, OR COLOR.

OWNER OF U.S. REG. NOS. 2,702,440, 3,137,122, AND 3,238,287.

SER. NO. 77-975,676, FILED 8-10-2007.

ERIN FALK, EXAMINING ATTORNEY

Int. Cls.: 39 and 41

Prior U.S. Cls.: 100, 101, 105 and 107

United States Patent and Trademark Office

Reg. No. 3,476,577

Registered July 29, 2008

**SERVICE MARK
PRINCIPAL REGISTER**

ELDERHOSTEL

ELDERHOSTEL, INC. (MASSACHUSETTS CORPORATION)
11 AVENUE DE LAFAYETTE
BOSTON, MA 02111

FOR: ARRANGING TRAVEL TOURS, IN CLASS 39 (U.S. CLS. 100 AND 105).

FIRST USE 1-31-1975; IN COMMERCE 1-31-1975.

FOR: EDUCATIONAL SERVICES, NAMELY, PROVIDING CONFERENCES, WORKSHOPS, SEMINARS, AND CLASSES THROUGH EXPERIENTIAL OR CLASSROOM LEARNING IN THE FIELDS OF HISTORY, NATURE, CULTURES, SCIENCE, ENTERTAINMENT, ART, SELF-IMPROVEMENT, AND POLITICS, IN CLASS 41 (U.S. CLS. 100, 101 AND 107).

FIRST USE 0-0-1988; IN COMMERCE 0-0-1988.

THE MARK CONSISTS OF STANDARD CHARACTERS WITHOUT CLAIM TO ANY PARTICULAR FONT, STYLE, SIZE, OR COLOR.

OWNER OF U.S. REG. NOS. 1,071,632, 1,741,825 AND OTHERS.

SEC. 2(F) LIMITED TO THE SERVICES IN INTERNATIONAL CLASS 39.

SER. NO. 77-975,702, FILED 2-1-2007.

JAMES MACFARLANE, EXAMINING ATTORNEY

Int. Cl.: 41

Prior U.S. Cls.: 100, 101 and 107

United States Patent and Trademark Office

Reg. No. 3,476,578

Registered July 29, 2008

**SERVICE MARK
PRINCIPAL REGISTER**

RIVER CROSSING

THINKFUN INC. (VIRGINIA CORPORATION)
1321 CAMERON STREET
ALEXANDRIA, VA 22314

FOR: PROVIDING ONLINE COMPUTER GAME PROGRAMS OFFERED VIA HANDHELD COMPUTERS, WIRELESS TELEPHONES AND MOBILE AND WIRELESS DEVICES; PROVIDING ONLINE COMPUTER GAMES, IN CLASS 41 (U.S. CLS. 100, 101 AND 107).

FIRST USE 9-0-2004; IN COMMERCE 9-0-2004.

THE MARK CONSISTS OF STANDARD CHARACTERS WITHOUT CLAIM TO ANY PARTICULAR FONT, STYLE, SIZE, OR COLOR.

OWNER OF U.S. REG. NO. 2,791,518.

SER. NO. 77-975,711, FILED 4-24-2007.

EDWARD NELSON, EXAMINING ATTORNEY

Int. Cls.: 9 and 41

Prior U.S. Cls.: 21, 23, 26, 36, 38, 100, 101 and 107

United States Patent and Trademark Office

Reg. No. 3,476,579

Registered July 29, 2008

**TRADEMARK
SERVICE MARK
PRINCIPAL REGISTER**

ANNIE DUKE

TEN DIMES PRODUCTIONS, INC. (CALIFORNIA CORPORATION)
7321 CAVERNA DRIVE
LOS ANGELES, CA 90068

FOR: PRE-RECORDED DVDS, VIDEO TAPES AND CD-ROMS FEATURING POKER AND GAMING ENTERTAINMENT AND INSTRUCTION; COMPUTER GAME SOFTWARE AND ENTERTAINMENT SOFTWARE IN THE NATURE OF A POKER GAME, IN CLASS 9 (U.S. CLS. 21, 23, 26, 36 AND 38).

FIRST USE 10-1-2005; IN COMMERCE 10-1-2005.

FOR: ENTERTAINMENT AND EDUCATIONAL SERVICES, NAMELY, PROVIDING INSTRUCTIONAL SEMINARS, AND TRAINING IN THE FIELD OF POKER AND GAMING; ENTERTAINMENT SERVI-

CES, NAMELY, PERFORMING AND COMPETING IN POKER TOURNAMENTS BROADCAST ON TELEVISION, IN CLASS 41 (U.S. CLS. 100, 101 AND 107).

FIRST USE 5-1-2004; IN COMMERCE 5-1-2004.

THE MARK CONSISTS OF STANDARD CHARACTERS WITHOUT CLAIM TO ANY PARTICULAR FONT, STYLE, SIZE, OR COLOR.

THE NAME(S), PORTRAIT(S), AND/OR SIGNATURE(S) SHOWN IN THE MARK IDENTIFIES ANNIE DUKE, AN INDIVIDUAL, WHOSE CONSENT(S) TO REGISTER IS MADE OF RECORD.

SER. NO. 77-975,724, FILED 4-6-2007.

JENNIFER MARTIN, EXAMINING ATTORNEY

Int. Cl.: 5

Prior U.S. Cls.: 6, 18, 44, 46, 51 and 52

United States Patent and Trademark Office

Reg. No. 3,476,580

Registered July 29, 2008

**TRADEMARK
PRINCIPAL REGISTER**

TOTAL HEALTH SOLUTIONS

TOTAL HEALTH SOLUTIONS, INC. (UTAH CORPORATION)
6337 S. HIGHLAND DRIVE
SUITE 123
SALT LAKE CITY, UT 84121

NO CLAIM IS MADE TO THE EXCLUSIVE RIGHT TO USE "HEALTH SOLUTIONS", APART FROM THE MARK AS SHOWN.

FOR: VITAMINS, MINERALS, DIETARY SUPPLEMENTS, IN CLASS 5 (U.S. CLS. 6, 18, 44, 46, 51 AND 52).

SER. NO. 78-044,909, FILED 1-25-2001.

FIRST USE 3-1-1999; IN COMMERCE 3-1-1999.

ARETHA SOMERVILLE, EXAMINING ATTORNEY

Int. Cl.: 44

Prior U.S. Cls.: 100 and 101

United States Patent and Trademark Office

Reg. No. 3,476,581

Registered July 29, 2008

**SERVICE MARK
PRINCIPAL REGISTER**

MEDICOR HEALTHCARE

MEDICOR HOMECARE, INC. (FLORIDA CORPORATION)
3403 W. WATERS AVE
TAMPA, FL 33614

FOR: RENTAL OF DURABLE MEDICAL EQUIPMENT, NAMELY, OXYGEN, HOSPITAL BEDS, ORTHOPEDIC SUPPLIES, RESPIRATORY EQUIPMENT, IN CLASS 44 (U.S. CLS. 100 AND 101).

FIRST USE 6-0-2000; IN COMMERCE 6-0-2000.

THE MARK CONSISTS OF STANDARD CHARACTERS WITHOUT CLAIM TO ANY PARTICULAR FONT, STYLE, SIZE, OR COLOR.

NO CLAIM IS MADE TO THE EXCLUSIVE RIGHT TO USE "HEALTHCARE", APART FROM THE MARK AS SHOWN.

SER. NO. 78-221,486, FILED 3-4-2003.

PAULA MAHONEY, EXAMINING ATTORNEY

Int. Cls.: 21 and 24

Prior U.S. Cls.: 2, 13, 23, 29, 30, 33, 40, 42 and 50

United States Patent and Trademark Office

Reg. No. 3,476,582

Registered July 29, 2008

**TRADEMARK
PRINCIPAL REGISTER**



THE TEMPLAR COMPANY PLC (UNITED KING-
DOM PUBLIC LIMITED COMPANY)
PIPPBROOK MILL LONDON ROAD
DORKING, SURREY, UNITED KINGDOM RH4 1JE

FOR: TABLEWARE FOR BABIES AND INFANTS,
NAMELY, PLATES, SAUCERS, DISHES, BOWLS,
EGG CUPS, NAPKIN HOLDERS, DRINKING GLAS-
SES, CUPS, MUGS, CHILDREN'S DRINKING CUPS
AND BEAKERS, JUGS, TEAPOTS NOT OF PRE-
CIOUS METALS, SALT AND PEPPER SHAKERS,
MEAL TRAYS AND SERVING TRAYS NOT OF
PRECIOUS METALS; BUCKETS; BABY BATH TUBS;
POTTIES FOR BABIES AND CHILDREN; HAIR
COMBS AND HAIR BRUSHES, IN CLASS 21 (U.S.
CLS. 2, 13, 23, 29, 30, 33, 40 AND 50).

FOR: PRAM AND COT LINEN; TEXTILE FUR-
NISHINGS, NAMELY, BLANKETS, BEDSHEETS,
BEDSPREADS, PILLOWCASES, MATTRESS COV-
ERS, THROWS, CUSHION COVERS, TABLE-
CLOTHS, AND TOWELS, IN CLASS 24 (U.S. CLS. 42
AND 50).

PRIORITY CLAIMED UNDER SEC. 44(D) ON
ERPN CMNTY TM OFC APPLICATION NO.
002958908, FILED 11-26-2002, REG. NO. 002958908,
DATED 11-28-2007, EXPIRES 11-26-2012.

SER. NO. 78-253,830, FILED 5-23-2003.

PAULA MAHONEY, EXAMINING ATTORNEY

Int. Cls.: 9, 35, 42 and 45

Prior U.S. Cls.: 21, 23, 26, 36, 38, 100, 101 and 102

United States Patent and Trademark Office

Reg. No. 3,476,583

Registered July 29, 2008

**TRADEMARK
SERVICE MARK
PRINCIPAL REGISTER**

METOR-ID

RAPISCAN SYSTEMS OY (FINLAND CORPORATION)
NIHTISILLANKUJA 5
ESPOO, FINLAND 02630

FOR: (BASED ON 44(E)) PHOTOGRAPHIC, OPTICAL, WEIGHING, MEASURING, SIGNALING, CHECKING (SUPERVISION) APPARATUS AND INSTRUMENTS, NAMELY, CAMERAS, VIDEOSCREENS, BATTERY CHARGERS, REMOTE DISPLAY UNITS, BATTERY BACKUP SETS, SCALES AND ALARMS FOR HAND-HELD AND WALK-THROUGH METAL DETECTORS; APPARATUS AND INSTRUMENTS FOR CONDUCTING, SWITCHING, TRANSFORMING, ACCUMULATING, REGULATING OR CONTROLLING ELECTRICITY, NAMELY, BREAKERS, SWITCHES, COUPLERS, TRANSFORMERS, ACCUMULATORS, ADJUSTERS, REGULATORS AND CONTROLLERS FOR HAND-HELD AND WALK-THROUGH METAL DETECTORS; APPARATUS FOR RECORDING, TRANSMISSION OR REPRODUCTION OF SOUND OR IMAGES, NAMELY, RECORDERS, VIDEOS AND VIDEO DISPLAYS, AND VIDEO SCREENS; BLANK MAGNETIC DATA CARRIERS, BLANK RECORDING DISCS, CALCULATING MACHINES, DATA PROCESSORS, COMPUTERS; RADAR DETECTORS; METAL DETECTORS; METAL DETECTORS COMBINED WITH OR WITHOUT VARIOUS PERSONAL IDENTIFICATION TECHNOLOGIES OR BIOMETRIC TECHNOLOGY; COMPUTERS AND PERIPHERALS THERETO, OPERATING SOFTWARE FOR METAL DETECTORS AND PERSONAL IDENTIFICATION READERS; VIDEO MONITORS, PROJECTION SCREENS, LIQUID CRYSTAL DISPLAYS, TRAFFIC LIGHTS AND ALARM RELAY CONTACTS TO BE USED IN THE FIELD OF METAL DETECTION AND PERSONAL IDENTIFICATION, IN CLASS 9 (U.S. CLS. 21, 23, 26, 36 AND 38).

FOR: (BASED ON 44(E)) RETAIL STORES AND ONLINE RETAIL STORES FEATURING SECURITY ALARMS, PERSONAL IDENTIFICATION APPARATUS AND INSTRUMENTS, AND METAL DETECTORS, IN CLASS 35 (U.S. CLS. 100, 101 AND 102).

FOR: (BASED ON 44(E)) SCIENTIFIC RESEARCH AND DESIGN SERVICES RELATING TO DEVELOPING METAL DETECTORS COMBINED WITH OR WITHOUT VARIOUS PERSONAL IDENTIFICATION TECHNOLOGIES OR BIOMETRIC TECHNOLOGY; INDUSTRIAL ANALYSIS AND RESEARCH SERVICES WITH REGARD TO METAL DETECTORS COMBINED WITH OR WITHOUT VARIOUS PERSONAL IDENTIFICATION TECHNOLOGIES OR BIOMETRIC TECHNOLOGY; DESIGN AND DEVELOPMENT OF COMPUTER HARDWARE AND SOFTWARE; DESIGNING, DEVELOPING, INSTALLATION, MAINTENANCE AND UPDATING OF COMPUTER SOFTWARE IN RESPECT OF METAL DETECTION AND PERSONAL IDENTIFICATION; COMPUTER SYSTEM DESIGN; COMPUTER SYSTEMS ANALYSIS, IN CLASS 42 (U.S. CLS. 100 AND 101).

FOR: (BASED ON 44(E)) MONITORING OF SECURITY ALARMS; SECURITY CONSULTANCY, IN CLASS 45 (U.S. CLS. 100 AND 101).

PRIORITY CLAIMED UNDER SEC. 44(D) ON ERPN CMNTY TM OFC APPLICATION NO. 2986511, FILED 12-20-2002, REG. NO. 2,986,511, DATED 2-16-2004, EXPIRES 12-20-2012.

OWNER OF U.S. REG. NO. 979,829.

SER. NO. 78-258,327, FILED 6-4-2003.

DAVID TOOLEY, EXAMINING ATTORNEY

Int. Cl.: 10

Prior U.S. Cls.: 26, 39 and 44

United States Patent and Trademark Office

Reg. No. 3,476,584

Registered July 29, 2008

**TRADEMARK
PRINCIPAL REGISTER**

PDN-SOLO XL

RAYMEDICA, LLC (DELAWARE LTD LIAB CO)
9401 JAMES AVENUE SOUTH
SUITE 120
MINNEAPOLIS, MN 55431

FOR: MEDICAL DEVICES, NAMELY, ARTIFICIAL SPINAL IMPLANTS AND TOOLS FOR SIZING AND IMPLANTING SAME, IN CLASS 10 (U.S. CLS. 26, 39 AND 44).

FIRST USE 9-5-2003; IN COMMERCE 9-5-2003.

OWNER OF U.S. REG. NOS. 2,173,777 AND 2,792,627.

NO CLAIM IS MADE TO THE EXCLUSIVE RIGHT TO USE "XL", APART FROM THE MARK AS SHOWN.

SER. NO. 78-298,073, FILED 9-9-2003.

LINDA E. BLOHM, EXAMINING ATTORNEY

Int. Cl.: 36

Prior U.S. Cls.: 100, 101 and 102

United States Patent and Trademark Office

Reg. No. 3,476,585

Registered July 29, 2008

**SERVICE MARK
PRINCIPAL REGISTER**

DYNAMIC FOCUS + WORLD EQUITY FUND I

DUNDEE CORPORATION (CANADA CORPORATION)
28TH FLOOR
1 ADELAIDE STREET EAST
TORONTO, ONTARIO, CANADA M5C 2V9

PRIORITY CLAIMED UNDER SEC. 44(D) ON
CANADA APPLICATION NO. 1192621, FILED 10-15-
2003, REG. NO. TMA661756, DATED 3-29-2006, EX-
PIRES 3-29-2021.

FOR: MUTUAL FUND SERVICES, NAMELY,
MUTUAL FUND BROKERAGE, MUTUAL FUND
DISTRIBUTION AND THE ADMINISTRATION
AND MANAGEMENT OF MUTUAL FUNDS , IN
CLASS 36 (U.S. CLS. 100, 101 AND 102).

NO CLAIM IS MADE TO THE EXCLUSIVE
RIGHT TO USE "EQUITY FUND", APART FROM
THE MARK AS SHOWN.

SER. NO. 78-324,065, FILED 11-6-2003.

THE MARK CONSISTS OF STANDARD CHAR-
ACTERS WITHOUT CLAIM TO ANY PARTICULAR
FONT, STYLE, SIZE, OR COLOR.

NAAKWAMA ANKRAH, EXAMINING ATTORNEY

Int. Cl.: 5

Prior U.S. Cls.: 6, 18, 44, 46, 51 and 52

United States Patent and Trademark Office

Reg. No. 3,476,586

Registered July 29, 2008

**TRADEMARK
PRINCIPAL REGISTER**

CELAMIR

ASTRAZENECA AB (SWEDEN CORPORATION)
VASTRA MALAREHAMNEN 9
SODERTALJE, SWEDEN SE-151 85

FOR: PHARMACEUTICAL PREPARATIONS FOR
THE TREATMENT OF GASTROINTESTINAL DIS-
EASES AND DISORDERS, IN CLASS 5 (U.S. CLS. 6,
18, 44, 46, 51 AND 52).

THE MARK CONSISTS OF STANDARD CHAR-
ACTERS WITHOUT CLAIM TO ANY PARTICULAR
FONT, STYLE, SIZE, OR COLOR.

OWNER OF ERPN CMNTY TM OFC REG. NO.
003438652, DATED 2-22-2005, EXPIRES 10-23-2013.

SER. NO. 78-328,132, FILED 11-14-2003.

KIM SAITO, EXAMINING ATTORNEY

Int. Cl.: 5

Prior U.S. Cls.: 6, 18, 44, 46, 51 and 52

Reg. No. 3,476,587

United States Patent and Trademark Office

Registered July 29, 2008

**TRADEMARK
PRINCIPAL REGISTER**

MiraFlex

MIRACLE WHITE CORPORATION (OKLAHOMA CORPORATION)
2534 WEST INTERSTATE 40
OKLAHOMA CITY, OK 73108

THE MARK CONSISTS OF STANDARD CHARACTERS WITHOUT CLAIM TO ANY PARTICULAR FONT, STYLE, SIZE, OR COLOR.

FOR: TOPICAL MEDICATED OINTMENT FOR RELIEF OF PAIN IN MUSCLES AND JOINTS, IN CLASS 5 (U.S. CLS. 6, 18, 44, 46, 51 AND 52).

SER. NO. 78-336,252, FILED 12-4-2003.

FIRST USE 12-4-2003; IN COMMERCE 12-4-2003.

ANN E. SAPPENFIELD, EXAMINING ATTORNEY

Int. Cl.: 16

Prior U.S. Cls.: 2, 5, 22, 23, 29, 37, 38 and 50

United States Patent and Trademark Office

Reg. No. 3,476,588

Registered July 29, 2008

TRADEMARK
PRINCIPAL REGISTER



KADOKAWA GROUP HOLDINGS, INC. (JAPAN CORPORATION)

13-2, 2-CHOME, FUJIMI, CHIYODA-KU

TOKYO, JAPAN

FOR: JAPANESE LANGUAGE NEWSPAPER, IN CLASS 16 (U.S. CLS. 2, 5, 22, 23, 29, 37, 38 AND 50).

FIRST USE 4-30-2004; IN COMMERCE 4-30-2004.

NO CLAIM IS MADE TO THE EXCLUSIVE RIGHT TO USE "NEW YORK", APART FROM THE MARK AS SHOWN.

THE MARK CONSISTS OF THE WORDS "NEW YORK" IN STANDARD BLOCK PRINT OVER THE WORD "WALKER" IN SCRIPT.

SER. NO. 78-337,450, FILED 12-6-2003.

HEATHER THOMPSON, EXAMINING ATTORNEY

Int. Cl.: 16

Prior U.S. Cls.: 2, 5, 22, 23, 29, 37, 38 and 50

United States Patent and Trademark Office

Reg. No. 3,476,589

Registered July 29, 2008

**TRADEMARK
PRINCIPAL REGISTER**

FIX ZONE

A.W. FABER-CASTELL S.A. (BRAZIL CORPORATION)
RUA 1 DE MAIO, 61 - BAIRRO NUCLEO RESIDENCIAL SILVIO VILARI;
SAO CARLOS, SAO PAULO, CEP 13560-911, BRAZIL

FOR: GRAPHITE PENCIL AND COLOR PENCIL,
IN CLASS 16 (U.S. CLS. 2, 5, 22, 23, 29, 37, 38 AND 50).

THE MARK CONSISTS OF STANDARD CHARACTERS WITHOUT CLAIM TO ANY PARTICULAR FONT, STYLE, SIZE, OR COLOR.

PRIORITY CLAIMED UNDER SEC. 44(D) ON BRAZIL APPLICATION NO. 825935989, FILED 9-22-2003, REG. NO. 825935989, DATED 3-7-2007, EXPIRES 3-7-2017.

SER. NO. 78-386,795, FILED 3-18-2004.

SHANNON TWOHIG, EXAMINING ATTORNEY

Int. Cl.: 3

Prior U.S. Cls.: 1, 4, 6, 50, 51 and 52

United States Patent and Trademark Office

Reg. No. 3,476,590

Registered July 29, 2008

**TRADEMARK
PRINCIPAL REGISTER**

A1

JAFER LIMITED (BERMUDA CORPORATION)
CLARENDON HOUSE, 2 CHURCH STREET
HAMILTON, BERMUDA HM12

FOR: PERFUMES; FRAGRANCES FOR PERSONAL USE; TOILET WATER; COLOGNE; AFTER SHAVING LOTIONS; COSMETICS; MAKE-UP PRODUCT FOR THE FACE AND BODY; MASCARA; EYE SHADOWS; LIPSTICKS; EYE LINERS; EYE PENCILS; LOTIONS FOR THE FACE, HANDS, AND BODY; CREAM FOR THE HAND, FACE AND BODY; TOILET SOAP; BATH SALT; DEODORANT FOR PERSONAL USE; DEODORANTS FOR PERSONAL USE FEATURING ANTIPERSPIRANT PROPERTIES; TALCUM POWDER; NAIL ENAMEL; HAIR SHAMPOO; HAIR CONDITIONERS; HAIR BALMS; HAIR GELS; HAIR SHAMPOOS AND CONDITIONERS, NAMELY, HAIR RINSES; HAIR STYLING PREPARATIONS, NAMELY, HAIR SPRAYS, GELS, MOUSSES, AND BALMS; HAIR CARE PREPARATIONS, NAMELY, HAIR SPRAYS, GELS, MOUSSES, AND BALMS; SUNBLOCK PREPARATIONS; SUNSCREEN PREPARATIONS; SUN TAN-

NING PREPARATIONS, NAMELY, LOTIONS; COSMETICS CREAMS FOR THE FACE, HANDS, FEET, ARMS AND BODY; FACIAL MAKEUP REMOVERS; ASTRINGENTS FOR COSMETIC PURPOSE; SKIN CLEANSING LOTIONS; COLD CREAMS; NIGHT CREAM; SKIN CLEANSING CREAM; SKIN CREAM; VANISHING CREAM; SKIN MOISTURIZER; WRINKLE REMOVING SKIN CARE PREPARATIONS; SKIN CLARIFIERS; SKIN LIGHTENERS; SKIN LOTIONS; AND SKIN TONER, IN CLASS 3 (U.S. CLS. 1, 4, 6, 50, 51 AND 52).

THE MARK CONSISTS OF STANDARD CHARACTERS WITHOUT CLAIM TO ANY PARTICULAR FONT, STYLE, SIZE, OR COLOR.

OWNER OF PERU REG. NO. 125660, DATED 1-25-2007, EXPIRES 1-25-2017.

SER. NO. 78-402,767, FILED 4-15-2004.

JASON LOTT, EXAMINING ATTORNEY

Int. Cls.: 9, 38 and 41

Prior U.S. Cls.: 21, 23, 26, 36, 38, 100, 101, 104 and 107

Reg. No. 3,476,591

United States Patent and Trademark Office

Registered July 29, 2008

**TRADEMARK
SERVICE MARK
PRINCIPAL REGISTER**

EYETOY CHAT

SONY COMPUTER ENTERTAINMENT EUROPE
LIMITED (UNITED KINGDOM CORPORATION)
30 GOLDEN SQUARE
LONDON, UNITED KINGDOM W1F 9LD

FOR: COMPUTER HARDWARE; VIDEO OUTPUT GAME MACHINES FOR USE WITH TELEVISIONS; COMPUTER GAME CONSOLES; COMPUTER SOFTWARE FOR USE WITH COMPUTER AND VIDEO GAMES; COMPUTER PERIPHERALS; AUDIO AND VIDEO TAPES FEATURING MATERIAL RELATING TO COMPUTER AND VIDEO GAMES; MAGNETIC DATA MEDIA, CASSETTES, COMPACT DISCS, VIDEO DISCS, DVDS, ALL FEATURING MATERIAL RELATING TO COMPUTER AND VIDEO GAMES; ELECTRONIC APPARATUS AND INSTRUMENTS, NAMELY, WEB CAMS AND WEB CAMS FOR USE WITH COMPUTER GAMING APPARATUS AND CONSOLES; CAMERAS, NAMELY, DIGITAL CAMERAS, VIDEO CAMERAS; SUNGLASSES AND SPECTACLE FRAMES; SUNGLASSES AND SPECTACLES FRAMES; PARTS AND ACCESSORIES FOR ALL THE AFORESAID GOODS, IN CLASS 9 (U.S. CLS. 21, 23, 26, 36 AND 38).

FOR: TELECOMMUNICATIONS SERVICES, NAMELY, ELECTRONIC MAIL SERVICES; INTERNET ACCESS SERVICES AND PROVIDING MULTIPLE USER DIAL UP AND DEDICATED ACCESS TO THE INTERNET; MESSAGING SERVICES, NAME-

LY, SMS MESSAGING AND TEXT MESSAGING SERVICES; AND INTERACTIVE CHAT ROOM SERVICES AND FACILITIES FROM A NON-DOWNLOADABLE COMPUTER DATABASE, OR VIA THE INTERNET, CONCERNING TOPICS OF GENERAL INTEREST, IN CLASS 38 (U.S. CLS. 100, 101 AND 104).

FOR: PROVISION OF ON-LINE ENTERTAINMENT, NAMELY, PROVIDING COMPUTER AND VIDEO GAMES, COMPUTER AND VIDEO GAME PROGRAMS, PRE-RECORDED MUSIC, AND VIDEO RECORDINGS IN THE FIELD OF MUSIC AND COMPUTER GAMING, IN CLASS 41 (U.S. CLS. 100, 101 AND 107).

THE MARK CONSISTS OF STANDARD CHARACTERS WITHOUT CLAIM TO ANY PARTICULAR FONT, STYLE, SIZE, OR COLOR.

OWNER OF UNITED KINGDOM REG. NO. 2363192, DATED 3-11-2005, EXPIRES 5-13-2014.

NO CLAIM IS MADE TO THE EXCLUSIVE RIGHT TO USE "CHAT", APART FROM THE MARK AS SHOWN.

SER. NO. 78-417,454, FILED 5-12-2004.

ROBIN CHOSID, EXAMINING ATTORNEY

Int. Cl.: 10

Prior U.S. Cls.: 26, 39 and 44

United States Patent and Trademark Office

Reg. No. 3,476,592

Registered July 29, 2008

**TRADEMARK
PRINCIPAL REGISTER**

SEP

SIMSURGERY AS (NORWAY CORPORATION)
SOGNSVEIEN 75B
OSLO, NORWAY 0855

FOR: SURGICAL, MEDICAL, DENTAL, AND VETERINARY APPARATUS AND INSTRUMENTS USED FOR IMAGE GUIDED SURGERY AND IMAGE GUIDED INTERVENTIONAL PROCEDURES NAMELY, FLEXIBLE AND RIGID OPTICAL SYSTEMS, NAMELY, CAMERA ENDOSCOPES AND LIGHT SOURCES; SURGICAL INSTRUMENTS, NAMELY NEEDLES, FORCEPS, ELECTROCAUTERY INSTRUMENTS, NEEDLE HOLDERS, SCISSORS, SCALPELS, CLIP APPLIERS, AND TROCARS; ENDOVASCULAR INSTRUMENTS, NAMELY CA-

THETERS, GUIDEWIRES, SHEATH INTRODUCERS AND INTRODUCER SETS; TUBES FOR LIQUID INFUSION ELECTRODES, IN CLASS 10 (U.S. CLS. 26, 39 AND 44).

THE MARK CONSISTS OF STANDARD CHARACTERS WITHOUT CLAIM TO ANY PARTICULAR FONT, STYLE, SIZE, OR COLOR.

OWNER OF NORWAY REG. NO. 228033, DATED 9-7-2005, EXPIRES 9-7-2015.

SER. NO. 78-477,578, FILED 9-2-2004.

CHRIS WELLS, EXAMINING ATTORNEY

Int. Cls.: 9, 14, 16, 18, 24, 25 and 28

**Prior U.S. Cls.: 1, 2, 3, 5, 21, 22, 23, 26, 27, 28, 29, 36,
37, 38, 39, 41, 42 and 50**

Reg. No. 3,476,593

United States Patent and Trademark Office

Registered July 29, 2008

**TRADEMARK
PRINCIPAL REGISTER**

SLAZENGER

SLAZENGER LIMITED (UNITED KINGDOM CORPORATION)
GRENVILLE COURT, BRITWELL ROAD, BURNHAM
BUCKINGHAMSHIRE, UNITED KINGDOM SL1
8DF

FOR: TELECOMMUNICATION APPARATUS, NAMELY, FACSIMILE MACHINES; TELEPHONES, MOBILE TELEPHONES, CORDLESS TELEPHONES; TELEPHONE ANSWERING APPARATUS; RADIO PAGERS; DVD PLAYERS; DVD RECORDERS; CD RECORDERS; PHOTOGRAPHIC APPARATUS AND INSTRUMENTS, NAMELY, DIGITAL CAMERAS, LENSES FOR CAMERAS, STRAPS FOR CAMERAS AND CASES FOR CAMERAS; CAMERAS; VIDEO CAMERAS; CAMERA LENSES; CAMCORDERS; TELEVISIONS; TELEVISIONS FOR RECEIVING SATELLITE BROADCASTING; SATELLITES AND DECODERS; VIDEO TAPE RECORDERS; VIDEO DISC PLAYERS; COMBINED TELEVISIONS AND VCRS; TELEVISION AERIALS; ANTENNAS; TRANSFORMERS; SURGE PROTECTORS; REMOTE CONTROL APPARATUS FOR AUTHENTICATION AND IDENTIFICATION TO PROVIDE ACCESS CONTROL TO COMPUTERS; REMOTE CONTROL APPARATUS FOR AUTHENTICATION AND IDENTIFICATION TO PROVIDE ACCESS TO A BUILDING OR A ROOM; REMOTE CONTROLS FOR TELEVISIONS, COMPUTERS, DVD RECORDERS AND PLAYERS, CD RECORDERS AND PLAYERS, VIDEO CASSETTE RECORDERS AND PLAYERS, AUDIO CASSETTE RECORDERS AND PLAYERS; RADIO TUNERS; RADIO RECEIVERS; RADIO CASSETTES

FOR REPRODUCING SOUNDS; CD RADIO CASSETTES; COMPACT DISC PLAYERS; TAPE RECORDERS; TAPE PLAYERS; RECORD PLAYERS; GRAPHIC EQUALIZERS; HEAD PHONES; SPEAKERS, NAMELY, BOOK SHELF SPEAKERS, FLOOR STANDING SPEAKERS, WIRELESS SPEAKERS, SUB-WOOFERS, MULTI MEDIA SPEAKERS AND SPEAKERS FOR COMPUTERS; LOUDSPEAKERS, EAR PHONE SPEAKERS, SPEAKER CABLES; AMPLIFIERS; RADIOS, RADIOS INCORPORATING CLOCKS; KARAOKE MACHINES, JUKE BOXES; COMPUTERS, LAPTOP AND NOTEBOOK COMPUTERS, GAME COMPUTERS; APPARATUS FOR USE WITH COMPUTERS, NAMELY, PRINTERS, COMPUTER SCREENS AND MODEMS; COMPUTER SOFTWARE FOR COMPUTER SYSTEM AND APPLICATION DEVELOPMENT, DEPLOYMENT AND MANAGEMENT; COMPUTER SOFTWARE FOR USE IN DATABASE MANAGEMENT; COMPUTER SOFTWARE FOR USE AS A SPREADSHEET; COMPUTER SOFTWARE FOR USE FOR WORD PROCESSING; COMPUTER SOFTWARE FOR ACCESSING INFORMATION DIRECTORIES; COMPUTER SOFTWARE FOR WIRELESS CONTENT DELIVERY; COMPUTER PROGRAMS FOR DOCUMENT PROCESSING; COMPUTER PROGRAMS FOR USE IN COMPUTER SECURITY; COMPUTER PROGRAMS FOR USE IN THE DEVELOPMENT OF COMPUTER PROGRAMS; COMPUTER PROGRAMS FOR USE IN DEVELOPING, EXECUTING AND MANAGING OTHER COMPUTER PROGRAMS, ON COMPUTERS, COMPUTER NETWORKS AND GLOBAL COMPUTER NETWORKS;

COMPUTER PROGRAMS FOR USE IN TRANSFERRING INFORMATION, AND DISTRIBUTING AND VIEWING OTHER COMPUTER PROGRAMS, ON COMPUTERS, COMPUTER NETWORKS AND GLOBAL COMPUTER NETWORKS; MULTIMEDIA SOFTWARE RECORDED ON CD-ROM FOR USE IN DESKTOP PUBLISHING, ELECTRONIC PUBLISHING, PRINTING, GRAPHICS AND TYPESETTING; MULTIMEDIA SOFTWARE RECORDED ON CD-ROM FOR USE IN GENERATING AND MANAGING PAGES ON GLOBAL COMPUTER NETWORKS AND OTHER NETWORKS; MULTIMEDIA SOFTWARE RECORDED ON CD-ROM FOR USE IN CONNECTION WITH THE CREATION, EDITING, MANIPULATION AND PRINTING OF TEXT, AUDIO, GRAPHICS, ANIMATED GRAPHICS AND FULL MOTION VIDEOS; CD ROMS, NAMELY, BLANK CD ROMS; MULTIMEDIA SOFTWARE RECORDED ON CD-ROM FOR USE IN PERSONAL COMMUNICATION SERVICES; PRE-RECORDED CD ROMS FEATURING SPORTS OR PROVIDING INSTRUCTION IN SPORTS; COMPUTER GAME PROGRAMS; VIDEO GAMES, NAMELY, VIDEO GAMES SOFTWARE, DISCS AND CARTRIDGES; PRE-RECORDED MAGNETIC TAPES AND PRE-RECORDED MAGNETIC DISCS FEATURING SPORTING AND LEISURE ACTIVITIES, ALL RECORDED WITH COMPUTER PROGRAMS FOR USE IN THE MANAGEMENT OF BUSINESSES, FOR USE IN STOCK CONTROL AND FOR PROVIDING INFORMATION ON SPORTS EVENTS; PRE-RECORDED MAGNETIC DISCS AND PRE-RECORDED MAGNETIC TAPES, ALL FEATURING VIDEO GAMES OR ADAPTED FOR USE WITH TELEVISION RECEIVERS; AUDIO AND VIDEO TAPES AND DISCS, ALL FEATURING SPORTS EVENTS OR INSTRUCTION IN SPORTS; BLANK TAPES FOR RECORDING AUDIO AND VIDEO; BLANK COMPACT DISCS; PRE-RECORDED COMPACT DISCS FEATURING SPORTS EVENTS OR INSTRUCTION IN SPORTS; PRE-RECORDED COMPACT DISCS CONTAINING DIRECTORY INFORMATION IN THE NATURE OF COMMUNICATION, TELEPHONE, PERSONAL, BUSINESS AND ADVERTISING INFORMATION; PHONOGRAPH RECORDS, PRE-RECORDED MAGNETIC CASSETTES AND PRE-RECORDED MAGNETIC DISCS, ALL CONTAINING SPORTING EVENTS OR PROVIDING INFORMATION ON SPORTS; CABINETS FOR LOUDSPEAKERS; PHOTOCOPIERS; CALCULATORS; PRICE COMPUTING SCALES; COUNTING SCALES; POSTAL SCALES; SCALES WITH DIGITAL DISPLAY; TIME CLOCKS; TIMERS; ENCODED ELECTRONIC CHIP CARDS FOR IDENTIFYING PARTICULAR USERS OF COMPUTERS AND MOBILE TELEPHONES; HOLOGRAM APPARATUS; MAGNIFYING GLASSES; PEDOMETERS; PERISCOPES; BATTERIES, BATTERY CHARGERS, BATTERY BOXES; ELECTRIC PLUGS; ELECTRIC IRONS; ELECTRIC HAIR CURLING BRUSHES; ELECTRIC HAIR CURLING IRONS; ELECTRICALY HEATED HAIR CURLERS; BINOCULARS; MONOCLES; SPECTACLES; SUNGLASSES; SPORTS GOGGLES; SWIMMING GOGGLES; FRAMES AND LENSES FOR SPECTACLES AND SUNGLASSES; CASES FOR SPECTACLES AND SUNGLASSES; CHAINS AND CORDS FOR SPECTACLES AND

SUNGLASSES; PROTECTIVE CLOTHING, NAMELY, JACKETS, OVERCOATS, PARKAS, PANTS, SHORTS, TROUSERS, SWEATERS AND SHIRTS; KNEE PADS FOR WORKERS, FACE PROTECTION SHIELDS; PROTECTIVE FACE SHIELDS FOR PROTECTIVE HELMETS, ALL FOR WORKERS; HELMETS FOR MOTORCYCLISTS; PROTECTIVE GLASSES, SUNGLASSES AND GOGGLES; FACE SHIELDS; LIFE BELTS; COMPUTER CARRYING CASES; CASES FOR MOBILE TELEPHONES, IN CLASS 9 (U.S. CLS. 21, 23, 26, 36 AND 38).

FOR: CLOCKS AND WATCHES; SPORTS WATCHES; WATCH STRAPS; MUGS OF PRECIOUS METAL; TANKARDS OF PRECIOUS METAL; TROPHIES, BELT BUCKLES, ALL BEING OF PRECIOUS METAL OR COATED THEREWITH; JEWELLERY AND IMITATION JEWELLERY; STOP WATCHES; ALARM CLOCKS; ASHTRAYS OF PRECIOUS METAL; BADGES OF PRECIOUS METAL; BOXES OF PRECIOUS METAL; BRACELETS; MEDALS, BADGES OF PRECIOUS METAL; CANDLE RINGS OF PRECIOUS METAL; CANDLESTICKS OF PRECIOUS METAL; CASES FOR CLOCK AND WATCH MAKING; CASES FOR WATCHES; CLOCK CASES; CLOCK HANDS; NON-ELECTRIC COFFEE POTS OF PRECIOUS METAL; HOUSEHOLD CONTAINERS OF PRECIOUS METAL, NAMELY, BOWLS; HOUSEHOLD UTENSILS OF PRECIOUS METAL, NAMELY, FORKS, SPOONS AND KNIVES; JEWEL CASES OF PRECIOUS METAL; JEWELLERY; KEY RINGS OF PRECIOUS METAL; RINGS BEING JEWELLERY; SAUCERS OF PRECIOUS METAL; CUFFLINKS, TIE CLIPS, TIE PINS; WATCH BANDS; WRIST WATCHES; ORNAMENTS OF PRECIOUS METAL; TRINKETS, NAMELY, KEY CHAINS MADE OF METAL, IN CLASS 14 (U.S. CLS. 2, 27, 28 AND 50).

FOR: BOOKS IN THE FIELD OF SPORTS, TUITION AND INSTRUCTION IN SPORTS, GYMNASTICS, ATHLETICS AND BUSINESS MANAGEMENT; PRINTED MATTER, NAMELY, POSTERS, CALENDARS, FLYERS, MAGAZINES FEATURING SPORTS; AND NEWSLETTERS IN THE FIELD OF SPORT; PICTURES, POSTERS, PRINTS; WRITING IMPLEMENTS, NAMELY, PENS, PENCILS AND CRAYONS; PRINTED CARDS, NAMELY, BUSINESS CARDS AND NOTE CARDS; POSTCARDS; BINDERS; GREETINGS CARDS; MECHANICAL PENCILS; PHOTOGRAPHS; PHOTOGRAPH ALBUMS; POSTCARD ALBUMS; AUTOGRAPH ALBUMS; RECEPTION ALBUMS; TOILET TISSUES, TOILET PAPER; NAPKIN PAPER, TISSUE PAPER; TABLE CLOTHS OF PAPER; PLACEMATS OF PAPER; ADDRESS BOOKS, BINDER NOTEBOOKS, LOOSE LEAF BOOKS, NOTEBOOKS, BOOK ENDS, PAINT BRUSHES, CALENDARS, DIARIES, PHOTOGRAPH MOUNTS; INSTRUCTION AND TEACHING SHEETS; PEN STANDS, PENCIL STANDS, PHOTO STANDS; STICKERS; ADHESIVE TAPES FOR DOMESTIC AND STATIONERY USE; MAGAZINES FEATURING SPORTS, GYMNASTICS, ATHLETICS AND TRAVEL; NEWSPAPERS; DECALCOMANIAS, PEN TRAYS, PENCIL TRAYS, MANUALS IN THE FIELD OF SPORTS; STATIONERY; TOWELS OF PAPER; TABLE LINERS OF

PAPER; FACE TOWELS OF PAPER; HYGIENIC PAPER, PAPER HANDKERCHIEFS, WRITING PAPER; CATALOGUES IN THE FIELD OF SPORTS, GYMNASTIC AND ATHLETIC APPARATUS; WRAPPING AND PACKING MATERIALS, NAME- LY, GIFT WRAP PAPER, GIFT BAGS; PLASTIC BAGS FOR PACKAGING; CHEQUE BOOK HOLD- ERS; DOCUMENT PORTFOLIOS; PAPER SHOP- PING BAGS; PLASTIC SHOPPING BAGS , IN CLASS 16 (U.S. CLS. 2, 5, 22, 23, 29, 37, 38 AND 50).

FOR: LEATHER; LUGGAGE; BUSINESS CARD CASES, CALLING CARD CASES, CREDIT CARD CASES, DOCUMENT CASES, KEY CASES; TRUNKS, TRAVELLING BAGS, TRAVELLING CASES, OVER- NIGHT LUGGAGE, TRAVEL BAGS, SHOE BAGS FOR TRAVEL AND GARMENT BAGS FOR TRAV- EL; BRIEFCASES; SCHOOL BAGS AND SCHOOL SATCHELS; CARRY ALL BAGS, HAVERSACKS, BACKPACKS, RUCKSACKS, KNAPSACKS, HAND- BAGS, SHOULDER BAGS, CLUTCH BAGS, TOTE BAGS, SPORTS BAGS, ATHLETIC BAGS, BEACH BAGS; MESH SHOPPING BAGS; TEXTILE SHOP- PING BAGS, BELT BAGS, WASH BAG FOR CARRY- ING TOILETRIES; HIP SACKS, SHORT BELTS, NAMELY, STRAPS FOR SPORTS BAGS, HAVER- SACKS, BACKPACKS, RUCKSACKS AND KNAP- SACKS; WALLET, PURSES, POUCHES OF LEATHER, KEY CASES OF LEATHER; UMBREL- LAS, GOLF UMBRELLAS, GOLF UMBRELLA SEATS, PARASOLS, CANES AND WALKING STICKS; WHIPS, HARNESES AND SADDLERY, IN CLASS 18 (U.S. CLS. 1, 2, 3, 22 AND 41).

FOR: TEXTILE FABRICS FOR THE MANUFAC- TURE OF CLOTHING; TEXTILE FABRICS FOR LINGERIE; TEXTILE FABRICS FOR HOME AND COMMERCIAL INTERIORS; TEXTILE LABELS; TEXTILE LININGS FOR GARMENTS; TEXTILE NAPKINS; TEXTILE PLACEMATS; TEXTILE SIG- NAGE PANELS; TEXTILE TABLE CLOTHS; TEX- TILE WALL HANGINGS; LINEN AND UPHOLSTERY FABRICS; BED LINEN; BED- SPREADS; BED SHEETS; QUILT COVERS, DUVET COVERS, PILLOW CASES, PILLOW COVERS, QUILTS, DUVETS, THROWS; BATH LINEN, TO- WELS, FLANNELS, FACE TOWELS, SHOWER CUR- TAINS; TABLE LINEN, TABLE CLOTHS NOT OF PAPER; TABLE MATS, NAMELY, PLACEMATS; TABLE LINEN, NAMELY, NAPKINS; TABLE LINEN, NAMELY, COASTERS; KITCHEN TOWELS, TEA TOWELS; CURTAINS, CURTAIN TIEBACKS, NAMELY, CURTAIN LOOPS OF TEXTILE MATE- RIAL; CUSHION COVERS; FURNITURE COVER- INGS, NAMELY, UPHOLSTERY FABRICS; HANDKERCHIEFS, IN CLASS 24 (U.S. CLS. 42 AND 50).

FOR: CLOTHING, NAMELY, SHORTS, SHIRTS, SPORT SHIRTS, UNDERSHIRTS, SWIMSUITS, PULLOVERS, SWEATERS, JUMPERS, SMOCKS, SALOPETTES, UNDERWEAR, LONG UNDER- WEAR, UNDERPANTS, BRASSIERES, GAITERS, GARTERS, STOCKINGS, SUSPENDERS, BRACES, WAIST BANDS, GLOVES, WATERPROOF CLOTH- ING, NAMELY, COATS, JACKETS, ANORAKS, PARKAS, PULLOVERS, TROUSERS, SMOCKS,

HOODS AND OVERALLS; FLEECE PULLOVERS, COATS, JACKETS, PARKAS, ANORAKS, OVER- COATS, RAINCOATS, RAIN SUITS, WIND JACK- ETS, SKIRTS, DRESSES, PANTIES, BRIEFS, TRACKSUITS AND WARM-UP SUITS; SPORTS- WEAR, NAMELY, GOAL KEEPING SMOCKS FOR HOCKEY, SWEATBANDS; FOOTWEAR; SPORTS SHOES; BOOTS, WALKING BOOTS, FOOTBALL BOOTS, SHOES, CYCLING SHOES; HEADGEAR, NAMELY, HEADBANDS, HATS AND CAPS; WA- TERPROOF CLOTHING, NAMELY, WATERPROOF JACKETS AND PANTS; THERMAL CLOTHING, NAMELY, THERMAL SOCKS AND THERMAL UN- DERWEAR; COATS; SPORTS CLOTHING, NAME- LY, SPORTS COATS, SPORTS SHIRTS, SPORTS JACKETS, SPORTS JERSEYS, BREECHES FOR SPORTS, SPORTS OVER UNIFORMS AND SPORTS SHIRTS; JACKETS, ANORAKS, PULLOVERS, TROUSERS, SHIRTS, T-SHIRTS, CAGOULES, SMOCKS, SKI PANTS; GLOVES, BALACLAVAS, SOCKS, UNDERWEAR AND GAITERS; GOLF SPIKES, IN CLASS 25 (U.S. CLS. 22 AND 39).

FOR: GYMNASTIC AND SPORTING ARTICLES AND APPARATUS, NAMELY, WATER POLO BALLS, SQUASH BALLS, SHUTTLECOCKS, GOLF BALLS, TENNIS BALLS, CRICKET BALLS, SPORTS BALLS, ICE HOCKEY PUCKS, DARTS, TENNIS RACKETS, BADMINTON RACKETS, SQUASH RACKETS, GRIP BANDS FOR TENNIS RACKETS, GRIP BANDS FOR BADMINTON RACKETS, GRIP BANDS FOR SQUASH RACKETS, HOCKEY STICKS, LACROSSE STICKS, BASEBALL BATS, SOFTBALL BATS, CRICKET BATS, STRINGS FOR TENNIS RACKETS, STRINGS FOR BADMINTON RACKETS, STRINGS FOR SQUASH RACKETS, GUTS FOR TENNIS RACKETS, GUTS FOR BAD- MINTON RACKETS, GUT FOR SQUASH RACKETS, GUTS FOR RACKET BALL RACKETS, TENNIS NETS, NETS FOR BALL GAMES, RACKET BALL NETS, TABLES FOR TABLE TENNIS, BALL PITCH- ING MACHINES, HEAD COVERS FOR TENNIS RACKETS, HEAD COVERS FOR BADMINTON RACKETS, HEAD COVERS FOR SQUASH RACK- ETS, GOLF CLUBS, COVERS FOR GOLF CLUBS, GOLF GRIPS, GOLF CLUB HEAD COVERS, GOLF BAG COVERS, GOLF BAG PEGS, GOLF BALL MARKERS, GOLF FLAGS, GOLF TEES, GOLF TEE MARKERS, NON-MOTORIZED GOLF CARTS, PUT- TING PRACTICE MATS, TAPES FOR WRAPPING TENNIS RACKET HANDLE GRIPS, TAPES FOR WRAPPING SQUASH RACKET HANDLE GRIPS, TAPES FOR WRAPPING BADMINTON RACKET HANDLE GRIPS, ICE SKATES, KITES, KITE REELS, TARGETS, FENCING GAUNTLETS, DISCS FOR SPORTS, BILLIARD CUES, BILLIARD CUE TIPS, SKATEBOARDS, ROLLER SKATES, ICE SKATES, CHEST EXPANDERS, GOLF BAGS, TENNIS RACK- ET BAGS, BADMINTON RACKET BAGS, SQUASH RACKET BAGS, RACKET BALL RACKET BAGS, HOCKEY STICK BAGS, FRAMES FOR TENNIS RACKETS, FRAMES FOR BADMINTON RACKETS, FRAMES FOR SQUASH RACKETS, RACKET GRIPS, CRICKET STUMPS, BATTING PADS FOR CRICKET, WICKET KEEPING PADS FOR CRICK- ET, THIGH GUARDS, HOCKEY BALLS, HOCKEY STICK BAGS, GOALKEEPING GLOVES FOR SOC-

CER AND HOCKEY, GOALKEEPING LEG GUARDS FOR SOCCER AND HOCKEY, CHEST PROTECTORS AND ABDOMINAL PROTECTORS; BALLS FOR USE IN SPORTS, NAMELY, BASEBALLS, BASKETBALLS, BEACH BALLS, BILLIARD BALLS, BOWLING BALLS, CRICKET BALLS, FIELD HOCKEY BALLS, FOOTBALLS, HAND BALLS, LACROSSE BALLS, NET BALLS, PADDLE BALLS, PLAYGROUND BALLS, PUNCHING BALLS, RACKET BALLS, RUBBER BALLS, RUGBY BALLS, SOCCER BALLS, TABLE TENNIS BALLS AND VOLLEYBALLS; TOYS, NAMELY, PLASTIC CHARACTER TOYS, PLUSH TOYS, PUNCHING TOYS, SOFT SCULPTURE TOYS, SQUEEZE TOYS, STUFFED TOYS, TALKING TOYS AND TOY ACTION FIGURES; BALLOONS; SPORTS BAGS, NAMELY, BAGS FOR SKATEBOARDS, BAGS ESPECIALLY ADAPTED FOR SPORTS EQUIPMENT, BOWLING BAGS, BOXING BAGS, GOLF BAGS, PUNCHING BAGS AND GOLF BALL BAGS; ELEC-

TRONIC GAMES, NAMELY, HANDHELD UNITS FOR PLAYING ELECTRONIC GAMES, HANDHELD GAMES WITH LIQUID CRYSTAL DISPLAYS AND HANDHELD UNITS FOR PLAYING VIDEO GAMES; MODELLED PLASTIC TOY FIGURINES; ARTIFICIAL CHRISTMAS TREES AND CHRISTMAS TREE STANDS; KALEIDOSCOPES, FACE MASKS FOR HOCKEY, LEG GUARDS FOR ATHLETIC USE; ELBOW PADS FOR ATHLETIC USE, IN CLASS 28 (U.S. CLS. 22, 23, 38 AND 50).

OWNER OF UNITED KINGDOM REG. NO. 2184297, DATED 5-26-2000, EXPIRES 12-11-2008.

OWNER OF U.S. REG. NOS. 859,637 AND 1,467,418.

SER. NO. 78-490,863, FILED 9-28-2004.

TEJBIR SINGH, EXAMINING ATTORNEY

Int. Cl.: 9

Prior U.S. Cls.: 21, 23, 26, 36 and 38

Reg. No. 3,476,594

United States Patent and Trademark Office

Registered July 29, 2008

**TRADEMARK
PRINCIPAL REGISTER**

SpaBox

SUNPLUS TECHNOLOGY CO., LTD. (TAIWAN CORPORATION)
1, SCIENCE-BASED INDUSTRIAL PARK
19, INNOVATION ROAD
HSIN-CHU, TAIWAN

FOR: AUDIO PROCESSOR FOR MODIFYING AND DISTORTING ELECTRONIC SOUND; COMPUTER SOFTWARE FOR GENERATING SOUND EFFECTS AND ELECTRONIC SOUND EFFECTS GENERATING RECORDERS AND PLAYERS; MIDI RECORDER; COMPUTER SOFTWARE FOR THE MOBILE, MULTIMEDIA AND BROADCAST INDUSTRIES USED FOR THE PURPOSE OF PROCESSING AND ENCODING DIGITAL MEDIA, NAMELY, MIDI, AUDIO, VIDEO AND DATA, FROM ONE ANALOG OR DIGITAL FORMAT TO OTHER DIGITAL FORMATS AND STREAMS; DOWNLOADABLE COMPUTER SOFTWARE FOR THE MOBILE, MULTIMEDIA AND BROADCAST INDUSTRIES USED FOR THE PURPOSE OF PROCESSING AND ENCODING DIGITAL MEDIA, NAMELY, MIDI, AUDIO, VIDEO AND DATA, FROM ONE ANALOG OR DIGITAL FORMAT TO

OTHER DIGITAL FORMATS AND STREAMS; ELECTRONIC INTEGRATED CIRCUIT; COMPUTER SOFTWARE FOR DOWNLOADABLE COMPUTER MELODIES FOR SIGNALING AN INCOMING CALL OF CELLULAR PHONES; COMPUTER SOFTWARE FOR DOWNLOADABLE AUTOMATICALLY INSPECTING DIGITAL CONTENTS, SUCH AS VIDEO AND SOUND INFORMATION, SOUND, MUSIC, IMAGES, CHARACTER INFORMATION AND WORDS FILES, IN CLASS 9 (U.S. CLS. 21, 23, 26, 36 AND 38).

OWNER OF CHINA REG. NO. 01153792, DATED 5-16-2005, EXPIRES 5-15-2015.

THE MARK CONSISTS OF THE WORD SPABOX IN A STYLIZED FONT WITH UPPERCASE LETTERS S AND B AND ALL OTHER LETTERS IN LOWERCASE.

SER. NO. 78-493,237, FILED 10-1-2004.

DAWN FELDMAN, EXAMINING ATTORNEY

Int. Cl.: 3

Prior U.S. Cls.: 1, 4, 6, 50, 51 and 52

Reg. No. 3,476,595

United States Patent and Trademark Office

Registered July 29, 2008

**TRADEMARK
PRINCIPAL REGISTER**



BE ! PRODUCTS, INC. (ILLINOIS CORPORATION)
25 SUNSET LANE
MUNDELEIN, IL 60060

FOR: NAIL POLISH, NAIL LACQUER, CUTICLE OIL, BODY LOTION, SPRAY BODY LOTION, COSMETICS, SKIN CARE PRODUCTS, NAMELY, NON-MEDICATED SKIN SERUM, SKIN LOTION, SKIN MOISTURIZERS, NAIL GROOMING PRODUCTS, NAMELY, TIPS, GLUE, LACQUER, GLITTER, OILS, LOTIONS, NAIL TREATMENTS, NAMELY, NAIL STRENGTHENERS, PREPARATIONS TO REPAIR NAILS, PREPARATIONS TO CONDITION NAILS,

FACE AND BODY OILS, FACE AND BODY SOAPS, FACE AND BODY MOISTURIZERS, FOOT GEL, FOOT LOTION, FOOT CREAM, FOOT POWDER, BODY WASH, FOOT AND BODY SCRUB, BATH GEL, BATH CREAM, BATH OILS, AND MASSAGE OILS., IN CLASS 3 (U.S. CLS. 1, 4, 6, 50, 51 AND 52).

FIRST USE 1-6-2004; IN COMMERCE 1-6-2004.

SER. NO. 78-549,958, FILED 1-19-2005.

ANDREA BUTLER, EXAMINING ATTORNEY

Int. Cl.: 41

Prior U.S. Cls.: 100, 101 and 107

United States Patent and Trademark Office

Reg. No. 3,476,596

Registered July 29, 2008

**SERVICE MARK
PRINCIPAL REGISTER**

T5

TRIPLE FIVE VIII LLC (NEVADA LTD LIAB CO)
8882 170 STREET, SUITE 3000
EDMONTON, ALBERTA, CANADA T5T 4M2

FOR: PROVIDING FACILITIES FOR ENTERTAINMENT AND RECREATIONAL ACTIVITIES, IN CLASS 41 (U.S. CLS. 100, 101 AND 107).

THE MARK CONSISTS OF STANDARD CHARACTERS WITHOUT CLAIM TO ANY PARTICULAR FONT, STYLE, SIZE, OR COLOR.

PRIORITY CLAIMED UNDER SEC. 44(D) ON CANADA APPLICATION NO. 1243255, FILED 1-12-2005, REG. NO. TMA706436, DATED 2-4-2008, EXPIRES 2-4-2023.

SER. NO. 78-553,272, FILED 1-25-2005.

BARBARA RUTLAND, EXAMINING ATTORNEY

Int. Cl.: 14

Prior U.S. Cls.: 2, 27, 28 and 50

United States Patent and Trademark Office

Reg. No. 3,476,597

Registered July 29, 2008

**TRADEMARK
PRINCIPAL REGISTER**

NEWD

ALESSANDRO MASINI (ITALY INDIVIDUAL)
VIA GIACOMO ZANELLA 44
FLORENCE, ITALY 50124

THE MARK CONSISTS OF STANDARD CHAR-
ACTERS WITHOUT CLAIM TO ANY PARTICULAR
FONT, STYLE, SIZE, OR COLOR.

FOR: JEWELRY, IN CLASS 14 (U.S. CLS. 2, 27, 28
AND 50).

SER. NO. 78-557,931, FILED 2-1-2005.

FIRST USE 7-15-2005; IN COMMERCE 10-15-2005.

NANCY CLARKE, EXAMINING ATTORNEY

Int. Cls.: 6, 9 and 19

**Prior U.S. Cls.: 1, 2, 12, 13, 14, 21, 23, 25, 26, 33, 36, 38
and 50**

Reg. No. 3,476,598

United States Patent and Trademark Office

Registered July 29, 2008

**TRADEMARK
PRINCIPAL REGISTER**

COMPANION SYSTEMS

CSI ACQUISITION CORP. (UTAH CORPORATION)
645 WEST 200 NORTH
NORTH SALT LAKE, UT 84854

FOR: BUILDINGS FOR HOUSING DRIVE-UP AUTOMATED TELLER MACHINES; SURROUNDS FOR HOUSING AUTOMATED TELLER MACHINES, NAMELY, ENCLOSURES FOR USE WITH AUTOMATED TELLER MACHINES MOUNTED ON WALLS; E-BANKING KIOSKS; SELF SERVICE KIOSKS; ENCLOSURES FOR AUTOMATED TELLER MACHINES; TOPPERS AND ISLAND IDENTIFIERS FOR AUTOMATED TELLER MACHINES, NAMELY, NON-MECHANICAL, NON-LUMINOUS SIGNS; AUTOMATED TELLER MACHINE ACCESSORY ORGANIZERS, NAMELY, HOLDERS FOR DEPOSIT ENVELOPES, ALL MADE OF METAL, IN CLASS 6 (U.S. CLS. 2, 12, 13, 14, 23, 25 AND 50).

FIRST USE 1-1-1980; IN COMMERCE 1-1-1980.

FOR: AUTOMATED TELLER MACHINE TOPPERS AND ISLAND IDENTIFIERS, NAMELY, ILLUMINATED SIGNS AND BACKLIT SIGNS, IN CLASS 9 (U.S. CLS. 21, 23, 26, 36 AND 38).

FIRST USE 1-1-1980; IN COMMERCE 1-1-1980.

FOR: BUILDINGS FOR HOUSING DRIVE-UP AUTOMATED TELLER MACHINES, SURROUNDS

FOR HOUSING AUTOMATED TELLER MACHINES, NAMELY, ENCLOSURES FOR USE WITH ATMS MOUNTED ON WALLS; E-BANKING KIOSKS, SELF SERVICE KIOSKS; ENCLOSURES FOR AUTOMATED TELLER MACHINES; TOPPERS AND ISLAND IDENTIFIERS FOR AUTOMATED TELLER MACHINES, NAMELY, NON-MECHANICAL, NON-LUMINOUS SIGNS; AUTOMATED TELLER MACHINE ACCESSORY ORGANIZERS, NAMELY, HOLDERS FOR DEPOSIT ENVELOPES, ALL MADE OF NON-METAL, IN CLASS 19 (U.S. CLS. 1, 12, 33 AND 50).

FIRST USE 1-1-1980; IN COMMERCE 1-1-1980.

THE MARK CONSISTS OF STANDARD CHARACTERS WITHOUT CLAIM TO ANY PARTICULAR FONT, STYLE, SIZE, OR COLOR.

NO CLAIM IS MADE TO THE EXCLUSIVE RIGHT TO USE "SYSTEMS", APART FROM THE MARK AS SHOWN.

SEC. 2(F).

SER. NO. 78-573,263, FILED 2-23-2005.

ALEXANDER L. POWERS, EXAMINING ATTORNEY

Int. Cls.: 2, 6, 19, 24 and 41

**Prior U.S. Cls.: 1, 2, 6, 11, 12, 13, 14, 16, 23, 25, 33, 42,
50, 100, 101 and 107**

Reg. No. 3,476,599

United States Patent and Trademark Office

Registered July 29, 2008

**TRADEMARK
SERVICE MARK
PRINCIPAL REGISTER**

HESCO

HESCO BASTION LIMITED (UNITED KINGDOM CORPORATION)
UNIT 37, KNOWSTHORPE GATE CROSS GREEN INDUSTRIAL ESTATE
LEEDS, UNITED KINGDOM LS9 0NP

FOR: PAINTS, VARNISHES, LACQUERS, PRESERVATIVES AGAINST RUST AND AGAINST DETERIORATION; CAMOUFLAGE PAINTS, IN CLASS 2 (U.S. CLS. 6, 11 AND 16).

FIRST USE 0-0-1991; IN COMMERCE 0-0-1991.

FOR: METALLIC CAGES AND CONTAINERS FOR FORTIFICATION PURPOSES; METALLIC CAGES AND CONTAINERS FOR MILITARY FORTIFICATION PURPOSES; METAL CAGES AND CAGE-STRUCTURES, BASTIONS AND GABIONS PRIMARILY OF METAL; METAL BASTION DEFENSE WALLS AND COMPONENT PARTS THEREOF; METAL CAGES AND CONTAINERS FOR HOLDING PARTICULATE MATERIAL, NAMELY, SNOW, SAND, EARTH, MUD, STONES, BUILDING RUBBLE, OR CONCRETE USED FOR FORMING BARRIER OR DEFENSE WALLS; MULTI-COMPARTMENTAL METAL CAGES AND CONTAINERS FOR HOLDING PARTICULATE MATERIAL, NAMELY, SNOW, SAND, EARTH, MUD, STONES, BUILDING RUBBLE, OR CONCRETE USED FOR FORMING BARRIER OR DEFENSE WALLS; METALLIC CLIPS AND FASTENERS FOR INTERCONNECTING COMPONENT PARTS OF BASTION OR GABION STRUCTURES; COMPONENT PARTS OF ALL THE AFORESAID GOODS, IN CLASS 6 (U.S. CLS. 2, 12, 13, 14, 23, 25 AND 50).

FIRST USE 0-0-1991; IN COMMERCE 0-0-1991.

FOR: NON-METALLIC CAGES AND CONTAINERS FOR FORTIFICATION PURPOSES; NON-ME-

TALLIC CAGES AND CONTAINERS FOR MILITARY FORTIFICATION PURPOSES; NON-METALLIC CAGES AND CAGE-STRUCTURES; NON-METALLIC BASTIONS AND GABIONS; NON-METAL BASTION DEFENSE WALLS AND COMPONENT PARTS THEREOF; NON-METALLIC CAGES AND CONTAINERS FOR HOLDING PARTICULATE MATERIAL, NAMELY, SNOW, SAND, EARTH, MUD, STONES, BUILDING RUBBLE OR CONCRETE USED FOR FORMING BARRIER OR DEFENSE WALLS; MULTI-COMPARTMENTAL NON-METALLIC CAGES AND CONTAINERS FOR HOLDING PARTICULATE MATERIAL, NAMELY, SNOW, SAND, EARTH, MUD, STONES, BUILDING RUBBLE, OR CONCRETE USED FOR FORMING BARRIER OR DEFENSE WALLS; NON-METALLIC COMPONENT PARTS TO ALL THE AFORESAID GOODS, IN CLASS 19 (U.S. CLS. 1, 12, 33 AND 50).

FIRST USE 0-0-1991; IN COMMERCE 0-0-1991.

FOR: TEXTILES AND TEXTILE GOODS, NAMELY, TEXTILES AND TEXTILE GOODS FOR USE AS COVERINGS OR LININGS FOR BASTION DEFENSE WALLS AND COMPONENT PARTS THEREOF, FOR GABIONS, AND FOR PROTECTIVE STRUCTURES, IN CLASS 24 (U.S. CLS. 42 AND 50).

FIRST USE 0-0-1991; IN COMMERCE 0-0-1991.

FOR: TRAINING SERVICES, NAMELY, TRAINING OF PERSONNEL IN CONNECTION WITH THE ERECTION OF BASTIONS, GABIONS, BARRIER OR DEFENSE WALLS, TRAINING OF MILITARY PERSONNEL IN CONNECTION WITH THE ERECTION OF BASTIONS, GABIONS, BARRIER OR DEFENSE WALLS, IN CLASS 41 (U.S. CLS. 100, 101 AND 107).

FIRST USE 0-0-1991; IN COMMERCE 0-0-1991.

THE MARK CONSISTS OF STANDARD CHAR-
ACTERS WITHOUT CLAIM TO ANY PARTICULAR
FONT, STYLE, SIZE, OR COLOR.

SER. NO. 78-574,306, FILED 2-24-2005.

DOMINICK J. SALEMI, EXAMINING ATTORNEY

Int. Cl.: 3

Prior U.S. Cls.: 1, 4, 6, 50, 51 and 52

United States Patent and Trademark Office

Reg. No. 3,476,600

Registered July 29, 2008

**TRADEMARK
PRINCIPAL REGISTER**

**LA DOLFINA ADOLFO
CAMBIASO**

LA DOLFINA S.A. (ARGENTINA CORPORATION)
CERRITO 1266, FLOOR 6, OFFICE 26
CAPITAL FEDERAL, ARGENTINA

FOR: PRODUCTS FOR CLEANING IN THE FORM OF LIQUIDS, SOLIDS, PASTES AND GELS, NAMELY, SOAPS, DETERGENTS AND BLEACHES; PERFUMERY, COSMETICS AND NON-MEDICATED TOILETRIES, IN CLASS 3 (U.S. CLS. 1, 4, 6, 50, 51 AND 52).

THE MARK CONSISTS OF STANDARD CHARACTERS WITHOUT CLAIM TO ANY PARTICULAR FONT, STYLE, SIZE, OR COLOR.

PRIORITY CLAIMED UNDER SEC. 44(D) ON ARGENTINA APPLICATION NO. 2540833, FILED 9-10-2004, REG. NO. 2135220, DATED 1-3-2007, EXPIRES 1-3-2017.

THE NAME "ADOLFO CAMBIASO" IDENTIFIES A LIVING INDIVIDUAL WHOSE CONSENT IS OF RECORD

SER. NO. 78-583,568, FILED 3-9-2005.

CAROLYN CATALDO, EXAMINING ATTORNEY

Int. Cl.: 28

Prior U.S. Cls.: 22, 23, 38 and 50

United States Patent and Trademark Office

Reg. No. 3,476,601

Registered July 29, 2008

**TRADEMARK
PRINCIPAL REGISTER**

CYCLONE CHAMBER

MATTEL, INC. (DELAWARE CORPORATION)
M1-1518
333 CONTINENTAL BLVD.
EL SEGUNDO, CA 902455012

THE MARK CONSISTS OF STANDARD CHARACTERS WITHOUT CLAIM TO ANY PARTICULAR FONT, STYLE, SIZE, OR COLOR.

FOR: TOYS, GAMES AND PLAYTHINGS, NAME-
LY, TRACK SETS AND ACCESSORIES FOR TOY
VEHICLES, IN CLASS 28 (U.S. CLS. 22, 23, 38 AND 50).

SER. NO. 78-594,047, FILED 3-24-2005.

FIRST USE 8-3-2005; IN COMMERCE 8-3-2005.

TEJBIR SINGH, EXAMINING ATTORNEY

Int. Cl.: 40

Prior U.S. Cls.: 100, 103 and 106

United States Patent and Trademark Office

Reg. No. 3,476,602

Registered July 29, 2008

**SERVICE MARK
PRINCIPAL REGISTER**



INTERNATIONAL ENVIRONMENTAL MAN-
AGEMENT, INC. (GEORGIA CORPORATION)
SUITE 245
11660 ALPHARETTA HIGHWAY
ROSWELL, GA 30076

FIRST USE 7-0-2003; IN COMMERCE 7-0-2003.

SER. NO. 78-607,398, FILED 4-12-2005.

FOR: WASTE MANAGEMENT AND RECY-
CLING, IN CLASS 40 (U.S. CLS. 100, 103 AND 106).

JOHN GARTNER, EXAMINING ATTORNEY

Int. Cl.: 41

Prior U.S. Cls.: 100, 101 and 107

United States Patent and Trademark Office

Reg. No. 3,476,603

Registered July 29, 2008

**SERVICE MARK
PRINCIPAL REGISTER**

1986

ANGELINI, GIORGIO (UNITED STATES INDIVIDUAL)
405 E. 51ST STREET APT 5C
MANHATTAN, NY 10022

THE MARK CONSISTS OF STANDARD CHARACTERS WITHOUT CLAIM TO ANY PARTICULAR FONT, STYLE, SIZE, OR COLOR.

FOR: ENTERTAINMENT SERVICES, NAMELY, LIVE PERFORMANCES BY A MUSICAL BAND, IN CLASS 41 (U.S. CLS. 100, 101 AND 107).

SER. NO. 78-613,153, FILED S.R. 4-20-2005 AM. P.R. 10-5-2006.

FIRST USE 5-15-2004; IN COMMERCE 5-15-2004.

KEVIN DINALLO, EXAMINING ATTORNEY

Int. Cls.: 1, 5, 29, 30 and 32

Prior U.S. Cls.: 1, 5, 6, 10, 18, 26, 44, 45, 46, 48, 51 and 52

Reg. No. 3,476,604

United States Patent and Trademark Office

Registered July 29, 2008

**TRADEMARK
PRINCIPAL REGISTER**

CARDIABEAT

ENZYMOTEC LTD. (ISRAEL LTD LIAB CO)
RAMAT GAVRIEL INDUSTRIAL PARK
MIGDAL HAEMEQ, ISRAEL 23106

FOR: LIPID STRUCTURES FOR USE IN THE MANUFACTURING OF DIETARY SUPPLEMENTS, FOODS, NAMELY, MILK AND DAIRY PRODUCTS, FATS AND OILS, BEVERAGES AND BEVERAGE BASES, BAKED GOODS, GRAIN PRODUCTS AND PASTAS, SNACK FOODS, SOUPS AND SOUP MIXES, CANDY, GRAVIES AND SAUCES, NUTRACEUTICALS, FOOD PRODUCTS AND BEVERAGES, PHARMACEUTICAL AND VETERINARY PREPARATIONS, EDIBLE OILS, EDIBLE FATS, FLOUR, AND NON-ALCOHOLIC DRINKS THAT LOWER OXIDATIVE STRESS AND/OR CHOLESTEROL AND/OR TRIGLYCERIDES IN BLOOD, IN CLASS 1 (U.S. CLS. 1, 5, 6, 10, 26 AND 46).

FOR: LIPID STRUCTURES THAT LOWER OXIDATIVE STRESS AND/OR CHOLESTEROL AND/OR TRIGLYCERIDES IN BLOOD FOR USE IN MANUFACTURING PHARMACEUTICAL AND VETERINARY PREPARATIONS; DIETETIC FOODS ADAPTED FOR MEDICAL USE; NUTRITIONAL ADDITIVES FOR USE IN FOODS FOR HUMAN CONSUMPTION; FOOD FOR BABIES, IN CLASS 5 (U.S. CLS. 6, 18, 44, 46, 51 AND 52).

FOR: EDIBLE OILS AND FATS; MILK AND MILK PRODUCTS, NAMELY MILK BEVERAGES CONTAINING FRUITS, BUTTERS, CREAM, YOGURT, CHEESE AND MILK DRINKS WITH FRUITS AND/OR VEGETABLES JUICE; CANNED FOOD, NAMELY COOKED MEAT, FRUIT, VEGETABLES, FRUIT IN THE FORM OF POWDER AND GRANULES, VEGETABLES IN THE FORM OF POWDER AND GRANULES, ALL CONTAINING ACTIVE LIPIDS THAT LOWER OXIDATIVE STRESS AND/OR CHOLESTEROL AND/OR TRIGLYCERIDES IN BLOOD, IN CLASS 29 (U.S. CL. 46).

FOR: FLOUR AND PREPARATIONS MADE FROM CEREALS, NAMELY, CEREAL BASED SNACK FOODS, BREAKFAST CEREALS, PROCESSED CEREALS, BREADS, PASTRY AND CONFECTIONERY, NAMELY, FLAVORED ICES; SALAD SAUCES; CONDIMENTS, NAMELY KETCHUP, RELISH, MAYONNAISE, MUSTARD, MILK PRODUCTS, NAMELY, ICE CREAM, MILK SHAKES AND FROZEN YOGURT, ICED TEAS, ALL CONTAINING ACTIVE LIPIDS THAT LOWER OXIDATIVE STRESS AND/OR CHOLESTEROL AND/OR TRIGLYCERIDES IN BLOOD; FOOD ADDITIVES FOR NON-NUTRITIONAL PURPOSES FOR USE AS A FLAVORING, IN CLASS 30 (U.S. CL. 46).

FOR: NON-ALCOHOLIC DRINKS, NAMELY, FRUIT DRINKS AND FRUIT JUICES; SYRUPS AND PREPARATIONS FOR MAKING NON-ALCOHOLIC CARBONATED BEVERAGES, NON-ALCOHOLIC NON-CARBONATED BEVERAGES, ALCOHOLIC NON-CARBONATED BEVERAGES, AND ALCOHOLIC CARBONATED BEVERAGES, NAMELY, FRUIT JUICES; NON-ALCOHOLIC FRUIT AND VEGETABLE EXTRACTS USED IN THE PREPARATION OF BEVERAGES; COLA EXTRACT IN THE NATURE OF SYRUP FOR MAKING BEVERAGES, ISOTONIC BEVERAGES, LEMONADES, BEVERAGE MIXERS, NAMELY, FRUIT DRINK MIXES AND VEGETABLE DRINK MIXES, IN CLASS 32 (U.S. CLS. 45, 46 AND 48).

THE MARK CONSISTS OF STANDARD CHARACTERS WITHOUT CLAIM TO ANY PARTICULAR FONT, STYLE, SIZE, OR COLOR.

PRIORITY CLAIMED UNDER SEC. 44(D) ON ISRAEL APPLICATION NO. 176696, FILED 12-5-2004, REG. NO. 176696, DATED 4-5-2006, EXPIRES 12-5-2011.

PRIORITY CLAIMED UNDER SEC. 44(D) ON ISRAEL APPLICATION NO. 176695, FILED 12-5-2004, REG. NO. 176695, DATED 5-7-2006, EXPIRES 12-5-2011.

PRIORITY CLAIMED UNDER SEC. 44(D) ON ISRAEL APPLICATION NO. 176694, FILED 12-5-2004, REG. NO. 176694, DATED 3-6-2006, EXPIRES 12-5-2011.

PRIORITY CLAIMED UNDER SEC. 44(D) ON ISRAEL APPLICATION NO. 176693, FILED 12-5-

2004, REG. NO. 176693, DATED 2-8-2006, EXPIRES 12-5-2011.

PRIORITY CLAIMED UNDER SEC. 44(D) ON ISRAEL APPLICATION NO. 176692, FILED 12-5-2004, REG. NO. 176692, DATED 2-8-2006, EXPIRES 12-5-2011.

SER. NO. 78-625,259, FILED 5-9-2005.

ALEX KEAM, EXAMINING ATTORNEY

Int. Cls.: 9, 16, 25, 35, 41 and 42

**Prior U.S. Cls.: 2, 5, 21, 22, 23, 26, 29, 36, 37, 38, 39,
50, 100, 101, 102 and 107**

Reg. No. 3,476,605

United States Patent and Trademark Office

Registered July 29, 2008

**TRADEMARK
SERVICE MARK
PRINCIPAL REGISTER**

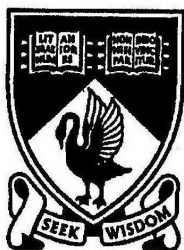

**THE UNIVERSITY OF
WESTERN AUSTRALIA**

UNIVERSITY OF WESTERN AUSTRALIA (AUSTRALIA CORPORATION)
35 STIRLING HIGHWAY
CRAWLEY WA, AUSTRALIA 6009

RIVERS, LEARN MUSIC, AND GRAPHICAL USER INTERFACES FOR USE WITH OTHER SOFTWARE; CALCULATING MACHINES, IN CLASS 9 (U.S. CLS. 21, 23, 26, 36 AND 38).

FOR: BLANK SOUND AND VIDEO MEDIA, NAMELY, BLANK DISKETTES, BLANK OPTICAL DISKS, BLANK AUDIO AND VIDEO TAPES, BLANK COMPACT DISCS, AND BLANK DIGITAL VIDEO DISKS OR DIGITAL VERSATILE DISKS; PRE-RECORDED SOUND AND VIDEO MEDIA CONSISTING OF PRERECORDED AUDIO TAPES, COMPACT DISKS AND VIDEO DISKS FEATURING MUSIC AND EDUCATIONAL MATERIAL IN THE FIELDS OF ANATOMY, BIOMECHANICS, CHEMISTRY, ART, PLANT AND BODY TISSUES, DRUG EDUCATION, BREAST PHYSIOLOGY AND EXPRESSION, AND WESTERN AUSTRALIA INFORMATION AND COMPUTER SOFTWARE TO RECORD LECTURES, TO AID IN MANAGEMENT OF AQUATIC SYSTEMS, INVESTIGATE CHEMICAL VARIABLES IN WATER BODIES, STUDY RIVERS, LEARN MUSIC, AND GRAPHICAL USER INTERFACES FOR USE WITH OTHER SOFTWARE; APPARATUS AND INSTRUMENTS FOR RECORDING AND REPRODUCING SOUND AND VIDEO; COMPUTER HARDWARE AND COMPUTER SOFTWARE FOR EDUCATIONAL, TRAINING, ENGINEERING AND SCIENTIFIC PURPOSES, NAMELY, TO RECORD LECTURES, AID IN MANAGEMENT OF AQUATIC SYSTEMS, INVESTIGATE CHEMICAL VARIABLES IN WATER BODIES, STUDY

FOR: PAPER AND CARDBOARD GOODS, NAMELY, STATIONERY CONSISTING OF BOOK-BINDING MATERIALS, PHOTOGRAPHS, ENVELOPES, CALENDARS, FOLDERS, GREETING CARDS, POSTCARDS, POSTERS, DRAWING RULERS, DIARIES AND NOTEPADS, TABLEMATS AND COASTERS MADE OF PAPER AND CARDBOARD; GENERAL PURPOSE PAPER AND PLASTIC BAGS; ADHESIVE MATERIALS, NAMELY, STICKERS AND TRANSFERS; FOUNTAIN PENS, PENS AND PENCILS; PRINTED MATTER, NAMELY, NEWSPAPERS AND MAGAZINES FEATURING FACULTY RESEARCH INFORMATION AND INFORMATION ABOUT THE PEOPLE AND VARIOUS ACTIVITIES OF THE UNIVERSITY OF WESTERN AUSTRALIA; PERIODICALS IN THE FIELD OF ARCHITECTURE, VISUAL ARTS, COMPUTING, PHYSICS, MEDICINE, DENTISTRY, GEOGRAPHY, MATHEMATICS, LAW, ENGLISH, EDUCATION, ANTHROPOLOGY, TEACHING AND LEARNING, HUMANITIES, ENGINEERING, ECONOMICS, BIOLOGY, AGRICULTURE, MUSIC; BOOKS, NAMELY, EDUCATIONAL BOOKS FEATURING COLLEGE AND POST-GRADUATE LEVEL COURSES, NAMELY, MATHEMATICS AND ENGLISH; MANUALS RELATING TO COMPUTER HARDWARE AND COMPUTER SOFTWARE FOR EDU-

CATIONAL, TRAINING, ENGINEERING AND SCIENTIFIC PURPOSES, IN CLASS 16 (U.S. CLS. 2, 5, 22, 23, 29, 37, 38 AND 50).

FOR: CLOTHING, NAMELY, T-SHIRTS, PANTS, SWEATSHIRTS, SWEATPANTS, SOCKS, JACKETS, SWEAT JACKETS, WARM-UP SUITS, SHORTS, SLEEPWEAR, RAINWEAR AND SWEATERS, FOOTWEAR AND HEADWEAR, IN CLASS 25 (U.S. CLS. 22 AND 39).

FOR: BUSINESS MANAGEMENT OF ENTERTAINMENT, NAMELY, THEATRE PRODUCTIONS AND CINEMA THEATRES; BUSINESS MANAGEMENT REGARDING THEATRE AND CINEMA ENTERTAINMENT; PROMOTING SPORTING AND CULTURAL ACTIVITIES OF FILMS, DRAMA, MUSIC OR THE VISUAL ARTS OF OTHERS, IN CLASS 35 (U.S. CLS. 100, 101 AND 102).

FOR: VOCATIONAL GUIDANCE; PUBLISHING SERVICES, NAMELY, PUBLICATION OF TEXTS; PRODUCTION OF RADIO AND TELEVISION PROGRAMS; COMMUNITY EDUCATION, NAMELY, PROVIDING CLASSES, SEMINARS AND WORKSHOPS IN THE FIELD OF THEATRE PRODUCTION AND ENTERTAINMENT; EDUCATIONAL SERVICES, NAMELY, PROVIDING COURSES OF INSTRUCTION AT THE COLLEGE AND POST-GRADUATE LEVEL; PROVIDING SERVICES OF AN EDUCATIONAL ORGANIZATION, NAMELY, COURSES OF INSTRUCTION AT THE COLLEGE AND POST-GRADUATE LEVEL; PROVIDING FACILITIES FOR STUDY, EDUCATION, TEACHING, INSTRUCTION AND TRAINING, NAMELY, ARRANGING AND CONDUCTING COLLOQUIUMS, CONFERENCES, CONGRESSES, SEMINARS AND SYMPOSIA, ALL BEING FACILITIES PROVIDED BY A UNIVERSITY; PRODUCTION OF VIDEO, AUDIO AND AUDIOVISUAL AIDS AND MATERIALS, NAMELY, MICROFILMS, VIDEOTAPES,

AUDIO TAPES, COMPACT DISKS AND DIGITAL VIDEO DISKS; DISTANCE EDUCATION VIA COMPUTER-BASED NETWORKS, NAMELY, CONDUCTING DISTANCE LEARNING INSTRUCTION AT THE SECONDARY, COLLEGE AND GRADUATE LEVELS; LIBRARY SERVICES; PROFESSIONAL EDUCATIONAL CONSULTANCY SERVICES IN THE FIELD OF COLLEGE AND POST-GRADUATE LEVEL CLASSES AND COURSEWORK AS PROVIDED BY AN EDUCATIONAL ORGANIZATION, IN CLASS 41 (U.S. CLS. 100, 101 AND 107).

FOR: RESEARCH IN THE FIELD OF ARCHITECTURE, LANDSCAPE, VISUAL ARTS, ARTS, HUMANITIES, SOCIAL SCIENCES, ECONOMICS, ENGINEERING, COMPUTING, MATHEMATICS, LAW, PHYSICS, AGRICULTURE, MEDICINE, DENTISTRY, GEOGRAPHY, BIOLOGY, INDIGENOUS STUDIES, HEALTH SCIENCES, MUSIC, AND CHEMISTRY; ANALYTICAL AND TESTING SERVICES, NAMELY, MATERIALS TESTING AND EVALUATION AND CHEMICAL, BIOCHEMICAL, BIOLOGICAL AND BACTERIOLOGICAL RESEARCH AND ANALYSIS; LABORATORY ANALYSIS AND INDEPENDENT TESTING SERVICES, NAMELY, PROVIDING MATERIAL TESTING AND CHEMICAL ANALYSIS FOR OTHERS, IN CLASS 42 (U.S. CLS. 100 AND 101).

OWNER OF AUSTRALIA REG. NO. 799708, DATED 7-8-1999, EXPIRES 7-8-2009.

NO CLAIM IS MADE TO THE EXCLUSIVE RIGHT TO USE "THE UNIVERSITY OF WESTERN AUSTRALIA", APART FROM THE MARK AS SHOWN.

SER. NO. 78-643,700, FILED 6-3-2005.

CHERYL CLAYTON, EXAMINING ATTORNEY

Int. Cl.: 42

Prior U.S. Cls.: 100 and 101

United States Patent and Trademark Office

Reg. No. 3,476,606

Registered July 29, 2008

**SERVICE MARK
PRINCIPAL REGISTER**

SOUL OF THE ULTIMATE NATION

WEBZEN, INC. (REPUBLIC OF KOREA CORPORATION)
6TH FL., DAELIM ACROTEL
467-6 DOGOK-DONG, GANGNAM-GU
SEOUL, REPUBLIC OF KOREA

FOR: CREATING AND MAINTAINING WEB SITES FOR OTHERS, CONVERSION OF DATA OR DOCUMENTS FROM PHYSICAL TO ELECTRONIC MEDIA, INSTALLATION OF COMPUTER SOFTWARE, RENTAL OF COMPUTER PROGRAMS, UPDATING OF COMPUTER SOFTWARE, MAINTENANCE OF COMPUTER SOFTWARE, COMPUTER SOFTWARE DESIGN FOR OTHERS, COMPUTER PROGRAMMING FOR OTHERS, RE-

COVERY OF COMPUTER DATA, DATA CONVERSION OF COMPUTER PROGRAMS AND DATA, IN CLASS 42 (U.S. CLS. 100 AND 101).

THE MARK CONSISTS OF STANDARD CHARACTERS WITHOUT CLAIM TO ANY PARTICULAR FONT, STYLE, SIZE, OR COLOR.

OWNER OF REPUBLIC OF KOREA REG. NO. 0127194, DATED 2-2-2006, EXPIRES 2-2-2016.

SER. NO. 78-648,296, FILED 6-10-2005.

KELLEY WELLS, EXAMINING ATTORNEY

Int. Cl.: 42

Prior U.S. Cls.: 100 and 101

United States Patent and Trademark Office

Reg. No. 3,476,607

Registered July 29, 2008

**SERVICE MARK
PRINCIPAL REGISTER**



RMSI PRIVATE LIMITED (INDIA CORPORATION)
A-7 SECTOR 16
NOIDA, INDIA 201 301

FOR: GEOSPATIAL DATA AND SOFTWARE SERVICES, NAMELY, DATABASE DEVELOPMENT AND UPDATING, GEOCODING MAPPING, IMAGE PROCESSING SOFTWARE DESIGN, REMOTE SENSING MAPPING, SOFTWARE DEVELOPMENT, AND COMPUTER SOFTWARE CONSULTATION, IN CLASS 42 (U.S. CLS. 100 AND 101).

FIRST USE 10-1-2000; IN COMMERCE 10-1-2000.

THE MARK CONSISTS OF A SERIES OF STRIPES IN A CIRCULAR SHAPE, WITH AN ARROW EXTENDING OFF THE UPPER, RIGHT HAND EDGE OF THE CIRCLE.

SER. NO. 78-652,954, FILED 6-17-2005.

COLLEEN DOMBROW, EXAMINING ATTORNEY

Int. Cl.: 42

Prior U.S. Cls.: 100 and 101

United States Patent and Trademark Office

Reg. No. 3,476,608

Registered July 29, 2008

**SERVICE MARK
PRINCIPAL REGISTER**



RMSI PRIVATE LIMITED (INDIA CORPORATION)
A-7 SECTOR 16
NOIDA, INDIA 201 301

FOR: GEOSPATIAL DATA AND SOFTWARE SERVICES, NAMELY, DATABASE DEVELOPMENT AND UPDATING, GEOCODING MAPPING, IMAGE PROCESSING SOFTWARE DESIGN, REMOTE SENSING MAPPING, SOFTWARE DEVELOPMENT, AND COMPUTER SOFTWARE CONSULTATION, IN CLASS 42 (U.S. CLS. 100 AND 101).

FIRST USE 10-1-2000; IN COMMERCE 10-1-2000.

THE MARK CONSISTS OF THE LETTERS "RMSI" CONTAINED WITHIN A RECTANGULAR BORDER, WITH A DESIGN CONSISTING OF CONCENTRIC STRIPES IN A SPHERICAL PATTERN WITH AN ARROW POINTING OFF THE UPPER RIGHT OF SAID SPHERE.

SER. NO. 78-652,974, FILED 6-17-2005.

COLLEEN DOMBROW, EXAMINING ATTORNEY

Int. Cl.: 42

Prior U.S. Cls.: 100 and 101

United States Patent and Trademark Office

Reg. No. 3,476,609

Registered July 29, 2008

**SERVICE MARK
PRINCIPAL REGISTER**



Delivering a world of solutions

RMSI PRIVATE LIMITED (INDIA CORPORATION)
A-7 SECTOR
NOIDA, INDIA 201 301

FOR: GEOSPATIAL DATA AND SOFTWARE SERVICES, NAMELY, DATABASE DEVELOPMENT AND UPDATING, GEOCODING MAPPING, IMAGE PROCESSING SOFTWARE DESIGN, REMOTE SENSING MAPPING, SOFTWARE DEVELOPMENT, AND COMPUTER SOFTWARE CONSULTATION, IN CLASS 42 (U.S. CLS. 100 AND 101).

FIRST USE 10-1-2000; IN COMMERCE 10-1-2000.

THE MARK CONSISTS OF THE LETTERS "RMSI", CONTAINED WITHIN A RECTANGULAR BORDER, FOLLOWED BY A SERIES OF PARALLEL LINES CREATING A SPHERICAL SHAPE TO THE RIGHT OF THE TEXT "RMSI", WITH AN ARROW FOLLOWING OFF THE TOP RIGHT SIDE OF THE SPHERE. THE PHRASE "DELIVERING A WORLD OF SOLUTIONS" APPEARS BELOW THE TEXT "RMSI" AND SPHERE.

SER. NO. 78-652,997, FILED 6-17-2005.

COLLEEN DOMBROW, EXAMINING ATTORNEY

Int. Cl.: 28

Prior U.S. Cls.: 22, 23, 38 and 50

Reg. No. 3,476,610

United States Patent and Trademark Office

Registered July 29, 2008

**TRADEMARK
PRINCIPAL REGISTER**



HIPGRIPS JOANNE GIUDICELLI, USA & CARYL
PARKER, USA PARTNERSHIP CALIFORNIA
(CALIFORNIA PARTNERSHIP)
713 BAYVIEW WAY
EMERALD HILLS, CA 94062

GOLF GLOVES; WEIGHT LIFTING GLOVES , IN
CLASS 28 (U.S. CLS. 22, 23, 38 AND 50).

FIRST USE 3-1-2004; IN COMMERCE 3-1-2004.

SER. NO. 78-659,698, FILED 6-28-2005.

FOR: RACQUET GRIPS; RACQUET OVERGRIPS
IN THE NATURE OF GRIP TAPE FOR RACQUETS;

ELLEN PERKINS, EXAMINING ATTORNEY

Int. Cl.: 9

Prior U.S. Cls.: 21, 23, 26, 36 and 38

Reg. No. 3,476,611

United States Patent and Trademark Office

Registered July 29, 2008

**TRADEMARK
PRINCIPAL REGISTER**

WORKWARE

INDUSTRIAL SERVICE TECHNOLOGY, INC.
(MICHIGAN CORPORATION)
3286 KENTLAND COURT SE
GRAND RAPIDS, MI 49548

THE MARK CONSISTS OF STANDARD CHAR-
ACTERS WITHOUT CLAIM TO ANY PARTICULAR
FONT, STYLE, SIZE, OR COLOR.

FOR: WORKOUT MANAGEMENT SOFTWARE
USED WITH AQUATIC SPORTS, IN CLASS 9 (U.S.
CLS. 21, 23, 26, 36 AND 38).

SER. NO. 78-672,613, FILED 7-18-2005.

FIRST USE 8-26-2002; IN COMMERCE 8-26-2002.

SHAUNIA CARLYLE, EXAMINING ATTORNEY

Int. Cl.: 33

Prior U.S. Cls.: 47 and 49

United States Patent and Trademark Office

Reg. No. 3,476,612

Registered July 29, 2008

**TRADEMARK
PRINCIPAL REGISTER**

SEAGRAM'S PLATINUM SELECT
VODKA

PERNOD RICARD USA, LLC (INDIANA LTD
LIAB CO)
ATTN: ADAM TRACY, ESQ.
777 WESTCHESTER AVENUE
WHITE PLAINS, NY 10604

FOR: POTABLE DISTILLED SPIRITS, IN CLASS 33
(U.S. CLS. 47 AND 49).

FIRST USE 4-0-2003; IN COMMERCE 4-0-2003.

THE MARK CONSISTS OF STANDARD CHAR-
ACTERS WITHOUT CLAIM TO ANY PARTICULAR
FONT, STYLE, SIZE, OR COLOR.

NO CLAIM IS MADE TO THE EXCLUSIVE
RIGHT TO USE "SELECT VODKA", APART FROM
THE MARK AS SHOWN.

SER. NO. 78-678,251, FILED 7-26-2005.

ROBIN CHOSID, EXAMINING ATTORNEY

Int. Cls.: 41 and 43

Prior U.S. Cls.: 100, 101 and 107

United States Patent and Trademark Office

Reg. No. 3,476,613

Registered July 29, 2008

**SERVICE MARK
PRINCIPAL REGISTER**

VIXEN'S DEN

ELGIN RIVERBOAT RESORT (ILLINOIS JOINT
VENTURE)
250 SOUTH GROVE AVENUE
ELGIN, IL 60120

FOR: NIGHTCLUB ENTERTAINMENT SERVICES, IN CLASS 41 (U.S. CLS. 100, 101 AND 107).

FIRST USE 4-1-2005; IN COMMERCE 4-1-2005.

FOR: RESTAURANT, BAR AND LOUNGE SERVICES, IN CLASS 43 (U.S. CLS. 100 AND 101).

FIRST USE 4-1-2005; IN COMMERCE 4-1-2005.

THE MARK CONSISTS OF STANDARD CHARACTERS WITHOUT CLAIM TO ANY PARTICULAR FONT, STYLE, SIZE, OR COLOR.

SER. NO. 78-680,988, FILED 7-28-2005.

MATTHEW PAPPAS, EXAMINING ATTORNEY

Int. Cls.: 9 and 42

Prior U.S. Cls.: 21, 23, 26, 36, 38, 100 and 101

United States Patent and Trademark Office

Reg. No. 3,476,614

Registered July 29, 2008

**TRADEMARK
SERVICE MARK
PRINCIPAL REGISTER**



EPAM ACQUISITION II, INC. (DELAWARE CORPORATION)
989 LENOX DRIVE
SUITE 305
LAWRENCEVILLE, NJ 08648

FOR: COMMUNICATIONS SOFTWARE FOR CONNECTING FINANCIAL INSTITUTIONS; COMPUTER COMMUNICATIONS SOFTWARE TO ALLOW CUSTOMERS TO ACCESS BANK ACCOUNT INFORMATION AND TRANSACT BANK BUSINESS; COMPUTER E-COMMERCE SOFTWARE TO ALLOW USERS TO PERFORM ELECTRONIC BUSINESS TRANSACTIONS VIA A GLOBAL COMPUTER NETWORK; COMPUTER SOFTWARE DEVELOPMENT TOOLS; COMPUTER SOFTWARE FOR ADMINISTRATION OF COMPUTER LOCAL AREA NETWORKS; COMPUTER SOFTWARE FOR APPLICATION AND DATABASE INTEGRATION, IN CLASS 9 (U.S. CLS. 21, 23, 26, 36 AND 38).

FIRST USE 2-1-2000; IN COMMERCE 2-1-2000.

FOR: COMPUTER SOFTWARE DEVELOPMENT SERVICES FOR OTHERS; CONSULTING SERVICES

IN THE FIELDS OF INFORMATION TECHNOLOGY AND COMPUTER SOFTWARE INTEGRATION, IN CLASS 42 (U.S. CLS. 100 AND 101).

FIRST USE 2-2-2000; IN COMMERCE 2-2-2000.

THE COLOR(S) BLUE, WHITE AND GRAY IS/ARE CLAIMED AS A FEATURE OF THE MARK.

THE MARK CONSISTS OF A GEOMETRICAL-LIKE FIGURE SHAPED LIKE A SQUARE WITH ROUNDED EDGES, EQUALLY DIVIDED BY A WHITE CURVY LINE, WHERE ONE HALF OF THE FIGURE IS BLUE, THE OTHER HALF IS GREY, AND THE WORDING "B2BITS" WITH THE NUMBER "2" IN A SLIGHTLY SMALLER FONT THAN THE OTHER LETTERS, WHERE FIRST LETTER "B" AND NUMBER "2" ARE BLUE AND THE REST OF THE LETTERS, "BITS" ARE GREY.

SER. NO. 78-685,666, FILED 8-4-2005.

SUE LAWRENCE, EXAMINING ATTORNEY

Int. Cl.: 5

Prior U.S. Cls.: 6, 18, 44, 46, 51 and 52

Reg. No. 3,476,615

United States Patent and Trademark Office

Registered July 29, 2008

**TRADEMARK
PRINCIPAL REGISTER**

MORNING START

MXM ESSENTIALS, INC. (DELAWARE CORPORATION)
9543 S. 213TH STREET
KENT, WA 98031

FOR: DIETARY FOOD SUPPLEMENTS; DIETARY SUPPLEMENTAL DRINKS; DIETARY SUPPLEMENTS; FOOD SUPPLEMENTS; MINERAL NUTRITIONAL SUPPLEMENTS; NUTRITIONAL DRINK MIX FOR USE AS A MEAL REPLACEMENT; NUTRITIONAL SUPPLEMENTS; POWDERED NUTRITIONAL SUPPLEMENT DRINK

MIX; VITAMIN SUPPLEMENTS; VITAMINS, IN CLASS 5 (U.S. CLS. 6, 18, 44, 46, 51 AND 52).

FIRST USE 2-11-1992; IN COMMERCE 3-2-1992.

THE MARK CONSISTS OF STANDARD CHARACTERS WITHOUT CLAIM TO ANY PARTICULAR FONT, STYLE, SIZE, OR COLOR.

SER. NO. 78-693,961, FILED 8-16-2005.

ALICIA COLLINS, EXAMINING ATTORNEY

Int. Cl.: 9

Prior U.S. Cls.: 21, 23, 26, 36 and 38

Reg. No. 3,476,616

United States Patent and Trademark Office

Registered July 29, 2008

**TRADEMARK
PRINCIPAL REGISTER**

IPODCAST

APPLE INC. (CALIFORNIA CORPORATION)
1 INFINITE LOOP
CUPERTINO, CA 95014

FOR: COMPUTERS, COMPUTER PERIPHERALS, HAND HELD COMPUTERS, COMPUTER TERMINALS, PERSONAL DIGITAL ASSISTANTS, ELECTRONIC ORGANIZERS, ELECTRONIC NOTEPADS, APPARATUS FOR RECORDING, TRANSMISSION AND REPRODUCTION OF SOUNDS, IMAGES, OR OTHER DATA; BLANK MAGNETIC DATA CARRIERS; TELEPHONES, MICROPROCESSORS, MEMORY BOARDS, COMPUTER AND VIDEO MONITORS, LIQUID CRYSTAL DISPLAYS, KEYBOARDS, ELECTRICAL CABLES, MODEMS, PRINTERS, VIDEOPHONES, DIGITAL DISK DRIVES, CAMERAS; COMPUTER SOFTWARE AND PRERECORDED COMPUTER PROGRAMS FOR PERSONAL INFORMATION MANAGEMENT, DATABASE MANAGEMENT SOFTWARE, TELEPHONY MANAGEMENT SOFTWARE, ELECTRONIC MAIL AND MESSAGING SOFTWARE, PAGING SOFTWARE, DATABASE SYNCHRONIZATION SOFTWARE, COMPUTER PROGRAMS FOR ACCESSING, BROWSING AND SEARCHING ONLINE DATABASES, COMPUTER SOFTWARE AND FIRMWARE FOR OPERATING SYSTEM PROGRAMS, DATA SYNCHRONIZATION PROGRAMS, AND APPLICATION DEVELOPMENT TOOL PROGRAMS; ELECTRONIC HANDHELD DEVICES FOR THE WIRELESS RECEIPT, STORAGE AND TRANSMISSION OF DATA, MESSAGES, AND DEVICES FOR KEEPING TRACK OF OR MANAGING PERSONAL INFORMATION; SOFTWARE FOR THE REDIRECTION OF MESSAGES, INTERNET ELECTRONIC MAIL, AND DATA TO ONE OR MORE ELECTRONIC HANDHELD DEVICES ON OR ASSOCIATED WITH A PERSONAL

COMPUTER OR A SERVER; AND SOFTWARE FOR THE SYNCHRONIZATION OF DATA BETWEEN A REMOTE STATION OR DEVICE AND A FIXED OR REMOTE STATION OR DEVICE; COMPUTER HARDWARE; ANSWERING MACHINES, TELEPHONE-BASED INFORMATION RETRIEVAL SOFTWARE AND HARDWARE; ADAPTERS, ADAPTER CARDS, CONNECTORS AND COMPUTER HARD DRIVES; BLANK RANDOM ACCESS ELECTRONIC MEMORY, READ ONLY ELECTRONIC MEMORY; SOLID STATE ELECTRONIC MEMORY; USER MANUALS IN ELECTRONICALLY READABLE, MACHINE READABLE OR COMPUTER READABLE FORM FOR USE WITH, AND SOLD AS A UNIT WITH, ALL THE AFOREMENTIONED GOODS, IN CLASS 9 (U.S. CLS. 21, 23, 26, 36 AND 38).

THE MARK CONSISTS OF STANDARD CHARACTERS WITHOUT CLAIM TO ANY PARTICULAR FONT, STYLE, SIZE, OR COLOR.

PRIORITY CLAIMED UNDER SEC. 44(D) ON HONG KONG APPLICATION NO. 300390375, FILED 3-22-2005, REG. NO. 300390375, DATED 7-28-2005, EXPIRES 3-28-2015.

PRIORITY CLAIMED UNDER SEC. 44(D) ON HONG KONG APPLICATION NO. 300390375, FILED 3-22-2005, REG. NO. 300390375, DATED 7-28-2005, EXPIRES 3-21-2015.

OWNER OF U.S. REG. NOS. 2,781,793 AND 2,835,698.

SER. NO. 78-706,741, FILED 9-4-2005.

CAROLINE WOOD, EXAMINING ATTORNEY

Int. Cl.: 38

Prior U.S. Cls.: 100, 101 and 104

United States Patent and Trademark Office

Reg. No. 3,476,617

Registered July 29, 2008

**SERVICE MARK
PRINCIPAL REGISTER**

IPODCAST

APPLE INC. (CALIFORNIA CORPORATION)
1 INFINITE LOOP
CUPERTINO, CA 95014

FOR: TELECOMMUNICATION ACCESS SERVICES; COMMUNICATION BY COMPUTER; TRANSMISSION OF DATA AND OF INFORMATION BY ELECTRONIC MEANS, BROADCASTING OR TRANSMISSION OF RADIO AND TELEVISION PROGRAMS; PROVISION OF TELECOMMUNICATIONS CONNECTIONS TO COMPUTER DATABASES AND THE INTERNET; ELECTRONIC TRANSMISSION OF STREAMED AND DOWNLOADABLE AUDIO AND VIDEO FILES VIA COMPUTER AND OTHER COMMUNICATIONS NETWORKS; WEB CASTING SERVICES; DELIVERY OF MESSAGES BY ELECTRONIC TRANSMISSION; PROVISION OF TELECOMMUNICATIONS CONNECTIONS TO ELECTRONIC COMMUNICATIONS NETWORKS, FOR TRANSMISSION OR RECEPTION OF AUDIO, VIDEO OR MULTIMEDIA CONTENT; STREAMING OF VIDEO CONTENT, STREAMING AND SUBSCRIPTION AUDIO BROADCASTING OF SPOKEN WORD, MUSIC, CONCERTS, AND RADIO PROGRAMS, BROADCASTING PRERECORDED VIDEOS FEATURING MUSIC AND ENTERTAINMENT, TELEVISION PROGRAMS, MOTION PICTURES, NEWS, SPORTS, GAMES, CULTURAL EVENTS, AND ENTERTAINMENT-RELATED PROGRAMS OF ALL KINDS, VIA COMPUTER AND OTHER COMMUNICATIONS NETWORKS; PROVIDING ON-LINE BULLETIN

BOARDS FOR THE TRANSMISSION OF MESSAGES AMONG COMPUTER USERS CONCERNING ENTERTAINMENT IN THE NATURE OF MUSIC, CONCERTS, VIDEOS, RADIO, TELEVISION, FILM, NEWS, SPORTS, GAMES AND CULTURAL EVENTS; COMMUNICATION SERVICES NAMELY, MATCHING USERS FOR THE TRANSFER OF MUSIC, VIDEO AND AUDIO RECORDINGS VIA COMMUNICATION NETWORKS PROVISION OF INFORMATION, CONSULTANCY AND ADVISORY SERVICES FOR ALL THE AFORESAID SERVICES, IN CLASS 38 (U.S. CLS. 100, 101 AND 104).

THE MARK CONSISTS OF STANDARD CHARACTERS WITHOUT CLAIM TO ANY PARTICULAR FONT, STYLE, SIZE, OR COLOR.

PRIORITY CLAIMED UNDER SEC. 44(D) ON HONG KONG APPLICATION NO. 300390375, FILED 3-22-2005, REG. NO. 300390375, DATED 7-28-2005, EXPIRES 3-21-2015.

PRIORITY CLAIMED UNDER SEC. 44(D) ON HONG KONG APPLICATION NO. 300390375, FILED 3-22-2005.

OWNER OF U.S. REG. NOS. 2,781,793 AND 2,835,698.

SER. NO. 78-706,746, FILED 9-4-2005.

CAROLINE WOOD, EXAMINING ATTORNEY

Int. Cl.: 41

Prior U.S. Cls.: 100, 101 and 107

United States Patent and Trademark Office

Reg. No. 3,476,618

Registered July 29, 2008

**SERVICE MARK
PRINCIPAL REGISTER**



SA SA OVERSEAS LIMITED (BR.VIRGIN ISLANDS LTD LIAB CO)
P.O. BOX 957
OFFSHORE INCORPORATIONS CENTRE
ROAD TOWN, TORTOLA, BR.VIRGIN ISLANDS

FOR: EDUCATIONAL SERVICES, NAMELY, CONDUCTING CLASSES, SEMINARS AND CONFERENCES RELATING TO HEALTH, MAKE UP, BEAUTY CARE, BEAUTY TREATMENT, PHARMACEUTICAL AND MEDICAL SERVICES, WEIGHT CONTROL AND WEIGHT REDUCTION; PROVIDING ON-LINE NON-DOWNLOADABLE ELECTRONIC PUBLICATIONS IN THE FORM OF NEWSLETTERS, MAGAZINES, BOOKS, BROCHURES, PAMPHLETS, JOURNALS AND INTERACTIVE WEBSITES RELATING TO HEALTH, MAKE UP, BEAUTY CARE, BEAUTY TREATMENT, PHARMACEUTICAL AND MEDICAL SERVICES, WEIGHT CONTROL AND WEIGHT REDUCTION; PHYSICAL FITNESS INSTRUCTION, TRAINING

SERVICES RELATING TO FITNESS, AND EXERCISE FITNESS TRAINING SERVICE; HEALTH CLUB SERVICES, NAMELY, PROVIDING INSTRUCTION AND EQUIPMENT IN THE FIELD OF PHYSICAL EXERCISE; PROVIDING GYMNASIUMS THAT OFFER TRAINING BODYBUILDING AND WEIGHT TRAINING, AND PROVIDING GYMNASIUM FACILITIES, IN CLASS 41 (U.S. CLS. 100, 101 AND 107).

OWNER OF HONG KONG REG. NO. 300490473, DATED 9-7-2005, EXPIRES 9-7-2015.

OWNER OF U.S. REG. NOS. 2,446,341, 2,857,114, AND 3,093,350.

SER. NO. 78-707,439, FILED 9-6-2005.

DOMINIC J. FERRAIUOLO, EXAMINING ATTORNEY

Int. Cls.: 35 and 38

Prior U.S. Cls.: 100, 101, 102 and 104

United States Patent and Trademark Office

Reg. No. 3,476,619

Registered July 29, 2008

**SERVICE MARK
PRINCIPAL REGISTER**

STREET TV

GIERCZYK MEDIA, LLC (ILLINOIS LTD LIAB
CO)
SUITE 2-A
17475 JOVANNA DRIVE
HOMWOOD, IL 60430

FOR: ADVERTISING SERVICES, NAMELY, DIS-
SEMINATION OF ADVERTISING MATERIAL IN
THE FORM OF ANIMATION, VIDEO AND STILL
IMAGES TO LARGE DIGITAL SCREEN DISPLAYS,
IN CLASS 35 (U.S. CLS. 100, 101 AND 102).

FIRST USE 8-1-2005; IN COMMERCE 8-1-2005.

FOR: BROADCASTING OF ANIMATION, VIDEO
AND STILL IMAGES TO LARGE DIGITAL SCREEN
DISPLAYS TO PROMOTE THE GOODS AND SER-

VICES OF OTHERS, IN CLASS 38 (U.S. CLS. 100, 101
AND 104).

FIRST USE 8-1-2005; IN COMMERCE 8-1-2005.

THE MARK CONSISTS OF STANDARD CHAR-
ACTERS WITHOUT CLAIM TO ANY PARTICULAR
FONT, STYLE, SIZE, OR COLOR.

NO CLAIM IS MADE TO THE EXCLUSIVE
RIGHT TO USE "TV" , APART FROM THE MARK
AS SHOWN.

SER. NO. 78-711,228, FILED 9-12-2005.

MICHAEL KEATING, EXAMINING ATTORNEY

Int. Cl.: 18

Prior U.S. Cls.: 1, 2, 3, 22 and 41

United States Patent and Trademark Office

Reg. No. 3,476,620

Registered July 29, 2008

**TRADEMARK
PRINCIPAL REGISTER**



FATBOY THE ORIGINAL B.V. (NETHERLANDS
LTD LIAB CO)
GASTHUISSTRAAT 18A
OISTERWIJK, NETHERLANDS 5061 PB

FOR: ALL-PURPOSE CARRYING BAGS, ALL
PURPOSE SPORT BAGS, IN CLASS 18 (U.S. CLS. 1,
2, 3, 22 AND 41).

OWNER OF ERPN CMNTY TM OFC REG. NO.
004636817, DATED 10-5-2007, EXPIRES 10-5-2017.

THE MARK CONSISTS OF THE WORD FATBOY
AND THE LABEL DESIGN.

SER. NO. 78-714,965, FILED 9-16-2005.

FLORENTINA BLANDU, EXAMINING ATTORNEY

Int. Cls.: 35 and 36

Prior U.S. Cls.: 100, 101 and 102

United States Patent and Trademark Office

Reg. No. 3,476,621

Registered July 29, 2008

**SERVICE MARK
PRINCIPAL REGISTER**

TDFX

THE TORONTO-DOMINION BANK (CANADA CORPORATION)
P.O. BOX 1, TORONTO-DOMINION CENTRE
TORONTO, ONTARIO, CANADA M5K 1A2

FOR: COMPUTERIZED DATA PROCESSING SERVICES, IN CLASS 35 (U.S. CLS. 100, 101 AND 102).

FOR: BANKING AND FINANCIAL SERVICES, NAMELY, FOREIGN CURRENCY EXCHANGE SERVICES, IN CLASS 36 (U.S. CLS. 100, 101 AND 102).

THE MARK CONSISTS OF STANDARD CHARACTERS WITHOUT CLAIM TO ANY PARTICULAR FONT, STYLE, SIZE, OR COLOR.

PRIORITY CLAIMED UNDER SEC. 44(D) ON CANADA APPLICATION NO. 1272103, FILED 9-15-2005, REG. NO. TMA673353, DATED 9-26-2006, EXPIRES 9-26-2021.

SER. NO. 78-717,544, FILED 9-21-2005.

PAUL F. GAST, EXAMINING ATTORNEY

Int. Cl.: 14

Prior U.S. Cls.: 2, 27, 28 and 50

United States Patent and Trademark Office

Reg. No. 3,476,622

Registered July 29, 2008

**TRADEMARK
PRINCIPAL REGISTER**

STARHAVEN

STARHAVEN, LLC (TEXAS LTD LIAB CO)
307 MARTEL LANE
COPPELL, TX 75019

THE MARK CONSISTS OF STANDARD CHAR-
ACTERS WITHOUT CLAIM TO ANY PARTICULAR
FONT, STYLE, SIZE, OR COLOR.

FOR: JEWELRY; JEWELRY, NAMELY, KEY
CHAINS MADE OF THE PRECIOUS METAL SIL-
VER, IN CLASS 14 (U.S. CLS. 2, 27, 28 AND 50).

SER. NO. 78-728,941, FILED 10-7-2005.

FIRST USE 1-15-2006; IN COMMERCE 4-15-2006.

MICHAEL WIENER, EXAMINING ATTORNEY

Int. Cl.: 31

Prior U.S. Cls.: 1 and 46

United States Patent and Trademark Office

Reg. No. 3,476,623

Registered July 29, 2008

**TRADEMARK
PRINCIPAL REGISTER**



J.L. GONZALEZ PRODUCE, INC. (ILLINOIS CORPORATION)
2402 S. WOLCOTT AVE. UNIT 5-7
CHICAGO, IL 60608

FOR: FRESH FRUITS AND VEGETABLES; RAW FRUITS AND VEGETABLES; UNPROCESSED FRUITS AND VEGETABLES, IN CLASS 31 (U.S. CLS. 1 AND 46).

FIRST USE 1-0-2003; IN COMMERCE 1-0-2003.

NO CLAIM IS MADE TO THE EXCLUSIVE RIGHT TO USE "PRODUCE OF MEXICO", APART FROM THE MARK AS SHOWN.

"DON HUGO" DOES NOT IDENTIFY A PARTICULAR LIVING INDIVIDUAL.

THE COLOR(S) GREEN, RED BLACK AND WHITE IS/ARE CLAIMED AS A FEATURE OF THE MARK.

THE COLOR BLACK APPEARS ON THE NAME, DON HUGO; THE COLOR WHITE APPEARS ON THE WORDING DON HUGO PRODUCE OF MEXICO, ON THE VEINS AND STEMS OF THE LEAVES, AND ON THE CENTER OVAL DESIGN; THE COLOR GREEN APPEARS ON THE THREE LEAVES; AND THE COLOR RED APPEARS ON THE OUTER OVAL DESIGN

THE MARK CONSISTS OF, IN PART, OF THE WORDING, "DON HUGO PRODUCE OF MEXICO", THE DESIGN OF THREE LEAVES WITHIN AN OVAL DESIGN, AND DESIGN.

SER. NO. 78-735,416, FILED 10-18-2005.

BARBARA A. GOLD, EXAMINING ATTORNEY

Int. Cl.: 20

Prior U.S. Cls.: 2, 13, 22, 25, 32 and 50

United States Patent and Trademark Office

Reg. No. 3,476,624

Registered July 29, 2008

TRADEMARK
PRINCIPAL REGISTER



ISOTECH LABORATORIES, INC. (ILLINOIS CORPORATION)
1308 PARKLAND CT.
CHAMPAIGN, IL 61821

FOR: CONTAINERS PRIMARILY OF PLASTIC BUT WITH METAL PARTS SOLD EMPTY FOR SAMPLES OF GASSES TO BE USED FOR ISOTOPIC ANALYSIS., IN CLASS 20 (U.S. CLS. 2, 13, 22, 25, 32 AND 50).

FIRST USE 6-1-2005; IN COMMERCE 6-1-2005.

NO CLAIM IS MADE TO THE EXCLUSIVE RIGHT TO USE "BAG" OR "LABORATORIES, INC.", APART FROM THE MARK AS SHOWN.

THE MARK CONSISTS OF THE MARK IS A LOGO CONSISTING OF THE WORD "ISOBAG" WITH THE "I" IN "ISO" CONSISTING OF A VALVE SIMILAR TO A TIRE STEM VALVE AND THE WORD ARCHED OVER AN INFLATED BAG.

SER. NO. 78-737,766, FILED 10-21-2005.

SEAN CROWLEY, EXAMINING ATTORNEY

Int. Cls.: 35 and 41

Prior U.S. Cls.: 100, 101, 102 and 107

United States Patent and Trademark Office

Reg. No. 3,476,625

Registered July 29, 2008

**SERVICE MARK
PRINCIPAL REGISTER**

**SKAGIT VALLEY TULIP
FESTIVAL**

SKAGIT VALLEY TULIP FESTIVAL (WASHING-
TON CORPORATION)
SUITE 250
100 EAST MONTGOMERY
MOUNT VERNON, WA 98273

FOR: SPONSORING ARTISAN DISPLAYS AND ORGANIZING EXHIBITS BY PROVIDING ADVERTISING, PUBLICITY AND PROMOTION SERVICES FOR THE PRODUCTS AND SERVICES OF THIRD PARTIES BY FEATURING EXHIBITS AND DISPLAYS OF WOODCRAFTING GOODS, WOODCARVING GOODS, WOODEN FURNITURE, PHOTOGRAPHY, POTTERY, GLASS GOODS AND TEXTILE GOODS; ADVERTISING SERVICES, NAMELY, FEATURING INFORMATION ABOUT RESTAURANTS AND HOTELS SPONSORING THE FESTIVAL IN FESTIVAL BROCHURES AND FESTIVAL INFORMATIONAL HANDOUTS; RETAIL SERVICES FEATURING TULIP FESTIVAL CLOTHING AND SOUVENIRS, IN CLASS 35 (U.S. CLS. 100, 101 AND 102).

FIRST USE 1-17-1986; IN COMMERCE 1-17-1986.

FOR: ORGANIZING AND SPONSORING COMMUNITY TULIP FESTIVALS, FEATURING A VARI-

ETY OF ACTIVITIES, NAMELY, TULIP DISPLAYS, ATHLETIC EVENTS, GOLF TOURNAMENTS, ART EXHIBITS, LIVE MUSIC CONCERTS, LIVE THEATRICAL PERFORMANCES, FIREWORKS DISPLAYS AND BARBEQUES; ENTERTAINMENT AND EDUCATION SERVICES, NAMELY, ORGANIZING GUIDED TOURS THROUGH TULIP FIELDS AND DISTRIBUTION OF TULIP FIELD MAPS IN CONNECTION THEREWITH, IN CLASS 41 (U.S. CLS. 100, 101 AND 107).

FIRST USE 1-17-1986; IN COMMERCE 1-17-1986.

THE MARK CONSISTS OF STANDARD CHARACTERS WITHOUT CLAIM TO ANY PARTICULAR FONT, STYLE, SIZE, OR COLOR.

NO CLAIM IS MADE TO THE EXCLUSIVE RIGHT TO USE "TULIP FESTIVAL", APART FROM THE MARK AS SHOWN.

SEC. 2(F).

SER. NO. 78-742,926, FILED 10-28-2005.

AMY MCMENAMIN, EXAMINING ATTORNEY

Int. Cls.: 38 and 41

Prior U.S. Cls.: 100, 101, 104 and 107

United States Patent and Trademark Office

Reg. No. 3,476,626

Registered July 29, 2008

**SERVICE MARK
PRINCIPAL REGISTER**

HARDCORE SPORTS RADIO

THE SCORE TELEVISION NETWORK LTD. (CANADA CORPORATION)
1605 MAIN STREET WEST
HAMILTON, ONTARIO, CANADA L8S 1E6

FOR: BROADCASTING AND TRANSMISSION OF RADIO PROGRAMS VIA A MULTI-CHANNEL RADIO SERVICE BROADCAST, IN CLASS 38 (U.S. CLS. 100, 101 AND 104).

FOR: PROVIDING INFORMATION IN THE FIELD OF SPORTS AND ENTERTAINMENT; ENTERTAINMENT SERVICES, NAMELY, THE PRODUCTION, RECORDING, AND DISTRIBUTION OF SPORTS PROGRAMS SPORTS AND ASSOCIATED EVENTS, IN CLASS 41 (U.S. CLS. 100, 101 AND 107).

THE MARK CONSISTS OF STANDARD CHARACTERS WITHOUT CLAIM TO ANY PARTICULAR FONT, STYLE, SIZE, OR COLOR.

OWNER OF CANADA REG. NO. TMA695278, DATED 8-30-2007, EXPIRES 8-30-2022.

NO CLAIM IS MADE TO THE EXCLUSIVE RIGHT TO USE "SPORTS RADIO" , APART FROM THE MARK AS SHOWN.

SER. NO. 78-751,296, FILED 11-10-2005.

ANTHONY RINKER, EXAMINING ATTORNEY

Int. Cls.: 9 and 16

Prior U.S. Cls.: 2, 5, 21, 22, 23, 26, 29, 36, 37, 38 and 50

Reg. No. 3,476,627

United States Patent and Trademark Office

Registered July 29, 2008

**TRADEMARK
PRINCIPAL REGISTER**

FAIRGATE

SMITHERS TOOLS AND MACHINE PRODUCTS,
INC. (NEW YORK CORPORATION)
P.O. BOX 391
3718 ROUTE 9G
RHINEBECK, NY 12572

FOR: GRADUATED RULERS, IN CLASS 9 (U.S.
CLS. 21, 23, 26, 36 AND 38).

FIRST USE 1-1-1955; IN COMMERCE 1-1-1955.

FOR: DRAWING RULERS; DRAFTING RULERS,
IN CLASS 16 (U.S. CLS. 2, 5, 22, 23, 29, 37, 38 AND 50).

FIRST USE 1-1-1955; IN COMMERCE 1-1-1955.

THE MARK CONSISTS OF STANDARD CHAR-
ACTERS WITHOUT CLAIM TO ANY PARTICULAR
FONT, STYLE, SIZE, OR COLOR.

OWNER OF U.S. REG. NO. 1,320,698.

SER. NO. 78-757,597, FILED 11-18-2005.

WILLIAM P. SHANAHAN, EXAMINING ATTOR-
NEY

Int. Cl.: 41

Prior U.S. Cls.: 100, 101 and 107

United States Patent and Trademark Office

Reg. No. 3,476,628

Registered July 29, 2008

**SERVICE MARK
PRINCIPAL REGISTER**

ANIMAL WOW

ANIMAL WOW ENTERTAINMENT, INC. (DELA-
WARE CORPORATION)
3940 LAUREL CANYON BLVD., SUITE 309
STUDIO CITY, CA 91604

FOR: ENTERTAINMENT, NAMELY, PRODU-
CING CHILDREN'S PROGRAMMING DESIGNED
TO EDUCATE CHILDREN ON ANIMAL CARE AND
FEATURING CHILDREN'S PERFORMANCES AND
ACTIVITIES, ANIMAL SOUNDS AND IMAGES,
ANTHROPOMORPHIC CHARACTERS AND IN-
FORMATION REGARDING ANIMAL CARE, IN
CLASS 41 (U.S. CLS. 100, 101 AND 107).

FIRST USE 9-1-2005; IN COMMERCE 9-1-2005.

THE MARK CONSISTS OF STANDARD CHAR-
ACTERS WITHOUT CLAIM TO ANY PARTICULAR
FONT, STYLE, SIZE, OR COLOR.

OWNER OF U.S. REG. NO. 3,080,301.

NO CLAIM IS MADE TO THE EXCLUSIVE
RIGHT TO USE "ANIMAL", APART FROM THE
MARK AS SHOWN.

SER. NO. 78-762,790, FILED 11-29-2005.

MICHAEL TANNER, EXAMINING ATTORNEY

Int. Cls.: 9 and 35

Prior U.S. Cls.: 21, 23, 26, 36, 38, 100, 101 and 102

United States Patent and Trademark Office

Reg. No. 3,476,629

Registered July 29, 2008

**TRADEMARK
SERVICE MARK
PRINCIPAL REGISTER**

TELE ATLAS LOGISTICS

TELE ATLAS NORTH AMERICA, INC. (CALIFORNIA CORPORATION)
11 LAFAYETTE STREET
LEBANON, NH 037661445

FOR: ELECTRONIC DATABASE FEATURING GEOGRAPHIC DATA AND TRANSPORTATION-RELATED INFORMATION RECORDED ON COMPUTER MEDIA; DOWNLOADABLE SOFTWARE FEATURING DIGITAL MAPS, IN CLASS 9 (U.S. CLS. 21, 23, 26, 36 AND 38).

FIRST USE 6-0-2006; IN COMMERCE 6-0-2006.

FOR: BUSINESS MANAGEMENT SERVICES, NAMELY, MANAGING LOGISTICS UTILIZING GLOBAL POSITIONING SYSTEM GEOGRAPHIC INFORMATION SYSTEMS, AND LOCATION AND DIGITAL MAPPING TECHNOLOGIES FOR VEHICLE TRACKING, ASSET TRACKING, PERSONNEL

TRACKING, MATERIAL TRACKING, ROUTING, ASSET LOCATION IDENTIFICATION, DATA COLLECTION, DATA VERIFICATION, NAVIGATION, INSPECTION AND LOCATION VERIFICATION, IN CLASS 35 (U.S. CLS. 100, 101 AND 102).

FIRST USE 6-0-2006; IN COMMERCE 6-0-2006.

THE MARK CONSISTS OF STANDARD CHARACTERS WITHOUT CLAIM TO ANY PARTICULAR FONT, STYLE, SIZE, OR COLOR.

NO CLAIM IS MADE TO THE EXCLUSIVE RIGHT TO USE "ATLAS LOGISTICS", APART FROM THE MARK AS SHOWN.

SER. NO. 78-764,684, FILED 12-1-2005.

ROBERT C. CLARK JR., EXAMINING ATTORNEY

Int. Cls.: 9 and 41

Prior U.S. Cls.: 21, 23, 26, 36, 38, 100, 101 and 107

Reg. No. 3,476,630

United States Patent and Trademark Office

Registered July 29, 2008

**TRADEMARK
SERVICE MARK
PRINCIPAL REGISTER**

mEIT

SIDEL (FRANCE SOCIÉTÉ PAR ACTIONS SIMPLIFIÉE)
AVENUE DE LA PATROUILLE DE FRANCE
76930 OCTEVILLE SUR MER, FRANCE

FOR: SOFTWARE FOR USE IN COMPILING AND ANALYZING DATA FROM PACKAGING AND BOTTLING MACHINES USED IN THE AGRI-FOOD AND PHARMACEUTICAL INDUSTRIES, IN CLASS 9 (U.S. CLS. 21, 23, 26, 36 AND 38).

FOR: TRAINING IN THE USE OF SOFTWARE USED IN COMPILING AND ANALYZING DATA FROM PACKAGING AND BOTTLING MACHINES USED IN THE AGRI-FOOD AND PHARMACEUTI-

CAL INDUSTRIES, IN CLASS 41 (U.S. CLS. 100, 101 AND 107).

THE MARK CONSISTS OF STANDARD CHARACTERS WITHOUT CLAIM TO ANY PARTICULAR FONT, STYLE, SIZE, OR COLOR.

PRIORITY CLAIMED UNDER SEC. 44(D) ON ERPN CMNTY TM OFC APPLICATION NO. 4767216, FILED 12-6-2005, REG. NO. 004767216, DATED 12-15-2006, EXPIRES 12-6-2015.

SER. NO. 78-770,051, FILED 12-9-2005.

EVELYN BRADLEY, EXAMINING ATTORNEY

Int. Cl.: 32

Prior U.S. Cls.: 45, 46 and 48

United States Patent and Trademark Office

Reg. No. 3,476,631

Registered July 29, 2008

**TRADEMARK
PRINCIPAL REGISTER**

PARADISE SMOOTHIE

NGUYEN, CHRIS S (LOUISIANA SOLE PROPRIETORSHIP)
SUITE A
1295 N. SHERWOOD FOREST BLVD.
BATON ROUGE, LA 70815

FOR: FRESH FRUIT SMOOTHIES ALSO KNOWN AS BUBBLE TEA OR TAPIOCA PEARL DRINKS, IN CLASS 32 (U.S. CLS. 45, 46 AND 48).

FIRST USE 11-1-2005; IN COMMERCE 11-1-2005.

THE MARK CONSISTS OF STANDARD CHARACTERS WITHOUT CLAIM TO ANY PARTICULAR FONT, STYLE, SIZE, OR COLOR.

NO CLAIM IS MADE TO THE EXCLUSIVE RIGHT TO USE "SMOOTHIE", APART FROM THE MARK AS SHOWN.

SER. NO. 78-776,160, FILED 12-19-2005.

CAROL SPILS, EXAMINING ATTORNEY

Int. Cl.: 34

Prior U.S. Cls.: 2, 8, 9 and 17

United States Patent and Trademark Office

Reg. No. 3,476,632

Registered July 29, 2008

**TRADEMARK
PRINCIPAL REGISTER**

EL MEJOR

CIGARS INTERNATIONAL INC. (DELAWARE
CORPORATION)
6771 CHRISPALT DRIVE
BATH, PA 18014

THE ENGLISH TRANSLATION OF THE WORD
"EL MEJOR" IN THE MARK IS THE BEST.

FOR: CIGARS, IN CLASS 34 (U.S. CLS. 2, 8, 9 AND
17).

SEC. 2(F).

FIRST USE 8-15-1999; IN COMMERCE 8-15-1999.

SER. NO. 78-782,531, FILED 12-29-2005.

THE MARK CONSISTS OF STANDARD CHAR-
ACTERS WITHOUT CLAIM TO ANY PARTICULAR
FONT, STYLE, SIZE, OR COLOR.

ELIZABETH HUGHITT, EXAMINING ATTORNEY

Int. Cl.: 12

Prior U.S. Cls.: 19, 21, 23, 31, 35 and 44

Reg. No. 3,476,633

United States Patent and Trademark Office

Registered July 29, 2008

**TRADEMARK
PRINCIPAL REGISTER**

Wrangler

RV MANUFACTURING ENTERPRISES, LLC
(FLORIDA LTD LIAB CO)
8003 JAMES ISLAND TRIAL
JACKSONVILLE, FL 32256

THE MARK CONSISTS OF STANDARD CHAR-
ACTERS WITHOUT CLAIM TO ANY PARTICULAR
FONT, STYLE, SIZE, OR COLOR.

FOR: RECREATIONAL VEHICLES, NAMELY,
NON-MOTORIZED RECREATIONAL CAMPERS
AND TRAILERS, IN CLASS 12 (U.S. CLS. 19, 21, 23,
31, 35 AND 44).

SER. NO. 78-782,966, FILED 12-30-2005.

FIRST USE 7-18-2005; IN COMMERCE 7-18-2005.

MARIAM MAHMOUDI, EXAMINING ATTORNEY

Int. Cl.: 41

Prior U.S. Cls.: 100, 101 and 107

United States Patent and Trademark Office

Reg. No. 3,476,634

Registered July 29, 2008

**SERVICE MARK
PRINCIPAL REGISTER**



AVILA UNIVERSITY (MISSOURI CORPORATION)
11901 WORNALL ROAD
KANSAS CITY, MO 64145

FOR: EDUCATIONAL SERVICES, NAMELY PROVIDING COURSES OF INSTRUCTION AND TRAINING COURSES AT THE UNIVERSITY LEVEL AND RELATED ENTERTAINMENT SERVICES, NAMELY ARRANGING AND CONDUCTING SPORTING EVENTS, NAMELY BASKETBALL, BASEBALL, SOFTBALL, SOCCER, FOOTBALL, VOLLEYBALL, AND GOLF GAMES, MATCHES, AND TOURNAMENTS, AS WELL AS DANCE AND CHEERING COMPETITIONS, AND ARRANGING AND CONDUCTING LIVE MUSIC CONCERTS, THEATER

PRODUCTIONS, AND LECTURES IN THE FIELD OF HUMANITARIAN AND SOCIAL JUSTICE ISSUES, AS WELL AS MATTERS OF GENERAL INTEREST, IN CLASS 41 (U.S. CLS. 100, 101 AND 107).

FIRST USE 6-7-2005; IN COMMERCE 6-7-2005.

NO CLAIM IS MADE TO THE EXCLUSIVE RIGHT TO USE "UNIVERSITY", APART FROM THE MARK AS SHOWN.

SER. NO. 78-784,538, FILED 1-4-2006.

JANICE L. MCMORROW, EXAMINING ATTORNEY

Int. Cl.: 9

Prior U.S. Cls.: 21, 23, 26, 36 and 38

Reg. No. 3,476,635

United States Patent and Trademark Office

Registered July 29, 2008

**TRADEMARK
PRINCIPAL REGISTER**

OpticTOOLS

KRAMER ELECTRONICS LTD. (ISRAEL COMPANY)
3 AM VEOLAMO STREET
GIVAT SHAUL, JERUSALEM, ISRAEL 95463

FOR: APPARATUS AND INSTRUMENTS FOR VIEWING, RECORDING, TRANSMISSION, PROCESSING AND REPRODUCTION OF SOUND OR IMAGES, NAMELY, VIDEO-AUDIO ENHANCERS, COLOR PROCESSORS, SIGNAL SWITCHERS, SIGNAL DISTRIBUTORS, RF PROCESSORS, SPECIAL EFFECTS GENERATORS, VIDEO ENCODERS AND DECODERS, VIDEO STANDARD CONVERTERS, VIDEO TIME BASE CORRECTORS, COMPUTER GUNLOCK EQUIPMENT, COMPUTER-CONTROLLED VIDEO EQUIPMENT, NAMELY, VIDEO MATRIX AND PROCESSING CONTROL, COMPUTER INTERFACE PRODUCTS, NAMELY, TTL (TRANSISTOR-TRANSISTOR LOGIC) ANALOGUE ENCODERS, TTL (TRANSISTOR-TRANSISTOR LOGIC) TO ANALOGUE CONVERTERS, TTL (TRANSISTOR-TRANSISTOR LOGIC) AUDIO VISUAL SIGNAL DISTRIBUTORS, TTL (TRANSISTOR-

TRANSISTOR LOGIC) GUNLOCK/ENCODER CARDS, AUDIO SIGNAL DEFECT CORRECTORS, VIDEO LINE AMPLIFIERS, VIDEO SCREEN SPLITTERS AND VIDEO TIME BASE SIGNAL DELAY CORRECTORS, BLANK MAGNETIC DATA CARRIERS; AND BLANK RECORDING DISCS, IN CLASS 9 (U.S. CLS. 21, 23, 26, 36 AND 38).

THE MARK CONSISTS OF STANDARD CHARACTERS WITHOUT CLAIM TO ANY PARTICULAR FONT, STYLE, SIZE, OR COLOR.

PRIORITY CLAIMED UNDER SEC. 44(D) ON ISRAEL APPLICATION NO. 186070, FILED 12-15-2005, REG. NO. 186070, DATED 8-7-2007, EXPIRES 8-7-2017.

OWNER OF U.S. REG. NO. 2,733,638.

SER. NO. 78-791,215, FILED 1-13-2006.

SUSAN RICHARDS, EXAMINING ATTORNEY

Int. Cl.: 41

Prior U.S. Cls.: 100, 101 and 107

United States Patent and Trademark Office

Reg. No. 3,476,636

Registered July 29, 2008

**SERVICE MARK
PRINCIPAL REGISTER**

SBK

FGS LICENCE S.R.L. (ITALY LTD LIAB CO)
VIA V. GALATI 100
ROME, ITALY

FOR: ENTERTAINMENT AND SPORTING
EVENTS, NAMELY, ARRANGING, ORGANIZING
AND CONDUCTING MOTORCYCLE AND CAR
RACES; ENTERTAINMENT IN THE NATURE OF
ON-GOING TELEVISION PROGRAMS IN THE
FIELD OF MOTORCYCLE AND CAR RACING;
MOTION PICTURE FILM AND VIDEOTAPE PRO-
DUCTION IN THE FIELD OF MOTORCYCLES, IN
CLASS 41 (U.S. CLS. 100, 101 AND 107).

FIRST USE 6-8-1990; IN COMMERCE 6-8-1990.

THE MARK CONSISTS OF STANDARD CHAR-
ACTERS WITHOUT CLAIM TO ANY PARTICULAR
FONT, STYLE, SIZE, OR COLOR.

PRIORITY CLAIMED UNDER SEC. 44(D) ON
ERPN CMNTY TM OFC APPLICATION NO.
4615936, FILED 9-27-2005.

SEC. 2(F).

SER. NO. 78-799,178, FILED 1-25-2006.

MARY CRAWFORD, EXAMINING ATTORNEY

Int. Cl.: 25

Prior U.S. Cls.: 22 and 39

United States Patent and Trademark Office

Reg. No. 3,476,637

Registered July 29, 2008

TRADEMARK
PRINCIPAL REGISTER



GRAFFEETI, INC. (CALIFORNIA CORPORATION)
142 MARINER PLACE
LINCOLN, CA 95648

FOR: SHIRTS; SHOES; T-SHIRTS, IN CLASS 25
(U.S. CLS. 22 AND 39).

FIRST USE 8-1-2005; IN COMMERCE 8-1-2005.

THE MARK CONSISTS OF THE WORD "GRAFFEETI" WITH THE DOUBLE LETTER "E" DRAWN

AS A SET OF FOOTPRINTS, WITH THE PHRASE "TAG...YOU'RE IT!" UNDERNEATH, ALL SUPERIMPOSED OVER A TRIANGLE, WITH A THREE-QUARTER OPEN OVAL AROUND THE TOP, LEFT, AND BOTTOM SIDES.

SER. NO. 78-802,243, FILED 1-30-2006.

ANDREA SAUNDERS, EXAMINING ATTORNEY

Int. Cls.: 3, 10, 25 and 35

**Prior U.S. Cls.: 1, 4, 6, 22, 26, 39, 44, 50, 51, 52, 100,
101 and 102**

Reg. No. 3,476,638

United States Patent and Trademark Office

Registered July 29, 2008

**TRADEMARK
SERVICE MARK
PRINCIPAL REGISTER**

ANATOM ACTIVE

ANATOM LIMITED (UNITED KINGDOM LIMITED COMPANY)
WARRENDER PARK ROAD
LINKS HOUSE 161
EDINBURGH, UNITED KINGDOM EH9 1DT

FOR: NON-MEDICATED HERBAL PREPARATIONS AND TREATMENTS FOR THE CARE OF THE SKIN, PARTICULARLY OF THE BODY AND/OR FEET, NAMELY, CREAMS AND LOTIONS FOR CLEANSING, EXFOLIATING, MOISTURIZING, VITALIZING AND TONING OF THE SKIN AND/OR FEET, DEPILATORY PREPARATIONS, PREPARATIONS FOR THE BATH AND SHOWER, BATH OILS, BATH SALTS, TALCUM POWDER; NATURAL BODY AND SKIN CARE PRODUCTS, NAMELY, CREAMS AND LOTIONS FOR CLEANSING, EXFOLIATING, MOISTURIZING, VITALIZING AND TONING OF THE SKIN AND/OR FEET, DEPILATORY PREPARATIONS, PREPARATIONS FOR THE BATH AND SHOWER, BATH OILS, BATH SALTS, TALCUM POWDER; NON-MEDICATED TOILETRIES; NON-MEDICATED SKIN CARE PREPARATIONS AND SUBSTANCES FOR APPLICATION TO, CONDITIONING, CLEANSING, MOISTURISING, VITALISING AND TONING OF THE SKIN, PARTICULARLY OF THE BODY AND/OR FEET; SOAPS FOR HOUSEHOLD AND PERSONAL USE AND CLEANING PREPARATIONS FOR HOUSEHOLD USE; COSMETICS; ESSENTIAL OILS; OILS, CREAMS AND LOTIONS FOR THE SKIN, PARTICULARLY THE BODY AND FEET; PERFUMERY, COLOGNES; DEODORANTS AND ANTI-PERSPIRANTS FOR PERSONAL USE, IN CLASS 3 (U.S. CLS. 1, 4, 6, 50, 51 AND 52).

FOR: FOOT ORTHOTICS; ORTHOPAEDIC FOOTWEAR; ORTHOPAEDIC APPLIANCES, INSTRUMENTS, APPARATUS AND ARTICLES, NAMELY, ORTHOPAEDIC INSOLES, INSERTS, CUSHIONS

AND SUPPORTS; PARTS AND FITTINGS FOR ALL THE AFORESAID GOODS, IN CLASS 10 (U.S. CLS. 26, 39 AND 44).

FOR: CLOTHING AND HEADGEAR, NAMELY, TROUSERS, SKIRTS, SHORTS, SHIRTS, T-SHIRTS, UNDERWEAR, SWEATERS, JERSEYS, CARDIGANS, SWEATSHIRTS, COATS, JACKETS, SWIMWEAR, HATS, CAPS AND VISORS; ARTICLES OF SPORTS CLOTHING, FOOTWEAR AND HEADGEAR, NAMELY, TROUSERS, SKIRTS, SHORTS, SHIRTS, T-SHIRTS, UNDERWEAR, SWEATERS, JERSEYS, CARDIGANS, SWEATSHIRTS, COATS, JACKETS, SWIMWEAR, HATS, CAPS, VISORS, SHOES, BOOTS, SOCK AND INSOLES; FOOTWEAR INCLUDING SHOES, BOOTS, SOCKS AND INSOLES, IN CLASS 25 (U.S. CLS. 22 AND 39).

FOR: RETAIL SERVICES, NAMELY, MAIL ORDER RETAIL SERVICES AND ONLINE ELECTRONIC SHOPPING RETAIL SERVICES, FEATURING COSMETICS, TOILETRIES, BEAUTY PRODUCTS, BODY AND SKIN CARE PRODUCTS, NON-MEDICATED HERBAL PREPARATIONS AND TREATMENTS, MEDICAL AND SURGICAL APPARATUS AND DEVICES, CLOTHING, FOOTWEAR AND HEADGEAR, IN CLASS 35 (U.S. CLS. 100, 101 AND 102).

THE MARK CONSISTS OF STANDARD CHARACTERS WITHOUT CLAIM TO ANY PARTICULAR FONT, STYLE, SIZE, OR COLOR.

PRIORITY CLAIMED UNDER SEC. 44(D) ON ERPN CMNTY TM OFC APPLICATION NO. 004894697, FILED 2-10-2006, REG. NO. 4894697, DATED 11-5-2007, EXPIRES 2-10-2016.

NO CLAIM IS MADE TO THE EXCLUSIVE
RIGHT TO USE "ACTIVE" , APART FROM THE
MARK AS SHOWN.

SER. NO. 78-816,028, FILED 2-16-2006.

HEATHER THOMPSON, EXAMINING ATTORNEY

Int. Cl.: 41

Prior U.S. Cls.: 100, 101 and 107

United States Patent and Trademark Office

Reg. No. 3,476,639

Registered July 29, 2008

**SERVICE MARK
PRINCIPAL REGISTER**

PRANA FLOW

REA, SHIVA (UNITED STATES INDIVIDUAL)
15945 FLORIDA AVENUE
LUTZ, FL 33549

FOR: YOGA INSTRUCTION; CONDUCTING RE-
TREATS, WORKSHOPS AND SEMINARS IN THE
FIELD OF YOGA, IN CLASS 41 (U.S. CLS. 100, 101
AND 107).

FIRST USE 5-0-2007; IN COMMERCE 5-0-2007.

THE MARK CONSISTS OF STANDARD CHAR-
ACTERS WITHOUT CLAIM TO ANY PARTICULAR
FONT, STYLE, SIZE, OR COLOR.

NO CLAIM IS MADE TO THE EXCLUSIVE
RIGHT TO USE "FLOW", APART FROM THE
MARK AS SHOWN.

THE ENGLISH TRANSLATION OF THE WORD
"PRANA FLOW" IN THE MARK IS "BREATH OF
LIFE".

SER. NO. 78-816,098, FILED 2-16-2006.

HANNO RITTNER, EXAMINING ATTORNEY

Int. Cl.: 38

Prior U.S. Cls.: 100, 101 and 104

United States Patent and Trademark Office

Reg. No. 3,476,640

Registered July 29, 2008

**SERVICE MARK
PRINCIPAL REGISTER**

SUPERCROSS LIVE!

LIVE NATION MOTOR SPORTS, INC. (TEXAS
CORPORATION)
4255 MERIDIAN PARKWAY
AURORA, IL 60504

NO CLAIM IS MADE TO THE EXCLUSIVE
RIGHT TO USE "LIVE", APART FROM THE MARK
AS SHOWN.

FOR: AUDIO BROADCASTING IN OR RELAT-
ING TO THE FIELD OF MOTOR SPORTS, IN CLASS
38 (U.S. CLS. 100, 101 AND 104).

SEC. 2(F).

FIRST USE 1-0-2004; IN COMMERCE 1-0-2004.

SER. NO. 78-817,274, FILED 2-17-2006.

THE MARK CONSISTS OF STANDARD CHAR-
ACTERS WITHOUT CLAIM TO ANY PARTICULAR
FONT, STYLE, SIZE, OR COLOR.

WARREN L. OLANDRIA, EXAMINING ATTOR-
NEY

Int. Cls.: 9 and 35

Prior U.S. Cls.: 21, 23, 26, 36, 38, 100, 101 and 102

United States Patent and Trademark Office

Reg. No. 3,476,641

Registered July 29, 2008

**TRADEMARK
SERVICE MARK
PRINCIPAL REGISTER**

MY ADHOUND

REPUMETRIX INC. (CANADA CORPORATION)
2100 BLOOR STREET WEST
SUITE 6230
TORONTO, ONTARIO, CANADA M6S 5A5

FOR: COMPUTER SOFTWARE FOR CREATING INDEXES USED IN CONDUCTING SEARCHES OF THE INTERNET FOR DATA AND INFORMATION INCLUDING TEXT, IMAGES, AND ADVERTISEMENT DESCRIPTIONS, AND USED IN RETRIEVING AND PROVIDING DATA AND INFORMATION FROM THE INTERNET INCLUDING TEXT FROM THOUSANDS OF ONLINE CLASSIFIED ADVERTISEMENT SITES SIMULTANEOUSLY ACROSS NORTH AMERICA, IN CLASS 9 (U.S. CLS. 21, 23, 26, 36 AND 38).

FOR: PROVIDING ONLINE SEARCH AND RETRIEVAL SERVICES FOR OTHERS OF ONLINE

CLASSIFIED ADVERTISEMENTS; PROVIDING MARKETING AND ADVERTISING SERVICES TO OTHERS THROUGH THE DISPLAY OF ADVERTISEMENTS IN AN ONLINE INTERNET ADVERTISEMENT DIRECTORY, IN CLASS 35 (U.S. CLS. 100, 101 AND 102).

THE MARK CONSISTS OF STANDARD CHARACTERS WITHOUT CLAIM TO ANY PARTICULAR FONT, STYLE, SIZE, OR COLOR.

OWNER OF CANADA REG. NO. TMA663087, DATED 4-21-2006, EXPIRES 4-21-2021.

SER. NO. 78-817,283, FILED 2-17-2006.

DEIRDRE ROBERTSON, EXAMINING ATTORNEY

Int. Cl.: 9

Prior U.S. Cls.: 21, 23, 26, 36 and 38

Reg. No. 3,476,642

United States Patent and Trademark Office

Registered July 29, 2008

**TRADEMARK
PRINCIPAL REGISTER**

DRAKONTAS

DRAKONTAS, LLC (NEW JERSEY LTD LIAB
CO)
SUITE #8
115 EAST GLENSIDE AVENUE
GLENSIDE, PA 19038

FOR: ELECTRONIC COMMUNICATION DEVICES, NAMELY, ANTENNAS FOR WIRELESS COMMUNICATIONS APPARATUS, COMMUNICATION HUBS AND COMPUTERS, DEVICES FOR WIRELESS RADIO TRANSMISSION, WIRELESS CONTROLLERS TO MONITOR AND CONTROL THE FUNCTIONING OF OTHER ELECTRONIC DEVICES, AND WIRELESS TELEPHONES; TELEMATICS APPARATUS, NAMELY, WIRELESS INTERNET DEVICES WHICH PROVIDE TELEMATIC SERVICES AND HAVE A CELLULAR PHONE FUNCTION; TELECOMMUNICATIONS AND DATA NETWORKING HARDWARE, NAMELY, DEVICES FOR TRANSPORTING AND AGGREGATING VOICE, DATA, AND VIDEO COMMUNICATIONS ACROSS MULTIPLE NETWORK INFRASTRUCTURES AND COMMUNICATIONS PROTOCOLS; ELECTRONIC

PERIPHERAL EQUIPMENT, NAMELY, MOTION DETECTORS, CHEMICAL AND BIOHAZARD DETECTORS, PHOTO OPTICAL IMAGE DETECTORS, SOUND DETECTORS; SOFTWARE, NAMELY, OPERATING SYSTEM AND INTEGRATED DATA EXCHANGE PROTOCOL FOR SECURE WIRELESS NETWORKS, IN CLASS 9 (U.S. CLS. 21, 23, 26, 36 AND 38).

FIRST USE 6-1-2005; IN COMMERCE 6-1-2005.

THE MARK CONSISTS OF STANDARD CHARACTERS WITHOUT CLAIM TO ANY PARTICULAR FONT, STYLE, SIZE, OR COLOR.

THE FOREIGN WORDING IN THE MARK TRANSLATES INTO ENGLISH AS DRAGON.

SER. NO. 78-822,621, FILED 2-24-2006.

DOMINIC FATHY, EXAMINING ATTORNEY

Int. Cl.: 9

Prior U.S. Cls.: 21, 23, 26, 36 and 38

Reg. No. 3,476,643

United States Patent and Trademark Office

Registered July 29, 2008

**TRADEMARK
PRINCIPAL REGISTER**

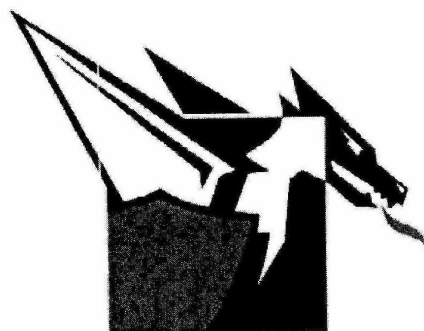

DRAKONTAS

DRAKONTAS, LLC (NEW JERSEY LTD LIAB
CO)
SUITE #8
115 EAST GLENSIDE AVENUE
GLENSIDE, PA 19038

FOR: ELECTRONIC COMMUNICATION DEVICES, NAMELY, ANTENNAS FOR WIRELESS COMMUNICATIONS APPARATUS, COMMUNICATION HUBS AND COMPUTERS, DEVICES FOR WIRELESS RADIO TRANSMISSION, WIRELESS CONTROLLERS TO MONITOR AND CONTROL THE FUNCTIONING OF OTHER ELECTRONIC DEVICES, AND WIRELESS TELEPHONES; TELEMATICS APPARATUS, NAMELY, WIRELESS INTERNET DEVICES WHICH PROVIDE TELEMATIC SERVICES AND HAVE A CELLULAR PHONE FUNCTION; TELECOMMUNICATIONS AND DATA NETWORKING HARDWARE, NAMELY, DEVICES FOR TRANSPORTING AND AGGREGATING VOICE, DATA, AND VIDEO COMMUNICATIONS ACROSS

MULTIPLE NETWORK INFRASTRUCTURES AND COMMUNICATIONS PROTOCOLS; ELECTRONIC PERIPHERAL EQUIPMENT, NAMELY, MOTION DETECTORS, CHEMICAL AND BIOHAZARD DETECTORS, PHOTO OPTICAL IMAGE DETECTORS, SOUND DETECTORS; SOFTWARE, NAMELY, OPERATING SYSTEM AND INTEGRATED DATA EXCHANGE PROTOCOL FOR SECURE WIRELESS NETWORKS, IN CLASS 9 (U.S. CLS. 21, 23, 26, 36 AND 38).

FIRST USE 12-1-2005; IN COMMERCE 12-1-2005.

THE FOREIGN WORDING IN THE MARK TRANSLATES INTO ENGLISH AS DRAGON.

SER. NO. 78-822,886, FILED 2-24-2006.

DOMINIC FATHY, EXAMINING ATTORNEY

Int. Cl.: 35

Prior U.S. Cls.: 100, 101 and 102

United States Patent and Trademark Office

Reg. No. 3,476,644

Registered July 29, 2008

**SERVICE MARK
PRINCIPAL REGISTER**

THE PANTY POSTMAN

COCO RIBBON LIMITED (UNITED KINGDOM
PRIVATE LIMITED COMPANY)
21 KENSINGTON PARK ROAD
LONDON, UNITED KINGDOM W11 2EU

FOR: THE BRINGING TOGETHER, FOR THE BENEFIT OF OTHERS, OF A VARIETY OF CLOTHING, LINGERIE, UNDERWEAR AND CLOTHING ACCESSORIES, ENABLING CUSTOMERS TO CONVENIENTLY VIEW AND PURCHASE THOSE GOODS; MAIL ORDER RETAIL SERVICES FEATURING CLOTHING, LINGERIE, UNDERWEAR AND CLOTHING ACCESSORIES; ON-LINE RETAIL STORE SERVICES FEATURING CLOTHING, LINGERIE, UNDERWEAR AND CLOTHING ACCESSORIES; THE BRINGING TOGETHER, FOR THE BENEFIT OF OTHERS, OF A VARIETY OF GOODS ENABLING CUSTOMERS TO CONVENIENTLY VIEW AND PURCHASE THOSE GOODS FROM A CLOTHING, LINGERIE, UNDERWEAR AND CLOTHING ACCESSORIES CATALOGUE BY MAIL ORDER; RETAIL STORE SERVICES, AVAILABLE

THROUGH COMPUTER COMMUNICATIONS AND INTERACTIVE TELEVISION, FEATURING CLOTHING, LINGERIE, UNDERWEAR AND CLOTHING ACCESSORIES, IN CLASS 35 (U.S. CLS. 100, 101 AND 102).

THE MARK CONSISTS OF STANDARD CHARACTERS WITHOUT CLAIM TO ANY PARTICULAR FONT, STYLE, SIZE, OR COLOR.

OWNER OF ERPN CMNTY TM OFC REG. NO. 004939914, DATED 2-27-2006, EXPIRES 2-27-2016.

NO CLAIM IS MADE TO THE EXCLUSIVE RIGHT TO USE "PANTY", APART FROM THE MARK AS SHOWN.

SER. NO. 78-824,004, FILED 2-27-2006.

MICHAEL SOUDERS, EXAMINING ATTORNEY

Int. Cl.: 7

Prior U.S. Cls.: 13, 19, 21, 23, 31, 34 and 35

United States Patent and Trademark Office

Reg. No. 3,476,645

Registered July 29, 2008

**TRADEMARK
PRINCIPAL REGISTER**

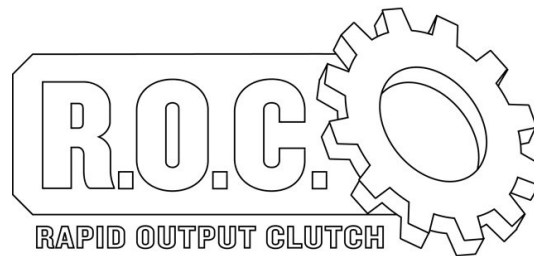

BLACK & DECKER CORPORATION, THE
(MARYLAND CORPORATION)
TW 199
701 E. JOPPA ROAD
TOWSON, MD 21286

FOR: POWER TOOLS, NAMELY, HAMMER
DRILLS, IN CLASS 7 (U.S. CLS. 13, 19, 21, 23, 31, 34
AND 35).

FIRST USE 9-1-2007; IN COMMERCE 9-1-2007.

OWNER OF U.S. REG. NOS. 3,336,880 AND
3,374,584.

NO CLAIM IS MADE TO THE EXCLUSIVE
RIGHT TO USE "RAPID OUTPUT CLUTCH",
APART FROM THE MARK AS SHOWN.

THE MARK CONSISTS OF A PARTIAL RECTAN-
GLE CONTAINING "R.O.C." WITH A REPRESEN-
TATION OF A GEAR DEVICE TO THE RIGHT OF
THE PARTIAL RECTANGLE; WITH THE WORD-
ING, "RAPID OUTPUT CLUTCH" BELOW THE
PARTIAL RECTANGLE AND GEAR DEVICE.

SER. NO. 78-825,041, FILED 2-28-2006.

ODESSA BIBBINS, EXAMINING ATTORNEY

Int. Cl.: 41

Prior U.S. Cls.: 100, 101 and 107

United States Patent and Trademark Office

Reg. No. 3,476,646

Registered July 29, 2008

**SERVICE MARK
PRINCIPAL REGISTER**

THE MIC

MOBITV, INC. (DELAWARE CORPORATION)
6425 CHRISTIE AVE., 5TH FLOOR
EMERYVILLE, CA 94608

FIRST USE 1-4-2006; IN COMMERCE 1-4-2006.

FOR: ENTERTAINMENT IN THE NATURE OF ON-GOING MUSIC AND MUSIC VIDEO PROGRAMS; DISTRIBUTION OF MUSIC PROGRAMMING AND MUSIC VIDEO PROGRAMMING FOR OTHERS; PROVIDING INFORMATION IN THE FIELDS OF MUSIC, MUSIC VIDEOS, ENTERTAINERS, AND CELEBRITIES, IN CLASS 41 (U.S. CLS. 100, 101 AND 107).

THE MARK CONSISTS OF STANDARD CHARACTERS WITHOUT CLAIM TO ANY PARTICULAR FONT, STYLE, SIZE, OR COLOR.

SER. NO. 78-826,861, FILED 3-1-2006.

HEATHER SAPP, EXAMINING ATTORNEY

Int. Cl.: 20

Prior U.S. Cls.: 2, 13, 22, 25, 32 and 50

United States Patent and Trademark Office

Reg. No. 3,476,647

Registered July 29, 2008

**TRADEMARK
PRINCIPAL REGISTER**

NATURAL EXPRESSIONS

RICHFIELD WINDOW COVERINGS, INC. (CALIFORNIA CORPORATION), DBA NIEN MADE (U.S.A.), INC.
13747 MIDWAY STREET
CERRITOS, CA 90703

FOR: WINDOW COVERINGS, NAMELY, INTERIOR SHUTTERS, SHUTTER INSERTS AND LOUVERS FOR INTERIOR SHUTTERS AND VENETIAN BLINDS, IN CLASS 20 (U.S. CLS. 2, 13, 22, 25, 32 AND 50).

FIRST USE 1-31-2006; IN COMMERCE 1-31-2006.

THE MARK CONSISTS OF STANDARD CHARACTERS WITHOUT CLAIM TO ANY PARTICULAR FONT, STYLE, SIZE, OR COLOR.

OWNER OF U.S. REG. NO. 2,545,426.

SER. NO. 78-838,915, FILED 3-16-2006.

G. MAYERSCHOFF, EXAMINING ATTORNEY

Int. Cl.: 42

Prior U.S. Cls.: 100 and 101

United States Patent and Trademark Office

Reg. No. 3,476,648

Registered July 29, 2008

**SERVICE MARK
PRINCIPAL REGISTER**

WWW.CYAGRA.COM

CYAGRA, INC. (DELAWARE CORPORATION)
197 BOSSLER ROAD
ELIZABETHTOWN, MA 17022

FOR: BIOTECHNOLOGY SERVICES, NAMELY,
CLONING ANIMALS, MAMMALIAN CLONING,
PRODUCING DIFFERENTIATED CELL TYPES
WHICH MAY BE TRANSGENIC, PRODUCING EM-
BRYONIC STEM CELL LINES, TRANSGENIC ANI-
MALS AND PROTEINS, ALL TO THE
SPECIFICATION OF OTHERS FOR RESEARCH,

MEDICAL AND AGRICULTURAL USE, IN CLASS
42 (U.S. CLS. 100 AND 101).

FIRST USE 3-7-2001; IN COMMERCE 3-7-2001.

THE MARK CONSISTS OF STANDARD CHAR-
ACTERS WITHOUT CLAIM TO ANY PARTICULAR
FONT, STYLE, SIZE, OR COLOR.

SER. NO. 78-845,176, FILED 3-24-2006.

GISELLE AGOSTO, EXAMINING ATTORNEY

Int. Cl.: 28

Prior U.S. Cls.: 22, 23, 38 and 50

United States Patent and Trademark Office

Reg. No. 3,476,649

Registered July 29, 2008

**TRADEMARK
PRINCIPAL REGISTER**

HUG 'N GLOW

MARVEL ENTERTAINMENT, INC. (DELAWARE
CORPORATION)
417 FIFTH AVENUE
NEW YORK, NY 10016

THE MARK CONSISTS OF STANDARD CHAR-
ACTERS WITHOUT CLAIM TO ANY PARTICULAR
FONT, STYLE, SIZE, OR COLOR.

FOR: PLUSH TOYS AND SOFT SCULPTURE
TOYS, IN CLASS 28 (U.S. CLS. 22, 23, 38 AND 50).

SER. NO. 78-845,516, FILED 3-24-2006.

FIRST USE 1-1-2002; IN COMMERCE 1-1-2002.

PETER B. BROMAGHIM, EXAMINING ATTORNEY

Int. Cl.: 3

Prior U.S. Cls.: 1, 4, 6, 50, 51 and 52

United States Patent and Trademark Office

Reg. No. 3,476,650

Registered July 29, 2008

**TRADEMARK
PRINCIPAL REGISTER**

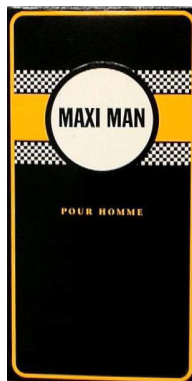

Y.Z.Y. INC (FLORIDA CORPORATION)
6300 NW 72ND AVENUE
MIAMI, FL 33166

FOR: BEAUTY CREAMS FOR BODY CARE; BODY LOTIONS; BODY SPRAY USED AS A PERSONAL DEODORANT AND AS FRAGRANCE; COLOGNE; CREAM SOAPS; DEODORANT FOR PERSONAL USE; EAU DE COLOGNE; EAU DE PERFUME; FRAGRANCES FOR PERSONAL USE; HAND CREAMS; HAND LOTIONS; NON-MEDICATED SKIN CREAMS; PERFUME; PERFUMED POWDERS, IN CLASS 3 (U.S. CLS. 1, 4, 6, 50, 51 AND 52).

FIRST USE 6-1-2005; IN COMMERCE 6-1-2005.

OWNER OF U.S. REG. NO. 3,108,149.

NO CLAIM IS MADE TO THE EXCLUSIVE RIGHT TO USE "MAN" AND "POUR HOMME", APART FROM THE MARK AS SHOWN.

THE COLOR(S) BLACK, YELLOW AND WHITE IS/ARE CLAIMED AS A FEATURE OF THE MARK.

THE COLOR BLACK APPEARS IN THE WORDING "MAXI MAN" AND IN THE OUTLINE OF THE CIRCLE WHICH IS I, POSED OVER THE YELLOW AND CHECKERED STRIPES. THE COLOR YELLOW APPEARS IN A RECTANGULAR OUTLINE AROUND THE EDGE OF THE MARK, A WIDE STRIPE GOING ACROSS NEAR THE TOP OF THE MARK AND THE WORDING "POUR HOMME". A CHECKERED BLACK AND WHITE DESIGN APPEARS IN WIDE STRIPES ABOVE AND BELOW THE WIDE YELLOW STRIPE. THE COLOR WHITE APPEARS IN THE CIRCLE AND IN THE INFORMATIONAL WORDING AT THE BOTTOM OF THE MARK. ALL IMPOSED ON A BLACK BACKGROUND AND APPLIED TO PRODUCT PACKAGING. NO CLAIM IS MADE TO THE SHAPE OF THE BOX.

THE FOREIGN WORDING IN THE MARK TRANSLATES INTO ENGLISH AS FOR MEN.

SER. NO. 78-847,476, FILED 3-28-2006.

KATHERINE CONNOLLY, EXAMINING ATTORNEY

Int. Cl.: 41

Prior U.S. Cls.: 100, 101 and 107

United States Patent and Trademark Office

Reg. No. 3,476,651

Registered July 29, 2008

**SERVICE MARK
PRINCIPAL REGISTER**

TRICKED OUT

SCRIPPS NETWORKS, INC. (DELAWARE CORPORATION)
9721 SHERRILL BOULEVARD
KNOXVILLE, TN 37932

FOR: ENTERTAINMENT SERVICES, NAMELY, AN ON-GOING AUDIO AND VISUAL PROGRAM DISTRIBUTED OVER TELEVISION, SATELLITE, WIRELESS, AUDIO AND VIDEO MEDIA, FIBER OPTICS, CABLE, AND A GLOBAL COMPUTER NETWORK IN THE FIELD OF MAINTENANCE AND CUSTOMIZATION OF AUTOMOBILES, IN CLASS 41 (U.S. CLS. 100, 101 AND 107).

FIRST USE 8-2-2004; IN COMMERCE 8-2-2004.

THE MARK CONSISTS OF STANDARD CHARACTERS WITHOUT CLAIM TO ANY PARTICULAR FONT, STYLE, SIZE, OR COLOR.

SER. NO. 78-848,167, FILED 3-28-2006.

FRED CARL, EXAMINING ATTORNEY

Int. Cls.: 35 and 41

Prior U.S. Cls.: 100, 101, 102 and 107

United States Patent and Trademark Office

Reg. No. 3,476,652

Registered July 29, 2008

**SERVICE MARK
PRINCIPAL REGISTER**

**Gallery of the American
Landscape**

WOLCOTT, TIMOTHY K. (UNITED STATES INDIVIDUAL)

40700 VILLAGE DRIVE

PO BOX 130244

BIG BEAR LAKE, CA 92315 AND

WOLCOTT, JAMIE P. (UNITED STATES INDIVIDUAL)

40700 VILLAGE DRIVE

PO BOX 130244

BIG BEAR LAKE, CA 92315

FOR: ART AND ARTWORK GALLERIES AND RETAIL STORE SERVICES FEATURING FINE ART AND ARTWORK, IN CLASS 35 (U.S. CLS. 100, 101 AND 102).

FIRST USE 5-0-2002; IN COMMERCE 5-0-2002.

FOR: CORPORATE, MUSEUM, INTERNATIONAL AND TOURING EXHIBITIONS FEATURING FINE ART AND ARTWORK, IN CLASS 41 (U.S. CLS. 100, 101 AND 107).

FIRST USE 5-0-2002; IN COMMERCE 5-0-2002.

THE MARK CONSISTS OF STANDARD CHARACTERS WITHOUT CLAIM TO ANY PARTICULAR FONT, STYLE, SIZE, OR COLOR.

SEC. 2(F).

SER. NO. 78-852,955, FILED S.R. 4-3-2006 AM. P.R. 7-16-2007.

FLORENTINA BLANDU, EXAMINING ATTORNEY

Int. Cl.: 41

Prior U.S. Cls.: 100, 101 and 107

United States Patent and Trademark Office

Reg. No. 3,476,653

Registered July 29, 2008

**SERVICE MARK
PRINCIPAL REGISTER**

TRILOGY LACROSSE

TRILOGY LACROSSE, LLC (MARYLAND LTD
LIAB CO)
POST OFFICE BOX 92
JACKSON, WY 83001

FOR: EDUCATIONAL SERVICES, NAMELY,
SPORTS CAMPS, IN CLASS 41 (U.S. CLS. 100, 101
AND 107).

FIRST USE 3-2-2005; IN COMMERCE 3-2-2005.

THE MARK CONSISTS OF STANDARD CHAR-
ACTERS WITHOUT CLAIM TO ANY PARTICULAR
FONT, STYLE, SIZE, OR COLOR.

NO CLAIM IS MADE TO THE EXCLUSIVE
RIGHT TO USE "LACROSSE", APART FROM THE
MARK AS SHOWN.

SER. NO. 78-862,815, FILED 4-17-2006.

DOMINIC FATHY, EXAMINING ATTORNEY

Int. Cl.: 41

Prior U.S. Cls.: 100, 101 and 107

United States Patent and Trademark Office

Reg. No. 3,476,654

Registered July 29, 2008

**SERVICE MARK
PRINCIPAL REGISTER**

sugarcane

LOFTEN, BRYAN, R. (UNITED STATES INDIVIDUAL)
219 W. 139TH ST. #4
NEW YORK, NY 10030

FOR: ENTERTAINMENT IN THE NATURE OF LIVE MUSICAL PERFORMANCES BY A MUSICAL GROUP; ENTERTAINMENT SERVICES, NAMELY, PROVIDING A WEB SITE FEATURING MUSICAL PERFORMANCES, MUSICAL VIDEOS, RELATED FILM CLIPS, PHOTOGRAPHS, AND OTHER MULTIMEDIA MATERIALS, IN CLASS 41 (U.S. CLS. 100, 101 AND 107).

FIRST USE 4-1-2006; IN COMMERCE 4-16-2006.

THE MARK CONSISTS OF STANDARD CHARACTERS WITHOUT CLAIM TO ANY PARTICULAR FONT, STYLE, SIZE, OR COLOR.

SER. NO. 78-864,552, FILED 4-19-2006.

SHARON MEIER, EXAMINING ATTORNEY

Int. Cl.: 41

Prior U.S. Cls.: 100, 101 and 107

United States Patent and Trademark Office

Reg. No. 3,476,655

Registered July 29, 2008

**SERVICE MARK
PRINCIPAL REGISTER**

**Lavender Capital of North
America**

SEQUIM LAVENDER GROWERS ASSOCIATION
(WASHINGTON NON-PROFIT ASSOCIATION)
P. O. BOX 3844
SEQUIM, WA 98382

FOR: ARRANGING AGRICULTURAL LEDUCATIONAL CONFERENCES RELATING TO PROPAGATING, CULTIVATING, HARVESTING AND MAKING AND USING LAVENDER PRODUCTS FOR MEDICINAL AND CULINARY PURPOSES, IN THE GARDEN AND FOR LANDSCAPING, IN CLASS 41 (U.S. CLS. 100, 101 AND 107).

FIRST USE 10-1-2003; IN COMMERCE 6-1-2004.

THE MARK CONSISTS OF STANDARD CHARACTERS WITHOUT CLAIM TO ANY PARTICULAR FONT, STYLE, SIZE, OR COLOR.

SER. NO. 78-866,587, FILED 4-21-2006.

TEJBIR SINGH, EXAMINING ATTORNEY

Int. Cl.: 10

Prior U.S. Cls.: 26, 39 and 44

United States Patent and Trademark Office

Reg. No. 3,476,656

Registered July 29, 2008

**TRADEMARK
PRINCIPAL REGISTER**

POCKET MASK

LAERDAL MEDICAL AS (NORWAY CORPORATION)
P.O. BOX 377, TANKE SVILANDSGATE 30
N-4002, STAVANGAR, NORWAY

FOR: CARDIOPULMONARY RESUSCITATION DEVICE, NAMELY, PROTECTIVE ORAL BARRIER WITH DISPOSABLE VALVE FOR USE DURING MOUTH-TO-MOUTH RESUSCITATION TO MINIMIZE CROSS MOISTURE CONTACT, IN CLASS 10 (U.S. CLS. 26, 39 AND 44).

FIRST USE 0-0-1969; IN COMMERCE 0-0-1971.

THE MARK CONSISTS OF STANDARD CHARACTERS WITHOUT CLAIM TO ANY PARTICULAR FONT, STYLE, SIZE, OR COLOR.

NO CLAIM IS MADE TO THE EXCLUSIVE RIGHT TO USE "MASK", APART FROM THE MARK AS SHOWN.

SEC. 2(F).

SER. NO. 78-868,261, FILED 4-24-2006.

WANDA KAY PRICE, EXAMINING ATTORNEY

Int. Cl.: 30

Prior U.S. Cl.: 46

United States Patent and Trademark Office

Reg. No. 3,476,657

Registered July 29, 2008

TRADEMARK
PRINCIPAL REGISTER

YIAYIA'S

GG&T CORPORATION (OHIO CORPORATION)
143 WESTWOOD ROAD
ASHEVILLE, NC 28804

FOR: SALAD DRESSINGS, IN CLASS 30 (U.S. CL.
46).

FIRST USE 5-1-1986; IN COMMERCE 5-1-1986.

THE MARK CONSISTS OF STANDARD CHAR-
ACTERS WITHOUT CLAIM TO ANY PARTICULAR
FONT, STYLE, SIZE, OR COLOR.

THE FOREIGN WORDING IN THE MARK
TRANSLATES INTO ENGLISH AS GRANDMA'S.

SER. NO. 78-869,056, FILED 4-25-2006.

INGRID C. EULIN, EXAMINING ATTORNEY

Int. Cl.: 43

Prior U.S. Cls.: 100 and 101

United States Patent and Trademark Office

Reg. No. 3,476,658

Registered July 29, 2008

**SERVICE MARK
PRINCIPAL REGISTER**



AREAS, S.A. (SPAIN CORPORATION)
VIA AUGUSTA, 21, 60
BARCELONA, SPAIN 08006

FOR: RESTAURANT SERVICES, IN CLASS 43
(U.S. CLS. 100 AND 101).

OWNER OF ERPN CMNTY TM OFC REG. NO.
002617074, DATED 8-27-2003, EXPIRES 3-13-2012.

"THE COLOR(S) LIGHT GREEN, DARK GREEN
AND ORANGE IS/ARE CLAIMED AS A FEATURE
OF THE MARK."

"THE MARK CONSISTS OF THE WORD NATUR-
AL IN SPECIAL FORM IN DARK GREEN, THE
WORD BREAK IN ORANGE AND LEAVES AND
APPLE ABOVE AND BELOW THE WORDS IN
LIGHT GREEN."

SER. NO. 78-870,409, FILED 4-26-2006.

KAPIL BHANOT, EXAMINING ATTORNEY

Int. Cl.: 36

Prior U.S. Cls.: 100, 101 and 102

Reg. No. 3,476,659

United States Patent and Trademark Office

Registered July 29, 2008

**SERVICE MARK
PRINCIPAL REGISTER**

DENTAL SELECT

SELECT BENEFITS GROUP, INC. (UTAH CORPORATION)
SUITE 400
5373 SOUTH GREEN STREET
SALT LAKE CITY, UT 84123

FOR: DENTAL HEALTH INSURANCE ADMINISTRATION, UNDERWRITING AND INSURANCE AGENCY SERVICES; DENTAL HEALTH INSURANCE ADMINISTRATION, UNDERWRITING AND INSURANCE AGENCY SERVICES FOR ROUTINE DENTAL CARE, ORTHODONTICS, PEDIATRIC DENTAL CARE, PERIODONTICS, ENDODONTICS, AND ORAL SURGERY; ORGANIZING DENTAL PREFERRED PROVIDER PROGRAMS; ADMINISTRATION, UNDERWRITING AND INSURANCE AGENCY SERVICES FEATURING DENTAL PLANS, INDIVIDUAL AND FAMILY DENTAL INSURANCE PLANS, GROUP DENTAL INSURANCE PLANS, PREFERRED PROVIDER DENTAL INSURANCE PLANS, AND DISCOUNT DENTAL INSURANCE PLANS; DENTAL INSURANCE CLAIMS PROCESSING; AND UNDERWRITING INDEMNITY INSURANCE AND PRE-PAID DENTAL CARE; ADMINISTRATION, UNDERWRITING AND INSURANCE AGENCY SERVICES FEATURING VISION PLANS, VISION PLANS FOR EYE EXAMS AND FRAMES AND LENSES, VISION PLANS OFFERING A NETWORK OF VISION CARE PROVIDERS, INDIVIDUAL AND FAMILY VISION PLANS, GROUP VISION PLANS, PREFERRED PROVIDER VISION PLANS, DISCOUNT VISION PLANS; ORGANIZING VISION PREFERRED PROVIDER PROGRAMS; AND VISION CLAIMS PROCESSING; ADMINISTRATION, UNDERWRITING AND INSURANCE AGENCY SERVICES FEATURING ACCIDENTAL DEATH AND DISMEMBERMENT INSURANCE, ACCIDENTAL DEATH AND DISMEMBERMENT INSURANCE PLANS, INDIVIDUAL AND FAMILY ACCIDENTAL DEATH AND DISMEMBERMENT INSURANCE PLANS, GROUP ACCIDENTAL DEATH AND DISMEMBERMENT

INSURANCE PLANS, ADMINISTRATION OF ACCIDENTAL DEATH AND DISMEMBERMENT INSURANCE PLANS; AND ACCIDENTAL DEATH AND DISMEMBERMENT INSURANCE CLAIMS PROCESSING; AND CONSULTATION SERVICES IN ALL OF THE FOLLOWING FIELDS, NAMELY, DENTAL INSURANCE, DENTAL INSURANCE FOR ROUTINE DENTAL CARE, DENTAL INSURANCE FOR ORTHODONTICS, DENTAL INSURANCE FOR PEDIATRIC DENTAL CARE, DENTAL INSURANCE FOR PERIODONTICS, DENTAL INSURANCE FOR ENDODONTICS, DENTAL INSURANCE FOR ORAL SURGERY, DENTAL INSURANCE OFFERING A NETWORK OF DENTAL CARE PROVIDERS, DENTAL INSURANCE PLANS, INDIVIDUAL AND FAMILY DENTAL INSURANCE PLANS, GROUP DENTAL INSURANCE PLANS, PREFERRED PROVIDER DENTAL INSURANCE PLANS, DISCOUNT DENTAL INSURANCE PLANS, ADMINISTRATION OF DENTAL INSURANCE PLANS, DENTAL INSURANCE CLAIMS PROCESSING, UNDERWRITING INDEMNITY INSURANCE, PRE-PAID DENTAL CARE, VISION PLANS, VISION PLANS FOR EYE EXAMS AND FRAMES AND LENSES, VISION PLANS OFFERING A NETWORK OF VISION CARE PROVIDERS, INDIVIDUAL AND FAMILY VISION PLANS, GROUP VISION PLANS, PREFERRED PROVIDER VISION PLANS, DISCOUNT VISION PLANS, ADMINISTRATION OF VISION PLANS, VISION CLAIMS PROCESSING, ACCIDENTAL DEATH AND DISMEMBERMENT INSURANCE, ACCIDENTAL DEATH AND DISMEMBERMENT INSURANCE PLANS, INDIVIDUAL AND FAMILY ACCIDENTAL DEATH AND DISMEMBERMENT INSURANCE PLANS, GROUP ACCIDENTAL DEATH AND DISMEMBERMENT INSURANCE PLANS, ADMINISTRATION OF ACCIDENTAL DEATH AND DISMEMBERMENT INSURANCE PLANS, AND ACCIDENTAL DEATH AND DISMEMBERMENT INSURANCE CLAIMS PROCESSING, IN CLASS 36 (U.S. CLS. 100, 101 AND 102).

FIRST USE 8-1-1989; IN COMMERCE 8-1-1989.

THE MARK CONSISTS OF STANDARD CHARACTERS WITHOUT CLAIM TO ANY PARTICULAR FONT, STYLE, SIZE, OR COLOR.

OWNER OF U.S. REG. NO. 2,579,869.

NO CLAIM IS MADE TO THE EXCLUSIVE RIGHT TO USE "DENTAL", APART FROM THE MARK AS SHOWN.

SER. NO. 78-872,575, FILED 4-28-2006.

TINA L. SNAPP, EXAMINING ATTORNEY

Int. Cl.: 36

Prior U.S. Cls.: 100, 101 and 102

United States Patent and Trademark Office

Reg. No. 3,476,660

Registered July 29, 2008

**SERVICE MARK
PRINCIPAL REGISTER**



ENCORE CAPITAL GROUP, INC. (CALIFORNIA CORPORATION)
8875 AERO DRIVE, SUITE 200
SAN DIEGO, CA 92123

FOR: DEBT RECOVERY AND COLLECTION AGENCIES, EXCLUDING FROM ALL OF THE FOREGOING, BANKING, BANK CARD, DEBIT CARD, CREDIT CARD, CHARGE CARD, MAGNETIC ENCODED CARD, STORED VALUE AND/OR

PREPAID CARD SERVICES, TRANSACTION AUTHORIZATION PROCESSING SERVICES, ATM SERVICES, IN CLASS 36 (U.S. CLS. 100, 101 AND 102).

FIRST USE 4-14-2004; IN COMMERCE 4-14-2004.

SER. NO. 78-874,229, FILED 5-2-2006.

GINA FINK, EXAMINING ATTORNEY

Int. Cls.: 35, 36 and 44

Prior U.S. Cls.: 100, 101 and 102

United States Patent and Trademark Office

Reg. No. 3,476,661

Registered July 29, 2008

**SERVICE MARK
PRINCIPAL REGISTER**

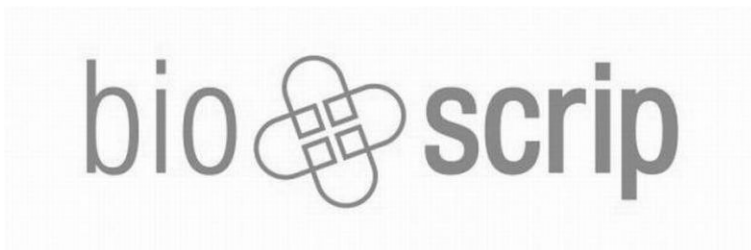

BIOSCRIP, INC. (DELAWARE CORPORATION)
100 CLEARBROOK ROAD
ELMSFORD, NY 10523

FOR: PHARMACEUTICAL COST MANAGEMENT SERVICES; HEALTH CARE COST REVIEW IN THE NATURE OF PHARMACEUTICAL ELIGIBILITY SCREENING; RETAIL, WHOLESALE AND MAIL ORDER PHARMACY SERVICES; AND PHARMACY SERVICES, NAMELY, TRADITIONAL DISTRIBUTION AND SPECIALTY DISTRIBUTION OF PHARMACEUTICALS ON BOTH RETAIL AND WHOLESALE LEVELS; PROVIDING HEALTH CARE STAFF TO OTHERS FOR ADMINISTERING PRESCRIPTION MEDICATION, IN CLASS 35 (U.S. CLS. 100, 101 AND 102).

FIRST USE 4-16-2000; IN COMMERCE 4-16-2000.

FOR: PHARMACEUTICAL BENEFIT MANAGEMENT SERVICES, IN CLASS 36 (U.S. CLS. 100, 101 AND 102).

FIRST USE 4-16-2000; IN COMMERCE 4-16-2000.

FOR: INFUSION THERAPY SERVICES; INFUSION OF PHARMACEUTICALS IN THE HOME AND IN OFFICE INFUSION SUITES AND CENTERS; CLINICAL MANAGEMENT, NAMELY, MONITORING, REVIEW AND ANALYSIS OF PATIENT PHARMACEUTICAL COMPLIANCE; LEASING OF MEDICAL EQUIPMENT, NAMELY, PROVIDING INSTRUMENTS AND APPARATUS FOR ADMINISTERING PRESCRIPTION MEDICATION, IN CLASS 44 (U.S. CLS. 100 AND 101).

FIRST USE 4-16-2000; IN COMMERCE 4-16-2000.

NO CLAIM IS MADE TO THE EXCLUSIVE RIGHT TO USE "SCRIP", APART FROM THE MARK AS SHOWN.

SER. NO. 78-877,538, FILED 5-5-2006.

KRISTIN DAHLING, EXAMINING ATTORNEY

Int. Cls.: 35, 38, 41 and 42

Prior U.S. Cls.: 100, 101, 102, 104 and 107

United States Patent and Trademark Office

Reg. No. 3,476,662

Registered July 29, 2008

**SERVICE MARK
PRINCIPAL REGISTER**



FUEST, LUDGER (FED REP GERMANY INDIVIDUAL)
AN DER EISENKAUL 16
EUSKIRCHEN, FED REP GERMANY 53881

FOR: AUCTIONEERING OF INTELLECTUAL PROPERTY, NAMELY, PATENTS, COPYRIGHTS AND TRADEMARKS; RETAIL SERVICES FEATURING ART, VIDEOS AND PHOTOGRAPHS, IN CLASS 35 (U.S. CLS. 100, 101 AND 102).

FOR: BROADCASTING OF VIDEO CONTENT AND TEXT CONTENT VIA THE INTERNET, IN CLASS 38 (U.S. CLS. 100, 101 AND 104).

FOR: EDUCATIONAL SERVICES, NAMELY, PROVIDING LIVE AND ON-LINE SEMINARS, WORKSHOPS, TUTORING AND MENTORING IN THE FIELDS OF BUSINESS MANAGEMENT AND BUSINESS ADMINISTRATION AND EXPLOITATION OF BUSINESS CONCEPTS AND INTELLECTUAL PROPERTY, NAMELY, PATENTS,

COPYRIGHTS AND TRADEMARKS, IN CLASS 41 (U.S. CLS. 100, 101 AND 107).

FOR: HOSTING OF DIGITAL CONTENT FEATURING MEDIA CONTRIBUTIONS ON BUSINESS CONCEPTS AND INTELLECTUAL PROPERTY, NAMELY, PATENTS, COPYRIGHTS AND TRADEMARKS; PROVIDING TEMPORARY USE OF NON-DOWNLOADABLE COMPUTER SOFTWARE FOR PREPARING SHIPPING DOCUMENTS OVER THE INTERNET, IN CLASS 42 (U.S. CLS. 100 AND 101).

PRIORITY CLAIMED UNDER SEC. 44(D) ON ERPN CMNTY TM OFC APPLICATION NO. 004737631, FILED 11-22-2005, REG. NO. 004737631, DATED 4-11-2007, EXPIRES 11-22-2015.

SER. NO. 78-889,161, FILED 5-22-2006.

CHRISTOPHER BUONGIORNO, EXAMINING ATTORNEY

Int. Cl.: 16

Prior U.S. Cls.: 2, 5, 22, 23, 29, 37, 38 and 50

United States Patent and Trademark Office

Reg. No. 3,476,663

Registered July 29, 2008

**TRADEMARK
PRINCIPAL REGISTER**

BOLDPRINT

BOLDPRINT INC. (CANADA CORPORATION)
281 WYECROFT ROAD
OAKVILLE, CANADA L6K 2H2

FOR: A SERIES OF FICTION BOOKS, NON-FICTION AND EDUCATIONAL BOOKS ON A VARIETY OF TOPICS, IN CLASS 16 (U.S. CLS. 2, 5, 22, 23, 29, 37, 38 AND 50).

FIRST USE 4-30-2004; IN COMMERCE 6-30-2005.

THE MARK CONSISTS OF STANDARD CHARACTERS WITHOUT CLAIM TO ANY PARTICULAR FONT, STYLE, SIZE, OR COLOR.

PRIORITY CLAIMED UNDER SEC. 44(D) ON CANADA APPLICATION NO. 1303946, FILED 6-2-2006, REG. NO. 700421, DATED 11-7-2007, EXPIRES 11-7-2021.

SER. NO. 78-901,407, FILED 6-6-2006.

FRANK LATTUCA, EXAMINING ATTORNEY

Int. Cls.: 16, 21 and 24

**Prior U.S. Cls.: 2, 5, 13, 22, 23, 29, 30, 33, 37, 38, 40, 42
and 50**

Reg. No. 3,476,664

United States Patent and Trademark Office

Registered July 29, 2008

**TRADEMARK
PRINCIPAL REGISTER**

Many Happy Returns

REED, SARAH (UNITED KINGDOM INDIVIDUAL)
19A GOODGE STREET
LONDON, UNITED KINGDOM W1T 2PH

FOR: PRINTED MATTER, NAMELY, MAGAZINES FEATURING HOUSEHOLD AND KITCHEN GOODS AND GIFTS; COMIC BOOKS; GIFT CATALOGUES; BOOKS IN THE FIELD OF ARTS, HUMANITIES, CULTURE, POLITICS, RELIGION, ENTERTAINMENT AND SPORTS; POSTERS; CALENDARS; PRINTS; NOTEBOOKS; NOTEPADS; PAPER BINDERS; FOLDERS; PERSONAL ORGANIZERS; PENCILS; PENS; ERASERS; PENCIL CASES; GREETINGS CARDS; COLLECTOR TRADING CARDS; PAPER STICKERS AND TRANSFERS; PACKAGING, NAMELY, PAPER GIFT WRAP; PHOTOGRAPHS; STATIONERY; ARTISTS' MATERIALS, NAMELY, PAINTBRUSHES; MEDICAL INFORMATION CARDS; CARDS BEARING INFORMATION DESIGNED TO STIMULATE THE MEMORY; CARDS BEARING HISTORICAL FACTS AND DIAGRAMS; CARDS BEARING INFORMATION TO ENABLE THE SHARING OF HISTORICAL INFORMATION; PAPER INSTRUCTIONAL AND TEACHING MATERIAL IN THE FIELDS OF ARTS, HUMANITIES, CULTURE, POLITICS, RELIGION, ENTERTAINMENT AND SPORTS ALL OF THE ABOVE EXPRESSLY NOT IN RELATION TO BIRTHDAYS, IN CLASS 16 (U.S. CLS. 2, 5, 22, 23, 29, 37, 38 AND 50).

FOR: DOMESTIC, BATHROOM AND KITCHEN CONTAINERS FOR HOUSEHOLD USE; GLASSWARE IN THE FORM OF DRINK GLASSES; PORCELAIN CONTAINERS, DISHES, AND FIGURINES, CERAMIC CONTAINERS, DISHES, AND FIGURINES, EARTHENWARE CONTAINERS, DISHES, AND FIGURINES, FOR DISPLAY PURPOSES AND HOUSEHOLD USE; BASINS; BOWLS; PITCHERS;

BOTTLES SOLD EMPTY; PLATES NOT OF PRECIOUS METAL; CUPS; MUGS; SAUCERS; JARS FOR KITCHEN STORAGE USE; POTS; PANS; DISHES; BREAD BASKETS FOR DOMESTIC USE; KITCHEN FOOD AND COLLECTION BINS; DUST PANS/BINS; BREAD BOARDS AND CUTTING BOARDS; NON-ELECTRIC EGG-BEATERS; BRUSHES FOR KITCHEN COOKING AND PREPARATION, NAMELY, BASTING AND CLEANING BRUSHES; BUCKETS; COOKING UTENSILS, NAMELY, LADLES, SPATULAS, TONGS, SPOONS, FORKS, HAIR COMBS AND KITCHEN SPONGES, ALL OF THE AFOREMENTIONED EXPRESSLY NOT IN RELATION TO BIRTHDAYS, IN CLASS 21 (U.S. CLS. 2, 13, 23, 29, 30, 33, 40 AND 50).

FOR: BEDCOVERS; CUSHION COVERS; TABLE COVERS NOT OF PAPER; TEA TOWELS; TOWELS; BED LINENS; BED BLANKETS; CURTAINS; UNFITTED FURNITURE COVERS; BED MATS MADE OF FABRIC, AND FABRIC TABLE RUNNERS; CLOTH NAPKINS; HOT-POT HOLDERS, ALL OF THE ABOVE EXPRESSLY NOT IN RELATION TO BIRTHDAYS, AND ALL OF THE ABOVE FOR SALE IN FINISHED FORM TO END USER CONSUMERS, IN CLASS 24 (U.S. CLS. 42 AND 50).

THE MARK CONSISTS OF STANDARD CHARACTERS WITHOUT CLAIM TO ANY PARTICULAR FONT, STYLE, SIZE, OR COLOR.

PRIORITY CLAIMED UNDER SEC. 44(D) ON ERPN CMNTY TM OFC APPLICATION NO. 004769246, FILED 12-7-2005, REG. NO. 004769246, DATED 10-27-2006, EXPIRES 12-7-2015.

SER. NO. 78-901,417, FILED 6-6-2006.

FRANK LATTUCA, EXAMINING ATTORNEY

Int. Cl.: 5

Prior U.S. Cls.: 6, 18, 44, 46, 51 and 52

United States Patent and Trademark Office

Reg. No. 3,476,665

Registered July 29, 2008

**TRADEMARK
PRINCIPAL REGISTER**

VEVO MICROMARKER

VISUALSONICS INC. (CANADA CORPORATION)
SUITE 6100 BOX 66
3080 YONGE STREET
TORONTO, CANADA M4N 3N1

FOR: INTRAVASCULAR CONTRAST AGENT
FOR IN-VIVO IMAGING FOR USE WITH IMAGING
EQUIPMENT, INCLUDING ULTRASOUND, MRI,
PET, SPECT, CT, OPTICAL AND OTHER IMAGING
MODALITIES, IN CLASS 5 (U.S. CLS. 6, 18, 44, 46, 51
AND 52).

THE MARK CONSISTS OF STANDARD CHAR-
ACTERS WITHOUT CLAIM TO ANY PARTICULAR
FONT, STYLE, SIZE, OR COLOR.

PRIORITY CLAIMED UNDER SEC. 44(D) ON
CANADA APPLICATION NO. 1303797, FILED 6-1-
2006, REG. NO. TMA705712, DATED 1-25-2008, EX-
PIRES 1-25-2023.

OWNER OF U.S. REG. NO. 3,052,172.

SER. NO. 78-901,590, FILED 6-6-2006.

LINDA LAVACHE, EXAMINING ATTORNEY

Int. Cl.: 9

Prior U.S. Cls.: 21, 23, 26, 36 and 38

Reg. No. 3,476,666

United States Patent and Trademark Office

Registered July 29, 2008

**TRADEMARK
PRINCIPAL REGISTER**

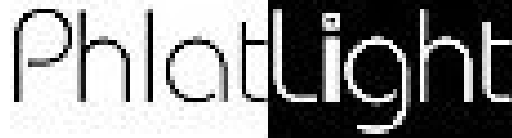
The logo for PhlatLight features the word "PhlatLight" in a white, sans-serif font. The letters "Phlat" are in a standard weight, while "Light" is in a bolder weight. The "i" in "Light" has a dot. The text is positioned to the left of a solid black square that partially overlaps the right side of the word "Light".

LUMINUS DEVICES, INC. (DELAWARE CORPORATION)
1100 TECHNOLOGY PARK DRIVE
BILLERICA, MA 01821

NO CLAIM IS MADE TO THE EXCLUSIVE RIGHT TO USE "FLATLIGHT", APART FROM THE MARK AS SHOWN.

FOR: LIGHT EMITTING DEVICES, NAMELY, LIGHT EMITTING DIODES, IN CLASS 9 (U.S. CLS. 21, 23, 26, 36 AND 38).

SER. NO. 78-904,108, FILED 6-8-2006.

FIRST USE 3-9-2006; IN COMMERCE 3-9-2006.

KATHERINE STOIDES, EXAMINING ATTORNEY

Int. Cl.: 16

Prior U.S. Cls.: 2, 5, 22, 23, 29, 37, 38 and 50

United States Patent and Trademark Office

Reg. No. 3,476,667

Registered July 29, 2008

**TRADEMARK
PRINCIPAL REGISTER**



FRANK K. LICCIARDI ESTATE, COMPRISING
PHYLLIS LICCIARDI, A U.S. CITIZEN
(SOUTH CAROLINA ESTATE)
1296 MARVIN AVENUE
CHARLESTON, SC 29407

FOR: PAINTING, IN CLASS 16 (U.S. CLS. 2, 5, 22,
23, 29, 37, 38 AND 50).

FIRST USE 1-1-1933; IN COMMERCE 1-1-1933.

THE NAME(S), PORTRAIT(S), AND/OR SIGNA-
TURE(S) SHOWN IN THE MARK IDENTIFIES
LICCIARDI, DECEASED HUSBAND OF PHYLLIS
LICCIARDI.

THE COLOR(S) GREEN ROSE AND BLACK AND
GRAY IS/ARE CLAIMED AS A FEATURE OF THE
MARK.

THE COLORS GRAY, GREEN AND ROSE AP-
PEAR IN AN ABSTRACT DESIGN; THE NAME
"LICCIARDI" APPEARS IN BLACK.

SER. NO. 78-904,492, FILED 6-9-2006.

CAROLYN GRAY, EXAMINING ATTORNEY

Int. Cl.: 7

Prior U.S. Cls.: 13, 19, 21, 23, 31, 34 and 35

United States Patent and Trademark Office

Reg. No. 3,476,668

Registered July 29, 2008

**TRADEMARK
PRINCIPAL REGISTER**

KOR-LOK

PFA, INC. (WISCONSIN CORPORATION)
N18 W18251 BUNSEN DRIVE
GERMANTOWN, WI 53022

FIRST USE 5-1-1996; IN COMMERCE 5-1-1996.

FOR: FLUID POWER MACHINE PARTS, NAME-
LY, HYDRAULIC CYLINDERS, PNEUMATIC CY-
LINDERS, PARTICULARLY, MECHANICAL AND
HYDROMECHANICAL CYLINDERS; HYDRAULIC
VALVE ACTUATORS; PNEUMATIC VALVE AC-
TUATORS; MECHANICAL AND HYDROMECHA-
NICAL ACTUATORS, IN CLASS 7 (U.S. CLS. 13, 19,
21, 23, 31, 34 AND 35).

THE MARK CONSISTS OF STANDARD CHAR-
ACTERS WITHOUT CLAIM TO ANY PARTICULAR
FONT, STYLE, SIZE, OR COLOR.

SER. NO. 78-907,675, FILED 6-14-2006.

RENEE MCCRAY, EXAMINING ATTORNEY

Int. Cl.: 9

Prior U.S. Cls.: 21, 23, 26, 36 and 38

Reg. No. 3,476,669

United States Patent and Trademark Office

Registered July 29, 2008

**TRADEMARK
PRINCIPAL REGISTER**

ACTIVPEN

PROMETHEAN LIMITED (UNITED KINGDOM COMPANY)
PROMETHEAN HOUSE, LOWER PHILIPS ROAD
BLACKBURNE, LANCASHIRE, UNITED KINGDOM BB1 5TH

FOR: ELECTRONIC APPARATUS AND INSTRUMENTS FOR USE IN TEACHING, AND PERSONAL COMPUTING EQUIPMENT FOR USE THEREWITH, NAMELY, COMPUTERS, KEYBOARDS, INTERACTIVE ELECTRONIC WHITEBOARDS AND ASSOCIATED ELECTRONIC PENS AND PADS AND HANDHELD TRANSMITTERS AND RECEIVERS OF DATA; DISPLAY APPARATUS AND LIGHT PROJECTORS, NAMELY, SLIDE PROJECTORS; PROJECTION AND DISPLAY SCREENS, NAMELY, LIQUID CRYSTAL DISPLAY SCREENS, AND VIDEO MONITORS; ELECTRONIC GRAPHIC PC TABLETS AND COMPUTER KEYPADS; COMPUTER SOFTWARE RECORDED ON ELECTRONIC DATA CARRIERS, AND COMPUTER SOFTWARE DOWNLOADABLE FROM ON-LINE DATABASES, ALL SUCH SOFTWARE FOR USE IN TEACHING, TRAINING, AND EDUCATION COMPRISING A GENERIC SOFTWARE TOOLSET FOR DEVELOPMENT AND INTERACTIVE PRESENTATION OF

LESSONS AND LECTURES; ELECTRONIC ENCRYPTION UNITS; WIRELESS COMPUTER PERIPHERALS AND WIRELESS TELEPHONES; DATA PROCESSORS; AUDIO, STEREO AND VIDEO RECEIVERS; SIGNAL PROCESSORS; RADIO AND TELEPHONE TRANSMITTERS; HANDHELD WIRELESS RECEIVERS AND TRANSMITTERS FOR USE IN EDUCATIONAL TEACHING; LIGHT EMITTING DIODE DISPLAYS; FLAT PANEL DISPLAY SCREENS; LIQUID CRYSTAL DISPLAYS; COMPUTER HARDWARE; COMPUTERS; COMPUTER PERIPHERALS; COMPUTER OPERATING PROGRAMS, IN CLASS 9 (U.S. CLS. 21, 23, 26, 36 AND 38).

THE MARK CONSISTS OF STANDARD CHARACTERS WITHOUT CLAIM TO ANY PARTICULAR FONT, STYLE, SIZE, OR COLOR.

OWNER OF UNITED KINGDOM REG. NO. 2376639, DATED 7-22-2005, EXPIRES 10-26-2014.

SER. NO. 78-910,233, FILED 6-16-2006.

JENNIFER VASQUEZ, EXAMINING ATTORNEY

Int. Cls.: 35, 41 and 42

Prior U.S. Cls.: 100, 101, 102 and 107

United States Patent and Trademark Office

Reg. No. 3,476,670

Registered July 29, 2008

**SERVICE MARK
PRINCIPAL REGISTER**

WILDFLOWERS INSTITUTE

WILDFLOWERS INSTITUTE (CALIFORNIA
NON-PROFIT ORGANIZATION)
354 PINE STREET, 7TH FLOOR
SAN FRANCISCO, CA 94104

FOR: ADVISORY SERVICE FOR ORGANIZATIONAL ISSUES AND BUSINESS ADMINISTRATION WITH AND WITHOUT THE HELP OF ELECTRONIC DATA BASES; ADVICE AND CONSULTING RELATING TO THE CREATION, ORGANIZATION AND MANAGEMENT OF BUSINESS; ASSISTANCE, ADVISORY SERVICES AND CONSULTANCY WITH REGARD TO BUSINESS ANALYSIS, MANAGEMENT AND ORGANIZATIONAL AND COMMUNITY EFFECTIVENESS; BUSINESS CONSULTATION SERVICES TO ASSIST NON-PROFIT ORGANIZATIONS IN PLANNING, MANAGING, AND CONDUCTING FUNDRAISING ACTIVITIES; DEVELOPING AND COORDINATING VOLUNTEER PROJECTS FOR CHARITABLE ORGANIZATIONS; ADMINISTRATION OF CULTURAL AND EDUCATIONAL EXCHANGE PROGRAMS; BUSINESS MANAGEMENT CONSULTATION IN THE FIELD OF LEADERSHIP DEVELOPMENT; BUSINESS LEADERSHIP DEVELOPMENT; MANAGEMENT CONSULTING SERVICES, NAMELY, MEETING FACILITATION, GROUP PROBLEM SOLVING, PRODUCTIVITY IMPROVEMENT, LARGE SCALE CHANGE EFFORTS, INNOVATION PLANNING, CONFLICT RESOLUTION, FOSTERING COMMUNICATION, BUILDING AGREEMENT AMONG MEMBERS OF GROUPS, AND BUSINESS AND STRATEGIC PLANNING FOR COMMUNITY AND BUSINESS LEADERS; PUBLIC POLICY RESEARCH SERVICES; URBAN PLANNING AND DEVELOPMENT, NAMELY, COMMUNITY MANAGEMENT CONSULTATION IN THE FIELD OF LEADERSHIP DEVELOPMENT, COMMUNITY LEADERSHIP DEVELOPMENT, AND MANAGEMENT CONSULTING SERVICES, NAMELY, MEETING FACILITATION, GROUP PROBLEM SOLVING,

PRODUCTIVITY IMPROVEMENT, LARGE SCALE CHANGE EFFORTS, INNOVATION PLANNING, CONFLICT RESOLUTION, FOSTERING COMMUNICATION, BUILDING AGREEMENT AMONG MEMBERS OF GROUPS, AND BUSINESS AND STRATEGIC PLANNING FOR COMMUNITY LEADERS, IN CLASS 35 (U.S. CLS. 100, 101 AND 102).

FIRST USE 11-24-2003; IN COMMERCE 11-24-2003.

FOR: ORGANIZATION OF SEMINARS, WORKING GROUPS, RESEARCH GROUPS, AND CONVENTIONS, IN THE FIELD OF URBAN AND RURAL PLANNING CULTURAL STUDIES, COMMUNITY DEVELOPMENT, HUMANITIES AND SOCIAL SCIENCE; EDUCATIONAL SERVICES, NAMELY, PROVIDING INCENTIVES TO NONPROFIT ORGANIZATIONS AND COMMUNITY GROUPS TO DEMONSTRATE EXCELLENCE IN THE FIELD OF COMMUNITY PLANNING, DESIGNS, AND CULTURAL STUDIES THROUGH THE ISSUANCE OF AWARDS; ORGANIZING COMMUNITY CULTURAL EVENTS; EDUCATIONAL SERVICES, NAMELY, CONDUCTING TRAINING WORKSHOPS IN THE FIELD OF GROUP PROBLEM SOLVING, PERFORMING EFFECTIVELY, CONFLICT RESOLUTION, AND CHANGE IN THE WORKPLACE, FOSTERING COMMUNICATION, BUILDING AGREEMENT AMONG MEMBERS OF GROUPS, AND BUSINESS AND STRATEGIC PLANNING FOR COMMUNITY AND BUSINESS LEADERS AND DISTRIBUTING PRINTED EDUCATIONAL MATERIAL AND PRINTED COURSE MATERIAL IN CONNECTION THEREWITH, IN CLASS 41 (U.S. CLS. 100, 101 AND 107).

FIRST USE 11-24-2003; IN COMMERCE 11-24-2003.

FOR: CONSULTATION IN THE FIELD OF DESIGN OF PUBLIC USE SOCIAL SPACES FOR CIVIC ENGAGEMENTS, IN CLASS 42 (U.S. CLS. 100 AND 101).

FIRST USE 11-24-2003; IN COMMERCE 11-24-2003.

THE MARK CONSISTS OF STANDARD CHARACTERS WITHOUT CLAIM TO ANY PARTICULAR FONT, STYLE, SIZE, OR COLOR.

NO CLAIM IS MADE TO THE EXCLUSIVE RIGHT TO USE "INSTITUTE", APART FROM THE MARK AS SHOWN.

SER. NO. 78-911,802, FILED 6-19-2006.

MATTHEW EINSTEIN, EXAMINING ATTORNEY

Int. Cls.: 16 and 41

Prior U.S. Cls.: 2, 5, 22, 23, 29, 37, 38, 50, 100, 101 and 107

Reg. No. 3,476,671

United States Patent and Trademark Office

Registered July 29, 2008

**TRADEMARK
SERVICE MARK
PRINCIPAL REGISTER**

WORLD NEWS AND PROPHECY

UNITED CHURCH OF GOD, AN INTERNATIONAL ASSOCIATION (CALIFORNIA NON-POFIT RELIGIOUS CORPORATION)
555 TECHNECENTER DRIVE
MILFORD, OH 45150

FOR: PRINTED PUBLICATIONS, NAMELY, A SERIES OF MAGAZINES CONCERNING INSPIRATIONAL, MOTIVATIONAL, POLITICAL AND RELIGIOUS ISSUES, IN CLASS 16 (U.S. CLS. 2, 5, 22, 23, 29, 37, 38 AND 50).

FIRST USE 8-0-1998; IN COMMERCE 8-0-1998.

FOR: ONLINE PUBLICATIONS, NAMELY, PERIODICALS AND MAGAZINES CONCERNING IN-

SPIRATIONAL, MOTIVATIONAL, POLITICAL AND RELIGIOUS ISSUES, IN CLASS 41 (U.S. CLS. 100, 101 AND 107).

FIRST USE 8-0-1998; IN COMMERCE 8-0-1998.

THE MARK CONSISTS OF STANDARD CHARACTERS WITHOUT CLAIM TO ANY PARTICULAR FONT, STYLE, SIZE, OR COLOR.

SEC. 2(F).

SER. NO. 78-912,854, FILED 6-21-2006.

RAMONA ORTIGA, EXAMINING ATTORNEY

Int. Cl.: 38

Prior U.S. Cls.: 100, 101 and 104

United States Patent and Trademark Office

Reg. No. 3,476,672

Registered July 29, 2008

**SERVICE MARK
PRINCIPAL REGISTER**

THE DOCUMENTARY CHANNEL

DOCUMENTARY CHANNEL, INC. (DELAWARE
CORPORATION)
142 8TH AVENUE NORTH
NASHVILLE, TN 37203

FOR: TELEVISION BROADCASTING SERVICES,
IN CLASS 38 (U.S. CLS. 100, 101 AND 104).

FIRST USE 12-4-1997; IN COMMERCE 12-4-1997.

THE MARK CONSISTS OF STANDARD CHAR-
ACTERS WITHOUT CLAIM TO ANY PARTICULAR
FONT, STYLE, SIZE, OR COLOR.

OWNER OF U.S. REG. NO. 2,200,786.

NO CLAIM IS MADE TO THE EXCLUSIVE
RIGHT TO USE "CHANNEL", APART FROM THE
MARK AS SHOWN.

SEC. 2(F).

SER. NO. 78-913,689, FILED 6-21-2006.

DAVID H. STINE, EXAMINING ATTORNEY

Int. Cl.: 14

Prior U.S. Cls.: 2, 27, 28 and 50

United States Patent and Trademark Office

Reg. No. 3,476,673

Registered July 29, 2008

**TRADEMARK
PRINCIPAL REGISTER**

CORALIE

CORALIE LLC (FLORIDA PARTNERSHIP)
260 CRANDON BLVD , SUITE 32, PMB147
KEY BISCAVNE, FL 33149

FOR: BEADS FOR USE IN THE MANUFACTURE OF JEWELRY; BRACELETS; CHARMS; COSTUME JEWELRY; IDENTIFICATION BRACELETS; JEWELRY; JEWELRY BOXES OF PRECIOUS METAL; JEWELRY CASES OF PRECIOUS METAL; JEWELRY CASKETS OF PRECIOUS METAL; JEWELRY CHAINS; JEWELRY FINDINGS; JEWELRY FOR THE HEAD; JEWELRY PINS FOR USE ON HATS; JEWELRY WATCHES; JEWELRY, NAMELY, AMULETS; JEWELRY, NAMELY, CROSSES; JEWELRY,

NAMELY, PRECIOUS METAL PLATED REAL LEAVES AND FLOWERS; LAPEL PINS; PET JEWELRY; PINS BEING JEWELRY; RINGS BEING JEWELRY, IN CLASS 14 (U.S. CLS. 2, 27, 28 AND 50).

FIRST USE 9-1-2004; IN COMMERCE 12-1-2004.

THE MARK CONSISTS OF STANDARD CHARACTERS WITHOUT CLAIM TO ANY PARTICULAR FONT, STYLE, SIZE, OR COLOR.

SER. NO. 78-916,343, FILED 6-25-2006.

CAROLYN CATALDO, EXAMINING ATTORNEY

Int. Cl.: 43

Prior U.S. Cls.: 100 and 101

United States Patent and Trademark Office

Reg. No. 3,476,674

Registered July 29, 2008

SERVICE MARK
PRINCIPAL REGISTER



THE PIE PIZZERIA, INC. (UTAH CORPORATION)
230 WEST 200 SOUTH #2608
SALT LAKE CITY, UT 84101

FOR: RESTAURANT SERVICES, IN CLASS 43
(U.S. CLS. 100 AND 101).

FIRST USE 9-30-1986; IN COMMERCE 9-30-1986.

NO CLAIM IS MADE TO THE EXCLUSIVE
RIGHT TO USE "PIZZERIA" , APART FROM THE
MARK AS SHOWN.

SEC. 2(F).

SER. NO. 78-917,814, FILED 6-27-2006.

NICHOLAS ALTREE, EXAMINING ATTORNEY

Int. Cls.: 35, 38 and 42

Prior U.S. Cls.: 100, 101, 102 and 104

United States Patent and Trademark Office

Reg. No. 3,476,675

Registered July 29, 2008

**SERVICE MARK
PRINCIPAL REGISTER**

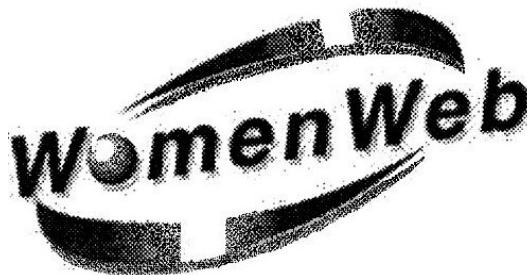

WOMENWEB AG (FED REP GERMANY CORPORATION)
FERINGASTR. 7
85774 UNTERFOHRING, FED REP GERMANY

FOR: ADVERTISING, BUSINESS MANAGEMENT, BUSINESS ADMINISTRATION, PROVIDING OFFICE FUNCTIONS, RENTAL OF ADVERTISING SPACE ON THE INTERNET, EMPLOYMENT RECRUITMENT AGENCIES; COMPUTER SERVICES, NAMELY, PROVIDING THE RETRIEVAL, INDEXING AND SORTING OF DATA ON AN ELECTRONIC COMMUNICATIONS NETWORK; ARRANGING OF ELECTRONIC BUSINESS TRANSACTIONS VIA A GLOBAL COMPUTER NETWORK, IN CLASS 35 (U.S. CLS. 100, 101 AND 102).

FOR: TELECOMMUNICATIONS, NAMELY, PERSONAL COMMUNICATIONS SERVICES; PROVIDING TELECOMMUNICATIONS NETWORKS FOR OTHERS; PROVIDING REMOTE INTERNET ACCESS; PROVIDING ACCESS TO DATABASES AND TO THE INTERNET; PROVIDING MULTIPLE ACCESS TO GLOBAL COMPUTER INFORMATION NETWORKS FOR THE TRANSFER AND DISSEMINATION OF A WIDE RANGE OF INFORMATION; COMPUTER HELPLINE SERVICES IN THE FIELD OF TELECOMMUNICATIONS, IN CLASS 38 (U.S. CLS. 100, 101 AND 104).

FOR: RENTAL OF COMPUTER HARDWARE AND SOFTWARE; COMPUTER AND COMPUTER NETWORK SERVICES, NAMELY, SOFTWARE IN-

STALLATION, SOFTWARE CONFIGURATION; COMPUTER CONSULTANCY, COMPUTER HARDWARE AND SOFTWARE DEVELOPMENT, WEBSITE DESIGN; COMPUTER PROGRAMMING; COMPUTER SERVICES, NAMELY, PROVIDING SEARCH ENGINES FOR OBTAINING DATA ON A GLOBAL COMPUTER NETWORK AND HOSTING THE WEB SITES OF OTHERS ON A COMPUTER SERVER FOR A GLOBAL COMPUTER NETWORK AND PROVIDING INFORMATION AT THE SPECIFIC REQUEST OF END-USERS BY MEANS OF GLOBAL COMPUTER NETWORKS (CUSTOMIZED SEARCHING), COMPUTER NETWORK DESIGN FOR OTHERS, HOSTING DIGITAL CONTENT ON THE INTERNET; MAINTENANCE OF COMPUTER SOFTWARE; TECHNICAL SUPPORT, NAMELY TROUBLE-SHOOTING OF COMPUTER HARDWARE AND SOFTWARE PROBLEMS; WEB HOSTING SERVICES; TELECOMMUNICATIONS CONSULTANCY, ONLINE SERVICES, NAMELY SEARCHING, RETRIEVING, INDEXING AND SORTING OF DATA ON ELECTRONIC COMMUNICATIONS NETWORKS, IN CLASS 42 (U.S. CLS. 100 AND 101).

OWNER OF FED REP GERMANY REG. NO. 30022143, DATED 7-20-2000, EXPIRES 3-31-2010.

SER. NO. 78-918,365, FILED 6-27-2006.

DAVID I, EXAMINING ATTORNEY

Int. Cl.: 40

Prior U.S. Cls.: 100, 103 and 106

United States Patent and Trademark Office

Reg. No. 3,476,676

Registered July 29, 2008

**SERVICE MARK
PRINCIPAL REGISTER**

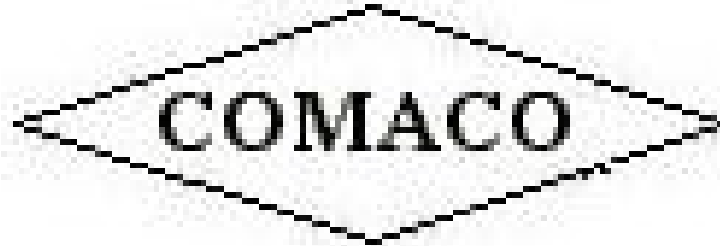

COX MANUFACTURING COMPANY (TEXAS
CORPORATION)
5500 NORTH LOOP 1604 EAST
SAN ANTONIO, TX 782474690

FIRST USE 1-1-1981; IN COMMERCE 1-1-1981.

SER. NO. 78-920,020, FILED 6-29-2006.

FOR: MACHINE SHOP SERVICES, NAMELY,
MACHINING METAL PARTS FOR OTHERS, IN
CLASS 40 (U.S. CLS. 100, 103 AND 106).

LANA PHAM, EXAMINING ATTORNEY

Int. Cls.: 16, 25, 35 and 43

**Prior U.S. Cls.: 2, 5, 22, 23, 29, 37, 38, 39, 50, 100, 101
and 102**

Reg. No. 3,476,677

United States Patent and Trademark Office

Registered July 29, 2008

**TRADEMARK
SERVICE MARK
PRINCIPAL REGISTER**



QATAR SPORTS INVESTMENTS CO. (QATAR CORPORATION)
P.O. BOX 24926
DOHA, QATAR

FOR: PAPER AND CARDBOARD; PAPER AND CARDBOARD ARTICLES, NAMELY, PAPER AND CARDBOARD BOXES, INDEX CARDS, CARDBOARD PACKAGING; NEWSPAPER; PRINTED PERIODICALS IN THE FIELD OF COMMERCIAL INVESTMENTS; BOOKBINDING MATERIALS, NAMELY, TAPE AND WIRE; PHOTOGRAPHS; CALENDARS; BROCHURES ABOUT COMMERCIAL INVESTMENTS, IN CLASS 16 (U.S. CLS. 2, 5, 22, 23, 29, 37, 38 AND 50).

FOR: CLOTHING, NAMELY, BOOTS, SHOES, CAPS, T-SHIRT, AND SPORTS SHOES, IN CLASS 25 (U.S. CLS. 22 AND 39).

FOR: COMMERCIAL BUSINESS MANAGEMENT SERVICES, IN CLASS 35 (U.S. CLS. 100, 101 AND 102).

FOR: PROVIDING TEMPORARY ACCOMMODATIONS, NAMELY, HOTELS AND BOARDING HOUSES; RESTAURANT AND COFFEE HOUSE

SERVICES; PROVIDING CAMPGROUND FACILITIES, IN CLASS 43 (U.S. CLS. 100 AND 101).

OWNER OF QATAR REG. NO. 37641, DATED 1-22-2008, EXPIRES 11-24-2015.

OWNER OF QATAR REG. NO. 37640, DATED 1-22-2008, EXPIRES 11-24-2015.

OWNER OF QATAR REG. NO. 37706, DATED 1-22-2008, EXPIRES 11-24-2015.

OWNER OF QATAR REG. NO. 37705, DATED 1-22-2008, EXPIRES 11-24-2015.

NO CLAIM IS MADE TO THE EXCLUSIVE RIGHT TO USE "QATAR SPORTS INVESTMENTS", APART FROM THE MARK AS SHOWN.

THE MARK CONSISTS OF THE LETTERS QSI IN STYLIZED FORM AND THE WORDS QATAR SPORTS INVESTMENTS.

SER. NO. 78-921,281, FILED 6-30-2006.

CURTIS FRENCH, EXAMINING ATTORNEY

Int. Cl.: 16

Prior U.S. Cls.: 2, 5, 22, 23, 29, 37, 38 and 50

United States Patent and Trademark Office

Reg. No. 3,476,678

Registered July 29, 2008

**TRADEMARK
PRINCIPAL REGISTER**



RIMROCK AUTOMATION, INC. (DELAWARE CORPORATION)
4600 INNOVATION DRIVE
FORT COLLINS, CO 80525

FOR: PRINTED MATERIALS, NAMELY, USER GUIDES FOR ROBOTS, IN CLASS 16 (U.S. CLS. 2, 5, 22, 23, 29, 37, 38 AND 50).

FIRST USE 3-1-2004; IN COMMERCE 3-1-2004.

THE COLOR(S) ORANGE, BLACK, AND WHITE IS/ARE CLAIMED AS A FEATURE OF THE MARK.

THE MARK SHOWS A BLACK SIDE VIEW OF A WOLF'S HEAD WITH AN ORANGE EYE, WHITE INNER EAR ALL OF WHICH APPEARS ON A ORANGE BACKGROUND, AND THE WOLF IS OUTLINED IN WHITE.

SER. NO. 78-923,750, FILED 7-6-2006.

LINDA MICKLEBURGH, EXAMINING ATTORNEY

Int. Cl.: 41

Prior U.S. Cls.: 100, 101 and 107

United States Patent and Trademark Office

Reg. No. 3,476,679

Registered July 29, 2008

**SERVICE MARK
PRINCIPAL REGISTER**

**California Baby Natural
Living**

ICLISOY, JESSICA (UNITED STATES INDIVIDUAL)
217 SOUTH LINDEN DRIVE
BEVERLY HILLS, CA 90212

FOR: BEAUTY ARTS INSTRUCTION; BOOK AND REVIEW PUBLISHING; CHARITABLE SERVICES, NAMELY, PROVIDING TRAINING IN THE FIELD OF BEAUTY, NATURAL HEALTH AND SUSTAINABLE LIVING; CONDUCTING EDUCATIONAL EXHIBITIONS IN THE NATURE OF BEAUTY, NATURAL HEALTH AND SUSTAINABLE LIVING; CONDUCTING WORKSHOPS AND SEMINARS IN PERSONAL AWARENESS; CONDUCTING WORKSHOPS AND SEMINARS IN SELF AWARENESS; CONDUCTING WORKSHOPS AND SEMINARS IN BEAUTY, NATURAL HEALTH AND SUSTAINABLE LIVING; DEVELOPING EDUCATIONAL MANUALS FOR OTHERS IN THE FIELD OF BEAUTY, NATURAL HEALTH AND SUSTAINABLE LIVING; DEVELOPMENT AND DISSEMINATION OF EDUCATIONAL MATERIALS OF OTHERS IN THE FIELD OF BEAUTY, NATURAL HEALTH AND SUSTAINABLE LIVING; ENTERTAINMENT SERVICES, NAMELY, PROVIDING A WEBSITE FEATURING, PHOTOGRAPHIC, AUDIO, VIDEO AND PROSE PRESENTATIONS FEATURING BEAUTY, NATURAL HEALTH AND SUSTAINABLE LIVING; HAIRDRESSING INSTRUCTION; INSTRUCTION IN THE FIELD OF BEAUTY, NATURAL HEALTH AND SUSTAINABLE LIVING; LIBRARIES; MAGAZINE PUBLISHING; MEDITATION TRAINING; NEWS AGENCIES, NAMELY, GATHERING AND DISSEMINATION OF NEWS; NEWS ANALYSIS AND FEATURES DISTRIBUTION; NEWS REPORTING SERVICES; NEWSPAPER PUBLICATION; NEWSPAPER PUBLISHING; ON-LINE LIBRARY SERVICES, NAMELY, PROVIDING ELECTRONIC LIBRARY SERVICES WHICH FEATURE NEWSPAPERS, MAGAZINES, PHOTOGRAPHS AND PICTURES VIA AN ON-LINE COMPUTER NETWORK; ON-LINE PUBLICATION OF BEAUTY, NATURAL

HEALTH AND SUSTAINABLE LIVING ARTICLES; ONLINE JOURNALS, NAMELY, BLOGS FEATURING BEAUTY, NATURAL HEALTH AND SUSTAINABLE LIVING; ORGANIZING EXHIBITIONS FOR COMMUNICATING METHODS OF BEAUTY, NATURAL HEALTH AND SUSTAINABLE LIVING; PERSONAL COACHING SERVICES IN THE FIELD OF BEAUTY, NATURAL HEALTH AND SUSTAINABLE LIVING; PHOTOGRAPHIC REPORTING; PHYSICAL FITNESS CONSULTATION; PRODUCTION OF RADIO AND TELEVISION PROGRAMS; PRODUCTION OF RADIO OR TELEVISION PROGRAMS; PRODUCTION OF VIDEO CASSETTES; PRODUCTION OF VIDEO DISCS FOR OTHERS; PROGRAMMING ON A GLOBAL COMPUTER NETWORK; PROVIDING AN ON-LINE COMPUTER DATABASE FEATURING INFORMATION REGARDING EXERCISE AND FITNESS BEFORE AND AFTER PREGNANCY; PROVIDING INFORMATION AND INSTRUCTION IN THE FIELD OF TRIATHLON EVENTS; PROVIDING INFORMATION IN THE FIELD OF EXERCISE TRAINING; PROVIDING NEWSLETTERS IN THE FIELD OF BEAUTY, NATURAL HEALTH AND SUSTAINABLE LIVING VIA E-MAIL; PROVIDING ON-LINE PUBLICATIONS IN THE NATURE OF ARTICLES, REVIEWS, TESTIMONIES, INSTRUCTION IN THE FIELD OF BEAUTY, NATURAL HEALTH AND SUSTAINABLE LIVING ; PUBLICATION AND EDITING OF PRINTED MATTER; PUBLICATION OF BOOKS; PUBLICATION OF BOOKS, MAGAZINES, ALMANACS AND JOURNALS; PUBLICATION OF BOOKS, OF MAGAZINES, OF JOURNALS, OF NEWSPAPERS, OF PERIODICALS, OF CATALOGS, OF BROCHURES; PUBLICATION OF BOOKS, REVIEWS; PUBLICATION OF BROCHURES; PUBLICATION OF ELECTRONIC MAGAZINES; PUBLICATION OF ELECTRONIC NEWSPAPERS ACCESSIBLE VIA A GLOBAL COMPUTER NETWORK; PUBLICATION OF JOURNALS; PUBLICATION OF LEAFLETS; PUBLICATION OF MAGAZINES; PUBLICATION OF MANUALS; PUB-

LICATION OF PRINTED MATTER; PUBLICATION OF TEXT BOOKS; PUBLICATION OF TEXTS, BOOKS, JOURNALS; PUBLICATION OF TEXTS, BOOKS, MAGAZINES AND OTHER PRINTED MATTER; PUBLICATION OF THE EDITORIAL CONTENT OF SITES ACCESSIBLE VIA A GLOBAL COMPUTER NETWORK; PUBLICATION OF ON-LINE AND PRINT MAGAZINE IN THE FIELDS OF BEAUTY, NATURAL HEALTH AND SUSTAINABLE LIVING; PUBLISHING AND DISTRIBUTION OF BOOKS, REVIEWS AND OTHER PRINTED MATTER AS WELL AS RELATED ELECTRONIC DATA CARRIERS; PUBLISHING OF BOOKS AND REVIEWS; PUBLISHING OF BOOKS, MAGAZINES; PUBLISHING OF ELECTRONIC PUBLICATIONS; PUBLISHING OF JOURNALS, BOOKS AND HANDBOOKS IN THE FIELD OF MEDICINE; PUBLISHING OF REVIEWS; PUBLISHING OF WEB MAGAZINES; REFERENCE LIBRARIES OF LITERATURE AND DOCUMENTARY RECORDS; TRAINING IN THE USE AND OPERATION OF BEAUTY, NATURAL HEALTH AND SUSTAINABLE LIVING TOOLS AND METHODS; TRAINING IN THE USE OF BEAUTY, NATURAL HEALTH

AND SUSTAINABLE LIVING TOOLS AND METHODS; TRAINING SERVICES IN THE FIELD OF BEAUTY, NATURAL HEALTH AND SUSTAINABLE LIVING; TRANSLATION; VOCATIONAL GUIDANCE; WORKSHOPS AND SEMINARS IN THE FIELD OF BEAUTY, NATURAL HEALTH AND SUSTAINABLE LIVING; YOGA INSTRUCTION, IN CLASS 41 (U.S. CLS. 100, 101 AND 107).

FIRST USE 4-1-1995; IN COMMERCE 4-1-1995.

THE MARK CONSISTS OF STANDARD CHARACTERS WITHOUT CLAIM TO ANY PARTICULAR FONT, STYLE, SIZE, OR COLOR.

OWNER OF U.S. REG. NO. 2,000,601.

NO CLAIM IS MADE TO THE EXCLUSIVE RIGHT TO USE "CALIFORNIA", APART FROM THE MARK AS SHOWN.

SER. NO. 78-924,525, FILED 7-7-2006.

GINA HAYES, EXAMINING ATTORNEY

Int. Cls.: 36, 37 and 42

Prior U.S. Cls.: 100, 101, 102, 103 and 106

United States Patent and Trademark Office

Reg. No. 3,476,680

Registered July 29, 2008

**SERVICE MARK
PRINCIPAL REGISTER**

STREETEASY

NMD INTERACTIVE, INC. (DELAWARE CORPORATION)
5TH FLOOR
895 BROADWAY
NEW YORK, NY 10003

FOR: WEBSITE FEATURING INFORMATION ON REAL ESTATE SALES, REAL ESTATE LISTINGS, REAL ESTATE NEWS, REAL ESTATE DISCUSSIONS, REAL ESTATE SALES STATISTICS, REAL ESTATE RENTAL LISTINGS AND SEARCHABLE DATABASES OF REAL ESTATE LISTINGS, SALES, RENTALS AND LISTINGS WITHIN SCHOOL DISTRICTS, IN CLASS 36 (U.S. CLS. 100, 101 AND 102).

FIRST USE 12-26-2005; IN COMMERCE 12-26-2005.

FOR: WEBSITE FEATURING INFORMATION ON NEW REAL ESTATE DEVELOPMENT, IN CLASS 37 (U.S. CLS. 100, 103 AND 106).

FIRST USE 12-26-2005; IN COMMERCE 12-26-2005.

FOR: WEBSITE FEATURING INFORMATION ON REAL ESTATE LEGAL REGULATIONS, IN CLASS 42 (U.S. CLS. 100 AND 101).

FIRST USE 12-26-2005; IN COMMERCE 12-26-2005.

THE MARK CONSISTS OF STANDARD CHARACTERS WITHOUT CLAIM TO ANY PARTICULAR FONT, STYLE, SIZE, OR COLOR.

SER. NO. 78-925,584, FILED 7-10-2006.

KRISTIN DAHLING, EXAMINING ATTORNEY

Int. Cl.: 18

Prior U.S. Cls.: 1, 2, 3, 22 and 41

United States Patent and Trademark Office

Reg. No. 3,476,681

Registered July 29, 2008

TRADEMARK
PRINCIPAL REGISTER



ALL FIRED UP CANDLE CO. LLC (NORTH
CAROLINA LTD LIAB CO)
99 VILLAGE DRIVE
SUITE 1
JACKSONVILLE, NC 28546

FOR: PURSES, IN CLASS 18 (U.S. CLS. 1, 2, 3, 22
AND 41).

FIRST USE 3-1-2006; IN COMMERCE 3-1-2006.

THE NAME(S), PORTRAIT(S), AND/OR SIGNA-
TURE(S) SHOWN IN THE MARK DOES NOT IDENTI-
FY A PARTICULAR LIVING INDIVIDUAL

THE COLOR(S) PINK, BROWN, BLACK, AND
GREEN IS/ARE CLAIMED AS A FEATURE OF THE
MARK.

THE MARK CONSISTS OF THE COLOR PINK
APPEARS IN THE WORDING IN THE MARK, IN
THE OUTLINE OF THE FLOWER, AND IN ITS
CENTER. THE COLORS BROWN, BLACK, AND
GREEN APPEAR RANDOMLY TO FORM A CA-
MOUFLAGE DESIGN IN THE INTERIOR OF THE
FLOWER.

SER. NO. 78-926,543, FILED 7-11-2006.

PAUL F. GAST, EXAMINING ATTORNEY

Int. Cl.: 14

Prior U.S. Cls.: 2, 27, 28 and 50

United States Patent and Trademark Office

Reg. No. 3,476,682

Registered July 29, 2008

**TRADEMARK
PRINCIPAL REGISTER**

THE VINCI DIAMOND

COHEN, SHLOMO (ISRAEL INDIVIDUAL)
8C SHDEROT NITZA
NETANYA, ISRAEL 44262

FOR: JEWELRY MADE IN PART OF DIAMONDS,
DIAMONDS, HOROLOGICAL AND CHRONOMET-
RIC INSTRUMENTS MADE IN PART OF DIA-
MONDS, IN CLASS 14 (U.S. CLS. 2, 27, 28 AND 50).

FIRST USE 5-1-2006; IN COMMERCE 8-1-2006.

THE MARK CONSISTS OF STANDARD CHAR-
ACTERS WITHOUT CLAIM TO ANY PARTICULAR
FONT, STYLE, SIZE, OR COLOR.

PRIORITY CLAIMED UNDER SEC. 44(D) ON
ISRAEL APPLICATION NO. 186690, FILED 1-12-2006.

NO CLAIM IS MADE TO THE EXCLUSIVE
RIGHT TO USE "DIAMOND", APART FROM THE
MARK AS SHOWN.

THE FOREIGN WORDING IN THE MARK
TRANSLATES INTO ENGLISH AS "TO CONQUER".

SER. NO. 78-926,693, FILED 7-11-2006.

KHANH LE, EXAMINING ATTORNEY

Int. Cl.: 7

Prior U.S. Cls.: 13, 19, 21, 23, 31, 34 and 35

United States Patent and Trademark Office

Reg. No. 3,476,683

Registered July 29, 2008

**TRADEMARK
PRINCIPAL REGISTER**

HYPET

HUSKY INJECTION MOLDING SYSTEMS LTD.
(CANADA CORPORATION)
500 QUEEN STREET SOUTH
BOLTON, CANADA L7E 5S5

FOR: INJECTION MOLDING MACHINES AND
STRUCTURAL PARTS AND FITTINGS THERE-
FORE, IN CLASS 7 (U.S. CLS. 13, 19, 21, 23, 31, 34
AND 35).

THE MARK CONSISTS OF STANDARD CHAR-
ACTERS WITHOUT CLAIM TO ANY PARTICULAR
FONT, STYLE, SIZE, OR COLOR.

PRIORITY CLAIMED UNDER SEC. 44(D) ON
CANADA APPLICATION NO. 1,289,786, FILED 2-13-
2006, REG. NO. TMA698243, DATED 10-11-2007, EX-
PIRES 10-11-2022.

SER. NO. 78-929,397, FILED 7-14-2006.

NATALIE POLZER, EXAMINING ATTORNEY

Int. Cls.: 35, 36, 41 and 42

Prior U.S. Cls.: 100, 101, 102 and 107

United States Patent and Trademark Office

Reg. No. 3,476,684

Registered July 29, 2008

**SERVICE MARK
PRINCIPAL REGISTER**

DATA360

WEBSTER SYSTEMS, LLC (CALIFORNIA LTD
LIAB CO)
1 MARITIME PLAZA, SUITE 1400
SAN FRANCISCO, CA 94111

FOR: ONLINE INFORMATION SERVICES,
NAMELY, PROVIDING BUSINESS INFORMATION
AND STATISTICS IN THE FIELDS OF GOVERN-
MENT SPENDING, EMPLOYMENT RATES AND
ECONOMIC FORECASTING AND INDIVIDUAL
COMPANY SALES AND DATA; INFORMATION
AND STATISTICS IN THE FIELD OF POLITICS,
NAMELY, POLLING DATA, ELECTION DATA,
APPROVAL RATINGS AND POLITICAL SURVEY
DATA, IN CLASS 35 (U.S. CLS. 100, 101 AND 102).

FIRST USE 10-6-2006; IN COMMERCE 10-6-2006.

FOR: ONLINE INFORMATION SERVICES,
NAMELY, PROVIDING INFORMATION AND STA-
TISTICS IN THE FIELDS OF INTEREST AND
MONETARY RATES, AND STOCK MARKET
GROWTH, IN CLASS 36 (U.S. CLS. 100, 101 AND 102).

FIRST USE 10-6-2006; IN COMMERCE 10-6-2006.

FOR: ONLINE INFORMATION SERVICES,
NAMELY, PROVIDING INFORMATION AND STA-
TISTICS IN THE FIELD OF SPORTS AND ENTER-

TAINMENT, IN CLASS 41 (U.S. CLS. 100, 101 AND
107).

FIRST USE 10-6-2006; IN COMMERCE 10-6-2006.

FOR: COMPUTER SERVICES, NAMELY, ACTING
AS AN APPLICATION SERVICE PROVIDER IN THE
FIELD OF KNOWLEDGE MANAGEMENT TO
HOST COMPUTER APPLICATION SOFTWARE
FOR THE COLLECTION, EDITING, ORGANIZING,
MODIFYING, BOOK MARKING, TRANSMISSION,
STORAGE AND SHARING OF DATA AND INFOR-
MATION; INFORMATION AND STATISTICS IN
THE FIELD OF THE ENVIRONMENT, NAMELY,
POLLUTION LEVELS, EMISSION LEVELS AND
SPECIES DIVERSITY DATA, IN CLASS 42 (U.S.
CLS. 100 AND 101).

FIRST USE 10-6-2006; IN COMMERCE 10-6-2006.

THE MARK CONSISTS OF STANDARD CHAR-
ACTERS WITHOUT CLAIM TO ANY PARTICULAR
FONT, STYLE, SIZE, OR COLOR.

SER. NO. 78-935,175, FILED 7-21-2006.

JOHN DWYER, EXAMINING ATTORNEY

Int. Cl.: 16

Prior U.S. Cls.: 2, 5, 22, 23, 29, 37, 38 and 50

United States Patent and Trademark Office

Reg. No. 3,476,685

Registered July 29, 2008

**TRADEMARK
PRINCIPAL REGISTER**



SANFORD, L.P. (ILLINOIS LIMITED PARTNER-
SHIP)
SUITE 600 LEGAL DEPARTMENT
10B GLENLAKE PKWY
ATLANTA, GA 30328

FOR: WRITING INSTRUMENTS, NAMELY MAR-
KERS, IN CLASS 16 (U.S. CLS. 2, 5, 22, 23, 29, 37, 38
AND 50).

FIRST USE 0-0-1964; IN COMMERCE 0-0-1964.

THE COLOR(S) GRAY IS/ARE CLAIMED AS A
FEATURE OF THE MARK.

THE MARK CONSISTS OF THE CONFIGURA-
TION OF A WRITING INSTRUMENT HAVING A
TAPERED, CIGAR-SHAPED GRAY BARREL, A

TAPERED CAP THAT IS FULLY COLORED AND
CONTRASTS WITH THE GRAY COLOR OF THE
BARREL, AND A CAP TO BARREL RATIO OF
APPROXIMATELY 1/3 TO 2/3. THE DOTTED LINES
ARE NOT A PART OF THE MARK AND SERVE
ONLY TO SHOW THE RELATIONSHIP OF A CLIP,
IF ANY, IN CONNECTION WITH THE MARK. THE
COLOR GRAY ON THE BARREL IS A FEATURE OF
THE MARK. THE COLOR BLACK ON THE CAP IS
NOT A FEATURE OF THE MARK, SUCH COLOR
TO VARY AND CORRESPOND WITH THE COLOR
OF THE INK.

SEC. 2(F).

SER. NO. 78-936,234, FILED 7-24-2006.

MARY BOAGNI, EXAMINING ATTORNEY

Int. Cl.: 9

Prior U.S. Cls.: 21, 23, 26, 36 and 38

Reg. No. 3,476,686

United States Patent and Trademark Office

Registered July 29, 2008

**TRADEMARK
PRINCIPAL REGISTER**

NIKKISO E MONITOR

NIKKISO CO., LTD. (JAPAN CORPORATION)
43-2, EBISU 3-CHOME
SHIBUYA-KU, TOKYO, JAPAN

FOR: ELECTRONIC DEVICES FOR MONITORING AND CONTROLLING THE CONDITION OF BEARINGS IN ORDER TO DETERMINE WHEN TO REPLACE OR REPAIR; ELECTRICAL AND MECHANICAL INSTRUMENTS FOR POWER DISTRIBUTION AND CONTROL, ELECTROMAGNETIC MEASURING INSTRUMENTS FOR MEASURING BEARING WEAR FOR ELECTRIC MOTORS AND PUMPS, AND ELECTROMAGNETIC MONITORS OF ELECTRIC MOTORS AND PUMPS; MACHINES FOR POWER DISTRIBUTION AND POWER CONTROL, NAMELY, ELECTRONIC MEASURING AND CONTROL EQUIPMENT AND ELECTRONIC APPARATUS AND INSTRUMENTS, ALL FOR CONTROLLING PUMPS; ELECTRIC RELAYS; ELECTRONIC DETECTORS FOR DETECTION OF ABNORMAL STATE OF OPERATION CONDITION AND RUNNING STATUS OF ELECTRIC MOTORS AND PUMPS; ELECTRONICALLY APPLIED MACHINES AND INSTRUMENTS, NAMELY, DEVICE IN THE NATURE OF A CENTRAL MONITOR TO CONTROL PUMP OPERATION, STORE AND DISPLAY INFORMATION AND DATA REGARDING PUMP STATUS

AND CONDITION OF BEARINGS; ELECTRONIC DETECTION AND COMMUNICATION MACHINES AND INSTRUMENTS, NAMELY, REMOTE CONTROL TELEMETERING MACHINES AND INSTRUMENTS, EQUIPMENT IN THE NATURE OF A CENTRALIZED MONITOR TO REMOTELY CONTROL AND MONITOR BEARING WEAR AND OPERATION STATUS OF PUMPS, POWER PLANTS, FACTORIES AND INDUSTRIAL FACILITIES, IN CLASS 9 (U.S. CLS. 21, 23, 26, 36 AND 38).

FIRST USE 6-26-2001; IN COMMERCE 6-26-2001.

THE MARK CONSISTS OF STANDARD CHARACTERS WITHOUT CLAIM TO ANY PARTICULAR FONT, STYLE, SIZE, OR COLOR.

OWNER OF U.S. REG. NOS. 784,203, 959,761, AND 2,756,955.

NO CLAIM IS MADE TO THE EXCLUSIVE RIGHT TO USE "MONITOR", APART FROM THE MARK AS SHOWN.

SER. NO. 78-939,384, FILED 7-27-2006.

JAMES GRIFFIN, EXAMINING ATTORNEY

Int. Cl.: 32

Prior U.S. Cls.: 45, 46 and 48

Reg. No. 3,476,687

United States Patent and Trademark Office

Registered July 29, 2008

**TRADEMARK
PRINCIPAL REGISTER**

**LIQUID
LIGHTNING**
ENERGY DRINK

LIQUID LIGHTNING INC. (NEW JERSEY CORPORATION)
31 CHELSEA WAY
BRIDGEWATER, NJ 08807

FOR: ENERGY DRINKS AND SUGAR FREE ENERGY DRINKS, IN CLASS 32 (U.S. CLS. 45, 46 AND 48).

FIRST USE 11-1-2004; IN COMMERCE 11-1-2004.

THE MARK CONSISTS OF STANDARD CHARACTERS WITHOUT CLAIM TO ANY PARTICULAR FONT, STYLE, SIZE, OR COLOR.

NO CLAIM IS MADE TO THE EXCLUSIVE RIGHT TO USE "ENERGY DRINK", APART FROM THE MARK AS SHOWN.

SER. NO. 78-939,651, FILED 7-28-2006.

GIANCARLO CASTRO, EXAMINING ATTORNEY

Int. Cls.: 25, 35 and 42

Prior U.S. Cls.: 22, 39, 100, 101 and 102

Reg. No. 3,476,688

United States Patent and Trademark Office

Registered July 29, 2008

**TRADEMARK
SERVICE MARK
PRINCIPAL REGISTER**

CLOTHES MAKE THE COMPANY

OMEGA FRONTLINE APPAREL LTD. (CANADA
COMPANY)
61 WEST 5TH AVENUE
VANCOUVER, CANADA V5Y 1H4

FOR: CLOTHING AND UNIFORMS, NAMELY
SHIRTS, VESTS, PANTS, JACKETS, SKIRTS, TU-
NICS, NECKTIES, NECK SCARVES, BLOUSES,
SWEATERS, DRESSES, COATS, APRONS, SHORTS,
GOLF SHIRTS, HATS, SUN VISORS, CAPS, IN
CLASS 25 (U.S. CLS. 22 AND 39).

FOR: BUSINESS MANAGEMENT SERVICES,
NAMELY, MANAGING LOGISTICS, REVERSE LO-
GISTICS, SUPPLY CHAIN SERVICES, SUPPLY
CHAIN VISIBILITY AND SYNCHRONIZATION,
SUPPLY AND DEMAND FORECASTING AND PRO-
DUCT DISTRIBUTION PROCESSES FOR OTHERS
IN THE FIELD OF UNIFORMS, IN CLASS 35 (U.S.
CLS. 100, 101 AND 102).

FOR: DESIGNING FOR OTHERS IN THE FIELD
OF MEN'S AND WOMEN'S UNIFORMS; DESIGN

CONSULTING IN THE FIELD OF MEN'S AND
WOMEN'S UNIFORMS, IN CLASS 42 (U.S. CLS. 100
AND 101).

THE MARK CONSISTS OF STANDARD CHAR-
ACTERS WITHOUT CLAIM TO ANY PARTICULAR
FONT, STYLE, SIZE, OR COLOR.

PRIORITY CLAIMED UNDER SEC. 44(D) ON
CANADA APPLICATION NO. 1292651, FILED 2-23-
2006, REG. NO. TMA689288, DATED 6-7-2007, EX-
PIRES 6-7-2022.

NO CLAIM IS MADE TO THE EXCLUSIVE
RIGHT TO USE "CLOTHES", APART FROM THE
MARK AS SHOWN.

SER. NO. 78-940,219, FILED 7-28-2006.

JIM RINGLE, EXAMINING ATTORNEY

Int. Cl.: 3

Prior U.S. Cls.: 1, 4, 6, 50, 51 and 52

Reg. No. 3,476,689

United States Patent and Trademark Office

Registered July 29, 2008

**TRADEMARK
PRINCIPAL REGISTER**

**Dermclar**

FACTOR ESTETIC, S.L. (SPAIN CORPORATION)
BALMES, 292 - PRAL. SEGUNDO
BARCELONA, SPAIN 08006

PRIORITY CLAIMED UNDER SEC. 44(D) ON
SPAIN APPLICATION NO. 2722270, FILED 7-12-
2006, REG. NO. 2722270, DATED 7-12-2006, EXPIRES
7-12-2016.

FOR: COSMETIC AMPOULES FOR AESTHETIC
FACIAL AND BODY TREATMENT, IN CLASS 3
(U.S. CLS. 1, 4, 6, 50, 51 AND 52).

SER. NO. 78-942,216, FILED 8-1-2006.

KAPIL BHANOT, EXAMINING ATTORNEY

Int. Cls.: 42 and 44

Prior U.S. Cls.: 100 and 101

United States Patent and Trademark Office

Reg. No. 3,476,690

Registered July 29, 2008

**SERVICE MARK
PRINCIPAL REGISTER**

TK Sense

PANACEA PHARMACEUTICALS, INC. (MARY-
LAND CORPORATION)
LEGAL DEPARTMENT
207 PERRY PARKWAY, SUITE 2
GAITHERSBURG, MD 20877

FOR: MEDICAL AND SCIENTIFIC RESEARCH
SERVICES IN THE FIELD OF CANCER TREAT-
MENT AND DIAGNOSIS, IN CLASS 42 (U.S. CLS. 100
AND 101).

FIRST USE 9-11-2006; IN COMMERCE 9-11-2006.

FOR: MEDICAL TESTING, IN CLASS 44 (U.S. CLS.
100 AND 101).

FIRST USE 9-11-2006; IN COMMERCE 9-11-2006.

THE MARK CONSISTS OF STANDARD CHAR-
ACTERS WITHOUT CLAIM TO ANY PARTICULAR
FONT, STYLE, SIZE, OR COLOR.

SER. NO. 78-942,242, FILED 8-1-2006.

LINDSEY RUBIN, EXAMINING ATTORNEY

Int. Cl.: 35

Prior U.S. Cls.: 100, 101 and 102

United States Patent and Trademark Office

Reg. No. 3,476,691

Registered July 29, 2008

**SERVICE MARK
PRINCIPAL REGISTER**

The logo for "MINICARDS" is displayed in a stylized, bold, red font with black outlines. The letters are blocky and have a slight shadow effect, giving them a three-dimensional appearance. The word "MINICARDS" is written in all capital letters.

MALEKAMES, TAMER (UNITED STATES INDIVIDUAL)
941 NORTH 20TH STREET
ALLENTOWN, PA 18104

FOR: DISTRIBUTION AND DISPLAY OF ADVERTISING MARKETING MEDIA PRODUCTS SUCH AS ADVERTISEMENT CARDS, MAPS, BROCHURES, AND POSTCARDS FOR OTHERS, IN CLASS 35 (U.S. CLS. 100, 101 AND 102).

FIRST USE 12-29-2006; IN COMMERCE 12-29-2006.

OWNER OF U.S. REG. NO. 3,245,637.

NO CLAIM IS MADE TO THE EXCLUSIVE RIGHT TO USE "MINICARDS", APART FROM THE MARK AS SHOWN.

THE COLOR(S) RED AND BLACK IS/ARE CLAIMED AS A FEATURE OF THE MARK.

THE MARK CONSISTS OF RED LETTERS WITH BLACK OUTLINING.

SER. NO. 78-948,960, FILED 8-9-2006.

JENNY PARK, EXAMINING ATTORNEY

Int. Cl.: 38

Prior U.S. Cls.: 100, 101 and 104

United States Patent and Trademark Office

Reg. No. 3,476,692

Registered July 29, 2008

**SERVICE MARK
PRINCIPAL REGISTER**

FONIX

FONIX CORPORATION (DELAWARE CORPORATION)
SUITE 700
9350 SOUTH 150 EAST
SANDY, UT 84070

FOR: CALL ROUTING SERVICES, VOICE COMMUNICATIONS SERVICES, NAMELY, PROVIDING TELEPHONE USERS WITH ACCESS TO INFORMATION AND DATA USING INTERACTIVE RESPONSE, SPEECH RECOGNITION, VOICE COMMAND, AND TEXT-TO-SPEECH SERVICES., IN CLASS 38 (U.S. CLS. 100, 101 AND 104).

FIRST USE 2-24-2004; IN COMMERCE 2-24-2004.

THE MARK CONSISTS OF STANDARD CHARACTERS WITHOUT CLAIM TO ANY PARTICULAR FONT, STYLE, SIZE, OR COLOR.

OWNER OF U.S. REG. NOS. 2,209,807, 2,232,449, AND 2,867,355.

SER. NO. 78-950,561, FILED 8-11-2006.

INGA ERVIN, EXAMINING ATTORNEY

Int. Cls.: 7 and 12

Prior U.S. Cls.: 13, 19, 21, 23, 31, 34, 35 and 44

United States Patent and Trademark Office

Reg. No. 3,476,693

Registered July 29, 2008

**TRADEMARK
PRINCIPAL REGISTER**

@JINSUNG

JINSUNG T.E.C. CO., LTD. (REPUBLIC OF KOREA LIMITED COMPANY)
538-5 SEGYO-DONG, PYUNGTAEK-SI
KYUNGKI-DO, REPUBLIC OF KOREA 450-100

FOR: MACHINE PARTS, NAMELY, IDLERS FOR MACHINE ENGINES; ENGINE TIMING COMPONENTS, NAMELY, CAM SPROCKETS AND CHAINS; ROLLER BEARINGS; AUTOMOTIVE PARTS, NAMELY, ENGINE AND TRANSMISSION SEALS, IN CLASS 7 (U.S. CLS. 13, 19, 21, 23, 31, 34 AND 35).

FIRST USE 2-3-2000; IN COMMERCE 2-3-2000.

FOR: LAND VEHICLES PARTS, NAMELY, IDLER ARMS; REAR WHEEL SPROCKETS; PARTS OF MOTORCYCLES, NAMELY, FORK SEALS, IN CLASS 12 (U.S. CLS. 19, 21, 23, 31, 35 AND 44).

FIRST USE 2-3-2000; IN COMMERCE 2-3-2000.

SER. NO. 78-951,384, FILED 8-14-2006.

GINA HAYES, EXAMINING ATTORNEY

Int. Cl.: 37

Prior U.S. Cls.: 100, 103 and 106

United States Patent and Trademark Office

Reg. No. 3,476,694

Registered July 29, 2008

**SERVICE MARK
PRINCIPAL REGISTER**

Generate Change

BORREGO SOLAR SYSTEMS, INC (CALIFORNIA CORPORATION)
SUITE B
727 ALLSTON WAY
BERKELEY, CA 94710

FOR: INSTALLATION OF GRID-CONNECTED PHOTOVOLTAIC SYSTEMS FOR RESIDENTIAL AND COMMERCIAL APPLICATIONS, IN CLASS 37 (U.S. CLS. 100, 103 AND 106).

FIRST USE 9-1-2006; IN COMMERCE 9-1-2006.

THE MARK CONSISTS OF STANDARD CHARACTERS WITHOUT CLAIM TO ANY PARTICULAR FONT, STYLE, SIZE, OR COLOR.

SER. NO. 78-953,225, FILED 8-16-2006.

ALICE BENMAMAN, EXAMINING ATTORNEY

Int. Cls.: 18, 25 and 35

Prior U.S. Cls.: 1, 2, 3, 22, 39, 41, 100, 101 and 102

United States Patent and Trademark Office

Reg. No. 3,476,695

Registered July 29, 2008

**TRADEMARK
SERVICE MARK
PRINCIPAL REGISTER**



NEWURBAN LIMITED (UNITED KINGDOM CORPORATION)
412 LINEN HALL 162-168 REGENT STREET
LONDON, UNITED KINGDOM W1B 5TD

FOR: HANDBAGS; SACHELS; PURSES; LUGGAGE, WALLETS; STRAPS FOR HANDBAGS AND SACHELS; LEATHER POUCHES; KEY CASES; TRAVELLING BAGS; SPORTS BAGS; BELT BAGS; HOLDALLS; TOILET BAGS SOLD EMPTY; CREDIT CARD CASES AND HOLDERS; BRIEFCASES; SUITCASES; TRAVEL BAGS; BRIEFCASE TYPE PORTFOLIOS; RUCKSACKS; UMBRELLAS; TANNED LEATHER AND IMITATIONS OF LEATHER; GOODS MADE OF LEATHER AND IMITATIONS OF LEATHER NOT INCLUDED IN OTHER CLASSES, NAMELY HAT BOXES MADE FROM TANNED LEATHER AND IMITATIONS OF LEATHER, IN CLASS 18 (U.S. CLS. 1, 2, 3, 22 AND 41).

FOR: CLOTHING, NAMELY, FOOTWEAR; HEADWEAR; SHIRTS; SWEATSHIRTS; JACKETS; KNITWEAR, NAMELY, KNITTED TOPS; HATS; CAPS; T-SHIRTS; RAINWEAR; UNDERWEAR; TRACKSUITS; COATS; MANTLES; NECKWEAR; SCARVES; GLOVES; BELTS; BOOTS; SHOES; SNEAKERS; SLIPPERS; SOCKS; ATHLETIC FOOTWEAR; PARTS AND FITTINGS FOR THE ABOVE MENTIONED GOODS, NAMELY, FINISHED TEXTILE LININGS FOR HATS; FINISHED TEXTILE LININGS FOR GARMENTS, HAT BANDS, IN CLASS 25 (U.S. CLS. 22 AND 39).

FOR: RETAIL STORES, ONLINE RETAIL STORES, RETAIL CATALOG SERVICES, AND MAIL ORDER RETAIL STORES FEATURING CLOTHING, FOOTWEAR, HEADGEAR, KEYCHAINS, LUGGAGE, JEWELLERY, EYEWEAR, HANDBAGS, ACCESSORIES TO BE WORN ABOUT THE BODY, HAIR ACCESSORIES, FURNISHINGS AND TEXTILES; BUSINESS MARKETING SERVICES; ADVERTISING SERVICES; PUBLIC RELATIONS SERVICES; MARKETING SERVICES, IN CLASS 35 (U.S. CLS. 100, 101 AND 102).

PRIORITY CLAIMED UNDER SEC. 44(D) ON ERPN CMNTY TM OFC APPLICATION NO. 005089172, FILED 5-22-2006, REG. NO. 005089172, DATED 6-18-2007, EXPIRES 5-22-2016.

THE COLOR(S) RED AND BLUE IS/ARE CLAIMED AS A FEATURE OF THE MARK.

THE MARK CONSISTS OF THE WORDING "NEWURBAN" AND DESIGN OF A DRAGONFLY INSIDE OF AN OVAL BROKEN LINE. THE WORD "NEWURBAN" IS IN RED, AND THE DRAGONFLY AND THE OVAL LINE ARE IN BLUE.

SER. NO. 78-953,582, FILED 8-16-2006.

ESTHER A. BORSUK, EXAMINING ATTORNEY

Int. Cls.: 11, 20 and 21

**Prior U.S. Cls.: 2, 13, 21, 22, 23, 25, 29, 30, 31, 32, 33,
34, 40 and 50**

Reg. No. 3,476,696

United States Patent and Trademark Office

Registered July 29, 2008

**TRADEMARK
PRINCIPAL REGISTER**

Alchemy Mosaic

ALCHEMY GLASS & LIGHT, INC. (CALIFORNIA CORPORATION)
5715 MCKINLEY AVENUE
LOS ANGELES, CA 90011

FOR: ELECTRIC LIGHTING FIXTURES; ELECTRIC LIGHTING FIXTURES, NAMELY, SCONCES; LIGHT DIFFUSERS; LIGHTING FIXTURES; SCONCE LIGHTING FIXTURES, IN CLASS 11 (U.S. CLS. 13, 21, 23, 31 AND 34).

FIRST USE 3-1-2003; IN COMMERCE 9-15-2003.

FOR: BATHROOM AND SHAVING MIRRORS; MIRROR FRAMES; MIRRORS, IN CLASS 20 (U.S. CLS. 2, 13, 22, 25, 32 AND 50).

FIRST USE 2-1-2001; IN COMMERCE 5-22-2001.

FOR: BASINS; DECORATIVE GLASS; GLASS BOWLS; GLASS DISHES; GLASS MOSAICS NOT FOR BUILDINGS; HAND WASH BASINS; SERVING

PLATTERS MADE OF GLASS, OR SERVING TRAYS MADE OF GLASS AND NOT OF PRECIOUS METAL; WASH BASINS, IN CLASS 21 (U.S. CLS. 2, 13, 23, 29, 30, 33, 40 AND 50).

FIRST USE 6-1-2003; IN COMMERCE 3-5-2004.

THE MARK CONSISTS OF STANDARD CHARACTERS WITHOUT CLAIM TO ANY PARTICULAR FONT, STYLE, SIZE, OR COLOR.

OWNER OF U.S. REG. NOS. 2,444,230 AND 2,446,113.

NO CLAIM IS MADE TO THE EXCLUSIVE RIGHT TO USE "MOSAIC", APART FROM THE MARK AS SHOWN.

SER. NO. 78-954,502, FILED 8-17-2006.

MARIAM MAHMOUDI, EXAMINING ATTORNEY

Int. Cls.: 16 and 17

Prior U.S. Cls.: 1, 2, 5, 12, 13, 22, 23, 29, 35, 37, 38 and 50

United States Patent and Trademark Office

Reg. No. 3,476,697

Registered July 29, 2008

**TRADEMARK
PRINCIPAL REGISTER**

NUANCE

CDM PAPIERS DECORS INC./CDM DECOR PAPERS INC. (CANADA CORPORATION)
3075, BERNIER STREET
DRUMMONDVILLE, CANADA J2C 6Y4

FOR: DECORATIVE COATED PAPER OVERLAYS FOR PLYWOOD, MEDIUM DENSITY FIBERBOARD, PARTICLEBOARD AND GYPSUM, IN CLASS 16 (U.S. CLS. 2, 5, 22, 23, 29, 37, 38 AND 50).

FOR: DECORATIVE COATED POLYPROPYLENE FILM OVERLAYS FOR PLYWOOD, MEDIUM DENSITY FIBERBOARD, PARTICLEBOARD AND GYPSUM, IN CLASS 17 (U.S. CLS. 1, 5, 12, 13, 35 AND 50).

THE MARK CONSISTS OF STANDARD CHARACTERS WITHOUT CLAIM TO ANY PARTICULAR FONT, STYLE, SIZE, OR COLOR.

PRIORITY CLAIMED UNDER SEC. 44(D) ON CANADA APPLICATION NO. 1313243, FILED 8-16-2006, REG. NO. TMA692848, DATED 7-26-2007, EXPIRES 7-26-2017.

SER. NO. 78-954,741, FILED 8-17-2006.

CAROLYN CATALDO, EXAMINING ATTORNEY

Int. Cl.: 35

Prior U.S. Cls.: 100, 101 and 102

United States Patent and Trademark Office

Reg. No. 3,476,698

Registered July 29, 2008

**SERVICE MARK
PRINCIPAL REGISTER**

McDONALD MARKETING

MCDONALD ADVERTISING AND MARKET-
ING, LTD. (TEXAS LIMITED PARTNERSHIP)
2909 COLE AVENUE
SUITE 115
DALLAS, TX 75204

FOR: ADVERTISING SERVICES, PUBLIC RELA-
TIONS AND MARKETING SERVICES, NAMELY,
PROMOTING AND MARKETING THE GOODS
AND SERVICES OF OTHERS THROUGH ALL PUB-
LIC COMMUNICATION MEANS, IN CLASS 35 (U.S.
CLS. 100, 101 AND 102).

FIRST USE 7-0-2002; IN COMMERCE 7-0-2002.

THE MARK CONSISTS OF STANDARD CHAR-
ACTERS WITHOUT CLAIM TO ANY PARTICULAR
FONT, STYLE, SIZE, OR COLOR.

NO CLAIM IS MADE TO THE EXCLUSIVE
RIGHT TO USE "MARKETING", APART FROM
THE MARK AS SHOWN.

SEC. 2(F).

SER. NO. 78-956,194, FILED 8-21-2006.

JENNIFER VASQUEZ, EXAMINING ATTORNEY

Int. Cl.: 43

Prior U.S. Cls.: 100 and 101

United States Patent and Trademark Office

Reg. No. 3,476,699

Registered July 29, 2008

**SERVICE MARK
PRINCIPAL REGISTER**

KYMA

KYMA 69, LLC (MARYLAND LTD LIAB CO)
69 WEST STREET
ANNAPOLIS, MD 21401

FOR: RESTAURANT, BAR AND LOUNGE SERVICES, IN CLASS 43 (U.S. CLS. 100 AND 101).

FIRST USE 6-6-2005; IN COMMERCE 6-6-2005.

THE MARK CONSISTS OF STANDARD CHARACTERS WITHOUT CLAIM TO ANY PARTICULAR FONT, STYLE, SIZE, OR COLOR.

THE ENGLISH TRANSLATION OF THE WORD KYMA IN THE MARK IS WAVE.

SER. NO. 78-956,256, FILED 8-21-2006.

KATHERINE CHANG, EXAMINING ATTORNEY

Int. Cl.: 35

Prior U.S. Cls.: 100, 101 and 102

United States Patent and Trademark Office

Reg. No. 3,476,700

Registered July 29, 2008

**SERVICE MARK
PRINCIPAL REGISTER**

Ecologix Group, Inc.

ECOLOGIX GROUP, INC. (MARYLAND CORPORATION)
410 ROWE BLVD.
ANNAPOLIS, MD 21403

FOR: BUSINESS CONSULTATION AND MANAGEMENT REGARDING MARKETING ACTIVITIES AND LAUNCHING OF NEW PRODUCTS; BUSINESS CONSULTATION SERVICES; BUSINESS CONSULTING SERVICES RELATING TO PRODUCT DISTRIBUTION, OPERATIONS MANAGEMENT SERVICES, LOGISTICS, REVERSE LOGISTICS, SUPPLY CHAIN, AND PRODUCTION SYSTEMS AND DISTRIBUTION SOLUTIONS, IN CLASS 35 (U.S. CLS. 100, 101 AND 102).

FIRST USE 1-1-2001; IN COMMERCE 1-1-2001.

THE MARK CONSISTS OF STANDARD CHARACTERS WITHOUT CLAIM TO ANY PARTICULAR FONT, STYLE, SIZE, OR COLOR.

NO CLAIM IS MADE TO THE EXCLUSIVE RIGHT TO USE "GROUP, INC.", APART FROM THE MARK AS SHOWN.

SER. NO. 78-957,995, FILED 8-22-2006.

SARA THOMAS, EXAMINING ATTORNEY

Int. Cls.: 9, 35, 36, 38, 39 and 42

**Prior U.S. Cls.: 21, 23, 26, 36, 38, 100, 101, 102, 104
and 105**

Reg. No. 3,476,701

United States Patent and Trademark Office

Registered July 29, 2008

**TRADEMARK
SERVICE MARK
PRINCIPAL REGISTER**

MOVENCY

MOVENCY LIMITED (UNITED KINGDOM CORPORATION)
93 WESTFIELDS, ST. ALBANS
HERTSFORDSHIRE, UNITED KINGDOM AL3 4LY

FOR: COMPUTERS, COMPUTER HARDWARE; COMPUTER FIRMWARE AND COMPUTER SOFTWARE FOR MESSAGING COLLABORATION AND DISTRIBUTED COMPUTING AMONG COMPUTERS; COMPUTER PERIPHERAL DEVICES, NAMELY, COMPUTER KEYBOARDS, COMPUTER MEMORIES, COMPUTER INTERFACE BOARDS, COMPUTER DISK DRIVES, ALL FOR USE IN THE NETWORKING OF COMPUTERS OR COMMUNICATION APPARATUS, FOR DATA EXCHANGE AND TRANSMISSION BETWEEN THEM AND FOR OPERATING AND CONTROLLING NETWORKS; BLANK MAGNETIC DATA CARRIERS; COMPUTER SOFTWARE DOWNLOADABLE FROM THE INTERNET IN THE FIELD OF COMPUTER NETWORKING TO ENABLE DISTRIBUTED COMPUTING BETWEEN COMPUTERS, MOBILE PHONES AND GAME CONSOLES; PRE-RECORDED COMPUTER PROGRAMS FOR PERSONAL INFORMATION MANAGEMENT, DATABASE MANAGEMENT, CHARACTER RECOGNITION, TELEPHONY MANAGEMENT, ELECTRONIC MAIL AND MESSAGING PAGING, MOBILE TELEPHONE DATA SYNCHRONIZATION; COMPUTER PROGRAMS FOR ACCESSING, BROWSING AND SEARCHING ONLINE DATABASES; COMPUTER SOFTWARE AND FIRMWARE, NAMELY, OPERATING SYSTEM PROGRAMS, DATA SYNCHRONIZATION PROGRAMS, AND APPLICATION DEVELOPMENT TOOL PROGRAMS FOR PERSONAL AND HANDHELD COMPUTERS; SOFTWARE FOR THE REDIRECTION OF MESSAGES, INTERNET E-MAIL, AND/OR OTHER DATA TO ONE OR MORE ELECTRONIC HANDHELD DEVICES FROM A DATA STORE ON OR ASSOCIATED WITH A

PERSONAL COMPUTER OR A SERVER; TELECOMMUNICATION APPARATUS FOR COMMUNICATION WITH COMPUTERS FOR OPERATING, CONTROLLING, AND COMMUNICATING WITH COMMUNICATION AND TELECOMMUNICATIONS EQUIPMENT, NAMELY, MOBILE PHONES, MOBILE PHONES INCORPORATING SECONDARY FUNCTIONALITY, PORTABLE TELEPHONES, TELEPHONE RECEIVERS, TELEPHONE TRANSMITTERS, TELEPHONE HANDSETS, VIDEO TELEPHONES, MOBILE TELEPHONE COVERS; RADIO PAGERS, WALKIE-TALKIES, AND USER MANUALS FOR ALL THE AFORESAID GOODS, IN CLASS 9 (U.S. CLS. 21, 23, 26, 36 AND 38).

FOR: ADVERTISING AND ADVERTISEMENT SERVICES; BUSINESS ADMINISTRATION AND MANAGEMENT; CONSULTING SERVICES IN THE FIELD OF ADVERTISING AND BUSINESS; PROVIDING INFORMATION IN THE FIELD OF BUSINESS AND ADVERTISING; RETAIL STORE SERVICES CONNECTED WITH PRE RECORDED MUSICAL WORKS, AUDIO VISUAL WORKS, MUSIC RELATED ELECTRONIC PRODUCTS, COMPUTER GAMES, COMPUTER SOFTWARE, FILMS, MOVIES, TELEVISION PROGRAMMES, ALL BEING FOR ENTERTAINMENT, PROVIDED VIA THE INTERNET AND OTHER ELECTRONIC AND COMMUNICATION NETWORKS; COMPILATION OF INFORMATION INTO COMPUTER DATABASES; COMPUTERIZED FILE MANAGEMENT; COMPILATION OF DIRECTORIES FOR PUBLISHING ON THE INTERNET; PROVISION OF SPACE ON WEB SITES FOR ADVERTISING GOODS AND SERVICES ADVERTISING; PROVISION OF BUSINESS STATISTICAL INFORMATION; COMPUTERIZED ACCOUNTING; INDUSTRIAL MANAGEMENT CONSULTATION INCLUDING COST/YIELD ANALYSIS, IN CLASS 35 (U.S. CLS. 100, 101 AND 102).

FOR: ELECTRONIC PAYMENT, NAMELY, ELECTRONIC PROCESSING AND TRANSMISSION OF BILL PAYMENT DATA, IN CLASS 36 (U.S. CLS. 100, 101 AND 102).

FOR: TELECOMMUNICATIONS SERVICES, NAMELY, TRANSMISSION OF LAND AND LONG DISTANCE TRANSMISSION OF VOICE, DATA AND GRAPHICS BY MEANS OF TELEPHONE, TELEGRAPHIC, CABLE AND SATELLITE TRANSMISSION; SATELLITE TELEVISION BROADCASTING OF MOTION PICTURE FILM, TELEVISION, VIDEO AND RADIO PROGRAMS AND CULTURAL SPORTING, MUSIC, OR OTHER ENTERTAINMENT EVENTS, INCLUDING VIA THE INTERNET OR THROUGH COMPUTERS; PROVISION OF TELECOMMUNICATION ACCESS AND LINKS TO COMPUTER DATABASES AND TO THE INTERNET; PROVIDING ACCESS TO AND LEASING ACCESS TIME TO COMPUTER DATABASES USING THE INTERNET; TRANSMISSION AND RECEPTION OF ELECTRONIC FINANCIAL TRANSACTIONS, IN CLASS 38 (U.S. CLS. 100, 101 AND 104).

FOR: ELECTRONIC DATA STORAGE; COMPUTERIZED ELECTRONIC DATA STORAGE SERVICES; DATA STORAGE OF ELECTRONIC MUSIC, IN CLASS 39 (U.S. CLS. 100 AND 105).

FOR: COMPUTER CONSULTING SERVICES; SCIENTIFIC AND TECHNOLOGICAL RESEARCH SERVICES; CONSULTING SERVICES IN THE FIELD OF COMPUTER, SCIENTIFIC, TECHNOLOGICAL, AND INDUSTRIAL RESEARCH; ADVISORY SERVICES IN THE FIELD OF COMPUTER, SCIENCE AND, TECHNOLOGY; COMPUTER PROGRAMMING SERVICES; DESIGN, RESEARCH, DEVELOPMENT, TESTING, INSTALLATION AND MAINTENANCE OF COMPUTER SOFTWARE; DESIGN, RESEARCH, DEVELOPMENT AND TESTING OF TELECOMMUNICATION APPARATUS AND INSTRUMENTS, COMPUTER HARDWARE, DATA PROCESSING EQUIPMENT AND COMPUTER NETWORKING SYSTEMS; DESIGN AND MAINTENANCE OF COMPUTER SOFTWARE PARTICULARLY FOR THE DISTRIBUTION OF PROCESSING BETWEEN COMPUTERS OR ACROSS A NETWORK OF COMPUTERS OR FROM THE INTERNET OF INFORMATION, SOUND, MUSIC, IMAGES, GRAPHICS OR DATA; MULTIMEDIA AND AUDIO-VISUAL SOFTWARE CONSULTING SERVICES; PROVIDING SEARCH ENGINES FOR OBTAINING DATA VIA COMMUNICATIONS NETWORKS; APPLICATION SERVICE PROVIDER (ASP) SERVICES FEATURING SOFTWARE FOR USE IN

CONNECTION WITH ONLINE MUSIC SUBSCRIPTION SERVICE, SOFTWARE THAT ENABLES USERS TO PLAY AND PROGRAM MUSIC AND ENTERTAINMENT-RELATED AUDIO, VIDEO, TEXT AND MULTIMEDIA CONTENT, AND SOFTWARE FEATURING MUSICAL SOUND RECORDINGS, ENTERTAINMENT-RELATED AUDIO, VIDEO, TEXT AND MULTIMEDIA CONTENT; PROVIDING TEMPORARY USE OF ON-LINE NON-DOWNLOADABLE SOFTWARE TO ENABLE USERS TO PROGRAM AUDIO, VIDEO, TEXT AND OTHER MULTIMEDIA CONTENT, INCLUDING MUSIC, CONCERTS, VIDEOS, RADIO, TELEVISION, NEWS, SPORTS, GAMES, CULTURAL EVENTS, AND ENTERTAINMENT-RELATED PROGRAMS; PROVIDING ON-LINE FACILITIES, VIA A GLOBAL COMPUTER NETWORK, TO ENABLE USERS TO PROGRAM THE SCHEDULING OF AUDIO, VIDEO, TEXT AND OTHER MULTIMEDIA CONTENT, INCLUDING MUSIC, CONCERTS, VIDEOS, RADIO, TELEVISION, NEWS, SPORTS, GAMES, CULTURAL EVENTS, AND ENTERTAINMENT-RELATED PROGRAMS AS THEY WILL BE AIRED; PROVIDING SEARCH ENGINES FOR OBTAINING DATA ON A GLOBAL COMPUTER NETWORK; CREATING INDEXES OF INFORMATION, SITES AND OTHER RESOURCES AVAILABLE ON GLOBAL COMPUTER NETWORKS FOR OTHERS; PROVIDING USERS OF ELECTRONIC COMMUNICATIONS NETWORKS WITH MEANS OF IDENTIFYING, LOCATING, GROUPING, DISTRIBUTING, AND MANAGING DATA AND LINKS TO THIRD-PARTY COMPUTER SERVERS, COMPUTER PROCESSORS AND COMPUTER USERS; SEARCHING, BROWSING AND RETRIEVING INFORMATION, SITES, AND OTHER RESOURCES AVAILABLE ON GLOBAL COMPUTER NETWORKS FOR OTHERS; ORGANIZING CONTENT OF INFORMATION PROVIDED OVER A GLOBAL COMPUTER NETWORK ACCORDING TO USER PREFERENCE, IN CLASS 42 (U.S. CLS. 100 AND 101).

THE MARK CONSISTS OF STANDARD CHARACTERS WITHOUT CLAIM TO ANY PARTICULAR FONT, STYLE, SIZE, OR COLOR.

PRIORITY CLAIMED UNDER SEC. 44(D) ON UNITED KINGDOM APPLICATION NO. 2414965, FILED 2-24-2006, REG. NO. 2414965, DATED 2-2-2007, EXPIRES 2-24-2016.

SER. NO. 78-958,543, FILED 8-23-2006.

DAWN FELDMAN, EXAMINING ATTORNEY

Int. Cl.: 15

Prior U.S. Cls.: 2, 21 and 36

United States Patent and Trademark Office

Reg. No. 3,476,702

Registered July 29, 2008

**TRADEMARK
PRINCIPAL REGISTER**

BRADY

BRADY, CHRISTOPHER P. (AUSTRALIA INDIVIDUAL)
21 CHALLIS ROAD
ARMADALE WA, AUSTRALIA 6112

THE MARK CONSISTS OF STANDARD CHARACTERS WITHOUT CLAIM TO ANY PARTICULAR FONT, STYLE, SIZE, OR COLOR.

FOR: MUSICAL INSTRUMENTS; DRUMS; MUSICAL DRUMS; AND DRUMS MADE FROM EXOTIC WOODS, IN CLASS 15 (U.S. CLS. 2, 21 AND 36).

SER. NO. 78-958,773, FILED 8-23-2006.

FIRST USE 3-0-1986; IN COMMERCE 1-12-1997.

CURTIS FRENCH, EXAMINING ATTORNEY

Int. Cl.: 41

Prior U.S. Cls.: 100, 101 and 107

United States Patent and Trademark Office

Reg. No. 3,476,703

Registered July 29, 2008

**SERVICE MARK
PRINCIPAL REGISTER**

EXPERT CONSENSUS GUIDELINES

EXPERT KNOWLEDGE SYSTEMS, LLC (NEW
HAMPSHIRE LTD LIAB CO)
21 BLOOMINGDALE ROAD
WHITE PLAINS, NY 10605

FOR: EDUCATION SERVICES, NAMELY, SEMI-
NARS IN THE FIELD OF MEDICINE, HEALTH,
CLINICAL RESEARCH AND PHARMACEUTICAL
PREPARATIONS, IN CLASS 41 (U.S. CLS. 100, 101
AND 107).

FIRST USE 7-0-1996; IN COMMERCE 7-0-1996.

THE MARK CONSISTS OF STANDARD CHAR-
ACTERS WITHOUT CLAIM TO ANY PARTICULAR
FONT, STYLE, SIZE, OR COLOR.

SEC. 2(F).

SER. NO. 78-959,020, FILED 8-23-2006.

BONNIE LUKEN, EXAMINING ATTORNEY

Int. Cl.: 35

Prior U.S. Cls.: 100, 101 and 102

United States Patent and Trademark Office

Reg. No. 3,476,704

Registered July 29, 2008

**SERVICE MARK
PRINCIPAL REGISTER**



CITY OF SIOUX CITY, IOWA (IOWA CORPORATION)
LEGAL DEPARTMENT, SUITE 511
405 6TH STREET, BOX 447
SIOUX CITY, IA 51102

FOR: ADVERTISING, MARKETING AND PROMOTION SERVICES; PROMOTING PUBLIC AWARENESS OF SIOUX CITY, IOWA; PROMOTING SPORTS COMPETITIONS AND/OR EVENTS OF OTHERS; PROMOTING THE CONCERTS OF OTHERS; PROMOTING THE ECONOMIC DEVELOPMENT IN THE CITY OF SIOUX CITY, IOWA; PROMOTION OF BUSINESS OPPORTUNITIES; PUBLICITY AND SALES PROMOTION SERVICES, IN CLASS 35 (U.S. CLS. 100, 101 AND 102).

FIRST USE 8-30-2006; IN COMMERCE 8-30-2006.

OWNER OF U.S. REG. NO. 3,019,611.

NO CLAIM IS MADE TO THE EXCLUSIVE RIGHT TO USE "SIOUX CITY", APART FROM THE MARK AS SHOWN.

THE MARK CONSISTS OF THE WORDS "SIOUX CITY" IN ALL UPPER CASE LETTERS WITH THE "X" IN "SIOUX CITY" HAVING AN ASCENDER AND DESCENDER THAT GOES SLIGHTLY ABOVE AND BELOW THE LETTERS IN THE REST OF THE WORD "SIOUX". THE LETTER "Y" HAS AN ASCENDER THAT IS HIGHER THAN THE REST OF THE LETTERS IN THE WORD "CITY". THE WORDS "SUCCESSFUL", "SURPRISING" AND THE SECOND "SIOUX CITY" ARE ALWAYS STACKED ON TOP OF EACH OTHER. THE SLOGAN "SUCCESSFUL SURPRISING SIOUX CITY" ALWAYS GOES BELOW THE WORDS "SIOUX CITY" AND IS ALWAYS THE SAME WIDTH AS "SIOUX CITY". THE STAR IS PLACED DIRECTLY BELOW THE LETTER "O".

SER. NO. 78-963,861, FILED 8-30-2006.

JENNIFER VASQUEZ, EXAMINING ATTORNEY

Int. Cls.: 35 and 41

Prior U.S. Cls.: 100, 101, 102 and 107

United States Patent and Trademark Office

Reg. No. 3,476,705

Registered July 29, 2008

SERVICE MARK
PRINCIPAL REGISTER



WUNDERMAN, HUGH (UNITED STATES INDIVIDUAL)
2195 REDMOND ROAD
MERRICK, NY 11566

FOR: PUBLIC RELATIONS AND BUSINESS MARKETING SERVICES; RETAIL STORE AND ONLINE RETAIL SERVICES FEATURING CLOTHING, HATS, VISORS, CAPS, T-SHIRTS, SWEAT SHIRTS AND SUITS, SOCKS, UNDERWEAR, JACKETS, COATS, UMBRELLAS, BANDANNAS, DU RAGS, BELTS, BACKPACKS, POCKETBOOKS, BATH TOWELS, AND SHEETS, BEDDING, AND PILLOWS, SLEEPING EYE MASKS, CARRYING BAGS, BAGS, BOXES, ACRYLIC AND PLASTIC ITEMS, WOOD, CARDBOARD, PAPER GOODS AND PLASTIC WARE, PENS, STICKY NOTES, PRINTED NOTE PADS, COMPUTER MOUSE PADS, FLYING DISCS, YO-YOS, JEWELRY, KEY CHAINS, BELT BUCKLES, BRACELETS, LIGHTERS, RINGS, TOE RINGS, NECKLACES, PENDANTS, EARRINGS, BOOKS, SCRIPTS, SHOWS, TREATMENTS, POSTERS, PICTURES, PHOTOGRAPHS, SNOW GLOBES, PICTURE FRAMES, CASES, LICENSE PLATE FRAMES, PRE-RECORDED CDS, VIDEO TAPES, LASER DISKS AND DVDS, PHONOGRAPH RECORDS, VINYL RECORDS, VIDEO CASSETTE TAPES, AUDIO CASSETTE TAPES, REEL-TO-REEL TAPES, MOTION PICTURE FILM; SPECIAL EVENT MANAGEMENT SERVICES FOR MEETINGS, CONVENTIONS, WEDDINGS, AND PARTIES; BUSINESS MEETING PLANNING, IN CLASS 35 (U.S. CLS. 100, 101 AND 102).

FIRST USE 1-1-2003; IN COMMERCE 1-1-2003.

FOR: SPECIAL EVENT PLANNING; SPECIAL EVENT PLANNING CONSULTATION SERVICES FOR MEETINGS, CONVENTIONS, WEDDINGS AND PARTIES; MULTIMEDIA ENTERTAINMENT SOFTWARE PRODUCTION SERVICES; PRODUCTION OF VIDEO ONTO DVDS, VIDEO CASSETTES, VIDEO TAPES, AND THE INTERNET, FOR OTHERS; PHOTOGRAPHY SERVICES; ENTERTAINMENT SERVICES, NAMELY, LIGHTING PRODUCTION, AND PRODUCTION OF VARIETY SHOWS; RENTAL OF AUDIO-VISUAL EQUIPMENT; RENTAL OF PORTABLE STAGES; ENTERTAINMENT SERVICES, NAMELY, PERSONAL APPEARANCES BY IMPERSONATORS, BANDS, CLOWNS, JUGGLERS, MAGICIANS, MIMES, MODELS, COMICS, AND MUSICIANS AND NOVELTY AND VARIETY ACTS AND SPECIALTY ACTS BY PERFORMERS, IN CLASS 41 (U.S. CLS. 100, 101 AND 107).

FIRST USE 1-1-2003; IN COMMERCE 1-1-2003.

SEC. 2(F).

SER. NO. 78-965,680, FILED 9-1-2006.

HOWARD SMIGA, EXAMINING ATTORNEY

Int. Cl.: 9

Prior U.S. Cls.: 21, 23, 26, 36 and 38

United States Patent and Trademark Office

Reg. No. 3,476,706

Registered July 29, 2008

**TRADEMARK
PRINCIPAL REGISTER**

TRELISE COOPER

TRELISE COOPER LIMITED (NEW ZEALAND
COMPANY)
8 LION PLACE, NEWMARKET
AUCKLAND, NEW ZEALAND

FOR: SUNGLASSES, SPORTS GLASSES, OPTICAL
GLASSES, EYEGLASSES; ACCESSORIES FOR EYE-
GLASSES, NAMELY CHAINS; EYEGLASS CASES;
FRAMES FOR GLASSES, EYEGLASS LENSES; SIDE
GUARDS FOR EYEGLASSES; AUDIO AND VISUAL
APPARATUS, NAMELY, MULTIMEDIA SOFT-
WARE RECORDED ON CD ROMS AND DVDS
FEATURING FASHION RELATED MATERIAL,
AND DVDS FEATURING FASHION SHOWS AND
FASHION RELATED MATERIAL, IN CLASS 9 (U.S.
CLS. 21, 23, 26, 36 AND 38).

THE MARK CONSISTS OF STANDARD CHAR-
ACTERS WITHOUT CLAIM TO ANY PARTICULAR
FONT, STYLE, SIZE, OR COLOR.

OWNER OF NEW ZEALAND REG. NO. 739883,
DATED 12-5-2005, EXPIRES 12-5-2015.

"THE NAME(S), PORTRAIT(S), AND/OR SIGNA-
TURE(S) SHOWN IN THE MARK IDENTIFIES
TRELISE COOPER , WHOSE CONSENT(S) TO REG-
ISTER IS SUBMITTED."

SER. NO. 78-966,336, FILED 9-1-2006.

ROBERT LAVACHE, EXAMINING ATTORNEY

Int. Cl.: 25

Prior U.S. Cls.: 22 and 39

United States Patent and Trademark Office

Reg. No. 3,476,707

Registered July 29, 2008

**TRADEMARK
PRINCIPAL REGISTER**

TRELISE COOPER

TRELISE COOPER LIMITED (NEW ZEALAND
COMPANY)

8 LION PLACE, NEWMARKET

AUCKLAND, NEW ZEALAND

FOR: CLOTHING NAMELY, PANTS, SHIRTS, T-SHIRTS, SWEATSHIRTS, SHORTS, SKIRTS, SUITS, TROUSERS, DRESSES, BELTS, SCARVES, SHAWLS, GLOVES, SWIMSUITS, JUMPSUITS, COATS, JACKETS, TOPS, SWEATERS, BLOUSES, VESTS, HOSIERY, BRAS, NIGHTGOWNS, DRESSING GOWNS, PAJAMAS; LINGERIE; FOOTWEAR; HEADWEAR, IN CLASS 25 (U.S. CLS. 22 AND 39).

THE MARK CONSISTS OF STANDARD CHARACTERS WITHOUT CLAIM TO ANY PARTICULAR FONT, STYLE, SIZE, OR COLOR.

OWNER OF NEW ZEALAND REG. NO. 739883, DATED 12-5-2005, EXPIRES 12-5-2015.

"THE NAME(S), PORTRAIT(S), AND/OR SIGNATURE(S) SHOWN IN THE MARK IDENTIFIES TRELISE COOPER, WHOSE CONSENT(S) TO REGISTER IS SUBMITTED."

SER. NO. 78-966,346, FILED 9-1-2006.

ROBERT LAVACHE, EXAMINING ATTORNEY

Int. Cl.: 35

Prior U.S. Cls.: 100, 101 and 102

United States Patent and Trademark Office

Reg. No. 3,476,708

Registered July 29, 2008

**SERVICE MARK
PRINCIPAL REGISTER**

TRELISE COOPER

TRELISE COOPER LIMITED (NEW ZEALAND
COMPANY)
8 LION PLACE, NEWMARKET
AUCKLAND, NEW ZEALAND

FOR: RETAIL AND WHOLESALE STORE SERVICES FEATURING CLOTHING, FOOTWEAR, HEADGEAR, LINGERIE, FASHION AND CLOTHING ACCESSORIES, OPTICAL GLASSES, EYEGLASSES, SUNGLASSES, BAGS, BELTS, TRAVELING BAGS, PERFUMERY, COSMETICS, SOAPS, ESSENTIAL OILS, JEWELRY, WATCHES, FURNITURE, HOMEWARES AND HOUSEHOLD ITEMS, GLASSWARE, STATIONERY, TEXTILES, BED AND TABLE COVERS, FLOOR COVERINGS AND WALL COVERINGS; INFORMATION, CONSULTANCY AND ADVISORY SERVICES IN RELATION TO THE

FOREGOING SERVICES, IN CLASS 35 (U.S. CLS. 100, 101 AND 102).

THE MARK CONSISTS OF STANDARD CHARACTERS WITHOUT CLAIM TO ANY PARTICULAR FONT, STYLE, SIZE, OR COLOR.

OWNER OF NEW ZEALAND REG. NO. 739883, DATED 12-5-2005, EXPIRES 12-5-2015.

THE NAME TRELISE COOPER IDENTIFIES A LIVING INDIVIDUAL WHOSE CONSENT IS OF RECORD.

SER. NO. 78-966,351, FILED 9-1-2006.

ROBERT LAVACHE, EXAMINING ATTORNEY

Int. Cl.: 42

Prior U.S. Cls.: 100 and 101

United States Patent and Trademark Office

Reg. No. 3,476,709

Registered July 29, 2008

**SERVICE MARK
PRINCIPAL REGISTER**

TRELISE COOPER

TRELISE COOPER LIMITED (NEW ZEALAND
COMPANY)
8 LION PLACE, NEWMARKET
AUCKLAND, NEW ZEALAND

FOR: FASHION DESIGN SERVICES; CLOTHING
DESIGN SERVICES; FASHION ACCESSORY DE-
SIGN SERVICES; SUNGLASSES DESIGN SERVICES;
FURNITURE DESIGN SERVICES; HOMEWARES
AND HOUSEHOLD ITEM DESIGN SERVICES;
FLOOR AND WALL COVERING DESIGN SERVI-
CES; INFORMATION, CONSULTANCY AND ADVI-
SORY SERVICES IN RELATION TO THE
FOREGOING SERVICES, IN CLASS 42 (U.S. CLS.
100 AND 101).

THE MARK CONSISTS OF STANDARD CHAR-
ACTERS WITHOUT CLAIM TO ANY PARTICULAR
FONT, STYLE, SIZE, OR COLOR.

OWNER OF NEW ZEALAND REG. NO. 739883,
DATED 12-5-2005, EXPIRES 12-5-2015.

THE NAME(S), PORTRAIT(S), AND/OR SIGNA-
TURE(S) SHOWN IN THE MARK IDENTIFIES
TRELISE COOPER, WHOSE CONSENT(S) TO REG-
ISTER IS SUBMITTED.

SER. NO. 78-966,355, FILED 9-1-2006.

ROBERT LAVACHE, EXAMINING ATTORNEY

Int. Cls.: 3, 14, 16, 18, 20, 24 and 27

Prior U.S. Cls.: 1, 2, 3, 4, 5, 6, 13, 19, 20, 22, 23, 25, 27, 28, 29, 32, 37, 38, 41, 42, 50, 51 and 52

Reg. No. 3,476,710

United States Patent and Trademark Office

Registered July 29, 2008

**TRADEMARK
PRINCIPAL REGISTER**

TRELISE COOPER

TRELISE COOPER LIMITED (NEW ZEALAND COMPANY)
8 LION PLACE, NEWMARKET
AUCKLAND, NEW ZEALAND

FOR: SOAPS; SHOWER GEL; BODY WASH; BATH CRYSTALS; PERFUMERY; ESSENTIAL OILS; COSMETICS; COSMETIC KITS NAMELY MAKE UP KITS COMPRISED OF LIPSTICK AND EYE SHADOW; HAIR LOTIONS; DENTIFRICES; PREPARATIONS FOR THE HAIR NAMELY, HAIR CARE PREPARATIONS, HAIR CLEANING PREPARATIONS AND HAIR STYLING PREPARATIONS; NON-MEDICATED SKIN CARE PREPARATIONS; NON-MEDICATED NAIL CARE PREPARATIONS; NON-MEDICATED LIP CARE PREPARATIONS; HAND AND BODY LOTIONS AND CREAMS; BODY TALC; NON-MEDICATED SUN CARE PREPARATIONS; SELF-TANNING PREPARATIONS; PREPARATIONS FOR REMOVING COSMETICS; FALSE NAILS AND EYELASHES AND ADHESIVES THEREFOR; PERSONAL DEODORANTS AND ANTIPERSPIRANTS; BLEACHING PREPARATIONS FOR COSMETIC PURPOSES; SUBSTANCES FOR LAUNDRY USE NAMELY, LAUNDRY SOAP, LAUNDRY DETERGENT AND LAUNDRY BLEACH; MASSAGE OIL; BATH AND BODY OIL; SHAVING PREPARATIONS; AFTER-SHAVE LOTIONS AND BALMS; POTPOURRI; FRAGRANT SACHETS AND ROOM FRAGRANCES; INCENSE STICKS; SCENTED LINEN SPRAY; SCENTED LINEN WATER; SHOE CREAM AND POLISH, IN CLASS 3 (U.S. CLS. 1, 4, 6, 50, 51 AND 52).

FOR: JEWELRY; COSTUME JEWELRY AND PRECIOUS JEWELRY; WATCHES AND CLOCKS; PRECIOUS STONES; GOODS FASHIONED OR MADE OF PRECIOUS METAL, PRECIOUS OR SEMI-PRECIOUS STONES, CULTURED PEARLS, OR A COMBINATION THEREOF, NAMELY, JEWELRY BOXES, DESKTOP BUSINESS CARD HOLD-

ERS, KEY RINGS, MONEY CLIPS, BOOKMARKS, SHOE HORNS, PERFUME FLASKS, PURSES, PICTURE FRAMES, HAIR BRUSHES, COMBS, MIRRORS, LETTER OPENERS, PEN STANDS, IN CLASS 14 (U.S. CLS. 2, 27, 28 AND 50).

FOR: PAPER; CARDBOARD; GOODS MADE FROM PAPER OR CARDBOARD, NAMELY, PAPER NAPKINS AND CARDBOARD GIFT BOXES; PRINTED MATTER, NAMELY, POSTERS, CALENDARS, ALBUMS FOR PHOTOGRAPHS, CATALOGS IN THE FIELD OF FASHION, BOOKS IN THE FIELD OF FASHION, PAMPHLETS IN THE FIELD OF FASHION; PHOTOGRAPHS; WRAPPING AND PACKAGING MATERIALS, NAMELY, GIFT WRAPPING PAPER, PAPER GIFT WRAPPING RIBBONS, PAPER BAGS FOR PACKAGING; PAPER, CARDBOARD, AND PLASTIC SHOPPING BAGS; STATIONERY; STATIONERY CASES; PEN CASES; FOUNTAIN PENS; PENS; PENCILS; ERASERS; ARTISTS' MATERIALS, NAMELY, ARTISTS' BRUSHES, ARTISTS' PENCILS, ARTISTS' PENS; PAINT BRUSHES; PAPER TABLE CLOTHS; DRAWER AND SHELF LINERS; PATTERNS FOR DRESSMAKING; PRINTED INSTRUCTIONAL AND TEACHING MATERIALS IN THE FIELD OF FASHION DESIGN, FASHION RETAILING AND THE FASHION INDUSTRY, IN CLASS 16 (U.S. CLS. 2, 5, 22, 23, 29, 37, 38 AND 50).

FOR: LEATHER AND IMITATIONS OF LEATHER; GOODS MADE OF LEATHER OR IMITATION LEATHER, NAMELY, LEATHER KEY CHAINS AND LEATHER TRUNKS; ANIMAL SKINS AND HIDES; TRUNKS AND TRAVELING BAGS; BAGS, NAMELY, CARRY-ON BAGS, ALL-PURPOSE CARRYING BAGS, AND BEACH BAGS; HANDBAGS; WALLETS; ATTACHÉ CASES; SPORTS BAGS; SHOULDER BAGS; GARMENT BAGS FOR TRAVEL; VANITY CASES SOLD EMPTY; SUITCASES; KEY CASES; CARD CASES, NAMELY, BUSI-

NESS CARD CASES; PURSES; UMBRELLAS, PARASOLS AND WALKING STICKS; WHIPS, HARNESSES AND SADDLERY, IN CLASS 18 (U.S. CLS. 1, 2, 3, 22 AND 41).

FOR: FURNITURE; MIRRORS; PICTURE FRAMES; WINDOW BLINDS OF TEXTILES, IN CLASS 20 (U.S. CLS. 2, 13, 22, 25, 32 AND 50).

FOR: TEXTILES AND TEXTILE GOODS, NAME-
LY, TEXTILE FABRICS FOR THE MANUFACTURE
OF CLOTHING, TEXTILE FABRICS FOR LINGERIE,
TEXTILE FABRICS FOR SWIMWEAR, AND
TEXTILE NAPKINS; KNITTED FABRICS; UPHOL-
STERY FABRICS; CURTAIN FABRICS; HOUSE-
HOLD LINENS; BED COVERS, NAMELY, DUVET
COVERS, BED BLANKETS AND BED SPREADS;
TABLE COVERS, NAMELY, TABLE CLOTHS NOT
OF PAPER; PLACE MATS NOT OF PAPER; TABLE
LINEN; BATH LINEN; BED LINEN; TEXTILE TO-
WELS; UNFITTED TEXTILE FURNITURE COVERS;
PILLOWCASES; QUILTS; TRAVELING RUGS,
NAMELY, LAP RUGS; TEXTILE CURTAINS; MOS-
QUITO NETS; FLAGS NOT OF PAPER, NAMELY,

CLOTH FLAGS AND FABRIC FLAGS; CLOTH
BANNERS, IN CLASS 24 (U.S. CLS. 42 AND 50).

FOR: CARPETS, RUGS, MATS AND MATTING,
AND LINOLEUM FOR COVERING EXISTING
FLOORS; NON-TEXTILE WALL HANGINGS;
WALLPAPER, IN CLASS 27 (U.S. CLS. 19, 20, 37, 42
AND 50).

THE MARK CONSISTS OF STANDARD CHAR-
ACTERS WITHOUT CLAIM TO ANY PARTICULAR
FONT, STYLE, SIZE, OR COLOR.

OWNER OF NEW ZEALAND REG. NO. 739883,
DATED 12-5-2005, EXPIRES 12-5-2015.

THE NAME(S), PORTRAIT(S), AND/OR SIGNA-
TURE(S) SHOWN IN THE MARK IDENTIFIES
"TRELISE COOPER ", WHOSE CONSENT(S) TO
REGISTER IS SUBMITTED.

SER. NO. 78-966,367, FILED 9-1-2006.

ROBERT LAVACHE, EXAMINING ATTORNEY

Int. Cl.: 35

Prior U.S. Cls.: 100, 101 and 102

United States Patent and Trademark Office

Reg. No. 3,476,711

Registered July 29, 2008

**SERVICE MARK
PRINCIPAL REGISTER**

ROCKIT BOX

THIRD WAVE RESEARCH GROUP, LTD. (WIS-
CONSIN CORPORATION)
305 SOUTH MAIN STREET
VERONA, WI 53593

FOR: BUSINESS ADVICE AND ANALYSIS OF
MARKETS; BUSINESS MARKETING AND DIRECT
MAIL CONSULTING SERVICES; DEVELOPMENT
OF MARKETING STRATEGIES AND CONCEPTS;
DIRECT MAIL ADVERTISING; DIRECT MARKET-
ING ADVERTISING FOR OTHERS; DIRECT MAR-
KETING SERVICES; MARKET RESEARCH;
MARKET RESEARCH CONSULTATION; MARKET
SEGMENTATION CONSULTATION; MARKETING
CONSULTING; PROMOTION AND MARKETING

SERVICES AND RELATED CONSULTING; PRO-
VIDING BUSINESS MARKETING INFORMATION;
STATISTICAL EVALUATIONS OF MARKETING
DATA, IN CLASS 35 (U.S. CLS. 100, 101 AND 102).

FIRST USE 10-7-2005; IN COMMERCE 11-30-2005.

THE MARK CONSISTS OF STANDARD CHAR-
ACTERS WITHOUT CLAIM TO ANY PARTICULAR
FONT, STYLE, SIZE, OR COLOR.

SER. NO. 78-968,778, FILED 9-7-2006.

MARY CRAWFORD, EXAMINING ATTORNEY

Int. Cl.: 28

Prior U.S. Cls.: 22, 23, 38 and 50

Reg. No. 3,476,712

United States Patent and Trademark Office

Registered July 29, 2008

**TRADEMARK
PRINCIPAL REGISTER**

TEDCO

TEDCO, INC. (INDIANA CORPORATION)
498 SOUTH WASHINGTON STREET
HAGERSTOWN, IN 47346

FOR: TOY EDUCATIONAL SCIENCE AND EXPERIMENT KITS, NAMELY, BASIC SCIENCE KITS, BIOLOGY SCIENCE KITS, ELECTRONICS KITS, CRYSTAL SCIENCE KITS, CHEMISTRY KITS, ENVIRONMENTAL SCIENCE KITS, ANATOMY KITS, CELL AND MICROBIOLOGY KITS, MECHANICAL SCIENCE KITS, OPTICAL SCIENCE KITS, NATURAL SCIENCE KITS, MARINE SCIENCE KITS, SPACE SCIENCE KITS, FLIGHT SCIENCE KITS, BUBBLE KITS, PHYSICAL FORCES SCIENCE KITS, WEATHER SCIENCE KITS, AIR SCIENCE KITS, ELASTIC KITS, EARTH SCIENCE KITS, SOUND EXPERIMENT KITS, WATER EXPERIMENT KITS, VOLCANO EXPERIMENT KITS, STICKY SCIENCE EXPERIMENT KITS, ENERGY AND ROCKETS EXPERIMENT KITS, ALL KITS BEING TOY EDUCATIONAL SCIENCE AND EXPERIMENT KITS; TOY ROBOT KITS COMPRISED OF TOY ROBOT BODY PARTS; TOYS SIMULATING TORNADOS; SPINNING TOYS, NAMELY, SPINNING TOPS AND SPIN DRILLS; TOY BUILDING BLOCKS AND

MARBLE SETS; FLYING TOYS, NAMELY, FLYING DISKS AND GLIDERS; TOY PRISMS; LIGHT REFRACTING TOYS, NAMELY, LIGHT REFRACTING SPINNING DISCS; TOY GEOLOGY KITS COMPRISED OF ROCKS; TOY PEG SCULPTURE KITS COMPRISED OF A TOY SCULPTURE, PEGS, CLAY AND MOLDING TOOLS; DINOSAUR TOYS AND GAMES, NAMELY REPLICA DINOSAURS AND FIGURINES AND SCENE MODELS; HAND HELD GAMES, NAMELY, HAND HELD PINBALL GAMES; BOARD GAMES; TOY SKELETONS; TOY FOSSIL MODELS; TOY DINOSAURS; KALEIDOSCOPES; TOY BADGES; REPLICA TOY EGGS; PUZZLES; MAGIC TRICKS; AND TOY GYROSCOPES, IN CLASS 28 (U.S. CLS. 22, 23, 38 AND 50).

FIRST USE 3-21-1985; IN COMMERCE 3-21-1985.

THE MARK CONSISTS OF STANDARD CHARACTERS WITHOUT CLAIM TO ANY PARTICULAR FONT, STYLE, SIZE, OR COLOR.

SER. NO. 78-970,240, FILED 9-8-2006.

DAYNA BROWNE, EXAMINING ATTORNEY

Int. Cl.: 35

Prior U.S. Cls.: 100, 101 and 102

United States Patent and Trademark Office

Reg. No. 3,476,713

Registered July 29, 2008

**SERVICE MARK
PRINCIPAL REGISTER**



SOUTH CAROLINA DEPARTMENT OF PARKS,
RECREATION & TOURISM (SOUTH CAROLINA
STATE AGENCY)
1205 PENDLETON STREET
COLUMBIA, SC 29602

NO CLAIM IS MADE TO THE EXCLUSIVE
RIGHT TO USE "CHARLES TOWNE LANDING
STATE HISTORIC SITE", APART FROM THE MARK
AS SHOWN.

FOR: PROMOTING BUSINESS AND TOURISM IN
CHARLES TOWNE LANDING SOUTH CAROLINA,
IN CLASS 35 (U.S. CLS. 100, 101 AND 102).

SER. NO. 78-970,309, FILED 9-8-2006.

FIRST USE 3-31-2006; IN COMMERCE 3-31-2006.

DAVID I, EXAMINING ATTORNEY

Int. Cl.: 19

Prior U.S. Cls.: 1, 12, 33 and 50

United States Patent and Trademark Office

Reg. No. 3,476,714

Registered July 29, 2008

**TRADEMARK
PRINCIPAL REGISTER**

HZ

OUTDOOR TECHNOLOGIES INC. (DELAWARE
CORPORATION)
1576 MAGNOLIA DRIVE
MACON, MS 39341

THE MARK CONSISTS OF STANDARD CHAR-
ACTERS WITHOUT CLAIM TO ANY PARTICULAR
FONT, STYLE, SIZE, OR COLOR.

FOR: VINYL FENCING, VINYL FENCE POST
PROFILES, AND VINYL FENCE RAILING PRO-
FILES, IN CLASS 19 (U.S. CLS. 1, 12, 33 AND 50).

SER. NO. 78-973,076, FILED 9-13-2006.

FIRST USE 1-5-2006; IN COMMERCE 1-5-2006.

HOWARD B. LEVINE, EXAMINING ATTORNEY

Int. Cl.: 36

Prior U.S. Cls.: 100, 101 and 102

United States Patent and Trademark Office

Reg. No. 3,476,715

Registered July 29, 2008

**SERVICE MARK
PRINCIPAL REGISTER**

LET'S SACK CELIAC

NATIONAL FOUNDATION FOR CELIAC
AWARENESS (PENNSYLVANIA NON-PROFIT
ORGANIZATION)
P.O. BOX 544
AMBLER, PA 19002

FOR: CHARITABLE FUNDRAISING SERVICES,
NAMELY, RAISING MONEY FOR CELIAC DIS-
EASE AWARENESS BY MEANS OF A FAMILY
ENTERTAINMENT EVENT , IN CLASS 36 (U.S.
CLS. 100, 101 AND 102).

FIRST USE 5-1-2005; IN COMMERCE 5-1-2005.

THE MARK CONSISTS OF STANDARD CHAR-
ACTERS WITHOUT CLAIM TO ANY PARTICULAR
FONT, STYLE, SIZE, OR COLOR.

NO CLAIM IS MADE TO THE EXCLUSIVE
RIGHT TO USE "CELIAC", APART FROM THE
MARK AS SHOWN.

SER. NO. 78-974,621, FILED 9-14-2006.

CIMMERIAN COLEMAN, EXAMINING ATTOR-
NEY

Int. Cls.: 3, 4, 5 and 10

Prior U.S. Cls.: 1, 4, 6, 15, 18, 26, 39, 44, 46, 50, 51 and 52

Reg. No. 3,476,716

United States Patent and Trademark Office

Registered July 29, 2008

**TRADEMARK
PRINCIPAL REGISTER**

IMS

HU-FRIEDY MFG. CO., INC. (ILLINOIS CORPORATION)
3232 NORTH ROCKWELL STREET
CHICAGO, IL 60618

FOR: DENTAL INSTRUMENT OILS, CLEANING SOLUTIONS FOR DENTAL ULTRASONIC STERILIZATION APPARATUS, IN CLASS 3 (U.S. CLS. 1, 4, 6, 50, 51 AND 52).

FIRST USE 2-28-1991; IN COMMERCE 2-28-1991.

FOR: DENTAL INSTRUMENT LUBRICATING OILS, IN CLASS 4 (U.S. CLS. 1, 6 AND 15).

FIRST USE 2-28-1991; IN COMMERCE 2-28-1991.

FOR: DENTAL INSTRUMENTS STERILIZING SOLUTIONS, CLEANSING SOLUTIONS FOR MEDICAL AND DENTAL USE, IN CLASS 5 (U.S. CLS. 6, 18, 44, 46, 51 AND 52).

FIRST USE 2-28-1991; IN COMMERCE 2-28-1991.

FOR: DENTAL INSTRUMENTS, NAMELY CASSETTES AND TRAYS FOR DENTAL INSTRUMENTS, AUTOCLAVE WRAPS, TAPES, AND POUCHES; STERILIZATION MONITOR STRIPS, IDENTIFICATION STRIPS, RINGS, TABS AND LABELS; EXAMINATION GLOVES, IN CLASS 10 (U.S. CLS. 26, 39 AND 44).

FIRST USE 2-28-1991; IN COMMERCE 2-28-1991.

THE MARK CONSISTS OF STANDARD CHARACTERS WITHOUT CLAIM TO ANY PARTICULAR FONT, STYLE, SIZE, OR COLOR.

OWNER OF U.S. REG. NO. 1,375,376.

SER. NO. 78-977,731, FILED 5-3-2006.

ANNE MADDEN, EXAMINING ATTORNEY

Int. Cl.: 25

Prior U.S. Cls.: 22 and 39

United States Patent and Trademark Office

Reg. No. 3,476,717

Registered July 29, 2008

**TRADEMARK
PRINCIPAL REGISTER**

**LEADERSHIP INSTITUTE FOR
TEENS**

LEADERSHIP INSTITUTE FOR TEENS (CALIFORNIA NON-PROFIT PUBLIC BENEFIT CORPORATION)

21163 NEWPORT COAST DR. #124
NEWPORT COAST, CA 92657

FOR: CLOTHING, NAMELY, T-SHIRTS, IN CLASS 25 (U.S. CLS. 22 AND 39).

FIRST USE 7-31-2005; IN COMMERCE 7-31-2005.

THE MARK CONSISTS OF STANDARD CHARACTERS WITHOUT CLAIM TO ANY PARTICULAR FONT, STYLE, SIZE, OR COLOR.

NO CLAIM IS MADE TO THE EXCLUSIVE RIGHT TO USE "INSTITUTE", APART FROM THE MARK AS SHOWN.

SER. NO. 78-979,492, FILED 4-20-2006.

DAVID C. REIHNER, EXAMINING ATTORNEY

Int. Cl.: 35

Prior U.S. Cls.: 100, 101 and 102

United States Patent and Trademark Office

Reg. No. 3,476,718

Registered July 29, 2008

**SERVICE MARK
PRINCIPAL REGISTER**

PRIZE CAPITAL

VIRTUAL CAPITAL, L.L.C. (NEVADA LTD LIAB
CO)
3525 DEL MAR HEIGHTS RD., #111
SAN DIEGO, CA 921302122

FOR: ADVISING CLIENTS ON MONETIZING
TECHNOLOGICAL INNOVATION; CONDUCTING
TRADE SHOWS IN THE FIELDS OF TECHNOLO-
GICAL INNOVATION, ENERGY, ENVIRONMEN-
TAL, VENTURE PHILANTHROPY, AND PRIZE
COMPETITIONS; CHARITABLE SERVICES, NAME-
LY PROMOTING AWARENESS AMONG INDIVI-
DUALS AND ORGANIZATIONS ON THE NEED
FOR PHILANTHROPIC GIVING, IN CLASS 35 (U.S.
CLS. 100, 101 AND 102).

FIRST USE 4-29-2007; IN COMMERCE 4-29-2007.

THE MARK CONSISTS OF STANDARD CHAR-
ACTERS WITHOUT CLAIM TO ANY PARTICULAR
FONT, STYLE, SIZE, OR COLOR.

NO CLAIM IS MADE TO THE EXCLUSIVE
RIGHT TO USE "CAPITAL", APART FROM THE
MARK AS SHOWN.

SER. NO. 78-980,007, FILED 1-25-2006.

ELLEN PERKINS, EXAMINING ATTORNEY

Int. Cl.: 9

Prior U.S. Cls.: 21, 23, 26, 36 and 38

United States Patent and Trademark Office

Reg. No. 3,476,719

Registered July 29, 2008

**TRADEMARK
PRINCIPAL REGISTER**

SPG SOLAR

SPG SOLAR, INC. (CALIFORNIA CORPORATION)
20 LEVER ONI COURT
NOVATO, CA 94949

FOR: APPARATUS FOR CONVERTING ELECTRONIC RADIATION TO ELECTRICAL ENERGY, NAMELY PHOTOVOLTAIC SOLAR MODULES, IN CLASS 9 (U.S. CLS. 21, 23, 26, 36 AND 38).

FIRST USE 3-1-2006; IN COMMERCE 3-1-2006.

THE MARK CONSISTS OF STANDARD CHARACTERS WITHOUT CLAIM TO ANY PARTICULAR FONT, STYLE, SIZE, OR COLOR.

NO CLAIM IS MADE TO THE EXCLUSIVE RIGHT TO USE "SOLAR", APART FROM THE MARK AS SHOWN.

SER. NO. 78-980,390, FILED 1-26-2006.

MATTHEW PAPPAS, EXAMINING ATTORNEY

Int. Cl.: 29

Prior U.S. Cl.: 46

United States Patent and Trademark Office

Reg. No. 3,476,720

Registered July 29, 2008

**TRADEMARK
PRINCIPAL REGISTER**

**LESS TIME IN THE KITCHEN.
MORE TIME FOR LIFE.**

CONTESSA PREMIUM FOODS, INC. (CALIFORNIA CORPORATION)
EIGHTH FLOOR
222 WEST SIXTH STREET
SAN PEDRO, CA 907313356

FOR: FROZEN SEAFOOD; FROZEN PREPARED DINNERS, ENTREES AND SIDE DISHES CONSISTING PRIMARILY OF SEAFOOD, POULTRY, MEAT, OR VEGETABLES , IN CLASS 29 (U.S. CL. 46).

FIRST USE 1-22-2006; IN COMMERCE 1-22-2006.

THE MARK CONSISTS OF STANDARD CHARACTERS WITHOUT CLAIM TO ANY PARTICULAR FONT, STYLE, SIZE, OR COLOR.

SER. NO. 78-980,410, FILED 3-9-2006.

ANDREW RHIM, EXAMINING ATTORNEY

Int. Cl.: 11

Prior U.S. Cls.: 13, 21, 23, 31 and 34

United States Patent and Trademark Office

Reg. No. 3,476,721

Registered July 29, 2008

**TRADEMARK
PRINCIPAL REGISTER**

LCC
LAUFEN CLEAN COAT

KERAMIK HOLDING AG LAUFEN (SWITZER-
LAND CORPORATION)
46, WAHLENSTRASSE
CH-4242 LAUFEN
SWITZERLAND

FOR: SANITARY APPARATUS AND INSTALLA-
TIONS, NAMELY, TOILETS, CERAMIC BOWLS,
BIDETS, WASHHAND BASINS, BATHTUBS, SHOW-
ERS, URINALS; CERAMIC TOILET BOWLS, CERA-
MIC BIDETS, CERAMIC LAVATORY BASINS,
CERAMIC BATHTUBS, CERAMIC SHOWERS,
CERAMIC URINALS; LIGHTING FIXTURES;
PARTS AND ELEMENTS OF THE ABOVE GOODS;

ALL OF THE ABOVE GOODS OF SWISS ORIGIN, IN
CLASS 11 (U.S. CLS. 13, 21, 23, 31 AND 34).

PRIORITY DATE OF 5-5-2004 IS CLAIMED.

OWNER OF INTERNATIONAL REGISTRATION
0849761 DATED 10-8-2004, EXPIRES 10-8-2014.

SER. NO. 79-010,969, FILED 10-8-2004.

BRIAN NEVILLE, EXAMINING ATTORNEY

Int. Cl.: 20

Prior U.S. Cls.: 2, 13, 22, 25, 32 and 50

United States Patent and Trademark Office

Reg. No. 3,476,722

Registered July 29, 2008

**TRADEMARK
PRINCIPAL REGISTER**

SUPRELLE

ADVANS A B.V.
HOLLAND OFFICE CENTER,
KRUISWEG 829, 2ND FLOOR NL-2132 NG HOOFD-
DORP
NETHERLANDS

OWNER OF INTERNATIONAL REGISTRATION
0852581 DATED 5-3-2005, EXPIRES 5-3-2015.

FOR: BEDS; PILLOWS; MATTRESSES, IN CLASS
20 (U.S. CLS. 2, 13, 22, 25, 32 AND 50).

SER. NO. 79-011,867, FILED 5-3-2005.

PRIORITY DATE OF 4-26-2005 IS CLAIMED.

JULIE WATSON, EXAMINING ATTORNEY

Int. Cl.: 25

Prior U.S. Cls.: 22 and 39

United States Patent and Trademark Office

Reg. No. 3,476,723

Registered July 29, 2008

TRADEMARK
PRINCIPAL REGISTER

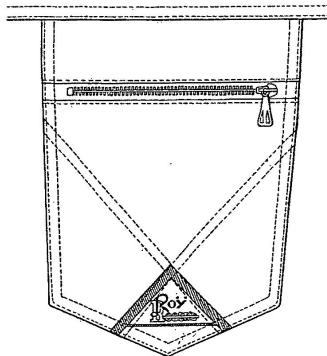

MANIFATTURE 7 BELL S.P.A. (ITALY SOCIETA
PER AZIONI)
172, VIA BRUNO BUOZZI
I-50013 CAMPI BISENZIO, ITALY

FOR: READY MADE CLOTHING, NAMELY,
OUTFITS, NAMELY, JACKETS, COATS, TROU-
SERS, SKIRTS, SHIRTS; WATERPROOF CLOTH-
ING, NAMELY, RAINCOATS, WATERPROOF
JACKETS; WORKWEAR, NAMELY, TROUSERS,
JACKETS, COATS, SHIRTS, SWEATERS, T-SHIRTS;
SPORTSWEAR, NAMELY, TROUSERS, JACKETS,
SKIRTS, SHIRTS, SWEATERS, IN CLASS 25 (U.S.
CLS. 22 AND 39).

OWNER OF INTERNATIONAL REGISTRATION
0858345 DATED 5-31-2005, EXPIRES 5-31-2015.

NO CLAIM IS MADE TO THE EXCLUSIVE
RIGHT TO USE THE SHAPE OF THE POCKET OR

THE POCKETS REINFORCEMENT STITCHING,
APART FROM THE MARK AS SHOWN.

THE NAME(S), PORTRAIT(S), AND/OR SIGNA-
TURE(S) SHOWN IN THE MARK DOES NOT IDENTI-
FY A PARTICULAR LIVING INDIVIDUAL.

THE MARK CONSISTS OF A STITCH PATTERN
ON A POCKET CONTAINING SLANTED STITCHES
WHICH INTERSECT. A HORIZONTAL ZIPPER IS
ABOVE THE SLANTED STITCHES AND THE
WORDS "ROY ROGERS" APPEAR IN A LOWER
TRIANGLE FORMED FROM THE INTERSECTION
OF THE SLANTED STITCHES.

SER. NO. 79-014,032, FILED 5-31-2005.

CHERYL CLAYTON, EXAMINING ATTORNEY

Int. Cl.: 7

Prior U.S. Cls.: 13, 19, 21, 23, 31, 34 and 35

Reg. No. 3,476,724

United States Patent and Trademark Office

Registered July 29, 2008

**TRADEMARK
PRINCIPAL REGISTER**



OMET S.R.L. (ITALY SOCIETA A RESPONSABILITA LIMITATA)

VIA CADUTI A FOSSOLI, 22
LECCO, ITALY I23900

FOR: MACHINES FOR THE PAPER AND GRAPHIC INDUSTRY, NAMELY, PRINT CONVERTING MACHINES FOR THE GRAPHIC INDUSTRY, PAPER COATING MACHINES, PAPER CUTTING MACHINES, PAPER SHREDDING MACHINES; PRINTING MACHINES FOR ALUMINUM HOLDERS, NAMELY, FLEXOGRAPHIC PRINTING MACHINES; LABELS AND FORMS MACHINES, NAMELY, LABEL PRINTING MACHINES FOR PRODUCING LABELS AND FORMS; BALL BEARINGS FOR AGRICULTURAL MACHINES, CONVEYING EQUIPMENT, NAMELY, AIR CONVEYORS; COVERED OR UNCOVERED BEARINGS FOR ALUMINUM STRUCTURES, NAMELY, ROLLER BEARINGS FOR MACHINES; AUTOMATIC BOTTLE BATCHER MACHINES AND BEARINGS THEREFOR; EQUIPMENT FOR BAKERIES, NAMELY, KNEADING MACHINES AND BALL BEARINGS THEREFOR; BALL-MOTION PARTS FOR BICYCLES, NAMELY, BALL BEARINGS FOR BICYCLES, BEER-HOUSE PLANT MACHINES, CABLE CRANES, INDEX CARD HOLDERS, AND INDEX CARD STORAGE BOXES; BALL BEARINGS FOR METAL DOOR HINGES; AXIAL BEARINGS FOR DOOR HINGES; BALL BEARINGS FOR METAL DRAWER RAILS; BALL BEARINGS FOR FOOD-SMOKING PLANTS AND MISCELLANEOUS GALVANIC-BATH PLANTS; COVERED AND UNCOVERED BALL BEARINGS FOR INDUSTRIAL DOORS; COVERED AND UNCOVERED BALL BEARINGS FOR GARAGE DOORS, HOSPITAL

DOORS, INDUSTRIALS DOORS, METAL AND NON-METAL LIFT DOORS; COVERED AND UNCOVERED BALL BEARINGS AND PROTECTION GUARDS FOR LIFT DOORS, MILK INDUSTRY MACHINES, PACKAGING MACHINES, REVOLVING CLOTH HOLDERS, AND BOTH METAL AND NON-METAL ROLLER SHUTTERS; COVERED AND UNCOVERED BALL BEARINGS FOR WAREHOUSE SHELVES, SHOWER BOXES AND FOR SLIDING ELEMENTS USED IN DOORS; METAL RUNNERS FOR SLIDING DOORS; NON-METAL RUNNERS FOR SLIDING DOORS; PLASTIC COVERED BALL BEARINGS FOR SLIDING DOORS; COVERED AND UNCOVERED BALL BEARINGS FOR METAL AND NON-METAL WINDOW FRAMES AND WEIGHBRIDGE DOORS; PLASTIC COVERED BALL BEARINGS FOR WINDOW FRAMES; BALL BEARINGS FOR SPORTS-HALL TOOLS, MACHINES STANDS, SUITCASES, TEXTILE MACHINES, TRUCK SLIDING COVERS, VARNISHING PLANTS AND WASHING EQUIPMENT; BALL BEARINGS FOR ROLLER SKATES AND TOYS USED AS SKATES; BALL BEARINGS FOR WHITE GOODS, NAMELY, BALL BEARINGS FOR LARGE HOUSEHOLD APPLIANCES; BALL BEARINGS FOR THE PACKAGING AND PRINTING INDUSTRY; WRAPPING AND PACKAGING MACHINERY, NAMELY, WRAPPING MACHINES, PACKAGING MACHINES AND BALL BEARINGS THEREFOR; HOT FOIL MACHINES FOR MAKING LABELS AND FILMS IN THE NATURE OF TIP TO TIP AND DERL SYSTEMS; GLUING MACHINE COMPONENTS, NAMELY, GLUING MACHINE UNITS USED ON GLUING MACHINES TO FACILITATE GLUING, EMBOSsing AND ENGRAVING OF SHEETS OF HANDKERCHIEFS; GLUING MA-

CHINES FOR EMBOSSING HANDKERCHIEFS; AND BALL BEARINGS THEREOF; HOSPITAL BEDS; PATIENT EXAMINATION TABLES, NAME-
LY, RADIOLOGICAL TABLES AND BALL BEAR-
INGS THEREFOR; BALL BEARINGS FOR CIVIL
AND INDUSTRIAL MACHINERY AND EQUIP-
MENT; PROTECTIVE SLIDING METAL DOORS
FOR MACHINES AND BALL BEARINGS THERE-
FOR, PLASTIC COVERED AND UNCOVERED
BALL BEARINGS FOR MACHINERY PROTECTION
AND THE PROTECTION OF SLIDING DOORS IN
MACHINERY; METAL AND NON-METAL FIRE
PROTECTION DOORS; PLASTIC COVERED AND
UNCOVERED BALL BEARINGS FOR METAL
RAILS FOR PROTECTION GUARD MACHINES
AND FOR THE HANDLING OF BIG DIMENSION
EXHIBITION EQUIPMENT, ELEVATORS AND
BALL BEARINGS FOR SLIDING DOORS OF ELE-
VATORS; BALL BEARINGS FOR FURNITURE,
CHAIRS, AND SETS OF DRAWERS; BALL BEAR-
INGS FOR PRINTERS AND COPIERS, REVOLVING
CLOTH HOLDERS, ROLLER SHUTTERS, ROLL-
GRAVITY AND WHEEL CONVEYORS, AND
SCALES; WHEELS FOR LAWNMOWERS, WHEELS
FOR TROLLEYS AND WHEELBARROWS, REPLA-
CEMENT ROLLERS FOR ROLLER SKATE
WHEELS, BALL BEARINGS OF WHEELS FOR TOYS

VEHICLES, AND BALL BEARINGS FOR THE
AFOREMENTIONED WHEELS; BALL BEARINGS
FOR WOOD-PROCESSING MACHINES; FOR ROLL-
ERS USED IN THE FOOD INDUSTRY, FOR FOOD
PRODUCT MACHINERY, AND FOR MACHINES
USED IN THE PACKAGING, PRINTING, WRAP-
PING AND PACKAGING MACHINERY INDUS-
TRIES, CUTTING PLOTTERS AND BALL
BEARINGS THEREFOR, IN CLASS 7 (U.S. CLS. 13,
19, 21, 23, 31, 34 AND 35).

OWNER OF INTERNATIONAL REGISTRATION
0865054 DATED 3-29-2005, EXPIRES 3-29-2015.

THE COLOR(S) RED AND BLACK IS/ARE
CLAIMED AS A FEATURE OF THE MARK.

THE MARK CONSISTS OF THE FOLLOWING:
THE COLOR BLACK APPEARS IN THE TOP DE-
SIGN AND THE COLOR RED APPEARS IN THE
BOTTOM DESIGN.

SER. NO. 79-016,539, FILED 3-29-2005.

ROBERT C. CLARK JR., EXAMINING ATTORNEY

Int. Cl.: 5

Prior U.S. Cls.: 6, 18, 44, 46, 51 and 52

United States Patent and Trademark Office

Reg. No. 3,476,725

Registered July 29, 2008

**TRADEMARK
PRINCIPAL REGISTER**

VIDALTA

INTERVET INTERNATIONAL B.V. (NETHER-
LANDS LTD LIAB CO)
WIM DE KÖRVERSTRAAT 35
AN BOXMEER BOXMEER, NETHERLANDS NL5831

FOR: PHARMACEUTICAL PREPARATIONS FOR
VETERINARY USE, NAMELY HORMONE PRE-
PARATIONS FOR DOGS, IN CLASS 5 (U.S. CLS. 6,
18, 44, 46, 51 AND 52).

THE MARK CONSISTS OF STANDARD CHAR-
ACTERS WITHOUT CLAIM TO ANY PARTICULAR
FONT, STYLE, SIZE, OR COLOR.

PRIORITY DATE OF 9-14-2005 IS CLAIMED.

OWNER OF INTERNATIONAL REGISTRATION
0872498 DATED 12-1-2005, EXPIRES 12-1-2015.

SER. NO. 79-019,334, FILED 12-1-2005.

TINA BROWN, EXAMINING ATTORNEY

Int. Cls.: 24 and 28

Prior U.S. Cls.: 22, 23, 38, 42 and 50

United States Patent and Trademark Office

Reg. No. 3,476,726

Registered July 29, 2008

**TRADEMARK
PRINCIPAL REGISTER**

SOF

POLYMER PROCESSING RESEARCH; INSTI-
TUTE LIMITED (JAPAN CORPORATION)
33-5 ITABASHI 4-CHOME
ITABASHI-KU; TOKYO, JAPAN 1730004

FOR: NON-WOVEN TEXTILE FABRICS, IN
CLASS 24 (U.S. CLS. 42 AND 50).

FOR: SPORTING EQUIPMENT, NAMELY, GOLF
CLUBS AND TENNIS RACKETS, IN CLASS 28 (U.S.
CLS. 22, 23, 38 AND 50).

THE MARK CONSISTS OF STANDARD CHAR-
ACTERS WITHOUT CLAIM TO ANY PARTICULAR
FONT, STYLE, SIZE, OR COLOR.

OWNER OF INTERNATIONAL REGISTRATION
0875242 DATED 11-16-2005, EXPIRES 11-16-2015.

SER. NO. 79-020,314, FILED 11-16-2005.

JORDAN BAKER, EXAMINING ATTORNEY

Int. Cls.: 9 and 15

Prior U.S. Cls.: 2, 21, 23, 26, 36 and 38

United States Patent and Trademark Office

Reg. No. 3,476,727

Registered July 29, 2008

**TRADEMARK
PRINCIPAL REGISTER**

BÖSENDORFER CEUS

L. BÖSENDORFER KLAVIERFABRIK GMBH
(AUSTRIA LIMITED LIABILITY)

BÖSENDORFERSTRASSE 12

A-1010 WIEN, AUSTRIA

FOR: APPARATUS FOR RECORDING, TRANSMISSION OR REPRODUCTION OF SOUND OR IMAGES; PRE-RECORDED MAGNETIC DATA CARRIERS FEATURING MUSIC; PRE-RECORDED CD'S AND DVD'S FEATURING MUSIC; DATA PROCESSORS AND COMPUTER HARDWARE, IN CLASS 9 (U.S. CLS. 21, 23, 26, 36 AND 38).

FOR: MUSICAL INSTRUMENTS; GRAND PIANOS, PIANOS, PIANINOS, PIANO KEYBOARDS, KEYBOARDS FOR MUSICAL INSTRUMENTS, MECHANICAL INTENSITY REGULATORS FOR PIANOS, PIANO STRINGS, PIANO KEYS, IN CLASS 15 (U.S. CLS. 2, 21 AND 36).

THE MARK CONSISTS OF STANDARD CHARACTERS WITHOUT CLAIM TO ANY PARTICULAR FONT, STYLE, SIZE, OR COLOR.

PRIORITY DATE OF 11-4-2005 IS CLAIMED.

OWNER OF INTERNATIONAL REGISTRATION 0878268 DATED 1-4-2006, EXPIRES 1-4-2016.

OWNER OF U.S. REG. NO. 868,194.

THE WORDING "BÖSENDORFER CEUS", "BÖSENDORFER" AND "CEUS" HAS NO MEANING IN A FOREIGN LANGUAGE.

SER. NO. 79-021,385, FILED 1-4-2006.

ATTIYA MALIK, EXAMINING ATTORNEY

Int. Cls.: 3, 5 and 35

**Prior U.S. Cls.: 1, 4, 6, 18, 44, 46, 50, 51, 52, 100, 101
and 102**

Reg. No. 3,476,728

United States Patent and Trademark Office

Registered July 29, 2008

**TRADEMARK
SERVICE MARK
PRINCIPAL REGISTER**

NUDE

NUDE BRANDS LIMITED (ENGLAND LIMITED
COMPANY)
1 ST PAUL'S CHURCHYARD
LONDON EC4M 8SH
UNITED KINGDOM

FOR: SKIN SOAPS; ANTIPERSPIRANTS, DEODORANTS FOR PERSONAL USE; ESSENTIAL OILS, OILS FOR PERFUMES AND SCENTS, PERFUMERY, EAU DE COLOGNE; SACHETS FOR PERFUMING LINEN, POTPOURRIS; SCENTED LINEN WATER, TOILET WATER, SCENTED WOOD, NAMELY, INCENSE; HAIR LOTIONS, SHAMPOOS, BLEACHING PREPARATIONS FOR COSMETIC PURPOSES, COSMETIC DYES, NAMELY, BEARD DYES, HAIR DYES, HAIR COLORANTS, HAIR SPRAY, HAIR WAVING LOTIONS, NEUTRALIZERS FOR PERMANENT HAIR WAVING, HYDROGEN PEROXIDE FOR COSMETIC PURPOSES, NAMELY, FOR USE ON HAIR; ADHESIVES FOR AFFIXING FALSE EYELASHES AND FALSE HAIR, MOUSTACHE WAX; DEPILATORIES AND DEPILATORY CREAMS; COSMETICS, COSMETIC PENCILS, EYEBROW PENCILS, FALSE EYELASHES, DECORATIVE TRANSFERS FOR COSMETIC PURPOSES; FALSE NAILS, NAIL CARE PREPARATIONS, NAIL POLISH, NAIL VARNISH FOR COSMETIC PURPOSES, NAIL VARNISH REMOVING PREPARATIONS; ADHESIVES FOR COSMETIC PURPOSES, NON-MEDICATED TOILETRIES, ASTRINGENTS FOR COSMETIC PURPOSES, BATH SALTS NOT FOR MEDICAL PURPOSES, NON-MEDICATED COSMETIC PREPARATIONS FOR BATHS, NON-MEDICATED COSMETIC PREPARATIONS FOR SKIN CARE, COTTON STICKS FOR COSMETIC PURPOSES, COTTON WOOL FOR COSMETIC PURPOSES, COSMETIC CREAMS, SKIN

WHITENING CREAMS, GREASES FOR COSMETIC PURPOSES, NAMELY, BATH OIL, LOTIONS FOR COSMETIC PURPOSES, NAMELY SUNTAN LOTION, OILS FOR COSMETIC PURPOSES AND FOR TOILETRY PURPOSES, PETROLEUM JELLY FOR COSMETIC PURPOSES, POMADES FOR COSMETIC PURPOSES, COTTON SWABS FOR COSMETIC PURPOSES, TALCUM POWDER FOR TOILET USE, PRE-MOISTENED COSMETIC TISSUES IMPREGNATED WITH COSMETIC LOTIONS, MAKE-UP REMOVING PREPARATIONS, CLEANSING MILK FOR TOILET PURPOSES, BEAUTY MASKS, PUMICE STONE FOR PERSONAL USE; DENTIFRICES, NON-MEDICATED MOUTH WASHES NOT FOR MEDICAL PURPOSES, TOOTHPASTE, DENTURE CLEANING PREPARATIONS, NAMELY, POLISHES, BREATH FRESHENING SPRAYS; SHAVING PREPARATIONS, AFTER-SHAVE LOTIONS, PASTES FOR RAZOR STROPS, NAMELY, SHAVING CREAM; SUNSCREEN PREPARATIONS, NAMELY SUNSCREEN CREAM, COSMETIC SUN-TANNING PREPARATIONS; BLEACHING PREPARATIONS FOR LAUNDRY USE; GENERAL PURPOSE CLEANING, POLISHING, SCOURING AND ABRASIVE LIQUIDS AND POWDERS., IN CLASS 3 (U.S. CLS. 1, 4, 6, 50, 51 AND 52).

FOR: DIETETIC FOOD ADAPTED FOR MEDICAL USE; DIETETIC FOOD PREPARATIONS ADAPTED FOR MEDICAL PURPOSES; FOOD FOR BABIES; MEDICATED CANDY AND MEDICATED CONFECTIONERY; MEDICINAL DRINKS, NAMELY TEA, MEDICINAL HERB EXTRACTS, MEDICATED BABY OILS; MINERAL FOOD-SUPPLEMENTS; HERBAL MUD PACKS FOR THERAPEUTIC BATH PURPOSES, MINERAL WATER SALTS AND SALTS FOR MINERAL WATER BATHS FOR MEDICAL

PURPOSES; SMELLING SALTS; MEDICATED SUN-BURN OINTMENTS; EYE WASHES; FIRST AID KITS; MEDICAL PLASTERS, MATERIALS FOR DRESSINGS, NAMELY, BANDAGES; MATERIAL FOR STOPPING TEETH, NAMELY, DENTAL WAX; ADHESIVES FOR DENTURES; ALL-PURPOSE DISINFECTANTS; PREPARATIONS FOR DESTROYING VERMIN; FUNGICIDES, HERBICIDES; AIR FRESHENING PREPARATIONS, AIR PURIFYING PREPARATIONS, NAMELY, AIR DEODORIZER, DEODORANTS OTHER THAN FOR PERSONAL USE, NAMELY, HOUSEHOLD DEODORANTS; THERAPEUTIC PREPARATIONS FOR THE BATH, NAMELY, ALOE VERA GEL, PHARMACEUTICAL PREPARATIONS, NAMELY, ANTICOAGULANTS, DIAGNOSTIC PREPARATIONS FOR VETERINARY USE; SANITARY PREPARATIONS FOR MEDICAL PURPOSES., IN CLASS 5 (U.S. CLS. 6, 18, 44, 46, 51 AND 52).

FOR: ADVERTISING AGENCIES; BUSINESS MANAGEMENT; BUSINESS ADMINISTRATION;

PROVIDING OFFICE FUNCTIONS; THE BRINGING TOGETHER, FOR THE BENEFIT OF OTHERS, OF A VARIETY OF GOODS RELATING TO PERSONAL CARE PRODUCTS AND FOOD AND BEVERAGES PRODUCTS, ENABLING CUSTOMERS TO CONVENIENTLY VIEW AND PURCHASE THOSE GOODS IN A RETAIL STORE, THROUGH A TELEVISION SHOPPING CHANNEL, VIA A MAIL ORDER CATALOGUE OR FROM AN INTERNET WEB SITE, IN CLASS 35 (U.S. CLS. 100, 101 AND 102).

THE MARK CONSISTS OF STANDARD CHARACTERS WITHOUT CLAIM TO ANY PARTICULAR FONT, STYLE, SIZE, OR COLOR.

OWNER OF INTERNATIONAL REGISTRATION 0878412 DATED 9-16-2005, EXPIRES 9-16-2015.

SER. NO. 79-021,431, FILED 9-16-2005.

DAVID MURRAY, EXAMINING ATTORNEY

Int. Cl.: 42

Prior U.S. Cls.: 100 and 101

United States Patent and Trademark Office

Reg. No. 3,476,729

Registered July 29, 2008

**SERVICE MARK
PRINCIPAL REGISTER**

ATLASPROFILAX

RENÉ-CLAUDIUS SCHÜMPERLI (SWITZER-
LAND INDIVIDUAL)
ROUTE DE SION 71
CH-3960 SIERRE
SWITZERLAND

FOR: PHYSICAL THERAPY, HEALTH CARE,
PHYSICAL EDUCATION, CHIROPRACTIC, PRE-
VENTIVE HEALTH CARE FOR MAINTAINING
GOOD HEALTH, SPINAL MANIPULATION AND
MASSAGE, PHYSICAL REHABILITATION, IN
CLASS 42 (U.S. CLS. 100 AND 101).

THE MARK CONSISTS OF STANDARD CHAR-
ACTERS WITHOUT CLAIM TO ANY PARTICULAR
FONT, STYLE, SIZE, OR COLOR.

OWNER OF INTERNATIONAL REGISTRATION
0694822 DATED 6-15-1998, EXPIRES 6-15-2018.

SER. NO. 79-023,008, FILED 2-17-2006.

KATHERINE CHANG, EXAMINING ATTORNEY

Int. Cl.: 14

Prior U.S. Cls.: 2, 27, 28 and 50

United States Patent and Trademark Office

Reg. No. 3,476,730

Registered July 29, 2008

CERTIFICATION MARK
PRINCIPAL REGISTER



AZIENDA SPECIALE; "REAL PRECIOUS QUALITY" (ITALY UNINCORPORATED ADMINISTRATIVE ORGANIZATION)

VIA AVOGADRO, 1

I-62010 MONTELUPONE (MC), ITALY

FOR: PRECIOUS METALS AND THEIR ALLOYS AND GOODS IN PRECIOUS METALS OR COATED THEREWITH, NAMELY, PICTURE FRAMES, DECORATIVE AND SACRED PICTURES, BOXES, GIFT AND FANCY GOODS FOR CHILDREN, NAMELY, NECKLACES, RINGS, BRACELETS, PENDANTS, CHAINS, PINS AND EARRINGS; PLATES OF PRECIOUS METAL; JEWELRY; RAW MATERIALS, NAMELY, BARS, BULLIONS, AND INGOTS ALL OF PRECIOUS METAL; NECKLACES, LOCKS FOR NECKLACES, RINGS, BRACELETS, PENDANTS, CHAINS, PINS AND EARRINGS; JEWELRY; PRECIOUS STONES; HOROLOGICAL AND CHRONOMETRIC INSTRUMENTS, IN CLASS 14 (U.S. CLS. 2, 27, 28 AND 50).

OWNER OF INTERNATIONAL REGISTRATION 0887050 DATED 11-18-2005, EXPIRES 11-18-2015.

NO CLAIM IS MADE TO THE EXCLUSIVE RIGHT TO USE "REAL PRECIOUS QUALITY", APART FROM THE MARK AS SHOWN.

THE MARK CONSISTS OF THE SIGN WITH "REAL PRECIOUS QUALITY" IN SMALL LETTERS, WITH CAPITAL INITIAL LETTER; THE SIGN IS WRITTEN IN THREE LINES; ON LEFT IS REPRESENTED A CAPITAL "Q" AND INSIDE THE "Q" ARE IMPRINTED OVER THE CAPITAL LETTERS "R" AND "P".

THE CERTIFICATION MARK, AS USED BY PERSONS AUTHORIZED BY THE CERTIFIER, CERTIFIES THAT THE GOODS PROVIDED HAVE BEEN EXAMINED AND TESTED TO ENSURE THAT THEY MEET THE STANDARDS OF JEWELRY MATERIALS, QUALITY AND WORKMANSHIP OF THE CERTIFIER.

SER. NO. 79-024,674, FILED 11-18-2005.

KAREN K. BUSH, EXAMINING ATTORNEY

Int. Cl.: 14

Prior U.S. Cls.: 2, 27, 28 and 50

United States Patent and Trademark Office

Reg. No. 3,476,731

Registered July 29, 2008

CERTIFICATION MARK
PRINCIPAL REGISTER



AZIENDA SPECIALE; "REAL PRECIOUS QUALITY" (ITALY UNINCORPORATED ADMINISTRATIVE ORGANIZATION)
VIA AVOGADRO, 1
I-62010 MONTELUPONE (MC), ITALY

FOR: PRECIOUS METALS AND THEIR ALLOYS AND GOODS IN PRECIOUS METALS OR COATED THEREWITH, NAMELY, PICTURE FRAMES, DECORATIVE AND SACRED PICTURES, BOXES, GIFT AND FANCY GOODS FOR CHILDREN, NAMELY, NECKLACES, RINGS, BRACELETS, PENDANTS, CHAINS, PINS AND EARRINGS; PLATES OF PRECIOUS METAL; JEWELRY; RAW MATERIALS, NAMELY, BARS, BULLIONS, AND INGOTS ALL OF PRECIOUS METAL; NECKLACES, LOCKS FOR NECKLACES, RINGS, BRACELETS, PENDANTS, CHAINS, PINS AND EARRINGS; JEWELRY; PRECIOUS STONES; HOROLOGICAL AND CHRONOMETRIC INSTRUMENTS, IN CLASS 14 (U.S. CLS. 2, 27, 28 AND 50).

OWNER OF INTERNATIONAL REGISTRATION
0887074 DATED 11-18-2005, EXPIRES 11-18-2015.

NO CLAIM IS MADE TO THE EXCLUSIVE RIGHT TO USE "REAL SILVER QUALITY", APART FROM THE MARK AS SHOWN.

THE MARK CONSISTS OF A SIGN WITH "REAL SILVER QUALITY" IN SMALL LETTERS, WITH CAPITAL INITIAL LETTER. THE SIGN IS WRITTEN IN THREE LINES. ON LEFT IS REPRESENTED A CAPITAL "Q" AND INSIDE THE "Q" ARE IMPRINTED OVER THE CAPITAL LETTERS "R" AND "S".

THE CERTIFICATION MARK, AS USED BY PERSONS AUTHORIZED BY THE CERTIFIER, CERTIFIES THAT THE GOODS PROVIDED HAVE BEEN EXAMINED AND TESTED TO ENSURE THAT THEY MEET THE STANDARDS OF JEWELRY MATERIALS, QUALITY AND WORKMANSHIP OF THE CERTIFIER.

SER. NO. 79-024,683, FILED 11-18-2005.

KAREN K. BUSH, EXAMINING ATTORNEY

Int. Cl.: 9

Prior U.S. Cls.: 21, 23, 26, 36 and 38

United States Patent and Trademark Office

Reg. No. 3,476,732

Registered July 29, 2008

**TRADEMARK
PRINCIPAL REGISTER**

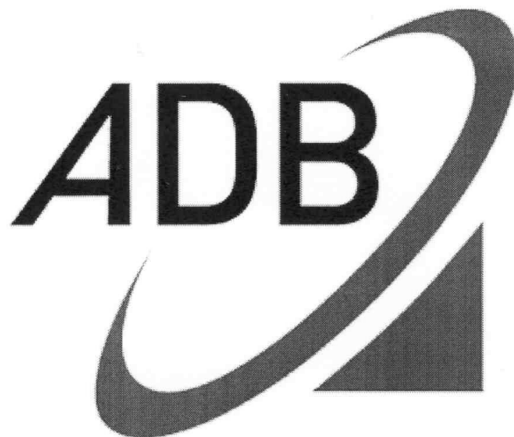

ADVANCED DIGITAL BROADCAST S.A. (SWITZERLAND SOCIÉTÉ ANONYME)
IMPASSE COLOMBELLE 8
CH-1218 LE GRAND-SACONNEX
SWITZERLAND

FOR: COMPUTERS, RECORDED COMPUTER SOFTWARE THAT ALLOWS THE NAVIGATION BETWEEN TV CHANNELS, NAMELY, CHANNEL CHANGING, INFORMATION ABOUT TV CHANNELS CURRENTLY PLAYING OR TO BE PLAYED; COMPUTER SOFTWARE THAT FACILITATES ELECTRONIC PROGRAM GUIDES, NAMELY, A VIEW OVER SEVERAL DAYS ABOUT WHAT TV PROGRAMS WILL BE AVAILABLE; COMPUTER SOFTWARE THAT FACILITATES THE SELECTION AND ACTIVATION OF ON-DEMAND CONTENT, NAMELY, MOVIES, VIDEOS, MUSIC AND THE LIKE AND COMPUTER SOFTWARE THAT FACILITATES THE INTERACTION WITH TV SHOWS,

NAMELY, POLLING, VOTING, GAMING, BETTING AND THE LIKE; COMPUTER SOFTWARE THAT FACILITATES THE RECORDING OF TV PROGRAMS ON A HARD DISK, TO SHARE STORED TV PROGRAMS WITH OTHER SUBSCRIBERS, TO FACILITATE ONLINE SHOPPING; ALL IN THE FIELD OF DIGITAL TELEVISION AND DECODERS, IN CLASS 9 (U.S. CLS. 21, 23, 26, 36 AND 38).

PRIORITY DATE OF 12-7-2005 IS CLAIMED.

OWNER OF INTERNATIONAL REGISTRATION 0888022 DATED 5-22-2006, EXPIRES 5-22-2016.

SER. NO. 79-025,052, FILED 5-22-2006.

DEZMONA MIZELLE, EXAMINING ATTORNEY

Int. Cls.: 37 and 42

Prior U.S. Cls.: 100, 101, 103 and 106

United States Patent and Trademark Office

Reg. No. 3,476,733

Registered July 29, 2008

**SERVICE MARK
PRINCIPAL REGISTER**

POLYMONT

POLYMONT INTERNATIONAL S.A.
55, AVENUE DE LA LIBERTÉ,
LIBERTY CENTERL-1930 LUXEMBOURG
LUXEMBOURG

FOR: REPAIR, SERVICING AND INSTALLATION
OF MACHINE AND MACHINE TOOLS FOR THE
MANUFACTURE, MAINTENANCE AND REPAIR
OF AIRCRAFT AND LAND VEHICLES , IN CLASS
37 (U.S. CLS. 100, 103 AND 106).

FOR: TECHNOLOGY DESIGN AND DEVELOP-
MENT OF INDUSTRIAL INSTALLATIONS FOR
OTHERS; SCIENTIFIC AND TECHNOLOGICAL RE-
SEARCH AND DESIGN SERVICES IN THE FIELD
OF MECHANICAL ENGINEERING, IN CLASS 42
(U.S. CLS. 100 AND 101).

THE MARK CONSISTS OF STANDARD CHAR-
ACTERS WITHOUT CLAIM TO ANY PARTICULAR
FONT, STYLE, SIZE, OR COLOR.

PRIORITY DATE OF 2-6-2006 IS CLAIMED.

OWNER OF INTERNATIONAL REGISTRATION
0890403 DATED 6-20-2006, EXPIRES 6-20-2016.

SER. NO. 79-025,875, FILED 6-20-2006.

JOSETTE BEVERLY, EXAMINING ATTORNEY

Int. Cls.: 9, 40 and 42

Prior U.S. Cls.: 21, 23, 26, 36, 38, 100, 101, 103 and 106

United States Patent and Trademark Office

Reg. No. 3,476,734

Registered July 29, 2008

**TRADEMARK
SERVICE MARK
PRINCIPAL REGISTER**



NANOTOOLS GMBH (FED REP GERMANY LIMITED LIABILITY COMPANY)
REICHENBACHSTRASSE 33
80469 MÜNCHEN
FED REP GERMANY

FOR: SCIENTIFIC APPARATUS AND INSTRUMENTS, NAMELY SCANNING PROBES FOR USE IN SCANNING PROBE MICROSCOPES FOR DETECTING STRUCTURES ON THE SUBMICRON SCALE BY MECHANICALLY CONTACTING SAID STRUCTURES, IN CLASS 9 (U.S. CLS. 21, 23, 26, 36 AND 38).

FOR: MATERIAL PROCESSING, NAMELY, USING SEMICONDUCTOR PROCESSING METHODS FOR THE COATING OF CARRIER MATERIALS, NAMELY SILICON, CARBON, SILICON OXIDE, SILICON NITRIDE, OR SILICON CARBIDE IN THE PREPARATION OF PROBES FOR SCANNING MICROSCOPES; CUSTOM PRODUCTION OF PRODS FOR PROBE DEVICES FOR MICROSCOPES THAT USE ADDITIVE AND/OR SUBTRACTIVE, CHEMICAL AND/OR MECHANICAL AND/OR ELECTRONIC METHODS; MATERIALS PROCESSING OF PROBE DEVICES, NAMELY SCANNING PROBES FOR MICROSCOPES BY COATING, USING MECHANICAL OR ELECTRONIC OR CHEMICAL METHODS; TREATMENT OF MATERIALS, NAMELY, SILICON, CARBON, SILICON OXIDE, SILICON NITRIDE, OR SILICON CARBIDE, BY COATING, ETCHING, METALLIZING, ANNEALING, OXIDIZING OR LASER TREATMENT; COATING SILICON, CARBON, SILICON OXIDE, SILICON NITRIDE, OR SILICON CARBIDE WITH METALS, INSULATORS, SEMICONDUCTORS OR ORGANIC CHEMICALS FOR THE PURPOSE OF PRODUCING CONDUCTIVE PROBES, INSULATING PROBES OR SEMICONDUCTING PROBES FOR SCANNING MICROSCOPES; ETCHING OF SURFACES, NAMELY, SILICON, CARBON, SILICON OXIDE, SILICON

NITRIDE, OR SILICON CARBIDE BY USING WET CHEMICAL, DRY CHEMICAL OR MECHANICAL OR ELECTRONIC METHODS., IN CLASS 40 (U.S. CLS. 100, 103 AND 106).

FOR: SCIENTIFIC AND INDUSTRIAL RESEARCH, NAMELY IN THE AREA OF MESOSCOPIC TECHNOLOGY; DEVELOPMENT OF CALIBRATIONS STANDARDS; USING SCANNING ELECTRON MICROSCOPES AND ATOMIC FORCE MICROSCOPES TO ANALYZE SURFACES AND PRESENT VISUAL REPRESENTATIONS OF THE SURFACES SO ANALYZED; SCIENTIFIC INVESTIGATIONS, SCIENTIFIC ANALYSES, SCIENTIFIC RECORDINGS, AND SCIENTIFIC EVALUATIONS, NAMELY USING SCANNING ELECTRON MICROSCOPES AND ATOMIC FORCE MICROSCOPES, IN THE FIELD OF MICROTECHNOLOGY OR NANOTECHNOLOGY., IN CLASS 42 (U.S. CLS. 100 AND 101).

PRIORITY DATE OF 12-22-2004 IS CLAIMED.

OWNER OF INTERNATIONAL REGISTRATION 0890864 DATED 6-17-2005, EXPIRES 6-17-2015.

THE COLOR(S) BLUE AND WHITE IS/ARE CLAIMED AS A FEATURE OF THE MARK.

BLUE: AREA OF THE CIRCLE AND LETTERS OF THE WORD "NANOTOOLS"; WHITE: THE LETTER "N" INSIDE THE CIRCLE.

SER. NO. 79-026,060, FILED 6-17-2005.

SUZANNE BLANE, EXAMINING ATTORNEY

Int. Cls.: 9 and 11

Prior U.S. Cls.: 13, 21, 23, 26, 31, 34, 36 and 38

United States Patent and Trademark Office

Reg. No. 3,476,735

Registered July 29, 2008

**TRADEMARK
PRINCIPAL REGISTER**



YANTEC (FRANCE SOCIÉTÉ À RESPONSABILITÉ LIMITÉE)
17-19, BOULEVARD DE LA MUETTE
F-95140 GARGES LES GONESSE
FRANCE

FOR: ELECTRIC BATTERIES AND ACCUMULATORS, IN CLASS 9 (U.S. CLS. 21, 23, 26, 36 AND 38).

FOR: PORTABLE LIGHTING, NAMELY, TORCH, LANTERN, SPOTLIGHT, BULB, NIGHT LIGHTING FOR GARDEN, STRIP LIGHT, LIGHT WITH BATTERIES, LAMPS, LIGHTS, PORTABLE BATTERY OPERATED LIGHTS, NIGHT LIGHT, IN CLASS 11 (U.S. CLS. 13, 21, 23, 31 AND 34).

PRIORITY DATE OF 11-16-2005 IS CLAIMED.

OWNER OF INTERNATIONAL REGISTRATION
0891146 DATED 5-12-2006, EXPIRES 5-12-2016.

THE COLOR(S) RED AND BLACK IS/ARE CLAIMED AS A FEATURE OF THE MARK.

THE MARK CONSISTS OF THE WORD "XAN-LITE" AND SWISH DESIGN. THE COLOR RED APPEARS IN THE WORDING AND THE COLOR BLACK APPEARS IN THE SWISH DESIGN.

SER. NO. 79-026,146, FILED 5-12-2006.

FLORENTINA BLANDU, EXAMINING ATTORNEY

Int. Cl.: 7

Prior U.S. Cls.: 13, 19, 21, 23, 31, 34 and 35

United States Patent and Trademark Office

Reg. No. 3,476,736

Registered July 29, 2008

**TRADEMARK
PRINCIPAL REGISTER**



FLUIDICS INSTRUMENTS B.V. (NETHERLANDS
CORPORATION)
DILLENBURGSTRAAT 34
NL-5652 AP EINDHOVEN, NETHERLANDS

FOR: ATOMIZERS IN THE NATURE OF POWER
OPERATED SPRAYING MACHINES, IN CLASS 7
(U.S. CLS. 13, 19, 21, 23, 31, 34 AND 35).

THE MARK CONSISTS OF STANDARD CHAR-
ACTERS WITHOUT CLAIM TO ANY PARTICULAR
FONT, STYLE, SIZE, OR COLOR.

PRIORITY DATE OF 9-16-2005 IS CLAIMED.

OWNER OF INTERNATIONAL REGISTRATION
0893204 DATED 3-16-2006, EXPIRES 3-16-2016.

SER. NO. 79-026,854, FILED 3-16-2006.

PAULA MAHONEY, EXAMINING ATTORNEY

Int. Cls.: 30 and 43

Prior U.S. Cls.: 46, 100 and 101

United States Patent and Trademark Office

Reg. No. 3,476,737

Registered July 29, 2008

**TRADEMARK
SERVICE MARK
PRINCIPAL REGISTER**



LADUREE INTERNATIONAL SA (SWITZERLAND JOINT STOCK COMPANY)
RUE SAINT-LÉGER 2
CH-1205 GENÈVE
SWITZERLAND

FOR: COFFEE, TEA, COCOA, SUGAR, RICE, TAPIOCA, SAGO, ARTIFICIAL COFFEE, FLOURS, AND CEREAL PREPARATIONS, NAMELY, BREAKFAST CEREALS, OATMEAL, CEREALS BASED SNACK FOOD, CRACKERS, READY TO EAT, CEREAL DERIVED FOOD BARS; BREAD, BREAD ROLLS, PASTRY, AND CONFECTIONERY, NAMELY, PASTILLES, CANDY, CRYSTAL SUGAR PIECES, FRUIT JELLIES, FROZEN YOGURT; COOKIES AND BISCUITS, BRIOCHES, CAKES, PIZZAS, SANDWICHES, TARTS, SHERBETS, PUDDINGS, GINGERBREAD, PASTA WAFFLES, PETITS FOURS, EDIBLE FRUIT ICES, EDIBLE FLAVOURED ICES, EDIBLE ICE CREAM; ICES; HONEY, TREACLE SYRUP; YEAST, BAKING-POWDER; SALT, MUSTARD; VINEGAR, SALAD DRESSINGS; SPICES; ICE FOR REFRESHMENT, PREPARED CHOCOLATE-BASED BEVERAGES AND PREPARED TEA-BASED BEVERAGES; CAN-

DY; EDIBLE DECORATIONS FOR CAKES, IN CLASS 30 (U.S. CL. 46).

FOR: PROVIDING FOOD AND DRINK, NAMELY, CATERING OF FOOD AND DRINKS, RESTAURANT SERVICES; BARS, CAFETERIAS, SELF-SERVICE RESTAURANTS, SNACK BARS, PREPARATION OF TAKE-OUT MEALS AND FOOD DISHES, TEA ROOMS, IN CLASS 43 (U.S. CLS. 100 AND 101).

PRIORITY DATE OF 2-24-2006 IS CLAIMED.

OWNER OF INTERNATIONAL REGISTRATION 0894594 DATED 8-8-2006, EXPIRES 8-8-2016.

THE MARK CONSIST OF AN ANGEL HOLDING A BRIOCHE ON A SPATULA.

SER. NO. 79-027,351, FILED 8-8-2006.

LEIGH LOWRY, EXAMINING ATTORNEY

Int. Cls.: 3, 14, 16, 18, 21 and 25

Prior U.S. Cls.: 1, 2, 3, 4, 5, 6, 13, 22, 23, 27, 28, 29, 30, 33, 37, 38, 39, 40, 41, 50, 51 and 52

Reg. No. 3,476,738

United States Patent and Trademark Office

Registered July 29, 2008

**TRADEMARK
PRINCIPAL REGISTER**



MARGARETE STEIFF GMBH (FED REP GER-
MANY LIMITED LIABILITY COMPANY)
ALLEENSTRASSE 2
89537 GIENGEN
FED REP GERMANY

FOR: PERFUMERY, COSMETIC PREPARA-
TIONS, NAMELY, BABY OIL, BABY SHAMPOO,
FACE CREAM, BODY CREAM, BODY LOTION,
PERFUMES, DEODORANTS FOR BODY CARE,
SOAPS, IN CLASS 3 (U.S. CLS. 1, 4, 6, 50, 51 AND 52).

FOR: CLOCKS AND WATCHES, JEWELRY,
NAMELY, EARRINGS, RINGS, BRACELETS,
NECKLACES, IN CLASS 14 (U.S. CLS. 2, 27, 28 AND
50).

FOR: BOOKS IN THE FIELDS OF NOVELS,
HISTORY BOOKS, GAME BOOKS, SCHOOL BOOKS
ABOUT ANIMALS AND CHILDREN, ALMANACS,
PRINTED CHARTS, STATIONERY, NAMELY, LET-
TER PAPER, PENS, PENCILS, ERASERS, EXERCISE-
BOOKS, PENCIL SHARPENERS, CRAYONS; NOTE
PADS, IN CLASS 16 (U.S. CLS. 2, 5, 22, 23, 29, 37, 38
AND 50).

FOR: SUITCASES, ATHLETIC BAGS, SPORT
BAGS, BABY CARRYING BAGS, UMBRELLAS,
PARASOLS, BACKPACKS, POUCHES, NAMELY,
FELT POUCHES, AND PURSES, TEXTILE SHOP-
PING BAGS AND POUCHES, LEATHER BAGS FOR
MERCHANDISE PACKAGING, PURSES, LEATHER
GOODS, NAMELY, LEATHER PURSES AND BAGS,
LEATHER POUCHES, IN CLASS 18 (U.S. CLS. 1, 2, 3,
22 AND 41).

FOR: TOILET UTENSILS, NAMELY, TOILET
BRUSHES, TOILET PAPER HOLDERS, IN CLASS
21 (U.S. CLS. 2, 13, 23, 29, 30, 33, 40 AND 50).

FOR: CLOTHING, NAMELY, T-SHIRTS, SWEA-
TERS, PULLOVERS, PANTS, FOOTWEAR, SOCKS,
STOCKINGS, HATS, HEADGEAR, NAMELY, CAPS,
SWIM WEAR, NAMELY, BATHING SUITS, BATH-
ING HATS, BATHING SHOES, SPORTS WEAR,
NAMELY, SHORTS, SLACKS, SHIRTS, STOCKINGS,
SPORTS SHOES, UNDERWEAR, SCARVES, HEAD
SCARVES, AND GLOVES, IN CLASS 25 (U.S. CLS. 22
AND 39).

PRIORITY DATE OF 8-16-2005 IS CLAIMED.

OWNER OF INTERNATIONAL REGISTRATION
0894730 DATED 1-11-2006, EXPIRES 1-11-2016.

THE COLOR(S) YELLOW, RED, GOLD, BLACK
AND WHITE IS/ARE CLAIMED AS A FEATURE OF
THE MARK.

THE COLORS GOLD, YELLOW, BLACK AND
WHITE APPEAR IN THE BUTTON AND THE WORD
"STEIFF" APPEARING ON THE BUTTON. THE
COLOR RED APPEARS IN THE OUTLINE OF THE
SMALL RECTANGLE AND IN THE WORDING
"STEIFF, BUTTON IN EAR" AND THE OUTLINE
OF THE BEAR HEAD, AND THE COLOR YELLOW
APPEARS IN THE BACKGROUND OF THE REC-
TANGLE.

SER. NO. 79-027,396, FILED 1-11-2006.

TRICIA SONNEBORN, EXAMINING ATTORNEY

Int. Cl.: 9

Prior U.S. Cls.: 21, 23, 26, 36 and 38

United States Patent and Trademark Office

Reg. No. 3,476,739

Registered July 29, 2008

**TRADEMARK
PRINCIPAL REGISTER**

CHECKSIGHT

LEUTRON VISION GMBH (FED REP GERMANY
LTD LIAB CO)
MACAIRESTRASSE 3 78467
KONSTANZ, FED REP GERMANY

FOR: OPTICAL AND ELECTRONIC APPARATUS AND INSTRUMENTS USED AS PERIPHERAL EQUIPMENT FOR DATA PROCESSING UNITS, NAMELY, FILM CAMERAS AND VIDEO CAMERAS, INCLUDING CAMERAS FOR ELECTRONIC OR DIGITAL IMAGE DETECTION AND IMAGE PROCESSING; ELECTRONIC COMPONENTS AND MODULES FOR IMAGE PROCESSING USED AS PERIPHERAL EQUIPMENT FOR DATA PROCESSING UNITS, NAMELY, DIGITAL CAMERAS; INTERFACES AND PERIPHERAL DEVICES FOR COMPUTERS; COMPUTER PROGRAMS FOR DIGITAL IMAGE PROCESSING AND IMAGE DATA TRANSFER RECORDED ON DATA CARRIERS

FOR SPECIAL USE IN THE FIELD OF DIGITAL IMAGE DETECTION AND FOR IMAGE PROCESSING, IN CLASS 9 (U.S. CLS. 21, 23, 26, 36 AND 38).

THE MARK CONSISTS OF STANDARD CHARACTERS WITHOUT CLAIM TO ANY PARTICULAR FONT, STYLE, SIZE, OR COLOR.

PRIORITY DATE OF 8-3-2005 IS CLAIMED.

OWNER OF INTERNATIONAL REGISTRATION 0898062 DATED 1-30-2006, EXPIRES 1-30-2016.

SER. NO. 79-028,673, FILED 1-30-2006.

SUNG IN, EXAMINING ATTORNEY

Int. Cl.: 5

Prior U.S. Cls.: 6, 18, 44, 46, 51 and 52

Reg. No. 3,476,740

United States Patent and Trademark Office

Registered July 29, 2008

**TRADEMARK
PRINCIPAL REGISTER**



NATBIO PTY. LTD. (AUSTRALIA COMPANY)
41/8 GOODWIN STREET
KANGAROO POINT QLD 4169
AUSTRALIA

FOR: PHARMACEUTICAL PREPARATIONS FOR THE TREATMENT OF VIRAL, BACTERIAL AND PARASITIC DISEASES, CANCER, FOOD ALLERGIES AND INTOLERANCES; REAGENTS FOR MEDICAL OR VETERINARY USE, NAMELY, ANTI-INFLAMMATORY PREPARATIONS; PREPARATIONS FOR EASING JOINT AND MUSCULAR PAIN, HERBAL AND NATURAL REMEDIES, NAMELY, HERBAL SUPPLEMENTS, HERBAL TEAS FOR MEDICAL PURPOSES; DIETETIC SUBSTANCES, NAMELY, DIETARY SUPPLEMENTS, FOOD SUPPLEMENTS; ANIMAL FEED SUPPLEMENTS; FOOD ADDITIVES, NAMELY, FOOD ADDITIVES OR INGREDIENTS TO ASSIST IN

REMOVING OR REDUCING INTOLERANCE AND ALLERGIES TO FOOD; NUTRITIONAL SUPPLEMENTS, NAMELY, PREPARATIONS FOR AIDING IN DIGESTION, ALL THE AFORESAID GOODS BEING FOR HUMAN OR ANIMAL USE; MEDICATED SKIN CARE PREPARATIONS, IN CLASS 5 (U.S. CLS. 6, 18, 44, 46, 51 AND 52).

PRIORITY DATE OF 12-8-2005 IS CLAIMED.

OWNER OF INTERNATIONAL REGISTRATION
0898205 DATED 6-8-2006, EXPIRES 6-8-2016.

SER. NO. 79-028,781, FILED 6-8-2006.

SUZANNE BLANE, EXAMINING ATTORNEY

Int. Cl.: 20

Prior U.S. Cls.: 2, 13, 22, 25, 32 and 50

United States Patent and Trademark Office

Reg. No. 3,476,741

Registered July 29, 2008

**TRADEMARK
PRINCIPAL REGISTER**

NET'n'NEST

VITRA PATENTE AG (SWITZERLAND JOINT
STOCK COMPANY)
KLÜNENFELDSTRASSE 22
CH-4132 MUTTENZ
SWITZERLAND

FOR: FURNITURE, PARTICULARLY OFFICE
FURNITURE, IN CLASS 20 (U.S. CLS. 2, 13, 22, 25,
32 AND 50).

THE MARK CONSISTS OF STANDARD CHAR-
ACTERS WITHOUT CLAIM TO ANY PARTICULAR
FONT, STYLE, SIZE, OR COLOR.

PRIORITY DATE OF 5-29-2006 IS CLAIMED.

OWNER OF INTERNATIONAL REGISTRATION
0899218 DATED 9-5-2006, EXPIRES 9-5-2016.

SER. NO. 79-029,218, FILED 9-5-2006.

BRENDAN MCCAULEY, EXAMINING ATTORNEY

Int. Cls.: 9 and 41

Prior U.S. Cls.: 21, 23, 26, 36, 38, 100, 101 and 107

United States Patent and Trademark Office

Reg. No. 3,476,742

Registered July 29, 2008

**TRADEMARK
SERVICE MARK
PRINCIPAL REGISTER**



SCIENTIFIC GAMES HOLDINGS LIMITED (IRELAND A COMPANY)
GROUND FLOOR, EMBASSY HOUSE,
HERBERT PARK LANE, BALLSBRIDGEDUBLIN 4
IRELAND

FOR: COMPUTER HARDWARE; COMPUTER SOFTWARE FOR ACCEPTING AND PROCESSING BETS IN THE FIELD OF ENTERTAINMENT SERVICES, IN CLASS 9 (U.S. CLS. 21, 23, 26, 36 AND 38).

FOR: OPERATION OF BETTING OFFICES, AMUSEMENT ARCADES AND CASINOS AND OF BETTING OUTLETS, GAMES OF CHANCE, ONLINE GAMING, IN CLASS 41 (U.S. CLS. 100, 101 AND 107).

PRIORITY DATE OF 2-6-2006 IS CLAIMED.

OWNER OF INTERNATIONAL REGISTRATION
0899344 DATED 8-4-2006, EXPIRES 8-4-2016.

THE COLOR(S) BLUE, GREEN IS/ARE CLAIMED
AS A FEATURE OF THE MARK.

THE DEVICE ELEMENT IS IN BLUE AND
GREEN WHILE THE WORDS "THE GLOBAL
DRAW" ARE IN BLUE.

SER. NO. 79-029,257, FILED 8-4-2006.

WENDY JUN, EXAMINING ATTORNEY

Int. Cls.: 14 and 35

Prior U.S. Cls.: 2, 27, 28, 50, 100, 101 and 102

United States Patent and Trademark Office

Reg. No. 3,476,743

Registered July 29, 2008

**TRADEMARK
SERVICE MARK
PRINCIPAL REGISTER**

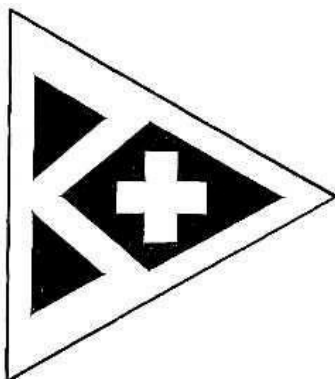

SMW SWISS MILITARY; WATCH COMPANY AG
(SWITZERLAND AG)
CHEMIN CREUX 18
CH-2503 BIEL/BIENNE
SWITZERLAND

FOR: PRECIOUS METALS AND THEIR ALLOYS;
JEWELRY, PRECIOUS STONES; HOROLOGICAL
AND CHRONOMETRIC INSTRUMENTS, IN CLASS
14 (U.S. CLS. 2, 27, 28 AND 50).

FOR: ADVERTISING; PUBLIC RELATIONS;
BUSINESS MANAGEMENT; CONSULTING CON-
CERNING COMPANY ORGANIZATION AND
MANAGEMENT; ADVICE ON PERFORMANCE OF
COMMERCIAL OPERATIONS; BUSINESS ADMIN-

ISTRATION; CONSULTING WITH REGARD TO
ALL THE AFOREMENTIONED SERVICES, IN
CLASS 35 (U.S. CLS. 100, 101 AND 102).

PRIORITY DATE OF 5-2-2006 IS CLAIMED.

OWNER OF INTERNATIONAL REGISTRATION
0899736 DATED 9-27-2006, EXPIRES 9-27-2016.

SER. NO. 79-029,397, FILED 9-27-2006.

DAYNA BROWNE, EXAMINING ATTORNEY

Int. Cls.: 9, 16 and 41

**Prior U.S. Cls.: 2, 5, 21, 22, 23, 26, 29, 36, 37, 38, 50,
100, 101 and 107**

Reg. No. 3,476,744

United States Patent and Trademark Office

Registered July 29, 2008

**TRADEMARK
SERVICE MARK
PRINCIPAL REGISTER**

SENSATION WHITE

ID & T TRADEMARK B.V.
RHÔNEWEG 54
NL-1043 AH AMSTERDAM
NETHERLANDS

FOR: APPARATUS FOR RECORDING, TRANSMISSION OR REPRODUCTION OF SOUND AND IMAGES; BLANK MAGNETIC DATA CARRIERS, PRERECORDED MAGNETIC DATA CARRIERS AND DOWNLOADABLE AUDIO/VIDEO FILES FEATURING INFORMATION ABOUT DANCE EVENTS, DJ'S AND HOUSE MUSIC, DOWNLOADABLE MP3 FILES FEATURING MUSIC; DISC-SHAPED DATA CARRIERS, NAMELY, BLANK MAGNETIC DATA CARRIERS; BLANK RECORDABLE OPTICAL DISCS; GRAMOPHONE RECORDS FEATURING MUSIC; AUDIO TAPES FEATURING MUSIC; COMPACT DISCS FEATURING MUSIC; VIDEO TAPES FEATURING DANCE EVENTS; PRE-RECORDED DIGITAL VIDEO DISCS FEATURING DANCE EVENTS, IN CLASS 9 (U.S. CLS. 21, 23, 26, 36 AND 38).

FOR: PRINTED MATTER, NAMELY, BOOKS, MAGAZINES, GUIDES IN THE FIELD OF MUSIC ENTERTAINMENT; PHOTOGRAPHS; MAGAZINES AND PERIODICALS IN THE FIELD OF MUSIC ENTERTAINMENT, IN CLASS 16 (U.S. CLS. 2, 5, 22, 23, 29, 37, 38 AND 50).

FOR: ENTERTAINMENT, NAMELY, ORGANIZATION OF DANCE EVENTS FEATURING UN-

IQUE THEMES; ENTERTAINMENT, NAMELY, LIVE DJs PERFORMANCES WITH AUDIO/VIDEO RECORDINGS FOR SPECIAL EVENTS AND CONCERTS; LIVE PERFORMANCE OF MUSIC AND CONCERTS BY A MUSICAL BAND AND ENTERTAINMENT PROGRAMS, NAMELY, ON-GOING TELEVISION PROGRAMS IN THE FIELD OF NATIONAL AND INTERNATIONAL DANCE EVENTS; ENTERTAINMENT IN THE NATURE OF THEATRE PRODUCTIONS; ORGANIZATION OF MUSICAL AND RECREATIONAL EVENTS, NAMELY, LIVE MUSIC CONCERTS AND DANCING PARTIES; ORGANIZATION OF CULTURAL EVENTS; SERVICES OF PERFORMING ARTISTS, NAMELY DISK JOCKEYS AND MUSIC BANDS; PUBLICATION OF BOOKS, NEWSPAPERS AND MAGAZINES, IN CLASS 41 (U.S. CLS. 100, 101 AND 107).

THE MARK CONSISTS OF STANDARD CHARACTERS WITHOUT CLAIM TO ANY PARTICULAR FONT, STYLE, SIZE, OR COLOR.

PRIORITY DATE OF 1-5-2006 IS CLAIMED.

OWNER OF INTERNATIONAL REGISTRATION 0901536 DATED 7-5-2006, EXPIRES 7-5-2016.

SER. NO. 79-030,104, FILED 7-5-2006.

DOMINIC FATHY, EXAMINING ATTORNEY

Int. Cls.: 12, 36, 37, 39 and 42

Prior U.S. Cls.: 19, 21, 23, 31, 35, 44, 100, 101, 102, 103, 105 and 106

Reg. No. 3,476,745

United States Patent and Trademark Office

Registered July 29, 2008

**TRADEMARK
SERVICE MARK
PRINCIPAL REGISTER**

ACERGY

STOLT OFFSHORE S.A. (LUXEMBOURG SOCIÉTÉ ANONYME (A LIMITED COMPANY))
26, RUE LOUVIGNY
L-1946 LUXEMBOURG
LUXEMBOURG

FOR: UNDERWATER VEHICLES, NAMELY, REMOTELY OPERATED VEHICLES, SUBMERSIBLE BOATS, UNMANNED SUBMARINES, AUTONOMOUS UNDERWATER VEHICLES, ROBOTIC SUBMARINES, ALL TERRAIN VEHICLES; SHIPS; BOATS; VEHICLES INCORPORATING PIPE LAYING AND CABLE LAYING APPARATUS, NAMELY, SUBMERSIBLE BOATS, UNMANNED SUBMARINES, AUTONOMOUS UNDERWATER VEHICLES, ROBOTIC SUBMARINES, ALL-TERRAIN VEHICLES, IN CLASS 12 (U.S. CLS. 19, 21, 23, 31, 35 AND 44).

FOR: LEASING OF SHIPS, IN CLASS 36 (U.S. CLS. 100, 101 AND 102).

FOR: BUILDING CONSTRUCTION; REPAIR AND INSTALLATION OF BUILDING INSULATION; UNDERWATER CONSTRUCTION OF PUMPS; UNDERWATER REPAIR OF PUMPS; UNDERWATER CLEANING OF PIPE LINES; SUPERVISION OF UNDERWATER CONSTRUCTION; LAYING OF PIPE LINES AND CABLES; LAYING OF SEA CABLES; MAINTENANCE AND REPAIR OF UNDERWATER DIVING APPARATUS, NAMELY, SUBMARINES; CONSTRUCTION, MAINTENANCE AND REPAIR OF OFF SHORE DRILLING RIGS, PLATFORMS, UNDERWATER PIPE LINES; INSTALLATION OF OIL AND GAS PRODUCTION PIPE LINES, IN CLASS 37 (U.S. CLS. 100, 103 AND 106).

FOR: DIVING SERVICES; TRANSPORTATION OF DIVING EQUIPMENT BY AIRPLANE, TRUCK, RAIL AND SHIP; RENTAL OF VEHICLES FOR USE

IN DIVING, NAMELY, REMOTELY OPERATED VEHICLES, SUBMERSIBLE BOATS, UNMANNED SUBMARINES, AUTONOMOUS UNDERWATER VEHICLES, ROBOTIC SUBMARINES, ALL TERRAIN VEHICLES; RENTAL OF SHIPS; RENTAL OF PIPE AND CABLE LAYING VEHICLES, IN CLASS 39 (U.S. CLS. 100 AND 105).

FOR: UNDERWATER EXPLORATIONS; SURVEYING SERVICES; CONSULTANCY SERVICES IN THE FIELDS OF UNDERWATER AND MARINE SURVEYING; CONDUCTING ENGINEERING SURVEYING, ENVIRONMENTAL SURVEYING, GEOLOGICAL SURVEYING, GEOPHYSICAL SURVEYING, HYDRO-GRAPHIC SURVEYING, AND UNDERWATER AND MARINE SURVEYING SERVICES; CONSULTATION AND ADVISORY SERVICES IN THE FIELDS OF SURVEYING AND ENGINEERING; DESIGN OF UNDERWATER VEHICLES FOR OTHERS; DESIGN OF UNDERWATER STRUCTURES FOR OTHERS; CIVIL ENGINEERING; UNDERWATER ENGINEERING SERVICES; INSPECTION OF OFF SHORE DRILLING RIGS, PLATFORMS, UNDERWATER PIPELINES; UNDERWATER ENGINEERING SERVICES IN THE FIELDS OF DESIGN AND INSTALLATION OF PIPE LINES; UNDERWATER ENGINEERING INSPECTIONS OF PIPELINES AND OFF-SHORE OIL RIGS, IN CLASS 42 (U.S. CLS. 100 AND 101).

PRIORITY DATE OF 10-18-2005 IS CLAIMED.

OWNER OF INTERNATIONAL REGISTRATION 0902467 DATED 4-18-2006, EXPIRES 4-18-2016.

SER. NO. 79-030,495, FILED 4-18-2006.

ERNEST SHOSHO, EXAMINING ATTORNEY

Int. Cls.: 3 and 5

Prior U.S. Cls.: 1, 4, 6, 18, 44, 46, 50, 51 and 52

United States Patent and Trademark Office

Reg. No. 3,476,746

Registered July 29, 2008

**TRADEMARK
PRINCIPAL REGISTER**

CLINUVEL

CLINUVEL PHARMACEUTICALS LIMITED
(AUSTRALIA PUBLIC COMPANY)
LEVEL 13
1 COLLINS STREET; MELBOURNE, VIC
AUSTRALIA

FOR: PREPARATIONS FOR TANNING THE SKIN FOR USE WITH SUNLIGHT OR OTHER ULTRAVIOLET LIGHT SOURCE, NAMELY, SUNTAN LOTIONS AND SUNTAN OILS; PREPARATIONS FOR TANNING THE SKIN WITHOUT SUNLIGHT, NAMELY, SELF-TANNING PREPARATIONS, IN CLASS 3 (U.S. CLS. 1, 4, 6, 50, 51 AND 52).

FOR: PHARMACEUTICAL PREPARATIONS FOR SKIN CARE; BIOLOGICAL AND CHEMICAL PREPARATIONS AND REAGENTS FOR MEDICAL OR VETERINARY USE; AND VACCINES; PHARMACEUTICAL PREPARATIONS AND DRUGS FOR THE TREATMENT OF SKIN DISORDERS; AND

DIAGNOSTIC PREPARATIONS FOR MEDICAL USE, IN CLASS 5 (U.S. CLS. 6, 18, 44, 46, 51 AND 52).

THE MARK CONSISTS OF STANDARD CHARACTERS WITHOUT CLAIM TO ANY PARTICULAR FONT, STYLE, SIZE, OR COLOR.

PRIORITY DATE OF 1-23-2006 IS CLAIMED.

OWNER OF INTERNATIONAL REGISTRATION 0902677 DATED 7-21-2006, EXPIRES 7-21-2016.

SER. NO. 79-030,581, FILED 7-21-2006.

CIMMERIAN COLEMAN, EXAMINING ATTORNEY

Int. Cl.: 3

Prior U.S. Cls.: 1, 4, 6, 50, 51 and 52

Reg. No. 3,476,747

United States Patent and Trademark Office

Registered July 29, 2008

TRADEMARK
PRINCIPAL REGISTER

ONE WEEK

INSTITUT JEANNE PIAUBERT (FRANCE SOCI-
ÉTÉ PAR ACTIONS SIMPLIFIÉE)
76/78, AVENUE DES CHAMPS ÉLYSÉES
F-75008 PARIS
FRANCE

FOR: PERFUMERY, NAMELY, PERFUMES AND
EAUX DE TOILETTE; BEAUTY PRODUCTS,
NAMELY, BLUSHES, EYE SHADOWS, FACIAL
FOUNDATIONS, FACIAL MASKS AND BEAUTY
MASKS, LIPSTICKS, NAIL VARNISH FOR COS-
METIC PURPOSES, NAIL-VARNISH REMOVER;
LOTIONS, CREAMS, GELS, MILKS AND WATERS
FOR REMOVING MAKE-UP; TOILETRY PRO-
DUCTS, NAMELY, SHAMPOOS, BATH SALTS,
BATH AND SHOWER GELS, BUBBLE BATHS, ES-
SENTIAL OILS, COSMETICS, HAIR LOTIONS;
SHAVING SOAPS, CREAMS AND FOAMS; AFTER-
SHAVE LOTIONS AND BALMS; DENTIFRICES;
SUN-TANNING PRODUCTS, NAMELY, SUNTAN
OILS, MILKS, LOTIONS AND CREAMS; SELF-TAN-
NING CREAMS; NON-MEDICATED BEAUTY
CARE PREPARATIONS FOR THE SKIN, BODY,
FACE, EYES, LIPS, NECK, BUST, HANDS, LEGS
AND FEET, NAMELY, COSMETIC CREAMS,

MOISTURIZING, EXFOLIATING, CLEANSING
AND MATTIFYING CREAMS AND LOTIONS;
ANTI-WRINKLE CREAMS; NON-MEDICATED EN-
ERGIZING AND TONING LOTIONS AND CREAMS
FOR THE SKIN, MOISTURIZING SKIN CREAMS
AND LOTIONS, COSMETIC FACIAL AND BODY
SCRUBS IN CREAM FORM; SLIMMING LOTIONS,
CREAMS, GELS AND FLUIDS, NAMELY, LO-
TIONS, CREAMS, GELS AND FLUIDS FOR CELLU-
LITE REDUCTION; PERSONAL BODY
DEODORANTS, IN CLASS 3 (U.S. CLS. 1, 4, 6, 50, 51
AND 52).

THE MARK CONSISTS OF STANDARD CHAR-
ACTERS WITHOUT CLAIM TO ANY PARTICULAR
FONT, STYLE, SIZE, OR COLOR.

OWNER OF INTERNATIONAL REGISTRATION
0902737 DATED 9-21-2006, EXPIRES 9-21-2016.

SER. NO. 79-030,606, FILED 9-21-2006.

LEIGH LOWRY, EXAMINING ATTORNEY

Int. Cl.: 7

Prior U.S. Cls.: 13, 19, 21, 23, 31, 34 and 35

United States Patent and Trademark Office

Reg. No. 3,476,748

Registered July 29, 2008

**TRADEMARK
PRINCIPAL REGISTER**

ROSTA

ROSTA AG (SWITZERLAND SOCIETE ANON-
YME)
CH-5502 HUNZENSCHWIL
SWITZERLAND

FOR: PROPULSION CLUTCHES, OSCILLATION
ELEMENTS, NAMELY, BELT TENSIONERS, SUS-
PENSION TENSIONERS, CHAIN AND BELT TEN-
SIONERS FOR SLACK COMPENSATION, AND
ANTI-VIBRATION MOUNTINGS, OSCILLATING
MOUNTINGS AND MOTORBASES; TENSION AND
PRESSURE ELEMENTS, NAMELY, CHAIN TEN-
SIONING DEVICES, BELT TENSIONING DEVICES
AND SELF-ADJUSTING MOTOR-BASES FOR FRIC-
TION BELT DRIVES, OSCILLATING MOUNTS FOR
SHAKER SCREENS, ELASTIC ROCKER ARMS FOR
SHAKER CONVEYORS, UNIVERSAL JOINTS FOR
GYRATORY SIFTER SUSPENSIONS, ANTI-VIBRA-

TION MOUNTS, SHOCK ABSORBERS, AND TOR-
QUE-ELASTIC SPRING DEVICES FOR THE
SUSPENSION OF FRICTION BELT DRIVES, ALL
FOR USE WITH MACHINES, IN CLASS 7 (U.S. CLS.
13, 19, 21, 23, 31, 34 AND 35).

OWNER OF INTERNATIONAL REGISTRATION
0308203 DATED 1-26-1966, EXPIRES 1-26-2016.

OWNER OF U.S. REG. NOS. 1,297,383 AND
1,297,384.

SER. NO. 79-030,725, FILED 10-16-2006.

MICHELE SWAIN, EXAMINING ATTORNEY

Int. Cl.: 9

Prior U.S. Cls.: 21, 23, 26, 36 and 38

Reg. No. 3,476,749

United States Patent and Trademark Office

Registered July 29, 2008

**TRADEMARK
PRINCIPAL REGISTER**

COSMETRICS

ASTRON CLINICA LIMITED (UNITED KING-
DOM LTD LIAB CO)
THE MOUNT, TOFT
CAMBRIDGESHIRE CB3 7RL, UNITED KINGDOM

FOR: TESTING AND MEASURING APPARATUS AND INSTRUMENTS, ALL FOR USE IN SKIN IMAGING TECHNOLOGY THAT ENABLES EXAMINATION OF THE SKIN AND NON-INVASIVE VIEWING BENEATH THE SURFACE OF THE SKIN FOR NON-MEDICAL PURPOSES, NAMELY, COMPUTER-OPERATED SCANNERS AND CAMERAS; COMPUTER HARDWARE; COMPUTER SOFTWARE FOR SCANNERS FOR NON-MEDICAL SCANNING OF THE SKIN AND NON-INVASIVE VIEWING BENEATH THE SURFACE OF THE SKIN FOR NON-MEDICAL PURPOSES AND FOR USE IN THE FIELD OF SKIN TECHNOLOGY DEALING WITH UNDERSTANDING THE CONSTRUCTION OF THE SKIN, IDENTIFYING THE PRESENCE OF SKIN CONDITIONS AND MONITORING AND RECOGNIZING THE EFFECT OF SKIN COSMETICS;

COMPUTER SOFTWARE TO ENABLE THE NON-INVASIVE SCANNING AND PROBING, CAPTURING, VISUAL INSPECTION, ANALYZING, UNDERSTANDING AND MONITORING OF THE SKIN SURFACE AND BENEATH THE SKIN BY CONTACT OR WITHOUT SKIN CONTACT; COMPUTER SOFTWARE FOR USE IN MONITORING AND DIAGNOSING BIOCHEMICAL REACTIONS AND PHENOMENA, COMPUTER SOFTWARE FOR EVALUATING THE EFFECTIVENESS OF PHARMACEUTICAL AND COSMETIC PREPARATIONS AND SUBSTANCES, IN CLASS 9 (U.S. CLS. 21, 23, 26, 36 AND 38).

OWNER OF INTERNATIONAL REGISTRATION
0903662 DATED 11-1-2006, EXPIRES 11-1-2016.

SER. NO. 79-030,974, FILED 11-1-2006.

THOMAS MANOR, EXAMINING ATTORNEY

Int. Cls.: 9, 18 and 25

Prior U.S. Cls.: 1, 2, 3, 21, 22, 23, 26, 36, 38, 39 and 41

Reg. No. 3,476,750

United States Patent and Trademark Office

Registered July 29, 2008

**TRADEMARK
PRINCIPAL REGISTER**



JAM SESSION S.R.L. (ITALY SOCIÉTÉ À RE-
SPONSABILITÉ LIMITÉE)
VIA MERCALLI, 8/A
I-43100 PARMA
ITALY

FOR: EYEGLASS CASES AND FRAMES, EYE-
GLASSES, SUNGLASSES, GOGGLES FOR SPORTS;
SCUBA MASKS AND SWIM MASKS, DIVING
SUITS, BUOYANCY COMPENSATOR JACKETS
FOR USE IN SCUBA DIVING; PROTECTIVE HEL-
METS FOR SPORTS, NAMELY, FOR CYCLING
AND KICKBOXING; CHILDREN'S PROTECTIVE
HELMETS FOR USE IN PLAYING SPORTS, IN
CLASS 9 (U.S. CLS. 21, 23, 26, 36 AND 38).

FOR: ALL-PURPOSE SPORT BAGS, ALL-PUR-
POSE CARRYING BAGS, DUFFEL BAGS, HAND-
BAGS, KEY CASES, LEATHER AND IMITATION
LEATHER BAGS, SLING BAGS FOR CARRYING
INFANTS, BEACH BAGS, MONEY BELTS, VANITY
CASES SOLD EMPTY, SCHOOL BAGS; BEACH
BAGS, TRAVELING BAGS; MESH, CANVAS, SKIN,
STRING AND TEXTILE SHOPPING BAGS; SCHOOL
KNAPSACKS, DRAWSTRING POUCHES, TRUNKS,
VALISES AND RUCKSACKS, UMBRELLAS, WALK-
ING STICKS, LEATHERWARE, NAMELY, DOCU-
MENTS HOLDERS; LEATHER; IMITATION
LEATHER; ARTICLES MADE OF LEATHER AND
IMITATION LEATHER, NAMELY, BABY CARRI-
ERS WORN ON THE BODY, BEACH UMBRELLAS,
BRIEFCASES, BUSINESS CARD CASES, NAME
CARD CASES, AND SHOPPING BAGS; COIN PUR-
SES, NOT OF PRECIOUS METALS, GOLF UMBREL-
LAS, SUITCASES AND WALLETS, MULTI-
PURPOSE PURSES, SUITCASES, WALLETS, IN
CLASS 18 (U.S. CLS. 1, 2, 3, 22 AND 41).

FOR: BELTS; SHOES; FOOTWEAR; SLIPPERS;
HEADWEAR; CLOTHING FOR MEN, WOMEN
AND CHILDREN, NAMELY, APRONS, BANDA-
NAS, BATHROBES, SASHES FOR WEAR, JUMPERS,
BERMUDA SHORTS, BRAS, COATS, CRAVATS,
DRESSES, EAR MUFFS, GLOVES, JACKETS, JEANS,
JERSEYS, LINGERIE, COATS, TROUSERS, VESTS,
BRIEFS, PANTS, POLO SHIRTS, PULLOVERS,
RAINWEAR, SHIRTS, SCARVES, SKINS, SLEEP-
WEAR, SLIPS, SUITS, TROUSERS, T-SHIRTS, UN-
DERWEAR, HOSIERY, SOCKS; BEACHWEAR AND
SEA CLOTHING, NAMELY, SWIMMING SUITS
AND SWIMMING TRUNKS; CLOTHING FOR SKI-
ING, CYCLING, GOLF, BASEBALL, SPINNING,
RUNNING AND GYM, NAMELY, SKI SUITS, CY-
CLING SHIRTS, CYCLING SHORTS, CYCLING
JACKETS, GOLF PANTS, GOLF SHINS, BASEBALL
UNIFORMS, SPINNING PANTS, SPINNING SUITS,
RUNNING PANTS, RUNNING SUITS; SKI BOOTS,
SPINNING SHOES, GYMNASTIC SHOES, KICK-
BOXING SHOES, FOOTBALL BOOTS, UNDER-
WEAR FOR THE PRACTICE OF SPORTS;
LEGWARMERS, WRISTBANDS, HEADBANDS,
SWEATBANDS, HATS AND CAPS FOR GOLF,
BASEBALL AND SPORTS IN GENERAL, IN CLASS
25 (U.S. CLS. 22 AND 39).

PRIORITY DATE OF 2-3-2006 IS CLAIMED.

OWNER OF INTERNATIONAL REGISTRATION
0903675 DATED 2-24-2006, EXPIRES 2-24-2016.

SER. NO. 79-030,979, FILED 2-24-2006.

SHAILA SETTLES, EXAMINING ATTORNEY

Int. Cl.: 32

Prior U.S. Cls.: 45, 46 and 48

United States Patent and Trademark Office

Reg. No. 3,476,751

Registered July 29, 2008

**TRADEMARK
PRINCIPAL REGISTER**



BEER MANIA SPRL (BELGIUM SPRL)
CHAUSSÉE DE WAVRE 174
B-1050 BRUXELLES
BELGIUM

FOR: BEERS, IN CLASS 32 (U.S. CLS. 45, 46 AND 48).

PRIORITY DATE OF 5-4-2006 IS CLAIMED.

OWNER OF INTERNATIONAL REGISTRATION
0904148 DATED 10-19-2006, EXPIRES 10-19-2016.

THE MARK CONSISTS OF THE CONFIGURATION OF PACKAGING FOR THE GOODS, NAMELY, A STYLIZED GLASS WITH A CIRCULAR BASE FOOT AND A CURVED STEM THAT ATTACHES TO THE SIDE OF AN OVOID BOWL BEARING THE STYLIZED WORDING "MEA CULPA".

SER. NO. 79-031,172, FILED 10-19-2006.

JOHN KELLY, EXAMINING ATTORNEY

Int. Cls.: 12, 35, 37 and 39

Prior U.S. Cls.: 19, 21, 23, 31, 35, 44, 100, 101, 102, 103, 105 and 106

Reg. No. 3,476,752

United States Patent and Trademark Office

Registered July 29, 2008

**TRADEMARK
SERVICE MARK
PRINCIPAL REGISTER**

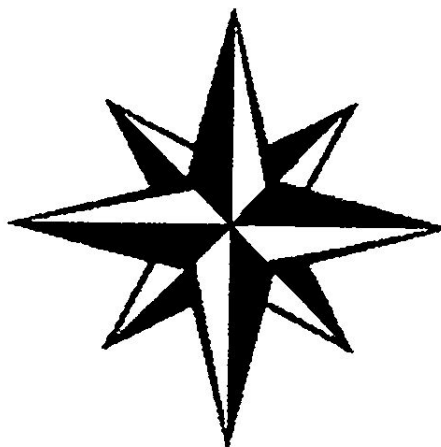

CHANTIERS JEANNEAU (FRANCE SOCIÉTÉ ANONYME)
ROUTE DE LA ROCHE SUR YON
F-85500 LES HERBIERS
FRANCE

FOR: VEHICLES AND APPARATUS FOR LOCOMOTION BY LAND, AIR AND WATER, NAMELY, AUTOMOBILES, TRUCKS, BICYCLES AND MOTORCYCLES, AIRPLANES, LAUNCHES, VESSELS; BOATS AND SHIPS, SAILBOATS AND MOTORBOATS, SAILBOATS AND MOTORBOATS FOR RECREATION; FISHING BOATS, SERVICE BOATS; FITTED COVERS FOR BOATS; BOAT HULLS; DEVICES FOR LAUNCHING BOATS AND SHIPS, NAMELY, DAVITS FOR BOATS; AMPHIBIOUS VEHICLES, TRAILER HITCHES FOR VEHICLES; TOWAGE, LAUNCHING, ANCHORING AND A STORING EQUIPMENT FOR BOATS AND WATERCRAFT, NAMELY, BOAT BUMPERS, BOAT CHOCKS, BOAT FENDERS; BUOYANCY APPLIANCES, NAMELY, PONTOONS FOR BOATS; BOAT TRAILERS; OARS; CANOE, KAYAK AND BOAT PADDLES; GAFFES; BOAT CLEATS; SCREW PROPELLERS FOR BOATS; PORTHOLES; INCLINED WAYS FOR BOATS, NAMELY, FOLDING GANG WAYS FOR BOARDING; MOORING PROTECTION IN THE NATURE OF BOAT BUMPERS; BEACH DEVICES, NAMELY, LAND YACHTS; PERSONAL WATERCRAFT, NAMELY, PERSONAL JET BOATS,

PERSONAL SAILBOATS AND KAYAKS; SEA CRAFT FOR RECREATIONAL AND PROFESSIONAL USE, NAMELY, PERSONAL JET BOATS, WATER SCOOTERS, RAFTS AND PADDLE BOATS; PARTS AND COMPONENTS FOR BOATS, NAMELY, STRUCTURAL PARTS FOR BOATS, RUDDERS AND TILLERS FOR BOATS; METAL SPARS FOR SHIPS, IN CLASS 12 (U.S. CLS. 19, 21, 23, 31, 35 AND 44).

FOR: PUBLICITY SERVICES NAMELY PROMOTING THE GOODS, SERVICES, BRAND IDENTITY AND COMMERCIAL INFORMATION AND NEWS OF THIRD PARTIES THROUGH PRINT, AUDIO, VIDEO, DIGITAL AND ON-LINE MEDIUM; BUSINESS MANAGEMENT, BUSINESS ADMINISTRATION, DIRECT MAIL ADVERTISING, BUSINESS ORGANIZATION AND MANAGEMENT CONSULTING SERVICES; ON-LINE ADVERTISING ON A COMPUTER NETWORK, NAMELY, PROVIDING A WEB SITE WHICH FEATURES ADVERTISEMENTS FOR THE GOODS AND SERVICES OF OTHERS ON A GLOBAL COMPUTER NETWORK; BUSINESS APPRAISALS; COMMERCIAL AND INDUSTRIAL MANAGEMENT ASSISTANCE; AUCTIONEERING; ORGANIZATION OF EXHIBITIONS FOR COMMERCIAL OR ADVERTISING PURPOSES IN THE FIELD OF WATER VEHICLES; COMPUTERIZED FILE MANAGEMENT; SALES PROMOTION SERVICES FOR OTHERS; PUBLISHING OF ADVERTIS-

ING TEXTS, ADVERTISING MAILING, NAMELY, DISPLAYING ADVERTISEMENTS FOR OTHERS AND DISSEMINATION OF ADVERTISING MATTER FOR OTHERS; PUBLICITY MATERIAL RENTAL; PROMOTING AND MARKETING THE GOODS AND SERVICES OF OTHERS THROUGH ALL PUBLIC COMMUNICATION MEANS; COMPI- LATION OF INFORMATION INTO COMPUTER DATABASES; RENTAL OF ADVERTISING SPACE; CREATING AND UPDATING ADVERTISING MA- TERIAL IN THE NATURE OF A CATALOGUE OF PRODUCTS; CUSTOMER RELATIONSHIP MAN- AGEMENT IN THE NATURE OF PRODUCTION AND UPDATING OF CUSTOMER FILES; PROMOT- ING THE SALE OF GOODS AND SERVICES OF OTHERS BY AWARDED PURCHASE POINTS FOR CREDIT CARD USE; ADVERTISING SERVICES; BUSINESS MANAGEMENT; BUSINESS ADMINIS- TRATION; PROVIDING OFFICE FUNCTIONS, IN CLASS 35 (U.S. CLS. 100, 101 AND 102).

FOR: SHIPBUILDING AND SHIP REPAIR SERVI- CES; MAINTENANCE AND REPAIR OF BOATS, INCLUDING MAINTENANCE AND REPAIR OF MOTORS, MARINE PROPULSION UNITS, IN- BOARD AND OUTBOARD MOTORS, BOATS, BOAT NAVIGATION ACCESSORIES AND EQUIPMENT; CONSTRUCTION OF HARBOURS, PORT FACIL- ITIES BUILDINGS AND PORT MOORINGS; CON- STRUCTION, REPAIR AND INSTALLATION OF NON-TRANSPORTABLE CONSTRUCTIONS, NAMELY, BUILDING CONSTRUCTION, MAINTEN- ANCE, AND REPAIR; INFORMATION ON CON- S T R U C T I O N M A N A G E M E N T A N D CONSTRUCTION WORK; PLANNING AND BUILD- ING RESIDENTIAL DEVELOPMENTS AND LEI- SURE PARKS, IN CLASS 37 (U.S. CLS. 100, 103 AND 106).

FOR: BOAT RENTAL; CONVEYING OF BOATS AND SHIPS; STORING AND SAFEKEEPING OF BOATS, ON LAND OR AFLOAT; RENTAL OF SAIL AND MOTORIZED PLEASURE BOATS, FISHING BOATS, SERVICE BOATS AND BEACH DEVICES, NAMELY LAND YACHTS, PERSONAL WATER- CRAFT, PERSONAL JET BOATS, WATER SCOO- TERS; RENTAL OF DIVING SUITS, RENTAL OF SKIN DIVING EQUIPMENT; GARAGE SPACE REN- TAL; PARKING SPACE RENTAL; TRANSPORT BY FERRY-BOAT, SHIP, AIR, TRAIN, BUS; RENTAL OF CARAVANS, VEHICLES, PARKING PLACES; TOURIST OFFICE SERVICES, NAMELY, ARRAN- GING TRAVEL TOURS; TRAVEL RESERVATIONS FOR TRANSPORTATION; TRAVEL ORGANIZA- TION SERVICES; ESCORTING OF TOURS FOR TRAVELERS; CONSULTING AND INFORMATION ON TRANSPORTATION, TRAVEL, AND TOURISM, EXCEPT INFORMATION ON BOARDING HOUSE AND HOTEL RESERVATIONS; ARRANGING OF CRUISES; ARRANGING OF TRAVEL TOURS, AR- RANGING OF EXCURSIONS FOR TOURISTS, AR- RANGING OF SIGHTSEEING TOURS; INFORMATION ON TRAVEL AND TRANSPORT OF TRAVELERS; BOOKING OF SEATS FOR TRAVEL TRANSPORTATION PURPOSES, SIGHTSEE- ING TOURS, TRAVEL RESERVATION SERVICES FOR TRANSPORTATION; TRANSPORT OF TRAVELERS BY BOAT; RENTAL OF TRANSPORT VEHICLES AND TOURISM VEHICLES, IN CLASS 39 (U.S. CLS. 100 AND 105).

OWNER OF INTERNATIONAL REGISTRATION 0877421 DATED 8-10-2005, EXPIRES 8-10-2015.

SER. NO. 79-031,546, FILED 4-12-2006.

LEIGH LOWRY, EXAMINING ATTORNEY

Int. Cls.: 9, 14, 16, 18, 24, 25, 26, 28 and 41

Prior U.S. Cls.: 1, 2, 3, 5, 21, 22, 23, 26, 27, 28, 29, 36, 37, 38, 39, 40, 41, 42, 50, 100, 101 and 107

Reg. No. 3,476,753

United States Patent and Trademark Office

Registered July 29, 2008

**TRADEMARK
SERVICE MARK
PRINCIPAL REGISTER**

DEPECHE MODE

VENUSNOTE LIMITED (UNITED KINGDOM LIMITED COMPANY)
C/O LEE & THOMPSON, GREENGARDEN HOUSE
15-22 ST
UNITED KINGDOM

FOR: SOUND, MUSIC AND VIDEO RECORDINGS FEATURING MUSIC, MUSICAL SOUND RECORDINGS, MUSICAL PERFORMANCES, VARIETY ENTERTAINMENT, AND PERFORMANCES BY A MUSICAL GROUP; PRE-RECORDED CDS, CDRS, DVDS, DVDRS, DATS, DACS, MINIDISCS, RECORDS, TAPES, CASSETTES AND DISCS, FEATURING SOUND, MUSICAL AND VIDEO RECORDINGS; MOUSE MATS; VIDEO RECORDINGS FEATURING MUSIC, MUSICAL SOUND RECORDINGS AND MUSICAL PERFORMANCES; DOWNLOADABLE DIGITAL MUSIC SOUND RECORDINGS FROM THE INTERNET; DOWNLOADABLE DIGITAL MUSIC SOUND RECORDINGS FROM THE INTERNET FROM WEBSITES OFFERING MP3 FILES; DOWNLOADABLE SCREEN SAVERS, PICTURE MESSAGE GRAPHICS, AND LOGO GRAPHICS FOR COMPUTERS AND TELEPHONES VIA A GLOBAL COMPUTER NETWORK AND WIRELESS MOBILE PHONES; DOWNLOADABLE RING TONES AND PICTURE MESSAGE GRAPHICS VIA A GLOBAL COMPUTER NETWORK AND WIRELESS MOBILE PHONES; CASES FOR TELEPHONES AND MOBILE TELEPHONES; MOBILE PHONES; DOWNLOADABLE ELECTRONIC MEDIA SOFTWARE FOR USE IN THE CREATION AND TRANSMISSION OF ELECTRONIC GREETING CARDS, ELECTRONIC GREETINGS MESSAGES, E-CARDS, E-MESSAGES, DIGITAL GREETINGS CARDS AND DIGITAL GREETING MESSAGES; DOWNLOADABLE ELECTRONIC GREETING CARDS, ELECTRONIC GREETINGS MESSAGES, E-CARDS, E-MESSAGES, DIGITAL GREETINGS CARDS AND DIGITAL GREETING MESSAGES; CARRYING CASES FOR MOBILE PHONES, NAMELY, CARRIERS, CASES, AND HOLDERS, IN CLASS 9 (U.S. CLS. 21, 23, 26, 36 AND 38).

FOR: JEWELRY, PRECIOUS STONES; GOODS OF PRECIOUS METALS OR COATED THEREWITH, NAMELY, HOROLOGICAL AND CHRONOMETRIC INSTRUMENTS, BADGES, JEWELRY AND WATCH CHAINS, CUFF LINKS, TIE PINS, TIE CLIPS, EARRINGS, EAR CLIPS AND NECKLACES; CLOCKS; WATCHES, IN CLASS 14 (U.S. CLS. 2, 27, 28 AND 50).

FOR: STATIONERY; ADVERTISING PAMPHLETS FEATURING INFORMATION AND ADVERTS RELATING TO A MUSICAL GROUP, MEMBERS THEREOF AND PERFORMANCES BY A MUSICAL GROUP; BOOKS FEATURING INFORMATION RELATING TO A MUSICAL GROUP, MEMBERS THEREOF AND PERFORMANCES BY A MUSICAL GROUP; PAMPHLETS FEATURING INFORMATION AND ADVERTS RELATING TO A MUSICAL GROUP, MEMBERS THEREOF AND PERFORMANCES BY A MUSICAL GROUP; MAGAZINES FEATURING INFORMATION AND ADVERTS RELATING TO A MUSICAL GROUP, MEMBERS THEREOF AND PERFORMANCES BY A MUSICAL GROUP; POSTCARDS; PICTURES; POSTERS; DIARIES; DRAWING INSTRUMENTS; GREETING CARDS; ADDRESS BOOKS; CATALOGUES FEATURING INFORMATION AND ADVERTS RELATING TO A MUSICAL GROUP, MEMBERS THEREOF, MUSICAL RECORDINGS AND PERFORMANCES BY A MUSICAL GROUP; BROCHURES FEATURING INFORMATION AND ADVERTS RELATING TO A MUSICAL GROUP, MEMBERS THEREOF, MUSICAL RECORDINGS AND PERFORMANCES BY A MUSICAL GROUP; PROGRAMS, NAMELY, CONCERT SOUVENIR PROGRAMS; PRINTED TICKETS, NAMELY, TICKETS FOR ENTRY TO MUSICAL PERFORMANCES AND CONCERT SOUVENIR TICKETS; CALENDARS; PHOTOGRAPHS; SIGNED PHOTOGRAPHS; AUTOGRAPHED PRINTED MATTER, NAMELY, POSTERS, CALENDARS, PHOTOGRAPHS, PHOTOGRAPH ALBUMS, AUTOGRAPH ALBUMS, PICTURE CARDS AND TRADING CARDS BEARING THE AUTOGRAPHS OF PERSONALITIES AND CELEBRITIES; PHOTOGRAPHIC ALBUMS; AUTO-

GRAPH ALBUMS; NEWSPAPERS AND NEWSLETTERS FEATURING INFORMATION AND ADVERTS RELATING TO A MUSICAL GROUP, MEMBERS THEREOF, MUSICAL RECORDINGS AND PERFORMANCES BY A MUSICAL GROUP; NOTE PADS AND NOTE BOOKS; STICKERS AND DECALCOMANIAS; PRINTED PERIODICALS FEATURING INFORMATION AND ADVERTS RELATING TO A MUSICAL GROUP, MEMBERS THEREOF, MUSICAL RECORDINGS AND PERFORMANCES BY A MUSICAL GROUP; RECORD TOKEN CARDS, GIFT TOKEN CARDS NAMELY FOLDED PIECES OF PAPER, CARD OR ENVELOPES HAVING SOME FORM OF PRINTED DESIGN ON THEM AND IN WHICH YOU CAN PLACE A RECORD OR GIFT TOKEN; WRITING IMPLEMENTS; PENS; BALLPOINT PENS; FOUNTAIN PENS; PENCILS; DRAWING RULERS; ERASERS; PENCIL SHARPENERS; PEN AND PENCIL CASES; PICTURE CARDS FEATURING A MUSICAL BAND AND MEMBERS THEREOF; PICTURE BOOKS; CARICATURES; SONG BOOKS; SHEET MUSIC; RECORD, TAPE, CASSETTE, CD, CDR, DVD, DVDR, DAT AND DAC ADHESIVE LABELS, PRINTED INSERTS AND INLAYS, IN CLASS 16 (U.S. CLS. 2, 5, 22, 23, 29, 37, 38 AND 50).

FOR: ARTICLES MADE OF LEATHER OR OF IMITATION LEATHER, NAMELY, ATTACHÉ CASES, BRIEFCASES AND BRIEFCASE-TYPE PORTFOLIOS, BUSINESS CARD CASES, CREDIT CARD CASES, KEY CASES; RUCKSACKS; BACKPACKS; BAGS, NAMELY, HANDBAGS, ATHLETIC BAGS, BAGS AND HOLD-ALLS FOR SPORTS CLOTHING, BOOK BAGS, CARRYALLS, CLUTCH BAGS AND PURSES, COSMETIC BAGS AND CASES SOLD EMPTY, SACHELS, SHAVING BAGS SOLD EMPTY; SPORTS BAGS; WALLETS; PURSES; LUGGAGE; UMBRELLAS; PARASOLS; SPORT BAGS AND HOLD ALLS; WALKING STICKS; ANIMAL HIDES AND SKINS; WHIPS, HARNESSES AND SADDLERY GOODS, NAMELY, COVERS FOR HORSE SADDLES, FASTENINGS FOR HORSE SADDLES, FITTINGS OF IRON FOR HARNESSES, HARNESS STRAPS, HARNESS TRACES, HEAD-STALLS, HORSE BLANKETS, HORSE COLLARS, KNEE PADS FOR HORSES, PADS FOR HORSE SADDLES, REINS, RIDING SADDLES, SADDLE CLOTHS FOR HORSES, SADDLE TREES, SADDLES, STIRRUPS, IN CLASS 18 (U.S. CLS. 1, 2, 3, 22 AND 41).

FOR: BED AND TABLE LINEN; BEDSPREADS; BED AND HOUSEHOLD LINEN; DUVET COVERS; FABRIC VALANCES; CURTAINS AND NET CURTAINS; TOWELS, BEACH TOWELS AND TEA-TOWELS; PILLOW CASES AND COVERS; TEXTILE TAPESTRIES AND BED LINEN THAT ARE EMBROIDERED OR FEATURE LACE; FABRIC AND CLOTH BANNERS; FABRIC AND CLOTH FLAGS, IN CLASS 24 (U.S. CLS. 42 AND 50).

FOR: CLOTHING RELATING TO MUSIC CONCERTS AND MUSIC CONCERT ARTISTS, NOT SOLD THROUGH RETAIL STORES SPECIALIZING IN WEARING APPAREL, BUT RATHER THROUGH RECORD STORES, MUSIC CONCERTS AND OTHER OUTLETS FEATURING PRIMARILY OR

SPECIALIZING IN PRODUCTS RELATING TO MUSIC CONCERTS AND MUSIC CONCERT ARTISTS, NAMELY, T-SHIRTS, SHIRTS, JACKETS, SWEATSHIRTS, SPORT SHIRTS, BASEBALL JERSEYS, HOODED TOPS, PULLOVERS, JUMPERS, SHORTS, BOXER SHORTS, UNDERWEAR, SOCKS, DRESSING GOWNS, BIBS, ROMPER SUITS, BABY SLEEP SUITS, DUNGAREES, BRACES, TRACKSUITS, TIES, LINGERIE, HOSIERY, BATHING COSTUMES, BATHING SUITS, BATHING TRUNKS, BATHROBES, BEACHWEAR, BIKINIS, BLOUSES, BRAS, BRIEFS, CAMISOLES, DRESSING GOWNS, FROCKS, GOWNS, INFANT WEAR, JEANS, JUMPERS, KILTS, MINISKIRTS, NIGHTWEAR, PAJAMAS, SLACKS, VESTS, SLEEPING GARMENTS, SLEEPWEAR, SWIM WEAR, SWIMSUITS, TANKINIS, TEDDIES, THONGS, TRACKSUITS, RUNNING AND JOGGING SUITS, TROUSERS, TUXEDOS, WAISTCOATS, HEADGEAR, NAMELY, HATS, CAPS, BANDANAS, BERETS AND BASEBALL CAPS, GLOVES, FOOTWEAR, WRISTBANDS, SWEAT BANDS, IN CLASS 25 (U.S. CLS. 22 AND 39).

FOR: ORNAMENTAL NOVELTY BADGES; ORNAMENTAL NOVELTY BUTTONS AND PINS; OVERSIZED NOVELTY BUTTONS; ORNAMENTAL CLOTH PATCHES; CUFF LINKS; EMBLEMS IN THE NATURE OF FABRIC APPLIQUÉS; FASTENERS, NAMELY, DECORATIVE CLOTHING BUCKLES, METAL FASTENERS FOR SHOES AND BOOTS; BELT BUCKLES, CLOTHING BUCKLES, SHOE BUCKLES, CLOTHING FASTENERS; BUTTONS FOR CLOTHING; TIE CLIPS; TIE PINS; EARRINGS; EAR CLIPS; HAIR PINS, HAT PINS, NOVELTY ORNAMENTAL PINS AND SOUVENIR PINS; EMBROIDERED EMBLEMS; HAIR BANDS; ACCESSORY BROOCHES; HAIR BUCKLES; BELT CLASPS; CLOTHING BUCKLES; SLIDE FASTENERS; HAIR BANDS; BUCKLES AND FASTENINGS FOR CLOTHES; PRESS STUDS, IN CLASS 26 (U.S. CLS. 37, 39, 40, 42 AND 50).

FOR: TOYS, NAMELY, BATH TOYS, BENDABLE TOYS, CHILDREN'S ART ACTIVITY TOYS, COLLECTABLE TOY FIGURES, INFANT TOYS, MUSICAL TOYS AND WATER SQUIRTING TOYS; DOLLS; GAMES AND PLAYTHINGS, NAMELY BOARD GAMES, JIGSAW PUZZLES, INTERACTIVE EDUCATIONAL GAMES, TOY VEHICLES, RIDE-ON TOYS, ROCKING HORSES, TOY PISTOLS, TOY MASKS, PLAY COSMETICS FOR CHILDREN, TOYS FOR PETS, BATHTUB TOYS, MOBILES, DOMINOS, CHESS AND CHECKERS GAMES, SKITTLES, BACKGAMMON GAMES, DICE, DICE GAMES, TABLES FOR INDOOR FOOTBALL; TOY FIGURES AND MODELED PLASTIC TOY FIGURINES; TOY ACTION FIGURES AND ACCESSORIES THEREFOR; PLAY FIGURES; SCALE MODEL FIGURES; SOFT PLUSH TOYS AND RAG DOLLS; TOY MODEL HOBBYCRAFT KITS; ORDINARY PLAYING CARDS; CARD GAMES; TRADING CARDS; PRINTED LOTTERY SCRATCH CARDS; BOARD GAMES, JIGSAW PUZZLES; TOY BUILDING BLOCKS; PADDLE BALL GAMES; COLLECTABLE TOY FIGURES MADE OF FABRIC AND FUR; MINIATURE AND MODEL TOY FIGURES OF

MEMBERS OF MUSICAL GROUPS, IN CLASS 28 (U.S. CLS. 22, 23, 38 AND 50).

FOR: ENTERTAINMENT SERVICES, NAMELY, LIVE AND RECORDED MUSICAL CONCERTS; MUSIC PRODUCTION SERVICES, ENTERTAINMENT SERVICES IN THE NATURE OF ARRANGING AND CONDUCTING MUSIC COMPETITIONS, DANCE FESTIVALS, LIVE MUSICAL PERFORMANCES, THEATRE PRODUCTIONS, DANCE PERFORMANCES, LIVE MUSIC SHOW PERFORMANCES, MUSIC CONCERT PERFORMANCES, LIVE MUSIC EXHIBITIONS, MUSICAL RECORD FAIRS AND MUSICIAN AUTOGRAPH SESSIONS; AUDIO, MUSIC AND VIDEO PRODUCTION, MIXING, RE-MIXING, EDITING AND RECORDING SERVICES; MUSIC PUBLISHING SERVICES; PUBLISHING OF MUSICAL WORKS; SONG PUBLISHING; PUBLICATION OF LYRICS OF SONGS IN BOOK AND SHEET FORM; PUBLICATION OF MUSIC AND MUSIC BOOKS; ARRANGEMENT AND PERFORMANCE OF MUSICAL CONCERTS AND MUSICAL FESTIVALS FOR ENTERTAINMENT PURPOSES; ARRANGEMENT AND PERFORMANCE OF MUSIC PERFORMANCES, MUSIC SHOWS AND MUSICAL ENTERTAINMENT FOR ENTERTAINMENT PURPOSES; PERFORMANCE OF DANCE, MUSIC AND DRAMA; PERFORMANCE AND PRODUCTION OF RECORDINGS OF SOUND OR OF IMAGES FOR ENTERTAINMENT PURPOSES; PERFORMANCE AND PRODUCTION OF THEATRICAL, STAGE AND MUSICAL ENTERTAINMENT; DISCOTHEQUE SERVICES; SERVICES PROVIDING ENTERTAINMENT IN THE FORM OF LIVE MUSICAL PERFORMANCES, IN THE FORM OF RECORDED MUSIC AND IN THE FORM OF TELEVISION AND RADIO PROGRAMMES; NIGHT CLUBS AND NIGHT CLUB SERVICES; ENTERTAINMENT IN THE NATURE OF VISUAL AND MUSICAL PERFORMANCES FOR RADIO AND TELEVISION PROGRAMS; PRODUCTION OF MUSIC, FILM AND SOUND RECORDINGS; PRODUCTION OF VIDEOS, TV AND RADIO PROGRAMS, INCLUDING PROGRAMS TRANSMITTED VIA THE INTERNET, THE WORLD-WIDE WEB, WAP (WIRELESS APPLICATION PROTOCOL) AND IDTV (INTERACTIVE DI-

GITAL TELEVISION), AND BY BROADCAST, BY TELECOMMUNICATION SYSTEMS AND NETWORKS, BY CABLE, BY TELECOMMUNICATIONS LINES, AND BY ON-LINE MEANS; ARRANGEMENT AND PERFORMANCE OF MUSIC CONCERTS FOR ENTERTAINMENT PURPOSES; PROVISION OF ON-LINE INFORMATION SERVICES RELATING TO MUSIC AND MUSICAL ENTERTAINMENT; PRODUCTION, PERFORMANCE AND PRESENTATION OF MUSIC SHOWS FOR ENTERTAINMENT PURPOSES; ORGANIZATION OF MUSIC COMPETITIONS FOR ENTERTAINMENT PURPOSES; CONCERT, DANCE CLUB, DANCE VENUE AND DANCE HALL SERVICES; RECORD FAIRS; ELECTRONIC MUSIC AND VIDEO LIBRARY SERVICES FOR THE SUPPLY OF ELECTRONIC INFORMATION RELATING TO MUSIC AND MUSICAL PERFORMANCES, INCLUDING ARCHIVE INFORMATION, IN THE FORM OF ELECTRONIC TEXTS, AUDIO AND/OR VIDEO INFORMATION AND DATA, GAMES AND AMUSEMENTS; PROVIDING NON-DOWNLOADABLE DIGITAL MUSIC FROM THE INTERNET; PROVIDING NON-DOWNLOADABLE DIGITAL MUSIC FROM MP3 INTERNET WEBSITES, IN CLASS 41 (U.S. CLS. 100, 101 AND 107).

PRIORITY DATE OF 8-19-2005 IS CLAIMED.

OWNER OF INTERNATIONAL REGISTRATION 0905554 DATED 1-5-2006, EXPIRES 1-5-2016.

OWNER OF U.S. REG. NO. 1,769,990.

NO CLAIM IS MADE TO THE EXCLUSIVE RIGHT TO USE "MODE", APART FROM THE MARK AS SHOWN.

THE FOREIGN WORDING IN THE MARK TRANSLATES INTO ENGLISH AS FAST FASHIONS.

SER. NO. 79-031,740, FILED 1-5-2006.

DANNEAN HETZEL, EXAMINING ATTORNEY

Int. Cl.: 10

Prior U.S. Cls.: 26, 39 and 44

United States Patent and Trademark Office

Reg. No. 3,476,754

Registered July 29, 2008

**TRADEMARK
PRINCIPAL REGISTER**

PERIOSCAN

SIRONA DENTAL SYSTEMS GMBH (FED REP
GERMANY PUBLIC LIMITED COMPANY)
FABRIKSTRASSE 31
64625 BENSHEIM, FED REP GERMANY

OWNER OF INTERNATIONAL REGISTRATION
0862486 DATED 6-9-2005, EXPIRES 6-9-2015.

FOR: MEDICAL INSTRUMENTS, NAMELY, UL-
TRASONIC HANDPIECES AND TIPS THEREFOR
FOR SCALING, DIAGNOSIS AND TREATMENT
FOR DENTAL USE, IN CLASS 10 (U.S. CLS. 26, 39
AND 44).

OWNER OF U.S. REG. NO. 3,093,466.

SER. NO. 79-031,934, FILED 8-9-2006.

THE MARK CONSISTS OF STANDARD CHAR-
ACTERS WITHOUT CLAIM TO ANY PARTICULAR
FONT, STYLE, SIZE, OR COLOR.

RAMONA ORTIGA, EXAMINING ATTORNEY

Int. Cl.: 9

Prior U.S. Cls.: 21, 23, 26, 36 and 38

Reg. No. 3,476,755

United States Patent and Trademark Office

Registered July 29, 2008

**TRADEMARK
PRINCIPAL REGISTER**

PROFIGOLD

BANDRIDGE EUROPE N.V. (NETHERLANDS
LTD LIAB CO)
LAMMENSCHANSWEG 130 C
NL-2321 JX LEIDEN
NETHERLANDS

FOR: OPTICAL, ELECTRONIC AND ELECTRIC CABLES; CORDS, SWITCHING BOXES AND POWER SUPPLIES; ELECTRICAL PLUGS; ELECTRICAL SOCKETS; IN-EARPHONES; HEADPHONES; MICROPHONES; LOUDSPEAKERS; SOUND IMPROVEMENT EQUIPMENT, NAMELY, AMPLIFIERS AND SOUND MIXERS; ELECTRICAL POWER EXTENSION CORDS; PARTS FOR AUDIO EQUIPMENT, VISUAL EQUIPMENT, AUDIO VISUAL EQUIPMENT, DIGITAL EQUIPMENT, TELEVISION, SATELLITE, AERIAL, CAMCORDER, COMPUTER, MULTIMEDIA, TELEPHONE, MOBILE TELEPHONE, REMOTE CONTROL AND RF CORDLESS EQUIPMENT, NAMELY, AUDIO SPEAKERS, PCI CARDS, NETWORK SWITCHES, CORDLESS ROUTERS, USB HUBS, MEMORY CARDS AND AERIALS; ACCESSORIES FOR AUDIO EQUIPMENT, VISUAL EQUIPMENT, AUDIO VI-

SUAL EQUIPMENT, DIGITAL EQUIPMENT, TELEVISION, SATELLITE, AERIAL, CAMCORDER, COMPUTER, MULTIMEDIA, TELEPHONE, MOBILE TELEPHONE, REMOTE CONTROL, AND RF CORDLESS EQUIPMENT, NAMELY, COMPUTER PERIPHERALS, MAINTENANCE EQUIPMENT IN THE NATURE OF CLEANING CASSETTES, CLEANING DISKS AND SCREEN CLEANERS AND REMOTE CONTROLS FOR AUDIO, VISUAL, AUDIO VISUAL AND COMPUTER EQUIPMENT, IN CLASS 9 (U.S. CLS. 21, 23, 26, 36 AND 38).

THE MARK CONSISTS OF STANDARD CHARACTERS WITHOUT CLAIM TO ANY PARTICULAR FONT, STYLE, SIZE, OR COLOR.

OWNER OF INTERNATIONAL REGISTRATION
0886490 DATED 3-1-2006, EXPIRES 3-1-2016.

SER. NO. 79-031,940, FILED 10-11-2006.

ELI HELLMAN, EXAMINING ATTORNEY

Int. Cls.: 9 and 42

Prior U.S. Cls.: 21, 23, 26, 36, 38, 100 and 101

United States Patent and Trademark Office

Reg. No. 3,476,756

Registered July 29, 2008

**TRADEMARK
SERVICE MARK
PRINCIPAL REGISTER**

The logo for 'Block 96' features the word 'Block' in a bold, dark blue, sans-serif font. The number '96' is positioned to the right of 'Block' and is rendered in a white, outlined, sans-serif font.

AVANTIUM INTERNATIONAL B.V. (NETHERLANDS CORPORATION)
ZEKERINGSTRAAT 29
NL-1014 BV AMSTERDAM, NETHERLANDS

FOR: SCIENTIFIC, ELECTRICAL AND ELECTRONIC APPARATUS AND INSTRUMENTS FOR CHEMICAL AND PHARMACEUTICAL RESEARCH, NAMELY, HIGH THROUGHPUT PARALLEL CHEMICAL REACTORS; APPARATUS FOR RECORDING, CONVEYING AND REPRODUCING SOUNDS OR IMAGES, NAMELY, IMAGE RECORDERS; DATA CARRIERS, NAMELY, PRE-RECORDED MAGNETIC TAPES, MEMORY CARDS, CDS AND DVDS CONTAINING CHEMICAL AND PHARMACEUTICAL DATA; DISK-SHAPED SOUND CARRIERS, NAMELY, PRE-RECORDED CDS AND DVDS CONTAINING CHEMICAL AND PHARMACEUTICAL DATA; DATA PROCESSING EQUIPMENT, NAMELY, DATA PROCESSORS AND COMPUTERS, IN CLASS 9 (U.S. CLS. 21, 23, 26, 36 AND 38).

FOR: SCIENTIFIC AND TECHNOLOGICAL SERVICES FOR THE CHEMICAL, PHARMACEUTICAL, MEDICAL AND FOOD SERVICES, NAMELY, HIGH THROUGHPUT PARALLEL CHEMICAL EXPERIMENTATION SERVICES; PRODUCT DEVELOPMENT FOR THE BENEFIT OF THE CHEMICAL, PHARMACEUTICAL, MEDICAL AND FOOD IN-

DUSTRIES AS WELL AS RESEARCH AND DESIGN SERVICES WITH RESPECT TO THE AFOREMENTIONED SERVICES; INDUSTRIAL ANALYSES AND RESEARCH SERVICES IN THE CHEMICAL, PHARMACEUTICAL, MEDICAL AND FOOD INDUSTRIES; LABORATORY SERVICES IN THE CHEMICAL, PHARMACEUTICAL, MEDICAL AND FOOD INDUSTRIES; SOFTWARE DEVELOPMENT; PRODUCT DEVELOPMENT; COMPUTER PROGRAMMING, IN CLASS 42 (U.S. CLS. 100 AND 101).

PRIORITY DATE OF 6-8-2006 IS CLAIMED.

OWNER OF INTERNATIONAL REGISTRATION 0906418 DATED 11-15-2006, EXPIRES 11-15-2016.

THE COLOR(S) BLUE (PMS 2766) AND WHITE IS/ARE CLAIMED AS A FEATURE OF THE MARK.

THE COLOR BLUE APPEARS IN THE WORD "BLOCK", THE NUMBER "96" APPEARS IN WHITE WITH A BLUE OUTLINE.

SER. NO. 79-032,066, FILED 11-15-2006.

RON FAIRBANKS, EXAMINING ATTORNEY

Int. Cls.: 39 and 41

Prior U.S. Cls.: 100, 101, 105 and 107

United States Patent and Trademark Office

Reg. No. 3,476,757

Registered July 29, 2008

**SERVICE MARK
PRINCIPAL REGISTER**



NEULANDS ACADEMY

NEULAND & PARTNER BERATENDE; DIPLOM-
KAUFFRAU DIPLOM-DESIGNER; MODERA-
TOREN UND SEMINARTRAINER (FED REP
GERMANY PARTNERSHIP)

VON-SCHILDECK-STRASSE 12-14
36043 FULDA, FED REP GERMANY

FOR: ARRANGING AND CONDUCTING OF
JOURNEYS FOR MOTIVATION PURPOSES , IN
CLASS 39 (U.S. CLS. 100 AND 105).

FOR: ADULT EDUCATIONAL SERVICES,
NAMELY, CONDUCTING CLASSES, WORKSHOPS,
TRAINING SESSIONS AND SEMINARS IN THE
FIELD OF MANAGING AND DEVELOPING COM-
PANIES; PERSONAL COACHING AND TRAINING
OF MANAGEMENT AND EMPLOYEES TO IM-
PROVE THE ABILITY TO WORK IN A TEAM
ENVIRONMENT VIA INDOOR AND OUTDOOR
TRAINING; EDUCATIONAL SERVICES, NAMELY,

ORGANIZING AND CONDUCTING CULTURAL
AND SPORTING EVENTS FOR PURPOSES OF
MOTIVATION AND TEAMBUILDING, IN CLASS
41 (U.S. CLS. 100, 101 AND 107).

OWNER OF INTERNATIONAL REGISTRATION
0906566 DATED 9-9-2006, EXPIRES 9-9-2016.

OWNER OF U.S. REG. NO. 2,342,550.

NO CLAIM IS MADE TO THE EXCLUSIVE
RIGHT TO USE "ACADEMY", APART FROM THE
MARK AS SHOWN.

SER. NO. 79-032,130, FILED 9-9-2006.

AMOS T. MATTHEWS, JR., EXAMINING ATTOR-
NEY

Int. Cls.: 9 and 42

Prior U.S. Cls.: 21, 23, 26, 36, 38, 100 and 101

United States Patent and Trademark Office

Reg. No. 3,476,758

Registered July 29, 2008

**TRADEMARK
SERVICE MARK
PRINCIPAL REGISTER**

Flowrence

AVANTIUM INTERNATIONAL B.V. (NETHERLANDS CORPORATION)
ZEKERINGSTRAAT 29
NL-1014 BV AMSTERDAM, NETHERLANDS

FOR: SCIENTIFIC, ELECTRICAL AND ELECTRONIC APPARATUS AND INSTRUMENTS FOR CHEMICAL AND PHARMACEUTICAL RESEARCH, NAMELY, HIGH THROUGHPUT PARALLEL CHEMICAL REACTORS; APPARATUS FOR RECORDING, CONVEYING AND REPRODUCING SOUNDS OR IMAGES, NAMELY IMAGE RECORDERS; DATA CARRIERS, NAMELY, PRE-RECORDED MAGNETIC TAPES, MEMORY CARDS, CDS AND DVDS CONTAINING CHEMICAL AND PHARMACEUTICAL DATA; DISK-SHAPED SOUND CARRIERS, NAMELY, PRE-RECORDED CDS AND DVDS CONTAINING CHEMICAL AND PHARMACEUTICAL DATA; DATA PROCESSING EQUIPMENT, NAMELY, DATA PROCESSORS AND COMPUTERS, IN CLASS 9 (U.S. CLS. 21, 23, 26, 36 AND 38).

FOR: SCIENTIFIC AND TECHNOLOGICAL SERVICES FOR THE CHEMICAL, PHARMACEUTICAL, MEDICAL AND FOOD SERVICES, NAMELY, HIGH THROUGHPUT PARALLEL CHEMICAL EXPERIMENTATION SERVICES; PRODUCT DEVELOPMENT FOR THE BENEFIT OF THE CHEMICAL, PHARMACEUTICAL, MEDICAL AND FOOD INDUSTRIES AS WELL AS RESEARCH AND DESIGN

SERVICES WITH RESPECT TO THE AFOREMENTIONED SERVICES; INDUSTRIAL ANALYSIS AND RESEARCH SERVICES IN THE CHEMICAL, PHARMACEUTICAL, MEDICAL AND FOOD SERVICE INDUSTRIES; LABORATORY SERVICES IN THE CHEMICAL, PHARMACEUTICAL, MEDICAL AND FOOD SERVICE INDUSTRIES; SOFTWARE DEVELOPMENT; PRODUCT DEVELOPMENT; COMPUTER PROGRAMMING, IN CLASS 42 (U.S. CLS. 100 AND 101).

PRIORITY DATE OF 6-8-2006 IS CLAIMED.

OWNER OF INTERNATIONAL REGISTRATION 0906988 DATED 11-15-2006, EXPIRES 11-15-2016.

THE COLOR(S) BLUE (PMS 2766), WHITE IS/ARE CLAIMED AS A FEATURE OF THE MARK.

THE COLOR BLUE APPEARS IN THE WORD "FLOWRENCE", AND THE BACKGROUND APPEARS IN WHITE.

SER. NO. 79-032,309, FILED 11-15-2006.

RON FAIRBANKS, EXAMINING ATTORNEY

Int. Cls.: 3, 5 and 10

Prior U.S. Cls.: 1, 4, 6, 18, 26, 39, 44, 46, 50, 51 and 52

United States Patent and Trademark Office

Reg. No. 3,476,759

Registered July 29, 2008

**TRADEMARK
PRINCIPAL REGISTER**

ROHTO PHARMACEUTICAL CO., LTD. (JAPAN CORPORATION)

8-1, TATSUMINISHI 1-CHOME
IKUNO-KU.; OSAKA-SHI
OSAKA 544-8666, JAPAN

FOR: SOAPS; PERFUMERY, ESSENTIAL OILS, COSMETICS, HAIR LOTIONS; DENTIFRICES; STAIN-REMOVING PREPARATIONS; ABRASIVE PAPERS; TOILET SOAPS; BODY SOAPS; SHAMPOOS; SHAMPOOS FOR PETS; HAIR CONDITIONERS; INCENSES; PERFUMES; COSMETIC PREPARATIONS FOR SKINCARE, NAMELY, CREAMS, LOTIONS, OILS, GEL, FOAM, TONERS, AND SKIN SERUM; NON-MEDICATED TOILETRIES; HAND AND FACE LOTIONS FOR COSMETIC PURPOSES; MILKS FOR COSMETIC PURPOSES; ASTRINGENTS FOR COSMETIC PURPOSES; BEAUTY MASKS; FACIAL WASHES; NON-MEDICATED LIP CARE PREPARATIONS; NON-MEDICATED LIP BALMS; MAKE-UP; MAKE-UP REMOVING LOTIONS, OILS, AND MILKS; COSMETIC PREPARATIONS FOR BATH, NAMELY, BATH FOAM, GEL, AND OILS; NON-MEDICATED BATH SALTS; HAND CREAMS; NON-MEDICATED BODY CARE PREPARATIONS, NAMELY, BODY LOTION; NON-MEDICATED SCRUBS FOR FACE AND BODY; ANTI-PERSPIRANTS; ANTI-PERSPIRANT SOAPS; DEODORANT FOR PERSONAL USE; NON-MEDICATED SOAP FOR FOOT PERSPIRATION; ANTI-PERSPIRANT/DEODORANT PREPARATIONS IN THE FORM OF CREAMS, SPRAYS, ROLL-ONS AND STICKS; TALCUM POWDERS; DEPILATORIES; SHAVING CREAMS; COSMETIC SUN-TANNING PREPARATIONS; SUNSCREEN PREPARATIONS; TOOTHPASTE; MOUTH WASHES, NOT FOR MEDICAL PURPOSES; DETERGENTS FOR ARTIFICIAL TEETH; AFTER-SHAVE LOTIONS; HAIR DYES; HAIR BLEACHES; DISINFECTANT SOAPS; TISSUES IMPREGNATED WITH

COSMETIC LOTIONS; NON-MEDICATED PREPARATIONS FOR FRESHENING THE BREATH, NAMELY, BREATH MINTS, GUM, AND SPRAYS; FALSE EYELASHES; FALSE NAILS; HAIR LOTIONS; HAIR SPRAYS; HAIR REJUVENATING PREPARATIONS, NAMELY, GEL, LOTIONS, AND SPRAYS; NAIL POLISH; COSMETIC PREPARATIONS FOR SLIMMING PURPOSES, NAMELY, CREAMS, LOTIONS, AND GEL; SKIN WHITENING CREAM; COTTON STICKS FOR COSMETIC PURPOSES; COTTON WOOL FOR COSMETIC PURPOSES, IN CLASS 3 (U.S. CLS. 1, 4, 6, 50, 51 AND 52).

FOR: SANITARY PREPARATIONS FOR MEDICAL PURPOSES; MEDICAL PLASTERS, BANDAGES, AND GAUZE FOR DRESSINGS; MATERIAL FOR STOPPING TEETH, DENTAL WAX; DISINFECTANTS FOR MEDICAL AND SANITARY PURPOSES; PREPARATIONS FOR DESTROYING VERMIN; FUNGICIDES, HERBICIDES; PHARMACEUTICAL PREPARATIONS FOR OPHTHALMIC USE; PHARMACEUTICAL PREPARATIONS FOR THE TREATMENT AND CARE OF THE EYES; EYE DROPS; EYE WASHES; VITAMIN PREPARATIONS FOR USE AS NUTRITIONAL AIDS FOR EYESIGHT; EYE OINTMENTS; GASTROINTESTINAL CLEANING AGENTS AFFECTING DIGESTIVE ORGANS; GASTROINTESTINAL MEDICINES; LAXATIVES; NUTRITIONAL SUPPLEMENTS IN THE FORM OF TONICS FOR MEDICAL PURPOSES; PHARMACEUTICAL PREPARATIONS FOR THE TREATMENT OF HAY FEVER; SPRAY-TYPE ANTIALLERGIC AGENTS FOR TREATMENT OF RHINITIS; MEDICATED CONFECTIONERY FOR THE TREATMENT OF THE THROAT; SPRAY-TYPE PHARMACEUTICAL PREPARATIONS FOR TREATMENT OF THROAT; ANTIMICROBIALS FOR DERMATOLOGICAL USE; PHARMACEUTICAL SKIN LOTIONS, GEL, AND CREAMS; MEDICATED PREPARATIONS FOR THE SKIN; MEDICATED SKIN LO-

TIONS; MEDICATED MILKY LOTIONS FOR SKIN-CARE; MEDICATED SUN CARE PREPARATIONS; ANTI-INFLAMMATORY AGENTS; HEMORRHOID PREPARATIONS; DIAGNOSTIC PREPARATIONS AND REAGENTS FOR MEDICAL USE; PREGNANCY TEST KITS; ADHESIVE PLASTERS, ADHESIVE BANDS AND TAPES FOR MEDICAL USE; LIQUID ADHESIVES FOR MEDICAL USE; EYE PATCHES FOR MEDICAL PURPOSES; VITAMINS AND MINERALS; CONTACT LENS SOLUTIONS; CONTACT LENS CLEANING SOLUTIONS; CONTACT LENS WETTING SOLUTIONS; CONTACT LENS DISINFECTANTS; STERILIZING PREPARATIONS; ANTI-SEPTICS; MEDICATED ANTI-PERSPIRANT/DEODORANT PREPARATIONS IN THE FORM OF CREAMS, SPRAYS, ROLL-ONS AND STICKS; PHARMACEUTICAL PREPARATIONS FOR THE TREATMENT OF EXCESSIVE PERSPIRATION; MEDICATED REMEDIES FOR FOOT PERSPIRATION, NAMELY, FOOT LOTIONS, POWDERS, AND SPRAYS; PHARMACEUTICAL ASTRINGENTS; MEDICATED OINTMENTS FOR THE TREATMENT OF ITCHING, CHAP, CHILBLAIN, ECZEMA, RASH, SORE, DERMATITIS, URTICARIA, AND INSECT BITES; ADHESIVES FOR DENTURES; PRE-MOISTENED TISSUES IMPREGNATED WITH PHARMACEUTICAL LOTIONS FOR SKIN, SCALP, FACE, BODY, HAND, AND FOOT; LIP POMADES FOR MEDICAL PURPOSES; POULTICES; STYPTIC PREPARATIONS; SUNBURN LOTIONS, CREAMS, AND SPRAYS FOR PHARMACEUTICAL PURPOSES; MEDICATED COMPRESSES; SUPPOSITORIES; MEDICAL TONICS FOR RELIEVING PHYSICAL FATIGUE; ANALGESICS; ANTIBIOTICS; BATH PREPARATIONS, MEDICATED; BURN TREATMENT MEDICATION; CONFECTIONERY, MEDICATED; MEDICINES FOR ALLEVIATING CONSTIPATION; DISINFECTANTS FOR HYGIENE PURPOSES; FUNGICIDES; GERMICIDES; MEDIC-

INAL HAIR GROWTH PREPARATIONS; RAT POISON; ABSORBENT COTTON FOR MEDICAL PURPOSES; ANTHELMINTICS; GELATIN CAPSULES SOLD EMPTY FOR PHARMACEUTICALS; DEODORANTS, OTHER THAN FOR PERSONAL USE; HERB TEA FOR MEDICINAL PURPOSES; INSECT REPELLENTS; INSECTICIDES; NUTRITIONAL ADDITIVES FOR USE IN FOODS AND DIETARY SUPPLEMENTS FOR HUMAN CONSUMPTION FOR MEDICAL PURPOSES; DIETARY SUPPLEMENTS FOR MEDICAL USE CONTAINING VITAMINS, MINERALS, DIETARY FIBERS, AMINO ACIDS, POLYPHENOL, CITRIC ACIDS, LIOLEIC ACIDS, GLYCERINE FATTY ACID ESTERS, GLUCOSAMINES, CHONDROITINS, LACTIC ACID BACTERIA, BACILLUS NATTO, OR OLIGOSACCHARIDE ALL IN THE FORM OF PILLS, LIQUIDS, PASTES, POWDERS, GRANULES, GRAINS, SOFT CAPSULES, CAPSULES, TABLETS, BLOCKS, MEDICAL JELLIED CONFECTIONARY, AND MEDICAL GUMMY CONFECTIONARY, IN CLASS 5 (U.S. CLS. 6, 18, 44, 46, 51 AND 52).

FOR: MASKS FOR PREVENTING HAY FEVER, FLU, COLD, SARS (SEVERE ACUTE RESPIRATORY SYNDROME) AND OTHER RESPIRATORY DISEASES, IN CLASS 10 (U.S. CLS. 26, 39 AND 44).

OWNER OF INTERNATIONAL REGISTRATION 0907217 DATED 4-4-2005, EXPIRES 4-4-2015.

OWNER OF U.S. REG. NOS. 2,633,109, 2,782,477 AND OTHERS.

SER. NO. 79-032,409, FILED 4-4-2005.

DANNEAN HETZEL, EXAMINING ATTORNEY

Int. Cls.: 29 and 30

Prior U.S. Cl.: 46

United States Patent and Trademark Office

Reg. No. 3,476,760

Registered July 29, 2008

TRADEMARK
PRINCIPAL REGISTER



TACCHINARDI S.R.L. (ITALY LIMITED LIABILITY COMPANY)
VIA MOLINO DELLE ARMI, 2
I-20123 MILANO
ITALY

FOR: PRESERVED, DRIED AND COOKED FRUITS AND VEGETABLES; JELLIES, JAMS, COMPOTES; EGGS; MILK; MILK PRODUCTS EXCLUDING ICE CREAM, ICE MILK AND FROZEN YOGURT; EDIBLE OILS AND FATS, IN CLASS 29 (U.S. CL. 46).

FOR: PASTRIES, NAMELY, PIES AND CAKES, IN CLASS 30 (U.S. CL. 46).

PRIORITY DATE OF 5-18-2006 IS CLAIMED.

OWNER OF INTERNATIONAL REGISTRATION
0907564 DATED 11-3-2006, EXPIRES 11-3-2016.

NO CLAIM IS MADE TO THE EXCLUSIVE RIGHT TO USE "TORTIONATA" FOR INTERNATIONAL CLASS 30, APART FROM THE MARK AS SHOWN.

THE MARK CONSISTS OF THE WORDS "TORTIONATA TACCHINARDI" ASSOCIATED TO THE FIGURE OF A STYLIZED "T" WITH BABY GIRL.

SER. NO. 79-032,523, FILED 11-3-2006.

KATHERINE E. HALMEN, EXAMINING ATTORNEY

Int. Cl.: 7

Prior U.S. Cls.: 13, 19, 21, 23, 31, 34 and 35

United States Patent and Trademark Office

Reg. No. 3,476,761

Registered July 29, 2008

**TRADEMARK
PRINCIPAL REGISTER**



ROSTA AG (SWITZERLAND SOCIÉTÉ ANON-
YME (SA))
CH-5502 HUNZENSCHWIL
SWITZERLAND

FOR: PROPULSION CLUTCHES, OSCILLATION
ELEMENTS, NAMELY, BELT TENSIONERS, SUS-
PENSION TENSIONERS, CHAIN AND BELT TEN-
SIONERS FOR SLACK COMPENSATION, AND
ANTI-VIBRATION MOUNTINGS, OSCILLATING
MOUNTINGS AND MOTORBASES; TENSION AND
PRESSURE ELEMENTS, NAMELY, CHAIN TEN-
SIONING DEVICES, BELT TENSIONING DEVICES
AND SELF-ADJUSTING MOTOR-BASES FOR FRIC-
TION BELT DRIVES, OSCILLATING MOUNTS FOR
SHAKER SCREENS, ELASTIC ROCKER ARMS FOR
SHAKER CONVEYORS, UNIVERSAL JOINTS FOR
GYRATORY SIFTER SUSPENSIONS, ANTI-VIBRA-

TION MOUNTS, SHOCK ABSORBERS, AND TOR-
QUE-ELASTIC SPRING DEVICES FOR THE
SUSPENSION OF FRICTION BELT DRIVES, ALL
FOR USE WITH MACHINES, IN CLASS 7 (U.S. CLS.
13, 19, 21, 23, 31, 34 AND 35).

OWNER OF INTERNATIONAL REGISTRATION
0308204 DATED 1-26-1966, EXPIRES 1-26-2016.

OWNER OF U.S. REG. NOS. 1,297,383 AND
1,297,384.

SER. NO. 79-032,786, FILED 11-6-2006.

MICHELE SWAIN, EXAMINING ATTORNEY

Int. Cl.: 6

Prior U.S. Cls.: 2, 12, 13, 14, 23, 25 and 50

Reg. No. 3,476,762

United States Patent and Trademark Office

Registered July 29, 2008

**TRADEMARK
PRINCIPAL REGISTER**

CABLECOM

NORINCO (FRANCE SOCIETE PAR ACTIONS
SIMPLIFEE)
ZONE INDUSTRIELLE DE MARIVAU,
SAINT-CRÉPIN IBOUVILLERS; F-60149 SAINT-CRÉ-
PIN IBOUVILLERS
FRANCE

FOR: METAL PIPES AND TUBES; CAST IRON,
CAST IRON FOR USE IN HYDRAULICS, SANITA-
TION, ROAD SYSTEMS AND BUILDINGS; UNDER-
GROUND CHAMBERS MADE PRIMARILY OF
METAL, NAMELY, MANHOLES FOR HYDRAU-
LICS, UTILITIES, SANITATION, AND MAINTEN-
ANCE OF ROADS AND BUILDINGS;
TELECOMMUNICATION CHAMBER COVERS IN
THE NATURE OF MANHOLE COVERS OF CAST-
IRON OR METAL; GRATINGS OF CAST-IRON OR
METAL; CAST-IRON GULLIES; GRATINGS,
NAMELY, UNDERGROUND CHAMBER COVERS
OF CAST IRON; CAST IRON FOR USE IN THE

MANUFACTURE OF ORNAMENTS AND DEC-
ORATION; POSTS OF CAST-IRON OR METAL,
BASKETS MADE OF CAST-IRON, BASKETS MADE
OF COMMON METALS, CAST-IRON CHIMNEY
PLATES; MODULAR COVERING OF CAST IRON
FOR GUTTERS AND HOPPERS, IN CLASS 6 (U.S.
CLS. 2, 12, 13, 14, 23, 25 AND 50).

PRIORITY DATE OF 2-10-2006 IS CLAIMED.

OWNER OF INTERNATIONAL REGISTRATION
0908708 DATED 7-26-2006, EXPIRES 7-26-2016.

SER. NO. 79-032,969, FILED 7-26-2006.

Laurie Mayes, Examining Attorney

Int. Cls.: 35, 36 and 41

Prior U.S. Cls.: 100, 101, 102 and 107

United States Patent and Trademark Office

Reg. No. 3,476,763

Registered July 29, 2008

**SERVICE MARK
PRINCIPAL REGISTER**

UNPUZZLED ACCOUNTING!

WILLIAM HOWARTH JARVIE (UNITED KING-
DOM INDIVIDUAL)
5 LOCH DRIVE, HELENSBURGH
ARGYLL & BUTE; SCOTLAND G84 8PY
UNITED KINGDOM

FOR: ACCOUNTING, DRAWING UP STATEMENTS OF ACCOUNTS, ADVERTISING, ADVERTISING AGENCIES, UPDATING OF ADVERTISING MATERIAL, DISSEMINATION OF ADVERTISING MATTER, RENTAL OF ADVERTISING SPACE, COST PRICE ANALYSIS, BUSINESS APPRAISALS, BUSINESS MANAGEMENT ASSISTANCE, AUDITING, BOOK-KEEPING, PROFESSIONAL BUSINESS CONSULTANCY, BUSINESS INFORMATION, BUSINESS INQUIRIES, BUSINESS INVESTIGATIONS, BUSINESS MANAGEMENT AND BUSINESS MANAGEMENT ORGANIZATION CONSULTANCY, BUSINESS MANAGEMENT CONSULTANCY, BUSINESS MANAGEMENT OF HOTELS, BUSINESS MANAGEMENT OF PERFORMING ARTISTS, BUSINESS ORGANIZATION CONSULTANCY, BUSINESS RESEARCH, RELOCATION SERVICES FOR BUSINESSES, COMMERCIAL INFORMATION AGENCIES, COMMERCIAL OR INDUSTRIAL MANAGEMENT ASSISTANCE, COMPILATION OF INFORMATION INTO COMPUTER DATABASES, SYSTEMIZATION OF INFORMATION INTO COMPUTER DATABASES, BUSINESS RESEARCH SERVICES IN THE NATURE OF FINANCIAL DATA SEARCH IN COMPUTER FILES FOR OTHERS, DEMONSTRATION OF GOODS FOR PROMOTIONAL PURPOSES, DIRECT MAIL ADVERTISING, DOCUMENT REPRODUCTION, ECONOMIC FORECASTING, EFFICIENCY EXPERTS, EMPLOYMENT AGENCIES, ORGANIZATION OF EXHIBITIONS FOR COMMERCIAL OR ADVERTISING PURPOSES IN THE FIELD OF ACCOUNTING, COMPUTERIZED FILE MANAGEMENT, MARKETING RESEARCH, MARKETING STUDIES, ON-LINE ADVERTISING ON A COMPUTER NETWORK, PAYROLL PREPARATION, PERSONNEL MANAGEMENT CONSULTANCY, WORD PROCESSING, PROCUREMENT SERVICES FOR OTHERS, NAMELY, PURCHASING GOODS AND SERVICES FOR OTHER BUSINESSES, PUBLICITY CONSULTATION, PUBLICITY AGENCIES, CREATING AND DISTRIBUTING RADIO ADVERTISING, PRODUC-

TION OF RADIO COMMERCIALS, RENTAL OF ADVERTISING TIME ON COMMUNICATIONS MEDIA, SALES PROMOTION FOR OTHERS, PROVIDING STATISTICAL INFORMATION, TAX PREPARATION, TELEVISION ADVERTISING, PRODUCTION OF TELEVISION COMMERCIALS, TYPING, IN CLASS 35 (U.S. CLS. 100, 101 AND 102).

FOR: FINANCIAL ANALYSIS, BANKING, HOME BANKING, CAPITAL INVESTMENTS, CHARITABLE FUND RAISING, CHECK VERIFICATION, COLLECTION OF DEBTS, FINANCIAL CONSULTANCY, INSURANCE CONSULTANCY, CREDIT CARD SERVICES, DEBIT CARD SERVICES, REAL ESTATE MANAGEMENT; FINANCIAL EVALUATION FOR INSURANCE, BANKING, REAL ESTATE, AND FACTORING PURPOSES, PROVIDING FINANCIAL INFORMATION, FINANCIAL MANAGEMENT, FINANCING SERVICES, FUND INVESTMENTS, ELECTRONIC FUNDS TRANSFER, FINANCIAL GUARANTEES, HIRE-PURCHASE FINANCING, PROVIDING INSURANCE INFORMATION, INSURANCE UNDERWRITING, LEASE-PURCHASE FINANCING, MONEY LENDING AGAINST SECURITY, MUTUAL FUNDS INVESTMENT, SAVINGS BANKS, IN CLASS 36 (U.S. CLS. 100, 101 AND 102).

FOR: ARRANGING AND CONDUCTING OF COLLOQUIUMS, CONFERENCES, CONGRESSES, SEMINARS, SYMPOSIUMS, AND TRAINING WORKSHOPS IN THE FIELD OF ACCOUNTING; BOOKING OF SEATS FOR SHOWS; CORRESPONDENCE COURSES IN ACCOUNTING; DIGITAL IMAGING SERVICES; PROVIDING INFORMATION ABOUT EDUCATIONAL COURSES; EDUCATIONAL SERVICES, NAMELY, PROVIDING COURSES IN THE FIELD OF ACCOUNTING; VOCATIONAL GUIDANCE IN THE NATURE OF EDUCATION OR TRAINING ADVICE IN THE FIELD OF ACCOUNTING; INSTRUCTION SERVICES IN THE FIELD OF ACCOUNTING; PRACTICAL TRAINING AND DEMONSTRATION IN THE FIELD OF ACCOUNTING; PRODUCTION OF RADIO AND TELEVISION SHOWS; PROVIDING ON-LINE, NON-DOWNLOADABLE PUBLICATIONS IN THE NATURE OF MAGAZINES, JOURNALS AND BOOKS IN THE FIELD OF ACCOUNTING; PUBLICATION OF

BOOKS; PUBLICATION OF ELECTRONIC BOOKS AND JOURNALS ON-LINE; TEACHING ACCOUNTING; PRODUCTION OF RADIO AND TELEVISION PROGRAMS; PUBLICATION OF TEXTS OTHER THAN PUBLICITY TEXTS; TRANSLATION, IN CLASS 41 (U.S. CLS. 100, 101 AND 107).

THE MARK CONSISTS OF STANDARD CHARACTERS WITHOUT CLAIM TO ANY PARTICULAR FONT, STYLE, SIZE, OR COLOR.

OWNER OF INTERNATIONAL REGISTRATION 0908741 DATED 1-19-2006, EXPIRES 1-19-2016.

NO CLAIM IS MADE TO THE EXCLUSIVE RIGHT TO USE "ACCOUNTING", APART FROM THE MARK AS SHOWN.

SER. NO. 79-032,983, FILED 1-19-2006.

CARRIE GENOVESE, EXAMINING ATTORNEY

Int. Cl.: 9

Prior U.S. Cls.: 21, 23, 26, 36 and 38

Reg. No. 3,476,764

United States Patent and Trademark Office

Registered July 29, 2008

**TRADEMARK
PRINCIPAL REGISTER**

SILVYN

U.L. LAPP GMBH (FED REP GERMANY GE-
SELLSCHAFT MIT BESCHRÄNKTER HAF-
TUNG)

SCHULZE-DELITZSCH-STR. 25
70565 STUTTGART, FED REP GERMANY

FOR: HOSES AND GUIDE SYSTEMS OF PLASTIC
FOR ELECTRICAL PURPOSES, IN PARTICULAR,
FOR CABLES; SCREW FITTINGS FOR PROTEC-
TIVE HOSES, OF PLASTIC AND METAL; TERMIN-
AL SLEEVES FOR HOSES; GUIDE SYSTEMS OF
PLASTIC FOR ELECTRICAL PURPOSES, IN PARTI-
CULAR FOR CABLES, COMPRISING DRAG

CHAINS AND POWER CHAINS, IN CLASS 9 (U.S.
CLS. 21, 23, 26, 36 AND 38).

OWNER OF INTERNATIONAL REGISTRATION
0909153 DATED 10-24-2006, EXPIRES 10-24-2016.

THE WORDING "SILVYN" HAS NO MEANING
IN A FOREIGN LANGUAGE.

SER. NO. 79-033,152, FILED 10-24-2006.

RON FAIRBANKS, EXAMINING ATTORNEY

Int. Cls.: 7 and 9

Prior U.S. Cls.: 13, 19, 21, 23, 26, 31, 34, 35, 36 and 38

United States Patent and Trademark Office

Reg. No. 3,476,765

Registered July 29, 2008

**TRADEMARK
PRINCIPAL REGISTER**

TimberRite

DEERE & COMPANY (DELAWARE CORPORATION)
ONE JOHN DEERE PLACE
MOLINE, IL 612658098

FOR: FOREST MACHINES, NAMELY, CUT-TO-LENGTH TREE HARVESTING MACHINES, FULL TREE FOREST CUTTING MACHINES, HARVESTER HEADS, AND WHEELED FELLER BUNCHERS, TRACKED FELLER BUNCHERS, SKIDDERS, KNUCKLE BOOM LOG LOADERS, TRACKED LOG LOADERS, IN CLASS 7 (U.S. CLS. 13, 19, 21, 23, 31, 34 AND 35).

FOR: ELECTRONIC CONTROLS SYSTEMS FOR TREE HARVESTING MACHINE HEADS; MEASURING SENSORS USED TO MEASURE THE TREE SIZE, LENGTH, DIAMETER AND PROCESS OTHER RELEVANT DATA WHICH ENABLE THE TREE HARVESTING MACHINE HEAD TO CUT TREE TO

SPECIFIC DESIRED LENGTH; SOFTWARE THAT ENABLES THE TREE HARVESTERS TO MEASURE FELLED TREES AND CUT THEM TO LENGTH TO MEET A NUMBER OF DIFFERENT HARVESTING SPECIFICATIONS, SUCH AS LENGTH, DIAMETER, AND ASSIST IN MAINTAINING INVENTORY OF THE HARVEST, IN CLASS 9 (U.S. CLS. 21, 23, 26, 36 AND 38).

PRIORITY DATE OF 2-3-2006 IS CLAIMED.

OWNER OF INTERNATIONAL REGISTRATION 0909254 DATED 8-3-2006, EXPIRES 8-3-2016.

SER. NO. 79-033,217, FILED 8-3-2006.

MARY BOAGNI, EXAMINING ATTORNEY

Int. Cls.: 35, 41 and 45

Prior U.S. Cls.: 100, 101, 102 and 107

United States Patent and Trademark Office

Reg. No. 3,476,766

Registered July 29, 2008

**SERVICE MARK
PRINCIPAL REGISTER**



HOLLAND EVENEMENTEN GROEP BV (NETHERLANDS CORPORATION)
ZOELENSESTRAATJE 3
NL-4011 LT ZOELLEN
NETHERLANDS

FOR: ADVERTISING; BUSINESS MANAGEMENT; BUSINESS ADMINISTRATION; OFFICE FUNCTIONS; BUSINESS CONSULTATION IN THE NATURE OF CONSULTING BUSINESS ON FINDING NEW AND EMERGING BUSINESS OPPORTUNITIES, IN CLASS 35 (U.S. CLS. 100, 101 AND 102).

FOR: EDUCATIONAL SERVICES, NAMELY, PROVIDING SEMINARS IN THE FIELD OF BUSINESS, NAMELY, FINDING NEW AND EMERGING BUSINESS OPPORTUNITIES, IN CLASS 41 (U.S. CLS. 100, 101 AND 107).

FOR: SOCIAL INTRODUCTION AGENCIES, IN CLASS 45 (U.S. CLS. 100 AND 101).

OWNER OF INTERNATIONAL REGISTRATION 0909530 DATED 11-15-2006, EXPIRES 11-15-2016.

THE COLOR(S) ORANGE, WHITE IS/ARE CLAIMED AS A FEATURE OF THE MARK.

THE COLOR ORANGE APPEARS IN THE BACKGROUND SQUARE ON THE LEFT AND THE LEFT SIDE OF THE BACKGROUND RECTANGLE BEHIND THE WORD "SPEED". THE COLOR ORANGE ALSO APPEARS IN THE TERM "MEET". THE COLOR WHITE APPEARS IN THE THREE SQUARE DESIGNS ON THE LEFT HAND SIDE OF THE MARK AND BEHIND THE TERM "MEET" IN THE BACKGROUND RECTANGLE ON THE RIGHT. THE COLOR WHITE ALSO APPEARS IN THE TERM "SPEED".

SER. NO. 79-033,277, FILED 11-15-2006.

COLLEEN KEARNEY, EXAMINING ATTORNEY

Int. Cls.: 24 and 26

Prior U.S. Cls.: 37, 39, 40, 42 and 50

United States Patent and Trademark Office

Reg. No. 3,476,767

Registered July 29, 2008

**TRADEMARK
PRINCIPAL REGISTER**



RICAMIFICIO UMBRO DI BARTOLUCCI ROBERTO E C. SAS (ITALY LIMITED PARTNERSHIP)

VIA DELLE INDUSTRIE, 13
I-06080 BASTIA UMBRA (PG)
ITALY

FOR: CLOTH BANNERS, IN CLASS 24 (U.S. CLS. 42 AND 50).

FOR: ACCESSORIES FOR RELIGIOUS FURNITURE, NAMELY, EMBROIDERED BORDERS FOR ALTAR CLOTHS AND GLASS COVERS, EMBROIDERIES FOR THE APPLICATION ON FABRICS,

FINGER TOWELS, CORPORALS, AMICES, AND VEILS, IN CLASS 26 (U.S. CLS. 37, 39, 40, 42 AND 50).

PRIORITY DATE OF 11-9-2005 IS CLAIMED.

OWNER OF INTERNATIONAL REGISTRATION 0909508 DATED 1-16-2006, EXPIRES 1-16-2016.

SER. NO. 79-033,306, FILED 1-16-2006.

REBECCA POVARCHUK, EXAMINING ATTORNEY

Int. Cl.: 25

Prior U.S. Cls.: 22 and 39

United States Patent and Trademark Office

Reg. No. 3,476,768

Registered July 29, 2008

TRADEMARK
PRINCIPAL REGISTER

I É N A

BAYCREW'S CO., LTD. (JAPAN CORPORATION)
1-5-6, JINNAN
SHIBUYA-KU; TOKYO 150-0041
JAPAN

FOR: CLOTHING, NAMELY, NON-JAPANESE STYLE DRESSES, EVENING DRESSES, WEDDING DRESSES, SCHOOL UNIFORMS; CHILDREN'S JACKETS, SHIRTS, TIES, PANTS, SOCKS, PAJAMAS, UNDERWEAR, BELTS, MUFFLERS, HEADWEAR, GLOVES AND BANDANAS; WORKING OVERALLS, JACKETS, JOGGING PANTS, SWEAT PANTS, SUITS, SKIRTS, SKI JACKETS, SKI PANTS, TROUSERS, SMOCKS, TUXEDOS, MORNING COATS, BLAZERS, BLOUSON, JERKINS, KNICKERS, BEACHWEAR, COATS FOR MEN AND WOMEN, OVERCOATS, TOPCOATS, MANTLES, RAINCOATS, GREAT COATS, TRENCH COATS, DUST COATS; SWEATERS AND THE LIKE, NAMELY, CARDIGANS, SWEATERS, VESTS AND WAISTCOATS, TWIN SETS; SHIRTS AND THE LIKE, NAMELY, OPEN-NECKED SHIRTS, CUFFS, COLLARS FOR CLOTHING, SPORT SHIRTS, BLOUSES, POLO SHIRTS, SHIRTS FOR SUITS, T-SHIRTS; NIGHTWEAR, NAMELY, NIGHT GOWNS, NEGLIGES, BABY DOLL PAJAMAS, PEIGNOIRS, JAPANESE SLEEPING ROBES (NEMAKI), PAJAMAS, BATH ROBES; UNDERWEAR, NAMELY, CAMISOLES, CORSETS, COMBINATIONS, UNDERSHIRTS, CHEMISES, DRAWERS AND UNDERPANTS, SLIPS, PANTIES, SHORTS AND BRIEFS, BERMUDA SHORTS, BOXER SHORTS, BRASSIERES, PETTICOATS, TANK-TOPS; SWIMWEAR, NAMELY BATHING SUIT; SWIMMING CAPS; JAPANESE TRADITIONAL CLOTHING, NAMELY, SASH BANDS FOR KIMONO (OBI), BUSTLE HOLDER BANDS FOR OBI (OBIAGE), BUSTLES FOR OBI-KNOTS (OBIAGE-SHIN), WAIST STRINGS FOR KIMONOS (KOSHIHIMO), UNDERSHIRTS FOR KIMONOS (KOSHIMAKI, JUBAN), TIGHTENING-UP STRINGS FOR KIMONOS (DA-

TEJIME), WRAP BELTS FOR KIMONOS (DATEMAKI), FULL-LENGTH KIMONOS (NAGAGI), SHORT OVERCOAT FOR KIMONO (HAORI), STRING FASTENERS FOR HAORI (HAORI-HIMO), PLEATED SKIRTS FOR FORMAL KIMONOS (HAKAMA), DETACHABLE NECKPIECES FOR KIMONOS (HANERI); APRONS; COLLAR PROTECTORS FOR WEAR; SOCKS AND STOCKINGS; ANKLE SOCKS; KNEE-HIGH STOCKINGS; PANTYHOSE; PUTTEES AND GAITERS; FUR STOLEES; PAREUS; SHAWLS; SERAPES; SCARVES; JAPANESE STYLE SOCKS (TABI, TABI COVERS); GLOVES AND MITTENS; BABIES' DIAPERS OF TEXTILE; NECKTIES; BOW TIES; NECKERCHIEVES; BANDANAS; WARMTH-KEEPING SUPPORTS; NAMELY, LEG WARMERS, MUFFLERS; EAR MUFFS; HOODS; SEDGE HATS (SUGE-GASA); NIGHTCAPS; HELMETS FOR USE AS CLOTHING; HEADWEAR FOR CLOTHING; KNITTED CAPS; CAP VISORS; LEG-WARMERS; ANKLE GARTERS; GARTER BELTS; SOCK SUSPENDERS; SUSPENDERS; WAISTBANDS; BELTS FOR CLOTHING; FOOTWEAR FOR MEN AND WOMEN, NAMELY, SHOES AND BOOTS, RAIN BOOTS, LACE BOOTS, TRAINING SHOES, OVERSHOES, WOODEN SHOES, WORK SHOES AND BOOTS, SANDALS, SHOES, JAPANESE SPLIT-TOED WORK FOOTWEAR (JIKATABI), BEACH FOOTWEAR, ANGLERS' SHOES, BOOTS, HALF-BOOTS, WOMEN'S SHOES, WINTER BOOTS, ANKLE BOOTS, HOSIERY SHOES, CANVAS SHOES, INFANTS' SHOES AND BOOTS, MULES, INNER SOLES FOR SHOES AND BOOTS, HEELPIECES FOR SHOES AND BOOTS, INSOLES FOR SHOES AND BOOTS, WELTS FOR SHOES AND BOOTS, RUBBER SOLES FOR JIKATABI, FOOTWEAR UPPEERS, TIPS FOR FOOTWEAR, SHOES SOLES FOR REPAIR; SHOE DOWELS; SHOE PEGS; TONGUE OR PULLSTRAP FOR SHOES AND BOOTS; HOBNAILS; PROTECTIVE METAL MEMBERS FOR SHOES AND BOOTS; JAPANESE STYLE WOODEN CLOGS (GETA), NAMELY, HIGH RAIN CLOGS (ASHIDA),

LOW WOODEN CLOGS (KOMA-GETA, HIYORI-GETA), SANDAL-CLOGS, METAL FITTINGS FOR JAPANESE STYLE WOODEN CLOGS, WOODEN MAIN BODIES OF JAPANESE STYLE WOODEN CLOGS, WOODEN SUPPORTS OF JAPANESE STYLE WOODEN CLOGS, TOE STRAPS FOR JAPANESE STYLE WOODEN CLOGS; JAPANESE STYLE SANDALS (ZORI), NAMELY, JAPANESE TOE-STRAP SANDALS (ASAURA-ZORI), JAPANESE STYLE SANDALS OF LEATHER, SLIPPERS, JAPANESE STYLE SANDALS OF FELT, JAPANESE FOOTWEAR OF RICE STRAW (WARAJI), SLIPPER SOLES, UPPERS FOR JAPANESE STYLE SANDALS, SOLES FOR JAPANESE STYLE SANDALS, TOE STRAPS FOR JAPANESE STYLE SANDALS, UPPERS OF WOVEN RATTAN FOR JAPANESE STYLE SANDALS; MASQUERADE COSTUMES; CLOTHES FOR SPORTS, NAMELY, ANORAKS, KARATE SUITS, SPORTS OVERUNIFORMS, KENDO OUTFITS, JUDO SUITS, SKI SUITS FOR COMPETITION, HEADBANDS CLOTHING, WIND-JACKETS, UNIFORMS AND STOCKINGS FOR SPECIAL SPORTSWEAR, WRISTBANDS; BOOTS FOR SPORTS, NAMELY, GOLF SHOES, SOCCER SHOES, SKI

BOOTS, GYMNASTIC SHOES, TENNIS SHOES, CLIMBING BOOTS FOR USE AS MOUNTAINEERING BOOTS, BASKETBALL SNEAKERS, VOLLEYBALL SHOES, HANDBALL SHOES, BOWLING SHOES, BOXING SHOES, HOCKEY SHOES, BASEBALL SHOES, RUGBY SHOES, BALLET SHOES, FOOTWEAR FOR TRACK AND FIELD ATHLETICS, HORSE-RIDING BOOTS, IN CLASS 25 (U.S. CLS. 22 AND 39).

PRIORITY DATE OF 2-13-2006 IS CLAIMED.

OWNER OF INTERNATIONAL REGISTRATION 0909900 DATED 7-3-2006, EXPIRES 7-3-2016.

THE FOREIGN WORDING IN THE MARK TRANSLATES INTO ENGLISH AS HYENA.

SER. NO. 79-033,359, FILED 7-3-2006.

ROBERT STRUCK, EXAMINING ATTORNEY

Int. Cls.: 9, 38 and 42

Prior U.S. Cls.: 21, 23, 26, 36, 38, 100, 101 and 104

Reg. No. 3,476,769

United States Patent and Trademark Office

Registered July 29, 2008

**TRADEMARK
SERVICE MARK
PRINCIPAL REGISTER**

FNSL

STG INTERACTIVE (FRANCE CORPORATION)
29, AVENUE MOZART
F-75016 PARIS
FRANCE

FOR: COMPUTER SOFTWARE AND COMPUTER LANGUAGES FOR PROVIDING ELECTRONIC MULTIMEDIA DATA PUBLISHING SYSTEMS AND FOR THE OPERATION OF COMPUTER NETWORKS INTENDED FOR THE PUBLICATION OF CONTENTS ON FIXED AND MOBILE RADIOTELEPHONE GLOBAL COMMUNICATION NETWORK, THE INTERNET, OR PRIVATE ACCESS COMMUNICATIONS NETWORKS, INTRANETS; COMPUTER INTERFACES NAMELY FOR PROVIDING ACCESS TO MULTIMEDIA DATA BANKS; COMPUTER DATABASE SERVERS; CD-ROMS, DIGITAL OPTICAL COMPACT DISCS CONTAINING SOFTWARE TO ACCESS ELECTRONIC MULTIMEDIA DATA PUBLISHING SYSTEM ON COMPUTER NETWORKS; COMPUTER SOFTWARE FOR APPLICATIONS USE IN THE FIELD OF COMPUTER NETWORKS, MANAGEMENT OF COMPUTER SYSTEMS AND THE DESIGN OF SOFTWARE; COMPUTER PROGRAMS, COMPUTER SOFTWARE AND SOFTWARE PACKAGES FOR USE IN REMOTELY CONNECTING COMPUTERS AND COMPUTERS NETWORKS; COMPUTER PROGRAMS FOR USE IN REMOTELY SEARCHING THE CONTENTS OF COMPUTER DATABASE SERVERS AND COMPUTER NETWORKS; NAVIGATION SOFTWARE, NAMELY SOFTWARE ENABLING USERS TO NAVIGATE THROUGH COMPUTER NETWORKS FROM FIXED AND MOBILE RADIOTELEPHONE GLOBAL COMMUNICATION NETWORK, THE INTERNET, OR PRIVATE ACCESS COMMUNICATIONS NETWORKS, INTRANETS, IN CLASS 9 (U.S. CLS. 21, 23, 26, 36 AND 38).

FOR: DATA TRANSMISSION SERVICES, NAMELY HIGH-SPEED TRANSMISSION FOR PUBLIC NETWORK OPERATORS AND COMPANIES; SENDING AND TRANSMITTING DIGITAL FILES VIA ELECTRONIC MULTIMEDIA DATA PUBLISHING SYSTEMS ON FIXED AND MOBILE RADIOTELEPHONE GLOBAL COMMUNICATION NETWORK, THE INTERNET, OR PRIVATE ACCESS COMMUNICATIONS NETWORKS, INTRANETS; TRANSMITTING INFORMATION RELATING TO A DIRECTORY OF INTERNET USERS VIA COMPUTER DATABASE SERVERS CONNECTED TO FIXED AND MOBILE RADIOTELEPHONE GLOBAL COMMUNICATION NETWORK, THE INTERNET, OR PRIVATE ACCESS COMMUNICATIONS NETWORKS, INTRANETS; ELECTRONIC MAIL SERVICES; ELECTRONIC MESSAGING SERVICES; DISSEMINATION OF INFORMATION BY ELECTRONIC MEANS, NAMELY, VIA FIXED AND MOBILE RADIOTELEPHONE GLOBAL COMMUNICATION NETWORK, THE INTERNET, OR PRIVATE ACCESS COMMUNICATIONS NETWORKS, INTRANETS; PROVIDING THE TRANSMISSION AND DISSEMINATION OF DATA, SOUND AND IMAGES VIA MULTIMEDIA DATA PUBLISHING SYSTEMS ON FIXED AND MOBILE RADIOTELEPHONE GLOBAL COMMUNICATION NETWORK, THE INTERNET, OR PRIVATE ACCESS COMMUNICATIONS NETWORKS, INTRANETS; PROVIDING THE SECURE TRANSMISSION OF DATA WITH ACCESS CODE VIA COMPUTER PROGRAMS ON FIXED AND MOBILE RADIOTELEPHONE GLOBAL COMMUNICATION NETWORK, THE INTERNET, OR PRIVATE ACCESS COMMUNICATIONS NETWORKS, INTRANETS; PROVIDING COMMUNICATIONS BY COMPUTER TERMINALS; TELECOMMUNICATIONS SERVICES, NAMELY, PROVIDING DATABASE ACCESS TO GLOBAL COMMUNICATIONS COMPUTER NETWORKS; PROVIDING THE TRANSMISSION

OF MULTIMEDIA DATA VIA DOWNLOADABLE SOFTWARE FROM FIXED AND MOBILE RADIO-TELEPHONE GLOBAL COMMUNICATION NETWORK, THE INTERNET, OR PRIVATE ACCESS COMMUNICATIONS NETWORKS, INTRANETS, AND BROWSER SOFTWARE, IN CLASS 38 (U.S. CLS. 100, 101 AND 104).

FOR: DESIGN AND DEVELOPMENT OF COMPUTER LANGUAGES, COMPUTER SYSTEMS AND TELECOMMUNICATIONS SYSTEMS FOR OTHERS; ENGINEERING SERVICES FOR APPLICATIONS ON LARGE AND MEDIUM SIZED COMPUTER SYSTEMS; COMPUTER MANAGEMENT SERVICES, NAMELY COMPUTER FACILITIES MANAGEMENT RELATING TO SOFTWARE DESIGN; TECHNICAL SURVEYING, CONSULTING AND ADVICE IN THE FIELDS OF TELECOMMUNICATIONS, INFORMATION TECHNOLOGY AND THE INTERNET; ENGINEERING AND ADMINISTRATION OF TELECOMMUNICATIONS NETWORKS, ELECTRONIC SECURITY CONSULTING SERVICES; SURVEYING FOR THE INSTALLATION OF TELECOMMUNICATION TERMINALS, NATIONAL AND INTERNATIONAL DATABASE SERVERS AND COMPUTER NETWORK ACCESS PROVIDER CENTERS; DESIGNING AND CREATING COMPUTER SOFTWARE, NAMELY NAVIGATION SOFTWARE; COMPUTER PROGRAMMING; SCIENTIFIC AND INDUSTRIAL RESEARCH; UPDATING COMPUTER DATABASES AND SOFTWARE; SOFTWARE MAINTENANCE SERVICES; PROVIDING ACCESS TO GLOBAL COMPUTER

NETWORKS; CREATING VIRTUAL AND INTERACTIVE COMPUTER IMAGES; COMPUTER SERVICES AND ONLINE SERVICES, NAMELY CREATING AND DESIGNING INDEXES OF INFORMATION AND CONTENTS PUBLISHED ON COMPUTER NETWORKS; PROVIDING ACCESS TO USERS OF COMPUTER NETWORKS FOR THE TRANSMISSION AND DISSEMINATION OF INFORMATION; DESIGN, CREATION; HOSTING AND MAINTENANCE OF INTERNET CONTENTS FOR OTHERS; COMPUTER LANGUAGE ENCRYPTION AND CODING SERVICES; INDEXING INTERNET SITES; RESEARCH AND MONITORING OF INTERNET SITES; TECHNICAL CONSULTING IN IMPLEMENTING COMPUTER OR TELECOMMUNICATIONS EQUIPMENT, IN CLASS 42 (U.S. CLS. 100 AND 101).

THE MARK CONSISTS OF STANDARD CHARACTERS WITHOUT CLAIM TO ANY PARTICULAR FONT, STYLE, SIZE, OR COLOR.

PRIORITY DATE OF 11-30-2005 IS CLAIMED.

OWNER OF INTERNATIONAL REGISTRATION 0909907 DATED 5-30-2006, EXPIRES 5-30-2016.

SER. NO. 79-033,376, FILED 5-30-2006.

REGINA DRUMMOND, EXAMINING ATTORNEY

Int. Cl.: 29

Prior U.S. Cl.: 46

United States Patent and Trademark Office

Reg. No. 3,476,770

Registered July 29, 2008

TRADEMARK
PRINCIPAL REGISTER



GIACHI GIOVANNI S.R.L. (ITALY SOCIÉTÉ À
RESPONSABILITÉ LIMITÉE)
VIA CAMPOLI, 31
I-50024 SAN CASCIANO VAL DI PESA (FI), ITALY

FOR: EXTRA VIRGIN OLIVE OIL, IN CLASS 29
(U.S. CL. 46).

OWNER OF INTERNATIONAL REGISTRATION
0909910 DATED 10-19-2006, EXPIRES 10-19-2016.

OWNER OF U.S. REG. NOS. 3,098,377 AND
3,139,242.

NO CLAIM IS MADE TO THE EXCLUSIVE
RIGHT TO USE "OLIO EXTRA VERGINE DI OLI-
VA", "SELEZIONATO E CONFEZIONATO DA GIA-
CHI GIOVANNI S.R.L.", "MERCATALE VAL DI
PESA", "FIRENZE - ITALIA", "NON DISPERDERE
IL VETRO NELL'AMBIENTE", APART FROM THE
MARK AS SHOWN.

THE NAME(S), PORTRAIT(S), AND/OR SIGNA-
TURE(S) SHOWN IN THE MARK DOES NOT IDENT-
IFY A PARTICULAR LIVING INDIVIDUAL.

THE COLOR(S) LIGHT YELLOW, DARK GREEN,
YELLOW, ORANGE, GREEN AND BLACK IS/ARE
CLAIMED AS A FEATURE OF THE MARK.

THE MARK CONSISTS OF A LABEL WITH A
LIGHT YELLOW BACKGROUND WITH A DARK
GREEN AREA CONTAINING THE WORD "GIO-
LIO" IN YELLOW, AN ORANGE STRIP ON WHICH
IS CENTERED THE WORD "GIACHI" IN BLACK
ON A GREEN OLIVE BELOW WHICH ARE OTHER
INSCRIPTIONS IN GREEN.

THE FOREIGN WORDING IN THE MARK
TRANSLATES INTO ENGLISH AS EXTRA VIRGIN
OLIVE OIL; SELECTED AND PACKED BY GIACHI
GIOVANNI; FLORENCE, ITALY; DO NOT DIS-
PERSE THE GLASS INTO THE ATMOSPHERE.
THE WORDING MERCATALE VAL DI PESA IS
THE NAME OF A TOWN IN ITALY AND HAS NO
TRANSLATION INTO ENGLISH.

SER. NO. 79-033,429, FILED 10-19-2006.

STEVEN R. FINE, EXAMINING ATTORNEY

Int. Cls.: 9, 38 and 42

Prior U.S. Cls.: 21, 23, 26, 36, 38, 100, 101 and 104

Reg. No. 3,476,771

United States Patent and Trademark Office

Registered July 29, 2008

**TRADEMARK
SERVICE MARK
PRINCIPAL REGISTER**

FSDL

STG INTERACTIVE (FRANCE CORPORATION)
29, AVENUE MOZART
F-75016 PARIS
FRANCE

FOR: COMPUTER SOFTWARE AND COMPUTER LANGUAGES FOR PROVIDING ELECTRONIC MULTIMEDIA DATA PUBLISHING SYSTEMS AND FOR THE OPERATION OF COMPUTER NETWORKS INTENDED FOR THE PUBLICATION OF CONTENTS ON FIXED AND MOBILE RADIOTELEPHONE GLOBAL COMMUNICATION NETWORK, THE INTERNET, OR PRIVATE ACCESS COMMUNICATIONS NETWORKS, INTRANETS; COMPUTER INTERFACES NAMELY FOR PROVIDING ACCESS TO MULTIMEDIA DATA BANKS; COMPUTER DATABASE SERVERS; CD-ROMS, DIGITAL OPTICAL COMPACT DISCS CONTAINING SOFTWARE TO ACCESS ELECTRONIC MULTIMEDIA DATA PUBLISHING SYSTEM ON COMPUTER NETWORKS; COMPUTER SOFTWARE FOR APPLICATIONS USE IN THE FIELD OF COMPUTER NETWORKS, MANAGEMENT OF COMPUTER SYSTEMS AND THE DESIGN OF SOFTWARE; COMPUTER PROGRAMS, COMPUTER SOFTWARE AND SOFTWARE PACKAGES FOR USE IN REMOTELY CONNECTING COMPUTERS AND COMPUTERS NETWORKS; COMPUTER PROGRAMS FOR USE IN REMOTELY SEARCHING THE CONTENTS OF COMPUTER DATABASE SERVERS AND COMPUTER NETWORKS; NAVIGATION SOFTWARE, NAMELY SOFTWARE ENABLING USERS TO NAVIGATE THROUGH COMPUTER NETWORKS FROM FIXED AND MOBILE RADIOTELEPHONE GLOBAL COMMUNICATION NETWORK, THE INTERNET, OR PRIVATE ACCESS COMMUNICATIONS NETWORKS, INTRANETS, IN CLASS 9 (U.S. CLS. 21, 23, 26, 36 AND 38).

FOR: DATA TRANSMISSION SERVICES, NAMELY HIGH-SPEED TRANSMISSION FOR PUBLIC NETWORK OPERATORS AND COMPANIES; SENDING AND TRANSMITTING DIGITAL FILES VIA ELECTRONIC MULTIMEDIA DATA PUBLISHING SYSTEMS ON FIXED AND MOBILE RADIOTELEPHONE GLOBAL COMMUNICATION NETWORK, THE INTERNET, OR PRIVATE ACCESS COMMUNICATIONS NETWORKS, INTRANETS; TRANSMITTING INFORMATION RELATING TO A DIRECTORY OF INTERNET USERS VIA COMPUTER DATABASE SERVERS CONNECTED TO FIXED AND MOBILE RADIOTELEPHONE GLOBAL COMMUNICATION NETWORK, THE INTERNET, OR PRIVATE ACCESS COMMUNICATIONS NETWORKS, INTRANETS; ELECTRONIC MAIL SERVICES; ELECTRONIC MESSAGING SERVICES; DISSEMINATION OF INFORMATION BY ELECTRONIC MEANS, NAMELY, VIA FIXED AND MOBILE RADIOTELEPHONE GLOBAL COMMUNICATION NETWORK, THE INTERNET, OR PRIVATE ACCESS COMMUNICATIONS NETWORKS, INTRANETS; PROVIDING THE TRANSMISSION AND DISSEMINATION OF DATA, SOUND AND IMAGES VIA MULTIMEDIA DATA PUBLISHING SYSTEMS ON FIXED AND MOBILE RADIOTELEPHONE GLOBAL COMMUNICATION NETWORK, THE INTERNET, OR PRIVATE ACCESS COMMUNICATIONS NETWORKS, INTRANETS; PROVIDING THE SECURE TRANSMISSION OF DATA WITH ACCESS CODE VIA COMPUTER PROGRAMS ON FIXED AND MOBILE RADIOTELEPHONE GLOBAL COMMUNICATION NETWORK, THE INTERNET, OR PRIVATE ACCESS COMMUNICATIONS NETWORKS, INTRANETS; PROVIDING COMMUNICATIONS BY COMPUTER TERMINALS; TELECOMMUNICATIONS SERVICES, NAMELY, PROVIDING DATABASE ACCESS TO GLOBAL COMMUNICATIONS COMPUTER NETWORKS; PROVIDING THE TRANSMISSION

OF MULTIMEDIA DATA VIA DOWNLOADABLE SOFTWARE FROM FIXED AND MOBILE RADIO-TELEPHONE GLOBAL COMMUNICATION NETWORK, THE INTERNET, OR PRIVATE ACCESS COMMUNICATIONS NETWORKS, INTRANETS, AND BROWSER SOFTWARE, IN CLASS 38 (U.S. CLS. 100, 101 AND 104).

FOR: DESIGN AND DEVELOPMENT OF COMPUTER LANGUAGES, COMPUTER SYSTEMS AND TELECOMMUNICATIONS SYSTEMS FOR OTHERS; ENGINEERING SERVICES FOR APPLICATIONS ON LARGE AND MEDIUM SIZED COMPUTER SYSTEMS; COMPUTER MANAGEMENT SERVICES, NAMELY COMPUTER FACILITIES MANAGEMENT RELATING TO SOFTWARE DESIGN; TECHNICAL SURVEYING, CONSULTING AND ADVICE IN THE FIELDS OF TELECOMMUNICATIONS, INFORMATION TECHNOLOGY AND THE INTERNET; ENGINEERING AND ADMINISTRATION OF TELECOMMUNICATIONS NETWORKS, ELECTRONIC SECURITY CONSULTING SERVICES; SURVEYING FOR THE INSTALLATION OF TELECOMMUNICATION TERMINALS, NATIONAL AND INTERNATIONAL DATABASE SERVERS AND COMPUTER NETWORK ACCESS PROVIDER CENTERS; DESIGNING AND CREATING COMPUTER SOFTWARE, NAMELY NAVIGATION SOFTWARE; COMPUTER PROGRAMMING; SCIENTIFIC AND INDUSTRIAL RESEARCH; UPDATING COMPUTER DATABASES AND SOFTWARE; SOFTWARE MAINTENANCE SERVICES; PROVIDING ACCESS TO GLOBAL COMPUTER

NETWORKS; CREATING VIRTUAL AND INTERACTIVE COMPUTER IMAGES; COMPUTER SERVICES AND ONLINE SERVICES, NAMELY CREATING AND DESIGNING INDEXES OF INFORMATION AND CONTENTS PUBLISHED ON COMPUTER NETWORKS; PROVIDING ACCESS TO USERS OF COMPUTER NETWORKS FOR THE TRANSMISSION AND DISSEMINATION OF INFORMATION; DESIGN, CREATION; HOSTING AND MAINTENANCE OF INTERNET CONTENTS FOR OTHERS; COMPUTER LANGUAGE ENCRYPTION AND CODING SERVICES; INDEXING INTERNET SITES; RESEARCH AND MONITORING OF INTERNET SITES; TECHNICAL CONSULTING IN IMPLEMENTING COMPUTER OR TELECOMMUNICATIONS EQUIPMENT, IN CLASS 42 (U.S. CLS. 100 AND 101).

THE MARK CONSISTS OF STANDARD CHARACTERS WITHOUT CLAIM TO ANY PARTICULAR FONT, STYLE, SIZE, OR COLOR.

PRIORITY DATE OF 11-30-2005 IS CLAIMED.

OWNER OF INTERNATIONAL REGISTRATION 0909908 DATED 5-30-2006, EXPIRES 5-30-2016.

SER. NO. 79-033,447, FILED 5-30-2006.

REGINA DRUMMOND, EXAMINING ATTORNEY

Int. Cl.: 10

Prior U.S. Cls.: 26, 39 and 44

United States Patent and Trademark Office

Reg. No. 3,476,772

Registered July 29, 2008

TRADEMARK
PRINCIPAL REGISTER



REWALL PTY LTD (AUSTRALIA PRIVATE LIMITED COMPANY)
5 TWIN OAKS PLACE
VARSITY LAKES QLD 4227
AUSTRALIA

FOR: SURGICAL, MEDICAL, DENTAL AND VETERINARY APPARATUS AND INSTRUMENTS, NAMELY, SYRINGES, CANNULAS, NEEDLES FOR INJECTIONS, NEEDLE-LESS INJECTION SYSTEMS, INFUSION DEVICES FOR ADMINISTERING DRUGS, AND INFUSION SETS, IN CLASS 10 (U.S. CLS. 26, 39 AND 44).

PRIORITY DATE OF 6-13-2006 IS CLAIMED.

OWNER OF INTERNATIONAL REGISTRATION 0911931 DATED 12-11-2006, EXPIRES 12-11-2016.

NO CLAIM IS MADE TO THE EXCLUSIVE RIGHT TO USE "CLIP", APART FROM THE MARK AS SHOWN.

THE COLOR(S) RED, WHITE, BLUE AND BLACK IS/ARE CLAIMED AS A FEATURE OF THE MARK.

THE COLOR BLUE APPEARS IN THE SYRINGE DESIGN AND IN THE WORDING "DOUBLE CHECK... AND BE." THE COLOR RED APPEARS IN THE CHECKMARK, IN THE WORD "SURE" AND IN THE OVAL. THE COLOR WHITE APPEARS IN THE WORD "CHECK" ON THE SYRINGE AND IN THE SYRINGE AROUND THE WORD "CLIP". THE COLOR BLACK APPEARS IN THE WORD "CLIP."

SER. NO. 79-034,070, FILED 12-11-2006.

LINDA LAVACHE, EXAMINING ATTORNEY

Int. Cls.: 3 and 5

Prior U.S. Cls.: 1, 4, 6, 18, 44, 46, 50, 51 and 52

United States Patent and Trademark Office

Reg. No. 3,476,773

Registered July 29, 2008

**TRADEMARK
PRINCIPAL REGISTER**

MEXIDOL

OBSHCHESTVO S OGRANICHENNOY; OT-
VETSTVENNOSTYU; "NAUCHNO-PROIZ-
VODSTVENNAYA KOMPANIYA;
"FARMASOFT" (RUSSIAN FED. LTD LIAB
CO)

22, UL. AVTOZAVODSKAYA
RU-115280 MOSCOW
RUSSIAN FED.

FOR: PERFUMERY; COSMETICS; COSMETIC
CREAMS; CREAMS FOR LEATHER; WAXES FOR
LEATHER; HAIR LOTIONS; LOTIONS FOR COS-
METIC PURPOSES, NAMELY, SKIN AND BODY
TOPICAL LOTIONS FOR COSMETIC USE; BEAUTY
MASKS; LIPSTICKS; POMADES FOR COSMETIC
PURPOSES; SHAVING PREPARATIONS; COSMET-
IC PREPARATIONS FOR BATHS; NON-MEDICA-
TED TOILETRIES; COSMETIC PREPARATIONS
FOR SKIN CARE; SHAMPOOS; NON-MEDICATED
SHAMPOOS FOR PETS, IN CLASS 3 (U.S. CLS. 1, 4, 6,
50, 51 AND 52).

FOR: PHARMACEUTICAL PREPARATIONS, EX-
CEPT THE PHARMACEUTICAL PREPARATIONS
FOR ORAL AND DENTAL CARE, FOR USE IN
COMPLEX THERAPY FOR THE TREATMENT OF
CERVICAL CARCINOMA IN ONCOGYNECOLOGI-
CAL PATIENTS AND FOR THE TREATMENT OF
BRACHIOPLEXOPATHY IN BREAST CANCER PA-
TIENTS, IN CLASS 5 (U.S. CLS. 6, 18, 44, 46, 51 AND
52).

THE MARK CONSISTS OF STANDARD CHAR-
ACTERS WITHOUT CLAIM TO ANY PARTICULAR
FONT, STYLE, SIZE, OR COLOR.

OWNER OF INTERNATIONAL REGISTRATION
0912149 DATED 8-11-2006, EXPIRES 8-11-2016.

SER. NO. 79-034,134, FILED 8-11-2006.

MARY MUNSON, EXAMINING ATTORNEY

Int. Cls.: 1, 9 and 19

Prior U.S. Cls.: 1, 5, 6, 10, 12, 21, 23, 26, 33, 36, 38, 46
and 50

Reg. No. 3,476,774

United States Patent and Trademark Office

Registered July 29, 2008

TRADEMARK
PRINCIPAL REGISTER

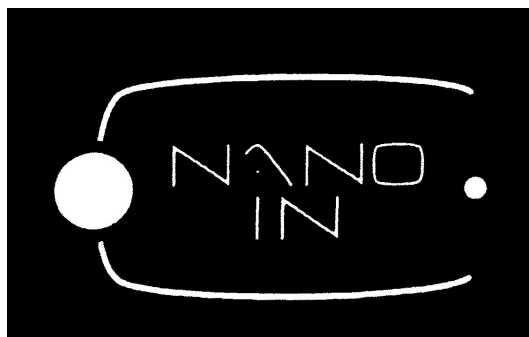

NANOEDGE (S.A.) (FRANCE SOCIÉTÉ ANON-
YME À DIRECTOIRE)
AVENUE DE L'EUROPE
F-34830 CLAPIERS
FRANCE

FOR: CHEMICAL PRODUCTS FOR USE IN IN-
DUSTRY AND SCIENCE; CARBON NANOTUBES
FOR USE BY THIRD PARTY MANUFACTURERS;
UNPROCESSED ARTIFICIAL RESINS; UNPROCES-
SED PLASTICS IN ALL FORMS; ADHESIVES FOR
INDUSTRIAL PURPOSES, NAMELY, GLUES; CAR-
BON CHEMICALS, FIBER COMPOSITES, AND
POLYMER COMPOSITIONS FOR GENERAL IN-
DUSTRIAL USE IN THE FURTHER MANUFAC-
TURE BY THIRD PARTIES OF A WIDE VARIETY
OF GOODS, IN CLASS 1 (U.S. CLS. 1, 5, 6, 10, 26 AND
46).

FOR: GLASS COVERED WITH ELECTRICAL
CONDUCTORS NOT USED AS BUILDING MATE-
RIALS; CAPACITORS; ELECTRICAL CONDUCT-
TORS; ELECTRICAL CONTACTORS; PRINTED
CIRCUITS; PHOTOVOLTAIC CELLS; CAPILLARY

TUBES FOR NON-MEDICAL PURPOSES; ELEC-
TRIC BATTERIES; ELECTRIC CELLS; SOLAR
CELLS; VIDEO SCREENS, IN CLASS 9 (U.S. CLS.
21, 23, 26, 36 AND 38).

FOR: CONCRETE; CEMENT MIXES, IN CLASS 19
(U.S. CLS. 1, 12, 33 AND 50).

PRIORITY DATE OF 8-24-2006 IS CLAIMED.

OWNER OF INTERNATIONAL REGISTRATION
0912362 DATED 10-23-2006, EXPIRES 10-23-2016.

NO CLAIM IS MADE TO THE EXCLUSIVE
RIGHT TO USE "NANO", APART FROM THE
MARK AS SHOWN.

SER. NO. 79-034,204, FILED 10-23-2006.

CORY BOONE, EXAMINING ATTORNEY

Int. Cl.: 30

Prior U.S. Cl.: 46

United States Patent and Trademark Office

Reg. No. 3,476,775

Registered July 29, 2008

TRADEMARK
PRINCIPAL REGISTER



OPEN-TYPE JOINT STOCK COMPANY; "CONFECTIONARY CONCERN BABAYEVSKY" (RUSSIAN FED. OPEN-TYPE JOINT STOCK COMPANY)

UL. MALAYA KRASNOSELSKAYA 7
RU-107140 MOSCOW
RUSSIAN FED.

FOR: WAFFLES; CANDY FOR DECORATING CHRISTMAS TREES; CAKES; PASTRIES; PEANUT BRITTLE; ALMOND CAKE; PASTY; COCOA; COCOA PRODUCTS, NAMELY, COCOA MIXES, CANDY WITH COCOA; CARAMELS; SWEETMEATS; LIQUORICES; PEPPERMINT CANDY; COFFEE; CRACKERS; CANDY FOR FOOD; FRUIT JELLIES MARZIPAN; CUSTARD; HONEY; ICE-CREAM; SHERBETS; CANDY MINTS; COCOA AND COFFEE BEVERAGES WITH MILK; COFFEE-BASED BEVERAGES; TEA-BASED BEVERAGES; CHOCOLATE BEVERAGES WITH MILK; CHOCOLATE FOOD BEVERAGES NOT BEING DAIRY-BASED OR VEGETABLE-BASED; COCOA-BASED BEVERAGES; NON-MEDICATED LOZENGES; PETITS FOURS; BISCUITS; FONDANTS; PRALINES; GINGERBREAD; CHEWING GUM NOT FOR MEDICAL PURPOSES SUGAR; CAKE PASTE; CONFECTIONERY, NAMELY, BONBONS, CANDY BARS, CHOCOLATE, CHOCOLATE BARS, CHOCOLATE CANDIES, CHOCOLATE TRUFFLES, FILLED CHOCOLATE, MILK CHOCOLATE, TOFFEE, MARSHMALLOW, COOKIES, CRACKERS, SPICE-CAKES, RUSKS; ALMOND PASTE; TARTS; EDIBLE DECORATIONS FOR CAKES; HALVAH; TEA, IN CLASS 30 (U.S. CL. 46).

OWNER OF INTERNATIONAL REGISTRATION 0913471 DATED 11-22-2006, EXPIRES 11-22-2016.

OWNER OF U.S. REG. NO. 3,093,376.

NO CLAIM IS MADE TO THE EXCLUSIVE RIGHT TO USE "1804", APART FROM THE MARK AS SHOWN.

THE COLOR(S) BROWN AND WHITE IS/ARE CLAIMED AS A FEATURE OF THE MARK.

THE COLOR BROWN IS IN THE RIBBON, IN THE NUMBER "1804" AND THE HYPHENS NEAR THAT NUMBER, IN THE BUILDING AND IN THE CONTOURS AROUND THE OVAL; THE COLOR WHITE IS IN THE CONTOURS OF THE RIBBON, IN THE NON-LATIN WORDING, IN THE BUILDING AND IN THE OVAL.

THE TRANSLITERATION OF THE NON-LATIN CHARACTERS IN THE MARK IS "BABAYEVSKY", AND THIS HAS NO MEANING IN A FOREIGN LANGUAGE.

SER. NO. 79-034,567, FILED 11-22-2006.

STEVEN R. FINE, EXAMINING ATTORNEY

Int. Cls.: 11, 17 and 19

Prior U.S. Cls.: 1, 5, 12, 13, 21, 23, 31, 33, 34, 35 and 50

United States Patent and Trademark Office

Reg. No. 3,476,776

Registered July 29, 2008

**TRADEMARK
PRINCIPAL REGISTER**

NUPI

NUPI S.P.A. (ITALY JOINT STOCK COMPANY)
VIA COLOMBAROTTO, 58
I-40026 IMOLA (BOLOGNA)
ITALY

FOR: FACILITIES FOR THE TRANSPORTING AND TRANSFER OF FUEL AND WATER, BEING PART OF A FUEL AND WATER TREATMENT INSTALLATION, IN CLASS 11 (U.S. CLS. 13, 21, 23, 31 AND 34).

FOR: FLEXIBLE PIPES NOT OF METAL; NON-METAL PIPE COUPLINGS AND JOINTS; JUNCTIONS NOT OF METAL FOR PIPES FOR USE IN GAS, WATER, AND FUEL DISTRIBUTION PLANTS, IN CLASS 17 (U.S. CLS. 1, 5, 12, 13, 35 AND 50).

FOR: RIGID PIPES NOT OF METAL; POLYETHYLENE PIPES FOR USE IN GAS, WATER, AND FUEL

DISTRIBUTION PLANTS, IN CLASS 19 (U.S. CLS. 1, 12, 33 AND 50).

THE MARK CONSISTS OF STANDARD CHARACTERS WITHOUT CLAIM TO ANY PARTICULAR FONT, STYLE, SIZE, OR COLOR.

OWNER OF INTERNATIONAL REGISTRATION 0913581 DATED 11-22-2006, EXPIRES 11-22-2016.

THE WORDING "NUPI" HAS NO MEANING IN ENGLISH.

SER. NO. 79-034,602, FILED 11-22-2006.

STEVEN R. FINE, EXAMINING ATTORNEY

Int. Cls.: 1 and 40

Prior U.S. Cls.: 1, 5, 6, 10, 26, 46, 100, 103 and 106

United States Patent and Trademark Office

Reg. No. 3,476,777

Registered July 29, 2008

**TRADEMARK
SERVICE MARK
PRINCIPAL REGISTER**

TAILORMAT

SCF TECHNOLOGIES A/S
SMEDEHOLM 13 B
DK-2730 HERLEV
DENMARK

FOR: NANO STRUCTURED INORGANIC AND CHEMICAL MATERIALS, NAMELY, CERAMICS AND ELECTROCERAMICS IN THE FORM OF POWDERS, LIQUIDS, PASTES AND GRANULES USED IN MANUFACTURING METAL AND SEMI METAL OXIDES, METAL AND SEMI METAL HYDROXIDES, METAL AND SEMIMETAL OXYHYDROXIDES, FROM THE ELEMENTS TITANIUM, ZIRCONIUM, ALUMINUM, SILICON, ZINC, TIN, CERIUM, BARIUM, STRONTIUM, IRON, NICKEL COBALT, YTTRIUM, GOLD, SILVER, PLATINUM AND MIXTURES THEREOF, CHEMICAL AGENTS FOR CHELATING AND SEQUESTERING, INORGANIC POLYMERIC COMPOSITIONS FOR INDUSTRIAL METAL SUBSTRATES, IN CLASS 1 (U.S. CLS. 1, 5, 6, 10, 26 AND 46).

FOR: HIGH PRESSURE TECHNOLOGICAL PREPARATION AND TREATMENT OF MATERIALS, NAMELY, HEAT TREATMENT SERVICES, EXTRACTION SERVICES AND COATING SERVICES OF WOOD, INDUSTRIAL METAL SUBSTRATES AND INDUSTRIAL POLYMER SUBSTRATES, IN CLASS 40 (U.S. CLS. 100, 103 AND 106).

THE MARK CONSISTS OF STANDARD CHARACTERS WITHOUT CLAIM TO ANY PARTICULAR FONT, STYLE, SIZE, OR COLOR.

PRIORITY DATE OF 6-13-2006 IS CLAIMED.

OWNER OF INTERNATIONAL REGISTRATION 0914052 DATED 12-13-2006, EXPIRES 12-13-2016.

SER. NO. 79-034,728, FILED 12-13-2006.

EMILY CARLSEN, EXAMINING ATTORNEY

Int. Cl.: 3

Prior U.S. Cls.: 1, 4, 6, 50, 51 and 52

United States Patent and Trademark Office

Reg. No. 3,476,778

Registered July 29, 2008

**TRADEMARK
PRINCIPAL REGISTER**

BYPHASSE



SOIN & COSMETIQUE

PARIS - BARCELONE

PETITOT, DIDIER (FRANCE INDIVIDUAL)
CALLE PINTOR FORTUNY, 18
BARCELONA, SPAIN E08001

FOR: SOAPS, NAMELY, BATH SOAPS, HAND SOAPS, AND FACE AND BODY SKIN SOAPS, PERFUMERY, ESSENTIAL OILS, COSMETICS, HAIR LOTIONS, DENTIFRICES, IN CLASS 3 (U.S. CLS. 1, 4, 6, 50, 51 AND 52).

OWNER OF INTERNATIONAL REGISTRATION
0914749 DATED 12-21-2006, EXPIRES 12-21-2016.

NO CLAIM IS MADE TO THE EXCLUSIVE RIGHT TO USE "SOIN, COSMETIQUE, PARIS, BARCELONE", APART FROM THE MARK AS SHOWN.

THE COLOR(S) GREY AND PINK IS/ARE CLAIMED AS A FEATURE OF THE MARK.

UNDER THE TERM "BYPHASSE" ARE DRAWN TWO WAVES.

THE MARK CONSISTS OF THE WORD "BY-PHASSE" IN GREY OVER A GREY WAVY BAND AND A PINK WAVY BAND, OVER THE WORDS "SOIN & COSMETIQUE IN" GREY, OVER A GREY HORIZONTAL BAR, AND OVER THE WORDS "PARIS - BARCELONE" IN GREY.

THE FOREIGN WORDING IN THE MARK TRANSLATES INTO ENGLISH AS "CARE & COSMETIC".

SER. NO. 79-034,962, FILED 12-21-2006.

MICHAEL LITZAU, EXAMINING ATTORNEY

Int. Cl.: 14

Prior U.S. Cls.: 2, 27, 28 and 50

United States Patent and Trademark Office

Reg. No. 3,476,779

Registered July 29, 2008

**TRADEMARK
PRINCIPAL REGISTER**

OPEN EYES

MAG. WOLFRAM KURZWEIL (AUSTRIA INDIVIDUAL)
OTHMARGASSE 25/76
A-1200 WIEN
AUSTRIA

FOR: JEWELRY AND PRECIOUS STONES
AVAILABLE IN JEWELRY STORES, IN CLASS 14
(U.S. CLS. 2, 27, 28 AND 50).

THE MARK CONSISTS OF STANDARD CHARACTERS WITHOUT CLAIM TO ANY PARTICULAR FONT, STYLE, SIZE, OR COLOR.

PRIORITY DATE OF 6-16-2006 IS CLAIMED.

OWNER OF INTERNATIONAL REGISTRATION
0916159 DATED 11-30-2006, EXPIRES 11-30-2016.

SER. NO. 79-035,458, FILED 11-30-2006.

KATHERINE E. HALMEN, EXAMINING ATTORNEY

Int. Cls.: 3, 9, 14, 18, 24 and 25

Prior U.S. Cls.: 1, 2, 3, 4, 6, 21, 22, 23, 26, 27, 28, 36, 38, 39, 41, 42, 50, 51 and 52

Reg. No. 3,476,780

United States Patent and Trademark Office

Registered July 29, 2008

**TRADEMARK
PRINCIPAL REGISTER**

DB9

MODA TRADING SRL (ITALY LTD LIAB CO)
VIA MONTE CRISTALLO, 26
I-63039 SAN BENEDETTO DEL TRONTO (AP)
ITALY

FOR: SOAPS, NAMELY, SKIN SOAP, PERFUMED SOAP, HAND SOAP, DETERGENT; PERFUMERY; ESSENTIAL OILS; COSMETICS; HAIR LOTIONS, DENTIFRICES, IN CLASS 3 (U.S. CLS. 1, 4, 6, 50, 51 AND 52).

FOR: GLASSES, NAMELY, READING, OPTICAL, CORRECTIVE; FRAMES FOR GLASSES; SUNGLASSES, CASES FOR SPECTACLES AND SUNGLASSES, CHAINS FOR EYEGASSES, STRINGS FOR GLASSES, IN CLASS 9 (U.S. CLS. 21, 23, 26, 36 AND 38).

FOR: PRECIOUS METALS AND THEIR ALLOYS AND GOODS IN PRECIOUS METALS OR COATED THEREWITH, NOT INCLUDED IN OTHER CLASSES, NAMELY, GOLD INGOTS, STATUES; JEWELRY, PRECIOUS STONES; HOROLOGICAL AND CHRONOMETRIC INSTRUMENTS, IN CLASS 14 (U.S. CLS. 2, 27, 28 AND 50).

FOR: LEATHER AND IMITATION OF LEATHER; TRUNKS AND SUITCASES, UMBRELLAS, BEACH UMBRELLAS, WALKING STICKS, HAVERSACK; BAGS, NAMELY, SPORT AND TRAVELLING BAGS; GARMENT BAGS FOR TRAVEL; BRIEFCASES, PURSES, WALLETS, WALLETS FOR KEEPING CREDIT CARDS; NAME CARD CASES; KEY CASES, SHOULDER BAGS, CARRY-ON BAGS, TOTE BAGS, HAND BAGS, LEATHER LEASHES FOR ANIMALS, SACHEL BAGS; BEAUTY CASES SOLD EMPTY; WAIST BAGS, IN CLASS 18 (U.S. CLS. 1, 2, 3, 22 AND 41).

FOR: TEXTILES AND TEXTILE GOODS, NAMELY, NAPKINS, TABLECLOTHS, HAND TOWELS; PAPER BED COVERS; TABLE COVERS, NAMELY,

TABLE LINEN, TABLE CLOTHS, IN CLASS 24 (U.S. CLS. 42 AND 50).

FOR: CLOTHING ITEMS, NAMELY, SWEATERS, CARDIGANS, SLIPOVER TOPS, SUITS, TROUSERS, SHORTS, JUMPERS, RAINCOATS, SUITS AND DRESSES MADE OF LEATHER, STOCKINGS AND SOCKS, GARTER BELTS; OUTWEARS, NAMELY, WIND-RESISTANT JACKETS, SKI TROUSERS, FUR COATS, OVERCOATS, JACKETS, SKIRTS, DRESSES, JACKETS, UNDERSHIRTS, POLO SHIRTS, SPORT T-SHIRTS, BLOUSES, COLLARS FOR SHIRTS, SHIRTS, FOULARDS, BEACHWEAR, SWIMSUITS, BIKINIS, TRACKSUITS, UNDERWEAR, BRAS, BRASSIERES, CORSETS, FOUNDATION SLIPS, BRIEFS AND BIKINI BRIEFS, VESTS, NIGHTGOWNS, NEGLIGEEES, PAJAMAS, GLOVES, SHAWLS, SCARVES, NECKTIES, BOW TIES, BELTS CLOTHING, HATS AND CAPS, SHOES, BOOTS, LACED BOOTS, LEATHER SHOES, RUBBER SHOES, RAINSHOES, SPORT SHOES, NAMELY, SOCCER SHOES, TENNIS SHOES, FOOTBALL SHOES, SANDALS, SLIPPERS, SHOE SOLES, SHOE HEELS, MOULDED BOTTOMS FOR SHOES BEING SHOE SOLES, IN CLASS 25 (U.S. CLS. 22 AND 39).

THE MARK CONSISTS OF STANDARD CHARACTERS WITHOUT CLAIM TO ANY PARTICULAR FONT, STYLE, SIZE, OR COLOR.

PRIORITY DATE OF 7-6-2006 IS CLAIMED.

OWNER OF INTERNATIONAL REGISTRATION 0916451 DATED 9-27-2006, EXPIRES 9-27-2016.

SER. NO. 79-035,564, FILED 9-27-2006.

BERNICE MIDDLETON, EXAMINING ATTORNEY

Int. Cls.: 7, 9 and 40

**Prior U.S. Cls.: 13, 19, 21, 23, 26, 31, 34, 35, 36, 38,
100, 103 and 106**

Reg. No. 3,476,781

United States Patent and Trademark Office

Registered July 29, 2008

**TRADEMARK
SERVICE MARK
PRINCIPAL REGISTER**



AMMANN SCHWEIZ AG (SWITZERLAND SOCI-
ÉTÉ ANONYME)
EISENBAHNSTRASSE 25
CH-4901 LANGENTHAL
SWITZERLAND

FOR: NON-MEDICAL MACHINES FOR SEPARATING AND FOR GRINDING OF INSULATING MATERIALS INCLUDING MINERAL MATERIALS; NON-MEDICAL MACHINES FOR THE GENERATING OF ELECTRICAL PULSES FOR SEPARATING AND FOR GRINDING OF INSULATING MATERIALS INCLUDING MINERAL MATERIALS, IN CLASS 7 (U.S. CLS. 13, 19, 21, 23, 31, 34 AND 35).

FOR: LABORATORY APPARATUS AND INSTRUMENTS FOR THE SCIENTIFIC SEPARATING AND FOR GRINDING OF INSULATING MATERIALS AND FOR THE ANALYSIS OF INSULATING MATERIALS; LABORATORY APPARATUS AND INSTRUMENTS FOR THE GENERATING OF ELECTRICAL PULSES FOR THE SCIENTIFIC SEPARAT-

ING AND FOR GRINDING OF INSULATING MATERIALS INCLUDING MINERAL MATERIALS, IN CLASS 9 (U.S. CLS. 21, 23, 26, 36 AND 38).

FOR: MILLING OF INSULATING MATERIALS, NAMELY, SEPARATING INSULATING MATERIALS AND GRINDING INSULATING MATERIAL BY USING ELECTRICITY, IN CLASS 40 (U.S. CLS. 100, 103 AND 106).

PRIORITY DATE OF 3-31-2006 IS CLAIMED.

OWNER OF INTERNATIONAL REGISTRATION 0917281 DATED 9-19-2006, EXPIRES 9-19-2016.

SER. NO. 79-035,888, FILED 9-19-2006.

DAVID TOOLEY, EXAMINING ATTORNEY

Int. Cls.: 7, 9 and 40

**Prior U.S. Cls.: 13, 19, 21, 23, 26, 31, 34, 35, 36, 38,
100, 103 and 106**

Reg. No. 3,476,782

United States Patent and Trademark Office

Registered July 29, 2008

**TRADEMARK
SERVICE MARK
PRINCIPAL REGISTER**

selfrag

AMMANN SCHWEIZ AG (SWITZERLAND SOCI-
ÉTÉ ANONYME)
EISENBAHNSTRASSE 25
CH-4901 LANGENTHAL
SWITZERLAND

FOR: NON-MEDICAL MACHINES FOR SEPAR-
ATING AND FOR GRINDING OF INSULATING
MATERIALS INCLUDING MINERAL MATERIALS;
NON-MEDICAL MACHINES FOR THE GENERAT-
ING OF ELECTRICAL PULSES FOR SEPARATING
AND FOR GRINDING OF INSULATING MATERI-
ALS INCLUDING MINERAL MATERIALS, IN
CLASS 7 (U.S. CLS. 13, 19, 21, 23, 31, 34 AND 35).

FOR: LABORATORY APPARATUS AND IN-
STRUMENTS FOR THE SCIENTIFIC SEPARATING
AND FOR GRINDING OF INSULATING MATERI-
ALS AND FOR THE ANALYSIS OF INSULATING
MATERIALS; LABORATORY APPARATUS AND
INSTRUMENTS FOR THE GENERATING OF ELEC-
TRICAL PULSES FOR THE SCIENTIFIC SEPARAT-
ING AND FOR GRINDING OF INSULATING

MATERIALS INCLUDING MINERAL MATERIALS,
IN CLASS 9 (U.S. CLS. 21, 23, 26, 36 AND 38).

FOR: MILLING OF INSULATING MATERIALS,
NAMELY, SEPARATING INSULATING MATERI-
ALS AND GRINDING INSULATING MATERIAL
BY USING ELECTRICITY, IN CLASS 40 (U.S. CLS.
100, 103 AND 106).

THE MARK CONSISTS OF STANDARD CHAR-
ACTERS WITHOUT CLAIM TO ANY PARTICULAR
FONT, STYLE, SIZE, OR COLOR.

PRIORITY DATE OF 3-31-2006 IS CLAIMED.

OWNER OF INTERNATIONAL REGISTRATION
0917282 DATED 9-19-2006, EXPIRES 9-19-2016.

SER. NO. 79-035,889, FILED 9-19-2006.

DAVID TOOLEY, EXAMINING ATTORNEY

Int. Cls.: 1 and 2

Prior U.S. Cls.: 1, 5, 6, 10, 11, 16, 26 and 46

United States Patent and Trademark Office

Reg. No. 3,476,783

Registered July 29, 2008

**TRADEMARK
PRINCIPAL REGISTER**

LUMISIL

WACKER CHEMIE AG (FED REP GERMANY
STOCK CORPORATION)
HANNS-SEIDEL-PLATZ 4
81737 MÜNCHEN, FED REP GERMANY

FOR: CHEMICALS USED IN INDUSTRY AND SCIENCE; UNPROCESSED PLASTICS; CHEMICAL COMPOUNDS THAT CROSSLINK TO FORM PLASTICS; ADDITIVES AND CATALYSTS USED IN PLASTICS PRODUCTION; SILANES; SILICONE FLUIDS AND SOLIDS; SILICONE ELASTOMERS, CHEMICAL COMPOUNDS THAT CROSSLINK TO FORM SILICONE ELASTOMERS; PLASTIC MOULDING COMPOUNDS FOR USE IN PLASTIC EXTRUSION OPERATIONS AND MANUFACTURE OF MOULDED PLASTIC ARTICLES; UNPROCESSED THERMOPLASTIC SYNTHETIC RESINS, IN CLASS 1 (U.S. CLS. 1, 5, 6, 10, 26 AND 46).

FOR: PAINTS, VARNISHES, LACQUERS; LACQUERS FOR COATING ELECTRICAL AND ELEC-

TRONIC PARTS AND COMPONENTS; AND BINDING AGENTS FOR PAINTS AND LACQUERS, IN CLASS 2 (U.S. CLS. 6, 11 AND 16).

THE MARK CONSISTS OF STANDARD CHARACTERS WITHOUT CLAIM TO ANY PARTICULAR FONT, STYLE, SIZE, OR COLOR.

PRIORITY DATE OF 8-25-2006 IS CLAIMED.

OWNER OF INTERNATIONAL REGISTRATION 0917391 DATED 1-16-2007, EXPIRES 1-16-2017.

SER. NO. 79-035,944, FILED 1-16-2007.

KATHERINE CHANG, EXAMINING ATTORNEY

Int. Cl.: 9

Prior U.S. Cls.: 21, 23, 26, 36 and 38

Reg. No. 3,476,784

United States Patent and Trademark Office

Registered July 29, 2008

**TRADEMARK
PRINCIPAL REGISTER**

MAXSEA EASY

MAXSEA INTERNATIONAL (FRANCE SOCIÉTÉ
PAR ACTIONS SIMPLIFIÉE)
TECHNOPOLE IZARBEL
F-64210 BIDART, FRANCE

OWNER OF INTERNATIONAL REGISTRATION
0917472 DATED 3-2-2007, EXPIRES 3-2-2017.

FOR: COMPUTER SOFTWARE FOR USE IN
NAVIGATION OF BOATS AND VESSELS, IN CLASS
9 (U.S. CLS. 21, 23, 26, 36 AND 38).

OWNER OF U.S. REG. NO. 2,174,385.

THE MARK CONSISTS OF STANDARD CHAR-
ACTERS WITHOUT CLAIM TO ANY PARTICULAR
FONT, STYLE, SIZE, OR COLOR.

SER. NO. 79-035,985, FILED 3-2-2007.

PRIORITY DATE OF 9-28-2006 IS CLAIMED.

KRISTINA MORRIS, EXAMINING ATTORNEY

Int. Cl.: 35

Prior U.S. Cls.: 100, 101 and 102

United States Patent and Trademark Office

Reg. No. 3,476,785

Registered July 29, 2008

**SERVICE MARK
PRINCIPAL REGISTER**

ELENA MIRO'

MIROGLIO S.P.A. (ITALY SOCIÉTÉ PAR AC-
TIONS)

STRADA S. MARGHERITA, 23

I-12051 ALBA (CN)

ITALY

FOR: RETAIL STORE SERVICES FOR CLOTH-
ING, FOOTWEAR, BAGS, GOODS OF LEATHER,
FASHION ACCESSORIES, PERFUMERY, COSMET-
ICS, SPECTACLES, WATCHES, SUNGLASSES, JEW-
ELLERY; DISTRIBUTORSHIP SERVICES IN THE
FIELD OF CLOTHING, FOOTWEAR, BAGS, GOODS
OF LEATHER, FASHION ACCESSORIES, PERFUM-
ERY, COSMETICS, SPECTACLES, WATCHES, SUN-
GLASSES, JEWELLERY, IN CLASS 35 (U.S. CLS. 100,
101 AND 102).

THE MARK CONSISTS OF STANDARD CHAR-
ACTERS WITHOUT CLAIM TO ANY PARTICULAR
FONT, STYLE, SIZE, OR COLOR.

OWNER OF INTERNATIONAL REGISTRATION
0907204 DATED 11-20-2006, EXPIRES 11-20-2016.

OWNER OF U.S. REG. NOS. 1,610,607 AND
2,822,084.

THE NAME(S), PORTRAIT(S), AND/OR SIGNA-
TURE(S) SHOWN IN THE MARK DOES NOT IDENT-
IFY A PARTICULAR LIVING INDIVIDUAL.

SER. NO. 79-036,006, FILED 1-24-2007.

FRANK LATTUCA, EXAMINING ATTORNEY

Int. Cl.: 11

Prior U.S. Cls.: 13, 21, 23, 31 and 34

United States Patent and Trademark Office

Reg. No. 3,476,786

Registered July 29, 2008

**TRADEMARK
PRINCIPAL REGISTER**

SIDEWAY

HANSGROHE AG (FED REP GERMANY COR-
PORATION)
AUESTR. 5-9
77761 SCHILTACH
FED REP GERMANY

FOR: PRE-ASSEMBLED MULTIFUNCTION
SHOWERS AND COMPONENTS THEREOF, NAME-
LY, SHOWER PANELS, OVERHEAD SHOWERS,
LATERAL SHOWERS, BODY SHOWERS, HAND
SHOWERS, MIXING VALVES, DIVERTER VALVES,

STOP VALVES AND MIXING TAPS FOR SHOWERS,
IN CLASS 11 (U.S. CLS. 13, 21, 23, 31 AND 34).

OWNER OF INTERNATIONAL REGISTRATION
0918149 DATED 1-3-2007, EXPIRES 1-3-2017.

SER. NO. 79-036,254, FILED 1-3-2007.

MARILYN IZZI, EXAMINING ATTORNEY

Int. Cls.: 1, 5, 9, 10, 42 and 44

**Prior U.S. Cls.: 1, 5, 6, 10, 18, 21, 23, 26, 36, 38, 39, 44,
46, 51, 52, 100 and 101**

Reg. No. 3,476,787

United States Patent and Trademark Office

Registered July 29, 2008

**TRADEMARK
SERVICE MARK
PRINCIPAL REGISTER**

Cervidx

MTM LABORATORIES AG (FED REP GERMA-
NY AKTIENGESELLSCHAFT (GERMAN
STOCK CORPORATION))
IM NEUENHEIMER FELD 583
69120 HEIDELBERG
FED REP GERMANY

FOR: CHEMICAL PREPARATIONS AND RE-
AGENTS FOR DETECTION OF CANCEROUS CON-
DITIONS, NEOPLASTIC CONDITIONS,
INFLAMMATORY CONDITIONS, INFECTIOUS
CONDITIONS, DEGENERATIVE CONDITIONS, GE-
NETICALLY ABERRANT OR DISEASED CONDI-
TIONS, PROLIFERATIVELY ABERRANT OR
DISEASED CONDITIONS, VASCULAR DISEASE
CONDITIONS, PREMALIGNANT CANCEROUS
CONDITIONS, MALIGNANT CANCEROUS CONDI-
TIONS, CANCER AND INBORN DEFICIENCIES
FOR SCIENTIFIC OR RESEARCH USE, IN CLASS 1
(U.S. CLS. 1, 5, 6, 10, 26 AND 46).

FOR: PHARMACEUTICAL PREPARATIONS FOR
THE TREATMENT AND PREVENTION OF NEO-
PLASTIC, INFLAMMATORY, INFECTIOUS, DE-
GENERATIVE, GENETIC, PROLIFERATIVE AND
VASCULAR DISEASES AND FOR THE TREAT-
MENT OF PREMALIGNANT AND MALIGNANT
CANCEROUS CONDITIONS, CANCER AND IN-
BORN DEFICIENCIES; VETERINARY PREPARA-
TIONS FOR THE TREATMENT AND PREVENTION
OF NEOPLASTIC, INFLAMMATORY, INFEC-
TIOUS, DEGENERATIVE, GENETIC AND PROLI-
FERATIVE AND VASCULAR DISEASES AND FOR
THE TREATMENT OF PREMALIGNANT AND MA-
LIGNANT CANCEROUS, CONDITIONS, CANCER
AND INBORN DEFICIENCIES IN LIVESTOCK,
CATTLE, PIGS, HORSES, DEER, ELK, MOOSE,
SHEEP, DOGS, CATS, MICE, RATS, MONKEYS,
APES AND BIRDS; MEDICAL DIAGNOSTIC RE-
AGENTS FOR DETECTION OF NEOPLASTIC, IN-

FLAMMATORY, INFECTIOUS, DEGENERATIVE,
GENETIC, PROLIFERATIVE AND VASCULAR DIS-
EASES AND FOR THE DETECTION OF PREMA-
LIGNANT AND MALIGNANT CANCEROUS
CONDITIONS, CANCER AND INBORN DEFICIEN-
CIES; MEDICAL DIAGNOSTIC PREPARATIONS,
NAMELY, IN-VITRO AND IN-VIVO DIAGNOSTIC
PREPARATIONS, DIAGNOSTIC IMMUNOCYTO-
CHEMICAL PREPARATIONS, DIAGNOSTIC IM-
MUNOHISTOCHEMICAL PREPARATIONS,
DIAGNOSTIC HISTOLOGY PREPARATIONS, DI-
AGNOSTIC CYTOLOGY PREPARATIONS, DIAG-
NOSTIC LIQUID-IMMUNO-ASSAY
PREPARATIONS, DIAGNOSTIC SOLID-PHASE IM-
MUNO-ASSAY PREPARATIONS, DIAGNOSTIC
TESTING STRIPS, DIAGNOSTIC DIP-STICK TESTS,
DIAGNOSTIC PREPARATIONS FOR USE AT POINT
OF CARE, DIAGNOSTIC LATERAL-FLOW ASSAY
PREPARATIONS, DIAGNOSTIC FLOW-THROUGH
ASSAY PREPARATIONS, DIAGNOSTIC IMMUNO-
CHROMATOGRAPHIC PREPARATIONS; DIAG-
NOSTIC EQUIPMENT FOR MEDICAL PURPOSES,
NAMELY, STRIPS, COTTON STICKS, SWABS, COT-
TON AND TAMPONS FOR USE IN SAMPLING,
STORING, TRANSPORTING, PREPARING, EN-
RICHING, CONCENTRATING, TESTING, ANA-
LYZING AND EVALUATING OF BIOLOGICAL
MATERIAL AND SAMPLES IN CONNECTION
WITH EARLY DIAGNOSIS, DIAGNOSIS, PROG-
NOSIS, GRADING, MONITORING, STAGING, PRE-
DICTIVE THERAPY GUIDANCE, PATIENT
STRATIFICATION OR THERAPY GUIDANCE
AND PREVENTION OF NEOPLASTIC, INFLAMMA-
TORY, INFECTIOUS, DEGENERATIVE, GENETIC,
PROLIFERATIVE AND VASCULAR DISEASES,
PREMALIGNANT AND MALIGNANT CANCER-
OUS CONDITIONS, CANCER AND INBORN DEFI-
CIENCIES AS INDICATED ABOVE, IN CLASS 5 (U.S.
CLS. 6, 18, 44, 46, 51 AND 52).

FOR: LABORATORY EQUIPMENT FOR DIAGNOSTIC PURPOSES, NAMELY, TEST TUBES, MULTIWELL TEST PLATES, MULTIWELL ELISA (ENZYME LINKED IMMUNOSORBENT ASSAY) PLATES AND CHROMATOGRAPHY COLUMNS FOR USE IN SAMPLING, STORING, TRANSPORTING, PREPARING, ENRICHING, CONCENTRATING, TESTING, ANALYZING AND EVALUATING BIOLOGICAL MATERIAL AND SAMPLES, IN CLASS 9 (U.S. CLS. 21, 23, 26, 36 AND 38).

FOR: MEDICAL DIAGNOSTIC TESTING MACHINES, NAMELY, POINT-OF-CARE TESTING MACHINES, DIAGNOSTIC LIQUID-IMMUNO-ASSAY MACHINES, DIAGNOSTIC IMMUNOCYTOCHEMICAL MACHINES, DIAGNOSTIC IMMUNOHISTOCHEMICAL MACHINES, DIAGNOSTIC HISTOLOGY MACHINES, DIAGNOSTIC CYTOLOGY MACHINES, DIAGNOSTIC SOLID-PHASE IMMUNO-ASSAY MACHINES, DIAGNOSTIC ELISA (ENZYME LINKED IMMUNOSORBENT ASSAY) TESTING MACHINES, DIAGNOSTIC IMMUNO-CHROMATOGRAPHIC MACHINES, ALL OF THE AFOREMENTIONED MACHINES BEING FOR USE IN ANALYZING AND PROVIDING DIAGNOSTIC TEST RESULTS AND USED IN CONNECTION WITH EARLY DIAGNOSIS, DIAGNOSIS, PROGNOSIS, GRADING, MONITORING, STAGING, PREDICTIVE THERAPY GUIDANCE, PATIENT STRATIFICATION OR THERAPY GUIDANCE AND PREVENTION OF NEOPLASTIC, INFLAMMATORY, INFECTIOUS, DEGENERATIVE, GENETIC, PROLIFERATIVE AND VASCULAR DISEASES, PREMALIGNANT AND MALIGNANT CANCEROUS CONDITIONS, CANCER AND INBORN DEFICIENCIES; DIAGNOSTIC EQUIPMENT FOR MEDICAL PURPOSES, NAMELY, SYRINGES, NEEDLES, BRUSHES, SPATULAS AND SAMPLE RECEPTACLES FOR USE IN SAMPLING, STORING, TRANSPORTING, PREPARING, ENRICHING, CONCENTRATING, TESTING, ANALYZING AND EVALUATING OF BIOLOGICAL MATERIAL AND SAMPLES IN CONNECTION WITH EARLY DIAGNOSIS, DIAGNOSIS, PROGNOSIS, GRADING, MONITORING, STAGING, PREDICTIVE THERAPY GUIDANCE, PATIENT STRATIFICATION OR THERAPY GUIDANCE AND PREVENTION OF NEOPLASTIC, INFLAMMATORY, INFECTIOUS, DEGENERATIVE, GENETIC, PROLIFERATIVE AND VASCULAR DISEASES, PREMALIGNANT AND MALIGNANT CANCEROUS CONDITIONS, CANCER AND INBORN DEFICIENCIES; DIAGNOSTIC NUCLEIC ACID DETECTION MACHINES FOR USE IN ANALYZING AND PROVIDING MEDICAL DIAGNOSTIC TEST RESULTS IN CONNECTION WITH EARLY DIAGNOSIS, DIAGNOSIS, PROGNOSIS, GRADING, MONITORING, STAGING, PREDICTIVE THERAPY GUIDANCE, PATIENT STRATIFICATION AND THERAPY GUIDANCE, AND PREVENTION OF NEOPLASTIC, INFLAMMATORY, INFECTIOUS, DEGENERATIVE, GENETIC, PROLIFERATIVE AND VASCULAR DISEASES, PREMALIGNANT AND MALIGNANT CANCEROUS CONDITIONS, CANCER AND INBORN DEFICIENCIES; DIAGNOSTIC NUCLEIC ACID AMPLIFICATION MACHINES FOR USE IN ANALYZING AND

PROVIDING MEDICAL DIAGNOSTIC TEST RESULTS IN CONNECTION WITH EARLY DIAGNOSIS, DIAGNOSIS, PROGNOSIS, GRADING, MONITORING, STAGING, PREDICTIVE THERAPY GUIDANCE, PATIENT STRATIFICATION AND THERAPY GUIDANCE, AND PREVENTION OF NEOPLASTIC, INFLAMMATORY, INFECTIOUS, DEGENERATIVE, GENETIC, PROLIFERATIVE AND VASCULAR DISEASES, PREMALIGNANT AND MALIGNANT CANCEROUS CONDITIONS, CANCER AND INBORN DEFICIENCIES; DIAGNOSTIC IMMUNO-HISTOLOGY MACHINES FOR USE IN ANALYZING AND PROVIDING MEDICAL DIAGNOSTIC TEST RESULTS IN CONNECTION WITH EARLY DIAGNOSIS, DIAGNOSIS, PROGNOSIS, GRADING, MONITORING, STAGING, PREDICTIVE THERAPY GUIDANCE, PATIENT STRATIFICATION AND THERAPY GUIDANCE, AND PREVENTION OF NEOPLASTIC, INFLAMMATORY, INFECTIOUS, DEGENERATIVE, GENETIC, PROLIFERATIVE AND VASCULAR DISEASES, PREMALIGNANT AND MALIGNANT CANCEROUS CONDITIONS, CANCER AND INBORN DEFICIENCIES; DIAGNOSTIC IMMUNO-CYTOLOGY MACHINES FOR USE IN ANALYZING AND PROVIDING MEDICAL DIAGNOSTIC TEST RESULTS IN CONNECTION WITH EARLY DIAGNOSIS, DIAGNOSIS, PROGNOSIS, GRADING, MONITORING, STAGING, PREDICTIVE THERAPY GUIDANCE, PATIENT STRATIFICATION AND THERAPY GUIDANCE, AND PREVENTION OF NEOPLASTIC, INFLAMMATORY, INFECTIOUS, DEGENERATIVE, GENETIC, PROLIFERATIVE AND VASCULAR DISEASES, PREMALIGNANT AND MALIGNANT CANCEROUS CONDITIONS, CANCER AND INBORN DEFICIENCIES; MEDICAL DIAGNOSTIC APPARATUS AND INSTRUMENTS, NAMELY, HAND-HELD, TABLE-TOP AND FLOOR-STANDING CENTRIFUGAL, GRAVITATIONAL-SEPARATING, ELECTROPHORETIC, CHROMATOGRAPHIC, CONDUCTOMETRIC, POTENTIOMETRIC, SPECTROMETRIC, SPECTRO-PHOTOMETRIC, RADIOLOGIC ELECTROMAGNETIC-RESONANCE, HISTOLOGICAL, MICROSCOPIC AND IN-VIVO IMAGING MACHINES, ALL FOR USE IN ANALYZING AND PROVIDING MEDICAL DIAGNOSTIC TEST RESULTS IN CONNECTION WITH EARLY DIAGNOSIS, DIAGNOSIS, PROGNOSIS, GRADING, MONITORING, STAGING, PREDICTIVE THERAPY GUIDANCE, PATIENT STRATIFICATION AND THERAPY GUIDANCE, AND PREVENTION OF NEOPLASTIC, INFLAMMATORY, INFECTIOUS, DEGENERATIVE, GENETIC, PROLIFERATIVE AND VASCULAR DISEASES, PREMALIGNANT AND MALIGNANT CANCEROUS CONDITIONS, CANCER AND INBORN DEFICIENCIES; AUTOMATED AND NON-AUTOMATED CELLULAR IMAGING DEVICES FOR MEDICAL USE FOR USE IN ANALYZING AND PROVIDING MEDICAL DIAGNOSTIC TEST RESULTS IN CONNECTION WITH EARLY DIAGNOSIS, DIAGNOSIS, PROGNOSIS, GRADING, MONITORING, STAGING, PREDICTIVE THERAPY GUIDANCE, PATIENT STRATIFICATION AND THERAPY GUIDANCE, AND PREVENTION OF NEOPLASTIC, INFLAMMATORY, INFECTIOUS, DEGENERATIVE, GENETIC, PROLIFERATIVE

AND VASCULAR DISEASES, PREMALIGNANT AND MALIGNANT CANCEROUS CONDITIONS, CANCER AND INBORN DEFICIENCIES, AUTOMATED AND NON-AUTOMATED MICROSCOPY DEVICES FOR MEDICAL USE FOR USE IN ANALYZING AND PROVIDING MEDICAL DIAGNOSTIC TEST RESULTS IN CONNECTION WITH EARLY DIAGNOSIS, DIAGNOSIS, PROGNOSIS, GRADING, MONITORING, STAGING, PREDICTIVE THERAPY GUIDANCE, PATIENT STRATIFICATION AND THERAPY GUIDANCE, AND PREVENTION OF NEOPLASTIC, INFLAMMATORY, INFECTIOUS, DEGENERATIVE, GENETIC, PROLIFERATIVE AND VASCULAR DISEASES, PREMALIGNANT AND MALIGNANT CANCEROUS CONDITIONS, CANCER AND INBORN DEFICIENCIES, AUTOMATED AND NON-AUTOMATED IMAGING ANALYSIS DEVICES FOR CLINICAL AND MEDICAL LABORATORY USE FOR USE IN PREPARING, ENRICHING, CONCENTRATING, TESTING, ANALYSING AND EVALUATING OF BIOLOGICAL MATERIAL AND SAMPLES IN CONNECTION WITH EARLY DIAGNOSIS, DIAGNOSIS, PROGNOSIS, GRADING, MONITORING, STAGING, PREDICTIVE THERAPY GUIDANCE, PATIENT STRATIFICATION OR THERAPY GUIDANCE AND PREVENTION OF NEOPLASTIC, INFLAMMATORY, INFECTIOUS, DEGENERATIVE, GENETIC, PROLIFERATIVE AND VASCULAR DISEASES, PREMALIGNANT AND MALIGNANT CANCEROUS CONDITIONS, CANCER AND INBORN DEFICIENCIES, IN CLASS 10 (U.S. CLS. 26, 39 AND 44).

FOR: SCIENTIFIC ANALYSIS IN THE FIELDS OF CHEMISTRY, BIOLOGY AND MOLECULAR BIOLOGY; LABORATORY RESEARCH IN THE FIELD OF MOLECULAR BIOLOGY; LABORATORY RESEARCH IN THE FIELDS OF PHARMACEUTICS AND FOOD TECHNOLOGY; PROVIDING RESEARCH IN THE FIELDS OF PHARMACEUTICAL, CHEMICAL AND MEDICAL DIAGNOSTIC RESEARCH; RESEARCH AND DEVELOPMENT OF

PHARMACEUTICAL PRODUCTS AND SUBSTANCES FOR OTHERS; SCIENTIFIC RESEARCH IN THE NATURE OF SCIENTIFIC INFORMATION RESEARCH SERVICES; CHEMICAL, BIOLOGICAL, MOLECULAR BIOLOGY AND PHARMACOGENOMIC ANALYSIS SERVICES, IN CLASS 42 (U.S. CLS. 100 AND 101).

FOR: MEDICAL DIAGNOSTIC SERVICES AND PROVISION OF MEDICAL DIAGNOSTIC INFORMATION IN THE FIELD OF DETECTION OF NEOPLASTIC, INFLAMMATORY, INFECTIOUS, DEGENERATIVE, GENETIC, PROLIFERATIVE AND VASCULAR DISEASES, PREMALIGNANT AND MALIGNANT CANCEROUS CONDITIONS, CANCER AND INBORN ERRORS; VETERINARY DIAGNOSTIC SERVICES AND PROVISION OF VETERINARY DIAGNOSTIC INFORMATION IN THE FIELD OF DETECTION OF NEOPLASTIC, INFLAMMATORY, INFECTIOUS, DEGENERATIVE, GENETIC, PROLIFERATIVE AND VASCULAR DISEASES, PREMALIGNANT AND MALIGNANT CANCEROUS CONDITIONS, CANCER AND INBORN DEFICIENCIES IN LIVESTOCK, CATTLE, PIGS, HORSES, DEER, ELK, MOOSE, SHEEP, DOGS, CATS, MICE, RATS, MONKEYS, APES AND BIRDS, IN CLASS 44 (U.S. CLS. 100 AND 101).

THE MARK CONSISTS OF STANDARD CHARACTERS WITHOUT CLAIM TO ANY PARTICULAR FONT, STYLE, SIZE, OR COLOR.

PRIORITY DATE OF 4-3-2006 IS CLAIMED.

OWNER OF INTERNATIONAL REGISTRATION 0918309 DATED 9-20-2006, EXPIRES 9-20-2016.

SER. NO. 79-036,313, FILED 9-20-2006.

DANIEL BRODY, EXAMINING ATTORNEY

Int. Cls.: 6, 7, 9, 12, 16 and 17

Prior U.S. Cls.: 1, 2, 5, 12, 13, 14, 19, 21, 22, 23, 25, 26, 29, 31, 34, 35, 36, 37, 38, 44 and 50

Reg. No. 3,476,788

United States Patent and Trademark Office

Registered July 29, 2008

**TRADEMARK
PRINCIPAL REGISTER**

CONTITECH

CONTINENTAL AKTIENGESELLSCHAFT (FED
REP GERMANY JOINT-STOCK COMPANY)
VAHRENWALDER STRABE 9,
30165 HANNOVER
FED REP GERMANY

FOR: METAL PIPES AND METAL FLEXIBLE TUBES EXCEPT FOR GENERAL CONSTRUCTION; METAL HOSE AND PIPE CONNECTORS; METAL HOSE AND PIPE COUPLINGS; METAL CONDUITS FOR VENTILATION AND AIR-CONDITIONING SYSTEMS, IN CLASS 6 (U.S. CLS. 2, 12, 13, 14, 23, 25 AND 50).

FOR: STRUCTURAL PARTS OF MOTORS AND ENGINES NOT FOR LAND VEHICLES; BELTS FOR MACHINES, NAMELY, DRIVING BELTS, V-BELTS, MULTI-RIB BELTS, TOOTHED BELTS, SYNCHRONOUS BELTS, BURL BELTS, DOUBLE TOOTHED BELTS, STROKE BELTS, PUMPING BELTS, POWER TRANSMISSION BELTS, TIMING BELTS, FAN BELTS, CONVEYOR BELTS; CONVEYORS; STRUCTURAL PARTS OF CONVEYORS AND CONVEYOR BELTS; PULLEYS BEING PARTS OF MACHINES; MACHINE PARTS, NAMELY, SPRINGS, PNEUMATIC SPRINGS, SHOCK ABSORBER PISTONS, VIBRATION DAMPERS, PRESSURE CYLINDERS, BELLOW CYLINDERS, HYDRAULIC BEARINGS, ROTATIONAL VIBRATION ATTENUATORS, RUBBER COMPENSATORS, SHOCK ABSORBERS; VALVES BEING PARTS OF ENGINES AND MOTORS, IN CLASS 7 (U.S. CLS. 13, 19, 21, 23, 31, 34 AND 35).

FOR: APPARATUSES AND INSTRUMENTS FOR CONDUCTING, SWITCHING, CONVERTING, STORING, REGULATING, AND CONTROLLING ELECTRICAL CURRENT, NAMELY, ELECTRICAL CONDUCTORS, ELECTRIC SWITCHES, TRANSFORMERS, ACCUMULATORS, VOLTAGE REGULATORS, ELECTRIC CONTROLLERS, TRANSPONDERS; PRESSURE SENSORS; VELOCITY SENSORS; ACCELERATION SENSORS; RESCUE EQUIPMENT, NAMELY, RESCUE RAFTS, IN CLASS 9 (U.S. CLS. 21, 23, 26, 36 AND 38).

FOR: VEHICLE PARTS, NAMELY, DRIVE BELTS, DRIVE CHAINS, TRANSMISSION BELTS, SERPENTINE BELTS, VEHICLE AND ARTICULATED BUS PASSAGEWAY BELLOWS IN RUBBER AND PLASTIC; DIAPHRAGM VALVES FOR CONTROLLING FUEL SUPPLY SYSTEMS IN VEHICLES; DIAPHRAGM VALVES FOR SUSPENSION SYSTEMS IN VEHICLES; MOUNTS FOR SUSPENSION SYSTEMS IN LAND VEHICLES; SUSPENSION STRUTS FOR VEHICLES; AIR SUPPLY UNITS FOR PNEUMATIC SPRINGS FOR VEHICLES; SHOCK ABSORBERS AND SHOCK-ABSORBING SPRINGS FOR VEHICLES AND THEIR PARTS, NAMELY, PNEUMATIC SPRINGS, AIR PRESSURE SPRINGS, GAS SPRINGS, AND SEALS; BEARING SPRINGS FOR VEHICLES; VIBRATION ABSORBERS AND ROTATIONAL VIBRATION ATTENUATORS FOR LAND VEHICLES NOT BEING LAND VEHICLE ENGINE COMPONENTS; SHAPED RUBBER AND RUBBER-METAL PARTS FOR OSCILLATION DAMPERS IN LAND VEHICLE DRIVE SHAFTS, LAND VEHICLE SUSPENSION SYSTEMS, LAND VEHICLE WHEEL SUSPENSION SYSTEMS, TRANSMISSION SYSTEMS IN LAND VEHICLES; HYDRAULIC BEARINGS FOR LAND VEHICLE SUSPENSION SYSTEMS; INTERIOR TRIM FOR LAND VEHICLES; AIRBAG COVERINGS FOR LAND VEHICLES; LININGS FOR DASHBOARDS; INTERIOR UPHOLSTERY FOR VEHICLES; VEHICLE SEATS; HEAD RESTRAINTS FOR VEHICLE SEATS; VEHICULAR AIRCRAFT BALLOONS, IN CLASS 12 (U.S. CLS. 19, 21, 23, 31, 35 AND 44).

FOR: PRINTING BLANKETS NOT MADE OF TEXTILES; PRINTING BLANKETS MADE OF RUBBER AND PLASTIC; ROAD ATLASES; PRINTED INSTRUCTIONAL AND TEACHING MATERIALS, NAMELY, TEXTBOOKS AND MAGAZINES FEATURING REPAIR AND USER INSTRUCTIONS IN THE FIELDS OF AIR SPRINGS, CONVEYOR BELTS, RUBBER COMPENSATORS, PIPING, DIAPHRAGM VALVES, HOSE LINES, SHAPED PLASTICS, PADDING MATERIALS, POWER TRANSMISSION SYSTEMS, UPHOLSTERY MATERIALS, FOOTWEAR, EXTRUDED RUBBER, TEXTILES, AND AUTOMO-

TIVE PARTS; PLASTIC BAGS FOR PACKAGING, IN CLASS 16 (U.S. CLS. 2, 5, 22, 23, 29, 37, 38 AND 50).

FOR: NATURAL RUBBER; GUTTA-PERCHA; RUBBER; ASBESTOS SHEETS; MICA; SEMI-FINISHED PLASTIC IN THE FORM OF PELLETS, SHEETS, RODS, SLABS, AND SHAPED PIECES FOR USE IN MANUFACTURING AND PRODUCTION; PLASTIC PACKING FOR SHIPPING CONTAINERS; RUBBER PACKING FOR SHIPPING CONTAINERS; PLASTIC FILM FOR INDUSTRIAL AND COMMERCIAL PACKING USE; EXPANDED PLASTIC PELLETS FOR PACKAGING; INDUSTRIAL PACKAGING CONTAINERS OF RUBBER; PACKING MATERIAL FOR FORMING SEALS; ACOUSTIC AND THERMAL INSULATION FOR USE MANUFACTURING AND PRODUCTION; GARDEN HOSES; NON-METAL PETROLEUM HOSES; NON-METAL HOSES FOR CONVEYING BEVERAGES; NON-METAL HOSES FOR CONVEYING FOOD; NON-METAL HOSES FOR CONVEYING CHEMICALS; NON-METAL HOSES FOR CONVEYING VEHICLE-RELATED CHEMICALS, NAMELY, NON-METAL HOSES FOR USE IN HEATING AND COOLING SYSTEMS IN VEHICLES, NON-METAL HOSES FOR USE IN FUEL SYSTEMS FOR VEHICLES, NON-METAL OIL HOSES FOR VEHICLES, NON-METAL WATER HOSES FOR VEHICLES, NON-METAL CHARGE AIR HOSES FOR VEHICLES, AND NON-METAL HYDRAULIC HOSES FOR VEHICLES; NON-METAL COUPLINGS FOR USE WITH GARDEN HOSES, PETROLEUM HOSES; HOSES FOR CONVEYING BEVERAGES, HOSES FOR CONVEYING FOOD, AND HOSES FOR CONVEYING CHEMICALS; NON-METAL MOUNTINGS FOR PIPES, NAMELY, PIPE COUPLINGS AND JOINTS, AND INSULATED PIPE SUPPORTS; RUBBER COMPENSATORS IN THE NATURE OF EXPANSION JOINTS FOR PIPING

AND RIGID DUCTING; PIPE JOINT SEALANTS; SEALING SLEEVES, SEALING RINGS, AND SEALING MEMBRANES MADE OF RUBBER; RUBBER SHOCK ABSORBERS FOR INDUSTRIAL MACHINERY, NAMELY, RUBBER PADS; RUBBER SUBSTITUTE VALVES; RUBBER SHEETING AND RUBBER SLEEVES FOR PROTECTING MACHINE PARTS; RUBBER AND RUBBER SUBSTITUTE SHOCK ABSORBERS FOR USE IN TRACK LAYING, NAMELY, RUBBER AND RUBBER-SUBSTITUTE MATS PLACED UNDER METAL TRACKS FOR RAIL VEHICLES TO ABSORB VIBRATION AND SHOCK; OIL ABSORBENT MATS FOR CONTAINING OIL LEAKS; RUBBER VALVES; NON-METAL SEALS FOR USE IN SUNROOF, DOOR, WINDOW, AND ENGINE COMPARTMENTS; PLASTIC SHEETS FOR SEALING AND INSULATION PURPOSES; PLASTIC IN THE FORM OF SHEETS FOR ROOFS AND PONDS; RUBBER AND PLASTIC PASSAGEWAY BELLOWS FOR AIRPORT PASSENGER BRIDGES, IN CLASS 17 (U.S. CLS. 1, 5, 12, 13, 35 AND 50).

THE MARK CONSISTS OF STANDARD CHARACTERS WITHOUT CLAIM TO ANY PARTICULAR FONT, STYLE, SIZE, OR COLOR.

PRIORITY DATE OF 4-13-2006 IS CLAIMED.

OWNER OF INTERNATIONAL REGISTRATION 0918385 DATED 8-8-2006, EXPIRES 8-8-2016.

OWNER OF U.S. REG. NOS. 1,777,543, 2,906,811 AND OTHERS.

SER. NO. 79-036,348, FILED 8-8-2006.

DANIEL BRODY, EXAMINING ATTORNEY

Int. Cl.: 10

Prior U.S. Cls.: 26, 39 and 44

United States Patent and Trademark Office

Reg. No. 3,476,789

Registered July 29, 2008

**TRADEMARK
PRINCIPAL REGISTER**

DIREXA

OTTO BOCK HEALTHCARE GMBH (FED REP
GERMANY LIMITED COMPANY)
MAX-NÄDER-STRASSE 15
37115 DUDERSTADT
FED REP GERMANY

FOR: ORTHOPEDIC ORTHESES, NAMELY, OR-
THOPEDIC BELTS, ORTHOPEDIC BRACES, OR-
THOPEDIC SUPPORTS, IN CLASS 10 (U.S. CLS. 26,
39 AND 44).

THE MARK CONSISTS OF STANDARD CHAR-
ACTERS WITHOUT CLAIM TO ANY PARTICULAR
FONT, STYLE, SIZE, OR COLOR.

PRIORITY DATE OF 9-28-2006 IS CLAIMED.

OWNER OF INTERNATIONAL REGISTRATION
0918774 DATED 2-15-2007, EXPIRES 2-15-2017.

SER. NO. 79-036,482, FILED 2-15-2007.

MARCIE MILONE, EXAMINING ATTORNEY

Int. Cl.: 9

Prior U.S. Cls.: 21, 23, 26, 36 and 38

United States Patent and Trademark Office

Reg. No. 3,476,790

Registered July 29, 2008

**TRADEMARK
PRINCIPAL REGISTER**

ZoneCentral

PRIM'X TECHNOLOGIES (FRANCE SA)

10, PLACE BÉRAUDIER

F-69428 LYON CEDEX 03, FRANCE

FOR: COMMUNICATIONS SOFTWARE FOR USE BETWEEN COMPUTERS USED TO ENCRYPT, EMBED, ERASE, AUTHENTICATE, SIGN, CONDITIONALLY DELIVER RECORDED OR EXCHANGED DATA, IN CLASS 9 (U.S. CLS. 21, 23, 26, 36 AND 38).

OWNER OF INTERNATIONAL REGISTRATION 0918891 DATED 2-8-2007, EXPIRES 2-8-2017.

THE COLOR(S) BLACK, RED AND MEDIUM GREY IS/ARE CLAIMED AS A FEATURE OF THE MARK.

THE MARK CONSISTS OF THE TERMS "ZONE-CENTRAL" WHERE THE "Z" IS A CAPITAL LETTER, THE WORDS "ZONE" AND "CENTRAL" ARE STUCK TOGETHER, THE "C" IN "CENTRAL" IS A CAPITAL LETTER, THE WORD "ZONE" IS IN BLACK, THE "C" IS IN RED AND "ENTRAL" IS IN MEDIUM GREY.

SER. NO. 79-036,514, FILED 2-8-2007.

FRED CARL, EXAMINING ATTORNEY

Int. Cl.: 29

Prior U.S. Cl.: 46

United States Patent and Trademark Office

Reg. No. 3,476,791

Registered July 29, 2008

**TRADEMARK
PRINCIPAL REGISTER**



CONSERVERA GALLEGA, S.A. (SPAIN SOCIE-
DAD ANONIMA)

EL CASTRO, S/N

E-36620 VILLANUEVA DE AROSA (PONTEVEDRA)
SPAIN

FOR: CANNED FISH AND SEAFOOD, IN CLASS
29 (U.S. CL. 46).

PRIORITY DATE OF 9-8-2006 IS CLAIMED.

OWNER OF INTERNATIONAL REGISTRATION
0920131 DATED 3-6-2007, EXPIRES 3-6-2017.

THE COLOR(S) RED IS/ARE CLAIMED AS A
FEATURE OF THE MARK.

THE MARKS CONSISTS OF THE WORDING
DINKY'S WHICH APPEARS IN THE COLOR RED
AND IS SET FORTH IN THE CENTER OF A
ROUNDED CORNER RECTANGLE WHICH IS
ALSO IN THE COLOR RED. PLEASE BE ADVISED
THAT THE WHITE BACKGROUND IS NOT
CLAIMED AS A FEATURE OF THE MARK.

SER. NO. 79-036,949, FILED 3-6-2007.

DAVID TAYLOR, EXAMINING ATTORNEY

Int. Cls.: 22, 24, 27 and 40

Prior U.S. Cls.: 1, 2, 7, 19, 20, 22, 37, 42, 50, 100, 103
and 106

Reg. No. 3,476,792

United States Patent and Trademark Office

Registered July 29, 2008

TRADEMARK
SERVICE MARK
PRINCIPAL REGISTER



JUNKERS + MÜLLERS GMBH (FED REP GER-
MANY GESELLSCHAFT MIT BESCHRÄNK-
TER HAFTUNG ACCORDING TO GERMAN
LAW)

BOLKSBUSCHER STRASSE 27

41239 MÖNCHENGLADBACH, FED REP GERMA-
NY

FOR: ROPES; STRING; COMMERCIAL NETS;
TENTS; TARPAULINS; SAILS; SACKS AND BAGS
FOR THE TRANSPORTATION AND STORAGE OF
MATERIALS IN BULK; AWNINGS OF PLASTIC OR
TEXTILE; PADDING AND STUFFING MATERIALS
NOT OF RUBBER, PAPER OR PLASTICS; RAW
FIBROUS TEXTILE MATERIALS, IN CLASS 22 (U.S.
CLS. 1, 2, 7, 19, 22, 42 AND 50).

FOR: WOVEN FABRICS, WOVEN FELT, KNIT-
TED FABRICS, WAVY FIBER TEXTILES, TEXTILE
FABRICS FOR HOME AND COMMERCIAL INTER-
IORS; INDUSTRIAL TEXTILE FABRICS FOR IN-
DOOR AND OUTDOOR USE; CURTAINS,
DRAPERY, DECORATIVE TEXTILE FABRICS FOR
COVERING WALLS, TEXTILE WALL HANGINGS;
BED SPREADS; TABLE CLOTHS NOT OF PAPER;
BED AND HOUSEHOLD LINEN, IN CLASS 24 (U.S.
CLS. 42 AND 50).

FOR: CARPETS, RUGS, MATS AND MATTING,
LINOLEUM FOR COVERING EXISTING FLOORS;
NON-TEXTILE WALL HANGINGS, IN CLASS 27
(U.S. CLS. 19, 20, 37, 42 AND 50).

FOR: TREATMENT OF MATERIALS, NAMELY,
FINISHING OF TEXTILES, IN CLASS 40 (U.S. CLS.
100, 103 AND 106).

PRIORITY DATE OF 9-8-2006 IS CLAIMED.

OWNER OF INTERNATIONAL REGISTRATION
0920578 DATED 2-6-2007, EXPIRES 2-6-2017.

NO CLAIM IS MADE TO THE EXCLUSIVE
RIGHT TO USE "TECHNICAL TEXTILES", APART
FROM THE MARK AS SHOWN.

SER. NO. 79-037,144, FILED 2-6-2007.

TANYA AMOS, EXAMINING ATTORNEY

Int. Cls.: 8, 14 and 21

Prior U.S. Cls.: 2, 13, 23, 27, 28, 29, 30, 33, 40, 44 and 50

Reg. No. 3,476,793

United States Patent and Trademark Office

Registered July 29, 2008

**TRADEMARK
PRINCIPAL REGISTER**

MARLY TECH

ORFEVRENERIE CHRISTOFLE (FRANCE SOCIÉTÉ
PAR ACTIONS SIMPLIFIÉE)
9, RUE ROYALE
F-75008 PARIS
FRANCE

FOR: HAND TOOLS AND HAND-OPERATED IMPLEMENTS, NAMELY, SUGAR TONGS, ICE CUBE TONGS; CUTLERY, FORKS AND SPOONS; SIDE ARMS, NOT INCLUDING FIREARMS, NAMELY, HUNTING KNIVES AND SWORDS; RAZORS; SILVERWARE, NAMELY, STERLING SILVER TABLE FORKS, STERLING SILVER TABLE KNIVES, AND STERLING SILVER TABLE SPOONS; SCISSORS; FLATWARE, NAMELY, CUTLERY, FORKS AND SPOONS, IN CLASS 8 (U.S. CLS. 23, 28 AND 44).

FOR: GOLD AND SILVER PLATED PRODUCTS MADE OF PRECIOUS METAL AND ALLOYS THEREOF OR PLATED THEREWITH, NAMELY, GOLD PLATED TABLE FORKS, GOLD PLATED TABLE KNIVES, AND GOLD PLATED TABLE SPOONS; WORKS OF ART OF PRECIOUS METAL, PLATES, CANDLE HOLDERS, WOODEN TEA BOXES AND BALLS, COFFEE SERVICES, NON-ELECTRIC CANDELABRAS, CANDLESTICKS, SMOKERS' ASHTRAYS, CIGAR HOLDERS, CIGAR BOXES, CIGAR CASES, CIGARETTE HOLDERS, CIGARETTE BOXES AND CASES, CIGARETTE HOLDERS, KEY RINGS OF PRECIOUS METALS; BASKETS FOR WASTE PAPER LITTERING FOR HOUSEHOLD USE, TIE PINS, TIE CLIPS; SMALL JUGS, KITCHEN CONTAINERS OF PRECIOUS METAL AND NOT OF PRECIOUS METAL, KITCHEN COOKING UTENSILS, NAMELY, GRILLS; CANDLE EXTINGUISHERS, FIGURINES OF PRECIOUS METAL, SMALL BOTTLES SOLD EMPTY, MUGS, CACHEPOTS, NAMELY, CERAMIC POTS, TANKARDS, CRUETS, PLASTIC HANG TAGS, HOUSEHOLD OR KITCHEN UTENSILS AND CONTAINERS, NAMELY, CRUET SETS, PURSES, SERVING TRAYS, EGG CUPS, TEA STRAINERS, COOKING SIEVES, MEAL TRAYS, DISHES, PEPPER POTS, NAPKIN HOLDERS, TOBACCO JARS, WOOD POWDER BOXES, ALARM CLOCKS; NAPKIN RINGS, SALAD BOWLS, SALT CELLARS, TABLE-

WARE, NAMELY, KNIVES, FORKS AND SPOONS, SAUCERS, SOUP TUREENS, STATUES AND STATUETTES OF CHINA, CRYSTAL, EARTHENWARE, GLASS, TERRA COTTA, AND PORCELAIN, SUGAR BOWLS, DECORATIVE PAPER TABLE CENTERPIECES, CUPS, TEA SERVICES, TEA POTS, TUMBLERS, VASES; ITEMS OF JEWELRY, NAMELY, RINGS, EARRINGS, BRACELETS, WATCH BANDS, CHARMS, BROOCHES, CHAINS, HAT ORNAMENTS NOT OF PRECIOUS METAL, NECKLACES, MEDALS, MEDALLIONS AND WATCHES; JEWELRY, HOROLOGICAL AND CHRONOMETRIC INSTRUMENTS, IN CLASS 14 (U.S. CLS. 2, 27, 28 AND 50).

FOR: HOUSEHOLD OR KITCHEN UTENSILS AND CONTAINERS NOT OF PRECIOUS METAL OR COATED THEREWITH, NAMELY, MIXING SPOONS; COMBS AND BATH SPONGES; SPRINKLING DEVICES, NAMELY, LAWN SPRINKLERS; NON-PAPER CACHEPOTS, NAMELY, FLOWER POTS; WATERING CANS; GLASSWARE, PORCELAIN, CRYSTAL WARE, AND EARTHENWARE, NAMELY, PLATES, CUPS, SAUCERS, DISHES, SERVING TRAYS FOR DOMESTIC PURPOSES, SOUP TUREENS, PEPPER POTS, SUGAR BOWLS, BUTTER-DISH COVERS; BUTTER DISHES; COFFEE SERVICES, DRINKING VESSELS; BOWLS; SWEET BOXES OF PRECIOUS METALS, TEA SERVICES, VASES, DRINKING GLASSES; GLASS STOPPERS; CANDLE HOLDERS, PERFUME BURNERS; CANDLESTICKS, DECORATIVE CRYSTALS PRISMS; FIGURINES AND STATUETTES OF PORCELAIN, TERRA-COTTA AND GLASS; NAPKIN HOLDERS, WOODEN POWDER BOXES, NAPKIN RINGS, CORK SCREWS; BOTTLE OPENERS; SKEWERS FOR COOKING; KITCHEN INSTRUMENTS, NAMELY, CHOPSTICKS; KNIFE RESTS FOR THE TABLE, IN CLASS 21 (U.S. CLS. 2, 13, 23, 29, 30, 33, 40 AND 50).

THE MARK CONSISTS OF STANDARD CHARACTERS WITHOUT CLAIM TO ANY PARTICULAR FONT, STYLE, SIZE, OR COLOR.

PRIORITY DATE OF 5-31-2006 IS CLAIMED.

OWNER OF INTERNATIONAL REGISTRATION
0921271 DATED 10-17-2006, EXPIRES 10-17-2016.

SER. NO. 79-037,421, FILED 10-17-2006.

NO CLAIM IS MADE TO THE EXCLUSIVE
RIGHT TO USE "TECH", APART FROM THE MARK
AS SHOWN.

WARREN L. OLANDRIA, EXAMINING ATTOR-
NEY

Int. Cls.: 7, 12 and 42

Prior U.S. Cls.: 13, 19, 21, 23, 31, 34, 35, 44, 100 and 101

Reg. No. 3,476,794

United States Patent and Trademark Office

Registered July 29, 2008

**TRADEMARK
SERVICE MARK
PRINCIPAL REGISTER**

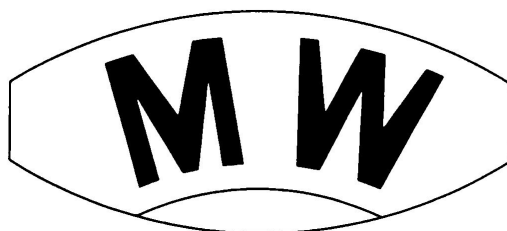

MAGNETTO WHEELS S.P.A. (ITALY SOCIETÀ
PER AZIONI)
VIA PAVIA, 72
I-10098 RIVOLI (TO)
ITALY

FOR: WHEELS BEING PART OF MACHINES, IN
CLASS 7 (U.S. CLS. 13, 19, 21, 23, 31, 34 AND 35).

FOR: WHEELS, WHEEL RIMS, WHEEL HUBS
AND TIRES FOR BOATS, SHIPS, LAND VEHICLES
AND AIRPLANES; AUTOMOBILES; LIGHT COM-
MERCIAL VEHICLES, NAMELY, VANS, LAND
VEHICLES; HEAVY TRUCKS, MOTORCYCLES,
MOTORBIKES, TRAVEL TRAILERS, MOTOR-
HOMES, BOATS, SHIPS, LAND VEHICLES, AIR-
PLANES, RAILCARS AND BICYCLES, IN CLASS 12
(U.S. CLS. 19, 21, 23, 31, 35 AND 44).

FOR: SCIENTIFIC AND TECHNOLOGICAL SER-
VICES INCLUDING RELATED RESEARCH AND

DESIGN SERVICES, NAMELY, SCIENTIFIC RE-
SEARCH AND TECHNOLOGICAL RESEARCH
FOR THE DEVELOPMENT OF PRODUCTIVE PRO-
CESSES IN THE FIELD OF WHEELS; INDUSTRIAL
ANALYSIS AND RESEARCH SERVICES, NAMELY,
THE DESIGN OF THE WHEELS, IN CLASS 42 (U.S.
CLS. 100 AND 101).

PRIORITY DATE OF 2-20-2007 IS CLAIMED.

OWNER OF INTERNATIONAL REGISTRATION
0921525 DATED 3-27-2007, EXPIRES 3-27-2017.

SER. NO. 79-037,517, FILED 3-27-2007.

CARRIE GENOVESE, EXAMINING ATTORNEY

Int. Cls.: 9 and 10

Prior U.S. Cls.: 21, 23, 26, 36, 38, 39 and 44

United States Patent and Trademark Office

Reg. No. 3,476,795

Registered July 29, 2008

**TRADEMARK
PRINCIPAL REGISTER**

Hypomon

AIMEDICS PTY LTD (AUSTRALIA PRIVATE LIMITED COMPANY)
G15 NATIONAL INNOVATION CENTRE
AUSTRALIAN TECHNOLOGY PARK
EVELEIGH, AUSTRALIA NSW2029

FOR: SCIENTIFIC APPARATUS AND INSTRUMENTS, NAMELY, A CHEST BELT UNIT HOUSING SKIN SURFACE BIO-SENSOR ELECTRODES AND A HAND-HELD COMPUTER CONTAINING A DETECTION ALGORITHM AND AN ALARM, ALL FOR USE IN THE DETECTION OF HYPOGLYCAEMIA IN TYPE I AND INSULIN DEPENDENT TYPE II DIABETICS, AND A DETECTION SYSTEM FOR LOW BLOOD GLUCOSE LEVELS COMPRISED OF A COUPLED ALARM TO PREVENT THE ONSET OF HYPOGLYCAEMIC COMPLICATIONS AND TO ASSIST IN MAINTAINING TIGHT GLYCAEMIO CONTROL OF PATIENTS, IN CLASS 9 (U.S. CLS. 21, 23, 26, 36 AND 38).

FOR: SURGICAL AND MEDICAL APPARATUS AND INSTRUMENT, NAMELY, ANALYTICAL DIAGNOSTIC APPARATUS FOR USE IN MEDICAL SCREENING AND DIAGNOSIS OF TYPE I AND INSULIN DEPENDENT TYPE II DIABETICS, AND DISPOSABLE COMPONENTS THEREFORE, IN CLASS 10 (U.S. CLS. 26, 39 AND 44).

THE MARK CONSISTS OF STANDARD CHARACTERS WITHOUT CLAIM TO ANY PARTICULAR FONT, STYLE, SIZE, OR COLOR.

OWNER OF INTERNATIONAL REGISTRATION 0921762 DATED 12-14-2006, EXPIRES 12-14-2016.

SER. NO. 79-037,602, FILED 12-14-2006.

WARREN L. OLANDRIA, EXAMINING ATTORNEY

Int. Cl.: 4

Prior U.S. Cls.: 1, 6 and 15

United States Patent and Trademark Office

Reg. No. 3,476,796

Registered July 29, 2008

**TRADEMARK
PRINCIPAL REGISTER**

AIRCOL

CASTROL LIMITED (UNITED KINGDOM LTD
LIAB CO)
WAKEFIELD HOUSE, PIPERS WAY
SWINDON
WILTSHIRE, UNITED KINGDOM SN3 1RE

FOR: LUBRICANTS FOR AIR AND GAS COM-
PRESSORS; REFRIGERATION LUBRICANTS; LU-
BRICANTS FOR AIR-CONDITIONING SYSTEMS,
IN CLASS 4 (U.S. CLS. 1, 6 AND 15).

THE MARK CONSISTS OF STANDARD CHAR-
ACTERS WITHOUT CLAIM TO ANY PARTICULAR
FONT, STYLE, SIZE, OR COLOR.

PRIORITY DATE OF 12-4-2006 IS CLAIMED.

OWNER OF INTERNATIONAL REGISTRATION
0921830 DATED 2-21-2007, EXPIRES 2-21-2017.

OWNER OF U.S. REG. NO. 2,616,485.

SER. NO. 79-037,628, FILED 2-21-2007.

ALICE SUE CARRUTHERS, EXAMINING ATTOR-
NEY

Int. Cls.: 14, 18 and 24

Prior U.S. Cls.: 1, 2, 3, 22, 27, 28, 41, 42 and 50

Reg. No. 3,476,797

United States Patent and Trademark Office

Registered July 29, 2008

**TRADEMARK
PRINCIPAL REGISTER**

Limited Unlimited Edition

URSULA PFAB (FED REP GERMANY INDIVIDUAL)
CLEMENSTRASSE 99
MÜNCHEN, FED REP GERMANY 80796

FOR: JEWELRY; COSTUME JEWELRY, IN CLASS 14 (U.S. CLS. 2, 27, 28 AND 50).

FOR: GOODS MADE OF LEATHER AND IMITATIONS OF LEATHER, ALL CONTAINED WITHIN THIS CLASS, NAMELY, BRIEFCASES, CASES, ALL PURPOSE CARRYING BAGS, STRAPS, PURSES, HANDBAGS, KEY CASES, KEY CHAINS, BILLFOLDS AND WALLETS; TRUNKS AND TRAVEL BAGS; UMBRELLAS, IN CLASS 18 (U.S. CLS. 1, 2, 3, 22 AND 41).

FOR: TEXTILES AND TEXTILE GOODS, ALL CONTAINED WITHIN THIS CLASS, NAMELY, QUILTS, NAPKINS, PLACE MATS, TOWELS, TABLE CLOTHS, THROWS, BED SHEETS, PILLOW CASES, PILLOW COVERS, BED SKIRTS, BED SPREADS, BED BLANKETS, DUVETS, SHAMS, CRIB LINENS,

CURTAINS, DRAPERIES, HANDKERCHIEFS, FABRICS FOR TEXTILE USE, MATTRESS COVERS, SHOWER CURTAINS; BED COVERS IN THE NATURE OF BED LINENS; TABLE COVERS IN THE NATURE OF TABLE CLOTHS NOT OF PAPER, IN CLASS 24 (U.S. CLS. 42 AND 50).

THE MARK CONSISTS OF STANDARD CHARACTERS WITHOUT CLAIM TO ANY PARTICULAR FONT, STYLE, SIZE, OR COLOR.

PRIORITY DATE OF 8-17-2006 IS CLAIMED.

OWNER OF INTERNATIONAL REGISTRATION 0922624 DATED 1-22-2007, EXPIRES 1-22-2017.

SER. NO. 79-037,917, FILED 1-22-2007.

TASHIA BUNCH, EXAMINING ATTORNEY

Int. Cls.: 10, 18 and 25

Prior U.S. Cls.: 1, 2, 3, 22, 26, 39, 41 and 44

Reg. No. 3,476,798

United States Patent and Trademark Office

Registered July 29, 2008

**TRADEMARK
PRINCIPAL REGISTER**



FOOTPRINTS SCHUH GMBH (FED REP GER-
MANY LTD LIAB CO)
RHEINSTRASSE 2-4
53604 BAD HONNEF, FED REP GERMANY

FOR: ORTHOPEDIC ARTICLES, NAMELY, ORTHOPEDIC AND THERAPEUTIC FOOTWEAR; ORTHOPEDIC FOOTWEAR FOR REHABILITATION PURPOSES TO RECREATE THE HEALTH OF FEET AND FOR GYMNAS TIC PURPOSE OF THE FEET; ORTHOPEDIC FOOTWEAR FOR USE BY PROFESSIONALS, ORTHOPEDIC FOOTWEAR FOR LEISURE AND SPORTS; ORTHOPEDIC FOOTWEAR, NAMELY, SANDALS, SANDALS FOR CHILDREN, SANDALS FOR GYMNAS TIC PURPOSES OF THE FEET, FLIP-FLOP SANDALS, SLIP-ONS, SLIPPERS, SLING-BACK SANDALS, HAND STITCHED SANDALS MADE TO MEASURE AND CLOGS EXHIBITING A FOOT BED, A MOULDED FOOT SOLE, AN ORTHOPEDIC OR A NON ORTHOPEDIC INSOLE OR SOLE; ORTHOPEDIC INSOLES AND SOLES COMPRISED OF FOOT BEDS, CUSHIONS TO PROTECT THE FOOT AGAINST PRESSURE, FOOTWEAR SHELLS AND ARCH SUPPORTS; PADDINGS FOR ORTHOPEDIC FOOTWEAR; HEEL INSERTS, WEDGES, PADS, INSOLES AND MOULDED FOOT SOLES, ALL FOR ORTHOPEDIC FOOTWEAR; ORTHOPEDIC FOOT BED INSOLES COMPRISED OF FOAM CUSHIONS, FOAM PADS AND MOULDED ORTHOPEDIC FOOT SOLES IN THE FORM OF SOLID PLASTIC INSERTS AND SUPPORTS WITH FOOT BED OR AN ANATOMI-CALLY SHAPED DEEP FOOT BED MADE FROM NATURAL CORK, THERMO-CORK, PLASTICS, LA-TEX OR EXPANDED SYNTHETIC MATERIALS, ELASTIC COMPOSITES OF CORK-LATEX AND PLASTIC-CORK MIXTURES FOR ORTHOPEDIC FOOTWEAR, IN CLASS 10 (U.S. CLS. 26, 39 AND 44).

FOR: LEATHER AND IMITATION LEATHER BAGS, LEATHER SUITCASES, LEATHER CASES,

LEATHER KEY CHAINS, LEATHER CASES FOR KEYS, LEATHER HANDBAGS, LEATHER BRIEF-CASES, LEATHER PURSES; POUCHES OF LEA-THER; BAGS, NAMELY, ALL PURPOSE CARRYING BAGS, CLUTCH BAGS, HANDBAGS, KEY BAGS, SHOULDER BAGS, TRAVEL BAGS, BEACH BAGS, WAIST BAGS, SADDLE BAGS; TRUNKS; BILLFOLDS, WALLETS, PURSES, CLUTCH PURSES, KEY CASES, BRIEFCASES; GRIPSACKS, HIP SACKS, FANNY PACKS; UM-BRELLAS, PARASOLS AND WALKING STICKS; HARNESSES, SADDLERY, SADDLERY OF LEA-THER, IN CLASS 18 (U.S. CLS. 1, 2, 3, 22 AND 41).

FOR: GLOVES, EAR MUFFS, HEADBANDS, MIT-TENS; FOOTWEAR, INCLUDING COMFORT FOOTWEAR, SPORTS AND LEISURE FOOTWEAR, NAMELY, SPORTS SHOES, LEISURE SHOES AND WORK SHOES; SHOES AND SANDALS; GYMNAS-TIC SHOES FOR REHABILITATION PURPOSES TO RECREATE THE HEALTH OF FEET; FOOTWEAR FOR WORK, SPORTS AND LEISURE; CHILDREN'S SANDALS, GYMNAS TICS SANDALS, FLIP-FLOP SANDALS, SLIP-ON SHOES, SLIPPERS, SLING-BACK SANDALS, HAND-STITCHED SANDALS, CLOGS; FOOTWEAR EXHIBITING A FOOT BED, A MOULDED FOOT SOLE, FOOTWEAR SHELLS AND ARCH SUPPORTS, CUSHIONS, NAMELY, INSOLES TO PROTECT THE FOOT AGAINST PRES-SURE; FOOT AND SHOE INSOLES WITH ANATO-MICALLY SHAPED DEEP FOOTBEDS; PROTECTIVE INSERTS, NAMELY, PADDED HEEL INSERTS FOR SENSITIVE PARTS OF THE FOOT; FOOT SUPPORTS, NAMELY, ARCH SUPPORTS FOR SHOES OR BOOTS; CORRECTION PIECES, NAMELY, HEEL PIECES FOR SHOES; SOLE IN-LAYS, NAMELY, INNER SOLES; HEELS; SHOE SOLES; SHOES SOLES, NAMELY, MOULDED FOOT SOLES AND THEIR COMPONENT PARTS; MOUL-DED SHOE SOLES IN THE FORM OF SOLID PLASTIC INSERTS WITH FOOT BEDS OR ANATO-

MICALLY FORMED DEEP FOOT BEDS MADE FROM NATURAL CORK, THERMO-CORK, PLASTICS, LATEX OR EXPANDED SYNTHETIC MATERIALS, ELASTIC COMPOSITES OF CORK OR PLASTICS-CORK MIXTURES; SHOE SOLES CONSISTING OUT OF AN OUTER SOLE AND AN INNER FOOT BED SOLE; SHOE UPPERS FOR SPORTS SHOES, LEISURE SHOES, WORK SHOES, AND SANDALS, IN CLASS 25 (U.S. CLS. 22 AND 39).

OWNER OF INTERNATIONAL REGISTRATION 0830651 DATED 1-16-2004, EXPIRES 1-16-2014.

OWNER OF U.S. REG. NO. 3,073,705.

THE MARK CONSISTS OF THE STYLIZED LETTERS "FP".

SER. NO. 79-037,969, FILED 11-7-2006.

CHARISMA HAMPTON, EXAMINING ATTORNEY

Int. Cl.: 33

Prior U.S. Cls.: 47 and 49

United States Patent and Trademark Office

Reg. No. 3,476,799

Registered July 29, 2008

TRADEMARK
PRINCIPAL REGISTER



PIPER HEIDSIECK -; ANCIENNE MAISON HEIDSIECK; FONDEE EN 1785.; COMPAGNIE CHAMPENOISE (FRANCE LTD LIAB CO)
51 BOULEVARD HENRY VASNIER
REIMS, FRANCE F51100

FOR: WINES, SPARKLING WINES, FRENCH WINES, NAMELY, WINES WITH THE CHAMPAGNE PROTECTED APPELLATION OF ORIGIN , IN CLASS 33 (U.S. CLS. 47 AND 49).

PRIORITY DATE OF 10-3-2006 IS CLAIMED.

OWNER OF INTERNATIONAL REGISTRATION 0922752 DATED 3-23-2007, EXPIRES 3-23-2017.

OWNER OF U.S. REG. NOS. 575,785, 3,063,807 AND OTHERS.

NO CLAIM IS MADE TO THE EXCLUSIVE RIGHT TO USE "BRUT" AND THE SHAPE OF THE BOTTLE, APART FROM THE MARK AS SHOWN.

THE COLOR(S) RED, WHITE, GOLD AND BLACK IS/ARE CLAIMED AS A FEATURE OF THE MARK.

THE MARK CONSISTS OF THE CONFIGURATION OF THE BOTTLE CONTAINER FOR THE GOODS AND LABELING CONTAINED THEREON. THE BOTTLE CONTAINER APPEARS IN THE COLOR RED. THE HORIZONTAL RECTANGULAR BAND ON THE NECK OF THE BOTTLE IS IN RED, HAVING THE WORDS "COOL BOX" IN THE COLOR WHITE, THREE CIRCULAR ILLUSTRATIONS IN WHITE SHOWING HOW TO USE THE PRODUCT ABOVE THE WORDS "COOL BOX", THE WORD "BRUT" APPEARS IN WHITE ABOVE THE CIRCULAR ILLUSTRATIONS. A GOLD RECTANGLE HAVING THE WORDS "PIPER-HEIDSIECK" IN BLACK LETTERING WITH A GOLD CREST ABOVE THE RECTANGLE APPEARS ABOVE THE WORD "BRUT". THE WORDING ON THE BOTTOM PORTION OF THE BOX CONTAINS THE WORDING "PIPER HEIDSIECK" IN RED WITH A GOLD CREST BETWEEN THE TWO WORDS.

SER. NO. 79-037,983, FILED 3-23-2007.

KATHERINE M. DUBRAY, EXAMINING ATTORNEY

Int. Cl.: 7

Prior U.S. Cls.: 13, 19, 21, 23, 31, 34 and 35

United States Patent and Trademark Office

Reg. No. 3,476,800

Registered July 29, 2008

**TRADEMARK
PRINCIPAL REGISTER**



SHANDONG INSTITUTE; OF ADVANCED
CERAMICS CO., LTD. (CHINA CORPOR-
TION)

LIUQUAN ROAD, ZIBO HIGH-NEW
TECHNOLOGY INDUSTRY DEVELOPMENT ZONE
SHANDONG, CHINA

FOR: PAPERMAKING MACHINES; ANTI-FRIC-
TION BEARINGS FOR MACHINES; COLLOID
GRINDING MACHINES FOR FOOD INDUSTRY;
BOBBINS FOR WEAVING LOOMS; GLASS WORK-
ING MACHINES; MACHINES FOR PETROLEUM

EXTRACTION AND PETROLEUM REFINING, IN
CLASS 7 (U.S. CLS. 13, 19, 21, 23, 31, 34 AND 35).

OWNER OF INTERNATIONAL REGISTRATION
0923150 DATED 2-15-2007, EXPIRES 2-15-2017.

SER. NO. 79-038,140, FILED 2-15-2007.

ASMAT KHAN, EXAMINING ATTORNEY

Int. Cl.: 21

Prior U.S. Cls.: 2, 13, 23, 29, 30, 33, 40 and 50

Reg. No. 3,476,801

United States Patent and Trademark Office

Registered July 29, 2008

**TRADEMARK
PRINCIPAL REGISTER**

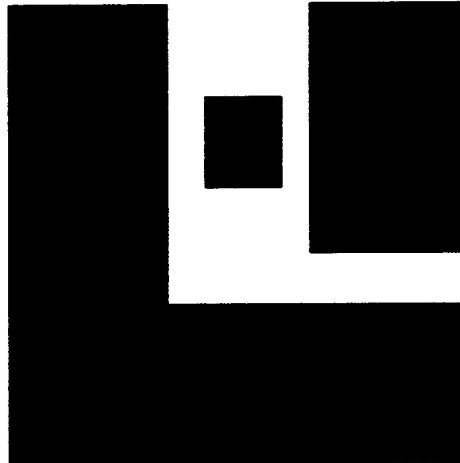

GUANGDONG LINKHILL; STAINLESS STEEL
CO., LTD. (CHINA CORPORATION)
DONGPANYANG NEW SECTION
HEPING INDUSTRIAL ZONE,; CAITANG, CHAO-
AN; GUANGDONG
CHINA

VESSELS, IN CLASS 21 (U.S. CLS. 2, 13, 23, 29, 30, 33,
40 AND 50).

OWNER OF INTERNATIONAL REGISTRATION
0923334 DATED 4-23-2007, EXPIRES 4-23-2017.

SER. NO. 79-038,199, FILED 4-23-2007.

FOR: KITCHEN CONTAINERS, NOT OF PRE-
CIOUS METAL; CHINA ORNAMENTS; DRINKING

CHRISIE B. KING, EXAMINING ATTORNEY

Int. Cls.: 35 and 41

Prior U.S. Cls.: 100, 101, 102 and 107

United States Patent and Trademark Office

Reg. No. 3,476,802

Registered July 29, 2008

**SERVICE MARK
PRINCIPAL REGISTER**



ICM-INTERCULTURAL MANAGEMENT ASSOCIATES (SOCIÉTÉ PAR ACTIONS SIMPLIFIÉE) (FRANCE CORPORATION)
2, RUE DE L'ÉGLISE
F-92200 NEULLY SUR SEINE, FRANCE

FOR: BUSINESS ADVICE, INFORMATION OR INQUIRIES FOR INDUSTRIAL OR COMMERCIAL COMPANIES OR FOR NON-PROFIT ORGANIZATIONS, NOT INVOLVED IN FIELDS OF TECHNOLOGY, ENTERTAINMENT, THE MEDIA AND COMMUNICATIONS; ADVISORY AND CONSULTING SERVICES FOR BUSINESS ORGANIZATION AND MANAGEMENT REGARDING PERSONNEL ISSUES WITH THE EXCEPTION OF THOSE PROVIDED IN THE TECHNOLOGY, ENTERTAINMENT, MEDIA AND COMMUNICATION SECTORS; ADVISORY AND CONSULTING SERVICES FOR PUBLIC RELATIONS, WITH THE EXCEPTION OF THOSE PROVIDED IN THE FIELDS OF TECHNOLOGY,

ENTERTAINMENT, THE MEDIA AND COMMUNICATIONS, IN CLASS 35 (U.S. CLS. 100, 101 AND 102).

FOR: EDUCATION, TEACHING AND PROFESSIONAL TRAINING, NOT IN THE FIELDS OF TECHNOLOGY, ENTERTAINMENT, THE MEDIA OR COMMUNICATIONS, NAMELY, BUSINESS TRAINING; TRAINING COURSES IN STRATEGIC PLANNING RELATING TO ADVERTISING, PROMOTION, MARKETING AND BUSINESS, IN CLASS 41 (U.S. CLS. 100, 101 AND 107).

OWNER OF INTERNATIONAL REGISTRATION 0564961 DATED 12-6-1990, EXPIRES 12-6-2010.

SER. NO. 79-038,295, FILED 11-17-2006.

BARBARA RUTLAND, EXAMINING ATTORNEY

Int. Cls.: 8, 10 and 20

Prior U.S. Cls.: 2, 13, 22, 23, 25, 26, 28, 32, 39, 44 and 50

Reg. No. 3,476,803

United States Patent and Trademark Office

Registered July 29, 2008

**TRADEMARK
PRINCIPAL REGISTER**

BENTLON

DANCOHR CORPORATION B.V. (NETHERLANDS PRIVATE LIMITED COMPANY)
MARCONILAAN 8
NL-6003 DD WEERT, NETHERLANDS

FOR: ELECTRIC AND NON-ELECTRIC SHAVERS; MANICURE, PEDICURE AND BEAUTY CARE APPARATUS AND INSTRUMENTS, NAMELY, HAND TOOLS AND HAND OPERATED IMPLEMENTS USED BY BEAUTY THERAPISTS, HAIRDRESSERS, MANICURISTS AND PEDICURISTS, NAMELY, ELECTRIC AND NON-ELECTRIC DEPILETORY APPLIANCES, RAZORS, CLIPPERS, RASPS, PLANES, CUTTING TOOLS, KNIVES AND PLIERS, IN CLASS 8 (U.S. CLS. 23, 28 AND 44).

FOR: MEDICAL APPARATUS, INSTALLATIONS AND INSTRUMENTS FOR PEDICURING AND MANICURING, BEAUTY APPARATUS AND MASSAGE APPARATUS, NAMELY, HIGH-FREQUENCY APPARATUS FOR STIMULATING THE BLOOD SATURATION OF THE SKIN AND FOR TREATING ACNE, VACUUM APPARATUS FOR REMOVING COMEDOS (BLACKHEADS), LOW-VOLTAGE MUSCLE STIMULATING APPARATUS FOR GIVING PASSIVE GYMNASTICS, NAMELY, FOR TRAINING AND SLIMMING PURPOSES, SLIMMING APPARATUS USING INFRARED HEAT AND LARGE WRAPPING UP ELECTRODES, BRUSHES FOR CLEANING BODY CAVITIES, MASSAGE APPARATUS, BEAUTY MASSAGE APPARATUS, SUCTION MASSAGE APPARATUS FOR WRINKLE TREATMENTS AND FACIALS, VIBRATING APPARATUS WITH ECCENTRICALLY ROTATING PARTS FOR GIVING MESSAGES, IONISATION UNIT USED

FOR REMOVAL OF HARDENED ACCUMULATIONS OF SEBACEOUS MATTER, SHAPE VIEWER AND LASER SCAN APPARATUS FOR SLIMMING PURPOSES AND SKIN TREATMENT, ULTRASOUND APPARATUS FOR SLIMMING PURPOSES AND SKIN TREATMENT, APPARATUS FOR ELECTROTHERAPY FOR SLIMMING PURPOSES AND SKIN TREATMENT, MICRO-DERMABRASION APPARATUS TO REMOVE SCARS AND LASER DEPILETION APPARATUS; MASSAGE APPARATUS, NAMELY, ELECTRIC FOOT SPA MASSAGERS, IN CLASS 10 (U.S. CLS. 26, 39 AND 44).

FOR: FURNITURE, NAMELY, TABLES, BENCHES, TREATMENT AND WORK CHAIRS FOR PEDICURES, MANICURES, BEAUTY EXPERTS AND BEAUTICIANS, IN CLASS 20 (U.S. CLS. 2, 13, 22, 25, 32 AND 50).

THE MARK CONSISTS OF STANDARD CHARACTERS WITHOUT CLAIM TO ANY PARTICULAR FONT, STYLE, SIZE, OR COLOR.

OWNER OF INTERNATIONAL REGISTRATION 0910395 DATED 5-24-2006, EXPIRES 5-24-2016.

"BENTLON" HAS NO MEANING IN A FOREIGN LANGUAGE.

SER. NO. 79-038,302, FILED 4-25-2007.

ESTHER A. BORSUK, EXAMINING ATTORNEY

Int. Cl.: 32

Prior U.S. Cls.: 45, 46 and 48

United States Patent and Trademark Office

Reg. No. 3,476,804

Registered July 29, 2008

**TRADEMARK
PRINCIPAL REGISTER**

FEVER-TREE

FEVERTREE LIMITED (UNITED KINGDOM
PRIVATE LIMITED COMPANY)

35A VICTORIA ROAD

SURBITON, SURREY KT6 4JT

UNITED KINGDOM

FOR: BEVERAGES, NAMELY, DRINKING WATERS, FLAVOURED WATERS, MINERAL AND AERATED WATERS; AND OTHER NON-ALCOHOLIC BEVERAGES, NAMELY, SOFT DRINKS, ENERGY DRINKS AND SPORTS DRINKS; FRUIT DRINKS AND JUICES; TONIC WATERS; SYRUPS, CONCENTRATES AND POWDERS FOR MAKING BEVERAGES; ALL OF THE AFORESAID NOT BEING FOR MEDICINAL PURPOSES, IN CLASS 32 (U.S. CLS. 45, 46 AND 48).

THE MARK CONSISTS OF STANDARD CHARACTERS WITHOUT CLAIM TO ANY PARTICULAR FONT, STYLE, SIZE, OR COLOR.

PRIORITY DATE OF 12-8-2006 IS CLAIMED.

OWNER OF INTERNATIONAL REGISTRATION
0913158 DATED 12-20-2006, EXPIRES 12-20-2016.

OWNER OF U.S. REG. NO. 3,118,764.

SEC. 2(F).

SER. NO. 79-038,303, FILED 5-10-2007.

ADA HAN, EXAMINING ATTORNEY

Int. Cls.: 9, 37, 38 and 42

**Prior U.S. Cls.: 21, 23, 26, 36, 38, 100, 101, 103, 104
and 106**

Reg. No. 3,476,805

United States Patent and Trademark Office

Registered July 29, 2008

**TRADEMARK
SERVICE MARK
PRINCIPAL REGISTER**

1000eyes

1000EYES GMBH (FED REP GERMANY LTD
LIAB CO)
JOACHIMSTALER STR. 12
10719 BERLIN
FED REP GERMANY

FOR: PHOTOTELEGRAPHY APPARATUS; REMOTE CONTROL FOR RADIOS, TELEVISIONS AND CAMERAS; PHOTOGRAPHIC FILTERS; PHOTOVOLTAIC CELLS; PHOTOMETERS; COMPUTER MONITORS; OBJECTIVES, NAMELY, OPTICAL LENSES; APPARATUS FOR RECORDING, TRANSMISSION OR REPRODUCTION OF SOUND OR IMAGES, NAMELY, AUDIO AND VIDEO RECEIVERS, MOTION PICTURE CAMERAS, SOUND RECORDING APPARATUS, SOUND TRANSMITTING APPARATUS, TELEPHONE TRANSMITTERS, BLANK VIDEOTAPES, VIDEO SCREENS, VIDEO CAMERAS, BLANK VIDEO CASSETTES, TIME RECORDING APPARATUS, NAMELY, CHRONOGRAPHS; DATA PROCESSORS AND COMPUTERS, COMPUTER OPERATING PROGRAMS, COMPUTER PERIPHERAL DEVICES, COMPUTER SOFTWARE FOR DATA TRANSMISSION AND FOR USE IN OPERATING VIDEO SURVEILLANCE SYSTEMS; COMPUTER SOFTWARE FOR DATA TRANSMISSION AND FOR USE IN OPERATING VIDEO SURVEILLANCE SYSTEMS THAT MAY BE DOWNLOADED FROM A GLOBAL COMPUTER NETWORK; COMPUTER INTERFACE BOARDS, IN CLASS 9 (U.S. CLS. 21, 23, 26, 36 AND 38).

FOR: REPAIR AND INSTALLATION SERVICES, NAMELY, INSTALLATION, MAINTENANCE AND REPAIR OF COMPUTER HARDWARE, INSTALLATION AND REPAIR OF BURGLAR AND SECURITY ALARM INSTALLATIONS, INSTALLATION, REPAIR AND MAINTENANCE OF DATA TECHNOL-

OGY INSTALLATIONS, NAMELY, COMPUTER HARDWARE, IN CLASS 37 (U.S. CLS. 100, 103 AND 106).

FOR: PROVIDING ACCESS TO A GLOBAL COMPUTER NETWORK, COMPUTER-AIDED TRANSMISSION OF MESSAGES AND IMAGES, PAGING SERVICES; COMMUNICATION VIA RADIO, TELEGRAPH, TELEPHONE AND TELEVISION TRANSMISSIONS, IN CLASS 38 (U.S. CLS. 100, 101 AND 104).

FOR: DEVELOPMENT OF COMPUTER HARDWARE AND SOFTWARE, NAMELY, UPDATING OF COMPUTER SOFTWARE, DESIGN OF COMPUTER SOFTWARE, DESIGN OF COMPUTER SYSTEMS, DESIGN AND DEVELOPMENT OF PROGRAMS FOR THE PROCESSING OF DATA/ COMPUTER PROGRAMMING, INSTALLATION AND MAINTENANCE OF COMPUTER PROGRAMS AND SOFTWARE, CONVERSION OF DATA OR DOCUMENTS FROM PHYSICAL TO ELECTRONIC MEDIA, DESIGN AND MAINTENANCE OF WEBSITES FOR THIRD PARTIES, WEB SITE HOSTING SERVICES; RENTAL OF COMPUTER SOFTWARE; CONSULTANCY IN THE FIELD OF COMPUTERS; RENTAL OF ELECTRONIC RECORDING APPARATUS, NAMELY, COMPUTERS AND COMPUTER PERIPHERAL DEVICES FOR DATA PROCESSING EQUIPMENT, WEB SERVERS, AND OTHER EQUIPMENT FOR DATA RECORDING, NAMELY, COMPUTER HARDWARE AND SOFTWARE, DATABASE SERVERS AND DATA PROCESSING EQUIPMENT, IN CLASS 42 (U.S. CLS. 100 AND 101).

PRIORITY DATE OF 1-25-2007 IS CLAIMED.

OWNER OF INTERNATIONAL REGISTRATION
0923781 DATED 3-30-2007, EXPIRES 3-30-2017.

SER. NO. 79-038,351, FILED 3-30-2007.
KAREN K. BUSH, EXAMINING ATTORNEY

Int. Cls.: 9 and 42

Prior U.S. Cls.: 21, 23, 26, 36, 38, 100 and 101

United States Patent and Trademark Office

Reg. No. 3,476,806

Registered July 29, 2008

**TRADEMARK
SERVICE MARK
PRINCIPAL REGISTER**

CROSSSELL

CROSSSELL PTY LTD (AUSTRALIA A PROPRIETARY COMPANY, LIMITED BY SHARES)
LEVEL 9
189 KENT STREET; SYDNEY, NSW 2000
AUSTRALIA

FOR: COMPUTER SOFTWARE FOR THE COLLECTION, EDITING, ORGANIZING, MODIFYING, BOOKMARKING, TRANSMISSION, STORAGE AND SHARING OF DATA AND INFORMATION, IN THE FIELD OF SALES DATA ANALYSIS, THAT MAY BE DOWNLOADED FROM A GLOBAL COMPUTER NETWORK; DOWNLOADABLE COMPUTER SOFTWARE PROGRAMS FOR PROCESSING AND ANALYZING SALES DATA AND INFORMATION; COMPUTER PROGRAMS RECORDED ON SOFTWARE FOR PROCESSING AND ANALYZING SALES DATA AND INFORMATION; COMPUTER OPERATING PROGRAMS RECORDED ON DATA MEDIA, IN CLASS 9 (U.S. CLS. 21, 23, 26, 36 AND 38).

FOR: DESIGN AND DEVELOPMENT OF COMPUTER HARDWARE AND COMPUTER SOFTWARE; INSTALLATION, MAINTENANCE AND UPDATING OF COMPUTER SOFTWARE; COMPUTER SYSTEM DESIGN; COMPUTER SYSTEMS ANALYSIS, IN CLASS 42 (U.S. CLS. 100 AND 101).

THE MARK CONSISTS OF STANDARD CHARACTERS WITHOUT CLAIM TO ANY PARTICULAR FONT, STYLE, SIZE, OR COLOR.

PRIORITY DATE OF 10-18-2006 IS CLAIMED.

OWNER OF INTERNATIONAL REGISTRATION 0923891 DATED 4-18-2007, EXPIRES 4-18-2017.

SER. NO. 79-038,390, FILED 4-18-2007.

SKYE YOUNG, EXAMINING ATTORNEY

Int. Cls.: 38, 41, 42 and 44

Prior U.S. Cls.: 100, 101, 104 and 107

Reg. No. 3,476,807

United States Patent and Trademark Office

Registered July 29, 2008

**SERVICE MARK
PRINCIPAL REGISTER**

shoot

SHOOT LIMITED (UNITED KINGDOM LIMITED COMPANY)
P.O. BOX 57501
LONDON NW6 9DQ
UNITED KINGDOM

FOR: ELECTRONIC DATA TRANSMISSION SERVICES, NAMELY, COMMUNICATION BY COMPUTER TERMINALS OF INFORMATION RELATING TO GARDENING; ELECTRONIC DATA TRANSMISSION SERVICES, NAMELY, COMMUNICATIONS VIA ELECTRONIC MEANS OF INFORMATION RELATING TO GARDENING; ELECTRONIC DATA TRANSMISSION SERVICES, NAMELY, CELLULAR TELEPHONE COMMUNICATION OF INFORMATION RELATING TO GARDENING; PROVIDING ON-LINE ELECTRONIC BULLETIN BOARDS FOR TRANSMISSION OF MESSAGES AMONG COMPUTER USERS CONCERNING GARDENING; ELECTRONIC MAIL SERVICES; ELECTRONIC MESSAGE TRANSMISSION SERVICES; ELECTRONIC ORDER TRANSMISSION FOR GARDENING AND HORTICULTURAL RELATED PURCHASES; PROVIDING ON-LINE ACCESS TO ELECTRONIC SITES FEATURING NEWS, WEATHER, CURRENT EVENTS AND REFERENCE MATERIALS; PROVIDING AN ONLINE FORUM WHERE COMPUTER USERS CAN INTERACT WITH OTHER COMPUTER USERS FOR THE TRANSMISSION OF MESSAGES AMONG COMPUTER USERS CONCERNING TOPICS OF GARDENING AND OTHER HORTICULTURAL INTERESTS, IN CLASS 38 (U.S. CLS. 100, 101 AND 104).

FOR: GARDEN CLUB SERVICES, NAMELY, EDUCATION SERVICES IN THE NATURE OF PROVIDING A WEBSITE FEATURING ON-LINE LEARNING MODULES AND SELF-TESTING RELATING TO GARDENING AND HORTICULTURE, IN CLASS 41 (U.S. CLS. 100, 101 AND 107).

FOR: COMPUTER SERVICES, NAMELY, CREATING INDEXES OF GARDENING INFORMATION, GARDENING SITES AND OTHER HORTICULTURAL RESOURCES AVAILABLE ON COMPUTER NETWORKS, IN CLASS 42 (U.S. CLS. 100 AND 101).

FOR: PROVIDING INFORMATION REGARDING LANDSCAPING, YARD AND PLANT CARE; PROVIDING INFORMATION AND ADVICE REGARDING PLANT DISEASES AND GARDENING PROBLEMS; PROVISION OF GARDENING INFORMATION VIA SEARCH ENGINE SERVICES; ADVISORY SERVICES RELATING TO GARDENING; GARDENING SERVICES; LANDSCAPE GARDENING DESIGN FOR OTHERS; GARDEN MAINTENANCE; LANDSCAPE GARDENING; HORTICULTURE SERVICES; PROVISION OF INFORMATION RELATING TO GARDENS AND GARDENING; PROVISION OF PROACTIVE GARDEN CARE ADVICE AND TIPS; PROVISION OF INFORMATION PERTAINING TO GARDENING, NAMELY, PROVIDING INFORMATION IN THE FORM OF AN ON-LINE GARDEN CARE CALENDAR FEATURING INFORMATION ABOUT GROWING SEASONS, PLANTING SEASONS, PRUNING SEASONS, PROPAGATING SEASONS, AND ABOUT THE OPTIMAL TIMES TO APPLY FERTILIZER, IN CLASS 44 (U.S. CLS. 100 AND 101).

THE MARK CONSISTS OF STANDARD CHARACTERS WITHOUT CLAIM TO ANY PARTICULAR FONT, STYLE, SIZE, OR COLOR.

OWNER OF INTERNATIONAL REGISTRATION 0924105 DATED 11-14-2006, EXPIRES 11-14-2016.

SER. NO. 79-038,454, FILED 11-14-2006.

DEBRA LEE, EXAMINING ATTORNEY

Int. Cls.: 1, 2 and 17

Prior U.S. Cls.: 1, 5, 6, 10, 11, 12, 13, 16, 26, 35, 46 and 50

Reg. No. 3,476,808

United States Patent and Trademark Office

Registered July 29, 2008

**TRADEMARK
PRINCIPAL REGISTER**

The logo for XENIOS SURFACE PERFECTION features the word "XENIOS" in a large, bold, sans-serif font. The letter "O" is replaced by a blue sphere with a white highlight, giving it a three-dimensional appearance. Below "XENIOS" is the phrase "SURFACE PERFECTION" in a smaller, all-caps, sans-serif font.

EVONIK DEGUSSA GMBH
RELLINGHAUSER STRAÙE 1-11
45128 ESSEN
FED REP GERMANY

FOR: CHEMICALS FOR USE IN INDUSTRY; CHEMICAL PRODUCTS IN THE FORM OF LIQUID COATING MATERIALS AND SEALING MATERIALS FOR THE TREATMENT OF STONE SURFACES, METAL SURFACES, PLASTIC SURFACES, WOOD SURFACES, TEXTILE SURFACES, LEATHER SURFACES AND FLOOR COVERINGS IN ORDER TO PROTECT AGAINST MECHANICAL DAMAGE, LINGERING SOILING, SPOTTING, DAMAGE DUE TO UV RADIATION, DAMAGE DUE TO ATTACK BY BACTERIA AND DAMAGE BY CHEMICALS, IN CLASS 1 (U.S. CLS. 1, 5, 6, 10, 26 AND 46).

FOR: PRESERVATIVES AGAINST DETERIORATION OF WOOD; LIQUID COATING MATERIALS AND SEALING MATERIALS BEING LACQUERS FOR THE TREATMENT OF STONE SURFACES, METAL SURFACES, PLASTIC SURFACES, WOOD SURFACES, TEXTILE SURFACES, LEATHER SURFACES AND FLOOR COVERINGS IN ORDER TO PROTECT AGAINST MECHANICAL DAMAGE, LINGERING SOILING, SPOTTING, DAMAGE DUE TO UV RADIATION, DAMAGE DUE TO ATTACK BY BACTERIA AND DAMAGE BY CHEMICALS, IN CLASS 2 (U.S. CLS. 6, 11 AND 16).

FOR: LIQUID COATING MATERIALS AND SEALING MATERIALS BEING PACKING AND IN-

SULATING MATERIALS FOR THE TREATMENT OF STONE SURFACES, METAL SURFACES AND PLASTIC SURFACES, TO PROTECT AGAINST MECHANICAL DAMAGE, LINGERING SOILING, SPOTTING, DAMAGE DUE TO UV RADIATION, DAMAGE DUE TO ATTACK BY BACTERIA AND DAMAGE BY CHEMICALS, IN CLASS 17 (U.S. CLS. 1, 5, 12, 13, 35 AND 50).

PRIORITY DATE OF 6-13-2006 IS CLAIMED.

OWNER OF INTERNATIONAL REGISTRATION 0924254 DATED 12-1-2006, EXPIRES 12-1-2016.

NO CLAIM IS MADE TO THE EXCLUSIVE RIGHT TO USE "SURFACE", APART FROM THE MARK AS SHOWN.

THE COLOR(S) BLUE, WHITE AND GRAY IS/ ARE CLAIMED AS A FEATURE OF THE MARK.

THE MARK CONSISTS OF THE COLOR BLUE APPEARS IN THE SPHERE THAT STANDS IN THE PLACE OF THE LETTER "O"; AND THE COLOR GRAY APPEARS IN ALL OF THE WORDING EXCEPT FOR THE "O" IN "XENIOS".

SER. NO. 79-038,514, FILED 12-1-2006.

SUZANNE BLANE, EXAMINING ATTORNEY

Int. Cl.: 29

Prior U.S. Cl.: 46

United States Patent and Trademark Office

Reg. No. 3,476,809

Registered July 29, 2008

TRADEMARK
PRINCIPAL REGISTER



LACTALIS MCLELLAND LTD (UNITED KING-
DOM LIMITED COMPANY (LTD.))
NEW CHEESE MARKET, TOWNHEAD
GLASGOW G4 0EF
UNITED KINGDOM

FOR: MILK AND DAIRY PRODUCTS EXCLUD-
ING ICE CREAM, ICE MILK AND FROZEN YO-
GURT; CHEESES; EDIBLE OILS AND FATS, IN
CLASS 29 (U.S. CL. 46).

PRIORITY DATE OF 11-28-2006 IS CLAIMED.

OWNER OF INTERNATIONAL REGISTRATION
0917838 DATED 1-30-2007, EXPIRES 1-30-2017.

OWNER OF U.S. REG. NO. 2,181,726.

NO CLAIM IS MADE TO THE EXCLUSIVE
RIGHT TO USE "SINCE 1850" AND "STRONG",
APART FROM THE MARK AS SHOWN.

THE COLOR(S) RED, BLACK, WHITE, BLUE,
AND GOLD IS/ARE CLAIMED AS A FEATURE OF
THE MARK.

THE MARK COMPRISES A RED LABEL WITH A
BLACK CIRCLE IN THE CENTRE SURROUNDED
BY A GOLD LINE AND IN THE MIDDLE TWO
INSERTS SURROUNDED BY A GOLD LINE, A
WHITE INSERT WITH THE DENOMINATION
"SERIOUSLY" IN BLACK ABOVE A RED INSERT
WITH THE DENOMINATION "STRONG" IN WHITE
OUTLINED IN BLACK; THESE TWO INSERTS ARE
SURMOUNTED BY A BLUE COAT OF ARMS WITH
A WHITE CROSS AND BELOW "MCLELLAND" IN
WHITE FOLLOWED BY "SERIOUS ABOUT CHEESE
SINCE 1850" IN RED.

SER. NO. 79-038,573, FILED 5-25-2007.

HEATHER BIDDULPH, EXAMINING ATTORNEY

Int. Cls.: 7 and 12

Prior U.S. Cls.: 13, 19, 21, 23, 31, 34, 35 and 44

United States Patent and Trademark Office

Reg. No. 3,476,810

Registered July 29, 2008

**TRADEMARK
PRINCIPAL REGISTER**



KEYSTER PRECISION WORKS LTD. (JAPAN CORPORATION)
85-1, MOTOHAMA-CHO 4-CHOME
AMAGASAKI-SHI; HYOGO 660-0085, JAPAN

OWNER OF INTERNATIONAL REGISTRATION
0924974 DATED 4-9-2007, EXPIRES 4-9-2017.

FOR: CARBURETORS FOR INTERNAL COMBUSTION ENGINES; SPARK PLUGS FOR INTERNAL COMBUSTION ENGINES, IN CLASS 7 (U.S. CLS. 13, 19, 21, 23, 31, 34 AND 35).

THE WORDING "KEYSTER" HAS NO MEANING IN A FOREIGN LANGUAGE.

FOR: INTERNAL COMBUSTION ENGINES FOR LAND VEHICLES, IN CLASS 12 (U.S. CLS. 19, 21, 23, 31, 35 AND 44).

SER. NO. 79-038,786, FILED 4-9-2007.

ESTHER BELENKER, EXAMINING ATTORNEY

Int. Cls.: 37 and 42

Prior U.S. Cls.: 100, 101, 103 and 106

United States Patent and Trademark Office

Reg. No. 3,476,811

Registered July 29, 2008

**SERVICE MARK
PRINCIPAL REGISTER**



DOMINO PRINTING SCIENCES PLC (UNITED
KINGDOM PUBLIC LIMITED COMPANY)
BAR HILL,
CAMBRIDGE CB3 8TU
UNITED KINGDOM

FOR: INSTALLATION, MAINTENANCE AND
REPAIR OF PRINTING APPARATUS, MARKING
APPARATUS IN THE NATURE OF MECHANICAL,
ELECTRICAL, ELECTROMECHANICAL OR LASER
MARKING MACHINES, PRINTING MACHINES,
PRINTING PRESSES, AND INK JET PRINTING
MACHINES, IN CLASS 37 (U.S. CLS. 100, 103 AND
106).

FOR: TECHNICAL SUPPORT SERVICES, NAME-
LY, PROVIDING TROUBLESHOOTING OF COM-
PUTER HARDWARE AND COMPUTER
SOFTWARE PROBLEMS CONCERNING PRINTING

APPARATUS, MARKING APPARATUS IN THE
NATURE OF MECHANICAL, ELECTRICAL, ELEC-
TROMECHANICAL OR LASER MARKING MA-
CHINES, PRINTING MACHINES, PRINTING
PRESSES, AND INK JET PRINTING MACHINES,
IN CLASS 42 (U.S. CLS. 100 AND 101).

PRIORITY DATE OF 12-9-2006 IS CLAIMED.

OWNER OF INTERNATIONAL REGISTRATION
0924975 DATED 5-15-2007, EXPIRES 5-15-2017.

SER. NO. 79-038,787, FILED 5-15-2007.

MICHAEL TANNER, EXAMINING ATTORNEY

Int. Cl.: 31

Prior U.S. Cls.: 1 and 46

United States Patent and Trademark Office

Reg. No. 3,476,812

Registered July 29, 2008

**TRADEMARK
PRINCIPAL REGISTER**

MARKO

SUNTORY FLOWERS LIMITED (JAPAN CORPORATION)

2-13-12, HIRAKAWACHO,
CHIYODA-KU; TOKYO 102-0093
JAPAN

FOR: FLOWER SEEDS; FLOWER BULBS; PLANT SEEDS; LIVE TREES; LIVE PLANTS, NAMELY, GRASSES; LIVE PLANTS; NATURAL TURF; DRIED FLOWERS; SEEDLINGS; SAPLINGS; AND LIVE FLOWERS EXCEPT EXCLUDING BARLEY, PERENNIAL RYEGRASS, SUN FLOWER, CARROT AND KOHLRABI FROM ALL SUCH GOODS, IN CLASS 31 (U.S. CLS. 1 AND 46).

THE MARK CONSISTS OF STANDARD CHARACTERS WITHOUT CLAIM TO ANY PARTICULAR FONT, STYLE, SIZE, OR COLOR.

PRIORITY DATE OF 4-11-2007 IS CLAIMED.

OWNER OF INTERNATIONAL REGISTRATION 0925050 DATED 5-10-2007, EXPIRES 5-10-2017.

SER. NO. 79-038,819, FILED 5-10-2007.

KATHERINE E. HALMEN, EXAMINING ATTORNEY

Int. Cls.: 6, 9, 11 and 17

Prior U.S. Cls.: 1, 2, 5, 12, 13, 14, 21, 23, 25, 26, 31, 34, 35, 36, 38 and 50

Reg. No. 3,476,813

United States Patent and Trademark Office

Registered July 29, 2008

**TRADEMARK
PRINCIPAL REGISTER**

APSOFLUID

ANGST & PFISTER AG (SWITZERLAND SOCIÉTÉ ANONYME (A JOINT STOCK COMPANY UNDER THE LAWS OF SWITZERLAND))
THURGAUERSTRASSE 66
CH-8050 ZÜRICH
SWITZERLAND

FOR: METAL BUILDING MATERIALS, NAME-
LY, NON-ELECTRIC CABLES AND WIRES OF
COMMON METAL, BINDING SCREWS FOR
CABLES AND NON-ELECTRIC CABLE JOINTS,
METAL SEALING CAPS, METAL IRONMONGERY,
NAMELY, BOLTS, NAILS, RIVETS, SCREWS;
SMALL ITEMS OF METAL HARDWARE, NAMELY,
NUTS, WASHERS, SPRINGS, TUBES; GOODS OF
COMMON METAL NOT INCLUDED IN OTHER
CLASSES, NAMELY, RINGS, PIPES, BOLTS, DISKS,
VALVES, CASINGS; FITTINGS OF METAL FOR
COMPRESSED AIR DUCTS AND FOR MACHINE
BELTS; CLEATS AND TAPPETS OF METAL FOR
MACHINE BELTS; FLAT GASKETS OF METAL
FOR USE AS SEALING ELEMENTS FOR HYDRAU-
LIC AND PNEUMATIC SYSTEMS; BOTTLE CLO-
SURES AND CAPS OF METAL; PIPE MUFFS OF
METAL AND COLLARS OF METAL FOR FASTEN-
ING PIPES, JUNCTIONS OF METAL FOR PIPES, IN
CLASS 6 (U.S. CLS. 2, 12, 13, 14, 23, 25 AND 50).

FOR: MEASURING APPARATUS, NAMELY,
PRESSURE GAUGES AND PRESSURE MEASUR-
ING SENSORS; APPARATUS FOR DISTRIBUTING,
ACCUMULATING, REGULATING AND CON-
TROLLING ELECTRICITY, NAMELY, CONTROL
UNITS FOR REGULATING START-UP ELECTRICAL
MOTORS, IN CLASS 9 (U.S. CLS. 21, 23, 26, 36
AND 38).

FOR: APPARATUS FOR LIGHTING, VENTILAT-
ING AND WATER SUPPLY AND SANITARY PUR-
POSES, NAMELY, AIR FILTERS FOR HEATING,
VENTILATION AND AIR CONDITIONING SYS-
TEMS; LIGHTING APPARATUS AND INSTALLA-
TIONS, NAMELY, LAMPS, FLASHLIGHTS,
PORTABLE SEARCHLIGHTS, POWER FAILURE
BACKUP SAFETY LIGHTS AND WARNING

LIGHTS, IN CLASS 11 (U.S. CLS. 13, 21, 23, 31 AND
34).

FOR: RUBBER, GUTTA-PERCHA, GUM AND
GOODS MADE FROM THESE MATERIALS, NAME-
LY, STOPS OF RUBBER, RINGS OF RUBBER, V-
BELTS, VIBRATING BUFFERS FOR INDUSTRIAL
MACHINERY, ADHESIVE BANDS OTHER THAN
STATIONERY AND NOT FOR MEDICAL OR
HOUSEHOLD PURPOSES; DRAUGHT EXCLUDER
STRIPS, NAMELY, NON-METAL WEATHER
STRIPS FOR BUILDINGS; PLASTICS IN EXTRU-
DED FORM FOR USE IN MANUFACTURE; FILTER
MATERIALS, NAMELY, SEMI-FINISHED PLAS-
TICS, SYNTHETIC PLASTIC AS SEMI-FINISHED
PRODUCTS IN THE FORM OF FOILS, PLATES,
RODS, PROFILES, HOSES, TUBES, BLOCKS, IN-
DUSTRIAL COATINGS, NAMELY, NATURAL AND
LIQUID RUBBER; THERMOPLASTIC ELASTOMER
RESINS IN PELLET FORM FOR USE IN FURTHER
MANUFACTURE; PACKING, STOPPING AND IN-
SULATING MATERIALS, NAMELY, SHEETS OF
GRAPHITE-BASED MATERIAL FOR USE AS GAS-
KETS, SEALS, PACKINGS, AND HEAT INSULA-
TORS; GASKET MATERIAL IN SHEETS FOR USE
IN BUILDING; GASKET SEALER FOR USE IN
PLUMBING; WEATHERSTRIPPING SEALANTS IN
THE NATURE OF CAULK; SOUNDPROOFING
MATERIALS FOR BUILDINGS AND MACHINERY;
FLEXIBLE TUBES OF PLASTIC FOR INDUSTRIAL
USE; FLEXIBLE COMPRESSED AIR PIPE FIT-
TINGS, NOT OF METAL; REINFORCING MATERI-
ALS, NOT OF METAL, FOR PIPES; PIPE MUFFS,
NOT OF METAL; JUNCTIONS, NOT OF METAL,
FOR PLASTIC PIPES, IN CLASS 17 (U.S. CLS. 1, 5, 12,
13, 35 AND 50).

THE MARK CONSISTS OF STANDARD CHAR-
ACTERS WITHOUT CLAIM TO ANY PARTICULAR
FONT, STYLE, SIZE, OR COLOR.

PRIORITY DATE OF 1-17-2007 IS CLAIMED.

OWNER OF INTERNATIONAL REGISTRATION
0925469 DATED 3-30-2007, EXPIRES 3-30-2017.

SER. NO. 79-039,003, FILED 3-30-2007.
ERIN FALK, EXAMINING ATTORNEY

Int. Cl.: 3

Prior U.S. Cls.: 1, 4, 6, 50, 51 and 52

United States Patent and Trademark Office

Reg. No. 3,476,814

Registered July 29, 2008

TRADEMARK
PRINCIPAL REGISTER

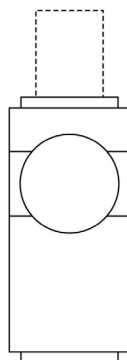

ROGER & GALLET (FRANCE SOCIÉTÉ PAR
ACTIONS SIMPLIFIÉE)

20/26 BOULEVARD DU PARC

F-92200 NEUILLY SUR SEINE

FRANCE

FOR: PERFUMES, EAUX DE TOILETTE; EAU-
DE-COLOGNE; DEODORANTS FOR PERSONAL
USE; ESSENTIAL OILS; OILS FOR COSMETIC USE;
LIQUID SOAPS; NON-MEDICATED TOILETRIES
AND BEAUTY CARE MILKS; COSMETIC PRE-
PARATIONS FOR SKIN CARE, FOR SLIMMING,
FOR BATHING, FOR SKIN TANNING; HAIR LO-
TIONS AND HAIR CARE PREPARATIONS; SHAM-
POOS; SHAVING FOAMS, GELS, AND LOTIONS,
SHAVING SOAPS, IN CLASS 3 (U.S. CLS. 1, 4, 6, 50, 51
AND 52).

PRIORITY DATE OF 10-26-2006 IS CLAIMED.

OWNER OF INTERNATIONAL REGISTRATION
0925522 DATED 4-23-2007, EXPIRES 4-23-2017.

THE MARK CONSISTS OF A CONFIGURATION
OF A CONTAINER, WHERE THE MAIN CYLIND-
RICAL BODY HAS SLIGHTLY SMALLER CYLIND-
RICAL PROJECTIONS ABOVE AND BELOW THE
MAIN CYLINDRICAL BODY. THE MAIN CYLIND-
RICAL BODY INCLUDES A DESIGN FORMED BY
A CIRCLE AND A WIDE HORIZONTAL STRIPE
CIRCUMFERENTIALLY EXTENDING AROUND
THE MAIN CYLINDRICAL BODY AND CEN-
TERED WITH RESPECT TO THE CIRCLE. THE
BROKEN LINE REPRESENT THE PLACEMENT OF
THE NOZZLE AND CAP AND ARE NOT PART OF
THE DESIGN.

SER. NO. 79-039,026, FILED 4-23-2007.

SUSAN LESLIE DUBOIS, EXAMINING ATTORNEY

Int. Cls.: 18 and 25

Prior U.S. Cls.: 1, 2, 3, 22, 39 and 41

United States Patent and Trademark Office

Reg. No. 3,476,815

Registered July 29, 2008

**TRADEMARK
PRINCIPAL REGISTER**



CINQ HUITIEMES (FRANCE SOCIETE ANON-
YME)
10 RUE DE MONT LOUIS
F-75011 PARIS, FRANCE

FOR: GOODS MADE OF LEATHER AND IMITATION LEATHER, NAMELY, TRUNKS AND SUITCASES, VALISES, TRAVEL BAGS, HANDBAGS, SCHOOL SATCHELS, RUCKSACKS, LEATHER TOOL BAGS SOLD EMPTY, SCHOOL BAGS, CYCLE BAGS, NAMELY, MESSENGER BAGS, COLLECTION BAGS, NAMELY, RUCK SACKS, MOTORCYCLE BAGS, NAMELY, MESSENGER BAGS, DOCUMENT CASES, NAMELY, BRIEFCASES, HUNTING BAGS; SMALL LEATHER GOODS, NAMELY, WALLETS, PURSES, CARD HOLDERS, NAMELY, SMALL WALLETS; SMALL LEATHER KEY CASES; UMBRELLAS, WALKING STICKS, PARASOLS AND SUNSHADES; WHIPS, SADDLES, HARNESSES AND HORSE BLANKETS, IN CLASS 18 (U.S. CLS. 1, 2, 3, 22 AND 41).

FOR: CLOTHING, NAMELY, SOCKS, BRIEFS, SWIMMING TRUNKS AND SUITS, UNDERCLOTHING, NAMELY, UNDERWEAR, BRAS, PANTIES, BOXER SHORTS; SUITS, TROUSERS, JACKETS, DRESSES AND SKIRTS; SHIRTS AND SHORT-SLEEVED SHIRTS; SWEATERS; COATS AND WATERPROOF CLOTHING, NAMELY, JACKETS AND PANTS; PAJAMAS AND NIGHTDRESSES; DUSTERS AND DRESSING GOWNS; TRACKSUITS,

SHORTS, SINGLETS AND COVERALLS FOR SPORTS; BELTS, TIES, SCARVES AND HEADSCARVES, GLOVES; FOOTWEAR, EXCEPT ORTHOPEDIC FOOTWEAR, NAMELY, SLIPPERS, BOOTS AND HALF-BOOTS; SANDALS AND BEACH SHOES; ATHLETIC SHOES; HEADGEAR, NAMELY, HATS, CAPS AND BONNETS, IN CLASS 25 (U.S. CLS. 22 AND 39).

PRIORITY DATE OF 10-30-2006 IS CLAIMED.

OWNER OF INTERNATIONAL REGISTRATION 0925565 DATED 4-6-2007, EXPIRES 4-6-2017.

THE COLOR(S) INDIGO, PINK, LIGHT BLUE AND WHITE IS/ARE CLAIMED AS A FEATURE OF THE MARK.

THE MARK CONSISTS OF HORIZONTAL STRIPES FROM TOP TO BOTTOM IN THE COLORS INDIGO, PINK, LIGHT BLUE AND WHITE, INDIGO, PINK, LIGHT BLUE.

SER. NO. 79-039,038, FILED 4-6-2007.

JESSICA FATHY, EXAMINING ATTORNEY

Int. Cls.: 18 and 25

Prior U.S. Cls.: 1, 2, 3, 22, 39 and 41

United States Patent and Trademark Office

Reg. No. 3,476,816

Registered July 29, 2008

**TRADEMARK
PRINCIPAL REGISTER**

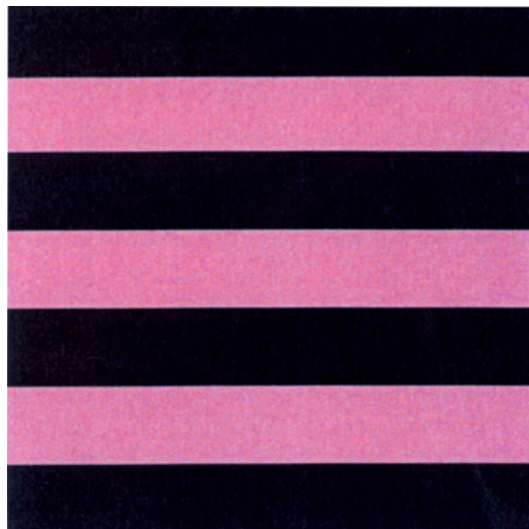

CINQ HUITIEMES (FRANCE SOCIETE ANON-
YME)
10 RUE DE MONT LOUIS
F-75011 PARIS, FRANCE

FOR: GOODS MADE OF LEATHER AND IMITATION LEATHER, NAMELY, TRUNKS AND SUITCASES, VALISES, TRAVEL BAGS, HANDBAGS, SCHOOL SACHELS, RUCKSACKS, LEATHER TOOL BAGS SOLD EMPTY, SCHOOL BAGS, CYCLE BAGS, NAMELY, MESSENGER BAGS, COLLECTION BAGS, NAMELY, RUCK SACKS, MOTORCYCLE BAGS, NAMELY, MESSENGER BAGS, DOCUMENT CASES, NAMELY, BRIEFCASES, HUNTING BAGS; SMALL LEATHER GOODS, NAMELY, WALLETS, PURSES, CARD HOLDERS, NAMELY, SMALL WALLETS; SMALL LEATHER KEY CASES; UMBRELLAS, WALKING STICKS, PARASOLS AND SUNSHADES; WHIPS, SADDLES, HARNESSES AND HORSE BLANKETS, IN CLASS 18 (U.S. CLS. 1, 2, 3, 22 AND 41).

FOR: CLOTHING, NAMELY, SOCKS, BRIEFS, SWIMMING TRUNKS AND SUITS, UNDERCLOTHING, NAMELY, UNDERWEAR, BRAS, PANTIES, BOXER SHORTS; SUITS, TROUSERS, JACKETS, DRESSES AND SKIRTS; SHIRTS AND SHORT-SLEEVED SHIRTS; SWEATERS; COATS AND WATERPROOF CLOTHING, NAMELY, JACKETS AND

PANTS; PAJAMAS AND NIGHTDRESSES; DUSTERS AND DRESSING GOWNS; TRACKSUITS, SHORTS, SINGLETS AND COVERALLS FOR SPORTS; BELTS, TIES, SCARVES AND HEADSCARVES, GLOVES; FOOTWEAR, EXCEPT ORTHOPEDIC FOOTWEAR, NAMELY, SLIPPERS, BOOTS AND HALF-BOOTS; SANDALS AND BEACH SHOES; ATHLETIC SHOES; HEADGEAR, NAMELY, HATS, CAPS AND BONNETS, IN CLASS 25 (U.S. CLS. 22 AND 39).

PRIORITY DATE OF 10-30-2006 IS CLAIMED.

OWNER OF INTERNATIONAL REGISTRATION
0925566 DATED 4-6-2007, EXPIRES 4-6-2017.

THE COLOR(S) INDIGO AND PINK IS/ARE
CLAIMED AS A FEATURE OF THE MARK.

THE MARK CONSISTS OF ALTERNATING IN-
DIGO AND PINK HORIZONTAL STRIPES.

SER. NO. 79-039,039, FILED 4-6-2007.

JESSICA FATHY, EXAMINING ATTORNEY

Int. Cls.: 18 and 25

Prior U.S. Cls.: 1, 2, 3, 22, 39 and 41

United States Patent and Trademark Office

Reg. No. 3,476,817

Registered July 29, 2008

TRADEMARK
PRINCIPAL REGISTER

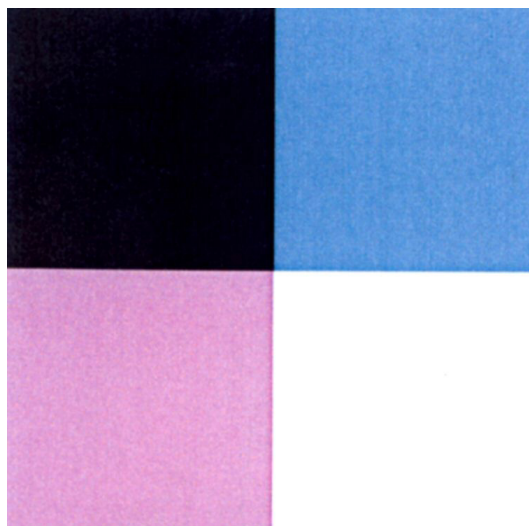

CINQ HUITIEMES (FRANCE SOCIETE ANON-
YME)
10 RUE DE MONT LOUIS
F-75011 PARIS
FRANCE

FOR: GOODS MADE OF LEATHER AND IMITATION LEATHER, NAMELY, TRUNKS AND SUITCASES, VALISES, TRAVEL BAGS, HANDBAGS, SCHOOL SATCHELS, RUCKSACKS, LEATHER TOOL BAGS SOLD EMPTY, SCHOOL BAGS, CYCLE BAGS, NAMELY, MESSENGER BAGS, COLLECTION BAGS, NAMELY, RUCK SACKS, MOTORCYCLE BAGS, NAMELY, MESSENGER BAGS, DOCUMENT CASES, NAMELY, BRIEFCASES, HUNTING BAGS; SMALL LEATHER GOODS, NAMELY, WALLETS, PURSES, CARD HOLDERS, NAMELY, SMALL WALLETS; SMALL LEATHER KEY CASES; UMBRELLAS, WALKING STICKS, PARASOLS AND SUNSHADES; WHIPS, SADDLES, HARNESSES AND HORSE BLANKETS, IN CLASS 18 (U.S. CLS. 1, 2, 3, 22 AND 41).

FOR: CLOTHING, NAMELY, SOCKS, BRIEFS, SWIMMING TRUNKS AND SUITS, UNDERCLOTHING, NAMELY, UNDERWEAR, BRAS, PANTIES, BOXER SHORTS; SUITS, TROUSERS, JACKETS, DRESSES AND SKIRTS; SHIRTS AND SHORT-SLEEVED SHIRTS; SWEATERS; COATS AND WATERPROOF CLOTHING, NAMELY, JACKETS AND PANTS; PAJAMAS AND NIGHT DRESSES; DUS-

TERS AND DRESSING GOWNS; TRACK SUITS, SHORTS, SINGLETs AND COVERALLS FOR SPORTS; BELTS, TIES, SCARVES AND HEADSCARVES, GLOVES; FOOTWEAR, EXCEPT ORTHOPEDIC FOOTWEAR, NAMELY, SLIPPERS, BOOTS AND HALF-BOOTS; SANDALS AND BEACH SHOES; ATHLETIC SHOES; HEADGEAR, NAMELY, HATS, CAPS AND BONNETS, IN CLASS 25 (U.S. CLS. 22 AND 39).

PRIORITY DATE OF 10-30-2006 IS CLAIMED.

OWNER OF INTERNATIONAL REGISTRATION 0925567 DATED 4-6-2007, EXPIRES 4-6-2017.

THE COLOR(S) INDIGO, PINK, LIGHT BLUE AND WHITE IS/ARE CLAIMED AS A FEATURE OF THE MARK.

THE MARK CONSISTS OF FOUR SQUARES. THE UPPER LEFT SQUARE IS INDIGO. THE LOWER LEFT SQUARE IS PINK. THE UPPER RIGHT SQUARE IS LIGHT BLUE. THE LOWER RIGHT SQUARE IS WHITE.

SER. NO. 79-039,040, FILED 4-6-2007.

JESSICA FATHY, EXAMINING ATTORNEY

Int. Cls.: 18 and 25

Prior U.S. Cls.: 1, 2, 3, 22, 39 and 41

United States Patent and Trademark Office

Reg. No. 3,476,818

Registered July 29, 2008

**TRADEMARK
PRINCIPAL REGISTER**



CINQ HUITIEMES (FRANCE SOCIETE ANON-
YME)
10 RUE DE MONT LOUIS
F-75011 PARIS
FRANCE

FOR: GOODS MADE OF LEATHER AND IMITATION LEATHER, NAMELY, TRUNKS AND SUITCASES, VALISES, TRAVEL BAGS, HANDBAGS, SCHOOL SACHELS, RUCKSACKS, LEATHER TOOL BAGS SOLD EMPTY, SCHOOL BAGS, CYCLE BAGS, NAMELY, MESSENGER BAGS, COLLECTION BAGS, NAMELY, RUCK SACKS, MOTORCYCLE BAGS, NAMELY, MESSENGER BAGS, DOCUMENT CASES, NAMELY, BRIEFCASES, HUNTING BAGS; SMALL LEATHER GOODS, NAMELY, WALLETS, PURSES, CARD HOLDERS, NAMELY, SMALL WALLETS; SMALL LEATHER KEY CASES; UMBRELLAS, WALKING STICKS, PARASOLS AND SUNSHADES; WHIPS, SADDLES, HARNESSSES AND HORSE BLANKETS, IN CLASS 18 (U.S. CLS. 1, 2, 3, 22 AND 41).

FOR: CLOTHING, NAMELY, SOCKS, BRIEFS, SWIMMING TRUNKS AND SUITS, UNDERCLOTHING, NAMELY, UNDERWEAR, BRAS, PANTIES,

BOXER SHORTS; SUITS, TROUSERS, JACKETS, DRESSES AND SKIRTS; SHIRTS AND SHORT-SLEEVED SHIRTS; SWEATERS; COATS AND WATERPROOF CLOTHING, NAMELY, JACKETS AND PANTS; PAJAMAS AND NIGHT DRESSES; DUSTERS AND DRESSING GOWNS; TRACKSUITS, SHORTS, SINGLETS AND COVERALLS FOR SPORTS; BELTS, TIES, SCARVES AND HEADSCARVES, GLOVES; FOOTWEAR, EXCEPT ORTHOPEDIC FOOTWEAR, NAMELY, SLIPPERS, BOOTS AND HALF-BOOTS; SANDALS AND BEACH SHOES; ATHLETIC SHOES; HEADGEAR, NAMELY, HATS, CAPS AND BONNETS, IN CLASS 25 (U.S. CLS. 22 AND 39).

PRIORITY DATE OF 10-30-2006 IS CLAIMED.

OWNER OF INTERNATIONAL REGISTRATION
0925568 DATED 4-6-2007, EXPIRES 4-6-2017.

SER. NO. 79-039,041, FILED 4-6-2007.

JESSICA FATHY, EXAMINING ATTORNEY

Int. Cl.: 9

Prior U.S. Cls.: 21, 23, 26, 36 and 38

Reg. No. 3,476,819

United States Patent and Trademark Office

Registered July 29, 2008

**TRADEMARK
PRINCIPAL REGISTER**

ICON

BIFFI ITALIA S.R.L. (ITALY LTD LIAB CO)
LOC. CASELLE S. PIETRO
I-29017 FIORENZUOLA D'ARDA (PIACENZA)
ITALY

THE MARK CONSISTS OF STANDARD CHARACTERS WITHOUT CLAIM TO ANY PARTICULAR FONT, STYLE, SIZE, OR COLOR.

PRIORITY DATE OF 12-20-2006 IS CLAIMED.

FOR: ELECTRIC VALVE ACTUATORS WHICH FEATURE WIRELESS REMOTE MONITORING, COMMUNICATION, AND DATA LOGGING CAPABILITIES FOR COLLECTING DIFFERENT TYPES OF DATA USEFUL IN MAINTENANCE OR DIAGNOSTIC PROGRAMS, IN CLASS 9 (U.S. CLS. 21, 23, 26, 36 AND 38).

OWNER OF INTERNATIONAL REGISTRATION 0925892 DATED 4-23-2007, EXPIRES 4-23-2017.

SER. NO. 79-039,179, FILED 4-23-2007.

MICHAEL GAFFAR, EXAMINING ATTORNEY

Int. Cls.: 11, 20 and 42

**Prior U.S. Cls.: 2, 13, 21, 22, 23, 25, 31, 32, 34, 50, 100
and 101**

Reg. No. 3,476,820

United States Patent and Trademark Office

Registered July 29, 2008

**TRADEMARK
SERVICE MARK
PRINCIPAL REGISTER**

PRISMA ARCHITECTURAL

PERFORMANCE IN LIGHTING S.P.A. (ITALY
SPA)
VIA MARCO POLO 24
I-10129 TORINO (TO)
ITALY

FOR: APPARATUS AND FIXTURES FOR LIGHT-
ING, NAMELY, ARC LAMPS, LIGHT DIFFUSERS,
LAMP GLOBES, LIGHTING APPARATUS FOR VE-
HICLES, LAMP POSTS, BURNERS FOR LAMPS,
LAMP REFLECTORS, LAMP CHIMNEYS, STREET
LAMPS, SAFETY LAMPS, ELECTRIC LAMPS,
LAMPS, CHINESE LANTERNS, LANTERNS, LAN-
TURNS FOR LIGHTING, LUMINOUS LIGHTING
TUBES, LAMP SHADES, CEILING LIGHTS, DIS-
CHARGE ELECTRIC TUBES FOR LIGHTING, OIL
LAMPS, AND LAMPS FOR SCENIC LIGHTING, IN
CLASS 11 (U.S. CLS. 13, 21, 23, 31 AND 34).

FOR: GARDEN FURNITURE AND OUTDOOR
FURNITURE, IN CLASS 20 (U.S. CLS. 2, 13, 22, 25, 32
AND 50).

FOR: DESIGN OF LAMPS AND FIXTURES FOR
LIGHTING; TECHNICAL STUDIES CONCERNING

LIGHTING INSTALLATIONS; AND TECHNICAL
SURVEYING, IN CLASS 42 (U.S. CLS. 100 AND 101).

THE MARK CONSISTS OF STANDARD CHAR-
ACTERS WITHOUT CLAIM TO ANY PARTICULAR
FONT, STYLE, SIZE, OR COLOR.

OWNER OF INTERNATIONAL REGISTRATION
0736194 DATED 2-4-2000, EXPIRES 2-4-2010.

OWNER OF U.S. REG. NOS. 2,454,887, 2,930,586
AND OTHERS.

NO CLAIM IS MADE TO THE EXCLUSIVE
RIGHT TO USE "ARCHITECTURAL", APART
FROM THE MARK AS SHOWN.

THE ENGLISH TRANSLATION OF PRISMA IS
PRISM.

SER. NO. 79-039,194, FILED 12-27-2006.

KIMBERLY FRYE, EXAMINING ATTORNEY

Int. Cls.: 1, 4, 17 and 40

**Prior U.S. Cls.: 1, 5, 6, 10, 12, 13, 15, 26, 35, 46, 50,
100, 103 and 106**

Reg. No. 3,476,821

United States Patent and Trademark Office

Registered July 29, 2008

**TRADEMARK
SERVICE MARK
PRINCIPAL REGISTER**

APSOSEAL

ANGST & PFISTER AG (SWITZERLAND SOCI-
ÉTÉ ANONYME (A JOINT STOCK COMPANY
UNDER THE LAWS OF SWITZERLAND).)
THURGAUERSTRASSE 66
CH-8050 ZÜRICH
SWITZERLAND

FOR: ADHESIVES USED IN INDUSTRY FOR
COATING AND SEALING; UNPROCESSED ARTI-
FICIAL RESINS; UNPROCESSED PLASTICS FOR
INDUSTRIAL USE; LATEX GLUE NOT FOR STA-
TIONERY OR HOUSEHOLD PURPOSES; CHEMI-
CAL PREPARATIONS, UNPROCESSED PLASTICS
AND MINERAL SUBSTANCES IN THE NATURE OF
FILTERING MATERIALS FOR DRY AND WET
FILTRATION, NAMELY, FOR USE IN DUST AND
INK MIST FILTRATION, IN CLASS 1 (U.S. CLS. 1, 5,
6, 10, 26 AND 46).

FOR: INDUSTRIAL OILS AND GREASES FOR
INDUSTRIAL USES; ALL-PURPOSE LUBRICANTS;
LUBRICATING GREASES AND OILS FOR INDUS-
TRIAL USES, IN CLASS 4 (U.S. CLS. 1, 6 AND 15).

FOR: RUBBER, GUTTA-PERCHA, GUM AND
GOODS MADE FROM THESE MATERIALS, NAME-
LY, STOPS OF RUBBER, RINGS OF RUBBER, V-
BELTS, VIBRATING BUFFERS FOR INDUSTRIAL
MACHINERY, ADHESIVE BANDS OTHER THAN
STATIONERY AND NOT FOR MEDICAL OR
HOUSEHOLD PURPOSES; DRAUGHT EXCLUDER
STRIPS, NAMELY, NON-METAL WEATHER
STRIPS FOR BUILDINGS; PLASTICS IN EXTRU-
DED FORM FOR USE IN MANUFACTURE; FILTER
MATERIALS, NAMELY, SEMI-FINISHED PLAS-
TICS, SYNTHETIC PLASTIC AS SEMI-FINISHED
PRODUCTS IN THE FORM OF FOILS, PLATES,
RODS, PROFILES, HOSES, TUBES, BLOCKS, IN-
DUSTRIAL COATINGS, NAMELY, NATURAL AND
LIQUID RUBBER; THERMOPLASTIC ELASTOMER
RESINS IN PELLET FORM FOR USE IN FURTHER

MANUFACTURE; PACKING, STOPPING AND IN-
SULATING MATERIALS, NAMELY, SHEETS OF
GRAPHITE-BASED MATERIAL FOR USE AS GAS-
KETS, SEALS, PACKINGS, AND HEAT INSULA-
TORS; GASKET MATERIAL IN SHEETS FOR USE
IN BUILDING; GASKET SEALER FOR USE IN
PLUMBING; WEATHERSTRIPPING SEALANTS IN
THE NATURE OF CAULK; SOUNDPROOFING
MATERIALS FOR BUILDINGS AND MACHINERY;
FLEXIBLE TUBES OF PLASTIC FOR INDUSTRIAL
USE; FLEXIBLE COMPRESSED AIR PIPE FIT-
TINGS, NOT OF METAL; REINFORCING MATERI-
ALS, NOT OF METAL, FOR PIPES; PIPE MUFFS,
NOT OF METAL; JUNCTIONS, NOT OF METAL,
FOR PLASTIC PIPES, IN CLASS 17 (U.S. CLS. 1, 5, 12,
13, 35 AND 50).

FOR: TREATMENT OF MATERIALS, NAMELY,
CUTTING SERVICE FOR SEMI-FINISHED RUBBER
AND PLASTICS MATERIALS; STAMPING AND
LASER-CUTTING SERVICE FOR METAL, PLAS-
TICS AND RUBBER; WATER-JET CONTOUR CUT-
TING OF SHEET MATERIALS, IN CLASS 40 (U.S.
CLS. 100, 103 AND 106).

THE MARK CONSISTS OF STANDARD CHAR-
ACTERS WITHOUT CLAIM TO ANY PARTICULAR
FONT, STYLE, SIZE, OR COLOR.

PRIORITY DATE OF 11-29-2006 IS CLAIMED.

OWNER OF INTERNATIONAL REGISTRATION
0925928 DATED 3-30-2007, EXPIRES 3-30-2017.

SER. NO. 79-039,216, FILED 3-30-2007.

LINDA ESTRADA, EXAMINING ATTORNEY

Int. Cl.: 29

Prior U.S. Cl.: 46

United States Patent and Trademark Office

Reg. No. 3,476,822

Registered July 29, 2008

TRADEMARK
PRINCIPAL REGISTER



MILKO EKONOMISK FÖRENING (SWEDEN
EKONOMISK FORENING)
BOX 362
SE-831 25 ÖSTERSUND
SWEDEN

FOR: MILK AND MILK PRODUCTS EXCLUD-
ING ICE CREAM, ICE MILK AND FROZEN YO-
GURT, IN CLASS 29 (U.S. CL. 46).

OWNER OF INTERNATIONAL REGISTRATION
0925961 DATED 5-22-2007, EXPIRES 5-22-2017.

NO CLAIM IS MADE TO THE EXCLUSIVE
RIGHT TO USE "HALSINGE", APART FROM THE
MARK AS SHOWN.

THE FOREIGN WORDING IN THE MARK
TRANSLATES INTO ENGLISH AS AN ADJECTIVE
FORM OF "HALSINGLAND, A REGION IN THE
NORTH OF SWEDEN".

SER. NO. 79-039,224, FILED 5-22-2007.

SHANNON TWOHIG, EXAMINING ATTORNEY

Int. Cl.: 33

Prior U.S. Cls.: 47 and 49

United States Patent and Trademark Office

Reg. No. 3,476,823

Registered July 29, 2008

**TRADEMARK
PRINCIPAL REGISTER**

VENTURINI

SOCIETA' AGRICOLA; VENTURINI MASSIMINO
E FIGLI S.S. (ITALY SIMPLE PARTNERSHIP)
VIA SEMONTE, 20
SAN PIETRO IN CARIANO FRAZ
SANFLORIANO (VR), ITALY I37020

FOR: WINES, IN CLASS 33 (U.S. CLS. 47 AND 49).

THE MARK CONSISTS OF STANDARD CHAR-
ACTERS WITHOUT CLAIM TO ANY PARTICULAR
FONT, STYLE, SIZE, OR COLOR.

OWNER OF INTERNATIONAL REGISTRATION
0926139 DATED 4-5-2007, EXPIRES 4-5-2017.

SEC. 2(F).

SER. NO. 79-039,300, FILED 4-5-2007.

ELI HELLMAN, EXAMINING ATTORNEY

Int. Cls.: 35 and 44

Prior U.S. Cls.: 100, 101 and 102

United States Patent and Trademark Office

Reg. No. 3,476,824

Registered July 29, 2008

**SERVICE MARK
PRINCIPAL REGISTER**

Medilang

DIAKONISCHES WERK TELTOW -; FLÄMING E.
V. (FED REP GERMANY EINGETRAGENER
VEREIN (E.V.))
AM KREISBAHNPLATZ 1
14913 JÜTERBOG
FED REP GERMANY

FOR: OFFICE FUNCTIONS, IN CLASS 35 (U.S.
CLS. 100, 101 AND 102).

FOR: HEALTH CARE , IN CLASS 44 (U.S. CLS. 100
AND 101).

THE MARK CONSISTS OF STANDARD CHAR-
ACTERS WITHOUT CLAIM TO ANY PARTICULAR
FONT, STYLE, SIZE, OR COLOR.

OWNER OF INTERNATIONAL REGISTRATION
0926254 DATED 12-8-2006, EXPIRES 12-8-2016.

SER. NO. 79-039,338, FILED 12-8-2006.

MARILYN IZZI, EXAMINING ATTORNEY

Int. Cl.: 9

Prior U.S. Cls.: 21, 23, 26, 36 and 38

Reg. No. 3,476,825

United States Patent and Trademark Office

Registered July 29, 2008

**TRADEMARK
PRINCIPAL REGISTER**

P O S T - L S I - P K G

KABUSHIKI KAISHA TOSHIBA (JAPAN CORPORATION)
1-1, SHIBAURA 1-CHOME
MINATO-KU; TOKYO 105-8001
JAPAN

PRIORITY DATE OF 11-24-2006 IS CLAIMED.

FOR: OPTOELECTRONIC DEVICES, NAMELY, OPTICAL-TO-ELECTRICAL TRANSDUCERS USED IN CENTRAL PROCESSING UNITS, MEMORY SYSTEMS, AND SEMICONDUCTORS, IN CLASS 9 (U.S. CLS. 21, 23, 26, 36 AND 38).

OWNER OF INTERNATIONAL REGISTRATION
0926284 DATED 5-2-2007, EXPIRES 5-2-2017.

SER. NO. 79-039,348, FILED 5-2-2007.

THE MARK CONSISTS OF STANDARD CHARACTERS WITHOUT CLAIM TO ANY PARTICULAR FONT, STYLE, SIZE, OR COLOR.

GEOFFREY FOSDICK, EXAMINING ATTORNEY

Int. Cl.: 9

Prior U.S. Cls.: 21, 23, 26, 36 and 38

United States Patent and Trademark Office

Reg. No. 3,476,826

Registered July 29, 2008

**TRADEMARK
PRINCIPAL REGISTER**

P O S T - P K G

KABUSHIKI KAISHA TOSHIBA (JAPAN CORPORATION)
1-1, SHIBAURA 1-CHOME
MINATO-KU; TOKYO 105-8001
JAPAN

FOR: OPTOELECTRONIC DEVICES, NAMELY, OPTICAL-TO-ELECTRICAL TRANSDUCERS USED IN CENTRAL PROCESSING UNITS, MEMORY SYSTEMS, AND SEMICONDUCTORS, IN CLASS 9 (U.S. CLS. 21, 23, 26, 36 AND 38).

THE MARK CONSISTS OF STANDARD CHARACTERS WITHOUT CLAIM TO ANY PARTICULAR FONT, STYLE, SIZE, OR COLOR.

PRIORITY DATE OF 11-24-2006 IS CLAIMED.

OWNER OF INTERNATIONAL REGISTRATION
0926285 DATED 5-2-2007, EXPIRES 5-2-2017.

SER. NO. 79-039,349, FILED 5-2-2007.

GEOFFREY FOSDICK, EXAMINING ATTORNEY

Int. Cl.: 9

Prior U.S. Cls.: 21, 23, 26, 36 and 38

Reg. No. 3,476,827

United States Patent and Trademark Office

Registered July 29, 2008

**TRADEMARK
PRINCIPAL REGISTER**

P O S T - P A C K

KABUSHIKI KAISHA TOSHIBA (JAPAN CORPORATION)
1-1, SHIBAURA 1-CHOME
MINATO-KU; TOKYO 105-8001
JAPAN

PRIORITY DATE OF 11-24-2006 IS CLAIMED.

FOR: OPTOELECTRONIC DEVICES, NAMELY, OPTICAL-TO-ELECTRICAL TRANSDUCERS USED IN CENTRAL PROCESSING UNITS, MEMORY SYSTEMS, AND SEMICONDUCTORS, IN CLASS 9 (U.S. CLS. 21, 23, 26, 36 AND 38).

OWNER OF INTERNATIONAL REGISTRATION
0926286 DATED 5-2-2007, EXPIRES 5-2-2017.

SER. NO. 79-039,350, FILED 5-2-2007.

THE MARK CONSISTS OF STANDARD CHARACTERS WITHOUT CLAIM TO ANY PARTICULAR FONT, STYLE, SIZE, OR COLOR.

GEOFFREY FOSDICK, EXAMINING ATTORNEY

Int. Cl.: 20

Prior U.S. Cls.: 2, 13, 22, 25, 32 and 50

United States Patent and Trademark Office

Reg. No. 3,476,828

Registered July 29, 2008

**TRADEMARK
PRINCIPAL REGISTER**

**FER
FOR**

FERFOR S.A. (SPAIN SOCIEDAD ANÓNIMA)
CRTA. N-340. KM. 1218
E-08739 AVINYONET DEL PENEDÉS
BARCELONA, SPAIN

FOR: FURNITURE, FURNITURE COMPOSED OF WOOD, CORK, REED, CANE, WICKER, HORN, IVORY, WHALEBONE, SHELL, AMBER, MOTHER OF PEARL, MEERSCHAUM, METAL, POLYMERS; OFFICE FURNITURE, SCHOOL FURNITURE, HOUSEHOLD AND GARDEN FURNITURE, INSTITUTIONAL, CORPORATE AND LIBRARY FURNITURE, AUDITORIUM FURNITURE, CLASSROOM FURNITURE, FURNITURE FOR TRAIN AND BUS STATIONS AND AIRPORTS, FURNITURE FOR

HEALTH CARE FACILITIES, RESTAURANT AND HOSPITALITY FURNITURE, FURNITURE FOR SHOPS, BARS AND CANTEENS, IN CLASS 20 (U.S. CLS. 2, 13, 22, 25, 32 AND 50).

OWNER OF INTERNATIONAL REGISTRATION 0926305 DATED 6-13-2007, EXPIRES 6-13-2017.

THE WORDING "FER FOR" HAS NO MEANING IN A FOREIGN LANGUAGE.

SER. NO. 79-039,352, FILED 6-13-2007.

AHSEN KHAN, EXAMINING ATTORNEY

Int. Cl.: 25

Prior U.S. Cls.: 22 and 39

United States Patent and Trademark Office

Reg. No. 3,476,829

Registered July 29, 2008

**TRADEMARK
PRINCIPAL REGISTER**

BUCKLE MY SHOE

WILLIAM LAMB FOOTWEAR LIMITED (UNI-
TED KINGDOM LTD LIAB CO)
BOTTOMBOAT ROAD, STANLEY,
WAKEFIELD, WEST YORKSHIRE WF3 4AY
UNITED KINGDOM

FOR: ARTICLES OF CLOTHING, NAMELY,
JACKETS, SHIRTS, T-SHIRTS, POLO SHIRTS,
TROUSERS, PANTS, UNDERWEAR, SWEATERS,
JUMPERS, SWEATPANTS AND SHORTS; HEAD-
GEAR, NAMELY, HEADWEAR, HATS AND CAPS;
FOOTWEAR, IN CLASS 25 (U.S. CLS. 22 AND 39).

THE MARK CONSISTS OF STANDARD CHAR-
ACTERS WITHOUT CLAIM TO ANY PARTICULAR
FONT, STYLE, SIZE, OR COLOR.

PRIORITY DATE OF 5-24-2007 IS CLAIMED.

OWNER OF INTERNATIONAL REGISTRATION
0926317 DATED 5-24-2007, EXPIRES 5-24-2017.

OWNER OF U.S. REG. NOS. 1,691,648 AND
2,975,954.

SER. NO. 79-039,357, FILED 5-24-2007.

SUZANNE BLANE, EXAMINING ATTORNEY

Int. Cl.: 25

Prior U.S. Cls.: 22 and 39

United States Patent and Trademark Office

Reg. No. 3,476,830

Registered July 29, 2008

TRADEMARK
PRINCIPAL REGISTER



GOMIASHVILI EKATERINA ARCHILOVNA
(RUSSIAN FED. INDIVIDUAL)

DEGTYARNY PEREULOK, 15-1-1

RU-125009 MOSCOW

RUSSIAN FED.

FOR: CLOTHING, NAMELY, UNDERWEAR, SMOCKS, BOAS, HALF-BOOTS, BREECHES, FOOTBALL BOOTS, TROUSERS, ASCOTS, NECKTIES, VEILS, VESTS, SPORT JERSEYS, HOSIERY, HOODS, POCKETS SQUARES FOR CLOTHING, COLLAR PROTECTORS, TIGHTS, COMBINATIONS, BODICES, SUITS, SWIMSUITS, MASQUERADE COSTUMES; BEACH CLOTHES, NAMELY, FOOTWEAR, SHOES, JACKETS, LIVERIES, CAMISOLES, T-SHIRTS, SHIRT FRONT, MANTILLAS, COATS, MUFFS, BIBS NOT OF PAPER, FUR STOLE, EAR MUFFS, SOCKS; FOOTWEAR, NAMELY, BATH SLIPPERS, BEACH SHOES, SPORTS SHOES; OUTERCLOTHING, NAMELY, JERSEYS, JACKETS, COATS, OVERCOATS, RAINCOATS; READY-MADE CLOTHING, NAMELY, JERSEYS, JACKETS, TROUSERS, SKIRTS, SHIRTS, SHORTS, DRESSES; CYCLISTS' CLOTHING, NAMELY, SHORTS, SHIRTS, JERSEYS, JACKETS; CLOTHING FOR GYMNASTICS, NAMELY, TIGHTS, JERSEYS, JACKETS, GABARDINES, JERSEYS; CLOTHING OF IMITATIONS OF LEATHER, NAMELY, TROUSERS, SKIRTS, JACKETS, COATS, VESTS; CLOTHING OF LEATHER, NAMELY, LEATHER TROUSERS, LEATHER SKIRTS, LEATHER JACKETS, LEATHER COATS, LEATHER VESTS, BELTS, GLOVES; KNITWEAR, NAMELY, KNIT TOPS, KNIT DRESSES, KNIT SWEATERS, KNIT SCARVES, KNIT GLOVES, KNIT JACKETS, KNIT CARDIGANS, UNIFORMS, TOPCOATS, PELERINES, GLOVES, PAJA-

MAS, FROCKS, SCARVES, BATHING TRUNKS; WATERPROOF CLOTHING, NAMELY, JACKETS, JERSEYS, TROUSERS; HEADGEAR FOR WEAR, NAMELY, HATS AND CAPS; GARTERS; READY-MADE LININGS, NAMELY, SLIPS, SUSPENDERS; LACE BOOTS, BELTS, PULLOVERS, SANDALS, BOOTS, SARIS, WOODEN SHOES, SHIRTS, SWEATERS, UNDERPANTS, SHOES, BATH ROBES, DRESSING GOWNS, STOCKINGS, SHAWLS, SASHES FOR WEAR, PELISSES, SKIRTS, PETTICOATS, ESPARTO SHOES AND SANDALS, BABIES' PANTS, SKULL CAPS, BATHING CAPS, IN CLASS 25 (U.S. CLS. 22 AND 39).

PRIORITY DATE OF 7-4-2006 IS CLAIMED.

OWNER OF INTERNATIONAL REGISTRATION
0926365 DATED 11-30-2006, EXPIRES 11-30-2016.

THE COLOR(S) RED, ORANGE, YELLOW, GREEN, LIGHT GREEN, PALE BLUE, BLUE AND PURPLE IS/ARE CLAIMED AS A FEATURE OF THE MARK.

THE MARK CONSISTS OF AN IMAGE OF A MULTICOLORED CURVED LINE IN WHICH THE COLORS RED, ORANGE, YELLOW, GREEN, LIGHT GREEN, PALE BLUE, BLUE, PURPLE APPEAR IN THE DESIGN OF THE MULTICOLORED CURVED LINE.

SER. NO. 79-039,377, FILED 11-30-2006.

NAPOLEON SHARMA, EXAMINING ATTORNEY

Int. Cl.: 5

Prior U.S. Cls.: 6, 18, 44, 46, 51 and 52

United States Patent and Trademark Office

Reg. No. 3,476,831

Registered July 29, 2008

TRADEMARK
PRINCIPAL REGISTER



SHANDONG REYOUNG; PHARMACEUTICAL
CO., LTD (CHINA CORPORATION)
NO. 6, ERLANGSHAN ROAD
YIYUAN COUNTY, ZIBO CITY; 256100 SHANDONG
PROVINCE
CHINA

FOR: SEDATIVES, ANALGESICS; MENSTRUATION
BANDAGES, SANITARY TOWELS, MENSTRUATION
TAMPONS, SANITARY PADS,
PLASTERS FOR MEDICAL PURPOSES; SURGICAL
TISSUES, IN CLASS 5 (U.S. CLS. 6, 18, 44, 46, 51 AND
52).

OWNER OF INTERNATIONAL REGISTRATION
0926391 DATED 5-21-2007, EXPIRES 5-21-2017.

THE ENGLISH TRANSLATION OF THE FOREIGN
WORD(S) IN THE MARK IS: THE FIRST
CHINESE CHARACTER WHOSE TRANSLITERATION
IS "RUI" MEANS "AUSPICIOUS"; THE SECOND
CHINESE CHARACTER WHOSE TRANSLITERATION
IS "YANG" MEANS "SUN"; THE COMBINATION
OF THE TWO CHINESE CHARACTERS MEANS
"AUSPICIOUS SUN".

THE TRANSLITERATION OF THE NON-LATIN
CHARACTERS IN THE MARK IS: RUI YANG.

SER. NO. 79-039,382, FILED 5-21-2007.

CHARISMA HAMPTON, EXAMINING ATTORNEY

Int. Cls.: 9, 41 and 42

Prior U.S. Cls.: 21, 23, 26, 36, 38, 100, 101 and 107

Reg. No. 3,476,832

United States Patent and Trademark Office

Registered July 29, 2008

**TRADEMARK
SERVICE MARK
PRINCIPAL REGISTER**

ILICORE

DIPRITEC AB (SWEDEN JOINT STOCK COMPANY)
HÖGBERGS GATAN 36
SE-116 20 STOCKHOLM
SWEDEN

FOR: RECORDED COMPUTER PROGRAMS AND RECORDED SOFTWARE FOR USE IN PRINTING; COMPUTERS AND COMPUTER PERIPHERALS, IN CLASS 9 (U.S. CLS. 21, 23, 26, 36 AND 38).

FOR: EDUCATION SERVICES, NAMELY, CLASSES, SEMINARS, CONFERENCES AND WORKSHOPS IN THE FIELD OF COMPUTER PROGRAMS AND SOFTWARE, COMPUTERS AND COMPUTER PERIPHERALS, AND INSTALLATION OF COMPUTER PROGRAMS AND SOFTWARE, IN CLASS 41 (U.S. CLS. 100, 101 AND 107).

FOR: COMPUTER CONSULTANCY SERVICES; DESIGN, DEVELOPMENT, INSTALLATION, MAIN-

TENANCE AND UPDATING COMPUTER PROGRAMS AND SOFTWARE; RENTAL OF COMPUTER PROGRAMS AND SOFTWARE, IN CLASS 42 (U.S. CLS. 100 AND 101).

THE MARK CONSISTS OF STANDARD CHARACTERS WITHOUT CLAIM TO ANY PARTICULAR FONT, STYLE, SIZE, OR COLOR.

PRIORITY DATE OF 12-5-2006 IS CLAIMED.

OWNER OF INTERNATIONAL REGISTRATION 0926465 DATED 5-11-2007, EXPIRES 5-11-2017.

SER. NO. 79-039,403, FILED 5-11-2007.

DAVID TAYLOR, EXAMINING ATTORNEY

Int. Cl.: 30

Prior U.S. Cl.: 46

United States Patent and Trademark Office

Reg. No. 3,476,833

Registered July 29, 2008

TRADEMARK
PRINCIPAL REGISTER



LIMITED LIABILITY COMPANY; "ABLE LTD
CO." (UKRAINE LTD LIAB CO)
23-A OBOLONSKIY PROSP.
KYIV 04205
UKRAINE

FOR: COFFEE, TEA, COCOA, SUGAR, RICE, TAPIOCA, SAGO, ARTIFICIAL COFFEE; FLOUR; PREPARATIONS MADE FROM CEREALS, NAME- LY, CEREAL BASED SNACK FOOD; BREAD; CON- FECTIONERY, NAMELY, SHAVED ICE CONFECTIONS, PASTILLES; FRUIT AND FLA- Voured ICES; HONEY, TREACLE; YEAST, BAK- ING-POWDER; SALT, MUSTARD; VINEGAR, SAUCES IN THE NATURE OF CONDIMENTS; SPICES; FARINACEOUS FOODS, NAMELY, STARCH-BASED CANDIES, STARCH SYRUPS; PAS- TRIES; BREAD ROLLS; BUNS; CAKES; RICE CAKES; CARAMEL CANDY; CHEWING GUM, NOT FOR MEDICAL PURPOSES; CORN FLAKES; CONFECTIONERY FOR DECORATING CHRIST- MAS TREES; CHOCOLATE; COOKIES; CRACKERS; COCOA-BASED BEVERAGES AND COFFEE-BASED BEVERAGES; COCOA PRODUCTS, NAMELY, CAN- DY WITH COCOA, COCOA MIXES, COCOA SPREADS; CHOCOLATE FOOD BEVERAGES NOT BEING DAIRY-BASED OR VEGETABLE BASED; FONDANTS, NAMELY, CHOCOLATE-BASED FILL- INGS FOR CAKES AND PIES, CUSTARD-BASED FILLINGS FOR CAKES AND PIES; FROZEN YO- GHURT; FRUIT JELLIES IN THE NATURE OF CONFECTIONERY; GINGERBREAD; HALVAH; MARZIPAN; MUESLI; OAT FLAKES; OAT-BASED FOOD, NAMELY, OAT-BASED COOKIES; PAN- CAKES, PASTRY; PETITS FOURS, NAMELY, PAS-

TRY; PIES, PIZZA, PUDDINGS, SANDWICHES; SUGAR CONFECTIONERY, NAMELY, CRYSTAL SUGAR PIECES; SWEETMEATS IN THE NATURE OF CANDY; WAFFLES, IN CLASS 30 (U.S. CL. 46).

OWNER OF INTERNATIONAL REGISTRATION
0926472 DATED 2-28-2007, EXPIRES 2-28-2017.

THE COLOR(S) RED, YELLOW, WHITE, AND BROWN IS/ARE CLAIMED AS A FEATURE OF THE MARK.

THE MARK CONSISTS OF A SHIELD IN RED, WITH A WHITE LINE AROUND IT AND LETTERS "CH" IN WHITE WITHIN; THE WORDING "CHOCO HOUSE" IN WHITE IN A RED RIBBON DESIGN; BROWN APPEARS IN THE LINES FORMING THE SUIT OF ARMOR AND ORNATE LEAF DESIGN ON TOP OF AND AROUND THE SHIELD, AND IN THE OUTER LINE AROUND THE RIBBON DESIGN; YELLOW APPEARS INSIDE THE SUIT OF ARMOR AND LEAVES, AND BETWEEN THE INNER RED AND OUTER BROWN LINE OF THE RIBBON DE- SIGN; WHITE APPEARS IN THE SPEARS APPEAR- ING FROM BEHIND THE UPPER AND LOWER LEFT AND RIGHT PORTIONS OF THE SHIELD.

SER. NO. 79-039,406, FILED 2-28-2007.

REBECCA POVARCHUK, EXAMINING ATTOR- NEY

Int. Cls.: 9, 41 and 42

Prior U.S. Cls.: 21, 23, 26, 36, 38, 100, 101 and 107

United States Patent and Trademark Office

Reg. No. 3,476,834

Registered July 29, 2008

**TRADEMARK
SERVICE MARK
PRINCIPAL REGISTER**

CIRRATO

DIPRITEC AB (SWEDEN JOINT STOCK COMPANY)
HÖGBERGSGATAN 36
SE-116 20 STOCKHOLM
SWEDEN

FOR: RECORDED COMPUTER PROGRAMS AND RECORDED SOFTWARE FOR USE IN PRINTING; COMPUTERS AND COMPUTER PERIPHERALS, IN CLASS 9 (U.S. CLS. 21, 23, 26, 36 AND 38).

FOR: EDUCATION SERVICES, NAMELY, CLASSES, SEMINARS, CONFERENCES AND WORKSHOPS IN THE FIELD OF COMPUTER PROGRAMS AND SOFTWARE, COMPUTER AND COMPUTER PERIPHERALS, AND INSTALLATION OF COMPUTER PROGRAMS AND SOFTWARE, IN CLASS 41 (U.S. CLS. 100, 101 AND 107).

FOR: COMPUTER CONSULTANCY SERVICES; DESIGN, DEVELOPMENT, INSTALLATION, MAIN-

TENANCE AND UPDATING COMPUTER PROGRAMS AND SOFTWARE; RENTAL OF COMPUTER PROGRAMS AND SOFTWARE, IN CLASS 42 (U.S. CLS. 100 AND 101).

THE MARK CONSISTS OF STANDARD CHARACTERS WITHOUT CLAIM TO ANY PARTICULAR FONT, STYLE, SIZE, OR COLOR.

PRIORITY DATE OF 12-5-2006 IS CLAIMED.

OWNER OF INTERNATIONAL REGISTRATION 0926715 DATED 5-11-2007, EXPIRES 5-11-2017.

SER. NO. 79-039,511, FILED 5-11-2007.

DAVID TAYLOR, EXAMINING ATTORNEY

Int. Cl.: 31

Prior U.S. Cls.: 1 and 46

United States Patent and Trademark Office

Reg. No. 3,476,835

Registered July 29, 2008

**TRADEMARK
PRINCIPAL REGISTER**

BONZA

SUNTORY FLOWERS LIMITED (JAPAN CORPORATION)

2-13-12, HIRAKAWACHO

CHIYODA-KU; TOKYO 102-0093

JAPAN

FOR: FLOWER SEEDS; FLOWER BULBS; PLANT SEEDS; LIVE TREES; LIVE PLANTS, NAMELY, GRASSES; LIVE PLANTS; NATURAL TURF; DRIED FLOWERS; SEEDLINGS; SAPLINGS; AND LIVE FLOWERS EXCEPT EXCLUDING APPLES AND WHEAT FROM ALL SUCH GOODS, IN CLASS 31 (U.S. CLS. 1 AND 46).

THE MARK CONSISTS OF STANDARD CHARACTERS WITHOUT CLAIM TO ANY PARTICULAR FONT, STYLE, SIZE, OR COLOR.

PRIORITY DATE OF 5-14-2007 IS CLAIMED.

OWNER OF INTERNATIONAL REGISTRATION 0926716 DATED 5-25-2007, EXPIRES 5-25-2017.

SER. NO. 79-039,512, FILED 5-25-2007.

KATHERINE E. HALMEN, EXAMINING ATTORNEY

Int. Cls.: 18, 25 and 28

Prior U.S. Cls.: 1, 2, 3, 22, 23, 38, 39, 41 and 50

Reg. No. 3,476,836

United States Patent and Trademark Office

Registered July 29, 2008

**TRADEMARK
PRINCIPAL REGISTER**

GLAGLA

OUMNIA KARIM (FRANCE INDIVIDUAL)
52 RUE STANISLAS
F-54000 NANCY
FRANCE

FOR: GOODS MADE OF LEATHER OR IMITATION LEATHER MATERIALS AND NOT INCLUDED IN OTHER CLASSES, NAMELY, KEY CASES, DOCUMENT CASES, WALLETS, PURSES NOT OF PRECIOUS METAL; HANDBAGS, SCHOOL SATCHELS AND BAGS, TOOL BAGS OF LEATHER SOLD EMPTY, RUCKSACKS, LEATHER SHOPPING BAGS; BAGS WITH WHEELS, NAMELY SHOPPING, DUFFEL, AND MESSENGER; BAGS FOR CLIMBING, CAMPING, THE BEACH; BAGS FOR TRAVEL, SCHOOL, AND GARMENTS; BOXES MADE OF LEATHER, IN CLASS 18 (U.S. CLS. 1, 2, 3, 22 AND 41).

FOR: CLOTHING, NAMELY, SHIRTS, PANTS, SHORTS, AND JERSEYS; FOOTWEAR, HEADGEAR, SHIRTS, CLOTHING MADE OF LEATHER OR IMITATION LEATHER, NAMELY, SHIRTS, PANTS, AND SHORTS; BELTS; FUR CLOTHING, NAMELY, COATS AND JACKETS, HATS, AND EARMUFFS; GLOVES; SCARVES; NECKTIES; HOSIERY; BEACH, SKI OR SPORTS FOOTWEAR, NAPPIES OF TEXTILE; UNDERWEAR, IN CLASS 25 (U.S. CLS. 22 AND 39).

FOR: GAMES, NAMELY, BOARD, DICE, AND PARTY; TOYS, NAMELY, INFLATABLE, MECHAN-

ICAL, AND PLUSH; PHYSICAL TRAINING EQUIPMENT, NAMELY, BARBELLS AND WEIGHT LIFTING MACHINES; GYMNASTICS APPARATI, NAMELY, SPRINGBOARDS AND PUMMEL HORSES; PARTS OF SPORTSWEAR ITEMS FOR ATHLETIC USE, NAMELY, SHIN GUARDS, KNEE GUARDS, ELBOW GUARDS, BOXING GLOVES, GLOVES FOR ATHLETIC USE, FOOTBALL GLOVES, SKI GLOVES, PAINTBALL GUNS, STATIONARY EXERCISE BICYCLES, PLAYING CARDS AND BOARD GAMES; ICE OR ROLLER SKATES, TOY SCOOTERS; SURF BOARDS AND WINDSURFING BOARDS; RACKETS, NAMELY, TENNIS, RACQUETBALL, SQUASH, AND BADMINTON; FISHING TACKLE; BALLS, NAMELY, TENNIS BALLS AND RACQUETBALL; BALLOONS FOR GAMES; TABLES FOR TABLE TENNIS, SKIS, IN CLASS 28 (U.S. CLS. 22, 23, 38 AND 50).

THE MARK CONSISTS OF STANDARD CHARACTERS WITHOUT CLAIM TO ANY PARTICULAR FONT, STYLE, SIZE, OR COLOR.

OWNER OF INTERNATIONAL REGISTRATION 0926837 DATED 4-16-2007, EXPIRES 4-16-2017.

SER. NO. 79-039,560, FILED 4-16-2007.

MARK SPARACINO, EXAMINING ATTORNEY

Int. Cl.: 33

Prior U.S. Cls.: 47 and 49

United States Patent and Trademark Office

Reg. No. 3,476,837

Registered July 29, 2008

TRADEMARK
PRINCIPAL REGISTER



WEBER, JOHST (FED REP GERMANY INDIVIDUAL)
HUNSRÜCKSTR. 3
45133 ESSEN
FED REP GERMANY

THE MARK CONSISTS OF A DESIGN OF A HOUSE AND A PALM TREE WITH STARS AND A MOON ABOVE THEM. IN THE BACKGROUND IS MOUNTAIN SCENERY.

FOR: WINES, IN CLASS 33 (U.S. CLS. 47 AND 49).

SER. NO. 79-039,674, FILED 5-14-2007.

OWNER OF INTERNATIONAL REGISTRATION
0927122 DATED 5-14-2007, EXPIRES 5-14-2017.

BERNICE MIDDLETON, EXAMINING ATTORNEY

Int. Cls.: 36, 37, 41 and 42

Prior U.S. Cls.: 100, 101, 102, 103, 106 and 107

Reg. No. 3,476,838

United States Patent and Trademark Office

Registered July 29, 2008

**SERVICE MARK
PRINCIPAL REGISTER**

STAGING CONNECTIONS

STAGING CONNECTIONS PTY LIMITED (AUSTRALIA COMPANY)
68-72 LILYFIELD ROAD
ROZELLE NSW 2039
AUSTRALIA

FOR: THE LEASING OF ELECTRICAL, CINEMATOGRAPHIC AND OPTICAL APPARATUS AND INSTRUMENTS, NAMELY, VIDEO EQUIPMENT, LIGHTING AND SPECIAL EFFECTS SYSTEMS, AUDIO AND SOUND PROJECTION EQUIPMENT SYSTEMS; LEASING OF THEATRICAL SETS AND SCENERY, IN CLASS 36 (U.S. CLS. 100, 101 AND 102).

FOR: SERVICING OF ELECTRICAL, CINEMATOGRAPHIC, LIGHTING APPARATUS AND EQUIPMENT AND OPTICAL APPARATUS AND INSTRUMENTS, NAMELY, VIDEO EQUIPMENT, SOUND EQUIPMENT, PROJECTION EQUIPMENT, SPECIAL EFFECTS SYSTEMS, AUDIO AND SOUND PROJECTION EQUIPMENT SYSTEMS; CONSTRUCTION AND/OR INSTALLATION OF PROPS, SETS AND SET PIECES, SCENERY AND TABLEAUX FOR THEATRICAL AND ENTERTAINMENT PURPOSES AND SOCIAL AND BUSINESS FUNCTIONS; THE CONSTRUCTION OF SET PIECES IN THE NATURE OF STAGES, STAGE LIGHTING, STANDS, AND FURNITURE FOR CORPORATE PRESENTATIONS, IN CLASS 37 (U.S. CLS. 100, 103 AND 106).

FOR: RENTAL OF ELECTRICAL, CINEMATOGRAPHIC AND OPTICAL APPARATUS AND INSTRUMENTS, NAMELY, VIDEO EQUIPMENT, LIGHTING AND SPECIAL EFFECTS SYSTEMS, AUDIO AND SOUND PROJECTION EQUIPMENT SYSTEMS; RENTAL OF THEATRICAL SETS AND SCENERY; SPECIAL EVENT PLANNING, NAMELY, PLANNING OF AND ARRANGING THE LOGISTICAL REQUIREMENTS FOR AND MANAGING AND CONDUCTING OF CONFERENCES, SEMI-

NARS, EXHIBITIONS AND CORPORATE PRESENTATIONS; PARTY PLANNING SERVICES, NAMELY, THE ARRANGING, CONDUCTING AND SETTING OF WEDDING RECEPTIONS AND SOCIAL AND CORPORATE EVENTS, CREATION AND OPERATION OF SPECIAL EFFECTS FOR THEATRICAL AND CORPORATE PRESENTATIONS AND SOCIAL EVENTS, IN CLASS 41 (U.S. CLS. 100, 101 AND 107).

FOR: DESIGN SERVICES FOR OTHERS, NAMELY, DESIGN OF PROP, SETS AND SET PIECES, SCENERY AND TABLEAUX FOR THEATRICAL ENTERPRISES AND ENTERTAINMENT PRODUCTIONS AND SHOWS, AND SOCIAL AND BUSINESS FUNCTIONS, NAMELY, WEDDINGS, PARTIES, CORPORATE EVENTS, CORPORATE PRESENTATIONS, SEMINARS, BUSINESS EXPOSITIONS, EVENTS, MEETINGS, CONVENTIONS, PRODUCT LAUNCHES, TRADE SHOWS, CONFERENCES, KEY NOTE ADDRESSES, PRESENTATIONS, AND AWARD CEREMONIES FOR OTHERS, IN CLASS 42 (U.S. CLS. 100 AND 101).

THE MARK CONSISTS OF STANDARD CHARACTERS WITHOUT CLAIM TO ANY PARTICULAR FONT, STYLE, SIZE, OR COLOR.

OWNER OF INTERNATIONAL REGISTRATION 0927151 DATED 8-11-2006, EXPIRES 8-11-2016.

NO CLAIM IS MADE TO THE EXCLUSIVE RIGHT TO USE "STAGING", APART FROM THE MARK AS SHOWN.

SER. NO. 79-039,687, FILED 8-11-2006.

DEBRA LEE, EXAMINING ATTORNEY

Int. Cl.: 12

Prior U.S. Cls.: 19, 21, 23, 31, 35 and 44

United States Patent and Trademark Office

Reg. No. 3,476,839

Registered July 29, 2008

**TRADEMARK
PRINCIPAL REGISTER**

x-creen

MRA KLEMENT GMBH (FED REP GERMANY
LTD LIAB CO)
SIEMENSSTRASSE 6
79331 TENINGEN
FED REP GERMANY

PRIORITY DATE OF 11-18-2006 IS CLAIMED.

FOR: PARTS AND SETTINGS FOR LAND VEHICLES, FOR TECHNICAL, AESTHETIC AND SAFETY PURPOSES, NAMELY, WINDSHIELD SHADE SCREENS, IN CLASS 12 (U.S. CLS. 19, 21, 23, 31, 35 AND 44).

OWNER OF INTERNATIONAL REGISTRATION
0927473 DATED 5-14-2007, EXPIRES 5-14-2017.

SER. NO. 79-039,789, FILED 5-14-2007.

THE MARK CONSISTS OF STANDARD CHARACTERS WITHOUT CLAIM TO ANY PARTICULAR FONT, STYLE, SIZE, OR COLOR.

BERNICE MIDDLETON, EXAMINING ATTORNEY

Int. Cl.: 33

Prior U.S. Cls.: 47 and 49

United States Patent and Trademark Office

Reg. No. 3,476,840

Registered July 29, 2008

**TRADEMARK
PRINCIPAL REGISTER**

GENUS 4

MCGUIGAN SIMEON WINES LIMITED (AUSTRALIA CORPORATION)
170 GREENHILL ROAD
PARKSIDE SA 5063
AUSTRALIA

FOR: WINES, TABLE WINES; SPARKLING WINES; WINE-BASED ALCOHOLIC BEVERAGES, NAMELY, APERITIFS WITH A WINE BASE; PREPARED WINE COCKTAILS; DRINKS, NAMELY, WINE COOLER; POTABLE SPIRITS, IN CLASS 33 (U.S. CLS. 47 AND 49).

THE MARK CONSISTS OF STANDARD CHARACTERS WITHOUT CLAIM TO ANY PARTICULAR FONT, STYLE, SIZE, OR COLOR.

OWNER OF INTERNATIONAL REGISTRATION
0927591 DATED 5-28-2007, EXPIRES 5-28-2017.

SER. NO. 79-039,837, FILED 5-28-2007.

SIMON TENG, EXAMINING ATTORNEY

Int. Cls.: 29, 30 and 32

Prior U.S. Cls.: 45, 46 and 48

United States Patent and Trademark Office

Reg. No. 3,476,841

Registered July 29, 2008

**TRADEMARK
PRINCIPAL REGISTER**

C SWISS

OSCAR SOLUTIONS PRODUKTIONS; UND VER-
TRIEBS GMBH (AUSTRIA PRIVATE LIMITED
COMPANY)

MILSER-HEIDE-STRASSE 65
A-6068 MILS
AUSTRIA

FOR: JAMS, STEWED FRUIT, NAMELY, FRUIT
CONSERVES, FRUIT PRESERVES, FRUIT PASTE
AND FRUIT PULP; MILK PRODUCTS EXCLUDING
ICE CREAM, ICE MILK AND FROZEN YOGURT,
EDIBLE OILS AND EDIBLE FATS; ALL THE
AFOREMENTIONED GOODS MADE ACCORDING
TO A SWISS RECIPE OR BY USING SWISS INGRE-
DIENTS, IN CLASS 29 (U.S. CL. 46).

FOR: TEA-BASED BEVERAGES WITH FRUIT
FLAVORINGS AND FOOD FLAVORINGS OTHER
THAN ESSENTIAL OILS FOR BEVERAGES; ALL
THE AFOREMENTIONED GOODS MADE AC-
CORDING TO A SWISS RECIPE OR BY USING
SWISS INGREDIENTS, IN CLASS 30 (U.S. CL. 46).

FOR: NON-ALCOHOLIC DRINKS, NAMELY,
NON-ALCOHOLIC BEER, WINE, MALT COOLERS,

COCKTAIL MIXERS, CARBONATED BEVERAGES
AND BEVERAGES CONTAINING FRUIT JUICES
AND TEA FLAVORS; ALL THE AFOREMEN-
TIONED GOODS MADE ACCORDING TO A SWISS
RECIPE OR BY USING SWISS INGREDIENTS, IN
CLASS 32 (U.S. CLS. 45, 46 AND 48).

THE MARK CONSISTS OF STANDARD CHAR-
ACTERS WITHOUT CLAIM TO ANY PARTICULAR
FONT, STYLE, SIZE, OR COLOR.

OWNER OF INTERNATIONAL REGISTRATION
0927849 DATED 2-22-2007, EXPIRES 2-22-2017.

NO CLAIM IS MADE TO THE EXCLUSIVE
RIGHT TO USE "SWISS", APART FROM THE MARK
AS SHOWN.

SER. NO. 79-039,916, FILED 2-22-2007.

CHARISMA HAMPTON, EXAMINING ATTORNEY

Int. Cl.: 3

Prior U.S. Cls.: 1, 4, 6, 50, 51 and 52

United States Patent and Trademark Office

Reg. No. 3,476,842

Registered July 29, 2008

TRADEMARK
PRINCIPAL REGISTER

Jean Paul
GAULTIER
monsieur

GAULME (FRANCE CORPORATION)
325, RUE SAINT MARTIN
F-75003 PARIS
FRANCE

OWNER OF INTERNATIONAL REGISTRATION
0928011 DATED 3-9-2007, EXPIRES 3-9-2017.

FOR: SOAPS; PERFUMES, EAUX DE TOILETTE,
EAUX DE PARFUM, ESSENTIAL OILS; COSMET-
ICS, HAIR LOTIONS, DENTIFRICES, DEODOR-
ANTS FOR PERSONAL USE, COSMETIC MILK,
TALCUM POWDER, COSMETIC BODY OILS, BODY
CREAM NOT FOR MEDICAL USE, MAKE-UP;
SHAVING PREPARATIONS, NAMELY, SHAVING
FOAM, SHAVING GELS, AFTER-SHAVE LOTIONS,
SHAVING SOAPS; COSMETIC SETS COMPRISING
COMPACTS, ROUGE, COSMETIC POWDER, EYE
SHADOW AND COSMETIC PENCILS; SHAMPOOS;
BATH OILS AND BATH SALTS, BATH LOTIONS
NOT FOR MEDICAL USE, IN CLASS 3 (U.S. CLS. 1, 4,
6, 50, 51 AND 52).

OWNER OF U.S. REG. NOS. 2,202,306, 2,609,418
AND OTHERS.

THE NAME "JEAN PAUL GAULTIER" IDENTI-
FIES A LIVING INDIVIDUAL WHOSE CONSENT IS
OF RECORD.

THE ENGLISH TRANSLATION OF THE WORD
"MONSIEUR" IN THE MARK IS "MISTER".

SER. NO. 79-039,967, FILED 3-9-2007.

PRIORITY DATE OF 9-11-2006 IS CLAIMED.

AMY ALFIERI, EXAMINING ATTORNEY

Int. Cl.: 18

Prior U.S. Cls.: 1, 2, 3, 22 and 41

United States Patent and Trademark Office

Reg. No. 3,476,843

Registered July 29, 2008

**TRADEMARK
PRINCIPAL REGISTER**

TULIP BY-LIN

EXPLOITATIEMAATSCHAPPIJ; VAN DER POEL
HENGELO B.V. (NETHERLANDS BESLOTEN
VENNOOTSCHAP)
BORNSESTRAAT 10
NL-7556 BG HENGELO OV.
NETHERLANDS

FOR: BAGS, NAMELY, CANVAS SHOPPING
BAG, TEXTILE SHOPPING BAG, LEATHER SHOP-
PING BAGS, CANVAS GARMENT BAGS FOR TRA-
VEL, LEATHER GARMENT BAGS FOR TRAVEL,
TEXTILE GARMENT BAGS FOR TRAVEL, CAN-
VAS NET BAGS FOR SHOPPING, LEATHER NET
BAGS FOR SHOPPING, TEXTILE NET BAGS FOR
SHOPPING, CANVAS BEACH BAGS, LEATHER
BEACH BAGS, TEXTILE BEACH BAGS, RUCK-
SACKS, SCHOOLBAGS, TOOL BAGS SOLD EMPTY;
SHOPPING BAGS, NAMELY, CANVAS SHOPPING

BAGS, LEATHER SHOPPING BAGS AND TEXTILE
SHOPPING BAGS; TRUNKS AND TRAVELING
BAGS; LEATHER AND IMITATIONS OF LEATHER
AND GOODS MADE OF THESE MATERIALS,
NAMELY, WALLETS, IN CLASS 18 (U.S. CLS. 1, 2,
3, 22 AND 41).

PRIORITY DATE OF 4-13-2007 IS CLAIMED.

OWNER OF INTERNATIONAL REGISTRATION
0928297 DATED 6-4-2007, EXPIRES 6-4-2017.

SER. NO. 79-040,037, FILED 6-4-2007.

FLORENTINA BLANDU, EXAMINING ATTORNEY

Int. Cls.: 9, 16 and 42

**Prior U.S. Cls.: 2, 5, 21, 22, 23, 26, 29, 36, 37, 38, 50,
100 and 101**

Reg. No. 3,476,844

United States Patent and Trademark Office

Registered July 29, 2008

**TRADEMARK
SERVICE MARK
PRINCIPAL REGISTER**

FRESHNESS AT A GLANCE

CRYOLOG (FRANCE S.A.)
1 PLACE PAUL VERLAINE
F-92100 BOULOGNE BILLANCOURT
FRANCE

FOR: SCIENTIFIC, CHECKING APPARATUS AND INSTRUMENTS, NAMELY, COLD CHAIN RUPTURE INDICATORS IN THE NATURE OF AN INDICATOR LAMP; TEMPERATURE REGULATING DEVICES FOR BREAKS IN THE COLD CHAIN, NAMELY, TEMPERATURE INDICATORS, THERMO-SENSITIVE TEMPERATURE INDICATOR STRIPS AND LABELS, TEMPERATURE SENSORS; TEMPERATURE INDICATORS FOR DETECTING BREAKS IN THE COLD CHAIN AND FOR QUANTIFYING THEM, IN CLASS 9 (U.S. CLS. 21, 23, 26, 36 AND 38).

FOR: BAGS, NAMELY, PAPER AND PLASTIC BAGS FOR PACKAGING PURPOSES, PAPER AND PLASTIC BOXES, ALL THE ABOVE DESIGNED FOR MONITORING BREAKS IN THE COLD CHAIN AND FOR VISUALIZING A PRODUCT'S FRESH-

NESS; LABELS, NAMELY, ADHESIVE LABELS USED FOR MONITORING BREAKS IN THE COLD CHAIN AND FOR VISUALIZING A PRODUCT'S FRESHNESS, IN CLASS 16 (U.S. CLS. 2, 5, 22, 23, 29, 37, 38 AND 50).

FOR: TECHNOLOGICAL SERVICES, NAMELY, QUALITY CONTROL FOR PRODUCTS IN THE AGRI-FOOD INDUSTRY AND CATERING AND HEALTH SECTORS FOR OTHERS, IN CLASS 42 (U.S. CLS. 100 AND 101).

PRIORITY DATE OF 9-29-2006 IS CLAIMED.

OWNER OF INTERNATIONAL REGISTRATION
0928461 DATED 3-16-2007, EXPIRES 3-16-2017.

SER. NO. 79-040,113, FILED 3-16-2007.

ANDREA K. NADELMAN, EXAMINING ATTORNEY

Int. Cl.: 32

Prior U.S. Cls.: 45, 46 and 48

United States Patent and Trademark Office

Reg. No. 3,476,845

Registered July 29, 2008

**TRADEMARK
PRINCIPAL REGISTER**



FABBRI 1905 S.P.A. (ITALY JOINT STOCK COMPANY)
VIA EMILIA PONENTE, 276
I-40132 BOLOGNA
ITALY

OWNER OF INTERNATIONAL REGISTRATION
0928699 DATED 5-22-2007, EXPIRES 5-22-2017.

FOR: CONCENTRATES, SYRUPS OR POWDERS
USED IN THE PREPARATION OF SOFT DRINKS,
SYRUPS FOR BEVERAGES, SYRUPS FOR MAKING
BEVERAGES, SYRUPS FOR MAKING SOFT
DRINKS, SYRUPS FOR MAKING WHEY-BASED
BEVERAGES, IN CLASS 32 (U.S. CLS. 45, 46 AND 48).

NO CLAIM IS MADE TO THE EXCLUSIVE
RIGHT TO USE "CAFE", APART FROM THE MARK
AS SHOWN.

SER. NO. 79-040,206, FILED 5-22-2007.

PRIORITY DATE OF 12-6-2006 IS CLAIMED.

KRISTINA MORRIS, EXAMINING ATTORNEY

Int. Cl.: 30

Prior U.S. Cl.: 46

United States Patent and Trademark Office

Reg. No. 3,476,846

Registered July 29, 2008

TRADEMARK
PRINCIPAL REGISTER

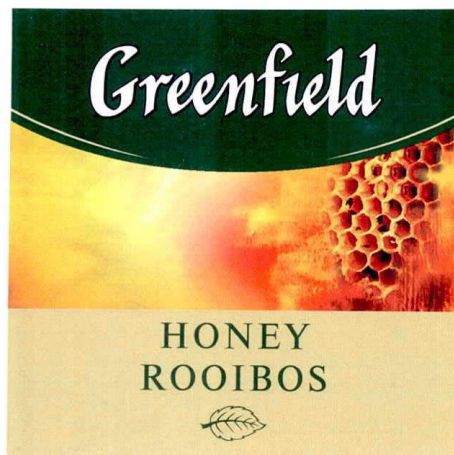

COMPANY "KARAVAN" LTD. (RUSSIAN FED.
LTD LIAB CO)
D.12, FAVORSKOGO STREET
RU-195220 SAINT-PETERSBURG
RUSSIAN FED.

FOR: TEA, ICED TEA, TEA-BASED BEVERAGES,
IN CLASS 30 (U.S. CL. 46).

OWNER OF INTERNATIONAL REGISTRATION
0928785 DATED 5-8-2007, EXPIRES 5-8-2017.

OWNER OF U.S. REG. NO. 3,095,841.

NO CLAIM IS MADE TO THE EXCLUSIVE
RIGHT TO USE "HONEY ROOIBOS", APART FROM
THE MARK AS SHOWN.

THE COLOR(S) GREEN, DARK GREEN, YEL-
LOW, GOLDEN, BEIGE, RED, ORANGE, BROWN,
WHITE, BLACK IS/ARE CLAIMED AS A FEATURE
OF THE MARK.

THE GREEN COLOUR APPEARS IN THE IN-
SCRIPTION "HONEY ROOIBOS" AND IN THE LEAF
IMAGE IN THE LOWER PART OF THE MARK. THE
DARK GREEN COLOUR APPEARS IN THE UPPER
PART OF THE MARK. THE GOLDEN COLOUR
APPEARS ON THE LEFT SIDE OF THE CENTRAL
PART OF THE MARK. THE YELLOW, RED, OR-
ANGE AND BROWN COLOURS APPEAR IN THE
CENTRAL PART OF THE MARK IN/BETWEEN
THE HONEYCOMB IMAGE. THE BEIGE COLOUR
APPEARS IN TWO CURVED LINES IN THE UPPER
PART & IN THE LOWER PART OF THE MARK. THE
WHITE COLOUR APPEARS IN THE INSCRIPTION
"GREENFIELD" WITH SIGN "®" IN THE UPPER
PART OF THE MARK. THE BLACK COLOUR
APPEARS IN THE CONTOURS OF THE INSCRIP-
TION "GREENFIELD" IN THE UPPER PART OF
THE MARK.

SER. NO. 79-040,233, FILED 5-8-2007.

REGINA DRUMMOND, EXAMINING ATTORNEY

Int. Cls.: 9, 16, 37, 38, 41, 42 and 45

**Prior U.S. Cls.: 2, 5, 21, 22, 23, 26, 29, 36, 37, 38, 50,
100, 101, 103, 104, 106 and 107**

Reg. No. 3,476,847

United States Patent and Trademark Office

Registered July 29, 2008

**TRADEMARK
SERVICE MARK
PRINCIPAL REGISTER**

ENTAVIO

SES DIGITAL DISTRIBUTION SERVICES AG; C/
O SCHELLENBERG WITTMER (SWITZER-
LAND S.A.)
LÖWENSTRASSE 19
CH-8023 ZÜRICH
SWITZERLAND

FOR: APPARATUS AND INSTRUMENTS FOR CONDUCTING, SWITCHING, TRANSFORMING, ACCUMULATING, REGULATING OR CONTROLLING ELECTRIC CURRENTS; APPARATUS FOR RECORDING, TRANSMITTING AND REPRODUCING SOUND OR IMAGES; AUTOMATIC AND MECHANICAL VENDING MACHINES FOR COIN-OPERATED APPARATUS; CASH REGISTERS; CALCULATING MACHINES; DATA PROCESSING AND COMPUTER EQUIPMENT; FIRE EXTINGUISHERS; APPARATUS FOR BROADCASTING, TRANSMITTING, RECORDING AND RECEIVING RADIO OR TELEVISION SIGNALS VIA SATELLITE OR CABLE; SATELLITES; TRANSPONDERS; APPARATUS FOR RECEIVING, RECORDING AND DECODING DATA WITH MODEM FUNCTION, NAMELY, SET-TOP BOXES; SIGNAL DISHES AND RECEIVING AERIALS; TELEVISIONS; REMOTE CONTROL UNITS FOR TELEVISIONS; ELECTRONIC APPARATUS FOR ACCESS TO CABLED NETWORKS, WIRELESS NETWORKS, COMPUTER NETWORKS AND GLOBAL COMMUNICATION NETWORKS; AMPLIFIERS; AERIALS FOR THE RECEPTION OF SIGNALS VIA SATELLITE; SPECTACLES; SUNGLASSES, IN CLASS 9 (U.S. CLS. 21, 23, 26, 36 AND 38).

FOR: NEWSPAPERS, PRINTED PERIODICALS, MORE SPECIFICALLY TELEVISION PROGRAM PERIODICALS; BOOKS, MORE SPECIFICALLY MANUALS FOR USE WITH TECHNICAL EQUIPMENT; PAPER, CARDBOARD, PHOTOGRAPHS, STATIONERY, OFFICE REQUISITES, EXCEPT FURNITURE, NAMELY, ADHESIVE TAPE DISPENSERS, CORRECTING FLUID FOR TYPE, FINGER-

STALLS, FRANKING MACHINES, ENVELOPE SEALING MACHINES, PUNCHES, RUBBER BANDS, STAPLERS; PLASTIC MATERIALS FOR PACKAGING, NOT INCLUDED IN OTHER CLASSES, NAMELY, ENVELOPES, BAGS AND PLASTIC FILM; PRINTING TYPE; PRINTING BLOCKS, IN CLASS 16 (U.S. CLS. 2, 5, 22, 23, 29, 37, 38 AND 50).

FOR: REPAIR, INSTALLATION AND MAINTENANCE OF TELECOMMUNICATION EQUIPMENT, EQUIPMENT FOR COMMUNICATION VIA SATELLITE, EQUIPMENT FOR BROADCASTING TELEVISION AND RADIO PROGRAMS, APPARATUS FOR RECEIVING, RECORDING AND DECODING DATA WITH MODEM FUNCTION, KNOWN AS "SET-TOP BOXES", AERIALS FOR THE RECEPTION OF SIGNALS VIA SATELLITE, MEMORY OR MICROPROCESSOR CARDS AS WELL AS OTHER RELATED EQUIPMENT, IN CLASS 37 (U.S. CLS. 100, 103 AND 106).

FOR: TELECOMMUNICATION CONSULTATION; TELEPHONE COMMUNICATION SERVICES; SATELLITE COMMUNICATIONS; TECHNICAL SERVICES IN THE FIELD OF BROADCASTING, NAMELY, SATELLITE COMMUNICATIONS, TRANSMISSION AND BROADCASTING OF RADIO PROGRAMS VIA SATELLITE AS WELL AS OF DATA, ALSO INTERACTIVE DATA, AND TELEVISION; TELETXT SERVICES; TRANSMISSION AND DISSEMINATION OF DATA, PICTURES AND NEWS VIA COMPUTER AND MODEM, OR BY NARROWBAND OR BY BROADBAND, MORE SPECIFICALLY TELEVISION CONNECTIONS; COMMUNICATIONS BY COMPUTER TERMINALS, NAMELY, TRANSMITTING DATA, TEXTS AND PICTURES; PROVIDING EQUIPMENT FOR COMMUNICATION VIA SATELLITE; COMPUTER ASSISTED TRANSMISSION OF DATA, PICTURES, MUSIC, FILMS AND MULTIMEDIA PROGRAMS, ALL THESE SERVICES ALSO VIA THE INTERNET; PROVIDING TELECOMMUNICATION CONNEC-

TIONS TO GLOBAL COMPUTER NETWORKS; PROVISION OF ACCESS TO A GLOBAL COMPUTER NETWORK; PROVIDING ACCESS TIME TO SATELLITES FOR TRANSMITTING TELEVISION PROGRAMS OR TRANSMITTING DATA ESPECIALLY ENCRYPTED; CONSULTING IN THE FIELD OF TRANSMITTING AND DISSEMINATING OF RADIO AND TELEVISION PROGRAMS AND DATA VIA SATELLITE; ELECTRONIC MAIL SERVICES MORE SPECIFICALLY IN CONNECTION WITH CABLED NETWORKS, SATELLITE NETWORKS, WIRELESS NETWORKS AND GLOBAL COMMUNICATION NETWORKS; PROVIDING TELECOMMUNICATION CHANNELS FOR TEleshopping; PROVIDING THE CONNECTION AND THE EQUIPMENT FOR VIDEO-CONFERENCES; TRANSMISSION OF ELECTRONIC MESSAGES; RENTAL OF EQUIPMENT AND INSTRUMENTS FOR TELECOMMUNICATIONS; RENTAL OF ACCESS TIME TO GLOBAL COMPUTER NETWORKS; CONSULTING IN THE FIELD OF TELECOMMUNICATIONS; PROVIDING DATA STORAGE ON THE INTERNET, IN CLASS 38 (U.S. CLS. 100, 101 AND 104).

FOR: PUBLICATION OF ELECTRONIC NEWSPAPERS ACCESSIBLE VIA A GLOBAL COMPUTER NETWORK, IN CLASS 41 (U.S. CLS. 100, 101 AND 107).

FOR: DESIGN AND DEVELOPMENT OF COMPUTERS AND SOFTWARE; DEVELOPMENT, INSTALLATION, MAINTENANCE AND UPDATING OF COMPUTER PROGRAMS AND SOFTWARE FOR THE TRANSFORMATION AND RECORDING OF RADIO AND TELEVISION PROGRAMS AS WELL AS OTHER DATA, AND COMPUTER PROGRAMMING FOR DATA-PROCESSING PURPOSES;

DESIGN AND DEVELOPMENT OF COMPUTERS AND THEIR PERIPHERAL EQUIPMENT; MANAGEMENT OF DATA ON COMPUTER SERVERS; DESIGN OF WEBSITES; COMPUTER SECURITY SERVICES IN THE NATURE OF PROVIDING AN INTERNET TRUST CENTER, NAMELY, ADMINISTRATION OF DIGITAL KEYS AND ELECTRONIC SIGNATURES; GRAPHIC ARTS DESIGN SERVICES; ELECTRONIC PROCESSING OF IMAGES; SECUREMENT AND RECORDING OF ELECTRONIC DATA FOR OTHERS ON OPTICAL, DIGITAL AND MAGNETIC MEDIA FOR ELECTRONIC STORAGE; COMPUTER RENTAL, IN CLASS 42 (U.S. CLS. 100 AND 101).

FOR: LEGAL SERVICES; COPYRIGHT MANAGEMENT, NAMELY, PREVENTING THE EXPLOITATION OF COPYRIGHTS AND INDUSTRIAL PROPERTY TITLES FOR THIRD PARTIES; LICENSING OF FILMS, TELEVISION AND VIDEO, IN CLASS 45 (U.S. CLS. 100 AND 101).

THE MARK CONSISTS OF STANDARD CHARACTERS WITHOUT CLAIM TO ANY PARTICULAR FONT, STYLE, SIZE, OR COLOR.

PRIORITY DATE OF 8-9-2006 IS CLAIMED.

OWNER OF INTERNATIONAL REGISTRATION 0928819 DATED 1-29-2007, EXPIRES 1-29-2017.

SER. NO. 79-040,241, FILED 1-29-2007.

ANDREA SAUNDERS, EXAMINING ATTORNEY

Int. Cl.: 5

Prior U.S. Cls.: 6, 18, 44, 46, 51 and 52

Reg. No. 3,476,848

United States Patent and Trademark Office

Registered July 29, 2008

TRADEMARK
PRINCIPAL REGISTER

I B A T E

OTSUKA PHARMACEUTICAL CO., LTD. (JAPAN
LTD LIAB CO)
2-9, KANDA-TSUKASAMACHI
CHIYODA-KU; TOKYO 101-8535
JAPAN

FOR: PHARMACEUTICAL PREPARATIONS FOR THE TREATMENT OF DISEASES AND DISORDERS OF THE CENTRAL NERVOUS SYSTEM, PERIPHERAL NERVOUS SYSTEM, SENSORY ORGANS, RESPIRATORY ORGANS AND DIGESTIVE ORGANS, CARDIOVASCULAR SYSTEM, UROGENITAL ORGANS, AND THE ANUS; PHARMACEUTICAL PREPARATIONS FOR THE TREATMENT OF DERMATOLOGICAL DISORDERS, AND FOR THE TREATMENT OF CANCER IN THE NATURE OF CHEMOTHERAPEUTIC AGENTS; PHARMACEUTICAL PREPARATIONS FOR THE ACTIVATION OF CELLULAR FUNCTION, FOR SUPPRESSION OF TUMORS; ALLERGY MEDICATIONS; HORMONES FOR HUMAN USE; VITAMIN PREPARATIONS; ANTIBIOTICS; PHARMACEUTICAL PREPARATIONS, NAMELY, PARENTERAL SOLUTIONS USED TO SUPPLY AMINO ACIDS IN CASES OF HYPOPROTEINEMIA, MALNUTRITION AND PRE AND/OR POST-OPERATIVE STATES; ORAL NUTRITIONAL ADDITIVES AND/OR TUBE FEEDING FORMULA FOR THE NUTRITIONAL SUPPORT OF DIABETIC PATIENTS; PHARMACEUTICAL PREPARATIONS CONTAINING A-INTERFERON FOR THE TREATMENT OF VIREMIA CAUSED BY VIRAL HEPATITIS TYPE B AND C AND TREATMENT OF HYPERNEPHROMA; PHARMACEUTICAL PREPARATIONS FOR THE TREATMENT OF LEUKEMIA; PHARMACEUTICAL PREPARATIONS FOR THE TREATMENT OF

HEPATITIS C; PHARMACEUTICAL DRUGS AND MEDICINES, NAMELY, CONTRAST MEDIUM FOR USE IN IN-VIVO IMAGING OF DIGESTIVE ORGANS; MEDICAL DIAGNOSTIC REAGENT FOR MEASURING GAS CONTENT IN EXHALED BREATH TO DETERMINE EXISTENCE OF MICRO-ORGANISM IN HUMAN DIGESTIVE ORGANS AND MEDICAL DIAGNOSTIC REAGENTS FOR DISEASES IN DIGESTIVE ORGANS; DIAGNOSTIC MEDICAL, CHEMICAL AND PHARMACEUTICAL PREPARATIONS FOR DETECTING HELICOBACTER-PYLORI FOR USE IN BREATH TESTS; PHARMACEUTICAL PREPARATIONS FOR THE ERADICATION OF HELICOBACTER PYLORI; BLOOD AND BODY FLUID AGENTS, NAMELY, INTRAVENOUS FLUIDS USED FOR REHYDRATION, NUTRITION AND THE DELIVERY OF PHARMACEUTICAL PREPARATIONS, IN CLASS 5 (U.S. CLS. 6, 18, 44, 46, 51 AND 52).

THE MARK CONSISTS OF STANDARD CHARACTERS WITHOUT CLAIM TO ANY PARTICULAR FONT, STYLE, SIZE, OR COLOR.

PRIORITY DATE OF 4-26-2007 IS CLAIMED.

OWNER OF INTERNATIONAL REGISTRATION
0928901 DATED 5-30-2007, EXPIRES 5-30-2017.

SER. NO. 79-040,281, FILED 5-30-2007.

STEVEN PEREZ, EXAMINING ATTORNEY

Int. Cl.: 1

Prior U.S. Cls.: 1, 5, 6, 10, 26 and 46

Reg. No. 3,476,849

United States Patent and Trademark Office

Registered July 29, 2008

**TRADEMARK
PRINCIPAL REGISTER**

POLYPLUS

POLYPLAST MÜLLER GMBH (FED REP GER-
MANY LTD LIAB CO)
AN DER BLEICHE 48
47638 STRAELEN
FED REP GERMANY

FOR: UNPROCESSED PLASTICS FOR USE IN
FURTHER MANUFACTURING; MASTER BAT-
CHES, NAMELY, CHEMICAL ADDITIVES FOR
USE IN THE MANUFACTURE OF PAINTS NOT
FOR USE IN THE PRODUCTION OF MOULDS FOR
CONFECTIONARY; CHEMICAL COMPOUNDS
NOT FOR USE IN THE PRODUCTION OF MOULDS
FOR CONFECTIONARY, NAMELY, PLASTIC
MOLDING COMPOUNDS FOR USE IN PLASTIC
EXTRUSION OPERATIONS, PLASTIC MOLDING
COMPOUNDS FOR USE IN THE MANUFACTURE
OF MOLDED PLASTIC ARTICLES, PLASTIC

SHEETS AND FILMS, AND CHEMICALLY MOD-
IFIED PLASTIC AND CLAY COMPOSITION FOR
USE IN THE MANUFACTURE OF PLASTICS, IN
CLASS 1 (U.S. CLS. 1, 5, 6, 10, 26 AND 46).

THE MARK CONSISTS OF STANDARD CHAR-
ACTERS WITHOUT CLAIM TO ANY PARTICULAR
FONT, STYLE, SIZE, OR COLOR.

OWNER OF INTERNATIONAL REGISTRATION
0929090 DATED 5-2-2007, EXPIRES 5-2-2017.

SER. NO. 79-040,376, FILED 5-2-2007.

SHANNON TWOHIG, EXAMINING ATTORNEY

Int. Cl.: 3

Prior U.S. Cls.: 1, 4, 6, 50, 51 and 52

United States Patent and Trademark Office

Reg. No. 3,476,850

Registered July 29, 2008

**TRADEMARK
PRINCIPAL REGISTER**

OXIACTION INTELLIGENCE

RECKITT BENCKISER N.V. (NETHERLANDS
NAAMLOZE VENNOOTSCHAP (NV))
SIRIUSDREEF 14
NL-2132 WT HOOFDDORP
NETHERLANDS

FOR: BLEACHING PREPARATIONS FOR LAUN-
DRY USE; LAUNDRY DETERGENTS; SOAPS FOR
LAUNDRY USE; LAUNDRY PREPARATIONS AND
ADDITIVES, NAMELY, LAUNDRY STARCH,
LAUNDRY BLEACH, LAUNDRY BLUEING, LAUN-
DRY PRE-SOAK, AND FABRIC SOFTENERS;
LAUNDRY PREPARATIONS FOR DRY CLEA-
NERS, NAMELY, DRY CLEANING SOLVENTS,
DRY CLEANING FLUIDS AND SPOT REMOVERS;
CARPET CLEANERS; CARPET SHAMPOOS; DEC-

ALCIFYING AND DESCALING PREPARATIONS
FOR HOUSEHOLD PURPOSES; STAIN REMOVING
PREPARATIONS, IN CLASS 3 (U.S. CLS. 1, 4, 6, 50, 51
AND 52).

PRIORITY DATE OF 1-8-2007 IS CLAIMED.

OWNER OF INTERNATIONAL REGISTRATION
0929174 DATED 6-8-2007, EXPIRES 6-8-2017.

SER. NO. 79-040,403, FILED 6-8-2007.

STEPHEN AQUILA, EXAMINING ATTORNEY

Int. Cl.: 28

Prior U.S. Cls.: 22, 23, 38 and 50

United States Patent and Trademark Office

Reg. No. 3,476,851

Registered July 29, 2008

**TRADEMARK
PRINCIPAL REGISTER**

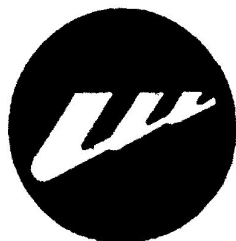

**威尔夫
Weierfu**

SHISHI CITY FEIFAN; SPORT EQUIPMENT CO.,
LTD (CHINA CORPORATION)
YONGNING TOWN, INDUSTRIAL PARK
SHISHI CITY
FUJIAN PROVINCE, CHINA

CISE MACHINES; FISHING TACKLE, IN CLASS 28
(U.S. CLS. 22, 23, 38 AND 50).

OWNER OF INTERNATIONAL REGISTRATION
0929247 DATED 3-5-2007, EXPIRES 3-5-2017.

FOR: SPORTS BALLS; SPORTS RACKETS, NAME-
LY, RACQUET BALL RACKETS, SQUASH RACKET;
TENNIS RACKETS; BADMINTON RACKETS; BAD-
MINTON SHUTTLECOCKS; RACKET STRINGS,
NAMELY, BADMINTON RACKET STRINGS, RAC-
QUET BALL RACKET STRINGS, SQUASH RACKET
STRINGS, TENNIS RACKET STRINGS; TABLE
TENNIS BATS; GOLF CLUBS; CASES FOR TENNIS
BALL; RACKET BAGS, NAMELY, RACKET CASES
FITTED OR ADAPTED FOR SPORTS RACKETS;
BODY-TRAINING APPARATUS, NAMELY, EXER-

THE WORDING "WEIERFU" HAS NO MEANING
IN A FOREIGN LANGUAGE.

THE TRANSLITERATION OF THE NON-LATIN
CHARACTERS IN THE MARK IS WEIERFU.

SER. NO. 79-040,434, FILED 3-5-2007.

JENNY PARK, EXAMINING ATTORNEY

Int. Cl.: 11

Prior U.S. Cls.: 13, 21, 23, 31 and 34

United States Patent and Trademark Office

Reg. No. 3,476,852

Registered July 29, 2008

**TRADEMARK
PRINCIPAL REGISTER**

Grohe Turbostat

GROHE AG (FED REP GERMANY CORPORATION)
HAUPTSTRAÙE 137
58675 HEMER
FED REP GERMANY

FOR: WATER CONDUITS BEING PARTS OF SANITARY FACILITIES FOR KITCHEN AND SANITARY USE; MIXER FAUCETS MIXING COLD AND WARM WATER, IN PARTICULAR THOSE OPERATED BY ONE HAND FOR WASHBASINS AND UTILITY SINKS, BIDETS, TUBS AND SHOWERS; SHOWERS; SHOWER FITTINGS, NAMELY, SHOWER FAUCET EXTENSIONS, SHOWER COMBINATION SYSTEMS FOR BATHROOMS, SHOWER BARS, SHOWER HOLDERS, INDIVIDUAL PARTS AND REPLACEMENTS PARTS FOR ALL THE AFORESAID GOODS, IN CLASS 11 (U.S. CLS. 13, 21, 23, 31 AND 34).

THE MARK CONSISTS OF STANDARD CHARACTERS WITHOUT CLAIM TO ANY PARTICULAR FONT, STYLE, SIZE, OR COLOR.

OWNER OF INTERNATIONAL REGISTRATION 0929262 DATED 4-12-2007, EXPIRES 4-12-2017.

OWNER OF U.S. REG. NOS. 1,151,616, 2,781,356 AND OTHERS.

SER. NO. 79-040,440, FILED 4-12-2007.

REBECCA POVARCHUK, EXAMINING ATTORNEY

Int. Cl.: 35

Prior U.S. Cls.: 100, 101 and 102

United States Patent and Trademark Office

Reg. No. 3,476,853

Registered July 29, 2008

**SERVICE MARK
PRINCIPAL REGISTER**

THE GOODBRAND SOCIAL EQUITY INDEX

THE GOOD BRAND WORKS LIMITED (UNITED
KINGDOM LIMITED COMPANY)
NEW BRIDGE STREET HOUSE,
30-34 NEW BRIDGE STREET; LONDON EC4V 6BJ
UNITED KINGDOM

NO CLAIM IS MADE TO THE EXCLUSIVE
RIGHT TO USE "SOCIAL EQUITY INDEX", APART
FROM THE MARK AS SHOWN.

FOR: MARKET RESEARCH SERVICES, IN CLASS
35 (U.S. CLS. 100, 101 AND 102).

SER. NO. 79-040,497, FILED 5-17-2007.

OWNER OF INTERNATIONAL REGISTRATION
0929406 DATED 5-17-2007, EXPIRES 5-17-2017.

CHARLES L. JENKINS, EXAMINING ATTORNEY

Int. Cls.: 35, 36 and 38

Prior U.S. Cls.: 100, 101, 102 and 104

United States Patent and Trademark Office

Reg. No. 3,476,854

Registered July 29, 2008

**SERVICE MARK
PRINCIPAL REGISTER**

Valuephone

DIPL.-ING. RAINER GLÄß (FED REP GERMA-
NY INDIVIDUAL)
WALDSTRASSE 7
08261 SCHÖNECK
FED REP GERMANY

FOR: MARKETING, NAMELY, DIRECT MAR-
KETING SERVICES AND VIRAL MARKETING
SERVICES PROMOTING AND MARKETING THE
GOODS AND SERVICES OF OTHERS VIA A WEB-
SITE OR A MOBILE PHONE, IN CLASS 35 (U.S. CLS.
100, 101 AND 102).

FOR: FINANCIAL TRANSACTIONS, NAMELY,
CREDIT CARD SERVICES, IN CLASS 36 (U.S. CLS.
100, 101 AND 102).

FOR: TELECOMMUNICATION SERVICES,
NAMELY, CELLULAR TELEPHONE COMMUNI-

CATION SERVICES; TRANSMISSION OF VOICE,
DATA, GRAPHICS TO CELLULAR TELEPHONES;
TRANSMISSION OF NEWS; PROVISION OF TELE-
COMMUNICATION CONNECTIONS TO A GLOBAL
COMPUTER NETWORK, IN CLASS 38 (U.S. CLS. 100,
101 AND 104).

THE MARK CONSISTS OF STANDARD CHAR-
ACTERS WITHOUT CLAIM TO ANY PARTICULAR
FONT, STYLE, SIZE, OR COLOR.

OWNER OF INTERNATIONAL REGISTRATION
0929437 DATED 3-16-2007, EXPIRES 3-16-2017.

SER. NO. 79-040,513, FILED 3-16-2007.

BERNICE MIDDLETON, EXAMINING ATTORNEY

Int. Cls.: 35, 36, 37 and 42

Prior U.S. Cls.: 100, 101, 102, 103 and 106

Reg. No. 3,476,855

United States Patent and Trademark Office

Registered July 29, 2008

**SERVICE MARK
PRINCIPAL REGISTER**



GAGFAH

GAGFAH M; IMMOBILIEN-MANAGEMENT
GMBH (FED REP GERMANY LTD LIAB CO)
HUYSSENALLEE 36/38
45128 ESSEN
FED REP GERMANY

FOR: BUSINESS SERVICES FOR A PROPERTY DEVELOPER OR BUILDER OR CONSTRUCTOR, NAMELY, BUSINESS ORGANIZATION AND MANAGEMENT IN THE CONSTRUCTION FIELD; BUSINESS ADMINISTRATION AND OFFICE WORK, IN CLASS 35 (U.S. CLS. 100, 101 AND 102).

FOR: REAL ESTATE AFFAIRS, NAMELY, REAL ESTATE BROKERAGE AND REAL ESTATE CONSULTANCY; REAL ESTATE MANAGEMENT; APARTMENT HOUSE MANAGEMENT; MANAGEMENT OF APARTMENTS; INITIATION OF REAL ESTATE FUNDS, NAMELY, REAL ESTATE INVESTMENT; MANAGEMENT OF REAL ESTATE FUNDS; CONSULTATION FOR BUILDING FINANCE, NAMELY, REAL ESTATE BROKERAGE CONSULTATION SERVICES; FINANCIAL MANAGEMENT OF CONSTRUCTION PROJECTS; REAL ESTATE AGENCIES; MORTGAGE AGENCY SERVICES, NAMELY, MORTGAGE BROKERAGE; RENTAL OF APARTMENTS AND OFFICE SPACE; REAL ESTATE APPRAISAL; SERVICES OF A BROKER FOR REAL ESTATE, IN CLASS 36 (U.S. CLS. 100, 101 AND 102).

FOR: CONSTRUCTION, NAMELY, BUILDING CONSTRUCTION, BUILDING CONSTRUCTION

SERVICES AND CONSTRUCTION PLANNING; CONSTRUCTION SUPERVISION; CONSTRUCTION OF APARTMENTS; RECONSTRUCTION AND RENOVATION OF BUILDINGS; CONSTRUCTION MANAGEMENT, IN CLASS 37 (U.S. CLS. 100, 103 AND 106).

FOR: ARCHITECTURAL DESIGN; ARCHITECTURAL CONSULTATION; SERVICES OF A PROPERTY DEVELOPER OR BUILDER OR CONSTRUCTOR, NAMELY, TECHNICAL PLANNING AND DEVELOPMENT OF CONSTRUCTION PROJECTS; TECHNICAL PROJECT PLANNING IN THE FIELD OF BUILDING CONSTRUCTION, PUBLIC WORKS AND CIVIL ENGINEERING, IN CLASS 42 (U.S. CLS. 100 AND 101).

PRIORITY DATE OF 9-28-2006 IS CLAIMED.

OWNER OF INTERNATIONAL REGISTRATION
0929480 DATED 3-23-2007, EXPIRES 3-23-2017.

THE MARK CONSISTS OF THE LETTERS "GAGFAH" WITH AN ARC OVER THE SECOND "G" AND THE "F".

SER. NO. 79-040,528, FILED 3-23-2007.

BERNICE MIDDLETON, EXAMINING ATTORNEY

Int. Cl.: 5

Prior U.S. Cls.: 6, 18, 44, 46, 51 and 52

Reg. No. 3,476,856

United States Patent and Trademark Office

Registered July 29, 2008

TRADEMARK
PRINCIPAL REGISTER

E K E V O

OTSUKA PHARMACEUTICAL CO., LTD. (JAPAN
JOINT STOCK COMPANY)
2-9, KANDA-TSUKASAMACHI
CHIYODA-KU; TOKYO 101-8535
JAPAN

FOR: PHARMACEUTICAL PREPARATIONS FOR THE TREATMENT OF DISEASES AND DISORDERS OF THE CENTRAL NERVOUS SYSTEM, PERIPHERAL NERVOUS SYSTEM, SENSORY ORGANS, RESPIRATORY ORGANS AND DIGESTIVE ORGANS, CARDIOVASCULAR SYSTEM, UROGENITAL ORGANS, AND THE ANUS; PHARMACEUTICAL PREPARATIONS FOR THE TREATMENT OF DERMATOLOGICAL DISORDERS, AND FOR THE TREATMENT OF CANCER IN THE NATURE OF CHEMOTHERAPEUTIC AGENTS; PHARMACEUTICAL PREPARATIONS FOR THE ACTIVATION OF CELLULAR FUNCTION, FOR SUPPRESSION OF TUMORS; ALLERGY MEDICATIONS; HORMONES FOR HUMAN USE; VITAMIN PREPARATIONS; ANTIBIOTICS; PHARMACEUTICAL PREPARATIONS, NAMELY, PARENTERAL SOLUTIONS USED TO SUPPLY AMINO ACIDS IN CASES OF HYPOPROTEINEMIA, MALNUTRITION AND PRE AND/OR POST-OPERATIVE STATES; ORAL NUTRITIONAL ADDITIVES AND/OR TUBE FEEDING FORMULA FOR THE NUTRITIONAL SUPPORT OF DIABETIC PATIENTS; PHARMACEUTICAL PREPARATIONS CONTAINING A-INTERFERON FOR THE TREATMENT OF VIREMIA CAUSED BY VIRAL HEPATITIS TYPE B AND C AND TREATMENT OF HYPERNEPHROMA; PHARMACEUTICAL PREPARATIONS FOR THE TREATMENT OF LEUKEMIA; PHARMACEUTICAL PREPARATIONS FOR THE TREATMENT OF

HEPATITIS C; PHARMACEUTICAL DRUGS AND MEDICINES, NAMELY, CONTRAST MEDIUM FOR USE IN IN-VIVO IMAGING OF DIGESTIVE ORGANS; MEDICAL DIAGNOSTIC REAGENT FOR MEASURING GAS CONTENT IN EXHALED BREATH TO DETERMINE EXISTENCE OF MICRO-ORGANISM IN HUMAN DIGESTIVE ORGANS AND MEDICAL DIAGNOSTIC REAGENTS FOR DISEASES IN DIGESTIVE ORGANS; DIAGNOSTIC MEDICAL, CHEMICAL AND PHARMACEUTICAL PREPARATIONS FOR DETECTING HELICOBACTER-PYLORI FOR USE IN BREATH TESTS; PHARMACEUTICAL PREPARATIONS FOR THE ERADICATION OF HELICOBACTER PYLORI; BLOOD AND BODY FLUID AGENTS, NAMELY, INTRAVENOUS FLUIDS USED FOR REHYDRATION, NUTRITION AND THE DELIVERY OF PHARMACEUTICAL PREPARATIONS, IN CLASS 5 (U.S. CLS. 6, 18, 44, 46, 51 AND 52).

THE MARK CONSISTS OF STANDARD CHARACTERS WITHOUT CLAIM TO ANY PARTICULAR FONT, STYLE, SIZE, OR COLOR.

PRIORITY DATE OF 4-26-2007 IS CLAIMED.

OWNER OF INTERNATIONAL REGISTRATION
0929565 DATED 5-30-2007, EXPIRES 5-30-2017.

SER. NO. 79-040,552, FILED 5-30-2007.

STEVEN PEREZ, EXAMINING ATTORNEY

Int. Cl.: 5

Prior U.S. Cls.: 6, 18, 44, 46, 51 and 52

Reg. No. 3,476,857

United States Patent and Trademark Office

Registered July 29, 2008

TRADEMARK
PRINCIPAL REGISTER

T R E L F R E E

OTSUKA PHARMACEUTICAL CO., LTD. (JAPAN
JOINT STOCK COMPANY)
2-9, KANDA-TSUKASAMACHI
CHIYODA-KU; TOKYO 101-8535
JAPAN

FOR: PHARMACEUTICAL PREPARATIONS FOR THE TREATMENT OF DISEASES AND DISORDERS OF THE CENTRAL NERVOUS SYSTEM, PERIPHERAL NERVOUS SYSTEM, SENSORY ORGANS, RESPIRATORY ORGANS AND DIGESTIVE ORGANS, CARDIOVASCULAR SYSTEM, UROGENITAL ORGANS, AND THE ANUS; PHARMACEUTICAL PREPARATIONS FOR THE TREATMENT OF DERMATOLOGICAL DISORDERS, AND FOR THE TREATMENT OF CANCER IN THE NATURE OF CHEMOTHERAPEUTIC AGENTS; PHARMACEUTICAL PREPARATIONS FOR THE ACTIVATION OF CELLULAR FUNCTION, FOR SUPPRESSION OF TUMORS; ALLERGY MEDICATIONS; HORMONES FOR HUMAN USE; VITAMIN PREPARATIONS; ANTIBIOTICS; PHARMACEUTICAL PREPARATIONS, NAMELY, PARENTERAL SOLUTIONS USED TO SUPPLY AMINO ACIDS IN CASES OF HYPOPROTEINEMIA, MALNUTRITION AND PRE AND/OR POST-OPERATIVE STATES; ORAL NUTRITIONAL ADDITIVES AND/OR TUBE FEEDING FORMULA FOR THE NUTRITIONAL SUPPORT OF DIABETIC PATIENTS; PHARMACEUTICAL PREPARATIONS CONTAINING A-INTERFERON FOR THE TREATMENT OF VIREMIA CAUSED BY VIRAL HEPATITIS TYPE B AND C AND TREATMENT OF HYPERNEPHROMA; PHARMACEUTICAL PREPARATIONS FOR THE TREATMENT OF LEUKEMIA; PHARMACEUTICAL PREPARATIONS FOR THE TREATMENT OF

HEPATITIS C; PHARMACEUTICAL DRUGS AND MEDICINES, NAMELY, CONTRAST MEDIUM FOR USE IN IN-VIVO IMAGING OF DIGESTIVE ORGANS; MEDICAL DIAGNOSTIC REAGENT FOR MEASURING GAS CONTENT IN EXHALED BREATH TO DETERMINE EXISTENCE OF MICRO-ORGANISM IN HUMAN DIGESTIVE ORGANS AND MEDICAL DIAGNOSTIC REAGENTS FOR DISEASES IN DIGESTIVE ORGANS; DIAGNOSTIC MEDICAL, CHEMICAL AND PHARMACEUTICAL PREPARATIONS FOR DETECTING HELICOBACTER-PYLORI FOR USE IN BREATH TESTS; PHARMACEUTICAL PREPARATIONS FOR THE ERADICATION OF HELICOBACTER PYLORI; BLOOD AND BODY FLUID AGENTS, NAMELY, INTRAVENOUS FLUIDS USED FOR REHYDRATION, NUTRITION AND THE DELIVERY OF PHARMACEUTICAL PREPARATIONS, IN CLASS 5 (U.S. CLS. 6, 18, 44, 46, 51 AND 52).

THE MARK CONSISTS OF STANDARD CHARACTERS WITHOUT CLAIM TO ANY PARTICULAR FONT, STYLE, SIZE, OR COLOR.

PRIORITY DATE OF 4-26-2007 IS CLAIMED.

OWNER OF INTERNATIONAL REGISTRATION 0929566 DATED 5-30-2007, EXPIRES 5-30-2017.

SER. NO. 79-040,553, FILED 5-30-2007.

STEVEN PEREZ, EXAMINING ATTORNEY

Int. Cl.: 30

Prior U.S. Cl.: 46

United States Patent and Trademark Office

Reg. No. 3,476,858

Registered July 29, 2008

TRADEMARK
PRINCIPAL REGISTER



CAPILANO HONEY LIMITED (AUSTRALIA
COMPANY)
399 ARCHERFIELD ROAD
RICHLANDS, QLD 4077
AUSTRALIA

FOR: HONEY, HONEY PRODUCTS, NAMELY,
TREACLE, GOLDEN SYRUP, FOOD FLAVOUR-
INGS MADE FROM HONEY, TOPPING SYRUP
MADE FROM HONEY, PANCAKE SYRUP, MAPLE
SYRUP, CHOCOLATE SYRUP, TOPPING SYRUP,
FLAVOURING SYRUP, SAUCES, GLUCOSE FOR
FOOD FOR USE AS A SUGAR SUBSTITUTE, IN
CLASS 30 (U.S. CL. 46).

PRIORITY DATE OF 5-17-2007 IS CLAIMED.

OWNER OF INTERNATIONAL REGISTRATION
0929589 DATED 6-15-2007, EXPIRES 6-15-2017.

THE MARK CONSISTS OF STYLIZED LETTER-
ING COMPRISING THE WORDING "SNAP'N"
OVER THE WORDING "SQUEEZE" WITH THE
APOSTROPHE REPRESENTED BY A STYLIZED
DESIGN OF A DROP OF HONEY..

SER. NO. 79-040,555, FILED 6-15-2007.

PAUL CROWLEY, EXAMINING ATTORNEY

Int. Cl.: 18

Prior U.S. Cls.: 1, 2, 3, 22 and 41

United States Patent and Trademark Office

Reg. No. 3,476,859

Registered July 29, 2008

**TRADEMARK
PRINCIPAL REGISTER**

ESPIEGLE

LANCEL INTERNATIONAL SA (SWITZERLAND
SOCIÉTÉ ANONYME (SA))
ROUTE DES BICHES 10
CH-1752 VILLARS-SUR-GLÂNE
SWITZERLAND

FOR: LEATHER ITEMS AND SMALL LEATHER ITEMS, NAMELY, HANDBAGS, CLUTCH BAGS, HOLDALLS, BEGGARS' BAGS, SHOULDER BAGS, RUCKSACKS, COLLEGE SATCHELS, BEACH BAGS, TRAVELLING BAGS, SADDLE BAGS, SPORTS BAGS, GARMENT BAGS, TRAVELLING SETS CONSISTING OF SUITCASES AND TRAVELLING BAGS, DOCUMENT CASES, CARD WALLETS, WALLETS, BUSINESS AND CREDIT CARD CASES, BUSINESS NOTE CASES, PURSES NOT OF PRECIOUS METAL, BRIEFCASES, SCHOOL BAGS, PURSES, KEY CASES, VANITY CASES SOLD EMP-

TY, TRUNKS AND SUITCASES; AND UMBRELLAS, IN CLASS 18 (U.S. CLS. 1, 2, 3, 22 AND 41).

THE MARK CONSISTS OF STANDARD CHARACTERS WITHOUT CLAIM TO ANY PARTICULAR FONT, STYLE, SIZE, OR COLOR.

PRIORITY DATE OF 12-22-2006 IS CLAIMED.

OWNER OF INTERNATIONAL REGISTRATION 0929629 DATED 6-20-2007, EXPIRES 6-20-2017.

SER. NO. 79-040,569, FILED 6-20-2007.

CAROLYN GRAY, EXAMINING ATTORNEY

Int. Cl.: 10

Prior U.S. Cls.: 26, 39 and 44

United States Patent and Trademark Office

Reg. No. 3,476,860

Registered July 29, 2008

**TRADEMARK
PRINCIPAL REGISTER**

HOYA CORPORATION (JAPAN CORPORATION)
7-5, NAKA-OCHIAI 2-CHOME
SHINJUKU-KU; TOKYO 161-8525
JAPAN

FOR: OPHTHALMIC SURGICAL APPARATUS
AND INSTRUMENTS FOR USE IN VITRECTOMY
PROCEDURES, NAMELY, SILICONE RING
SLEEVES FOR USE WITH A METAL RING TO FIX
A VITRECTOMY LENS ON THE CORNEA IN A
VITREOUS SURGERY, IN CLASS 10 (U.S. CLS. 26, 39
AND 44).

THE MARK CONSISTS OF STANDARD CHAR-
ACTERS WITHOUT CLAIM TO ANY PARTICULAR
FONT, STYLE, SIZE, OR COLOR.

PRIORITY DATE OF 5-10-2007 IS CLAIMED.

OWNER OF INTERNATIONAL REGISTRATION
0929670 DATED 6-18-2007, EXPIRES 6-18-2017.

SER. NO. 79-040,627, FILED 6-18-2007.

TINA KUAN, EXAMINING ATTORNEY

Int. Cl.: 14

Prior U.S. Cls.: 2, 27, 28 and 50

Reg. No. 3,476,861

United States Patent and Trademark Office

Registered July 29, 2008

**TRADEMARK
PRINCIPAL REGISTER**

KIDOU

COSMOLEDO (FRANCE SOCIETE PAR ACTIONS
SIMPLIFIEE)
AVENUE DE GENÈVE
MARCLAZ
F-74200 ANTHY SUR LEMAN, FRANCE

FOR: PRECIOUS METALS AND THEIR ALLOYS
OTHER THAN FOR DENTAL USE; JEWELLERY,
PRECIOUS STONES, PEARLS AS JEWELLERY;
JEWELLERY ITEMS, NECKLACES AS JEWEL-
LERY, CHAINS AS JEWELLERY, PENDANTS,
CHARMS, BRACELETS AS JEWELLERY, BRACE-
LET CHAINS, EARRINGS, BUCKLES OF PRECIOUS
METAL, RINGS AS JEWELLERY, BROOCHES AS
JEWELLERY, MEDALS, MEDALLIONS AS JEWEL-
LERY; ORNAMENTS OF PRECIOUS METAL; CUFF
LINKS, TIE PINS; FANCY KEY RINGS; HOROLO-
GICAL AND CHRONOMETRIC INSTRUMENTS,

ALARM CLOCKS, WALL CLOCKS, CLOCKS,
WATCHES, WATCH BANDS, WRIST-WATCHES;
JEWEL CASES OF PRECIOUS METAL, PRECIOUS
METAL BOXES, JEWELLERY CASKETS OF PRE-
CIOUS METAL, CASES FOR WATCHES, IN CLASS
14 (U.S. CLS. 2, 27, 28 AND 50).

OWNER OF INTERNATIONAL REGISTRATION
0929889 DATED 6-6-2007, EXPIRES 6-6-2017.

THE WORDING ""KIDOU" HAS NO MEANING
IN A FOREIGN LANGUAGE.

SER. NO. 79-040,712, FILED 6-6-2007.

ALLISON HOLTZ, EXAMINING ATTORNEY

Int. Cl.: 1

Prior U.S. Cls.: 1, 5, 6, 10, 26 and 46

Reg. No. 3,476,862

United States Patent and Trademark Office

Registered July 29, 2008

**TRADEMARK
PRINCIPAL REGISTER**

DIREFIX

CLARIANT AG (SWITZERLAND SOCIÉTÉ
ANONYME)
ROTHAUSSTRASSE 61
CH-4132 MUTTENZ
SWITZERLAND

PRIORITY DATE OF 1-30-2007 IS CLAIMED.

FOR: CHEMICAL PRODUCTS, NAMELY, DYE-
ING AUXILIARIES FOR THE TEXTILE, LEATHER
AND PAPER INDUSTRIES, IN CLASS 1 (U.S. CLS. 1,
5, 6, 10, 26 AND 46).

OWNER OF INTERNATIONAL REGISTRATION
0929893 DATED 7-3-2007, EXPIRES 7-3-2017.

THE MARK CONSISTS OF STANDARD CHAR-
ACTERS WITHOUT CLAIM TO ANY PARTICULAR
FONT, STYLE, SIZE, OR COLOR.

SER. NO. 79-040,716, FILED 7-3-2007.

ALLISON HOLTZ, EXAMINING ATTORNEY

Int. Cls.: 18 and 25

Prior U.S. Cls.: 1, 2, 3, 22, 39 and 41

United States Patent and Trademark Office

Reg. No. 3,476,863

Registered July 29, 2008

**TRADEMARK
PRINCIPAL REGISTER**



LOTTO SPORT ITALIA S.P.A. (ITALY JOINT STOCK COMPANY)

VIA MONTEBELLUNA, 5/7

I-31040 TREVIGNANO (TREVISO)

ITALY

FOR: GARMENT BAGS FOR TRAVEL; BEACH BAGS; BRIEFCASES; HANDBAGS; SCHOOL BAGS AND SCHOOL SATCHELS; SUITCASES; TRAVELLING BAGS; BRIEFCASES FOR DOCUMENTS; SPORT BAGS; RUCKSACKS; LEATHER KEY CASES; POCKET WALLETS; PURSES, NOT OF PRECIOUS METAL; ARTICLES MADE OF IMITATION LEATHER AND IMITATION HIDE, NAMELY, GARMENT BAGS FOR TRAVEL, BEACH BAGS, BRIEFCASES, HANDBAGS, SCHOOL BAGS AND SCHOOL SATCHELS, SUITCASES, TRAVELLING BAGS, BRIEFCASES FOR DOCUMENTS, SPORT BAGS, RUCKSACKS, IMITATION LEATHER KEY CASES AND IMITATION HIDE KEY CASES, POCKET WALLETS, PURSES, NOT OF PRECIOUS METAL; ARTICLES MADE OF ARTIFICIAL LEATHER AND POLYURETHANE LEATHER, NAMELY, GARMENT BAGS FOR TRAVEL, BEACH BAGS, BRIEFCASES, HANDBAGS, SCHOOL BAGS AND SCHOOL SATCHELS, SUITCASES, TRAVELLING BAGS, BRIEFCASES FOR DOCUMENTS, SPORT BAGS, RUCKSACKS, ARTIFICIAL LEATHER KEY CASES, POLYURETHANE LEATHER KEY CASES, POCKET WALLETS, PURSES, NOT OF PRECIOUS METAL; UMBRELLAS; BEACH UMBRELLAS; WALKING STICKS, IN CLASS 18 (U.S. CLS. 1, 2, 3, 22 AND 41).

FOR: SPORTING SHOES, NAMELY, TENNIS SHOES, VOLLEYBALL SHOES, RUNNING SHOES, TRAINING SHOES, SOCCER SHOES, ESPADRILLES, BOOTS, SANDALS, SLIPPERS; SKI BOOTS; GYM SUITS; BERMUDA SHORTS; BLOUSES; BODY SUITS; SHIRTS; COATS; GLOVES; CULLOTTES; HATS; CAPS; JACKETS; JEANS; SWEATERS; JERSEYS; TROUSERS; SKI PANTS; PULLOVERS; RAIN COATS; SCARVES; CARDIGANS; POLO SHIRTS; SPORT SHIRTS; SHORTS; GYM SHORTS; SOCKS; SWIMSUITS; T-SHIRTS; TENNIS PULLOVERS; TENNIS SHORTS; TENNIS SKIRTS; TURTLENECK SWEATERS; V-NECK SWEATERS; WIND RESISTANT JACKETS; SHAWLS; QUILTED VESTS; KNITTED SWEATERS; FROCKS; SWEAT SHIRTS; DUNGAREES; HEAD BANDS; SWEAT BANDS; WRIST BANDS; BELTS; BRIEFS; PANTSUITS; ATHLETIC UNIFORMS; JUMPERS; MAILLOTS; ROMPERS; INSOLES; STOCKINGS; HOODS; WAISTCOATS; AND HALTER TOPS, IN CLASS 25 (U.S. CLS. 22 AND 39).

PRIORITY DATE OF 12-18-2006 IS CLAIMED.

OWNER OF INTERNATIONAL REGISTRATION 0929948 DATED 2-12-2007, EXPIRES 2-12-2017.

THE MARK CONSISTS OF THE LETTERING "LE DD" IN STYLIZED FONT BELOW THE IMAGE OF A STYLIZED FIGURE OF A FROG OF WHICH ONLY THE HEAD AND THE FRONT LIMBS APPEAR.

SER. NO. 79-040,733, FILED 2-12-2007.

MARILYN IZZI, EXAMINING ATTORNEY

Int. Cls.: 9 and 11

Prior U.S. Cls.: 13, 21, 23, 26, 31, 34, 36 and 38

Reg. No. 3,476,864

United States Patent and Trademark Office

Registered July 29, 2008

**TRADEMARK
PRINCIPAL REGISTER**

HANSAPUBLIC

HANSA METALLWERKE AG (FED REP GERMANY AG)
SIGMARINGER STR. 107
70547 STUTTGART
FED REP GERMANY

FOR: ELECTRIC CONTROLLERS FOR WIRELESS CONTROL OF SANITARY FITTINGS; COMPUTER SOFTWARE PROGRAMS FOR CONTROLLING THE TEMPERATURE AND PRESSURE OF PLUMBING DEVICES AND SANITARY FACILITIES; CONSUMER ELECTRONICS AND INFORMATION TECHNOLOGY COMPONENTS, NAMELY, RADIOS, TELEVISION SETS, PERSONAL COMPUTERS, CD PLAYERS, DVD PLAYERS, ALL FOR USE OR INSTALLATION ON SHOWERS, SHOWER FACILITIES, SANITARY FACILITIES, IN CLASS 9 (U.S. CLS. 21, 23, 26, 36 AND 38).

FOR: FITTINGS FOR PLUMBING, WATER HEATING, BATHING, SHOWERING, FLUSHING, BIDET AND WASHING FACILITIES, NAMELY MANUALLY, THERMOSTATICALLY AND ELECTRONICALLY CONTROLLED MIXER TAPS, MIXING VALVES, CONTROL VALVES AS PARTS OF SANITARY FACILITIES; SHOWERS AND SHOWER FITTINGS, NAMELY, SHOWER HEADS AND DOORS; SHOWER COMBINATIONS COMPRISED OF SHOWERS AND SHOWER HEADS; OVERHEAD SHOWER ATTACHMENTS, NAMELY, HEADS; LATERAL SHOWER ATTACHMENTS, NAMELY, SHOWER SURROUNDS; SPRAY NOZZLES FOR SHOWERS, TUBS AND BATH; PLUMBING FIXTURES AND FITTINGS, NAMELY, SHOWER ATTACHMENT SUPPORTS, SHOWER HOSES, SHOWER RAILS, HOSE COUPLINGS FOR SUCH SHOWERS AND BATH HANDLES; WATER INLETS AND WATER OUTLETS AS PARTS OF SANITARY FACILITIES, NAMELY, PIPES AND FAUCETS, CARTRIDGES AND UPPER PARTS FOR SANI-

TARY FITTINGS, NAMELY, CARTRIDGE FILTRATION UNITS FOR WATER PURIFICATION SYSTEMS AND PLUMBING FITTINGS IN THE NATURE OF PIPE CONNECTORS, T-PIECES, PIPE CLOSURE CAPS AND PIPE VENTING VALVES; MECHANICAL SAFETY VALVES MADE OF METAL AND SAFETY GROUPS SUBSTANTIALLY COMPOSED THEREOF, THE PREVIOUSLY DESCRIBED GOODS IN CONNECTION, CONTROL AND SAFETY FITTINGS FOR SANITARY INSTALLATIONS; COOLING, VENTILATING AND PLUMBING EQUIPMENT AND SANITARY FACILITIES, NAMELY, AIR CONDITIONING UNITS, VENTILATING EXHAUST FANS, MANUALLY-OPERATED PLUMBING VALVES; WATER CONDITIONING UNITS, LIGHTING FIXTURES, REPLACEMENT AND COMPONENT PARTS OF THE PREVIOUSLY DESCRIBED GOODS; UV LIGHT RADIATION DEVICES FOR NON-MEDICAL PURPOSES, NAMELY, LAMPS AND LIGHTING FIXTURES, IN CLASS 11 (U.S. CLS. 13, 21, 23, 31 AND 34).

THE MARK CONSISTS OF STANDARD CHARACTERS WITHOUT CLAIM TO ANY PARTICULAR FONT, STYLE, SIZE, OR COLOR.

PRIORITY DATE OF 10-26-2006 IS CLAIMED.

OWNER OF INTERNATIONAL REGISTRATION 0930015 DATED 4-26-2007, EXPIRES 4-26-2017.

OWNER OF U.S. REG. NOS. 1,467,191, 2,724,516 AND OTHERS.

SER. NO. 79-040,757, FILED 4-26-2007.

ERNEST SHOSHO, EXAMINING ATTORNEY

Int. Cl.: 16

Prior U.S. Cls.: 2, 5, 22, 23, 29, 37, 38 and 50

United States Patent and Trademark Office

Reg. No. 3,476,865

Registered July 29, 2008

**TRADEMARK
PRINCIPAL REGISTER**



**DELFORT GROUP AG (AUSTRIA JOINT STOCK
COMPANY)**

FABRIKSTR. 20

A-4050 TRAUN

AUSTRIA

**FOR: PAPER AND PAPER PRODUCTS, NAMELY,
PRINTING PAPER, THIN BASE PAPER, RELEASE
BASE PAPER, WRITING PAPER, COPY PAPER,
OFFICE PAPER, GRAPHICAL PAPER, IN CLASS
16 (U.S. CLS. 2, 5, 22, 23, 29, 37, 38 AND 50).**

PRIORITY DATE OF 4-3-2007 IS CLAIMED.

**OWNER OF INTERNATIONAL REGISTRATION
0930220 DATED 6-29-2007, EXPIRES 6-29-2017.**

**NO CLAIM IS MADE TO THE EXCLUSIVE
RIGHT TO USE "THIN", "THINCOAT" AND "29
GSM", APART FROM THE MARK AS SHOWN.**

**THE MARK CONSISTS OF A RECTANGLE, A
SMALLER RECTANGLE INSIDE, AND A STY-
LIZED DEPICTION OF AN OVERCOAT.**

SER. NO. 79-040,824, FILED 6-29-2007.

STEVEN R. FINE, EXAMINING ATTORNEY

Int. Cl.: 16

Prior U.S. Cls.: 2, 5, 22, 23, 29, 37, 38 and 50

United States Patent and Trademark Office

Reg. No. 3,476,866

Registered July 29, 2008

**TRADEMARK
PRINCIPAL REGISTER**



thinopaque

**DELFORT GROUP AG (AUSTRIA JOINT STOCK
COMPANY)**

FABRIKSTR. 20

A-4050 TRAUN

AUSTRIA

**FOR: PAPER AND PAPER PRODUCTS, NAMELY,
PRINTING PAPER, THIN BASE PAPER, RELEASE
BASE PAPER, WRITING PAPER, COPY PAPER,
OFFICE PAPER, GRAPHICAL PAPER , IN CLASS
16 (U.S. CLS. 2, 5, 22, 23, 29, 37, 38 AND 50).**

PRIORITY DATE OF 4-3-2007 IS CLAIMED.

**OWNER OF INTERNATIONAL REGISTRATION
0930222 DATED 6-29-2007, EXPIRES 6-29-2017.**

**NO CLAIM IS MADE TO THE EXCLUSIVE
RIGHT TO USE "THIN", "THIN OPAQUE" AND
"GSM 25", APART FROM THE MARK AS SHOWN.**

**THE MARK CONSISTS OF A LARGE RECTAN-
GLE, A SMALLER RECTANGLE INSIDE, AND
VERBAL ELEMENTS.**

SER. NO. 79-040,826, FILED 6-29-2007.

STEVEN R. FINE, EXAMINING ATTORNEY

Int. Cl.: 16

Prior U.S. Cls.: 2, 5, 22, 23, 29, 37, 38 and 50

United States Patent and Trademark Office

Reg. No. 3,476,867

Registered July 29, 2008

**TRADEMARK
PRINCIPAL REGISTER**



**DELFORT GROUP AG (AUSTRIA JOINT-STOCK
COMPANY)**

FABRIKSTR. 20

A-4050 TRAUN

AUSTRIA

**FOR: PAPER AND PAPER PRODUCTS, NAMELY,
PRINTING PAPER, THIN BASE PAPER, RELEASE
BASE PAPER, WRITING PAPER, COPY PAPER,
OFFICE PAPER, GRAPHICAL PAPER, IN CLASS 16
(U.S. CLS. 2, 5, 22, 23, 29, 37, 38 AND 50).**

PRIORITY DATE OF 4-3-2007 IS CLAIMED.

**OWNER OF INTERNATIONAL REGISTRATION
0930224 DATED 6-29-2007, EXPIRES 6-29-2017.**

**NO CLAIM IS MADE TO THE EXCLUSIVE
RIGHT TO USE "THIN" AND "32 GSM", APART
FROM THE MARK AS SHOWN.**

**THE MARK CONSISTS OF A RECTANGLE WITH
A STAR AND A SMALLER RECTANGLE INSIDE,
AND VERBAL ELEMENTS.**

SER. NO. 79-040,828, FILED 6-29-2007.

STEVEN R. FINE, EXAMINING ATTORNEY

Int. Cl.: 18

Prior U.S. Cls.: 1, 2, 3, 22 and 41

United States Patent and Trademark Office

Reg. No. 3,476,868

Registered July 29, 2008

**TRADEMARK
PRINCIPAL REGISTER**

BALANCEL

LANCEL INTERNATIONAL SA (SWITZERLAND
SOCIÉTÉ ANONYME (SA))
ROUTE DES BICHES 10
CH-1752 VILLARS-SUR-GLÂNE
SWITZERLAND

FOR: LEATHER GOODS AND SMALL LEATHER
ITEMS, NAMELY, HANDBAGS, POCHETTES, HOL-
DALLS, BEGGARS' BAGS, SHOULDER BAGS,
RUCKSACKS, COLLEGE SATCHELS, BEACH
BAGS, TRAVELLING BAGS, SADDLE BAGS,
SPORTS BAGS, GARMENT BAGS, TRAVELLING
SETS CONSISTING OF SUITCASES AND TRAVEL
BAGS, DOCUMENT CASES, BUSINESS AND NAME
CARD CASES, CARD WALLETS, WALLETS, CASES
FOR NOTES AND OTHER RELATED DOCU-
MENTS, PURSES NOT OF PRECIOUS METAL,
BRIEF CASES, ATTACHE CASES, SCHOOL BAGS,
KEY CASES, VANITY CASES SOLD EMPTY,

TRUNKS AND SUITCASES; AND UMBRELLAS, IN
CLASS 18 (U.S. CLS. 1, 2, 3, 22 AND 41).

THE MARK CONSISTS OF STANDARD CHAR-
ACTERS WITHOUT CLAIM TO ANY PARTICULAR
FONT, STYLE, SIZE, OR COLOR.

PRIORITY DATE OF 12-22-2006 IS CLAIMED.

OWNER OF INTERNATIONAL REGISTRATION
0930265 DATED 6-20-2007, EXPIRES 6-20-2017.

SER. NO. 79-040,843, FILED 6-20-2007.

CAROLYN GRAY, EXAMINING ATTORNEY

Int. Cl.: 3

Prior U.S. Cls.: 1, 4, 6, 50, 51 and 52

United States Patent and Trademark Office

Reg. No. 3,476,869

Registered July 29, 2008

**TRADEMARK
PRINCIPAL REGISTER**



JURLIQUE INTERNATIONAL PTY LTD (AUSTRALIA INCORPORATED COMPANY)
52-54 OBORN ROAD
MOUNT BARKER SA 5251
AUSTRALIA

FOR: NON-MEDICATED SKIN CARE PREPARATIONS; BEAUTY PRODUCTS, NAMELY, COSMETICS FOR THE BODY AND FACE; FACE POWDER, BODY POWDER, FACIAL SCRUBS; BODY SCRUBS; BATH AND SHOWER GELS NOT FOR MEDICAL PURPOSES; BATH AND SHOWER SALTS NOT FOR MEDICAL PURPOSES; BUBBLE BATH; NON-MEDICATED LIP BALM; NAIL CARE PREPARATIONS; NON-MEDICATED SKIN CARE CREAMS; NON-MEDICATED FOOT CARE CREAMS AND LOTIONS; NON-MEDICATED HAND CARE CREAMS; FACIAL LOTIONS, CREAMS AND GELS; SUNSCREEN CREAMS, LOTIONS, AND GEL; COSMETICS;

SKIN SOAPS, NON-MEDICATED TOILETRIES, PERFUMES, ESSENTIAL OILS FOR PERSONAL USE; HAIR CARE PREPARATIONS INCLUDING SHAMPOOS AND CONDITIONERS; HAND LOTIONS AND BODY LOTIONS; NON-MEDICATED BATH PREPARATIONS; POTPOURRIS, IN CLASS 3 (U.S. CLS. 1, 4, 6, 50, 51 AND 52).

PRIORITY DATE OF 5-31-2007 IS CLAIMED.

OWNER OF INTERNATIONAL REGISTRATION 0930276 DATED 7-6-2007, EXPIRES 7-6-2017.

SER. NO. 79-040,847, FILED 7-6-2007.

JOHN GARTNER, EXAMINING ATTORNEY

Int. Cl.: 10

Prior U.S. Cls.: 26, 39 and 44

United States Patent and Trademark Office

Reg. No. 3,476,870

Registered July 29, 2008

**TRADEMARK
PRINCIPAL REGISTER**

HOYA CORPORATION (JAPAN CORPORATION)
7-5, NAKA-OCHIAI 2-CHOME
SHINJUKU-KU; TOKYO 161-8525
JAPAN

FOR: OPHTHALMIC SURGICAL APPARATUS
AND INSTRUMENTS FOR USE IN VITRECTOMY
PROCEDURES, NAMELY, METAL RINGS TO FIX A
VITRECTOMY LENS ON THE CORNEA IN VITR-
EOUS SURGERY, IN CLASS 10 (U.S. CLS. 26, 39 AND
44).

THE MARK CONSISTS OF STANDARD CHAR-
ACTERS WITHOUT CLAIM TO ANY PARTICULAR
FONT, STYLE, SIZE, OR COLOR.

OWNER OF INTERNATIONAL REGISTRATION
0930374 DATED 6-18-2007, EXPIRES 6-18-2017.

SER. NO. 79-040,880, FILED 6-18-2007.

TINA KUAN, EXAMINING ATTORNEY

Int. Cls.: 18 and 25

Prior U.S. Cls.: 1, 2, 3, 22, 39 and 41

Reg. No. 3,476,871

United States Patent and Trademark Office

Registered July 29, 2008

**TRADEMARK
PRINCIPAL REGISTER**

TWICE

ORIGINAL SERGIO SALMASO SRL (ITALY LTD
LIAB CO)
VIA ANGI, 14
I-30039 STRA' (VE)
ITALY

FOR: LEATHER BAGS, NAMELY, HANDBAGS,
DUFFEL BAGS, BOSTON BAGS, SHOPPING BAGS;
SUITCASES, TRUNKS; LEATHER AND IMITATION
LEATHER ARTICLES, NAMELY, KEY CHAINS
AND WALLETS, IN CLASS 18 (U.S. CLS. 1, 2, 3, 22
AND 41).

FOR: MEN'S AND WOMEN'S SHOES AND
BOOTS; MEN'S AND WOMEN'S LEATHER CLOTH-
ING, NAMELY, PANTS, SKIRTS, COATS, DRESSES,
JACKETS, LIGHT JACKETS; BELTS, IN CLASS 25
(U.S. CLS. 22 AND 39).

OWNER OF INTERNATIONAL REGISTRATION
0814109 DATED 10-2-2003, EXPIRES 10-2-2013.

SER. NO. 79-040,945, FILED 11-24-2006.

MARILYN IZZI, EXAMINING ATTORNEY

Int. Cl.: 33

Prior U.S. Cls.: 47 and 49

United States Patent and Trademark Office

Reg. No. 3,476,872

Registered July 29, 2008

**TRADEMARK
PRINCIPAL REGISTER**

PORTA REGIA

BODEGAS VALLE DEL CARCHE, S.L. (SPAIN
SOCIEDAD LIMITADA)
PASEO DE LA CONSTITUCIÓN, 76-A
E-03650 PINOSO (ALICANTE)
SPAIN

FOR: WINES WITH THE GUARANTEED LABEL
OF ORIGIN FROM ALICANTE, IN CLASS 33 (U.S.
CLS. 47 AND 49).

THE MARK CONSISTS OF STANDARD CHAR-
ACTERS WITHOUT CLAIM TO ANY PARTICULAR
FONT, STYLE, SIZE, OR COLOR.

OWNER OF INTERNATIONAL REGISTRATION
0862021 DATED 7-21-2005, EXPIRES 7-21-2015.

THE FOREIGN WORDING IN THE MARK
TRANSLATES INTO ENGLISH AS "ROYAL GATE."

SER. NO. 79-040,955, FILED 2-6-2007.

MARILYN IZZI, EXAMINING ATTORNEY

Int. Cl.: 9

Prior U.S. Cls.: 21, 23, 26, 36 and 38

United States Patent and Trademark Office

Reg. No. 3,476,873

Registered July 29, 2008

**TRADEMARK
PRINCIPAL REGISTER**

CLEAN TOUCH

ESSILOR INTERNATIONAL (COMPAGNIE GENERALE D'OPTIQUE) (FRANCE SOCIETE ANONYME)
147 RUE DE PARIS
F-94220 CHARENTON LE PONT
FRANCE

FOR: OPHTHALMIC LENSES; SPECTACLE LENSES, NAMELY, PLASTIC LENSES, MINERAL LENSES, CORRECTIVE LENSES, PROGRESSIVE LENSES, SUNGLASS LENSES, POLARIZED LENSES, PHOTOCHROMIC LENSES, TREATED LENSES, COATED LENSES, ANTI-REFLECTIVE LENSES, SEMI-FINISHED LENSES; SPECTACLE LENS BLANKS; SEMI-FINISHED SPECTACLE LENS BLANKS; CONTACT LENSES; SPECTACLE FRAMES; CASES FOR OPHTHALMIC LENSES,

FOR SPECTACLE LENSES AND FOR SPECTACLE FRAMES, IN CLASS 9 (U.S. CLS. 21, 23, 26, 36 AND 38).

THE MARK CONSISTS OF STANDARD CHARACTERS WITHOUT CLAIM TO ANY PARTICULAR FONT, STYLE, SIZE, OR COLOR.

OWNER OF INTERNATIONAL REGISTRATION 0880701 DATED 1-27-2006, EXPIRES 1-27-2016.

SER. NO. 79-040,958, FILED 10-6-2006.

ALICE SUE CARRUTHERS, EXAMINING ATTORNEY

Int. Cl.: 25

Prior U.S. Cls.: 22 and 39

United States Patent and Trademark Office

Reg. No. 3,476,874

Registered July 29, 2008

**TRADEMARK
PRINCIPAL REGISTER**



Woolenstocks

WOOLENSTOCKS LTD (UNITED KINGDOM
LTD LIAB CO)
54, STAFFORD COURT
UNITED KINGDOM

FOR: SLIPPERS, BOOTS, SHOES AND GENERAL
CLOTHING, NAMELY, SHIRTS, PANTS, SHORTS,
DRESSES AND SKIRTS, ALL OF THE FOREGOING
MADE IN WHOLE OR IN SUBSTANTIAL PART OF
WOOL , IN CLASS 25 (U.S. CLS. 22 AND 39).

OWNER OF INTERNATIONAL REGISTRATION
0930620 DATED 7-24-2006, EXPIRES 7-24-2016.

THE COLOR(S) GREEN AND WHITE IS/ARE
CLAIMED AS A FEATURE OF THE MARK.

THE MARK CONSISTS OF THE WORDING
"WOOLENSTOCKS", WHICH APPEARS IN GREEN
UNDERNEATH A GREEN AND WHITE FROG.

SER. NO. 79-041,047, FILED 7-24-2006.

SHAILA SETTLES, EXAMINING ATTORNEY

Int. Cl.: 2

Prior U.S. Cls.: 6, 11 and 16

United States Patent and Trademark Office

Reg. No. 3,476,875

Registered July 29, 2008

**TRADEMARK
PRINCIPAL REGISTER**

INTERTUF

AKZO NOBEL COATINGS INTERNATIONAL
B.V. (NETHERLANDS B.V.)
VELPERWEG 76
NL-6824 BM ARNHEM
NETHERLANDS

FOR: PAINTS; COATINGS IN THE NATURE OF
PAINTS; ENAMEL PAINTS; VARNISHES; COLOR-
ANTS USED IN THE MANUFACTURE OF COAT-
INGS; DISTEMPERS; LACQUERS; SICCATIVES,
NAMELY, DRYING AGENTS FOR PAINTS AND
VARNISHES; WOOD PRESERVATIVES; MOR-
DANTS USED IN THE MANUFACTURE OF COAT-
INGS; ANTI-CORROSIVE COATINGS; ANTI-
FOULING PAINTS; ANTI-FOULING COATINGS IN
THE NATURE OF PAINTS; THINNERS FOR
PAINTS, ENAMELS, VARNISHES, AND LAC-

QUERS; AND PRIMERS, IN CLASS 2 (U.S. CLS. 6,
11 AND 16).

THE MARK CONSISTS OF STANDARD CHAR-
ACTERS WITHOUT CLAIM TO ANY PARTICULAR
FONT, STYLE, SIZE, OR COLOR.

PRIORITY DATE OF 6-12-2007 IS CLAIMED.

OWNER OF INTERNATIONAL REGISTRATION
0930648 DATED 6-22-2007, EXPIRES 6-22-2017.

SER. NO. 79-041,060, FILED 6-22-2007.

PAM WILLIS, EXAMINING ATTORNEY

Int. Cl.: 2

Prior U.S. Cls.: 6, 11 and 16

United States Patent and Trademark Office

Reg. No. 3,476,876

Registered July 29, 2008

**TRADEMARK
PRINCIPAL REGISTER**

INTERSWIFT

AKZO NOBEL COATINGS INTERNATIONAL
B.V. (NETHERLANDS B.V.)
VELPERWEG 76
NL-6824 BM ARNHEM
NETHERLANDS

FOR: PAINTS; COATINGS IN THE NATURE OF PAINTS; ENAMEL PAINTS; VARNISHES; COLORANTS USED IN THE MANUFACTURE OF COATINGS; DISTEMPERS; LACQUERS; SICCATIVES, NAMELY, DRYING AGENTS FOR PAINTS AND VARNISHES; WOOD PRESERVATIVES; MOR-DANTS USED IN THE MANUFACTURE OF COATINGS; ANTI-CORROSIVE COATINGS; ANTI-FOULING PAINTS; ANTI-FOULING COATINGS IN THE NATURE OF PAINTS; THINNERS FOR PAINTS, ENAMELS, VARNISHES, AND LAC-

QUERS; AND PRIMERS, IN CLASS 2 (U.S. CLS. 6, 11 AND 16).

THE MARK CONSISTS OF STANDARD CHARACTERS WITHOUT CLAIM TO ANY PARTICULAR FONT, STYLE, SIZE, OR COLOR.

PRIORITY DATE OF 6-12-2007 IS CLAIMED.

OWNER OF INTERNATIONAL REGISTRATION 0930653 DATED 6-22-2007, EXPIRES 6-22-2017.

SER. NO. 79-041,064, FILED 6-22-2007.

PAM WILLIS, EXAMINING ATTORNEY

Int. Cls.: 3 and 8

Prior U.S. Cls.: 1, 4, 6, 23, 28, 44, 50, 51 and 52

United States Patent and Trademark Office

Reg. No. 3,476,877

Registered July 29, 2008

**TRADEMARK
PRINCIPAL REGISTER**



RECKITT & COLMAN (OVERSEAS) LTD (UNITED KINGDOM A COMPANY REGISTERED IN THE UNITED KINGDOM)

DANSOM LANE
HULL, YORKSHIRE HU8 7DS
UNITED KINGDOM

FOR: NON-MEDICATED TOILETRIES; COSMETIC PREPARATIONS FOR BODY CARE; COSMETIC CREAMS AND LOTIONS; MOISTURIZING CREAMS, LOTIONS AND GELS; EXFOLIANTS; SOAPS; DETERGENTS; BLEACHING PREPARATIONS ALL FOR PERSONAL USE; PREPARATIONS FOR SHAVING; DEPILATORY PREPARATIONS; DEPILATORY WAXES; PREPARATIONS, INCLUDING CREAMS, GELS AND MOUSSES, FOR USE BEFORE, DURING AND AFTER SHAVING, IN CLASS 3 (U.S. CLS. 1, 4, 6, 50, 51 AND 52).

FOR: RAZORS; SHAVING BLADES; EPILATORS; HAIR REMOVAL DEVICES, NAMELY, EPILATORY APPLIANCES; HAND INSTRUMENTS FOR USE IN SHAVING OR DEPILATION, NAMELY, EPILATORY APPLIANCES, NON-ELECTRIC SHAVERS;

PARTS AND FITTINGS FOR THE AFORESAID GOODS, IN CLASS 8 (U.S. CLS. 23, 28 AND 44).

OWNER OF INTERNATIONAL REGISTRATION 0930779 DATED 6-11-2007, EXPIRES 6-11-2017.

OWNER OF U.S. REG. NOS. 2,626,317, 2,978,398, AND 3,008,971.

THE COLOR(S) BLUE, GREEN, SHADES OF PINK AND SHADES OF LILAC IS/ARE CLAIMED AS A FEATURE OF THE MARK.

THE MARK CONSISTS OF THE COLOR GREEN APPEARING IN THE LEAF DESIGN, THE COLOR BLUE APPEARS IN THE WORDING "VEET" AND THE COLORS PINK AND LILAC APPEAR IN FADE IN THE CIRCLE BEHIND THE WORDING AND LEAF DESIGN.

SER. NO. 79-041,111, FILED 6-11-2007.

CAROLINE WOOD, EXAMINING ATTORNEY

Int. Cl.: 16

Prior U.S. Cls.: 2, 5, 22, 23, 29, 37, 38 and 50

United States Patent and Trademark Office

Reg. No. 3,476,878

Registered July 29, 2008

**TRADEMARK
PRINCIPAL REGISTER**

GardaPat 13 KLASSICA

CARTIERE DEL GARDA S.P.A. (ITALY CORPORATION)
VIALE ROVERETO, 15
I-38066 RIVA DEL GARDA (TN)
ITALY

FOR: CARDBOARD AND COATED PRINTING PAPER IN SHEETS AND REELS, IN CLASS 16 (U.S. CLS. 2, 5, 22, 23, 29, 37, 38 AND 50).

THE MARK CONSISTS OF STANDARD CHARACTERS WITHOUT CLAIM TO ANY PARTICULAR FONT, STYLE, SIZE, OR COLOR.

OWNER OF INTERNATIONAL REGISTRATION
0930837 DATED 6-7-2007, EXPIRES 6-7-2017.

OWNER OF U.S. REG. NO. 3,029,323.

SER. NO. 79-041,124, FILED 6-7-2007.

RAMONA ORTIGA, EXAMINING ATTORNEY

Int. Cl.: 33

Prior U.S. Cls.: 47 and 49

United States Patent and Trademark Office

Reg. No. 3,476,879

Registered July 29, 2008

TRADEMARK
PRINCIPAL REGISTER

PERLAT UNIO

UNION AGRARIA COOPERATIVA, SCCL (SPAIN
SOCIEDAD COOPERATIVA CATALANA LIM-
ITADA)

POL. IND. MAS DE LES ANIMES
C/ JOAN OLIVER, 16-24
E-43206 REUS (TARRAGONA), SPAIN

FOR: WINES, SPARKLING CAVA WINES AND
LIQUEURS, IN CLASS 33 (U.S. CLS. 47 AND 49).

THE MARK CONSISTS OF STANDARD CHAR-
ACTERS WITHOUT CLAIM TO ANY PARTICULAR
FONT, STYLE, SIZE, OR COLOR.

OWNER OF INTERNATIONAL REGISTRATION
0930907 DATED 5-3-2007, EXPIRES 5-3-2017.

"PERLAT UNIO" DOES NOT IDENTIFY A LIV-
ING INDIVIDUAL.

THE TRANSLATION OF "PERLAT UNIO" IS
"PEARLY UNION".

SER. NO. 79-041,138, FILED 5-3-2007.

DOMINIC FATHY, EXAMINING ATTORNEY

Int. Cl.: 33

Prior U.S. Cls.: 47 and 49

United States Patent and Trademark Office

Reg. No. 3,476,880

Registered July 29, 2008

**TRADEMARK
PRINCIPAL REGISTER**

ROUREDA LLICORELLA

UNION AGRARIA COOPERATIVA, SCCL (SPAIN
SOCIEDAD COOPERATIVA CATALANA LIM-
ITADA)

POL. IND. MAS DE LES ANIMES
C/ JOAN OLIVER, 16-24
E-43206 REUS (TARRAGONA), SPAIN

FOR: WINES, SPARKLING WINES AND LI-
QUEURS, IN CLASS 33 (U.S. CLS. 47 AND 49).

THE MARK CONSISTS OF STANDARD CHAR-
ACTERS WITHOUT CLAIM TO ANY PARTICULAR
FONT, STYLE, SIZE, OR COLOR.

OWNER OF INTERNATIONAL REGISTRATION
0930931 DATED 5-3-2007, EXPIRES 5-3-2017.

"ROUREDA LICORELLA" DOES NOT IDENTIFY
A LIVING INDIVIDUAL.

THE WORDING IN THE MARK HAS NO MEAN-
ING IN A FOREIGN LANGUAGE.

SER. NO. 79-041,142, FILED 5-3-2007.

DOMINIC FATHY, EXAMINING ATTORNEY

Int. Cl.: 3

Prior U.S. Cls.: 1, 4, 6, 50, 51 and 52

United States Patent and Trademark Office

Reg. No. 3,476,881

Registered July 29, 2008

TRADEMARK
PRINCIPAL REGISTER

化粧惑星

SHISEIDO CO., LTD (JAPAN CORPORATION)
5-5, GINZA 7-CHOME
CHUOU-KU; TOKYO 104-8010
JAPAN

FOR: SKIN SOAPS, DEODORANT SOAPS; PERFUMERY, NAMELY, PERFUME, COLOGNE; COSMETICS, NAMELY, LIPSTICK, BLUSH, ROUGE, MAKEUP; HAIR CARE PRODUCTS, NAMELY, SHAMPOO, CONDITIONER, HAIR GEL; SKIN CARE AND BODY CARE PRODUCTS, NAMELY, SKIN CREAM, SKIN CONDITIONER, BODY MASKS, BODY OILS, BODY POWDER; DENTIFRICES, IN CLASS 3 (U.S. CLS. 1, 4, 6, 50, 51 AND 52).

OWNER OF INTERNATIONAL REGISTRATION
0931074 DATED 6-28-2007, EXPIRES 6-28-2017.

NO CLAIM IS MADE TO THE EXCLUSIVE RIGHT TO USE THE NON-LATIN CHARACTERS THAT MEAN "COSMETIC", APART FROM THE MARK AS SHOWN.

THE FOREIGN WORDING IN THE MARK TRANSLATES INTO ENGLISH AS "COSMETIC PLANET".

THE TRANSLITERATION OF THE NON-LATIN CHARACTERS IN THE MARK IS "KESHOWAKU-SEI".

SER. NO. 79-041,174, FILED 6-28-2007.

KELLEY WELLS, EXAMINING ATTORNEY

Int. Cl.: 7

Prior U.S. Cls.: 13, 19, 21, 23, 31, 34 and 35

United States Patent and Trademark Office

Reg. No. 3,476,882

Registered July 29, 2008

**TRADEMARK
PRINCIPAL REGISTER**

FLAVY

BUCHER VASLIN; (SOCIÉTÉ ANONYME)
(FRANCE SOCIÉTÉ ANONYME)
RUE GASTON BERNIER
F-49290 CHALONNES SUR LOIRE
FRANCE

FOR: FILTERING AND SEPARATING MACHINES, NAMELY, FOR USE IN THE WINE AND FRUIT JUICES PRODUCTION SECTORS; FILTERS AND FILTERING MEMBRANES FOR USE WITH FILTERING AND SEPARATING MACHINES USED IN THE WINE AND FRUIT JUICES PRODUCTION SECTORS; INDUSTRIAL FILTERING AND SEPARATING MACHINES FOR USE IN THE WINE AND FRUIT JUICES PRODUCTION SECTORS; MACHINES AND REPLACEMENT PARTS THEREFOR FOR THE PROCESSING OF GRAPES PRODUCTS DERIVED FROM GRAPE HARVESTS, WINES AND LIQUIDS, IN CLASS 7 (U.S. CLS. 13, 19, 21, 23, 31, 34 AND 35).

THE MARK CONSISTS OF STANDARD CHARACTERS WITHOUT CLAIM TO ANY PARTICULAR FONT, STYLE, SIZE, OR COLOR.

PRIORITY DATE OF 8-7-2006 IS CLAIMED.

OWNER OF INTERNATIONAL REGISTRATION
0931186 DATED 2-7-2007, EXPIRES 2-7-2017.

THE WORDING "FLAVY" HAS NO MEANING IN A FOREIGN LANGUAGE.

SER. NO. 79-041,210, FILED 2-7-2007.

ALICE BENMAMAN, EXAMINING ATTORNEY

Int. Cl.: 20

Prior U.S. Cls.: 2, 13, 22, 25, 32 and 50

United States Patent and Trademark Office

Reg. No. 3,476,883

Registered July 29, 2008

**TRADEMARK
PRINCIPAL REGISTER**



BD BARCELONA 1972, S.L. (SPAIN SOCIEDAD DE RESPONSABILIDAD LIMITADA)
C. PUJADES, 63
E-08005 BARCELONA
SPAIN

FOR: FURNITURE FOR OFFICES, HOMES, LIBRARIES AND OTHER PUBLIC PLACES, NAMELY, TABLES, SEATS, SHELVES, ARMCHAIRS, MAGAZINE STANDS, FOOTRESTS, SOFAS, WRITING TABLES, BAR CABINETS, STOOLS, FOLDING SCREENS, CUPBOARDS, WARDROBES, BED HEADBOARDS, WORKING TABLES, WOODEN FILE CABINETS, BENCHES, MODULAR BOOK-SHELVES, SHELVING AND COMPONENTS THEREOF, NAMELY, SHELVES AND BRACKETS SOLD AS A UNIT FOR VERTICAL USE FOR HOLDING COMPACT DISCS AND DIGITAL VIDEO DISCS; FLOWER STANDS, MIRRORS, PICTURE FRAMES, OF WOOD, CORK, CANE, RUSH, WICKER, HORN, BONE, IVORY, WHALEBONE, TORTOI-

SEHELL, AMBER, MOTHER-OF-PEARL, MEERSCHAUM, SUBSTITUTES FOR ALL THESE MATERIALS, AND OF PLASTICS, IN CLASS 20 (U.S. CLS. 2, 13, 22, 25, 32 AND 50).

PRIORITY DATE OF 12-12-2006 IS CLAIMED.

OWNER OF INTERNATIONAL REGISTRATION 0931253 DATED 4-16-2007, EXPIRES 4-16-2017.

NO CLAIM IS MADE TO THE EXCLUSIVE RIGHT TO USE "BARCELONA DESIGN", APART FROM THE MARK AS SHOWN.

SER. NO. 79-041,227, FILED 4-16-2007.

LAURA HAMMEL, EXAMINING ATTORNEY

Int. Cl.: 33

Prior U.S. Cls.: 47 and 49

United States Patent and Trademark Office

Reg. No. 3,476,884

Registered July 29, 2008

**TRADEMARK
PRINCIPAL REGISTER**

Orphan Bank

LANGMEIL PTY LTD (AUSTRALIA COMPANY)
CNR LANGMEIL AND PARA ROADS
TANUNDA SA 5352
AUSTRALIA

OWNER OF INTERNATIONAL REGISTRATION
0931276 DATED 6-13-2007, EXPIRES 6-13-2017.

FOR: WINES, IN CLASS 33 (U.S. CLS. 47 AND 49).

SER. NO. 79-041,235, FILED 6-13-2007.

THE MARK CONSISTS OF STANDARD CHAR-
ACTERS WITHOUT CLAIM TO ANY PARTICULAR
FONT, STYLE, SIZE, OR COLOR.

ELISSA GARBER KON, EXAMINING ATTORNEY

Int. Cl.: 32

Prior U.S. Cls.: 45, 46 and 48

United States Patent and Trademark Office

Reg. No. 3,476,885

Registered July 29, 2008

**TRADEMARK
PRINCIPAL REGISTER**

HOUBLON CHOUFFE

BRASSERIE D'ACHOUFFE,; SOCIÉTÉ ANON-
YME (BELGIUM JOINT STOCK COMPANY)
ACHOUFFE 32
B-6666 WIBRIN-HOUFFALIZE
BELGIUM

FOR: BEERS, NAMELY, ALE, LAGER, STOUT, IN
CLASS 32 (U.S. CLS. 45, 46 AND 48).

THE MARK CONSISTS OF STANDARD CHAR-
ACTERS WITHOUT CLAIM TO ANY PARTICULAR
FONT, STYLE, SIZE, OR COLOR.

PRIORITY DATE OF 1-15-2007 IS CLAIMED.

OWNER OF INTERNATIONAL REGISTRATION
0931286 DATED 6-6-2007, EXPIRES 6-6-2017.

OWNER OF U.S. REG. NO. 2,156,924.

NO CLAIM IS MADE TO THE EXCLUSIVE
RIGHT TO USE "HOUBLON", APART FROM THE
MARK AS SHOWN.

THE ENGLISH TRANSLATION OF THE WORD
"HOUBLON" IN THE MARK IS HOP. THE WORD-
ING "CHOUFFE" HAS NO MEANING IN A FOR-
EIGN LANGUAGE.

SER. NO. 79-041,238, FILED 6-6-2007.

ALLISON HOLTZ, EXAMINING ATTORNEY

Int. Cls.: 41, 42 and 45

Prior U.S. Cls.: 100, 101 and 107

United States Patent and Trademark Office

Reg. No. 3,476,886

Registered July 29, 2008

**SERVICE MARK
PRINCIPAL REGISTER**

BLUE BRAIN

RMB S.A.; C/O RWB AVOCATS (SWITZERLAND
SOCIÉTÉ ANONYME)
C.-F. RAMUZ 43
CH-1009 PULLY, SWITZERLAND

FOR: EDUCATIONAL SERVICES, NAMELY,
PROVIDING COURSES OF INSTRUCTION AND
TRAINING IN THE FIELD OF NEUROSCIENCE,
COMPUTATIONAL NEUROSCIENCE, NEU-
ROSCIENCE-BASED ALGORITHMS, AND SIMU-
LATION-BASED RESEARCH IN NEUROSCIENCE,
IN CLASS 41 (U.S. CLS. 100, 101 AND 107).

FOR: SCIENTIFIC AND TECHNOLOGICAL SER-
VICES AND RELATED RESEARCH AND DESIGN
SERVICES IN THE FIELD OF NEUROSCIENCE,
COMPUTATIONAL NEUROSCIENCE, NEU-
ROSCIENCE-BASED ALGORITHMS, AND SIMU-
LATION-BASED NEUROSCIENCE; INDUSTRIAL
ANALYSIS AND RESEARCH SERVICES, NAMELY,
ADVISORY AND CONSULTANCY SERVICES IN
THE FIELD OF THE DESIGN AND DEVELOPMENT
OF COMPUTER HARDWARE AND SOFTWARE;
DESIGN AND DEVELOPMENT OF COMPUTERS

AND COMPUTER SOFTWARE, IN CLASS 42 (U.S.
CLS. 100 AND 101).

FOR: LEGAL SERVICES, IN CLASS 45 (U.S. CLS.
100 AND 101).

THE MARK CONSISTS OF STANDARD CHAR-
ACTERS WITHOUT CLAIM TO ANY PARTICULAR
FONT, STYLE, SIZE, OR COLOR.

PRIORITY DATE OF 12-19-2006 IS CLAIMED.

OWNER OF INTERNATIONAL REGISTRATION
0931726 DATED 5-30-2007, EXPIRES 5-30-2017.

NO CLAIM IS MADE TO THE EXCLUSIVE
RIGHT TO USE "BRAIN" AS TO CLASS(ES) 41
AND 42, APART FROM THE MARK AS SHOWN.

SER. NO. 79-041,430, FILED 5-30-2007.

EDWARD NELSON, EXAMINING ATTORNEY

Int. Cls.: 9 and 11

Prior U.S. Cls.: 13, 21, 23, 26, 31, 34, 36 and 38

United States Patent and Trademark Office

Reg. No. 3,476,887

Registered July 29, 2008

**TRADEMARK
PRINCIPAL REGISTER**



PELTECH S.R.L. (ITALY LTD LIAB CO)
VIA MAZZINI, S.N.C.
I-23801 CALOLZIOCORTE (LECCO)
ITALY

FOR: SOLID STATE ELECTRONIC DEVICES, NAMELY, DEVICES FOR CHECKING AND REGULATING FLUIDS, THERMIC AND GEOTHERMIC ENERGY, IN CLASS 9 (U.S. CLS. 21, 23, 26, 36 AND 38).

FOR: HEATING, COOLING AND AIR-CONDITIONING APPARATUSES, NAMELY, AIR CONDITIONERS, HEAT EXCHANGERS, HUMIDIFIERS, DEHUMIDIFIERS, ELECTRIC WATER HEATERS, STEAM GENERATORS, WATER TEMPERATURE REGULATORS FOR AQUARIUMS, THERMOELECTRIC COOLERS/HEATERS FOR AQUARIUMS; HEAT PUMPS, IN CLASS 11 (U.S. CLS. 13, 21, 23, 31 AND 34).

OWNER OF INTERNATIONAL REGISTRATION
0931910 DATED 4-20-2007, EXPIRES 4-20-2017.

THE COLOR(S) BLACK, FUCHSIA AND BLUE IS/
ARE CLAIMED AS A FEATURE OF THE MARK.

BLACK: THE WORD "PELTECH"; FUCHSIA: THE
UPPER ORNAMENT; BLUE: THE LOWER ORNA-
MENT.

THE TRADEMARK CONSISTS OF THE WORD
"PELTECH", IN SPECIAL LETTERING, CON-
TAINED BETWEEN TWO ORNAMENTS, THE UP-
PER ONE IS DEPICTED IN FUCHSIA AND THE
LOWER ONE IN BLUE.

SER. NO. 79-041,517, FILED 4-20-2007.

MARK PILARO, EXAMINING ATTORNEY

Int. Cls.: 3, 9, 14, 16, 18, 25 and 34

Prior U.S. Cls.: 1, 2, 3, 4, 5, 6, 8, 9, 17, 21, 22, 23, 26, 27, 28, 29, 36, 37, 38, 39, 41, 50, 51 and 52

Reg. No. 3,476,888

United States Patent and Trademark Office

Registered July 29, 2008

**TRADEMARK
PRINCIPAL REGISTER**

BALLON BLEU

CARTIER INTERNATIONAL N.V., A HOLDING AND TRADING COMPANY; ORGANIZED AND EXISTING UNDER THE LAWS OF THE NETHERLANDS ANTILLES (NETHERLD ANTILLES NAAMLOZE VENNOOTSCHAP (NV))

SCHARLOOWEG 33
CURAÇAO
NETHERLD ANTILLES

FOR: SOAPS FOR PERSONAL USE; PERFUMERY, ESSENTIAL OILS, COSMETICS, HAIR LOTION, IN CLASS 3 (U.S. CLS. 1, 4, 6, 50, 51 AND 52).

FOR: EYEGLASSES, SUNGLASSES, EYEGLASS FRAMES AND CASES, MAGNIFYING GLASSES, IN CLASS 9 (U.S. CLS. 21, 23, 26, 36 AND 38).

FOR: GOODS IN PRECIOUS METALS AND COATED THEREWITH, NAMELY, CUFF-LINKS, TIE CLIPS, RINGS BEING JEWELRY, BRACELETS, EARRINGS, NECKLACES, BROOCHES; WATCHES, CHRONOMETERS, CLOCKS, WATCH STRAPS, WATCH BRACELETS, BOXES OF PRECIOUS METALS FOR WATCHES AND JEWELLERY, IN CLASS 14 (U.S. CLS. 2, 27, 28 AND 50).

FOR: PENS, FOUNTAIN PENS, BALL-POINT PENS, PENCILS, MECHANICAL PENCILS, FELT-TIP PENS, ROLLERBALL PENS, DOCUMENT MARKERS, WRITING BRUSHES; SEALING WAXES; POUCHES, CASES AND BOXES FOR WRITING INSTRUMENTS; INKS FOR WRITING INSTRUMENTS AND INK REFILLS FOR WRITING INSTRUMENTS; NOTE PAPER, WRITING PAPER, NOTE PADS, MEMO PADS; NAME CARDS, ENVELOPES, DIARIES; CALENDARS; PAPERWEIGHTS, ERASERS, PENCIL SHARPENERS, PAPER KNIVES, PEN AND PENCIL HOLDERS; PAINTINGS, ENGRAVINGS, IN CLASS 16 (U.S. CLS. 2, 5, 22, 23, 29, 37, 38 AND 50).

FOR: LEATHERWARE, NAMELY, BRIEFCASES, TRAVELLING SETS IN THE NATURE OF SETS OF SUITCASES AND TRAVELLING BAGS, VANITY CASES SOLD EMPTY, KEY CASES; GOODS MADE

OF LEATHER AND IMITATIONS OF LEATHER, NOT INCLUDED IN OTHER CLASSES, NAMELY, ATTACHÉ CASES, WALLETS, HANDBAGS, BACKPACKS, TRAVELLING BAGS, WHEELED TOTE BAGS, TRUNKS, SUITCASES, PURSES NOT OF PRECIOUS METAL, CREDIT AND BUSINESS CARD CASES, POUCHES; BANDS OF LEATHER IN THE NATURE OF LEATHER STRAPS FOR USE WITH BAGS; UMBRELLAS, PARASOLS, WALKING STICKS, WHIPS AND SADDLERY, IN CLASS 18 (U.S. CLS. 1, 2, 3, 22 AND 41).

FOR: CLOTHING, NAMELY, BATHING SUITS, COATS, CUMMERBUNDS, DRESSING GOWNS, FUR COATS AND STOLE, HOSIERY, JACKETS, PULLOVERS, PAJAMAS, ROBES, SHIRTS, SKIRTS, SUITS, SWEATERS, TROUSERS, UNDERWEAR, BELTS, BRACES IN THE NATURE OF SUSPENDERS, GLOVES, MUFFLERS, SASHES FOR WEAR, SCARVES, SHAWLS, SUSPENDERS, TIES, BOW TIES; BOOTS, SHOES AND SLIPPERS, CAPS AND HATS, IN CLASS 25 (U.S. CLS. 22 AND 39).

FOR: LIGHTERS FOR SMOKERS; SMOKERS' ARTICLES, NAMELY, CIGARETTE HOLDERS, CIGARETTE AND CIGAR CASES, CIGAR CUTTERS, HUMIDORS AND ASHTRAYS, IN CLASS 34 (U.S. CLS. 2, 8, 9 AND 17).

THE MARK CONSISTS OF STANDARD CHARACTERS WITHOUT CLAIM TO ANY PARTICULAR FONT, STYLE, SIZE, OR COLOR.

PRIORITY DATE OF 9-4-2006 IS CLAIMED.

OWNER OF INTERNATIONAL REGISTRATION 0931951 DATED 3-1-2007, EXPIRES 3-1-2017.

THE ENGLISH TRANSLATION OF THE FOREIGN WORD IN THE MARK IS BLUE BALLOON.

SER. NO. 79-041,537, FILED 3-1-2007.

COLLEEN KEARNEY, EXAMINING ATTORNEY

Int. Cls.: 35 and 36

Prior U.S. Cls.: 100, 101 and 102

United States Patent and Trademark Office

Reg. No. 3,476,889

Registered July 29, 2008

**SERVICE MARK
PRINCIPAL REGISTER**

SCOR Global P&C

SCOR (FRANCE SOCIETE ANONYME)
1 AVENUE DU GÉNÉRAL DE GAULLE
F-92800 PUTEAUX
FRANCE

FOR: COMMERCIAL CONSULTANCY WITH RESPECT TO ANALYSIS, ORGANIZATION AND PREVENTION OF BUSINESS RISKS OR THE COMBINATION THEREOF; MANAGEMENT OF COMPUTERIZED FILES; BUSINESS ADVICE ON THE ORGANIZATION AND MANAGEMENT OF INDUSTRIAL AND COMMERCIAL COMPANIES; BUSINESS MANAGEMENT ASSISTANCE; ACCOUNTANCY CONSULTANCY AND BUSINESS EXPERT APPRAISAL; BUSINESS ADVICE AND EXPERT OPINIONS REGARDING ACCOUNTING EVALUATION OF TANGIBLE OR INTANGIBLE CORPORATE ASSETS; ORGANIZATION OF EXHIBITIONS IN THE FORM OF SEMINARS AND COLLOQUIUMS FOR COMMERCIAL PURPOSES RELATING TO CORPORATE AND SOCIAL RISK ANALYSIS, MANAGEMENT AND PREVENTION; COMMERCIAL MANAGEMENT AND ON-LINE COMMERCIAL MANAGEMENT SERVICES FOR THIRD PARTIES OF TELECOMMUNICATIONS NETWORKS AND TELECOMMUNICATIONS SITES FOR ELECTRONIC COMMERCE; ALL OF THE FOREGOING SERVICES RELATE TO INSURANCE AND REINSURANCE, IN CLASS 35 (U.S. CLS. 100, 101 AND 102).

FOR: INSURANCE AND REINSURANCE SERVICES, NAMELY, ADVICE, CONSULTING AND INFORMATION ON INSURANCE AND REINSURANCE; FINANCIAL INTERMEDIATION IN THE NATURE OF INVESTMENT ADVICE; INSURANCE AND REINSURANCE BROKERAGE; ACTUARIAL SERVICES; FINANCIAL ADVICE AND INFORMATION, NAMELY, FINANCIAL ANALYSIS AND CONSULTATION, FINANCIAL

INFORMATION PROCESSING, FINANCIAL FORECASTING, FINANCIAL INFORMATION AND EVALUATIONS, FINANCIAL RISK MANAGEMENT CONSULTATIONS; FINANCIAL MANAGEMENT IN THE NATURE OF ADVICE ON LIQUIDITY MANAGEMENT; INVESTMENT SERVICES, NAMELY, ASSET ACQUISITION AND ACQUISITION AND TRANSFER OF MONETARY CLAIMS OF ENTERPRISES AND INTERESTS IN ENTERPRISES; INVESTMENT SERVICES, NAMELY, FINANCIAL ADVICE AND EXPERT OPINIONS REGARDING ACCOUNTING EVALUATION OF TANGIBLE OR INTANGIBLE CORPORATE ASSETS; FINANCIAL RISK MANAGEMENT IN THE NATURE OF ADVICE AND EXPERT OPINIONS REGARDING FINANCIAL EVALUATION OF CORPORATE AND SOCIAL RISKS; FISCAL ASSESSMENT AND EVALUATION IN THE NATURE OF ADVICE AND EXPERT OPINIONS REGARDING FINANCIAL ASSESSMENT OF DAMAGES IN CONNECTION WITH INSURANCE OR REINSURANCE UNDERWRITING, IN CLASS 36 (U.S. CLS. 100, 101 AND 102).

PRIORITY DATE OF 12-6-2006 IS CLAIMED.

OWNER OF INTERNATIONAL REGISTRATION 0931999 DATED 5-29-2007, EXPIRES 5-29-2017.

OWNER OF U.S. REG. NOS. 1,589,312, 2,779,080 AND OTHERS.

NO CLAIM IS MADE TO THE EXCLUSIVE RIGHT TO USE "GLOBAL P&C", APART FROM THE MARK AS SHOWN.

SER. NO. 79-041,557, FILED 5-29-2007.

NATALIE POLZER, EXAMINING ATTORNEY

Int. Cls.: 35, 36, 43 and 45

Prior U.S. Cls.: 100, 101 and 102

United States Patent and Trademark Office

Reg. No. 3,476,890

Registered July 29, 2008

**SERVICE MARK
PRINCIPAL REGISTER**

ESSENZA

BLV GROUP HOLDINGS LIMITED (UNITED KINGDOM COMPANY)
KEMP HOUSE 152-160 CITY ROAD
LONDON EC1V 2NX
UNITED KINGDOM

FOR: BUSINESS MANAGEMENT OF HOTELS; ADVERTISING AND PUBLICITY, IN CLASS 35 (U.S. CLS. 100, 101 AND 102).

FOR: APARTMENT HOUSE MANAGEMENT, RENTING OF APARTMENTS, REAL ESTATE AGENCIES AND REAL ESTATE MANAGEMENT; REAL ESTATE BROKERS, NAMELY, REAL ESTATE BROKERAGE; REAL ESTATE APPRAISAL, LEASING OF REAL ESTATE, IN CLASS 36 (U.S. CLS. 100, 101 AND 102).

FOR: ACCOMMODATION BUREAUX, NAMELY, PROVIDING TEMPORARY ACCOMMODATION SERVICES IN THE NATURE OF HOTELS, HOSTELS, MOTELS AND BOARDING HOUSES; RENTAL OF TEMPORARY ACCOMMODATION, NAMELY, PROVIDING TEMPORARY ACCOMMO-

DATION SERVICES; PROVIDING TEMPORARY ACCOMMODATIONS; MAKING HOTEL RESERVATIONS FOR OTHERS; BAR SERVICES, CAFES, CAFETERIAS, FOOD AND DRINK CATERING, HOTELS, RESTAURANTS, SNACK BARS, IN CLASS 43 (U.S. CLS. 100 AND 101).

FOR: SECURITY CONSULTANCY; MONITORING OF BURGLAR AND SECURITY ALARMS; GUARD SERVICES; NIGHT GUARD SERVICES, IN CLASS 45 (U.S. CLS. 100 AND 101).

OWNER OF INTERNATIONAL REGISTRATION 0932017 DATED 6-21-2007, EXPIRES 6-21-2017.

THE ENGLISH TRANSLATION OF "ESSENZA" IS "ESSENCE."

SER. NO. 79-041,568, FILED 6-21-2007.

MAUREEN DALL, EXAMINING ATTORNEY

Int. Cls.: 1, 17 and 19

Prior U.S. Cls.: 1, 5, 6, 10, 12, 13, 26, 33, 35, 46 and 50

United States Patent and Trademark Office

Reg. No. 3,476,891

Registered July 29, 2008

**TRADEMARK
PRINCIPAL REGISTER**

THERMOSILIT

DULLINGER GESELLSCHAFT M.B.H. (AUSTRIA
PRIVATE LIMITED COMPANY)
AUSTRASSE 7-10
A-5061 ELSBETHEN-GLASEN
AUSTRIA

FOR: CHEMICALS USED IN INDUSTRY, BUILD-
ING CHEMISTRY PRODUCTS, NAMELY, PRE-
MIXED ADHESIVE FOAM CEMENTS , IN CLASS 1
(U.S. CLS. 1, 5, 6, 10, 26 AND 46).

FOR: BUILDING INSULATION, NAMELY, ISO-
LATORS AND MEANS OF INSULATING, PACKING
AND INSULATING MATERIALS FOR FORMING
SEALS, MEANS OF INSULATING MOISTURE FOR
BUILDINGS, AND PACKING MATERIALS FOR
SEALING EXPANSION JOINTS, IN CLASS 17 (U.S.
CLS. 1, 5, 12, 13, 35 AND 50).

FOR: NON-METAL BUILDING MATERIALS,
NAMELY, FILLING CEMENT, LIME, MORTAR,
UNTREATED OR BURNT PLASTER, AND GRAV-
EL, IN CLASS 19 (U.S. CLS. 1, 12, 33 AND 50).

THE MARK CONSISTS OF STANDARD CHAR-
ACTERS WITHOUT CLAIM TO ANY PARTICULAR
FONT, STYLE, SIZE, OR COLOR.

PRIORITY DATE OF 3-13-2007 IS CLAIMED.

OWNER OF INTERNATIONAL REGISTRATION
0932054 DATED 5-8-2007, EXPIRES 5-8-2017.

SER. NO. 79-041,589, FILED 5-8-2007.

KRISTIN DAHLING, EXAMINING ATTORNEY

Int. Cl.: 12

Prior U.S. Cls.: 19, 21, 23, 31, 35 and 44

United States Patent and Trademark Office

Reg. No. 3,476,892

Registered July 29, 2008

**TRADEMARK
PRINCIPAL REGISTER**

HENGTAR

QINGDDAO HENGDA TYRES CO., LTD (CHINA CORPORATION)
QIANLOU RUBBER INDUSTRIAL PARK
MINGCUN TOWN, PINGDU CITY
266724 QINGDAO, CHINA

FOR: INNER TUBES FOR PNEUMATIC TIRES; TIRES FOR VEHICLE WHEELS; BICYCLE TIRES; AUTOMOBILE TIRES; REPAIR OUTFITS FOR INNER TUBES COMPRISED PRIMARILY OF ADHESIVE RUBBER PATCHES; TREADS FOR VEHICLES, NAMELY, RUBBER TRACKS FOR TRACKED VEHICLES; CASINGS FOR PNEUMATIC TIRES, NAMELY, SPARE TIRE CARRIERS FOR VEHICLES; ADHESIVE RUBBER PATCHES FOR REPAIRING

INNER TUBES; LAND VEHICLE PARTS, NAMELY, SPIKES FOR TIRES, IN CLASS 12 (U.S. CLS. 19, 21, 23, 31, 35 AND 44).

OWNER OF INTERNATIONAL REGISTRATION 0932187 DATED 6-21-2007, EXPIRES 6-21-2017.

THE WORDING "HENGTAR" HAS NO MEANING IN ENGLISH.

SER. NO. 79-041,654, FILED 6-21-2007.

MAUREEN DALL, EXAMINING ATTORNEY

Int. Cl.: 3

Prior U.S. Cls.: 1, 4, 6, 50, 51 and 52

United States Patent and Trademark Office

Reg. No. 3,476,893

Registered July 29, 2008

**TRADEMARK
PRINCIPAL REGISTER**

MODEL ME

MODEL ME LIMITED (UNITED KINGDOM LIMITED COMPANY)

19 DOUGHTY STREET

LONDON, UNITED KINGDOM WC1N 2PL

FOR: PERFUMES; ESSENTIAL OILS; SOAPS; COSMETICS; EYE SHADOWS; LIPSTICKS; FOUNDATIONS; SKIN CLEANSERS; SKIN TONERS; MOISTURIZERS; NON-MEDICATED TOILET PREPARATIONS; COSMETIC PREPARATIONS FOR THE HAIR AND SCALP; SHAMPOOS; HAIR COLORING PREPARATIONS; HAIR LOTIONS; HAIR CONDITIONERS; HAIR STYLING PRODUCTS; HAIR GELS; HAIR MOUSSE; HAIR SPRAYS; DENTIFRICES, IN CLASS 3 (U.S. CLS. 1, 4, 6, 50, 51 AND 52).

THE MARK CONSISTS OF STANDARD CHARACTERS WITHOUT CLAIM TO ANY PARTICULAR FONT, STYLE, SIZE, OR COLOR.

PRIORITY DATE OF 1-17-2007 IS CLAIMED.

OWNER OF INTERNATIONAL REGISTRATION 0932238 DATED 7-16-2007, EXPIRES 7-16-2017.

NO CLAIM IS MADE TO THE EXCLUSIVE RIGHT TO USE "MODEL", APART FROM THE MARK AS SHOWN.

SER. NO. 79-041,694, FILED 7-16-2007.

WILLIAM ROSSMAN, EXAMINING ATTORNEY

Int. Cls.: 6 and 19

Prior U.S. Cls.: 1, 2, 12, 13, 14, 23, 25, 33 and 50

United States Patent and Trademark Office

Reg. No. 3,476,894

Registered July 29, 2008

**TRADEMARK
PRINCIPAL REGISTER**



AQUAFENCE AS (NORWAY AS)
POSTBOKS 705
N-1509 MOSS
NORWAY

FOR: TANKS OF METAL FOR THE TRANSPORT OF WATER, PORCHES OF METAL FOR BUILDING, FRAMEWORKS OF METAL FOR BUILDING, PILLARS OF METAL FOR BUILDING, FLASHING OF METAL FOR BUILDING, WALL PANELS OF METAL FOR BUILDING, METAL CEILING PANELS FOR BUILDING, PREFABRICATED BUILDING SETS OF METAL, BRACKETS OF METAL FOR BUILDING, SEMI-PERMANENT BARRIERS FOR THE PREVENTION OF FLOOD, AND PORTABLE FLOOD BARRIERS MADE PRIMARILY OF METAL, IN CLASS 6 (U.S. CLS. 2, 12, 13, 14, 23, 25 AND 50).

FOR: FRAMEWORKS NOT OF METAL FOR BUILDING, PILLARS NOT OF METAL FOR BUILDING, FLASHING NOT OF METAL FOR BUILDING, PLASTERED WALL PANELS NOT OF METAL FOR BUILDING, CEILING PANELS NOT OF METAL FOR BUILDING, PREFABRICATED BUILDING SETS NOT OF METAL, SEMI-PERMANENT BARRIERS NOT OF METAL FOR THE PREVENTION OF

FLOOD, AND PORTABLE NON-METAL FLOOD BARRIERS, IN CLASS 19 (U.S. CLS. 1, 12, 33 AND 50).

PRIORITY DATE OF 7-11-2006 IS CLAIMED.

OWNER OF INTERNATIONAL REGISTRATION 0932304 DATED 1-11-2007, EXPIRES 1-11-2017.

THE COLOR(S) RED AND BLUE IS/ARE CLAIMED AS A FEATURE OF THE MARK.

THE MARK CONSISTS OF THE WORDING "AQUAFENCE" AND "WWW.AQUAFENCE.COM", WITH THE COLOR BLUE APPEARING IN THE TOP WORDING "AQUA" AND THE COLOR RED APPEARING IN THE TOP WORDING "FENCE" OF "AQUAFENCE", AND THE COLOR BLUE APPEARING IN THE WORDING "WWW.AQUAFENCE.COM" BELOW.

SER. NO. 79-041,727, FILED 1-11-2007.

NAPOLEON SHARMA, EXAMINING ATTORNEY

Int. Cls.: 3 and 5

Prior U.S. Cls.: 1, 4, 6, 18, 44, 46, 50, 51 and 52

United States Patent and Trademark Office

Reg. No. 3,476,895

Registered July 29, 2008

**TRADEMARK
PRINCIPAL REGISTER**



G. R. LANE HEALTH PRODUCTS LIMITED
(UNITED KINGDOM LTD LIAB CO)
SISSION ROAD
GLOUCESTER; GLOUCESTERSHIRE GL1 3QB
UNITED KINGDOM

FOR: COSMETICS, IN CLASS 3 (U.S. CLS. 1, 4, 6, 50,
51 AND 52).

FOR: PHARMACEUTICAL PREPARATIONS,
NAMELY, DECONGESTANTS; PHARMACEUTI-
CAL PREPARATIONS FOR USE IN THE TREAT-
MENT OF STRESS, SLEEPLESSNESS, MINOR
ANXIETY, NERVOUS TENSION, INSOMNIA,
SYMPTOMS ASSOCIATED WITH MENOPAUSE,
HAY FEVER, MUSCLE PAIN; SANITARY PRE-
PARATIONS FOR MEDICAL PURPOSES; DIETETIC
SUBSTANCES ADAPTED FOR MEDICAL USE,

NAMELY, DIETARY SUPPLEMENTS, IN CLASS 5
(U.S. CLS. 6, 18, 44, 46, 51 AND 52).

PRIORITY DATE OF 6-19-2007 IS CLAIMED.

OWNER OF INTERNATIONAL REGISTRATION
0932428 DATED 6-28-2007, EXPIRES 6-28-2017.

NO CLAIM IS MADE TO THE EXCLUSIVE
RIGHT TO USE "HEALTH", APART FROM THE
MARK AS SHOWN.

SER. NO. 79-041,775, FILED 6-28-2007.

SHARON MEIER, EXAMINING ATTORNEY

Int. Cls.: 5 and 10

Prior U.S. Cls.: 6, 18, 26, 39, 44, 46, 51 and 52

United States Patent and Trademark Office

Reg. No. 3,476,896

Registered July 29, 2008

**TRADEMARK
PRINCIPAL REGISTER**

PREDNISPORIN

FOVEA PHARMACEUTICALS (FRANCE SOCI-
ÉTÉ ANONYME)
3-5 IMPASSE REILLE
F-75014 PARIS
FRANCE

FOR: PHARMACEUTICAL PREPARATIONS FOR
THE TREATMENT OF DISEASES OF THE EYE AND
THE RETINA, IN CLASS 5 (U.S. CLS. 6, 18, 44, 46, 51
AND 52).

FOR: SURGICAL, MEDICAL APPARATUS AND
INSTRUMENTS FOR USE IN GENERAL SURGERY;
ARTIFICIAL EYES; SUTURE MATERIALS; SURGI-
CAL AND MEDICAL APPARATUS AND INSTRU-

MENTS FOR USE IN THE SURGICAL TREATMENT
OF DISEASES AND DISORDERS OF THE EYE AND
THE RETINA, IN CLASS 10 (U.S. CLS. 26, 39 AND 44).

PRIORITY DATE OF 12-26-2006 IS CLAIMED.

OWNER OF INTERNATIONAL REGISTRATION
0932448 DATED 6-26-2007, EXPIRES 6-26-2017.

SER. NO. 79-041,782, FILED 6-26-2007.

JEFFERY COWARD, EXAMINING ATTORNEY

Int. Cls.: 18, 25 and 35

Prior U.S. Cls.: 1, 2, 3, 22, 39, 41, 100, 101 and 102

United States Patent and Trademark Office

Reg. No. 3,476,897

Registered July 29, 2008

**TRADEMARK
SERVICE MARK
PRINCIPAL REGISTER**



SPRIS CO., LTD. (REPUBLIC OF KOREA LIMITED COMPANY)
48-3 SINGAL-RI, JIKSAN-EUP,
CHEONAN-SHI; CHUNGNAM
REPUBLIC OF KOREA

FOR: BRIEFCASES, PURSES, HANDBAGS, BACKPACKS, UMBRELLAS, PARASOLS, WALKING STICKS, IN CLASS 18 (U.S. CLS. 1, 2, 3, 22 AND 41).

FOR: SHOES; LONG BOOTS; BASKETBALL SHOES; MOUNTAINEERING SHOES; GOLF SHOES; PROTECTIVE ACCESSORIES FOR SHOES, NAMELY, INSOLES FOR SHOES AND BOOTS, SHOE INSERTS FOR PRIMARILY NON-ORTHOPEDIC PURPOSES, AND PROTECTIVE METAL MEMBERS FOR SHOES AND BOOTS; SANDALS; SOLES FOR FOOTWEAR; TENNIS SHOES; JOGGING SHOES; FOOTBALL SHOES; CHILDREN'S CLOTHING, NAMELY, CHILDREN'S HEADWEAR, CHILDREN'S AND INFANTS' CLOTH BIBS, INFANT AND TODDLER ONE PIECE CLOTHING, INFANT DIAPER COVERS BEING TEXTILE, INFANT SLEEPERS, INFANT WEAR, INFANTS' TROUSERS, ONE PIECE GARMENT FOR INFANTS AND TODDLERS, LEOTARDS AND TIGHTS FOR CHILDREN OF NYLON, COTTON OR OTHER TEXTILE FIBERS; OVERCOATS; JUMPERS; COTTON TROUSERS;

BLUE JEANS; JACKETS; SWEATERS; CARDIGANS; SPORTS SHIRTS; VESTS; SLIPS; SWIMSUITS; NECKTIES; GLOVES BEING CLOTHING, LEATHER BELTS BEING CLOTHING; BRACES; DUCK DOWN PARKAS; SWEAT CLOTHING, NAMELY, SWEAT PANTS, SWEAT SHIRTS, SWEAT SHORTS, SWEAT SUITS; SLEEVELESS SHIRTS; SKI SHIRTS; JERSEY JEANS BEING CLOTHING; CEREMONIAL DRESSES; SKIRTS; MEN'S SUITS; SPORTS WEAR, NAMELY, SPORTS JERSEYS, BREECHES FOR SPORTS, SPORTS UNIFORMS, SPORTS SHIRTS, SPORTS BRAS, SPORTS JACKETS, IN CLASS 25 (U.S. CLS. 22 AND 39).

FOR: IMPORT AND EXPORT AGENCIES FEATURING CLOTHING AND SHOES; BUSINESS DATA RESEARCH; RETAIL STORE SERVICES FEATURING CLOTHING AND SHOES, IN CLASS 35 (U.S. CLS. 100, 101 AND 102).

OWNER OF INTERNATIONAL REGISTRATION
0932501 DATED 2-16-2007, EXPIRES 2-16-2017.

SER. NO. 79-041,807, FILED 2-16-2007.

KRISTINA MORRIS, EXAMINING ATTORNEY

Int. Cls.: 14, 18 and 25

Prior U.S. Cls.: 1, 2, 3, 22, 27, 28, 39, 41 and 50

United States Patent and Trademark Office

Reg. No. 3,476,898

Registered July 29, 2008

**TRADEMARK
PRINCIPAL REGISTER**

JENNYFER

STOCK J BOUTIQUE JENNYFER (FRANCE SOCIÉTÉ PAR ACTIONS SIMPLIFIÉE)
7 RUE PIERRE DREYFUS
F-92110 CLICHY
FRANCE

FOR: PRECIOUS METALS AND ALLOYS THEREOF; REAL AND IMITATION JEWELLERY; JEWELLERY; PRECIOUS STONES; TIMEPIECES; WATCHES, IN CLASS 14 (U.S. CLS. 2, 27, 28 AND 50).

FOR: LEATHER AND IMITATIONS OF LEATHER; ANIMAL SKINS AND HIDES; LEATHER AND IMITATION LEATHER GOODS, NAMELY, WALLETS, PURSES, HANDBAGS, RUCKSACKS, TRAVEL BAGS, WHEELED BAGS, COLLEGE SATCHELS, BEACH BAGS, TRAVELLING SETS OF LUGGAGE, BOXES DESIGNED TO CONTAIN TOILETRY ARTICLES KNOWN AS VANITY CASES SOLD EMPTY; TRUNKS AND SUITCASES; UMBRELLAS, PARASOLS, IN CLASS 18 (U.S. CLS. 1, 2, 3, 22 AND 41).

FOR: CLOTHING, NAMELY, T-SHIRTS, PANTS, CAPRI PANTS, BERMUDA SHORTS, PANTACOURTS BEING CROPPED PANTS, SWEATSHIRTS, SHIRTS, JACKETS, SWEATERS, SKIRTS, PAREOS,

BLOUSES, DRESSES, TROUSERS, PULLOVERS, PYJAMAS, SHORTS, COATS, RAINCOATS, PARKAS, NECKTIES, VESTS, SCARVES, STOCKINGS, SOCKS, BATHING SUITS, DRESSING GOWNS; FOOTWEAR; HEADWEAR, NAMELY, CAPS, HATS, SASHES FOR WEAR; CLOTHING BELTS; CLOTHING GLOVES; UNDERWEAR, IN CLASS 25 (U.S. CLS. 22 AND 39).

THE MARK CONSISTS OF STANDARD CHARACTERS WITHOUT CLAIM TO ANY PARTICULAR FONT, STYLE, SIZE, OR COLOR.

PRIORITY DATE OF 12-5-2006 IS CLAIMED.

OWNER OF INTERNATIONAL REGISTRATION 0932554 DATED 5-14-2007, EXPIRES 5-14-2017.

OWNER OF U.S. REG. NO. 2,895,180.

SER. NO. 79-041,830, FILED 5-14-2007.

MARILYN IZZI, EXAMINING ATTORNEY

Int. Cl.: 10

Prior U.S. Cls.: 26, 39 and 44

United States Patent and Trademark Office

Reg. No. 3,476,899

Registered July 29, 2008

**TRADEMARK
PRINCIPAL REGISTER**

SMART toe

MEMOMETAL TECHNOLOGIES (FRANCE SOCI-
ÉTÉ PAR ACTIONS SIMPLIFIÉE (SAS))
CAMPUS DE KER LANN -
RUE BLAISE PASCAL; F-35170 BRUZ
FRANCE

FOR: ORTHOPEDIC IMPLANTS COMPRISING
ARTIFICIAL MATERIAL; SURGICAL CLIPS,
NAMESLY, OSTEOSYNTHESIS AND ARTHRODESIS
CLIPS; IMPLANTS COMPRISING ARTIFICIAL MA-
TERIAL USED IN FOOT, HAND AND MAXILLO-
FACIAL SURGERY, IN CLASS 10 (U.S. CLS. 26, 39
AND 44).

OWNER OF INTERNATIONAL REGISTRATION
0932623 DATED 6-27-2007, EXPIRES 6-27-2017.

NO CLAIM IS MADE TO THE EXCLUSIVE
RIGHT TO USE "TOE", APART FROM THE MARK
AS SHOWN.

SER. NO. 79-041,858, FILED 6-27-2007.

JUSTINE D. PARKER, EXAMINING ATTORNEY

Int. Cls.: 18 and 25

Prior U.S. Cls.: 1, 2, 3, 22, 39 and 41

United States Patent and Trademark Office

Reg. No. 3,476,900

Registered July 29, 2008

**TRADEMARK
PRINCIPAL REGISTER**

BALDAQUIN

LANCEL INTERNATIONAL SA (SWITZERLAND
SOCIÉTÉ ANONYME (SA))
ROUTE DES BICHES 10
CH-1752 VILLARS-SUR-GLÂNE
SWITZERLAND

FOR: LEATHER ITEMS AND SMALL LEATHER ITEMS, NAMELY, HANDBAGS, POCHETTES, HOLLERS, BEGGARS' BAGS, SHOULDER BAGS, RUCKSACKS, COLLEGE SATCHELS, BEACH BAGS, TRAVELLING BAGS, SADDLE BAGS, SPORTS BAGS, GARMENT BAGS, TRAVELLING SETS CONSISTING OF SUITCASES AND TRAVELLING BAGS, DOCUMENT CASES, BUSINESS AND CREDIT CARD CASES, CARD WALLETS, WALLETS, BUSINESS NOTE CASES, PURSES NOT OF PRECIOUS METAL, BRIEFCASES, SCHOOL BAGS, PURSES, KEY CASES, VANITY CASES SOLD EMPTY, TRUNKS AND SUITCASES; AND UMBRELLAS, IN CLASS 18 (U.S. CLS. 1, 2, 3, 22 AND 41).

FOR: CLOTHING, NAMELY, SPORTSWEAR IN THE NATURE OF SPORTS TROUSERS, SPORTS SHORTS, SPORTS JACKETS, SPORTS SUITS,

SPORTS PANTS, SPORTS SKIRTS, SPORTS DRESSES, SPORTS JERSEYS, SPORTS SHIRTS, AND SPORTS SOCKS; SASHES FOR WEAR; SHAWLS; SCARVES; TIES; BRACES; GLOVES; BELTS; FOOTWEAR OTHER THAN ORTHOPAEDIC FOOTWEAR; AND HEADGEAR IN THE NATURE OF CAPS AND HATS, IN CLASS 25 (U.S. CLS. 22 AND 39).

THE MARK CONSISTS OF STANDARD CHARACTERS WITHOUT CLAIM TO ANY PARTICULAR FONT, STYLE, SIZE, OR COLOR.

PRIORITY DATE OF 11-30-2006 IS CLAIMED.

OWNER OF INTERNATIONAL REGISTRATION
0932669 DATED 5-30-2007, EXPIRES 5-30-2017.

SER. NO. 79-041,869, FILED 5-30-2007.

CAROLYN GRAY, EXAMINING ATTORNEY

Int. Cls.: 14, 18 and 21

Prior U.S. Cls.: 1, 2, 3, 13, 22, 23, 27, 28, 29, 30, 33, 40,
41 and 50

Reg. No. 3,476,901

United States Patent and Trademark Office

Registered July 29, 2008

TRADEMARK
PRINCIPAL REGISTER

WESTBAY SERVIÇOS E INVESTIMENTOS, LDA.
(PORTUGAL CORPORATION)
AVENIDA DO INFANTE, N.º 50 P
P-9000-001 FUNCHAL, MADEIRA
PORTUGAL

FOR: PRECIOUS METALS AND THEIR ALLOYS,
NAMELY, GOLD, SILVER, PLATINUM, STEEL,
BRONZE, BRASS, EBONY AND GALALITH;
GOODS OF PRECIOUS METALS OR COATED
THEREWITH, NAMELY, KEY CASES; JEWELRY,
NAMELY, EARRINGS, RINGS, PENDANTS, BRA-
CELETS, KEY RINGS, NECKLACES; JEWELRY
MADE WITH PRECIOUS STONES; HOROLOGICAL
AND CHRONOMETRIC INSTRUMENTS, NAMELY,
WATCHES, IN CLASS 14 (U.S. CLS. 2, 27, 28 AND 50).

FOR: LEATHER; IMITATION LEATHER; GOODS
MADE OF LEATHER AND IMITATION LEATHER
NOT INCLUDED IN OTHER CLASSES, NAMELY,
HANDBAGS, WALLETS AND PURSES; ANIMAL
SKINS AND HIDES; TRUNKS AND SUITCASES;

UMBRELLAS AND PARASOLS, IN CLASS 18 (U.S.
CLS. 1, 2, 3, 22 AND 41).

FOR: HOUSEHOLD AND KITCHEN UTENSILS
AND CONTAINERS NOT OF PRECIOUS METAL
OR COATED THEREWITH, NAMELY, COOKING
POTS, COOKIE JARS; CLEANING SPONGES; BRU-
SHES, NAMELY, HAIR BRUSHES; CERAMICS,
PORCELAIN AND EARTHENWARE, NAMELY,
MUGS, JARS, SCULPTURES AND DOLLS, IN
CLASS 21 (U.S. CLS. 2, 13, 23, 29, 30, 33, 40 AND 50).

PRIORITY DATE OF 12-20-2006 IS CLAIMED.

OWNER OF INTERNATIONAL REGISTRATION
0932673 DATED 5-14-2007, EXPIRES 5-14-2017.

SER. NO. 79-041,873, FILED 5-14-2007.

MARILYN IZZI, EXAMINING ATTORNEY

Int. Cl.: 3

Prior U.S. Cls.: 1, 4, 6, 50, 51 and 52

Reg. No. 3,476,902

United States Patent and Trademark Office

Registered July 29, 2008

**TRADEMARK
PRINCIPAL REGISTER**

TØREAD

DREAMSCO CO., LTD.
11F. CHANG GYEONG BLDG,
28-7, WONNAM-DONGJONGNO-GU, SEOUL
REPUBLIC OF KOREA

FOR: NOURISHING CREAMS BEING COSMETICS; NAIL ENAMEL REMOVERS; EYEBROW PENCILS; HAIR CARE PREPARATIONS, NAMELY, HAIR-WASHING POWDER; LAVENDER WATER, NAMELY, TOILET WATER, SCENTED LINEN WATER; LIQUID ROUGE; SACHETS FOR PERFUMING LINEN; LIPSTICKS; MASCARA; FACE MASK PACK FOR COSMETIC USE; MASSAGE GEL; MASSAGE OIL; NAIL POLISH; ENAMEL FOR MANICURES; VARNISH-REMOVING PREPARATIONS; HAIR COLORANTS; HAIR WAVING PREPARATIONS; COLOR-REMOVING PREPARATIONS FOR HAIR; ESSENTIAL OILS, NAMELY, BADIAN ESSENCE; VANISHING CREAMS; BATH OIL; BATH POWDER; BABY OIL; BABY POWDER; BLUSHER; PERFUMED TALCUM POWDER FOR COSMETIC USE; DANDRUFF LOTIONS NOT FOR MEDICAL TREATMENT; DANDRUFF CREAMS NOT FOR MEDICAL TREATMENT; BATH SALTS, NOT FOR MEDICAL PURPOSES; AROMATICS OTHER THAN FOR MEDICAL PURPOSES, NAMELY, AROMATHERAPY CREAMS, AROMATHERAPY OILS, INCENSE, ROOM FRAGRANCES; ESSENTIAL OILS, NAMELY, SAFROL; AFTER-SUN MILK; SUNSCREEN CREAMS; SUNTAN OILS FOR COSMETIC PURPOSES; SUN-TANNING PREPARATIONS; SHAVING CREAMS; NAIL POLISHING POWDER; NAIL COLORANTS; LOTIONS FOR SKIN CARE; COSMETIC SKIN FRESHENERS, NAMELY, BODY SPRAY, SCENTED BODY SPRAY; ESSENTIAL OILS OF CITRON; EYELINERS; EYE MAKE-UP REMOV-

ERS; EYE SHADOW; AFTER SHAVE LOTIONS; ESSENTIAL OILS; EAU DE COLOGNE; DEODORANTS FOR PERSONAL USE; COSMETIC LOTIONS; LIP GLOSS; LIP COATINGS, NAMELY, NON-MEDICATED LIP CARE PREPARATIONS; LIP CONDITIONERS; NON-MEDICATED PROTECTIVE PREPARATIONS FOR LIPS; COSMETIC PREPARATIONS FOR SLIMMING PURPOSES; COLD CREAMS; COLD WAVING SOLUTIONS; SOLID POWDER FOR COMPACTS; MOUSTACHE WAX; SKIN CLEANSING CREAM; DEPILATORY WAX; DEPILATORY PREPARATIONS; BEARD DYES; PERMANENT WAVE PREPARATIONS; NEUTRALIZERS FOR PERMANENT WAVING; FOUNDATION CREAMS; PERMANENT WAVING LOTIONS; FACE POWDER; POTPOURRI PERFUMES; SKIN WHITENING CREAMS; HAND CREAMS FOR COSMETIC PURPOSES; PERFUMES; LIP BALMS; HAIR GEL; HAIR GLAZE; HAIR STYLING PREPARATIONS; HAIR LACQUERS; HAIR LOTIONS; HAIR MOISTURIZERS; HAIR MOUSSE; HAIR SPRAY; HAIR CONDITIONERS; HAIR CREAMS; HAIR TONIC; PERFUME OILS, NAMELY, HELIOTROPINE; HYDROGEN PEROXIDE FOR COSMETIC PURPOSES; GREASES FOR COSMETIC PURPOSES; PETEROLEUM JELLY FOR COSMETIC PURPOSES; ASTRINGENTS FOR COSMETIC PURPOSES; COSMETIC PENCILS; COSMETIC DYES; COSMETIC BATH SALTS; HAIR COLORANTS; CLEANSING MILK FOR TOILET PURPOSES; TALCUM POWDER FOR TOILET USE; POMADES FOR COSMETIC PURPOSES; COSMETIC ADDITIVES FOR BATHS, NAMELY, BATH BEADS; AFTERSHAVE COLOGNE; MAKE-UP POWDER; SOAP POWDER; SHAVING SOAP; BATH SOAPS; LIQUID SOAPS; COSMETIC SOAPS; SOAPS FOR FOOT PERSPIRA-

TION; DEODORANT SOAP; SHAMPOOS; SOAP FOR BRIGHTENING TEXTILE; EXFOLIANTS FOR THE CARE OF THE SKIN; ALL PURPOSE CLEANING PREPARATIONS; OILS FOR CLEANING PURPOSES; DETERGENTS FOR HOUSEHOLD USE; LAUNDRY SOAPS; DISINFECTANT SOAP; ALMOND SOAP; MEDICATED SOAP; GLASS CLEANING PREPARATIONS; RINSE AGENTS FOR LAUNDRY; WINDSCREEN CLEANING LIQUIDS; CREAM SOAPS; TOILET BOWL DETERGENTS; HAIR RINSES FOR COSMETIC USE; GENERAL PURPOSE ABRASIVE POWDERS; MOUTH WASHES, NOT FOR MEDICAL PURPOSES; NON-MEDICATED

DENTAL RINSES; DENTURE POLISHES; PREPARATIONS FOR CLEANING DENTURES; TOOTH POWDERS FOR COSMETIC USE; BREATH FRESHENING SPRAYS; DENTIFRICES, IN CLASS 3 (U.S. CLS. 1, 4, 6, 50, 51 AND 52).

OWNER OF INTERNATIONAL REGISTRATION
0932709 DATED 1-31-2007, EXPIRES 1-31-2017.

SER. NO. 79-041,883, FILED 1-31-2007.

KRISTINA MORRIS, EXAMINING ATTORNEY

Int. Cl.: 7

Prior U.S. Cls.: 13, 19, 21, 23, 31, 34 and 35

United States Patent and Trademark Office

Reg. No. 3,476,903

Registered July 29, 2008

**TRADEMARK
PRINCIPAL REGISTER**



SANTONI S.P.A. (ITALY JOINT STOCK COMPANY)
VIA CARLO FENZI, 14
I-25135 BRESCIA
ITALY

CHINES, IN CLASS 7 (U.S. CLS. 13, 19, 21, 23, 31, 34 AND 35).

PRIORITY DATE OF 3-13-2007 IS CLAIMED.

OWNER OF INTERNATIONAL REGISTRATION
0932742 DATED 5-22-2007, EXPIRES 5-22-2017.

OWNER OF U.S. REG. NOS. 2,549,016 AND
2,549,017.

THE MARK CONSISTS OF A SIGN DEPICTING THE WORDING "SANTONI" IN FANCY CHARACTERS, IN A CURVED EXTENSION, UNDER A CIRCULAR SHAPE CONTAINING TWO SPECULAR IDENTICAL BANDS, FORMED BY SEVERAL PARALLEL AND CURVILINEAR LINES, EACH TERMINATING, NEAR THE CENTRE, IN THE INNER CURVED PORTION OF THE OTHER, ALL EVOCATIVE OF A STYLIZED LETTER "S."

SER. NO. 79-041,896, FILED 5-22-2007.

MARILYN IZZI, EXAMINING ATTORNEY

FOR: DYEING MACHINES; HOT AIR DRYING MACHINES FOR TEXTILES; KNITTING MACHINES; PORTABLE ROTARY STEAM PRESSES FOR FABRICS; SPINNING MACHINES FOR THREAD AND TEXTILES; YARN WARPING MACHINES; PRINTING MACHINES FOR TEXTILES; EMBROIDERY MACHINES; HOSIERY LOOMS; LACE MAKING MACHINES; HOSIERY KNITTING MACHINES AND PARTS THEREOF; SPINNING WHEELS AND FRAMES FOR TEXTILE WEAVING MACHINES; POWER WEAVING LOOMS; SIZING MACHINES FOR TEXTILES; PRESSING MACHINES TO MAKE SATIN-LIKE FINISH ON TEXTILES; CARDING MACHINES; WIRE DRAWING MACHINES; REELS FOR WEAVING LOOMS; BOBBINS FOR WEAVING LOOMS; SLIDES FOR KNITTING MACHINES; CARRIAGES FOR KNITTING MACHINES; THREAD TWISTING MACHINES; THREADING MACHINES; LOOM SHAFTS; LOOMS BEING MACHINES; TAMBOURS FOR EMBROIDERY MACHINES; INDUSTRIAL SEWING MA-

Int. Cls.: 9 and 42

Prior U.S. Cls.: 21, 23, 26, 36, 38, 100 and 101

United States Patent and Trademark Office

Reg. No. 3,476,904

Registered July 29, 2008

**TRADEMARK
SERVICE MARK
PRINCIPAL REGISTER**

SPECTRUM POWER

SIEMENS AKTIENGESELLSCHAFT (FED REP
GERMANY JOINT STOCK COMPANY)
WITTELSBACHERPLATZ 2
80333 MÜNCHEN
FED REP GERMANY

FOR: COMPUTER PROGRAMS RECORDED ON
DATA MEDIA FOR USE IN DATA PROCESSING,
NAMELY, FOR POWER SYSTEMS CONTROL AND
ENERGY MANAGEMENT OF INDUSTRIAL POW-
ER SUPPLIES AND MANAGEMENT SYSTEMS DE-
SIGN FOR ELECTRICITY, GAS AND WATER
DISTRIBUTION NETWORKS, IN CLASS 9 (U.S.
CLS. 21, 23, 26, 36 AND 38).

FOR: DEVELOPMENT AND RENTAL OF COM-
PUTER SOFTWARE FEATURING DATA PROCES-
SING PROGRAMS FOR POWER SYSTEMS
CONTROL AND ENERGY MANAGEMENT OF IN-
DUSTRIAL POWER SUPPLIES AND MANAGE-
MENT SYSTEMS DESIGN FOR ELECTRICITY,
GAS AND WATER DISTRIBUTION NETWORKS;
DESIGNING DATA PROCESSING PROGRAMS,

NAMELY, COMPUTER PROGRAMS FOR POWER
SYSTEMS CONTROL AND ENERGY MANAGE-
MENT OF INDUSTRIAL POWER SUPPLIES AND
MANAGEMENT SYSTEMS DESIGN FOR ELECTRI-
CITY , GAS AND WATER DISTRIBUTION NET-
WORKS, IN CLASS 42 (U.S. CLS. 100 AND 101).

THE MARK CONSISTS OF STANDARD CHAR-
ACTERS WITHOUT CLAIM TO ANY PARTICULAR
FONT, STYLE, SIZE, OR COLOR.

OWNER OF INTERNATIONAL REGISTRATION
0932779 DATED 7-4-2007, EXPIRES 7-4-2017.

NO CLAIM IS MADE TO THE EXCLUSIVE
RIGHT TO USE "POWER", APART FROM THE
MARK AS SHOWN.

SER. NO. 79-041,904, FILED 7-4-2007.

SUZANNE BLANE, EXAMINING ATTORNEY

Int. Cls.: 9, 35, 36, 38 and 42

Prior U.S. Cls.: 21, 23, 26, 36, 38, 100, 101, 102 and 104

Reg. No. 3,476,905

United States Patent and Trademark Office

Registered July 29, 2008

**TRADEMARK
SERVICE MARK
PRINCIPAL REGISTER**

KEONNECTED

HAUTE ECOLE D'INGÉNIERIE ET DE GESTION;
DU CANTON DE VAUD (HEIG-VD) (SWIT-
ZERLAND HIGH SCHOOL)
ROUTE DE CHESEAUX 1
CH-1401 YVERDON-LES-BAINS
SWITZERLAND

FOR: COMPUTER SOFTWARE FOR THE MAN-
AGEMENT OF INFORMATION AND DOCUMENTS
AND USED TO CREATE AUTOMATED COLLA-
BORATIVE WORKSPACES AND CUSTOMER MAN-
AGEMENT SYSTEMS THAT MANAGE DATA IN
THE AREA OF INTERNET AND ON-LINE RETAIL
SALES THROUGH THE COLLECTION, EDITING,
ORGANIZING, MODIFYING, BOOK MARKING,
TRANSMISSION, STORAGE AND SHARING OF
DATA AND INFORMATION, IN CLASS 9 (U.S.
CLS. 21, 23, 26, 36 AND 38).

FOR: ASSISTANCE, ADVISORY SERVICES AND
CONSULTANCY WITH REGARD TO BUSINESS
PLANNING, BUSINESS ANALYSIS, BUSINESS
MANAGEMENT, AND BUSINESS ORGANIZA-
TION; ADVERTISING COMPILATION OF DATA
IN DATABASES, IN CLASS 35 (U.S. CLS. 100, 101
AND 102).

FOR: FINANCIAL SERVICES, NAMELY, INVEST-
MENT FUND TRANSFER AND TRANSACTION
SERVICES, IN CLASS 36 (U.S. CLS. 100, 101 AND 102).

FOR: TELECOMMUNICATIONS SERVICES,
NAMELY, ELECTRONIC TRANSMISSION OF MES-
SAGES, IMAGES AND VOICE COMMUNICATIONS
VIA A CABLE NETWORK, VIA A FIBER-OPTIC
NETWORK OR VIA THE INTERNET; COMMUNI-
CATIONS BY COMPUTER TERMINALS; PROVI-
SION OF ACCESS TO A GLOBAL COMPUTER

NETWORK; TELECOMMUNICATIONS SERVICES,
NAMELY, LEASING OF TELECOMMUNICATION
EQUIPMENT, TELECOMMUNICATION ACCESS
SERVICES, CALL HUNTING, PERSONAL COMMU-
NICATION SERVICES; VIDEO CONFERENCING
SERVICES, NAMELY, PROVIDING FACILITIES
AND EQUIPMENT FOR VIDEO CONFERENCING,
IN CLASS 38 (U.S. CLS. 100, 101 AND 104).

FOR: DESIGN AND DEVELOPMENT OF SOFT-
WARE FOR OTHERS FOR THE MANAGEMENT
AND TRANSMISSION OF INFORMATION AND
DOCUMENTS WITH A VIEW TO CREATING AND
OPERATING AUTOMATED COLLABORATIVE
WORKSPACES; RENTAL AND UPDATING OF
COMPUTER SOFTWARE FOR OTHERS; HOSTING
COMPUTER WEB SITES FOR OTHERS; COMPU-
TER SECURITY SERVICES, NAMELY, HARD
DRIVE ERASURE; DEVELOPMENT OF SOFTWARE
FOR SECURE NETWORK OPERATIONS; COMPU-
TER DATA ENCRYPTION SERVICES, IN CLASS 42
(U.S. CLS. 100 AND 101).

THE MARK CONSISTS OF STANDARD CHAR-
ACTERS WITHOUT CLAIM TO ANY PARTICULAR
FONT, STYLE, SIZE, OR COLOR.

PRIORITY DATE OF 11-13-2006 IS CLAIMED.

OWNER OF INTERNATIONAL REGISTRATION
0932905 DATED 5-11-2007, EXPIRES 5-11-2017.

SER. NO. 79-041,952, FILED 5-11-2007.

WILLIAM ROSSMAN, EXAMINING ATTORNEY

Int. Cls.: 9, 35, 36, 38 and 42

Prior U.S. Cls.: 21, 23, 26, 36, 38, 100, 101, 102 and 104

Reg. No. 3,476,906

United States Patent and Trademark Office

Registered July 29, 2008

**TRADEMARK
SERVICE MARK
PRINCIPAL REGISTER**

KEOWARD

HAUTE ECOLE D'INGÉNIERIE ET DE GESTION;
DU CANTON DE VAUD (HEIG-VD) (SWITZERLAND HIGH SCHOOL)
ROUTE DE CHESEAUX 1
CH-1401 YVERDON-LES-BAINS
SWITZERLAND

FOR: COMPUTER SOFTWARE FOR THE MANAGEMENT OF INFORMATION AND DOCUMENTS AND USED TO CREATE AUTOMATED COLLABORATIVE WORKSPACES AND CUSTOMER MANAGEMENT SYSTEMS THAT MANAGE DATA IN THE AREA OF INTERNET AND ON-LINE RETAIL SALES THROUGH THE COLLECTION, EDITING, ORGANIZING, MODIFYING, BOOK MARKING, TRANSMISSION, STORAGE AND SHARING OF DATA AND INFORMATION, IN CLASS 9 (U.S. CLS. 21, 23, 26, 36 AND 38).

FOR: ASSISTANCE, ADVISORY SERVICES AND CONSULTANCY WITH REGARD TO BUSINESS PLANNING, BUSINESS ANALYSIS, BUSINESS MANAGEMENT, AND BUSINESS ORGANIZATION; ADVERTISING COMPILATION OF DATA IN DATABASES, IN CLASS 35 (U.S. CLS. 100, 101 AND 102).

FOR: FINANCIAL SERVICES, NAMELY, INVESTMENT FUND TRANSFER AND TRANSACTION SERVICES, IN CLASS 36 (U.S. CLS. 100, 101 AND 102).

FOR: TELECOMMUNICATIONS SERVICES, NAMELY, ELECTRONIC TRANSMISSION OF MESSAGES, IMAGES AND VOICE COMMUNICATIONS VIA A CABLE NETWORK, VIA A FIBER-OPTIC NETWORK OR VIA THE INTERNET; COMMUNICATIONS BY COMPUTER TERMINALS; PROVISION OF ACCESS TO A GLOBAL COMPUTER

NETWORK; TELECOMMUNICATIONS SERVICES, NAMELY, LEASING OF TELECOMMUNICATION EQUIPMENT, TELECOMMUNICATION ACCESS SERVICES, CALL HUNTING, PERSONAL COMMUNICATION SERVICES; VIDEO CONFERENCING SERVICES, NAMELY, PROVIDING FACILITIES AND EQUIPMENT FOR VIDEO CONFERENCING, IN CLASS 38 (U.S. CLS. 100, 101 AND 104).

FOR: DESIGN AND DEVELOPMENT OF SOFTWARE FOR OTHERS FOR THE MANAGEMENT AND TRANSMISSION OF INFORMATION AND DOCUMENTS WITH A VIEW TO CREATING AND OPERATING AUTOMATED COLLABORATIVE WORKSPACES; RENTAL AND UPDATING OF COMPUTER SOFTWARE FOR OTHERS; HOSTING COMPUTER WEB SITES FOR OTHERS; COMPUTER SECURITY SERVICES, NAMELY, HARD DRIVE ERASURE; DEVELOPMENT OF SOFTWARE FOR SECURE NETWORK OPERATIONS; COMPUTER DATA ENCRYPTION SERVICES, IN CLASS 42 (U.S. CLS. 100 AND 101).

THE MARK CONSISTS OF STANDARD CHARACTERS WITHOUT CLAIM TO ANY PARTICULAR FONT, STYLE, SIZE, OR COLOR.

PRIORITY DATE OF 11-13-2006 IS CLAIMED.

OWNER OF INTERNATIONAL REGISTRATION 0932906 DATED 5-11-2007, EXPIRES 5-11-2017.

SER. NO. 79-041,953, FILED 5-11-2007.

WILLIAM ROSSMAN, EXAMINING ATTORNEY

Int. Cls.: 5, 10, 41, 42 and 44

**Prior U.S. Cls.: 6, 18, 26, 39, 44, 46, 51, 52, 100, 101
and 107**

Reg. No. 3,476,907

United States Patent and Trademark Office

Registered July 29, 2008

**TRADEMARK
SERVICE MARK
PRINCIPAL REGISTER**

NYCOMED

NYCOMED PHARMA AS (NORWAY AKSJE-
SELSKAP (AS))
DRAMMENSVEIEN 852
N-1372 ASKER
NORWAY

FOR: PHARMACEUTICAL PREPARATIONS FOR THE TREATMENT OF DISEASES AND CONDITIONS OF THE RESPIRATORY SYSTEM, THE GASTRO-INTESTINAL SYSTEM, THE ENDOCRINE SYSTEM, THE CARDIOVASCULAR SYSTEM, THE NERVOUS SYSTEM, CENTRAL NERVOUS SYSTEM, THE URINARY SYSTEM, THE INTEGUMENTARY SYSTEM, THE REPRODUCTIVE SYSTEM, THE METABOLIC SYSTEM, THE IMMUNE SYSTEM, THE GENITOURINARY SYSTEM; PHARMACEUTICAL PREPARATIONS FOR WOUNDS; PHARMACEUTICAL PRODUCTS AND PREPARATIONS FOR CHLOASMA; PHARMACEUTICAL PRODUCTS FOR THE TREATMENT OF VIRAL AND INFECTIOUS DISEASES; PHARMACEUTICAL PREPARATIONS FOR USE IN UROLOGY; PHARMACEUTICAL PREPARATIONS FOR THE TREATMENT AND/OR PREVENTION OF BONE DISEASES, BACTERIA-BASED DISEASES, CANCER, DIABETES, OSTEOPOROSIS, HORMONAL DISORDERS, PAIN, INFLAMMATORY DISEASES, RHEUMATISM, LOW BLOOD PRESSURE, CORONARY ARTERY DISEASES, DISEASES OF THE MUSCULOSKELETAL SYSTEM, INFECTIOUS DISEASES, ALLERGIC RHINITIS AND ASTHMA, DIABETES, SKIN DISORDERS, DERMATOLOGY; PHARMACEUTICAL PREPARATIONS FOR USE IN ONCOLOGY, HAEMATOLOGY AND IN TISSUE AND ORGAN TRANSPLANTATION; ANTIBIOTICS, ANALGESICS, ANTIRHEUMATICS, ANTIPHLOGISTICS, NARCOTICS, ANTIALLERGICS, ANTIMYCOTICS, PSYCHOTROPICS; OTOLOGICS, OPHTHALMIC, ANTI-INFECTIVE PREPARATIONS, ANTIVIRAL PREPARATIONS, ANTIFUNGAL PREPARATIONS AND VACCINES; CALCIUM SUPPLEMENTS; CALCIUM SUPPLEMENTS FOR MEDICAL USE, NAMELY, CALCIUM CARBO-

NATE; MINERAL SUPPLEMENTS FOR MEDICAL USE; VITAMIN AND MINERAL PREPARATIONS FOR MEDICAL USE, NAMELY, MAGNESIUM FOR MEDICAL USE; DIAGNOSTIC PREPARATIONS FOR MEDICAL AND VETERINARY USE; SANITARY PREPARATIONS FOR MEDICAL PURPOSES; DIETETIC SUBSTANCES AND PREPARATIONS, NAMELY, FOOD, ADAPTED FOR MEDICAL USE; VITAMINS AND VITAMIN PREPARATIONS; FOOD FOR BABIES; MEDICAL PLASTERS; GAUZE AND BANDAGES FOR DRESSING, IN CLASS 5 (U.S. CLS. 6, 18, 44, 46, 51 AND 52).

FOR: SURGICAL AND MEDICAL APPARATUS AND INSTRUMENTS FOR USE IN GENERAL SURGERY AND PARTS AND FITTINGS THEREFORE; IMPLANTS CONSISTING OF ARTIFICIAL MATERIALS; ARTIFICIAL ORTHOPAEDIC JOINT IMPLANT; SURGICAL SPONGES, TISSUE SEALANTS AND HAEMOSTATICS FOR SURGICAL USE, NAMELY, TISSUE ADHESIVE FOR SURGICAL USE, SURGICAL HAEMOSTATIC COLLAGEN SPONGES AND WOUND FLEECE FOR SUTURE SUPPORT; SUTURES, IN CLASS 10 (U.S. CLS. 26, 39 AND 44).

FOR: EDUCATION, INSTRUCTION AND TRAINING SERVICES, NAMELY, PROVIDING CLASSES, SEMINARS, WORKSHOPS AND INDIVIDUAL TRAINING WITHIN THE FIELD OF MEDICINE, PHARMACY AND HEALTHCARE; MEDICAL TRAINING AND TEACHING; PUBLICATION OF BOOKS, MAGAZINES, NEWSLETTERS, BROCHURES, JOURNALS, PERIODICALS AND CATALOGUES AS WELL AS PUBLICATION OF ELECTRONIC PUBLICATIONS, MAGAZINES, BROCHURES AND CATALOGUES WITHIN THE FIELD OF MEDICINE, PHARMACY, LIFESTYLE AND HEALTHCARE; ORGANISATION AND PERFORMING OF CONGRESSES, CONFERENCES AND SEMINARS WITHIN THE FIELD OF MEDICINE, PHARMACY, LIFESTYLE AND HEALTHCARE, IN CLASS 41 (U.S. CLS. 100, 101 AND 107).

FOR: SCIENTIFIC AND TECHNOLOGICAL RESEARCH AND DESIGN SERVICES WITHIN THE FIELD OF MEDICINE, PHARMACY AND HEALTHCARE; INDUSTRIAL ANALYSIS AND RESEARCH SERVICES WITHIN THE FIELD OF MEDICINE, PHARMACY AND HEALTHCARE , IN CLASS 42 (U.S. CLS. 100 AND 101).

FOR: MEDICAL SERVICES; HYGIENIC AND BEAUTY CARE FOR HUMAN BEINGS OR ANIMALS, NAMELY, SKIN CARE FOR HUMANS AND ANIMAL GROOMING SERVICES; PROVIDING OF ADVICE WITHIN THE FIELD OF MEDICINE, PHARMACY AND HEALTHCARE, MEDICAL COUNSELLING AND CONSULTANCY, IN CLASS 44 (U.S. CLS. 100 AND 101).

THE MARK CONSISTS OF STANDARD CHARACTERS WITHOUT CLAIM TO ANY PARTICULAR FONT, STYLE, SIZE, OR COLOR.

PRIORITY DATE OF 1-17-2007 IS CLAIMED.

OWNER OF INTERNATIONAL REGISTRATION 0932977 DATED 2-7-2007, EXPIRES 2-7-2017.

OWNER OF U.S. REG. NOS. 1,546,929, 2,124,835, AND 3,100,977.

SER. NO. 79-041,980, FILED 2-7-2007.

AISHA SALEM, EXAMINING ATTORNEY

Int. Cls.: 20 and 24

Prior U.S. Cls.: 2, 13, 22, 25, 32, 42 and 50

United States Patent and Trademark Office

Reg. No. 3,476,908

Registered July 29, 2008

**TRADEMARK
PRINCIPAL REGISTER**

F FENDI

FENDI ADELE S.R.L. (ITALY LTD LIAB CO)
VIA FLAMINIA, 968
I-00189 ROMA
ITALY

FOR: FURNITURE, NAMELY, SOFAS, BEDS, CONVERTIBLE SOFA-BEDS, CHAIRS, SEATS, ARM-CHAIRS, TABLES, DESKS, WARDROBES, UP-HOLSTERED POUFS, BACKLESS COUCHES, FURNITURE SCREENS; GOODS, NAMELY, PICTURE FRAMES, COAT HANGERS AND MIRRORS MADE OF WOOD, CORK, REED, CANE, WICKER, HORN, BONE, IVORY, WHALEBONE, SHELL, AMBER, MOTHER-OF-PEARL, MEERSCHAUM AND SUBSTITUTES FOR ALL THESE MATERIALS, IN CLASS 20 (U.S. CLS. 2, 13, 22, 25, 32 AND 50).

FOR: TEXTILE FABRICS FOR THE MANUFACTURE OF CLOTHING, BEDSPREADS, AND TEXTILE TABLECLOTHS; FABRIC FOR TEXTILE USE; POCKET HANDKERCHIEFS, HANDKERCHIEFS; TEXTILE WALL HANGINGS; HOME LINENS,

NAMELY, TOWELS, SHEETS, PILLOWCASES, QUILTS, BEDSPREADS, BED BLANKETS FOR DECORATION MADE OF CASHMERE, WOOL, SILK, COTTON OR POLYESTER, TEXTILE TABLE CLOTHS, TEXTILE NAPKINS, TEXTILE PLACE MATS, FABRIC AND PLASTIC CURTAINS, IN CLASS 24 (U.S. CLS. 42 AND 50).

PRIORITY DATE OF 3-5-2007 IS CLAIMED.

OWNER OF INTERNATIONAL REGISTRATION 0933096 DATED 5-22-2007, EXPIRES 5-22-2017.

OWNER OF U.S. REG. NOS. 1,439,955, 1,842,972 AND OTHERS.

SER. NO. 79-042,015, FILED 5-22-2007.

KRISTINA MORRIS, EXAMINING ATTORNEY

Int. Cls.: 3, 7 and 8

**Prior U.S. Cls.: 1, 4, 6, 13, 19, 21, 23, 28, 31, 34, 35, 44,
50, 51 and 52**

Reg. No. 3,476,909

United States Patent and Trademark Office

Registered July 29, 2008

**TRADEMARK
PRINCIPAL REGISTER**

KRONENFLEX

KLINGSPOR AG (FED REP GERMANY COR-
PORATION)
HÜTTENSTR. 36
35708 HAIGER
FED REP GERMANY

FOR: ABRASIVE CLOTH, ABRASIVE PAPER,
ABRASIVE PASTE, AND EMERY PAPER; COATED
ABRASIVES AND SANDPAPER IN THE FORM OF
BELTS, SHEETS, ROLLS, AND DISCS; GENERAL
PURPOSE CLEANING, POLISHING, AND ABRA-
SIVE LIQUIDS AND POWDERS; FINISHING PA-
PERS, NAMELY, SANDPAPER; IMPREGNATED
CLOTHS FOR POLISHING, IN CLASS 3 (U.S. CLS.
1, 4, 6, 50, 51 AND 52).

FOR: MACHINE TOOLS FOR CUTTING, GRIND-
ING, AND POLISHING METALS, WOOD, GLASS,
STONE, CERAMIC, PLASTICS, AND OTHER MA-
TERIALS; VIBRATING DISCS, POLISHERS, GRIND-
ING DISCS, CUTTING-OFF WHEELS, DIAMOND
BLADES, GRINDSTONES, GRINDING WHEELS
AND ROLLERS, AND GRINDING PINS, NAMELY,
GRINDING MOUNTED POINTS, ALL BEING
PARTS OF POWER-OPERATED MACHINE TOOLS;
ABRASIVE FLAP WHEELS, ABRASIVE LAMELLAR
GRINDING WHEELS, ABRASIVE FAN-TYPE
GRINDING WHEELS, ABRASIVE FLAP DISCS,
ABRASIVE LAMELLAR DISCS, ALL BEING PARTS
OF POWER-OPERATED GRINDERS; PARTS FOR
MACHINE TOOLS FOR GRINDING, NAMELY,
SUPPORT PLATES FOR GRINDING DISCS, CON-
TACT WHEELS FOR ABRASIVE BELTS, AND EX-
PANDERS FOR MOUNTING GRINDING WHEELS
AND DISCS; ABRASIVE DISKS FOR POWER-OPER-

ATED GRINDERS; ABRASIVE WHEELS FOR POW-
ER-OPERATED GRINDERS; POWER-OPERATED
ABRASIVE WHEELS, ABRASIVE BELTS AND
DISCS, DISCS OF ABRASIVE FIBER, ABRASIVE
PAPER, ABRASIVE CLOTH, AND ABRASIVE NON-
WOVEN MATERIAL, ALL BEING PARTS FOR
POWER-OPERATED GRINDERS, IN CLASS 7 (U.S.
CLS. 13, 19, 21, 23, 31, 34 AND 35).

FOR: HAND TOOLS, NAMELY, MANUAL-OPER-
ATED GRINDSTONES AND GRINDING WHEELS,
MANUALLY OPERATED SHARPENERS AND
SHARPENING WHEELS, HAND-OPERATED SHAR-
PENING TOOLS AND INSTRUMENTS, HAND-OP-
ERATED SANDERS AND BLOCKS TREATED
WITH ABRASIVES FOR GRINDING, SANDING,
AND POLISHING, IN CLASS 8 (U.S. CLS. 23, 28
AND 44).

PRIORITY DATE OF 4-20-2006 IS CLAIMED.

OWNER OF INTERNATIONAL REGISTRATION
0933120 DATED 10-18-2006, EXPIRES 10-18-2016.

OWNER OF U.S. REG. NO. 3,051,112.

THE WORDING "KRONENFLEX" HAS NO
MEANING IN A FOREIGN LANGUAGE.

SER. NO. 79-042,025, FILED 10-18-2006.

SHAILA SETTLES, EXAMINING ATTORNEY

Int. Cl.: 10

Prior U.S. Cls.: 26, 39 and 44

Reg. No. 3,476,910

United States Patent and Trademark Office

Registered July 29, 2008

**TRADEMARK
PRINCIPAL REGISTER**

ZIRCONNECT

SUDIMPLANT (FRANCE SOCIETE ANONYME)
24, IMPASSE RENÉ COUZINET
ZI DE LA PLAINE; F-31500 TOULOUSE
FRANCE

FOR: SURGICAL, MEDICAL AND DENTAL APPARATUS AND INSTRUMENTS NAMELY, SCREW TAPS, SURGICAL PILOT DRILL BITS, SURGICAL DRILL BITS WITH IRRIGATION, SURGICAL DRILL BIT EXTENSIONS, SURGICAL DRILLING GUIDES, CIRCULAR SURGICAL KNIVES, SURGICAL TORQUE WRENCHES, SURGICAL WRENCHES, SURGICAL SCREWDRIVERS, ALL FOR USE IN DENTAL IMPLANTOLOGY; APPARATUS AND INSTRUMENTS FOR DENTAL IMPLANTOLOGY, NAMELY, DENTAL IMPLANTS, ARTIFICIAL TEETH, DENTAL SCREWS FOR USE IN DENTAL IMPLANTOLOGY, PINS FOR ARTIFICIAL TEETH FOR USE IN DENTAL IMPLANTOLOGY, ARTIFICIAL TEETH STUMPS, PROTECTION SCREWS FOR USE IN DENTAL IMPLANTOLOGY, STABILISA-

TION CLIPS FOR ARTIFICIAL TEETH; SURGICAL AND PROSTHETIC KITS CONSISTING PRIMARILY OF DENTAL SCREWS AND DENTAL IMPLANTS FOR USE IN DENTAL IMPLANTOLOGY, IN CLASS 10 (U.S. CLS. 26, 39 AND 44).

THE MARK CONSISTS OF STANDARD CHARACTERS WITHOUT CLAIM TO ANY PARTICULAR FONT, STYLE, SIZE, OR COLOR.

PRIORITY DATE OF 1-22-2007 IS CLAIMED.

OWNER OF INTERNATIONAL REGISTRATION
0933205 DATED 6-29-2007, EXPIRES 6-29-2017.

SER. NO. 79-042,062, FILED 6-29-2007.

MONIQUE MILLER, EXAMINING ATTORNEY

Int. Cls.: 1, 2 and 17

Prior U.S. Cls.: 1, 5, 6, 10, 11, 12, 13, 16, 26, 35, 46 and 50

Reg. No. 3,476,911

United States Patent and Trademark Office

Registered July 29, 2008

**TRADEMARK
PRINCIPAL REGISTER**

TELALED

CLARIANT AG (SWITZERLAND SOCIÉTÉ ANONYME (SA))
ROTHAUSSTRASSE 61
CH-4132 MUTTENZ
SWITZERLAND

FOR: CHEMICALS USED IN INDUSTRY, SCIENCE AND PHOTOGRAPHY, NAMELY, CHEMICALS USED IN THE COLORATION OF PLASTICS IN THE PLASTICS AND PLASTICS PROCESSING INDUSTRY; UNPROCESSED ARTIFICIAL RESINS FOR THERMOPLASTIC AND THERMOSET PROCESSING; UNPROCESSED PLASTICS, IN CLASS 1 (U.S. CLS. 1, 5, 6, 10, 26 AND 46).

FOR: PAINTS, VARNISHES, LACQUERS; RUST PRESERVATIVES IN THE NATURE OF A COATING; WOOD PRESERVATIVES; DYESTUFFS; RAW NATURAL RESINS FOR USE IN THE MANUFACTURE OF RESINS AND FOR GENERAL INDUSTRIAL USE; METAL IN FOIL AND POWDER FORM FOR PAINTERS, DECORATORS, PRINTERS AND ARTISTS; CONCENTRATES OF COLORANTS AND PIGMENTS FOR THE PLASTICS INDUSTRY, FOR THE PRODUCTION OF COLORED MASTERBATCHES OR COMPOUNDS BASED ON ORGANIC PIGMENTS, INORGANIC PIGMENTS OR SOLVENT DYES, IN CLASS 2 (U.S. CLS. 6, 11 AND 16).

FOR: PROCESSED AND UNPROCESSED RUBBER, GUTTA-PERCHA, GUM, ASBESTOS, AND

MICA FOR USE IN FURTHER MANUFACTURE; GOODS OF SEMI-PROCESSED PLASTICS, FOR EXAMPLE, SEMI-PROCESSED PLASTIC IN THE FORM OF FILMS, SHEETS, TUBES, BARS, OR RODS; SEALING, PACKING AND INSULATING MATERIALS, FOR EXAMPLE, SEMI-PROCESSED PLASTIC IN THE FORM OF FILMS, SHEETS, TUBES, BARS, OR RODS; NON-METALLIC FLEXIBLE PIPES; POLYMERIC MEDIUMS BASED ON THERMOPLASTIC, ELASTOMERIC OR THERMOSET BASED POLYMERS, GRANULES OF PLASTIC CONTAINING COLORANTS AND/OR ADDITIVES FOR USE IN MANUFACTURING IN THE PLASTICS INDUSTRY, IN CLASS 17 (U.S. CLS. 1, 5, 12, 13, 35 AND 50).

THE MARK CONSISTS OF STANDARD CHARACTERS WITHOUT CLAIM TO ANY PARTICULAR FONT, STYLE, SIZE, OR COLOR.

PRIORITY DATE OF 2-13-2007 IS CLAIMED.

OWNER OF INTERNATIONAL REGISTRATION 0933451 DATED 7-19-2007, EXPIRES 7-19-2017.

SER. NO. 79-042,172, FILED 7-19-2007.

ALLISON HOLTZ, EXAMINING ATTORNEY

Int. Cls.: 18 and 25

Prior U.S. Cls.: 1, 2, 3, 22, 39 and 41

United States Patent and Trademark Office

Reg. No. 3,476,912

Registered July 29, 2008

**TRADEMARK
PRINCIPAL REGISTER**

SARA KENT

CALZATURIFICIO GIOVANNI FABIANI S.R.L.
(ITALY LTD LIAB CO)
VIA DELL'INDUSTRIA, 50
I-63023 FERMO (ASCOLI PICENO)
ITALY

FOR: LEATHER AND IMITATIONS OF LEATHER; GOODS MADE OF LEATHER AND IMITATIONS OF LEATHER, NAMELY, BAGS AND RUCKSACKS, WALLETS AND PURSUES, KEY CASES; TRUNKS AND TRAVELLING BAGS; UMBRELLAS AND WALKING STICKS; WHIPS AND SADDLERY, IN CLASS 18 (U.S. CLS. 1, 2, 3, 22 AND 41).

FOR: CLOTHING ITEMS, NAMELY, BELTS, HATS AND CAPS, SHOES, BOOTS, LACED SHOES, LEATHER SHOES, RUBBER SHOES, RAIN SHOES, SPORT SHOES, SANDALS, SLIPPERS, SHOE SOLES, MOLDED BOTTOMS FOR SHOES, SWEATERS, CARDIGANS, SLIPOVER SHIRT, SUITS, TROUSERS, SHORTS, JUMPERS, RAINCOATS, SUITS AND DRESSES MADE OF LEATHER, COATS, OVERCOATS, JACKETS, SKIRTS, DRESSES, UN-

DERSHIRTS, POLO, SHIRTS, SPORT T-SHIRTS, BLOUSES, FOULARDS, TRACKSUITS, VESTS, GLOVES, SHAWLS, SCARVES, NECKTIES AND BOW TIES, IN CLASS 25 (U.S. CLS. 22 AND 39).

PRIORITY DATE OF 2-26-2007 IS CLAIMED.

OWNER OF INTERNATIONAL REGISTRATION 0933491 DATED 5-30-2007, EXPIRES 5-30-2017.

THE NAME(S), PORTRAIT(S), AND/OR SIGNATURE(S) SHOWN IN THE MARK DOES NOT IDENTIFY A PARTICULAR LIVING INDIVIDUAL.

THE TRADEMARK CONSISTS OF THE WORDING "SARA KENT" WRITTEN IN SPECIAL CHARACTERS.

SER. NO. 79-042,189, FILED 5-30-2007.

BERNICE MIDDLETON, EXAMINING ATTORNEY

Int. Cls.: 18 and 25

Prior U.S. Cls.: 1, 2, 3, 22, 39 and 41

United States Patent and Trademark Office

Reg. No. 3,476,913

Registered July 29, 2008

**TRADEMARK
PRINCIPAL REGISTER**

ADAM JONES

AWJ PRODUCTIONS (FRANCE SOCIÉTÉ À RE-
SPONSABILITE LIMITEE (SARL))
44 RUE LUCIEN SAMPAIX
F-75010 PARIS
FRANCE

FOR: LEATHER GOODS, NAMELY, SPORT BAGS
OTHER THAN THOSE ADAPTED FOR THEIR
CONTENTS; TRAVELING BAGS, BEACH BAGS,
HANDBAGS, WHEELED BAGS, RUCKSACKS, LEA-
THER BRIEFCASES, UMBRELLAS, PARASOLS, VA-
LISES, WALKING STICKS, UMBRELLA STICKS,
CARD CASES AND WALLETS WITH ATTACH-
MENTS FOR HOLDING CARDS; WALLETS, PUR-
SES NOT OF PRECIOUS METAL, KEY CASES,
ATTACHÉ CASES, TRUNKS, SUITCASES, BUSI-
NESS CASES, IN CLASS 18 (U.S. CLS. 1, 2, 3, 22
AND 41).

FOR: CLOTHING, NAMELY, SHIRTS, PANTS,
JACKETS, SHORTS, UNDERGARMENTS AND
OUTER GARMENTS, NAMELY, JACKETS, COATS,
SWEATERS, RAINCOATS; FOOTWEAR EXCLUD-
ING ORTHOPEDIC FOOTWEAR; SPORTS FOOT-
WEAR, BOOTS, HEADGEAR, NAMELY, HATS,
CAPS; BONNETS, CAPS, BATHING SUITS, BATH-

ROBES, SOCKS, SHIRTS, SCARVES, CLOTHING
FOR GYMNASTICS AND SPORTS, NAMELY, LEO-
TARDS, BODYSUITS, TANK SHIRTS, SHOES, EX-
ERCISE SHORTS, SWEAT SOCKS AND SPORT
BRAS, IN CLASS 25 (U.S. CLS. 22 AND 39).

THE MARK CONSISTS OF STANDARD CHAR-
ACTERS WITHOUT CLAIM TO ANY PARTICULAR
FONT, STYLE, SIZE, OR COLOR.

PRIORITY DATE OF 12-20-2006 IS CLAIMED.

OWNER OF INTERNATIONAL REGISTRATION
0933498 DATED 6-19-2007, EXPIRES 6-19-2017.

"THE NAME(S), PORTRAIT(S), AND/OR SIGNA-
TURE(S) SHOWN IN THE MARK IDENTIFIES
ADAM JONES, WHOSE CONSENT(S) TO REGISTER
IS SUBMITTED."

SER. NO. 79-042,195, FILED 6-19-2007.

RON FAIRBANKS, EXAMINING ATTORNEY

Int. Cls.: 1 and 2

Prior U.S. Cls.: 1, 5, 6, 10, 11, 16, 26 and 46

United States Patent and Trademark Office

Reg. No. 3,476,914

Registered July 29, 2008

TRADEMARK
PRINCIPAL REGISTER



ZHEJIANG HUANGMA; CHEMICAL INDUSTRY
GROUP CO., LTD (CHINA CORPORATION)
ZHANGZHEN INDUSTRIAL ESTATE
SHANGYU CITY; 312363 ZHEJIANG PROVINCE
CHINA

FOR: CHEMICALS FOR INDUSTRY PURPOSES;
CHEMICAL ADDITIVES FOR USE IN THE MANU-
FACTURE OF INSECTICIDES; CHEMICAL RE-
AGENTS OTHER THAN FOR MEDICAL OR
VETERINARY PURPOSES; PLASTICS, UNPROCES-
SED; FERTILIZERS; FIRE EXTINGUISHING COM-
POSITIONS; CHEMICAL SUBSTANCES FOR
PRESERVING FOODSTUFFS; CHEMICALS FOR
USE IN THE MANUFACTURE OF LEATHER-RE-
NOVATING PREPARATIONS; WOOD FIBRE PULP
FOR MANUFACTURING PURPOSES; ADHESIVES
FOR INDUSTRY PURPOSES, IN CLASS 1 (U.S. CLS.
1, 5, 6, 10, 26 AND 46).

FOR: MORDANTS FOR USE IN THE LEATHER
GOODS INDUSTRY; DYES FOR USE IN THE MAN-
UFACTURE OF FOOD AND LEATHER; FOOD
DYES; DRY INK FOR LEATHER; PRINTING INK;
ANTI-CORROSIVE INHIBITANTS IN THE NATURE
OF A COATING ; ANTI-RUST GREASES; COLOPH-

ONY IN THE NATURE OF RAW NATURAL RESINS
FOR GENERAL INDUSTRIAL USE; NATURAL
GUM RESINS FOR USE IN THE MANUFACTURE
OF ADHESIVES, IN CLASS 2 (U.S. CLS. 6, 11 AND 16).

OWNER OF INTERNATIONAL REGISTRATION
0933532 DATED 6-20-2007, EXPIRES 6-20-2017.

THE ENGLISH TRANSLATION OF THE FOR-
EIGN WORD(S) IN THE MARK IS: THE FIRST
CHINESE CHARACTER WHOSE TRANSLITERA-
TION IS "HUANG" MEANS "IMPERIAL"; THE
SECOND CHINESE CHARACTER WHOSE TRANSLI-
TERATION IS "MA" MEANS "HORSE"; THE
COMBINATION OF THE TWO CHINESE CHARAC-
TERS MEANS IMPERIAL HORSE.

THE TRANSLITERATION OF THE NON-LATIN
CHARACTERS IN THE MARK IS: HUANG MA.

SER. NO. 79-042,218, FILED 6-20-2007.

ERNEST SHOSHO, EXAMINING ATTORNEY

Int. Cls.: 35 and 36

Prior U.S. Cls.: 100, 101 and 102

United States Patent and Trademark Office

Reg. No. 3,476,915

Registered July 29, 2008

**SERVICE MARK
PRINCIPAL REGISTER**

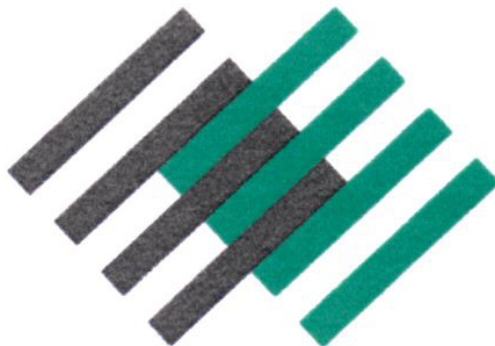

COMPAGNIE GENERALE DE LOCATION;
D'EQUIPEMENTS (FRANCE SOCIÉTÉ ANON-
YME À CONSEIL D'ADMINISTRATION)
69 AVENUE DE FLANDRE
F-59700 MARCQ EN BAROEUL
FRANCE

FOR: ADVERTISING, PUBLICITY AND PROMO-
TION SERVICES, DISSEMINATION OF ADVERTIS-
ING MATTERS, PROFESSIONAL BUSINESS
CONSULTANCY, ONLINE ORDERING SERVICES,
ORGANIZATION OF EXHIBITIONS AND TRADE
FAIRS ALL BEING RENDERED IN THE FIELD OF
FINANCIAL SERVICES FOR VEHICLES AND AP-
PARATUS FOR LOCOMOTION BY AIR, LAND
AND WATER, THEIR PARTS AND ACCESSORIES,
IN CLASS 35 (U.S. CLS. 100, 101 AND 102).

FOR: BANKING, BANKING CONSULTATION,
COMMERCIAL LENDING SERVICES, CONSUMER
LENDING SERVICES, CREDIT AND FINANCIAL
CONSULTATION, CREDIT AGENCIES, HIRE-PUR-
CHASE FINANCING, FINANCIAL SERVICES,
NAMELY, MONEY LENDING AND CURRENCY
EXCHANGE AND ADVICE, INSURANCE CONSUL-
TATION, INSURANCE BROKERAGE, ACCIDENT
INSURANCE UNDERWRITING, MULTI-RISK AND
MULTI-PROTECTION AUTO INSURANCE,

BREAKDOWN VEHICLE AUTO INSURANCE, ALL
BEING RENDERED IN THE FIELD OF VEHICLES
AND APPARATUS FOR LOCOMOTION BY AIR,
LAND AND WATER, THEIR PARTS AND ACCES-
SORIES, IN CLASS 36 (U.S. CLS. 100, 101 AND 102).

PRIORITY DATE OF 12-15-2006 IS CLAIMED.

OWNER OF INTERNATIONAL REGISTRATION
0933583 DATED 6-13-2007, EXPIRES 6-13-2017.

THE COLOR(S) GRAY AND TEAL GREEN IS/
ARE CLAIMED AS A FEATURE OF THE MARK.

THE COLOR GRAY APPEARS IN THE FOUR
LINES CREATING THE DESIGN OF THE TILTED
SQUARE ON THE LEFT SIDE OF THE MARK. THE
COLOR TEAL GREEN APPEARS IN THE FOUR
LINES CREATING THE DESIGN OF THE TILTED
SQUARE ON THE RIGHT SIDE OF THE MARK.

SER. NO. 79-042,236, FILED 6-13-2007.

KELLEY WELLS, EXAMINING ATTORNEY

Int. Cls.: 35 and 36

Prior U.S. Cls.: 100, 101 and 102

United States Patent and Trademark Office

Reg. No. 3,476,916

Registered July 29, 2008

**SERVICE MARK
PRINCIPAL REGISTER**



COMPAGNIE GENERALE DE LOCATION;
D'EQUIPEMENTS (FRANCE SOCIÉTÉ ANON-
YME À CONSEIL D'ADMINISTRATION)
69 AVENUE DE FLANDRE
F-59700 MARCQ EN BAROEUL
FRANCE

FOR: ADVERTISING, PUBLICITY AND PROMO-
TION SERVICES, DISSEMINATION OF ADVERTIS-
ING MATTERS, PROFESSIONAL BUSINESS
CONSULTANCY, ON-LINE ORDERING SERVICES,
ORGANIZATION OF EXHIBITIONS AND TRADE
FAIRS ALL BEING RENDERED IN THE FIELD OF
FINANCIAL SERVICES FOR VEHICLES AND AP-
PARATUS FOR LOCOMOTION BY AIR, LAND
AND WATER, THEIR PARTS AND ACCESSORIES,
IN CLASS 35 (U.S. CLS. 100, 101 AND 102).

FOR: BANKING, BANKING CONSULTATION,
COMMERCIAL LENDING SERVICES, CONSUMER
LENDING SERVICES, CREDIT AND FINANCIAL
CONSULTATION, CREDIT AGENCIES, HIRE-PUR-
CHASE FINANCING, FINANCIAL SERVICES,
NAMELY, MONEY LENDING AND CURRENCY
EXCHANGE AND ADVICE, INSURANCE CONSUL-
TATION, INSURANCE BROKERAGE, ACCIDENT
INSURANCE UNDERWRITING, MULTI-RISK AND
MULTI-PROTECTION AUTO INSURANCE,

BREAKDOWN VEHICLE AUTO INSURANCE, ALL
BEING RENDERED IN THE FIELD OF VEHICLES
AND APPARATUS FOR LOCOMOTION BY AIR,
LAND AND WATER, THEIR PARTS AND ACCES-
SORIES, IN CLASS 36 (U.S. CLS. 100, 101 AND 102).

PRIORITY DATE OF 12-15-2006 IS CLAIMED.

OWNER OF INTERNATIONAL REGISTRATION
0933584 DATED 6-13-2007, EXPIRES 6-13-2017.

THE COLOR(S) GREY AND RED IS/ARE
CLAIMED AS A FEATURE OF THE MARK.

THE COLOR GRAY APPEARS IN THE FOUR
LINES CREATING THE DESIGN OF THE TILTED
SQUARE ON THE LEFT SIDE OF THE MARK. THE
COLOR RED APPEARS IN THE FOUR LINES
CREATING THE DESIGN OF THE TILTED
SQUARE ON THE RIGHT SIDE OF THE MARK.

SER. NO. 79-042,237, FILED 6-13-2007.

KELLEY WELLS, EXAMINING ATTORNEY

Int. Cls.: 35 and 36

Prior U.S. Cls.: 100, 101 and 102

United States Patent and Trademark Office

Reg. No. 3,476,917

Registered July 29, 2008

**SERVICE MARK
PRINCIPAL REGISTER**



COMPAGNIE GENERALE DE LOCATION;
D'EQUIPEMENTS (FRANCE SOCIÉTÉ ANON-
YME A CONSEIL D'ADMINISTRATION)
69 AVENUE DE FLANDRE
F-59700 MARCQ EN BAROEUL
FRANCE

FOR: ADVERTISING, PUBLICITY AND PROMO-
TION SERVICES, DISSEMINATION OF ADVERTIS-
ING MATTERS, PROFESSIONAL BUSINESS
CONSULTANCY, ON-LINE ORDERING SERVICES,
ORGANIZATION OF EXHIBITIONS AND TRADE
FAIRS ALL BEING RENDERED IN THE FIELD OF
FINANCIAL SERVICES FOR VEHICLES AND AP-
PARATUS FOR LOCOMOTION BY AIR, LAND
AND WATER, THEIR PARTS AND ACCESSORIES,
IN CLASS 35 (U.S. CLS. 100, 101 AND 102).

FOR: BANKING, BANKING CONSULTATION,
COMMERCIAL LENDING SERVICES, CONSUMER
LENDING SERVICES, CREDIT AND FINANCIAL
CONSULTATION, CREDIT AGENCIES, HIRE-PUR-
CHASE FINANCING, FINANCIAL SERVICES,
NAMELY, MONEY LENDING AND CURRENCY
EXCHANGE AND ADVICE, INSURANCE CONSUL-
TATION, INSURANCE BROKERAGE, ACCIDENT
INSURANCE UNDERWRITING, MULTI-RISK AND
MULTI PROTECTION AUTO INSURANCE, BREAK-

DOWN VEHICLE AUTO INSURANCE, ALL BEING
RENDERED IN THE FIELD OF VEHICLES AND
APPARATUS FOR LOCOMOTION BY AIR, LAND
AND WATER, THEIR PARTS AND ACCESSORIES,
IN CLASS 36 (U.S. CLS. 100, 101 AND 102).

PRIORITY DATE OF 12-15-2006 IS CLAIMED.

OWNER OF INTERNATIONAL REGISTRATION
0933585 DATED 6-13-2007, EXPIRES 6-13-2017.

THE COLOR(S) GREY AND YELLOW IS/ARE
CLAIMED AS A FEATURE OF THE MARK.

THE COLOR GRAY APPEARS IN THE FOUR
LINES CREATING THE DESIGN OF THE TILTED
SQUARE ON THE LEFT SIDE OF THE MARK. THE
COLOR GOLD APPEARS IN THE FOUR LINES
CREATING THE DESIGN OF THE TILTED
SQUARE ON THE RIGHT SIDE OF THE MARK.

SER. NO. 79-042,238, FILED 6-13-2007.

KELLEY WELLS, EXAMINING ATTORNEY

Int. Cls.: 35 and 36

Prior U.S. Cls.: 100, 101 and 102

United States Patent and Trademark Office

Reg. No. 3,476,918

Registered July 29, 2008

**SERVICE MARK
PRINCIPAL REGISTER**

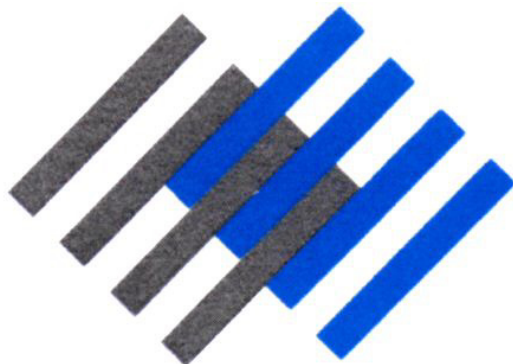

COMPAGNIE GENERALE DE LOCATION;
D'EQUIPEMENTS (FRANCE SOCIÉTÉ ANON-
YME À CONSEIL D'ADMINISTRATION)
69 AVENUE DE FLANDRE
F-59700 MARCQ EN BAROEUL
FRANCE

FOR: ADVERTISING, PUBLICITY AND PROMO-
TION SERVICES, DISSEMINATION OF ADVERTIS-
ING MATTERS, PROFESSIONAL BUSINESS
CONSULTANCY, ONLINE ORDERING SERVICES,
ORGANIZATION OF EXHIBITIONS AND TRADE
FAIRS ALL BEING RENDERED IN THE FIELD OF
FINANCIAL SERVICES FOR VEHICLES AND AP-
PARATUS FOR LOCOMOTION BY AIR, LAND
AND WATER. THEIR PARTS AND ACCESSORIES,
IN CLASS 35 (U.S. CLS. 100, 101 AND 102).

FOR: BANKING, BANKING CONSULTATION,
COMMERCIAL LENDING SERVICES, CONSUMER
LENDING SERVICES, CREDIT AND FINANCIAL
CONSULTATION, CREDIT AGENCIES, HIRE-PUR-
CHASE FINANCING, FINANCIAL SERVICES,
NAMELY, MONEY LENDING AND CURRENCY
EXCHANGE AND ADVICE, INSURANCE CONSUL-
TATION, INSURANCE BROKERAGE, ACCIDENT
INSURANCE UNDERWRITING, MULTI-RISK AND
MULTI-PROTECTION AUTO INSURANCE BREAK-

DOWN VEHICLE AUTO INSURANCE, ALL BEING
RENDERED IN THE FIELD OF VEHICLES AND
APPARATUS FOR LOCOMOTION BY AIR, LAND
AND WATER THEIR PARTS AND ACCESSORIES,
IN CLASS 36 (U.S. CLS. 100, 101 AND 102).

PRIORITY DATE OF 12-15-2006 IS CLAIMED.

OWNER OF INTERNATIONAL REGISTRATION
0933586 DATED 6-13-2007, EXPIRES 6-13-2017.

THE COLOR(S) GREY AND BLUE IS/ARE
CLAIMED AS A FEATURE OF THE MARK.

THE COLOR GRAY APPEARS IN THE FOUR
LINES CREATING THE DESIGN OF THE TILTED
SQUARE ON THE LEFT SIDE OF THE MARK. THE
COLOR BLUE APPEARS IN THE FOUR LINES
CREATING THE DESIGN OF THE TILTED
SQUARE ON THE RIGHT SIDE OF THE MARK.

SER. NO. 79-042,239, FILED 6-13-2007.

KELLEY WELLS, EXAMINING ATTORNEY

Int. Cls.: 35, 38, 39 and 43

Prior U.S. Cls.: 100, 101, 102, 104 and 105

Reg. No. 3,476,919

United States Patent and Trademark Office

Registered July 29, 2008

**SERVICE MARK
PRINCIPAL REGISTER**

SPRICE

TRAVEL META SEARCH, SOCIÉTÉ PRIVÉE DE
DROIT SINGAPOURIEN (SINGAPORE COR-
PORATION)
9B STANLEY STREET
SINGAPOUR 068728
SINGAPORE

FOR: DISTRIBUTION AND UPDATING OF AD-
VERTISEMENTS; RENTAL OF ADVERTISING
SPACE IN PARTICULAR ON COMPUTER NET-
WORKS; COST ANALYSIS OF GOODS AND SER-
VICES, IN PARTICULAR OF SERVICES PROVIDED
BY AIRLINES, HOTELS AND ACCOMMODATION,
SERVICES OF RENTING COACHES, ARRANGING
CRUISES, AND PACKAGE TOUR SERVICES; COM-
PARATIVE TESTS AND QUALITATIVE STUDIES,
IN PARTICULAR OF ALL KINDS OF SERVICES
PROVIDED OVER THE INTERNET, NAMELY,
BUSINESS RESEARCH AND SURVEYS; AUCTION-
EERING OVER THE INTERNET; ORGANIZATION
OF COMMERCIAL OR ADVERTISING EXHIBI-
TIONS AND EVENTS, IN PARTICULAR IN THE
FIELD OF TRAVEL, OF TOURISM, OF HOTELS, OF
ACCOMMODATION AND TRANSPORTATION;
COMMERCIAL ADVICE AND BUSINESS CONSUL-
TATION SERVICES FOR ENTERPRISES IN THE
FIELD OF TRAVEL, TOURISM AND TRANSPOR-
TATION, IN CLASS 35 (U.S. CLS. 100, 101 AND 102).

FOR: TELECOMMUNICATION SERVICES, IN
PARTICULAR VIA THE INTERNET, NAMELY,
PROVIDING ACCESS TO TELECOMMUNICA-
TIONS NETWORKS; SERVICES TRANSMITTING
ONLINE DATA FROM A COMPUTER DATABASE
VIA THE INTERNET, NAMELY, TRANSFER OF
DATA BY TELECOMMUNICATION; PROVISION
AND LEASING OF ACCESS TIME TO DATABANKS,
NAMELY, PROVIDING ACCESS TO DATABASES;
PROVISION OF ACCESS AND LINKS TO COMPU-
TER DATABASES, NAMELY, PROVIDING AN ON-
LINE COMPUTER DATABASE IN THE FIELD OF
TRAVEL INFORMATION SERVICES; COMMUNI-
CATION VIA COMPUTER TERMINALS; PROVID-
ING INFORMATION ON
TELECOMMUNICATIONS; ELECTRONIC MES-

SAGE TRANSMISSION; FORWARDING OF MES-
SAGES OF ALL KINDS TO INTERNET ADDRESSES,
NAMELY, ELECTRONIC STORE-AND-FORWARD
MESSAGING; INTERNET BROADCASTING AND
RADIO BROADCASTING OF DATA, OF SOUNDS
AND IMAGES USING TELECOMMUNICATION
MEDIA, IN CLASS 38 (U.S. CLS. 100, 101 AND 104).

FOR: SERVICES OF TRAVEL AGENTS, IN PAR-
TICULAR RESERVATION OF TRAVEL SEATS,
FLIGHTS, RENTAL OF CARS, RESERVATION OF
CRUISES AND PACKAGE TOURS, NAMELY, TRA-
VEL AND TOUR TICKET RESERVATION SERVICE,
FLIGHT TICKETS RESERVATION SERVICE AND
RENTAL CAR RESERVATION; INFORMATION
RELATING TO TRAVEL AND TOURISM, IN CLASS
39 (U.S. CLS. 100 AND 105).

FOR: HOTEL AND ACCOMMODATION SERVI-
CES, NAMELY, PROVIDING TEMPORARY AC-
COMMODATIONS; ARRANGEMENT OF
HOLIDAY ACCOMMODATION, NAMELY, AR-
RANGING TEMPORARY HOUSING ACCOMMO-
DATIONS; RESERVATION OF HOTELS AND
ACCOMMODATION, NAMELY, RESERVATION
OF HOTEL ROOMS FOR TRAVELERS; INFORMA-
TION PERTAINING TO HOTELS AND LODGINGS,
NAMELY, PROVIDING PERSONALIZED INFOR-
MATION ABOUT HOTELS AND TEMPORARY AC-
COMMODATIONS FOR TRAVEL VIA THE
INTERNET, IN CLASS 43 (U.S. CLS. 100 AND 101).

PRIORITY DATE OF 9-8-2006 IS CLAIMED.

OWNER OF INTERNATIONAL REGISTRATION
0933643 DATED 2-9-2007, EXPIRES 2-9-2017.

THE MARK HAS NO MEANING IN A FOREIGN
LANGUAGE.

SER. NO. 79-042,270, FILED 2-9-2007.

ROBERT STRUCK, EXAMINING ATTORNEY

Int. Cls.: 35, 36 and 41

Prior U.S. Cls.: 100, 101, 102 and 107

Reg. No. 3,476,920

United States Patent and Trademark Office

Registered July 29, 2008

**SERVICE MARK
PRINCIPAL REGISTER**

ART AMBASSADOR INSTITUTE

ZEPHYROS S.R.L. (ITALY LTD LIAB CO)
VIA GABBA FRATELLI, 3
I-20121 MILANO
ITALY

FOR: BUSINESS MANAGEMENT ASSISTANCE, BUSINESS MANAGEMENT CONSULTANCY, EFFICIENCY EXPERTS, BUSINESS MANAGEMENT AND ORGANIZATION CONSULTANCY, BUSINESS APPRAISALS, EXPERTS EVALUATIONS RELATING TO BUSINESS MATTERS, ORGANIZATION OF EXHIBITIONS FOR COMMERCIAL AND ADVERTISING PURPOSES, MARKET STUDY, PUBLIC RELATIONS, MARKET RESEARCH, WORD PROCESSING, BUSINESS ASSESSMENT, ARRANGING AND CONDUCTION OF AUCTION SALES, PROVIDING ADVERTISING SPACE IN PERIODICALS, NEWSPAPERS AND MAGAZINES; DISSEMINATION OF ADVERTISING MATTER; ARRANGING OF SUBSCRIPTIONS FOR THE PUBLICATIONS OF OTHERS, PRODUCT MERCHANDISING, ADVERTISING AGENCIES, RENTAL OF ADVERTISING SPACE, COST/PRICE ANALYSIS, RATING OF ACCOMODATION, BUSINESS AUDITING, PROFESSIONAL BUSINESS CONSULTANCY, COMMERCIAL OR INDUSTRIAL MANAGEMENT ASSISTANCE, IMPORT-EXPORT AGENCIES, SALES PROMOTION FOR OTHERS, RENTAL OF DATA PROCESSING EQUIPMENT, STATISTICAL INFORMATION, AUCTIONEERING, DEMONSTRATION OF GOODS, DISSEMINATION OF ADVERTISING SAMPLES, BOOKKEEPING, PERSONNEL PLACEMENT AND RECRUITMENT, PERSONNEL RELOCATION, PSYCHOLOGICAL TESTING FOR THE SELECTION OF PERSONNEL, PERSONNEL MANAGEMENT, PERSONNEL MANAGEMENT CONSULTATION; SECRETARIAL AND CLERICAL SERVICES, ACCOUNTING, SHOP WINDOW DISPLAY ARRANGEMENT SERVICES; ALL BEING SERVICES FOR THIRD PARTIES, IN CLASS 35 (U.S. CLS. 100, 101 AND 102).

FOR: FINANCIAL ANALYSIS, FINANCIAL INFORMATION PROCESSING, FINANCIAL VALUATION OF PERSONAL PROPERTY AND REAL

ESTATE, FINANCIAL MANAGEMENT, TEMPORARY FINANCING LOANS, LEASE-PURCHASE FINANCING, FUND INVESTMENTS, ELECTRONIC FUNDS TRANSFER, FINANCING SERVICES, FINANCIAL EXCHANGE, FINANCIAL FORECASTING, FINANCIAL GUARANTEE AND SURETY, FINANCIAL CONSULTANCY, ANTIQUE OBJECT APPRAISAL, INSURANCE BROKERAGE, INSURANCE CONSULTANCY, INSURANCE ADMINISTRATION, INSURANCE UNDERWRITING, UNDERWRITING FIDELITY INSURANCE, CREDIT AND DEBIT CARD SERVICES, SAFE DEPOSIT BOX SERVICES, MONETARY EXCHANGE, HOME BANKING, MORTGAGE BANKING, TRUSTEESHIP REPRESENTATION, REAL ESTATE AGENCIES, REAL ESTATE APPRAISAL, LEASING OF REAL ESTATE, REAL ESTATE BROKERAGE, REAL ESTATE MANAGEMENT, REAL ESTATE DEVELOPMENT, REAL ESTATE PROCUREMENT FOR OTHERS, TOLL COLLECTION AND PAYMENT SERVICES FOR URBAN AND EXTRAURBAN HIGHWAYS, FOR CAR PARKS, FOR PASSING OVER A BRIDGE AND THROUGH TUNNELS, RENTAL OF OFFICES, APARTMENTS AND FLATS, HOUSING AGENCIES, ALL BEING SERVICES FOR THIRD PARTIES, IN CLASS 36 (U.S. CLS. 100, 101 AND 102).

FOR: PUBLICATION OF BOOKS AND MAGAZINES, PUBLICATION OF TEXTS EXCEPT OF ADVERTISING TEXTS, PRESENTATIONS IN MUSEUMS, NAMELY, ART EXHIBITIONS, ARRANGING AND CONDUCTING CONVENTIONS, CONGRESSES, CONFERENCES, SEMINARS AND SYMPOSIA ALL IN THE FIELDS OF MEDICINE, HISTORY, ART, AND SCIENCE FOR EDUCATIONAL AND CULTURAL PURPOSES; ORGANIZATION OF EXHIBITIONS FOR EDUCATIONAL, CULTURAL OR ENTERTAINMENT PURPOSES IN THE FIELDS OF MEDICINE, HISTORY, ART, AND SCIENCE, ORGANIZATION OF COMMUNITY SPORTING AND CULTURAL EVENTS, ORGANIZING AND CONDUCTING TRAINING CLASSES, SEMINARS AND WORKSHOPS IN THE FIELD OF MUSIC, ART AND WRITING, IN COOKERY, IN

PERSONAL AWARENESS; EDUCATIONAL SERVICES IN THE NATURE OF FINE ARTS SCHOOLS AND IN THE NATURE OF COURSES AT THE UNIVERSITY LEVEL, COMPUTER EDUCATION TRAINING, SWIMMING INSTRUCTION, HORSE TRAINING, CONDUCTING HORSE RACES, AMUSEMENT PARKS, ORGANIZING ENTERTAINMENT FESTIVALS, NAMELY, CULTURAL FESTIVALS AND ETHNIC FESTIVALS, FLEA MARKETS, PERSONAL DEVELOPMENT, NAMELY, STRENGTH AND CONDITIONING TRAINING, ARRANGING FOR TICKET RESERVATIONS FOR SHOWS AND OTHER ENTERTAINMENT EVENTS; CASINOS; ENTERTAINMENT EVENTS IN THE NATURE OF THEATER PRODUCTIONS, OF BALLET AND DANCE PERFORMANCES, OF ORCHESTRA PERFORMANCES, OF ATHLETIC COMPETITIONS, OF LIVE MUSICAL GROUP PERFORMANCES, OF MUSICAL BAND PERFORMANCES, OF COMEDY SHOWS, OF MUSICAL VARIETY SHOWS, OF AMUSEMENT PARK RIDES, OF FASHION SHOWS, OF GOLF TOURNAMENTS, OF TENNIS TOURNAMENTS, OF SOCCER AND FOOTBALL GAMES, AND OF TRACK AND FIELD

COMPETITIONS, MULTIMEDIA ENTERTAINMENT SOFTWARE PRODUCTION SERVICES, PROVIDING ON-LINE COMPUTER GAMES FOR OTHERS, PRODUCTION AND RENTAL OF MOTION PICTURE FILMS AND OF MOVIES; RENTAL OF BOOKS, RENTAL OF COMPUTER GAME PROGRAMS; ALL BEING SERVICES FOR THIRD PARTIES, IN CLASS 41 (U.S. CLS. 100, 101 AND 107).

THE MARK CONSISTS OF STANDARD CHARACTERS WITHOUT CLAIM TO ANY PARTICULAR FONT, STYLE, SIZE, OR COLOR.

OWNER OF INTERNATIONAL REGISTRATION 0933670 DATED 4-16-2007, EXPIRES 4-16-2017.

NO CLAIM IS MADE TO THE EXCLUSIVE RIGHT TO USE "INSTITUTE", APART FROM THE MARK AS SHOWN.

SER. NO. 79-042,278, FILED 4-16-2007.

DOMINIC FATHY, EXAMINING ATTORNEY

Int. Cls.: 35, 36, 38 and 39

Prior U.S. Cls.: 100, 101, 102, 104 and 105

United States Patent and Trademark Office

Reg. No. 3,476,921

Registered July 29, 2008

**SERVICE MARK
PRINCIPAL REGISTER**



CONG TY CO PHAN DICH VU BUU CHINH
VIEN THONG SAI GON (VIETNAM COR-
PORATION)

45 LE DUAN

PHUONG BEN NGHE,; QUAN 1; TP. HO CHI MINH
VIETNAM

FOR: PROVIDING INFORMATION ABOUT THE
TRADING OF POST AND TELECOMMUNICA-
TIONS EQUIPMENT, IN CLASS 35 (U.S. CLS. 100,
101 AND 102).

FOR: MONEY TRANSFER SERVICES, IN CLASS
36 (U.S. CLS. 100, 101 AND 102).

FOR: PROVISION OF PUBLIC TELECOMMUNI-
CATIONS NETWORK SERVICES, NAMELY, LOCAL
AND LONG DISTANCE TELEPHONE SERVICES;
TELECOMMUNICATIONS SERVICES, NAMELY,
ELECTRONIC DATA TRANSMISSION SERVICES,
INTERNET SERVICE PROVIDER, INTERNET TEL-
EPHONY SERVICES, MOBILE TELEPHONE COM-
MUNICATION SERVICES, CO-LOCATION
SERVICES FOR VOICE, VIDEO AND DATA COM-
MUNICATIONS, AND VOICE OVER IP SERVICES;
TELECOMMUNICATION CONSULTATION IN THE
NATURE OF TECHNICAL CONSULTING IN THE
FIELD OF AUDIO, TEXT AND VISUAL DATA

TRANSMISSION AND COMMUNICATION, IN
CLASS 38 (U.S. CLS. 100, 101 AND 104).

FOR: POSTAL SERVICES, NAMELY, EXPRESS
PARCEL DELIVERY, PACKAGING ARTICLES FOR
TRANSPORTATION, AND RENTAL OF MAIL-
BOXES, IN CLASS 39 (U.S. CLS. 100 AND 105).

PRIORITY DATE OF 8-1-2006 IS CLAIMED.

OWNER OF INTERNATIONAL REGISTRATION
0933715 DATED 1-25-2007, EXPIRES 1-25-2017.

THE COLOR(S) BLUE AND WHITE IS/ARE
CLAIMED AS A FEATURE OF THE MARK.

THE MARK CONSISTS OF THE COLOR BLUE
WHICH APPEARS IN THE DESIGN ELEMENT AND
IN THE LETTERS "SPT", AND THE COLOR WHITE
APPEARS IN THE BACKGROUND.

SER. NO. 79-042,296, FILED 1-25-2007.

DAYNA BROWNE, EXAMINING ATTORNEY

Int. Cls.: 12 and 17

Prior U.S. Cls.: 1, 5, 12, 13, 19, 21, 23, 31, 35, 44 and 50

United States Patent and Trademark Office

Reg. No. 3,476,922

Registered July 29, 2008

**TRADEMARK
PRINCIPAL REGISTER**

BLACK CHILI

CONTINENTAL AKTIENGESELLSCHAFT (FED
REP GERMANY JOINT STOCK COMPANY)
VAHRENWALDER STRABE 9
30165 HANNOVER, FED REP GERMANY

FOR: VEHICLE TIRES, INNER TUBES FOR VE-
HICLE TIRES, SOLID RUBBER TIRES, IN CLASS 12
(U.S. CLS. 19, 21, 23, 31, 35 AND 44).

FOR: NATURAL RUBBER, GUTTA-PERCHA,
RUBBER, RUBBER COMPOUND FOR USE IN THE
MANUFACTURE OF PARTS OF AUTOMOBILES,
TRUCKS, BOATS AND PLANES, IN CLASS 17 (U.S.
CLS. 1, 5, 12, 13, 35 AND 50).

THE MARK CONSISTS OF STANDARD CHAR-
ACTERS WITHOUT CLAIM TO ANY PARTICULAR
FONT, STYLE, SIZE, OR COLOR.

PRIORITY DATE OF 1-24-2007 IS CLAIMED.

OWNER OF INTERNATIONAL REGISTRATION
0933731 DATED 4-12-2007, EXPIRES 4-12-2017.

SER. NO. 79-042,305, FILED 4-12-2007.

DOMINIC FATHY, EXAMINING ATTORNEY

Int. Cl.: 30

Prior U.S. Cl.: 46

United States Patent and Trademark Office

Reg. No. 3,476,923

Registered July 29, 2008

TRADEMARK
PRINCIPAL REGISTER



BORELLA & C. S.R.L. (ITALY LTD LIAB CO)
VIA INDUSTRIA, 49
I-30010 CAMPANOGARA (VENEZIA)
ITALY

OWNER OF INTERNATIONAL REGISTRATION
0933780 DATED 6-8-2007, EXPIRES 6-8-2017.

NO CLAIM IS MADE TO THE EXCLUSIVE
RIGHT TO USE "BIGOLI" , APART FROM THE
MARK AS SHOWN.

FOR: DOUGH, FLOUR, WHEAT FLOUR, RICE
FLOUR, CORN FLOUR, SOYA PROCESSED CER-
EALS, BREAKFAST CEREALS, PROCESSED
WHEAT, CORN FLAKES, PUFFED CORN SNACKS,
CEREAL-BASED SNACK FOOD, BAKERY GOODS,
TORTILLAS, PIZZAS, POPPED POPCORN, FLOUR-
BASED CHIPS, GRAIN-BASED CHIPS, TACO CHIPS,
TORTILLA CHIPS, CRÊPES, FLOUR-BASED PRE-
PARED MEALS; BREAD AND BUN, COOKIES,
BISCUITS, BRIOCHES, CROISSANTS, WAFFLES,
MARZIPAN, PANCAKES, CAKES AND PIES,
YEAST, BAKING POWDER, IN CLASS 30 (U.S. CL.
46).

THE MARK CONSISTS OF A SIGN COMPOSED
OF THE WORDING "BIGOLI DE BASSAN" IN
FANCY CHARACTERS, PARTIALLY OVERLAP-
PING THE ILLUSTRATION OF A STYLIZED
BRIDGE THAT CROSSES A RIVER SURROUNDED
BY HOUSES ON BOTH BANKS, AND PLACED IN
COMBINATION WITH A CIRCULAR ILLUSTRA-
TION CONTAINING THE STYLIZED ILLUSTRATION
OF A HAT WITH A FEATHER.

SER. NO. 79-042,326, FILED 6-8-2007.

PRIORITY DATE OF 3-29-2007 IS CLAIMED.

DOMINIC FATHY, EXAMINING ATTORNEY

Int. Cls.: 1, 30, 35 and 42

Prior U.S. Cls.: 1, 5, 6, 10, 26, 46, 100, 101 and 102

United States Patent and Trademark Office

Reg. No. 3,476,924

Registered July 29, 2008

**TRADEMARK
SERVICE MARK
PRINCIPAL REGISTER**



DSM IP ASSETS B.V. (NETHERLANDS DUTCH
LIMITED LIABILITY COMPANY)
HET OVERLOON 1
NL-6411 TE HEERLEN
NETHERLANDS

FOR: CHEMICALS FOR USE IN INDUSTRY;
BIOCHEMICALS, NAMELY, DETOXIFYING
AGENTS USED IN INDUSTRY; CHEMICAL ADDI-
TIVES AND BIOCHEMICAL ADDITIVES, NAMELY,
DETOXIFYING AGENTS FOR USE IN WINE MAK-
ING, IN CLASS 1 (U.S. CLS. 1, 5, 6, 10, 26 AND 46).

FOR: YEAST; YEAST EXTRACTS, IN CLASS 30
(U.S. CL. 46).

FOR: ADVERTISING SERVICES; RETAIL STORE
SERVICES FEATURING YEAST AND FEATURING
CHEMICALS AND BIOCHEMICALS FOR WINE
MAKING, IN CLASS 35 (U.S. CLS. 100, 101 AND 102).

FOR: SCIENTIFIC RESEARCH AND CONSUL-
TANCY IN THE FIELD OF CHEMICAL PROCESSES,
IN CLASS 42 (U.S. CLS. 100 AND 101).

PRIORITY DATE OF 1-26-2007 IS CLAIMED.

OWNER OF INTERNATIONAL REGISTRATION
0933811 DATED 7-20-2007, EXPIRES 7-20-2017.

OWNER OF U.S. REG. NOS. 813,235 AND 1,249,543.

THE MARK CONSISTS OF THE LETTERS "H",
"A", "L" AND "O", A PARTIAL ARC AROUND THE
LETTERS "H" AND "A", AND THE LETTER "L"
APPEARS ABOVE THE LETTER "O".

SER. NO. 79-042,340, FILED 7-20-2007.

BERNICE MIDDLETON, EXAMINING ATTORNEY

Int. Cls.: 1, 3 and 5

Prior U.S. Cls.: 1, 4, 5, 6, 10, 18, 26, 44, 46, 50, 51 and 52

Reg. No. 3,476,925

United States Patent and Trademark Office

Registered July 29, 2008

**TRADEMARK
PRINCIPAL REGISTER**

BEAUACTIVE

DSM IP ASSETS B.V. (NETHERLANDS PRIVATE LIMITED COMPANY)
HET OVERLOON 1
NL-6411 TE HEERLEN
NETHERLANDS

FOR: CHEMICAL PREPARATIONS FOR THE MANUFACTURE OF COSMETICS AND SKIN-CARE PRODUCTS, OTHER THAN FOR MEDICAL OR VETERINARY PURPOSES; BIOCHEMICAL SUBSTANCES, NAMELY, PEPTIDES, MILK PROTEINS, FOR THE MANUFACTURE OF COSMETICS AND SKIN-CARE PRODUCTS, OTHER THAN FOR MEDICAL OR VETERINARY PURPOSES, IN CLASS 1 (U.S. CLS. 1, 5, 6, 10, 26 AND 46).

FOR: COSMETICS; COSMETICS FOR SKIN-CARE; HAIR LOTIONS; PRODUCTS FOR SKIN-CARE, NAMELY, WRINKLE REMOVING SKIN-CARE PREPARATIONS; COSMETIC PREPARATIONS FOR SKIN RENEWAL; NON-MEDICATED PREPARATIONS ALL FOR THE CARE OF SKIN, HAIR AND SCALP; SKIN LOTIONS, CREAMS, GELS, TEXTURIZERS, TONERS AND POWDERS; SKIN AND BODY TOPICAL LOTIONS, CREAMS AND OILS FOR COSMETIC USE; NON-MEDICATED SKIN CARE PREPARATIONS, NAMELY, LOTIONS, CREAMS, GELS, TEXTURIZERS, TONERS AND POWDERS, IN CLASS 3 (U.S. CLS. 1, 4, 6, 50, 51 AND 52).

FOR: PHARMACEUTICAL PREPARATIONS FOR SKIN CARE FOR COLLAGEN INDUCTION, ANTI-AGING, REDUCTION OF WRINKLES AND LINES, IMPROVED SKIN TEXTURE; MEDICATED SKIN CARE PREPARATIONS; MEDICATED SKIN CARE PRODUCTS, NAMELY, BIOCHEMICAL PREPARATIONS FOR MEDICAL PURPOSES, MEDICINAL CREAMS FOR SKIN CARE, MEDICATED SKIN CARE PREPARATIONS, NAMELY, LOTIONS, CREAMS, GELS, TEXTURIZERS, TONERS AND POWDERS, NUTRITIONAL SUPPLEMENTS IN LOTION FORM SOLD AS A COMPONENT OF NUTRITIONAL SKIN CARE PRODUCTS, IN CLASS 5 (U.S. CLS. 6, 18, 44, 46, 51 AND 52).

THE MARK CONSISTS OF STANDARD CHARACTERS WITHOUT CLAIM TO ANY PARTICULAR FONT, STYLE, SIZE, OR COLOR.

PRIORITY DATE OF 2-1-2007 IS CLAIMED.

OWNER OF INTERNATIONAL REGISTRATION 0933825 DATED 7-27-2007, EXPIRES 7-27-2017.

SER. NO. 79-042,343, FILED 7-27-2007.

BERNICE MIDDLETON, EXAMINING ATTORNEY

Int. Cls.: 29 and 30

Prior U.S. Cl.: 46

United States Patent and Trademark Office

Reg. No. 3,476,926

Registered July 29, 2008

**TRADEMARK
PRINCIPAL REGISTER**



PRE GEL S.P.A. (ITALY JOINT STOCK COMPANY)
VIA COMPARONI, 64
I-42029 VILLA GAVASSETO (RE)
ITALY

OWNER OF INTERNATIONAL REGISTRATION
0933843 DATED 6-4-2007, EXPIRES 6-4-2017.

FOR: MILK AND MILK PRODUCTS EXCLUDING ICE CREAM, ICE MILK AND FROZEN YOGURT; MILK BEVERAGES WITH MILK AS DOMINANT INGREDIENT, IN CLASS 29 (U.S. CL. 46).

THE MARK IS MADE OF THE WORDING "HAPPY YO" IN FANCIFUL CHARACTERS. TWO DIVERGING LINES, ONE WITH CURVILINEAR EDGES, THE OTHER WITH A CURVILINEAR EDGE AND A SUBSTANTIALLY RECTILINEAR EDGE, LEAD OFF THE LETTER "O".

FOR: SEMI PROCESSED FOOD ADDITIVES FOR NON-NUTRITIONAL PURPOSES FOR ICE CREAMS AND PASTRIES, NAMELY, SEASONING PASTES, SEASONING POWDERS AND FLAVOURINGS, IN CLASS 30 (U.S. CL. 46).

SER. NO. 79-042,358, FILED 6-4-2007.

PRIORITY DATE OF 5-24-2007 IS CLAIMED.

MARILYN IZZI, EXAMINING ATTORNEY

Int. Cls.: 29 and 30

Prior U.S. Cl.: 46

United States Patent and Trademark Office

Reg. No. 3,476,927

Registered July 29, 2008

**TRADEMARK
PRINCIPAL REGISTER**



PRE GEL S.P.A. (ITALY JOINT STOCK COMPANY)
VIA COMPARONI, 64
I-42029 VILLA GAVASSETO (RE)
ITALY

OWNER OF INTERNATIONAL REGISTRATION
0933844 DATED 6-4-2007, EXPIRES 6-4-2017.

FOR: MILK AND MILK PRODUCTS EXCLUDING ICE CREAM, ICE MILK AND FROZEN YOGURT; MILK BEVERAGES WITH MILK AS DOMINANT INGREDIENT, IN CLASS 29 (U.S. CL. 46).

THE MARK IS MADE OF THE WORDING "YO-TIME" IN FANCIFUL CHARACTERS; TWO THICK DIVERGING LINES HAVING CURVILINEAR OUTLINE LEAD OFF THE LETTER "O", WHILST A CURVED LINE SURMOUNTED BY THREE DESIGNS WITH IRREGULAR CONTOUR SHAPED LIKE SPOTS LEADS OFF THE LETTER "Y".

FOR: SEMI PROCESSED FOOD ADDITIVES FOR NON-NUTRITIONAL PURPOSES FOR ICE CREAMS AND PASTRIES, NAMELY, SEASONING PASTES, SEASONING POWDERS AND FLAVOURINGS, IN CLASS 30 (U.S. CL. 46).

SER. NO. 79-042,359, FILED 6-4-2007.

PRIORITY DATE OF 5-24-2007 IS CLAIMED.

MARILYN IZZI, EXAMINING ATTORNEY

Int. Cls.: 3, 4, 5, 14, 16, 24, 25, 27 and 35

Prior U.S. Cls.: 1, 2, 4, 5, 6, 15, 18, 19, 20, 22, 23, 27, 28, 29, 37, 38, 39, 42, 44, 46, 50, 51, 52, 100, 101 and 102

Reg. No. 3,476,928

United States Patent and Trademark Office

Registered July 29, 2008

**TRADEMARK
SERVICE MARK
PRINCIPAL REGISTER**

THE WHITE COMPANY

THE WHITE COMPANY (UK) LIMITED (UNITED KINGDOM LTD LIAB CO)
UNIT 30 PERIVALE INDUSTRIAL PARK
HORSENDEN LANE SOUTH; GREENFORD, MIDDLESEX UB6 7RJ
UNITED KINGDOM

FOR: SOAPS FOR PERSONAL USE; NON-MEDICATED BATH AND SHOWER WASHES, MILKS, OILS, CREAMS AND GELS; NON-MEDICATED NAIL HAND AND BODY CREAMS, SERUMS, MILKS, GELS, OILS, MOISTURIZERS, LOTIONS; PERFUMES AND PERFUMERY; ESSENTIAL AND HERBAL OILS FOR PERSONAL USE; COSMETICS AND NON-MEDICATED TOILETRIES; INCENSE; PREPARATIONS FOR USE BEFORE SHAVING AND AFTER SHAVING; SHAVING SOAP, SHAVING CREAM AND SHAVING GELS; POTPOURRI, IN CLASS 3 (U.S. CLS. 1, 4, 6, 50, 51 AND 52).

FOR: CANDLES, FRAGRANCED AND SCENTED CANDLES; ILLUMINANTS, TAPERS, WICKS AND LAMP OIL, IN CLASS 4 (U.S. CLS. 1, 6 AND 15).

FOR: AIR FRESHENING PREPARATIONS; AROMATIC PREPARATIONS AND SUBSTANCES FOR FRESHENING THE AIR; PREPARATIONS FOR FRESHENING THE AMBIENT ATMOSPHERE; ROOM AIR FRESHENERS, IN CLASS 5 (U.S. CLS. 6, 18, 44, 46, 51 AND 52).

FOR: JEWELRY CASES NOT MADE OF PRECIOUS METAL, IN CLASS 14 (U.S. CLS. 2, 27, 28 AND 50).

FOR: WRITING PAPER; WRITING PAPER HOLDERS; ENGAGEMENT CARDS, VISITING CARDS, INVITATION CARDS; NOTEBOOKS; BOOK COVERS; BOOK MARKS; PRINTS; PICTURES; PHOTOGRAPHS; PHOTOGRAPH ALBUMS; PEN AND PENCIL HOLDERS; PENS AND PENCILS; STATIONERY; PRINTED PUBLICATIONS, NAMELY, CATALOGS IN THE FIELD OF CLOTHING, GENERAL HOUSEWARES AND BATH PRODUCTS; CALEN-

DARS, DIARIES; PAPER TAGS AND LABELS; PAPER PACKAGING MATERIALS, NAMELY, CARDBOARD GIFT BOXES AND STORAGE BOXES, IN CLASS 16 (U.S. CLS. 2, 5, 22, 23, 29, 37, 38 AND 50).

FOR: TEXTILES AND TEXTILE GOODS, NAMELY, BED AND TABLE COVERS, HOUSEHOLD LINEN, LINEN CLOTH, BED LINEN, TABLE LINEN, CURTAINS, PILLOW SHAMS, PILLOW CASES, BED SHEETS, TOWELS, EIDERDOWNS, DUVETS, COVERS FOR EIDERDOWNS AND DUVETS, NAPKINS, SERVIETTES, FACE TOWELS, FLANNELS, TISSUES OF TEXTILE FOR REMOVING MAKE-UP, IN CLASS 24 (U.S. CLS. 42 AND 50).

FOR: CLOTHING, NAMELY, SHIRTS, SHORTS, PANTS, SKIRTS, BLOUSES, SWEATERS, VESTS, SOCKS, SLIPPERS AND SLEEPWEAR; FOOTWEAR; HEADGEAR, NAMELY, HATS AND CAPS, IN CLASS 25 (U.S. CLS. 22 AND 39).

FOR: RUGS, BATH MATS, IN CLASS 27 (U.S. CLS. 19, 20, 37, 42 AND 50).

FOR: RETAIL STORE SERVICES AND RETAIL STORE SERVICES PROVIDED VIA MAIL ORDER CATALOGUE AND PROVIDED OVER THE INTERNET, ALL FEATURING TOILETRIES AND COSMETICS, CANDLES AND INCENSE, HAND TOOLS AND IMPLEMENTS, RAZORS, GOODS OF PRECIOUS METALS AND THEIR ALLOYS, PHOTO FRAMES, NAPKIN RINGS AND CUTLERY, JEWELRY AND PRECIOUS STONES, HOROLOGICAL AND CHRONOMETRIC INSTRUMENTS, WRITING PAPER, PHOTOGRAPHS, STATIONERY, GOODS OF LEATHER AND IMITATION LEATHER, TRUNKS AND TRAVELING BAGS, UMBRELLAS, HOUSEHOLD AND KITCHEN UTENSILS AND CONTAINERS, COMBS AND SPONGES, BRUSHES, GOODS OF UNWORKED OR SEMI-WORKED GLASS, GLASSWARE, PORCELAIN AND EARTHENWARE, CROCKERY, TEXTILES AND TEXTILE GOODS, BED AND TABLEWARE, CLOTHING,

FOOTWEAR, HEADGEAR, CARPETS, RUGS, MATS AND MATTING, WALL-HANGINGS, GAMES AND PLAYTHINGS, DECORATIONS FOR CHRISTMAS TREES AND SOFT TOYS, IN CLASS 35 (U.S. CLS. 100, 101 AND 102).

THE MARK CONSISTS OF STANDARD CHARACTERS WITHOUT CLAIM TO ANY PARTICULAR FONT, STYLE, SIZE, OR COLOR.

PRIORITY DATE OF 3-21-2007 IS CLAIMED.

OWNER OF INTERNATIONAL REGISTRATION 0933951 DATED 6-6-2007, EXPIRES 6-6-2017.

OWNER OF U.S. REG. NOS. 3,021,197 AND 3,029,459.

NO CLAIM IS MADE TO THE EXCLUSIVE RIGHT TO USE COMPANY, APART FROM THE MARK AS SHOWN.

SER. NO. 79-042,395, FILED 6-6-2007.

PETER B. BROMAGHIM, EXAMINING ATTORNEY

Int. Cl.: 7

Prior U.S. Cls.: 13, 19, 21, 23, 31, 34 and 35

United States Patent and Trademark Office

Reg. No. 3,476,929

Registered July 29, 2008

**TRADEMARK
PRINCIPAL REGISTER**

SJEC

SUZHOU JIANGNAN JIAJIE ELEVATOR COR-
PORATION
88 LOUJIANG ROAD,
SUZHOU INDUSTRIAL PARKSUZHOU
CHINA

OWNER OF INTERNATIONAL REGISTRATION
0933987 DATED 8-6-2007, EXPIRES 8-6-2017.

FOR: ELEVATORS; ELEVATING APPARATUS,
NAMELY, MOVING WALKWAYS; HOISTS; ESCA-
LATORS, IN CLASS 7 (U.S. CLS. 13, 19, 21, 23, 31, 34
AND 35).

SER. NO. 79-042,412, FILED 8-6-2007.

KRISTIN DAHLING, EXAMINING ATTORNEY

Int. Cls.: 9 and 42

Prior U.S. Cls.: 21, 23, 26, 36, 38, 100 and 101

United States Patent and Trademark Office

Reg. No. 3,476,930

Registered July 29, 2008

**TRADEMARK
SERVICE MARK
PRINCIPAL REGISTER**

MEDIAHEDGE

KONINKLIJKE PHILIPS ELECTRONICS N.V.
(NETHERLANDS LTD LIAB CO)

GROENEWOUDSEWEG 1
NL-5621 BA EINDHOVEN
NETHERLANDS

FOR: SOFTWARE FOR CONTENT IDENTIFICATION USING WATERMARKING, FINGERPRINTING, TO ENCODE ACCESS RIGHTS TO THE CONTENT; SOFTWARE FOR CONTENT RIGHTS CLEARING BY READING WATERMARKING, FINGERPRINTING ENCODED IN THE CONTENT TO DETERMINE ACCESS RIGHTS TO THE CONTENT, IN CLASS 9 (U.S. CLS. 21, 23, 26, 36 AND 38).

FOR: DEVELOPMENT, INSTALLATION AND UPDATING OF SOFTWARE, IN CLASS 42 (U.S. CLS. 100 AND 101).

THE MARK CONSISTS OF STANDARD CHARACTERS WITHOUT CLAIM TO ANY PARTICULAR FONT, STYLE, SIZE, OR COLOR.

OWNER OF INTERNATIONAL REGISTRATION
0934099 DATED 7-10-2007, EXPIRES 7-10-2017.

SER. NO. 79-042,449, FILED 7-10-2007.

PETER B. BROMAGHIM, EXAMINING ATTORNEY

Int. Cls.: 35 and 42

Prior U.S. Cls.: 100, 101 and 102

United States Patent and Trademark Office

Reg. No. 3,476,931

Registered July 29, 2008

**SERVICE MARK
PRINCIPAL REGISTER**



BLUEFREEWAY LIMITED; ACN: 122 262 819
(AUSTRALIA PUBLICLY LISTED COMPANY
LISTED BY SHARES)

LEVEL 2

151 MACQUARIE STREET; SYDNEY NSW 2000
AUSTRALIA

FOR: ADVERTISING SERVICES, BUSINESS
MANAGEMENT, BUSINESS ADMINISTRATION;
PROVIDING OFFICE FUNCTIONS , IN CLASS 35
(U.S. CLS. 100, 101 AND 102).

FOR: SCIENTIFIC AND TECHNOLOGICAL CON-
SULTATION IN THE FIELD OF ONLINE MARKET-
ING AND WEB HOSTING INCLUDING SOFTWARE
SYSTEMS, AND RESEARCH AND DESIGN RELAT-
ING THERETO; INDUSTRIAL ANALYSIS IN THE
FIELD OF ONLINE MARKETING AND COMMU-
NICATIONS AND WEBHOSTING; INDUSTRIAL
RESEARCH IN THE FIELD OF TECHNOLOGY
FOR ONLINE MARKETING, COMMUNICATIONS
AND WEBHOSTING; DESIGN AND DEVELOP-
MENT OF COMPUTER SOFTWARE, IN CLASS 42
(U.S. CLS. 100 AND 101).

OWNER OF INTERNATIONAL REGISTRATION
0934205 DATED 8-2-2007, EXPIRES 8-2-2017.

OWNER OF U.S. REG. NO. 3,366,208.

THE COLOR(S) NAVY BLUE, LIGHT BLUE,
BLUE, AND DARK BLUE IS/ARE CLAIMED AS A
FEATURE OF THE MARK.

THE COLOR NAVY BLUE APPEARS IN THE
WORDING "BLUE" AND "ANALYSE. CREATE.
OPTIMISE."; THE COLOR LIGHT BLUE APPEARS
IN THE WORD "FREEWAY" AND IN THE UPPER
LEFT REGION OF THE PYRAMID DESIGN; THE
COLOR BLUE APPEARS IN THE UPPER RIGHT
REGION OF THE PYRAMID DESIGN; AND THE
COLOR DARK BLUE APPEARS IN THE LOWER
REGION OF THE PYRAMID DESIGN.

SER. NO. 79-042,489, FILED 8-2-2007.

KATHERINE E. HALMEN, EXAMINING ATTOR-
NEY

Int. Cls.: 21 and 25

Prior U.S. Cls.: 2, 13, 22, 23, 29, 30, 33, 39, 40 and 50

United States Patent and Trademark Office

Reg. No. 3,476,932

Registered July 29, 2008

**TRADEMARK
PRINCIPAL REGISTER**



MEMPHIS, S.R.L. (ITALY SOCIÉTÉ À RESPONSABILITÉ LIMITÉE)
9, VIA OLIVETTI,
I-20010 PREGNANA MILANESE
ITALY

FOR: VASES OF PORCELAIN, CRYSTAL OR GLASS; FLOWERPOTS OF PORCELAIN, CRYSTAL OR GLASS; FRUIT DISHES OF PORCELAIN, CRYSTAL OR GLASS; TEAPOTS OF PORCELAIN, CRYSTAL OR GLASS; CUPS OF PORCELAIN, CRYSTAL OR GLASS; TRAYS FOR DOMESTIC PURPOSES OF PORCELAIN, CRYSTAL OR GLASS; DRINKING GLASSES OF PORCELAIN, CRYSTAL OR GLASS; DISHES OF PORCELAIN, CRYSTAL OR GLASS; CONTAINERS FOR HOUSEHOLD OR KITCHEN USE OF PORCELAIN, CRYSTAL OR GLASS; COFFEE SERVICES OF PORCELAIN, CRYSTAL OR GLASS; TEA SERVICES OF PORCELAIN, CRYSTAL OR GLASS; SALAD BOWLS OF PORCELAIN, CRYSTAL OR GLASS; FRUIT CUPS OF PORCELAIN, CRYSTAL OR GLASS; GLASS BOXES; URNS OF PORCELAIN, CRYSTAL OR GLASS; STATUETTES OF PORCELAIN, CRYSTAL OR GLASS; CUPS OF PORCELAIN, CRYSTAL OR GLASS; EMPTY PER-

FUME VAPORIZERS OF PORCELAIN, CRYSTAL OR GLASS, IN CLASS 21 (U.S. CLS. 2, 13, 23, 29, 30, 33, 40 AND 50).

FOR: OVERCOATS, JACKETS, WATERPROOF JACKET AND PANTS, SHIRTS, JERSEYS, BLOUSONS, SKIRTS, TROUSERS, SWIMSUITS, BATHROBES, SHAWLS, SCARVES, NECKTIES, BELTS, BOOTS, FOOTWEAR, SLIPPERS, GLOVES, HATS, LINGERIE, SASHES FOR WEAR, IN CLASS 25 (U.S. CLS. 22 AND 39).

OWNER OF INTERNATIONAL REGISTRATION
0536377 DATED 4-17-1989, EXPIRES 4-17-2009.

NO CLAIM IS MADE TO THE EXCLUSIVE RIGHT TO USE "MILANO", APART FROM THE MARK AS SHOWN.

SER. NO. 79-042,504, FILED 12-20-2006.

ANGELA M. MICHELI, EXAMINING ATTORNEY

Int. Cl.: 12

Prior U.S. Cls.: 19, 21, 23, 31, 35 and 44

United States Patent and Trademark Office

Reg. No. 3,476,933

Registered July 29, 2008

**TRADEMARK
PRINCIPAL REGISTER**



IVECO S.P.A. (ITALY CORPORATION)
VIA PUGLIA, 35
I-10156 TORINO
ITALY

FOR: MOTOR VEHICLES, NAMELY, TRUCKS
AND VANS, IN CLASS 12 (U.S. CLS. 19, 21, 23, 31, 35
AND 44).

PRIORITY DATE OF 4-6-2007 IS CLAIMED.

OWNER OF INTERNATIONAL REGISTRATION
0934565 DATED 6-12-2007, EXPIRES 6-12-2017.

THE TRADEMARK CONSISTS OF THE WORD-
ING "AS3" IN FANCIFUL LETTERS.

"AS3" HAS NO MEANING IN A FOREIGN LAN-
GUAGE.

SER. NO. 79-042,638, FILED 6-12-2007.

WILLIAM ROSSMAN, EXAMINING ATTORNEY

Int. Cls.: 5 and 10

Prior U.S. Cls.: 6, 18, 26, 39, 44, 46, 51 and 52

United States Patent and Trademark Office

Reg. No. 3,476,934

Registered July 29, 2008

**TRADEMARK
PRINCIPAL REGISTER**

TUTOGRAFT

TUTOGEN MEDICAL GMBH (FED REP GER-
MANY LTD LIAB CO)
INDUSTRIESTR. 6
91077 NEUNKIRCHEN AM BRAND
FED REP GERMANY

FOR: BIOLOGICAL IMPLANTS, NAMELY, AVI-
TAL PROCESSED HUMAN OR ANIMAL CONNec-
TIVE OR SUPPORTIVE TISSUE, BIOLOGICAL
BONE TISSUE INTENDED FOR SUBSEQUENT IM-
PLANTATION, SURGICAL IMPLANTS COMPRIS-
ING LIVING TISSUE, NAMELY, BONE IMPLANTS
MADE FROM NATURAL BONE AND DEHYDRA-
TED HUMAN DURA MATTER, IN CLASS 5 (U.S.
CLS. 6, 18, 44, 46, 51 AND 52).

FOR: SURGICAL IMPLANTS COMPRISING AR-
TIFICIAL BONE MATERIAL, DENTAL IMPLANTS

COMPRISING BONE MATERIAL, IN CLASS 10 (U.S.
CLS. 26, 39 AND 44).

PRIORITY DATE OF 2-21-2007 IS CLAIMED.

OWNER OF INTERNATIONAL REGISTRATION
0934610 DATED 8-2-2007, EXPIRES 8-2-2017.

OWNER OF U.S. REG. NOS. 2,606,836, 2,665,343
AND OTHERS.

SER. NO. 79-042,650, FILED 8-2-2007.

KATHERINE E. HALMEN, EXAMINING ATTOR-
NEY

Int. Cls.: 3 and 5

Prior U.S. Cls.: 1, 4, 6, 18, 44, 46, 50, 51 and 52

United States Patent and Trademark Office

Reg. No. 3,476,935

Registered July 29, 2008

**TRADEMARK
PRINCIPAL REGISTER**

FLAMISPRAY

FLEN PHARMA, NAAMLOZE VENNOOTSCHAP
(BELGIUM A JOINT STOCK COMPANY
DULY ORGANIZED UNDER THE LAWS OF
BELGIUM)

DRIE EIKENSTRAAT 661
B-2650 EDEGEM
BELGIUM

FOR: BLEACHING PREPARATIONS FOR
HOUSEHOLD USE AND OTHER LAUNDRY PRE-
PARATIONS, NAMELY, LAUNDRY DETERGENT;
CLEANING AND POLISHING PREPARATIONS,
ABRASIVE LIQUIDS FOR GENERAL PURPOSE
CLEANING, SOAPS, PERFUMERY, ETHEREAL
OILS, COSMETICS, HAIR LOTIONS; DENTIFRICES,
IN CLASS 3 (U.S. CLS. 1, 4, 6, 50, 51 AND 52).

FOR: PHARMACEUTICAL AND MEDICAL PRE-
PARATIONS FOR TOPICAL TREATMENT OF
ACUTE WOUNDS, BURNS, GRAZES AND CHRON-
IC WOUNDS SUCH AS PRESSURE SORES, LEG
ULCERS AND DIABETES ULCERS, NAMELY,
MEDICATED SPRAYS WHICH PROMOTE HEAL-
ING, IN CLASS 5 (U.S. CLS. 6, 18, 44, 46, 51 AND 52).

OWNER OF INTERNATIONAL REGISTRATION
0934697 DATED 7-27-2007, EXPIRES 7-27-2017.

SER. NO. 79-042,668, FILED 7-27-2007.

WILLIAM ROSSMAN, EXAMINING ATTORNEY

Int. Cls.: 9, 18, 25 and 28

Prior U.S. Cls.: 1, 2, 3, 21, 22, 23, 26, 36, 38, 39, 41 and 50

Reg. No. 3,476,936

United States Patent and Trademark Office

Registered July 29, 2008

**TRADEMARK
PRINCIPAL REGISTER**



LASSE KJUS (NORWAY INDIVIDUAL)
DIAKONVEIEN 7
N-0370 OSLO
NORWAY

FOR: PROTECTIVE HELMETS FOR SPORTS, NAMELY, SKIING; CORRECTIVE GLASSES, SPORT'S GLASSES, SKI GLASSES, CASES FOR EYE GLASSES, CASES FOR SPORT'S GLASSES, CASES FOR SUN GLASSES, CASES FOR CORRECTIVE GLASSES, SUNGLASSES, SKI GOGGLES, PROTECTIVE FACE MASKS FOR SKIING, IN CLASS 9 (U.S. CLS. 21, 23, 26, 36 AND 38).

FOR: TRUNKS; TRAVELING BAGS; BAGS, NAMELY ATHLETIC BAGS, BAGS FOR SPORTS CLOTHING, BAGS FOR SPORTS, BEACH BAGS, SPORTS BAGS, CARRY-ALL BAGS, DUFFEL BAGS, GARMENT BAGS FOR TRAVEL, GYM BAGS, TOTE BAGS, WAIST BAGS, SHOULDER BAGS, WRISTLET BAGS; RUCKSACKS; HANDBAGS; BAGS TO BE WORN ON THE BELT; SHOPPING BAGS MADE OF CANVAS, TEXTILE, LEATHER, MESH; SHOE BAGS FOR TRAVEL; ALPINE BAGS FOR CARRYING SPORTS EQUIPMENT; SCHOOL BAGS; ROLLING BAGS, NAMELY, WHEELED BAGS, WHEELED TOTE BAGS, WHEELED MESSENGER BAGS, WHEELED DUFFEL BAGS, SHOPPING BAGS WITH WHEELS ATTACHED, LUGGAGE WITH WHEELS ATTACHED; TOOL BAGS SOLD EMPTY; SUIT BAGS; ALL PURPOSE SPORTS BAGS, IN CLASS 18 (U.S. CLS. 1, 2, 3, 22 AND 41).

FOR: CLOTHING, NAMELY, SPORTS CLOTHING IN THE FORM OF SKI JACKETS, SKI PANTS, SKI MASKS, SKI WEAR, SKI SUITS, BIBS, GLOVES; SPORTS CLOTHING FOR MOUNTAIN SPORTS IN THE FORM OF JACKETS, TROUSERS, PARKAS, SHORTS, GLOVES, CLIMBING BOOTS; INSULATED CLOTHING, NAMELY, JACKETS, PANTS, GLOVES; GAITERS; OVER CLOTHES, NAMELY, OVERCOATS, OVERALLS, OVER-TROUSERS, OVERSHOES; RAINCOATS, RAINWEAR, NAMELY, RAIN RESISTANT JACKETS, TROUSERS AND PONCHOS; GLOVES; MITTENS; MITTENS COVERS,

NAMELY, MITTENS WORN OVER MITTENS; BEANIES, HEADBANDS; BELTS; SKI CLOTHES, NAMELY, PARKAS, ANORAKS; SHIRTS; POLO SHIRTS; T-SHIRTS; SHORTS; SKIRTS; SWEATSHIRTS; BERMUDA SHORTS; VESTS; WIND-RESISTANT JACKETS AND TROUSERS; SOCKS, FOOTWEAR, NAMELY, BOOTS, HIKING SHOES, WALKING SHOES, MOUNTAIN SHOES, LEISURE SHOES, SKI BOOTS, AFTER-SKI SHOES; SKI GLOVES; HEADGEAR, NAMELY, HATS AND CAPS, VISORS FOR CAPS, BEANIES, IN CLASS 25 (U.S. CLS. 22 AND 39).

FOR: GYMNASTIC AND SPORTS ARTICLES, NAMELY, SNOW SKIS, CROSS-COUNTRY SKIS, SNOW BOARDS, SNOW SAUCERS, PORTABLE SKI CARRIERS, SKI STICKS, SKI ROPES, ALPINE SKIS, SKI BINDINGS, SKI POLES, DISCS FOR SKI POLES, GRIPS AND LOOPS FOR SKI POLES, SKI EDGES, BINDINGS FOR SKIS, SKI BRAKES, FRICTION DISCS FOR SKIS, SKI COVERINGS, BINDING COVERINGS, SCRAPERS AND SCRAPER PROTECTORS FOR SKIS, SLALOM PLUGS AND GATES, SKI WAX, KNEE PROTECTORS FOR ATHLETIC USE, TIBIA PROTECTORS FOR ATHLETIC USE, ELBOW PROTECTORS, NAMELY, ELBOW GUARDS AND PADS FOR ATHLETIC USE; SKI SCRAPERS; PROTECTION PADDING FOR SPORTS, NAMELY, FOR ELBOWS, KNEES AND WRISTS, FOR USE IN SKIING, HOCKEY, FOOTBALL, BASEBALL; SPORTS BAGS ESPECIALLY ADAPTED FOR SPORTS ARTICLES, NAMELY, SKIS, SKI POLES, BINDING FOR SKIS, SKI BRAKES, BINDING COVERS, IN CLASS 28 (U.S. CLS. 22, 23, 38 AND 50).

OWNER OF INTERNATIONAL REGISTRATION
0934731 DATED 4-20-2007, EXPIRES 4-20-2017.

OWNER OF U.S. REG. NOS. 2,572,723, 2,711,705,
AND 2,711,706.

SER. NO. 79-042,679, FILED 4-20-2007.

DAYNA BROWNE, EXAMINING ATTORNEY

Int. Cls.: 3, 5 and 35

**Prior U.S. Cls.: 1, 4, 6, 18, 44, 46, 50, 51, 52, 100, 101
and 102**

Reg. No. 3,476,937

United States Patent and Trademark Office

Registered July 29, 2008

**TRADEMARK
SERVICE MARK
PRINCIPAL REGISTER**



OMNI PHARMA AS (NORWAY LTD LIAB CO)
STENERSGATEN 2
N-0184 OSLO, NORWAY

OWNER OF INTERNATIONAL REGISTRATION
0934858 DATED 4-13-2007, EXPIRES 4-13-2017.

FOR: NON-MEDICATED MOUTH SPRAY AND MOUTH RINSES FOR PREVENTING BAD BREATH; NON-MEDICATED MOUTH CARE PREPARATIONS, NAMELY, GUM, MINTS, AND LOZENGES; DEODORANTS FOR PERSONAL USE, IN CLASS 3 (U.S. CLS. 1, 4, 6, 50, 51 AND 52).

THE COLOR(S) BLUE, WHITE, GREEN AND YELLOW IS/ARE CLAIMED AS A FEATURE OF THE MARK.

FOR: MINERAL AND FOOD SUPPLEMENTS; MEDICATED LOZENGES AGAINST BAD BREATH, IN CLASS 5 (U.S. CLS. 6, 18, 44, 46, 51 AND 52).

THE MARK CONSISTS OF THE LETTERS "BREATHSAFE" IN BLUE, GREEN AND YELLOW COLORS AND THE COLOR BLUE BACKGROUND. THE COLOR BLUE APPEARS IN THE BACKGROUND AND THE LETTERS "BREATH"; THE COLOR WHITE APPEARS ON THE EXTERIOR AND INTERIOR BORDERS OF THE LETTERS "BREATHSAFE"; THE COLOR GREEN APPEARS IN THE UPPER AND BOTTOM PORTIONS OF THE LETTERS "SAFE"; THE COLOR YELLOW APPEARS IN THE MIDDLE PORTION OF THE LETTERS "SAFE".

FOR: MAIL ORDER RETAILING SERVICES, ONLINE RETAIL STORE SERVICES AND MAIL ORDER SUBSCRIPTION RETAILING SERVICES FEATURING MOUTH SPRAY, MOUTH RINSES, LOZENGES AGAINST BAD BREATH, PREPARATIONS AGAINST BAD BREATH, MOUTH CARE PREPARATIONS, DEODORANTS FOR PERSONAL USE, AND FOOD SUPPLEMENTS, IN CLASS 35 (U.S. CLS. 100, 101 AND 102).

SER. NO. 79-042,710, FILED 4-13-2007.

PRIORITY DATE OF 3-28-2007 IS CLAIMED.

JOHN DALIER, EXAMINING ATTORNEY

Int. Cls.: 9, 35, 38 and 42

Prior U.S. Cls.: 21, 23, 26, 36, 38, 100, 101, 102 and 104

United States Patent and Trademark Office

Reg. No. 3,476,938

Registered July 29, 2008

**TRADEMARK
SERVICE MARK
PRINCIPAL REGISTER**

EASYCO

ACTARIS S.A.S. (FRANCE SOCIÉTÉ PAR ACTIONS SIMPLIFIÉE)
62 BIS, AVENUE ANDRÉ MORIZET
F-92100 BOULOGNE-BILLANCOURT, FRANCE

FOR: FLOW METERS AND FLUID METERS FOR GAS, WATER AND THERMAL ENERGY; FLUID OSCILLATORS, ELECTROMAGNETIC STATIC FLOW METERS; ELECTRONIC OR MECHANICAL ELECTRICITY METERS; SPARE PARTS RELATED TO SUCH FLOW METERS; PREPAYMENT APPARATUS FOR SUCH FLOW METERS AND METERS, NAMELY, TOKEN-OPERATED, COIN-OPERATED, CARD-OPERATED, SMART-CARD OPERATED, KEY-PAD OPERATED METERS FOR ELECTRICITY, GAS AND FLUID FLOW METERS AND SUPPLY; APPARATUS FOR THE MEMORIZATION OF DATA RELATED TO SUCH FLOW METERS, NAMELY, EVENT RECORDERS AND COMPUTERS; APPARATUS, NAMELY, RADIO TRANSMITTERS, CABLE TRANSMITTERS FOR THE ELECTRONIC TRANSMISSION OF DATA; SYSTEMS CONSISTING OF COMPUTERS AND COMPUTER SOFTWARE FOR USE IN DATABASE MANAGEMENT, RADIO TRANSMITTERS, CABLE TRANSMITTERS, COMPUTER NETWORK HUBS AND COMPUTER PRINTERS FOR REMOTELY READING AND/OR REMOTELY TRANSMITTING AND/OR REMOTELY RETRIEVING AND REVIEWING DATA RELATED TO SUCH METERS; ELECTRONIC MODEMS; ELECTRONIC PAYMENT TERMINALS; TERMINALS FOR TRANSACTION MANAGEMENT, IN CLASS 9 (U.S. CLS. 21, 23, 26, 36 AND 38).

FOR: UTILITY METERS READING SERVICES, NAMELY, READING AND RECORDING IN A

COMPUTER FILE OF DATA RELATING TO WATER, GAS, THERMAL ENERGY AND/OR ELECTRICITY METERS; AUTOMATIC BILLING SERVICE; REMOTE UTILITY METER READING, IN CLASS 35 (U.S. CLS. 100, 101 AND 102).

FOR: ELECTRONIC REMOTE TRANSMISSION OF DATA RELATING TO WATER, GAS, THERMAL ENERGY AND/OR ELECTRICITY METERS; RADIO, TELEGRAPH OR TELEPHONE COMMUNICATION SERVICES; ELECTRONIC DATA TRANSMISSION OF MESSAGES AND INFORMATION VIA ELECTRONIC COMMUNICATIONS NETWORK; COMMUNICATIONS BETWEEN COMPUTER TERMINALS AND/OR BETWEEN A METER, A DETECTOR, A DATA READER AND A COMPUTER TERMINAL, IN CLASS 38 (U.S. CLS. 100, 101 AND 104).

FOR: COMPUTER PROGRAMMING, PROVIDING TECHNICAL INFORMATION AND ADVICE RELATING TO REMOTE METER READING AND AUTOMATIC BILLING, IN CLASS 42 (U.S. CLS. 100 AND 101).

PRIORITY DATE OF 2-27-2007 IS CLAIMED.

OWNER OF INTERNATIONAL REGISTRATION 0934877 DATED 8-3-2007, EXPIRES 8-3-2017.

SER. NO. 79-042,717, FILED 8-3-2007.

KATINA MISTER, EXAMINING ATTORNEY

Int. Cls.: 11, 20, 21, 24, 25, 27 and 35

Prior U.S. Cls.: 2, 13, 19, 20, 21, 22, 23, 25, 29, 30, 31, 32, 33, 34, 37, 39, 40, 42, 50, 100, 101 and 102

Reg. No. 3,476,939

United States Patent and Trademark Office

Registered July 29, 2008

**TRADEMARK
SERVICE MARK
PRINCIPAL REGISTER**



H&M HENNES & MAURITZ AB (SWEDEN CORPORATION)
SALÉN-H/O
REGERINGSGATAN 48
SE-106 38 STOCKHOLM, SWEDEN

FOR: LAMPS; CHANDELIERS; LIGHTING FIXTURES; CEILING LIGHTS; LIGHT BULBS; LAMP SHADES; FLUORESCENT LAMP TUBES; LIGHTING TRACKS, IN CLASS 11 (U.S. CLS. 13, 21, 23, 31 AND 34).

FOR: CURTAIN HOOKS; NON-METAL HOOKS; CURTAIN RODS; CURTAIN RAILS; CURTAIN RINGS; NON-TEXTILE WINDOW BLINDS; NON-TEXTILE SLATTED INDOOR BLINDS, IN CLASS 20 (U.S. CLS. 2, 13, 22, 25, 32 AND 50).

FOR: DISHWASHING BRUSHES; DISHCLOTHS, IN CLASS 21 (U.S. CLS. 2, 13, 23, 29, 30, 33, 40 AND 50).

FOR: BED LINENS; SHEETS, PILLOW CASES, DUVET COVERS; QUILTS; THROWS; BEDSPREADS; FABRIC VALANCES; BED BLANKETS; TRAVELING RUGS; TABLE MATS NOT OF PAPER; TABLE CLOTHS NOT OF PAPER; OIL CLOTHS FOR USE AS TABLECLOTHS; FABRIC TABLE RUNNERS; PLACE MATS NOT OF PAPER; TABLE NAPKINS OF TEXTILE; HOUSEHOLD LINEN; BLANKETS; BATH TOWELS AND HAND TOWELS; KITCHEN TOWELS; SHOWER CURTAINS; CUR-

TAINS; FURNITURE COVERINGS OF PLASTIC; TEXTILE FURNITURE COVERINGS; CUSHION COVERS, IN CLASS 24 (U.S. CLS. 42 AND 50).

FOR: CLOTHING, NAMELY, JACKETS, UNDERWEAR, PANTS, SWEATERS, SLEEPWEAR, PAJAMAS, NIGHTDRESSES, SHIRTS, T-SHIRTS, SWEATSHIRTS, BATHROBES, SLIPPERS, HATS, CAPS, SHOES; HEADWEAR, IN CLASS 25 (U.S. CLS. 22 AND 39).

FOR: CARPETS AND RUGS; BATH MATS, IN CLASS 27 (U.S. CLS. 19, 20, 37, 42 AND 50).

FOR: MARKETING; CUSTOMER SERVICES IN THE FIELD OF HOUSE HOLD GOODS, NAMELY, PROVIDING DO-IT-YOURSELF CUSTOMER COUNSELING AND CUSTOMER SERVICE INFORMATION; RETAIL STORE AND ON-LINE RETAIL STORE SERVICES FEATURING LAMPS, CHANDELIERS AND APPARATUS FOR LIGHTING IN GENERAL, LAMP HANGING SUPPORTS, HOOKS, CURTAIN RODS, CURTAIN RAILS, CURTAIN RINGS, NON-TEXTILE BLINDS, TOILET CASES FITTED, DISH WASHING BRUSHES, DISH CLOTHS, BEDDING, SHEETS, PILLOW CASES, DUVET COVERS, QUILTS, THROWS, BEDSPREADS, VALANCES, BED BLANKETS, TRAVEL RUGS, TABLE MATS NOT OF PAPER, TABLE CLOTHS NOT OF PAPER, OIL CLOTHS FOR USE AS TABLECLOTHS, RUNNERS, PLACE MATS NOT OF PA-

PER, TABLE NAPKINS OF TEXTILE, HOUSEHOLD LINEN, BLANKETS, BATH TOWELS AND HAND TOWELS, KITCHEN TOWELS, SHOWER CURTAINS, CURTAINS, FURNITURE COVERINGS OF PLASTIC, TEXTILE FURNITURE COVERINGS, CUSHION COVERS, CLOTHING, SHOES, HEADGEAR, UNDERWEAR, PAJAMAS, NIGHTDRESSES, DRESSING GOWNS, BATHROBES, STOCKINGS, SLIPPERS, CARPETS AND RUGS, BATH MATS, IN CLASS 35 (U.S. CLS. 100, 101 AND 102).

PRIORITY DATE OF 2-21-2007 IS CLAIMED.

OWNER OF INTERNATIONAL REGISTRATION 0934899 DATED 4-24-2007, EXPIRES 4-24-2017.

OWNER OF U.S. REG. NO. 2,397,326.

NO CLAIM IS MADE TO THE EXCLUSIVE RIGHT TO USE "HOME" , APART FROM THE MARK AS SHOWN.

SER. NO. 79-042,722, FILED 4-24-2007.

WILLIAM ROSSMAN, EXAMINING ATTORNEY

Int. Cl.: 3

Prior U.S. Cls.: 1, 4, 6, 50, 51 and 52

United States Patent and Trademark Office

Reg. No. 3,476,940

Registered July 29, 2008

**TRADEMARK
PRINCIPAL REGISTER**

SMH

RUAN CO., LTD (JAPAN CORPORATION)

1-300-5, NISHIKATAKAI-MACHI

MAEBASHI-SHI; GUNMA 371-0013

JAPAN

THE MARK CONSISTS OF STANDARD CHARACTERS WITHOUT CLAIM TO ANY PARTICULAR FONT, STYLE, SIZE, OR COLOR.

OWNER OF INTERNATIONAL REGISTRATION
0934968 DATED 8-2-2007, EXPIRES 8-2-2017.

FOR: HAIR SPRAY; HAIR FIXERS; HAIR SETTING LOTION, IN CLASS 3 (U.S. CLS. 1, 4, 6, 50, 51 AND 52).

SER. NO. 79-042,744, FILED 8-2-2007.

ASMAT KHAN, EXAMINING ATTORNEY

Int. Cls.: 9 and 42

Prior U.S. Cls.: 21, 23, 26, 36, 38, 100 and 101

Reg. No. 3,476,941

United States Patent and Trademark Office

Registered July 29, 2008

**TRADEMARK
SERVICE MARK
PRINCIPAL REGISTER**

STEP

SIEMENS AKTIENGESELLSCHAFT (FED REP
GERMANY JOINT STOCK COMPANY)
WITTELSBACHERPLATZ 2
80333 MÜNCHEN
FED REP GERMANY

PROGRAMMING AND CONFIGURATION OF
PROGRAMMABLE LOGIC CONTROLLERS USED
IN INDUSTRIAL AUTOMATION, IN CLASS 42 (U.S.
CLS. 100 AND 101).

FOR: COMPUTER SOFTWARE PROGRAMS FOR
PROGRAMMING AND CONFIGURATION OF
PROGRAMMABLE LOGIC CONTROLLERS USED
IN INDUSTRIAL AUTOMATION, IN CLASS 9 (U.S.
CLS. 21, 23, 26, 36 AND 38).

OWNER OF INTERNATIONAL REGISTRATION
0594818 DATED 10-26-1992, EXPIRES 10-26-2012.

SER. NO. 79-042,819, FILED 7-25-2007.

FOR: DEVELOPMENT, DESIGN AND RENTAL
FOR OTHERS OF COMPUTER SOFTWARE FOR

VERNA BETH RIRIE, EXAMINING ATTORNEY

Int. Cls.: 1, 6 and 11

**Prior U.S. Cls.: 1, 2, 5, 6, 10, 12, 13, 14, 21, 23, 25, 26,
31, 34, 46 and 50**

Reg. No. 3,476,942

United States Patent and Trademark Office

Registered July 29, 2008

**TRADEMARK
PRINCIPAL REGISTER**

AQUACYCLE

HANSGROHE AG (FED REP GERMANY AG)
AUESTRASSE 5-9
77761 SCHILTACH
FED REP GERMANY

FOR: BACTERIOLOGICAL CULTURES FOR
WASTEWATER TREATMENT, IN CLASS 1 (U.S.
CLS. 1, 5, 6, 10, 26 AND 46).

FOR: METAL WATERPIPES AND WATERLINES,
WATER TANKS, FLEXIBLE PIPES AND CONNEC-
TORS PRIMARILY MADE OF METAL, IN CLASS 6
(U.S. CLS. 2, 12, 13, 14, 23, 25 AND 50).

FOR: APPARATUS FOR WATER SUPPLY AND
SANITARY PURPOSES, NAMELY, WATER TANKS;
WATER TREATMENT INSTALLATIONS, NAMELY,
WATER TANKS AND WATER FILTERS; WATER
PURIFICATION INSTALLATIONS, NAMELY,

GREY WATER PURIFICATION UNITS, INSTRU-
MENTS AND WATER PURIFICATION APPARA-
TUS; DISINFECTING EQUIPMENT, NAMELY,
ULTRAVIOLET LIGHT TREATMENT APPLIAN-
CES; WATER VALVES , IN CLASS 11 (U.S. CLS. 13,
21, 23, 31 AND 34).

THE MARK CONSISTS OF STANDARD CHAR-
ACTERS WITHOUT CLAIM TO ANY PARTICULAR
FONT, STYLE, SIZE, OR COLOR.

OWNER OF INTERNATIONAL REGISTRATION
0738773 DATED 2-10-2000, EXPIRES 2-10-2010.

SER. NO. 79-042,841, FILED 2-1-2007.

LINDA MICKLEBURGH, EXAMINING ATTORNEY

Int. Cl.: 6

Prior U.S. Cls.: 2, 12, 13, 14, 23, 25 and 50

United States Patent and Trademark Office

Reg. No. 3,476,943

Registered July 29, 2008

TRADEMARK
PRINCIPAL REGISTER

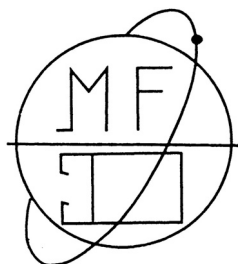

闽发
MINFA

FUJIAN MINFA ALUMINIUM CO., LTD (CHINA CORPORATION)

NANMEI COMPREHENSIVE DEVELOPMENT
ZONE OF NANAN; FUJIAN 362300
CHINA

FOR: ALUMINIUM FOIL; BUILDING MATERIALS OF METAL, NAMELY, SOFFITS; REINFORCING MATERIALS OF METAL FOR BUILDING; FRAMEWORK OF METAL FOR BUILDING; GUTTER PIPES OF METAL; WINDOW FRAMES OF METAL; NON-ELECTRIC LOCKS OF METAL; COMMON METALS, UNWROUGHT OR SEMI-WROUGHT FOR FURTHER MANUFACTURE; SIGNBOARDS OF METAL; FITTINGS OF METAL FOR FURNITURE, IN CLASS 6 (U.S. CLS. 2, 12, 13, 14, 23, 25 AND 50).

OWNER OF INTERNATIONAL REGISTRATION
0833132 DATED 7-19-2004, EXPIRES 7-19-2014.

NO CLAIM IS MADE TO THE EXCLUSIVE RIGHT TO USE "MINFA AND THE NON-LATIN CHARACTERS THAT MEAN 'ABBREVIATION FOR FUJIAN PROVINCE'" , APART FROM THE MARK AS SHOWN.

THE MARK CONSISTS OF CHINESE CHARACTERS + FIGURE.

THE ENGLISH TRANSLATION OF THE FOREIGN WORD(S) IN THE MARK IS "ABBREVIATION FOR FUJIAN PROVINCE" AND "SEND OUT"; THE COMBINATION OF THE WORDS HAS NO ACTUAL MEANING.

THE TRANSLITERATION OF THE NON-LATIN CHARACTERS IN THE MARK IS: MIN FA.

SER. NO. 79-042,850, FILED 12-15-2006.

HEATHER THOMPSON, EXAMINING ATTORNEY

Int. Cl.: 33

Prior U.S. Cls.: 47 and 49

United States Patent and Trademark Office

Reg. No. 3,476,944

Registered July 29, 2008

**TRADEMARK
PRINCIPAL REGISTER**

ARACO

S.A.T. N. 59 ARACO (SPAIN COMPANY)
CTRA. DE LA PUEBLA DE LABARCA, S/N
E-01306 LAGUARDIA (ALAVA), SPAIN

OWNER OF INTERNATIONAL REGISTRATION
0935235 DATED 6-19-2007, EXPIRES 6-19-2017.

FOR: WINES, SPIRITS AND ALCOHOLIC BEV-
ERAGES EXCEPT BEER, NAMELY, COGNAC, GIN,
RUM, VODKA, WHISKY, IN CLASS 33 (U.S. CLS. 47
AND 49).

SER. NO. 79-042,908, FILED 6-19-2007.

SHANNON TWOHIG, EXAMINING ATTORNEY

Int. Cl.: 20

Prior U.S. Cls.: 2, 13, 22, 25, 32 and 50

United States Patent and Trademark Office

Reg. No. 3,476,945

Registered July 29, 2008

**TRADEMARK
PRINCIPAL REGISTER**

FREECAT

TRIXIE HEIMTIERBEDARF GMBH & CO. KG
(FED REP GERMANY KG)
INDUSTRIESTRAÙE 32
24963 TARP, FED REP GERMANY

FOR: NON-METAL CAT FLAPS AND EXTENSION TUNNELS, IN CLASS 20 (U.S. CLS. 2, 13, 22, 25, 32 AND 50).

THE MARK CONSISTS OF STANDARD CHARACTERS WITHOUT CLAIM TO ANY PARTICULAR FONT, STYLE, SIZE, OR COLOR.

PRIORITY DATE OF 1-2-2007 IS CLAIMED.

OWNER OF INTERNATIONAL REGISTRATION
0935437 DATED 6-30-2007, EXPIRES 6-30-2017.

SER. NO. 79-042,989, FILED 6-30-2007.

FLORENTINA BLANDU, EXAMINING ATTORNEY

Int. Cls.: 6 and 11

Prior U.S. Cls.: 2, 12, 13, 14, 21, 23, 25, 31, 34 and 50

United States Patent and Trademark Office

Reg. No. 3,476,946

Registered July 29, 2008

**TRADEMARK
PRINCIPAL REGISTER**

Smart Draft

SCHÄFER WERKE GMBH (FED REP GERMANY
LIMITED COMPANY)
PFANNENBERGSTRASSE 1
57290 NEUNKIRCHEN
FED REP GERMANY

FOR: BEVERAGE CONTAINERS MADE OF METAL, NAMELY, BEVERAGE KEGS, CASKS, BEVERAGE CANS, ALUMINUM AND TIN-PLATE CANS, BARRELS, IN CLASS 6 (U.S. CLS. 2, 12, 13, 14, 23, 25 AND 50).

FOR: REFRIGERATED DISPENSING UNITS FOR BEVERAGES COOLING DEVICES FOR BEVERAGE DISPENSING SYSTEMS, BEVERAGE DISPENSING SYSTEMS COMPRISED OF REFRIGERATORS, COOLING BOXES, BAR COOLERS, COOLED COUNTERS FOR BEVERAGES, COOLING MACHINES, TAPS, TAPPING FITTINGS, DISPENSE

HEADS AND SHUT-OFF VALVES, IN CLASS 11 (U.S. CLS. 13, 21, 23, 31 AND 34).

THE MARK CONSISTS OF STANDARD CHARACTERS WITHOUT CLAIM TO ANY PARTICULAR FONT, STYLE, SIZE, OR COLOR.

PRIORITY DATE OF 10-11-2006 IS CLAIMED.

OWNER OF INTERNATIONAL REGISTRATION 0935463 DATED 2-7-2007, EXPIRES 2-7-2017.

OWNER OF U.S. REG. NO. 3,151,123.

SER. NO. 79-043,003, FILED 2-7-2007.

GIANCARLO CASTRO, EXAMINING ATTORNEY

Int. Cls.: 16, 25 and 41

**Prior U.S. Cls.: 2, 5, 22, 23, 29, 37, 38, 39, 50, 100, 101
and 107**

Reg. No. 3,476,947

United States Patent and Trademark Office

Registered July 29, 2008

**TRADEMARK
SERVICE MARK
PRINCIPAL REGISTER**



STREETSPOT

FLORIAN D. MUNZ (FED REP GERMANY IN-
DIVIDUAL)
CONNOLLYSTR. 3 G 816
80809 MÜNCHEN
FED REP GERMANY

FOR: EDUCATIONAL BOOKS FEATURING
SPORTS TRAINING, PRINTED INSTRUCTIONAL
AND TEACHING MATERIAL IN THE FIELD OF
SPORTS, IN CLASS 16 (U.S. CLS. 2, 5, 22, 23, 29, 37, 38
AND 50).

FOR: SHIRTS, SWEATERS, JACKETS, SHORTS,
PANTS, TRAINING SUITS, SOCKS, HATS, CAPS,
SHOES, IN CLASS 25 (U.S. CLS. 22 AND 39).

FOR: SPORT CAMP SERVICES, ORGANISATION
OF SPORTS COMPETITIONS, IN CLASS 41 (U.S.
CLS. 100, 101 AND 107).

OWNER OF INTERNATIONAL REGISTRATION
0935521 DATED 7-23-2007, EXPIRES 7-23-2017.

SER. NO. 79-043,035, FILED 7-23-2007.

CARYN GLASSER, EXAMINING ATTORNEY

Int. Cl.: 30

Prior U.S. Cl.: 46

United States Patent and Trademark Office

Reg. No. 3,476,948

Registered July 29, 2008

**TRADEMARK
PRINCIPAL REGISTER**



VINACAFÉ

CONG TY CO PHAN VINACAFE BIEN HOA
(VIETNAM JOINT STOCK COMPANY)
KHU CONG NGHIEP BIEN HOA 1
PHUONG AN BINH, THANH PHO BIEN HOA;
TINH DONG NAI
VIETNAM

FOR: PROCESSED COFFEE; TEA, IN CLASS 30
(U.S. CL. 46).

OWNER OF INTERNATIONAL REGISTRATION
0935546 DATED 3-18-2007, EXPIRES 3-18-2017.

OWNER OF U.S. REG. NOS. 2,751,673, 2,794,951,
AND 3,214,792.

THE MARK CONSISTS OF THE WORDING "VI-
NACAFÉ" BENEATH A STYLIZED COFFEE NUT
PUT IN A SQUARE.

SER. NO. 79-043,040, FILED 3-18-2007.

TINA BROWN, EXAMINING ATTORNEY

Int. Cls.: 39, 41 and 42

Prior U.S. Cls.: 100, 101, 105 and 107

United States Patent and Trademark Office

Reg. No. 3,476,949

Registered July 29, 2008

**SERVICE MARK
PRINCIPAL REGISTER**



IMEC VZW (BELGIUM NON POFIT ASSOCIATION)
75, KAPELDREEF
B-3001 LEUVEN, BELGIUM

FOR: CUSTOMIZED PACKAGING OF ARTICLES, NAMELY, ELECTRONIC COMPONENTS TO SPECIFICATION FOR THIRD PARTIES, ESPECIALLY INTEGRATED CIRCUITS, MAGNETIC COMPONENTS, OPTICAL COMPONENTS, MICRO AND NANO-ELECTRICAL COMPONENTS AND PHOTO-VOLTAIC CELLS, IN CLASS 39 (U.S. CLS. 100 AND 105).

FOR: TRAINING SERVICES IN THE FIELD OF NANO-TECHNOLOGIES AND IN THE FIELD OF MICRO AND NANO-ELECTRONICS, NAMELY, THE DEVELOPMENT OF ELECTRONIC COMPONENTS, INTEGRATED CIRCUITS, MAGNETIC AND OPTICAL COMPONENTS; PUBLISHING OF WRITTEN PUBLICATIONS AND TRAINING FOR INDIVIDUALS IN THE FIELD OF PACKAGING TECHNIQUES FOR ELECTRONIC COMPONENTS, INTEGRATED CIRCUITS, MAGNETIC AND OPTICAL COMPONENTS, PROCESS TECHNOLOGIES, PROCESS MODULES AND PROCESS STAGES FOR THE PRODUCTION OF ELECTRONIC COMPONENTS, INTEGRATED CIRCUITS, MAGNETIC AND OPTICAL COMPONENTS, MICRO AND NANO-ELECTROMECHANICAL SYSTEMS AND METHODS OF DESIGNING ELECTRONIC SYSTEMS AND INTEGRATED CIRCUITS, IN CLASS 41 (U.S. CLS. 100, 101 AND 107).

FOR: RESEARCH AND DEVELOPMENT IN THE FIELD OF NANO-TECHNOLOGIES AND IN THE FIELD OF MICROELECTRONICS INCLUDING

THE DEVELOPMENT OF ELECTRONIC COMPONENTS, INTEGRATED CIRCUITS, MAGNETIC AND OPTICAL COMPONENTS; SCIENTIFIC RESEARCH IN THE FIELD OF DEVELOPING PACKAGING TECHNIQUES FOR ELECTRONIC COMPONENTS, INTEGRATED CIRCUITS, MAGNETIC AND OPTICAL COMPONENTS, PROCESS TECHNOLOGIES, PROCESS MODULES AND PROCESS STAGES FOR THE PRODUCTION OF ELECTRONIC COMPONENTS, INTEGRATED CIRCUITS, MAGNETIC AND OPTICAL COMPONENTS, MICRO AND NANO-ELECTROMECHANICAL SYSTEMS AND METHODS OF DESIGNING ELECTRONIC SYSTEMS AND INTEGRATED CIRCUITS, IN CLASS 42 (U.S. CLS. 100 AND 101).

OWNER OF INTERNATIONAL REGISTRATION 0935640 DATED 5-31-2007, EXPIRES 5-31-2017.

OWNER OF U.S. REG. NO. 2,460,655.

THE COLOR(S) BLUE AND WHITE IS/ARE CLAIMED AS A FEATURE OF THE MARK.

THE COLOR(S) BLUE APPEARS IN THE WORDING "IMEC" AND IN THE OUTLINE OF THE INCOMPLETE INTERSECTING CIRCLES AND THE COLOR WHITE APPEARS IN THE INTERIOR OF THE INCOMPLETE INTERSECTING CIRCLES.

SER. NO. 79-043,075, FILED 5-31-2007.

WILLIAM ROSSMAN, EXAMINING ATTORNEY

Int. Cls.: 9, 37 and 42

Prior U.S. Cls.: 21, 23, 26, 36, 38, 100, 101, 103 and 106

United States Patent and Trademark Office

Reg. No. 3,476,950

Registered July 29, 2008

**TRADEMARK
SERVICE MARK
PRINCIPAL REGISTER**

syngo iPerfuse

SIEMENS AKTIENGESELLSCHAFT (FED REP
GERMANY JOINT STOCK COMPANY)
WITTELSBACHERPLATZ 2
80333 MÜNCHEN
FED REP GERMANY

FOR: DATA PROCESSING PROGRAMS, NAME-
LY, COMPUTER SOFTWARE FOR MEDICAL IN-
FORMATION SYSTEMS; COMPUTER SOFTWARE
FOR REPRODUCING, TRANSMITTING AND PRO-
CESSING MEDICAL DATA, IMAGES AND SCAN
ORDERS; COMMUNICATIONS SOFTWARE FOR
CONNECTING COMPUTER NETWORK USERS
FOR USE BY HOSPITALS AND OTHER MEDICAL
INSTITUTIONS AND FOR COMMUNICATION
WITHIN AND IN BETWEEN HOSPITALS AND
OTHER MEDICAL INSTITUTIONS, IN CLASS 9
(U.S. CLS. 21, 23, 26, 36 AND 38).

FOR: COMPUTER HARDWARE UPGRADING
FOR ELECTROMEDICAL IMAGING SYSTEMS, IN
CLASS 37 (U.S. CLS. 100, 103 AND 106).

FOR: PROGRAMMING, DEVELOPMENT, CREA-
TION AND IMPLEMENTATION OF SOFTWARE
AND DATA PROCESSING PROGRAMS; CONSUL-

TANCY IN THE FIELD OF DATA PROCESSING, IN
PARTICULAR THE USE OF HARDWARE AND
SOFTWARE; CONSULTANT ENGINEER'S SERVI-
CES; SOFTWARE UPDATING AND UPGRADING
FOR ELECTROMEDICAL IMAGING SYSTEMS
FOR OTHERS, IN CLASS 42 (U.S. CLS. 100 AND 101).

THE MARK CONSISTS OF STANDARD CHAR-
ACTERS WITHOUT CLAIM TO ANY PARTICULAR
FONT, STYLE, SIZE, OR COLOR.

PRIORITY DATE OF 3-15-2007 IS CLAIMED.

OWNER OF INTERNATIONAL REGISTRATION
0935704 DATED 7-24-2007, EXPIRES 7-24-2017.

OWNER OF U.S. REG. NOS. 2,596,757, 2,790,091
AND OTHERS.

SER. NO. 79-043,100, FILED 7-24-2007.

VERNA BETH RIRIE, EXAMINING ATTORNEY

Int. Cls.: 3 and 44

Prior U.S. Cls.: 1, 4, 6, 50, 51, 52, 100 and 101

United States Patent and Trademark Office

Reg. No. 3,476,951

Registered July 29, 2008

**TRADEMARK
SERVICE MARK
PRINCIPAL REGISTER**



DB.F.SO.CAP. S.R.L. (ITALY LTD LIAB CO)
VIA DEGLI OLEANDRI, 40
I-80029 SANT'ANTIMO (NAPOLI), ITALY

FOR: PERFUMERY, COSMETICS, HAIR LO-
TIONS, IN CLASS 3 (U.S. CLS. 1, 4, 6, 50, 51 AND 52).

FOR: BEAUTY SALONS , IN CLASS 44 (U.S. CLS.
100 AND 101).

OWNER OF INTERNATIONAL REGISTRATION
0935977 DATED 6-26-2007, EXPIRES 6-26-2017.

THE COLOR(S) GOLD, WHITE AND BLACK IS/
ARE CLAIMED AS A FEATURE OF THE MARK.

THE OUTLINE OF EACH LETTER IN THE WORD
"SOCAP" IS GOLD; THE WORD "ORIGINAL" IS
WHITE; THE BACKGROUND IS BLACK.

THE MARK CONSISTS OF THE WORDS "SO-
CAP." WRITTEN IN NON-STYLIZED CAPITAL
LETTERS OF THE SAME SIZE, AND THE WORD
"ORIGINAL" WRITTEN IN A SMALLER SIZE AND
SET IN THE CURVE OF THE LETTER "C".

SER. NO. 79-043,188, FILED 6-26-2007.

SHANNON TWOHIG, EXAMINING ATTORNEY

Int. Cl.: 9

Prior U.S. Cls.: 21, 23, 26, 36 and 38

Reg. No. 3,476,952

United States Patent and Trademark Office

Registered July 29, 2008

**TRADEMARK
PRINCIPAL REGISTER**

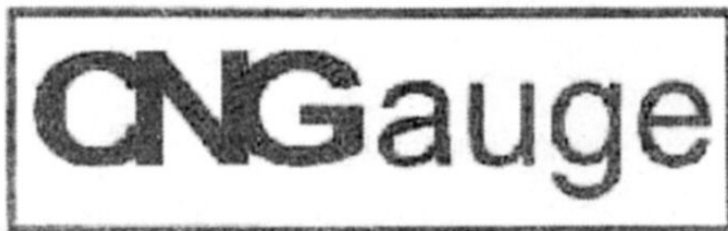

SONG TAO (CHINA INDIVIDUAL)
NO. 46, HUANZHEN BEILU,
DITANG ZHEN, YUYAO CITY; ZHEJIANG
CHINA

FOR: HIGH PRESSURE MANOMETERS; BAROMETERS; AUTOMATIC MEASURING INSTRUMENTS, NAMELY, VACUUM GAUGES, PETROL GAUGES, GASOLINE GAUGES; TEMPERATURE INDICATORS; APPARATUS AND INSTRUMENT FOR CONDUCTING, SWITCHING, TRANSFORMING, ACCUMULATING, REGULATING OR CONTROLLING ELECTRICITY, NAMELY, TIRE-PRESSURE MEASURERS, TIRE BALANCING MA-

CHINES FOR LAND VEHICLES, PRESSURE GAUGES, PRESSURE INDICATORS, PRESSURE SENSORS, PRESSURE RECORDERS; SPEED INDICATORS; WATER METER, IN CLASS 9 (U.S. CLS. 21, 23, 26, 36 AND 38).

OWNER OF INTERNATIONAL REGISTRATION
0936111 DATED 5-21-2007, EXPIRES 5-21-2017.

SER. NO. 79-043,282, FILED 5-21-2007.

VIVIAN MICZNIK FIRST, EXAMINING ATTORNEY

Int. Cl.: 41

Prior U.S. Cls.: 100, 101 and 107

United States Patent and Trademark Office

Reg. No. 3,476,953

Registered July 29, 2008

**SERVICE MARK
PRINCIPAL REGISTER**

ISLE OF TOMORROW

NOVOZYMES A/S, (DENMARK SOCIÉTÉ (CORPORATION))
KROGSHOEJVEJ 36,
DK-2880 BAGSVAERD
DENMARK

FOR: EDUCATIONAL SERVICES, NAMELY, PROVIDING CLASSES, SEMINARS AND WORKSHOPS IN THE FIELD OF CHEMICALS FOR INDUSTRIAL PURPOSES; PROVIDING OF TRAINING IN USE OF ENZYMATIC SOLUTIONS IN INDUSTRY; ENTERTAINMENT SERVICES, NAMELY, PROVIDING ONLINE COMPUTER GAMES; AND ORGANIZING SPORTING AND CULTURAL EVENTS, NAMELY, EVENTS TO PROMOTE SUSTAINABLE DEVELOPMENT, IN CLASS 41 (U.S. CLS. 100, 101 AND 107).

THE MARK CONSISTS OF STANDARD CHARACTERS WITHOUT CLAIM TO ANY PARTICULAR FONT, STYLE, SIZE, OR COLOR.

PRIORITY DATE OF 3-29-2007 IS CLAIMED.

OWNER OF INTERNATIONAL REGISTRATION 0936116 DATED 8-27-2007, EXPIRES 8-27-2017.

SER. NO. 79-043,285, FILED 8-27-2007.

DAVID MURRAY, EXAMINING ATTORNEY

Int. Cls.: 16, 35, 38, 39, 41 and 43

Prior U.S. Cls.: 2, 5, 22, 23, 29, 37, 38, 50, 100, 101, 102, 104, 105 and 107

Reg. No. 3,476,954

United States Patent and Trademark Office

Registered July 29, 2008

**TRADEMARK
SERVICE MARK
PRINCIPAL REGISTER**



TUI AG (FED REP GERMANY JOINT STOCK COMPANY)
KARL-WIECHERT-ALLEE 4
30625 HANNOVER, FED REP GERMANY

FOR: PAPER, CARDBOARD AND GOODS MADE FROM THESE MATERIALS, NAMELY, STICKERS, CONTAINERS FOR STATIONERY, BEER MATS, PAPER AND PLASTIC PACKING BAGS, PAPER BAGS, PADS OF PAPER FOR WRITING AND WRITING PAPER; PRINTED MATTER, NAMELY, BOOKS, LEAFLETS, BROCHURES, NEWSPAPERS AND MAGAZINES IN THE FIELD OF BUSINESS MANAGEMENT, TRAVEL AND ENTERTAINMENT MANAGEMENT; PHOTOGRAPHS, POSTCARDS; PRINTED TICKETS, ENTRY TICKETS, CALENDARS, CARDS, NAMELY, NOTE CARDS, GREETING CARDS, BUSINESS CARDS AND BLANK CARDS, AND CATALOGUES IN THE FIELD OF TRAVEL AND TRAVEL MANAGEMENT; WRITING INSTRUMENTS, NAMELY, PENS, PENCILS AND FOUNTAIN PENS; ARTISTS' MATERIALS, NAMELY, PAINTING SETS, PASTELS AND PAINT BRUSHES; OFFICE REQUISITES OTHER THAN FURNITURE, NAMELY, ADHESIVE TAPE DISPENSERS, CORRECTING FLUID FOR TYPE, STAPLERS, FRANKING MACHINES; PRINTED INSTRUCTIONAL AND TEACHING MATERIAL, NAMELY, WORKBOOKS AND WORKSHEETS DIRECTED TO THE FIELDS OF BUSINESS MANAGEMENT, BUSINESS OUTSOURCING, TRAVEL AND ENTERTAINMENT; CARDBOARD, PAPER AND PLASTIC MATERIALS FOR PACKAGING, NAMELY, PLASTIC BAGS, PLASTIC BUBBLE PACKS; PRINTERS' TYPE; PAPER FLAGS AND PENNANTS; BOOKBINDING MATERIAL, NAMELY, NAMELY, CORDS, TAPE, WIRE, BOOKBINDS, CLOTH FOR BOOKBINDING; ADHESIVES FOR STATIONERY PURPOSES, IN CLASS 16 (U.S. CLS. 2, 5, 22, 23, 29, 37, 38 AND 50).

FOR: ADVERTISING, INCLUDING ADVERTISING ON THE INTERNET, MARKETING, PUBLIC RELATIONS, ADVERTISING AND PROMOTIONAL SERVICES FOR THIRD PARTIES, RENTAL OF ADVERTISING MATERIAL, DIRECT MAIL ADVERTISING, MARKET RESEARCH INCLUDING PUBLIC OPINION POLLING AND MARKET ANALYSIS; BUSINESS MANAGEMENT; BUSINESS ORGANIZATION AND MANAGEMENT ADVISORY SERVICES; BOOKKEEPING, BUSINESS AND BUSINESS ORGANIZATIONAL CONSULTANCY; BUSINESS ADVISORY AND COORDINATION SERVICES IN THE AREA OF DATA PROCESSING, HOTEL MANAGEMENT FOR THIRD PARTIES; BUSINESS MANAGEMENT ADVISORY AND ADMINISTRATIVE COORDINATION SERVICES FOR TRAVEL AGENCIES, FITNESS CLUBS AND SPORTS AND LEISURE FACILITIES; DISTRIBUTION OF SAMPLES FOR ADVERTISING PURPOSES, DUPLICATION OF DOCUMENTS; BUSINESS ORGANIZATIONAL CONSULTATION RELATING TO THE PREPARATION OF BUILDING PROJECTS AS A SERVICE OF A BUILDING CONTRACTOR; FRANCHISE SERVICES, NAMELY, OFFERING TECHNICAL AND BUSINESS MANAGEMENT ASSISTANCE IN THE ESTABLISHMENT AND OPERATION OF HOTEL RESORTS, FITNESS CLUBS, SPORTS AND LEISURE FACILITIES; RENTAL OF ADVERTISING SPACE ON THE INTERNET; SPONSORSHIP, NAMELY, PROCURING OF ADVERTISING AND PROMOTIONAL CONTRACTS FOR THIRD PARTIES; LOCATION OF FREIGHT VEHICLES BY COMPUTER; TELEMARKETING, COMMERCIAL ADVISORY SERVICES FOR CONSUMERS RELATED TO EXPORT PROMOTION INFORMATION; SALES PROMOTION OF GOODS AND SERVICES FOR THIRD PARTIES; RENTAL OF OFFICE EQUIPMENT; RECRUITMENT OF OFFICE STAFF; PROVIDING OF ADVERTISING SPACE AND ADVERTISING OF BUSINESS CONTACTS

ON THE INTERNET; ADVERTISING ON THE INTERNET, NAMELY, ONLINE ADVERTISING AND MARKETING FOR THIRD PARTIES; AUCTIONEERING SERVICES, NAMELY, ON THE INTERNET; BUSINESS MANAGEMENT OF PERFORMING ARTISTS; ALL THE ABOVE SERVICES FOR THE TRAVEL AND RECREATIONAL SECTOR; ORGANIZATION OF FAIRS AND EXHIBITIONS FOR COMMERCIAL OR FOR ADVERTISING PURPOSES OF OTHERS; PROCUREMENT SERVICES, NAMELY, PROCURING OF CONTRACTS FOR THIRD PARTIES FOR THE PURCHASE AND SALE OF GOODS AND SERVICES IN THE FIELD OF TELESHOPPING EMPLOYMENT STAFFING SERVICES FOR HOTLINES AND CALL CENTER; PROCUREMENT OF CONTRACTS FOR THIRD PARTIES FOR THE PURCHASE AND SALE OF SERVICES VIA THE TELESHOPPING CHANNEL; EMPLOYMENT RECRUITING AND HIRING FOR HOTLINES AND CALL CENTRE; ORDER FULFILLMENT SERVICES, NAMELY, ORDER COUNTER BY HOTLINE AND CALL CENTER; DATA PROCESSING SERVICES; BUSINESS ORGANIZATIONAL CONSULTING FOR CUSTOMER RETENTION MEASURES; DEVELOPING MARKETING ACTIVITIES THAT FEATURE A BONUS INCENTIVE PROGRAM FOR CUSTOMERS; BUSINESS ORGANIZATIONAL CONSULTING FOR PROMOTING SALES BY IMPLEMENTING AWARD, BONUS AND CUSTOMER LOYALTY PROGRAMS; LOCATION OF PASSENGER VEHICLES BY COMPUTER FOR BUSINESS AND COMMERCIAL PURPOSES, IN CLASS 35 (U.S. CLS. 100, 101 AND 102).

FOR: TELECOMMUNICATION SERVICES, NAMELY, ELECTRONIC MESSAGE SENDING; DATA COMMUNICATION BY ELECTRONIC MAIL AND TELEPHONE; ONLINE SERVICES, NAMELY, INFORMATION TRANSMISSION VIA ELECTRONIC COMMUNICATIONS NETWORKS; PROVIDING ONLINE CHAT ROOMS, CHAT LINES, FORUMS, AND ELECTRONIC BULLETIN BOARDS FOR TRANSMISSION OF MESSAGES AMONG USERS IN THE FIELD OF GENERAL INTEREST; TELEVISION BROADCASTING, NAMELY, BROADCASTING OF A TELESHOPPING CHANNEL; TELEPHONE COMMUNICATION SERVICES; TELECOMMUNICATION SERVICES, NAMELY, TRANSMISSION OF TRAFFIC INFORMATION; BROADCASTING OF RADIO AND TELEVISION PROGRAMS; INTERNET CAFE SERVICES, NAMELY, PROVIDING TELECOMMUNICATIONS CONNECTIONS TO THE INTERNET IN A CAFE ENVIRONMENT; PROVIDING ACCESS TO DATABASES; PROVIDING INTERNET CHATROOMS, IN CLASS 38 (U.S. CLS. 100, 101 AND 104).

FOR: TRANSPORT SERVICES, NAMELY, TRANSPORT OF PERSONS, CURRENCY, VALUABLES AND GOODS, IN PARTICULAR BY ROAD, RAIL, SEA AND AIR; PORTERAGE; TRAVEL ORGANIZATION, BOOKING AND ARRANGEMENT OF TRAVEL, EXCURSIONS, DAY TRIPS, HOLIDAYS, SIGHTSEEING TOURS AND CRUISES; ARRANGEMENT OF TRANSPORT SERVICES; TRAVEL CONSULTANCY AND TRAVEL GUIDE SERVICES; RENTAL AND CHARTERING OF AIR-

CRAFT, RENTAL AND CHARTERING OF SHIPS, NAMELY, ROWING AND MOTOR BOATS, SAILING VESSELS AND CANOES; RENTAL OF MOTOR VEHICLES AND BICYCLES, HORSES AND DIVING SUITS; PACKAGING OF ARTICLES FOR TRANSPORTATION; STORAGE OF DOCUMENTS, RAW MATERIALS, FURNITURE, LUGGAGE, AUTOMOBILES AND OTHER FREIGHT FOR OTHERS; PARCEL DELIVERY; TRAVEL AGENCY SERVICES, NAMELY, MAKING RESERVATIONS AND BOOKINGS FOR TRANSPORTATION; TRANSPORTATION RESERVATION SERVICES; PROVIDING ONLINE INFORMATION IN THE FIELD OF TOURISM AND BUSINESS TRAVEL; DELIVERY OF NEWSPAPERS AND MAGAZINES; OPERATION OF A CALL CENTRE, NAMELY, PROVIDING OF TRAVEL INFORMATION, IN CLASS 39 (U.S. CLS. 100 AND 105).

FOR: EDUCATION AND CONTINUOUS TRAINING IN THE FIELD OF MUSIC, ART AND CULTURE RENDERED THROUGH WORKSHOPS, SEMINARS AND CLASSES; EDUCATIONAL CONSULTANCY; TEACHING IN THE FIELD OF LANGUAGE COURSES RENDERED THROUGH CORRESPONDENCE COURSES; ENTERTAINMENT, NAMELY, ENTERTAINMENT IN THE NATURE OF LIVE PERFORMANCES BY THEATER GROUPS, ETHNIC FESTIVALS, TOURIST AND CULTURE SHOWS, LIVE THEATRICAL PERFORMANCES, BASEBALL, FOOTBALL AND BASKETBALL GAMES; MOTION PICTURE FILM PRODUCTION; VIDEO PRODUCTION; FILM AND VIDEO RENTAL; ENTERTAINMENT IN THE NATURE OF LIVE VISUAL AND AUDIO PERFORMANCES, NAMELY, MUSICAL BANDS, ROCK GROUPS, DANCE, AND PERFORMANCES; THEATRICAL BOOKING AGENCY SERVICES; PRESENTATION OF MUSICAL PERFORMANCES, PRESENTATION OF CIRCUS PERFORMANCES; ENTERTAINMENT IN THE NATURE OF THEATER PRODUCTIONS, AND PUBLIC ENTERTAINMENT IN THE NATURE OF MUSICAL GROUPS, ETHNIC FESTIVALS; ORGANIZATION AND PROVIDING OF CHILDREN'S ENTERTAINMENT IN THE NATURE OF MUSICAL GROUPS, ETHNIC FESTIVAL; ORGANISATION OF RECREATIONAL CAMPS; ENTERTAINMENT IN THE NATURE OF FOOTBALL AND SOCCER GAMES; PROVIDING FILMS, NAMELY, PROVISION OF NON-DOWNLOADABLE FILMS VIA A VIDEO-ON-DEMAND SERVICE; HEALTH CLUB SERVICES, NAMELY, PROVIDING INSTRUCTION AND EQUIPMENT IN THE FIELD OF PHYSICAL EXERCISE; TRAINING CLUBS AND FITNESS CLUBS, NAMELY, PROVIDING FITNESS AND EXERCISE FACILITIES; GOLF COURSES; PROVIDING TENNIS COURTS; RECREATIONAL SERVICES IN THE NATURE OF HORSEBACK RIDING FACILITIES; EDUCATIONAL SERVICES, NAMELY, PROVIDING COURSES OF INSTRUCTION FOR CHILDREN AT THE KINDERGARTEN LEVEL; CINEMA THEATERS; DISCOTHEQUES; MUSEUMS; AMUSEMENT ARCADES; SPORTS CAMPS AND PROVIDING SPORTS FACILITIES; AMUSEMENT PARKS; RENTAL OF SKINDIVING EQUIPMENT; ORGANIZATION OF SPORTS COMPETITIONS, NAMELY, SOCCER AND VOL-

LEYBALL COMPETITIONS; ORGANIZATION AND ARRANGEMENT OF CULTURAL AND SPORTING EVENTS; TRAINING IN THE USE AND OPERATION OF INTERNET CAFES; RESERVATION SERVICES, INCLUDED IN THIS CLASS, FOR SPORTING, SCIENTIFIC, POLITICAL AND CULTURAL EVENTS, NAMELY, ARRANGING FOR TICKET RESERVATIONS FOR ENTERTAINMENT EVENTS; GAME SERVICES PROVIDED ONLINE, NAMELY, PROVIDING ON-LINE COMPUTER GAMES FOR ENTERTAINMENT PURPOSES; RENTAL OF RECORDED DATA CARRIERS, NAMELY, VIDEOTAPES, SOUND RECORDINGS, DVDS, CD-ROMS, NAMELY, FEATURING FILMS, MUSIC, AND GAMES, AND RENTAL OF OVERHEAD PROJECTORS; HIRE OF NEWSPAPERS AND MAGAZINES, NAMELY, NEWSPAPER AND MAGAZINE PUBLISHING; PUBLICATION OF BOOKS, NEWSPAPERS, MAGAZINES AND OTHER PRINTED MATERIAL, NAMELY, JOURNALS AND LEAFLETS; PUBLICATION OF ELECTRONIC MEDIA, NAMELY, NEWSPAPERS AND MAGAZINES; PROVIDING ON-LINE NON DOWNLOADABLE PUBLICATIONS IN THE NATURE OF BROCHURES AND MAGAZINES IN THE FIELD OF TRAVEL AND CULTURE; DVD, CD-ROM, AND VIDEO TAPE RECORDING FOR OTHERS; ORGANIZATION OF EXHIBITIONS FOR CULTURAL AND TEACHING PURPOSES; EDUCATIONAL AMUSEMENT PARKS; INTERPRETER AND TRANSLATOR SERVICES; PHOTOGRAPHY; RADIO AND TELEVISION ENTERTAINMENT, NAMELY, PRODUCTION OF RADIO OR TELEVISION PROGRAMS; ENTERTAINMENT SERVICES, NAMELY, PROVIDING INFORMATION ONLINE IN THE FIELD OF ENTERTAINMENT, IN CLASS 41 (U.S. CLS. 100, 101 AND 107).

FOR: PROVIDING TEMPORARY HOTEL ROOM ACCOMMODATION; PROVIDING OF FOOD AND DRINKS FOR GUESTS; ACCOMMODATION BUREAU SERVICES, NAMELY, RESERVATION SERVICES FOR TRAVELERS ROOM

ACCOMMODATION VIA TRAVEL AGENCIES AND BROKERS; RENTAL OF ROOMS FOR HOLIDAY; PROVIDING ROOM RESERVATION AND HOTEL RESERVATION SERVICES; PROVIDING HOTEL, BOARDING HOUSE AND MOTEL SERVICES; CATERING SERVICES; PROVIDING HOTEL, BOARDING HOUSE AND MOTEL SERVICES; PROVIDING OF MEETING FACILITIES; PROVIDING OF FOOD AND DRINKS IN RESTAURANTS AND BARS; PROVIDING FOOD AND DRINKS IN INTERNET CAFES; TRAVEL AGENCY SERVICES, NAMELY, MAKING RESERVATIONS AND BOOKING FOR TEMPORARY ROOM AND BOARD ACCOMMODATION, RESERVATIONS FOR HOTELS, HOLIDAY HOMES FOR TOURISTS, AND ROOM ACCOMMODATIONS FOR TRAVELERS BY PHONE, IN CLASS 43 (U.S. CLS. 100 AND 101).

PRIORITY DATE OF 3-22-2007 IS CLAIMED.

OWNER OF INTERNATIONAL REGISTRATION 0936171 DATED 4-25-2007, EXPIRES 4-25-2017.

OWNER OF U.S. REG. NOS. 2,928,468, 2,958,958, AND 2,975,052.

NO CLAIM IS MADE TO THE EXCLUSIVE RIGHT TO USE "TRAVEL", APART FROM THE MARK AS SHOWN.

THE COLOR(S) RED IS/ARE CLAIMED AS A FEATURE OF THE MARK.

THE MARK CONSISTS OF A DESIGN OF A SMILEY FACE AND THE WORDING "TUI TRAVEL" IN RED.

SER. NO. 79-043,305, FILED 4-25-2007.

BERNICE MIDDLETON, EXAMINING ATTORNEY

Int. Cls.: 7, 12 and 17

**Prior U.S. Cls.: 1, 5, 12, 13, 19, 21, 23, 31, 34, 35, 44
and 50**

Reg. No. 3,476,955

United States Patent and Trademark Office

Registered July 29, 2008

**TRADEMARK
PRINCIPAL REGISTER**

NECTEC

NECTEC AUTOMOTIVE S.R.O. (CZECH REPUBLIC S.R.O./LIMITED LIABILITY COMPANY)
LITOMERICKÁ 86
CZ-470 01 CESKÁ LÍPA, DUBICE
CZECH REPUBLIC

FOR: METALWORKING, WOODWORKING AND PLASTIC PROCESSING MACHINES FOR THE CHEMICAL INDUSTRY AND FOR AGRICULTURE; MACHINE TOOLS FOR THE PRODUCTION OF CUSHIONING AND OF INTERIOR TRIM AND UPHOLSTERY FOR VEHICLES; CONSTRUCTION MACHINES, NAMELY, CONSTRUCTION MACHINES FOR THE PRODUCTION OF CUSHIONING AND OF INTERIOR TRIM AND UPHOLSTERY FOR VEHICLES; MOULDING MACHINES, NAMELY, COMPRESSION MOULDING MACHINES, EXTRUSION MOULDING MACHINES AND INJECTION MOULDING MACHINES; MACHINE PARTS, NAMELY, MOULDS FOR USE IN THE MANUFACTURE OF CUSHIONING AND OF INTERIOR TRIM AND UPHOLSTERY FOR VEHICLES; PLASTIC WORKING MACHINES, IN CLASS 7 (U.S. CLS. 13, 19, 21, 23, 31, 34 AND 35).

FOR: SADDLE COVERS FOR BICYCLES OR MOTORCYCLES; VEHICLE SEATS; HOODS FOR VEHICLES AND SLIDING ROOF COVERS FOR VEHICLE ROOFS; LUGGAGE NETS FOR VEHICLES; UPHOLSTERY FOR VEHICLES; HEADRESTS FOR VEHICLES SEATS; SADDLES FOR BICYCLES, CYCLES OR MOTORCYCLES; SAFETY HARNESSSES FOR VEHICLE SEATS; SAFETY SEATS FOR CHILDREN FOR VEHICLES; SEAT COVERS FOR VEHICLES; SUN-BLINDS FOR AUTOMOBILES; LINING PARTS FOR VEHICLES, NAMELY, SUN ROOF COVERS, TRIM PANELS, STRUCTURAL PARTS OF PLASTIC, SIDE HOLSTERS; PADDED HEADRESTS, SEAT PADS, CENTRAL ARM RESTS

AND SEAT FRAMES FOR VEHICLE SEATS; NON-WOVEN CUSHIONING FOR VEHICLE SEATS, IN CLASS 12 (U.S. CLS. 19, 21, 23, 31, 35 AND 44).

FOR: RUBBER, GUTTA-PERCHA, ASBESTOS, MICA FOR USE IN THE MANUFACTURE OF CUSHIONING AND OF INTERIOR TRIM AND UPHOLSTERY FOR VEHICLES; PLASTICS IN EXTRUDED FORM FOR USE IN MANUFACTURE; PACKING, SEALING AND INSULATING MATERIALS; FLEXIBLE PIPES, NOT OF METAL; ELASTIC THREAD AND YARN, NOT FOR USE IN TEXTILES; RUBBER, RAW OR SEMI-WORKED; THREADS OF RUBBER, NOT FOR USE IN TEXTILES; EBONITE (VULCANITE); SEMI-PROCESSED PLASTIC SUBSTANCES IN THE FORM OF SHEETS, TUBES, BARDS AND RODS FOR USE IN THE MANUFACTURE OF CUSHIONING AND OF INTERIOR TRIM AND UPHOLSTERY FOR VEHICLES; PLASTIC FIBRES, NOT FOR TEXTILE USE, NAMELY, PLASTIC FIBRES FOR USE IN THE MANUFACTURE OF CUSHIONING AND OF INTERIOR TRIM AND UPHOLSTERY FOR VEHICLES; STUFFING OF RUBBER AND PLASTIC; MOULDS OF PLASTIC OR GUM IN EXTRUDED FORM FOR USE IN THE MANUFACTURE OF CUSHIONING AND OF INTERIOR TRIM AND UPHOLSTERY FOR VEHICLES, IN CLASS 17 (U.S. CLS. 1, 5, 12, 13, 35 AND 50).

PRIORITY DATE OF 4-17-2007 IS CLAIMED.

OWNER OF INTERNATIONAL REGISTRATION
0936599 DATED 8-17-2007, EXPIRES 8-17-2017.

SER. NO. 79-043,483, FILED 8-17-2007.

MORGAN WYNNE, EXAMINING ATTORNEY

Int. Cls.: 9 and 35

Prior U.S. Cls.: 21, 23, 26, 36, 38, 100, 101 and 102

United States Patent and Trademark Office

Reg. No. 3,476,956

Registered July 29, 2008

TRADEMARK
SERVICE MARK
PRINCIPAL REGISTER

ExplosivSniff

SIEGFRIED STAUBER (SWITZERLAND INDIVIDUAL)
HÜTTENKOPFSTRASSE 32
CH-8051 ZÜRICH, SWITZERLAND

FOR: INDICATORS, NAMELY, GAUGES FOR DETECTING EXPLOSIVES, IN CLASS 9 (U.S. CLS. 21, 23, 26, 36 AND 38).

FOR: RETAIL STORE AND ON-LINE RETAIL STORE SERVICES FEATURING INDICATORS, NAMELY, GAUGES FOR DETECTING EXPLOSIVES; WHOLESALE DISTRIBUTORSHIPS, WHOLESALE ORDERING SERVICES AND WHOLESALE STORES FEATURING INDICATORS,

NAMELY, GAUGES FOR DETECTING EXPLOSIVES, IN CLASS 35 (U.S. CLS. 100, 101 AND 102).

PRIORITY DATE OF 4-23-2007 IS CLAIMED.

OWNER OF INTERNATIONAL REGISTRATION 0936611 DATED 8-20-2007, EXPIRES 8-20-2017.

SER. NO. 79-043,491, FILED 8-20-2007.

HOWARD SMIGA, EXAMINING ATTORNEY

Int. Cls.: 9, 18, 25 and 28

Prior U.S. Cls.: 1, 2, 3, 21, 22, 23, 26, 36, 38, 39, 41 and 50

Reg. No. 3,476,957

United States Patent and Trademark Office

Registered July 29, 2008

**TRADEMARK
PRINCIPAL REGISTER**

FI'ZI:K BIKE WEAR

SELLE ROYAL S.P.A. (ITALY STOCK CORPORATION)
VIA VITTORIO EMANUELE, 119
I-36050 POZZOLEONE (VI)
ITALY

FOR: PROTECTIVE HELMETS FOR CYCLISTS AND MOTORCYCLISTS, SPECTACLES FOR CYCLISTS AND MOTORCYCLISTS, CASES FOR SPECTACLES, IN CLASS 9 (U.S. CLS. 21, 23, 26, 36 AND 38).

FOR: BAGS, HANDBAGS, RUCKSACKS, SMALL RUCKSACKS, BUM BAGS, ALL FOR CYCLISTS, IN CLASS 18 (U.S. CLS. 1, 2, 3, 22 AND 41).

FOR: JACKETS, SHORTS, TROUSERS, JERSEYS, SWEATSHIRTS, DUNGAREES, TOPS, BODYSUITS, ALL FOR CYCLISTS, CLOTHING ACCESSORIES FOR CYCLISTS IN PARTICULAR GLOVES, SHOES, SHOE COVERS, CAPS, CAP PEAKS, HEAD BANDS, UNDERWEAR FOR CYCLISTS, GLOVES FOR CYCLISTS AND MOTORCYCLISTS, BIB TIGHTS FOR CYCLISTS AND MOTORCYCLISTS, IN CLASS 25 (U.S. CLS. 22 AND 39).

FOR: GYMNAS TIC AND SPORTING ARTICLES, NAMELY, ELBOW GUARDS AND KNEE-PADS

FOR CYCLISTS AND MOTORCYCLISTS, IN CLASS 28 (U.S. CLS. 22, 23, 38 AND 50).

THE MARK CONSISTS OF STANDARD CHARACTERS WITHOUT CLAIM TO ANY PARTICULAR FONT, STYLE, SIZE, OR COLOR.

PRIORITY DATE OF 3-16-2007 IS CLAIMED.

OWNER OF INTERNATIONAL REGISTRATION 0936652 DATED 3-23-2007, EXPIRES 3-23-2017.

OWNER OF U.S. REG. NOS. 2,045,461 AND 3,218,231.

NO CLAIM IS MADE TO THE EXCLUSIVE RIGHT TO USE "BIKE WEAR", APART FROM THE MARK AS SHOWN.

SER. NO. 79-043,512, FILED 3-23-2007.

CURTIS FRENCH, EXAMINING ATTORNEY

Int. Cls.: 3 and 21

**Prior U.S. Cls.: 1, 2, 4, 6, 13, 23, 29, 30, 33, 40, 50, 51
and 52**

Reg. No. 3,476,958

United States Patent and Trademark Office

Registered July 29, 2008

**TRADEMARK
PRINCIPAL REGISTER**



SPAZZOLIFICIO PIAVE SPA (ITALY SOCIÉTÉ
PAR ACTIONS)
VIA PALLADIO 5
I-35010 ONARA DI TOMBOLO (PD)
ITALY

FOR: DENTIFRICES; BREATH-FRESHENING
MOUTHWASHES, IN CLASS 3 (U.S. CLS. 1, 4, 6, 50,
51 AND 52).

FOR: TOOTHBRUSHES, ELECTRIC TOOTHBRU-
SHES, IN CLASS 21 (U.S. CLS. 2, 13, 23, 29, 30, 33, 40
AND 50).

PRIORITY DATE OF 2-1-2007 IS CLAIMED.

OWNER OF INTERNATIONAL REGISTRATION
0936665 DATED 5-15-2007, EXPIRES 5-15-2017.

"THE COLOR(S) DARK BLUE AND LIGHT BLUE
IS/ARE CLAIMED AS A FEATURE OF THE MARK."

"THE MARK CONSISTS OF THE WORDING
"SILVER CARE" IN DARK BLUE, WITH THE "C"
IN "CARE" LINED BELOW THE LETTER "R" IN
"SILVER." THE COLOR LIGHT BLUE TRACES THE
WORDING IN THE MARK. THE COLOR WHITE
THAT APPEARS BETWEEN THE LETTERS AND
BETWEEN THE LETTERS AND THE LIGHT BLUE
LINE CONSTITUTES BACKGROUND, OUTLIN-
ING, SHADING OR TRANSPARENT AREAS AND
IS NOT PART OF THE MARK."

SER. NO. 79-043,524, FILED 5-15-2007.

SANDRA MANIOS, EXAMINING ATTORNEY

Int. Cl.: 6

Prior U.S. Cls.: 2, 12, 13, 14, 23, 25 and 50

Reg. No. 3,476,959

United States Patent and Trademark Office

Registered July 29, 2008

**TRADEMARK
PRINCIPAL REGISTER**



BLUE WAVE A/S (DENMARK LIMITED COMPANY (AKTIESELSKAB))
H.C. ØRSTEDSVEJ 2
DK-6100 HADERSLEV
DENMARK

OWNER OF U.S. REG. NO. 3,183,987.

FOR: BUILDING MATERIALS OF METAL, NAMELY, STAINLESS STEEL TURNBUCKLES AND STAINLESS STEEL WIRE END CONNECTIONS, NAMELY, FORK AND RING-SHAPED FITTINGS, METAL SHACKLES, THIMBLES, EYEBOLTS AND U-BOLTS; ALL ABOVE-MENTIONED ARTICLES ALSO FOR MARITIME USE, IN CLASS 6 (U.S. CLS. 2, 12, 13, 14, 23, 25 AND 50).

NO CLAIM IS MADE TO THE EXCLUSIVE RIGHT TO USE "WIRE DESIGN SYSTEM", APART FROM THE MARK AS SHOWN.

THE MARK CONSISTS OF STYLIZED SEA WAVE (AND TEXT) "WDS WIRE DESIGN SYSTEM".

SER. NO. 79-043,531, FILED 6-18-2007.

OWNER OF INTERNATIONAL REGISTRATION 0936681 DATED 6-18-2007, EXPIRES 6-18-2017.

KRISTINA MORRIS, EXAMINING ATTORNEY

Int. Cl.: 18

Prior U.S. Cls.: 1, 2, 3, 22 and 41

United States Patent and Trademark Office

Reg. No. 3,476,960

Registered July 29, 2008

TRADEMARK
PRINCIPAL REGISTER

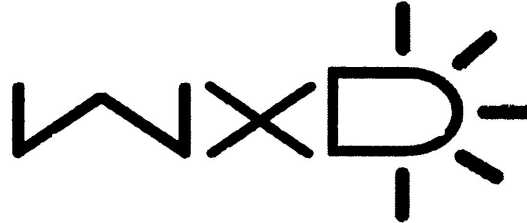

CHEN RI LING (CHINA INDIVIDUAL)
LINGXI ROAD, NO. 2 ACCESSORY ZONE
AUTOMOBILE CITY, HUADU DISTRICT.,;
GUANGZHOU CITY; GUANGDONG PROVINCE
CHINA

FOR: DOCUMENT CASES; BACKPACKS; AT-
TACHÉ CASES; HANDBAGS; VALISES; HAVER-
SACKS; LEATHER BAGS FOR MERCHANDISE
PACKAGING; BRIEFCASES; BOXES OF LEATHER-
BOARD, NAMELY, TRUNKS; LEATHER ENVEL-
OPES FOR MERCHANDISE PACKAGING;
LEATHER POUCHES FOR MERCHANDISE
PACKAGING; LEATHER TRAVELLING SETS,
NAMELY, TRAVELLING BAGS, TRUNKS, TRA-
VELLING TRUNKS AND GARMENT BAGS FOR

TRAVEL; CASES, OF LEATHER OR LEATHER-
BOARD; SUITCASES; CANVAS LUGGAGE, IN
CLASS 18 (U.S. CLS. 1, 2, 3, 22 AND 41).

OWNER OF INTERNATIONAL REGISTRATION
0936862 DATED 4-24-2007, EXPIRES 4-24-2017.

THE MARK CONSISTS OF THE VERBAL ELE-
MENT "WXD", SIMPLY A COMBINATION OF
THREE LETTERS "W", "X" AND "D" WITH IRRE-
GULAR LINES.

SER. NO. 79-043,607, FILED 4-24-2007.

BENJAMIN OKEKE, EXAMINING ATTORNEY

Int. Cls.: 6, 8, 9, 17 and 20

Prior U.S. Cls.: 1, 2, 5, 12, 13, 14, 21, 22, 23, 25, 26, 28, 32, 35, 36, 38, 44 and 50

Reg. No. 3,476,961

United States Patent and Trademark Office

Registered July 29, 2008

**TRADEMARK
PRINCIPAL REGISTER**

CABAC

LEGEND (PACIFIC) PTY LTD (AUSTRALIA
PROPRIETARY LIMITED COMPANY (PTY
LTD))
212 GREENHILL ROAD
EASTWOOD SA 5063
AUSTRALIA

FOR: METAL TOOL BOXES; METAL HARDWARE ITEMS IN THIS CLASS, NAMELY, METAL NUTS AND CRIMP LUGS IN THE NATURE OF METAL CABLE CLIPS, IN CLASS 6 (U.S. CLS. 2, 12, 13, 14, 23, 25 AND 50).

FOR: HAND TOOLS, NAMELY, WIRE CRIMPERS, PLIERS, WIRE CUTTERS, AND WIRE STRIPPERS, IN CLASS 8 (U.S. CLS. 23, 28 AND 44).

FOR: ELECTRICAL CONNECTION BOXES AND ELECTRICAL CONNECTORS; ELECTRIC AND ELECTRONIC APPARATUS AND INSTRUMENTS, NAMELY, AEROMETERS, AMMETERS, BAROMETERS, ELECTRIC CABLES, COAXIAL CABLES, OPTICAL FIBRE CABLES, JUNCTION SLEEVES FOR ELECTRIC CABLES, CAPACITORS, CATHODES, DVD PLAYERS, ELECTRIC WELDERS, ELECTRO-MAGNETIC COILS, ELECTRONIC NOTICE-BOARDS, GALVANOMETERS, GASOMETERS, HYDROMETERS, HYGROMETERS, INTEGRATED CIRCUITS, SIGNALLING PANELS IN THE NATURE OF ELECTRONIC INDICATOR PANELS, SOUND LOCATING AND RECORDING INSTRUMENTS IN THE NATURE OF MICROPHONES, SOUND REPRODUCTION APPARATUS, TELEGRAPH WIRES, TELEMETERS, TELEPHONE RECEIVERS AND TRANSMITTERS, TELEPHONE WIRES, PORTABLE TELEPHONES, TELEVISION SETS, THERMOSTATS, VOLTMETERS, OHMMETERS; AND STRUCTURAL PARTS THEREOF, IN CLASS 9 (U.S. CLS. 21, 23, 26, 36 AND 38).

FOR: PACKING, STOPPING AND INSULATING MATERIALS, NAMELY, INSULATORS FOR ELEC-

TRICAL CABLE, ELECTRICAL INSULATING TAPES, HEAT SHRINK NYLON TUBING FOR COVERING ELECTRICAL WIRE AND NYLON GROMMETS, PLASTIC BINDING FOR CABLES IN THE NATURE OF INSULATING SPLICE COVER FOR ELECTRICAL CABLE, INSULATING FIBERGLASS SLEEVES FOR CABLES, INSULATORS FOR ELECTRIC MAINS, HEAT SHRINK NYLON TUBING NOT OF METAL FOR COVERING ELECTRICAL WIRE AND NYLON GROMMETS, NYLON CABLE INSULATING TILES, CABLE GLANDS OF NYLON IN THE NATURE OF NON-METAL PIPE COLLARS, CABLE PROTECTION COVERS IN THE NATURE OF INSULATING SPLICE COVER FOR ELECTRICAL CABLE; FLEXIBLE PIPES NOT OF METAL; SEMI-FINISHED ARTIFICIAL AND SYNTHETIC RESINS AS SEMI-FINISHED PRODUCTS IN FORM OF PELLETS, RODS, FOILS, FOAMS, FIBERS, FILMS AND SHEETS FOR USE AS ELECTRICAL JOINT FILLERS, IN CLASS 17 (U.S. CLS. 1, 5, 12, 13, 35 AND 50).

FOR: PLASTIC PILLAR BOXES AND BASES, NAMELY, PLASTIC MAIL BOXES; AND PLASTIC CABLE CLIPS, IN CLASS 20 (U.S. CLS. 2, 13, 22, 25, 32 AND 50).

THE MARK CONSISTS OF STANDARD CHARACTERS WITHOUT CLAIM TO ANY PARTICULAR FONT, STYLE, SIZE, OR COLOR.

OWNER OF INTERNATIONAL REGISTRATION
0937051 DATED 5-17-2007, EXPIRES 5-17-2017.

THE MARK HAS NO MEANING IN A FOREIGN LANGUAGE.

SER. NO. 79-043,693, FILED 5-17-2007.

ROBERT STRUCK, EXAMINING ATTORNEY

Int. Cls.: 7, 9 and 11

Prior U.S. Cls.: 13, 19, 21, 23, 26, 31, 34, 35, 36 and 38

Reg. No. 3,476,962

United States Patent and Trademark Office

Registered July 29, 2008

**TRADEMARK
PRINCIPAL REGISTER**

The logo for ANIDY features the word "ANIDY" in a bold, sans-serif font. The letter "A" is stylized with three curved lines to its left, suggesting motion or a signal. The letters "NIDY" are solid black.

NINGBO ANDY; OPTOELECTRONIC CO., LTD.
(CHINA CORPORATION)
XINAN STREET INDUSTRIAL ZONE
YUYAO CITY; 315400 ZHEJIANG PROVINCE
CHINA

FOR: WHISKS, ELECTRIC, FOR HOUSEHOLD PURPOSES; GARBAGE DISPOSALS; MACHINES AND APPARATUS FOR CARPET SHAMPOOING, NAMELY, CARPET CLEANING MACHINES; CENTRAL VACUUM CLEANING INSTALLATIONS, NAMELY, VACUUM CLEANERS; CLEANING APPLIANCES UTILIZING STEAM, NAMELY, STEAM CLEANING MACHINES; DUST EXHAUSTING INSTALLATIONS FOR CLEANING PURPOSES, NAMELY, DUST SEPARATORS; DUST REMOVING INSTALLATIONS FOR CLEANING PURPOSES, NAMELY, ROBOTIC VACUUM CLEANERS; ELECTRIC PARQUET WAX-POLISHERS, NAMELY, POWER-OPERATED POLISHERS; VACUUM CLEANERS; MAINTENANCE FACILITIES FOR AUTO, NAMELY, CAR LIFTS, IN CLASS 7 (U.S. CLS. 13, 19, 21, 23, 31, 34 AND 35).

FOR: COMPUTER MOUSE; MECHANICAL SIGNS; SIGNAL LANTERNS, NAMELY, TRAFFIC LIGHTS; SIGNALS, LUMINOUS OR MECHANICAL, NAMELY, TRAFFIC-LIGHT APPARATUS; AUTO-

MATIC INDICATORS OF LOW PRESSURE IN VEHICLE TIRES, NAMELY, PRESSURE GAUGES; SEMICONDUCTOR CHIPS; BURGLAR ALARMS; CHARGERS FOR ELECTRIC BATTERIES, IN CLASS 9 (U.S. CLS. 21, 23, 26, 36 AND 38).

FOR: LIGHT BULBS; LAMPS; LIGHTING APPARATUS AND INSTALLATIONS, NAMELY, LIGHTING FIXTURES; FLARES; LUMINOUS TUBES FOR LIGHTING; MINERS' LAMPS; STANDARD LAMPS; FLUORESCENT LAMP TUBES; LIGHTS FOR VEHICLES; LIGHTING APPARATUS FOR VEHICLES, NAMELY, VEHICLE HEADLIGHTS; NEON LAMPS; LAMP HOUSINGS, NAMELY, LAMP BASES AND LAMP SHADES, IN CLASS 11 (U.S. CLS. 13, 21, 23, 31 AND 34).

OWNER OF INTERNATIONAL REGISTRATION
0937162 DATED 5-8-2007, EXPIRES 5-8-2017.

THE NAME "ANDY" DOES NOT IDENTIFY A LIVING INDIVIDUAL.

SER. NO. 79-043,728, FILED 5-8-2007.

ROBERT STRUCK, EXAMINING ATTORNEY

Int. Cl.: 12

Prior U.S. Cls.: 19, 21, 23, 31, 35 and 44

United States Patent and Trademark Office

Reg. No. 3,476,963

Registered July 29, 2008

**TRADEMARK
PRINCIPAL REGISTER**



FENDI ADELE S.R.L. (ITALY LTD LIAB CO)
VIA FLAMINIA, 968
I-00189 ROMA
ITALY

OWNER OF INTERNATIONAL REGISTRATION
0937334 DATED 8-10-2007, EXPIRES 8-10-2017.

OWNER OF U.S. REG. NOS. 1,244,466, 1,569,570
AND OTHERS.

FOR: BABY CARRIAGES; PRAMS; STROLLERS;
PUSH CHAIRS, IN CLASS 12 (U.S. CLS. 19, 21, 23, 31,
35 AND 44).

SER. NO. 79-043,768, FILED 8-10-2007.

JAMES STEIN, EXAMINING ATTORNEY

Int. Cl.: 35

Prior U.S. Cls.: 100, 101 and 102

United States Patent and Trademark Office

Reg. No. 3,476,964

Registered July 29, 2008

**SERVICE MARK
PRINCIPAL REGISTER**

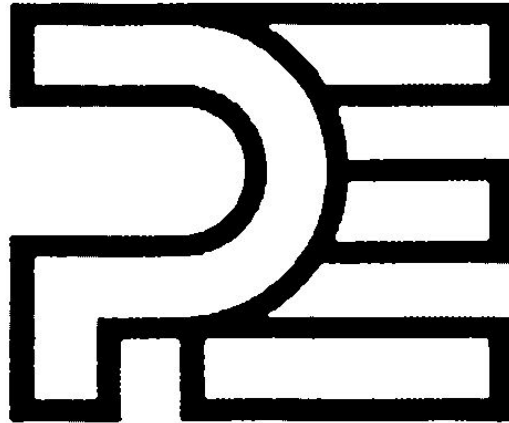

PE EUROPE GMBH (FED REP GERMANY COR-
PORATION OF GERMANY)
HAUPTSTR. 111-113
70771 LEINFELDEN-ECHTERDINGEN, FED REP
GERMANY

OWNER OF INTERNATIONAL REGISTRATION
0937935 DATED 8-9-2007, EXPIRES 8-9-2017.

FOR: ADVERTISING; BUSINESS MANAGE-
MENT; BUSINESS ADMINISTRATION; OFFICE
FUNCTIONS, IN CLASS 35 (U.S. CLS. 100, 101 AND
102).

SER. NO. 79-043,976, FILED 8-9-2007.

PRIORITY DATE OF 2-13-2007 IS CLAIMED.

JESSICA A. POWERS, EXAMINING ATTORNEY

Int. Cl.: 1

Prior U.S. Cls.: 1, 5, 6, 10, 26 and 46

Reg. No. 3,476,965

United States Patent and Trademark Office

Registered July 29, 2008

**TRADEMARK
PRINCIPAL REGISTER**

CHERRY

DELPHI GENETICS SA (BELGIUM SA)
RUE CLÉMENT ADER 16
B-6041 CHARLEROI, BELGIUM

FOR: INDUSTRIAL CHEMICALS, NAMELY, BIOMEDICALS, NAMELY, PRECURSORS FOR IN VITRO GENETIC ENGINEERING USE; CHEMICAL PREPARATIONS FOR SCIENTIFIC PURPOSES, NOT FOR MEDICAL OR VETERINARY USE; BACTERIA FOR USE IN FOOD MANUFACTURE AND WASTE WATER TREATMENT; GENETIC AMPLIFICATION BACTERIA AND PRIMERS, NAMELY, ASSAYS AND REAGENTS FOR USE IN GENETIC RESEARCH, IN CLASS 1 (U.S. CLS. 1, 5, 6, 10, 26 AND 46).

THE MARK CONSISTS OF STANDARD CHARACTERS WITHOUT CLAIM TO ANY PARTICULAR FONT, STYLE, SIZE, OR COLOR.

PRIORITY DATE OF 3-29-2007 IS CLAIMED.

OWNER OF INTERNATIONAL REGISTRATION 0938079 DATED 7-24-2007, EXPIRES 7-24-2017.

SER. NO. 79-044,026, FILED 7-24-2007.

CHRISTOPHER BUONGIORNO, EXAMINING ATTORNEY

Int. Cl.: 33

Prior U.S. Cls.: 47 and 49

United States Patent and Trademark Office

Reg. No. 3,476,966

Registered July 29, 2008

**TRADEMARK
PRINCIPAL REGISTER**

PILLAR BOX

HENRY'S DRIVE VIGNERONS PTY LTD (AUSTRALIA COMPANY)
HODGSON'S ROAD
PADTHAWAY SA 5271
AUSTRALIA

OWNER OF INTERNATIONAL REGISTRATION
0938210 DATED 9-6-2007, EXPIRES 9-6-2017.

FOR: WINE, IN CLASS 33 (U.S. CLS. 47 AND 49).

OWNER OF U.S. REG. NO. 3,149,214.

THE MARK CONSISTS OF STANDARD CHARACTERS WITHOUT CLAIM TO ANY PARTICULAR FONT, STYLE, SIZE, OR COLOR.

SER. NO. 79-044,067, FILED 9-6-2007.

PRIORITY DATE OF 7-2-2007 IS CLAIMED.

BERNICE MIDDLETON, EXAMINING ATTORNEY

Int. Cl.: 17

Prior U.S. Cls.: 1, 5, 12, 13, 35 and 50

United States Patent and Trademark Office

Reg. No. 3,476,967

Registered July 29, 2008

**TRADEMARK
PRINCIPAL REGISTER**

PENTAFORM

KLÖCKNER PENTAPLAST GMBH & CO. KG
(FED REP GERMANY LIMITED PARTNER-
SHIP)

INDUSTRIESTRASSE 3-5
56412 HEILIGENROTH
FED REP GERMANY

FOR: PLASTIC FOILS, NAMELY, SEMI-WORKED
SYNTHETIC PLASTIC, IN PARTICULAR, PVC AS
SEMI-FINISHED PRODUCTS IN FORM OF HARD
FOILS FOR USE IN THE THERMO-FORMING
INDUSTRY, IN CLASS 17 (U.S. CLS. 1, 5, 12, 13, 35
AND 50).

THE MARK CONSISTS OF STANDARD CHAR-
ACTERS WITHOUT CLAIM TO ANY PARTICULAR
FONT, STYLE, SIZE, OR COLOR.

OWNER OF INTERNATIONAL REGISTRATION
0780472 DATED 2-27-2002, EXPIRES 2-27-2012.

OWNER OF U.S. REG. NOS. 2,600,247, 3,006,042
AND OTHERS.

THE WORDING "PENTAFORM" HAS NO MEAN-
ING IN A FOREIGN LANGUAGE.

SER. NO. 79-044,104, FILED 8-28-2007.

MYRIAH HABEEB, EXAMINING ATTORNEY

Int. Cl.: 42

Prior U.S. Cls.: 100 and 101

United States Patent and Trademark Office

Reg. No. 3,476,968

Registered July 29, 2008

**SERVICE MARK
PRINCIPAL REGISTER**

MOFOBOX

B33HIVE PTY LIMITED (AUSTRALIA CORPORATION)

SUITE 504

282 OXFORD STREET; BONDI JUNCTION NSW 2022
AUSTRALIA

FOR: PROVIDING A WEBSITE AND WAP SITE THAT GIVES COMPUTER AND MOBILE PHONE USERS THE ABILITY TO UPLOAD, DOWNLOAD, EXCHANGE AND SHARE VIDEO, IMAGES, DATA, TEXT AND SOUNDS, IN CLASS 42 (U.S. CLS. 100 AND 101).

THE MARK CONSISTS OF STANDARD CHARACTERS WITHOUT CLAIM TO ANY PARTICULAR FONT, STYLE, SIZE, OR COLOR.

PRIORITY DATE OF 3-21-2007 IS CLAIMED.

OWNER OF INTERNATIONAL REGISTRATION 0938314 DATED 7-27-2007, EXPIRES 7-27-2017.

SER. NO. 79-044,144, FILED 7-27-2007.

JORDAN BAKER, EXAMINING ATTORNEY

Int. Cls.: 25 and 35

Prior U.S. Cls.: 22, 39, 100, 101 and 102

United States Patent and Trademark Office

Reg. No. 3,476,969

Registered July 29, 2008

**TRADEMARK
SERVICE MARK
PRINCIPAL REGISTER**



H&M HENNES & MAURITZ AB (SWEDEN CORPORATION)
SALÉN-H/O,
REGERINGSGATAN 48; SE-106 38 STOCKHOLM
SWEDEN

FOR: CLOTHING, NAMELY TROUSERS, T-SHIRTS, COATS, JACKETS, CARDIGANS, SKIRTS, DRESSES, BLOUSES, OVERALLS, UNDERWEAR, JUMPERS, VESTS, FUR COATS AND JACKETS, PANTS, HOODS, SHORTS, BLAZERS, MEN'S SUITS, WOMEN'S SUITS, EVENING GOWNS, TOPS, JEANS, BELTS, SHOULDER WRAPS, GLOVES, MITTENS, SCARVES, TIES, WRAPS, DRESSING GOWNS, NIGHT GOWNS, PAJAMAS, SLEEPWEAR, BATHING SUITS, SWIMWEAR, BIKINIS, SOCKS, STOCKINGS, HATS, CAPS, SHAWLS, BERETS, AND VEILS; HEADWEAR; FOOTWEAR, IN CLASS 25 (U.S. CLS. 22 AND 39).

FOR: RETAIL STORE SERVICES AND ONLINE RETAIL STORE SERVICES FEATURING SOAPS,

PERFUMERY, ESSENTIAL OILS, COSMETICS, HAIR LOTIONS, DENTIFRICES, COSTUME JEWELRY, LEATHER AND IMITATION LEATHER GOODS, CLOCKS AND WATCHES, BAGS AND LUGGAGE, UMBRELLAS, CLOTHING, FOOTWEAR AND HEADWEAR, IN CLASS 35 (U.S. CLS. 100, 101 AND 102).

PRIORITY DATE OF 6-8-2007 IS CLAIMED.

OWNER OF INTERNATIONAL REGISTRATION
0938711 DATED 8-29-2007, EXPIRES 8-29-2017.

OWNER OF U.S. REG. NO. 2,766,051.

SER. NO. 79-044,294, FILED 8-29-2007.

MYRIAH HABEEB, EXAMINING ATTORNEY

Int. Cl.: 43

Prior U.S. Cls.: 100 and 101

United States Patent and Trademark Office

Reg. No. 3,476,970

Registered July 29, 2008

**SERVICE MARK
PRINCIPAL REGISTER**

CUISINE PURE ALTITUDE

SIGESTEL (FRANCE SOCIÉTÉ ANONYME À
DIRECTOIRE)
ROUTE DE RIANTE COLLINE
LES FERMES DE MARIE
F-74120 MEGEVE, FRANCE

FOR: SERVICES FOR PROVIDING FOOD AND
DRINK; TEMPORARY ACCOMMODATION; BAR
SERVICES; CATERING SERVICES; HOTEL SERVI-
CES; MAKING HOTELS RESERVATIONS FOR OTH-
ERS; CAFÉ-RESTAURANTS; SELF-SERVICES
RESTAURANTS; GOURMET RESTAURANTS; HO-
TEL SERVICES IN THE NATURE OF BED AND
BREAKFASTS; RESTAURANT SERVICES FEATUR-
ING TABLES D'HÔTES; ARRANGING TEMPOR-
ARY HOUSING ACCOMMODATIONS IN GÎTES;
RURAL TOURIST ACCOMMODATION SERVICES
IN THE NATURE OF TOURIST HOMES, INNS AND
HOSTELS, IN CLASS 43 (U.S. CLS. 100 AND 101).

THE MARK CONSISTS OF STANDARD CHAR-
ACTERS WITHOUT CLAIM TO ANY PARTICULAR
FONT, STYLE, SIZE, OR COLOR.

PRIORITY DATE OF 3-19-2007 IS CLAIMED.

OWNER OF INTERNATIONAL REGISTRATION
0938813 DATED 8-24-2007, EXPIRES 8-24-2017.

NO CLAIM IS MADE TO THE EXCLUSIVE
RIGHT TO USE "CUISINE", APART FROM THE
MARK AS SHOWN.

SER. NO. 79-044,330, FILED 8-24-2007.

ELISSA GARBER KON, EXAMINING ATTORNEY

Int. Cls.: 1, 5, 41 and 42

**Prior U.S. Cls.: 1, 5, 6, 10, 18, 26, 44, 46, 51, 52, 100,
101 and 107**

Reg. No. 3,476,971

United States Patent and Trademark Office

Registered July 29, 2008

**TRADEMARK
SERVICE MARK
PRINCIPAL REGISTER**



NOVOZYMES A/S, (DENMARK SOCIÉTÉ/CORPORATION)
KROGSHOEJVEJ 36
DK-2880 BAGSVAERD
DENMARK

FOR: CHEMICALS USED IN INDUSTRY, IN CLASS 1 (U.S. CLS. 1, 5, 6, 10, 26 AND 46).

FOR: PHARMACEUTICAL AND VETERINARY PREPARATIONS FOR CANCER TREATMENT AND ENZYME REPLACEMENT THERAPY; SANITARY PREPARATIONS FOR MEDICAL USE; DISINFECTANTS FOR SANITARY PURPOSES; PREPARATIONS FOR DESTROYING VERMIN; FUNGICIDES AND HERBICIDES, IN CLASS 5 (U.S. CLS. 6, 18, 44, 46, 51 AND 52).

FOR: EDUCATION SERVICES, NAMELY, PROVIDING CLASSES, SEMINARS AND WORKSHOPS IN THE FIELD OF CHEMICALS FOR INDUSTRIAL PURPOSES, IN CLASS 41 (U.S. CLS. 100, 101 AND 107).

FOR: SCIENTIFIC AND TECHNICAL CONSULTING SERVICES RELATED TO FOODS AND DIETARY SUPPLEMENTS; SCIENTIFIC RESEARCH IN THE FIELD OF FOOD AND DIETARY SUPPLEMENTS; DESIGN FOR OTHERS IN THE FIELD OF FOOD AND DIETARY SUPPLEMENTS; AND INDUSTRIAL ANALYSIS AND RESEARCH SERVICES IN THE FIELDS OF USE OF ENZYMES AND MICROBES IN INDUSTRIAL APPLICATIONS, IN CLASS 42 (U.S. CLS. 100 AND 101).

PRIORITY DATE OF 6-5-2007 IS CLAIMED.

OWNER OF INTERNATIONAL REGISTRATION 0938836 DATED 9-12-2007, EXPIRES 9-12-2017.

OWNER OF U.S. REG. NOS. 2,531,502, 2,593,558, AND 2,958,900.

SER. NO. 79-044,340, FILED 9-12-2007.

DAVID MURRAY, EXAMINING ATTORNEY

Int. Cl.: 32

Prior U.S. Cls.: 45, 46 and 48

United States Patent and Trademark Office

Reg. No. 3,476,972

Registered July 29, 2008

**TRADEMARK
PRINCIPAL REGISTER**



STOPTIME S.R.L. (ITALY LIMITED LIABILITY
COMPANY (S.R.L))
VIALE PIAVE, 30
I-59100 PRATO
ITALY

FOR: NON-ALCOHOLIC DRINKS, NAMELY,
NON CARBONATED SOFT DRINKS AND CARBO-
NATED BEVERAGES, IN CLASS 32 (U.S. CLS. 45, 46
AND 48).

OWNER OF INTERNATIONAL REGISTRATION
0938984 DATED 8-28-2007, EXPIRES 8-28-2017.

THE COLOR(S) BLACK, RED AND BLUE IS/ARE
CLAIMED AS A FEATURE OF THE MARK.

THE MARK CONSISTS OF THE WORDING
"STOPTIME" IN THE COLOR BLACK, AN HOUR-
GLASS AND OVAL DESIGN IN THE COLOR BLUE
AND THE REPRESENTATION OF SAND WITHIN
THE HOURGLASS IN THE COLOR RED.

SER. NO. 79-044,397, FILED 8-28-2007.

DOMINIC FATHY, EXAMINING ATTORNEY

Int. Cl.: 3

Prior U.S. Cls.: 1, 4, 6, 50, 51 and 52

United States Patent and Trademark Office

Reg. No. 3,476,973

Registered July 29, 2008

**TRADEMARK
PRINCIPAL REGISTER**

CICABIO

LABORATOIRE BIODERMA, (FRANCE SOCIÉTÉ
PAR ACTIONS SIMPLIFIÉE)
75, COURS ALBERT THOMAS
F-69003 LYON
FRANCE

FOR: BLEACHING PREPARATIONS; CLEAN-
ING, POLISHING, SCOURING AND ABRASIVE
PREPARATIONS; SOAPS; PERFUMERY, ESSEN-
TIAL OILS, COSMETICS, HAIR LOTIONS; DENTI-
FRICES, FOOD SUPPLEMENTS FOR COSMETIC
USE, IN CLASS 3 (U.S. CLS. 1, 4, 6, 50, 51 AND 52).

THE MARK CONSISTS OF STANDARD CHAR-
ACTERS WITHOUT CLAIM TO ANY PARTICULAR
FONT, STYLE, SIZE, OR COLOR.

OWNER OF INTERNATIONAL REGISTRATION
0939039 DATED 7-25-2007, EXPIRES 7-25-2017.

SER. NO. 79-044,463, FILED 7-25-2007.

JANET LEE, EXAMINING ATTORNEY

Int. Cl.: 18

Prior U.S. Cls.: 1, 2, 3, 22 and 41

United States Patent and Trademark Office

Reg. No. 3,476,974

Registered July 29, 2008

**TRADEMARK
PRINCIPAL REGISTER**

dry me!

AION CO., LTD. (JAPAN CORPORATION LIMITED)
6-5, TANIMACHI 2-CHOME,
CHUO-KU.; OSAKA-SHI; OSAKA 540-0012
JAPAN

OWNER OF INTERNATIONAL REGISTRATION
0939267 DATED 7-25-2007, EXPIRES 7-25-2017.

FOR: PET ACCESSORIES, NAMELY, TOWELS
FOR PETS, IN CLASS 18 (U.S. CLS. 1, 2, 3, 22 AND 41).

SER. NO. 79-044,529, FILED 7-25-2007.

PRIORITY DATE OF 6-29-2007 IS CLAIMED.

NAPOLEON SHARMA, EXAMINING ATTORNEY

Int. Cl.: 1

Prior U.S. Cls.: 1, 5, 6, 10, 26 and 46

Reg. No. 3,476,975

United States Patent and Trademark Office

Registered July 29, 2008

**TRADEMARK
PRINCIPAL REGISTER**



CHANGZHOU ZHAOLONG; MACROMOLECULE MATERIAL CO., LTD (CHINA CORPORATION)

NO.29, GUIHUA ROAD, ZHONGLOU ECONOMIC DEVELOPMENT ZONE,; CHANGZHOU; 213023 JIANGSU CHINA

FOR: UNPROCESSED SYNTHETIC RESINS; UNPROCESSED PLASTIC RESIN; UNPROCESSED SILICONE PLASTICS , IN CLASS 1 (U.S. CLS. 1, 5, 6, 10, 26 AND 46).

OWNER OF INTERNATIONAL REGISTRATION 0939480 DATED 6-25-2007, EXPIRES 6-25-2017.

NO CLAIM IS MADE TO THE EXCLUSIVE RIGHT TO USE THE LAST THREE CHINESE CHARACTERS SHOWN IN THE MARK, WHICH TRANSLITERATE AS "XIN CAI LIAO", MEANING "NEW MATERIAL", APART FROM THE MARK AS SHOWN.

THE FIRST CHINESE CHARACTER TRANSLITERATES TO "ZHAO," WHICH MEANS "PORTEND" IN ENGLISH; THE SECOND CHINESE CHARACTER TRANSLITERATES TO "LONG," WHICH MEANS "GRAND." THE COMBINATION OF THE TWO CHINESE CHARACTERS HAS NO ENGLISH TRANSLATION. THE LAST THREE CHINESE CHARACTERS TRANSLITERATE TO "XIN CAI LIAO," WHICH MEANS "NEW MATERIAL." THE WORD "ZHAOLONG" IS THE TRANSLITERATION OF THE FIRST TWO CHINESE CHARACTERS IN THE MARK AND HAS NO ENGLISH TRANSLATION.

THE TRANSLITERATION OF THE NON-LATIN CHARACTERS IN THE MARK IS: ZHAO LONG XIN CAI LIAO.

SER. NO. 79-044,588, FILED 6-25-2007.

STEVEN PEREZ, EXAMINING ATTORNEY

Int. Cl.: 7

Prior U.S. Cls.: 13, 19, 21, 23, 31, 34 and 35

United States Patent and Trademark Office

Reg. No. 3,476,976

Registered July 29, 2008

**TRADEMARK
PRINCIPAL REGISTER**

ROLL-RING

DIPL.-ING. OEC. SIEGFRIED EBERT (FED REP
GERMANY INDIVIDUAL)
18, RADEFELDER STRASSE
04509 FREIRODA
FED REP GERMANY

FOR: MACHINE COMPONENTS IN THE NAT-
URE OF TENSION RINGS FOR USE IN BELT AND
CHAIN DRIVES THAT ROTATE BETWEEN THE
STRANDS OF MACHINE DRIVES, IN CLASS 7 (U.S.
CLS. 13, 19, 21, 23, 31, 34 AND 35).

OWNER OF INTERNATIONAL REGISTRATION
0641683 DATED 8-11-1995, EXPIRES 8-11-2015.

OWNER OF U.S. REG. NO. 2,176,383.

SER. NO. 79-044,663, FILED 8-7-2007.

CARYN GLASSER, EXAMINING ATTORNEY

Int. Cl.: 33

Prior U.S. Cls.: 47 and 49

United States Patent and Trademark Office

Reg. No. 3,476,977

Registered July 29, 2008

TRADEMARK
PRINCIPAL REGISTER

POÇAS

MANOEL D. POÇAS JÚNIOR -; VINHOS, S.A.
(PORTUGAL SOCIETE ANONYME (INCORPORATED SOCIETY))
RUA VISCONDE DAS DEVESAS, 186
P-4400 VILA NOVA DE GAIA, PORTUGAL

FOR: PORT WINE, TABLE WINES, NATURAL SPARKLING WINES, DISTILLED SPIRITS AND LIQUEURS, IN CLASS 33 (U.S. CLS. 47 AND 49).

THE MARK CONSISTS OF STANDARD CHARACTERS WITHOUT CLAIM TO ANY PARTICULAR FONT, STYLE, SIZE, OR COLOR.

OWNER OF INTERNATIONAL REGISTRATION
0781597 DATED 5-21-2002, EXPIRES 5-21-2012.

THE FOREIGN WORDING IN THE MARK
TRANSLATES INTO ENGLISH AS PUDDLES.

SER. NO. 79-044,680, FILED 9-25-2007.

MARILYN IZZI, EXAMINING ATTORNEY

Int. Cls.: 18 and 25

Prior U.S. Cls.: 1, 2, 3, 22, 39 and 41

Reg. No. 3,476,978

United States Patent and Trademark Office

Registered July 29, 2008

**TRADEMARK
PRINCIPAL REGISTER**

Kazar

KAZAR FOOTWEAR; SPÓLKA Z OGRANICZONĄ
ODPOWIEDZIALNOŚCIĄ (POLAND LTD
LIAB CO)
LWOWSKA 154
PL-37-700 PRZEMYSŁ
POLAND

FOR: LEATHER AND LEATHER IMITATIONS;
PRODUCTS MADE OF LEATHER AND IMITATION
LEATHER, NAMELY, HANDBAGS, BACKPACKS,
BOOK BAGS, SPORTS BAGS, PURSES AND WAL-
LETS; TRUNKS, CHESTS, SUITCASES AND TRA-
VEL BAGS, IN CLASS 18 (U.S. CLS. 1, 2, 3, 22 AND 41).

FOR: CLOTHING, NAMELY, PANTS, SKIRTS,
JACKETS, SHIRTS MADE OF LEATHER AND LEA-
THER IMITATIONS; BELTS; GLOVES; FOOTWEAR,
HEADWEAR, FUR COATS, FUR STOLEES, FUR
MUFFS, IN CLASS 25 (U.S. CLS. 22 AND 39).

OWNER OF INTERNATIONAL REGISTRATION
0939750 DATED 8-13-2007, EXPIRES 8-13-2017.

SER. NO. 79-044,691, FILED 8-13-2007.

CAROLYN CATALDO, EXAMINING ATTORNEY

Int. Cl.: 16

Prior U.S. Cls.: 2, 5, 22, 23, 29, 37, 38 and 50

United States Patent and Trademark Office

Reg. No. 3,476,979

Registered July 29, 2008

**TRADEMARK
PRINCIPAL REGISTER**

Pentadur

KLÖCKNER PENTAPLAST GMBH & CO. KG
(FED REP GERMANY LIMITED PARTNER-
SHIP)

INDUSTRIESTR. 3-5
56412 HEILIGENROTH
FED REP GERMANY

FOR: PLASTIC FILMS FOR PACKAGING, IN
CLASS 16 (U.S. CLS. 2, 5, 22, 23, 29, 37, 38 AND 50).

THE MARK CONSISTS OF STANDARD CHAR-
ACTERS WITHOUT CLAIM TO ANY PARTICULAR
FONT, STYLE, SIZE, OR COLOR.

OWNER OF INTERNATIONAL REGISTRATION
0939794 DATED 6-26-2007, EXPIRES 6-26-2017.

OWNER OF U.S. REG. NOS. 2,600,247, 3,006,042
AND OTHERS.

THE WORDING "PENTADUR" HAS NO MEAN-
ING IN A FOREIGN LANGUAGE.

SER. NO. 79-044,713, FILED 6-26-2007.

MYRIAH HABEEB, EXAMINING ATTORNEY

Int. Cl.: 29

Prior U.S. Cl.: 46

United States Patent and Trademark Office

Reg. No. 3,476,980

Registered July 29, 2008

**TRADEMARK
PRINCIPAL REGISTER**



APOSTOLOU KONSTANTINOS (GREECE INDIVIDUAL)
SOTIRIOU CHOUNTA STR. 8
GR-190 02 PEANIA - ATTICA
GREECE

FOR: EDIBLE OILS AND FATS, IN CLASS 29 (U.S. CL. 46).

OWNER OF INTERNATIONAL REGISTRATION
0933457 DATED 1-9-2007, EXPIRES 1-9-2017.

THE COLOR(S) GOLD, BLACK AND WHITE IS/ARE CLAIMED AS A FEATURE OF THE MARK.

THE LEAF IS GOLD. THE BACKGROUND OF THE MARK IS IN BLACK. THE WORDS "OLIVE CULTURE" ARE IN WHITE.

SER. NO. 79-044,948, FILED 6-13-2007.

ERNEST SHOSHO, EXAMINING ATTORNEY

Int. Cl.: 28

Prior U.S. Cls.: 22, 23, 38 and 50

United States Patent and Trademark Office

Reg. No. 3,476,981

Registered July 29, 2008

**TRADEMARK
PRINCIPAL REGISTER**

SERIE 

TRETORN AKTIEBOLAG (SWEDEN JOINT
STOCK COMPANY)
BOX 931,
SE-251 09 HELSINGBORG
SWEDEN

OWNER OF INTERNATIONAL REGISTRATION
0940486 DATED 9-26-2007, EXPIRES 9-26-2017.

FOR: GYMNASTIC AND SPORTING APPARA-
TUS AND ARTICLES, NAMELY, TENNIS RACK-
ETS, NETS FOR TENNIS, TENNIS RACKET
STRINGS, GAME BALLS, TENNIS BALLS; TENNIS
TRAINING EQUIPMENT, NAMELY, TENNIS BALL
BAGS, CARRYING CASES FOR TENNIS EQUIP-
MENT; BAGS, CASES AND COVERS FOR TENNIS
RACKETS, IN CLASS 28 (U.S. CLS. 22, 23, 38 AND 50).

THE FOREIGN WORDING IN THE MARK
TRANSLATES INTO ENGLISH AS "SERIES".

SER. NO. 79-045,028, FILED 9-26-2007.

NAPOLEON SHARMA, EXAMINING ATTORNEY

Int. Cls.: 9, 35 and 42

Prior U.S. Cls.: 21, 23, 26, 36, 38, 100, 101 and 102

Reg. No. 3,476,982

United States Patent and Trademark Office

Registered July 29, 2008

**TRADEMARK
SERVICE MARK
PRINCIPAL REGISTER**

TIPPYTERM

SYSKON SYSTEMLÖSUNGEN GMBH (FED REP
GERMANY GMBH)
BRANDENBURGERSTR. 1
78467 KONSTANZ
FED REP GERMANY

FOR: APPLICATION SOFTWARE FOR USE IN DATA MANAGEMENT AND TERMINOLOGY MANAGEMENT, COMPUTER SOFTWARE FOR USE IN DATA MANAGEMENT AND TERMINOLOGY MANAGEMENT; APPARATUS, INSTRUMENTS, MEDIA FOR RECORDING, REPRODUCTION, STORING, PROCESSING, MANIPULATING, TRANSMITTING, BROADCASTING AND RETRIEVING MUSIC, SOUNDS, IMAGES, TEXT, SIGNALS, SOFTWARE, INFORMATION, DATA AND CODE, IN CLASS 9 (U.S. CLS. 21, 23, 26, 36 AND 38).

FOR: DATA-PROCESSING SERVICES FOR BUSINESS MANAGEMENT AND TERMINOLOGY MANAGEMENT; COLLATING OF DATA IN COMPUTER DATABASES FOR BUSINESS MANAGEMENT AND TERMINOLOGY MANAGEMENT; SYSTEMISING OF DATA IN COMPUTER DATABASES FOR BUSINESS MANAGEMENT AND TERMINOLOGY MANAGEMENT; COMPILING OF TECHNICAL DOCUMENTATION FOR BUSINESS MANAGE-

MENT AND TERMINOLOGY MANAGEMENT, IN CLASS 35 (U.S. CLS. 100, 101 AND 102).

FOR: UPDATING, CARE, DESIGN, PROGRAMMING, RENTAL, NETWORKING, MAINTENANCE AND INSTALLATION AND UPGRADING AND UPDATING OF SOFTWARE; CONSULTANCY IN THE FIELDS OF COMPUTER SOFTWARE AND HARDWARE; DEVELOPMENT OF SOFTWARE, FOR OTHERS; SCIENTIFIC AND TECHNOLOGICAL SERVICES AND RESEARCH, AND DESIGN RELATING THERETO, NAMELY TECHNOLOGICAL CONSULTATION IN THE FIELD OF HARDWARE AND SOFTWARE SYSTEMS, IN CLASS 42 (U.S. CLS. 100 AND 101).

PRIORITY DATE OF 3-6-2007 IS CLAIMED.

OWNER OF INTERNATIONAL REGISTRATION
0940677 DATED 8-28-2007, EXPIRES 8-28-2017.

SER. NO. 79-045,121, FILED 8-28-2007.

DAVID HOFFMAN, EXAMINING ATTORNEY

Int. Cl.: 24

Prior U.S. Cls.: 42 and 50

United States Patent and Trademark Office

Reg. No. 3,476,983

Registered July 29, 2008

TRADEMARK
PRINCIPAL REGISTER

Le Pâtissier

PRAIRIE DOG CO., LTD. (JAPAN JOINT-STOCK
COMPANY)
SENBA OSEN BLDG. 7F
3-4-16, AZUCHIMACHI
CHUO-KU., OSAKA-SHI; OSAKA-FU 541-0052, JA-
PAN

FOR: TOWELS; TERRY TOWELS; FACE TOWELS
MADE OF TEXTILE MATERIALS; HAND TOWELS;
HANDKERCHIEFS OF TEXTILE; JAPANESE COT-
TON TOWELS, NAMELY, TENUGUI; BED SHEETS;
QUILTS; COMFORTERS; MATTRESS PADS; UN-
FITTED FUTON COVERS NOT OF PAPER; BED
PADS; PILLOW CASES; PILLOW COVERS; CHIL-
DREN'S BLANKETS; BLANKET THROWS; BLAN-
KETS FOR OUTDOOR USE; BED BLANKETS;
COVERINGS OF TEXTILE FOR CHAIRS; TAPES-
TRIES OF TEXTILE; CURTAINS OF TEXTILE;

FABRIC TABLE RUNNERS; TABLE CLOTHS NOT
OF PAPER, IN CLASS 24 (U.S. CLS. 42 AND 50).

PRIORITY DATE OF 6-20-2007 IS CLAIMED.

OWNER OF INTERNATIONAL REGISTRATION
0940694 DATED 7-30-2007, EXPIRES 7-30-2017.

THE ENGLISH TRANSLATION OF "LE PATISSI-
ER" IN THE MARK IS THE PASTRY CHEF.

SER. NO. 79-045,127, FILED 7-30-2007.

EDWARD NELSON, EXAMINING ATTORNEY

Int. Cl.: 9

Prior U.S. Cls.: 21, 23, 26, 36 and 38

United States Patent and Trademark Office

Reg. No. 3,476,984

Registered July 29, 2008

**TRADEMARK
PRINCIPAL REGISTER**

CARESSE D'ORCHIDEES

CARTIER INTERNATIONAL N.V.; A HOLDING
AND TRADING COMPANY; ORGANIZED
AND EXISTING UNDER THE LAWS OF
THE NETHERLANDS ANTILLES (NETHERLD
ANTILLES LTD LIAB CO)

SCHARLOOWEG 33
CURAÇAO, NETHERLD ANTILLES

FOR: EYEGASSES, SUNGLASSES, EYEGLASS
FRAMES AND CASES, MAGNIFYING GLASSES, IN
CLASS 9 (U.S. CLS. 21, 23, 26, 36 AND 38).

THE MARK CONSISTS OF STANDARD CHAR-
ACTERS WITHOUT CLAIM TO ANY PARTICULAR
FONT, STYLE, SIZE, OR COLOR.

OWNER OF INTERNATIONAL REGISTRATION
0941161 DATED 7-31-2007, EXPIRES 7-31-2017.

THE FOREIGN WORDING IN THE MARK
TRANSLATES INTO ENGLISH AS CARESS OF
ORCHIDS.

SER. NO. 79-045,288, FILED 7-31-2007.

WARREN L. OLANDRIA, EXAMINING ATTOR-
NEY

Int. Cl.: 43

Prior U.S. Cls.: 100 and 101

United States Patent and Trademark Office

Reg. No. 3,476,985

Registered July 29, 2008

**SERVICE MARK
PRINCIPAL REGISTER**

PARIS ON YOUR LIPS

FAUCHON (FRANCE SOCIÉTÉ PAR ACTIONS
SIMPLIFIÉE)
26, PLACE DE LA MADELEINE
F-75008 PARIS, FRANCE

FOR: RESTAURANT AND BAR SERVICES; CA-
TERING SERVICES FEATURING BAKERY AND
PASTRY GOODS; TEMPORARY ACCOMMODA-
TION SERVICES, NAMELY, HOTEL AND MOTEL
SERVICES; HOTEL RESERVATION SERVICES, IN
CLASS 43 (U.S. CLS. 100 AND 101).

THE MARK CONSISTS OF STANDARD CHAR-
ACTERS WITHOUT CLAIM TO ANY PARTICULAR
FONT, STYLE, SIZE, OR COLOR.

PRIORITY DATE OF 3-1-2007 IS CLAIMED.

OWNER OF INTERNATIONAL REGISTRATION
0941493 DATED 8-31-2007, EXPIRES 8-31-2017.

NO CLAIM IS MADE TO THE EXCLUSIVE
RIGHT TO USE "PARIS", APART FROM THE
MARK AS SHOWN.

SER. NO. 79-045,396, FILED 8-31-2007.

KELLY MCCOY, EXAMINING ATTORNEY

Int. Cls.: 11, 16 and 42

**Prior U.S. Cls.: 2, 5, 13, 21, 22, 23, 29, 31, 34, 37, 38,
50, 100 and 101**

Reg. No. 3,476,986

United States Patent and Trademark Office

Registered July 29, 2008

**TRADEMARK
SERVICE MARK
PRINCIPAL REGISTER**

SieMatic
BeauxArts

SIEMATIC MÖBELWERKE GMBH & CO. KG
(FED REP GERMANY PARTNERSHIP LIMITED BY SHARES)

AUGUST-SIEKMANN-STRABE 1-5
32584 LÖHNE
FED REP GERMANY

FOR: SINKS; ELECTRIC LAMPS, LAMPS FOR LIGHTING, CEILING LIGHTS, FITTED LAMPS FOR FURNITURE, IN CLASS 11 (U.S. CLS. 13, 21, 23, 31 AND 34).

FOR: PRINTED MATTER, NAMELY, STATIONERY, BOOKS ABOUT INTERIOR DECORATING AND MAGAZINES ABOUT INTERIOR DECORATING, IN CLASS 16 (U.S. CLS. 2, 5, 22, 23, 29, 37, 38 AND 50).

FOR: DESIGN OF INTERIOR DECOR; PLANNING AND ADVICE WITH RESPECT TO INTERIOR DECORATION, IN CLASS 42 (U.S. CLS. 100 AND 101).

PRIORITY DATE OF 6-8-2007 IS CLAIMED.

OWNER OF INTERNATIONAL REGISTRATION
0941559 DATED 10-29-2007, EXPIRES 10-29-2017.

OWNER OF U.S. REG. NOS. 1,072,510 AND
3,211,689.

NO CLAIM IS MADE TO THE EXCLUSIVE RIGHT TO USE "BEAUXARTS", APART FROM THE MARK AS SHOWN.

THE COLOR(S) GRAY AND BLACK IS/ARE CLAIMED AS A FEATURE OF THE MARK.

THE COLOR GRAY APPEARS IN THE WORDING "BEAUX" BUT ONLY IN ONE LINE OF THE LETTER "X", AND THE COLOR BLACK APPEARS IN THE WORDING "SIEMATIC" AND THE WORD "ARTS" WITH ONE LINE OF THE LETTER "A" ALSO FORMING PART OF THE LETTER "X".

SER. NO. 79-045,420, FILED 10-29-2007.

SUSAN STIGLITZ, EXAMINING ATTORNEY

Int. Cl.: 33

Prior U.S. Cls.: 47 and 49

United States Patent and Trademark Office

Reg. No. 3,476,987

Registered July 29, 2008

**TRADEMARK
PRINCIPAL REGISTER**

BARON OTARD

CHÂTEAU DE COGNAC (FRANCE SOCIÉTÉ
PAR ACTIONS SIMPLIFIÉE)
BOULEVARD DENFERT ROCHEREAU
F-16100 COGNAC
FRANCE

FOR: ALCOHOLIC BEVERAGES, NAMELY,
EAUX-DE-VIE, NAMELY, FRUIT BRANDIES, SPIR-
ITS AND LIQUEURS, IN CLASS 33 (U.S. CLS. 47 AND
49).

OWNER OF INTERNATIONAL REGISTRATION
0941827 DATED 9-28-2007, EXPIRES 9-28-2017.

"BARON OTARD" DOES NOT IDENTIFY A LIV-
ING INDIVIDUAL.

SER. NO. 79-045,510, FILED 9-28-2007.

INGA ERVIN, EXAMINING ATTORNEY

Int. Cl.: 5

Prior U.S. Cls.: 6, 18, 44, 46, 51 and 52

Reg. No. 3,476,988

United States Patent and Trademark Office

Registered July 29, 2008

**TRADEMARK
PRINCIPAL REGISTER**

ANVI

ZAO "NPO" ANTIVIRAL" (RUSSIAN FED. CJSC)
UL. PROF. POPOVA, 15/17
RU-197376 SAINT PETERSBURG, RUSSIAN FED.

FOR: VITAMIN PREPARATIONS; PHARMACEUTICAL PREPARATIONS FOR PREVENTION OF ACUTE RESPIRATORY VIRAL INFECTION (ARVI), ACUTE RESPIRATORY DISEASE (ARD), FLU, NEUROSAL ANXIETY DISORDER, ANXIETY, PSYCHOPATHY, OBSESSIVE-COMPULSIVE REACTION, PRIMARY OPEN-ANGLE GLAUCOMA, STAMMERING, INSOMNOLENCE, ANXIETY DREAMS, VESTIBULAR VERTIGO, MENIERE'S DISEASE, HYPOXIA, ASTHENIA, CEREBROVASCULAR ACCIDENT, HYPOMNESIA, TOXICOPATHY, TRAUMATIC BRAIN INJURY, MENINGITIS, ENCEPHALITIS, PRIMARY HYPERCHOLESTEREMIA, COMBINED HYPERLIPIDEMIA, HOMOZYGOUS FAMILIAL HYPERCHOLESTEREMIA, CORONARY HEART DISEASE, ATHEROTHROMBOSIS, ISHEMIC INSULT, ACUTE CORONARY SYNDROME, MYOCARDIAL INFRACTION, TONSILLITIS, PHARYNGITIS, LARYNGITIS, APHTHOUS STOMATITIS, GINGIVITIS, TRACHEITIS, BRONCHITIS, PNEUMONIA, RHINITIS; CHEMICO-PHARMACEUTICAL PREPARATIONS, NAMELY, PHARMACEUTICAL PREPARATIONS FOR USE

IN CHEMOTHERAPY; MEDICINAL PREPARATIONS FOR MEDICAL PURPOSES, NAMELY, MEDICINAL PREPARATIONS FOR THE TREATMENT OF INFECTIOUS DISEASES AND FOR USE IN ONCOLOGY; DIETETIC FOODS ADAPTED FOR MEDICAL PURPOSES; DIETETIC SUBSTANCES ADAPTED FOR MEDICAL USE; NAMELY, DIETETIC SUGAR FOR MEDICAL USE; NUTRITIONAL ADDITIVES FOR MEDICAL PURPOSES FOR USE IN FOODS AND DIETARY SUPPLEMENTS FOR HUMAN CONSUMPTION; DIETETIC ALBUMINOUS PREPARATIONS FOR MEDICAL PURPOSES; ALBUMINOUS FOODSTUFFS FOR MEDICAL PURPOSES; BIOLOGICAL PREPARATIONS FOR MEDICAL PURPOSES; PHARMACEUTICAL PREPARATIONS, NAMELY, ELIXIRS FOR SKIN AND HEALTH IMPROVEMENT, IN CLASS 5 (U.S. CLS. 6, 18, 44, 46, 51 AND 52).

OWNER OF INTERNATIONAL REGISTRATION
0941922 DATED 9-19-2007, EXPIRES 9-19-2017.

SER. NO. 79-045,533, FILED 9-19-2007.

CAROL SPILS, EXAMINING ATTORNEY

Int. Cl.: 7

Prior U.S. Cls.: 13, 19, 21, 23, 31, 34 and 35

United States Patent and Trademark Office

Reg. No. 3,476,989

Registered July 29, 2008

**TRADEMARK
PRINCIPAL REGISTER**

BATCH FORMULA

GEA LIQUID PROCESSING SCANDINAVIA A/S
(DENMARK LTD LIAB CO)
NORSKOWEJ 1 B
DK-8660 SKANDERBORG
DENMARK

FOR: MIXING MACHINES FOR MIXING SOLIDS
WITH LIQUIDS AND FOR MIXING LIQUIDS WITH
LIQUIDS, IN CLASS 7 (U.S. CLS. 13, 19, 21, 23, 31, 34
AND 35).

THE MARK CONSISTS OF STANDARD CHAR-
ACTERS WITHOUT CLAIM TO ANY PARTICULAR
FONT, STYLE, SIZE, OR COLOR.

PRIORITY DATE OF 3-16-2006 IS CLAIMED.

OWNER OF INTERNATIONAL REGISTRATION
0942130 DATED 9-11-2006, EXPIRES 9-11-2016.

SER. NO. 79-045,668, FILED 9-11-2006.

SHAILA SETTLES, EXAMINING ATTORNEY

Int. Cl.: 32

Prior U.S. Cls.: 45, 46 and 48

United States Patent and Trademark Office

Reg. No. 3,476,990

Registered July 29, 2008

**TRADEMARK
PRINCIPAL REGISTER**

SCANDIA GOLD

ROYAL UNIBREW A/S (DENMARK LTD LIAB
CO)
FAXE ALLÉ 1
DK-4640 FAKSE
DENMARK

OWNER OF INTERNATIONAL REGISTRATION
0942512 DATED 8-29-2006, EXPIRES 8-29-2016.

FOR: BEERS, IN CLASS 32 (U.S. CLS. 45, 46 AND
48).

NO CLAIM IS MADE TO THE EXCLUSIVE
RIGHT TO USE "GOLD", APART FROM THE
MARK AS SHOWN.

THE MARK CONSISTS OF STANDARD CHAR-
ACTERS WITHOUT CLAIM TO ANY PARTICULAR
FONT, STYLE, SIZE, OR COLOR.

SER. NO. 79-045,796, FILED 8-29-2006.

JANET LEE, EXAMINING ATTORNEY

Int. Cls.: 29, 30 and 43

Prior U.S. Cls.: 46, 100 and 101

United States Patent and Trademark Office

Reg. No. 3,476,991

Registered July 29, 2008

**TRADEMARK
SERVICE MARK
PRINCIPAL REGISTER**

ICHIRAN

YOSHITOMI MANABU (JAPAN INDIVIDUAL)
MOMOCHI TOWER 2701
1-2-6, MOMOCHIHAMA, SAWARA-KU; FUKUOKA-
SHI;
FUKUOKA 814-0001, JAPAN

FOR: SOUP FEATURING CHINESE NOODLES,
IN CLASS 29 (U.S. CL. 46).

FOR: CHINESE NOODLES; GYOZA, NAMELY,
COOKED CHINESE STUFFED DUMPLINGS, IN
CLASS 30 (U.S. CL. 46).

FOR: PROVIDING CHINESE NOODLES SERVED
IN SOUP; PROVIDING ALCOHOLIC DRINKS,
NAMELY, SAKE, BEER, SHOCHU, WHISKEY,
COCKTAIL; PROVIDING TEA, COFFEE, SOFT

DRINKS AND FRUIT BEVERAGES, IN CLASS 43
(U.S. CLS. 100 AND 101).

THE MARK CONSISTS OF STANDARD CHAR-
ACTERS WITHOUT CLAIM TO ANY PARTICULAR
FONT, STYLE, SIZE, OR COLOR.

OWNER OF INTERNATIONAL REGISTRATION
0942525 DATED 7-27-2007, EXPIRES 7-27-2017.

THE FOREIGN WORDING IN THE MARK
TRANSLATES INTO ENGLISH AS ONE ORCHID.

SER. NO. 79-045,804, FILED 7-27-2007.

TASHIA BUNCH, EXAMINING ATTORNEY

Int. Cl.: 41

Prior U.S. Cls.: 100, 101 and 107

United States Patent and Trademark Office

Reg. No. 3,476,992

Registered July 29, 2008

**SERVICE MARK
PRINCIPAL REGISTER**

RMIT English Worldwide

RMIT TRAINING PTY LTD (AUSTRALIA PROPRIETARY COMPANY)
P.O. BOX 12058,
A'BECKETT STREET; MELBOURNE VIC 8006
AUSTRALIA

FOR: EDUCATION, INSTRUCTIONAL, TEACHING, TRAINING, ORGANISATION, INFORMATION AND CONSULTING FOR TRAINING AND EDUCATION SERVICES, NAMELY, ENGLISH LANGUAGE SKILLS AND ENGLISH LANGUAGE SKILLS PROGRAMS, TRAINING FOR INSTRUCTORS IN ENGLISH LANGUAGE SKILLS AND FOR IMPROVEMENT AND DEVELOPMENT OF ENGLISH SKILLS, PROVIDING FACILITIES OR SERVICES FOR THE ABOVE, ARRANGING AND CONDUCTING OF COLLOQUIUMS, CONFERENCES, CONGRESSES, SEMINARS, SYMPOSIUMS AND TRAINING WORKSHOPS, DISTANCE EDUCATION, NAMELY, THE PROVISION OF EDUCATION, INSTRUCTION, INFORMATION, TEACHING, CONSULTING AND MANAGEMENT

TRAINING VIA ON-LINE FACILITIES, THE INTERNET AND ANY OTHER COMPUTER OR COMMUNICATIONS NETWORK OR INTERACTIVE WEB SITE, PROVIDING A WEBSITE FEATURING NON-DOWNLOADABLE INSTRUCTIONAL CD ROMS, VIDEOS AND ELECTRONIC PUBLICATIONS IN THE FIELD OF ENGLISH LANGUAGE SKILLS, IN CLASS 41 (U.S. CLS. 100, 101 AND 107).

OWNER OF INTERNATIONAL REGISTRATION
0798479 DATED 12-2-2002, EXPIRES 12-2-2012.

NO CLAIM IS MADE TO THE EXCLUSIVE RIGHT TO USE "ENGLISH WORLDWIDE", APART FROM THE MARK AS SHOWN.

SER. NO. 79-045,927, FILED 8-15-2007.

H. M. FISHER, EXAMINING ATTORNEY

Int. Cl.: 3

Prior U.S. Cls.: 1, 4, 6, 50, 51 and 52

United States Patent and Trademark Office

Reg. No. 3,476,993

Registered July 29, 2008

**TRADEMARK
PRINCIPAL REGISTER**



SALVATORE FERRAGAMO ITALIA S.P.A. (ITALY JOINT STOCK COMPANY)
VIA DEI TORNABUONI, 2
I-50123 FIRENZE (FI)
ITALY

FOR: PERFUMES, EAU DE PARFUM, COLOGNE, TOILET WATER, ESSENTIAL OILS, COLD CREAM, PERSONAL DEODORANTS, ANTIPERSPIRANTS, SKIN CLEANSING LOTIONS, SKIN MOISTURIZER, BODY OIL, SKIN EMOLLIENT, SOAPS, BATH SOAPS, BATH AND SHOWER GEL, BODY LOTIONS, SKIN LOTIONS, IN CLASS 3 (U.S. CLS. 1, 4, 6, 50, 51 AND 52).

PRIORITY DATE OF 6-28-2007 IS CLAIMED.

OWNER OF INTERNATIONAL REGISTRATION 0942942 DATED 10-8-2007, EXPIRES 10-8-2017.

OWNER OF U.S. REG. NO. 3,245,185.

SER. NO. 79-046,005, FILED 10-8-2007.

CHARISMA HAMPTON, EXAMINING ATTORNEY

Int. Cl.: 5

Prior U.S. Cls.: 6, 18, 44, 46, 51 and 52

Reg. No. 3,476,994

United States Patent and Trademark Office

Registered July 29, 2008

**TRADEMARK
PRINCIPAL REGISTER**

ONABRIQAD

BOEHRINGER INGELHEIM INTERNATIONAL
GMBH (FED REP GERMANY CORPORATION
ORGANIZED UNDER THE LAWS OF GER-
MANY)
55218 INGELHEIM
FED REP GERMANY

FOR: PHARMACEUTICAL PREPARATIONS
AND SUBSTANCES FOR THE TREATMENT OF
DISEASES AND DISORDERS OF THE ALIMEN-
TARY TRACT AND METABOLISM, AND BLOOD
AND BLOOD FORMING ORGANS; PHARMACEU-
TICAL PREPARATIONS AND SUBSTANCES FOR
THE TREATMENT OF DISEASES AND DISORDERS
OF THE CARDIOVASCULAR SYSTEM, MUSCU-
LOSKELETAL SYSTEM, CENTRAL NERVOUS SYS-
TEM, PERIPHERAL NERVOUS SYSTEM,
GENITOURINARY SYSTEM AND RESPIRATORY
SYSTEM; AND PHARMACEUTICAL PREPARA-
TIONS AND SUBSTANCES FOR THE TREATMENT
OF DERMATOLOGICAL, HORMONAL, INFEC-

TIOUS, VIRAL AND ONCOLOGICAL DISEASES
AND DISORDERS, IN CLASS 5 (U.S. CLS. 6, 18, 44,
46, 51 AND 52).

THE MARK CONSISTS OF STANDARD CHAR-
ACTERS WITHOUT CLAIM TO ANY PARTICULAR
FONT, STYLE, SIZE, OR COLOR.

PRIORITY DATE OF 4-28-2007 IS CLAIMED.

OWNER OF INTERNATIONAL REGISTRATION
0942984 DATED 10-17-2007, EXPIRES 10-17-2017.

SER. NO. 79-046,014, FILED 10-17-2007.

CHRISTOPHER BUONGIORNO, EXAMINING AT-
TORNEY

Int. Cl.: 5

Prior U.S. Cls.: 6, 18, 44, 46, 51 and 52

United States Patent and Trademark Office

Reg. No. 3,476,995

Registered July 29, 2008

**TRADEMARK
PRINCIPAL REGISTER**

ONJORKA

BOEHRINGER INGELHEIM INTERNATIONAL
GMBH (FED REP GERMANY CORPORATION
ORGANIZED UNDER THE LAWS OF GER-
MANY)

55218 INGELHEIM
FED REP GERMANY

FOR: PHARMACEUTICAL PREPARATIONS
AND SUBSTANCES FOR THE TREATMENT OF
DISEASES AND DISORDERS OF THE ALIMEN-
TARY TRACT AND METABOLISM, AND BLOOD
AND BLOOD FORMING ORGANS; PHARMACEU-
TICAL PREPARATIONS AND SUBSTANCES FOR
THE TREATMENT OF DISEASES AND DISORDERS
OF THE CARDIOVASCULAR SYSTEM, MUSCU-
LOSKELETAL SYSTEM, CENTRAL NERVOUS SYS-
TEM, PERIPHERAL NERVOUS SYSTEM,
GENITOURINARY SYSTEM AND RESPIRATORY
SYSTEM; AND PHARMACEUTICAL PREPARA-
TIONS AND SUBSTANCES FOR THE TREATMENT
OF DERMATOLOGICAL, HORMONAL, INFEC-

TIOUS, VIRAL AND ONCOLOGICAL DISEASES
AND DISORDERS, IN CLASS 5 (U.S. CLS. 6, 18, 44,
46, 51 AND 52).

THE MARK CONSISTS OF STANDARD CHAR-
ACTERS WITHOUT CLAIM TO ANY PARTICULAR
FONT, STYLE, SIZE, OR COLOR.

PRIORITY DATE OF 4-28-2007 IS CLAIMED.

OWNER OF INTERNATIONAL REGISTRATION
0942985 DATED 10-17-2007, EXPIRES 10-17-2017.

SER. NO. 79-046,015, FILED 10-17-2007.

CHRISTOPHER BUONGIORNO, EXAMINING AT-
TORNEY

Int. Cl.: 9

Prior U.S. Cls.: 21, 23, 26, 36 and 38

United States Patent and Trademark Office

Reg. No. 3,476,996

Registered July 29, 2008

**TRADEMARK
PRINCIPAL REGISTER**

FERROXTAG

HISPANO FERRITAS S.A. (SPAIN SOCIEDAD ANONIMA)

C/ HERNÁN CORTÉS, S/N,

POLÍGONO EL HENARES; E-19004 GUADALAJARA
SPAIN

FOR: DEVICES AND INSTRUMENTS OF CONTROL AND INSPECTION, NAMELY, HIGH RADIO-FREQUENCY TRANSPONDERS AND ANTENNAS, CARDS AND TAGS, AND READERS FOR HIGH RADIO FREQUENCY IDENTIFICATION CREDENTIALS, IN CLASS 9 (U.S. CLS. 21, 23, 26, 36 AND 38).

THE MARK CONSISTS OF STANDARD CHARACTERS WITHOUT CLAIM TO ANY PARTICULAR FONT, STYLE, SIZE, OR COLOR.

PRIORITY DATE OF 3-15-2007 IS CLAIMED.

OWNER OF INTERNATIONAL REGISTRATION 0943165 DATED 8-16-2007, EXPIRES 8-16-2017.

SER. NO. 79-046,089, FILED 8-16-2007.

BERNICE MIDDLETON, EXAMINING ATTORNEY

Int. Cls.: 11, 16 and 42

**Prior U.S. Cls.: 2, 5, 13, 21, 22, 23, 29, 31, 34, 37, 38,
50, 100 and 101**

Reg. No. 3,476,997

United States Patent and Trademark Office

Registered July 29, 2008

**TRADEMARK
SERVICE MARK
PRINCIPAL REGISTER**

SieMatic

SIEMATIC MÖBELWERKE GMBH & CO. KG
(FED REP GERMANY PARTNERSHIP LIMITED BY SHARES)

AUGUST-SIEKMANN-STRABE 1-5
32584 LÖHNE
FED REP GERMANY

FOR: SINKS; ELECTRIC LAMPS, LAMPS FOR LIGHTING, CEILING LIGHTS, FITTED LAMPS FOR FURNITURE, IN CLASS 11 (U.S. CLS. 13, 21, 23, 31 AND 34).

FOR: PRINTED MATTER, NAMELY, STATIONERY, BOOKS ABOUT INTERIOR DECORATING AND MAGAZINES ABOUT INTERIOR DECORATING, IN CLASS 16 (U.S. CLS. 2, 5, 22, 23, 29, 37, 38 AND 50).

FOR: DESIGN OF INTERIOR DECOR; PLANNING AND ADVICE WITH RESPECT TO INTERIOR

DECORATION, IN CLASS 42 (U.S. CLS. 100 AND 101).

THE MARK CONSISTS OF STANDARD CHARACTERS WITHOUT CLAIM TO ANY PARTICULAR FONT, STYLE, SIZE, OR COLOR.

PRIORITY DATE OF 6-8-2007 IS CLAIMED.

OWNER OF INTERNATIONAL REGISTRATION 0944208 DATED 9-15-2007, EXPIRES 9-15-2017.

OWNER OF U.S. REG. NO. 1,072,510.

SER. NO. 79-046,515, FILED 9-15-2007.

SUSAN STIGLITZ, EXAMINING ATTORNEY

Int. Cl.: 5

Prior U.S. Cls.: 6, 18, 44, 46, 51 and 52

United States Patent and Trademark Office

Reg. No. 3,476,998

Registered July 29, 2008

**TRADEMARK
PRINCIPAL REGISTER**

MIVOLGET

BOEHRINGER INGELHEIM INTERNATIONAL
GMBH (FED REP GERMANY CORPORATION)
55218 INGELHEIM
FED REP GERMANY

FOR: PHARMACEUTICAL PREPARATIONS AND SUBSTANCES FOR THE TREATMENT OF DISEASES AND DISORDERS OF THE ALIMENTARY TRACT AND METABOLISM, AND BLOOD AND BLOOD FORMING ORGANS; PHARMACEUTICAL PREPARATIONS AND SUBSTANCES FOR THE TREATMENT OF DISEASES AND DISORDERS OF THE CARDIOVASCULAR SYSTEM, MUSCULOSKELETAL SYSTEM, CENTRAL NERVOUS SYSTEM, PERIPHERAL NERVOUS SYSTEM, GENITOURINARY SYSTEM AND RESPIRATORY SYSTEM; AND PHARMACEUTICAL PREPARATIONS AND SUBSTANCES FOR THE TREATMENT OF DERMATOLOGICAL, HORMONAL, INFEC-

TIOUS, VIRAL AND ONCOLOGICAL DISEASES AND DISORDERS, IN CLASS 5 (U.S. CLS. 6, 18, 44, 46, 51 AND 52).

THE MARK CONSISTS OF STANDARD CHARACTERS WITHOUT CLAIM TO ANY PARTICULAR FONT, STYLE, SIZE, OR COLOR.

PRIORITY DATE OF 4-28-2007 IS CLAIMED.

OWNER OF INTERNATIONAL REGISTRATION 0944263 DATED 10-25-2007, EXPIRES 10-25-2017.

SER. NO. 79-046,542, FILED 10-25-2007.

CHRISTOPHER BUONGIORNO, EXAMINING ATTORNEY

Int. Cl.: 5

Prior U.S. Cls.: 6, 18, 44, 46, 51 and 52

Reg. No. 3,476,999

United States Patent and Trademark Office

Registered July 29, 2008

**TRADEMARK
PRINCIPAL REGISTER**

MIQAVADIO

BOEHRINGER INGELHEIM INTERNATIONAL
GMBH (FED REP GERMANY CORPORATION
ORGANIZED UNDER THE LAWS OF GER-
MANY)
55218 INGELHEIM
FED REP GERMANY

FOR: PHARMACEUTICAL PREPARATIONS
AND SUBSTANCES FOR THE TREATMENT OF
DISEASES AND DISORDERS OF THE ALIMEN-
TARY TRACT AND METABOLISM, AND BLOOD
AND BLOOD FORMING ORGANS; PHARMACEU-
TICAL PREPARATIONS AND SUBSTANCES FOR
THE TREATMENT OF DISEASES AND DISORDERS
OF THE CARDIOVASCULAR SYSTEM, MUSCU-
LOSKELETAL SYSTEM, CENTRAL NERVOUS SYS-
TEM, PERIPHERAL NERVOUS SYSTEM,
GENITOURINARY SYSTEM AND RESPIRATORY
SYSTEM; AND PHARMACEUTICAL PREPARA-
TIONS AND SUBSTANCES FOR THE TREATMENT
OF DERMATOLOGICAL, HORMONAL, INFEC-

TIOUS, VIRAL AND ONCOLOGICAL DISEASES
AND DISORDERS, IN CLASS 5 (U.S. CLS. 6, 18, 44,
46, 51 AND 52).

THE MARK CONSISTS OF STANDARD CHAR-
ACTERS WITHOUT CLAIM TO ANY PARTICULAR
FONT, STYLE, SIZE, OR COLOR.

PRIORITY DATE OF 4-28-2007 IS CLAIMED.

OWNER OF INTERNATIONAL REGISTRATION
0944264 DATED 10-25-2007, EXPIRES 10-25-2017.

SER. NO. 79-046,543, FILED 10-25-2007.

CHRISTOPHER BUONGIORNO, EXAMINING AT-
TORNEY

Int. Cl.: 5

Prior U.S. Cls.: 6, 18, 44, 46, 51 and 52

Reg. No. 3,477,000

United States Patent and Trademark Office

Registered July 29, 2008

**TRADEMARK
PRINCIPAL REGISTER**

ONDUARP

BOEHRINGER INGELHEIM INTERNATIONAL
GMBH (FED REP GERMANY CORPORATION)
55218 INGELHEIM
FED REP GERMANY

FOR: PHARMACEUTICAL PREPARATIONS AND SUBSTANCES FOR THE TREATMENT OF DISEASES AND DISORDERS OF THE ALIMENTARY TRACT AND METABOLISM, AND BLOOD AND BLOOD FORMING ORGANS; PHARMACEUTICAL PREPARATIONS AND SUBSTANCES FOR THE TREATMENT OF DISEASES AND DISORDERS OF THE CARDIOVASCULAR SYSTEM, MUSCULOSKELETAL SYSTEM, CENTRAL NERVOUS SYSTEM, PERIPHERAL NERVOUS SYSTEM, GENITOURINARY SYSTEM AND RESPIRATORY SYSTEM; AND PHARMACEUTICAL PREPARATIONS AND SUBSTANCES FOR THE TREATMENT OF DERMATOLOGICAL, HORMONAL, INFEC-

TIOUS, VIRAL AND ONCOLOGICAL DISEASES AND DISORDERS, IN CLASS 5 (U.S. CLS. 6, 18, 44, 46, 51 AND 52).

THE MARK CONSISTS OF STANDARD CHARACTERS WITHOUT CLAIM TO ANY PARTICULAR FONT, STYLE, SIZE, OR COLOR.

PRIORITY DATE OF 4-28-2007 IS CLAIMED.

OWNER OF INTERNATIONAL REGISTRATION 0944272 DATED 10-25-2007, EXPIRES 10-25-2017.

SER. NO. 79-046,546, FILED 10-25-2007.

CHRISTOPHER BUONGIORNO, EXAMINING ATTORNEY

Int. Cl.: 1

Prior U.S. Cls.: 1, 5, 6, 10, 26 and 46

United States Patent and Trademark Office

Reg. No. 3,477,001

Registered July 29, 2008

**TRADEMARK
PRINCIPAL REGISTER**

A G P

ASAHI KASEI MEDICAL CO., LTD. (JAPAN CORPORATION)
9-1, KANDA MITOSHIRO-CHO
CHIYODA-KU; TOKYO 101-8481, JAPAN

FOR: COLLOIDAL GOLD PARTICLE SOLUTIONS USED FOR INTEGRITY TESTING OF THE FILTER THAT REMOVES VIRUSES FROM PROTEIN-CONTAINING SOLUTIONS, NAMELY, BLOOD PRODUCTS AND BIOPHARMACEUTICAL SOLUTIONS; AQUEOUS SURFACTANT SOLUTIONS, NAMELY, LIQUIDS MIXED WITH WATER AND ANIONIC SURFACTANT, NONIONIC SURFACTANT OR AMPHOLYTIC SURFACTANT, USED FOR INTEGRITY TESTING OF THE FILTER THAT REMOVES VIRUSES FROM PROTEIN-CONTAINING SOLUTIONS, NAMELY, BLOOD PRO-

DUCTS AND BIOPHARMACEUTICAL SOLUTIONS, IN CLASS 1 (U.S. CLS. 1, 5, 6, 10, 26 AND 46).

THE MARK CONSISTS OF STANDARD CHARACTERS WITHOUT CLAIM TO ANY PARTICULAR FONT, STYLE, SIZE, OR COLOR.

OWNER OF INTERNATIONAL REGISTRATION 0944438 DATED 9-19-2007, EXPIRES 9-19-2017.

SER. NO. 79-046,603, FILED 9-19-2007.

CHRISTOPHER BUONGIORNO, EXAMINING ATTORNEY

Int. Cl.: 10

Prior U.S. Cls.: 26, 39 and 44

United States Patent and Trademark Office

Reg. No. 3,477,002

Registered July 29, 2008

**TRADEMARK
PRINCIPAL REGISTER**

VANTAGE

TOSHIBA MEDICAL SYSTEMS CORPORATION
(JAPAN CORPORATION)
1385, SHIMOISHIGAMI
OTAWARA-SHI
TOCHIGI 324-8550, JAPAN

FOR: MEDICAL MAGNETIC RESONANCE IMAGING DIAGNOSTIC APPARATUS, NAMELY, MRI DIAGNOSTIC APPARATUS, IN CLASS 10 (U.S. CLS. 26, 39 AND 44).

THE MARK CONSISTS OF STANDARD CHARACTERS WITHOUT CLAIM TO ANY PARTICULAR FONT, STYLE, SIZE, OR COLOR.

PRIORITY DATE OF 11-1-2007 IS CLAIMED.

OWNER OF INTERNATIONAL REGISTRATION 0945201 DATED 11-14-2007, EXPIRES 11-14-2017.

OWNER OF U.S. REG. NOS. 2,448,220, 3,366,176, AND 3,366,177.

SER. NO. 79-046,890, FILED 11-14-2007.

MARILYN IZZI, EXAMINING ATTORNEY

Int. Cl.: 10

Prior U.S. Cls.: 26, 39 and 44

United States Patent and Trademark Office

Reg. No. 3,477,003

Registered July 29, 2008

**TRADEMARK
PRINCIPAL REGISTER**

J E T

TOSHIBA MEDICAL SYSTEMS CORPORATION
(JAPAN CORPORATION)
1385, SHIMOISHIGAMI
OTAWARA-SHI
TOCHIGI 324-8550, JAPAN

FOR: MEDICAL MAGNETIC RESONANCE IMAGING DIAGNOSTIC APPARATUS, NAMELY, MRI DIAGNOSTIC APPARATUS, IN CLASS 10 (U.S. CLS. 26, 39 AND 44).

THE MARK CONSISTS OF STANDARD CHARACTERS WITHOUT CLAIM TO ANY PARTICULAR FONT, STYLE, SIZE, OR COLOR.

PRIORITY DATE OF 11-1-2007 IS CLAIMED.

OWNER OF INTERNATIONAL REGISTRATION
0945202 DATED 11-14-2007, EXPIRES 11-14-2017.

SER. NO. 79-046,891, FILED 11-14-2007.

MARILYN IZZI, EXAMINING ATTORNEY

Int. Cls.: 14 and 24

Prior U.S. Cls.: 2, 27, 28, 42 and 50

United States Patent and Trademark Office

Reg. No. 3,477,004

Registered July 29, 2008

**TRADEMARK
PRINCIPAL REGISTER**

BATUCADA

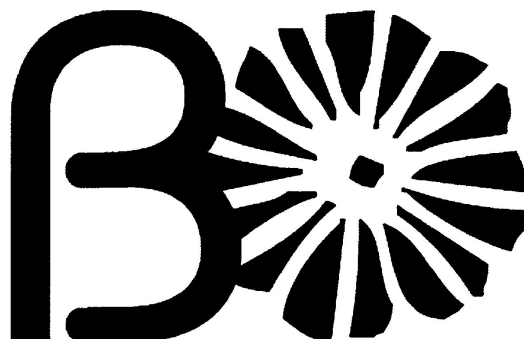

BATUCADA (FRANCE S.A.R.L.)
24 RUE VAUTHIER
F-92100 BOULOGNE BILLANCOURT, FRANCE

FOR: JEWELRY AND PRECIOUS STONES; HOROLOGICAL AND CHRONOMETRIC INSTRUMENTS; PRECIOUS METALS AND THEIR ALLOYS; JEWEL CASES; WATCH CASES, STRAPS, CHAINS, WATCH SPRINGS AND GLASSES; CLOCK AND WATCH CASES AND BOXES, IN CLASS 14 (U.S. CLS. 2, 27, 28 AND 50).

FOR: TEXTILE FABRICS FOR THE MANUFACTURE OF BED LINENS AND HOUSEHOLD LINENS; BED SHEETS AND TABLE CLOTHS NOT OF PAPER; FABRICS FOR TEXTILE USE; ELASTIC FABRICS FOR BED LINENS AND HOUSEHOLD LINENS; VELVET; BED LINEN; HOUSEHOLD

LINEN; TABLE LINEN NOT OF PAPER; BATH LINEN; TABLE MATS NOT OF PAPER, IN CLASS 24 (U.S. CLS. 42 AND 50).

PRIORITY DATE OF 6-8-2007 IS CLAIMED.

OWNER OF INTERNATIONAL REGISTRATION 0945878 DATED 11-9-2007, EXPIRES 11-9-2017.

THE TERM "BATUCADA" HAS NO MEANING IN A FOREIGN LANGUAGE.

SER. NO. 79-047,135, FILED 11-9-2007.

CHRISTOPHER BUONGIORNO, EXAMINING ATTORNEY

Int. Cls.: 7, 9, 37, 40 and 42

**Prior U.S. Cls.: 13, 19, 21, 23, 26, 31, 34, 35, 36, 38,
100, 101, 103 and 106**

Reg. No. 3,477,005

United States Patent and Trademark Office

Registered July 29, 2008

**TRADEMARK
SERVICE MARK
PRINCIPAL REGISTER**

P E R M I T

NSCORE, INC. (JAPAN CORPORATION)
3-8-33 MOMOCHIHAMA
SAWARA-KU.; FUKUOKA-SHI; FUKUOKA 814-
0001
JAPAN

FOR: APPARATUS FOR USE IN THE MANUFACTURE OF SEMICONDUCTORS, NAMELY PHOTO MASKS FOR FORMING SEMICONDUCTOR INTEGRATED CIRCUITS; AND SEMICONDUCTOR MANUFACTURING, PROCESSING AND PRODUCTION MACHINES, IN CLASS 7 (U.S. CLS. 13, 19, 21, 23, 31, 34 AND 35).

FOR: INTEGRATED CIRCUITS; SEMICONDUCTOR MEMORIES; SEMICONDUCTOR CHIPS; ELECTRONIC CHIPS FOR THE MANUFACTURE OF INTEGRATED CIRCUITS; SEMICONDUCTOR WAFERS; SEMICONDUCTOR INGOTS; SEMICONDUCTOR DEVICES; LEAD FRAMES AS PARTS OF SEMICONDUCTOR DEVICES, IN CLASS 9 (U.S. CLS. 21, 23, 26, 36 AND 38).

FOR: PROVIDING INFORMATION IN THE FIELDS OF MAINTENANCE OF SEMICONDUCTORS AND INTEGRATED CIRCUITS; CONSULTING SERVICES IN THE FIELDS OF MAINTENANCE OF SEMICONDUCTORS AND INTEGRATED CIRCUITS, IN CLASS 37 (U.S. CLS. 100, 103 AND 106).

FOR: CUSTOM ASSEMBLY OF SEMICONDUCTORS AND INTEGRATED CIRCUITS, IN CLASS 40 (U.S. CLS. 100, 103 AND 106).

FOR: INDUSTRIAL ANALYSIS AND RESEARCH IN THE FIELDS OF SEMICONDUCTORS AND INTEGRATED CIRCUITS; PROVIDING INFORMATION IN THE FIELDS OF DEVELOPING, DESIGNING AND TESTING OF SEMICONDUCTORS AND INTEGRATED CIRCUITS; DESIGN OF SEMICONDUCTORS AND INTEGRATED CIRCUITS AND CONSULTING SERVICES RELATED THERETO; INDUSTRIAL ANALYSIS, RESEARCH, AND CONSULTANCY IN THE FIELDS OF SEMICONDUCTORS AND INTEGRATED CIRCUITS; CONSULTING SERVICES IN THE FIELDS OF DEVELOPING, DESIGNING AND TESTING OF SEMICONDUCTORS AND INTEGRATED CIRCUITS, IN CLASS 42 (U.S. CLS. 100 AND 101).

THE MARK CONSISTS OF STANDARD CHARACTERS WITHOUT CLAIM TO ANY PARTICULAR FONT, STYLE, SIZE, OR COLOR.

PRIORITY DATE OF 7-27-2007 IS CLAIMED.

OWNER OF INTERNATIONAL REGISTRATION
0945920 DATED 8-10-2007, EXPIRES 8-10-2017.

SER. NO. 79-047,157, FILED 8-10-2007.

JUDITH HELFMAN, EXAMINING ATTORNEY

Int. Cl.: 7

Prior U.S. Cls.: 13, 19, 21, 23, 31, 34 and 35

Reg. No. 3,477,006

United States Patent and Trademark Office

Registered July 29, 2008

**TRADEMARK
PRINCIPAL REGISTER**

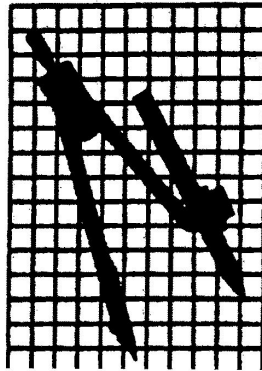

DALLAN S.P.A. (ITALY JOINT STOCK COMPAN-
NY)
VIA PER SALVATRONDA, 50
I-31033 CASTELFRANCO VENETO (TV)
ITALY

THE MARK CONSISTS OF THE STYLIZED IM-
AGE OF A COMPASS ON A RECTANGULAR
SHAPED GRAPH BACKGROUND DESIGN.

FOR: SHEET METAL PROCESSING MACHINES,
NAMELY, ROLLFORMERS, IN CLASS 7 (U.S. CLS.
13, 19, 21, 23, 31, 34 AND 35).

SER. NO. 79-047,175, FILED 10-24-2007.

OWNER OF INTERNATIONAL REGISTRATION
0945966 DATED 10-24-2007, EXPIRES 10-24-2017.

CARYN GLASSER, EXAMINING ATTORNEY

Int. Cl.: 3

Prior U.S. Cls.: 1, 4, 6, 50, 51 and 52

United States Patent and Trademark Office

Reg. No. 3,477,007

Registered July 29, 2008

**TRADEMARK
PRINCIPAL REGISTER**



**NATURAL
BEAUTY**

BEIERSDORF AG (FED REP GERMANY JOINT
STOCK COMPANY)
UNNASTRASSE 48
20253 HAMBURG
FED REP GERMANY

FOR: COSMETICS, IN CLASS 3 (U.S. CLS. 1, 4, 6, 50,
51 AND 52).

PRIORITY DATE OF 9-6-2007 IS CLAIMED.

OWNER OF INTERNATIONAL REGISTRATION
0946404 DATED 11-19-2007, EXPIRES 11-19-2017.

OWNER OF U.S. REG. NOS. 3,087,838 AND
3,340,389.

THE COLOR(S) BLUE, SILVER, WHITE AND
ORANGE IS/ARE CLAIMED AS A FEATURE OF
THE MARK.

THE COLOR WHITE APPEARS IN THE DESIG-
NATION "NIVEA". THE COLOR BLUE APPEARS IN
THE WORDING "VISAGE" AND IN THE BACK-
GROUND PANEL IN WHICH "NIVEA" APPEARS.
THE COLOR SILVER APPEARS IN THE BACK-
GROUND PANEL IN WHICH "VISAGE" APPEARS.
THE COLOR ORANGE APPEARS IN THE WORD-
ING "NATURAL BEAUTY".

SER. NO. 79-047,335, FILED 11-19-2007.

LINDA E. BLOHM, EXAMINING ATTORNEY

Int. Cl.: 3

Prior U.S. Cls.: 1, 4, 6, 50, 51 and 52

United States Patent and Trademark Office

Reg. No. 3,477,008

Registered July 29, 2008

**TRADEMARK
PRINCIPAL REGISTER**



My Silhouette!

BEIERSDORF AG (FED REP GERMANY JOINT
STOCK COMPANY)
UNNASTRASSE 48
20253 HAMBURG
FED REP GERMANY

FOR: COSMETIC BODY LOTIONS, IN CLASS 3
(U.S. CLS. 1, 4, 6, 50, 51 AND 52).

PRIORITY DATE OF 8-29-2007 IS CLAIMED.

OWNER OF INTERNATIONAL REGISTRATION
0946405 DATED 11-19-2007, EXPIRES 11-19-2017.

OWNER OF U.S. REG. NOS. 1,401,796, 1,509,797
AND OTHERS.

THE COLOR(S) BLUE, SILVER AND WHITE IS/
ARE CLAIMED AS A FEATURE OF THE MARK.

THE MARK CONSISTS OF A RECTANGULAR
DESIGN WITH A CURVED BOTTOM DISPLAYING
THE DESIGNATION "NIVEA" IN WHITE LETTERS
AGAINST A BLUE BACKGROUND. THE COLOR
SILVER APPEARS AS THE OUTSIDE BORDER OF
THE DESIGN. THE WORDING "MY SILHOUETTE!"
APPEARS IN BLUE BELOW IT.

SER. NO. 79-047,336, FILED 11-19-2007.

REBECCA SMITH, EXAMINING ATTORNEY

Int. Cl.: 14

Prior U.S. Cls.: 2, 27, 28 and 50

United States Patent and Trademark Office

Reg. No. 3,477,009

Registered July 29, 2008

**TRADEMARK
PRINCIPAL REGISTER**

REFLET

BOUCHERON HOLDING (FRANCE COMPANY)
26, PLACE VENDÔME
F-75001 PARIS
FRANCE

FOR: HOROLOGICAL AND CHRONOMETRIC
INSTRUMENTS; WATCHES, WRISTWATCHES,
WALL CLOCKS, PENDULUM CLOCKS, CHRON-
OMETERS, CHRONOGRAPHS (WATCHES),
WATCH CASES, WATCH BANDS, WATCH CHAINS,
WATCH GLASSES, CASES FOR WATCHES, CASES
FOR CLOCK AND WATCH-MAKING, IN CLASS 14
(U.S. CLS. 2, 27, 28 AND 50).

OWNER OF INTERNATIONAL REGISTRATION
0946763 DATED 11-5-2007, EXPIRES 11-5-2017.

OWNER OF U.S. REG. NOS. 2,794,766, 2,802,342,
AND 2,916,124.

THE FOREIGN WORDING IN THE MARK
TRANSLATES INTO ENGLISH AS REFLECTION,
GLINT.

SER. NO. 79-047,474, FILED 11-5-2007.

FLORENTINA BLANDU, EXAMINING ATTORNEY

Int. Cls.: 16, 35 and 37

**Prior U.S. Cls.: 2, 5, 22, 23, 29, 37, 38, 50, 100, 101,
102, 103 and 106**

Reg. No. 3,477,010

Registered July 29, 2008

United States Patent and Trademark Office

**TRADEMARK
SERVICE MARK
PRINCIPAL REGISTER**



Brisa

BRISA - AUTO ESTRADAS; DE PORTUGAL, S.A.
(PORTUGAL SOCIEDADE POR AÇÕES (S.A.))
QUINTA DA TORRE DA AGUILHA,
EDIFICIO BRISA; P-2785-599 SÃO DOMINGOSDE
RANA
PORTUGAL

FOR: BUSINESS MAGAZINES AND BOOKS IN
THE FIELDS OF ROAD CONSTRUCTION, ENGI-
NEERING, AND TRANSPORTATION, IN CLASS 16
(U.S. CLS. 2, 5, 22, 23, 29, 37, 38 AND 50).

FOR: BUSINESS MANAGEMENT AND ADVER-
TISING, IN CLASS 35 (U.S. CLS. 100, 101 AND 102).

FOR: CIVIL ENGINEERING WORKS BASED ON
ENGINEERING PROJECTS AND RELATED WORK,
NAMELY, ROAD AND MOTORWAY CONSTRUC-
TION, IN CLASS 37 (U.S. CLS. 100, 103 AND 106).

OWNER OF INTERNATIONAL REGISTRATION
0947037 DATED 8-24-2007, EXPIRES 8-24-2017.

THE ENGLISH TRANSLATION OF THE WORD
"BRISA" IN THE MARK IS "BREEZE".

SER. NO. 79-047,583, FILED 8-24-2007.

DAYNA BROWNE, EXAMINING ATTORNEY

Int. Cl.: 5

Prior U.S. Cls.: 6, 18, 44, 46, 51 and 52

United States Patent and Trademark Office

Reg. No. 3,477,011

Registered July 29, 2008

**TRADEMARK
PRINCIPAL REGISTER**

ITEXTAR

SANOFI-AVENTIS (FRANCE SOCIÉTÉ ANON-
YME)
174 AVENUE DE FRANCE
F-75013 PARIS
FRANCE

FOR: PHARMACEUTICAL PRODUCTS, NAME-
LY, PREPARATIONS FOR THE PREVENTION AND
TREATMENT OF CARDIOVASCULAR DISEASES;
PHARMACEUTICAL PRODUCTS, NAMELY, PRE-
PARATIONS FOR THE PREVENTION AND TREAT-
MENT OF CANCER; PHARMACEUTICAL
PRODUCTS, NAMELY, PREPARATIONS FOR THE
PREVENTION AND TREATMENT OF THROMBO-
SIS; PHARMACEUTICAL PRODUCTS, NAMELY,
PREPARATIONS FOR DISEASE PREVENTION
AND TREATMENT IN THE FIELD OF INTERNAL
MEDICINE; PHARMACEUTICAL PRODUCTS,
NAMELY, PREPARATIONS FOR PREVENTION
AND TREATMENT OF DISEASES OF THE CENT-
RAL NERVOUS SYSTEM; PHARMACEUTICAL

PRODUCTS, NAMELY, PREPARATIONS FOR PRE-
VENTION AND TREATMENT OF RESPIRATORY
DISEASES, IN CLASS 5 (U.S. CLS. 6, 18, 44, 46, 51 AND
52).

THE MARK CONSISTS OF STANDARD CHAR-
ACTERS WITHOUT CLAIM TO ANY PARTICULAR
FONT, STYLE, SIZE, OR COLOR.

PRIORITY DATE OF 6-20-2007 IS CLAIMED.

OWNER OF INTERNATIONAL REGISTRATION
0947379 DATED 12-4-2007, EXPIRES 12-4-2017.

SER. NO. 79-047,681, FILED 12-4-2007.

SAIMA MAKHDOOM, EXAMINING ATTORNEY

Int. Cls.: 35 and 40

Prior U.S. Cls.: 100, 101, 102, 103 and 106

United States Patent and Trademark Office

Reg. No. 3,477,012

Registered July 29, 2008

**SERVICE MARK
PRINCIPAL REGISTER**

SHIRTLAB

THOMAS SCHUGK (SWITZERLAND INDIVIDUAL)
DOLLÄGERTEN
CH-8934 KNONAU, SWITZERLAND

THE MARK CONSISTS OF STANDARD CHARACTERS WITHOUT CLAIM TO ANY PARTICULAR FONT, STYLE, SIZE, OR COLOR.

FOR: RETAIL STORES SERVICES FEATURING TEXTILES, CLOTHING, PRINTED FABRIC CLOTHING, AND CLOTHING WITH PRINTED ADVERTISEMENTS, IN CLASS 35 (U.S. CLS. 100, 101 AND 102).

OWNER OF INTERNATIONAL REGISTRATION 0737308 DATED 5-5-2000, EXPIRES 5-5-2010.

FOR: TREATING, PRINTING, EMBROIDERY OF TEXTILES, CLOTHING AND MATERIALS, NAMELY, FABRICS, IN CLASS 40 (U.S. CLS. 100, 103 AND 106).

SER. NO. 79-048,050, FILED 11-13-2007.

DAVID HOFFMAN, EXAMINING ATTORNEY

Int. Cl.: 9

Prior U.S. Cls.: 21, 23, 26, 36 and 38

United States Patent and Trademark Office

Reg. No. 3,477,013

Registered July 29, 2008

**TRADEMARK
PRINCIPAL REGISTER**

SpiderScan

BAUMER ELECTRIC AG (SWITZERLAND SOCI-
ÉTÉ ANONYME)
17, HUMMELSTRASSE
CH-8500 FRAUENFELD, SWITZERLAND

FOR: OPTICAL SENSORS, IN CLASS 9 (U.S. CLS.
21, 23, 26, 36 AND 38).

THE MARK CONSISTS OF STANDARD CHAR-
ACTERS WITHOUT CLAIM TO ANY PARTICULAR
FONT, STYLE, SIZE, OR COLOR.

PRIORITY DATE OF 6-18-2007 IS CLAIMED.

OWNER OF INTERNATIONAL REGISTRATION
0948282 DATED 12-17-2007, EXPIRES 12-17-2017.

SER. NO. 79-048,075, FILED 12-17-2007.

TASHIA BUNCH, EXAMINING ATTORNEY

Int. Cl.: 10

Prior U.S. Cls.: 26, 39 and 44

United States Patent and Trademark Office

Reg. No. 3,477,014

Registered July 29, 2008

**TRADEMARK
PRINCIPAL REGISTER**

MAGNETOM Essenza

SIEMENS AKTIENGESELLSCHAFT (FED REP
GERMANY JOINT STOCK COMPANY)
WITTELSBACHERPLATZ 2
80333 MÜNCHEN, FED REP GERMANY

OWNER OF INTERNATIONAL REGISTRATION
0949022 DATED 11-15-2007, EXPIRES 11-15-2017.

FOR: MEDICAL APPARATUS AND DEVICES
USED IN MAGNETIC RESONANCE TOMOGRA-
PHY; MEDICAL DEVICES FOR PROTON IMAGING
AND PARTS THEREFOR , IN CLASS 10 (U.S. CLS. 26,
39 AND 44).

OWNER OF U.S. REG. NOS. 1,342,120, 3,344,516
AND OTHERS.

THE MARK CONSISTS OF STANDARD CHAR-
ACTERS WITHOUT CLAIM TO ANY PARTICULAR
FONT, STYLE, SIZE, OR COLOR.

THE FOREIGN WORDING IN THE MARK
TRANSLATES INTO ENGLISH AS ESSENCE.

PRIORITY DATE OF 8-14-2007 IS CLAIMED.

SER. NO. 79-048,298, FILED 11-15-2007.

PETER B. BROMAGHIM, EXAMINING ATTORNEY

Int. Cls.: 3, 14 and 25

Prior U.S. Cls.: 1, 2, 4, 6, 22, 27, 28, 39, 50, 51 and 52

United States Patent and Trademark Office

Reg. No. 3,477,015

Registered July 29, 2008

**TRADEMARK
PRINCIPAL REGISTER**



ALFRED HOFFMANN (AUSTRIA INDIVIDUAL)
ECKWEG 2
A-9851 LIESERBRÜCKE, AUSTRIA

FOR: PERFUMERY; ESSENTIAL OILS; COSMETICS; AND HAIR LOTIONS, IN CLASS 3 (U.S. CLS. 1, 4, 6, 50, 51 AND 52).

FOR: JEWELLERY; PRECIOUS STONES; AND HOROLOGICAL AND CHRONOMETRIC INSTRUMENTS, IN CLASS 14 (U.S. CLS. 2, 27, 28 AND 50).

FOR: CLOTHING, NAMELY, SHIRTS, SWEATER, TOPS, PANTS, JEANS, TRACK SUITS, ATHLETIC UNIFORMS, PAJAMAS, SKIRTS, SCARFS, JACKETS, COATS, BELTS, UNDERWEAR, DESSOUS, BRAS, G-STRINGS, BRIEFS, BIKINIS, SWIMMING TRUNKS, SOCKS, STOCKINGS, BANDANAS, TIES; FOOTWEAR; AND HEADGEAR, NAMELY, HATS, CAPS, SKULLIES, BANDEAUX, BERETS, BEANIES, IN CLASS 25 (U.S. CLS. 22 AND 39).

PRIORITY DATE OF 7-24-2007 IS CLAIMED.

OWNER OF INTERNATIONAL REGISTRATION
0949026 DATED 10-16-2007, EXPIRES 10-16-2017.

THE COLOR(S) BLACK, WHITE, DIFFERENT SHADES OF GREY IS/ARE CLAIMED AS A FEATURE OF THE MARK.

A GRADUALLY FADING GRADATION OF THE COLORS BLACK, WHITE AND GRAY APPEARS IN THE LITERAL PORTION "PH 9818783" WHICH IS SUPERIMPOSED OVER A WHITE BACKGROUND AND SURROUNDED BY A SINGLE-LINE BLACK RECTANGLE FRAME.

THE WORDING "PH" AND NUMERALS "9818783" HAS NO MEANING IN A FOREIGN LANGUAGE.

SER. NO. 79-048,301, FILED 10-16-2007.

BENJAMIN OKEKE, EXAMINING ATTORNEY

Int. Cls.: 18, 25 and 35

Prior U.S. Cls.: 1, 2, 3, 22, 39, 41, 100, 101 and 102

United States Patent and Trademark Office

Reg. No. 3,477,016

Registered July 29, 2008

**TRADEMARK
SERVICE MARK
PRINCIPAL REGISTER**

SPOOM

CUILLÈRE B.V. (NETHERLANDS B.V.)
GOUWZEESTRAAT 10-12
NL-1282 KD WEESP
NETHERLANDS

FOR: LEATHER AND IMITATIONS OF LEATHER; LEATHER AND IMITATION LEATHER GOODS, NAMELY, BAGS, PURSES, HANDBAGS, CASES, SUITCASES AND WALLETS; TRUNKS AND TRAVELLING BAGS; BACKPACKS, ALL-PURPOSE SPORT, ATHLETIC AND CARRYING BAGS, UMBRELLAS AND PARASOLS, IN CLASS 18 (U.S. CLS. 1, 2, 3, 22 AND 41).

FOR: CLOTHING, NAMELY, TROUSERS, SHIRTS, T-SHIRTS, SWEATSHIRTS, POLO SHIRTS, SWEATERS, SOCKS, UNDERWEAR, SWIM WEAR, SHORTS, SKIRT, JACKET, COATS AND SUITS; FOOTWEAR; HEADGEAR, NAMELY HATS AND CAPS, IN CLASS 25 (U.S. CLS. 22 AND 39).

FOR: BUSINESS INTERMEDIARY SERVICES IN THE FIELD OF PURCHASING AND SELLING PRODUCTS AND RENDERING IMPORT AND EXPORT AGENCY SERVICES WITH RELATION TO CLOTHING, FOOTWEAR, HEADGEAR, LEATHER AND IMITATIONS OF LEATHER AND GOODS MADE OF THESE MATERIALS, TRUNKS AND TRAVELLING BAGS, BACKPACKS, BAGS, UMBRELLAS AND PARASOLS, IN CLASS 35 (U.S. CLS. 100, 101 AND 102).

THE MARK CONSISTS OF STANDARD CHARACTERS WITHOUT CLAIM TO ANY PARTICULAR FONT, STYLE, SIZE, OR COLOR.

OWNER OF INTERNATIONAL REGISTRATION
0932375 DATED 6-5-2007, EXPIRES 6-5-2017.

SER. NO. 79-048,356, FILED 11-1-2007.

JOHN DALIER, EXAMINING ATTORNEY

Int. Cl.: 44

Prior U.S. Cls.: 100 and 101

United States Patent and Trademark Office

Reg. No. 3,477,017

Registered July 29, 2008

**SERVICE MARK
PRINCIPAL REGISTER**

PATENT 7000

PATENT 7000 B.V. (NETHERLANDS LTD LIAB
CO)
HANZEWEWEG 26
NL-7241 CS LOCHEM
NETHERLANDS

FOR: RENTAL OF SANITARY INSTALLATIONS,
NAMELY, URINALS, IN CLASS 44 (U.S. CLS. 100
AND 101).

THE MARK CONSISTS OF STANDARD CHAR-
ACTERS WITHOUT CLAIM TO ANY PARTICULAR
FONT, STYLE, SIZE, OR COLOR.

PRIORITY DATE OF 12-6-2007 IS CLAIMED.

OWNER OF INTERNATIONAL REGISTRATION
0949297 DATED 12-10-2007, EXPIRES 12-10-2017.

SER. NO. 79-048,414, FILED 12-10-2007.

JENNIFER MARTIN, EXAMINING ATTORNEY

Int. Cl.: 9

Prior U.S. Cls.: 21, 23, 26, 36 and 38

United States Patent and Trademark Office

Reg. No. 3,477,018

Registered July 29, 2008

**TRADEMARK
PRINCIPAL REGISTER**

VIPOW

GUIPING JIELI (VIPOW) BATTERY CO., LTD.
(CHINA CORPORATION)
DAKENGKOU
GUIPING CITY
GUANGXI PROVINCE, CHINA

OWNER OF INTERNATIONAL REGISTRATION
0949474 DATED 12-21-2007, EXPIRES 12-21-2017.

FOR: BATTERY CHARGERS; ELECTRIC ACCUMULATORS; ACCUMULATOR JARS; CAMERAS; ELECTRIC WIRES AND CABLES; BATTERIES; ELECTRIC ACCUMULATORS FOR VEHICLES, IN CLASS 9 (U.S. CLS. 21, 23, 26, 36 AND 38).

SER. NO. 79-048,469, FILED 12-21-2007.

BERNICE MIDDLETON, EXAMINING ATTORNEY

Int. Cls.: 1 and 19

Prior U.S. Cls.: 1, 5, 6, 10, 12, 26, 33, 46 and 50

United States Patent and Trademark Office

Reg. No. 3,477,019

Registered July 29, 2008

**TRADEMARK
PRINCIPAL REGISTER**

ROHAGLAS

EVONIK RÖHM GMBH (FED REP GERMANY
GESELLSCHAFT MIT BESCHRÄNKTER HAF-
TUNG (GMBH))
KIRSCHENALLEE
64293 DARMSTADT
FED REP GERMANY

FOR: ACRYLIC INJECTION AND EXTRUSION
MOULDING COMPOUNDS, IN CLASS 1 (U.S. CLS. 1,
5, 6, 10, 26 AND 46).

FOR: PLASTIC BUILDING ELEMENTS IN FORM
OF ACRYLIC SHEETS, BLOCKS, TUBES AND
SQUARE AND ROUND RODS FOR THE MANU-
FACTURE OF TRANSPARENT AND TRANSLU-
CENT CEILINGS AND WALLS, ESPECIALLY

ILLUMINATED CEILINGS, IN CLASS 19 (U.S. CLS.
1, 12, 33 AND 50).

THE MARK CONSISTS OF STANDARD CHAR-
ACTERS WITHOUT CLAIM TO ANY PARTICULAR
FONT, STYLE, SIZE, OR COLOR.

OWNER OF INTERNATIONAL REGISTRATION
0949765 DATED 11-8-2007, EXPIRES 11-8-2017.

SER. NO. 79-048,588, FILED 11-8-2007.

MARCIE MILONE, EXAMINING ATTORNEY

Int. Cls.: 9 and 42

Prior U.S. Cls.: 21, 23, 26, 36, 38, 100 and 101

United States Patent and Trademark Office

Reg. No. 3,477,020

Registered July 29, 2008

**TRADEMARK
SERVICE MARK
PRINCIPAL REGISTER**

DEMS

SIEMENS AKTIENGESELLSCHAFT (FED REP
GERMANY JOINT STOCK COMPANY)
WITTELSBACHERPLATZ 2
80333 MÜNCHEN
FED REP GERMANY

FOR: DATA PROCESSING PROGRAMS, IN
CLASS 9 (U.S. CLS. 21, 23, 26, 36 AND 38).

FOR: DEVELOPMENT, GENERATION AND
RENTAL OF DATA PROCESSING PROGRAMS, IN
CLASS 42 (U.S. CLS. 100 AND 101).

THE MARK CONSISTS OF STANDARD CHAR-
ACTERS WITHOUT CLAIM TO ANY PARTICULAR
FONT, STYLE, SIZE, OR COLOR.

OWNER OF INTERNATIONAL REGISTRATION
0951142 DATED 12-10-2007, EXPIRES 12-10-2017.

SER. NO. 79-049,082, FILED 12-10-2007.

ALLISON HOLTZ, EXAMINING ATTORNEY

Int. Cl.: 42

Prior U.S. Cls.: 100 and 101

United States Patent and Trademark Office

Reg. No. 3,477,021

Registered July 29, 2008

**SERVICE MARK
PRINCIPAL REGISTER**

UNVEIL

NOVO NORDISK A/S (DENMARK LTD LIAB CO)
NOVO ALLÉ
DK-2880 BAGSVAERD
DENMARK

FOR: MEDICAL AND SCIENTIFIC RESEARCH,
NAMELY, CONDUCTING CLINICAL TRIALS AND
STUDIES FOR PHARMACEUTICAL PREPARA-
TIONS RELATED TO THE TREATMENT OF DIA-
BETES RELATED DISEASES AND DISORDERS , IN
CLASS 42 (U.S. CLS. 100 AND 101).

THE MARK CONSISTS OF STANDARD CHAR-
ACTERS WITHOUT CLAIM TO ANY PARTICULAR
FONT, STYLE, SIZE, OR COLOR.

PRIORITY DATE OF 11-29-2007 IS CLAIMED.

OWNER OF INTERNATIONAL REGISTRATION
0951285 DATED 12-19-2007, EXPIRES 12-19-2017.

SER. NO. 79-049,110, FILED 12-19-2007.

SHANNON TWOHIG, EXAMINING ATTORNEY

Int. Cls.: 1 and 17

Prior U.S. Cls.: 1, 5, 6, 10, 12, 13, 26, 35, 46 and 50

United States Patent and Trademark Office

Reg. No. 3,477,022

Registered July 29, 2008

**TRADEMARK
PRINCIPAL REGISTER**

switchTec

UZIN UTZ AKTIENGESELLSCHAFT (FED REP
GERMANY SHAREHOLDERS COMPANY)
DIESELSTR. 3
89079 ULM
FED REP GERMANY

FOR: ADHESIVES FOR INDUSTRIAL PURPOSES,
IN CLASS 1 (U.S. CLS. 1, 5, 6, 10, 26 AND 46).

FOR: ADHESIVE BANDS, ADHESIVE FOILS AND
ADHESIVE STRIPS OTHER THAN FOR STATION-
ERY AND NOT FOR MEDICAL OR HOUSEHOLD
PURPOSES; ADHESIVE BANDS, ADHESIVE FOILS

AND ADHESIVE STRIPS FOR FLOOR COVERINGS,
IN CLASS 17 (U.S. CLS. 1, 5, 12, 13, 35 AND 50).

PRIORITY DATE OF 9-27-2007 IS CLAIMED.

OWNER OF INTERNATIONAL REGISTRATION
0951414 DATED 12-18-2007, EXPIRES 12-18-2017.

SER. NO. 79-049,156, FILED 12-18-2007.

LINDA LAVACHE, EXAMINING ATTORNEY

Int. Cl.: 12

Prior U.S. Cls.: 19, 21, 23, 31, 35 and 44

United States Patent and Trademark Office

Reg. No. 3,477,023

Registered July 29, 2008

**TRADEMARK
PRINCIPAL REGISTER**

KIWI

OTTO BOCK HEALTHCARE GMBH (FED REP
GERMANY LTD LIAB CO)
MAX-NÄDER-STRASSE 15
37115 DUDERSTADT
FED REP GERMANY

FOR: CHILDREN'S PUSH CHAIRS, IN PARTICULAR BUGGIES FOR REHABILITATION PURPOSES, IN CLASS 12 (U.S. CLS. 19, 21, 23, 31, 35 AND 44).

THE MARK CONSISTS OF STANDARD CHARACTERS WITHOUT CLAIM TO ANY PARTICULAR FONT, STYLE, SIZE, OR COLOR.

PRIORITY DATE OF 8-13-2007 IS CLAIMED.

OWNER OF INTERNATIONAL REGISTRATION
0951562 DATED 12-13-2007, EXPIRES 12-13-2017.

SER. NO. 79-049,219, FILED 12-13-2007.

AMEETA JORDAN, EXAMINING ATTORNEY

Int. Cl.: 10

Prior U.S. Cls.: 26, 39 and 44

United States Patent and Trademark Office

Reg. No. 3,477,024

Registered July 29, 2008

**TRADEMARK
PRINCIPAL REGISTER**

Secu-Pack

SENGEWALD KLINIKPRODUKTE GMBH (FED
REP GERMANY GMBH)
ADLERSTR. 2
83101 ROHRDORF-THANSAU
FED REP GERMANY

OWNER OF INTERNATIONAL REGISTRATION
0951640 DATED 12-21-2007, EXPIRES 12-21-2017.

FOR: STERILE AND NON-STERILE OPERATING
COVERING CLOTHS FOR MEDICAL AND SURGI-
CAL PURPOSES, FOR COVERING PATIENTS, TA-
BLES AND EQUIPMENT; OPERATING TABLE
COVERS , IN CLASS 10 (U.S. CLS. 26, 39 AND 44).

SER. NO. 79-049,255, FILED 12-21-2007.

KELLEY WELLS, EXAMINING ATTORNEY

Int. Cls.: 1 and 9

Prior U.S. Cls.: 1, 5, 6, 10, 21, 23, 26, 36, 38 and 46

United States Patent and Trademark Office

Reg. No. 3,477,025

Registered July 29, 2008

**TRADEMARK
PRINCIPAL REGISTER**

WEAR-LITE

INTERGLASS TECHNOLOGY AG (SWITZER-
LAND SOCIÉTÉ ANONYME)

HINTERBERGSTRASSE 26

CH-6330 CHAM

SWITZERLAND

FOR: SYNTHETIC RESINS FOR MOULDING
SPECTACLE LENSES, IN CLASS 1 (U.S. CLS. 1, 5, 6,
10, 26 AND 46).

FOR: SPECTACLES AND SPECTACLE LENSES,
IN CLASS 9 (U.S. CLS. 21, 23, 26, 36 AND 38).

THE MARK CONSISTS OF STANDARD CHAR-
ACTERS WITHOUT CLAIM TO ANY PARTICULAR
FONT, STYLE, SIZE, OR COLOR.

PRIORITY DATE OF 7-9-2007 IS CLAIMED.

OWNER OF INTERNATIONAL REGISTRATION
0951658 DATED 12-12-2007, EXPIRES 12-12-2017.

SER. NO. 79-049,263, FILED 12-12-2007.

MARILYN IZZI, EXAMINING ATTORNEY

Int. Cl.: 9

Prior U.S. Cls.: 21, 23, 26, 36 and 38

United States Patent and Trademark Office

Reg. No. 3,477,026

Registered July 29, 2008

**TRADEMARK
PRINCIPAL REGISTER**

CIGRAPH

CIGRAPH, S.R.L. (ITALY S.R.L.)
VIA ORSATO 38
I-30175 MARGHERA
ITALY

FOR: ARCHITECTURAL DESIGN SOFTWARE
TO BE USED FOR MEASURING, SKETCHING
AND DRAWING, IN CLASS 9 (U.S. CLS. 21, 23, 26,
36 AND 38).

OWNER OF INTERNATIONAL REGISTRATION
0626657 DATED 10-6-1994, EXPIRES 10-6-2014.

OWNER OF U.S. REG. NOS. 2,148,734 AND
2,148,903.

SER. NO. 79-049,412, FILED 11-29-2007.

DAYNA BROWNE, EXAMINING ATTORNEY

Int. Cl.: 9

Prior U.S. Cls.: 21, 23, 26, 36 and 38

Reg. No. 3,477,027

United States Patent and Trademark Office

Registered July 29, 2008

**TRADEMARK
PRINCIPAL REGISTER**



AXE CO., LTD. (JAPAN CORPORATION)
1-14-7, NAKANO
HIGASHISUMIYOSHI-KU
OSAKA-SHI, OSAKA 546-0012, JAPAN

OWNER OF INTERNATIONAL REGISTRATION
0952176 DATED 12-27-2007, EXPIRES 12-27-2017.

FOR: SPORTS GOGGLES, SUNGLASSES, EYE-
GLASSES, DUST PROTECTIVE MASKS, GAS
MASKS, WELDING MASKS, IN CLASS 9 (U.S. CLS.
21, 23, 26, 36 AND 38).

SER. NO. 79-049,425, FILED 12-27-2007.

PRIORITY DATE OF 12-13-2007 IS CLAIMED.

WENDY GOODMAN, EXAMINING ATTORNEY

Int. Cl.: 28

Prior U.S. Cls.: 22, 23, 38 and 50

Reg. No. 3,477,028

United States Patent and Trademark Office

Registered July 29, 2008

**TRADEMARK
PRINCIPAL REGISTER**

TENERGY

TAMASU BUTTERFLY EUROPA GMBH (FED
REP GERMANY GMBH (LIMITED LIABILITY
COMPANY))
AM SCHÜRMANNHÜTT 30H
47441 MOERS
FED REP GERMANY

FOR: SPORTS AND GAMES EQUIPMENT FOR
TABLE TENNIS AND TENNIS AND PARTS THERE-
FOR, IN PARTICULAR TABLE TENNIS BATS,
TENNIS RACQUETS, TABLE TENNIS COVERS
AND TABLE TENNIS BALLS, BALL PITCHING
MACHINES, IN CLASS 28 (U.S. CLS. 22, 23, 38 AND
50).

THE MARK CONSISTS OF STANDARD CHAR-
ACTERS WITHOUT CLAIM TO ANY PARTICULAR
FONT, STYLE, SIZE, OR COLOR.

PRIORITY DATE OF 9-24-2007 IS CLAIMED.

OWNER OF INTERNATIONAL REGISTRATION
0952312 DATED 12-17-2007, EXPIRES 12-17-2017.

SER. NO. 79-049,478, FILED 12-17-2007.

KYLE PEETE, EXAMINING ATTORNEY

Int. Cl.: 35

Prior U.S. Cls.: 100, 101 and 102

United States Patent and Trademark Office

Reg. No. 3,477,029

Registered July 29, 2008

**SERVICE MARK
PRINCIPAL REGISTER**

RELIASSET

RELIASSET A/S (DENMARK LIMITED COMPANY)
DIPLOMVEJ 373, 1
DK-2880 BAGSVÆRD
DENMARK

FOR: BUSINESS MANAGEMENT AND BUSINESS ADMINISTRATION, NAMELY, COMMERCIAL ADVICE ON BUSINESS STRATEGIES, RELOCATION SERVICES FOR BUSINESSES, COST ANALYSIS, BUSINESS RESEARCH, BUSINESS APPRAISALS; SYSTEMIZATION OF INFORMATION INTO COMPUTER DATABASES, IN CLASS 35 (U.S. CLS. 100, 101 AND 102).

THE MARK CONSISTS OF STANDARD CHARACTERS WITHOUT CLAIM TO ANY PARTICULAR FONT, STYLE, SIZE, OR COLOR.

PRIORITY DATE OF 6-27-2007 IS CLAIMED.

OWNER OF INTERNATIONAL REGISTRATION
0952569 DATED 12-20-2007, EXPIRES 12-20-2017.

SER. NO. 79-049,575, FILED 12-20-2007.

ANNE MADDEN, EXAMINING ATTORNEY

Int. Cl.: 33

Prior U.S. Cls.: 47 and 49

United States Patent and Trademark Office

Reg. No. 3,477,030

Registered July 29, 2008

TRADEMARK
PRINCIPAL REGISTER

紅
乙
女

BENIOTOME SHUZO CO., LTD (JAPAN CORPORATION)
732 TANUSHIMARU
TANUSHIMARUMACHI, KURUME SHI; FUKUOKA 839-1233
JAPAN

FOR: JAPANESE WHITE LIQUOR (SHOCHU);
ALCOHOLIC BEVERAGES (EXCEPT BEERS), IN
CLASS 33 (U.S. CLS. 47 AND 49).

OWNER OF INTERNATIONAL REGISTRATION
0952588 DATED 12-20-2007, EXPIRES 12-20-2017.

MARK HAS NO MEANING.

THE TANSLITERATION OF THE NON-LATIN
CHARACTERS IN THE MARK IS: "BENIOTOME".

SER. NO. 79-049,583, FILED 12-20-2007.

BARBARA BROWN, EXAMINING ATTORNEY

Int. Cl.: 30

Prior U.S. Cl.: 46

United States Patent and Trademark Office

Reg. No. 3,477,031

Registered July 29, 2008

**TRADEMARK
PRINCIPAL REGISTER**

MORETTINO

ANGELO MORETTINO S.P.A. (ITALY SOCIÉTÉ
PAR ACTIONS)
VIA NUOVA, 105 A-B
I-90146 PALERMO
ITALY

OWNER OF INTERNATIONAL REGISTRATION
0813835 DATED 9-26-2003, EXPIRES 9-26-2013.

FOR: ROASTED COFFEE AND ARTIFICIAL COFFEE, IN CLASS 30 (U.S. CL. 46).

SER. NO. 79-049,758, FILED 12-18-2007.

THE MARK CONSISTS OF STANDARD CHARACTERS WITHOUT CLAIM TO ANY PARTICULAR FONT, STYLE, SIZE, OR COLOR.

CAROLYN GRAY, EXAMINING ATTORNEY

Int. Cl.: 37

Prior U.S. Cls.: 100, 103 and 106

United States Patent and Trademark Office

Reg. No. 3,477,032

Registered July 29, 2008

**SERVICE MARK
PRINCIPAL REGISTER**

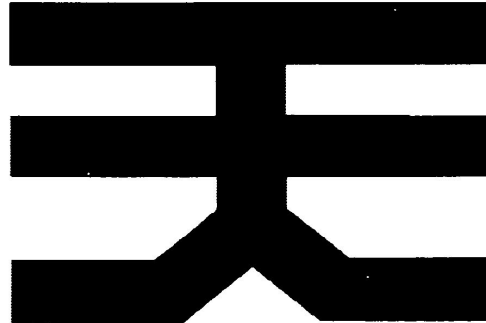

TSUNEISHI HOLDINGS CORPORATION (JAPAN
CORPORATION)
1083, TSUNEISHI
NUMAKUMA-CHO, FUKUYAMA-CITY
HIROSHIMA 720-0393, JAPAN

THE TANSLITERATION OF THE NON-LATIN
CHARACTERS IN THE MARK IS: TEN.

FOR: SHIPBUILDING, IN CLASS 37 (U.S. CLS. 100,
103 AND 106).

SER. NO. 79-049,924, FILED 1-23-2008.

OWNER OF INTERNATIONAL REGISTRATION
0953391 DATED 1-23-2008, EXPIRES 1-23-2018.

KATHERINE E. HALMEN, EXAMINING ATTOR-
NEY

Int. Cls.: 7 and 8

Prior U.S. Cls.: 13, 19, 21, 23, 28, 31, 34, 35 and 44

United States Patent and Trademark Office

Reg. No. 3,477,033

Registered July 29, 2008

**TRADEMARK
PRINCIPAL REGISTER**

TCTYRE

WIKUS-SÄGENFABRIK; WILHELM H. KULL-
MANN GMBH & CO. KG (FED REP GERMA-
NY LIMITED PARTNERSHIP)

MELSUNGER STRASSE 30
34286 SPANGENBERG, FED REP GERMANY

FOR: PARTS OF POWER SAWS, NAMELY, SAW
BLADES, SAW BANDS, CIRCULAR SAW BLADES,
BAND SAW BLADES, IN CLASS 7 (U.S. CLS. 13, 19,
21, 23, 31, 34 AND 35).

FOR: PARTS OF HAND SAWS, NAMELY, SAW
BLADES, SAW BANDS, CIRCULAR SAW BLADES,
IN CLASS 8 (U.S. CLS. 23, 28 AND 44).

THE MARK CONSISTS OF STANDARD CHAR-
ACTERS WITHOUT CLAIM TO ANY PARTICULAR
FONT, STYLE, SIZE, OR COLOR.

PRIORITY DATE OF 6-30-2007 IS CLAIMED.

OWNER OF INTERNATIONAL REGISTRATION
0953466 DATED 12-21-2007, EXPIRES 12-21-2017.

SER. NO. 79-049,960, FILED 12-21-2007.

WILLIAM BRECKENFELD, EXAMINING ATTOR-
NEY

Int. Cls.: 9, 35, 41 and 42

Prior U.S. Cls.: 21, 23, 26, 36, 38, 100, 101, 102 and 107

United States Patent and Trademark Office

Reg. No. 3,477,034

Registered July 29, 2008

**TRADEMARK
SERVICE MARK
PRINCIPAL REGISTER**

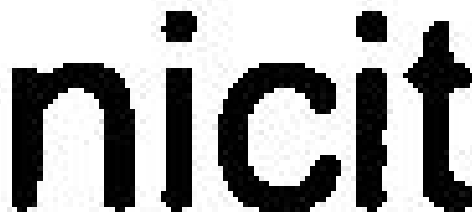

NICIT IT-SOLUTIONS GMBH (FED REP GER-
MANY GMBH (LIMITED LIABILITY COMPA-
NY))
KÄTHE-KOLLWITZ-STR. 2
79111 FREIBURG, FED REP GERMANY

FOR: COMPUTER HARDWARE, COMPUTERS,
IN CLASS 9 (U.S. CLS. 21, 23, 26, 36 AND 38).

FOR: PRESENTATION OF GOODS ON COMMU-
NICATION MEDIA, FOR RETAIL SERVICES USING
ONLINE TRADING PLATFORMS; LAYOUT SERVI-
CES FOR ADVERTISING PURPOSES, IN CLASS 35
(U.S. CLS. 100, 101 AND 102).

FOR: LAYOUT SERVICES FOR GRAPHICS, IN
CLASS 41 (U.S. CLS. 100, 101 AND 107).

FOR: GENERATION OF COMPUTER PRO-
GRAMS OR PROGRAM PARTS FOR DATA PRO-

CESSING SOFTWARE; CREATING AND
MAINTAINING WEB SITES FOR OTHERS; DEVEL-
OPMENT OF INTERNET APPLICATIONS, NAME-
LY, DEVELOPMENT OF WEBPAGES ON THE
INTERNET , IN CLASS 42 (U.S. CLS. 100 AND 101).

THE MARK CONSISTS OF STANDARD CHAR-
ACTERS WITHOUT CLAIM TO ANY PARTICULAR
FONT, STYLE, SIZE, OR COLOR.

OWNER OF INTERNATIONAL REGISTRATION
0953519 DATED 8-23-2007, EXPIRES 8-23-2017.

SER. NO. 79-049,976, FILED 8-23-2007.

SANDRA MANIOS, EXAMINING ATTORNEY

Int. Cl.: 32

Prior U.S. Cls.: 45, 46 and 48

United States Patent and Trademark Office

Reg. No. 3,477,035

Registered July 29, 2008

**TRADEMARK
PRINCIPAL REGISTER**



SANPELLEGRINO S.P.A. (ITALY JOINT STOCK
COMPANY)
VIA LODOVICO IL MORO, 35
I-20143 MILANO
ITALY

FOR: STILL WATER, SPARKLING AND CARBO-
NATED WATERS, PROCESSED WATER, SPRING
WATERS, MINERAL WATER, FLAVOURED WA-
TER, FUNCTIONAL AND/OR NUTRITIONAL WA-
TER-BASED BEVERAGES, INCLUDING THOSE
WITH A VITAMIN, MINERAL OR HERB; ISOTONIC
BEVERAGES; ENERGY BEVERAGES, IN CLASS 32
(U.S. CLS. 45, 46 AND 48).

PRIORITY DATE OF 7-13-2007 IS CLAIMED.

OWNER OF INTERNATIONAL REGISTRATION
0953648 DATED 12-18-2007, EXPIRES 12-18-2017.

THE COLOR(S) BLUE IS/ARE CLAIMED AS A
FEATURE OF THE MARK.

THE TRADEMARK CONSISTS OF A STYLIZED
BLUE FLOWER THAT EVOKES A LILY.

SER. NO. 79-050,039, FILED 12-18-2007.

CAROLYN GRAY, EXAMINING ATTORNEY

Int. Cl.: 10

Prior U.S. Cls.: 26, 39 and 44

United States Patent and Trademark Office

Reg. No. 3,477,036

Registered July 29, 2008

**TRADEMARK
PRINCIPAL REGISTER**

Sympress

RENFERT GMBH (FED REP GERMANY GMBH)
UNTERE GIEßWIESEN 2
78247 HILZINGEN
FED REP GERMANY

OWNER OF INTERNATIONAL REGISTRATION
0953807 DATED 12-20-2007, EXPIRES 12-20-2017.

FOR: MEDICAL DEVICES, NAMELY, AUTO-
MATIC MIXING DEVICES FOR IMPRESSION MA-
TERIALS AS USED IN THE FIELD OF DENTAL
MEDICINE, IN CLASS 10 (U.S. CLS. 26, 39 AND 44).

SER. NO. 79-050,097, FILED 12-20-2007.

PRIORITY DATE OF 8-30-2007 IS CLAIMED.

MAUREEN DALL, EXAMINING ATTORNEY

Int. Cl.: 33

Prior U.S. Cls.: 47 and 49

United States Patent and Trademark Office

Reg. No. 3,477,037

Registered July 29, 2008

**TRADEMARK
PRINCIPAL REGISTER**

BLACK TIME

SARL JL BALDÈS (FRANCE SARL)
LES POUJOLS
F-46700 VIRE SUR LOT, FRANCE

OWNER OF INTERNATIONAL REGISTRATION
0953927 DATED 12-26-2007, EXPIRES 12-26-2017.

FOR: WINE, IN CLASS 33 (U.S. CLS. 47 AND 49).

SER. NO. 79-050,155, FILED 12-26-2007.

PRIORITY DATE OF 9-12-2007 IS CLAIMED.

ANTHONY RINKER, EXAMINING ATTORNEY

Int. Cl.: 20

Prior U.S. Cls.: 2, 13, 22, 25, 32 and 50

United States Patent and Trademark Office

Reg. No. 3,477,038

Registered July 29, 2008

**TRADEMARK
PRINCIPAL REGISTER**

INSPIRATION 

AISAPACK HOLDING S.A. (SWITZERLAND SO-
CIEÉTÉ ANONYME)
RUE DE LA PRAISE
CH-1896 VOUVRY
SWITZERLAND

OWNER OF INTERNATIONAL REGISTRATION
0953962 DATED 12-18-2007, EXPIRES 12-18-2017.

FOR: PACKAGING CONTAINERS OF PLASTIC,
IN CLASS 20 (U.S. CLS. 2, 13, 22, 25, 32 AND 50).

SER. NO. 79-050,169, FILED 12-18-2007.

PRIORITY DATE OF 7-19-2007 IS CLAIMED.

CAROLYN GRAY, EXAMINING ATTORNEY

Int. Cl.: 9

Prior U.S. Cls.: 21, 23, 26, 36 and 38

Reg. No. 3,477,039

United States Patent and Trademark Office

Registered July 29, 2008

**TRADEMARK
PRINCIPAL REGISTER**

WINGLET

HALIAETUS TECHNOLOGIES (FRANCE SOCI-
ÉTÉ PAR ACTIONS SIMPLIFIÉE)
PARC DE L'ÉVÈNEMENT,
1 ALLÉE D'EFFIAT; F-91160 LONGJUMEAU
FRANCE

FOR: APPARATUS AND INSTRUMENTS FOR
RECORDING, TRANSMITTING, REPRODUCING
OR PROCESSING SOUND, LOUD-SPEAKER CABI-
NETS, ACOUSTIC ENCLOSURES, LOUD-SPEAK-

ERS, VENTS FOR BROADCASTING SOUND, IN
CLASS 9 (U.S. CLS. 21, 23, 26, 36 AND 38).

OWNER OF INTERNATIONAL REGISTRATION
0953971 DATED 12-14-2007, EXPIRES 12-14-2017.

SER. NO. 79-050,173, FILED 12-14-2007.

ALICIA COLLINS, EXAMINING ATTORNEY

Int. Cls.: 35, 41 and 42

Prior U.S. Cls.: 100, 101, 102 and 107

United States Patent and Trademark Office

Reg. No. 3,477,040

Registered July 29, 2008

**SERVICE MARK
PRINCIPAL REGISTER**

NORTH KINGDOM

NORTH KINGDOM DESIGN & COMMUNICA-
TION AB (SWEDEN JOINT STOCK COMPA-
NY)

STORGATAN 32
SE-931 31 SKELLETEÅ
SWEDEN

FOR: ADVERTISING AND PUBLICITY SERVI-
CES ONLINE; PRODUCTION OF SOUND AND
VIDEO RECORDINGS FOR ADVERTISING PUR-
POSES; PRODUCTION OF ADVERTISING MATERI-
AL, INCLUDING ADVERTISING FILMS, IN CLASS
35 (U.S. CLS. 100, 101 AND 102).

FOR: DIGITAL IMAGING SERVICES; RECORD-
ING STUDIO SERVICES; RECORDING AND PRO-
DUCTION OF FILM; PRODUCTION OF SPECIAL
EFFECTS FOR FILM, RADIO AND TV, IN CLASS 41
(U.S. CLS. 100, 101 AND 107).

FOR: DESIGN OF WEBSITES; DESIGN AND
DEVELOPMENT OF COMPUTER SOFTWARE
AND WEBSITES; ENCODING AND CODING OF
DIGITAL IMAGES AND MUSIC, IN CLASS 42 (U.S.
CLS. 100 AND 101).

THE MARK CONSISTS OF STANDARD CHAR-
ACTERS WITHOUT CLAIM TO ANY PARTICULAR
FONT, STYLE, SIZE, OR COLOR.

PRIORITY DATE OF 11-26-2007 IS CLAIMED.

OWNER OF INTERNATIONAL REGISTRATION
0954031 DATED 12-19-2007, EXPIRES 12-19-2017.

SER. NO. 79-050,204, FILED 12-19-2007.

PAUL F. GAST, EXAMINING ATTORNEY

Int. Cl.: 9

Prior U.S. Cls.: 21, 23, 26, 36 and 38

United States Patent and Trademark Office

Reg. No. 3,477,041

Registered July 29, 2008

**TRADEMARK
PRINCIPAL REGISTER**

SATELLAR

SATEL OY (FINLAND LTD LIAB CO)
MERINIITYNKATU 17
FI-24100 SALO, FINLAND

OWNER OF INTERNATIONAL REGISTRATION
0954728 DATED 12-28-2007, EXPIRES 12-28-2017.

FOR: RADIO MODEMS, IN CLASS 9 (U.S. CLS. 21,
23, 26, 36 AND 38).

SER. NO. 79-050,396, FILED 12-28-2007.

THE MARK CONSISTS OF STANDARD CHAR-
ACTERS WITHOUT CLAIM TO ANY PARTICULAR
FONT, STYLE, SIZE, OR COLOR.

WENDY GOODMAN, EXAMINING ATTORNEY

Int. Cl.: 14

Prior U.S. Cls.: 2, 27, 28 and 50

United States Patent and Trademark Office

Reg. No. 3,477,042

Registered July 29, 2008

**TRADEMARK
PRINCIPAL REGISTER**

A NEW DIMENSION IN TIME

HI-TEK OFFICE S.R.L. (ITALY LTD LIAB CO)
VIA VECCHIA ROMANA, 685
I-55100 ANTRACCOLI (LU)
ITALY

FOR: PRECIOUS METALS AND THEIR ALLOYS
AND GOODS IN PRECIOUS METALS OR COATED
THEREWITH, NAMELY, RINGS, NECKLACES,
BRACELETS, BROOCHES, EARRINGS, CUF-
FLINKS; JEWELERY, PRECIOUS STONES; HORO-
LOGICAL AND CHRONOMETRIC INSTRUMENTS,
IN CLASS 14 (U.S. CLS. 2, 27, 28 AND 50).

THE MARK CONSISTS OF STANDARD CHAR-
ACTERS WITHOUT CLAIM TO ANY PARTICULAR
FONT, STYLE, SIZE, OR COLOR.

PRIORITY DATE OF 12-17-2007 IS CLAIMED.

OWNER OF INTERNATIONAL REGISTRATION
0954751 DATED 12-21-2007, EXPIRES 12-21-2017.

SER. NO. 79-050,402, FILED 12-21-2007.

CYNTHIA SLOAN, EXAMINING ATTORNEY

Int. Cl.: 33

Prior U.S. Cls.: 47 and 49

United States Patent and Trademark Office

Reg. No. 3,477,043

Registered July 29, 2008

**TRADEMARK
PRINCIPAL REGISTER**

INFINITE

MIGUEL TORRES S.A. (SPAIN SOCIEDAD ANÓNIMA)
MIQUEL TORRES I CARBÓ, 6
E-08720 VILAFRANCA DEL PENEDES (BARCELONA)
SPAIN

OWNER OF INTERNATIONAL REGISTRATION
0955077 DATED 12-20-2007, EXPIRES 12-20-2017.

FOR: WINES, IN CLASS 33 (U.S. CLS. 47 AND 49).

SER. NO. 79-050,523, FILED 12-20-2007.

THE MARK CONSISTS OF STANDARD CHARACTERS WITHOUT CLAIM TO ANY PARTICULAR FONT, STYLE, SIZE, OR COLOR.

EUGENIA MARTIN, EXAMINING ATTORNEY

Int. Cl.: 33

Prior U.S. Cls.: 47 and 49

United States Patent and Trademark Office

Reg. No. 3,477,044

Registered July 29, 2008

**TRADEMARK
PRINCIPAL REGISTER**

VILLA PARADISO

GESTIONI PICCINI, S.R.L. (ITALY SOCIÉTÉ À
RESPONSABILITÉ LIMITÉE)

LOCALITA' PIAZZOLE

I-53011 CASTELLINA IN CHIANTI (SI), ITALY

FOR: WINES, IN CLASS 33 (U.S. CLS. 47 AND 49).

THE MARK CONSISTS OF STANDARD CHAR-
ACTERS WITHOUT CLAIM TO ANY PARTICULAR
FONT, STYLE, SIZE, OR COLOR.

OWNER OF INTERNATIONAL REGISTRATION
0955198 DATED 12-21-2007, EXPIRES 12-21-2017.

THE ENGLISH TRANSLATION OF THE FOR-
EIGN WORDS IN THE MARK IS HOUSE PARA-
DISE.

SER. NO. 79-050,552, FILED 12-21-2007.

EUGENIA MARTIN, EXAMINING ATTORNEY

Int. Cl.: 25

Prior U.S. Cls.: 22 and 39

United States Patent and Trademark Office

Reg. No. 3,477,045

Registered July 29, 2008

**TRADEMARK
PRINCIPAL REGISTER**

bastard

CLAUDIO BERNARDINI (ITALY INDIVIDUAL)
48, VIA SANTINI
PARABIAGO, ITALY I20015

FOR: CLOTHING, NAMELY, COATS, OVER-
COATS, RAINCOATS, JACKETS, TROUSERS,
SKIRTS, SKI SUITS, SHORTS, PULLOVERS, SWIM-
SUITS, SWEATERS, T-SHIRTS, SHIRTS; SOCKS;
GLOVES, SKI GLOVES, BELTS; SCARVES; FOOT-
WEAR, NAMELY, BOOTS FOR SPORTS, SHOES,

SLIPPERS AND SANDALS; HEADWEAR, NAMELY,
HATS, CAPS, IN CLASS 25 (U.S. CLS. 22 AND 39).

OWNER OF INTERNATIONAL REGISTRATION
0645360 DATED 10-16-1995, EXPIRES 10-16-2015.

SER. NO. 79-975,041, FILED 3-5-2007.

JIM RINGLE, EXAMINING ATTORNEY

Int. Cls.: 9, 16, and 42

**Prior U.S. Cls.: 2, 5, 21, 22, 23, 26, 29, 36, 37, 38, 50,
100, and 101**

Reg. No. 3,477,046

United States Patent and Trademark Office

Registered July 29, 2008

**TRADEMARK
SERVICE MARK
PRINCIPAL REGISTER**

CONEXON

INTERACTIVE ENTERPRISE LIMITED, THE
(IRELAND CORPORATION)
CITYWEST BUSINESS CAMPUS
7 RIVERWALK, NATIONAL DIGITAL PARK
DUBLIN 24, IRELAND

FOR: COMPUTER SOFTWARE AND COMPUTER PROGRAMS, NAMELY, COMPUTER MIDDLEWARE AND PROGRAMS USED TO CONNECT RESIDENTIAL AND BUSINESS SUBSCRIBERS AND END USERS TO INTERACTIVE SERVICES IN BROADBAND COMMUNICATIONS NETWORKS SUCH AS CABLE NETWORKS, TELEPHONY AND DSL NETWORKS, WIRELESS NETWORKS, OPTICAL NETWORKS FOR USE BY NETWORK OPERATORS IN THE PROVISION TO SUBSCRIBERS OR FOR USE BY SUBSCRIBERS OF TELECOMMUNICATIONS SERVICES AND MEDIA SERVICES, NAMELY, INTERACTIVE TELECOMMUNICATIONS SERVICES, IN CLASS 9 (U.S. CLS. 21, 23, 26, 36 AND 38).

FIRST USE 5-3-2000; IN COMMERCE 5-3-2000.

FOR: PRINTED MATTER IN THE NATURE OF PAMPHLETS, BOOKLETS, BROCHURES, USERS MANUALS, INSTALLATIONS MANUALS, TEACHING AND TRAINING MANUALS AND MATERIALS, ALL ON THE SUBJECT OF BROADBAND COMMUNICATIONS SERVICES PROVISIONING

AND ACTIVATION FOR USE BY SUBSCRIBERS OF SERVICES PROVIDED BY A NETWORK OPERATOR AND FOR USE BY NETWORK OPERATORS; PRINTED PAPER PUBLICATIONS IN THE NATURE OF PAMPHLETS, BOOKLETS, BROCHURES, USERS MANUALS, INSTALLATIONS MANUALS, TEACHING AND TRAINING MANUALS AND MATERIALS, ALL ON THE SUBJECT OF BROADBAND COMMUNICATIONS SERVICES PROVISIONING AND ACTIVATION, AND PRINTED BUSINESS FORMS, IN CLASS 16 (U.S. CLS. 2, 5, 22, 23, 29, 37, 38 AND 50).

FIRST USE 4-1-2001; IN COMMERCE 4-1-2001.

FOR: COMPUTER PROGRAMMING FOR OTHERS; COMPUTER RELATED SERVICES, NAMELY, INSTALLATION, MAINTENANCE AND UPGRADE OF COMPUTER SOFTWARE FOR NETWORK OPERATOR AND SUBSCRIBER TELEPHONE AND COMMUNICATIONS SYSTEMS, IN CLASS 42 (U.S. CLS. 100 AND 101).

FIRST USE 5-3-2000; IN COMMERCE 5-3-2000.

SN 75-754,310, FILED 7-19-1999.

DAVID MILLER, EXAMINING ATTORNEY

Int. Cl.: 25

Prior U.S. Cls.: 22 and 39

United States Patent and Trademark Office

Reg. No. 3,477,047

Registered July 29, 2008

**TRADEMARK
PRINCIPAL REGISTER**

HEISMAN TROPHY

HEISMAN TROPHY TRUST, THE (NEW YORK
TRUST)
19 WEST STREET
NEW YORK, NY 10004

NO CLAIM IS MADE TO THE EXCLUSIVE
RIGHT TO USE "TROPHY", APART FROM THE
MARK AS SHOWN.

FOR: CLOTHING, NAMELY, T-SHIRTS AND
HATS, IN CLASS 25 (U.S. CLS. 22 AND 39).

SEC. 2(F).

FIRST USE 12-9-2006; IN COMMERCE 12-9-2006.

SN 75-835,860, FILED 10-29-1999.

OWNER OF U.S. REG. NOS. 936,853, 1,397,161,
AND OTHERS.

HENRY S. ZAK, EXAMINING ATTORNEY

Int. Cls.: 2 and 17

Prior U.S. Cls.: 1, 5, 6, 11, 12, 13, 16, 35, and 50

United States Patent and Trademark Office

Reg. No. 3,477,048

Registered July 29, 2008

**TRADEMARK
PRINCIPAL REGISTER**

TAIYO AMERICA, INC.

TAIYO INK MFG. CO., LTD. (JAPAN CORPORATION)
2-7-1 HAZAWA, NERIMA-KU
TOKYO 176-8508, JAPAN

FOR: PRINTERS' INK, PRIMER OILS FOR PRINTING, AND RESIST INK FOR USE IN PRODUCTION OF CIRCUIT BOARDS, IN CLASS 2 (U.S. CLS. 6, 11 AND 16).

FIRST USE 12-0-1990; IN COMMERCE 12-0-1990.

FOR: INSULATING MATERIALS, NAMELY, SOLDER MASKS FOR PRINTING CIRCUIT BOARDS, IN CLASS 17 (U.S. CLS. 1, 5, 12, 13, 35 AND 50).

FIRST USE 12-0-1990; IN COMMERCE 12-0-1990.

NO CLAIM IS MADE TO THE EXCLUSIVE RIGHT TO USE "AMERICA, INC.", APART FROM THE MARK AS SHOWN.

THE ENGLISH TRANSLATION OF "TAIYO" IS "SUN".

SN 76-012,755, FILED 3-29-2000.

MONIQUE MILLER, EXAMINING ATTORNEY

Int. Cl.: 42

Prior U.S. Cls.: 100 and 101

United States Patent and Trademark Office

Reg. No. 3,477,049

Registered July 29, 2008

**SERVICE MARK
PRINCIPAL REGISTER**

PLANET EARTH NEWS

PLANET EARTH FOUNDATION (WASHINGTON
NON-PROFIT CORPORATION)
P.O BOX 1190
SEATTLE, WA 98111

FIRST USE 5-1-2000; IN COMMERCE 5-1-2000.

NO CLAIM IS MADE TO THE EXCLUSIVE
RIGHT TO USE "NEWS", APART FROM THE
MARK AS SHOWN.

FOR: DISSEMINATION OF NEWS AND INFOR-
MATION OF LOCAL, NATIONAL AND GLOBAL
INTEREST VIA PRINTED PUBLICATIONS, AUDIO
MEDIA, AUDIO-VISUAL MEDIA, AND VIA A GLO-
BAL COMPUTER NETWORK, IN CLASS 42 (U.S.
CLS. 100 AND 101).

SN 76-032,988, FILED 4-24-2000.

ROBERT C. CLARK JR., EXAMINING ATTORNEY

Int. Cl.: 42

Prior U.S. Cls.: 100 and 101

United States Patent and Trademark Office

Reg. No. 3,477,050

Registered July 29, 2008

**SERVICE MARK
PRINCIPAL REGISTER**

PLANET EARTH NETWORKS

PLANET EARTH FOUNDATION (WASHINGTON
NON-PROFIT CORPORATION)
P.O. BOX 1190
SEATTLE, WA 98111

FOR: PROVIDING INFORMATION AND RE-
SOURCES TO OTHERS ON LOCAL, GLOBAL AND
NATIONAL ISSUES VIA PRINTED PUBLICATIONS,
AUDIO MEDIA AUDIO-VISUAL MEDIA AND VIA
A GLOBAL COMPUTER NETWORK, IN CLASS 42
(U.S. CLS. 100 AND 101).

FIRST USE 5-1-2000; IN COMMERCE 5-1-2000.

NO CLAIM IS MADE TO THE EXCLUSIVE
RIGHT TO USE "NETWORKS", APART FROM
THE MARK AS SHOWN.

SN 76-033,024, FILED 4-24-2000.

ROBERT C. CLARK JR., EXAMINING ATTORNEY

Int. Cl.: 35

Prior U.S. Cls.: 100, 101, and 102

United States Patent and Trademark Office

Reg. No. 3,477,051

Registered July 29, 2008

**SERVICE MARK
PRINCIPAL REGISTER**

URBAN ZEN

DONNA KARAN (UNITED STATES INDIVIDUAL)
C/O URBAN ZEN LLC, 570 SEVENTH AVENUE
NEW YORK, NY 10018

FIRST USE 5-10-2007; IN COMMERCE 5-10-2007.

SN 76-036,856, FILED 4-28-2000.

FOR: RETAIL STORE SERVICES FEATURING
COSMETICS, TOILETRIES, FRAGRANCES, CLOTHING,
FOOTWEAR AND ACCESSORIES, IN CLASS 35
(U.S. CLS. 100, 101 AND 102).

MICHAEL KAZAZIAN, EXAMINING ATTORNEY

Int. Cl.: 42

Prior U.S. Cls.: 100 and 101

United States Patent and Trademark Office

Reg. No. 3,477,052

Registered July 29, 2008

**SERVICE MARK
PRINCIPAL REGISTER**

PLANET EARTH FILM

PLANET EARTH FOUNDATION (WASHINGTON
NON-PROFIT CORPORATION)
P.O. BOX 1190
SEATTLE, WA 98111

FIRST USE 5-1-2000; IN COMMERCE 5-1-2000.

FOR: NEWS AGENCY SERVICES, NAMELY, DIS-
SEMINATION OF NEWS AND INFORMATION OF
LOCAL, NATIONAL AND GLOBAL INTEREST VIA
PRINTED PUBLICATIONS, AUDIO MEDIA,
AUDIO-VISUAL MEDIA, AND VIA A GLOBAL
COMPUTER NETWORK, IN CLASS 42 (U.S. CLS.
100 AND 101).

NO CLAIM IS MADE TO THE EXCLUSIVE
RIGHT TO USE "FILM", APART FROM THE MARK
AS SHOWN.

SN 76-044,312, FILED 5-9-2000.

ROBERT C. CLARK JR., EXAMINING ATTORNEY

Int. Cl.: 42

Prior U.S. Cls.: 100 and 101

United States Patent and Trademark Office

Reg. No. 3,477,053

Registered July 29, 2008

**SERVICE MARK
PRINCIPAL REGISTER**

PLANET EARTH PRODUCTION

PLANET EARTH FOUNDATION (WASHINGTON
NON-PROFIT CORPORATION)
P.O. BOX 1190
SEATTLE, WA 98111

FOR: NEWS AGENCY SERVICES, NAMELY, DIS-
SEMINATION OF NEWS AND INFORMATION OF
LOCAL, NATIONAL AND GLOBAL INTEREST VIA
PRINTED PUBLICATIONS, AUDIO MEDIA,
AUDIO-VISUAL MEDIA, AND VIA A GLOBAL
COMPUTER NETWORK, IN CLASS 42 (U.S. CLS.
100 AND 101).

FIRST USE 5-1-2000; IN COMMERCE 5-1-2000.

NO CLAIM IS MADE TO THE EXCLUSIVE
RIGHT TO USE "PRODUCTION", APART FROM
THE MARK AS SHOWN.

SN 76-044,577, FILED 5-9-2000.

ROBERT C. CLARK JR., EXAMINING ATTORNEY

Int. Cl.: 42

Prior U.S. Cls.: 100 and 101

United States Patent and Trademark Office

Reg. No. 3,477,054

Registered July 29, 2008

**SERVICE MARK
PRINCIPAL REGISTER**

PLANET EARTH INFORMATION

PLANET EARTH FOUNDATION (WASHINGTON
NOT-PROFIT CORPORATION)
P.O. BOX 1190
SEATTLE, WA 98111

FOR: NEWS AGENCY SERVICES, NAMELY, DIS-
SEMINATION OF NEWS AND INFORMATION OF
LOCAL, NATIONAL AND GLOBAL INTEREST VIA
PRINTED PUBLICATIONS, AUDIO MEDIA,
AUDIO-VISUAL MEDIA, AND VIA A GLOBAL
COMPUTER NETWORK, IN CLASS 42 (U.S. CLS.
100 AND 101).

FIRST USE 5-1-2000; IN COMMERCE 5-1-2000.

NO CLAIM IS MADE TO THE EXCLUSIVE
RIGHT TO USE "INFORMATION", APART FROM
THE MARK AS SHOWN.

SN 76-044,843, FILED 5-9-2000.

ROBERT C. CLARK JR., EXAMINING ATTORNEY

Int. Cl.: 35

Prior U.S. Cls.: 100, 101, and 102

United States Patent and Trademark Office

Reg. No. 3,477,055

Registered July 29, 2008

**SERVICE MARK
PRINCIPAL REGISTER**

E4E

E4E, INC. (DELAWARE CORPORATION)
3979 FREEDOM CIRCLE, SIXTH FLOOR
SANTA CLARA, CA 95054

FOR: BUSINESS CONSULTATION AND BUSI-
NESS OPERATIONAL MANAGEMENT SERVICES
FOR TECHNOLOGY COMPANIES, ELECTRONIC
COMMERCE COMPANIES, GLOBAL COMPUTER
NETWORK BASED COMPANIES AND EXCHAN-

GES, AND INFRASTRUCTURE SERVICE PROVI-
DERS, IN CLASS 35 (U.S. CLS. 100, 101 AND 102).

FIRST USE 11-0-2000; IN COMMERCE 11-0-2000.

SN 76-065,459, FILED 6-6-2000.

ALICE BENMAMAN, EXAMINING ATTORNEY

Int. Cls.: 35 and 36

Prior U.S. Cls.: 100, 101, and 102

United States Patent and Trademark Office

Reg. No. 3,477,056

Registered July 29, 2008

**SERVICE MARK
PRINCIPAL REGISTER**



E4E, INC. (DELAWARE CORPORATION)
3979 FREEDOM CIRCLE, SIXTH FLOOR
SANTA CLARA, CA 95054

FOR: CUSTOMER RELATIONSHIP MANAGEMENT SERVICES; ACQUISITION OF TECHNOLOGY COMPANIES, ELECTRONIC COMMERCE COMPANIES, GLOBAL COMPUTER NETWORK BASED COMPANIES AND EXCHANGES, AND INFRASTRUCTURE SERVICE PROVIDERS FOR OTHERS, IN CLASS 35 (U.S. CLS. 100, 101 AND 102).

FIRST USE 11-0-2000; IN COMMERCE 11-0-2000.

FOR: FINANCIAL INVESTMENT IN THE FIELD OF TECHNOLOGY COMPANIES, ELECTRONIC

COMMERCE COMPANIES, GLOBAL COMPUTER NETWORK BASED COMPANIES AND EXCHANGES, AND INFRASTRUCTURE SERVICE PROVIDERS; FINANCIAL ANALYSIS AND CONSULTATION SERVICES FOR TECHNOLOGY COMPANIES, ELECTRONIC COMMERCE COMPANIES, GLOBAL COMPUTER NETWORK BASED COMPANIES AND EXCHANGES, AND INFRASTRUCTURE SERVICE PROVIDERS, IN CLASS 36 (U.S. CLS. 100, 101 AND 102).

FIRST USE 11-0-2000; IN COMMERCE 11-0-2000.

SN 76-164,894, FILED 11-13-2000.

ALICE BENMAMAN, EXAMINING ATTORNEY

Int. Cl.: 28

Prior U.S. Cls.: 22, 23, 38, and 50

United States Patent and Trademark Office

Reg. No. 3,477,057

Registered July 29, 2008

TRADEMARK
PRINCIPAL REGISTER

Alien



RICE, JACK (UNITED STATES INDIVIDUAL)
9006 WIMBLEY COURT
ELK GROVE, CA 95624

FOR: SPORTING GOODS, NAMELY, PAINTBALL
GUNS AND RELATED EQUIPMENT, NAMELY,
TRIGGERS, GRIP FRAMES, VOLUMIZERS, RI-
SERS, BARRELS, HOPPERS, PODS, HARNESSSES,

AIR TANKS, AND REGULATORS , IN CLASS 28
(U.S. CLS. 22, 23, 38 AND 50).

FIRST USE 5-10-2004; IN COMMERCE 5-10-2004.

SN 76-278,869, FILED 6-27-2001.

COLLEEN DOMBROW, EXAMINING ATTORNEY

Int. Cls.: 2, 9, and 16

Prior U.S. Cls.: 2, 5, 6, 11, 16, 21, 22, 23, 26, 29, 36, 37, 38, and 50

Reg. No. 3,477,058

United States Patent and Trademark Office

Registered July 29, 2008

**TRADEMARK
PRINCIPAL REGISTER**

OUR EARTH, OUR TOMORROW

RICOH COMPANY, LTD. (JAPAN CORPORATION)
3-6, 1-CHOME, NAKA-MAGOME
OHTA-KU
TOKYO, JAPAN

FOR: PRINTER'S INKS; TONER CARTRIDGES FOR USE IN COPYING MACHINES, FACSIMILE MACHINES, PRINTING MACHINES AND PRINTERS; PRINTING PIGMENTS, PHOTOCOPIER TONER CONTAINED IN CARTRIDGES; INKS CONTAINED IN TONER CARTRIDGES; INKS CONTAINED IN ROLLER CASSETTE AND PRINTING INKS, IN CLASS 2 (U.S. CLS. 6, 11 AND 16).

FIRST USE 3-1-2002; IN COMMERCE 3-1-2002.

FOR: ELECTROSTATIC, ELECTROCARDIOGRAPHIC, THERMAL AND PHOTOGRAPHIC COPYING MACHINES; AUTOMATIC DOCUMENT FEEDERS; MOVIE PROJECTORS, LANDSCAPE PROJECTORS, SLIDE PROJECTORS AND CASES FOR ALL THE AFORESAID GOODS; INTER-CHANGEABLE OPTICAL LENSES AND CAMERA TRIPODS; CAMERA FILTERS, CAMERA SHUTTER RELEASE, CAMERA STANDS, CAMERA RANGE FINDERS; MICROFILM CAMERAS, BAR CODE READERS; VIDEO CASSETTE RECORDERS, DIGITAL CAMERAS; DATA PROCESSORS; COMPUTER SYSTEM, NAMELY, A CENTRAL PROCESSING UNIT; COMPUTER DISC DRIVE, MAGNETIC AND OPTICAL COMPACT DISC MEDIA; FACSIMILE MACHINES; AUTOMATIC DOCUMENT FEEDERS; GAS AND WATER METERS; WORD PROCESSORS, IMPACT PRINTERS; SHEET FEEDERS FOR MAIL PROCESSING MACHINES; SEMICONDUCTORS, INTEGRATED CIRCUITS, TELEPHONES AND TELEPHONE EXCHANGE SYSTEM COMPRISED OF A PRIVATE BRANCH EXCHANGE; TV CONFERENCE SYSTEM COMPRISED OF TELEVISION MONITOR, TELEPHONE AND TELEPHONE SPEAKERS; COMPUTER SOFTWARE, COMPUTER PROGRAMS

FEATURING DOCUMENT MANAGEMENT; PHOTOCOPYING MACHINES; PRINTER COPIERS AND FACSIMILE COPIERS; COLOR FILTERS FOR TELEVISION AND MOTION PICTURE FILM CAMERAS; CINEMATOGRAPHIC FILM; FILM HOLDERS; FILM PROCESSING APPARATUS AND INSTRUMENTS, NAMELY, PROCESSING AND EDITING MACHINES FOR MOVIE FILM, PHOTOGRAPH FILM AND VIDEO; MOVIE PROJECTORS; DIGITAL VIDEO RECORDERS, VIDEO SCREENS, FILM STRIP VIEWERS; BLANK VIDEO TAPES; COMPUTERS; COMPUTER PERIPHERALS ALL FOR USE WITH COMPUTERS AND DATA PROCESSING EQUIPMENT; COMPUTER MOUSE; MODEMS; AUDIO TAPE RECORDER; VIDEO TAPE RECORDERS; VIDEO GAMES MACHINES FOR USE WITH TELEVISIONS; VIDEO MIXERS; VIDEO MONITORS; FIRE ALARMS; CENTRIFUGAL METERING PUMPS AND PARTS AND FITTINGS FOR ALL THE AFORESAID GOODS; DIGITAL PRINTING MACHINES; VIDEO PRINTERS; VIDEO CAMERAS; IMAGE SCANNERS; BARCODE SCANNER, BARCODE READERS, FILM PRINTERS; FACSIMILE MAIL SYSTEM COMPRISED OF FACSIMILE MACHINE; DOWNLOADABLE PRINTING FONT; ELECTRIC SENSORS FOR USE IN DETECTING GAS LEAKS; ELECTRIC SENSORS FOR AUTO-FOCUS CAMERA AND ELECTRIC SENSORS TO DETECT OPERATOR OF COPYING MACHINE, ELECTRIC LUMINESCENT DISPLAY PANELS; PHOTO COMPOSING MACHINES; PHOTOENGRAVING MACHINES; PHOTOTYPESETTING MACHINES, IN CLASS 9 (U.S. CLS. 21, 23, 26, 36 AND 38).

FIRST USE 3-1-2002; IN COMMERCE 3-1-2002.

FOR: COPY PAPER, OFFSET MASTER PAPER, XEROGRAPHIC PAPER; DUPLICATING MACHINES AND ATTACHMENTS THEREFOR; PRINTER RIBBON CARTRIDGES AND THERMAL PAPER; PLAIN PAPER; ELECTRIC AND NON-ELECTRIC TYPEWRITERS; TYPEWRITER RIBBONS; DUPLICATING INKS; DUPLICATING PA-

PER; STATIONERY; PRINTED PUBLICATIONS, NAMELY, CATALOGS, BROCHURES AND LEAFLETS IN THE FIELD OF PHOTOGRAPHIC, COMPUTER HARDWARE AND SOFTWARE, DOCUMENT MANAGEMENT AND REPRODUCTION AND SCANNING PRODUCTS AND SERVICES; IN-HOUSE NEWSPAPERS IN THE FIELD OF BUSINESS DEVELOPMENTS AND PHOTOGRAPHIC, COMPUTER HARDWARE AND SOFTWARE, DOCUMENT MANAGEMENT AND REPRODUCTION AND SCANNING PRODUCTS AND SERVICES; IN-HOUSE MAGAZINES REGARDING BUSINESS DEVELOPMENTS AND PHOTOGRAPH-

IC, COMPUTER HARDWARE AND SOFTWARE, DOCUMENT MANAGEMENT AND REPRODUCTION AND SCANNING PRODUCTS AND SERVICES; MIMEOGRAPH MASTER PAPER; THERMAL RIBBON FOR PRINTING, OFFSET MASTER PAPER, FILE SORTERS, IN CLASS 16 (U.S. CLS. 2, 5, 22, 23, 29, 37, 38 AND 50).

FIRST USE 3-1-2002; IN COMMERCE 3-1-2002.

SN 76-402,585, FILED 4-29-2002.

CHARLES L. JENKINS, EXAMINING ATTORNEY

Int. Cl.: 30

Prior U.S. Cl.: 46

United States Patent and Trademark Office

Reg. No. 3,477,059

Registered July 29, 2008

**TRADEMARK
PRINCIPAL REGISTER**

MINNIE

SEGAL, JONATHAN (UNITED STATES INDIVIDUAL)

#3

331 WEST BELDEN
CHICAGO, IL 60614

FIRST USE 3-31-1989; IN COMMERCE 5-3-2006.

SN 76-428,013, FILED 7-8-2002.

FOR: MEATS AND PROCESSED FOODS, NAME-
LY, SANDWICHES, IN CLASS 30 (U.S. CL. 46).

TANYA AMOS, EXAMINING ATTORNEY

Int. Cl.: 35

Prior U.S. Cls.: 100, 101, and 102

United States Patent and Trademark Office

Reg. No. 3,477,060

Registered July 29, 2008

**SERVICE MARK
PRINCIPAL REGISTER**

NURSE WORX

NURSING SOLUTIONS, INC. (PENNSYLVANIA CORPORATION), DBA NURSEWORX NURSING SOLUTIONS,
500 SOUTHAMPTON ROAD
PHILADELPHIA, PA 19116

FOR: NURSE STAFFING SERVICES, NAMELY, MAKING NURSES AVAILABLE TO HOSPITALS AND OTHER HEALTH-CARE PROVIDERS, IN CLASS 35 (U.S. CLS. 100, 101 AND 102).

FIRST USE 10-18-2000; IN COMMERCE 9-30-2004.

NO CLAIM IS MADE TO THE EXCLUSIVE RIGHT TO USE "NURSE", APART FROM THE MARK AS SHOWN.

SN 76-441,065, FILED 8-16-2002.

STEVEN R. FOSTER, EXAMINING ATTORNEY

Int. Cls.: 35 and 36

Prior U.S. Cls.: 100, 101, and 102

United States Patent and Trademark Office

Reg. No. 3,477,061

Registered July 29, 2008

**SERVICE MARK
PRINCIPAL REGISTER**

S.USA FINANCIAL EMPOWERMENT STORE

SBLI USA MUTUAL LIFE INSURANCE COMPAN-
NY, INC. (NEW YORK CORPORATION)
460 WEST 34TH STREET, SUITE 800
NEW YORK, NY 10001

FOR: RETAIL STORE SERVICES FEATURING
OFFICE SUPPLIES AND COMPUTER PRODUCTS,
IN CLASS 35 (U.S. CLS. 100, 101 AND 102).

FIRST USE 10-30-2007; IN COMMERCE 10-30-2007.

FOR: INSURANCE AND FINANCIAL SERVICES,
NAMELY, UNDERWRITING AND ADMINISTER-
ING ANNUITIES, LIFE INSURANCE, HEALTH IN-

SURANCE AND ACCIDENT INSURANCE, IN
CLASS 36 (U.S. CLS. 100, 101 AND 102).

FIRST USE 10-30-2007; IN COMMERCE 10-30-2007.

NO CLAIM IS MADE TO THE EXCLUSIVE
RIGHT TO USE "STORE", APART FROM THE
MARK AS SHOWN.

SN 76-483,530, FILED 1-16-2003.

LESLIE RICHARDS, EXAMINING ATTORNEY

Int. Cl.: 25

Prior U.S. Cls.: 22 and 39

United States Patent and Trademark Office

Reg. No. 3,477,062

Registered July 29, 2008

TRADEMARK
PRINCIPAL REGISTER

Di and Yi

ORIGINALES LEPE'S DE OCCIDENTE. S.A. DE
C.V. (MEXICO SOCIEDAD ANONIMA)
EMILIANO ZAPATA 48
TECUALTITAN, ZAPOTLAN DEL REY, JALISCO,
MEXICO

FOR: CLOTHING, NAMELY, JEANS, JACKETS,
SKIRTS, PANTS, SHORTS, DRESSES; FOOTWEAR;
HEADGEAR, NAMELY, CAPS AND HATS, IN
CLASS 25 (U.S. CLS. 22 AND 39).

FIRST USE 8-15-2005; IN COMMERCE 8-15-2005.

OWNER OF MEXICO REG. NO. 773735, DATED
12-19-2001, EXPIRES 12-19-2011.

THE NAMES "DI" AND "YI" DO NOT IDENTIFY
LIVING INDIVIDUALS.

THE MARK "DI AND YI" HAS NO MEANING IN
A FOREIGN LANGUAGE.

SN 76-507,111, FILED 4-11-2003.

INGA ERVIN, EXAMINING ATTORNEY

Int. Cl.: 25

Prior U.S. Cls.: 22 and 39

United States Patent and Trademark Office

Reg. No. 3,477,063

Registered July 29, 2008

**TRADEMARK
PRINCIPAL REGISTER**

LIQUID COURAGE

FREEMAN, PATRICK (UNITED STATES INDIVIDUAL)
1324 QUINCY AVE.
LONG BEACH, CA 90804

FIRST USE 5-4-2004; IN COMMERCE 5-4-2007.

SN 76-520,157, FILED 5-23-2003.

FOR: SHIRTS, PANTS, AND HATS, IN CLASS 25
(U.S. CLS. 22 AND 39).

RAUL CORDOVA, EXAMINING ATTORNEY

Int. Cl.: 42

Prior U.S. Cls.: 100 and 101

United States Patent and Trademark Office

Reg. No. 3,477,064

Registered July 29, 2008

**SERVICE MARK
PRINCIPAL REGISTER**



THE JIM CARRELL TEAM, P.A. (FLORIDA CORPORATION)
2030 GORDON DRIVE
NAPLES, FL 341027560

FOR: LICENSING OF INTELLECTUAL PROPERTY, NAMELY, LICENSING OF TRADEMARKS AND SERVICE MARKS TO OTHERS FOR ADVERTISING SERVICES THAT EMPHASIZE THE NEED TO STOP SEARCHING FOR A PARTICULAR KIND OF GOODS OR SERVICES, EXCEPT FOR RETAIL SERVICES FEATURING THE SALE OF AUTOMO-

TIVE PARTS AND ACCESSORIES, IN CLASS 42 (U.S. CLS. 100 AND 101).

FIRST USE 10-31-2005; IN COMMERCE 3-30-2007.

THE STIPPLING SHOWN IN THE DRAWING IS A FEATURE OF THE MARK AND NOT INTENDED TO INDICATE COLOR.

SN 76-530,494, FILED 6-30-2003.

RICHARD WHITE, EXAMINING ATTORNEY

Int. Cl.: 41

Prior U.S. Cls.: 100, 101, and 107

United States Patent and Trademark Office

Reg. No. 3,477,065

Registered July 29, 2008

**SERVICE MARK
PRINCIPAL REGISTER**



VALETTA INTERNATIONAL LIMITED (NEW
ZEALAND COMPANY)
95 QUARANTINE ROAD
NELSON, NEW ZEALAND

FOR: EDUCATIONAL AND TRAINING SERVICES, NAMELY, CLASSES AND WORKSHOPS IN THE FIELD OF SHOW ORGANIZATION AND CULTURAL EVENTS, NAMELY, ARTS AND FASHION EXHIBITIONS; ORGANIZING ART COMPETITIONS FOR OTHERS; ORGANIZING CULTURAL EVENTS CONSISTING OF A COMBINATION OF ART EXHIBITION, MUSICAL PERFORMANCE, DRAMATIC PERFORMANCE, AND DANCE PER-

FORMANCE FEATURING WEARABLE ART; ORGANIZING FASHION SHOWS FOR OTHERS; ALL OF THE FOREGOING IN THE FIELD OF FASHION AND ART SHOW PRODUCTION; ARTWORK EXHIBITION AND ONLINE ARTWORK EXHIBITION, IN CLASS 41 (U.S. CLS. 100, 101 AND 107).

FIRST USE 0-0-1998; IN COMMERCE 0-0-1998.

SN 76-533,044, FILED 7-29-2003.

JOHN LINCOSKI, EXAMINING ATTORNEY

Int. Cls.: 9, 14, 16, 25, 28, and 41

Prior U.S. Cls.: 2, 5, 21, 22, 23, 26, 27, 28, 29, 36, 37, 38, 39, 50, 100, 101, and 107

Reg. No. 3,477,066

Registered July 29, 2008

United States Patent and Trademark Office

**TRADEMARK
SERVICE MARK
PRINCIPAL REGISTER**

AIR + STYLE

GLOBAL SPORTS LIMITED (MALTA CORPORATION)
PORTICO BUILDING MARINA STREET
PIETA, MALTA MSD 08

FOR: SOUND CARRIERS, NAMELY, PRE-RECORDED CDS, RECORDS AND CASSETTES CONTAINING MODERN ALTERNATIVE AND URBAN THEMED MUSIC; PRERECORDED DVDS, VIDEOTAPES AND MOTION PICTURE FILMS FOR TELEVISION FEATURING SNOWBOARDING EVENTS, IN CLASS 9 (U.S. CLS. 21, 23, 26, 36 AND 38).

FIRST USE 12-1-1998; IN COMMERCE 12-1-1998.

FOR: WRISTWATCHES AND RINGS, IN CLASS 14 (U.S. CLS. 2, 27, 28 AND 50).

FIRST USE 10-1-1999; IN COMMERCE 10-1-1999.

FOR: EVENT PROGRAM BOOKLETS, POSTERS, FLYERS, AND PRINTED ADVERTISEMENTS FOR SNOWBOARDING EVENTS, IN CLASS 16 (U.S. CLS. 2, 5, 22, 23, 29, 37, 38 AND 50).

FIRST USE 1-17-1994; IN COMMERCE 1-17-1994.

FOR: T-SHIRTS, SWEATSHIRTS, JACKETS, PANTS, SHOES AND HEADWEAR, IN CLASS 25 (U.S. CLS. 22 AND 39).

FIRST USE 1-17-1994; IN COMMERCE 1-17-1994.

FOR: PADDLES USED AS GAME CONTROLLERS FOR VIDEO GAMES, AND SPORTING GOODS, NAMELY, SNOWBOARDS, SKATEBOARDS, SKIS, SURFBOARDS, WIND SURFBOARDS AND WAKEBOARDS, IN CLASS 28 (U.S. CLS. 22, 23, 38 AND 50).

FIRST USE 8-15-2001; IN COMMERCE 8-15-2001.

FOR: ORGANIZING SPORTING EVENTS, NAMELY, SNOWBOARDING EVENTS, IN CLASS 41 (U.S. CLS. 100, 101 AND 107).

FIRST USE 1-17-1994; IN COMMERCE 1-17-1994.

OWNER OF AUSTRIA REG. NO. 162642, DATED 2-21-1996, EXPIRES 2-21-2016.

NO CLAIM IS MADE TO THE EXCLUSIVE RIGHT TO USE "STYLE", APART FROM THE MARK AS SHOWN.

SN 76-543,522, FILED 9-6-2003.

ROBERT C. CLARK JR., EXAMINING ATTORNEY

Int. Cls.: 9, 10, and 16

Prior U.S. Cls.: 2, 5, 21, 22, 23, 26, 29, 36, 37, 38, 39, 44, and 50

Reg. No. 3,477,067

United States Patent and Trademark Office

Registered July 29, 2008

**TRADEMARK
PRINCIPAL REGISTER**

SPI

S. P. INTERNATIONAL, INC. (TEXAS CORPORATION)
3506 CEDAR SPRINGS ROAD
DALLAS, TX 75219

FOR: RELAXATION DEVICES, NAMELY, SOUND MACHINES; ELECTRONIC NUTRITIONAL CALCULATORS; WEIGHT SCALES; SCALES FOR USE IN DIETARY OR NUTRITIONAL PROGRAMS; PROTECTIVE FLACK JACKETS; PEDOMETERS AND ATHLETIC HELMETS, IN CLASS 9 (U.S. CLS. 21, 23, 26, 36 AND 38).

FIRST USE 6-1-2000; IN COMMERCE 6-1-2000.

FOR: MAGNETIC THERAPY PRODUCTS; MASSAGE APPARATUS, NAMELY, NECK MASSAGERS, MASSAGE PILLOWS AND MASSAGE LOUNGERS; EYEMASKS; HEALTH PRODUCTS,

NAMELY, HEART-RATE MONITORS, BLOOD PRESSURE MONITORS, BODY FAT MONITORING APPARATUS, PEDOMETERS, BODY, TORSO AND LIMB SUPPORTS AND WRAPS FOR MEDICAL OR THERAPEUTIC USE, IN CLASS 10 (U.S. CLS. 26, 39 AND 44).

FIRST USE 6-1-2000; IN COMMERCE 6-1-2000.

FOR: LAP DESKS, IN CLASS 16 (U.S. CLS. 2, 5, 22, 23, 29, 37, 38 AND 50).

FIRST USE 6-1-2000; IN COMMERCE 6-1-2000.

SN 76-545,888, FILED 9-22-2003.

NORA BUCHANAN WILL, EXAMINING ATTORNEY

Int. Cl.: 5

Prior U.S. Cls.: 6, 18, 44, 46, 51, and 52

Reg. No. 3,477,068

United States Patent and Trademark Office

Registered July 29, 2008

**TRADEMARK
PRINCIPAL REGISTER**

EXXENTEROL

EXXENTIA, GRUPO FITOTERAPEUTICO, S.A.
(SPAIN CORPORATION)
CAMINO DE HORMIGUERAS, 176 NAVE 7 Y 9
MADRID, SPAIN 28031

FOR: PHARMACEUTICAL PREPARATIONS FOR USE IN THE TREATMENT OF HEART DISEASE, THYROID DISEASE, AND ALLERGIES; VETERINARY PREPARATIONS, NAMELY, VACCINES FOR CATS AND DOGS; SANITARY PREPARATIONS, NAMELY, ANTISEPTICS; DIETETIC SUBSTANCES ADAPTED FOR MEDICAL USE, NAMELY, FOOD FOR MEDICALLY RESTRICTED DIETS; BABY FOOD; MEDICAL PLASTERS; SURGICAL, WOUND, AND BURN DRESSINGS; DENTAL WAX; DISINFECTANTS, NAMELY, ALL PURPOSE

DISINFECTANTS; PREPARATIONS FOR DESTROYING VERMIN; FUNGICIDE FOR AGRICULTURAL AND DOMESTIC USE; HERBICIDES FOR AGRICULTURAL AND DOMESTIC USE, IN CLASS 5 (U.S. CLS. 6, 18, 44, 46, 51 AND 52).

FIRST USE 1-22-2008; IN COMMERCE 1-22-2008.

THE MARK CONSISTS OF STANDARD CHARACTERS WITHOUT CLAIM TO ANY PARTICULAR FONT, STYLE, SIZE, OR COLOR.

SN 76-546,562, FILED 11-10-2003.

MARTHA FROMM, EXAMINING ATTORNEY

Int. Cls.: 7 and 11

Prior U.S. Cls.: 13, 19, 21, 23, 31, 34, and 35

United States Patent and Trademark Office

Reg. No. 3,477,069

Registered July 29, 2008

**TRADEMARK
PRINCIPAL REGISTER**

THERMADOR. AN AMERICAN ICON

BSH HOME APPLIANCES CORPORATION (DE-
LAWARE CORPORATION)
5551 MCFADDEN AVE
HUNTINGTON BEACH, CA 92649

FOR: DISHWASHERS AND PARTS THEREFOR,
IN CLASS 7 (U.S. CLS. 13, 19, 21, 23, 31, 34 AND 35).

FIRST USE 9-1-2007; IN COMMERCE 9-1-2007.

FOR: ELECTRIC AND/OR FUEL OPERATED
APPLIANCES FOR COOKING, BAKING, FRYING,
GRILLING, TOASTING, THAWING, AND HOT-
KEEPING OF FOODS, NAMELY, ELECTRIC AND
GAS RANGES, DOMESTIC COOKING OVENS,
ELECTRIC HOT PLATES, IMMERSION HEATERS,
ELECTRIC COOKING POTS, MICROWAVE OVENS
FOR COOKING AND PARTS THEREFOR; COOL-

ING MACHINES, NAMELY, REFRIGERATORS,
FREEZERS, ICE MAKING MACHINES, AND PARTS
THEREFOR; VENTILATION MACHINES, NAME-
LY, VENTILATING EXHAUST FANS, GREASE FIL-
TER DEVICES AND EXTRACTOR DEVICES,
NAMELY, VENTILATION HOODS FOR STOVES,
IN CLASS 11 (U.S. CLS. 13, 21, 23, 31 AND 34).

FIRST USE 9-1-2007; IN COMMERCE 9-1-2007.

OWNER OF U.S. REG. NOS. 1,144,768, 1,853,576,
AND OTHERS.

SN 76-552,536, FILED 9-29-2003.

KATHLEEN M. VANSTON, EXAMINING ATTOR-
NEY

Int. Cl.: 3

Prior U.S. Cls.: 1, 4, 6, 50, 51, and 52

United States Patent and Trademark Office

Reg. No. 3,477,070

Registered July 29, 2008

**TRADEMARK
PRINCIPAL REGISTER**

AMERICAN LEGEND

AMERICAN LEGEND COOPERATIVE (WA-
SHINGTON CORPORATION)

200 S.W. 34TH STREET

RENTON, WA 98005

FOR: PERFUMES AND AFTER SHAVE LOTIONS
AND GELS, IN CLASS 3 (U.S. CLS. 1, 4, 6, 50, 51 AND
52).

FIRST USE 3-27-2008; IN COMMERCE 3-27-2008.

THE MARK CONSISTS OF STANDARD CHAR-
ACTERS WITHOUT CLAIM TO ANY PARTICULAR
FONT, STYLE, SIZE, OR COLOR.

NO CLAIM IS MADE TO THE EXCLUSIVE
RIGHT TO USE "AMERICAN", APART FROM THE
MARK AS SHOWN.

SN 76-559,258, FILED 11-12-2003.

CHRISTOPHER BUONGIORNO, EXAMINING AT-
TORNEY

Int. Cl.: 35

Prior U.S. Cls.: 100, 101, and 102

United States Patent and Trademark Office

Reg. No. 3,477,071

Registered July 29, 2008

**SERVICE MARK
PRINCIPAL REGISTER**

KNOW THE NFCC DIFFERENCE

NATIONAL FOUNDATION FOR CREDIT COUNSELING, INC. (D.C. NON-PROFIT CORPORATION)

801 ROEDER ROAD
SUITE 900
SILVER SPRING, MD 20910

FOR: ASSOCIATION SERVICES, NAMELY, PROMOTING THE INTERESTS OF CONSUMER CREDIT AND DEBT MANAGEMENT AGENCIES BY FOSTERING AND ENCOURAGING THEIR ESTABLISHMENT AND PROPER FUNCTIONING, IN CLASS 35 (U.S. CLS. 100, 101 AND 102).

FIRST USE 1-0-2005; IN COMMERCE 1-0-2005.

THE MARK CONSISTS OF STANDARD CHARACTERS WITHOUT CLAIM TO ANY PARTICULAR FONT, STYLE, SIZE, OR COLOR.

OWNER OF U.S. REG. NO. 2,452,433.

SN 76-561,469, FILED 11-24-2003.

WILLIAM VERHOSEK, EXAMINING ATTORNEY

Int. Cl.: 41

Prior U.S. Cls.: 100, 101, and 107

United States Patent and Trademark Office

Reg. No. 3,477,072

Registered July 29, 2008

**SERVICE MARK
PRINCIPAL REGISTER**

STIR

HOLT, ELIZABETH (UNITED STATES INDIVIDUAL)
206 EAST 68 TERRACE
KANSAS CITY, MO 64113

FOR: ENTERTAINMENT IN THE NATURE OF AN ON-GOING TELEVISION SHOW ON THE SUBJECT OF PERSONAL RELATIONSHIPS AND COOKING, IN CLASS 41 (U.S. CLS. 100, 101 AND 107).

FIRST USE 5-1-2008; IN COMMERCE 5-1-2008.

THE MARK CONSISTS OF STANDARD CHARACTERS WITHOUT CLAIM TO ANY PARTICULAR FONT, STYLE, SIZE, OR COLOR.

SN 76-564,594, FILED 11-26-2003.

GIANCARLO CASTRO, EXAMINING ATTORNEY

Int. Cl.: 11

Prior U.S. Cls.: 13, 21, 23, 31, and 34

United States Patent and Trademark Office

Reg. No. 3,477,073

Registered July 29, 2008

**TRADEMARK
PRINCIPAL REGISTER**

SPEEDLINK

TROY-CSL LIGHTING, INC. (NEW YORK CORPORATION)
14625 EAST CLARK AVENUE
CITY OF INDUSTRY, CA 91745

FOR: INTEGRATED HARDWARE AS A FEATURE OF ELECTRIC LIGHTING FIXTURES THAT ALLOWS FOR THE INTERCONNECTION AND POWERING OF THE FIXTURES , IN CLASS 11 (U.S. CLS. 13, 21, 23, 31 AND 34).

FIRST USE 6-30-2007; IN COMMERCE 6-30-2007.

THE MARK CONSISTS OF STANDARD CHARACTERS WITHOUT CLAIM TO ANY PARTICULAR FONT, STYLE, SIZE, OR COLOR.

SN 76-572,977, FILED 1-29-2004.

JAMES MACFARLANE, EXAMINING ATTORNEY

Int. Cls.: 1 and 42

Prior U.S. Cls.: 1, 5, 6, 10, 26, 46, 100, and 101

United States Patent and Trademark Office

Reg. No. 3,477,074

Registered July 29, 2008

**TRADEMARK
SERVICE MARK
PRINCIPAL REGISTER**

instrAction

INSTRACTION GMBH (FED REP GERMANY CORPORATION)
DONNERSBERGWEG 1
LUDWIGSHAFEN, FED REP GERMANY 67059

FOR: CHEMICALS FOR USE IN INDUSTRY AND SCIENCE; STATIONARY PHASES FOR CHROMATOGRAPHY, IN CLASS 1 (U.S. CLS. 1, 5, 6, 10, 26 AND 46).

FIRST USE 11-1-2005; IN COMMERCE 11-1-2005.

FOR: MEDICAL LABORATORIES; SERVICES OF A CHEMICAL LABORATORY, NAMELY, THE DEVELOPMENT OF CUSTOM MADE STATIONARY PHASES FOR CHROMATOGRAPHY USED IN INDUSTRY AND THE DEVELOPMENT OF CHIRAL PHASES FOR A BROAD APPLICATION; PROVIDING INFORMATION VIA THE INTERNET IN THE FIELD OF STATIONARY PHASES FOR CHROMATOGRAPHY USED IN INDUSTRY; DEVELOPMENT OF CHEMICAL SEPARATION AND PURIFICA-

TION PROCESSES FOR THIRD PARTIES; CONSULTING IN THE FIELD OF DEVELOPING AND IMPROVING ACTIVE AGENTS USED IN PHARMACEUTICALS, IN CLASS 42 (U.S. CLS. 100 AND 101).

FIRST USE 11-1-2005; IN COMMERCE 11-1-2005.

THE MARK CONSISTS OF STANDARD CHARACTERS WITHOUT CLAIM TO ANY PARTICULAR FONT, STYLE, SIZE, OR COLOR.

PRIORITY CLAIMED UNDER SEC. 44(D) ON FED REP GERMANY APPLICATION NO. 30347485.8/0, FILED 8-8-2003, REG. NO. 30347485, DATED 11-28-2003, EXPIRES 8-31-2013.

OWNER OF U.S. REG. NO. 2,706,159.

SN 76-574,145, FILED 2-5-2004.

AMY GEARIN, EXAMINING ATTORNEY

Int. Cl.: 41

Prior U.S. Cls.: 100, 101, and 107

United States Patent and Trademark Office

Reg. No. 3,477,075

Registered July 29, 2008

**SERVICE MARK
PRINCIPAL REGISTER**

DIGITALEXPLORATIONS

DIGITALEXPLORATIONS, LLC (VIRGINIA LTD
LIAB CO)
1400 TROUVILLE AVE.
NORFOLK, VA 23505

FOR: ON-LINE PUBLICATION OF PHOTO-
GRAPHS, RECORDED MUSICAL PERFORMAN-
CES, VIDEOS, GRAPHIC ART WORKS,
MULTIMEDIA PRESENTATIONS, AND LITERARY
WORKS, IN CLASS 41 (U.S. CLS. 100, 101 AND 107).

FIRST USE 12-11-2007; IN COMMERCE 12-11-2007.

THE MARK CONSISTS OF STANDARD CHAR-
ACTERS WITHOUT CLAIM TO ANY PARTICULAR
FONT, STYLE, SIZE, OR COLOR.

SN 76-577,206, FILED 2-18-2004.

JOHN LINCOSKI, EXAMINING ATTORNEY

Int. Cl.: 9

Prior U.S. Cls.: 21, 23, 26, 36, and 38

United States Patent and Trademark Office

Reg. No. 3,477,076

Registered July 29, 2008

**TRADEMARK
PRINCIPAL REGISTER**

ePortpass

EPORATION L.L.C. (PENNSYLVANIA CORPORATION)
601 SOUTH AMERICAN STREET, SUITE 305
PHILADELPHIA, PA 19147

FOR: SECURITY SYSTEMS, NAMELY, SOFTWARE AND EQUIPMENT THAT PROVIDES ACCESS SECURITY AT FACILITIES AND SECURITY COMPLIANCE FOR OVERSEAS SHIPPING , IN CLASS 9 (U.S. CLS. 21, 23, 26, 36 AND 38).

FIRST USE 10-4-2004; IN COMMERCE 10-4-2004.

THE MARK CONSISTS OF STANDARD CHARACTERS WITHOUT CLAIM TO ANY PARTICULAR FONT, STYLE, SIZE, OR COLOR.

SN 76-580,740, FILED 3-12-2004.

MARY ROSSMAN, EXAMINING ATTORNEY

Int. Cl.: 42

Prior U.S. Cls.: 100 and 101

United States Patent and Trademark Office

Reg. No. 3,477,077

Registered July 29, 2008

**SERVICE MARK
PRINCIPAL REGISTER**

ePrintmaker

EPRODUCTION SERVICES CORPORATION (CALIFORNIA CORPORATION)
748 VISTA ENSUENO
ALPINE, CA 91901

FIRST USE 10-1-2007; IN COMMERCE 10-1-2007.

FOR: COMPUTER SERVICE, NAMELY, ACTING AS A DATABASE HOST AND WEB-BASED FULFILLMENT PROVIDER FOR THE MANAGEMENT OF CONTENT AND DISTRIBUTION OF TARGETED PUBLISHED MATERIALS, NAMELY, EDITING, ORGANIZING, STORING AND SHARING ELECTRONIC CONTENT, IN CLASS 42 (U.S. CLS. 100 AND 101).

THE MARK CONSISTS OF STANDARD CHARACTERS WITHOUT CLAIM TO ANY PARTICULAR FONT, STYLE, SIZE, OR COLOR.

SN 76-582,925, FILED 3-18-2004.

SOPHIA S. KIM, EXAMINING ATTORNEY

Int. Cl.: 25

Prior U.S. Cls.: 22 and 39

United States Patent and Trademark Office

Reg. No. 3,477,078

Registered July 29, 2008

**TRADEMARK
PRINCIPAL REGISTER**

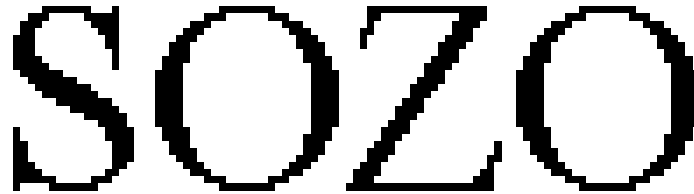
The word "SOZO" is rendered in a large, bold, pixelated font. Each letter is composed of a grid of small squares, giving it a digital or retro aesthetic. The letters are black on a white background.

SOZO LLC (CONNECTICUT LTD LIAB CO)
29 LAKE STREET
FARMINGTON, CT 06032

FOR: CHILDREN'S AND INFANT'S APPAREL,
NAMELY, ONE PIECE BABY UNDERSHIRTS WITH
DIAPER COVER, PANTS, CAPS, SHIRTS, DIAPER
COVERS, BOOTIES, AND SLEEPWEAR, IN CLASS
25 (U.S. CLS. 22 AND 39).

FIRST USE 11-0-2003; IN COMMERCE 11-0-2003.

THE MARK CONSISTS OF STANDARD CHAR-
ACTERS WITHOUT CLAIM TO ANY PARTICULAR
FONT, STYLE, SIZE, OR COLOR.

THE ENGLISH TRANSLATION OF THE WORD
"SOZO" IN THE MARK IS "CREATION AND IMA-
GINATION".

SN 76-585,290, FILED 4-6-2004.

INGA ERVIN, EXAMINING ATTORNEY

Int. Cl.: 1

Prior U.S. Cls.: 1, 5, 6, 10, 26, and 46

Reg. No. 3,477,079

United States Patent and Trademark Office

Registered July 29, 2008

**TRADEMARK
PRINCIPAL REGISTER**

BUOYBALL

XENOSEP TECHNOLOGIES LLC (NEW JERSEY
LTD LIAB CO)
508 MAIN STREET
BOONTON, NJ 07005

ONE ANOTHER, IN LABORATORY AND RE-
SEARCH FACILITIES OR IN CONNECTION WITH
A MANUFACTURING PROCESS, IN CLASS 1 (U.S.
CLS. 1, 5, 6, 10, 26 AND 46).

FOR: CHEMICALS, BIOCHEMICALS AND RE-
AGENTS FOR USE IN SCIENCE, RESEARCH AND
INDUSTRY, NAMELY, CHEMICAL COMPOUNDS
AND COMPOSITIONS USED IN CONNECTION
WITH THE SEPARATION OF CHEMICAL OR MO-
LECULAR SUBSTANCES OR COMPONENTS FROM

FIRST USE 5-8-2008; IN COMMERCE 5-8-2008.

SN 76-588,253, FILED 4-22-2004.

DORITT L. CARROLL, EXAMINING ATTORNEY

Int. Cl.: 28

Prior U.S. Cls.: 22, 23, 38, and 50

United States Patent and Trademark Office

Reg. No. 3,477,080

Registered July 29, 2008

**TRADEMARK
PRINCIPAL REGISTER**



HOUGHTON MIFFLIN HARCOURT PUBLISH-
ING COMPANY (MASSACHUSETTS COR-
PORATION)
222 BERKELEY STREET
BOSTON, MA 02116

FOR: PUPPETS, IN CLASS 28 (U.S. CLS. 22, 23, 38
AND 50).

FIRST USE 9-0-2004; IN COMMERCE 9-0-2004.

SEC. 2(F) AS TO "FIVE LITTLE MONKEYS" .

SN 76-591,695, FILED 5-12-2004.

GRETТА YAO, EXAMINING ATTORNEY

Int. Cl.: 28

Prior U.S. Cls.: 22, 23, 38, and 50

United States Patent and Trademark Office

Reg. No. 3,477,081

Registered July 29, 2008

**TRADEMARK
PRINCIPAL REGISTER**

FIVE LITTLE MONKEYS

HOUGHTON MIFFLIN HARCOURT PUBLISH-
ING COMPANY (MASSACHUSETTS COR-
PORATION)
222 BERKELEY STREET
BOSTON, MA 02116

FOR: PUPPETS, IN CLASS 28 (U.S. CLS. 22, 23, 38
AND 50).

FIRST USE 9-0-2004; IN COMMERCE 9-0-2004.

THE MARK CONSISTS OF STANDARD CHAR-
ACTERS WITHOUT CLAIM TO ANY PARTICULAR
FONT, STYLE, SIZE, OR COLOR.

SEC. 2(F).

SN 76-591,699, FILED 5-12-2004.

GRETTA YAO, EXAMINING ATTORNEY

Int. Cls.: 3 and 16

**Prior U.S. Cls.: 1, 2, 4, 5, 6, 22, 23, 29, 37, 38, 50, 51,
and 52**

Reg. No. 3,477,082

United States Patent and Trademark Office

Registered July 29, 2008

**TRADEMARK
PRINCIPAL REGISTER**

ZOCOOL

GOODMARK USA, INC. (DELAWARE CORPORATION)
1877 S. FEDERAL HIGHWAY, #204
BOCA RATON, FL 33432

FOR: PERFUMERY; COSMETICS AND PRODUCTS FOR THE HAIR AND SKIN CARE, NAME-
LY, DECORATIVE COLORED SPRAY AND SPRAY
PAINT AND SPRAY PAINT TO BE APPLIED TO
THE HAIR; SUB BLOCK PREPARATIONS, NAME-
LY, CREAMS AND SPRAYS, IN CLASS 3 (U.S. CLS. 1,
4, 6, 50, 51 AND 52).

FIRST USE 7-0-2004; IN COMMERCE 7-0-2004.

FOR: PAPER, CARDBOARD, PAPER AND CARD-
BOARD CUT-OUT FORMS, STENCILS AND TEM-
PLATES FOR USE FOR THE APPLICATION OF
DECORATIVE SPRAY AND GLITTER TO THE

HAIR AND TO SURFACES SUCH AS WALLS AND
WINDOWS; MAGAZINES AND BOOKLETS IN THE
FIELD OF PARTY SUPPLIES, PAINTS AND GLIT-
TER; POSTCARDS; COLOR CHARTS; PHOTO-
GRAPHS; STATIONARY; PAINT BRUSHES; AND
PLASTIC BUBBLE PACKS FOR PACKAGING, IN
CLASS 16 (U.S. CLS. 2, 5, 22, 23, 29, 37, 38 AND 50).

FIRST USE 7-0-2004; IN COMMERCE 7-0-2004.

THE MARK CONSISTS OF STANDARD CHAR-
ACTERS WITHOUT CLAIM TO ANY PARTICULAR
FONT, STYLE, SIZE, OR COLOR.

SN 76-602,605, FILED 7-16-2004.

EMILY CARLSEN, EXAMINING ATTORNEY

Int. Cl.: 9

Prior U.S. Cls.: 21, 23, 26, 36, and 38

Reg. No. 3,477,083

United States Patent and Trademark Office

Registered July 29, 2008

**TRADEMARK
PRINCIPAL REGISTER**

SYSTIMAX AIRSPEED

COMMSCOPE, INC. OF NORTH CAROLINA
(NORTH CAROLINA CORPORATION)
1100 COMMSCOPE PLACE, SE
HICKORY, NC 28602

FOR: TELECOMMUNICATIONS HARDWARE,
NAMELY, TRANSCEIVERS, ANTENNAS, SIGNAL
CONVERTERS, ROUTERS, BASE STATIONS, SUB-
SCRIBER UNITS, ACCESS POINTS AND GATE-
WAYS FOR USE IN WIRELESS RF AND FREE-
SPACE OPTICS COMMUNICATIONS SYSTEMS;
SOFTWARE FOR USE IN THE PLANNING, MAIN-
TENANCE AND MANAGEMENT OF WIRELESS
COMMUNICATION, IN CLASS 9 (U.S. CLS. 21, 23,
26, 36 AND 38).

FIRST USE 7-31-2004; IN COMMERCE 7-31-2004.

THE MARK CONSISTS OF STANDARD CHAR-
ACTERS WITHOUT CLAIM TO ANY PARTICULAR
FONT, STYLE, SIZE, OR COLOR.

OWNER OF U.S. REG. NOS. 1,605,354 AND
1,644,744.

SN 76-603,374, FILED 7-22-2004.

C. DIONNE CLYBURN, EXAMINING ATTORNEY

Int. Cl.: 9

Prior U.S. Cls.: 21, 23, 26, 36, and 38

Reg. No. 3,477,084

United States Patent and Trademark Office

Registered July 29, 2008

**TRADEMARK
PRINCIPAL REGISTER**

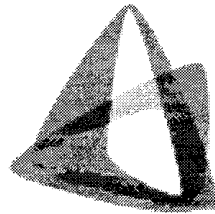

systemware

SYSTEMWARE, INC. (TEXAS CORPORATION)
SUITE 1000
15301 DALLAS PARKWAY
ADDISON, TX 75001

OWNER OF U.S. REG. NOS. 1,582,365, 2,056,814,
AND 2,843,437.

FOR: COMPUTER SOFTWARE, NAMELY, DA-
TABASE MANAGEMENT SOFTWARE FOR USE IN
OUTPUT, DOCUMENT AND CONTENT MANAGE-
MENT, IN CLASS 9 (U.S. CLS. 21, 23, 26, 36 AND 38).

THE STIPLING IS FOR SHADING PURPOSES
ONLY.

SN 76-604,171, FILED 7-27-2004.

FIRST USE 1-1-2005; IN COMMERCE 1-1-2005.

MICHELLE DUBOIS, EXAMINING ATTORNEY

Int. Cl.: 7

Prior U.S. Cls.: 13, 19, 21, 23, 31, 34, and 35

United States Patent and Trademark Office

Reg. No. 3,477,085

Registered July 29, 2008

**TRADEMARK
PRINCIPAL REGISTER**



AIRTEX PRODUCTS, LP (ILLINOIS LIMITED PARTNERSHIP)
407 WEST MAIN STREET
FAIRFIELD, IL 62837

FOR: AUTOMOTIVE PARTS FOR INTERNAL COMBUSTION ENGINES, NAMELY, COILS, CONDENSERS, DISTRIBUTOR CAPS, POINT SETS, ROTORS, AND STARTER SOLENOIDS; TUNE-UP KITS FEATURING INTERNAL COMBUSTION ENGINE LAND VEHICLE PARTS AND CONSISTING PRIMARILY OF DISTRIBUTOR CAPS, IGNITION ROTORS, BREAKER POINTS AND CONDENSERS AND SOLD AS A UNIT FOR LAND VEHICLES; DISTRIBUTOR CAP AND ROTOR KITS FEATURING INTERNAL COMBUSTION ENGINE LAND VEHICLE PARTS AND CONSISTING PRIMARILY OF DISTRIBUTOR CAPS AND DISTRIBUTOR ROTORS FOR USE IN IGNITION DISTRIBUTORS AND SOLD AS A UNIT FOR LAND VEHICLES, IN CLASS 7 (U.S. CLS. 13, 19, 21, 23, 31, 34 AND 35).

FIRST USE 1-0-2004; IN COMMERCE 9-0-2004.

OWNER OF U.S. REG. NO. 2,289,775 AND OTHERS.

THE COLOR(S) RED AND GOLD IS/ARE CLAIMED AS A FEATURE OF THE MARK.

THE TERM "AIRTEX" IN THE MARK IS COLORED RED, AND THE TERM "XP" IN THE MARK IS COLORED GOLD WITH A RED OUTLINE.

SN 76-607,315, FILED 8-13-2004.

RICHARD WHITE, EXAMINING ATTORNEY

Int. Cl.: 41

Prior U.S. Cls.: 100, 101, and 107

United States Patent and Trademark Office

Reg. No. 3,477,086

Registered July 29, 2008

**SERVICE MARK
PRINCIPAL REGISTER**

CO-CREATING A MORE COLLABORATIVE WORLD

ACCLIVUS CORPORATION (TEXAS CORPORATION)
14500 MIDWAY ROAD
DALLAS, TX 75244

FIRST USE 6-13-2008; IN COMMERCE 6-13-2008.

FOR: EDUCATION SERVICES, NAMELY, CONDUCTING WORKSHOPS, LECTURES, COURSE SYMPOSIA AND CONFERENCES IN THE FIELD OF BUSINESS MANAGEMENT, SALES COMMUNICATION AND BUILDING RELATIONSHIPS WITH CUSTOMERS AND DISTRIBUTING COURSE MATERIALS IN CONNECTION THEREWITH, IN CLASS 41 (U.S. CLS. 100, 101 AND 107).

THE MARK CONSISTS OF STANDARD CHARACTERS WITHOUT CLAIM TO ANY PARTICULAR FONT, STYLE, SIZE, OR COLOR.

SN 76-612,933, FILED 9-27-2004.

ROBERT LAVACHE, EXAMINING ATTORNEY

Int. Cl.: 43

Prior U.S. Cls.: 100 and 101

United States Patent and Trademark Office

Reg. No. 3,477,087

Registered July 29, 2008

**SERVICE MARK
PRINCIPAL REGISTER**

BLUE STATE COFFEE

RUBEN, MARSHALL S. (UNITED STATES INDIVIDUAL)
249 PEARL STREET, 3RD FLOOR
HARTFORD, CT 06103

FOR: RETAIL RESTAURANT SERVICES, NAME-
LY, RESTAURANT SERVICES SPECIALIZING IN
COFFEE AND TEA DRINKS AND LIGHT FOOD, IN
CLASS 43 (U.S. CLS. 100 AND 101).

FIRST USE 8-0-2007; IN COMMERCE 8-0-2007.

THE MARK CONSISTS OF STANDARD CHAR-
ACTERS WITHOUT CLAIM TO ANY PARTICULAR
FONT, STYLE, SIZE, OR COLOR.

NO CLAIM IS MADE TO THE EXCLUSIVE
RIGHT TO USE "COFFEE", APART FROM THE
MARK AS SHOWN.

SN 76-620,829, FILED 11-16-2004.

DAWN HAN, EXAMINING ATTORNEY

Int. Cls.: 1, 3, and 5

Prior U.S. Cls.: 1, 4, 5, 6, 10, 18, 26, 44, 46, 50, 51, and 52

Reg. No. 3,477,088

United States Patent and Trademark Office

Registered July 29, 2008

TRADEMARK
PRINCIPAL REGISTER



NAGAOKA & CO., LTD (JAPAN CORPORATION)
7-18 NISHINOMIYAHAMA 4-CHOME
NISHINOMIYA-SHI
HYOGO-KEN, JAPAN

FOR: CHEMICAL PREPARATIONS IN THE NATURE OF MENTHOL CRYSTALS FOR USE IN THE MANUFACTURE OF GUM IN ANY FORMS, SUCH AS SHEETS, STICKS OR TABLETS AND THE MANUFACTURE OF CANDIES IN ANY FORMS, SUCH AS FILMS, SHEETS, STICKS OR TABLETS, IN CLASS 1 (U.S. CLS. 1, 5, 6, 10, 26 AND 46).

FIRST USE 3-2-1939; IN COMMERCE 5-1-1964.

FOR: PEPPERMINT OIL FOR INDUSTRIAL USE FOR MANUFACTURING GUM IN ANY FORMS, SUCH AS SHEETS, STICKS OR TABLETS AND MANUFACTURING CANDIES IN ANY FORMS, SUCH AS FILMS, SHEETS, STICKS OR TABLETS;

PEPPERMINT OIL FOR INDUSTRIAL USE FOR MANUFACTURING MEDICAL PLASTERS AND OINTMENTS, IN CLASS 3 (U.S. CLS. 1, 4, 6, 50, 51 AND 52).

FIRST USE 3-2-1939; IN COMMERCE 5-1-1964.

FOR: MENTHOL CRYSTALS AND PEPPERMINT OIL SOLD AS INGREDIENTS IN MEDICAL PLASTERS AND MEDICATED OINTMENTS, IN CLASS 5 (U.S. CLS. 6, 18, 44, 46, 51 AND 52).

FIRST USE 3-2-1939; IN COMMERCE 5-1-1964.

THE STIPPLING SHOWN IN THE DRAWINGS IS A FEATURE OF THE MARK.

SN 76-623,653, FILED 12-8-2004.

LINDA ESTRADA, EXAMINING ATTORNEY

Int. Cls.: 9, 16, 35, 36, 38, and 41

**Prior U.S. Cls.: 2, 5, 21, 22, 23, 26, 29, 36, 37, 38, 50,
100, 101, 102, 104, and 107**

Reg. No. 3,477,089

United States Patent and Trademark Office

Registered July 29, 2008

**TRADEMARK
SERVICE MARK
PRINCIPAL REGISTER**

pre[k]now

THE PEW CHARITABLE TRUSTS (PENNSYLVANIA NONPROFIT CORPORATION)
ONE COMMERCE SQUARE
2005 MARKET STREET, SUITE 1700
PHILADELPHIA, PA 191037017

FOR: DOWNLOADABLE ELECTRONIC PUBLICATIONS, NAMELY, NEWSLETTERS, RESOURCE GUIDES, REPORTS, PRESS RELEASES, AND GRANT APPLICATION AND REPORT FORMS, ALL IN THE FIELD OF EARLY EDUCATION; ELECTRONIC PUBLICATIONS, NAMELY, NEWSLETTERS, RESOURCE GUIDES, REPORTS, PRESS RELEASES, ALL IN THE FIELD OF EARLY EDUCATION RECORDED ON COMPUTER MEDIA, IN CLASS 9 (U.S. CLS. 21, 23, 26, 36 AND 38).

FIRST USE 2-3-2005; IN COMMERCE 2-3-2005.

FOR: PRINTED MATERIALS, NAMELY, BROCHURES, RESOURCE GUIDES, REPORTS, PRESS RELEASES, AND GRANT APPLICATION AND REPORT FORMS, ALL FEATURING AND PROMOTING EARLY EDUCATION, IN CLASS 16 (U.S. CLS. 2, 5, 22, 23, 29, 37, 38 AND 50).

FIRST USE 2-3-2005; IN COMMERCE 2-3-2005.

FOR: COORDINATING WITH AND ASSISTING NATIONAL, STATE, AND LOCAL ORGANIZATIONS TO PROMOTE PUBLIC AWARENESS OF THE NEED FOR EARLY EDUCATION; PROVIDING A WEBSITE ON GLOBAL COMPUTER NETWORKS FEATURING AND PROMOTING EARLY EDUCATION, IN CLASS 35 (U.S. CLS. 100, 101 AND 102).

FIRST USE 1-26-2005; IN COMMERCE 1-26-2005.

FOR: GRANT-MAKING SERVICES, NAMELY, PROVIDING GRANTS TO ORGANIZATIONS WORKING TO STUDY AND/OR PROMOTE EARLY EDUCATION; AND PROVIDING INFORMATION IN THE FIELD OF GRANT-MAKING, IN CLASS 36 (U.S. CLS. 100, 101 AND 102).

FIRST USE 1-26-2005; IN COMMERCE 1-26-2005.

FOR: WEBCASTING SERVICES, NAMELY, PROVIDING AUDIO AND VIDEO WEB CASTS, IN CLASS 38 (U.S. CLS. 100, 101 AND 104).

FIRST USE 2-16-2005; IN COMMERCE 2-16-2005.

FOR: PROVIDING INFORMATION AND NEWS IN THE FIELD OF EARLY EDUCATION; PUBLISHING NEWSLETTERS, RESOURCE GUIDES, REPORTS, EDITORIALS, ARTICLES, PRESS RELEASES, AND RESULTS OF PUBLIC OPINION SURVEYS AND POLLS IN THE FIELD OF EARLY EDUCATION; ARRANGING AND CONDUCTING CONFERENCES IN THE FIELD OF EARLY EDUCATION AND PROVIDING ONLINE REGISTRATION SERVICES FOR SAME, IN CLASS 41 (U.S. CLS. 100, 101 AND 107).

FIRST USE 1-26-2005; IN COMMERCE 1-26-2005.

THE MARK CONSISTS OF STANDARD CHARACTERS WITHOUT CLAIM TO ANY PARTICULAR FONT, STYLE, SIZE, OR COLOR.

SN 7 6-623,676, FILED 12-8-2004.

MARIAM MAHMOUDI, EXAMINING ATTORNEY

Int. Cls.: 36 and 41

Prior U.S. Cls.: 100, 101, 102, and 107

United States Patent and Trademark Office

Reg. No. 3,477,090

Registered July 29, 2008

**SERVICE MARK
PRINCIPAL REGISTER**

Pre-K Now

THE PEW CHARITABLE TRUSTS (PENNSYLVANIA NONPROFIT CORPORATION)
ONE COMMERCE SQUARE
2005 MARKET STREET, SUITE 1700
PHILADELPHIA, PA 191037017

FOR: GRANT-MAKING SERVICES, NAMELY, PROVIDING GRANTS TO ORGANIZATIONS WORKING TO STUDY AND/OR PROMOTE EARLY EDUCATION; PROVIDING INFORMATION IN THE FIELD OF GRANT-MAKING, IN CLASS 36 (U.S. CLS. 100, 101 AND 102).

FIRST USE 1-26-2005; IN COMMERCE 1-26-2005.

FOR: PROVIDING INFORMATION AND NEWS IN THE FIELD OF EARLY EDUCATION; PUBLISHING NEWSLETTERS, RESOURCE GUIDES, REPORTS, EDITORIALS, ARTICLES, PRESS RELEASES, AND RESULTS OF PUBLIC OPINION SURVEYS AND POLLS IN THE FIELD OF EARLY

EDUCATION; ARRANGING AND CONDUCTING CONFERENCES IN THE FIELD OF EARLY EDUCATION AND PROVIDING ONLINE REGISTRATION SERVICES FOR SAME, IN CLASS 41 (U.S. CLS. 100, 101 AND 107).

FIRST USE 1-26-2005; IN COMMERCE 1-26-2005.

THE MARK CONSISTS OF STANDARD CHARACTERS WITHOUT CLAIM TO ANY PARTICULAR FONT, STYLE, SIZE, OR COLOR.

NO CLAIM IS MADE TO THE EXCLUSIVE RIGHT TO USE "PRE-K", APART FROM THE MARK AS SHOWN.

SN 76-623,688, FILED 12-8-2004.

MARIAM MAHMOUDI, EXAMINING ATTORNEY

Int. Cl.: 12

Prior U.S. Cls.: 19, 21, 23, 31, 35, and 44

United States Patent and Trademark Office

Reg. No. 3,477,091

Registered July 29, 2008

**TRADEMARK
PRINCIPAL REGISTER**

Piggybagger

MONTGOMERY, CHARLES (UNITED STATES
INDIVIDUAL)
2570 #5 CLOVERDALE AVENUE
CONCORD, CA 94518

THE MARK CONSISTS OF STANDARD CHAR-
ACTERS WITHOUT CLAIM TO ANY PARTICULAR
FONT, STYLE, SIZE, OR COLOR.

FOR: MOTORCYCLE ASSEMBLIES, NAMELY,
SUSPENSION SYSTEMS, IN CLASS 12 (U.S. CLS. 19,
21, 23, 31, 35 AND 44).

SN 76-624,858, FILED 12-16-2004.

FIRST USE 6-4-2002; IN COMMERCE 6-4-2002.

DANIEL BRODY, EXAMINING ATTORNEY

Int. Cl.: 35

Prior U.S. Cls.: 100, 101, and 102

United States Patent and Trademark Office

Reg. No. 3,477,092

Registered July 29, 2008

**SERVICE MARK
PRINCIPAL REGISTER**

HOME DISCPLAY

PRODUCER'S NETWORK, LLC (ARIZONA LTD
LIAB CO)
7442 E. NORA ST.
MESA, AZ 85207

FOR: REAL ESTATE ADVERTISING SERVICES; ADVERTISING, INCLUDING PROMOTION OF REAL ESTATE, REAL ESTATE AGENTS, MORTGAGE COMPANIES, TITLE COMPANIES AND OTHER REAL ESTATE SERVICE PROVIDERS THROUGH SPONSORING ARRANGEMENTS AND LICENSING AGREEMENTS RELATING TO ADVERTISING MEDIA DISTRIBUTED IN ASSOCIATION WITH THE PROMOTION OF REAL ESTATE SALES; CREATION OF MARKETING TOOLS, NAMELY, PREPARING ADVERTISEMENTS TO BE INCLUDED ON ELECTRONIC BUSINESS CARDS AND PREPARING ADVERTISEMENTS FOR DISTRIBUTION BY REAL ESTATE AGENTS, MORTGAGE COMPANIES AND TITLE COMPANIES IN CONJUNCTION WITH THE PROMOTION OF REAL ESTATE SALES; ADVERTISING SERVI-

CES, NAMELY, CREATING CUSTOM ELECTRONIC AUDIO-VISUAL PRESENTATIONS FOR USE IN ADVERTISING REAL ESTATE; ADVERTISING OF REAL ESTATE VIA ELECTRONIC MEDIA AND SPECIFICALLY VIA ELECTRONIC PRESENTATION MEDIA AND THE INTERNET, IN CLASS 35 (U.S. CLS. 100, 101 AND 102).

FIRST USE 8-15-2005; IN COMMERCE 9-15-2005.

THE MARK CONSISTS OF STANDARD CHARACTERS WITHOUT CLAIM TO ANY PARTICULAR FONT, STYLE, SIZE, OR COLOR.

NO CLAIM IS MADE TO THE EXCLUSIVE RIGHT TO USE "HOME", APART FROM THE MARK AS SHOWN.

SN 76-625,832, FILED 12-27-2004.

MAUREEN DALL, EXAMINING ATTORNEY

Int. Cl.: 43

Prior U.S. Cls.: 100 and 101

United States Patent and Trademark Office

Reg. No. 3,477,093

Registered July 29, 2008

**SERVICE MARK
PRINCIPAL REGISTER**



THE S&Q SHACK, LLC (GEORGIA LTD LIAB
CO)
2915 PEACHTREE ROAD, NE
ATLANTA, GA 30305

FOR: RESTAURANT SERVICES, IN CLASS 43
(U.S. CLS. 100 AND 101).

FIRST USE 3-13-2002; IN COMMERCE 3-13-2002.

NO CLAIM IS MADE TO THE EXCLUSIVE
RIGHT TO USE "RIB SHACK" , APART FROM
THE MARK AS SHOWN.

THE COLOR(S) RED, YELLOW, BLACK, AND
GRAY IS/ARE CLAIMED AS A FEATURE OF THE
MARK.

THE MARK CONSISTS OF THE COLOR RED
APPEARING IN THE LETTERING FOR THE WORD
"SHANE'S" AND IN THE HOUSE DESIGN. THE
COLOR YELLOW APPEARS IN THE LETTERING
FOR THE WORDING "RIB SHACK" AND IN THE
HOUSE DESIGN. THE COLOR BLACK APPEARS IN
THE ROOF OF THE HOUSE DESIGN AND THE
CHIMNEY OF THE HOUSE DESIGN. THE COLOR
GRAY APPEARS IN THE SMOKE THAT EMA-
NATES FROM THE CHIMNEY AND IN THE ROOF
OF THE HOUSE DESIGN.

SN 76-627,423, FILED 1-10-2005.

SETH A. RAPPAPORT, EXAMINING ATTORNEY

Int. Cl.: 9

Prior U.S. Cls.: 21, 23, 26, 36, and 38

United States Patent and Trademark Office

Reg. No. 3,477,094

Registered July 29, 2008

**TRADEMARK
PRINCIPAL REGISTER**

THE FIRST STEP TO CANCER SURVIVAL

NATIONAL COALITION FOR CANCER SURVIVORSHIP (NEW MEXICO CORPORATION)
1010 WAYNE AVENUE, SUITE 770
SILVER SPRING, MD 20910

FOR: CD'S FEATURING INFORMATION RELATING TO CANCER AND CANCER-RELATED ISSUES, IN CLASS 9 (U.S. CLS. 21, 23, 26, 36 AND 38).

FIRST USE 2-0-2008; IN COMMERCE 2-0-2008.

THE MARK CONSISTS OF STANDARD CHARACTERS WITHOUT CLAIM TO ANY PARTICULAR FONT, STYLE, SIZE, OR COLOR.

SN 76-633,535, FILED 3-17-2005.

ROBERT LAVACHE, EXAMINING ATTORNEY

Int. Cl.: 9

Prior U.S. Cls.: 21, 23, 26, 36, and 38

United States Patent and Trademark Office

Reg. No. 3,477,095

Registered July 29, 2008

**TRADEMARK
PRINCIPAL REGISTER**

ENEMY TERRITORY: QUAKE WARS

ID SOFTWARE, INC. (TEXAS CORPORATION)
3819 TOWNE CROSSING BOULEVARD, SUITE 222
MESQUITE, TX 751506123

FOR: COMPUTER SOFTWARE GAMES, AND
COMPUTER SOFTWARE GAME PROGRAMS FOR
ENTERTAINMENT USES WITH USER MANUALS
SOLD AS A UNIT, IN CLASS 9 (U.S. CLS. 21, 23, 26, 36
AND 38).

FIRST USE 10-31-2007; IN COMMERCE 10-31-2007.

THE MARK CONSISTS OF STANDARD CHAR-
ACTERS WITHOUT CLAIM TO ANY PARTICULAR
FONT, STYLE, SIZE, OR COLOR.

OWNER OF U.S. REG. NOS. 2,032,587, 2,257,815,
AND OTHERS.

SN 76-640,115, FILED 6-3-2005.

JERI J. FICKES, EXAMINING ATTORNEY

Int. Cl.: 28

Prior U.S. Cls.: 22, 23, 38, and 50

United States Patent and Trademark Office

Reg. No. 3,477,096

Registered July 29, 2008

**TRADEMARK
PRINCIPAL REGISTER**

KING KYLE'S TOYS

ANDERSON, JOSEPH M. (UNITED STATES INDIVIDUAL)
2293 SAUNDERS SETTLEMENT ROAD
SANBORN, NY 14132

FOR: TOYS GAMES AND PLAY THINGS, NAME-
LY, STUFFED ANIMALS, DOLLS, TOY VEHICLES,
ACTION FIGURES, BALLS, NAMELY, BASEBALLS,
BASKETBALLS, PLAYGROUND BALLS, SOCCER
BALLS, LACROSSE BALLS, SQUASH BALLS, SPORT
BALLS AND RUBBER BALLS, LACROSSE STICKS
AND PLAYGROUND EQUIPMENT, NAMELY,
SWING SETS, SLIDES AND CLIMBING UNITS, IN
CLASS 28 (U.S. CLS. 22, 23, 38 AND 50).

FIRST USE 6-12-2008; IN COMMERCE 6-13-2008.

THE MARK CONSISTS OF STANDARD CHAR-
ACTERS WITHOUT CLAIM TO ANY PARTICULAR
FONT, STYLE, SIZE, OR COLOR.

NO CLAIM IS MADE TO THE EXCLUSIVE
RIGHT TO USE "TOYS", APART FROM THE MARK
AS SHOWN.

THE NAME "KYLE" IDENTIFIES A LIVING IN-
DIVIDUAL WHOSE CONSENT IS OF RECORD.

SN 76-642,066, FILED 7-1-2005.

KATHLEEN M. VANSTON, EXAMINING ATTOR-
NEY

Int. Cl.: 28

Prior U.S. Cls.: 22, 23, 38, and 50

United States Patent and Trademark Office

Reg. No. 3,477,097

Registered July 29, 2008

**TRADEMARK
PRINCIPAL REGISTER**

QOLF BALLS

BONFIT AMERICA, INC. (CALIFORNIA CORPORATION)

8460 HIGUERA STREET

CULVER CITY, CA 90232

FOR: BALLS SOLD INDIVIDUALLY TO BE USED WITH POSTS AND CLUBS TO HIT THE BALL THROUGH THE POSTS, IN CLASS 28 (U.S. CLS. 22, 23, 38 AND 50).

FIRST USE 2-9-2006; IN COMMERCE 2-9-2006.

THE MARK CONSISTS OF STANDARD CHARACTERS WITHOUT CLAIM TO ANY PARTICULAR FONT, STYLE, SIZE, OR COLOR.

OWNER OF U.S. REG. NO. 3,036,304.

NO CLAIM IS MADE TO THE EXCLUSIVE RIGHT TO USE "BALLS", APART FROM THE MARK AS SHOWN.

SN 76-650,184, FILED 11-14-2005.

PRISCILLA MILTON, EXAMINING ATTORNEY

Int. Cl.: 36

Prior U.S. Cls.: 100, 101, and 102

United States Patent and Trademark Office

Reg. No. 3,477,098

Registered July 29, 2008

SERVICE MARK
PRINCIPAL REGISTER

CARDIF

CARDIF ASSURANCE VIE (FRANCE CORPORATION)
5 AVENUE KLÉBER
75016 PARIS, FRANCE

FOR: INSURANCE UNDERWRITING IN THE FIELD OF LIFE, HEALTH, ACCIDENT, FIRE, SHIPPING, TRAVEL, HOME CONTENTS, FLOOD AND WATER DAMAGE, NATURAL HAZARDS, BURGLARY AND THEFT, INSURANCE CLAIMS PROCESSING, ELECTRONIC PROCESSING OF INSURANCE CLAIMS AND PAYMENT DATA, UNDERWRITING INSURANCE FOR PRE-PAID LEGAL SERVICES; PROVIDING INFORMATION IN

INSURANCE MATTERS, INSURANCE CONSULTATION, IN CLASS 36 (U.S. CLS. 100, 101 AND 102).

FIRST USE 9-28-1973; IN COMMERCE 4-23-2002.

THE MARK CONSISTS OF STANDARD CHARACTERS WITHOUT CLAIM TO ANY PARTICULAR FONT, STYLE, SIZE, OR COLOR.

SN 76-650,797, FILED 11-21-2005.

TINA L. SNAPP, EXAMINING ATTORNEY

Int. Cl.: 31

Prior U.S. Cls.: 1 and 46

United States Patent and Trademark Office

Reg. No. 3,477,099

Registered July 29, 2008

**TRADEMARK
PRINCIPAL REGISTER**

SMART SYSTEM

NUTRO PRODUCTS, INC. (CALIFORNIA CORPORATION)

445 WILSON WAY

CITY OF INDUSTRY, CA 91744

FOR: PET FOOD, NAMELY, DOG FOOD, IN CLASS 31 (U.S. CLS. 1 AND 46).

FIRST USE 0-0-2006; IN COMMERCE 0-0-2006.

THE MARK CONSISTS OF STANDARD CHARACTERS WITHOUT CLAIM TO ANY PARTICULAR FONT, STYLE, SIZE, OR COLOR.

NO CLAIM IS MADE TO THE EXCLUSIVE RIGHT TO USE "SYSTEM", APART FROM THE MARK AS SHOWN.

SN 76-650,979, FILED 11-28-2005.

ANDREA SAUNDERS, EXAMINING ATTORNEY

Int. Cl.: 42

Prior U.S. Cls.: 100 and 101

United States Patent and Trademark Office

Reg. No. 3,477,100

Registered July 29, 2008

**SERVICE MARK
PRINCIPAL REGISTER**

BLUENORTHER

FD2S, INC. (TEXAS CORPORATION)
500 CHICON
AUSTIN, TX 78702

FOR: DESIGNING MAPS AND DIRECTIONAL
SIGNS FOR HEALTHCARE COMPLEXES, CORPO-
RATE CAMPUSES, COMMERCIAL PROJECTS,
PUBLIC TRANSIT SYSTEMS AND CIVIC INSTITU-
TIONS, IN CLASS 42 (U.S. CLS. 100 AND 101).

FIRST USE 5-1-2006; IN COMMERCE 5-1-2006.

THE MARK CONSISTS OF STANDARD CHAR-
ACTERS WITHOUT CLAIM TO ANY PARTICULAR
FONT, STYLE, SIZE, OR COLOR.

SN 76-651,115, FILED 11-18-2005.

AMY MCMENAMIN, EXAMINING ATTORNEY

Int. Cl.: 9

Prior U.S. Cls.: 21, 23, 26, 36, and 38

United States Patent and Trademark Office

Reg. No. 3,477,101

Registered July 29, 2008

**TRADEMARK
PRINCIPAL REGISTER**



KONAMI DIGITAL ENTERTAINMENT COMPAN-
NY LIMITED (JAPAN LIMITED COMPANY)
9-7-2, AKASAKA, MINATO-KU,
TOKYO, JAPAN

FOR: VIDEO GAME SOFTWARE; INTERACTIVE
VIDEO GAME PROGRAMS; COMPUTER GAME
PROGRAMS; VIDEO GAME DISCS FOR USE WITH
VIDEO GAME MACHINES; DOWNLOADABLE
ELECTRONIC GAME SOFTWARE, DOWNLOAD-
ABLE COMPUTER GAME SOFTWARE AND
DOWNLOADABLE VIDEO GAME SOFTWARE;
ELECTRONIC APPARATUS, INSTRUMENTS AND

ACCESSORIES FOR USE IN COMPUTER AND
VIDEO GAME MACHINES, NAMELY, A STEREO-
SCOPIC THREE DIMENSIONAL VIEWING PERIPH-
ERAL ATTACHMENT, IN CLASS 9 (U.S. CLS. 21, 23,
26, 36 AND 38).

FIRST USE 3-21-2006; IN COMMERCE 3-21-2006.

SN 76-651,123, FILED 11-29-2005.

MICHAEL GAAFAR, EXAMINING ATTORNEY

Int. Cl.: 5

Prior U.S. Cls.: 6, 18, 44, 46, 51, and 52

Reg. No. 3,477,102

United States Patent and Trademark Office

Registered July 29, 2008

**TRADEMARK
PRINCIPAL REGISTER**

ZEOMAX

ZEOTECH CORPORATION (TEXAS CORPORATION)
P.O. BOX 1718
FT. WORTH, TX 76010

THE MARK CONSISTS OF STANDARD CHARACTERS WITHOUT CLAIM TO ANY PARTICULAR FONT, STYLE, SIZE, OR COLOR.

FOR: ANIMAL FEED SUPPLEMENT, IN CLASS 5
(U.S. CLS. 6, 18, 44, 46, 51 AND 52).

SN 76-651,235, FILED 12-1-2005.

FIRST USE 2-22-2008; IN COMMERCE 2-22-2008.

BERYL GARDNER, EXAMINING ATTORNEY

Int. Cl.: 10

Prior U.S. Cls.: 26, 39, and 44

United States Patent and Trademark Office

Reg. No. 3,477,103

Registered July 29, 2008

**TRADEMARK
PRINCIPAL REGISTER**

"CIRCU-LITE"

BAKER, RAYMOND N. (UNITED STATES JOINT
APPLICANT)
2801 NEW MEXICO AVENUE #814
WASHINGTON, DC 20007 AND
WILLIAMS, EMMANUEL R. (UNITED STATES
JOINT APPLICANT)
2801 NEW MEXICO AVENUE #814
WASHINGTON, DC 20007

FIRST USE 4-8-2008; IN COMMERCE 4-8-2008.

THE MARK CONSISTS OF STANDARD CHAR-
ACTERS WITHOUT CLAIM TO ANY PARTICULAR
FONT, STYLE, SIZE, OR COLOR.

SN 76-651,344, FILED 12-2-2005.

FOR: HOSIERY, NAMELY WOMEN'S AND
MEN'S THERAPEUTIC SOCKS, IN CLASS 10 (U.S.
CLS. 26, 39 AND 44).

CAROL SPILS, EXAMINING ATTORNEY

Int. Cl.: 25

Prior U.S. Cls.: 22 and 39

United States Patent and Trademark Office

Reg. No. 3,477,104

Registered July 29, 2008

**TRADEMARK
PRINCIPAL REGISTER**



COUGAR HUNTING, INC. (MASSACHUSETTS
CORPORATION)
60 CROSBY STREET
QUINCY, MA 02169

FIRST USE 9-0-2006; IN COMMERCE 9-0-2006.

SN 76-651,700, FILED 12-9-2005.

FOR: CLOTHING, NAMELY, T-SHIRTS, SWEAT-
SHIRTS, SWEATPANTS, SHORTS, IN CLASS 25 (U.S.
CLS. 22 AND 39).

MARY ROSSMAN, EXAMINING ATTORNEY

Int. Cl.: 41

Prior U.S. Cls.: 100, 101, and 107

United States Patent and Trademark Office

Reg. No. 3,477,105

Registered July 29, 2008

**SERVICE MARK
PRINCIPAL REGISTER**

AMERICAN SOUNDWAYS

CLARKE, EDWIN V., III (UNITED STATES IN-
DIVIDUAL)
208 WESTERN AVENUE
PITTSBURGH, PA 15215

FOR: ENTERTAINMENT SERVICES, NAMELY,
PRODUCTION OF RADIO PROGRAMS, IN CLASS
41 (U.S. CLS. 100, 101 AND 107).

FIRST USE 12-31-2005; IN COMMERCE 12-31-2005.

THE MARK CONSISTS OF STANDARD CHAR-
ACTERS WITHOUT CLAIM TO ANY PARTICULAR
FONT, STYLE, SIZE, OR COLOR.

NO CLAIM IS MADE TO THE EXCLUSIVE
RIGHT TO USE "AMERICAN", APART FROM THE
MARK AS SHOWN.

SN 76-652,360, FILED 12-22-2005.

STEVEN JACKSON, EXAMINING ATTORNEY

Int. Cl.: 42

Prior U.S. Cls.: 100 and 101

United States Patent and Trademark Office

Reg. No. 3,477,106

Registered July 29, 2008

**SERVICE MARK
PRINCIPAL REGISTER**

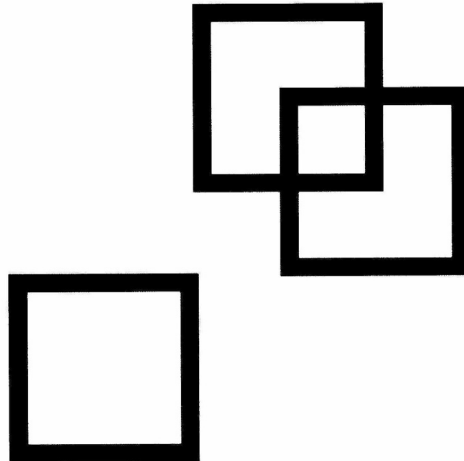

EVOLUTION ROBOTICS RETAIL, INC. (DELA-
WARE CORPORATION)
433 N. FAIR OAKS AVE.
PASADENA, CA 91103

FOR: COMPUTER HARDWARE AND COMPU-
TER SOFTWARE DEVELOPMENT FOR ROBOTICS
TECHNOLOGIES; COMPUTER HARDWARE AND
COMPUTER SOFTWARE DEVELOPMENT FOR VI-
SION OBJECT RECOGNITION AND NAVIGATION
SYSTEMS; DEVELOPMENT OF RETAIL MONITOR-
ING SYSTEM COMPRISING COMPUTER HARD-

WARE AND COMPUTER SOFTWARE FOR
TRACKING PRODUCTS IN RETAIL OPERATIONS,
IN CLASS 42 (U.S. CLS. 100 AND 101).

FIRST USE 1-31-2006; IN COMMERCE 1-31-2006.

THE MARK CONSISTS OF THREE SQUARES.

SN 76-653,070, FILED 1-3-2006.

ROBIN CHOSID, EXAMINING ATTORNEY

Int. Cl.: 35

Prior U.S. Cls.: 100, 101, and 102

United States Patent and Trademark Office

Reg. No. 3,477,107

Registered July 29, 2008

**SERVICE MARK
PRINCIPAL REGISTER**

WINNING WORK TEAMS

LARSON, RICHARD S. (UNITED STATES INDIVIDUAL)
5454 BROOKLINE DRIVE
ORLANDO, FL 32819

FOR: HUMAN RESOURCES CONSULTING SERVICES, IN CLASS 35 (U.S. CLS. 100, 101 AND 102).

FIRST USE 5-27-2008; IN COMMERCE 5-27-2008.

THE MARK CONSISTS OF STANDARD CHARACTERS WITHOUT CLAIM TO ANY PARTICULAR FONT, STYLE, SIZE, OR COLOR.

SN 76-653,846, FILED 1-23-2006.

ODESSA BIBBINS, EXAMINING ATTORNEY

Int. Cl.: 5

Prior U.S. Cls.: 6, 18, 44, 46, 51, and 52

United States Patent and Trademark Office

Reg. No. 3,477,108

Registered July 29, 2008

**TRADEMARK
PRINCIPAL REGISTER**

FRUIT FIGHT

MARS, INCORPORATED (DELAWARE CORPORATION)
6885 ELM STREET
MCLEAN, VA 221013883

THE MARK CONSISTS OF STANDARD CHARACTERS WITHOUT CLAIM TO ANY PARTICULAR FONT, STYLE, SIZE, OR COLOR.

FOR: NUTRITIONALLY FORTIFIED ENERGY FOOD BARS FOR USE AS NUTRITIONAL SUPPLEMENTS OR FOR MEAL REPLACEMENT, IN CLASS 5 (U.S. CLS. 6, 18, 44, 46, 51 AND 52).

SN 76-654,554, FILED 2-3-2006.

FIRST USE 12-0-2006; IN COMMERCE 12-0-2006.

EVELYN BRADLEY, EXAMINING ATTORNEY

Int. Cl.: 5

Prior U.S. Cls.: 6, 18, 44, 46, 51, and 52

Reg. No. 3,477,109

United States Patent and Trademark Office

Registered July 29, 2008

**TRADEMARK
PRINCIPAL REGISTER**

NUTS N' NANA

MARS, INCORPORATED (DELAWARE CORPORATION)
6885 ELM STREET
MCLEAN, VA 221013883

THE MARK CONSISTS OF STANDARD CHARACTERS WITHOUT CLAIM TO ANY PARTICULAR FONT, STYLE, SIZE, OR COLOR.

FOR: NUTRITIONALLY FORTIFIED ENERGY FOOD BARS FOR USE AS NUTRITIONAL SUPPLEMENTS OR MEAL REPLACEMENT, IN CLASS 5 (U.S. CLS. 6, 18, 44, 46, 51 AND 52).

SN 76-654,555, FILED 2-3-2006.

FIRST USE 12-0-2006; IN COMMERCE 12-0-2006.

EVELYN BRADLEY, EXAMINING ATTORNEY

Int. Cl.: 5

Prior U.S. Cls.: 6, 18, 44, 46, 51, and 52

United States Patent and Trademark Office

Reg. No. 3,477,110

Registered July 29, 2008

**TRADEMARK
PRINCIPAL REGISTER**

BIG BAD BBQ

MARS, INCORPORATED (DELAWARE CORPORATION)
6885 ELM STREET
MCLEAN, VA 221013883

FOR: NUTRITIONALLY FORTIFIED ENERGY FOOD MIXES FOR USE AS NUTRITIONAL SUPPLEMENT OR MEAL REPLACEMENT, IN CLASS 5 (U.S. CLS. 6, 18, 44, 46, 51 AND 52).

FIRST USE 12-0-2006; IN COMMERCE 12-0-2006.

THE MARK CONSISTS OF STANDARD CHARACTERS WITHOUT CLAIM TO ANY PARTICULAR FONT, STYLE, SIZE, OR COLOR.

NO CLAIM IS MADE TO THE EXCLUSIVE RIGHT TO USE "BBQ", APART FROM THE MARK AS SHOWN.

SN 76-654,557, FILED 2-3-2006.

EVELYN BRADLEY, EXAMINING ATTORNEY

Int. Cl.: 9

Prior U.S. Cls.: 21, 23, 26, 36, and 38

Reg. No. 3,477,111

United States Patent and Trademark Office

Registered July 29, 2008

**TRADEMARK
PRINCIPAL REGISTER**

DPROFILER

BECK TECHNOLOGY, LTD. (TEXAS LTD LIAB
CO)
1807 ROSS AVENUE, SUITE 500
DALLAS, TX 75201

THE MARK CONSISTS OF STANDARD CHAR-
ACTERS WITHOUT CLAIM TO ANY PARTICULAR
FONT, STYLE, SIZE, OR COLOR.

FOR: COMPUTER SOFTWARE FOR USE IN
CONCEPTUAL DESIGN AND ESTIMATING APPLI-
CATIONS, IN CLASS 9 (U.S. CLS. 21, 23, 26, 36 AND
38).

SN 76-662,160, FILED 6-26-2006.

FIRST USE 8-1-2004; IN COMMERCE 8-8-2005.

JESSICA FATHY, EXAMINING ATTORNEY

Int. Cl.: 9

Prior U.S. Cls.: 21, 23, 26, 36, and 38

United States Patent and Trademark Office

Reg. No. 3,477,112

Registered July 29, 2008

**TRADEMARK
PRINCIPAL REGISTER**

AccompanEase

TRUSTEES OF THE FAMILY TRUST U/W OF
RICHARD RODGERS (NEW YORK TRUST)
C/O THE RODGERS AND HAMMERSTEIN ORG
1065 AVENUE OF THE AMERICAS, SUITE 2400
NEW YORK, NY 10018 AND
HAMMERSTEIN PROPERTIES LLC (DELAWARE
LTD LIAB CO)
C/O DAVIS WRIGHT TREMAINE LLP
1633 BROADWAY - 27TH FLOOR ATTN: R. AN-
DREW BOOSENDREW BOOSE
NEW YORK, NY 10019

FOR: COMPUTER SOFTWARE THAT CONTAINS
PIANO/CONDUCTOR SCORES FOR REHEARSING

MUSICAL THEATRE PRODUCTIONS, IN CLASS 9
(U.S. CLS. 21, 23, 26, 36 AND 38).

FIRST USE 9-17-2007; IN COMMERCE 9-17-2007.

THE MARK CONSISTS OF STANDARD CHAR-
ACTERS WITHOUT CLAIM TO ANY PARTICULAR
FONT, STYLE, SIZE, OR COLOR.

SN 76-662,512, FILED 7-3-2006.

ELLEN PERKINS, EXAMINING ATTORNEY

Int. Cls.: 6 and 19

Prior U.S. Cls.: 1, 2, 12, 13, 14, 23, 25, 33, and 50

United States Patent and Trademark Office

Reg. No. 3,477,113

Registered July 29, 2008

**TRADEMARK
PRINCIPAL REGISTER**

SEQUEL

WEATHER SHIELD MFG., INC. (WISCONSIN CORPORATION)

ONE WEATHER SHIELD PLAZA

P.O. BOX 309

MEDFORD, WI 54451

FOR: WINDOWS AND DOORS PRIMARILY OF METAL, IN CLASS 6 (U.S. CLS. 2, 12, 13, 14, 23, 25 AND 50).

FIRST USE 9-25-2006; IN COMMERCE 9-25-2006.

FOR: WINDOWS AND DOORS PRIMARILY NOT OF METAL, IN CLASS 19 (U.S. CLS. 1, 12, 33 AND 50).

FIRST USE 9-25-2006; IN COMMERCE 9-25-2006.

THE MARK CONSISTS OF STANDARD CHARACTERS WITHOUT CLAIM TO ANY PARTICULAR FONT, STYLE, SIZE, OR COLOR.

SN 76-663,691, FILED 7-26-2006.

ROBIN CHOSID, EXAMINING ATTORNEY

Int. Cl.: 37

Prior U.S. Cls.: 100, 103, and 106

United States Patent and Trademark Office

Reg. No. 3,477,114

Registered July 29, 2008

SERVICE MARK
PRINCIPAL REGISTER

S P A R T A N



S Y S T E M S

SPARTAN SYSTEMS INC. (CALIFORNIA CORPORATION)
3723 HAVEN AVE.
MENLO PARK, CA 94025

THE COLOR(S) GOLD AND BLACK IS/ARE CLAIMED AS A FEATURE OF THE MARK.

FOR: INSTALLATION AND REPAIR OF LOW VOLTAGE WIRING AND ELECTRONIC COMMUNICATION EQUIPMENT, IN CLASS 37 (U.S. CLS. 100, 103 AND 106).

THE OUTLINE AND LINING OF THE DESIGN ELEMENT OF A STYLIZED SPARTAN WARRIOR IS A GOLD COLOR. THE REST OF THE MARK IS IN BLACK.

FIRST USE 1-23-2005; IN COMMERCE 3-15-2006.

SN 76-663,708, FILED 7-27-2006.

NO CLAIM IS MADE TO THE EXCLUSIVE RIGHT TO USE "SYSTEMS", APART FROM THE MARK AS SHOWN.

GINA FINK, EXAMINING ATTORNEY

Int. Cl.: 3

Prior U.S. Cls.: 1, 4, 6, 50, 51, and 52

United States Patent and Trademark Office

Reg. No. 3,477,115

Registered July 29, 2008

TRADEMARK
PRINCIPAL REGISTER

BEDTIME MOISTURE WASH

JOHNSON & JOHNSON (NEW JERSEY CORPORATION)

ONE JOHNSON & JOHNSON PLAZA
NEW BRUNSWICK, NJ 089337001

FOR: SKIN CLEANSER AND BATH WASH, IN CLASS 3 (U.S. CLS. 1, 4, 6, 50, 51 AND 52).

FIRST USE 10-2-2007; IN COMMERCE 10-2-2007.

OWNER OF U.S. REG. NOS. 2,694,549, 3,022,637, AND OTHERS.

NO CLAIM IS MADE TO THE EXCLUSIVE RIGHT TO USE "MOISTURE WASH", APART FROM THE MARK AS SHOWN.

SN 76-663,764, FILED 7-27-2006.

LINDA MICKLEBURGH, EXAMINING ATTORNEY

Int. Cls.: 36 and 40

Prior U.S. Cls.: 100, 101, 102, 103, and 106

United States Patent and Trademark Office

Reg. No. 3,477,116

Registered July 29, 2008

**SERVICE MARK
PRINCIPAL REGISTER**

MY COMMUNITY CARD

EFT SOURCE, INC. (TENNESSEE CORPORATION)
5000 LINBAR DRIVE, SUITE 230
NASHVILLE, TN 37211

FOR: DEBIT CARD, CASH CARD, AND CREDIT CARD SERVICES, IN CLASS 36 (U.S. CLS. 100, 101 AND 102).

FIRST USE 1-1-2006; IN COMMERCE 1-1-2006.

FOR: CUSTOM MANUFACTURE OF PERSONALIZED FINANCIAL TRANSACTION CARDS, IN CLASS 40 (U.S. CLS. 100, 103 AND 106).

FIRST USE 1-1-2006; IN COMMERCE 1-1-2006.

THE MARK CONSISTS OF STANDARD CHARACTERS WITHOUT CLAIM TO ANY PARTICULAR FONT, STYLE, SIZE, OR COLOR.

NO CLAIM IS MADE TO THE EXCLUSIVE RIGHT TO USE "CARD", APART FROM THE MARK AS SHOWN.

SN 76-664,014, FILED 8-2-2006.

ALEXANDER L. POWERS, EXAMINING ATTORNEY

Int. Cl.: 20

Prior U.S. Cls.: 2, 13, 22, 25, 32, and 50

United States Patent and Trademark Office

Reg. No. 3,477,117

Registered July 29, 2008

**TRADEMARK
PRINCIPAL REGISTER**

BOTERO WORLD

BOTERO, SAMUEL (UNITED STATES INDIVIDUAL)
215 EAST 58TH STREET, SUITE 6B
NEW YORK, NY 10022

THE MARK CONSISTS OF STANDARD CHARACTERS WITHOUT CLAIM TO ANY PARTICULAR FONT, STYLE, SIZE, OR COLOR.

FOR: FURNITURE, IN CLASS 20 (U.S. CLS. 2, 13, 22, 25, 32 AND 50).

SN 76-664,984, FILED 8-18-2006.

FIRST USE 3-20-2008; IN COMMERCE 3-20-2008.

GRETТА YAO, EXAMINING ATTORNEY

Int. Cl.: 24

Prior U.S. Cls.: 42 and 50

United States Patent and Trademark Office

Reg. No. 3,477,118

Registered July 29, 2008

**TRADEMARK
PRINCIPAL REGISTER**

SEAT SHEET

CRESCENT PRODUCTS (MINNESOTA CORPORATION)
9444 DEERWOOD LANE NORTH
MAPLE GROVE, MN 55369

FOR: DISPOSABLE BARRIERS, NAMELY, CLOTH SEAT BARRIERS AND CLOTH HEAD REST BARRIERS; AND DISPOSABLE SHAMS, IN CLASS 24 (U.S. CLS. 42 AND 50).

FIRST USE 5-22-2008; IN COMMERCE 5-22-2008.

THE MARK CONSISTS OF STANDARD CHARACTERS WITHOUT CLAIM TO ANY PARTICULAR FONT, STYLE, SIZE, OR COLOR.

NO CLAIM IS MADE TO THE EXCLUSIVE RIGHT TO USE "SEAT", APART FROM THE MARK AS SHOWN.

SN 76-665,951, FILED 9-13-2006.

RAUL CORDOVA, EXAMINING ATTORNEY

Int. Cl.: 7

Prior U.S. Cls.: 13, 19, 21, 23, 31, 34, and 35

Reg. No. 3,477,119

United States Patent and Trademark Office

Registered July 29, 2008

**TRADEMARK
PRINCIPAL REGISTER**

POSITIONIT

ACTUA SYSTEMS INC. (MINNESOTA CORPORATION)
1065 24TH AVENUE SW
OWATONNA, MN 55060

FIRST USE 2-26-2008; IN COMMERCE 2-26-2008.

FOR: POWER OPERATED LIFTING AND MOVING EQUIPMENT, NAMELY, LIFTS; TOWER CRANES; HOISTS; ELECTRIC ACTUATORS AND EXTENDERS FOR LIFTING, LOWERING, MOVING OR POSITIONING EQUIPMENT, CARGO, PERSONS OR OTHER OBJECTS, IN CLASS 7 (U.S. CLS. 13, 19, 21, 23, 31, 34 AND 35).

THE MARK CONSISTS OF STANDARD CHARACTERS WITHOUT CLAIM TO ANY PARTICULAR FONT, STYLE, SIZE, OR COLOR.

SN 76-666,418, FILED 9-21-2006.

SUSAN LESLIE DUBOIS, EXAMINING ATTORNEY

Int. Cl.: 11

Prior U.S. Cls.: 13, 21, 23, 31, and 34

United States Patent and Trademark Office

Reg. No. 3,477,120

Registered July 29, 2008

TRADEMARK
PRINCIPAL REGISTER



TOTO CONCEPTS, INC. (WASHINGTON CORPORATION)
23300 SE BLACK NUGGET ROAD
#N5
ISSAQUAH, WA 98029

FOR: DRINKING WATER SUPPLY APPARATUS, NAMELY, DRINKING FOUNTAINS, WATER COOLERS, AND HOT AND COLD DISPENSING CONSOLES; WATER DISPENSERS, NAMELY, TEMPERATURE-CONTROLLED FOOD AND BEVERAGE DISPENSERS, AND COMPONENTS THEREOF; FILTERS FOR DRINKING WATER FOR HOUSEHOLD PURPOSES AND COMMERCIAL PURPOSES; WATER COOLERS; BEVERAGE COOLERS, NAMELY, THERMOELECTRIC COOLER AND HEATER FOR BEVERAGES; WATER PURIFIERS; ICE MAKERS; ELECTRIC WATER

HEATERS, IN CLASS 11 (U.S. CLS. 13, 21, 23, 31 AND 34).

FIRST USE 9-0-2006; IN COMMERCE 10-0-2006.

THE MARK CONSISTS OF A STYLIZED DEPICTION OF A DROP OF WATER ABOVE THE WORD "SERRARA" IN STYLIZED FONT, WITHIN AN OVAL.

THE WORDING "SERRARA" HAS NO MEANING IN A FOREIGN LANGUAGE.

SN 76-666,777, FILED 9-29-2006.

ROBIN CHOSID, EXAMINING ATTORNEY

Int. Cl.: 36

Prior U.S. Cls.: 100, 101, and 102

United States Patent and Trademark Office

Reg. No. 3,477,121

Registered July 29, 2008

**SERVICE MARK
PRINCIPAL REGISTER**

QUBIT INVESTMENTS, LLC

QUBIT INVESTMENTS, LLC (DELAWARE LTD
LIAB CO)
6 TIMBER MILL LANE
LANDENBERG, PA 19350

FOR: PROVIDING INVESTMENT ADVISORY
AND MANAGEMENT SERVICES TO INSTITU-
TIONS AND HIGH-NET-WORTH INDIVIDUALS,
IN CLASS 36 (U.S. CLS. 100, 101 AND 102).

FIRST USE 4-9-2007; IN COMMERCE 4-9-2007.

THE MARK CONSISTS OF STANDARD CHAR-
ACTERS WITHOUT CLAIM TO ANY PARTICULAR
FONT, STYLE, SIZE, OR COLOR.

NO CLAIM IS MADE TO THE EXCLUSIVE
RIGHT TO USE "INVESTMENTS, LLC", APART
FROM THE MARK AS SHOWN.

SN 76-667,248, FILED 10-10-2006.

EDWARD NELSON, EXAMINING ATTORNEY

Int. Cl.: 36

Prior U.S. Cls.: 100, 101, and 102

United States Patent and Trademark Office

Reg. No. 3,477,122

Registered July 29, 2008

**SERVICE MARK
PRINCIPAL REGISTER**



QUBIT INVESTMENTS, LLC (DELAWARE LTD
LIAB CO)
6 TIMBER MILL LANE
LANDENBERG, PA 19350

THE MARK CONSISTS OF A STYLIZED MAGNI-
FYING GLASS AND THE GREEK LETTER "PSI".

FOR: PROVIDING INVESTMENT ADVISORY
AND MANAGEMENT SERVICES TO INSTITU-
TIONS AND HIGH-NET-WORTH INDIVIDUALS,
IN CLASS 36 (U.S. CLS. 100, 101 AND 102).

"QUBIT" OR THE GREEK LETTER "PSI" AP-
PEARING IN THE MARK HAS NO MEANING IN A
FOREIGN LANGUAGE.

FIRST USE 4-9-2007; IN COMMERCE 9-4-2007.

SN 76-667,249, FILED 10-10-2006.

NO CLAIM IS MADE TO THE EXCLUSIVE
RIGHT TO USE "INVESTMENTS, LLC", APART
FROM THE MARK AS SHOWN.

EDWARD NELSON, EXAMINING ATTORNEY

Int. Cls.: 7 and 8

Prior U.S. Cls.: 13, 19, 21, 23, 28, 31, 34, 35, and 44

United States Patent and Trademark Office

Reg. No. 3,477,123

Registered July 29, 2008

**TRADEMARK
PRINCIPAL REGISTER**

EQUIPOIS

EQUIPOIS INC. (DELAWARE CORPORATION)
6601 SANTA MONICA BOULEVARD
LOS ANGELES, CA 90038

FOR: MECHANICAL AND ELECTRICAL LIFTS AND SUPPORT EQUIPMENT, NAMELY, ARMS, EXTENDERS, LIFTS AND BALANCERS USED TO MOVE, GUIDE, LIFT, HOLD OR STABILIZE PAYLOADS COMPRISED OF TOOLS AND CARGO, IN CLASS 7 (U.S. CLS. 13, 19, 21, 23, 31, 34 AND 35).

FIRST USE 9-28-2006; IN COMMERCE 11-28-2006.

FOR: HAND OPERATED SUPPORT EQUIPMENT, NAMELY, ARMS OR EXTENDERS TO ASSIST,

GUIDE, LIFT, HOLD OR STABILIZE THE HUMAN ARM OR HAND IN REACHING, LIFTING AND PLACEMENT ACTIVITY, IN CLASS 8 (U.S. CLS. 23, 28 AND 44).

FIRST USE 9-28-2006; IN COMMERCE 11-28-2006.

THE MARK CONSISTS OF STANDARD CHARACTERS WITHOUT CLAIM TO ANY PARTICULAR FONT, STYLE, SIZE, OR COLOR.

SN 76-667,889, FILED 10-23-2006.

SUZANNE BLANE, EXAMINING ATTORNEY

Int. Cls.: 3, 5, 10, and 16

**Prior U.S. Cls.: 1, 2, 4, 5, 6, 18, 22, 23, 26, 29, 37, 38,
39, 44, 46, 50, 51, and 52**

Reg. No. 3,477,124

United States Patent and Trademark Office

Registered July 29, 2008

**TRADEMARK
PRINCIPAL REGISTER**

MOM TO MOM

SAFeway INC. (DELAWARE CORPORATION)
5918 STONERIDGE MALL ROAD
PLEASANTON, CA 945882322

FOR: BABY WIPES, NON-MEDICATED TOILETRIES FOR BABIES AND CHILDREN, IN CLASS 3 (U.S. CLS. 1, 4, 6, 50, 51 AND 52).

FIRST USE 4-18-2008; IN COMMERCE 4-18-2008.

FOR: BABY FOOD, NURSING PADS, INFANT FORMULA, IN CLASS 5 (U.S. CLS. 6, 18, 44, 46, 51 AND 52).

FIRST USE 4-18-2008; IN COMMERCE 4-18-2008.

FOR: BABY BOTTLES; BABY BOTTLE NIPPLES; DISPOSABLE BABY BOTTLE LINERS; NIPPLES FOR BABY BOTTLES, BABY PACIFIERS, CUPS, PLATES, BOWLS AND UTENSILS, NAMELY

FORKS AND SPOONS ADAPTED FOR FEEDING BABIES AND CHILDREN, IN CLASS 10 (U.S. CLS. 26, 39 AND 44).

FIRST USE 4-18-2008; IN COMMERCE 4-18-2008.

FOR: DIAPERS, NAMELY, PAPER DIAPERS AND DISPOSABLE DIAPERS, IN CLASS 16 (U.S. CLS. 2, 5, 22, 23, 29, 37, 38 AND 50).

FIRST USE 4-18-2008; IN COMMERCE 4-18-2008.

THE MARK CONSISTS OF STANDARD CHARACTERS WITHOUT CLAIM TO ANY PARTICULAR FONT, STYLE, SIZE, OR COLOR.

SN 76-668,060, FILED 10-25-2006.

SANI KHOURI, EXAMINING ATTORNEY

Int. Cl.: 3

Prior U.S. Cls.: 1, 4, 6, 50, 51, and 52

United States Patent and Trademark Office

Reg. No. 3,477,125

Registered July 29, 2008

**TRADEMARK
PRINCIPAL REGISTER**



JOHNSON & JOHNSON (NEW JERSEY CORPORATION)
ONE JOHNSON & JOHNSON PLAZA
NEW BRUNSWICK, NJ 089337001

FIRST USE 2-0-2007; IN COMMERCE 2-0-2007.

SN 76-668,960, FILED 11-13-2006.

FOR: SKIN CLEANSERS AND BODY WASHES,
IN CLASS 3 (U.S. CLS. 1, 4, 6, 50, 51 AND 52).

KEVIN DINALLO, EXAMINING ATTORNEY

Int. Cl.: 3

Prior U.S. Cls.: 1, 4, 6, 50, 51, and 52

United States Patent and Trademark Office

Reg. No. 3,477,126

Registered July 29, 2008

**TRADEMARK
PRINCIPAL REGISTER**



JOHNSON & JOHNSON (NEW JERSEY CORPORATION)
ONE JOHNSON & JOHNSON PLAZA
NEW BRUNSWICK, NJ 089337001

FIRST USE 2-0-2007; IN COMMERCE 2-0-2007.

SN 76-668,963, FILED 11-13-2006.

FOR: HAIR SHAMPOO, HAIR CONDITIONER
AND HAIR DETANGLER, IN CLASS 3 (U.S. CLS. 1,
4, 6, 50, 51 AND 52).

KEVIN DINALLO, EXAMINING ATTORNEY

Int. Cl.: 19

Prior U.S. Cls.: 1, 12, 33, and 50

United States Patent and Trademark Office

Reg. No. 3,477,127

Registered July 29, 2008

**TRADEMARK
PRINCIPAL REGISTER**

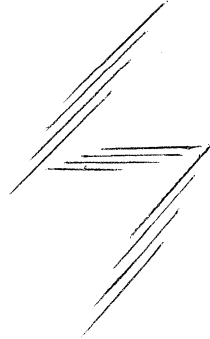

RODGERS, ALLISTER H (HARPHA) (UNITED STATES INDIVIDUAL)
122 NORTH STREET
WINTER GARDEN, FL 34787

FOR: SAFETY SEASONAL STORM SHELTER NOT MADE OF METAL, IN CLASS 19 (U.S. CLS. 1, 12, 33 AND 50).

FIRST USE 3-7-2008; IN COMMERCE 3-7-2008.

THE LINING SHOWN IN THE DRAWING IS A FEATURE OF THE MARK.

THE MARK IS COMPRISED OF FOUR STYLIZED S'S.

SN 76-669,053, FILED 11-13-2006.

TINA L. SNAPP, EXAMINING ATTORNEY

Int. Cls.: 16, 41, and 44

Prior U.S. Cls.: 2, 5, 22, 23, 29, 37, 38, 50, 100, 101, and 107

Reg. No. 3,477,128

United States Patent and Trademark Office

Registered July 29, 2008

**TRADEMARK
SERVICE MARK
PRINCIPAL REGISTER**

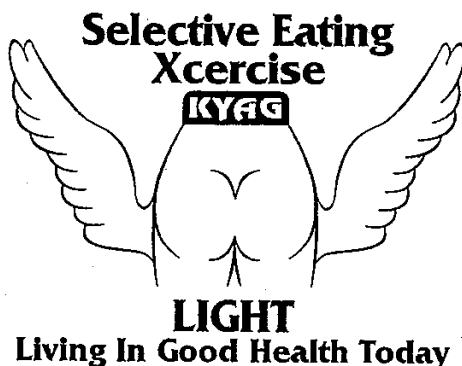

KYAG, LLC (KENTUCKY LTD LIAB CO)
5637 UPPER RIVER ROAD
PROSPECT, KY 40059

FOR: PRINTED INSTRUCTIONAL MATERIALS IN THE FIELDS OF DIET, HEALTH AND NUTRITION; PRINTED MENUS; COOKING INSTRUCTION SHEETS FOR THE PREPARATION OF FOOD AND MEALS; AND FOOD RECIPE BOOKS, IN CLASS 16 (U.S. CLS. 2, 5, 22, 23, 29, 37, 38 AND 50).

FIRST USE 5-14-2008; IN COMMERCE 5-14-2008.

FOR: EDUCATIONAL SERVICES, NAMELY, PROVIDING COURSES OF INSTRUCTION IN THE FIELD OF DIET, HEALTH AND NUTRITION; EDUCATIONAL SERVICES, NAMELY, PROVIDING COURSES OF INSTRUCTION IN THE FIELD OF COOKING FOR THE PREPARATION OF FOOD

AND MEALS; AND PERSONAL FITNESS TRAINING, IN CLASS 41 (U.S. CLS. 100, 101 AND 107).

FIRST USE 5-14-2008; IN COMMERCE 5-14-2008.

FOR: FOOD NUTRITION CONSULTATION, IN CLASS 44 (U.S. CLS. 100 AND 101).

FIRST USE 5-14-2008; IN COMMERCE 5-14-2008.

OWNER OF U.S. REG. NO. 2,862,123.

NO CLAIM IS MADE TO THE EXCLUSIVE RIGHT TO USE "SELECTIVE EATING, HEALTH AND EXERCISE", APART FROM THE MARK AS SHOWN.

SN 76-669,225, FILED 11-20-2006.

JENNIFER VASQUEZ, EXAMINING ATTORNEY

Int. Cl.: 41

Prior U.S. Cls.: 100, 101, and 107

United States Patent and Trademark Office

Reg. No. 3,477,129

Registered July 29, 2008

**SERVICE MARK
PRINCIPAL REGISTER**



KYAG, LLC (KENTUCKY LTD LIAB CO)
5637 UPPER RIVER ROAD
PROSPECT, KY 40059

FOR: PERSONAL FITNESS TRAINING, IN CLASS
41 (U.S. CLS. 100, 101 AND 107).

FIRST USE 5-14-2008; IN COMMERCE 5-14-2008.

OWNER OF U.S. REG. NO. 2,862,123.

NO CLAIM IS MADE TO THE EXCLUSIVE
RIGHT TO USE "SELECTIVE EATING, EXERCISE"
AND "AWARDS", APART FROM THE MARK AS
SHOWN.

SN 76-669,226, FILED 11-20-2006.

JENNIFER VASQUEZ, EXAMINING ATTORNEY

Int. Cl.: 41

Prior U.S. Cls.: 100, 101, and 107

United States Patent and Trademark Office

Reg. No. 3,477,130

Registered July 29, 2008

**SERVICE MARK
PRINCIPAL REGISTER**



KYAG, LLC (KENTUCKY LTD LIAB CO)
5637 UPPER RIVER ROAD
PROSPECT, KY 40059

NO CLAIM IS MADE TO THE EXCLUSIVE
RIGHT TO USE "SELECTIVE EATING" AND "EX-
ERCISE", APART FROM THE MARK AS SHOWN.

FOR: PERSONAL FITNESS TRAINING, IN CLASS
41 (U.S. CLS. 100, 101 AND 107).

SN 76-669,228, FILED 11-20-2006.

FIRST USE 5-14-2008; IN COMMERCE 5-14-2008.

OWNER OF U.S. REG. NO. 2,862,123.

JENNIFER VASQUEZ, EXAMINING ATTORNEY

Int. Cl.: 41

Prior U.S. Cls.: 100, 101, and 107

United States Patent and Trademark Office

Reg. No. 3,477,131

Registered July 29, 2008

**SERVICE MARK
PRINCIPAL REGISTER**



KYAG, LLC (KENTUCKY LTD LIAB CO)
5637 UPPER RIVER ROAD
PROSPECT, KY 40059

NO CLAIM IS MADE TO THE EXCLUSIVE
RIGHT TO USE "SELECTIVE EATING" AND "EX-
ERCISE", APART FROM THE MARK AS SHOWN.

FOR: PERSONAL FITNESS TRAINING, IN CLASS
41 (U.S. CLS. 100, 101 AND 107).

SN 76-669,229, FILED 11-20-2006.

FIRST USE 5-14-2008; IN COMMERCE 5-14-2008.

OWNER OF U.S. REG. NO. 2,862,123.

JENNIFER VASQUEZ, EXAMINING ATTORNEY

Int. Cl.: 41

Prior U.S. Cls.: 100, 101, and 107

United States Patent and Trademark Office

Reg. No. 3,477,132

Registered July 29, 2008

**SERVICE MARK
PRINCIPAL REGISTER**



KYAG, LLC (KENTUCKY LTD LIAB CO)
5637 UPPER RIVER ROAD
PROSPECT, KY 40059

NO CLAIM IS MADE TO THE EXCLUSIVE
RIGHT TO USE "SELECTIVE EATING" AND "EX-
ERCISE", APART FROM THE MARK AS SHOWN.

FOR: PERSONAL FITNESS TRAINING, IN CLASS
41 (U.S. CLS. 100, 101 AND 107).

SN 76-669,230, FILED 11-20-2006.

FIRST USE 5-14-2008; IN COMMERCE 5-14-2008.

OWNER OF U.S. REG. NO. 2,862,123.

JENNIFER VASQUEZ, EXAMINING ATTORNEY

Int. Cl.: 41

Prior U.S. Cls.: 100, 101, and 107

United States Patent and Trademark Office

Reg. No. 3,477,133

Registered July 29, 2008

**SERVICE MARK
PRINCIPAL REGISTER**



KYAG, LLC (KENTUCKY LTD LIAB CO)
5637 UPPER RIVER ROAD
PROSPECT, KY 40059

NO CLAIM IS MADE TO THE EXCLUSIVE
RIGHT TO USE "SELECTIVE EATING" AND "EX-
ERCISE", APART FROM THE MARK AS SHOWN.

FOR: PERSONAL FITNESS TRAINING, IN CLASS
41 (U.S. CLS. 100, 101 AND 107).

SN 76-669,231, FILED 11-20-2006.

FIRST USE 5-14-2008; IN COMMERCE 5-14-2008.

OWNER OF U.S. REG. NO. 2,862,123.

JENNIFER VASQUEZ, EXAMINING ATTORNEY

Int. Cl.: 45

Prior U.S. Cls.: 100 and 101

United States Patent and Trademark Office

Reg. No. 3,477,134

Registered July 29, 2008

**SERVICE MARK
PRINCIPAL REGISTER**

**YOUR HELP-MATE IN
RESPONDING TO EVERYDAY
SITUATIONS AND PROBLEMS
INVOLVING ORGANIZATIONS**

DOUGLAS, RALPH E. (UNITED STATES INDIVIDUAL)
329 CHERRY HILL BLVD.
CHERRY HILL, NJ 08002

FOR: PROVIDE CONSUMER ADVOCACY SERVICES TO INDIVIDUALS IN DEALING WITH ORGANIZATIONS, INCLUDING SCHOOLS, LOCAL, STATE, AND FEDERAL AGENCIES, UNIONS, CORPORATIONS, NON-PROFITS AND ASSOCIATIONS, IN THE NATURE OF RESEARCHING TOPICS, DEVELOPING BRIEFING PAPERS, DRAFTING LETTERS FOR CLIENT SIGNATURE, ACCOMPANYING CLIENT AND PARTICIPATING AS REQUESTED IN SCHEDULED MEETINGS AND CONFERENCES, AND HAVING DIRECT WRITTEN

AND ORAL COMMUNICATIONS WITH REPRESENTATIVES OF ORGANIZATIONS WHEN DIRECTED BY THE CLIENT, IN CLASS 45 (U.S. CLS. 100 AND 101).

FIRST USE 1-28-2007; IN COMMERCE 1-28-2007.

THE MARK CONSISTS OF STANDARD CHARACTERS WITHOUT CLAIM TO ANY PARTICULAR FONT, STYLE, SIZE, OR COLOR.

SN 76-670,149, FILED 12-7-2006.

ANDREA BUTLER, EXAMINING ATTORNEY

Int. Cl.: 36

Prior U.S. Cls.: 100, 101, and 102

United States Patent and Trademark Office

Reg. No. 3,477,135

Registered July 29, 2008

**SERVICE MARK
PRINCIPAL REGISTER**

TODAY PAY

OASIS OUTSOURCING HOLDINGS, INC. (FLOR-
IDA CORPORATION)
SUITE 300
2054 VISTA PARKWAY
WEST PALM BEACH, FL 33411

FOR: FINANCIAL SERVICES, NAMELY, SHORT
TERM LOANS PROVIDED AS PAYDAY LOAN
ADVANCES, IN CLASS 36 (U.S. CLS. 100, 101 AND
102).

FIRST USE 10-17-2007; IN COMMERCE 10-17-2007.

THE MARK CONSISTS OF STANDARD CHAR-
ACTERS WITHOUT CLAIM TO ANY PARTICULAR
FONT, STYLE, SIZE, OR COLOR.

NO CLAIM IS MADE TO THE EXCLUSIVE
RIGHT TO USE "PAY", APART FROM THE MARK
AS SHOWN.

SN 76-670,360, FILED 12-14-2006.

FLORENTINA BLANDU, EXAMINING ATTORNEY

Int. Cl.: 28

Prior U.S. Cls.: 22, 23, 38, and 50

United States Patent and Trademark Office

Reg. No. 3,477,136

Registered July 29, 2008

**TRADEMARK
PRINCIPAL REGISTER**

TUM-TUMS

MAHAR MANUFACTURING CORP. (CALIFORNIA CORPORATION), DBA FIESTA CONCESSION CORP.,
2834 E. 46TH STREET
VERNON, CA 90058

THE MARK CONSISTS OF STANDARD CHARACTERS WITHOUT CLAIM TO ANY PARTICULAR FONT, STYLE, SIZE, OR COLOR.

FOR: STUFFED PLUSH TOYS, IN CLASS 28 (U.S. CLS. 22, 23, 38 AND 50).

SN 76-670,622, FILED 12-20-2006.

FIRST USE 5-7-2007; IN COMMERCE 5-7-2007.

KATHLEEN LORENZO, EXAMINING ATTORNEY

Int. Cl.: 14

Prior U.S. Cls.: 2, 27, 28, and 50

United States Patent and Trademark Office

Reg. No. 3,477,137

Registered July 29, 2008

TRADEMARK
PRINCIPAL REGISTER

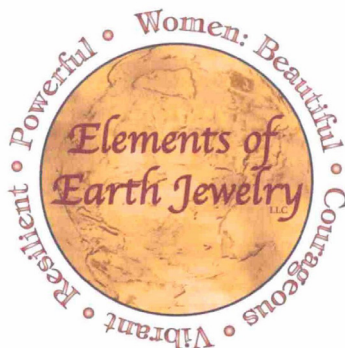

EARTH O ROWE (NEW YORK LTD LIAB CO)
656 EAST 37TH STREET
BROOKLYN, NY 11203

FOR: JEWELRY, IN CLASS 14 (U.S. CLS. 2, 27, 28 AND 50).

FIRST USE 11-14-2007; IN COMMERCE 11-14-2007.

NO CLAIM IS MADE TO THE EXCLUSIVE RIGHT TO USE "JEWELRY" , APART FROM THE MARK AS SHOWN.

THE COLOR(S) BURGUNDY AND VARIEGATED GOLD IS/ARE CLAIMED AS A FEATURE OF THE MARK.

THE COLOR BURGUNDY APPEARS IN THE WORDING "ELEMENTS OF EARTH JEWELRY WOMEN: BEAUTIFUL", "COURAGEOUS", "VIBRANT", "RESILIENT", "POWERFUL" AND IN THE OUTLINE OF THE CIRCLE. THE COLOR VARIEGATED GOLD APPEARS IN THE SHADING OF THE CIRCLE DESIGN.

SN 76-670,997, FILED 1-3-2007.

ALLISON HOLTZ, EXAMINING ATTORNEY

Int. Cl.: 16

Prior U.S. Cls.: 2, 5, 22, 23, 29, 37, 38, and 50

United States Patent and Trademark Office

Reg. No. 3,477,138

Registered July 29, 2008

**TRADEMARK
PRINCIPAL REGISTER**

SOLVING CROSSWORDS
SCALAWAG
A LAUGH•A WAY•A GAME

KREISSMAN, BERN (UNITED STATES INDIVIDUAL)
926 PLUM LANE
DAVIS, CA 95616

NO CLAIM IS MADE TO THE EXCLUSIVE RIGHT TO USE "CROSSWORDS" AND "GAME", APART FROM THE MARK AS SHOWN.

FOR: CROSSWORD PUZZLES, IN CLASS 16 (U.S. CLS. 2, 5, 22, 23, 29, 37, 38 AND 50).

SN 76-671,387, FILED 1-16-2007.

FIRST USE 9-30-2005; IN COMMERCE 9-30-2005.

KIMBERLY PERRY, EXAMINING ATTORNEY

Int. Cl.: 15

Prior U.S. Cls.: 2, 21, and 36

United States Patent and Trademark Office

Reg. No. 3,477,139

Registered July 29, 2008

**TRADEMARK
PRINCIPAL REGISTER**

HEXRACK

YAMAHA CORPORATION (JAPAN CORPORATION)
10-1, NAKAZAWA-CHO
HAMAMATSU-SHI
SHIZUOKA 430, JAPAN

FOR: DRUMS AND PERCUSSION INSTRUMENTS AND STRUCTURAL PARTS THEREFOR AND RACKS FOR DRUMS, IN CLASS 15 (U.S. CLS. 2, 21 AND 36).

FIRST USE 4-16-2008; IN COMMERCE 4-16-2008.

THE MARK CONSISTS OF STANDARD CHARACTERS WITHOUT CLAIM TO ANY PARTICULAR FONT, STYLE, SIZE, OR COLOR.

SN 76-671,438, FILED 1-16-2007.

CHARLES L. JENKINS, EXAMINING ATTORNEY

Int. Cl.: 36

Prior U.S. Cls.: 100, 101, and 102

United States Patent and Trademark Office

Reg. No. 3,477,140

Registered July 29, 2008

**SERVICE MARK
PRINCIPAL REGISTER**

COREFIRST BANK & TRUST

COREFIRST BANK & TRUST (KANSAS CORPORATION)
3035 SOUTH TOPEKA BLVD.
TOPEKA, KS 66611

FOR: FINANCIAL AND BANKING SERVICES, NAMELY, ACCOUNTS RECEIVABLE FINANCING; EQUIPMENT FINANCING SERVICES; FACILITATING AND ARRANGING FOR THE FINANCING OF COMMERCIAL LOANS, AGRICULTURAL LOANS, REAL ESTATE SECURED LOANS AND PERSONAL LOANS; FINANCIAL ANALYSIS AND CONSULTATION; FINANCIAL FORECASTING; FINANCIAL GUARANTY AND SURETY; FINANCIAL INFORMATION PROVIDED BY ELECTRONIC MEANS; FINANCIAL INFORMATION PROCESSING; FINANCIAL INVESTMENT IN THE FIELD OF SECURITIES, FINANCIAL MANAGEMENT; FINANCIAL PLANNING; FINANCIAL PORTFOLIO MANAGEMENT; FINANCIAL SERVICES IN THE NATURE OF INVESTMENT SECURITY; FINANCIAL SERVICES IN THE FIELD OF MONEY LENDING; FINANCING SERVICES, NAMELY, LEASE PURCHASE FINANCING AND LOAN FINANCING; SOLICITA-

TION AND ARRANGEMENT OF DEMAND DEPOSITS, SAVINGS DEPOSITS, INVESTMENT RETIREMENT ACCOUNTS, TIME DEPOSITS AND TERM INVESTMENTS, AND REPURCHASE AGREEMENTS; AND FACILITATION AND ARRANGEMENT OF CASH MANAGEMENT SERVICES FIRST USE ANYWHERE DATE 09, IN CLASS 36 (U.S. CLS. 100, 101 AND 102).

FIRST USE 9-4-2007; IN COMMERCE 5-21-2008.

THE MARK CONSISTS OF STANDARD CHARACTERS WITHOUT CLAIM TO ANY PARTICULAR FONT, STYLE, SIZE, OR COLOR.

NO CLAIM IS MADE TO THE EXCLUSIVE RIGHT TO USE "BANK & TRUST", APART FROM THE MARK AS SHOWN.

SN 76-671,794, FILED 1-25-2007.

INGRID C. EULIN, EXAMINING ATTORNEY

Int. Cl.: 28

Prior U.S. Cls.: 22, 23, 38, and 50

United States Patent and Trademark Office

Reg. No. 3,477,141

Registered July 29, 2008

**TRADEMARK
PRINCIPAL REGISTER**



GRAND DIRECT INTERNATIONAL LIMITED
(BR.VIRGIN ISLANDS CORPORATION)
P.O. BOX 957
OFFSHORE INCORPORATIONS CENTRE, ROAD
TOWNWN
TORTOLA, BR.VIRGIN ISLANDS

FOR: TOYS, GAMES AND PLAYTHINGS, NAME-
LY, TOY VEHICLES, TOY VEHICLE TRUCK SETS,
TOY VEHICLE PLAYSETS, TOY LOCOMOTIVES,
TOY CARS, TOY TRUCKS, TOY MOTORCYCLES,
TOY BICYCLES AND TRICYCLES; TOY AERO-
PLANES, AIRCRAFT AND SPACE CRAFT; TOY

VESSELS, SHIPS AND BOATS; TOY FIGURES; TOY
ANIMALS; TOY BUILDINGS AND FIXTURES;
THREE-DIMENSIONAL PLAYSETS DEPICTING
SCENES AND SCENERY; PLAYSETS COMPRISING
ONE OR MORE OF THESE ITEMS, IN CLASS 28 (U.S.
CLS. 22, 23, 38 AND 50).

FIRST USE 4-15-2007; IN COMMERCE 4-15-2007.

SN 76-671,974, FILED 1-29-2007.

SHARON MEIER, EXAMINING ATTORNEY

Int. Cl.: 11

Prior U.S. Cls.: 13, 21, 23, 31, and 34

Reg. No. 3,477,142

United States Patent and Trademark Office

Registered July 29, 2008

**TRADEMARK
PRINCIPAL REGISTER**

SMART_{du}O

WITTBOLD, EDWARD H. (UNITED STATES IN-
DIVIDUAL)
19203 SKYRIDGE CIRCLE
BOCA RATON, FL 33498

FOR: TEMPERATURE CONTROLLED DRINK-
ING WATER DISPENSERS, WATER FOUNTAINS
AND WATER COOLERS, ALL WITH MEANS FOR

DISPENSING SUPPLEMENTAL DIETARY ADDI-
TIVES, IN CLASS 11 (U.S. CLS. 13, 21, 23, 31 AND 34).

FIRST USE 1-15-2008; IN COMMERCE 1-15-2008.

SN 76-673,109, FILED 2-23-2007.

WILLIAM VERHOSEK, EXAMINING ATTORNEY

Int. Cls.: 36 and 37

Prior U.S. Cls.: 100, 101, 102, 103, and 106

United States Patent and Trademark Office

Reg. No. 3,477,143

Registered July 29, 2008

**SERVICE MARK
PRINCIPAL REGISTER**

LENNAR

LENNAR PACIFIC PROPERTIES MANAGEMENT, INC. (DELAWARE CORPORATION)
700 N.W. 107TH AVENUE
MIAMI, FL 33172

FOR: REAL ESTATE LISTING SERVICES; REAL ESTATE MANAGEMENT, NAMELY, THE OPERATION, MAINTENANCE, BROKERAGE, AND RENTAL OF MID AND HIGH-RISE CONDOMINIUM PROPERTIES FOR BOTH RESIDENTIAL, BUSINESS, AND RETAIL USE, IN CLASS 36 (U.S. CLS. 100, 101 AND 102).

FIRST USE 3-0-2006; IN COMMERCE 11-0-2006.

FOR: REAL ESTATE DEVELOPMENT OF MID AND HIGH-RISE BUILDINGS FOR BOTH RESIDENTIAL, BUSINESS, AND RETAIL USE, NAMELY, CONSTRUCTION CONSULTING IN THE NATURE OF SITE SELECTION AND CONSTRUCTION PLANNING; CONSTRUCTION MANAGEMENT AND SUPERVISION; AND

CONSTRUCTION SERVICES, NAMELY, PLANNING, LAYING OUT AND CUSTOM CONSTRUCTION OF MID AND HIGH-RISE PROPERTIES, IN CLASS 37 (U.S. CLS. 100, 103 AND 106).

FIRST USE 3-0-2006; IN COMMERCE 11-0-2006.

THE MARK CONSISTS OF STANDARD CHARACTERS WITHOUT CLAIM TO ANY PARTICULAR FONT, STYLE, SIZE, OR COLOR.

OWNER OF U.S. REG. NOS. 2,606,292, 2,689,911, AND 3,108,401.

SEC. 2(F).

SN 76-673,170, FILED 2-26-2007.

JENNIFER VASQUEZ, EXAMINING ATTORNEY

Int. Cl.: 25

Prior U.S. Cls.: 22 and 39

United States Patent and Trademark Office

Reg. No. 3,477,144

Registered July 29, 2008

**TRADEMARK
PRINCIPAL REGISTER**

AIR ★ PORT

DC HOLDING CORP. (NEW YORK CORPORATION)
1400 BROADWAY
NEW YORK, NY 10018

FOR: MEN'S SPORTSWEAR, NAMELY, SWEATERS, SHIRTS, SHORTS AND PANTS, IN CLASS 25 (U.S. CLS. 22 AND 39).

FIRST USE 5-2-2008; IN COMMERCE 5-2-2008.

OWNER OF U.S. REG. NO. 1,336,847.

SN 76-673,566, FILED 3-5-2007.

PRISCILLA MILTON, EXAMINING ATTORNEY

Int. Cl.: 35

Prior U.S. Cls.: 100, 101, and 102

United States Patent and Trademark Office

Reg. No. 3,477,145

Registered July 29, 2008

**SERVICE MARK
PRINCIPAL REGISTER**

ORDER & GO

WALGREEN CO. (ILLINOIS CORPORATION)
200 WILMOT ROAD
DEERFIELD, IL 60015

THE MARK CONSISTS OF STANDARD CHAR-
ACTERS WITHOUT CLAIM TO ANY PARTICULAR
FONT, STYLE, SIZE, OR COLOR.

FOR: RETAIL PHARMACY SERVICES, IN CLASS
35 (U.S. CLS. 100, 101 AND 102).

SN 76-673,780, FILED 3-6-2007.

FIRST USE 5-31-2007; IN COMMERCE 5-31-2007.

JENNIFER MARTIN, EXAMINING ATTORNEY

Int. Cls.: 18 and 25

Prior U.S. Cls.: 1, 2, 3, 22, 39, and 41

United States Patent and Trademark Office

Reg. No. 3,477,146

Registered July 29, 2008

TRADEMARK
PRINCIPAL REGISTER

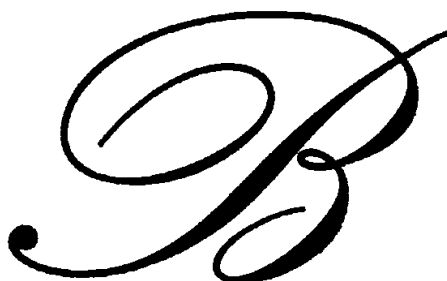

BLUFIN S.P.A. (ITALY LIMITED COMPANY)
VIA G. FERRARIS 13, 15, 15/A
CARPI, ITALY 1-41012

FOR: ALL PURPOSE SPORT BAGS; HANDBAGS; SUITCASES; BACKPACKS; WALLETS; PURSES; BRIEFCASES; DOCUMENT HOLDERS MADE OF SKIN, HIDE AND IMITATION LEATHER; MEN'S HANDBAGS; TRUNKS; ANIMAL SKINS AND HIDES; ARTICLES OF SKIN OR HIDE, NAMELY, LEATHER KEY CASES; PARASOLS; BEACH UMBRELLAS; AND WALKING CANES, IN CLASS 18 (U.S. CLS. 1, 2, 3, 22 AND 41).

FIRST USE 3-23-1986; IN COMMERCE 6-18-1987.

FOR: CLOTHING FOR MEN, WOMEN AND CHILDREN, NAMELY, DRESSES AND SHORTS, SHIRTS; CHEMISETTES; SKIRTS; LADIES' SUITS;

JACKETS; TROUSERS; SHORT TROUSERS; SWEATERS; WOOLEN CLOTHING, NAMELY, COATS; PAJAMAS; STOCKINGS; SLEEVELESS T-SHIRTS; CORSETS; SOCK SUSPENDERS; BRIEFS; BRASSIERES; UNDERWEAR; HATS; SCARVES; NECKTIES; RAINCOATS; OVERCOATS; COATS; BATHING SUITS; SPORTS SUITS; WIND RESISTANT JACKETS; SKI PANTS; BELTS; PELISSES; SASHES FOR WEAR; GLOVES; DRESSING GOWNS; FOOTWEAR IN GENERAL, NAMELY, SLIPPERS, SHOES, SPORTS SHOES, BOOTS AND SANDALS, IN CLASS 25 (U.S. CLS. 22 AND 39).

FIRST USE 3-23-1986; IN COMMERCE 6-18-1987.

SN 76-673,876, FILED 3-9-2007.

DEIRDRE ROBERTSON, EXAMINING ATTORNEY

Int. Cls.: 9, 18, and 25

Prior U.S. Cls.: 1, 2, 3, 21, 22, 23, 26, 36, 38, 39, and 41

United States Patent and Trademark Office

Reg. No. 3,477,147

Registered July 29, 2008

**TRADEMARK
PRINCIPAL REGISTER**



ATOMIC PROPS AND EFFECTS LIMITED LLC
(MINNESOTA LTD LIAB CO)

895 HALE AVENUE
ST. PAUL, MN 55128

FOR: WOMEN'S FASHION ACCESSORIES,
NAMELY, CELL PHONE HOLDERS AND SUN-
GLASSES, IN CLASS 9 (U.S. CLS. 21, 23, 26, 36 AND
38).

FIRST USE 8-15-2007; IN COMMERCE 8-15-2007.

FOR: WOMEN'S FASHION ACCESSORIES,
NAMELY, PURSES AND WALLETS, IN CLASS 18
(U.S. CLS. 1, 2, 3, 22 AND 41).

FIRST USE 8-15-2007; IN COMMERCE 8-15-2007.

FOR: WOMEN'S FASHION ACCESSORIES,
NAMELY, SCARVES, HATS, SHIRTS, BELTS AND
PANTS, IN CLASS 25 (U.S. CLS. 22 AND 39).

FIRST USE 8-15-2007; IN COMMERCE 8-15-2007.

THE COLOR(S) BLACK, RED AND WHITE IS/
ARE CLAIMED AS A FEATURE OF THE MARK.

THE BACKGROUND INCLUDING THE TWO
BARS ABOVE AND BELOW ARE SHOWN IN THE
COLOR BLACK, THE "R" IS SHOWN IN THE
COLOR RED AND THE REMAINDER OF THE
MARK IS SHOWN IN THE COLOR WHITE.

SN 76-674,157, FILED 3-16-2007.

RONALD MCMORROW, EXAMINING ATTORNEY

Int. Cl.: 44

Prior U.S. Cls.: 100 and 101

United States Patent and Trademark Office

Reg. No. 3,477,148

Registered July 29, 2008

**SERVICE MARK
PRINCIPAL REGISTER**

AlphaCell

FRANCO, WAYNE P. (UNITED STATES INDIVIDUAL)
500 COLD SPRING ROAD, E217
ROCKY HILL, CT 06067

FOR: PROVIDING MEDICAL SERVICES, NAMELY, THE TREATMENT OF A VARIETY OF DISEASED ORGANS THROUGH THE USE OF HUMAN, BIOLOGICAL AND BIOMEDICAL GROWTH FACTORS AND STEM CELLS TO PROMOTE THE SURVIVAL OF CELLS, IN CLASS 44 (U.S. CLS. 100 AND 101).

FIRST USE 8-1-2007; IN COMMERCE 8-1-2007.

THE MARK CONSISTS OF STANDARD CHARACTERS WITHOUT CLAIM TO ANY PARTICULAR FONT, STYLE, SIZE, OR COLOR.

SN 76-674,312, FILED 3-20-2007.

MARGERY A. TIERNEY, EXAMINING ATTORNEY

Int. Cl.: 5

Prior U.S. Cls.: 6, 18, 44, 46, 51, and 52

United States Patent and Trademark Office

Reg. No. 3,477,149

Registered July 29, 2008

**TRADEMARK
PRINCIPAL REGISTER**

CITRACURE

THEODORE O. MANDISH, LLC (FLORIDA LTD
LIAB CO)
5055 STATE ROAD 46
MIMS, FL 32754

FOR: MEDICATED SKIN CARE PREPARATIONS,
NAMELY, ORGANIC ANTI-BACTERIAL AND
ANTI-FUNGAL COMPOUNDS DESIGNED TO SUP-
PORT HEALTHY SKIN, IN CLASS 5 (U.S. CLS. 6, 18,
44, 46, 51 AND 52).

FIRST USE 4-1-2007; IN COMMERCE 4-1-2007.

THE MARK CONSISTS OF STANDARD CHAR-
ACTERS WITHOUT CLAIM TO ANY PARTICULAR
FONT, STYLE, SIZE, OR COLOR.

SN 76-674,595, FILED 3-26-2007.

BARBARA GAYNOR, EXAMINING ATTORNEY

Int. Cl.: 25

Prior U.S. Cls.: 22 and 39

United States Patent and Trademark Office

Reg. No. 3,477,150

Registered July 29, 2008

**TRADEMARK
PRINCIPAL REGISTER**

FROGDOG INTERNATIONAL

THE GEORGE B. PATTERSON GROUP, INC.
(PENNSYLVANIA CORPORATION)
311 MYRTLE LANE
SEWICKLEY, PA 15143

FOR: CLOTHING, NAMELY, SHIRTS, SHORTS,
PANTS, SWEATSHIRTS, SWEATPANTS, HATS,
JACKETS, BELTS, BANDANAS, IN CLASS 25 (U.S.
CLS. 22 AND 39).

FIRST USE 1-20-2007; IN COMMERCE 3-1-2007.

THE MARK CONSISTS OF STANDARD CHAR-
ACTERS WITHOUT CLAIM TO ANY PARTICULAR
FONT, STYLE, SIZE, OR COLOR.

NO CLAIM IS MADE TO THE EXCLUSIVE
RIGHT TO USE "INTERNATIONAL", APART
FROM THE MARK AS SHOWN.

SN 76-674,764, FILED 3-29-2007.

MICHAEL TANNER, EXAMINING ATTORNEY

Int. Cl.: 35

Prior U.S. Cls.: 100, 101, and 102

United States Patent and Trademark Office

Reg. No. 3,477,151

Registered July 29, 2008

**SERVICE MARK
PRINCIPAL REGISTER**

KINGS ROAD BOUTIQUE

HRP CREATIVE SERVICES CO., LLC (FLORIDA
LTD LIAB CO)
200 EAST ROBINSON STREET, SUITE 510
ORLANDO, FL 32801

FOR: RETAIL STORE SERVICES FEATURING
COLLECTIBLES AND MEMORABILIA, IN CLASS 35
(U.S. CLS. 100, 101 AND 102).

FIRST USE 10-15-2007; IN COMMERCE 10-15-2007.

THE MARK CONSISTS OF STANDARD CHAR-
ACTERS WITHOUT CLAIM TO ANY PARTICULAR
FONT, STYLE, SIZE, OR COLOR.

NO CLAIM IS MADE TO THE EXCLUSIVE
RIGHT TO USE "BOUTIQUE", APART FROM THE
MARK AS SHOWN.

SN 76-675,205, FILED 4-9-2007.

RAUL CORDOVA, EXAMINING ATTORNEY

Int. Cl.: 9

Prior U.S. Cls.: 21, 23, 26, 36, and 38

United States Patent and Trademark Office

Reg. No. 3,477,152

Registered July 29, 2008

**TRADEMARK
PRINCIPAL REGISTER**

COSMIQUA

LINOTYPE GMBH (FED REP GERMANY LTD
LIAB CO)
DU-PONT-STRASSE 1
61352 BAD HOMBURG, FED REP GERMANY

THE MARK CONSISTS OF STANDARD CHAR-
ACTERS WITHOUT CLAIM TO ANY PARTICULAR
FONT, STYLE, SIZE, OR COLOR.

FOR: COMPUTER SOFTWARE FOR GENERAT-
ING TYPEFACE DESIGNS AND ORNAMENTAL
DESIGNS, IN CLASS 9 (U.S. CLS. 21, 23, 26, 36 AND
38).

SN 76-675,602, FILED 4-17-2007.

FIRST USE 5-0-2008; IN COMMERCE 5-0-2008.

GRETTA YAO, EXAMINING ATTORNEY

Int. Cl.: 7

Prior U.S. Cls.: 13, 19, 21, 23, 31, 34, and 35

United States Patent and Trademark Office

Reg. No. 3,477,153

Registered July 29, 2008

**TRADEMARK
PRINCIPAL REGISTER**

LRW

NOVELLUS SYSTEMS, INC. (CALIFORNIA CORPORATION)
4000 NORTH FIRST STREET
SAN JOSE, CA 951341568

FOR: MACHINES FOR MANUFACTURING SEMICONDUCTORS, AND PARTS FOR SUCH MACHINES, IN CLASS 7 (U.S. CLS. 13, 19, 21, 23, 31, 34 AND 35).

FIRST USE 2-25-2008; IN COMMERCE 2-25-2008.

THE MARK CONSISTS OF STANDARD CHARACTERS WITHOUT CLAIM TO ANY PARTICULAR FONT, STYLE, SIZE, OR COLOR.

SN 76-675,642, FILED 4-18-2007.

WILLIAM BRECKENFELD, EXAMINING ATTORNEY

Int. Cl.: 6

Prior U.S. Cls.: 2, 12, 13, 14, 23, 25, and 50

Reg. No. 3,477,154

United States Patent and Trademark Office

Registered July 29, 2008

**TRADEMARK
PRINCIPAL REGISTER**

FLUXCOAT

ESPRIX TECHNOLOGIES, L.P. (DELAWARE
LIMITED PARTNERSHIP), DBA ESPRIX
TECHNOLOGIES,
7680 MATOAKA ROAD
SARASOTA, FL 34243

THE MARK CONSISTS OF STANDARD CHAR-
ACTERS WITHOUT CLAIM TO ANY PARTICULAR
FONT, STYLE, SIZE, OR COLOR.

FOR: ALUMINUM COATING USED IN THE
MANUFACTURE OF HEAT EXCHANGERS, IN
CLASS 6 (U.S. CLS. 2, 12, 13, 14, 23, 25 AND 50).

SN 76-675,690, FILED 4-18-2007.

FIRST USE 4-30-2007; IN COMMERCE 4-30-2007.

SHAUNIA CARLYLE, EXAMINING ATTORNEY

Int. Cl.: 16

Prior U.S. Cls.: 2, 5, 22, 23, 29, 37, 38, and 50

United States Patent and Trademark Office

Reg. No. 3,477,155

Registered July 29, 2008

**TRADEMARK
PRINCIPAL REGISTER**

GIFTELOPE

SCHLUGER, ALLEN (UNITED STATES INDIVIDUAL)
21 WEST 68TH STREET
NEW YORK, NY 10023

THE MARK CONSISTS OF STANDARD CHARACTERS WITHOUT CLAIM TO ANY PARTICULAR FONT, STYLE, SIZE, OR COLOR.

FOR: STATIONERY AND GREETING CARDS, IN CLASS 16 (U.S. CLS. 2, 5, 22, 23, 29, 37, 38 AND 50).

SN 76-675,745, FILED 4-19-2007.

FIRST USE 4-15-2007; IN COMMERCE 4-15-2007.

GIANCARLO CASTRO, EXAMINING ATTORNEY

Int. Cl.: 9

Prior U.S. Cls.: 21, 23, 26, 36, and 38

United States Patent and Trademark Office

Reg. No. 3,477,156

Registered July 29, 2008

**TRADEMARK
PRINCIPAL REGISTER**

iTEST

MCAR MANAGEMENT LLC (NEW YORK LTD
LIAB CO)
15 HARBOR PARK DRIVE
PORT WASHINGTON, NY 11050

FIRST USE 10-1-2007; IN COMMERCE 10-1-2007.

SN 76-675,774, FILED 4-20-2007.

FOR: ELECTRONIC COUNTERFEIT MONEY DE-
TECTORS, IN CLASS 9 (U.S. CLS. 21, 23, 26, 36 AND
38).

ODESSA BIBBINS, EXAMINING ATTORNEY

Int. Cl.: 20

Prior U.S. Cls.: 2, 13, 22, 25, 32, and 50

United States Patent and Trademark Office

Reg. No. 3,477,157

Registered July 29, 2008

**TRADEMARK
PRINCIPAL REGISTER**

BUILD ON IT

BERCO INDUSTRIES, INC. (MISSOURI CORPORATION)
1120 MONTROSE AVE.
ST. LOUIS, MO 63104

THE MARK CONSISTS OF STANDARD CHARACTERS WITHOUT CLAIM TO ANY PARTICULAR FONT, STYLE, SIZE, OR COLOR.

FOR: TABLES, IN CLASS 20 (U.S. CLS. 2, 13, 22, 25, 32 AND 50).

SN 76-676,262, FILED 4-30-2007.

FIRST USE 6-13-2007; IN COMMERCE 7-30-2007.

EMILY CARLSEN, EXAMINING ATTORNEY

Int. Cl.: 42

Prior U.S. Cls.: 100 and 101

United States Patent and Trademark Office

Reg. No. 3,477,158

Registered July 29, 2008

**SERVICE MARK
PRINCIPAL REGISTER**

CREDO

CREDO CONSULTING ENGINEERS, LLC
(FLORIDA LTD LIAB CO)
13375 NW 11TH PLACE
SUNRISE, FL 33323

THE MARK CONSISTS OF STANDARD CHARACTERS WITHOUT CLAIM TO ANY PARTICULAR FONT, STYLE, SIZE, OR COLOR.

FOR: ENGINEERING DESIGN AND CONSULTING SERVICES, IN CLASS 42 (U.S. CLS. 100 AND 101).

SN 76-676,542, FILED 5-8-2007.

FIRST USE 6-10-2008; IN COMMERCE 6-10-2008.

TINA BROWN, EXAMINING ATTORNEY

Int. Cls.: 18, 20, and 28

Prior U.S. Cls.: 1, 2, 3, 13, 22, 23, 25, 32, 38, 41, and 50

United States Patent and Trademark Office

Reg. No. 3,477,159

Registered July 29, 2008

**TRADEMARK
PRINCIPAL REGISTER**



INGLE, COLE & COMPANY, LLC (TEXAS LTD
LIAB CO)
3201 NORTH SYLVANIA AVENUE
BUILDING 100D
FORT WORTH, TX 70111

FOR: LUGGAGE TAGS, IN CLASS 18 (U.S. CLS. 1,
2, 3, 22 AND 41).

FIRST USE 9-19-2007; IN COMMERCE 9-19-2007.

FOR: PLASTIC HANG TAGS, IN CLASS 20 (U.S.
CLS. 2, 13, 22, 25, 32 AND 50).

FIRST USE 9-19-2007; IN COMMERCE 9-19-2007.

FOR: GOLF BAG TAGS, IN CLASS 28 (U.S. CLS. 22,
23, 38 AND 50).

FIRST USE 9-19-2007; IN COMMERCE 9-19-2007.

SN 76-676,879, FILED 5-15-2007.

LOURDES AYALA, EXAMINING ATTORNEY

Int. Cls.: 8 and 21

Prior U.S. Cls.: 2, 13, 23, 28, 29, 30, 33, 40, 44, and 50

United States Patent and Trademark Office

Reg. No. 3,477,160

Registered July 29, 2008

**TRADEMARK
PRINCIPAL REGISTER**

**FIRST IMPRESSIONS
CREATES LASTING MEMORIES**

SABERT CORPORATION (NEW JERSEY CORPORATION)
879-899 MAIN STREET
SAYREVILLE, NJ 08872

FOR: CUTLERY, NAMELY, FORKS, SPOONS AND KNIVES; CAKE CUTTERS; SPREADER KNIVES, IN CLASS 8 (U.S. CLS. 23, 28 AND 44).

FIRST USE 3-0-2006; IN COMMERCE 3-0-2006.

FOR: PLASTIC FOOD CONTAINERS OF ALL KINDS, NAMELY, SERVING TRAYS, PLATTERS, PLASTIC EATING PLATES, BOWLS, AND LIDS RELATED THERETO, SOLD AS A UNIT FOR FOOD SERVICE; PLASTIC SERVING UTENSILS, NAME-

LY, SERVING FORKS; SERVING SPOONS AND SERVING TONGS; CUPS, SERVING SPREADERS, AND ICE BUCKETS, IN CLASS 21 (U.S. CLS. 2, 13, 23, 29, 30, 33, 40 AND 50).

FIRST USE 3-0-2006; IN COMMERCE 3-0-2006.

THE MARK CONSISTS OF STANDARD CHARACTERS WITHOUT CLAIM TO ANY PARTICULAR FONT, STYLE, SIZE, OR COLOR.

SN 76-677,317, FILED 5-23-2007.

MICHAEL LITZAU, EXAMINING ATTORNEY

Int. Cl.: 18

Prior U.S. Cls.: 1, 2, 3, 22, and 41

United States Patent and Trademark Office

Reg. No. 3,477,161

Registered July 29, 2008

**TRADEMARK
PRINCIPAL REGISTER**

J★TECH

STEADY FLYING ENTERPRISE CO., LTD. (TAI-
WAN CORPORATION)
NO. 235, TA YOU ROAD
TAIPEI, TAIWAN

FOR: ALL-PURPOSE SPORT BAGS, ALL-PUR-
POSE CARRYING BAGS, ATHLETIC BAGS, EQUIP-
MENT CARRYING BAGS, BACKPACKS,
BANDOLIERS, BELT BAGS, BUTT PACKS, BAGS
FOR UMBRELLAS, FANNY PACKS, WAIST PACKS,
SPORTS PACKS, HARNESS FITTINGS, HARNESS

STRAPS, HARNESSES, HIKING BAGS, SHOULDER
STRAPS, LEATHER STRAPS, STRAPS FOR BAGS
AND PACKS, SLING BAGS, IN CLASS 18 (U.S. CLS.
1, 2, 3, 22 AND 41).

FIRST USE 4-10-2006; IN COMMERCE 3-4-2008.

SN 76-677,436, FILED 5-25-2007.

BRIAN CALLAGHAN, EXAMINING ATTORNEY

Int. Cl.: 30

Prior U.S. Cl.: 46

United States Patent and Trademark Office

Reg. No. 3,477,162

Registered July 29, 2008

**TRADEMARK
PRINCIPAL REGISTER**

Focolate

BURKE, DOUGLAS (UNITED STATES INDIVIDUAL)
2507 PORT WHITBY
NEWPORT BEACH, CA 92660

FOR: CHOCOLATE CANDIES INCLUDING CHOCOLATE CANDY BARS; BITE SIZED WRAPPED CANDY; CANDY IN BOXES, CHOCOLATE CHIPS, CHOCOLATE COVERED NUTS, CHOCOLATE COVERED RAISINS, CHOCOLATE FONDUE, CHOCOLATE FOOD BEVERAGES NOT BEING DAIRY-BASED OR VEGETABLE BASED , CHOCOLATE MOUSSE, CHOCOLATE PASTES, CHOCOLATE POWDER, CHOCOLATE SYRUP, CHOCOLATE TOPPING , CHOCOLATE TRUFFLES, CHOCO-

LATE-BASED FILLINGS FOR CAKES AND PIES, CHOCOLATE-BASED READY-TO-EAT FOOD BARS, CHOCOLATE-COVERED POTATO CHIPS, IN CLASS 30 (U.S. CL. 46).

FIRST USE 12-1-2007; IN COMMERCE 12-1-2007.

THE MARK CONSISTS OF STANDARD CHARACTERS WITHOUT CLAIM TO ANY PARTICULAR FONT, STYLE, SIZE, OR COLOR.

SN 76-678,149, FILED 6-13-2007.

ODESSA BIBBINS, EXAMINING ATTORNEY

Int. Cl.: 35

Prior U.S. Cls.: 100, 101, and 102

United States Patent and Trademark Office

Reg. No. 3,477,163

Registered July 29, 2008

**SERVICE MARK
PRINCIPAL REGISTER**

DIVERSITY ONE

RADIO ONE, INC. (DELAWARE CORPORATION)
5900 PRINCESS GARDEN PARKWAY - 7TH FLOOR
LANHAM, MD 20706

FOR: PROVIDING AN ON-LINE SEARCHABLE DATABASE FEATURING CLASSIFIED AD LISTINGS AND EMPLOYMENT OPPORTUNITIES; AND BUSINESS INFORMATION SERVICES IN THE NATURE OF PROVIDING INFORMATION ON BUSINESS OPPORTUNITIES, IN CLASS 35 (U.S. CLS. 100, 101 AND 102).

FIRST USE 5-7-2008; IN COMMERCE 5-7-2008.

THE MARK CONSISTS OF STANDARD CHARACTERS WITHOUT CLAIM TO ANY PARTICULAR FONT, STYLE, SIZE, OR COLOR.

SN 76-678,384, FILED 6-18-2007.

AHSEN KHAN, EXAMINING ATTORNEY

Int. Cl.: 20

Prior U.S. Cls.: 2, 13, 22, 25, 32, and 50

Reg. No. 3,477,164

United States Patent and Trademark Office

Registered July 29, 2008

**TRADEMARK
PRINCIPAL REGISTER**

SAVING AMERICA'S WATER

CHANNELL COMMERCIAL CORPORATION
(DELAWARE CORPORATION)
76040 YNEZ ROAD
P.O. BOX 9022
TEMECULA, CA 925899022

FIRST USE 5-12-2008; IN COMMERCE 5-12-2006.

THE MARK CONSISTS OF STANDARD CHARACTERS WITHOUT CLAIM TO ANY PARTICULAR FONT, STYLE, SIZE, OR COLOR.

SN 76-678,454, FILED 6-20-2007.

FOR: POLYETHYLENE TANKS, NAMELY, RAINWATER STORAGE TANKS, MOLASSES TANKS, TRANSPORTER TANKS, BELLY TANKS; OTHER POLYETHYLENE PRODUCTS, NAMELY, GRADE LEVEL BOXES, VAULTS, AND HAND HOLES, IN CLASS 20 (U.S. CLS. 2, 13, 22, 25, 32 AND 50).

GIANCARLO CASTRO, EXAMINING ATTORNEY

Int. Cl.: 36

Prior U.S. Cls.: 100, 101, and 102

United States Patent and Trademark Office

Reg. No. 3,477,165

Registered July 29, 2008

**SERVICE MARK
PRINCIPAL REGISTER**

NWL LIFETIME RETURNS SELECT

NATIONAL WESTERN LIFE INSURANCE COM-
PANY (COLORADO CORPORATION)
850 EAST ANDERSON LANE
AUSTIN, TX 787521602

OWNER OF U.S. REG. NO. 3,171,953 AND OTH-
ERS.

FOR: LIFE INSURANCE UNDERWRITING SER-
VICES, IN CLASS 36 (U.S. CLS. 100, 101 AND 102).

NO CLAIM IS MADE TO THE EXCLUSIVE
RIGHT TO USE "LIFETIME RETURNS SELECT",
APART FROM THE MARK AS SHOWN.

FIRST USE 11-0-2007; IN COMMERCE 11-26-2007.

SN 76-679,418, FILED 7-12-2007.

THE MARK CONSISTS OF STANDARD CHAR-
ACTERS WITHOUT CLAIM TO ANY PARTICULAR
FONT, STYLE, SIZE, OR COLOR.

KAREN K. BUSH, EXAMINING ATTORNEY

Int. Cl.: 37

Prior U.S. Cls.: 100, 103, and 106

United States Patent and Trademark Office

Reg. No. 3,477,166

Registered July 29, 2008

**SERVICE MARK
PRINCIPAL REGISTER**

“Others sell parts, WE SELL SUPPORT”

PRECISION AVIATION GROUP (GEORGIA CORPORATION)
BUILDING 800G
495 LAKE MIRROR ROAD BUILDING 800G
ATLANTA, GA 30349

THE MARK CONSISTS OF STANDARD CHARACTERS WITHOUT CLAIM TO ANY PARTICULAR FONT, STYLE, SIZE, OR COLOR.

FOR: REPAIR AND MAINTENANCE OF AIRCRAFT, IN CLASS 37 (U.S. CLS. 100, 103 AND 106).

SN 76-680,098, FILED 7-30-2007.

FIRST USE 3-1-2005; IN COMMERCE 3-1-2005.

SANDRA MANIOS, EXAMINING ATTORNEY

Int. Cl.: 37

Prior U.S. Cls.: 100, 103, and 106

United States Patent and Trademark Office

Reg. No. 3,477,167

Registered July 29, 2008

**SERVICE MARK
PRINCIPAL REGISTER**

ISMRO

PRECISION AVIATION GROUP (GEORGIA CORPORATION)
RSHUMAKE@HELIPARTS.COM
495 LAKE MIRROR ROAD BUILDING 800G
ATLANTA, GA 30349

FOR: REPAIR AND MAINTENANCE OF AIRCRAFT, IN CLASS 37 (U.S. CLS. 100, 103 AND 106).

FIRST USE 3-1-2005; IN COMMERCE 3-1-2005.

THE MARK CONSISTS OF STANDARD CHARACTERS WITHOUT CLAIM TO ANY PARTICULAR FONT, STYLE, SIZE, OR COLOR.

SN 76-680,099, FILED 7-30-2007.

SANDRA MANIOS, EXAMINING ATTORNEY

Int. Cl.: 18

Prior U.S. Cls.: 1, 2, 3, 22, and 41

United States Patent and Trademark Office

Reg. No. 3,477,168

Registered July 29, 2008

**TRADEMARK
PRINCIPAL REGISTER**

TINSLEY BLAKE

BFSM, L.L.C (TEXAS LTD LIAB CO)
3920 SOUTH WALTON WALKER BLVD.
DALLAS, TX 752361510

FOR: PURSES, DUFFEL BAGS, BACKPACKS,
TOTE BAGS AND COSMETIC BAGS SOLD EMPTY,
IN CLASS 18 (U.S. CLS. 1, 2, 3, 22 AND 41).

FIRST USE 11-19-2007; IN COMMERCE 11-19-2007.

THE MARK CONSISTS OF STANDARD CHAR-
ACTERS WITHOUT CLAIM TO ANY PARTICULAR
FONT, STYLE, SIZE, OR COLOR.

THE NAME "TINSLEY BLAKE" DOES NOT
IDENTIFY A PARTICULAR LIVING INDIVIDUAL.

SN 76-680,127, FILED 7-31-2007.

BONNIE LUKEN, EXAMINING ATTORNEY

Int. Cls.: 9 and 41

Prior U.S. Cls.: 21, 23, 26, 36, 38, 100, 101, and 107

United States Patent and Trademark Office

Reg. No. 3,477,169

Registered July 29, 2008

**TRADEMARK
SERVICE MARK
PRINCIPAL REGISTER**

WEW WOMEN'S EROTIC WRESTLING

WRESTLING ZONE, INC., THE (NEW YORK CORPORATION)
201 EAST 87TH STREET
SUITE 24R
NEW YORK, NY 10128

FOR: VIDEO TAPES, CD'S AND DVD'S FEATURING WRESTLING EXHIBITIONS, IN CLASS 9 (U.S. CLS. 21, 23, 26, 36 AND 38).

FIRST USE 4-1-2002; IN COMMERCE 4-1-2002.

FOR: ENTERTAINMENT SERVICES, NAMELY, ORGANIZING AND STAGING LIVE PROFESSIONAL WRESTLING EXHIBITIONS AND TELEVISION PROGRAMS FEATURING PROFESSIONAL WRESTLING; AND TELEVISION PROGRAMS SYNDICATION, IN CLASS 41 (U.S. CLS. 100, 101 AND 107).

FIRST USE 4-1-2002; IN COMMERCE 4-1-2002.

THE MARK CONSISTS OF STANDARD CHARACTERS WITHOUT CLAIM TO ANY PARTICULAR FONT, STYLE, SIZE, OR COLOR.

OWNER OF U.S. REG. NO. 2,753,991.

NO CLAIM IS MADE TO THE EXCLUSIVE RIGHT TO USE "WOMEN'S" AND "WRESTLING", APART FROM THE MARK AS SHOWN.

SN 76-681,025, FILED 11-29-2000.

DAVID HOFFMAN, EXAMINING ATTORNEY

Int. Cl.: 42

Prior U.S. Cls.: 100 and 101

United States Patent and Trademark Office

Reg. No. 3,477,170

Registered July 29, 2008

**SERVICE MARK
PRINCIPAL REGISTER**

COMBIPLX

CELATOR PHARMACEUTICALS, INC. (DELA-
WARE CORPORATION)
303B COLLEGE ROAD EAST
PRINCETON, NJ 08540

FOR: PRODUCT RESEARCH AND DEVELOP-
MENT SERVICES FOR THE DEVELOPMENT OF
THERAPEUTIC AGENTS FOR DISEASES OF HU-
MANS; RESEARCH AND DEVELOPMENT SERVI-
CES IN THE FIELD OF ADMINISTERING
THERAPEUTIC AGENTS FOR DISEASES OF HU-
MANS, IN CLASS 42 (U.S. CLS. 100 AND 101).

FIRST USE 5-31-2008; IN COMMERCE 5-31-2008.

PRIORITY CLAIMED UNDER SEC. 44(D) ON
CANADA APPLICATION NO. 1172182, FILED 4-10-
2003.

SN 76-977,901, FILED 5-2-2003.

FRED MANDIR, EXAMINING ATTORNEY

Int. Cl.: 31

Prior U.S. Cls.: 1 and 46

United States Patent and Trademark Office

Reg. No. 3,477,171

Registered July 29, 2008

**TRADEMARK
PRINCIPAL REGISTER**

PRIORITY TOTAL PET CARE

SAFeway INC. (DELAWARE CORPORATION)
5918 STONERIDGE MALL ROAD
PLEASANTON, CA 945882322

NO CLAIM IS MADE TO THE EXCLUSIVE
RIGHT TO USE "PET CARE", APART FROM THE
MARK AS SHOWN.

FOR: PET FOODS, IN CLASS 31 (U.S. CLS. 1 AND
46).

SN 76-978,615, FILED 4-14-2006.

FIRST USE 5-19-2006; IN COMMERCE 5-19-2006.

THE MARK CONSISTS OF STANDARD CHAR-
ACTERS WITHOUT CLAIM TO ANY PARTICULAR
FONT, STYLE, SIZE, OR COLOR.

WILLIAM BRECKENFELD, EXAMINING ATTOR-
NEY

Int. Cl.: 41

Prior U.S. Cls.: 100, 101, and 107

United States Patent and Trademark Office

Reg. No. 3,477,172

Registered July 29, 2008

**SERVICE MARK
PRINCIPAL REGISTER**

eCDLS

AMERICAN MEDICAL ASSOCIATION (ILLINOIS CORPORATION)
515 NORTH STATE STREET
CHICAGO, IL 60610

FOR: EDUCATIONAL AND TRAINING SERVICES, NAMELY, PROVIDING ALL-HAZARDS PREPAREDNESS PROGRAMS BY WAY OF COURSES THAT ARE AVAILABLE VIA A GLOBAL COMPUTER OR OTHER ONLINE ELECTRONIC COMMUNICATIONS NETWORK FOR HEALTH AND SAFETY WORKERS IN PREPARATION FOR RE-

SPONDING TO PUBLIC HEALTH EMERGENCIES, IN CLASS 41 (U.S. CLS. 100, 101 AND 107).

FIRST USE 5-14-2008; IN COMMERCE 5-14-2008.

THE MARK CONSISTS OF STANDARD CHARACTERS WITHOUT CLAIM TO ANY PARTICULAR FONT, STYLE, SIZE, OR COLOR.

SN 76-978,702, FILED 4-8-2005.

MELISSA VALLILLO, EXAMINING ATTORNEY

Int. Cl.: 11

Prior U.S. Cls.: 13, 21, 23, 31, and 34

United States Patent and Trademark Office

Reg. No. 3,477,173

Registered July 29, 2008

**TRADEMARK
PRINCIPAL REGISTER**

EVEN GLO

IR ENERGY INC. (CANADA CORPORATION)
428 MILLEN ROAD, UNIT 23
STONE CREEK, CANADA L8E 3N9

THE MARK CONSISTS OF STANDARD CHAR-
ACTERS WITHOUT CLAIM TO ANY PARTICULAR
FONT, STYLE, SIZE, OR COLOR.

FOR: GAS FIRED PATIO HEATERS, GAS FIRED
RADIANT PATIO HEATERS, GAS FIRED INFRA
RED RADIANT PATIO HEATERS, IN CLASS 11 (U.S.
CLS. 13, 21, 23, 31 AND 34).

SN 77-000,458, FILED 9-15-2006.

FIRST USE 8-5-2004; IN COMMERCE 6-12-2007.

SOPHIA S. KIM, EXAMINING ATTORNEY

Int. Cls.: 35 and 41

Prior U.S. Cls.: 100, 101, 102, and 107

United States Patent and Trademark Office

Reg. No. 3,477,174

Registered July 29, 2008

**SERVICE MARK
PRINCIPAL REGISTER**

PEOPLE WORTH

PEOPLE WORTH LLC (NEW JERSEY LIMITED
LIABILITY CORPORATION)

#381

177 MAIN STREET
FORT LEE, NJ 07024

FOR: BUSINESS MANAGEMENT CONSULTING
SERVICES AND BUSINESS STRATEGY CONSULT-
ING SERVICES, HUMAN RESOURCE CONSULTA-
TION SERVICES, IN CLASS 35 (U.S. CLS. 100, 101
AND 102).

FIRST USE 8-2-2006; IN COMMERCE 8-2-2006.

FOR: CAREER COUNSELING, IN CLASS 41 (U.S.
CLS. 100, 101 AND 107).

FIRST USE 8-2-2006; IN COMMERCE 8-2-2006.

THE MARK CONSISTS OF STANDARD CHAR-
ACTERS WITHOUT CLAIM TO ANY PARTICULAR
FONT, STYLE, SIZE, OR COLOR.

NO CLAIM IS MADE TO THE EXCLUSIVE
RIGHT TO USE "PEOPLE", APART FROM THE
MARK AS SHOWN.

SN 77-000,612, FILED 9-15-2006.

VIVIAN MICZNIK FIRST, EXAMINING ATTOR-
NEY

Int. Cl.: 7

Prior U.S. Cls.: 13, 19, 21, 23, 31, 34, and 35

Reg. No. 3,477,175

United States Patent and Trademark Office

Registered July 29, 2008

**TRADEMARK
PRINCIPAL REGISTER**



DAILY COLLECTION INC. (CANADA CORPORATION)
15AP-2220 MIDLAND AVE.
TORONTO, CANADA

THE MARK CONSISTS OF STANDARD CHARACTERS WITHOUT CLAIM TO ANY PARTICULAR FONT, STYLE, SIZE, OR COLOR.

FOR: CLOTHES WASHING MACHINES; WASHING MACHINES FOR CLOTHES, IN CLASS 7 (U.S. CLS. 13, 19, 21, 23, 31, 34 AND 35).

SN 77-001,546, FILED 9-18-2006.

FIRST USE 11-20-2006; IN COMMERCE 11-20-2006.

SUSAN RICHARDS, EXAMINING ATTORNEY

Int. Cls.: 35, 36, and 37

Prior U.S. Cls.: 100, 101, 102, 103, and 106

United States Patent and Trademark Office

Reg. No. 3,477,176

Registered July 29, 2008

**SERVICE MARK
PRINCIPAL REGISTER**

SITEMAX

BECKMAN COULTER, INC. (DELAWARE CORPORATION)
4300 N. HARBOR BLVD.
FULLERTON, CA 92834

FOR: BUSINESS MANAGEMENT SERVICES, NAMELY, MANAGEMENT OF LABORATORY SITES; BUSINESS MANAGEMENT SERVICES, NAMELY, PURCHASING OF EQUIPMENT, INSTRUMENTS, AND MACHINERY FOR USE IN LABORATORIES; BUSINESS MANAGEMENT SERVICES, NAMELY, COORDINATION OF INSTALLATION, REPAIR AND MAINTENANCE OF LABORATORY INSTRUMENTS, LABORATORY EQUIPMENT, AND LABORATORY MACHINERY; BUSINESS MANAGEMENT SERVICES, NAMELY, MANAGEMENT OF LABORATORY WORKFLOW AND PROCESSES; BUSINESS MANAGEMENT SERVICES, NAMELY, PROCURING OF CONTRACTS FOR OTHERS FOR THE PURCHASE OF GOODS AND LABOR CONTRACTING SERVICES; PERSONNEL MANAGEMENT, IN CLASS 35 (U.S. CLS. 100, 101 AND 102).

FIRST USE 1-23-2007; IN COMMERCE 1-23-2007.

FOR: ASSET MANAGEMENT SERVICES, IN CLASS 36 (U.S. CLS. 100, 101 AND 102).

FIRST USE 1-23-2007; IN COMMERCE 1-23-2007.

FOR: PROVIDING INSTALLATION, REPAIR AND MAINTENANCE OF LABORATORY EQUIPMENT, LABORATORY INSTRUMENTS AND LABORATORY MACHINERY, IN CLASS 37 (U.S. CLS. 100, 103 AND 106).

FIRST USE 1-23-2007; IN COMMERCE 1-23-2007.

THE MARK CONSISTS OF STANDARD CHARACTERS WITHOUT CLAIM TO ANY PARTICULAR FONT, STYLE, SIZE, OR COLOR.

SN 77-002,030, FILED 9-19-2006.

CHRISTOPHER BUONGIORNO, EXAMINING ATTORNEY

Int. Cl.: 45

Prior U.S. Cls.: 100 and 101

United States Patent and Trademark Office

Reg. No. 3,477,177

Registered July 29, 2008

**SERVICE MARK
PRINCIPAL REGISTER**

lowcountrylawyer

VERNON GLENN (UNITED STATES INDIVIDUAL)
211 SCOTT STREET
MOUNT PLEASANT, SC 29464 AND
ANDREA GLENN (UNITED STATES INDIVIDUAL)
211 SCOTT STREET
MOUNT PLEASANT, SC 29464

FOR: LEGAL RESEARCH; LEGAL SERVICES, IN
CLASS 45 (U.S. CLS. 100 AND 101).

FIRST USE 8-31-2005; IN COMMERCE 8-31-2005.

THE MARK CONSISTS OF STANDARD CHARACTERS WITHOUT CLAIM TO ANY PARTICULAR FONT, STYLE, SIZE, OR COLOR.

SN 77-002,309, FILED 9-19-2006.

INGA ERVIN, EXAMINING ATTORNEY

Int. Cls.: 6, 20, 21, 24, and 27

Prior U.S. Cls.: 2, 12, 13, 14, 19, 20, 22, 23, 25, 29, 30, 32, 33, 37, 40, 42, and 50

Reg. No. 3,477,178

United States Patent and Trademark Office

Registered July 29, 2008

**TRADEMARK
PRINCIPAL REGISTER**

RIDGEFIELD HOME

HOMEGOODS, INC. (DELAWARE CORPORATION)
770 COCHITUATE ROAD
FRAMINGHAM, MA 01701

FOR: BATHROOM ACCESSORIES MADE OF METAL, NAMELY, ROBE HOOKS, AND SHOWER CURTAIN HOOKS, IN CLASS 6 (U.S. CLS. 2, 12, 13, 14, 23, 25 AND 50).

FIRST USE 1-30-2007; IN COMMERCE 1-30-2007.

FOR: BED PILLOWS, DECORATIVE PILLOWS, METAL AND NON-METAL BATHROOM SHELVES, NON-METAL ROBE HOOKS, NON-METAL SHOWER CURTAIN HOOKS, METAL AND NON-METAL SHOWER CURTAIN RINGS; AND LAUNDRY HAMPERS, IN CLASS 20 (U.S. CLS. 2, 13, 22, 25, 32 AND 50).

FIRST USE 1-30-2007; IN COMMERCE 1-30-2007.

FOR: BATHROOM ACCESSORIES, NAMELY, SOAP DISHES, TOOTHBRUSH HOLDERS, WASTE-BASKETS, BATHROOM TUMBLERS, LOTION PUMP DISPENSERS SOLD EMPTY, TOWEL BARS, TISSUE HOLDERS, AND BATH AND SHOWER CADDIES, IN CLASS 21 (U.S. CLS. 2, 13, 23, 29, 30, 33, 40 AND 50).

FIRST USE 1-30-2007; IN COMMERCE 1-30-2007.

FOR: BEDDING, NAMELY, BED SHEET SETS, BED SHEETS, PILLOW CASES, PILLOW SHAMS, BED SKIRTS, BED BLANKETS, COMFORTERS, DOWN COMFORTERS, DUVETS, DUVET COVERS, QUILTS, COVERLETS, THROWS, AND MATTRESS PADS; BATH TOWELS AND WASH CLOTHS, SHOWER CURTAINS, FABRIC WINDOW VALANCES AND PANELS; KITCHEN LINENS, NAMELY, KITCHEN TOWELS AND DISH CLOTHS; TABLE LINENS, NAMELY, TABLECLOTHS, TABLE RUNNERS, TABLE SCARVES, PLACEMATS, AND CLOTH NAPKINS, IN CLASS 24 (U.S. CLS. 42 AND 50).

FIRST USE 1-30-2007; IN COMMERCE 1-30-2007.

FOR: BATH RUGS AND BATH MATS, IN CLASS 27 (U.S. CLS. 19, 20, 37, 42 AND 50).

FIRST USE 1-30-2007; IN COMMERCE 1-30-2007.

THE MARK CONSISTS OF STANDARD CHARACTERS WITHOUT CLAIM TO ANY PARTICULAR FONT, STYLE, SIZE, OR COLOR.

NO CLAIM IS MADE TO THE EXCLUSIVE RIGHT TO USE "HOME" , APART FROM THE MARK AS SHOWN.

SN 77-002,344, FILED 9-19-2006.

MONIQUE MILLER, EXAMINING ATTORNEY

Int. Cls.: 9 and 42

Prior U.S. Cls.: 21, 23, 26, 36, 38, 100, and 101

United States Patent and Trademark Office

Reg. No. 3,477,179

Registered July 29, 2008

**TRADEMARK
SERVICE MARK
PRINCIPAL REGISTER**

COMPARION

EXPERT CHOICE, INC. (DELAWARE CORPORATION)
1501 LEE HIGHWAY
SUITE 302
ARLINGTON, VA 22101

FOR: COMPUTER SOFTWARE WHICH SYNTHESIZES DATA AND QUALITATIVE INPUT USED IN BUSINESS AND PERSONAL DECISION MAKING PROCESSES; DOWNLOADABLE SOFTWARE WHICH SYNTHESIZES DATA AND QUALITATIVE INPUT USED IN BUSINESS AND PERSONAL DECISION MAKING PROCESSES, IN CLASS 9 (U.S. CLS. 21, 23, 26, 36 AND 38).

FIRST USE 9-19-2006; IN COMMERCE 3-14-2007.

FOR: PROVIDING ON-LINE NON-DOWNLOADABLE SOFTWARE WHICH SYNTHESIZES DATA

AND QUALITATIVE INPUT USED IN BUSINESS AND PERSONAL DECISION MAKING PROCESSES; PROVIDING TEMPORARY USE OF ON-LINE NON-DOWNLOADABLE SOFTWARE WHICH SYNTHESIZES DATA AND QUALITATIVE INPUT USED IN BUSINESS AND PERSONAL DECISION MAKING PROCESSES, IN CLASS 42 (U.S. CLS. 100 AND 101).

FIRST USE 9-19-2006; IN COMMERCE 10-31-2006.

THE MARK CONSISTS OF STANDARD CHARACTERS WITHOUT CLAIM TO ANY PARTICULAR FONT, STYLE, SIZE, OR COLOR.

SN 77-002,430, FILED 9-19-2006.

TEJBIR SINGH, EXAMINING ATTORNEY

Int. Cl.: 28

Prior U.S. Cls.: 22, 23, 38, and 50

Reg. No. 3,477,180

United States Patent and Trademark Office

Registered July 29, 2008

**TRADEMARK
PRINCIPAL REGISTER**

**AMERICAN GIRL BOUTIQUE AND
BISTRO**

AMERICAN GIRL, LLC (DELAWARE LIMITED
LIABILITY COMPANY)
MAIL STOP M1-1518
333 CONTINENTAL BOULEVARD
EL SEGUNDO, CA 90245

FOR: TOYS, GAMES AND PLAYTHINGS, NAME-
LY, DOLLS, DOLL OUTFITS AND DOLL ACCES-
SORIES, IN CLASS 28 (U.S. CLS. 22, 23, 38 AND 50).

FIRST USE 8-17-2007; IN COMMERCE 8-17-2007.

THE MARK CONSISTS OF STANDARD CHAR-
ACTERS WITHOUT CLAIM TO ANY PARTICULAR
FONT, STYLE, SIZE, OR COLOR.

OWNER OF U.S. REG. NOS. 2,731,917, 3,116,340,
AND OTHERS.

SN 77-003,555, FILED 9-20-2006.

FLORENTINA BLANDU, EXAMINING ATTORNEY

Int. Cl.: 14

Prior U.S. Cls.: 2, 27, 28, and 50

United States Patent and Trademark Office

Reg. No. 3,477,181

Registered July 29, 2008

**TRADEMARK
PRINCIPAL REGISTER**



MARTIN, ROBERT B., JR. (UNITED STATES
INDIVIDUAL)
SUITE 200
7700 SUNSET BLVD.
LOS ANGELES, CA 90046

FOR: BRACELETS; BRACELETS OF PRECIOUS
METAL; JEWEL PENDANTS; JEWELRY; NECKLA-
CES; RINGS BEING JEWELRY; SHOE ORNAMENTS
OF PRECIOUS METAL, IN CLASS 14 (U.S. CLS. 2, 27,
28 AND 50).

FIRST USE 7-5-2007; IN COMMERCE 7-5-2007.

THE COLOR(S) BLUE, WHITE, BLACK AND TAN
IS/ARE CLAIMED AS A FEATURE OF THE MARK.

THE MARK CONSISTS OF A CAUCASIAN MAN
WITH TAN SKIN AND BLACK HAIR DOING A
ONE-HAND HANDSTAND, WEARING A WHITE T-
SHIRT, BLUE PANTS, AND BLACK AND WHITE
SNEAKERS, EACH OF SUCH SNEAKERS BEARING
A WHITE AND BLUE BAR OF SPARKLING JEW-
ELRY.

SN 77-004,917, FILED 9-22-2006.

RAMONA ORTIGA, EXAMINING ATTORNEY

Int. Cl.: 9

Prior U.S. Cls.: 21, 23, 26, 36, and 38

United States Patent and Trademark Office

Reg. No. 3,477,182

Registered July 29, 2008

**TRADEMARK
PRINCIPAL REGISTER**

REDBOX

GLOBAL CHARTER SERVICES, LTD. (DELA-
WARE CORPORATION)
SUITE 1100
200 WEST ADAMS
CHICAGO, IL 60606

FOR: CUSTOMIZED COMMUNICATION SYS-
TEM AND VOICE AND DATA COMMUNICATION
SYSTEM PLACED IN A VEHICLE USED IN CON-
NECTION WITH VEHICLE LOCATING, TRACING
AND SECURITY, COMPRISED OF ANTENNAE,
SPEAKER, MICROPHONE AND POWER CABLES,
IN CLASS 9 (U.S. CLS. 21, 23, 26, 36 AND 38).

FIRST USE 8-31-2006; IN COMMERCE 8-31-2006.

THE MARK CONSISTS OF STANDARD CHAR-
ACTERS WITHOUT CLAIM TO ANY PARTICULAR
FONT, STYLE, SIZE, OR COLOR.

SN 77-004,938, FILED 9-22-2006.

SOPHIA S. KIM, EXAMINING ATTORNEY

Int. Cls.: 5, 9, 16, 35, 38, 41, and 44

Prior U.S. Cls.: 2, 5, 6, 18, 21, 22, 23, 26, 29, 36, 37, 38, 44, 46, 50, 51, 52, 100, 101, 102, 104, and 107

Reg. No. 3,477,183

United States Patent and Trademark Office

Registered July 29, 2008

**TRADEMARK
SERVICE MARK
PRINCIPAL REGISTER**



ON TARGET LIVING, LLC (MICHIGAN LTD
LIAB CO)
5572 SILVERLEAF COURT
HASLETT, MI 48840

FOR: DIETARY AND NUTRITIONAL SUPPLEMENTS, NAMELY, ENERGY BARS, MEAL REPLACEMENT DRINKS, MEAL REPLACEMENT BARS, PROTEIN SHAKES FOR USE AS A DIETARY SUPPLEMENT, PROTEIN BARS FOR USE AS A DIETARY SUPPLEMENT; NUTRITIONAL SUPPLEMENTS IN THE NATURE OF NON-PRESCRIPTION VITAMINS, MINERALS, NUTRIENTS AND BOTANICALS; VITAMIN FOOD SUPPLEMENTS, NAMELY, MUSCLE BUILDING POWDERS AND METABOLIC ENHANCEMENT DRINKS AND TABLETS FOR USE IN EXERCISE, NUTRITION, BODYBUILDING AND WEIGHT TRAINING; NON-PRESCRIPTION PREPARATIONS TO PROMOTE WEIGHT GAIN, NON-PRESCRIPTION PREPARATIONS TO PROMOTE WEIGHT LOSS, NON-PRESCRIPTION PREPARATIONS TO PROMOTE MUSCLE GROWTH; NON-PRESCRIPTION GROWTH HORMONES; NON-PRESCRIPTION METABOLIC PREPARATIONS TO PROMOTE FAT BURNING; NON-PRESCRIPTION METABOLIC PREPARATIONS TO BLOCK CARBOHYDRATE ABSORPTION, IN CLASS 5 (U.S. CLS. 6, 18, 44, 46, 51 AND 52).

FIRST USE 10-1-2006; IN COMMERCE 10-1-2006.

FOR: PRERECORDED ELECTRONIC MEDIA, NAMELY, AUDIO AND VIDEO CASSETTES, CDS AND DVDS ALL FEATURING INFORMATION ON

AGING, BODY CONDITIONING, DIET, ENERGY, EXERCISE, HEALTH, FITNESS, NUTRITION, SPORTS TRAINING, STRESS MANAGEMENT, WEIGHT REDUCTION AND WELLNESS, IN CLASS 9 (U.S. CLS. 21, 23, 26, 36 AND 38).

FIRST USE 10-1-2006; IN COMMERCE 10-1-2006.

FOR: PAPER AND PRINTED MATTER, NAMELY, ARTICLES FOR PUBLICATION IN BOOKLETS, BROCHURES, CATALOGS, GUIDES, MAGAZINES, MANUALS AND NEWSLETTERS ALL FEATURING INFORMATION ON AGING, BODY CONDITIONING, DIET, ENERGY, EXERCISE, HEALTH, FITNESS, NUTRITION, SPORTS TRAINING, STRESS MANAGEMENT, WEIGHT REDUCTION AND WELLNESS; FLASH CARDS; PAPERWEIGHTS, PHOTOGRAPHS MOUNTED AND UNMOUNTED; POSTERS; POSTCARDS; PRINTED GREETING CARDS; PRINTED EDUCATIONAL, INSTRUCTIONAL AND TEACHING MATERIALS ALL FEATURING INFORMATION ON AGING, BODY CONDITIONING, DIET, ENERGY, EXERCISE, HEALTH, FITNESS, NUTRITION, SPORTS TRAINING, STRESS MANAGEMENT, WEIGHT REDUCTION AND WELLNESS; SERIES OF NON-FICTION BOOKS ALL FEATURING INFORMATION ON AGING, BODY CONDITIONING, DIET, ENERGY, EXERCISE, HEALTH, FITNESS, NUTRITION, SPORTS TRAINING, STRESS MANAGEMENT, WEIGHT REDUCTION AND WELLNESS; FOLDERS, PENS, PENCILS, STICKERS AND WRITING PADS, IN CLASS 16 (U.S. CLS. 2, 5, 22, 23, 29, 37, 38 AND 50).

FIRST USE 10-1-2006; IN COMMERCE 10-1-2006.

FOR: ARRANGING AND CONDUCTING BUSINESS CONFERENCES AND SPECIAL EVENT PLANNING; PRODUCTION AND DISTRIBUTION OF RADIO AND TELEVISION COMMERCIALS; RETAIL, WHOLESALE, MAIL-ORDER AND ONLINE RETAIL STORE SERVICES FEATURING PRODUCTS RELATING TO AGING, BODY CONDITIONING, DIET, ENERGY, EXERCISE, HEALTH, FITNESS, NUTRITION, SPORTS TRAINING, STRESS MANAGEMENT, WEIGHT REDUCTION AND WELLNESS, IN CLASS 35 (U.S. CLS. 100, 101 AND 102).

FIRST USE 10-1-2006; IN COMMERCE 10-1-2006.

FOR: TELECOMMUNICATIONS SERVICES, NAMELY, BROADCASTING RADIO AND TELEVISION PROGRAMS AND MOTION PICTURE FILMS VIA A GLOBAL COMPUTER NETWORK; ELECTRONIC, ELECTRIC AND DIGITAL TRANSMISSION OF VOICE, DATA, IMAGES, SOUND, SIGNAL AND MESSAGES; ELECTRONIC TRANSMISSION OF E-BOOKS, E-ZINES AND NEWSLETTERS VIA A GLOBAL COMPUTER NETWORK; TRANSMISSION OF INFORMATION BY ELECTRONIC MEDIA; VIDEO AND AUDIO TELECONFERENCING SERVICES VIA THE INTERNET, IN CLASS 38 (U.S. CLS. 100, 101 AND 104).

FIRST USE 10-1-2006; IN COMMERCE 10-1-2006.

FOR: EDUCATIONAL AND INSTRUCTIONAL SERVICES, NAMELY, CONDUCTING EDUCATIONAL CLASSES, CONFERENCES, RETREATS, SEMINARS AND WORKSHOPS ALL FEATURING INFORMATION ON AGING, BODY CONDITIONING, DIET, ENERGY, EXERCISE, HEALTH, FITNESS, NUTRITION, SPORTS TRAINING, STRESS MANAGEMENT, WEIGHT REDUCTION AND WELLNESS AND DISTRIBUTING INSTRUCTIONAL MATERIALS IN CONNECTION THEREWITH; ENTERTAINMENT SERVICES, NAMELY, LIVE SPEAKING ENGAGEMENTS ALL FEATURING IN-

FORMATION ON AGING, BODY CONDITIONING, DIET, ENERGY, EXERCISE, HEALTH, FITNESS, NUTRITION, SPORTS TRAINING, STRESS MANAGEMENT, WEIGHT REDUCTION AND WELLNESS; PRODUCTION OF RADIO, TELEVISION, AND MOTION PICTURE FILMS OF OTHERS FOR BROADCAST TRANSMISSION VIA BROADCAST, CABLE, DIGITAL AND GLOBAL COMPUTER NETWORK; PUBLICATION OF BOOKS; PERSONAL TRAINING SERVICES; PROVIDING INFORMATION IN THE FIELDS OF BODY CONDITIONING, PHYSICAL EXERCISE AND FITNESS, AND SPORTS TRAINING, IN CLASS 41 (U.S. CLS. 100, 101 AND 107).

FIRST USE 10-1-2006; IN COMMERCE 10-1-2006.

FOR: PROVIDING INFORMATION IN THE FIELDS OF AGING, DIET PLANNING, PHYSICAL AND MENTAL ENERGY, HEALTH CARE, NUTRITION, STRESS MANAGEMENT, WEIGHT REDUCTION AND WELLNESS, IN CLASS 44 (U.S. CLS. 100 AND 101).

FIRST USE 10-1-2006; IN COMMERCE 10-1-2006.

THE COLOR(S) BLUE, YELLOW, GREEN AND BLACK IS/ARE CLAIMED AS A FEATURE OF THE MARK.

THE COLOR BLUE APPEARS IN THE STYLIZED SILHOUETTE DESIGN OF A HUMAN FIGURE WITH YELLOW AND GREEN CONCENTRIC OPEN CIRCLES SPINNING AROUND THE FIGURE; THE WORD "ON" APPEARS IN YELLOW LOWERCASE LETTERING WITH THE WORD "TARGET" IN BLUE LOWERCASE LETTERING DIRECTLY UNDER THE DESIGN ELEMENTS; THE WORD "LIVING" IS IN BLACK UPPERCASE LETTERING AT THE BOTTOM OF THE MARK.

SN 77-005,266, FILED 9-22-2006.

RUSS HERMAN, EXAMINING ATTORNEY

Int. Cl.: 35

Prior U.S. Cls.: 100, 101, and 102

United States Patent and Trademark Office

Reg. No. 3,477,184

Registered July 29, 2008

SERVICE MARK
PRINCIPAL REGISTER



KRESSATY, JOHN T (UNITED STATES INDIVIDUAL)

601 OLD HICKORY BLVD. UNIT 74
BRENTWOOD, TN 37027

FOR: ON-LINE RETAIL STORE SERVICES FEATURING COSMETICS AND SKIN CARE PRODUCTS; RETAIL STORE SERVICES FEATURING A WIDE VARIETY OF CONSUMER GOODS OF OTHERS; RETAIL STORES FEATURING COSMETICS AND SKIN CARE PRODUCTS, IN CLASS 35 (U.S. CLS. 100, 101 AND 102).

FIRST USE 10-10-2006; IN COMMERCE 5-1-2007.

THE COLOR(S) CHOCOLATE BROWN AND TEAL IS/ARE CLAIMED AS A FEATURE OF THE MARK.

THE MARK CONSISTS OF "THE SKIN", ACCENT MARK OVER LETTER "B" AND "FACING MODERN BEAUTY" ARE CHOCOLATE BROWN AND DOT OVER THE LETTER "I" AND "BAR" ARE TEAL AND A STEMWARE GLASS FORMS THE LETTER "B".

SN 77-005,974, FILED 9-23-2006.

G. MAYERSCHOFF, EXAMINING ATTORNEY

Int. Cls.: 3 and 4

Prior U.S. Cls.: 1, 4, 6, 15, 50, 51, and 52

United States Patent and Trademark Office

Reg. No. 3,477,185

Registered July 29, 2008

**TRADEMARK
PRINCIPAL REGISTER**

**JEROME PRIVEE POUR LA
MAISON**

PERFUMANIA, INC. (FLORIDA CORPORATION)
251 INTERNATIONAL PARKWAY
SUNRISE, FL 33325

FOR: POTPOURRI, SACHETS, SCENTED OILS
USED TO PRODUCE AROMAS WHEN HEATED
FOR HOME USE, SCENTED CERAMIC STONES,
DETERGENT FOR WASHING CLOTHING, NAME-
LY, LINENS; DISH DETERGENT SOAP, HAND
SOAP, HAND LOTION, IN CLASS 3 (U.S. CLS. 1, 4,
6, 50, 51 AND 52).

FIRST USE 9-1-2006; IN COMMERCE 9-1-2006.

FOR: CANDLES, IN CLASS 4 (U.S. CLS. 1, 6 AND
15).

FIRST USE 9-1-2006; IN COMMERCE 9-1-2006.

THE MARK CONSISTS OF STANDARD CHAR-
ACTERS WITHOUT CLAIM TO ANY PARTICULAR
FONT, STYLE, SIZE, OR COLOR.

OWNER OF U.S. REG. NO. 1,829,140.

THE NAME(S), PORTRAIT(S), AND/OR SIGNA-
TURE(S) SHOWN IN THE MARK DOES NOT IDEN-
TIFY A PARTICULAR LIVING INDIVIDUAL.

THE ENGLISH TRANSLATION OF "PRIVEE" IN
THE MARK IS PRIVATE AND THE ENGLISH
TRANSLATION OF "POUR LA MAISON" IS FOR
THE HOME.

SN 77-007,370, FILED 9-26-2006.

BONNIE LUKEN, EXAMINING ATTORNEY

Int. Cl.: 9

Prior U.S. Cls.: 21, 23, 26, 36, and 38

Reg. No. 3,477,186

United States Patent and Trademark Office

Registered July 29, 2008

**TRADEMARK
PRINCIPAL REGISTER**



GLOBAL CHARTER SERVICES, LTD. (DELA-
WARE CORPORATION)
SUITE 1100
200 WEST ADAMS
CHICAGO, IL 60606

FOR: CUSTOMIZED COMMUNICATION SYS-
TEM AND VOICE AND DATA COMMUNICATION
SYSTEM PLACED IN A VEHICLE USED IN CON-
NECTION WITH VEHICLE LOCATING, TRACING
AND SECURITY, COMPRISED OF ANTENNAE,

SPEAKER, MICROPHONE AND POWER CABLES,
IN CLASS 9 (U.S. CLS. 21, 23, 26, 36 AND 38).

FIRST USE 8-31-2006; IN COMMERCE 8-31-2006.

THE MARK CONSISTS OF THE WORDS "RED
BOX" ENCLOSED IN A SQUARE.

SN 77-007,764, FILED 9-26-2006.

SOPHIA S. KIM, EXAMINING ATTORNEY

Int. Cls.: 35 and 41

Prior U.S. Cls.: 100, 101, 102, and 107

United States Patent and Trademark Office

Reg. No. 3,477,187

Registered July 29, 2008

**SERVICE MARK
PRINCIPAL REGISTER**

E.I.S. Travel, Inc.

E.I.S. TRAVEL, INC. (NEVADA CORPORATION)
2248 MERIDIAN BLVD., STE. H
MINDEN, NV 89423

FOR: EMPLOYMENT AGENCIES FOR TRAVELING PROFESSIONALS; EMPLOYMENT COUNSELING, HIRING, RECRUITING, PLACEMENT, STAFFING, CAREER NETWORKING SERVICES AND OUTPLACEMENT SERVICES FOR TRAVELING PROFESSIONALS; JOB PLACEMENT AND COUNSELING, EITHER ON A TEMPORARY AND PERMANENT BASIS, OF TRAVELING PROFESSIONALS; PERSONNEL RECRUITMENT, COUNSELING, PLACEMENT, AND MANAGEMENT SERVICES OF TRAVELING PROFESSIONALS, IN CLASS 35 (U.S. CLS. 100, 101 AND 102).

FIRST USE 1-1-2007; IN COMMERCE 1-1-2007.

FOR: EMPLOYEE SKILLS ENHANCEMENT NAMELY CONDUCTING WORKSHOPS AND SEMINARS, IN THE FIELD OF HEALTHCARE, FOR TRAVELING PROFESSIONALS, IN CLASS 41 (U.S. CLS. 100, 101 AND 107).

FIRST USE 1-1-2007; IN COMMERCE 1-1-2007.

THE MARK CONSISTS OF STANDARD CHARACTERS WITHOUT CLAIM TO ANY PARTICULAR FONT, STYLE, SIZE, OR COLOR.

NO CLAIM IS MADE TO THE EXCLUSIVE RIGHT TO USE "TRAVEL, INC.", APART FROM THE MARK AS SHOWN.

SN 77-008,752, FILED 9-27-2006.

RICHARD WHITE, EXAMINING ATTORNEY

Int. Cl.: 13

Prior U.S. Cls.: 2 and 9

United States Patent and Trademark Office

Reg. No. 3,477,188

Registered July 29, 2008

**TRADEMARK
PRINCIPAL REGISTER**

RED RIVER SHOOTOUT

INGRAM ENTERPRISES, INC. (MISSOURI CORPORATION)
3010 N. INGRAM DR.
SPRINGFIELD, MO 65803

THE MARK CONSISTS OF STANDARD CHARACTERS WITHOUT CLAIM TO ANY PARTICULAR FONT, STYLE, SIZE, OR COLOR.

FOR: FIREWORKS IN SHELL FORMS, IN CLASS 13 (U.S. CLS. 2 AND 9).

SN 77-010,650, FILED 9-29-2006.

FIRST USE 3-20-2007; IN COMMERCE 3-20-2007.

ELLEN BURNS, EXAMINING ATTORNEY

Int. Cls.: 9, 38, and 39

Prior U.S. Cls.: 21, 23, 26, 36, 38, 100, 101, 104, and 105

Reg. No. 3,477,189

United States Patent and Trademark Office

Registered July 29, 2008

**TRADEMARK
SERVICE MARK
PRINCIPAL REGISTER**

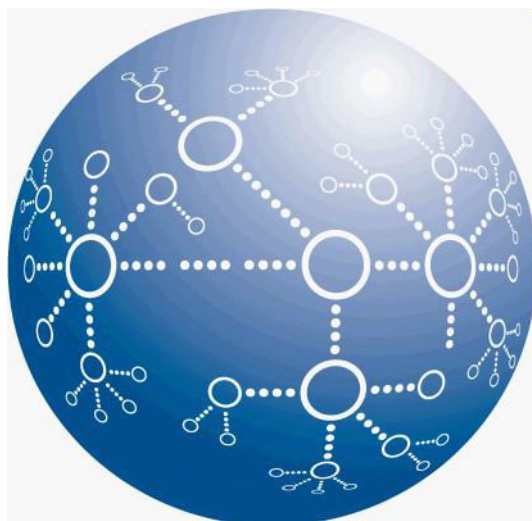

**I3ARCHIVE, INC. (DELAWARE CORPORATION)
1000 CHESTERBROOK BLVD., SUITE 110
BERWYN, PA 19312**

**FOR: COMPUTER PROGRAMS FOR STORAGE,
RETRIEVAL AND DISTRIBUTION OF DATA RE-
LATING TO MEDICAL IMAGING FOR CLINICAL
AND RESEARCH PURPOSES, IN CLASS 9 (U.S. CLS.
21, 23, 26, 36 AND 38).**

FIRST USE 6-1-2006; IN COMMERCE 6-1-2006.

**FOR: ELECTRONIC TRANSMISSION OF DATA
RELATING TO MEDICAL IMAGING, IN CLASS 38
(U.S. CLS. 100, 101 AND 104).**

FIRST USE 6-1-2006; IN COMMERCE 6-1-2006.

**FOR: ELECTRONIC STORAGE OF DATA RELAT-
ING TO MEDICAL IMAGING, IN CLASS 39 (U.S.
CLS. 100 AND 105).**

FIRST USE 6-1-2006; IN COMMERCE 6-1-2006.

**THE COLOR(S) BLUE AND WHITE IS/ARE
CLAIMED AS A FEATURE OF THE MARK.**

**THE COLOR WHITE APPEARS IN THE GEO-
METRIC DESIGNS APPEARING IN THE BLUE
CIRCLE.**

SN 77-010,829, FILED 9-29-2006.

RON FAIRBANKS, EXAMINING ATTORNEY

Int. Cls.: 35, 37, and 42

Prior U.S. Cls.: 100, 101, 102, 103, and 106

United States Patent and Trademark Office

Reg. No. 3,477,190

Registered July 29, 2008

**SERVICE MARK
PRINCIPAL REGISTER**

REDUCE • PRODUCE • MANAGE

TICK TOCK ENERGY, INC. (ILLINOIS CORPORATION)
15550 NORTH 2100TH
TEUTOPOLIS, IL 62467

FOR: RETAIL SERVICES BY DIRECT SOLICITATION BY SALES AGENTS FEATURING THE GOODS OF OTHERS, NAMELY, EQUIPMENT FOR ENERGY EFFICIENCY, RENEWABLE ENERGY, AND DISTRIBUTED POWER GENERATION; BUSINESS SERVICES IN THE NATURE OF ENERGY USAGE MANAGEMENT IN THE FIELD OF ENERGY AND UTILITIES MANAGEMENT, ENERGY EFFICIENCY, ENERGY CONSERVATION, RENEWABLE ENERGY, AND DISTRIBUTED POWER GENERATION, COST ANALYSIS WITH REGARDS TO FUND, LEASE AND/OR REDUCE THE COST OF IMPLEMENTING ENERGY MANAGEMENT, RENEWABLE ENERGY, AND DISTRIBUTED POWER GENERATION EQUIPMENT, MONITORING AND REPORTING ENERGY PERFORMANCE FOR EQUIPMENT AND BUILDINGS, EVALUATING ENERGY CONSUMPTION TRENDS, AND PROVIDING ON-GOING ADVISORY SERVICES ON METHODS TO MINIMIZE ENERGY AND UTILITY CONSUMPTION AND RELATED OPERATING COSTS; CONDUCTING ENERGY EFFICIENCY SURVEYS, ENERGY AUDITING, ENERGY EFFICIENCY ANALYSIS AND STUDIES ALL IN THE FIELDS OF ENERGY CONSERVATION, EFFICIENCY, MANAGEMENT, RENEWABLE ENERGY AND ENERGY GENERATION; BUSINESS CONSULTING RELAT-

ING TO OPERATIONS MANAGEMENT, IN CLASS 35 (U.S. CLS. 100, 101 AND 102).

FIRST USE 6-9-2006; IN COMMERCE 6-9-2006.

FOR: INSTALLATION, MAINTENANCE AND REPAIR OF ENERGY EFFICIENCY, RENEWABLE ENERGY, AND DISTRIBUTED POWER GENERATION EQUIPMENT AND SYSTEMS, AND ANCILLARY COMPONENTS FOR FACILITIES, IN CLASS 37 (U.S. CLS. 100, 103 AND 106).

FIRST USE 6-9-2006; IN COMMERCE 6-9-2006.

FOR: DESIGN ENGINEERING OF ENERGY EQUIPMENT, CONDUCTING ECONOMIC FEASIBILITY STUDIES, DESIGN SERVICES IN THE FIELD OF ENERGY EQUIPMENT, INSPECTION OF ENERGY EQUIPMENT, IN CLASS 42 (U.S. CLS. 100 AND 101).

FIRST USE 6-9-2006; IN COMMERCE 6-9-2006.

THE MARK CONSISTS OF STANDARD CHARACTERS WITHOUT CLAIM TO ANY PARTICULAR FONT, STYLE, SIZE, OR COLOR.

SN 77-011,710, FILED 10-2-2006.

FRANK LATTUCA, EXAMINING ATTORNEY

Int. Cl.: 35

Prior U.S. Cls.: 100, 101, and 102

United States Patent and Trademark Office

Reg. No. 3,477,191

Registered July 29, 2008

**SERVICE MARK
PRINCIPAL REGISTER**

DIABETES WIRELESS

DIABETES WIRELESS, LLC (TEXAS LTD LIAB
CO)
3 RIVERWAY, SUITE 825
HOUSTON, TX 77056

THE MARK CONSISTS OF STANDARD CHAR-
ACTERS WITHOUT CLAIM TO ANY PARTICULAR
FONT, STYLE, SIZE, OR COLOR.

FOR: MANAGED CARE SERVICES, NAMELY,
ELECTRONIC PROCESSING OF HEALTH CARE
INFORMATION, IN CLASS 35 (U.S. CLS. 100, 101
AND 102).

SN 77-012,612, FILED 10-3-2006.

FIRST USE 10-0-2006; IN COMMERCE 10-0-2006.

STEVEN JACKSON, EXAMINING ATTORNEY

Int. Cl.: 38

Prior U.S. Cls.: 100, 101, and 104

United States Patent and Trademark Office

Reg. No. 3,477,192

Registered July 29, 2008

**SERVICE MARK
PRINCIPAL REGISTER**

DIABETES WIRELESS

DIABETES WIRELESS, LLC (TEXAS LTD LIAB
CO)
3 RIVERWAY, SUITE 825
HOUSTON, TX 77056

FOR: TEXT AND NUMERIC WIRELESS DIGITAL
MESSAGING SERVICES; WIRELESS COMMUNICA-
TIONS SERVICES, NAMELY, TRANSMISSION TO
AND FROM MOBILE TELEPHONES; WIRELESS
DIGITAL MESSAGING SERVICES; WIRELESS TEL-
EPHONE TELECOMMUNICATIONS SERVICES,
NAMELY, WIRELESS MOBILE TELEPHONE CALL-
ING PLANS, IN CLASS 38 (U.S. CLS. 100, 101 AND
104).

FIRST USE 10-0-2006; IN COMMERCE 10-0-2006.

THE MARK CONSISTS OF STANDARD CHAR-
ACTERS WITHOUT CLAIM TO ANY PARTICULAR
FONT, STYLE, SIZE, OR COLOR.

NO CLAIM IS MADE TO THE EXCLUSIVE
RIGHT TO USE "WIRELESS", APART FROM THE
MARK AS SHOWN.

SN 77-012,618, FILED 10-3-2006.

STEVEN JACKSON, EXAMINING ATTORNEY

Int. Cl.: 35

Prior U.S. Cls.: 100, 101, and 102

United States Patent and Trademark Office

Reg. No. 3,477,193

Registered July 29, 2008

**SERVICE MARK
PRINCIPAL REGISTER**

FRYS.COM

FRY'S ELECTRONICS, INC. (CALIFORNIA CORPORATION)
LEGAL DEPARTMENT
600 E. BROKAW ROAD
SAN JOSE, CA 95112

FOR: ONLINE RETAIL STORE SERVICES FEATURING CONSUMER ELECTRONICS AND GENERAL CONSUMER MERCHANDISE RELATED TO ELECTRONICS, IN CLASS 35 (U.S. CLS. 100, 101 AND 102).

FIRST USE 12-1-2006; IN COMMERCE 12-1-2006.

OWNER OF U.S. REG. NOS. 2,031,351 AND 2,102,637.

THE COLOR(S) RED AND WHITE IS/ARE CLAIMED AS A FEATURE OF THE MARK.

THE MARK CONSISTS OF "FRYS.COM" IN RED ON A WHITE BACKGROUND.

SEC. 2(F) AS TO "FRYS".

SN 77-013,030, FILED 10-3-2006.

JAMES STEIN, EXAMINING ATTORNEY

Int. Cl.: 35

Prior U.S. Cls.: 100, 101, and 102

United States Patent and Trademark Office

Reg. No. 3,477,194

Registered July 29, 2008

**SERVICE MARK
PRINCIPAL REGISTER**

30 MINUTE VACATION

GABBERT, JAMES (UNITED STATES INDIVIDUAL)
7140 WILLOW CREEK ROAD
EDEN PRAIRIE, MN 55344

THE MARK CONSISTS OF STANDARD CHARACTERS WITHOUT CLAIM TO ANY PARTICULAR FONT, STYLE, SIZE, OR COLOR.

FOR: RETAIL STORE SERVICES FEATURING HOME FURNISHINGS, IN CLASS 35 (U.S. CLS. 100, 101 AND 102).

SN 77-013,106, FILED 10-4-2006.

FIRST USE 11-15-2006; IN COMMERCE 11-15-2006.

GIANCARLO CASTRO, EXAMINING ATTORNEY

Int. Cl.: 42

Prior U.S. Cls.: 100 and 101

United States Patent and Trademark Office

Reg. No. 3,477,195

Registered July 29, 2008

**SERVICE MARK
PRINCIPAL REGISTER**



INTRIALS LLC (DELAWARE LTD LIAB CO)
1308 DELAWARE AVENUE
WILMINGTON, DE 19806

FOR: RESEARCH AND CONSULTANCY SERVICES IN THE SCIENTIFIC FIELD, NAMELY, THERAPEUTIC SCIENCE AND MEDICINE; BASIC AND CLINICAL RESEARCH IN THE FIELD OF THER-

APEUTIC SCIENCE AND MEDICINE , IN CLASS 42
(U.S. CLS. 100 AND 101).

FIRST USE 0-0-1999; IN COMMERCE 4-14-2007.

SN 77-014,492, FILED 10-5-2006.

TIMOTHY FINNEGAN, EXAMINING ATTORNEY

Int. Cl.: 41

Prior U.S. Cls.: 100, 101, and 107

United States Patent and Trademark Office

Reg. No. 3,477,196

Registered July 29, 2008

**SERVICE MARK
PRINCIPAL REGISTER**

PLAYGATE

MATTEL, INC. (DELAWARE CORPORATION)
MAIL STOP M1-1518
333 CONTINENTAL BOULEVARD
EL SEGUNDO, CA 90245

THE MARK CONSISTS OF STANDARD CHAR-
ACTERS WITHOUT CLAIM TO ANY PARTICULAR
FONT, STYLE, SIZE, OR COLOR.

FOR: PROVIDING FACILITIES IN THE NATURE
OF CHILDREN'S PLAY AREAS, IN CLASS 41 (U.S.
CLS. 100, 101 AND 107).

SN 77-014,496, FILED 10-5-2006.

FIRST USE 11-4-2004; IN COMMERCE 11-4-2004.

LINDA E. BLOHM, EXAMINING ATTORNEY

Int. Cl.: 26

Prior U.S. Cls.: 37, 39, 40, 42, and 50

United States Patent and Trademark Office

Reg. No. 3,477,197

Registered July 29, 2008

**TRADEMARK
PRINCIPAL REGISTER**

DESIGN LENGTHS

BEAUTY HOLDING LLC (DELAWARE LTD
LIAB CO)

3001 COLORADO BOULEVARD

DENTON, TX 76210

FOR: HAIR EXTENSIONS, IN CLASS 26 (U.S. CLS.
37, 39, 40, 42 AND 50).

FIRST USE 2-1-2007; IN COMMERCE 2-1-2007.

THE MARK CONSISTS OF STANDARD CHAR-
ACTERS WITHOUT CLAIM TO ANY PARTICULAR
FONT, STYLE, SIZE, OR COLOR.

NO CLAIM IS MADE TO THE EXCLUSIVE
RIGHT TO USE "LENGTHS", APART FROM THE
MARK AS SHOWN.

SN 77-014,504, FILED 10-5-2006.

PETER B. BROMAGHIM, EXAMINING ATTORNEY

Int. Cl.: 36

Prior U.S. Cls.: 100, 101, and 102

United States Patent and Trademark Office

Reg. No. 3,477,198

Registered July 29, 2008

**SERVICE MARK
PRINCIPAL REGISTER**

**COMPASS BUSINESSCLASS
ONLINE CASH MANAGER**

COMPASS BANCSHARES, INC. (DELAWARE
CORPORATION)
15 SOUTH 20TH STREET, 12TH FLOOR
BIRMINGHAM, AL 35233

FOR: 10BANKING SERVICES, IN CLASS 36 (U.S.
CLS. 100, 101 AND 102).

FIRST USE 10-8-2007; IN COMMERCE 10-8-2007.

THE MARK CONSISTS OF STANDARD CHAR-
ACTERS WITHOUT CLAIM TO ANY PARTICULAR
FONT, STYLE, SIZE, OR COLOR.

OWNER OF U.S. REG. NOS. 1,604,027, 1,894,328,
AND OTHERS.

NO CLAIM IS MADE TO THE EXCLUSIVE
RIGHT TO USE "BUSINESSCLASS ONLINE CASH
MANAGER", APART FROM THE MARK AS
SHOWN.

SN 77-014,950, FILED 10-5-2006.

MARGERY A. TIERNEY, EXAMINING ATTORNEY

Int. Cl.: 9

Prior U.S. Cls.: 21, 23, 26, 36, and 38

United States Patent and Trademark Office

Reg. No. 3,477,199

Registered July 29, 2008

**TRADEMARK
PRINCIPAL REGISTER**

ncase

HAZARD PROTECTION SYSTEMS, INC. (ALASKA CORPORATION)
7210 THIEL CIRCLE
ANCHORAGE, AK 99502

THE MARK CONSISTS OF STANDARD CHARACTERS WITHOUT CLAIM TO ANY PARTICULAR FONT, STYLE, SIZE, OR COLOR.

FOR: FIRE-EXTINGUISHING SYSTEMS, IN CLASS 9 (U.S. CLS. 21, 23, 26, 36 AND 38).

SN 77-016,049, FILED 10-6-2006.

FIRST USE 10-23-2007; IN COMMERCE 10-23-2007.

LA TONIA FISHER, EXAMINING ATTORNEY

Int. Cl.: 42

Prior U.S. Cls.: 100 and 101

United States Patent and Trademark Office

Reg. No. 3,477,200

Registered July 29, 2008

**SERVICE MARK
PRINCIPAL REGISTER**



XLLERATE CONSULTING, LLC (TEXAS LTD
LIAB CO)
5435 NORTH GARLAND AVENUE
SUITE 140-202
GARLAND, TX 750402787

FOR: COMPUTER SOFTWARE DESIGN, DEVELOPMENT, CUSTOMIZATION, CONSULTING, MAINTENANCE AND TECHNICAL SUPPORT SERVICES FOR OTHERS, AND CONSULTING ON SELECTION AND INTEGRATION OF COMPUTER HARDWARE AND SOFTWARE, IN THE FIELDS OF AUTOMATING MANUAL BUSINESS PRACTICES, DOCUMENTING BUSINESS PROCESSES, MANAGING AND INTEGRATING DATABASES, PROVIDING STATISTICAL ANALYSES, NOTIFICATIONS

AND REPORTS, AND PROVIDING REAL-TIME, INTEGRATED BUSINESS MANAGEMENT TOOLS; CONSULTATION SERVICES IN THE FIELD OF OFFICE AND WORKPLACE AUTOMATION, IN CLASS 42 (U.S. CLS. 100 AND 101).

FIRST USE 9-7-2005; IN COMMERCE 9-7-2005.

THE MARK CONSISTS OF A STYLIZED VERSION OF THE WORD "XLLERATE".

SN 77-016,480, FILED 10-8-2006.

BRENDAN REGAN, EXAMINING ATTORNEY

Int. Cls.: 38 and 42

Prior U.S. Cls.: 100, 101, and 104

United States Patent and Trademark Office

Reg. No. 3,477,201

Registered July 29, 2008

**SERVICE MARK
PRINCIPAL REGISTER**

MY INTERNET

DOTSTER, INC. (DELAWARE CORPORATION)
SUITE 300
8100 NE PARKWAY DRIVE
VANCOUVER, WA 98662

FOR: ELECTRONIC MAIL SERVICES FOR OTHERS OVER A GLOBAL COMPUTER NETWORK; ELECTRONIC MAIL FORWARDING SERVICES FOR OTHERS OVER A GLOBAL COMPUTER NETWORK; WEB SITE FORWARDING SERVICES FOR OTHERS OVER A GLOBAL COMPUTER NETWORK, IN CLASS 38 (U.S. CLS. 100, 101 AND 104).

FIRST USE 6-20-2008; IN COMMERCE 6-20-2008.

FOR: COMPUTER NETWORK ADDRESS MANAGEMENT SERVICES, NAMELY, PROVIDING SERVICES ENABLING ENTITIES TO RESERVE AND SECURE COMPUTER NETWORK ADDRESSES AND TO ACCESS, ADD, MODIFY, OR DELETE INFORMATION RELATING TO THEIR COMPUTER NETWORK ADDRESSES; HOSTING DOMAIN

NAMES FOR OTHERS; COMPUTER SERVICES, NAMELY, CREATING AND MAINTAINING WEB SITES FOR OTHERS; REGISTRATION OF DOMAIN NAMES FOR IDENTIFICATION OF USERS ON A GLOBAL COMPUTER NETWORK, IN CLASS 42 (U.S. CLS. 100 AND 101).

FIRST USE 6-20-2008; IN COMMERCE 6-20-2008.

THE MARK CONSISTS OF STANDARD CHARACTERS WITHOUT CLAIM TO ANY PARTICULAR FONT, STYLE, SIZE, OR COLOR.

OWNER OF U.S. REG. NO. 2,611,501.

NO CLAIM IS MADE TO THE EXCLUSIVE RIGHT TO USE "INTERNET", APART FROM THE MARK AS SHOWN.

SN 77-017,424, FILED 10-10-2006.

JIM RINGLE, EXAMINING ATTORNEY

Int. Cl.: 38

Prior U.S. Cls.: 100, 101, and 104

United States Patent and Trademark Office

Reg. No. 3,477,202

Registered July 29, 2008

**SERVICE MARK
PRINCIPAL REGISTER**

Diabetes
Wireless

DIABETES WIRELESS, LLC (TEXAS LTD LIAB
CO)
3 RIVERWAY, SUITE 825
HOUSTON, TX 77056

FOR: TEXT AND NUMERIC WIRELESS DIGITAL
MESSAGING SERVICES; WIRELESS COMMUNICA-
TIONS SERVICES, NAMELY, TRANSMISSION TO
AND FROM MOBILE TELEPHONES; WIRELESS
DIGITAL MESSAGING SERVICES; WIRELESS TEL-
EPHONE TELECOMMUNICATIONS SERVICES,
NAMELY, WIRELESS MOBILE TELEPHONE CALL-

ING PLANS, IN CLASS 38 (U.S. CLS. 100, 101 AND
104).

FIRST USE 10-0-2006; IN COMMERCE 10-0-2006.

NO CLAIM IS MADE TO THE EXCLUSIVE
RIGHT TO USE "WIRELESS", APART FROM THE
MARK AS SHOWN.

SN 77-018,534, FILED 10-11-2006.

STEVEN JACKSON, EXAMINING ATTORNEY

Int. Cl.: 16

Prior U.S. Cls.: 2, 5, 22, 23, 29, 37, 38, and 50

Reg. No. 3,477,203

United States Patent and Trademark Office

Registered July 29, 2008

**TRADEMARK
PRINCIPAL REGISTER**

**THE MASTER ILLUSTRATOR
SERIES**

THE ZONDERVAN CORPORATION L.L.C. (DE-
LAWARE LTD LIAB CO)
5300 PATTERSON AVENUE SOUTHEAST
GRAND RAPIDS, MI 49530

FOR: PRINTED NON-FICTION BOOKS ON THE
SUBJECT OF THE BIBLE, IN CLASS 16 (U.S. CLS. 2, 5,
22, 23, 29, 37, 38 AND 50).

FIRST USE 2-1-2008; IN COMMERCE 2-1-2008.

THE MARK CONSISTS OF STANDARD CHAR-
ACTERS WITHOUT CLAIM TO ANY PARTICULAR
FONT, STYLE, SIZE, OR COLOR.

NO CLAIM IS MADE TO THE EXCLUSIVE
RIGHT TO USE "ILLUSTRATOR SERIES", APART
FROM THE MARK AS SHOWN.

SN 77-018,981, FILED 10-11-2006.

DANNEAN HETZEL, EXAMINING ATTORNEY

Int. Cl.: 36

Prior U.S. Cls.: 100, 101, and 102

United States Patent and Trademark Office

Reg. No. 3,477,204

Registered July 29, 2008

**SERVICE MARK
PRINCIPAL REGISTER**

BUILDING FLORIDA'S BANK

AMERICAN MOMENTUM BANK (FLORIDA
CORPORATION)

4830 W. KENNEDY BOULEVARD, SUITE 200

TAMPA, FL 33609

FOR: BANKING AND RELATED FINANCIAL
SERVICES, IN CLASS 36 (U.S. CLS. 100, 101 AND 102).

FIRST USE 10-25-2006; IN COMMERCE 10-25-2006.

THE MARK CONSISTS OF STANDARD CHAR-
ACTERS WITHOUT CLAIM TO ANY PARTICULAR
FONT, STYLE, SIZE, OR COLOR.

NO CLAIM IS MADE TO THE EXCLUSIVE
RIGHT TO USE "FLORIDA'S BANK", APART FROM
THE MARK AS SHOWN.

SN 77-019,126, FILED 10-11-2006.

ALLISON HOLTZ, EXAMINING ATTORNEY

Int. Cl.: 41

Prior U.S. Cls.: 100, 101, and 107

United States Patent and Trademark Office

Reg. No. 3,477,205

Registered July 29, 2008

**SERVICE MARK
PRINCIPAL REGISTER**

**Strong National Museum of
Play**

THE MARGARET WOODBURY STRONG MUSE-
UM (NEW YORK CORPORATION)
ONE MANHATTAN SQUARE
ROCHESTER, NY 14604

FOR: MUSEUMS, IN CLASS 41 (U.S. CLS. 100, 101
AND 107).

FIRST USE 7-1-2006; IN COMMERCE 7-1-2006.

THE MARK CONSISTS OF STANDARD CHAR-
ACTERS WITHOUT CLAIM TO ANY PARTICULAR
FONT, STYLE, SIZE, OR COLOR.

OWNER OF U.S. REG. NO. 2,874,295.

NO CLAIM IS MADE TO THE EXCLUSIVE
RIGHT TO USE "MUSEUM", APART FROM THE
MARK AS SHOWN.

SEC. 2(F) "NATIONAL MUSEUM OF PLAY".

SN 77-019,326, FILED 10-12-2006.

KATHLEEN LORENZO, EXAMINING ATTORNEY

Int. Cl.: 35

Prior U.S. Cls.: 100, 101, and 102

United States Patent and Trademark Office

Reg. No. 3,477,206

Registered July 29, 2008

**SERVICE MARK
PRINCIPAL REGISTER**



MPL, LTD. (BELIZE CORPORATION)
1 MECHANIC STREET, P.O. BOX 215
HOOSICK FALLS, NY 12090

FOR: RETAIL STORE SERVICES FEATURING
MATTRESSES AND ACCESSORIES FOR USE
THERewith, IN CLASS 35 (U.S. CLS. 100, 101 AND
102).

FIRST USE 10-0-2006; IN COMMERCE 10-0-2006.

THE COLOR(S) OFF-WHITE, BEIGE, VARI-
ATIONS OF PURPLE IS/ARE CLAIMED AS A FEAT-
URE OF THE MARK.

THE MARK CONSISTS OF THE WORDS "NAT-
URAL" AND "FORM" WITH A WAVE GOING

THROUGH THE BOTTOM OF THE WORD "NAT-
URAL" AND THE TOP OF THE WORD "FORM".
THE WAVE STARTS OFF AS OFF-WHITE ON THE
LEFT HAND SIDE, THEN TURNING LIGHTER
SHADES OF PURPLE AND CLIMAXING TO A
DEEPER PURPLE IN THE MIDDLE OF THE WAVE
AND ENDING BACK IN AN OFF-WHITE COLOR
TO THE RIGHT. THE BACKGROUND IS OFF-
WHITE. THE FILL MATERIAL OF THE WORDS
BEING BEIGE IN COLOR.

SN 77-019,660, FILED 10-12-2006.

VIVIAN MICZNIK FIRST, EXAMINING ATTOR-
NEY

Int. Cl.: 35

Prior U.S. Cls.: 100, 101, and 102

United States Patent and Trademark Office

Reg. No. 3,477,207

Registered July 29, 2008

**SERVICE MARK
PRINCIPAL REGISTER**

LEADERSHIP ARCHIVES

LEADERSHIP DIRECTORIES, INC. (D.C. CORPORATION)
104 FIFTH AVENUE
NEW YORK, NY 10011

FOR: RESEARCH AND PREPARATION OF REPORTS FOR OTHERS REGARDING PAST AND CURRENT PROMINENT INDIVIDUALS AND ORGANIZATIONS IN GOVERNMENT, BUSINESS, AND PROFESSIONAL ARENAS , IN CLASS 35 (U.S. CLS. 100, 101 AND 102).

FIRST USE 11-30-2006; IN COMMERCE 11-30-2006.

THE MARK CONSISTS OF STANDARD CHARACTERS WITHOUT CLAIM TO ANY PARTICULAR FONT, STYLE, SIZE, OR COLOR.

NO CLAIM IS MADE TO THE EXCLUSIVE RIGHT TO USE "ARCHIVES", APART FROM THE MARK AS SHOWN.

SN 77-019,828, FILED 10-12-2006.

SHAUNIA CARLYLE, EXAMINING ATTORNEY

Int. Cl.: 35

Prior U.S. Cls.: 100, 101, and 102

United States Patent and Trademark Office

Reg. No. 3,477,208

Registered July 29, 2008

**SERVICE MARK
PRINCIPAL REGISTER**

LEADERSHIP ALERTS

LEADERSHIP DIRECTORIES, INC. (D.C. CORPORATION)
104 FIFTH AVENUE
NEW YORK, NY 10011

FOR: PROVIDING E-MAIL AND ON-LINE UPDATES REGARDING USER-DEFINED INFORMATION IN THE NATURE OF PROFILES OF PROMINENT INDIVIDUALS AND ORGANIZATIONS IN GOVERNMENT, BUSINESS, AND PROFESSIONAL ARENAS, IN CLASS 35 (U.S. CLS. 100, 101 AND 102).

FIRST USE 2-28-2007; IN COMMERCE 2-28-2007.

THE MARK CONSISTS OF STANDARD CHARACTERS WITHOUT CLAIM TO ANY PARTICULAR FONT, STYLE, SIZE, OR COLOR.

NO CLAIM IS MADE TO THE EXCLUSIVE RIGHT TO USE "ALERTS", APART FROM THE MARK AS SHOWN.

SN 77-019,841, FILED 10-12-2006.

SHAUNIA CARLYLE, EXAMINING ATTORNEY

Int. Cl.: 2

Prior U.S. Cls.: 6, 11, and 16

United States Patent and Trademark Office

Reg. No. 3,477,209

Registered July 29, 2008

**TRADEMARK
PRINCIPAL REGISTER**

DELTA-LUBE

EWALD DÖRKEN AG (FED REP GERMANY
JOINT STOCK COMPANY)
WETTERSTRASSE 58
58313 HERDECKE, FED REP GERMANY

FOR: DYES, PAINTS, LACQUERS, GLAZES,
VARNISHES, AND OIL PAINTS FOR USE ON
METAL PARTS, EXCLUDING AUTOMOTIVE USE;
MORDANTS USED FOR PROTECTION AGAINST
CORROSION AND AS A PRESERVATIVE, WOOD
PRESERVATIVES, COATINGS FOR PROTECTION
AGAINST CORROSION, AND ANTI-RUST PRE-
PARATIONS IN THE NATURE OF COATINGS
APPLIED TO METAL PARTS; CATAPHORETIC
AND ELECTROLYTIC COATINGS FOR USE IN
COATING METALS; COATINGS IN THE NATURE
OF CATHODIC CORROSION PROTECTIONS LAY-
ERS FOR USE IN CONNECTION WITH ELECTRO-
PLATING OR GALVANIZING; COATINGS IN THE

NATURE OF PROTECTIVE LAYERS FOR USE IN
CONTROLLING HOW SURFACES SLIDE, ZINC-
FLAKE COATINGS FOR USE IN INDUSTRY, IN
CLASS 2 (U.S. CLS. 6, 11 AND 16).

FIRST USE 12-31-2004; IN COMMERCE 12-31-2004.

THE MARK CONSISTS OF STANDARD CHAR-
ACTERS WITHOUT CLAIM TO ANY PARTICULAR
FONT, STYLE, SIZE, OR COLOR.

OWNER OF U.S. REG. NOS. 2,840,935, 3,185,428,
AND OTHERS.

SN 77-019,918, FILED 10-12-2006.

DAYNA BROWNE, EXAMINING ATTORNEY

Int. Cl.: 41

Prior U.S. Cls.: 100, 101, and 107

United States Patent and Trademark Office

Reg. No. 3,477,210

Registered July 29, 2008

**SERVICE MARK
PRINCIPAL REGISTER**

EXPAND YOUR FOCUS

MANDEVILLE, WILLIAM (UNITED STATES INDIVIDUAL)
11040 E. MISSION LANE
SCOTTSDALE, AZ 85259

FOR: PROVIDING NON-DOWNLOADABLE ONLINE PUBLICATIONS IN THE NATURE OF A MAGAZINE CONCERNING MULTICULTURAL FAMILY AND COMMUNITY ISSUES; ENTERTAINMENT, NAMELY, PROVIDING DEVELOPMENT, ORGANIZATION, AND PRODUCTION OF FAMILY AND CULTURAL EVENTS AND ACTIVITIES; ORGANIZING AND HOLDING OF CONFERENCES, COLLOQUIUMS, CONVENTIONS, SEMINARS, AND SYMPOSIUMS CONCERNING MULTICULTURAL FAMILIES AND COMMUNITIES; ORGANIZING AND HOLDING OF MULTICULTURAL FAMILY AND COMMUNITY EXHIBITIONS AND EVENTS FOR CULTURAL OR EDUCATIONAL

PURPOSES; PRODUCTION OF RADIO AND TELEVISION PROGRAMS; VIDEOTAPING SERVICES; PRODUCTION OF SOUND RECORDINGS; PRODUCTION OF MOTION PICTURE FILMS AND FILM STUDIES; AND PRODUCTION OF RADIO PROGRAMS, IN CLASS 41 (U.S. CLS. 100, 101 AND 107).

FIRST USE 5-19-2008; IN COMMERCE 5-19-2008.

THE MARK CONSISTS OF STANDARD CHARACTERS WITHOUT CLAIM TO ANY PARTICULAR FONT, STYLE, SIZE, OR COLOR.

SN 77-020,082, FILED 10-12-2006.

CORY BOONE, EXAMINING ATTORNEY

Int. Cl.: 9

Prior U.S. Cls.: 21, 23, 26, 36, and 38

United States Patent and Trademark Office

Reg. No. 3,477,211

Registered July 29, 2008

**TRADEMARK
PRINCIPAL REGISTER**



NOVELL, INC. (DELAWARE CORPORATION)
PRV-H-544
1800 SOUTH NOVELL PLACE
PROVO, UT 846066194

FOR: PRE-RECORDED COMPUTER PROGRAMS
FOR USE AS AN OPERATING SYSTEM, FOR
WORD PROCESSING, FOR ELECTRONIC DATA
PROCESSING, AND FOR NETWORKING, AND
INSTRUCTION MANUALS DISTRIBUTED TOGE-

TER AS A UNIT, IN CLASS 9 (U.S. CLS. 21, 23, 26, 36
AND 38).

FIRST USE 8-31-2006; IN COMMERCE 8-31-2006.

THE MARK CONSISTS OF A GECKO OR LIZARD
LOGO.

SN 77-020,212, FILED 10-12-2006.

TRICIA SONNEBORN, EXAMINING ATTORNEY

Int. Cl.: 41

Prior U.S. Cls.: 100, 101, and 107

United States Patent and Trademark Office

Reg. No. 3,477,212

Registered July 29, 2008

**SERVICE MARK
PRINCIPAL REGISTER**

FUN K TOWN

KELLOGG NORTH AMERICA COMPANY (DE-
LAWARE CORPORATION)
LEGAL DEPARTMENT
ONE KELLOGG SQUARE - P.O. BOX 3599
BATTLE CREEK, MI 490163599

FOR: PROVIDING GENERAL INFORMATION
OVER A GLOBAL COMPUTER NETWORK IN THE
FIELDS OF NEWS, ENTERTAINMENT, GAMES,
INTERACTIVE GAMES, IN CLASS 41 (U.S. CLS.
100, 101 AND 107).

FIRST USE 9-16-2004; IN COMMERCE 9-16-2004.

THE MARK CONSISTS OF STANDARD CHAR-
ACTERS WITHOUT CLAIM TO ANY PARTICULAR
FONT, STYLE, SIZE, OR COLOR.

SN 77-021,286, FILED 10-14-2006.

TIMOTHY FINNEGAN, EXAMINING ATTORNEY

Int. Cl.: 41

Prior U.S. Cls.: 100, 101, and 107

United States Patent and Trademark Office

Reg. No. 3,477,213

Registered July 29, 2008

**SERVICE MARK
PRINCIPAL REGISTER**

PDUS ON THE GO

OPTIMO, INC. (GEORGIA CORPORATION)
TWO PIEDMONT CENTER SUITE 318
3565 PIEDMONT RD NE
ATLANTA, GA 30305

THE MARK CONSISTS OF STANDARD CHAR-
ACTERS WITHOUT CLAIM TO ANY PARTICULAR
FONT, STYLE, SIZE, OR COLOR.

FOR: PROVIDING CONTINUING PROJECT
MANAGEMENT EDUCATION COURSES, IN CLASS
41 (U.S. CLS. 100, 101 AND 107).

SN 77-021,341, FILED 10-14-2006.

FIRST USE 10-14-2006; IN COMMERCE 10-14-2006.

JENNIFER MARTIN, EXAMINING ATTORNEY

Int. Cl.: 41

Prior U.S. Cls.: 100, 101, and 107

United States Patent and Trademark Office

Reg. No. 3,477,214

Registered July 29, 2008

**SERVICE MARK
PRINCIPAL REGISTER**

PDUS 2 GO

OPTIMO, INC. (GEORGIA CORPORATION)
3565 PIEDMONT RD NE
TWO PIEDMONT CENTER SUITE 318
ATLANTA, GA 30305

THE MARK CONSISTS OF STANDARD CHAR-
ACTERS WITHOUT CLAIM TO ANY PARTICULAR
FONT, STYLE, SIZE, OR COLOR.

FOR: PROVIDING CONTINUING PROJECT
MANAGEMENT EDUCATION COURSES, IN CLASS
41 (U.S. CLS. 100, 101 AND 107).

SN 77-021,343, FILED 10-14-2006.

FIRST USE 10-14-2006; IN COMMERCE 10-14-2006.

JENNIFER MARTIN, EXAMINING ATTORNEY

Int. Cl.: 41

Prior U.S. Cls.: 100, 101, and 107

United States Patent and Trademark Office

Reg. No. 3,477,215

Registered July 29, 2008

**SERVICE MARK
PRINCIPAL REGISTER**

THE PDU PLACE

OPTIMO, INC. (GEORGIA CORPORATION)
3565 PIEDMONT RD NE
TWO PIEDMONT CENTER SUITE 318
ATLANTA, GA 30305

THE MARK CONSISTS OF STANDARD CHAR-
ACTERS WITHOUT CLAIM TO ANY PARTICULAR
FONT, STYLE, SIZE, OR COLOR.

FOR: PROVIDING CONTINUING PROJECT
MANAGEMENT EDUCATION COURSES, IN CLASS
41 (U.S. CLS. 100, 101 AND 107).

SN 77-021,346, FILED 10-14-2006.

FIRST USE 10-14-2006; IN COMMERCE 10-14-2006.

JENNIFER MARTIN, EXAMINING ATTORNEY

Int. Cl.: 44

Prior U.S. Cls.: 100 and 101

United States Patent and Trademark Office

Reg. No. 3,477,216

Registered July 29, 2008

**SERVICE MARK
PRINCIPAL REGISTER**

STATISDX

HERITAGE PROVIDER NETWORK, INC. (CALIFORNIA CORPORATION)
12062 VALLEY VIEW STREET, SUITE 200
GARDEN GROVE, CA 92845

FOR: MEDICAL SERVICES, NAMELY, CREATING AND MAINTAINING FILES AND RECORDS CONCERNING THE MEDICAL CONDITION AND HISTORIES OF INDIVIDUAL PATIENTS AND GROUPS OF PATIENTS FOR USE IN IDENTIFYING THE PRESENCE AND RELATIVE FREQUENCY OF ILLNESS AND DISEASE AND FOR PREDICTING THE PRESENCE AND RELATIVE FREQUENCY OF ILLNESS AND DISEASE; CREATING AND MAINTAINING MEDICAL FILES AND RECORDS FOR INDIVIDUAL PATIENTS OR GROUPS OF PATIENTS CONCERNING MEDICATIONS USED, LAB TEST RESULTS, AND PATIENT-RELATED

PHYSIOLOGICAL METRICS; AND CONSULTING IN THE FIELD OF MEDICINE, NAMELY, DEVELOPING HOLISTIC MEDICAL TREATMENT APPROACHES FOR DISEASE AND POPULATION HEALTHCARE MANAGEMENT, IN CLASS 44 (U.S. CLS. 100 AND 101).

FIRST USE 1-1-2006; IN COMMERCE 1-1-2006.

THE MARK CONSISTS OF STANDARD CHARACTERS WITHOUT CLAIM TO ANY PARTICULAR FONT, STYLE, SIZE, OR COLOR.

SN 77-022,039, FILED 10-16-2006.

CHARLOTTE CORWIN, EXAMINING ATTORNEY

Int. Cl.: 36

Prior U.S. Cls.: 100, 101, and 102

United States Patent and Trademark Office

Reg. No. 3,477,217

Registered July 29, 2008

**SERVICE MARK
PRINCIPAL REGISTER**

GRAND PURPOSE ACTIVITY

KOWALIK, WENDY H. (UNITED STATES INDIVIDUAL)
10101 REUNION PLACE, SUITE 400
SAN ANTONIO, TX 78216 AND
OLIPHINT, THOMAS H. (UNITED STATES INDIVIDUAL)
10101 REUNION PLACE, SUITE 400
SAN ANTONIO, TX 78216

FOR: FINANCIAL AND INVESTMENT SERVICES, NAMELY, FINANCIAL ANALYSIS AND CONSULTATION; FINANCIAL DUE DILIGENCE; FINANCIAL EVALUATION FOR INSURANCE PURPOSES; FINANCIAL FORECASTING; FINANCIAL INFORMATION PROVIDED BY ELECTRONIC MEANS; FINANCIAL INVESTMENT IN THE FIELD OF SECURITIES; FINANCIAL PLANNING; FINANCIAL PORTFOLIO MANAGEMENT; FINANCIAL RESEARCH; FINANCIAL RISK MANAGEMENT; FINANCIAL SERVICES IN THE NATURE OF INVESTMENT SECURITY; FINANCIAL SERVICES, NAMELY ASSISTING OTHERS WITH THE COMPLETION OF FINANCIAL TRANSACTIONS FOR STOCKS, BONDS, SECURITIES AND EQUITIES, INVESTMENT FUND TRANSFER AND TRANSACTION SERVICES, A TOTAL PORTFOLIO OFFERING FOR HIGH NET WORTH CLIENTS CONSISTING OF BOTH SEPARATE ACCOUNTS AND MUTUAL FUNDS FOR EQUITY AND FIXED

INCOME INVESTMENTS, SAVING PROGRAMS FOR YOUTHS, AND ESTATE SETTLEMENT SERVICES; PROVIDING ONLINE INFORMATION IN THE FIELD OF CHARITABLE MONETARY GIVING THROUGH FINANCIAL AND ESTATE PLANNING; PROVIDING ON-LINE FINANCIAL CALCULATOR; ADVICE RELATING TO INVESTMENTS; FUND INVESTMENT CONSULTATION; FUNDS INVESTMENT; HEDGE FUND INVESTMENT SERVICES; INVESTMENT ADVISORY SERVICES; INVESTMENT BROKERAGE; INVESTMENT CONSULTATION; INVESTMENT MANAGEMENT; INVESTMENT MANAGEMENT OF AND DISTRIBUTION OF VARIABLE ANNUITIES; PRIVATE EQUITY FUND INVESTMENT SERVICES; REAL ESTATE INVESTMENT, IN CLASS 36 (U.S. CLS. 100, 101 AND 102).

FIRST USE 9-30-2005; IN COMMERCE 9-30-2005.

THE MARK CONSISTS OF STANDARD CHARACTERS WITHOUT CLAIM TO ANY PARTICULAR FONT, STYLE, SIZE, OR COLOR.

SN 77-022,788, FILED 10-17-2006.

BRENDAN MCCAULEY, EXAMINING ATTORNEY

Int. Cl.: 21

Prior U.S. Cls.: 2, 13, 23, 29, 30, 33, 40, and 50

United States Patent and Trademark Office

Reg. No. 3,477,218

Registered July 29, 2008

**TRADEMARK
PRINCIPAL REGISTER**

**GREAT RESULTS NO MATTER
WHAT COLOR YOUR THUMB IS**

LAMINATIONS, INC. (PENNSYLVANIA CORPORATION)
P.O. BOX 2021
1300 MEYLERT AVENUE
SCRANTON, PA 18509

FOR: CONTAINER GARDENING SYSTEM CONSISTING OF A CONTAINER FOR GROWING VEGETABLES AND FLOWERS INCLUDING A STAKING SYSTEM CONSISTING OF RIGID TUBING SECTIONS AND CONNECTORS THEREFOR AND PLANTING KIT CONSISTING OF POTTING MIX, DOLOMITE AND FERTILIZER, SOLD AS A

UNIT, IN CLASS 21 (U.S. CLS. 2, 13, 23, 29, 30, 33, 40 AND 50).

FIRST USE 12-1-2006; IN COMMERCE 2-1-2007.

THE MARK CONSISTS OF STANDARD CHARACTERS WITHOUT CLAIM TO ANY PARTICULAR FONT, STYLE, SIZE, OR COLOR.

SN 77-024,199, FILED 10-18-2006.

BONNIE LUKEN, EXAMINING ATTORNEY

Int. Cl.: 3

Prior U.S. Cls.: 1, 4, 6, 50, 51, and 52

United States Patent and Trademark Office

Reg. No. 3,477,219

Registered July 29, 2008

**TRADEMARK
PRINCIPAL REGISTER**

PURE REPLENISHMENT

BONNE BELL, INC. (OHIO CORPORATION)
18519 DETROIT AVENUE
LAKEWOOD, OH 44107

THE MARK CONSISTS OF STANDARD CHAR-
ACTERS WITHOUT CLAIM TO ANY PARTICULAR
FONT, STYLE, SIZE, OR COLOR.

FOR: LIP BALM, IN CLASS 3 (U.S. CLS. 1, 4, 6, 50,
51 AND 52).

SN 77-024,576, FILED 10-19-2006.

FIRST USE 2-1-2007; IN COMMERCE 2-1-2007.

SOPHIA S. KIM, EXAMINING ATTORNEY

Int. Cl.: 16

Prior U.S. Cls.: 2, 5, 22, 23, 29, 37, 38, and 50

Reg. No. 3,477,220

United States Patent and Trademark Office

Registered July 29, 2008

**TRADEMARK
PRINCIPAL REGISTER**

HOME ENTHUSIAST

MEREDITH CORPORATION (IOWA CORPORATION)
1716 LOCUST STREET
DES MOINES, IA 503093023

FOR: PERIODIC PUBLICATIONS, NAMELY, REPORTS AND NEWSLETTERS RELATING TO RESEARCH CONDUCTED ON CONSUMER PRODUCTS AND MARKET TRENDS, EXCLUDING WINE AND WINE-RELATED MERCHANDISE, IN CLASS 16 (U.S. CLS. 2, 5, 22, 23, 29, 37, 38 AND 50).

FIRST USE 1-9-2008; IN COMMERCE 1-9-2008.

THE MARK CONSISTS OF STANDARD CHARACTERS WITHOUT CLAIM TO ANY PARTICULAR FONT, STYLE, SIZE, OR COLOR.

OWNER OF U.S. REG. NOS. 2,041,419 AND 2,980,092.

NO CLAIM IS MADE TO THE EXCLUSIVE RIGHT TO USE "HOME", APART FROM THE MARK AS SHOWN.

SN 77-024,714, FILED 10-19-2006.

LAURIE KAUFMAN, EXAMINING ATTORNEY

Int. Cl.: 7

Prior U.S. Cls.: 13, 19, 21, 23, 31, 34, and 35

Reg. No. 3,477,221

United States Patent and Trademark Office

Registered July 29, 2008

**TRADEMARK
PRINCIPAL REGISTER**

SIX SHOOTER

IDEAVILLAGE PRODUCTS CORP. (NEW JERSEY CORPORATION)
WAYNE PLAZA II, 155 ROUTE 46 WEST
WAYNE, NJ 07470

THE MARK CONSISTS OF STANDARD CHARACTERS WITHOUT CLAIM TO ANY PARTICULAR FONT, STYLE, SIZE, OR COLOR.

FOR: BATTERY-OPERATED DRILL; ELECTRIC DRILL, IN CLASS 7 (U.S. CLS. 13, 19, 21, 23, 31, 34 AND 35).

SN 77-024,984, FILED 10-19-2006.

FIRST USE 11-26-2007; IN COMMERCE 11-26-2007.

ALICE BENMAMAN, EXAMINING ATTORNEY

Int. Cl.: 40

Prior U.S. Cls.: 100, 103, and 106

United States Patent and Trademark Office

Reg. No. 3,477,222

Registered July 29, 2008

**SERVICE MARK
PRINCIPAL REGISTER**

The logo for VOMELA THE IMAGEMAKERS. The word "VOMELA" is written in a bold, italicized, sans-serif font. The letter "E" in "VOMELA" is highlighted with a red horizontal bar. Below "VOMELA", the words "THE IMAGEMAKERS" are written in a smaller, spaced-out, all-caps sans-serif font.

VOMELA SPECIALTY COMPANY (MINNESOTA CORPORATION)
SUITE 705
380 ST. PETER STREET
ST. PAUL, MN 55102

FOR: CUSTOM PRINTING SERVICES FOR DECORATIVE PROMOTIONAL, ARCHITECTURAL AND COMMERCIAL GRAPHICS AND LOGOS FOR DISPLAY IN RETAIL AND PUBLIC FACILITIES AND ON CARS, OVER-THE-ROAD TRUCKS, BUSES, COMMERCIAL VEHICLES, AND RECREATIONAL VEHICLES, IN CLASS 40 (U.S. CLS. 100, 103 AND 106).

FIRST USE 3-1-2005; IN COMMERCE 3-1-2005.

OWNER OF U.S. REG. NOS. 2,370,694, 2,391,228, AND OTHERS.

THE COLOR(S) GREY AND RED IS/ARE CLAIMED AS A FEATURE OF THE MARK.

THE COLOR GREY APPEARS IN ALL OF THE WORDING, EXCEPT FOR THE TOP HORIZONTAL LINE IN THE LETTER "E" IN "VOMELA" WHICH IS RED.

SN 77-025,104, FILED 10-19-2006.

GIANCARLO CASTRO, EXAMINING ATTORNEY

Int. Cl.: 18

Prior U.S. Cls.: 1, 2, 3, 22, and 41

United States Patent and Trademark Office

Reg. No. 3,477,223

Registered July 29, 2008

**TRADEMARK
PRINCIPAL REGISTER**

ENCHANTMENT

SAMSONITE CORPORATION (DELAWARE CORPORATION)
575 WEST STREET, SUITE 110
MANSFIELD, MA 02048

THE MARK CONSISTS OF STANDARD CHARACTERS WITHOUT CLAIM TO ANY PARTICULAR FONT, STYLE, SIZE, OR COLOR.

FOR: LUGGAGE, IN CLASS 18 (U.S. CLS. 1, 2, 3, 22 AND 41).

SN 77-025,563, FILED 10-20-2006.

FIRST USE 1-1-2007; IN COMMERCE 1-1-2007.

SARA THOMAS, EXAMINING ATTORNEY

Int. Cl.: 41

Prior U.S. Cls.: 100, 101, and 107

United States Patent and Trademark Office

Reg. No. 3,477,224

Registered July 29, 2008

**SERVICE MARK
PRINCIPAL REGISTER**

EARN N' LEARN

OPTIMO, INC. (GEORGIA CORPORATION)
TWO PIEDMONT CENTER SUITE 318
3565 PIEDMONT RD NE
ATLANTA, GA 30305

THE MARK CONSISTS OF STANDARD CHAR-
ACTERS WITHOUT CLAIM TO ANY PARTICULAR
FONT, STYLE, SIZE, OR COLOR.

FOR: PROVIDING CONTINUING PROJECT
MANAGEMENT EDUCATION COURSES, IN CLASS
41 (U.S. CLS. 100, 101 AND 107).

SN 77-026,646, FILED 10-22-2006.

FIRST USE 10-22-2006; IN COMMERCE 10-22-2006.

JENNIFER MARTIN, EXAMINING ATTORNEY

Int. Cl.: 25

Prior U.S. Cls.: 22 and 39

United States Patent and Trademark Office

Reg. No. 3,477,225

Registered July 29, 2008

**TRADEMARK
PRINCIPAL REGISTER**

IMPERIAL STAR

REVISE CLOTHING, INC. (NEW JERSEY CORPORATION)
20 HENRY STREET
TETERBORO, NJ 07608

FOR: JACKETS; JEANS; PANTS; SHIRTS, IN CLASS 25 (U.S. CLS. 22 AND 39).

FIRST USE 10-30-2006; IN COMMERCE 10-30-2006.

THE MARK CONSISTS OF STANDARD CHARACTERS WITHOUT CLAIM TO ANY PARTICULAR FONT, STYLE, SIZE, OR COLOR.

OWNER OF U.S. REG. NO. 2,762,901.

SN 77-026,972, FILED 10-23-2006.

MATTHEW EINSTEIN, EXAMINING ATTORNEY

Int. Cl.: 36

Prior U.S. Cls.: 100, 101, and 102

United States Patent and Trademark Office

Reg. No. 3,477,226

Registered July 29, 2008

**SERVICE MARK
PRINCIPAL REGISTER**

XLE

PHILADELPHIA STOCK EXCHANGE, INC. (DE-
LAWARE CORPORATION)
1900 MARKET STREET
PHILADELPHIA, PA 191033584

THE MARK CONSISTS OF STANDARD CHAR-
ACTERS WITHOUT CLAIM TO ANY PARTICULAR
FONT, STYLE, SIZE, OR COLOR.

FOR: FINANCIAL EXCHANGE, NAMELY, EQUI-
TY TRADING SERVICES BY MEANS OF COMPU-
TER SOFTWARE, IN CLASS 36 (U.S. CLS. 100, 101
AND 102).

SN 77-027,121, FILED 10-23-2006.

FIRST USE 7-2-2006; IN COMMERCE 7-2-2006.

GINA FINK, EXAMINING ATTORNEY

Int. Cl.: 3

Prior U.S. Cls.: 1, 4, 6, 50, 51, and 52

United States Patent and Trademark Office

Reg. No. 3,477,227

Registered July 29, 2008

**TRADEMARK
PRINCIPAL REGISTER**

DAILY CLEANSE

TED GIBSON & COMPANY, INC. (NEW YORK CORPORATION)
C/O KANTOR, DAVIDOFF ET AL.
51 EAST 42ND STREET
NEW YORK, NY 10017

FOR: HAIR CARE PRODUCTS, NAMELY, HAIR SHAMPOO, IN CLASS 3 (U.S. CLS. 1, 4, 6, 50, 51 AND 52).

FIRST USE 3-1-2007; IN COMMERCE 3-1-2007.

THE MARK CONSISTS OF STANDARD CHARACTERS WITHOUT CLAIM TO ANY PARTICULAR FONT, STYLE, SIZE, OR COLOR.

NO CLAIM IS MADE TO THE EXCLUSIVE RIGHT TO USE "CLEANSE", APART FROM THE MARK AS SHOWN.

SN 77-028,510, FILED 10-24-2006.

WENDY GOODMAN, EXAMINING ATTORNEY

Int. Cl.: 9

Prior U.S. Cls.: 21, 23, 26, 36, and 38

Reg. No. 3,477,228

United States Patent and Trademark Office

Registered July 29, 2008

**TRADEMARK
PRINCIPAL REGISTER**

FUSIONQUAD

AMKOR TECHNOLOGY, INC. (DELAWARE
CORPORATION)
1900 SOUTH PRICE ROAD
CHANDLER, AZ 85248

THE MARK CONSISTS OF STANDARD CHAR-
ACTERS WITHOUT CLAIM TO ANY PARTICULAR
FONT, STYLE, SIZE, OR COLOR.

FOR: SEMICONDUCTOR PACKAGES, NAMELY,
SEMICONDUCTOR PACKAGES COMPRISED OF
SEMICONDUCTOR DIES AND INTERCONNECTS,
IN CLASS 9 (U.S. CLS. 21, 23, 26, 36 AND 38).

SN 77-029,465, FILED 10-25-2006.

FIRST USE 10-4-2006; IN COMMERCE 2-28-2008.

ROBERT LAVACHE, EXAMINING ATTORNEY

Int. Cl.: 5

Prior U.S. Cls.: 6, 18, 44, 46, 51, and 52

Reg. No. 3,477,229

United States Patent and Trademark Office

Registered July 29, 2008

**TRADEMARK
PRINCIPAL REGISTER**

AVED-KIDS

ANABOLIC LABORATORIES, LLC (CALIFORNIA LTD LIAB CO)
46 CORPORATE PARK, SUITE 100
IRVINE, CA 92606

THE MARK CONSISTS OF STANDARD CHARACTERS WITHOUT CLAIM TO ANY PARTICULAR FONT, STYLE, SIZE, OR COLOR.

FOR: VITAMINS AND NUTRITIONAL SUPPLEMENTS, IN CLASS 5 (U.S. CLS. 6, 18, 44, 46, 51 AND 52).

SN 77-029,470, FILED 10-25-2006.

FIRST USE 2-0-2004; IN COMMERCE 2-0-2004.

DAVID TOOLEY, EXAMINING ATTORNEY

Int. Cl.: 42

Prior U.S. Cls.: 100 and 101

United States Patent and Trademark Office

Reg. No. 3,477,230

Registered July 29, 2008

**SERVICE MARK
PRINCIPAL REGISTER**

**Bridging Challenges with
Solutions**

FINLEY ENGINEERING GROUP, INC. (FLORIDA CORPORATION)
1589 METROPOLITAN BOULEVARD
TALLAHASSEE, FL 323083776

FOR: ENGINEERING SERVICES, NAMELY, ENGINEERING FOR THE DESIGN AND CONSTRUCTION OF BRIDGES, IN CLASS 42 (U.S. CLS. 100 AND 101).

FIRST USE 10-1-2004; IN COMMERCE 10-1-2004.

THE MARK CONSISTS OF STANDARD CHARACTERS WITHOUT CLAIM TO ANY PARTICULAR FONT, STYLE, SIZE, OR COLOR.

SN 77-029,682, FILED 10-26-2006.

JENNY PARK, EXAMINING ATTORNEY

Int. Cls.: 35 and 42

Prior U.S. Cls.: 100, 101, and 102

United States Patent and Trademark Office

Reg. No. 3,477,231

Registered July 29, 2008

**SERVICE MARK
PRINCIPAL REGISTER**

THE DEPTH TEAM

CHAMPION TECHNOLOGIES, INC. (TEXAS CORPORATION)
SUITE 2700
3200 S.W. FREEWAY
HOUSTON, TX 77025

FOR: CONSULTING SERVICES TO THE OIL AND GAS INDUSTRY IN THE FIELD OF TECHNICAL MARKETING, IN CLASS 35 (U.S. CLS. 100, 101 AND 102).

FIRST USE 12-31-2007; IN COMMERCE 12-31-2007.

FOR: CONSULTING SERVICES TO THE OIL AND GAS INDUSTRY IN THE FIELD OF SCIENTIFIC

DEEPWATER RESEARCH AND THE DESIGN AND PRODUCTION OF SPECIALTY CHEMICALS FOR DEEPWATER PRODUCTION OF OIL AND GAS, IN CLASS 42 (U.S. CLS. 100 AND 101).

FIRST USE 12-31-2007; IN COMMERCE 12-31-2007.

THE MARK CONSISTS OF STANDARD CHARACTERS WITHOUT CLAIM TO ANY PARTICULAR FONT, STYLE, SIZE, OR COLOR.

SN 77-030,104, FILED 10-26-2006.

GIANCARLO CASTRO, EXAMINING ATTORNEY

Int. Cl.: 6

Prior U.S. Cls.: 2, 12, 13, 14, 23, 25, and 50

United States Patent and Trademark Office

Reg. No. 3,477,232

Registered July 29, 2008

**TRADEMARK
PRINCIPAL REGISTER**

TAHOE BLUE B.M.P.'S

GARY BELL (CALIFORNIA SOLE PROPRIETOR-
SHIP), DBA ALPINE METALS,
2152 RUTH AVENUE
SOUTH LAKE TAHOE, CA 96150

FOR: METAL SLOTTED DRAINS FOR USE ON
DRIVEWAYS, IN CLASS 6 (U.S. CLS. 2, 12, 13, 14, 23,
25 AND 50).

FIRST USE 4-8-2008; IN COMMERCE 4-8-2008.

THE MARK CONSISTS OF STANDARD CHAR-
ACTERS WITHOUT CLAIM TO ANY PARTICULAR
FONT, STYLE, SIZE, OR COLOR.

NO CLAIM IS MADE TO THE EXCLUSIVE
RIGHT TO USE "TAHOE" AND "B.M.P.'S", APART
FROM THE MARK AS SHOWN.

SN 77-031,184, FILED 10-27-2006.

ODESSA BIBBINS, EXAMINING ATTORNEY

Int. Cls.: 7, 12, 25, and 27

**Prior U.S. Cls.: 13, 19, 20, 21, 22, 23, 31, 34, 35, 37, 39,
42, 44, and 50**

Reg. No. 3,477,233

United States Patent and Trademark Office

Registered July 29, 2008

**TRADEMARK
PRINCIPAL REGISTER**



PRO FX DESIGN, INC. (FLORIDA CORPORATION)
620 N.W. 167TH STREET
MIAMI, FL 33317

FOR: ENGINE OR MOTOR MUFFLERS, IN CLASS 7 (U.S. CLS. 13, 19, 21, 23, 31, 34 AND 35).

FIRST USE 5-30-2008; IN COMMERCE 5-30-2008.

FOR: FITTED COVERS FOR VEHICLES; FITTED DASHBOARD COVERS FOR VEHICLES; SEMI-FITTED COVERS FOR VEHICLES; STEERING WHEEL COVERS; TIRES; VEHICLE SEAT COVERS, IN CLASS 12 (U.S. CLS. 19, 21, 23, 31, 35 AND 44).

FIRST USE 5-30-2008; IN COMMERCE 5-30-2008.

FOR: GLOVES, IN CLASS 25 (U.S. CLS. 22 AND 39).

FIRST USE 5-30-2008; IN COMMERCE 5-30-2008.

FOR: FLOOR MATS FOR VEHICLES, IN CLASS 27 (U.S. CLS. 19, 20, 37, 42 AND 50).

FIRST USE 5-30-2008; IN COMMERCE 5-30-2008.

OWNER OF U.S. REG. NOS. 2,805,328 AND 2,861,439.

NO CLAIM IS MADE TO THE EXCLUSIVE RIGHT TO USE "PRO" AND "SPORTS", APART FROM THE MARK AS SHOWN.

THE MARK CONSISTS OF STYLIZED LETTERS "F" AND "X" ABOVE THE WORDS "PRO SPORTS".

SN 77-031,210, FILED 10-27-2006.

DAVID MURRAY, EXAMINING ATTORNEY

Int. Cl.: 35

Prior U.S. Cls.: 100, 101, and 102

United States Patent and Trademark Office

Reg. No. 3,477,234

Registered July 29, 2008

**SERVICE MARK
PRINCIPAL REGISTER**

DECISION INTELLIGENCE

DECISION INTELLIGENCE, INCORPORATED
(MINNESOTA CORPORATION)
7090 SHADY OAK ROAD
EDEN PRAIRIE, MN 553443505

FOR: COMPUTATIONAL DATABASE MARKET-
ING MANAGEMENT CONSULTANCY USING A
NEW SET OF PROCESSES AND TECHNOLOGIES
MAKING MARKETING MANAGERS MORE OPER-
ATIONALLY EFFECTIVE; IDENTIFICATION OF
HARD TO FIND MARKET SEGMENTS IN CUSTO-
MERS' DATA THROUGH UNIQUE CLUSTERING
ALGORITHMS; IDENTIFICATION OF CUSTO-
MERS' PROPENSITY TO ENGAGE IN AN ACTIV-
ITY THROUGH SCORING ALGORITHMS;
MAXIMIZING MARKETING RETURN ON INVEST-
MENT WHILE MINIMIZING MEDIA RISK
THROUGH ASSET ALLOCATION SOLUTIONS; OP-
TIMIZATION OF CUSTOMER CAMPAIGNS TO
INSURE HIGHEST RETURN ON INVESTED PRO-

MOTIONS; PRICING OPTIMIZATION TO PROVIDE
EVERYDAY PRICES, RETAIL MARKDOWN, AND
PRICE PROMOTIONS; CREATION OF MARKET-
ING TOOLS DESIGNED TO INCREASE CLIENT
COMPANIES' KNOWLEDGE OF CUSTOMER
NEEDS, AND ITS COMPETITORS' PRODUCTS
AND SERVICES, PRICING, ADVERTISING STRAT-
EGY AND SALES STRATEGY, IN CLASS 35 (U.S.
CLS. 100, 101 AND 102).

FIRST USE 4-0-2002; IN COMMERCE 4-0-2002.

THE MARK CONSISTS OF STANDARD CHAR-
ACTERS WITHOUT CLAIM TO ANY PARTICULAR
FONT, STYLE, SIZE, OR COLOR.

SN 77-033,250, FILED 10-31-2006.

SHAUNIA CARLYLE, EXAMINING ATTORNEY

Int. Cl.: 41

Prior U.S. Cls.: 100, 101, and 107

United States Patent and Trademark Office

Reg. No. 3,477,235

Registered July 29, 2008

**SERVICE MARK
PRINCIPAL REGISTER**



THE DEVEREUX FOUNDATION (PENNSYLVANIA CORPORATION)
444 DEVEREUX DRIVE
VILLANOVA, PA 19085

FOR: EDUCATIONAL SERVICES, NAMELY, PROVIDING EDUCATIONAL COURSES OF INSTRUCTION TO SPECIAL NEEDS STUDENTS AT THE PRIMARY AND SECONDARY SCHOOL LEVEL; AND EDUCATIONAL RESEARCH, IN CLASS 41 (U.S. CLS. 100, 101 AND 107).

FIRST USE 6-0-2000; IN COMMERCE 6-0-2000.

THE MARK CONSISTS OF STYLIZED DESIGN OF TREE IN SILHOUETTE.

SN 77-033,907, FILED 11-1-2006.

LORETTA C. BECK, EXAMINING ATTORNEY

Int. Cls.: 16 and 20

Prior U.S. Cls.: 2, 5, 13, 22, 23, 25, 29, 32, 37, 38, and 50

United States Patent and Trademark Office

Reg. No. 3,477,236

Registered July 29, 2008

**TRADEMARK
PRINCIPAL REGISTER**

MOUNTED MEMORIES

DREAMS PRODUCTS, INC. (FLORIDA CORPORATION)
2 SOUTH UNIVERSITY DRIVE
SUITE 325
PLANTATION, FL 33324

FOR: SPORTS MEMORABILIA, NAMELY, PHOTOGRAPH MOUNTS AND MOUNTING BOARDS, IN CLASS 16 (U.S. CLS. 2, 5, 22, 23, 29, 37, 38 AND 50).

FIRST USE 5-5-1997; IN COMMERCE 5-5-1997.

FOR: ACRYLIC DISPLAY BOARDS AND DISPLAY CASES, IN CLASS 20 (U.S. CLS. 2, 13, 22, 25, 32 AND 50).

FIRST USE 5-5-1997; IN COMMERCE 5-5-1997.

THE MARK CONSISTS OF STANDARD CHARACTERS WITHOUT CLAIM TO ANY PARTICULAR FONT, STYLE, SIZE, OR COLOR.

NO CLAIM IS MADE TO THE EXCLUSIVE RIGHT TO USE "MOUNTED", APART FROM THE MARK AS SHOWN.

SN 77-035,312, FILED 11-2-2006.

LINDA M. KING, EXAMINING ATTORNEY

Int. Cls.: 28 and 40

Prior U.S. Cls.: 22, 23, 38, 50, 100, 103, and 106

United States Patent and Trademark Office

Reg. No. 3,477,237

Registered July 29, 2008

**TRADEMARK
SERVICE MARK
PRINCIPAL REGISTER**

YOUR BEST BET

DOUGLAS PRESS, INC. (ILLINOIS CORPORATION)
2810 MADISON STREET
BELLWOOD, IL 60104

FOR: GAME CARDS AND DISPOSABLE GAME TICKETS FOR PLAYING GAMES OF CHANCE ASSOCIATED WITH FUND RAISING AND PROMOTIONAL PROGRAMS, IN CLASS 28 (U.S. CLS. 22, 23, 38 AND 50).

FIRST USE 0-0-2000; IN COMMERCE 0-0-2000.

FOR: MANUFACTURING SERVICES FOR OTHERS IN THE FIELD OF GAME TICKETS AND

GAME CARDS, IN CLASS 40 (U.S. CLS. 100, 103 AND 106).

FIRST USE 0-0-1989; IN COMMERCE 0-0-1989.

THE MARK CONSISTS OF STANDARD CHARACTERS WITHOUT CLAIM TO ANY PARTICULAR FONT, STYLE, SIZE, OR COLOR.

SN 77-035,619, FILED 11-2-2006.

TAMARA FRAZIER, EXAMINING ATTORNEY

Int. Cl.: 25

Prior U.S. Cls.: 22 and 39

United States Patent and Trademark Office

Reg. No. 3,477,238

Registered July 29, 2008

**TRADEMARK
PRINCIPAL REGISTER**

bebe Boudoir

BEBE STUDIO, INC. (CALIFORNIA CORPORATION)
10345 WEST OLYMPIC BLVD.
LOS ANGELES, CA 90064

THE MARK CONSISTS OF STANDARD CHARACTERS WITHOUT CLAIM TO ANY PARTICULAR FONT, STYLE, SIZE, OR COLOR.

FOR: ARTICLES OF CLOTHING FOR WOMEN, NAMELY, PAJAMAS, LINGERIE, BRAS, UNDERWEAR, AND UNDERGARMENTS, IN CLASS 25 (U.S. CLS. 22 AND 39).

SN 77-035,637, FILED 11-2-2006.

FIRST USE 1-5-2007; IN COMMERCE 1-5-2007.

KIMBERLY PERRY, EXAMINING ATTORNEY

Int. Cl.: 7

Prior U.S. Cls.: 13, 19, 21, 23, 31, 34, and 35

Reg. No. 3,477,239

United States Patent and Trademark Office

Registered July 29, 2008

**TRADEMARK
PRINCIPAL REGISTER**

Clean Well

WELLBORE ENERGY SOLUTIONS, LLC
(LOUISIANA LTD LIAB CO)
6127 HWY. 90 E
BROUSSARD, LA 70518

THE MARK CONSISTS OF STANDARD CHARACTERS WITHOUT CLAIM TO ANY PARTICULAR FONT, STYLE, SIZE, OR COLOR.

FOR: DRILLING MACHINES; DRILLING MACHINES AND PARTS THEREFOR, IN CLASS 7 (U.S. CLS. 13, 19, 21, 23, 31, 34 AND 35).

SN 77-035,656, FILED 11-2-2006.

FIRST USE 12-20-2006; IN COMMERCE 12-20-2006.

ANDREA HACK, EXAMINING ATTORNEY

Int. Cl.: 11

Prior U.S. Cls.: 13, 21, 23, 31, and 34

United States Patent and Trademark Office

Reg. No. 3,477,240

Registered July 29, 2008

TRADEMARK
PRINCIPAL REGISTER

KIWAMI

TOTO USA, INC. (DELAWARE CORPORATION)
1155 SOUTHERN ROAD
MORROW, GA 30260

FOR: PLUMBING FIXTURES, NAMELY, TOILETS, BIDETS, BATHTUBS, SHOWERS, SINKS, FAUCETS, AND LIGHTING FIXTURES, IN CLASS 11 (U.S. CLS. 13, 21, 23, 31 AND 34).

FIRST USE 1-16-2008; IN COMMERCE 1-16-2008.

THE MARK CONSISTS OF STANDARD CHARACTERS WITHOUT CLAIM TO ANY PARTICULAR FONT, STYLE, SIZE, OR COLOR.

THE ENGLISH TRANSLATION OF THE WORD "KIWAMI" IN THE MARK IS "BEST OF THE BEST", "ACME", AND "ULTIMATE".

SN 77-036,334, FILED 11-3-2006.

LEIGH CAROLINE CASE, EXAMINING ATTORNEY

Int. Cl.: 11

Prior U.S. Cls.: 13, 21, 23, 31, and 34

United States Patent and Trademark Office

Reg. No. 3,477,241

Registered July 29, 2008

**TRADEMARK
PRINCIPAL REGISTER**

OBLO

KOHLER CO. (WISCONSIN CORPORATION)
444 HIGHLAND DRIVE
KOHLER, WI 53044

THE MARK CONSISTS OF STANDARD CHAR-
ACTERS WITHOUT CLAIM TO ANY PARTICULAR
FONT, STYLE, SIZE, OR COLOR.

FOR: FAUCETS AND FAUCET HANDLES;
VALVE TRIM; BATH, SHOWER FAUCET TRIM, IN
CLASS 11 (U.S. CLS. 13, 21, 23, 31 AND 34).

SN 77-036,965, FILED 11-4-2006.

FIRST USE 4-11-2008; IN COMMERCE 4-11-2008.

ESTHER A. BORSUK, EXAMINING ATTORNEY

Int. Cl.: 35

Prior U.S. Cls.: 100, 101, and 102

United States Patent and Trademark Office

Reg. No. 3,477,242

Registered July 29, 2008

**SERVICE MARK
PRINCIPAL REGISTER**



T.A. America Corporation

T.A. AMERICA CORPORATION (CALIFORNIA CORPORATION)
12636 CLARK STREET
SANTA FE SPRINGS, CA 90670

FOR: IMPORT AGENCIES AND DISTRIBUTORSHIPS IN THE FIELD OF ADHESIVES, ALUMINUM DIE CAST PARTS, COIL/PLATE SPRINGS, COLD FORGED PARTS, DIE CUT PARTS, EXTRUDED ALUMINUM PARTS, INDUSTRIAL TAPE, MACHINED PARTS, PACKAGING PRODUCTS, PLASTIC FASTENERS, PLASTIC INJECTION MOLDED PARTS, POWDER METAL PARTS, RUBBER/FOAM MOLDING, SPECIAL COLD FORMED PARTS, STAINLESS STEEL FABRICATED PARTS, STAMPED PARTS, STANDARD AND SPECIAL METAL FASTENERS, UV PAINTED PLASTIC PARTS

AND WIRE FORMED PRODUCTS, IN CLASS 35 (U.S. CLS. 100, 101 AND 102).

FIRST USE 8-31-2006; IN COMMERCE 8-31-2006.

NO CLAIM IS MADE TO THE EXCLUSIVE RIGHT TO USE "AMERICA CORPORATION" , APART FROM THE MARK AS SHOWN.

THE MARK CONSISTS OF THE WORDS "T.A. AMERICA CORPORATION" AND LOGO.

SN 77-040,876, FILED 11-9-2006.

CAROL SPILS, EXAMINING ATTORNEY

Int. Cl.: 35

Prior U.S. Cls.: 100, 101, and 102

United States Patent and Trademark Office

Reg. No. 3,477,243

Registered July 29, 2008

**SERVICE MARK
PRINCIPAL REGISTER**



INSTITUTE FOR DIVERSITY
in Health Management

AMERICAN HOSPITAL ASSOCIATION (ILLINOIS NOT FOR PROFIT CORPORATION)
ONE NORTH FRANKLIN
CHICAGO, IL 60606

FOR: ASSOCIATION SERVICES, NAMELY, PROMOTING DIVERSITY IN THE FIELD OF HEALTH MANAGEMENT BY SPONSORING AND DEVELOPING PROGRAMS FOR INDIVIDUALS TO AID IN THEIR CAREER DEVELOPMENTS ASSOCIATED WITH THE HEALTHCARE INDUSTRY, IN CLASS 35 (U.S. CLS. 100, 101 AND 102).

FIRST USE 6-1-2007; IN COMMERCE 6-1-2007.

OWNER OF U.S. REG. NO. 2,190,264.

NO CLAIM IS MADE TO THE EXCLUSIVE RIGHT TO USE "INSTITUTE", APART FROM THE MARK AS SHOWN.

THE MARK CONSISTS OF A CIRCLE CONTAINING A TREE WITH LEAVES THEREIN.

SEC. 2(F) AS TO "INSTITUTE FOR DIVERSITY IN HEALTH MANAGEMENT".

SN 77-041,434, FILED 11-10-2006.

JOHN KELLY, EXAMINING ATTORNEY

Int. Cl.: 7

Prior U.S. Cls.: 13, 19, 21, 23, 31, 34, and 35

United States Patent and Trademark Office

Reg. No. 3,477,244

Registered July 29, 2008

**TRADEMARK
PRINCIPAL REGISTER**

TERRA-FLO

OUTERWEARS, INC. (MICHIGAN CORPORATION)
12611 U.S. 131
SCHOOLCRAFT, MI 49087

FOR: PRE-FILTERS FOR KEEPING SAND, DIRT, METAL AND/OR WATER FROM ENTERING THE AIR INTAKE OPENING TO INTERNAL COMBUSTION, TURBINE OR ELECTRIC ENGINE MOTORS, IN CLASS 7 (U.S. CLS. 13, 19, 21, 23, 31, 34 AND 35).

FIRST USE 5-0-2008; IN COMMERCE 5-0-2008.

THE MARK CONSISTS OF STANDARD CHARACTERS WITHOUT CLAIM TO ANY PARTICULAR FONT, STYLE, SIZE, OR COLOR.

SN 77-042,814, FILED 11-13-2006.

PAULA MAHONEY, EXAMINING ATTORNEY

Int. Cl.: 42

Prior U.S. Cls.: 100 and 101

United States Patent and Trademark Office

Reg. No. 3,477,245

Registered July 29, 2008

**SERVICE MARK
PRINCIPAL REGISTER**



MACROSERVE PTE LTD (SINGAPORE CORPORATION)
UNIT 10-03
BLK 211 HENDERSON ROAD
SINGAPORE, SINGAPORE 159552

FOR: PRODUCT RESEARCH AND DEVELOPMENT IN THE FIELDS OF NATURAL DIETARY SUPPLEMENTS, BODY AND HAIR CARE AND AROMATHERAPY, IN CLASS 42 (U.S. CLS. 100 AND 101).

FIRST USE 1-1-2008; IN COMMERCE 1-1-2008.

OWNER OF U.S. REG. NO. 3,040,874.

NO CLAIM IS MADE TO THE EXCLUSIVE RIGHT TO USE "NUTRIENTS", APART FROM THE MARK AS SHOWN.

THE COLOR(S) RED AND WHITE IS/ARE CLAIMED AS A FEATURE OF THE MARK.

THE MARK CONSISTS OF THE COLOR WHITE APPEARS IN THE WORDINGS "HDI" AND IN THE BACKGROUND OF THE RIGHT PORTION OF THE CAPSULE DESIGN. THE COLOR RED APPEARS IN THE WORDINGS "NUTRIENTS", IN THE BACKGROUND OF THE LEFT PORTION OF THE CAPSULE DESIGN AND IN THE OUTER LINING OF THE CAPSULE. THE WORDS "HDI NUTRIENTS" APPEAR INSIDE THE ELONGATED CAPSULE DESIGN.

SN 77-043,180, FILED 11-14-2006.

NATALIE POLZER, EXAMINING ATTORNEY

Int. Cl.: 9

Prior U.S. Cls.: 21, 23, 26, 36, and 38

Reg. No. 3,477,246

United States Patent and Trademark Office

Registered July 29, 2008

**TRADEMARK
PRINCIPAL REGISTER**

**TIM AND ERIC AWESOME SHOW,
GREAT JOB**

THE CARTOON NETWORK, INC. (DELAWARE
CORPORATION)
C/O TURNER BROADCASTING SYSTEM, INC.
ONE CNN CENTER, 13 NORTH
ATLANTA, GA 30303

FOR: DIGITAL VERSATILE DISCS FEATURING
MUSIC, COMEDY, DRAMA, ACTION, ADVEN-
TURE, AND/OR ANIMATION; DOWNLOADABLE
GRAPHICS AND MUSIC VIA A GLOBAL COMPU-
TER NETWORK AND WIRELESS DEVICES; DOWN-
LOADABLE TELEVISION PROGRAMS PROVIDED

VIA VIDEO-ON-DEMAND, IN CLASS 9 (U.S. CLS. 21,
23, 26, 36 AND 38).

FIRST USE 4-22-2008; IN COMMERCE 4-22-2008.

THE MARK CONSISTS OF STANDARD CHAR-
ACTERS WITHOUT CLAIM TO ANY PARTICULAR
FONT, STYLE, SIZE, OR COLOR.

SN 77-043,197, FILED 11-14-2006.

TOBY BULLOFF, EXAMINING ATTORNEY

Int. Cl.: 9

Prior U.S. Cls.: 21, 23, 26, 36, and 38

United States Patent and Trademark Office

Reg. No. 3,477,247

Registered July 29, 2008

**TRADEMARK
PRINCIPAL REGISTER**



THE CARTOON NETWORK, INC. (DELAWARE CORPORATION)
ONE CNN CENTER, 13 NORTH
C/O TURNER BROADCASTING SYSTEM, INC.
ATLANTA, GA 30303

FOR: DIGITAL VERSATILE DISCS FEATURING MUSIC, COMEDY, DRAMA, ACTION, ADVENTURE, AND/OR ANIMATION; DOWNLOADABLE GRAPHICS AND MUSIC VIA A GLOBAL COMPUTER NETWORK AND WIRELESS DEVICES; DOWNLOADABLE TELEVISION PROGRAMS PROVIDED

VIA VIDEO-ON-DEMAND, IN CLASS 9 (U.S. CLS. 21, 23, 26, 36 AND 38).

FIRST USE 10-2-2007; IN COMMERCE 10-2-2007.

THE MARK CONSISTS OF AN IMAGE OF A SKULL WITH STYLIZED WINGS.

SN 77-043,202, FILED 11-14-2006.

TOBY BULLOFF, EXAMINING ATTORNEY

Int. Cl.: 25

Prior U.S. Cls.: 22 and 39

United States Patent and Trademark Office

Reg. No. 3,477,248

Registered July 29, 2008

**TRADEMARK
PRINCIPAL REGISTER**

**ELITE EQUIPMENT FOR THE
ELITE PLAYER**

MIKEN SPORTS LLC (DELAWARE LTD LIAB
CO)
510 MARYVILLE UNIVERSITY DR.
#110
ST. LOUIS, MO 63141

THE MARK CONSISTS OF STANDARD CHAR-
ACTERS WITHOUT CLAIM TO ANY PARTICULAR
FONT, STYLE, SIZE, OR COLOR.

FOR: CLOTHING, NAMELY, SWEATSHIRTS, IN
CLASS 25 (U.S. CLS. 22 AND 39).

SN 77-046,008, FILED 11-16-2006.

FIRST USE 5-1-2008; IN COMMERCE 5-1-2008.

MONIQUE MILLER, EXAMINING ATTORNEY

Int. Cl.: 28

Prior U.S. Cls.: 22, 23, 38, and 50

United States Patent and Trademark Office

Reg. No. 3,477,249

Registered July 29, 2008

**TRADEMARK
PRINCIPAL REGISTER**

**ELITE EQUIPMENT FOR THE
ELITE PLAYER**

MIKEN SPORTS LLC (DELAWARE LTD LIAB
CO)
510 MARYVILLE UNIVERSITY DR.
#110
ST. LOUIS, MO 63141

FOR: BASEBALL GLOVES, SOFTBALL GLOVES,
IN CLASS 28 (U.S. CLS. 22, 23, 38 AND 50).

FIRST USE 5-0-2007; IN COMMERCE 5-0-2007.

THE MARK CONSISTS OF STANDARD CHAR-
ACTERS WITHOUT CLAIM TO ANY PARTICULAR
FONT, STYLE, SIZE, OR COLOR.

NO CLAIM IS MADE TO THE EXCLUSIVE
RIGHT TO USE "EQUIPMENT", APART FROM
THE MARK AS SHOWN.

SN 77-046,010, FILED 11-16-2006.

MONIQUE MILLER, EXAMINING ATTORNEY

Int. Cl.: 10

Prior U.S. Cls.: 26, 39, and 44

United States Patent and Trademark Office

Reg. No. 3,477,250

Registered July 29, 2008

**TRADEMARK
PRINCIPAL REGISTER**

STABILITY UNDER PRESSURE

KREG MEDICAL, INC. (ILLINOIS CORPORATION)
2240 W. WALNUT STREET
CHICAGO, IL 60612

THE MARK CONSISTS OF STANDARD CHARACTERS WITHOUT CLAIM TO ANY PARTICULAR FONT, STYLE, SIZE, OR COLOR.

FOR: THERAPEUTIC MATTRESSES USED FOR MEDICAL PURPOSES, IN CLASS 10 (U.S. CLS. 26, 39 AND 44).

SN 77-046,288, FILED 11-17-2006.

FIRST USE 6-30-2007; IN COMMERCE 6-30-2007.

STEVEN R. FOSTER, EXAMINING ATTORNEY

Int. Cls.: 35 and 44

Prior U.S. Cls.: 100, 101, and 102

United States Patent and Trademark Office

Reg. No. 3,477,251

Registered July 29, 2008

**SERVICE MARK
PRINCIPAL REGISTER**



ALLONE HEALTH GROUP, INC. (PENNSYLVANIA CORPORATION)
19 NORTH MAIN STREET
WILKES-BARRE, PA 18711

FOR: HEALTH MANAGEMENT SERVICES, NAMELY, PROVIDING ASSISTANCE, EVALUATION AND CONSULTATION TO ENTITIES TO HELP THEIR EMPLOYEES AND MEMBERS MAKE HEALTH, WELLNESS AND NUTRITIONAL CHANGES TO INCREASE PRODUCTIVITY AND LOWER HEALTH CARE COSTS, IN CLASS 35 (U.S. CLS. 100, 101 AND 102).

FIRST USE 9-0-2007; IN COMMERCE 9-0-2007.

FOR: HEALTH MANAGEMENT SERVICES, NAMELY, PROVIDING WELLNESS PROGRAMS

FOR HEALTHY INDIVIDUALS, INDIVIDUALS AT RISK FOR HEALTH PROBLEMS, AND INDIVIDUALS WITH ILLNESSES; HEALTH MANAGEMENT SERVICES, NAMELY, PROVIDING DISEASE MANAGEMENT PROGRAMS FOR INDIVIDUALS WITH ILLNESSES, IN CLASS 44 (U.S. CLS. 100 AND 101).

FIRST USE 9-0-2007; IN COMMERCE 9-0-2007.

NO CLAIM IS MADE TO THE EXCLUSIVE RIGHT TO USE "HEALTH MANAGEMENT SOLUTIONS", APART FROM THE MARK AS SHOWN.

SN 77-046,823, FILED 11-17-2006.

JOHN KELLY, EXAMINING ATTORNEY

Int. Cl.: 18

Prior U.S. Cls.: 1, 2, 3, 22, and 41

United States Patent and Trademark Office

Reg. No. 3,477,252

Registered July 29, 2008

**TRADEMARK
PRINCIPAL REGISTER**

CORDOBA

SAMSONITE CORPORATION (DELAWARE CORPORATION)
575 WEST STREET, SUITE 110
MANSFIELD, MA 02048

THE MARK CONSISTS OF STANDARD CHARACTERS WITHOUT CLAIM TO ANY PARTICULAR FONT, STYLE, SIZE, OR COLOR.

FOR: LUGGAGE, IN CLASS 18 (U.S. CLS. 1, 2, 3, 22 AND 41).

SN 77-047,778, FILED 11-20-2006.

FIRST USE 1-1-2008; IN COMMERCE 1-1-2008.

WANDA KAY PRICE, EXAMINING ATTORNEY

Int. Cl.: 35

Prior U.S. Cls.: 100, 101, and 102

United States Patent and Trademark Office

Reg. No. 3,477,253

Registered July 29, 2008

**SERVICE MARK
PRINCIPAL REGISTER**

Galacticpet

HURWIT, ERIC (UNITED STATES INDIVIDUAL)
202 ISINGLASS HILL ROAD
PORTLAND, CT 06480

THE MARK CONSISTS OF STANDARD CHAR-
ACTERS WITHOUT CLAIM TO ANY PARTICULAR
FONT, STYLE, SIZE, OR COLOR.

FOR: ADVERTISING SERVICES, NAMELY, AD-
VERTISING SERVICES FOR ANIMAL CARE PRO-
VIDERS AND ANIMAL HEALTH PRODUCTS, IN
CLASS 35 (U.S. CLS. 100, 101 AND 102).

SN 77-047,797, FILED 11-20-2006.

FIRST USE 1-1-2008; IN COMMERCE 1-1-2008.

ODESSA BIBBINS, EXAMINING ATTORNEY

Int. Cl.: 20

Prior U.S. Cls.: 2, 13, 22, 25, 32, and 50

Reg. No. 3,477,254

United States Patent and Trademark Office

Registered July 29, 2008

**TRADEMARK
PRINCIPAL REGISTER**

LOADRUNNER

CONITEX SONOCO, LLC (DELAWARE LTD
LIAB CO)
1302 INDUSTRIAL PIKE
GASTONIA, NC 280520010

THE MARK CONSISTS OF STANDARD CHAR-
ACTERS WITHOUT CLAIM TO ANY PARTICULAR
FONT, STYLE, SIZE, OR COLOR.

FOR: NON-METAL PALLETS, IN CLASS 20 (U.S.
CLS. 2, 13, 22, 25, 32 AND 50).

SN 77-048,420, FILED 11-21-2006.

FIRST USE 5-23-2007; IN COMMERCE 5-24-2007.

CHARLOTTE CORWIN, EXAMINING ATTORNEY

Int. Cls.: 42 and 45

Prior U.S. Cls.: 100 and 101

United States Patent and Trademark Office

Reg. No. 3,477,255

Registered July 29, 2008

**SERVICE MARK
PRINCIPAL REGISTER**

OurChart.com

SHOWTIME NETWORKS INC. (DELAWARE
CORPORATION)
1633 BROADWAY
NEW YORK, NY 10019

FOR: COMPUTER SERVICES, NAMELY, HOST-
ING ONLINE WEB FACILITIES FOR GENERAL
USE FOR OTHERS, ORGANIZING AND CON-
DUCTING ONLINE GATHERINGS AND INTERAC-
TIVE DISCUSSIONS, IN CLASS 42 (U.S. CLS. 100
AND 101).

FIRST USE 1-7-2008; IN COMMERCE 1-7-2008.

FOR: SOCIAL NETWORKING SERVICES; INTER-
NET BASED DATING AND INTRODUCTION SER-
VICES, IN CLASS 45 (U.S. CLS. 100 AND 101).

FIRST USE 1-7-2008; IN COMMERCE 1-7-2008.

THE MARK CONSISTS OF STANDARD CHAR-
ACTERS WITHOUT CLAIM TO ANY PARTICULAR
FONT, STYLE, SIZE, OR COLOR.

SN 77-048,841, FILED 11-21-2006.

DANNEAN HETZEL, EXAMINING ATTORNEY

Int. Cl.: 5

Prior U.S. Cls.: 6, 18, 44, 46, 51, and 52

United States Patent and Trademark Office

Reg. No. 3,477,256

Registered July 29, 2008

**TRADEMARK
PRINCIPAL REGISTER**

PERANEX

BRADLEY PHARMACEUTICALS, INC. (DELA-
WARE CORPORATION)
383 ROUTE 46 WEST
FAIRFIELD, NJ 07004

THE MARK CONSISTS OF STANDARD CHAR-
ACTERS WITHOUT CLAIM TO ANY PARTICULAR
FONT, STYLE, SIZE, OR COLOR.

FOR: HEMORRHOID PREPARATIONS,
CREAMS, OINTMENTS AND PADS, IN CLASS 5
(U.S. CLS. 6, 18, 44, 46, 51 AND 52).

SN 77-048,903, FILED 11-21-2006.

FIRST USE 12-14-2007; IN COMMERCE 12-14-2007.

JACLYN KIDWELL, EXAMINING ATTORNEY

Int. Cl.: 44

Prior U.S. Cls.: 100 and 101

United States Patent and Trademark Office

Reg. No. 3,477,257

Registered July 29, 2008

**SERVICE MARK
PRINCIPAL REGISTER**

BECAUSE GRAY MATTERS

BRAIN SAVERS, LLC (ARIZONA LTD LIAB CO)
6111 N. PALO CRISTI ROAD
PARADISE VALLEY, AZ 85253

FOR: HEALTH CARE; NUTRITION COUNSELING; PHYSICAL REHABILITATION; PHYSICAL THERAPY; PROVIDING PHYSICAL REHABILITATION FACILITIES; HEALTH SPA SERVICES, NAMELY, COSMETIC BODY CARE SERVICES; FOOD NUTRITION CONSULTATION; PROVIDING INFORMATION ABOUT DIETARY SUPPLEMENTS

AND NUTRITION; DIETARY AND NUTRITIONAL GUIDANCE, IN CLASS 44 (U.S. CLS. 100 AND 101).

FIRST USE 3-29-2007; IN COMMERCE 3-29-2007.

THE MARK CONSISTS OF STANDARD CHARACTERS WITHOUT CLAIM TO ANY PARTICULAR FONT, STYLE, SIZE, OR COLOR.

SN 77-049,889, FILED 11-22-2006.

PAUL MORENO, EXAMINING ATTORNEY

Int. Cl.: 9

Prior U.S. Cls.: 21, 23, 26, 36, and 38

United States Patent and Trademark Office

Reg. No. 3,477,258

Registered July 29, 2008

**TRADEMARK
PRINCIPAL REGISTER**

SHARCC

UEVEN, LLC (ARIZONA LTD LIAB CO)
17505 N 79TH AVENUE, STE. 303
GLENDALE, AZ 85308

FOR: COMPUTER SOFTWARE FOR TIME MANAGEMENT AND TIME ATTENDANCE OF CONTRACTORS; COMPUTER SOFTWARE FOR PROJECT MANAGEMENT IN THE CONSTRUCTION OF BUILDINGS; COMPUTER SOFTWARE FOR THE CONSTRUCTION INDUSTRY ASSISTING IN OPERATIONS AND PROJECT MANAGEMENT, INCLUDING FACILITATING PAYROLL, PUR-

CHASING AND SCHEDULING ACTIVITIES, IN CLASS 9 (U.S. CLS. 21, 23, 26, 36 AND 38).

FIRST USE 6-1-2007; IN COMMERCE 6-1-2007.

THE MARK CONSISTS OF STANDARD CHARACTERS WITHOUT CLAIM TO ANY PARTICULAR FONT, STYLE, SIZE, OR COLOR.

SN 77-049,940, FILED 11-22-2006.

BARNEY CHARLON, EXAMINING ATTORNEY

Int. Cl.: 32

Prior U.S. Cls.: 45, 46, and 48

United States Patent and Trademark Office

Reg. No. 3,477,259

Registered July 29, 2008

**TRADEMARK
PRINCIPAL REGISTER**

RACE TO THE ULTRA

ANHEUSER-BUSCH, INCORPORATED (MIS-
SOURI CORPORATION)

202-6

ONE BUSCH PLACE

ST. LOUIS, MO 63118

THE MARK CONSISTS OF STANDARD CHAR-
ACTERS WITHOUT CLAIM TO ANY PARTICULAR
FONT, STYLE, SIZE, OR COLOR.

OWNER OF U.S. REG. NOS. 2,739,178, 3,114,367,
AND OTHERS.

FOR: BEER, IN CLASS 32 (U.S. CLS. 45, 46 AND 48).

SN 77-050,915, FILED 11-27-2006.

FIRST USE 1-31-2007; IN COMMERCE 1-31-2007.

WILLIAM VERHOSEK, EXAMINING ATTORNEY

Int. Cl.: 16

Prior U.S. Cls.: 2, 5, 22, 23, 29, 37, 38, and 50

United States Patent and Trademark Office

Reg. No. 3,477,260

Registered July 29, 2008

**TRADEMARK
PRINCIPAL REGISTER**

The Zoopremes

WILD ABOUT LEARNING, INC (ILLINOIS COR-
PORATION)
964 JOHN STREET
JOLIET, IL 60435

THE MARK CONSISTS OF STANDARD CHAR-
ACTERS WITHOUT CLAIM TO ANY PARTICULAR
FONT, STYLE, SIZE, OR COLOR.

FOR: CARTOON PRINTS, IN CLASS 16 (U.S. CLS.
2, 5, 22, 23, 29, 37, 38 AND 50).

SN 77-051,161, FILED 11-27-2006.

FIRST USE 1-1-2000; IN COMMERCE 12-1-2007.

GIANCARLO CASTRO, EXAMINING ATTORNEY

Int. Cl.: 35

Prior U.S. Cls.: 100, 101, and 102

United States Patent and Trademark Office

Reg. No. 3,477,261

Registered July 29, 2008

**SERVICE MARK
PRINCIPAL REGISTER**



Career Placement Specialists

AEROTEK, INC. (MARYLAND CORPORATION)
7301 PARKWAY DRIVE
HANOVER, MD 21076

FOR: EMPLOYMENT AGENCIES; EMPLOYMENT HIRING, RECRUITING, PLACEMENT, STAFFING AND CAREER NETWORKING SERVICES; TEMPORARY EMPLOYMENT AGENCIES, IN CLASS 35 (U.S. CLS. 100, 101 AND 102).

FIRST USE 4-14-2008; IN COMMERCE 4-14-2008.

OWNER OF U.S. REG. NOS. 1,557,200, 1,595,657, AND 2,524,549.

NO CLAIM IS MADE TO THE EXCLUSIVE RIGHT TO USE "AUTOMOTIVE" AND "CAREER PLACEMENT SPECIALISTS", APART FROM THE MARK AS SHOWN.

THE MARK CONSISTS OF THE DESIGN OF A TRIANGLE MADE OF HORIZONTAL BARS AND THE WORDS "AEROTEK, AUTOMOTIVE", AND "CAREER PLACEMENT SPECIALISTS."

SN 77-051,382, FILED 11-27-2006.

MARTHA FROMM, EXAMINING ATTORNEY

Int. Cl.: 9

Prior U.S. Cls.: 21, 23, 26, 36, and 38

United States Patent and Trademark Office

Reg. No. 3,477,262

Registered July 29, 2008

TRADEMARK
PRINCIPAL REGISTER

popnovella

VOELZ, JOHN FRED FRANK (UNITED STATES
INDIVIDUAL)
4035 AVIARA OAKS PARKWAY
JACKSON, MI 49201

FOR: AUDIO RECORDINGS FEATURING MUSIC AND SOUNDTRACKS; DOWNLOADABLE FILMS AND TV PROGRAMS PROVIDED VIA A VIDEO-ON-DEMAND; DOWNLOADABLE MP3 FILES, MP3 RECORDINGS, ONLINE DISCUSSION BOARDS, WEB CASTS, POD CASTS, WEBINARS FEATURING MUSIC, AUDIO BOOKS AND NEWS BROADCASTS; DOWNLOADABLE MULTIMEDIA FILE CONTAINING ARTWORK, TEXT, AUDIO, VIDEO, GAMES, AND INTERNET WEB LINKS RELATING TO RELIGIOUS EXPERIENCE; DOWNLOADABLE MUSICAL SOUND RECORDINGS; DOWNLOADABLE VIDEO RECORDINGS FEATURING RELIGIOUS TEACHINGS; MUSICAL SOUND RECORDINGS; MUSICAL VIDEO RE-

CORDINGS; PRERECORDED DIGITAL VIDEO DISKS FEATURING RELIGIOUS TEACHINGS; SOUND RECORDINGS FEATURING MUSIC; VIDEO DISCS FEATURING RELIGIOUS TEACHINGS; VIDEO DISKS AND VIDEO TAPES WITH RECORDED ANIMATED CARTOONS; VIDEO RECORDINGS FEATURING RELIGIOUS TEACHINGS; VIDEO TAPES FEATURING RELIGIOUS TEACHINGS, IN CLASS 9 (U.S. CLS. 21, 23, 26, 36 AND 38).

FIRST USE 11-30-2006; IN COMMERCE 6-1-2007.

THE MARK CONSISTS OF STANDARD CHARACTERS WITHOUT CLAIM TO ANY PARTICULAR FONT, STYLE, SIZE, OR COLOR.

SN 77-052,457, FILED 11-28-2006.

GIANCARLO CASTRO, EXAMINING ATTORNEY

Int. Cl.: 3

Prior U.S. Cls.: 1, 4, 6, 50, 51, and 52

United States Patent and Trademark Office

Reg. No. 3,477,263

Registered July 29, 2008

**TRADEMARK
PRINCIPAL REGISTER**

BERRY ICE

AMPRO INDUSTRIES, INC. (TENNESSEE CORPORATION)
SUITE 800
65 UNION AVENUE
MEMPHIS, TN 38103

FOR: HAIR BLEACH, HAIR CARE CREAMS, HAIR CARE LOTIONS, HAIR CLEANING PREPARATIONS, HAIR CONDITIONERS, HAIR DRESSING, HAIR DYE, HAIR EMMOLIENTS, HAIR GEL, HAIR OILS, HAIR RELAXERS, HAIR SHAMPOO, PRE-SHAVE CREAMS, AFTER-SHAVE CREAMS,

AFTER-SHAVE GELS, IN CLASS 3 (U.S. CLS. 1, 4, 6, 50, 51 AND 52).

FIRST USE 5-15-2007; IN COMMERCE 3-15-2007.

THE MARK CONSISTS OF STANDARD CHARACTERS WITHOUT CLAIM TO ANY PARTICULAR FONT, STYLE, SIZE, OR COLOR.

SN 77-052,840, FILED 11-29-2006.

BERYL GARDNER, EXAMINING ATTORNEY

Int. Cl.: 42

Prior U.S. Cls.: 100 and 101

United States Patent and Trademark Office

Reg. No. 3,477,264

Registered July 29, 2008

**SERVICE MARK
PRINCIPAL REGISTER**

**CRITICAL ONGOING RESIDUE
EVALUATION**

VELTEK ASSOCIATES, INC. (PENNSYLVANIA
CORPORATION)
15 LEE BOULEVARD
MALVERN, PA 19355

FOR: LABORATORY AND CONSULTING SER-
VICES, NAMELY, TESTING OF LABORATORY
AND MANUFACTURING FACILITIES DRUG PRO-
DUCTION SURFACES, IN CLASS 42 (U.S. CLS. 100
AND 101).

FIRST USE 1-0-2006; IN COMMERCE 1-0-2006.

THE MARK CONSISTS OF STANDARD CHAR-
ACTERS WITHOUT CLAIM TO ANY PARTICULAR
FONT, STYLE, SIZE, OR COLOR.

NO CLAIM IS MADE TO THE EXCLUSIVE
RIGHT TO USE "ONGOING RESIDUE EVALUA-
TION", APART FROM THE MARK AS SHOWN.

SN 77-053,168, FILED 11-29-2006.

MARY CRAWFORD, EXAMINING ATTORNEY

Int. Cl.: 41

Prior U.S. Cls.: 100, 101, and 107

United States Patent and Trademark Office

Reg. No. 3,477,265

Registered July 29, 2008

SERVICE MARK
PRINCIPAL REGISTER



APOLLO GROUP, INC. (ARIZONA CORPORATION)
4025 S. RIVERPOINT PARKWAY
PHOENIX, AZ 85040

FOR: EDUCATION SERVICES, NAMELY, PROVIDING COURSES OF INSTRUCTION AT THE POST-SECONDARY LEVEL, IN CLASS 41 (U.S. CLS. 100, 101 AND 107).

FIRST USE 12-16-2006; IN COMMERCE 12-16-2006.

OWNER OF U.S. REG. NOS. 1,521,279, 1,540,927, AND OTHERS.

NO CLAIM IS MADE TO THE EXCLUSIVE RIGHT TO USE "UNIVERSITY", APART FROM THE MARK AS SHOWN.

THE MARK CONSISTS OF THE WORDS "UNIVERSITY OF PHOENIX THINKING AHEAD" WITH A PHOENIX BIRD DESIGN.

SEC. 2(F) AS TO "UNIVERSITY OF PHOENIX".

SN 77-053,496, FILED 11-29-2006.

JUSTINE D. PARKER, EXAMINING ATTORNEY

Int. Cl.: 7

Prior U.S. Cls.: 13, 19, 21, 23, 31, 34, and 35

Reg. No. 3,477,266

United States Patent and Trademark Office

Registered July 29, 2008

**TRADEMARK
PRINCIPAL REGISTER**

METERMIZER

LSP INDUSTRIES, INC. (ILLINOIS CORPORATION)
P.O. BOX 5303
2511 20TH STREET
ROCKFORD, IL 61125

THE MARK CONSISTS OF STANDARD CHARACTERS WITHOUT CLAIM TO ANY PARTICULAR FONT, STYLE, SIZE, OR COLOR.

FOR: POWER OPERATED SPRAYER FOR INJECTING LUBRICANT INTO AIR STREAM, IN CLASS 7 (U.S. CLS. 13, 19, 21, 23, 31, 34 AND 35).

SN 77-053,927, FILED 11-30-2006.

FIRST USE 1-22-2008; IN COMMERCE 1-22-2008.

MARY ROSSMAN, EXAMINING ATTORNEY

Int. Cl.: 7

Prior U.S. Cls.: 13, 19, 21, 23, 31, 34, and 35

Reg. No. 3,477,267

United States Patent and Trademark Office

Registered July 29, 2008

**TRADEMARK
PRINCIPAL REGISTER**

GEMINI

STOWE WOODWARD LLC (DELAWARE LTD
LIAB CO)
14101 CAPITAL BLVD.
YOUNGSVILLE, NC 27596

THE MARK CONSISTS OF STANDARD CHAR-
ACTERS WITHOUT CLAIM TO ANY PARTICULAR
FONT, STYLE, SIZE, OR COLOR.

FOR: MACHINE PARTS, NAMELY, INDUSTRIAL
ROLL COVERS FOR USE IN PAPERMAKING MA-
CHINES, IN CLASS 7 (U.S. CLS. 13, 19, 21, 23, 31, 34
AND 35).

SN 77-054,366, FILED 11-30-2006.

FIRST USE 3-1-2007; IN COMMERCE 3-1-2007.

BARBARA BROWN, EXAMINING ATTORNEY

Int. Cls.: 35 and 42

Prior U.S. Cls.: 100, 101, and 102

United States Patent and Trademark Office

Reg. No. 3,477,268

Registered July 29, 2008

**SERVICE MARK
PRINCIPAL REGISTER**

ALCHEMYGRID

ORCHESTR8, LLC (COLORADO LTD LIAB CO)
3773 CHERRY CREEK NORTH DR., SUITE 575
DENVER, CO 80209

FOR: OPERATING ON-LINE MARKETPLACES
FOR SELLERS AND BUYERS OF COMPUTER
SOFTWARE AND ON-DEMAND APPLICATIONS,
IN CLASS 35 (U.S. CLS. 100, 101 AND 102).

FIRST USE 1-11-2008; IN COMMERCE 1-11-2008.

FOR: APPLICATION SERVICE PROVIDER (ASP)
FEATURING COMPUTER SOFTWARE IN THE
FIELD OF BUSINESS PROCESS MANAGEMENT,
BUSINESS KNOWLEDGE, INFORMATION AND

ASSET MANAGEMENT, ENTERPRISE APPLICA-
TION INTEGRATION, BUSINESS PROCESS MAN-
AGEMENT, E-COMMERCE, ELECTRONIC
MESSAGING, AND WEB SITE DEVELOPMENT, IN
CLASS 42 (U.S. CLS. 100 AND 101).

FIRST USE 1-11-2008; IN COMMERCE 1-11-2008.

THE MARK CONSISTS OF STANDARD CHAR-
ACTERS WITHOUT CLAIM TO ANY PARTICULAR
FONT, STYLE, SIZE, OR COLOR.

SN 77-056,391, FILED 12-4-2006.

RICHARD WHITE, EXAMINING ATTORNEY

Int. Cl.: 35

Prior U.S. Cls.: 100, 101, and 102

United States Patent and Trademark Office

Reg. No. 3,477,269

Registered July 29, 2008

**SERVICE MARK
PRINCIPAL REGISTER**

CYBIZMO

C JOINT VENTURES (CALIFORNIA CORPORATION)
PO BOX 640204
SAN JOSE, CA 951640204

FOR: COMMUNITY CLASSIFIED ADS WEB SERVICES, NAMELY, PROVIDING A WEBSITE THAT ENABLES USERS TO POST ITEMS FOR SALE THROUGH ON-LINE CLASSIFIED ADVERTISEMENTS, IN CLASS 35 (U.S. CLS. 100, 101 AND 102).

FIRST USE 5-25-2008; IN COMMERCE 5-25-2008.

THE MARK CONSISTS OF STANDARD CHARACTERS WITHOUT CLAIM TO ANY PARTICULAR FONT, STYLE, SIZE, OR COLOR.

SN 77-056,789, FILED 12-4-2006.

DAVID MILLER, EXAMINING ATTORNEY

Int. Cls.: 42 and 45

Prior U.S. Cls.: 100 and 101

United States Patent and Trademark Office

Reg. No. 3,477,270

Registered July 29, 2008

**SERVICE MARK
PRINCIPAL REGISTER**



AARP (D.C. NON-PROFIT CORPORATION)
601 E STREET, N.W.
WASHINGTON, DC 20049

FOR: PROVIDING TEMPORARY USE OF NON-DOWNLOADABLE SOFTWARE USED TO ACCESS, SORT, DISPLAY AND MANAGE DATABASES IN THE FIELDS OF SENIOR CITIZENSHIP, RETIREMENT, MATURE AND RETIRED LIFESTYLES, HEALTH, MEDICINE, FAMILY RELATIONSHIPS AND TOPICS RELATED TO AGING; PROVIDING ONLINE SEARCH ENGINES; PROVIDING INFORMATION IN THE NATURE OF ONLINE DATABASES IN THE FIELDS OF SENIOR CITIZENSHIP, RETIREMENT, MATURE AND RETIRED LIFESTYLES, FAMILY RELATIONSHIPS AND TOPICS RELATED TO AGING; TELEPHONE HOTLINE SERVICES IN THE FIELDS OF ELDERLY LIFESTYLES AND RETIREMENT, NAMELY, PROVIDING ELDERLY LIFESTYLES AND RETIREMENT INFORMATION AT THE SPECIFIC REQUEST OF END-USERS BY MEANS OF TELEPHONE; AND DATA RETRIEVAL SERVICES PERFORMED OVER COMPUTER NETWORKS, IN CLASS 42 (U.S. CLS. 100 AND 101).

FIRST USE 1-0-2007; IN COMMERCE 1-0-2007.

FOR: LEGAL SERVICES; PROVIDING INFORMATION AND CONSULTING IN THE FIELDS OF LAW; TELEPHONE HOTLINES IN THE FIELDS OF

LAW AND ELDER LAW; COUNSELING SERVICES, NAMELY, PROVIDING PERSONAL SUPPORT SERVICES FOR FAMILIES OF PATIENTS WITH LIFE THREATENING DISORDERS, NAMELY, COMPANIONSHIP, HELP WITH MEDICAL FORMS, COUNSELING AND EMOTIONAL SUPPORT; COUNSELING SERVICES, NAMELY, ORGANIZING AND CONDUCTING SUPPORT GROUPS IN THE FIELDS OF CARE GIVING, CHILDCARE, GRANDPARENTING, PARENTING, RETIREMENT, ELDERCARE, ASSISTED CARE FACILITIES, MATURE LIFESTYLES, AND ELDER ASSISTANCE, IN CLASS 45 (U.S. CLS. 100 AND 101).

FIRST USE 1-0-2007; IN COMMERCE 1-0-2007.

OWNER OF U.S. REG. NOS. 741,334, 2,623,034, AND OTHERS.

THE COLOR(S) RED IS/ARE CLAIMED AS A FEATURE OF THE MARK.

THE MARK CONSISTS OF AARP SHOWN ALL IN RED, WITH A STYLIZED BANNER-LIKE DESIGN PROJECTING FROM THE HORIZONTAL ELEMENT OF THE FIRST "A" .

SN 77-056,877, FILED 12-5-2006.

RON FAIRBANKS, EXAMINING ATTORNEY

Int. Cl.: 39

Prior U.S. Cls.: 100 and 105

United States Patent and Trademark Office

Reg. No. 3,477,271

Registered July 29, 2008

**SERVICE MARK
PRINCIPAL REGISTER**



AARP (D.C. NON-PROFIT CORPORATION)
601 E STREET, N.W.
WASHINGTON, DC 20049

FOR: TRAVEL SERVICES, NAMELY, ARRANGING TRAVEL TOURS PROGRAMS THROUGH TRAVEL AGENCIES; TRAVEL CLUBS; AIRLINE, CAR RENTAL, CRUISE AND TOUR PACKAGE RESERVATION SERVICES FOR OTHERS VIA COMPUTER NETWORKS AND CALL CENTERS; PROVIDING AIRLINE, CAR RENTAL, CRUISE, TOUR PACKAGE, AND GENERAL TRAVEL INFORMATION VIA A GLOBAL COMPUTER NETWORK; PROVIDING AN ONLINE DATABASE IN THE FIELD OF TRAVEL, NAMELY, ORGANIZATION OF EXCURSIONS, SIGHTSEEING TOURS, AIRLINE RESERVATIONS, CRUISE RESERVATIONS AND CAR RENTALS; ORGANIZATION OF TRAVEL; AND PROVIDING LINKS TO WEB SITES OF OTH-

ERS FEATURING TRAVEL, IN CLASS 39 (U.S. CLS. 100 AND 105).

FIRST USE 1-0-2007; IN COMMERCE 1-0-2007.

OWNER OF U.S. REG. NOS. 741,334, 2,623,034, AND OTHERS.

THE COLOR(S) RED IS/ARE CLAIMED AS A FEATURE OF THE MARK.

THE MARK CONSISTS OF "ARP" SHOWN ALL IN RED, WITH A STYLIZED BANNER-LIKE DESIGN PROJECTING FROM THE HORIZONTAL ELEMENT OF THE FIRST "A".

SN 77-056,879, FILED 12-5-2006.

RON FAIRBANKS, EXAMINING ATTORNEY

Int. Cl.: 20

Prior U.S. Cls.: 2, 13, 22, 25, 32, and 50

Reg. No. 3,477,272

United States Patent and Trademark Office

Registered July 29, 2008

**TRADEMARK
PRINCIPAL REGISTER**



FACTORY DIRECT, INC. (OKLAHOMA CORPORATION)
219 S. PORTLAND
OKLAHOMA CITY, OK 73108

THE MARK CONSISTS OF THE LETTERS "VLS"
IN STYLIZED FORM.

FOR: BOX SPRINGS; MATTRESSES, IN CLASS 20
(U.S. CLS. 2, 13, 22, 25, 32 AND 50).

SN 77-057,133, FILED 12-5-2006.

FIRST USE 1-30-2007; IN COMMERCE 1-30-2007.

BONNIE LUKEN, EXAMINING ATTORNEY

Int. Cl.: 43

Prior U.S. Cls.: 100 and 101

United States Patent and Trademark Office

Reg. No. 3,477,273

Registered July 29, 2008

**SERVICE MARK
PRINCIPAL REGISTER**

D'ARCY MCGEE'S

PRIME RESTAURANTS OF AMERICA, INC.
(DELAWARE CORPORATION)
10 KINGSBRIDGE GARDEN CIRCLE, SUITE 600
MISSISSAUGA, ONTARIO, CANADA L5R3K6

THE MARK CONSISTS OF STANDARD CHAR-
ACTERS WITHOUT CLAIM TO ANY PARTICULAR
FONT, STYLE, SIZE, OR COLOR.

FOR: RESTAURANT AND BAR SERVICES, IN
CLASS 43 (U.S. CLS. 100 AND 101).

SN 77-057,838, FILED 12-6-2006.

FIRST USE 5-24-2008; IN COMMERCE 5-24-2008.

PAUL MORENO, EXAMINING ATTORNEY

Int. Cl.: 35

Prior U.S. Cls.: 100, 101, and 102

United States Patent and Trademark Office

Reg. No. 3,477,274

Registered July 29, 2008

SERVICE MARK
PRINCIPAL REGISTER



GREATER LOUISVILLE CONVENTION & VISITORS BUREAU (KENTUCKY INDEPENDENT COMMISSION ESTABLISHED BY KENTUCKY STATUTE AND ORGANIZED UNDER KENTUCKY LAW)

401 W. MAIN ST., SUITE 2300
LOUISVILLE, KY 40202

FOR: CHAMBER OF COMMERCE SERVICES, NAMELY, PROMOTING BUSINESS AND TOURISM IN THE BOURBON-PRODUCING REGION OF KENTUCKY, IN CLASS 35 (U.S. CLS. 100, 101 AND 102).

FIRST USE 10-1-2006; IN COMMERCE 10-1-2006.

NO CLAIM IS MADE TO THE EXCLUSIVE RIGHT TO USE "BOURBON", APART FROM THE MARK AS SHOWN.

THE MARK CONSISTS OF THE WORD "BOURBON" WITHIN A SOLID BLOCK, POSITIONED OVER THE WORD "COUNTRY".

SN 77-057,888, FILED 12-6-2006.

MATTHEW EINSTEIN, EXAMINING ATTORNEY

Int. Cl.: 9

Prior U.S. Cls.: 21, 23, 26, 36, and 38

United States Patent and Trademark Office

Reg. No. 3,477,275

Registered July 29, 2008

**TRADEMARK
PRINCIPAL REGISTER**

DESIGN UNLIMITED

PUNCH SOFTWARE LLC (DELAWARE LTD
LIAB CO)
7900 NW 100TH ST., SUITE LL6
KANSAS CITY, MO 64153

FOR: COMPUTER SOFTWARE FOR DEVELOP-
ING DESIGNS AND PLANS FOR HOME AND
COMMERCIAL DESIGN, IMPROVEMENT AND
LANDSCAPING, IN CLASS 9 (U.S. CLS. 21, 23, 26,
36 AND 38).

FIRST USE 11-0-2006; IN COMMERCE 11-0-2006.

THE MARK CONSISTS OF STANDARD CHAR-
ACTERS WITHOUT CLAIM TO ANY PARTICULAR
FONT, STYLE, SIZE, OR COLOR.

NO CLAIM IS MADE TO THE EXCLUSIVE
RIGHT TO USE "DESIGN", APART FROM THE
MARK AS SHOWN.

SN 77-058,221, FILED 12-6-2006.

TIMOTHY FINNEGAN, EXAMINING ATTORNEY

Int. Cl.: 9

Prior U.S. Cls.: 21, 23, 26, 36, and 38

United States Patent and Trademark Office

Reg. No. 3,477,276

Registered July 29, 2008

**TRADEMARK
PRINCIPAL REGISTER**

OPTIONSCITY

OPTIONSCITY SOFTWARE, INC. (DELAWARE CORPORATION)
300 WEST ADAMS STREET, SUITE 829
CHICAGO, IL 60606

FOR: COMPUTER SOFTWARE PLATFORM FOR USE IN MARKET MAKING FOR OPTIONS, DERIVATIVES, EQUITY AND DEBT SECURITIES, COMMODITIES, AND FOREIGN CURRENCY, PERFORMING ORDER-ENTRY, PROVIDING AND REPORTING MARKET ANALYSIS, RISK MANAGEMENT, RECORD MAINTENANCE, AND PERFORMING AUTOMATED TRADING TRANSACTIONS AND PRICING CAPABILITIES IN

THE FIELDS OF ELECTRONIC AND INTERNET-BASED DERIVATIVES AND SECURITIES TRADING, IN CLASS 9 (U.S. CLS. 21, 23, 26, 36 AND 38).

FIRST USE 5-13-2008; IN COMMERCE 5-13-2008.

THE MARK CONSISTS OF STANDARD CHARACTERS WITHOUT CLAIM TO ANY PARTICULAR FONT, STYLE, SIZE, OR COLOR.

SN 77-059,806, FILED 12-8-2006.

ELLEN PERKINS, EXAMINING ATTORNEY

Int. Cl.: 5

Prior U.S. Cls.: 6, 18, 44, 46, 51, and 52

Reg. No. 3,477,277

United States Patent and Trademark Office

Registered July 29, 2008

**TRADEMARK
PRINCIPAL REGISTER**

TRISYNEX

IMAGENETIX (CALIFORNIA CORPORATION)
10845 RANCHO BERNARDO ROAD #105
SAN DIEGO, CA 92125

THE MARK CONSISTS OF STANDARD CHAR-
ACTERS WITHOUT CLAIM TO ANY PARTICULAR
FONT, STYLE, SIZE, OR COLOR.

FOR: DIETARY SUPPLEMENTS; TOPICAL AN-
ALGESICS, IN CLASS 5 (U.S. CLS. 6, 18, 44, 46, 51
AND 52).

SN 77-060,304, FILED 12-8-2006.

FIRST USE 10-15-2007; IN COMMERCE 10-15-2007.

JIM RINGLE, EXAMINING ATTORNEY

Int. Cl.: 33

Prior U.S. Cls.: 47 and 49

United States Patent and Trademark Office

Reg. No. 3,477,278

Registered July 29, 2008

**TRADEMARK
PRINCIPAL REGISTER**

DAMA

TUURI WINES (WASHINGTON LTD LIAB CO)
536 EAST ALDER
WALLA WALLA, WA 99362

THE MARK CONSISTS OF STANDARD CHAR-
ACTERS WITHOUT CLAIM TO ANY PARTICULAR
FONT, STYLE, SIZE, OR COLOR.

FOR: WINES, IN CLASS 33 (U.S. CLS. 47 AND 49).

SN 77-060,663, FILED 12-8-2006.

FIRST USE 7-23-2007; IN COMMERCE 7-23-2007.

JAMES LOVELACE, EXAMINING ATTORNEY

Int. Cl.: 36

Prior U.S. Cls.: 100, 101, and 102

United States Patent and Trademark Office

Reg. No. 3,477,279

Registered July 29, 2008

**SERVICE MARK
PRINCIPAL REGISTER**

THE SAVE YOURSELF PLAN

TRUSTEE OF THE SUZE ORMAN REVOCABLE
TRUST (CALIFORNIA TRUST)
64 EAST UWCHLAN AVENUE
SUITE 270
EXTON, PA 19341

FOR: FINANCIAL SERVICES, NAMELY, SAV-
INGS PROGRAMS FOR INDIVIDUALS AND AD-
MINISTRATION OF SAVINGS PROGRAMS, IN
CLASS 36 (U.S. CLS. 100, 101 AND 102).

FIRST USE 2-27-2007; IN COMMERCE 2-27-2007.

THE MARK CONSISTS OF STANDARD CHAR-
ACTERS WITHOUT CLAIM TO ANY PARTICULAR
FONT, STYLE, SIZE, OR COLOR.

NO CLAIM IS MADE TO THE EXCLUSIVE
RIGHT TO USE "PLAN", APART FROM THE MARK
AS SHOWN.

SN 77-061,212, FILED 12-11-2006.

WILLIAM ROSSMAN, EXAMINING ATTORNEY

Int. Cl.: 16

Prior U.S. Cls.: 2, 5, 22, 23, 29, 37, 38, and 50

Reg. No. 3,477,280

United States Patent and Trademark Office

Registered July 29, 2008

**TRADEMARK
PRINCIPAL REGISTER**

ONE: THE FIFTH GOSPEL

OUG PRESS (PENNSYLVANIA CORPORATION)
SUITE 1212
429 FORBES AVENUE
PITTSBURGH, PA 15219

FOR: BIBLES, IN CLASS 16 (U.S. CLS. 2, 5, 22, 23, 29,
37, 38 AND 50).

FIRST USE 5-13-2008; IN COMMERCE 5-13-2008.

THE MARK CONSISTS OF STANDARD CHAR-
ACTERS WITHOUT CLAIM TO ANY PARTICULAR
FONT, STYLE, SIZE, OR COLOR.

NO CLAIM IS MADE TO THE EXCLUSIVE
RIGHT TO USE "THE FIFTH GOSPEL", APART
FROM THE MARK AS SHOWN.

SN 77-061,994, FILED 12-12-2006.

KELLY CHOE, EXAMINING ATTORNEY

Int. Cl.: 5

Prior U.S. Cls.: 6, 18, 44, 46, 51, and 52

Reg. No. 3,477,281

United States Patent and Trademark Office

Registered July 29, 2008

**TRADEMARK
PRINCIPAL REGISTER**

NATIVE PHYTONUTRIENTS

HEALTHY DIRECTIONS, LLC (DELAWARE LTD
LIAB CO)

7811 MONTROSE ROAD

POTOMAC, MD 20854

FOR: NUTRITIONAL SUPPLEMENTS, IN CLASS
5 (U.S. CLS. 6, 18, 44, 46, 51 AND 52).

FIRST USE 4-0-2007; IN COMMERCE 4-0-2007.

THE MARK CONSISTS OF STANDARD CHAR-
ACTERS WITHOUT CLAIM TO ANY PARTICULAR
FONT, STYLE, SIZE, OR COLOR.

NO CLAIM IS MADE TO THE EXCLUSIVE
RIGHT TO USE "PHYTONUTRIENTS", APART
FROM THE MARK AS SHOWN.

SN 77-063,249, FILED 12-13-2006.

LINDA ESTRADA, EXAMINING ATTORNEY

Int. Cl.: 22

Prior U.S. Cls.: 1, 2, 7, 19, 22, 42, and 50

Reg. No. 3,477,282

United States Patent and Trademark Office

Registered July 29, 2008

**TRADEMARK
PRINCIPAL REGISTER**



Tarprat, LLC

BARR, J. GORDON (CANADA INDIVIDUAL)
85 RICHMOND TOWNHOUSE ROAD
CAROLINA, RI 02812

FOR: TARPAULINS, IN CLASS 22 (U.S. CLS. 1, 2, 7,
19, 22, 42 AND 50).

FIRST USE 4-18-2007; IN COMMERCE 10-1-2007.

NO CLAIM IS MADE TO THE EXCLUSIVE
RIGHT TO USE "LLC", APART FROM THE MARK
AS SHOWN.

THE MARK CONSISTS OF RAT HOLDING
SWORD AND SHIELD.

SN 77-063,539, FILED 12-13-2006.

GIANCARLO CASTRO, EXAMINING ATTORNEY

Int. Cl.: 7

Prior U.S. Cls.: 13, 19, 21, 23, 31, 34, and 35

Reg. No. 3,477,283

United States Patent and Trademark Office

Registered July 29, 2008

**TRADEMARK
PRINCIPAL REGISTER**

MAD FLUSHER

VACTOR MANUFACTURING, INC. (ILLINOIS
CORPORATION)
1621 S. ILLINOIS
STREATOR, IL 61364

FOR: WATER DRIVEN NOZZLE WITH MULTIPLE ORIFICE ANGLES FOR USE IN CLEANING PIPES BY A HIGH PRESSURE CLEANING MACHINE, IN CLASS 7 (U.S. CLS. 13, 19, 21, 23, 31, 34 AND 35).

FIRST USE 10-20-2006; IN COMMERCE 10-20-2006.

THE MARK CONSISTS OF STANDARD CHARACTERS WITHOUT CLAIM TO ANY PARTICULAR FONT, STYLE, SIZE, OR COLOR.

NO CLAIM IS MADE TO THE EXCLUSIVE RIGHT TO USE "FLUSHER", APART FROM THE MARK AS SHOWN.

SN 77-064,628, FILED 12-14-2006.

DAWN FELDMAN, EXAMINING ATTORNEY

Int. Cl.: 28

Prior U.S. Cls.: 22, 23, 38, and 50

United States Patent and Trademark Office

Reg. No. 3,477,284

Registered July 29, 2008

**TRADEMARK
PRINCIPAL REGISTER**



GRETZKY, WAYNE (CANADA INDIVIDUAL)
650 NORTH SEPULVEDA BOULEVARD
C/O WDG ENTERPRISES, INC.
LOS ANGELES, CA 90049

FOR: ICE HOCKEY EQUIPMENT, NAMELY,
HOCKEY STICKS, HOCKEY PUCKS AND GLOVES,
GOLF PUTTERS, IN CLASS 28 (U.S. CLS. 22, 23, 38
AND 50).

FIRST USE 6-0-2000; IN COMMERCE 6-0-2000.

OWNER OF U.S. REG. NOS. 1,584,806, 2,512,633,
AND OTHERS.

NO CLAIM IS MADE TO THE EXCLUSIVE
RIGHT TO USE "2000" AND "AUTHENTIC", APART
FROM THE MARK AS SHOWN.

THE MARK CONSISTS OF REARVIEW OF
HOCKEY PLAYER IN UNIFORM.

SN 77-064,797, FILED 12-14-2006.

SARA THOMAS, EXAMINING ATTORNEY

Int. Cl.: 16

Prior U.S. Cls.: 2, 5, 22, 23, 29, 37, 38, and 50

Reg. No. 3,477,285

United States Patent and Trademark Office

Registered July 29, 2008

**TRADEMARK
PRINCIPAL REGISTER**



GRETZKY, WAYNE (CANADA INDIVIDUAL)
650 NORTH SEPULVEDA BOULEVARD
C/O WDG ENTERPRISES, INC.
LOS ANGELES, CA 90049

NO CLAIM IS MADE TO THE EXCLUSIVE
RIGHT TO USE "2000 AND AUTHENTIC", APART
FROM THE MARK AS SHOWN.

FOR: COLLECTIBLE PHOTOGRAPHS, COL-
LAGES, TRADING CARDS, SCORE SHEETS, IN
CLASS 16 (U.S. CLS. 2, 5, 22, 23, 29, 37, 38 AND 50).

THE MARK CONSISTS OF REARVIEW OF
HOCKEY PLAYER IN UNIFORM.

FIRST USE 3-31-2000; IN COMMERCE 3-31-2000.

SN 77-064,801, FILED 12-14-2006.

OWNER OF U.S. REG. NOS. 1,584,806, 2,512,633,
AND OTHERS.

SARA THOMAS, EXAMINING ATTORNEY

Int. Cl.: 18

Prior U.S. Cls.: 1, 2, 3, 22, and 41

United States Patent and Trademark Office

Reg. No. 3,477,286

Registered July 29, 2008

**TRADEMARK
PRINCIPAL REGISTER**



GRETZKY, WAYNE (CANADA INDIVIDUAL)
650 NORTH SEPULVEDA BOULEVARD
C/O WDG ENTERPRISES, INC.
LOS ANGELES, CA 90049

NO CLAIM IS MADE TO THE EXCLUSIVE
RIGHT TO USE "FOUNDATION", APART FROM
THE MARK AS SHOWN.

FOR: ATHLETIC BAGS, IN CLASS 18 (U.S. CLS. 1,
2, 3, 22 AND 41).

THE MARK CONSISTS OF REARVIEW OF
HOCKEY PLAYER IN UNIFORM.

FIRST USE 4-5-2004; IN COMMERCE 4-5-2004.

SN 77-064,814, FILED 12-14-2006.

OWNER OF U.S. REG. NOS. 1,584,806 AND
1,597,558.

SARA THOMAS, EXAMINING ATTORNEY

Int. Cl.: 35

Prior U.S. Cls.: 100, 101, and 102

United States Patent and Trademark Office

Reg. No. 3,477,287

Registered July 29, 2008

**SERVICE MARK
PRINCIPAL REGISTER**

YARDPARTSEXPRESS.COM

DEERE & COMPANY (DELAWARE CORPORATION)
TRADEMARK LAW GROUP
PATENT DEPARTMENT ONE JOHN DEERE PLACE
MOLINE, IL 61265

FOR: ONLINE RETAIL STORE SERVICES FEATURING NEW PARTS FOR RIDING LAWN MOWERS, WALK BEHIND LAWN MOWERS, CHAIN SAWS, TRIMMERS, AND BLOWERS , IN CLASS 35 (U.S. CLS. 100, 101 AND 102).

FIRST USE 10-1-2007; IN COMMERCE 10-1-2007.

THE MARK CONSISTS OF STANDARD CHARACTERS WITHOUT CLAIM TO ANY PARTICULAR FONT, STYLE, SIZE, OR COLOR.

SN 77-065,372, FILED 12-15-2006.

JAMES MACFARLANE, EXAMINING ATTORNEY

Int. Cl.: 35

Prior U.S. Cls.: 100, 101, and 102

United States Patent and Trademark Office

Reg. No. 3,477,288

Registered July 29, 2008

**SERVICE MARK
PRINCIPAL REGISTER**



GIFTLIT LLC (CALIFORNIA LTD LIAB CO)
24 - 17TH AVENUE
SAN FRANCISCO, CA 94121

FOR: ONLINE RETAIL STORE SERVICES AND
MAIL ORDER SERVICES IN THE FIELDS OF
GIFTWARE, BOOKS, AUDIO BOOKS, VIDEOS,
DVDS, AND MUSIC, IN CLASS 35 (U.S. CLS. 100,
101 AND 102).

FIRST USE 6-8-2007; IN COMMERCE 6-8-2007.

THE MARK CONSISTS OF THE WORD "GIF-
TLIT" PLUS AN IMAGE OF AN OPEN BOOK.

SN 77-065,652, FILED 12-15-2006.

ADA HAN, EXAMINING ATTORNEY

Int. Cl.: 41

Prior U.S. Cls.: 100, 101, and 107

United States Patent and Trademark Office

Reg. No. 3,477,289

Registered July 29, 2008

**SERVICE MARK
PRINCIPAL REGISTER**

POWERBRAIN

BR CONSULTING, INC. (NEW JERSEY CORPORATION)
340 JORDAN ROAD
SEDONA, AZ 86336

FOR: EDUCATIONAL SERVICES, NAMELY, CONDUCTING CLASSES, SEMINARS AND WORKSHOPS TO ENHANCE MENTAL, EMOTIONAL AND PHYSICAL CAPABILITIES, IN CLASS 41 (U.S. CLS. 100, 101 AND 107).

FIRST USE 3-20-2001; IN COMMERCE 3-20-2001.

THE MARK CONSISTS OF STANDARD CHARACTERS WITHOUT CLAIM TO ANY PARTICULAR FONT, STYLE, SIZE, OR COLOR.

SN 77-066,807, FILED 12-18-2006.

JENNIFER MARTIN, EXAMINING ATTORNEY

Int. Cl.: 30

Prior U.S. Cl.: 46

United States Patent and Trademark Office

Reg. No. 3,477,290

Registered July 29, 2008

TRADEMARK
PRINCIPAL REGISTER



MCCLEARY, INC. (DELAWARE CORPORATION)
239 OAK GROVE AVENUE
SOUTH BELOIT, IL 61080

THE MARK CONSISTS OF THE WORDS "LIL' DIPZ" WITH A SMILING FACE AS THE DOT ON THE "I" AND A BOWL WITH A CHIP BEING DIPPED INTO IT OVER THE LETTER "P".

FOR: TORTILLA CHIPS, IN CLASS 30 (U.S. CL. 46).

SN 77-067,600, FILED 12-19-2006.

FIRST USE 2-0-2007; IN COMMERCE 2-0-2007.

WILLIAM ROSSMAN, EXAMINING ATTORNEY

Int. Cl.: 9

Prior U.S. Cls.: 21, 23, 26, 36, and 38

United States Patent and Trademark Office

Reg. No. 3,477,291

Registered July 29, 2008

**TRADEMARK
PRINCIPAL REGISTER**

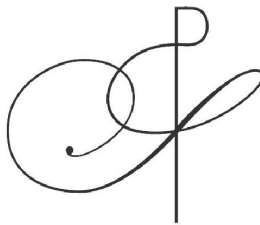

PROENZA SCHOUER, LLC (NEW YORK LTD
LIAB CO)
120 WALKER STREET
NEW YORK, NY 10013

FOR: EYEGLASSES; SUNGLASSES, IN CLASS 9
(U.S. CLS. 21, 23, 26, 36 AND 38).

FIRST USE 9-9-2007; IN COMMERCE 9-9-2007.

OWNER OF U.S. REG. NO. 2,873,454.

THE MARK CONSISTS OF AN ABSTRACT DE-
SIGN.

SN 77-068,646, FILED 12-20-2006.

LORETTA C. BECK, EXAMINING ATTORNEY

Int. Cl.: 35

Prior U.S. Cls.: 100, 101, and 102

United States Patent and Trademark Office

Reg. No. 3,477,292

Registered July 29, 2008

**SERVICE MARK
PRINCIPAL REGISTER**

INSIGHT:ADVISOR

INSIGHT DIRECT USA, INC. (ILLINOIS CORPORATION)
6820 SOUTH HARL AVE.
TEMPE, AZ 85283

FOR: BUSINESS CONSULTING SERVICES IN THE FIELD OF INFORMATION TECHNOLOGY LIFECYCLE MANAGEMENT DESIGNED TO MAXIMIZE INFORMATION TECHNOLOGY CYCLES, IN CLASS 35 (U.S. CLS. 100, 101 AND 102).

FIRST USE 1-0-2008; IN COMMERCE 1-0-2008.

THE MARK CONSISTS OF STANDARD CHARACTERS WITHOUT CLAIM TO ANY PARTICULAR FONT, STYLE, SIZE, OR COLOR.

SN 77-069,254, FILED 12-21-2006.

MICHAEL LITZAU, EXAMINING ATTORNEY

Int. Cl.: 29

Prior U.S. Cl.: 46

United States Patent and Trademark Office

Reg. No. 3,477,293

Registered July 29, 2008

TRADEMARK
PRINCIPAL REGISTER



NUT HOUSE LLC (VIETNAM LTD LIAB CO)
PHU HOA, HOA LOI, BEN CAT
BINH DUONG, VIETNAM

FOR: ROASTED CASHEW NUTS, IN CLASS 29
(U.S. CL. 46).

FIRST USE 1-1-2006; IN COMMERCE 1-1-2006.

NO CLAIM IS MADE TO THE EXCLUSIVE
RIGHT TO USE "CASHEWS" OR THE PICTORIAL
REPRESENTATION OF CASHEWS, APART FROM
THE MARK AS SHOWN.

THE COLOR(S) TAN, RED, ORANGE, GOLD,
BLACK, WHITE, LIGHT BLUE, DARK BLUE, AND
LIGHT PINK IS/ARE CLAIMED AS A FEATURE OF
THE MARK.

THE COLOR TAN APPEARS IN THE DESIGN OF
THE CASHEWS, AND THE LINE UNDERNEATH
THE RECTANGLE CONTAINING THE WORDING
"CASHEWS"; RED APPEARS IN THE BACK-
GROUND BENEATH THE TOP LINE OF CASHEWS

AND BEHIND THE "NUT HOUSE" AND "NH"
WORDING; ORANGE APPEARS IN THE BAND
AND SEAL AROUND THE CUP HOLDING THE
CASHEWS; GOLD APPEARS IN THE "NH" ACRO-
NYM AND THE CUP HOLDING THE CASHEWS;
BLACK APPEARS IN THE SUNGLASSES OF THE
MAN, HIS TIE, HIS HAIR, THE RECTANGLE
BEHIND THE WORDING "CASHEWS", IN THE
WORDING "NUT HOUSE" BELOW THE "NH",
AND THE OUTLINE OF THE LETTERING "NUT
HOUSE", THE CUP, THE MAN AND HIS ACCES-
SORIES; WHITE APPEARS IN THE WORDING
"NUT HOUSE", "CASHEWS", AND THE APRON;
LIGHT BLUE APPEARS IN THE BACKGROUND IN
THE LOWER THIRD OF THE MARK; DARK BLUE
APPEARS IN THE SHIRT OF THE MAN AND THE
SHADING BEHIND THE MOUND OF CASHEWS IN
THE CUP AND TO THE LEFT OF THE BLACK
RECTANGLE; LIGHT PINK APPEARS IN THE
FLESH OF THE MAN.

SN 77-070,148, FILED 12-22-2006.

REBECCA POVARCHUK, EXAMINING ATTOR-
NEY

Int. Cl.: 42

Prior U.S. Cls.: 100 and 101

United States Patent and Trademark Office

Reg. No. 3,477,294

Registered July 29, 2008

**SERVICE MARK
PRINCIPAL REGISTER**

PINCERT

ISO CLAIMS SERVICES, INC. (DELAWARE CORPORATION)
250 BERRYHILL ROAD
COLUMBIA, SC 29210

FOR: PROVIDING TEMPORARY USE OF NON-DOWNLOADABLE COMPUTER PROGRAMS FOR ACCREDITED AND LICENSED USERS OF INFORMATION OVER A GLOBAL INFORMATION NETWORK, NAMELY, COMPUTER PROGRAMS USED TO PROTECT AGAINST IDENTITY THEFT AND TO PROTECT AGAINST THE UNAUTHORIZED DISCLOSURE OF CONFIDENTIAL AND PERSONALLY IDENTIFIABLE INFORMATION BY PROVIDING LICENSE VERIFICATION AND SECURE, DIGITALLY SIGNED DOCUMENTS WITH VISUAL REPRESENTATIONS OF SIGNATURES AND OTHER INFORMATION FOR TAMPER-RESISTANT VERIFICATION OF DIGITAL SIGNING, IN CLASS 42 (U.S. CLS. 100 AND 101).

SENTATIONS OF SIGNATURES AND OTHER INFORMATION FOR TAMPER-RESISTANT VERIFICATION OF DIGITAL SIGNING, IN CLASS 42 (U.S. CLS. 100 AND 101).

FIRST USE 11-1-2007; IN COMMERCE 11-1-2007.

THE MARK CONSISTS OF STANDARD CHARACTERS WITHOUT CLAIM TO ANY PARTICULAR FONT, STYLE, SIZE, OR COLOR.

SN 77-070,665, FILED 12-22-2006.

CAROL SPILS, EXAMINING ATTORNEY

Int. Cl.: 25

Prior U.S. Cls.: 22 and 39

United States Patent and Trademark Office

Reg. No. 3,477,295

Registered July 29, 2008

**TRADEMARK
PRINCIPAL REGISTER**



KUHN, STEVE (UNITED STATES INDIVIDUAL)
145 ELM STREET
SAYVILLE, NY 11782

FOR: SHORT-SLEEVED OR LONG-SLEEVED T-SHIRTS; SWEAT SHIRTS, IN CLASS 25 (U.S. CLS. 22 AND 39).

FIRST USE 6-30-1971; IN COMMERCE 9-1-1972.

NO CLAIM IS MADE TO THE EXCLUSIVE RIGHT TO USE "DESIGNED BY" AND "1971", APART FROM THE MARK AS SHOWN.

THE MARK CONSISTS OF THE PHRASE OF "CLAM POWER" IN CAPITALIZED BOLD LETTERS ARRANGED AND CENTERED IN AN ARC ABOVE THE STYLIZED FIGURE OF AN ANTHROPOMORPHIZED SHOUTING CLAM WITH EYES, LEGS AND A RAISED CLENCHED FIST STANDING ON A STYLIZED SHORELINE AND THE PHRASE "DESIGNED BY STEVE KUHN- 1971" CENTERED UNDERNEATH THE STYLIZED SHORELINE.

SN 77-071,603, FILED 12-27-2006.

AHSEN KHAN, EXAMINING ATTORNEY

Int. Cl.: 3

Prior U.S. Cls.: 1, 4, 6, 50, 51, and 52

United States Patent and Trademark Office

Reg. No. 3,477,296

Registered July 29, 2008

**TRADEMARK
PRINCIPAL REGISTER**

BE HEALED

ELEMENTAGE, LLC (DELAWARE LTD LIAB
CO)
754 FIFTH AVENUE
NEW YORK, NY 10019

FOR: HAIR CARE PREPARATIONS, IN CLASS 3
(U.S. CLS. 1, 4, 6, 50, 51 AND 52).

FIRST USE 6-20-2007; IN COMMERCE 6-20-2007.

THE MARK CONSISTS OF STANDARD CHAR-
ACTERS WITHOUT CLAIM TO ANY PARTICULAR
FONT, STYLE, SIZE, OR COLOR.

OWNER OF U.S. REG. NO. 2,294,726.

SN 77-071,817, FILED 12-27-2006.

KYLE PEETE, EXAMINING ATTORNEY

Int. Cl.: 28

Prior U.S. Cls.: 22, 23, 38, and 50

United States Patent and Trademark Office

Reg. No. 3,477,297

Registered July 29, 2008

**TRADEMARK
PRINCIPAL REGISTER**

ELFING AROUND

DANIEL HUCKEMEYER (UNITED STATES INDIVIDUAL)
26727 SANDBURN PLACE
STEVENSON RANCH, CA 91381 AND
LISA HUCKEMEYER (UNITED STATES INDIVIDUAL)
26727 SANDBURN PLACE
STEVENSON RANCH, CA 91381

FOR: FAMILY ACTIVITY KIT PROMOTING HOLIDAY SPIRIT, CONSISTING OF A MULTIPLE ACTIVITY TOY, NAMELY, A STUFFED DOLL AND

ACTIVITY BOOK SOLD AS A UNIT, IN CLASS 28 (U.S. CLS. 22, 23, 38 AND 50).

FIRST USE 9-15-2007; IN COMMERCE 9-15-2007.

THE MARK CONSISTS OF STANDARD CHARACTERS WITHOUT CLAIM TO ANY PARTICULAR FONT, STYLE, SIZE, OR COLOR.

SN 77-071,912, FILED 12-27-2006.

ANTHONY RINKER, EXAMINING ATTORNEY

Int. Cl.: 35

Prior U.S. Cls.: 100, 101, and 102

United States Patent and Trademark Office

Reg. No. 3,477,298

Registered July 29, 2008

**SERVICE MARK
PRINCIPAL REGISTER**

EVERYTHING PARTY

POTTER, MARK D. (UNITED STATES INDIVIDUAL)
2519 CRESTMONT PLACE WEST
SEATTLE, WA 98199

FOR: RETAIL STORE SERVICES FEATURING PARTY SUPPLIES, IN CLASS 35 (U.S. CLS. 100, 101 AND 102).

FIRST USE 8-1-2007; IN COMMERCE 8-1-2007.

THE MARK CONSISTS OF STANDARD CHARACTERS WITHOUT CLAIM TO ANY PARTICULAR FONT, STYLE, SIZE, OR COLOR.

NO CLAIM IS MADE TO THE EXCLUSIVE RIGHT TO USE "PARTY", APART FROM THE MARK AS SHOWN.

SN 77-071,954, FILED 12-27-2006.

BONNIE LUKEN, EXAMINING ATTORNEY

Int. Cl.: 30

Prior U.S. Cl.: 46

United States Patent and Trademark Office

Reg. No. 3,477,299

Registered July 29, 2008

**TRADEMARK
PRINCIPAL REGISTER**

SkipKenny

SKIPKENNY, LLC. (OHIO LTD LIAB CO)
1268 GLENHAVEN LANE
BATAVIA, OH 45103

THE MARK CONSISTS OF STANDARD CHAR-
ACTERS WITHOUT CLAIM TO ANY PARTICULAR
FONT, STYLE, SIZE, OR COLOR.

FOR: BARBECUE SAUCE, IN CLASS 30 (U.S. CL.
46).

SN 77-071,967, FILED 12-27-2006.

FIRST USE 9-27-2007; IN COMMERCE 9-27-2007.

GEORGE LORENZO, EXAMINING ATTORNEY

Int. Cls.: 25 and 33

Prior U.S. Cls.: 22, 39, 47, and 49

United States Patent and Trademark Office

Reg. No. 3,477,300

Registered July 29, 2008

**TRADEMARK
PRINCIPAL REGISTER**

OZLANDIA

RICE, REBECCA S. (UNITED STATES INDIVIDUAL)
P.O. BOX 4108
TOPEKA, KS 66604

FOR: CAPS; TOPS, IN CLASS 25 (U.S. CLS. 22 AND 39).

FIRST USE 7-4-2007; IN COMMERCE 8-1-2007.

FOR: APERITIF WINES; APERITIFS WITH A WINE BASE; COOKING WINE; FRUIT WINE; GRAPE WINE; KITS FOR MAKING WINE; NATURAL SPARKLING WINES; PORT WINES; PREPARED WINE COCKTAILS; RED WINE; SPARKLING FRUIT WINE; SPARKLING GRAPE WINE; SPARK-

LING WINE; STRAWBERRY WINE; SWEET WINES; TABLE WINES; WHITE WINE; WINE; WINE COOLERS; WINE PUNCH; WINE PUNCHES; WINES, IN CLASS 33 (U.S. CLS. 47 AND 49).

FIRST USE 7-4-2007; IN COMMERCE 7-4-2007.

THE MARK CONSISTS OF STANDARD CHARACTERS WITHOUT CLAIM TO ANY PARTICULAR FONT, STYLE, SIZE, OR COLOR.

SN 77-073,825, FILED 12-30-2006.

CORY BOONE, EXAMINING ATTORNEY

Int. Cl.: 25

Prior U.S. Cls.: 22 and 39

United States Patent and Trademark Office

Reg. No. 3,477,301

Registered July 29, 2008

TRADEMARK
PRINCIPAL REGISTER



LUO, WEIJING (UNITED STATES INDIVIDUAL)
555 PIERCE STREET #1535
ALBANY, CA 94706

FOR: ANGLERS' SHOES; APRES-SKI SHOES; ATHLETIC SHOES; BALLET SHOES; BASEBALL SHOES; BEACH SHOES; BOWLING SHOES; BOXING SHOES; CANVAS SHOES; CLEATS FOR ATTACHMENT TO SPORTS SHOES; CYCLING SHOES; DECK-SHOES; FOOTBALL SHOES; GOLF SHOES; GYMNASTIC SHOES; HANDBALL SHOES; HEEL PIECES FOR SHOES; HOCKEY SHOES; INFANTS' SHOES AND BOOTS; INSOLES; JEANS; LEATHER SHOES; PROTECTIVE METAL MEMBERS FOR SHOES AND BOOTS; RUBBER SHOES; RUGBY SHOES; RUNNING SHOES; SHOE DOWELS; SHOE INSERTS FOR PRIMARILY NON-ORTHOPEDIC PURPOSES; SHOE PEGS; SHOE SOLES; SHOES;

SHOES SOLES FOR REPAIR; SKI AND SNOWBOARD SHOES AND PARTS THEREOF; SKIING SHOES; SOCCER SHOES; TAP SHOES; TENNIS SHOES; TONGUE OR PULLSTRAP FOR SHOES AND BOOTS; TRACK AND FIELD SHOES; TRAINING SHOES; VOLLEYBALL SHOES; WOMEN'S SHOES; WORK SHOES AND BOOTS, IN CLASS 25 (U.S. CLS. 22 AND 39).

FIRST USE 3-18-2008; IN COMMERCE 3-18-2008.

THE MARK CONSISTS OF AN AIRCRAFT WITHIN A CIRCLE.

SN 77-073,873, FILED 12-31-2006.

MICHELLE DUBOIS, EXAMINING ATTORNEY

Int. Cl.: 5

Prior U.S. Cls.: 6, 18, 44, 46, 51, and 52

United States Patent and Trademark Office

Reg. No. 3,477,302

Registered July 29, 2008

**TRADEMARK
PRINCIPAL REGISTER**

SHEAFLEX 75

BSP PHARMA INC. (NEW JERSEY CORPORATION)
SUITE 301
500 SCARBOROUGH ROAD
EGG HARBOR TOWNSHIP, NJ 08234

FOR: DIETARY SUPPLEMENTS PRIMARILY
COMPOSED OF A SHEA OIL DERIVED INGREDIENT,
IN CLASS 5 (U.S. CLS. 6, 18, 44, 46, 51 AND 52).

FIRST USE 1-2-2007; IN COMMERCE 2-21-2007.

THE MARK CONSISTS OF STANDARD CHARACTERS
WITHOUT CLAIM TO ANY PARTICULAR FONT,
STYLE, SIZE, OR COLOR.

SN 77-074,285, FILED 1-2-2007.

CHRISTOPHER BUONGIORNO, EXAMINING ATTORNEY

Int. Cl.: 28

Prior U.S. Cls.: 22, 23, 38, and 50

United States Patent and Trademark Office

Reg. No. 3,477,303

Registered July 29, 2008

**TRADEMARK
PRINCIPAL REGISTER**

X-TREME TWINS

THE LANCASTER BINGO COMPANY, INC.
(OHIO CORPORATION)
200 QUARRY ROAD
LANCASTER, OH 43130

THE MARK CONSISTS OF STANDARD CHARACTERS WITHOUT CLAIM TO ANY PARTICULAR FONT, STYLE, SIZE, OR COLOR.

FOR: DISPOSABLE TICKET SETS FOR PLAYING GAMES OF CHANCE, IN CLASS 28 (U.S. CLS. 22, 23, 38 AND 50).

SN 77-074,863, FILED 1-3-2007.

FIRST USE 8-11-2006; IN COMMERCE 1-26-2007.

KATHRYN COWARD, EXAMINING ATTORNEY

Int. Cls.: 25 and 35

Prior U.S. Cls.: 22, 39, 100, 101, and 102

United States Patent and Trademark Office

Reg. No. 3,477,304

Registered July 29, 2008

TRADEMARK
SERVICE MARK
PRINCIPAL REGISTER

Berjouhi

MEDARD, PAULA (UNITED STATES INDIVIDUAL)
112-15 WHITTOFF ST.
QUEENS VILLAGE, NY 11429

FOR: CLOTHING, NAMELY, SHIRTS, SHORTS, DRESSES, PANTS, JACKETS; SKIRTS, SHOES, T-SHIRTS, SWEATSHIRTS, CAPS, HATS, IN CLASS 25 (U.S. CLS. 22 AND 39).

FIRST USE 12-5-2007; IN COMMERCE 12-5-2007.

FOR: RETAIL STORE AND ONLINE RETAIL STORE SERVICES FEATURING CLOTHING AND ACCESSORIES, IN CLASS 35 (U.S. CLS. 100, 101 AND 102).

FIRST USE 12-5-2007; IN COMMERCE 12-5-2007.

THE MARK CONSISTS OF STANDARD CHARACTERS WITHOUT CLAIM TO ANY PARTICULAR FONT, STYLE, SIZE, OR COLOR.

"BERJOUHI" DOES NOT IDENTIFY A LIVING INDIVIDUAL.

SN 77-075,546, FILED 1-3-2007.

RICHARD WHITE, EXAMINING ATTORNEY

Int. Cl.: 31

Prior U.S. Cls.: 1 and 46

United States Patent and Trademark Office

Reg. No. 3,477,305

Registered July 29, 2008

**TRADEMARK
PRINCIPAL REGISTER**



KDW ENTERPRISES (CALIFORNIA SOLE PROPRIETORSHIP)

9580 ANNIKA COURT

ELK GROVE, CA 95624

FOR: EDIBLE HORSE TREATS; FOOD FOR ANIMALS, IN CLASS 31 (U.S. CLS. 1 AND 46).

FIRST USE 1-1-2007; IN COMMERCE 5-1-2007.

NO CLAIM IS MADE TO THE EXCLUSIVE RIGHT TO USE "HORSE" , APART FROM THE MARK AS SHOWN.

THE MARK CONSISTS OF A GRAPHIC IMAGE OF THE HEAD OF A HORSE ALONG WITH THE TERMS "HEALTHY HORSE".

SN 77-076,184, FILED 1-4-2007.

DAYNA BROWNE, EXAMINING ATTORNEY

Int. Cl.: 29

Prior U.S. Cl.: 46

United States Patent and Trademark Office

Reg. No. 3,477,306

Registered July 29, 2008

TRADEMARK
PRINCIPAL REGISTER



NUT HOUSE LLC (VIETNAM LTD LIAB CO)
PHU HOA, HOA LOI, BEN CAT
BINH DUONG, VIETNAM

FOR: ROASTED CASHEWS NUTS, IN CLASS 29
(U.S. CL. 46).

FIRST USE 1-1-2007; IN COMMERCE 1-1-2007.

NO CLAIM IS MADE TO THE EXCLUSIVE
RIGHT TO USE "GOLDEN CASHEW", "GOLDEN
CASHEWS", OR THE PICTORIAL REPRESENTA-
TION OF CASHEWS, APART FROM THE MARK AS
SHOWN.

THE COLOR(S) BLUE, BRIGHT YELLOW, RED,
GOLD, BLACK, TAN, WHITE, AND MUSTARD
YELLOW IS/ARE CLAIMED AS A FEATURE OF
THE MARK.

THE COLOR BLUE APPEARS IN THE LETTER-
ING "GC" AND "GOLDEN CASHEW" BENEATH
THE GLOBE, AND IN THE POINTED BANNER AT
THE TOP BEHIND THE GLOBE AND LETTERING;

BRIGHT YELLOW APPEARS IN THE HAIR, SKIN,
AND SHIRT, AND BRACELET OF THE WOMAN
DESIGN, IN THE GLOBE DESIGN, IN THE REC-
TANGLE BENEATH THE GLOBE, AND IN THE
GOBLET; RED APPEARS IN THE LIPS OF THE
WOMAN; GOLD APPEARS IN THE MERIDIAN
LINES IN THE GLOBE, THE OUTLINE OF THE
RECTANGLE BENEATH THE GLOBE, THE BACK-
GROUND RECTANGLE BEHIND THE AREA
FROM THE BLUE BANNER DOWN TO THE LINE
AT THE BOTTOM OF THE RECTANGLE; BLACK
APPEARS IN THE PUPILS OF THE WOMAN AND
HER AND THE GOBLET'S OUTLINE; TAN AP-
PEARS IN THE CASHEWS; WHITE APPEARS IN
THE EYE OF THE WOMAN; MUSTARD YELLOW
APPEARS IN THE THICK HORIZONTAL STRIPES
AT THE TOP AND BOTTOM OF THE OVERALL
RECTANGULAR SHAPE OF THE MARK

SN 77-077,331, FILED 1-5-2007.

REBECCA POVARCHUK, EXAMINING ATTOR-
NEY

Int. Cl.: 25

Prior U.S. Cls.: 22 and 39

United States Patent and Trademark Office

Reg. No. 3,477,307

Registered July 29, 2008

**TRADEMARK
PRINCIPAL REGISTER**

Duty free husband

GENGRINOVICH, LEONID (UNITED STATES INDIVIDUAL)
373 ORADELL AVE
ORADELL, NJ 07649 AND
POLYAKOVA, IRENE (UNITED STATES INDIVIDUAL)
373 ORADELL AVE
ORADELL, NJ 07649

FOR: OPEN-NECKED SHIRTS, SHIRTS, SHORT-SLEEVED OR LONG-SLEEVED T-SHIRTS, SLEEP-SHIRTS, SWEAT-SHIRTS, T-SHIRTS, TOPS, SPORTS JERSEYS, JERSEYS, OPEN-NECKED SHIRTS, SHIRTS, SHORT-SLEEVED OR LONG-SLEEVED T-SHIRTS, SLEEP-SHIRTS, SWEAT-SHIRTS, T-SHIRTS, TOPS, HOODED SWEATSHIRTS, BASE-

BALL CAPS, CAPS, GOLF CAPS, KNITTED CAPS, HEADGEAR, NAMELY, HATS, CAPS, SMALL HATS, WOOLLY HATS, HATS, IN CLASS 25 (U.S. CLS. 22 AND 39).

FIRST USE 6-5-2008; IN COMMERCE 6-5-2008.

THE MARK CONSISTS OF STANDARD CHARACTERS WITHOUT CLAIM TO ANY PARTICULAR FONT, STYLE, SIZE, OR COLOR.

SN 77-077,597, FILED 1-7-2007.

LAURIE KAUFMAN, EXAMINING ATTORNEY

Int. Cl.: 16

Prior U.S. Cls.: 2, 5, 22, 23, 29, 37, 38, and 50

United States Patent and Trademark Office

Reg. No. 3,477,308

Registered July 29, 2008

**TRADEMARK
PRINCIPAL REGISTER**

Photo Icing

PHOTO ICING LLC (TEXAS LTD LIAB CO)

11907 COLETO CREEK

SAN ANTONIO, TX 78253

FOR: MEMORY BOOKS, IN CLASS 16 (U.S. CLS. 2, 5, 22, 23, 29, 37, 38 AND 50).

FIRST USE 8-1-2007; IN COMMERCE 8-1-2007.

THE MARK CONSISTS OF STANDARD CHARACTERS WITHOUT CLAIM TO ANY PARTICULAR FONT, STYLE, SIZE, OR COLOR.

NO CLAIM IS MADE TO THE EXCLUSIVE RIGHT TO USE "PHOTO", APART FROM THE MARK AS SHOWN.

SN 77-077,599, FILED 1-7-2007.

LAURIE KAUFMAN, EXAMINING ATTORNEY

Int. Cls.: 40 and 41

Prior U.S. Cls.: 100, 101, 103, 106, and 107

United States Patent and Trademark Office

Reg. No. 3,477,309

Registered July 29, 2008

**SERVICE MARK
PRINCIPAL REGISTER**

Abella

ABELLA SKIN CARE, INC. (FLORIDA CORPORATION)
4240 OAK CIRCLE
BOCA RATON, FL 33431

FOR: MANUFACTURE OF SKIN CARE PREPARATIONS TO THE ORDER AND SPECIFICATION OF OTHERS, IN CLASS 40 (U.S. CLS. 100, 103 AND 106).

FIRST USE 5-28-1999; IN COMMERCE 5-28-1999.

FOR: TRAINING IN THE FIELD OF SKIN CARE AND THE USE OF SKIN CARE PREPARATIONS, IN CLASS 41 (U.S. CLS. 100, 101 AND 107).

FIRST USE 5-28-1999; IN COMMERCE 5-28-1999.

THE MARK CONSISTS OF STYLIZED LETTERS.

SEC. 2(F).

SN 77-077,786, FILED 1-8-2007.

VIVIAN MICZNIK FIRST, EXAMINING ATTORNEY

Int. Cls.: 9 and 41

Prior U.S. Cls.: 21, 23, 26, 36, 38, 100, 101, and 107

United States Patent and Trademark Office

Reg. No. 3,477,310

Registered July 29, 2008

**TRADEMARK
SERVICE MARK
PRINCIPAL REGISTER**

THE CHAOTIC THRONE

NCSOFT CORPORATION (REPUBLIC OF KOREA CORPORATION)

143-8 SAMSUNG-DONG, KANGNAM-GU,
SEOUL, REPUBLIC OF KOREA

FOR: COMPUTER GAME SOFTWARE; INTERACTIVE MULTIMEDIA COMPUTER GAME PROGRAMS; INTERACTIVE VIDEO GAME PROGRAM; COMPUTER GAME EQUIPMENT CONTAINING MEMORY DEVICES, NAMELY, DISCS; VIDEO GAME SOFTWARE; MULTIMEDIA SOFTWARE RECORDED ON CD-ROM IN THE FIELD OF COMPUTER GAMES; VIRTUAL REALITY GAME SOFTWARE; AND MOTION PICTURE FEATURING ANIMATED CARTOONS, IN CLASS 9 (U.S. CLS. 21, 23, 26, 36 AND 38).

FIRST USE 12-13-2006; IN COMMERCE 3-31-2007.

FOR: ENTERTAINMENT, TRAINING, SPORTING AND CULTURAL ACTIVITIES, NAMELY, PROVISION OF ON-LINE COMPUTER GAMES ACCESSIBLE NETWORK-WIDE BY NETWORK USERS; AND ENTERTAINMENT, TRAINING, SPORTING AND CULTURAL ACTIVITIES, NAMELY, PROVIDING ON-LINE COMPUTER GAMES VIA A GLOBAL COMPUTER NETWORK, IN CLASS 41 (U.S. CLS. 100, 101 AND 107).

FIRST USE 12-13-2006; IN COMMERCE 3-31-2007.

THE MARK CONSISTS OF STANDARD CHARACTERS WITHOUT CLAIM TO ANY PARTICULAR FONT, STYLE, SIZE, OR COLOR.

SN 77-078,449, FILED 1-8-2007.

JIM RINGLE, EXAMINING ATTORNEY

Int. Cls.: 3, 35, and 44

Prior U.S. Cls.: 1, 4, 6, 50, 51, 52, 100, 101, and 102

United States Patent and Trademark Office

Reg. No. 3,477,311

Registered July 29, 2008

**TRADEMARK
SERVICE MARK
PRINCIPAL REGISTER**



SHIM, ELISABETH K. (UNITED STATES INDIVIDUAL)
1301 20TH STREET
SUITE 570
SANTA MONICA, CA 90404

FOR: BODY AND SKIN CARE PRODUCTS FOR WOMEN AND MEN, NAMELY, FACE CREAMS, HAND CREAMS AND BODY CREAMS, FACE AND BODY LOTIONS, FACE AND BODY SKIN CLEANSERS, FACE AND BODY MASKS; SUN CARE PRODUCTS, NAMELY, SUNSCREEN PREPARATIONS; NON-MEDICATED TOPICALLY APPLIED PREPARATIONS TO PROTECT THE SKIN FROM SUN AND ENVIRONMENTAL EFFECTS; COMPLEXION LIGHTENERS; AND NON-MEDICATED PREPARATIONS TO DRY SKIN BLEMISHES, IN CLASS 3 (U.S. CLS. 1, 4, 6, 50, 51 AND 52).

FIRST USE 11-0-2007; IN COMMERCE 11-0-2007.

FOR: ON-LINE RETAIL STORE SERVICES FEATURING SKIN AND BEAUTY CARE PRODUCTS,

PERSONAL CARE PRODUCTS; PROVIDING A WEB SITE VIA THE GLOBAL COMPUTER NETWORK FEATURING CONSUMER PRODUCT INFORMATION IN THE FIELDS OF SKIN CARE AND HEALTH PRODUCTS, IN CLASS 35 (U.S. CLS. 100, 101 AND 102).

FIRST USE 12-0-2007; IN COMMERCE 12-0-2007.

FOR: PROVIDING A WEBSITE VIA THE GLOBAL COMPUTER NETWORK FEATURING INFORMATION IN THE FIELDS OF DERMATOLOGY, SKIN CARE, AND HEALTH ISSUES, IN CLASS 44 (U.S. CLS. 100 AND 101).

FIRST USE 12-0-2007; IN COMMERCE 12-0-2007.

THE MARK CONSISTS OF THREE BLADES OF GRASS GROWING OUT OF A BACKGROUND.

SN 77-078,769, FILED 1-9-2007.

TRICIA SONNEBORN, EXAMINING ATTORNEY

Int. Cl.: 36

Prior U.S. Cls.: 100, 101, and 102

United States Patent and Trademark Office

Reg. No. 3,477,312

Registered July 29, 2008

**SERVICE MARK
PRINCIPAL REGISTER**



FIRST FINANCIAL FEDERAL CREDIT UNION
(UNITED STATES FEDERALLY CHARTERED
CREDIT UNION)
P.O. BOX 1172
TOMS RIVER, NJ 08754

FIRST USE 0-0-2006; IN COMMERCE 0-0-2006.

SN 77-079,296, FILED 1-9-2007.

FOR: BANKING AND CREDIT UNION SERVI-
CES, IN CLASS 36 (U.S. CLS. 100, 101 AND 102).

ANNE E. GUSTASON, EXAMINING ATTORNEY

Int. Cls.: 29 and 41

Prior U.S. Cls.: 46, 100, 101, and 107

United States Patent and Trademark Office

Reg. No. 3,477,313

Registered July 29, 2008

**TRADEMARK
SERVICE MARK
PRINCIPAL REGISTER**



LINK SNACKS, INC. (WISCONSIN CORPORATION)
ONE SNACKFOOD LANE, P.O. BOX 397
MINONG, WI 54859

FOR: MEAT SNACKS, IN CLASS 29 (U.S. CL. 46).

FIRST USE 7-31-2007; IN COMMERCE 7-31-2007.

FOR: PROVIDING TEMPORARY USE OF ON-LINE NON-DOWNLOADABLE COMPUTER GAMES, IN CLASS 41 (U.S. CLS. 100, 101 AND 107).

FIRST USE 7-31-2007; IN COMMERCE 7-31-2007.

NO CLAIM IS MADE TO THE EXCLUSIVE RIGHT TO USE "GAMES", APART FROM THE MARK AS SHOWN.

SN 77-079,322, FILED 1-9-2007.

ANTHONY RINKER, EXAMINING ATTORNEY

Int. Cl.: 38

Prior U.S. Cls.: 100, 101, and 104

United States Patent and Trademark Office

Reg. No. 3,477,314

Registered July 29, 2008

**SERVICE MARK
PRINCIPAL REGISTER**

DSR

BAY COM LLC (NEVADA LTD LIAB CO)
224 E RINCON AVE.
CAMPBELL, CA 95008

FIRST USE 1-9-2007; IN COMMERCE 1-22-2007.

FOR: WIRELESS COMMUNICATIONS SERVICES, NAMELY, THE TRANSMISSION OF A SUBSCRIBERS POSTED TEXT OR PICTURE(S) TO A MOBILE PHONE AS REQUESTED BY MOBILE PHONE USERS VIA DIALING THE SUBSCRIBER'S ASSIGNED NUMBER, IN CLASS 38 (U.S. CLS. 100, 101 AND 104).

THE MARK CONSISTS OF STANDARD CHARACTERS WITHOUT CLAIM TO ANY PARTICULAR FONT, STYLE, SIZE, OR COLOR.

SN 77-079,495, FILED 1-10-2007.

THOMAS MANOR, EXAMINING ATTORNEY

Int. Cl.: 35

Prior U.S. Cls.: 100, 101, and 102

United States Patent and Trademark Office

Reg. No. 3,477,315

Registered July 29, 2008

**SERVICE MARK
PRINCIPAL REGISTER**

RESTOCKBID.COM

RESTOCKBID.COM, LLC (CALIFORNIA LTD
LIAB CO)
STE 400
3330 THIRD AVE
SAN DIEGO, CA 92103

FOR: ON-LINE ORDERING SERVICES FEATUR-
ING DENTAL SUPPLIES; PROVIDING A SEARCH-
ABLE ONLINE ADVERTISING GUIDE
FEATURING THE GOODS AND SERVICES OF
OTHER ON-LINE VENDORS ON THE INTERNET;
WHOLESALE ORDERING SERVICES IN THE

FIELD OF DENTAL SUPPLIES, IN CLASS 35 (U.S.
CLS. 100, 101 AND 102).

FIRST USE 1-1-2008; IN COMMERCE 1-1-2008.

THE MARK CONSISTS OF STANDARD CHAR-
ACTERS WITHOUT CLAIM TO ANY PARTICULAR
FONT, STYLE, SIZE, OR COLOR.

SN 77-079,821, FILED 1-10-2007.

ODESSA BIBBINS, EXAMINING ATTORNEY

Int. Cl.: 3

Prior U.S. Cls.: 1, 4, 6, 50, 51, and 52

United States Patent and Trademark Office

Reg. No. 3,477,316

Registered July 29, 2008

**TRADEMARK
PRINCIPAL REGISTER**

MAKE HIM SWEAT

THE DIAL CORPORATION (DELAWARE CORPORATION)
15501 NORTH DIAL BOULEVARD
M.S. 2214
SCOTTSDALE, AZ 852601619

FOR: DEODORANT FOR PERSONAL USE; DEODORANTS AND ANTIPERSPIRANTS; DEODORANTS FOR BODY CARE; PERSONAL DEODORANTS, IN CLASS 3 (U.S. CLS. 1, 4, 6, 50, 51 AND 52).

FIRST USE 4-1-2008; IN COMMERCE 4-1-2008.

THE MARK CONSISTS OF STANDARD CHARACTERS WITHOUT CLAIM TO ANY PARTICULAR FONT, STYLE, SIZE, OR COLOR.

SN 77-080,260, FILED 1-10-2007.

CAROL SPILS, EXAMINING ATTORNEY

Int. Cl.: 3

Prior U.S. Cls.: 1, 4, 6, 50, 51, and 52

Reg. No. 3,477,317

United States Patent and Trademark Office

Registered July 29, 2008

**TRADEMARK
PRINCIPAL REGISTER**

ABHA

AYUSH HERBS, INC. (WASHINGTON COR-
PORATION)
2115 112TH NE
BELLEVUE, WA 98004

THE MARK CONSISTS OF STANDARD CHAR-
ACTERS WITHOUT CLAIM TO ANY PARTICULAR
FONT, STYLE, SIZE, OR COLOR.

FOR: COSMETICS, IN CLASS 3 (U.S. CLS. 1, 4, 6, 50,
51 AND 52).

SN 77-080,579, FILED 1-11-2007.

FIRST USE 8-1-2005; IN COMMERCE 11-1-2006.

HELENE LIWINSKI, EXAMINING ATTORNEY

Int. Cl.: 36

Prior U.S. Cls.: 100, 101, and 102

United States Patent and Trademark Office

Reg. No. 3,477,318

Registered July 29, 2008

**SERVICE MARK
PRINCIPAL REGISTER**

GREEN-GARD

FIREMAN'S FUND INSURANCE COMPANY
(CALIFORNIA CORPORATION)
777 SAN MARIN DRIVE
NOVATO, CA 94998

FOR: UNDERWRITING PROPERTY AND CASUALTY INSURANCE FOR THE COMMERCIAL GREENHOUSE AND PLANT AND TREE NURSERY INDUSTRY, IN CLASS 36 (U.S. CLS. 100, 101 AND 102).

FIRST USE 10-1-2006; IN COMMERCE 10-1-2006.

THE MARK CONSISTS OF STANDARD CHARACTERS WITHOUT CLAIM TO ANY PARTICULAR FONT, STYLE, SIZE, OR COLOR.

OWNER OF U.S. REG. NOS. 1,017,125, 2,578,902, AND OTHERS.

SN 77-080,611, FILED 1-11-2007.

MARILYN IZZI, EXAMINING ATTORNEY

Int. Cl.: 9

Prior U.S. Cls.: 21, 23, 26, 36, and 38

United States Patent and Trademark Office

Reg. No. 3,477,319

Registered July 29, 2008

**TRADEMARK
PRINCIPAL REGISTER**

OPTI-GRIP

GERMANTON, KYLE (UNITED STATES INDIVIDUAL)
255 RIDGE DRIVE
POMPTON LAKES, NJ 07442

FOR: TEMPERATURE SENSOR SYSTEM, NAME-
LY, AN INFRARED TEMPERATURE SENSOR SYS-
TEM, CONSISTING OF LCD SCREEN, INFRARED
SENSORS WITH CABLES, MOUNTING BRACKETS
AND A CIGARETTE POWER ADAPTOR, INSTAL-
LED INTO RACE CARS TO PERMIT THE OPERA-
TOR TO MONITOR THE TEMPERATURE OF THE
TIRES, IN CLASS 9 (U.S. CLS. 21, 23, 26, 36 AND 38).

FIRST USE 12-15-2007; IN COMMERCE 12-15-2007.

THE MARK CONSISTS OF STANDARD CHAR-
ACTERS WITHOUT CLAIM TO ANY PARTICULAR
FONT, STYLE, SIZE, OR COLOR.

SN 77-081,070, FILED 1-11-2007.

BONNIE LUKEN, EXAMINING ATTORNEY

Int. Cls.: 11, 35, 37, 40, and 42

**Prior U.S. Cls.: 13, 21, 23, 31, 34, 100, 101, 102, 103,
and 106**

Reg. No. 3,477,320

United States Patent and Trademark Office

Registered July 29, 2008

**TRADEMARK
SERVICE MARK
PRINCIPAL REGISTER**

XOGEN

XOGEN TECHNOLOGIES INC. (CANADA CORPORATION)
440 - 10816 MACLEOD TRAIL S, STE. 362
CALGARY, CANADA T2J5N8

FOR: (BASED ON 44(E)) MACHINES USED TO GENERATE HYDROGEN AND OXYGEN FROM WATER AND/OR SUBSTANCES COMPRISED OF WATER, IN CLASS 11 (U.S. CLS. 13, 21, 23, 31 AND 34).

FOR: BUSINESS AND MARKET RESEARCH FOR OTHERS IN THE FIELDS OF WATER PURIFICATION AND HYDROGEN AND/OR OXYGEN GENERATION FROM WATER AND/OR SUBSTANCES COMPRISED OF WATER, IN CLASS 35 (U.S. CLS. 100, 101 AND 102).

FIRST USE 5-2-2008; IN COMMERCE 5-2-2008.

FOR: INSTALLATION, MAINTENANCE AND REPAIR OF MACHINES FOR OTHERS IN THE FIELDS OF WATER PURIFICATION AND HYDROGEN AND/OR OXYGEN GENERATION FROM WATER AND/OR SUBSTANCES COMPRISED OF WATER, IN CLASS 37 (U.S. CLS. 100, 103 AND 106).

FIRST USE 5-2-2008; IN COMMERCE 5-2-2008.

FOR: MANUFACTURING OF MACHINES FOR OTHERS IN THE FIELDS OF WATER PURIFICATION AND HYDROGEN AND/OR OXYGEN GENERATION FROM WATER AND/OR SUBSTANCES COMPRISED OF WATER, IN CLASS 40 (U.S. CLS. 100, 103 AND 106).

FIRST USE 5-2-2008; IN COMMERCE 5-2-2008.

FOR: SCIENTIFIC RESEARCH FOR OTHERS IN THE FIELDS OF WATER PURIFICATION AND HYDROGEN AND/OR OXYGEN GENERATION FROM WATER AND/OR SUBSTANCES COMPRISED OF WATER, IN CLASS 42 (U.S. CLS. 100 AND 101).

FIRST USE 5-2-2008; IN COMMERCE 5-2-2008.

THE MARK CONSISTS OF STANDARD CHARACTERS WITHOUT CLAIM TO ANY PARTICULAR FONT, STYLE, SIZE, OR COLOR.

OWNER OF CANADA REG. NO. TMA632856, DATED 2-15-2005, EXPIRES 2-15-2020.

SN 77-081,829, FILED 1-12-2007.

JULIE WATSON, EXAMINING ATTORNEY

Int. Cl.: 35

Prior U.S. Cls.: 100, 101, and 102

United States Patent and Trademark Office

Reg. No. 3,477,321

Registered July 29, 2008

**SERVICE MARK
PRINCIPAL REGISTER**

SmartWind

FIRSTENERGY SOLUTIONS CORP. (OHIO CORPORATION)
395 GHENT ROAD
AKRON, OH 44333

FOR: WHOLESALE AND RETAIL DISTRIBUTORSHIP SERVICES FEATURING ELECTRICITY GENERATION SUPPLY SERVICES AND RENEWABLE ENERGY WIND POWER OF OTHERS, IN CLASS 35 (U.S. CLS. 100, 101 AND 102).

FIRST USE 2-19-2007; IN COMMERCE 3-0-2007.

THE MARK CONSISTS OF STANDARD CHARACTERS WITHOUT CLAIM TO ANY PARTICULAR FONT, STYLE, SIZE, OR COLOR.

SN 77-081,841, FILED 1-12-2007.

ODESSA BIBBINS, EXAMINING ATTORNEY

Int. Cl.: 9

Prior U.S. Cls.: 21, 23, 26, 36, and 38

Reg. No. 3,477,322

United States Patent and Trademark Office

Registered July 29, 2008

**TRADEMARK
PRINCIPAL REGISTER**

Cosmic Family

UBISOFT INC. (CALIFORNIA CORPORATION)
625, THIRD STREET, THIRD FLOOR
SAN FRANCISCO, CA 94107

BILE PHONES, PERSONAL DIGITAL ASSISTANTS,
AND HANDHELD COMPUTERS, IN CLASS 9 (U.S.
CLS. 21, 23, 26, 36 AND 38).

FOR: SOFTWARE AND ELECTRONIC GAMES,
NAMELY, SOFTWARE GAMES RECORDED ON
CD-ROM AND DIGITAL VIDEO DISCS FOR COM-
PUTERS; SOFTWARE GAMES RECORDED ON CD-
ROMS, DIGITAL VIDEO DISCS, AND CARTRIDGES
FOR CONSOLE AND INDIVIDUAL, PORTABLE
GAMING SYSTEMS; SOFTWARE GAMES THAT
ARE DOWNLOADABLE FROM A REMOTE COM-
PUTER SITE; AND SOFTWARE GAMES FOR MO-

FIRST USE 9-30-2007; IN COMMERCE 9-30-2007.

THE MARK CONSISTS OF STANDARD CHAR-
ACTERS WITHOUT CLAIM TO ANY PARTICULAR
FONT, STYLE, SIZE, OR COLOR.

SN 77-081,927, FILED 1-12-2007.

DAVID TOOLEY, EXAMINING ATTORNEY

Int. Cl.: 33

Prior U.S. Cls.: 47 and 49

United States Patent and Trademark Office

Reg. No. 3,477,323

Registered July 29, 2008

**TRADEMARK
PRINCIPAL REGISTER**



TNT VINEYARDS, LLC (CALIFORNIA LTD LIAB
CO)
5800 PETRIFIED FOREST ROAD
ST. HELENA, CA 94515

FOR: WINE, IN CLASS 33 (U.S. CLS. 47 AND 49).

FIRST USE 1-22-2008; IN COMMERCE 1-22-2008.

NO CLAIM IS MADE TO THE EXCLUSIVE
RIGHT TO USE THE REPRESENTATION OF THE
SHAPE OF THE BOTTLE, APART FROM THE
MARK AS SHOWN.

THE COLOR(S) WHITE, YELLOW, ORANGE,
RED AND BLACK IS/ARE CLAIMED AS A FEAT-
TURE OF THE MARK.

THE MARK CONSISTS OF A BLACK COLORED
BOTTLE, WITH THE COLOR RED ON THE TOP
PORTION OF THE BOTTLE NECK. THE COLOR
RED ALSO APPEARS IN THE WORDING "KISS
RIDGE". ABOVE THE WORDING IS A STYLIZED
MOUNTAIN RANGE OF YELLOW AND ORANGE,
SURROUNDED BY WHITE CLOUDS.

SN 77-082,142, FILED 1-12-2007.

ANDREA K. NADELMAN, EXAMINING ATTOR-
NEY

Int. Cl.: 44

Prior U.S. Cls.: 100 and 101

United States Patent and Trademark Office

Reg. No. 3,477,324

Registered July 29, 2008

**SERVICE MARK
PRINCIPAL REGISTER**

EVERYTHING POSSIBLE

THE BRIGHAM AND WOMEN'S HOSPITAL,
INC. (MASSACHUSETTS CORPORATION)
75 FRANCIS STREET
BOSTON, MA 02115

THE MARK CONSISTS OF STANDARD CHAR-
ACTERS WITHOUT CLAIM TO ANY PARTICULAR
FONT, STYLE, SIZE, OR COLOR.

FOR: HEALTH CARE, IN CLASS 44 (U.S. CLS. 100
AND 101).

SN 77-083,115, FILED 1-15-2007.

FIRST USE 5-27-2008; IN COMMERCE 5-27-2008.

GENE MACIOL, EXAMINING ATTORNEY

Int. Cls.: 9 and 16

Prior U.S. Cls.: 2, 5, 21, 22, 23, 26, 29, 36, 37, 38, and 50

Reg. No. 3,477,325

United States Patent and Trademark Office

Registered July 29, 2008

TRADEMARK
PRINCIPAL REGISTER



JOHN-PAUL INTERNATIONAL, LLC (WYOMING LTD LIAB CO)
60 EAST SIMPSON AVE.
JACKSON, WY 83001

FOR: AUDIO AND VIDEO RECORDINGS FEATURING INFORMATION IN THE FIELD OF FINANCE, BUSINESS AND PERSONAL DEVELOPMENT; COMPUTER SOFTWARE FOR MULTIMEDIA PURPOSE, RECORDED ON CD-ROMS, SUCH AS EDUCATIONAL DEMONSTRATIONS AND INSTRUCTION, FEATURING INFORMATION IN THE FIELD OF FINANCE, BUSINESS AND PERSONAL DEVELOPMENT., IN CLASS 9 (U.S. CLS. 21, 23, 26, 36 AND 38).

FIRST USE 6-8-2006; IN COMMERCE 6-8-2006.

FOR: EDUCATIONAL BOOKS IN THE FIELD OF FINANCE, BUSINESS AND PERSONAL DEVELOPMENT; STICKERS, BUMPER STICKERS, POSTCARDS, DECALS; PRINTED MATTER AND PUBLICATIONS, NAMELY, NEWSLETTERS IN THE FIELD OF FINANCE, BUSINESS AND PERSONAL DEVELOPMENT; PHOTOGRAPHS; POSTERS; PRESSURE SENSITIVE STICKERS; PERSONAL DIARIES, AND SOUVENIR PROGRAMS; MAGAZINES IN THE FIELD OF FINANCE, BUSINESS AND PERSONAL DEVELOPMENT; CALENDARS; COMIC BOOKS, COMIC STRIPS, CHILDREN'S BOOKS, TALKING CHILDREN'S BOOKS, ACTIVITY BOOKS, COLORING BOOKS, CARTOON PRINTS, PICTURE BOOKS, TALKING BOOKS, ILLUSTRATIONS, ADDRESS BOOKS, ADDRESS LABELS, ALBUMS FOR STICKERS, ADHESIVE LABELS, ADHESIVE NOTE PADS, ADHESIVE

NOTE PAPER, ANIMATION CELS, ANNIVERSARY BOOKS, BIRTHDAY CARDS, ANNOUNCEMENT CARDS, DECORATIVE PAPER CENTERPIECES, HOLIDAY CARDS, EVENT CARDS, STENCILS, APPOINTMENT BOOKS, ART PICTURES, ART PRINTS, AUTOGRAPH BOOKS, BABY BOOKS, BINDERS, BLANK JOURNAL BOOKS, BLANK NOTE CARDS, BLANK OR PARTIALLY PRINTED PAPER LABELS, BLANK OR PARTIALLY PRINTED POSTCARDS, BRAG BOOKS, BOOK COVERS, STORAGE CONTAINERS MADE OF PAPER, BOOK-COVER PAPER, BOOKMARKS, CALENDAR DESK PADS, CALENDAR DESK STANDS, CALENDAR STANDS, TEMPORARY TATTOOS, CARDBOARD CONTAINERS, CHILDREN'S STORYBOOKS, COMPOSITION BOOKS, COOK BOOKS, CRAFT PAPER, CRAYONS, DESK STANDS AND HOLDERS FOR PENS, PENCILS, AND INK PENS, DESK SETS, TACK BOARDS, DESKTOP ORGANIZERS, DESKTOP PLANNERS, DIARIES, EASELS, ERASERS, ENVELOPES, WRITING TABLETS, STATIONERY, INK PENS, STATIONERY BOXES, PENS, PENCILS, WIRE BOUND BOOKS, SKETCH BOOKS, STORY BOOKS, GREETING CARDS, PRINTED PAPER INVITATIONS, PAPER PLATES, PAPER NAPKINS, FLASH CARDS, PAPER BAGS, PAPER BADGES, PAPER BOWS FOR GIFT WRAP, PAPER CAKE DECORATIONS, PAPER CONTAINERS, PAPER FOLDERS, PAPER FLAGS, PAPER GIFT BAGS, PAPER MATS, PAPER TABLE CLOTHS, PAPER PARTY BAGS, PEN AND PENCIL CASES AND BOXES, RUBBER STAMPS, SCRAPBOOKS, WIRE-BOUND NOTEBOOKS, TRADING CARDS, STAMP PAD INKS, STAMP PADS; PAMPHLETS AND BROCHURES IN THE FIELD OF FINANCE, BUSINESS AND PERSONAL

DEVELOPMENT, IN CLASS 16 (U.S. CLS. 2, 5, 22, 23, 29, 37, 38 AND 50).

FIRST USE 1-1-2007; IN COMMERCE 1-1-2007.

NO CLAIM IS MADE TO THE EXCLUSIVE RIGHT TO USE "LLC" , APART FROM THE MARK AS SHOWN.

THE NAME(S), PORTRAIT(S), AND/OR SIGNATURE(S) SHOWN IN THE MARK IDENTIFIES

"JOHN-PAUL" , WHOSE CONSENT(S) TO REGISTER IS SUBMITTED.

THE MARK CONSISTS OF THE CAPITOL LETTERS "JP" HAVE A SILHOUETTE OF A HUMAN FIGURE LEANING ON THE LETTERS WITH THE WORDS UNDERNEATH "JOHN-PAUL INTERNATIONAL, LLC" .

SN 77-083,508, FILED 1-16-2007.

KELLEY WELLS, EXAMINING ATTORNEY

Int. Cl.: 9

Prior U.S. Cls.: 21, 23, 26, 36, and 38

United States Patent and Trademark Office

Reg. No. 3,477,326

Registered July 29, 2008

**TRADEMARK
PRINCIPAL REGISTER**

SMEAD IPUBLISH

THE SMEAD MANUFACTURING COMPANY
(MINNESOTA CORPORATION)
600 SMEAD BOULEVARD
HASTINGS, MN 55033

FOR: COMPUTER SOFTWARE FOR DOCUMENT IMAGING, SCANNING, RETRIEVAL AND TRACKING, FILE MANAGEMENT, RECORDKEEPING, ELECTRONIC RECORDS STORAGE AND DATABASE MANAGEMENT; COMPUTER SOFTWARE FOR FORMATTING DATABASE INFORMATION AND IMAGES, IN CLASS 9 (U.S. CLS. 21, 23, 26, 36 AND 38).

FIRST USE 3-1-2002; IN COMMERCE 3-1-2002.

THE MARK CONSISTS OF STANDARD CHARACTERS WITHOUT CLAIM TO ANY PARTICULAR FONT, STYLE, SIZE, OR COLOR.

OWNER OF U.S. REG. NOS. 2,748,241, 3,003,820, AND OTHERS.

NO CLAIM IS MADE TO THE EXCLUSIVE RIGHT TO USE "IPUBLISH", APART FROM THE MARK AS SHOWN.

SN 77-083,543, FILED 1-16-2007.

ALEXANDER L. POWERS, EXAMINING ATTORNEY

Int. Cl.: 25

Prior U.S. Cls.: 22 and 39

United States Patent and Trademark Office

Reg. No. 3,477,327

Registered July 29, 2008

**TRADEMARK
PRINCIPAL REGISTER**

DREAMABLES

THE QUACK, INC. (FLORIDA CORPORATION)
1080 LAKE DRIVE
DELRAY BEACH, FL 33444

THE MARK CONSISTS OF STANDARD CHAR-
ACTERS WITHOUT CLAIM TO ANY PARTICULAR
FONT, STYLE, SIZE, OR COLOR.

FOR: CLOTHING, NAMELY, SLEEPWEAR, IN
CLASS 25 (U.S. CLS. 22 AND 39).

SN 77-083,849, FILED 1-16-2007.

FIRST USE 5-19-2008; IN COMMERCE 5-19-2008.

EVELYN BRADLEY, EXAMINING ATTORNEY

Int. Cl.: 20

Prior U.S. Cls.: 2, 13, 22, 25, 32, and 50

Reg. No. 3,477,328

United States Patent and Trademark Office

Registered July 29, 2008

**TRADEMARK
PRINCIPAL REGISTER**

T H E S T U D I O ³ P R O J E C T

HAINES, MICHAEL ALLEN (UNITED STATES
INDIVIDUAL)
176 PERRYDALE AVENUE
MEDFORD, OR 97501

NO CLAIM IS MADE TO THE EXCLUSIVE
RIGHT TO USE "STUDIO", APART FROM THE
MARK AS SHOWN.

FOR: FURNITURE, IN CLASS 20 (U.S. CLS. 2, 13,
22, 25, 32 AND 50).

SN 77-083,983, FILED 1-16-2007.

FIRST USE 6-13-2005; IN COMMERCE 6-13-2005.

ELLEN PERKINS, EXAMINING ATTORNEY

Int. Cl.: 41

Prior U.S. Cls.: 100, 101, and 107

United States Patent and Trademark Office

Reg. No. 3,477,329

Registered July 29, 2008

**SERVICE MARK
PRINCIPAL REGISTER**



ON THE LOT PARTNERS, LLC (CALIFORNIA
LTD LIAB CO)
640 N. SEPULVEDA BOULEVARD
LOS ANGELES, CA 90049

FOR: ENTERTAINMENT SERVICES IN THE
NATURE OF A REALITY TELEVISION SERIES;
PROVIDING INFORMATION ABOUT A REALITY
TELEVISION SERIES VIA AN ON-LINE GLOBAL
COMPUTER NETWORK, IN CLASS 41 (U.S. CLS. 100,
101 AND 107).

FIRST USE 5-22-2007; IN COMMERCE 5-22-2007.

THE MARK CONSISTS OF A RECTANGULAR
AREA WITH A SERIES OF SMALLER RECTAN-
GLES ALONG THE LEFT AND RIGHT EDGES
RESEMBLING A FILM STRIP. WITHIN THE REC-
TANGULAR AREA IS A FIGURE OF A DIRECTORS
CHAIR THAT INCLUDES A STAR IN THE CENTER
OF ITS BACK PANEL. ADJACENT TO THE DIREC-
TORS CHAIR ARE THE WORDS "ON THE LOT",
WITH THE WORDS "ON THE" LOCATED ABOVE
THE WORD "LOT".

SN 77-084,181, FILED 1-16-2007.

INGA ERVIN, EXAMINING ATTORNEY

Int. Cl.: 10

Prior U.S. Cls.: 26, 39, and 44

United States Patent and Trademark Office

Reg. No. 3,477,330

Registered July 29, 2008

**TRADEMARK
PRINCIPAL REGISTER**

VisiTrax

CONTACT SURGICAL, INC. (DELAWARE
CORPORATION)
1001 AVIATION PARKWAY, SUITE 400
MORRISVILLE, NC 27560

THE MARK CONSISTS OF STANDARD CHAR-
ACTERS WITHOUT CLAIM TO ANY PARTICULAR
FONT, STYLE, SIZE, OR COLOR.

FOR: ACCESS DEVICES AND CATHETERS FOR
COAGULATION OF TISSUE, IN CLASS 10 (U.S. CLS.
26, 39 AND 44).

SN 77-084,259, FILED 1-17-2007.

FIRST USE 1-16-2007; IN COMMERCE 3-4-2008.

GIANCARLO CASTRO, EXAMINING ATTORNEY

Int. Cl.: 41

Prior U.S. Cls.: 100, 101, and 107

United States Patent and Trademark Office

Reg. No. 3,477,331

Registered July 29, 2008

**SERVICE MARK
PRINCIPAL REGISTER**

CONFIDENT STUDENT

THE CONFIDENT STUDENT, LLC. (MARY-
LAND LTD LIAB CO)
76 CRANBROOK ROAD #289
COCKEYSVILLE, MD 21030

FOR: ANALYZING EDUCATIONAL TESTS
SCORES AND DATA FOR OTHERS; ARRANGING
OF SEMINARS; CAREER COUNSELING; CONSUL-
TANCY IN THE FIELD OF LEARNING DIFFICUL-
TIES; EDUCATIONAL SERVICES IN THE NATURE
OF CORRESPONDENCE SCHOOLS; EDUCATION-
AL SERVICES, NAMELY, CONDUCTING DIS-
TANCE LEARNING INSTRUCTION AT THE
SECONDARY, COLLEGE AND GRADUATE LE-
VELS; EDUCATIONAL SERVICES, NAMELY, CON-
DUCTING INFORMAL PROGRAMS IN THE
FIELDS OF EDUCATIONAL CONSULTING, USING
ON-LINE ACTIVITIES AND INTERACTIVE EXHI-
BITS, AND PRIM TABLE MATERIALS DISTRIBU-
TED THEREWITH; EDUCATIONAL SERVICES,
NAMELY, PROVIDING COURSES OF INSTRUC-

TION AT THE ACADEMIC LEVEL AND DISTRIBU-
TION OF COURSE MATERIAL IN CONNECTION
THEREWITH; PERSONAL COACHING SERVICES
IN THE FIELD OF PARENTING AND EDUCATION;
PREPARING, ADMINISTERING, AND SCORING
STANDARDIZED TESTS; PROVIDING COURSES
OF INSTRUCTION AT THE HIGH SCHOOL, COL-
LEGE, POST-GRADUATE LEVEL; SUMMER
CAMPS, IN CLASS 41 (U.S. CLS. 100, 101 AND 107).

FIRST USE 8-25-2003; IN COMMERCE 8-25-2003.

THE MARK CONSISTS OF STANDARD CHAR-
ACTERS WITHOUT CLAIM TO ANY PARTICULAR
FONT, STYLE, SIZE, OR COLOR.

SN 77-084,712, FILED 1-17-2007.

TIMOTHY FINNEGAN, EXAMINING ATTORNEY

Int. Cl.: 9

Prior U.S. Cls.: 21, 23, 26, 36, and 38

United States Patent and Trademark Office

Reg. No. 3,477,332

Registered July 29, 2008

TRADEMARK
PRINCIPAL REGISTER



ESOBİ INC. (CAYMAN ISLANDS CORPORATION)
OFFSHORE INCORPORATIONS (CAYMAN) LIMITED
SCOTIA CENTRE, 4TH FLOOR, P.O. BOX 2804
GEORGETOWN GRAND CAYMAN, CAYMAN ISLANDS

FOR: COMPUTERS, COMPUTER MEMORIES, COMPUTER MEMORY HARDWARE, NAMELY, COMPUTER REGISTERS; COMPUTER INTERFACE BOARDS FOR COMPUTER NETWORKS AND COMMUNICATIONS; SEMI-CONDUCTORS, INTEGRATED CIRCUITS, VIRTUAL PRIVATE NETWORK OPERATING SOFTWARE, WIDE AREA NETWORK OPERATING SOFTWARE, WEBSITE DEVELOPMENT SOFTWARE, NETWORK ACCESS SERVER OPERATING SOFTWARE, COMPUTER RSS AGGREGATOR SOFTWARE, COMPUTER INFORMATION SYNCHRONIZATION SOFTWARE, INTERNET INSTANT INFORMATION EXCHANGE SOFTWARE, COMPUTER SEARCH ENGINE SOFTWARE, COMPUTER SOFTWARE FOR ACCESSING INFORMATION DIRECTORIES THAT MAY BE DOWNLOADED FROM THE GLOBAL COMPUTER NETWORK, COMPUTER SOFTWARE FOR CREATING SEARCHABLE DATABASES OF INFORMATION AND DATA, COMPUTER SOFTWARE FOR

THE COLLECTION, EDITING, ORGANIZING, MODIFYING, BOOK MARKING, TRANSMISSION, STORAGE AND SHARING OF DATA AND INFORMATION, PHOTOGRAPHIC CAMERAS, WEBPAGE DOWNLOAD SOFTWARE, COMPUTER DISC DRIVES, NAMELY, WEBPAGE DOWNLOAD DRIVES, COMPUTER HARDWARE; COMPUTER PERIPHERAL DEVICE EQUIPMENT, NAMELY, KEYBOARD, MOUSE, MICROPHONE, FLASHDISK AND MEMORY CARD; ELECTRONIC PRODUCTS, NAMELY, MP3 PLAYERS, MOBILE GAMING DEVICES, FLASHDISKS; AUDIO RECORDING DEVICES, NAMELY, MP3 PLAYERS AND COMPACT AUDIO RECORDERS; VIDEO RECORDING DEVICES, NAMELY, DVD DIGITAL CAMCORDERS AND WEBCAMS; TELEPHONES; PERSONAL COMMUNICATION DEVICE EQUIPMENT, NAMELY, MOBILE PHONES AND PERSONAL DIGITAL ASSISTANTS, IN CLASS 9 (U.S. CLS. 21, 23, 26, 36 AND 38).

FIRST USE 6-15-2006; IN COMMERCE 5-15-2007.

SN 77-085,303, FILED 1-18-2007.

LINDA ORNDORFF, EXAMINING ATTORNEY

Int. Cl.: 29

Prior U.S. Cl.: 46

United States Patent and Trademark Office

Reg. No. 3,477,333

Registered July 29, 2008

**TRADEMARK
PRINCIPAL REGISTER**

**CLIF KID ORGANIC TWISTED
FRUIT**

CLIF BAR & CO. (CALIFORNIA CORPORATION)
1610 FIFTH STREET
BERKELEY, CA 94710

OWNER OF U.S. REG. NOS. 2,089,042 AND
2,573,420.

FOR: ORGANIC DRIED FRUIT SNACKS, IN
CLASS 29 (U.S. CL. 46).

NO CLAIM IS MADE TO THE EXCLUSIVE
RIGHT TO USE "ORGANIC TWISTED FRUIT",
APART FROM THE MARK AS SHOWN.

FIRST USE 7-9-2007; IN COMMERCE 7-9-2007.

SN 77-086,054, FILED 1-18-2007.

THE MARK CONSISTS OF STANDARD CHAR-
ACTERS WITHOUT CLAIM TO ANY PARTICULAR
FONT, STYLE, SIZE, OR COLOR.

KATHERINE M. DUBRAY, EXAMINING ATTOR-
NEY

Int. Cl.: 36

Prior U.S. Cls.: 100, 101, and 102

United States Patent and Trademark Office

Reg. No. 3,477,334

Registered July 29, 2008

**SERVICE MARK
PRINCIPAL REGISTER**

**THE LANDLORD OF WHERE
AMERICA SHOPS**

COLE CAPITAL ADVISORS, INC. (ARIZONA
CORPORATION)

SUITE 400
2555 E. CAMELBACK ROAD
PHOENIX, AZ 85016

FOR: FINANCIAL AND INVESTMENT SERVICES, NAMELY, MANAGEMENT AND INVESTMENT OF FUNDS; MANAGING RETAIL INVESTMENT PROPERTY AND REIT FUNDS ASSOCIATED WITH RETAIL INVESTMENT PROPERTY, IN CLASS 36 (U.S. CLS. 100, 101 AND 102).

FIRST USE 2-29-2008; IN COMMERCE 2-29-2008.

THE MARK CONSISTS OF STANDARD CHARACTERS WITHOUT CLAIM TO ANY PARTICULAR FONT, STYLE, SIZE, OR COLOR.

SN 77-086,263, FILED 1-19-2007.

AMY HELLA, EXAMINING ATTORNEY

Int. Cl.: 25

Prior U.S. Cls.: 22 and 39

United States Patent and Trademark Office

Reg. No. 3,477,335

Registered July 29, 2008

**TRADEMARK
PRINCIPAL REGISTER**

STRETCH PERFECT

HBI BRANDED APPAREL ENTERPRISES, LLC
(DELAWARE LTD LIAB CO)
1000 EAST HANES MILL ROAD
WINSTON-SALEM, NC 27105

OWNER OF U.S. REG. NOS. 2,151,449 AND
2,414,372.

FOR: FINISHED TEXTILE LININGS SOLD AS AN
INTEGRAL COMPONENT OF GARMENTS, IN
CLASS 25 (U.S. CLS. 22 AND 39).

NO CLAIM IS MADE TO THE EXCLUSIVE
RIGHT TO USE "STRETCH", APART FROM THE
MARK AS SHOWN.

FIRST USE 9-15-2005; IN COMMERCE 9-15-2005.

SN 77-086,611, FILED 1-19-2007.

THE MARK CONSISTS OF STANDARD CHAR-
ACTERS WITHOUT CLAIM TO ANY PARTICULAR
FONT, STYLE, SIZE, OR COLOR.

CURTIS FRENCH, EXAMINING ATTORNEY

Int. Cl.: 35

Prior U.S. Cls.: 100, 101, and 102

United States Patent and Trademark Office

Reg. No. 3,477,336

Registered July 29, 2008

**SERVICE MARK
PRINCIPAL REGISTER**

TOWNBOT

TOWNBOT, INC. (GEORGIA CORPORATION)
P. O. BOX 1862
CHATSWORTH, GA 30705

INGS AND EMPLOYMENT OPPORTUNITIES, IN
CLASS 35 (U.S. CLS. 100, 101 AND 102).

FIRST USE 3-25-2008; IN COMMERCE 3-25-2008.

FOR: ADVERTISING SERVICES; ADVERTISING
VIA ELECTRONIC MEDIA AND SPECIFICALLY
THE INTERNET; ON-LINE ADVERTISING AND
MARKETING SERVICES; PROVIDING A WEB SITE
THAT ENABLES USERS TO POST ITEMS FOR SALE
THROUGH ON-LINE CLASSIFIED ADVERTISE-
MENTS; PROVIDING AN ON-LINE SEARCHABLE
DATABASE FEATURING CLASSIFIED AD LIST-

THE MARK CONSISTS OF STANDARD CHAR-
ACTERS WITHOUT CLAIM TO ANY PARTICULAR
FONT, STYLE, SIZE, OR COLOR.

SN 77-086,922, FILED 1-19-2007.

GIANCARLO CASTRO, EXAMINING ATTORNEY

Int. Cl.: 9

Prior U.S. Cls.: 21, 23, 26, 36, and 38

United States Patent and Trademark Office

Reg. No. 3,477,337

Registered July 29, 2008

**TRADEMARK
PRINCIPAL REGISTER**

tuneslider

FINNAGO, INC. (CALIFORNIA CORPORATION)
P.O. BOX 755
SAN BRUNO, CA 94066

FOR: COMPUTER SOFTWARE FOR USE IN ORGANIZING, MANIPULATING, CREATING, PLAYING, TRANSMITTING, DELIVERING, BROADCASTING, AND VIEWING PHOTO SLIDE-SHOWS AND VIDEO, AUDIO, GRAPHIC, TEXT, PHOTOS, IMAGES, MULTIMEDIA CONTENT, AND OTHER DATA FILES VIA COMPUTER AND

OTHER COMMUNICATIONS NETWORKS, IN CLASS 9 (U.S. CLS. 21, 23, 26, 36 AND 38).

FIRST USE 2-1-2008; IN COMMERCE 2-1-2008.

THE MARK CONSISTS OF STANDARD CHARACTERS WITHOUT CLAIM TO ANY PARTICULAR FONT, STYLE, SIZE, OR COLOR.

SN 77-087,096, FILED 1-19-2007.

BARNEY CHARLON, EXAMINING ATTORNEY

Int. Cl.: 35

Prior U.S. Cls.: 100, 101, and 102

United States Patent and Trademark Office

Reg. No. 3,477,338

Registered July 29, 2008

**SERVICE MARK
PRINCIPAL REGISTER**

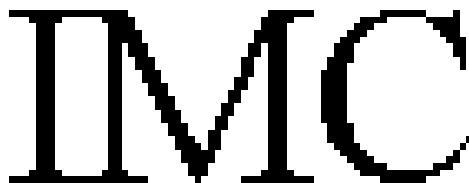

INTEGRATION MARKETING & COMMUNICATIONS, LIMITED (CYPRUS LTD LIAB CO)
504 LIBRA HOUSE, 21 P. CATELARIS STREET
1306 NICOSIA, CYPRUS

FOR: BUSINESS MARKETING SERVICES AND RELATED MARKETING CONSULTING FOR OTHERS; CREATION OF MARKETING TOOLS FOR OTHERS DESIGNED TO MEASURE AND INCREASE THE EFFECTIVENESS OF A CLIENT COMPANY'S MARKETING COMMUNICATIONS AND STRATEGY; CONDUCTING, SUPERVISING AND ANALYZING BUSINESS AND MARKET RESEARCH AND RELATED MARKETING CONSULTING FOR OTHERS; CONDUCTING, SUPERVISING AND ANALYZING BUSINESS AND MARKET RESEARCH SURVEYS AND MARKET RESEARCH

STUDIES AND RELATED MARKETING CONSULTING FOR OTHERS; COLLECTION, PREPARATION, COMPOSITION, STORAGE, PROCESSING, ACQUISITION AND PROVISION OF BUSINESS INFORMATION, DATA AND STATISTICS, IN CLASS 35 (U.S. CLS. 100, 101 AND 102).

FIRST USE 10-31-2001; IN COMMERCE 10-31-2001.

THE MARK CONSISTS OF STANDARD CHARACTERS WITHOUT CLAIM TO ANY PARTICULAR FONT, STYLE, SIZE, OR COLOR.

SN 77-087,109, FILED 1-19-2007.

ANDREA SAUNDERS, EXAMINING ATTORNEY

Int. Cl.: 35

Prior U.S. Cls.: 100, 101, and 102

United States Patent and Trademark Office

Reg. No. 3,477,339

Registered July 29, 2008

**SERVICE MARK
PRINCIPAL REGISTER**



MyRepSpace

HOVENDICK, JASON (UNITED STATES INDIVIDUAL)
1336 FAIRWAY FOREST DRIVE
CORDOVA, TN 38016

FOR: ONLINE BUSINESS MANAGEMENT SERVICES PROVIDED TO OTHERS OVER AN ON-LINE WEBSITE ACCESSED THROUGH A GLOBAL COMPUTER NETWORK; WEBSITE PROVIDING ON-LINE BUSINESS NETWORKING SERVICES; WEBSITE PROVIDING BUSINESS MANAGEMENT SERVICES IN THE NATURE OF CLIENT ACCOUNT MANAGEMENT ON BEHALF OF OTHERS; AND

CUSTOMER RELATIONSHIP MANAGEMENT SERVICES, IN CLASS 35 (U.S. CLS. 100, 101 AND 102).

FIRST USE 1-1-2007; IN COMMERCE 1-1-2008.

THE MARK CONSISTS OF TWO HANDS SHAKING IN A CIRCLE WITH THE WORDS "MYREPSpace" UNDERNEATH.

SN 77-087,957, FILED 1-22-2007.

YAT SYE, LEE, EXAMINING ATTORNEY

Int. Cl.: 9

Prior U.S. Cls.: 21, 23, 26, 36, and 38

United States Patent and Trademark Office

Reg. No. 3,477,340

Registered July 29, 2008

**TRADEMARK
PRINCIPAL REGISTER**



COHEN, KEVIN (UNITED STATES INDIVIDUAL)
11742 DOROTHY ST. #5
LOS ANGELES, CA 90049

FOR: AUDIO RECORDINGS FEATURING MUSIC; DOWNLOADABLE MP3 FILES, MP3 RECORDINGS, ONLINE DISCUSSION BOARDS, WEB CASTS, POD CASTS FEATURING MUSIC, AUDIO BOOKS AND NEWS BROADCASTS; DOWNLOADABLE MUSICAL SOUND RECORDINGS; DOWNLOADABLE RING TONES, GRAPHICS AND MUSIC VIA A GLOBAL COMPUTER NETWORK AND WIRELESS DEVICES; DOWNLOADABLE VIDEO RECORDINGS FEATURING MUSIC; MUSICAL SOUND RECORDINGS; MUSICAL VIDEO RECORDINGS; SOUND RECORDINGS FEATURING MUSIC; VIDEO RECORDINGS FEATURING MUSIC; VISUAL RECORDINGS AND AUDIO VISUAL

RECORDINGS FEATURING MUSIC AND ANIMATION, IN CLASS 9 (U.S. CLS. 21, 23, 26, 36 AND 38).

FIRST USE 6-1-2007; IN COMMERCE 6-1-2007.

THE COLOR(S) GOLD AND BLACK IS/ARE CLAIMED AS A FEATURE OF THE MARK.

THE MARK CONSISTS OF A GOLD "G" WITH A GOLD "B" IN THE MIDDLE OF THE "G" AGAINST A BLACK BACKGROUND WITH A GOLD SQUARE BORDER, AND THE GOLD "G" AND "B" HAVE SHADOWS ON THE RIGHT SIDE OF THE LETTERS.

SN 77-088,503, FILED 1-23-2007.

VERNA BETH RIRIE, EXAMINING ATTORNEY

Int. Cl.: 16

Prior U.S. Cls.: 2, 5, 22, 23, 29, 37, 38, and 50

Reg. No. 3,477,341

United States Patent and Trademark Office

Registered July 29, 2008

**TRADEMARK
PRINCIPAL REGISTER**

**PRL-Primera Revista
Latinoamericana de Libros**

GUBBINS, FERNANDO (PERU INDIVIDUAL)
476 CENTRAL PARK W. 4-A
NEW YORK, NY 10025

FOR: LITERATURE MAGAZINE, IN CLASS 16
(U.S. CLS. 2, 5, 22, 23, 29, 37, 38 AND 50).

FIRST USE 9-1-2007; IN COMMERCE 9-1-2007.

THE MARK CONSISTS OF STANDARD CHAR-
ACTERS WITHOUT CLAIM TO ANY PARTICULAR
FONT, STYLE, SIZE, OR COLOR.

NO CLAIM IS MADE TO THE EXCLUSIVE
RIGHT TO USE "REVISTA LATINOAMERICANA
DE LIBROS", APART FROM THE MARK AS
SHOWN.

THE ENGLISH TRANSLATION OF "PRIMERA
REVISTA LATINOAMERICANA DE LIBROS" IS
"FIRST LATIN AMERICAN MAGAZINE OF
BOOKS."

SN 77-088,689, FILED 1-23-2007.

JUSTINE D. PARKER, EXAMINING ATTORNEY

Int. Cl.: 16

Prior U.S. Cls.: 2, 5, 22, 23, 29, 37, 38, and 50

Reg. No. 3,477,342

United States Patent and Trademark Office

Registered July 29, 2008

**TRADEMARK
PRINCIPAL REGISTER**



GUBBINS, FERNANDO (PERU INDIVIDUAL)
476 CENTRAL PARK W, 4-A
NEW YORK, NY 10025

FOR: LITERATURE MAGAZINE, IN CLASS 16
(U.S. CLS. 2, 5, 22, 23, 29, 37, 38 AND 50).

FIRST USE 9-1-2007; IN COMMERCE 9-1-2007.

NO CLAIM IS MADE TO THE EXCLUSIVE
RIGHT TO USE "PRIMERA REVISTA LATINOAMERICANA DE LIBROS", APART FROM THE
MARK AS SHOWN.

THE ENGLISH TRANSLATION OF "PRIMERA
REVISTA LATINOAMERICANA DE LIBROS" IS
"FIRST LATIN AMERICAN MAGAZINE OF
BOOKS".

SN 77-088,700, FILED 1-23-2007.

JUSTINE D. PARKER, EXAMINING ATTORNEY

Int. Cl.: 35

Prior U.S. Cls.: 100, 101, and 102

United States Patent and Trademark Office

Reg. No. 3,477,343

Registered July 29, 2008

**SERVICE MARK
PRINCIPAL REGISTER**

LOCATENOW

PRO TECH MONITORING, INC. (DELAWARE
CORPORATION)
2549 SUCCESS DRIVE
ODESSA, FL 33556

FOR: ONLINE ELECTRONIC MONITORING
SERVICES WHICH REPORT, LOG AND TRACK
THE MOVEMENTS AND PRESENCE OF PERSONS,
PRODUCTS, FREIGHT AND VEHICLES FOR COM-
MERCIAL PURPOSES, IN CLASS 35 (U.S. CLS. 100,
101 AND 102).

FIRST USE 1-31-2006; IN COMMERCE 1-31-2006.

THE MARK CONSISTS OF STANDARD CHAR-
ACTERS WITHOUT CLAIM TO ANY PARTICULAR
FONT, STYLE, SIZE, OR COLOR.

SN 77-089,870, FILED 1-24-2007.

GRETTA YAO, EXAMINING ATTORNEY

Int. Cl.: 10

Prior U.S. Cls.: 26, 39, and 44

United States Patent and Trademark Office

Reg. No. 3,477,344

Registered July 29, 2008

**TRADEMARK
PRINCIPAL REGISTER**

A Place 2 Relax

A PLACE 2 RELAX (DELAWARE LTD LIAB CO)
64 ASPEN LOOK DRIVE
HENRIETTA, NY 14467 AND
A PLACE 2 RELAX (DELAWARE LTD LIAB CO)
P.O. BOX 20941
ROCHESTER, NY 14602

FOR: MASSAGE CHAIRS, IN CLASS 10 (U.S. CLS.
26, 39 AND 44).

FIRST USE 10-28-2007; IN COMMERCE 10-28-2007.

THE MARK CONSISTS OF STANDARD CHAR-
ACTERS WITHOUT CLAIM TO ANY PARTICULAR
FONT, STYLE, SIZE, OR COLOR.

SN 77-090,131, FILED 1-24-2007.

PRISCILLA MILTON, EXAMINING ATTORNEY

Int. Cl.: 28

Prior U.S. Cls.: 22, 23, 38, and 50

Reg. No. 3,477,345

United States Patent and Trademark Office

Registered July 29, 2008

**TRADEMARK
PRINCIPAL REGISTER**

AFG

HORIZON FITNESS, INC. (WISCONSIN CORPORATION)
800 BURTON BOULEVARD
DEFOREST, WI 53532

FOR: EXERCISE EQUIPMENT, NAMELY, TREADMILLS, ELLIPTICALS, STATIONARY BIKES, ROWERS, STAIR-STEPPING MACHINES, AEROBIC STEP MACHINES, AEROBIC STEPS, EXERCISE EQUIPMENT FOR LATERAL MOVEMENT IN A SKATING MOTION, SKI MACHINES IN THE NATURE OF MANUALLY OPERATED SKI MACHINES, SKI SIMULATION MACHINES; STRENGTH EQUIPMENT, NAMELY, WEIGHT LIFTING BENCHES AND BENCH ACCESSORIES,

HOME GYMS, WEIGHT LIFTING MACHINES, FREE WEIGHTS, AND EXERCISE BANDS; EXERCISE BALLS; PERSONAL EXERCISE MATS, IN CLASS 28 (U.S. CLS. 22, 23, 38 AND 50).

FIRST USE 8-0-2007; IN COMMERCE 8-0-2007.

THE MARK CONSISTS OF STANDARD CHARACTERS WITHOUT CLAIM TO ANY PARTICULAR FONT, STYLE, SIZE, OR COLOR.

SN 77-090,765, FILED 1-25-2007.

LAURIE KAUFMAN, EXAMINING ATTORNEY

Int. Cl.: 33

Prior U.S. Cls.: 47 and 49

United States Patent and Trademark Office

Reg. No. 3,477,346

Registered July 29, 2008

**TRADEMARK
PRINCIPAL REGISTER**

TOWER ROAD

J. LOHR WINERY CORP. (CALIFORNIA CORPORATION)
1000 LENZEN AVENUE
SAN JOSE, CA 95126

THE MARK CONSISTS OF STANDARD CHARACTERS WITHOUT CLAIM TO ANY PARTICULAR FONT, STYLE, SIZE, OR COLOR.

FOR: WINE, IN CLASS 33 (U.S. CLS. 47 AND 49).

SN 77-091,460, FILED 1-25-2007.

FIRST USE 6-11-2008; IN COMMERCE 6-11-2008.

PAUL F. GAST, EXAMINING ATTORNEY

Int. Cl.: 35

Prior U.S. Cls.: 100, 101, and 102

United States Patent and Trademark Office

Reg. No. 3,477,347

Registered July 29, 2008

**SERVICE MARK
PRINCIPAL REGISTER**

EXTENDED DIRECT

SMARTTALENT LLC (WASHINGTON LTD LIAB
CO)
1321 4TH AVENUE
SEATTLE, WA 98101

FOR: BUSINESS SERVICES, NAMELY, BUSINESS
CONSULTING SERVICES IN THE FIELD OF HU-
MAN RESOURCES; STAFFING SERVICES IN THE
NATURE OF EXTENDING A CLIENT'S GUARAN-
TEE OF SATISFACTION BEYOND THE TIME
WHEN A TEMPORARY EMPLOYEE IS CONVER-
TED TO A CLIENT'S DIRECT PAYROLL, IN CLASS
35 (U.S. CLS. 100, 101 AND 102).

FIRST USE 0-0-2006; IN COMMERCE 0-0-2007.

THE MARK CONSISTS OF STANDARD CHAR-
ACTERS WITHOUT CLAIM TO ANY PARTICULAR
FONT, STYLE, SIZE, OR COLOR.

SN 77-092,608, FILED 1-26-2007.

BARBARA RUTLAND, EXAMINING ATTORNEY

Int. Cl.: 33

Prior U.S. Cls.: 47 and 49

United States Patent and Trademark Office

Reg. No. 3,477,348

Registered July 29, 2008

**TRADEMARK
PRINCIPAL REGISTER**

Pipon

OLE IMPORTS, LLC (NEW YORK LTD LIAB CO)
56 HARRISON STREET, SUITE 405
NEW ROCHELLE, NY 10801

THE WORD "PIPON" APPEARING IN THE
MARK HAS NO MEANING IN A FOREIGN LAN-
GUAGE.

FOR: WINE, IN CLASS 33 (U.S. CLS. 47 AND 49).

FIRST USE 4-15-2008; IN COMMERCE 4-15-2008.

SN 77-092,617, FILED 1-26-2007.

THE MARK CONSISTS OF STANDARD CHAR-
ACTERS WITHOUT CLAIM TO ANY PARTICULAR
FONT, STYLE, SIZE, OR COLOR.

ODESSA BIBBINS, EXAMINING ATTORNEY

Int. Cl.: 33

Prior U.S. Cls.: 47 and 49

United States Patent and Trademark Office

Reg. No. 3,477,349

Registered July 29, 2008

**TRADEMARK
PRINCIPAL REGISTER**

Compania Mata

OLE IMPORTS, LLC (NEW YORK LTD LIAB CO)
SUITE 405
56 HARRISON ST.
NEW ROCHELLE, NY 10801

FOR: WINE, IN CLASS 33 (U.S. CLS. 47 AND 49).

FIRST USE 5-10-2008; IN COMMERCE 5-10-2008.

THE MARK CONSISTS OF STANDARD CHARACTERS WITHOUT CLAIM TO ANY PARTICULAR FONT, STYLE, SIZE, OR COLOR.

NO CLAIM IS MADE TO THE EXCLUSIVE RIGHT TO USE "COMPANIA", APART FROM THE MARK AS SHOWN.

THE FOREIGN WORDING "COMPANIA MATA" IN THE MARK TRANSLATES INTO ENGLISH AS "MATA COMPANY"

SN 77-092,719, FILED 1-26-2007.

ODESSA BIBBINS, EXAMINING ATTORNEY

Int. Cl.: 33

Prior U.S. Cls.: 47 and 49

United States Patent and Trademark Office

Reg. No. 3,477,350

Registered July 29, 2008

**TRADEMARK
PRINCIPAL REGISTER**

Gordo

OLE IMPORTS, LLC (NEW YORK LTD LIAB CO)
SUITE 405
56 HARRISON ST.
NEW ROCHELLE, NY 10801

FOR: WINE, IN CLASS 33 (U.S. CLS. 47 AND 49).

FIRST USE 4-15-2008; IN COMMERCE 4-15-2008.

THE MARK CONSISTS OF STANDARD CHARACTERS WITHOUT CLAIM TO ANY PARTICULAR FONT, STYLE, SIZE, OR COLOR.

THE FOREIGN WORDING IN THE MARK TRANSLATES INTO ENGLISH AS FAT.

SN 77-092,722, FILED 1-26-2007.

ODESSA BIBBINS, EXAMINING ATTORNEY

Int. Cl.: 33

Prior U.S. Cls.: 47 and 49

United States Patent and Trademark Office

Reg. No. 3,477,351

Registered July 29, 2008

**TRADEMARK
PRINCIPAL REGISTER**

Flaco

OLE IMPORTS, LLC (NEW YORK LTD LIAB CO)
SUITE 405
56 HARRISON ST.
NEW ROCHELLE, NY 10801

FOR: WINE, IN CLASS 33 (U.S. CLS. 47 AND 49).

FIRST USE 7-23-2007; IN COMMERCE 7-23-2007.

THE MARK CONSISTS OF STANDARD CHARACTERS WITHOUT CLAIM TO ANY PARTICULAR FONT, STYLE, SIZE, OR COLOR.

THE FOREIGN WORDING "FLACO" IN THE MARK TRANSLATES INTO ENGLISH AS "THIN"

SN 77-092,725, FILED 1-26-2007.

ODESSA BIBBINS, EXAMINING ATTORNEY

Int. Cl.: 33

Prior U.S. Cls.: 47 and 49

United States Patent and Trademark Office

Reg. No. 3,477,352

Registered July 29, 2008

**TRADEMARK
PRINCIPAL REGISTER**

Matano

OLE IMPORTS, LLC (NEW YORK LTD LIAB CO)
SUITE 405
56 HARRISON ST.
NEW ROCHELLE, NY 10801

THE MARK CONSISTS OF STANDARD CHAR-
ACTERS WITHOUT CLAIM TO ANY PARTICULAR
FONT, STYLE, SIZE, OR COLOR.

FOR: WINE, IN CLASS 33 (U.S. CLS. 47 AND 49).

SN 77-092,728, FILED 1-26-2007.

FIRST USE 5-10-2008; IN COMMERCE 5-10-2008.

TIMOTHY FINNEGAN, EXAMINING ATTORNEY

Int. Cl.: 33

Prior U.S. Cls.: 47 and 49

United States Patent and Trademark Office

Reg. No. 3,477,353

Registered July 29, 2008

**TRADEMARK
PRINCIPAL REGISTER**

Nabuko

OLE IMPORTS, LLC (NEW YORK LTD LIAB CO)
SUITE 405
56 HARRISON ST.
NEW ROCHELLE, NY 10801

THE MARK CONSISTS OF STANDARD CHAR-
ACTERS WITHOUT CLAIM TO ANY PARTICULAR
FONT, STYLE, SIZE, OR COLOR.

FOR: WINE, IN CLASS 33 (U.S. CLS. 47 AND 49).

SN 77-092,729, FILED 1-26-2007.

FIRST USE 6-15-2007; IN COMMERCE 6-15-2007.

TIMOTHY FINNEGAN, EXAMINING ATTORNEY

Int. Cl.: 33

Prior U.S. Cls.: 47 and 49

United States Patent and Trademark Office

Reg. No. 3,477,354

Registered July 29, 2008

**TRADEMARK
PRINCIPAL REGISTER**

MUTI

OLE IMPORTS, LLC (NEW YORK LTD LIAB CO)
SUITE 405
56 HARRISON ST.
NEW ROCHELLE, NY 10801

THE MARK CONSISTS OF STANDARD CHAR-
ACTERS WITHOUT CLAIM TO ANY PARTICULAR
FONT, STYLE, SIZE, OR COLOR.

FOR: WINE, IN CLASS 33 (U.S. CLS. 47 AND 49).

SN 77-092,736, FILED 1-26-2007.

FIRST USE 5-10-2008; IN COMMERCE 5-10-2008.

TIMOTHY FINNEGAN, EXAMINING ATTORNEY

Int. Cl.: 33

Prior U.S. Cls.: 47 and 49

United States Patent and Trademark Office

Reg. No. 3,477,355

Registered July 29, 2008

**TRADEMARK
PRINCIPAL REGISTER**

Vico

OLE IMPORTS, LLC (NEW YORK LTD LIAB CO)
SUITE 405
56 HARRISON ST.
NEW ROCHELLE, NY 10801

THE MARK CONSISTS OF STANDARD CHAR-
ACTERS WITHOUT CLAIM TO ANY PARTICULAR
FONT, STYLE, SIZE, OR COLOR.

FOR: WINE, IN CLASS 33 (U.S. CLS. 47 AND 49).

SN 77-092,737, FILED 1-26-2007.

FIRST USE 5-10-2008; IN COMMERCE 5-10-2008.

TIMOTHY FINNEGAN, EXAMINING ATTORNEY

Int. Cl.: 33

Prior U.S. Cls.: 47 and 49

United States Patent and Trademark Office

Reg. No. 3,477,356

Registered July 29, 2008

**TRADEMARK
PRINCIPAL REGISTER**

Katas

OLE IMPORTS, LLC (NEW YORK LTD LIAB CO)
SUITE 405
56 HARRISON ST.
NEW ROCHELLE, NY 10801

THE MARK CONSISTS OF STANDARD CHAR-
ACTERS WITHOUT CLAIM TO ANY PARTICULAR
FONT, STYLE, SIZE, OR COLOR.

FOR: WINE, IN CLASS 33 (U.S. CLS. 47 AND 49).

SN 77-092,744, FILED 1-26-2007.

FIRST USE 4-15-2008; IN COMMERCE 4-15-2008.

TIMOTHY FINNEGAN, EXAMINING ATTORNEY

Int. Cl.: 33

Prior U.S. Cls.: 47 and 49

United States Patent and Trademark Office

Reg. No. 3,477,357

Registered July 29, 2008

**TRADEMARK
PRINCIPAL REGISTER**

Liquid Geography

OLE IMPORTS, LLC (NEW YORK LTD LIAB CO)
SUITE 405
56 HARRISON ST.
NEW ROCHELLE, NY 10801

FOR: WINE, IN CLASS 33 (U.S. CLS. 47 AND 49).

FIRST USE 5-10-2008; IN COMMERCE 5-10-2008.

THE MARK CONSISTS OF STANDARD CHARACTERS WITHOUT CLAIM TO ANY PARTICULAR FONT, STYLE, SIZE, OR COLOR.

NO CLAIM IS MADE TO THE EXCLUSIVE RIGHT TO USE "LIQUID", APART FROM THE MARK AS SHOWN.

SN 77-092,748, FILED 1-26-2007.

ODESSA BIBBINS, EXAMINING ATTORNEY

Int. Cl.: 16

Prior U.S. Cls.: 2, 5, 22, 23, 29, 37, 38, and 50

United States Patent and Trademark Office

Reg. No. 3,477,358

Registered July 29, 2008

**TRADEMARK
PRINCIPAL REGISTER**

THOUGHT MASTER

OPTIMO, INC. (GEORGIA CORPORATION)
3565 PIEDMONT RD NE
TWO PIEDMONT CENTER SUITE 318
ATLANTA, GA 30305

FOR: PRINTED MATERIALS, NAMELY, BOOKS,
BOOKLETS AND MANUALS FEATURING TEAM
BUILDING AND TRAINING EXERCISES AND AC-
TIVITIES, IN CLASS 16 (U.S. CLS. 2, 5, 22, 23, 29, 37, 38
AND 50).

FIRST USE 1-28-2007; IN COMMERCE 1-28-2007.

THE MARK CONSISTS OF STANDARD CHAR-
ACTERS WITHOUT CLAIM TO ANY PARTICULAR
FONT, STYLE, SIZE, OR COLOR.

SN 77-093,052, FILED 1-28-2007.

ANDREW RHIM, EXAMINING ATTORNEY

Int. Cl.: 33

Prior U.S. Cls.: 47 and 49

United States Patent and Trademark Office

Reg. No. 3,477,359

Registered July 29, 2008

**TRADEMARK
PRINCIPAL REGISTER**

PICK GOOD GRAPES

NORDLUND, LEE (UNITED STATES INDIVIDUAL)
164 BONNIEBROOK DRIVE
NAPA, CA 945581210

NO CLAIM IS MADE TO THE EXCLUSIVE RIGHT TO USE "GRAPES", APART FROM THE MARK AS SHOWN.

FOR: WINE, IN CLASS 33 (U.S. CLS. 47 AND 49).

FIRST USE 8-15-2004; IN COMMERCE 1-31-2005.

SN 77-093,672, FILED 1-29-2007.

THE MARK CONSISTS OF STANDARD CHARACTERS WITHOUT CLAIM TO ANY PARTICULAR FONT, STYLE, SIZE, OR COLOR.

INGA ERVIN, EXAMINING ATTORNEY

Int. Cl.: 9

Prior U.S. Cls.: 21, 23, 26, 36, and 38

United States Patent and Trademark Office

Reg. No. 3,477,360

Registered July 29, 2008

**TRADEMARK
PRINCIPAL REGISTER**

LEGWORK

LEG WORK VIDEO, LLC (NEW YORK LTD LIAB
CO)
#2CN
252 EAST 61ST STREET
NEW YORK, NY 10021

THE MARK CONSISTS OF STANDARD CHAR-
ACTERS WITHOUT CLAIM TO ANY PARTICULAR
FONT, STYLE, SIZE, OR COLOR.

FOR: INSTRUCTIONAL DVDS IN THE FIELD OF
LEG STRENGTH AND FITNESS, IN CLASS 9 (U.S.
CLS. 21, 23, 26, 36 AND 38).

SN 77-094,169, FILED 1-30-2007.

FIRST USE 10-2-2006; IN COMMERCE 10-2-2006.

SARA THOMAS, EXAMINING ATTORNEY

Int. Cl.: 5

Prior U.S. Cls.: 6, 18, 44, 46, 51, and 52

United States Patent and Trademark Office

Reg. No. 3,477,361

Registered July 29, 2008

**TRADEMARK
PRINCIPAL REGISTER**

TrimFit

IMAGENETIX (CALIFORNIA CORPORATION)
10845 RANCHO BERNARDO ROAD #105
SAN DIEGO, CA 92127

THE MARK CONSISTS OF STANDARD CHAR-
ACTERS WITHOUT CLAIM TO ANY PARTICULAR
FONT, STYLE, SIZE, OR COLOR.

FOR: DIETARY SUPPLEMENTS, IN CLASS 5 (U.S.
CLS. 6, 18, 44, 46, 51 AND 52).

SN 77-094,877, FILED 1-30-2007.

FIRST USE 10-15-2007; IN COMMERCE 10-15-2007.

JIM RINGLE, EXAMINING ATTORNEY

Int. Cls.: 35 and 42

Prior U.S. Cls.: 100, 101, and 102

United States Patent and Trademark Office

Reg. No. 3,477,362

Registered July 29, 2008

**SERVICE MARK
PRINCIPAL REGISTER**

TMS WORK FLOW

THE MAIL STORE, INC. (ILLINOIS CORPORATION)
7221 NORTH RIDGE BLVD.
CHICAGO, IL 60645

FOR: RETAIL DISTRIBUTORSHIP SERVICES, FEATURING, FREE STANDING AND BUILT-IN OFFICE FURNITURE AND EQUIPMENT, IN CLASS 35 (U.S. CLS. 100, 101 AND 102).

FIRST USE 4-1-2007; IN COMMERCE 4-1-2007.

FOR: INTERIOR SPACE DESIGN, NAMELY, THE DESIGN OF SPACE IN BUSINESSES AND OFFICES FOR THE PURPOSE OF REGULATING AND INCREASING THE EFFICIENCY OF HUMAN AND EQUIPMENT TRAFFIC FLOW; CUSTOM DESIGN OF FREE STANDING AND BUILT-IN OFFICE EQUIPMENT AND FURNITURE, IN CLASS 42 (U.S. CLS. 100 AND 101).

FIRST USE 4-1-2007; IN COMMERCE 4-1-2007.

THE MARK CONSISTS OF STANDARD CHARACTERS WITHOUT CLAIM TO ANY PARTICULAR FONT, STYLE, SIZE, OR COLOR.

OWNER OF U.S. REG. NOS. 2,445,963 AND 2,481,603.

NO CLAIM IS MADE TO THE EXCLUSIVE RIGHT TO USE "WORK FLOW", APART FROM THE MARK AS SHOWN.

SN 77-095,027, FILED 1-30-2007.

INGA ERVIN, EXAMINING ATTORNEY

Int. Cl.: 16

Prior U.S. Cls.: 2, 5, 22, 23, 29, 37, 38, and 50

Reg. No. 3,477,363

United States Patent and Trademark Office

Registered July 29, 2008

**TRADEMARK
PRINCIPAL REGISTER**

**MAKING THE THINGS THAT GO,
GO BETTER**

CHEVRON INTELLECTUAL PROPERTY LLC
(DELAWARE LTD LIAB CO)
6001 BOLLINGER CANYON ROAD
SAN RAMON, CA 94583

FIRST USE 12-1-2007; IN COMMERCE 12-1-2007.

FOR: OFFICE STATIONERY; PRINTED MAT-
TERS, NAMELY, NEWSLETTERS, REPORTS, BRO-
CHURES, PRESS RELEASES IN THE FIELD OF
GASOLINE, GASOLINE ADDITIVE AND THE EN-
ERGY INDUSTRY, IN CLASS 16 (U.S. CLS. 2, 5, 22, 23,
29, 37, 38 AND 50).

THE MARK CONSISTS OF STANDARD CHAR-
ACTERS WITHOUT CLAIM TO ANY PARTICULAR
FONT, STYLE, SIZE, OR COLOR.

SN 77-095,106, FILED 1-30-2007.

SARA THOMAS, EXAMINING ATTORNEY

Int. Cl.: 14

Prior U.S. Cls.: 2, 27, 28, and 50

United States Patent and Trademark Office

Reg. No. 3,477,364

Registered July 29, 2008

**TRADEMARK
PRINCIPAL REGISTER**

**MAKING THE THINGS THAT GO,
GO BETTER**

CHEVRON INTELLECTUAL PROPERTY LLC
(DELAWARE LTD LIAB CO)
6001 BOLLINGER CANYON ROAD
SAN RAMON, CA 94583

THE MARK CONSISTS OF STANDARD CHAR-
ACTERS WITHOUT CLAIM TO ANY PARTICULAR
FONT, STYLE, SIZE, OR COLOR.

FOR: CLOCKS, IN CLASS 14 (U.S. CLS. 2, 27, 28
AND 50).

SN 77-095,110, FILED 1-30-2007.

FIRST USE 5-1-2007; IN COMMERCE 5-1-2007.

SARA THOMAS, EXAMINING ATTORNEY

Int. Cl.: 45

Prior U.S. Cls.: 100 and 101

United States Patent and Trademark Office

Reg. No. 3,477,365

Registered July 29, 2008

**SERVICE MARK
PRINCIPAL REGISTER**

**COMPLIANCE CYA
COVER YOUR ACTIONS!**

THE COUNCIL OF INSURANCE AGENTS &
BROKERS (ILLINOIS CORPORATION)
SUITE 750
701 PENNSYLVANIA AVENUE, NW
WASHINGTON, DC 20004

FOR: PROVIDING AN ONLINE COMPUTER DA-
TABASE IN THE FIELD OF INSURANCE AGENCY
AND INSURANCE BROKERAGE RELATED REG-
ULATIONS AND STATUTES , IN CLASS 45 (U.S.
CLS. 100 AND 101).

FIRST USE 3-0-2007; IN COMMERCE 3-0-2007.

THE MARK CONSISTS OF STANDARD CHAR-
ACTERS WITHOUT CLAIM TO ANY PARTICULAR
FONT, STYLE, SIZE, OR COLOR.

SN 77-095,754, FILED 1-31-2007.

WILLIAM ROSSMAN, EXAMINING ATTORNEY

Int. Cl.: 9

Prior U.S. Cls.: 21, 23, 26, 36, and 38

Reg. No. 3,477,366

United States Patent and Trademark Office

Registered July 29, 2008

**TRADEMARK
PRINCIPAL REGISTER**

Nirvana

EPOINT MARKETING, LTD (NEVADA LTD
LIAB CO)
325 E WARM SPRINGS RD
LAS VEGAS, NV 89119

THE MARK CONSISTS OF STANDARD CHAR-
ACTERS WITHOUT CLAIM TO ANY PARTICULAR
FONT, STYLE, SIZE, OR COLOR.

FOR: COMPUTER SOFTWARE FOR USE IN
TECHNOLOGY MARKETING, NOT ASSOCIATED
WITH MUSICAL ARTISTS OR MUSICAL RECORD-
INGS, IN CLASS 9 (U.S. CLS. 21, 23, 26, 36 AND 38).

SN 77-096,856, FILED 2-1-2007.

FIRST USE 4-1-2005; IN COMMERCE 9-1-2007.

CHARLES L. JENKINS, EXAMINING ATTORNEY

Int. Cl.: 9

Prior U.S. Cls.: 21, 23, 26, 36, and 38

Reg. No. 3,477,367

United States Patent and Trademark Office

Registered July 29, 2008

TRADEMARK
PRINCIPAL REGISTER

phoenix

CALLPOD, INC. (ILLINOIS CORPORATION)
SUITE 260
850 W. JACKSON BLVD
CHICAGO, IL 60607

THE COLOR(S) BLACK AND GREEN IS/ARE
CLAIMED AS A FEATURE OF THE MARK.

FOR: WIRELESS AND CELLULAR TELEPHONE
CONFERENCING DEVICE, NAMELY, WIRELESS
AUDIO AND VIDEO TRANSMITTER AND RECEI-
VER THAT ENABLES WIRELESS AND CELLULAR
TELEPHONES TO CONDUCT CONFERENCE
CALLS WITH MORE THAN ONE CALLER AT A
TIME, IN CLASS 9 (U.S. CLS. 21, 23, 26, 36 AND 38).

THE LETTERS "P" "H" "E" "N" "I" "X" ARE
BLACK AND "O" IS GREEN.

SN 77-096,874, FILED 2-1-2007.

FIRST USE 1-10-2007; IN COMMERCE 1-10-2007.

SUNG IN, EXAMINING ATTORNEY

Int. Cl.: 45

Prior U.S. Cls.: 100 and 101

United States Patent and Trademark Office

Reg. No. 3,477,368

Registered July 29, 2008

**SERVICE MARK
PRINCIPAL REGISTER**

**It's not about what you do
for a living
It's about what you do to
LIVE!**

WRIGHT MONA R (UNITED STATES INDIVIDUAL)
5137 W PURDUE AVE
GLENDALE, AZ 85302

THE MARK CONSISTS OF STANDARD CHARACTERS WITHOUT CLAIM TO ANY PARTICULAR FONT, STYLE, SIZE, OR COLOR.

FOR: ADVERTISING SLOGAN AND CARTOON CHARACTER LICENSING, IN CLASS 45 (U.S. CLS. 100 AND 101).

SN 77-097,470, FILED 2-2-2007.

FIRST USE 6-1-2007; IN COMMERCE 6-1-2007.

MARY ROSSMAN, EXAMINING ATTORNEY

Int. Cls.: 5, 28, and 31

Prior U.S. Cls.: 1, 6, 18, 22, 23, 38, 44, 46, 50, 51, and 52

United States Patent and Trademark Office

Reg. No. 3,477,369

Registered July 29, 2008

**TRADEMARK
PRINCIPAL REGISTER**

FatFactor

COMMERCIAL BUSINESS SERVICES LLC
(GEORGIA LTD LIAB CO)
P.O. BOX 1433
WAYCROSS, GA 31502

FOR: FEED SUPPLEMENTS FOR ANIMALS AND WILDLIFE, IN CLASS 5 (U.S. CLS. 6, 18, 44, 46, 51 AND 52).

FIRST USE 6-1-2007; IN COMMERCE 6-1-2007.

FOR: ANIMAL ATTRACTANT SCENTS, IN CLASS 28 (U.S. CLS. 22, 23, 38 AND 50).

FIRST USE 6-1-2007; IN COMMERCE 6-1-2007.

FOR: FOOD FOR ANIMALS; NON-MEDICATED ADDITIVES FOR ANIMAL FEED, IN CLASS 31 (U.S. CLS. 1 AND 46).

FIRST USE 6-1-2007; IN COMMERCE 6-1-2007.

THE MARK CONSISTS OF STANDARD CHARACTERS WITHOUT CLAIM TO ANY PARTICULAR FONT, STYLE, SIZE, OR COLOR.

SN 77-097,720, FILED 2-2-2007.

INGA ERVIN, EXAMINING ATTORNEY

Int. Cl.: 9

Prior U.S. Cls.: 21, 23, 26, 36, and 38

United States Patent and Trademark Office

Reg. No. 3,477,370

Registered July 29, 2008

**TRADEMARK
PRINCIPAL REGISTER**

MAKE A SPLASH

UNITED STATES SWIMMING, INC. (OHIO NON-
PROFIT CORPORATION)
ONE OLYMPIC PLAZA
COLORADO SPRINGS, CO 80909

THE MARK CONSISTS OF STANDARD CHAR-
ACTERS WITHOUT CLAIM TO ANY PARTICULAR
FONT, STYLE, SIZE, OR COLOR.

FOR: DECORATIVE MAGNETS, IN CLASS 9 (U.S.
CLS. 21, 23, 26, 36 AND 38).

SN 77-097,948, FILED 2-2-2007.

FIRST USE 4-1-2007; IN COMMERCE 5-1-2007.

SARA THOMAS, EXAMINING ATTORNEY

Int. Cl.: 18

Prior U.S. Cls.: 1, 2, 3, 22, and 41

United States Patent and Trademark Office

Reg. No. 3,477,371

Registered July 29, 2008

**TRADEMARK
PRINCIPAL REGISTER**

MAKE A SPLASH

UNITED STATES SWIMMING, INC. (OHIO NON-
PROFIT CORPORATION)
ONE OLYMPIC PLAZA
COLORADO SPRINGS, CO 80909

FOR: ALL PURPOSE SPORT BAGS; ALL-PUR-
POSE ATHLETIC BAGS; ALL-PURPOSE CARRYING
BAGS; GYM BAGS, IN CLASS 18 (U.S. CLS. 1, 2, 3, 22
AND 41).

FIRST USE 4-1-2007; IN COMMERCE 5-1-2007.

THE MARK CONSISTS OF STANDARD CHAR-
ACTERS WITHOUT CLAIM TO ANY PARTICULAR
FONT, STYLE, SIZE, OR COLOR.

SN 77-097,957, FILED 2-2-2007.

SARA THOMAS, EXAMINING ATTORNEY

Int. Cl.: 24

Prior U.S. Cls.: 42 and 50

United States Patent and Trademark Office

Reg. No. 3,477,372

Registered July 29, 2008

**TRADEMARK
PRINCIPAL REGISTER**

MAKE A SPLASH

UNITED STATES SWIMMING, INC. (OHIO NON-
PROFIT CORPORATION)
ONE OLYMPIC PLAZA
COLORADO SPRINGS, CO 80909

THE MARK CONSISTS OF STANDARD CHAR-
ACTERS WITHOUT CLAIM TO ANY PARTICULAR
FONT, STYLE, SIZE, OR COLOR.

FOR: TOWELS, IN CLASS 24 (U.S. CLS. 42 AND 50).

SN 77-097,971, FILED 2-2-2007.

FIRST USE 4-1-2007; IN COMMERCE 5-1-2007.

SARA THOMAS, EXAMINING ATTORNEY

Int. Cl.: 25

Prior U.S. Cls.: 22 and 39

United States Patent and Trademark Office

Reg. No. 3,477,373

Registered July 29, 2008

**TRADEMARK
PRINCIPAL REGISTER**

MAKE A SPLASH

UNITED STATES SWIMMING, INC. (OHIO NON-
PROFIT CORPORATION)
ONE OLYMPIC PLAZA
COLORADO SPRINGS, CO 80909

FOR: CLOTHING, NAMELY, SHIRTS, POLO
SHIRTS, T-SHIRTS, HATS, SWIM CAPS; HEAD-
GEAR, NAMELY CAPS, IN CLASS 25 (U.S. CLS. 22
AND 39).

FIRST USE 4-1-2007; IN COMMERCE 5-1-2007.

THE MARK CONSISTS OF STANDARD CHAR-
ACTERS WITHOUT CLAIM TO ANY PARTICULAR
FONT, STYLE, SIZE, OR COLOR.

SN 77-097,976, FILED 2-2-2007.

SARA THOMAS, EXAMINING ATTORNEY

Int. Cl.: 2

Prior U.S. Cls.: 6, 11, and 16

United States Patent and Trademark Office

Reg. No. 3,477,374

Registered July 29, 2008

**TRADEMARK
PRINCIPAL REGISTER**

STEELNOX

GRAFF FAUCETS (WISCONSIN CORPORATION)
3701 WEST BURNHAM STREET, SUITE B
MILWAUKEE, WI 53215

THE MARK CONSISTS OF STANDARD CHAR-
ACTERS WITHOUT CLAIM TO ANY PARTICULAR
FONT, STYLE, SIZE, OR COLOR.

FOR: COATINGS NAMELY, BRUSHED FINISHES
FOR APPLICATION TO METAL GOODS SUCH AS
FAUCETS, FAUCET HANDLES AND THE LIKE, IN
CLASS 2 (U.S. CLS. 6, 11 AND 16).

SN 77-098,067, FILED 2-2-2007.

FIRST USE 4-1-2007; IN COMMERCE 4-1-2007.

RICHARD WHITE, EXAMINING ATTORNEY

Int. Cl.: 9

Prior U.S. Cls.: 21, 23, 26, 36, and 38

United States Patent and Trademark Office

Reg. No. 3,477,375

Registered July 29, 2008

**TRADEMARK
PRINCIPAL REGISTER**

device native

GATEROCKET, INC. (DELAWARE CORPORATION)
SUITE 100
19 CROSBY DRIVE
BEDFORD, MA 01730

FOR: COMPUTER BASED HARDWARE FOR DESIGNING THE LAYOUT OF ELECTRONIC CIRCUITS; COMPUTER SOFTWARE FOR DESIGNING THE LAYOUT OF ELECTRONIC CIRCUITS, IN CLASS 9 (U.S. CLS. 21, 23, 26, 36 AND 38).

FIRST USE 9-7-2007; IN COMMERCE 9-7-2007.

THE MARK CONSISTS OF STANDARD CHARACTERS WITHOUT CLAIM TO ANY PARTICULAR FONT, STYLE, SIZE, OR COLOR.

NO CLAIM IS MADE TO THE EXCLUSIVE RIGHT TO USE "DEVICE", APART FROM THE MARK AS SHOWN.

SN 77-098,349, FILED 2-2-2007.

MICHAEL LITZAU, EXAMINING ATTORNEY

Int. Cl.: 20

Prior U.S. Cls.: 2, 13, 22, 25, 32, and 50

United States Patent and Trademark Office

Reg. No. 3,477,376

Registered July 29, 2008

**TRADEMARK
PRINCIPAL REGISTER**

PRISM BEVELS

HEADWEST, INC. (CALIFORNIA CORPORATION)

15650 S. AVALON BOULEVARD

COMPTON, CA 90220

FOR: MIRRORS, IN CLASS 20 (U.S. CLS. 2, 13, 22, 25, 32 AND 50).

FIRST USE 1-6-2004; IN COMMERCE 1-6-2004.

THE MARK CONSISTS OF STANDARD CHARACTERS WITHOUT CLAIM TO ANY PARTICULAR FONT, STYLE, SIZE, OR COLOR.

NO CLAIM IS MADE TO THE EXCLUSIVE RIGHT TO USE "BEVELS", APART FROM THE MARK AS SHOWN.

SN 77-098,395, FILED 2-2-2007.

ALLISON HOLTZ, EXAMINING ATTORNEY

Int. Cls.: 35 and 45

Prior U.S. Cls.: 100, 101, and 102

United States Patent and Trademark Office

Reg. No. 3,477,377

Registered July 29, 2008

**SERVICE MARK
PRINCIPAL REGISTER**

Bloodhound Research, LLC

BLOODHOUND RESEARCH, LLC (NEW YORK
LTD LIAB CO)
320 EAST 42ND STREET #2505
NEW YORK, NY 10017 AND
MOKED, EYTAN (UNITED STATES INDIVIDUAL)
320 EAST 42ND STREET #2505
NEW YORK, NY 10017 AND
MOKED, NEELY (UNITED STATES INDIVIDUAL)
320 EAST 42ND STREET #2505
NEW YORK, NY 10017

FOR: BUSINESS INVESTIGATIONS, EVALUA-
TIONS, EXPERT APPRAISALS, INFORMATION
AND RESEARCH; BUSINESS RESEARCH; BUSI-
NESS RESEARCH AND SURVEYS; BUSINESS RE-
SEARCH CONSULTATION; BUSINESS RESEARCH
SERVICES, NAMELY PROVIDING ANALYSIS OF
RETAIL DATA ON SPECIFIC BUSINESS LOCA-
TIONS; CONDUCTING BUSINESS AND MARKET
RESEARCH SURVEYS; CONDUCTING BUSINESS
RESEARCH AND SURVEYS; CONSULTATION SER-
VICES IN THE FIELD OF COMPANY, BUSINESS
SECTOR AND INDUSTRY DATA AND RESEARCH,
IN CLASS 35 (U.S. CLS. 100, 101 AND 102).

FIRST USE 8-1-2007; IN COMMERCE 8-1-2007.

FOR: BACKGROUND INVESTIGATION AND
RESEARCH SERVICES; LEGAL DOCUMENT PRE-
PARATION AND RESEARCH SERVICES FOR AT-
TORNEYS; LEGAL RESEARCH, IN CLASS 45 (U.S.
CLS. 100 AND 101).

FIRST USE 8-1-2007; IN COMMERCE 8-1-2007.

THE MARK CONSISTS OF STANDARD CHAR-
ACTERS WITHOUT CLAIM TO ANY PARTICULAR
FONT, STYLE, SIZE, OR COLOR.

NO CLAIM IS MADE TO THE EXCLUSIVE
RIGHT TO USE "RESEARCH, LLC" , APART FROM
THE MARK AS SHOWN.

SN 77-099,822, FILED 2-5-2007.

ANGELA M. MICHELI, EXAMINING ATTORNEY

Int. Cl.: 30

Prior U.S. Cl.: 46

United States Patent and Trademark Office

Reg. No. 3,477,378

Registered July 29, 2008

**TRADEMARK
PRINCIPAL REGISTER**

EMBER

STRANGE BREW LLC (WASHINGTON LTD
LIAB CO)
426 MOUNTAIN SHADOWS LANE
FRIDAY HARBOR, WA 98250

THE MARK CONSISTS OF STANDARD CHAR-
ACTERS WITHOUT CLAIM TO ANY PARTICULAR
FONT, STYLE, SIZE, OR COLOR.

FOR: COCOA BEVERAGES WITH MILK, IN
CLASS 30 (U.S. CL. 46).

SN 77-100,140, FILED 2-6-2007.

FIRST USE 6-1-2008; IN COMMERCE 6-1-2008.

MARCIE MILONE, EXAMINING ATTORNEY

Int. Cl.: 5

Prior U.S. Cls.: 6, 18, 44, 46, 51, and 52

Reg. No. 3,477,379

United States Patent and Trademark Office

Registered July 29, 2008

**TRADEMARK
PRINCIPAL REGISTER**

ENERGY-LIX

RIDLEY U.S. HOLDINGS, INC. (DELAWARE
CORPORATION)
424 NORTH RIVERFRONT DRIVE
MANKATO, MN 56002

THE MARK CONSISTS OF STANDARD CHAR-
ACTERS WITHOUT CLAIM TO ANY PARTICULAR
FONT, STYLE, SIZE, OR COLOR.

FOR: ANIMAL FEED SUPPLEMENTS, IN CLASS
5 (U.S. CLS. 6, 18, 44, 46, 51 AND 52).

SN 77-100,222, FILED 2-6-2007.

FIRST USE 4-18-2008; IN COMMERCE 4-18-2008.

EDWARD NELSON, EXAMINING ATTORNEY

Int. Cls.: 29 and 30

Prior U.S. Cl.: 46

United States Patent and Trademark Office

Reg. No. 3,477,380

Registered July 29, 2008

**TRADEMARK
PRINCIPAL REGISTER**

CABIN CREEK

JTM PROVISIONS COMPANY, INC. (OHIO CORPORATION)
200 SALES DRIVE
HARRISON, OH 45030

FOR: SOUPS, IN CLASS 29 (U.S. CL. 46).

FIRST USE 5-4-2007; IN COMMERCE 5-4-2007.

FOR: SAUCES; MIXES FOR MAKING COMBINED NOODLE AND SAUCE DISHES, IN CLASS 30 (U.S. CL. 46).

FIRST USE 5-4-2007; IN COMMERCE 5-4-2007.

THE MARK CONSISTS OF STANDARD CHARACTERS WITHOUT CLAIM TO ANY PARTICULAR FONT, STYLE, SIZE, OR COLOR.

SN 77-100,234, FILED 2-6-2007.

SOPHIA S. KIM, EXAMINING ATTORNEY

Int. Cl.: 41

Prior U.S. Cls.: 100, 101, and 107

United States Patent and Trademark Office

Reg. No. 3,477,381

Registered July 29, 2008

**SERVICE MARK
PRINCIPAL REGISTER**

EQUIPPED FOR EXCELLENCE

LEACH, MARTIN (UNITED STATES JOINT APPLICANT - INDIVIDUAL)
6857 INDIANA AVE.
RIVERSIDE, CA 92506 AND
INLAND EMPIRE BAPTIST ASSOCIATION (CALIFORNIA JOINT APPLICANT - NON-PROFIT ORGANIZATION)
6857 INDIANA AVE.
RIVERSIDE, CA 92506

FIRST USE 4-0-1993; IN COMMERCE 4-0-1993.

THE MARK CONSISTS OF STANDARD CHARACTERS WITHOUT CLAIM TO ANY PARTICULAR FONT, STYLE, SIZE, OR COLOR.

SN 77-100,638, FILED 2-6-2007.

FOR: ARRANGING AND CONDUCTING EDUCATIONAL CONFERENCES, IN CLASS 41 (U.S. CLS. 100, 101 AND 107).

BERYL GARDNER, EXAMINING ATTORNEY

Int. Cls.: 6 and 19

Prior U.S. Cls.: 1, 2, 12, 13, 14, 23, 25, 33, and 50

United States Patent and Trademark Office

Reg. No. 3,477,382

Registered July 29, 2008

**TRADEMARK
PRINCIPAL REGISTER**



RAILTECH LTÉE. (CANADA CORPORATION)
325 LEE AVENUE
BAIE-D'URFÉ, CANADA H9X3S3

FOR: LAMINATED ARCHITECTURAL METAL PANELS USED IN EXTERNAL AND INTERNAL CONSTRUCTIONS; CURTAIN WALLS IN THE NATURE OF ACOUSTICAL PARTITIONING MADE PRIMARILY OF METAL; FOLDABLE BUILDING WALLS MADE PRIMARILY OF METAL; AND FOLDABLE PARTITIONING WALLS MADE PRIMARILY OF METAL, IN CLASS 6 (U.S. CLS. 2, 12, 13, 14, 23, 25 AND 50).

FIRST USE 12-31-2007; IN COMMERCE 12-31-2007.

FOR: FOLDABLE BUILDING WALLS MADE PRIMARILY OF NON-METAL; FOLDABLE PARTITIONING WALLS MADE PRIMARILY OF NON-METAL, IN CLASS 19 (U.S. CLS. 1, 12, 33 AND 50).

FIRST USE 12-31-2007; IN COMMERCE 12-31-2007.

SN 77-101,723, FILED 2-7-2007.

MARY ROSSMAN, EXAMINING ATTORNEY

Int. Cl.: 44

Prior U.S. Cls.: 100 and 101

United States Patent and Trademark Office

Reg. No. 3,477,383

Registered July 29, 2008

**SERVICE MARK
PRINCIPAL REGISTER**

ZWEENA

ZWEENA LLC (NEW JERSEY LTD LIAB CO)
213 CONSTITUTION DRIVE
PRINCETON, NJ 08540

FOR: PROVIDING AN ONLINE, INTERACTIVE
COMPUTER DATABASE IN THE FIELDS OF
HEALTH INFORMATION AND PERSONAL
HEALTH DATA; MAINTAINING PERSONAL MED-
ICAL HISTORY RECORDS AND FILES; PROVID-
ING MEDICAL INFORMATION, CONSULTANCY
AND ADVISORY SERVICES, IN CLASS 44 (U.S. CLS.
100 AND 101).

FIRST USE 1-1-2007; IN COMMERCE 1-1-2007.

THE MARK CONSISTS OF STANDARD CHAR-
ACTERS WITHOUT CLAIM TO ANY PARTICULAR
FONT, STYLE, SIZE, OR COLOR.

THE NAME(S), PORTRAIT(S), AND/OR SIGNA-
TURE(S) SHOWN IN THE MARK DOES NOT IDENT-
IFY A PARTICULAR LIVING INDIVIDUAL.

SN 77-101,754, FILED 2-7-2007.

ODESSA BIBBINS, EXAMINING ATTORNEY

Int. Cl.: 44

Prior U.S. Cls.: 100 and 101

United States Patent and Trademark Office

Reg. No. 3,477,384

Registered July 29, 2008

**SERVICE MARK
PRINCIPAL REGISTER**

ZWEENA IT'S YOUR HEALTH.

ZWEENA LLC (NEW JERSEY LTD LIAB CO)
213 CONSTITUTION DRIVE
PRINCETON, NJ 08540

FIRST USE 1-1-2007; IN COMMERCE 1-1-2007.

FOR: PROVIDING AN ONLINE, INTERACTIVE
COMPUTER DATABASE IN THE FIELDS OF
HEALTH INFORMATION AND PERSONAL
HEALTH DATA; MAINTAINING PERSONAL MED-
ICAL HISTORY RECORDS AND FILES; PROVID-
ING MEDICAL INFORMATION, CONSULTANCY
AND ADVISORY SERVICES, IN CLASS 44 (U.S. CLS.
100 AND 101).

THE MARK CONSISTS OF STANDARD CHAR-
ACTERS WITHOUT CLAIM TO ANY PARTICULAR
FONT, STYLE, SIZE, OR COLOR.

SN 77-101,768, FILED 2-7-2007.

ODESSA BIBBINS, EXAMINING ATTORNEY

Int. Cl.: 44

Prior U.S. Cls.: 100 and 101

United States Patent and Trademark Office

Reg. No. 3,477,385

Registered July 29, 2008

**SERVICE MARK
PRINCIPAL REGISTER**



ZWEENA LLC (NEW JERSEY LTD LIAB CO)
213 CONSTITUTION DRIVE
PRINCETON, NJ 08540

FIRST USE 1-1-2007; IN COMMERCE 1-1-2007.

FOR: PROVIDING AN ONLINE, INTERACTIVE
COMPUTER DATABASE IN THE FIELDS OF
HEALTH INFORMATION AND PERSONAL
HEALTH DATA; MAINTAINING PERSONAL MED-
ICAL HISTORY RECORDS AND FILES; PROVID-
ING MEDICAL INFORMATION, CONSULTANCY
AND ADVISORY SERVICES, IN CLASS 44 (U.S. CLS.
100 AND 101).

THE MARK CONSISTS OF A LAPTOP COMPU-
TER DEPICTED WITHIN A CAPSULE-SHAPED
FIGURE.

SN 77-101,777, FILED 2-7-2007.

ODESSA BIBBINS, EXAMINING ATTORNEY

Int. Cl.: 41

Prior U.S. Cls.: 100, 101, and 107

United States Patent and Trademark Office

Reg. No. 3,477,386

Registered July 29, 2008

**SERVICE MARK
PRINCIPAL REGISTER**

MARIANO FILMS

MARIANO FILMS, LLC (NEW JERSEY LTD LIAB
CO)
SUITE 320-358
726 ROUTE 202 SOUTH
BRIDGEWATER, NJ 08807

FOR: DISTRIBUTION OF TELEVISION PROGRAMMING TO CABLE TELEVISION SYSTEMS; ENTERTAINMENT SERVICES NAMELY PROVIDING A WEBSITE FEATURING, PHOTOGRAPHIC, AUDIO, VIDEO AND PROSE PRESENTATIONS FEATURING DRAMA, COMEDY, REALITY AND VARIETY CONTENT; ENTERTAINMENT SERVICES, NAMELY, PROVIDING A TELEVISION PROGRAM IN THE FIELD OF DRAMA, COMEDY, REALITY AND VARIETY VIA A GLOBAL COMPUTER NETWORK; ENTERTAINMENT SERVICES, NAMELY, PROVIDING A WEB SITE FEATURING MUSICAL PERFORMANCES, MUSICAL VIDEOS, RELATED FILM CLIPS, PHOTOGRAPHS, AND OTHER MULTIMEDIA MATERIALS; ENTERTAINMENT, NAMELY A CONTINUING DRAMA, COMEDY, REALITY AND VARIETY SHOW BROADCAST OVER TELEVISION, SATELLITE, AUDIO, AND VIDEO MEDIA; FILM DISTRIBUTION;

MOTION PICTURE FILM PRODUCTION; PRODUCTION AND DISTRIBUTION OF INDEPENDENT MOTION PICTURES; PRODUCTION AND DISTRIBUTION OF MOTION PICTURES; PRODUCTION AND DISTRIBUTION OF TELEVISION SHOWS AND MOVIES; PRODUCTION OF VIDEO DISCS AND TAPES; PROVISION OF NON-DOWNLOADABLE FILMS AND TV PROGRAMMES VIA A VIDEO-ON-DEMAND SERVICE, IN CLASS 41 (U.S. CLS. 100, 101 AND 107).

FIRST USE 11-1-2007; IN COMMERCE 11-1-2007.

THE MARK CONSISTS OF STANDARD CHARACTERS WITHOUT CLAIM TO ANY PARTICULAR FONT, STYLE, SIZE, OR COLOR.

NO CLAIM IS MADE TO THE EXCLUSIVE RIGHT TO USE "FILMS", APART FROM THE MARK AS SHOWN.

SN 77-101,834, FILED 2-7-2007.

RON FAIRBANKS, EXAMINING ATTORNEY

Int. Cls.: 16, 25, 35, 36, and 44

**Prior U.S. Cls.: 2, 5, 22, 23, 29, 37, 38, 39, 50, 100, 101,
and 102**

Reg. No. 3,477,387

United States Patent and Trademark Office

Registered July 29, 2008

**TRADEMARK
SERVICE MARK
PRINCIPAL REGISTER**

**HEALING HEALTH CARE.
TOGETHER.**

UNITEDHEALTH GROUP INCORPORATED
(MINNESOTA CORPORATION)
MN008-T202
9900 BREN ROAD EAST
MINNETONKA, MN 55343

FOR: PRINTED MATTER AND PAPER GOODS, NAMELY, PAPER IDENTIFICATION AND MEMBERSHIP CARDS, MEDICAL IDENTIFICATION CARDS NON-MAGNETICALLY CODED, WRITING PAPER, STATIONERY WRITING PAPER AND ENVELOPES, NOTE PADS, BUSINESS CARDS, PEN AND PENCIL HOLDERS, PENS, POSTERS; PRINTED PUBLICATIONS, NAMELY, NEWSLETTERS, MANUALS, BOOKLETS, PAMPHLETS, AND BROCHURES REGARDING ISSUES RELATED TO HEALTH AND WELLNESS, HEALTH INSURANCE, HEALTH CARE BENEFIT PLANS, HEALTH INSURANCE ADMINISTRATION AND CLAIMS PROCESSING, AND EMPLOYEE BENEFIT PLANS; NON-MAGNETICALLY ENCODED PRINTED MATTER AND PAPER GOODS, NAMELY, PRINTED PLASTIC AND PAPER CARDS USED AS CREDIT CARDS, DEBIT CARDS, CHARGE CARDS, STORED-VALUE CARDS, IDENTIFICATION CARDS AND MEMBERSHIP CARDS, IN CLASS 16 (U.S. CLS. 2, 5, 22, 23, 29, 37, 38 AND 50).

FIRST USE 1-0-2007; IN COMMERCE 1-0-2007.

FOR: CLOTHING, NAMELY, SHIRTS, T-SHIRTS, POLO SHIRTS, GOLF SHIRTS, HATS, CAPS, SWEATSHIRTS, WIND RESISTANT JACKETS, AND KNIT SHIRTS, IN CLASS 25 (U.S. CLS. 22 AND 39).

FIRST USE 1-0-2007; IN COMMERCE 1-0-2007.

FOR: COST MANAGEMENT SERVICES FOR HEALTH CARE BENEFIT AND DISABILITY PLANS

OF OTHERS; COST MANAGEMENT OF PRE-PAID VISION BENEFIT PLANS OF OTHERS; COST MANAGEMENT SERVICES FOR PHARMACY BENEFIT AND PRESCRIPTION DRUG BENEFIT PLANS OF OTHERS; COST MANAGEMENT THROUGH APPROPRIATENESS AND TECHNOLOGY ASSESSMENT FOR TRANSPLANTATION PLAN BENEFITS; HEALTH CARE UTILIZATION AND REVIEW SERVICES; HEALTH CARE COST CONTAINMENT; MANAGED CARE SERVICES, NAMELY, ELECTRONIC PROCESSING OF HEALTH CARE INFORMATION; EMPLOYEE ASSISTANCE PROGRAMS CONSISTING OF REFERRAL SERVICES TO ASSIST EMPLOYEES WITH PERSONAL PROBLEMS; COST MANAGEMENT SERVICES FOR HEALTH CARE BENEFIT PLANS OF OTHERS PROVIDED VIA A GLOBAL COMPUTER NETWORK; HEALTH CARE UTILIZATION AND REVIEW SERVICES PROVIDED VIA A GLOBAL COMPUTER NETWORK; INVOICING SERVICES IN THE FIELD OF HEALTH CARE PROVIDED VIA A GLOBAL COMPUTER NETWORK; REFERRAL SERVICES FOR LEGAL ISSUES AND WORK AND FAMILY PROBLEMS; EMPLOYEE ASSISTANCE SERVICES, NAMELY, PROVIDING ONLINE, TELEPHONIC, AND IN-PERSON CONSULTATION, INFORMATION AND ASSESSMENT FOR WORK PROBLEMS, IN CLASS 35 (U.S. CLS. 100, 101 AND 102).

FIRST USE 1-0-2007; IN COMMERCE 1-0-2007.

FOR: ADMINISTRATION OF EMPLOYEE BENEFIT PLANS; ADMINISTRATION OF PRE-PAID HEALTHCARE PLANS; ADMINISTRATION OF HEALTH CARE BENEFIT PLANS; ADMINISTRATION OF PRE-PAID VISION CARE PLANS; ADMINISTRATION OF PRE-PAID HEALTH CARE PLANS IN THE FIELDS OF CHIROPRACTIC, PHYSICAL

MEDICINE, AND COMPLEMENTARY AND ALTERNATIVE MEDICINES; ADMINISTRATION AND MANAGEMENT OF PHARMACY BENEFIT AND PRESCRIPTION DRUG BENEFIT PROGRAMS; ADMINISTRATION OF PRE-PAID PHARMACY BENEFIT PLANS; PHARMACY BENEFIT MANAGEMENT SERVICES; CLAIMS ADMINISTRATION SERVICES FOR DISABILITY BENEFIT PLANS OF OTHERS; REINSURANCE FOR DISABILITY PLANS; STOP-LOSS INSURANCE FOR SELF-FUNDED HEALTH BENEFIT PLANS OF OTHERS; INSURANCE UNDERWRITING IN THE FIELD OF HEALTH FOR HEALTH CARE INSURANCE; INSURANCE UNDERWRITING IN THE FIELD OF DISABILITY INSURANCE; ELECTRONIC PROCESSING OF INSURANCE CLAIMS AND PAYMENT DATA, INCLUDING DISABILITY CLAIMS; PROVIDING DENTAL HEALTH INSURANCE UNDERWRITING AND ADMINISTRATION; DENTAL HEALTH INSURANCE UNDERWRITING AND ADMINISTRATION; ADMINISTRATION OF PRE-PAID DENTAL HEALTH PLANS; ADMINISTRATION OF EMPLOYEE BENEFIT DENTAL HEALTH PLANS; ADMINISTRATION OF PREFERRED PROVIDER PLANS IN THE FIELD OF HEALTH CARE; INSURANCE ACTUARIAL SERVICES IN THE FIELD OF HEALTH AND DISABILITY INSURANCE; PROVIDING LIFE, ACCIDENT AND CRITICAL ILLNESS BENEFIT PLANS; HEALTH CARE INSURANCE UNDERWRITING AND ADMINISTRATION PROVIDED VIA A GLOBAL COMPUTER NETWORK; PROVIDING BENEFITS ADMINISTRATION SERVICES FOR OTHERS, IN CLASS 36 (U.S. CLS. 100, 101 AND 102).

FIRST USE 1-0-2007; IN COMMERCE 1-0-2007.

FOR: MANAGED HEALTH CARE SERVICES; MANAGED VISION CARE SERVICES PROVIDED THROUGH A NETWORK OF VISION CARE PROVIDERS; MANAGED HEALTH CARE SERVICES IN THE FIELD OF VISION CARE; MANAGED HEALTH CARE SERVICES IN THE FIELD OF DISABILITY CARE; MANAGED HEALTH CARE SERVICES IN THE FIELD OF DENTAL CARE; MANAGED DENTAL HEALTH CARE SERVICES PROVIDED THROUGH A NETWORK OF DENTAL CARE PROVIDERS; MANAGED PHYSICAL THER-

APY SERVICES PROVIDED THROUGH A NETWORK OF PHYSICAL THERAPY PROVIDERS; COMPLEMENTARY AND ALTERNATIVE MEDICINE SERVICES; MANAGED COMPLEMENTARY AND ALTERNATIVE MEDICINE SERVICES PROVIDED THROUGH A NETWORK OF COMPLEMENTARY AND ALTERNATIVE MEDICINE PROVIDERS TO HEALTH PLANS AND SELF-INSURED COMPANIES; NURSE TRIAGE AND NURSE CALL CENTERS PROVIDING INFORMATION REGARDING THE IDENTIFICATION OF SPECIFIC HEALTH RELATED CONCERNS AND GENERAL HEALTH ISSUES; PRE-TRANSPLANT MEDICAL REVIEW PROGRAM FOR REINSURANCE AND INSURANCE COMPANIES, SELF-FUNDED EMPLOYERS AND HEALTH MAINTENANCE ORGANIZATIONS (HMOS) TO ASSESS TRANSPLANT-RELATED TECHNOLOGY AND PROVIDE RECOMMENDATIONS FOR TRANSPLANTS; PROVIDING HEALTH CARE INFORMATION ON CARE GIVING SERVICES, CARE MANAGEMENT SERVICES, AND PHARMACY AND OVER-THE-COUNTER PRODUCTS AND SERVICES; HEALTH CARE IN THE NATURE OF HEALTH MAINTENANCE ORGANIZATIONS (HMOS) AND PREFERRED PROVIDER ORGANIZATIONS (PPOS); EMPLOYEE ASSISTANCE SERVICES, NAMELY, PROVIDING ON-LINE, TELEPHONIC, AND IN-PERSON CONSULTATION, INFORMATION, ASSESSMENT, AND REFERRAL SERVICES FOR PHYSICAL, AND MENTAL HEALTH, AND SUBSTANCE ABUSE; EMPLOYEE ASSISTANCE SERVICES, NAMELY, PROVIDING ON-LINE, TELEPHONIC, AND IN-PERSON CONSULTATION, INFORMATION AND ASSESSMENT SERVICES FOR PHYSICAL, MENTAL HEALTH AND SUBSTANCE ABUSE PROBLEMS, IN CLASS 44 (U.S. CLS. 100 AND 101).

FIRST USE 1-0-2007; IN COMMERCE 1-0-2007.

THE MARK CONSISTS OF STANDARD CHARACTERS WITHOUT CLAIM TO ANY PARTICULAR FONT, STYLE, SIZE, OR COLOR.

SN 77-103,136, FILED 2-8-2007.

ANGELA M. MICHELI, EXAMINING ATTORNEY

Int. Cl.: 33

Prior U.S. Cls.: 47 and 49

United States Patent and Trademark Office

Reg. No. 3,477,388

Registered July 29, 2008

**TRADEMARK
PRINCIPAL REGISTER**

SHINKUN

SANWA SHURUI KABUSHIKI GAISHA (JAPAN
CORPORATION)
2231, OAZA YAMAMOTO
USASHI, OITAKEN, JAPAN

THE MARK CONSISTS OF STANDARD CHAR-
ACTERS WITHOUT CLAIM TO ANY PARTICULAR
FONT, STYLE, SIZE, OR COLOR.

FOR: DISTILLED LIQUORS, IN CLASS 33 (U.S.
CLS. 47 AND 49).

SN 77-103,791, FILED 2-9-2007.

FIRST USE 9-6-2006; IN COMMERCE 2-20-2008.

TASNEEM HUSSAIN, EXAMINING ATTORNEY

Int. Cl.: 3

Prior U.S. Cls.: 1, 4, 6, 50, 51, and 52

United States Patent and Trademark Office

Reg. No. 3,477,389

Registered July 29, 2008

TRADEMARK
PRINCIPAL REGISTER

The logo features the word "Lifty" in a fluid, cursive script. The letter "y" has a long, sweeping tail that loops back under the "t". To the right of "Lifty" is a large, bold, blocky letter "S". The "S" is solid black and has a slightly irregular, hand-drawn appearance.

STRATEGIC MARKETING ALLIANCE, LLC
(FLORIDA LTD LIAB CO)
3670 S.W. 37 AVENUE
MIAMI, FL 33133

FOR: ADHESIVES FOR COSMETIC USE, NAME-
LY, AN ADHESIVE PAD OR STRIP FOR USE IN
CONSTRICTING THE SKIN ABOVE THE BREAST

FOR USE IN RESHAPING THE BREAST, IN CLASS 3
(U.S. CLS. 1, 4, 6, 50, 51 AND 52).

FIRST USE 4-0-2007; IN COMMERCE 4-0-2007.

SN 77-105,273, FILED 2-12-2007.

JENNIFER MARTIN, EXAMINING ATTORNEY

Int. Cl.: 39

Prior U.S. Cls.: 100 and 105

United States Patent and Trademark Office

Reg. No. 3,477,390

Registered July 29, 2008

**SERVICE MARK
PRINCIPAL REGISTER**



THE DESIGNATE, LTD. (MICHIGAN CORPORATION)
233 PIERCE STREET
BIRMINGHAM, MI 48009

FOR: TRANSPORTATION SERVICES, NAMELY, TRANSPORTATION OF CUSTOMERS IN THEIR OWN VEHICLES, IN CLASS 39 (U.S. CLS. 100 AND 105).

FIRST USE 3-17-2007; IN COMMERCE 3-17-2007.

THE COLOR(S) YELLOW AND BLACK IS/ARE CLAIMED AS A FEATURE OF THE MARK.

THE MARK CONSISTS OF A YELLOW LETTER "D" ON A BLACK CIRCLE.

SN 77-105,529, FILED 2-12-2007.

DANNEAN HETZEL, EXAMINING ATTORNEY

Int. Cl.: 34

Prior U.S. Cls.: 2, 8, 9, and 17

United States Patent and Trademark Office

Reg. No. 3,477,391

Registered July 29, 2008

**TRADEMARK
PRINCIPAL REGISTER**

SHERIFF

DFA HOLDINGS, INC. (FLORIDA CORPORATION)
6100 HOLLYWOOD BLVD. 7TH FLOOR
HOLLYWOOD, FL 33024

THE MARK CONSISTS OF STANDARD CHARACTERS WITHOUT CLAIM TO ANY PARTICULAR FONT, STYLE, SIZE, OR COLOR.

FOR: CIGARETTES, IN CLASS 34 (U.S. CLS. 2, 8, 9 AND 17).

SN 77-105,753, FILED 2-13-2007.

FIRST USE 5-27-2008; IN COMMERCE 5-27-2008.

SONYA STEPHENS, EXAMINING ATTORNEY

Int. Cl.: 11

Prior U.S. Cls.: 13, 21, 23, 31, and 34

United States Patent and Trademark Office

Reg. No. 3,477,392

Registered July 29, 2008

TRADEMARK
PRINCIPAL REGISTER

AMERICAN TAP

UNIMEX INDUSTRIES, INC. (UTAH CORPORATION)
SUITE 4
1948 W. 2425 SO.
WOODS CROSS, UT 84087

FOR: FAUCETS; HAND-HELD SHOWERS;
PLUMBING FITTINGS, NAMELY, SHOWER CONTROL VALVES;
SHOWER HEAD SPRAYERS;
SHOWER HEADS, IN CLASS 11 (U.S. CLS. 13, 21, 23,
31 AND 34).

FIRST USE 12-15-2002; IN COMMERCE 12-15-2002.

THE MARK CONSISTS OF STANDARD CHARACTERS WITHOUT CLAIM TO ANY PARTICULAR FONT, STYLE, SIZE, OR COLOR.

NO CLAIM IS MADE TO THE EXCLUSIVE RIGHT TO USE "TAP", APART FROM THE MARK AS SHOWN.

SN 77-106,256, FILED 2-13-2007.

JENNIFER MARTIN, EXAMINING ATTORNEY

Int. Cl.: 28

Prior U.S. Cls.: 22, 23, 38, and 50

United States Patent and Trademark Office

Reg. No. 3,477,393

Registered July 29, 2008

**TRADEMARK
PRINCIPAL REGISTER**

CANDY POPS

THOSE CHARACTERS FROM CLEVELAND,
INC. (OHIO CORPORATION)
ONE AMERICAN ROAD
CLEVELAND, OH 44144

THE MARK CONSISTS OF STANDARD CHAR-
ACTERS WITHOUT CLAIM TO ANY PARTICULAR
FONT, STYLE, SIZE, OR COLOR.

FOR: TOY ACTION FIGURES AND ACCESSOR-
IES THEREFOR; TOY FIGURES, IN CLASS 28 (U.S.
CLS. 22, 23, 38 AND 50).

SN 77-106,444, FILED 2-13-2007.

FIRST USE 7-31-2006; IN COMMERCE 7-31-2006.

RICHARD WHITE, EXAMINING ATTORNEY

Int. Cl.: 44

Prior U.S. Cls.: 100 and 101

United States Patent and Trademark Office

Reg. No. 3,477,394

Registered July 29, 2008

**SERVICE MARK
PRINCIPAL REGISTER**

SPIFF

GREGORY SARWAY (UNITED STATES INDIVIDUAL)
809 AVENUE K
BROOKLYN, NY 11230 AND
MARGARET SARWAY (UNITED STATES INDIVIDUAL)
809 AVENUE K
BROOKLYN, NY 11230

FOR: MEN'S BARBERING, MANICURE, PEDICURE, DEPILATORY HAIR REMOVAL AND SKIN CARE SALON SERVICES , IN CLASS 44 (U.S. CLS. 100 AND 101).

FIRST USE 3-25-2008; IN COMMERCE 3-25-2008.

THE MARK CONSISTS OF STANDARD CHARACTERS WITHOUT CLAIM TO ANY PARTICULAR FONT, STYLE, SIZE, OR COLOR.

SN 77-107,175, FILED 2-14-2007.

TINA L. SNAPP, EXAMINING ATTORNEY

Int. Cl.: 5

Prior U.S. Cls.: 6, 18, 44, 46, 51, and 52

United States Patent and Trademark Office

Reg. No. 3,477,395

Registered July 29, 2008

**TRADEMARK
PRINCIPAL REGISTER**



MERIDIAN BIOSCIENCE, INC. (OHIO CORPORATION)
3471 RIVER HILLS DRIVE
CINCINNATI, OH 45244

FOR: DIAGNOSTIC TESTS FOR THE QUALITATIVE DETECTION OF VARIOUS ILLNESS-INDUCING AGENTS, NAMELY, THOSE CAUSING FOODBORNE ILLNESSES, RESPIRATORY ILLNESSES, GASTROINTESTINAL ILLNESSES, IMMUNOLOGICAL ILLNESSES AND FUNGAL ILLNESSES TO AID IN THE DIAGNOSIS OF THOSE ILLNESSES FOR USE IN MEDICAL OR CLINICAL LABORATORIES, IN CLASS 5 (U.S. CLS. 6, 18, 44, 46, 51 AND 52).

FIRST USE 10-26-2006; IN COMMERCE 10-26-2006.

THE MARK CONSISTS OF AN ABSTRACT REPRESENTING A TEST TUBE.

SN 77-107,203, FILED 2-14-2007.

EDWARD NELSON, EXAMINING ATTORNEY

Int. Cl.: 25

Prior U.S. Cls.: 22 and 39

United States Patent and Trademark Office

Reg. No. 3,477,396

Registered July 29, 2008

**TRADEMARK
PRINCIPAL REGISTER**

KARTA

LAMBERT, JUDI (UNITED STATES INDIVIDUAL)
639 S. SPRING STREET, SUITE 8B
LOS ANGELES, CA 90014

FOR: BELTS; BELTS MADE OF LEATHER; BELTS OF TEXTILE; BOTTOMS; CAPRI PANTS; CARGO PANTS; CROP TOPS; DRESS SHIRTS; DRESSES; HALTER TOPS; HATS; JOGGING PANTS; KNIT SHIRTS; LEGGINGS; LINGERIE; LOUNGEWEAR; POLO SHIRTS; SHIRTS; SHOES; SHORTS; SKIRTS; SLEEPWEAR; SWEAT PANTS; SWEAT SHIRTS; T-SHIRTS; TANK TOPS, IN CLASS 25 (U.S. CLS. 22 AND 39).

FIRST USE 3-16-2007; IN COMMERCE 7-12-2007.

THE MARK CONSISTS OF STANDARD CHARACTERS WITHOUT CLAIM TO ANY PARTICULAR FONT, STYLE, SIZE, OR COLOR.

THE ENGLISH TRANSLATION OF THE WORD "KARTA" IN THE MARK IS PLAYING CARD.

SN 77-107,230, FILED 2-14-2007.

EDWARD NELSON, EXAMINING ATTORNEY

Int. Cl.: 41

Prior U.S. Cls.: 100, 101, and 107

United States Patent and Trademark Office

Reg. No. 3,477,397

Registered July 29, 2008

**SERVICE MARK
PRINCIPAL REGISTER**

GUIDE-US

KNIGHT, GRADY U. (UNITED STATES INDIVIDUAL)
6816 CLOVER LANE
UPPER DARBY, PA 19082

FOR: CHARITABLE SERVICES, NAMELY, PROVIDING TRAINING IN THE FIELD OF ACADEMICS, ATHLETICS, CAREER SKILLS AND SOCIAL SKILLS TO YOUNG MALES, IN CLASS 41 (U.S. CLS. 100, 101 AND 107).

FIRST USE 11-26-2007; IN COMMERCE 2-1-2008.

THE MARK CONSISTS OF STANDARD CHARACTERS WITHOUT CLAIM TO ANY PARTICULAR FONT, STYLE, SIZE, OR COLOR.

SN 77-107,961, FILED 2-15-2007.

KATHERINE M. DUBRAY, EXAMINING ATTORNEY

Int. Cl.: 41

Prior U.S. Cls.: 100, 101, and 107

United States Patent and Trademark Office

Reg. No. 3,477,398

Registered July 29, 2008

**SERVICE MARK
PRINCIPAL REGISTER**

Hot Shots!

KNIGHT, GRADY U. (UNITED STATES INDIVIDUAL)
6816 CLOVER LANE
UPPER DARBY, PA 19082

FOR: CHARITABLE SERVICES, NAMELY, PROVIDING TRAINING IN THE FIELD OF ACADEMICS, ATHLETICS, CAREER SKILLS AND SOCIAL SKILLS TO YOUNG MALES, IN CLASS 41 (U.S. CLS. 100, 101 AND 107).

FIRST USE 11-26-2007; IN COMMERCE 2-1-2008.

THE MARK CONSISTS OF STANDARD CHARACTERS WITHOUT CLAIM TO ANY PARTICULAR FONT, STYLE, SIZE, OR COLOR.

SN 77-107,962, FILED 2-15-2007.

KATHERINE M. DUBRAY, EXAMINING ATTORNEY

Int. Cl.: 41

Prior U.S. Cls.: 100, 101, and 107

United States Patent and Trademark Office

Reg. No. 3,477,399

Registered July 29, 2008

**SERVICE MARK
PRINCIPAL REGISTER**



EYE CANDY MODEL MANAGEMENT, LLC
(MISSOURI LTD LIAB CO)
232 S. DELLWOOD
ST. LOUIS, MO 63135

FOR: ENTERTAINMENT SERVICES, NAMELY,
MODEL SEARCH CONTESTS AND COMPETI-
TIONS, IN CLASS 41 (U.S. CLS. 100, 101 AND 107).

FIRST USE 1-0-2007; IN COMMERCE 1-0-2007.

NO CLAIM IS MADE TO THE EXCLUSIVE
RIGHT TO USE "MODELS", APART FROM THE
MARK AS SHOWN.

THE STIPPLING IS FOR SHADING PURPOSES
ONLY.

THE MARK CONSISTS OF THE LETTER "E" AND
THE LETTER "C", WHICH CONTAINS A SILHOU-
ETTE OF A WOMAN, ALL OF WHICH IS ABOVE
THE WORDS "EYE CANDY MODELS".

SN 77-108,106, FILED 2-15-2007.

JENNY PARK, EXAMINING ATTORNEY

Int. Cl.: 7

Prior U.S. Cls.: 13, 19, 21, 23, 31, 34, and 35

Reg. No. 3,477,400

United States Patent and Trademark Office

Registered July 29, 2008

**TRADEMARK
PRINCIPAL REGISTER**

BULLET

COMMERCIAL GROUNDS CARE, INC. (WIS-
CONSIN CORPORATION)
ONE BOB CAT LANE
JOHNSON CREEK, WI 53028

THE MARK CONSISTS OF STANDARD CHAR-
ACTERS WITHOUT CLAIM TO ANY PARTICULAR
FONT, STYLE, SIZE, OR COLOR.

FOR: MACHINES FOR LAWN, TURF AND
GROUNDS MAINTENANCE, NAMELY, LAWN
MOWERS, IN CLASS 7 (U.S. CLS. 13, 19, 21, 23, 31,
34 AND 35).

SN 77-108,372, FILED 2-15-2007.

FIRST USE 12-31-1996; IN COMMERCE 12-31-1996.

GIANCARLO CASTRO, EXAMINING ATTORNEY

Int. Cl.: 9

Prior U.S. Cls.: 21, 23, 26, 36, and 38

Reg. No. 3,477,401

United States Patent and Trademark Office

Registered July 29, 2008

**TRADEMARK
PRINCIPAL REGISTER**

WATERDOG

BELDEN TECHNOLOGIES, INC. (DELAWARE
CORPORATION)
7701 FORSYTH BOULEVARD, SUITE 800
ST. LOUIS, MO 63105

THE MARK CONSISTS OF STANDARD CHAR-
ACTERS WITHOUT CLAIM TO ANY PARTICULAR
FONT, STYLE, SIZE, OR COLOR.

FOR: ELECTRICAL AND ELECTRONIC WIRE
AND CABLE, IN CLASS 9 (U.S. CLS. 21, 23, 26, 36
AND 38).

SN 77-108,577, FILED 2-15-2007.

FIRST USE 6-15-2007; IN COMMERCE 6-15-2007.

INGA ERVIN, EXAMINING ATTORNEY

Int. Cl.: 45

Prior U.S. Cls.: 100 and 101

United States Patent and Trademark Office

Reg. No. 3,477,402

Registered July 29, 2008

**SERVICE MARK
PRINCIPAL REGISTER**

EFCA ENCORE

EVANGELICAL FREE CHURCH OF AMERICA,
THE (MINNESOTA NON-PROFIT CORPORATION)
901 EAST 78TH STREET
MINNEAPOLIS, MN 554201300

FOR: EVANGELICAL MISSIONARY AND MINISTERIAL SERVICES, NAMELY, SENIOR ADULT MINISTRIES, IN CLASS 45 (U.S. CLS. 100 AND 101).

FIRST USE 1-4-2008; IN COMMERCE 1-4-2008.

THE MARK CONSISTS OF STANDARD CHARACTERS WITHOUT CLAIM TO ANY PARTICULAR FONT, STYLE, SIZE, OR COLOR.

OWNER OF U.S. REG. NOS. 2,777,789, 2,946,659, AND OTHERS.

SN 77-109,642, FILED 2-16-2007.

PAULA MAHONEY, EXAMINING ATTORNEY

Int. Cl.: 25

Prior U.S. Cls.: 22 and 39

United States Patent and Trademark Office

Reg. No. 3,477,403

Registered July 29, 2008

**TRADEMARK
PRINCIPAL REGISTER**

GAHNAS

LOCO SPORTSWEAR, LLC (PENNSYLVANIA
LTD LIAB CO)
P.O. BOX 7
FAIRVIEW VILLAGE, PA 19409

FOR: CLOTHING NAMELY, SHIRTS, T-SHIRTS,
POLO SHIRTS, JERSEYS, SHORTS, SHOES, SWEAT-
SHIRTS, SWEATPANTS, JACKETS, HATS, BABY
CLOTHES, NAMELY, ROMPERS, T-SHIRTS, VESTS
AND PANTS, SOCKS, UNDERGARMENTS, UN-
DERWEAR, SWIM SUITS, JEANS AND PANTS, IN
CLASS 25 (U.S. CLS. 22 AND 39).

FIRST USE 8-17-2007; IN COMMERCE 8-17-2007.

THE MARK CONSISTS OF STANDARD CHAR-
ACTERS WITHOUT CLAIM TO ANY PARTICULAR
FONT, STYLE, SIZE, OR COLOR.

SN 77-109,895, FILED 2-16-2007.

SHANNON TWOHIG, EXAMINING ATTORNEY

Int. Cls.: 39 and 40

Prior U.S. Cls.: 100, 103, 105, and 106

United States Patent and Trademark Office

Reg. No. 3,477,404

Registered July 29, 2008

**SERVICE MARK
PRINCIPAL REGISTER**

**NATURAL FUEL FROM THE
NATURAL STATE**

FUTUREFUEL CORP. (DELAWARE CORPORATION)
8235 FORSYTH BLVD., 4TH FLOOR
CLAYTON, MO 63105

FOR: STORAGE AND TRANSPORTATION OF FUELS, NAMELY, BIODIESEL AND ETHANOL, IN CLASS 39 (U.S. CLS. 100 AND 105).

FIRST USE 0-0-2007; IN COMMERCE 0-0-2007.

FOR: MANUFACTURE AND PRODUCTION OF RENEWABLE FUELS AND SPECIALTY CHEMICALS, IN CLASS 40 (U.S. CLS. 100, 103 AND 106).

FIRST USE 0-0-2007; IN COMMERCE 0-0-2007.

THE MARK CONSISTS OF STANDARD CHARACTERS WITHOUT CLAIM TO ANY PARTICULAR FONT, STYLE, SIZE, OR COLOR.

NO CLAIM IS MADE TO THE EXCLUSIVE RIGHT TO USE "FUEL", APART FROM THE MARK AS SHOWN.

SN 77-111,202, FILED 2-20-2007.

INGA ERVIN, EXAMINING ATTORNEY

Int. Cl.: 2

Prior U.S. Cls.: 6, 11, and 16

Reg. No. 3,477,405

United States Patent and Trademark Office

Registered July 29, 2008

**TRADEMARK
PRINCIPAL REGISTER**

DAIHARD

DAICH COATINGS CORP. (CANADA CORPORATION)
2360A SOUTHFIELD ROAD
MISSISSAUGA, CANADA L5N2W8

FOR: PROTECTIVE COATINGS FOR FLOORINGS; EPOXY AND URETHANE BASED COATINGS FOR FLOORINGS; EPOXY CLEAR COAT FLOORINGS COATING; PROTECTIVE COATING FOR FLOORING, WALLS, COUNTERTOPS, STAIR RISES AND BASEBOARDS, IN CLASS 2 (U.S. CLS. 6, 11 AND 16).

FIRST USE 1-1-2007; IN COMMERCE 1-1-2007.

THE MARK CONSISTS OF STANDARD CHARACTERS WITHOUT CLAIM TO ANY PARTICULAR FONT, STYLE, SIZE, OR COLOR.

SN 77-111,435, FILED 2-20-2007.

PAUL E. FAHRENKOPF, EXAMINING ATTORNEY

Int. Cl.: 25

Prior U.S. Cls.: 22 and 39

United States Patent and Trademark Office

Reg. No. 3,477,406

Registered July 29, 2008

**TRADEMARK
PRINCIPAL REGISTER**

CLIMATE CONTROL

OUTERSTUFF, LTD. (NEW YORK CORPORATION)
1370 BROADWAY
NEW YORK, NY 10018

THE MARK CONSISTS OF STANDARD CHARACTERS WITHOUT CLAIM TO ANY PARTICULAR FONT, STYLE, SIZE, OR COLOR.

FOR: OVERALLS; PANTS; PARKAS; SNOW SUITS, IN CLASS 25 (U.S. CLS. 22 AND 39).

SN 77-111,670, FILED 2-20-2007.

FIRST USE 1-30-1990; IN COMMERCE 12-30-2007.

GIANCARLO CASTRO, EXAMINING ATTORNEY

Int. Cl.: 8

Prior U.S. Cls.: 23, 28, and 44

United States Patent and Trademark Office

Reg. No. 3,477,407

Registered July 29, 2008

**TRADEMARK
PRINCIPAL REGISTER**

BUTTON ANGEL

SNYDER NATIONAL CORPORATION (OHIO
CORPORATION)
3709 COLUMBUS ROAD NE
CANTON, OH 44705

FOR: HAND TOOLS, NAMELY, BUTTON FAS-
TENING AIDS THAT ARE USED TO ASSIST A
PERSON PULLING A BUTTON THROUGH A BUT-
TON HOLE AND ZIPPER PULLING AIDS FOR
ASSISTING A PERSON IN OPENING AND CLOS-
ING A ZIPPER, IN CLASS 8 (U.S. CLS. 23, 28 AND 44).

FIRST USE 12-31-2007; IN COMMERCE 12-31-2007.

THE MARK CONSISTS OF STANDARD CHAR-
ACTERS WITHOUT CLAIM TO ANY PARTICULAR
FONT, STYLE, SIZE, OR COLOR.

NO CLAIM IS MADE TO THE EXCLUSIVE
RIGHT TO USE "BUTTON", APART FROM THE
MARK AS SHOWN.

SN 77-111,742, FILED 2-20-2007.

DAVID ELTON, EXAMINING ATTORNEY

Int. Cl.: 41

Prior U.S. Cls.: 100, 101, and 107

United States Patent and Trademark Office

Reg. No. 3,477,408

Registered July 29, 2008

**SERVICE MARK
PRINCIPAL REGISTER**

Hungry Bytes

MEYER INTELLECTUAL PROPERTIES LIMITED
(BR.VIRGIN ISLANDS CORPORATION)
382 KWUN TONG ROAD
KOWLOON, HONGKONG, CHINA

FOR: ENTERTAINMENT SERVICES, NAMELY,
THE PRODUCTION AND DISTRIBUTION OF ON-
LINE FOOD AND COOKING PROGRAMS VIA
INTERNET WEBCASTS , IN CLASS 41 (U.S. CLS.
100, 101 AND 107).

FIRST USE 3-1-2007; IN COMMERCE 3-1-2007.

THE MARK CONSISTS OF STANDARD CHAR-
ACTERS WITHOUT CLAIM TO ANY PARTICULAR
FONT, STYLE, SIZE, OR COLOR.

SN 77-111,901, FILED 2-20-2007.

TINA L. SNAPP, EXAMINING ATTORNEY

Int. Cl.: 30

Prior U.S. Cl.: 46

United States Patent and Trademark Office

Reg. No. 3,477,409

Registered July 29, 2008

**TRADEMARK
PRINCIPAL REGISTER**

CINNABUNNIES

ANNIE'S HOMEGROWN (DELAWARE COR-
PORATION)
564 GATEWAY DRIVE
NAPA, CA 94558

THE MARK CONSISTS OF STANDARD CHAR-
ACTERS WITHOUT CLAIM TO ANY PARTICULAR
FONT, STYLE, SIZE, OR COLOR.

FOR: BREAKFAST CEREAL, IN CLASS 30 (U.S.
CL. 46).

SN 77-112,102, FILED 2-21-2007.

FIRST USE 7-11-2007; IN COMMERCE 7-11-2007.

SANJEEV VOHRA, EXAMINING ATTORNEY

Int. Cls.: 9 and 16

Prior U.S. Cls.: 2, 5, 21, 22, 23, 26, 29, 36, 37, 38, and 50

United States Patent and Trademark Office

Reg. No. 3,477,410

Registered July 29, 2008

**TRADEMARK
PRINCIPAL REGISTER**

PREVENTPAK

REALITYWORKS, INC. (WISCONSIN CORPORATION)
2709 MONDOVI ROAD
EAU CLAIRE, WI 54701

FOR: PORTABLE AND HANDHELD ELECTRONIC EDUCATIONAL CIGARETTE SMOKING SIMULATORS HAVING A SPEAKER FOR PLAYING RECORDED MESSAGES, A MICROPHONE FOR USER INPUT, VOICE RECOGNITION CAPABILITIES, AND AN ELECTRONIC TAG AND ASSOCIATED READER DEVICE FOR INTERACTIVE COMMUNICATION WITH THE USER AND PRINTED INSTRUCTIONAL MATERIALS FOR USE WITH THE SIMULATORS, ALL SOLD AS A UNIT, IN CLASS 9 (U.S. CLS. 21, 23, 26, 36 AND 38).

FIRST USE 10-5-2007; IN COMMERCE 10-5-2007.

FOR: PRINTED INSTRUCTIONAL, EDUCATIONAL AND TEACHING MATERIAL IN THE FIELD OF TOBACCO USAGE DETERRENCE, IN CLASS 16 (U.S. CLS. 2, 5, 22, 23, 29, 37, 38 AND 50).

FIRST USE 10-5-2007; IN COMMERCE 10-5-2007.

THE MARK CONSISTS OF STANDARD CHARACTERS WITHOUT CLAIM TO ANY PARTICULAR FONT, STYLE, SIZE, OR COLOR.

SN 77-112,270, FILED 2-21-2007.

ADA HAN, EXAMINING ATTORNEY

Int. Cl.: 9

Prior U.S. Cls.: 21, 23, 26, 36, and 38

Reg. No. 3,477,411

United States Patent and Trademark Office

Registered July 29, 2008

**TRADEMARK
PRINCIPAL REGISTER**

ITW

ILLINOIS TOOL WORKS INC. (DELAWARE
CORPORATION)
3600 WEST LAKE AVENUE
GLENVIEW, IL 60026

FOR: ELECTRIC CONNECTORS, IN CLASS 9 (U.S.
CLS. 21, 23, 26, 36 AND 38).

FIRST USE 11-0-1997; IN COMMERCE 11-0-1997.

THE MARK CONSISTS OF STANDARD CHAR-
ACTERS WITHOUT CLAIM TO ANY PARTICULAR
FONT, STYLE, SIZE, OR COLOR.

OWNER OF U.S. REG. NOS. 2,624,665, 3,162,173,
AND OTHERS.

SN 77-112,723, FILED 2-21-2007.

TEJBIR SINGH, EXAMINING ATTORNEY

Int. Cl.: 25

Prior U.S. Cls.: 22 and 39

United States Patent and Trademark Office

Reg. No. 3,477,412

Registered July 29, 2008

**TRADEMARK
PRINCIPAL REGISTER**

Yogachik

WILLIAMS, JANET (UNITED STATES INDIVIDUAL)
839 CRESCENT DRIVE
GLEN ELLYN, IL 60137

THE MARK CONSISTS OF STANDARD CHARACTERS WITHOUT CLAIM TO ANY PARTICULAR FONT, STYLE, SIZE, OR COLOR.

FOR: JACKETS; PANTS; SHORTS; SLEEPWEAR; T-SHIRTS, IN CLASS 25 (U.S. CLS. 22 AND 39).

SN 77-112,960, FILED 2-21-2007.

FIRST USE 11-18-2007; IN COMMERCE 11-18-2007.

ADA HAN, EXAMINING ATTORNEY

Int. Cl.: 9

Prior U.S. Cls.: 21, 23, 26, 36, and 38

United States Patent and Trademark Office

Reg. No. 3,477,413

Registered July 29, 2008

**TRADEMARK
PRINCIPAL REGISTER**

PROVERGENT

DIGITAL FAIRWAY CORPORATION (CANADA CORPORATION)
170 ATTWELL DRIVE
TORONTO, ONTARIO, CANADA M9W5Z5

FOR: SOFTWARE FOR USE IN PLANNING, DESIGNING, PROVISIONING, ORDERING, TRACKING, ALLOCATING, SERVICING, AND FOR MANAGING OPERATIONS, INVENTORY, TIME AND COST EFFICIENCY WITH RESPECT TO VOICE AND DATA CIRCUITS, VOICE AND VIDEO SERVICES, WIRELESS AND MOBILE COMMUNICATIONS DEVICES AND SERVICES, AND

NETWORK EQUIPMENT MANAGEMENT, IN CLASS 9 (U.S. CLS. 21, 23, 26, 36 AND 38).

FIRST USE 6-30-2007; IN COMMERCE 12-31-2007.

THE MARK CONSISTS OF STANDARD CHARACTERS WITHOUT CLAIM TO ANY PARTICULAR FONT, STYLE, SIZE, OR COLOR.

SN 77-113,262, FILED 2-22-2007.

RON FAIRBANKS, EXAMINING ATTORNEY

Int. Cl.: 41

Prior U.S. Cls.: 100, 101, and 107

United States Patent and Trademark Office

Reg. No. 3,477,414

Registered July 29, 2008

**SERVICE MARK
PRINCIPAL REGISTER**

WOMEN FRIENDLY

PASSI, DELIA P. (UNITED STATES INDIVIDUAL)
2029 TAFT STREET
HOLLYWOOD, FL 33020

FOR: WORKSHOPS AND SEMINARS IN THE FIELD OF SALES TRAINING, IN CLASS 41 (U.S. CLS. 100, 101 AND 107).

FIRST USE 5-9-2008; IN COMMERCE 5-9-2008.

THE MARK CONSISTS OF STANDARD CHARACTERS WITHOUT CLAIM TO ANY PARTICULAR FONT, STYLE, SIZE, OR COLOR.

NO CLAIM IS MADE TO THE EXCLUSIVE RIGHT TO USE "WOMEN", APART FROM THE MARK AS SHOWN.

SN 77-113,273, FILED 2-22-2007.

CHERYL CLAYTON, EXAMINING ATTORNEY

Int. Cl.: 17

Prior U.S. Cls.: 1, 5, 12, 13, 35, and 50

United States Patent and Trademark Office

Reg. No. 3,477,415

Registered July 29, 2008

**TRADEMARK
PRINCIPAL REGISTER**

HOUSEMATES

PLASTIC SPECIALTIES AND TECHNOLOGIES,
INC. (DELAWARE CORPORATION)
201 INDUSTRIAL PARKWAY
SOMERVILLE, NJ 08876

THE MARK CONSISTS OF STANDARD CHAR-
ACTERS WITHOUT CLAIM TO ANY PARTICULAR
FONT, STYLE, SIZE, OR COLOR.

FOR: GARDEN HOSES, IN CLASS 17 (U.S. CLS. 1,
5, 12, 13, 35 AND 50).

SN 77-113,564, FILED 2-22-2007.

FIRST USE 11-8-2007; IN COMMERCE 11-8-2007.

INGA ERVIN, EXAMINING ATTORNEY

Int. Cl.: 17

Prior U.S. Cls.: 1, 5, 12, 13, 35, and 50

United States Patent and Trademark Office

Reg. No. 3,477,416

Registered July 29, 2008

**TRADEMARK
PRINCIPAL REGISTER**

AERO-TUBE

PLASTIC SPECIALTIES AND TECHNOLOGIES,
INC. (DELAWARE CORPORATION)
201 INDUSTRIAL PARKWAY
SOMERVILLE, NJ 08876

THE MARK CONSISTS OF STANDARD CHAR-
ACTERS WITHOUT CLAIM TO ANY PARTICULAR
FONT, STYLE, SIZE, OR COLOR.

FOR: RUBBER TUBES USED IN WATER AERA-
TION EQUIPMENT, IN CLASS 17 (U.S. CLS. 1, 5, 12,
13, 35 AND 50).

SN 77-113,570, FILED 2-22-2007.

FIRST USE 10-1-2007; IN COMMERCE 10-1-2007.

INGA ERVIN, EXAMINING ATTORNEY

Int. Cl.: 17

Prior U.S. Cls.: 1, 5, 12, 13, 35, and 50

Reg. No. 3,477,417

United States Patent and Trademark Office

Registered July 29, 2008

**TRADEMARK
PRINCIPAL REGISTER**

DURAFLOW

PLASTIC SPECIALTIES AND TECHNOLOGIES,
INC. (DELAWARE CORPORATION)
201 INDUSTRIAL PARKWAY
SOMERVILLE, NJ 08876

THE MARK CONSISTS OF STANDARD CHAR-
ACTERS WITHOUT CLAIM TO ANY PARTICULAR
FONT, STYLE, SIZE, OR COLOR.

FOR: GARDEN HOSES, IN CLASS 17 (U.S. CLS. 1,
5, 12, 13, 35 AND 50).

SN 77-113,577, FILED 2-22-2007.

FIRST USE 10-25-2007; IN COMMERCE 10-25-2007.

INGA ERVIN, EXAMINING ATTORNEY

Int. Cl.: 19

Prior U.S. Cls.: 1, 12, 33, and 50

United States Patent and Trademark Office

Reg. No. 3,477,418

Registered July 29, 2008

**TRADEMARK
PRINCIPAL REGISTER**

WEEDBLOCK NATURAL

EASY GARDENER PRODUCTS, INC. (DELA-
WARE CORPORATION)
3022 FRANKLIN AVENUE
WACO, TX 76710

FOR: GEOTEXTILES, NAMELY, FABRIC MADE
OF A BIODEGRADABLE POLYMER FOR LAND-
SCAPING, IN CLASS 19 (U.S. CLS. 1, 12, 33 AND 50).

FIRST USE 5-1-2007; IN COMMERCE 5-1-2007.

THE MARK CONSISTS OF STANDARD CHAR-
ACTERS WITHOUT CLAIM TO ANY PARTICULAR
FONT, STYLE, SIZE, OR COLOR.

OWNER OF U.S. REG. NOS. 1,408,576, 3,218,131,
AND OTHERS.

NO CLAIM IS MADE TO THE EXCLUSIVE
RIGHT TO USE "NATURAL", APART FROM THE
MARK AS SHOWN.

SEC. 2(F).

SN 77-113,648, FILED 2-22-2007.

BARBARA GAYNOR, EXAMINING ATTORNEY

Int. Cl.: 9

Prior U.S. Cls.: 21, 23, 26, 36, and 38

United States Patent and Trademark Office

Reg. No. 3,477,419

Registered July 29, 2008

**TRADEMARK
PRINCIPAL REGISTER**

RAPID Z

CARL ZEISS OPTICAL, INCORPORATED (DELA-
WARE CORPORATION)
13005 NORTH KINGSTON AVENUE
CHESTER, VA 23836

THE MARK CONSISTS OF STANDARD CHAR-
ACTERS WITHOUT CLAIM TO ANY PARTICULAR
FONT, STYLE, SIZE, OR COLOR.

FOR: RIFLE SCOPES AND SPOTTING SCOPES, IN
CLASS 9 (U.S. CLS. 21, 23, 26, 36 AND 38).

SN 77-114,455, FILED 2-23-2007.

FIRST USE 6-0-2007; IN COMMERCE 6-0-2007.

JUSTINE D. PARKER, EXAMINING ATTORNEY

Int. Cls.: 9, 16, and 41

**Prior U.S. Cls.: 2, 5, 21, 22, 23, 26, 29, 36, 37, 38, 50,
100, 101, and 107**

Reg. No. 3,477,420

United States Patent and Trademark Office

Registered July 29, 2008

**TRADEMARK
SERVICE MARK
PRINCIPAL REGISTER**

GROUNDSPARK

GROUNDSPARK (CALIFORNIA NON-PROFIT CORPORATION)
2180 BRYANT STREET, SUITE 203
SAN FRANCISCO, CA 94110

FOR: PRE-RECORDED DVDS AND VIDEO TAPES FEATURING DOCUMENTARIES, SOCIAL AND POLITICAL TOPICS, AND EDUCATIONAL MATERIAL IN THE FIELDS OF SOCIAL JUSTICE, ENVIRONMENT, RACE, ETHNICITY, GENDER, SEXUAL ORIENTATION, VIOLENCE, DIVERSITY; VISUAL RECORDINGS AND AUDIO VISUAL RECORDINGS FEATURING DOCUMENTARIES, SOCIAL AND POLITICAL TOPICS, EDUCATIONAL MATERIAL IN THE FIELDS OF SOCIAL JUSTICE, ENVIRONMENT, RACE, ETHNICITY, GENDER, SEXUAL ORIENTATION, VIOLENCE, DIVERSITY; VISUAL RECORDINGS AND AUDIO VISUAL RECORDINGS FEATURING DOCUMENTARIES, SOCIAL AND POLITICAL TOPICS, EDUCATIONAL MATERIAL IN THE FIELDS OF SOCIAL JUSTICE, ENVIRONMENT, RACE, ETHNICITY, GENDER, SEXUAL ORIENTATION, VIOLENCE, AND DIVERSITY, ALL DOWNLOADABLE VIA THE INTERNET, IN CLASS 9 (U.S. CLS. 21, 23, 26, 36 AND 38).

FIRST USE 3-6-2008; IN COMMERCE 3-6-2008.

FOR: PRINTED GUIDES FOR TEACHING AND DISCUSSION OF FILMS, DOCUMENTARIES, SOCIAL AND POLITICAL TOPICS, AND SOCIAL JUSTICE ISSUES; PRINTED GUIDES FEATURING

SAMPLE LESSON PLANS, FREQUENTLY ASKED QUESTIONS, DISCUSSION STARTERS; PRINTED INSTRUCTIONAL, EDUCATIONAL, AND TEACHING MATERIALS IN THE FIELDS OF SOCIAL JUSTICE, SOCIAL AND POLITICAL TOPICS, ENVIRONMENT, RACE, ETHNICITY, GENDER, SEXUAL ORIENTATION, VIOLENCE, DIVERSITY, AND FILM AS A MEDIUM FOR SOCIAL CHANGE, IN CLASS 16 (U.S. CLS. 2, 5, 22, 23, 29, 37, 38 AND 50).

FIRST USE 2-28-2008; IN COMMERCE 2-28-2008.

FOR: PRODUCTION AND DISTRIBUTION OF MOTION PICTURES; EDUCATIONAL SERVICES, NAMELY, CONDUCTING WORKSHOPS, CONFERENCES, LECTURES IN THE FIELD OF EDUCATION AND SOCIAL CHANGE THROUGH FILMS, AND DISTRIBUTION OF COURSE MATERIAL IN CONNECTION THEREWITH, IN CLASS 41 (U.S. CLS. 100, 101 AND 107).

FIRST USE 10-1-2007; IN COMMERCE 10-1-2007.

THE MARK CONSISTS OF STANDARD CHARACTERS WITHOUT CLAIM TO ANY PARTICULAR FONT, STYLE, SIZE, OR COLOR.

SN 77-114,861, FILED 2-23-2007.

SANJEEV VOHRA, EXAMINING ATTORNEY

Int. Cl.: 3

Prior U.S. Cls.: 1, 4, 6, 50, 51, and 52

United States Patent and Trademark Office

Reg. No. 3,477,421

Registered July 29, 2008

**TRADEMARK
PRINCIPAL REGISTER**

ColorLife Technology

CHRISTAL, DEAN V. (UNITED STATES INDIVIDUAL)
498 FREEHAVEN DRIVE
SANTA BARBARA, CA 93108

FOR: HAIR CARE PREPARATIONS, COLOR TREATMENT PRODUCTS, NAMELY, SHAMPOOS, CONDITIONERS, HAIR GELS, HAIR CREAMS AND LOTIONS, HAIR SPRAYS, HAIR MOUSSES, HAIR TONICS, NON-MEDICATED SKIN CARE PREPARATIONS, NAMELY, SKIN CLEANSER, SKIN MOISTURIZER, SKIN CREAM, SKIN LOTION; COSMETICS, NAMELY, FACIAL MAKE-UP, FOUNDATION MAKE-UP, EYE MAKE-UP, EYE CREAM, EYE SHADOW, CHEEK BLUSH, MAKE-UP REMOVER, LIPSTICK, LIP GLOSS, LIP BALM, BODY LOTION, BATH SOAP, BATH OILS, ESSENTIAL

OILS FOR PERSONAL USE, MASSAGE OILS, AROMATHERAPY OILS, PERFUME, COLOGNE, TOILET WATER, INCENSE, LIQUID SOAPS FOR HANDS, FACE AND BODY, IN CLASS 3 (U.S. CLS. 1, 4, 6, 50, 51 AND 52).

FIRST USE 5-15-2008; IN COMMERCE 5-15-2008.

THE MARK CONSISTS OF STANDARD CHARACTERS WITHOUT CLAIM TO ANY PARTICULAR FONT, STYLE, SIZE, OR COLOR.

SN 77-114,916, FILED 2-23-2007.

RONALD MCMORROW, EXAMINING ATTORNEY

Int. Cl.: 25

Prior U.S. Cls.: 22 and 39

United States Patent and Trademark Office

Reg. No. 3,477,422

Registered July 29, 2008

TRADEMARK
PRINCIPAL REGISTER



JENKINS, JIMMY (UNITED STATES INDIVIDUAL)
APT. F2
1025 ST. JOHNS PL.
BROOKLYN, NY 11213

FIRST USE 8-25-2006; IN COMMERCE 8-30-2006.

THE MARK CONSISTS OF THE WORDING "JIM-JIM" IN STYLIZED LETTERS.

FOR: BELTS; BLOUSES; COATS; DRESSES; GLOVES; HATS; INFANT AND TODDLER ONE PIECE CLOTHING; JACKETS; PANTS; SCARVES; SHIRTS; SHOES; SHORTS; SOCKS; SWEAT SHIRTS; SWEATERS; UNDERGARMENTS, IN CLASS 25 (U.S. CLS. 22 AND 39).

SN 77-115,285, FILED 2-23-2007.

SONYA STEPHENS, EXAMINING ATTORNEY

Int. Cl.: 9

Prior U.S. Cls.: 21, 23, 26, 36, and 38

Reg. No. 3,477,423

United States Patent and Trademark Office

Registered July 29, 2008

**TRADEMARK
PRINCIPAL REGISTER**

VSIP

VIALOGY LLC (DELAWARE LTD LIAB CO)
2400 LINCOLN AVENUE
ALTADENA, CA 91001

FIRST USE 5-31-2006; IN COMMERCE 5-31-2006.

FOR: NETWORK-CENTRIC SOFTWARE AND
HARDWARE FOR INTEROPERATION BETWEEN
SENSING, SIGNAGE AND CONTROL DEVICES
ATTACHED TO A NETWORK; EMBEDDED SOFT-
WARE OR FIRMWARE FOR IMPLEMENTING IN-
TEROPERABILITY FRAMEWORKS, IN CLASS 9
(U.S. CLS. 21, 23, 26, 36 AND 38).

THE MARK CONSISTS OF STANDARD CHAR-
ACTERS WITHOUT CLAIM TO ANY PARTICULAR
FONT, STYLE, SIZE, OR COLOR.

SN 77-115,675, FILED 2-25-2007.

CHARLES L. JENKINS, EXAMINING ATTORNEY

Int. Cl.: 36

Prior U.S. Cls.: 100, 101, and 102

United States Patent and Trademark Office

Reg. No. 3,477,424

Registered July 29, 2008

**SERVICE MARK
PRINCIPAL REGISTER**

IT'S TIME TO EXPECT MORE

REGIONS ASSET COMPANY (DELAWARE COR-
PORATION)
SUITE 209
3501 SILVERSIDE ROAD
WILMINGTON, DE 19810

FOR: BANKING SERVICES, IN CLASS 36 (U.S.
CLS. 100, 101 AND 102).

FIRST USE 4-19-2007; IN COMMERCE 4-19-2007.

THE MARK CONSISTS OF STANDARD CHAR-
ACTERS WITHOUT CLAIM TO ANY PARTICULAR
FONT, STYLE, SIZE, OR COLOR.

SN 77-115,979, FILED 2-26-2007.

LINDA LAVACHE, EXAMINING ATTORNEY

Int. Cl.: 14

Prior U.S. Cls.: 2, 27, 28, and 50

United States Patent and Trademark Office

Reg. No. 3,477,425

Registered July 29, 2008

**TRADEMARK
PRINCIPAL REGISTER**

TAMALON

ALTAM STYLEWORKS, INC. (NEW YORK COR-
PORATION)

#138

487 EAST MAIN STREET
MOUNT KISCO, NY 10549

FOR: JEWELRY, IN CLASS 14 (U.S. CLS. 2, 27, 28
AND 50).

FIRST USE 2-1-2008; IN COMMERCE 2-1-2008.

THE MARK CONSISTS OF STANDARD CHAR-
ACTERS WITHOUT CLAIM TO ANY PARTICULAR
FONT, STYLE, SIZE, OR COLOR.

OWNER OF U.S. REG. NO. 3,050,258.

SN 77-116,397, FILED 2-26-2007.

GEORGE LORENZO, EXAMINING ATTORNEY

Int. Cl.: 14

Prior U.S. Cls.: 2, 27, 28, and 50

United States Patent and Trademark Office

Reg. No. 3,477,426

Registered July 29, 2008

**TRADEMARK
PRINCIPAL REGISTER**

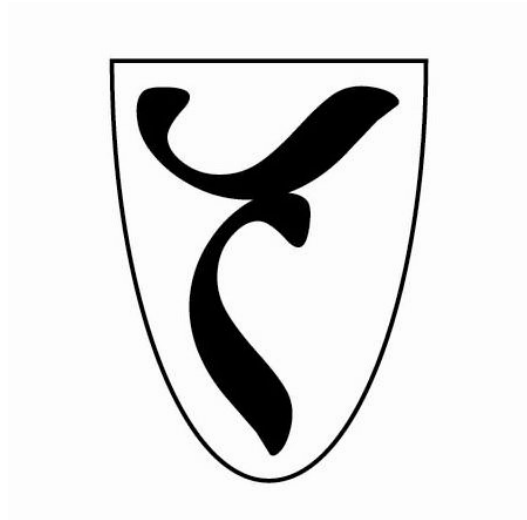

ALTAM STYLEWORKS, INC. (NEW YORK CORPORATION)
487 EAST MAIN STREET
138
MOUNT KISCO, NY 10549

THE MARK CONSISTS OF IMAGE CONSISTS OF A CREST WITH A DESIGN OF TWO WAVY LINES INSIDE.

FOR: JEWELRY, IN CLASS 14 (U.S. CLS. 2, 27, 28 AND 50).

SN 77-116,410, FILED 2-26-2007.

FIRST USE 2-1-2008; IN COMMERCE 2-1-2008.

GEORGE LORENZO, EXAMINING ATTORNEY

Int. Cl.: 16

Prior U.S. Cls.: 2, 5, 22, 23, 29, 37, 38, and 50

United States Patent and Trademark Office

Reg. No. 3,477,427

Registered July 29, 2008

**TRADEMARK
PRINCIPAL REGISTER**

CAREGIVING MADE EASY

ACCESSIBLE PRODUCTS, LLC (DELAWARE
LTD LIAB CO)
UNIT 503A
7900 OLD YORK RD.
ELKINS PARK, PA 190272341

THE MARK CONSISTS OF STANDARD CHAR-
ACTERS WITHOUT CLAIM TO ANY PARTICULAR
FONT, STYLE, SIZE, OR COLOR.

FOR: PRINTED CARDS FEATURING MEDICAL
AND HEALTH CARE INFORMATION, IN CLASS 16
(U.S. CLS. 2, 5, 22, 23, 29, 37, 38 AND 50).

SN 77-117,674, FILED 2-27-2007.

FIRST USE 5-15-2008; IN COMMERCE 5-15-2008.

ERIN FALK, EXAMINING ATTORNEY

Int. Cls.: 9 and 42

Prior U.S. Cls.: 21, 23, 26, 36, 38, 100, and 101

United States Patent and Trademark Office

Reg. No. 3,477,428

Registered July 29, 2008

**TRADEMARK
SERVICE MARK
PRINCIPAL REGISTER**

**Building Applications at
the Speed of Thought**

TENFOLD CORPORATION (DELAWARE CORPORATION)
698 WEST 10000 SOUTH, SUITE 200
SOUTH JORDAN, UT 84095

FOR: COMPUTER SOFTWARE AND MANUALS SOLD AS A UNIT FOR APPLICATIONS DEVELOPMENT; COMPUTER SOFTWARE FOR USE IN SEARCHING, GATHERING, ORGANIZING, MANIPULATING OR DISPLAYING DATA FROM DATABASES; COMPUTER SOFTWARE FOR USE IN SEARCHING, GATHERING, ORGANIZING, MANIPULATING OR DISPLAYING INFORMATION OR FOR ENABLING OR FACILITATING TRANSACTIONS IN THE FIELDS OF FINANCE, INSURANCE, PUBLIC UTILITIES, MANUFACTURING, ACCOUNTING, PHARMACEUTICALS, CUSTOMER INFORMATION OR CUSTOMER RESOURCES, IN CLASS 9 (U.S. CLS. 21, 23, 26, 36 AND 38).

FIRST USE 1-7-2007; IN COMMERCE 1-7-2007.

FOR: COMPUTER SOFTWARE DESIGN FOR OTHERS; COMPUTER CONSULTATION, IN CLASS 42 (U.S. CLS. 100 AND 101).

FIRST USE 1-7-2007; IN COMMERCE 1-7-2007.

THE MARK CONSISTS OF STANDARD CHARACTERS WITHOUT CLAIM TO ANY PARTICULAR FONT, STYLE, SIZE, OR COLOR.

SN 77-117,677, FILED 2-27-2007.

ERIN FALK, EXAMINING ATTORNEY

Int. Cl.: 29

Prior U.S. Cl.: 46

United States Patent and Trademark Office

Reg. No. 3,477,429

Registered July 29, 2008

**TRADEMARK
PRINCIPAL REGISTER**

STEAMBOAT JACK'S

JTM PROVISIONS COMPANY, INC. (OHIO CORPORATION)
200 SALES DRIVE
HARRISON, OH 45030

THE MARK CONSISTS OF STANDARD CHARACTERS WITHOUT CLAIM TO ANY PARTICULAR FONT, STYLE, SIZE, OR COLOR.

FOR: PRE-MADE, FULLY COOKED BARBECUE MEATS, IN CLASS 29 (U.S. CL. 46).

SN 77-118,651, FILED 2-28-2007.

FIRST USE 5-4-2007; IN COMMERCE 5-4-2007.

SOPHIA S. KIM, EXAMINING ATTORNEY

Int. Cl.: 28

Prior U.S. Cls.: 22, 23, 38, and 50

United States Patent and Trademark Office

Reg. No. 3,477,430

Registered July 29, 2008

**TRADEMARK
PRINCIPAL REGISTER**

Out of Your Mind

FRANKLIN LEARNING SYSTEMS, INC. (CON-
NECTICUT CORPORATION)
325 POST ROAD WEST
WESTPORT, CT 06880

THE MARK CONSISTS OF STANDARD CHAR-
ACTERS WITHOUT CLAIM TO ANY PARTICULAR
FONT, STYLE, SIZE, OR COLOR.

FOR: BOARD GAMES, IN CLASS 28 (U.S. CLS. 22,
23, 38 AND 50).

SN 77-118,682, FILED 2-28-2007.

FIRST USE 2-19-2008; IN COMMERCE 5-20-2008.

LA TONIA FISHER, EXAMINING ATTORNEY

Int. Cl.: 36

Prior U.S. Cls.: 100, 101, and 102

United States Patent and Trademark Office

Reg. No. 3,477,431

Registered July 29, 2008

**SERVICE MARK
PRINCIPAL REGISTER**

**IT'S NOT MAGIC IT'S JUST
MATH**

CMG FINANCIAL SERVICES, INC. (CALIFORNIA CORPORATION)
SUITE 350
3160 CROW CANYON ROAD
SAN RAMON, CA 94583

THE MARK CONSISTS OF STANDARD CHARACTERS WITHOUT CLAIM TO ANY PARTICULAR FONT, STYLE, SIZE, OR COLOR.

FOR: PROVIDING HOME EQUITY LOANS FEATURING A LINE OF CREDIT, IN CLASS 36 (U.S. CLS. 100, 101 AND 102).

SN 77-118,931, FILED 2-28-2007.

FIRST USE 8-1-2005; IN COMMERCE 8-1-2005.

RON FAIRBANKS, EXAMINING ATTORNEY

Int. Cl.: 34

Prior U.S. Cls.: 2, 8, 9, and 17

United States Patent and Trademark Office

Reg. No. 3,477,432

Registered July 29, 2008

**TRADEMARK
PRINCIPAL REGISTER**

KNOCKOFF

GOLDMAN, ALEX (UNITED STATES INDIVIDUAL)
P.O. BOX 6030
SOMERSET, NJ 088756030

THE MARK CONSISTS OF STANDARD CHARACTERS WITHOUT CLAIM TO ANY PARTICULAR FONT, STYLE, SIZE, OR COLOR.

FOR: CIGARS, IN CLASS 34 (U.S. CLS. 2, 8, 9 AND 17).

SN 77-119,428, FILED 3-1-2007.

FIRST USE 6-10-2008; IN COMMERCE 6-10-2008.

SETH A. RAPPAPORT, EXAMINING ATTORNEY

Int. Cls.: 40 and 42

Prior U.S. Cls.: 100, 101, 103, and 106

United States Patent and Trademark Office

Reg. No. 3,477,433

Registered July 29, 2008

**SERVICE MARK
PRINCIPAL REGISTER**

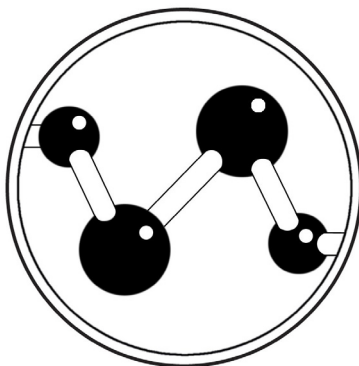

ALBANY MOLECULAR RESEARCH, INC. (DE-
LAWARE CORPORATION)
21 CORPORATE CIRCLE, P.O. BOX 15098
ALBANY, NY 12212

FOR: CUSTOM MANUFACTURE OF PHARMA-
CEUTICALS AND CHEMICALS, IN CLASS 40 (U.S.
CLS. 100, 103 AND 106).

FIRST USE 5-1-2007; IN COMMERCE 5-1-2007.

FOR: RESEARCH AND DEVELOPMENT AND
CONSULTATION RELATED THERETO IN THE

FIELD OF PHARMACEUTICALS AND CHEMI-
CALS, IN CLASS 42 (U.S. CLS. 100 AND 101).

FIRST USE 5-1-2007; IN COMMERCE 5-1-2007.

THE MARK CONSISTS OF A CIRCLE CONTAIN-
ING FOUR SPHERES CONNECTED WITH BARS,
REMINISCENT OF ATOMS IN A MOLECULE.

SN 77-119,587, FILED 3-1-2007.

CAROLYN CATALDO, EXAMINING ATTORNEY

Int. Cl.: 3

Prior U.S. Cls.: 1, 4, 6, 50, 51, and 52

United States Patent and Trademark Office

Reg. No. 3,477,434

Registered July 29, 2008

**TRADEMARK
PRINCIPAL REGISTER**

ULTRA PROCARE

RECKITT BENCKISER INC. (DELAWARE CORPORATION)
399 INTERPACE PARKWAY
PARSIPPANY, NJ 07054

FOR: BLEACHING PREPARATIONS AND OTHER SUBSTANCES FOR LAUNDRY USE AND DISHWASHING; LAUNDRY PREPARATIONS, NAMELY, LAUNDRY BLEACH AND LAUNDRY DETERGENT; LAUNDRY PREPARATIONS FOR DRY CLEANERS, NAMELY, LAUNDRY FLUIDS; POLISHING PREPARATIONS FOR KITCHEN AND GLASSWARE; GENERAL PURPOSE CLEANING, POLISHING, SCOURING AND ABRASIVE PREPARATIONS; CARPET CLEANERS; SHAMPOOS; DISHWASHING DETERGENTS; SOAPS; DECALCI-FYING AND DESCALING PREPARATIONS FOR HOUSEHOLD PURPOSES; FABRIC SOFTENERS; LAUNDRY ADDITIVES, NAMELY, LAUNDRY

BLUEING, LAUNDRY PRE-SOAK AND WATER SOFTENERS; STAIN REMOVING PREPARATIONS; ALL AFOREMENTIONED GOODS WITH OR WITHOUT A DISINFECTIVE COMPONENT, IN CLASS 3 (U.S. CLS. 1, 4, 6, 50, 51 AND 52).

FIRST USE 12-3-2007; IN COMMERCE 12-7-2007.

THE MARK CONSISTS OF STANDARD CHARACTERS WITHOUT CLAIM TO ANY PARTICULAR FONT, STYLE, SIZE, OR COLOR.

OWNER OF U.S. REG. NO. 3,220,487.

SN 77-119,664, FILED 3-1-2007.

JENNY PARK, EXAMINING ATTORNEY

Int. Cls.: 16, 18, and 28

Prior U.S. Cls.: 1, 2, 3, 5, 22, 23, 29, 37, 38, 41, and 50

United States Patent and Trademark Office

Reg. No. 3,477,435

Registered July 29, 2008

**TRADEMARK
PRINCIPAL REGISTER**

STERLING PEAR

J&H CONCEPTS, INC. (NEW YORK CORPORATION)
1838 2ND AVENUE
SUITE 245
NEW YORK, NY 10128

FOR: CHRISTMAS TREE ORNAMENT KITS COMPRISED PRIMARILY OF BOXES FOR ORNAMENT STORAGE, MADE OF HEAVY CARDBOARD COVERED WITH PAPER ON WHICH ARTWORK IS REPRODUCED, IN CLASS 16 (U.S. CLS. 2, 5, 22, 23, 29, 37, 38 AND 50).

FIRST USE 12-1-2007; IN COMMERCE 12-1-2007.

FOR: CHRISTMAS TREE ORNAMENT KITS COMPRISED PRIMARILY OF BOXES FOR ORNAMENT STORAGE, MADE OF LEATHER AND IMITATION LEATHER, ON WHICH ARTWORK IS REPRODUCED, IN CLASS 18 (U.S. CLS. 1, 2, 3, 22 AND 41).

FIRST USE 12-1-2007; IN COMMERCE 12-1-2007.

FOR: CHRISTMAS TREE ORNAMENTS AND CHRISTMAS TREE ORNAMENT KITS CONTAINING ORNAMENTS, STOCKINGS, TREE SKIRTS, AND HANGING HARDWARE, ALL IN VARIOUS HOLIDAY THEMES, IN CLASS 28 (U.S. CLS. 22, 23, 38 AND 50).

FIRST USE 12-1-2007; IN COMMERCE 12-1-2007.

THE MARK CONSISTS OF STANDARD CHARACTERS WITHOUT CLAIM TO ANY PARTICULAR FONT, STYLE, SIZE, OR COLOR.

SN 77-119,678, FILED 3-1-2007.

KIMBERLY FRYE, EXAMINING ATTORNEY

Int. Cl.: 35

Prior U.S. Cls.: 100, 101, and 102

United States Patent and Trademark Office

Reg. No. 3,477,436

Registered July 29, 2008

**SERVICE MARK
PRINCIPAL REGISTER**

ChatThreads

CARL, WALTER J. (UNITED STATES INDIVIDUAL)
238 HUMPHREY STREET
MARBLEHEAD, MA 01945

FOR: CONDUCTING MARKETING RESEARCH BY MEANS OF TRACKING HOW CONVERSATIONS ABOUT COMPANIES, BRANDS, PRODUCTS, AND SERVICES SPREAD FROM ONE PERSON TO ANOTHER, IN CLASS 35 (U.S. CLS. 100, 101 AND 102).

FIRST USE 11-1-2007; IN COMMERCE 11-1-2007.

THE MARK CONSISTS OF STANDARD CHARACTERS WITHOUT CLAIM TO ANY PARTICULAR FONT, STYLE, SIZE, OR COLOR.

SN 77-119,706, FILED 3-1-2007.

ANDREA HACK, EXAMINING ATTORNEY

Int. Cl.: 45

Prior U.S. Cls.: 100 and 101

United States Patent and Trademark Office

Reg. No. 3,477,437

Registered July 29, 2008

**SERVICE MARK
PRINCIPAL REGISTER**

YOUR BUSINESS ADVANTAGE

RUDNITSKY & HACKMAN, LLP (PENNSYLVANIA LIMITED LIABILITY PARTNERSHIP)

1372 N. SUSQUEHANNA TRAIL, SUITE 130

SELINGROVE, PA 17870

FOR: LEGAL SERVICES, IN CLASS 45 (U.S. CLS. 100 AND 101).

FIRST USE 4-17-2007; IN COMMERCE 4-17-2007.

THE MARK CONSISTS OF STANDARD CHARACTERS WITHOUT CLAIM TO ANY PARTICULAR FONT, STYLE, SIZE, OR COLOR.

NO CLAIM IS MADE TO THE EXCLUSIVE RIGHT TO USE "BUSINESS", APART FROM THE MARK AS SHOWN.

SN 77-120,589, FILED 3-2-2007.

JORDAN BAKER, EXAMINING ATTORNEY

Int. Cls.: 9 and 41

Prior U.S. Cls.: 21, 23, 26, 36, 38, 100, 101, and 107

United States Patent and Trademark Office

Reg. No. 3,477,438

Registered July 29, 2008

TRADEMARK
SERVICE MARK
PRINCIPAL REGISTER

employaid

Your lifeline at work.

EMPLOYAID, INC. (CONNECTICUT CORPORATION)
54 DANBURY ROAD #306
RIDGEFIELD, CT 06877

FOR: DOWNLOADABLE PODCASTS FEATURING COURSES, SEMINARS AND WORKSHOPS IN THE FIELD OF EMPLOYEE COMMUNICATION SKILLS VIA THE INTERNET AND WIRELESS DEVICES, IN CLASS 9 (U.S. CLS. 21, 23, 26, 36 AND 38).

FIRST USE 5-1-2007; IN COMMERCE 3-5-2008.

FOR: EDUCATION SERVICES, NAMELY, PROVIDING CLASSES, SEMINARS, WORKSHOPS, CONFERENCES IN THE FIELD OF COMMUNICATION SKILLS; EDUCATIONAL SERVICES, NAMELY, CONDUCTING CLASSES, SEMINARS, CONFERENCES, WORKSHOPS IN THE FIELD OF COMMUNI-

CATION SKILLS; PROVIDING ON-LINE TRAINING CONFERENCES, COURSES, SEMINARS, WORKSHOPS IN THE FIELD OF COMMUNICATION SKILLS; TRAINING SERVICES IN THE FIELD OF COMMUNICATION SKILLS, IN CLASS 41 (U.S. CLS. 100, 101 AND 107).

FIRST USE 5-1-2007; IN COMMERCE 3-5-2008.

THE MARK CONSISTS OF STYLIZED TEXT OF THE WORDING "EMPLOYAID YOUR LIFELINE AT WORK." THE STIPPLING IN THE DRAWING IS FOR SHADING PURPOSES ONLY.

SN 77-120,687, FILED 3-2-2007.

ELLEN PERKINS, EXAMINING ATTORNEY

Int. Cl.: 16

Prior U.S. Cls.: 2, 5, 22, 23, 29, 37, 38, and 50

United States Patent and Trademark Office

Reg. No. 3,477,439

Registered July 29, 2008

**TRADEMARK
PRINCIPAL REGISTER**

Stretch your imagination

INVENTOR'S WORKSHOP, LLC (DELAWARE
LTD LIAB CO)
141 PARKER STREET, SUITE 202
MAYNARD, MA 01754

FOR: RUBBER BANDS, IN CLASS 16 (U.S. CLS. 2,
5, 22, 23, 29, 37, 38 AND 50).

FIRST USE 4-1-2007; IN COMMERCE 4-1-2007.

THE MARK CONSISTS OF STANDARD CHAR-
ACTERS WITHOUT CLAIM TO ANY PARTICULAR
FONT, STYLE, SIZE, OR COLOR.

SN 77-121,066, FILED 3-2-2007.

JANICE L. MCMORROW, EXAMINING ATTOR-
NEY

Int. Cl.: 9

Prior U.S. Cls.: 21, 23, 26, 36, and 38

Reg. No. 3,477,440

United States Patent and Trademark Office

Registered July 29, 2008

**TRADEMARK
PRINCIPAL REGISTER**

SELLINGEDGE

OUTSTART, INC. (DELAWARE CORPORATION)
745 ATLANTIC AVENUE
BOSTON, MA 02111

FOR: COMPUTER SOFTWARE FOR USE IN POSTING, CAPTURING, SEARCHING AND DELIVERING INFORMATION, FOR ALLOWING IDENTIFICATION OF KNOWLEDGE EXPERTS AND FOR FACILITATING COMMUNICATION AND COLLABORATION, FOR USE BY SALES PROFESSIONALS TO MORE EFFECTIVELY SERVICE CLI-

ENTS AND PROSPECTIVE CLIENTS, IN CLASS 9 (U.S. CLS. 21, 23, 26, 36 AND 38).

FIRST USE 3-5-2008; IN COMMERCE 3-5-2008.

THE MARK CONSISTS OF STANDARD CHARACTERS WITHOUT CLAIM TO ANY PARTICULAR FONT, STYLE, SIZE, OR COLOR.

SN 77-121,175, FILED 3-2-2007.

TINA L. SNAPP, EXAMINING ATTORNEY

Int. Cls.: 9, 16, and 41

**Prior U.S. Cls.: 2, 5, 21, 22, 23, 26, 29, 36, 37, 38, 50,
100, 101, and 107**

Reg. No. 3,477,441

United States Patent and Trademark Office

Registered July 29, 2008

**TRADEMARK
SERVICE MARK
PRINCIPAL REGISTER**

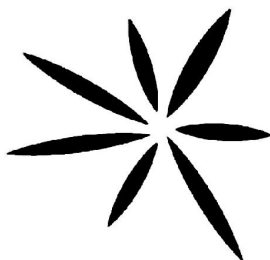

GROUNDSPARK

GROUNDSPARK (CALIFORNIA NON-PROFIT CORPORATION)
2180 BRYANT STREET, SUITE 203
SAN FRANCISCO, CA 94110

FOR: PRE-RECORDED DVDS AND VIDEO TAPES FEATURING DOCUMENTARIES, SOCIAL AND POLITICAL TOPICS, AND EDUCATIONAL MATERIAL IN THE FIELDS OF SOCIAL JUSTICE, ENVIRONMENT, RACE, ETHNICITY, GENDER, SEXUAL ORIENTATION, VIOLENCE, DIVERSITY; VISUAL RECORDINGS AND AUDIO VISUAL RECORDINGS FEATURING DOCUMENTARIES, SOCIAL AND POLITICAL TOPICS, EDUCATIONAL MATERIAL IN THE FIELDS OF SOCIAL JUSTICE, ENVIRONMENT, RACE, ETHNICITY, GENDER, SEXUAL ORIENTATION, VIOLENCE, DIVERSITY; VISUAL RECORDINGS AND AUDIO VISUAL RECORDINGS FEATURING DOCUMENTARIES, SOCIAL AND POLITICAL TOPICS, EDUCATIONAL MATERIAL IN THE FIELDS OF SOCIAL JUSTICE, ENVIRONMENT, RACE, ETHNICITY, GENDER, SEXUAL ORIENTATION, VIOLENCE, AND DIVERSITY, ALL DOWNLOADABLE VIA THE INTERNET, IN CLASS 9 (U.S. CLS. 21, 23, 26, 36 AND 38).

FIRST USE 3-6-2008; IN COMMERCE 3-6-2008.

FOR: PRINTED GUIDES FOR TEACHING AND DISCUSSION OF FILMS, DOCUMENTARIES, SOCIAL AND POLITICAL TOPICS, AND SOCIAL JUSTICE ISSUES; PRINTED GUIDES FEATURING

SAMPLE LESSON PLANS, FREQUENTLY ASKED QUESTIONS, DISCUSSION STARTERS; PRINTED INSTRUCTIONAL, EDUCATIONAL, AND TEACHING MATERIALS IN THE FIELDS OF SOCIAL JUSTICE, SOCIAL AND POLITICAL TOPICS, ENVIRONMENT, RACE, ETHNICITY, GENDER, SEXUAL ORIENTATION, VIOLENCE, DIVERSITY, AND FILM AS A MEDIUM FOR SOCIAL CHANGE, IN CLASS 16 (U.S. CLS. 2, 5, 22, 23, 29, 37, 38 AND 50).

FIRST USE 2-8-2008; IN COMMERCE 2-8-2008.

FOR: PRODUCTION AND DISTRIBUTION OF MOTION PICTURES; EDUCATIONAL SERVICES, NAMELY, CONDUCTING WORKSHOPS, CONFERENCES, LECTURES IN THE FIELD OF EDUCATION AND SOCIAL CHANGE THROUGH FILMS, AND DISTRIBUTION OF COURSE MATERIAL IN CONNECTION THEREWITH, IN CLASS 41 (U.S. CLS. 100, 101 AND 107).

FIRST USE 10-1-2007; IN COMMERCE 10-1-2007.

THE MARK CONSISTS OF THE WORD "GROUNDSPARK" AND A STYLIZED DESIGN OF A SEVEN-RAYED FIRE, FLAME OR SPARK.

SN 77-121,511, FILED 3-2-2007.

SANJEEV VOHRA, EXAMINING ATTORNEY

Int. Cls.: 9, 16, and 41

**Prior U.S. Cls.: 2, 5, 21, 22, 23, 26, 29, 36, 37, 38, 50,
100, 101, and 107**

Reg. No. 3,477,442

United States Patent and Trademark Office

Registered July 29, 2008

**TRADEMARK
SERVICE MARK
PRINCIPAL REGISTER**

**IGNITING CHANGE THROUGH
FILM**

GROUNDSPARK (CALIFORNIA NON-PROFIT CORPORATION)
2180 BRYANT STREET, SUITE 203
SAN FRANCISCO, CA 94110

FOR: PRE-RECORDED DVDS, VIDEO TAPES, FEATURING DOCUMENTARIES, SOCIAL AND POLITICAL TOPICS, AND EDUCATIONAL MATERIAL IN THE FIELDS OF SOCIAL JUSTICE, ENVIRONMENT, RACE, ETHNICITY, GENDER, SEXUAL ORIENTATION, VIOLENCE, DIVERSITY; VISUAL RECORDINGS AND AUDIO VISUAL RECORDINGS FEATURING DOCUMENTARIES, SOCIAL AND POLITICAL TOPICS, EDUCATIONAL MATERIAL IN THE FIELDS OF SOCIAL JUSTICE, ENVIRONMENT, RACE, ETHNICITY, GENDER, SEXUAL ORIENTATION, VIOLENCE, DIVERSITY; VISUAL RECORDINGS AND AUDIO VISUAL RECORDINGS FEATURING DOCUMENTARIES, SOCIAL AND POLITICAL TOPICS, EDUCATIONAL MATERIAL IN THE FIELDS OF SOCIAL JUSTICE, ENVIRONMENT, RACE, ETHNICITY, GENDER, SEXUAL ORIENTATION, VIOLENCE, AND DIVERSITY, ALL DOWNLOADABLE VIA THE INTERNET, IN CLASS 9 (U.S. CLS. 21, 23, 26, 36 AND 38).

FIRST USE 3-8-2008; IN COMMERCE 3-8-2008.

FOR: PRINTED GUIDES FOR TEACHING AND DISCUSSION OF FILMS, DOCUMENTARIES, SOCIAL AND POLITICAL TOPICS, AND SOCIAL JUSTICE ISSUES; PRINTED GUIDES FEATURING

SAMPLE LESSON PLANS, FREQUENTLY ASKED QUESTIONS, DISCUSSION STARTERS; PRINTED INSTRUCTIONAL, EDUCATIONAL, AND TEACHING MATERIALS IN THE FIELDS OF SOCIAL JUSTICE, SOCIAL AND POLITICAL TOPICS, ENVIRONMENT, RACE, ETHNICITY, GENDER, SEXUAL ORIENTATION, VIOLENCE, DIVERSITY, AND FILM AS A MEDIUM FOR SOCIAL CHANGE, IN CLASS 16 (U.S. CLS. 2, 5, 22, 23, 29, 37, 38 AND 50).

FIRST USE 2-8-2008; IN COMMERCE 2-8-2008.

FOR: PRODUCTION AND DISTRIBUTION OF MOTION PICTURES; EDUCATIONAL SERVICES, NAMELY, CONDUCTING WORKSHOPS, CONFERENCES, LECTURES IN THE FIELD OF EDUCATION AND SOCIAL CHANGE THROUGH FILMS, AND DISTRIBUTION OF COURSE MATERIAL IN CONNECTION THEREWITH, IN CLASS 41 (U.S. CLS. 100, 101 AND 107).

FIRST USE 10-1-2007; IN COMMERCE 10-1-2007.

THE MARK CONSISTS OF STANDARD CHARACTERS WITHOUT CLAIM TO ANY PARTICULAR FONT, STYLE, SIZE, OR COLOR.

SN 77-121,519, FILED 3-2-2007.

SANJEEV VOHRA, EXAMINING ATTORNEY

Int. Cl.: 35

Prior U.S. Cls.: 100, 101, and 102

United States Patent and Trademark Office

Reg. No. 3,477,443

Registered July 29, 2008

**SERVICE MARK
PRINCIPAL REGISTER**



MASTERMYND ENTERTAINMENT (UNITED STATES LTD LIAB CO)
8706 RAMSGATE AVENUE, #2
LOS ANGELES, CA 90045

FOR: MANAGEMENT AND BUSINESS CONSULTING SERVICES IN THE FIELD OF ENTERTAINMENT; PERSONAL MANAGEMENT SERVICES FOR ENTERTAINERS, IN CLASS 35 (U.S. CLS. 100, 101 AND 102).

THE MARK CONSISTS OF A DRAWING OF A PERSON WHOSE BODY DEPICTS THE LETTER "M", THE ARMS AND FOREFINGERS POINTING TO THE HEAD WITH THOUGHT SYMBOL TO THE RIGHT OF THE HEAD.

SN 77-121,623, FILED 3-3-2007.

FIRST USE 1-2-2008; IN COMMERCE 1-2-2008.

KAREN BRACEY, EXAMINING ATTORNEY

Int. Cl.: 11

Prior U.S. Cls.: 13, 21, 23, 31, and 34

United States Patent and Trademark Office

Reg. No. 3,477,444

Registered July 29, 2008

**TRADEMARK
PRINCIPAL REGISTER**

THINK OUTSIDE THE BARREL.

CENTRAL BOILER, INC. (MINNESOTA CORPORATION)
20502 160TH STREET
GREENBUSH, MN 56726

THE MARK CONSISTS OF STANDARD CHARACTERS WITHOUT CLAIM TO ANY PARTICULAR FONT, STYLE, SIZE, OR COLOR.

FOR: OUTDOOR WOOD, WOOD PELLET, AND CORN FURNACES, IN CLASS 11 (U.S. CLS. 13, 21, 23, 31 AND 34).

SN 77-121,689, FILED 3-3-2007.

FIRST USE 7-3-2007; IN COMMERCE 7-3-2007.

ROBERT C. CLARK JR., EXAMINING ATTORNEY

Int. Cl.: 31

Prior U.S. Cls.: 1 and 46

United States Patent and Trademark Office

Reg. No. 3,477,445

Registered July 29, 2008

**TRADEMARK
PRINCIPAL REGISTER**



WOOF CANINE CUISINE, INC. (CALIFORNIA CORPORATION)
8424-A SANTA MONICA BLVD., #730
WEST HOLLYWOOD, CA 90069

THE MARK CONSISTS OF A DOG HOUSE WITH "WOOF CHALET" THEREON, AND A DOG AND BOWL IN FRONT OF THE HOUSE.

FOR: PET FOOD, IN CLASS 31 (U.S. CLS. 1 AND 46).

SN 77-122,287, FILED 3-5-2007.

FIRST USE 6-30-2007; IN COMMERCE 11-30-2007.

ELLEN PERKINS, EXAMINING ATTORNEY

Int. Cl.: 36

Prior U.S. Cls.: 100, 101, and 102

United States Patent and Trademark Office

Reg. No. 3,477,446

Registered July 29, 2008

**SERVICE MARK
PRINCIPAL REGISTER**

Personal EDGE

UTICA MUTUAL INSURANCE COMPANY DBA
UTICA NATIONAL INSURANCE GROUP
(NEW YORK CORPORATION)
180 GENESEE STREET
NEW HARTFORD, NY 13413

FOR: PROPERTY AND CASUALTY INSURANCE
UNDERWRITING SERVICES, IN CLASS 36 (U.S.
CLS. 100, 101 AND 102).

FIRST USE 2-0-2007; IN COMMERCE 2-0-2007.

THE MARK CONSISTS OF STANDARD CHAR-
ACTERS WITHOUT CLAIM TO ANY PARTICULAR
FONT, STYLE, SIZE, OR COLOR.

OWNER OF U.S. REG. NO. 1,861,454.

SN 77-122,923, FILED 3-6-2007.

ANDREA BUTLER, EXAMINING ATTORNEY

Int. Cl.: 9

Prior U.S. Cls.: 21, 23, 26, 36, and 38

United States Patent and Trademark Office

Reg. No. 3,477,447

Registered July 29, 2008

**TRADEMARK
PRINCIPAL REGISTER**

Tappinese

TAP & TECHNOLOGY PRODUCTIONS, LLC
(VIRGINIA LTD LIAB CO)
3500 KINGS LAKE DRIVE
VIRGINIA BEACH, VA 23452

THE MARK CONSISTS OF STANDARD CHARACTERS WITHOUT CLAIM TO ANY PARTICULAR FONT, STYLE, SIZE, OR COLOR.

FOR: COMPUTER SOFTWARE FOR SIMPLIFYING THE PROCESS OF CHOREOGRAPHING TAP DANCE ROUTINES, IN CLASS 9 (U.S. CLS. 21, 23, 26, 36 AND 38).

SN 77-123,596, FILED 3-6-2007.

FIRST USE 4-30-2008; IN COMMERCE 5-8-2008.

B. PARADEWELAI, EXAMINING ATTORNEY

Int. Cl.: 9

Prior U.S. Cls.: 21, 23, 26, 36, and 38

United States Patent and Trademark Office

Reg. No. 3,477,448

Registered July 29, 2008

**TRADEMARK
PRINCIPAL REGISTER**

4 Track Mind Records

BRIAN TEEL (UNITED STATES INDIVIDUAL)
442 NAUTILUS ST
LA JOLLA, CA 92037

FOR: MUSICAL SOUND RECORDINGS, IN
CLASS 9 (U.S. CLS. 21, 23, 26, 36 AND 38).

FIRST USE 5-13-2008; IN COMMERCE 5-13-2008.

THE MARK CONSISTS OF STANDARD CHAR-
ACTERS WITHOUT CLAIM TO ANY PARTICULAR
FONT, STYLE, SIZE, OR COLOR.

NO CLAIM IS MADE TO THE EXCLUSIVE
RIGHT TO USE "RECORDS", APART FROM THE
MARK AS SHOWN.

SN 77-123,775, FILED 3-6-2007.

LINDA LAVACHE, EXAMINING ATTORNEY

Int. Cl.: 41

Prior U.S. Cls.: 100, 101, and 107

United States Patent and Trademark Office

Reg. No. 3,477,449

Registered July 29, 2008

**SERVICE MARK
PRINCIPAL REGISTER**

FOCUS

SUNSTONE YOGA, L.L.C. (TEXAS LTD LIAB CO)
2907 ROUTH STREET
DALLAS, TX 75201

THE MARK CONSISTS OF STANDARD CHAR-
ACTERS WITHOUT CLAIM TO ANY PARTICULAR
FONT, STYLE, SIZE, OR COLOR.

FOR: YOGA INSTRUCTION, NAMELY PROVID-
ING INSTRUCTION IN YOGA TO OTHERS USING
MOTIVATIONAL SAYINGS AND WRISTBANDS, IN
CLASS 41 (U.S. CLS. 100, 101 AND 107).

SN 77-124,547, FILED 3-7-2007.

FIRST USE 5-1-2005; IN COMMERCE 5-1-2005.

CAROL SPILS, EXAMINING ATTORNEY

Int. Cl.: 20

Prior U.S. Cls.: 2, 13, 22, 25, 32, and 50

Reg. No. 3,477,450

United States Patent and Trademark Office

Registered July 29, 2008

**TRADEMARK
PRINCIPAL REGISTER**



CLIMACOVER (WASHINGTON CORPORATION)
P O BOX 443
MILTON, WA 98354

FIRST USE 3-1-2008; IN COMMERCE 3-1-2008.

FOR: A FLUID-FILLED VINYL BLADDER AND
RUBBER BLADDERS USED TO HOLD DOWN
TARPS AND OTHER TYPES OF COVERS, IN CLASS
20 (U.S. CLS. 2, 13, 22, 25, 32 AND 50).

SN 77-124,600, FILED 3-7-2007.

BRIDGETT SMITH, EXAMINING ATTORNEY

Int. Cl.: 5

Prior U.S. Cls.: 6, 18, 44, 46, 51, and 52

United States Patent and Trademark Office

Reg. No. 3,477,451

Registered July 29, 2008

**TRADEMARK
PRINCIPAL REGISTER**

ShoreKlear-Plus

ADVANTIS TECHNOLOGIES, INC. (DELAWARE
CORPORATION)
1400 BLUEGRASS LAKES PARKWAY
ALPHARETTA, GA 30004

FOR: AQUATIC HERBICIDE FOR USE ON
EMERGED WEEDS AND BRUSH IN AQUATIC
AND OTHER NONCROP SITES, NAMELY, LAKES,
RIVERS, STREAMS, PONDS, SEEPS, IRRIGATION
AND DRAINAGE DITCHES, CANALS, RESER-
VOIRS, ESTUARIES AND SIMILAR SITES, IN
CLASS 5 (U.S. CLS. 6, 18, 44, 46, 51 AND 52).

FIRST USE 2-15-2007; IN COMMERCE 2-15-2007.

THE MARK CONSISTS OF STANDARD CHAR-
ACTERS WITHOUT CLAIM TO ANY PARTICULAR
FONT, STYLE, SIZE, OR COLOR.

SN 77-124,912, FILED 3-7-2007.

TINA L. SNAPP, EXAMINING ATTORNEY

Int. Cl.: 35

Prior U.S. Cls.: 100, 101, and 102

United States Patent and Trademark Office

Reg. No. 3,477,452

Registered July 29, 2008

**SERVICE MARK
PRINCIPAL REGISTER**



TWENTIETH CENTURY FOX FILM CORPORATION (DELAWARE CORPORATION)
10201 WEST PICO BOULEVARD
LOS ANGELES, CA 90035

FIRST USE 9-21-2007; IN COMMERCE 9-21-2007.

SN 77-125,059, FILED 3-7-2007.

FOR: EMPLOYMENT HIRING, RECRUITING, PLACEMENT, STAFFING AND RETENTION SERVICES, IN CLASS 35 (U.S. CLS. 100, 101 AND 102).

LA TONIA FISHER, EXAMINING ATTORNEY

Int. Cl.: 24

Prior U.S. Cls.: 42 and 50

United States Patent and Trademark Office

Reg. No. 3,477,453

Registered July 29, 2008

**TRADEMARK
PRINCIPAL REGISTER**

LIFE2

KAMRIN-BALFOUR, LORI (UNITED STATES
INDIVIDUAL)

#81

3020 ISSAQUAH-PINE LAKE ROAD
SAMMAMISH, WA 98075

THE MARK CONSISTS OF STANDARD CHAR-
ACTERS WITHOUT CLAIM TO ANY PARTICULAR
FONT, STYLE, SIZE, OR COLOR.

FOR: KITS COMPRISED OF FABRICS FOR MAK-
ING BLANKETS OR CLOTHING FOR MEN, WO-
MEN AND CHILDREN, IN CLASS 24 (U.S. CLS. 42
AND 50).

SN 77-125,069, FILED 3-7-2007.

FIRST USE 9-10-2007; IN COMMERCE 11-28-2007.

NORA BUCHANAN WILL, EXAMINING ATTOR-
NEY

Int. Cls.: 39 and 43

Prior U.S. Cls.: 100, 101, and 105

United States Patent and Trademark Office

Reg. No. 3,477,454

Registered July 29, 2008

**SERVICE MARK
PRINCIPAL REGISTER**

RAIL▶EUROPE

RAIL EUROPE GROUP, INC. (DELAWARE CORPORATION)
WESTCHESTER ONE, 44 SOUTH BROADWAY
WHITE PLAINS, NY 10601

FOR: TRAVEL AGENCY SERVICES, NAMELY, MAKING RESERVATIONS AND BOOKINGS FOR TRANSPORTATION FEATURING RAIL TRANSPORTATION IN EUROPE, IN CLASS 39 (U.S. CLS. 100 AND 105).

FIRST USE 11-7-2007; IN COMMERCE 11-7-2007.

FOR: TRAVEL AGENCY SERVICES, NAMELY, MAKING RESERVATIONS AND BOOKINGS FOR TEMPORARY LODGING FEATURING TEMPORARY LODGING IN EUROPE, IN CLASS 43 (U.S. CLS. 100 AND 101).

FIRST USE 11-7-2007; IN COMMERCE 11-7-2007.

OWNER OF U.S. REG. NO. 2,519,565.

THE COLOR(S) PURPLE, RED AND BLUE IS/ARE CLAIMED AS A FEATURE OF THE MARK.

THE COLOR BLUE APPEARS IN THE TRIANGLE IN BETWEEN THE WORDS "RAIL" AND "EUROPE." THE COLOR PURPLE APPEARS IN THE WORD "RAIL" AND FADES INTO THE COLOR RED, WHICH BEGINS TO APPEAR IN THE WORD "EUROPE."

SN 77-125,248, FILED 3-8-2007.

TASHIA BUNCH, EXAMINING ATTORNEY

Int. Cl.: 38

Prior U.S. Cls.: 100, 101, and 104

United States Patent and Trademark Office

Reg. No. 3,477,455

Registered July 29, 2008

**SERVICE MARK
PRINCIPAL REGISTER**

TILEFILE

TILEFILE LIMITED (AUSTRALIA PUBLIC COMPANY, LIMITED BY SHARES)
SUITE 601, 282 OXFORD STREET
BONDI JUNCTION
NSW 2022, AUSTRALIA

FOR: TELECOMMUNICATION SERVICES, NAMELY, PROVIDING THE TRANSMISSION OF INFORMATION VIA COMMUNICATION NETWORKS AND CONVERGED NETWORKS; PROVIDING TELECOMMUNICATION SERVICES BY LINKING, ACCESSING, DISSEMINATING, COMMUNICATING AND SHARING INFORMATION VIA A GLOBAL COMMUNICATIONS NETWORK; VOICE OVER INTERNET PROTOCOL (VOIP) COM-

MUNICATION SERVICES, NAMELY, FIXED, WIRELESS AND MOBILE PHONE VOIP SERVICES, IN CLASS 38 (U.S. CLS. 100, 101 AND 104).

FIRST USE 9-1-2004; IN COMMERCE 10-26-2006.

THE MARK CONSISTS OF STANDARD CHARACTERS WITHOUT CLAIM TO ANY PARTICULAR FONT, STYLE, SIZE, OR COLOR.

SN 77-125,337, FILED 3-8-2007.

LINDA ESTRADA, EXAMINING ATTORNEY

Int. Cls.: 29 and 30

Prior U.S. Cl.: 46

United States Patent and Trademark Office

Reg. No. 3,477,456

Registered July 29, 2008

**TRADEMARK
PRINCIPAL REGISTER**

INTRODUCTIONS

MAPLE LEAF TECHNOLOGIES, INC. (DELA-
WARE CORPORATION)
SUITE 202
103 FOULK ROAD
WILMINGTON, DE 19803

FOR: POULTRY PRODUCTS, NAMELY, DUCK
TENDERLOINS AND BREADED DUCK TENDERS,
IN CLASS 29 (U.S. CL. 46).

FIRST USE 4-14-2008; IN COMMERCE 4-14-2008.

FOR: DUCK AND CHICKEN QUESADILLAS,
POT STICKERS AND SPRING ROLLS, IN CLASS 30
(U.S. CL. 46).

FIRST USE 4-14-2008; IN COMMERCE 4-14-2008.

THE MARK CONSISTS OF STANDARD CHAR-
ACTERS WITHOUT CLAIM TO ANY PARTICULAR
FONT, STYLE, SIZE, OR COLOR.

SN 77-125,365, FILED 3-8-2007.

JANICE L. MCMORROW, EXAMINING ATTOR-
NEY

Int. Cl.: 29

Prior U.S. Cl.: 46

United States Patent and Trademark Office

Reg. No. 3,477,457

Registered July 29, 2008

**TRADEMARK
PRINCIPAL REGISTER**

FEEL THE FIZZ

YOPLAIT MARQUES INTERNATIONALES
(FRANCE CORPORATION)
170 BIS, BOULEVARD DU MONTPARNASSE
PARIS, FRANCE 75014

THE MARK CONSISTS OF STANDARD CHAR-
ACTERS WITHOUT CLAIM TO ANY PARTICULAR
FONT, STYLE, SIZE, OR COLOR.

FOR: DAIRY PRODUCTS EXCLUDING ICE
MILK, ICE CREAM AND FROZEN YOGURT, IN
CLASS 29 (U.S. CL. 46).

SN 77-125,659, FILED 3-8-2007.

FIRST USE 5-2-2008; IN COMMERCE 5-2-2008.

GIANCARLO CASTRO, EXAMINING ATTORNEY

Int. Cl.: 41

Prior U.S. Cls.: 100, 101, and 107

United States Patent and Trademark Office

Reg. No. 3,477,458

Registered July 29, 2008

**SERVICE MARK
PRINCIPAL REGISTER**

BETTER STEPS

JTM PROVISIONS COMPANY, INC. (OHIO CORPORATION)
200 SALES DRIVE
HARRISON, OH 45030

FOR: EDUCATIONAL SERVICES, NAMELY, CONDUCTING PROGRAMS IN THE FIELD OF HEALTHY EATING AND NUTRITION, AND PRINTED MATERIALS DISTRIBUTED IN CONNECTION THEREWITH, IN CLASS 41 (U.S. CLS. 100, 101 AND 107).

FIRST USE 5-4-2007; IN COMMERCE 5-4-2007.

THE MARK CONSISTS OF STANDARD CHARACTERS WITHOUT CLAIM TO ANY PARTICULAR FONT, STYLE, SIZE, OR COLOR.

SN 77-125,722, FILED 3-8-2007.

SOPHIA S. KIM, EXAMINING ATTORNEY

Int. Cl.: 21

Prior U.S. Cls.: 2, 13, 23, 29, 30, 33, 40, and 50

United States Patent and Trademark Office

Reg. No. 3,477,459

Registered July 29, 2008

**TRADEMARK
PRINCIPAL REGISTER**

SERENA'S PARTY BOUTIQUE

CASTILLO, SOCORRO (UNITED STATES INDIVIDUAL)
10 OVERLOOK AVE.
HAVERHILL, MA 01832

FOR: PARTY FAVORS COMPRISED OF CERAMIC FIGURINES, RIBBONS AND FABRICS, FOR WEDDINGS, BRIDAL SHOWERS AND BABY SHOWERS, IN CLASS 21 (U.S. CLS. 2, 13, 23, 29, 30, 33, 40 AND 50).

FIRST USE 4-1-2007; IN COMMERCE 4-1-2007.

THE MARK CONSISTS OF STANDARD CHARACTERS WITHOUT CLAIM TO ANY PARTICULAR FONT, STYLE, SIZE, OR COLOR.

NO CLAIM IS MADE TO THE EXCLUSIVE RIGHT TO USE "PARTY BOUTIQUE", APART FROM THE MARK AS SHOWN.

SN 77-125,915, FILED 3-8-2007.

CHARLOTTE CORWIN, EXAMINING ATTORNEY

Int. Cl.: 42

Prior U.S. Cls.: 100 and 101

United States Patent and Trademark Office

Reg. No. 3,477,460

Registered July 29, 2008

**SERVICE MARK
PRINCIPAL REGISTER**



PALEO WORLD RESEARCH FOUNDATION
(VIRGINIA NON-PROFIT CORPORATION)
8665 SUDLEY ROAD #230
MANASSAS PARK, VA 20110

FOR: SCIENTIFIC RESEARCH IN THE FIELD OF
PALEONTOLOGY, IN CLASS 42 (U.S. CLS. 100 AND
101).

FIRST USE 6-1-2001; IN COMMERCE 6-1-2001.

NO CLAIM IS MADE TO THE EXCLUSIVE
RIGHT TO USE "RESEARCH FOUNDATION"
AND "DINOSAUR EXPEDITIONS", APART FROM
THE MARK AS SHOWN.

THE COLOR(S) BLACK AND BROWN IS/ARE
CLAIMED AS A FEATURE OF THE MARK.

THE COLOR BLACK APPEARS IN THE DESIGN
OF THE TRICERATOPS HEAD; THE COLOR
BROWN APPEARS IN THE TERMS "PALEO-
WORLD RESEARCH FOUNDATION" AND "DINO-
SAUR EXPEDITIONS"; THE BACKGROUND OF
THE MARK IS TRANSLUCENT.

SN 77-126,329, FILED 3-8-2007.

JIM RINGLE, EXAMINING ATTORNEY

Int. Cl.: 41

Prior U.S. Cls.: 100, 101, and 107

United States Patent and Trademark Office

Reg. No. 3,477,461

Registered July 29, 2008

**SERVICE MARK
PRINCIPAL REGISTER**

**THE GREAT SOUTHEAST
BALLOON FEST**

ANDERSON COUNTY, SOUTH CAROLINA
(SOUTH CAROLINA BODY POLITIC AND
CORPORATE)

ROOM 217
101 S. MAIN ST.
ANDERSON, SC 29621

FOR: ENTERTAINMENT SERVICES, NAME-
LY LIVE PERFORMANCES BY MUSICAL BANDS;
ORGANIZING EXHIBITIONS FOR ENTERTAIN-
MENT PURPOSES, NAMELY COMMUNITY FESTI-
VALS AND ART EXHIBITIONS; ORGANIZING
COMMUNITY FESTIVALS FEATURING A VARI-
ETY OF ACTIVITIES, NAMELY SPORTING
EVENTS, ART EXHIBITIONS, FLEA MARKETS,

ETHNIC DANCES AND THE LIKE, IN CLASS 41
(U.S. CLS. 100, 101 AND 107).

FIRST USE 4-1-2007; IN COMMERCE 4-1-2007.

THE MARK CONSISTS OF STANDARD CHAR-
ACTERS WITHOUT CLAIM TO ANY PARTICULAR
FONT, STYLE, SIZE, OR COLOR.

NO CLAIM IS MADE TO THE EXCLUSIVE
RIGHT TO USE SOUTHEAST BALLOON FEST ,
APART FROM THE MARK AS SHOWN.

SN 77-126,529, FILED 3-9-2007.

EMILY CARLSEN, EXAMINING ATTORNEY

Int. Cl.: 7

Prior U.S. Cls.: 13, 19, 21, 23, 31, 34, and 35

Reg. No. 3,477,462

United States Patent and Trademark Office

Registered July 29, 2008

**TRADEMARK
PRINCIPAL REGISTER**



BBB INDUSTRIES, LLC (DELAWARE LTD LIAB
CO)
5640 COMMERCE BOULEVARD EAST
MOBILE, AL 36619

NO CLAIM IS MADE TO THE EXCLUSIVE
RIGHT TO USE "INDUSTRIES", APART FROM
THE MARK AS SHOWN.

FOR: AUTOMOBILE AND TRUCK PARTS,
NAMELY, STARTERS, ALTERNATORS AND COM-
PONENTS THEREFOR, IN CLASS 7 (U.S. CLS. 13, 19,
21, 23, 31, 34 AND 35).

SN 77-126,625, FILED 3-9-2007.

FIRST USE 4-5-2008; IN COMMERCE 4-8-2008.

LINDSEY RUBIN, EXAMINING ATTORNEY

Int. Cl.: 25

Prior U.S. Cls.: 22 and 39

United States Patent and Trademark Office

Reg. No. 3,477,463

Registered July 29, 2008

**TRADEMARK
PRINCIPAL REGISTER**

BUSINESS NEVER PERSONAL

BUSINESS NEVER PERSONAL INC. (NEVADA
CORPORATION)
528 BENINE RD.
WESTBURY, NY 11590

FOR: BELTS; DRESSES; HATS; JACKETS; JEANS;
JOGGING SUITS; SPORTS BRA; SWEAT SUITS;
SWEATERS; T-SHIRTS; TANK TOPS; UNDER-
WEAR; WARM UP SUITS, IN CLASS 25 (U.S. CLS.
22 AND 39).

FIRST USE 2-14-2007; IN COMMERCE 8-7-2007.

THE MARK CONSISTS OF STANDARD CHAR-
ACTERS WITHOUT CLAIM TO ANY PARTICULAR
FONT, STYLE, SIZE, OR COLOR.

SN 77-126,641, FILED 3-9-2007.

NELSON SNYDER, EXAMINING ATTORNEY

Int. Cl.: 3

Prior U.S. Cls.: 1, 4, 6, 50, 51, and 52

Reg. No. 3,477,464

United States Patent and Trademark Office

Registered July 29, 2008

TRADEMARK
PRINCIPAL REGISTER

O'Mineral
verde cascada

JAFER LIMITED (BERMUDA CORPORATION)
CLARENDON HOUSE, 2 CHURCH STREET
HAMILTON, BERMUDA HM12

THE FOREIGN WORDING IN THE MARK
TRANSLATES INTO ENGLISH AS GREEN CAS-
CADE.

FOR: TOILET WATER, COLOGNE, FRAGRAN-
CES FOR PERSONAL USE, BODY LOTIONS, IN
CLASS 3 (U.S. CLS. 1, 4, 6, 50, 51 AND 52).

SN 77-127,124, FILED 3-9-2007.

FIRST USE 3-31-2007; IN COMMERCE 5-30-2008.

TIMOTHY FINNEGAN, EXAMINING ATTORNEY

Int. Cl.: 3

Prior U.S. Cls.: 1, 4, 6, 50, 51, and 52

United States Patent and Trademark Office

Reg. No. 3,477,465

Registered July 29, 2008

**TRADEMARK
PRINCIPAL REGISTER**

SENTIVA EXFOLIAGE

JAFER LIMITED (BERMUDA CORPORATION)
CLARENDON HOUSE, 2 CHURCH STREET
HAMILTON, BERMUDA HM12

FOR: EXFOLIATING CREAM, EXFOLIANTS
FOR SKIN, COSMETIC CREAMS, IN CLASS 3 (U.S.
CLS. 1, 4, 6, 50, 51 AND 52).

FIRST USE 1-31-2007; IN COMMERCE 5-15-2008.

THE MARK CONSISTS OF STANDARD CHAR-
ACTERS WITHOUT CLAIM TO ANY PARTICULAR
FONT, STYLE, SIZE, OR COLOR.

NO CLAIM IS MADE TO THE EXCLUSIVE
RIGHT TO USE "EXFOLIAGE", APART FROM
THE MARK AS SHOWN.

SN 77-127,149, FILED 3-9-2007.

TIMOTHY FINNEGAN, EXAMINING ATTORNEY

Int. Cl.: 2

Prior U.S. Cls.: 6, 11, and 16

United States Patent and Trademark Office

Reg. No. 3,477,466

Registered July 29, 2008

**TRADEMARK
PRINCIPAL REGISTER**

HINT-O-TINT

MADISON CHEMICAL INDUSTRIES INC. (CANADA CORPORATION)
490 MCGEACHIE DRIVE
MILTON, ONTARIO, CANADA L9T3Y5

FOR: PIGMENTED COATINGS IN THE NATURE OF PAINT, IN CLASS 2 (U.S. CLS. 6, 11 AND 16).

FIRST USE 4-15-2008; IN COMMERCE 4-15-2008.

THE MARK CONSISTS OF STANDARD CHARACTERS WITHOUT CLAIM TO ANY PARTICULAR FONT, STYLE, SIZE, OR COLOR.

SN 77-127,207, FILED 3-9-2007.

MATTHEW MCDOWELL, EXAMINING ATTORNEY

Int. Cl.: 25

Prior U.S. Cls.: 22 and 39

United States Patent and Trademark Office

Reg. No. 3,477,467

Registered July 29, 2008

**TRADEMARK
PRINCIPAL REGISTER**

CIVIL SOCIETY

URGENT GEAR, INC. (CALIFORNIA CORPORATION)
728 EAST COMMERCIAL STREET
LOS ANGELES, CA 90012

FOR: MEN'S AND WOMEN'S CLOTHING,
NAMELY, SHIRTS, T-SHIRTS, PANTS, SHORTS,
JEANS, HATS, JACKETS, FOOTWEAR AND BELTS,
IN CLASS 25 (U.S. CLS. 22 AND 39).

FIRST USE 5-5-2008; IN COMMERCE 5-8-2008.

THE MARK CONSISTS OF STANDARD CHARACTERS WITHOUT CLAIM TO ANY PARTICULAR FONT, STYLE, SIZE, OR COLOR.

SN 77-127,243, FILED 3-9-2007.

MARGARET POWER, EXAMINING ATTORNEY

Int. Cl.: 9

Prior U.S. Cls.: 21, 23, 26, 36, and 38

Reg. No. 3,477,468

United States Patent and Trademark Office

Registered July 29, 2008

**TRADEMARK
PRINCIPAL REGISTER**



WIRELESS CONTROL NETWORK SOLUTIONS,
L.L.C. (ALABAMA LTD LIAB CO), DBA "SY-
NAPSE",
132 EXPORT CIRCLE
HUNTSVILLE, AL 35806

FIRST USE 5-24-2007; IN COMMERCE 5-24-2007.

SN 77-127,294, FILED 3-9-2007.

FOR: COMPUTER HARDWARE AND SOFT-
WARE FOR WIRELESS COMMUNICATION, IN
CLASS 9 (U.S. CLS. 21, 23, 26, 36 AND 38).

ROBERT LAVACHE, EXAMINING ATTORNEY

Int. Cl.: 25

Prior U.S. Cls.: 22 and 39

United States Patent and Trademark Office

Reg. No. 3,477,469

Registered July 29, 2008

**TRADEMARK
PRINCIPAL REGISTER**



SPA UNIFORMS INC. (CANADA CORPORATION)
1500 - 885 WEST GEORGIA STREET
VANCOUVER, BRITISH COLUMBIA, CANADA
V6C3E8

FIRST USE 4-0-2007; IN COMMERCE 4-0-2007.

SN 77-127,595, FILED 3-9-2007.

FOR: SHOES, SANDALS AND SLIPPERS, IN
CLASS 25 (U.S. CLS. 22 AND 39).

KAREN SEVERSON, EXAMINING ATTORNEY

Int. Cls.: 16 and 25

Prior U.S. Cls.: 2, 5, 22, 23, 29, 37, 38, 39, and 50

United States Patent and Trademark Office

Reg. No. 3,477,470

Registered July 29, 2008

**TRADEMARK
PRINCIPAL REGISTER**

TO THE HUNT

BKB EMBROIDERY LLC (WISCONSIN LTD LIAB
CO)
6077 HWY 60 EAST
HARTFORD, WI 53027

FOR: BUMPER STICKERS; DECALS, IN CLASS 16
(U.S. CLS. 2, 5, 22, 23, 29, 37, 38 AND 50).

FIRST USE 3-1-2008; IN COMMERCE 3-1-2008.

FOR: POLO SHIRTS; HATS; JACKETS; SPORT
SHIRTS, IN CLASS 25 (U.S. CLS. 22 AND 39).

FIRST USE 3-1-2008; IN COMMERCE 3-1-2008.

THE MARK CONSISTS OF STANDARD CHAR-
ACTERS WITHOUT CLAIM TO ANY PARTICULAR
FONT, STYLE, SIZE, OR COLOR.

SN 77-127,766, FILED 3-10-2007.

SAMUEL E. SHARPER JR., EXAMINING ATTOR-
NEY

Int. Cls.: 41 and 42

Prior U.S. Cls.: 100, 101, and 107

United States Patent and Trademark Office

Reg. No. 3,477,471

Registered July 29, 2008

**SERVICE MARK
PRINCIPAL REGISTER**

PRONETOS

LGM LLC (IDAHO LTD LIAB CO)
P.O. BOX 1022
BOISE, ID 83701

FOR: MULTIMEDIA PUBLISHING OF BOOKS, MAGAZINES, JOURNALS, SOFTWARE, GAMES, MUSIC, AND ELECTRONIC PUBLICATIONS, IN CLASS 41 (U.S. CLS. 100, 101 AND 107).

FIRST USE 6-1-2008; IN COMMERCE 6-1-2008.

FOR: COMPUTER SERVICES, NAMELY, CREATING AN ONLINE COMMUNITY FOR REGISTERED USERS TO PARTICIPATE IN COMPETITIONS, SHOWCASE THEIR SKILLS, GET FEEDBACK

FROM THEIR PEERS, FORM VIRTUAL COMMUNITIES, ENGAGE IN SOCIAL NETWORKING AND IMPROVE THEIR TALENT, IN CLASS 42 (U.S. CLS. 100 AND 101).

FIRST USE 8-31-2007; IN COMMERCE 8-31-2007.

THE MARK CONSISTS OF STANDARD CHARACTERS WITHOUT CLAIM TO ANY PARTICULAR FONT, STYLE, SIZE, OR COLOR.

SN 77-128,328, FILED 3-12-2007.

MARILYN IZZI, EXAMINING ATTORNEY

Int. Cl.: 3

Prior U.S. Cls.: 1, 4, 6, 50, 51, and 52

United States Patent and Trademark Office

Reg. No. 3,477,472

Registered July 29, 2008

**TRADEMARK
PRINCIPAL REGISTER**

SPLASHING APPLE TOSS

UNILEVER SUPPLY CHAIN, INC. (DELAWARE
CORPORATION)

1 JOHN STREET

CLINTON, CT 06413

FOR: HAIR SHAMPOO; BODY WASHES, IN
CLASS 3 (U.S. CLS. 1, 4, 6, 50, 51 AND 52).

FIRST USE 1-1-2008; IN COMMERCE 1-1-2008.

THE MARK CONSISTS OF STANDARD CHAR-
ACTERS WITHOUT CLAIM TO ANY PARTICULAR
FONT, STYLE, SIZE, OR COLOR.

NO CLAIM IS MADE TO THE EXCLUSIVE
RIGHT TO USE "APPLE", APART FROM THE
MARK AS SHOWN.

SN 77-128,388, FILED 3-12-2007.

LINDSEY RUBIN, EXAMINING ATTORNEY

Int. Cl.: 36

Prior U.S. Cls.: 100, 101, and 102

United States Patent and Trademark Office

Reg. No. 3,477,473

Registered July 29, 2008

**SERVICE MARK
PRINCIPAL REGISTER**

REDWOODS

THE REDWOODS GROUP, INC. (NORTH CAROLINA CORPORATION)
SUITE 110
2801 SLATER ROAD
MORRISVILLE, NC 27650

FOR: RISK MANAGEMENT SERVICES; INSURANCE UNDERWRITING SERVICES FOR ALL TYPES OF INSURANCE; CLAIMS ADJUSTMENT IN THE FIELD OF INSURANCE, IN CLASS 36 (U.S. CLS. 100, 101 AND 102).

FIRST USE 6-23-2000; IN COMMERCE 4-0-2001.

THE MARK CONSISTS OF STANDARD CHARACTERS WITHOUT CLAIM TO ANY PARTICULAR FONT, STYLE, SIZE, OR COLOR.

SN 77-129,150, FILED 3-13-2007.

EDWARD NELSON, EXAMINING ATTORNEY

Int. Cl.: 5

Prior U.S. Cls.: 6, 18, 44, 46, 51, and 52

Reg. No. 3,477,474

United States Patent and Trademark Office

Registered July 29, 2008

**TRADEMARK
PRINCIPAL REGISTER**

THIN & SLIM ENERGIZER

CHESED DIRECT HOLDINGS LIMITED (BR. VIRGIN ISLANDS CORPORATION)
P.O. BOX 3175, ROAD TOWN
TORTOLA, BR. VIRGIN ISLANDS

THE MARK CONSISTS OF STANDARD CHARACTERS WITHOUT CLAIM TO ANY PARTICULAR FONT, STYLE, SIZE, OR COLOR.

FOR: NUTRITIONAL SUPPLEMENTS, IN CLASS 5 (U.S. CLS. 6, 18, 44, 46, 51 AND 52).

SN 77-129,516, FILED 3-13-2007.

FIRST USE 8-23-2007; IN COMMERCE 8-23-2007.

ALLISON HOLTZ, EXAMINING ATTORNEY

Int. Cl.: 35

Prior U.S. Cls.: 100, 101, and 102

United States Patent and Trademark Office

Reg. No. 3,477,475

Registered July 29, 2008

**SERVICE MARK
PRINCIPAL REGISTER**

Bluedilla

BLUEDILLA, LLC (ARKANSAS LTD LIAB CO)
P.O. BOX 56376
LITTLE ROCK, AR 72215

THE MARK CONSISTS OF STANDARD CHAR-
ACTERS WITHOUT CLAIM TO ANY PARTICULAR
FONT, STYLE, SIZE, OR COLOR.

FOR: PROVIDING A WEB SITE AT WHICH
USERS CAN OFFER GOODS FOR SALE AND BUY
GOODS OFFERED BY OTHERS, IN CLASS 35 (U.S.
CLS. 100, 101 AND 102).

SN 77-129,533, FILED 3-13-2007.

FIRST USE 3-19-2008; IN COMMERCE 3-19-2008.

ALLISON HOLTZ, EXAMINING ATTORNEY

Int. Cl.: 41

Prior U.S. Cls.: 100, 101, and 107

United States Patent and Trademark Office

Reg. No. 3,477,476

Registered July 29, 2008

**SERVICE MARK
PRINCIPAL REGISTER**

CAPTAIN'S CURSE

LIVE NATION MOTOR SPORTS, INC. (TEXAS
CORPORATION)
4255 MERIDIAN PARKWAY
AURORA, IL 60504

THE MARK CONSISTS OF STANDARD CHAR-
ACTERS WITHOUT CLAIM TO ANY PARTICULAR
FONT, STYLE, SIZE, OR COLOR.

FOR: ENTERTAINMENT SERVICES, NAMELY,
PERFORMING AND COMPETING IN MOTOR
SPORTS EVENTS, IN CLASS 41 (U.S. CLS. 100, 101
AND 107).

SN 77-129,563, FILED 3-13-2007.

FIRST USE 3-24-2007; IN COMMERCE 3-24-2007.

ANNE E. GUSTASON, EXAMINING ATTORNEY

Int. Cl.: 21

Prior U.S. Cls.: 2, 13, 23, 29, 30, 33, 40, and 50

United States Patent and Trademark Office

Reg. No. 3,477,477

Registered July 29, 2008

**TRADEMARK
PRINCIPAL REGISTER**

FUN GRIPZ

CONAIR CORPORATION (DELAWARE CORPORATION)
ONE CUMMINGS POINT ROAD
STAMFORD, CT 06902

THE MARK CONSISTS OF STANDARD CHARACTERS WITHOUT CLAIM TO ANY PARTICULAR FONT, STYLE, SIZE, OR COLOR.

FOR: HAIR BRUSHES; HAIR COMBS, IN CLASS 21 (U.S. CLS. 2, 13, 23, 29, 30, 33, 40 AND 50).

SN 77-129,935, FILED 3-13-2007.

FIRST USE 4-0-2007; IN COMMERCE 4-0-2007.

BARBARA BROWN, EXAMINING ATTORNEY

Int. Cl.: 36

Prior U.S. Cls.: 100, 101, and 102

United States Patent and Trademark Office

Reg. No. 3,477,478

Registered July 29, 2008

**SERVICE MARK
PRINCIPAL REGISTER**

nHealth

NHEALTH, INC. (VIRGINIA CORPORATION)
8004 UNIVERSITY DRIVE
RICHMOND, VA 23229

FOR: INSURANCE ADMINISTRATION AND INSURANCE UNDERWRITING IN THE FIELD OF HEALTH CARE INSURANCE; INSURANCE CLAIMS PROCESSING IN THE FIELD OF HEALTH CARE INSURANCE, IN CLASS 36 (U.S. CLS. 100, 101 AND 102).

FIRST USE 1-31-2008; IN COMMERCE 3-17-2008.

THE MARK CONSISTS OF STANDARD CHARACTERS WITHOUT CLAIM TO ANY PARTICULAR FONT, STYLE, SIZE, OR COLOR.

SN 77-130,419, FILED 3-14-2007.

TIMOTHY FINNEGAN, EXAMINING ATTORNEY

Int. Cl.: 35

Prior U.S. Cls.: 100, 101, and 102

United States Patent and Trademark Office

Reg. No. 3,477,479

Registered July 29, 2008

SERVICE MARK
PRINCIPAL REGISTER



BLUEDILLA, LLC (ARKANSAS LTD LIAB CO)
P.O. BOX 56376
LITTLE ROCK, AR 72215

FOR: PROVIDING A WEB SITE AT WHICH
USERS CAN OFFER GOODS FOR SALE AND BUY
GOODS OFFERED BY OTHERS, IN CLASS 35 (U.S.
CLS. 100, 101 AND 102).

FIRST USE 3-19-2008; IN COMMERCE 3-19-2008.

THE COLOR(S) WHITE, LIGHT BLUE, MEDIUM
BLUE, DARK BLUE, YELLOW, AND RED IS/ARE
CLAIMED AS A FEATURE OF THE MARK.

THE MARK CONSISTS OF THE LITERAL ELE-
MENT "BLUEDILLA" AND A BLUE ARMADILLO

WEARING SUNGLASSES. THE COLOR WHITE
APPEARS IN THE WORD "BLUEDILLA" AND
THE ARMADILLO TAIL, FEET, AND NOSE. THE
COLORS LIGHT BLUE, MEDIUM BLUE, AND
DARK BLUE APPEARS IN THE SHADING AND
DETAILS OF THE ARMADILLO, THE SUNGLAS-
SES, AND THE CURVED RECTANGLE. THE COL-
OR DARK BLUE APPEARS IN THE OUTLINE OF
THE CIRCLE AND THE OUTLINE OF THE LET-
TERS. THE COLOR YELLOW APPEARS IN THE
CIRCULAR BACKGROUND. THE COLOR RED
APPEARS IN THE ARMADILLO'S TONGUE.

SN 77-130,584, FILED 3-14-2007.

ALLISON HOLTZ, EXAMINING ATTORNEY

Int. Cl.: 20

Prior U.S. Cls.: 2, 13, 22, 25, 32, and 50

Reg. No. 3,477,480

United States Patent and Trademark Office

Registered July 29, 2008

**TRADEMARK
PRINCIPAL REGISTER**

ON THE WAY

ANNEMARIE DOCKENDORF (UNITED STATES
INDIVIDUAL)
3740 BRENNAN DRIVE
MELBOURNE, FL 32934

THE MARK CONSISTS OF STANDARD CHAR-
ACTERS WITHOUT CLAIM TO ANY PARTICULAR
FONT, STYLE, SIZE, OR COLOR.

FOR: MATERNITY PILLOWS; NURSING PIL-
LOWS; PILLOWS; CRADLES; INFANT CRADLES;
MATS FOR INFANT PLAYPENS, IN CLASS 20 (U.S.
CLS. 2, 13, 22, 25, 32 AND 50).

SN 77-131,107, FILED 3-14-2007.

FIRST USE 3-30-2007; IN COMMERCE 4-14-2007.

MONIQUE MILLER, EXAMINING ATTORNEY

Int. Cl.: 25

Prior U.S. Cls.: 22 and 39

United States Patent and Trademark Office

Reg. No. 3,477,481

Registered July 29, 2008

**TRADEMARK
PRINCIPAL REGISTER**

ANGELS AIR

VICTORIA'S SECRET STORES BRAND MAN-
AGEMENT, INC. (DELAWARE CORPORA-
TION)
FOUR LIMITED PARKWAY
REYNOLDSBURG, OH 43068

THE MARK CONSISTS OF STANDARD CHAR-
ACTERS WITHOUT CLAIM TO ANY PARTICULAR
FONT, STYLE, SIZE, OR COLOR.

FOR: BRAS, IN CLASS 25 (U.S. CLS. 22 AND 39).

SN 77-131,489, FILED 3-15-2007.

FIRST USE 3-27-2007; IN COMMERCE 3-27-2007.

CHRIS WELLS, EXAMINING ATTORNEY

Int. Cl.: 25

Prior U.S. Cls.: 22 and 39

United States Patent and Trademark Office

Reg. No. 3,477,482

Registered July 29, 2008

**TRADEMARK
PRINCIPAL REGISTER**



PRODUCTOS MEXICANOS DON JOSE, INC.
(GEORGIA CORPORATION)
410 CONNECTICUT DR.
TIFTON, GA 317944210

FOR: MEN AND WOMEN JACKETS, COATS, TROUSERS, VESTS MADE AT LEAST SIGNIFICANTLY IN PART OF PIGSKIN; GLOVES MADE AT LEAST SIGNIFICANTLY IN PART OF PIGSKIN; DO RAGS MADE AT LEAST SIGNIFICANTLY IN PART OF PIGSKIN; HATS MADE AT LEAST SIGNIFICANTLY IN PART OF PIGSKIN; CHAPS MADE AT LEAST SIGNIFICANTLY IN PART OF PIGSKIN, IN CLASS 25 (U.S. CLS. 22 AND 39).

FIRST USE 7-26-2007; IN COMMERCE 7-26-2007.

NO CLAIM IS MADE TO THE EXCLUSIVE RIGHT TO USE "HAWG HIDES MOTORCYCLE LEATHER GEAR", APART FROM THE MARK AS SHOWN.

THE MARK CONSISTS OF TWO WILD BOAR RUNNING IN OPPOSITE DIRECTIONS WITH A VEHICLE LICENSE PLATE PARTIALLY COVERING THEIR BODIES. INSIDE THE LICENSE PLATES ARE THE WORDS "HAWG HIDES" IN LARGE LETTERS ACROSS THE MIDDLE, WITH THE WORD "MOTORCYCLE" ABOVE "HAWG HIDES" AND THE WORDS "LEATHER GEAR" BELOW IT.

SN 77-131,814, FILED 3-15-2007.

TASHIA BUNCH, EXAMINING ATTORNEY

Int. Cl.: 42

Prior U.S. Cls.: 100 and 101

United States Patent and Trademark Office

Reg. No. 3,477,483

Registered July 29, 2008

**SERVICE MARK
PRINCIPAL REGISTER**

Safeguard Your Sight

SAFEGUARD YOUR SIGHT, LLC (FLORIDA
LTD LIAB CO)
SAFEGUARD YOUR SIGHT, LLC, PO BOX 3301
TAMPA, FL 33601

FOR: MEDICAL AND SCIENTIFIC RESEARCH
INFORMATION IN THE FIELD OF OCULAR ME-
TRICS AND SURGICAL HISTORY ANALYSIS, IN
CLASS 42 (U.S. CLS. 100 AND 101).

FIRST USE 4-28-2007; IN COMMERCE 8-3-2007.

THE MARK CONSISTS OF STANDARD CHAR-
ACTERS WITHOUT CLAIM TO ANY PARTICULAR
FONT, STYLE, SIZE, OR COLOR.

SN 77-131,835, FILED 3-15-2007.

INGRID C. EULIN, EXAMINING ATTORNEY

Int. Cl.: 35

Prior U.S. Cls.: 100, 101, and 102

United States Patent and Trademark Office

Reg. No. 3,477,484

Registered July 29, 2008

**SERVICE MARK
PRINCIPAL REGISTER**

ZENMARX

ZENMARK BRANDING SERVICES, INCORPORATED (DELAWARE CORPORATION)
25 MAIDEN LANE -SUITE 328
SAN FRANCISCO, CA 94108

FOR: ADVERTISING SERVICES, NAMELY, CREATING AND DEVELOPING NAMES FOR COMPANIES, PRODUCTS, SERVICES AND WEBSITES; STRATEGIC BUSINESS CONSULTATION IN THE FIELDS OF BRANDING, NAMING, MARKETING, ADVERTISING, PROMOTION, SALES AND PUBLIC RELATIONS, IN CLASS 35 (U.S. CLS. 100, 101 AND 102).

FIRST USE 8-0-2007; IN COMMERCE 8-0-2007.

THE MARK CONSISTS OF STANDARD CHARACTERS WITHOUT CLAIM TO ANY PARTICULAR FONT, STYLE, SIZE, OR COLOR.

OWNER OF U.S. REG. NO. 2,501,713.

SN 77-132,300, FILED 3-15-2007.

DAVID MURRAY, EXAMINING ATTORNEY

Int. Cls.: 9, 35, and 39

Prior U.S. Cls.: 21, 23, 26, 36, 38, 100, 101, 102, and 105

Reg. No. 3,477,485

United States Patent and Trademark Office

Registered July 29, 2008

**TRADEMARK
SERVICE MARK
PRINCIPAL REGISTER**



MICROSOFT CORPORATION (WASHINGTON CORPORATION)
ONE MICROSOFT WAY
REDMOND, WA 980526399

FOR: COMPUTER SOFTWARE FOR DOWNLOADING AND INSTALLING OTHER SOFTWARE ON A PERSONAL COMPUTER, AND FOR CREATING BACK-UP COPIES OF THE DOWNLOADED SOFTWARE, IN CLASS 9 (U.S. CLS. 21, 23, 26, 36 AND 38).

FIRST USE 9-13-2005; IN COMMERCE 9-13-2005.

FOR: ONLINE RETAIL STORE SERVICES IN THE FIELD OF SOFTWARE, IN CLASS 35 (U.S. CLS. 100, 101 AND 102).

FIRST USE 9-13-2005; IN COMMERCE 9-13-2005.

FOR: ELECTRONIC STORAGE OF FILES AND DOCUMENTS FOR OTHERS; ELECTRONIC STORAGE OF DOCUMENTS AND FILES, ARCHIVAL

COPIES OF SOFTWARE, SOFTWARE PURCHASE HISTORY, LICENSE INFORMATION AND SOFTWARE USER KEYS, IN CLASS 39 (U.S. CLS. 100 AND 105).

FIRST USE 9-13-2005; IN COMMERCE 9-13-2005.

THE COLOR(S) GREY, GREEN, BLUE, AND WHITE IS/ARE CLAIMED AS A FEATURE OF THE MARK.

THE MARK CONSISTS OF AN IMAGE OF A GREY PADLOCK WITH FOUR PIE-SHAPED QUADRANTS, THE TOP ONE OF WHICH IS GREEN AND THE OTHERS ARE BLUE. THE COLOR WHITE APPEARS AS HIGHLIGHTING ON THE PADLOCK AND PIE-SHAPED QUADRANTS.

SN 77-133,504, FILED 3-16-2007.

MICHAEL TANNER, EXAMINING ATTORNEY

Int. Cl.: 43

Prior U.S. Cls.: 100 and 101

United States Patent and Trademark Office

Reg. No. 3,477,486

Registered July 29, 2008

**SERVICE MARK
PRINCIPAL REGISTER**

YUMBUS

THE YUMBUS COMPANY (ILLINOIS CORPORATION)
P.O. BOX 361
PALATINE, IL 60078

THE MARK CONSISTS OF STANDARD CHARACTERS WITHOUT CLAIM TO ANY PARTICULAR FONT, STYLE, SIZE, OR COLOR.

FOR: CATERING; RESTAURANT SERVICES; FAST FOOD AND NON-STOP RESTAURANT SERVICES; TAKE-OUT RESTAURANT SERVICES, IN CLASS 43 (U.S. CLS. 100 AND 101).

SN 77-134,049, FILED 3-19-2007.

FIRST USE 1-7-2008; IN COMMERCE 1-7-2008.

JANET LEE, EXAMINING ATTORNEY

Int. Cl.: 6

Prior U.S. Cls.: 2, 12, 13, 14, 23, 25, and 50

United States Patent and Trademark Office

Reg. No. 3,477,487

Registered July 29, 2008

**TRADEMARK
PRINCIPAL REGISTER**

BBQ BASICS

HANDI-FOIL CORPORATION (ILLINOIS CORPORATION)
135 E. HINTZ RD.
WHEELING, IL 60090

OWNER OF U.S. REG. NO. 3,181,660.

FOR: ALUMINUM FOIL AND ALUMINUM FOIL PAPER, IN CLASS 6 (U.S. CLS. 2, 12, 13, 14, 23, 25 AND 50).

NO CLAIM IS MADE TO THE EXCLUSIVE RIGHT TO USE "BBQ", APART FROM THE MARK AS SHOWN.

FIRST USE 3-0-2007; IN COMMERCE 3-0-2007.

SN 77-134,131, FILED 3-19-2007.

THE MARK CONSISTS OF STANDARD CHARACTERS WITHOUT CLAIM TO ANY PARTICULAR FONT, STYLE, SIZE, OR COLOR.

JENNIFER MARTIN, EXAMINING ATTORNEY

Int. Cl.: 7

Prior U.S. Cls.: 13, 19, 21, 23, 31, 34, and 35

Reg. No. 3,477,488

United States Patent and Trademark Office

Registered July 29, 2008

**TRADEMARK
PRINCIPAL REGISTER**

MIXSTIR

BELANGER, INC. (MICHIGAN CORPORATION)
1001 DOHENY COURT
NORTHVILLE, MI 48167

FIRST USE 3-22-2007; IN COMMERCE 3-22-2007.

FOR: CAR WASHING INSTALLATIONS COM-
PRISING CONTAINERS, HOSES, VALVES, CON-
NECTORS AND SUPPORT STRUCTURES TO ADD
CHEMICALS TO WATER FOR USE IN CLEANING
VEHICLES IN A CAR WASH , IN CLASS 7 (U.S. CLS.
13, 19, 21, 23, 31, 34 AND 35).

THE MARK CONSISTS OF STANDARD CHAR-
ACTERS WITHOUT CLAIM TO ANY PARTICULAR
FONT, STYLE, SIZE, OR COLOR.

SN 77-134,274, FILED 3-19-2007.

ALLISON HOLTZ, EXAMINING ATTORNEY

Int. Cl.: 14

Prior U.S. Cls.: 2, 27, 28, and 50

United States Patent and Trademark Office

Reg. No. 3,477,489

Registered July 29, 2008

**TRADEMARK
PRINCIPAL REGISTER**

RIGHT CONNECTION

ROMA INDUSTRIES, LLC (NEW YORK LTD
LIAB CO)
12 WEST 37TH STREET
NEW YORK, NY 10018

FOR: JEWELRY, INCLUDING IDENTIFICATION
BRACELETS, IN CLASS 14 (U.S. CLS. 2, 27, 28 AND
50).

FIRST USE 5-0-2007; IN COMMERCE 5-0-2007.

THE MARK CONSISTS OF STANDARD CHAR-
ACTERS WITHOUT CLAIM TO ANY PARTICULAR
FONT, STYLE, SIZE, OR COLOR.

SN 77-134,370, FILED 3-19-2007.

DOMINIC J. FERRAIUOLO, EXAMINING ATTOR-
NEY

Int. Cl.: 9

Prior U.S. Cls.: 21, 23, 26, 36, and 38

United States Patent and Trademark Office

Reg. No. 3,477,490

Registered July 29, 2008

**TRADEMARK
PRINCIPAL REGISTER**

o-trim

CAPELLA MICROSYSTEMS, CORP. (TAIWAN
CORPORATION)
6F-1, NO.43, FUSING ROAD
SINDIAN CITY, TAIPEI COUNTY 231, TAIWAN

FOR: ELECTRIC OR ELECTRONIC HIGH PRECI-
SION SENSOR WITH OPTICAL TRIMMING IN
DIGITAL FORMAT FOR SENSING ELECTROMAG-
NETIC ENERGY HAVING PARTICULAR WAVE-
LENGTHS, IN CLASS 9 (U.S. CLS. 21, 23, 26, 36 AND
38).

FIRST USE 1-1-2007; IN COMMERCE 1-1-2007.

THE MARK CONSISTS OF STANDARD CHAR-
ACTERS WITHOUT CLAIM TO ANY PARTICULAR
FONT, STYLE, SIZE, OR COLOR.

SN 77-134,521, FILED 3-19-2007.

MARGERY A. TIERNEY, EXAMINING ATTORNEY

Int. Cls.: 35, 36, 41, and 42

Prior U.S. Cls.: 100, 101, 102, and 107

United States Patent and Trademark Office

Reg. No. 3,477,491

Registered July 29, 2008

**SERVICE MARK
PRINCIPAL REGISTER**

BUILDING COMMON GROUND

SHANE'S INSPIRATION (CALIFORNIA NON-PROFIT CORPORATION)
15213 BURBANK BOULEVARD
VAN NUYS, CA 91411

FOR: PROMOTING PUBLIC AWARENESS OF THE NEED FOR PLAYGROUNDS ACCESSIBLE TO CHILDREN OF ALL ABILITY LEVELS, IN CLASS 35 (U.S. CLS. 100, 101 AND 102).

FIRST USE 3-1-2007; IN COMMERCE 3-1-2007.

FOR: CHARITABLE FUND RAISING, IN CLASS 36 (U.S. CLS. 100, 101 AND 102).

FIRST USE 3-1-2008; IN COMMERCE 3-1-2008.

FOR: EDUCATIONAL SERVICES, NAMELY, PROVIDING CLASSROOM PRESENTATIONS AND FIELD TRIPS IN THE FIELDS OF INTEGRATION OF CHILDREN OF ALL ABILITY LEVELS IN A UNIVERSALLY ACCESSIBLE PLAYGROUND ENVIRONMENT AND THE FACILITATION OF UN-

DERSTANDING AMONG CHILDREN OF ALL ABILITY LEVELS, IN CLASS 41 (U.S. CLS. 100, 101 AND 107).

FIRST USE 3-1-2008; IN COMMERCE 3-1-2008.

FOR: DESIGN FOR OTHERS IN THE FIELD OF PLAYGROUNDS, PLAYGROUND EQUIPMENT, AND CUSTOM SENSORY FEATURES FOR PLAYGROUNDS CONFIGURED FOR USE BY CHILDREN OF ALL ABILITY LEVELS, IN CLASS 42 (U.S. CLS. 100 AND 101).

FIRST USE 3-1-2007; IN COMMERCE 3-1-2007.

THE MARK CONSISTS OF STANDARD CHARACTERS WITHOUT CLAIM TO ANY PARTICULAR FONT, STYLE, SIZE, OR COLOR.

SN 77-135,005, FILED 3-20-2007.

LA TONIA FISHER, EXAMINING ATTORNEY

Int. Cl.: 10

Prior U.S. Cls.: 26, 39, and 44

United States Patent and Trademark Office

Reg. No. 3,477,492

Registered July 29, 2008

**TRADEMARK
PRINCIPAL REGISTER**

ADJUSTAFLO

SURGIMARK, INC. (WASHINGTON CORPORATION)
3516 WEST WASHINGTON AVENUE
YAKIMA, WA 98903

FOR: SURGICAL ASPIRATORS, SLEEVES FOR SURGICAL ASPIRATORS, AND SURGICAL SUCTION APPARATUS, IN CLASS 10 (U.S. CLS. 26, 39 AND 44).

FIRST USE 3-7-2007; IN COMMERCE 3-7-2007.

THE MARK CONSISTS OF STANDARD CHARACTERS WITHOUT CLAIM TO ANY PARTICULAR FONT, STYLE, SIZE, OR COLOR.

SN 77-135,971, FILED 3-20-2007.

VIVIAN MICZNIK FIRST, EXAMINING ATTORNEY

Int. Cl.: 9

Prior U.S. Cls.: 21, 23, 26, 36, and 38

United States Patent and Trademark Office

Reg. No. 3,477,493

Registered July 29, 2008

**TRADEMARK
PRINCIPAL REGISTER**

PRIMUS AW

DAYMEN PHOTO MARKETING LP (CANADA
LIMITED PARTNERSHIP)
55 VALLEYWOOD DRIVE
MARKHAM, ONTARIO, CANADA L3R 5L9

FOR: BAGS, HARD AND SOFT COVERED CASES,
BACKPACKS, POCKETS AND POUCHES, ALL DE-
SIGNER FOR CARRYING PHOTOGRAPHIC, VI-
DEOGRAPHIC, OPTICAL, AUDIO, AND
ELECTRONIC EQUIPMENT; WAIST HARNESES
AND SHOULDER HARNESES DESIGNED FOR
USE WITH THE FOREGOING GOODS, IN CLASS 9
(U.S. CLS. 21, 23, 26, 36 AND 38).

FIRST USE 12-12-2006; IN COMMERCE 12-12-2006.

THE MARK CONSISTS OF STANDARD CHAR-
ACTERS WITHOUT CLAIM TO ANY PARTICULAR
FONT, STYLE, SIZE, OR COLOR.

SN 77-136,135, FILED 3-21-2007.

APRIL ROACH, EXAMINING ATTORNEY

Int. Cl.: 29

Prior U.S. Cl.: 46

United States Patent and Trademark Office

Reg. No. 3,477,494

Registered July 29, 2008

**TRADEMARK
PRINCIPAL REGISTER**

SMOO DELITE

MM VITAOILS SDN BHD (394937-P) (MALAYSIA
CORPORATION)
LOT 3, PERSIARAN PERUSAHAAN SECTION 23
40300 SHAH ALAM
SELANGOR DARUL EHSAN, MALAYSIA 40300

FOR: BLENDED OIL; COOKING OIL; EDIBLE
OIL; OLIVE OIL; SALAD OIL; VEGETABLE OILS;
VEGETABLE OILS AND FATS; OLIVE OIL; CORN
OIL; MARGARINE; MARGARINE SUBSTITUTES,
IN CLASS 29 (U.S. CL. 46).

FIRST USE 1-19-2008; IN COMMERCE 5-9-2008.

THE MARK CONSISTS OF STANDARD CHAR-
ACTERS WITHOUT CLAIM TO ANY PARTICULAR
FONT, STYLE, SIZE, OR COLOR.

"SMOO" HAS NO MEANING IN A FOREIGN
LANGUAGE.

SN 77-136,153, FILED 3-21-2007.

PAUL E. FAHRENKOPF, EXAMINING ATTORNEY

Int. Cl.: 25

Prior U.S. Cls.: 22 and 39

United States Patent and Trademark Office

Reg. No. 3,477,495

Registered July 29, 2008

**TRADEMARK
PRINCIPAL REGISTER**

CONSOLE

FALCON FOOTWEAR, INC. (NEW YORK CORPORATION)
34 WEST 33RD STREET, 9TH FLOOR
NEW YORK, NY 10001

THE MARK CONSISTS OF STANDARD CHARACTERS WITHOUT CLAIM TO ANY PARTICULAR FONT, STYLE, SIZE, OR COLOR.

FOR: FOOTWEAR, IN CLASS 25 (U.S. CLS. 22 AND 39).

SN 77-136,316, FILED 3-21-2007.

FIRST USE 6-0-2007; IN COMMERCE 6-0-2007.

ANDREA HACK, EXAMINING ATTORNEY

Int. Cl.: 35

Prior U.S. Cls.: 100, 101, and 102

United States Patent and Trademark Office

Reg. No. 3,477,496

Registered July 29, 2008

**SERVICE MARK
PRINCIPAL REGISTER**

Gantt Group

THE GANTT GROUP, INC. (MICHIGAN CORPORATION)
822 DURANT PLACE
ATLANTA, GA 303081610

FOR: BUSINESS CONSULTATION SERVICES, IN CLASS 35 (U.S. CLS. 100, 101 AND 102).

FIRST USE 12-31-2004; IN COMMERCE 12-31-2004.

THE MARK CONSISTS OF STANDARD CHARACTERS WITHOUT CLAIM TO ANY PARTICULAR FONT, STYLE, SIZE, OR COLOR.

OWNER OF U.S. REG. NO. 2,378,357.

NO CLAIM IS MADE TO THE EXCLUSIVE RIGHT TO USE "GROUP", APART FROM THE MARK AS SHOWN.

SN 77-136,467, FILED 3-21-2007.

ROBERT LAVACHE, EXAMINING ATTORNEY

Int. Cl.: 43

Prior U.S. Cls.: 100 and 101

United States Patent and Trademark Office

Reg. No. 3,477,497

Registered July 29, 2008

**SERVICE MARK
PRINCIPAL REGISTER**

**TRAVELSINTASTE.COM THE
REAL DEAL**

LAM ENDEAVORS LTD. (NEW YORK COR-
PORATION)
APT. 37C
330 EAST 75TH STREET
NEW YORK, NY 10021

FOR: PROVIDING A WEB SITE FEATURING
EXTENSIVE INFORMATION FOR RESTAURANT
AND BAR DESTINATIONS, IN CLASS 43 (U.S. CLS.
100 AND 101).

FIRST USE 11-26-2007; IN COMMERCE 11-26-2007.

THE MARK CONSISTS OF STANDARD CHAR-
ACTERS WITHOUT CLAIM TO ANY PARTICULAR
FONT, STYLE, SIZE, OR COLOR.

SN 77-136,645, FILED 3-21-2007.

CHERYL CLAYTON, EXAMINING ATTORNEY

Int. Cl.: 2

Prior U.S. Cls.: 6, 11, and 16

United States Patent and Trademark Office

Reg. No. 3,477,498

Registered July 29, 2008

**TRADEMARK
PRINCIPAL REGISTER**

COOL-TEX

TEXTURED COATINGS OF AMERICA, INC.
(CALIFORNIA CORPORATION)
5950 SOUTH AVALON BOULEVARD
LOS ANGELES, CA 900031384

FOR: SILICATE IMPREGNATED INDOOR AND
OUTDOOR SURFACE NON-SLIP SURFACE COAT-
INGS; PROTECTIVE AND DECORATIVE COAT-
INGS IN THE NATURE OF PAINTS, FINISHINGS,
WATER REPELLANT PAINTS, AND STAINS FOR
INTERIOR AND EXTERIOR APPLICATION ON
RESIDENTIAL, COMMERCIAL, NEW CONSTRUC-

TION AND INDUSTRIAL STRUCTURES, IN CLASS
2 (U.S. CLS. 6, 11 AND 16).

FIRST USE 1-31-2008; IN COMMERCE 1-31-2008.

THE MARK CONSISTS OF STANDARD CHAR-
ACTERS WITHOUT CLAIM TO ANY PARTICULAR
FONT, STYLE, SIZE, OR COLOR.

SN 77-136,887, FILED 3-21-2007.

SETH A. RAPPAPORT, EXAMINING ATTORNEY

Int. Cl.: 10

Prior U.S. Cls.: 26, 39, and 44

United States Patent and Trademark Office

Reg. No. 3,477,499

Registered July 29, 2008

**TRADEMARK
PRINCIPAL REGISTER**

PENTAX I-FLEX

PENTAX OF AMERICA, INC. (DELAWARE COR-
PORATION)
102 CHESTNUT RIDGE ROAD
MONTVALE, NJ 07645

THE MARK CONSISTS OF STANDARD CHAR-
ACTERS WITHOUT CLAIM TO ANY PARTICULAR
FONT, STYLE, SIZE, OR COLOR.

FOR: MEDICAL ENDOSCOPIC EQUIPMENT
AND ENDOSCOPIC INSERTION TUBES, IN CLASS
10 (U.S. CLS. 26, 39 AND 44).

SN 77-136,934, FILED 3-21-2007.

FIRST USE 10-15-2006; IN COMMERCE 5-20-2007.

MARGERY A. TIERNEY, EXAMINING ATTORNEY

Int. Cl.: 7

Prior U.S. Cls.: 13, 19, 21, 23, 31, 34, and 35

Reg. No. 3,477,500

United States Patent and Trademark Office

Registered July 29, 2008

**TRADEMARK
PRINCIPAL REGISTER**

WOODY-VAC

WILLIAM W. MEYER & SONS, INC. (ILLINOIS
CORPORATION)
1700 FRANKLIN BOULEVARD
LIBERTYVILLE, IL 600484407

THE MARK CONSISTS OF STANDARD CHAR-
ACTERS WITHOUT CLAIM TO ANY PARTICULAR
FONT, STYLE, SIZE, OR COLOR.

FOR: VACUUM CLEANERS FOR INDUSTRIAL
PURPOSES, IN CLASS 7 (U.S. CLS. 13, 19, 21, 23, 31, 34
AND 35).

SN 77-137,045, FILED 3-21-2007.

FIRST USE 1-18-2008; IN COMMERCE 1-18-2008.

WENDY JUN, EXAMINING ATTORNEY

Int. Cl.: 36

Prior U.S. Cls.: 100, 101, and 102

United States Patent and Trademark Office

Reg. No. 3,477,501

Registered July 29, 2008

**SERVICE MARK
PRINCIPAL REGISTER**

Step One

MODERN WOODMEN OF AMERICA (ILLINOIS
CORPORATION)
1701 - 1ST AVENUE
ROCK ISLAND, IL 61201

FOR: INSURANCE SERVICES, NAMELY, UN-
DERWRITING, ISSUING AND ADMINISTRATION
OF LIFE INSURANCE, IN CLASS 36 (U.S. CLS. 100,
101 AND 102).

FIRST USE 5-6-2008; IN COMMERCE 5-6-2008.

THE MARK CONSISTS OF STANDARD CHAR-
ACTERS WITHOUT CLAIM TO ANY PARTICULAR
FONT, STYLE, SIZE, OR COLOR.

SN 77-137,352, FILED 3-22-2007.

PAUL E. FAHRENKOPF, EXAMINING ATTORNEY

Int. Cl.: 36

Prior U.S. Cls.: 100, 101, and 102

United States Patent and Trademark Office

Reg. No. 3,477,502

Registered July 29, 2008

**SERVICE MARK
PRINCIPAL REGISTER**

Junior Max

MODERN WOODMEN OF AMERICA (ILLINOIS
CORPORATION)
1701 - 1ST AVENUE
ROCK ISLAND, IL 61201

FOR: INSURANCE SERVICES, NAMELY, UN-
DERWRITING, ISSUING AND ADMINISTRATION
OF LIFE INSURANCE, IN CLASS 36 (U.S. CLS. 100,
101 AND 102).

FIRST USE 5-6-2008; IN COMMERCE 5-6-2008.

THE MARK CONSISTS OF STANDARD CHAR-
ACTERS WITHOUT CLAIM TO ANY PARTICULAR
FONT, STYLE, SIZE, OR COLOR.

SN 77-137,378, FILED 3-22-2007.

PAUL E. FAHRENKOPF, EXAMINING ATTORNEY

Int. Cl.: 35

Prior U.S. Cls.: 100, 101, and 102

United States Patent and Trademark Office

Reg. No. 3,477,503

Registered July 29, 2008

**SERVICE MARK
PRINCIPAL REGISTER**

SHOETRADER

LANE BRYANT PURCHASING CORP. (OHIO
CORPORATION)
3344 MORSE CROSSING ROAD
COLUMBUS, OH 43219

THE MARK CONSISTS OF STANDARD CHAR-
ACTERS WITHOUT CLAIM TO ANY PARTICULAR
FONT, STYLE, SIZE, OR COLOR.

FOR: ONLINE RETAIL STORE SERVICES FEA-
TURING FOOTWEAR, FOOTWEAR RELATED
PRODUCTS AND ACCESSORIES, IN CLASS 35
(U.S. CLS. 100, 101 AND 102).

SN 77-137,384, FILED 3-22-2007.

FIRST USE 7-15-2005; IN COMMERCE 7-15-2005.

SHANNON TWOHIG, EXAMINING ATTORNEY

Int. Cl.: 16

Prior U.S. Cls.: 2, 5, 22, 23, 29, 37, 38, and 50

United States Patent and Trademark Office

Reg. No. 3,477,504

Registered July 29, 2008

**TRADEMARK
PRINCIPAL REGISTER**

SILHOUETTES

DEFLECTO CORPORATION (DELAWARE CORPORATION)
11937 EXIT FIVE PARKWAY
FISHERS, IN 46038

THE MARK CONSISTS OF STANDARD CHARACTERS WITHOUT CLAIM TO ANY PARTICULAR FONT, STYLE, SIZE, OR COLOR.

FOR: DESKTOP ORGANIZERS, IN CLASS 16 (U.S. CLS. 2, 5, 22, 23, 29, 37, 38 AND 50).

SN 77-137,578, FILED 3-22-2007.

FIRST USE 4-30-2007; IN COMMERCE 4-30-2007.

LA TONIA FISHER, EXAMINING ATTORNEY

Int. Cl.: 36

Prior U.S. Cls.: 100, 101, and 102

United States Patent and Trademark Office

Reg. No. 3,477,505

Registered July 29, 2008

**SERVICE MARK
PRINCIPAL REGISTER**

NOVELLUS CAPITAL MANAGEMENT

NOVELLUS CAPITAL MANAGEMENT, LLC (DE-
LAWARE LTD LIAB CO)
19TH FLOOR
601 108TH AVENUE N.E.
BELLEVUE, WA 98004

FOR: FINANCIAL SERVICES, NAMELY, THE
PURCHASE OF RESIDENTIAL MORTGAGES ON
BEHALF OF OTHERS AND THE ISSUANCE OF
MORTGAGE-BACKED SECURITIES; FINANCIAL
SERVICES IN THE NATURE OF AN INVESTMENT
SECURITY; INVESTMENT ADVISORY SERVICES;
INVESTMENT MANAGEMENT; MUTUAL FUND
DISTRIBUTION, IN CLASS 36 (U.S. CLS. 100, 101
AND 102).

FIRST USE 4-1-2007; IN COMMERCE 4-1-2007.

THE MARK CONSISTS OF STANDARD CHAR-
ACTERS WITHOUT CLAIM TO ANY PARTICULAR
FONT, STYLE, SIZE, OR COLOR.

NO CLAIM IS MADE TO THE EXCLUSIVE
RIGHT TO USE "CAPITAL MANAGEMENT",
APART FROM THE MARK AS SHOWN.

THE FOREIGN WORDING IN THE MARK
TRANSLATES INTO ENGLISH AS NEW, FRESH
OR RECENT.

SN 77-137,961, FILED 3-22-2007.

SETH A. RAPPAPORT, EXAMINING ATTORNEY

Int. Cl.: 39

Prior U.S. Cls.: 100 and 105

United States Patent and Trademark Office

Reg. No. 3,477,506

Registered July 29, 2008

**SERVICE MARK
PRINCIPAL REGISTER**



HORNTHAL INVESTMENT PARTNERS, A CALIFORNIA LIMITED PARTNERSHIP (CALIFORNIA LIMITED PARTNERSHIP)
2234 BEACH STREET
SAN FRANCISCO, CA 94123

THE MARK CONSISTS OF A DESIGN OF A GLOBE WITH 4 PINS INSERTED AT VARIOUS POINTS.

FOR: ONLINE INFORMATION SERVICES IN THE FIELD OF TRAVEL, IN CLASS 39 (U.S. CLS. 100 AND 105).

SN 77-138,120, FILED 3-22-2007.

FIRST USE 11-21-2007; IN COMMERCE 2-29-2008.

CAROL SPILS, EXAMINING ATTORNEY

Int. Cl.: 9

Prior U.S. Cls.: 21, 23, 26, 36, and 38

United States Patent and Trademark Office

Reg. No. 3,477,507

Registered July 29, 2008

**TRADEMARK
PRINCIPAL REGISTER**

**SEE IT. FIND IT. SOLVE
IT.**

EMERSON ELECTRIC CO. (MISSOURI COR-
PORATION)
8000 WEST FLORISSANT AVE.
ST. LOUIS, MO 63136

THE MARK CONSISTS OF STANDARD CHAR-
ACTERS WITHOUT CLAIM TO ANY PARTICULAR
FONT, STYLE, SIZE, OR COLOR.

FOR: PORTABLE FIBER OPTIC INSPECTION
CAMERAS, IN CLASS 9 (U.S. CLS. 21, 23, 26, 36
AND 38).

SN 77-138,204, FILED 3-22-2007.

FIRST USE 4-26-2007; IN COMMERCE 4-26-2007.

GENE MACIOL, EXAMINING ATTORNEY

Int. Cl.: 5

Prior U.S. Cls.: 6, 18, 44, 46, 51, and 52

United States Patent and Trademark Office

Reg. No. 3,477,508

Registered July 29, 2008

**TRADEMARK
PRINCIPAL REGISTER**

MOLD MAGIC

THE SAVOGRAN COMPANY (MASSACHUSETTS
CORPORATION)
259 LENOX STREET
NORWOOD, MA 02062

FOR: ALL-PURPOSE DISINFECTANTS FOR
HOUSEHOLD, HOSPITAL, INSTITUTIONAL, AND
INDUSTRIAL USE, IN CLASS 5 (U.S. CLS. 6, 18, 44, 46,
51 AND 52).

FIRST USE 8-31-2007; IN COMMERCE 8-31-2007.

THE MARK CONSISTS OF STANDARD CHAR-
ACTERS WITHOUT CLAIM TO ANY PARTICULAR
FONT, STYLE, SIZE, OR COLOR.

NO CLAIM IS MADE TO THE EXCLUSIVE
RIGHT TO USE "MOLD", APART FROM THE
MARK AS SHOWN.

SN 77-138,766, FILED 3-23-2007.

COLLEEN DOMBROW, EXAMINING ATTORNEY

Int. Cl.: 28

Prior U.S. Cls.: 22, 23, 38, and 50

United States Patent and Trademark Office

Reg. No. 3,477,509

Registered July 29, 2008

**TRADEMARK
PRINCIPAL REGISTER**

TANGLER

TALON INDUSTRIES, LLC (MAINE LTD LIAB
CO)
SUITE C
349 HARLOW STREET
BANGOR, ME 04401

THE MARK CONSISTS OF STANDARD CHAR-
ACTERS WITHOUT CLAIM TO ANY PARTICULAR
FONT, STYLE, SIZE, OR COLOR.

FOR: ARCHERY EQUIPMENT, NAMELY, AR-
ROW AND GAME RETRIEVAL DEVICES, IN CLASS
28 (U.S. CLS. 22, 23, 38 AND 50).

SN 77-138,950, FILED 3-23-2007.

FIRST USE 1-9-2008; IN COMMERCE 1-9-2008.

G. MAYERSCHOFF, EXAMINING ATTORNEY

Int. Cls.: 9, 38, and 42

Prior U.S. Cls.: 21, 23, 26, 36, 38, 100, 101, and 104

United States Patent and Trademark Office

Reg. No. 3,477,510

Registered July 29, 2008

**TRADEMARK
SERVICE MARK
PRINCIPAL REGISTER**

D-LIFE

D-LINK CORPORATION (TAIWAN CORPORATION)
NEIHU DISTRICT
NO. 289, SINHU 3RD RD.
TAIPEI, TAIWAN

FOR: COMPUTER SOFTWARE FOR USE IN NETWORK COMMUNICATION, NAMELY, COMMUNICATIONS SOFTWARE FOR CONNECTING COMPUTER NETWORK USERS; INTERNET PHONES; TELEMATICS APPARATUS, NAMELY, WIRELESS INTERNET DEVICES WHICH PROVIDE TELEMATICS SERVICES AND HAVE A CELLULAR PHONE FUNCTION; COMPUTER PROGRAMS RECORDED ON OPTICAL OR MAGNETIC DISKS FOR USE IN NETWORK MANAGEMENT; FIREWALL SOFTWARE USED IN COMPUTERS AND COMPUTER NETWORKS; COMPUTER NETWORK HUBS, SWITCHES AND ROUTERS; COMPUTER CAMERAS, IN CLASS 9 (U.S. CLS. 21, 23, 26, 36 AND 38).

FIRST USE 1-7-2008; IN COMMERCE 1-7-2008.

FOR: TELEPHONE COMMUNICATION SERVICES; TELECOMMUNICATION SERVICES, NAMELY, TRANSMISSION OF VIDEO, VOICE, DATA AND DOCUMENTS IN THE FIELD OF VALUE ADDED NETWORKS; PROVIDING MULTIPLE-USER ACCESS TO A GLOBAL COMPUTER INFORMATION NETWORK; ONLINE TRANSMISSION OF

DATA VIA INTERNET AND COMMUNICATION NETWORKS; TELECOMMUNICATION CONNECTION VIA INTERNET, IN CLASS 38 (U.S. CLS. 100, 101 AND 104).

FIRST USE 1-7-2008; IN COMMERCE 1-7-2008.

FOR: PROVIDING AN ONLINE WEBSITE THAT ENABLES THE MANAGEMENT OF NETWORK SYSTEMS OF OTHERS BY PROVIDING TECHNICAL MAINTENANCE AND PERFORMANCE REPORTS BASED ON DATA PROVIDED BY USERS; DESIGN OF COMPUTER SOFTWARE FOR OTHERS; DESIGN AND DEVELOPMENT OF NETWORK INFORMATION AND DATABASES, IN CLASS 42 (U.S. CLS. 100 AND 101).

FIRST USE 1-7-2008; IN COMMERCE 1-7-2008.

THE MARK CONSISTS OF STANDARD CHARACTERS WITHOUT CLAIM TO ANY PARTICULAR FONT, STYLE, SIZE, OR COLOR.

"D-LIFE" HAS NO MEANING IN A NON-ENGLISH LANGUAGE.

SN 77-139,971, FILED 3-26-2007.

JENNIFER MARTIN, EXAMINING ATTORNEY

Int. Cl.: 39

Prior U.S. Cls.: 100 and 105

United States Patent and Trademark Office

Reg. No. 3,477,511

Registered July 29, 2008

**SERVICE MARK
PRINCIPAL REGISTER**

DIAMOND HEAD SELF STORAGE

MASTERS PROPERTIES LLC (MARYLAND LTD
LIAB CO)

400 CENTRE STREET

NEWTON, MA 02458

FOR: PROVIDING SELF-STORAGE FACILITIES
FOR OTHERS, IN CLASS 39 (U.S. CLS. 100 AND 105).

FIRST USE 2-0-2007; IN COMMERCE 2-0-2007.

THE MARK CONSISTS OF STANDARD CHAR-
ACTERS WITHOUT CLAIM TO ANY PARTICULAR
FONT, STYLE, SIZE, OR COLOR.

NO CLAIM IS MADE TO THE EXCLUSIVE
RIGHT TO USE "SELF STORAGE", APART FROM
THE MARK AS SHOWN.

SN 77-140,263, FILED 3-26-2007.

SUSAN STIGLITZ, EXAMINING ATTORNEY

Int. Cl.: 45

Prior U.S. Cls.: 100 and 101

United States Patent and Trademark Office

Reg. No. 3,477,512

Registered July 29, 2008

**SERVICE MARK
PRINCIPAL REGISTER**

LODIS

DNA SECURITY, INC. (NORTH CAROLINA
CORPORATION)
1902 TUCKER STREET
BURLINGTON, NC 27215

THE MARK CONSISTS OF STANDARD CHAR-
ACTERS WITHOUT CLAIM TO ANY PARTICULAR
FONT, STYLE, SIZE, OR COLOR.

FOR: PROVIDING AN ONLINE DATABASE OF
DNA PROFILES FOR USE IN THE FIELD OF LAW
ENFORCEMENT, IN CLASS 45 (U.S. CLS. 100 AND
101).

SN 77-140,306, FILED 3-26-2007.

FIRST USE 1-0-2007; IN COMMERCE 1-1-2008.

STEPHEN AQUILA, EXAMINING ATTORNEY

Int. Cl.: 39

Prior U.S. Cls.: 100 and 105

United States Patent and Trademark Office

Reg. No. 3,477,513

Registered July 29, 2008

**SERVICE MARK
PRINCIPAL REGISTER**



MASTERS PROPERTIES LLC (MARYLAND LTD
LIAB CO)
400 CENTRE STREET
NEWTON, MA 02109

FOR: PROVIDING SELF-STORAGE FACILITIES
FOR OTHERS, IN CLASS 39 (U.S. CLS. 100 AND 105).

FIRST USE 2-0-2007; IN COMMERCE 2-0-2007.

NO CLAIM IS MADE TO THE EXCLUSIVE
RIGHT TO USE "SELF-STORAGE", APART FROM
THE MARK AS SHOWN.

THE MARK CONSISTS OF A STYLIZED REPRESENTATION OF A PADLOCK IN THE FORM OF A SQUARE-SHAPED BUILDING WITH A UPSIDE-DOWN U SHAPE ON TOP.

SN 77-140,311, FILED 3-26-2007.

SUSAN STIGLITZ, EXAMINING ATTORNEY

Int. Cl.: 9

Prior U.S. Cls.: 21, 23, 26, 36, and 38

United States Patent and Trademark Office

Reg. No. 3,477,514

Registered July 29, 2008

**TRADEMARK
PRINCIPAL REGISTER**



MICROSOFT CORPORATION (WASHINGTON CORPORATION)
ONE MICROSOFT WAY
REDMOND, WA 980526399

FOR: OPERATING SYSTEM SOFTWARE; COMPUTER SOFTWARE FOR STORING, EDITING AND VIEWING DIGITAL PHOTOGRAPHS AND IMAGES, IN CLASS 9 (U.S. CLS. 21, 23, 26, 36 AND 38).

FIRST USE 1-30-2007; IN COMMERCE 1-30-2007.

OWNER OF U.S. REG. NOS. 2,730,599, 3,246,454, AND OTHERS.

THE MARK CONSISTS OF AN IMAGE OF A VASE AND FLOWER AND PICTURE FRAME WITH A STYLIZED FLAG DESIGN.

SN 77-140,440, FILED 3-26-2007.

MICHAEL TANNER, EXAMINING ATTORNEY

Int. Cl.: 9

Prior U.S. Cls.: 21, 23, 26, 36, and 38

United States Patent and Trademark Office

Reg. No. 3,477,515

Registered July 29, 2008

**TRADEMARK
PRINCIPAL REGISTER**



MICROSOFT CORPORATION (WASHINGTON CORPORATION)
ONE MICROSOFT WAY
REDMOND, WA 980526399

FOR: OPERATING SYSTEM SOFTWARE; GRAPHICAL USER INTERFACE SOFTWARE, IN CLASS 9 (U.S. CLS. 21, 23, 26, 36 AND 38).

FIRST USE 1-30-2007; IN COMMERCE 1-30-2007.

OWNER OF U.S. REG. NOS. 2,730,599, 3,246,454, AND OTHERS.

THE MARK CONSISTS OF AN IMAGE OF A COMPUTER MONITOR WITH DOCUMENTS IN FRONT OF THE MONITOR INCLUDING A FLOWER AND STYLIZED FLAG DESIGN.

SN 77-140,456, FILED 3-26-2007.

MICHAEL TANNER, EXAMINING ATTORNEY

Int. Cls.: 9, 35, and 42

Prior U.S. Cls.: 21, 23, 26, 36, 38, 100, 101, and 102

United States Patent and Trademark Office

Reg. No. 3,477,516

Registered July 29, 2008

**TRADEMARK
SERVICE MARK
PRINCIPAL REGISTER**



MICROSOFT CORPORATION (WASHINGTON CORPORATION)
ONE MICROSOFT WAY
REDMOND, WA 980526399

FOR: OPERATING SYSTEM SOFTWARE; COMPUTER PROGRAMS FOR USE IN LINKING COMPUTER USERS TO WEBSITES FEATURING INFORMATION ON GOODS AND SERVICES OF OTHERS TARGETED FOR USERS OF THE WINDOWS OPERATING SYSTEM, IN CLASS 9 (U.S. CLS. 21, 23, 26, 36 AND 38).

FIRST USE 1-30-2007; IN COMMERCE 1-30-2007.

FOR: ONLINE RETAIL STORE SERVICES FEATURING COMPUTERS, COMPUTER HARDWARE, COMPUTER SOFTWARE, COMPUTER PERIPHERALS, SPEAKERS, PHONES, DIGITAL CAMERAS, WEB CAMS, AND COMPUTER GAMES; PROMOTING THE GOODS AND SERVICES OF OTHERS VIA THE INTERNET; PROVIDING ONLINE CONSUMER PRODUCT INFORMATION CONCERNING COMPUTERS, COMPUTER PERIPHERALS AND

COMPUTER SOFTWARE, IN CLASS 35 (U.S. CLS. 100, 101 AND 102).

FIRST USE 1-30-2007; IN COMMERCE 1-30-2007.

FOR: COMPUTER SERVICES, NAMELY, PROVIDING ONLINE TECHNICAL INFORMATION CONCERNING COMPUTERS, COMPUTER PERIPHERALS AND COMPUTER SOFTWARE, IN CLASS 42 (U.S. CLS. 100 AND 101).

FIRST USE 1-30-2007; IN COMMERCE 1-30-2007.

OWNER OF U.S. REG. NOS. 2,730,599, 3,246,454, AND OTHERS.

THE MARK CONSISTS OF AN IMAGE OF A SHOPPING BASKET WITH A STYLIZED FLAG DESIGN, HOLDING A SOFTWARE PACKAGE, A DVD PACKAGE AND A PAD LOCK.

SN 77-140,492, FILED 3-26-2007.

MICHAEL TANNER, EXAMINING ATTORNEY

Int. Cl.: 9

Prior U.S. Cls.: 21, 23, 26, 36, and 38

United States Patent and Trademark Office

Reg. No. 3,477,517

Registered July 29, 2008

**TRADEMARK
PRINCIPAL REGISTER**



MICROSOFT CORPORATION (WASHINGTON CORPORATION)
ONE MICROSOFT WAY
REDMOND, WA 980526399

FOR: OPERATING SYSTEM SOFTWARE; COMPUTER SOFTWARE FOR MANAGING EMAIL ADDRESS AND CONTACT INFORMATION, IN CLASS 9 (U.S. CLS. 21, 23, 26, 36 AND 38).

FIRST USE 1-30-2007; IN COMMERCE 1-30-2007.

OWNER OF U.S. REG. NOS. 2,730,599, 3,246,454, AND OTHERS.

THE MARK CONSISTS OF AN IMAGE OF A BUSINESS CARD HOLDER WITH A STYLIZED FLAG DESIGN.

SN 77-140,497, FILED 3-26-2007.

MICHAEL TANNER, EXAMINING ATTORNEY

Int. Cl.: 9

Prior U.S. Cls.: 21, 23, 26, 36, and 38

United States Patent and Trademark Office

Reg. No. 3,477,518

Registered July 29, 2008

**TRADEMARK
PRINCIPAL REGISTER**



MICROSOFT CORPORATION (WASHINGTON CORPORATION)
ONE MICROSOFT WAY
REDMOND, WA 980526399

FOR: OPERATING SYSTEM SOFTWARE; COMPUTER SOFTWARE FOR VIEWING AND MANAGING USER'S CALENDARS AND TASK LISTS, IN CLASS 9 (U.S. CLS. 21, 23, 26, 36 AND 38).

FIRST USE 1-30-2007; IN COMMERCE 1-30-2007.

OWNER OF U.S. REG. NOS. 2,730,599, 3,246,454, AND OTHERS.

THE MARK CONSISTS OF AN IMAGE OF A MONTHLY CALENDAR WITH A FLOWER AND STYLIZED FLAG DESIGN.

SN 77-140,503, FILED 3-26-2007.

MICHAEL TANNER, EXAMINING ATTORNEY

Int. Cl.: 9

Prior U.S. Cls.: 21, 23, 26, 36, and 38

United States Patent and Trademark Office

Reg. No. 3,477,519

Registered July 29, 2008

**TRADEMARK
PRINCIPAL REGISTER**

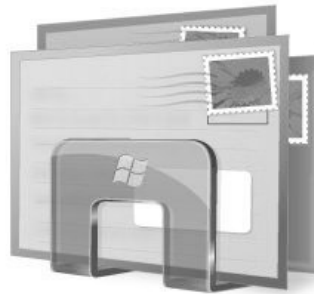

MICROSOFT CORPORATION (WASHINGTON CORPORATION)
ONE MICROSOFT WAY
REDMOND, WA 980526399

FOR: OPERATING SYSTEM SOFTWARE; COMPUTER SOFTWARE FOR SENDING, RECEIVING, MANAGING AND SEARCHING ELECTRONIC MAIL; COMPUTER SOFTWARE FOR FILTERING ALL JUNK EMAIL; COMPUTER SOFTWARE FOR ACCESSING ONLINE NEWSGROUPS AND WEB COMMUNITIES, IN CLASS 9 (U.S. CLS. 21, 23, 26, 36 AND 38).

FIRST USE 1-30-2007; IN COMMERCE 1-30-2007.

OWNER OF U.S. REG. NOS. 2,730,599, 3,246,454, AND OTHERS.

THE MARK CONSISTS OF AN IMAGE OF A LETTER HOLDER WITH THREE LETTERS AND A STYLIZED FLAG DESIGN.

SN 77-140,518, FILED 3-26-2007.

MICHAEL TANNER, EXAMINING ATTORNEY

Int. Cl.: 28

Prior U.S. Cls.: 22, 23, 38, and 50

Reg. No. 3,477,520

United States Patent and Trademark Office

Registered July 29, 2008

**TRADEMARK
PRINCIPAL REGISTER**

KRYPTIK

BASS PRO INTELLECTUAL PROPERTY, L.L.C
(MISSOURI LTD LIAB CO)
2500 EAST KEARNEY
SPRINGFIELD, MO 65898

THE MARK CONSISTS OF STANDARD CHAR-
ACTERS WITHOUT CLAIM TO ANY PARTICULAR
FONT, STYLE, SIZE, OR COLOR.

FOR: ARCHERY PRODUCTS, NAMELY, BOWS,
IN CLASS 28 (U.S. CLS. 22, 23, 38 AND 50).

SN 77-141,014, FILED 3-27-2007.

FIRST USE 5-0-2007; IN COMMERCE 5-0-2007.

GIANCARLO CASTRO, EXAMINING ATTORNEY

Int. Cl.: 32

Prior U.S. Cls.: 45, 46, and 48

Reg. No. 3,477,521

United States Patent and Trademark Office

Registered July 29, 2008

TRADEMARK
PRINCIPAL REGISTER

TROPICAL RAIN

KRAFT FOODS HOLDINGS, INC. (DELAWARE
CORPORATION)
NF-577
THREE LAKES DRIVE
NORTHFIELD, IL 60093

THE MARK CONSISTS OF STANDARD CHAR-
ACTERS WITHOUT CLAIM TO ANY PARTICULAR
FONT, STYLE, SIZE, OR COLOR.

FOR: FLAVORED WATERS, IN CLASS 32 (U.S.
CLS. 45, 46 AND 48).

SN 77-141,107, FILED 3-27-2007.

FIRST USE 1-1-2008; IN COMMERCE 1-1-2008.

AHSEN KHAN, EXAMINING ATTORNEY

Int. Cl.: 6

Prior U.S. Cls.: 2, 12, 13, 14, 23, 25, and 50

United States Patent and Trademark Office

Reg. No. 3,477,522

Registered July 29, 2008

**TRADEMARK
PRINCIPAL REGISTER**

CLEAR VISION

DAB DOOR COMPANY, INC. (FLORIDA CORPORATION)
12195 N.W. 98TH AVENUE
HIALEAH GARDENS, FL 33018

THE MARK CONSISTS OF STANDARD CHARACTERS WITHOUT CLAIM TO ANY PARTICULAR FONT, STYLE, SIZE, OR COLOR.

FOR: METAL GARAGE DOORS, IN CLASS 6 (U.S. CLS. 2, 12, 13, 14, 23, 25 AND 50).

SN 77-141,169, FILED 3-27-2007.

FIRST USE 7-25-2005; IN COMMERCE 7-25-2007.

JENNIFER MARTIN, EXAMINING ATTORNEY

Int. Cl.: 3

Prior U.S. Cls.: 1, 4, 6, 50, 51, and 52

United States Patent and Trademark Office

Reg. No. 3,477,523

Registered July 29, 2008

**TRADEMARK
PRINCIPAL REGISTER**

Transform+

HOLYFIELD, LOUISE (UNITED STATES INDIVIDUAL)
5609 BENT TRAIL
DALLAS, TX 75248

FOR: NON-MEDICATED SKIN CARE PREPARATIONS; HAIR CARE PREPARATIONS; BODY CARE PRODUCTS, NAMELY, BODY SOAPS, BODY CREAMS, BODY LOTIONS, BODY POWDERS, NON-MEDICATED DEODORANTS AND ANTIPERSPIRANTS; NON-MEDICATED SUNCARE PRODUCTS, NAMELY, SUNSCREEN, SUN BLOCK AND SUN TANNING PREPARATIONS; PREPARATIONS TO PROTECT THE SKIN FROM THE SUN, NAMELY, NON-MEDICATED SUN CREAMS AND NON-MEDICATED AFTER-SUN LOTIONS; BATH PRO-

DUCTS, NAMELY, BATH BEADS, BATH FOAM, BATH GELS, BATH LOTION, BATH OIL, BATH POWDER, AND NON-MEDICATED BATH SALTS; PERFUME, COLOGNE, COSMETICS AND MAKEUP, IN CLASS 3 (U.S. CLS. 1, 4, 6, 50, 51 AND 52).

FIRST USE 6-11-2008; IN COMMERCE 6-11-2008.

THE MARK CONSISTS OF STANDARD CHARACTERS WITHOUT CLAIM TO ANY PARTICULAR FONT, STYLE, SIZE, OR COLOR.

SN 77-141,232, FILED 3-27-2007.

GINA FINK, EXAMINING ATTORNEY

Int. Cl.: 25

Prior U.S. Cls.: 22 and 39

United States Patent and Trademark Office

Reg. No. 3,477,524

Registered July 29, 2008

**TRADEMARK
PRINCIPAL REGISTER**

PieceForAll

PIECEFORALL, LLC (DELAWARE LTD LIAB
CO)
UNIT K-1
4282 ROSWELL ROAD
ATLANTA, GA 30342

THE MARK CONSISTS OF STANDARD CHAR-
ACTERS WITHOUT CLAIM TO ANY PARTICULAR
FONT, STYLE, SIZE, OR COLOR.

FOR: APPAREL, NAMELY, TOPS AND PANTS
FOR ACTIVE WEAR, IN CLASS 25 (U.S. CLS. 22 AND
39).

SN 77-141,346, FILED 3-27-2007.

FIRST USE 5-9-2008; IN COMMERCE 5-9-2008.

TASNEEM HUSSAIN, EXAMINING ATTORNEY

Int. Cl.: 25

Prior U.S. Cls.: 22 and 39

United States Patent and Trademark Office

Reg. No. 3,477,525

Registered July 29, 2008

**TRADEMARK
PRINCIPAL REGISTER**

HY-GENS

PATAKOS DESIGNS, LLC (NEW JERSEY LTD
LIAB CO)
1 LARCH DRIVE
MONMOUTH JUNCTION, NJ 08852

THE MARK CONSISTS OF STANDARD CHAR-
ACTERS WITHOUT CLAIM TO ANY PARTICULAR
FONT, STYLE, SIZE, OR COLOR.

FOR: ATHLETIC FOOTWEAR, IN CLASS 25 (U.S.
CLS. 22 AND 39).

SN 77-141,650, FILED 3-27-2007.

FIRST USE 2-11-2008; IN COMMERCE 2-11-2008.

JUDITH HELFMAN, EXAMINING ATTORNEY

Int. Cl.: 44

Prior U.S. Cls.: 100 and 101

United States Patent and Trademark Office

Reg. No. 3,477,526

Registered July 29, 2008

**SERVICE MARK
PRINCIPAL REGISTER**



HORTON, BRENDA L. (UNITED STATES INDIVIDUAL)
5392 BAYLEY STREET
NORTH PORT, FL 34288

FOR: CONSULTING SERVICES IN THE FIELD OF MENTAL HEALTH AND WELLNESS; HEALTH CARE; HEALTH CARE IN THE NATURE OF HEALTH MAINTENANCE ORGANIZATIONS; HEALTH CARE SERVICES, NAMELY, DISEASE MANAGEMENT PROGRAMS; HEALTH CARE SERVICES, NAMELY, WELLNESS PROGRAMS; HEALTH SPA SERVICES FOR HEALTH AND WELLNESS OF THE BODY AND SPIRIT OFFERED AT A HEALTH RESORT; HEALTH SPA SERVICES FOR HEALTH AND WELLNESS OF THE MIND, BODY AND SPIRIT OFFERED IN OR FROM A REMOTE, MOBILE OR TEMPORARY ON-SITE LOCATION; HEALTH SPA SERVICES, NAMELY, COSMETIC BODY CARE SERVICES; HOME HEALTH CARE SERVICES; MANAGED HEALTH CARE SER-

VICES; MENTAL HEALTH COUNSELING AND PSYCHOTHERAPY AS IT RELATES TO RELATIONSHIPS; MENTAL HEALTH SERVICES; PROVIDING A WEBSITE FEATURING INFORMATION IN THE FIELD OF MENTAL HEALTH AND WELLNESS; PROVIDING HEALTH CARE INFORMATION BY TELEPHONE; PROVIDING HEALTH CARE INFORMATION BY TELEPHONE AND THE INTERNET; PROVIDING HEALTH INFORMATION, IN CLASS 44 (U.S. CLS. 100 AND 101).

FIRST USE 6-1-2005; IN COMMERCE 6-1-2005.

THE MARK CONSISTS OF THE EYE OF HORUS INTEGRATED WITH A HAND AND A FREE STANDING HEART.

SN 77-142,074, FILED 3-27-2007.

KIMBERLY PERRY, EXAMINING ATTORNEY

Int. Cls.: 14, 18, and 25

Prior U.S. Cls.: 1, 2, 3, 22, 27, 28, 39, 41, and 50

Reg. No. 3,477,527

United States Patent and Trademark Office

Registered July 29, 2008

**TRADEMARK
PRINCIPAL REGISTER**

WWP

WWP PRODUCTIONS, LLC (MINNESOTA LTD
LIAB CO)
226 WATER STREET
EXCELSIOR, MN 55441

FOR: JEWELRY, NAMELY, BRACELETS, NECK-
LACES, RINGS, EARRINGS, ANKLE BRACELETS,
CHOKERS, TOE RINGS, BROOCHES, CHARITY
BRACELETS, CHARMS, PENDANTS, CHAINS,
CROSSES; WATCHES, IN CLASS 14 (U.S. CLS. 2, 27,
28 AND 50).

FIRST USE 5-10-2008; IN COMMERCE 5-10-2008.

FOR: HANDBAGS; WALLETS; TOTE BAGS;
BRIEFCASES; SPORT BAGS; EVENING HAND-
BAGS; TRAVEL BAGS; CLUTCHES; COIN PURSES;
WRISTLET BAGS, IN CLASS 18 (U.S. CLS. 1, 2, 3, 22
AND 41).

FIRST USE 5-10-2008; IN COMMERCE 5-10-2008.

FOR: CLOTHING, NAMELY, LONG-SLEEVED
TOPS, SHORT-SLEEVED TOPS, BLOUSES, VESTS,

BLAZERS, PULLOVERS, SWEATERS, CARDIGANS,
SWEATSHIRTS, SHIRTS, T-SHIRTS, PANTS, JEANS,
CAPRI PANTS, SKIRTS, DRESSES, SHORTS, PAJA-
MAS, SUITS, JUMPSUITS, LOUNGEWEAR, JACK-
ETS, COATS, UNDERCLOTHING, NAMELY,
BODICES, CAMISOLES, BRASSIERES, DRESSING
GOWNS; BEACH CLOTHING, NAMELY COVER
UPS, SCARVES, SHAWLS; MITTENS; GLOVES;
BELTS; FOOTWEAR, NAMELY, SHOES, BOOTS,
SLIPPERS, SANDALS, BEACH SHOES, FLIP FLOPS;
HEADWEAR, NAMELY, HATS, EAR BANDS, CAPS,
IN CLASS 25 (U.S. CLS. 22 AND 39).

FIRST USE 5-10-2008; IN COMMERCE 5-10-2008.

THE MARK CONSISTS OF STANDARD CHAR-
ACTERS WITHOUT CLAIM TO ANY PARTICULAR
FONT, STYLE, SIZE, OR COLOR.

SN 77-142,315, FILED 3-28-2007.

REBECCA GILBERT, EXAMINING ATTORNEY

Int. Cls.: 14, 18, and 25

Prior U.S. Cls.: 1, 2, 3, 22, 27, 28, 39, 41, and 50

United States Patent and Trademark Office

Reg. No. 3,477,528

Registered July 29, 2008

**TRADEMARK
PRINCIPAL REGISTER**

WOMEN WITH PURPOSE

WWP PRODUCTIONS, LLC (MINNESOTA LTD
LIAB CO)
226 WATER STREET
EXCELSIOR, MN 55331

FOR: JEWELRY, NAMELY, BRACELETS, NECK-
LACES, RINGS, EARRINGS, ANKLE BRACELETS,
CHOKERS, TOE RINGS, BROOCHES, CHARITY
BRACELETS, CHARMS, PENDANTS, CHAINS,
CROSSES; WATCHES, IN CLASS 14 (U.S. CLS. 2, 27,
28 AND 50).

FIRST USE 5-10-2008; IN COMMERCE 5-10-2008.

FOR: HANDBAGS; WALLETS; TOTE BAGS;
BRIEFCASES; SPORT BAGS; EVENING HAND-
BAGS; TRAVEL BAGS; CLUTCHES; COIN PURSES;
WRISTLET BAGS, IN CLASS 18 (U.S. CLS. 1, 2, 3, 22
AND 41).

FIRST USE 5-10-2008; IN COMMERCE 5-10-2008.

FOR: CLOTHING, NAMELY, LONG-SLEEVED
TOPS, SHORT-SLEEVED TOPS, BLOUSES, VESTS,
BLAZERS, PULLOVERS, SWEATERS, CARDIGANS,
SWEATSHIRTS, SHIRTS, T-SHIRTS, PANTS, JEANS,

CAPRI PANTS, SKIRTS, DRESSES, SHORTS, PAJA-
MAS, SUITS, JUMPSUITS, LOUNGEWEAR, SKI
WEAR, JACKETS, COATS, PARKAS; UNDER-
CLOTHING, NAMELY, BODICES, CAMISOLES,
BRASSIERES, UNDERWEAR; DRESSING GOWNS;
BEACH CLOTHING, NAMELY , COVER UPS,
SCARVES, SHAWLS; MITTENS; GLOVES; BELTS;
FOOTWEAR, NAMELY, SHOES, BOOTS, SLIPPERS,
SANDALS, BEACH SHOES, FLIP FLOPS; HEAD-
WEAR, NAMELY, HATS, EAR BANDS, CAPS, IN
CLASS 25 (U.S. CLS. 22 AND 39).

FIRST USE 5-10-2008; IN COMMERCE 5-10-2008.

THE MARK CONSISTS OF STANDARD CHAR-
ACTERS WITHOUT CLAIM TO ANY PARTICULAR
FONT, STYLE, SIZE, OR COLOR.

NO CLAIM IS MADE TO THE EXCLUSIVE
RIGHT TO USE "WOMEN", APART FROM THE
MARK AS SHOWN.

SN 77-142,345, FILED 3-28-2007.

REBECCA GILBERT, EXAMINING ATTORNEY

Int. Cl.: 3

Prior U.S. Cls.: 1, 4, 6, 50, 51, and 52

Reg. No. 3,477,529

United States Patent and Trademark Office

Registered July 29, 2008

**TRADEMARK
PRINCIPAL REGISTER**

**Great Skin Care Does Not
End At The Chin!**

LOUISE HOLYFIELD (UNITED STATES INDIVIDUAL)
5609 BENT TRAIL
DALLAS, TX 75248

BATH LOTION, BATH OIL, BATH POWDER, AND NON-MEDICATED BATH SALTS, IN CLASS 3 (U.S. CLS. 1, 4, 6, 50, 51 AND 52).

FOR: NON-MEDICATED SKIN CARE PREPARATIONS; BODY CARE PRODUCTS, NAMELY, BODY SOAPS, BODY CREAMS, BODY LOTIONS; NON-MEDICATED SUNCARE PRODUCTS, NAMELY, SUNSCREEN, SUN BLOCK AND SUN TANNING PREPARATIONS; PREPARATIONS TO PROTECT THE SKIN FROM THE SUN, NAMELY, NON-MEDICATED SUN CREAMS AND NON-MEDICATED AFTER-SUN LOTIONS; BATH PRODUCTS, NAMELY, BATH BEADS, BATH FOAM, BATH GELS,

FIRST USE 6-11-2008; IN COMMERCE 6-11-2008.

THE MARK CONSISTS OF STANDARD CHARACTERS WITHOUT CLAIM TO ANY PARTICULAR FONT, STYLE, SIZE, OR COLOR.

SN 77-142,925, FILED 3-28-2007.

GINA FINK, EXAMINING ATTORNEY

Int. Cl.: 28

Prior U.S. Cls.: 22, 23, 38, and 50

Reg. No. 3,477,530

United States Patent and Trademark Office

Registered July 29, 2008

TRADEMARK
PRINCIPAL REGISTER

HEAVEN IN SMALL HANDS

DER MARDEROSIAN, MARK (UNITED STATES
INDIVIDUAL)
P.O. BOX 600576
NEWTONVILLE, MA 02460

FOR: ACTION FIGURES; ACTION FIGURES AND ACCESSORIES THEREFOR; BABY MULTIPLE ACTIVITY TOYS; BABY RATTLES; BABY RATTLES INCORPORATING TEETHING RINGS; BALLOONS; BALLS FOR GAMES; BATH TOYS; BATHTUB TOYS; BATTERY OPERATED ACTION TOYS; BEACH BALLS; BEAN BAG DOLLS; BEAN BAGS; BENDABLE TOYS; BOARD GAMES; CASES FOR ACTION FIGURES; CASES FOR PLAY ACCESSORIES; CASES FOR TENNIS BALLS; CASES FOR TOY STRUCTURES; CHILDREN'S MULTIPLE ACTIVITY TOYS; CHILDREN'S MULTIPLE ACTIVITY TOYS SOLD AS A UNIT WITH PRINTED BOOKS; CHILDREN'S PLAY COSMETICS; CHRISTMAS TREE DECORATIONS; CHRISTMAS TREE ORNAMENTS; CHRISTMAS TREE ORNAMENTS OF BRONZE; CHRISTMAS TREE ORNAMENTS WITH A MUSIC FEATURE; CHRISTMAS TREE ORNAMENTS, NAMELY, BELLS; COLLECTABLE TOY FIGURES; CRIB MOBILES; CRIB TOYS; DECORATIVE WIND SOCKS; DOLL ACCESSORIES; DOLL CASES; DOLL CLOTHING; DOLL COSTUMES; DOLL FURNITURE; DOLL HOUSE FURNISHINGS; DOLL HOUSES; DOLLS; DOLLS AND ACCESSORIES THEREFOR; DOLLS AND PLAYSETS THEREFOR; DOLLS FOR PLAYING; DOMINOES; DRAWING TOYS; ELECTRIC ACTION TOYS; ELECTRONIC LEARNING TOYS; FANTASY CHARACTER TOYS; FURNITURE FOR DOLL'S HOUSES; FURNITURE FOR DOLLS' HOUSES; HAND PUPPETS; INFANT ACTION CRIB TOYS; INFANT DEVELOPMENT TOYS; INFANT TOYS; INFANT'S RATTLES; INFLATABLE BATH TOYS; INFLATABLE BOP BAGS;

INFLATABLE TOYS; INFLATABLE TOYS SHOWING DECORATIVE PICTURES; JACK-IN-THE-BOXES; JIGSAW PUZZLES; KITES; MANIPULATIVE GAMES; MANIPULATIVE PUZZLES; MARIONETTE PUPPETS; MECHANICAL ACTION TOYS; MECHANICAL TOYS; MOBILES FOR CHILDREN; MODELED PLASTIC TOY FIGURINES; MUSIC BOX TOYS; MUSICAL TOYS; PAPER DOLLS; PARTY FAVORS IN THE NATURE OF SMALL TOYS; PARTY GAMES; PINATAS; PLASTIC CHARACTER TOYS; PLAY FIGURES; PLAY HOUSES; PLAYGROUND BALLS; PLUSH TOYS; PULL TOYS; PUPPETS; PUSH TOYS; PUZZLES; RAG DOLLS; ROCKING HORSES; SAND TOYS; SANDBOX TOYS; SOFT SCULPTURE PLUSH TOYS; SOFT SCULPTURE TOYS; SQUEEZABLE SQUEAKING TOYS; SQUEEZE TOYS; STACKING TOYS; STUFFED DOLLS AND ANIMALS; STUFFED PUPPETS; STUFFED TOY ANIMALS; STUFFED TOY BEARS; STUFFED TOYS; TALKING TOYS; TEDDY BEARS; TOY ACTION FIGURES; TOY ACTION FIGURES AND ACCESSORIES THEREFOR; TOY ANIMALS AND ACCESSORIES THEREFORE; TOY FIGURES; TOY WIND SOCK S; WIND-UP TOYS; WIND-UP WALKING TOYS; YO-YOS, IN CLASS 28 (U.S. CLS. 22, 23, 38 AND 50).

FIRST USE 1-1-2008; IN COMMERCE 1-1-2008.

THE MARK CONSISTS OF STANDARD CHARACTERS WITHOUT CLAIM TO ANY PARTICULAR FONT, STYLE, SIZE, OR COLOR.

SN 77-143,299, FILED 3-29-2007.

ELISSA GARBER KON, EXAMINING ATTORNEY

Int. Cl.: 28

Prior U.S. Cls.: 22, 23, 38, and 50

Reg. No. 3,477,531

United States Patent and Trademark Office

Registered July 29, 2008

TRADEMARK
PRINCIPAL REGISTER

ANGELS FROM THE ATTIC

DER MARDEROSIAN, MARK (UNITED STATES
INDIVIDUAL)
P.O. BOX 600576
NEWTONVILLE, MA 02460

FOR: ACTION FIGURES; ACTION FIGURES AND ACCESSORIES THEREFOR; BABY MULTIPLE ACTIVITY TOYS; BABY RATTLES; BABY RATTLES INCORPORATING TEETHING RINGS; BALLOONS; BALLS FOR GAMES; BATH TOYS; BATHTUB TOYS; BATTERY OPERATED ACTION TOYS; BEACH BALLS; BEAN BAG DOLLS; BEAN BAGS; BENDABLE TOYS; BOARD GAMES; BUBBLE MAKING WAND AND SOLUTION SETS; CARD GAMES; CASES FOR ACTION FIGURES; CASES FOR PLAY ACCESSORIES; CASES FOR TOY STRUCTURES; CHILDREN'S MULTIPLE ACTIVITY TOYS; CHILDREN'S MULTIPLE ACTIVITY TOYS SOLD AS A UNIT WITH PRINTED BOOKS; CHILDREN'S PLAY COSMETICS; CHRISTMAS STOCKINGS; CHRISTMAS TREE DECORATIONS; CHRISTMAS TREE ORNAMENTS; CHRISTMAS TREE ORNAMENTS OF BRONZE; CHRISTMAS TREE ORNAMENTS WITH A MUSIC FEATURE; CHRISTMAS TREE ORNAMENTS, NAMELY, BELLS; COLLECTABLE TOY FIGURES; CRIB MOBILES; CRIB TOYS; DECORATIVE WIND SOCKS; DICE GAMES; DOLL ACCESSORIES; DOLL CASES; DOLL CLOTHING; DOLL COSTUMES; DOLL FURNITURE; DOLL HOUSE FURNISHINGS; DOLL HOUSES; DOLLS; DOLLS AND ACCESSORIES THEREFOR; DOLLS AND PLAYSETS THEREFOR; DOLLS FOR PLAYING; DOLLS IN SITTING POSTURE (OSUWARI DOLLS); DOMINOES; DRAWING TOYS; ELECTRONIC EDUCATIONAL GAME MACHINES FOR CHILDREN; ELECTRONIC LEARNING TOYS; EQUIPMENT SOLD AS A UNIT FOR PLAYING A MEMORY GAME; EQUIPMENT SOLD AS A UNIT FOR PLAYING BOARD GAMES; EQUIPMENT SOLD AS A UNIT FOR PLAYING CARD GAMES; FANTASY CHARACTER TOYS; FLYING DISCS; FURNITURE FOR DOLL'S HOUSES; FURNITURE

FOR DOLLS' HOUSES; HAND PUPPETS; HEADGEAR FOR DOLLS; INFANT ACTION CRIB TOYS; INFANT DEVELOPMENT TOYS; INFANT TOYS; INFANT'S RATTLES; INFLATABLE BATH TOYS; INFLATABLE BOP BAGS; INFLATABLE TOYS; JACK-IN-THE-BOXES; JIGSAW PUZZLES; KITES; MANIPULATIVE GAMES; MANIPULATIVE PUZZLES; MARIONETTE PUPPETS; MECHANICAL ACTION TOYS; MECHANICAL TOYS; MOBILES FOR CHILDREN; MUSIC BOX TOYS; MUSICAL TOYS; PAPER DOLLS; PARTY FAVORS IN THE NATURE OF SMALL TOYS; PARTY GAMES; PINATAS; PLASTIC CHARACTER TOYS; PLAY FIGURES; PLAY HOUSES; PLAYSETS FOR DOLLS; PLUSH TOYS; POP UP TOYS; POSITIONABLE TOY FIGURES; PULL TOYS; PUPPETS; PUSH TOYS; PUZZLES; RAG DOLLS; ROCKING HORSES; RUBBER ACTION BALLS; RUBBER BALLS; RUBBER CHARACTER TOYS; SANDBOX TOYS; SHOES FOR DOLLS; SOFT SCULPTURE PLUSH TOYS; SOFT SCULPTURE TOYS; SQUEEZABLE SQUEAKING TOYS; SQUEEZE TOYS; STACKING TOYS; STUFFED DOLLS AND ANIMALS; STUFFED PUPPETS; STUFFED TOY ANIMALS; STUFFED TOY BEARS; STUFFED TOYS; TEDDY BEARS; TOY ACTION FIGURES; TOY ACTION FIGURES AND ACCESSORIES THEREFOR; TOY ANIMALS AND ACCESSORIES THEREFORE; TOY FIGURES; TOY MUSIC BOXES; YO-YOS, IN CLASS 28 (U.S. CLS. 22, 23, 38 AND 50).

FIRST USE 1-1-2008; IN COMMERCE 1-1-2008.

THE MARK CONSISTS OF STANDARD CHARACTERS WITHOUT CLAIM TO ANY PARTICULAR FONT, STYLE, SIZE, OR COLOR.

SN 77-143,300, FILED 3-29-2007.

ELISSA GARBER KON, EXAMINING ATTORNEY

Int. Cl.: 37

Prior U.S. Cls.: 100, 103, and 106

United States Patent and Trademark Office

Reg. No. 3,477,532

Registered July 29, 2008

**SERVICE MARK
PRINCIPAL REGISTER**

ECOLAV

ECOLAVATION, LLC (FLORIDA LTD LIAB CO)
1451 S. MIAMI AVENUE
MIAMI, FL 33130

THE MARK CONSISTS OF STANDARD CHAR-
ACTERS WITHOUT CLAIM TO ANY PARTICULAR
FONT, STYLE, SIZE, OR COLOR.

FOR: DRY CLEANING SERVICES, IN CLASS 37
(U.S. CLS. 100, 103 AND 106).

SN 77-143,380, FILED 3-29-2007.

FIRST USE 6-9-2008; IN COMMERCE 6-9-2008.

JOHN HWANG, EXAMINING ATTORNEY

Int. Cl.: 22

Prior U.S. Cls.: 1, 2, 7, 19, 22, 42, and 50

Reg. No. 3,477,533

United States Patent and Trademark Office

Registered July 29, 2008

**TRADEMARK
PRINCIPAL REGISTER**

Rocky Mountain Tea Bag

NICASTLE, LARRY P. (UNITED STATES INDIVIDUAL)
12832 APPALOOSA AVENUE
WELLINGTON, CO 80549

FOR: HANGING NON-METAL MESH NET SECURED TO CONTAINERS OF LIQUID TO CAPTURE DEPOSITED MATERIAL, IN CLASS 22 (U.S. CLS. 1, 2, 7, 19, 22, 42 AND 50).

FIRST USE 10-7-2007; IN COMMERCE 10-7-2007.

THE MARK CONSISTS OF STANDARD CHARACTERS WITHOUT CLAIM TO ANY PARTICULAR FONT, STYLE, SIZE, OR COLOR.

NO CLAIM IS MADE TO THE EXCLUSIVE RIGHT TO USE "ROCKY MOUNTAIN", APART FROM THE MARK AS SHOWN.

SN 77-143,618, FILED 3-29-2007.

REBECCA SMITH, EXAMINING ATTORNEY

Int. Cls.: 30 and 32

Prior U.S. Cls.: 45, 46, and 48

United States Patent and Trademark Office

Reg. No. 3,477,534

Registered July 29, 2008

**TRADEMARK
PRINCIPAL REGISTER**



CLIF BAR & CO. (CALIFORNIA CORPORATION)
1610 FIFTH ST.
BERKELEY, CA 94710

FOR: HIGH ENERGY GELS MADE PRIMARILY FROM BROWN RICE SYRUP, SNACK FOOD CHEWS MADE PRIMARILY FROM BROWN RICE SYRUP FOR CONSUMPTION DURING ATHLETIC ACTIVITIES, IN CLASS 30 (U.S. CL. 46).

FIRST USE 5-1-2007; IN COMMERCE 5-1-2007.

FOR: POWDERS USED IN THE PREPARATION OF SPORTS BEVERAGES, IN CLASS 32 (U.S. CLS. 45, 46 AND 48).

FIRST USE 5-1-2007; IN COMMERCE 5-1-2007.

OWNER OF U.S. REG. NOS. 2,089,043, 3,057,646, AND OTHERS.

THE MARK CONSISTS OF THE WORDS "1/2 SHOT" AND A CUP DESIGN SUPERIMPOSED OVER AN OVAL.

SN 77-143,698, FILED 3-29-2007.

SANI KHOURI, EXAMINING ATTORNEY

Int. Cl.: 24

Prior U.S. Cls.: 42 and 50

United States Patent and Trademark Office

Reg. No. 3,477,535

Registered July 29, 2008

**TRADEMARK
PRINCIPAL REGISTER**



TORAY ULTRASUEDE (AMERICA), INC. (NEW YORK CORPORATION)
1450 BROADWAY, 15TH FLOOR
NEW YORK, NY 10018

FOR: NON-WOVEN SUEDE-LIKE FABRICS IN THE PIECE MADE WHOLLY OR PARTIALLY OF SYNTHETIC FIBERS AND IMPREGNATED WITH SYNTHETIC RESINS, IN CLASS 24 (U.S. CLS. 42 AND 50).

THE MARK CONSISTS OF THE LETTER "U" APPEARING FOUR TIMES IN A SQUARE, WITH EACH "U" ORIENTED EITHER UP, DOWN, LEFT, OR RIGHT.

SN 77-143,951, FILED 3-29-2007.

FIRST USE 4-30-2008; IN COMMERCE 4-30-2008.

ELLEN PERKINS, EXAMINING ATTORNEY

Int. Cl.: 12

Prior U.S. Cls.: 19, 21, 23, 31, 35, and 44

United States Patent and Trademark Office

Reg. No. 3,477,536

Registered July 29, 2008

**TRADEMARK
PRINCIPAL REGISTER**

VAULT

FELT RACING, LLC (CALIFORNIA LTD LIAB
CO)
12 CHRYSLER
IRVINE, CA 92618

THE MARK CONSISTS OF STANDARD CHAR-
ACTERS WITHOUT CLAIM TO ANY PARTICULAR
FONT, STYLE, SIZE, OR COLOR.

FOR: BICYCLES AND BICYCLE STRUCTURAL
PARTS, IN CLASS 12 (U.S. CLS. 19, 21, 23, 31, 35 AND
44).

SN 77-144,312, FILED 3-29-2007.

FIRST USE 8-8-2007; IN COMMERCE 8-8-2007.

GIANCARLO CASTRO, EXAMINING ATTORNEY

Int. Cl.: 35

Prior U.S. Cls.: 100, 101, and 102

United States Patent and Trademark Office

Reg. No. 3,477,537

Registered July 29, 2008

SERVICE MARK
PRINCIPAL REGISTER

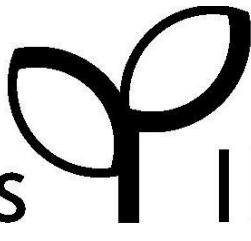
ageless  IDEAS

AGELESS IDEAS (FLORIDA SOLE PROPRIETORSHIP)
1303 TROON WAY
ROCKLEDGE, FL 32955

FOR: MANAGEMENT AND BUSINESS CONSULTING SERVICES IN THE FIELD OF HEALTH/FITNESS PROGRAMS FOR ORGANIZATIONS, RETIREMENT COMMUNITIES AND CORPORATIONS, IN CLASS 35 (U.S. CLS. 100, 101 AND 102).

FIRST USE 5-25-2007; IN COMMERCE 5-25-2007.

THE MARK CONSISTS OF AN ABSTRACT DESIGN WITH STYLIZED TEXT.

SN 77-144,676, FILED 3-30-2007.

TINA L. SNAPP, EXAMINING ATTORNEY

Int. Cl.: 6

Prior U.S. Cls.: 2, 12, 13, 14, 23, 25, and 50

Reg. No. 3,477,538

United States Patent and Trademark Office

Registered July 29, 2008

**TRADEMARK
PRINCIPAL REGISTER**



BUMPERITE WATERGUARDS "LLC" (CALIFORNIA LTD LIAB CO)
817 CAPITAN ST.
THOUSAND OAKS, CA 91320

FOR: SEALABLE SCAFFOLD ATTACHMENT SYSTEM FOR EXTERIOR PLASTER WALLS COMPRISED PRIMARILY OF STEEL PIPES, NUTS, BOLTS AND FLAT STEEL PLATES , IN CLASS 6 (U.S. CLS. 2, 12, 13, 14, 23, 25 AND 50).

FIRST USE 3-10-2007; IN COMMERCE 4-1-2007.

THE MARK CONSISTS OF THE WORD "BUMPERITE" WITH THE INNER AND OUTER PART OF THE "B" OUTLINED. "WATERGUARDS", SITS BELOW "BUMPERITE" BEGINNING AFTER THE LETTER "P". BELOW THIS IS A DRAWING OF A BUMPER WITH TWO DROPS OF WATER AT THE BASE OF THE "P". ".COM" IS AT THE END OF THE WORD "BUMPERITE".

SN 77-146,104, FILED 4-2-2007.

MELISSA VALLILLO, EXAMINING ATTORNEY

Int. Cls.: 16 and 41

Prior U.S. Cls.: 2, 5, 22, 23, 29, 37, 38, 50, 100, 101, and 107

Reg. No. 3,477,539

United States Patent and Trademark Office

Registered July 29, 2008

**TRADEMARK
SERVICE MARK
PRINCIPAL REGISTER**

Hollywords

HOLLYWORDS, LLC (CALIFORNIA LTD LIAB
CO)
7058 BIANCA AVE.
LAKE BALBOA, CA 91406

FOR: SERIES OF BOOKS FEATURING REFER-
ENCE AND CONTACT INFORMATION FOR USE
IN THE AUDIOVISUAL INDUSTRY, IN CLASS 16
(U.S. CLS. 2, 5, 22, 23, 29, 37, 38 AND 50).

FIRST USE 4-17-2008; IN COMMERCE 6-16-2008.

FOR: PROVIDING AN ONLINE DATABASE FEAT-
URING ON-LINE NONDOWNLOADABLE ELEC-
TRONIC REFERENCE DICTIONARIES

CONTAINING TERMS USED IN THE AUDIOVI-
SUAL INDUSTRY, IN CLASS 41 (U.S. CLS. 100, 101
AND 107).

FIRST USE 4-17-2005; IN COMMERCE 4-17-2005.

THE MARK CONSISTS OF STANDARD CHAR-
ACTERS WITHOUT CLAIM TO ANY PARTICULAR
FONT, STYLE, SIZE, OR COLOR.

SN 77-146,640, FILED 4-2-2007.

KATHLEEN M. VANSTON, EXAMINING ATTOR-
NEY

Int. Cl.: 9

Prior U.S. Cls.: 21, 23, 26, 36, and 38

Reg. No. 3,477,540

United States Patent and Trademark Office

Registered July 29, 2008

**TRADEMARK
PRINCIPAL REGISTER**

Techcare

TEHCARE TECHNOLOGY LIMITED (HONG
KONG LTD LIAB CO)
UNIT 1, 7/F., LEMMI CENTRE
50 HOI YUEN ROAD, KWUN TONG
KOWLOON, HONG KONG

FOR: ELECTRONIC CARD READERS; PEDOM-
ETERS; ELECTRONIC INDICATOR BOARDS; TEM-
PERATURE INDICATORS; PARKING METERS;
TIMERS; CHRONOGRAPHS FOR USE AS SPECIA-
LIZED TIME RECORDING APPARATUSES; TIME
CLOCKS; ELECTRIC METERS; LEVEL INDICA-
TORS; MEASURING INSTRUMENTATION AND

APPARATUS, NAMELY, DIGITIZERS; MEASUR-
ING APPARATUS, NAMELY, RAIN GAUGES; MEA-
SURING APPARATUS, NAMELY, BEVELS;
APPARATUS FOR TESTING GAS, LIQUIDS AND
SOLIDS, IN CLASS 9 (U.S. CLS. 21, 23, 26, 36 AND 38).

FIRST USE 2-1-2008; IN COMMERCE 2-1-2008.

SN 77-146,958, FILED 4-3-2007.

DAYNA BROWNE, EXAMINING ATTORNEY

Int. Cl.: 36

Prior U.S. Cls.: 100, 101, and 102

United States Patent and Trademark Office

Reg. No. 3,477,541

Registered July 29, 2008

**SERVICE MARK
PRINCIPAL REGISTER**



FL FOOD LION, INC. (FLORIDA CORPORATION)
2110 EXECUTIVE DRIVE
SALISBURY, NC 28145

NO CLAIM IS MADE TO THE EXCLUSIVE
RIGHT TO USE "CREDIT UNION", APART FROM
THE MARK AS SHOWN.

FOR: FINANCIAL SERVICES, NAMELY, CREDIT
UNION SERVICES, IN CLASS 36 (U.S. CLS. 100, 101
AND 102).

SN 77-146,986, FILED 4-3-2007.

FIRST USE 4-7-2007; IN COMMERCE 4-7-2007.

CHRIS WELLS, EXAMINING ATTORNEY

Int. Cls.: 20 and 21

Prior U.S. Cls.: 2, 13, 22, 23, 25, 29, 30, 32, 33, 40, and 50

Reg. No. 3,477,542

United States Patent and Trademark Office

Registered July 29, 2008

**TRADEMARK
PRINCIPAL REGISTER**

EDELHOLZ

CORMELL, RICHARD L. (UNITED STATES INDIVIDUAL)

26 NORTH SEVENTH STREET
LEWISBURG, PA 17837 AND

HASELOFF, IRIS C. (UNITED STATES INDIVIDUAL)

26 NORTH SEVENTH STREET
LEWISBURG, PA 17837

FOR: WOODEN FURNITURE , IN CLASS 20 (U.S. CLS. 2, 13, 22, 25, 32 AND 50).

FIRST USE 8-0-2007; IN COMMERCE 8-0-2007.

FOR: CUTTING BOARDS, IN CLASS 21 (U.S. CLS. 2, 13, 23, 29, 30, 33, 40 AND 50).

FIRST USE 5-27-2007; IN COMMERCE 5-27-2007.

THE MARK CONSISTS OF STANDARD CHARACTERS WITHOUT CLAIM TO ANY PARTICULAR FONT, STYLE, SIZE, OR COLOR.

THE ENGLISH TRANSLATION OF WORD "EDELHOLZ" IN THE MARK IS NOBLE WOOD.

SN 77-147,245, FILED 4-3-2007.

ANTHONY RINKER, EXAMINING ATTORNEY

Int. Cl.: 40

Prior U.S. Cls.: 100, 103, and 106

United States Patent and Trademark Office

Reg. No. 3,477,543

Registered July 29, 2008

**SERVICE MARK
PRINCIPAL REGISTER**

OLIVER

A.M. CASTLE & CO. (DELAWARE CORPORATION)
3400 NORTH WOLF ROAD
FRANKLIN PARK, IL 60131

FOR: CUSTOM PROCESSING OF CARBON STEEL PLATE AND ALLOY STEEL PLATE, NAMELY, FLAME CUTTING, SAW CUTTING, THERMAL TREATMENT, FLATTENING AND STRAIGHTENING, MILLING AND GRINDING, IN CLASS 40 (U.S. CLS. 100, 103 AND 106).

FIRST USE 12-31-1978; IN COMMERCE 12-31-1978.

THE MARK CONSISTS OF STANDARD CHARACTERS WITHOUT CLAIM TO ANY PARTICULAR FONT, STYLE, SIZE, OR COLOR.

SN 77-147,320, FILED 4-3-2007.

PAUL CROWLEY, EXAMINING ATTORNEY

Int. Cl.: 5

Prior U.S. Cls.: 6, 18, 44, 46, 51, and 52

United States Patent and Trademark Office

Reg. No. 3,477,544

Registered July 29, 2008

**TRADEMARK
PRINCIPAL REGISTER**

WORKING BETTER TOGETHER

WYETH HOLDINGS CORPORATION (MAINE
CORPORATION)
FIVE GIRALDA FARMS
MADISON, NJ 07940

THE MARK CONSISTS OF STANDARD CHAR-
ACTERS WITHOUT CLAIM TO ANY PARTICULAR
FONT, STYLE, SIZE, OR COLOR.

FOR: DIETARY AND NUTRITIONAL SUPPLE-
MENTS, IN CLASS 5 (U.S. CLS. 6, 18, 44, 46, 51 AND
52).

SN 77-147,339, FILED 4-3-2007.

FIRST USE 8-31-2007; IN COMMERCE 8-31-2007.

CHRIS WELLS, EXAMINING ATTORNEY

Int. Cl.: 16

Prior U.S. Cls.: 2, 5, 22, 23, 29, 37, 38, and 50

United States Patent and Trademark Office

Reg. No. 3,477,545

Registered July 29, 2008

**TRADEMARK
PRINCIPAL REGISTER**

JUICIEZ

JAKKS PACIFIC, INC. (DELAWARE CORPORATION)
22619 PACIFIC COAST HIGHWAY
MALIBU, CA 90265

THE MARK CONSISTS OF STANDARD CHARACTERS WITHOUT CLAIM TO ANY PARTICULAR FONT, STYLE, SIZE, OR COLOR.

FOR: WRITING INSTRUMENTS; ERASERS, IN CLASS 16 (U.S. CLS. 2, 5, 22, 23, 29, 37, 38 AND 50).

SN 77-147,844, FILED 4-3-2007.

FIRST USE 4-1-2008; IN COMMERCE 4-1-2008.

JAMES LOVELACE, EXAMINING ATTORNEY

Int. Cl.: 33

Prior U.S. Cls.: 47 and 49

United States Patent and Trademark Office

Reg. No. 3,477,546

Registered July 29, 2008

**TRADEMARK
PRINCIPAL REGISTER**

ROLLING ESTATE WINES

CUMULUS WINES PTY LIMITED (AUSTRALIA
COMPANY)
44 PITT STREET
SYDNEY, AUSTRALIA 2000

NO CLAIM IS MADE TO THE EXCLUSIVE
RIGHT TO USE "ESTATE WINES", APART FROM
THE MARK AS SHOWN.

FOR: WINE, IN CLASS 33 (U.S. CLS. 47 AND 49).

FIRST USE 4-0-2007; IN COMMERCE 4-0-2007.

SN 77-147,921, FILED 4-3-2007.

THE MARK CONSISTS OF STANDARD CHAR-
ACTERS WITHOUT CLAIM TO ANY PARTICULAR
FONT, STYLE, SIZE, OR COLOR.

JENNIFER MARTIN, EXAMINING ATTORNEY

Int. Cl.: 32

Prior U.S. Cls.: 45, 46, and 48

United States Patent and Trademark Office

Reg. No. 3,477,547

Registered July 29, 2008

**TRADEMARK
PRINCIPAL REGISTER**

YIN SMOOTHIE

YAKAMA JUICE, LLC (WASHINGTON LTD
LIAB CO)

1 RAILROAD AVENUE

SELAH, WA 98942

FOR: FRUIT BEVERAGES, IN CLASS 32 (U.S. CLS.
45, 46 AND 48).

FIRST USE 6-0-2007; IN COMMERCE 6-0-2007.

THE MARK CONSISTS OF STANDARD CHAR-
ACTERS WITHOUT CLAIM TO ANY PARTICULAR
FONT, STYLE, SIZE, OR COLOR.

NO CLAIM IS MADE TO THE EXCLUSIVE
RIGHT TO USE "SMOOTHIE", APART FROM THE
MARK AS SHOWN.

SN 77-148,011, FILED 4-4-2007.

CYNTHIA SLOAN, EXAMINING ATTORNEY

Int. Cl.: 20

Prior U.S. Cls.: 2, 13, 22, 25, 32, and 50

Reg. No. 3,477,548

United States Patent and Trademark Office

Registered July 29, 2008

**TRADEMARK
PRINCIPAL REGISTER**

VARIATIONS

GRAND RAPIDS CHAIR COMPANY (MICHIGAN CORPORATION)
625 CHESTNUT SW
GRAND RAPIDS, MI 49503

THE MARK CONSISTS OF STANDARD CHARACTERS WITHOUT CLAIM TO ANY PARTICULAR FONT, STYLE, SIZE, OR COLOR.

FOR: CHAIRS, IN CLASS 20 (U.S. CLS. 2, 13, 22, 25, 32 AND 50).

SN 77-148,992, FILED 4-4-2007.

FIRST USE 4-21-2008; IN COMMERCE 4-21-2008.

LINDA M. KING, EXAMINING ATTORNEY

Int. Cl.: 41

Prior U.S. Cls.: 100, 101, and 107

United States Patent and Trademark Office

Reg. No. 3,477,549

Registered July 29, 2008

**SERVICE MARK
PRINCIPAL REGISTER**

SOCIALLY OFFENSIVE BEHAVIOR

BLACK ENTERTAINMENT TELEVISION LLC
(D.C. LTD LIAB CO)
LEGAL AFFAIRS
ONE BET PLAZA, 1235 W STREET, N.E.
WASHINGTON, DC 20018

FOR: ENTERTAINMENT SERVICES IN THE
NATURE OF A CONTINUING TELEVISION TA-
LENT SHOW ACCESSIBLE BY CABLE TELEVISION,
BROADCAST TELEVISION, SATELLITE, WIRELESS
AND THE INTERNET, IN CLASS 41 (U.S. CLS. 100,
101 AND 107).

FIRST USE 7-25-2007; IN COMMERCE 7-25-2007.

THE MARK CONSISTS OF STANDARD CHAR-
ACTERS WITHOUT CLAIM TO ANY PARTICULAR
FONT, STYLE, SIZE, OR COLOR.

SN 77-149,032, FILED 4-4-2007.

JANET LEE, EXAMINING ATTORNEY

Int. Cl.: 3

Prior U.S. Cls.: 1, 4, 6, 50, 51, and 52

United States Patent and Trademark Office

Reg. No. 3,477,550

Registered July 29, 2008

**TRADEMARK
PRINCIPAL REGISTER**

A87

AEROPOSTALE WEST, INC. (DELAWARE CORPORATION)
201 WILLOWBROOK BOULEVARD, 7TH FLOOR
WAYNE, NJ 07470

FOR: COSMETICS, NAMELY, SUNSCREEN PREPARATIONS, NAMELY, SUNSCREEN LOTIONS, SUNSCREEN CREAMS, SUNSCREEN GEL, SUNTAN OILS, SKIN LOTIONS, SKIN GEL, HAIR SHAMPOO, HAIR CONDITIONERS, NON-MEDICATED SKIN AND FACIAL CLEANSERS AND CREAMS, DEODORANT, BODY SPRAY, NAIL POLISH, LIPSTICK, LIP GLOSS, LIP BALM, HAIR GEL, HAIR MOUSSE, HAIR SPRAY, BATH GEL AND SOAPS, IN CLASS 3 (U.S. CLS. 1, 4, 6, 50, 51 AND 52).

FIRST USE 4-1-2005; IN COMMERCE 11-1-2005.

THE MARK CONSISTS OF STANDARD CHARACTERS WITHOUT CLAIM TO ANY PARTICULAR FONT, STYLE, SIZE, OR COLOR.

OWNER OF U.S. REG. NO. 3,151,023.

SN 77-149,505, FILED 4-5-2007.

ELIZABETH BEYER, EXAMINING ATTORNEY

Int. Cl.: 35

Prior U.S. Cls.: 100, 101, and 102

United States Patent and Trademark Office

Reg. No. 3,477,551

Registered July 29, 2008

**SERVICE MARK
PRINCIPAL REGISTER**

WHERE DEALS GET DONE

TRANSACTION COMMONS, LLC (MISSOURI
LTD LIAB CO)
4144 PENNSYLVANIA AVENUE
KANSAS CITY, MO 64111

FOR: ELECTRONIC DOCUMENT MANAGE-
MENT FOR OTHERS, NAMELY, DOCUMENT RE-
CEIPT, DOCUMENT CATEGORIZATION AND
DOCUMENT RETRIEVAL VIA A SECURE WEBSITE
, IN CLASS 35 (U.S. CLS. 100, 101 AND 102).

FIRST USE 6-15-2008; IN COMMERCE 6-15-2008.

THE MARK CONSISTS OF STANDARD CHAR-
ACTERS WITHOUT CLAIM TO ANY PARTICULAR
FONT, STYLE, SIZE, OR COLOR.

SN 77-149,818, FILED 4-5-2007.

MARCIE MILONE, EXAMINING ATTORNEY

Int. Cl.: 41

Prior U.S. Cls.: 100, 101, and 107

United States Patent and Trademark Office

Reg. No. 3,477,552

Registered July 29, 2008

**SERVICE MARK
PRINCIPAL REGISTER**

Don't Drag The Rag

LOUISE HOLYFIELD (UNITED STATES INDIVIDUAL)
5609 BENT TRAIL
DALLAS, TX 75248

THE MARK CONSISTS OF STANDARD CHARACTERS WITHOUT CLAIM TO ANY PARTICULAR FONT, STYLE, SIZE, OR COLOR.

FOR: TEACHING AND TRAINING ON PROPER SKIN-CARE AND MAKE-UP APPLICATION, IN CLASS 41 (U.S. CLS. 100, 101 AND 107).

SN 77-150,001, FILED 4-5-2007.

FIRST USE 6-11-2008; IN COMMERCE 6-11-2008.

GINA FINK, EXAMINING ATTORNEY

Int. Cl.: 5

Prior U.S. Cls.: 6, 18, 44, 46, 51, and 52

United States Patent and Trademark Office

Reg. No. 3,477,553

Registered July 29, 2008

**TRADEMARK
PRINCIPAL REGISTER**

PAMPREX

U.S. NONWOVENS CORPORATION (NEW YORK
CORPORATION)
100 EMJAY BLVD
BRENTWOOD, NY 11717

FOR: FEMININE HYGIENE PRODUCTS, NAME-
LY, SANITARY NAPKINS, PANTILINERS, FEMI-
NINE PROTECTION PADS, TAMPONS AND
SANITARY BELTS, IN CLASS 5 (U.S. CLS. 6, 18, 44,
46, 51 AND 52).

FIRST USE 5-15-2008; IN COMMERCE 5-15-2008.

THE MARK CONSISTS OF STANDARD CHAR-
ACTERS WITHOUT CLAIM TO ANY PARTICULAR
FONT, STYLE, SIZE, OR COLOR.

SN 77-150,687, FILED 4-6-2007.

NORA BUCHANAN WILL, EXAMINING ATTOR-
NEY

Int. Cl.: 25

Prior U.S. Cls.: 22 and 39

United States Patent and Trademark Office

Reg. No. 3,477,554

Registered July 29, 2008

**TRADEMARK
PRINCIPAL REGISTER**

alove

MANFREDI, ANTHONY (UNITED STATES IN-
DIVIDUAL)
1845 US HWY 130
NORTH BRUNSWICK, NJ 08902

THE MARK CONSISTS OF ALL LOWER CASE
PRINTED AND/OR EMBROIDERED ON CLOTH-
ING. ALOVE WILL BE MY CLOTHING COMPANY.

FOR: T-SHIRTS, FLEECE SWEAT PANTS,
FLEECE SWEAT SHIRTS, CUT-SEW TOPS, SHORTS,
AND PANTS, IN CLASS 25 (U.S. CLS. 22 AND 39).

SN 77-150,711, FILED 4-6-2007.

FIRST USE 1-1-2008; IN COMMERCE 4-5-2008.

RICHARD A. STRASER, EXAMINING ATTORNEY

Int. Cls.: 9, 25, and 41

Prior U.S. Cls.: 21, 22, 23, 26, 36, 38, 39, 100, 101, and 107

Reg. No. 3,477,555

United States Patent and Trademark Office

Registered July 29, 2008

**TRADEMARK
SERVICE MARK
PRINCIPAL REGISTER**

Battle of the Gods

CLINT ROGERS MINISTRIES (ARIZONA NON-PROFIT ORGANIZATION)
7914 E HERMOSA VISTA DRIVE
MESA, AZ 85207

FOR: PRE-RECORDED CDS, VIDEO TAPES, LASER DISKS AND DVDS FEATURING CLINT ROGERS, IN CLASS 9 (U.S. CLS. 21, 23, 26, 36 AND 38).

FIRST USE 4-7-2007; IN COMMERCE 4-7-2007.

FOR: SHORT-SLEEVED OR LONG-SLEEVED T-SHIRTS, IN CLASS 25 (U.S. CLS. 22 AND 39).

FIRST USE 4-7-2007; IN COMMERCE 4-7-2007.

FOR: ENTERTAINMENT, NAMELY, LIVE MUSIC CONCERTS, IN CLASS 41 (U.S. CLS. 100, 101 AND 107).

FIRST USE 4-7-2007; IN COMMERCE 4-7-2007.

THE MARK CONSISTS OF STANDARD CHARACTERS WITHOUT CLAIM TO ANY PARTICULAR FONT, STYLE, SIZE, OR COLOR.

SN 77-151,084, FILED 4-6-2007.

RAMONA ORTIGA, EXAMINING ATTORNEY

Int. Cls.: 35 and 36

Prior U.S. Cls.: 100, 101, and 102

United States Patent and Trademark Office

Reg. No. 3,477,556

Registered July 29, 2008

**SERVICE MARK
PRINCIPAL REGISTER**

MY SHOPKO REWARDS

SHOPKO STORES OPERATING CO., LLC (DELA-
WARE LTD LIAB CO)
700 PILGRIM WAY
GREEN BAY, WI 543079060

FOR: CUSTOMER LOYALTY SERVICES AND
CUSTOMER CLUB SERVICES, FOR COMMERCIAL,
PROMOTIONAL AND/OR ADVERTISING PURPO-
SES, IN CLASS 35 (U.S. CLS. 100, 101 AND 102).

FIRST USE 8-5-2007; IN COMMERCE 8-5-2007.

FOR: CREDIT CARD SERVICES, IN CLASS 36
(U.S. CLS. 100, 101 AND 102).

FIRST USE 8-5-2007; IN COMMERCE 8-5-2007.

THE MARK CONSISTS OF STANDARD CHAR-
ACTERS WITHOUT CLAIM TO ANY PARTICULAR
FONT, STYLE, SIZE, OR COLOR.

OWNER OF U.S. REG. NOS. 1,408,068, 1,847,974,
AND OTHERS.

NO CLAIM IS MADE TO THE EXCLUSIVE
RIGHT TO USE "REWARDS", APART FROM THE
MARK AS SHOWN.

SN 77-151,599, FILED 4-9-2007.

AHSEN KHAN, EXAMINING ATTORNEY

Int. Cl.: 25

Prior U.S. Cls.: 22 and 39

United States Patent and Trademark Office

Reg. No. 3,477,557

Registered July 29, 2008

**TRADEMARK
PRINCIPAL REGISTER**

BABY TREADS & THREADS

BABY TREADS & THREADS (MICHIGAN CORPORATION)
6079 SALINE ANN ARBOR RD.
SALINE, MI 48176

FOR: ATHLETIC SHOES; CANVAS SHOES; INFANTS' SHOES AND BOOTS; LEATHER SHOES; SHOES; TENNIS SHOES; DENIMS; PANTS; DRESSES; SKIRTS AND DRESSES; SHIRTS; SHORT-SLEEVED OR LONG-SLEEVED T-SHIRTS; SHORT-SLEEVED SHIRTS; T-SHIRTS; HATS; HEADGEAR, HATS; COATS OF DENIM, IN CLASS 25 (U.S. CLS. 22 AND 39).

FIRST USE 1-19-2007; IN COMMERCE 1-15-2008.

THE MARK CONSISTS OF STANDARD CHARACTERS WITHOUT CLAIM TO ANY PARTICULAR FONT, STYLE, SIZE, OR COLOR.

NO CLAIM IS MADE TO THE EXCLUSIVE RIGHT TO USE "BABY", APART FROM THE MARK AS SHOWN.

SN 77-152,280, FILED 4-9-2007.

ROBIN CHOSID, EXAMINING ATTORNEY

Int. Cl.: 1

Prior U.S. Cls.: 1, 5, 6, 10, 26, and 46

Reg. No. 3,477,558

United States Patent and Trademark Office

Registered July 29, 2008

**TRADEMARK
PRINCIPAL REGISTER**

TruScent

FILLMORE CONTAINER, INC. (PENNSYLVANIA CORPORATION)
2316 NORMAN ROAD
LANCASTER, PA 17601

THE MARK CONSISTS OF STANDARD CHARACTERS WITHOUT CLAIM TO ANY PARTICULAR FONT, STYLE, SIZE, OR COLOR.

FOR: FRAGRANCES FOR USE IN MANUFACTURING CANDLES, BATH AND BODY, AND ROOM FRAGRANCE SYSTEMS, IN CLASS 1 (U.S. CLS. 1, 5, 6, 10, 26 AND 46).

SN 77-152,550, FILED 4-10-2007.

FIRST USE 8-2-2007; IN COMMERCE 8-2-2007.

MIDGE BUTLER, EXAMINING ATTORNEY

Int. Cl.: 18

Prior U.S. Cls.: 1, 2, 3, 22, and 41

United States Patent and Trademark Office

Reg. No. 3,477,559

Registered July 29, 2008

**TRADEMARK
PRINCIPAL REGISTER**

PRINCESS PANTS

SO SEW ME, LLC (OHIO LTD LIAB CO)
3052 MANN ROAD
BLACKLICK, OH 43004

NO CLAIM IS MADE TO THE EXCLUSIVE
RIGHT TO USE "PANTS", APART FROM THE
MARK AS SHOWN.

FOR: DOG CLOTHING, IN CLASS 18 (U.S. CLS. 1,
2, 3, 22 AND 41).

SN 77-152,694, FILED 4-10-2007.

FIRST USE 3-15-2005; IN COMMERCE 3-15-2005.

THE MARK CONSISTS OF STANDARD CHAR-
ACTERS WITHOUT CLAIM TO ANY PARTICULAR
FONT, STYLE, SIZE, OR COLOR.

VIVIAN MICZNIK FIRST, EXAMINING ATTOR-
NEY

Int. Cl.: 18

Prior U.S. Cls.: 1, 2, 3, 22, and 41

United States Patent and Trademark Office

Reg. No. 3,477,560

Registered July 29, 2008

**TRADEMARK
PRINCIPAL REGISTER**

PISSTOL PANTS

SO SEW ME, LLC (OHIO LTD LIAB CO)
3052 MANN ROAD
BLACKLICK, OH 43004

NO CLAIM IS MADE TO THE EXCLUSIVE
RIGHT TO USE "PANTS", APART FROM THE
MARK AS SHOWN.

FOR: DOG CLOTHING, IN CLASS 18 (U.S. CLS. 1,
2, 3, 22 AND 41).

SN 77-152,705, FILED 4-10-2007.

FIRST USE 3-15-2005; IN COMMERCE 3-15-2005.

THE MARK CONSISTS OF STANDARD CHAR-
ACTERS WITHOUT CLAIM TO ANY PARTICULAR
FONT, STYLE, SIZE, OR COLOR.

VIVIAN MICZNIK FIRST, EXAMINING ATTOR-
NEY

Int. Cls.: 16 and 25

Prior U.S. Cls.: 2, 5, 22, 23, 29, 37, 38, 39, and 50

United States Patent and Trademark Office

Reg. No. 3,477,561

Registered July 29, 2008

**TRADEMARK
PRINCIPAL REGISTER**

We are the Green Kids

SCHILLER DISKIN BARBARA A (UNITED STATES INDIVIDUAL)

PO BOX 3130

ASHLAND, OR 97520

FOR: A SERIES OF BOOKS, WRITTEN ARTICLES, HANDOUTS AND WORKSHEETS IN THE FIELD OF TEACHING CHILDREN ABOUT RECYCLING, SELF-ESTEEM AND TOOLS FOR DEVELOPING SELF-ESTEEM; ADDRESS BOOKS; APPOINTMENT BOOKS; AUTOGRAPH BOOKS; BABY BOOKS; BIRTHDAY BOOKS; BOOK COVERS; BOOK-COVER PAPER; BRAG BOOKS; CHILDREN'S ACTIVITY BOOKS; CHILDREN'S BOOKS; CHILDREN'S INTERACTIVE EDUCATIONAL BOOKS; CHILDREN'S STORYBOOKS; COLORING BOOKS; COMIC BOOKS; COOK BOOKS; DATE BOOKS; DISPOSABLE SWIM PANTS FOR CHILDREN AND INFANTS; EDUCATIONAL BOOKS FEATURING CHILDREN, NAMELY, EDUCATIONAL BOOK FOR USE IN TEACHING CHILDREN ABOUT RECYCLING, SELF-ESTEEM AND TOOLS FOR DEVELOPING SELF-ESTEEM; EDUCATIONAL PUBLICATIONS, NAMELY, EDUCATIONAL LEARNING CARDS, FLASH CARDS, ACTIVITY CARDS, WORKBOOKS, TEXTBOOKS, ACTIVITY BOOKS, STORY BOOKS, PUZZLE BOOKS, PUZZLES, TEACHER GUIDES, MANUALS, POSTERS, EDUCATIONAL CARD GAMES AND EDUCATIONAL BOOKLETS IN THE FIELD OF TEACHING CHILDREN ABOUT RECYCLING, SELF-ESTEEM AND TOOLS FOR DEVELOPING SELF-ESTEEM; EXERCISE BOOKS; EXERCISE-BOOK COVERS; GIFT BOOKS FEATURING PHOTOGRAPHS OF CHILDREN; MANUSCRIPT BOOKS; MODELING CLAY FOR CHILDREN; MODELING MATERIALS AND COMPOUNDS FOR USE BY CHILDREN; NOTE BOOKS; PAINTING SETS FOR CHILDREN; PICTURE BOOKS; POCKET MEMORANDUM BOOKS; PRINTED MUSIC BOOKS; PROTECTIVE COVERS FOR BOOKS; ROLE PLAYING GAME EQUIPMENT IN THE NATURE OF GAME BOOK MANUALS;

SCHOOL SUPPLY KITS CONTAINING VARIOUS COMBINATIONS OF SELECTED SCHOOL SUPPLIES, NAMELY, WRITING INSTRUMENTS, PENS, PENCILS, MECHANICAL PENCILS, ERASERS, MARKERS, CRAYONS, HIGHLIGHTERS, FOLDERS, NOTEBOOKS, PAPER, GRADUATED RULERS, PROTRACTORS, PAPER CLIPS, PENCIL SHARPENERS, WRITING GRIPS, GLUE AND BOOK MARKS; SCHOOL WRITING BOOKS; SERIES OF FICTION BOOKS; SERIES OF NON-FICTION BOOKS IN THE FIELD OF CHILDREN, NAMELY, CHILD BEHAVIOR, PARENTING SKILLS AND TOOLS FOR DEVELOPING SELF-ESTEEM; SKETCH BOOKS; SONG BOOKS; STORY BOOKS; TALKING CHILDREN'S BOOKS, IN CLASS 16 (U.S. CLS. 2, 5, 22, 23, 29, 37, 38 AND 50).

FIRST USE 10-2-2006; IN COMMERCE 1-16-2008.

FOR: CAPS; CHILDREN'S AND INFANTS' CLOTH BIBS; CHILDREN'S CLOTH EATING BIBS; CHILDREN'S HEADWEAR; CLOTH BIBS; CLOTH DIAPERS; CLOTHING FOR WEAR IN JUDO PRACTICES; CLOTHING, NAMELY, ARM WARMERS; CLOTHING, NAMELY, KNEE WARMERS; CLOTHING, NAMELY, NECK TUBES; CLOTHING, NAMELY, WRAP-AROUNDS; FOULARDS; HOODS; INFANT AND TODDLER ONE PIECE CLOTHING; INFANT CLOTH DIAPERS; JERSEYS; LEOTARDS AND TIGHTS FOR WOMEN, MEN AND CHILDREN OF NYLON, COTTON OR OTHER TEXTILE FIBERS; NON-DISPOSABLE CLOTH TRAINING PANTS; PAPER HATS FOR USE AS CLOTHING ITEMS; PARTS OF CLOTHING, NAMELY, GUSSETS FOR TIGHTS, GUSSETS FOR STOCKINGS, GUSSETS FOR BATHING SUITS, GUSSETS FOR UNDERWEAR, GUSSETS FOR LEOTARDS AND GUSSETS FOR FOOTLETS; PERSPIRATION ABSORBENT UNDERWEAR CLOTHING; SHIFTS; SHORT SETS; TIES; TOPS; UNDERARM CLOTHING SHIELDS; WRAPS, IN CLASS 25 (U.S. CLS. 22 AND 39).

FIRST USE 4-9-2008; IN COMMERCE 5-1-2008.

SN 77-152,713, FILED 4-10-2007.

THE MARK CONSISTS OF STANDARD CHARACTERS WITHOUT CLAIM TO ANY PARTICULAR FONT, STYLE, SIZE, OR COLOR.

JENNIFER MARTIN, EXAMINING ATTORNEY

Int. Cl.: 18

Prior U.S. Cls.: 1, 2, 3, 22, and 41

United States Patent and Trademark Office

Reg. No. 3,477,562

Registered July 29, 2008

TRADEMARK
PRINCIPAL REGISTER



WAHLOO, LLC (ILLINOIS LTD LIAB CO)
1513 GREENWOOD AVE
WILMETTE, IL 60091

FOR: BABY CARRIERS WORN ON THE BODY;
BABY CARRYING BAGS; INFANT CARRIERS
WORN ON THE BODY; SLINGS FOR CARRYING
INFANTS, IN CLASS 18 (U.S. CLS. 1, 2, 3, 22 AND 41).

FIRST USE 5-19-2008; IN COMMERCE 5-28-2008.

THE MARK CONSISTS OF A SMALL BIRD,
FACING LEFT, WITH AN OPEN BEAK, AND A
HEART IN THE PLACE OF THE EYE, SITS AT THE
TOP OF A CLOUD. INSIDE THE CLOUD IS THE
WORD "WAHLOO". BOTH THE WORD "WAHLOO"
AND THE CLOUD HAVE DOTTED LINES INSIDE
THEM, MEANT TO MIMIC A HAND-STITCHED
LOOK.

SN 77-153,430, FILED 4-10-2007.

REBECCA GILBERT, EXAMINING ATTORNEY

Int. Cl.: 29

Prior U.S. Cl.: 46

United States Patent and Trademark Office

Reg. No. 3,477,563

Registered July 29, 2008

**TRADEMARK
PRINCIPAL REGISTER**

BETTUR FREE

SUMMIT FOODS, INC. (MINNESOTA CORPORATION)
238 CHESTER STREET
ST. PAUL, MN 55107

FOR: BUTTER SUBSTITUTES, IN CLASS 29 (U.S. CL. 46).

FIRST USE 7-6-2007; IN COMMERCE 7-6-2007.

THE MARK CONSISTS OF STANDARD CHARACTERS WITHOUT CLAIM TO ANY PARTICULAR FONT, STYLE, SIZE, OR COLOR.

OWNER OF U.S. REG. NO. 1,232,916.

NO CLAIM IS MADE TO THE EXCLUSIVE RIGHT TO USE "FREE", APART FROM THE MARK AS SHOWN.

SN 77-153,460, FILED 4-10-2007.

TINA KUAN, EXAMINING ATTORNEY

Int. Cl.: 28

Prior U.S. Cls.: 22, 23, 38, and 50

United States Patent and Trademark Office

Reg. No. 3,477,564

Registered July 29, 2008

TRADEMARK
PRINCIPAL REGISTER



JAMES O. LUCAS (UNITED STATES INDIVIDUAL)
190 CUMBERLAND PARK DR.
ST. AUGUSTINE, FL 32095

FOR: POOL CUE CASES; POOL CUES, IN CLASS 28 (U.S. CLS. 22, 23, 38 AND 50).

FIRST USE 8-0-2007; IN COMMERCE 8-0-2007.

OWNER OF U.S. REG. NO. 2,255,758.

THE COLOR(S) RED, BLACK AND WHITE IS/ARE CLAIMED AS A FEATURE OF THE MARK.

THE MARK CONSISTS OF A BLACK RECTANGLE WITH THE WORDING "PLAYERS FLIRT" IN WHITE ALONG WITH A RED PAIR OF LIPS.

SN 77-153,674, FILED 4-11-2007.

NORA BUCHANAN WILL, EXAMINING ATTORNEY

Int. Cl.: 41

Prior U.S. Cls.: 100, 101, and 107

United States Patent and Trademark Office

Reg. No. 3,477,565

Registered July 29, 2008

**SERVICE MARK
PRINCIPAL REGISTER**

**YOU TAKE THE FIRST STEP.
WE'LL TEACH YOU THE REST.**

EXPERIENCE BALLROOM, INC. (GEORGIA CORPORATION), DBA ACADEMY BALLROOM CUMBERLAND,
2980 COBB PARKWAY
SUITE 104
ATLANTA, GA 30339

THE MARK CONSISTS OF STANDARD CHARACTERS WITHOUT CLAIM TO ANY PARTICULAR FONT, STYLE, SIZE, OR COLOR.

FOR: DANCE INSTRUCTION, IN CLASS 41 (U.S. CLS. 100, 101 AND 107).

SN 77-154,406, FILED 4-11-2007.

FIRST USE 5-27-2008; IN COMMERCE 5-27-2008.

TOBY BULLOFF, EXAMINING ATTORNEY

Int. Cl.: 28

Prior U.S. Cls.: 22, 23, 38, and 50

United States Patent and Trademark Office

Reg. No. 3,477,566

Registered July 29, 2008

**TRADEMARK
PRINCIPAL REGISTER**

THE SPIDERWICK CHRONICLES

PARAMOUNT PICTURES CORPORATION (DE-
LAWARE CORPORATION)
5555 MELROSE AVENUE
HOLLYWOOD, CA 90038

FOR: ACTION FIGURES AND ACCESSORIES
THEREFOR; BOARD GAMES; PLAYING CARDS;
JIGSAW PUZZLES; MODELED PLASTIC TOY FIG-
URINES, IN CLASS 28 (U.S. CLS. 22, 23, 38 AND 50).

FIRST USE 2-1-2008; IN COMMERCE 2-1-2008.

THE MARK CONSISTS OF STANDARD CHAR-
ACTERS WITHOUT CLAIM TO ANY PARTICULAR
FONT, STYLE, SIZE, OR COLOR.

SN 77-154,502, FILED 4-11-2007.

REBECCA GILBERT, EXAMINING ATTORNEY

Int. Cl.: 30

Prior U.S. Cl.: 46

United States Patent and Trademark Office

Reg. No. 3,477,567

Registered July 29, 2008

**TRADEMARK
PRINCIPAL REGISTER**

SUNNY YELLOW

ALIGN PARTNERS, LLC (NEW JERSEY LTD
LIAB CO)
P.O. BOX 8148
PRINCETON, NJ 08543

FOR: BAKING MIXES, CAKES, COOKIES, MUF-
FINS, BROWNIES, ICINGS AND FROSTINGS, IN
CLASS 30 (U.S. CL. 46).

FIRST USE 4-18-2008; IN COMMERCE 4-18-2008.

THE MARK CONSISTS OF STANDARD CHAR-
ACTERS WITHOUT CLAIM TO ANY PARTICULAR
FONT, STYLE, SIZE, OR COLOR.

NO CLAIM IS MADE TO THE EXCLUSIVE
RIGHT TO USE "YELLOW", APART FROM THE
MARK AS SHOWN.

SN 77-155,063, FILED 4-12-2007.

RICHARD WHITE, EXAMINING ATTORNEY

Int. Cl.: 11

Prior U.S. Cls.: 13, 21, 23, 31, and 34

United States Patent and Trademark Office

Reg. No. 3,477,568

Registered July 29, 2008

**TRADEMARK
PRINCIPAL REGISTER**

FIT-FLO

THE SWAN CORPORATION (MISSOURI COR-
PORATION)
ONE CITY CENTRE
ST. LOUIS, MO 63101

THE MARK CONSISTS OF STANDARD CHAR-
ACTERS WITHOUT CLAIM TO ANY PARTICULAR
FONT, STYLE, SIZE, OR COLOR.

FOR: SHOWER FLOORS, IN CLASS 11 (U.S. CLS.
13, 21, 23, 31 AND 34).

SN 77-155,205, FILED 4-12-2007.

FIRST USE 5-8-2006; IN COMMERCE 5-8-2006.

ROBERT LAVACHE, EXAMINING ATTORNEY

Int. Cl.: 3

Prior U.S. Cls.: 1, 4, 6, 50, 51, and 52

United States Patent and Trademark Office

Reg. No. 3,477,569

Registered July 29, 2008

**TRADEMARK
PRINCIPAL REGISTER**

GAMPAINTS

POSITIVE OUTCOMES, INC. (MISSOURI CORPORATION)
1200 SHEPARD ROAD
WILDWOOD, MO 63038

THE MARK CONSISTS OF STANDARD CHARACTERS WITHOUT CLAIM TO ANY PARTICULAR FONT, STYLE, SIZE, OR COLOR.

FOR: FACE PAINT, IN CLASS 3 (U.S. CLS. 1, 4, 6, 50, 51 AND 52).

SN 77-155,331, FILED 4-12-2007.

FIRST USE 6-0-2007; IN COMMERCE 6-0-2007.

INGA ERVIN, EXAMINING ATTORNEY

Int. Cl.: 30

Prior U.S. Cl.: 46

United States Patent and Trademark Office

Reg. No. 3,477,570

Registered July 29, 2008

**TRADEMARK
PRINCIPAL REGISTER**

CHEERFUL CHOCOLATE

ALIGN PARTNERS, LLC (NEW JERSEY LTD
LIAB CO)
P.O. BOX 8148
PRINCETON, NJ 08543

FOR: BAKING MIXES, CAKES, COOKIES, MUF-
FINS, BROWNIES, ICINGS AND FROSTINGS, IN
CLASS 30 (U.S. CL. 46).

FIRST USE 4-18-2008; IN COMMERCE 4-18-2008.

THE MARK CONSISTS OF STANDARD CHAR-
ACTERS WITHOUT CLAIM TO ANY PARTICULAR
FONT, STYLE, SIZE, OR COLOR.

NO CLAIM IS MADE TO THE EXCLUSIVE
RIGHT TO USE "CHOCOLATE", APART FROM
THE MARK AS SHOWN.

SN 77-155,696, FILED 4-12-2007.

RICHARD WHITE, EXAMINING ATTORNEY

Int. Cl.: 10

Prior U.S. Cls.: 26, 39, and 44

United States Patent and Trademark Office

Reg. No. 3,477,571

Registered July 29, 2008

**TRADEMARK
PRINCIPAL REGISTER**

JOURNEY

SMITH & NEPHEW, INC. (DELAWARE CORPORATION)
1450 BROOKS ROAD
MEMPHIS, TN 38116

FOR: MEDICAL PRODUCTS, NAMELY, UNICONDYLAR, BICOMPARTMENTAL, AND PATELLO-FEMORAL JOINT PROSTHESES AND RELATED INSTRUMENTS, NAMELY, ALIGNMENT GUIDE, CUTTING BLOCK, HEX DRIVER, RESECTION GUIDE, TRIALS, REMOVAL TOOL, IMPACTOR, DRILL GUIDE, REAMER, AND DEPTH GAUGE, IN CLASS 10 (U.S. CLS. 26, 39 AND 44).

FIRST USE 2-28-2006; IN COMMERCE 2-28-2006.

THE MARK CONSISTS OF STANDARD CHARACTERS WITHOUT CLAIM TO ANY PARTICULAR FONT, STYLE, SIZE, OR COLOR.

OWNER OF U.S. REG. NO. 3,170,008.

SN 77-155,998, FILED 4-13-2007.

TINA BROWN, EXAMINING ATTORNEY

Int. Cl.: 3

Prior U.S. Cls.: 1, 4, 6, 50, 51, and 52

United States Patent and Trademark Office

Reg. No. 3,477,572

Registered July 29, 2008

**TRADEMARK
PRINCIPAL REGISTER**

CITROS ESSENTIALS

GUEST SUPPLY, INC. (NEW JERSEY CORPORATION)

4301 US HIGHWAY 1

MONMOUTH JUNCTION, NJ 08852

FOR: HAIR CARE PREPARATIONS; SKIN SOAP,
IN CLASS 3 (U.S. CLS. 1, 4, 6, 50, 51 AND 52).

FIRST USE 1-1-2008; IN COMMERCE 1-1-2008.

THE MARK CONSISTS OF STANDARD CHARACTERS WITHOUT CLAIM TO ANY PARTICULAR FONT, STYLE, SIZE, OR COLOR.

NO CLAIM IS MADE TO THE EXCLUSIVE RIGHT TO USE "CITRUS", APART FROM THE MARK AS SHOWN.

SN 77-156,182, FILED 4-13-2007.

ADA HAN, EXAMINING ATTORNEY

Int. Cl.: 9

Prior U.S. Cls.: 21, 23, 26, 36, and 38

United States Patent and Trademark Office

Reg. No. 3,477,573

Registered July 29, 2008

**TRADEMARK
PRINCIPAL REGISTER**

LIETZMANN

COTRON CORPORATION (CHINA CORPORATION)
12 FL., NO. 150, SEC. 4, CHENG-DE RD.
SHIHLIN DISTRICT
TAIPEI CITY, TAIWAN 111

FOR: EARPHONES; WIRELESS EARPHONES;
HEADPHONES; WIRELESS HEADPHONES; SPEAKER
BOXES; MICROPHONES, IN CLASS 9 (U.S. CLS.
21, 23, 26, 36 AND 38).

FIRST USE 1-7-2008; IN COMMERCE 1-7-2008.

THE MARK CONSISTS OF STANDARD CHARACTERS WITHOUT CLAIM TO ANY PARTICULAR FONT, STYLE, SIZE, OR COLOR.

SN 77-156,729, FILED 4-13-2007.

CHRIS WELLS, EXAMINING ATTORNEY

Int. Cl.: 9

Prior U.S. Cls.: 21, 23, 26, 36, and 38

Reg. No. 3,477,574

United States Patent and Trademark Office

Registered July 29, 2008

**TRADEMARK
PRINCIPAL REGISTER**

Cord Captor

LOGAN, MARK CAMPBELL (UNITED STATES
INDIVIDUAL)
2904 FONTAINEBLEAU DRIVE
ATLANTA, GA 30360

FOR: DEVICE FOR PHYSICAL MANAGEMENT
OF ELECTRICAL CORDS, NAMELY, HOLDING
UNITS AND STORAGE UNITS, IN CLASS 9 (U.S.
CLS. 21, 23, 26, 36 AND 38).

FIRST USE 5-18-2007; IN COMMERCE 5-18-2007.

THE MARK CONSISTS OF STANDARD CHAR-
ACTERS WITHOUT CLAIM TO ANY PARTICULAR
FONT, STYLE, SIZE, OR COLOR.

NO CLAIM IS MADE TO THE EXCLUSIVE
RIGHT TO USE "CORD", APART FROM THE
MARK AS SHOWN.

SN 77-156,841, FILED 4-14-2007.

SOPHIA S. KIM, EXAMINING ATTORNEY

Int. Cl.: 3

Prior U.S. Cls.: 1, 4, 6, 50, 51, and 52

United States Patent and Trademark Office

Reg. No. 3,477,575

Registered July 29, 2008

**TRADEMARK
PRINCIPAL REGISTER**



YOLI ENTERPRISES (NEW JERSEY SOLE PROPRIETORSHIP)
35 HEMLOCK DR
JAMESBURG, NJ 08831

FOR: DEODORANTS FOR BODY CARE; BATH OIL; BATH SALTS; BODY LOTIONS; HAND LOTIONS; SHOWER AND BATH GEL; BODY SCRUB; FACIAL SCRUBS; NON-MEDICATED FOOT CREAM; BEAUTY CREAMS FOR BODY CARE; CUTICLE CREAM; HAIR CREAMS; HAND CREAMS; NAIL CREAM; SKIN CREAMS IN LIQUID AND IN SOLID FORM; BODY SPRAYS; BEAUTY LOTIONS; LIP BALM; FOOT DEODORANT SPRAY, IN CLASS 3 (U.S. CLS. 1, 4, 6, 50, 51 AND 52).

FIRST USE 4-1-2007; IN COMMERCE 1-4-2008.

THE COLOR(S) GREEN AND PURPLE IS/ARE CLAIMED AS A FEATURE OF THE MARK.

THE MARK CONSISTS OF THE WORD "SUVONNE" IN PURPLE WITH A GREEN RIBBON ATTACHED TO THE LETTER "V" IN "SUVONNE".

SN 77-157,012, FILED 4-15-2007.

JAMES LOVELACE, EXAMINING ATTORNEY

Int. Cl.: 20

Prior U.S. Cls.: 2, 13, 22, 25, 32, and 50

United States Patent and Trademark Office

Reg. No. 3,477,576

Registered July 29, 2008

**TRADEMARK
PRINCIPAL REGISTER**

DREAMLOFT

LOUISVILLE BEDDING COMPANY (DELA-
WARE CORPORATION)
10400 BUNSEN WAY
LOUISVILLE, KY 40299

THE MARK CONSISTS OF STANDARD CHAR-
ACTERS WITHOUT CLAIM TO ANY PARTICULAR
FONT, STYLE, SIZE, OR COLOR.

FOR: PILLOWS; BED PILLOWS, IN CLASS 20 (U.S.
CLS. 2, 13, 22, 25, 32 AND 50).

SN 77-157,186, FILED 4-16-2007.

FIRST USE 11-8-2007; IN COMMERCE 11-8-2007.

JAMES LOVELACE, EXAMINING ATTORNEY

Int. Cl.: 41

Prior U.S. Cls.: 100, 101, and 107

United States Patent and Trademark Office

Reg. No. 3,477,577

Registered July 29, 2008

SERVICE MARK
PRINCIPAL REGISTER



LORTON ARTS FOUNDATION, INC. (VIRGINIA CORPORATION)
9601 OX ROAD
LORTON, VA 22079

FOR: EDUCATION SERVICES, NAMELY, PROVIDING LECTURES, WORKSHOPS AND CLASSES IN THE FIELDS OF PERFORMING ARTS, ACTING, THEATER, FINE ARTS, PAINTING, CRAFTS; ENTERTAINMENT IN THE NATURE OF DANCE PERFORMANCES; ENTERTAINMENT IN THE NATURE OF THEATER PRODUCTIONS; ENTERTAINMENT, NAMELY, PRODUCTION OF THEATRICAL SHOWS AND MUSIC CONCERTS; ENTERTAINMENT, NAMELY, LIVE MUSIC CONCERTS; ART EXHIBITIONS; CONDUCTING WORKSHOPS AND SEMINARS IN PERFORMING ARTS AND FINE ART, IN CLASS 41 (U.S. CLS. 100, 101 AND 107).

FIRST USE 5-0-2008; IN COMMERCE 5-0-2008.

NO CLAIM IS MADE TO THE EXCLUSIVE RIGHT TO USE "LORTON ARTS FOUNDATION", APART FROM THE MARK AS SHOWN.

THE COLOR(S) RED, YELLOW AND BLACK IS/ ARE CLAIMED AS A FEATURE OF THE MARK.

THE COLOR(S) RED APPEARS ON THE ROOF OF THE STYLIZED HOUSE AND THE WORD "ARTS" AND THE WORD "FOUNDATION". THE COLOR(S) BLACK APPEARS IN THE WORD "LORTON". THE COLOR(S) YELLOW APPEARS IN THE SEMI OBLONGS AND THE LINE OVER THE WORD "FOUNDATION".

SN 77-157,203, FILED 4-16-2007.

LOURDES AYALA, EXAMINING ATTORNEY

Int. Cl.: 36

Prior U.S. Cls.: 100, 101, and 102

United States Patent and Trademark Office

Reg. No. 3,477,578

Registered July 29, 2008

**SERVICE MARK
PRINCIPAL REGISTER**

minuteman

JOHN M. YONAN III (UNITED STATES INDIVIDUAL)
601 UNIVERSITY AVE. STE 278
SACRAMENTO, CA 95825

THE MARK CONSISTS OF STANDARD CHARACTERS WITHOUT CLAIM TO ANY PARTICULAR FONT, STYLE, SIZE, OR COLOR.

FOR: BAIL BONDING, IN CLASS 36 (U.S. CLS. 100, 101 AND 102).

SN 77-157,531, FILED 4-16-2007.

FIRST USE 1-15-2006; IN COMMERCE 1-15-2006.

ROBIN CHOSID, EXAMINING ATTORNEY

Int. Cl.: 8

Prior U.S. Cls.: 23, 28, and 44

United States Patent and Trademark Office

Reg. No. 3,477,579

Registered July 29, 2008

**TRADEMARK
PRINCIPAL REGISTER**

TORPEDO

AMES TRUE TEMPER PROPERTIES, INC. (MI-
CHIGAN CORPORATION)
300 DELAWARE AVENUE, SUITE 1704
WILMINGTON, DE 19801

THE MARK CONSISTS OF STANDARD CHAR-
ACTERS WITHOUT CLAIM TO ANY PARTICULAR
FONT, STYLE, SIZE, OR COLOR.

FOR: MANUALLY OPERATED HAND TOOLS,
NAMELY, WEDGES, IN CLASS 8 (U.S. CLS. 23, 28
AND 44).

SN 77-158,141, FILED 4-17-2007.

FIRST USE 4-0-2007; IN COMMERCE 4-0-2007.

JORDAN BAKER, EXAMINING ATTORNEY

Int. Cl.: 25

Prior U.S. Cls.: 22 and 39

United States Patent and Trademark Office

Reg. No. 3,477,580

Registered July 29, 2008

TRADEMARK
PRINCIPAL REGISTER

HEADJOCK

FREER, JOHN L. (UNITED STATES INDIVIDUAL)
3465 WEST CORRAL GATE
FLAGSTAFF, AZ 86001 AND
CLARK, JAMES S. (UNITED STATES INDIVIDUAL)
15301 FALCON CREST CT.
DRAPER, UT 84020

FIRST USE 5-11-2008; IN COMMERCE 5-11-2008.

THE MARK CONSISTS OF STANDARD CHARACTERS WITHOUT CLAIM TO ANY PARTICULAR FONT, STYLE, SIZE, OR COLOR.

FOR: CLOTHING, NAMELY, HATS, CAPS, LONG-SLEEVED OR SHORT-SLEEVED T-SHIRTS, SWEAT SHIRTS, SWEAT PANTS, PANTS, JACKETS, SHORTS AND SOCKS, IN CLASS 25 (U.S. CLS. 22 AND 39).

SN 77-159,087, FILED 4-17-2007.

AISHA SALEM, EXAMINING ATTORNEY

Int. Cl.: 25

Prior U.S. Cls.: 22 and 39

United States Patent and Trademark Office

Reg. No. 3,477,581

Registered July 29, 2008

**TRADEMARK
PRINCIPAL REGISTER**

LA TECHNOLOGIE

VANITY FAIR, INC. (DELAWARE CORPORATION)
ONE FRUIT OF THE LOOM DRIVE
BOWLING GREEN, KY 42103

FOR: LINGERIE, IN CLASS 25 (U.S. CLS. 22 AND 39).

FIRST USE 3-28-2008; IN COMMERCE 3-28-2008.

THE MARK CONSISTS OF STANDARD CHARACTERS WITHOUT CLAIM TO ANY PARTICULAR FONT, STYLE, SIZE, OR COLOR.

THE MARK TRANSLATES INTO ENGLISH AS "THE TECHNOLOGY."

SN 77-159,392, FILED 4-18-2007.

PAUL F. GAST, EXAMINING ATTORNEY

Int. Cl.: 12

Prior U.S. Cls.: 19, 21, 23, 31, 35, and 44

Reg. No. 3,477,582

United States Patent and Trademark Office

Registered July 29, 2008

**TRADEMARK
PRINCIPAL REGISTER**

RAZE

KANEI INC. (CALIFORNIA CORPORATION)
13775 MAGNOLIA AVE.
CHINO, CA 91710

THE MARK CONSISTS OF STANDARD CHAR-
ACTERS WITHOUT CLAIM TO ANY PARTICULAR
FONT, STYLE, SIZE, OR COLOR.

FOR: WHEELS FOR AUTOMOBILES, IN CLASS 12
(U.S. CLS. 19, 21, 23, 31, 35 AND 44).

SN 77-160,431, FILED 4-19-2007.

FIRST USE 12-31-2003; IN COMMERCE 12-31-2003.

KYLE PEETE, EXAMINING ATTORNEY

Int. Cl.: 9

Prior U.S. Cls.: 21, 23, 26, 36, and 38

Reg. No. 3,477,583

United States Patent and Trademark Office

Registered July 29, 2008

**TRADEMARK
PRINCIPAL REGISTER**

Tasktop

TASKTOP TECHNOLOGIES INCORPORATED
(CANADA CORPORATION)
510 WEST HASTINGS ST.
SUITE 700
VANCOUVER, CANADA V6B 1L8

FIRST USE 3-6-2007; IN COMMERCE 2-5-2008.

THE MARK CONSISTS OF STANDARD CHARACTERS WITHOUT CLAIM TO ANY PARTICULAR FONT, STYLE, SIZE, OR COLOR.

FOR: COMPUTER SOFTWARE FOR THE COLLECTION, EDITING, ORGANIZING, MODIFYING, BOOK MARKING, TRANSMISSION, STORAGE AND SHARING OF DATA AND INFORMATION, IN CLASS 9 (U.S. CLS. 21, 23, 26, 36 AND 38).

SN 77-161,078, FILED 4-19-2007.

JESSICA A. POWERS, EXAMINING ATTORNEY

Int. Cl.: 36

Prior U.S. Cls.: 100, 101, and 102

United States Patent and Trademark Office

Reg. No. 3,477,584

Registered July 29, 2008

**SERVICE MARK
PRINCIPAL REGISTER**

ALPHASTREAM

ALPHASTREAM PORTFOLIOS, INC. (GEORGIA
CORPORATION)
2625 CUMBERLAND PARKWAY, SUITE 220
ATLANTA, GA 303393911

FOR: FINANCIAL PORTFOLIO MANAGEMENT;
MANAGING PRIVATE EQUITY, MUTUAL FUNDS,
HEDGE FUNDS, AND SEPARATELY MANAGED
ACCOUNTS; FUNDS INVESTMENT , IN CLASS 36
(U.S. CLS. 100, 101 AND 102).

FIRST USE 8-1-2007; IN COMMERCE 8-1-2007.

THE MARK CONSISTS OF STANDARD CHAR-
ACTERS WITHOUT CLAIM TO ANY PARTICULAR
FONT, STYLE, SIZE, OR COLOR.

SN 77-161,359, FILED 4-20-2007.

KYLE PEETE, EXAMINING ATTORNEY

Int. Cl.: 20

Prior U.S. Cls.: 2, 13, 22, 25, 32, and 50

Reg. No. 3,477,585

United States Patent and Trademark Office

Registered July 29, 2008

**TRADEMARK
PRINCIPAL REGISTER**

GENAMERICA

STANLEY FURNITURE COMPANY, INC. (DE-
LAWARE CORPORATION)
1641 FAIRYSTONE PARK HWY.
STANLEYTOWN, VA 24168

FOR: BEDROOM FURNITURE FOR CHILDREN,
IN CLASS 20 (U.S. CLS. 2, 13, 22, 25, 32 AND 50).

FIRST USE 8-31-2007; IN COMMERCE 8-31-2007.

THE MARK CONSISTS OF STANDARD CHAR-
ACTERS WITHOUT CLAIM TO ANY PARTICULAR
FONT, STYLE, SIZE, OR COLOR.

OWNER OF U.S. REG. NOS. 2,500,012, 2,852,047,
AND 2,921,738.

SN 77-161,370, FILED 4-20-2007.

COLLEEN DOMBROW, EXAMINING ATTORNEY

Int. Cl.: 9

Prior U.S. Cls.: 21, 23, 26, 36, and 38

United States Patent and Trademark Office

Reg. No. 3,477,586

Registered July 29, 2008

**TRADEMARK
PRINCIPAL REGISTER**

AGILEJURY

ACS MARKETING, L.P. (DELAWARE LIMITED
PARTNERSHIP)
2828 N. HASKELL
DALLAS, TX 75204

FOR: JURY MANAGEMENT SOFTWARE, IN
CLASS 9 (U.S. CLS. 21, 23, 26, 36 AND 38).

FIRST USE 7-10-2007; IN COMMERCE 7-10-2007.

THE MARK CONSISTS OF STANDARD CHAR-
ACTERS WITHOUT CLAIM TO ANY PARTICULAR
FONT, STYLE, SIZE, OR COLOR.

SN 77-161,384, FILED 4-20-2007.

DOMINIC J. FERRAIUOLO, EXAMINING ATTOR-
NEY

Int. Cl.: 9

Prior U.S. Cls.: 21, 23, 26, 36, and 38

United States Patent and Trademark Office

Reg. No. 3,477,587

Registered July 29, 2008

**TRADEMARK
PRINCIPAL REGISTER**

AGILECOURT

ACS MARKETING, L.P. (DELAWARE LIMITED
PARTNERSHIP)
2828 N. HASKELL
DALLAS, TX 75204

FOR: COURT MANAGEMENT SOFTWARE, IN
CLASS 9 (U.S. CLS. 21, 23, 26, 36 AND 38).

FIRST USE 7-10-2007; IN COMMERCE 7-10-2007.

THE MARK CONSISTS OF STANDARD CHAR-
ACTERS WITHOUT CLAIM TO ANY PARTICULAR
FONT, STYLE, SIZE, OR COLOR.

SN 77-161,386, FILED 4-20-2007.

DOMINIC J. FERRAIUOLO, EXAMINING ATTOR-
NEY

Int. Cl.: 3

Prior U.S. Cls.: 1, 4, 6, 50, 51, and 52

United States Patent and Trademark Office

Reg. No. 3,477,588

Registered July 29, 2008

**TRADEMARK
PRINCIPAL REGISTER**

NUTRI GLOSS

L'OREAL (FRANCE SOCIETE ANONYME)
14 RUE ROYALE
PARIS, FRANCE 75008

OWNER OF U.S. REG. NO. 3,268,813.

FOR: HAIR COLOR, IN CLASS 3 (U.S. CLS. 1, 4, 6,
50, 51 AND 52).

NO CLAIM IS MADE TO THE EXCLUSIVE
RIGHT TO USE "GLOSS", APART FROM THE
MARK AS SHOWN.

FIRST USE 1-0-2008; IN COMMERCE 1-0-2008.

SN 77-161,497, FILED 4-20-2007.

THE MARK CONSISTS OF STANDARD CHAR-
ACTERS WITHOUT CLAIM TO ANY PARTICULAR
FONT, STYLE, SIZE, OR COLOR.

JENNY PARK, EXAMINING ATTORNEY

Int. Cl.: 25

Prior U.S. Cls.: 22 and 39

United States Patent and Trademark Office

Reg. No. 3,477,589

Registered July 29, 2008

**TRADEMARK
PRINCIPAL REGISTER**

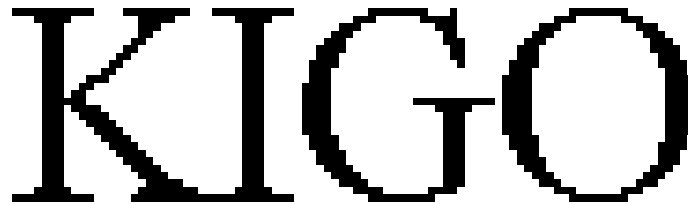

KIGOFOOTWEAR LLC (COLORADO LTD LIAB
CO)
108 PIONEER CT.
CARBONDALE, CO 81623

THE MARK CONSISTS OF STANDARD CHAR-
ACTERS WITHOUT CLAIM TO ANY PARTICULAR
FONT, STYLE, SIZE, OR COLOR.

FOR: ATHLETIC SHOES; SHOES, IN CLASS 25
(U.S. CLS. 22 AND 39).

SN 77-162,598, FILED 4-22-2007.

FIRST USE 5-1-2008; IN COMMERCE 6-1-2008.

WILLIAM VERHOSEK, EXAMINING ATTORNEY

Int. Cl.: 41

Prior U.S. Cls.: 100, 101, and 107

United States Patent and Trademark Office

Reg. No. 3,477,590

Registered July 29, 2008

**SERVICE MARK
PRINCIPAL REGISTER**



INDIEWORKS CORP (UTAH CORPORATION)
1216 COTTAGE PLACE
GARDENA, CA 90247

FOR: ARRANGING OF TRIVIA CONTESTS OF-
FERED VIA AN INTERNET BLOG, IN CLASS 41
(U.S. CLS. 100, 101 AND 107).

FIRST USE 10-15-2007; IN COMMERCE 10-15-2007.

THE MARK CONSISTS OF THE PHRASE "JJ
JIVEJIVE" IN STYLIZED FONTS, WITH SPEAKER
BOXES ON EITHER SIDE OF THE DOTS ON EACH
"J" IN "JJ".

SN 77-163,634, FILED 4-23-2007.

LINDA M. KING, EXAMINING ATTORNEY

Int. Cls.: 35 and 42

Prior U.S. Cls.: 100, 101, and 102

United States Patent and Trademark Office

Reg. No. 3,477,591

Registered July 29, 2008

**SERVICE MARK
PRINCIPAL REGISTER**

SMARTISTRY

HUNT & GATHER, INC. (MASSACHUSETTS
CORPORATION)
119 BRAINTREE STREET, SUITE 519
BOSTON, MA 02134

FOR: PROVIDING ADVERTISING, PROMOTION,
AND MARKETING SERVICES FOR OTHERS; PRO-
VIDING MARKETING CONSULTATION; PROVID-
ING ON-LINE ADVERTISING, MARKETING AND
PROMOTION SERVICES, IN CLASS 35 (U.S. CLS. 100,
101 AND 102).

FIRST USE 3-0-2006; IN COMMERCE 12-0-2006.

FOR: DESIGN, CREATION, MAINTENANCE OF
WEBSITES FOR OTHERS; DESIGN AND DEVELOP-
MENT OF MULTIMEDIA PRODUCTS AND SERVI-
CES, IN CLASS 42 (U.S. CLS. 100 AND 101).

FIRST USE 3-0-2006; IN COMMERCE 12-0-2006.

THE MARK CONSISTS OF STANDARD CHAR-
ACTERS WITHOUT CLAIM TO ANY PARTICULAR
FONT, STYLE, SIZE, OR COLOR.

SN 77-164,066, FILED 4-24-2007.

NICHOLAS ALTREE, EXAMINING ATTORNEY

Int. Cl.: 1

Prior U.S. Cls.: 1, 5, 6, 10, 26, and 46

United States Patent and Trademark Office

Reg. No. 3,477,592

Registered July 29, 2008

**TRADEMARK
PRINCIPAL REGISTER**

NEBULA

ALBEMARLE CORPORATION (VIRGINIA CORPORATION)
451 FLORIDA STREET
BATON ROUGE, LA 70801

THE MARK CONSISTS OF STANDARD CHARACTERS WITHOUT CLAIM TO ANY PARTICULAR FONT, STYLE, SIZE, OR COLOR.

FOR: BULK METAL OXIDE HYDROPROCESSING CATALYSTS, IN CLASS 1 (U.S. CLS. 1, 5, 6, 10, 26 AND 46).

SN 77-164,114, FILED 4-24-2007.

FIRST USE 6-6-2001; IN COMMERCE 6-6-2001.

KATHY DE JONGE, EXAMINING ATTORNEY

Int. Cl.: 9

Prior U.S. Cls.: 21, 23, 26, 36, and 38

United States Patent and Trademark Office

Reg. No. 3,477,593

Registered July 29, 2008

**TRADEMARK
PRINCIPAL REGISTER**

Twilight Archive

MANCINELLI, CHRISTOPHER E. (UNITED STATES INDIVIDUAL)
524 CUMBRE ST
MONTEREY PARK, CA 91754

FOR: AUDIO RECORDINGS FEATURING MUSIC; DOWNLOADABLE MP3 FILES, MP3 RECORDINGS, ONLINE DISCUSSION BOARDS, WEB CASTS, POD CASTS FEATURING MUSIC, AUDIO BOOKS AND NEWS BROADCASTS; DOWNLOADABLE MUSICAL SOUND RECORDINGS; DOWNLOADABLE MUSIC VIA THE INTERNET AND WIRELESS DEVICES; MUSICAL SOUND RECORDINGS; SOUND RECORDINGS FEATURING MUSIC, IN CLASS 9 (U.S. CLS. 21, 23, 26, 36 AND 38).

FIRST USE 5-30-2003; IN COMMERCE 8-11-2003.

THE MARK CONSISTS OF STANDARD CHARACTERS WITHOUT CLAIM TO ANY PARTICULAR FONT, STYLE, SIZE, OR COLOR.

NO CLAIM IS MADE TO THE EXCLUSIVE RIGHT TO USE "ARCHIVE", APART FROM THE MARK AS SHOWN.

SN 77-165,545, FILED 4-25-2007.

GENE MACIOL, EXAMINING ATTORNEY

Int. Cl.: 29

Prior U.S. Cl.: 46

United States Patent and Trademark Office

Reg. No. 3,477,594

Registered July 29, 2008

**TRADEMARK
PRINCIPAL REGISTER**



CONTESSA PREMIUM FOODS, INC. (CALIFORNIA CORPORATION)
222 WEST SIXTH STREET, 8TH FLOOR
SAN PEDRO, CA 907313356

FOR: DINNERS, ENTREES AND SIDE DISHES INCLUDING SEAFOOD, POULTRY OR MEAT, IN CLASS 29 (U.S. CL. 46).

FIRST USE 10-23-2007; IN COMMERCE 11-2-2007.

THE COLOR(S) GREEN IS/ARE CLAIMED AS A FEATURE OF THE MARK.

THE MARK CONSISTS OF A STYLIZED GREEN LETTER "G".

SN 77-165,748, FILED 4-25-2007.

AMY HELLA, EXAMINING ATTORNEY

Int. Cl.: 3

Prior U.S. Cls.: 1, 4, 6, 50, 51, and 52

United States Patent and Trademark Office

Reg. No. 3,477,595

Registered July 29, 2008

**TRADEMARK
PRINCIPAL REGISTER**

LOVE YOURSELF

MBL/TIGI PRODUCTS, LP (TEXAS LIMITED
PARTNERSHIP)
2311 MIDWAY ROAD
CARROLLTON, TX 75006

FOR: SOAPS FOR BODY; BATH CARE PREPARA-
TIONS IN THE NATURE OF BATH GELS, BATH
POWDER, BATH SOAPS, AND BATH LOTIONS,
OILS, FOAMS, PERSONAL CARE PREPARATIONS,
NAMELY, BATH, BODY LOTION, IN CLASS 3 (U.S.
CLS. 1, 4, 6, 50, 51 AND 52).

FIRST USE 5-0-2008; IN COMMERCE 5-0-2008.

THE MARK CONSISTS OF STANDARD CHAR-
ACTERS WITHOUT CLAIM TO ANY PARTICULAR
FONT, STYLE, SIZE, OR COLOR.

SN 77-166,189, FILED 4-26-2007.

MARGERY A. TIERNEY, EXAMINING ATTORNEY

Int. Cl.: 44

Prior U.S. Cls.: 100 and 101

United States Patent and Trademark Office

Reg. No. 3,477,596

Registered July 29, 2008

**SERVICE MARK
PRINCIPAL REGISTER**

1-800
Optometrist

SANDHU, BALDEV (UNITED STATES INDIVIDUAL)
600 PALISADE AVENUE
ENGLEWOOD CLIFFS, NJ 07632

NO CLAIM IS MADE TO THE EXCLUSIVE RIGHT TO USE "1-800 OPTOMETRIST", APART FROM THE MARK AS SHOWN.

FOR: OPTOMETRY SERVICES, IN CLASS 44 (U.S. CLS. 100 AND 101).

SN 77-166,725, FILED 4-26-2007.

FIRST USE 7-15-2007; IN COMMERCE 12-15-2007.

JUSTINE D. PARKER, EXAMINING ATTORNEY

Int. Cl.: 16

Prior U.S. Cls.: 2, 5, 22, 23, 29, 37, 38, and 50

Reg. No. 3,477,597

United States Patent and Trademark Office

Registered July 29, 2008

**TRADEMARK
PRINCIPAL REGISTER**

MYSTERIES UNWRAPPED

STERLING PUBLISHING CO., INC. (DELAWARE
CORPORATION)
387 PARK AVENUE SOUTH
NEW YORK, NY 10016

FOR: SERIES OF FICTION AND NON-FICTION
BOOKS ON A VARIETY OF TOPICS, IN CLASS 16
(U.S. CLS. 2, 5, 22, 23, 29, 37, 38 AND 50).

FIRST USE 4-1-2008; IN COMMERCE 4-1-2008.

THE MARK CONSISTS OF STANDARD CHAR-
ACTERS WITHOUT CLAIM TO ANY PARTICULAR
FONT, STYLE, SIZE, OR COLOR.

NO CLAIM IS MADE TO THE EXCLUSIVE
RIGHT TO USE "MYSTERIES", APART FROM
THE MARK AS SHOWN.

SN 77-167,382, FILED 4-27-2007.

APRIL ROACH, EXAMINING ATTORNEY

Int. Cl.: 43

Prior U.S. Cls.: 100 and 101

United States Patent and Trademark Office

Reg. No. 3,477,598

Registered July 29, 2008

SERVICE MARK
PRINCIPAL REGISTER

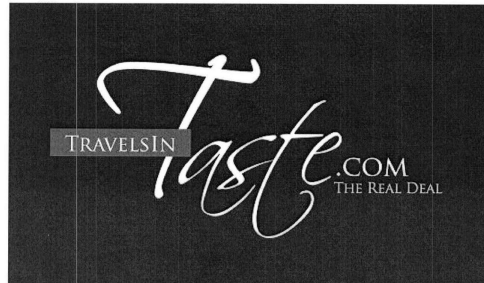

LAM ENDEAVORS LTD. (NEW YORK CORPORATION)
APT. 37C 330 EAST 75TH STREET
NEW YORK, NY 10021

FOR: PROVIDING A WEB SITE FEATURING EXTENSIVE INFORMATION FOR RESTAURANT AND BAR DESTINATIONS BY CITY, IN CLASS 43 (U.S. CLS. 100 AND 101).

THE MARK CONSISTS OF THE WORDING "TRAVELSINTASTE.COM THE REAL DEAL" IN STYLIZED FORM ON A DARK RECTANGULAR BACKGROUND.

SN 77-167,863, FILED 4-27-2007.

FIRST USE 11-26-2007; IN COMMERCE 11-26-2007.

CHERYL CLAYTON, EXAMINING ATTORNEY

Int. Cl.: 34

Prior U.S. Cls.: 2, 8, 9, and 17

United States Patent and Trademark Office

Reg. No. 3,477,599

Registered July 29, 2008

**TRADEMARK
PRINCIPAL REGISTER**

HONEY T

DISTRIBUTION G.V.A. (CANADA) INC. (CANADA CORPORATION)

211 PLACE MICHEL-GAMELIN

LAVAL, QUEBEC, CANADA H7M5L6

FOR: TOBACCO PRODUCTS, IN CLASS 34 (U.S. CLS. 2, 8, 9 AND 17).

FIRST USE 8-16-2007; IN COMMERCE 5-14-2008.

THE MARK CONSISTS OF STANDARD CHARACTERS WITHOUT CLAIM TO ANY PARTICULAR FONT, STYLE, SIZE, OR COLOR.

NO CLAIM IS MADE TO THE EXCLUSIVE RIGHT TO USE "HONEY", APART FROM THE MARK AS SHOWN.

SN 77-168,642, FILED 4-30-2007.

CHRIS WELLS, EXAMINING ATTORNEY

Int. Cl.: 16

Prior U.S. Cls.: 2, 5, 22, 23, 29, 37, 38, and 50

United States Patent and Trademark Office

Reg. No. 3,477,600

Registered July 29, 2008

**TRADEMARK
PRINCIPAL REGISTER**



IBASIS, INC. (DELAWARE CORPORATION)
20 SECOND AVENUE
BURLINGTON, MA 01803

FOR: PRE-PAID TELEPHONE CALLING CARDS,
NOT MAGNETICALLY ENCODED; TELEPHONE
CALLING CARDS, NOT MAGNETICALLY ENCO-
DED, IN CLASS 16 (U.S. CLS. 2, 5, 22, 23, 29, 37, 38
AND 50).

FIRST USE 6-11-2008; IN COMMERCE 6-11-2008.

THE COLOR(S) COLORS RED, BEIGE, WHITE,
AND BLACK IS/ARE CLAIMED AS A FEATURE OF
THE MARK.

THE COLOR BEIGE APPEARS IN THE LETTER-
ING THAT COMPRISES "H" AND "L"; THE COLOR
WHITE APPEARS IN THE LETTERING "OT" AND
"INE"; THE COLOR RED APPEARS IN THE BACK-
GROUND AND IN THE STYLIZED MAP OF THE
SOUTH AMERICA CONTINENT; THE COLOR
BLACK APPEARS AS HORIZONTAL AND VERTI-
CAL LINES IN THE BACKGROUND AND IN
SHADING AROUND THE BORDER OF THE
SOUTH AMERICA CONTINENT; THE COLOR
BLACK ALSO APPEARS AS SHADING AROUND
ALL OF THE LETTERING IN THE MARK

SN 77-169,017, FILED 4-30-2007.

JORDAN BAKER, EXAMINING ATTORNEY

Int. Cl.: 30

Prior U.S. Cl.: 46

United States Patent and Trademark Office

Reg. No. 3,477,601

Registered July 29, 2008

**TRADEMARK
PRINCIPAL REGISTER**

VISIONARY GOURMET COFFEE

INTELLIDON ENTERPRISES INC. (COLORADO
CORPORATION)
SUITE 575
3773 CHERRY CREEK NORTH DRIVE
DENVER, CO 80209

FOR: COFFEE; COFFEE BEANS; GROUND COFFEE BEANS; ROASTED COFFEE BEANS; COFFEE, IN CLASS 30 (U.S. CL. 46).

FIRST USE 11-1-2007; IN COMMERCE 11-1-2007.

THE MARK CONSISTS OF STANDARD CHARACTERS WITHOUT CLAIM TO ANY PARTICULAR FONT, STYLE, SIZE, OR COLOR.

NO CLAIM IS MADE TO THE EXCLUSIVE RIGHT TO USE "GOURMET COFFEE", APART FROM THE MARK AS SHOWN.

SN 77-169,129, FILED 4-30-2007.

LINDSEY RUBIN, EXAMINING ATTORNEY

Int. Cl.: 41

Prior U.S. Cls.: 100, 101, and 107

United States Patent and Trademark Office

Reg. No. 3,477,602

Registered July 29, 2008

**SERVICE MARK
PRINCIPAL REGISTER**

POWER RANGERS JUNGLE FURY

BVS ENTERTAINMENT, INC. (DELAWARE CORPORATION)
500 SOUTH BUENA VISTA STREET
BURBANK, CA 91521

RELATING TO TELEVISION SHOW PROGRAMS AND FAMILY ENTERTAINMENT VIA A GLOBAL COMMUNICATIONS NETWORK, IN CLASS 41 (U.S. CLS. 100, 101 AND 107).

FOR: ENTERTAINMENT SERVICES IN THE NATURE OF PRODUCTION AND DISTRIBUTION OF MOTION PICTURE FILMS AND TELEVISION SHOW PROGRAMS FEATURING ACTION-ADVENTURE SERIES AND LIVE-ACTION SERIES, BY MEANS OF AND FOR CABLE TELEVISION, SATELLITE-DELIVERED AND TELEVISION BROADCASTING; ENTERTAINMENT SERVICES, NAMELY, COMPUTER ON-LINE SERVICES OFFERED OVER A WORLDWIDE COMMUNICATION NETWORK FEATURING AND ENTERTAINMENT

FIRST USE 2-29-2008; IN COMMERCE 2-29-2008.

THE MARK CONSISTS OF STANDARD CHARACTERS WITHOUT CLAIM TO ANY PARTICULAR FONT, STYLE, SIZE, OR COLOR.

SN 77-170,460, FILED 5-1-2007.

MIDGE BUTLER, EXAMINING ATTORNEY

Int. Cl.: 5

Prior U.S. Cls.: 6, 18, 44, 46, 51, and 52

Reg. No. 3,477,603

United States Patent and Trademark Office

Registered July 29, 2008

**TRADEMARK
PRINCIPAL REGISTER**

SERRANOL

GOOD HEALTH NATURALLY, INC. (NEVADA
CORPORATION)
4560 SOUTH DECATUR BLVD., SUITE 202
LAS VEGAS, NV 89103

THE MARK CONSISTS OF STANDARD CHAR-
ACTERS WITHOUT CLAIM TO ANY PARTICULAR
FONT, STYLE, SIZE, OR COLOR.

FOR: DIETARY AND NUTRITIONAL SUPPLE-
MENTS; FOOD SUPPLEMENTS; MINERAL NUTRI-
TIONAL SUPPLEMENTS; VITAMINS, IN CLASS 5
(U.S. CLS. 6, 18, 44, 46, 51 AND 52).

SN 77-171,205, FILED 5-2-2007.

FIRST USE 5-16-2008; IN COMMERCE 5-16-2008.

KYLE PEETE, EXAMINING ATTORNEY

Int. Cl.: 9

Prior U.S. Cls.: 21, 23, 26, 36, and 38

Reg. No. 3,477,604

United States Patent and Trademark Office

Registered July 29, 2008

**TRADEMARK
PRINCIPAL REGISTER**



DESIGN MANUFACTURE LIMITED (HONG
KONG LTD LIAB CO)
ROOM 406, WAH YIU IND. CTR.
30-32 AU PUI WAN ST., FOTAN
N.T., HONG KONG

SPEAKERS; ADAPTER PLUGS, IN CLASS 9 (U.S.
CLS. 21, 23, 26, 36 AND 38).

FIRST USE 3-28-2008; IN COMMERCE 3-28-2008.

FOR: ELECTRIC PLUGS; PLUG CONNECTORS;
ELECTRIC SOCKETS; ELECTRIC TRANSFOR-
MERS; ELECTRONIC AGENDAS; RECEIVERS
FOR TELEPHONE, AUDIO AND VIDEO; LOUD-

SN 77-171,582, FILED 5-3-2007.

TIMOTHY FINNEGAN, EXAMINING ATTORNEY

Int. Cl.: 7

Prior U.S. Cls.: 13, 19, 21, 23, 31, 34, and 35

United States Patent and Trademark Office

Reg. No. 3,477,605

Registered July 29, 2008

**TRADEMARK
PRINCIPAL REGISTER**

FAB-U-MOTION

VSM GROUP AKTIEBOLAG (SWEDEN CORPORATION)
SE-561 84
HUSKVARNA, SWEDEN

THE MARK CONSISTS OF STANDARD CHARACTERS WITHOUT CLAIM TO ANY PARTICULAR FONT, STYLE, SIZE, OR COLOR.

FOR: PERIPHERAL ATTACHMENTS TO SEWING MACHINES USED TO HOLD FABRIC TAUT IN FREE-MOTION SEWING, IN CLASS 7 (U.S. CLS. 13, 19, 21, 23, 31, 34 AND 35).

SN 77-172,223, FILED 5-3-2007.

FIRST USE 6-1-2007; IN COMMERCE 6-1-2007.

ANDREA HACK, EXAMINING ATTORNEY

Int. Cl.: 14

Prior U.S. Cls.: 2, 27, 28, and 50

United States Patent and Trademark Office

Reg. No. 3,477,606

Registered July 29, 2008

**TRADEMARK
PRINCIPAL REGISTER**

E&L COLLECTION

ERICA LYONS, INC. (FLORIDA CORPORATION)
10421 SW 187TH TERRACE
MIAMI, FL 33157

FOR: JEWELRY, IN CLASS 14 (U.S. CLS. 2, 27, 28
AND 50).

FIRST USE 8-1-2007; IN COMMERCE 8-1-2007.

THE MARK CONSISTS OF STANDARD CHAR-
ACTERS WITHOUT CLAIM TO ANY PARTICULAR
FONT, STYLE, SIZE, OR COLOR.

NO CLAIM IS MADE TO THE EXCLUSIVE
RIGHT TO USE "COLLECTION", APART FROM
THE MARK AS SHOWN.

SN 77-172,351, FILED 5-3-2007.

ROBERT C. CLARK JR., EXAMINING ATTORNEY

Int. Cls.: 16 and 41

Prior U.S. Cls.: 2, 5, 22, 23, 29, 37, 38, 50, 100, 101, and 107

Reg. No. 3,477,607

United States Patent and Trademark Office

Registered July 29, 2008

**TRADEMARK
SERVICE MARK
PRINCIPAL REGISTER**

**THE SCIENCE OF CREATING
WEALTH**

SCHUSTER, E. MICHAEL (UNITED STATES INDIVIDUAL)
9312 EAST RAINTREE DRIVE
SCOTTSDALE, AZ 85260

FOR: SERIES OF BOOKS, WRITTEN ARTICLES, HANDOUTS AND WORKSHEETS IN THE FIELD OF FINANCIAL EDUCATION AND TRAINING; BOOKS IN THE FIELD OF FINANCIAL EDUCATION AND TRAINING, IN CLASS 16 (U.S. CLS. 2, 5, 22, 23, 29, 37, 38 AND 50).

FIRST USE 11-16-2007; IN COMMERCE 11-16-2007.

FOR: ARRANGING OF SEMINARS; ARRANGING OF SEMINARS AND CONFERENCES; CONDUCTING WORKSHOPS AND SEMINARS IN FINANCIAL WHEREWITHAL; EDUCATION SERVICES, NAMELY, PROVIDING LIVE AND ON-LINE

SEMINARS IN THE FIELD OF FINANCIAL EDUCATION AND TRAINING; EDUCATION SERVICES, NAMELY, PROVIDING SEMINARS IN THE FIELD OF FINANCIAL EDUCATION AND TRAINING; WORKSHOPS AND SEMINARS IN THE FIELD OF FINANCIAL EDUCATION AND TRAINING, IN CLASS 41 (U.S. CLS. 100, 101 AND 107).

FIRST USE 8-17-2007; IN COMMERCE 11-16-2007.

THE MARK CONSISTS OF STANDARD CHARACTERS WITHOUT CLAIM TO ANY PARTICULAR FONT, STYLE, SIZE, OR COLOR.

SN 77-172,495, FILED 5-3-2007.

LEIGH CAROLINE CASE, EXAMINING ATTORNEY

Int. Cl.: 35

Prior U.S. Cls.: 100, 101, and 102

United States Patent and Trademark Office

Reg. No. 3,477,608

Registered July 29, 2008

**SERVICE MARK
PRINCIPAL REGISTER**

VIANT

VIANT HOLDINGS, INC. (DELAWARE CORPORATION)
535 EAST DIEHL ROAD
NAPERVILLE, IL 60563

FOR: MEDICAL CLAIMS MANAGEMENT SERVICES, NAMELY, ELECTRONIC RE-PRICING OF PHYSICIAN, HOSPITAL, AND ANCILLARY MEDICAL CARE PROVIDER TRANSACTIONS VIA THE GLOBAL INFORMATION NETWORK; MEDICAL CLAIMS MANAGEMENT SERVICES, NAMELY, RECEIVING, DATA ENTERING, AND RE-PRICING OF TRANSACTIONS THAT ARE ORIGINATED BY PHYSICIANS, HOSPITALS, AND ANCILLARY MEDICAL CARE PROVIDERS; MEDICAL COST MANAGEMENT; MANAGEMENT AND BUSINESS

CONSULTING SERVICES IN THE FIELD OF PREFERRED PROVIDER NETWORKS, IN CLASS 35 (U.S. CLS. 100, 101 AND 102).

FIRST USE 6-25-2007; IN COMMERCE 6-25-2007.

THE MARK CONSISTS OF STANDARD CHARACTERS WITHOUT CLAIM TO ANY PARTICULAR FONT, STYLE, SIZE, OR COLOR.

SN 77-172,864, FILED 5-4-2007.

NORA BUCHANAN WILL, EXAMINING ATTORNEY

Int. Cl.: 31

Prior U.S. Cls.: 1 and 46

United States Patent and Trademark Office

Reg. No. 3,477,609

Registered July 29, 2008

**TRADEMARK
PRINCIPAL REGISTER**

BUCK'N OATS

NEWMAN, MATTHEW (UNITED STATES INDIVIDUAL)

2261 MORGANZA HIGHWAY

NEW ROADS, LA 70760

FOR: FOOD PLOT SEED MIX FOR WILDLIFE, IN CLASS 31 (U.S. CLS. 1 AND 46).

FIRST USE 7-3-2007; IN COMMERCE 7-3-2007.

THE MARK CONSISTS OF STANDARD CHARACTERS WITHOUT CLAIM TO ANY PARTICULAR FONT, STYLE, SIZE, OR COLOR.

NO CLAIM IS MADE TO THE EXCLUSIVE RIGHT TO USE "OATS", APART FROM THE MARK AS SHOWN.

SN 77-173,491, FILED 5-4-2007.

INGRID C. EULIN, EXAMINING ATTORNEY

Int. Cl.: 9

Prior U.S. Cls.: 21, 23, 26, 36, and 38

United States Patent and Trademark Office

Reg. No. 3,477,610

Registered July 29, 2008

**TRADEMARK
PRINCIPAL REGISTER**

OptiRAT

ANIMAL CARE SYSTEMS, INC. (COLORADO
CORPORATION)
1460 WEST CANAL COURT, SUITE 100
LITTLETON, CO 80120

FOR: LABORATORY CAGES FOR SMALL ANI-
MALS, IN CLASS 9 (U.S. CLS. 21, 23, 26, 36 AND 38).

FIRST USE 1-15-2008; IN COMMERCE 1-15-2008.

THE MARK CONSISTS OF STANDARD CHAR-
ACTERS WITHOUT CLAIM TO ANY PARTICULAR
FONT, STYLE, SIZE, OR COLOR.

OWNER OF U.S. REG. NO. 3,151,783.

SN 77-173,616, FILED 5-4-2007.

STEVEN JACKSON, EXAMINING ATTORNEY

Int. Cl.: 28

Prior U.S. Cls.: 22, 23, 38, and 50

United States Patent and Trademark Office

Reg. No. 3,477,611

Registered July 29, 2008

**TRADEMARK
PRINCIPAL REGISTER**

Lightning Nock

FIRENOCK, LLC (ILLINOIS LTD LIAB CO)
511 ROBERT STREET
HENRY, IL 615371146

FOR: ARCHERY EQUIPMENT, NAMELY, LIGHTED ARROW NOCKS, LIGHTED PROJECTILES AND LIGHTED END OF AN ARROW OR CROSS-BOW BOLT, IN CLASS 28 (U.S. CLS. 22, 23, 38 AND 50).

FIRST USE 2-12-2007; IN COMMERCE 4-30-2007.

THE MARK CONSISTS OF STANDARD CHARACTERS WITHOUT CLAIM TO ANY PARTICULAR FONT, STYLE, SIZE, OR COLOR.

NO CLAIM IS MADE TO THE EXCLUSIVE RIGHT TO USE "NOCK", APART FROM THE MARK AS SHOWN.

SN 77-173,811, FILED 5-6-2007.

JENNY PARK, EXAMINING ATTORNEY

Int. Cl.: 7

Prior U.S. Cls.: 13, 19, 21, 23, 31, 34, and 35

Reg. No. 3,477,612

United States Patent and Trademark Office

Registered July 29, 2008

**TRADEMARK
PRINCIPAL REGISTER**

PTC

PR HOFFMAN MACHINE PRODUCTS, INC.
(ARIZONA CORPORATION)
1517 COMMERCE AVENUE
CARLISLE, PA 17015

THE MARK CONSISTS OF STANDARD CHAR-
ACTERS WITHOUT CLAIM TO ANY PARTICULAR
FONT, STYLE, SIZE, OR COLOR.

FOR: MACHINE PARTS, NAMELY, POLISHING
AND LAPPING CARRIERS, IN CLASS 7 (U.S. CLS.
13, 19, 21, 23, 31, 34 AND 35).

SN 77-174,029, FILED 5-7-2007.

FIRST USE 2-18-2008; IN COMMERCE 2-18-2008.

RICHARD WHITE, EXAMINING ATTORNEY

Int. Cl.: 35

Prior U.S. Cls.: 100, 101, and 102

United States Patent and Trademark Office

Reg. No. 3,477,613

Registered July 29, 2008

**SERVICE MARK
PRINCIPAL REGISTER**

**CAN A WEBSITE CHANGE YOUR
WORLD?**

REDCATS USA, L.P. (DELAWARE LIMITED
PARTNERSHIP)
2300 SOUTHEASTERN AVE.
INDIANAPOLIS, IN 46201

THE MARK CONSISTS OF STANDARD CHAR-
ACTERS WITHOUT CLAIM TO ANY PARTICULAR
FONT, STYLE, SIZE, OR COLOR.

FOR: ON-LINE RETAIL STORE SERVICES FEATURING WOMEN'S CLOTHING, SHOES, AND CLOTHING ACCESSORIES, IN CLASS 35 (U.S. CLS. 100, 101 AND 102).

SN 77-174,268, FILED 5-7-2007.

FIRST USE 6-6-2008; IN COMMERCE 6-6-2008.

THOMAS MANOR, EXAMINING ATTORNEY

Int. Cls.: 41 and 43

Prior U.S. Cls.: 100, 101, and 107

United States Patent and Trademark Office

Reg. No. 3,477,614

Registered July 29, 2008

**SERVICE MARK
PRINCIPAL REGISTER**

PARTY SAVVY

RELD, INC. (PENNSYLVANIA CORPORATION)
4315 OLD WILLIAM PENN HIGHWAY
MONROEVILLE, PA 15146

FOR: RENTAL OF ENTERTAINMENT EQUIPMENT, NAMELY, RENTAL PORTABLE STAGES, DANCE FLOORS, AND AUDIO-VISUAL EQUIPMENT, IN CLASS 41 (U.S. CLS. 100, 101 AND 107).

FIRST USE 8-31-2007; IN COMMERCE 8-31-2007.

FOR: RENTAL OF PARTY EQUIPMENT, NAMELY, RENTAL OF TENTS, TABLES, CHAIRS, TABLE LINENS, BAR EQUIPMENT, AND FOOD SERVICE EQUIPMENT, IN CLASS 43 (U.S. CLS. 100 AND 101).

FIRST USE 8-31-2007; IN COMMERCE 8-31-2007.

THE MARK CONSISTS OF STANDARD CHARACTERS WITHOUT CLAIM TO ANY PARTICULAR FONT, STYLE, SIZE, OR COLOR.

NO CLAIM IS MADE TO THE EXCLUSIVE RIGHT TO USE "PARTY", APART FROM THE MARK AS SHOWN.

SN 77-174,404, FILED 5-7-2007.

CAROL SPILS, EXAMINING ATTORNEY

Int. Cl.: 25

Prior U.S. Cls.: 22 and 39

United States Patent and Trademark Office

Reg. No. 3,477,615

Registered July 29, 2008

**TRADEMARK
PRINCIPAL REGISTER**

IT STARTS AT THE TOP

H.M.S. PRODUCTIONS, INC. (NEW YORK CORPORATION)
250 WEST 39TH STREET
NEW YORK, NY 10018

FOR: CLOTHING, NAMELY, BLOUSES, SWEATERS, SHIRTS AND T-SHIRTS AND JACKETS, IN CLASS 25 (U.S. CLS. 22 AND 39).

FIRST USE 1-1-2007; IN COMMERCE 1-1-2007.

THE MARK CONSISTS OF STANDARD CHARACTERS WITHOUT CLAIM TO ANY PARTICULAR FONT, STYLE, SIZE, OR COLOR.

SN 77-174,414, FILED 5-7-2007.

CAROL SPILS, EXAMINING ATTORNEY

Int. Cl.: 41

Prior U.S. Cls.: 100, 101, and 107

United States Patent and Trademark Office

Reg. No. 3,477,616

Registered July 29, 2008

**SERVICE MARK
PRINCIPAL REGISTER**

SWANN FITNESS

SWANN FITNESS CENTERS INC. (CANADA CORPORATION)
SUITE 105
2520 BOULEVARD DES ENTREPRISES
TERREBONNE, CANADA J6X4J8

FOR: EDUCATION SERVICES, NAMELY, PROVIDING CLASSES IN THE FIELD OF NUTRITION, WEIGHT LOSS, HEALTH AND FITNESS PROGRAMS FOR FITNESS CLUBS AND HEALTH AND EXERCISE CENTERS; PHYSICAL FITNESS CONDITIONING CLASSES; PHYSICAL FITNESS CONSULTATION; PHYSICAL FITNESS INSTRUCTION; PROVIDING ASSISTANCE, PERSONAL TRAINING AND PHYSICAL FITNESS CONSULTATION TO CORPORATE CLIENTS TO HELP THEIR EMPLOYEES MAKE PHYSICAL FITNESS, STRENGTH, CONDITIONING, AND EXERCISE

ALTERATIONS IN THEIR DAILY LIVING; PROVIDING FITNESS AND EXERCISE FACILITIES, IN CLASS 41 (U.S. CLS. 100, 101 AND 107).

FIRST USE 1-14-2005; IN COMMERCE 5-7-2007.

THE MARK CONSISTS OF STANDARD CHARACTERS WITHOUT CLAIM TO ANY PARTICULAR FONT, STYLE, SIZE, OR COLOR.

NO CLAIM IS MADE TO THE EXCLUSIVE RIGHT TO USE "FITNESS", APART FROM THE MARK AS SHOWN.

SN 77-174,423, FILED 5-7-2007.

CAROL SPILS, EXAMINING ATTORNEY

Int. Cl.: 32

Prior U.S. Cls.: 45, 46, and 48

United States Patent and Trademark Office

Reg. No. 3,477,617

Registered July 29, 2008

**TRADEMARK
PRINCIPAL REGISTER**

tumai means to hope

SPERO GROUP, INC. (NEW YORK CORPORATION)
P.O. BOX 1751
MARTINSBURG, WV 25402

FOR: BOTTLED DRINKING WATER, IN CLASS
32 (U.S. CLS. 45, 46 AND 48).

FIRST USE 1-15-2008; IN COMMERCE 3-1-2008.

THE MARK CONSISTS OF STANDARD CHARACTERS WITHOUT CLAIM TO ANY PARTICULAR FONT, STYLE, SIZE, OR COLOR.

THE FOREIGN WORDING IN THE MARK TRANSLATES INTO ENGLISH AS TO HOPE.

SN 77-174,490, FILED 5-7-2007.

PAUL F. GAST, EXAMINING ATTORNEY

Int. Cl.: 28

Prior U.S. Cls.: 22, 23, 38, and 50

United States Patent and Trademark Office

Reg. No. 3,477,618

Registered July 29, 2008

**TRADEMARK
PRINCIPAL REGISTER**



TURNER, RANDAL SCOTT (UNITED STATES
INDIVIDUAL)
3528 ALYSON DRIVE
GRANITE FALLS, WA 98252

FOR: ARTIFICIAL FISHING LURES, IN CLASS 28
(U.S. CLS. 22, 23, 38 AND 50).

FIRST USE 2-15-2008; IN COMMERCE 4-26-2008.

NO CLAIM IS MADE TO THE EXCLUSIVE
RIGHT TO USE "LURES", APART FROM THE
MARK AS SHOWN.

THE COLOR(S) GREEN, WHITE AND BLACK IS/
ARE CLAIMED AS A FEATURE OF THE MARK.

THE MARK CONSISTS OF THE COMPANY
NAME "VERSALURES" IN BRIGHT GREEN,
THERE IS A BLACK AND WHITE CRESTING
MOON IN THE BACKGROUND WITH AN OUT-
LINED DRAWING OF A FISH IN BLACK THAT
HAS WHITE FISHING LINE CONNECTED AT THE
MOUTH OF THE FISH AND OF WHICH FISHING
LINE ANGLES DOWNWARD AND OUTWARD TO
THE BORDER OF THE IMAGE.

SN 77-174,679, FILED 5-7-2007.

LOURDES AYALA, EXAMINING ATTORNEY

Int. Cl.: 35

Prior U.S. Cls.: 100, 101, and 102

United States Patent and Trademark Office

Reg. No. 3,477,619

Registered July 29, 2008

**SERVICE MARK
PRINCIPAL REGISTER**

u.talk.back

EREWARDS, INC. (DELAWARE CORPORATION)
8401 N. CENTRAL EXPRESSWAY, STE. 900
DALLAS, TX 75225

FOR: BUSINESS AND MARKET RESEARCH SERVICES; CONDUCTING AND ANALYZING BUSINESS, MARKET AND PUBLIC OPINION RESEARCH SURVEYS; ORGANIZATION AND MANAGEMENT OF FOCUS GROUPS, PANEL GROUPS, AND ON-LINE OPINION PANEL PARTICIPANTS; PREPARING SURVEY STATISTICAL REPORTS; PROVIDING A COMPUTERIZED ONLINE INTERACTIVE DATABASE FOR BUSINESS AND MARKETING RESEARCH SURVEYS OF SUBSCRIBERS FEATURING SURVEY DATA AND ANALYSES; CONSULTING SERVICES IN THE FIELD OF MAR-

KET RESEARCH AND PUBLIC OPINION SURVEYS; PROVIDING CUSTOMER AND PROSPECTIVE CUSTOMER RELATIONSHIP MANAGEMENT CONSULTATION SERVICES TO BUSINESSES, IN CLASS 35 (U.S. CLS. 100, 101 AND 102).

FIRST USE 10-23-2007; IN COMMERCE 10-23-2007.

THE MARK CONSISTS OF STANDARD CHARACTERS WITHOUT CLAIM TO ANY PARTICULAR FONT, STYLE, SIZE, OR COLOR.

SN 77-174,814, FILED 5-7-2007.

ELLEN PERKINS, EXAMINING ATTORNEY

Int. Cl.: 38

Prior U.S. Cls.: 100, 101, and 104

United States Patent and Trademark Office

Reg. No. 3,477,620

Registered July 29, 2008

**SERVICE MARK
PRINCIPAL REGISTER**

IN TOUCH, IN FLIGHT

AIRCELL LLC (DELAWARE LTD LIAB CO)
BUILDING B, SUITE 280
1172 CENTURY DRIVE
LOUISVILLE, CO 80027

FOR: BROADBAND AND NARROWBAND COMMUNICATION SERVICES ONBOARD AIRCRAFTS TO ENABLE USERS TO TRANSMIT AND RECEIVE VOICE, VIDEO, AND DATA WITHIN THE AIRCRAFTS, BETWEEN THE AIRCRAFTS, BETWEEN THE AIRCRAFTS AND THE GROUND, AND BETWEEN THE GROUND AND THE AIRCRAFTS; BROADBAND AND NARROWBAND COMMUNICATION SERVICES TO INTERCONNECT USERS, LOCATED ONBOARD AN AIRCRAFT, WITH USERS LOCATED ONBOARD ANOTHER AIRCRAFT, TO INTERCONNECT USERS LOCATED ONBOARD AN AIRCRAFT WITH USERS AND DESTINATIONS ON THE GROUND, TO INTER-

CONNECT USERS AND DESTINATIONS ON THE GROUND WITH USERS ONBOARD THE AIRCRAFTS, AND TO INTERCONNECT USERS LOCATED ONBOARD AN AIRCRAFT, IN CLASS 38 (U.S. CLS. 100, 101 AND 104).

FIRST USE 4-0-1998; IN COMMERCE 4-0-1998.

THE MARK CONSISTS OF STANDARD CHARACTERS WITHOUT CLAIM TO ANY PARTICULAR FONT, STYLE, SIZE, OR COLOR.

OWNER OF U.S. REG. NOS. 2,307,311 AND 2,600,307.

SN 77-175,218, FILED 5-8-2007.

BRENDAN MCCAULEY, EXAMINING ATTORNEY

Int. Cl.: 35

Prior U.S. Cls.: 100, 101, and 102

United States Patent and Trademark Office

Reg. No. 3,477,621

Registered July 29, 2008

**SERVICE MARK
PRINCIPAL REGISTER**

Pulp Fashion

GARTNER STUDIOS, INC. (MINNESOTA CORPORATION)
220 EAST MYRTLE STREET
STILLWATER, MN 55082

FOR: RETAIL STORE SERVICES FEATURING STATIONERY, DESIGNER PAPER, CARDSTOCK, NOTE CARDS, THANK YOU CARDS, GREETING CARDS, INVITATIONS FOR ALL OCCASIONS, ANNOUNCEMENTS FOR ALL OCCASIONS, WEDDING PAPERS, ENVELOPES, BLANK JOURNALS, CALENDARS, BANNERS, DECORATIONS, RIBBONS, CENTERPIECES, GAMES, PENS, BUTTONS,

PUZZLES AND NOVELTY ITEMS, IN CLASS 35 (U.S. CLS. 100, 101 AND 102).

FIRST USE 6-0-2007; IN COMMERCE 6-0-2007.

THE MARK CONSISTS OF STANDARD CHARACTERS WITHOUT CLAIM TO ANY PARTICULAR FONT, STYLE, SIZE, OR COLOR.

SN 77-175,357, FILED 5-8-2007.

ERIN FALK, EXAMINING ATTORNEY

Int. Cl.: 9

Prior U.S. Cls.: 21, 23, 26, 36, and 38

Reg. No. 3,477,622

United States Patent and Trademark Office

Registered July 29, 2008

**TRADEMARK
PRINCIPAL REGISTER**

NITETIME

HUNTER FAN COMPANY (DELAWARE CORPORATION)
2500 FRISCO AVENUE
MEMPHIS, TN 38114

FOR: PRE-PROGRAMMED TIMER FOR INDOOR USE WHICH CONNECTS TO A LAMP OR OTHER SMALL APPLIANCE TO CONTROL THE ON/OFF FUNCTIONALITY, IN CLASS 9 (U.S. CLS. 21, 23, 26, 36 AND 38).

FIRST USE 1-0-2008; IN COMMERCE 1-0-2008.

THE MARK CONSISTS OF STANDARD CHARACTERS WITHOUT CLAIM TO ANY PARTICULAR FONT, STYLE, SIZE, OR COLOR.

SN 77-175,507, FILED 5-8-2007.

ADA HAN, EXAMINING ATTORNEY

Int. Cl.: 35

Prior U.S. Cls.: 100, 101, and 102

United States Patent and Trademark Office

Reg. No. 3,477,623

Registered July 29, 2008

**SERVICE MARK
PRINCIPAL REGISTER**



MY CREDENTIALS, INC. (CALIFORNIA CORPORATION)
28202 CABOT ROAD, SUITE 300
LAGUNA NIGUEL, CA 92677

FOR: ONLINE BUSINESS NETWORKING SERVICES; EMPLOYMENT HIRING, RECRUITING, PLACEMENT, STAFFING AND CAREER NETWORKING SERVICES; RESUME PREPARATION; PROVIDING AN ONLINE DIRECTORY INFORMATION SERVICE FEATURING INFORMATION REGARDING EMPLOYMENT OPPORTUNITIES AND CAREER PLACEMENT, IN CLASS 35 (U.S. CLS. 100, 101 AND 102).

FIRST USE 8-29-2007; IN COMMERCE 8-29-2007.

THE COLOR(S) BLUE, WHITE, RED, YELLOW, AND ORANGE IS/ARE CLAIMED AS A FEATURE OF THE MARK.

THE MARK CONSISTS OF A RED RECTANGULAR BACKGROUND WITH WHITE BORDERS.

THE LITERAL ELEMENT OF THE MARK, "WWW.MYCREDS.NET", IS WRITTEN IN BLUE, AND LOCATED IN THE CENTER OF THE RECTANGLE. THE LETTERS OF THE LITERAL ELEMENT PORTRAY A SHADOW, THE INTENSITY OF WHICH INCREASES FROM THE MIDDLE OF THE LITERAL ELEMENT TOWARD THE ENDS. THE LETTER Y IN THE LITERAL ELEMENT OF THE MARK IS DEPICTED AS A HUMAN. THE HUMAN'S HEAD IS A SOLID BLUE CIRCLE, AND THE HUMAN BODY'S BORDER IS ALSO BLUE WITH A WHITE FILLER. THERE IS A SQUARE ON THE HUMAN'S CHEST. THE FOUR SIDES OF THE SQUARE ARE CONCAVED IN. THE SQUARE HAS BLUE BORDERS WITH AN ORANGE FILLER. A YELLOW CIRCULAR GLOWING OBJECT RESEMBLING THE SUN IS DEPICTED ABOVE THE HUMAN'S HEAD..

SN 77-175,824, FILED 5-8-2007.

KATHERINE M. DUBRAY, EXAMINING ATTORNEY

Int. Cls.: 39, 41, and 43

Prior U.S. Cls.: 100, 101, 105, and 107

United States Patent and Trademark Office

Reg. No. 3,477,624

Registered July 29, 2008

**SERVICE MARK
PRINCIPAL REGISTER**

CARNIVAL INSPIRATION

CARNIVAL CORPORATION (PANAMA CORPORATION)
3655 N.W. 87TH AVENUE
MIAMI, FL 33178

FOR: CRUISE SHIP SERVICES, IN CLASS 39 (U.S. CLS. 100 AND 105).

FIRST USE 6-15-2007; IN COMMERCE 6-15-2007.

FOR: ENTERTAINMENT SERVICES, NAMELY, CASINO SERVICES, ORGANIZING AND CONDUCTING STAGE SHOWS, NIGHTCLUB SHOWS, CONTESTS, DANCES AND PARTIES, IN CLASS 41 (U.S. CLS. 100, 101 AND 107).

FIRST USE 6-15-2007; IN COMMERCE 6-15-2007.

FOR: HOTEL SERVICES AND RESTAURANT SERVICES, IN CLASS 43 (U.S. CLS. 100 AND 101).

FIRST USE 6-15-2007; IN COMMERCE 6-15-2007.

THE MARK CONSISTS OF STANDARD CHARACTERS WITHOUT CLAIM TO ANY PARTICULAR FONT, STYLE, SIZE, OR COLOR.

OWNER OF U.S. REG. NOS. 1,495,405, 3,189,529, AND OTHERS.

SN 77-175,831, FILED 5-8-2007.

MARCIE MILONE, EXAMINING ATTORNEY

Int. Cl.: 35

Prior U.S. Cls.: 100, 101, and 102

United States Patent and Trademark Office

Reg. No. 3,477,625

Registered July 29, 2008

**SERVICE MARK
PRINCIPAL REGISTER**

Eccolo Media

ECCOLO MEDIA, INC. (CALIFORNIA CORPORATION)

SUITE 202

470 THIRD STREET

SAN FRANCISCO, CA 94107

FOR: BUSINESS MARKETING SERVICES AND CUSTOM WRITING SERVICES, NAMELY, WRITING CUSTOM MARKETING MATERIALS FOR OTHERS, IN CLASS 35 (U.S. CLS. 100, 101 AND 102).

FIRST USE 8-1-2007; IN COMMERCE 8-1-2007.

THE MARK CONSISTS OF STANDARD CHARACTERS WITHOUT CLAIM TO ANY PARTICULAR FONT, STYLE, SIZE, OR COLOR.

NO CLAIM IS MADE TO THE EXCLUSIVE RIGHT TO USE "MEDIA", APART FROM THE MARK AS SHOWN.

THE FOREIGN WORDING IN THE MARK TRANSLATES INTO ENGLISH AS HERE IT IS.

SN 77-176,806, FILED 5-9-2007.

TASHIA BUNCH, EXAMINING ATTORNEY

Int. Cls.: 36 and 37

Prior U.S. Cls.: 100, 101, 102, 103, and 106

United States Patent and Trademark Office

Reg. No. 3,477,626

Registered July 29, 2008

**SERVICE MARK
PRINCIPAL REGISTER**

MONZ

MONZON, VICTOR J. (UNITED STATES INDIVIDUAL)
11440 SW 47 STREET
MIAMI, FL 33165

FOR: APPRAISAL OF REAL ESTATE; APPRAISALS FOR INSURANCE CLAIMS OF REAL ESTATE; ASSESSMENT AND MANAGEMENT OF REAL ESTATE; ESTATE PLANNING; ESTATE TRUST MANAGEMENT; EVALUATION OF REAL PROPERTY; FINANCIAL INVESTMENT IN THE FIELD OF REAL ESTATE; FINANCIAL SERVICES, NAMELY, ESTATE SETTLEMENT SERVICES; FINANCIAL VALUATION OF PERSONAL PROPERTY AND REAL ESTATE; HOUSING SERVICES, NAMELY, REAL PROPERTY ACQUISITION AND CONSUMER FINANCING TO FACILITATE HOME OWNERSHIP; LAND ACQUISITION, NAMELY, REAL ESTATE BROKERAGE; LEASING OF REAL ESTATE; LEASING OF REAL PROPERTY; PROVIDING INFORMATION IN THE FIELD OF REAL ESTATE BY MEANS OF LINKING THE WEB SITE TO OTHER WEB SITES FEATURING REAL ESTATE INFORMATION; PROVIDING INFORMATION IN THE FIELD OF REAL ESTATE VIA THE INTERNET; PROVIDING ONLINE INFORMATION IN THE FIELD CHARITABLE MONETARY GIVING THROUGH FINANCIAL AND ESTATE PLANNING; PROVIDING REAL ESTATE LISTINGS AND REAL ESTATE INFORMATION VIA THE INTERNET; REAL ESTATE ACQUISITION SERVICES; REAL ESTATE AGENCIES; REAL ESTATE APPRAISAL; REAL ESTATE BROKERAGE; REAL ESTATE CONSULTANCY; REAL ESTATE CONSULTATION; REAL ESTATE EQUITY SHARING, NAMELY, MANAGING AND ARRANGING FOR CO-OWNERSHIP OF REAL ESTATE; REAL ESTATE ESCROW SERVICES; REAL ESTATE INVESTMENT; REAL ESTATE LENDING SERVICES; REAL ESTATE LIST-

ING; REAL ESTATE MANAGEMENT; REAL ESTATE MANAGEMENT CONSULTATION; REAL ESTATE MULTIPLE LISTING SERVICES; REAL ESTATE PROCUREMENT FOR OTHERS; REAL ESTATE SERVICES, NAMELY, RENTAL OF VACATION HOMES, CONDOMINIUMS, CABINS, AND VILLAS USING PAY PER CLICK ADVERTISING ON A GLOBAL COMPUTER NETWORK; REAL ESTATE SYNDICATION; REAL ESTATE TIME-SHARING; REAL ESTATE TRUSTEE SERVICES; REAL ESTATE VALUATION SERVICES; REAL ESTATE VALUATIONS; VACATION REAL ESTATE TIME SHARE EXCHANGE SERVICES; VACATION REAL ESTATE TIME-SHARING; VACATION REAL ESTATE TIME-SHARE SERVICES, IN CLASS 36 (U.S. CLS. 100, 101 AND 102).

FIRST USE 6-1-2007; IN COMMERCE 7-1-2007.

FOR: HOUSING SERVICES, NAMELY, DEVELOPMENT OF REAL PROPERTY, NAMELY, REPAIR, IMPROVEMENT, AND NEW CONSTRUCTION; HOUSING SERVICES, NAMELY, REPAIR, IMPROVEMENT, AND CONSTRUCTION OF RESIDENTIAL REAL PROPERTY; REAL ESTATE DEVELOPMENT; REAL ESTATE SITE SELECTION, IN CLASS 37 (U.S. CLS. 100, 103 AND 106).

FIRST USE 6-1-2007; IN COMMERCE 7-1-2007.

THE MARK CONSISTS OF STANDARD CHARACTERS WITHOUT CLAIM TO ANY PARTICULAR FONT, STYLE, SIZE, OR COLOR.

SN 77-176,891, FILED 5-9-2007.

HOWARD SMIGA, EXAMINING ATTORNEY

Int. Cl.: 36

Prior U.S. Cls.: 100, 101, and 102

United States Patent and Trademark Office

Reg. No. 3,477,627

Registered July 29, 2008

**SERVICE MARK
PRINCIPAL REGISTER**

WHITNEY

WHITNEY NATIONAL BANK (UNITED STATES
NATIONAL BANKING ASSOCIATION)
228 ST. CHARLES AVENUE
NEW ORLEANS, LA 70130

FOR: SECURITIES AND INVESTMENT BROKER-
AGE SERVICES; INSURANCE BROKERAGE SER-
VICES; FINANCIAL SERVICES, NAMELY,
PROVIDING INVESTMENT ADVISORY SERVICES
IN CONNECTION WITH SECURITIES OR INVEST-
MENT BROKERAGE SERVICES; FINANCIAL SER-
VICES, NAMELY, PROVIDING INVESTMENT
RESEARCH SERVICES IN CONNECTION WITH
SECURITIES OR INVESTMENT BROKERAGE SER-
VICES; FINANCIAL SERVICES, NAMELY, FINAN-
CIAL ANALYSIS, CONSULTATION, PLANNING
AND ADVISING SERVICES; FINANCIAL SERVI-
CES, NAMELY, INVESTMENT MANAGEMENT

SERVICES; AND, FINANCIAL SERVICES, NAME-
LY, MONITORING OF INVESTMENTS AND ANA-
LYSIS OF PERFORMANCE RESULTS, IN CLASS 36
(U.S. CLS. 100, 101 AND 102).

FIRST USE 9-30-1999; IN COMMERCE 9-30-1999.

THE MARK CONSISTS OF STANDARD CHAR-
ACTERS WITHOUT CLAIM TO ANY PARTICULAR
FONT, STYLE, SIZE, OR COLOR.

OWNER OF U.S. REG. NOS. 1,311,441, 2,439,672,
AND 2,704,964.

SN 77-176,906, FILED 5-9-2007.

FRANK LATTUCA, EXAMINING ATTORNEY

Int. Cl.: 5

Prior U.S. Cls.: 6, 18, 44, 46, 51, and 52

United States Patent and Trademark Office

Reg. No. 3,477,628

Registered July 29, 2008

**TRADEMARK
PRINCIPAL REGISTER**



NGUYEN, HIEN (UNITED STATES INDIVIDUAL)
P.O.BOX 611954
SAN JOSE, CA 95161

FOR: DIETARY SUPPLEMENTS; HERBAL SUPPLEMENTS; NUTRITIONAL SUPPLEMENTS, IN CLASS 5 (U.S. CLS. 6, 18, 44, 46, 51 AND 52).

FIRST USE 4-18-2008; IN COMMERCE 4-18-2008.

THE MARK CONSISTS OF A SHIELD IN THE CENTER WHICH WILL HAVE THE NAME "BEE CLEAN" WITHIN IT. THERE IS A STROKE THAT IS ON THE OUTSIDE OF THIS SHIELD. EXPANDING FROM THE SHIELD ARE TWO FEATHERED WINGS. THERE IS A STROKE SURROUNDING EACH WING.

SN 77-177,071, FILED 5-9-2007.

RICHARD WHITE, EXAMINING ATTORNEY

Int. Cls.: 35 and 44

Prior U.S. Cls.: 100, 101, and 102

United States Patent and Trademark Office

Reg. No. 3,477,629

Registered July 29, 2008

**SERVICE MARK
PRINCIPAL REGISTER**

ANSWERS FOR EVERY BODY

VITAMIN SHOPPE INDUSTRIES INC. (NEW
YORK CORPORATION)
2101 91ST STREET
NORTH BERGEN, NJ 07047

FOR: RETAIL STORE SERVICES, MAIL ORDER
CATALOG SERVICES AND ONLINE RETAIL
STORE SERVICES PROVIDED VIA A GLOBAL
COMPUTER NETWORK FEATURING VITAMINS,
NUTRITIONAL SUPPLEMENTS, COMPLEMEN-
TARY AND ALTERNATIVE MEDICINE PRO-
DUCTS, BOOKS, HERBAL SUPPLEMENTS,
AROMATHERAPY PRODUCTS, BATH AND SHOW-
ER PRODUCTS, HEALTH AND BEAUTY PRO-
DUCTS, SKIN TREATMENT CREAMS AND
RELATED ITEMS, IN CLASS 35 (U.S. CLS. 100, 101
AND 102).

FIRST USE 7-31-2007; IN COMMERCE 7-31-2007.

FOR: PROVIDING INFORMATION VIA A WEB
SITE ON VITAMINS, NUTRITIONAL SUPPLE-
MENTS, HERBAL SUPPLEMENT, AROMATHER-
APY CREAMS, AROMATHERAPY LOTIONS,
AROMATHERAPY OILS, NON-MEDICATED BATH
AND SHOWER PRODUCTS, BODY AND BEAUTY
CARE, SKIN CREAMS AND COSMETICS, IN CLASS
44 (U.S. CLS. 100 AND 101).

FIRST USE 7-31-2007; IN COMMERCE 7-31-2007.

THE MARK CONSISTS OF STANDARD CHAR-
ACTERS WITHOUT CLAIM TO ANY PARTICULAR
FONT, STYLE, SIZE, OR COLOR.

SN 77-177,210, FILED 5-10-2007.

RICHARD A. STRASER, EXAMINING ATTORNEY

Int. Cl.: 11

Prior U.S. Cls.: 13, 21, 23, 31, and 34

United States Patent and Trademark Office

Reg. No. 3,477,630

Registered July 29, 2008

**TRADEMARK
PRINCIPAL REGISTER**

**It's the bright thing to
do.**

FEIT ELECTRIC COMPANY (CALIFORNIA COR-
PORATION)
WWW.FEIT.COM
4901 GREGG ROAD
PICO RIVERA, CA 90660

THE MARK CONSISTS OF STANDARD CHAR-
ACTERS WITHOUT CLAIM TO ANY PARTICULAR
FONT, STYLE, SIZE, OR COLOR.

FOR: ELECTRIC LIGHT BULBS; LAMPS; ELEC-
TRIC LIGHTING FIXTURES, IN CLASS 11 (U.S. CLS.
13, 21, 23, 31 AND 34).

SN 77-177,430, FILED 5-10-2007.

FIRST USE 6-8-2007; IN COMMERCE 6-8-2007.

ROBIN CHOSID, EXAMINING ATTORNEY

Int. Cls.: 35 and 36

Prior U.S. Cls.: 100, 101, and 102

United States Patent and Trademark Office

Reg. No. 3,477,631

Registered July 29, 2008

**SERVICE MARK
PRINCIPAL REGISTER**

EARTHSMART

FIA CARD SERVICES, NATIONAL ASSOCIATION (UNITED STATES NATIONAL BANKING ASSOCIATION)
RODNEY SQUARE
WILMINGTON, DE 19884

FOR: PROMOTING THE SALE OF CREDIT CARD ACCOUNTS AND PROMOTING THE USE OF CREDIT CARD SERVICES THROUGH THE ADMINISTRATION OF INCENTIVE AWARD PROGRAMS, IN CLASS 35 (U.S. CLS. 100, 101 AND 102).

FIRST USE 11-29-2007; IN COMMERCE 11-29-2007.

FOR: CREDIT CARD SERVICES, IN CLASS 36 (U.S. CLS. 100, 101 AND 102).

FIRST USE 11-29-2007; IN COMMERCE 11-29-2007.

THE MARK CONSISTS OF STANDARD CHARACTERS WITHOUT CLAIM TO ANY PARTICULAR FONT, STYLE, SIZE, OR COLOR.

SN 77-177,516, FILED 5-10-2007.

EDWARD NELSON, EXAMINING ATTORNEY

Int. Cl.: 30

Prior U.S. Cl.: 46

United States Patent and Trademark Office

Reg. No. 3,477,632

Registered July 29, 2008

**TRADEMARK
PRINCIPAL REGISTER**

NANCY'S FANCY CHEDDAR SNAPS

NANCY'S FANCY, LLC (KENTUCKY LTD LIAB
CO)
838 EAST HIGH STREET, P.O. BOX 266
LEXINGTON, KY 40502

NO CLAIM IS MADE TO THE EXCLUSIVE
RIGHT TO USE "CHEDDAR SNAPS", APART FROM
THE MARK AS SHOWN.

FOR: CRACKERS, IN CLASS 30 (U.S. CL. 46).

FIRST USE 6-13-2008; IN COMMERCE 6-13-2008.

SN 77-177,844, FILED 5-10-2007.

THE MARK CONSISTS OF STANDARD CHAR-
ACTERS WITHOUT CLAIM TO ANY PARTICULAR
FONT, STYLE, SIZE, OR COLOR.

ELLEN B. AWRICH, EXAMINING ATTORNEY

Int. Cls.: 9 and 16

Prior U.S. Cls.: 2, 5, 21, 22, 23, 26, 29, 36, 37, 38, and 50

Reg. No. 3,477,633

United States Patent and Trademark Office

Registered July 29, 2008

TRADEMARK
PRINCIPAL REGISTER



REALITYWORKS, INC. (WISCONSIN CORPORATION)
2709 MONDOVI ROAD
EAU CLAIRE, WI 54701

FOR: PORTABLE AND HANDHELD ELECTRONIC EDUCATIONAL CIGARETTE SMOKING SIMULATORS HAVING A SPEAKER FOR PLAYING RECORDED MESSAGES, A MICROPHONE FOR USER INPUT, VOICE RECOGNITION CAPABILITIES, AND AN ELECTRONIC TAG AND ASSOCIATED READER DEVICE FOR INTERACTIVE COMMUNICATION WITH THE USER AND PRINTED INSTRUCTIONAL MATERIALS FOR USE WITH THE SIMULATORS, ALL SOLD AS A UNIT; PORTABLE AND HANDHELD ELECTRONIC EDUCATIONAL ADDICTIVE AND ABUSIVE BEHAVIOR SIMULATORS HAVING A SPEAKER FOR PLAYING RECORDED MESSAGES, A MICROPHONE FOR USER INPUT, VOICE RECOGNITION CAPABILITIES, AND AN ELECTRONIC TAG AND ASSOCIATED READER DEVICE FOR INTERACTIVE COMMUNICATION WITH THE USER AND PRINTED INSTRUCTIONAL MATERIALS FOR USE WITH THE SIMULATORS, ALL SOLD AS A UNIT;

DVDS FEATURING ABUSIVE AND ADDICTIVE BEHAVIOR DETERRENCE EDUCATIONAL MATERIALS, IN CLASS 9 (U.S. CLS. 21, 23, 26, 36 AND 38).

FIRST USE 10-5-2007; IN COMMERCE 10-5-2007.

FOR: PRINTED INSTRUCTIONAL, EDUCATIONAL, AND TEACHING MATERIALS IN THE FIELD OF ABUSIVE AND ADDICTIVE BEHAVIOR DETERRENCE; PRINTED INSTRUCTIONAL, EDUCATIONAL, AND TEACHING MATERIALS IN THE FIELD OF TOBACCO USAGE DETERRENCE, IN CLASS 16 (U.S. CLS. 2, 5, 22, 23, 29, 37, 38 AND 50).

FIRST USE 10-5-2007; IN COMMERCE 10-5-2007.

THE MARK CONSISTS OF THE WORD "ySTART" FOLLOWED BY A GROUP OF DOTS FORMING THE LETTER "Y".

SN 77-178,418, FILED 5-11-2007.

ADA HAN, EXAMINING ATTORNEY

Int. Cl.: 43

Prior U.S. Cls.: 100 and 101

United States Patent and Trademark Office

Reg. No. 3,477,634

Registered July 29, 2008

**SERVICE MARK
PRINCIPAL REGISTER**

POWERED UP

SUBMARINA, INC. (CALIFORNIA CORPORATION)
SUITE 340
100 EAST SAN MARCOS BLVD.
SAN MARCOS, CA 92069

THE MARK CONSISTS OF STANDARD CHARACTERS WITHOUT CLAIM TO ANY PARTICULAR FONT, STYLE, SIZE, OR COLOR.

FOR: RESTAURANT SERVICES, CARRY-OUT RESTAURANT SERVICES AND CATERING SERVICES, IN CLASS 43 (U.S. CLS. 100 AND 101).

SN 77-178,943, FILED 5-11-2007.

FIRST USE 2-29-2008; IN COMMERCE 2-29-2008.

JENNY PARK, EXAMINING ATTORNEY

Int. Cl.: 28

Prior U.S. Cls.: 22, 23, 38, and 50

United States Patent and Trademark Office

Reg. No. 3,477,635

Registered July 29, 2008

**TRADEMARK
PRINCIPAL REGISTER**

SNOWLINE EXPRESS

WAKEFERN FOOD CORP. (NEW JERSEY COR-
PORATION)
600 YORK STREET
ELIZABETH, NJ 07207

THE MARK CONSISTS OF STANDARD CHAR-
ACTERS WITHOUT CLAIM TO ANY PARTICULAR
FONT, STYLE, SIZE, OR COLOR.

FOR: TOY MODEL TRAIN SETS, IN CLASS 28
(U.S. CLS. 22, 23, 38 AND 50).

SN 77-179,838, FILED 5-14-2007.

FIRST USE 11-0-2007; IN COMMERCE 11-0-2007.

ODESSA BIBBINS, EXAMINING ATTORNEY

Int. Cl.: 9

Prior U.S. Cls.: 21, 23, 26, 36, and 38

United States Patent and Trademark Office

Reg. No. 3,477,636

Registered July 29, 2008

**TRADEMARK
PRINCIPAL REGISTER**

OGS

TOPLAY INC. (TAIWAN CORPORATION)
8F, NO. 48, SEC. 2, SHUANG 10TH RD.
BANCIAO CITY, TAIPEI COUNTY, TAIWAN R.O.C.

FOR: EARPHONES; AUDIO SPEAKERS; CABINETS FOR LOUDSPEAKERS; SOUND LOUDSPEAKER; HANDHELD RECEIVERS FOR AUDIO; AUDIO SPEAKERS FOR COMPUTER; PORTABLE MEDIA PLAYER; ACOUSTIC CONDUITS; EARPHONE FOR MOBILE PHONE IN CAR USE, IN CLASS 9 (U.S. CLS. 21, 23, 26, 36 AND 38).

FIRST USE 6-5-2007; IN COMMERCE 6-5-2007.

THE MARK CONSISTS OF STANDARD CHARACTERS WITHOUT CLAIM TO ANY PARTICULAR FONT, STYLE, SIZE, OR COLOR.

SN 77-179,873, FILED 5-14-2007.

CHRISIE B. KING, EXAMINING ATTORNEY

Int. Cls.: 29 and 33

Prior U.S. Cls.: 46, 47, and 49

United States Patent and Trademark Office

Reg. No. 3,477,637

Registered July 29, 2008

**TRADEMARK
PRINCIPAL REGISTER**

Junior Johnson

JUNIOR JOHNSON ENTERPRISES, INC. (NORTH
CAROLINA CORPORATION)
1100 GLEN OAKS DRIVE
HAMPTONVILLE, NC 27020

THE MARK CONSISTS OF STANDARD CHAR-
ACTERS WITHOUT CLAIM TO ANY PARTICULAR
FONT, STYLE, SIZE, OR COLOR.

FOR: HAM; HOT DOGS; PORK; PORK RINDS, IN
CLASS 29 (U.S. CL. 46).

THE NAME "JUNIOR JOHNSON" IDENTIFIES A
LIVING INDIVIDUAL WHOSE CONSENT IS OF
RECORD.

FIRST USE 3-1-1995; IN COMMERCE 3-1-1995.

FOR: LIQUOR , IN CLASS 33 (U.S. CLS. 47 AND
49).

SN 77-180,194, FILED 5-14-2007.

FIRST USE 5-7-2007; IN COMMERCE 5-7-2007.

INGRID C. EULIN, EXAMINING ATTORNEY

Int. Cl.: 33

Prior U.S. Cls.: 47 and 49

United States Patent and Trademark Office

Reg. No. 3,477,638

Registered July 29, 2008

TRADEMARK
PRINCIPAL REGISTER

A handwritten signature in black ink that reads "Junior Johnson". The signature is written in a cursive, flowing style with a long horizontal stroke at the end.

JUNIOR JOHNSON ENTERPRISES, INC. (NORTH
CAROLINA CORPORATION)
1100 GLEN OAKS DRIVE
HAMPTONVILLE, NC 27020

THE NAME(S), PORTRAIT(S), AND/OR SIGNA-
TURE(S) SHOWN IN THE MARK IDENTIFIES
ROBERT G. JOHNSON, JR. AKA "JUNIOR JOHN-
SON", WHOSE CONSENT(S) TO REGISTER IS SUB-
MITTED.

FOR: LIQUOR, IN CLASS 33 (U.S. CLS. 47 AND 49).

SN 77-180,244, FILED 5-14-2007.

FIRST USE 5-7-2007; IN COMMERCE 5-7-2007.

INGRID C. EULIN, EXAMINING ATTORNEY

Int. Cl.: 5

Prior U.S. Cls.: 6, 18, 44, 46, 51, and 52

Reg. No. 3,477,639

United States Patent and Trademark Office

Registered July 29, 2008

**TRADEMARK
PRINCIPAL REGISTER**

**Unification of Western
Science and Eastern Wisdom**

ESSENIX PHARMACEUTICALS, INC. (DELA-
WARE CORPORATION)
6 GREAT ROCK CIRCLE
NATICK, MA 01760

THE MARK CONSISTS OF STANDARD CHAR-
ACTERS WITHOUT CLAIM TO ANY PARTICULAR
FONT, STYLE, SIZE, OR COLOR.

FOR: DIETARY SUPPLEMENTS; DIETARY SUP-
PLEMENTS FOR HUMAN CONSUMPTION; HER-
BAL SUPPLEMENTS, IN CLASS 5 (U.S. CLS. 6, 18, 44,
46, 51 AND 52).

SN 77-180,278, FILED 5-14-2007.

FIRST USE 4-30-2008; IN COMMERCE 4-30-2008.

INGRID C. EULIN, EXAMINING ATTORNEY

Int. Cl.: 3

Prior U.S. Cls.: 1, 4, 6, 50, 51, and 52

Reg. No. 3,477,640

United States Patent and Trademark Office

Registered July 29, 2008

**TRADEMARK
PRINCIPAL REGISTER**

Lira

EVOLVING SOLUTIONS, INC (PENNSYLVANIA CORPORATION)
103 GREENFIELD DRIVE
MIDDLEBURY, IN 46540

FIRST USE 2-1-2008; IN COMMERCE 5-1-2008.

FOR: CLEANING PREPARATIONS FOR HOUSEHOLD PURPOSES; HOUSEHOLD CLEANING PREPARATIONS; ROOM FRAGRANCES; BATH OILS; BATHING LOTIONS; BEAUTY LOTIONS; BODY LOTIONS; MASSAGE OILS; PERFUME OILS; PERFUMES; SKIN LOTIONS, IN CLASS 3 (U.S. CLS. 1, 4, 6, 50, 51 AND 52).

THE MARK CONSISTS OF STANDARD CHARACTERS WITHOUT CLAIM TO ANY PARTICULAR FONT, STYLE, SIZE, OR COLOR.

SN 77-180,760, FILED 5-14-2007.

AISHA SALEM, EXAMINING ATTORNEY

Int. Cl.: 9

Prior U.S. Cls.: 21, 23, 26, 36, and 38

Reg. No. 3,477,641

United States Patent and Trademark Office

Registered July 29, 2008

**TRADEMARK
PRINCIPAL REGISTER**

TestPilot

GREENLINE FINANCIAL TECHNOLOGIES, INC.
(ILLINOIS CORPORATION)
20 N. WACKER DRIVE, STE 3800
CHICAGO, IL 60606

FOR: COMPUTER SOFTWARE, NAMELY, SOFTWARE FOR PERFORMING AUTOMATED VERIFICATION OF ELECTRONIC TRADING AND BANKING SYSTEMS, IN CLASS 9 (U.S. CLS. 21, 23, 26, 36 AND 38).

FIRST USE 3-4-2008; IN COMMERCE 3-4-2008.

THE MARK CONSISTS OF STANDARD CHARACTERS WITHOUT CLAIM TO ANY PARTICULAR FONT, STYLE, SIZE, OR COLOR.

SN 77-181,021, FILED 5-15-2007.

JOHN GARTNER, EXAMINING ATTORNEY

Int. Cl.: 9

Prior U.S. Cls.: 21, 23, 26, 36, and 38

Reg. No. 3,477,642

United States Patent and Trademark Office

Registered July 29, 2008

**TRADEMARK
PRINCIPAL REGISTER**

MetriFIX

GREENLINE FINANCIAL TECHNOLOGIES, INC.
(ILLINOIS CORPORATION)
20 N. WACKER DRIVE, STE 3800
CHICAGO, IL 60606

FIRST USE 12-31-2007; IN COMMERCE 12-31-2007.

FOR: COMPUTER SOFTWARE, NAMELY, SOFTWARE DESIGNED FOR USE WITHIN AN ELECTRONIC TRADING ENVIRONMENT TO ENABLE USERS TO SUBMIT QUERIES AND GATHER STATISTICS REGARDING INFORMATION FLOW WITHIN THE ELECTRONIC TRADING ENVIRONMENT, IN CLASS 9 (U.S. CLS. 21, 23, 26, 36 AND 38).

THE MARK CONSISTS OF STANDARD CHARACTERS WITHOUT CLAIM TO ANY PARTICULAR FONT, STYLE, SIZE, OR COLOR.

SN 77-181,120, FILED 5-15-2007.

JOHN GARTNER, EXAMINING ATTORNEY

Int. Cl.: 1

Prior U.S. Cls.: 1, 5, 6, 10, 26, and 46

Reg. No. 3,477,643

United States Patent and Trademark Office

Registered July 29, 2008

**TRADEMARK
PRINCIPAL REGISTER**

AG-LIFE

RHIZOGEN, INC. (DELAWARE CORPORATION)
4200 RESEARCH FOREST AVENUE, SUITE 100
THE WOODLANDS, TX 77381

THE MARK CONSISTS OF STANDARD CHAR-
ACTERS WITHOUT CLAIM TO ANY PARTICULAR
FONT, STYLE, SIZE, OR COLOR.

FOR: ORGANIC BIOFERTILIZERS FOR TREES,
SHRUBS, LAWNS, GARDENS, AND ROW CROPS,
IN CLASS 1 (U.S. CLS. 1, 5, 6, 10, 26 AND 46).

SN 77-181,278, FILED 5-15-2007.

FIRST USE 5-14-2007; IN COMMERCE 5-14-2007.

DAVID H. STINE, EXAMINING ATTORNEY

Int. Cl.: 30

Prior U.S. Cl.: 46

United States Patent and Trademark Office

Reg. No. 3,477,644

Registered July 29, 2008

**TRADEMARK
PRINCIPAL REGISTER**

RAZZLES DAZZLES

CONCORD BRANDS ULC (CANADA CORPORATION)
2900-10180 101 STREET
EDMONTON, CANADA T5J3V5

FOR: CANDY, IN CLASS 30 (U.S. CL. 46).

FIRST USE 5-23-2008; IN COMMERCE 5-23-2008.

THE MARK CONSISTS OF STANDARD CHARACTERS WITHOUT CLAIM TO ANY PARTICULAR FONT, STYLE, SIZE, OR COLOR.

SN 77-181,514, FILED 5-15-2007.

CHRIS WELLS, EXAMINING ATTORNEY

Int. Cl.: 9

Prior U.S. Cls.: 21, 23, 26, 36, and 38

United States Patent and Trademark Office

Reg. No. 3,477,645

Registered July 29, 2008

**TRADEMARK
PRINCIPAL REGISTER**

CRP

UNICO, INC. (WISCONSIN CORPORATION)
3725 NICHOLSON ROAD
FRANKSVILLE, WI 53216

THE MARK CONSISTS OF STANDARD CHARACTERS WITHOUT CLAIM TO ANY PARTICULAR FONT, STYLE, SIZE, OR COLOR.

FOR: COMPUTER HARDWARE AND SOFTWARE TO CONTROL LINEAR RECIPROCATING MOTION OF A PUMP ROD, IN CLASS 9 (U.S. CLS. 21, 23, 26, 36 AND 38).

SN 77-181,623, FILED 5-15-2007.

FIRST USE 11-15-2007; IN COMMERCE 3-25-2008.

GIANCARLO CASTRO, EXAMINING ATTORNEY

Int. Cl.: 9

Prior U.S. Cls.: 21, 23, 26, 36, and 38

United States Patent and Trademark Office

Reg. No. 3,477,646

Registered July 29, 2008

**TRADEMARK
PRINCIPAL REGISTER**

YOUR BRAIN WILL THANK YOU

POSIT SCIENCE CORPORATION (CALIFORNIA CORPORATION)
225 BUSH STREET, 7TH FLOOR
SAN FRANCISCO, CA 94104

FOR: COMPUTER SOFTWARE FOR USE IN MAINTAINING OR IMPROVING COGNITIVE PERFORMANCE AND/OR BRAIN PLASTICITY AND MANUALS PROVIDED TOGETHER AS A UNIT, IN CLASS 9 (U.S. CLS. 21, 23, 26, 36 AND 38).

FIRST USE 7-1-2007; IN COMMERCE 7-1-2007.

THE MARK CONSISTS OF STANDARD CHARACTERS WITHOUT CLAIM TO ANY PARTICULAR FONT, STYLE, SIZE, OR COLOR.

SN 77-181,906, FILED 5-15-2007.

NICHOLAS ALTREE, EXAMINING ATTORNEY

Int. Cl.: 32

Prior U.S. Cls.: 45, 46, and 48

United States Patent and Trademark Office

Reg. No. 3,477,647

Registered July 29, 2008

**TRADEMARK
PRINCIPAL REGISTER**

What's Your Cool?

WATERMARK INNOVATION LLC (NEW YORK
LTD LIAB CO)
SUITE 1A
400 NOYAC ROAD
SOUTHAMPTON, NY 11968

THE MARK CONSISTS OF STANDARD CHAR-
ACTERS WITHOUT CLAIM TO ANY PARTICULAR
FONT, STYLE, SIZE, OR COLOR.

FOR: CARBONATED AND NON-CARBONATED
FLAVORED WATERS, IN CLASS 32 (U.S. CLS. 45, 46
AND 48).

SN 77-182,175, FILED 5-16-2007.

FIRST USE 8-0-2007; IN COMMERCE 8-0-2007.

REGINA DRUMMOND, EXAMINING ATTORNEY

Int. Cl.: 28

Prior U.S. Cls.: 22, 23, 38, and 50

United States Patent and Trademark Office

Reg. No. 3,477,648

Registered July 29, 2008

**TRADEMARK
PRINCIPAL REGISTER**

BELLA BUTTONS

HONG KONG CITY TOYS FACTORY LIMITED
(BR. VIRGIN ISLANDS CORPORATION)
ROOM 701-5 SILVERCORD TOWER 1 30 CANTON
KOWLOON, HONG KONG

FOR: DOLLS, DOLL CLOTHING, DOLL PLAY
SETS AND DOLL ACCESSORIES, IN CLASS 28 (U.S.
CLS. 22, 23, 38 AND 50).

FIRST USE 1-31-2008; IN COMMERCE 1-31-2008.

THE MARK CONSISTS OF STANDARD CHAR-
ACTERS WITHOUT CLAIM TO ANY PARTICULAR
FONT, STYLE, SIZE, OR COLOR.

THE FOREIGN WORDING IN THE MARK
TRANSLATES INTO ENGLISH AS "BEAUTIFUL".

SN 77-182,252, FILED 5-16-2007.

ERNEST SHOSHO, EXAMINING ATTORNEY

Int. Cl.: 22

Prior U.S. Cls.: 1, 2, 7, 19, 22, 42, and 50

United States Patent and Trademark Office

Reg. No. 3,477,649

Registered July 29, 2008

**TRADEMARK
PRINCIPAL REGISTER**



NORTH POLE LIMITED (HONG KONG CORPORATION)
UNIT A905, DRAGON INDUSTRIAL BUILDING
NO. 93 KING LAM STREET, CHEUNG SHA WAN
KOWLOON, HONG KONG

FOR: PORTABLE NON-METAL SHELTERS,
NAMELY, TENTS, SCREEN HOUSE TENTS, CANVAS
CANOPIES, AWNINGS, IN CLASS 22 (U.S. CLS.
1, 2, 7, 19, 22, 42 AND 50).

FIRST USE 3-0-2007; IN COMMERCE 3-0-2007.

OWNER OF U.S. REG. NOS. 2,585,841, 2,769,440,
AND 2,927,743.

THE MARK CONSISTS OF THE WORDS
"NORTHPOLE OUTDOORS WITH BORDERS" IN-
SIDE A DOUBLE OVAL.

SN 77-182,581, FILED 5-16-2007.

MICHAEL TANNER, EXAMINING ATTORNEY

Int. Cl.: 43

Prior U.S. Cls.: 100 and 101

United States Patent and Trademark Office

Reg. No. 3,477,650

Registered July 29, 2008

**SERVICE MARK
PRINCIPAL REGISTER**

**THERE'S GOOD, AND THEN
THERE'S MIGHTY FINE**

K&N MANAGEMENT (TEXAS PARTNERSHIP)
11570 RESEARCH BLVD.
AUSTIN, TX 78759

THE MARK CONSISTS OF STANDARD CHAR-
ACTERS WITHOUT CLAIM TO ANY PARTICULAR
FONT, STYLE, SIZE, OR COLOR.

FOR: RESTAURANT SERVICES, IN CLASS 43
(U.S. CLS. 100 AND 101).

SN 77-183,768, FILED 5-17-2007.

FIRST USE 12-6-2007; IN COMMERCE 12-6-2007.

MARK SPARACINO, EXAMINING ATTORNEY

Int. Cl.: 44

Prior U.S. Cls.: 100 and 101

United States Patent and Trademark Office

Reg. No. 3,477,651

Registered July 29, 2008

**SERVICE MARK
PRINCIPAL REGISTER**

GROOM WIZARD

GROOM WIZARD (GEORGIA CORPORATION)
4054 FLINTRIDGE DR
STONE MOUNTAIN, GA 30083

FOR: ANIMAL GROOMING, IN CLASS 44 (U.S.
CLS. 100 AND 101).

FIRST USE 8-4-2007; IN COMMERCE 8-25-2007.

THE MARK CONSISTS OF STANDARD CHAR-
ACTERS WITHOUT CLAIM TO ANY PARTICULAR
FONT, STYLE, SIZE, OR COLOR.

NO CLAIM IS MADE TO THE EXCLUSIVE
RIGHT TO USE "GROOM", APART FROM THE
MARK AS SHOWN.

SN 77-184,496, FILED 5-18-2007.

BARBARA BROWN, EXAMINING ATTORNEY

Int. Cl.: 1

Prior U.S. Cls.: 1, 5, 6, 10, 26, and 46

Reg. No. 3,477,652

United States Patent and Trademark Office

Registered July 29, 2008

**TRADEMARK
PRINCIPAL REGISTER**

FORE TURF

RHIZOGEN, INC. (DELAWARE CORPORATION)
4200 RESEARCH FOREST AVENUE, SUITE 100
THE WOODLANDS, TX 77381

FOR: BIOSTIMULANT AND FERTILIZER FOR
GOLF AND SPORT TURFS, TREES, SHRUBS,
LANDSCAPES, GARDENS, NURSERY PLANTS,
AND GREENHOUSE PLANTS , IN CLASS 1 (U.S.
CLS. 1, 5, 6, 10, 26 AND 46).

FIRST USE 5-18-2007; IN COMMERCE 5-18-2007.

THE MARK CONSISTS OF STANDARD CHAR-
ACTERS WITHOUT CLAIM TO ANY PARTICULAR
FONT, STYLE, SIZE, OR COLOR.

NO CLAIM IS MADE TO THE EXCLUSIVE
RIGHT TO USE "TURF", APART FROM THE MARK
AS SHOWN.

SN 77-184,526, FILED 5-18-2007.

DAVID H. STINE, EXAMINING ATTORNEY

Int. Cl.: 33

Prior U.S. Cls.: 47 and 49

United States Patent and Trademark Office

Reg. No. 3,477,653

Registered July 29, 2008

**TRADEMARK
PRINCIPAL REGISTER**

LONG LAKE

BRONCO WINE COMPANY (CALIFORNIA COR-
PORATION)
6342 BYSTRUM ROAD
CERES, CA 95307

THE MARK CONSISTS OF STANDARD CHAR-
ACTERS WITHOUT CLAIM TO ANY PARTICULAR
FONT, STYLE, SIZE, OR COLOR.

FOR: WINE, IN CLASS 33 (U.S. CLS. 47 AND 49).

SN 77-184,577, FILED 5-18-2007.

FIRST USE 11-9-2007; IN COMMERCE 11-9-2007.

LINDSEY RUBIN, EXAMINING ATTORNEY

Int. Cl.: 44

Prior U.S. Cls.: 100 and 101

United States Patent and Trademark Office

Reg. No. 3,477,654

Registered July 29, 2008

**SERVICE MARK
PRINCIPAL REGISTER**

VitaDocs

LUCCHESI, STEVEN J (UNITED STATES INDIVIDUAL)
1007 ANNADALE RD
STATEN ISLAND, NY 10312

FOR: MANAGED HEALTH CARE SERVICES; PROVIDING A WEBSITE FEATURING INFORMATION IN THE FIELD OF MENTAL HEALTH AND WELLNESS; PROVIDING ASSISTANCE, FITNESS EVALUATION AND CONSULTATION TO CORPORATE CLIENTS TO HELP THEIR EMPLOYEES MAKE HEALTH, WELLNESS AND NUTRITIONAL CHANGES IN THEIR DAILY LIVING TO IMPROVE HEALTH; PROVIDING HEALTH CARE INFORMATION BY TELEPHONE; PROVIDING HEALTH CARE INFORMATION BY TELEPHONE AND THE INTERNET; PROVIDING HEALTH INFORMATION; REMOTE MONITORING OF DATA INDICATIVE OF THE HEALTH OR CONDITION OF AN INDIVIDUAL OR GROUP OF INDIVIDUALS; CONSULTING SERVICES IN THE FIELD OF MENTAL

HEALTH AND WELLNESS; CONSULTING SERVICES IN THE FIELD OF WOMEN'S HEALTH; HEALTH CARE; HEALTH CARE IN THE NATURE OF HEALTH MAINTENANCE ORGANIZATIONS; HEALTH CARE SERVICES, NAMELY, DISEASE MANAGEMENT PROGRAMS; HEALTH CARE SERVICES, NAMELY, WELLNESS PROGRAMS; HEALTH CARE, NAMELY, ASSISTING INDIVIDUALS TO STOP SMOKING, IN CLASS 44 (U.S. CLS. 100 AND 101).

FIRST USE 7-16-2007; IN COMMERCE 7-16-2007.

THE MARK CONSISTS OF STANDARD CHARACTERS WITHOUT CLAIM TO ANY PARTICULAR FONT, STYLE, SIZE, OR COLOR.

SN 77-184,748, FILED 5-18-2007.

REGINA DRUMMOND, EXAMINING ATTORNEY

Int. Cl.: 33

Prior U.S. Cls.: 47 and 49

United States Patent and Trademark Office

Reg. No. 3,477,655

Registered July 29, 2008

TRADEMARK
PRINCIPAL REGISTER



MILLER PRODUCTS COMPANY (WISCONSIN CORPORATION)
3939 WEST HIGHLAND BOULEVARD
MILWAUKEE, WI 53208

FOR: ALCOHOLIC BEVERAGE PRODUCED FROM A BREWED MALT BASE WITH NATURAL FLAVORS, IN CLASS 33 (U.S. CLS. 47 AND 49).

FIRST USE 0-0-2002; IN COMMERCE 0-0-2002.

OWNER OF U.S. REG. NOS. 2,583,672, 3,072,037, AND 3,148,800.

THE MARK CONSISTS OF A STYLIZED OUTLINE OF A MAN WITH LIGHTNING BOLT INSIDE A DIAMOND-SHAPED OUTLINE WITH THE WORDING "SPARKS" THROUGH THE CENTER OF THE DESIGN.

SN 77-186,426, FILED 5-21-2007.

CHRISTINA SOBRAL, EXAMINING ATTORNEY

Int. Cl.: 36

Prior U.S. Cls.: 100, 101, and 102

United States Patent and Trademark Office

Reg. No. 3,477,656

Registered July 29, 2008

**SERVICE MARK
PRINCIPAL REGISTER**

Turning opportunities into
profit

MJCM, LLC. (TEXAS LTD LIAB CO)
SUITE 800
1235 NORTH LOOP WEST
HOUSTON, TX 77008

FOR: FINANCIAL CONSULTING SERVICES OF-
FERED TO BANKS AND CREDIT UNIONS TO
IMPROVE THEIR OPERATIONS, IN CLASS 36 (U.S.
CLS. 100, 101 AND 102).

FIRST USE 6-30-2007; IN COMMERCE 6-30-2007.

THE MARK CONSISTS OF STANDARD CHAR-
ACTERS WITHOUT CLAIM TO ANY PARTICULAR
FONT, STYLE, SIZE, OR COLOR.

SN 77-187,122, FILED 5-22-2007.

JUSTINE D. PARKER, EXAMINING ATTORNEY

Int. Cl.: 21

Prior U.S. Cls.: 2, 13, 23, 29, 30, 33, 40, and 50

United States Patent and Trademark Office

Reg. No. 3,477,657

Registered July 29, 2008

**TRADEMARK
PRINCIPAL REGISTER**

BUTTER BABY

TALISMAN DESIGNS, LLC (MINNESOTA CORPORATION)
2112 BROADWAY ST. NE, SUITE 105
MINNEAPOLIS, MN 55413

THE MARK CONSISTS OF STANDARD CHARACTERS WITHOUT CLAIM TO ANY PARTICULAR FONT, STYLE, SIZE, OR COLOR.

FOR: CORN COB HOLDERS, IN CLASS 21 (U.S. CLS. 2, 13, 23, 29, 30, 33, 40 AND 50).

SN 77-187,164, FILED 5-22-2007.

FIRST USE 6-26-2007; IN COMMERCE 6-26-2007.

LA TONIA FISHER, EXAMINING ATTORNEY

Int. Cl.: 12

Prior U.S. Cls.: 19, 21, 23, 31, 35, and 44

United States Patent and Trademark Office

Reg. No. 3,477,658

Registered July 29, 2008

**TRADEMARK
PRINCIPAL REGISTER**

CYPRESS CAY

BRUNSWICK CORPORATION (DELAWARE
CORPORATION)
1 N. FIELD COURT
LAKE FOREST, IL 60045

THE MARK CONSISTS OF STANDARD CHAR-
ACTERS WITHOUT CLAIM TO ANY PARTICULAR
FONT, STYLE, SIZE, OR COLOR.

FOR: BOATS AND STRUCTURAL PARTS
THEREFOR, IN CLASS 12 (U.S. CLS. 19, 21, 23, 31,
35 AND 44).

SN 77-187,566, FILED 5-22-2007.

FIRST USE 9-17-2007; IN COMMERCE 9-17-2007.

TIMOTHY FINNEGAN, EXAMINING ATTORNEY

Int. Cl.: 36

Prior U.S. Cls.: 100, 101, and 102

United States Patent and Trademark Office

Reg. No. 3,477,659

Registered July 29, 2008

**SERVICE MARK
PRINCIPAL REGISTER**



FIRST NATIONAL OF NEBRASKA, INC. (NE-
BRASKA CORPORATION)
STOP 3290 ATTN: TRADEMARK OFFICE
1620 DODGE STREET
OMAHA, NE 68197

THE MARK CONSISTS OF AN ARROW, WITHIN
AN INCOMPLETE CIRCLE, FOLLOWED BY THE
WORD "FNBO DIRECT".

FOR: INTERNET BANKING SERVICES, IN
CLASS 36 (U.S. CLS. 100, 101 AND 102).

SN 77-187,984, FILED 5-23-2007.

FIRST USE 12-3-2006; IN COMMERCE 12-3-2006.

GINA FINK, EXAMINING ATTORNEY

Int. Cl.: 5

Prior U.S. Cls.: 6, 18, 44, 46, 51, and 52

Reg. No. 3,477,660

United States Patent and Trademark Office

Registered July 29, 2008

**TRADEMARK
PRINCIPAL REGISTER**

**WORKING BETTER TOGETHER.
FROM A TO ZINC.**

WYETH HOLDINGS CORPORATION (MAINE
CORPORATION)
FIVE GIRALDA FARMS
MADISON, NJ 07940

FOR: DIETARY AND NUTRITIONAL SUPPLE-
MENTS, IN CLASS 5 (U.S. CLS. 6, 18, 44, 46, 51 AND
52).

FIRST USE 8-31-2007; IN COMMERCE 8-31-2007.

THE MARK CONSISTS OF STANDARD CHAR-
ACTERS WITHOUT CLAIM TO ANY PARTICULAR
FONT, STYLE, SIZE, OR COLOR.

OWNER OF U.S. REG. NO. 1,360,049.

SN 77-188,261, FILED 5-23-2007.

CHRIS WELLS, EXAMINING ATTORNEY

Int. Cl.: 44

Prior U.S. Cls.: 100 and 101

United States Patent and Trademark Office

Reg. No. 3,477,661

Registered July 29, 2008

**SERVICE MARK
PRINCIPAL REGISTER**

CARECORPS

CLINICAL RESOURCES GROUP, INC. (ARIZONA CORPORATION)
SUITE 100
6900 EAST INDIAN SCHOOL ROAD
SCOTTSDALE, AZ 85251

FOR: PROVIDING EMPLOYER-SITE BASED MEDICAL SERVICES, MEDICAL CONSULTATION, MEDICAL TESTING AND MEDICAL CLINICS FOR EMPLOYEES OF PRIVATE AND PUBLIC SECTOR EMPLOYERS, IN CLASS 44 (U.S. CLS. 100 AND 101).

FIRST USE 3-31-2006; IN COMMERCE 3-31-2006.

THE MARK CONSISTS OF STANDARD CHARACTERS WITHOUT CLAIM TO ANY PARTICULAR FONT, STYLE, SIZE, OR COLOR.

SN 77-188,811, FILED 5-23-2007.

DAVID MURRAY, EXAMINING ATTORNEY

Int. Cl.: 44

Prior U.S. Cls.: 100 and 101

United States Patent and Trademark Office

Reg. No. 3,477,662

Registered July 29, 2008

SERVICE MARK
PRINCIPAL REGISTER



Professional. Convenient. Affordable.

MASSAGE ENVY LIMITED, LLC (ARIZONA LTD
LIAB CO)
14350 NORTH 87TH STREET, SUITE 200
SCOTTSDALE, AZ 85260

FOR: SALON AND DAY SPA SERVICES, NAME-
LY, MASSAGE THERAPY AND FACIAL TREAT-
MENTS, IN CLASS 44 (U.S. CLS. 100 AND 101).

FIRST USE 5-29-2008; IN COMMERCE 5-29-2008.

OWNER OF U.S. REG. NOS. 2,852,856, 2,994,755,
AND OTHERS.

NO CLAIM IS MADE TO THE EXCLUSIVE
RIGHT TO USE "MASSAGE" AND "PROFESSION-
AL. CONVENIENT. AFFORDABLE.", APART FROM
THE MARK AS SHOWN.

THE MARK CONSISTS OF A HUMAN FIGURE
IN A RECLINING POSITION OVER THE WORDS
"MASSAGE ENVY" OVER A STYLIZED TABLE
OVER THE WORDS "PROFESSIONAL. CONVENI-
ENT. AFFORDABLE."

SN 77-188,909, FILED 5-23-2007.

AHSEN KHAN, EXAMINING ATTORNEY

Int. Cl.: 3

Prior U.S. Cls.: 1, 4, 6, 50, 51, and 52

Reg. No. 3,477,663

United States Patent and Trademark Office

Registered July 29, 2008

**TRADEMARK
PRINCIPAL REGISTER**

PRES

LOUISE HOLYFIELD (UNITED STATES INDIVIDUAL)
5609 BENT TRAIL
DALLAS, TX 75248

FOR: NON-MEDICATED SKIN CARE PREPARATIONS; HAIR CARE PREPARATIONS; BODY CARE PRODUCTS, NAMELY, BODY SOAPS, BODY CREAMS, BODY LOTIONS, BODY POWDERS, NON-MEDICATED DEODORANTS AND ANTIPERSPIRANTS; NON-MEDICATED SUNCARE PRODUCTS, NAMELY, SUNSCREEN, SUN BLOCK AND SUN TANNING PREPARATIONS; PREPARATIONS TO PROTECT THE SKIN FROM THE SUN, NAMELY, NON-MEDICATED SUN CREAMS AND NON-MEDICATED AFTER-SUN LOTIONS; BATH PRO-

DUCTS, NAMELY, BATH BEADS, BATH FOAM, BATH GELS, BATH LOTION, BATH OIL, BATH POWDER, AND NON-MEDICATED BATH SALTS; PERFUME, COLOGNE, COSMETICS AND MAKE-UP, IN CLASS 3 (U.S. CLS. 1, 4, 6, 50, 51 AND 52).

FIRST USE 6-11-2008; IN COMMERCE 6-11-2008.

THE MARK CONSISTS OF STANDARD CHARACTERS WITHOUT CLAIM TO ANY PARTICULAR FONT, STYLE, SIZE, OR COLOR.

SN 77-189,173, FILED 5-24-2007.

GINA FINK, EXAMINING ATTORNEY

Int. Cl.: 33

Prior U.S. Cls.: 47 and 49

United States Patent and Trademark Office

Reg. No. 3,477,664

Registered July 29, 2008

**TRADEMARK
PRINCIPAL REGISTER**

ZENITH VINEYARD

ZENITH VINEYARD, LLC (OREGON LTD LIAB
CO), DBA ZENITH VINEYARD,

5657 ZENA RD NW

SALEM, OR 97304

FOR: GRAPE WINE, IN CLASS 33 (U.S. CLS. 47
AND 49).

FIRST USE 9-13-2007; IN COMMERCE 1-11-2008.

THE MARK CONSISTS OF STANDARD CHAR-
ACTERS WITHOUT CLAIM TO ANY PARTICULAR
FONT, STYLE, SIZE, OR COLOR.

NO CLAIM IS MADE TO THE EXCLUSIVE
RIGHT TO USE "VINEYARD", APART FROM THE
MARK AS SHOWN.

SN 77-189,455, FILED 5-24-2007.

GEORGE LORENZO, EXAMINING ATTORNEY

Int. Cl.: 16

Prior U.S. Cls.: 2, 5, 22, 23, 29, 37, 38, and 50

United States Patent and Trademark Office

Reg. No. 3,477,665

Registered July 29, 2008

**TRADEMARK
PRINCIPAL REGISTER**

CHIQUITA

CHIQUITA BRANDS L.L.C. (DELAWARE LTD
LIAB CO)
250 EAST FIFTH STREET
CINCINNATI, OH 45202

OWNER OF U.S. REG. NOS. 670,320, 2,422,224,
AND OTHERS.

FOR: GREETING CARDS; MUSICAL GREETING
CARDS, IN CLASS 16 (U.S. CLS. 2, 5, 22, 23, 29, 37, 38
AND 50).

THE FOREIGN WORDING IN THE MARK
TRANSLATES INTO ENGLISH AS "LITTLE GIRL".

FIRST USE 6-26-2007; IN COMMERCE 6-26-2007.

SN 77-190,349, FILED 5-25-2007.

THE MARK CONSISTS OF STANDARD CHAR-
ACTERS WITHOUT CLAIM TO ANY PARTICULAR
FONT, STYLE, SIZE, OR COLOR.

GEOFFREY FOSDICK, EXAMINING ATTORNEY

Int. Cl.: 14

Prior U.S. Cls.: 2, 27, 28, and 50

United States Patent and Trademark Office

Reg. No. 3,477,666

Registered July 29, 2008

TRADEMARK
PRINCIPAL REGISTER



WALTERS, BRIAN (UNITED STATES INDIVIDUAL)
P.O. BOX 603
EXCELSIOR, MN 55331

FOR: JEWELRY, IN CLASS 14 (U.S. CLS. 2, 27, 28 AND 50).

FIRST USE 4-0-2007; IN COMMERCE 5-0-2007.

THE MARK CONSISTS OF THE TERM "TIERDROPS", WITH THE LETTER "O" IN THE TERM "DROPS" FILLED IN WITH THE IMAGE OF A DIAMOND, AND A DIAMOND SHAPE BELOW THE LETTER "O" IN "TIERDROPS".

SN 77-190,420, FILED 5-25-2007.

ODESSA BIBBINS, EXAMINING ATTORNEY

Int. Cl.: 35

Prior U.S. Cls.: 100, 101, and 102

United States Patent and Trademark Office

Reg. No. 3,477,667

Registered July 29, 2008

**SERVICE MARK
PRINCIPAL REGISTER**

OPPELLE

OPPELLE, LLC (NEW JERSEY LTD LIAB CO)
807 SOUTH BROAD STREET
FRANKLINVILLE, NJ 08322

FOR: BUSINESS MANAGEMENT CONSULTATION IN THE FIELD OF EXECUTIVE AND LEADERSHIP DEVELOPMENT; COUNSELING IN THE FIELD OF BUSINESS, IN CLASS 35 (U.S. CLS. 100, 101 AND 102).

FIRST USE 7-9-2007; IN COMMERCE 7-9-2007.

THE MARK CONSISTS OF STANDARD CHARACTERS WITHOUT CLAIM TO ANY PARTICULAR FONT, STYLE, SIZE, OR COLOR.

SN 77-190,467, FILED 5-25-2007.

MICHELLE DUBOIS, EXAMINING ATTORNEY

Int. Cls.: 27 and 40

Prior U.S. Cls.: 19, 20, 37, 42, 50, 100, 103, and 106

United States Patent and Trademark Office

Reg. No. 3,477,668

Registered July 29, 2008

**TRADEMARK
SERVICE MARK
PRINCIPAL REGISTER**

EXPECT INNOVATION

TANDUS US, INC. (DELAWARE CORPORATION)
311 SMITH INDUSTRIAL BOULEVARD
DALTON, GA 30721

FOR: CARPET TILES; CARPETS; FLOOR COVERINGS, IN CLASS 27 (U.S. CLS. 19, 20, 37, 42 AND 50).

FIRST USE 2-28-2007; IN COMMERCE 2-28-2007.

FOR: RECYCLING; MANUFACTURING SERVICES FOR OTHERS IN THE FIELD OF CARPETS

AND FLOOR COVERINGS, IN CLASS 40 (U.S. CLS. 100, 103 AND 106).

FIRST USE 2-28-2007; IN COMMERCE 2-28-2007.

THE MARK CONSISTS OF STANDARD CHARACTERS WITHOUT CLAIM TO ANY PARTICULAR FONT, STYLE, SIZE, OR COLOR.

SN 77-192,295, FILED 5-29-2007.

TIMOTHY FINNEGAN, EXAMINING ATTORNEY

Int. Cl.: 25

Prior U.S. Cls.: 22 and 39

United States Patent and Trademark Office

Reg. No. 3,477,669

Registered July 29, 2008

**TRADEMARK
PRINCIPAL REGISTER**

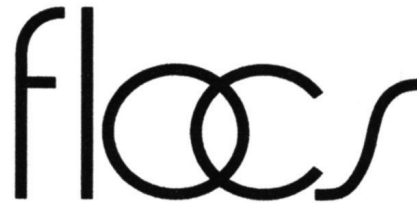

BACK BEAT, INC. (CALIFORNIA CORPORATION)
17352 VON KARMAN AVENUE
IRVINE, CA 92614

THE MARK CONSISTS OF A STYLIZED REPRESENTATION OF THE TERM "FLOCS".

FOR: FOOTWEAR, IN CLASS 25 (U.S. CLS. 22 AND 39).

SN 77-192,465, FILED 5-29-2007.

FIRST USE 7-0-2007; IN COMMERCE 7-0-2007.

GIANCARLO CASTRO, EXAMINING ATTORNEY

Int. Cl.: 3

Prior U.S. Cls.: 1, 4, 6, 50, 51, and 52

United States Patent and Trademark Office

Reg. No. 3,477,670

Registered July 29, 2008

**TRADEMARK
PRINCIPAL REGISTER**

URGENT RELIEF CREAM

CLINIQUE LABORATORIES LLC (DELAWARE
LTD LIAB CO)

767 FIFTH AVENUE

NEW YORK, NY 10153

FOR: NON-MEDICATED SKIN CARE PREPARA-
TIONS, IN CLASS 3 (U.S. CLS. 1, 4, 6, 50, 51 AND 52).

FIRST USE 11-30-2007; IN COMMERCE 11-30-2007.

THE MARK CONSISTS OF STANDARD CHAR-
ACTERS WITHOUT CLAIM TO ANY PARTICULAR
FONT, STYLE, SIZE, OR COLOR.

NO CLAIM IS MADE TO THE EXCLUSIVE
RIGHT TO USE "CREAM", APART FROM THE
MARK AS SHOWN.

SN 77-193,199, FILED 5-30-2007.

ANNE MADDEN, EXAMINING ATTORNEY

Int. Cl.: 3

Prior U.S. Cls.: 1, 4, 6, 50, 51, and 52

United States Patent and Trademark Office

Reg. No. 3,477,671

Registered July 29, 2008

**TRADEMARK
PRINCIPAL REGISTER**

LONG LAST GLOSSWEAR

CLINIQUE LABORATORIES LLC (DELAWARE
LTD LIAB CO)
767 FIFTH AVENUE
NEW YORK, NY 10153

OWNER OF U.S. REG. NOS. 2,173,565 AND
2,704,855.

FOR: COSMETICS, IN CLASS 3 (U.S. CLS. 1, 4, 6, 50,
51 AND 52).

NO CLAIM IS MADE TO THE EXCLUSIVE
RIGHT TO USE "LONG LAST", APART FROM
THE MARK AS SHOWN.

FIRST USE 3-31-2008; IN COMMERCE 3-31-2008.

SN 77-193,323, FILED 5-30-2007.

THE MARK CONSISTS OF STANDARD CHAR-
ACTERS WITHOUT CLAIM TO ANY PARTICULAR
FONT, STYLE, SIZE, OR COLOR.

ANNE MADDEN, EXAMINING ATTORNEY

Int. Cl.: 3

Prior U.S. Cls.: 1, 4, 6, 50, 51, and 52

United States Patent and Trademark Office

Reg. No. 3,477,672

Registered July 29, 2008

**TRADEMARK
PRINCIPAL REGISTER**

MINI MARK-IT

AVON PRODUCTS, INC. (NEW YORK CORPORATION)
LEGAL DEPARTMENT - 3RD FL.
1251 AVENUE OF THE AMERICAS
NEW YORK, NY 10020

OWNER OF U.S. REG. NO. 2,995,753.

FOR: COSMETICS, IN CLASS 3 (U.S. CLS. 1, 4, 6, 50, 51 AND 52).

NO CLAIM IS MADE TO THE EXCLUSIVE RIGHT TO USE "MINI", APART FROM THE MARK AS SHOWN.

FIRST USE 5-29-2008; IN COMMERCE 5-29-2008.

SN 77-193,593, FILED 5-30-2007.

THE MARK CONSISTS OF STANDARD CHARACTERS WITHOUT CLAIM TO ANY PARTICULAR FONT, STYLE, SIZE, OR COLOR.

LOURDES AYALA, EXAMINING ATTORNEY

Int. Cl.: 1

Prior U.S. Cls.: 1, 5, 6, 10, 26, and 46

Reg. No. 3,477,673

United States Patent and Trademark Office

Registered July 29, 2008

**TRADEMARK
PRINCIPAL REGISTER**

DermaLife

LIFELINE CELL TECHNOLOGY (CALIFORNIA
LTD LIAB CO)
10 EAST FREDERICK STREET
WALKERSVILLE, MD 21793

THE MARK CONSISTS OF STANDARD CHAR-
ACTERS WITHOUT CLAIM TO ANY PARTICULAR
FONT, STYLE, SIZE, OR COLOR.

FOR: REAGENTS FOR RESEARCH PURPOSES,
NAMELY, FOR RESEARCH FOR THE CULTURE
OF SKIN CELLS, IN CLASS 1 (U.S. CLS. 1, 5, 6, 10, 26
AND 46).

SN 77-193,736, FILED 5-30-2007.

FIRST USE 5-23-2007; IN COMMERCE 11-21-2007.

ADA HAN, EXAMINING ATTORNEY

Int. Cl.: 3

Prior U.S. Cls.: 1, 4, 6, 50, 51, and 52

United States Patent and Trademark Office

Reg. No. 3,477,674

Registered July 29, 2008

**TRADEMARK
PRINCIPAL REGISTER**

DOWNTOWN DARLING

LERNER NEW YORK, INC. (DELAWARE CORPORATION)
450 WEST 33RD STREET
NEW YORK, NY 10001

FOR: PERSONAL CARE PRODUCTS, NAMELY, BODY MIST, BODY SCRUB, CREAM FOR THE BODY, CREAM FOR THE HANDS, LOTION FOR THE BODY, SHAVING GELS, IN CLASS 3 (U.S. CLS. 1, 4, 6, 50, 51 AND 52).

FIRST USE 10-25-2007; IN COMMERCE 10-25-2007.

THE MARK CONSISTS OF STANDARD CHARACTERS WITHOUT CLAIM TO ANY PARTICULAR FONT, STYLE, SIZE, OR COLOR.

SN 77-193,891, FILED 5-31-2007.

IRA J. GOODSaid, EXAMINING ATTORNEY

Int. Cls.: 9 and 35

Prior U.S. Cls.: 21, 23, 26, 36, 38, 100, 101, and 102

United States Patent and Trademark Office

Reg. No. 3,477,675

Registered July 29, 2008

**TRADEMARK
SERVICE MARK
PRINCIPAL REGISTER**

KNEXUS

DRALLOS, PAUL (UNITED STATES INDIVIDUAL)
1691 EARLMONT
BERKLEY, MI 48072

FOR: COMPUTER SOFTWARE FOR MANAGEMENT OF COMPUTER FILES FOR STAND-ALONE AND/OR NETWORKED COMPUTER SYSTEMS FEATURING GRAPHICAL USER INTERFACES; GRAPHICAL USER INTERFACE SOFTWARE, NAMELY, VIRTUAL REALITY USER INTERFACE, IN CLASS 9 (U.S. CLS. 21, 23, 26, 36 AND 38).

FIRST USE 6-3-2007; IN COMMERCE 7-18-2007.

FOR: COMPUTER DATABASE MANAGEMENT, IN CLASS 35 (U.S. CLS. 100, 101 AND 102).

FIRST USE 6-3-2007; IN COMMERCE 7-18-2007.

THE MARK CONSISTS OF STANDARD CHARACTERS WITHOUT CLAIM TO ANY PARTICULAR FONT, STYLE, SIZE, OR COLOR.

SN 77-194,286, FILED 5-31-2007.

RICHARD A. STRASER, EXAMINING ATTORNEY

Int. Cl.: 25

Prior U.S. Cls.: 22 and 39

United States Patent and Trademark Office

Reg. No. 3,477,676

Registered July 29, 2008

**TRADEMARK
PRINCIPAL REGISTER**

匹克

FUJIAN QUANZHOU PEAK SPORTS PRODUCTS
CO., LTD. (CHINA CORPORATION)
DONGBAO INDUSTRIAL DIST., DONGHAI ST.
FENGZE DISTRICT, QUANZHOU CITY
FUJIAN PROVINCE, CHINA

FOR: T-SHIRTS; LAYETTES; FOOTBALL SHOES;
FOOTWEAR; CAPS; HOSIERY; NECKTIES; BELTS;
GYM SUITS; SWIMSUITS, IN CLASS 25 (U.S. CLS. 22
AND 39).

FIRST USE 3-20-1991; IN COMMERCE 2-16-2007.

THE MARK CONSISTS OF TWO STYLIZED CHI-
NESE CHARACTERS.

THE NON-LATIN CHARACTERS IN THE MARK
TRANSLITERATE TO PI; KE AND THESE MEAN
EQUAL; SUBDUE IN ENGLISH.

SN 77-195,039, FILED 5-31-2007.

CAROL SPILS, EXAMINING ATTORNEY

Int. Cl.: 25

Prior U.S. Cls.: 22 and 39

United States Patent and Trademark Office

Reg. No. 3,477,677

Registered July 29, 2008

**TRADEMARK
PRINCIPAL REGISTER**

ALPEAK

FUJIAN QUANZHOU PEAK SPORTS PROUCTS
CO., LTD. (CHINA CORPORATION)
DONGBAO INDUSTRIAL DIST., DONGHAI ST.
FENGZE DISTRICT, QUANZHOU CITY
FUJIAN PROVINCE, CHINA

FIRST USE 2-10-2004; IN COMMERCE 2-16-2007.

THE MARK CONSISTS OF THE WORD "AL-
PEAK".

FOR: T-SHIRTS; LAYETTES; FOOTBALL SHOES;
FOOTWEAR; CAPS; HOSIERY; NECKTIES; BELTS;
GYM SUITS; SWIMSUITS , IN CLASS 25 (U.S. CLS. 22
AND 39).

SN 77-195,041, FILED 5-31-2007.

CAROL SPILS, EXAMINING ATTORNEY

Int. Cl.: 8

Prior U.S. Cls.: 23, 28, and 44

United States Patent and Trademark Office

Reg. No. 3,477,678

Registered July 29, 2008

**TRADEMARK
PRINCIPAL REGISTER**

PHENOM

THE GILLETTE COMPANY (DELAWARE CORPORATION)
PRUDENTIAL TOWER BUILDING
BOSTON, MA 02199

FOR: RAZORS AND RAZOR BLADES; DISPENSERS, CASSETTES, HOLDERS AND CARTRIDGES ALL CONTAINING BLADES; AND STRUCTURAL PARTS THEREFOR, IN CLASS 8 (U.S. CLS. 23, 28 AND 44).

FIRST USE 2-5-2008; IN COMMERCE 2-5-2008.

THE MARK CONSISTS OF STANDARD CHARACTERS WITHOUT CLAIM TO ANY PARTICULAR FONT, STYLE, SIZE, OR COLOR.

SN 77-195,472, FILED 6-1-2007.

PAUL F. GAST, EXAMINING ATTORNEY

Int. Cl.: 32

Prior U.S. Cls.: 45, 46, and 48

United States Patent and Trademark Office

Reg. No. 3,477,679

Registered July 29, 2008

**TRADEMARK
PRINCIPAL REGISTER**

GRAPE SPRINGS

WAKEFERN FOOD CORP. (NEW JERSEY CORPORATION)

600 YORK STREET

ELIZABETH, NJ 07207

FOR: FLAVORED WATERS, IN CLASS 32 (U.S. CLS. 45, 46 AND 48).

FIRST USE 3-28-2008; IN COMMERCE 3-28-2008.

THE MARK CONSISTS OF STANDARD CHARACTERS WITHOUT CLAIM TO ANY PARTICULAR FONT, STYLE, SIZE, OR COLOR.

NO CLAIM IS MADE TO THE EXCLUSIVE RIGHT TO USE "GRAPE", APART FROM THE MARK AS SHOWN.

SN 77-196,042, FILED 6-1-2007.

ROBERT LAVACHE, EXAMINING ATTORNEY

Int. Cl.: 35

Prior U.S. Cls.: 100, 101, and 102

United States Patent and Trademark Office

Reg. No. 3,477,680

Registered July 29, 2008

**SERVICE MARK
PRINCIPAL REGISTER**

Veri-Safe

BUSINESS CATALYST GROUP, LTD (PENNSYLVANIA LTD LIAB CO)
1186 COLTS LANE
YARDLEY, PA 19067

FOR: ASSISTANCE, ADVISORY SERVICES AND CONSULTANCY WITH REGARD TO BUSINESS PLANNING, BUSINESS ANALYSIS, BUSINESS MANAGEMENT, AND BUSINESS ORGANIZATION; BUSINESS CONSULTING AND INFORMATION SERVICES; BUSINESS CONSULTING SERVICES RELATING TO PRODUCT DISTRIBUTION, OPERATIONS MANAGEMENT SERVICES, LOGISTICS, REVERSE LOGISTICS, SUPPLY CHAIN, AND PRODUCTION SYSTEMS AND DISTRIBUTION SOLUTIONS; BUSINESS MANAGEMENT CONSULTING AND ADVISORY SERVICES; BUSINESS SERVICES, NAMELY, REGISTERING, SCREENING, CREDENTIALING, AND ORGANIZ-

ING THIRD-PARTY VENDORS, SUPPLIERS, AND CONTRACTORS, AND DOCUMENTATION AND INFORMATION ON BEHALF OF OTHERS; CONSULTATION SERVICES IN THE FIELD OF COMPANY, BUSINESS SECTOR AND INDUSTRY DATA AND RESEARCH; MARKET RESEARCH SERVICES, IN CLASS 35 (U.S. CLS. 100, 101 AND 102).

FIRST USE 6-1-2007; IN COMMERCE 10-23-2007.

THE MARK CONSISTS OF STANDARD CHARACTERS WITHOUT CLAIM TO ANY PARTICULAR FONT, STYLE, SIZE, OR COLOR.

SN 77-196,161, FILED 6-2-2007.

VERNA BETH RIRIE, EXAMINING ATTORNEY

Int. Cl.: 5

Prior U.S. Cls.: 6, 18, 44, 46, 51, and 52

United States Patent and Trademark Office

Reg. No. 3,477,681

Registered July 29, 2008

**TRADEMARK
PRINCIPAL REGISTER**



MACK PROFESSIONAL PACKAGING INTERNATIONAL, INC. (FLORIDA CORPORATION)
169 FELLSWOOD DRIVE
MOORESTOWN, NJ 08057

FOR: VITAMIN SUPPLEMENTS, DIETARY SUPPLEMENTS, HERBAL SUPPLEMENTS, AND ENERGY SUPPLEMENTS, IN CLASS 5 (U.S. CLS. 6, 18, 44, 46, 51 AND 52).

FIRST USE 2-1-2008; IN COMMERCE 2-1-2008.

NO CLAIM IS MADE TO THE EXCLUSIVE RIGHT TO USE "MADE WITH GREEN TEA", APART FROM THE MARK AS SHOWN.

THE COLOR(S) BLACK, WHITE AND GREEN IS/ ARE CLAIMED AS A FEATURE OF THE MARK.

THE MARK CONSISTS OF A GREEN LEAF DESIGN PARTIALLY SURROUNDING A BLACK CIRCLE WITH THE WORDS "MADE WITH GREEN TEA" WRITTEN WITHIN THE BLACK CIRCLE IN WHITE LETTERS.

SN 77-197,773, FILED 6-5-2007.

THEODORE MCBRIDE, EXAMINING ATTORNEY

Int. Cl.: 5

Prior U.S. Cls.: 6, 18, 44, 46, 51, and 52

United States Patent and Trademark Office

Reg. No. 3,477,682

Registered July 29, 2008

**TRADEMARK
PRINCIPAL REGISTER**

Hemo Cease Xtreme

PEAK PERFORMANCE NUTRIENTS, INC.
(FLORIDA CORPORATION)
SUITE 4
1505 POINSETTIA DRIVE
DELRAY BEACH, FL 33444

FOR: EQUINE SUPPLEMENTS, IN CLASS 5 (U.S.
CLS. 6, 18, 44, 46, 51 AND 52).

FIRST USE 6-1-2007; IN COMMERCE 6-1-2007.

THE MARK CONSISTS OF STANDARD CHAR-
ACTERS WITHOUT CLAIM TO ANY PARTICULAR
FONT, STYLE, SIZE, OR COLOR.

OWNER OF U.S. REG. NO. 2,661,942.

SN 77-197,873, FILED 6-5-2007.

CAROL SPILS, EXAMINING ATTORNEY

Int. Cl.: 3

Prior U.S. Cls.: 1, 4, 6, 50, 51, and 52

Reg. No. 3,477,683

United States Patent and Trademark Office

Registered July 29, 2008

**TRADEMARK
PRINCIPAL REGISTER**

AMDERMA

PRODUCT QUEST MANUFACTURING, INC.
(FLORIDA CORPORATION)
330 CARSWELL AVENUE
HOLLY HILL, FL 32117

FOR: NON-MEDICATED SKIN CARE PREPARATIONS, IN CLASS 3 (U.S. CLS. 1, 4, 6, 50, 51 AND 52).

FIRST USE 10-29-2007; IN COMMERCE 10-29-2007.

THE MARK CONSISTS OF STANDARD CHARACTERS WITHOUT CLAIM TO ANY PARTICULAR FONT, STYLE, SIZE, OR COLOR.

THE WORD "AMDERMA" IS A RUSSIAN WORD THAT REFERS TO AN URBAN SETTLEMENT.

SN 77-197,914, FILED 6-5-2007.

DAVID C. REIHNER, EXAMINING ATTORNEY

Int. Cl.: 44

Prior U.S. Cls.: 100 and 101

United States Patent and Trademark Office

Reg. No. 3,477,684

Registered July 29, 2008

**SERVICE MARK
PRINCIPAL REGISTER**

WELGENIX

HEALTH CONTACT PARTNERS, INC. (ILLINOIS
CORPORATION)
6200 CAPITOL DRIVE
WHEELING, IL 60090

THE MARK CONSISTS OF STANDARD CHAR-
ACTERS WITHOUT CLAIM TO ANY PARTICULAR
FONT, STYLE, SIZE, OR COLOR.

FOR: MEDICAL COUNSELING, IN CLASS 44 (U.S.
CLS. 100 AND 101).

SN 77-198,237, FILED 6-5-2007.

FIRST USE 10-1-2007; IN COMMERCE 10-1-2007.

SHAUNIA CARLYLE, EXAMINING ATTORNEY

Int. Cl.: 3

Prior U.S. Cls.: 1, 4, 6, 50, 51, and 52

Reg. No. 3,477,685

United States Patent and Trademark Office

Registered July 29, 2008

**TRADEMARK
PRINCIPAL REGISTER**

Face d'Ange Cosmetics

YARIJANIAN, TONY (UNITED STATES INDIVIDUAL)
3415 LAS PALMAS AVE.
GLENDALE, CA 91208

NO CLAIM IS MADE TO THE EXCLUSIVE RIGHT TO USE "COSMETICS", APART FROM THE MARK AS SHOWN.

FOR: SKIN AND BODY TOPICAL LOTIONS, CREAMS AND OILS FOR COSMETIC USE, IN CLASS 3 (U.S. CLS. 1, 4, 6, 50, 51 AND 52).

THE ENGLISH TRANSLATION OF THE FRENCH WORD "FACE D'ANGE" IN THE MARK IS "ANGEL FACE".

FIRST USE 1-1-2008; IN COMMERCE 1-1-2008.

SN 77-199,577, FILED 6-6-2007.

THE MARK CONSISTS OF STANDARD CHARACTERS WITHOUT CLAIM TO ANY PARTICULAR FONT, STYLE, SIZE, OR COLOR.

CHRISTINA SOBRAL, EXAMINING ATTORNEY

Int. Cl.: 28

Prior U.S. Cls.: 22, 23, 38, and 50

United States Patent and Trademark Office

Reg. No. 3,477,686

Registered July 29, 2008

**TRADEMARK
PRINCIPAL REGISTER**

CASH BASH

LEARNING RESOURCES, INC. (ILLINOIS CORPORATION)
380 N. FAIRWAY DRIVE
VERNON HILLS, IL 60061

FOR: GAMES, NAMELY, ELECTRONIC EDUCATIONAL GAME MACHINES, IN CLASS 28 (U.S. CLS. 22, 23, 38 AND 50).

FIRST USE 2-25-2008; IN COMMERCE 2-25-2008.

THE MARK CONSISTS OF STANDARD CHARACTERS WITHOUT CLAIM TO ANY PARTICULAR FONT, STYLE, SIZE, OR COLOR.

SN 77-199,952, FILED 6-7-2007.

NORA BUCHANAN WILL, EXAMINING ATTORNEY

Int. Cl.: 41

Prior U.S. Cls.: 100, 101, and 107

United States Patent and Trademark Office

Reg. No. 3,477,687

Registered July 29, 2008

**SERVICE MARK
PRINCIPAL REGISTER**

BonusVision

LAS VEGAS GAMING, INC. (NEVADA CORPORATION)
4000 WEST ALI BABA LANE, SUITE D
LAS VEGAS, NV 89118

FOR: ENTERTAINMENT SERVICES, NAMELY, FACILITATING PLAYER PARTICIPATION IN CASINO, WAGERING AND GAMING EVENTS AND ACTIVITIES, IN CLASS 41 (U.S. CLS. 100, 101 AND 107).

FIRST USE 11-14-2007; IN COMMERCE 11-14-2007.

THE MARK CONSISTS OF STANDARD CHARACTERS WITHOUT CLAIM TO ANY PARTICULAR FONT, STYLE, SIZE, OR COLOR.

SN 77-200,846, FILED 6-7-2007.

TOBY BULLOFF, EXAMINING ATTORNEY

Int. Cl.: 30

Prior U.S. Cl.: 46

United States Patent and Trademark Office

Reg. No. 3,477,688

Registered July 29, 2008

**TRADEMARK
PRINCIPAL REGISTER**

ELOTINTA

PRODUCTOS MILKEN DE MEXICO S.A. DE C.V.
(MEXICO CORPORATION)
KM 1 CARRETERA A BUENAVISTA S/N
TLAJOMULCO DE ZUÑIGA, MEXICO

FOR: CANDY, COCOA, TAPIOCA, CARMELS,
FROZEN CONFECTIONS, SUGAR, HONEY, PRE-
PARATIONS MADE OF CEREALS AND FLOUR,
NAMELY, COOKIES, CAKES, BREAD AND ROLLS,
AND CHOCOLATE, IN CLASS 30 (U.S. CL. 46).

FIRST USE 3-4-2008; IN COMMERCE 3-4-2008.

THE MARK CONSISTS OF STANDARD CHAR-
ACTERS WITHOUT CLAIM TO ANY PARTICULAR
FONT, STYLE, SIZE, OR COLOR.

SN 77-203,277, FILED 6-11-2007.

PAUL F. GAST, EXAMINING ATTORNEY

Int. Cl.: 12

Prior U.S. Cls.: 19, 21, 23, 31, 35, and 44

Reg. No. 3,477,689

United States Patent and Trademark Office

Registered July 29, 2008

**TRADEMARK
PRINCIPAL REGISTER**

The image shows the trademark "NKB" in a bold, blocky, sans-serif font. The letters are dark grey or black with a slight shadow effect, giving them a three-dimensional appearance. The "N" and "K" are connected at the top, and the "B" has a distinct shape with a horizontal bar.

THAI DIENG INDUSTRY CO., LTD. (TAIWAN CORPORATION)
NO. 49, YU SHIH RD., JIH NAN LI, TA CHIA
NO. 49, YU SHIN RD.
TAICHUNG, TAIWAN 437

FIRST USE 3-1-2005; IN COMMERCE 3-1-2005.

OWNER OF U.S. REG. NO. 2,148,347.

FOR: BEARINGS FOR USE ON LAND VEHICLES;
BEARINGS UNITS FOR USE ON LAND VEHICLES;
BALL BEARINGS FOR USE ON LAND VEHICLES;
PILLOW BLOCKS FOR USE ON LAND VEHICLES;
DISC HARROW BEARINGS FOR USE ON LAND
VEHICLES; MAST GUIDE BEARINGS FOR USE ON
LAND VEHICLES, IN CLASS 12 (U.S. CLS. 19, 21, 23,
31, 35 AND 44).

THE MARK CONSISTS OF STYLIZED LETTERS
"NKB".

SN 77-203,476, FILED 6-12-2007.

MARY ROSSMAN, EXAMINING ATTORNEY

Int. Cl.: 5

Prior U.S. Cls.: 6, 18, 44, 46, 51, and 52

Reg. No. 3,477,690

United States Patent and Trademark Office

Registered July 29, 2008

**TRADEMARK
PRINCIPAL REGISTER**

**ADVANCED PHYTONUTRIENT
SHIELD**

HEALTHY DIRECTIONS, LLC (DELAWARE LTD
LIAB CO)
7811 MONTROSE ROAD
POTOMAC, MD 20854

FOR: DIETARY AND NUTRITIONAL FOOD
SUPPLEMENTS, IN CLASS 5 (U.S. CLS. 6, 18, 44, 46,
51 AND 52).

FIRST USE 10-0-2007; IN COMMERCE 10-0-2007.

THE MARK CONSISTS OF STANDARD CHAR-
ACTERS WITHOUT CLAIM TO ANY PARTICULAR
FONT, STYLE, SIZE, OR COLOR.

NO CLAIM IS MADE TO THE EXCLUSIVE
RIGHT TO USE "ADVANCED PHYTONUTRIENT",
APART FROM THE MARK AS SHOWN.

SN 77-203,586, FILED 6-12-2007.

HEATHER SAPP, EXAMINING ATTORNEY

Int. Cl.: 42

Prior U.S. Cls.: 100 and 101

United States Patent and Trademark Office

Reg. No. 3,477,691

Registered July 29, 2008

**SERVICE MARK
PRINCIPAL REGISTER**

MVista

MIRABELLA TECHNOLOGIES, LLC (INDIANA
LTD LIAB CO)
SUITE 300
4444 DECATUR BLVD.
INDIANAPOLIS, IN 46241

FOR: DIAGNOSTIC SERVICES IN THE FIELD OF
INFECTIOUS DISEASES, INCLUDING ANTIBODY
OR ANTIGEN TESTING SERVICES, IN CLASS 42
(U.S. CLS. 100 AND 101).

FIRST USE 10-1-2007; IN COMMERCE 10-2-2007.

THE MARK CONSISTS OF STANDARD CHAR-
ACTERS WITHOUT CLAIM TO ANY PARTICULAR
FONT, STYLE, SIZE, OR COLOR.

SN 77-203,977, FILED 6-12-2007.

RON FAIRBANKS, EXAMINING ATTORNEY

Int. Cl.: 20

Prior U.S. Cls.: 2, 13, 22, 25, 32, and 50

Reg. No. 3,477,692

United States Patent and Trademark Office

Registered July 29, 2008

**TRADEMARK
PRINCIPAL REGISTER**

UNILOCKER

PRO-FORM TOOL & STAMPING INC. (CANADA
CORPORATION)
2057 OXFORD STREET EAST
LONDON, CANADA N5V2Z7

THE MARK CONSISTS OF STANDARD CHAR-
ACTERS WITHOUT CLAIM TO ANY PARTICULAR
FONT, STYLE, SIZE, OR COLOR.

FOR: LOCKERS, IN CLASS 20 (U.S. CLS. 2, 13, 22,
25, 32 AND 50).

SN 77-203,987, FILED 6-12-2007.

FIRST USE 4-4-2008; IN COMMERCE 4-4-2008.

CAROL SPILS, EXAMINING ATTORNEY

Int. Cls.: 29 and 30

Prior U.S. Cl.: 46

United States Patent and Trademark Office

Reg. No. 3,477,693

Registered July 29, 2008

**TRADEMARK
PRINCIPAL REGISTER**

DANCING IGUANA

AVOMEX, INC. (TEXAS CORPORATION)
3000 GALVEZ AVENUE
FORT WORTH, TX 76111

FIRST USE 11-16-2007; IN COMMERCE 11-16-2007.

FOR: GUACAMOLE, IN CLASS 29 (U.S. CL. 46).

THE MARK CONSISTS OF STANDARD CHARACTERS WITHOUT CLAIM TO ANY PARTICULAR FONT, STYLE, SIZE, OR COLOR.

FIRST USE 11-16-2007; IN COMMERCE 11-16-2007.

FOR: MEXICAN FOOD SAUCES, NAMELY, CHIPOTLE-BASED SAUCE, PICO DE GALLO SAUCE, RED SALSA AND GREEN SALSA AND GUACAMOLE BASED SAUCES, IN CLASS 30 (U.S. CL. 46).

SN 77-204,062, FILED 6-12-2007.

JAMES MACFARLANE, EXAMINING ATTORNEY

Int. Cl.: 6

Prior U.S. Cls.: 2, 12, 13, 14, 23, 25, and 50

Reg. No. 3,477,694

United States Patent and Trademark Office

Registered July 29, 2008

**TRADEMARK
PRINCIPAL REGISTER**

STRUCTURA

CALLUCE, INC. (CALIFORNIA CORPORATION)
253 EAST HARRIS AVENUE
SOUTH SAN FRANCISCO, CA 94080

FIRST USE 4-2-2007; IN COMMERCE 5-30-2008.

FOR: METAL TRIANGULAR SECTIONS OF VARIOUS LENGTHS, COMPRISED OF METAL TUBES WELDED TOGETHER WITH METAL WIRE, IN STRAIGHT AND CURVED FORMS, WHICH TOGETHER FORM SYSTEMS FOR FURNISHING INDOOR SPACES AND HOLDING LIGHTING SYSTEMS, IN CLASS 6 (U.S. CLS. 2, 12, 13, 14, 23, 25 AND 50).

THE MARK CONSISTS OF STANDARD CHARACTERS WITHOUT CLAIM TO ANY PARTICULAR FONT, STYLE, SIZE, OR COLOR.

SN 77-204,159, FILED 6-12-2007.

ROBERT LAVACHE, EXAMINING ATTORNEY

Int. Cl.: 25

Prior U.S. Cls.: 22 and 39

United States Patent and Trademark Office

Reg. No. 3,477,695

Registered July 29, 2008

**TRADEMARK
PRINCIPAL REGISTER**

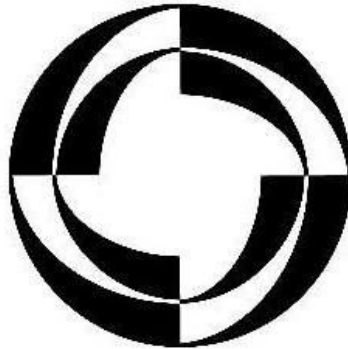

PINAL COUNTY COMMUNITY COLLEGE DISTRICT (ARIZONA POLITICAL SUBDIVISION OF THE STATE OF ARIZONA)
8470 NORTH OVERFIELD ROAD
COOLIDGE, AZ 85228

FOR: CLOTHING, NAMELY, SHIRTS, IN CLASS 25 (U.S. CLS. 22 AND 39).

FIRST USE 2-28-2007; IN COMMERCE 2-28-2007.

THE MARK CONSISTS OF A STYLIZED CIRCLE WITHIN A STYLIZED CIRCLE.

SN 77-204,337, FILED 6-12-2007.

SONYA STEPHENS, EXAMINING ATTORNEY

Int. Cl.: 32

Prior U.S. Cls.: 45, 46, and 48

United States Patent and Trademark Office

Reg. No. 3,477,696

Registered July 29, 2008

**TRADEMARK
PRINCIPAL REGISTER**

GET TO IT

THE COCA-COLA COMPANY (DELAWARE
CORPORATION)
ONE COCA-COLA PLAZA
ATLANTA, GA 30313

THE MARK CONSISTS OF STANDARD CHAR-
ACTERS WITHOUT CLAIM TO ANY PARTICULAR
FONT, STYLE, SIZE, OR COLOR.

FOR: NON-ALCOHOLIC BEVERAGES, NAMELY,
SOFT DRINKS AND ENERGY DRINKS, IN CLASS
32 (U.S. CLS. 45, 46 AND 48).

SN 77-204,740, FILED 6-13-2007.

FIRST USE 8-0-2005; IN COMMERCE 8-0-2006.

RICHARD A. STRASER, EXAMINING ATTORNEY

Int. Cl.: 35

Prior U.S. Cls.: 100, 101, and 102

United States Patent and Trademark Office

Reg. No. 3,477,697

Registered July 29, 2008

**SERVICE MARK
PRINCIPAL REGISTER**

ERI

EREWARDS, INC. (DELAWARE CORPORATION)
8401 N. CENTRAL EXPRESSWAY, SUITE 900
DALLAS, TX 75225

FOR: BUSINESS AND MARKET RESEARCH SERVICES; CONDUCTING AND ANALYZING BUSINESS, MARKET AND PUBLIC OPINION RESEARCH SURVEYS; ORGANIZATION AND MANAGEMENT OF FOCUS GROUPS, PANEL GROUPS, AND ON-LINE OPINION PANEL PARTICIPANTS; PREPARING SURVEY STATISTICAL REPORTS; PROVIDING A COMPUTERIZED ON-LINE INTERACTIVE DATABASE FOR BUSINESS AND MARKETING RESEARCH SURVEYS OF SUBSCRIBERS FEATURING SURVEY DATA AND ANALYSES; CONSULTING SERVICES IN THE FIELD OF MAR-

KET RESEARCH AND PUBLIC OPINION SURVEYS; PROVIDING CUSTOMER AND PROSPECTIVE CUSTOMER RELATIONSHIP MANAGEMENT CONSULTATION SERVICES TO BUSINESSES, IN CLASS 35 (U.S. CLS. 100, 101 AND 102).

FIRST USE 5-15-2008; IN COMMERCE 5-15-2008.

THE MARK CONSISTS OF STANDARD CHARACTERS WITHOUT CLAIM TO ANY PARTICULAR FONT, STYLE, SIZE, OR COLOR.

SN 77-204,845, FILED 6-13-2007.

SARA THOMAS, EXAMINING ATTORNEY

Int. Cl.: 10

Prior U.S. Cls.: 26, 39, and 44

United States Patent and Trademark Office

Reg. No. 3,477,698

Registered July 29, 2008

**TRADEMARK
PRINCIPAL REGISTER**

LifeBack

LIFE BACK ENTERPRISES, INC. (FLORIDA
CORPORATION)
SUITE 620
905 E. MARTIN LUTHER KING JR. DR.
TARPON SPRINGS, FL 34689

THE MARK CONSISTS OF STANDARD CHAR-
ACTERS WITHOUT CLAIM TO ANY PARTICULAR
FONT, STYLE, SIZE, OR COLOR.

FOR: BELTS FOR MEDICAL PURPOSES; ORTHO-
PEDIC BELTS, IN CLASS 10 (U.S. CLS. 26, 39 AND 44).

SN 77-205,062, FILED 6-13-2007.

FIRST USE 6-1-2007; IN COMMERCE 8-28-2007.

THEODORE MCBRIDE, EXAMINING ATTORNEY

Int. Cl.: 16

Prior U.S. Cls.: 2, 5, 22, 23, 29, 37, 38, and 50

United States Patent and Trademark Office

Reg. No. 3,477,699

Registered July 29, 2008

**TRADEMARK
PRINCIPAL REGISTER**

TRUE TO LIFE

CRAYOLA PROPERTIES, INC. (DELAWARE
CORPORATION)
2035 EDGEWOOD AVENUE
EASTON, PA 18042

THE MARK CONSISTS OF STANDARD CHAR-
ACTERS WITHOUT CLAIM TO ANY PARTICULAR
FONT, STYLE, SIZE, OR COLOR.

FOR: MARKERS; CRAYONS; COLOR PENCILS,
IN CLASS 16 (U.S. CLS. 2, 5, 22, 23, 29, 37, 38 AND 50).

SN 77-205,142, FILED 6-13-2007.

FIRST USE 1-8-2008; IN COMMERCE 1-8-2008.

PAUL F. GAST, EXAMINING ATTORNEY

Int. Cl.: 44

Prior U.S. Cls.: 100 and 101

United States Patent and Trademark Office

Reg. No. 3,477,700

Registered July 29, 2008

SERVICE MARK
PRINCIPAL REGISTER

Massage Envy
Face & Body

MESSAGE ENVY LIMITED, LLC (ARIZONA LTD
LIAB CO)
SUITE 200
14350 NORTH 87TH STREET
SCOTTSDALE, AZ 85260

FOR: BEAUTY SALON AND DAY SPA SERVICES,
NAMELY, MASSAGE THERAPY AND ESTHETIC
SKIN CARE TREATMENTS, IN CLASS 44 (U.S. CLS.
100 AND 101).

FIRST USE 10-29-2007; IN COMMERCE 10-29-2007.

OWNER OF U.S. REG. NOS. 2,852,856 AND
2,994,755.

NO CLAIM IS MADE TO THE EXCLUSIVE
RIGHT TO USE "MASSAGE" AND "FACE & BODY",
APART FROM THE MARK AS SHOWN.

THE MARK CONSISTS OF THE WORDS "MAS-
SAGE ENVY FACE & BODY" WITH TWO CURVED
LINE DESIGNS.

SN 77-205,631, FILED 6-13-2007.

AHSEN KHAN, EXAMINING ATTORNEY

Int. Cl.: 43

Prior U.S. Cls.: 100 and 101

United States Patent and Trademark Office

Reg. No. 3,477,701

Registered July 29, 2008

**SERVICE MARK
PRINCIPAL REGISTER**



PACIUGO PROPERTIES L.P. (TEXAS LIMITED PARTNERSHIP)
9761 CLIFFORD DRIVE, SUITE 170
DALLAS, TX 75220

FOR: RESTAURANT SERVICES; COFFEE BAR SERVICES, IN CLASS 43 (U.S. CLS. 100 AND 101).

FIRST USE 6-0-2007; IN COMMERCE 6-0-2007.

NO CLAIM IS MADE TO THE EXCLUSIVE RIGHT TO USE "GRAN MISCELA CAFFÈ", APART FROM THE MARK AS SHOWN.

THE MARK CONSISTS OF TWO ELEPHANT HEADS WITH MOUNTAIN IN THE BACKGROUND.

THE FOREIGN WORDING IN THE MARK TRANSLATES INTO ENGLISH AS "GREAT BLEND COFFEE"

SN 77-206,059, FILED 6-14-2007.

CAROL SPILS, EXAMINING ATTORNEY

Int. Cl.: 33

Prior U.S. Cls.: 47 and 49

United States Patent and Trademark Office

Reg. No. 3,477,702

Registered July 29, 2008

**TRADEMARK
PRINCIPAL REGISTER**

Villa Sunset

STONE VILLA WINE CELLARS, INC. (PENNSYLVANIA CORPORATION)
1085 CLAY PIKE ROAD
ACME, PA 15610

THE MARK CONSISTS OF STANDARD CHARACTERS WITHOUT CLAIM TO ANY PARTICULAR FONT, STYLE, SIZE, OR COLOR.

FOR: WINE, IN CLASS 33 (U.S. CLS. 47 AND 49).

SN 77-206,268, FILED 6-14-2007.

FIRST USE 3-4-2008; IN COMMERCE 3-19-2008.

RICHARD WHITE, EXAMINING ATTORNEY

Int. Cl.: 35

Prior U.S. Cls.: 100, 101, and 102

United States Patent and Trademark Office

Reg. No. 3,477,703

Registered July 29, 2008

**SERVICE MARK
PRINCIPAL REGISTER**

PAR4

POWER ASSURE, INC. (DELAWARE CORPORATION)
2394 WALSH AVENUE
SANTA CLARA, CA 95051

FOR: PROVIDING INFORMATION ON CUSTOMERS' ENERGY USAGE BY ANALYZING AND RATING THE ENERGY USAGE BY COMPUTERS AND OTHER ELECTRONIC POWER CONSUMING DEVICES IN DATA CENTERS AND DEPARTMENTS THAT HOUSE LARGE AMOUNTS OF SERVERS, IN CLASS 35 (U.S. CLS. 100, 101 AND 102).

FIRST USE 1-1-2008; IN COMMERCE 3-1-2008.

THE MARK CONSISTS OF STANDARD CHARACTERS WITHOUT CLAIM TO ANY PARTICULAR FONT, STYLE, SIZE, OR COLOR.

SN 77-206,792, FILED 6-15-2007.

DANNEAN HETZEL, EXAMINING ATTORNEY

Int. Cl.: 28

Prior U.S. Cls.: 22, 23, 38, and 50

United States Patent and Trademark Office

Reg. No. 3,477,704

Registered July 29, 2008

**TRADEMARK
PRINCIPAL REGISTER**

GHOST

CLAWSON CUSTOM CUES, INC. (FLORIDA
CORPORATION)
5055-5 ST. AUGUSTINE ROAD
JACKSONVILLE, FL 32207

THE MARK CONSISTS OF STANDARD CHAR-
ACTERS WITHOUT CLAIM TO ANY PARTICULAR
FONT, STYLE, SIZE, OR COLOR.

FOR: COMPONENTS FOR BILLIARD CUES,
NAMELY, JOINTS, INSERTS, PINS AND JOINT
PROTECTORS, IN CLASS 28 (U.S. CLS. 22, 23, 38
AND 50).

SN 77-206,822, FILED 6-15-2007.

FIRST USE 9-18-2007; IN COMMERCE 9-18-2007.

MICHELE SWAIN, EXAMINING ATTORNEY

Int. Cl.: 28

Prior U.S. Cls.: 22, 23, 38, and 50

United States Patent and Trademark Office

Reg. No. 3,477,705

Registered July 29, 2008

**TRADEMARK
PRINCIPAL REGISTER**

BULLET

CLAWSON CUSTOM CUES, INC. (FLORIDA
CORPORATION)
5055-5 ST. AUGUSTINE ROAD
JACKSONVILLE, FL 32207

THE MARK CONSISTS OF STANDARD CHAR-
ACTERS WITHOUT CLAIM TO ANY PARTICULAR
FONT, STYLE, SIZE, OR COLOR.

FOR: COMPONENTS FOR BILLIARD CUES,
NAMELY, JOINTS, INSERTS, PINS AND JOINT
PROTECTORS, IN CLASS 28 (U.S. CLS. 22, 23, 38
AND 50).

SN 77-206,823, FILED 6-15-2007.

FIRST USE 9-18-2007; IN COMMERCE 9-18-2007.

MICHELE SWAIN, EXAMINING ATTORNEY

Int. Cl.: 30

Prior U.S. Cl.: 46

United States Patent and Trademark Office

Reg. No. 3,477,706

Registered July 29, 2008

**TRADEMARK
PRINCIPAL REGISTER**

MALAWI GARDEN

MARS, INCORPORATED (DELAWARE CORPORATION)
6885 ELM STREET
MCLEAN, VA 221013883

NO CLAIM IS MADE TO THE EXCLUSIVE RIGHT TO USE "MALAWI", APART FROM THE MARK AS SHOWN.

FOR: TEA, IN CLASS 30 (U.S. CL. 46).

FIRST USE 10-0-2007; IN COMMERCE 10-0-2007.

SN 77-206,896, FILED 6-15-2007.

THE MARK CONSISTS OF STANDARD CHARACTERS WITHOUT CLAIM TO ANY PARTICULAR FONT, STYLE, SIZE, OR COLOR.

CHARISMA HAMPTON, EXAMINING ATTORNEY

Int. Cl.: 18

Prior U.S. Cls.: 1, 2, 3, 22, and 41

United States Patent and Trademark Office

Reg. No. 3,477,707

Registered July 29, 2008

**TRADEMARK
PRINCIPAL REGISTER**



LUCKY DOG COMPANY (NORTH CAROLINA CORPORATION)
1915 THOMAS AVE.
CHARLOTTE, NC 28205

FOR: DOG COLLARS; DOG LEASHES; ANIMAL LEASHES, IN CLASS 18 (U.S. CLS. 1, 2, 3, 22 AND 41).

FIRST USE 4-8-2008; IN COMMERCE 4-8-2008.

NO CLAIM IS MADE TO THE EXCLUSIVE RIGHT TO USE "DOG", APART FROM THE MARK AS SHOWN.

THE COLOR(S) BROWN, GREEN AND WHITE IS/ ARE CLAIMED AS A FEATURE OF THE MARK.

THE MARK CONSISTS OF A WHITE DOG HEAD AND THE WORD "DOG" ARE CENTERED IN A BROWN CIRCLE. THE DOG IS WEARING A WHITE COLLAR WITH A GREEN FOUR LEAF CLOVER ATTACHED. THE WORD "DUBLIN" IS WRITTEN IN BROWN LETTERING TO THE LEFT OF THE CIRCLE. THE WORDS "YOU SHOULD BE SO LUCKY" ARE WRITTEN IN GREEN LETTERING.

SN 77-208,707, FILED 6-18-2007.

ANGELA M. MICHELI, EXAMINING ATTORNEY

Int. Cl.: 41

Prior U.S. Cls.: 100, 101, and 107

United States Patent and Trademark Office

Reg. No. 3,477,708

Registered July 29, 2008

SERVICE MARK
PRINCIPAL REGISTER



SANCHEZ, ABEL (UNITED STATES INDIVIDUAL)
PO BOX 1317
ROCKLIN, CA 95677

FOR: ENTERTAINMENT IN THE NATURE OF VISUAL AND AUDIO PERFORMANCES, NAMELY, VOCALISTS, MUSICAL BANDS AND ROCK GROUPS; ENTERTAINMENT SERVICES, NAMELY, PROVIDING A WEBSITE FEATURING PHOTOGRAPHIC, AUDIO, VIDEO AND PROSE PRESENTATIONS FEATURING LATIN ROCK, LATIN MUSIC AND MUSICAL BANDS, GROUPS AND VOCALISTS; ENTERTAINMENT SERVICES, NAMELY, PROVIDING A WEBSITE FEATURING PHOTOGRAPHIC, AUDIO, VIDEO AND PROSE PRESENTATIONS FEATURING LATIN ROCK, LATIN MUSIC AND MUSICAL BANDS, GROUPS AND VOCALISTS; PRESENTATION OF MUSICAL PER-

FORMANCE; PRESENTATION OF LIVE SHOW PERFORMANCES, IN CLASS 41 (U.S. CLS. 100, 101 AND 107).

FIRST USE 1-24-2008; IN COMMERCE 1-24-2008.

NO CLAIM IS MADE TO THE EXCLUSIVE RIGHT TO USE "LATIN ROCK", APART FROM THE MARK AS SHOWN.

THE MARK CONSISTS OF THE WORDS "VOICES OF LATIN ROCK" IN A STYLIZED TEXT.

SN 77-209,096, FILED 6-18-2007.

DOMINIC J. FERRAIUOLO, EXAMINING ATTORNEY

Int. Cl.: 19

Prior U.S. Cls.: 1, 12, 33, and 50

United States Patent and Trademark Office

Reg. No. 3,477,709

Registered July 29, 2008

**TRADEMARK
PRINCIPAL REGISTER**

SUREWOOD

LASHLEY SR., STEVE E. (UNITED STATES IN-
DIVIDUAL)
4405 ENTERPRISE AVENUE
NAPLES, FL 34104 AND
STANLEY, JILL M. (UNITED STATES INDIVI-
DUAL)
4405 ENTERPRISE AVENUE
NAPLES, FL 34104

FIRST USE 6-30-2004; IN COMMERCE 1-28-2005.

THE MARK CONSISTS OF STANDARD CHAR-
ACTERS WITHOUT CLAIM TO ANY PARTICULAR
FONT, STYLE, SIZE, OR COLOR.

SN 77-211,162, FILED 6-20-2007.

FOR: NON-METAL DOORS, IN CLASS 19 (U.S.
CLS. 1, 12, 33 AND 50).

HEATHER THOMPSON, EXAMINING ATTORNEY

Int. Cl.: 5

Prior U.S. Cls.: 6, 18, 44, 46, 51, and 52

United States Patent and Trademark Office

Reg. No. 3,477,710

Registered July 29, 2008

**TRADEMARK
PRINCIPAL REGISTER**

ENERGY & PERFORMANCE RUSH

BIO-ENGINEERED SUPPLEMENTS & NUTRI-
TION, INC. (DELAWARE CORPORATION)

5901 BROKEN SOUND PARKWAY NW

6TH FLOOR

BOCA RATON, FL 33487

FOR: DIETARY SUPPLEMENTS, IN CLASS 5 (U.S.
CLS. 6, 18, 44, 46, 51 AND 52).

FIRST USE 6-1-2007; IN COMMERCE 6-1-2007.

THE MARK CONSISTS OF STANDARD CHAR-
ACTERS WITHOUT CLAIM TO ANY PARTICULAR
FONT, STYLE, SIZE, OR COLOR.

NO CLAIM IS MADE TO THE EXCLUSIVE
RIGHT TO USE "ENERGY & PERFORMANCE",
APART FROM THE MARK AS SHOWN.

SN 77-211,254, FILED 6-20-2007.

WILLIAM BRECKENFELD, EXAMINING ATTOR-
NEY

Int. Cl.: 9

Prior U.S. Cls.: 21, 23, 26, 36, and 38

United States Patent and Trademark Office

Reg. No. 3,477,711

Registered July 29, 2008

**TRADEMARK
PRINCIPAL REGISTER**

DVDSHRINK

IBISWEB CORP. (PANAMA CORPORATION)
VIA PERI 9
LUGANO, SWITZERLAND CH6900

THE MARK CONSISTS OF STANDARD CHAR-
ACTERS WITHOUT CLAIM TO ANY PARTICULAR
FONT, STYLE, SIZE, OR COLOR.

FOR: COMPUTER SOFTWARE FOR MAKING
BACK-UP COPIES OF DVDS, IN CLASS 9 (U.S. CLS.
21, 23, 26, 36 AND 38).

SN 77-211,545, FILED 6-21-2007.

FIRST USE 6-9-2008; IN COMMERCE 6-9-2008.

MICHAEL TANNER, EXAMINING ATTORNEY

Int. Cl.: 28

Prior U.S. Cls.: 22, 23, 38, and 50

United States Patent and Trademark Office

Reg. No. 3,477,712

Registered July 29, 2008

**TRADEMARK
PRINCIPAL REGISTER**

TOTALLY FUNKY SCIENCE

TOTALLY FUNKY SCIENCE (DELAWARE COR-
PORATION)
ONE EASTON OVAL
COLUMBUS, OH 43219

THE MARK CONSISTS OF STANDARD CHAR-
ACTERS WITHOUT CLAIM TO ANY PARTICULAR
FONT, STYLE, SIZE, OR COLOR.

FOR: CHILDREN'S MULTIPLE ACTIVITY TOYS,
IN CLASS 28 (U.S. CLS. 22, 23, 38 AND 50).

SN 77-211,592, FILED 6-21-2007.

FIRST USE 8-1-2007; IN COMMERCE 8-1-2007.

FRED MANDIR, EXAMINING ATTORNEY

Int. Cls.: 30, 35, and 43

Prior U.S. Cls.: 46, 100, 101, and 102

United States Patent and Trademark Office

Reg. No. 3,477,713

Registered July 29, 2008

**TRADEMARK
SERVICE MARK
PRINCIPAL REGISTER**

Personalize Your Pop!

FREUNDLICH, ANDREW (UNITED STATES INDIVIDUAL)
16359 CHAMPION DRIVE
CHESTERFIELD, MO 630055405

FOR: POPPED POPCORN, FLAVORED POPPED POPCORN, SNACK MIX CONSISTING PRIMARILY OF FLAVORED POPPED POPCORN AND MIXED WITH NUTS, POPCORN BALLS AND CONFECTIONS, NAMELY, CANDY BARS, MARSHMALLOWS, COCONUT, CHOCOLATE AND CANDY, IN CLASS 30 (U.S. CL. 46).

FIRST USE 8-27-2007; IN COMMERCE 8-27-2007.

FOR: RETAIL STORE SERVICES, ONLINE RETAIL STORE SERVICES AND MAIL ORDER SERVICES FEATURING POPPED POPCORN, FLAVORED POPPED POPCORN, FLAVORED POPPED POPCORN MIXED WITH NUTS, POPCORN

BALLS AND CONFECTIONS, IN CLASS 35 (U.S. CLS. 100, 101 AND 102).

FIRST USE 8-27-2007; IN COMMERCE 8-27-2007.

FOR: RESTAURANT SERVICES FEATURING POPPED POPCORN, FLAVORED POPPED POPCORN, FLAVORED POPPED POPCORN MIXED WITH NUTS, POPCORN BALLS AND CONFECTIONS, IN CLASS 43 (U.S. CLS. 100 AND 101).

FIRST USE 8-27-2007; IN COMMERCE 8-27-2007.

THE MARK CONSISTS OF STANDARD CHARACTERS WITHOUT CLAIM TO ANY PARTICULAR FONT, STYLE, SIZE, OR COLOR.

SN 77-212,790, FILED 6-22-2007.

KRISTINA MORRIS, EXAMINING ATTORNEY

Int. Cls.: 3 and 5

Prior U.S. Cls.: 1, 4, 6, 18, 44, 46, 50, 51, and 52

United States Patent and Trademark Office

Reg. No. 3,477,714

Registered July 29, 2008

**TRADEMARK
PRINCIPAL REGISTER**

ph+

ORAL BIOTECH (OREGON LTD LIAB CO)
812 WATER AVE NE
ALBANY, OR 97321

FIRST USE 6-22-2007; IN COMMERCE 7-1-2007.

FOR: NON-MEDICATED DENTAL RINSE, IN
CLASS 3 (U.S. CLS. 1, 4, 6, 50, 51 AND 52).

THE MARK CONSISTS OF STANDARD CHAR-
ACTERS WITHOUT CLAIM TO ANY PARTICULAR
FONT, STYLE, SIZE, OR COLOR.

FIRST USE 6-22-2007; IN COMMERCE 7-1-2007.

SN 77-213,007, FILED 6-22-2007.

FOR: ANTICAVITY MOUTH RINSES , IN CLASS 5
(U.S. CLS. 6, 18, 44, 46, 51 AND 52).

TOBY BULLOFF, EXAMINING ATTORNEY

Int. Cl.: 25

Prior U.S. Cls.: 22 and 39

United States Patent and Trademark Office

Reg. No. 3,477,715

Registered July 29, 2008

**TRADEMARK
PRINCIPAL REGISTER**

CLAIRE & CHARLIE

CHACON, BRENDA CAROLINA PERLA (EL
SALVADOR INDIVIDUAL)
AVENIDA LOS OLIVOS NUMERO 54
COLONIA MIRAMONTE PONIENTE
SAN SALVADOR, EL SALVADOR

FOR: CHILDREN'S CLOTHING, NAMELY,
DRESSES, ROMPERS, OVERALLS, SHORTS AND
ONE PIECE PLAYSUITS; SPORTSWEAR, NAMELY,
T-SHIRTS, IN CLASS 25 (U.S. CLS. 22 AND 39).

FIRST USE 7-29-2007; IN COMMERCE 7-29-2007.

THE MARK CONSISTS OF STANDARD CHAR-
ACTERS WITHOUT CLAIM TO ANY PARTICULAR
FONT, STYLE, SIZE, OR COLOR.

SN 77-213,649, FILED 6-22-2007.

GIANCARLO CASTRO, EXAMINING ATTORNEY

Int. Cls.: 16 and 28

Prior U.S. Cls.: 2, 5, 22, 23, 29, 37, 38, and 50

United States Patent and Trademark Office

Reg. No. 3,477,716

Registered July 29, 2008

**TRADEMARK
PRINCIPAL REGISTER**

HUGGY SLUGGYS

HUGGY SLUGGYS, LLC (FLORIDA LTD LIAB
CO)
5641 SHIRLEY DRIVE
JUPITER, FL 33458

FOR: CHILDREN'S BOOKS, IN CLASS 16 (U.S.
CLS. 2, 5, 22, 23, 29, 37, 38 AND 50).

FIRST USE 11-21-2007; IN COMMERCE 4-4-2008.

FOR: STUFFED TOYS, IN CLASS 28 (U.S. CLS. 22,
23, 38 AND 50).

FIRST USE 11-21-2007; IN COMMERCE 4-4-2008.

THE MARK CONSISTS OF STANDARD CHAR-
ACTERS WITHOUT CLAIM TO ANY PARTICULAR
FONT, STYLE, SIZE, OR COLOR.

SN 77-214,465, FILED 6-25-2007.

CHERYL CLAYTON, EXAMINING ATTORNEY

Int. Cl.: 12

Prior U.S. Cls.: 19, 21, 23, 31, 35, and 44

United States Patent and Trademark Office

Reg. No. 3,477,717

Registered July 29, 2008

**TRADEMARK
PRINCIPAL REGISTER**



BRITAX CHILD SAFETY, INC. (SOUTH CAROLINA CORPORATION)
13501 SOUTH RIDGE DRIVE
CHARLOTTE, NC 28273

FOR: CHILD SAFETY SEATS FOR USE IN CARS AND VEHICLES, CHILD SAFETY HARNESSSES FOR THE SEATS OF VEHICLES; CHILD SAFETY BELTS FOR THE SEAT OF VEHICLES, CHILD RESTRAINTS FOR USE IN VEHICLES; REPLACEMENT PARTS AND REPLACEMENT FITTINGS FOR CHILD SAFETY SEATS FOR USE VEHICLES, CHILD SAFETY HARNESSSES FOR THE SEATS OF VEHICLES, CHILD SAFETY BELTS FOR THE SEATS OF VEHICLES, AND CHILD RESTRAINTS FOR USE IN VEHICLES, IN CLASS 12 (U.S. CLS. 19, 21, 23, 31, 35 AND 44).

FIRST USE 7-0-2007; IN COMMERCE 7-0-2007.

NO CLAIM IS MADE TO THE EXCLUSIVE RIGHT TO USE "SIDE IMPACT PROTECTION", APART FROM THE MARK AS SHOWN.

THE MARK CONSISTS OF A SHIELD DISPLAYING THE GRAPHIC REPRESENTATION OF A CHILD SITTING IN A CHILD SAFETY SEAT WITH THE WORDING "TRUE SIDE IMPACT PROTECTION" APPEARING ABOVE THE GRAPHIC WITHIN THE SHIELD.

SN 77-214,946, FILED 6-25-2007.

ALYSSA PALADINO, EXAMINING ATTORNEY

Int. Cl.: 3

Prior U.S. Cls.: 1, 4, 6, 50, 51, and 52

United States Patent and Trademark Office

Reg. No. 3,477,718

Registered July 29, 2008

**TRADEMARK
PRINCIPAL REGISTER**

STETSON FRESH

JOHN B.STETSON COMPANY (DELAWARE
CORPORATION)
ONE EXCHANGE PLACE
JERSEY CITY, NJ 073023919

FOR: COLOGNE; AFTER-SHAVE LOTIONS, IN
CLASS 3 (U.S. CLS. 1, 4, 6, 50, 51 AND 52).

FIRST USE 2-1-2008; IN COMMERCE 2-1-2008.

THE MARK CONSISTS OF STANDARD CHAR-
ACTERS WITHOUT CLAIM TO ANY PARTICULAR
FONT, STYLE, SIZE, OR COLOR.

OWNER OF U.S. REG. NOS. 1,245,716, 2,926,616,
AND OTHERS.

SN 77-216,433, FILED 6-27-2007.

RICHARD WHITE, EXAMINING ATTORNEY

Int. Cls.: 9, 14, 18, and 25

Prior U.S. Cls.: 1, 2, 3, 21, 22, 23, 26, 27, 28, 36, 38, 39, 41, and 50

Reg. No. 3,477,719

United States Patent and Trademark Office

Registered July 29, 2008

**TRADEMARK
PRINCIPAL REGISTER**



WILLIAMS, VENUS (UNITED STATES INDIVIDUAL)
C/O STELLAR BRANDS 12 HARBOR PARK DRIVE
PORT WASHINGTON, NY 11050

FOR: SUNGLASSES, IN CLASS 9 (U.S. CLS. 21, 23, 26, 36 AND 38).

FIRST USE 11-15-2007; IN COMMERCE 11-15-2007.

FOR: JEWELRY, NECKLACES, EARRINGS, BRACELETS BEING JEWELRY, IN CLASS 14 (U.S. CLS. 2, 27, 28 AND 50).

FIRST USE 11-15-2007; IN COMMERCE 11-15-2007.

FOR: WALLETS, BOOKBAGS, CARRY ALL BAGS, TOTE BAGS, MESSENGER BAGS, OVERNIGHT BAGS, BACKPACKS, PURSES, DUFFEL BAGS, IN CLASS 18 (U.S. CLS. 1, 2, 3, 22 AND 41).

FIRST USE 11-15-2007; IN COMMERCE 11-15-2007.

FOR: PANTS, JEANS, SHIRTS, SKIRTS, SHORTS, DRESSES, SWEATERS, HOSIERY, JACKETS, OUTERWEAR IN THE NATURE OF PARKAS, COATS, FOOTWEAR, HEADWEAR, SOCKS, TRACKSUITS, SWIMWEAR, BEACHWEAR, BODYWEAR, BRAS, IN CLASS 25 (U.S. CLS. 22 AND 39).

FIRST USE 11-15-2007; IN COMMERCE 11-15-2007.

THE MARK CONSISTS OF FOUR ROMAN NUMERAL ONES ARRANGED IN A CHEVRON DESIGN REPRESENTING A STYLIZED DEPICTION OF BOTH A LETTER V AND THE NUMBER ELEVEN.

SN 77-216,540, FILED 6-27-2007.

JAMES MACFARLANE, EXAMINING ATTORNEY

Int. Cl.: 3

Prior U.S. Cls.: 1, 4, 6, 50, 51, and 52

United States Patent and Trademark Office

Reg. No. 3,477,720

Registered July 29, 2008

**TRADEMARK
PRINCIPAL REGISTER**

Aladdino

PRI-EL LLC (NEW YORK LTD LIAB CO)
16 MAGAW PL. #42C
NEW YORK, NY 10033

THE MARK CONSISTS OF STANDARD CHAR-
ACTERS WITHOUT CLAIM TO ANY PARTICULAR
FONT, STYLE, SIZE, OR COLOR.

FOR: ROOM FRAGRANCES, IN CLASS 3 (U.S.
CLS. 1, 4, 6, 50, 51 AND 52).

SN 77-216,583, FILED 6-27-2007.

FIRST USE 8-1-2007; IN COMMERCE 9-15-2007.

DORITT L. CARROLL, EXAMINING ATTORNEY

Int. Cl.: 16

Prior U.S. Cls.: 2, 5, 22, 23, 29, 37, 38, and 50

Reg. No. 3,477,721

United States Patent and Trademark Office

Registered July 29, 2008

**TRADEMARK
PRINCIPAL REGISTER**

**GIGGLES, SQUIGGLES, &
SQUIRMS**

CHANDLER EDUCATION FOUNDATION, INC.
(ARIZONA CORPORATION)
1525 WEST FRYE ROAD
CHANDLER, AZ 85224

PENCILS, ERASERS, MARKERS, CRAYONS, PAPER, AND GLUE, IN CLASS 16 (U.S. CLS. 2, 5, 22, 23, 29, 37, 38 AND 50).

FOR: SERIES OF EDUCATIONAL ACTIVITY BOOKS, NAMELY, BOOKS FOR USE BY PARENTS AND OTHER ADULTS TO HELP CHILDREN DEVELOP SKILLS AND KNOWLEDGE IN THE FIELDS OF READING, MATHEMATICS, SCIENCE, SOCIAL STUDIES, AND PERSONAL CARE AND HYGIENE; SCHOOL SUPPLY KITS CONTAINING VARIOUS COMBINATIONS OF SELECTED SCHOOL SUPPLIES, NAMELY, WRITING INSTRUMENTS, PENS,

FIRST USE 2-2-2008; IN COMMERCE 2-2-2008.

THE MARK CONSISTS OF STANDARD CHARACTERS WITHOUT CLAIM TO ANY PARTICULAR FONT, STYLE, SIZE, OR COLOR.

SN 77-216,985, FILED 6-27-2007.

SARA THOMAS, EXAMINING ATTORNEY

Int. Cls.: 39 and 40

Prior U.S. Cls.: 100, 103, 105, and 106

United States Patent and Trademark Office

Reg. No. 3,477,722

Registered July 29, 2008

**SERVICE MARK
PRINCIPAL REGISTER**

peeq

PEEQ MEDIA LLC (DELAWARE LLC)
30-00 47TH AVENUE
LOMG ISLAND CITY, NY 11101

FOR: STORAGE OF ELECTRONIC MEDIA,
NAMELY, IMAGES, IN CLASS 39 (U.S. CLS. 100
AND 105).

FIRST USE 12-24-2007; IN COMMERCE 12-24-2007.

FOR: PHOTOGRAPHIC COMPUTER IMAGING;
PHOTOGRAPHIC PRINTING; PHOTOGRAPHIC
REPRODUCTION; ELECTRONIC IMAGING, SCAN-

NING, DIGITIZING, ALTERATION AND RE-
TOUCHING OF PHOTOGRAPHIC IMAGES, IN
CLASS 40 (U.S. CLS. 100, 103 AND 106).

FIRST USE 12-24-2007; IN COMMERCE 12-24-2007.

THE MARK CONSISTS OF STANDARD CHAR-
ACTERS WITHOUT CLAIM TO ANY PARTICULAR
FONT, STYLE, SIZE, OR COLOR.

SN 77-217,284, FILED 6-27-2007.

HELENE LIWINSKI, EXAMINING ATTORNEY

Int. Cls.: 41 and 45

Prior U.S. Cls.: 100, 101, and 107

United States Patent and Trademark Office

Reg. No. 3,477,723

Registered July 29, 2008

**SERVICE MARK
PRINCIPAL REGISTER**

OVER 40 FIT & FAB

LUTTRELL, JUDITH ANN (UNITED STATES
INDIVIDUAL)
10641 MISSOURI AVENUE, #103
LOS ANGELES, CA 90025

FOR: EDUCATIONAL AND ENTERTAINMENT
SERVICES, NAMELY, PROVIDING MOTIVATION-
AL AND EDUCATIONAL SPEAKERS; ENTERTAIN-
MENT IN THE NATURE OF SEMINARS,
WORKSHOPS, AND MOTIVATIONAL SPEAKERS
IN SELF-IMPROVEMENT.; EDUCATION SERVI-
CES, NAMELY, PROVIDING SEMINARS, WORK-
SHOPS, AND MOTIVATIONAL SPEAKERS IN THE
FIELDS OF SELF-IMPROVEMENT, IN CLASS 41
(U.S. CLS. 100, 101 AND 107).

FIRST USE 10-1-2007; IN COMMERCE 10-1-2007.

FOR: PERSONAL GROWTH AND MOTIVATION
CONSULTING SERVICES; PERSONAL LIFESTYLE
CONSULTING SERVICES, IN CLASS 45 (U.S. CLS.
100 AND 101).

FIRST USE 10-1-2007; IN COMMERCE 10-1-2007.

THE MARK CONSISTS OF STANDARD CHAR-
ACTERS WITHOUT CLAIM TO ANY PARTICULAR
FONT, STYLE, SIZE, OR COLOR.

SN 77-219,146, FILED 6-29-2007.

NICHOLAS ALTREE, EXAMINING ATTORNEY

Int. Cl.: 14

Prior U.S. Cls.: 2, 27, 28, and 50

United States Patent and Trademark Office

Reg. No. 3,477,724

Registered July 29, 2008

**TRADEMARK
PRINCIPAL REGISTER**

A I I Z

J. C. PENNEY PRIVATE BRANDS, INC. (DELA-
WARE CORPORATION)
6501 LEGACY DRIVE
PLANO, TX 750243698

THE MARK CONSISTS OF STANDARD CHAR-
ACTERS WITHOUT CLAIM TO ANY PARTICULAR
FONT, STYLE, SIZE, OR COLOR.

FOR: WATCHES, IN CLASS 14 (U.S. CLS. 2, 27, 28
AND 50).

SN 77-219,207, FILED 6-29-2007.

FIRST USE 10-30-2007; IN COMMERCE 10-30-2007.

ESTHER A. BORSUK, EXAMINING ATTORNEY

Int. Cl.: 25

Prior U.S. Cls.: 22 and 39

United States Patent and Trademark Office

Reg. No. 3,477,725

Registered July 29, 2008

**TRADEMARK
PRINCIPAL REGISTER**

GIRLS GONE BIKER

OLGA DANIEL (UNITED STATES INDIVIDUAL)
1207 N VERDUGO RD
GLENDALE, CA 912061592

FOR: CLOTHING, NAMELY, BANDANAS, CAPS, HATS, GLOVES, ARM WARMERS, WRIST BANDS, NECK BANDS, SCARVES, JEANS, PANTS, CHAPS, COVERALLS, SHORTS, SHIRTS, SWEATERS, HALTER TOPS, TANK TOPS, T-SHIRTS, SWEATSHIRTS, SWEAT PANTS, HOSIERY, DRESSES, HEAD BANDS, BELTS, COATS, JACKETS, LEATHER COATS, LEATHER JACKETS, LEATHER PANTS, LEATHER CHAPS, LEATHER VESTS, RAIN COATS, RAIN SUITS, SUITS, SWIMSUITS, SKIRTS, SLEEP-

WEAR, LINGERIE, BUSTIERS, BRASSIERES, PANTIES, UNDERWEAR, SLIPPERS, VESTS, WRISTBANDS, FOOTWEAR, NAMELY, SHOES AND BOOTS, IN CLASS 25 (U.S. CLS. 22 AND 39).

FIRST USE 1-1-2008; IN COMMERCE 1-9-2008.

THE MARK CONSISTS OF STANDARD CHARACTERS WITHOUT CLAIM TO ANY PARTICULAR FONT, STYLE, SIZE, OR COLOR.

SN 77-220,258, FILED 7-2-2007.

MICHAEL GAAFAR, EXAMINING ATTORNEY

Int. Cl.: 9

Prior U.S. Cls.: 21, 23, 26, 36, and 38

United States Patent and Trademark Office

Reg. No. 3,477,726

Registered July 29, 2008

**TRADEMARK
PRINCIPAL REGISTER**

DOUBLE DECKER

SPY OPTIC, INC. (CALIFORNIA CORPORATION)
2070 LAS PALMAS DRIVE
CARLSBAD, CA 92009

FOR: SUNGLASSES, IN CLASS 9 (U.S. CLS. 21, 23,
26, 36 AND 38).

FIRST USE 3-0-2008; IN COMMERCE 3-0-2008.

THE MARK CONSISTS OF STANDARD CHAR-
ACTERS WITHOUT CLAIM TO ANY PARTICULAR
FONT, STYLE, SIZE, OR COLOR.

SN 77-220,332, FILED 7-2-2007.

RON FAIRBANKS, EXAMINING ATTORNEY

Int. Cl.: 20

Prior U.S. Cls.: 2, 13, 22, 25, 32, and 50

United States Patent and Trademark Office

Reg. No. 3,477,727

Registered July 29, 2008

**TRADEMARK
PRINCIPAL REGISTER**

**YOUR BEDTIME CLEAVAGE
CUSHION**

ARC LUXE LLC (NORTH CAROLINA LTD LIAB
CO)
1508 EAST FOURTH STREET
CHARLOTTE, NC 28204

THE MARK CONSISTS OF STANDARD CHAR-
ACTERS WITHOUT CLAIM TO ANY PARTICULAR
FONT, STYLE, SIZE, OR COLOR.

FOR: BREAST SEPARATOR, NAMELY, AN ANTI-
SLIP SEPARATOR USED IN BETWEEN THE
BREASTS OF A HUMAN BEING FOR USE DURING
SLEEP, IN CLASS 20 (U.S. CLS. 2, 13, 22, 25, 32 AND
50).

SN 77-220,829, FILED 7-2-2007.

FIRST USE 5-1-2007; IN COMMERCE 5-1-2007.

WILLIAM BRECKENFELD, EXAMINING ATTOR-
NEY

Int. Cl.: 44

Prior U.S. Cls.: 100 and 101

United States Patent and Trademark Office

Reg. No. 3,477,728

Registered July 29, 2008

**SERVICE MARK
PRINCIPAL REGISTER**



PRIORITY PET HOSPITAL, LLC (ARIZONA LTD
LIAB CO)
1565 E KENT AVE
CHANDLER, AZ 852251643

FOR: VETERINARY SERVICES, NAMELY, PRE-
VENTATIVE MEDICAL CARE FOR PETS, CARE OF
AGED PETS, CARE OF YOUNG PETS, SMALL
ANIMAL MEDICINE, REPTILE AND AMPHIBIAN
MEDICINE AND PET NUTRITION COUNSELING;
VETERINARY SURGICAL SERVICES, NAMELY,
GENERAL SURGICAL SERVICES, IN CLASS 44
(U.S. CLS. 100 AND 101).

FIRST USE 1-2-2008; IN COMMERCE 1-2-2008.

NO CLAIM IS MADE TO THE EXCLUSIVE
RIGHT TO USE "PET HOSPITAL", APART FROM
THE MARK AS SHOWN.

THE MARK CONSISTS OF A STYLIZED STETHO-
SCOPE; THE TEMPLES (EARPIECES) FORM THE
SHAPE OF A HEART ENCIRCLING THE SILHOU-
ETTES OF A DOG AND A CAT SUPERIMPOSED
UPON EACH OTHER. THE BUSINESS NAME AND
TAGLINE "PUTTING PETS FIRST" APPEAR TO
THE RIGHT OF THE STETHOSCOPE GRAPHIC.

SN 77-223,294, FILED 7-6-2007.

EDWARD NELSON, EXAMINING ATTORNEY

Int. Cl.: 5

Prior U.S. Cls.: 6, 18, 44, 46, 51, and 52

United States Patent and Trademark Office

Reg. No. 3,477,729

Registered July 29, 2008

**TRADEMARK
PRINCIPAL REGISTER**

HANDISTRIPS

MEDRAD, INC. (DELAWARE CORPORATION)
ONE MEDRAD DRIVE
INDIANOLA, PA 15051

THE MARK CONSISTS OF STANDARD CHAR-
ACTERS WITHOUT CLAIM TO ANY PARTICULAR
FONT, STYLE, SIZE, OR COLOR.

FOR: MEDICAL ADHESIVE TAPE AND BANDA-
GES, IN CLASS 5 (U.S. CLS. 6, 18, 44, 46, 51 AND 52).

SN 77-223,476, FILED 7-6-2007.

FIRST USE 11-30-2007; IN COMMERCE 11-30-2007.

RICHARD WHITE, EXAMINING ATTORNEY

Int. Cl.: 45

Prior U.S. Cls.: 100 and 101

United States Patent and Trademark Office

Reg. No. 3,477,730

Registered July 29, 2008

**SERVICE MARK
PRINCIPAL REGISTER**

PHISHME

INTREPIDUS GROUP, INC. (VIRGINIA CORPORATION)
ONE PENN PLAZA
SUITE 6180
NEW YORK, NY 10119

FOR: SECURITY SERVICES, NAMELY, PROVIDING SECURITY ASSESSMENTS OF INFORMATION SYSTEMS AND HUMAN SUSCEPTIBILITY TO PHISHING ATTACKS, IN CLASS 45 (U.S. CLS. 100 AND 101).

FIRST USE 4-15-2007; IN COMMERCE 4-15-2008.

THE MARK CONSISTS OF STANDARD CHARACTERS WITHOUT CLAIM TO ANY PARTICULAR FONT, STYLE, SIZE, OR COLOR.

SN 77-224,741, FILED 7-9-2007.

JOHN DWYER, EXAMINING ATTORNEY

Int. Cl.: 45

Prior U.S. Cls.: 100 and 101

United States Patent and Trademark Office

Reg. No. 3,477,731

Registered July 29, 2008

**SERVICE MARK
PRINCIPAL REGISTER**

CUPIDS X FACTORS

CASTILLO, RAFAEL (UNITED STATES INDIVIDUAL)
3876 S.W. 112 AVENUE, SUITE 185
MIAMI, FL 33165

THE MARK CONSISTS OF STANDARD CHARACTERS WITHOUT CLAIM TO ANY PARTICULAR FONT, STYLE, SIZE, OR COLOR.

FOR: COMPUTER DATING SERVICES, IN CLASS 45 (U.S. CLS. 100 AND 101).

SN 77-225,835, FILED 7-10-2007.

FIRST USE 12-31-2007; IN COMMERCE 12-31-2007.

JUDITH HELFMAN, EXAMINING ATTORNEY

Int. Cl.: 9

Prior U.S. Cls.: 21, 23, 26, 36, and 38

United States Patent and Trademark Office

Reg. No. 3,477,732

Registered July 29, 2008

**TRADEMARK
PRINCIPAL REGISTER**

SPATIAL ARRAY

DEI HEADQUARTERS, INC. (FLORIDA CORPORATION)
1 VIPER WAY
VISTA, CA 92081

FOR: AUDIO EQUIPMENT, NAMELY, AMPLIFIERS, SUBWOOFERS, LOUDSPEAKERS AND LOUDSPEAKER SYSTEMS COMPRISED OF SUBWOOFERS, AMPLIFIERS AND LOUDSPEAKERS, IN CLASS 9 (U.S. CLS. 21, 23, 26, 36 AND 38).

FIRST USE 3-15-2008; IN COMMERCE 3-15-2008.

THE MARK CONSISTS OF STANDARD CHARACTERS WITHOUT CLAIM TO ANY PARTICULAR FONT, STYLE, SIZE, OR COLOR.

NO CLAIM IS MADE TO THE EXCLUSIVE RIGHT TO USE "ARRAY", APART FROM THE MARK AS SHOWN.

SN 77-226,371, FILED 7-10-2007.

ALYSSA PALADINO, EXAMINING ATTORNEY

Int. Cl.: 11

Prior U.S. Cls.: 13, 21, 23, 31, and 34

United States Patent and Trademark Office

Reg. No. 3,477,733

Registered July 29, 2008

**TRADEMARK
PRINCIPAL REGISTER**



interspa

ROBERTSON, TROY W. (UNITED STATES INDIVIDUAL)
PO BOX 503
CHAPPELL HILL, TX 77426

FOR: BATHTUBS; WHIRLPOOL BATHS; STEP-IN BATH TUBS; TUB PARTS, NAMELY, TUB SPOUTS, TUB OVERFLOWS, AND TUB WASTES; SPAS IN THE NATURE OF HEATED POOLS, IN CLASS 11 (U.S. CLS. 13, 21, 23, 31 AND 34).

THE MARK CONSISTS OF THE WORDING "I INTERSPA" WITH THE STAND-ALONE LETTER "I" PLACED INSIDE A CIRCULAR DESIGN ELEMENT FEATURING THREE WAVY HORIZONTAL LINES.

SN 77-226,830, FILED 7-11-2007.

FIRST USE 1-0-2007; IN COMMERCE 1-0-2007.

MICHAEL GAAFAR, EXAMINING ATTORNEY

Int. Cl.: 29

Prior U.S. Cl.: 46

United States Patent and Trademark Office

Reg. No. 3,477,734

Registered July 29, 2008

**TRADEMARK
PRINCIPAL REGISTER**

SWEETGLOW

MEDURI FARMS, INC. (OREGON CORPORATION)
P.O. BOX 636
DALLAS, OR 97338

THE MARK CONSISTS OF STANDARD CHARACTERS WITHOUT CLAIM TO ANY PARTICULAR FONT, STYLE, SIZE, OR COLOR.

FOR: FRUIT-BASED SNACK FOODS, IN CLASS 29 (U.S. CL. 46).

SN 77-227,259, FILED 7-11-2007.

FIRST USE 9-0-2007; IN COMMERCE 9-0-2007.

AHSEN KHAN, EXAMINING ATTORNEY

Int. Cl.: 29

Prior U.S. Cl.: 46

United States Patent and Trademark Office

Reg. No. 3,477,735

Registered July 29, 2008

**TRADEMARK
PRINCIPAL REGISTER**

GOLDEN BLUSH

MEDURI FARMS, INC. (OREGON CORPORATION)
P.O. BOX 636
DALLAS, OR 97338

THE MARK CONSISTS OF STANDARD CHARACTERS WITHOUT CLAIM TO ANY PARTICULAR FONT, STYLE, SIZE, OR COLOR.

FOR: FRUIT-BASED SNACK FOODS, IN CLASS 29 (U.S. CL. 46).

SN 77-227,267, FILED 7-11-2007.

FIRST USE 9-0-2007; IN COMMERCE 9-0-2007.

AHSEN KHAN, EXAMINING ATTORNEY

Int. Cl.: 3

Prior U.S. Cls.: 1, 4, 6, 50, 51, and 52

United States Patent and Trademark Office

Reg. No. 3,477,736

Registered July 29, 2008

**TRADEMARK
PRINCIPAL REGISTER**

HOT FLASH MIRACLE

FLASHBLASTER, INC. (NEW JERSEY CORPORATION)
11 VANDERBILT COURT
OLD BRIDGE, NJ 08857

THE MARK CONSISTS OF STANDARD CHARACTERS WITHOUT CLAIM TO ANY PARTICULAR FONT, STYLE, SIZE, OR COLOR.

FOR: COSMETICS, IN CLASS 3 (U.S. CLS. 1, 4, 6, 50, 51 AND 52).

SN 77-227,364, FILED 7-11-2007.

FIRST USE 1-1-2007; IN COMMERCE 10-7-2007.

LINDA E. BLOHM, EXAMINING ATTORNEY

Int. Cl.: 9

Prior U.S. Cls.: 21, 23, 26, 36, and 38

United States Patent and Trademark Office

Reg. No. 3,477,737

Registered July 29, 2008

**TRADEMARK
PRINCIPAL REGISTER**

SAFE-VIEW

ARMORED SOLUTIONS, INC. (MASSACHU-
SETTS CORPORATION)
20 KEELER STREET
PITTSFIELD, MA 01201

FOR: BALLISTIC ARMOR KITS FOR VEHICLE
WINDOWS COMPRISED OF PROTECTIVE ARMOR
PANELS FOR PROTECTING AGAINST BALLISTIC
PROJECTILES AND EXPLOSIVE FRAGMENTS IN-
STALLED IN OR ATTACHED TO VEHICLE WIN-
DOWS, IN CLASS 9 (U.S. CLS. 21, 23, 26, 36 AND 38).

FIRST USE 2-13-2007; IN COMMERCE 2-13-2007.

THE MARK CONSISTS OF STANDARD CHAR-
ACTERS WITHOUT CLAIM TO ANY PARTICULAR
FONT, STYLE, SIZE, OR COLOR.

SN 77-227,740, FILED 7-12-2007.

DAVID YONTEF, EXAMINING ATTORNEY

Int. Cl.: 9

Prior U.S. Cls.: 21, 23, 26, 36, and 38

United States Patent and Trademark Office

Reg. No. 3,477,738

Registered July 29, 2008

**TRADEMARK
PRINCIPAL REGISTER**

SAFE-SIDE

ARMORED SOLUTIONS, INC. (MASSACHU-
SETTS CORPORATION)
20 KEELER STREET
PITTSFIELD, MA 01201

FOR: BALLISTIC ARMOR KITS FOR VEHICLE
DOORS COMPRISED OF PROTECTIVE ARMOR
PANELS FOR PROTECTING AGAINST BALLISTIC
PROJECTILES AND EXPLOSIVE FRAGMENTS IN-
STALLED IN OR ATTACHED TO VEHICLE DOORS,
IN CLASS 9 (U.S. CLS. 21, 23, 26, 36 AND 38).

FIRST USE 2-13-2007; IN COMMERCE 2-13-2007.

THE MARK CONSISTS OF STANDARD CHAR-
ACTERS WITHOUT CLAIM TO ANY PARTICULAR
FONT, STYLE, SIZE, OR COLOR.

SN 77-227,752, FILED 7-12-2007.

DAVID YONTEF, EXAMINING ATTORNEY

Int. Cl.: 36

Prior U.S. Cls.: 100, 101, and 102

United States Patent and Trademark Office

Reg. No. 3,477,739

Registered July 29, 2008

**SERVICE MARK
PRINCIPAL REGISTER**



FIRST COLONY BANK OF FLORIDA (FLORIDA
STATE BANKING ASSOCIATION)
P.O. BOX 940370
MAITLAND, FL 327940370

NO CLAIM IS MADE TO THE EXCLUSIVE
RIGHT TO USE "BANK", APART FROM THE
MARK AS SHOWN.

FOR: BANKING SERVICES, IN CLASS 36 (U.S.
CLS. 100, 101 AND 102).

SN 77-229,286, FILED 7-13-2007.

FIRST USE 1-28-2008; IN COMMERCE 1-28-2008.

MARILYN IZZI, EXAMINING ATTORNEY

Int. Cl.: 33

Prior U.S. Cls.: 47 and 49

United States Patent and Trademark Office

Reg. No. 3,477,740

Registered July 29, 2008

**TRADEMARK
PRINCIPAL REGISTER**

FRESH CATCH WHITE

BIAGIO CRU & ESTATE WINES, LLC (FED REP
GERMANY LTD LIAB CO)
73 POWERHOUSE ROAD
ROSLYN HEIGHTS, NY 11577

NO CLAIM IS MADE TO THE EXCLUSIVE
RIGHT TO USE "WHITE", APART FROM THE
MARK AS SHOWN.

FOR: WINES, IN CLASS 33 (U.S. CLS. 47 AND 49).

FIRST USE 1-1-2008; IN COMMERCE 1-1-2008.

SN 77-229,931, FILED 7-15-2007.

THE MARK CONSISTS OF STANDARD CHAR-
ACTERS WITHOUT CLAIM TO ANY PARTICULAR
FONT, STYLE, SIZE, OR COLOR.

MICHAEL TANNER, EXAMINING ATTORNEY

Int. Cl.: 9

Prior U.S. Cls.: 21, 23, 26, 36, and 38

Reg. No. 3,477,741

United States Patent and Trademark Office

Registered July 29, 2008

**TRADEMARK
PRINCIPAL REGISTER**

Demand Balancer

POWER ASSURE, INC. (DELAWARE CORPORATION)
2394 WALSH AVENUE
SANTA CLARA, CA 95051

FOR: COMPUTER POWER PRODUCTS, NAME-
LY, POWER MANAGEMENT CONTROLLERS AND
MONITORS; COMPUTER SOFTWARE FOR POWER
CONTROL, MANAGEMENT, AND MONITORING
FOR USE WITH ELECTRICAL POWER CONSUM-
ING DEVICES, IN CLASS 9 (U.S. CLS. 21, 23, 26, 36
AND 38).

FIRST USE 10-1-2007; IN COMMERCE 3-1-2008.

THE MARK CONSISTS OF STANDARD CHAR-
ACTERS WITHOUT CLAIM TO ANY PARTICULAR
FONT, STYLE, SIZE, OR COLOR.

NO CLAIM IS MADE TO THE EXCLUSIVE
RIGHT TO USE "BALANCER", APART FROM THE
MARK AS SHOWN.

SN 77-231,861, FILED 7-17-2007.

DANNEAN HETZEL, EXAMINING ATTORNEY

Int. Cl.: 9

Prior U.S. Cls.: 21, 23, 26, 36, and 38

Reg. No. 3,477,742

United States Patent and Trademark Office

Registered July 29, 2008

**TRADEMARK
PRINCIPAL REGISTER**

Supply Balancer

POWER ASSURE, INC. (DELAWARE CORPORATION)
2394 WALSH AVENUE
SANTA CLARA, CA 95051

FOR: COMPUTER POWER PRODUCTS, NAME-
LY, POWER MANAGEMENT CONTROLLERS AND
MONITORS; COMPUTER SOFTWARE FOR POWER
CONTROL, MANAGEMENT, AND MONITORING
FOR ELECTRICAL DEVICES THAT CREATE, SUP-
PLY, AND DISTRIBUTE POWER, IN CLASS 9 (U.S.
CLS. 21, 23, 26, 36 AND 38).

FIRST USE 10-1-2007; IN COMMERCE 3-1-2008.

THE MARK CONSISTS OF STANDARD CHAR-
ACTERS WITHOUT CLAIM TO ANY PARTICULAR
FONT, STYLE, SIZE, OR COLOR.

NO CLAIM IS MADE TO THE EXCLUSIVE
RIGHT TO USE "BALANCER", APART FROM THE
MARK AS SHOWN.

SN 77-231,877, FILED 7-17-2007.

DANNEAN HETZEL, EXAMINING ATTORNEY

Int. Cl.: 42

Prior U.S. Cls.: 100 and 101

United States Patent and Trademark Office

Reg. No. 3,477,743

Registered July 29, 2008

**SERVICE MARK
PRINCIPAL REGISTER**

LIGHT PLAN DESIGN

SCHNACKEL ENGINEERS, INC. (NEBRASKA
CORPORATION)
SUITE 101
3035 SOUTH 72ND STREET
OMAHA, NE 68124

FOR: COMMERCIAL AND RESIDENTIAL IN-
TERIOR ARCHITECTURAL LIGHTING DESIGN;
CONSULTING SERVICES IN THE FIELD OF EN-
VIRONMENTAL ASSESSMENT, COMPLIANCE
AND PLANNING; SITE AND LANDSCAPE LIGHT-
ING DESIGN, IN CLASS 42 (U.S. CLS. 100 AND 101).

FIRST USE 5-15-2008; IN COMMERCE 5-15-2008.

THE MARK CONSISTS OF STANDARD CHAR-
ACTERS WITHOUT CLAIM TO ANY PARTICULAR
FONT, STYLE, SIZE, OR COLOR.

NO CLAIM IS MADE TO THE EXCLUSIVE
RIGHT TO USE "LIGHT" AND "DESIGN", APART
FROM THE MARK AS SHOWN.

SN 77-232,353, FILED 7-18-2007.

CHRIS WELLS, EXAMINING ATTORNEY

Int. Cl.: 9

Prior U.S. Cls.: 21, 23, 26, 36, and 38

United States Patent and Trademark Office

Reg. No. 3,477,744

Registered July 29, 2008

**TRADEMARK
PRINCIPAL REGISTER**

thinkmicro

THINKORSWIM HOLDINGS INC. (DELAWARE
CORPORATION)
600 WEST CHICAGO AVENUE, SUITE 100
CHICAGO, IL 60654

FOR: COMPUTER SOFTWARE, NAMELY, SOFTWARE THAT ALLOWS PERSONS TO ACCESS BROKERAGE ACCOUNTS AND TRADE SECURITIES FROM NON-STYLUS MOBILE DEVICES , IN CLASS 9 (U.S. CLS. 21, 23, 26, 36 AND 38).

FIRST USE 9-29-2007; IN COMMERCE 9-29-2007.

THE MARK CONSISTS OF STANDARD CHARACTERS WITHOUT CLAIM TO ANY PARTICULAR FONT, STYLE, SIZE, OR COLOR.

SN 77-233,485, FILED 7-19-2007.

ALICE BENMAMAN, EXAMINING ATTORNEY

Int. Cl.: 33

Prior U.S. Cls.: 47 and 49

United States Patent and Trademark Office

Reg. No. 3,477,745

Registered July 29, 2008

**TRADEMARK
PRINCIPAL REGISTER**

UNCLE RED

BIAGIO CRU & ESTATE WINES, LLC (DELA-
WARE LTD LIAB CO)
73 POWERHOUSE ROAD
ROSLYN HEIGHTS, NY 11577

NO CLAIM IS MADE TO THE EXCLUSIVE
RIGHT TO USE "RED", APART FROM THE MARK
AS SHOWN.

FOR: WINES, IN CLASS 33 (U.S. CLS. 47 AND 49).

FIRST USE 1-1-2008; IN COMMERCE 1-1-2008.

SN 77-233,701, FILED 7-19-2007.

THE MARK CONSISTS OF STANDARD CHAR-
ACTERS WITHOUT CLAIM TO ANY PARTICULAR
FONT, STYLE, SIZE, OR COLOR.

MICHAEL TANNER, EXAMINING ATTORNEY

Int. Cl.: 43

Prior U.S. Cls.: 100 and 101

United States Patent and Trademark Office

Reg. No. 3,477,746

Registered July 29, 2008

**SERVICE MARK
PRINCIPAL REGISTER**



ELMER'S RESTAURANTS, INC. (OREGON CORPORATION)

P.O. BOX 16938

PORTLAND, OR 972920938

FOR: RESTAURANT SERVICES, IN CLASS 43
(U.S. CLS. 100 AND 101).

FIRST USE 2-6-2008; IN COMMERCE 2-6-2008.

NO CLAIM IS MADE TO THE EXCLUSIVE RIGHT TO USE "NORTHWEST GRILL" , APART FROM THE MARK AS SHOWN.

THE MARK CONSISTS OF THE STYLIZED WORD "TAPROCK" OVER THE WORDS "NORTHWEST GRILL" INSIDE A RECTANGLE.

SN 77-233,757, FILED 7-19-2007.

JUSTINE D. PARKER, EXAMINING ATTORNEY

Int. Cl.: 17

Prior U.S. Cls.: 1, 5, 12, 13, 35, and 50

United States Patent and Trademark Office

Reg. No. 3,477,747

Registered July 29, 2008

**TRADEMARK
PRINCIPAL REGISTER**

M-SHIELD

FI-FOIL COMPANY, INC. (FLORIDA CORPORATION)
P.O. BOX 800
612 BRIDGERS AVENUE WEST
AUBURNDALE, FL 33823

THE MARK CONSISTS OF STANDARD CHARACTERS WITHOUT CLAIM TO ANY PARTICULAR FONT, STYLE, SIZE, OR COLOR.

FOR: INSULATION FOR MASONRY WALLS, IN CLASS 17 (U.S. CLS. 1, 5, 12, 13, 35 AND 50).

SN 77-234,629, FILED 7-20-2007.

FIRST USE 7-24-2007; IN COMMERCE 7-24-2007.

SHAUNIA CARLYLE, EXAMINING ATTORNEY

Int. Cl.: 9

Prior U.S. Cls.: 21, 23, 26, 36, and 38

United States Patent and Trademark Office

Reg. No. 3,477,748

Registered July 29, 2008

**TRADEMARK
PRINCIPAL REGISTER**

HAZMATCH

KAPPLER, INC. (ALABAMA CORPORATION)
P.O. BOX 490
115 GRIMES DRIVE
GUNTERSVILLE, AL 35976

FIRST USE 4-1-2008; IN COMMERCE 4-1-2008.

FOR: COMPUTER SOFTWARE FOR SELECTION
OF CHEMICAL, BIOLOGICAL, AND HAZARDOUS
MATERIAL PROTECTIVE APPAREL AND PERSONAL
PROTECTION EQUIPMENT, IN CLASS 9 (U.S.
CLS. 21, 23, 26, 36 AND 38).

THE MARK CONSISTS OF STANDARD CHAR-
ACTERS WITHOUT CLAIM TO ANY PARTICULAR
FONT, STYLE, SIZE, OR COLOR.

SN 77-234,721, FILED 7-20-2007.

ALEX KEAM, EXAMINING ATTORNEY

Int. Cls.: 35 and 42

Prior U.S. Cls.: 100, 101, and 102

United States Patent and Trademark Office

Reg. No. 3,477,749

Registered July 29, 2008

**SERVICE MARK
PRINCIPAL REGISTER**

MedBeyond

ELECTRONIC MEDICAL RESOURCES LLC (NE-
VADA LTD LIAB CO)

#226

3881 SOUTHWEST FREEWAY
HOUSTON, TX 77027

FOR: MEDICAL BILLING SUPPORT SERVICES,
IN CLASS 35 (U.S. CLS. 100, 101 AND 102).

FIRST USE 8-1-2007; IN COMMERCE 8-1-2007.

FOR: APPLICATION SERVICE PROVIDER (ASP)
FEATURING SOFTWARE FOR PRACTICE MAN-
AGEMENT, ELECTRONIC MEDICAL RECORDS,

AND BILLING AND COLLECTION IN THE
HEALTH CARE INDUSTRY, IN CLASS 42 (U.S.
CLS. 100 AND 101).

FIRST USE 8-1-2007; IN COMMERCE 8-1-2007.

THE MARK CONSISTS OF STANDARD CHAR-
ACTERS WITHOUT CLAIM TO ANY PARTICULAR
FONT, STYLE, SIZE, OR COLOR.

SN 77-235,134, FILED 7-20-2007.

RONALD MCMORROW, EXAMINING ATTORNEY

Int. Cl.: 21

Prior U.S. Cls.: 2, 13, 23, 29, 30, 33, 40, and 50

United States Patent and Trademark Office

Reg. No. 3,477,750

Registered July 29, 2008

**TRADEMARK
PRINCIPAL REGISTER**

FLIRTY CAT

SERGEANT'S PET CARE PRODUCTS, INC. (NE-
VADA CORPORATION)
2625 S 158TH PLAZA
OMAHA, NE 68124

FOR: PET GROOMING PRODUCTS, NAMELY,
COMBS AND BRUSHES, IN CLASS 21 (U.S. CLS. 2,
13, 23, 29, 30, 33, 40 AND 50).

FIRST USE 9-0-2007; IN COMMERCE 9-0-2007.

THE MARK CONSISTS OF STANDARD CHAR-
ACTERS WITHOUT CLAIM TO ANY PARTICULAR
FONT, STYLE, SIZE, OR COLOR.

NO CLAIM IS MADE TO THE EXCLUSIVE
RIGHT TO USE "CAT", APART FROM THE MARK
AS SHOWN.

SN 77-236,391, FILED 7-23-2007.

ADA HAN, EXAMINING ATTORNEY

Int. Cl.: 28

Prior U.S. Cls.: 22, 23, 38, and 50

United States Patent and Trademark Office

Reg. No. 3,477,751

Registered July 29, 2008

**TRADEMARK
PRINCIPAL REGISTER**

FLIRTY CAT

SERGEANT'S PET CARE PRODUCTS, INC. (NE-
VADA CORPORATION)

2625 S 158TH PLAZA

OMAHA, NE 681301770

FOR: PET TOYS, IN CLASS 28 (U.S. CLS. 22, 23, 38
AND 50).

FIRST USE 9-0-2007; IN COMMERCE 9-0-2007.

THE MARK CONSISTS OF STANDARD CHAR-
ACTERS WITHOUT CLAIM TO ANY PARTICULAR
FONT, STYLE, SIZE, OR COLOR.

NO CLAIM IS MADE TO THE EXCLUSIVE
RIGHT TO USE "CAT", APART FROM THE MARK
AS SHOWN.

SN 77-236,408, FILED 7-23-2007.

ADA HAN, EXAMINING ATTORNEY

Int. Cl.: 41

Prior U.S. Cls.: 100, 101, and 107

United States Patent and Trademark Office

Reg. No. 3,477,752

Registered July 29, 2008

**SERVICE MARK
PRINCIPAL REGISTER**

SHADES OF BEAUTY

HIP HOP 4 LIFE, INC. (NEW YORK NON-PROFIT CORPORATION)
511 AVENUE OF THE AMERICAS #179
NEW YORK, NY 10011

FOR: CONDUCTING WORKSHOPS AND SEMINARS IN PERSONAL AWARENESS; CONDUCTING WORKSHOPS AND SEMINARS IN SELF AWARENESS; CONDUCTING WORKSHOPS, SEMINARS AND PANEL DISCUSSIONS IN THE FIELD OF SELF-ESTEEM, EMPOWERMENT AND HEALTH AND WELL BEING OF YOUTH AND DISTRIBUTION OF COURSE MATERIAL IN CONNECTION THEREWITH; ORGANIZING EVENTS, NAMELY,

SPORTS COMPETITIONS AND CELEBRATE AUTOGRAPH SIGNING EVENTS FOR YOUTH, IN CLASS 41 (U.S. CLS. 100, 101 AND 107).

FIRST USE 6-27-2003; IN COMMERCE 6-27-2003.

THE MARK CONSISTS OF STANDARD CHARACTERS WITHOUT CLAIM TO ANY PARTICULAR FONT, STYLE, SIZE, OR COLOR.

SN 77-236,619, FILED 7-23-2007.

JENNY PARK, EXAMINING ATTORNEY

Int. Cl.: 9

Prior U.S. Cls.: 21, 23, 26, 36, and 38

United States Patent and Trademark Office

Reg. No. 3,477,753

Registered July 29, 2008

**TRADEMARK
PRINCIPAL REGISTER**

PharmaTrack

BIOMETRIC ACCESS COMPANY (TEXAS CORPORATION), DBA BIOMETRIC ACCESS CORPORATION,
SUITE 200
2555 NORTH INTERSTATE HIGHWAY 35
ROUND ROCK, TX 78664

FOR: DATABASE MANAGEMENT SOFTWARE FOR PHARMACIES TO TRACK CONTROLLED SUBSTANCE SALES TRANSACTIONS , IN CLASS 9 (U.S. CLS. 21, 23, 26, 36 AND 38).

FIRST USE 8-2-2007; IN COMMERCE 10-25-2007.

THE MARK CONSISTS OF STANDARD CHARACTERS WITHOUT CLAIM TO ANY PARTICULAR FONT, STYLE, SIZE, OR COLOR.

SN 77-237,205, FILED 7-24-2007.

YAT SYE, LEE, EXAMINING ATTORNEY

Int. Cls.: 35 and 41

Prior U.S. Cls.: 100, 101, 102, and 107

United States Patent and Trademark Office

Reg. No. 3,477,754

Registered July 29, 2008

**SERVICE MARK
PRINCIPAL REGISTER**

IMPOSSIBLE STOPS HERE.

INVACARE CORPORATION (OHIO CORPORATION)
ONE INVACARE WAY
ELYRIA, OH 44035

FOR: PROVIDING BUSINESS MANAGEMENT CONSULTATION IN THE FIELD OF HOME HEALTH CARE FOR THIRD PARTY DEALERS, HEALTH CARE INSTITUTIONS AND FACILITIES ABOUT HOME HEALTH CARE PRODUCTS AND SERVICES AND PUBLIC AND PRIVATE HEALTH CARE PROGRAMS, IN CLASS 35 (U.S. CLS. 100, 101 AND 102).

FIRST USE 8-15-2007; IN COMMERCE 9-1-2007.

FOR: PREPARING, COMPILING AND DISSEMINATING EDUCATIONAL MATERIALS AND AR-

RANGING AND CONDUCTING EDUCATIONAL SEMINARS FOR THIRD PARTY DEALERS AND HEALTH CARE INSTITUTIONS AND FACILITIES ABOUT HOME HEALTH CARE PRODUCTS AND SERVICES AND PUBLIC AND PRIVATE HEALTH CARE PROGRAMS, IN CLASS 41 (U.S. CLS. 100, 101 AND 107).

FIRST USE 8-15-2007; IN COMMERCE 9-1-2007.

THE MARK CONSISTS OF STANDARD CHARACTERS WITHOUT CLAIM TO ANY PARTICULAR FONT, STYLE, SIZE, OR COLOR.

SN 77-237,536, FILED 7-24-2007.

WILLIAM VERHOSEK, EXAMINING ATTORNEY

Int. Cl.: 10

Prior U.S. Cls.: 26, 39, and 44

United States Patent and Trademark Office

Reg. No. 3,477,755

Registered July 29, 2008

**TRADEMARK
PRINCIPAL REGISTER**

ZEROWEIGHT

INTERNICOLA, PAOLO (UNITED STATES INDIVIDUAL)
23000 PORTOFINO CIRCLE #111
PALM BEACH GARDENS, FL 33418

THE MARK CONSISTS OF STANDARD CHARACTERS WITHOUT CLAIM TO ANY PARTICULAR FONT, STYLE, SIZE, OR COLOR.

FOR: APPARATUS FOR ACUPRESSURE THERAPY; APPARATUS FOR MAGNET THERAPY, IN CLASS 10 (U.S. CLS. 26, 39 AND 44).

SN 77-237,704, FILED 7-24-2007.

FIRST USE 1-0-2008; IN COMMERCE 1-0-2008.

TIMOTHY FINNEGAN, EXAMINING ATTORNEY

Int. Cl.: 42

Prior U.S. Cls.: 100 and 101

United States Patent and Trademark Office

Reg. No. 3,477,756

Registered July 29, 2008

**SERVICE MARK
PRINCIPAL REGISTER**

WEATHERBUG WEATHERMAIL

AWS CONVERGENCE TECHNOLOGIES, INC.
(DELAWARE CORPORATION)
12410 MILESTONE CENTER DRIVE
GERMANTOWN, MD 20876

FOR: PROVIDING WEATHER FORECASTS AND
OTHER WEATHER RELATED INFORMATION
OVER THE INTERNET, IN CLASS 42 (U.S. CLS. 100
AND 101).

FIRST USE 11-14-2007; IN COMMERCE 11-14-2007.

THE MARK CONSISTS OF STANDARD CHAR-
ACTERS WITHOUT CLAIM TO ANY PARTICULAR
FONT, STYLE, SIZE, OR COLOR.

OWNER OF U.S. REG. NOS. 2,620,037, 3,101,836,
AND OTHERS.

SN 77-238,567, FILED 7-25-2007.

MIDGE BUTLER, EXAMINING ATTORNEY

Int. Cl.: 30

Prior U.S. Cl.: 46

United States Patent and Trademark Office

Reg. No. 3,477,757

Registered July 29, 2008

**TRADEMARK
PRINCIPAL REGISTER**

Barbalo

DAUGINAS, EDWARD (UNITED STATES INDIVIDUAL)
333 WEST TRADE STREET, SUITE 1608
CHARLOTTE, NC 28202

FOR: BARBECUE SAUCE; BARBEQUE SAUCE;
CHICKEN WING SAUCE; SAUCES FOR BARBECUED MEAT;
SEASONED COATING MIXTURES FOR FOODS, IN CLASS 30 (U.S. CL. 46).

FIRST USE 6-1-2008; IN COMMERCE 6-1-2008.

THE MARK CONSISTS OF STANDARD CHARACTERS WITHOUT CLAIM TO ANY PARTICULAR FONT, STYLE, SIZE, OR COLOR.

SN 77-238,943, FILED 7-25-2007.

MICHAEL KEATING, EXAMINING ATTORNEY

Int. Cl.: 21

Prior U.S. Cls.: 2, 13, 23, 29, 30, 33, 40, and 50

Reg. No. 3,477,758

United States Patent and Trademark Office

Registered July 29, 2008

**TRADEMARK
PRINCIPAL REGISTER**

DELIGHT'S COLLECTION

W M DELIGHTS INC. (WISCONSIN CORPORATION)
1896 GOLDEN BELL DR.
GREEN BAY, WI 54313

FOR: BIODEGRADABLE PAPER PULP-BASED PLATES, BOWLS AND CUPS; CARDBOARD CUPS; COFFEE CUPS; DINNERWARE, NAMELY, PLATES, CUPS AND SAUCERS; DRINKING CUPS; SERVING SPOONS, IN CLASS 21 (U.S. CLS. 2, 13, 23, 29, 30, 33, 40 AND 50).

FIRST USE 5-3-2008; IN COMMERCE 5-3-2008.

THE MARK CONSISTS OF STANDARD CHARACTERS WITHOUT CLAIM TO ANY PARTICULAR FONT, STYLE, SIZE, OR COLOR.

NO CLAIM IS MADE TO THE EXCLUSIVE RIGHT TO USE "COLLECTION", APART FROM THE MARK AS SHOWN.

SN 77-239,113, FILED 7-26-2007.

SANI KHOURI, EXAMINING ATTORNEY

Int. Cl.: 28

Prior U.S. Cls.: 22, 23, 38, and 50

United States Patent and Trademark Office

Reg. No. 3,477,759

Registered July 29, 2008

**TRADEMARK
PRINCIPAL REGISTER**

SCORPION BOW

PRIME TIME TOYS LTD. (HONG KONG LTD
LIAB CO)
ROOM 205
KWONGSANGHONG CENTRE, 151-153 HOI BUN
RD
KWUN TONG, HONG KONG

FOR: TOY BOW AND ARROW SETS, IN CLASS 28
(U.S. CLS. 22, 23, 38 AND 50).

FIRST USE 7-31-2007; IN COMMERCE 9-30-2007.

THE MARK CONSISTS OF STANDARD CHAR-
ACTERS WITHOUT CLAIM TO ANY PARTICULAR
FONT, STYLE, SIZE, OR COLOR.

NO CLAIM IS MADE TO THE EXCLUSIVE
RIGHT TO USE "BOW", APART FROM THE MARK
AS SHOWN.

SN 77-239,658, FILED 7-26-2007.

LINDA LAVACHE, EXAMINING ATTORNEY

Int. Cl.: 35

Prior U.S. Cls.: 100, 101, and 102

United States Patent and Trademark Office

Reg. No. 3,477,760

Registered July 29, 2008

**SERVICE MARK
PRINCIPAL REGISTER**



WORLD GOLD COUNCIL (SWITZERLAND ASSOCIATION)
C/O PRICEWATERHOUSECOOPERS DEPT. FISCAL
AVE GIUSEPPE-MOTTA 50, CASE POSTALE 2895
GENEVA 2, SWITZERLAND CH-1211

FOR: ADVERTISING AND PROMOTING THE USE OF GOLD, IN CLASS 35 (U.S. CLS. 100, 101 AND 102).

FIRST USE 5-0-2007; IN COMMERCE 5-0-2007.

OWNER OF U.S. REG. NO. 2,639,750.

NO CLAIM IS MADE TO THE EXCLUSIVE RIGHT TO USE "GOLD", APART FROM THE MARK AS SHOWN.

THE COLOR(S) GOLD IS/ARE CLAIMED AS A FEATURE OF THE MARK.

THE MARK CONSISTS OF A REPRESENTATION OF A GOLD BAR UPON THE FACE OF WHICH ARE THE WORDS "ONLY GOLD IS MAJESTIC", TOWARD THE TOP, AND THE WORD "GOLD" AND A CONCENTRIC CIRCLE DESIGN, TOWARD THE BOTTOM, ALL IN THE COLOR GOLD.

SN 77-240,068, FILED 7-26-2007.

LOURDES AYALA, EXAMINING ATTORNEY

Int. Cl.: 35

Prior U.S. Cls.: 100, 101, and 102

United States Patent and Trademark Office

Reg. No. 3,477,761

Registered July 29, 2008

**SERVICE MARK
PRINCIPAL REGISTER**

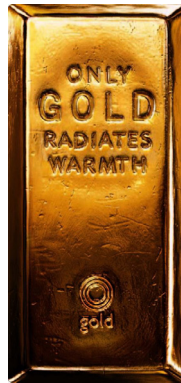

WORLD GOLD COUNCIL (SWITZERLAND ASSOCIATION)
C/O PRICEWATERHOUSECOOPERS DEPT. FISCAL
AVE GIUSEPPE-MOTTA 50, CASE POSTALE 2895
GENEVA 2, SWITZERLAND CH-1211

FOR: ADVERTISING AND PROMOTING THE
USE OF GOLD, IN CLASS 35 (U.S. CLS. 100, 101
AND 102).

FIRST USE 11-0-2007; IN COMMERCE 11-0-2007.

OWNER OF U.S. REG. NO. 2,639,750.

NO CLAIM IS MADE TO THE EXCLUSIVE
RIGHT TO USE "GOLD", APART FROM THE
MARK AS SHOWN.

THE COLOR(S) GOLD IS/ARE CLAIMED AS A
FEATURE OF THE MARK.

THE MARK CONSISTS OF A REPRESENTATION
OF A GOLD BAR UPON THE FACE OF WHICH ARE
THE WORDS "ONLY GOLD RADIATES WARMTH",
TOWARD THE TOP, AND THE WORD "GOLD"
AND A CONCENTRIC CIRCLE DESIGN, TOWARD
THE BOTTOM, ALL IN THE COLOR GOLD.

SN 77-240,072, FILED 7-26-2007.

LOURDES AYALA, EXAMINING ATTORNEY

Int. Cl.: 35

Prior U.S. Cls.: 100, 101, and 102

United States Patent and Trademark Office

Reg. No. 3,477,762

Registered July 29, 2008

**SERVICE MARK
PRINCIPAL REGISTER**



WORLD GOLD COUNCIL (SWITZERLAND ASSOCIATION)
C/O PRICEWATERHOUSECOOPERS DEPT. FISCAL
AVE GIUSEPPE-MOTTA 50, CASE POSTALE 2895
GENEVA 2, SWITZERLAND CH-1211

FOR: ADVERTISING AND PROMOTING THE USE OF GOLD, IN CLASS 35 (U.S. CLS. 100, 101 AND 102).

FIRST USE 12-0-2007; IN COMMERCE 12-0-2007.

OWNER OF U.S. REG. NO. 2,639,750.

NO CLAIM IS MADE TO THE EXCLUSIVE RIGHT TO USE "GOLD", APART FROM THE MARK AS SHOWN.

THE COLOR(S) GOLD IS/ARE CLAIMED AS A FEATURE OF THE MARK.

THE MARK CONSISTS OF A REPRESENTATION OF A GOLD BAR UPON THE FACE OF WHICH ARE THE WORDS "ONLY GOLD INSPIRES LEGENDS", TOWARD THE TOP, AND THE WORD "GOLD" AND A CONCENTRIC CIRCLE DESIGN, TOWARD THE BOTTOM, ALL IN THE COLOR GOLD.

SN 77-240,073, FILED 7-26-2007.

LOURDES AYALA, EXAMINING ATTORNEY

Int. Cl.: 35

Prior U.S. Cls.: 100, 101, and 102

United States Patent and Trademark Office

Reg. No. 3,477,763

Registered July 29, 2008

**SERVICE MARK
PRINCIPAL REGISTER**



WORLD GOLD COUNCIL (SWITZERLAND ASSOCIATION)
C/O PRICEWATERHOUSECOOPERS DEPT. FISCAL
AVE GIUSEPPE-MOTTA 50, CASE POSTALE 2895
GENEVA 2, SWITZERLAND CH-1211

FOR: ADVERTISING AND PROMOTING THE USE OF GOLD, IN CLASS 35 (U.S. CLS. 100, 101 AND 102).

FIRST USE 12-0-2007; IN COMMERCE 12-0-2007.

OWNER OF U.S. REG. NO. 2,639,750.

NO CLAIM IS MADE TO THE EXCLUSIVE RIGHT TO USE "GOLD", APART FROM THE MARK AS SHOWN.

THE COLOR(S) GOLD IS/ARE CLAIMED AS A FEATURE OF THE MARK.

THE MARK CONSISTS OF A REPRESENTATION OF A GOLD BAR UPON THE FACE OF WHICH ARE THE WORDS "ONLY GOLD IS RADIANT", TOWARD THE TOP, AND THE WORD "GOLD" AND A CONCENTRIC CIRCLE DESIGN, TOWARD THE BOTTOM, ALL IN THE COLOR GOLD.

SN 77-240,080, FILED 7-26-2007.

LOURDES AYALA, EXAMINING ATTORNEY

Int. Cl.: 11

Prior U.S. Cls.: 13, 21, 23, 31, and 34

United States Patent and Trademark Office

Reg. No. 3,477,764

Registered July 29, 2008

**TRADEMARK
PRINCIPAL REGISTER**

**Pioneering Enviromentally
Safe Washouts**

WASTE CRETE SYSTEMS, LLC (TEXAS LTD
LIAB CO)

SUITE B

7015 SAN ANTONIO

HOUSTON, TX 77040

FOR: EQUIPMENT USED TO RECYCLE THE
WATER USED TO WASH CONCRETE EQUIPMENT,
IN CLASS 11 (U.S. CLS. 13, 21, 23, 31 AND 34).

FIRST USE 10-1-2007; IN COMMERCE 12-1-2007.

THE MARK CONSISTS OF STANDARD CHAR-
ACTERS WITHOUT CLAIM TO ANY PARTICULAR
FONT, STYLE, SIZE, OR COLOR.

NO CLAIM IS MADE TO THE EXCLUSIVE
RIGHT TO USE "ENVIRONMENTALLY SAFE
WASHOUTS", APART FROM THE MARK AS
SHOWN.

SN 77-240,548, FILED 7-27-2007.

VIVIAN MICZNIK FIRST, EXAMINING ATTOR-
NEY

Int. Cl.: 9

Prior U.S. Cls.: 21, 23, 26, 36, and 38

Reg. No. 3,477,765

United States Patent and Trademark Office

Registered July 29, 2008

**TRADEMARK
PRINCIPAL REGISTER**

E-FLEX

BELDEN EUROPE B.V. & BELDEN WIRE &
CABLE B.V. FINANCE GBR (FED REP GER-
MANY PARTNERSHIP)
EDISONSTRAAT 9
VENLO, NETHERLANDS 5928PG

THE MARK CONSISTS OF STANDARD CHAR-
ACTERS WITHOUT CLAIM TO ANY PARTICULAR
FONT, STYLE, SIZE, OR COLOR.

FOR: ELECTRICAL AND ELECTRONIC WIRES
AND CABLES AND CORD SETS, IN CLASS 9 (U.S.
CLS. 21, 23, 26, 36 AND 38).

SN 77-241,070, FILED 7-27-2007.

FIRST USE 7-17-2007; IN COMMERCE 7-17-2007.

JOHN HWANG, EXAMINING ATTORNEY

Int. Cl.: 9

Prior U.S. Cls.: 21, 23, 26, 36, and 38

United States Patent and Trademark Office

Reg. No. 3,477,766

Registered July 29, 2008

**TRADEMARK
PRINCIPAL REGISTER**

NETFLEX-10M

BELDEN EUROPE B.V. & BELDEN WIRE &
CABLE B.V. FINANCE GBR (FED REP GER-
MANY PARTNERSHIP)
EDISONSTRAAT 9
VENLO, NETHERLANDS 5928PG

THE MARK CONSISTS OF STANDARD CHAR-
ACTERS WITHOUT CLAIM TO ANY PARTICULAR
FONT, STYLE, SIZE, OR COLOR.

FOR: ELECTRICAL AND ELECTRONIC WIRES
AND CABLES AND CORD SETS, IN CLASS 9 (U.S.
CLS. 21, 23, 26, 36 AND 38).

SN 77-241,077, FILED 7-27-2007.

FIRST USE 11-0-2006; IN COMMERCE 11-0-2006.

JOHN HWANG, EXAMINING ATTORNEY

Int. Cl.: 4

Prior U.S. Cls.: 1, 6, and 15

United States Patent and Trademark Office

Reg. No. 3,477,767

Registered July 29, 2008

**TRADEMARK
PRINCIPAL REGISTER**

DestiScents

GAINES GROUP LLC (TEXAS LTD LIAB CO)
SUITE A-100
2901 W. SAM HOUSTON PKWY
HOUSTON, TX 77043

THE MARK CONSISTS OF STANDARD CHAR-
ACTERS WITHOUT CLAIM TO ANY PARTICULAR
FONT, STYLE, SIZE, OR COLOR.

FOR: CANDLES; CANDLES FOR LIGHTING;
PERFUMED CANDLES; SCENTED CANDLES, IN
CLASS 4 (U.S. CLS. 1, 6 AND 15).

SN 77-243,102, FILED 7-31-2007.

FIRST USE 12-2-2007; IN COMMERCE 12-7-2007.

KYLE PEETE, EXAMINING ATTORNEY

Int. Cl.: 4

Prior U.S. Cls.: 1, 6, and 15

United States Patent and Trademark Office

Reg. No. 3,477,768

Registered July 29, 2008

**TRADEMARK
PRINCIPAL REGISTER**

Scentlicious 6

GAINES GROUP LLC (TEXAS LTD LIAB CO)
SUITE A-100
2901 W. SAM HOUSTON PKWY
HOUSTON, TX 77043

THE MARK CONSISTS OF STANDARD CHAR-
ACTERS WITHOUT CLAIM TO ANY PARTICULAR
FONT, STYLE, SIZE, OR COLOR.

FOR: CANDLES; CANDLES FOR LIGHTING;
PERFUMED CANDLES; SCENTED CANDLES, IN
CLASS 4 (U.S. CLS. 1, 6 AND 15).

SN 77-243,356, FILED 7-31-2007.

FIRST USE 8-22-2007; IN COMMERCE 8-22-2007.

KYLE PEETE, EXAMINING ATTORNEY

Int. Cl.: 9

Prior U.S. Cls.: 21, 23, 26, 36, and 38

United States Patent and Trademark Office

Reg. No. 3,477,769

Registered July 29, 2008

**TRADEMARK
PRINCIPAL REGISTER**



HM ELECTRONICS, INC. (CALIFORNIA CORPORATION)
ATTN: S. HOEPTNER
14110 STOWE DRIVE
POWAY, CA 92064

FOR: RADIO PAGERS; RADIO TRANSMITTERS; COMPUTER SOFTWARE FOR COMMUNICATING WITH, OR PAGING, WIRELESS DEVICES, IN CLASS 9 (U.S. CLS. 21, 23, 26, 36 AND 38).

FIRST USE 6-1-2007; IN COMMERCE 8-1-2007.

OWNER OF U.S. REG. NOS. 1,499,393 AND 2,960,213.

NO CLAIM IS MADE TO THE EXCLUSIVE RIGHT TO USE "WIRELESS", APART FROM THE MARK AS SHOWN.

THE MARK CONSISTS OF THE LETTERS "H", "M" AND "E" IN A RECTANGULAR BOX AND THE WORD "WIRELESS" BOTH LEFT AND RIGHT JUSTIFIED UNDER THE RECTANGULAR BOX.

SN 77-243,516, FILED 7-31-2007.

ANDREW RHIM, EXAMINING ATTORNEY

Int. Cl.: 25

Prior U.S. Cls.: 22 and 39

United States Patent and Trademark Office

Reg. No. 3,477,770

Registered July 29, 2008

**TRADEMARK
PRINCIPAL REGISTER**

Harry Vardon

SEJUNG USA HARRY VARDON GOLF, COR-
PORATION (MINNESOTA CORPORATION)
1220 E. 7TH STREET
WINONA, MN 55987

FOR: CAPS, HATS, CLOTHING OF LEATHER,
NAMELY, LEATHER JACKETS, JACKETS, JUM-
PERS, KNITWEAR IN THE NATURE OF SWEA-
TERS, LONG AND SHORT SLEEVED GOLF SHIRTS
AND VESTS, NECKTIES, LONG AND SHORT
PANTS, PARKAS, SPORTS JERSEYS, SWEATERS,
TEE-SHIRTS, UNDERCLOTHING, NAMELY, UN-
DERGARMENTS, AND VESTS, IN CLASS 25 (U.S.
CLS. 22 AND 39).

FIRST USE 2-28-2006; IN COMMERCE 2-28-2006.

THE MARK CONSISTS OF STANDARD CHAR-
ACTERS WITHOUT CLAIM TO ANY PARTICULAR
FONT, STYLE, SIZE, OR COLOR.

THE NAME "HARRY VARDON" DOES NOT
IDENTIFY A LIVING INDIVIDUAL.

SN 77-244,342, FILED 8-1-2007.

MARILYN IZZI, EXAMINING ATTORNEY

Int. Cl.: 28

Prior U.S. Cls.: 22, 23, 38, and 50

United States Patent and Trademark Office

Reg. No. 3,477,771

Registered July 29, 2008

**TRADEMARK
PRINCIPAL REGISTER**

GEEZER

WILSON SPORTING GOODS CO. (DELAWARE
CORPORATION)
8750 W. BRYN MAWR AVE.
CHICAGO, IL 60631

THE MARK CONSISTS OF STANDARD CHAR-
ACTERS WITHOUT CLAIM TO ANY PARTICULAR
FONT, STYLE, SIZE, OR COLOR.

FOR: BASEBALL AND SOFTBALL BATS, IN
CLASS 28 (U.S. CLS. 22, 23, 38 AND 50).

SN 77-245,144, FILED 8-2-2007.

FIRST USE 9-1-2007; IN COMMERCE 9-1-2007.

MICHAEL ENGEL, EXAMINING ATTORNEY

Int. Cl.: 36

Prior U.S. Cls.: 100, 101, and 102

United States Patent and Trademark Office

Reg. No. 3,477,772

Registered July 29, 2008

**SERVICE MARK
PRINCIPAL REGISTER**

CMAP

LEHMAN BROTHERS INC. (DELAWARE COR-
PORATION)
745 SEVENTH AVENUE
NEW YORK, NY 10019

THE MARK CONSISTS OF STANDARD CHAR-
ACTERS WITHOUT CLAIM TO ANY PARTICULAR
FONT, STYLE, SIZE, OR COLOR.

FOR: INVESTMENT SERVICES, NAMELY, GEN-
ERATING STRUCTURED INVESTMENT PRO-
DUCTS FOR OTHERS, NAMELY, INVESTORS, IN
CLASS 36 (U.S. CLS. 100, 101 AND 102).

SN 77-245,260, FILED 8-2-2007.

FIRST USE 3-18-2008; IN COMMERCE 3-18-2008.

MARGARET POWER, EXAMINING ATTORNEY

Int. Cl.: 5

Prior U.S. Cls.: 6, 18, 44, 46, 51, and 52

United States Patent and Trademark Office

Reg. No. 3,477,773

Registered July 29, 2008

**TRADEMARK
PRINCIPAL REGISTER**

I-PAK

DENCOR RESEARCH, LLC (CALIFORNIA LTD
LIAB CO)
5901 PRIESTLY DRIVE, SUITE 130
CARLSBAD, CA 92008

FOR: VITAMINS, VITAMIN SUPPLEMENTS,
DIETARY SUPPLEMENTS AND NUTRITIONAL
SUPPLEMENTS; DIETARY SUPPLEMENTAL
DRINKS, IN CLASS 5 (U.S. CLS. 6, 18, 44, 46, 51
AND 52).

FIRST USE 3-11-2008; IN COMMERCE 3-11-2008.

THE MARK CONSISTS OF STANDARD CHAR-
ACTERS WITHOUT CLAIM TO ANY PARTICULAR
FONT, STYLE, SIZE, OR COLOR.

SN 77-246,950, FILED 8-3-2007.

ROBERT C. CLARK JR., EXAMINING ATTORNEY

Int. Cl.: 5

Prior U.S. Cls.: 6, 18, 44, 46, 51, and 52

Reg. No. 3,477,774

United States Patent and Trademark Office

Registered July 29, 2008

**TRADEMARK
PRINCIPAL REGISTER**

Resvatol

IC-MEDTECH (CALIFORNIA CORPORATION)
9902 INDIAN CREEK LANE
EL CAJON, CA 92021

FOR: CARDIOVASCULAR PHARMACEUTICALS; DERMATOLOGICAL PHARMACEUTICAL PRODUCTS; DRUG DELIVERY AGENTS CONSISTING OF COMPOUNDS THAT FACILITATE DELIVERY OF A WIDE RANGE OF PHARMACEUTICALS; PHARMACEUTICAL ANTI-ALLERGIC PREPARATIONS AND SUBSTANCES; PHARMACEUTICAL ANTITUSSIVE-COLD PREPARATIONS; PHARMACEUTICAL PREPARATIONS ACTING ON THE CENTRAL NERVOUS SYSTEM; PHARMACEUTICAL PREPARATIONS AND SUBSTANCES FOR THE TREATMENT OF GASTRO-INTESTINAL DISEASES; PHARMACEUTICAL PREPARATIONS FOR ANIMAL SKINCARE; PHARMACEUTICAL PREPARATIONS FOR INHALATION FOR THE TREATMENT OF PULMONARY HYPERTENSION; PHARMACEUTICAL PREPARATIONS FOR THE PREVENTION AND TREATMENT OF DISORDERS OF THE NERVOUS SYSTEM, THE IMMUNE SYSTEM, THE CARDIO-VASCULAR SYSTEM, THE METABOLIC SYSTEM, THE RESPIRATORY SYSTEM, THE MUSCULAR-SKELETAL SYSTEM, THE GENITOURINARY SYSTEM; FOR THE TREATMENT OF INFLAMMATORY DISORDERS; FOR USE IN DERMATOLOGY, ONCOLOGY, HEMATOLOGY AND IN TISSUE AND ORGAN TRANSPLANTATION, IN OPHTHALMOLOGY AND FOR GASTROENTEROLOGICAL DISORDERS; PHARMACEUTICAL PREPARATIONS FOR THE TREATMENT OF EYE DISEASES AND CONDITIONS;

PHARMACEUTICAL PREPARATIONS FOR THE TREATMENT OF HEART RHYTHM DISORDERS; PHARMACEUTICAL PREPARATIONS FOR THE TREATMENT OF HORMONAL DISORDERS AND THE PREVENTION OF OSTEOPOROSIS; PHARMACEUTICAL PREPARATIONS FOR THE TREATMENT OF INFECTIOUS DISEASES; PHARMACEUTICAL PREPARATIONS FOR TREATING DIABETES; PHARMACEUTICAL PREPARATIONS FOR TREATING SKIN DISORDERS; PHARMACEUTICAL PREPARATIONS FOR USE IN CHEMOTHERAPY; PHARMACEUTICAL PREPARATIONS FOR USE IN DERMATOLOGY; PHARMACEUTICAL PREPARATIONS FOR USE IN UROLOGY; PHARMACEUTICAL PREPARATIONS FOR WOUNDS; PHARMACEUTICAL PRODUCTS FOR THE TREATMENT OF VIRAL AND INFECTIOUS DISEASES, FOR THE TREATMENT OF CANCER; PHARMACEUTICAL SKIN LOTIONS; PHARMACEUTICALS, NAMELY, ANTI-INFECTIVES; PHARMACEUTICALS, NAMELY, LIPID LOWERING AGENTS, IN CLASS 5 (U.S. CLS. 6, 18, 44, 46, 51 AND 52).

FIRST USE 8-3-2007; IN COMMERCE 2-28-2008.

THE MARK CONSISTS OF STANDARD CHARACTERS WITHOUT CLAIM TO ANY PARTICULAR FONT, STYLE, SIZE, OR COLOR.

SN 77-247,040, FILED 8-3-2007.

IRA J. GOODSaid, EXAMINING ATTORNEY

Int. Cl.: 39

Prior U.S. Cls.: 100 and 105

United States Patent and Trademark Office

Reg. No. 3,477,775

Registered July 29, 2008

**SERVICE MARK
PRINCIPAL REGISTER**

EZSTASH

LADOM, L.L.C. (NEBRASKA LTD LIAB CO)
3902 SUGARBERRY ROAD
NORTH PLATTE, NE 69101

THE MARK CONSISTS OF STANDARD CHAR-
ACTERS WITHOUT CLAIM TO ANY PARTICULAR
FONT, STYLE, SIZE, OR COLOR.

FOR: ELECTRONIC STORAGE OF PERSONAL
DOCUMENTS, IN CLASS 39 (U.S. CLS. 100 AND 105).

SN 77-247,081, FILED 8-3-2007.

FIRST USE 1-28-2008; IN COMMERCE 4-6-2008.

AHSEN KHAN, EXAMINING ATTORNEY

Int. Cl.: 10

Prior U.S. Cls.: 26, 39, and 44

United States Patent and Trademark Office

Reg. No. 3,477,776

Registered July 29, 2008

**TRADEMARK
PRINCIPAL REGISTER**

RIPMATE

EPM DEVELOPMENT SYSTEMS CORP. (VIRGINIA CORPORATION)
SUITE 301
1 PARK WEST CIRCLE
RICHMOND, VA 23114

THE MARK CONSISTS OF STANDARD CHARACTERS WITHOUT CLAIM TO ANY PARTICULAR FONT, STYLE, SIZE, OR COLOR.

FOR: MEDICAL DEVICE TO MONITOR BREATHING, IN CLASS 10 (U.S. CLS. 26, 39 AND 44).

SN 77-247,632, FILED 8-6-2007.

FIRST USE 1-31-2008; IN COMMERCE 1-31-2008.

LESLIE RICHARDS, EXAMINING ATTORNEY

Int. Cl.: 36

Prior U.S. Cls.: 100, 101, and 102

United States Patent and Trademark Office

Reg. No. 3,477,777

Registered July 29, 2008

**SERVICE MARK
PRINCIPAL REGISTER**

≡ BLUE HARBOUR GROUP

BLUE HARBOUR GROUP, L.P. (DELAWARE
LIMITED PARTNERSHIP)
646 STEAMBOAT ROAD
GREENWICH, CT 06830

FOR: FUND INVESTMENT SERVICES; INVEST-
MENT RELATED SERVICES, NAMELY, ASSET
ACQUISITION, ASSET DIVESTITURE, CONSULTA-
TION, DEVELOPMENT, AND MANAGEMENT SER-
VICES; INVESTMENT ADVISORY SERVICES;
MANAGEMENT OF INVESTMENT FUNDS OF
OTHERS; AND EQUITY CAPITAL INVESTMENTS,
IN CLASS 36 (U.S. CLS. 100, 101 AND 102).

FIRST USE 9-15-2007; IN COMMERCE 9-15-2007.

OWNER OF U.S. REG. NOS. 2,573,155 AND
3,107,379.

NO CLAIM IS MADE TO THE EXCLUSIVE
RIGHT TO USE "GROUP", APART FROM THE
MARK AS SHOWN.

SN 77-249,764, FILED 8-8-2007.

BONNIE LUKEN, EXAMINING ATTORNEY

Int. Cl.: 35

Prior U.S. Cls.: 100, 101, and 102

United States Patent and Trademark Office

Reg. No. 3,477,778

Registered July 29, 2008

SERVICE MARK
PRINCIPAL REGISTER



INSTITUTE FOR CORPORATE PRODUCTIVITY,
INC. (WASHINGTON CORPORATION)
SUITE 403
411 FIRST AVENUE SOUTH
SEATTLE, WA 98104

FOR: BUSINESS LEADERSHIP DEVELOPMENT;
BUSINESS RESEARCH AND CONSULTATION IN
THE FIELDS OF COMPLIANCE, HUMAN RESOUR-
CES, EXECUTIVE DEVELOPMENT, AND TALENT
MANAGEMENT AND COMPENSATION, IN CLASS
35 (U.S. CLS. 100, 101 AND 102).

FIRST USE 5-1-2007; IN COMMERCE 5-1-2007.

THE MARK CONSISTS OF RECTANGULAR,
ROUGH-EDGED BLACK BACKGROUND WITHIN
WHICH APPEAR IN WHITE A STYLIZED LOWER-
CASE LETTER "I" FOLLOWED BY A STYLIZED
NUMERAL "4" FOLLOWED BY THE STYLIZED
LETTERS "C" AND "P"; A BLACK DOT OVER THE
STYLIZED "I" APPEARS OUTSIDE THE BLACK
RECTANGLE.

SN 77-250,304, FILED 8-8-2007.

ANDREA HACK, EXAMINING ATTORNEY

Int. Cl.: 38

Prior U.S. Cls.: 100, 101, and 104

United States Patent and Trademark Office

Reg. No. 3,477,779

Registered July 29, 2008

SERVICE MARK
PRINCIPAL REGISTER



INSTITUTE FOR CORPORATE PRODUCTIVITY,
INC. (WASHINGTON CORPORATION)
SUITE 403
411 FIRST AVENUE SOUTH
SEATTLE, WA 98104

FOR: PROVIDING ON-LINE CHAT ROOMS AND
ELECTRONIC BULLETIN BOARDS FOR TRANS-
MISSION OF MESSAGES AMONG USERS IN THE
FIELD OF EXECUTIVE TRAINING, EDUCATION
AND MANAGEMENT; PROVIDING EMAIL AND
INSTANT MESSAGING SERVICES, IN CLASS 38
(U.S. CLS. 100, 101 AND 104).

THE MARK CONSISTS OF RECTANGULAR,
ROUGH-EDGED BLACK BACKGROUND WITHIN
WHICH APPEAR IN WHITE A STYLIZED LOWER-
CASE LETTER "I" FOLLOWED BY A STYLIZED
NUMERAL "4" FOLLOWED BY THE STYLIZED
LETTERS "C" AND "P"; A BLACK DOT OVER THE
STYLIZED "I" APPEARS OUTSIDE THE BLACK
RECTANGLE.

SN 77-250,314, FILED 8-8-2007.

FIRST USE 5-1-2007; IN COMMERCE 5-1-2007.

ANDREA HACK, EXAMINING ATTORNEY

Int. Cl.: 9

Prior U.S. Cls.: 21, 23, 26, 36, and 38

Reg. No. 3,477,780

United States Patent and Trademark Office

Registered July 29, 2008

**TRADEMARK
PRINCIPAL REGISTER**

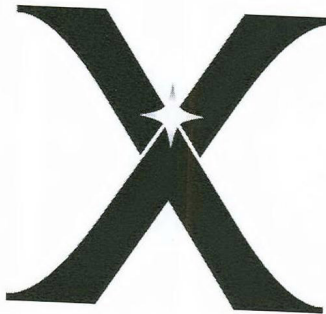

XENITH, LLC (DELAWARE LTD LIAB CO)
29 COMMONWEALTH AVENUE
BOSTON, MA 02116

FOR: PROTECTIVE HEADGEAR FOR USE IN
SPORTS AND HAZARDOUS ACTIVITIES, IN CLASS
9 (U.S. CLS. 21, 23, 26, 36 AND 38).

FIRST USE 1-0-2008; IN COMMERCE 1-0-2008.

THE STIPPLING IS FOR SHADING PURPOSES
ONLY.

THE MARK CONSISTS OF A STYLIZED REN-
DERING OF THE LETTER "X" WITH A FOUR-
SIDED STAR SYMBOL AT THE UPPER PART OF
THE INTERSECTION OF THE CROSSING SEG-
MENTS OF THE "X."

SN 77-250,334, FILED 8-8-2007.

INGA ERVIN, EXAMINING ATTORNEY

Int. Cl.: 28

Prior U.S. Cls.: 22, 23, 38, and 50

Reg. No. 3,477,781

United States Patent and Trademark Office

Registered July 29, 2008

**TRADEMARK
PRINCIPAL REGISTER**

DISTRACT-A-MATCH

INNOCORP. LTD. (WISCONSIN CORPORATION)
500 SOUTH NINE MOUND ROAD
VERONA, WI 53593

THE MARK CONSISTS OF STANDARD CHAR-
ACTERS WITHOUT CLAIM TO ANY PARTICULAR
FONT, STYLE, SIZE, OR COLOR.

FOR: BOARD GAMES, IN CLASS 28 (U.S. CLS. 22,
23, 38 AND 50).

SN 77-250,352, FILED 8-8-2007.

FIRST USE 3-0-2007; IN COMMERCE 3-0-2007.

B. PARADEWELAI, EXAMINING ATTORNEY

Int. Cl.: 29

Prior U.S. Cl.: 46

United States Patent and Trademark Office

Reg. No. 3,477,782

Registered July 29, 2008

**TRADEMARK
PRINCIPAL REGISTER**

SIMPLY AVO

AVOMEX, INC. (TEXAS CORPORATION)
3000 GALVEZ AVENUE
FORT WORTH, TX 76111

THE MARK CONSISTS OF STANDARD CHAR-
ACTERS WITHOUT CLAIM TO ANY PARTICULAR
FONT, STYLE, SIZE, OR COLOR.

FOR: GUACAMOLE, IN CLASS 29 (U.S. CL. 46).

SN 77-250,494, FILED 8-8-2007.

FIRST USE 9-3-2007; IN COMMERCE 9-3-2007.

JAMES MACFARLANE, EXAMINING ATTORNEY

Int. Cl.: 29

Prior U.S. Cl.: 46

United States Patent and Trademark Office

Reg. No. 3,477,783

Registered July 29, 2008

**TRADEMARK
PRINCIPAL REGISTER**

FUNCHIES

RAYNALDO GARZA (UNITED STATES INDIVIDUAL)
14 MONARCH BAY PLAZA, SUITE 475
MONARCH BEACH, CA 92629

FOR: CANDIED FRUIT SNACKS, DAIRY-BASED SNACK FOODS EXCLUDING ICE CREAM, ICE MILK AND FROZEN YOGURT, DEHYDRATED FRUIT SNACKS, FRUIT AND SOY BASED SNACK FOOD, FRUIT-BASED SNACK FOOD, MEAT-BASED SNACK FOODS, ORGANIC NUT AND SEED-BASED SNACK BARS, POTATO-BASED SNACK FOODS, PROTEIN BASED, NUTRIENT-DENSE SNACK BARS, SNACK DIPS, SNACK FOOD DIPS, SNACK MIX CONSISTING PRIMARILY OF PROCESSED FRUITS, PROCESSED NUTS AND/OR

RAISINS, SOY-BASED SNACK FOODS, VEGETABLE-BASED SNACK FOODS, IN CLASS 29 (U.S. CL. 46).

FIRST USE 5-11-2005; IN COMMERCE 2-18-2008.

THE MARK CONSISTS OF STANDARD CHARACTERS WITHOUT CLAIM TO ANY PARTICULAR FONT, STYLE, SIZE, OR COLOR.

SN 77-251,886, FILED 8-9-2007.

ALEXANDER L. POWERS, EXAMINING ATTORNEY

Int. Cl.: 9

Prior U.S. Cls.: 21, 23, 26, 36, and 38

Reg. No. 3,477,784

United States Patent and Trademark Office

Registered July 29, 2008

**TRADEMARK
PRINCIPAL REGISTER**



The image shows the word "XENITH" in a bold, serif font. The letter "X" is stylized with a four-pointed star or cross symbol at its top intersection. The entire wordmark is enclosed in a light, stippled rectangular border.

XENITH, LLC (DELAWARE LTD LIAB CO)
29 COMMONWEALTH AVENUE
BOSTON, MA 02116

FOR: PROTECTIVE HEADGEAR FOR USE IN
SPORTS AND HAZARDOUS ACTIVITIES, IN CLASS
9 (U.S. CLS. 21, 23, 26, 36 AND 38).

FIRST USE 1-0-2008; IN COMMERCE 1-0-2008.

THE STIPPLING IS FOR SHADING PURPOSES
ONLY.

THE MARK CONSISTS OF A STYLIZED REN-
DERING OF THE WORD "XENITH" WITH A FOUR-
SIDED SYMBOL AT THE UPPER PART OF THE
INTERSECTION OF THE CROSSING SEGMENTS
OF THE "X".

SN 77-252,090, FILED 8-10-2007.

INGA ERVIN, EXAMINING ATTORNEY

Int. Cl.: 44

Prior U.S. Cls.: 100 and 101

United States Patent and Trademark Office

Reg. No. 3,477,785

Registered July 29, 2008

**SERVICE MARK
PRINCIPAL REGISTER**

OCEAN PEARL SPA

GRAND PACIFIC CARLSBAD HOTEL, L.P. (DE-
LAWARE LIMITED PARTNERSHIP)
5900 PASTEUR COURT, SUITE 200
CARLSBAD, CA 92008

FOR: HEALTH SPA SERVICES FOR HEALTH
AND WELLNESS OF THE BODY AND SPIRIT
OFFERED AT A RESORT, IN CLASS 44 (U.S. CLS.
100 AND 101).

FIRST USE 12-31-2007; IN COMMERCE 12-31-2007.

THE MARK CONSISTS OF STANDARD CHAR-
ACTERS WITHOUT CLAIM TO ANY PARTICULAR
FONT, STYLE, SIZE, OR COLOR.

NO CLAIM IS MADE TO THE EXCLUSIVE
RIGHT TO USE "SPA", APART FROM THE MARK
AS SHOWN.

SN 77-253,514, FILED 8-13-2007.

JUSTINE D. PARKER, EXAMINING ATTORNEY

Int. Cl.: 43

Prior U.S. Cls.: 100 and 101

United States Patent and Trademark Office

Reg. No. 3,477,786

Registered July 29, 2008

**SERVICE MARK
PRINCIPAL REGISTER**



**BROOKSHIRE GROCERY COMPANY (TEXAS
CORPORATION)**

1600 W.S.W. LOOP 323

TYLER, TX 75701

**FOR: COFFEE-HOUSE AND SNACK-BAR SERVI-
CES, IN CLASS 43 (U.S. CLS. 100 AND 101).**

FIRST USE 8-0-2007; IN COMMERCE 8-0-2007.

**NO CLAIM IS MADE TO THE EXCLUSIVE
RIGHT TO USE "JAVA", APART FROM THE MARK
AS SHOWN.**

**THE MARK CONSISTS OF A COFFEE RING
STAIN WITH THE STYLIZED WORDS "JAVA
JAMS".**

SN 77-254,592, FILED 8-14-2007.

CHRIS WELLS, EXAMINING ATTORNEY

Int. Cl.: 35

Prior U.S. Cls.: 100, 101, and 102

United States Patent and Trademark Office

Reg. No. 3,477,787

Registered July 29, 2008

SERVICE MARK
PRINCIPAL REGISTER

BIZMAX

BRINKLEY, LINSTER E. (UNITED STATES INDIVIDUAL)
SUITE 310
146 SECOND STREET N.
ST. PETERSBURG, FL 33701

FOR: ADVICE RELATING TO THE ORGANISATION AND MANAGEMENT OF BUSINESS; ADVISORY SERVICE FOR ORGANIZATIONAL ISSUES AND BUSINESS ADMINISTRATION, WITH AND WITHOUT THE HELP OF ELECTRONIC DATA BASES; ADVISORY SERVICES RELATING TO BUSINESS MANAGEMENT AND BUSINESS OPERATIONS; ASSISTANCE IN BUSINESS MANAGEMENT AND PRODUCT COMMERCIALIZATION, WITHIN THE FRAMEWORK OF A FRANCHISE CONTRACT; ASSISTANCE IN FRANCHISED COMMERCIAL BUSINESS MANAGEMENT; ASSISTANCE IN MANAGEMENT OF BUSINESS ACTIVITIES; ASSISTANCE TO INDUSTRIAL OR COMMERCIAL ENTERPRISES IN THE RUNNING OF THEIR BUSINESS; ASSISTANCE WITH BUSINESS MANAGEMENT AND PLANNING; ASSISTANCE, ADVISORY SERVICES AND CONSULTANCY WITH REGARD TO BUSINESS PLANNING, BUSINESS ANALYSIS, BUSINESS MANAGEMENT, AND BUSINESS ORGANIZATION; BUSINESS ACQUISITION AND MERGER CONSULTATION; BUSINESS ACQUISITIONS CONSULTATION; BUSINESS ADMINISTRATION AND MANAGEMENT; BUSINESS ADMINISTRATION AND OFFICE WORK; BUSINESS ADMINISTRATION CONSULTANCY; BUSINESS ADVISORY SERVICES, CONSULTANCY AND INFORMATION;

BUSINESS CONSULTATION; BUSINESS CONSULTATION AND MANAGEMENT REGARDING MARKETING ACTIVITIES AND LAUNCHING OF NEW PRODUCTS; BUSINESS CONSULTATION SERVICES; BUSINESS CONSULTATION SERVICES TO ASSIST NON-PROFIT ORGANIZATIONS IN PLANNING, MANAGING, AND CONDUCTING FUND RAISING ACTIVITIES VIA A GLOBAL COMPUTER NETWORK; BUSINESS CONSULTING AND BUSINESS INFORMATION FOR ENTERPRISES; BUSINESS CONSULTING, INQUIRIES OR INFORMATION; BUSINESS CONSULTING, MANAGEMENT, PLANNING AND SUPERVISION; BUSINESS DEVELOPMENT SERVICES, NAMELY, PROVIDING START-UP SUPPORT FOR BUSINESSES OF OTHERS; BUSINESS MANAGEMENT AND CONSULTATION; BUSINESS MANAGEMENT CONSULTANCY AND ADVISORY SERVICES; BUSINESS ORGANIZATIONAL CONSULTATION; BUSINESS PLANNING; CONSULTATION IN THE FIELD OF BUSINESS ACQUISITIONS; PROFESSIONAL BUSINESS CONSULTATION, IN CLASS 35 (U.S. CLS. 100, 101 AND 102).

FIRST USE 8-10-2007; IN COMMERCE 9-6-2007.

THE MARK CONSISTS OF STANDARD CHARACTERS WITHOUT CLAIM TO ANY PARTICULAR FONT, STYLE, SIZE, OR COLOR.

SN 77-254,784, FILED 8-14-2007.

AHSEN KHAN, EXAMINING ATTORNEY

Int. Cls.: 35, 37, and 39

Prior U.S. Cls.: 100, 101, 102, 103, 105, and 106

United States Patent and Trademark Office

Reg. No. 3,477,788

Registered July 29, 2008

**SERVICE MARK
PRINCIPAL REGISTER**



AFFINION PUBLISHING, LLC (DELAWARE LTD
LIAB CO)

SUITE 130

10750 WEST CHARLESTON BLVD.

LAS VEGAS, NV 89135

FOR: CARD-BASED AND ONLINE CONSUMER MEMBERSHIP SERVICES, NAMELY, ADMINISTRATION OF A CONSUMER DISCOUNT PROGRAM ENABLING MEMBERS TO OBTAIN DISCOUNTS ON GOODS AND SERVICES INCLUDING GASOLINE, AUTOMOBILE PRODUCTS, AUTOMOBILE MAINTENANCE, CAR RENTALS, PARKING SERVICES, NEW AND USED VEHICLES, AND HOTEL AND MOTEL SERVICES; PROVIDING ONLINE COMMERCIAL INFORMATION IN THE FIELD OF BUYING AND SELLING NEW AND USED VEHICLES, IN CLASS 35 (U.S. CLS. 100, 101 AND 102).

FIRST USE 9-1-2007; IN COMMERCE 9-1-2007.

FOR: PROVIDING EMERGENCY ROADSIDE ASSISTANCE FOR MOTOR VEHICLES, IN CLASS 37 (U.S. CLS. 100, 103 AND 106).

FIRST USE 9-1-2007; IN COMMERCE 9-1-2007.

FOR: TRAVEL INFORMATION SERVICES, NAMELY, PROVIDING TRIP ROUTING INFORMATION, IN CLASS 39 (U.S. CLS. 100 AND 105).

FIRST USE 9-1-2007; IN COMMERCE 9-1-2007.

OWNER OF U.S. REG. NOS. 1,553,199, 3,246,891, AND OTHERS.

THE MARK CONSISTS OF THE ITALICIZED WORDS "AUTOVANTAGE" WITH A STYLIZED ILLUSTRATION OF THE TOP PORTION OF AN AUTOMOBILE APPEARING ABOVE THEM

SN 77-254,993, FILED 8-14-2007.

GENE MACIOL, EXAMINING ATTORNEY

Int. Cl.: 8

Prior U.S. Cls.: 23, 28, and 44

United States Patent and Trademark Office

Reg. No. 3,477,789

Registered July 29, 2008

**TRADEMARK
PRINCIPAL REGISTER**



PRODUCTOS MEXICANOS DON JOSE, INC.
(GEORGIA CORPORATION)
410 CONNECTICUT DR.
TIFTON, GA 317944210

THE MARK CONSISTS OF SILHOUETTE OF A
DRAGON AND THE WORD "DRAGONFLY".

FOR: KNIVES, NAMELY, HUNTING KNIVES,
FISH FILLET KNIVES, FOLDING KNIVES, IN
CLASS 8 (U.S. CLS. 23, 28 AND 44).

SN 77-255,897, FILED 8-15-2007.

FIRST USE 4-1-2008; IN COMMERCE 4-1-2008.

SANJEEV VOHRA, EXAMINING ATTORNEY

Int. Cl.: 35

Prior U.S. Cls.: 100, 101, and 102

United States Patent and Trademark Office

Reg. No. 3,477,790

Registered July 29, 2008

**SERVICE MARK
PRINCIPAL REGISTER**

Wall of Diamonds

SHANE CO. (COLORADO CORPORATION)
SUITE 200
9200 E. MINERAL AVE.
CENTENNIAL, CO 80112

FOR: RETAIL JEWELRY STORE SERVICES, IN
CLASS 35 (U.S. CLS. 100, 101 AND 102).

FIRST USE 5-7-2007; IN COMMERCE 5-7-2007.

THE MARK CONSISTS OF STANDARD CHAR-
ACTERS WITHOUT CLAIM TO ANY PARTICULAR
FONT, STYLE, SIZE, OR COLOR.

NO CLAIM IS MADE TO THE EXCLUSIVE
RIGHT TO USE "DIAMONDS", APART FROM THE
MARK AS SHOWN.

SN 77-256,298, FILED 8-15-2007.

SHANNON TWOHIG, EXAMINING ATTORNEY

Int. Cl.: 5

Prior U.S. Cls.: 6, 18, 44, 46, 51, and 52

Reg. No. 3,477,791

United States Patent and Trademark Office

Registered July 29, 2008

**TRADEMARK
PRINCIPAL REGISTER**

Dark Matter

MAXIMUM HUMAN PERFORMANCE, INC.
(NEW JERSEY CORPORATION)
21 DWIGHT PLACE
FAIRFIELD, NJ 07004

THE MARK CONSISTS OF STANDARD CHARACTERS WITHOUT CLAIM TO ANY PARTICULAR FONT, STYLE, SIZE, OR COLOR.

FOR: DIETARY SUPPLEMENTS, IN CLASS 5 (U.S. CLS. 6, 18, 44, 46, 51 AND 52).

SN 77-256,592, FILED 8-16-2007.

FIRST USE 11-30-2007; IN COMMERCE 11-30-2007.

ERIN FALK, EXAMINING ATTORNEY

Int. Cl.: 16

Prior U.S. Cls.: 2, 5, 22, 23, 29, 37, 38, and 50

Reg. No. 3,477,792

United States Patent and Trademark Office

Registered July 29, 2008

**TRADEMARK
PRINCIPAL REGISTER**

UCRATE

GREAT NORTHERN CORPORATION (WISCONSIN CORPORATION)
395 STROEBE ROAD
APPLETON, WI 54911

THE MARK CONSISTS OF STANDARD CHARACTERS WITHOUT CLAIM TO ANY PARTICULAR FONT, STYLE, SIZE, OR COLOR.

FOR: SHIPPING CONTAINERS FORMED FROM PAPERBOARD, IN CLASS 16 (U.S. CLS. 2, 5, 22, 23, 29, 37, 38 AND 50).

SN 77-256,952, FILED 8-16-2007.

FIRST USE 5-1-2008; IN COMMERCE 5-1-2008.

LA TONIA FISHER, EXAMINING ATTORNEY

Int. Cl.: 36

Prior U.S. Cls.: 100, 101, and 102

United States Patent and Trademark Office

Reg. No. 3,477,793

Registered July 29, 2008

**SERVICE MARK
PRINCIPAL REGISTER**

ICE FUTURES EUROPE

INTERCONTINENTALEXCHANGE, INC. (DELA-
WARE CORPORATION)
2100 RIVEREDGE PARKWAY, 5TH FLOOR
ATLANTA, GA 30328

FOR: ELECTRONIC COMMODITIES EXCHANGE SERVICES; PROVIDING FINANCIAL SERVICES IN THE NATURE OF PROVIDING AN EXCHANGE FOR COMMODITIES AND COMMODITIES DERIVATIVES, PROVIDING ONLINE EXCHANGE SERVICES IN THE NATURE OF ONLINE PURCHASING AND/OR SELLING OF COMMODITIES AND COMMODITIES DERIVATIVES; PROVIDING ONLINE COMMODITIES AND COMMODITY DERIVATIVES PRICING AND RELATED INFORMATION; FINANCIAL SERVICES IN THE NATURE OF ASSISTING OTHERS WITH THE COMPLETION OF FINANCIAL TRANSACTIONS FOR COMMODITIES AND COMMODITY DERIVATIVES; SERVICES RELATING TO FINANCIAL TRANSACTIONS, NAMELY, TRADING OF COMMODITIES AND COMMODITY DERIVATIVES; PROVIDING FINANCIAL SERVICES IN THE NATURE OF OFFERING, SPONSORING,

MANAGING AND/OR ADMINISTERING COMMODITIES, COMMODITY DERIVATIVES AND RELATED FINANCIAL INSTRUMENTS, IN CLASS 36 (U.S. CLS. 100, 101 AND 102).

FIRST USE 8-30-2007; IN COMMERCE 8-30-2007.

THE MARK CONSISTS OF STANDARD CHARACTERS WITHOUT CLAIM TO ANY PARTICULAR FONT, STYLE, SIZE, OR COLOR.

OWNER OF U.S. REG. NOS. 2,442,215, 3,277,230, AND OTHERS.

NO CLAIM IS MADE TO THE EXCLUSIVE RIGHT TO USE "FUTURES EUROPE", APART FROM THE MARK AS SHOWN.

SN 77-256,988, FILED 8-16-2007.

JULIE WATSON, EXAMINING ATTORNEY

Int. Cl.: 25

Prior U.S. Cls.: 22 and 39

United States Patent and Trademark Office

Reg. No. 3,477,794

Registered July 29, 2008

**TRADEMARK
PRINCIPAL REGISTER**



SCOOP MANAGEMENT LLC (DELAWARE LTD
LIAB CO)
532 BROADWAY, 4TH FLOOR
NEW YORK, NY 10012

FOR: MEN'S AND WOMEN'S CLOTHING,
NAMELY, PANTS, JEANS, SKIRTS, SHIRTS, T-
SHIRTS, SWEATERS, SWEAT SHIRTS, SWEAT
PANTS, DRESSES, BLOUSES, JACKETS, SUITS,
TANK TOPS, BATHING SUITS, SCARVES, SOCKS,
UNDERGARMENTS, HEADWEAR AND FOOT-
WEAR, IN CLASS 25 (U.S. CLS. 22 AND 39).

FIRST USE 1-1-2008; IN COMMERCE 1-1-2008.

OWNER OF U.S. REG. NOS. 1,964,866, 2,912,560,
AND OTHERS.

THE COLOR(S) BLUE IS/ARE CLAIMED AS A
FEATURE OF THE MARK.

THE MARK CONSISTS OF THE WORDS "SCOOP"
AND "BEACH" IN A DOUBLE RING OVAL ALL IN
THE COLOR BLUE.

SN 77-258,340, FILED 8-17-2007.

GRETTA YAO, EXAMINING ATTORNEY

Int. Cl.: 5

Prior U.S. Cls.: 6, 18, 44, 46, 51, and 52

United States Patent and Trademark Office

Reg. No. 3,477,795

Registered July 29, 2008

**TRADEMARK
PRINCIPAL REGISTER**

EYZ-A-BLUE

FACE AND BODY PROFESSIONALS, INC. (CALIFORNIA CORPORATION)
371 BEL MARIN KEYS BLVD., SUITE 220
NOVATO, CA 94949

THE MARK CONSISTS OF STANDARD CHARACTERS WITHOUT CLAIM TO ANY PARTICULAR FONT, STYLE, SIZE, OR COLOR.

FOR: TOPICAL ANESTHETIC, NAMELY, A NUMBING CREAM FOR LINING ONE'S EYE, IN CLASS 5 (U.S. CLS. 6, 18, 44, 46, 51 AND 52).

SN 77-258,413, FILED 8-17-2007.

FIRST USE 10-24-2007; IN COMMERCE 10-24-2007.

LINDA E. BLOHM, EXAMINING ATTORNEY

Int. Cl.: 41

Prior U.S. Cls.: 100, 101, and 107

United States Patent and Trademark Office

Reg. No. 3,477,796

Registered July 29, 2008

**SERVICE MARK
PRINCIPAL REGISTER**

MaxAvenue

HAROLD WARE (UNITED STATES INDIVIDUAL)
1700 BARTON CREEK BLVD.
AUSTIN, TX 78735

THE MARK CONSISTS OF STANDARD CHARACTERS WITHOUT CLAIM TO ANY PARTICULAR FONT, STYLE, SIZE, OR COLOR.

FOR: EDUCATION SERVICES, NAMELY, PROVIDING PROGRAMS IN THE FIELD OF RESIDENTIAL REAL ESTATE, IN CLASS 41 (U.S. CLS. 100, 101 AND 107).

SN 77-258,463, FILED 8-17-2007.

FIRST USE 10-9-2007; IN COMMERCE 10-9-2007.

MARGERY A. TIERNEY, EXAMINING ATTORNEY

Int. Cl.: 25

Prior U.S. Cls.: 22 and 39

United States Patent and Trademark Office

Reg. No. 3,477,797

Registered July 29, 2008

TRADEMARK
PRINCIPAL REGISTER



SEJUNG USA HARRY VARDON GOLF, COR-
PORATION (MINNESOTA CORPORATION)
1220 E. 7TH STREET
WINONA, MN 55987

FOR: CLOTHING, NAMELY, CAPS, HATS,
CLOTHING OF LEATHER, NAMELY, LEATHER
JACKETS, JACKETS, JUMPERS, KNITWEAR IN
THE NATURE OF SWEATERS, LONG AND SHORT
SLEEVED GOLF SHIRTS AND VESTS, LONG AND
SHORT PANTS, PARKAS, SPORTS JERSEYS, SWEA-
TERS, TEE-SHIRTS, UNDERCLOTHING, NAMELY,
UNDERGARMENTS, AND VESTS, IN CLASS 25
(U.S. CLS. 22 AND 39).

FIRST USE 6-30-2007; IN COMMERCE 6-30-2007.

THE MARK CONSISTS OF THE WORDS "VAR-
DON& RAY" IN STACKED, STAGGERED FOR-
MAT, WITH THE STYLIZED, SILHOUETTED
IMAGE OF A GOLFER STANDING ON THE "Y"
IN "RAY" AND RESTING A FLAGSTICK AGAINST
THE UPPER RIGHT CORNER OF THE "R" IN
"RAY".

SN 77-258,630, FILED 8-18-2007.

MARILYN IZZI, EXAMINING ATTORNEY

Int. Cl.: 44

Prior U.S. Cls.: 100 and 101

United States Patent and Trademark Office

Reg. No. 3,477,798

Registered July 29, 2008

**SERVICE MARK
PRINCIPAL REGISTER**

Ace Cuts

NRW CORPORATION, INC (MASSACHUSETTS CORPORATION)
409 WASHINGTON ST.
BRIGHTON, MA 02135

FOR: HAIR SALON SERVICES, NAMELY, HAIR CUTTING, HAIR COLORING, PERMANENTS FOR HAIR, MANICURES, PEDICURES, FACIALS, MASSAGES AND BODY WAXING, IN CLASS 44 (U.S. CLS. 100 AND 101).

FIRST USE 1-1-2008; IN COMMERCE 1-1-2008.

THE MARK CONSISTS OF STANDARD CHARACTERS WITHOUT CLAIM TO ANY PARTICULAR FONT, STYLE, SIZE, OR COLOR.

NO CLAIM IS MADE TO THE EXCLUSIVE RIGHT TO USE "CUTS", APART FROM THE MARK AS SHOWN.

SN 77-259,534, FILED 8-20-2007.

SUSAN LESLIE DUBOIS, EXAMINING ATTORNEY

Int. Cl.: 16

Prior U.S. Cls.: 2, 5, 22, 23, 29, 37, 38, and 50

Reg. No. 3,477,799

United States Patent and Trademark Office

Registered July 29, 2008

**TRADEMARK
PRINCIPAL REGISTER**

AirWine

WEST COAST PAPER COMPANY (WASHING-
TON CORPORATION)
SUITE 120
6703 S 234TH STREET
KENT, WA 980322903

FOR: PACKAGING MADE OF CORRUGATED
CARDBOARD FOR TRANSPORTING WINE AND
LIQUOR BOTTLES IN THE CARGO HOLD OF AN
AIRPLANE, IN CLASS 16 (U.S. CLS. 2, 5, 22, 23, 29, 37,
38 AND 50).

FIRST USE 12-13-2007; IN COMMERCE 12-13-2007.

THE MARK CONSISTS OF STANDARD CHAR-
ACTERS WITHOUT CLAIM TO ANY PARTICULAR
FONT, STYLE, SIZE, OR COLOR.

SN 77-259,641, FILED 8-20-2007.

B. PARADEWELAI, EXAMINING ATTORNEY

Int. Cl.: 16

Prior U.S. Cls.: 2, 5, 22, 23, 29, 37, 38, and 50

Reg. No. 3,477,800

United States Patent and Trademark Office

Registered July 29, 2008

TRADEMARK
PRINCIPAL REGISTER



ANNE MCKEVITT (UNITED KINGDOM INDIVIDUAL)
LEVEL 20, TOWER 2
201 SUSSEX STREET
SYDNEY, AUSTRALIA NSW2060

THE MARK CONSISTS OF THE WORD "MILLION" IN LARGE STYLIZED FONT, ABOVE THE WORDS "DOLLAR PLUS CLUB".

FOR: BOOKS IN THE FIELD OF BUSINESS AND WEALTH CREATION, IN CLASS 16 (U.S. CLS. 2, 5, 22, 23, 29, 37, 38 AND 50).

SN 77-260,414, FILED 8-21-2007.

FIRST USE 5-1-2008; IN COMMERCE 5-1-2008.

ADA HAN, EXAMINING ATTORNEY

Int. Cl.: 41

Prior U.S. Cls.: 100, 101, and 107

United States Patent and Trademark Office

Reg. No. 3,477,801

Registered July 29, 2008

**SERVICE MARK
PRINCIPAL REGISTER**

ROCK 'N' ROLL SAN ANTONIO

ROCK 'N' ROLL MARATHON, INC. (CALIFORNIA CORPORATION)
#150
9401 WAPLES STREET
SAN DIEGO, CA 92121

FOR: ENTERTAINMENT IN THE NATURE OF ORGANIZING A SPORTING EVENT IN THE NATURE OF A RUNNING RACE AND RELATED SPORTING AND ENTERTAINMENT EVENTS, NAMELY, ORGANIZING COMMUNITY FAIRS FEATURING VENDOR BOOTHS OF FOOD AND RACE RELATED SPORTING GOODS, AND PLANNING PARTIES AND DINNERS, IN CLASS 41 (U.S. CLS. 100, 101 AND 107).

FIRST USE 9-20-2007; IN COMMERCE 9-20-2007.

THE MARK CONSISTS OF STANDARD CHARACTERS WITHOUT CLAIM TO ANY PARTICULAR FONT, STYLE, SIZE, OR COLOR.

OWNER OF U.S. REG. NOS. 2,131,333, 2,530,120, AND 2,700,186.

NO CLAIM IS MADE TO THE EXCLUSIVE RIGHT TO USE "SAN ANTONIO", APART FROM THE MARK AS SHOWN.

SN 77-261,441, FILED 8-22-2007.

COLLEEN DOMBROW, EXAMINING ATTORNEY

Int. Cl.: 9

Prior U.S. Cls.: 21, 23, 26, 36, and 38

Reg. No. 3,477,802

United States Patent and Trademark Office

Registered July 29, 2008

**TRADEMARK
PRINCIPAL REGISTER**



Avekṣa

AVEKSA, INC. (DELAWARE CORPORATION)
265 WINTER STREET
WALTHAM, MA 02451

FOR: COMPUTER SOFTWARE FOR ENTER-
PRISE SECURITY AND AUDITING OF SOFTWARE
FOR MANAGING INFORMATION TECHNOLOGY
INFRASTRUCTURE, IN CLASS 9 (U.S. CLS. 21, 23, 26,
36 AND 38).

FIRST USE 7-30-2007; IN COMMERCE 7-30-2007.

THE MARK CONSISTS OF THE WORD "AVEK-
SA" WITH FIVE SMALL CUBES IN A LINE ABOVE
THE "K", "S" AND THE "A".

THE FOREIGN WORDING IN THE MARK
TRANSLATES INTO ENGLISH AS TO CONSIDER
OR TO SEE.

SN 77-261,596, FILED 8-22-2007.

CHRIS WELLS, EXAMINING ATTORNEY

Int. Cl.: 37

Prior U.S. Cls.: 100, 103, and 106

United States Patent and Trademark Office

Reg. No. 3,477,803

Registered July 29, 2008

**SERVICE MARK
PRINCIPAL REGISTER**



AVEKSA, INC. (DELAWARE CORPORATION)
265 WINTER STREET
WALTHAM, MA 02451

FOR: INSTALLATION OF COMPUTER NETWORKS; INSTALLATION OF COMPUTER SYSTEMS; MAINTENANCE AND REPAIR OF COMPUTER HARDWARE; MAINTENANCE AND REPAIR OF COMPUTER NETWORKS; MAINTENANCE OF COMPUTER HARDWARE SYSTEMS, IN CLASS 37 (U.S. CLS. 100, 103 AND 106).

FIRST USE 7-30-2007; IN COMMERCE 7-30-2007.

THE MARK CONSISTS OF THE WORD "AVEKSA" WITH FIVE SMALL CUBES IN A LINE ABOVE THE "K", "S" AND THE "A".

THE FOREIGN WORDING IN THE MARK TRANSLATES INTO ENGLISH AS TO CONSIDER OR TO SEE.

SN 77-261,600, FILED 8-22-2007.

CHRIS WELLS, EXAMINING ATTORNEY

Int. Cl.: 41

Prior U.S. Cls.: 100, 101, and 107

United States Patent and Trademark Office

Reg. No. 3,477,804

Registered July 29, 2008

**SERVICE MARK
PRINCIPAL REGISTER**



AVEKSA, INC. (DELAWARE CORPORATION)
265 WINTER STREET
WALTHAM, MA 02451

FOR: TRAINING IN THE USE OF SOFTWARE
FOR MANAGING INFORMATION TECHNOLOGY
INFRASTRUCTURE, IN CLASS 41 (U.S. CLS. 100, 101
AND 107).

FIRST USE 6-6-2008; IN COMMERCE 6-6-2008.

THE MARK CONSISTS OF THE WORD "AVEK-
SA" WITH FIVE SMALL CUBES IN A LINE ABOVE
THE "K", "S" AND THE "A".

THE FOREIGN WORDING IN THE MARK
TRANSLATES INTO ENGLISH AS TO CONSIDER
OR TO SEE.

SN 77-261,603, FILED 8-22-2007.

CHRIS WELLS, EXAMINING ATTORNEY

Int. Cl.: 42

Prior U.S. Cls.: 100 and 101

United States Patent and Trademark Office

Reg. No. 3,477,805

Registered July 29, 2008

**SERVICE MARK
PRINCIPAL REGISTER**



AVEKSA, INC. (DELAWARE CORPORATION)
265 WINTER STREET
WALTHAM, MA 02451

FOR: TECHNICAL SUPPORT SERVICES, NAME-
LY, TROUBLESHOOTING OF COMPUTER HARD-
WARE AND SOFTWARE PROBLEMS;
INSTALLATION OF COMPUTER SOFTWARE; IN-
TEGRATION OF COMPUTER SYSTEMS AND NET-
WORKS , IN CLASS 42 (U.S. CLS. 100 AND 101).

FIRST USE 7-30-2007; IN COMMERCE 7-30-2007.

THE MARK CONSISTS OF THE WORD "AVEK-
SA" WITH FIVE SMALL CUBES IN A LINE ABOVE
THE "K", "S" AND THE "A".

THE FOREIGN WORDING IN THE MARK
TRANSLATES INTO ENGLISH AS TO CONSIDER
OR TO SEE.

SN 77-261,604, FILED 8-22-2007.

CHRIS WELLS, EXAMINING ATTORNEY

Int. Cl.: 10

Prior U.S. Cls.: 26, 39, and 44

Reg. No. 3,477,806

United States Patent and Trademark Office

Registered July 29, 2008

**TRADEMARK
PRINCIPAL REGISTER**

HEARTEN

PINK, INC. (VIRGINIA CORPORATION)
513 NORTH ADAMS STREET
RICHMOND, VA 23220

FOR: SURGICAL PROCEDURAL KITS FOR USE BY HEALTH CARE PROVIDERS COMPRISING SURGICAL INSTRUMENTS IN THE NATURE OF SCISSORS, FORCEPS, NEEDLE HOLDERS, CLAMPS, KNIVES, SYRINGES, NEEDLES, DRESSINGS, TAPE, DRAPES, BOWLS, TUBING, SPONGES, TOWELS, CATHETERS, FOAM, CANNULAE, AND IV SETS; MEDICAL APPAREL, NAMELY, SURGICAL GOWNS, SURGICAL CAPS, SURGICAL GLOVES, SURGICAL FOOT COVERS, SURGICAL MASKS, AND SURGICAL LEGGINGS; ADHESIVE LABELS SPECIFICALLY DESIGNED FOR MEDI-

CAL APPLICATIONS FOR USE DURING SURGICAL PROCEDURES; MEDICAL BAGS ADAPTED FOR AND SOLD WITH MEDICAL, SURGICAL AND VETERINARY INSTRUMENTS, IN CLASS 10 (U.S. CLS. 26, 39 AND 44).

FIRST USE 5-30-2008; IN COMMERCE 5-30-2008.

THE MARK CONSISTS OF STANDARD CHARACTERS WITHOUT CLAIM TO ANY PARTICULAR FONT, STYLE, SIZE, OR COLOR.

SN 77-262,023, FILED 8-22-2007.

MICHAEL TANNER, EXAMINING ATTORNEY

Int. Cl.: 43

Prior U.S. Cls.: 100 and 101

United States Patent and Trademark Office

Reg. No. 3,477,807

Registered July 29, 2008

SERVICE MARK
PRINCIPAL REGISTER



DEPARTMENT OF THE ARMY (UNITED STATES AGENCY OF THE UNITED STATES GOVERNMENT)

JALS-RL/IP

901 N. STUART ST., STE. 700
ARLINGTON, VA 22203

FOR: CATERING, IN CLASS 43 (U.S. CLS. 100 AND 101).

FIRST USE 7-0-2007; IN COMMERCE 7-0-2007.

NO CLAIM IS MADE TO THE EXCLUSIVE RIGHT TO USE "CATERING", APART FROM THE MARK AS SHOWN.

THE MARK CONSISTS OF FIVE FIVE-POINTED STARS OF INCREASING SIZE ALIGNED ALONG AN ARCING LINE OVER THE WORDS, "FIVE STAR CATERING".

SN 77-263,819, FILED 8-24-2007.

ATTIYA MALIK, EXAMINING ATTORNEY

Int. Cl.: 11

Prior U.S. Cls.: 13, 21, 23, 31, and 34

United States Patent and Trademark Office

Reg. No. 3,477,808

Registered July 29, 2008

**TRADEMARK
PRINCIPAL REGISTER**

MAX-DRY

PLASTIC PROCESS EQUIPMENT, INC. (OHIO
CORPORATION)
8303 CORPORATE PARK
MACEDONIA, OH 44056

THE MARK CONSISTS OF STANDARD CHAR-
ACTERS WITHOUT CLAIM TO ANY PARTICULAR
FONT, STYLE, SIZE, OR COLOR.

FOR: INDUSTRIAL DRYERS FOR HEATING
AND DEHUMIDIFYING, IN CLASS 11 (U.S. CLS.
13, 21, 23, 31 AND 34).

SN 77-264,709, FILED 8-27-2007.

FIRST USE 1-1-2008; IN COMMERCE 1-1-2008.

JENNIFER HETU, EXAMINING ATTORNEY

Int. Cl.: 10

Prior U.S. Cls.: 26, 39, and 44

United States Patent and Trademark Office

Reg. No. 3,477,809

Registered July 29, 2008

**TRADEMARK
PRINCIPAL REGISTER**

NEOMED

NEOMED, INC. (GEORGIA CORPORATION)
507 HICKORY RIDGE TRL., SUITE 130
WOODSTOCK, GA 30188

FOR: NEONATAL PRODUCTS, NAMELY, CATHETERIZATION TRAYS, NEONATAL PROCEDURE KITS COMPOSED OF STERILE FORCEPS, HEMOSTATS, SCISSORS, NEEDLES, STERILE SALINE, SCALPELS FOR USE IN CUT-DOWN PROCEDURES OR CATHETERIZATION PROCEDURES, URINARY DRAINAGE KITS COMPOSED OF URINARY CATHETER AND COLLECTION BURETTE, LUMBAR PUNCTURE KITS COMPOSED OF LUMBAR PUNCTURE NEEDLE AND SPINAL FLUID COLLECTION VIALS; NEONATAL AND PEDIATRIC ENTERAL PRODUCTS, NAMELY, FEEDING TUBES, ORAL SYRINGES AND ENTERAL EXTENSIONS THAT TOGETHER COMPRISE AN ENTERAL NUTRITION DELIVERY SYSTEM; CATHETERS,

NAMELY, UMBILICAL CATHETERS AND URINARY DRAINAGE CATHETERS; SPECIALTY NEONATAL AND PEDIATRIC ITEMS, NAMELY, POLYETHYLENE OCCLUSIVE SURGICAL DRAPES AND DRAPES USED FOR EXAMINATION PURPOSES DURING REHABILITATION THAT DO NOT BLOCK HEAT, IN CLASS 10 (U.S. CLS. 26, 39 AND 44).

FIRST USE 2-28-2007; IN COMMERCE 3-31-2007.

THE MARK CONSISTS OF STANDARD CHARACTERS WITHOUT CLAIM TO ANY PARTICULAR FONT, STYLE, SIZE, OR COLOR.

SN 77-264,779, FILED 8-27-2007.

HENRY S. ZAK, EXAMINING ATTORNEY

Int. Cl.: 41

Prior U.S. Cls.: 100, 101, and 107

United States Patent and Trademark Office

Reg. No. 3,477,810

Registered July 29, 2008

**SERVICE MARK
PRINCIPAL REGISTER**

PRE-OWNED VEHICLE BOOTCAMP

NCM ASSOCIATES, INC. (MISSOURI CORPORATION)
SUITE 200
10551 BARKLEY
OVERLAND PARK, KS 66212

FOR: AUTOMOTIVE DEALER TRAINING, IN CLASS 41 (U.S. CLS. 100, 101 AND 107).

FIRST USE 10-16-2007; IN COMMERCE 10-16-2007.

THE MARK CONSISTS OF STANDARD CHARACTERS WITHOUT CLAIM TO ANY PARTICULAR FONT, STYLE, SIZE, OR COLOR.

OWNER OF U.S. REG. NOS. 2,946,224, 3,076,648, AND OTHERS.

NO CLAIM IS MADE TO THE EXCLUSIVE RIGHT TO USE "PRE-OWNED VEHICLE", APART FROM THE MARK AS SHOWN.

SN 77-264,790, FILED 8-27-2007.

MARGARET POWER, EXAMINING ATTORNEY

Int. Cl.: 32

Prior U.S. Cls.: 45, 46, and 48

Reg. No. 3,477,811

United States Patent and Trademark Office

Registered July 29, 2008

**TRADEMARK
PRINCIPAL REGISTER**

**A LITTLE NATURAL DOES A
LOT OF GOOD**

NESTLE WATERS NORTH AMERICA INC. (DE-
LAWARE CORPORATION)
777 WEST PUTNAM AVENUE
GREENWICH, CT 06830

THE MARK CONSISTS OF STANDARD CHAR-
ACTERS WITHOUT CLAIM TO ANY PARTICULAR
FONT, STYLE, SIZE, OR COLOR.

FOR: NATURAL SPRING WATER; BOTTLED
DRINKING WATERS, IN CLASS 32 (U.S. CLS. 45,
46 AND 48).

SN 77-264,989, FILED 8-27-2007.

FIRST USE 10-30-2007; IN COMMERCE 10-30-2007.

DANNEAN HETZEL, EXAMINING ATTORNEY

Int. Cl.: 36

Prior U.S. Cls.: 100, 101, and 102

United States Patent and Trademark Office

Reg. No. 3,477,812

Registered July 29, 2008

**SERVICE MARK
PRINCIPAL REGISTER**

ADOB

AMERICAN STOCK EXCHANGE LLC (DELA-
WARE LTD LIAB CO)
86 TRINITY PLACE
NEW YORK, NY 10006

FOR: STOCK MARKET SERVICES, NAMELY,
PROVIDING A REAL-TIME COMPILATION OF
EQUITY AND EXCHANGE-TRADED FUND LIMIT
ORDERS WITHIN AN INTEGRATED ELECTRONIC
TRADING PLATFORM , IN CLASS 36 (U.S. CLS. 100,
101 AND 102).

FIRST USE 1-1-2008; IN COMMERCE 1-1-2008.

THE MARK CONSISTS OF STANDARD CHAR-
ACTERS WITHOUT CLAIM TO ANY PARTICULAR
FONT, STYLE, SIZE, OR COLOR.

SN 77-265,305, FILED 8-27-2007.

LINDSEY RUBIN, EXAMINING ATTORNEY

Int. Cl.: 9

Prior U.S. Cls.: 21, 23, 26, 36, and 38

United States Patent and Trademark Office

Reg. No. 3,477,813

Registered July 29, 2008

**TRADEMARK
PRINCIPAL REGISTER**

DIGITAL LIVING

TARGET BRANDS, INC. (MINNESOTA CORPORATION)
TPS-3165
1000 NICOLLET MALL
MINNEAPOLIS, MN 55403

FOR: DIGITAL PHOTO FRAMES FOR DISPLAYING DIGITAL PICTURES, VIDEO CLIPS AND MUSIC, IN CLASS 9 (U.S. CLS. 21, 23, 26, 36 AND 38).

FIRST USE 10-9-2007; IN COMMERCE 10-9-2007.

THE MARK CONSISTS OF STANDARD CHARACTERS WITHOUT CLAIM TO ANY PARTICULAR FONT, STYLE, SIZE, OR COLOR.

NO CLAIM IS MADE TO THE EXCLUSIVE RIGHT TO USE "DIGITAL", APART FROM THE MARK AS SHOWN.

SN 77-266,285, FILED 8-28-2007.

SETH A. RAPPAPORT, EXAMINING ATTORNEY

Int. Cl.: 9

Prior U.S. Cls.: 21, 23, 26, 36, and 38

Reg. No. 3,477,814

United States Patent and Trademark Office

Registered July 29, 2008

**TRADEMARK
PRINCIPAL REGISTER**

CORTEX

POSIT SCIENCE CORPORATION (CALIFORNIA
CORPORATION)
225 BUSH STREET, 7TH FLOOR
SAN FRANCISCO, CA 94104

FOR: COMPUTER SOFTWARE FOR USE IN
MAINTAINING OR IMPROVING COGNITIVE PER-
FORMANCE AND FUNCTION AND/OR STIMU-
LATING BRAIN PLASTICITY AND MANUALS
PROVIDED TOGETHER AS A UNIT, IN CLASS 9
(U.S. CLS. 21, 23, 26, 36 AND 38).

FIRST USE 3-1-2008; IN COMMERCE 3-1-2008.

THE MARK CONSISTS OF STANDARD CHAR-
ACTERS WITHOUT CLAIM TO ANY PARTICULAR
FONT, STYLE, SIZE, OR COLOR.

SN 77-266,647, FILED 8-28-2007.

RONALD MCMORROW, EXAMINING ATTORNEY

Int. Cl.: 43

Prior U.S. Cls.: 100 and 101

United States Patent and Trademark Office

Reg. No. 3,477,815

Registered July 29, 2008

**SERVICE MARK
PRINCIPAL REGISTER**

REAL EASY ITALIAN

FAST FRESH ITALIAN, LLC (ILLINOIS LTD
LIAB CO)
462 E. OXFORD
NORTHBARRINGTON, IL 60010

NO CLAIM IS MADE TO THE EXCLUSIVE
RIGHT TO USE "ITALIAN", APART FROM THE
MARK AS SHOWN.

FOR: RESTAURANT AND CATERING SERVI-
CES, IN CLASS 43 (U.S. CLS. 100 AND 101).

SN 77-267,225, FILED 8-29-2007.

FIRST USE 7-8-2007; IN COMMERCE 7-8-2007.

THE MARK CONSISTS OF STANDARD CHAR-
ACTERS WITHOUT CLAIM TO ANY PARTICULAR
FONT, STYLE, SIZE, OR COLOR.

DOMINIC J. FERRAIUOLO, EXAMINING ATTOR-
NEY

Int. Cl.: 25

Prior U.S. Cls.: 22 and 39

United States Patent and Trademark Office

Reg. No. 3,477,816

Registered July 29, 2008

**TRADEMARK
PRINCIPAL REGISTER**

SPLIT STEP

SPLIT STEP, INC. (COLORADO CORPORATION)
630 GRAPE STREET
DENVER, CO 80220

FOR: SOCKS; SWEATBANDS; HEADGEAR,
NAMELY, VISORS, CAPS, AND HATS; TENNIS
WEAR; SKIRTS AND DRESSES; SPORTS JACKETS;
SPORTS SHIRTS; SHORTS; GOLF SHIRTS; SPORTS
JERSEYS AND BREECHES FOR SPORTS; PANTS ,
IN CLASS 25 (U.S. CLS. 22 AND 39).

FIRST USE 1-3-2008; IN COMMERCE 1-3-2008.

THE MARK CONSISTS OF STANDARD CHAR-
ACTERS WITHOUT CLAIM TO ANY PARTICULAR
FONT, STYLE, SIZE, OR COLOR.

SN 77-267,563, FILED 8-29-2007.

MICHAEL TANNER, EXAMINING ATTORNEY

Int. Cl.: 5

Prior U.S. Cls.: 6, 18, 44, 46, 51, and 52

Reg. No. 3,477,817

United States Patent and Trademark Office

Registered July 29, 2008

**TRADEMARK
PRINCIPAL REGISTER**

EURO-C

ROEX, INC. (CALIFORNIA CORPORATION)
16841 ARMSTRONG AVENUE
IRVINE, CA 92626

THE MARK CONSISTS OF STANDARD CHAR-
ACTERS WITHOUT CLAIM TO ANY PARTICULAR
FONT, STYLE, SIZE, OR COLOR.

FOR: DIETARY SUPPLEMENTS, IN CLASS 5 (U.S.
CLS. 6, 18, 44, 46, 51 AND 52).

SN 77-267,628, FILED 8-29-2007.

FIRST USE 11-5-2007; IN COMMERCE 11-5-2007.

MICHAEL TANNER, EXAMINING ATTORNEY

Int. Cl.: 9

Prior U.S. Cls.: 21, 23, 26, 36, and 38

Reg. No. 3,477,818

United States Patent and Trademark Office

Registered July 29, 2008

TRADEMARK
PRINCIPAL REGISTER

life|media

EXCEPTIONAL INNOVATION LLC (OHIO LTD
LIAB CO)
480 OLDE WORTHINGTON ROAD, SUITE 350
WESTERVILLE, OH 43082

FOR: COMPUTER HARDWARE FOR STORAGE
AND ACCESS OF DIGITAL CONTENT AND FOR
BUILDING AUTOMATION AND CONTROL, IN
CLASS 9 (U.S. CLS. 21, 23, 26, 36 AND 38).

FIRST USE 1-7-2008; IN COMMERCE 1-7-2008.

NO CLAIM IS MADE TO THE EXCLUSIVE
RIGHT TO USE "MEDIA", APART FROM THE
MARK AS SHOWN.

THE MARK CONSISTS OF THE WORD "LIFE"
FOLLOWED BY A VERTICLE LINE KNOWN AS
THE PIPE SYMBOL FOLLOWED BY THE WORD
"MEDIA".

SN 77-268,513, FILED 8-30-2007.

INGRID C. EULIN, EXAMINING ATTORNEY

Int. Cl.: 10

Prior U.S. Cls.: 26, 39, and 44

United States Patent and Trademark Office

Reg. No. 3,477,819

Registered July 29, 2008

**TRADEMARK
PRINCIPAL REGISTER**

CASCADE

CASCADE DAFO, INC. (WASHINGTON CORPORATION)
1360 SUNSET AVENUE
FERNDALE, WA 982488913

THE MARK CONSISTS OF STANDARD CHARACTERS WITHOUT CLAIM TO ANY PARTICULAR FONT, STYLE, SIZE, OR COLOR.

FOR: ANKLE FOOT ORTHOTICS; ORTHOTIC DEVICES FOR FEET, ANKLES, LEGS; AND LOWER LIMB ORTHOSES, IN CLASS 10 (U.S. CLS. 26, 39 AND 44).

SN 77-268,772, FILED 8-30-2007.

FIRST USE 2-1-2007; IN COMMERCE 2-1-2007.

KIMBERLY PERRY, EXAMINING ATTORNEY

Int. Cl.: 35

Prior U.S. Cls.: 100, 101, and 102

United States Patent and Trademark Office

Reg. No. 3,477,820

Registered July 29, 2008

**SERVICE MARK
PRINCIPAL REGISTER**

TWENTY TWO SQUARED

22SQUARED, INC. (GEORGIA CORPORATION)
1170 PEACHTREE STREET, SUITE 1500
ATLANTA, GA 30309

FIRST USE 8-30-2007; IN COMMERCE 8-30-2007.

FOR: ADVERTISING AGENCY SERVICES; BUSINESS CONSULTATION SERVICES, NAMELY, DEVELOPING PROMOTIONAL CAMPAIGNS AND MATERIALS FOR THE ADVERTISEMENT OF GOODS AND SERVICES OF OTHERS THROUGH MASS MEDIA AND INTERACTIVE MEDIA; PUBLIC RELATIONS SERVICES; MARKET RESEARCH SERVICES, IN CLASS 35 (U.S. CLS. 100, 101 AND 102).

THE MARK CONSISTS OF STANDARD CHARACTERS WITHOUT CLAIM TO ANY PARTICULAR FONT, STYLE, SIZE, OR COLOR.

SN 77-269,222, FILED 8-31-2007.

KELLY MCCOY, EXAMINING ATTORNEY

Int. Cl.: 35

Prior U.S. Cls.: 100, 101, and 102

United States Patent and Trademark Office

Reg. No. 3,477,821

Registered July 29, 2008

**SERVICE MARK
PRINCIPAL REGISTER**

Celebrate LA

ASSISTANCE LEAGUE OF SOUTHERN CALIFORNIA (CALIFORNIA CORPORATION)
VOLUNTEER CENTER OF LOS ANGELES
8134 VAN NUYS BLVD, SUITE 200
PANORAMA CITY, CA 91402

FOR: CHARITABLE SERVICES, NAMELY, ORGANIZING AND CONDUCTING VOLUNTEER PROGRAMS AND COMMUNITY SERVICE PROJECTS, IN CLASS 35 (U.S. CLS. 100, 101 AND 102).

FIRST USE 1-30-2008; IN COMMERCE 1-30-2008.

THE MARK CONSISTS OF STANDARD CHARACTERS WITHOUT CLAIM TO ANY PARTICULAR FONT, STYLE, SIZE, OR COLOR.

NO CLAIM IS MADE TO THE EXCLUSIVE RIGHT TO USE "LA", APART FROM THE MARK AS SHOWN.

SN 77-269,228, FILED 8-31-2007.

JULIE WATSON, EXAMINING ATTORNEY

Int. Cl.: 25

Prior U.S. Cls.: 22 and 39

United States Patent and Trademark Office

Reg. No. 3,477,822

Registered July 29, 2008

TRADEMARK
PRINCIPAL REGISTER

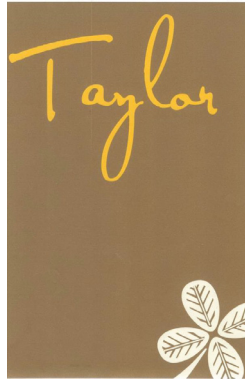

SIOUNI & ZAR CORP. (NEW YORK CORPORATION)
49 WEST 37TH STREET
NEW YORK, NY 10018

FOR: DRESS SUITS; DRESSES; LADIES' SUITS;
SUITS; SKIRTS; BLOUSES; VESTS; TROUSERS, IN
CLASS 25 (U.S. CLS. 22 AND 39).

FIRST USE 1-24-2008; IN COMMERCE 1-24-2008.

OWNER OF U.S. REG. NO. 2,781,605.

THE COLOR(S) TAUPE, GOLD AND WHITE IS/
ARE CLAIMED AS A FEATURE OF THE MARK.

THE MARK CONSISTS OF A RECTANGULAR
BOX WITH A TAUPE BACKGROUND IN WHICH
THE WORD TAYLOR IS WRITTEN IN SCRIPT IN
GOLD LETTERS NEAR THE TOP. IN THE BOTTOM
RIGHT CORNER THERE IS A LEAF DESIGN IN
WHITE..

SN 77-269,569, FILED 8-31-2007.

MARILYN IZZI, EXAMINING ATTORNEY

Int. Cl.: 44

Prior U.S. Cls.: 100 and 101

United States Patent and Trademark Office

Reg. No. 3,477,823

Registered July 29, 2008

**SERVICE MARK
PRINCIPAL REGISTER**

EMBELLISH

MCQUEEN PURSCH, LLC (TEXAS LTD LIAB
CO)
STE. 300
4615 N. LAMAR BLVD.
AUSTIN, TX 78751

THE MARK CONSISTS OF STANDARD CHAR-
ACTERS WITHOUT CLAIM TO ANY PARTICULAR
FONT, STYLE, SIZE, OR COLOR.

FOR: BEAUTY SALONS; NAIL CARE SALONS;
SKIN CARE SALONS, IN CLASS 44 (U.S. CLS. 100
AND 101).

SN 77-269,627, FILED 8-31-2007.

FIRST USE 12-7-2007; IN COMMERCE 2-18-2008.

KELLY MCCOY, EXAMINING ATTORNEY

Int. Cl.: 39

Prior U.S. Cls.: 100 and 105

United States Patent and Trademark Office

Reg. No. 3,477,824

Registered July 29, 2008

**SERVICE MARK
PRINCIPAL REGISTER**

ResortCompete

RESORTCOMPETE, LLC (IOWA LTD LIAB CO)
3314 SW 33RD STREET
DES MOINES, IA 50321

FOR: ARRANGING TRAVEL TOURS; COORDINATING TRAVEL ARRANGEMENTS FOR INDIVIDUALS AND FOR GROUPS; ORGANIZATION OF TRAVEL; ORGANIZATION OF EXCURSIONS, SIGHTSEEING TOURS, HOLIDAYS, TOURS AND TRAVEL; ORGANIZATION OF TRAVEL AND BOAT TRIPS; PROVIDING AN ON-LINE COMPUTER DATABASE IN THE FIELD OF TRAVEL INFORMATION SERVICES; PROVIDING INFORMATION, NEWS AND COMMENTARY IN THE FIELD OF TRAVEL; PROVIDING LINKS TO WEB SITES OF OTHERS FEATURING TRAVEL; PROVIDING REVIEWS OF TRAVEL SERVICE PROVIDERS; TRAVEL AGENCY SERVICES, NAMELY,

MAKING RESERVATIONS AND BOOKINGS FOR TRANSPORTATION; TRAVEL AND TOUR INFORMATION SERVICE; TRAVEL BOOKING AGENCIES; TRAVEL CLUBS; TRAVEL INFORMATION SERVICES; TRAVEL, EXCURSION AND CRUISE ARRANGEMENT, IN CLASS 39 (U.S. CLS. 100 AND 105).

FIRST USE 6-2-2008; IN COMMERCE 6-2-2008.

THE MARK CONSISTS OF STANDARD CHARACTERS WITHOUT CLAIM TO ANY PARTICULAR FONT, STYLE, SIZE, OR COLOR.

SN 77-271,777, FILED 9-5-2007.

ADA HAN, EXAMINING ATTORNEY

Int. Cl.: 5

Prior U.S. Cls.: 6, 18, 44, 46, 51, and 52

Reg. No. 3,477,825

United States Patent and Trademark Office

Registered July 29, 2008

**TRADEMARK
PRINCIPAL REGISTER**

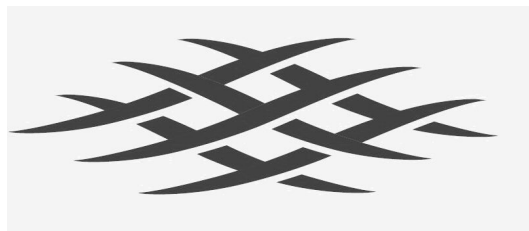

ZYMOGENETICS, INC. (WASHINGTON CORPORATION)
1201 EASTLAKE AVE., E.
SEATTLE, WA 98102

FOR: PHARMACEUTICAL PREPARATIONS, NAMELY, CLOTTING AGENTS, CLOTTING PREPARATIONS, AND AGENTS FOR CONVERTING AND ACTIVATING CLOTTING POLYMERS FOR USE IN THE CONTROL OF BLEEDING ASSOCIATED WITH A WIDE RANGE OF SURGERIES, TRAUMA AND BURN INJURIES; PHARMACEUTICAL PREPARATIONS FOR USE IN ACCELERATING CLOTTING TIME AND ARRESTING BLOOD FLOW DURING MEDICAL PROCEDURES PHARMACEUTICAL PREPARATIONS FOR USE AS A TOPICAL HEMOSTAT TO CONTROL SURGICAL

BLEEDING, FOR THE TREATMENT OF BLEEDING COMPLICATIONS, TRAUMA AND BURN INJURIES, AND TO MAKE ALTERATIONS AND ENHANCEMENTS IN TISSUE REPAIR; SURGICAL PREPARATIONS WHICH ARE USED LOCALLY OR TOPICALLY FOR HEMOSTATIC CONTROL IN THE FORM OF LIQUID WITH A HEMOSTATIC EFFECT, IN CLASS 5 (U.S. CLS. 6, 18, 44, 46, 51 AND 52).

FIRST USE 1-28-2008; IN COMMERCE 1-28-2008.

SN 77-271,840, FILED 9-5-2007.

GIANCARLO CASTRO, EXAMINING ATTORNEY

Int. Cl.: 41

Prior U.S. Cls.: 100, 101, and 107

United States Patent and Trademark Office

Reg. No. 3,477,826

Registered July 29, 2008

**SERVICE MARK
PRINCIPAL REGISTER**

SPA SEEKERS

ULTRA HD COMPANY LLC (DELAWARE LTD
LIAB CO)
1111 STEWART AVENUE
BETHPAGE, NY 11714

FOR: ENTERTAINMENT SERVICES, NAMELY,
AN ON-GOING REALITY BASED TELEVISION
PROGRAM IN THE FIELD OF TRAVEL, IN CLASS
41 (U.S. CLS. 100, 101 AND 107).

FIRST USE 1-8-2008; IN COMMERCE 1-8-2008.

THE MARK CONSISTS OF STANDARD CHAR-
ACTERS WITHOUT CLAIM TO ANY PARTICULAR
FONT, STYLE, SIZE, OR COLOR.

NO CLAIM IS MADE TO THE EXCLUSIVE
RIGHT TO USE "SPA", APART FROM THE MARK
AS SHOWN.

SN 77-273,156, FILED 9-6-2007.

ROBERT LAVACHE, EXAMINING ATTORNEY

Int. Cl.: 1

Prior U.S. Cls.: 1, 5, 6, 10, 26, and 46

United States Patent and Trademark Office

Reg. No. 3,477,827

Registered July 29, 2008

**TRADEMARK
PRINCIPAL REGISTER**

OROBOOST

ORO AGRI, INC. (MISSOURI CORPORATION)
990 TROPHY CLUB DRIVE
TROPHY CLUB, TX 76262

THE MARK CONSISTS OF STANDARD CHAR-
ACTERS WITHOUT CLAIM TO ANY PARTICULAR
FONT, STYLE, SIZE, OR COLOR.

FOR: ADJUVANTS FOR USE WITH PESTICIDES,
IN CLASS 1 (U.S. CLS. 1, 5, 6, 10, 26 AND 46).

SN 77-273,512, FILED 9-6-2007.

FIRST USE 12-11-2007; IN COMMERCE 12-11-2007.

KELLEY WELLS, EXAMINING ATTORNEY

Int. Cl.: 35

Prior U.S. Cls.: 100, 101, and 102

United States Patent and Trademark Office

Reg. No. 3,477,828

Registered July 29, 2008

**SERVICE MARK
PRINCIPAL REGISTER**

**CITY LIGHTS, SOUTHERN
NIGHTS**

BRAND ATLANTA, INC. (GEORGIA NON-PROFIT CORPORATION)
1180 PEACHTREE STREET, 41ST FLOOR
ATLANTA, GA 30309

FOR: PROMOTING TRAVEL AND TOURISM
AND ECONOMIC DEVELOPMENT IN THE CITY
OF ATLANTA, GEORGIA, IN CLASS 35 (U.S. CLS.
100, 101 AND 102).

FIRST USE 2-0-2008; IN COMMERCE 2-0-2008.

THE MARK CONSISTS OF STANDARD CHARACTERS WITHOUT CLAIM TO ANY PARTICULAR FONT, STYLE, SIZE, OR COLOR.

SN 77-273,966, FILED 9-7-2007.

DOMINIC FATHY, EXAMINING ATTORNEY

Int. Cl.: 40

Prior U.S. Cls.: 100, 103, and 106

United States Patent and Trademark Office

Reg. No. 3,477,829

Registered July 29, 2008

SERVICE MARK
PRINCIPAL REGISTER

The logo for 'Affiliated Ink' is written in a highly decorative, cursive script. The word 'Affiliated' is on the top line and 'Ink' is on the bottom line, positioned to the right and slightly below 'Affiliated'. The letters are fluid and interconnected, with long, sweeping flourishes, particularly on the 'A' and 'I'.

WATERS, JUSTIN (UNITED STATES INDIVIDUAL)
525 N. FAIRVIEW ST.
BURBANK, CA 91505

THE MARK CONSISTS OF A SCRIPT TEXT OF THE WORDS "AFFILIATED INK". THE WORD "INK" IS BELOW THE WORD "AFFILIATED" AND STARTS UNDER THE "D".

FOR: SCREEN PRINTING, IN CLASS 40 (U.S. CLS. 100, 103 AND 106).

SN 77-277,535, FILED 9-12-2007.

FIRST USE 10-1-2007; IN COMMERCE 2-25-2008.

LINDA MICKLEBURGH, EXAMINING ATTORNEY

Int. Cl.: 36

Prior U.S. Cls.: 100, 101, and 102

United States Patent and Trademark Office

Reg. No. 3,477,830

Registered July 29, 2008

**SERVICE MARK
PRINCIPAL REGISTER**

BIMINI CAPITAL MANAGEMENT

BIMINI CAPITAL MANAGEMENT, INC. (MARY-
LAND CORPORATION)

3305 FLAMINGO DRIVE

VERO BEACH, FL 32963

FOR: REAL ESTATE INVESTMENT TRUST SER-
VICES, IN CLASS 36 (U.S. CLS. 100, 101 AND 102).

FIRST USE 9-20-2007; IN COMMERCE 9-28-2007.

THE MARK CONSISTS OF STANDARD CHAR-
ACTERS WITHOUT CLAIM TO ANY PARTICULAR
FONT, STYLE, SIZE, OR COLOR.

NO CLAIM IS MADE TO THE EXCLUSIVE
RIGHT TO USE "CAPITAL MANAGEMENT",
APART FROM THE MARK AS SHOWN.

SN 77-279,100, FILED 9-13-2007.

EMILY CHUO, EXAMINING ATTORNEY

Int. Cl.: 36

Prior U.S. Cls.: 100, 101, and 102

United States Patent and Trademark Office

Reg. No. 3,477,831

Registered July 29, 2008

**SERVICE MARK
PRINCIPAL REGISTER**



BIMINI CAPITAL MANAGEMENT, INC. (MARY-
LAND CORPORATION)
3305 FLAMINGO DRIVE
VERO BEACH, FL 32963

THE MARK CONSISTS OF THE TERM "BIMINI
CAPITAL MANAGEMENT" COMBINED WITH A
SQUARE DEVICE ON WHICH IS IMPOSED THE
OUTLINE OF A SPEAR HEAD.

FOR: REAL ESTATE INVESTMENT TRUST, IN
CLASS 36 (U.S. CLS. 100, 101 AND 102).

FIRST USE 9-20-2007; IN COMMERCE 9-28-2007.

SN 77-279,121, FILED 9-13-2007.

NO CLAIM IS MADE TO THE EXCLUSIVE
RIGHT TO USE "CAPITAL MANAGEMENT",
APART FROM THE MARK AS SHOWN.

EMILY CHUO, EXAMINING ATTORNEY

Int. Cl.: 28

Prior U.S. Cls.: 22, 23, 38, and 50

United States Patent and Trademark Office

Reg. No. 3,477,832

Registered July 29, 2008

**TRADEMARK
PRINCIPAL REGISTER**

GROOVEZZ

LEON AUERBACH (UNITED STATES INDIVIDUAL)
306 CAPTAINS WAY
BAY SHORE, NY 11706

THE MARK CONSISTS OF STANDARD CHARACTERS WITHOUT CLAIM TO ANY PARTICULAR FONT, STYLE, SIZE, OR COLOR.

FOR: MANIPULATIVE PUZZLES, IN CLASS 28 (U.S. CLS. 22, 23, 38 AND 50).

SN 77-280,069, FILED 9-14-2007.

FIRST USE 7-3-2007; IN COMMERCE 7-31-2007.

RAUL CORDOVA, EXAMINING ATTORNEY

Int. Cl.: 35

Prior U.S. Cls.: 100, 101, and 102

United States Patent and Trademark Office

Reg. No. 3,477,833

Registered July 29, 2008

**SERVICE MARK
PRINCIPAL REGISTER**

**Where Fashion Meets
Philanthropy**

COMMUNITY CLOSET INC. (MONTANA CORPORATION)
416 E. PARK STREET
LIVINGSTON, MT 59047

FOR: SECOND HAND DEALERSHIPS FEATURING CLOTHING, IN CLASS 35 (U.S. CLS. 100, 101 AND 102).

FIRST USE 2-1-2008; IN COMMERCE 3-12-2008.

THE MARK CONSISTS OF STANDARD CHARACTERS WITHOUT CLAIM TO ANY PARTICULAR FONT, STYLE, SIZE, OR COLOR.

SN 77-280,442, FILED 9-15-2007.

SAMUEL E. SHARPER JR., EXAMINING ATTORNEY

Int. Cl.: 28

Prior U.S. Cls.: 22, 23, 38, and 50

United States Patent and Trademark Office

Reg. No. 3,477,834

Registered July 29, 2008

**TRADEMARK
PRINCIPAL REGISTER**

SPIN SOAKER

HOLSTEN, WILLIAM A. (UNITED STATES IN-
DIVIDUAL)
16 TWIN OAKS ROAD
PARSIPPANY, NJ 07054

THE MARK CONSISTS OF STANDARD CHAR-
ACTERS WITHOUT CLAIM TO ANY PARTICULAR
FONT, STYLE, SIZE, OR COLOR.

FOR: AMUSEMENT GAME MACHINES, IN
CLASS 28 (U.S. CLS. 22, 23, 38 AND 50).

SN 77-280,544, FILED 9-15-2007.

FIRST USE 11-4-2007; IN COMMERCE 2-10-2008.

SHAUNIA CARLYLE, EXAMINING ATTORNEY

Int. Cl.: 16

Prior U.S. Cls.: 2, 5, 22, 23, 29, 37, 38, and 50

United States Patent and Trademark Office

Reg. No. 3,477,835

Registered July 29, 2008

TRADEMARK
PRINCIPAL REGISTER

the stuff in my house

DON SHEARN MARKETING SERVICES (ILLINOIS LTD LIAB CO)
1256 FOREST AVE.
HIGHLAND PARK, IL 60035 AND
SHEARN, PEGGY S. (UNITED STATES INDIVIDUAL)
1256 FOREST AVE.
HIGHLAND PARK, IL 60035

FOR: STATIONERY; STATIONERY WRITING PAPER AND ENVELOPES; STATIONERY-TYPE PORTFOLIOS; STICKERS; OFFICE STATIONERY;

PAPER STATIONERY; ENVELOPES FOR STATIONERY USE; STATIONERY BOXES; STATIONERY CASES; STATIONERY FOLDERS, IN CLASS 16 (U.S. CLS. 2, 5, 22, 23, 29, 37, 38 AND 50).

FIRST USE 5-14-2008; IN COMMERCE 5-14-2008.

SN 77-281,452, FILED 9-17-2007.

MICHAEL LITZAU, EXAMINING ATTORNEY

Int. Cl.: 37

Prior U.S. Cls.: 100, 103, and 106

United States Patent and Trademark Office

Reg. No. 3,477,836

Registered July 29, 2008

**SERVICE MARK
PRINCIPAL REGISTER**



MCBRIDE ELECTRIC, INC. (KANSAS CORPORATION)
6480 WEATHERS PLACE, SUITE 340
SAN DIEGO, CA 92121

FOR: CONSULTING IN THE FIELD OF ELECTRICAL CONTRACTING SERVICES; ELECTRICAL CONTRACTOR SERVICES, NAMELY, MULTI-CITY AND MULTI-SITE INSTALLATION OF ELECTRICAL SYSTEMS, POWER SYSTEMS, AND DATA TRANSMISSION SYSTEMS, IN CLASS 37 (U.S. CLS. 100, 103 AND 106).

FIRST USE 1-11-2008; IN COMMERCE 2-18-2008.

OWNER OF U.S. REG. NO. 1,142,882.

THE COLOR(S) RED, BLUE, AND BLACK IS/ARE CLAIMED AS A FEATURE OF THE MARK.

THE MARK CONSISTS OF ONE RED ARROW AND ONE BLUE ARROW OVERLAPPING EACH OTHER AND PRECEDING THE WORD "MCBRIDE" IN BLACK LETTERS.

SN 77-281,606, FILED 9-17-2007.

REBECCA EISINGER, EXAMINING ATTORNEY

Int. Cl.: 19

Prior U.S. Cls.: 1, 12, 33, and 50

United States Patent and Trademark Office

Reg. No. 3,477,837

Registered July 29, 2008

**TRADEMARK
PRINCIPAL REGISTER**

TL

TL DOORS, INC. (CALIFORNIA CORPORATION)
2646 RIVER AVE. #D
ROSEMEAD, CA 91770

FOR: DOOR JAMBS NOT OF METAL; DOOR PANELS, NOT OF METAL; NON-METAL DOOR FRAMES; NON-METAL DOOR PANELS; NON-METAL DOOR UNITS; NON-METAL DOORS; NON-METAL PATIO DOORS; NON-METAL SLIDING DOORS; NONMETAL DOOR PARTS FOR BUILDINGS, NAMELY, ADJUSTERS FOR ADJUSTING THE HEIGHT OF A DOOR, FLOOR BOARDS, COLUMNS, BEAMS, PANELING BOARDS, SILLS, SLEEPERS, BACKINGS FOR CEILINGS OR WALLS, STILES, RAILS AND CEILING BOARDS; WOOD DOOR FRAMES; DOOR FRAMES, NOT OF METAL; DOOR CASINGS, NOT OF METAL; HIGH PERFORMANCE FABRIC COVERS FOR USE IN PROTECT-

ING WINDOW AND DOOR OPENINGS DURING STORMS; NON-METAL GARAGE DOORS; NON-METAL RUNNERS FOR SLIDING DOORS; NON-METAL PET DOORS; REVOLVING DOORS NOT OF METAL; VINYL DOORS; VINYL PATIO DOORS; VINYL SLIDING DOORS, IN CLASS 19 (U.S. CLS. 1, 12, 33 AND 50).

FIRST USE 11-30-2007; IN COMMERCE 5-27-2008.

THE MARK CONSISTS OF STANDARD CHARACTERS WITHOUT CLAIM TO ANY PARTICULAR FONT, STYLE, SIZE, OR COLOR.

SN 77-284,076, FILED 9-20-2007.

RONALD MCMORROW, EXAMINING ATTORNEY

Int. Cl.: 41

Prior U.S. Cls.: 100, 101, and 107

United States Patent and Trademark Office

Reg. No. 3,477,838

Registered July 29, 2008

SERVICE MARK
PRINCIPAL REGISTER



MASTER AMY REED'S BLACK BELT ACADEMY
(FLORIDA LTD LIAB CO)
377 SE SOUTHWOOD TRAIL
STUART, FL 34997

FOR: MARTIAL ARTS INSTRUCTION, IN CLASS
41 (U.S. CLS. 100, 101 AND 107).

FIRST USE 10-1-2006; IN COMMERCE 1-15-2007.

NO CLAIM IS MADE TO THE EXCLUSIVE
RIGHT TO USE "MASTER," "ORH," "TKD," AND
"BLACK BELT ACADEMY", APART FROM THE
MARK AS SHOWN.

THE NAME "AMY REED" IDENTIFIES A LIVING
INDIVIDUAL WHOSE CONSENT IS OF RECORD.

THE MARKS CONSISTS OF THE WORDING
"MASTER AMY REED'S BLACK BELT ACADEMY
ORH TKD" SPREAD AROUND A CIRCULAR
FRAME WITH SMALL CIRCLES SEPARATING
OUT "MASTER AMY REED'S" FROM "TKD" FROM
"BLACK BELT ACADEMY" FROM "ORH". THE
MIDDLE OF THE CIRCLE CONTAINS TWO STY-
LIZED DRAGONS FORMING A CIRCULAR YIN
YANG DESIGN.

SN 77-284,513, FILED 9-20-2007.

TOBY BULLOFF, EXAMINING ATTORNEY

Int. Cl.: 43

Prior U.S. Cls.: 100 and 101

United States Patent and Trademark Office

Reg. No. 3,477,839

Registered July 29, 2008

**SERVICE MARK
PRINCIPAL REGISTER**

SPUD BROS

J.R. SIMPLOT COMPANY (NEVADA CORPORATION)
P.O. BOX 27
BOISE, ID 83707

FOR: FAST-FOOD RESTAURANTS AND SNACK-BARS; RESTAURANTS; TAKE-OUT RESTAURANT SERVICES, IN CLASS 43 (U.S. CLS. 100 AND 101).

FIRST USE 5-12-2008; IN COMMERCE 5-12-2008.

THE MARK CONSISTS OF STANDARD CHARACTERS WITHOUT CLAIM TO ANY PARTICULAR FONT, STYLE, SIZE, OR COLOR.

NO CLAIM IS MADE TO THE EXCLUSIVE RIGHT TO USE "SPUD", APART FROM THE MARK AS SHOWN.

SN 77-284,928, FILED 9-20-2007.

KATHERINE CHANG, EXAMINING ATTORNEY

Int. Cl.: 16

Prior U.S. Cls.: 2, 5, 22, 23, 29, 37, 38, and 50

Reg. No. 3,477,840

United States Patent and Trademark Office

Registered July 29, 2008

**TRADEMARK
PRINCIPAL REGISTER**

**Turning Hindsight into
Foresight**

CENTER OF THE AMERICAN WEST (COLOR-
ADO EDUCATIONAL INSTITUTION)
282 UCB UNIVERSITY OF COLORADO
BOULDER, CO 803090282

FOR: RESEARCH REPORTS FEATURING TO-
PICS OF CRUCIAL INTEREST TO THE AMERICAN
WEST, NAMELY, MULTICULTURALISM, COM-
MUNITY BUILDING, FIRE POLICY, AND LAND,
WATER, AND ENERGY USE; BOOKS IN THE
FIELD OF TOPICS OF CRUCIAL INTEREST TO
THE AMERICAN WEST, NAMELY MULTICUL-
TURALISM, COMMUNITY BUILDING, FIRE POL-

ICY, AND LAND, WATER, AND ENERGY USE, IN
CLASS 16 (U.S. CLS. 2, 5, 22, 23, 29, 37, 38 AND 50).

FIRST USE 4-1-2008; IN COMMERCE 4-1-2008.

THE MARK CONSISTS OF STANDARD CHAR-
ACTERS WITHOUT CLAIM TO ANY PARTICULAR
FONT, STYLE, SIZE, OR COLOR.

SN 77-285,670, FILED 9-21-2007.

ELLEN BURNS, EXAMINING ATTORNEY

Int. Cl.: 9

Prior U.S. Cls.: 21, 23, 26, 36, and 38

United States Patent and Trademark Office

Reg. No. 3,477,841

Registered July 29, 2008

**TRADEMARK
PRINCIPAL REGISTER**

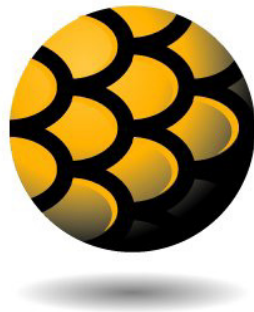

CARP DATA SERVICE, LLC (FLORIDA LTD
LIAB CO)
13435 S. MCCALL RD., #126
PORT CHARLOTTE, FL 33981

FOR: COMPUTER SOFTWARE FOR PROVIDING
AN ON-LINE DATABASE IN THE FIELD OF
TRANSACTION PROCESSING TO UPLOAD
TRANSACTIONAL DATA, PROVIDE STATISTICAL
ANALYSIS, AND PRODUCE NOTIFICATIONS AND
REPORTS, IN CLASS 9 (U.S. CLS. 21, 23, 26, 36 AND
38).

FIRST USE 11-1-2007; IN COMMERCE 11-1-2007.

THE COLOR(S) BLACK AND GOLD IS/ARE
CLAIMED AS A FEATURE OF THE MARK.

THE MARK CONSISTS OF A GLOBE COVERED
WITH GOLD AND BLACK FISH-SCALES AND IS
GRADUALLY SHADED TOWARD LOWER RIGHT
HAND SIDE AND FLOATS ABOVE SHADOW.

SN 77-286,569, FILED 9-23-2007.

SHAUNIA CARLYLE, EXAMINING ATTORNEY

Int. Cl.: 20

Prior U.S. Cls.: 2, 13, 22, 25, 32, and 50

Reg. No. 3,477,842

United States Patent and Trademark Office

Registered July 29, 2008

**TRADEMARK
PRINCIPAL REGISTER**

GLORY DAYS

RAYTEX FABRICS INC. (NEW YORK COR-
PORATION)
130 CROSSWAYS PARK DR.
WOODBURY, NY 11797

THE MARK CONSISTS OF STANDARD CHAR-
ACTERS WITHOUT CLAIM TO ANY PARTICULAR
FONT, STYLE, SIZE, OR COLOR.

FOR: PET BEDS, IN CLASS 20 (U.S. CLS. 2, 13, 22,
25, 32 AND 50).

SN 77-287,854, FILED 9-25-2007.

FIRST USE 2-8-2008; IN COMMERCE 2-8-2008.

MARK RADEMACHER, EXAMINING ATTORNEY

Int. Cl.: 9

Prior U.S. Cls.: 21, 23, 26, 36, and 38

United States Patent and Trademark Office

Reg. No. 3,477,843

Registered July 29, 2008

**TRADEMARK
PRINCIPAL REGISTER**

SURECRIMP

ILSCO CORPORATION (OHIO CORPORATION)
4730 MADISON ROAD
CINCINNATI, OH 452271426

THE MARK CONSISTS OF STANDARD CHAR-
ACTERS WITHOUT CLAIM TO ANY PARTICULAR
FONT, STYLE, SIZE, OR COLOR.

FOR: ELECTRICAL CONNECTORS, IN CLASS 9
(U.S. CLS. 21, 23, 26, 36 AND 38).

SN 77-288,255, FILED 9-25-2007.

FIRST USE 10-12-2007; IN COMMERCE 10-12-2007.

MARCIE MILONE, EXAMINING ATTORNEY

Int. Cl.: 20

Prior U.S. Cls.: 2, 13, 22, 25, 32, and 50

Reg. No. 3,477,844

United States Patent and Trademark Office

Registered July 29, 2008

**TRADEMARK
PRINCIPAL REGISTER**

STRONG ARM

SLIGH FURNITURE CO. (MICHIGAN CORPORATION)
LOFT 102
217 E. 24TH ST.
HOLLAND, MI 49423

FOR: HOME ENTERTAINMENT FURNITURE, NAMELY, A COMPONENT OF A TELEVISION CONSOLE CONSISTING OF AN ADJUSTABLE SUPPORT FOR MOUNTING A TELEVISION ON THE CONSOLE, IN CLASS 20 (U.S. CLS. 2, 13, 22, 25, 32 AND 50).

FIRST USE 9-30-2007; IN COMMERCE 9-30-2007.

THE MARK CONSISTS OF STANDARD CHARACTERS WITHOUT CLAIM TO ANY PARTICULAR FONT, STYLE, SIZE, OR COLOR.

SN 77-289,098, FILED 9-26-2007.

ALEXANDER L. POWERS, EXAMINING ATTORNEY

Int. Cl.: 18

Prior U.S. Cls.: 1, 2, 3, 22, and 41

United States Patent and Trademark Office

Reg. No. 3,477,845

Registered July 29, 2008

**TRADEMARK
PRINCIPAL REGISTER**



YH FOREVER, INC. (CALIFORNIA CORPORATION)
109 E 11TH ST
LOS ANGELES, CA 90015

FIRST USE 5-10-2008; IN COMMERCE 5-10-2008.

SN 77-289,484, FILED 9-26-2007.

FOR: HANDBAGS; SCHOOL BAGS; SUITCASES
AND WALLETS, IN CLASS 18 (U.S. CLS. 1, 2, 3, 22
AND 41).

MICHAEL KAZAZIAN, EXAMINING ATTORNEY

Int. Cl.: 36

Prior U.S. Cls.: 100, 101, and 102

United States Patent and Trademark Office

Reg. No. 3,477,846

Registered July 29, 2008

**SERVICE MARK
PRINCIPAL REGISTER**

LEGACY PATH

PROTECTIVE LIFE INSURANCE COMPANY
(TENNESSEE CORPORATION)
2801 HIGHWAY 280 SOUTH
BIRMINGHAM, AL 35223

FOR: FINANCIAL PLANNING SERVICES; LIFE
INSURANCE AND ANNUITY UNDERWRITING
SERVICES, IN CLASS 36 (U.S. CLS. 100, 101 AND 102).

FIRST USE 4-8-2008; IN COMMERCE 4-8-2008.

THE MARK CONSISTS OF STANDARD CHAR-
ACTERS WITHOUT CLAIM TO ANY PARTICULAR
FONT, STYLE, SIZE, OR COLOR.

OWNER OF U.S. REG. NO. 2,528,050.

SN 77-291,345, FILED 9-28-2007.

NAAKWAMA ANKRAH, EXAMINING ATTORNEY

Int. Cls.: 35 and 42

Prior U.S. Cls.: 100, 101, and 102

United States Patent and Trademark Office

Reg. No. 3,477,847

Registered July 29, 2008

**SERVICE MARK
PRINCIPAL REGISTER**

GiftGrinder

PERLMAN ERIC (UNITED STATES INDIVIDUAL)
10343 RUBIO AVE
GRANADA HILLS, CA 91344

FOR: COMPUTERIZED ON-LINE GIFT ORDERING SERVICE WHICH MATCHES THE GIFT GIVER'S REQUIREMENTS WITH THE GIFT RECIPIENT'S WANTS AND NEEDS, IN CLASS 35 (U.S. CLS. 100, 101 AND 102).

FIRST USE 2-1-2003; IN COMMERCE 1-1-2008.

FOR: COMPUTER SERVICES, NAMELY, HOSTING ON-LINE INTERACTIVE PUBLIC CALEN-

DARS THAT ALLOW MULTIPLE PARTICIPANTS TO SHARE EVENT SCHEDULES, FACILITY RESERVATIONS, AND TRANSPORTATION REQUESTS, IN CLASS 42 (U.S. CLS. 100 AND 101).

FIRST USE 2-1-2003; IN COMMERCE 1-1-2008.

THE MARK CONSISTS OF STANDARD CHARACTERS WITHOUT CLAIM TO ANY PARTICULAR FONT, STYLE, SIZE, OR COLOR.

SN 77-292,804, FILED 10-1-2007.

JORDAN BAKER, EXAMINING ATTORNEY

Int. Cl.: 28

Prior U.S. Cls.: 22, 23, 38, and 50

United States Patent and Trademark Office

Reg. No. 3,477,848

Registered July 29, 2008

**TRADEMARK
PRINCIPAL REGISTER**

MONKEY SPELLER

CHEUNG, JASON (UNITED STATES INDIVIDUAL)

32408 CENTRAL AVENUE

UNION CITY, CA 94587

FOR: MANIPULATIVE GAMES, IN CLASS 28 (U.S. CLS. 22, 23, 38 AND 50).

FIRST USE 1-1-2008; IN COMMERCE 1-1-2008.

THE MARK CONSISTS OF STANDARD CHARACTERS WITHOUT CLAIM TO ANY PARTICULAR FONT, STYLE, SIZE, OR COLOR.

NO CLAIM IS MADE TO THE EXCLUSIVE RIGHT TO USE "SPELLER", APART FROM THE MARK AS SHOWN.

SN 77-293,337, FILED 10-1-2007.

GINA FINK, EXAMINING ATTORNEY

Int. Cl.: 32

Prior U.S. Cls.: 45, 46, and 48

United States Patent and Trademark Office

Reg. No. 3,477,849

Registered July 29, 2008

TRADEMARK
PRINCIPAL REGISTER



TROPICANA PRODUCTS, INC. (DELAWARE CORPORATION)

1001 13TH AVENUE EAST

BRADENTON, FL 34208

FOR: FRUIT JUICES AND FRUIT JUICE DRINKS, IN CLASS 32 (U.S. CLS. 45, 46 AND 48).

FIRST USE 2-18-2008; IN COMMERCE 2-18-2008.

OWNER OF U.S. REG. NOS. 630,572, 1,303,002, AND OTHERS.

NO CLAIM IS MADE TO THE EXCLUSIVE RIGHT TO USE "EST. 1947" AND "PURE VALENCIA", APART FROM THE MARK AS SHOWN.

THE MARK CONSISTS OF A SQUARE CONTAINING THE WORDS "EST. 1947 TROPICANA PURE VALENCIA" WITH A SYMBOL BETWEEN THE WORD "EST." AND NUMBER "1947" CONSISTING OF THE LETTER "T" IN A CIRCLE SURROUNDED BY A LEAF DESIGN.

SN 77-293,940, FILED 10-2-2007.

TERESA M. RUPP, EXAMINING ATTORNEY

Int. Cl.: 32

Prior U.S. Cls.: 45, 46, and 48

Reg. No. 3,477,850

United States Patent and Trademark Office

Registered July 29, 2008

TRADEMARK
PRINCIPAL REGISTER



TROPICANA PRODUCTS, INC. (DELAWARE CORPORATION)
1001 13TH AVENUE EAST
BRADENTON, FL 34208

FOR: FRUIT JUICES AND FRUIT JUICE DRINKS, IN CLASS 32 (U.S. CLS. 45, 46 AND 48).

FIRST USE 2-18-2008; IN COMMERCE 2-18-2008.

OWNER OF U.S. REG. NOS. 630,572, 1,303,002, AND OTHERS.

NO CLAIM IS MADE TO THE EXCLUSIVE RIGHT TO USE "EST. 1947" AND "PURE 100% JUICE", APART FROM THE MARK AS SHOWN.

THE MARK CONSISTS OF THE WORDS "EST. 1947" WITH A DESIGN BETWEEN "EST." AND "1947" CONSISTING OF A LETTER "T" INSIDE A CIRCLE AND THE WORDS "TROPICANA PURE 100% JUICE" UNDERNEATH.

SN 77-293,948, FILED 10-2-2007.

TERESA M. RUPP, EXAMINING ATTORNEY

Int. Cl.: 16

Prior U.S. Cls.: 2, 5, 22, 23, 29, 37, 38, and 50

United States Patent and Trademark Office

Reg. No. 3,477,851

Registered July 29, 2008

**TRADEMARK
PRINCIPAL REGISTER**

FAMOUS FABRICS

IN THE GAME, INC. (DELAWARE CORPORATION)
300 SE 5TH AVENUE, SUITE 1040
BOCA RATON, FL 33432

THE MARK CONSISTS OF STANDARD CHARACTERS WITHOUT CLAIM TO ANY PARTICULAR FONT, STYLE, SIZE, OR COLOR.

FOR: TRADING CARDS, IN CLASS 16 (U.S. CLS. 2, 5, 22, 23, 29, 37, 38 AND 50).

SN 77-295,061, FILED 10-3-2007.

FIRST USE 4-29-2008; IN COMMERCE 4-29-2008.

ODESSA BIBBINS, EXAMINING ATTORNEY

Int. Cl.: 16

Prior U.S. Cls.: 2, 5, 22, 23, 29, 37, 38, and 50

Reg. No. 3,477,852

United States Patent and Trademark Office

Registered July 29, 2008

**TRADEMARK
PRINCIPAL REGISTER**

BABY BEGINNINGS

GOSPEL LIGHT PUBLICATIONS, INC. (CALIFORNIA CORPORATION)
1957 EASTMAN AVE.
VENTURA, CA 97759

FOR: PRINTED MATERIALS, NAMELY, BOOKS, PAMPHLETS, ACTIVITY BOOKS, PICTURE CARDS, POSTERS, TRAINING GUIDES, AND CURRICULUM IN THE NATURE OF PRINTED INSTRUCTIONAL, EDUCATIONAL, AND TEACHING MATERIALS, ALL FEATURING RELIGIOUS, MORAL, OR ETHICAL TOPICS, OR RELATED INSTRUCTIONAL SUBJECT MATTER, IN CLASS 16 (U.S. CLS. 2, 5, 22, 23, 29, 37, 38 AND 50).

FIRST USE 6-6-2008; IN COMMERCE 6-6-2008.

THE MARK CONSISTS OF STANDARD CHARACTERS WITHOUT CLAIM TO ANY PARTICULAR FONT, STYLE, SIZE, OR COLOR.

NO CLAIM IS MADE TO THE EXCLUSIVE RIGHT TO USE "BABY", APART FROM THE MARK AS SHOWN.

SN 77-295,410, FILED 10-3-2007.

MELVIN AXILBUND, EXAMINING ATTORNEY

Int. Cls.: 35 and 36

Prior U.S. Cls.: 100, 101, and 102

United States Patent and Trademark Office

Reg. No. 3,477,853

Registered July 29, 2008

**SERVICE MARK
PRINCIPAL REGISTER**

VIRIATHUS

VIRIATHUS HOLDINGS LLC (DELAWARE LTD
LIAB CO)
DAVID BATISTA
85 FRANKLIN STREET, APT. 201
NEW YORK, NY 10013

FOR: BUSINESS MARKETING CONSULTING SERVICES; PROVIDING ON-LINE FACILITIES FEATURING TRANSACTION ORDER ENTRY, ORDER DIRECTING AND ORDER CONFIRMATION SERVICES TO CUSTOMERS IN THE FIELD OF INVESTING; ADVICE IN THE FIELD OF BUSINESS MANAGEMENT AND MARKETING; ANALYZING AND COMPILING DATA FOR MEASURING THE PERFORMANCE OF FINANCIAL MARKETS; ARRANGING AND CONDUCTING MARKETING PROMOTIONAL EVENTS FOR OTHERS; BUSINESS ADVICE AND ANALYSIS OF MARKETS; BUSINESS CONSULTATION AND MANAGEMENT REGARDING MARKETING ACTIVITIES AND LAUNCHING OF NEW PRODUCTS; BUSINESS MANAGEMENT CONSULTING WITH RELATION TO STRATEGY, MARKETING, PRODUCTION, PERSONNEL AND RETAIL SALE MATTERS; BUSINESS MARKETING SERVICES; MARKET ANALYSIS; MARKET REPORTS AND STUDIES; MARKET RESEARCH; MARKET RESEARCH SERVICES; MARKET RESEARCH STUDIES, IN CLASS 35 (U.S. CLS. 100, 101 AND 102).

FIRST USE 1-2-2007; IN COMMERCE 1-2-2007.

FOR: BANKING CONSULTATION; BANKING SERVICES; CAPITAL INVESTMENT CONSULTATION; CONSULTATION IN ART AS AN INVESTMENT; EQUITY CAPITAL INVESTMENT; FINANCIAL AND INVESTMENT SERVICES, NAMELY, MANAGEMENT AND BROKERAGE IN THE FIELDS OF STOCKS, BONDS, OPTIONS, COMMODITIES, FUTURES AND OTHER SECURITIES,

AND THE INVESTMENT OF FUNDS OF OTHERS; FINANCIAL INVESTMENT IN THE FIELD OF SECURITIES; FINANCIAL PLANNING AND INVESTMENT ADVISORY SERVICES; FINANCIAL SERVICES IN THE NATURE OF AN INVESTMENT SECURITY; FINANCIAL SERVICES, NAMELY, A TOTAL PORTFOLIO OFFERING FOR HIGH NET WORTH CLIENTS CONSISTING OF BOTH SEPARATE ACCOUNTS AND MUTUAL FUNDS FOR EQUITY AND FIXED INCOME INVESTMENTS; FINANCIAL SERVICES, NAMELY, INVESTMENT FUND TRANSFER AND TRANSACTION SERVICES; FUND INVESTMENT CONSULTATION; FUNDS INVESTMENT; HEDGE FUND INVESTMENT SERVICES; INVESTMENT ADVICE; INVESTMENT ADVISORY SERVICES; INVESTMENT BANKING SERVICES; INVESTMENT BROKERAGE; INVESTMENT CONSULTATION; INVESTMENT MANAGEMENT SERVICES IN THE FIELD OF ACQUIRING JOINT VENTURES; INVESTMENT OF FUNDS FOR OTHERS; INVESTMENT SERVICES, NAMELY, ASSET ACQUISITION, CONSULTATION, DEVELOPMENT AND MANAGEMENT SERVICES; PRIVATE EQUITY FUND INVESTMENT SERVICES; FINANCIAL ANALYSIS AND CONSULTATION; FINANCIAL RESEARCH; FINANCIAL RISK MANAGEMENT CONSULTATION, IN CLASS 36 (U.S. CLS. 100, 101 AND 102).

FIRST USE 3-3-2006; IN COMMERCE 5-1-2007.

THE MARK CONSISTS OF STANDARD CHARACTERS WITHOUT CLAIM TO ANY PARTICULAR FONT, STYLE, SIZE, OR COLOR.

SN 77-296,522, FILED 10-4-2007.

CHRISTINA SOBRAL, EXAMINING ATTORNEY

Int. Cl.: 36

Prior U.S. Cls.: 100, 101, and 102

United States Patent and Trademark Office

Reg. No. 3,477,854

Registered July 29, 2008

**SERVICE MARK
PRINCIPAL REGISTER**

AIG PRIVATEEDGE PLUS

AMERICAN INTERNATIONAL GROUP, INC.
(DELAWARE CORPORATION)
70 PINE STREET
NEW YORK, NY 10270

FOR: INSURANCE UNDERWRITING IN THE
FIELD OF PROFESSIONAL LIABILITY, IN CLASS
36 (U.S. CLS. 100, 101 AND 102).

FIRST USE 1-1-2008; IN COMMERCE 1-1-2008.

THE MARK CONSISTS OF STANDARD CHAR-
ACTERS WITHOUT CLAIM TO ANY PARTICULAR
FONT, STYLE, SIZE, OR COLOR.

OWNER OF U.S. REG. NOS. 1,151,229, 2,424,761,
AND OTHERS.

SN 77-297,537, FILED 10-5-2007.

ELLEN BURNS, EXAMINING ATTORNEY

Int. Cl.: 36

Prior U.S. Cls.: 100, 101, and 102

United States Patent and Trademark Office

Reg. No. 3,477,855

Registered July 29, 2008

**SERVICE MARK
PRINCIPAL REGISTER**

**ANNUITIES STRENGTHEN
RETIREMENT**

AMERICAN INTERNATIONAL GROUP, INC.
(DELAWARE CORPORATION)
70 PINE STREET
NEW YORK, NY 10270

THE MARK CONSISTS OF STANDARD CHAR-
ACTERS WITHOUT CLAIM TO ANY PARTICULAR
FONT, STYLE, SIZE, OR COLOR.

FOR: ANNUITY UNDERWRITING; ISSUANCE
AND ADMINISTRATION OF ANNUITIES, IN
CLASS 36 (U.S. CLS. 100, 101 AND 102).

SN 77-297,559, FILED 10-5-2007.

FIRST USE 9-7-2007; IN COMMERCE 9-7-2007.

ELLEN BURNS, EXAMINING ATTORNEY

Int. Cl.: 41

Prior U.S. Cls.: 100, 101, and 107

United States Patent and Trademark Office

Reg. No. 3,477,856

Registered July 29, 2008

**SERVICE MARK
PRINCIPAL REGISTER**



ASSISTANCE LEAGUE OF SOUTHERN CALIFORNIA (CALIFORNIA CORPORATION)
8134 VAN NUYS BLVD., SUITE 200
PANORAMA CITY, CA 91402

FOR: ORGANIZING COMMUNITY FESTIVALS FEATURING A VARIETY OF ACTIVITIES, NAMELY, SPORTING EVENTS, ART EXHIBITIONS, FLEA MARKETS, ETHNIC DANCES AND THE LIKE, IN CLASS 41 (U.S. CLS. 100, 101 AND 107).

FIRST USE 1-1-2008; IN COMMERCE 1-1-2008.

NO CLAIM IS MADE TO THE EXCLUSIVE RIGHT TO USE "LA", APART FROM THE MARK AS SHOWN.

THE COLOR(S) BLACK, GOLD IS/ARE CLAIMED AS A FEATURE OF THE MARK.

THE MARK CONSISTS OF A GOLD HEART WITH THE WORDING "CELEBRATELA" IN GOLD AND UNDERLINED IN GOLD, SIX GOLD STARS FLOATING ABOVE THE FINAL LETTER "L" ALL WITHIN A BLACK OVAL WITH GOLD TRIM.

SN 77-302,904, FILED 10-12-2007.

JULIE WATSON, EXAMINING ATTORNEY

Int. Cl.: 42

Prior U.S. Cls.: 100 and 101

United States Patent and Trademark Office

Reg. No. 3,477,857

Registered July 29, 2008

**SERVICE MARK
PRINCIPAL REGISTER**

Campaign360

MAINTENANCENET, INC. (CALIFORNIA CORPORATION)
5963 LA PLACE COURT #300
CARLSBAD, CA 92008

FOR: PROVIDING TEMPORARY USE OF ON-LINE, NON-DOWNLOADABLE SOFTWARE TO STORE, MANAGE, TRACK, ANALYZE AND REPORT DATA IN THE FIELD OF TECHNOLOGY MAINTENANCE CONTRACTS; PROVIDING TEMPORARY USE OF ON-LINE NON-DOWNLOADABLE SOFTWARE TO FACILITATE COMMUNICATING WITH TECHNOLOGY MANUFACTURERS AND THEIR CHANNEL PARTNERS

IN THE ADVERTISING, MARKETING AND SALE OF MAINTENANCE SERVICE CONTRACTS, IN CLASS 42 (U.S. CLS. 100 AND 101).

FIRST USE 4-1-2008; IN COMMERCE 4-1-2008.

THE MARK CONSISTS OF STANDARD CHARACTERS WITHOUT CLAIM TO ANY PARTICULAR FONT, STYLE, SIZE, OR COLOR.

SN 77-305,438, FILED 10-16-2007.

SUSAN LESLIE DUBOIS, EXAMINING ATTORNEY

Int. Cl.: 30

Prior U.S. Cl.: 46

United States Patent and Trademark Office

Reg. No. 3,477,858

Registered July 29, 2008

**TRADEMARK
PRINCIPAL REGISTER**

TAVERN MIX

RICE INVESTMENTS, LP (DELAWARE LIMITED
PARTNERSHIP)
900 HIGH STREET
HANOVER, PA 17331

OWNER OF U.S. REG. NO. 2,941,776.

FOR: SNACK MIX CONSISTING PRIMARILY OF
CRACKERS, PRETZELS, NUTS AND/OR CORN
CHIPS, IN CLASS 30 (U.S. CL. 46).

NO CLAIM IS MADE TO THE EXCLUSIVE
RIGHT TO USE "MIX", APART FROM THE MARK
AS SHOWN.

FIRST USE 4-25-2008; IN COMMERCE 4-25-2008.

SN 77-310,644, FILED 10-23-2007.

THE MARK CONSISTS OF STANDARD CHAR-
ACTERS WITHOUT CLAIM TO ANY PARTICULAR
FONT, STYLE, SIZE, OR COLOR.

ATTIYA MALIK, EXAMINING ATTORNEY

Int. Cl.: 5

Prior U.S. Cls.: 6, 18, 44, 46, 51, and 52

United States Patent and Trademark Office

Reg. No. 3,477,859

Registered July 29, 2008

**TRADEMARK
PRINCIPAL REGISTER**

THE BIBLICAL SOLUTION

ROEX, INC. (CALIFORNIA CORPORATION)
16841 ARMSTRONG AVENUE
IRVINE, CA 92606

THE MARK CONSISTS OF STANDARD CHAR-
ACTERS WITHOUT CLAIM TO ANY PARTICULAR
FONT, STYLE, SIZE, OR COLOR.

FOR: DIETARY SUPPLEMENTS, IN CLASS 5 (U.S.
CLS. 6, 18, 44, 46, 51 AND 52).

SN 77-314,843, FILED 10-26-2007.

FIRST USE 3-11-2008; IN COMMERCE 3-11-2008.

MICHAEL TANNER, EXAMINING ATTORNEY

Int. Cl.: 28

Prior U.S. Cls.: 22, 23, 38, and 50

United States Patent and Trademark Office

Reg. No. 3,477,860

Registered July 29, 2008

**TRADEMARK
PRINCIPAL REGISTER**

GIGGLE & SHAKE

HONG KONG CITY TOYS FACTORY LIMITED
(BR.VIRGIN ISLANDS CORPORATION)
ROOM 701 5 SILVERCORD TOWER 1
30 CANTON ROAD
KOWLOON, HONG KONG

THE MARK CONSISTS OF STANDARD CHAR-
ACTERS WITHOUT CLAIM TO ANY PARTICULAR
FONT, STYLE, SIZE, OR COLOR.

FOR: DOLLS, DOLL CLOTHING, DOLL PLAY-
SETS AND DOLL ACCESSORIES, IN CLASS 28 (U.S.
CLS. 22, 23, 38 AND 50).

SN 77-353,392, FILED 12-17-2007.

FIRST USE 5-31-2008; IN COMMERCE 5-31-2008.

CHRISIE B. KING, EXAMINING ATTORNEY

Int. Cl.: 25

Prior U.S. Cls.: 22 and 39

United States Patent and Trademark Office

Reg. No. 3,477,861

Registered July 29, 2008

**TRADEMARK
PRINCIPAL REGISTER**

FAT TURTLE

ISLAND GLOBAL YACHTING LTD. (NEW
YORK CORPORATION)
717 FIFTH AVENUE
NEW YORK, NY 10022

FOR: ROBES, T-SHIRTS, CAPS, JACKETS, IN
CLASS 25 (U.S. CLS. 22 AND 39).

FIRST USE 2-28-2006; IN COMMERCE 2-28-2006.

THE MARK CONSISTS OF STANDARD CHAR-
ACTERS WITHOUT CLAIM TO ANY PARTICULAR
FONT, STYLE, SIZE, OR COLOR.

SN 77-975,453, FILED 12-12-2006.

AMOS T. MATTHEWS, JR., EXAMINING ATTOR-
NEY

Int. Cl.: 25

Prior U.S. Cls.: 22 and 39

United States Patent and Trademark Office

Reg. No. 3,477,862

Registered July 29, 2008

**TRADEMARK
PRINCIPAL REGISTER**



ISLAND GLOBAL YACHTING LTD. (NEW
YORK CORPORATION)
717 FIFTH AVENUE
NEW YORK, NY 10022

FOR: ROBES, T-SHIRTS, CAPS AND JACKETS, IN
CLASS 25 (U.S. CLS. 22 AND 39).

FIRST USE 2-28-2006; IN COMMERCE 2-28-2006.

THE MARK CONSISTS OF A PICTURE OF A
TURTLE.

SN 77-975,454, FILED 12-12-2006.

AMOS T. MATTHEWS, JR., EXAMINING ATTOR-
NEY

Int. Cl.: 21

Prior U.S. Cls.: 2, 13, 23, 29, 30, 33, 40, and 50

United States Patent and Trademark Office

Reg. No. 3,477,863

Registered July 29, 2008

**TRADEMARK
PRINCIPAL REGISTER**

CANOPY

WAL-MART STORES, INC. (DELAWARE CORPORATION)
702 S.W. 8TH ST.
BENTONVILLE, AR 727160520

FOR: BATH ACCESSORIES, NAMELY, TOOTH-BRUSH HOLDERS; SOAP DISHES; TOILET BRUSH HOLDERS; SOAP DISPENSERS, LOTION DISPENSERS; COTTON BALL DISPENSERS; TRASH CANS, IN CLASS 21 (U.S. CLS. 2, 13, 23, 29, 30, 33, 40 AND 50).

FIRST USE 1-5-2008; IN COMMERCE 1-5-2008.

THE MARK CONSISTS OF STANDARD CHARACTERS WITHOUT CLAIM TO ANY PARTICULAR FONT, STYLE, SIZE, OR COLOR.

SN 77-975,482, FILED 6-22-2007.

SARA THOMAS, EXAMINING ATTORNEY

Int. Cl.: 27

Prior U.S. Cls.: 19, 20, 37, 42, and 50

United States Patent and Trademark Office

Reg. No. 3,477,864

Registered July 29, 2008

**TRADEMARK
PRINCIPAL REGISTER**

CANOPY

WAL-MART STORES, INC. (DELAWARE COR-
PORATION)
702 S.W. 8TH ST.
BENTONVILLE, AR 727160520

THE MARK CONSISTS OF STANDARD CHAR-
ACTERS WITHOUT CLAIM TO ANY PARTICULAR
FONT, STYLE, SIZE, OR COLOR.

FOR: RUGS, IN CLASS 27 (U.S. CLS. 19, 20, 37, 42
AND 50).

SN 77-975,488, FILED 6-22-2007.

FIRST USE 1-12-2008; IN COMMERCE 1-12-2008.

SARA THOMAS, EXAMINING ATTORNEY

Int. Cls.: 5 and 31

Prior U.S. Cls.: 1, 6, 18, 44, 46, 51, and 52

Reg. No. 3,477,865

United States Patent and Trademark Office

Registered July 29, 2008

**TRADEMARK
PRINCIPAL REGISTER**

MORINDAMAX

TAHITIAN NONI INTERNATIONAL, INC.
(UTAH CORPORATION)

333 WEST RIVER PARK DRIVE

PROVO, UT 84604

FOR: NUTRITIONAL SUPPLEMENTS FOR ANIMALS, NAMELY, LIQUID AND SOLID SUPPLEMENTS FOR HORSES, COWS, SHEEP, PIGS AND CHICKEN; PHARMACEUTICAL LOTIONS FOR ANIMALS, NAMELY, HORSES, COWS, SHEEP, PIGS AND CHICKEN, IN CLASS 5 (U.S. CLS. 6, 18, 44, 46, 51 AND 52).

FIRST USE 3-0-2008; IN COMMERCE 3-0-2008.

FOR: ANIMAL FEED, NAMELY, LIQUID AND SOLID FEED FOR HORSES, COWS, SHEEP, PIGS AND CHICKEN, IN CLASS 31 (U.S. CLS. 1 AND 46).

FIRST USE 3-0-2008; IN COMMERCE 3-0-2008.

THE MARK CONSISTS OF STANDARD CHARACTERS WITHOUT CLAIM TO ANY PARTICULAR FONT, STYLE, SIZE, OR COLOR.

OWNER OF U.S. REG. NOS. 2,186,940, 3,106,564, AND OTHERS.

SN 77-975,538, FILED 2-7-2007.

MARY ROSSMAN, EXAMINING ATTORNEY

Int. Cl.: 25

Prior U.S. Cls.: 22 and 39

United States Patent and Trademark Office

Reg. No. 3,477,866

Registered July 29, 2008

**TRADEMARK
PRINCIPAL REGISTER**

SONG OF LOVE

SWEET PEOPLE APPAREL, INC. (CALIFORNIA CORPORATION)
4715 S. ALAMEDA ST.
LOS ANGELES, CA 90058

THE MARK CONSISTS OF STANDARD CHARACTERS WITHOUT CLAIM TO ANY PARTICULAR FONT, STYLE, SIZE, OR COLOR.

FOR: WOMEN'S APPAREL, NAMELY, BLOUSES, CAMISOLES, CARDIGANS, COATS, DRESSES, JACKETS, VESTS; PANTS, SHIRTS, SKIRTS, SWEATERS, T-SHIRTS, IN CLASS 25 (U.S. CLS. 22 AND 39).

SN 77-975,598, FILED 1-8-2007.

FIRST USE 7-31-2007; IN COMMERCE 7-31-2007.

MARY ROSSMAN, EXAMINING ATTORNEY

Int. Cls.: 14, 18, 25, and 35

**Prior U.S. Cls.: 1, 2, 3, 22, 27, 28, 39, 41, 50, 100, 101,
and 102**

Reg. No. 3,477,867

United States Patent and Trademark Office

Registered July 29, 2008

**TRADEMARK
SERVICE MARK
PRINCIPAL REGISTER**

DUSSAULT CUSTOM INK

DEUCE JEANS INC. (CANADA CORPORATION)
3742 WEST 10TH AVENUE
VANCOUVER, CANADA V6R254

FOR: JEWELRY, IN CLASS 14 (U.S. CLS. 2, 27, 28
AND 50).

FIRST USE 11-8-2007; IN COMMERCE 11-8-2007.

FOR: LUGGAGE, DUFFEL BAGS, LEATHER
BAGS AND WALLETS, IN CLASS 18 (U.S. CLS. 1, 2,
3, 22 AND 41).

FIRST USE 10-22-2007; IN COMMERCE 10-22-2007.

FOR: JEANS, T-SHIRTS, JACKETS AND HATS, IN
CLASS 25 (U.S. CLS. 22 AND 39).

FIRST USE 10-22-2007; IN COMMERCE 11-6-2007.

FOR: ON-LINE RETAIL STORE SERVICES FEA-
TURING CLOTHING, ACCESSORIES AND GENER-
AL MERCHANDISE; COMPUTERIZED ON-LINE
ORDERING AND WHOLESALE DISTRIBUTOR-
SHIP SERVICES FEATURING CLOTHING, ACCES-
SORIES AND GENERAL MERCHANDISE;
DISSEMINATION OF ADVERTISING FOR OTHERS
VIA AN ON-LINE ELECTRONIC COMMUNICA-
TIONS NETWORK, IN CLASS 35 (U.S. CLS. 100, 101
AND 102).

FIRST USE 2-21-2008; IN COMMERCE 2-21-2008.

THE MARK CONSISTS OF STANDARD CHAR-
ACTERS WITHOUT CLAIM TO ANY PARTICULAR
FONT, STYLE, SIZE, OR COLOR.

SN 77-975,602, FILED 1-19-2007.

JANET LEE, EXAMINING ATTORNEY

Int. Cl.: 9

Prior U.S. Cls.: 21, 23, 26, 36, and 38

Reg. No. 3,477,868

United States Patent and Trademark Office

Registered July 29, 2008

**TRADEMARK
PRINCIPAL REGISTER**



JS PRODUCTS, INC. (NEVADA CORPORATION)
5440 S. PROCYON AVENUE
LAS VEGAS, NV 89118

FIRST USE 7-13-2007; IN COMMERCE 7-13-2007.

FOR: EMERGENCY, PORTABLE-POWERED WEATHER RELATED EQUIPMENT, NAMELY, BATTERY OR CRANK-POWERED RADIOS, TELEVISIONS, OR TWO WAY RADIOS; BATTERY OR CRANK-POWERED ELECTRICAL POWER SUPPLIES, IN CLASS 9 (U.S. CLS. 21, 23, 26, 36 AND 38).

THE MARK CONSISTS OF THUNDERCLOUDS, LIGHTENING BOLTS, HURRICANE SYMBOL, FLOODWATER SYMBOL AND THE WORD "WEATHERGEAR".

SN 77-975,639, FILED 1-15-2007.

MICHAEL TANNER, EXAMINING ATTORNEY

Int. Cl.: 28

Prior U.S. Cls.: 22, 23, 38, and 50

United States Patent and Trademark Office

Reg. No. 3,477,869

Registered July 29, 2008

**TRADEMARK
PRINCIPAL REGISTER**

GHOST LAND

FLYNN, BRIAN M. (UNITED STATES INDIVIDUAL)

HYBRID DESIGN

540 DELANCEY STREET, SUITE 303

SAN FRANCISCO, CA 94107 AND

DRIMALAS, DORA M. (UNITED STATES INDIVIDUAL)

HYBRID DESIGN

540 DELANCEY STREET, SUITE 303

SAN FRANCISCO, CA 94107

FIRST USE 7-31-2007; IN COMMERCE 7-31-2007.

THE MARK CONSISTS OF STANDARD CHARACTERS WITHOUT CLAIM TO ANY PARTICULAR FONT, STYLE, SIZE, OR COLOR.

SN 77-975,642, FILED 4-2-2007.

FOR: COLLECTABLE TOY FIGURES, IN CLASS 28 (U.S. CLS. 22, 23, 38 AND 50).

BARBARA BROWN, EXAMINING ATTORNEY

Int. Cl.: 18

Prior U.S. Cls.: 1, 2, 3, 22, and 41

United States Patent and Trademark Office

Reg. No. 3,477,870

Registered July 29, 2008

**TRADEMARK
PRINCIPAL REGISTER**



INDONESIAN IMPORTS, INC. (DELAWARE
CORPORATION)
440 ALABAMA STREET
SAN FRANCISCO, CA 94110

FOR: PURSES, HANDBAGS, TOTE BAGS, IN
CLASS 18 (U.S. CLS. 1, 2, 3, 22 AND 41).

FIRST USE 1-31-2008; IN COMMERCE 1-31-2008.

THE MARK CONSISTS OF STYLIZED LETTER L.

SN 77-975,694, FILED 8-13-2007.

TERESA M. RUPP, EXAMINING ATTORNEY

Int. Cl.: 43

Prior U.S. Cls.: 100 and 101

United States Patent and Trademark Office

Reg. No. 3,477,871

Registered July 29, 2008

**SERVICE MARK
PRINCIPAL REGISTER**

VENUTO'S OLD WORLD PIZZA

VENUTOS OLD WORLD PIZZA SYSTEMS LLC
(NEW JERSEY LTD LIAB CO)
11 ENTERPRISE COURT
SEWELL, NJ 08080

FOR: TAKE-OUT RESTAURANT SERVICES;
FAST FOOD RESTAURANT SERVICES, IN CLASS
43 (U.S. CLS. 100 AND 101).

FIRST USE 3-1-2007; IN COMMERCE 3-1-2007.

THE MARK CONSISTS OF STANDARD CHAR-
ACTERS WITHOUT CLAIM TO ANY PARTICULAR
FONT, STYLE, SIZE, OR COLOR.

NO CLAIM IS MADE TO THE EXCLUSIVE
RIGHT TO USE "PIZZA", APART FROM THE
MARK AS SHOWN.

SN 77-975,695, FILED 10-10-2006.

KATHLEEN LORENZO, EXAMINING ATTORNEY

Int. Cl.: 1

Prior U.S. Cls.: 1, 5, 6, 10, 26, and 46

Reg. No. 3,477,872

United States Patent and Trademark Office

Registered July 29, 2008

**TRADEMARK
PRINCIPAL REGISTER**

WATER SMART

OMS INVESTMENTS, INC. (DELAWARE CORPORATION)
10250 CONSTELLATION BLVD., SUITE 2800
LOS ANGELES, CA 90067

THE MARK CONSISTS OF STANDARD CHARACTERS WITHOUT CLAIM TO ANY PARTICULAR FONT, STYLE, SIZE, OR COLOR.

FOR: FERTILIZERS FOR DOMESTIC, AGRICULTURAL AND HORTICULTURAL USE, IN CLASS 1 (U.S. CLS. 1, 5, 6, 10, 26 AND 46).

SN 77-975,703, FILED 6-7-2007.

FIRST USE 1-31-2008; IN COMMERCE 1-31-2008.

ODESSA BIBBINS, EXAMINING ATTORNEY

Int. Cl.: 30

Prior U.S. Cl.: 46

United States Patent and Trademark Office

Reg. No. 3,477,873

Registered July 29, 2008

**TRADEMARK
PRINCIPAL REGISTER**

SOUTHERN SUPERIOR COFFEE

APOSTOLO, MAURICIO C. (UNITED STATES
INDIVIDUAL)
11377 S.W. 84TH LANE
MIAMI, FL 33173

NO CLAIM IS MADE TO THE EXCLUSIVE
RIGHT TO USE "SUPERIOR COFFEE", APART
FROM THE MARK AS SHOWN.

FOR: ROASTED AND GROUND COFFEE; GRIN-
DED COFFEE, IN CLASS 30 (U.S. CL. 46).

SN 78-041,919, FILED 1-5-2001.

FIRST USE 0-0-2001; IN COMMERCE 0-0-2001.

RON FAIRBANKS, EXAMINING ATTORNEY

Int. Cl.: 28

Prior U.S. Cls.: 22, 23, 38, and 50

United States Patent and Trademark Office

Reg. No. 3,477,874

Registered July 29, 2008

**TRADEMARK
PRINCIPAL REGISTER**

EDGE

POLARIS INDUSTRIES INC. (DELAWARE COR-
PORATION)
2100 HIGHWAY 55
MEDINA, MN 55340

FIRST USE 1-0-2004; IN COMMERCE 1-0-2004.

SN 78-053,313, FILED 3-15-2001.

FOR: REMOTE CONTROLLED TOY SNOWMO-
BILES, IN CLASS 28 (U.S. CLS. 22, 23, 38 AND 50).

ESTHER A. BORSUK, EXAMINING ATTORNEY

Int. Cl.: 25

Prior U.S. Cls.: 22 and 39

United States Patent and Trademark Office

Reg. No. 3,477,875

Registered July 29, 2008

**TRADEMARK
PRINCIPAL REGISTER**



beneath the underdog.com

LEWIS, JEAN-CLAUDE (UNITED STATES INDIVIDUAL)
26705 DARTMOUTH
MADISON HEIGHTS, MI 48071

JOHNS, UNIFORMS AND HEADBANDS, IN CLASS 25 (U.S. CLS. 22 AND 39).

FIRST USE 10-10-2002; IN COMMERCE 11-10-2002.

FOR: CLOTHING FOR MEN, WOMEN AND CHILDREN, NAMELY, T-SHIRTS, UNDERWEAR, SOCKS, HATS, PANTS, SHOES, BELTS, LONG-

SN 78-114,516, FILED 3-13-2002.

JOHN DWYER, EXAMINING ATTORNEY

Int. Cls.: 3, 26, and 44

**Prior U.S. Cls.: 1, 4, 6, 37, 39, 40, 42, 50, 51, 52, 100,
and 101**

Reg. No. 3,477,876

United States Patent and Trademark Office

Registered July 29, 2008

**TRADEMARK
SERVICE MARK
PRINCIPAL REGISTER**

FOLLEA

FOLLEA, INC. (CALIFORNIA CORPORATION)
3532 MULTIVIEW DRIVE
LOS ANGELES, CA 90068

FOR: COSMETICS, SOAPS, AND HAIR CARE PRODUCTS, NAMELY, SHAMPOOS, CONDITIONERS, MOISTURIZERS AND DYES, IN CLASS 3 (U.S. CLS. 1, 4, 6, 50, 51 AND 52).

FIRST USE 12-1-2007; IN COMMERCE 12-1-2007.

FOR: WIGS, HAIR WEAVES, HAIR PIECES, HAIR BUNDLES, ARTIFICIAL BEARDS, ARTIFICIAL MUSTACHES, AND ARTIFICIAL TEMPLE PIECES AND SIDE BURNS, IN CLASS 26 (U.S. CLS. 37, 39, 40, 42 AND 50).

FIRST USE 12-1-2007; IN COMMERCE 12-1-2007.

FOR: BEAUTY SALONS, HAIR SALONS, HAIR WEAVE AND TRANSPLANT SERVICES, SAUNA SERVICES, MASSAGE SERVICES, NURSING AND REST HOME SERVICES, AND MEDICAL SERVICES, NAMELY, EXAMINATION, ANALYSIS AND COUNSELING SERVICES, IN CLASS 44 (U.S. CLS. 100 AND 101).

FIRST USE 12-1-2007; IN COMMERCE 12-1-2007.

SN 78-151,295, FILED 8-6-2002.

DAVID TOOLEY, EXAMINING ATTORNEY

Int. Cls.: 9, 16, 25, and 41

**Prior U.S. Cls.: 2, 5, 21, 22, 23, 26, 29, 36, 37, 38, 39,
50, 100, 101, and 107**

Reg. No. 3,477,877

United States Patent and Trademark Office

Registered July 29, 2008

**TRADEMARK
SERVICE MARK
PRINCIPAL REGISTER**

The logo for Shinergy features a large, stylized, black 'S' on the left. To the right of the 'S', the word 'hinergy' is written in a lowercase, black, sans-serif font. The 'S' is composed of two curved lines that meet at the top and bottom, creating a sense of motion or energy.

KOKERT, RONALD (AUSTRIA INDIVIDUAL)
MÜLLNERGASSE 26/12
1090 VIENNA, AUSTRIA

FOR: COMPACT DISCS FEATURING MUSIC;
VIDEO TAPES AND DVDS FEATURING PRO-
GRAMS RELATED TO THE INSTRUCTION OF
MARTIAL ARTS, SELF DEFENSE, AND FITNESS
TECHNIQUES, IN CLASS 9 (U.S. CLS. 21, 23, 26, 36
AND 38).

FIRST USE 2-0-1999; IN COMMERCE 1-0-2008.

FOR: PRINTED MATTER, NAMELY, EXERCISE
BOOKS AND INSTRUCTIONAL BOOKS IN THE
AREA OF MARTIAL ARTS, SELF DEFENSE, AND
FITNESS TECHNIQUES; PRINTED TEACHING MA-
TERIALS IN THE AREA OF MARTIAL ARTS, SELF
DEFENSE, AND FITNESS TECHNIQUES, IN CLASS
16 (U.S. CLS. 2, 5, 22, 23, 29, 37, 38 AND 50).

FIRST USE 2-0-1999; IN COMMERCE 1-0-2008.

FOR: ATHLETIC AND EXERCISE CLOTHING,
NAMELY, T-SHIRTS, LONG SLEEVE TOPS, TANK

TOPS, POLO SHIRTS, JERSEYS, SWEATSHIRTS,
JACKETS, VESTS, SWEATPANTS, WARM-UP
PANTS, SHORTS, ALL TYPES OF FOOTWEAR EX-
CLUDING SLIPPERS, HEADGEAR, NAMELY,
HATS, CAPS, AND VISORS, IN CLASS 25 (U.S. CLS.
22 AND 39).

FIRST USE 2-0-1999; IN COMMERCE 1-0-2008.

FOR: EDUCATIONAL SERVICES, NAMELY,
CONDUCTING CLASSES AND WORKSHOPS IN
THE FIELD OF MARTIAL ARTS, SELF DEFENSE,
AND FITNESS TECHNIQUES; TRAINING SERVIC-
ES IN THE FIELD OF MARTIAL ARTS, SELF
DEFENSE, AND FITNESS TECHNIQUES; ENTER-
TAINMENT IN THE NATURE OF COMPETITIONS
IN THE FIELD OF MARTIAL ARTS; ORGANIZING
SPORTING AND CULTURAL EVENTS, IN CLASS 41
(U.S. CLS. 100, 101 AND 107).

FIRST USE 2-0-1999; IN COMMERCE 1-0-2008.

SN 78-167,943, FILED 9-25-2002.

JOHN GARTNER, EXAMINING ATTORNEY

Int. Cl.: 10

Prior U.S. Cls.: 26, 39, and 44

United States Patent and Trademark Office

Reg. No. 3,477,878

Registered July 29, 2008

**TRADEMARK
PRINCIPAL REGISTER**

NAVIGANT BIOTECHNOLOGIES

NAVIGANT BIOTECHNOLOGIES, LLC (DELA-
WARE LTD LIAB CO)
1215 QUAIL STREET
LAKEWOOD, CO 80215

FOR: MEDICAL APPARATUS FOR PATHOGEN
REDUCTION AND TREATMENT OF COLLECTED
BLOOD AND BLOOD COMPONENTS, NAMELY,
BLOOD COLLECTION APPARATUS, NAMELY,
APHERESIS MACHINES, WHOLE BLOOD COLLEC-
TION BLOOD SETS, IRRADIATORS, BLOOD MIX-
ERS, BLOOD CONTAINERS AND DISPOSABLES
FOR BLOOD COLLECTION AND TREATMENT,
NAMELY, BLOOD TUBING SETS, BLOOD COLLEC-

TION BAGS, BLOOD STORAGE BAGS, BAG SETS
AND FILTERS, IN CLASS 10 (U.S. CLS. 26, 39 AND
44).

FIRST USE 11-30-2007; IN COMMERCE 11-30-2007.

NO CLAIM IS MADE TO THE EXCLUSIVE
RIGHT TO USE "BIOTECHNOLOGIES", APART
FROM THE MARK AS SHOWN.

SN 78-177,080, FILED 10-22-2002.

JUSTINE D. PARKER, EXAMINING ATTORNEY

Int. Cl.: 9

Prior U.S. Cls.: 21, 23, 26, 36, and 38

Reg. No. 3,477,879

United States Patent and Trademark Office

Registered July 29, 2008

**TRADEMARK
PRINCIPAL REGISTER**

EVEREST

GENERAL ATOMICS (CALIFORNIA CORPORATION)
3550 GENERAL ATOMICS COURT
SAN DIEGO, CA 92121

FOR: ELECTRONIC OPTICAL APPARATUS, NAMELY, SHORT LASERS AND LASERS CONSISTING OF SOLID-STATE OR SEMICONDUCTOR LASER SOURCES, ALL FOR USE IN SCIENTIFIC RESEARCH AND INDUSTRIAL LASER MACHIN-

ING APPLICATIONS AND COMMUNICATIONS DEVICES, NOT FOR MEDICAL PURPOSES, IN CLASS 9 (U.S. CLS. 21, 23, 26, 36 AND 38).

FIRST USE 1-1-2005; IN COMMERCE 1-1-2005.

SN 78-225,931, FILED 3-14-2003.

JERI J. FICKES, EXAMINING ATTORNEY

Int. Cls.: 9 and 36

Prior U.S. Cls.: 21, 23, 26, 36, 38, 100, 101, and 102

United States Patent and Trademark Office

Reg. No. 3,477,880

Registered July 29, 2008

**TRADEMARK
SERVICE MARK
PRINCIPAL REGISTER**

PURVIEW

TERANET ENTERPRISES INC. (CANADA CORPORATION)
ONE FINANCIAL PLACE, 1 ADELAIDE STREET EAST
TORONTO, ONTARIO, CANADA M5C 2V9

FOR: ELECTRONIC DATA STORED ON MAGNETIC DATA CARRIERS IN THE FORM OF CD-ROMS, MAGNETIC TAPE, COMPUTER DISKS AND DATA CARDS IN THE FIELDS OF CONSUMER CREDIT REPORTING, REAL PROPERTY DATA COMPILED FROM PUBLIC RECORDS, AND AUTOMATED PROPERTY VALUATIONS, IN CLASS 9 (U.S. CLS. 21, 23, 26, 36 AND 38).

FIRST USE 4-30-2007; IN COMMERCE 4-30-2007.

FOR: PROVIDING SERVICES IN THE NATURE OF CONSUMER CREDIT REPORTING, AUTOMATED PROPERTY VALUATIONS, AND LENDING RISK MANAGEMENT; INFORMATION SERVICES, NAMELY, PROVIDING CREDIT INFORMATION

RELATING TO CONSUMER APPLICANTS FOR CREDIT, MORTGAGE LOANS, AND FRAUD PREVENTION; PROVIDING CREDIT APPLICATION PROCESSING; CREDIT INQUIRY AND CONSULTING SERVICES; CONSULTING SERVICES CONCERNING FINANCIAL DATA AND STATISTICS FOR USE BY LENDERS, FINANCIAL INSTITUTIONS AND INSURANCE COMPANIES, IN CLASS 36 (U.S. CLS. 100, 101 AND 102).

FIRST USE 4-30-2007; IN COMMERCE 4-30-2007.

PRIORITY CLAIMED UNDER SEC. 44(D) ON CANADA APPLICATION NO. 1157627, FILED 10-31-2002, REG. NO. TMA653041, DATED 11-21-2005, EXPIRES 11-21-2020.

SN 78-233,255, FILED 4-2-2003.

KHANH LE, EXAMINING ATTORNEY

Int. Cl.: 5

Prior U.S. Cls.: 6, 18, 44, 46, 51, and 52

Reg. No. 3,477,881

United States Patent and Trademark Office

Registered July 29, 2008

TRADEMARK
PRINCIPAL REGISTER



ENVIVO PHARMACEUTICALS, INC. (DELA-
WARE CORPORATION)
480 ARSENAL STREET, BUILDING 1
WATERTOWN, MA 02472

FOR: PHARMACEUTICAL PREPARATIONS FOR
THE TREATMENT OF CENTRAL NERVOUS SYS-
TEM DISORDERS, IN CLASS 5 (U.S. CLS. 6, 18, 44, 46,
51 AND 52).

FIRST USE 9-18-2007; IN COMMERCE 9-18-2007.

NO CLAIM IS MADE TO THE EXCLUSIVE
RIGHT TO USE "PHARMACEUTICALS", APART
FROM THE MARK AS SHOWN.

THE MARK CONSISTS OF A FANCIFUL HUMAN
CHARACTER AND THE WORDS "ENVIVO PHAR-
MACEUTICALS".

SN 78-240,753, FILED 4-22-2003.

SOPHIA S. KIM, EXAMINING ATTORNEY

Int. Cl.: 5

Prior U.S. Cls.: 6, 18, 44, 46, 51, and 52

United States Patent and Trademark Office

Reg. No. 3,477,882

Registered July 29, 2008

**TRADEMARK
PRINCIPAL REGISTER**

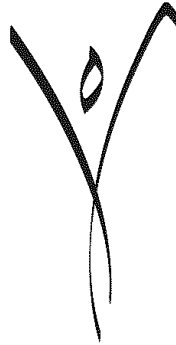

ENVIVO PHARMACEUTICALS, INC. (DELA-
WARE CORPORATION)
480 ARSENAL STREET, BUILDING 1
WATERTOWN, MA 02472

FOR: PHARMACEUTICAL PREPARATIONS FOR
THE TREATMENT OF CENTRAL NERVOUS SYS-
TEM DISORDERS, IN CLASS 5 (U.S. CLS. 6, 18, 44, 46,
51 AND 52).

FIRST USE 9-17-2007; IN COMMERCE 9-17-2007.

THE MARK CONSISTS OF A FANCIFUL HUMAN
FIGURE.

SN 78-240,755, FILED 4-22-2003.

SOPHIA S. KIM, EXAMINING ATTORNEY

Int. Cls.: 9, 37, 38, and 42

**Prior U.S. Cls.: 21, 23, 26, 36, 38, 100, 101, 103, 104,
and 106**

Reg. No. 3,477,883

United States Patent and Trademark Office

Registered July 29, 2008

**TRADEMARK
SERVICE MARK
PRINCIPAL REGISTER**

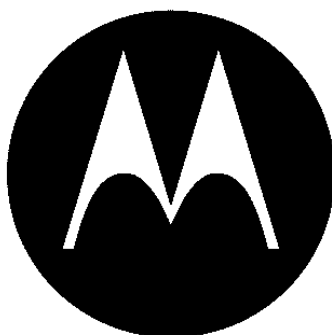

MOTOROLA, INC. (DELAWARE CORPORATION)
1303 EAST ALGONQUIN ROAD
SCHAUMBURG, IL 60196

FOR: TELEPHONES; CORDLESS, WIRELESS, AND SMART PHONES; BATTERIES; BATTERY CHARGERS; CLIPS FOR MOBILE TELEPHONES; HOLDERS FOR MOBILE TELEPHONES; DESKTOP STANDS FOR MOBILE TELEPHONES; MICROPHONES; MOBILE PHONE ACCESSORIES IN THE NATURE OF HANDS FREE HOLDERS, HEADSETS, MICROPHONES AND SPEAKERS FOR MOBILE PHONES; CAR KITS FOR THE ADAPTATION OF PORTABLE COMMUNICATION APPARATUS AND INSTRUMENTS FOR VEHICULAR USE, COMPRISING OF ANTENNAS, ANTENNA TRANSMISSION WIRES, ANTENNA ADAPTERS, CABLES, EARPHONES, HANDSFREE MICROPHONES, PHONE HOLDERS, SPEAKERS, CAR CHARGERS, DATA CABLES AND ELECTRICAL WIRES; ELECTRIC ADAPTOR CABLES; TWO-WAY RADIOS; PAGERS; RADIO FREQUENCY IDENTIFICATION TAGS FOR RADIO FREQUENCY CODES; RADIO TELEPHONE INFRASTRUCTURE EQUIPMENT AND SYSTEMS COMPRISED OF BASE STATIONS, REPEATERS, RECEIVERS, CONTROLLERS AND COMPARATORS; GPS RECEIVERS AND TRANSMITTERS; MULTIPLEXERS; ANTENNAS; SERVERS; ROUTERS; DATA SMART CARDS; MODEMS; ELECTRONIC SYSTEMS AND APPARATUS, NAMELY, SCRAMBLERS, DE SCRAMBLERS, ENCODERS AND DECODERS, FOR SCRAMBLING, DESCRAMBLING, ENCODING AND DECODING

OF VOICE, DATA, IMAGE AND VIDEO TRANSMISSIONS; ELECTRONIC DATA INPUT AND OUTPUT APPARATUS, NAMELY TERMINALS, RECEIVERS, TRANSMITTERS, DECODERS, AND TRANSCIEVERS CAPABLE OF PROCESSING BROADCAST, SATELLITE, FACSIMILE, TELEVISION, TELECOMMUNICATION, NETWORK, INFRARED, VIDEO GAME, AND COMPUTER DATA SIGNALS AND FOR TRANSMISSION, REPRODUCING AND RECEIVING OF SOUND, IMAGES, VIDEO, MULTIMEDIA AND DATA; DATA PROCESSING EQUIPMENT, NAMELY DIGITAL SIGNAL PROCESSORS; COMPUTERS, COMPUTER SOFTWARE AND COMPUTER PROGRAMS USED FOR TRANSMISSION, REPRODUCING AND RECEIVING OF SOUND, IMAGES, VIDEO AND DATA OVER A TELECOMMUNICATIONS NETWORK OR SYSTEM BETWEEN TERMINALS AND FOR ENHANCING AND FACILITATING USE AND ACCESS TO COMPUTER NETWORKS AND TELEPHONE NETWORKS; TRAINING AND PRODUCT SUPPORT SOFTWARE FOR COMPUTERS AND MOBILE PHONES IN THE FIELD OF COMMUNICATIONS; COMPUTER UTILITY SOFTWARE FOR PERFORMING COMPUTER MAINTENANCE WORK; POWER SOURCES FOR COMMUNICATION NETWORK ELEMENTS, NAMELY BATTERIES AND POWER SUPPLIES; SUBSTATIONS AND REPEATERS, NAMELY SIGNAL AMPLIFIERS AND REPEATER AMPLIFIERS; ANALOG AND DIGITAL RADIO TRANSCIEVERS AND RECEIVERS FOR DATA, VOICE, IMAGE AND VIDEO COMMUNICATION; CAMERAS, NAMELY DIGITAL CAMERAS AND

VIDEO CAMERAS; CALCULATORS; MODEM CARDS ALL FOR USE WITH COMMUNICATIONS APPARATUS; PRESSURE AND TEMPERATURE SENSORS; VEHICLE NAVIGATION APPARATUS, NAMELY, ON-BOARD COMPUTERS; SOFTWARE FOR SATELLITE TELEVISION PROGRAMMING; SOFTWARE FOR ON-SCREEN PROGRAM GUIDE; SET TOP BOXES; DVD PLAYERS AND RECORDERS; AND REMOTE CONTROLS, IN CLASS 9 (U.S. CLS. 21, 23, 26, 36 AND 38).

FIRST USE 10-31-2001; IN COMMERCE 10-31-2001.

FOR: INSTALLATION, MAINTENANCE AND REPAIR OF ELECTRONIC EQUIPMENT, NAMELY, RADIO RECEIVING EQUIPMENT, RADIO TRANSMITTING EQUIPMENT, TWO-WAY AND TRUNKING APPARATUS, PAGING APPARATUS, CELLULAR RADIOTELEPHONE APPARATUS AND COMMUNICATION EQUIPMENT, IN CLASS 37 (U.S. CLS. 100, 103 AND 106).

FIRST USE 10-31-2001; IN COMMERCE 10-31-2001.

FOR: PROVIDING ACCESS TO A FIBER-OPTIC TELECOMMUNICATIONS NETWORK; NETWORK MANAGEMENT AND ADMINISTRATION; TELECOMMUNICATIONS NETWORK PLANNING; CONSULTING SERVICES IN THE FIELD OF TELECOMMUNICATIONS LIVE AND VIA THE GLOBAL COMPUTER INFORMATION NETWORK; AND COMPUTER SERVICES, NAMELY, PROVIDING AN INTERACTIVE SITE ON A GLOBAL COMPUTER NETWORK, ACCESSIBLE VIA COMPUTER

AND WIRELESS COMMUNICATION DEVICES, WHICH INTERACTIVE SITE CONTAINS A PERSONAL DATA CENTER, FEATURING A CUSTOMIZABLE ADDRESS BOOK, IN CLASS 38 (U.S. CLS. 100, 101 AND 104).

FIRST USE 10-31-2001; IN COMMERCE 10-31-2001.

FOR: BASIC AND APPLIED RESEARCH IN THE FIELDS OF PHYSICS, CHEMISTRY, ENGINEERING, COMPUTER PROGRAMMING, INFORMATION TECHNOLOGY AND TELECOMMUNICATIONS; RESEARCH AND DEVELOPMENT OF NEW PRODUCTS FOR OTHERS IN THE FIELD OF TELECOMMUNICATIONS; COMPUTER SOFTWARE DESIGN FOR OTHERS; COMPUTER DATABASE DESIGN FOR OTHERS; COMPUTER SOFTWARE INTERFACE DESIGN FOR OTHERS; COMPUTER PROGRAMMING FOR OTHERS; DESIGN AND DEVELOPMENT OF DIGITAL TELECOMMUNICATIONS SYSTEMS FOR PUBLIC AND PRIVATE NETWORKS, IN CLASS 42 (U.S. CLS. 100 AND 101).

FIRST USE 10-31-2001; IN COMMERCE 10-31-2001.

OWNER OF U.S. REG. NOS. 847,770, 2,201,018, AND OTHERS.

THE MARK CONSISTS OF "M" IN A CIRCLE.

SN 78-250,829, FILED 5-16-2003.

GENE MACIOL, EXAMINING ATTORNEY

Int. Cl.: 44

Prior U.S. Cls.: 100 and 101

United States Patent and Trademark Office

Reg. No. 3,477,884

Registered July 29, 2008

**SERVICE MARK
PRINCIPAL REGISTER**

HOME CARE ONE

HOME CARE GIVER SERVICES, INC. (FLORIDA CORPORATION)
1801 SO. FEDERAL HIGHWAY, SUITE 206
DELRAY BEACH, FL 33483

FOR: HOME HEALTHCARE AGENCY SERVICES, NAMELY, PROVIDING SKILLED NURSING AND CARE GIVER SERVICES TO THE ELDERLY AND MEDICALLY INFIRM, IN CLASS 44 (U.S. CLS. 100 AND 101).

FIRST USE 7-9-2003; IN COMMERCE 7-9-2003.

NO CLAIM IS MADE TO THE EXCLUSIVE RIGHT TO USE "HOME CARE", APART FROM THE MARK AS SHOWN.

SN 78-252,112, FILED 5-20-2003.

GEORGE LORENZO, EXAMINING ATTORNEY

Int. Cls.: 16, 18, and 25

Prior U.S. Cls.: 1, 2, 3, 5, 22, 23, 29, 37, 38, 39, 41, and 50

Reg. No. 3,477,885

United States Patent and Trademark Office

Registered July 29, 2008

**TRADEMARK
PRINCIPAL REGISTER**

CIMARRON

MELOPHONE - CONSULTORES E SERVICOS,
LDA. (PORTUGAL CORPORATION)
RUA DR. BRITO CÂMARA, 20-1
9000-039 FUNCHAL (MADEIRA), PORTUGAL

FOR: NOTE BOOKS, ENVELOPES, BUSINESS PAPER PADS, FOUNTAIN PENS, BALL-POINT PENS, RUBBER ERASERS, LOOSE-LEAF BINDERS, WRITING CASE SETS, FOLDERS FOR PAPERS, PENCIL SHARPENERS, PENCIL HOLDERS, BOXES FOR PENS, PENCIL CASES, PAPER BAGS FOR PACKAGING, PLASTIC BAGS FOR PACKAGING, YEARBOOKS, DIARIES, PHONE BOOKS, CLOTHING AND ACCESSORIES CATALOGS, IN CLASS 16 (U.S. CLS. 2, 5, 22, 23, 29, 37, 38 AND 50).

FIRST USE 0-0-2002; IN COMMERCE 2-10-2006.

FOR: PORTABLE COSMETIC CASES SOLD EMPTY; LEATHER KEY CASES, ALL PURPOSE SPORTS BAGS FOR MOUNTAIN-CLIMBING; BACKPACKS, PURSES NOT OF PRECIOUS METAL; BEACH BAGS; BRIEFCASES; SUITCASES, CREDIT CARD CASES; TRAVELING BAGS; TRAVELING TRUNKS; PASSPORT CASES; LEATHER BAGS FOR PACKAGING; SCHOOL BAGS, HANDBAGS; PARASOLS; UMBRELLAS; AND LEATHER STRAPS, IN CLASS 18 (U.S. CLS. 1, 2, 3, 22 AND 41).

FIRST USE 0-0-2002; IN COMMERCE 2-10-2006.

FOR: LEATHER SHOES, GALOSHES, HALF-BOOTS, SANDALS, SLIPPERS, SNEAKERS, LONG COATS, SHORTS, HALF COATS, SUITS, SKIRTS, SLACKS, ANORAKS EXCEPT FOR EXERCISE; TROUSERS, OVERCOATS, JACKETS, JUMPERS, BLUE JEANS, PARKAS, FROCKS, BATHING GOWNS, BLOUSES, UNDERWEAR, SWIMMING SUITS, SWEATERS, SWEATSHIRTS, NIGHTWEAR, NAMELY, PAJAMAS, NIGHT DRESSES, NIGHT GOWNS, DRESSING GOWNS, NEGLIGEEES, NIGHT SHIRTS AND BABY DOLL LINGERIE, JERSEYS, VESTS, CARDIGANS, TANK TOPS, POLO SHIRTS, PULLOVERS, T-SHIRTS, SCARVES, HATS AND BELTS, IN CLASS 25 (U.S. CLS. 22 AND 39).

FIRST USE 0-0-1979; IN COMMERCE 2-10-2006.

OWNER OF U.S. REG. NO. 1,830,404.

SN 78-255,537, FILED 5-29-2003.

RON FAIRBANKS, EXAMINING ATTORNEY

Int. Cls.: 9, 16, and 41

**Prior U.S. Cls.: 2, 5, 21, 22, 23, 26, 29, 36, 37, 38, 50,
100, 101, and 107**

Reg. No. 3,477,886

United States Patent and Trademark Office

Registered July 29, 2008

**TRADEMARK
SERVICE MARK
PRINCIPAL REGISTER**

SUDDEN STRIKE

FIREGLOW LIMITED (CYPRUS CORPORATION)
1 GEORGIU GRIVA DIGENI STREET STAVROS
PITTA BUILDING 3RD FLOOR
LIASSOL, CYPRUS 3035

FOR: COMPUTER GAMES PROGRAMS, COMPUTER GAMES SOFTWARE; IMAGE AND/OR SOUND DATA CARRIERS AND/OR DATA CARRIERS SUPPLIED WITH PROGRAMS AND/OR DATA LINES, IN PARTICULAR, OPTICAL MEMORIES INCLUDING CD-ROMS AND WORM, ALL CONTAINING VIDEO GAMES OR COMPUTER GAMES, IN CLASS 9 (U.S. CLS. 21, 23, 26, 36 AND 38).

FIRST USE 4-16-2008; IN COMMERCE 4-16-2008.

FOR: PRINTING PRODUCTS IN THE FIELDS OF COMPUTER TECHNOLOGY AND COMPUTER PROGRAMS, IN PARTICULAR INSTRUCTIONS AND USER MANUALS, FORMS, WORKING PROCEDURES, BOOKS INCLUDING HANDBOOKS, PROGRAM DOCUMENTATION, WRITTEN BACKGROUND MATERIAL FOR COMPUTER PROGRAMS; TEACHING AND TRAINING

MATERIALS IN THE FORM OF PRINTED MATTER, IN PARTICULAR WORK BOOKS AND TRAINING HANDBOOKS, OR RECORDED ON DATA CARRIERS, IN THE FIELD OF COMPUTER TECHNOLOGY AND COMPUTER PROGRAMS, IN CLASS 16 (U.S. CLS. 2, 5, 22, 23, 29, 37, 38 AND 50).

FIRST USE 4-16-2008; IN COMMERCE 4-16-2008.

FOR: ENTERTAINMENT SERVICES, NAMELY, PROVISION OF GAMES BY MEANS OF A COMPUTER BASED SYSTEM, A COMPUTER NETWORK OR VIA THE INTERNET; INFORMATION ADVISORY AND CONSULTANCY SERVICES RELATING TO THE PROVISION OF GAMES BY MEANS OF A COMPUTER BASED SYSTEM, A COMPUTER NETWORK OR VIA THE INTERNET, IN CLASS 41 (U.S. CLS. 100, 101 AND 107).

FIRST USE 4-16-2008; IN COMMERCE 4-16-2008.

SN 78-270,935, FILED 7-7-2003.

DAVID H. STINE, EXAMINING ATTORNEY

Int. Cls.: 5 and 31

Prior U.S. Cls.: 1, 6, 18, 44, 46, 51, and 52

United States Patent and Trademark Office

Reg. No. 3,477,887

Registered July 29, 2008

**TRADEMARK
PRINCIPAL REGISTER**

J/D

HILL'S PET NUTRITION, INC. (DELAWARE CORPORATION)
400 SW EIGHTH STREET
TOPEKA, KS 66603

FOR: VETERINARIAN SUPERVISED DIETARY PET FOOD, IN CLASS 5 (U.S. CLS. 6, 18, 44, 46, 51 AND 52).

FIRST USE 12-31-2004; IN COMMERCE 12-31-2004.

FOR: PET FOOD, IN CLASS 31 (U.S. CLS. 1 AND 46).

FIRST USE 12-31-2004; IN COMMERCE 12-31-2004.

OWNER OF U.S. REG. NOS. 596,058, 1,848,950, AND OTHERS.

SN 78-277,649, FILED 7-23-2003.

DANIEL CAPSHAW, EXAMINING ATTORNEY

Int. Cl.: 3

Prior U.S. Cls.: 1, 4, 6, 50, 51, and 52

United States Patent and Trademark Office

Reg. No. 3,477,888

Registered July 29, 2008

**TRADEMARK
PRINCIPAL REGISTER**

LUV THAT SUN

FRUIT OF THE EARTH, INC. (DELAWARE
CORPORATION)
SUITE 175
3101 HIGH RIVER ROAD
FORT WORTH, TX 76155

FIRST USE 6-13-2008; IN COMMERCE 6-13-2008.

NO CLAIM IS MADE TO THE EXCLUSIVE
RIGHT TO USE "SUN", APART FROM THE MARK
AS SHOWN.

FOR: SKIN CARE PRODUCTS, NAMELY, SUN
SCREEN AND SUN TANNING LOTIONS, CREAMS,
OILS, AND GELS; NON-MEDICATED SUN BURN
OINTMENTS, IN CLASS 3 (U.S. CLS. 1, 4, 6, 50, 51
AND 52).

SN 78-284,646, FILED 8-7-2003.

RICHARD A. STRASER, EXAMINING ATTORNEY

Int. Cl.: 9

Prior U.S. Cls.: 21, 23, 26, 36, and 38

Reg. No. 3,477,889

United States Patent and Trademark Office

Registered July 29, 2008

**TRADEMARK
PRINCIPAL REGISTER**

VANGUARD SAGA OF HEROES

SONY ONLINE ENTERTAINMENT LLC (DELA-
WARE LTD LIAB CO)
10202 W. WASHINGTON BLVD.
CULVER CITY, CA 90232

FOR: SOFTWARE GAMES RECORDED ON CD-
ROMS AND DVDS FOR CONSOLE AND PORTABLE
GAMING SYSTEMS; SOFTWARE GAMES FOR MO-
BILE PHONES, PERSONAL DIGITAL ASSISTANTS,
AND HANDHELD COMPUTERS RECORDED ON
COMPUTER MEDIA; DOWNLOADABLE SOFT-
WARE GAMES FOR MOBILE PHONES, PERSONAL
DIGITAL ASSISTANTS, AND HANDHELD COMPU-
TERS; GAME MACHINES SOLD AS A UNIT FOR
PLAYING SOFTWARE GAMES RECORDED ON
CD-ROMS AND DVDS FOR USE WITH TELEVI-
SIONS AND COMPUTERS; PRE-RECORDED CD-

ROMS AND DVDS FEATURING ACTION AND
ADVENTURE PRODUCTIONS; DOWNLOADABLE
ELECTRONIC PUBLICATIONS IN THE NATURE
OF NEWSLETTERS AND MAGAZINES FEATUR-
ING ACTION AND ADVENTURE GAMES, IN
CLASS 9 (U.S. CLS. 21, 23, 26, 36 AND 38).

FIRST USE 3-16-2004; IN COMMERCE 3-16-2004.

THE MARK CONSISTS OF STANDARD CHAR-
ACTERS WITHOUT CLAIM TO ANY PARTICULAR
FONT, STYLE, SIZE, OR COLOR.

SN 78-290,685, FILED 8-21-2003.

ELLEN B. AWRICH, EXAMINING ATTORNEY

Int. Cl.: 29

Prior U.S. Cl.: 46

United States Patent and Trademark Office

Reg. No. 3,477,890

Registered July 29, 2008

**TRADEMARK
PRINCIPAL REGISTER**

CARB CONTROL

THE DANNON COMPANY, INC. (DELAWARE
CORPORATION)
120 WHITE PLAINS ROAD
TARRYTOWN, NY 10591

FOR: DAIRY-BASED BEVERAGES; DAIRY PRO-
DUCTS EXCLUDING ICE CREAM, ICE MILK AND
FROZEN YOGURT, IN CLASS 29 (U.S. CL. 46).

FIRST USE 1-0-2004; IN COMMERCE 1-0-2004.

THE MARK CONSISTS OF STANDARD CHAR-
ACTERS WITHOUT CLAIM TO ANY PARTICULAR
FONT, STYLE, SIZE, OR COLOR.

NO CLAIM IS MADE TO THE EXCLUSIVE
RIGHT TO USE "CARB", APART FROM THE MARK
AS SHOWN.

SN 78-308,765, FILED 10-2-2003.

ODESSA BIBBINS, EXAMINING ATTORNEY

Int. Cl.: 5

Prior U.S. Cls.: 6, 18, 44, 46, 51, and 52

Reg. No. 3,477,891

United States Patent and Trademark Office

Registered July 29, 2008

**TRADEMARK
PRINCIPAL REGISTER**

POWER JERKY

FRITZ, BOB (UNITED STATES INDIVIDUAL)
1346 HIGHLAND AVE
MARTINEZ, DC 94553

NO CLAIM IS MADE TO THE EXCLUSIVE
RIGHT TO USE "JERKY", APART FROM THE
MARK AS SHOWN.

FOR: DIETARY SUPPLEMENTS CONSISTING OF
DRIED MEAT WITH NUTRITIONAL ADDITIVES,
IN CLASS 5 (U.S. CLS. 6, 18, 44, 46, 51 AND 52).

SN 78-315,988, FILED 10-20-2003.

FIRST USE 4-8-2008; IN COMMERCE 4-8-2008.

KELLY MCCOY, EXAMINING ATTORNEY

Int. Cl.: 9

Prior U.S. Cls.: 21, 23, 26, 36, and 38

Reg. No. 3,477,892

United States Patent and Trademark Office

Registered July 29, 2008

**TRADEMARK
PRINCIPAL REGISTER**

CARSCAN

INNOVA ELECTRONICS CORPORATION (NE-
VADA CORPORATION)
17291 MT. HERRMANN STREET
FOUNTAIN VALLEY, CA 92708

FOR: AUTOMOTIVE DIAGNOSTIC DEVICES,
NAMELY, TACHOMETERS, DIAGNOSTIC CODE
READERS AND SCAN TOOLS FOR USE IN DIAG-
NOSTIC TESTING AND LIVE DATA RETRIEVAL
FOR COMPUTERIZED AUTOMOBILE SYSTEMS
AND CODE READERS FOR USE IN RETRIEVING
AND CLEARING DIAGNOSTIC TROUBLE CODES
FOR COMPUTERIZED AUTOMOBILE SYSTEMS;
AUTOMOTIVE DIAGNOSTIC DEVICES, NAMELY,

FUEL PUMP TESTERS, VACUUM GAUGES, INJEC-
TION PRESSURE TESTERS, COMPRESSION TES-
TERS, IGNITION MODULE TESTERS AND
DIGITAL MULTI METERS FOR MEASURING VOL-
TAGE AND RESISTANCE, IN CLASS 9 (U.S. CLS. 21,
23, 26, 36 AND 38).

FIRST USE 10-26-2007; IN COMMERCE 10-26-2007.

SN 78-318,177, FILED 10-24-2003.

TRACY WHITTAKER-BROWN, EXAMINING AT-
TORNEY

Int. Cls.: 9 and 42

Prior U.S. Cls.: 21, 23, 26, 36, 38, 100, and 101

United States Patent and Trademark Office

Reg. No. 3,477,893

Registered July 29, 2008

**TRADEMARK
SERVICE MARK
PRINCIPAL REGISTER**

OUT OF OFFICE

SEVEN NETWORKS, INC. (DELAWARE CORPORATION)
901 MARSHALL STREET
REDWOOD CITY, CA 94063

FOR: COMPUTER AND COMMUNICATIONS SOFTWARE FOR WIRELESS AND REMOTE ACCESS AND CONNECTIVITY; COMPUTER SOFTWARE FOR ENABLING, MONITORING, AND MANAGING WIRELESS AND REMOTE COMMUNICATIONS AND CONNECTIVITY BETWEEN COMMUNICATIONS NETWORKS; COMPUTER SOFTWARE FOR ENABLING, MONITORING, AND MANAGING WIRELESS AND REMOTE COMMUNICATIONS AND CONNECTIVITY BETWEEN WIRELESS AND REMOTE DEVICES AND COMMUNICATIONS NETWORKS; AND INSTRUCTION AND USER MANUALS PROVIDED THEREWITH, IN CLASS 9 (U.S. CLS. 21, 23, 26, 36 AND 38).

FIRST USE 8-14-2007; IN COMMERCE 8-14-2007.

FOR: TECHNICAL SUPPORT SERVICES, NAMELY, TROUBLESHOOTING OF COMPUTER HARDWARE AND SOFTWARE PROBLEMS; COMPUTER SOFTWARE CONSULTATION; CONSULTING SERVICES IN THE FIELD OF MOBILE COMMUNICATIONS; COMPUTER SOFTWARE DESIGN FOR OTHERS; CUSTOMIZATION OF COMPUTER HARDWARE AND SOFTWARE; APPLICATION SERVICE PROVIDER (ASP) FEATURING SOFTWARE IN THE FIELD OF MOBILE COMMUNICATIONS, IN CLASS 42 (U.S. CLS. 100 AND 101).

FIRST USE 8-14-2007; IN COMMERCE 8-14-2007.

SN 78-320,291, FILED 10-29-2003.

NORA BUCHANAN WILL, EXAMINING ATTORNEY

Int. Cl.: 18

Prior U.S. Cls.: 1, 2, 3, 22, and 41

United States Patent and Trademark Office

Reg. No. 3,477,894

Registered July 29, 2008

**TRADEMARK
PRINCIPAL REGISTER**

PARALLEL

AZ3, INC. (CALIFORNIA CORPORATION)
2761 FRUITLAND AVENUE
VERNON, CA 90058

FOR: HANDBAGS, PURSES, CLUTCHES, COSMETIC BAGS SOLD EMPTY, SHOULDER BAGS, SATCHELS AND BACK PACKS, IN CLASS 18 (U.S. CLS. 1, 2, 3, 22 AND 41).

FIRST USE 2-7-2005; IN COMMERCE 2-7-2005.

THE MARK CONSISTS OF STANDARD CHARACTERS WITHOUT CLAIM TO ANY PARTICULAR FONT, STYLE, SIZE, OR COLOR.

OWNER OF U.S. REG. NO. 1,747,190.

SN 78-325,806, FILED 11-10-2003.

GRETTA YAO, EXAMINING ATTORNEY

Int. Cl.: 1

Prior U.S. Cls.: 1, 5, 6, 10, 26, and 46

Reg. No. 3,477,895

United States Patent and Trademark Office

Registered July 29, 2008

**TRADEMARK
PRINCIPAL REGISTER**

ALLEROL

AHD INTERNATIONAL, LLC (GEORGIA LTD
LIAB CO)
3340 PEACHTREE ROAD, SUITE 850
ATLANTA, GA 30326

THE MARK CONSISTS OF STANDARD CHAR-
ACTERS WITHOUT CLAIM TO ANY PARTICULAR
FONT, STYLE, SIZE, OR COLOR.

FOR: DIETARY SUPPLEMENT INGREDIENTS,
NAMELY, CHEMICAL ADDITIVES FOR USE IN
THE MANUFACTURE OF DIETARY SUPPLE-
MENTS, IN CLASS 1 (U.S. CLS. 1, 5, 6, 10, 26 AND 46).

SN 78-358,493, FILED 1-28-2004.

FIRST USE 5-23-2008; IN COMMERCE 5-23-2008.

INGA ERVIN, EXAMINING ATTORNEY

Int. Cls.: 16 and 41

Prior U.S. Cls.: 2, 5, 22, 23, 29, 37, 38, 50, 100, 101, and 107

Reg. No. 3,477,896

United States Patent and Trademark Office

Registered July 29, 2008

**TRADEMARK
SERVICE MARK
PRINCIPAL REGISTER**

GPS-ENABLED

CRUZ BAY PUBLISHING, INC. (PENNSYLVANIA CORPORATION)
300 N. CONTINENTAL BLVD
SUITE 650
EL SEGUNDO, CA 90245

FOR: MAGAZINES CONTAINING COLUMNS AND ARTICLES IN THE FIELD OF HEALTH, FITNESS, DIET, EXERCISE AND LIFESTYLE, IN CLASS 16 (U.S. CLS. 2, 5, 22, 23, 29, 37, 38 AND 50).

FIRST USE 5-1-2008; IN COMMERCE 5-1-2008.

FOR: PROVIDING INFORMATION IN THE FIELD OF FITNESS, EXERCISE AND FITNESS

RELATED LIFESTYLE ISSUES, IN CLASS 41 (U.S. CLS. 100, 101 AND 107).

FIRST USE 5-1-2008; IN COMMERCE 5-1-2008.

THE MARK CONSISTS OF STANDARD CHARACTERS WITHOUT CLAIM TO ANY PARTICULAR FONT, STYLE, SIZE, OR COLOR.

SN 78-359,545, FILED 1-29-2004.

CHRISTOPHER BUONGIORNO, EXAMINING ATTORNEY

Int. Cl.: 9

Prior U.S. Cls.: 21, 23, 26, 36, and 38

Reg. No. 3,477,897

United States Patent and Trademark Office

Registered July 29, 2008

**TRADEMARK
PRINCIPAL REGISTER**

AMBISOUND

WAVES AUDIO LTD. (ISRAEL CORPORATION)
AZRIELI CENTER 1, ROUND BUILDING
132 DERECH PETACH-TIKVA
TEL AVIV, ISRAEL 67021

FOR: MICROPHONES FOR USE IN MAKING SOUND RECORDINGS; COMPUTER SOFTWARE BEING ALGORITHMS FOR USE IN RECORDING OF SOUND SIGNALS, FOR PROCESSING OF SOUND WHILE STREAMED OR DECODED, FOR ENCODING AND DECODING PERIPHONIC SOUND OR 3-DIMENSIONAL SOUND AND FOR IMPROVING HUMAN PERCEPTION OF SOUND; ELECTRONIC PROCESSORS FOR USE IN THE REPRODUCTION OF RECORDED SOUND OR STREAMING OF SOUND; SOUND RECORDINGS

EMBODYING ENCODED INFORMATION; SPEAKER SYSTEMS, NAMELY, SPEAKERS AND POWER AMPLIFIERS INCLUDING THE ABILITY TO DECODE ENCODED INFORMATION, IN CLASS 9 (U.S. CLS. 21, 23, 26, 36 AND 38).

FIRST USE 1-0-2007; IN COMMERCE 5-0-2007.

THE MARK CONSISTS OF STANDARD CHARACTERS WITHOUT CLAIM TO ANY PARTICULAR FONT, STYLE, SIZE, OR COLOR.

SN 78-360,985, FILED 2-2-2004.

EDWARD NELSON, EXAMINING ATTORNEY

Int. Cl.: 39

Prior U.S. Cls.: 100 and 105

United States Patent and Trademark Office

Reg. No. 3,477,898

Registered July 29, 2008

**SERVICE MARK
PRINCIPAL REGISTER**

LIVING AT ALTITUDE

AVACUS CORPORATION (WYOMING CORPORATION)
2800 DONALD DOUGLAS LOOP NORTH
SANTA MONICA, CA 90405

THE MARK CONSISTS OF STANDARD CHARACTERS WITHOUT CLAIM TO ANY PARTICULAR FONT, STYLE, SIZE, OR COLOR.

FOR: AIR TRANSPORTATION SERVICES, IN CLASS 39 (U.S. CLS. 100 AND 105).

SN 78-362,183, FILED 2-4-2004.

FIRST USE 11-30-2003; IN COMMERCE 11-30-2003.

INGA ERVIN, EXAMINING ATTORNEY

Int. Cl.: 33

Prior U.S. Cls.: 47 and 49

United States Patent and Trademark Office

Reg. No. 3,477,899

Registered July 29, 2008

**TRADEMARK
PRINCIPAL REGISTER**

FREE YOUR SENSES

ENOITALIA S.P.A. (ITALY CORPORATION)
LOCALITA' COLOMBARE, 5
CALMASINO DI BARDOLINO (VR), ITALY 37010

FOR: WINES, IN CLASS 33 (U.S. CLS. 47 AND 49).

FIRST USE 4-10-2008; IN COMMERCE 4-10-2008.

THE MARK CONSISTS OF STANDARD CHAR-
ACTERS WITHOUT CLAIM TO ANY PARTICULAR
FONT, STYLE, SIZE, OR COLOR.

SN 78-376,594, FILED 3-1-2004.

HENRY S. ZAK, EXAMINING ATTORNEY

Int. Cl.: 41

Prior U.S. Cls.: 100, 101, and 107

United States Patent and Trademark Office

Reg. No. 3,477,900

Registered July 29, 2008

**SERVICE MARK
PRINCIPAL REGISTER**

**LEADERSHIP BALANCE
SHEET**

LORE INTERNATIONAL INSTITUTE, INC. (COL-
ORADO CORPORATION)
P.O. BOX 1287
DURANGO, CO 81302

FOR: EDUCATIONAL SERVICES, NAMELY,
CONDUCTING CLASSES IN THE FIELD OF ORGA-
NIZATIONAL LEADERSHIP, IN CLASS 41 (U.S. CLS.
100, 101 AND 107).

FIRST USE 3-5-2004; IN COMMERCE 10-9-2006.

THE MARK CONSISTS OF STANDARD CHAR-
ACTERS WITHOUT CLAIM TO ANY PARTICULAR
FONT, STYLE, SIZE, OR COLOR.

NO CLAIM IS MADE TO THE EXCLUSIVE
RIGHT TO USE "LEADERSHIP", APART FROM
THE MARK AS SHOWN.

SN 78-379,550, FILED 3-5-2004.

RICHARD WHITE, EXAMINING ATTORNEY

Int. Cl.: 34

Prior U.S. Cls.: 2, 8, 9, and 17

United States Patent and Trademark Office

Reg. No. 3,477,901

Registered July 29, 2008

TRADEMARK
PRINCIPAL REGISTER



ROSENTHAL, JOSHUA (UNITED STATES INDIVIDUAL)
9265 AND 1/2 BURTON WAY
BEVERLY HILLS, CA 90210

AND INHALATION OF TOBACCO, HERBS AND OTHER SUBSTANCES, IN CLASS 34 (U.S. CLS. 2, 8, 9 AND 17).

FOR: SMOKING URN, NAMELY, A DEVICE USED FOR THE VAPORIZATION AND INHALATION OF TOBACCO, HERBS AND OTHER SUBSTANCES AND ADAPTOR DEVICES FOR CONVERTING OTHER SMOKING IMPLEMENTS INTO DEVICES USED FOR THE VAPORIZATION

FIRST USE 5-24-2005; IN COMMERCE 5-20-2008.

SN 78-388,049, FILED 3-21-2004.

JASON TURNER, EXAMINING ATTORNEY

Int. Cl.: 29

Prior U.S. Cl.: 46

United States Patent and Trademark Office

Reg. No. 3,477,902

Registered July 29, 2008

**TRADEMARK
PRINCIPAL REGISTER**

Nature's Design

ISE AMERICA, INC. (DELAWARE CORPORATION)
P.O. BOX 267
GALENA, MD 21635

THE MARK CONSISTS OF STANDARD CHARACTERS WITHOUT CLAIM TO ANY PARTICULAR FONT, STYLE, SIZE, OR COLOR.

FOR: EGG PRODUCTS, NAMELY, LIQUID PASTEURIZED EGGS AND HARD-COOKED EGGS, IN CLASS 29 (U.S. CL. 46).

SN 78-392,513, FILED 3-29-2004.

FIRST USE 10-16-2006; IN COMMERCE 10-16-2006.

DAVID MURRAY, EXAMINING ATTORNEY

Int. Cl.: 9

Prior U.S. Cls.: 21, 23, 26, 36, and 38

Reg. No. 3,477,903

United States Patent and Trademark Office

Registered July 29, 2008

**TRADEMARK
PRINCIPAL REGISTER**

CRITICAL NETWORKS

CRITICAL NETWORKS, INC. (DELAWARE CORPORATION)
10180 SCRIPPS RANCH BLVD.
SAN DIEGO, CA 92123

FOR: COMPUTER HARDWARE FOR USE IN DATA NETWORKING, NAMELY, SWITCHES, AND CIRCUIT PROTECTION DEVICES, IN CLASS 9 (U.S. CLS. 21, 23, 26, 36 AND 38).

FIRST USE 5-17-2008; IN COMMERCE 5-17-2008.

THE MARK CONSISTS OF STANDARD CHARACTERS WITHOUT CLAIM TO ANY PARTICULAR FONT, STYLE, SIZE, OR COLOR.

NO CLAIM IS MADE TO THE EXCLUSIVE RIGHT TO USE "NETWORKS", APART FROM THE MARK AS SHOWN.

SN 78-399,875, FILED 4-10-2004.

SUSAN LESLIE DUBOIS, EXAMINING ATTORNEY

Int. Cl.: 21

Prior U.S. Cls.: 2, 13, 23, 29, 30, 33, 40, and 50

United States Patent and Trademark Office

Reg. No. 3,477,904

Registered July 29, 2008

**TRADEMARK
PRINCIPAL REGISTER**

COUNTRY WARE

THE WILTON COMPANY (PENNSYLVANIA
CORPORATION)
PLUMB AND SQUARE STREETS
MOUNT JOY, PA 17552

FOR: DINNERWARE AND RELATED SERVICE
PIECES, ALL OF ALUMINUM BASE ALLOY—
NAMELY, PLATES, PLATTERS, MUGS, GOBLETS,
BOWLS, PORRINGERS, PITCHERS, COFFEE AND
TEA POTS, CANDLE HOLDERS, NAPKIN RINGS,
SUGAR HOLDERS, CREAMERS, SALT AND PEP-
PER HOLDERS, ASH TRAYS, GRAVY BOATS,
LADLES, SAUCE CUPS, SHELLS FOR SEA FOOD,
AU GRATINS AND BREAD TRAYS, IN CLASS 21
(U.S. CLS. 2, 13, 23, 29, 30, 33, 40 AND 50).

FIRST USE 12-27-1973; IN COMMERCE 12-27-1973.

THE MARK CONSISTS OF STANDARD CHAR-
ACTERS WITHOUT CLAIM TO ANY PARTICULAR
FONT, STYLE, SIZE, OR COLOR.

OWNER OF U.S. REG. NO. 1,275,228.

NO CLAIM IS MADE TO THE EXCLUSIVE
RIGHT TO USE "WARE" , APART FROM THE
MARK AS SHOWN.

SN 78-401,447, FILED 4-14-2004.

SOPHIA S. KIM, EXAMINING ATTORNEY

Int. Cl.: 41

Prior U.S. Cls.: 100, 101, and 107

United States Patent and Trademark Office

Reg. No. 3,477,905

Registered July 29, 2008

**SERVICE MARK
PRINCIPAL REGISTER**

HOOKED ON READING

SMARTERVILLE PRODUCTIONS LLC (DELA-
WARE LTD LIAB CO)
1407 FLEET STREET
BALTIMORE, MD 21231

FOR: PROVIDING INFORMATION IN THE
FIELD OF READING THROUGH ARTICLES, AND
RECOMMENDATIONS VIA THE INTERNET, IN
CLASS 41 (U.S. CLS. 100, 101 AND 107).

FIRST USE 2-0-2007; IN COMMERCE 2-0-2007.

THE MARK CONSISTS OF STANDARD CHAR-
ACTERS WITHOUT CLAIM TO ANY PARTICULAR
FONT, STYLE, SIZE, OR COLOR.

NO CLAIM IS MADE TO THE EXCLUSIVE
RIGHT TO USE "READING", APART FROM THE
MARK AS SHOWN.

SN 78-401,658, FILED 4-14-2004.

TIMOTHY FINNEGAN, EXAMINING ATTORNEY

Int. Cl.: 35

Prior U.S. Cls.: 100, 101, and 102

United States Patent and Trademark Office

Reg. No. 3,477,906

Registered July 29, 2008

**SERVICE MARK
PRINCIPAL REGISTER**

Strategic4sight

STRATEGIC4SIGHT, INC. (TEXAS CORPORATION)
3131 MAPLE AVE. SUITE 8G
DALLAS, TX 75201

FOR: BUSINESS CONSULTATION SERVICES TO ASSIST ENTERPRISES IN COMMUNICATING EFFECTIVELY, NAMELY, DEVELOPING COMMUNICATIONS RELATING TO ACQUISITIONS AND MERGERS TO ALL STAKEHOLDERS; DEVELOPING AND IMPLEMENTING MARKETING COMMUNICATION AND PUBLIC RELATIONS STRATEGIES AND CAMPAIGNS AND INTEGRATING A GLOBAL DIMENSION INTO US FOCUSED

COMMUNICATIONS, IN CLASS 35 (U.S. CLS. 100, 101 AND 102).

FIRST USE 1-5-2005; IN COMMERCE 1-5-2005.

THE MARK CONSISTS OF STANDARD CHARACTERS WITHOUT CLAIM TO ANY PARTICULAR FONT, STYLE, SIZE, OR COLOR.

SN 78-404,919, FILED 4-20-2004.

BONNIE LUKEN, EXAMINING ATTORNEY

Int. Cl.: 16

Prior U.S. Cls.: 2, 5, 22, 23, 29, 37, 38, and 50

Reg. No. 3,477,907

United States Patent and Trademark Office

Registered July 29, 2008

**TRADEMARK
PRINCIPAL REGISTER**

SILVER BULLETIN

COORS BREWING COMPANY (COLORADO
CORPORATION)
1225 17TH STREET
SUITE 3200
DENVER, CO 80202

FOR: HOUSE ORGAN, IN CLASS 16 (U.S. CLS. 2, 5,
22, 23, 29, 37, 38 AND 50).

FIRST USE 6-0-2004; IN COMMERCE 6-0-2004.

THE MARK CONSISTS OF STANDARD CHAR-
ACTERS WITHOUT CLAIM TO ANY PARTICULAR
FONT, STYLE, SIZE, OR COLOR.

NO CLAIM IS MADE TO THE EXCLUSIVE
RIGHT TO USE "BULLETIN", APART FROM THE
MARK AS SHOWN.

SN 78-409,984, FILED 4-29-2004.

ANGELA M. MICHELI, EXAMINING ATTORNEY

Int. Cl.: 35

Prior U.S. Cls.: 100, 101, and 102

United States Patent and Trademark Office

Reg. No. 3,477,908

Registered July 29, 2008

**SERVICE MARK
PRINCIPAL REGISTER**

CURVATION

VANITY FAIR, INC. (DELAWARE CORPORATION)
ONE FRUIT OF THE LOOM DRIVE
LEGAL DEPARTMENT
BOWLING GREEN, KY 42103

FOR: PROVIDING CONSUMER PRODUCT INFORMATION VIA THE INTERNET, IN CLASS 35 (U.S. CLS. 100, 101 AND 102).

FIRST USE 1-23-2003; IN COMMERCE 1-23-2003.

THE MARK CONSISTS OF STANDARD CHARACTERS WITHOUT CLAIM TO ANY PARTICULAR FONT, STYLE, SIZE, OR COLOR.

OWNER OF U.S. REG. NO. 2,757,539.

SN 78-414,073, FILED 5-6-2004.

BRIDGETT SMITH, EXAMINING ATTORNEY

Int. Cl.: 25

Prior U.S. Cls.: 22 and 39

United States Patent and Trademark Office

Reg. No. 3,477,909

Registered July 29, 2008

**TRADEMARK
PRINCIPAL REGISTER**

DONNER MOUNTAIN

ATSCO FOOTWEAR, INC. (MASSACHUSETTS
CORPORATION)
500 BODWELL STREET EXTENSION
AVON, MA 02322

FOR: FOOTWEAR, IN CLASS 25 (U.S. CLS. 22 AND
39).

FIRST USE 0-0-1991; IN COMMERCE 0-0-1991.

THE MARK CONSISTS OF STANDARD CHAR-
ACTERS WITHOUT CLAIM TO ANY PARTICULAR
FONT, STYLE, SIZE, OR COLOR.

OWNER OF U.S. REG. NO. 1,289,130.

SN 78-416,700, FILED 5-11-2004.

ALICE BENMAMAN, EXAMINING ATTORNEY

Int. Cl.: 33

Prior U.S. Cls.: 47 and 49

United States Patent and Trademark Office

Reg. No. 3,477,910

Registered July 29, 2008

**TRADEMARK
PRINCIPAL REGISTER**



TGI FRIDAY'S OF MINNESOTA, INC. (MINNE-
SOTA CORPORATION)
4201 MARSH LANE
CARROLLTON, TX 75007

FIRST USE 6-1-2008; IN COMMERCE 6-1-2008.

SN 78-421,820, FILED 5-19-2004.

FOR: WINES, LIQUEURS AND SPIRITS; NAME-
LY, PREPARED ALCOHOLIC COCKTAILS, IN
CLASS 33 (U.S. CLS. 47 AND 49).

DAVID MURRAY, EXAMINING ATTORNEY

Int. Cls.: 5, 31, 35, 42, and 44

Prior U.S. Cls.: 1, 6, 18, 44, 46, 51, 52, 100, 101, and 102

Reg. No. 3,477,911

United States Patent and Trademark Office

Registered July 29, 2008

**TRADEMARK
SERVICE MARK
PRINCIPAL REGISTER**

GENESUS

KEYSTONE PIG ADVANCEMENT, INC. (CANADA CORPORATION)
101 2ND STREET, BOX 278
OAKVILLE, MANITOBA, CANADA R0H 0Y0

FOR: PIG GENETIC MATERIAL, NAMELY, NUCLEUS SIRE AND DAM LINES, PIG SEMEN AND PIG OVA, IN CLASS 5 (U.S. CLS. 6, 18, 44, 46, 51 AND 52).

FIRST USE 2-13-2004; IN COMMERCE 2-13-2004.

FOR: LIVE ANIMALS, NAMELY, PIGS; PIG GENETIC MATERIALS, NAMELY, BREEDING STOCK AND PIG EMBRYO, IN CLASS 31 (U.S. CLS. 1 AND 46).

FIRST USE 2-13-2004; IN COMMERCE 2-13-2004.

FOR: DISTRIBUTORSHIP SERVICES IN THE FIELD OF PIGS, NAMELY, DISTRIBUTING PUREBRED BREEDING STOCK TO FARMERS FOR BREEDING AND DISTRIBUTING THE CROSS-BRED OFFSPRING TO COMMERCIAL FARMS; BUSINESS MANAGEMENT AND BUSINESS CONSULTATION SERVICES FOR THIRD PARTIES IN THE FIELD OF PIG BREEDING, PIG PRODUCTION AND PIG PROCESSING, FEATURING, PREPARING AND FILLING MULTIPLICATION CONTRACTS

FOR BREEDING PROGRAMS, IN CLASS 35 (U.S. CLS. 100, 101 AND 102).

FIRST USE 2-13-2004; IN COMMERCE 2-13-2004.

FOR: RESEARCH AND DEVELOPMENT SERVICES CONCERNING LIVESTOCK, NAMELY, PIGS, PIG BREEDING, AND PIG PROCESSING; GENEALOGY RESEARCH AND MANAGEMENT FOR LIVESTOCK, NAMELY, PIGS, NAMELY, THE EVALUATION OF PUREBRED PIGS; MONITORING AND MANAGEMENT OF LIVESTOCK GENEALOGY, NAMELY, LITTER TESTING AND PROLIFICACY TESTING, AND DEVELOPING GENETIC IMPROVEMENT PLANS FOR LIVESTOCK, NAMELY, PIGS; RESEARCH CONCERNING LIVESTOCK, NAMELY, PIGS, PIG BREEDING, AND PIG PROCESSING, IN CLASS 42 (U.S. CLS. 100 AND 101).

FIRST USE 2-13-2004; IN COMMERCE 2-13-2004.

FOR: ANIMAL HUSBANDRY SERVICES; PIG BREEDING, IN CLASS 44 (U.S. CLS. 100 AND 101).

FIRST USE 2-13-2004; IN COMMERCE 2-13-2004.

THE MARK CONSISTS OF STANDARD CHARACTERS WITHOUT CLAIM TO ANY PARTICULAR FONT, STYLE, SIZE, OR COLOR.

PRIORITY CLAIMED UNDER SEC. 44(D) ON
CANADA APPLICATION NO. 1205759, FILED 2-9-
2004.

SN 78-426,250, FILED 5-27-2004.

DAWN HAN, EXAMINING ATTORNEY

Int. Cl.: 41

Prior U.S. Cls.: 100, 101, and 107

United States Patent and Trademark Office

Reg. No. 3,477,912

Registered July 29, 2008

**SERVICE MARK
PRINCIPAL REGISTER**

**Essentials for
Vitality**

MOVEMENT COORDINATION INC. (CALIFORNIA CORPORATION)
53 CORTE BARISTO
GREENBRAE, CA 94904

FOR: EDUCATIONAL SERVICES, NAMELY, CONDUCTING LECTURES, WORKSHOPS, CLASSES, SEMINARS, AND TRAINING PROGRAMS IN THE FIELD OF VITALITY, EXERCISE, ANTI-AGING, AND HEALTH , IN CLASS 41 (U.S. CLS. 100, 101 AND 107).

FIRST USE 3-26-2003; IN COMMERCE 3-26-2003.

THE MARK CONSISTS OF STANDARD CHARACTERS WITHOUT CLAIM TO ANY PARTICULAR FONT, STYLE, SIZE, OR COLOR.

SN 78-426,671, FILED 5-28-2004.

MICHAEL KEATING, EXAMINING ATTORNEY

Int. Cl.: 24

Prior U.S. Cls.: 42 and 50

United States Patent and Trademark Office

Reg. No. 3,477,913

Registered July 29, 2008

**TRADEMARK
PRINCIPAL REGISTER**

Fabric Palette

FABRIC EDITIONS LLC (SOUTH CAROLINA
LTD LIAB CO), FORMERLY FE ACQUISITION LLC,
7025 AUGUSTA ROAD
GREENVILLE, SC 29605

FOR: PRE-CUT COTTON FABRICS, IN CLASS 24
(U.S. CLS. 42 AND 50).

FIRST USE 7-6-2004; IN COMMERCE 7-6-2004.

NO CLAIM IS MADE TO THE EXCLUSIVE
RIGHT TO USE "FABRIC", APART FROM THE
MARK AS SHOWN.

SN 78-436,807, FILED 6-17-2004.

AMOS T. MATTHEWS, JR., EXAMINING ATTORNEY

Int. Cl.: 16

Prior U.S. Cls.: 2, 5, 22, 23, 29, 37, 38, and 50

United States Patent and Trademark Office

Reg. No. 3,477,914

Registered July 29, 2008

**TRADEMARK
PRINCIPAL REGISTER**

WONDERBABY

CHIN, OLIVER C. (UNITED STATES INDIVIDUAL)
535 ROCKDALE DRIVE
SAN FRANCISCO, CA 94127

FIRST USE 5-1-2005; IN COMMERCE 9-1-2005.

FOR: BOOKS, NAMELY, CHILDREN'S BOOKS, COMIC BOOKS, MAGAZINES FEATURING CHILDREN'S ENTERTAINMENT; STATIONARY, GREETING CARDS, PRINTED INVITATIONS, ANNOUNCEMENT CARDS AND PRINTED PERIODICALS IN THE FIELD OF CHILDREN'S ENTERTAINMENT, IN CLASS 16 (U.S. CLS. 2, 5, 22, 23, 29, 37, 38 AND 50).

THE MARK CONSISTS OF STANDARD CHARACTERS WITHOUT CLAIM TO ANY PARTICULAR FONT, STYLE, SIZE, OR COLOR.

SN 78-440,424, FILED 6-24-2004.

INGA ERVIN, EXAMINING ATTORNEY

Int. Cl.: 16

Prior U.S. Cls.: 2, 5, 22, 23, 29, 37, 38, and 50

Reg. No. 3,477,915

United States Patent and Trademark Office

Registered July 29, 2008

**TRADEMARK
PRINCIPAL REGISTER**

**MAXIM RISK
MANAGEMENT**

BICKMORE & ASSOCIATES INC (CALIFORNIA
CORPORATION)
1831 K STREET
SACRAMENTO, CA 95811

FOR: PRINTED INSTRUCTIONAL MATERIALS
FOR TRAINING EMPLOYERS, MANAGERS, SU-
PERVISORS, AND EMPLOYEES ON MANAGING
AND REDUCING EMPLOYMENT PRACTICES LIA-
BILITY RISKS IN THE WORKPLACE, IN CLASS 16
(U.S. CLS. 2, 5, 22, 23, 29, 37, 38 AND 50).

FIRST USE 3-0-2004; IN COMMERCE 7-0-2004.

THE MARK CONSISTS OF STANDARD CHAR-
ACTERS WITHOUT CLAIM TO ANY PARTICULAR
FONT, STYLE, SIZE, OR COLOR.

NO CLAIM IS MADE TO THE EXCLUSIVE
RIGHT TO USE "RISK MANAGEMENT", APART
FROM THE MARK AS SHOWN.

SN 78-446,290, FILED 7-6-2004.

GIANCARLO CASTRO, EXAMINING ATTORNEY

Int. Cls.: 3 and 26

Prior U.S. Cls.: 1, 4, 6, 37, 39, 40, 42, 50, 51, and 52

United States Patent and Trademark Office

Reg. No. 3,477,916

Registered July 29, 2008

**TRADEMARK
PRINCIPAL REGISTER**

KONA FIORE

MAYLAND INC. (CALIFORNIA SOLE PROPRIETORSHIP)
2909 LEONIS BLVD.
VERNON, CA 90058

FOR: ARTIFICIAL DECORATIVE FINGERNAILS, IN CLASS 3 (U.S. CLS. 1, 4, 6, 50, 51 AND 52).

FIRST USE 5-18-2004; IN COMMERCE 5-18-2004.

FOR: PONYTAIL HOLDERS AND JAW CLIPS FOR THE HAIR, IN CLASS 26 (U.S. CLS. 37, 39, 40, 42 AND 50).

FIRST USE 5-18-2004; IN COMMERCE 5-18-2004.

THE MARK CONSISTS OF STANDARD CHARACTERS WITHOUT CLAIM TO ANY PARTICULAR FONT, STYLE, SIZE, OR COLOR.

KONA FIORE MEANS FLOWER OF KONA.

SN 78-451,905, FILED 7-16-2004.

GINA HAYES, EXAMINING ATTORNEY

Int. Cl.: 14

Prior U.S. Cls.: 2, 27, 28, and 50

United States Patent and Trademark Office

Reg. No. 3,477,917

Registered July 29, 2008

**TRADEMARK
PRINCIPAL REGISTER**

JUELLCUT

ROGERS ENTERPRISES (DELAWARE COR-
PORATION)
20821 SOUTH CICERO AVENUE
MATTTESON, IL 60443

THE MARK CONSISTS OF STANDARD CHAR-
ACTERS WITHOUT CLAIM TO ANY PARTICULAR
FONT, STYLE, SIZE, OR COLOR.

FOR: JEWELRY, NAMELY, DIAMONDS, IN
CLASS 14 (U.S. CLS. 2, 27, 28 AND 50).

SN 78-452,440, FILED 7-18-2004.

FIRST USE 9-0-2006; IN COMMERCE 9-0-2006.

MAUREEN DALL, EXAMINING ATTORNEY

Int. Cls.: 35, 36, 37, 39, and 42

Prior U.S. Cls.: 100, 101, 102, 103, 105, and 106

United States Patent and Trademark Office

Reg. No. 3,477,918

Registered July 29, 2008

**SERVICE MARK
PRINCIPAL REGISTER**

**LANDLORD OF CHOICE
TO THE BIOMEDICAL
INDUSTRY**

ALEXANDRIA REAL ESTATE EQUITIES, INC.
(MARYLAND CORPORATION)
385 E. COLORADO BLVD., SUITE 299
PASADENA, CA 91101

FOR: BUSINESS MANAGEMENT; BUSINESS CONSULTING SERVICES; BUSINESS INCUBATOR SERVICES, NAMELY, BUSINESS MANAGEMENT AND BUSINESS DEVELOPMENT SERVICES IN THE FORM OF START-UP SUPPORT FOR BUSINESSES OF OTHERS; RENTAL AND LEASING OF OFFICE MACHINERY AND EQUIPMENT, IN CLASS 35 (U.S. CLS. 100, 101 AND 102).

FIRST USE 8-0-2004; IN COMMERCE 8-0-2004.

FOR: REAL ESTATE SERVICES, NAMELY, REAL ESTATE BROKERAGE, LEASING AND MANAGEMENT SERVICES; LAND ACQUISITION, NAMELY, REAL ESTATE BROKERAGE SERVICES; RENTAL OF REAL ESTATE, NAMELY, RENTAL OF COMMERCIAL, MANUFACTURING, AND RESEARCH AND DEVELOPMENT SPACE; INVESTMENT BROKERAGE, CONSULTATION, AND MANAGEMENT; FINANCIAL PORTFOLIO MANAGEMENT; FINANCIAL SERVICE, NAMELY, FINANCIAL CONSULTATION, FINANCIAL ANALYSIS, FINANCIAL PLANNING, FINANCIAL MANAGEMENT, FINANCIAL PORTFOLIO MANAGEMENT; FINANCING SERVICES, NAMELY, PROVIDING FINANCING TO EMERGING AND START-UP COMPANIES, NAMELY, PROVIDING DEBT AND EQUITY CAPITAL INCUBATOR FINANCING SERVICES, IN CLASS 36 (U.S. CLS. 100, 101 AND 102).

FIRST USE 8-0-2004; IN COMMERCE 8-0-2004.

FOR: REAL ESTATE DEVELOPMENT SERVICES; BUILDING CONSTRUCTION AND REPAIR SERVICES; MAINTENANCE AND/OR REPAIR OF BUILDINGS, ELECTRICAL SYSTEMS, HEATING AND AIR CONDITIONING SYSTEMS, AND PLUMBING SYSTEMS, IN CLASS 37 (U.S. CLS. 100, 103 AND 106).

FIRST USE 8-0-2004; IN COMMERCE 8-0-2004.

FOR: RENTAL OF WAREHOUSE SPACE, IN CLASS 39 (U.S. CLS. 100 AND 105).

FIRST USE 8-0-2004; IN COMMERCE 8-0-2004.

FOR: ARCHITECTURAL DESIGN SERVICES; ENGINEERING SERVICES; RENTAL AND LEASING OF COMPUTERS, IN CLASS 42 (U.S. CLS. 100 AND 101).

FIRST USE 8-0-2004; IN COMMERCE 8-0-2004.

THE MARK CONSISTS OF STANDARD CHARACTERS WITHOUT CLAIM TO ANY PARTICULAR FONT, STYLE, SIZE, OR COLOR.

OWNER OF U.S. REG. NOS. 2,789,134, 2,798,326, AND 2,798,328.

NO CLAIM IS MADE TO THE EXCLUSIVE RIGHT TO USE "BIOMEDICAL INDUSTRY", APART FROM THE MARK AS SHOWN.

SN 78-461,243, FILED 8-3-2004.

TIMOTHY FINNEGAN, EXAMINING ATTORNEY

Int. Cl.: 3

Prior U.S. Cls.: 1, 4, 6, 50, 51, and 52

United States Patent and Trademark Office

Reg. No. 3,477,919

Registered July 29, 2008

**TRADEMARK
PRINCIPAL REGISTER**

SWEET EARTH

CGE ENTERPRISES, LLC (DELAWARE LTD
LIAB CO)
5650 MAIN STREET
MANCHESTER CENTER, VT 05255

THE MARK CONSISTS OF STANDARD CHAR-
ACTERS WITHOUT CLAIM TO ANY PARTICULAR
FONT, STYLE, SIZE, OR COLOR.

FOR: PERFUMES, COLOGNES, FRAGRANCES
FOR PERSONAL USE, IN CLASS 3 (U.S. CLS. 1, 4, 6,
50, 51 AND 52).

SN 78-461,840, FILED 8-4-2004.

FIRST USE 12-1-2006; IN COMMERCE 12-1-2006.

JASON TURNER, EXAMINING ATTORNEY

Int. Cl.: 3

Prior U.S. Cls.: 1, 4, 6, 50, 51, and 52

Reg. No. 3,477,920

United States Patent and Trademark Office

Registered July 29, 2008

**TRADEMARK
PRINCIPAL REGISTER**

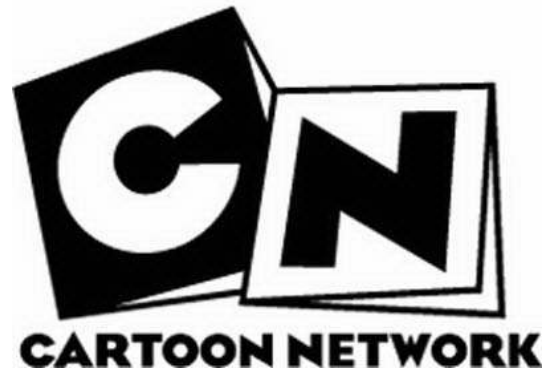

THE CARTOON NETWORK, INC. (DELAWARE CORPORATION)
C/OTURNER BROADCASTING SYSTEM, INC.
ONE CNN CENTER
ATLANTA, GA 303032762

FIRST USE 11-30-2007; IN COMMERCE 11-30-2007.

SN 78-464,445, FILED 8-9-2004.

FOR: EAU DE PARFUM, EAU DE TOILETTE, LIP BALM, IN CLASS 3 (U.S. CLS. 1, 4, 6, 50, 51 AND 52).

ROBIN CHOSID, EXAMINING ATTORNEY

Int. Cl.: 9

Prior U.S. Cls.: 21, 23, 26, 36, and 38

Reg. No. 3,477,921

United States Patent and Trademark Office

Registered July 29, 2008

**TRADEMARK
PRINCIPAL REGISTER**

JOBLO

JOBLO MEDIA INC. (CANADA CORPORATION)
3360 SAVARD
MONTREAL, QUEBEC, CANADA H4K 2N3

FOR: PRE-RECORDED VIDEO CASSETTE
TAPES, PRE-RECORDED DIGITAL VIDEO DISCS
ALL FEATURING SUBJECTS RELATED TO MO-
VIES, THE INTERNET OR ENTERTAINMENT, IN
CLASS 9 (U.S. CLS. 21, 23, 26, 36 AND 38).

FIRST USE 4-15-2008; IN COMMERCE 4-15-2008.

THE MARK CONSISTS OF STANDARD CHAR-
ACTERS WITHOUT CLAIM TO ANY PARTICULAR
FONT, STYLE, SIZE, OR COLOR.

SN 78-467,114, FILED 8-13-2004.

JOHN LINCOSKI, EXAMINING ATTORNEY

Int. Cl.: 14

Prior U.S. Cls.: 2, 27, 28, and 50

United States Patent and Trademark Office

Reg. No. 3,477,922

Registered July 29, 2008

**TRADEMARK
PRINCIPAL REGISTER**



LAFAYETTE COLLEGE (PENNSYLVANIA NON-
PROFIT CORPORATION)
6 MARBLE HALL
EASTON, PA 18042

THE MARK CONSISTS OF "L" WITH A LEOPARD
HEAD.

FOR: WATCHES, IN CLASS 14 (U.S. CLS. 2, 27, 28
AND 50).

SN 78-469,297, FILED 8-18-2004.

FIRST USE 1-1-2005; IN COMMERCE 1-1-2005.

FLORENTINA BLANDU, EXAMINING ATTORNEY

Int. Cls.: 16 and 17

Prior U.S. Cls.: 1, 2, 5, 12, 13, 22, 23, 29, 35, 37, 38, and 50

Reg. No. 3,477,923

United States Patent and Trademark Office

Registered July 29, 2008

**TRADEMARK
PRINCIPAL REGISTER**

V-TECH

VITAL TECHNICAL, LLC (CALIFORNIA LIMITED LIABILITY CORPORATION)
711 E. WALNUT ST., STE. 204
PASADENA, CA 91101

FOR: ADHESIVES, NAMELY, PASTES AND ADHESIVES FOR STATIONERY OR HOUSEHOLD PURPOSES AND DO-IT-YOURSELF PURPOSES; OFFICE REQUISITES, NAMELY, GLUE FOR THE OFFICE, IN CLASS 16 (U.S. CLS. 2, 5, 22, 23, 29, 37, 38 AND 50).

FIRST USE 11-30-2002; IN COMMERCE 11-30-2002.

FOR: RUBBER, GUTTA-PERCHA, GUM ASBESTOS, MICA GOODS, NAMELY, ADHESIVE SEALANT AND CAULKING COMPOUND; ADHESIVE SEALANTS FOR GENERAL USE; ADHESIVE TAPE FOR INDUSTRIAL AND COMMERCIAL USE;

CAULKING COMPOUNDS; GENERAL PURPOSE SILICONE RUBBER SEALANT; GROUT SEALANT; MOLDABLE COMPOUNDS FOR USE IN JOINTING AND PACKING; RUBBER SEALANT FOR CAULKING AND ADHESIVE PURPOSES; SEALANTS FOR BUILDINGS; SEALANTS FOR PAVEMENT JOINTS, IN CLASS 17 (U.S. CLS. 1, 5, 12, 13, 35 AND 50).

FIRST USE 11-30-2002; IN COMMERCE 11-30-2002.

THE MARK CONSISTS OF STANDARD CHARACTERS WITHOUT CLAIM TO ANY PARTICULAR FONT, STYLE, SIZE, OR COLOR.

SN 78-470,963, FILED 8-20-2004.

WILLIAM VERHOSEK, EXAMINING ATTORNEY

Int. Cl.: 35

Prior U.S. Cls.: 100, 101, and 102

United States Patent and Trademark Office

Reg. No. 3,477,924

Registered July 29, 2008

**SERVICE MARK
PRINCIPAL REGISTER**



OXFORD PUBLISHING, INC. (MISSISSIPPI CORPORATION)
307 WEST JACKSON AVENUE
OXFORD, MS 38655

FOR: ARRANGING AND CONDUCTING TRADE SHOWS AND CONVENTIONS IN THE FIELD OF FOOD AND BEVERAGE; DISSEMINATING MARKETING MATERIALS TO EXHIBITORS AND ATTENDEES AT TRADE SHOWS AND CONVENTIONS

ARRANGED BY OTHERS, IN CLASS 35 (U.S. CLS. 100, 101 AND 102).

FIRST USE 3-5-2006; IN COMMERCE 3-5-2006.

SN 78-480,757, FILED 9-9-2004.

ANNE E. GUSTASON, EXAMINING ATTORNEY

Int. Cl.: 35

Prior U.S. Cls.: 100, 101, and 102

United States Patent and Trademark Office

Reg. No. 3,477,925

Registered July 29, 2008

**SERVICE MARK
PRINCIPAL REGISTER**

BIDCO

BIDCO AUCTION WAREHOUSE, INC. (NEVADA CORPORATION)
1974 EAST 75 SOUTH
LAYTON, UT 84040

FOR: AUCTION SERVICES; PROVIDING ON-LINE INTERACTIVE AUCTION SERVICES OVER LOCAL, NATIONAL AND GLOBAL INFORMATION NETWORKS; PROVIDING ELECTRONIC INTERACTIVE AUCTION SERVICES FOR GOODS AND SERVICES IN A GIVEN LOCATION, NAMELY, WAREHOUSES AND RETAIL LOCATIONS; MANAGING THE AUCTION OF ITEMS, ON BEHALF OF OTHERS, WHETHER ONLINE OR IN A GIVEN

LOCATIONS, NAMELY, WAREHOUSES AND RETAIL LOCATIONS, IN CLASS 35 (U.S. CLS. 100, 101 AND 102).

FIRST USE 3-28-2006; IN COMMERCE 3-28-2006.

THE MARK CONSISTS OF STANDARD CHARACTERS WITHOUT CLAIM TO ANY PARTICULAR FONT, STYLE, SIZE, OR COLOR.

SN 78-486,524, FILED 9-20-2004.

PRISCILLA MILTON, EXAMINING ATTORNEY

Int. Cl.: 41

Prior U.S. Cls.: 100, 101, and 107

United States Patent and Trademark Office

Reg. No. 3,477,926

Registered July 29, 2008

**SERVICE MARK
PRINCIPAL REGISTER**

WOODGRANE

WALKER, NATHANIEL IV (UNITED STATES
INDIVIDUAL)
6623 MITCHELL LANE
MABLETON, GA 30126 AND
DOTHARD, MICHAEL A. (UNITED STATES INDI-
VIDUAL)
6583 MITCHELL LANE
MABLETON, GA 30126

FOR: ENTERTAINMENT SERVICES IN THE
NATURE OF LIVE MUSICAL PERFORMANCES
BY A PERFORMER OR GROUP, IN CLASS 41 (U.S.
CLS. 100, 101 AND 107).

FIRST USE 8-26-2006; IN COMMERCE 8-26-2006.

THE MARK CONSISTS OF STANDARD CHAR-
ACTERS WITHOUT CLAIM TO ANY PARTICULAR
FONT, STYLE, SIZE, OR COLOR.

SN 78-492,761, FILED 9-30-2004.

MICHAEL TANNER, EXAMINING ATTORNEY

Int. Cl.: 29

Prior U.S. Cl.: 46

United States Patent and Trademark Office

Reg. No. 3,477,927

Registered July 29, 2008

**TRADEMARK
PRINCIPAL REGISTER**

TENDER SELECT

PERDUE HOLDINGS, INC. (DELAWARE CORPORATION)
1105 NORTH MARKET STREET
SUITE 1300
WILMINGTON, DE 19801

FOR: POULTRY AND PARTS THEREOF; PROCESSED MEATS AND POULTRY; PROCESSED MEATS MADE FROM POULTRY AND PARTS THEREOF, IN CLASS 29 (U.S. CL. 46).

FIRST USE 1-28-2008; IN COMMERCE 1-28-2008.

THE MARK CONSISTS OF STANDARD CHARACTERS WITHOUT CLAIM TO ANY PARTICULAR FONT, STYLE, SIZE, OR COLOR.

OWNER OF U.S. REG. NO. 1,609,930.

NO CLAIM IS MADE TO THE EXCLUSIVE RIGHT TO USE "TENDER", APART FROM THE MARK AS SHOWN.

SN 78-494,576, FILED 10-5-2004.

KELLY CHOE, EXAMINING ATTORNEY

Int. Cl.: 37

Prior U.S. Cls.: 100, 103, and 106

United States Patent and Trademark Office

Reg. No. 3,477,928

Registered July 29, 2008

**SERVICE MARK
PRINCIPAL REGISTER**



SELF-SERV. INC. (NORTH CAROLINA CORPORATION)
P.O. BOX 470456
CHARLOTTE, NC 282470456

FOR: PROVIDING COIN-OPERATED LAUNDRY FACILITIES, IN CLASS 37 (U.S. CLS. 100, 103 AND 106).

FIRST USE 6-0-2006; IN COMMERCE 6-0-2006.

THE MARK CONSISTS OF THE WORDING "WASHZONE" APPEARING IN STYLIZED LETTERS, WITH THE FIRST LETTER "O" IN "WASHZONE" FORMED WITH THE GRAPHIC OF AN ANTHROPOMORPHIC BUBBLE WITH OTHER BUBBLES APPEARING BETWEEN THE WORDING.

SN 78-495,663, FILED 10-6-2004.

ADA HAN, EXAMINING ATTORNEY

Int. Cl.: 35

Prior U.S. Cls.: 100, 101, and 102

United States Patent and Trademark Office

Reg. No. 3,477,929

Registered July 29, 2008

**SERVICE MARK
PRINCIPAL REGISTER**



HALL, LOIS (UNITED STATES INDIVIDUAL)
7618 N. WHILEAWAY ROAD EAST
PARK CITY, UT 84098

FOR: RETAIL STORE SERVICES, MAIL ORDER SERVICES AND ON-LINE RETAIL STORE SERVICES FEATURING DECORATIVE AND SEASONAL GIFTS AND HOME ACCENTS, IN CLASS 35 (U.S. CLS. 100, 101 AND 102).

FIRST USE 1-1-2003; IN COMMERCE 1-1-2003.

THE COLORS PINK, BLACK, GRAY, ORANGE AND PURPLE ARE CLAIMED AS A FEATURE OF THE MARK.

THE TEXT APPEARS IN BLACK. THE SKY BACKGROUND APPEARS IN BLACK AND THE MOON AND STARS APPEAR IN ORANGE AND GRAY. THE FEMALE FIGURES APPEAR IN GRAY AND HAVE PINK SKIN AND ARE POSITIONS UPON A PURPLE SQUARED-SHAPED MOUNTAIN. THE WORDS "MOUNTAIN" AND "MAMAS" APPEAR IN GRAY BOXES. THE WORDING "LIVE, LOVE AND LAUGH" APPEAR IN AN ORANGE BOX AND THE HEART IS PINK.

SN 78-505,201, FILED 10-25-2004.

INGRID C. EULIN, EXAMINING ATTORNEY

Int. Cl.: 7

Prior U.S. Cls.: 13, 19, 21, 23, 31, 34, and 35

Reg. No. 3,477,930

United States Patent and Trademark Office

Registered July 29, 2008

**TRADEMARK
PRINCIPAL REGISTER**

WITRON LOGISTIK + INFORMATIK GMBH
(FED REP GERMANY CORPORATION)

NEUSTADTER STR. 21

PARKSTEIN, FED REP GERMANY 92711

FOR: MACHINES FOR AUTOMATED LOADING
OF CARRIERS, IN PARTICULAR OF PALLETS, IN
CLASS 7 (U.S. CLS. 13, 19, 21, 23, 31, 34 AND 35).

FIRST USE 3-0-2003; IN COMMERCE 9-0-2003.

THE MARK CONSISTS OF STANDARD CHAR-
ACTERS WITHOUT CLAIM TO ANY PARTICULAR
FONT, STYLE, SIZE, OR COLOR.

PRIORITY CLAIMED UNDER SEC. 44(D) ON
ERPNTY TM OFC APPLICATION NO.
004015401, FILED 9-8-2004, REG. NO. 004015401,
DATED 1-16-2006, EXPIRES 9-8-2014.

SN 78-510,911, FILED 11-3-2004.

ADA HAN, EXAMINING ATTORNEY

Int. Cls.: 37, 40, and 42

Prior U.S. Cls.: 100, 101, 103, and 106

United States Patent and Trademark Office

Reg. No. 3,477,931

Registered July 29, 2008

**SERVICE MARK
PRINCIPAL REGISTER**

PERFORMANCE 20

GENERAL ELECTRIC COMPANY (NEW YORK CORPORATION)
1 RIVER ROAD
SCHENECTADY, NY 12345

FOR: REPAIR AND REPLACEMENT OF NUCLEAR POWER PLANT SYSTEM AND EQUIPMENT, IN CLASS 37 (U.S. CLS. 100, 103 AND 106).

FIRST USE 3-31-2005; IN COMMERCE 3-31-2005.

FOR: CONSULTING SERVICES IN THE FIELD OF NUCLEAR ELECTRICITY GENERATION, NAMELY, CONSULTING SERVICES REGARDING NUCLEAR POWER PLANT PERFORMANCE AND OPTIMIZATION, NAMELY, PLANT RELIABILITY EVALUATION PROGRAMS AND PLANT MODIFICATION SOLUTIONS RELATING TO FUEL OPTIMIZATION, WATER CHEMISTRY, AND POWER PLANT UPRATE, IN CLASS 40 (U.S. CLS. 100, 103 AND 106).

FIRST USE 3-31-2005; IN COMMERCE 3-31-2005.

FOR: CONSULTING SERVICES IN THE FIELD OF REGULATIONS AND REQUIREMENTS, NAMELY, REQUIREMENTS REGARDING NUCLEAR POWER PLANT LICENSE RENEWAL AND POWER UPRATE APPLICATIONS; TECHNICAL MONITORING IN THE FIELD OF NUCLEAR POWER PLANT OPERATIONS; AND DIAGNOSTIC SERVICES IN THE FIELD OF NUCLEAR POWER PLANT EQUIPMENT, IN CLASS 42 (U.S. CLS. 100 AND 101).

FIRST USE 3-31-2005; IN COMMERCE 3-31-2005.

THE MARK CONSISTS OF STANDARD CHARACTERS WITHOUT CLAIM TO ANY PARTICULAR FONT, STYLE, SIZE, OR COLOR.

NO CLAIM IS MADE TO THE EXCLUSIVE RIGHT TO USE "PERFORMANCE", APART FROM THE MARK AS SHOWN.

SN 78-519,054, FILED 11-18-2004.

ROBERT LAVACHE, EXAMINING ATTORNEY

Int. Cl.: 3

Prior U.S. Cls.: 1, 4, 6, 50, 51, and 52

United States Patent and Trademark Office

Reg. No. 3,477,932

Registered July 29, 2008

**TRADEMARK
PRINCIPAL REGISTER**

GINKGO LIFT

CA BOTANA INTERNATIONAL, INC. (CALI-
FORNIA CORPORATION)

9365 WAPLES STREET

SAN DIEGO, CA 92121

FOR: COSMETICS, IN CLASS 3 (U.S. CLS. 1, 4, 6, 50,
51 AND 52).

FIRST USE 10-31-2005; IN COMMERCE 10-31-2005.

THE MARK CONSISTS OF STANDARD CHAR-
ACTERS WITHOUT CLAIM TO ANY PARTICULAR
FONT, STYLE, SIZE, OR COLOR.

NO CLAIM IS MADE TO THE EXCLUSIVE
RIGHT TO USE "GINKGO", APART FROM THE
MARK AS SHOWN.

SN 78-520,500, FILED 11-19-2004.

KELLY CHOE, EXAMINING ATTORNEY

Int. Cl.: 41

Prior U.S. Cls.: 100, 101, and 107

United States Patent and Trademark Office

Reg. No. 3,477,933

Registered July 29, 2008

**SERVICE MARK
PRINCIPAL REGISTER**

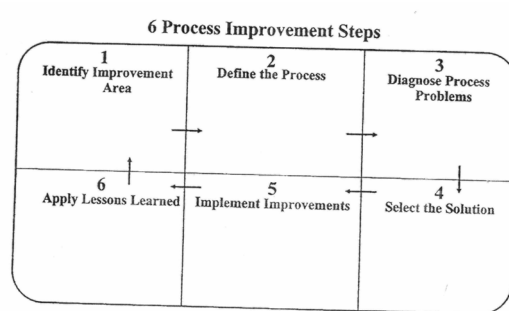

TARGET MANAGEMENT (CALIFORNIA PART-
NERSHIP)
225 CROSSROADS BLVD, #338
CARMEL, CA 93923

FOR: TRAINING AND COACHING AND EDU-
CATIONAL CONSULTING SERVICES IN THE
FIELD OF ORGANIZATIONAL AND LEADERSHIP
PROBLEM SOLVING, IN CLASS 41 (U.S. CLS. 100, 101
AND 107).

FIRST USE 5-31-2007; IN COMMERCE 5-31-2007.

NO CLAIM IS MADE TO THE EXCLUSIVE
RIGHT TO USE "6 PROCESS IMPROVEMENT
STEPS" "1 IDENTIFY IMPROVEMENT AREA" "2
DEFINE THE PROCESS" "3 DIAGNOSE PROCESS
PROBLEMS" "4 SELECT THE SOLUTION" "5 IM-
PLEMENT IMPROVEMENTS" "6 APPLY LESSONS
LEARNED", APART FROM THE MARK AS
SHOWN.

SN 78-521,379, FILED 11-22-2004.

DAVID C. REIHNER, EXAMINING ATTORNEY

Int. Cl.: 30

Prior U.S. Cl.: 46

United States Patent and Trademark Office

Reg. No. 3,477,934

Registered July 29, 2008

**TRADEMARK
PRINCIPAL REGISTER**

**NATURE'S OWN
SPECIAL MORNINGS**

FLOWERS BAKERIES BRANDS, INC. (DELA-
WARE CORPORATION)
1105 NORTH MARKET STREET SUITE 1300
WILMINGTON, DE 19899

FOR: BAKED GOODS, NAMELY, BREAD, IN
CLASS 30 (U.S. CL. 46).

FIRST USE 4-21-2008; IN COMMERCE 4-21-2008.

THE MARK CONSISTS OF STANDARD CHAR-
ACTERS WITHOUT CLAIM TO ANY PARTICULAR
FONT, STYLE, SIZE, OR COLOR.

OWNER OF U.S. REG. NOS. 1,121,956, 1,707,062,
AND OTHERS.

SN 78-523,921, FILED 11-29-2004.

SANI KHOURI, EXAMINING ATTORNEY

Int. Cl.: 30

Prior U.S. Cl.: 46

United States Patent and Trademark Office

Reg. No. 3,477,935

Registered July 29, 2008

TRADEMARK
PRINCIPAL REGISTER

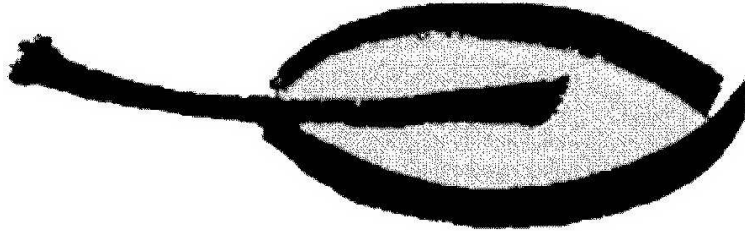

STOWE, LESLEY (CANADA INDIVIDUAL)
1685 WEST FIFTH AVENUE
VANCOUVER, CANADA V6J 1N5

THE STIPPLING IS FOR SHADING PURPOSES
ONLY.

FOR: FOOD PRODUCTS, NAMELY, CRACKERS,
IN CLASS 30 (U.S. CL. 46).

THE MARK CONSISTS OF LEAF DESIGN.

FIRST USE 0-0-2003; IN COMMERCE 0-0-2003.

SN 78-525,895, FILED 12-2-2004.

OWNER OF CANADA REG. NO. TMA653925,
DATED 11-30-2005, EXPIRES 11-30-2020.

BRIDGETT SMITH, EXAMINING ATTORNEY

Int. Cls.: 29 and 30

Prior U.S. Cl.: 46

United States Patent and Trademark Office

Reg. No. 3,477,936

Registered July 29, 2008

TRADEMARK
PRINCIPAL REGISTER



KIM, BOCK HYUN (REPUBLIC OF KOREA IN-
DIVIDUAL)
206-1602, HANJIN APARTMENT
609-1, DONAM-DONG, SEONGBUK-KU
SEOUL, REPUBLIC OF KOREA 136-060

FOR: SOUP SEASONING, IN CLASS 29 (U.S. CL.
46).

FIRST USE 3-3-2003; IN COMMERCE 4-2-2006.

FOR: NOODLES AND UNCOOKED NOODLES;
INSTANT NOODLES; HOT PEPPER SPICE POW-
DER; PEPPER AND PEPPER SEASONINGS, IN
CLASS 30 (U.S. CL. 46).

FIRST USE 3-3-2003; IN COMMERCE 4-2-2006.

THE WORD "TEUMSAE" IS TRANSLATED AS
GAP.

THE TRANSLITERATION OF THE KOREAN
CHARACTERS IN THE MARK IS "TEUMSAE".

SN 78-528,685, FILED 12-7-2004.

DAVID C. REIHNER, EXAMINING ATTORNEY

Int. Cl.: 42

Prior U.S. Cls.: 100 and 101

United States Patent and Trademark Office

Reg. No. 3,477,937

Registered July 29, 2008

**SERVICE MARK
PRINCIPAL REGISTER**

FALCONSTRIKE

GENERAL ATOMICS AERONAUTICAL SYSTEMS, INC. (DELAWARE CORPORATION)
16761 VIA DEL CAMPO COURT
SAN DIEGO, CA 92127

FOR: INSPECTIONS OF LARGE OR REMOTE FACILITIES RELATED TO SAFETY OF THE FACILITIES AND/OR PROGRESS MADE ON CONSTRUCTION OR REPAIR OPERATIONS OF THE FACILITIES IN THE FIELD OF SECURITY AND MILITARY PLANNING CONDUCTED BY FLYING OVER THE FACILITIES, IN CLASS 42 (U.S. CLS. 100 AND 101).

FIRST USE 1-9-2008; IN COMMERCE 1-9-2008.

THE MARK CONSISTS OF STANDARD CHARACTERS WITHOUT CLAIM TO ANY PARTICULAR FONT, STYLE, SIZE, OR COLOR.

SN 78-529,997, FILED 12-9-2004.

LINDA ORNDORFF, EXAMINING ATTORNEY

Int. Cl.: 9

Prior U.S. Cls.: 21, 23, 26, 36, and 38

Reg. No. 3,477,938

United States Patent and Trademark Office

Registered July 29, 2008

**TRADEMARK
PRINCIPAL REGISTER**



CROSS MATCH TECHNOLOGIES GMBH (FED
REP GERMANY GMBH)
UNSTRUTWEG 4
JENA, FED REP GERMANY 07743

FOR: OPTO-ELECTRONIC SCANNER TO PERFORM LIVE MAPPING OF THE BIOMETRIC FEATURES OF A LIVING PERSON, NAMELY, FINGER PRINTS, HAND PRINTS, FINGER GEOMETRIES, HAND GEOMETRIES; SOFTWARE TO RECORD, VIEW, PROCESS AND FORWARD BIOMETRIC FEATURES OF A LIVING PERSON, NAMELY, FINGER PRINTS, HAND PRINTS, FINGER GEOMETRIES, HAND GEOMETRIES; COMPUTERS TO

SAVE SUCH BIOMETRIC FEATURES OF A LIVING PERSON, NAMELY, FINGER PRINTS, HAND PRINTS, FINGER GEOMETRIES, HAND GEOMETRIES; IN DATABASES TO KEEP THEM READY FOR USE IN A COMPUTER READABLE FORM, IN CLASS 9 (U.S. CLS. 21, 23, 26, 36 AND 38).

FIRST USE 6-30-2004; IN COMMERCE 12-31-2005.

SN 78-531,443, FILED 12-13-2004.

LYDIA BELZER, EXAMINING ATTORNEY

Int. Cls.: 9 and 10

Prior U.S. Cls.: 21, 23, 26, 36, 38, 39, and 44

United States Patent and Trademark Office

Reg. No. 3,477,939

Registered July 29, 2008

**TRADEMARK
PRINCIPAL REGISTER**

**THE PERSONAL
TRAINER**

HOMEDICS, INC. (MICHIGAN CORPORATION)
3000 PONTIAC TRAIL
COMMERCE TOWNSHIP, MI 48390

FOR: SCALES, IN CLASS 9 (U.S. CLS. 21, 23, 26, 36
AND 38).

FIRST USE 9-27-2007; IN COMMERCE 9-27-2007.

FOR: BODY FAT ANALYZERS, IN CLASS 10 (U.S.
CLS. 26, 39 AND 44).

FIRST USE 9-27-2007; IN COMMERCE 9-27-2007.

THE MARK CONSISTS OF STANDARD CHAR-
ACTERS WITHOUT CLAIM TO ANY PARTICULAR
FONT, STYLE, SIZE, OR COLOR.

SN 78-532,433, FILED 12-14-2004.

ROBERT LAVACHE, EXAMINING ATTORNEY

Int. Cl.: 5

Prior U.S. Cls.: 6, 18, 44, 46, 51, and 52

Reg. No. 3,477,940

United States Patent and Trademark Office

Registered July 29, 2008

**TRADEMARK
PRINCIPAL REGISTER**

PRISTIQ

WYETH (DELAWARE CORPORATION)
TRADEMARK DEPARTMENT
FIVE GIRALDA FARMS
MADISON, NJ 07940

THE MARK CONSISTS OF STANDARD CHAR-
ACTERS WITHOUT CLAIM TO ANY PARTICULAR
FONT, STYLE, SIZE, OR COLOR.

FOR: A PHARMACEUTICAL PREPARATION TO
TREAT DEPRESSION, IN CLASS 5 (U.S. CLS. 6, 18, 44,
46, 51 AND 52).

SN 78-541,902, FILED 1-4-2005.

FIRST USE 4-16-2008; IN COMMERCE 4-16-2008.

SOPHIA S. KIM, EXAMINING ATTORNEY

Int. Cl.: 31

Prior U.S. Cls.: 1 and 46

United States Patent and Trademark Office

Reg. No. 3,477,941

Registered July 29, 2008

**TRADEMARK
PRINCIPAL REGISTER**

SMALL SPACES

SOCIETE DES PRODUITS NESTLE, S. A. (SWIT-
ZERLAND SOCIETE ANONYME)
CASE POSTAL 353
INTELLECTUAL PROPERTY DEPARTMENT
VEVEY, SWITZERLAND 1800

FOR: CAT LITTER, IN CLASS 31 (U.S. CLS. 1 AND
46).

FIRST USE 7-1-2005; IN COMMERCE 7-1-2005.

THE MARK CONSISTS OF STANDARD CHAR-
ACTERS WITHOUT CLAIM TO ANY PARTICULAR
FONT, STYLE, SIZE, OR COLOR.

SN 78-545,629, FILED 1-11-2005.

ROBERT C. CLARK JR., EXAMINING ATTORNEY

Int. Cl.: 3

Prior U.S. Cls.: 1, 4, 6, 50, 51, and 52

Reg. No. 3,477,942

United States Patent and Trademark Office

Registered July 29, 2008

**TRADEMARK
PRINCIPAL REGISTER**

JOHNSON'S BUDDIES

JOHNSON & JOHNSON (NEW JERSEY CORPORATION)
ONE JOHNSON & JOHNSON PLAZA
NEW BRUNSWICK, NJ 089337001

FOR: TOILETRIES, NAMELY, HAIR SHAMPOO, HAIR CONDITIONER, HAIR DETANGLERS, BODY WASH AND SKIN CLEANSERS, AND BODY SOAP, IN CLASS 3 (U.S. CLS. 1, 4, 6, 50, 51 AND 52).

FIRST USE 2-0-2007; IN COMMERCE 2-0-2007.

THE MARK CONSISTS OF STANDARD CHARACTERS WITHOUT CLAIM TO ANY PARTICULAR FONT, STYLE, SIZE, OR COLOR.

OWNER OF U.S. REG. NOS. 88,088, 2,751,530, AND OTHERS.

SN 78-549,698, FILED 1-19-2005.

ELISSA GARBER KON, EXAMINING ATTORNEY

Int. Cls.: 9, 16, and 25

**Prior U.S. Cls.: 2, 5, 21, 22, 23, 26, 29, 36, 37, 38, 39,
and 50**

Reg. No. 3,477,943

United States Patent and Trademark Office

Registered July 29, 2008

**TRADEMARK
PRINCIPAL REGISTER**

EDDIE WOULD GO

THE AIKAU FAMILY LLC (HAWAII LTD LIAB
CO)
352 AUWAIOLIMU STREET
HONOLULU, HI 96813

FOR: SUNGLASSES CASES; PRE-RECORDED DI-
GITAL VIDEO DISCS, AND VIDEO DISKS, FEA-
TURING SURFING, BODYBOARDING,
SNOWBOARDING, SKIING, KITEBOARDING
AND SKATEBOARDING, IN CLASS 9 (U.S. CLS. 21,
23, 26, 36 AND 38).

FIRST USE 1-31-2008; IN COMMERCE 1-31-2008.

FOR: BOOKS RELATED TO THE SUBJECT OF
SURFING; BOOK COVERS; CALENDARS; STICK-
ERS; DECALCOMANIAS; BUMPER STICKERS;
POSTERS; PHOTOGRAPHS, IN CLASS 16 (U.S. CLS.
2, 5, 22, 23, 29, 37, 38 AND 50).

FIRST USE 1-1-1990; IN COMMERCE 1-1-1990.

FOR: FOOTWEAR; SWIMWEAR; SINGLET; T-
SHIRTS; SHIRTS AND CASUAL TOPS WITH LONG

AND SHORT SLEEVES; SLEEVELESS SHIRTS AND
TOPS; SLEEVELESS TOPS; JERSEYS; TANK TOPS;
SWEAT TOPS; SWEAT HOODED PARKAS; JACK-
ETS; WIND RESISTANT JACKETS; SHORTS;
BOARD SHORTS; WALK SHORTS; VOLLEY
SHORTS; RASH GUARDS; STOCKINGS; SOCKS;
WRIST BRANDS; BEANIES, HATS, VISORS, CAPS,
BERETS, HEAD COVERINGS WITH CANOPY OF
SUNSHIELD; SURF WEAR; SURF CAPS; SURF
HOODS; SLIPPERS; THONGED AND STRAPPED
SANDALS, IN CLASS 25 (U.S. CLS. 22 AND 39).

FIRST USE 1-1-1990; IN COMMERCE 1-1-1990.

THE MARK CONSISTS OF STANDARD CHAR-
ACTERS WITHOUT CLAIM TO ANY PARTICULAR
FONT, STYLE, SIZE, OR COLOR.

OWNER OF U.S. REG. NO. 2,654,016.

SN 78-552,968, FILED 1-24-2005.

ODESSA BIBBINS, EXAMINING ATTORNEY

Int. Cl.: 35

Prior U.S. Cls.: 100, 101, and 102

United States Patent and Trademark Office

Reg. No. 3,477,944

Registered July 29, 2008

**SERVICE MARK
PRINCIPAL REGISTER**

O2HR

O2HR, LLC (ILLINOIS LTD LIAB CO)
11921 BRINLEY AVENUE, SUITE 203
LOUISVILLE, KY 40243

FOR: HUMAN RESOURCES CONSULTATION;
HUMAN RESOURCES MANAGEMENT; SERVING
AS A HUMAN RESOURCES DEPARTMENT FOR
OTHERS; EMPLOYEE LEASING SERVICES, IN
CLASS 35 (U.S. CLS. 100, 101 AND 102).

FIRST USE 8-31-2005; IN COMMERCE 2-21-2006.

THE MARK CONSISTS OF STANDARD CHAR-
ACTERS WITHOUT CLAIM TO ANY PARTICULAR
FONT, STYLE, SIZE, OR COLOR.

SN 78-560,800, FILED 2-4-2005.

NORA BUCHANAN WILL, EXAMINING ATTOR-
NEY

Int. Cls.: 6, 7, and 17

Prior U.S. Cls.: 1, 2, 5, 12, 13, 14, 19, 21, 23, 25, 31, 34,
35, and 50

Reg. No. 3,477,945

United States Patent and Trademark Office

Registered July 29, 2008

TRADEMARK
PRINCIPAL REGISTER

deva.tex

FEDERAL-MOGUL DEVA GMBH (FED REP
GERMANY GMBH)
SCHULSTR. 20
STADTALLENDORF, FED REP GERMANY 35260

FOR: METALS IN THE FORM OF SEMI-FINISHED PRODUCTS FOR USE IN THE FURTHER MANUFACTURE OF SEALS AND PACKINGS; SHAPED SINTERED METAL PARTS AS SEMI-FINISHED PRODUCTS FOR USE IN THE FURTHER MANUFACTURE OF SEALS, PACKING AND BUSHES; SHAPED SINTERED METAL PARTS FOR USE IN THE MANUFACTURE OF SEALS AND PACKINGS; METAL IN POWDER FORM WITH SOLID LUBRICANT PROPERTIES FOR USE IN THE MANUFACTURE OF SEALS, PACKINGS AND BUSHES, IN CLASS 6 (U.S. CLS. 2, 12, 13, 14, 23, 25 AND 50).

FIRST USE 1-31-2004; IN COMMERCE 1-31-2004.

FOR: MACHINE PARTS OF SHAPED POWDER METALLURGICAL AND SINTERED METAL PARTS, NAMELY, PLAIN BEARINGS, SLIDING ELEMENTS, SLIDING PLATES AND BUSHES, IN CLASS 7 (U.S. CLS. 13, 19, 21, 23, 31, 34 AND 35).

FIRST USE 1-31-2004; IN COMMERCE 1-31-2004.

FOR: NON-METALLIC MINERAL FIBERS FROM POLYESTER IN THE FORM OF SEMI-FINISHED PRODUCTS FOR USE IN THE MANUFACTURE OF SEALS AND PACKINGS, IN CLASS 17 (U.S. CLS. 1, 5, 12, 13, 35 AND 50).

FIRST USE 1-31-2004; IN COMMERCE 1-31-2004.

THE MARK CONSISTS OF STANDARD CHARACTERS WITHOUT CLAIM TO ANY PARTICULAR FONT, STYLE, SIZE, OR COLOR.

PRIORITY CLAIMED UNDER SEC. 44(D) ON FED REP GERMANY APPLICATION NO. 30447300, FILED 8-18-2004, REG. NO. 30447300, DATED 8-18-2004, EXPIRES 8-31-2014.

OWNER OF U.S. REG. NOS. 1,176,842 AND 2,776,051.

SN 78-561,723, FILED 2-7-2005.

DEIRDRE ROBERTSON, EXAMINING ATTORNEY

Int. Cls.: 6, 7, and 17

Prior U.S. Cls.: 1, 2, 5, 12, 13, 14, 19, 21, 23, 25, 31, 34,
35, and 50

Reg. No. 3,477,946

United States Patent and Trademark Office

Registered July 29, 2008

TRADEMARK
PRINCIPAL REGISTER

deva.bm

FEDERAL-MOGUL DEVA GMBH (FED REP
GERMANY GMBH)
SCHULSTR. 20
STADTALLENDORF, FED REP GERMANY 35260

FOR: METALS IN THE FORM OF SEMI-FINISHED PRODUCTS FOR USE IN THE FURTHER MANUFACTURE OF SEALS AND PACKINGS; SHAPED SINTERED METAL PARTS AS SEMI-FINISHED PRODUCTS FOR USE IN THE FURTHER MANUFACTURE OF SEALS, PACKING, BUSHES AND SHAFTS; MOLDS OF METAL FOR CASTING CERAMIC MATERIALS; SHAPED SINTERED METAL PARTS FOR USE IN THE MANUFACTURE OF SEALS AND PACKINGS; METAL IN POWDER FORM WITH SOLID LUBRICANT PROPERTIES FOR USE IN THE MANUFACTURE OF SEALS, PACKINGS, BUSHES AND SHAFTS, IN CLASS 6 (U.S. CLS. 2, 12, 13, 14, 23, 25 AND 50).

FIRST USE 1-31-2004; IN COMMERCE 1-31-2008.

FOR: MACHINE PARTS, NAMELY, PISTON RINGS AND SEALING RINGS; MACHINE PARTS OF SHAPED POWDER METALLURGICAL AND SINTERED METAL PARTS, NAMELY, PLAIN BEARINGS, SLIDING ELEMENTS, SLIDING PLATES, BUSHES AND SPINDLE NUTS, IN CLASS 7 (U.S. CLS. 13, 19, 21, 23, 31, 34 AND 35).

FIRST USE 1-31-2004; IN COMMERCE 1-31-2004.

FOR: NON-METALLIC MINERAL FIBERS IN THE FORM OF SEMI-FINISHED PRODUCTS FOR USE IN THE MANUFACTURE OF SEALS AND PACKINGS, IN CLASS 17 (U.S. CLS. 1, 5, 12, 13, 35 AND 50).

FIRST USE 1-31-2004; IN COMMERCE 1-31-2004.

THE MARK CONSISTS OF STANDARD CHARACTERS WITHOUT CLAIM TO ANY PARTICULAR FONT, STYLE, SIZE, OR COLOR.

PRIORITY CLAIMED UNDER SEC. 44(D) ON FED REP GERMANY APPLICATION NO. 30441899.9/1, FILED 8-18-2004, REG. NO. 30447299, DATED 12-23-2004, EXPIRES 8-31-2014.

OWNER OF U.S. REG. NOS. 1,176,842 AND 2,776,051.

SN 78-561,825, FILED 2-7-2005.

RONALD MCMORROW, EXAMINING ATTORNEY

Int. Cl.: 14

Prior U.S. Cls.: 2, 27, 28, and 50

United States Patent and Trademark Office

Reg. No. 3,477,947

Registered July 29, 2008

**TRADEMARK
PRINCIPAL REGISTER**

LUCKY KARMA

TOM, YIM (UNITED STATES INDIVIDUAL)
376 BROADWAY, APT. 14G
NEW YORK, NY 10013

THE MARK CONSISTS OF STANDARD CHARACTERS WITHOUT CLAIM TO ANY PARTICULAR FONT, STYLE, SIZE, OR COLOR.

FOR: JEWELRY OF PRECIOUS METAL, NAME-
LY, BRACELETS, NECKLACES, ORNAMENTAL
PINS, CHARMS, CHAINS, PENDANTS, EARRINGS,
RINGS, IN CLASS 14 (U.S. CLS. 2, 27, 28 AND 50).

SN 78-565,399, FILED 2-11-2005.

FIRST USE 2-22-2008; IN COMMERCE 2-22-2008.

INGA ERVIN, EXAMINING ATTORNEY

Int. Cl.: 7

Prior U.S. Cls.: 13, 19, 21, 23, 31, 34, and 35

Reg. No. 3,477,948

United States Patent and Trademark Office

Registered July 29, 2008

**TRADEMARK
PRINCIPAL REGISTER**

WIDGETEER

WIDGETEER, INC. (ILLINOIS CORPORATION)
3 NORMANDY COURT
OAKWOOD HILLS, IL 60013

FIRST USE 3-17-2008; IN COMMERCE 3-17-2008.

FOR: VACUUM PUMP FOR EXTRACTING AIR FROM A PLASTIC STORAGE BAG, OR GLASS STORAGE CONTAINER, OR PLASTIC STORAGE CONTAINER AND RESEALING THE BAG OR CONTAINER FOR DOMESTIC HOUSEHOLD USE, IN CLASS 7 (U.S. CLS. 13, 19, 21, 23, 31, 34 AND 35).

THE MARK CONSISTS OF STANDARD CHARACTERS WITHOUT CLAIM TO ANY PARTICULAR FONT, STYLE, SIZE, OR COLOR.

SN 78-567,857, FILED 2-15-2005.

COLLEEN DOMBROW, EXAMINING ATTORNEY

Int. Cls.: 35, 36, 37, 39, and 41

Prior U.S. Cls.: 100, 101, 102, 103, 105, 106, and 107

United States Patent and Trademark Office

Reg. No. 3,477,949

Registered July 29, 2008

**SERVICE MARK
PRINCIPAL REGISTER**



TRAILER FLEET INTERNATIONAL LLC (PENN-
SYLVANIA LTD LIAB CO)
290 KING OF PRUSSIA ROAD
SUITE 300, BUILDING 1
RADNOR, PA 19087

FOR: ADVERTISING AND MARKETING SERVI-
CES AND RELATED CONSULTING; COMPUTER-
IZED ONLINE RETAIL STORE SERVICES IN THE
FIELD OF VEHICLE TRAILERS, AND STORAGE
FACILITIES, AND PARTS AND SUPPLIES FOR
SAME, IN CLASS 35 (U.S. CLS. 100, 101 AND 102).

FIRST USE 7-1-2004; IN COMMERCE 7-1-2004.

FOR: FINANCING SERVICES, IN CLASS 36 (U.S.
CLS. 100, 101 AND 102).

FIRST USE 4-28-2005; IN COMMERCE 4-28-2005.

FOR: REPAIR AND MAINTENANCE OF STO-
RAGE FACILITIES AND VEHICLE TRAILERS, IN
CLASS 37 (U.S. CLS. 100, 103 AND 106).

FIRST USE 6-23-2005; IN COMMERCE 6-23-2005.

FOR: TRANSPORTATION AND STORAGE OF
VEHICLE TRAILERS AND STORAGE FACILITIES

FOR OTHERS; AGENCIES OR BROKERAGE FOR
THE RENTAL AND LEASE OF VEHICLE TRAILERS
AND STORAGE FACILITIES, IN CLASS 39 (U.S. CLS.
100 AND 105).

FIRST USE 6-23-2005; IN COMMERCE 6-23-2005.

FOR: ENTERTAINMENT SERVICES, NAMELY,
PROVIDING A WEBSITE AT WHICH USERS CAN
LINK TO SITES FEATURING MOTION PICTURE
AND VIDEO GAME TRAILERS, STILLS AND RE-
LATED INFORMATION, IN CLASS 41 (U.S. CLS. 100,
101 AND 107).

FIRST USE 6-12-2006; IN COMMERCE 6-12-2006.

NO CLAIM IS MADE TO THE EXCLUSIVE
RIGHT TO USE "TRAILERS.COM", APART FROM
THE MARK AS SHOWN.

THE STIPLING IS FOR SHADING PURPOSES
ONLY.

SN 78-570,045, FILED 2-17-2005.

SUSAN LESLIE DUBOIS, EXAMINING ATTORNEY

Int. Cls.: 36, 39, and 43

Prior U.S. Cls.: 100, 101, 102, and 105

United States Patent and Trademark Office

Reg. No. 3,477,950

Registered July 29, 2008

**SERVICE MARK
PRINCIPAL REGISTER**

Quiksilver

QUIKSILVER, INC (CALIFORNIA CORPORATION)
15202 GRAHAM STREET
HUNTINGTON BEACH, CA 92649

FOR: CHARITABLE FUND RAISING, NAMELY, ORGANIZING FUND RAISING EVENTS; MANAGING AND MONITORING OF CHARITABLE FUNDS, NAMELY, ACCEPTING AND ADMINISTERING MONETARY CHARITABLE CONTRIBUTIONS, IN CLASS 36 (U.S. CLS. 100, 101 AND 102).

FIRST USE 1-1-2005; IN COMMERCE 1-1-2005.

FOR: TRAVEL SERVICES, NAMELY, ORGANIZATION OF TRAVEL; TOURIST AGENCY SERVICES; TRAVEL BOOKING AGENCIES; ARRANGING OF TRAVEL TOURS; ARRANGING EXCURSIONS FOR TOURISTS; TOUR CONDUCTING AND ESCORTING; TRAVEL AGENCY SERVICES, NAMELY, MAKING RESERVATIONS AND BOOKINGS FOR TRANSPORTATION; TRAVEL ADVISORY AND TRAVEL INFORMATION SERVICES RELATING TO TRAVEL AND TOURISM; TRAVEL BOOKING AGENCY SERVICES FOR ARRANGING TRAVEL; COMPUTERIZED TRAVEL INFORMA-

TION SERVICES; TRAVEL CONSULTANCY FOR TRAVEL PLANNING OF TRIP ROUTES; TRAVEL GUIDE SERVICES; PROVISION OF TRAVEL INFORMATION AND TRAVEL ADVICE IN FIELD OF TRAVEL AND TOURISM, IN CLASS 39 (U.S. CLS. 100 AND 105).

FIRST USE 2-26-2001; IN COMMERCE 2-26-2001.

FOR: TRAVEL AGENCY SERVICES, NAMELY, MAKING RESERVATIONS AND BOOKING FOR TEMPORARY LODGING; MAKING HOTEL RESERVATIONS FOR OTHERS; PROVIDING TEMPORARY ACCOMMODATION, IN CLASS 43 (U.S. CLS. 100 AND 101).

FIRST USE 2-26-2001; IN COMMERCE 2-26-2001.

THE MARK CONSISTS OF STANDARD CHARACTERS WITHOUT CLAIM TO ANY PARTICULAR FONT, STYLE, SIZE, OR COLOR.

SN 78-584,055, FILED 3-9-2005.

CAROL SPILS, EXAMINING ATTORNEY

Int. Cl.: 10

Prior U.S. Cls.: 26, 39, and 44

United States Patent and Trademark Office

Reg. No. 3,477,951

Registered July 29, 2008

**TRADEMARK
PRINCIPAL REGISTER**

DURATUBE

RIC INVESTMENTS, LLC (DELAWARE CORPORATION)
2ND FLOOR
801 WEST STREET
WILMINGTON, DE 198011545

FOR: NON-METALLIC, FORM-FITTING CONNECTOR TO ATTACH A MEDICAL NEBULIZER TO A COMPRESSOR FOR USE IN A HOME ENVIRONMENT, IN CLASS 10 (U.S. CLS. 26, 39 AND 44).

FIRST USE 10-1-1993; IN COMMERCE 10-1-2004.

THE MARK CONSISTS OF STANDARD CHARACTERS WITHOUT CLAIM TO ANY PARTICULAR FONT, STYLE, SIZE, OR COLOR.

SN 78-585,159, FILED 3-11-2005.

AMOS T. MATTHEWS, JR., EXAMINING ATTORNEY

Int. Cl.: 35

Prior U.S. Cls.: 100, 101, and 102

United States Patent and Trademark Office

Reg. No. 3,477,952

Registered July 29, 2008

**SERVICE MARK
PRINCIPAL REGISTER**

IFAS

AMERICAN ASSOCIATION OF HOMES AND
SERVICES FOR THE AGING (NEW YORK
CORPORATION)
2519 CONNECTICUT AVENUE, N.W.
WASHINGTON, DC 20008

FOR: PUBLIC POLICY RESEARCH SERVICES,
NAMELY, RESEARCH INVOLVING RESEARCH-
ERS, ACADEMICS, PROVIDERS AND GOVERN-
MENT REPRESENTATIVES TO ENHANCE
QUALITY AND EFFICIENCY IN THE AGING SER-
VICES FIELD, IN CLASS 35 (U.S. CLS. 100, 101 AND
102).

FIRST USE 0-0-1999; IN COMMERCE 0-0-1999.

THE MARK CONSISTS OF STANDARD CHAR-
ACTERS WITHOUT CLAIM TO ANY PARTICULAR
FONT, STYLE, SIZE, OR COLOR.

SN 78-585,329, FILED 3-11-2005.

SUNG IN, EXAMINING ATTORNEY

Int. Cl.: 1

Prior U.S. Cls.: 1, 5, 6, 10, 26, and 46

United States Patent and Trademark Office

Reg. No. 3,477,953

Registered July 29, 2008

**TRADEMARK
PRINCIPAL REGISTER**



U.S. SALT, INC. (MINNESOTA CORPORATION)
1020 BLACK DOG RD.
BURNSVILLE, MN 55337

NO CLAIM IS MADE TO THE EXCLUSIVE
RIGHT TO USE "SOLAR SALT", APART FROM
THE MARK AS SHOWN.

FOR: WATER CONDITIONING SALT AND DEI-
CING SALT, IN CLASS 1 (U.S. CLS. 1, 5, 6, 10, 26 AND
46).

SN 78-586,419, FILED 3-14-2005.

FIRST USE 11-25-2005; IN COMMERCE 11-25-2005.

ALLISON HOLTZ, EXAMINING ATTORNEY

Int. Cls.: 9, 36, and 41

Prior U.S. Cls.: 21, 23, 26, 36, 38, 100, 101, 102, and 107

Reg. No. 3,477,954

United States Patent and Trademark Office

Registered July 29, 2008

**TRADEMARK
SERVICE MARK
PRINCIPAL REGISTER**

D&B REWARDS

DAVE & BUSTER'S I, L.P. (TEXAS LIMITED PARTNERSHIP)
2481 MANANA DRIVE
DALLAS, TX 75220

FOR: PRE-PAID MAGNETICALLY ENCODED CARDS USED FOR PURCHASING ENTERTAINMENT SERVICES, IN CLASS 9 (U.S. CLS. 21, 23, 26, 36 AND 38).

FIRST USE 4-15-2005; IN COMMERCE 4-15-2005.

FOR: PAYMENT CARD SERVICES FOR ENTERTAINMENT DEVICES, NAMELY, PROVIDING RECHARGEABLE INTERACTIVE ACTIVATION CARDS FOR GAME PLAY ON ARCADE-TYPE AMUSEMENT MACHINES, IN CLASS 36 (U.S. CLS. 100, 101 AND 102).

FIRST USE 4-15-2005; IN COMMERCE 4-15-2005.

FOR: PROVIDING ENTERTAINMENT SERVICES IN THE NATURE OF INDOOR AMUSEMENT COM-

PLEXES FEATURING A PROGRAM OF INCENTIVE AWARDS AND DISCOUNTS FOR CUSTOMERS, IN CLASS 41 (U.S. CLS. 100, 101 AND 107).

FIRST USE 4-15-2005; IN COMMERCE 4-15-2005.

THE MARK CONSISTS OF STANDARD CHARACTERS WITHOUT CLAIM TO ANY PARTICULAR FONT, STYLE, SIZE, OR COLOR.

OWNER OF U.S. REG. NOS. 1,543,908, 2,228,792, AND 2,759,615.

NO CLAIM IS MADE TO THE EXCLUSIVE RIGHT TO USE "REWARDS", APART FROM THE MARK AS SHOWN.

SN 78-586,531, FILED 3-14-2005.

TERESA M. RUPP, EXAMINING ATTORNEY

Int. Cl.: 25

Prior U.S. Cls.: 22 and 39

United States Patent and Trademark Office

Reg. No. 3,477,955

Registered July 29, 2008

**TRADEMARK
PRINCIPAL REGISTER**

VS UPLIFT

VICTORIA'S SECRET STORES BRAND MANAGEMENT, INC. (DELAWARE CORPORATION)

FOUR LIMITED PARKWAY
REYNOLDSBURG, OH 43068

FOR: CLOTHING, NAMELY, JEANS, IN CLASS 25
(U.S. CLS. 22 AND 39).

FIRST USE 5-1-2008; IN COMMERCE 5-1-2008.

THE MARK CONSISTS OF STANDARD CHARACTERS WITHOUT CLAIM TO ANY PARTICULAR FONT, STYLE, SIZE, OR COLOR.

OWNER OF U.S. REG. NO. 2,244,265.

NO CLAIM IS MADE TO THE EXCLUSIVE RIGHT TO USE "UPLIFT", APART FROM THE MARK AS SHOWN.

SN 78-588,192, FILED 3-16-2005.

LINDA ORNDORFF, EXAMINING ATTORNEY

Int. Cl.: 30

Prior U.S. Cl.: 46

United States Patent and Trademark Office

Reg. No. 3,477,956

Registered July 29, 2008

**TRADEMARK
PRINCIPAL REGISTER**

MAGIC SELECTIONS

DISNEY ENTERPRISES, INC. (DELAWARE CORPORATION)
500 SOUTH BUENA VISTA STREET
BURBANK, CA 91521

FOR: BASES FOR MAKING MILKSHAKES; BREAD; CANDIES; CAKE DECORATIONS MADE OF CANDY; CHOCOLATE-BASED BEVERAGES; COCOA-BASED BEVERAGES; CONES FOR ICE CREAM; COOKIES; FROZEN YOGURT; POPCORN; SHERBETS, IN CLASS 30 (U.S. CL. 46).

FIRST USE 4-23-2008; IN COMMERCE 4-23-2008.

THE MARK CONSISTS OF STANDARD CHARACTERS WITHOUT CLAIM TO ANY PARTICULAR FONT, STYLE, SIZE, OR COLOR.

NO CLAIM IS MADE TO THE EXCLUSIVE RIGHT TO USE "SELECTIONS", APART FROM THE MARK AS SHOWN.

SN 78-588,889, FILED 3-16-2005.

HELENE LIWINSKI, EXAMINING ATTORNEY

Int. Cls.: 39 and 42

Prior U.S. Cls.: 100, 101, and 105

United States Patent and Trademark Office

Reg. No. 3,477,957

Registered July 29, 2008

SERVICE MARK
PRINCIPAL REGISTER

Speaking your
business

PARUS HOLDINGS, INC. (DELAWARE CORPORATION)
3000 LAKESIDE DRIVE
SUITE 300N
BANNOCKBURN, IL 60015

FOR: ELECTRONIC STORAGE AND ARCHIVING FOR OTHERS OF MESSAGES, DATA, FILES, DOCUMENTS, TEXT, AUDIO DATA, AND IMAGES, IN CLASS 39 (U.S. CLS. 100 AND 105).

FIRST USE 10-23-2007; IN COMMERCE 10-23-2007.

FOR: TECHNICAL SUPPORT SERVICES, NAMELY, TROUBLE SHOOTING OF TELECOMMUNICATIONS AND SPEECH-ENABLED COMMUNICATIONS COMPUTER SOFTWARE SERVICES; INSTALLATION MAINTENANCE,

AND UPDATING OF COMPUTER SOFTWARE SYSTEMS IN THE FIELD OF TELECOMMUNICATIONS AND SPEECH-ENABLED COMMUNICATIONS; TELECOMMUNICATIONS AND SPEECH-ENABLED COMMUNICATIONS COMPUTER SOFTWARE DESIGN AND DEVELOPMENT SERVICES FOR OTHERS, IN CLASS 42 (U.S. CLS. 100 AND 101).

FIRST USE 10-23-2007; IN COMMERCE 10-23-2007.

THE MARK CONSISTS OF STANDARD CHARACTERS WITHOUT CLAIM TO ANY PARTICULAR FONT, STYLE, SIZE, OR COLOR.

SN 78-589,199, FILED 3-17-2005.

GIANCARLO CASTRO, EXAMINING ATTORNEY

Int. Cls.: 38, 39, and 42

Prior U.S. Cls.: 100, 101, 104, and 105

United States Patent and Trademark Office

Reg. No. 3,477,958

Registered July 29, 2008

**SERVICE MARK
PRINCIPAL REGISTER**



PARUS HOLDINGS, INC. (DELAWARE CORPORATION)
3000 LAKESIDE DRIVE, SUITE 300N
BANNOCKBURN, IL 60015

FOR: PROVIDING UNIFIED COMMUNICATIONS AND MESSAGING SERVICES FEATURING TELEPHONE, FACSIMILE, E-MAIL, AND TELEPHONE AND WEB CONFERENCING VIA GLOBAL COMPUTER AND TELECOMMUNICATIONS NETWORKS; PROVIDING UNIFIED COMMUNICATIONS AND MESSAGING SERVICES FEATURING SPEECH-ENABLED COMMUNICATIONS AND TELEPHONE VOICE AND WEB MESSAGING SERVICES THAT FACILITATE LOCAL AND LONG-DISTANCE TRANSMISSION OF VOICE, DATA, AND GRAPHICS BY MEANS OF GLOBAL COMPUTER AND TELECOMMUNICATIONS NETWORKS; PROVIDING UNIFIED COMMUNICATIONS AND MESSAGING SERVICES FEATURING SPEECH-ENABLED COMMUNICATIONS AND TELEPHONE VOICE AND WEB MESSAGING SERVICES BY WHICH A SINGLE USER MAY MANAGE AND RETRIEVE PERSONAL MESSAGES, CALENDAR ENTRIES, AND CONTACT INFORMATION VIA GLOBAL COMPUTER AND TELECOMMUNICATIONS NETWORKS; PROVIDING UNIFIED COMMUNICATIONS AND MESSAGING SERVICES FEATURING INTERNET TELEPHONY SERVICES, NAMELY, PROVIDING TELEPHONE, FACSIMILE, E-MAIL, AND TELEPHONE AND WEB CONFERENCE CALLING SERVICES VIA GLOBAL COMPUTER, I P T E L E P H O N Y , A N D

TELECOMMUNICATIONS NETWORKS; TELECOMMUNICATIONS VOICE-ACTIVATED CALLING SERVICES, NAMELY, FIND-ME AND FOLLOW-ME CALL FORWARDING, CALL SCREENING, CALL WAITING, VOICE-ACTIVATED DIALING SERVICES, ELECTRONIC VOICE CONFERENCING, ELECTRONIC VOICE MESSAGING AND AUDIO VOICE BROADCASTING, NAMELY, THE RECORDING AND SUBSEQUENT TRANSMISSION OF VOICE MESSAGES BY GLOBAL COMPUTER AND TELECOMMUNICATIONS NETWORKS; E-MAIL AND FACSIMILE TRANSMISSION MANAGEMENT SERVICES FOR TEXT-TO-VOICE CONVERSION OF E-MAIL MESSAGES AND VOICE-ACTIVATED CONVERSION OF E-MAIL MESSAGES TO FACSIMILE MESSAGES AND FACSIMILE MESSAGES TO E-MAIL MESSAGES; TELECOMMUNICATIONS SERVICES PROVIDED VIA TELEPHONE AND COMPUTER TERMINALS THAT FACILITATE THE PROVISION BY OTHERS OF AUTOMATED, SPEECH-ENABLED CUSTOMER SELF-SERVICE INFORMATION TO BE OBTAINED VIA THE INTERNET AND THE TELEPHONE, IN CLASS 38 (U.S. CLS. 100, 101 AND 104).

FIRST USE 7-2-2007; IN COMMERCE 7-2-2007.

FOR: ELECTRONIC STORAGE AND ARCHIVING FOR OTHERS OF MESSAGES, DATA, FILES, DOCUMENTS, TEXT, AUDIO DATA, AND IMAGES, IN CLASS 39 (U.S. CLS. 100 AND 105).

FIRST USE 7-2-2007; IN COMMERCE 7-2-2007.

FOR: CONSULTING IN THE FIELD OF DESIGN, SELECTION, IMPLEMENTATION AND USE OF TELECOMMUNICATIONS AND SPEECH-ENABLED COMMUNICATIONS SOFTWARE; TECHNICAL SUPPORT SERVICES, NAMELY TROUBLE SHOOTING OF TELECOMMUNICATIONS AND SPEECH-ENABLED COMMUNICATIONS COMPUTER SOFTWARE SERVICES; INSTALLATION, MAINTENANCE, AND UPDATING OF COMPUTER SOFTWARE IN THE FIELD OF TELECOMMUNICATIONS AND SPEECH-ENABLED COMMUNICATIONS; TELECOMMUNICATIONS AND SPEECH-ENABLED COMMUNICATIONS COMPUTER SOFTWARE DESIGN AND DEVELOPMENT SERVICES FOR OTHERS; AND APPLICATION SERVICE PROVIDER, NAMELY, HOSTING COMPUTER SOFTWARE APPLICATIONS IN THE FIELD OF TELECOMMUNICATIONS FOR ENABLING TELEPHONE, FAX, EMAIL, AND WEB CONFERENCE CALLING VIA A GLOBAL COMPUTER NETWORK

AND A TELECOMMUNICATIONS NETWORK; PROVIDING TEMPORARY USE OF NON-DOWNLOADABLE COMPUTER OPERATING SYSTEMS FOR TELECOMMUNICATION AND SPEECH-ENABLED COMMUNICATIONS SYSTEMS; PROVIDING TEMPORARY USE OF NON-DOWNLOADABLE COMPUTER SOFTWARE FOR TELECOMMUNICATION AND SPEECH-ENABLED COMMUNICATION SYSTEMS, NAMELY, FOR OPERATING AUTOMATED TELEPHONY SIGNALING AND CALL PROCESSING SYSTEMS AND FOR USE IN DATABASE MANAGEMENT, IN CLASS 42 (U.S. CLS. 100 AND 101).

FIRST USE 7-2-2007; IN COMMERCE 7-2-2007.

THE MARK CONSISTS OF A STYLIZED PARROT HEAD.

SN 78-589,378, FILED 3-17-2005.

ELISSA GARBER KON, EXAMINING ATTORNEY

Int. Cl.: 44

Prior U.S. Cls.: 100 and 101

United States Patent and Trademark Office

Reg. No. 3,477,959

Registered July 29, 2008

**SERVICE MARK
PRINCIPAL REGISTER**

Clearly Lasik

CLEARLY LASIK INC. (NEVADA CORPORATION)
900 SW 16TH STREET, STE. 320
RENTON, WA 98057

FOR: VISION CORRECTION SERVICES, NAME-
LY, PROVIDING LASER VISION SURGERY, IN
CLASS 44 (U.S. CLS. 100 AND 101).

FIRST USE 2-0-2005; IN COMMERCE 2-0-2005.

THE MARK CONSISTS OF STANDARD CHAR-
ACTERS WITHOUT CLAIM TO ANY PARTICULAR
FONT, STYLE, SIZE, OR COLOR.

NO CLAIM IS MADE TO THE EXCLUSIVE
RIGHT TO USE "LASIK", APART FROM THE
MARK AS SHOWN.

SN 78-589,657, FILED 3-17-2005.

GIANCARLO CASTRO, EXAMINING ATTORNEY

Int. Cl.: 35

Prior U.S. Cls.: 100, 101, and 102

United States Patent and Trademark Office

Reg. No. 3,477,960

Registered July 29, 2008

**SERVICE MARK
PRINCIPAL REGISTER**

CASH MAGIC REWARDS

JACOBS ENTERTAINMENT, INC. (DELAWARE CORPORATION)

BOX S21

240 MAIN STREET

BLACK HAWK, CO 80422

FOR: PROMOTING THE SALE OF GOODS AND SERVICES OF OTHERS THROUGH CUSTOMER LOYALTY AND INCENTIVE REWARD PROGRAMS, IN CLASS 35 (U.S. CLS. 100, 101 AND 102).

FIRST USE 4-23-2008; IN COMMERCE 4-23-2008.

THE MARK CONSISTS OF STANDARD CHARACTERS WITHOUT CLAIM TO ANY PARTICULAR FONT, STYLE, SIZE, OR COLOR.

OWNER OF U.S. REG. NO. 2,903,761.

NO CLAIM IS MADE TO THE EXCLUSIVE RIGHT TO USE "CASH" AND "REWARDS", APART FROM THE MARK AS SHOWN.

SN 78-593,493, FILED 3-23-2005.

ANDREA K. NADELMAN, EXAMINING ATTORNEY

Int. Cl.: 41

Prior U.S. Cls.: 100, 101, and 107

United States Patent and Trademark Office

Reg. No. 3,477,961

Registered July 29, 2008

**SERVICE MARK
PRINCIPAL REGISTER**

**THE MARVELOUS
MISADVENTURES OF
FLAPJACK**

THE CARTOON NETWORK, INC. (DELAWARE CORPORATION)
C/O TURNER BROADCASTING SYSTEM, INC.
ONE CNN CENTER 13 NORTH
ATLANTA, GA 303032762

FOR: ENTERTAINMENT SERVICES IN THE NATURE OF A CONTINUING COMEDY, DRAMA, ACTION, ADVENTURE AND/OR ANIMATION PROGRAM SERIES PROVIDED THROUGH CABLE TELEVISION, BROADCAST TELEVISION, AND THE GLOBAL COMPUTER INFORMATION NETWORK, IN CLASS 41 (U.S. CLS. 100, 101 AND 107).

FIRST USE 6-5-2008; IN COMMERCE 6-5-2008.

THE MARK CONSISTS OF STANDARD CHARACTERS WITHOUT CLAIM TO ANY PARTICULAR FONT, STYLE, SIZE, OR COLOR.

SN 78-596,134, FILED 3-28-2005.

RICHARD A. STRASER, EXAMINING ATTORNEY

Int. Cls.: 9 and 42

Prior U.S. Cls.: 21, 23, 26, 36, 38, 100, and 101

Reg. No. 3,477,962

United States Patent and Trademark Office

Registered July 29, 2008

**TRADEMARK
SERVICE MARK
PRINCIPAL REGISTER**

C-EVIDENCE

CATAPHORA, INC. (DELAWARE CORPORATION)
1200 BRIDGE PARKWAY
REDWOOD CITY, CA 940651159

FOR: COMPUTER SOFTWARE, NAMELY, SOFTWARE FOR ACCESSING, COLLECTING, STORING, ORGANIZING, AGGREGATING, MANAGING, AND ANALYZING ELECTRONIC DOCUMENTS AND DATA FOR USE IN THE LEGAL FIELD; COMPUTER SOFTWARE, NAMELY, LITIGATION-SUPPORT SOFTWARE FOR USE IN THE LEGAL FIELD; COMPUTER SOFTWARE, NAMELY, SOFTWARE FOR REGULATORY COMPLIANCE MANAGEMENT IN THE LEGAL FIELD; COMPUTER SOFTWARE, NAMELY, SOFTWARE TO CREATE CHARTS, GRAPHS, STATISTICAL SUMMARIES AND DIAGRAMS TO VISUALIZE SEQUENCES OF EVENTS FOR USE IN THE LEGAL FIELD; COMPUTER SOFTWARE, NAMELY, SOFTWARE TO RECONSTRUCT COMPLEX EVIDENCE AND SEQUENCES OF EVENTS FOR USE IN THE LEGAL FIELD; DATABASE MANAGEMENT SOFTWARE; DATABASE MANAGEMENT SOFTWARE FOR USE IN DOCUMENT MANAGEMENT AND KNOWLEDGE MANAGEMENT, IN CLASS 9 (U.S. CLS. 21, 23, 26, 36 AND 38).

FIRST USE 10-11-2007; IN COMMERCE 10-11-2007.

FOR: LITIGATION CONSULTING SERVICES; EVIDENCE EVALUATION AND ANALYSIS SERVICES; ELECTRONIC LEGAL DISCOVERY AND INVESTIGATION SERVICES; PROVIDING

TEMPORARY USE OF NON-DOWNLOADABLE COMPUTER SOFTWARE FOR ACCESSING, COLLECTING, STORING, ORGANIZING, AGGREGATING, MANAGING, AND ANALYZING ELECTRONIC DOCUMENTS AND DATA FOR USE IN THE LEGAL FIELD; PROVIDING TEMPORARY USE OF NON-DOWNLOADABLE LITIGATION-SUPPORT COMPUTER SOFTWARE AND COMPUTER SOFTWARE FOR REGULATORY COMPLIANCE MANAGEMENT; PROVIDING TEMPORARY USE OF NON-DOWNLOADABLE COMPUTER SOFTWARE TO CREATE CHARTS, GRAPHS, STATISTICAL SUMMARIES AND DIAGRAMS TO VISUALIZE SEQUENCES OF EVENTS FOR USE IN THE LEGAL FIELD; PROVIDING TEMPORARY USE OF NON-DOWNLOADABLE COMPUTER SOFTWARE TO RECONSTRUCT COMPLEX EVIDENCE AND SEQUENCES OF EVENTS FOR USE IN THE LEGAL FIELD; PROVIDING TEMPORARY USE OF NON-DOWNLOADABLE DATABASE MANAGEMENT SOFTWARE; PROVIDING TEMPORARY USE OF NON-DOWNLOADABLE COMPUTER SOFTWARE FOR DOCUMENT MANAGEMENT AND KNOWLEDGE MANAGEMENT; DATABASE DEVELOPMENT SERVICES; PROVIDING A DATABASE IN THE LEGAL FIELD ACCESSIBLE OVER ELECTRONIC OR OPTICAL COMMUNICATIONS NETWORKS; DOCUMENT MANAGEMENT AND KNOWLEDGE MANAGEMENT SERVICES; LEGAL RESEARCH AND SERVICES; TECHNICAL COMPUTER SOFTWARE SUPPORT SERVICES, NAMELY, REPAIR, MAINTENANCE AND TROUBLESHOOTING OF COMPUTER SOFTWARE; DATA AUTOMATION

AND COLLECTION SERVICES USING PROPRIETARY SOFTWARE TO ACCESS, COLLECT, STORE, ORGANIZE, AGGREGATE, MANAGE, AND ANALYZE ELECTRONIC DOCUMENTS AND DATA, IN CLASS 42 (U.S. CLS. 100 AND 101).

FIRST USE 7-0-2002; IN COMMERCE 7-0-2002.

THE MARK CONSISTS OF STANDARD CHARACTERS WITHOUT CLAIM TO ANY PARTICULAR FONT, STYLE, SIZE, OR COLOR.

SN 78-596,408, FILED 3-28-2005.

RON FAIRBANKS, EXAMINING ATTORNEY

Int. Cls.: 6, 9, and 11

Prior U.S. Cls.: 2, 12, 13, 14, 21, 23, 25, 26, 31, 34, 36, 38, and 50

Reg. No. 3,477,963

United States Patent and Trademark Office

Registered July 29, 2008

**TRADEMARK
PRINCIPAL REGISTER**



SIGMA ELECTRIC MANUFACTURING CORPORATION (DELAWARE CORPORATION)
120 SIGMA DRIVE
GARNER, NC 27529

FOR: METAL PRODUCTS FOR USE IN ELECTRICAL WIRING, NAMELY, METAL CONDUIT, METAL ELECTRICAL CONDUIT CONNECTORS, METAL ELECTRICAL CONDUIT COUPLINGS, METAL ELECTRICAL CONDUIT ELBOWS, METAL HANGERS, STRAPS, AND SUPPORTS FOR HANGING ELECTRICAL CONDUITS, METAL LOCK NUTS, METAL ELECTRICAL CONDUIT HUBS, METAL NIPPLES, NAMELY, METAL ELECTRICAL CONDUIT ENDCAPS, METAL ELECTRICAL CONDUIT SPACERS, METAL WASHERS, METAL SCREWS; METAL NAIL PLATES; METAL STRAPS, CLAMPS, AND CLIPS FOR GROUNDING ELECTRICAL FIXTURES; METAL ROOF FLASHING, IN CLASS 6 (U.S. CLS. 2, 12, 13, 14, 23, 25 AND 50).

FIRST USE 2-28-2006; IN COMMERCE 2-28-2006.

FOR: ELECTRICAL OUTLET BOXES; ELECTRICAL OUTLET BOX COVERS; ELECTRICAL CONNECTION BOXES; ELECTRICAL OUTLET PLATES; ELECTRICAL SERVICE HEADS, NAMELY, AN ELECTRICAL CONNECTION FEED THROUGH FOR CONNECTING ELECTRICAL LINES TO

BUILDING STRUCTURES, IN CLASS 9 (U.S. CLS. 21, 23, 26, 36 AND 38).

FIRST USE 2-28-2006; IN COMMERCE 2-28-2006.

FOR: ELECTRIC LIGHTING FIXTURES FOR RESIDENTIAL AND COMMERCIAL INSTALLATIONS NOT INCLUDING LAMPS FOR SPORTING, TRANSPORT, OR LEISURE USE; WATER RESISTANT OUTDOOR ELECTRIC LIGHTING FIXTURES NOT FOR CAMPING OR SECURITY USE COMPRISED OF AN ELECTRIC LIGHT RECEPTACLE, ELECTRIC LIGHT RECEPTACLE COVER, AND ELECTRIC LIGHT RECEPTACLE GASKET, IN CLASS 11 (U.S. CLS. 13, 21, 23, 31 AND 34).

FIRST USE 2-28-2006; IN COMMERCE 2-28-2006.

NO CLAIM IS MADE TO THE EXCLUSIVE RIGHT TO USE "ELECTRIC", APART FROM THE MARK AS SHOWN.

THE MARK CONSISTS OF STYLIZED LETTER "S" PLUS THE WORDING "SIGMA ELECTRIC".

SN 78-596,827, FILED 3-29-2005.

MICHAEL TANNER, EXAMINING ATTORNEY

Int. Cl.: 30

Prior U.S. Cl.: 46

United States Patent and Trademark Office

Reg. No. 3,477,964

Registered July 29, 2008

**TRADEMARK
PRINCIPAL REGISTER**

DR. SINGHA'S

SEARLES, ANNA GAY (UNITED STATES INDIVIDUAL)
2500 SIDE COVE
AUSTIN, TX 78704

FOR: TEAS, COFFEES, SALTS, AND SPICES, IN CLASS 30 (U.S. CL. 46).

FIRST USE 4-13-2005; IN COMMERCE 6-13-2008.

THE MARK CONSISTS OF STANDARD CHARACTERS WITHOUT CLAIM TO ANY PARTICULAR FONT, STYLE, SIZE, OR COLOR.

THE NAME "DR. SINGHA'S" DOES NOT IDENTIFY A LIVING INDIVIDUAL.

SEC. 2(F).

SN 78-607,674, FILED 4-13-2005.

ELLEN PERKINS, EXAMINING ATTORNEY

Int. Cls.: 16 and 25

Prior U.S. Cls.: 2, 5, 22, 23, 29, 37, 38, 39, and 50

United States Patent and Trademark Office

Reg. No. 3,477,965

Registered July 29, 2008

**TRADEMARK
PRINCIPAL REGISTER**

XTRIX

KINNEY, BRADFORD DAVID (UNITED STATES
INDIVIDUAL)

SUITE B3

1560 SUPERIOR AVE.

COSTA MESA, CA 92627

FOR: BUMPER STICKERS; ADHESIVE DECALS;
ORNAMENTAL STICKERS, IN CLASS 16 (U.S. CLS.
2, 5, 22, 23, 29, 37, 38 AND 50).

FIRST USE 5-5-2008; IN COMMERCE 5-5-2008.

FOR: SHIRTS; T-SHIRTS; TANK TOPS, IN CLASS
25 (U.S. CLS. 22 AND 39).

FIRST USE 5-5-2008; IN COMMERCE 5-5-2008.

THE MARK CONSISTS OF STANDARD CHAR-
ACTERS WITHOUT CLAIM TO ANY PARTICULAR
FONT, STYLE, SIZE, OR COLOR.

SN 78-608,341, FILED 4-13-2005.

JOHN KELLY, EXAMINING ATTORNEY

Int. Cl.: 11

Prior U.S. Cls.: 13, 21, 23, 31, and 34

United States Patent and Trademark Office

Reg. No. 3,477,966

Registered July 29, 2008

**TRADEMARK
PRINCIPAL REGISTER**

NEVIS

HUBBELL INCORPORATED (CONNECTICUT
CORPORATION)
584 DERBY MILFORD ROAD
ORANGE, CT 064774024

THE MARK CONSISTS OF STANDARD CHAR-
ACTERS WITHOUT CLAIM TO ANY PARTICULAR
FONT, STYLE, SIZE, OR COLOR.

FOR: LIGHTING FIXTURES, IN CLASS 11 (U.S.
CLS. 13, 21, 23, 31 AND 34).

SN 78-609,132, FILED 4-14-2005.

FIRST USE 4-21-2008; IN COMMERCE 4-21-2008.

ALYSSA PALADINO, EXAMINING ATTORNEY

Int. Cl.: 35

Prior U.S. Cls.: 100, 101, and 102

United States Patent and Trademark Office

Reg. No. 3,477,967

Registered July 29, 2008

**SERVICE MARK
PRINCIPAL REGISTER**

SING & DREAM MACHINE

GILLETTE, RICHARD B. (UNITED STATES IN-
DIVIDUAL)
1811 W. SUNSET
SPRINGFIELD, MO 65807

FOR: TALENT MANAGEMENT SERVICES,
NAMELY, PROVIDING RECRUITING, AND RE-
FERRALS, ALL FOR PERSONS SEEKING OPPOR-
TUNITIES OR CAREERS AS SONG PERFORMERS,
IN CLASS 35 (U.S. CLS. 100, 101 AND 102).

FIRST USE 6-13-2008; IN COMMERCE 6-13-2008.

THE MARK CONSISTS OF STANDARD CHAR-
ACTERS WITHOUT CLAIM TO ANY PARTICULAR
FONT, STYLE, SIZE, OR COLOR.

NO CLAIM IS MADE TO THE EXCLUSIVE
RIGHT TO USE "SING", APART FROM THE MARK
AS SHOWN.

SN 78-609,650, FILED 4-15-2005.

ELLEN PERKINS, EXAMINING ATTORNEY

Int. Cl.: 3

Prior U.S. Cls.: 1, 4, 6, 50, 51, and 52

Reg. No. 3,477,968

United States Patent and Trademark Office

Registered July 29, 2008

**TRADEMARK
PRINCIPAL REGISTER**



COTTON INCORPORATED (TENNESSEE CORPORATION)
488 MADISON AVENUE, 20TH FLOOR
NEW YORK, NY 10022

FOR: BABY WIPES; DISPOSABLE WIPES IMPREGNATED WITH CHEMICALS OR COMPOUNDS FOR PERSONAL HYGIENE AND HOUSEHOLD USE; PRE-MOISTENED COSMETIC WIPES, IN CLASS 3 (U.S. CLS. 1, 4, 6, 50, 51 AND 52).

FIRST USE 3-1-2005; IN COMMERCE 8-1-2005.

OWNER OF U.S. REG. NOS. 184,442, 1,736,009, AND OTHERS.

NO CLAIM IS MADE TO THE EXCLUSIVE RIGHT TO USE "COTTON ENHANCED", APART FROM THE MARK AS SHOWN.

SN 78-612,500, FILED 4-20-2005.

BRIDGETT SMITH, EXAMINING ATTORNEY

Int. Cls.: 35 and 36

Prior U.S. Cls.: 100, 101, and 102

United States Patent and Trademark Office

Reg. No. 3,477,969

Registered July 29, 2008

**SERVICE MARK
PRINCIPAL REGISTER**



BREWER INVESTMENT GROUP, LLC (ILLINOIS CORPORATION)
200 SOUTH MICHIGAN, SUITE 2100
CHICAGO, IL 60604

FOR: FINANCIAL SERVICES, NAMELY, TAX ADVISORY SERVICES NOT RELATED TO BASEBALL OR SOFTBALL OR TO A BASEBALL OR SOFTBALL TEAM, IN CLASS 35 (U.S. CLS. 100, 101 AND 102).

FIRST USE 9-1-2007; IN COMMERCE 9-1-2007.

FOR: FINANCIAL SERVICES, NAMELY, ASSET PROTECTION, WEALTH MANAGEMENT, ESTATE PLANNING, CASH FLOW ANALYSIS, INSURANCE PLANNING, INVESTMENT PLANNING, RETIRE-

MENT PLANNING AND INVESTMENT MARKET RESEARCH, FUTURES, CURRENCIES, COMMODITIES, AND DERIVATIVE TRADING TIED TO INTEREST RATES, ALL OF THE FOREGOING NOT RELATED TO BASEBALL OR SOFTBALL OR TO A BASEBALL OR SOFTBALL TEAM, IN CLASS 36 (U.S. CLS. 100, 101 AND 102).

FIRST USE 9-1-2007; IN COMMERCE 9-1-2007.

THE MARK CONSISTS OF "BREWER" AND "B" IN A BOX DESIGN.

SN 78-612,666, FILED 4-20-2005.

JAMES A. RAUEN, EXAMINING ATTORNEY

Int. Cl.: 9

Prior U.S. Cls.: 21, 23, 26, 36, and 38

Reg. No. 3,477,970

United States Patent and Trademark Office

Registered July 29, 2008

**TRADEMARK
PRINCIPAL REGISTER**

PERFECT FIT

PERFECT FIT HEALTH, INC. (MINNESOTA CORPORATION), DBA RANKIN INNOVATIONS, INC.,
8317 MARSH CREEK ROAD
WOODBURY, MN 55125

FOR: COMPUTER SOFTWARE, NAMELY, SOFTWARE FOR USE BY PHYSICAL AND OCCUPATIONAL THERAPY PROVIDERS, INDUSTRIAL REHABILITATION AND WORK CONDITIONING PROVIDERS, ATHLETIC AND PERSONAL TRAINERS AND COACHES/INSTRUCTORS, PHYSICAL AND HEALTH EDUCATION TEACHERS, EXERCISE PHYSIOLOGISTS, WELLNESS PROVIDERS, NUTRITIONISTS/DIETICIANS, CHIROPRACTORS, PHYSICIANS, HEALTH INSURANCE COMPANIES

AND THEIR PATIENTS, AND THE GENERAL PUBLIC, FEATURING 3D EXERCISE IMAGING AND A VIRTUAL HEALTH CLUB EXPERIENCE, IN CLASS 9 (U.S. CLS. 21, 23, 26, 36 AND 38).

FIRST USE 10-31-2007; IN COMMERCE 10-31-2007.

THE MARK CONSISTS OF STANDARD CHARACTERS WITHOUT CLAIM TO ANY PARTICULAR FONT, STYLE, SIZE, OR COLOR.

SN 78-615,044, FILED 4-22-2005.

VIVIAN MICZNIK FIRST, EXAMINING ATTORNEY

Int. Cls.: 9, 41, 43, and 44

Prior U.S. Cls.: 21, 23, 26, 36, 38, 100, 101, and 107

United States Patent and Trademark Office

Reg. No. 3,477,971

Registered July 29, 2008

**TRADEMARK
SERVICE MARK
PRINCIPAL REGISTER**

THE BIGGEST LOSER

REVEILLE LLC (DELAWARE LIMITED LIABILITY CORPORATION)
100 UNIVERSAL CITY PLAZA
UNIVERSAL CITY, CA 91608

FOR: PROVIDING ENTERTAINMENT INFORMATION IN THE FIELD OF TELEVISION SHOWS, HEALTH, FITNESS, LIFESTYLE, EXERCISE, DIET, NUTRITION, RECIPES, WEIGHT LOSS, CONDITIONING, WORK-OUTS AND EDUCATIONAL INFORMATION IN THE FIELD OF TELEVISION SHOWS, HEALTH, FITNESS, LIFESTYLE, EXERCISE, DIET, NUTRITION, RECIPES, WEIGHT LOSS, CONDITIONING, WORK-OUTS IN THE NATURE OF DOWNLOADABLE MULTIMEDIA FILES AND DOWNLOADABLE STREAMING MEDIA, AUDIO AND VIDEO FILES VIA A MULTI-USER GLOBAL COMPUTER INFORMATION NETWORK, IN CLASS 9 (U.S. CLS. 21, 23, 26, 36 AND 38).

FIRST USE 1-0-2008; IN COMMERCE 1-0-2008.

FOR: PROVIDING GENERAL INTEREST ENTERTAINMENT AND EDUCATIONAL INFORMATION IN THE FIELD OF TELEVISION SHOWS, PHYSICAL FITNESS, EXERCISE, EXERCISE WORK-OUTS, AND PHYSICAL CONDITIONING, VIA A MULTI-USER GLOBAL COMPUTER INFORMATION NETWORK AND STREAMING MEDIA, AUDIO AND VIDEO FILES VIA A MULTI-USER GLOBAL COMPUTER INFORMATION NETWORK, IN CLASS 41 (U.S. CLS. 100, 101 AND 107).

FIRST USE 9-0-2005; IN COMMERCE 9-0-2005.

FOR: PROVIDING GENERAL INTEREST ENTERTAINMENT AND EDUCATIONAL INFORMATION IN THE FIELD OF RECIPES, VIA A MULTI-USER GLOBAL COMPUTER INFORMATION NETWORK AND STREAMING MEDIA, AUDIO AND VIDEO FILES VIA A MULTI-USER GLOBAL COMPUTER INFORMATION NETWORK, IN CLASS 43 (U.S. CLS. 100 AND 101).

FIRST USE 9-0-2006; IN COMMERCE 9-0-2006.

FOR: PROVIDING GENERAL INTEREST ENTERTAINMENT AND EDUCATIONAL INFORMATION IN THE FIELD OF HEALTH, NUTRITION, DIET, AND WEIGHT LOSS, VIA A MULTI-USER GLOBAL COMPUTER INFORMATION NETWORK AND STREAMING MEDIA, AUDIO AND VIDEO FILES VIA A MULTI-USER GLOBAL COMPUTER INFORMATION NETWORK, IN CLASS 44 (U.S. CLS. 100 AND 101).

FIRST USE 9-0-2006; IN COMMERCE 9-0-2006.

THE MARK CONSISTS OF STANDARD CHARACTERS WITHOUT CLAIM TO ANY PARTICULAR FONT, STYLE, SIZE, OR COLOR.

SN 78-617,485, FILED 4-26-2005.

JEAN IM, EXAMINING ATTORNEY

Int. Cl.: 7

Prior U.S. Cls.: 13, 19, 21, 23, 31, 34, and 35

United States Patent and Trademark Office

Reg. No. 3,477,972

Registered July 29, 2008

TRADEMARK
PRINCIPAL REGISTER

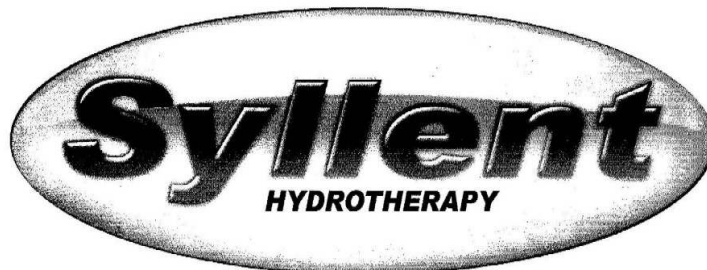

MUNDIAL S/A PRODUTOS DE CONSUMO
(BRAZIL CORPORATION)
RUA VISCONDE DE PELOTAS, 360
PORTO ALEGRE, BRAZIL

FOR: WATER PUMPS FOR BATHS, SPAS, WHIRLPOOLS, JAPANESE BATHS (OFUROS), PRESSURIZATION OF HOME WATER PIPING SYSTEMS, PRESSURIZATION OF PASSAGE OR ACCUMULATING WATER HEATING SYSTEMS, PRESSURIZATION OF ELECTRIC, GAS OR SOLAR HEATING SYSTEMS, CLEAN WATER CIRCULATION, IRRIGATION AND DECORATION, DRAINAGE OF BOATS AND WATERCRAFTS, REPRESSION OF HOT WATER IN CLOSED OR NON-CLOSED CIRCUITS, REPRESSION OF FROZEN WATER IN REFRIGERATION CIRCUITS,

AND REPRESSION OF WATER IN LAKES AND VIVARIUMS, IN CLASS 7 (U.S. CLS. 13, 19, 21, 23, 31, 34 AND 35).

FIRST USE 12-0-2004; IN COMMERCE 12-0-2004.

NO CLAIM IS MADE TO THE EXCLUSIVE RIGHT TO USE "HYDROTHERAPY", APART FROM THE MARK AS SHOWN.

THE STIPPLING IS A FEATURE OF THE MARK.

SN 78-618,181, FILED 4-27-2005.

MARY CRAWFORD, EXAMINING ATTORNEY

Int. Cls.: 35, 38, 42, and 44

Prior U.S. Cls.: 100, 101, 102, and 104

United States Patent and Trademark Office

Reg. No. 3,477,973

Registered July 29, 2008

**SERVICE MARK
PRINCIPAL REGISTER**

WEBMD

WEBMD LLC (DELAWARE LTD LIAB CO)
111 EIGHTH AVENUE
111 EIGHTH AVENUE
NEW YORK, NY 10011

FOR: LICENSING COMPUTER SOFTWARE FOR USE IN ANALYZING THE PERFORMANCE OF AND QUALITY OF CARE PROVIDED BY HOSPITALS, AND AIDING CONSUMERS TO COMPARE AND SELECT HOSPITALS; HEALTH CARE UTILIZATION AND REVIEW SERVICES; BUSINESS MANAGEMENT CONSULTATION, NAMELY, DEVELOPMENT OF HEALTH CARE DELIVERY SYSTEMS FOR INDEPENDENT PRACTICE ASSOCIATIONS, MEDICAL CLINICS AND OTHER FORMS OF PHYSICIAN ORGANIZATIONS, IN CLASS 35 (U.S. CLS. 100, 101 AND 102).

FIRST USE 1-0-2003; IN COMMERCE 1-0-2003.

FOR: PROVIDING MULTIPLE-USE ACCESS TO A GLOBAL COMPUTER INFORMATION NETWORK IN THE FIELD OF HEALTH CARE, IN CLASS 38 (U.S. CLS. 100, 101 AND 104).

FIRST USE 3-0-1998; IN COMMERCE 3-0-1998.

FOR: PROVIDING HEALTH INFORMATION AND ANALYSIS IN THE NATURE OF THE PERFORMANCE OF AND QUALITY OF CARE PROVIDED BY HOSPITALS VIA A GLOBAL COMPUTER NETWORK; DATABASE DEVELOPMENT SERVICES IN THE FIELD OF HEALTH CARE; COMPUTER SERVICES, NAMELY, PROVIDING ANALYSIS OF COMPUTER DATABASES IN THE FIELD OF HEALTH CARE; COMPUTER SOFTWARE DEVELOPMENT; MAINTENANCE OF COMPUTER SOFT-

WARE FOR OTHERS; PROVIDING TEMPORARY USE OF ON-LINE NON-DOWNLOADABLE SOFTWARE FOR HEALTH RISK ASSESSMENT AND PROFILING FOR USE IN THE FIELD OF PREVENTATIVE HEALTH; QUALITY ASSURANCE SERVICES IN THE FIELD OF HEALTH CARE, IN CLASS 42 (U.S. CLS. 100 AND 101).

FIRST USE 1-0-2003; IN COMMERCE 1-0-2003.

FOR: CONSULTING AND COUNSELING SERVICES IN THE FIELD OF PREVENTATIVE HEALTH CARE, NAMELY, ESTABLISHING HEALTH RISK ASSESSMENT PROFILES TO IDENTIFY PERSONAL AND GROUP HEALTH RISKS, PERSONAL AND GROUP HEALTH RISK COUNSELING, HEALTH RISK INTERVENTION, HEALTH PROMOTION, HEALTH RISK AND BEHAVIOR MODIFICATION, AND PREVENTATIVE MEDICAL ASSESSMENT AND SCREENING; CONSULTING SERVICES IN THE FIELD OF MEDICAL TRIAGE PROTOCOLS, POLICIES, AND PRACTICES, IN CLASS 44 (U.S. CLS. 100 AND 101).

FIRST USE 1-0-2003; IN COMMERCE 1-0-2003.

THE MARK CONSISTS OF STANDARD CHARACTERS WITHOUT CLAIM TO ANY PARTICULAR FONT, STYLE, SIZE, OR COLOR.

OWNER OF U.S. REG. NOS. 2,349,285, 2,524,138, AND OTHERS.

SN 78-619,789, FILED 4-29-2005.

ELLEN PERKINS, EXAMINING ATTORNEY

Int. Cl.: 29

Prior U.S. Cl.: 46

United States Patent and Trademark Office

Reg. No. 3,477,974

Registered July 29, 2008

**TRADEMARK
PRINCIPAL REGISTER**

HAPPY BREAKFAST

SARA LEE FOODS, LLC (DELAWARE LTD LIAB
JT ST CO)

11370 REED HARTMAN HWY

BLUE ASH, OH 45241

FOR: PROCESSED MEATS, NAMELY, PORK,
POULTRY AND BEEF, IN CLASS 29 (U.S. CL. 46).

FIRST USE 8-1-2007; IN COMMERCE 8-1-2007.

THE MARK CONSISTS OF STANDARD CHAR-
ACTERS WITHOUT CLAIM TO ANY PARTICULAR
FONT, STYLE, SIZE, OR COLOR.

NO CLAIM IS MADE TO THE EXCLUSIVE
RIGHT TO USE "BREAKFAST", APART FROM
THE MARK AS SHOWN.

SN 78-626,280, FILED 5-10-2005.

RICHARD WHITE, EXAMINING ATTORNEY

Int. Cl.: 38

Prior U.S. Cls.: 100, 101, and 104

United States Patent and Trademark Office

Reg. No. 3,477,975

Registered July 29, 2008

**SERVICE MARK
PRINCIPAL REGISTER**

SIX STAR

CONFERENCE AMERICA, INC. (ALABAMA
CORPORATION)
7079 UNIVERSITY COURT
MONTGOMERY, AL 36117

FOR: TELECOMMUNICATION SERVICES,
NAMELY, TELECONFERENCING, VIDEO TELE-
CONFERENCING, DATA TELECONFERENCING
AND INTERNET CONFERENCING, IN CLASS 38
(U.S. CLS. 100, 101 AND 104).

FIRST USE 3-0-2008; IN COMMERCE 3-0-2008.

THE MARK CONSISTS OF STANDARD CHAR-
ACTERS WITHOUT CLAIM TO ANY PARTICULAR
FONT, STYLE, SIZE, OR COLOR.

OWNER OF U.S. REG. NO. 2,961,830.

SN 78-630,009, FILED 5-13-2005.

NORA BUCHANAN WILL, EXAMINING ATTOR-
NEY

Int. Cl.: 42

Prior U.S. Cls.: 100 and 101

United States Patent and Trademark Office

Reg. No. 3,477,976

Registered July 29, 2008

**SERVICE MARK
PRINCIPAL REGISTER**

BIOCURE

BIOCURE, INC. (DELAWARE CORPORATION)
2975 GATEWAY DRIVE SUITE 100
NORCROSS, GA 30071

FIRST USE 1-1-2008; IN COMMERCE 1-1-2008.

FOR: TECHNOLOGY CONSULTATION AND RESEARCH IN THE FIELD OF POLYMERS; TECHNOLOGY CONSULTATION AND RESEARCH IN THE FIELD OF MEDICAL DEVICES; RESEARCH AND DEVELOPMENT FOR NEW PRODUCTS FOR OTHERS; PRODUCT DEVELOPMENT FOR OTHERS, IN CLASS 42 (U.S. CLS. 100 AND 101).

THE MARK CONSISTS OF STANDARD CHARACTERS WITHOUT CLAIM TO ANY PARTICULAR FONT, STYLE, SIZE, OR COLOR.

SN 78-631,313, FILED 5-17-2005.

RON FAIRBANKS, EXAMINING ATTORNEY

Int. Cls.: 9, 41, and 42

Prior U.S. Cls.: 21, 23, 26, 36, 38, 100, 101, and 107

United States Patent and Trademark Office

Reg. No. 3,477,977

Registered July 29, 2008

**TRADEMARK
SERVICE MARK
PRINCIPAL REGISTER**

SINGLE-PING

CHAOTIC.COM, INC. (VIRGINIA CORPORATION)
P.O. BOX 1010
GREAT FALLS, VA 22006

FOR: COMPUTER SOFTWARE FOR DETECTING AND CLASSIFYING OBJECTS IN BODIES OF WATER FOR USE IN THE FIELD OF SONAR SYSTEMS, ALL OF THE FOREGOING PRODUCTS AND SERVICES MARKETED TO GOVERNMENT AGENCIES AND TO BUSINESS CONTRACTOR-RESELLERS TO GOVERNMENT AGENCIES, IN CLASS 9 (U.S. CLS. 21, 23, 26, 36 AND 38).

FIRST USE 10-17-2007; IN COMMERCE 10-17-2007.

FOR: EDUCATION, NAMELY, TRAINING SERVICES IN THE FIELD OF OPERATING SONAR AND SONAR SYSTEMS, ALL OF THE FOREGOING PRODUCTS AND SERVICES MARKETED TO GOVERNMENT AGENCIES AND TO BUSINESS CONTRACTOR-RESELLERS TO GOVERNMENT AGENCIES, IN CLASS 41 (U.S. CLS. 100, 101 AND 107).

FIRST USE 8-12-2007; IN COMMERCE 8-12-2007.

FOR: TECHNICAL AND ENGINEERING CONSULTING SERVICES IN THE FIELD OF DEFENSE, NAMELY, SONAR SIGNAL PROCESSING ANALYSIS AND SONAR SYSTEMS ANALYSIS, ALL OF THE FOREGOING PRODUCTS AND SERVICES MARKETED TO GOVERNMENT AGENCIES AND TO BUSINESS CONTRACTOR-RESELLERS TO GOVERNMENT AGENCIES, IN CLASS 42 (U.S. CLS. 100 AND 101).

FIRST USE 8-12-2007; IN COMMERCE 8-12-2007.

THE MARK CONSISTS OF STANDARD CHARACTERS WITHOUT CLAIM TO ANY PARTICULAR FONT, STYLE, SIZE, OR COLOR.

SN 78-631,816, FILED 5-17-2005.

SHAUNIA CARLYLE, EXAMINING ATTORNEY

Int. Cl.: 12

Prior U.S. Cls.: 19, 21, 23, 31, 35, and 44

United States Patent and Trademark Office

Reg. No. 3,477,978

Registered July 29, 2008

**TRADEMARK
PRINCIPAL REGISTER**

PROBELL RACING

PROBELL RACING PRODUCTS COMPANY
(OHIO CORPORATION)
PO BOX 149
WEST LAFAYETTE, OH 43845

FOR: HIGH PERFORMANCE RACE CAR PRODUCTS, NAMELY, CLUTCH MECHANISMS FOR MOTOR CARS AND OTHER CAR PARTS CONSISTING OF STEEL BELLHOUSINGS FOR MOTOR CARS, IN CLASS 12 (U.S. CLS. 19, 21, 23, 31, 35 AND 44).

FIRST USE 6-1-2006; IN COMMERCE 6-1-2006.

THE MARK CONSISTS OF STANDARD CHARACTERS WITHOUT CLAIM TO ANY PARTICULAR FONT, STYLE, SIZE, OR COLOR.

NO CLAIM IS MADE TO THE EXCLUSIVE RIGHT TO USE "RACING", APART FROM THE MARK AS SHOWN.

SN 78-632,094, FILED 5-18-2005.

INGA ERVIN, EXAMINING ATTORNEY

Int. Cl.: 9

Prior U.S. Cls.: 21, 23, 26, 36, and 38

United States Patent and Trademark Office

Reg. No. 3,477,979

Registered July 29, 2008

**TRADEMARK
PRINCIPAL REGISTER**

KLEER

KLEER CORPORATION (DELAWARE CORPORATION)
2375 SAND HILL ROAD
MENLO PARK, CA 94025

THE MARK CONSISTS OF STANDARD CHARACTERS WITHOUT CLAIM TO ANY PARTICULAR FONT, STYLE, SIZE, OR COLOR.

FOR: INTEGRATED CIRCUITS USED IN WIRELESS COMMUNICATIONS DEVICES, IN CLASS 9 (U.S. CLS. 21, 23, 26, 36 AND 38).

SN 78-632,630, FILED 5-18-2005.

FIRST USE 10-0-2007; IN COMMERCE 10-0-2007.

INGA ERVIN, EXAMINING ATTORNEY

Int. Cl.: 9

Prior U.S. Cls.: 21, 23, 26, 36, and 38

United States Patent and Trademark Office

Reg. No. 3,477,980

Registered July 29, 2008

**TRADEMARK
PRINCIPAL REGISTER**

BEAR IN THE BIG BLUE HOUSE

MUPPETS STUDIO, LLC, THE (DELAWARE LTD
LIAB CO)
500 SOUTH BUENA VISTA STREET
BURBANK, CA 91521

FOR: AUDIO DISCS FEATURING LIVE ACTION
ENTERTAINMENT AND STORIES; CD-ROMS,
COMPACT DISCS, DIGITAL VIDEO DISCS, DVDS,
DIGITAL VERSATILE DISCS FEATURING LIVE
ACTION ENTERTAINMENT AND STORIES; MO-
TION PICTURE FILMS FEATURING LIVE ACTION
ENTERTAINMENT AND STORIES, IN CLASS 9 (U.S.
CLS. 21, 23, 26, 36 AND 38).

FIRST USE 9-7-2004; IN COMMERCE 9-7-2004.

THE MARK CONSISTS OF STANDARD CHAR-
ACTERS WITHOUT CLAIM TO ANY PARTICULAR
FONT, STYLE, SIZE, OR COLOR.

OWNER OF U.S. REG. NOS. 2,411,459, 2,413,235,
AND 2,502,292.

SN 78-633,125, FILED 5-19-2005.

MARY ROSSMAN, EXAMINING ATTORNEY

Int. Cl.: 9

Prior U.S. Cls.: 21, 23, 26, 36, and 38

Reg. No. 3,477,981

United States Patent and Trademark Office

Registered July 29, 2008

TRADEMARK
PRINCIPAL REGISTER



MUPPETS STUDIO, LLC, THE (DELAWARE LTD
LIAB CO)
500 SOUTH BUENA VISTA STREET
BURBANK, CA 91521

FOR: AUDIO DISCS FEATURING LIVE ACTION
ENTERTAINMENT AND STORIES; CD-ROMS,
COMPACT DISCS, DIGITAL VIDEO DISCS, DVDS,
DIGITAL VERSATILE DISCS FEATURING LIVE
ACTION ENTERTAINMENT AND STORIES; MO-
TION PICTURE FILMS FEATURING LIVE ACTION

ENTERTAINMENT AND STORIES, IN CLASS 9 (U.S.
CLS. 21, 23, 26, 36 AND 38).

FIRST USE 9-7-2004; IN COMMERCE 9-7-2004.

OWNER OF U.S. REG. NOS. 2,411,459, 2,413,235,
AND 2,502,292.

SN 78-633,278, FILED 5-19-2005.

MARY ROSSMAN, EXAMINING ATTORNEY

Int. Cl.: 8

Prior U.S. Cls.: 23, 28, and 44

Reg. No. 3,477,982

United States Patent and Trademark Office

Registered July 29, 2008

**TRADEMARK
PRINCIPAL REGISTER**

18-Xray

ACME UNITED CORPORATION (CONNECTI-
CUT CORPORATION)
60 ROUND HILL ROAD
FAIRFIELD, CT 06824

THE MARK CONSISTS OF STANDARD CHAR-
ACTERS WITHOUT CLAIM TO ANY PARTICULAR
FONT, STYLE, SIZE, OR COLOR.

FOR: CUTLERY, NAMELY, FOLDING KNIVES,
SPORT KNIVES, HUNTING KNIVES, IN CLASS 8
(U.S. CLS. 23, 28 AND 44).

SN 78-633,715, FILED 5-20-2005.

FIRST USE 1-11-2006; IN COMMERCE 1-11-2006.

KATHRYN COWARD, EXAMINING ATTORNEY

Int. Cl.: 10

Prior U.S. Cls.: 26, 39, and 44

Reg. No. 3,477,983

United States Patent and Trademark Office

Registered July 29, 2008

**TRADEMARK
PRINCIPAL REGISTER**

eLIBRA

SYNVASIVE TECHNOLOGY, INC. (CALIFORNIA CORPORATION)
4925 ROBERT J. MATHEWS PARKWAY
EL DORADO HILLS, CA 95762

FOR: INSTRUMENT SET FOR KNEE SURGERY COMPRISING ASSEMBLIES, PLATES AND FASTENERS FOR A TOTAL KNEE REPLACEMENT; SURGICAL INSTRUMENTS FOR KNEE SURGERY; SURGICAL EQUIPMENT, NAMELY, STERILE TRAYS, IN CLASS 10 (U.S. CLS. 26, 39 AND 44).

FIRST USE 7-9-2007; IN COMMERCE 7-9-2007.

THE MARK CONSISTS OF STANDARD CHARACTERS WITHOUT CLAIM TO ANY PARTICULAR FONT, STYLE, SIZE, OR COLOR.

SN 78-638,441, FILED 5-26-2005.

RICHARD WHITE, EXAMINING ATTORNEY

Int. Cl.: 5

Prior U.S. Cls.: 6, 18, 44, 46, 51, and 52

United States Patent and Trademark Office

Reg. No. 3,477,984

Registered July 29, 2008

**TRADEMARK
PRINCIPAL REGISTER**

XPRESS-FIT

WARNER-LAMBERT COMPANY LLC (DELA-
WARE LTD LIAB CO)
235 EAST 42ND STREET
NEW YORK, NY 100175755

FOR: PROTECTIVE, UNIT DOSE CAPSULES
SOLD EMPTY FOR PHARMACEUTICAL USE, IN
CLASS 5 (U.S. CLS. 6, 18, 44, 46, 51 AND 52).

FIRST USE 12-31-2007; IN COMMERCE 12-31-2007.

THE MARK CONSISTS OF STANDARD CHAR-
ACTERS WITHOUT CLAIM TO ANY PARTICULAR
FONT, STYLE, SIZE, OR COLOR.

OWNER OF U.S. REG. NO. 2,099,915.

SN 78-638,702, FILED 5-27-2005.

ELIZABETH BEYER, EXAMINING ATTORNEY

Int. Cl.: 18

Prior U.S. Cls.: 1, 2, 3, 22, and 41

United States Patent and Trademark Office

Reg. No. 3,477,985

Registered July 29, 2008

**TRADEMARK
PRINCIPAL REGISTER**

Funcovers

STOLLAR, WENDY A (UNITED STATES INDIVIDUAL)
229 JOHNSON RD.
WHITEHOUSE STATION, NJ 08889

THE MARK CONSISTS OF STANDARD CHARACTERS WITHOUT CLAIM TO ANY PARTICULAR FONT, STYLE, SIZE, OR COLOR.

FOR: DECORATIVE THEME PATIO UMBRELLA SLIPCOVER, NAMELY, TARPAULINS, IN CLASS 18 (U.S. CLS. 1, 2, 3, 22 AND 41).

SN 78-639,794, FILED 5-31-2005.

FIRST USE 3-15-2007; IN COMMERCE 6-20-2007.

ELLEN PERKINS, EXAMINING ATTORNEY

Int. Cl.: 5

Prior U.S. Cls.: 6, 18, 44, 46, 51, and 52

Reg. No. 3,477,986

United States Patent and Trademark Office

Registered July 29, 2008

**TRADEMARK
PRINCIPAL REGISTER**

SILENOR

SOMAXON PHARMACEUTICALS, INC. (DELA-
WARE CORPORATION)
SUITE 310
12750 HIGH BLUFF DRIVE
SAN DIEGO, CA 92130

THE MARK CONSISTS OF STANDARD CHAR-
ACTERS WITHOUT CLAIM TO ANY PARTICULAR
FONT, STYLE, SIZE, OR COLOR.

FOR: PHARMACEUTICAL PREPARATIONS FOR
THE TREATMENT OF SLEEP DISORDERS, IN
CLASS 5 (U.S. CLS. 6, 18, 44, 46, 51 AND 52).

SN 78-640,504, FILED 5-31-2005.

FIRST USE 5-13-2008; IN COMMERCE 5-13-2008.

JAY BESCH, EXAMINING ATTORNEY

Int. Cl.: 18

Prior U.S. Cls.: 1, 2, 3, 22, and 41

United States Patent and Trademark Office

Reg. No. 3,477,987

Registered July 29, 2008

**TRADEMARK
PRINCIPAL REGISTER**

cinch-it

JORDAN BRANDS, INC (WASHINGTON COR-
PORATION)
P.O. BOX 3535
NEWCASTLE, WA 98059

THE MARK CONSISTS OF STANDARD CHAR-
ACTERS WITHOUT CLAIM TO ANY PARTICULAR
FONT, STYLE, SIZE, OR COLOR.

FOR: PET COLLAR, IN CLASS 18 (U.S. CLS. 1, 2, 3,
22 AND 41).

SN 78-642,856, FILED 6-3-2005.

FIRST USE 3-2-2003; IN COMMERCE 9-23-2004.

RAMONA ORTIGA, EXAMINING ATTORNEY

Int. Cl.: 35

Prior U.S. Cls.: 100, 101, and 102

United States Patent and Trademark Office

Reg. No. 3,477,988

Registered July 29, 2008

SERVICE MARK
PRINCIPAL REGISTER



ALLIANCE TRADING, INC. (DELAWARE CORPORATION)
109 NORTHPARK BOULEVARD
COVINGTON, LA 70433

FOR: PROMOTING THE GOODS AND SERVICES OF OTHERS, NAMELY, SWIMMING POOLS AND RELATED SERVICES, BY MEANS OF A PREFERRED CUSTOMER PROGRAM FEATURING NATIONWIDE ADVERTISING, WEBSITE DESIGNING AND HOSTING, PROFESSIONALLY DESIGNED LITERATURE, USE OF PRE-PRODUCED ADVERTISING, TELEVISION COMMERCIALS AND BILLBOARDS, AND A COMPANY LISTING ON

APPLICANT'S WEBSITE, IN CLASS 35 (U.S. CLS. 100, 101 AND 102).

FIRST USE 6-30-1999; IN COMMERCE 6-30-1999.

OWNER OF U.S. REG. NOS. 603,196 AND 656,817.

NO CLAIM IS MADE TO THE EXCLUSIVE RIGHT TO USE "SWIMMING POOLS", APART FROM THE MARK AS SHOWN.

SN 78-644,181, FILED 6-6-2005.

MARY ROSSMAN, EXAMINING ATTORNEY

Int. Cl.: 5

Prior U.S. Cls.: 6, 18, 44, 46, 51, and 52

Reg. No. 3,477,989

United States Patent and Trademark Office

Registered July 29, 2008

**TRADEMARK
PRINCIPAL REGISTER**

BLINK

ADVANCED MEDICAL OPTICS, INC. (DELA-
WARE CORPORATION)
1700 EAST ST. ANDREW PLACE
SANTA ANA, CA 92705

THE MARK CONSISTS OF STANDARD CHAR-
ACTERS WITHOUT CLAIM TO ANY PARTICULAR
FONT, STYLE, SIZE, OR COLOR.

FOR: OPHTHALMIC PREPARATIONS, NAMELY,
LUBRICATING AND REWETTING SOLUTIONS, IN
CLASS 5 (U.S. CLS. 6, 18, 44, 46, 51 AND 52).

SN 78-645,591, FILED 6-7-2005.

FIRST USE 1-18-2008; IN COMMERCE 1-18-2008.

WENDY JUN, EXAMINING ATTORNEY

Int. Cl.: 11

Prior U.S. Cls.: 13, 21, 23, 31, and 34

United States Patent and Trademark Office

Reg. No. 3,477,990

Registered July 29, 2008

**TRADEMARK
PRINCIPAL REGISTER**

CICERO

MASCO CORPORATION OF INDIANA (INDI-
ANA CORPORATION)
55 EAST 111TH STREET
INDIANAPOLIS, IN 46280

THE MARK CONSISTS OF STANDARD CHAR-
ACTERS WITHOUT CLAIM TO ANY PARTICULAR
FONT, STYLE, SIZE, OR COLOR.

FOR: PLUMBING PRODUCTS, NAMELY, FAU-
CETS, IN CLASS 11 (U.S. CLS. 13, 21, 23, 31 AND 34).

SN 78-646,217, FILED 6-8-2005.

FIRST USE 11-0-2007; IN COMMERCE 11-0-2007.

INGA ERVIN, EXAMINING ATTORNEY

Int. Cl.: 35

Prior U.S. Cls.: 100, 101, and 102

United States Patent and Trademark Office

Reg. No. 3,477,991

Registered July 29, 2008

**SERVICE MARK
PRINCIPAL REGISTER**

Smart Communities

THE MENTORING COMPANY (COLORADO
SOLE PROPRIETORSHIP)
PO BOX 2246
6016 NORTH COUNTY ROAD 27
LOVELAND, CO 80539

THE MARK CONSISTS OF STANDARD CHAR-
ACTERS WITHOUT CLAIM TO ANY PARTICULAR
FONT, STYLE, SIZE, OR COLOR.

FOR: BUSINESS CONSULTING SERVICES, IN
CLASS 35 (U.S. CLS. 100, 101 AND 102).

SN 78-646,898, FILED 6-9-2005.

FIRST USE 6-5-2008; IN COMMERCE 6-5-2008.

SUNG IN, EXAMINING ATTORNEY

Int. Cls.: 35, 36, and 44

Prior U.S. Cls.: 100, 101, and 102

United States Patent and Trademark Office

Reg. No. 3,477,992

Registered July 29, 2008

**SERVICE MARK
PRINCIPAL REGISTER**

RITE AID HEALTH SOLUTIONS

NAME RITE, L.L.C. (DELAWARE LTD LIAB CO)
27710 JEFFERSON AVENUE, SUITE 105
TEMECULA, CA 92590

FOR: PHARMACY BENEFIT MANAGEMENT SERVICES, NAMELY, ADMINISTERING REIMBURSEMENT PROGRAMS; PHARMACEUTICAL COST MANAGEMENT FOR THE HEALTH CARE BENEFIT PLANS OF OTHERS; PHARMACEUTICAL UTILIZATION REVIEW SERVICES; CLAIMS PROCESSING OF PHARMACEUTICAL BENEFITS; BUSINESS MANAGEMENT SERVICES IN THE NATURE OF PHARMACY MANAGEMENT SERVICES, NAMELY, PRESCRIPTION DRUG FORMULARY MANAGEMENT SERVICES; RETAIL PHARMACY SERVICES; MAIL ORDER OF PHARMACEUTICALS; AND SPECIALTY PHARMACY SERVICES, NAMELY, THE PROVISION OF SPECIAL PURPOSE PHARMACEUTICALS, IN CLASS 35 (U.S. CLS. 100, 101 AND 102).

FIRST USE 5-31-2005; IN COMMERCE 5-31-2005.

FOR: ADMINISTRATION OF PRESCRIPTION DRUG HEALTH CARE PLANS FOR HEALTH BENEFIT PLAN PROVIDERS, IN CLASS 36 (U.S. CLS. 100, 101 AND 102).

FIRST USE 5-31-2005; IN COMMERCE 5-31-2005.

FOR: HEALTH CARE SERVICES, NAMELY, INDIVIDUALIZED HEALTH AND WELLNESS SCREENINGS PROVIDED BY A NETWORK OF PHARMACISTS AND OTHER HEALTH CARE PRO-

VIDERS; COMPREHENSIVE HEALTH CARE SERVICES IN THE FIELD OF CHRONIC ILLNESSES; MEDICAL COUNSELING IN THE NATURE OF DRUG THERAPY COUNSELING AND MANAGEMENT, AND DISEASE MANAGEMENT COUNSELING; PRESCRIPTION COMPLIANCE SERVICES, NAMELY, PRESCRIPTION MONITORING AND ALERT SERVICE FOR REMINDING CLIENTS OF MEDICAL INFORMATION, NAMELY, MEDICINAL DOSAGE, CONTRAINDICATIONS, DRUG INTERACTIONS, ALLERGIC SENSITIVITY AND PRESCRIPTION REFILLS; AND PROVIDING MEDICAL, HEALTH AND HEALTH CARE INFORMATION, NAMELY, INDIVIDUAL PATIENT HEALTH CARE INFORMATION, IN CLASS 44 (U.S. CLS. 100 AND 101).

FIRST USE 5-31-2005; IN COMMERCE 5-31-2005.

THE MARK CONSISTS OF STANDARD CHARACTERS WITHOUT CLAIM TO ANY PARTICULAR FONT, STYLE, SIZE, OR COLOR.

OWNER OF U.S. REG. NOS. 1,427,920, 2,905,999, AND OTHERS.

NO CLAIM IS MADE TO THE EXCLUSIVE RIGHT TO USE "HEALTH SOLUTIONS", APART FROM THE MARK AS SHOWN.

SN 78-647,117, FILED 6-9-2005.

TRACY WHITTAKER-BROWN, EXAMINING ATTORNEY

Int. Cls.: 9, 16, and 41

**Prior U.S. Cls.: 2, 5, 21, 22, 23, 26, 29, 36, 37, 38, 50,
100, 101, and 107**

Reg. No. 3,477,993

United States Patent and Trademark Office

Registered July 29, 2008

**TRADEMARK
SERVICE MARK
PRINCIPAL REGISTER**

MASTERY IMPACT!

E-MYTH WORLDWIDE, INC. (DELAWARE CORPORATION)
2235 MERCURY WAY, SUITE 200
SANTA ROSA, CA 95407

FOR: DOWNLOADABLE COMPUTER SOFTWARE, NAMELY, TOOLS FOR ENTREPRENEURS AND SMALL BUSINESS OWNERS INCLUDING WORKBOOKS, WORKSHEETS, TEMPLATES, AND FORMS FOR USE IN CONJUNCTION WITH INSTRUCTION AND INFORMATION DIRECTED TO PERSONAL AND BUSINESS ISSUES OF ENTREPRENEURSHIP AND THE OPERATION OF SMALL BUSINESSES, IN CLASS 9 (U.S. CLS. 21, 23, 26, 36 AND 38).

FIRST USE 5-31-2006; IN COMMERCE 5-31-2006.

FOR: PRINTED BOOKS, MANUALS, WORKBOOKS, WORKSHEETS AND FORMS FEATURING INSTRUCTION AND INFORMATION DIRECTED TO PERSONAL AND BUSINESS ISSUES OF ENTREPRENEURSHIP AND THE OPERATION OF SMALL BUSINESSES; PRINTED TEMPLATES FOR USE IN GENERATING COMMON BUSINESS DOCUMENTS, IN CLASS 16 (U.S. CLS. 2, 5, 22, 23, 29, 37, 38 AND 50).

FIRST USE 5-31-2006; IN COMMERCE 5-31-2006.

FOR: EDUCATION SERVICES, NAMELY, PROVIDING ONE-ON-ONE TELEPHONIC INSTRU-

TION IN THE FIELDS OF BUSINESS AND MANAGEMENT; TRAINING SERVICES IN THE FIELDS OF BUSINESS AND MANAGEMENT; COMPUTER-BASED AND ONLINE COURSES IN THE FIELDS OF BUSINESS AND MANAGEMENT; DISTANCE LEARNING SERVICES IN THE FIELDS OF BUSINESS AND MANAGEMENT; CONDUCTING CLASSES, SEMINARS, CONFERENCES, WORKSHOPS AND INDIVIDUAL TRAINING SESSIONS IN THE FIELD OF ENTREPRENEURSHIP AND SMALL BUSINESS OPERATION IN PERSON, BY TELEPHONE, AND VIA A GLOBAL COMPUTER NETWORK; PROVIDING WEB SITES FEATURING INFORMATION, LINKS, AND DOCUMENTS IN THE FIELDS OF BUSINESS EDUCATION AND BUSINESS COACHING; ON-LINE JOURNALS, NAMELY, BLOGS IN THE FIELDS OF BUSINESS AND MANAGEMENT; COACHING OF BUSINESS OWNERS VIA ELECTRONIC NETWORKS, IN CLASS 41 (U.S. CLS. 100, 101 AND 107).

FIRST USE 5-31-2006; IN COMMERCE 5-31-2006.

THE MARK CONSISTS OF STANDARD CHARACTERS WITHOUT CLAIM TO ANY PARTICULAR FONT, STYLE, SIZE, OR COLOR.

SN 78-649,582, FILED 6-13-2005.

CHERYL CLAYTON, EXAMINING ATTORNEY

Int. Cls.: 16, 21, 29, and 30

Prior U.S. Cls.: 2, 5, 13, 22, 23, 29, 30, 33, 37, 38, 40,
46, and 50

Reg. No. 3,477,994

United States Patent and Trademark Office

Registered July 29, 2008

TRADEMARK
PRINCIPAL REGISTER



GORDON FOOD SERVICE, INC. (MICHIGAN CORPORATION)
333 FIFTIETH STREET
GRAND RAPIDS, MI 49548

FOR: PAPER NAPKINS, IN CLASS 16 (U.S. CLS. 2, 5, 22, 23, 29, 37, 38 AND 50).

FIRST USE 9-30-2004; IN COMMERCE 9-30-2004.

FOR: PAPER PLATES AND PLASTIC TAKE-OUT CONTAINERS FOR FOOD, IN CLASS 21 (U.S. CLS. 2, 13, 23, 29, 30, 33, 40 AND 50).

FIRST USE 9-30-2003; IN COMMERCE 9-30-2003.

FOR: CANNED FRUITS AND VEGETABLES, SHORTENING, VEGETABLE OIL, SLICE DELI MEATS, BEEF, SEAFOOD, PORK, HAM, FRENCH

FRIED POTATOES, CHEESE, SOUP, AND TURKEY, IN CLASS 29 (U.S. CL. 46).

FIRST USE 9-30-2003; IN COMMERCE 9-30-2003.

FOR: BUNS, BREAD, MAYONNAISE, KETCHUP, PANCAKE SYRUP, AND SPAGHETTI SAUCE , IN CLASS 30 (U.S. CL. 46).

FIRST USE 9-30-2004; IN COMMERCE 9-30-2004.

NO CLAIM IS MADE TO THE EXCLUSIVE RIGHT TO USE "KITCHEN", APART FROM THE MARK AS SHOWN.

SN 78-649,972, FILED 6-14-2005.

RONALD DELGIZZI, EXAMINING ATTORNEY

Int. Cl.: 16

Prior U.S. Cls.: 2, 5, 22, 23, 29, 37, 38, and 50

Reg. No. 3,477,995

United States Patent and Trademark Office

Registered July 29, 2008

**TRADEMARK
PRINCIPAL REGISTER**

OYCH

LEVY, LEE M. (UNITED STATES INDIVIDUAL)
2124 CHURCHILL COURT
HIGHLAND PARK, IL 60035

FIRST USE 12-6-2006; IN COMMERCE 2-24-2008.

FOR: PAPER NAPKINS; LUNCH BAGS; STATIONERY; ENVELOPES; NOTE PADS; PAPER BOXES; LEGAL PADS; ADHESIVE STICK-ONS; PLASTIC SHEETS FOR WRITING, PRINTING AND MARKING; PLASTIC SACKS AND BAGS FOR WRAPPING; PLASTIC DIAPERS, IN CLASS 16 (U.S. CLS. 2, 5, 22, 23, 29, 37, 38 AND 50).

THE MARK CONSISTS OF STANDARD CHARACTERS WITHOUT CLAIM TO ANY PARTICULAR FONT, STYLE, SIZE, OR COLOR.

SN 78-653,988, FILED 6-20-2005.

INGA ERVIN, EXAMINING ATTORNEY

Int. Cl.: 16

Prior U.S. Cls.: 2, 5, 22, 23, 29, 37, 38, and 50

United States Patent and Trademark Office

Reg. No. 3,477,996

Registered July 29, 2008

**TRADEMARK
PRINCIPAL REGISTER**

**ARE YOU LIVING THE LIFE
YOU INTEND?**

MANAGING THOUGHT, LLC (MICHIGAN LTD
LIAB CO)
7363 CREEK VIEW COURT
WEST BLOOMFIELD, MI 48332

FOR: PRINTED MATTER, NAMELY, BOOKS,
WORKBOOKS, MAGAZINES, MAGAZINE COL-
UMNS, NEWSLETTERS, SYNDICATED NEWSPA-
PER COLUMNS ALL IN THE FIELDS OF SELF
IMPROVEMENT; PRINTED MATTER, NAMELY,
MOTIVATIONAL CARDS, FLASHCARDS, CALEN-
DARS, BOOKMARKS, BLANK JOURNAL BOOKS

AND BLANK WRITING JOURNALS, IN CLASS 16
(U.S. CLS. 2, 5, 22, 23, 29, 37, 38 AND 50).

FIRST USE 4-20-2005; IN COMMERCE 4-20-2005.

THE MARK CONSISTS OF STANDARD CHAR-
ACTERS WITHOUT CLAIM TO ANY PARTICULAR
FONT, STYLE, SIZE, OR COLOR.

SN 78-654,194, FILED 6-20-2005.

WILLIAM VERHOSEK, EXAMINING ATTORNEY

Int. Cl.: 36

Prior U.S. Cls.: 100, 101, and 102

United States Patent and Trademark Office

Reg. No. 3,477,997

Registered July 29, 2008

**SERVICE MARK
PRINCIPAL REGISTER**

FBTEN.COM

AMERICAN FARM BUREAU FEDERATION (IL-
LINOIS CORPORATION)
SUITE 800
600 MARYLAND AVENUE, SW
WASHINGTON, DC 20024

FOR: PROVIDING A PROGRAM UNDER WHICH
HOLDERS OF TOBACCO QUOTAS MAY RECEIVE
ONE LUMP SUM PAYMENT, AT A DISCOUNTED
RATE, FOR THEIR TOBACCO QUOTAS, IN LIEU
OF ANNUAL PAYMENTS TO BUY OUT THEIR
QUOTAS UNDER THE USDA TOBACCO TRANSI-
TION PAYMENT PROGRAM, AND PROVIDING
FINANCIAL ADVICE IN CONNECTION THERE-
WITH, NAMELY FINANCIAL PLANNING SERVI-
CES AND ESTATE, RETIREMENT AND

INVESTMENT PLANNING SERVICES, IN CLASS
36 (U.S. CLS. 100, 101 AND 102).

FIRST USE 8-1-2005; IN COMMERCE 8-1-2005.

THE MARK CONSISTS OF STANDARD CHAR-
ACTERS WITHOUT CLAIM TO ANY PARTICULAR
FONT, STYLE, SIZE, OR COLOR.

OWNER OF U.S. REG. NOS. 985,201, 2,960,158,
AND OTHERS.

SN 78-654,319, FILED 6-20-2005.

ADA HAN, EXAMINING ATTORNEY

Int. Cl.: 24

Prior U.S. Cls.: 42 and 50

United States Patent and Trademark Office

Reg. No. 3,477,998

Registered July 29, 2008

**TRADEMARK
PRINCIPAL REGISTER**

HIFLOW

HIGHLAND INDUSTRIES, INC. (DELAWARE
CORPORATION)
629 GREEN VALLEY ROAD, SUITE 300
GREENSBORO, NC 27408

FOR: KNITTED FABRIC FOR USE IN THE MAN-
UFACTURE OF AUTOMOBILE SEATS, UPHOL-
STERED FURNITURE, MATTRESSES,
FOOTWEAR, APPAREL, PROTECTIVE APPAREL,
BACKPACKS AND MEDICAL APPLICATIONS, IN
CLASS 24 (U.S. CLS. 42 AND 50).

FIRST USE 5-1-2006; IN COMMERCE 5-1-2006.

THE MARK CONSISTS OF STANDARD CHAR-
ACTERS WITHOUT CLAIM TO ANY PARTICULAR
FONT, STYLE, SIZE, OR COLOR.

SN 78-656,059, FILED 6-22-2005.

SARA THOMAS, EXAMINING ATTORNEY

Int. Cl.: 9

Prior U.S. Cls.: 21, 23, 26, 36, and 38

Reg. No. 3,477,999

United States Patent and Trademark Office

Registered July 29, 2008

**TRADEMARK
PRINCIPAL REGISTER**

ARIES

COOPER TECHNOLOGIES COMPANY (DELA-
WARE CORPORATION)
600 TRAVIS, SUITE 5800
HOUSTON, TX 77002

FOR: ELECTRICAL SUBSTATION AND LINE
POWER EQUIPMENT, LINE AUTOMATION EQUIP-
MENT AND CONTROLLERS THEREFOR, NAME-
LY, TRANSFORMERS, VOLTAGE REGULATORS,
POWER CAPACITORS, AIR BREAK DISCONNECT
SWITCHES, LOAD BREAK SWITCHES, RECLO-
SERS, SECTIONALIZERS, VACUUM FAULT IN-
TERRUPTERS, SWITCHGEAR, SURGE
ARRESTERS, FUSES, FUSE EQUIPMENT, FAULT
INDICATORS, TRANSFORMER SWITCHES, HY-

DRULIC RECLOSER CONTROL UNITS, ELEC-
TRONIC RECLOSER CONTROL UNITS, IN CLASS 9
(U.S. CLS. 21, 23, 26, 36 AND 38).

FIRST USE 12-1-2006; IN COMMERCE 12-1-2006.

THE MARK CONSISTS OF STANDARD CHAR-
ACTERS WITHOUT CLAIM TO ANY PARTICULAR
FONT, STYLE, SIZE, OR COLOR.

SN 78-657,893, FILED 6-24-2005.

MELVIN AXILBUND, EXAMINING ATTORNEY

Int. Cl.: 30

Prior U.S. Cl.: 46

United States Patent and Trademark Office

Reg. No. 3,478,000

Registered July 29, 2008

**TRADEMARK
PRINCIPAL REGISTER**

BEADBAR

THE NANTUCKET BEADBOARD COMPANY
INC. (NEW HAMPSHIRE CORPORATION)
109 CHESTNUT HILL ROAD
ROCHESTER, NH 03866

THE MARK CONSISTS OF STANDARD CHAR-
ACTERS WITHOUT CLAIM TO ANY PARTICULAR
FONT, STYLE, SIZE, OR COLOR.

FOR: EDIBLE CONFECTIONS, NAMELY, CHO-
COLATE BARS, CHOCOLATE, BROWNIES, COOK-
IES, CANDY, AND SWEET BAKERY DESSERTS, IN
CLASS 30 (U.S. CL. 46).

SN 78-660,669, FILED 6-29-2005.

FIRST USE 5-14-2008; IN COMMERCE 5-14-2008.

MICHELLE DUBOIS, EXAMINING ATTORNEY

Int. Cl.: 10

Prior U.S. Cls.: 26, 39, and 44

United States Patent and Trademark Office

Reg. No. 3,478,001

Registered July 29, 2008

**TRADEMARK
PRINCIPAL REGISTER**

OLYMPUS EC

OLYMPUS CORPORATION (JAPAN JOINT
STOCK COMPANY)
43-2, HATAGAYA 2-CHOME SHIBUYA-KU
TOKYO, JAPAN

FOR: MEDICAL CAPSULE ENDOSCOPES, IN
CLASS 10 (U.S. CLS. 26, 39 AND 44).

FIRST USE 10-1-2007; IN COMMERCE 10-1-2007.

THE MARK CONSISTS OF STANDARD CHAR-
ACTERS WITHOUT CLAIM TO ANY PARTICULAR
FONT, STYLE, SIZE, OR COLOR.

OWNER OF U.S. REG. NOS. 2,952,250, 2,989,940,
AND OTHERS.

SN 78-663,585, FILED 7-5-2005.

SOPHIA S. KIM, EXAMINING ATTORNEY

Int. Cl.: 17

Prior U.S. Cls.: 1, 5, 12, 13, 35, and 50

United States Patent and Trademark Office

Reg. No. 3,478,002

Registered July 29, 2008

**TRADEMARK
PRINCIPAL REGISTER**

ENDOLIGN

INVIBIO LIMITED (UNITED KINGDOM CORPORATION)
VICTREX TECHNOLOGY CENTRE
HILLHOUSE INTERNATIONAL
THORNTON CLEVELEYS, LANCASHIRE, UNITED KINGDOM F75 4QD

FOR: PLASTICS IN SEMI-FINISHED FORM FOR USE IN MANUFACTURE; PLASTICS IN THE FORM OF RODS OR OTHER SHAPES, ALL FOR USE IN MANUFACTURE, IN CLASS 17 (U.S. CLS. 1, 5, 12, 13, 35 AND 50).

FIRST USE 6-14-2005; IN COMMERCE 6-14-2005.

THE MARK CONSISTS OF STANDARD CHARACTERS WITHOUT CLAIM TO ANY PARTICULAR FONT, STYLE, SIZE, OR COLOR.

OWNER OF U.S. REG. NOS. 2,755,252 AND 2,755,256.

SN 78-663,904, FILED 7-5-2005.

MELVIN AXILBUND, EXAMINING ATTORNEY

Int. Cl.: 21

Prior U.S. Cls.: 2, 13, 23, 29, 30, 33, 40, and 50

United States Patent and Trademark Office

Reg. No. 3,478,003

Registered July 29, 2008

**TRADEMARK
PRINCIPAL REGISTER**

SHOTSTICK

FLANNERY, NEIL M. (UNITED STATES INDIVIDUAL)
199 HELM RD
MANTOLOKING, NJ 08738

FOR: BEVERAGE TRAY NOT MADE OF PRECIOUS METAL FOR HOLDING OR CONTAINING DRINKING VESSELS, DRINKING CUPS, DRINKING GLASSES AND BEVERAGE GLASSWARE WHILE IN USE; DRINKING VESSELS, DRINKING CUPS NOT OF PRECIOUS METAL, DRINKING GLASSES, AND BEVERAGE GLASSWARE, IN CLASS 21 (U.S. CLS. 2, 13, 23, 29, 30, 33, 40 AND 50).

FIRST USE 4-0-2008; IN COMMERCE 5-0-2008.

THE MARK CONSISTS OF STANDARD CHARACTERS WITHOUT CLAIM TO ANY PARTICULAR FONT, STYLE, SIZE, OR COLOR.

SN 78-664,874, FILED 7-6-2005.

SALLY SHIH, EXAMINING ATTORNEY

Int. Cl.: 5

Prior U.S. Cls.: 6, 18, 44, 46, 51, and 52

Reg. No. 3,478,004

United States Patent and Trademark Office

Registered July 29, 2008

**TRADEMARK
PRINCIPAL REGISTER**

INZOR

RISKEVICH, MICHAEL (UNITED STATES INDIVIDUAL)
SUITE # 1
2818 OCEAN AVE
BROOKLYN, NY 11235

FOR: DIETARY SUPPLEMENT, NAMELY, A COMBINATION OF INOSINE AND POTASSIUM/CALCIUM OROTATE, IN CLASS 5 (U.S. CLS. 6, 18, 44, 46, 51 AND 52).

FIRST USE 6-1-2007; IN COMMERCE 6-1-2007.

THE MARK CONSISTS OF STANDARD CHARACTERS WITHOUT CLAIM TO ANY PARTICULAR FONT, STYLE, SIZE, OR COLOR.

SN 78-665,519, FILED 7-7-2005.

ELLEN B. AWRICH, EXAMINING ATTORNEY

Int. Cl.: 40

Prior U.S. Cls.: 100, 103, and 106

United States Patent and Trademark Office

Reg. No. 3,478,005

Registered July 29, 2008

**SERVICE MARK
PRINCIPAL REGISTER**

EASY FIND

TRG ACCESSORIES, L.L.C. (MISSOURI LTD
LIAB CO)
2047 WESTPORT CENTER DRIVE
ST. LOUIS, MO 63146

THE MARK CONSISTS OF STANDARD CHAR-
ACTERS WITHOUT CLAIM TO ANY PARTICULAR
FONT, STYLE, SIZE, OR COLOR.

FOR: MONOGRAMMING OF LUGGAGE, IN
CLASS 40 (U.S. CLS. 100, 103 AND 106).

SN 78-667,812, FILED 7-11-2005.

FIRST USE 8-0-2005; IN COMMERCE 8-0-2005.

STEVEN R. FOSTER, EXAMINING ATTORNEY

Int. Cl.: 30

Prior U.S. Cl.: 46

United States Patent and Trademark Office

Reg. No. 3,478,006

Registered July 29, 2008

**TRADEMARK
PRINCIPAL REGISTER**

Color Your Palate

BOVE, MEENAKSHI J. (INDIA INDIVIDUAL)
2 JEFFERSON RUN ROAD
GREAT FALLS, VA 22066

FOR: SPICES AND FOOD FLAVORING BASES, IN
CLASS 30 (U.S. CL. 46).

FIRST USE 3-16-2005; IN COMMERCE 3-16-2005.

THE MARK CONSISTS OF STANDARD CHAR-
ACTERS WITHOUT CLAIM TO ANY PARTICULAR
FONT, STYLE, SIZE, OR COLOR.

OWNER OF U.S. REG. NO. 2,802,624.

SN 78-670,131, FILED 7-14-2005.

MARK SPARACINO, EXAMINING ATTORNEY

Int. Cl.: 9

Prior U.S. Cls.: 21, 23, 26, 36, and 38

Reg. No. 3,478,007

United States Patent and Trademark Office

Registered July 29, 2008

**TRADEMARK
PRINCIPAL REGISTER**

SONGBIRD

POTI INC. (DELAWARE CORPORATION)
585 HOWARD STREET
2ND FLOOR
SAN FRANCISCO, CA 94105

HAND HELD DEVICE, AND/OR MOBILE PHONE,
IN CLASS 9 (U.S. CLS. 21, 23, 26, 36 AND 38).

FIRST USE 2-8-2006; IN COMMERCE 2-8-2006.

FOR: COMPUTER APPLICATION SOFTWARE
AND DEVELOPMENT TOOLS FOR REFERENCE
MEDIA PLAYER THAT ENABLES CUSTOMERS TO
RECORD, PLAY BACK AND/OR DISPLAY AUDIO,
VIDEO AND/OR OTHER DATA FILES ON ONE OR
MORE PLATFORMS INCLUDING, PERSONAL
COMPUTER, CONSUMER ELECTRONICS DEVICE,

THE MARK CONSISTS OF STANDARD CHAR-
ACTERS WITHOUT CLAIM TO ANY PARTICULAR
FONT, STYLE, SIZE, OR COLOR.

SN 78-670,999, FILED 7-14-2005.

CHRISTINE BLOMQUIST, EXAMINING ATTOR-
NEY

Int. Cl.: 9

Prior U.S. Cls.: 21, 23, 26, 36, and 38

Reg. No. 3,478,008

United States Patent and Trademark Office

Registered July 29, 2008

**TRADEMARK
PRINCIPAL REGISTER**

SONICSPLASH

REVOLUTION ACOUSTICS, LTD. (IRELAND CORPORATION)
7TH FLOOR, HUME HOUSE, BALLSBRIDGE
DUBLIN 4, IRELAND

FOR: AUDIO TRANSDUCERS, NAMELY, ELECTROACOUSTICS TRANSDUCERS, AUDIO AMPLIFIERS, ALL OF THE AFOREMENTIONED WARES FOR HOME, MARINE, BATH, AND SPA, HOT TUBS, RETAIL, OFFICE AND OTHER COMMERCIAL APPLICATIONS, INDUSTRIAL ELECTROACOUSTIC TRANSDUCERS FOR INDUSTRIAL PROCES-

SES AND INDUSTRIAL MARKETS, IN CLASS 9 (U.S. CLS. 21, 23, 26, 36 AND 38).

FIRST USE 6-10-2005; IN COMMERCE 8-15-2005.

THE MARK CONSISTS OF STANDARD CHARACTERS WITHOUT CLAIM TO ANY PARTICULAR FONT, STYLE, SIZE, OR COLOR.

SN 78-672,554, FILED 7-18-2005.

LA TONIA FISHER, EXAMINING ATTORNEY

Int. Cl.: 35

Prior U.S. Cls.: 100, 101, and 102

United States Patent and Trademark Office

Reg. No. 3,478,009

Registered July 29, 2008

**SERVICE MARK
PRINCIPAL REGISTER**



Applejack
WINE SPIRITS

APPLEJACK ASSOCIATES, INC. (COLORADO CORPORATION)
3320 YOUNGFIELD
WHEAT RIDGE, CO 80033

OWNER OF U.S. REG. NO. 2,720,509.

FOR: RETAIL STORE SERVICES FEATURING ALCOHOLIC AND NON-ALCOHOLIC BEVERAGES FOR CONSUMPTION ON OR OFF PREMISES AS ALLOWED BY LAW, GLASSWARE, BAR SUPPLIES, CIGARS AND GIFT BASKETS CONSISTING OF ALCOHOLIC AND NON-ALCOHOLIC BEVERAGES AND ALCOHOLIC BEVERAGE CONDIMENTS; AND PRIVATE LABEL ALCOHOLIC BEVERAGES, IN CLASS 35 (U.S. CLS. 100, 101 AND 102).

NO CLAIM IS MADE TO THE EXCLUSIVE RIGHT TO USE "WINE SPIRIT", APART FROM THE MARK AS SHOWN.

SEC. 2(F) AS TO "APPLEJACK".

SN 78-673,409, FILED 7-19-2005.

FIRST USE 9-8-2005; IN COMMERCE 9-8-2005.

RICHARD WHITE, EXAMINING ATTORNEY

Int. Cl.: 7

Prior U.S. Cls.: 13, 19, 21, 23, 31, 34, and 35

Reg. No. 3,478,010

United States Patent and Trademark Office

Registered July 29, 2008

**TRADEMARK
PRINCIPAL REGISTER**

DIAMANTE

MIELE, INC. (DELAWARE CORPORATION)
9 INDEPENDENCE WAY
PRINCETON, NJ 08540

FOR: DISH WASHING MACHINES, IN CLASS 7
(U.S. CLS. 13, 19, 21, 23, 31, 34 AND 35).

FIRST USE 1-1-2005; IN COMMERCE 1-1-2005.

THE MARK CONSISTS OF STANDARD CHAR-
ACTERS WITHOUT CLAIM TO ANY PARTICULAR
FONT, STYLE, SIZE, OR COLOR.

THE FOREIGN WORDING IN THE MARK
TRANSLATES INTO ENGLISH AS DIAMOND.

SN 78-674,570, FILED 7-20-2005.

WILLIAM VERHOSEK, EXAMINING ATTORNEY

Int. Cl.: 7

Prior U.S. Cls.: 13, 19, 21, 23, 31, 34, and 35

Reg. No. 3,478,011

United States Patent and Trademark Office

Registered July 29, 2008

**TRADEMARK
PRINCIPAL REGISTER**

EXCELLA SERIES

MIELE, INC. (DELAWARE CORPORATION)
9 INDEPENDENCE WAY
PRINCETON, NJ 08540

FOR: DISH WASHING MACHINES, IN CLASS 7
(U.S. CLS. 13, 19, 21, 23, 31, 34 AND 35).

FIRST USE 1-1-2005; IN COMMERCE 1-1-2005.

THE MARK CONSISTS OF STANDARD CHARACTERS WITHOUT CLAIM TO ANY PARTICULAR FONT, STYLE, SIZE, OR COLOR.

NO CLAIM IS MADE TO THE EXCLUSIVE RIGHT TO USE "SERIES", APART FROM THE MARK AS SHOWN.

SN 78-674,580, FILED 7-20-2005.

G. MAYERSCHOFF, EXAMINING ATTORNEY

Int. Cl.: 20

Prior U.S. Cls.: 2, 13, 22, 25, 32, and 50

Reg. No. 3,478,012

United States Patent and Trademark Office

Registered July 29, 2008

**TRADEMARK
PRINCIPAL REGISTER**

SUPPORT NEVER FELT SO SOFT

SEALY TECHNOLOGY LLC (NORTH CAROLINA LTD LIAB CO)
ONE OFFICE PARKWAY
TRINITY, NC 27370

THE MARK CONSISTS OF STANDARD CHARACTERS WITHOUT CLAIM TO ANY PARTICULAR FONT, STYLE, SIZE, OR COLOR.

FOR: MATTRESSES AND BOXSPRINGS, IN CLASS 20 (U.S. CLS. 2, 13, 22, 25, 32 AND 50).

SN 78-681,233, FILED 7-29-2005.

FIRST USE 9-1-2005; IN COMMERCE 9-1-2005.

RICHARD WHITE, EXAMINING ATTORNEY

Int. Cls.: 29 and 31

Prior U.S. Cls.: 1 and 46

United States Patent and Trademark Office

Reg. No. 3,478,013

Registered July 29, 2008

**TRADEMARK
PRINCIPAL REGISTER**

YOGA E.S. NUTS

BERG, RICHARD C. (UNITED STATES INDIVIDUAL)
1895-91ST PLACE NE
CLYDE HILL, WA 98004

FOR: NUT MEATS, NUT TOPPING, SHELLED NUTS, ROASTED NUTS OR OTHERWISE PROCESSED NUTS, SNACK MIX CONSISTING PRIMARILY OF PROCESSED FRUITS, PROCESSED NUTS AND/OR RAISINS , IN CLASS 29 (U.S. CL. 46).

FIRST USE 3-31-2008; IN COMMERCE 4-1-2008.

FOR: FRESH NUTS, RAW NUTS, UNPROCESSED NUTS, IN CLASS 31 (U.S. CLS. 1 AND 46).

FIRST USE 3-31-2008; IN COMMERCE 4-1-2008.

THE MARK CONSISTS OF STANDARD CHARACTERS WITHOUT CLAIM TO ANY PARTICULAR FONT, STYLE, SIZE, OR COLOR.

NO CLAIM IS MADE TO THE EXCLUSIVE RIGHT TO USE "NUTS", APART FROM THE MARK AS SHOWN.

SN 78-681,632, FILED 7-29-2005.

GIANCARLO CASTRO, EXAMINING ATTORNEY

Int. Cl.: 9

Prior U.S. Cls.: 21, 23, 26, 36, and 38

Reg. No. 3,478,014

United States Patent and Trademark Office

Registered July 29, 2008

**TRADEMARK
PRINCIPAL REGISTER**

BALANCED LEADERSHIP

MID-CONTINENT RESEARCH FOR EDUCATION AND LEARNING (MISSOURI CORPORATION)
4601 DTC BOULEVARD, SUITE 500
DENVER, CO 80237

FOR: VIDEO TAPES AND DIGITAL VIDEO DISCS IN THE FIELDS OF K THROUGH 12 EDUCATION AND LEADERSHIP SKILLS FOR EDUCATORS, SCHOOL PRINCIPALS, SCHOOL STAFF AND SCHOOL SUPERVISORS, IN CLASS 9 (U.S. CLS. 21, 23, 26, 36 AND 38).

FIRST USE 5-1-2008; IN COMMERCE 5-1-2008.

THE MARK CONSISTS OF STANDARD CHARACTERS WITHOUT CLAIM TO ANY PARTICULAR FONT, STYLE, SIZE, OR COLOR.

SN 78-681,772, FILED 7-29-2005.

TIMOTHY FINNEGAN, EXAMINING ATTORNEY

Int. Cl.: 3

Prior U.S. Cls.: 1, 4, 6, 50, 51, and 52

United States Patent and Trademark Office

Reg. No. 3,478,015

Registered July 29, 2008

**TRADEMARK
PRINCIPAL REGISTER**

BODYACTIVE O BOTICÁRIO

**BOTICA COMERCIAL FARMACEUTICA S.A.
(BRAZIL CORPORATION)**

AV. RUI BARBOSA, 3450

AFONSO PENA

**SAO JOSE DOS PINHAIS, PARANA, BRAZIL
83065260**

**FOR: PERFUMERY, COSMETICS IN GENERAL,
AND SOAPS, IN CLASS 3 (U.S. CLS. 1, 4, 6, 50, 51 AND
52).**

FIRST USE 12-19-2006; IN COMMERCE 12-19-2006.

**THE MARK CONSISTS OF STANDARD CHAR-
ACTERS WITHOUT CLAIM TO ANY PARTICULAR
FONT, STYLE, SIZE, OR COLOR.**

**OWNER OF U.S. REG. NOS. 2,233,304, 2,875,382,
AND OTHERS.**

**THE ENGLISH TRANSLATION OF THE WORD-
ING "O BOTICÁRIO" IS THE PHARMACIST.**

SN 78-685,807, FILED 8-4-2005.

MARY ROSSMAN, EXAMINING ATTORNEY

Int. Cls.: 35 and 41

Prior U.S. Cls.: 100, 101, 102, and 107

Reg. No. 3,478,016

United States Patent and Trademark Office

Registered July 29, 2008

**SERVICE MARK
PRINCIPAL REGISTER**

TVM

RMC OF ILLINOIS, INC. (ILLINOIS CORPORATION)
1818 MARKET STREET 33RD FLOOR
PHILADELPHIA, PA 191033614

FOR: EMPLOYMENT AGENCY SERVICES; TEMPORARY AND PERMANENT EMPLOYMENT AGENCY SERVICES; EMPLOYEE LEASING; EMPLOYMENT RELATED SERVICES, NAMELY, PROVIDING JOB PLACEMENT, CAREER DEVELOPMENT, EMPLOYMENT RECRUITMENT, AND GENERAL EMPLOYMENT INFORMATION TO OTHERS; BUSINESS MANAGEMENT AND CONSULTING SERVICES, NAMELY, ASSISTING BUSINESSES IN MANAGING WORKFORCE CHANGES, NAMELY, MERGERS, ACQUISITIONS, AMALGAMATIONS, DOWNSIZING, AND EXPANSION; PERSONNEL MANAGEMENT, HUMAN RESOURCES MANAGEMENT; EMPLOYMENT OUTPLACEMENT CONSULTATION SERVICES FOR PERSONNEL AFFECTED BY WORKFORCE CHANGES; SUPPLYING TO OTHERS ON A TEMPORARY AND PERMANENT BASIS ENGINEERS, COMPUTER PROGRAMMERS, DRAFTSMEN, AND SKILLED TECHNICAL PERSONNEL; PROVIDING AND MANAGING CONTRACT PERSONNEL PROGRAMS; ANALYZING AND CONSULTING ON PERSONNEL NEEDS; PROVIDING CONTRACT, TEMPORARY, AND PERMANENT PERSONNEL STAFFING SERVICES; ARRANGING FOR AND MANAGING THE PROVISION OF TEMPORARY CONTRACT PERSONNEL; PERSONNEL MANAGEMENT AND CONSULTANCY SERVICES; PROVIDING INFORMATION AND CONSULTANCY SERVICES ON THE PROCUREMENT OF TEMPORARY, CONTRACT, AND PERMANENT PERSONNEL; COMPUTER ON-LINE ORDERING VIA A GLOBAL INFORMATION NETWORK, AND PROVIDING COMPUTER ON-LINE REPORTS VIA A GLOBAL INFORMATION NETWORK, ALL IN THE FIELD OF PERSONNEL PROCUREMENT; HUMAN RESOURCES CONSULTING ON RECRUITING

AND TESTING OF EMPLOYEES; CONTRACT AND PERMANENT STAFFING AGENCY SERVICES FEATURING STAFF PROFESSIONALS IN FINANCE, INFORMATION TECHNOLOGY, ENGINEERING, SCIENTIFIC AND TECHNICAL PERSONNEL, AS WELL AS OFFICE ADMINISTRATIVE STAFF, FACTORY STAFF, INDUSTRIAL STAFF AND CALL CENTER STAFF; SERVING AS A HUMAN RESOURCE DEPARTMENT FOR OTHERS; EMPLOYMENT OUTPLACEMENT SERVICES; TESTING TO DETERMINE EMPLOYMENT SKILLS; EMPLOYMENT COUNSELING; WORKFORCE DEVELOPMENT SERVICES; PROVIDING CAREER INFORMATION VIA A WEBSITE ON A GLOBAL INFORMATION NETWORK; PROVIDING INFORMATION ON JOBS VIA A WEBSITE ON A GLOBAL INFORMATION NETWORK; PROVIDING AN ON-LINE COMPUTER DATABASE IN THE FIELDS OF CONTRACT AND PERMANENT PERSONNEL STAFFING; PROVIDING EMPLOYEE SCREENING AND ASSESSMENT TOOLS VIA A WEBSITE ON A GLOBAL INFORMATION NETWORK; RESUME LISTING SERVICES; RESUME MATCHING SERVICES; RELOCATION SERVICES FOR PEOPLE AND GROUPS OF PEOPLE WHO ARE BEING TRANSFERRED BY THEIR EMPLOYERS FROM ONE GEOGRAPHICAL AREA TO ANOTHER, INTERNATIONAL AND DOMESTIC, NAMELY, PROVIDING INFORMATION AND COUNSELING ON FINDING A NEW HOME, PROVIDING PRE-DECISION DESTINATION INFORMATION, PROVIDING INFORMATION AND COUNSELING FOR FAMILY MEMBERS' JOB SEARCH, PROVIDING DESTINATION AREA INFORMATION; RELOCATION SERVICES FOR INDIVIDUALS, INTERNATIONAL AND DOMESTIC, NAMELY, PROVIDING INFORMATION AND COUNSELING ON FINDING A NEW HOME, PROVIDING PRE-DECISION DESTINATION INFORMATION, PROVIDING INFORMATION AND COUNSELING FOR FAMILY MEMBERS' JOB SEARCH, PROVIDING DESTINATION AREA INFORMATION; COUNSELING, AND/

OR TOURS TO RELOCATING PEOPLE IN ORDER TO FIND A NEW HOME TO BUY OR RENT, IN CLASS 35 (U.S. CLS. 100, 101 AND 102).

FIRST USE 2-1-2004; IN COMMERCE 2-1-2004.

FOR: PROVIDING TRAINING CLASSES AND COURSES IN BUSINESS, JOB SKILLS AND OFFICE TECHNOLOGY; PROVIDING ON-LINE COURSES OF STUDY IN THE FIELD OF INFORMATION TECHNOLOGY, SOFTWARE USE, JOB AND BUSINESS SKILLS VIA A WEBSITE ON A GLOBAL INFORMATION NETWORK; CAREER COUNSELING SERVICES; EDUCATION AND TRAINING SERVICES, NAMELY, PROVIDING TRAINING CLASSES AND COURSES IN RELATION TO JOB SEARCH, CAREER DEVELOPMENT, SELF-MARKETING, INTERVIEW SKILLS, RESEARCH WORKSHOPS AND TRAINING CLASSES AND COURSES OF HUMAN RESOURCE PERSONNEL IN EMPLOY-

MENT SEPARATION ISSUES; CONDUCTING CLASSES, WORKSHOPS AND SEMINARS IN THE FIELDS OF BUSINESS MANAGEMENT, HUMAN RESOURCE MANAGEMENT AND CORPORATE AND ORGANIZATION TRAINING; WORKSHOPS, SEMINARS AND TRAINING IN THE FIELD OF BUSINESS AND PERSONAL IMPROVEMENT; AND CONSULTING SERVICES IN CONNECTION THEREWITH, IN CLASS 41 (U.S. CLS. 100, 101 AND 107).

FIRST USE 2-1-2004; IN COMMERCE 2-1-2004.

THE MARK CONSISTS OF STANDARD CHARACTERS WITHOUT CLAIM TO ANY PARTICULAR FONT, STYLE, SIZE, OR COLOR.

SN 78-687,834, FILED 8-8-2005.

MARGERY A. TIERNEY, EXAMINING ATTORNEY

Int. Cl.: 9

Prior U.S. Cls.: 21, 23, 26, 36, and 38

United States Patent and Trademark Office

Reg. No. 3,478,017

Registered July 29, 2008

**TRADEMARK
PRINCIPAL REGISTER**

CHEM-TECH PRIME PERFORMANCE

PULSAFEEDER, INC. (DELAWARE CORPORATION)
2883 BRIGHTON HENRIETTA TOWN LINE ROAD
ROCHESTER, NY 14623

FOR: DIAPHRAGM METERING PUMPS, IN
CLASS 9 (U.S. CLS. 21, 23, 26, 36 AND 38).

FIRST USE 4-26-2005; IN COMMERCE 4-26-2005.

THE MARK CONSISTS OF STANDARD CHARACTERS WITHOUT CLAIM TO ANY PARTICULAR FONT, STYLE, SIZE, OR COLOR.

OWNER OF U.S. REG. NO. 2,903,087.

SN 78-689,418, FILED 8-10-2005.

AMY HELLA, EXAMINING ATTORNEY

Int. Cl.: 9

Prior U.S. Cls.: 21, 23, 26, 36, and 38

United States Patent and Trademark Office

Reg. No. 3,478,018

Registered July 29, 2008

**TRADEMARK
PRINCIPAL REGISTER**



PHOTODEX CORPORATION (TEXAS CORPORATION)
925 WESTBANK DRIVE
AUSTIN, TX 78746

FOR: COMPUTER APPARATUS, NAMELY, DIGITAL IMAGE PROCESSING AND PRESENTATION HARDWARE, IN CLASS 9 (U.S. CLS. 21, 23, 26, 36 AND 38).

FIRST USE 8-16-2005; IN COMMERCE 8-16-2005.

OWNER OF U.S. REG. NO. 3,032,246.

SN 78-690,740, FILED 8-11-2005.

TIMOTHY FINNEGAN, EXAMINING ATTORNEY

Int. Cl.: 41

Prior U.S. Cls.: 100, 101, and 107

United States Patent and Trademark Office

Reg. No. 3,478,019

Registered July 29, 2008

**SERVICE MARK
PRINCIPAL REGISTER**

EX-WIVES CLUB

LOOKING GLASS STUDIOS LLC (DELAWARE
LTD LIAB CO)
C/O COLDEN MCKUIN & FRANKEL LLP
141 EL CAMINO DRIVE, SUITE 100
BEVERLY HILLS, CA 902122717

FOR: ENTERTAINMENT SERVICES, NAMELY, A
TELEVISION SERIES IN THE FIELD OF AN ON-
GOING REALITY-BASED TELEVISION PROGRAM
, IN CLASS 41 (U.S. CLS. 100, 101 AND 107).

FIRST USE 5-28-2007; IN COMMERCE 5-28-2007.

THE MARK CONSISTS OF STANDARD CHAR-
ACTERS WITHOUT CLAIM TO ANY PARTICULAR
FONT, STYLE, SIZE, OR COLOR.

NO CLAIM IS MADE TO THE EXCLUSIVE
RIGHT TO USE "EX-WIVES", APART FROM THE
MARK AS SHOWN.

SN 78-690,748, FILED 8-11-2005.

TIMOTHY FINNEGAN, EXAMINING ATTORNEY

Int. Cl.: 18

Prior U.S. Cls.: 1, 2, 3, 22, and 41

United States Patent and Trademark Office

Reg. No. 3,478,020

Registered July 29, 2008

**TRADEMARK
PRINCIPAL REGISTER**

BEEN BAGS

SCHUMAN, DANIEL SCOTT (UNITED STATES INDIVIDUAL)
204 EAST 25TH STREET #2D
NEW YORK, NY 10010 AND
BEEN-ISAACSON, JODI (UNITED STATES INDIVIDUAL)
13563 MURPHY HILL DRIVE
WHITTIER, CA 90601

FOR: HAND-MADE BAGS AND PURSES OF NYLON, MICROFIBER, COTTON, POLYESTER AND SYNTHETIC FIBER, NAMELY, SHOULDER BAGS, CLUTCH PURSES, EVENING PURSES, CARRY ALL BAGS, HOBO BAGS, ACCORDION BAGS, SACHEL BAGS, SWAGGER BAGS, ENVELOPE BAGS, POUCH BAGS, BOX BAGS, KNITTING BAGS; LEATHER, SUEDE, FUR AND VARIOUS ANIMAL SKIN ALL PURPOSE CARRYING BAGS, AND STRAPS FOR HANDBAGS, IN CLASS 18 (U.S. CLS. 1, 2, 3, 22 AND 41).

FIRST USE 4-1-2008; IN COMMERCE 4-1-2008.

THE MARK CONSISTS OF STANDARD CHARACTERS WITHOUT CLAIM TO ANY PARTICULAR FONT, STYLE, SIZE, OR COLOR.

NO CLAIM IS MADE TO THE EXCLUSIVE RIGHT TO USE "BAG", APART FROM THE MARK AS SHOWN.

THE NAME(S), PORTRAIT(S), AND/OR SIGNATURE(S) SHOWN IN THE MARK IDENTIFIES "JODI BEEN", WHOSE CONSENT(S) TO REGISTER IS SUBMITTED.

SN 78-692,272, FILED 8-14-2005.

VIVIAN MICZNIK FIRST, EXAMINING ATTORNEY

Int. Cls.: 38 and 42

Prior U.S. Cls.: 100, 101, and 104

United States Patent and Trademark Office

Reg. No. 3,478,021

Registered July 29, 2008

**SERVICE MARK
PRINCIPAL REGISTER**

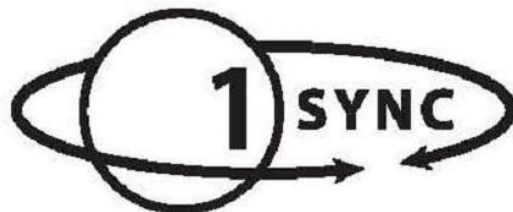

GS1 US, INC. (DELAWARE CORPORATION)
1009 LENOX DRIVE
SUITE 202
LAWRENCEVILLE, NJ 08648

FOR: ELECTRONIC EXCHANGE OF DATA STORED IN DATABASES ACCESSIBLE VIA TELECOMMUNICATION NETWORKS, NAMELY, FACILITATING THE EXCHANGE OF SERVICE, PRODUCT AND PRICING DATA ELECTRONICALLY BETWEEN TRADING PARTNERS THROUGH DATA SYNCHRONIZATION, IN CLASS 38 (U.S. CLS. 100, 101 AND 104).

FIRST USE 8-12-2005; IN COMMERCE 8-12-2005.

FOR: DEVELOPMENT, UPDATING AND MAINTENANCE OF SOFTWARE AND DATABASES TO

FACILITATE THE EXCHANGE OF PRODUCT AND PRICING DATA ELECTRONICALLY BETWEEN TRADING PARTNERS THROUGH DATA SYNCHRONIZATION, IN CLASS 42 (U.S. CLS. 100 AND 101).

FIRST USE 8-12-2005; IN COMMERCE 8-12-2005.

THE MARK CONSISTS OF THE STYLIZED NUMBER "1" AND THE STYLIZED WORDING "SYNC", AND THE DESIGN OF AN OUTLINE OF A CIRCLE AROUND THE NUMBER "1" AND AN INCOMPLETE OVAL WITH ARROWHEADS AROUND ALL OTHER ELEMENTS OF THE MARK.

SN 78-695,213, FILED 8-18-2005.

JAY BESCH, EXAMINING ATTORNEY

Int. Cl.: 35

Prior U.S. Cls.: 100, 101, and 102

United States Patent and Trademark Office

Reg. No. 3,478,022

Registered July 29, 2008

**SERVICE MARK
PRINCIPAL REGISTER**

PIVOTAL STRATEGIES

PIVOTAL STRATEGIES LLC (FLORIDA LTD
LIAB CO)

5150 TAMIAMI TRAIL N., SUITE 302

NAPLES, FL 34103

FOR: BUSINESS CONSULTATION SERVICES, IN
CLASS 35 (U.S. CLS. 100, 101 AND 102).

FIRST USE 2-28-2007; IN COMMERCE 8-1-2007.

THE MARK CONSISTS OF STANDARD CHAR-
ACTERS WITHOUT CLAIM TO ANY PARTICULAR
FONT, STYLE, SIZE, OR COLOR.

NO CLAIM IS MADE TO THE EXCLUSIVE
RIGHT TO USE "STRATEGIES", APART FROM
THE MARK AS SHOWN.

SN 78-703,903, FILED 8-31-2005.

JERI J. FICKES, EXAMINING ATTORNEY

Int. Cl.: 14

Prior U.S. Cls.: 2, 27, 28, and 50

Reg. No. 3,478,023

United States Patent and Trademark Office

Registered July 29, 2008

**TRADEMARK
PRINCIPAL REGISTER**

SCOIN

SCOIN COINS (PROPRIETARY) LIMITED
(SOUTH AFRICA CORPORATION)
FIFTH FLOOR, TWIN TOWERS WEST
SANDTON CITY, SANDTON, SOUTH AFRICA

FOR: PRECIOUS METALS AND THEIR ALLOYS;
ITEMS MADE OF PRECIOUS METAL OR COATED
THEREWITH, NAMELY, BADGES, INSIGNIA,
COMMEMORATIVE COINS, COLLECTIBLE COINS
AND WORKS OF ART, IN CLASS 14 (U.S. CLS. 2, 27,
28 AND 50).

FIRST USE 6-0-1999; IN COMMERCE 9-10-2007.

THE MARK CONSISTS OF STANDARD CHAR-
ACTERS WITHOUT CLAIM TO ANY PARTICULAR
FONT, STYLE, SIZE, OR COLOR.

SN 78-706,045, FILED 9-2-2005.

KYLE PEETE, EXAMINING ATTORNEY

Int. Cl.: 12

Prior U.S. Cls.: 19, 21, 23, 31, 35, and 44

United States Patent and Trademark Office

Reg. No. 3,478,024

Registered July 29, 2008

**TRADEMARK
PRINCIPAL REGISTER**

NULOOK

HEATH TECNA INC. (DELAWARE CORPORATION)
3225 WOBURN STREET
BELLINGHAM, WA 98226

FOR: PREFABRICATED AIRCRAFT GALLEY SECTIONS; STRUCTURAL COMPONENTS OF AIRCRAFT, NAMELY, AIRCRAFT INTERIOR STORAGE CONTAINERS, STOWAGE CLOSETS, CONTAINERS; BIN DOORS, NAMELY, AIRCRAFT INTERIOR LUGGAGE BIN DOORS; AIRCRAFT INTERIOR BULKHEAD GAP COVERS; STRUCTURAL COMPONENTS OF AIRCRAFT, NAMELY, AIRCRAFT INTERIOR STORAGE CONTAINERS, STOWAGE CLOSETS, CONTAINERS AND AIR-

CRAFT INTERIOR LUGGAGE BIN DOORS, AIRCRAFT INTERIOR BULKHEAD GAP COVERS, IN CLASS 12 (U.S. CLS. 19, 21, 23, 31, 35 AND 44).

FIRST USE 4-5-2005; IN COMMERCE 7-1-2005.

THE MARK CONSISTS OF STANDARD CHARACTERS WITHOUT CLAIM TO ANY PARTICULAR FONT, STYLE, SIZE, OR COLOR.

SN 78-711,192, FILED 9-12-2005.

ELLEN PERKINS, EXAMINING ATTORNEY

Int. Cl.: 41

Prior U.S. Cls.: 100, 101, and 107

United States Patent and Trademark Office

Reg. No. 3,478,025

Registered July 29, 2008

**SERVICE MARK
PRINCIPAL REGISTER**

IOOS

NATIONAL OCEANIC AND ATMOSPHERIC AD-
MINISTRATION (UNITED STATES AGENCY
OF THE UNITED STATES GOVERNMENT)
1401 CONSTITUTION AVENUE, NW
WASHINGTON, DC 20230

FOR: EDUCATIONAL SERVICES, NAMELY,
CONDUCTING SEMINARS, WORKSHOPS AND
CONFERENCES ABOUT OCEAN PRESERVATION,
MEASUREMENT, AND OBSERVATION, IN CLASS
41 (U.S. CLS. 100, 101 AND 107).

FIRST USE 3-22-2004; IN COMMERCE 3-22-2004.

THE MARK CONSISTS OF STANDARD CHAR-
ACTERS WITHOUT CLAIM TO ANY PARTICULAR
FONT, STYLE, SIZE, OR COLOR.

SN 78-713,649, FILED 9-15-2005.

DANIEL BRODY, EXAMINING ATTORNEY

Int. Cl.: 16

Prior U.S. Cls.: 2, 5, 22, 23, 29, 37, 38, and 50

Reg. No. 3,478,026

United States Patent and Trademark Office

Registered July 29, 2008

**TRADEMARK
PRINCIPAL REGISTER**

HANNAH MONTANA

DISNEY ENTERPRISES, INC. (DELAWARE CORPORATION)
500 SOUTH BUENA VISTA STREET
BURBANK, CA 91521

THE MARK CONSISTS OF STANDARD CHARACTERS WITHOUT CLAIM TO ANY PARTICULAR FONT, STYLE, SIZE, OR COLOR.

FOR: ART PRINTS; GIFT CARDS; PAPER PARTY HATS; PAPER PLACE MATS; PAPER TABLE CLOTHS; PEN OR PENCIL HOLDERS; PEN AND PENCIL BOXES; PHOTOGRAPHS; PICTORIAL PRINTS; PICTURE BOOKS; POSTCARDS; TRADING CARDS, IN CLASS 16 (U.S. CLS. 2, 5, 22, 23, 29, 37, 38 AND 50).

"HANNAH MONTANA" DOES NOT IDENTIFY A LIVING INDIVIDUAL.

SN 78-719,993, FILED 9-24-2005.

FIRST USE 5-20-2008; IN COMMERCE 5-20-2008.

ERNEST SHOSHO, EXAMINING ATTORNEY

Int. Cl.: 9

Prior U.S. Cls.: 21, 23, 26, 36, and 38

United States Patent and Trademark Office

Reg. No. 3,478,027

Registered July 29, 2008

**TRADEMARK
PRINCIPAL REGISTER**

VIZIA RF

LEVITON MANUFACTURING CO., INC. (DELA-
WARE CORPORATION)
59-25 LITTLE NECK PARKWAY
LITTLE NECK, NY 11362

FOR: REMOTE CONTROLLED LIGHTING CON-
TROLS AND DIMMERS, IN CLASS 9 (U.S. CLS. 21,
23, 26, 36 AND 38).

FIRST USE 9-1-2006; IN COMMERCE 2-1-2007.

THE MARK CONSISTS OF STANDARD CHAR-
ACTERS WITHOUT CLAIM TO ANY PARTICULAR
FONT, STYLE, SIZE, OR COLOR.

NO CLAIM IS MADE TO THE EXCLUSIVE
RIGHT TO USE "RF", APART FROM THE MARK
AS SHOWN.

SN 78-720,385, FILED 9-26-2005.

ESTHER A. BORSUK, EXAMINING ATTORNEY

Int. Cl.: 18

Prior U.S. Cls.: 1, 2, 3, 22, and 41

United States Patent and Trademark Office

Reg. No. 3,478,028

Registered July 29, 2008

**TRADEMARK
PRINCIPAL REGISTER**

NBA CARES

NBA PROPERTIES, INC. (NEW YORK CORPORATION)
OLYMPIC TOWER - 645 FIFTH AVENUE
NEW YORK, NY 10022

FOR: ATHLETIC BAGS, SHOE BAGS FOR TRAVEL, OVERNIGHT BAGS, UMBRELLAS, BACKPACKS, BABY BACKPACKS, KNAPSACKS, DUFFEL BAGS, TOTE BAGS, BEACH BAGS, BEACH TOTE BAGS, DRAWSTRING POUCHES, LUGGAGE, LUGGAGE TAGS, PATIO UMBRELLAS, BEACH UMBRELLAS, VALISES, ATTACHE CASES, BILLFOLDS, WALLETS, BRIEFCASES, CANES, BUSINESS CARD CASES, BOOK BAGS, ALL PURPOSE SPORTS BAGS, GOLF UMBRELLAS, GYM BAGS, PURSES, COIN PURSES, FANNY PACKS, WAIST PACKS, COSMETIC CASES SOLD EMPTY, GARMENT BAGS FOR TRAVEL, HANDBAGS, KEY CASES, LEATHER KEY CHAINS, SUITCASES, TOILETRY CASES SOLD EMPTY, TRUNKS FOR TRA-

VELING AND RUCKSACKS, PET CLOTHING, PET LEASHES, AND PET COLLARS, IN CLASS 18 (U.S. CLS. 1, 2, 3, 22 AND 41).

FIRST USE 1-31-2006; IN COMMERCE 1-31-2006.

THE MARK CONSISTS OF STANDARD CHARACTERS WITHOUT CLAIM TO ANY PARTICULAR FONT, STYLE, SIZE, OR COLOR.

OWNER OF U.S. REG. NOS. 2,358,655 AND 2,453,589.

SEC. 2(F).

SN 78-721,159, FILED 9-27-2005.

CURTIS FRENCH, EXAMINING ATTORNEY

Int. Cls.: 37, 42, and 45

Prior U.S. Cls.: 100, 101, 103, and 106

United States Patent and Trademark Office

Reg. No. 3,478,029

Registered July 29, 2008

**SERVICE MARK
PRINCIPAL REGISTER**

**LEADING THE CONVERGENCE OF
NATIONAL SECURITY AND
TECHNOLOGY**

MANTECH INTERNATIONAL CORPORATION
(DELAWARE CORPORATION)
12015 LEE JACKSON HIGHWAY
FAIRFAX, VA 220333300

FOR: INSTALLATION, MAINTENANCE AND REPAIR OF COMPUTER NETWORKS; REPAIR AND MAINTENANCE OF COMPUTERS, IN CLASS 37 (U.S. CLS. 100, 103 AND 106).

FIRST USE 2-12-2002; IN COMMERCE 2-12-2002.

FOR: COMPUTER SYSTEM DESIGN AND ENGINEERING SERVICES FOR OTHERS, COMPUTER PROGRAMMING FOR OTHERS, COMPUTER SYSTEM INTEGRATION SERVICES FOR OTHERS, COMPUTER HARDWARE AND SOFTWARE DESIGN FOR OTHERS, ENGINEERING, AND COMPUTER AND TELECOMMUNICATIONS NETWORK DESIGN FOR OTHERS, SOFTWARE APPLICATION DEVELOPMENT AND INTEGRATION SERVICES OF COMPUTER SYSTEMS AND NETWORKS IN THE FIELDS OF DEFENSE, ENVIRONMENT, AEROSPACE, AERONAUTICAL, INTELLIGENCE, COUNTER-INTELLIGENCE, SIGNALS INTELLIGENCE, SIMULATION, NATIONAL SECURITY, INFORMATION ASSURANCE, INFORMATION TECHNOLOGY, DRUG ENFORCEMENT, AND SECURE COMPUTER COMMUNICATIONS AND NETWORK INFRASTRUCTURES; COMPUTER SECURITY SERVICES, NAMELY, RESTRICTING ACCESS TO AND BY COMPUTER NETWORKS TO AND OF UNDESIRED WEB SITES, MEDIA AND INDIVIDUALS AND FACILITIES; TESTING AND DESIGN OF NEW PRODUCTS FOR OTHERS; COMPUTER SERVICES, NAMELY, WEBSITE DEVELOPMENT AND DESIGN SERVICES FOR OTHERS, WEB-BASED SOFTWARE APPLICATION DEVELOPMENT FOR OTHERS; DESIGNING SECURE WEB SITES FOR OTHERS; COMMUNICATIONS NETWORK DISASTER RECOVERY PLANNING SERVICES; COMPUTER DATA RECOVERY SERVI-

CES; COMPUTER SERVICES, NAMELY, FORENSIC ANALYSIS OF COMPUTER CRIMES FOR OTHERS, COMPUTER RECOVERY OPERATIONS FOR OTHERS, FORENSIC ANALYSIS OF COMPUTER MEDIA FOR OTHERS, ANALYSIS OF DIGITAL ENCRYPTION AND DECRYPTION FOR OTHERS; COMPUTER SERVICES, NAMELY, PROVIDING SECURE DIGITAL AUTHENTICATION SUPPORT FOR OTHERS; COMPUTER SERVICES, NAMELY, ANALYSIS OF COMPUTER AND COMPUTER NETWORK INTRUSION FOR OTHERS; COMPUTER SERVICES, NAMELY, COMMUNICATIONS NETWORK PLANNING AND MANAGEMENT SERVICES FOR OTHERS; COMPUTER SERVICES, NAMELY, PROVIDING COMPUTER NETWORK SIMULATION SERVICES AND PENETRATION TESTING SERVICES FOR OTHERS; DATA WAREHOUSING AND DOCUMENT MANAGEMENT SERVICES FOR OTHERS; COMPUTER SERVICES, NAMELY, DESIGNING SECURE ENTERPRISE MESSAGING SERVICES FOR OTHERS; TECHNICAL SUPPORT SERVICES, NAMELY, TROUBLESHOOTING OF COMPUTER HARDWARE AND SOFTWARE PROBLEMS; DESIGN AND DEVELOPMENT OF COMPUTER MULTI-MEDIA SOFTWARE APPLICATIONS, IN CLASS 42 (U.S. CLS. 100 AND 101).

FIRST USE 2-12-2002; IN COMMERCE 2-12-2002.

FOR: MONITORING OF COMPUTER SYSTEMS AND NETWORKS FOR SECURITY PURPOSES, IN CLASS 45 (U.S. CLS. 100 AND 101).

FIRST USE 2-12-2002; IN COMMERCE 2-12-2002.

THE MARK CONSISTS OF STANDARD CHARACTERS WITHOUT CLAIM TO ANY PARTICULAR FONT, STYLE, SIZE, OR COLOR.

SN 78-721,200, FILED 9-27-2005.

CAROL SPILS, EXAMINING ATTORNEY

Int. Cl.: 20

Prior U.S. Cls.: 2, 13, 22, 25, 32, and 50

Reg. No. 3,478,030

United States Patent and Trademark Office

Registered July 29, 2008

**TRADEMARK
PRINCIPAL REGISTER**

**BECAUSE - HEALTHY SLEEP
CAN'T START EARLY ENOUGH**

KINGSDOWN, INC. (NORTH CAROLINA COR-
PORATION)
P.O. BOX 388
MEBANE, NC 27302

THE MARK CONSISTS OF STANDARD CHAR-
ACTERS WITHOUT CLAIM TO ANY PARTICULAR
FONT, STYLE, SIZE, OR COLOR.

FOR: MATTRESSES AND BOX SPRINGS, IN
CLASS 20 (U.S. CLS. 2, 13, 22, 25, 32 AND 50).

SN 78-722,195, FILED 9-28-2005.

FIRST USE 10-20-2005; IN COMMERCE 1-4-2006.

ESTHER A. BORSUK, EXAMINING ATTORNEY

Int. Cl.: 20

Prior U.S. Cls.: 2, 13, 22, 25, 32, and 50

Reg. No. 3,478,031

United States Patent and Trademark Office

Registered July 29, 2008

**TRADEMARK
PRINCIPAL REGISTER**

THE MATTRESS THAT GROWS UP
WITH YOU

KINGSDOWN, INC. (NORTH CAROLINA COR-
PORATION)
P.O. BOX 388
MEBANE, NC 27302

THE MARK CONSISTS OF STANDARD CHAR-
ACTERS WITHOUT CLAIM TO ANY PARTICULAR
FONT, STYLE, SIZE, OR COLOR.

FOR: MATTRESSES AND BOX SPRINGS, IN
CLASS 20 (U.S. CLS. 2, 13, 22, 25, 32 AND 50).

SN 78-722,212, FILED 9-28-2005.

FIRST USE 10-20-2005; IN COMMERCE 1-4-2006.

DAVID TOOLEY, EXAMINING ATTORNEY

Int. Cl.: 36

Prior U.S. Cls.: 100, 101, and 102

United States Patent and Trademark Office

Reg. No. 3,478,032

Registered July 29, 2008

**SERVICE MARK
PRINCIPAL REGISTER**



GIFTCO, INC. (ILLINOIS CORPORATION)
700 WOODLANDS PARKWAY
VERNON HILLS, IL 60061

FIRST USE 2-0-2005; IN COMMERCE 2-0-2005.

FOR: CHARITABLE FUND RAISING CONSULTING SERVICES, NAMELY, PROVIDING GUIDANCE TO OTHERS REGARDING MERCHANDISE, EQUIPMENT, FACILITIES, PROGRAMS, AND PROMOTIONAL MATERIALS FOR FUND RAISING, IN CLASS 36 (U.S. CLS. 100, 101 AND 102).

THE MARK CONSISTS OF A STYLIZED BEAR HOLDING A STACK OF GIFT BOXES.

SN 78-722,487, FILED 9-28-2005.

MATTHEW PAPPAS, EXAMINING ATTORNEY

Int. Cl.: 35

Prior U.S. Cls.: 100, 101, and 102

United States Patent and Trademark Office

Reg. No. 3,478,033

Registered July 29, 2008

**SERVICE MARK
PRINCIPAL REGISTER**

LUSH
WINE AND SPIRITS

LUSH WINE & SPIRITS, LLC (ILLINOIS LTD
LIAB CO)
1251 SOUTH HALSTED STREET
CHICAGO, IL 60607

FOR: RETAIL STORE SERVICES FEATURING
WINE AND SPIRITS, IN CLASS 35 (U.S. CLS. 100, 101
AND 102).

FIRST USE 12-0-2005; IN COMMERCE 12-0-2005.

NO CLAIM IS MADE TO THE EXCLUSIVE
RIGHT TO USE "WINE AND SPIRITS", APART
FROM THE MARK AS SHOWN.

THE MARK CONSISTS OF STYLIZED LETTERS
AND PLACEMENT OF THE WORDS "LUSH WINE
AND SPIRITS".

SN 78-728,823, FILED 10-7-2005.

STEVEN JACKSON, EXAMINING ATTORNEY

Int. Cl.: 1

Prior U.S. Cls.: 1, 5, 6, 10, 26, and 46

United States Patent and Trademark Office

Reg. No. 3,478,034

Registered July 29, 2008

**TRADEMARK
PRINCIPAL REGISTER**

POSTER DOTS

GLUE DOTS INTERNATIONAL, LLC (WISCONSIN LTD LIAB CO)
5575 SOUTH WESTRIDGE DRIVE
NEW BERLIN, WI 53151

OWNER OF U.S. REG. NOS. 2,478,948, 2,756,882,
AND OTHERS.

FOR: ADHESIVES FOR GENERAL COMMERCIAL, GENERAL INDUSTRIAL AND HOUSEHOLD PURPOSES, IN CLASS 1 (U.S. CLS. 1, 5, 6, 10, 26 AND 46).

NO CLAIM IS MADE TO THE EXCLUSIVE RIGHT TO USE "POSTER", APART FROM THE MARK AS SHOWN.

FIRST USE 6-1-2008; IN COMMERCE 6-1-2008.

SN 78-730,976, FILED 10-11-2005.

THE MARK CONSISTS OF STANDARD CHARACTERS WITHOUT CLAIM TO ANY PARTICULAR FONT, STYLE, SIZE, OR COLOR.

EDWARD NELSON, EXAMINING ATTORNEY

Int. Cl.: 16

Prior U.S. Cls.: 2, 5, 22, 23, 29, 37, 38, and 50

United States Patent and Trademark Office

Reg. No. 3,478,035

Registered July 29, 2008

TRADEMARK
PRINCIPAL REGISTER



WEST, DAVID A. (UNITED STATES INDIVIDUAL)
22852 NORTH 103RD LANE
PEORIA, AZ 85383

FOR: SERIES OF NON-FICTION BOOKS IN THE FIELD OF SPORTS, IN CLASS 16 (U.S. CLS. 2, 5, 22, 23, 29, 37, 38 AND 50).

FIRST USE 4-16-2008; IN COMMERCE 4-16-2008.

NO CLAIM IS MADE TO THE EXCLUSIVE RIGHT TO USE "BOOK", APART FROM THE MARK AS SHOWN.

THE COLOR(S) YELLOW, RED, WHITE AND BLACK IS/ARE CLAIMED AS A FEATURE OF THE MARK.

THE MARK CONSISTS OF THE COLOR YELLOW IN THE SQUARE WITH THE WORDS A J.O.C.K. BOOK AND SURROUNDING THE RUNNING MAN DESIGN PORTION OF THE MARK; THE COLOR RED IN THE RECTANGLE WITH THE WORDS JOURNEY OF CHAMPIONSHIP KIDS AND THE RUNNING MAN DESIGN PORTION OF THE MARK; THE COLOR BLACK FOR THE LETTERING FOR THE WORDS A J.O.C.K. BOOK AND JOURNEY OF CHAMPIONSHIP KIDS; AND THE COLOR WHITE APPEARS IN THE BODY OF THE RUNNING MAN DESIGN PORTION OF THE MARK

SN 78-731,833, FILED 10-12-2005.

INGA ERVIN, EXAMINING ATTORNEY

Int. Cls.: 39 and 44

Prior U.S. Cls.: 100, 101, and 105

United States Patent and Trademark Office

Reg. No. 3,478,036

Registered July 29, 2008

**SERVICE MARK
PRINCIPAL REGISTER**



JBS UNITED, INC. (INDIANA CORPORATION)
4310 STATE ROAD 38 WEST
SHERIDAN, IN 46069

FOR: FREIGHT TRANSPORTATION BY TRUCK;
TRANSPORTATION AND STORAGE OF GRAINS
AND BEANS, IN CLASS 39 (U.S. CLS. 100 AND 105).

FIRST USE 11-0-2007; IN COMMERCE 11-0-2007.

FOR: PIG FARMS; AQUACULTURE SERVICES,
IN CLASS 44 (U.S. CLS. 100 AND 101).

FIRST USE 8-0-2006; IN COMMERCE 8-0-2006.

OWNER OF U.S. REG. NOS. 2,167,093 AND
2,176,242.

SN 78-732,875, FILED 10-13-2005.

ADA HAN, EXAMINING ATTORNEY

Int. Cl.: 9

Prior U.S. Cls.: 21, 23, 26, 36, and 38

Reg. No. 3,478,037

United States Patent and Trademark Office

Registered July 29, 2008

**TRADEMARK
PRINCIPAL REGISTER**

GTSGI

G TECH SYSTEMS GROUP INC. (CALIFORNIA
CORPORATION)
1259 E LOCUST STREET
ONTARIO, CA 91761

THE MARK CONSISTS OF STANDARD CHAR-
ACTERS WITHOUT CLAIM TO ANY PARTICULAR
FONT, STYLE, SIZE, OR COLOR.

FOR: SEMICONDUCTOR DEVICES AND PARTS
THEREOF, IN CLASS 9 (U.S. CLS. 21, 23, 26, 36 AND
38).

SN 78-733,907, FILED 10-14-2005.

FIRST USE 8-30-2006; IN COMMERCE 5-12-2008.

ALICE BENMAMAN, EXAMINING ATTORNEY

Int. Cl.: 41

Prior U.S. Cls.: 100, 101, and 107

United States Patent and Trademark Office

Reg. No. 3,478,038

Registered July 29, 2008

**SERVICE MARK
PRINCIPAL REGISTER**

IMPRINT SCIENCE

WPP PROPERTIES (DELAWARE PARTNERSHIP)
1001 FRONT STREET
SAN FRANCISCO, CA 94111

FOR: MEDICAL EDUCATIONAL SERVICES, NAMELY, DEVELOPING, ORGANIZING AND CONDUCTING CONTINUING EDUCATIONAL CONFERENCES, SEMINARS, MEETINGS AND OTHER EVENTS FOR PHYSICIANS AND HEALTH CARE PROFESSIONALS, AND DEVELOPING COURSE MATERIALS DISTRIBUTED THEREWITH; CONDUCTING INDEPENDENT OR ACCREDITED EDUCATIONAL CONFERENCES, SEMINARS AND MEETINGS FUNDED THROUGH EDUCATIONAL GRANTS IN THE FIELDS OF HEALTHCARE AND PHARMACEUTICALS; AND

PUBLICATION PLANNING SERVICES IN THE HEALTHCARE AND PHARMACEUTICAL FIELDS, IN CLASS 41 (U.S. CLS. 100, 101 AND 107).

FIRST USE 10-0-2003; IN COMMERCE 10-0-2003.

THE MARK CONSISTS OF STANDARD CHARACTERS WITHOUT CLAIM TO ANY PARTICULAR FONT, STYLE, SIZE, OR COLOR.

OWNER OF U.S. REG. NO. 2,484,699.

SN 78-738,992, FILED 10-24-2005.

DAVID TOOLEY, EXAMINING ATTORNEY

Int. Cl.: 44

Prior U.S. Cls.: 100 and 101

United States Patent and Trademark Office

Reg. No. 3,478,039

Registered July 29, 2008

**SERVICE MARK
PRINCIPAL REGISTER**



MEDICAL BARIATRICS AMERICA, LLC (IDAHO
LTD LIAB CO)
1423 WEST FRANKLIN
BOISE, ID 83702

FOR: WEIGHT REDUCTION DIET PLANNING
AND SUPERVISION, IN CLASS 44 (U.S. CLS. 100
AND 101).

FIRST USE 12-31-2006; IN COMMERCE 12-31-2006.

NO CLAIM IS MADE TO THE EXCLUSIVE
RIGHT TO USE "MEDICAL BARIATRICS AMER-
ICA", APART FROM THE MARK AS SHOWN.

THE MARK CONSISTS OF A STYLIZED BODY
OF A PERSON IN A CIRCLE AND THE WORDS
"MEDICAL BARIATRICS AMERICA".

SN 78-739,523, FILED 10-24-2005.

ELLEN PERKINS, EXAMINING ATTORNEY

Int. Cl.: 19

Prior U.S. Cls.: 1, 12, 33, and 50

United States Patent and Trademark Office

Reg. No. 3,478,040

Registered July 29, 2008

**TRADEMARK
PRINCIPAL REGISTER**

MODULUS

HOMELAND VINYL PRODUCTS, INC. (ALABA-
MA CORPORATION)
3300 PINSON VALLEY PARKWAY, INC.
BIRMINGHAM, AL 352170729

THE MARK CONSISTS OF STANDARD CHAR-
ACTERS WITHOUT CLAIM TO ANY PARTICULAR
FONT, STYLE, SIZE, OR COLOR.

FOR: PVC FENCING, RAILING, AND DECKING,
AND RELATED HARDWARE NECESSARY FOR
INSTALLATION SOLD AS A UNIT, IN CLASS 19
(U.S. CLS. 1, 12, 33 AND 50).

SN 78-739,741, FILED 10-25-2005.

FIRST USE 4-17-2007; IN COMMERCE 4-17-2007.

EDWARD NELSON, EXAMINING ATTORNEY

Int. Cl.: 11

Prior U.S. Cls.: 13, 21, 23, 31, and 34

Reg. No. 3,478,041

United States Patent and Trademark Office

Registered July 29, 2008

TRADEMARK
PRINCIPAL REGISTER

ATARA

TECKNOWLEDGE CAPITAL HOLDINGS LIMITED (BR.VIRGIN ISLANDS LIMITED COMPANY)
CITCO BUILDING WICKHAMS CAY
P.O. BOX 662
ROAD TOWN, TORTOLA, BR.VIRGIN ISLANDS

FOR: WASTEWATER TREATMENT AND WATER RECLAMATION UNITS, IN CLASS 11 (U.S. CLS. 13, 21, 23, 31 AND 34).

FIRST USE 8-20-2007; IN COMMERCE 8-20-2007.

THE MARK CONSISTS OF STANDARD CHARACTERS WITHOUT CLAIM TO ANY PARTICULAR FONT, STYLE, SIZE, OR COLOR.

PRIORITY CLAIMED UNDER SEC. 44(D) ON CANADA APPLICATION NO. 1274739, FILED 10-6-2005.

SN 78-739,916, FILED 10-25-2005.

MARK RADEMACHER, EXAMINING ATTORNEY

Int. Cl.: 11

Prior U.S. Cls.: 13, 21, 23, 31, and 34

United States Patent and Trademark Office

Reg. No. 3,478,042

Registered July 29, 2008

**TRADEMARK
PRINCIPAL REGISTER**



TECKNOWLEDGE CAPITAL HOLDINGS LIMITED (BR.VIRGIN ISLANDS LIMITED COMPANY)
CITCO BUILDING, WICKHAMS CAY
P.O. BOX 662
ROAD TOWN, TORTOLA, BR.VIRGIN ISLANDS

FOR: WASTEWATER TREATMENT AND WATER RECLAMATION UNITS, IN CLASS 11 (U.S. CLS. 13, 21, 23, 31 AND 34).

FIRST USE 8-20-2007; IN COMMERCE 8-20-2007.

PRIORITY CLAIMED UNDER SEC. 44(D) ON CANADA APPLICATION NO. 1274742, FILED 10-6-2005.

SN 78-739,962, FILED 10-25-2005.

MARK RADEMACHER, EXAMINING ATTORNEY

Int. Cl.: 41

Prior U.S. Cls.: 100, 101, and 107

United States Patent and Trademark Office

Reg. No. 3,478,043

Registered July 29, 2008

**SERVICE MARK
PRINCIPAL REGISTER**

GRETTASTYLE

GRETТА ENTERPRISES, LLC (MASSACHU-
SETTS LTD LIAB CO)
19 KEARNEY ROAD
NEEDHAM, MA 02494

FOR: PROVIDING AN ON-LINE PUBLICATION,
NAMELY, A NEWSLETTER ON BEAUTY AND
FASHION TRENDS VIA A GLOBAL COMPUTER
NETWORK, IN CLASS 41 (U.S. CLS. 100, 101 AND
107).

FIRST USE 1-0-2004; IN COMMERCE 1-0-2004.

THE MARK CONSISTS OF STANDARD CHAR-
ACTERS WITHOUT CLAIM TO ANY PARTICULAR
FONT, STYLE, SIZE, OR COLOR.

OWNER OF U.S. REG. NOS. 2,821,023 AND
2,980,421.

THE NAME "GRETTA" IDENTIFIES A LIVING
INDIVIDUAL WHOSE CONSENT IS OF RECORD.

SN 78-740,350, FILED 10-25-2005.

SOPHIA S. KIM, EXAMINING ATTORNEY

Int. Cl.: 35

Prior U.S. Cls.: 100, 101, and 102

United States Patent and Trademark Office

Reg. No. 3,478,044

Registered July 29, 2008

**SERVICE MARK
PRINCIPAL REGISTER**

ME B'N ME

THE MADJO COMPANY, LLC (VIRGINIA LTD
LIAB CO)
2669 EINSTEIN DRIVE
VIRGINIA BEACH, VA 23456

FOR: COMPUTERIZED ON-LINE RETAIL STORE
SERVICES IN THE FIELD OF CLOTHING AND
APPAREL; ELECTRONIC RETAILING SERVICES
VIA COMPUTER FEATURING CLOTHING AND
APPAREL; ON-LINE RETAIL STORE SERVICES
FEATURING CLOTHING AND APPAREL, IN
CLASS 35 (U.S. CLS. 100, 101 AND 102).

FIRST USE 7-20-2007; IN COMMERCE 8-1-2007.

THE MARK CONSISTS OF STANDARD CHAR-
ACTERS WITHOUT CLAIM TO ANY PARTICULAR
FONT, STYLE, SIZE, OR COLOR.

SN 78-742,478, FILED 10-28-2005.

EDWARD NELSON, EXAMINING ATTORNEY

Int. Cl.: 30

Prior U.S. Cl.: 46

United States Patent and Trademark Office

Reg. No. 3,478,045

Registered July 29, 2008

TRADEMARK
PRINCIPAL REGISTER



JUST LIKE SISTERS, LLC (VIRGINIA LTD LIAB
CO)
12740 STONEBRIAR LANE
RICHMON, VA 23233

FOR: GIFT BOXES, NAMELY, A CARDBOARD
BOX COMPRISING GOURMET TEA AND CHOCO-
LATES, A JOURNAL AND A TEACUP AND SAU-
CER, IN CLASS 30 (U.S. CL. 46).

FIRST USE 6-0-2007; IN COMMERCE 6-0-2007.

NO CLAIM IS MADE TO THE EXCLUSIVE
RIGHT TO USE "BOX", APART FROM THE MARK
AS SHOWN.

THE COLOR(S) PINK, ORANGE, BLACK AND
WHITE IS/ARE CLAIMED AS A FEATURE OF THE
MARK.

THE MARK CONSISTS OF A PARTIALLY
OPENED GIFT BOX WITH WHITE, PINK AND
ORANGE STRIPES AND PINK BOW ON TOP.
WORDS JOY BOX APPEAR IN BLACK ABOVE
THE BOW.

SN 78-742,658, FILED 10-28-2005.

CHARLES L. JENKINS, EXAMINING ATTORNEY

Int. Cl.: 30

Prior U.S. Cl.: 46

United States Patent and Trademark Office

Reg. No. 3,478,046

Registered July 29, 2008

**TRADEMARK
PRINCIPAL REGISTER**

joy box

JUST LIKE SISTERS, LLC (VIRGINIA LTD LIAB
CO)
12740 STONEBRIAR LANE
RICHMON, VA 23233

FOR: GIFT BOXES, NAMELY, A CARDBOARD
BOX COMPRISING GOURMET TEA AND CHOCO-
LATES, A JOURNAL, AND A TEACUP AND SAU-
CER, IN CLASS 30 (U.S. CL. 46).

FIRST USE 6-0-2007; IN COMMERCE 6-0-2007.

THE MARK CONSISTS OF STANDARD CHAR-
ACTERS WITHOUT CLAIM TO ANY PARTICULAR
FONT, STYLE, SIZE, OR COLOR.

NO CLAIM IS MADE TO THE EXCLUSIVE
RIGHT TO USE "BOX", APART FROM THE MARK
AS SHOWN.

SN 78-742,671, FILED 10-28-2005.

CHARLES L. JENKINS, EXAMINING ATTORNEY

Int. Cls.: 17 and 40

Prior U.S. Cls.: 1, 5, 12, 13, 35, 50, 100, 103, and 106

Reg. No. 3,478,047

United States Patent and Trademark Office

Registered July 29, 2008

**TRADEMARK
SERVICE MARK
PRINCIPAL REGISTER**



PENTAGON PROTECTION USA (NEBRASKA
LTD LIAB CO)
6365 SHIER-RINGS ROAD
DUBLIN, OH 43016

FOR: PLASTIC FILM THAT IS USED TO TINT,
PROTECT, SHATTER-PROOF, AND ADD REFLEC-
TIVE PROPERTIES TO GLASS AND WINDOWS
FOR USE IN ALL HOME, AUTO, AND COMMERCIAL
APPLICATIONS, IN CLASS 17 (U.S. CLS. 1, 5,
12, 13, 35 AND 50).

FIRST USE 10-27-2005; IN COMMERCE 10-27-2005.

FOR: GLASS AND WINDOW TINTING, IN CLASS
40 (U.S. CLS. 100, 103 AND 106).

FIRST USE 10-27-2005; IN COMMERCE 10-27-2005.

NO CLAIM IS MADE TO THE EXCLUSIVE
RIGHT TO USE "PROTECTION USA", APART
FROM THE MARK AS SHOWN.

THE COLOR(S) RED AND BLUE IS/ARE
CLAIMED AS A FEATURE OF THE MARK.

THE COLOR RED APPEARS IN THE INNER
LINING OF THE DESIGN OF A PENTAGON AND
THE WORDING "PROTECTION USA". THE COLOR
BLUE APPEARS IN THE OUTER LINING OF THE
DESIGN OF A PENTAGON AND THE WORDING
"PENTAGON".

SN 78-743,962, FILED 10-31-2005.

DANNEAN HETZEL, EXAMINING ATTORNEY

Int. Cl.: 35

Prior U.S. Cls.: 100, 101, and 102

United States Patent and Trademark Office

Reg. No. 3,478,048

Registered July 29, 2008

**SERVICE MARK
PRINCIPAL REGISTER**

Cool Art Stuff

COOLGRAPHICSSTUFF (NEW YORK PARTNER-
SHIP)
481 8TH AVE BOX J29 SUITE 1738
NEW YORK, NY 10001

FOR: MAIL ORDER CATALOG SERVICES AND
RETAIL STORE SERVICES FEATURING ARTISTS'
SUPPLIES, IN CLASS 35 (U.S. CLS. 100, 101 AND 102).

FIRST USE 9-0-2005; IN COMMERCE 9-0-2005.

THE MARK CONSISTS OF STANDARD CHAR-
ACTERS WITHOUT CLAIM TO ANY PARTICULAR
FONT, STYLE, SIZE, OR COLOR.

NO CLAIM IS MADE TO THE EXCLUSIVE
RIGHT TO USE "ART", APART FROM THE MARK
AS SHOWN.

SN 78-748,513, FILED 11-7-2005.

DAWN HAN, EXAMINING ATTORNEY

Int. Cl.: 41

Prior U.S. Cls.: 100, 101, and 107

United States Patent and Trademark Office

Reg. No. 3,478,049

Registered July 29, 2008

SERVICE MARK
PRINCIPAL REGISTER



ATLANTA NATIONAL LEAGUE BASEBALL
CLUB, INC. (GEORGIA CORPORATION)
755 HANK AARON DRIVE
ATLANTA, GA 30315

FOR: ENTERTAINMENT SERVICES, NAMELY, BASEBALL GAMES, COMPETITIONS, TOURNAMENTS AND EXHIBITIONS RENDERED LIVE AND THROUGH BROADCAST MEDIA, NAMELY, TELEVISION, RADIO, SATELLITE, WIRELESS, AUDIO AND VIDEO MEDIA, TELEPHONE, FIBER OPTICS, WI-FI AND OTHER ELECTRONIC MEDIA AND VIA A GLOBAL COMPUTER NETWORK OR A COMMERCIAL ON-LINE SERVICE; INFORMATION SERVICES, NAMELY, PROVIDING INFORMATION IN THE FIELD OF SPORTS, ENTERTAINMENT AND RELATED TOPICS, AND PROVIDING FOR INFORMATIONAL MESSAGES RELATING THERETO; ENTERTAINMENT SERVICES, NAMELY, PROVIDING MULTI-USER INTERACTIVE NON-DOWNLOADABLE COMPUTER GAMES ALL VIA A GLOBAL COMPUTER NETWORK OR A COMMERCIAL ON-LINE SERVICE; EDUCATIONAL SERVICES IN THE NATURE OF BASEBALL SKILLS PROGRAMS, BASEBALL CAMPS, SEMINARS AND CLINICS OFFERED LIVE

AND THROUGH ON-LINE INSTRUCTION; ENTERTAINMENT SERVICES, NAMELY, PRODUCTION OF PROGRAMMING BROADCAST VIA TELEVISION, RADIO AND A GLOBAL COMPUTER NETWORK OR A COMMERCIAL ON-LINE SERVICE; ORGANIZING COMMUNITY SPORTING EVENTS; PROVIDING FACILITIES FOR SPORTS TOURNAMENTS AND COMPETITIONS RELATING TO BASEBALL; ORGANIZING AND CONDUCTING FANTASY SPORTS, SPORTS CONTESTS AND SWEEPSTAKES; FAN CLUBS; PROVIDING ON-LINE NEWSLETTERS IN THE FIELD OF BASEBALL, IN CLASS 41 (U.S. CLS. 100, 101 AND 107).

FIRST USE 4-10-1987; IN COMMERCE 4-10-1987.

OWNER OF U.S. REG. NO. 1,562,208.

NO CLAIM IS MADE TO THE EXCLUSIVE RIGHT TO USE "ATLANTA", APART FROM THE MARK AS SHOWN.

SN 78-749,015, FILED 11-8-2005.

ALYSSA PALADINO, EXAMINING ATTORNEY

Int. Cls.: 9 and 42

Prior U.S. Cls.: 21, 23, 26, 36, 38, 100, and 101

United States Patent and Trademark Office

Reg. No. 3,478,050

Registered July 29, 2008

**TRADEMARK
SERVICE MARK
PRINCIPAL REGISTER**

MULTICORE PLUS

MERCURY COMPUTER SYSTEMS, INC. (MAS-
SACHUSETTS CORPORATION)
199 RIVERNECK ROAD
CHELMSFORD, MA 01824

FOR: COMPUTER SOFTWARE DEVELOPMENT
TOOLS AND RUN-TIME LIBRARIES FOR USE IN
RUNNING COMPUTER SOFTWARE PROGRAMS,
IN CLASS 9 (U.S. CLS. 21, 23, 26, 36 AND 38).

FIRST USE 12-0-2005; IN COMMERCE 12-0-2005.

FOR: DESIGN AND IMPLEMENTATION OF
COMPUTER SOFTWARE, IN CLASS 42 (U.S. CLS.
100 AND 101).

FIRST USE 12-0-2005; IN COMMERCE 12-0-2005.

THE MARK CONSISTS OF STANDARD CHAR-
ACTERS WITHOUT CLAIM TO ANY PARTICULAR
FONT, STYLE, SIZE, OR COLOR.

SN 78-750,051, FILED 11-9-2005.

GIANCARLO CASTRO, EXAMINING ATTORNEY

Int. Cl.: 32

Prior U.S. Cls.: 45, 46, and 48

Reg. No. 3,478,051

United States Patent and Trademark Office

Registered July 29, 2008

**TRADEMARK
PRINCIPAL REGISTER**

TORQ

HYDROPOUCH CORPORATION (ILLINOIS CORPORATION)
SUITE 202
1601 S. MICHIGAN AVE.
CHICAGO, IL 60616

FOR: NON-ALCOHOLIC BEVERAGES, NAMELY, FRUIT FLAVORED DRINKS, SOFT DRINKS, NON-ALCOHOLIC WINE, FRUIT JUICES, DRINKING WATER, AND SPORTS DRINKS, IN CLASS 32 (U.S. CLS. 45, 46 AND 48).

FIRST USE 4-9-2008; IN COMMERCE 4-9-2008.

THE MARK CONSISTS OF STANDARD CHARACTERS WITHOUT CLAIM TO ANY PARTICULAR FONT, STYLE, SIZE, OR COLOR.

SN 78-750,317, FILED 11-9-2005.

TIMOTHY FINNEGAN, EXAMINING ATTORNEY

Int. Cl.: 9

Prior U.S. Cls.: 21, 23, 26, 36, and 38

United States Patent and Trademark Office

Reg. No. 3,478,052

Registered July 29, 2008

**TRADEMARK
PRINCIPAL REGISTER**

Billy the Kid

GLOBAL GAMING GROUP (NEVADA CORPORATION)
SUITE 14
3035 E. PATRICK LANE
LAS VEGAS, NV 89120

FOR: GAMBLING MACHINES; GAMING EQUIPMENT, NAMELY, SLOT MACHINES WITH OR WITHOUT VIDEO OUTPUT; GAMING MACHINES; MACHINES FOR PLAYING GAMES OF CHANCE; SLOT MACHINES, IN CLASS 9 (U.S. CLS. 21, 23, 26, 36 AND 38).

FIRST USE 6-21-2006; IN COMMERCE 6-21-2006.

THE MARK CONSISTS OF STANDARD CHARACTERS WITHOUT CLAIM TO ANY PARTICULAR FONT, STYLE, SIZE, OR COLOR.

SN 78-750,876, FILED 11-9-2005.

ELIZABETH BEYER, EXAMINING ATTORNEY

Int. Cl.: 9

Prior U.S. Cls.: 21, 23, 26, 36, and 38

United States Patent and Trademark Office

Reg. No. 3,478,053

Registered July 29, 2008

**TRADEMARK
PRINCIPAL REGISTER**

Bad to the Bone

GLOBAL GAMING GROUP (NEVADA CORPORATION)
SUITE 14
3035 E. PATRICK LANE
LAS VEGAS, NV 89120

FOR: GAMBLING MACHINES; GAMING EQUIPMENT, NAMELY, SLOT MACHINES WITH OR WITHOUT VIDEO OUTPUT; GAMING MACHINES; MACHINES FOR PLAYING GAMES OF CHANCE; SLOT MACHINES, IN CLASS 9 (U.S. CLS. 21, 23, 26, 36 AND 38).

FIRST USE 4-19-2007; IN COMMERCE 4-19-2007.

THE MARK CONSISTS OF STANDARD CHARACTERS WITHOUT CLAIM TO ANY PARTICULAR FONT, STYLE, SIZE, OR COLOR.

SN 78-750,880, FILED 11-9-2005.

ELIZABETH BEYER, EXAMINING ATTORNEY

Int. Cl.: 9

Prior U.S. Cls.: 21, 23, 26, 36, and 38

Reg. No. 3,478,054

United States Patent and Trademark Office

Registered July 29, 2008

**TRADEMARK
PRINCIPAL REGISTER**

Tippy Toe Toons

KOCH, GEOFF B. (UNITED STATES INDIVIDUAL)
1920 CHURCHILL DOWNS
LEBANON, TN 37087

FOR: MUSICAL SOUND RECORDINGS; CDS FEATURING MUSICALS THAT LEAD A CHILD THROUGH THEIR NIGHT TIME ROUTINE WITH SONGS FOR WASHING, SHAMPOOING, PLAYING IN THE TUB, PUTTING ON THEIR PAJAMAS, BRUSHING THEIR TEETH, PREPARING TO READ A BEDTIME BOOK AND A LULLABY, AND THAT REINFORCE THE PROPER BEDTIME ROUTINE THROUGH SONGS AND HUMOR THAT MAKE GETTING READY FOR BEDTIME FUN FOR CHILDREN AND PARENTS; DIGITAL DOWNLOADS, NAMELY DOWNLOADABLE FILMS AND TV PROGRAMS PROVIDED VIA A VIDEO-ON-DEMAND; DOWNLOADABLE MOTION PICTURES AND TV SHOWS ABOUT BATH AND BEDTIME ENTERTAINMENT; DOWNLOADABLE ELECTRONIC PUBLICATIONS IN THE NATURE OF MUSIC BOOKS, SHEET MUSIC, CHILDREN'S STORY

BOOKS, COLORING BOOKS, ACTIVITY BOOKLETS CONTAINING COLORING PAGES AND NEWSLETTERS THAT HELP LEAD A CHILD THROUGH THEIR NIGHT TIME ROUTINE AND MAKE GETTING READY FOR BEDTIME FUN FOR CHILDREN AND PARENTS, IN CLASS 9 (U.S. CLS. 21, 23, 26, 36 AND 38).

FIRST USE 1-31-2006; IN COMMERCE 1-31-2006.

THE MARK CONSISTS OF STANDARD CHARACTERS WITHOUT CLAIM TO ANY PARTICULAR FONT, STYLE, SIZE, OR COLOR.

NO CLAIM IS MADE TO THE EXCLUSIVE RIGHT TO USE "TOONS", APART FROM THE MARK AS SHOWN.

SN 78-751,998, FILED 11-11-2005.

COLLEEN DOMBROW, EXAMINING ATTORNEY

Int. Cl.: 3

Prior U.S. Cls.: 1, 4, 6, 50, 51, and 52

United States Patent and Trademark Office

Reg. No. 3,478,055

Registered July 29, 2008

**TRADEMARK
PRINCIPAL REGISTER**

DESIGNER SKIN MOOD

DESIGNER SKIN, LLC (ARIZONA LTD LIAB CO)
6270 CORPORATE DRIVE
INDIANAPOLIS, IN 46278

FOR: COSMETIC SUN-TANNING PREPARATIONS; SELF-TANNING PREPARATIONS; SKIN GELS FOR ACCELERATING, ENHANCING OR EXTENDING TANS; TANNING CREAMS, IN CLASS 3 (U.S. CLS. 1, 4, 6, 50, 51 AND 52).

FIRST USE 11-1-2007; IN COMMERCE 11-1-2007.

THE MARK CONSISTS OF STANDARD CHARACTERS WITHOUT CLAIM TO ANY PARTICULAR FONT, STYLE, SIZE, OR COLOR.

OWNER OF U.S. REG. NOS. 2,415,111, 3,085,867, AND OTHERS.

NO CLAIM IS MADE TO THE EXCLUSIVE RIGHT TO USE "SKIN", APART FROM THE MARK AS SHOWN.

SN 78-755,387, FILED 11-16-2005.

MARY MUNSON, EXAMINING ATTORNEY

Int. Cl.: 31

Prior U.S. Cls.: 1 and 46

United States Patent and Trademark Office

Reg. No. 3,478,056

Registered July 29, 2008

**TRADEMARK
PRINCIPAL REGISTER**

ORCHARD'S PRIDE

ORCHARD SUPPLY HARDWARE LLC (DELA-
WARE LTD LIAB CO)
6450 VIA DEL ORO
SAN JOSE, CA 95119

THE MARK CONSISTS OF STANDARD CHAR-
ACTERS WITHOUT CLAIM TO ANY PARTICULAR
FONT, STYLE, SIZE, OR COLOR.

FOR: ROSES, IN CLASS 31 (U.S. CLS. 1 AND 46).

SN 78-755,985, FILED 11-17-2005.

FIRST USE 5-0-2007; IN COMMERCE 5-0-2007.

JENNY PARK, EXAMINING ATTORNEY

Int. Cl.: 31

Prior U.S. Cls.: 1 and 46

United States Patent and Trademark Office

Reg. No. 3,478,057

Registered July 29, 2008

**TRADEMARK
PRINCIPAL REGISTER**

SWEET SAN CARLOS

ORCHARD SUPPLY HARDWARE LLC (DELA-
WARE LTD LIAB CO)
6450 VIA DEL ORO
SAN JOSE, CA 95119

THE MARK CONSISTS OF STANDARD CHAR-
ACTERS WITHOUT CLAIM TO ANY PARTICULAR
FONT, STYLE, SIZE, OR COLOR.

FOR: ROSES, IN CLASS 31 (U.S. CLS. 1 AND 46).

SN 78-755,991, FILED 11-17-2005.

FIRST USE 5-0-2007; IN COMMERCE 5-0-2007.

JENNY PARK, EXAMINING ATTORNEY

Int. Cls.: 6 and 9

Prior U.S. Cls.: 2, 12, 13, 14, 21, 23, 25, 26, 36, 38, and 50

United States Patent and Trademark Office

Reg. No. 3,478,058

Registered July 29, 2008

**TRADEMARK
PRINCIPAL REGISTER**

FUKUI BYORA

FUKUI BYORA CO., LTD. (JAPAN CORPORATION)
1-7, YAMAZYURAKU
AWARA-SHI, FUKUI, JAPAN 919-0898

FOR: METAL HARDWARE, NAMELY, NUTS, SPRINGS, SCREWS, STUDS AND BOLTS; METAL PINS, NAMELY, BUCKLE PINS, CORE PINS, CONTACT PINS; METAL EXPANDING SLEEVES FOR AFFIXING SCREWS; METAL PIN CLUTCHES; METAL POLE PIECES; AND METAL BALL BLANKS, IN CLASS 6 (U.S. CLS. 2, 12, 13, 14, 23, 25 AND 50).

FIRST USE 10-0-2006; IN COMMERCE 10-0-2006.

FOR: WELDING ELECTRODES; COMPUTER TERMINALS; INSULATED ELECTRICAL CONNECTORS, IN CLASS 9 (U.S. CLS. 21, 23, 26, 36 AND 38).

FIRST USE 10-0-2006; IN COMMERCE 10-0-2006.

THE MARK CONSISTS OF STANDARD CHARACTERS WITHOUT CLAIM TO ANY PARTICULAR FONT, STYLE, SIZE, OR COLOR.

OWNER OF U.S. REG. NO. 2,018,641.

NO CLAIM IS MADE TO THE EXCLUSIVE RIGHT TO USE "FUKUI", APART FROM THE MARK AS SHOWN.

SN 78-757,308, FILED 11-18-2005.

INGA ERVIN, EXAMINING ATTORNEY

Int. Cl.: 40

Prior U.S. Cls.: 100, 103, and 106

United States Patent and Trademark Office

Reg. No. 3,478,059

Registered July 29, 2008

**SERVICE MARK
PRINCIPAL REGISTER**

TZAVORITE

OPTICOTE, INC. (ILLINOIS CORPORATION)
10455 SEYMOUR
FRANKLIN PARK, IL 60131

THE MARK CONSISTS OF STANDARD CHAR-
ACTERS WITHOUT CLAIM TO ANY PARTICULAR
FONT, STYLE, SIZE, OR COLOR.

FOR: APPLICATION OF COATINGS TO OPTICAL
SUBSTRATES INCLUDING OPTICAL LENSES, IN
CLASS 40 (U.S. CLS. 100, 103 AND 106).

SN 78-757,655, FILED 11-19-2005.

FIRST USE 3-31-2004; IN COMMERCE 3-31-2004.

LINDA E. BLOHM, EXAMINING ATTORNEY

Int. Cl.: 40

Prior U.S. Cls.: 100, 103, and 106

United States Patent and Trademark Office

Reg. No. 3,478,060

Registered July 29, 2008

**SERVICE MARK
PRINCIPAL REGISTER**

MAXXIMUS

OPTICOTE, INC. (ILLINOIS CORPORATION)
10455 SEYMOUR
FRANKLIN PARK, IL 60131

THE MARK CONSISTS OF STANDARD CHAR-
ACTERS WITHOUT CLAIM TO ANY PARTICULAR
FONT, STYLE, SIZE, OR COLOR.

FOR: APPLICATION OF COATINGS TO OPTICAL
SUBSTRATES INCLUDING OPTICAL LENSES, IN
CLASS 40 (U.S. CLS. 100, 103 AND 106).

SN 78-757,656, FILED 11-19-2005.

FIRST USE 10-15-2004; IN COMMERCE 10-15-2004.

LINDA E. BLOHM, EXAMINING ATTORNEY

Int. Cl.: 17

Prior U.S. Cls.: 1, 5, 12, 13, 35, and 50

Reg. No. 3,478,061

United States Patent and Trademark Office

Registered July 29, 2008

**TRADEMARK
PRINCIPAL REGISTER**

ULTI-LAST

AQUASYN LLC (NEVADA CORPORATION)
930 TAHOE BLVD. #802 PMB 489
INCLINE VILLAGE, NV 89451

FOR: ELASTOMERIC COMPOUNDS, ELASTOMERS, BLEND OF RUBBER MATERIAL, OR SYNTHETIC POLYMERS AND MATERIAL IN SHEETS MADE FROM THE ELASTOMERIC COMPOUNDS, ELASTOMERS, BLEND OF RUBBER MATERIAL, OR SYNTHETIC POLYMERS USED FOR THE PREPARATION OF O-RINGS, RINGS, DIAPHRAGMS, WASHERS, SEALS, GASKET SEALERS, GASKETS, AND SPECIALITY GASKETS THAT ARE USED IN THE BIOCHEMICAL, BIOTECHNICAL, PHARMA-

CEUTICAL AND SEMI-CONDUCTOR INDUSTRIES, IN CLASS 17 (U.S. CLS. 1, 5, 12, 13, 35 AND 50).

FIRST USE 1-13-2006; IN COMMERCE 1-13-2006.

THE MARK CONSISTS OF STANDARD CHARACTERS WITHOUT CLAIM TO ANY PARTICULAR FONT, STYLE, SIZE, OR COLOR.

OWNER OF U.S. REG. NOS. 2,569,362 AND 2,590,609.

SN 78-758,717, FILED 11-21-2005.

JAMES GRIFFIN, EXAMINING ATTORNEY

Int. Cl.: 9

Prior U.S. Cls.: 21, 23, 26, 36, and 38

United States Patent and Trademark Office

Reg. No. 3,478,062

Registered July 29, 2008

**TRADEMARK
PRINCIPAL REGISTER**



UWT GMBH (FED REP GERMANY CORPORATION)
WESTENDSTRASSE 5
BETZIGAU, FED REP GERMANY D-87488

FOR: ELECTRONIC MEASURE AND CONTROL APPARATUS FOR LEVEL CONTROL, CAPACITIVE AND CONDUCTIVE MEASURING PROBES, AND ULTRASONIC MEASURING SYSTEMS NOT DESTINED FOR MEDICAL PURPOSES, NAMELY, ROTATING PADDLE SWITCHES, LEVEL LIMIT SWITCHES, VIBRATING PROBES FOR LEVEL CONTROL; COMPUTER SOFTWARE FOR VISUALIZATION AND EVALUATION OF THE OUTPUT SIGNAL OF LEVEL CONTROL APPARATUS AND

FOR PROGRAMMING SAID LEVEL CONTROL APPARATUS, IN CLASS 9 (U.S. CLS. 21, 23, 26, 36 AND 38).

FIRST USE 0-0-1977; IN COMMERCE 0-0-2006.

PRIORITY CLAIMED UNDER SEC. 44(D) ON FED REP GERMANY APPLICATION NO. 30530296.5, FILED 5-25-2005.

SN 78-760,246, FILED 11-23-2005.

GIANCARLO CASTRO, EXAMINING ATTORNEY

Int. Cl.: 41

Prior U.S. Cls.: 100, 101, and 107

United States Patent and Trademark Office

Reg. No. 3,478,063

Registered July 29, 2008

SERVICE MARK
PRINCIPAL REGISTER



DEVELOPMENT CENTER FOR TEACHING CHINESE AS A FOREIGN LANGUAGE OF THE MINISTRY OF EDUCATION P.R.C. (CHINA MINISTRY OF EDUCATION)
17TH FLOOR, FANGYUAN MANSION B56 ZHONGGU
ANOUN SOUTH STREET;
BEIJING, CHINA 100044

FOR: EDUCATIONAL SERVICES, NAMELY, CONDUCTING CLASSES, PROGRAMS, EXAMINATIONS AND TRAINING IN THE FIELD OF CHINESE LANGUAGE INSTRUCTION; PUBLICATION OF BOOKS AND JOURNALS IN THE FIELD OF CHINESE LANGUAGE INSTRUCTION; PROVIDING A WEBSITE FEATURING CONTENT IN THE FIELD OF CHINESE LANGUAGE INSTRUCTION; TELEVISION AND RADIO PROGRAMMING FEATURING CONTENT IN THE FIELD OF CHINESE LANGUAGE INSTRUCTION; CONDUCTING SEMINARS, CONFERENCES, COLLOQUIUMS, CONVENTIONS AND SYMPOSIUMS IN THE FIELD OF CHINESE LANGUAGE INSTRUCTION, IN CLASS 41 (U.S. CLS. 100, 101 AND 107).

FIRST USE 11-17-2004; IN COMMERCE 3-1-2005.

NO CLAIM IS MADE TO THE EXCLUSIVE RIGHT TO USE "INSTITUTE" AND "THE NON-LATIN CHARACTERS WHICH TRANSLATE INTO INSTITUTE", APART FROM THE MARK AS SHOWN.

THE MARK CONSISTS OF A STYLIZED IMAGE OF A BIRD SUPERIMPOSED OVER A STYLIZED IMAGE OF A GLOBE, ALL WITHIN A CIRCLE.

THE FOREIGN WORDING IN THE MARK TRANSLATES INTO ENGLISH AS "CONFUCIUS INSTITUTE".

THE NON-LATIN CHARACTER(S) IN THE MARK TRANSLITERATES INTO KONG ZI XUE YUAN , AND THIS MEANS CONFUCIUS INSTITUTE IN ENGLISH.

SN 78-761,946, FILED 11-28-2005.

ELLEN PERKINS, EXAMINING ATTORNEY

Int. Cl.: 9

Prior U.S. Cls.: 21, 23, 26, 36, and 38

Reg. No. 3,478,064

United States Patent and Trademark Office

Registered July 29, 2008

**TRADEMARK
PRINCIPAL REGISTER**

GLOBAL STAR SUDOKU FEVER

TAKE-TWO INTERACTIVE SOFTWARE, INC.
(DELAWARE CORPORATION)
622 BROADWAY
NEW YORK, NY 10012

THE MARK CONSISTS OF STANDARD CHARACTERS WITHOUT CLAIM TO ANY PARTICULAR FONT, STYLE, SIZE, OR COLOR.

FOR: COMPUTER GAME PROGRAMS AND SOFTWARE; COMPUTER GAME CARTRIDGES AND INSTRUCTION MANUALS SOLD THEREWITH, IN CLASS 9 (U.S. CLS. 21, 23, 26, 36 AND 38).

OWNER OF U.S. REG. NO. 3,033,531.

SN 78-762,161, FILED 11-29-2005.

FIRST USE 2-9-2006; IN COMMERCE 2-9-2006.

EDWARD NELSON, EXAMINING ATTORNEY

Int. Cl.: 42

Prior U.S. Cls.: 100 and 101

United States Patent and Trademark Office

Reg. No. 3,478,065

Registered July 29, 2008

**SERVICE MARK
PRINCIPAL REGISTER**

MAPMORPH

HOUSTON ENGINEERING, INC. (NORTH DAKOTA CORPORATION)
2505 N. UNIVERSITY DRIVE
FARGO, ND 581055054

FOR: PROVIDING ONLINE NON-DOWNLOADABLE SOFTWARE FOR DISPLAYING INTERACTIVE GEOGRAPHICAL MAPS, INCLUDING TRANSPORTATION FEATURES, POLITICAL BOUNDARIES, AERIAL IMAGERY AND RIVERS, LAKES AND STREAMS, VIA THE INTERNET, IN CLASS 42 (U.S. CLS. 100 AND 101).

FIRST USE 7-31-2006; IN COMMERCE 12-31-2006.

THE MARK CONSISTS OF STANDARD CHARACTERS WITHOUT CLAIM TO ANY PARTICULAR FONT, STYLE, SIZE, OR COLOR.

SN 78-763,187, FILED 11-30-2005.

DAVID ELTON, EXAMINING ATTORNEY

Int. Cls.: 16, 25, 35, and 41

Prior U.S. Cls.: 2, 5, 22, 23, 29, 37, 38, 39, 50, 100, 101, 102, and 107

Reg. No. 3,478,066

United States Patent and Trademark Office

Registered July 29, 2008

**TRADEMARK
SERVICE MARK
PRINCIPAL REGISTER**

NYA JADE

OFOSU-BARKO, AMA (UNITED STATES INDIVIDUAL)
101 JEFFERSON DRIVE
MENLO PARK, CA 94025

FOR: STICKERS; POSTERS; PHOTOS; SOUVENIR PROGRAMS, IN CLASS 16 (U.S. CLS. 2, 5, 22, 23, 29, 37, 38 AND 50).

FIRST USE 1-1-2008; IN COMMERCE 1-1-2008.

FOR: CLOTHING FOR MEN, WOMEN, AND CHILDREN, NAMELY, T-SHIRTS, SHIRTS, SWEAT-SHIRTS, JACKETS, PANTS, FOOTWEAR, SOCKS, STOCKINGS, HEADBANDS, WRISTBANDS, SHORTS, HATS, CAPS, AND SCARVES, IN CLASS 25 (U.S. CLS. 22 AND 39).

FIRST USE 1-1-2008; IN COMMERCE 1-1-2008.

FOR: ON-LINE RETAIL STORE SERVICES FEATURING CDS, DVDS, ELECTRONIC MEDIA AND DATA FILES, CLOTHING, STICKERS, POSTERS, SOUVENIR PROGRAMS OF AND ABOUT PERFORMING AND RECORDING MUSICAL ARTIST, IN CLASS 35 (U.S. CLS. 100, 101 AND 102).

FIRST USE 1-1-2008; IN COMMERCE 1-1-2008.

FOR: ENTERTAINMENT SERVICES, NAMELY, LIVE MUSICAL AND VOCAL PERFORMANCES BY AN INDIVIDUAL; PROVIDING INFORMATION ON PERFORMING AND RECORDING MUSICAL ARTIST VIA WEB SITE, IN CLASS 41 (U.S. CLS. 100, 101 AND 107).

FIRST USE 1-1-2008; IN COMMERCE 1-1-2008.

THE MARK CONSISTS OF STANDARD CHARACTERS WITHOUT CLAIM TO ANY PARTICULAR FONT, STYLE, SIZE, OR COLOR.

THE NAME(S), PORTRAIT(S), AND/OR SIGNATURE(S) SHOWN IN THE MARK IDENTIFIES "NYA JADE", WHOSE CONSENT(S) TO REGISTER IS SUBMITTED.

SN 78-763,414, FILED 11-30-2005.

LA TONIA FISHER, EXAMINING ATTORNEY

Int. Cl.: 35

Prior U.S. Cls.: 100, 101, and 102

United States Patent and Trademark Office

Reg. No. 3,478,067

Registered July 29, 2008

**SERVICE MARK
PRINCIPAL REGISTER**

**ONLINE. OFFLINE. BOTTOM
LINE.**

GL NESS ADVERTISING & MARKETING, INC.
(NORTH DAKOTA CORPORATION)
SIXTH FLOOR
2000 - 44TH ST SW
FARGO, ND 58106

FOR: ADVERTISING AGENCY SERVICES,
NAMELY, PROMOTING THE GOODS AND SERVI-
CES OF OTHERS THROUGH CREATING AND
DISTRIBUTING PRINTED, AUDIO/VIDEO AND
OTHER ADVERTISING AND PROMOTIONAL MES-
SAGES, AND BY RENDERING MARKETING COM-

MUNICATIONS ADVICE, IN CLASS 35 (U.S. CLS.
100, 101 AND 102).

FIRST USE 2-1-2006; IN COMMERCE 2-1-2006.

THE MARK CONSISTS OF STANDARD CHAR-
ACTERS WITHOUT CLAIM TO ANY PARTICULAR
FONT, STYLE, SIZE, OR COLOR.

SN 78-763,559, FILED 11-30-2005.

DAVID ELTON, EXAMINING ATTORNEY

Int. Cl.: 9

Prior U.S. Cls.: 21, 23, 26, 36, and 38

Reg. No. 3,478,068

United States Patent and Trademark Office

Registered July 29, 2008

**TRADEMARK
PRINCIPAL REGISTER**

SMARTWAVE

SMARTIRE SYSTEMS, INC. (CANADA CORPORATION)
SUITE 150
13151 VANIER PLACE
RICHMOND, BRITISH COLUMBIA, CANADA V6V
2J1

FOR: ELECTRIC SENSOR FOR SENSING TIRE PRESSURE, ELECTRIC TRANSMITTER AND WIRELESS RECEIVER USED FOR COMMUNICATING VEHICLE INFORMATION , IN CLASS 9 (U.S. CLS. 21, 23, 26, 36 AND 38).

FIRST USE 1-31-2006; IN COMMERCE 1-31-2006.

THE MARK CONSISTS OF STANDARD CHARACTERS WITHOUT CLAIM TO ANY PARTICULAR FONT, STYLE, SIZE, OR COLOR.

SN 78-764,744, FILED 12-1-2005.

TEJBIR SINGH, EXAMINING ATTORNEY

Int. Cl.: 9

Prior U.S. Cls.: 21, 23, 26, 36, and 38

Reg. No. 3,478,069

United States Patent and Trademark Office

Registered July 29, 2008

**TRADEMARK
PRINCIPAL REGISTER**

PURBLE PLACE

MICROSOFT CORPORATION (WASHINGTON
CORPORATION)
ONE MICROSOFT WAY
REDMOND, WA 980526399

THE MARK CONSISTS OF STANDARD CHAR-
ACTERS WITHOUT CLAIM TO ANY PARTICULAR
FONT, STYLE, SIZE, OR COLOR.

FOR: COMPUTER PROGRAMS, NAMELY,
GAME SOFTWARE FOR USE ON COMPUTERS
AND VIDEO GAME PLAYERS, IN CLASS 9 (U.S.
CLS. 21, 23, 26, 36 AND 38).

SN 78-765,104, FILED 12-1-2005.

FIRST USE 1-30-2007; IN COMMERCE 1-30-2007.

RENEE MCCRAY, EXAMINING ATTORNEY

Int. Cl.: 10

Prior U.S. Cls.: 26, 39, and 44

United States Patent and Trademark Office

Reg. No. 3,478,070

Registered July 29, 2008

**TRADEMARK
PRINCIPAL REGISTER**

TEMPSCAN

SCHERING-PLOUGH HOME AGAIN LLC (DE-
LAWARE LTD LIAB CO)
2000 GALLOPING HILL ROAD
KENILWORTH, NJ 07033

FOR: TEMPERATURE MEASURING SYSTEM
FOR COMPANION ANIMALS CONSISTING OF A
MICROCHIP CONTAINING A TEMPERATURE
SENSOR AND A TRANSPONDER AND A MANU-
ALLY OPERATED APPARATUS, NAMELY, AN
INJECTOR CONSISTING OF A SYRINGE, TO IN-
SERT THE MICROCHIP SUBCUTANEOUSLY, ALL

SOLD AS A UNIT, IN CLASS 10 (U.S. CLS. 26, 39 AND
44).

FIRST USE 3-31-2008; IN COMMERCE 3-31-2008.

THE MARK CONSISTS OF STANDARD CHAR-
ACTERS WITHOUT CLAIM TO ANY PARTICULAR
FONT, STYLE, SIZE, OR COLOR.

SN 78-765,754, FILED 12-2-2005.

BONNIE LUKEN, EXAMINING ATTORNEY

Int. Cl.: 41

Prior U.S. Cls.: 100, 101, and 107

United States Patent and Trademark Office

Reg. No. 3,478,071

Registered July 29, 2008

**SERVICE MARK
PRINCIPAL REGISTER**

**The Center for Human
Flourishing**

DACHER, ELLIOTT S. (UNITED STATES INDIVIDUAL)
3 EAST PASTURE WAY
AQUINNAH, MA 02535

FOR: EDUCATIONAL SERVICES, NAMELY, PROGRAMS AND WORKSHOPS IN THE FIELD OF PHYSICAL, MENTAL, AND SPIRITUAL HEALTH AND WELL-BEING, PRACTITIONER TRAINING PROGRAMS IN THE FIELD OF MEDICINE, PSYCHOLOGY, AND SPIRITUAL MINISTRY, AND WORKSITE TRAINING AND PROGRAMS IN THE FIELD OF PHYSICAL, MENTAL, AND SPIRITUAL HEALTH AND WELL-BEING, IN CLASS 41 (U.S. CLS. 100, 101 AND 107).

FIRST USE 10-15-2006; IN COMMERCE 1-25-2008.

THE MARK CONSISTS OF STANDARD CHARACTERS WITHOUT CLAIM TO ANY PARTICULAR FONT, STYLE, SIZE, OR COLOR.

NO CLAIM IS MADE TO THE EXCLUSIVE RIGHT TO USE "CENTER" AND "HUMAN", APART FROM THE MARK AS SHOWN.

SN 78-766,014, FILED 12-2-2005.

JEAN IM, EXAMINING ATTORNEY

Int. Cl.: 12

Prior U.S. Cls.: 19, 21, 23, 31, 35, and 44

Reg. No. 3,478,072

United States Patent and Trademark Office

Registered July 29, 2008

**TRADEMARK
PRINCIPAL REGISTER**

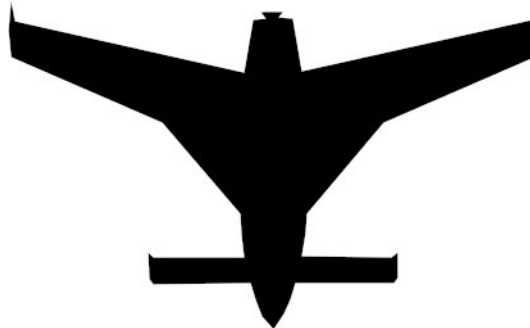

ROCKET RACING, INC. (DELAWARE COR-
PORATION)
405 LEXINGTON AVENUE
26TH FLOOR
NEW YORK, NY 10174

FIRST USE 5-10-2008; IN COMMERCE 5-10-2008.

SN 78-766,039, FILED 12-2-2005.

FOR: ROCKET-POWERED AIRCRAFT AND
SPACECRAFT, IN CLASS 12 (U.S. CLS. 19, 21, 23, 31,
35 AND 44).

AMY MCMENAMIN, EXAMINING ATTORNEY

Int. Cl.: 9

Prior U.S. Cls.: 21, 23, 26, 36, and 38

United States Patent and Trademark Office

Reg. No. 3,478,073

Registered July 29, 2008

**TRADEMARK
PRINCIPAL REGISTER**

THE ANSWER

USA COMPUTER SYSTEMS (MAINE CORPORATION)
169 BAR HARBOR ROAD
TRENTON, ME 04605

FOR: COMPUTER SOFTWARE PROVIDING DATABASE AND ACCOUNTING FUNCTIONS FOR INVENTORY MANAGEMENT, CUSTOMER RELATIONS MANAGEMENT (CRM), DEALERSHIP FINANCIAL ACCOUNTING, CUSTOMER CREDIT MANAGEMENT, AND CUSTOMER BILLING AND TRACKING IN THE FIELD OF MOTOR VEHICLE

DEALERSHIP MANAGEMENT, IN CLASS 9 (U.S. CLS. 21, 23, 26, 36 AND 38).

FIRST USE 9-15-2006; IN COMMERCE 4-30-2008.

THE MARK CONSISTS OF STANDARD CHARACTERS WITHOUT CLAIM TO ANY PARTICULAR FONT, STYLE, SIZE, OR COLOR.

SN 78-767,305, FILED 12-6-2005.

ELIZABETH BEYER, EXAMINING ATTORNEY

Int. Cl.: 16

Prior U.S. Cls.: 2, 5, 22, 23, 29, 37, 38, and 50

United States Patent and Trademark Office

Reg. No. 3,478,074

Registered July 29, 2008

**TRADEMARK
PRINCIPAL REGISTER**

PPXPRESS

SPICERS PAPER, INC. (NEVADA CORPORATION)
12310 EAST SLAUSON AVENUE
SANTA FE SPRINGS, CA 90670

THE MARK CONSISTS OF STANDARD CHARACTERS WITHOUT CLAIM TO ANY PARTICULAR FONT, STYLE, SIZE, OR COLOR.

FOR: PAPER AND PAPER PRODUCTS, NAMELY, COMMERCIAL PRINTING PAPER, IN CLASS 16 (U.S. CLS. 2, 5, 22, 23, 29, 37, 38 AND 50).

SN 78-767,950, FILED 12-6-2005.

FIRST USE 1-0-2006; IN COMMERCE 1-0-2006.

CAROLYN CATALDO, EXAMINING ATTORNEY

Int. Cl.: 5

Prior U.S. Cls.: 6, 18, 44, 46, 51, and 52

United States Patent and Trademark Office

Reg. No. 3,478,075

Registered July 29, 2008

**TRADEMARK
PRINCIPAL REGISTER**

NUMOISYN

SINCLAIR PHARMACEUTICALS LIMITED (UNI-
TED KINGDOM COMPANY)
BOROUGH ROAD, GODALMING
SURREY, UNITED KINGDOM GU7 2AB

FOR: PHARMACEUTICAL PREPARATIONS FOR
THE TREATMENT OF XEROSTOMIA AND SJO-
GREN'S SYNDROME; CHEMICAL PREPARATIONS
AND REAGENTS FOR PHARMACEUTICAL PUR-
POSES; SALIVA SUBSTITUTES FOR PHARMACEU-
TICAL PURPOSES; PHARMACEUTICAL
PREPARATIONS IN THE NATURE OF SALIVA

STIMULATING TABLETS, IN CLASS 5 (U.S. CLS. 6,
18, 44, 46, 51 AND 52).

FIRST USE 2-1-2006; IN COMMERCE 2-1-2006.

THE MARK CONSISTS OF STANDARD CHAR-
ACTERS WITHOUT CLAIM TO ANY PARTICULAR
FONT, STYLE, SIZE, OR COLOR.

SN 78-767,979, FILED 12-6-2005.

JOHN GARTNER, EXAMINING ATTORNEY

Int. Cl.: 36

Prior U.S. Cls.: 100, 101, and 102

United States Patent and Trademark Office

Reg. No. 3,478,076

Registered July 29, 2008

**SERVICE MARK
PRINCIPAL REGISTER**

MASTERCARD ATM ALLIANCE

MASTERCARD INTERNATIONAL INCORPORATED (DELAWARE CORPORATION)
2000 PURCHASE STREET
PURCHASE, NY 105772405

FOR: FINANCIAL SERVICES, NAMELY, BANKING, CASH DISBURSEMENT, AUTOMATED TELLER MACHINE AND ELECTRONIC FUNDS TRANSFER SERVICES, IN CLASS 36 (U.S. CLS. 100, 101 AND 102).

FIRST USE 10-0-2006; IN COMMERCE 10-0-2006.

THE MARK CONSISTS OF STANDARD CHARACTERS WITHOUT CLAIM TO ANY PARTICULAR FONT, STYLE, SIZE, OR COLOR.

NO CLAIM IS MADE TO THE EXCLUSIVE RIGHT TO USE "ATM ALLIANCE", APART FROM THE MARK AS SHOWN.

SN 78-769,108, FILED 12-8-2005.

GIANCARLO CASTRO, EXAMINING ATTORNEY

Int. Cl.: 36

Prior U.S. Cls.: 100, 101, and 102

United States Patent and Trademark Office

Reg. No. 3,478,077

Registered July 29, 2008

SERVICE MARK
PRINCIPAL REGISTER



MASTERCARD INTERNATIONAL INCORPORATED (DELAWARE CORPORATION)
2000 PURCHASE STREET
PURCHASE, NY 105772405

FOR: FINANCIAL SERVICES, NAMELY, BANKING, CASH DISBURSEMENT, AUTOMATED TELLER MACHINE AND ELECTRONIC FUNDS TRANSFER SERVICES, IN CLASS 36 (U.S. CLS. 100, 101 AND 102).

FIRST USE 10-0-2006; IN COMMERCE 10-0-2006.

NO CLAIM IS MADE TO THE EXCLUSIVE RIGHT TO USE "ATM ALLIANCE", APART FROM THE MARK AS SHOWN.

THE MARK CONSISTS OF THE WORD MARK "MASTERCARD" WITH THE WORDS "ATM ALLIANCE" BELOW AND THE DESIGN OF TWO OVERLAPPING CIRCLES BEHIND THE WORDING.

SN 78-769,211, FILED 12-8-2005.

GIANCARLO CASTRO, EXAMINING ATTORNEY

Int. Cl.: 16

Prior U.S. Cls.: 2, 5, 22, 23, 29, 37, 38, and 50

United States Patent and Trademark Office

Reg. No. 3,478,078

Registered July 29, 2008

**TRADEMARK
PRINCIPAL REGISTER**



O'MAHONEY, PATRICK (UNITED STATES IN-
DIVIDUAL)
109 EAST CHOPIN WAY
GEORGETOWN, KY 40324

FIRST USE 6-6-2008; IN COMMERCE 6-6-2008.

SN 78-769,988, FILED 12-9-2005.

FOR: STICKERS, PRINTED EMBLEMS, AND
PLASTIC TRANSFERS FOR AFFIXING TO AN
AUTOMOBILE, IN CLASS 16 (U.S. CLS. 2, 5, 22, 23,
29, 37, 38 AND 50).

DOMINIC J. FERRAIUOLO, EXAMINING ATTOR-
NEY

Int. Cl.: 36

Prior U.S. Cls.: 100, 101, and 102

United States Patent and Trademark Office

Reg. No. 3,478,079

Registered July 29, 2008

**SERVICE MARK
PRINCIPAL REGISTER**



MASTERCARD INTERNATIONAL INCORPORATED (DELAWARE CORPORATION)
2000 PURCHASE STREET
PURCHASE, NY 105772405

FOR: FINANCIAL SERVICES, NAMELY, BANKING, CASH DISBURSEMENT, AUTOMATED TELLER MACHINE AND ELECTRONIC FUNDS TRANSFER SERVICES, IN CLASS 36 (U.S. CLS. 100, 101 AND 102).

FIRST USE 10-0-2006; IN COMMERCE 10-0-2006.

NO CLAIM IS MADE TO THE EXCLUSIVE RIGHT TO USE "ATM ALLIANCE", APART FROM THE MARK AS SHOWN.

THE COLOR(S) GREEN, BLACK AND WHITE IS/ ARE CLAIMED AS A FEATURE OF THE MARK.

THE MARK CONSISTS OF THE WORD MARK "MASTERCARD" WITH THE WORDS "ATM ALLIANCE" BELOW AND THE DESIGN OF TWO OVERLAPPING CIRCLES BEHIND THE WORDING. THE COLOR GREEN APPEARS INSIDE EACH CIRCLE; THE COLOR BLACK APPEARS IN THE OUTLINE OF EACH CIRCLE; THE COLOR WHITE APPEARS IN THE WORDING AND SURROUNDING EACH CIRCLE.

SN 78-771,260, FILED 12-12-2005.

GIANCARLO CASTRO, EXAMINING ATTORNEY

Int. Cl.: 9

Prior U.S. Cls.: 21, 23, 26, 36, and 38

Reg. No. 3,478,080

United States Patent and Trademark Office

Registered July 29, 2008

**TRADEMARK
PRINCIPAL REGISTER**

AKROS SILICON

AKROS SILICON, INC. (CALIFORNIA CORPORATION)
275 TURNPIKE DRIVE
FOLSOM, CA 95630

NO CLAIM IS MADE TO THE EXCLUSIVE RIGHT TO USE "SILICON", APART FROM THE MARK AS SHOWN.

FOR: SEMICONDUCTORS, IN CLASS 9 (U.S. CLS. 21, 23, 26, 36 AND 38).

SN 78-771,496, FILED 12-12-2005.

FIRST USE 2-26-2007; IN COMMERCE 2-26-2007.

THE MARK CONSISTS OF STANDARD CHARACTERS WITHOUT CLAIM TO ANY PARTICULAR FONT, STYLE, SIZE, OR COLOR.

CIMMERIAN COLEMAN, EXAMINING ATTORNEY

Int. Cl.: 9

Prior U.S. Cls.: 21, 23, 26, 36, and 38

Reg. No. 3,478,081

United States Patent and Trademark Office

Registered July 29, 2008

**TRADEMARK
PRINCIPAL REGISTER**

RosenView

ROSEN AVIATION, LLC (OREGON LTD LIAB
CO)
1020 OWEN LOOP SOUTH
EUGENE, OR 97402

FOR: COMPUTER SOFTWARE PROVIDING A
PASSENGER INFORMATION AND BRIEFING SYS-
TEM INCLUDING THE ACCESS AND DISPLAY OF
MAPS AND TRAVEL INFORMATION FOR USE IN
THE AVIATION INDUSTRY , IN CLASS 9 (U.S. CLS.
21, 23, 26, 36 AND 38).

FIRST USE 8-15-2007; IN COMMERCE 8-15-2007.

THE MARK CONSISTS OF STANDARD CHAR-
ACTERS WITHOUT CLAIM TO ANY PARTICULAR
FONT, STYLE, SIZE, OR COLOR.

SN 78-771,525, FILED 12-12-2005.

NAAKWAMA ANKRAH, EXAMINING ATTORNEY

Int. Cl.: 10

Prior U.S. Cls.: 26, 39, and 44

United States Patent and Trademark Office

Reg. No. 3,478,082

Registered July 29, 2008

**TRADEMARK
PRINCIPAL REGISTER**

INTELLI-ADJUST

NEUROMECHANICAL INNOVATIONS, LLC
(ARIZONA LTD LIAB CO)
SUITE 205
11011 S. 48TH STREET
PHOENIX, AZ 85044

FOR: MEDICAL DEVICE IN THE NATURE OF
CHIROPRACTIC ADJUSTING AND ASSESSMENT
INSTRUMENTS WHICH USE BIOMECHANICAL
ASSESSMENTS TO DETERMINE THE BODY'S RE-
SPONSE AND DOSAGE OF TREATMENT FOR
CHIROPRACTIC ADJUSTING AND SPINAL MA-

NIPULATION, IN CLASS 10 (U.S. CLS. 26, 39 AND
44).

FIRST USE 5-1-2007; IN COMMERCE 5-1-2007.

THE MARK CONSISTS OF STANDARD CHAR-
ACTERS WITHOUT CLAIM TO ANY PARTICULAR
FONT, STYLE, SIZE, OR COLOR.

SN 78-772,364, FILED 12-13-2005.

RICHARD A. STRASER, EXAMINING ATTORNEY

Int. Cl.: 25

Prior U.S. Cls.: 22 and 39

United States Patent and Trademark Office

Reg. No. 3,478,083

Registered July 29, 2008

TRADEMARK
PRINCIPAL REGISTER



DEYOUNG, DENNIS (ILLINOIS PARTNERSHIP)
15941 S. HARLEM AVE. SUITE 268
TINLEY PARK, IL 60477 AND
DEYOUNG, SUZANNE (ILLINOIS PARTNERSHIP)
15941 S. HARLEM AVE. SUITE 268
TINLEY PARK, IL 60477

FOR: BRIEFS; CAMP SHIRTS; CAPRI PANTS;
DENIM JACKETS; DENIMS; DISPOSABLE UNDER-
WEAR; DRESS SHIRTS; GOLF SHIRTS; HATS;
JACKETS; KNITTED UNDERWEAR; LADIES' UN-
DERWEAR; LEATHER JACKETS; LONG JACKETS;
PANTS; POLO SHIRTS; RAIN JACKETS; RAIN-
PROOF JACKETS; SHIRTS; SHIRTS FOR SUITS;
SHORT-SLEEVED OR LONG-SLEEVED T-SHIRTS;
SHORT-SLEEVED SHIRTS; SKI JACKETS; SKI
PANTS; SLEEP SHIRTS; SMALL HATS; SMOKING

JACKETS; SNOW PANTS; SOCKS; SOCKS AND
STOCKINGS; SPORT SHIRTS; SPORTS SHIRTS;
SPORTS SHIRTS WITH SHORT SLEEVES; SUEDE
JACKETS; SWEAT PANTS; SWEAT SHIRTS; SWEA-
TERS; T-SHIRTS; THONGS; UNDERWEAR; WO-
MEN'S UNDERWEAR; WOOLLY HATS, IN CLASS
25 (U.S. CLS. 22 AND 39).

FIRST USE 1-1-2007; IN COMMERCE 1-1-2007.

THE MARK CONSISTS OF THE IMAGE OF A
DOG WEARING A HAT ABOVE THE WORDS
"SPARKY THE FLYING DOG".

SN 78-772,964, FILED 12-14-2005.

DAVID H. STINE, EXAMINING ATTORNEY

Int. Cl.: 6

Prior U.S. Cls.: 2, 12, 13, 14, 23, 25, and 50

Reg. No. 3,478,084

United States Patent and Trademark Office

Registered July 29, 2008

**TRADEMARK
PRINCIPAL REGISTER**

MediTrac

OMEGA FLEX, INC. (PENNSYLVANIA CORPORATION)
451 CREAMERY WAY
EXTON, PA 19341

THE MARK CONSISTS OF STANDARD CHARACTERS WITHOUT CLAIM TO ANY PARTICULAR FONT, STYLE, SIZE, OR COLOR.

FOR: CORRUGATED STAINLESS STEEL TUBING FOR MEDICAL GAS PIPELINES; METAL TUBING FOR MEDICAL GAS PIPELINES, IN CLASS 6 (U.S. CLS. 2, 12, 13, 14, 23, 25 AND 50).

SN 78-773,314, FILED 12-14-2005.

FIRST USE 1-24-2008; IN COMMERCE 1-24-2008.

MARY ROSSMAN, EXAMINING ATTORNEY

Int. Cls.: 16 and 41

Prior U.S. Cls.: 2, 5, 22, 23, 29, 37, 38, 50, 100, 101, and 107

Reg. No. 3,478,085

United States Patent and Trademark Office

Registered July 29, 2008

**TRADEMARK
SERVICE MARK
PRINCIPAL REGISTER**

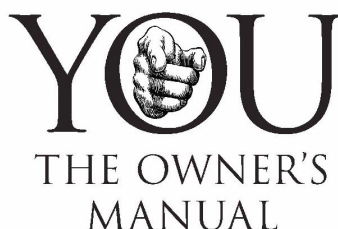

ROIZEN, MICHAEL F. (UNITED STATES INDIVIDUAL)

18600 S. PARK BOULEVARD
SHAKER HEIGHTS, OH 44122 AND

OZ, MEHMET C. (UNITED STATES INDIVIDUAL)
MILSTEIN 7-435

177 FORT WASHINGTON AVE.
NEW YORK, NY 10032

FOR: PUBLICATIONS, NAMELY A SERIES OF BOOKS, NEWSLETTERS IN THE FIELD OF HEALTH, FITNESS, DIET, EXERCISE AND LIFESTYLE, IN CLASS 16 (U.S. CLS. 2, 5, 22, 23, 29, 37, 38 AND 50).

FIRST USE 12-8-2007; IN COMMERCE 4-29-2007.

FOR: PUBLICATIONS, NAMELY, PROVIDING NEWSLETTERS IN THE FIELD OF HEALTH, FITNESS, DIET, EXERCISE, AND LIFESTYLE VIA E-MAIL AND THE INTERNET, IN CLASS 41 (U.S. CLS. 100, 101 AND 107).

FIRST USE 12-8-2007; IN COMMERCE 12-8-2007.

THE MARK CONSISTS OF THE WORDS "YOU THE OWNER'S MANUAL" AND INSIDE THE LETTER "O" IN THE WORD "YOU" APPEARS A CLOSED FIST WITH AN EXTENDED INDEX FINGER.

SN 78-773,877, FILED 12-15-2005.

LOURDES AYALA, EXAMINING ATTORNEY

Int. Cl.: 29

Prior U.S. Cl.: 46

United States Patent and Trademark Office

Reg. No. 3,478,086

Registered July 29, 2008

**TRADEMARK
PRINCIPAL REGISTER**

CELTIC GOLD

ABBHEY SPECIALTY FOODS, LLC (MINNESOTA
LTD LIAB CO)
SUITE 201
13 FAIRFIELD AVE
LITTLE FALLS, NJ 07424

FOR: CHEESE, IN CLASS 29 (U.S. CL. 46).

FIRST USE 3-17-2006; IN COMMERCE 3-17-2006.

THE MARK CONSISTS OF STANDARD CHAR-
ACTERS WITHOUT CLAIM TO ANY PARTICULAR
FONT, STYLE, SIZE, OR COLOR.

SN 78-774,586, FILED 12-15-2005.

KATHERINE M. DUBRAY, EXAMINING ATTOR-
NEY

Int. Cl.: 42

Prior U.S. Cls.: 100 and 101

United States Patent and Trademark Office

Reg. No. 3,478,087

Registered July 29, 2008

**SERVICE MARK
PRINCIPAL REGISTER**



NutriScript

UNITED AGRI PRODUCTS, INC. (DELAWARE
CORPORATION)
7251 W. 4TH STREET
GREELEY, CO 80634

FOR: TESTING, ANALYSIS AND EVALUATION
OF PLANT AND SOIL SAMPLES AND PROVIDING
RECOMMENDATIONS REGARDING PLANT AND
SOIL NUTRIENTS IN RELATION THERETO, IN
CLASS 42 (U.S. CLS. 100 AND 101).

FIRST USE 3-1-2006; IN COMMERCE 3-1-2006.

OWNER OF U.S. REG. NOS. 2,888,430 AND
3,010,797.

SN 78-775,331, FILED 12-16-2005.

COLLEEN DOMBROW, EXAMINING ATTORNEY

Int. Cls.: 25 and 35

Prior U.S. Cls.: 22, 39, 100, 101, and 102

United States Patent and Trademark Office

Reg. No. 3,478,088

Registered July 29, 2008

**TRADEMARK
SERVICE MARK
PRINCIPAL REGISTER**



TARDIEU GROUP, INC. (FLORIDA CORPORATION)
8600 N.W. 30 TERRACE, STE. B
MIAMI, FL 33122

FOR: MEN'S SHIRTS, CLOTHING, NAMELY, SHIRTS, T-SHIRTS, TOPS, PANTS, BLOUSES, SHORTS, TROUSERS, JACKETS, COATS, SUITS, TIES, SLACKS, SCARVES, HATS, IN CLASS 25 (U.S. CLS. 22 AND 39).

FIRST USE 6-15-2004; IN COMMERCE 6-15-2004.

FOR: ON-LINE RETAIL STORE SERVICES FEATURING CLOTHING AND ACCESSORIES, IN CLASS 35 (U.S. CLS. 100, 101 AND 102).

FIRST USE 5-23-2007; IN COMMERCE 5-23-2007.

SN 78-776,271, FILED 12-19-2005.

MICHAEL TANNER, EXAMINING ATTORNEY

Int. Cl.: 9

Prior U.S. Cls.: 21, 23, 26, 36, and 38

United States Patent and Trademark Office

Reg. No. 3,478,089

Registered July 29, 2008

**TRADEMARK
PRINCIPAL REGISTER**

PIT CREW PAYOUT

GAMELOGIC INC. (DELAWARE CORPORATION)
411 WAVERLY OAKS ROAD, SUITE 312
WALTHAM, MA 02452

FOR: COMPUTER GAME SOFTWARE, IN CLASS
9 (U.S. CLS. 21, 23, 26, 36 AND 38).

FIRST USE 4-12-2006; IN COMMERCE 4-12-2006.

THE MARK CONSISTS OF STANDARD CHARACTERS WITHOUT CLAIM TO ANY PARTICULAR FONT, STYLE, SIZE, OR COLOR.

NO CLAIM IS MADE TO THE EXCLUSIVE RIGHT TO USE "PAYOUT", APART FROM THE MARK AS SHOWN.

SN 78-776,305, FILED 12-19-2005.

TRACY WHITTAKER-BROWN, EXAMINING ATTORNEY

Int. Cl.: 41

Prior U.S. Cls.: 100, 101, and 107

United States Patent and Trademark Office

Reg. No. 3,478,090

Registered July 29, 2008

**SERVICE MARK
PRINCIPAL REGISTER**

PEG LEG'S PLUNDER

GAMELOGIC INC. (DELAWARE CORPORATION)
880 WINTER STREET, SUITE 350
WALTHAM, MA 02451

FOR: ENTERTAINMENT SERVICES, NAMELY,
PROVIDING ONLINE COMPUTER GAMES; ELECTRONIC CASINO GAMING SERVICES, IN CLASS 41 (U.S. CLS. 100, 101 AND 107).

FIRST USE 3-9-2006; IN COMMERCE 3-9-2006.

THE MARK CONSISTS OF STANDARD CHARACTERS WITHOUT CLAIM TO ANY PARTICULAR FONT, STYLE, SIZE, OR COLOR.

SN 78-776,320, FILED 12-19-2005.

TRACY WHITTAKER-BROWN, EXAMINING ATTORNEY

Int. Cl.: 9

Prior U.S. Cls.: 21, 23, 26, 36, and 38

United States Patent and Trademark Office

Reg. No. 3,478,091

Registered July 29, 2008

**TRADEMARK
PRINCIPAL REGISTER**

PEG LEG'S PLUNDER

GAMELOGIC INC. (DELAWARE CORPORATION)
880 WINTER STREET, SUITE 350
WALTHAM, MA 02451

FOR: COMPUTER GAME SOFTWARE, IN CLASS
9 (U.S. CLS. 21, 23, 26, 36 AND 38).

FIRST USE 3-9-2006; IN COMMERCE 3-9-2006.

THE MARK CONSISTS OF STANDARD CHARACTERS WITHOUT CLAIM TO ANY PARTICULAR FONT, STYLE, SIZE, OR COLOR.

SN 78-776,323, FILED 12-19-2005.

TRACY WHITTAKER-BROWN, EXAMINING ATTORNEY

Int. Cl.: 5

Prior U.S. Cls.: 6, 18, 44, 46, 51, and 52

Reg. No. 3,478,092

United States Patent and Trademark Office

Registered July 29, 2008

**TRADEMARK
PRINCIPAL REGISTER**

Ready Flu

READY SOLUTIONS, INC. (NORTH CAROLINA CORPORATION)
PO BOX 1333
CORNELIUS, NC 28031

FOR: PERSONAL INFLUENZA PREVENTION KIT CONSISTING PRIMARILY OF SANITIZING HAND GEL, SANITARY MASKS, ALCOHOL PADS, FACIAL TISSUES, AND TIP CARD SOLD AS A UNIT, IN CLASS 5 (U.S. CLS. 6, 18, 44, 46, 51 AND 52).

FIRST USE 12-2-2005; IN COMMERCE 12-2-2005.

THE MARK CONSISTS OF STANDARD CHARACTERS WITHOUT CLAIM TO ANY PARTICULAR FONT, STYLE, SIZE, OR COLOR.

NO CLAIM IS MADE TO THE EXCLUSIVE RIGHT TO USE "FLU", APART FROM THE MARK AS SHOWN.

SN 78-776,874, FILED 12-20-2005.

ANDREA SAUNDERS, EXAMINING ATTORNEY

Int. Cls.: 35 and 36

Prior U.S. Cls.: 100, 101, and 102

United States Patent and Trademark Office

Reg. No. 3,478,093

Registered July 29, 2008

SERVICE MARK
PRINCIPAL REGISTER



INNUITY, INC. (UTAH CORPORATION)
8644 154TH AVENUE NE
REDMOND, WA 98052

FOR: PROMOTING THE GOODS AND SERVICES OF OTHERS BY PROVIDING A WEB SITE AT WHICH USERS CAN LINK TO MARKETING TOOLS, INFORMATION REGARDING SALES LEADS, PAY-PER-CLICK CAMPAIGN MANAGEMENT, AFFILIATE MARKETING MANAGEMENT, SEARCH ENGINE SUBMISSION, PERMISSION EMAIL MARKETING, WEB ANALYTICS TOOLS AND MANAGEMENT, DOMAIN NAME REGISTRATION, BUSINESS AND E-COMMERCE WEBSITES, CUSTOM DESIGN SERVICES, MERCHANT ACCOUNTS AND PAYMENT PROCESSING SERVICES FOR CREDIT CARDS AND AUTOMATED CLEARINGHOUSE (ACH) TRANSACTIONS, AND BILL PRESENTMENT AND PAYMENT; PROVIDING A SEARCHABLE ONLINE ADVERTISING GUIDE FEATURING THE GOODS AND SERVICES OF OTHER ONLINE VENDORS ON THE INTERNET; PROMOTING THE GOODS AND SERVICES OF OTHERS BY MEANS OF OPERATING AN ONLINE SHOPPING MALL WITH LINKS TO THE RETAIL WEB SITES OF OTHERS; RETAIL STORE

SERVICES FEATURING POINT-OF-SALE (POS) HARDWARE, SOFTWARE FOR ACCOUNTING, PAYROLL, CUSTOMER CARE, HR, AND OTHER MANAGEMENT INFORMATION APPLICATIONS FOR E-COMMERCE AND SMALL BUSINESSES, IN CLASS 35 (U.S. CLS. 100, 101 AND 102).

FIRST USE 11-0-2005; IN COMMERCE 11-0-2005.

FOR: CREDIT CARD TRANSACTION PROCESSING SERVICES, IN CLASS 36 (U.S. CLS. 100, 101 AND 102).

FIRST USE 5-0-2007; IN COMMERCE 5-0-2007.

THE STIPPLING IS FOR SHADING PURPOSES ONLY.

THE MARK CONSISTS OF SEVEN RECTANGULAR-SHAPED BOXES EACH BOX CONTAINING ONE STYLIZED LETTER OF THE WORD "INNUITY".

SN 78-777,486, FILED 12-20-2005.

RAMONA ORTIGA, EXAMINING ATTORNEY

Int. Cls.: 6, 35, and 40

Prior U.S. Cls.: 2, 12, 13, 14, 23, 25, 50, 100, 101, 102, 103, and 106

Reg. No. 3,478,094

United States Patent and Trademark Office

Registered July 29, 2008

**TRADEMARK
SERVICE MARK
PRINCIPAL REGISTER**



RYERSON PROCUREMENT CORPORATION
(DELAWARE CORPORATION)
2621 WEST 15TH PLACE
CHICAGO, IL 60608

FOR: STEEL IN BAR, ROD, SHEET, AND PLATE FORM; STEEL FLOOR PLATES AND TREAD PLATES; STRUCTURAL STEEL TUBING; EXPANDED STEEL SHEETS; CORRUGATED STEEL SHEETS; CORRUGATED STEEL SHEETS FOR CONSTRUCTION PURPOSES, NAMELY, IN THE WALL AND ROOF SECTION OF BUILDINGS; STAINLESS STEEL SOLD IN BULK; METAL CONSTRUCTION MATERIALS, NAMELY, BAR, ROD, SHEET, AND PLATE SHAPES; METAL ROOFING AND ALUMINUM SIDING; METAL FLOOR PLATES AND TREAD PLATES; METAL OPEN FLOORING AND GRATING; ARCHITECTURAL METAL ROOFING IN STEEL AND ALUMINUM; METAL STRUCTURAL TUBING; METAL EXPANDED SHEETS AND GRATING; METAL PERFORATED SHEETS; METAL MECHANICAL TUBING; METAL THREADED TUBING AND BARS; METAL STRUCTURAL SHAPES FOR USE IN THE FURTHER MANUFACTURE OR FINISHED GOODS; METAL PIPE AND PIPE FITTINGS; CARBON STEEL; ALLOY STEEL; STRIP STEEL; SCREW STEEL; METAL SOLD IN BULK FOR FURTHER MANUFACTURING; STAINLESS STEEL; METAL FORGINGS; COLD ROLLED STEEL, FLAME CUT METAL SHAPES, FLAME CUT STEEL SHAPES AND METAL BANDS AND HOOPS; METAL SHAFTING; MACHINED METAL RINGS AND DISCS, IN CLASS 6 (U.S. CLS. 2, 12, 13, 14, 23, 25 AND 50).

FIRST USE 3-31-2006; IN COMMERCE 3-31-2006.

FOR: WHOLESALE DISTRIBUTORSHIP AND RETAIL SERVICES BY DIRECT SOLICITATION BY SALES AGENTS IN THE FIELD OF STEEL, METAL

AND FABRICATED METAL AND STEEL PRODUCTS MANUFACTURED BY OTHERS; AND PROVIDING PERSONAL COMPUTER-BASED ON-LINE ORDERING SERVICES FOR CARBON STEEL, STAINLESS STEEL, ALLOY STEEL, COPPER, NICKEL, PLASTIC, AND ALUMINUM STRUCTURAL COMPONENTS, NAMELY, ANGLES, BEAMS, CHANNELS, TEES, PLATES, BARS, SHEETS, COILS, TUBING, PIPE AND FLOORING AND GRATING PRODUCTS, AND FOR THE PROCESSING, MACHINING, AND FINISHING THEREOF; INVENTORY CONTROL SERVICES IN THE NATURE OF VENDOR MANAGEMENT OF CUSTOMER INVENTORIES AND RECEIPT OF GOODS FOR CUSTOMER INVENTORIES, PROVIDING A MAIL ORDER AND AN ON-LINE CATALOG OF THE GOODS AND SERVICES OF OTHERS IN THE FIELD OF STEEL, METAL, AND RELATED CONSTRUCTION EQUIPMENT, IN CLASS 35 (U.S. CLS. 100, 101 AND 102).

FIRST USE 3-31-2006; IN COMMERCE 3-31-2006.

FOR: FABRICATION, PREPARATION, AND TREATMENT OF METALS AND METAL PRODUCTS COMPRISING FLAME CUTTING, SAWING, THREADING, PUNCHING, BENDING, WELDING, DRILLING, GRINDING, AND SHEARING, AND FABRICATION, PREPARATION, AND TREATMENT OF PLASTICS COMPRISING OF MILLING, SANDING, TURNING AND SPECIAL EXTRUSIONS, IN CLASS 40 (U.S. CLS. 100, 103 AND 106).

FIRST USE 3-31-2006; IN COMMERCE 3-31-2006.

OWNER OF U.S. REG. NOS. 567,013, 2,631,496, AND 2,649,199.

THE MARK CONSISTS OF STYLIZED "R" WITH-
IN A CIRCLE IN PROXIMITY TO THE MARKS
"RYERSON" AND "THE STRENGTH IN METAL".

SN 78-777,509, FILED 12-20-2005.

CHERYL CLAYTON, EXAMINING ATTORNEY

Int. Cls.: 6, 35, and 40

Prior U.S. Cls.: 2, 12, 13, 14, 23, 25, 50, 100, 101, 102, 103, and 106

Reg. No. 3,478,095

United States Patent and Trademark Office

Registered July 29, 2008

**TRADEMARK
SERVICE MARK
PRINCIPAL REGISTER**



RYERSON PROCUREMENT CORPORATION
(DELAWARE CORPORATION)
2621 WEST 15TH PLACE
CHICAGO, IL 60608

FOR: STEEL IN BAR, ROD, SHEET, AND PLATE FORM; STEEL FLOOR PLATES AND TREAD PLATES; STRUCTURAL STEEL TUBING; EXPANDED STEEL SHEETS; CORRUGATED STEEL SHEETS; CORRUGATED STEEL SHEETS FOR CONSTRUCTION PURPOSES, NAMELY, IN THE WALL AND ROOF SECTION OF BUILDINGS; STAINLESS STEEL SOLD IN BULK; METAL CONSTRUCTION MATERIALS, NAMELY, BAR, ROD, SHEET, AND PLATE SHAPES; METAL ROOFING AND ALUMINUM SIDING; METAL FLOOR PLATES AND TREAD PLATES; METAL OPEN FLOORING AND GRATING; ARCHITECTURAL METAL ROOFING IN STEEL AND ALUMINUM; METAL STRUCTURAL TUBING; METAL EXPANDED SHEETS AND GRATING; METAL PERFORATED SHEETS; METAL MECHANICAL TUBING; METAL THREADED TUBING AND BARS; METAL STRUCTURAL SHAPES FOR USE IN THE FURTHER MANUFACTURE OR FINISHED GOODS; METAL PIPE AND PIPE FITTINGS; CARBON STEEL; ALLOY STEEL; STRIP STEEL; SCREW STEEL; METAL SOLD IN BULK FOR FURTHER MANUFACTURING; STAINLESS STEEL; METAL FORGINGS; COLD ROLLED STEEL, FLAME CUT METAL SHAPES, FLAME CUT STEEL SHAPES AND METAL BANDS AND HOOPS; METAL SHAFTING; MACHINED METAL RINGS AND DISCS, IN CLASS 6 (U.S. CLS. 2, 12, 13, 14, 23, 25 AND 50).

FIRST USE 3-31-2006; IN COMMERCE 3-31-2006.

FOR: WHOLESALE DISTRIBUTORSHIP AND RETAIL SERVICES BY DIRECT SOLICITATION BY SALES AGENTS IN THE FIELD OF STEEL, METAL

AND FABRICATED METAL AND STEEL PRODUCTS MANUFACTURED BY OTHERS; AND PROVIDING PERSONAL COMPUTER-BASED ON-LINE ORDERING SERVICES FOR CARBON STEEL, STAINLESS STEEL, ALLOY STEEL, COPPER, NICKEL, PLASTIC, AND ALUMINUM STRUCTURAL COMPONENTS, NAMELY, ANGLES, BEAMS, CHANNELS, TEES, PLATES, BARS, SHEETS, COILS, TUBING, PIPE AND FLOORING AND GRATING PRODUCTS, AND FOR THE PROCESSING, MACHINING, AND FINISHING THEREOF; INVENTORY CONTROL SERVICES IN THE NATURE OF VENDOR MANAGEMENT OF CUSTOMER INVENTORIES AND RECEIPT OF GOODS FOR CUSTOMER INVENTORIES, PROVIDING A MAIL ORDER AND AN ON-LINE CATALOG OF THE GOODS AND SERVICES OF OTHERS IN THE FIELD OF STEEL, METAL, AND RELATED CONSTRUCTION EQUIPMENT, IN CLASS 35 (U.S. CLS. 100, 101 AND 102).

FIRST USE 3-31-2006; IN COMMERCE 3-31-2006.

FOR: FABRICATION, PREPARATION, AND TREATMENT OF METALS AND METAL PRODUCTS COMPRISING FLAME CUTTING, SAWING, THREADING, PUNCHING, BENDING, WELDING, DRILLING, GRINDING, AND SHEARING, AND FABRICATION, PREPARATION, AND TREATMENT OF PLASTICS COMPRISING OF MILLING, SANDING, TURNING AND SPECIAL EXTRUSIONS, IN CLASS 40 (U.S. CLS. 100, 103 AND 106).

FIRST USE 3-31-2006; IN COMMERCE 3-31-2006.

OWNER OF U.S. REG. NOS. 567,013, 2,631,496, AND 2,649,199.

THE MARK CONSISTS OF A STYLIZED "R"
WITHIN A CIRCLE IN PROXIMITY TO THE MARK
"RYERSON".

SN 78-777,515, FILED 12-20-2005.

CHERYL CLAYTON, EXAMINING ATTORNEY

Int. Cls.: 6, 35, and 40

Prior U.S. Cls.: 2, 12, 13, 14, 23, 25, 50, 100, 101, 102, 103, and 106

Reg. No. 3,478,096

United States Patent and Trademark Office

Registered July 29, 2008

**TRADEMARK
SERVICE MARK
PRINCIPAL REGISTER**

RYERSON

RYERSON PROCUREMENT CORPORATION
(DELAWARE CORPORATION)
2621 WEST 15TH PLACE
CHICAGO, IL 60608

FOR: STEEL IN BAR, ROD, SHEET, AND PLATE FORM; STEEL FLOOR PLATES AND TREAD PLATES; STRUCTURAL STEEL TUBING; EXPANDED STEEL SHEETS; CORRUGATED STEEL SHEETS; CORRUGATED STEEL SHEETS FOR CONSTRUCTION PURPOSES, NAMELY, IN THE WALL AND ROOF SECTION OF BUILDINGS; STAINLESS STEEL SOLD IN BULK; METAL CONSTRUCTION MATERIALS, NAMELY, BAR, ROD, SHEET, AND PLATE SHAPES; METAL ROOFING AND ALUMINUM SIDING; METAL FLOOR PLATES AND TREAD PLATES; METAL OPEN FLOORING AND GRATING; ARCHITECTURAL METAL ROOFING IN STEEL AND ALUMINUM; METAL STRUCTURAL TUBING; METAL EXPANDED SHEETS AND GRATING; METAL PERFORATED SHEETS; METAL MECHANICAL TUBING; METAL THREADED TUBING AND BARS; METAL STRUCTURAL SHAPES FOR USE IN THE FURTHER MANUFACTURE OR FINISHED GOODS; METAL PIPE AND PIPE FITTINGS; CARBON STEEL; ALLOY STEEL; STRIP STEEL; SCREW STEEL; METAL SOLD IN BULK FOR FURTHER MANUFACTURING; STAINLESS STEEL; METAL FORGINGS; COLD ROLLED STEEL, FLAME CUT METAL SHAPES, FLAME CUT STEEL SHAPES AND METAL BANDS AND HOOPS; METAL SHAFTING; MACHINED METAL RINGS AND DISCS, IN CLASS 6 (U.S. CLS. 2, 12, 13, 14, 23, 25 AND 50).

FIRST USE 3-31-2006; IN COMMERCE 3-31-2006.

FOR: WHOLESALE DISTRIBUTORSHIP AND RETAIL SERVICES BY DIRECT SOLICITATION BY SALES AGENTS IN THE FIELD OF STEEL, METAL

AND FABRICATED METAL AND STEEL PRODUCTS MANUFACTURED BY OTHERS; AND PROVIDING PERSONAL COMPUTER-BASED ON-LINE ORDERING SERVICES FOR CARBON STEEL, STAINLESS STEEL, ALLOY STEEL, COPPER, NICKEL, PLASTIC, AND ALUMINUM STRUCTURAL COMPONENTS, NAMELY, ANGLES, BEAMS, CHANNELS, TEES, PLATES, BARS, SHEETS, COILS, TUBING, PIPE AND FLOORING AND GRATING PRODUCTS, AND FOR THE PROCESSING, MACHINING, AND FINISHING THEREOF; INVENTORY CONTROL SERVICES IN THE NATURE OF VENDOR MANAGEMENT OF CUSTOMER INVENTORIES AND RECEIPT OF GOODS FOR CUSTOMER INVENTORIES, PROVIDING A MAIL ORDER AND AN ON-LINE CATALOG OF THE GOODS AND SERVICES OF OTHERS IN THE FIELD OF STEEL, METAL, AND RELATED CONSTRUCTION EQUIPMENT, IN CLASS 35 (U.S. CLS. 100, 101 AND 102).

FIRST USE 3-31-2006; IN COMMERCE 3-31-2006.

FOR: FABRICATION, PREPARATION, AND TREATMENT OF METALS AND METAL PRODUCTS COMPRISING FLAME CUTTING, SAWING, THREADING, PUNCHING, BENDING, WELDING, DRILLING, GRINDING, AND SHEARING, AND FABRICATION, PREPARATION, AND TREATMENT OF PLASTICS COMPRISING OF MILLING, SANDING, TURNING AND SPECIAL EXTRUSIONS, IN CLASS 40 (U.S. CLS. 100, 103 AND 106).

FIRST USE 3-31-2006; IN COMMERCE 3-31-2006.

THE MARK CONSISTS OF STANDARD CHARACTERS WITHOUT CLAIM TO ANY PARTICULAR FONT, STYLE, SIZE, OR COLOR.

OWNER OF U.S. REG. NOS. 567,013, 2,631,496,
AND 2,649,199.

SN 78-777,522, FILED 12-20-2005.

SEC. 2(F).

CHERYL CLAYTON, EXAMINING ATTORNEY

Int. Cls.: 6, 35, and 40

Prior U.S. Cls.: 2, 12, 13, 14, 23, 25, 50, 100, 101, 102, 103, and 106

Reg. No. 3,478,097

United States Patent and Trademark Office

Registered July 29, 2008

**TRADEMARK
SERVICE MARK
PRINCIPAL REGISTER**

THE STRENGTH IN METAL

RYERSON PROCUREMENT CORPORATION
(DELAWARE CORPORATION)
2621 WEST 15TH PLACE
CHICAGO, IL 60608

FOR: STEEL IN BAR, ROD, SHEET, AND PLATE FORM; STEEL FLOOR PLATES AND TREAD PLATES; STRUCTURAL STEEL TUBING; EXPANDED STEEL SHEETS; CORRUGATED STEEL SHEETS; CORRUGATED STEEL SHEETS FOR CONSTRUCTION PURPOSES, NAMELY, IN THE WALL AND ROOF SECTION OF BUILDINGS; STAINLESS STEEL SOLD IN BULK; METAL CONSTRUCTION MATERIALS NAMELY, BAR, ROD, SHEET, AND PLATE SHAPES; METAL ROOFING AND ALUMINUM SIDING; METAL FLOOR PLATES AND TREAD PLATES; METAL OPEN FLOORING AND GRATING; ARCHITECTURAL METAL ROOFING IN STEEL AND ALUMINUM; METAL STRUCTURAL TUBING; METAL EXPANDED SHEETS AND GRATING; METAL PERFORATED SHEETS; METAL MECHANICAL TUBING; METAL THREADED TUBING AND BARS; METAL STRUCTURAL SHAPES FOR USE IN THE FURTHER MANUFACTURE OR FINISHED GOODS; METAL PIPE AND PIPE FITTINGS; CARBON STEEL; ALLOY STEEL; STRIP STEEL; SCREW STEEL; METAL SOLD IN BULK FOR FURTHER MANUFACTURING; STAINLESS STEEL; METAL FORGINGS; COLD ROLLED STEEL, FLAME CUT METAL SHAPES, FLAME CUT STEEL SHAPES AND METAL BANDS AND HOOPS; METAL SHAFTING; MACHINED METAL RINGS AND DISCS, IN CLASS 6 (U.S. CLS. 2, 12, 13, 14, 23, 25 AND 50).

FIRST USE 3-31-2006; IN COMMERCE 3-31-2006.

FOR: WHOLESALE DISTRIBUTORSHIP AND RETAIL SERVICES BY DIRECT SOLICITATION BY SALES AGENTS IN THE FIELD OF STEEL, METAL

AND FABRICATED METAL AND STEEL PRODUCTS MANUFACTURED BY OTHERS; AND PROVIDING PERSONAL COMPUTER-BASED ON-LINE ORDERING SERVICES FOR CARBON STEEL, STAINLESS STEEL, ALLOY STEEL, COPPER, NICKEL, PLASTIC, AND ALUMINUM STRUCTURAL COMPONENTS, NAMELY, ANGLES, BEAMS, CHANNELS, TEES, PLATES, BARS, SHEETS, COILS, TUBING, PIPE AND FLOORING AND GRATING PRODUCTS, AND FOR THE PROCESSING, MACHINING, AND FINISHING THEREOF; INVENTORY CONTROL SERVICES IN THE NATURE OF VENDOR MANAGEMENT OF CUSTOMER INVENTORIES AND RECEIPT OF GOODS FOR CUSTOMER INVENTORIES, PROVIDING A MAIL ORDER AND AN ON-LINE CATALOG OF THE GOODS AND SERVICES OF OTHERS IN THE FIELD OF STEEL, METAL, AND RELATED CONSTRUCTION EQUIPMENT, IN CLASS 35 (U.S. CLS. 100, 101 AND 102).

FIRST USE 3-31-2006; IN COMMERCE 3-31-2006.

FOR: FABRICATION, PREPARATION, AND TREATMENT OF METALS AND METAL PRODUCTS COMPRISING FLAME CUTTING, SAWING, THREADING, PUNCHING, BENDING, WELDING, DRILLING, GRINDING, AND SHEARING, AND FABRICATION, PREPARATION, AND TREATMENT OF PLASTICS COMPRISING OF MILLING, SANDING, TURNING AND SPECIAL EXTRUSIONS, IN CLASS 40 (U.S. CLS. 100, 103 AND 106).

FIRST USE 3-31-2006; IN COMMERCE 3-31-2006.

THE MARK CONSISTS OF STANDARD CHARACTERS WITHOUT CLAIM TO ANY PARTICULAR FONT, STYLE, SIZE, OR COLOR.

OWNER OF U.S. REG. NOS. 567,013, 2,631,496,
AND 2,649,199.

SN 78-777,524, FILED 12-20-2005.

CHERYL CLAYTON, EXAMINING ATTORNEY

Int. Cl.: 7

Prior U.S. Cls.: 13, 19, 21, 23, 31, 34, and 35

Reg. No. 3,478,098

United States Patent and Trademark Office

Registered July 29, 2008

**TRADEMARK
PRINCIPAL REGISTER**

MAGNUM

HUSQVARNA PROFESSIONAL OUTDOOR PRODUCTS INC. (OHIO CORPORATION)
1030 STEVENS CREEK ROAD
AUGUSTA, GA 30907

FOR: CONCRETE AND STONE WORKING POWER TOOLS, NAMELY, DIAMOND SEGMENTED MILLING WHEELS, CORING BITS, SINK WHEELS, POLISHING WHEELS, DIAMOND IMPREGNATED PADS, DIAMOND IMPREGNATED CYLINDRICAL WHEELS AND DIAMOND TIPPED BLADES, IN CLASS 7 (U.S. CLS. 13, 19, 21, 23, 31, 34 AND 35).

FIRST USE 12-31-1988; IN COMMERCE 1-1-2005.

THE MARK CONSISTS OF STANDARD CHARACTERS WITHOUT CLAIM TO ANY PARTICULAR FONT, STYLE, SIZE, OR COLOR.

OWNER OF U.S. REG. NOS. 1,418,153 AND 1,418,933.

SN 78-779,034, FILED 12-22-2005.

ANDREA K. NADELMAN, EXAMINING ATTORNEY

Int. Cl.: 16

Prior U.S. Cls.: 2, 5, 22, 23, 29, 37, 38, and 50

Reg. No. 3,478,099

United States Patent and Trademark Office

Registered July 29, 2008

**TRADEMARK
PRINCIPAL REGISTER**

VIVA PIÑATA

MICROSOFT CORPORATION (WASHINGTON CORPORATION)
ONE MICROSOFT WAY
REDMOND, WA 980526399

STORE OUTLETS, IN CLASS 16 (U.S. CLS. 2, 5, 22, 23, 29, 37, 38 AND 50).

FIRST USE 4-10-2007; IN COMMERCE 4-10-2007.

FOR: PUBLICATIONS, NAMELY, STRATEGY GUIDES FOR VIDEO GAMES, USER MANUALS FOR VIDEO GAMES, ALL IN THE FIELDS OF CHILDREN'S STORIES, GAMES, TELEVISION PROGRAMS, MOVIES AND ENTERTAINMENT, ALL NON-BILINGUAL, ALL MARKETED TO PROMOTE VIDEOGAMES, TELEVISION PROGRAMS AND RELATED CHARACTERS, AND ALL SOLD AND MARKETED TO THE GENERAL PUBLIC THROUGH GENERAL ONLINE AND RETAIL

THE MARK CONSISTS OF STANDARD CHARACTERS WITHOUT CLAIM TO ANY PARTICULAR FONT, STYLE, SIZE, OR COLOR.

SN 78-779,816, FILED 12-22-2005.

TRACY WHITTAKER-BROWN, EXAMINING ATTORNEY

Int. Cl.: 35

Prior U.S. Cls.: 100, 101, and 102

United States Patent and Trademark Office

Reg. No. 3,478,100

Registered July 29, 2008

**SERVICE MARK
PRINCIPAL REGISTER**

BIKERS OF THE LINKS

M2 OF MYRTLE BEACH (SOUTH CAROLINA
LTD LIAB CO)
4450 PARKLAND DRIVE
MYRTLE BEACH, SC 29579

FOR: ASSOCIATION SERVICES, NAMELY, PROMOTING THE INTERESTS OF MOTOCYCLE OWNERS, RIDERS AND ENTHUSIASTS AND GOLF PLAYERS, FANS AND ENTHUSIASTS, IN CLASS 35 (U.S. CLS. 100, 101 AND 102).

FIRST USE 2-28-2006; IN COMMERCE 2-28-2006.

THE MARK CONSISTS OF STANDARD CHARACTERS WITHOUT CLAIM TO ANY PARTICULAR FONT, STYLE, SIZE, OR COLOR.

NO CLAIM IS MADE TO THE EXCLUSIVE RIGHT TO USE "BIKERS", APART FROM THE MARK AS SHOWN.

SN 78-780,886, FILED 12-27-2005.

RONALD MCMORROW, EXAMINING ATTORNEY

Int. Cl.: 26

Prior U.S. Cls.: 37, 39, 40, 42, and 50

United States Patent and Trademark Office

Reg. No. 3,478,101

Registered July 29, 2008

**TRADEMARK
PRINCIPAL REGISTER**

FRILLY FEET

SWEETFEET, LLC (MISSOURI LIMITED LIABILITY COMPANY)
1707 N.W. WILLOWBROOK DRIVE
BLUE SPRINGS, MO 64015

FOR: SHOE ORNAMENTS NOT OF PRECIOUS METAL, OF PLASTIC, FABRIC, STONES, PRECIOUS STONES, CRYSTALS AND GLASS, IN CLASS 26 (U.S. CLS. 37, 39, 40, 42 AND 50).

FIRST USE 3-0-2006; IN COMMERCE 3-0-2006.

THE MARK CONSISTS OF STANDARD CHARACTERS WITHOUT CLAIM TO ANY PARTICULAR FONT, STYLE, SIZE, OR COLOR.

SN 78-783,987, FILED 1-3-2006.

ODESSA BIBBINS, EXAMINING ATTORNEY

Int. Cl.: 10

Prior U.S. Cls.: 26, 39, and 44

Reg. No. 3,478,102

United States Patent and Trademark Office

Registered July 29, 2008

**TRADEMARK
PRINCIPAL REGISTER**

THINPRO

TERUMO MEDICAL CORPORATION (DELA-
WARE CORPORATION)
2101 COTTONTAIL LANE
SOMERSET, NJ 08873

THE MARK CONSISTS OF STANDARD CHAR-
ACTERS WITHOUT CLAIM TO ANY PARTICULAR
FONT, STYLE, SIZE, OR COLOR.

FOR: SURGICAL, MEDICAL, DENTAL AND VE-
TERINARY APPARTUS AND INSTRUMENTS,
NAMELY, INJECTION NEEDLES FOR MEDICAL
USE, IN CLASS 10 (U.S. CLS. 26, 39 AND 44).

SN 78-787,375, FILED 1-9-2006.

FIRST USE 3-31-2008; IN COMMERCE 3-31-2008.

SHAUNIA CARLYLE, EXAMINING ATTORNEY

Int. Cls.: 35, 36, and 42

Prior U.S. Cls.: 100, 101, and 102

United States Patent and Trademark Office

Reg. No. 3,478,103

Registered July 29, 2008

**SERVICE MARK
PRINCIPAL REGISTER**

LOOP

LOOPNET, INC. (CALIFORNIA CORPORATION)
SUITE 208
181 W. HUNTINGTON DRIVE
MONROVIA, CA 91016

FOR: PROVIDING A WEBSITE FOR THE LISTING OF BUSINESSES FOR SALE, IN CLASS 35 (U.S. CLS. 100, 101 AND 102).

FIRST USE 4-17-2008; IN COMMERCE 4-17-2008.

FOR: REAL ESTATE LISTING, NAMELY, PROVIDING REAL ESTATE LISTINGS, DATA AND RELATED INFORMATION VIA GLOBAL COMPUTER NETWORKS; MORTGAGE BROKERAGE; MORTGAGE LENDING AND LOAN FINANCING; PROVIDING A SUBSCRIBER BASED REAL ESTATE WEBSITE WHICH PERMITS THE USER TO ENTER, STORE, MANAGE, ACCESS, AND/OR MANIPULATE DATA AND INFORMATION ON REAL ESTATE PROPERTIES AND PREPARE REPORTS THEREON, IN CLASS 36 (U.S. CLS. 100, 101 AND 102).

FIRST USE 4-17-2008; IN COMMERCE 4-17-2008.

FOR: COMPUTER SERVICES, NAMELY, DESIGNING, CUSTOMIZING, IMPLEMENTING AND MAINTAINING WEBSITES FOR OTHERS; HOSTING THE WEBSITES OF OTHERS ON A COMPUTER SERVER FOR A GLOBAL COMPUTER NETWORK, IN CLASS 42 (U.S. CLS. 100 AND 101).

FIRST USE 4-17-2008; IN COMMERCE 4-17-2008.

THE MARK CONSISTS OF STANDARD CHARACTERS WITHOUT CLAIM TO ANY PARTICULAR FONT, STYLE, SIZE, OR COLOR.

OWNER OF U.S. REG. NOS. 2,340,750, 2,494,775, AND OTHERS.

SN 78-788,779, FILED 1-10-2006.

MARY ROSSMAN, EXAMINING ATTORNEY

Int. Cl.: 36

Prior U.S. Cls.: 100, 101, and 102

United States Patent and Trademark Office

Reg. No. 3,478,104

Registered July 29, 2008

**SERVICE MARK
PRINCIPAL REGISTER**

**INFINITY SPECIALTY
INSURANCE COMPANY**

INFINITY INSURANCE COMPANY (INDIANA
CORPORATION)
3700 COLONNADE PARKWAY
BIRMINGHAM, AL 35243

OWNER OF U.S. REG. NOS. 1,819,181, 2,472,418,
AND OTHERS.

FOR: PROPERTY AND CASUALTY INSURANCE
UNDERWRITING SERVICES, IN CLASS 36 (U.S.
CLS. 100, 101 AND 102).

NO CLAIM IS MADE TO THE EXCLUSIVE
RIGHT TO USE "SPECIALTY INSURANCE COM-
PANY", APART FROM THE MARK AS SHOWN.

FIRST USE 1-17-2006; IN COMMERCE 1-17-2006.

SN 78-791,348, FILED 1-13-2006.

THE MARK CONSISTS OF STANDARD CHAR-
ACTERS WITHOUT CLAIM TO ANY PARTICULAR
FONT, STYLE, SIZE, OR COLOR.

SANDRA MANIOS, EXAMINING ATTORNEY

Int. Cl.: 35

Prior U.S. Cls.: 100, 101, and 102

United States Patent and Trademark Office

Reg. No. 3,478,105

Registered July 29, 2008

SERVICE MARK
PRINCIPAL REGISTER



MORGAN, ROBERT H (UNITED STATES INDIVIDUAL)
2111 W 80TH PLACE
DENVER, CO 80221 AND
MORGAN, CAROL D (UNITED STATES INDIVIDUAL)
2111 W 80TH PLACE
DENVER, CO 80221

FOR: COMPUTERIZED ONLINE ORDERING FEATURING GENERAL MERCHANDISE AND GENERAL CONSUMER GOODS; OPERATING ONLINE MARKETPLACES FOR SELLERS OF GOODS AND/OR SERVICES, IN CLASS 35 (U.S. CLS. 100, 101 AND 102).

FIRST USE 3-25-2005; IN COMMERCE 3-25-2005.

NO CLAIM IS MADE TO THE EXCLUSIVE RIGHT TO USE "ARTS", APART FROM THE MARK AS SHOWN.

THE COLOR(S) RED AND WHITE IS/ARE CLAIMED AS A FEATURE OF THE MARK.

THE MARK CONSISTS OF A WHITE TREE WITH WHITE WINGED-DRAGONS ON A RED BACKGROUND WITH WORDS "MEDULLA ARTS" IN RED SUPERIMPOSED ON THE TREE

SN 78-791,860, FILED 1-13-2006.

ANDREA SAUNDERS, EXAMINING ATTORNEY

Int. Cl.: 9

Prior U.S. Cls.: 21, 23, 26, 36, and 38

United States Patent and Trademark Office

Reg. No. 3,478,106

Registered July 29, 2008

**TRADEMARK
PRINCIPAL REGISTER**



CPACKET NETWORKS INC. (DELAWARE CORPORATION)
2061 LANDINGS DRIVE
MOUNTAIN VIEW, CA 94043

FOR: COMPUTER HARDWARE AND COMPUTER SOFTWARE FOR USE IN MONITORING, SECURING, RESPONDING TO AND CONTROLLING COMPUTER AND COMMUNICATIONS NETWORK TRAFFIC, IN CLASS 9 (U.S. CLS. 21, 23, 26, 36 AND 38).

FIRST USE 3-1-2006; IN COMMERCE 3-1-2006.

NO CLAIM IS MADE TO THE EXCLUSIVE RIGHT TO USE "NETWORKS", APART FROM THE MARK AS SHOWN.

THE COLORS BLUE, BLACK, AND WHITE ARE CLAIMED AS A FEATURE OF THE MARK.

THE COLOR BLUE APPEARS IN THE PORTION OF THE BORDER OF THE CIRCLE COMPRISING THE TOP, LEFT, AND BOTTOM SIDES OF THE CIRCLE; THE COLOR BLACK APPEARS IN THE DOT INSIDE THE CIRCLE, THE PORTION OF THE BORDER OF THE CIRCLE COMPRISING THE RIGHT SIDE OF THE CIRCLE, AND IN THE WORDING "CPACKET NETWORKS"; THE COLOR WHITE APPEARS IN THE BREAKS IN THE BORDER OF THE CIRCLE AND THE BACKGROUND OF THE MARK.

SN 78-792,969, FILED 1-17-2006.

MICHAEL GAAFAR, EXAMINING ATTORNEY

Int. Cls.: 8, 21, 25, and 26

**Prior U.S. Cls.: 2, 13, 22, 23, 28, 29, 30, 33, 37, 39, 40,
42, 44, and 50**

Reg. No. 3,478,107

United States Patent and Trademark Office

Registered July 29, 2008

**TRADEMARK
PRINCIPAL REGISTER**

NATALIE

ADOLFO HOUSE DISTRIBUTING CORP. (FLOR-
IDA CORPORATION)
3655 NW 71 STREET
MIAMI, FL 33147

FOR: STRAIGHT EDGE RAZORS USED FOR
CUTTING HAIR, IN CLASS 8 (U.S. CLS. 23, 28 AND
44).

FIRST USE 12-20-2007; IN COMMERCE 1-17-2008.

FOR: DUSTING BRUSHES FOR USE ON NECKS,
BOWLS FOR MIXING HAIR COLOR PRODUCTS,
AND BRUSHES FOR APPLYING HAIR COLOR
AND HIGHLIGHTING PRODUCTS, IN CLASS 21
(U.S. CLS. 2, 13, 23, 29, 30, 33, 40 AND 50).

FIRST USE 12-12-2007; IN COMMERCE 1-17-2008.

FOR: PLASTIC SHOWER CAPS AND PLASTIC
CAPES, IN CLASS 25 (U.S. CLS. 22 AND 39).

FIRST USE 12-13-2007; IN COMMERCE 12-17-2007.

FOR: NON-ELECTRIC HAIR CURLERS, IN
CLASS 26 (U.S. CLS. 37, 39, 40, 42 AND 50).

FIRST USE 1-18-2008; IN COMMERCE 2-6-2008.

THE MARK CONSISTS OF STANDARD CHAR-
ACTERS WITHOUT CLAIM TO ANY PARTICULAR
FONT, STYLE, SIZE, OR COLOR.

SN 78-793,811, FILED 1-18-2006.

KEVIN DINALLO, EXAMINING ATTORNEY

Int. Cl.: 9

Prior U.S. Cls.: 21, 23, 26, 36, and 38

Reg. No. 3,478,108

United States Patent and Trademark Office

Registered July 29, 2008

**TRADEMARK
PRINCIPAL REGISTER**

SIMENTERPRISE

MSC.SOFTWARE CORPORATION (DELAWARE
CORPORATION)
2 MACARTHUR PLACE
SANTA ANA, CA 92707

THE MARK CONSISTS OF STANDARD CHAR-
ACTERS WITHOUT CLAIM TO ANY PARTICULAR
FONT, STYLE, SIZE, OR COLOR.

FOR: COMPUTER SOFTWARE FOR ENGINEER-
ING ANALYSIS, NAMELY, SOFTWARE FOR
BUILDING, TESTING, REVIEWING AND IMPROV-
ING DESIGNS OF PRODUCTS, IN CLASS 9 (U.S.
CLS. 21, 23, 26, 36 AND 38).

OWNER OF U.S. REG. NO. 3,030,400.

SN 78-794,779, FILED 1-19-2006.

FIRST USE 10-26-2007; IN COMMERCE 10-26-2007.

LA TONIA FISHER, EXAMINING ATTORNEY

Int. Cl.: 5

Prior U.S. Cls.: 6, 18, 44, 46, 51, and 52

United States Patent and Trademark Office

Reg. No. 3,478,109

Registered July 29, 2008

**TRADEMARK
PRINCIPAL REGISTER**

NURSING ESSENTIALS

CLARK, KATHRINE (UNITED STATES INDIVIDUAL)

10837 SCAGGSVILLE ROAD

LAUREL, MD 20723

FOR: AREOLA PADS, IN CLASS 5 (U.S. CLS. 6, 18, 44, 46, 51 AND 52).

FIRST USE 7-0-2006; IN COMMERCE 7-0-2006.

THE MARK CONSISTS OF STANDARD CHARACTERS WITHOUT CLAIM TO ANY PARTICULAR FONT, STYLE, SIZE, OR COLOR.

NO CLAIM IS MADE TO THE EXCLUSIVE RIGHT TO USE "NURSING", APART FROM THE MARK AS SHOWN.

SN 78-797,050, FILED 1-23-2006.

KELLY CHOE, EXAMINING ATTORNEY

Int. Cl.: 41

Prior U.S. Cls.: 100, 101, and 107

United States Patent and Trademark Office

Reg. No. 3,478,110

Registered July 29, 2008

**SERVICE MARK
PRINCIPAL REGISTER**



MAMMOTH MOUNTAIN SKI AREA, LLC (DE-
LAWARE LTD LIAB CO)
1 MINARET ROAD
MAMMOTH LAKES, CA 93546

FIRST USE 11-0-2004; IN COMMERCE 11-0-2004.

OWNER OF U.S. REG. NOS. 2,720,400, 2,723,086,
AND 2,959,479.

FOR: RECREATIONAL SERVICES IN THE NAT-
URE OF DOWNHILL SKI AND SNOWBOARD FA-
CILITIES, CROSS-COUNTRY SKI FACILITIES AND
TRAILS, SNOWMOBILING FACILITIES AND
TRAILS, SNOW-SHOEING TRAILS, EQUESTRIAN
FACILITIES, AND GOLF COURSE FACILITIES, IN
CLASS 41 (U.S. CLS. 100, 101 AND 107).

THE MARK CONSISTS, IN PART, OF AN UPSIDE-
DOWN "V" REPRESENTING A MOUNTAIN PEAK.

SN 78-797,375, FILED 1-23-2006.

DAVID MILLER, EXAMINING ATTORNEY

Int. Cl.: 16

Prior U.S. Cls.: 2, 5, 22, 23, 29, 37, 38, and 50

United States Patent and Trademark Office

Reg. No. 3,478,111

Registered July 29, 2008

**TRADEMARK
PRINCIPAL REGISTER**



LEVY, LEE M (UNITED STATES INDIVIDUAL)
2124 CHURCHILL COURT
HIGHLAND PARK, IL 60035

FOR: PAPER NAPKINS; LUNCH BAGS; STA-
TIONERY; ENVELOPES; NOTE PADS; PAPER
BOXES; LEGAL PADS; ADHESIVE STICK-ONS;
PLASTIC SHEETS FOR WRITING, PRINTING AND
MARKING; PLASTIC SACKS AND BAGS FOR

WRAPPING; PLASTIC DIAPERS, IN CLASS 16 (U.S.
CLS. 2, 5, 22, 23, 29, 37, 38 AND 50).

FIRST USE 6-19-2007; IN COMMERCE 2-24-2008.

SN 78-797,695, FILED 1-24-2006.

TIMOTHY FINNEGAN, EXAMINING ATTORNEY

Int. Cl.: 9

Prior U.S. Cls.: 21, 23, 26, 36, and 38

United States Patent and Trademark Office

Reg. No. 3,478,112

Registered July 29, 2008

**TRADEMARK
PRINCIPAL REGISTER**

Snap Doc

FABSOFT (NEW JERSEY CORPORATION)
25 CANFIELD RD
CEDAR GROVE, NJ 07009

FOR: COMPUTER SOFTWARE FOR THE MANAGEMENT OF CAPTURING AND ORGANIZING DIGITAL PICTURES AND ELECTRONIC DISTRIBUTION OF DIGITAL PICTURES TO PRINTERS, FAX, EMAIL, ARCHIVE , IN CLASS 9 (U.S. CLS. 21, 23, 26, 36 AND 38).

FIRST USE 2-5-2007; IN COMMERCE 2-5-2007.

THE MARK CONSISTS OF STANDARD CHARACTERS WITHOUT CLAIM TO ANY PARTICULAR FONT, STYLE, SIZE, OR COLOR.

SN 78-797,854, FILED 1-24-2006.

AMY GEARIN, EXAMINING ATTORNEY

Int. Cl.: 36

Prior U.S. Cls.: 100, 101, and 102

United States Patent and Trademark Office

Reg. No. 3,478,113

Registered July 29, 2008

**SERVICE MARK
PRINCIPAL REGISTER**

RAVA 4 SELECT

AMERIPRISE FINANCIAL, INC. (DELAWARE
CORPORATION)
707 SECOND AVENUE
MINNEAPOLIS, MN 55402

FOR: FINANCIAL SERVICES, NAMELY, INVEST-
MENT MANAGEMENT OF ANNUITIES AND DIS-
TRIBUTION OF ANNUITIES, IN CLASS 36 (U.S. CLS.
100, 101 AND 102).

FIRST USE 1-0-2007; IN COMMERCE 1-0-2007.

THE MARK CONSISTS OF STANDARD CHAR-
ACTERS WITHOUT CLAIM TO ANY PARTICULAR
FONT, STYLE, SIZE, OR COLOR.

SN 78-798,945, FILED 1-25-2006.

JERI J. FICKES, EXAMINING ATTORNEY

Int. Cl.: 36

Prior U.S. Cls.: 100, 101, and 102

United States Patent and Trademark Office

Reg. No. 3,478,114

Registered July 29, 2008

**SERVICE MARK
PRINCIPAL REGISTER**



PERIGEE INVESTMENT ADVISORS, LLC (PENN-
SYLVANIA LTD LIAB CO)
P.O. BOX 351
HERSHEY, PA 17033

FOR: INVESTMENT ADVISORY SERVICES, IN
CLASS 36 (U.S. CLS. 100, 101 AND 102).

FIRST USE 11-1-2005; IN COMMERCE 6-11-2008.

THE COLORS WHITE, GREEN AND ORANGE
ARE CLAIMED AS A FEATURE OF THE MARK.

THE MARK CONSISTS OF THREE DIFFERENT-
LY SIZED CIRCLES ON A WHITE BACKGROUND.
THE LARGEST CIRCLE IS GREEN WITH A SMAL-
LER WHITE CIRCLE ON TOP OF IT AND A
SMALLER ORANGE CIRCLE OVERLAPPING
BOTH LARGER CIRCLES AT THE POINT WHERE
THE TWO LARGER CIRCLES' BORDERS ARE
CLOSEST TO ONE ANOTHER.

SN 78-801,057, FILED 1-27-2006.

JAMES A. RAUEN, EXAMINING ATTORNEY

Int. Cl.: 36

Prior U.S. Cls.: 100, 101, and 102

United States Patent and Trademark Office

Reg. No. 3,478,115

Registered July 29, 2008

**SERVICE MARK
PRINCIPAL REGISTER**

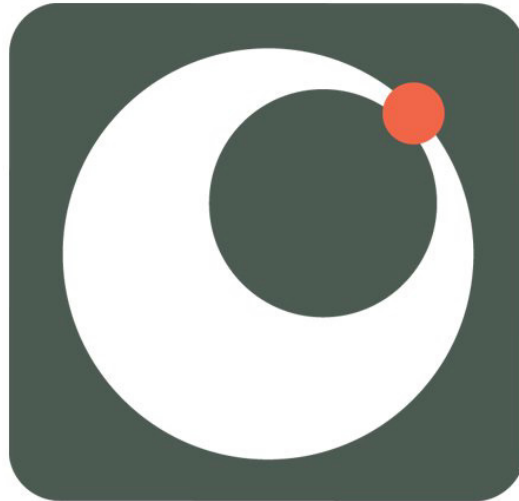

PERIGEE INVESTMENT ADVISORS, LLC (PENNSYLVANIA LTD LIAB CO)
P.O. BOX 351
HERSHEY, PA 17033

FOR: INVESTMENT ADVISORY SERVICES, IN CLASS 36 (U.S. CLS. 100, 101 AND 102).

FIRST USE 11-1-2005; IN COMMERCE 6-11-2008.

THE COLORS WHITE, GREEN AND ORANGE ARE CLAIMED AS A FEATURE OF THE MARK.

THE MARK CONSISTS OF THREE DIFFERENTLY SIZED CIRCLES ON A GREEN BACKGROUND. THE LARGEST CIRCLE IS WHITE WITH A SMALLER GREEN CIRCLE ON TOP OF IT AND A SMALLER ORANGE CIRCLE OVERLAPPING BOTH LARGER CIRCLES AT THE POINT WHERE THE TWO LARGER CIRCLES' BORDERS ARE CLOSEST TO ONE ANOTHER.

SN 78-801,077, FILED 1-27-2006.

JAMES A. RAUEN, EXAMINING ATTORNEY

Int. Cl.: 38

Prior U.S. Cls.: 100, 101, and 104

United States Patent and Trademark Office

Reg. No. 3,478,116

Registered July 29, 2008

**SERVICE MARK
PRINCIPAL REGISTER**

FAXMAGIC

CONFERENCE AMERICA, INC. (ALABAMA
CORPORATION)
7079 UNIVERSITY COURT
MONTGOMERY, AL 36117

THE MARK CONSISTS OF STANDARD CHAR-
ACTERS WITHOUT CLAIM TO ANY PARTICULAR
FONT, STYLE, SIZE, OR COLOR.

FOR: FACSIMILE TRANSMISSION SERVICES, IN
CLASS 38 (U.S. CLS. 100, 101 AND 104).

SN 78-801,100, FILED 1-27-2006.

FIRST USE 4-0-2008; IN COMMERCE 4-0-2008.

GENE MACIOL, EXAMINING ATTORNEY

Int. Cl.: 3

Prior U.S. Cls.: 1, 4, 6, 50, 51, and 52

Reg. No. 3,478,117

United States Patent and Trademark Office

Registered July 29, 2008

**TRADEMARK
PRINCIPAL REGISTER**

KEEP YOUR POWDER DRY

LOGERFO, JODI (UNITED STATES INDIVIDUAL)
909 FIFTH AVENUE
NEW YORK, NY 10021 AND
ORENTRICH, DAVID (UNITED STATES INDIVIDUAL)
909 FIFTH AVENUE
NEW YORK, NY 10021

FIRST USE 5-31-2008; IN COMMERCE 5-31-2008.

THE MARK CONSISTS OF STANDARD CHARACTERS WITHOUT CLAIM TO ANY PARTICULAR FONT, STYLE, SIZE, OR COLOR.

SN 78-801,142, FILED 1-27-2006.

FOR: DEODORANTS AND ANTIPERSPIRANTS,
IN CLASS 3 (U.S. CLS. 1, 4, 6, 50, 51 AND 52).

ELLEN PERKINS, EXAMINING ATTORNEY

Int. Cl.: 9

Prior U.S. Cls.: 21, 23, 26, 36, and 38

Reg. No. 3,478,118

United States Patent and Trademark Office

Registered July 29, 2008

**TRADEMARK
PRINCIPAL REGISTER**

NOSSO

WESSLING, OLIVER H. (FED REP GERMANY
INDIVIDUAL)
7181 ENCINA LANE
BOCA RATON, FL 33433

FIRST USE 10-24-2005; IN COMMERCE 10-24-2005.

FOR: COMPUTER NETWORK OPERATIONS
SYSTEMS SIZE OPTIMIZER SOFTWARE FOR OP-
TIMIZATION OF DATA VOLUMES AND NET-
WORK DATA MANAGEMENT, IN CLASS 9 (U.S.
CLS. 21, 23, 26, 36 AND 38).

THE MARK CONSISTS OF STANDARD CHAR-
ACTERS WITHOUT CLAIM TO ANY PARTICULAR
FONT, STYLE, SIZE, OR COLOR.

SN 78-801,955, FILED 1-30-2006.

JUSTINE D. PARKER, EXAMINING ATTORNEY

Int. Cl.: 41

Prior U.S. Cls.: 100, 101, and 107

United States Patent and Trademark Office

Reg. No. 3,478,119

Registered July 29, 2008

**SERVICE MARK
PRINCIPAL REGISTER**

Career Window

NEISENDORF & ASSOCIATES, INC. (CALIFORNIA CORPORATION)

30 VISTA DEL SOL

MILL VALLEY, CA 94941

FOR: CAREER COUNSELING, IN CLASS 41 (U.S. CLS. 100, 101 AND 107).

FIRST USE 11-15-2006; IN COMMERCE 11-15-2006.

THE MARK CONSISTS OF STANDARD CHARACTERS WITHOUT CLAIM TO ANY PARTICULAR FONT, STYLE, SIZE, OR COLOR.

NO CLAIM IS MADE TO THE EXCLUSIVE RIGHT TO USE "CAREER", APART FROM THE MARK AS SHOWN.

SN 78-802,760, FILED 1-30-2006.

TIMOTHY FINNEGAN, EXAMINING ATTORNEY

Int. Cl.: 25

Prior U.S. Cls.: 22 and 39

United States Patent and Trademark Office

Reg. No. 3,478,120

Registered July 29, 2008

**TRADEMARK
PRINCIPAL REGISTER**

TOTAL SKULL

ZOMBIE, SHERI (UNITED STATES INDIVIDUAL)
C/O LONDON & COMPANY
11601 WILSHIRE BOULEVARD, SUITE 2040
LOS ANGELES, CA 90025

FOR: CLOTHING, NAMELY, SHIRTS, T-SHIRTS, TANK TOPS, SWEATSHIRTS, HOODED SWEATSHIRTS, JEANS, SWEAT SUITS, SHORTS, UNDERWEAR, AND JACKETS; CLOTHING ACCESSORIES, NAMELY, WRISTBANDS, SCARVES, BANDANAS, BELTS, SOCKS, AND GLOVES; HEADWEAR; HATS;

AND FOOTWEAR, IN CLASS 25 (U.S. CLS. 22 AND 39).

FIRST USE 2-15-2006; IN COMMERCE 2-15-2006.

THE MARK CONSISTS OF STANDARD CHARACTERS WITHOUT CLAIM TO ANY PARTICULAR FONT, STYLE, SIZE, OR COLOR.

SN 78-804,839, FILED 2-1-2006.

MARCIE MILONE, EXAMINING ATTORNEY

Int. Cl.: 9

Prior U.S. Cls.: 21, 23, 26, 36, and 38

Reg. No. 3,478,121

United States Patent and Trademark Office

Registered July 29, 2008

**TRADEMARK
PRINCIPAL REGISTER**

PASSPORT

UNITED STATES THERMOAMP INC. (PENNSYLVANIA CORPORATION)
1223 HEAT SIPHON LANE
LATROBE, PA 15650

FOR: WIRELESS DIGITAL RELAYS FOR USE WITH WIRELESS POOL AND SPA CONTROLLERS; WIRELESS DIGITAL RELAYS FOR USE WITH WIRED POOL AND SPA CONTROLLERS; WIRELESS DIGITAL RELAYS FOR USE WITH WIRELESS DEVICES WHICH CONTROL PUMPS, HEATERS, AUTOMATIC CLEANERS, UNDERWATER LIGHTING, LANDSCAPE LIGHTING, OUTDOOR LIGHTING, INDOOR LIGHTING, POOL OR SPA COVERS AND AUXILIARY EQUIPMENT, ALL OF THE ABOVE FOR POOLS AND SPAS; WIRELESS DIGITAL RELAYS FOR USE WITH WIRED DEVICES WHICH CONTROL PUMPS, HEATERS, AUTOMATIC CLEANERS, UNDERWATER LIGHTING, LANDSCAPE LIGHTING, OUTDOOR LIGHTING, INDOOR LIGHTING, POOL OR SPA COVERS AND AUXILIARY EQUIPMENT, ALL OF THE ABOVE FOR POOLS AND SPAS; WIRELESS CONTROLS FOR USE WITH WIRELESS POOL AND SPA CONTROLLERS; WIRELESS CONTROLS FOR USE WITH WIRED POOL AND SPA CONTROLLERS; WIRELESS CONTROLS FOR USE WITH WIRELESS

DEVICES WHICH CONTROL PUMPS, HEATERS, AUTOMATIC CLEANERS, UNDERWATER LIGHTING, LANDSCAPE LIGHTING, OUTDOOR LIGHTING, INDOOR LIGHTING, POOL OR SPA COVERS AND AUXILIARY EQUIPMENT, ALL OF THE ABOVE FOR POOLS AND SPAS; WIRELESS CONTROLS FOR USE WITH WIRED DEVICES WHICH CONTROL PUMPS, HEATERS, AUTOMATIC CLEANERS, UNDERWATER LIGHTING, LANDSCAPE LIGHTING, OUTDOOR LIGHTING, INDOOR LIGHTING, POOL OR SPA COVERS AND AUXILIARY EQUIPMENT, ALL OF THE ABOVE FOR POOLS AND SPAS, IN CLASS 9 (U.S. CLS. 21, 23, 26, 36 AND 38).

FIRST USE 5-31-2008; IN COMMERCE 5-31-2008.

THE MARK CONSISTS OF STANDARD CHARACTERS WITHOUT CLAIM TO ANY PARTICULAR FONT, STYLE, SIZE, OR COLOR.

SN 78-805,359, FILED 2-2-2006.

DOMINIC J. FERRAIUOLO, EXAMINING ATTORNEY

Int. Cl.: 9

Prior U.S. Cls.: 21, 23, 26, 36, and 38

United States Patent and Trademark Office

Reg. No. 3,478,122

Registered July 29, 2008

**TRADEMARK
PRINCIPAL REGISTER**

CLEAN CONTROL

NOSO CONTROL, LLC (FLORIDA LTD LIAB CO)
12914 DUPONT CIRCLE
TAMPA, FL 33626

FOR: REMOTE CONTROLS FOR TELEVISIONS,
IN CLASS 9 (U.S. CLS. 21, 23, 26, 36 AND 38).

FIRST USE 3-12-2008; IN COMMERCE 3-12-2008.

THE MARK CONSISTS OF STANDARD CHAR-
ACTERS WITHOUT CLAIM TO ANY PARTICULAR
FONT, STYLE, SIZE, OR COLOR.

NO CLAIM IS MADE TO THE EXCLUSIVE
RIGHT TO USE "CONTROL", APART FROM THE
MARK AS SHOWN.

SN 78-805,498, FILED 2-2-2006.

JUSTINE D. PARKER, EXAMINING ATTORNEY

Int. Cls.: 41 and 44

Prior U.S. Cls.: 100, 101, and 107

United States Patent and Trademark Office

Reg. No. 3,478,123

Registered July 29, 2008

**SERVICE MARK
PRINCIPAL REGISTER**

RAISING OUR CHILDREN

JACKSON, JULIE (UNITED STATES INDIVIDUAL)
1225 W. MORSE AVENUE #306
CHICAGO, IL 60016

FOR: EDUCATION SERVICES, NAMELY, PROVIDING CLASSES AND WORKSHOPS IN THE FIELD OF PARENTING; CHARITABLE SERVICES, NAMELY, ACADEMIC MENTORING OF SCHOOL AGE CHILDREN; EDUCATION SERVICES, NAMELY, ONE-ON-ONE MENTORING IN THE FIELD OF PERSONAL DEVELOPMENT; EDUCATION SERVICES, NAMELY, MENTORING IN THE FIELD OF PERSONAL DEVELOPMENT; CHARITABLE SERVICES, NAMELY, PROVIDING ARTS AND CRAFTS AND EDUCATIONAL MATERIALS IN THE NATURE OF RECYCLED MANUFACTURING BY-PRODUCTS TO NEEDY AND UNDERPRIVILEGED CHILDREN; CONDUCTING WORKSHOPS AND SEMINARS IN THE FIELD OF ART APPRECIATION; DANCE INSTRUCTION; ENTERTAINMENT

IN THE NATURE OF DANCE PERFORMANCES, IN CLASS 41 (U.S. CLS. 100, 101 AND 107).

FIRST USE 5-1-2005; IN COMMERCE 5-1-2005.

FOR: MENTAL HEALTH COUNSELING AND PSYCHOTHERAPY AS IT RELATES TO RELATIONSHIPS; NUTRITION COUNSELING, IN CLASS 44 (U.S. CLS. 100 AND 101).

FIRST USE 5-1-2005; IN COMMERCE 5-1-2005.

THE MARK CONSISTS OF STANDARD CHARACTERS WITHOUT CLAIM TO ANY PARTICULAR FONT, STYLE, SIZE, OR COLOR.

SN 78-805,705, FILED 2-2-2006.

TIMOTHY FINNEGAN, EXAMINING ATTORNEY

Int. Cls.: 3 and 21

**Prior U.S. Cls.: 1, 2, 4, 6, 13, 23, 29, 30, 33, 40, 50, 51,
and 52**

Reg. No. 3,478,124

United States Patent and Trademark Office

Registered July 29, 2008

**TRADEMARK
PRINCIPAL REGISTER**



MINERAL RADIANCE, LLC (WASHINGTON
LTD LIAB CO)
SUITE 212
801 W. FIFTH AVENUE
SPOKANE, WA 99204

FOR: COSMETICS, IN CLASS 3 (U.S. CLS. 1, 4, 6, 50,
51 AND 52).

FIRST USE 12-30-2005; IN COMMERCE 12-30-2005.

FOR: COSMETIC BRUSHES FOR THE PURPOSE
OF APPLYING COSMETICS; APPLICATOR STICKS
FOR APPLYING MAKE-UP, IN CLASS 21 (U.S. CLS.
2, 13, 23, 29, 30, 33, 40 AND 50).

FIRST USE 12-30-2005; IN COMMERCE 12-30-2005.

NO CLAIM IS MADE TO THE EXCLUSIVE
RIGHT TO USE "MINERAL", APART FROM THE
MARK AS SHOWN.

THE STIPPLING IS FOR SHADING PURPOSES
ONLY.

THE MARK CONSISTS OF "PLATTHAND" FONT
WITH A STYLIZED CAPITAL "M" AND "R", AND
TWO STYLIZED "E"'S WITHIN THE MARK.

SN 78-805,869, FILED 2-2-2006.

CAROL SPILS, EXAMINING ATTORNEY

Int. Cl.: 9

Prior U.S. Cls.: 21, 23, 26, 36, and 38

United States Patent and Trademark Office

Reg. No. 3,478,125

Registered July 29, 2008

**TRADEMARK
PRINCIPAL REGISTER**

LIBERTY AV SOLUTIONS

LIBERTY WIRE & CABLE, INC. (DELAWARE
CORPORATION)
11675 RIDGELINE DRIVE
COLORADO SPRINGS, CO 80921

FOR: ELECTRIC WIRE AND CABLE, IN CLASS 9
(U.S. CLS. 21, 23, 26, 36 AND 38).

FIRST USE 11-1-2007; IN COMMERCE 11-1-2007.

THE MARK CONSISTS OF STANDARD CHAR-
ACTERS WITHOUT CLAIM TO ANY PARTICULAR
FONT, STYLE, SIZE, OR COLOR.

OWNER OF U.S. REG. NO. 3,079,345.

NO CLAIM IS MADE TO THE EXCLUSIVE
RIGHT TO USE "AV SOLUTIONS", APART FROM
THE MARK AS SHOWN.

SN 78-809,704, FILED 2-8-2006.

KATHLEEN M. VANSTON, EXAMINING ATTOR-
NEY

Int. Cl.: 28

Prior U.S. Cls.: 22, 23, 38, and 50

United States Patent and Trademark Office

Reg. No. 3,478,126

Registered July 29, 2008

**TRADEMARK
PRINCIPAL REGISTER**

HAWAIIAN ISLAND CREATIONS

HAWAIIAN ISLAND CREATIONS, INC. (HAWAII CORPORATION)
354 HAHANI STREET
KAILUA, HI 96734

FOR: SURFBOARDS; AND ACCESSORIES RELATING TO SURFBOARDS, NAMELY, LEASHES, IN CLASS 28 (U.S. CLS. 22, 23, 38 AND 50).

FIRST USE 1-0-1975; IN COMMERCE 1-0-1975.

THE MARK CONSISTS OF STANDARD CHARACTERS WITHOUT CLAIM TO ANY PARTICULAR FONT, STYLE, SIZE, OR COLOR.

NO CLAIM IS MADE TO THE EXCLUSIVE RIGHT TO USE "HAWAIIAN ISLAND", APART FROM THE MARK AS SHOWN.

SN 78-810,114, FILED 2-8-2006.

COLLEEN DOMBROW, EXAMINING ATTORNEY

Int. Cls.: 11 and 21

Prior U.S. Cls.: 2, 13, 21, 23, 29, 30, 31, 33, 34, 40, and 50

Reg. No. 3,478,127

United States Patent and Trademark Office

Registered July 29, 2008

**TRADEMARK
PRINCIPAL REGISTER**

**ARCHITECTURALLY INSPIRED
COLLECTIONS**

NEWFREY LLC (DELAWARE LTD LIAB CO)
1207 DRUMMOND PLAZA
NEWARK, DE 19711

FOR: PLUMBING PRODUCTS, NAMELY, FAUCETS, FAUCET FILTERS, AERATORS AND FAUCETS, SHOWERHEADS, FAUCET HANDLES, LEVERS, SPOUTS, VALVES, POP-UP DRAINS , IN CLASS 11 (U.S. CLS. 13, 21, 23, 31 AND 34).

FIRST USE 1-31-2006; IN COMMERCE 1-31-2006.

FOR: BATHROOM ACCESSORIES, NAMELY, TOWEL BARS, TOWEL RINGS, TOILET TISSUE HOLDERS, SOAP DISHES AND TOOTHBRUSH-

TUMBLER HOLDERS, IN CLASS 21 (U.S. CLS. 2, 13, 23, 29, 30, 33, 40 AND 50).

FIRST USE 1-31-2006; IN COMMERCE 1-31-2006.

THE MARK CONSISTS OF STANDARD CHARACTERS WITHOUT CLAIM TO ANY PARTICULAR FONT, STYLE, SIZE, OR COLOR.

NO CLAIM IS MADE TO THE EXCLUSIVE RIGHT TO USE "COLLECTIONS", APART FROM THE MARK AS SHOWN.

SN 78-810,981, FILED 2-9-2006.

PAUL F. GAST, EXAMINING ATTORNEY

Int. Cl.: 5

Prior U.S. Cls.: 6, 18, 44, 46, 51, and 52

Reg. No. 3,478,128

United States Patent and Trademark Office

Registered July 29, 2008

**TRADEMARK
PRINCIPAL REGISTER**

CLEAR FOCUS

GRANVILLE SMYTHE INTERNATIONAL, INC.
(CALIFORNIA CORPORATION)
140 BURLINGAME AVENUE
LOS ANGELES, CA 90049

THE MARK CONSISTS OF STANDARD CHAR-
ACTERS WITHOUT CLAIM TO ANY PARTICULAR
FONT, STYLE, SIZE, OR COLOR.

FOR: DIETARY SUPPLEMENTS; HERBAL SUP-
PLEMENTS, IN CLASS 5 (U.S. CLS. 6, 18, 44, 46, 51
AND 52).

SN 78-812,934, FILED 2-12-2006.

FIRST USE 4-7-2008; IN COMMERCE 4-7-2008.

RICHARD A. STRASER, EXAMINING ATTORNEY

Int. Cl.: 37

Prior U.S. Cls.: 100, 103, and 106

United States Patent and Trademark Office

Reg. No. 3,478,129

Registered July 29, 2008

**SERVICE MARK
PRINCIPAL REGISTER**

Build To Minister

ARKS, INCORPORATED (NORTH CAROLINA
CORPORATION)
SUITE 130
6118 SAINT GILES STREET
RALEIGH, NC 27612

FOR: CHURCH CONSTRUCTION SERVICES, IN
CLASS 37 (U.S. CLS. 100, 103 AND 106).

FIRST USE 1-1-2006; IN COMMERCE 1-1-2006.

THE MARK CONSISTS OF STANDARD CHAR-
ACTERS WITHOUT CLAIM TO ANY PARTICULAR
FONT, STYLE, SIZE, OR COLOR.

NO CLAIM IS MADE TO THE EXCLUSIVE
RIGHT TO USE "BUILD", APART FROM THE
MARK AS SHOWN.

SN 78-815,045, FILED 2-15-2006.

FLORENTINA BLANDU, EXAMINING ATTORNEY

Int. Cls.: 35 and 36

Prior U.S. Cls.: 100, 101, and 102

United States Patent and Trademark Office

Reg. No. 3,478,130

Registered July 29, 2008

**SERVICE MARK
PRINCIPAL REGISTER**

Beyond Breast Cancer

LINKS IN PINK (D.C. CORPORATION)
2020 PENNSYLVANIA AVE. NW, #139
WASHINGTON, DC 20006

FOR: ASSOCIATION SERVICES, NAMELY, PROMOTING THE INTERESTS OF COMMUNITIES, ORGANIZATIONS AND THEIR EMPLOYEES IN THE PREVENTION, DETECTION AND ELIMINATION OF SERIOUS DISEASES AND ILLNESSES, SUCH AS CANCER; PROMOTING PUBLIC AWARENESS OF THE FIGHT AGAINST CANCER AND OTHER CATASTROPHIC ILLNESSES; HUMAN RESOURCES AND RELATED SERVICES, NAMELY, PROVIDING HUMAN RESOURCE GUIDELINES FOR BUSINESS ENTITIES; PROVIDING BUSINESS NETWORKING OPPORTUNITIES; PERFORMING LOBBYING EFFORTS RELATED TO THE PREVENTION, DETECTION AND ELIMINATION OF SERIOUS DISEASES AND ILLNESSES, SUCH AS CANCER; MARKETING CO-BRANDED PRODUCTS, IN CLASS 35 (U.S. CLS. 100, 101 AND 102).

FIRST USE 10-24-2005; IN COMMERCE 10-24-2005.

FOR: CHARITABLE FUNDRAISING SERVICES; CHARITABLE FUNDRAISING TO SUPPORT CANCER AND OTHER CATASTROPHIC ILLNESS RE-

SEARCH, EDUCATION, ADVOCACY, AND PATIENT AND FAMILY SERVICES; CHARITABLE FUNDRAISING TO SUPPORT THOSE DIAGNOSED WITH CANCER, INCLUDING BREAST CANCER, AND OTHER CATASTROPHIC ILLNESSES; CHARITABLE FUNDRAISING VIA PRODUCT SALES, RETREATS, EVENTS, WORKSHOPS; CHARITABLE FUNDRAISING VIA ONLINE, MAIL, TELLER MACHINE OR KIOSK; CHARITABLE SERVICES, NAMELY, PROVIDING FINANCIAL DONATIONS TO ASSIST WITH MEDICAL COSTS, IN CLASS 36 (U.S. CLS. 100, 101 AND 102).

FIRST USE 10-24-2005; IN COMMERCE 10-24-2005.

THE MARK CONSISTS OF STANDARD CHARACTERS WITHOUT CLAIM TO ANY PARTICULAR FONT, STYLE, SIZE, OR COLOR.

NO CLAIM IS MADE TO THE EXCLUSIVE RIGHT TO USE "BREAST CANCER", APART FROM THE MARK AS SHOWN.

SN 78-815,074, FILED 2-15-2006.

ANNE MADDEN, EXAMINING ATTORNEY

Int. Cl.: 25

Prior U.S. Cls.: 22 and 39

United States Patent and Trademark Office

Reg. No. 3,478,131

Registered July 29, 2008

TRADEMARK
PRINCIPAL REGISTER



FREEMAN, BELINDA J./ BELINDA J FREEMAN
(UNITED KINGDOM INDIVIDUAL)
11 GAYTON END GAYTON FARM ROAD HES-
WALL
MERSEYSIDE, UNITED KINGDOM CH60 8NN

FOR: APRONS, BANDANAS, BATH SLIPPERS, BATH CAPS, BATHING COSTUMES, BATH ROBES, BEACH COVER UPS, BEACH SHOES, BEACHWEAR, BELTS, BIKINIS, BLOUSES, BOARD SHORTS, BOOTS, BRIEFS, BRAS, BUSTIERS, CAF-TANS, CAMISOLES, CARDIGANS, CAPS, CHILDREN'S HEAD WEAR, COATS, CORSETS, CROP TOPS, DENIMS, DRESSES, DRESSING GOWNS, ESPADRILLES, EVENING GOWNS, FOOTWEAR, GLOVES, GOLF CAPS, GOLF TROUSERS, GOWNS, GYM SHORTS, GYM SUITS, G-STRINGS, HALTER TOPS, HATS, HEAD SCARVES, HEAD WEAR, HEAD BANDS, HEELS, HOODS, HOISERY, JEANS, JOG-GING OUTFITS, KIMONOS, LADIES UNDERWEAR, LEATHER BELTS, LEGGINGS, LEOTARDS, MINISKIRTS, MITTENS, MOCK TUR-TLE NECK, SWEATERS, MONEY BELTS, NECK-ERCHIEFS, NIGHT GOWNS, NIGHTIES, OPEN NECK SHIRTS, OVER COATS, PAJAMAS, PEDEL PUSHERS, PETTICOATS, PLEATED SKIRTS, POK-ET KERCHIEFS, POLO SHIRTS, PONCHOS, PULL-OVERS, PUMPS, RAIN COATS, RAINWEAR, RASH GUARDS, ROBES, RUGBY TOPS, SARONGS, SA-SHES, SCARVES, SHAWLS AND STOLES, SHOUL-DER WRAPS, SHOWER CAPS, SHRUGS SILK SCARVES, SINGLETs, SKIRTS AND DRESSES,

SKORTS, SLEEP MASKS, SLIPPERS, SMALL HATS, SNEAKERS, SUITS, SUN VISORS, SURF WEAR, SWEAT BANDS, SWEAT PANTS, SWEATERS, SWIM CAPS, SWIM TRUNKS, SWIMMING COSTUMES, SWIMMING TRUNKS, TANK TOPS, TANKINIS, TENNIS WEAR, THOINGS, TOGAS, TOPS, TROU-SERS, TRUNKS, TUNICS, TURTLENECK, VEILS, V-NECK SWEATERS, WAISTBELTS, WAISTBANDS, WAISTCOATS, WALKING SHORTS, WATERPROOF JACKET AND PANTS, WOMEN'S SHOES, WOOLEN SOCKS, WOOLEN HATS, WRAPS, WRISTBANDS, IN CLASS 25 (U.S. CLS. 22 AND 39).

FIRST USE 10-28-2005; IN COMMERCE 1-10-2008.

PRIORITY CLAIMED UNDER SEC. 44(D) ON UNITED KINGDOM APPLICATION NO. 2405150, FILED 10-28-2005.

THE COLOR(S) PINK AND BLACK IS/ARE CLAIMED AS A FEATURE OF THE MARK.

THE COLOUR PINK APPEARS IN THE BACK-GROUND AND THE COLOUR BLACK APPEARS IN THE WORDING AND BEE DESIGN.

SN 78-815,084, FILED 2-15-2006.

AISHA CLARKE, EXAMINING ATTORNEY

Int. Cl.: 37

Prior U.S. Cls.: 100, 103, and 106

United States Patent and Trademark Office

Reg. No. 3,478,132

Registered July 29, 2008

**SERVICE MARK
PRINCIPAL REGISTER**

Successful Church Building

ARKS, INCORPORATED (NORTH CAROLINA
CORPORATION)
SUITE 220
6118 SAINT GILES STREET
RALEIGH, NC 27612

FOR: CONSTRUCTION CONSULTING SERVICES
OFFERED TO CHURCHES, IN CLASS 37 (U.S. CLS.
100, 103 AND 106).

FIRST USE 1-1-2006; IN COMMERCE 1-1-2006.

THE MARK CONSISTS OF STANDARD CHAR-
ACTERS WITHOUT CLAIM TO ANY PARTICULAR
FONT, STYLE, SIZE, OR COLOR.

NO CLAIM IS MADE TO THE EXCLUSIVE
RIGHT TO USE "CHURCH BUILDING", APART
FROM THE MARK AS SHOWN.

SN 78-815,092, FILED 2-15-2006.

FLORENTINA BLANDU, EXAMINING ATTORNEY

Int. Cl.: 9

Prior U.S. Cls.: 21, 23, 26, 36, and 38

Reg. No. 3,478,133

United States Patent and Trademark Office

Registered July 29, 2008

**TRADEMARK
PRINCIPAL REGISTER**

HYDRASDO

ROGUE WAVE SOFTWARE, INC. (DELAWARE
CORPORATION)
SUITE 300-S
7600 EAST ORCHARD ROAD
GREENWOOD VILLAGE, CO 80111

THE MARK CONSISTS OF STANDARD CHAR-
ACTERS WITHOUT CLAIM TO ANY PARTICULAR
FONT, STYLE, SIZE, OR COLOR.

FOR: COMPUTER SOFTWARE FOR USE IN THE
DEVELOPMENT OF OTHER COMPUTER PRO-
GRAMS, IN CLASS 9 (U.S. CLS. 21, 23, 26, 36 AND 38).

SN 78-815,208, FILED 2-15-2006.

FIRST USE 2-28-2006; IN COMMERCE 6-30-2006.

STEPHEN AQUILA, EXAMINING ATTORNEY

Int. Cl.: 9

Prior U.S. Cls.: 21, 23, 26, 36, and 38

United States Patent and Trademark Office

Reg. No. 3,478,134

Registered July 29, 2008

**TRADEMARK
PRINCIPAL REGISTER**

SIFOVIEW

O2MICRO, INC. (CALIFORNIA CORPORATION)
3118 PATRICK HENRY DRIVE
SANTA CLARA, CA 95054

THE MARK CONSISTS OF STANDARD CHAR-
ACTERS WITHOUT CLAIM TO ANY PARTICULAR
FONT, STYLE, SIZE, OR COLOR.

FOR: COMPUTER HARDWARE AND SOFT-
WARE FOR NETWORK CONFIGURATION AND
MANAGEMENT, IN CLASS 9 (U.S. CLS. 21, 23, 26, 36
AND 38).

SN 78-817,392, FILED 2-17-2006.

FIRST USE 2-0-2006; IN COMMERCE 2-0-2006.

VERNA BETH RIRIE, EXAMINING ATTORNEY

Int. Cl.: 9

Prior U.S. Cls.: 21, 23, 26, 36, and 38

United States Patent and Trademark Office

Reg. No. 3,478,135

Registered July 29, 2008

**TRADEMARK
PRINCIPAL REGISTER**

DIGI PASSPORT

DIGI INTERNATIONAL INC. (DELAWARE CORPORATION)
11001 BREN ROAD EAST
MINNETONKA, MN 55343

FOR: COMPUTER NETWORK CONNECTIVITY
HARDWARE AND EMBEDDED COMPUTER NETWORK
CONNECTIVITY SOFTWARE, IN CLASS 9
(U.S. CLS. 21, 23, 26, 36 AND 38).

FIRST USE 7-13-2006; IN COMMERCE 7-13-2006.

THE MARK CONSISTS OF STANDARD CHARACTERS
WITHOUT CLAIM TO ANY PARTICULAR
FONT, STYLE, SIZE, OR COLOR.

OWNER OF U.S. REG. NOS. 2,019,613, 2,630,891,
AND OTHERS.

SN 78-818,157, FILED 2-17-2006.

MARTHA FROMM, EXAMINING ATTORNEY

Int. Cl.: 27

Prior U.S. Cls.: 19, 20, 37, 42, and 50

United States Patent and Trademark Office

Reg. No. 3,478,136

Registered July 29, 2008

TRADEMARK
PRINCIPAL REGISTER

Welcome To My

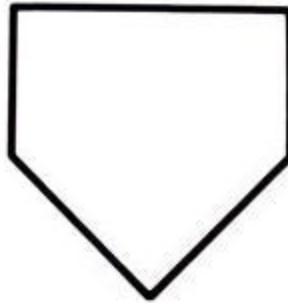

KOKEN, GEORGE SCOTT (UNITED STATES
INDIVIDUAL)
840 17TH STREET UNIT 202
SAN DIEGO, CA 92101

FOR: DOOR MATS, IN CLASS 27 (U.S. CLS. 19, 20,
37, 42 AND 50).

FIRST USE 2-28-2008; IN COMMERCE 2-28-2008.

THE MARK CONSISTS OF THE STANDARDIZED
WORDS "WELCOME TO MY" FOLLOWED BY A

DESIGN DEPICTING A BASEBALL OR SOFTBALL
HOMEPLATE OR HOMEBASE. THE HOMPLATE IS
TYPICALLY THOUGHT OF, READ AND SPOKEN
OF AS "HOME". THEREFORE THE PRODUCT LINE
LOGO READS "WELCOME TO MY HOME."

SN 78-821,247, FILED 2-23-2006.

KHANH LE, EXAMINING ATTORNEY

Int. Cl.: 27

Prior U.S. Cls.: 19, 20, 37, 42, and 50

United States Patent and Trademark Office

Reg. No. 3,478,137

Registered July 29, 2008

TRADEMARK
PRINCIPAL REGISTER

Welcome

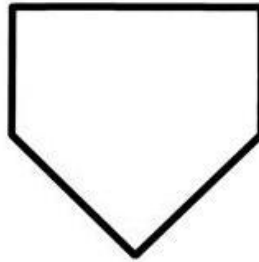

KOKEN, GEORGE SCOTT (UNITED STATES
INDIVIDUAL)
840 17TH STREET UNIT 202
SAN DIEGO, CA 92101

THE MARK CONSISTS OF THE STANDARDIZED
WORD "WELCOME" FOLLOWED BY THE DESIGN
OF A BASEBALL OR SOFTBALL HOMEPLATE OR
HOMEBASE.

FOR: DOOR MATS, IN CLASS 27 (U.S. CLS. 19, 20,
37, 42 AND 50).

SN 78-821,248, FILED 2-23-2006.

FIRST USE 2-28-2008; IN COMMERCE 2-28-2008.

KHANH LE, EXAMINING ATTORNEY

Int. Cl.: 9

Prior U.S. Cls.: 21, 23, 26, 36, and 38

Reg. No. 3,478,138

United States Patent and Trademark Office

Registered July 29, 2008

**TRADEMARK
PRINCIPAL REGISTER**

God's Love Bank

ROACH, ANTHONY E. (TEXAS SOLE PROPRIETORSHIP)
1342 SUMMONER LANE
ABILENE, TX 79602

THE MARK CONSISTS OF STANDARD CHARACTERS WITHOUT CLAIM TO ANY PARTICULAR FONT, STYLE, SIZE, OR COLOR.

FOR: PRERECORDED AUDIO CASSETTES, VIDEO CASSETTES, COMPACT DISKS, DVD'S, ALL FEATURING SPIRITUALITY AND RELIGION; DOWNLOADABLE VIDEO AND AUDIO RECORDINGS FEATURING SPIRITUALITY AND RELIGION, IN CLASS 9 (U.S. CLS. 21, 23, 26, 36 AND 38).

OWNER OF U.S. REG. NO. 3,027,916.

SN 78-822,488, FILED 2-24-2006.

FIRST USE 6-14-2008; IN COMMERCE 6-14-2008.

ADA HAN, EXAMINING ATTORNEY

Int. Cl.: 42

Prior U.S. Cls.: 100 and 101

United States Patent and Trademark Office

Reg. No. 3,478,139

Registered July 29, 2008

**SERVICE MARK
PRINCIPAL REGISTER**



LAVALIFE INC. (DELAWARE CORPORATION)
SUITE 500
905 KING STREET WEST
TORONTO, ONTARIO, CANADA M6K 3G9

FOR: COMPUTER SERVICES, NAMELY, CREATING INDEXES OF INFORMATION, SITES, AND OTHER RESOURCES FOR TEXT MESSAGING SERVICES ON COMPUTER NETWORKS AND ON WIRELESS MOBILE NETWORKS, IN CLASS 42 (U.S. CLS. 100 AND 101).

FIRST USE 4-0-2006; IN COMMERCE 4-0-2006.

THE COLOR(S) WHITE, YELLOW, ORANGE AND RED IS/ARE CLAIMED AS A FEATURE OF THE MARK.

THE MARK CONSISTS OF A WINKING SMILEY FACE WITHIN A CIRCLE FOLLOWED BY THE LETTERS "TEXTCHATFUN". THE COLOR RED APPEARS IN THE TEXT "TEXTCHATFUN". THE COLORS WHITE, YELLOW, AND ORANGE APPEAR IN THE FORM OF A CIRCULAR WINKING SMILEY FACE WITH WHITE EYES AND MOUTH, AND THE UPPER RIGHT PORTION OF THE CIRCLE IN THE COLOR YELLOW SHADING ACROSS AND DOWNWARD INTO THE COLOR ORANGE.

SN 78-823,546, FILED 2-26-2006.

SEAN CROWLEY, EXAMINING ATTORNEY

Int. Cl.: 3

Prior U.S. Cls.: 1, 4, 6, 50, 51, and 52

United States Patent and Trademark Office

Reg. No. 3,478,140

Registered July 29, 2008

TRADEMARK
PRINCIPAL REGISTER

SPLENDORE DI FIORI DI LINO

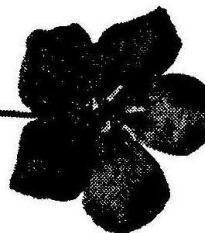

BEAUTY BUSINESS HOLDING S.P.A. (ITALY CORPORATION)
VIA CESARE CANTU, 1
MILANO, ITALY 20123

FOR: PREPARATIONS FOR THE CARE OF SCALP AND HAIR, NAMELY, HAIR DYES, HAIR COLORING PREPARATIONS AND HAIR BLEACHING PREPARATIONS; HAIR DYEING SHAMPOOS; AND HAIR LOTIONS; PERMANENT WAVE PREPARATIONS; CREAMS AND LOTIONS FOR FIXING THE PERM, NAMELY, HAIR WAVING LOTIONS AND CREAMS, HAIR RELAXING CREAMS AND LOTIONS, HAIR STRAIGHTENING CREAMS AND LOTIONS; HAIR CLEANING PREPARATIONS; PREPARATIONS FOR FORMING AND WAVING HAIR IN THE FORM OF SPRAYS, GELS AND LOTIONS, NAMELY, HAIR STYLING GEL, HAIR STYLING SPRAY, HAIR STYLING LOTION, HAIR WAVING SPRAY, HAIR WAVING GEL, HAIR WAVING LOTION; HAIR CREAMS; HAIR BALMS; HAIR FOAMS, NAMELY, FOAMING HAIR MOUSSE; HAIR GREASE, IN CLASS 3 (U.S. CLS. 1, 4, 6, 50, 51 AND 52).

FIRST USE 5-0-2006; IN COMMERCE 5-0-2006.

NO CLAIM IS MADE TO THE EXCLUSIVE RIGHT TO USE "FIORI DI LINO", APART FROM THE MARK AS SHOWN.

THE STIPPLING IN THE MARK IS NOT A FEATURE OF THE MARK AND IS FOR SHADING PURPOSES ONLY.

THE MARK CONSISTS OF THE WORDS "SPLENDORE DI FIORI DI LINO" UNDERLINED, AND A FLOWER ON THE RIGHT-HAND SIDE.

"SPLENDORE DI FIORI DI LINO" MAY BE TRANSLATED AS "SPLENDOR OF LINEN FLOWERS"

SN 78-824,254, FILED 2-27-2006.

MICHAEL TANNER, EXAMINING ATTORNEY

Int. Cl.: 35

Prior U.S. Cls.: 100, 101, and 102

United States Patent and Trademark Office

Reg. No. 3,478,141

Registered July 29, 2008

**SERVICE MARK
PRINCIPAL REGISTER**

MINEQUEST

HENKEL CORPORATION (DELAWARE CORPORATION)
THE TRIAD, SUITE 200
2200 RENAISSANCE BOULEVARD
GULPH MILLS, PA 19406

THE MARK CONSISTS OF STANDARD CHARACTERS WITHOUT CLAIM TO ANY PARTICULAR FONT, STYLE, SIZE, OR COLOR.

FOR: COLLECTING, ANALYZING AND REPORTING OF BUSINESS AND MARKET INFORMATION, IN CLASS 35 (U.S. CLS. 100, 101 AND 102).

SN 78-825,630, FILED 2-28-2006.

FIRST USE 8-15-2006; IN COMMERCE 8-15-2006.

HENRY S. ZAK, EXAMINING ATTORNEY

Int. Cl.: 9

Prior U.S. Cls.: 21, 23, 26, 36, and 38

United States Patent and Trademark Office

Reg. No. 3,478,142

Registered July 29, 2008

**TRADEMARK
PRINCIPAL REGISTER**

ThawMometer

THAWMOMETER, L.L.C. (FLORIDA LTD LIAB
CO)
3417 BAYFIELD ST.
COCOA, FL 32926

FOR: VISUAL FREEZABLE LIQUID INDICATORS FOR INDICATING FREEZE AND NON-FREEZE TEMPERATURE CONDITIONS INSIDE OF ELECTRIC FREEZERS, ELECTRIC COOLERS, AND INSIDE OF NON-ELECTRIC COOLERS; VISUAL TEMPERATURE CHANGE INDICATOR FOR DETECTING POWER OUTAGES AND POWER INTERRUPTIONS TO ELECTRIC FREEZERS AND ELECTRIC COOLERS THAT ARE USED TO STORE PERISHABLES, NAMELY, FOOD, BEVERAGES,

BAIT AND TACKLE, BLOOD, MEDICINES; THE INDICATOR BEING USEFUL FOR DETERMINING SPOILAGE, IN CLASS 9 (U.S. CLS. 21, 23, 26, 36 AND 38).

FIRST USE 5-16-2008; IN COMMERCE 5-16-2008.

THE MARK CONSISTS OF STANDARD CHARACTERS WITHOUT CLAIM TO ANY PARTICULAR FONT, STYLE, SIZE, OR COLOR.

SN 78-826,551, FILED 3-1-2006.

MARILYN IZZI, EXAMINING ATTORNEY

Int. Cl.: 25

Prior U.S. Cls.: 22 and 39

United States Patent and Trademark Office

Reg. No. 3,478,143

Registered July 29, 2008

**TRADEMARK
PRINCIPAL REGISTER**

ORDER OF CHAOS

MIMS, STEPHEN M. (UNITED STATES INDIVIDUAL)

4703 MCALPINE LANE

CHARLOTTE, NC 28212 AND

MODE, JOSHUA C. (UNITED STATES INDIVIDUAL)

2418 PROVIDENCE ROAD S

WAXHAW, NC 28173 AND

STARNES, ALLAN C. (UNITED STATES INDIVIDUAL)

4207 HIGHWAY 5

ROCK HILL, SC 29730 AND

JOHNSON, MATTHEW A. (UNITED STATES INDIVIDUAL)

11861 KEARNEY COURT

CHARLOTTE, NC 28273

FOR: SHIRTS, PANTS, HEAD WEAR, IN CLASS 25 (U.S. CLS. 22 AND 39).

FIRST USE 5-1-2006; IN COMMERCE 9-1-2007.

THE MARK CONSISTS OF STANDARD CHARACTERS WITHOUT CLAIM TO ANY PARTICULAR FONT, STYLE, SIZE, OR COLOR.

SN 78-827,205, FILED 3-2-2006.

STEVEN R. FINE, EXAMINING ATTORNEY

Int. Cls.: 11 and 16

**Prior U.S. Cls.: 2, 5, 13, 21, 22, 23, 29, 31, 34, 37, 38,
and 50**

Reg. No. 3,478,144

United States Patent and Trademark Office

Registered July 29, 2008

**TRADEMARK
PRINCIPAL REGISTER**

THINK FAST

ZELCO INDUSTRIES, INC. (NEW YORK COR-
PORATION)
65 HAVEN AVENUE
MOUNT VERNON, NY 10553

FOR: BOOK LIGHTS, IN CLASS 11 (U.S. CLS. 13,
21, 23, 31 AND 34).

FIRST USE 7-31-2006; IN COMMERCE 7-31-2006.

FOR: PLASTIC PAPER CLIPS FOR LOCATING
PAGES IN BOOKS AND STICKERS THEREFOR, IN
CLASS 16 (U.S. CLS. 2, 5, 22, 23, 29, 37, 38 AND 50).

FIRST USE 7-31-2006; IN COMMERCE 7-31-2006.

THE MARK CONSISTS OF STANDARD CHAR-
ACTERS WITHOUT CLAIM TO ANY PARTICULAR
FONT, STYLE, SIZE, OR COLOR.

SN 78-827,510, FILED 3-2-2006.

WILLIAM VERHOSEK, EXAMINING ATTORNEY

Int. Cl.: 30

Prior U.S. Cl.: 46

United States Patent and Trademark Office

Reg. No. 3,478,145

Registered July 29, 2008

**TRADEMARK
PRINCIPAL REGISTER**



PEREZ MELGOSA, ADRIAN (NEW YORK LTD
LIAB CO)
26 PILGRIM DR
PORT JEFFERSON, NY 11777

FOR: HONEY, IN CLASS 30 (U.S. CL. 46).

FIRST USE 6-1-2007; IN COMMERCE 1-15-2008.

NO CLAIM IS MADE TO THE EXCLUSIVE
RIGHT TO USE "ORGANIC HABITAT", APART
FROM THE MARK AS SHOWN.

THE COLOR(S) BLACK AND ORANGE IS/ARE
CLAIMED AS A FEATURE OF THE MARK.

THE MARK CONSISTS OF A CAPITAL LETTER
"O" IN ORANGE COLOR TRAVERSED HORIZON-
TALLY ON ITS TOP HALF BY TWELVE PARALLEL
LINES, A CAPITAL LETTER "H" IN BLACK COLOR
TRAVERSED HORIZONTALLY ON ITS BOTTOM
HALF BY TWELVE PARALLEL LINES, AN EXCLAMATION MARK COLORED BLACK AT THE TOP
AND ORANGE AT THE BOTTOM, THE WORD
"ORGANIC" IN CAPITAL LETTERS RUNNING
UNDERNEATH THE LETTER "O" ALONG ALL
ITS WITH AND THE WORD "HABITAT" IN CAPI-
TAL LETTERS RUNNING UNDER THE LETER "H"
ALONG ALL IT WITH.

SN 78-827,760, FILED 3-2-2006.

JASON TURNER, EXAMINING ATTORNEY

Int. Cl.: 25

Prior U.S. Cls.: 22 and 39

United States Patent and Trademark Office

Reg. No. 3,478,146

Registered July 29, 2008

**TRADEMARK
PRINCIPAL REGISTER**

ESSENTIALS BY VICKI WAYNE

ARIZONA MAIL ORDER COMPANY, INC. (DE-
LAWARE CORPORATION)
3740 E. 34TH STREET
TUSCON, AZ 85713

FOR: BELTS, BELTS MADE OF LEATHER, BELTS OF TEXTILE, BERMUDA SHORTS, BLAZERS, BLOUSES, BOTTOMS, CAMP SHIRTS, CAPRI PANTS, CAPRIS, CARDIGANS, CLOTHING, NAME-
LY, WRAP-AROUNDS, COATS, COATS FOR WOMEN, COATS MADE OF COTTON, COATS OF DENIM, CULOTTES, DRESS SUITS, DRESSES, DUSTERS, FABRIC BELTS, FOOTWEAR, GABERDINES, GAUCHOS, HAT, JACKETS, JUMPSUITS, KILTS, KNIT SHIRTS, LADIES' SUITS, LEATHER BELTS, LEATHER COATS, LEATHER JACKETS, LEATHER PANTS, LONG JACKETS, LONG SLEEVED VESTS, WOMEN JACKETS, TROUSERS, VESTS, WOMEN'S SUITS, MINISKIRTS, MOCK TURTLE-NECK SWEATERS, OPEN-NECKED SHIRTS, OVER COATS, PANTS, PANTSUITS, PEDAL PUSHERS, PIQUET SHIRTS, POLO SHIRTS, PULLOVERS, QUILTED VESTS, RAIN COATS, RAINCOATS, SASHES, SCARVES, SHIRTS, SHIRTS FOR SUITS, SHOES, SHORT TROUSERS, SHORT-SLEEVED SHIRTS, SILK SCARVES, SKIRT SUITS, SKIRTS, SKIRTS

AND SKORTS, SLACKS, SPORT COATS, SUEDE JACKETS, SUIT COATS, SUITS, SUITS OF LEATHER, SWEATERS, TOP COATS, TOPCOATS, TOPS, TRENCH COATS, TROUSERS, TROUSERS OF LEATHER, TUNICS, TURTLENECK SWEATERS, TURTLENECKS, TWIN SETS, VESTED SUITS, VESTS, V-NECK SWEATERS, WAISTCOATS, WRAPS, IN CLASS 25 (U.S. CLS. 22 AND 39).

FIRST USE 1-2-2008; IN COMMERCE 1-2-2008.

THE MARK CONSISTS OF STANDARD CHARACTERS WITHOUT CLAIM TO ANY PARTICULAR FONT, STYLE, SIZE, OR COLOR.

OWNER OF U.S. REG. NOS. 1,336,665, 1,342,544, AND 2,055,472.

THE NAME(S), PORTRAIT(S), AND/OR SIGNATURE(S) SHOWN IN THE MARK DOES NOT IDENTIFY A PARTICULAR LIVING INDIVIDUAL.

SN 78-828,887, FILED 3-3-2006.

JULIE WATSON, EXAMINING ATTORNEY

Int. Cl.: 25

Prior U.S. Cls.: 22 and 39

United States Patent and Trademark Office

Reg. No. 3,478,147

Registered July 29, 2008

TRADEMARK
PRINCIPAL REGISTER

STUDIO SERIES BY VICKI
WAYNE

ARIZONA MAIL ORDER COMPANY, INC. (DE-
LAWARE CORPORATION)
3740 E. 34TH STREET
TUCSON, AZ 85713

FOR: BELTS, BELTS MADE OF LEATHER, BELTS OF TEXTILE, BERMUDA SHORTS, BLAZERS, BLOUSES, BOTTOMS, CAMP SHIRTS, CAPRI PANTS, CAPRIS, CARDIGANS, CLOTHING, NAME-
LY, WRAP-AROUNDS, COATS, COATS FOR WO-
MEN, COATS MADE OF COTTON, COATS OF DENIM, CULOTTES, DRESS SUITS, DRESSES, DUS-
TERS, FABRIC BELTS, FOOTWEAR, GABERDINES, GAUCHOS, HAT, JACKETS, JUMPSUITS, KILTS, KNIT SHIRTS, LADIES' SUITS, LEATHER BELTS, LEATHER COATS, LEATHER JACKETS, LEATHER PANTS, LONG JACKETS, LONG SLEEVED VESTS, WOMEN JACKETS, TROUSERS, VESTS, WOMEN'S SUITS, MINISKIRTS, MOCK TURTLE-NECK SWEATERS, OPEN-NECKED SHIRTS, OVER COATS, PANTS, PANTSUITS, PEDAL PUSHERS, PIQUET SHIRTS, POLO SHIRTS, PULLOVERS, QUILTED VESTS, RAIN COATS, RAINCOATS, SASHES, SCARVES, SHIRTS, SHIRTS FOR SUITS, SHOES, SHORT TROUSERS, SHORT-SLEEVED SHIRTS, SILK SCARVES, SKIRT SUITS, SKIRTS, SKIRTS AND SKORTS, SLACKS, SPORT COATS, SUEDE JACKETS, SUIT COATS, SUITS, SUITS OF LEA-

THER, SWEATERS, TOP COATS, TOPCOATS, TOPS, TRENCH COATS, TROUSERS, TROUSERS OF LEA-
THER, TUNICS, TURTLENECK SWEATERS, TUR-
TLENECKS, TWIN SETS, VESTED SUITS, VESTS, V-
NECK SWEATERS, WAISTCOATS, WRAPS, IN
CLASS 25 (U.S. CLS. 22 AND 39).

FIRST USE 4-1-2008; IN COMMERCE 4-1-2008.

THE MARK CONSISTS OF STANDARD CHAR-
ACTERS WITHOUT CLAIM TO ANY PARTICULAR
FONT, STYLE, SIZE, OR COLOR.

OWNER OF U.S. REG. NOS. 1,336,665, 1,342,544,
AND 2,055,472.

NO CLAIM IS MADE TO THE EXCLUSIVE
RIGHT TO USE "STUDIO SERIES", APART FROM
THE MARK AS SHOWN.

THE NAME(S), PORTRAIT(S), AND/OR SIGNA-
TURE(S) SHOWN IN THE MARK DOES NOT IDEN-
TIFY A PARTICULAR LIVING INDIVIDUAL.

SN 78-828,910, FILED 3-3-2006.

JULIE WATSON, EXAMINING ATTORNEY

Int. Cls.: 35, 36, and 44

Prior U.S. Cls.: 100, 101, and 102

United States Patent and Trademark Office

Reg. No. 3,478,148

Registered July 29, 2008

**SERVICE MARK
PRINCIPAL REGISTER**



DAVISVISION, INC. (NEW YORK CORPORATION)
159 EXPRESS STREET
PLAINVIEW, NY 11803

FOR: RETAIL STORE SERVICES FEATURING EYEGASSES AND CONTACT LENSES; RETAIL OPTICAL STORE SERVICES, IN CLASS 35 (U.S. CLS. 100, 101 AND 102).

FIRST USE 7-1-1996; IN COMMERCE 7-1-1996.

FOR: ADMINISTRATION OF PRE-PAID HEALTH CARE PLANS, NAMELY, VISION CARE BENEFITS PROGRAMS PROVIDED TO MEMBERS OF GROUP AND INDIVIDUAL HEALTH CARE PROGRAMS, IN CLASS 36 (U.S. CLS. 100, 101 AND 102).

FIRST USE 7-1-1996; IN COMMERCE 7-1-1996.

FOR: OPTICIAN AND OPTOMETRIC SERVICES, IN CLASS 44 (U.S. CLS. 100 AND 101).

FIRST USE 7-1-1996; IN COMMERCE 7-1-1996.

OWNER OF U.S. REG. NOS. 2,410,099 AND 2,612,181.

NO CLAIM IS MADE TO THE EXCLUSIVE RIGHT TO USE "EYECARE", APART FROM THE MARK AS SHOWN.

THE LINING IS A FEATURE OF THE MARK AND DOES NOT INDICATE COLOR.

SN 78-830,328, FILED 3-6-2006.

AMOS T. MATTHEWS, JR., EXAMINING ATTORNEY

Int. Cl.: 1

Prior U.S. Cls.: 1, 5, 6, 10, 26, and 46

Reg. No. 3,478,149

United States Patent and Trademark Office

Registered July 29, 2008

**TRADEMARK
PRINCIPAL REGISTER**

Sweet Design

CARGILL, INCORPORATED (DELAWARE CORPORATION)
15407 MCGINTY ROAD WEST
WAYZATA, MN 55391

THE MARK CONSISTS OF THE WORDS "SWEET" AND "DESIGN" WITH A SWIRL ABOVE THE "I" IN "DESIGN".

FOR: ARTIFICIAL SWEETENERS, IN CLASS 1 (U.S. CLS. 1, 5, 6, 10, 26 AND 46).

SN 78-830,697, FILED 3-7-2006.

FIRST USE 7-12-2007; IN COMMERCE 7-12-2007.

JENNY PARK, EXAMINING ATTORNEY

Int. Cl.: 29

Prior U.S. Cl.: 46

United States Patent and Trademark Office

Reg. No. 3,478,150

Registered July 29, 2008

**TRADEMARK
PRINCIPAL REGISTER**

EAT WELL RIGHT NOW

PPC MARKETING, LTD. (TEXAS LIMITED
PARTNERSHIP)
4845 US HIGHWAY 271 NORTH
PITTSBURGH, TX 75686

THE MARK CONSISTS OF STANDARD CHAR-
ACTERS WITHOUT CLAIM TO ANY PARTICULAR
FONT, STYLE, SIZE, OR COLOR.

FOR: POULTRY, IN CLASS 29 (U.S. CL. 46).

SN 78-831,878, FILED 3-8-2006.

FIRST USE 3-1-2007; IN COMMERCE 3-1-2007.

CHRIS WELLS, EXAMINING ATTORNEY

Int. Cl.: 7

Prior U.S. Cls.: 13, 19, 21, 23, 31, 34, and 35

Reg. No. 3,478,151

United States Patent and Trademark Office

Registered July 29, 2008

**TRADEMARK
PRINCIPAL REGISTER**

JUST SLINGG IT!

SLINGGER, INC. (DELAWARE CORPORATION)
4450 ARAPAHOE AVENUE, SUITE 100
BOULDER, CO 80303

FIRST USE 3-31-2006; IN COMMERCE 3-31-2006.

FOR: METAL STORAGE APPARATUS, NAMELY,
A VERTICAL HOIST FOR RAISING AND STORING
RECREATIONAL EQUIPMENT, SPORTING GOODS
AND HOUSEHOLD ITEMS ELEVATED FROM
GROUND LEVEL, IN CLASS 7 (U.S. CLS. 13, 19, 21,
23, 31, 34 AND 35).

THE MARK CONSISTS OF STANDARD CHAR-
ACTERS WITHOUT CLAIM TO ANY PARTICULAR
FONT, STYLE, SIZE, OR COLOR.

SN 78-835,711, FILED 3-13-2006.

AMY GEARIN, EXAMINING ATTORNEY

Int. Cls.: 25 and 28

Prior U.S. Cls.: 22, 23, 38, 39, and 50

United States Patent and Trademark Office

Reg. No. 3,478,152

Registered July 29, 2008

**TRADEMARK
PRINCIPAL REGISTER**



NICK'S CIGAR COMPANY (FLORIDA CORPORATION), DBA TABACALERA PERDOMO S.A.,
5150 NORTHWEST 167TH STREET
MIAMI LAKES, FL 33014

FOR: CLOTHING, NAMELY, GOLF SHIRTS, IN CLASS 25 (U.S. CLS. 22 AND 39).

FIRST USE 0-0-2006; IN COMMERCE 0-0-2006.

FOR: GOLF BALLS, IN CLASS 28 (U.S. CLS. 22, 23, 38 AND 50).

FIRST USE 0-0-2005; IN COMMERCE 0-0-2005.

OWNER OF U.S. REG. NOS. 2,498,219, 2,803,302, AND OTHERS.

NO CLAIM IS MADE TO THE EXCLUSIVE RIGHT TO USE "GOLF", APART FROM THE MARK AS SHOWN.

SN 78-838,942, FILED 3-16-2006.

DAYNA BROWNE, EXAMINING ATTORNEY

Int. Cl.: 9

Prior U.S. Cls.: 21, 23, 26, 36, and 38

Reg. No. 3,478,153

United States Patent and Trademark Office

Registered July 29, 2008

**TRADEMARK
PRINCIPAL REGISTER**

**THE MASKED QUEEN AND THE
TOWER OF MIRRORS**

KABUSHIKI KAISHA SQUARE ENIX (JAPAN CORPORATION), TA SQUARE ENIX CO., LTD.,
3-22-7 YOYOGI, SHIBUYA-KU
TOKYO, JAPAN

THE MARK CONSISTS OF STANDARD CHARACTERS WITHOUT CLAIM TO ANY PARTICULAR FONT, STYLE, SIZE, OR COLOR.

FOR: COMPUTER GAME SOFTWARE; VIDEO GAME SOFTWARE, IN CLASS 9 (U.S. CLS. 21, 23, 26, 36 AND 38).

SN 78-841,024, FILED 3-20-2006.

FIRST USE 2-19-2008; IN COMMERCE 2-19-2008.

ELLEN BURNS, EXAMINING ATTORNEY

Int. Cl.: 6

Prior U.S. Cls.: 2, 12, 13, 14, 23, 25, and 50

United States Patent and Trademark Office

Reg. No. 3,478,154

Registered July 29, 2008

**TRADEMARK
PRINCIPAL REGISTER**



NERVI, MICHAEL (UNITED STATES INDIVIDUAL)
132 POND STREET
SOUTH WEYMOUTH, MA 02190

THE MARK CONSISTS OF THE WORDS "EZ POST" WITHIN AN OVAL, WITH A SIGN POST REPRESENTING THE LETTER "T".

FOR: METAL HOLDERS FOR SIGNS; METAL POSTS, IN CLASS 6 (U.S. CLS. 2, 12, 13, 14, 23, 25 AND 50).

SN 78-841,397, FILED 3-20-2006.

FIRST USE 9-3-2006; IN COMMERCE 9-3-2006.

MIDGE BUTLER, EXAMINING ATTORNEY

Int. Cls.: 14, 18, and 25

Prior U.S. Cls.: 1, 2, 3, 22, 27, 28, 39, 41, and 50

United States Patent and Trademark Office

Reg. No. 3,478,155

Registered July 29, 2008

**TRADEMARK
PRINCIPAL REGISTER**

RMC MARTIN KSOHOH

MYM UNTUNK LIMITED (HONG KONG LTD
LIAB CO)
CHO YIU ESTATE, KAI KWONG HOUSE
ROOM 419, 4/F
KWAI CHUNG, NEW TERRITORIES, HONG KONG

FOR: PRECIOUS METALS AND THEIR ALLOYS, NAMELY, GOLD AND SILVER; GOODS IN PRECIOUS METALS OR COATED THEREWITH, NOT INCLUDED IN OTHER CLASSES, NAMELY, JEWELRY, COSTUME JEWELRY, EARRINGS, CUFFLINKS, JEWELRY CHAINS, NECKLACES, PENDANTS, RINGS BEING JEWELRY, TIE CLIPS, TIE PINS, BRACELETS AND BROOCHES, CIGAR BOXES, KEY CHAINS, SILVER ORNAMENTS, ORNAMENTS, HAT ORNAMENTS, ORNAMENTAL PINS FOR HEAD WEAR AND SHOES, PURSES, BOXES FOR JEWELRY, NON-MONETARY COINS, WATCH GLASSES, WATCHES AND CLOCKS; HOROLOGICAL AND CHRONOMETRIC INSTRUMENTS, NAMELY, CLOCKS, WATCHES, CHRONOMETERS AND CHRONOSCOPES, IN CLASS 14 (U.S. CLS. 2, 27, 28 AND 50).

FIRST USE 9-1-2005; IN COMMERCE 9-1-2005.

FOR: LEATHER AND IMITATION LEATHER SOLD IN BULK, NAMELY, CATTLE SKINS, ANIMAL SKINS AND HIDES; GOODS MADE OF LEATHER, IMITATION LEATHER AND SNAKE SKIN NOT INCLUDED IN OTHER CLASSES, NAMELY, BAGS OF LEATHER, CASES OF LEATHER, TRUNKS AND TRAVELING BAGS, LUGGAGE, CARRY-ON BAGS, BAGS FOR TRAVEL, SUIT BAGS, SPORTS BAGS, KEY CASES, HANDBAGS, LEATHER KEY CHAIN HOLDERS, PURSES, WALLET, COSMETIC BAGS SOLD EMPTY, SHOULDER

BAGS AND BACKPACKS, UMBRELLAS AND WALKING STICK HANDLES, IN CLASS 18 (U.S. CLS. 1, 2, 3, 22 AND 41).

FIRST USE 9-1-2005; IN COMMERCE 9-1-2005.

FOR: CLOTHING, NAMELY, FOOTWEAR, HEAD WEAR, JEANS, OVERALLS, COATS, APRONS, DRESSING GOWNS, FUR COATS, JACKETS, UNIFORMS, MASQUERADE COSTUMES, OVERCOATS, SUITS, WAISTCOATS, SWEATERS, PARKAS, TROUSERS, SHIRTS, BLOUSES, VESTS AND PULLOVERS, PANTS, SHIRTS, T-SHIRTS, DRESSES, SANDALS, SWIMSUITS, WRISTBANDS, HOT PANTS, UNDERGARMENTS, BRASSIERES, CAPS, GLOVES, BELTS, SCARVES, SOCKS, BOOTS FOR SPORTS, BOOTS, SPORT SHOES, AND SHOES; CLOTHING MADE OF LEATHER AND IMITATION LEATHER, NAMELY, GLOVES, SHOES, LEATHER JACKETS, COATS, BELTS AND PANTS, IN CLASS 25 (U.S. CLS. 22 AND 39).

FIRST USE 9-1-2005; IN COMMERCE 9-1-2005.

THE MARK CONSISTS OF STANDARD CHARACTERS WITHOUT CLAIM TO ANY PARTICULAR FONT, STYLE, SIZE, OR COLOR.

THE NAME SHOWN IN THE MARK IDENTIFIES "MARTIN KSOHOH" WHOSE CONSENT IS OF RECORD.

SN 78-849,168, FILED 3-29-2006.

JAMES MACFARLANE, EXAMINING ATTORNEY

Int. Cl.: 9

Prior U.S. Cls.: 21, 23, 26, 36, and 38

Reg. No. 3,478,156

United States Patent and Trademark Office

Registered July 29, 2008

**TRADEMARK
PRINCIPAL REGISTER**

WORD SAFARI

JAYAWEERA, SURYA (UNITED STATES INDIVIDUAL)
303 ROUGHRIDER ROAD
LA VERNE, CA 91750

FOR: COMPUTER SOFTWARE GAMES AND ELECTRONIC GAME PROGRAMS, NAMELY, EDUCATIONAL GAMES IN THE FIELDS OF READING, SPELLING, GRAMMAR, PHONICS, WORD PLAY, AND LANGUAGE DEVELOPMENT; EDUCATIONAL GAMES AND VIDEO GAMES IN THE NATURE OF COMPUTER GAMES AND ELECTRONIC PROGRAMS; COMPUTER GAME CARTRIDGES AND VIDEO GAME CARTRIDGES FOR EDUCATIONAL GAMES, IN CLASS 9 (U.S. CLS. 21, 23, 26, 36 AND 38).

FIRST USE 12-1-2007; IN COMMERCE 12-1-2007.

THE MARK CONSISTS OF STANDARD CHARACTERS WITHOUT CLAIM TO ANY PARTICULAR FONT, STYLE, SIZE, OR COLOR.

NO CLAIM IS MADE TO THE EXCLUSIVE RIGHT TO USE "WORD", APART FROM THE MARK AS SHOWN.

SN 78-850,503, FILED 3-30-2006.

DOMINIC FATHY, EXAMINING ATTORNEY

Int. Cls.: 5 and 31

Prior U.S. Cls.: 1, 6, 18, 44, 46, 51, and 52

United States Patent and Trademark Office

Reg. No. 3,478,157

Registered July 29, 2008

**TRADEMARK
PRINCIPAL REGISTER**

GRAINLAND SELECT

LAND O'LAKES PURINA FEED LLC (DELA-
WARE LTD LIAB CO)
555 MARYVILLE UNIVERSITY DRIVE
ST. LOUIS, MO 63141

FOR: MEDICATED ANIMAL FEED, IN CLASS 5
(U.S. CLS. 6, 18, 44, 46, 51 AND 52).

FIRST USE 6-19-2006; IN COMMERCE 6-19-2006.

FOR: ANIMAL FEED, IN CLASS 31 (U.S. CLS. 1
AND 46).

FIRST USE 6-9-2006; IN COMMERCE 6-9-2006.

THE MARK CONSISTS OF STANDARD CHAR-
ACTERS WITHOUT CLAIM TO ANY PARTICULAR
FONT, STYLE, SIZE, OR COLOR.

OWNER OF U.S. REG. NO. 1,387,701.

NO CLAIM IS MADE TO THE EXCLUSIVE
RIGHT TO USE "SELECT", APART FROM THE
MARK AS SHOWN.

SN 78-850,600, FILED 3-30-2006.

MARGERY A. TIERNEY, EXAMINING ATTORNEY

Int. Cl.: 28

Prior U.S. Cls.: 22, 23, 38, and 50

United States Patent and Trademark Office

Reg. No. 3,478,158

Registered July 29, 2008

**TRADEMARK
PRINCIPAL REGISTER**

INDUSTRIAL RAIL

ATLAS O, L.L.C. (NEW JERSEY LTD LIAB CO)
378 FLORENCE AVENUE
HILLSIDE, NJ 07205

FOR: TOY TRAINS AND PARTS AND ACCESSORIES THEREFOR; TOY TRAIN CARS, TOY TROLLEYS, TOY TRAIN HANDCARS, TOY TRAIN LOCOMOTIVES, TOY TRAIN TRACK, ELECTRIC TOY TRANSFORMERS, TOY TRAIN SETS, IN CLASS 28 (U.S. CLS. 22, 23, 38 AND 50).

FIRST USE 11-30-2007; IN COMMERCE 11-30-2007.

THE MARK CONSISTS OF STANDARD CHARACTERS WITHOUT CLAIM TO ANY PARTICULAR FONT, STYLE, SIZE, OR COLOR.

SN 78-851,411, FILED 3-31-2006.

ALEXANDER L. POWERS, EXAMINING ATTORNEY

Int. Cl.: 34

Prior U.S. Cls.: 2, 8, 9, and 17

United States Patent and Trademark Office

Reg. No. 3,478,159

Registered July 29, 2008

**TRADEMARK
PRINCIPAL REGISTER**

PASSATORE

HERMANN HAUSER RAUCHERBEDARF GMBH
(FED REP GERMANY GMBH)
MERANER STRASSE 46
AUGSBURG, FED REP GERMANY D-86165

FOR: TOBACCO AND TOBACCO PRODUCTS, NAMELY, CIGARS, CIGARILLOS, CIGARETTES, SMOKING TOBACCO, CHEWING TOBACCO, SNUFF; SMOKERS' ARTICLES, NAMELY, CIGAR AND CIGARETTE TIPS AND THEIR MOUTHPIECES, CIGARETTE MOUTHPIECES, CIGARETTE FILTERS, CIGARETTE PAPER, CIGARETTE TUBES, CIGAR CUTTERS, TOBACCO PIPES, LIGHTERS FOR SMOKERS, PIPE CLEANERS AND PIPE STANDS, TOBACCO TINS, NOT MADE OF PRECIOUS METAL, ALSO SNUFF TINS, TOBACCO POUCHES, CIGAR AND CIGARETTE CASES, HOLDERS AND CASES FOR TOBACCO PIPES, CIGAR BOX, ALSO WITH HUMIDOR, POCKET APPLIANCES FOR ROLLING CIGARETTES AND/

OR FILLING CIGARETTE TUBES, NAMELY, CIGARETTE ROLLERS AND CIGARETTE STUFFING MACHINES, ASHTRAYS, NOT MADE OF PRECIOUS METAL, MATCHES AND HOLDERS FOR MATCHES, NOT MADE OF PRECIOUS METAL, IN CLASS 34 (U.S. CLS. 2, 8, 9 AND 17).

FIRST USE 8-30-2007; IN COMMERCE 8-30-2007.

THE MARK CONSISTS OF STANDARD CHARACTERS WITHOUT CLAIM TO ANY PARTICULAR FONT, STYLE, SIZE, OR COLOR.

THE FOREIGN WORDING IN THE MARK TRANSLATES INTO ENGLISH AS BRIGAND.

SN 78-852,575, FILED 4-3-2006.

ELLEN PERKINS, EXAMINING ATTORNEY

Int. Cl.: 25

Prior U.S. Cls.: 22 and 39

United States Patent and Trademark Office

Reg. No. 3,478,160

Registered July 29, 2008

**TRADEMARK
PRINCIPAL REGISTER**

NOSTIC

NOSTIC HOLDINGS, LLC (NEW YORK LTD
LIAB CO)
SUITE 803
1400 BROADWAY
NEW YORK, NY 10018

THE MARK CONSISTS OF STANDARD CHAR-
ACTERS WITHOUT CLAIM TO ANY PARTICULAR
FONT, STYLE, SIZE, OR COLOR.

FOR: BLAZERS; COATS; HATS; JACKETS;
PANTS; SHIRTS; SWEAT SHIRTS; T-SHIRTS; TOPS,
IN CLASS 25 (U.S. CLS. 22 AND 39).

SN 78-852,909, FILED 4-3-2006.

FIRST USE 9-27-2007; IN COMMERCE 9-27-2007.

ODESSA BIBBINS, EXAMINING ATTORNEY

Int. Cl.: 42

Prior U.S. Cls.: 100 and 101

United States Patent and Trademark Office

Reg. No. 3,478,161

Registered July 29, 2008

**SERVICE MARK
PRINCIPAL REGISTER**

MONTAGNA

MONTAGNA LLC (NEVADA LTD LIAB CO)
SUITE 830
3993 HOWARD HUGHES PARKWAY
LAS VEGAS, NV 89109

FOR: INTERIOR DESIGN SERVICES, IN CLASS 42
(U.S. CLS. 100 AND 101).

FIRST USE 3-1-2006; IN COMMERCE 3-1-2006.

THE MARK CONSISTS OF STANDARD CHAR-
ACTERS WITHOUT CLAIM TO ANY PARTICULAR
FONT, STYLE, SIZE, OR COLOR.

THE ENGLISH TRANSLATION OF THE WORD
"MONTAGNA" IN THE MARK IS MOUNTAIN.

SN 78-853,657, FILED 4-4-2006.

SUSAN RICHARDS, EXAMINING ATTORNEY

Int. Cl.: 3

Prior U.S. Cls.: 1, 4, 6, 50, 51, and 52

Reg. No. 3,478,162

United States Patent and Trademark Office

Registered July 29, 2008

**TRADEMARK
PRINCIPAL REGISTER**

LYCITRATE

DR. NICK'S WHITE & HEALTHY, LLC (FLOR-
IDA LTD LIAB CO)
3410 HENDERSON BLVD., SUITE 100
TAMPA, FL 33609

FOR: NON-MEDICATED DENTAL PRODUCTS
AND DENTAL WHITENING PRODUCTS, NAME-
LY, TOOTH GELS, TOOTH WHITENING GELS,
TOOTH CREAMS, TOOTH WHITENING CREAMS,
TOOTH PASTES, TOOTH WHITENING PASTES,
MOUTHWASH, TOOTH WHITENING
MOUTHWASH, MOUTH SPRAYS, TOOTH
WHITENING SPRAYS, BREATH FRESHENING
LIP BALMS, BREATH FRESHENING LIP GELS

AND BREATH FRESHENING LIP CREAMS, IN
CLASS 3 (U.S. CLS. 1, 4, 6, 50, 51 AND 52).

FIRST USE 1-0-2006; IN COMMERCE 2-26-2007.

THE MARK CONSISTS OF STANDARD CHAR-
ACTERS WITHOUT CLAIM TO ANY PARTICULAR
FONT, STYLE, SIZE, OR COLOR.

SN 78-854,510, FILED 4-5-2006.

JUSTINE D. PARKER, EXAMINING ATTORNEY

Int. Cl.: 9

Prior U.S. Cls.: 21, 23, 26, 36, and 38

Reg. No. 3,478,163

United States Patent and Trademark Office

Registered July 29, 2008

**TRADEMARK
PRINCIPAL REGISTER**

SPECTRALEX

SIGNAL TREE RESEARCH, INC. (MARYLAND
CORPORATION)
14704 PEBBLESTONE DRIVE
SILVER SPRING, MD 20905

THE MARK CONSISTS OF STANDARD CHAR-
ACTERS WITHOUT CLAIM TO ANY PARTICULAR
FONT, STYLE, SIZE, OR COLOR.

FOR: COMPUTER SOFTWARE FOR GRAPHI-
CALLY ENCODING AND DE-CODING INFORMA-
TION, IN CLASS 9 (U.S. CLS. 21, 23, 26, 36 AND 38).

SN 78-855,199, FILED 4-6-2006.

FIRST USE 4-12-2006; IN COMMERCE 4-12-2006.

WILLIAM VERHOSEK, EXAMINING ATTORNEY

Int. Cl.: 35

Prior U.S. Cls.: 100, 101, and 102

United States Patent and Trademark Office

Reg. No. 3,478,164

Registered July 29, 2008

SERVICE MARK
PRINCIPAL REGISTER

LEVERAGE

LEVERAGE INCORPORATED (DELAWARE CORPORATION)
26 FORT SUMTER
IRVINE, CA 92620

FOR: PROVIDING ONLINE RETAIL INFORMATION CONSOLIDATION ACCOUNTS, NAMELY, PROVIDING INFORMATION ABOUT THE GOODS AND SERVICES OF OTHERS VIA GLOBAL COMPUTER NETWORK WHICH IS SET UP USING CONSOLIDATED INFORMATION ACCOUNTS FOR EACH INDIVIDUAL CUSTOMER; PROVIDING ONLINE MANAGEMENT OF COMMERCIAL TRANSACTIONS RELATING TO CONSUMER RESOURCES, SPECIFICALLY ELECTRONIC AND VIRTUAL GIFT CARDS, LOYALTY AND AFFINITY CARDS AND PROGRAMS, RECEIPTS, REBATES, PROMOTIONS, OFFERS AND PRODUCT REGISTRATIONS; PROVIDING DATA ANALYTICS TO A TARGETED AND GENERAL MARKETING CHANNEL RELATED TO THE GOODS AND SERVICES OF OTHERS, NAMELY, PROVIDING ADVICE ON THE ANALYSIS OF CONSUMER BUYING HABITS, NEEDS AND INTEREST PROVIDED WITH THE HELP OF SENSORY, QUALITY AND QUANTITY-RELATED DATA, INCLUDING PERSONAL AND DEMOGRAPHIC DATA, INTEGRATED TRACK-

ING OF COMMERCIAL TRANSACTIONS RELATED TO THE GOODS AND SERVICES OF OTHERS ON A GLOBAL COMPUTER NETWORK, SALE VOLUME TRACKING FOR OTHERS, GIFT CARD PURCHASE AND GIFT CARD USE TRACKING FOR OTHERS, LOYALTY PROGRAM ENROLLMENT AND BENEFIT USE TRACKING FOR OTHERS, REBATE AND PROMOTION USE TRACKING FOR OTHERS, AND PROVIDING CONSUMERS WITH DATA REGARDING THE CONSUMER'S RECEIPT OF A PARTICULAR PROMOTIONAL OFFER, NAMELY, IDENTIFYING WHICH DATA ANALYTICS CAUSED THE CONSUMER TO RECEIVE THE PROMOTIONAL OFFER, IN CLASS 35 (U.S. CLS. 100, 101 AND 102).

FIRST USE 9-26-2006; IN COMMERCE 9-26-2006.

THE MARK CONSISTS OF STANDARD CHARACTERS WITHOUT CLAIM TO ANY PARTICULAR FONT, STYLE, SIZE, OR COLOR.

SN 78-855,650, FILED 4-6-2006.

TINA BROWN, EXAMINING ATTORNEY

Int. Cls.: 9, 25, 35, and 41

**Prior U.S. Cls.: 21, 22, 23, 26, 36, 38, 39, 100, 101, 102,
and 107**

Reg. No. 3,478,165

United States Patent and Trademark Office

Registered July 29, 2008

**TRADEMARK
SERVICE MARK
PRINCIPAL REGISTER**



GAMEAMP, LLC (FLORIDA LTD LIAB CO)
600 JULIAN LANE, SUITE 650
ARDEN, NC 28704

FOR: DOWNLOADABLE COMPUTER SOFTWARE, NAMELY, COMPUTER GAMING SOFTWARE FOR USE IN ALLOWING ONLINE GAMING AND SENDING AND RECEIVING IN-GAME ELECTRONIC AND INSTANT MESSAGES, INSTANT MESSAGING SOFTWARE AND TELECOMMUNICATION SOFTWARE FOR USE IN ACCESSING GAMING RELATED CHAT ROOMS AND ON-LINE GAMING VIA COMPUTER NETWORKS; DOWNLOADABLE ELECTRONIC PUBLICATIONS, NAMELY, ARTICLES, MAGAZINES, AND REVIEWS FEATURING COMPUTER GAMING, MOVIES, ANIMATION, AND COMICS, IN CLASS 9 (U.S. CLS. 21, 23, 26, 36 AND 38).

FIRST USE 4-6-2007; IN COMMERCE 4-6-2007.

FOR: CLOTHING, NAMELY, SHIRTS, AND HATS, IN CLASS 25 (U.S. CLS. 22 AND 39).

FIRST USE 6-15-2007; IN COMMERCE 6-15-2007.

FOR: ONLINE RETAIL STORE SERVICES FEATURING COMPUTER AND VIDEO GAMING RELATED MERCHANDISE, NAMELY, PROMOTIONAL PRODUCTS, CLOTHING, COUPONS, PRINTED VISUALS IN THE NATURE OF PROMOTIONAL MATERIALS, GAMING BOOKS, GUIDES, GAME GUIDES, WALKTHROUGHS,

NEWSLETTERS, MAGAZINES, GAMING MAPS, GRAPHIC NOVELS, ORIGINAL ART, IMAGES, ANIME, ANIMATION, COMPUTER ANIMATION, 3D ANIMATION COMPUTER GAMES AND VIDEO GAMES, IN CLASS 35 (U.S. CLS. 100, 101 AND 102).

FIRST USE 6-15-2007; IN COMMERCE 6-15-2007.

FOR: ENTERTAINMENT SERVICES, NAMELY, PROVIDING ON-LINE FAN CLUBS AND INFORMATION SOURCES RELEVANT TO THE GAMING INDUSTRY VIA THE INTERNET; PROVIDING INFORMATION AND REVIEWS ON-LINE RELATED TO COMPUTER GAMES, COMPUTER ENHANCEMENTS FOR GAMES, MOVIES, ANIMATION, AND COMICS; PROVIDING LINKS TO WEBSITES OF OTHERS FEATURING DIFFERENT ONLINE COMPUTER GAMES; PROVIDING A WEB SITE FEATURING INFORMATION AND ARTICLES IN CONNECTION WITH COMPUTER GAMING, MOVIES, ANIMATION, AND COMICS, IN CLASS 41 (U.S. CLS. 100, 101 AND 107).

FIRST USE 3-1-2005; IN COMMERCE 3-1-2005.

THE MARK CONSISTS OF THE LETTERS "G" AND "A" WITH A CIRCLE AND LIGHTNING BOLT AND THE WORD "GAMEAMP".

SN 78-856,115, FILED 4-6-2006.

STEPHANIE ALI, EXAMINING ATTORNEY

Int. Cl.: 7

Prior U.S. Cls.: 13, 19, 21, 23, 31, 34, and 35

Reg. No. 3,478,166

United States Patent and Trademark Office

Registered July 29, 2008

**TRADEMARK
PRINCIPAL REGISTER**

ROLLERPRO

DELANVAN AG PUMPS, INC. (MINNESOTA CORPORATION)
1228 CHESTNUT AVENUE
MINNEAPOLIS, MN 554031230

FIRST USE 1-31-2008; IN COMMERCE 1-31-2008.

FOR: ROLLER PUMPS FOR USE IN AGRICULTURAL SPRAYING EQUIPMENT, FLUID TRANSFER FOR MOBILE EQUIPMENT, COMMERCIAL FLOOR CARE EQUIPMENT, AND INDUSTRIAL WASH DOWN EQUIPMENT, IN CLASS 7 (U.S. CLS. 13, 19, 21, 23, 31, 34 AND 35).

THE MARK CONSISTS OF STANDARD CHARACTERS WITHOUT CLAIM TO ANY PARTICULAR FONT, STYLE, SIZE, OR COLOR.

SN 78-857,853, FILED 4-10-2006.

ALICE BENMAMAN, EXAMINING ATTORNEY

Int. Cl.: 3

Prior U.S. Cls.: 1, 4, 6, 50, 51, and 52

United States Patent and Trademark Office

Reg. No. 3,478,167

Registered July 29, 2008

**TRADEMARK
PRINCIPAL REGISTER**

**DESIGNER SKIN SPEED OF
LIGHT**

DESIGNER SKIN, LLC (ARIZONA LTD LIAB CO)
6270 CORPORATE DRIVE
INDIANAPOLIS, IN 46278

FOR: COSMETIC SUN-TANNING PREPARATIONS; SELF-TANNING PREPARATIONS; SKIN GELS FOR ACCELERATING, ENHANCING OR EXTENDING TANS; TANNING CREAMS, IN CLASS 3 (U.S. CLS. 1, 4, 6, 50, 51 AND 52).

FIRST USE 11-1-2007; IN COMMERCE 11-1-2007.

THE MARK CONSISTS OF STANDARD CHARACTERS WITHOUT CLAIM TO ANY PARTICULAR FONT, STYLE, SIZE, OR COLOR.

OWNER OF U.S. REG. NOS. 2,415,111, 3,085,867, AND OTHERS.

NO CLAIM IS MADE TO THE EXCLUSIVE RIGHT TO USE "SKIN", APART FROM THE MARK AS SHOWN.

SN 78-858,254, FILED 4-10-2006.

MARY MUNSON, EXAMINING ATTORNEY

Int. Cl.: 25

Prior U.S. Cls.: 22 and 39

United States Patent and Trademark Office

Reg. No. 3,478,168

Registered July 29, 2008

**TRADEMARK
PRINCIPAL REGISTER**

RIPLEY SHIRTS



OAK CLIFF SHIRT COMPANY, INC. (TEXAS CORPORATION)
206 SUNSET AVENUE
DALLAS, TX 75208

THE COLOR(S) BLACK AND BLUE IS/ARE CLAIMED AS A FEATURE OF THE MARK.

FOR: MEN'S CLOTHING, NAMELY, CUSTOM-FITTED SHIRTS MADE-TO-ORDER ACCORDING TO SIZE INFORMATION PROVIDED BY THE CUSTOMER, IN CLASS 25 (U.S. CLS. 22 AND 39).

THE COLOR BLACK APPEARS IN THE WORDING RIPLEY SHIRTS. THE COLOR BLUE APPEARS IN THE LETTERS RS.

FIRST USE 8-0-2005; IN COMMERCE 9-0-2005.

OWNER OF U.S. REG. NO. 3,013,317.

SN 78-859,745, FILED 4-12-2006.

NO CLAIM IS MADE TO THE EXCLUSIVE RIGHT TO USE "SHIRTS", APART FROM THE MARK AS SHOWN.

JENNIFER MARTIN, EXAMINING ATTORNEY

Int. Cl.: 25

Prior U.S. Cls.: 22 and 39

United States Patent and Trademark Office

Reg. No. 3,478,169

Registered July 29, 2008

**TRADEMARK
PRINCIPAL REGISTER**

FATBAXX

3D SPORTING GOODS LLC (MICHIGAN CORPORATION)
47090 SARNUS DRIVE
MACOMB TOWNSHIP, MI 48044

FOR: CLOTHING, NAMELY, SHIRTS, T-SHIRTS, SWEATSHIRTS, JACKETS, BEACHWEAR, SWIMSUITS, BOARD SHORTS, SLEEPWEAR, AND SOCKS; HEADGEAR, NAMELY, HATS AND CAPS; AND FOOTWEAR, NAMELY, SANDALS, IN CLASS 25 (U.S. CLS. 22 AND 39).

FIRST USE 5-5-2006; IN COMMERCE 5-5-2006.

THE MARK CONSISTS OF STANDARD CHARACTERS WITHOUT CLAIM TO ANY PARTICULAR FONT, STYLE, SIZE, OR COLOR.

SN 78-859,822, FILED 4-12-2006.

INGA ERVIN, EXAMINING ATTORNEY

Int. Cls.: 9, 25, and 41

Prior U.S. Cls.: 21, 22, 23, 26, 36, 38, 39, 100, 101, and 107

Reg. No. 3,478,170

United States Patent and Trademark Office

Registered July 29, 2008

**TRADEMARK
SERVICE MARK
PRINCIPAL REGISTER**



GARIBAY, JUAN CARLOS (MEXICO INDIVIDUAL)
3318 W. HUTCHINSON AVE., 3RD FLOOR
CHICAGO, IL 60618

FOR: PRE-RECORDED COMPACT DISCS, PHONOGRAPH RECORDS, AUDIO TAPES, VIDEO CASSETTES AND OPTICAL DISCS, NAMELY, LASER DISCS, ALL FEATURING MUSICAL PERFORMANCES, IN CLASS 9 (U.S. CLS. 21, 23, 26, 36 AND 38).

FIRST USE 0-0-2004; IN COMMERCE 0-0-2004.

FOR: CLOTHING, NAMELY, SHORTS, PANTS, JERSEYS, SHIRTS, TANK-TOPS, T-SHIRTS, POLO SHIRTS, SWEAT SHIRTS, HEADBANDS, BANDANAS, JACKETS, CAPS, AND HATS, IN CLASS 25 (U.S. CLS. 22 AND 39).

FIRST USE 0-0-2004; IN COMMERCE 0-0-2004.

FOR: ENTERTAINMENT SERVICES, NAMELY, LIVE PERFORMANCES AND APPEARANCES BY A MUSICAL GROUP; FAN CLUB SERVICES; PROVIDING A WEBSITE FEATURING ENTERTAINMENT INFORMATION, NAMELY, REVIEWS, ARTICLES, INTERVIEWS, MUSIC VIDEOS, MUSIC CHARTS, PERSONAL BIOGRAPHIES, DIARIES, TOUR DATES, ACCESS TO MEMORABILIA, PHOTOGRAPHS, VIDEO CLIPS, AND AUDIO CLIPS, ALL AVAILABLE VIA A GLOBAL COMPUTER NETWORK, IN CLASS 41 (U.S. CLS. 100, 101 AND 107).

FIRST USE 0-0-2004; IN COMMERCE 0-0-2004.

THE FOREIGN WORDING IN THE MARK TRANSLATES INTO ENGLISH AS THE AUTHORITY OF THE MOUNTAIN RANGE.

SN 78-861,352, FILED 4-13-2006.

GILBERT SWIFT, EXAMINING ATTORNEY

Int. Cls.: 16, 25, 32, 35, and 43

Prior U.S. Cls.: 2, 5, 22, 23, 29, 37, 38, 39, 45, 46, 48, 50, 100, 101, and 102

Reg. No. 3,478,171

United States Patent and Trademark Office

Registered July 29, 2008

**TRADEMARK
SERVICE MARK
PRINCIPAL REGISTER**

EL FAMOUS BURRITO

EL FAMOUS RESTAURANTS, INC. (ILLINOIS CORPORATION)
6159 SOUTH ARCHER ROAD
SUMMIT, IL 60501

FOR: ADVERTISING SIGNS OF PAPER OR CARDBOARD; GIFT CARDS; PAPER SIGN HOLDERS; PLASTIC OR PAPER BAGS FOR MERCHANDISE PACKAGING; PRE-PAID TELEPHONE CALLING CARDS, NOT MAGNETICALLY ENCODED; PRINTED MENUS; PRINTED PAPER SIGNS; PRINTED PRODUCTS, NAMELY, MENU BOARDS, IN CLASS 16 (U.S. CLS. 2, 5, 22, 23, 29, 37, 38 AND 50).

FIRST USE 1-0-1991; IN COMMERCE 1-0-1991.

FOR: CAPS; HATS; SHIRTS; T-SHIRTS, IN CLASS 25 (U.S. CLS. 22 AND 39).

FIRST USE 1-0-1986; IN COMMERCE 1-0-1986.

FOR: SPRING WATER, IN CLASS 32 (U.S. CLS. 45, 46 AND 48).

FIRST USE 3-0-2005; IN COMMERCE 3-0-2005.

FOR: FRANCHISE SERVICES, NAMELY, OFFERING TECHNICAL AND BUSINESS MANAGEMENT ASSISTANCE IN THE ESTABLISHMENT AND OPERATION OF RESTAURANTS AND CARRY OUT RESTAURANTS; ISSUING GIFT CERTIFICATES

WHICH MAY THEN BE REDEEMED FOR GOODS OR SERVICES, IN CLASS 35 (U.S. CLS. 100, 101 AND 102).

FIRST USE 12-14-2007; IN COMMERCE 12-14-2007.

FOR: CARRY-OUT RESTAURANTS; RESTAURANT SERVICES; TAKE-OUT RESTAURANT SERVICES, IN CLASS 43 (U.S. CLS. 100 AND 101).

FIRST USE 1-0-1986; IN COMMERCE 1-0-1986.

THE MARK CONSISTS OF STANDARD CHARACTERS WITHOUT CLAIM TO ANY PARTICULAR FONT, STYLE, SIZE, OR COLOR.

OWNER OF U.S. REG. NO. 1,953,094.

NO CLAIM IS MADE TO THE EXCLUSIVE RIGHT TO USE "BURRITO", WITH RESPECT TO INTERNATIONAL CLASSES 035 AND 043 ONLY, APART FROM THE MARK AS SHOWN.

THE FOREIGN WORDING IN THE MARK "EL" TRANSLATES INTO ENGLISH AS THE.

SN 78-862,690, FILED 4-17-2006.

SARA THOMAS, EXAMINING ATTORNEY

Int. Cl.: 25

Prior U.S. Cls.: 22 and 39

United States Patent and Trademark Office

Reg. No. 3,478,172

Registered July 29, 2008

**TRADEMARK
PRINCIPAL REGISTER**

NOVEL-TEE SHIRT COMPANY

NB2 APPAREL CO. LLC (DELAWARE LTD LIAB
CO)
39 CORNELL ROAD
BALA CYNWYD, PA 19004

NO CLAIM IS MADE TO THE EXCLUSIVE
RIGHT TO USE "COMPANY", APART FROM THE
MARK AS SHOWN.

FOR: TOPS, IN CLASS 25 (U.S. CLS. 22 AND 39).

FIRST USE 6-0-2007; IN COMMERCE 6-0-2007.

SN 78-865,199, FILED 4-19-2006.

THE MARK CONSISTS OF STANDARD CHAR-
ACTERS WITHOUT CLAIM TO ANY PARTICULAR
FONT, STYLE, SIZE, OR COLOR.

RICHARD WHITE, EXAMINING ATTORNEY

Int. Cl.: 9

Prior U.S. Cls.: 21, 23, 26, 36, and 38

United States Patent and Trademark Office

Reg. No. 3,478,173

Registered July 29, 2008

**TRADEMARK
PRINCIPAL REGISTER**

3SPACE

BOSE CORPORATION (DELAWARE CORPORATION)
THE MOUNTAIN
FRAMINGHAM, MA 01701

FOR: AUDIO SIGNAL PROCESSING SOFTWARE,
IN CLASS 9 (U.S. CLS. 21, 23, 26, 36 AND 38).

FIRST USE 7-31-2006; IN COMMERCE 7-31-2006.

THE MARK CONSISTS OF STANDARD CHARACTERS WITHOUT CLAIM TO ANY PARTICULAR FONT, STYLE, SIZE, OR COLOR.

OWNER OF U.S. REG. NOS. 1,210,335, 3,034,365,
AND OTHERS.

SN 78-865,665, FILED 4-20-2006.

MICHAEL TANNER, EXAMINING ATTORNEY

Int. Cl.: 25

Prior U.S. Cls.: 22 and 39

United States Patent and Trademark Office

Reg. No. 3,478,174

Registered July 29, 2008

**TRADEMARK
PRINCIPAL REGISTER**

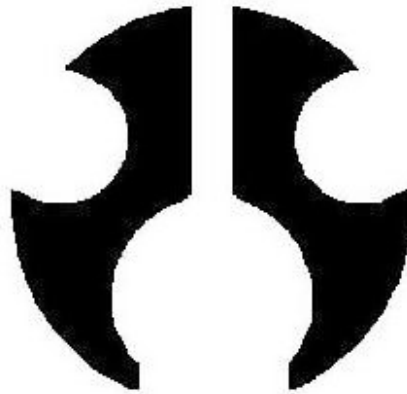

KINGSTAR USA, INC. (CALIFORNIA CORPORATION)
21092 BAKE PARKWAY #114
LAKE FOREST, CA 92630

THE MARK CONSISTS OF AN ABSTRACT OF
THE UPPER VIEW OF A SPORTS CAR.

FOR: CLOTHING, NAMELY, SHIRTS, T-SHIRTS,
CAPS, BASEBALL CAPS, IN CLASS 25 (U.S. CLS. 22
AND 39).

SN 78-866,171, FILED 4-20-2006.

FIRST USE 10-0-2007; IN COMMERCE 10-0-2007.

MARK SPARACINO, EXAMINING ATTORNEY

Int. Cls.: 14, 16, 35, and 39

Prior U.S. Cls.: 2, 5, 22, 23, 27, 28, 29, 37, 38, 50, 100,
101, 102, and 105

Reg. No. 3,478,175

United States Patent and Trademark Office

Registered July 29, 2008

TRADEMARK
SERVICE MARK
PRINCIPAL REGISTER

YES
the bronx

PAVE DEVELOPMENT LLC (NEW YORK LTD
LIAB CO)
4720 GROSVENOR AVE
BRONX, NY 104713307

FOR: JEWELRY PINS, IN CLASS 14 (U.S. CLS. 2,
27, 28 AND 50).

FIRST USE 5-9-2006; IN COMMERCE 5-9-2006.

FOR: NEWSLETTERS IN THE FIELD OF ECO-
NOMIC DEVELOPMENT, BUSINESS, AND TOUR-
ISM IN THE NEW YORK AREA, IN CLASS 16 (U.S.
CLS. 2, 5, 22, 23, 29, 37, 38 AND 50).

FIRST USE 1-0-2008; IN COMMERCE 1-0-2008.

FOR: PROMOTING ECONOMIC DEVELOP-
MENT, BUSINESS, AND TOURISM IN THE NEW
YORK AREA; ADVERTISING AND PUBLICITY
SERVICES; PROVIDING INFORMATION RELAT-
ING TO ECONOMIC DEVELOPMENT AND BUSI-
NESS VIA THE INTERNET; CONSULTATION

SERVICES IN THE FIELD OF ECONOMIC DEVEL-
OPMENT, BUSINESS, AND TOURISM IN THE NEW
YORK AREA, IN CLASS 35 (U.S. CLS. 100, 101 AND
102).

FIRST USE 7-0-2006; IN COMMERCE 7-0-2006.

FOR: PROVIDING AN INTERACTIVE COMPU-
TER DATABASE IN THE FIELD OF TOURISM VIA
A GLOBAL COMPUTER NETWORK, IN CLASS 39
(U.S. CLS. 100 AND 105).

FIRST USE 7-0-2006; IN COMMERCE 7-0-2006.

NO CLAIM IS MADE TO THE EXCLUSIVE
RIGHT TO USE "BRONX", APART FROM THE
MARK AS SHOWN.

SN 78-866,429, FILED 4-21-2006.

INGRID C. EULIN, EXAMINING ATTORNEY

Int. Cl.: 21

Prior U.S. Cls.: 2, 13, 23, 29, 30, 33, 40, and 50

Reg. No. 3,478,176

United States Patent and Trademark Office

Registered July 29, 2008

**TRADEMARK
PRINCIPAL REGISTER**

ALTIMUS

JOHNSON, JOHN E. (UNITED STATES INDIVIDUAL)
2348 EAST TUSC
CANTON, OH 44707

THE MARK CONSISTS OF STANDARD CHARACTERS WITHOUT CLAIM TO ANY PARTICULAR FONT, STYLE, SIZE, OR COLOR.

FOR: HAIR COMBS AND HAIR BRUSHES, IN CLASS 21 (U.S. CLS. 2, 13, 23, 29, 30, 33, 40 AND 50).

SN 78-869,282, FILED 4-25-2006.

FIRST USE 5-30-2007; IN COMMERCE 5-30-2007.

RONALD MCMORROW, EXAMINING ATTORNEY

Int. Cls.: 9 and 16

Prior U.S. Cls.: 2, 5, 21, 22, 23, 26, 29, 36, 37, 38, and 50

Reg. No. 3,478,177

United States Patent and Trademark Office

Registered July 29, 2008

**TRADEMARK
PRINCIPAL REGISTER**

**CHARLES SCHWAB INVESTMENT
MANAGEMENT PERSPECTIVES**

CHARLES SCHWAB & CO., INC. (CALIFORNIA CORPORATION)
101 MONTGOMERY STREET
SAN FRANCISCO, CA 94104

FOR: DOWNLOADABLE ELECTRONIC PUBLICATIONS, NAMELY, NEWSLETTERS AND REPORTS IN THE FIELD FINANCIAL INVESTMENTS, IN CLASS 9 (U.S. CLS. 21, 23, 26, 36 AND 38).

FIRST USE 4-0-2006; IN COMMERCE 4-0-2006.

FOR: NEWSLETTERS AND REPORTS IN THE FIELD OF FINANCIAL INVESTMENTS, IN CLASS 16 (U.S. CLS. 2, 5, 22, 23, 29, 37, 38 AND 50).

FIRST USE 3-0-2006; IN COMMERCE 3-0-2006.

THE MARK CONSISTS OF STANDARD CHARACTERS WITHOUT CLAIM TO ANY PARTICULAR FONT, STYLE, SIZE, OR COLOR.

OWNER OF U.S. REG. NOS. 2,331,730, 2,934,746, AND OTHERS.

NO CLAIM IS MADE TO THE EXCLUSIVE RIGHT TO USE "INVESTMENT MANAGEMENT", APART FROM THE MARK AS SHOWN.

THE NAME "CHARLES SCHWAB" IDENTIFIES A LIVING INDIVIDUAL WHOSE CONSENT IS OF RECORD.

SN 78-869,903, FILED 4-26-2006.

NORA BUCHANAN WILL, EXAMINING ATTORNEY

Int. Cl.: 41

Prior U.S. Cls.: 100, 101, and 107

United States Patent and Trademark Office

Reg. No. 3,478,178

Registered July 29, 2008

**SERVICE MARK
PRINCIPAL REGISTER**

EVEREST UNIVERSITY

CORINTHIAN COLLEGES, INC. (DELAWARE CORPORATION)
SUITE 400
400 HUTTON CENTRE DRIVE
SANTA ANA, CA 927075764

FOR: EDUCATIONAL SERVICES, NAMELY, PROVIDING CAREER-ORIENTED POST-SECONDARY EDUCATION IN THE ACCOUNTING, ADMINISTRATIVE, BUSINESS, COMPUTER SCIENCE, HEALTHCARE, INFORMATION TECHNOLOGY, TECHNICAL, TECHNOLOGY, LEGAL, CRIMINAL JUSTICE, TRAVEL AND HOSPITALITY FIELDS, IN CLASS 41 (U.S. CLS. 100, 101 AND 107).

FIRST USE 11-5-2007; IN COMMERCE 11-5-2007.

THE MARK CONSISTS OF STANDARD CHARACTERS WITHOUT CLAIM TO ANY PARTICULAR FONT, STYLE, SIZE, OR COLOR.

OWNER OF U.S. REG. NO. 2,798,638.

NO CLAIM IS MADE TO THE EXCLUSIVE RIGHT TO USE "UNIVERSITY", APART FROM THE MARK AS SHOWN.

SN 78-870,431, FILED 4-26-2006.

ANNE FARRELL, EXAMINING ATTORNEY

Int. Cl.: 5

Prior U.S. Cls.: 6, 18, 44, 46, 51, and 52

Reg. No. 3,478,179

United States Patent and Trademark Office

Registered July 29, 2008

**TRADEMARK
PRINCIPAL REGISTER**

MERIX

MERIX PHARMACEUTICAL CORPORATION
(ILLINOIS CORPORATION)
2 GOOSE LAKE DRIVE
BARRINGTON HILLS, IL 60010

THE MARK CONSISTS OF STANDARD CHAR-
ACTERS WITHOUT CLAIM TO ANY PARTICULAR
FONT, STYLE, SIZE, OR COLOR.

FOR: MEDICINAL HERBAL EXTRACTS; AND
MEDICINAL INFUSIONS, NAMELY, HERBAL IN-
FUSIONS FOR MEDICINAL PURPOSES, IN CLASS 5
(U.S. CLS. 6, 18, 44, 46, 51 AND 52).

OWNER OF U.S. REG. NO. 2,676,044.

SN 78-870,813, FILED 4-27-2006.

FIRST USE 5-19-1999; IN COMMERCE 5-19-1999.

GENE MACIOL, EXAMINING ATTORNEY

Int. Cl.: 25

Prior U.S. Cls.: 22 and 39

United States Patent and Trademark Office

Reg. No. 3,478,180

Registered July 29, 2008

**TRADEMARK
PRINCIPAL REGISTER**



KAHN, DAVID (UNITED STATES INDIVIDUAL)
92 LITTLEBROOK RD.
PRINCETON, NJ 08540

FOR: FOOTWEAR AND APPAREL, NAMELY, SHIRTS, TANK TOPS, JACKETS, PANTS, SHORTS, HATS, SHOES, SPORT BRAS, BELTS, SWEAT BANDS, UNITARDS, LEOTARDS, IN CLASS 25 (U.S. CLS. 22 AND 39).

FIRST USE 12-0-2006; IN COMMERCE 2-0-2007.

THE COLOR(S) THE COLORS DARK GREY, LIGHT GREY, BLACK, AND WHITE ARE CLAIMED AS A FEATURE OF THE MARK IS/ARE CLAIMED AS A FEATURE OF THE MARK.

THE COLOR DARK GREY APPEARS IN THE SWORD HANDLE DESIGN, THE COLOR LIGHT GREY APPEARS IN THE SWORD BLADE, THE SWORD HANDLE, AND IN THE WING DESIGN; THE COLOR BLACK APPEARS IN THE DESIGN OF THE KRAVIST MAN; AND THE COLOR WHITE APPEARS IN THE LINES IN THE WING DESIGN AND HIGHLIGHTS THE SWORD DESIGN.

SN 78-871,144, FILED 4-27-2006.

JUSTINE D. PARKER, EXAMINING ATTORNEY

Int. Cl.: 8

Prior U.S. Cls.: 23, 28, and 44

Reg. No. 3,478,181

United States Patent and Trademark Office

Registered July 29, 2008

**TRADEMARK
PRINCIPAL REGISTER**

THE BRUTE

AMES TRUE TEMPER PROPERTIES, INC. (MI-
CHIGAN CORPORATION)
300 DELAWARE AVENUE, SUITE 1704
WILMINGTON, DE 19801

THE MARK CONSISTS OF STANDARD CHAR-
ACTERS WITHOUT CLAIM TO ANY PARTICULAR
FONT, STYLE, SIZE, OR COLOR.

FOR: MANUALLY OPERATED HAND TOOLS,
NAMELY, ICE SCRAPERS, IN CLASS 8 (U.S. CLS. 23,
28 AND 44).

SN 78-871,206, FILED 4-27-2006.

FIRST USE 12-31-2006; IN COMMERCE 12-31-2006.

ANTHONY RINKER, EXAMINING ATTORNEY

Int. Cl.: 31

Prior U.S. Cls.: 1 and 46

United States Patent and Trademark Office

Reg. No. 3,478,182

Registered July 29, 2008

**TRADEMARK
PRINCIPAL REGISTER**

IQ Treats

CANINE GENIUS COMPANY (CALIFORNIA
PARTNERSHIP)

3037 EAGLE STREET

SAN DIEGO, CA 92103

FOR: EDIBLE DOG TREATS, IN CLASS 31 (U.S.
CLS. 1 AND 46).

FIRST USE 8-11-2007; IN COMMERCE 8-11-2007.

THE MARK CONSISTS OF STANDARD CHAR-
ACTERS WITHOUT CLAIM TO ANY PARTICULAR
FONT, STYLE, SIZE, OR COLOR.

NO CLAIM IS MADE TO THE EXCLUSIVE
RIGHT TO USE "TREATS", APART FROM THE
MARK AS SHOWN.

SN 78-872,733, FILED 4-28-2006.

CAROL SPILS, EXAMINING ATTORNEY

Int. Cl.: 9

Prior U.S. Cls.: 21, 23, 26, 36, and 38

United States Patent and Trademark Office

Reg. No. 3,478,183

Registered July 29, 2008

**TRADEMARK
PRINCIPAL REGISTER**

DON'T HOLD BACK

BRANDON B. HYNES (CANADA INDIVIDUAL)
2075 ROUTE 600W
ST. ALBERT, ONTARIO, CANADA K0A3C0

FOR: PRE-RECORDED CDS, VIDEO TAPES, LASER DISKS AND DVDS FEATURING MUSIC AND MOVIES AND FILMS FEATURING DOCUMENTARY, BIOGRAPHICAL AND FICTIONAL DRAMATIC THEMES, IN CLASS 9 (U.S. CLS. 21, 23, 26, 36 AND 38).

FIRST USE 7-1-2005; IN COMMERCE 5-1-2008.

THE MARK CONSISTS OF STANDARD CHARACTERS WITHOUT CLAIM TO ANY PARTICULAR FONT, STYLE, SIZE, OR COLOR.

SN 78-873,837, FILED 5-1-2006.

DAYNA BROWNE, EXAMINING ATTORNEY

Int. Cl.: 25

Prior U.S. Cls.: 22 and 39

United States Patent and Trademark Office

Reg. No. 3,478,184

Registered July 29, 2008

TRADEMARK
PRINCIPAL REGISTER



NB2 APPAREL CO. LLC (DELAWARE LTD LIAB
CO)
39 CORNELL ROAD
BALA CYNWYD, PA 19004

FOR: TOPS, IN CLASS 25 (U.S. CLS. 22 AND 39).

FIRST USE 6-0-2007; IN COMMERCE 6-0-2007.

NO CLAIM IS MADE TO THE EXCLUSIVE
RIGHT TO USE "SHIRT COMPANY", APART FROM
THE MARK AS SHOWN.

THE MARK CONSISTS OF A CIRCLE CONTAIN-
ING THE WORDS "NOVEL-TEE SHIRT COMPANY"
SURROUNDING A BOY WEARING A "PORKY'S
PLACE" TOP, SET AGAINST A LINED BACK-
GROUND.

SN 78-874,632, FILED 5-2-2006.

RICHARD WHITE, EXAMINING ATTORNEY

Int. Cl.: 41

Prior U.S. Cls.: 100, 101, and 107

United States Patent and Trademark Office

Reg. No. 3,478,185

Registered July 29, 2008

**SERVICE MARK
PRINCIPAL REGISTER**

BUILD-A-BOAT CHALLENGE

OCEAN INSTITUTE (CALIFORNIA NON-PROFIT CORPORATION)
24200 DANA POINT HARBOR DRIVE
DANA POINT, CA 92629

FOR: EDUCATIONAL SERVICES, NAMELY, CONDUCTING WORKSHOPS, SEMINARS, CONFERENCES, AND RETREATS IN LEADERSHIP, TEAM BUILDING, POSITIVE ATTITUDE, CHOICES AND SELF-ESTEEM, IN CLASS 41 (U.S. CLS. 100, 101 AND 107).

FIRST USE 4-0-2003; IN COMMERCE 4-0-2003.

THE MARK CONSISTS OF STANDARD CHARACTERS WITHOUT CLAIM TO ANY PARTICULAR FONT, STYLE, SIZE, OR COLOR.

NO CLAIM IS MADE TO THE EXCLUSIVE RIGHT TO USE "CHALLENGE", APART FROM THE MARK AS SHOWN.

SN 78-874,749, FILED 5-2-2006.

JENNY PARK, EXAMINING ATTORNEY

Int. Cl.: 9

Prior U.S. Cls.: 21, 23, 26, 36, and 38

Reg. No. 3,478,186

United States Patent and Trademark Office

Registered July 29, 2008

**TRADEMARK
PRINCIPAL REGISTER**

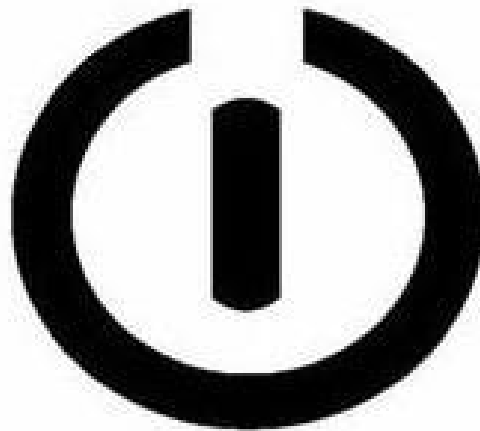

MM-PARTNER D.O.O. (SLOVENIA LTD LIAB
CO)

TRZASKA 2

1000 LJUBLJANA, SLOVENIA

FOR: ELECTRIC SWITCHES; ELECTRIC SWITCH
COVER PLATES; DECORATIVE SWITCH COVER

PLATES; ELECTRONIC DIMMER SWITCHES, IN
CLASS 9 (U.S. CLS. 21, 23, 26, 36 AND 38).

FIRST USE 9-30-2007; IN COMMERCE 9-30-2007.

SN 78-878,999, FILED 5-8-2006.

SOPHIA S. KIM, EXAMINING ATTORNEY

Int. Cls.: 9 and 41

Prior U.S. Cls.: 21, 23, 26, 36, 38, 100, 101, and 107

United States Patent and Trademark Office

Reg. No. 3,478,187

Registered July 29, 2008

**TRADEMARK
SERVICE MARK
PRINCIPAL REGISTER**

GREEN OCEAN RACE

FORSYTH, ERIC B. (UNITED STATES INDIVIDUAL)
2 BOND LANE
BROOKHAVEN, NY 11719

FOR: NAUTICAL APPARATUS AND INSTRUMENTS, NAMELY, APPARATUS TO EFFICIENT POWER GENERATION UNDER WAY, EFFICIENT ONBOARD LIGHTING, AND EFFICIENT ONBOARD COOKING MEANS; VIDEO TAPES AND DISCS FEATURING DOCUMENTARY AND INSTRUCTIONAL MATERIAL IN THE FIELD OF BOATING, SAILING AND YACHTING; COMPUTER SOFTWARE IN THE FIELD OF MARINE MAPPING, NAVIGATION, AND VESSEL OPERATION; REFRIGERATOR MAGNETS; CASES FOR PERSONAL ELECTRONICS, NAMELY, WATERTIGHT CASES FOR CELL PHONES, FOR PERSONAL DIGITAL DEVICES (PDAS), FOR LAPTOP COMPUTERS, FOR CAMERAS, AND FOR MP3 PLAYERS, IN CLASS 9 (U.S. CLS. 21, 23, 26, 36 AND 38).

FIRST USE 11-9-2007; IN COMMERCE 4-17-2008.

FOR: ENTERTAINMENT IN THE NATURE OF BOAT, SAILING, AND YACHT RACES; PROVIDING EDUCATIONAL PROGRAMS IN THE FIELD OF BOATING, SAILING, AND YACHTING, IN CLASS 41 (U.S. CLS. 100, 101 AND 107).

FIRST USE 11-9-2007; IN COMMERCE 5-20-2008.

THE MARK CONSISTS OF STANDARD CHARACTERS WITHOUT CLAIM TO ANY PARTICULAR FONT, STYLE, SIZE, OR COLOR.

NO CLAIM IS MADE TO THE EXCLUSIVE RIGHT TO USE "OCEAN RACE", APART FROM THE MARK AS SHOWN.

SN 78-879,425, FILED 5-9-2006.

ALICE BENMAMAN, EXAMINING ATTORNEY

Int. Cl.: 19

Prior U.S. Cls.: 1, 12, 33, and 50

United States Patent and Trademark Office

Reg. No. 3,478,188

Registered July 29, 2008

**TRADEMARK
PRINCIPAL REGISTER**

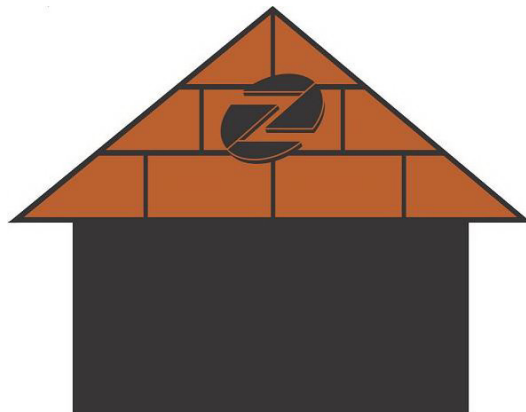

HUBER ENGINEERED WOODS LLC (DELA-
WARE LTD LIAB CO)
10925 DAVID TAYLOR DRIVE
SUITE 300
CHARLOTTE, NC 28262

FOR: NON-METALLIC BUILDING MATERIALS,
CONSISTING OF LAMINATED ORIENTED
STRAND BOARD, IN CLASS 19 (U.S. CLS. 1, 12, 33
AND 50).

FIRST USE 1-21-2005; IN COMMERCE 1-21-2005.

THE COLOR(S) ORANGE (PANTONE 167U) AND
BLACK IS/ARE CLAIMED AS A FEATURE OF THE
MARK.

THE MARK FEATURES A DRAWING OF AN
ORANGE (PANTONE 167U) ROOF WITH A BLACK
HOUSE, BLACK LINING, AND A BLACK OVAL
DIVIDED TO CREATE THE APPEARANCE OF THE
LETTER "Z".

SN 78-881,047, FILED 5-11-2006.

RICHARD WHITE, EXAMINING ATTORNEY

Int. Cl.: 38

Prior U.S. Cls.: 100, 101, and 104

United States Patent and Trademark Office

Reg. No. 3,478,189

Registered July 29, 2008

**SERVICE MARK
PRINCIPAL REGISTER**

Peachhead Families

PEACHHEAD FAMILIES, LLC (CALIFORNIA
LTD LIAB CO)
4640 ADMIRALTY WAY, STE. 500
MARINA DEL REY, CA 90292

FOR: PROVIDING ON-LINE FORUMS FOR
TRANSMISSION OF MESSAGES AMONG COMPU-
TER USERS CONCERNING DOMESTIC AND FA-
MILY LIFE, IN CLASS 38 (U.S. CLS. 100, 101 AND
104).

FIRST USE 4-24-2008; IN COMMERCE 4-24-2008.

THE MARK CONSISTS OF STANDARD CHAR-
ACTERS WITHOUT CLAIM TO ANY PARTICULAR
FONT, STYLE, SIZE, OR COLOR.

NO CLAIM IS MADE TO THE EXCLUSIVE
RIGHT TO USE "FAMILIES", APART FROM THE
MARK AS SHOWN.

SN 78-883,128, FILED 5-14-2006.

ADA HAN, EXAMINING ATTORNEY

Int. Cls.: 16, 28, and 35

Prior U.S. Cls.: 2, 5, 22, 23, 29, 37, 38, 50, 100, 101, and 102

United States Patent and Trademark Office

Reg. No. 3,478,190

Registered July 29, 2008

**TRADEMARK
SERVICE MARK
PRINCIPAL REGISTER**

Brain Teasers

HUGHES, MICHAEL L (UNITED STATES INDIVIDUAL)
6714 SELMA AVE.
LOS ANGELES, CA 90028

FOR: PRINTED DISPOSABLE TICKET SETS, IN CLASS 16 (U.S. CLS. 2, 5, 22, 23, 29, 37, 38 AND 50).

FIRST USE 6-5-2006; IN COMMERCE 7-28-2006.

FOR: PROMOTIONAL GAME MATERIALS IN THE NATURE OF TRADING CARDS FOR USE IN PLAYING GAMES OF CHANCE, GAMES OF SKILL, AND EDUCATIONAL GAMES WHERE RECIPIENTS HAVE THE OPPORTUNITY TO RECEIVE PRIZES, IN CLASS 28 (U.S. CLS. 22, 23, 38 AND 50).

FIRST USE 6-5-2006; IN COMMERCE 7-28-0006.

FOR: PROMOTING THE GOODS AND SERVICES OF OTHERS THROUGH THE DISTRIBUTION OF DISPOSABLE TICKET SETS, PROMOTIONAL GAME MATERIALS AND TRADING CARDS, IN CLASS 35 (U.S. CLS. 100, 101 AND 102).

FIRST USE 6-5-2006; IN COMMERCE 7-28-2006.

THE MARK CONSISTS OF STANDARD CHARACTERS WITHOUT CLAIM TO ANY PARTICULAR FONT, STYLE, SIZE, OR COLOR.

SN 78-883,558, FILED 5-15-2006.

ELLEN PERKINS, EXAMINING ATTORNEY

Int. Cls.: 9, 16, and 41

**Prior U.S. Cls.: 2, 5, 21, 22, 23, 26, 29, 36, 37, 38, 50,
100, 101, and 107**

Reg. No. 3,478,191

United States Patent and Trademark Office

Registered July 29, 2008

**TRADEMARK
SERVICE MARK
PRINCIPAL REGISTER**

TALK, LISTEN, CONNECT

SESAME WORKSHOP (NEW YORK NON-PROFIT CORPORATION)
ONE LINCOLN PLAZA
NEW YORK, NY 10023

FOR: AUDIO RECORDINGS, VIDEO RECORDINGS, VIDEO TAPES, AND DVDS FEATURING ENTERTAINMENT AND EDUCATIONAL INFORMATION ON ISSUES RELATED TO MILITARY SERVICE AND DEPLOYMENT DIRECTED TO CHILDREN, PARENTS, FAMILIES, AND CAREGIVERS, IN CLASS 9 (U.S. CLS. 21, 23, 26, 36 AND 38).

FIRST USE 8-1-2006; IN COMMERCE 8-1-2006.

FOR: PRINTED MATERIALS, NAMELY, MAGAZINES, NEWSLETTERS, BROCHURES, PAMPHLETS, AND BOOKLETS FEATURING ENTERTAINMENT AND EDUCATIONAL INFORMATION ON ISSUES RELATED TO MILITARY SERVICE AND DEPLOYMENT DIRECTED TO CHILDREN, PARENTS, FAMILIES, AND CAREGIVERS, IN CLASS 16 (U.S. CLS. 2, 5, 22, 23, 29, 37, 38 AND 50).

FIRST USE 8-1-2006; IN COMMERCE 8-1-2006.

FOR: EDUCATIONAL SERVICES, NAMELY, PROVIDING ON-LINE PROGRAMS IN THE FIELDS OF MILITARY SERVICE AND DEPLOYMENT DIRECTED TO CHILDREN, PARENTS, FAMILIES, AND CAREGIVERS USING ON-LINE ACTIVITIES, AND PRINTABLE MATERIALS DISTRIBUTED THEREWITH, IN CLASS 41 (U.S. CLS. 100, 101 AND 107).

FIRST USE 8-1-2006; IN COMMERCE 8-1-2006.

THE MARK CONSISTS OF STANDARD CHARACTERS WITHOUT CLAIM TO ANY PARTICULAR FONT, STYLE, SIZE, OR COLOR.

SN 78-884,603, FILED 5-16-2006.

ELLEN PERKINS, EXAMINING ATTORNEY

Int. Cl.: 1

Prior U.S. Cls.: 1, 5, 6, 10, 26, and 46

United States Patent and Trademark Office

Reg. No. 3,478,192

Registered July 29, 2008

**TRADEMARK
PRINCIPAL REGISTER**



NAVINTA LLC (NEW JERSEY LTD LIAB CO)
1499 LOWER FERRY RD.
EWING, NJ 08618

FIRST USE 4-30-2008; IN COMMERCE 4-30-2008.

FOR: CHEMICAL PRECURSORS AND ADDI-
TIVES FOR USE IN THE MANUFACTURE OF
PHARMACEUTICALS, IN CLASS 1 (U.S. CLS. 1, 5,
6, 10, 26 AND 46).

SN 78-885,902, FILED 5-17-2006.

BERYL GARDNER, EXAMINING ATTORNEY

Int. Cls.: 9, 38, and 41

Prior U.S. Cls.: 21, 23, 26, 36, 38, 100, 101, 104, and 107

Reg. No. 3,478,193

United States Patent and Trademark Office

Registered July 29, 2008

**TRADEMARK
SERVICE MARK
PRINCIPAL REGISTER**

ZWINKY

IAC SEARCH & MEDIA, INC. (DELAWARE CORPORATION)
555 12TH STREET, SUITE 500
OAKLAND, CA 94607

FOR: COMPUTER SOFTWARE FOR OPERATING AND MAINTAINING AN ONLINE VIRTUAL WORLD FEATURING AVATAR-BASED COMMUNICATIONS FOR TRANSMISSION OF ELECTRONIC MESSAGES AMONG COMPUTER USERS, CHAT ROOMS, ELECTRONIC BULLETIN BOARDS, COMPUTER GAMES AND ACTIVITIES, A VIRTUAL ECONOMY AND A VIRTUAL CURRENCY FOR TRANSACTION OF VIRTUAL COMMERCE, AND DELIVERY OF AUDIO, VIDEO AND MULTIMEDIA CONTENT; COMPUTER SOFTWARE FOR CREATING CUSTOMIZED AVATARS AND DOWNLOADING SUCH AVATARS TO PERSONAL COMPUTERS AND MOBILE DEVICES; DOWNLOADABLE SOFTWARE, NAMELY, BROWSER TOOL BARS; DOWNLOADABLE COMPUTER SOFTWARE FOR USE IN ATTACHING FANCIFUL DESIGNS, ICONS OR SYMBOLS IN E-MAIL CORRESPONDENCE, IN CLASS 9 (U.S. CLS. 21, 23, 26, 36 AND 38).

FIRST USE 4-26-2007; IN COMMERCE 4-26-2007.

FOR: OPERATING AND MAINTAINING AN ONLINE VIRTUAL WORLD, NAMELY, PROVIDING

AVATAR-BASED COMMUNICATIONS FOR TRANSMISSION OF ELECTRONIC MESSAGES AMONG COMPUTER USERS, PROVIDING CHAT ROOMS AND ELECTRONIC BULLETIN BOARDS IN THE FIELD OF GENERAL INTEREST, AND DELIVERY OF AUDIO, VIDEO AND MULTIMEDIA CONTENT, IN CLASS 38 (U.S. CLS. 100, 101 AND 104).

FIRST USE 4-26-2007; IN COMMERCE 4-26-2007.

FOR: OPERATING AND MAINTAINING AN ONLINE VIRTUAL WORLD FOR ENTERTAINMENT PURPOSES, NAMELY, PROVIDING ONLINE COMPUTER GAMES AND ENTERTAINMENT CONTENT, AND PROVIDING A VIRTUAL ECONOMY AND A VIRTUAL CURRENCY FOR TRANSACTION OF VIRTUAL COMMERCE, IN CLASS 41 (U.S. CLS. 100, 101 AND 107).

FIRST USE 4-26-2007; IN COMMERCE 4-26-2007.

THE MARK CONSISTS OF STANDARD CHARACTERS WITHOUT CLAIM TO ANY PARTICULAR FONT, STYLE, SIZE, OR COLOR.

SN 78-886,251, FILED 5-17-2006.

PAUL E. FAHRENKOPF, EXAMINING ATTORNEY

Int. Cls.: 9 and 10

Prior U.S. Cls.: 21, 23, 26, 36, 38, 39, and 44

United States Patent and Trademark Office

Reg. No. 3,478,194

Registered July 29, 2008

**TRADEMARK
PRINCIPAL REGISTER**



"...it's in the bag"

**BLOOD CELL STORAGE, INC. (DELAWARE
CORPORATION)
146 CANAL STREET, SUITE 330
SEATTLE, WA 98103**

**FOR: NON-INVASIVE DEVICES FOR DETER-
MINING PH LEVELS, NAMELY, SENSORS FOR
MEASURING PH LEVELS IN DISPOSABLE BIOR-
EACTORS, BLOOD AND CELL STORAGE DEVICES,
FOR USE IN BIOPHARMACEUTICAL MANUFAC-
TURING, IN CLASS 9 (U.S. CLS. 21, 23, 26, 36 AND
38).**

FIRST USE 3-18-2008; IN COMMERCE 3-18-2008.

**FOR: MEDICAL DEVICES, NAMELY, A NON-
INVASIVE DEVICE FOR MEASURING PH LEVELS,
IN CLASS 10 (U.S. CLS. 26, 39 AND 44).**

FIRST USE 3-18-2008; IN COMMERCE 3-18-2008.

SN 78-888,311, FILED 5-19-2006.

SUSAN STIGLITZ, EXAMINING ATTORNEY

Int. Cl.: 5

Prior U.S. Cls.: 6, 18, 44, 46, 51, and 52

Reg. No. 3,478,195

United States Patent and Trademark Office

Registered July 29, 2008

**TRADEMARK
PRINCIPAL REGISTER**

LADA

ROTAM LTD. (HONG KONG CORPORATION)
7/F., CHEUNG TAT CENTRE
18 CHEUNG LEE STREET
CHAI WAN, HONG KONG

THE MARK CONSISTS OF STANDARD CHAR-
ACTERS WITHOUT CLAIM TO ANY PARTICULAR
FONT, STYLE, SIZE, OR COLOR.

FOR: AGRICULTURAL HERBICIDES, INSECTI-
CIDES AND FUNGICIDES, IN CLASS 5 (U.S. CLS. 6,
18, 44, 46, 51 AND 52).

SN 78-890,339, FILED 5-23-2006.

FIRST USE 9-0-2007; IN COMMERCE 9-0-2007.

CAROL SPILS, EXAMINING ATTORNEY

Int. Cl.: 5

Prior U.S. Cls.: 6, 18, 44, 46, 51, and 52

Reg. No. 3,478,196

United States Patent and Trademark Office

Registered July 29, 2008

**TRADEMARK
PRINCIPAL REGISTER**

PLOTTER

ROTAM LTD. (HONG KONG CORPORATION)
7/F., CHEUNG TAT CENTRE
18 CHEUNG LEE STREET
CHAI WAN, HONG KONG

THE MARK CONSISTS OF STANDARD CHAR-
ACTERS WITHOUT CLAIM TO ANY PARTICULAR
FONT, STYLE, SIZE, OR COLOR.

FOR: AGRICULTURAL HERBICIDES, INSECTI-
CIDES AND FUNGICIDES, IN CLASS 5 (U.S. CLS. 6,
18, 44, 46, 51 AND 52).

SN 78-890,424, FILED 5-23-2006.

FIRST USE 2-0-2007; IN COMMERCE 2-0-2007.

CAROL SPILS, EXAMINING ATTORNEY

Int. Cl.: 41

Prior U.S. Cls.: 100, 101, and 107

United States Patent and Trademark Office

Reg. No. 3,478,197

Registered July 29, 2008

**SERVICE MARK
PRINCIPAL REGISTER**

GAMER SALOON

BEYOND GAMING, LLC (MICHIGAN LTD LIAB
CO)
24370 NORTHWESTERN HIGHWAY, SUITE 101
SOUTHFIELD, MI 48075

FIRST USE 11-29-2006; IN COMMERCE 11-29-2006.

FOR: ENTERTAINMENT SERVICES, NAMELY,
ARRANGING AND CONDUCTING INTERACTIVE,
MULTIPLAYER VIDEO AND COMPUTER GAME
TOURNAMENTS OVER THE INTERNET; ARRAN-
GING AND CONDUCTING TOURNAMENTS FOR
VIDEO AND COMPUTER GAME PLAYERS OVER
THE INTERNET, IN CLASS 41 (U.S. CLS. 100, 101
AND 107).

THE MARK CONSISTS OF STANDARD CHAR-
ACTERS WITHOUT CLAIM TO ANY PARTICULAR
FONT, STYLE, SIZE, OR COLOR.

SN 78-891,608, FILED 5-24-2006.

JENNIFER VASQUEZ, EXAMINING ATTORNEY

Int. Cl.: 41

Prior U.S. Cls.: 100, 101, and 107

United States Patent and Trademark Office

Reg. No. 3,478,198

Registered July 29, 2008

**SERVICE MARK
PRINCIPAL REGISTER**



The **In**quisitive Canine

JOAN HUNTER MAYER (CALIFORNIA LTD
LIAB CO)
2423 HYLAND AVE.
VENTURA, CA 93001

FOR: DOG TRAINING AND BEHAVIOR CON-
SULTING, IN CLASS 41 (U.S. CLS. 100, 101 AND 107).

FIRST USE 7-1-2006; IN COMMERCE 7-23-2006.

NO CLAIM IS MADE TO THE EXCLUSIVE
RIGHT TO USE "CANINE", APART FROM THE
MARK AS SHOWN.

THE COLOR(S) BLUE AND BLACK IS/ARE
CLAIMED AS A FEATURE OF THE MARK.

THE COLOR BLACK APPEARS IN THE DOG
DESIGN, IN THE TASSEL, ON THE END OF THE
DIPLOMA AND IN THE "N" UISITIVE CANINE.
THE COLOR BLUE APPEARS IN THE HAT, IN THE
BODY OF THE DIPLOMA AND IN THE "I" AND
THE "Q".

SN 78-892,676, FILED 5-25-2006.

JENNIFER VASQUEZ, EXAMINING ATTORNEY

Int. Cl.: 41

Prior U.S. Cls.: 100, 101, and 107

United States Patent and Trademark Office

Reg. No. 3,478,199

Registered July 29, 2008

**SERVICE MARK
PRINCIPAL REGISTER**



SHORN INDUSTRIES, LLC (DELAWARE LTD
LIAB CO)
204 PEBBLE CREED COURT
PENNINGTON, NJ 08534

FOR: ENTERTAINMENT IN THE NATURE OF
AN ON-GOING REALITY SHOW BROADCAST
OVER TELEVISION, SATELLITE, AUDIO, RADIO,

AND VIDEO MEDIA, IN CLASS 41 (U.S. CLS. 100, 101
AND 107).

FIRST USE 5-15-2006; IN COMMERCE 5-15-2006.

SN 78-892,938, FILED 5-25-2006.

DAWN HAN, EXAMINING ATTORNEY

Int. Cl.: 25

Prior U.S. Cls.: 22 and 39

United States Patent and Trademark Office

Reg. No. 3,478,200

Registered July 29, 2008

**TRADEMARK
PRINCIPAL REGISTER**

HANDWRITTEN

SARNE, TANYA (UNITED KINGDOM INDIVIDUAL)
58 ST HELEN'S GARDENS
LONDON W10 6LH, UNITED KINGDOM

FOR: CLOTHING, NAMELY, DRESSES, COATS, JACKETS, JUMPERS, TOPS, DRESSES, TROUSERS; EVENING WEAR, NAMELY, EVENING DRESSES, EVENING GOWNS; KNITWEAR, NAMELY, KNIT SHIRTS, KNIT SWEATERS, KNIT DRESSES, IN CLASS 25 (U.S. CLS. 22 AND 39).

FIRST USE 7-1-2007; IN COMMERCE 3-0-2008.

THE MARK CONSISTS OF STANDARD CHARACTERS WITHOUT CLAIM TO ANY PARTICULAR FONT, STYLE, SIZE, OR COLOR.

SN 78-892,956, FILED 5-25-2006.

ADA HAN, EXAMINING ATTORNEY

Int. Cl.: 5

Prior U.S. Cls.: 6, 18, 44, 46, 51, and 52

Reg. No. 3,478,201

United States Patent and Trademark Office

Registered July 29, 2008

**TRADEMARK
PRINCIPAL REGISTER**

The logo for the TOLEDO trademark features the word "TOLEDO" in a bold, sans-serif, uppercase font. The letters are thick and closely spaced. To the right of the word, there is a stylized graphic element consisting of a curved line that starts below the 'O' and arches over the top of the 'O', resembling a partial circle or a swoosh. Below the entire logo, there is a thin horizontal line.

ROTAM LTD. (HONG KONG CORPORATION)
7/F., CHEUNG TAT CENTRE
18 CHEUNG LEE STREET
CHAI WAN, HONG KONG

FIRST USE 5-0-2007; IN COMMERCE 5-0-2007.

SN 78-893,810, FILED 5-26-2006.

FOR: AGRICULTURAL HERBICIDES, INSECTI-
CIDES AND FUNGICIDES, IN CLASS 5 (U.S. CLS. 6,
18, 44, 46, 51 AND 52).

CAROL SPILS, EXAMINING ATTORNEY

Int. Cl.: 1

Prior U.S. Cls.: 1, 5, 6, 10, 26, and 46

Reg. No. 3,478,202

United States Patent and Trademark Office

Registered July 29, 2008

**TRADEMARK
PRINCIPAL REGISTER**

QZ

UOP LLC (DELAWARE LIMITED LIABILITY CORPORATION)
25 EAST ALGONQUIN ROAD
DES PLAINES, IL 60017

THE MARK CONSISTS OF STANDARD CHARACTERS WITHOUT CLAIM TO ANY PARTICULAR FONT, STYLE, SIZE, OR COLOR.

FOR: CATALYSTS FOR USE IN THE MANUFACTURE OF INDUSTRIAL CHEMICALS, IN CLASS 1 (U.S. CLS. 1, 5, 6, 10, 26 AND 46).

SN 78-894,263, FILED 5-26-2006.

FIRST USE 1-1-1996; IN COMMERCE 12-31-1996.

SARA THOMAS, EXAMINING ATTORNEY

Int. Cl.: 16

Prior U.S. Cls.: 2, 5, 22, 23, 29, 37, 38, and 50

United States Patent and Trademark Office

Reg. No. 3,478,203

Registered July 29, 2008

**TRADEMARK
PRINCIPAL REGISTER**



GENENTECH, INC. (DELAWARE CORPORATION)
1 DNA WAY
SOUTH SAN FRANCISCO, CA 940804990

FOR: PRINTED EDUCATIONAL AND INFORMATIONAL PUBLICATIONS, NAMELY, REPORTS ON CONFERENCE SEMINARS AND DISCUSSIONS, SUMMARY REPORTS ON CONFERENCE SEMINARS AND DISCUSSIONS, NEWSLETTERS, BULLETINS, BROCHURES, TRAINING MATERIALS, AND LEAFLETS; ALL OF THE FOREGOING RE-

LATED TO THE FIELDS OF MEDICINE AND MEDICINAL TREATMENT, IN CLASS 16 (U.S. CLS. 2, 5, 22, 23, 29, 37, 38 AND 50).

FIRST USE 11-0-2006; IN COMMERCE 11-0-2006.

OWNER OF U.S. REG. NO. 2,157,198.

SN 78-894,502, FILED 5-26-2006.

PAUL CROWLEY, EXAMINING ATTORNEY

Int. Cl.: 44

Prior U.S. Cls.: 100 and 101

United States Patent and Trademark Office

Reg. No. 3,478,204

Registered July 29, 2008

**SERVICE MARK
PRINCIPAL REGISTER**



GENENTECH, INC. (DELAWARE CORPORATION)
1 DNA WAY
SOUTH SAN FRANCISCO, CA 940804990

FIRST USE 3-0-2006; IN COMMERCE 3-0-2006.

OWNER OF U.S. REG. NO. 2,157,198.

FOR: PROVIDING INFORMATION ON THE SUBJECT OF MEDICAL CONDITIONS AND THERAPIES VIA A GLOBAL COMPUTER NETWORK, IN CLASS 44 (U.S. CLS. 100 AND 101).

SN 78-894,574, FILED 5-26-2006.

PAUL CROWLEY, EXAMINING ATTORNEY

Int. Cl.: 37

Prior U.S. Cls.: 100, 103, and 106

United States Patent and Trademark Office

Reg. No. 3,478,205

Registered July 29, 2008

**SERVICE MARK
PRINCIPAL REGISTER**



COINMACH CORPORATION (DELAWARE CORPORATION)
303 SUNNYSIDE BLVD., SUITE 70
PLAINVIEW, NY 11803

FOR: PROVIDING WASHING AND DRYING
LAUNDRY FACILITIES, NAMELY, RENTAL AND
MAINTENANCE OF COIN AND NON-COIN OPER-
ATED LAUNDRY EQUIPMENT TO COLLEGES

AND UNIVERSITIES, IN CLASS 37 (U.S. CLS. 100,
103 AND 106).

FIRST USE 4-4-2006; IN COMMERCE 4-4-2006.

SN 78-896,030, FILED 5-30-2006.

JUSTINE D. PARKER, EXAMINING ATTORNEY

Int. Cl.: 5

Prior U.S. Cls.: 6, 18, 44, 46, 51, and 52

Reg. No. 3,478,206

United States Patent and Trademark Office

Registered July 29, 2008

**TRADEMARK
PRINCIPAL REGISTER**



The logo consists of the word "MAXHEAL" in a bold, sans-serif font. The letter "X" is stylized as a stick figure with its arms raised, positioned between the "M" and "H".

MDECHEM, INC (TEXAS CORPORATION)
STE 118
1717 ST JAMES PLACE
HOUSTON, TX 77056

THE MARK CONSISTS OF THE STYLIZED TEXT
OF THE WORDING "MAXHEAL" WITH THE "X" AS
A STICK FIGURE.

FOR: TOPICAL FIRST AID GEL, IN CLASS 5 (U.S.
CLS. 6, 18, 44, 46, 51 AND 52).

SN 78-899,001, FILED 6-2-2006.

FIRST USE 9-1-2007; IN COMMERCE 9-1-2007.

INGA ERVIN, EXAMINING ATTORNEY

Int. Cl.: 25

Prior U.S. Cls.: 22 and 39

United States Patent and Trademark Office

Reg. No. 3,478,207

Registered July 29, 2008

**TRADEMARK
PRINCIPAL REGISTER**



NBA PROPERTIES, INC. (NEW YORK CORPORATION)
OLYMPIC TOWER - 645 FIFTH AVENUE
NEW YORK, NY 10022

OWNER OF U.S. REG. NOS. 1,525,782 AND 1,966,924.

FOR: CLOTHING, NAMELY, SWIMWEAR AND BEACHWEAR, NAMELY, BATHING SUITS, T-SHIRTS, SHIRTS, SHORTS, PANTS AND COVERUPS, SOCKS; FOOTWEAR, NAMELY, SHOES, SNEAKERS AND SANDALS; HEADWEAR, NAMELY, SWIM CAPS, BEACH CAPS, VISORS AND CAPS, IN CLASS 25 (U.S. CLS. 22 AND 39).

THE MARK CONSISTS OF A SILHOUETTE OF A BASKETBALL PLAYER WITH A PALM TREE DEPICTED INSIDE A BASKETBALL.

SN 78-899,621, FILED 6-2-2006.

FIRST USE 11-30-2007; IN COMMERCE 11-30-2007.

LA TONIA FISHER, EXAMINING ATTORNEY

Int. Cl.: 28

Prior U.S. Cls.: 22, 23, 38, and 50

United States Patent and Trademark Office

Reg. No. 3,478,208

Registered July 29, 2008

**TRADEMARK
PRINCIPAL REGISTER**

DINKY TOYS

MATTEL, INC. (DELAWARE CORPORATION)
MAIL STOP M1-1518
333 CONTINENTAL BOULEVARD
EL SEGUNDO, CA 90245

FOR: TOYS, GAMES AND PLAYTHINGS, NAME-
LY, TOY VEHICLES AND ACCESSORIES FOR ALL
OF THE FOREGOING, IN CLASS 28 (U.S. CLS. 22, 23,
38 AND 50).

FIRST USE 4-15-2008; IN COMMERCE 4-15-2008.

THE MARK CONSISTS OF STANDARD CHAR-
ACTERS WITHOUT CLAIM TO ANY PARTICULAR
FONT, STYLE, SIZE, OR COLOR.

OWNER OF U.S. REG. NO. 800,255.

NO CLAIM IS MADE TO THE EXCLUSIVE
RIGHT TO USE "TOYS", APART FROM THE MARK
AS SHOWN.

SN 78-902,081, FILED 6-6-2006.

JEAN IM, EXAMINING ATTORNEY

Int. Cl.: 9

Prior U.S. Cls.: 21, 23, 26, 36, and 38

Reg. No. 3,478,209

United States Patent and Trademark Office

Registered July 29, 2008

TRADEMARK
PRINCIPAL REGISTER

DaysAgo

DOUBLE U PRODUCTS (CALIFORNIA PART-
NERSHIP)
P.O. BOX 2009
ST. HELENA, CA 94574

FOR: TIMERS; ELECTRONIC TIMER; DIGITAL DAY COUNTER; DIGITAL HOUR COUNTER; DIGITAL DAY AND HOUR COUNTER; COUNT UP TIMER; FOOD FRESHNESS MONITORS IN THE NATURE OF TIMERS FOR TRACKING THE FRESHNESS OF PERISHABLE FOODS; FOOD FRESHNESS MONITORS IN THE NATURE OF COUNTERS FOR TRACKING THE FRESHNESS OF PERISHABLE FOODS; ACTIVITY EXPIRATION MONITORS IN THE NATURE OF TIMERS FOR MONITORING A WIDE VARIETY OF ACTIVITIES INCLUDING FOR EXAMPLE EXERCISE PROGRAMS, HEALTH REGIMENS, PLANT CARE, PET CARE, AND LABORATORY EXPERIMENTS; ACTIVITY EXPIRATION MONITORS IN THE NATURE OF COUNTERS FOR MONITORING A WIDE VARIETY OF ACTIVITIES INCLUDING FOR EXAMPLE EXERCISE PROGRAMS, HEALTH REGIMENS, PLANT CARE, PET CARE, AND LABORATORY EXPERIMENTS USAGE TRACKERS IN THE NAT-

URE OF TIMERS FOR TRACKING THE USAGE OF A WIDE VARIETY OF PRODUCTS AND DEVICES INCLUDING FOR EXAMPLE REPLACEABLE AIR AND WATER FILTERS, PERISHABLE ORGANIC FOOD AND BEAUTY PRODUCTS, AND EXERCISE EQUIPMENT; USAGE TRACKERS IN THE NATURE OF COUNTERS FOR TRACKING THE USAGE OF A WIDE VARIETY OF PRODUCTS AND DEVICES INCLUDING FOR EXAMPLE REPLACEABLE AIR AND WATER FILTERS, PERISHABLE ORGANIC FOOD AND BEAUTY PRODUCTS, AND EXERCISE EQUIPMENT; CHORE TIMERS, IN CLASS 9 (U.S. CLS. 21, 23, 26, 36 AND 38).

FIRST USE 7-31-2006; IN COMMERCE 7-31-2006.

THE MARK CONSISTS OF STANDARD CHARACTERS WITHOUT CLAIM TO ANY PARTICULAR FONT, STYLE, SIZE, OR COLOR.

SN 78-902,210, FILED 6-6-2006.

BRIDGETT SMITH, EXAMINING ATTORNEY

Int. Cl.: 35

Prior U.S. Cls.: 100, 101, and 102

United States Patent and Trademark Office

Reg. No. 3,478,210

Registered July 29, 2008

**SERVICE MARK
PRINCIPAL REGISTER**

ECO-PAK

ECO-PAK, LLC (INDIANA LTD LIAB CO)
9211 E. JACKSON STREET
SELMA, IN 47383

FIRST USE 1-1-2001; IN COMMERCE 1-1-2001.

FOR: CONTAINER MANAGEMENT SERVICES
FOR OTHERS, NAMELY TRACKING REUSABLE
CONTAINERS OF THE TYPE USED FOR STORING
AND TRANSPORTING LIQUIDS AND FLOWABLE
SOLIDS USED FOR VEGETATION MANAGEMENT,
IN CLASS 35 (U.S. CLS. 100, 101 AND 102).

THE MARK CONSISTS OF STANDARD CHAR-
ACTERS WITHOUT CLAIM TO ANY PARTICULAR
FONT, STYLE, SIZE, OR COLOR.

SN 78-902,459, FILED 6-7-2006.

RICHARD WHITE, EXAMINING ATTORNEY

Int. Cls.: 9 and 11

Prior U.S. Cls.: 13, 21, 23, 26, 31, 34, 36, and 38

United States Patent and Trademark Office

Reg. No. 3,478,211

Registered July 29, 2008

**TRADEMARK
PRINCIPAL REGISTER**

**INTELLIGENT SOLUTIONS FOR
INDOOR AIR**

RESEARCH PRODUCTS CORPORATION (WIS-
CONSIN CORPORATION)
1015 EAST WASHINGTON AVENUE
MADISON, WI 53701

FOR: ELECTRONIC THERMOSTATS, IN CLASS 9
(U.S. CLS. 21, 23, 26, 36 AND 38).

FIRST USE 3-31-2006; IN COMMERCE 3-31-2006.

FOR: HUMIDIFIERS, HOUSEHOLD AIR CLEA-
NERS, DEHUMIDIFIERS, UV GERMICIDAL
LAMPS, IN CLASS 11 (U.S. CLS. 13, 21, 23, 31 AND 34).

FIRST USE 3-31-2006; IN COMMERCE 3-31-2006.

THE MARK CONSISTS OF STANDARD CHAR-
ACTERS WITHOUT CLAIM TO ANY PARTICULAR
FONT, STYLE, SIZE, OR COLOR.

SN 78-902,842, FILED 6-7-2006.

CHERYL CLAYTON, EXAMINING ATTORNEY

Int. Cl.: 36

Prior U.S. Cls.: 100, 101, and 102

United States Patent and Trademark Office

Reg. No. 3,478,212

Registered July 29, 2008

**SERVICE MARK
PRINCIPAL REGISTER**

PLATINUM POINT

GOLD POINT REAL ESTATE, LLC (VIRGINIA
LTD LIAB CO)
SUITE 180
8730 STONY POINT PARKWAY
RICHMOND, VA 23235

FOR: REAL ESTATE LISTING, IN CLASS 36 (U.S.
CLS. 100, 101 AND 102).

FIRST USE 2-29-2008; IN COMMERCE 2-29-2008.

THE MARK CONSISTS OF STANDARD CHAR-
ACTERS WITHOUT CLAIM TO ANY PARTICULAR
FONT, STYLE, SIZE, OR COLOR.

OWNER OF U.S. REG. NO. 3,002,949.

SN 78-903,013, FILED 6-7-2006.

REGINA DRUMMOND, EXAMINING ATTORNEY

Int. Cl.: 16

Prior U.S. Cls.: 2, 5, 22, 23, 29, 37, 38, and 50

Reg. No. 3,478,213

United States Patent and Trademark Office

Registered July 29, 2008

**TRADEMARK
PRINCIPAL REGISTER**

TECH REST

DEFLECTO CORPORATION (DELAWARE CORPORATION)

11937 EXIT FIVE PARKWAY

FISHERS, IN 46038

FOR: DESKTOP ORGANIZER, IN CLASS 16 (U.S. CLS. 2, 5, 22, 23, 29, 37, 38 AND 50).

FIRST USE 7-31-2007; IN COMMERCE 7-31-2007.

THE MARK CONSISTS OF STANDARD CHARACTERS WITHOUT CLAIM TO ANY PARTICULAR FONT, STYLE, SIZE, OR COLOR.

NO CLAIM IS MADE TO THE EXCLUSIVE RIGHT TO USE "TECH", APART FROM THE MARK AS SHOWN.

SN 78-903,579, FILED 6-8-2006.

CAROL SPILS, EXAMINING ATTORNEY

Int. Cl.: 29

Prior U.S. Cl.: 46

United States Patent and Trademark Office

Reg. No. 3,478,214

Registered July 29, 2008

**TRADEMARK
PRINCIPAL REGISTER**

SUPERFRUIT

WELLS' DAIRY, INC. (IOWA CORPORATION)
ONE BLUE BUNNY DRIVE, P.O. BOX 1310
LE MARS, IA 51031

THE MARK CONSISTS OF STANDARD CHAR-
ACTERS WITHOUT CLAIM TO ANY PARTICULAR
FONT, STYLE, SIZE, OR COLOR.

FOR: YOGURT, IN CLASS 29 (U.S. CL. 46).

SN 78-904,009, FILED 6-8-2006.

FIRST USE 6-6-2007; IN COMMERCE 6-6-2007.

COLLEEN DOMBROW, EXAMINING ATTORNEY

Int. Cl.: 37

Prior U.S. Cls.: 100, 103, and 106

United States Patent and Trademark Office

Reg. No. 3,478,215

Registered July 29, 2008

**SERVICE MARK
PRINCIPAL REGISTER**

DOMI VITA

STRAT B, INC. (NEW YORK CORPORATION)
134 SPRING STREET
NEW YORK, NY 10012

FOR: CONSTRUCTION AND RENOVATION OF
BUILDINGS, IN CLASS 37 (U.S. CLS. 100, 103 AND
106).

FIRST USE 7-15-2005; IN COMMERCE 7-15-2005.

THE MARK CONSISTS OF STANDARD CHAR-
ACTERS WITHOUT CLAIM TO ANY PARTICULAR
FONT, STYLE, SIZE, OR COLOR.

THE FOREIGN WORDING IN THE MARK
TRANSLATES INTO ENGLISH AS HOME LIFE.

SN 78-904,675, FILED 6-9-2006.

DOMINIC J. FERRAIUOLO, EXAMINING ATTOR-
NEY

Int. Cls.: 35 and 44

Prior U.S. Cls.: 100, 101, and 102

United States Patent and Trademark Office

Reg. No. 3,478,216

Registered July 29, 2008

**SERVICE MARK
PRINCIPAL REGISTER**

**BLUE DISTINCTION CENTERS
FOR TRANSPLANTS**

BLUE CROSS AND BLUE SHIELD ASSOCIATION
(ILLINOIS NON-PROFIT CORPORATION)
6TH FLOOR
225 NORTH MICHIGAN AVENUE
CHICAGO, IL 60601

FOR: ASSESSING HEALTHCARE SERVICE PROVIDER PERFORMANCE; PROVIDING SPECIALTY CARE CENTERS, NAMELY, CONDUCTING QUALITY MEASUREMENT, IMPROVEMENT AND ASSURANCE SURVEYS IN HOSPITALS TO DETERMINE SERVICE QUALITY, IN CLASS 35 (U.S. CLS. 100, 101 AND 102).

FIRST USE 6-30-2007; IN COMMERCE 6-30-2007.

FOR: PROVIDING CENTERS FOR EXCELLENCE PROGRAMS IN THE FIELD OF HEALTHCARE, NAMELY, PROVIDING HEALTH AND MEDICAL CARE INFORMATION TO ENABLE CONSUMERS TO MAKE MORE INFORMED HEALTHCARE DECISIONS IN COLLABORATION WITH HEALTH

CARE PROVIDERS TO IMPROVE OUTCOMES AND AFFORDABILITY, IN CLASS 44 (U.S. CLS. 100 AND 101).

FIRST USE 6-30-2007; IN COMMERCE 6-30-2007.

THE MARK CONSISTS OF STANDARD CHARACTERS WITHOUT CLAIM TO ANY PARTICULAR FONT, STYLE, SIZE, OR COLOR.

OWNER OF U.S. REG. NOS. 554,488, 1,426,942, AND OTHERS.

NO CLAIM IS MADE TO THE EXCLUSIVE RIGHT TO USE "CENTERS FOR TRANSPLANTS", APART FROM THE MARK AS SHOWN.

SN 78-906,561, FILED 6-13-2006.

MARY ROSSMAN, EXAMINING ATTORNEY

Int. Cls.: 35 and 44

Prior U.S. Cls.: 100, 101, and 102

United States Patent and Trademark Office

Reg. No. 3,478,217

Registered July 29, 2008

**SERVICE MARK
PRINCIPAL REGISTER**

**BLUE DISTINCTION CENTERS
FOR BARIATRIC SURGERY**

BLUE CROSS AND BLUE SHIELD ASSOCIATION
(ILLINOIS NON-PROFIT CORPORATION)
6TH FLOOR
225 NORTH MICHIGAN AVENUE
CHICAGO, IL 60601

FOR: ASSESSING HEALTHCARE SERVICE PROVIDER PERFORMANCE; PROVIDING SPECIALTY CARE CENTERS, NAMELY, CONDUCTING QUALITY MEASUREMENT, IMPROVEMENT AND ASSURANCE SURVEYS IN HOSPITALS TO DETERMINE SERVICE QUALITY, IN CLASS 35 (U.S. CLS. 100, 101 AND 102).

FIRST USE 6-30-2007; IN COMMERCE 6-30-2007.

FOR: PROVIDING CENTERS FOR EXCELLENCE PROGRAMS IN THE FIELD OF HEALTHCARE, NAMELY, PROVIDING HEALTH AND MEDICAL CARE INFORMATION TO ENABLE CONSUMERS TO MAKE MORE INFORMED HEALTHCARE DECISIONS IN COLLABORATION WITH HEALTH

CARE PROVIDERS TO IMPROVE OUTCOMES AND AFFORDABILITY, IN CLASS 44 (U.S. CLS. 100 AND 101).

FIRST USE 6-30-2007; IN COMMERCE 6-30-2007.

THE MARK CONSISTS OF STANDARD CHARACTERS WITHOUT CLAIM TO ANY PARTICULAR FONT, STYLE, SIZE, OR COLOR.

OWNER OF U.S. REG. NOS. 554,488, 1,426,942, AND OTHERS.

NO CLAIM IS MADE TO THE EXCLUSIVE RIGHT TO USE "CENTERS FOR BARIATRIC SURGERY", APART FROM THE MARK AS SHOWN.

SN 78-906,564, FILED 6-13-2006.

MARY ROSSMAN, EXAMINING ATTORNEY

Int. Cls.: 35 and 44

Prior U.S. Cls.: 100, 101, and 102

United States Patent and Trademark Office

Reg. No. 3,478,218

Registered July 29, 2008

**SERVICE MARK
PRINCIPAL REGISTER**

**BLUE DISTINCTION CENTERS
FOR CARDIAC CARE**

BLUE CROSS AND BLUE SHIELD ASSOCIATION
(ILLINOIS NON-PROFIT CORPORATION)
6TH FLOOR
225 NORTH MICHIGAN AVENUE
CHICAGO, IL 60601

FOR: ASSESSING HEALTHCARE SERVICE PROVIDER PERFORMANCE; PROVIDING SPECIALTY CARE CENTERS, NAMELY, CONDUCTING QUALITY MEASUREMENT, IMPROVEMENT AND ASSURANCE SURVEYS IN HOSPITALS TO DETERMINE SERVICE QUALITY, IN CLASS 35 (U.S. CLS. 100, 101 AND 102).

FIRST USE 2-2-2007; IN COMMERCE 6-30-2007.

FOR: PROVIDING CENTERS FOR EXCELLENCE PROGRAMS IN THE FIELD OF HEALTHCARE, NAMELY, PROVIDING HEALTH AND MEDICAL CARE INFORMATION TO ENABLE CONSUMERS TO MAKE MORE INFORMED HEALTHCARE DECISIONS IN COLLABORATION WITH HEALTH

CARE PROVIDERS TO IMPROVE OUTCOMES AND AFFORDABILITY, IN CLASS 44 (U.S. CLS. 100 AND 101).

FIRST USE 2-2-2007; IN COMMERCE 6-30-2007.

THE MARK CONSISTS OF STANDARD CHARACTERS WITHOUT CLAIM TO ANY PARTICULAR FONT, STYLE, SIZE, OR COLOR.

OWNER OF U.S. REG. NOS. 554,488, 1,426,942, AND OTHERS.

NO CLAIM IS MADE TO THE EXCLUSIVE RIGHT TO USE "CENTERS FOR CARDIAC CARE", APART FROM THE MARK AS SHOWN.

SN 78-906,569, FILED 6-13-2006.

MARY ROSSMAN, EXAMINING ATTORNEY

Int. Cls.: 35 and 44

Prior U.S. Cls.: 100, 101, and 102

United States Patent and Trademark Office

Reg. No. 3,478,219

Registered July 29, 2008

**SERVICE MARK
PRINCIPAL REGISTER**

**BLUE DISTINCTION HOSPITAL
MEASUREMENT AND
IMPROVEMENT PROGRAM**

BLUE CROSS AND BLUE SHIELD ASSOCIATION
(ILLINOIS NON-PROFIT CORPORATION)
6TH FLOOR
225 NORTH MICHIGAN AVENUE
CHICAGO, IL 60601

FOR: ASSESSING HEALTHCARE SERVICE PROVIDER PERFORMANCE; PROVIDING SPECIALTY CARE CENTERS, NAMELY, CONDUCTING QUALITY MEASUREMENT, IMPROVEMENT AND ASSURANCE SURVEYS IN HOSPITALS TO DETERMINE SERVICE QUALITY, IN CLASS 35 (U.S. CLS. 100, 101 AND 102).

FIRST USE 6-30-2006; IN COMMERCE 6-30-2006.

FOR: PROVIDING CENTERS FOR EXCELLENCE PROGRAMS IN THE FIELD OF HEALTHCARE, NAMELY, PROVIDING HEALTH AND MEDICAL CARE INFORMATION TO ENABLE CONSUMERS TO MAKE MORE INFORMED HEALTHCARE DECISIONS IN COLLABORATION WITH HEALTH

CARE PROVIDERS TO IMPROVE OUTCOMES AND AFFORDABILITY, IN CLASS 44 (U.S. CLS. 100 AND 101).

FIRST USE 6-30-2006; IN COMMERCE 6-30-2006.

THE MARK CONSISTS OF STANDARD CHARACTERS WITHOUT CLAIM TO ANY PARTICULAR FONT, STYLE, SIZE, OR COLOR.

OWNER OF U.S. REG. NOS. 554,488, 1,426,942, AND OTHERS.

NO CLAIM IS MADE TO THE EXCLUSIVE RIGHT TO USE "HOSPITAL MEASUREMENT AND IMPROVEMENT PROGRAM", APART FROM THE MARK AS SHOWN.

SN 78-906,584, FILED 6-13-2006.

MARY ROSSMAN, EXAMINING ATTORNEY

Int. Cl.: 9

Prior U.S. Cls.: 21, 23, 26, 36, and 38

Reg. No. 3,478,220

United States Patent and Trademark Office

Registered July 29, 2008

**TRADEMARK
PRINCIPAL REGISTER**

OPENTOUCH

COMMOCA, INC. (PUERTO RICO CORPORATION)
SUITE 204
720 AUSTIN AVENUE
ERIE, CO 80516

FOR: COMPUTER TELEPHONY SOFTWARE AND COMPUTER SOFTWARE FOR ENABLING DATA AND INFORMATION DISPLAY, STORAGE AND RETRIEVAL, IN CLASS 9 (U.S. CLS. 21, 23, 26, 36 AND 38).

FIRST USE 9-1-2005; IN COMMERCE 9-1-2005.

THE MARK CONSISTS OF STANDARD CHARACTERS WITHOUT CLAIM TO ANY PARTICULAR FONT, STYLE, SIZE, OR COLOR.

SN 78-906,613, FILED 6-13-2006.

DAWN HAN, EXAMINING ATTORNEY

Int. Cl.: 11

Prior U.S. Cls.: 13, 21, 23, 31, and 34

United States Patent and Trademark Office

Reg. No. 3,478,221

Registered July 29, 2008

TRADEMARK
PRINCIPAL REGISTER

“THE”

One Cup!

CENTRIC GROUP, LLC (DELAWARE LTD LIAB
CO)
1260 ANDES BOULEVARD
ST. LOUIS, MO 63132

NO CLAIM IS MADE TO THE EXCLUSIVE
RIGHT TO USE "ONE CUP", APART FROM THE
MARK AS SHOWN.

FOR: ELECTRIC COFFEE MAKERS, IN CLASS 11
(U.S. CLS. 13, 21, 23, 31 AND 34).

SN 78-907,042, FILED 6-13-2006.

FIRST USE 6-0-2006; IN COMMERCE 6-0-2006.

CHERYL CLAYTON, EXAMINING ATTORNEY

Int. Cls.: 42 and 44

Prior U.S. Cls.: 100 and 101

United States Patent and Trademark Office

Reg. No. 3,478,222

Registered July 29, 2008

**SERVICE MARK
PRINCIPAL REGISTER**

**HELPING PATIENTS AND
PROVIDERS PULL TOGETHER**

HEALTHSTRING, LLC (DELAWARE LTD LIAB
CO)
1911 NORTH FREMONT STREET
CHICAGO, IL 60614

FOR: PROVIDING TEMPORARY USE OF ON-
LINE, NON-DOWNLOADABLE DATABASE MAN-
AGEMENT SOFTWARE FOR PURPOSES OF
HEALTH RISK ASSESSMENT AND HEALTH RISK
PROFILING BY ANALYZING USER-PROVIDED
INFORMATION IN THE FIELD OF PREVENTA-
TIVE HEALTH, IN CLASS 42 (U.S. CLS. 100 AND 101).

FIRST USE 7-15-2006; IN COMMERCE 7-15-2006.

FOR: CONSULTATION SERVICES, NAMELY,
ADVISING INDIVIDUALS HOW TO COLLECT, IN-
PUT AND REVIEW MEDICAL AND HEALTH CARE
DATA AND RELATED STORED INFORMATION

VIA A PERSONALIZED ONLINE COMPUTER DA-
TABASE; HEALTH INFORMATION SERVICES,
NAMELY, PROVIDING A PRIVATE USERS' ON-
LINE DATABASE OF PHYSICAL AND MENTAL
HEALTH RECORDS, AND ASSESSMENT SERVICES
FOR PURPOSES OF GUIDING PHYSICAL AND
MENTAL HEALTH MAINTENANCE, IN CLASS 44
(U.S. CLS. 100 AND 101).

FIRST USE 7-15-2006; IN COMMERCE 7-15-2006.

THE MARK CONSISTS OF STANDARD CHAR-
ACTERS WITHOUT CLAIM TO ANY PARTICULAR
FONT, STYLE, SIZE, OR COLOR.

SN 78-907,231, FILED 6-13-2006.

JUDITH HELFMAN, EXAMINING ATTORNEY

Int. Cls.: 39, 42, and 44

Prior U.S. Cls.: 100, 101, and 105

United States Patent and Trademark Office

Reg. No. 3,478,223

Registered July 29, 2008

**SERVICE MARK
PRINCIPAL REGISTER**

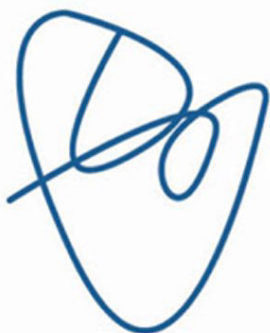

HEALTHSTRING, LLC (DELAWARE LTD LIAB
CO)
1911 NORTH FREMONT STREET
CHICAGO, IL 60614

FOR: ELECTRONIC STORAGE OF DATA FOR
OTHERS OF PERSONALIZED HEALTH AND MED-
ICAL INFORMATION, IN CLASS 39 (U.S. CLS. 100
AND 105).

FIRST USE 7-15-2006; IN COMMERCE 7-15-2006.

FOR: PROVIDING TEMPORARY USE OF ON-
LINE, NON-DOWNLOADABLE DATABASE MAN-
AGEMENT SOFTWARE FOR PURPOSES OF
HEALTH RISK ASSESSMENT AND HEALTH RISK
PROFILING BY ANALYZING USER-PROVIDED
INFORMATION IN THE FIELD OF PREVENTA-
TIVE HEALTH, IN CLASS 42 (U.S. CLS. 100 AND 101).

FIRST USE 7-15-2006; IN COMMERCE 7-15-2006.

FOR: PROVIDING AND MAINTAINING ON ON-
LINE COMPUTER DATABASE OF PERSONAL
HEALTHCARE AND MEDICAL INFORMATION
TO ALLOW INPUTTING, COLLECTION, AND RE-
VIEWING THEREOF BY OTHERS; CONSULTA-
TION SERVICES, NAMELY, ADVISING
INDIVIDUALS HOW TO COLLECT, INPUT AND

REVIEW MEDICAL AND HEALTH CARE DATA
AND RELATED STORED INFORMATION VIA A
PERSONALIZED ONLINE COMPUTER DATABASE;
HEALTH INFORMATION SERVICES, NAMELY,
PROVIDING A PRIVATE USERS' ONLINE DATA-
BASE OF PHYSICAL AND MENTAL HEALTH RE-
CORDS, AND ASSESSMENT SERVICES FOR
PURPOSES OF GUIDING PHYSICAL AND MEN-
TAL HEALTH MAINTENANCE, IN CLASS 44 (U.S.
CLS. 100 AND 101).

FIRST USE 7-15-2006; IN COMMERCE 7-15-2006.

THE COLOR BLUE IS CLAIMED AS A FEATURE
OF THE MARK.

THE MARK CONSISTS OF A FANCIFUL
STRING-LIKE DESIGN OF A HEART APPEARING
ENTIRELY IN THE COLOR BLUE. NO SPECIFIC
COLOR CLAIM IS MADE WITH RESPECT TO THE
BACKGROUND.

SN 78-907,237, FILED 6-13-2006.

JUDITH HELFMAN, EXAMINING ATTORNEY

Int. Cl.: 34

Prior U.S. Cls.: 2, 8, 9, and 17

United States Patent and Trademark Office

Reg. No. 3,478,224

Registered July 29, 2008

**TRADEMARK
PRINCIPAL REGISTER**

WINTER WIND

LA AURORA, C. POR A. (DOMINICAN REP
CORPORATION)
CALLE EDUARDO LEON JIMENES NO. 2
VILLA PROGRESO, DOMINICAN REP

THE MARK CONSISTS OF STANDARD CHAR-
ACTERS WITHOUT CLAIM TO ANY PARTICULAR
FONT, STYLE, SIZE, OR COLOR.

FOR: CIGARS, IN CLASS 34 (U.S. CLS. 2, 8, 9 AND
17).

SN 78-907,850, FILED 6-14-2006.

FIRST USE 10-13-2006; IN COMMERCE 10-13-2006.

GIANCARLO CASTRO, EXAMINING ATTORNEY

Int. Cl.: 36

Prior U.S. Cls.: 100, 101, and 102

United States Patent and Trademark Office

Reg. No. 3,478,225

Registered July 29, 2008

**SERVICE MARK
PRINCIPAL REGISTER**

BIMCO

BOSSHARD INVESTMENT MANAGEMENT
COMPANY (OHIO CORPORATION)
1230 KINGS RIDGE BOULEVARD
WADSWORTH, OH 44281

FOR: INVESTMENT ADVICE AND MANAGING
THE MONIES OF OTHERS SPECIFICALLY FOR
STOCK MARKET INVESTMENTS, IN CLASS 36
(U.S. CLS. 100, 101 AND 102).

FIRST USE 1-1-2006; IN COMMERCE 1-1-2006.

THE MARK CONSISTS OF STANDARD CHAR-
ACTERS WITHOUT CLAIM TO ANY PARTICULAR
FONT, STYLE, SIZE, OR COLOR.

SN 78-909,727, FILED 6-16-2006.

LA TONIA FISHER, EXAMINING ATTORNEY

Int. Cl.: 35

Prior U.S. Cls.: 100, 101, and 102

United States Patent and Trademark Office

Reg. No. 3,478,226

Registered July 29, 2008

**SERVICE MARK
PRINCIPAL REGISTER**

StandPoint

NQUERY, INC. (GEORGIA CORPORATION)
STE. 103
2897 N. DRUID HILLS ROAD
ATLANTA, GA 30329

FOR: CONDUCTING BUSINESS AND MARKET RESEARCH SURVEYS; CONDUCTING BUSINESS RESEARCH AND SURVEYS; CONDUCTING MARKETING STUDIES; CONSUMER RESEARCH; CREATION OF MARKETING TOOLS DESIGNED TO INCREASE A CLIENT COMPANY'S KNOWLEDGE OF CUSTOMER NEEDS, AND ITS COMPETITORS' PRODUCTS AND SERVICES, PRICING, ADVERTISING STRATEGY AND SALES STRATEGY; DEVELOPMENT OF MARKETING STRATEGIES AND CONCEPTS; MARKET ANALYSIS; MARKET OPINION POLLING STUDIES; MARKET REPORTS AND STUDIES; MARKET RESEARCH CONSULTATION; MARKET RESEARCH SERVI-

CES; MARKET RESEARCH STUDIES; MARKET SEGMENTATION CONSULTATION; MARKET STUDY AND ANALYSIS OF MARKET STUDIES; STATISTICAL EVALUATION OF MARKETING DATA; MARKET MANIPULATION, RESEARCH AND ANALYSIS, WHETHER OR NOT VIA THE INTERNET, IN CLASS 35 (U.S. CLS. 100, 101 AND 102).

FIRST USE 12-15-2006; IN COMMERCE 1-2-2007.

THE MARK CONSISTS OF STANDARD CHARACTERS WITHOUT CLAIM TO ANY PARTICULAR FONT, STYLE, SIZE, OR COLOR.

SN 78-910,100, FILED 6-16-2006.

MICHAEL TANNER, EXAMINING ATTORNEY

Int. Cl.: 12

Prior U.S. Cls.: 19, 21, 23, 31, 35, and 44

United States Patent and Trademark Office

Reg. No. 3,478,227

Registered July 29, 2008

**TRADEMARK
PRINCIPAL REGISTER**

SHAKERTANK

BRENNER TANK LLC (WISCONSIN LTD LIAB
CO)
P.O. BOX 670
FOND DU LAC, WI 549360670

THE MARK CONSISTS OF STANDARD CHAR-
ACTERS WITHOUT CLAIM TO ANY PARTICULAR
FONT, STYLE, SIZE, OR COLOR.

FOR: TANKERS, IN CLASS 12 (U.S. CLS. 19, 21, 23,
31, 35 AND 44).

SN 78-910,314, FILED 6-16-2006.

FIRST USE 11-0-2007; IN COMMERCE 1-3-2008.

ATTIYA MALIK, EXAMINING ATTORNEY

Int. Cl.: 16

Prior U.S. Cls.: 2, 5, 22, 23, 29, 37, 38, and 50

Reg. No. 3,478,228

United States Patent and Trademark Office

Registered July 29, 2008

**TRADEMARK
PRINCIPAL REGISTER**

Away from home

DESIGNER GREETINGS, INC. (NEW YORK
CORPORATION)
P.O. BOX 140729
STATEN ISLAND, NY 10314

THE MARK CONSISTS OF STANDARD CHAR-
ACTERS WITHOUT CLAIM TO ANY PARTICULAR
FONT, STYLE, SIZE, OR COLOR.

FOR: GREETING CARDS, IN CLASS 16 (U.S. CLS.
2, 5, 22, 23, 29, 37, 38 AND 50).

SN 78-911,292, FILED 6-19-2006.

FIRST USE 11-2-2007; IN COMMERCE 11-2-2007.

CAROL SPILS, EXAMINING ATTORNEY

Int. Cl.: 6

Prior U.S. Cls.: 2, 12, 13, 14, 23, 25, and 50

Reg. No. 3,478,229

United States Patent and Trademark Office

Registered July 29, 2008

**TRADEMARK
PRINCIPAL REGISTER**

TRI-MOUNT

WATERLOO INDUSTRIES, INC. (DELAWARE
CORPORATION)
100 EAST 4TH STREET
WATERLOO, IA 507034714

FOR: METAL MOUNTING BRACKETS FOR USE
IN HANGING TOOLS, GARDENING EQUIPMENT
AND SPORTS EQUIPMENT FROM A VERTICAL
SURFACE, NAMELY, A WALL STUD, SLAT WALL
OR PEGBOARD, IN CLASS 6 (U.S. CLS. 2, 12, 13, 14,
23, 25 AND 50).

FIRST USE 8-23-2006; IN COMMERCE 8-23-2006.

THE MARK CONSISTS OF STANDARD CHAR-
ACTERS WITHOUT CLAIM TO ANY PARTICULAR
FONT, STYLE, SIZE, OR COLOR.

SN 78-914,631, FILED 6-22-2006.

GIANCARLO CASTRO, EXAMINING ATTORNEY

Int. Cls.: 35, 41, and 43

Prior U.S. Cls.: 100, 101, 102, and 107

United States Patent and Trademark Office

Reg. No. 3,478,230

Registered July 29, 2008

**SERVICE MARK
PRINCIPAL REGISTER**

NORTHWEST BOUNTY

NORTHWEST BOUNTY, LLC (OREGON LTD
LIAB CO)
23732 S. LEISURE LANE
BEAVERCREEK, OR 97004

FOR: RETAIL STORE SERVICES FEATURING WINE, SPECIALTY FOOD ITEMS, AND COOKING TOOLS AND ACCESSORIES; PROVISION OF INFORMATION VIA COMPUTER AND COMMUNICATION NETWORKS IN THE FIELDS OF FARMERS' MARKETS AND SPECIALTY FOOD MARKETS, IN CLASS 35 (U.S. CLS. 100, 101 AND 102).

FIRST USE 6-1-2007; IN COMMERCE 6-1-2007.

FOR: ENTERTAINMENT SERVICES, NAMELY, PROVIDING WEBCAST, TELEVISION AND AUDIO AND/OR VISUAL PROGRAMS IN THE FIELD OF COOKING, WINE, AND FOOD AND WINE PAIRING, IN CLASS 41 (U.S. CLS. 100, 101 AND 107).

FIRST USE 6-1-2007; IN COMMERCE 6-1-2007.

FOR: PROVISION OF INFORMATION VIA COMPUTER AND COMMUNICATION NETWORKS IN THE FIELDS OF FOOD PREPARATION, COOKING, WINE CHARACTERISTICS, FOOD AND WINE PAIRING AND RECIPES, IN CLASS 43 (U.S. CLS. 100 AND 101).

FIRST USE 6-1-2007; IN COMMERCE 6-1-2007.

THE MARK CONSISTS OF STANDARD CHARACTERS WITHOUT CLAIM TO ANY PARTICULAR FONT, STYLE, SIZE, OR COLOR.

SN 78-915,392, FILED 6-23-2006.

CHRIS WELLS, EXAMINING ATTORNEY

Int. Cl.: 6

Prior U.S. Cls.: 2, 12, 13, 14, 23, 25, and 50

Reg. No. 3,478,231

United States Patent and Trademark Office

Registered July 29, 2008

**TRADEMARK
PRINCIPAL REGISTER**



WATERLOO INDUSTRIES, INC. (DELAWARE CORPORATION)
100 EAST 4TH STREET
WATERLOO, IA 507034714

NO CLAIM IS MADE TO THE EXCLUSIVE RIGHT TO USE "PEGBOARD SOLUTIONS", APART FROM THE MARK AS SHOWN.

FOR: METAL HOOKS, NAMELY, HOOKS FOR PEGBOARDS, IN CLASS 6 (U.S. CLS. 2, 12, 13, 14, 23, 25 AND 50).

SN 78-915,684, FILED 6-23-2006.

FIRST USE 8-31-2006; IN COMMERCE 8-31-2006.

GIANCARLO CASTRO, EXAMINING ATTORNEY

Int. Cl.: 6

Prior U.S. Cls.: 2, 12, 13, 14, 23, 25, and 50

Reg. No. 3,478,232

United States Patent and Trademark Office

Registered July 29, 2008

**TRADEMARK
PRINCIPAL REGISTER**

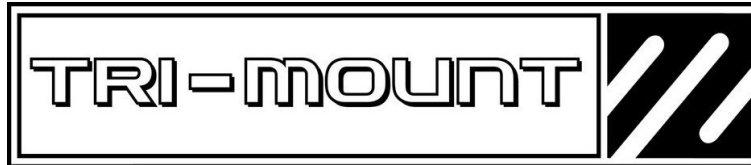

WATERLOO INDUSTRIES, INC. (DELAWARE CORPORATION)
100 EAST 4TH STREET
WATERLOO, IA 507034714

FIRST USE 8-23-2006; IN COMMERCE 8-23-2006.

FOR: METAL MOUNTING BRACKETS FOR USE IN HANGING TOOLS, GARDENING EQUIPMENT AND SPORTS EQUIPMENT FROM A VERTICAL SURFACE, NAMELY, A WALL STUD, SLAT WALL OR PEGBOARD, IN CLASS 6 (U.S. CLS. 2, 12, 13, 14, 23, 25 AND 50).

THE MARK CONSISTS OF THE WORDING "TRI-MOUNT" WITH THE DESIGN OF A SQUARE WITH THREE DIAGONAL LINES TO THE RIGHT, ALL ENCLOSED WITHIN A RECTANGLE.

SN 78-915,689, FILED 6-23-2006.

GIANCARLO CASTRO, EXAMINING ATTORNEY

Int. Cls.: 38 and 44

Prior U.S. Cls.: 100, 101, and 104

United States Patent and Trademark Office

Reg. No. 3,478,233

Registered July 29, 2008

**SERVICE MARK
PRINCIPAL REGISTER**

iStaffWell

DOCTATIONS INC. (NEW YORK CORPORATION)
SUITE 403
2000 NORTH VILLAGE AVE
ROCKVILLE CENTER, NY 11570

FOR: PROVISION OF ACCESS TO PERSONAL MEDICAL HISTORY DATA RECORDS AND DATA FILES STORED ELECTRONICALLY IN CENTRAL FILES FOR REMOTE ACCESS AND/OR PROCESSING, IN CLASS 38 (U.S. CLS. 100, 101 AND 104).

FIRST USE 6-30-2006; IN COMMERCE 6-30-2006.

FOR: MAINTAINING ELECTRONIC PERSONAL MEDICAL HISTORY RECORDS AND FILES: PRO-

VIDING HEALTH INFORMATION, NAMELY, PROVIDING ELECTRONIC PERSONAL MEDICAL HISTORY RECORDS AND FILES TO SUBSCRIBERS AND/OR MEDICAL STAFFING PERSONEL, IN CLASS 44 (U.S. CLS. 100 AND 101).

FIRST USE 6-30-2006; IN COMMERCE 6-30-2006.

THE MARK CONSISTS OF STANDARD CHARACTERS WITHOUT CLAIM TO ANY PARTICULAR FONT, STYLE, SIZE, OR COLOR.

SN 78-916,010, FILED 6-23-2006.

JOHN KELLY, EXAMINING ATTORNEY

Int. Cl.: 25

Prior U.S. Cls.: 22 and 39

United States Patent and Trademark Office

Reg. No. 3,478,234

Registered July 29, 2008

**TRADEMARK
PRINCIPAL REGISTER**

GATORGIRL

HUFF, TIMOTHY L. (UNITED STATES INDIVIDUAL)
3248 GREENFIELD ROAD F-11
ROYAL OAK, MI 48073

FOR: BELTS; BLOUSES; CAPRI PANTS; CAPS; CARDIGANS; COATS; DENIM JACKETS; DENIMS; DRESS SHIRTS; DRESSES; FLIP FLOPS; GLOVES; HATS; HEADBANDS; JACKETS; JEANS; JOGGING PANTS; KNIT SHIRTS; LADIES' BOOTS; LADIES' SUITS; LADIES' UNDERWEAR; LINGERIE; NECKTIES; PANTS; PIQUET SHIRTS; RAIN COATS; SANDALS; SCARVES; SHORTS; SKIRTS AND DRESSES; SKULL CAPS; SLEEPWEAR; SOCKS; SPORT COATS; SUN VISORS; SWEAT PANTS; SWEAT SHIRTS;

SWEATERS; SWIM WEAR; T-SHIRTS; TANK-TOPS; TENNIS SHOES; TOP COATS; TRACKSUITS; TRENCH COATS; TROUSERS; VESTS; WOMEN'S SHOES, IN CLASS 25 (U.S. CLS. 22 AND 39).

FIRST USE 5-18-2007; IN COMMERCE 6-18-2008.

THE MARK CONSISTS OF STANDARD CHARACTERS WITHOUT CLAIM TO ANY PARTICULAR FONT, STYLE, SIZE, OR COLOR.

SN 78-916,302, FILED 6-25-2006.

ANDREA BUTLER, EXAMINING ATTORNEY

Int. Cl.: 8

Prior U.S. Cls.: 23, 28, and 44

United States Patent and Trademark Office

Reg. No. 3,478,235

Registered July 29, 2008

**TRADEMARK
PRINCIPAL REGISTER**

MAKE SENSE

ELIOT, INC. (IOWA CORPORATION)
505 410TH ST.
JOICE, IA 50446

FOR: HAND OPERATED TOOLS, TOOL ATTACHMENTS AND TOOL ADAPTERS FOR RESIDENTIAL, COMMERCIAL, CONSTRUCTION, AUTOMOTIVE AND INDUSTRIAL USE; NAMELY, TAPPING TOOLS, NAMELY, TAPS AND DIES, TAP ADAPTERS, NAMELY, TAP EXTENSIONS, SOCKET WRENCHES, SOCKET WRENCH ADAPTERS, ADJUSTABLE WRENCHES, ADJUSTABLE WRENCH ADAPTERS, RATCHETING WRENCHES, RATCH-

ET WRENCH ADAPTERS, TOOL ADAPTERS, IN CLASS 8 (U.S. CLS. 23, 28 AND 44).

FIRST USE 11-12-2005; IN COMMERCE 1-20-2006.

THE MARK CONSISTS OF STANDARD CHARACTERS WITHOUT CLAIM TO ANY PARTICULAR FONT, STYLE, SIZE, OR COLOR.

SN 78-916,333, FILED 6-25-2006.

SANI KHOURI, EXAMINING ATTORNEY

Int. Cl.: 9

Prior U.S. Cls.: 21, 23, 26, 36, and 38

United States Patent and Trademark Office

Reg. No. 3,478,236

Registered July 29, 2008

**TRADEMARK
PRINCIPAL REGISTER**

PILATES FOR ALL BODIES

PILATES! UNLIMITED, LLC (TEXAS LTD LIAB
CO)
7019 SOUTHRIDGE DR.
DALLAS, TX 75214

FOR: PRE-RECORDED DVDS FEATURING EX-
ERCISE AND FITNESS INSTRUCTION AND IN-
FORMATION; PRE-RECORDED COMPACT DISKS
FEATURING EXERCISE AND FITNESS INSTRU-
CTION AND INFORMATION , IN CLASS 9 (U.S. CLS.
21, 23, 26, 36 AND 38).

FIRST USE 9-17-2005; IN COMMERCE 9-17-2005.

THE MARK CONSISTS OF STANDARD CHAR-
ACTERS WITHOUT CLAIM TO ANY PARTICULAR
FONT, STYLE, SIZE, OR COLOR.

NO CLAIM IS MADE TO THE EXCLUSIVE
RIGHT TO USE "PILATES", APART FROM THE
MARK AS SHOWN.

SN 78-916,383, FILED 6-26-2006.

MICHAEL KAZAZIAN, EXAMINING ATTORNEY

Int. Cl.: 36

Prior U.S. Cls.: 100, 101, and 102

United States Patent and Trademark Office

Reg. No. 3,478,237

Registered July 29, 2008

**SERVICE MARK
PRINCIPAL REGISTER**

consultNC

NATIONAL CITY CORPORATION (DELAWARE
CORPORATION)
1900 EAST NINTH STREET
CLEVELAND, OH 44114

THE MARK CONSISTS OF STANDARD CHAR-
ACTERS WITHOUT CLAIM TO ANY PARTICULAR
FONT, STYLE, SIZE, OR COLOR.

FOR: BANKING SERVICES, IN CLASS 36 (U.S.
CLS. 100, 101 AND 102).

SN 78-917,054, FILED 6-26-2006.

FIRST USE 10-13-2006; IN COMMERCE 10-13-2006.

SETH A. RAPPAPORT, EXAMINING ATTORNEY

Int. Cl.: 36

Prior U.S. Cls.: 100, 101, and 102

United States Patent and Trademark Office

Reg. No. 3,478,238

Registered July 29, 2008

**SERVICE MARK
PRINCIPAL REGISTER**

PURINACARE

SOCIETE DES PRODUITS NESTLE S.A. (SWITZERLAND SOCIETE ANONYME)
INTELLECTUAL PROPERTY DEPARTMENT
CASE POSTALE 353
VEVEY, SWITZERLAND 1800

FOR: INSURANCE UNDERWRITING IN THE
FIELD OF HEALTH INSURANCE FOR ANIMALS
AND PETS, IN CLASS 36 (U.S. CLS. 100, 101 AND 102).

FIRST USE 6-6-2008; IN COMMERCE 6-6-2008.

THE MARK CONSISTS OF STANDARD CHARACTERS WITHOUT CLAIM TO ANY PARTICULAR FONT, STYLE, SIZE, OR COLOR.

OWNER OF U.S. REG. NOS. 61,064, 772,457, AND OTHERS.

SN 78-917,085, FILED 6-26-2006.

THOMAS MANOR, EXAMINING ATTORNEY

Int. Cl.: 1

Prior U.S. Cls.: 1, 5, 6, 10, 26, and 46

Reg. No. 3,478,239

United States Patent and Trademark Office

Registered July 29, 2008

**TRADEMARK
PRINCIPAL REGISTER**

Lumi4

LUMIPHORE, INC. (DELAWARE CORPORATION)
1201 DOUGLAS AVE.
REDWOOD CITY, CA 94063

FOR: CHEMICAL AGENTS FOR CHELATING AND SEQUESTERING; CHEMICAL PREPARATIONS FOR SCIENTIFIC PURPOSES; REAGENT FOR CHEMICAL ANALYSES, IN CLASS 1 (U.S. CLS. 1, 5, 6, 10, 26 AND 46).

FIRST USE 4-29-2008; IN COMMERCE 4-29-2008.

THE MARK CONSISTS OF STANDARD CHARACTERS WITHOUT CLAIM TO ANY PARTICULAR FONT, STYLE, SIZE, OR COLOR.

SN 78-918,639, FILED 6-28-2006.

ROBERT C. CLARK JR., EXAMINING ATTORNEY

Int. Cl.: 36

Prior U.S. Cls.: 100, 101, and 102

United States Patent and Trademark Office

Reg. No. 3,478,240

Registered July 29, 2008

**SERVICE MARK
PRINCIPAL REGISTER**



GAIN GLOBAL MARKETS, INC. (CAYMAN ISLANDS COMPANY)
256 CREWE ROAD, SUITE 104
GRAND CAYMAN, CAYMAN ISLANDS

FOR: FINANCIAL SERVICES, NAMELY, PROVIDING FOR THE EXCHANGE OF FOREIGN CURRENCY, COMMODITIES, FINANCIAL DERIVATIVES, INTEREST RATE PRODUCTS, AND EQUITIES VIA THE INTERNET AND INTRANET SYSTEMS; FINANCIAL SERVICES, NAMELY, PROVIDING INFORMATION IN THE FIELDS OF FOREIGN CURRENCY, COMMODITIES, FINANCIAL DERIVATIVES, INTEREST RATE PRODUCTS, AND EQUITIES VIA THE INTERNET AND INTRANET SYSTEMS, IN CLASS 36 (U.S. CLS. 100, 101 AND 102).

FIRST USE 7-13-2007; IN COMMERCE 7-13-2007.

NO CLAIM IS MADE TO THE EXCLUSIVE RIGHT TO USE "TRADE REAL-TIME", APART FROM THE MARK AS SHOWN.

"THE COLOR(S) BLUE AND WHITE IS/ARE CLAIMED AS A FEATURE OF THE MARK."

THE MARK CONSISTS OF TRADE IN BOLD, DARK BLUE, CAPITAL LETTERS ABOVE A DARK BLUE BOX CONTAINING REAL-TIME IN WHITE CAPITAL LETTERS. TO THE RIGHT OF "TRADE REAL-TIME" IS A GRAPH IN LIGHT BLUE WITH AN UPWARD DARK BLUE ARROW OUTLINED BY WHITE.

SN 78-918,870, FILED 6-28-2006.

JOHN DALIER, EXAMINING ATTORNEY

Int. Cl.: 42

Prior U.S. Cls.: 100 and 101

United States Patent and Trademark Office

Reg. No. 3,478,241

Registered July 29, 2008

**SERVICE MARK
PRINCIPAL REGISTER**

POWERSKILLS PLAYBOOK

POWERSKILLS, INC. (DELAWARE CORPORATION)
PO BOX 611
GLOUCESTER, MA 01931

FOR: APPLICATION SERVICE PROVIDER (ASP)
FEATURING SOFTWARE IN THE FIELD OF STRATEGIC
MANAGEMENT, IN CLASS 42 (U.S. CLS. 100
AND 101).

FIRST USE 6-29-2007; IN COMMERCE 6-29-2007.

THE MARK CONSISTS OF STANDARD CHARACTERS
WITHOUT CLAIM TO ANY PARTICULAR FONT,
STYLE, SIZE, OR COLOR.

OWNER OF U.S. REG. NOS. 2,484,301, 2,615,059,
AND 2,705,342.

SN 78-919,500, FILED 6-29-2006.

KRISTINA MORRIS, EXAMINING ATTORNEY

Int. Cl.: 28

Prior U.S. Cls.: 22, 23, 38, and 50

United States Patent and Trademark Office

Reg. No. 3,478,242

Registered July 29, 2008

**TRADEMARK
PRINCIPAL REGISTER**

TRIBALL

TRIBALL LIMITED (UNITED KINGDOM CORPORATION)
41A GREEN END, FEN DITTON
CAMBRIDGESHIRE, UNITED KINGDOM CB5 8SX

FOR: TOYS AND GAMES, NAMELY, EQUIPMENT SOLD AS A UNIT FOR PLAYING A PARLOR GAME, IN CLASS 28 (U.S. CLS. 22, 23, 38 AND 50).

FIRST USE 12-0-2004; IN COMMERCE 5-0-2006.

THE MARK CONSISTS OF STANDARD CHARACTERS WITHOUT CLAIM TO ANY PARTICULAR FONT, STYLE, SIZE, OR COLOR.

"TRIBALL" HAS NO MEANING IN A FOREIGN LANGUAGE.

SN 78-923,357, FILED 7-6-2006.

ANNE MADDEN, EXAMINING ATTORNEY

Int. Cl.: 3

Prior U.S. Cls.: 1, 4, 6, 50, 51, and 52

United States Patent and Trademark Office

Reg. No. 3,478,243

Registered July 29, 2008

**TRADEMARK
PRINCIPAL REGISTER**

PINKY LIQUID LIP SMACKER

BONNE BELL, INC. (OHIO CORPORATION)
18519 DETROIT AVENUE
LAKEWOOD, OH 44107

OWNER OF U.S. REG. NOS. 1,087,952, 2,617,490,
AND 2,929,652.

FOR: LIP GLOSS, IN CLASS 3 (U.S. CLS. 1, 4, 6, 50,
51 AND 52).

NO CLAIM IS MADE TO THE EXCLUSIVE
RIGHT TO USE "LIP", APART FROM THE MARK
AS SHOWN.

FIRST USE 12-15-2006; IN COMMERCE 12-15-2006.

SN 78-923,800, FILED 7-6-2006.

THE MARK CONSISTS OF STANDARD CHAR-
ACTERS WITHOUT CLAIM TO ANY PARTICULAR
FONT, STYLE, SIZE, OR COLOR.

SOPHIA S. KIM, EXAMINING ATTORNEY

Int. Cls.: 16, 41, and 42

Prior U.S. Cls.: 2, 5, 22, 23, 29, 37, 38, 50, 100, 101, and 107

United States Patent and Trademark Office

Reg. No. 3,478,244

Registered July 29, 2008

**TRADEMARK
SERVICE MARK
PRINCIPAL REGISTER**

TOEFL ACCELERATOR

EDUCATIONAL TESTING SERVICE (NEW YORK NON-PROFIT CORPORATION)
ROSEDALE ROAD
PRINCETON, NJ 08451

FOR: PRINTED INSTRUCTIONAL, EDUCATIONAL, AND TEACHING MATERIALS IN THE FIELD OF STANDARDIZED ENGLISH LANGUAGE TESTS, IN CLASS 16 (U.S. CLS. 2, 5, 22, 23, 29, 37, 38 AND 50).

FIRST USE 3-31-2007; IN COMMERCE 3-31-2007.

FOR: EDUCATIONAL SERVICES, NAMELY, CONDUCTING PROGRAMS IN THE FIELD OF PREPARING FOR STANDARDIZED ENGLISH LANGUAGE TESTS, IN CLASS 41 (U.S. CLS. 100, 101 AND 107).

FIRST USE 3-31-2007; IN COMMERCE 3-31-2007.

FOR: PROVIDING ONLINE NON-DOWNLOADABLE SOFTWARE FOR PREPARING FOR STANDARDIZED ENGLISH LANGUAGE TESTS, IN CLASS 42 (U.S. CLS. 100 AND 101).

FIRST USE 3-31-2007; IN COMMERCE 3-31-2007.

THE MARK CONSISTS OF STANDARD CHARACTERS WITHOUT CLAIM TO ANY PARTICULAR FONT, STYLE, SIZE, OR COLOR.

OWNER OF U.S. REG. NOS. 1,103,426, 1,103,427, AND 2,461,224.

SN 78-923,859, FILED 7-6-2006.

MARTHA FROMM, EXAMINING ATTORNEY

Int. Cls.: 35, 37, 42, and 44

Prior U.S. Cls.: 100, 101, 102, 103, and 106

United States Patent and Trademark Office

Reg. No. 3,478,245

Registered July 29, 2008

**SERVICE MARK
PRINCIPAL REGISTER**

NAS TECHNOLOGIES

NA-CHURS PLANT FOOD COMPANY (DELA-
WARE CORPORATION)
421 LEADER STREET
MARION, OH 43302

FOR: ADVERTISING AND PROMOTION SERVI-
CES AND RELATED CONSULTING; ADVERTIS-
ING GOODS AND SERVICES OF OTHERS;
MARKETING GOODS AND SERVICES OF OTHERS
, IN CLASS 35 (U.S. CLS. 100, 101 AND 102).

FIRST USE 8-1-2006; IN COMMERCE 8-1-2006.

FOR: MAINTAINING AND REPAIRING FARM-
ING AND AGRICULTURAL EQUIPMENT OF OTH-
ERS, IN CLASS 37 (U.S. CLS. 100, 103 AND 106).

FIRST USE 8-1-2006; IN COMMERCE 8-1-2006.

FOR: TECHNICAL SUPPORT, NAMELY, TROU-
Bleshooting FARMING AND AGRICULTURAL
EQUIPMENT FOR OTHERS, SOIL SAMPLING AND
TESTING, IN CLASS 42 (U.S. CLS. 100 AND 101).

FIRST USE 8-1-2006; IN COMMERCE 8-1-2006.

FOR: AGRICULTURAL AND AGRONOMY SER-
VICES FOR OTHERS, NAMELY, CROP AND LAND
MEASUREMENT, CROP, LAND, WATER AND SOIL
MAPPING, CROP MANAGEMENT, CROP NUTRI-
ENT MANAGEMENT, AGRICULTURAL CHEMI-
CAL MANAGEMENT AND CROP PLANNING;
CONSULTING SERVICES IN THE FIELDS OF
AGRICULTURE AND AGRONOMY, IN CLASS 44
(U.S. CLS. 100 AND 101).

FIRST USE 8-1-2006; IN COMMERCE 8-1-2006.

THE MARK CONSISTS OF STANDARD CHAR-
ACTERS WITHOUT CLAIM TO ANY PARTICULAR
FONT, STYLE, SIZE, OR COLOR.

NO CLAIM IS MADE TO THE EXCLUSIVE
RIGHT TO USE "TECHNOLOGIES", APART FROM
THE MARK AS SHOWN.

SN 78-924,530, FILED 7-7-2006.

ELLEN PERKINS, EXAMINING ATTORNEY

Int. Cl.: 38

Prior U.S. Cls.: 100, 101, and 104

United States Patent and Trademark Office

Reg. No. 3,478,246

Registered July 29, 2008

**SERVICE MARK
PRINCIPAL REGISTER**

IPSOBOX

IPSOBOX, S.A. DE C.V. (MEXICO CORPORATION)
ESCUELA MEDICO MILITAR 88-501
IRAPUATO, MEXICO 36660

FOR: TELECOMMUNICATION SERVICES, NAMELY, ELECTRONIC MAIL SERVICES, VOICE-MAIL SERVICES, FACSIMILE SERVICES, TELEGRAPH SERVICES, AND COMMUNICATION SERVICES VIA COMPUTER AND TELEGRAPH; ELECTRONIC TRANSMISSION OF DATA AND IMAGES, IN CLASS 38 (U.S. CLS. 100, 101 AND 104).

FIRST USE 1-1-2002; IN COMMERCE 1-1-2002.

THE MARK CONSISTS OF STANDARD CHARACTERS WITHOUT CLAIM TO ANY PARTICULAR FONT, STYLE, SIZE, OR COLOR.

SN 78-924,601, FILED 7-7-2006.

RONALD MCMORROW, EXAMINING ATTORNEY

Int. Cl.: 29

Prior U.S. Cl.: 46

United States Patent and Trademark Office

Reg. No. 3,478,247

Registered July 29, 2008

**TRADEMARK
PRINCIPAL REGISTER**

ilovebutter.com

ODELL'S (NEVADA CORPORATION)
UNIT D-1
8543 WHITE FIR ST.
RENO, NV 89523

THE MARK CONSISTS OF STANDARD CHAR-
ACTERS WITHOUT CLAIM TO ANY PARTICULAR
FONT, STYLE, SIZE, OR COLOR.

FOR: BUTTER, IN CLASS 29 (U.S. CL. 46).

SN 78-925,069, FILED 7-8-2006.

FIRST USE 2-16-2000; IN COMMERCE 2-16-2000.

ELLEN PERKINS, EXAMINING ATTORNEY

Int. Cl.: 33

Prior U.S. Cls.: 47 and 49

United States Patent and Trademark Office

Reg. No. 3,478,248

Registered July 29, 2008

**TRADEMARK
PRINCIPAL REGISTER**

PROYECTO MAS AVE

GLOBAL UNION S.A. (ARGENTINA CORPORATION)
AGUSTÍN ALVAREZ 232 DPTO. 19
MENDOZA, ARGENTINA 5500

FOR: SPARKLING FRUIT WINE; SPARKLING GRAPE WINE; SPARKLING WINE; WINES, IN CLASS 33 (U.S. CLS. 47 AND 49).

FIRST USE 2-28-2007; IN COMMERCE 2-29-2008.

THE MARK CONSISTS OF STANDARD CHARACTERS WITHOUT CLAIM TO ANY PARTICULAR FONT, STYLE, SIZE, OR COLOR.

THE FOREIGN WORDING IN THE MARK TRANSLATES INTO ENGLISH AS "PROJECT MORE BIRD"

SN 78-925,073, FILED 7-8-2006.

BARBARA GAYNOR, EXAMINING ATTORNEY

Int. Cl.: 9

Prior U.S. Cls.: 21, 23, 26, 36, and 38

Reg. No. 3,478,249

United States Patent and Trademark Office

Registered July 29, 2008

**TRADEMARK
PRINCIPAL REGISTER**

IS EYEWEAR

TRUSTUS INTERNATIONAL TRADING INC.
(CANADA CORPORATION)
1131 WILLIAM STREET
VANCOUVER, BRITISH COLUMBIA, CANADA V6A
2J1

FOR: SUNGLASSES; SPORTS GOGGLES FOR
WINTER SPORTS, NAMELY, SKIING, SNOW-
BOARDING, SNOWSHOEING, SNOWMOBILING
AND ICE SKATING, IN CLASS 9 (U.S. CLS. 21, 23,
26, 36 AND 38).

FIRST USE 1-0-2008; IN COMMERCE 1-0-2008.

THE MARK CONSISTS OF STANDARD CHAR-
ACTERS WITHOUT CLAIM TO ANY PARTICULAR
FONT, STYLE, SIZE, OR COLOR.

NO CLAIM IS MADE TO THE EXCLUSIVE
RIGHT TO USE "EYEWEAR", APART FROM THE
MARK AS SHOWN.

SN 78-925,466, FILED 7-10-2006.

JENNY PARK, EXAMINING ATTORNEY

Int. Cls.: 9, 39, and 41

Prior U.S. Cls.: 21, 23, 26, 36, 38, 100, 101, 105, and 107

Reg. No. 3,478,250

United States Patent and Trademark Office

Registered July 29, 2008

TRADEMARK
SERVICE MARK
PRINCIPAL REGISTER



RAND McNALLY & COMPANY (DELAWARE CORPORATION)
8255 NORTH CENTRAL PARK AVENUE
SKOKIE, IL 60076

FOR: SUBSCRIPTION-BASED DOWNLOADABLE ELECTRONIC PUBLICATIONS IN THE NATURE OF REFERENCE MATERIALS, ACTIVITIES AND TEACHING RESOURCE MATERIALS IN THE FIELD OF GEOGRAPHY, SOCIAL STUDIES, HISTORY, READING, MATH AND SCIENCE, IN CLASS 9 (U.S. CLS. 21, 23, 26, 36 AND 38).

FIRST USE 10-0-2006; IN COMMERCE 10-0-2006.

FOR: PROVIDING A SUBSCRIPTION-BASED WEB SITE FEATURING MAPS, IN CLASS 39 (U.S. CLS. 100 AND 105).

FIRST USE 10-0-2006; IN COMMERCE 10-0-2006.

FOR: EDUCATIONAL SERVICES, NAMELY, PROVIDING SUBSCRIPTION-BASED ON-LINE

PUBLICATIONS IN THE NATURE OF REFERENCE MATERIALS, ACTIVITIES AND TEACHING RESOURCE MATERIALS IN THE FIELD OF GEOGRAPHY, SOCIAL STUDIES, HISTORY, READING, MATH AND SCIENCE; AND PROVIDING ON-LINE SUBSCRIPTION-BASED EDUCATIONAL COMPUTER GAMES IN THE FIELDS OF GEOGRAPHY, SOCIAL STUDIES, HISTORY, READING, MATH AND SCIENCE, IN CLASS 41 (U.S. CLS. 100, 101 AND 107).

FIRST USE 10-0-2006; IN COMMERCE 10-0-2006.

OWNER OF U.S. REG. NOS. 734,948 AND 1,387,417.

NO CLAIM IS MADE TO THE EXCLUSIVE RIGHT TO USE "CLASSROOM", APART FROM THE MARK AS SHOWN.

SN 78-925,850, FILED 7-10-2006.

NAPOLEON SHARMA, EXAMINING ATTORNEY

Int. Cls.: 16 and 41

Prior U.S. Cls.: 2, 5, 22, 23, 29, 37, 38, 50, 100, 101, and 107

Reg. No. 3,478,251

United States Patent and Trademark Office

Registered July 29, 2008

**TRADEMARK
SERVICE MARK
PRINCIPAL REGISTER**



EL UNIVERSAL COMPANIA PERIODISTICA NACIONAL S.A. DE C.V. (MEXICO LTD LIAB CO)
BUCARELI #8
COL. CENTRO, MEXICO D.F. 0604

FOR: PRINTED PUBLICATIONS, NAMELY, CLASSIFIED LISTINGS AND CLASSIFIED DIRECTORIES FEATURING A WIDE VARIETY OF TOPICS OF GENERAL INTEREST TO THE SPANISH-SPEAKING COMMUNITY, IN CLASS 16 (U.S. CLS. 2, 5, 22, 23, 29, 37, 38 AND 50).

FIRST USE 6-29-2006; IN COMMERCE 6-29-2006.

FOR: COMPUTER SERVICES, NAMELY, PROVIDING ON-LINE PUBLICATIONS IN THE NATURE OF CLASSIFIED LISTINGS AND CLASSIFIED DIRECTORIES FEATURING A WIDE VARIETY OF TOPICS OF GENERAL INTEREST TO THE SPANISH-SPEAKING COMMUNITY, IN CLASS 41 (U.S. CLS. 100, 101 AND 107).

FIRST USE 6-29-2006; IN COMMERCE 6-29-2006.

NO CLAIM IS MADE TO THE EXCLUSIVE RIGHT TO USE "PRIMERA SECCION DE CLASIFICADOS PARA MEXICANOS EN ESTADOS UNI-

DOS" OR "USA", APART FROM THE MARK AS SHOWN.

THE COLOR(S) BLACK, GREEN AND RED IS/ARE CLAIMED AS A FEATURE OF THE MARK.

THE MARK CONSISTS OF THE COLORS GREEN AND RED BEHIND THE LETTERS "USA" ON THE RIGHT SIDE OF THE MARK FORMING A PARTIAL DESIGN OF THE MEXICAN FLAG, THE COLOR BLACK IN ALL THE LETTERS AND THE BRACKETS, AND THE COLOR WHITE CONSTITUTING THE BACKGROUND.

THE ENGLISH TRANSLATION OF THE WORD "AVISO OPORTUNO PRIMERA SECOÓN DE CLASIFICADOS PARA MEXICANOS EN ESTADOS UNIDOS" IN THE MARK IS "OPORTUVE WARNING FIRST CLASSIFIED ADVERTISING FOR MEXICANS IN UNITED STATES".

SN 78-926,717, FILED 7-11-2006.

KATHLEEN LORENZO, EXAMINING ATTORNEY

Int. Cl.: 42

Prior U.S. Cls.: 100 and 101

United States Patent and Trademark Office

Reg. No. 3,478,252

Registered July 29, 2008

**SERVICE MARK
PRINCIPAL REGISTER**

INTERSECT

MCKIM & CREED, P.A. (NORTH CAROLINA CORPORATION)
243 NORTH FRONT STREET
WILMINGTON, NC 28401

THE MARK CONSISTS OF STANDARD CHARACTERS WITHOUT CLAIM TO ANY PARTICULAR FONT, STYLE, SIZE, OR COLOR.

FOR: SCIENTIFIC AND TECHNOLOGICAL SERVICES, NAMELY, LAND SURVEYING AND GEOGRAPHIC INFORMATION SYSTEM (GIS) SERVICES, IN CLASS 42 (U.S. CLS. 100 AND 101).

SN 78-926,983, FILED 7-11-2006.

FIRST USE 10-1-2005; IN COMMERCE 10-1-2005.

STEPHANIE ALI, EXAMINING ATTORNEY

Int. Cl.: 25

Prior U.S. Cls.: 22 and 39

United States Patent and Trademark Office

Reg. No. 3,478,253

Registered July 29, 2008

**TRADEMARK
PRINCIPAL REGISTER**



KIMBERLY BONADIO (UNITED STATES INDIVIDUAL)
23 ALBERT STREET
WALTHAM, MA 02453

PIECE CLOTHING, CLOTH BIBS, IN CLASS 25 (U.S. CLS. 22 AND 39).

FIRST USE 3-6-2007; IN COMMERCE 5-21-2007.

FOR: CLOTHING, NAMELY, SHIRTS, T-SHIRTS, TANK TOPS, APRONS, UNDERWEAR, HATS, BASEBALL CAPS, INFANT AND TODDLER ONE

SN 78-927,743, FILED 7-12-2006.

BERYL GARDNER, EXAMINING ATTORNEY

Int. Cl.: 35

Prior U.S. Cls.: 100, 101, and 102

United States Patent and Trademark Office

Reg. No. 3,478,254

Registered July 29, 2008

**SERVICE MARK
PRINCIPAL REGISTER**

FAITH REWARDS

FAITH REWARDS LLC (NORTH CAROLINA
LTD LIAB CO)
3301 LAKEWOOD EDGE DRIVE
CHARLOTTE, NC 28269

FOR: ADVERTISING SERVICES, NAMELY, PRO-
VIDING A WEBSITE FORUM FOR BUSINESSES TO
PROMOTE AND ADVERTISE GOODS AND SERVI-
CES THROUGH FAITH-BASED RELATIONSHIPS,
IN CLASS 35 (U.S. CLS. 100, 101 AND 102).

FIRST USE 5-1-2008; IN COMMERCE 5-1-2008.

THE MARK CONSISTS OF STANDARD CHAR-
ACTERS WITHOUT CLAIM TO ANY PARTICULAR
FONT, STYLE, SIZE, OR COLOR.

NO CLAIM IS MADE TO THE EXCLUSIVE
RIGHT TO USE "FAITH", APART FROM THE
MARK AS SHOWN.

SN 78-928,610, FILED 7-13-2006.

KRISTIN DAHLING, EXAMINING ATTORNEY

Int. Cl.: 30

Prior U.S. Cl.: 46

United States Patent and Trademark Office

Reg. No. 3,478,255

Registered July 29, 2008

**TRADEMARK
PRINCIPAL REGISTER**

DELICIOUS CALORIES

VITALICIOUS, INC. (NEW YORK CORPORATION)
11 BROADWAY
SUITE 1155
NEW YORK, NY 10004

FOR: CAKE BATTER AND MUFFIN BATTER;
PREPARED FOOD MIXES, NAMELY, BREAD
MIXES AND MIXES WITH BREAD AS A SUBSTANTIAL
INGREDIENT, NAMELY, HOT BREAD
MIXES, STUFFING MIXES CONTAINING BREAD;
MUFFIN MIXES, PANCAKE MIXES, DOUGHNUT
MIXES, CAKE MIXES, FROSTING MIXES, PASTRY
MIXES, FLOUR-BASED BAKING MIXES FOR
MAKING BAKERY GOODS AND BREAD CRUMBS;

BROWNIES, CAKES, MUFFINS, MUFFIN TOPS,
PROCESSED CEREALS, COOKIES, IN CLASS 30
(U.S. CL. 46).

FIRST USE 5-26-2008; IN COMMERCE 5-26-2008.

THE MARK CONSISTS OF STANDARD CHARACTERS
WITHOUT CLAIM TO ANY PARTICULAR
FONT, STYLE, SIZE, OR COLOR.

SN 78-929,459, FILED 7-14-2006.

DEIRDRE ROBERTSON, EXAMINING ATTORNEY

Int. Cl.: 38

Prior U.S. Cls.: 100, 101, and 104

United States Patent and Trademark Office

Reg. No. 3,478,256

Registered July 29, 2008

**SERVICE MARK
PRINCIPAL REGISTER**

SI ON DEMAND

TIME INC. (DELAWARE CORPORATION)
1271 AVENUE OF THE AMERICAS
NEW YORK, NY 10020

FOR: CABLE TELEVISION BROADCASTING;
CABLE TELEVISION TRANSMISSION; COMMUNI-
CATION SERVICES, NAMELY, ELECTRONIC
TRANSMISSION OF DATA AND DOCUMENTS BY
DIGITAL TRANSMISSION OR BY SATELLITE;
DATA TRANSMISSION AND RECEPTION SERVI-
CES VIA TELECOMMUNICATION MEANS; ELEC-
TRONIC, ELECTRIC, AND DIGITAL
TRANSMISSION OF VOICE, DATA, IMAGES, SIG-
NALS, AND MESSAGES; PAY-PER-VIEW TELEVI-
SION TRANSMISSION SERVICES; SATELLITE,
CABLE, NETWORK TRANSMISSION OF SOUNDS,
IMAGES, SIGNALS AND DATA, IN CLASS 38 (U.S.
CLS. 100, 101 AND 104).

FIRST USE 2-14-2007; IN COMMERCE 2-14-2007.

THE MARK CONSISTS OF STANDARD CHAR-
ACTERS WITHOUT CLAIM TO ANY PARTICULAR
FONT, STYLE, SIZE, OR COLOR.

OWNER OF U.S. REG. NOS. 754,203, 1,463,508,
AND OTHERS.

NO CLAIM IS MADE TO THE EXCLUSIVE
RIGHT TO USE "ON DEMAND", APART FROM
THE MARK AS SHOWN.

SN 78-929,638, FILED 7-14-2006.

JOHN KELLY, EXAMINING ATTORNEY

Int. Cl.: 41

Prior U.S. Cls.: 100, 101, and 107

United States Patent and Trademark Office

Reg. No. 3,478,257

Registered July 29, 2008

**SERVICE MARK
PRINCIPAL REGISTER**

SI ON DEMAND

TIME INC. (DELAWARE CORPORATION)
1271 AVENUE OF THE AMERICAS
NEW YORK, NY 10020

FOR: CABLE TELEVISION PROGRAMMING ;
DISTRIBUTION OF TELEVISION PROGRAMMING
TO CABLE TELEVISION SYSTEMS; ENTERTAIN-
MENT IN THE NATURE OF ON-GOING TELEVI-
SION PROGRAMS IN THE FIELD OF SPORTS,
NEWS, CELEBRITIES, ATHLETES AND POPULAR
CULTURE; PRODUCTION OF CABLE TELEVISION
PROGRAMS, IN CLASS 41 (U.S. CLS. 100, 101 AND
107).

FIRST USE 2-17-2008; IN COMMERCE 2-17-2008.

THE MARK CONSISTS OF STANDARD CHAR-
ACTERS WITHOUT CLAIM TO ANY PARTICULAR
FONT, STYLE, SIZE, OR COLOR.

OWNER OF U.S. REG. NOS. 754,203, 1,463,508,
AND OTHERS.

NO CLAIM IS MADE TO THE EXCLUSIVE
RIGHT TO USE "ON DEMAND", APART FROM
THE MARK AS SHOWN.

SN 78-929,639, FILED 7-14-2006.

JOHN KELLY, EXAMINING ATTORNEY

Int. Cl.: 35

Prior U.S. Cls.: 100, 101, and 102

United States Patent and Trademark Office

Reg. No. 3,478,258

Registered July 29, 2008

**SERVICE MARK
PRINCIPAL REGISTER**

MOTIVATED FROM WITHIN

ENTHOSYS, INC. (DELAWARE CORPORATION)
615 NATIONAL AVE, SUITE 220
ENTHOSYS, INC.
MOUNTAIN VIEW, CA 94043

FOR: PRODUCT MANAGEMENT CONSULTING
AND MARKETING CONSULTING BOTH DE-
SIGNER TO IMPROVE THE EFFECTIVENESS OF
A CLIENT'S ABILITY TO DELIVER PRODUCTS
AND SERVICE OFFERINGS, IN CLASS 35 (U.S. CLS.
100, 101 AND 102).

FIRST USE 9-0-2006; IN COMMERCE 9-0-2006.

THE MARK CONSISTS OF STANDARD CHAR-
ACTERS WITHOUT CLAIM TO ANY PARTICULAR
FONT, STYLE, SIZE, OR COLOR.

SN 78-930,769, FILED 7-17-2006.

INGA ERVIN, EXAMINING ATTORNEY

Int. Cl.: 7

Prior U.S. Cls.: 13, 19, 21, 23, 31, 34, and 35

Reg. No. 3,478,259

United States Patent and Trademark Office

Registered July 29, 2008

**TRADEMARK
PRINCIPAL REGISTER**

GIVING POLLUTION THE BOOT

ENVIRONMENTAL SAFETY SOLUTIONS, LLC
(DELAWARE LTD LIAB CO)
9TH FLOOR
240 MADISON AVENUE
NEW YORK, NY 10016

FOR: JACKHAMMER ATTACHMENT, NAMELY,
A RUBBER MOLDED SLEEVE, WHICH IS AT-
TACHED TO A JACKHAMMER, THAT CONNECTS
TO AN INDUSTRIAL VACUUM FOR USE IN DE-
MOLITION, RENOVATION, OR CONSTRUCTION
OF BUILDINGS OR ROADS USED FOR DUST

SUPPRESSION AND COLLECTION, IN CLASS 7
(U.S. CLS. 13, 19, 21, 23, 31, 34 AND 35).

FIRST USE 7-26-2007; IN COMMERCE 8-6-2007.

THE MARK CONSISTS OF STANDARD CHAR-
ACTERS WITHOUT CLAIM TO ANY PARTICULAR
FONT, STYLE, SIZE, OR COLOR.

SN 78-931,746, FILED 7-18-2006.

MARY CRAWFORD, EXAMINING ATTORNEY

Int. Cls.: 35, 38, and 41

Prior U.S. Cls.: 100, 101, 102, 104, and 107

United States Patent and Trademark Office

Reg. No. 3,478,260

Registered July 29, 2008

**SERVICE MARK
PRINCIPAL REGISTER**

HollywoodNexus.com

ADIO TURNING POINT, INC. (CALIFORNIA CORPORATION)

#401

2554 LINCOLN BLVD.

MARINA DEL REY, CA 90291

FOR: PROVIDING CONSUMER INFORMATION IN THE FIELD OF ENTERTAINMENT INDUSTRY GOODS AND SERVICES VIA THE INTERNET; ADVERTISING AND COMMERCIAL INFORMATION SERVICES, VIA THE INTERNET; DISSEMINATION OF ADVERTISING FOR OTHERS VIA THE INTERNET; PROVIDING A SEARCHABLE ONLINE ADVERTISING GUIDE FEATURING THE GOODS AND SERVICES OF OTHER ONLINE VENDORS ON THE INTERNET; PROVIDING AN ONLINE COMMERCIAL INFORMATION DIRECTORY ON THE INTERNET; PROVIDING AND RENTAL OF ADVERTISING SPACE ON THE INTERNET; PROVIDING CONSUMERS INFORMATION ABOUT THE GOODS AND SERVICES OF OTHERS VIA THE GLOBAL COMPUTER NETWORK, IN CLASS 35 (U.S. CLS. 100, 101 AND 102).

FIRST USE 1-4-2005; IN COMMERCE 1-4-2005.

FOR: PROVIDING AN ONLINE INTERACTIVE BULLETIN BOARD FEATURING CLASSIFIED LISTINGS, JOB LISTINGS, EVENT LISTINGS, COMMERCIAL NOTICES AND RESUME LISTINGS; PROVIDING ONLINE INTERACTIVE BULLETIN BOARDS FOR TRANSMISSION OF MESSAGES AMONG COMPUTER USERS CONCERNING CLASSIFIED LISTINGS AND LISTINGS FOR AN-

NOUNCEMENTS, EVENTS, ACTIVITIES, FOR-SALE ADVERTISEMENTS, CLASSIFIED LISTINGS, WANT ADS, JOB OPENINGS, RESUMES, AND EVENTS; PROVIDING ON-LINE CHAT ROOMS AND ELECTRONIC BULLETIN BOARDS FOR TRANSMISSION OF MESSAGES AMONG USERS IN THE FIELD OF GENERAL INTEREST; PROVIDING E-MAIL AND INSTANT MESSAGING SERVICES, IN CLASS 38 (U.S. CLS. 100, 101 AND 104).

FIRST USE 3-15-2005; IN COMMERCE 3-15-2005.

FOR: PROVIDING ON-LINE COMPUTER DATABASES AND ON-LINE SEARCHABLE DATABASES FEATURING ENTERTAINMENT NEWS INFORMATION CONCERNING THE ENTERTAINMENT INDUSTRY; AND PROVIDING ENTERTAINMENT NEWS INFORMATION IN THE FIELD OF ENTERTAINMENT INDUSTRY GOODS AND SERVICES; PROVIDING NEWSLETTERS IN THE FIELD OF ENTERTAINMENT VIA E-MAIL, IN CLASS 41 (U.S. CLS. 100, 101 AND 107).

FIRST USE 7-3-2005; IN COMMERCE 7-3-2005.

THE MARK CONSISTS OF STANDARD CHARACTERS WITHOUT CLAIM TO ANY PARTICULAR FONT, STYLE, SIZE, OR COLOR.

SN 78-932,352, FILED 7-18-2006.

INGRID C. EULIN, EXAMINING ATTORNEY

Int. Cl.: 25

Prior U.S. Cls.: 22 and 39

United States Patent and Trademark Office

Reg. No. 3,478,261

Registered July 29, 2008

**TRADEMARK
PRINCIPAL REGISTER**

Chi-Rho Apparel

LITTLE, RICHARD E., JR. (UNITED STATES
INDIVIDUAL)
27429 GARZA DRIVE
SANTA CLARITA, CA 91350

FOR: SHIRTS; T-SHIRTS; TANK TOPS; TOPS, IN
CLASS 25 (U.S. CLS. 22 AND 39).

FIRST USE 5-1-2007; IN COMMERCE 5-1-2007.

THE MARK CONSISTS OF STANDARD CHAR-
ACTERS WITHOUT CLAIM TO ANY PARTICULAR
FONT, STYLE, SIZE, OR COLOR.

NO CLAIM IS MADE TO THE EXCLUSIVE
RIGHT TO USE "APPAREL", APART FROM THE
MARK AS SHOWN.

THE WORDS "CHI-RHO" IS THE FIRST TWO
LETTERS OF THE GREEK SPELLING OF THE
WORD CHRIST.

SN 78-932,401, FILED 7-18-2006.

ODESSA BIBBINS, EXAMINING ATTORNEY

Int. Cl.: 28

Prior U.S. Cls.: 22, 23, 38, and 50

United States Patent and Trademark Office

Reg. No. 3,478,262

Registered July 29, 2008

**TRADEMARK
PRINCIPAL REGISTER**

Volume Fitness

FITNESS FIRST, INC. (UTAH CORPORATION)
4040 GARY ROAD
SALT LAKE CITY, UT 84124

FOR: FITNESS AND EXERCISE MACHINES AND EQUIPMENT IN THE NATURE OF CARDIO AND STRENGTH TRAINING EQUIPMENT AND RELATED ACCESSORIES, IN CLASS 28 (U.S. CLS. 22, 23, 38 AND 50).

FIRST USE 7-19-2006; IN COMMERCE 7-19-2006.

THE MARK CONSISTS OF STANDARD CHARACTERS WITHOUT CLAIM TO ANY PARTICULAR FONT, STYLE, SIZE, OR COLOR.

NO CLAIM IS MADE TO THE EXCLUSIVE RIGHT TO USE "FITNESS", APART FROM THE MARK AS SHOWN.

SN 78-933,240, FILED 7-19-2006.

ANNE E. GUSTASON, EXAMINING ATTORNEY

Int. Cl.: 3

Prior U.S. Cls.: 1, 4, 6, 50, 51, and 52

United States Patent and Trademark Office

Reg. No. 3,478,263

Registered July 29, 2008

**TRADEMARK
PRINCIPAL REGISTER**

**Not all mascaras are
created equal**

DAWN MARKS FISHER LLC (OREGON LTD
LIAB CO)
11020 SW ESQUILINE CIRCUS
PORTLAND, OR 97219

THE MARK CONSISTS OF STANDARD CHAR-
ACTERS WITHOUT CLAIM TO ANY PARTICULAR
FONT, STYLE, SIZE, OR COLOR.

FOR: MASCARA, IN CLASS 3 (U.S. CLS. 1, 4, 6, 50,
51 AND 52).

SN 78-933,677, FILED 7-20-2006.

FIRST USE 1-0-2007; IN COMMERCE 1-0-2007.

RON FAIRBANKS, EXAMINING ATTORNEY

Int. Cls.: 35 and 42

Prior U.S. Cls.: 100, 101, and 102

United States Patent and Trademark Office

Reg. No. 3,478,264

Registered July 29, 2008

**SERVICE MARK
PRINCIPAL REGISTER**

MIS DIVISION

GLOBAL TECHNOLOGY SOLUTIONS, INC. (NEVADA CORPORATION)
848 NORTH RAINBOW BLVD. #743
LAS VEGAS, NV 89107

FOR: HUMAN CAPITAL MANAGEMENT OUTSOURCING SERVICES; OUTSOURCING IN THE FIELD OF PROFESSIONAL SERVICES, IN CLASS 35 (U.S. CLS. 100, 101 AND 102).

FIRST USE 6-9-2008; IN COMMERCE 6-9-2008.

FOR: COMPUTER COLOCATION SERVICES, NAMELY, PROVIDING FACILITIES FOR THE LOCATION OF COMPUTER SERVERS WITH THE EQUIPMENT OF OTHERS; COMPUTER SERVICES, NAMELY, REMOTE AND ON-SITE MANAGEMENT OF ELECTRONIC MESSAGING SYSTEMS AND APPLICATIONS FOR OTHERS; DESIGN AND

DEVELOPMENT OF ONLINE COMPUTER SOFTWARE SYSTEMS, IN CLASS 42 (U.S. CLS. 100 AND 101).

FIRST USE 6-9-2008; IN COMMERCE 6-9-2008.

THE MARK CONSISTS OF STANDARD CHARACTERS WITHOUT CLAIM TO ANY PARTICULAR FONT, STYLE, SIZE, OR COLOR.

NO CLAIM IS MADE TO THE EXCLUSIVE RIGHT TO USE "MIS", APART FROM THE MARK AS SHOWN.

SN 78-934,357, FILED 7-20-2006.

LAURIE KAUFMAN, EXAMINING ATTORNEY

Int. Cls.: 16 and 35

Prior U.S. Cls.: 2, 5, 22, 23, 29, 37, 38, 50, 100, 101, and 102

Reg. No. 3,478,265

United States Patent and Trademark Office

Registered July 29, 2008

**TRADEMARK
SERVICE MARK
PRINCIPAL REGISTER**

KINGDOMPRO

PRO MUSIC GROUP LLC (CALIFORNIA LTD
LIAB JT ST CO)
11070 VALLEY VIEW STREET
CYPRESS, CA 90630

FOR: PUBLICATIONS, NAMELY, CATALOGS, IN
CLASS 16 (U.S. CLS. 2, 5, 22, 23, 29, 37, 38 AND 50).

FIRST USE 5-12-2008; IN COMMERCE 5-12-2008.

FOR: RETAIL STORE, ONLINE RETAIL STORE,
AND MAIL ORDER CATALOG SERVICES ALL
FEATURING A WIDE VARIETY OF MUSICAL
AND DISC JOCKEY EQUIPMENT, LIGHTING,

SPEAKERS, AND SOUND EQUIPMENT, IN CLASS
35 (U.S. CLS. 100, 101 AND 102).

FIRST USE 5-12-2008; IN COMMERCE 5-12-2008.

THE MARK CONSISTS OF STANDARD CHAR-
ACTERS WITHOUT CLAIM TO ANY PARTICULAR
FONT, STYLE, SIZE, OR COLOR.

SN 78-934,748, FILED 7-21-2006.

MARGERY A. TIERNEY, EXAMINING ATTORNEY

Int. Cl.: 25

Prior U.S. Cls.: 22 and 39

United States Patent and Trademark Office

Reg. No. 3,478,266

Registered July 29, 2008

**TRADEMARK
PRINCIPAL REGISTER**

ALLIE N.

HOOPER, TERRANCE J. (UNITED STATES IN-
DIVIDUAL)

5 SNOWDROP PLACE

NEWTOWN, PA 18940

FOR: FOOTWEAR, SHOES, IN CLASS 25 (U.S. CLS.
22 AND 39).

FIRST USE 8-8-2006; IN COMMERCE 8-8-2006.

THE MARK CONSISTS OF STANDARD CHAR-
ACTERS WITHOUT CLAIM TO ANY PARTICULAR
FONT, STYLE, SIZE, OR COLOR.

THE NAME(S), PORTRAIT(S), AND/OR SIGNA-
TURE(S) SHOWN IN THE MARK DOES NOT IDEN-
TIFY A PARTICULAR LIVING INDIVIDUAL.

SN 78-936,593, FILED 7-25-2006.

KATHLEEN LORENZO, EXAMINING ATTORNEY

Int. Cl.: 30

Prior U.S. Cl.: 46

United States Patent and Trademark Office

Reg. No. 3,478,267

Registered July 29, 2008

**TRADEMARK
PRINCIPAL REGISTER**

RITUALS ESTATE

E & H DISTRIBUTING CO. (NEVADA CORPORATION)
1685 WEST CHEYENNE AVENUE
NORTH LAS VEGAS, NV 89030

FOR: COFFEE; TEA, IN CLASS 30 (U.S. CL. 46).

FIRST USE 7-0-2006; IN COMMERCE 7-0-2006.

THE MARK CONSISTS OF STANDARD CHARACTERS WITHOUT CLAIM TO ANY PARTICULAR FONT, STYLE, SIZE, OR COLOR.

OWNER OF U.S. REG. NOS. 2,088,117 AND 3,004,484.

NO CLAIM IS MADE TO THE EXCLUSIVE RIGHT TO USE "ESTATE", APART FROM THE MARK AS SHOWN.

SN 78-937,517, FILED 7-26-2006.

JENNIFER MARTIN, EXAMINING ATTORNEY

Int. Cl.: 3

Prior U.S. Cls.: 1, 4, 6, 50, 51, and 52

Reg. No. 3,478,268

United States Patent and Trademark Office

Registered July 29, 2008

**TRADEMARK
PRINCIPAL REGISTER**

SECRESEA

FOREVERGREEN IP LLC (UTAH LTD LIAB CO)
ATTN: GENERAL COUNSEL
972 NORTH 1430 WEST
OREM, UT 84057

FOR: COSMETICS, NAMELY, FACIAL MOISTURIZERS, TONERS, CLEANSERS, GELS, MASKS SKIN TREATMENTS, FACIAL SCRUBS, EYE CREAMS; NON-MEDICATED TOILET PREPARATIONS, NAMELY, HAND AND BODY SOAPS, BODY LOTIONS AND CONDITIONERS, SKIN SALVES, SKIN CREAM; SKIN LOTIONS AND SKIN CONDI-

TIONING GELS; MASSAGE LOTIONS, IN CLASS 3 (U.S. CLS. 1, 4, 6, 50, 51 AND 52).

FIRST USE 8-19-2006; IN COMMERCE 8-19-2006.

THE MARK CONSISTS OF STANDARD CHARACTERS WITHOUT CLAIM TO ANY PARTICULAR FONT, STYLE, SIZE, OR COLOR.

SN 78-938,268, FILED 7-26-2006.

RAUL CORDOVA, EXAMINING ATTORNEY

Int. Cl.: 9

Prior U.S. Cls.: 21, 23, 26, 36, and 38

United States Patent and Trademark Office

Reg. No. 3,478,269

Registered July 29, 2008

**TRADEMARK
PRINCIPAL REGISTER**

LAVENDER LINE

TELIGENCE (CANADA) LTD. (CANADA CORPORATION)
SUITE 700
1045 HOWE STREET
VANCOUVER, CANADA V6Z 2A9

FOR: COMPUTER SOFTWARE AND HARDWARE USED FOR COMMUNICATIONS BETWEEN AND AMONG GLOBAL AND LOCAL COMMUNICATIONS NETWORKS, AND WIRELESS NETWORKS; DOWNLOADABLE SOFTWARE DELIVERED TO COMPUTERS, TELEPHONES, MOBILE PHONES, MEDIA PLAYERS, AND PERSONAL DIGITAL DEVICES, NAMELY, COMPUTER SEARCH ENGINE SOFTWARE FOR SEARCHING THE CONTENTS OF COMPUTERS AND COMPUTER NETWORKS BY REMOTE CONTROL; DOWNLOADABLE MULTIMEDIA FILE CONTAINING ARTWORK, TEXT, AUDIO, VIDEO, GAMES, AND INTERNET WEB LINKS RELATING TO DATING,

MEETING PEOPLE, HOROSCOPES, AND TOPICS OF GENERAL INTEREST, IN CLASS 9 (U.S. CLS. 21, 23, 26, 36 AND 38).

FIRST USE 11-7-2007; IN COMMERCE 11-7-2007.

THE MARK CONSISTS OF STANDARD CHARACTERS WITHOUT CLAIM TO ANY PARTICULAR FONT, STYLE, SIZE, OR COLOR.

OWNER OF U.S. REG. NO. 3,416,194.

NO CLAIM IS MADE TO THE EXCLUSIVE RIGHT TO USE "LINE", APART FROM THE MARK AS SHOWN.

SN 78-938,480, FILED 7-26-2006.

JIM RINGLE, EXAMINING ATTORNEY

Int. Cls.: 35 and 42

Prior U.S. Cls.: 100, 101, and 102

United States Patent and Trademark Office

Reg. No. 3,478,270

Registered July 29, 2008

**SERVICE MARK
PRINCIPAL REGISTER**

Thinking Between the Boxes

COLE, VERA JEAN (UNITED STATES INDIVIDUAL)
2045 UPPER ROCKY DALE ROAD
GREEN LANE, PA 18054

FOR: ADVICE IN THE FIELD OF BUSINESS MANAGEMENT AND MARKETING; ADVICE RELATING TO THE ORGANIZATION AND MANAGEMENT OF BUSINESS; ANALYSES AND APPRAISALS OF ENTERPRISES; ASSISTANCE IN MANAGEMENT OF BUSINESS ACTIVITIES; ASSISTANCE TO INDUSTRIAL OR COMMERCIAL ENTERPRISES IN THE RUNNING OF THEIR BUSINESS; ASSISTANCE WITH BUSINESS MANAGEMENT AND PLANNING; BUSINESS ADMINISTRATION AND MANAGEMENT; BUSINESS ADVICE AND INFORMATION; BUSINESS CONSULTATION; BUSINESS CONSULTATION SERVICES; BUSINESS CONSULTING AND BUSINESS INFORMATION FOR ENTERPRISES; BUSINESS CONSULTING AND INFORMATION SERVICES; BUSINESS CONSULTING SERVICES RELATING TO PRODUCT DISTRIBUTION, OPERATIONS MANAGEMENT SERVICES, LOGISTICS, REVERSE LOGISTICS, SUPPLY CHAIN, AND PRODUCTION SYSTEMS AND DISTRIBUTION SOLUTIONS; BUSINESS CONSULTING, INQUIRIES OR INFORMATION; BUSINESS CONSULTING, MANAGEMENT, PLANNING AND SUPERVISION; BUSINESS DEVELOPMENT SERVICES, NAMELY, PROVIDING START-UP SUPPORT FOR BUSINESSES OF OTHERS; BUSINESS INFORMATION IN THE FIELD OF BUSINESS PROCESS MANAGEMENT; BUSINESS INFORMATION MANAGEMENT; BUSINESS MANAGEMENT; BUSINESS MANAGEMENT AND ADVICE; BUSINESS MANAGEMENT AND CONSULTATION; BUSINESS MANAGEMENT ASSISTANCE TO INDUSTRIAL OR COMMERCIAL COMPANIES; BUSINESS MANAGEMENT CONSULTANCY AND ADVISORY SERVICES; BUSINESS MANAGEMENT CONSULTANCY AS WELL AS DEVELOPMENT OF PROCESSES FOR THE ANA-

LYSIS AND THE IMPLEMENTATION OF STRATEGY PLANS AND MANAGEMENT PROJECTS; BUSINESS MANAGEMENT CONSULTATION; BUSINESS MANAGEMENT CONSULTATION IN THE FIELD OF EXECUTIVE AND LEADERSHIP DEVELOPMENT; BUSINESS MANAGEMENT CONSULTING AND ADVISORY SERVICES; BUSINESS MANAGEMENT CONSULTING WITH RELATION TO STRATEGY, MARKETING, PRODUCTION, PERSONNEL AND RETAIL SALE MATTERS; BUSINESS MANAGEMENT INFORMATION ON A WIDE VARIETY OF TOPICS TO SERVICE PROVIDING PROFESSIONALS; BUSINESS MANAGEMENT PLANNING; BUSINESS MANAGEMENT SERVICES, NAMELY, MANAGING LOGISTICS, REVERSE LOGISTICS, SUPPLY CHAIN SERVICES, SUPPLY CHAIN VISIBILITY AND SYNCHRONIZATION, SUPPLY AND DEMAND FORECASTING AND PRODUCT DISTRIBUTION PROCESSES FOR OTHERS; BUSINESS OPERATION, BUSINESS ADMINISTRATION AND OFFICE FUNCTIONS; BUSINESS ORGANIZATION AND MANAGEMENT CONSULTING SERVICES; BUSINESS ORGANIZATION ADVICE; BUSINESS ORGANIZATION AND OPERATION CONSULTANCY; BUSINESS ORGANIZATIONAL CONSULTATION; BUSINESS PLANNING; BUSINESS PROCESS RE-ENGINEERING SERVICES; CONSULTANCY SERVICES REGARDING BUSINESS STRATEGIES; CONSULTATION SERVICES IN THE FIELD OF COMPANY, BUSINESS SECTOR AND INDUSTRY DATA AND RESEARCH; CONSULTING SERVICES IN BUSINESS ORGANIZATION AND MANAGEMENT; DATABASE MANAGEMENT; INFORMATION IN BUSINESS MATTERS; INFORMATION SERVICES RELATING TO BUSINESS MATTERS; INFORMATION, ADVISORY AND CONSULTANCY SERVICES RELATING TO BUSINESS AND MANAGEMENT OR BUSINESS ADMINISTRATION, INCLUDING SUCH SERVICES PROVIDED ON LINE OR VIA THE INTERNET; MANAGEMENT AND BUSINESS CONSULTING SERVICES IN THE FIELD OF BUSI-

NESS PROCESS MANAGEMENT; MANAGEMENT ASSISTANCE; PREPARING BUSINESS REPORTS; PREPARING COMPUTER SLIDE TRANSPARENCIES FOR USE BY BUSINESS; PROFESSIONAL BUSINESS CONSULTATION; PROVIDING BUSINESS INFORMATION, ALSO VIA INTERNET, THE CABLE NETWORK OR OTHER FORMS OF DATA TRANSFER; PROVIDING BUSINESS MANAGEMENT INFORMATION IN CONNECTION WITH CONSULTING AND ADVISORY SERVICES IN THE FIELD OF STRATEGIC PLANNING; VALUE ENGINEERING, NAMELY COST ANALYSIS; BUSINESS PROCESS ENGINEERING SERVICES, IN CLASS 35 (U.S. CLS. 100, 101 AND 102).

FIRST USE 6-30-2006; IN COMMERCE 6-30-2006.

FOR: COMPUTER CONSULTATION; COMPUTER SOFTWARE CONSULTATION; COMPUTER SOFTWARE DESIGN FOR OTHERS; COMPUTER SOFTWARE DESIGN, COMPUTER PROGRAMMING, OR MAINTENANCE OF COMPUTER SOFTWARE; COMPUTER SOFTWARE DEVELOPMENT; CONSULTANCY IN THE FIELD OF SOFTWARE DESIGN; CONSULTATION SERVICES IN THE FIELDS OF SELECTION, IMPLEMENTATION AND USE OF COMPUTER HARDWARE AND SOFTWARE SYSTEMS FOR OTHERS; CONSULTING SERVICES IN THE FIELD OF DESIGN, SELECTION, IMPLEMENTATION AND USE OF

COMPUTER HARDWARE AND SOFTWARE SYSTEMS FOR OTHERS; CONSULTING SERVICES IN THE FIELD OF OFFICE AND WORKPLACE AUTOMATION; CUSTOMIZATION OF COMPUTER HARDWARE AND SOFTWARE; DESIGN OF COMPUTER NETWORKS AND SOFTWARE FOR OTHERS FOR THE FIELD OF BUSINESS PROCESS MANAGEMENT; DOCUMENT DATA TRANSFER FROM ONE COMPUTER FORMAT TO ANOTHER; ENGINEERING; INFORMATION TECHNOLOGY CONSULTATION; INSTALLATION OF COMPUTER SOFTWARE; INTEGRATION OF COMPUTER SYSTEMS AND NETWORKS; TECHNICAL WRITING FOR OTHERS; UP-DATING OF COMPUTER SOFTWARE; UP-DATING OF COMPUTER PROGRAMS FOR THIRD PARTIES; UP-DATING OF COMPUTER SOFTWARE FOR OTHERS; LICENSING OF COMPUTER SOFTWARE, IN CLASS 42 (U.S. CLS. 100 AND 101).

FIRST USE 6-30-2006; IN COMMERCE 6-30-2006.

THE MARK CONSISTS OF STANDARD CHARACTERS WITHOUT CLAIM TO ANY PARTICULAR FONT, STYLE, SIZE, OR COLOR.

SN 78-938,929, FILED 7-27-2006.

BARNEY CHARLON, EXAMINING ATTORNEY

Int. Cl.: 1

Prior U.S. Cls.: 1, 5, 6, 10, 26, and 46

Reg. No. 3,478,271

United States Patent and Trademark Office

Registered July 29, 2008

**TRADEMARK
PRINCIPAL REGISTER**

GREENTEMP

GREENTEMP INNOVATIONS, LLC (MICHIGAN
LTD LIAB CO)
P.O. BOX 751
BLOOMFIELD HILLS, MI 48303

THE MARK CONSISTS OF STANDARD CHAR-
ACTERS WITHOUT CLAIM TO ANY PARTICULAR
FONT, STYLE, SIZE, OR COLOR.

FOR: HEAT TRANSFER FLUID FOR RESIDEN-
TIAL, COMMERCIAL AND INDUSTRIAL USE, IN
CLASS 1 (U.S. CLS. 1, 5, 6, 10, 26 AND 46).

SN 78-939,735, FILED 7-28-2006.

FIRST USE 12-1-2006; IN COMMERCE 12-1-2006.

ANNE E. GUSTASON, EXAMINING ATTORNEY

Int. Cl.: 41

Prior U.S. Cls.: 100, 101, and 107

United States Patent and Trademark Office

Reg. No. 3,478,272

Registered July 29, 2008

SERVICE MARK
PRINCIPAL REGISTER



ANSARI, NADEEM (UNITED STATES INDIVIDUAL)
6994 GILLIS WAY
GAINESVILLE, VA 20155

FOR: MARTIAL ARTS INSTRUCTION, IN CLASS 41 (U.S. CLS. 100, 101 AND 107).

FIRST USE 12-1-2005; IN COMMERCE 8-1-2006.

NO CLAIM IS MADE TO THE EXCLUSIVE RIGHT TO USE "JUJITSU" AND "RYU", APART FROM THE MARK AS SHOWN.

THE COLOR(S) NAVY BLUE, BOTTLE GREEN AND WHITE IS/ARE CLAIMED AS A FEATURE OF THE MARK.

THE MARK CONSISTS OF THE COLORS AS A NAVY BLUE CIRCULAR BORDER CONTAINING IN WHITE LETTERING THE WORDS "KIHEN RYU

JU JITSU", ON THE INSIDE OF THE SYMBOL IS A BOTTLE GREEN BACKGROUND, INSET IS A NAVY BLUE TRIANGLE ABOVE WHICH IS A RECTANGULAR STRIP CONTAINING 5 JAPANESE KANJI TRANSLATING TO THE WORDS KI, HEN, RYU, JU AND JITSU VERTICALLY IN WHITE WITH A NAVY BLUE BACKGROUND AND WHITE BORDER.

THE ENGLISH TRANSLATION OF THE WORD "RYU" IN THE MARK IS SCHOOL.

THE NON-LATIN CHARACTER(S) IN THE MARK TRANSLITERATE INTO "KIHEN RYU JU JITSU", AND THIS MEANS KIHEN RYU JU JITSU IN ENGLISH.

SN 78-940,084, FILED 7-28-2006.

FLORENTINA BLANDU, EXAMINING ATTORNEY

Int. Cl.: 1

Prior U.S. Cls.: 1, 5, 6, 10, 26, and 46

Reg. No. 3,478,273

United States Patent and Trademark Office

Registered July 29, 2008

**TRADEMARK
PRINCIPAL REGISTER**

NOVERITE

LUBRIZOL ADVANCED MATERIALS, INC. (DE-
LAWARE CORPORATION)
9911 BRECKSVILLE ROAD
CLEVELAND, OH 441413247

THE MARK CONSISTS OF STANDARD CHAR-
ACTERS WITHOUT CLAIM TO ANY PARTICULAR
FONT, STYLE, SIZE, OR COLOR.

FOR: POLYMERS FOR USE IN DETERGENTS
AND CLEANERS, IN CLASS 1 (U.S. CLS. 1, 5, 6, 10, 26
AND 46).

SN 78-940,841, FILED 7-31-2006.

FIRST USE 5-10-2007; IN COMMERCE 5-10-2007.

NORA BUCHANAN WILL, EXAMINING ATTOR-
NEY

Int. Cl.: 9

Prior U.S. Cls.: 21, 23, 26, 36, and 38

United States Patent and Trademark Office

Reg. No. 3,478,274

Registered July 29, 2008

TRADEMARK
PRINCIPAL REGISTER

A large, stylized handwritten signature in black ink that reads "John R. Wood". The signature is written in a cursive, flowing style with a prominent 'J' and 'W'.

JOHN R. WOOD, INC. (FLORIDA CORPORATION)
3255 TAMiami TRAIL NORTH
NAPLES, FL 34103

FOR: DOWNLOADABLE ELECTRONIC PUBLICATIONS IN THE NATURE OF BOOKLETS, NEWSLETTERS, MAGAZINES, PAMPHLETS, LEAFLETS, MANUALS, BROCHURES, HANDBOOKS AND DIRECTORIES ALL OF THE FOREGOING IN THE FIELD OF REAL ESTATE, IN CLASS 9 (U.S. CLS. 21, 23, 26, 36 AND 38).

FIRST USE 8-29-2006; IN COMMERCE 8-29-2006.

OWNER OF U.S. REG. NOS. 2,174,456, 2,238,023, AND 2,439,737.

THE NAME(S), PORTRAIT(S), AND/OR SIGNATURE(S) SHOWN IN THE MARK IDENTIFIES "JOHN R. WOOD", A LIVING INDIVIDUAL, WHOSE CONSENT(S) TO REGISTER IS SUBMITTED.

SN 78-940,985, FILED 7-31-2006.

DAVID YONTEF, EXAMINING ATTORNEY

Int. Cl.: 9

Prior U.S. Cls.: 21, 23, 26, 36, and 38

Reg. No. 3,478,275

United States Patent and Trademark Office

Registered July 29, 2008

**TRADEMARK
PRINCIPAL REGISTER**



JOHN R. WOOD, INC. (FLORIDA CORPORATION)
3255 TAMiami TRAIL NORTH
NAPLES, FL 34103

FIRST USE 8-29-2006; IN COMMERCE 8-29-2006.

FOR: DOWNLOADABLE ELECTRONIC PUBLICATIONS IN THE NATURE OF BOOKLETS, NEWSLETTERS, MAGAZINES, PAMPHLETS, LEAFLETS, MANUALS, BROCHURES, HANDBOOKS AND DIRECTORIES ALL OF THE FOREGOING IN THE FIELD OF REAL ESTATE, IN CLASS 9 (U.S. CLS. 21, 23, 26, 36 AND 38).

OWNER OF U.S. REG. NOS. 2,238,023 AND 2,439,737.

SN 78-940,991, FILED 7-31-2006.

DAVID YONTEF, EXAMINING ATTORNEY

Int. Cls.: 35, 36, 41, 42, 44, and 45

Prior U.S. Cls.: 100, 101, 102, and 107

United States Patent and Trademark Office

Reg. No. 3,478,276

Registered July 29, 2008

SERVICE MARK
PRINCIPAL REGISTER

Administaff 

Good for Small Business.

ADMINISTAFF, INC. (DELAWARE CORPORATION)
19001 CRESCENT SPRINGS DRIVE
KINGWOOD, TX 773393802

FOR: PROFESSIONAL EMPLOYER ORGANIZATION SERVICES, NAMELY, OPERATION OF THE PERSONNEL PART OF A BUSINESS FOR OTHERS FOR THE PURPOSE OF SERVING AS AN OFFSITE HUMAN RESOURCES DEPARTMENT; CO-EMPLOYER SERVICES FOR THE PURPOSE OF SERVING AS AN OFFSITE HUMAN RESOURCES DEPARTMENT; PROVIDING INFORMATION IN THE FIELD OF HUMAN RESOURCES; PROVIDING PROFESSIONAL EMPLOYER SERVICES DIRECTLY AND VIA THE INTERNET; PROVIDING TO CLIENT COMPANIES DETAILED DEDUCTION REPORTS, TIMESHEETS, AND INVOICES FOR PAYROLL REPORTS; HUMAN RESOURCES CONSULTING AND MANAGEMENT; PROVIDING INFORMATION IN THE FIELDS OF EMPLOYMENT ADMINISTRATION, PERSONNEL POLICIES AND PROCEDURES, EMPLOYMENT RECORDS AND CLAIMS MANAGEMENT, WAGE CLAIMS AND AUDITS, PAYROLL PREPARATION, PROCESSING, AND MANAGEMENT, EMPLOYMENT CONSULTING AND MANAGEMENT, EMPLOYMENT RECRUITING AND SELECTION SERVICES, EMPLOYMENT OUTPLACEMENT SERVICES, EMPLOYMENT VERIFICATION, EMPLOYEE AND POTENTIAL EMPLOYEE SKILL TESTING AND PLACEMENT, EMPLOYEE PERFORMANCE AND APPRAISAL MANAGEMENT, EMPLOYEE PSYCHOLOGICAL ASSESSMENT, EMPLOYEE RETENTION, AND EMPLOYEE TERMINATION; PROVIDING HUMAN RESOURCES FORMS; PROVIDING A PLACE ON A WEB SITE FOR A CLIENT COMPANY TO POST JOB OPENINGS; PROVIDING A RESUME DATABASE TO CLIENTS; PROVIDING WEB SITE LINKS TO OTHER SERVICE PROVIDERS' COMPANY WEB PAGES FOR PROMOTIONAL PURPOSES; PROMOTING THE GOODS AND SERVICES OF OTHERS BY PROVIDING INFORMA-

TION ABOUT SPECIAL EMPLOYER AND EMPLOYEE DISCOUNTS ARRANGED BY THE REGISTRANT; PROVIDING ANSWERS TO FREQUENTLY ASKED PERSONNEL QUESTIONS; MEDICAL REFERRAL SERVICES, NAMELY, PROVIDING INFORMATION ABOUT MEDICAL BENEFIT PROVIDERS TO A GIVEN EMPLOYEE; AND PROVIDING SERVICES AND INFORMATION DIRECTLY AND VIA THE INTERNET IN THE FIELD OF EMPLOYMENT ADMINISTRATION, IN CLASS 35 (U.S. CLS. 100, 101 AND 102).

FIRST USE 1-10-2006; IN COMMERCE 1-10-2006.

FOR: PROFESSIONAL EMPLOYER ORGANIZATION SERVICES, NAMELY, ADMINISTRATION OF EMPLOYEE BENEFITS PLANS; ADMINISTRATION OF EMPLOYEE RETIREMENT PLANS; PROVIDING INFORMATION RELATING TO HEALTH AND DISABILITY INSURANCE AND MEDICAL BENEFITS PROVIDERS; PROVIDING INFORMATION IN THE FIELDS OF EMPLOYEE BENEFITS MANAGEMENT, INSURANCE MANAGEMENT, AND EMPLOYEE RETIREMENT PLANS, DIRECTLY AND VIA THE INTERNET; AND PROVIDING EMPLOYER LIABILITY MANAGEMENT, WORKERS' COMPENSATION, AND INDEMNITY INSURANCE, IN CLASS 36 (U.S. CLS. 100, 101 AND 102).

FIRST USE 1-10-2006; IN COMMERCE 1-10-2006.

FOR: PROFESSIONAL EMPLOYER ORGANIZATION SERVICES, NAMELY, PROVIDING INFORMATION IN THE FIELDS OF EMPLOYMENT TRAINING AND DEVELOPMENT AND WORKPLACE SAFETY TRAINING DIRECTLY AND VIA THE INTERNET; AND PROVIDING ONLINE NON-DOWNLOADABLE NEWSLETTERS FEATURING ARTICLES ABOUT LIFESTYLE, TRAVEL, FINANCE, HEALTH, FAMILY, EMPLOYEE TRAINING, EMPLOYEE BENEFITS, EMPLOYEE SERVICES AND HUMAN RESOURCES, IN CLASS 41 (U.S. CLS. 100, 101 AND 107).

FIRST USE 1-10-2006; IN COMMERCE 1-10-2006.

FOR: PROFESSIONAL EMPLOYER ORGANIZATION SERVICES, EMPLOYMENT COMPLIANCE SERVICES AND INFORMATION DIRECTLY AND VIA THE INTERNET, NAMELY, PROVIDING INFORMATION AND SERVICES DIRECTLY AND VIA THE INTERNET REGARDING GOVERNMENT REGULATORY AND REPORTING REQUIREMENTS FOR EMPLOYMENT, IN CLASS 42 (U.S. CLS. 100 AND 101).

FIRST USE 1-10-2006; IN COMMERCE 1-10-2006.

FOR: PROVIDING EMPLOYEE DRUG TESTING, IN CLASS 44 (U.S. CLS. 100 AND 101).

FIRST USE 1-10-2006; IN COMMERCE 1-10-2006.

FOR: PROVIDING INFORMATION IN THE FIELD OF WORKPLACE SAFETY REQUIREMENTS DIRECTLY AND VIA THE INTERNET; PROVIDING PRE-EMPLOYMENT BACKGROUND SCREENING, IN CLASS 45 (U.S. CLS. 100 AND 101).

FIRST USE 1-10-2006; IN COMMERCE 1-10-2006.

OWNER OF U.S. REG. NOS. 1,751,231, 3,045,041, AND OTHERS.

SN 78-941,334, FILED 7-31-2006.

TINA KUAN, EXAMINING ATTORNEY

Int. Cl.: 9

Prior U.S. Cls.: 21, 23, 26, 36, and 38

Reg. No. 3,478,277

United States Patent and Trademark Office

Registered July 29, 2008

**TRADEMARK
PRINCIPAL REGISTER**

**Cooking With Uncle Tony,
Giving your guest
nothing but the best!,
www.cookingwithuncleony.com**

COOKING WITH UNCLE TONY, LLC (VIRGINIA
LTD LIAB CO)
19 FREEMAN DRIVE
HAMPTON, VA 23666

THE MARK CONSISTS OF STANDARD CHAR-
ACTERS WITHOUT CLAIM TO ANY PARTICULAR
FONT, STYLE, SIZE, OR COLOR.

FOR: PRE-RECORDED CD'S, VIDEO TAPES, LA-
SER DISKS AND DVD'S FEATURING COOKING,
IN CLASS 9 (U.S. CLS. 21, 23, 26, 36 AND 38).

SN 78-941,784, FILED 7-31-2006.

FIRST USE 5-1-2006; IN COMMERCE 8-1-2006.

ESTHER BELENKER, EXAMINING ATTORNEY

Int. Cl.: 16

Prior U.S. Cls.: 2, 5, 22, 23, 29, 37, 38, and 50

United States Patent and Trademark Office

Reg. No. 3,478,278

Registered July 29, 2008

**TRADEMARK
PRINCIPAL REGISTER**

TENDENCIAS

EDICIONES URANO, S.A. (SPAIN SOCIEDAD ANONIMA)
ARIBAU, 142 PRAL.
BARCELONA, SPAIN 08036

FOR: PUBLICATIONS, NAMELY, BOOKS FEATURING ESSAYS IN THE FIELDS OF ECONOMY, SOCIOLOGY, CONSUMER CONSUMPTION AND GEOPOLITICS, IN CLASS 16 (U.S. CLS. 2, 5, 22, 23, 29, 37, 38 AND 50).

FIRST USE 12-9-2002; IN COMMERCE 12-9-2002.

THE MARK CONSISTS OF STANDARD CHARACTERS WITHOUT CLAIM TO ANY PARTICULAR FONT, STYLE, SIZE, OR COLOR.

THE FOREIGN WORDING IN THE MARK TRANSLATES INTO ENGLISH AS TRENDS.

SN 78-941,924, FILED 8-1-2006.

ALEX KEAM, EXAMINING ATTORNEY

Int. Cl.: 14

Prior U.S. Cls.: 2, 27, 28, and 50

United States Patent and Trademark Office

Reg. No. 3,478,279

Registered July 29, 2008

**TRADEMARK
PRINCIPAL REGISTER**

TANZANITE DREAMS BY TIMOTHY PASHA

STS JEWELS, INC. (NEW YORK CORPORATION)
30-00 47TH STREET
5TH FLOOR
LONG ISLAND CITY, NY 11101

FOR: JEWELRY AND PRECIOUS STONES, IN
CLASS 14 (U.S. CLS. 2, 27, 28 AND 50).

FIRST USE 12-0-2006; IN COMMERCE 12-0-2006.

NO CLAIM IS MADE TO THE EXCLUSIVE
RIGHT TO USE "TANZANITE", APART FROM
THE MARK AS SHOWN.

THE NAME "TIMOTHY PASHA" IDENTIFIES A
LIVING INDIVIDUAL WHOSE CONSENT IS OF
RECORD.

SN 78-942,263, FILED 8-1-2006.

JEAN IM, EXAMINING ATTORNEY

Int. Cls.: 9 and 10

Prior U.S. Cls.: 21, 23, 26, 36, 38, 39, and 44

Reg. No. 3,478,280

United States Patent and Trademark Office

Registered July 29, 2008

**TRADEMARK
PRINCIPAL REGISTER**

PHARMAFLUOR

SAINT-GOBAIN PERFORMANCE PLASTICS
CORPORATION (CALIFORNIA CORPORATION)
1199 CHILLICOTHE ROAD
AURORA, OH 44202

FOR: LABORATORY EQUIPMENT, NAMELY,
FLUOROPOLYMER TUBING FOR USE IN THE
TRANSPORT OF LIQUIDS AND BIOLOGICALS, IN
CLASS 9 (U.S. CLS. 21, 23, 26, 36 AND 38).

FIRST USE 7-21-2006; IN COMMERCE 3-24-2008.

FOR: MEDICAL FLUOROPOLYMER TUBING
FOR USE IN THE TRANSPORT OF LIQUIDS AND

BIOLOGICALS, IN CLASS 10 (U.S. CLS. 26, 39 AND
44).

FIRST USE 7-21-2006; IN COMMERCE 3-24-2008.

THE MARK CONSISTS OF STANDARD CHAR-
ACTERS WITHOUT CLAIM TO ANY PARTICULAR
FONT, STYLE, SIZE, OR COLOR.

OWNER OF U.S. REG. NO. 2,846,577.

SN 78-942,297, FILED 8-1-2006.

MICHAEL GAAFAR, EXAMINING ATTORNEY

Int. Cl.: 38

Prior U.S. Cls.: 100, 101, and 104

United States Patent and Trademark Office

Reg. No. 3,478,281

Registered July 29, 2008

**SERVICE MARK
PRINCIPAL REGISTER**

SIRIUS INTERNET RADIO

SIRIUS SATELLITE RADIO INC. (DELAWARE CORPORATION)
36TH FLOOR
1221 AVENUE OF THE AMERICAS
NEW YORK, NY 10020

FOR: RADIO BROADCASTING SERVICES; WEB-CASTING SERVICES; STREAMING OF AUDIO, VISUAL AND DATA INFORMATION VIA A GLOBAL COMPUTER NETWORK, MOBILE TELEPHONE OR OTHER ELECTRONIC OR DIGITAL COMMUNICATIONS NETWORK OR DIGITAL COMMUNICATIONS DEVICE; ELECTRONIC AND DIGITAL TRANSMISSION AND DELIVERY OF VOICE, DATA, TEXT, IMAGES, GRAPHICS, SIGNALS AND MESSAGES VIA A GLOBAL COMPUTER NETWORK, MOBILE TELEPHONE OR OTHER ELECTRONIC OR DIGITAL COMMUNICATIONS NETWORK OR DEVICE; TRANSMISSION OF AUDIO, VISUAL AND DATA INFORMATION AVAILABLE FOR DOWNLOAD VIA A GLOBAL COMPUTER NETWORK, MOBILE TELEPHONE OR

OTHER ELECTRONIC OR DIGITAL COMMUNICATIONS NETWORK OR DIGITAL COMMUNICATIONS DEVICE, IN CLASS 38 (U.S. CLS. 100, 101 AND 104).

FIRST USE 10-16-2006; IN COMMERCE 10-16-2006.

THE MARK CONSISTS OF STANDARD CHARACTERS WITHOUT CLAIM TO ANY PARTICULAR FONT, STYLE, SIZE, OR COLOR.

OWNER OF U.S. REG. NOS. 2,914,720, 3,114,506, AND OTHERS.

NO CLAIM IS MADE TO THE EXCLUSIVE RIGHT TO USE "INTERNET RADIO", APART FROM THE MARK AS SHOWN.

SN 78-943,154, FILED 8-2-2006.

PAULA MAHONEY, EXAMINING ATTORNEY

Int. Cl.: 25

Prior U.S. Cls.: 22 and 39

United States Patent and Trademark Office

Reg. No. 3,478,282

Registered July 29, 2008

**TRADEMARK
PRINCIPAL REGISTER**

READY OR NOT

ORR, DANIELLE (UNITED STATES INDIVIDUAL)
3090 NE 48TH STREET, #211
FORT LAUDERDALE, FL 33308

FOR: MATERNITY CLOTHING, NAMELY, MATERNITY DRESSES, MATERNITY BLOUSES, MATERNITY SWEATSHIRTS AND MATERNITY T-SHIRTS DISPLAYING BABY'S DUE DATE AND GENDER, IN CLASS 25 (U.S. CLS. 22 AND 39).

FIRST USE 5-20-2008; IN COMMERCE 5-20-2008.

THE MARK CONSISTS OF STANDARD CHARACTERS WITHOUT CLAIM TO ANY PARTICULAR FONT, STYLE, SIZE, OR COLOR.

SN 78-944,834, FILED 8-4-2006.

C. DIONNE CLYBURN, EXAMINING ATTORNEY

Int. Cl.: 42

Prior U.S. Cls.: 100 and 101

United States Patent and Trademark Office

Reg. No. 3,478,283

Registered July 29, 2008

**SERVICE MARK
PRINCIPAL REGISTER**

TranscrIPts

SHARI MOSS (UNITED STATES INDIVIDUAL),
DBA SHARI MOSS & ASSOCIATES,
877 COWAN ROAD, SUITE A
BURLINGAME, CA 94010

FOR: COURT REPORTING; LITIGATION SUPPORT SERVICES; COURT REPORTING SERVICES VIA A GLOBAL COMMUNICATIONS NETWORK; LEGAL SUPPORT SERVICES, NAMELY, CONVERSION OF DOCUMENTS AND EXHIBITS FROM PHYSICAL TO ELECTRONIC MEDIA, IN CLASS 42 (U.S. CLS. 100 AND 101).

FIRST USE 3-1-2001; IN COMMERCE 3-1-2001.

NO CLAIM IS MADE TO THE EXCLUSIVE RIGHT TO USE "TRANSCRIPTS" AND "IP", APART FROM THE MARK AS SHOWN.

SN 78-945,650, FILED 8-4-2006.

G. MAYERSCHOFF, EXAMINING ATTORNEY

Int. Cl.: 28

Prior U.S. Cls.: 22, 23, 38, and 50

United States Patent and Trademark Office

Reg. No. 3,478,284

Registered July 29, 2008

**TRADEMARK
PRINCIPAL REGISTER**

MUSIC N MOTION

MOOSE MOUNTAIN TOYMAKERS LTD. (HONG
KONG CORPORATION)
UNIT 704-6, 7TH FLOOR ENERGY PLAZA
92 GRANVILLE ROAD TSIMSHATSUI EAST
KOWLOON, HONG KONG

FOR: TOYS, NAMELY, AN INFLATABLE CHILDREN'S PLAY STRUCTURE, IN CLASS 28 (U.S. CLS. 22, 23, 38 AND 50).

FIRST USE 11-23-2006; IN COMMERCE 11-23-2006.

THE MARK CONSISTS OF STANDARD CHARACTERS WITHOUT CLAIM TO ANY PARTICULAR FONT, STYLE, SIZE, OR COLOR.

OWNER OF U.S. REG. NO. 2,412,918.

NO CLAIM IS MADE TO THE EXCLUSIVE RIGHT TO USE "MUSIC", APART FROM THE MARK AS SHOWN.

SN 78-946,031, FILED 8-7-2006.

NANCY CLARKE, EXAMINING ATTORNEY

Int. Cl.: 3

Prior U.S. Cls.: 1, 4, 6, 50, 51, and 52

United States Patent and Trademark Office

Reg. No. 3,478,285

Registered July 29, 2008

TRADEMARK
PRINCIPAL REGISTER



GERMANTOWN DAY SPA, LLC (TENNESSEE
LTD LIAB CO)
SUITE 104
9030 POPLAR PIKE
MEMPHIS, TN 38138

FIRST USE 7-13-2006; IN COMMERCE 9-1-2006.

SN 78-947,778, FILED 8-8-2006.

FOR: COSMETICS, IN CLASS 3 (U.S. CLS. 1, 4, 6, 50,
51 AND 52).

APRIL ROACH, EXAMINING ATTORNEY

Int. Cl.: 35

Prior U.S. Cls.: 100, 101, and 102

United States Patent and Trademark Office

Reg. No. 3,478,286

Registered July 29, 2008

**SERVICE MARK
PRINCIPAL REGISTER**

Guard Dog Branding

CASINI, MARIA (UNITED STATES INDIVIDUAL)
16 KEVIN CT.
MALVERNE, NY 11565 AND
DESANTIS, CAMILLE (UNITED STATES INDIVIDUAL)
16 KEVIN CT.
MALVERNE, NY 11565

FOR: ADVERTISING, MARKETING, BRANDING, NAMELY, CREATING BRAND STRATEGIES AND BRAND IDENTITIES FOR COMPANIES AND PRODUCTS, AND PROMOTION SERVICES, IN CLASS 35 (U.S. CLS. 100, 101 AND 102).

FIRST USE 11-1-2007; IN COMMERCE 11-1-2007.

THE MARK CONSISTS OF STANDARD CHARACTERS WITHOUT CLAIM TO ANY PARTICULAR FONT, STYLE, SIZE, OR COLOR.

NO CLAIM IS MADE TO THE EXCLUSIVE RIGHT TO USE "BRANDING", APART FROM THE MARK AS SHOWN.

SN 78-947,801, FILED 8-8-2006.

DANIEL BRODY, EXAMINING ATTORNEY

Int. Cl.: 36

Prior U.S. Cls.: 100, 101, and 102

United States Patent and Trademark Office

Reg. No. 3,478,287

Registered July 29, 2008

**SERVICE MARK
PRINCIPAL REGISTER**

PROFITGLANCE

MONERIS SOLUTIONS CORPORATION (CANADA CORPORATION)
14TH FLOOR, EAST TOWER
3250 BLOOR STREET WEST
TORONTO, CANADA M8X 2X9

FOR: FINANCIAL REPORTING AND PORTFOLIO INFORMATION FOR BANKS AND MERCHANTS PROVIDED BY ELECTRONIC MEANS VIA ACCESS TO A GLOBAL COMPUTER NETWORK, IN CLASS 36 (U.S. CLS. 100, 101 AND 102).

FIRST USE 4-1-2008; IN COMMERCE 4-1-2008.

THE MARK CONSISTS OF STANDARD CHARACTERS WITHOUT CLAIM TO ANY PARTICULAR FONT, STYLE, SIZE, OR COLOR.

SN 78-948,065, FILED 8-9-2006.

DAWN FELDMAN, EXAMINING ATTORNEY

Int. Cl.: 30

Prior U.S. Cl.: 46

United States Patent and Trademark Office

Reg. No. 3,478,288

Registered July 29, 2008

**TRADEMARK
PRINCIPAL REGISTER**

KIDS FUN'N GUM BOOK

WM. WRIGLEY JR. COMPANY (DELAWARE
CORPORATION)

410 NORTH MICHIGAN AVENUE

CHICAGO, IL 60611

FOR: CONFECTIONERY, NAMELY, CHEWING
GUM, BUBBLE GUM, IN CLASS 30 (U.S. CL. 46).

FIRST USE 10-1-2006; IN COMMERCE 10-1-2006.

THE MARK CONSISTS OF STANDARD CHAR-
ACTERS WITHOUT CLAIM TO ANY PARTICULAR
FONT, STYLE, SIZE, OR COLOR.

NO CLAIM IS MADE TO THE EXCLUSIVE
RIGHT TO USE "GUM BOOK", APART FROM
THE MARK AS SHOWN.

SN 78-948,191, FILED 8-9-2006.

SARA THOMAS, EXAMINING ATTORNEY

Int. Cl.: 36

Prior U.S. Cls.: 100, 101, and 102

United States Patent and Trademark Office

Reg. No. 3,478,289

Registered July 29, 2008

SERVICE MARK
PRINCIPAL REGISTER

ALEXANDER & COMPANY
Insurance and Investment Brokers

ALEXANDER, DALE A. (GEORGIA CORPORATION)
291 HERITAGE WALK
WOODSTOCK, GA 30188

FOR: INSURANCE AND INVESTMENT
BROKERAGE IN THE FIELD OF HEALTH AND
WELFARE EMPLOYEE BENEFIT PROGRAMS, IN
CLASS 36 (U.S. CLS. 100, 101 AND 102).

FIRST USE 9-1-2006; IN COMMERCE 9-1-2006.

NO CLAIM IS MADE TO THE EXCLUSIVE
RIGHT TO USE "& COMPANY INSURANCE AND
INVESTMENT BROKERS", APART FROM THE
MARK AS SHOWN.

SN 78-948,585, FILED 8-9-2006.

ALLISON HOLTZ, EXAMINING ATTORNEY

Int. Cl.: 9

Prior U.S. Cls.: 21, 23, 26, 36, and 38

United States Patent and Trademark Office

Reg. No. 3,478,290

Registered July 29, 2008

**TRADEMARK
PRINCIPAL REGISTER**

PRECISION PILOT

BRUNSWICK CORPORATION (DELAWARE
CORPORATION)
ONE NORTH FIELD COURT
LAKE FOREST, IL 60045

FOR: COMPUTER HARDWARE AND SOFTWARE FOR USE IN PILOTING A MARINE VESSEL, IN CLASS 9 (U.S. CLS. 21, 23, 26, 36 AND 38).

FIRST USE 5-31-2008; IN COMMERCE 5-31-2008.

THE MARK CONSISTS OF STANDARD CHARACTERS WITHOUT CLAIM TO ANY PARTICULAR FONT, STYLE, SIZE, OR COLOR.

NO CLAIM IS MADE TO THE EXCLUSIVE RIGHT TO USE "PILOT", APART FROM THE MARK AS SHOWN.

SN 78-950,010, FILED 8-11-2006.

SETH A. RAPPAPORT, EXAMINING ATTORNEY

Int. Cl.: 42

Prior U.S. Cls.: 100 and 101

United States Patent and Trademark Office

Reg. No. 3,478,291

Registered July 29, 2008

**SERVICE MARK
PRINCIPAL REGISTER**



GREAT AMERICAN INSURANCE COMPANY
(OHIO CORPORATION)
580 WALNUT STREET
CINCINNATI, OH 45202

FOR: PROVIDING ONLINE NON-DOWNLOAD-
ABLE COMPUTER SOFTWARE FOR INSURANCE
AGENTS FOR ISSUING AND MAINTAINING IN-
SURANCE POLICIES AND PROCESSING INSUR-
ANCE POLICY BILLINGS AND CLAIMS, IN CLASS
42 (U.S. CLS. 100 AND 101).

FIRST USE 8-0-2006; IN COMMERCE 8-0-2006.

NO CLAIM IS MADE TO THE EXCLUSIVE
RIGHT TO USE "INTERFACE", APART FROM
THE MARK AS SHOWN.

THE MARK CONSISTS OF A ROAD-SIGN STYLE
LOGO CONTAINING THE WORDS "INTERFACE
360".

SN 78-951,431, FILED 8-14-2006.

LINDA LAVACHE, EXAMINING ATTORNEY

Int. Cl.: 25

Prior U.S. Cls.: 22 and 39

United States Patent and Trademark Office

Reg. No. 3,478,292

Registered July 29, 2008

**TRADEMARK
PRINCIPAL REGISTER**

STAG PONY

PIROZZI, CIRO (UNITED STATES INDIVIDUAL)
28609 GUNTER ROAD
RANCHO PALOS VERDES, CA 90275

FIRST USE 5-5-2008; IN COMMERCE 5-5-2008.

FOR: CLOTHING ITEMS, NAMELY, SWEATERS,
SHIRTS, T-SHIRTS, SWEATSHIRTS, SWEAT PANTS,
JERSEYS, PANTS, SHORTS, TANK TOPS, HATS,
CAPS, VISORS, JACKETS, SHOES, SANDALS, BEA-
NIES, UNDERWEAR , IN CLASS 25 (U.S. CLS. 22
AND 39).

THE MARK CONSISTS OF STANDARD CHAR-
ACTERS WITHOUT CLAIM TO ANY PARTICULAR
FONT, STYLE, SIZE, OR COLOR.

SN 78-951,860, FILED 8-14-2006.

GINA FINK, EXAMINING ATTORNEY

Int. Cl.: 25

Prior U.S. Cls.: 22 and 39

United States Patent and Trademark Office

Reg. No. 3,478,293

Registered July 29, 2008

**TRADEMARK
PRINCIPAL REGISTER**

STAG KITTY

PIROZZI, CIRO (UNITED STATES INDIVIDUAL)
28609 GUNTER ROAD
RANCHO PALOS VERDES, CA 90275

FIRST USE 5-5-2008; IN COMMERCE 5-5-2008.

FOR: CLOTHING ITEMS, NAMELY, SWEATERS,
SHIRTS, T-SHIRTS, SWEATSHIRTS, SWEAT PANTS,
JERSEYS, PANTS, SHORTS, TANK TOPS, HATS,
CAPS, VISORS, JACKETS, SHOES, SANDALS, BEA-
NIES, UNDERWEAR , IN CLASS 25 (U.S. CLS. 22
AND 39).

THE MARK CONSISTS OF STANDARD CHAR-
ACTERS WITHOUT CLAIM TO ANY PARTICULAR
FONT, STYLE, SIZE, OR COLOR.

SN 78-951,864, FILED 8-14-2006.

GINA FINK, EXAMINING ATTORNEY

Int. Cl.: 16

Prior U.S. Cls.: 2, 5, 22, 23, 29, 37, 38, and 50

Reg. No. 3,478,294

United States Patent and Trademark Office

Registered July 29, 2008

**TRADEMARK
PRINCIPAL REGISTER**

SMOTHERHOOD

GRIFFIN, AMANDA LAMB (UNITED STATES
INDIVIDUAL)
115 LOCHWOOD EAST
CARY, NC 27511

THE MARK CONSISTS OF STANDARD CHAR-
ACTERS WITHOUT CLAIM TO ANY PARTICULAR
FONT, STYLE, SIZE, OR COLOR.

FOR: BOOKS AND BOOKLETS IN THE FIELD OF
MOTHERHOOD, CHILD REARING, AND FAMILY
LIFE, IN CLASS 16 (U.S. CLS. 2, 5, 22, 23, 29, 37, 38
AND 50).

SN 78-953,313, FILED 8-16-2006.

FIRST USE 9-1-2007; IN COMMERCE 9-1-2007.

DAVID MILLER, EXAMINING ATTORNEY

Int. Cl.: 5

Prior U.S. Cls.: 6, 18, 44, 46, 51, and 52

United States Patent and Trademark Office

Reg. No. 3,478,295

Registered July 29, 2008

**TRADEMARK
PRINCIPAL REGISTER**

Sharp-PS

ENZYMOTEC LTD. (ISRAEL LTD LIAB CO)
HITAASIA 5 ST.
P.O. BOX 6
MIGDAL HAEMEQ, ISRAEL 23106

THE MARK CONSISTS OF STANDARD CHAR-
ACTERS WITHOUT CLAIM TO ANY PARTICULAR
FONT, STYLE, SIZE, OR COLOR.

FOR: DIETARY AND NUTRITIONAL SUPPLE-
MENTS, IN CLASS 5 (U.S. CLS. 6, 18, 44, 46, 51 AND
52).

SN 78-954,117, FILED 8-17-2006.

FIRST USE 10-26-2003; IN COMMERCE 10-26-2003.

ALYSSA PALADINO, EXAMINING ATTORNEY

Int. Cls.: 16 and 41

Prior U.S. Cls.: 2, 5, 22, 23, 29, 37, 38, 50, 100, 101, and 107

Reg. No. 3,478,296

United States Patent and Trademark Office

Registered July 29, 2008

**TRADEMARK
SERVICE MARK
PRINCIPAL REGISTER**

CIP

AMERICAN READING COMPANY (PENNSYLVANIA CORPORATION)
SUITE E
421 FEHELEY DRIVE
KING OF PRUSSIA, PA 19406

FOR: PRINTED EDUCATIONAL MATERIALS, NAMELY, PAMPLETS, INSTRUCTIONAL GUIDES, WORKSHEETS, LESSON PLANS; BOOKS; SKILL CARDS; FOLDERS, IN CLASS 16 (U.S. CLS. 2, 5, 22, 23, 29, 37, 38 AND 50).

FIRST USE 8-10-2006; IN COMMERCE 8-10-2006.

FOR: EDUCATIONAL SERVICES, NAMELY, CONDUCTING A READING PROGRAM FOR PRE-KINDERGARTEN THROUGH SECONDARY

SCHOOL STUDENTS AND CONDUCTING A PROGRAM FOR ASSESSING THE LEVEL OF DIFFICULTY OF BOOKS AS PART OF A READING PROGRAM, IN CLASS 41 (U.S. CLS. 100, 101 AND 107).

FIRST USE 6-0-2006; IN COMMERCE 6-0-2006.

THE MARK CONSISTS OF STANDARD CHARACTERS WITHOUT CLAIM TO ANY PARTICULAR FONT, STYLE, SIZE, OR COLOR.

SN 78-954,360, FILED 8-17-2006.

RAUL CORDOVA, EXAMINING ATTORNEY

Int. Cl.: 44

Prior U.S. Cls.: 100 and 101

United States Patent and Trademark Office

Reg. No. 3,478,297

Registered July 29, 2008

**SERVICE MARK
PRINCIPAL REGISTER**

EFEED

ST. JOSEPH'S REGIONAL MEDICAL CENTER
(NEW JERSEY NON-PROFIT CORPORATION)
703 MAIN STREET
PATERSON, NJ 07503

THE MARK CONSISTS OF STANDARD CHAR-
ACTERS WITHOUT CLAIM TO ANY PARTICULAR
FONT, STYLE, SIZE, OR COLOR.

FOR: MEDICAL SERVICES CONCERNING
TREATMENT FOR EATING DISABILITIES, IN
CLASS 44 (U.S. CLS. 100 AND 101).

SN 78-954,495, FILED 8-17-2006.

FIRST USE 1-14-2008; IN COMMERCE 5-1-2008.

MATTHEW PAPPAS, EXAMINING ATTORNEY

Int. Cl.: 7

Prior U.S. Cls.: 13, 19, 21, 23, 31, 34, and 35

Reg. No. 3,478,298

United States Patent and Trademark Office

Registered July 29, 2008

**TRADEMARK
PRINCIPAL REGISTER**

SHOPMASTER

BLACK & DECKER CORPORATION, THE
(MARYLAND CORPORATION)

TW 199

701 E. JOPPA ROAD
TOWSON, MD 21286

FOR: POWER OPERATED TOOLS AND MACHINES, NAMELY, MITER SAW AND MITER SAW STAND, TABLE SAW, DRILL PRESS, BAND SAW, COMBINATION BELT/DISC SANDER, AND SCROLL SAW, IN CLASS 7 (U.S. CLS. 13, 19, 21, 23, 31, 34 AND 35).

FIRST USE 8-31-2002; IN COMMERCE 8-31-2002.

THE MARK CONSISTS OF STANDARD CHARACTERS WITHOUT CLAIM TO ANY PARTICULAR FONT, STYLE, SIZE, OR COLOR.

SN 78-955,054, FILED 8-18-2006.

KRISTIN DAHLING, EXAMINING ATTORNEY

Int. Cl.: 12

Prior U.S. Cls.: 19, 21, 23, 31, 35, and 44

Reg. No. 3,478,299

United States Patent and Trademark Office

Registered July 29, 2008

**TRADEMARK
PRINCIPAL REGISTER**



TRIANGLE SUSPENSION SYSTEMS, INC. (DE-
LAWARE CORPORATION)

P.O. BOX 425

200 EAST MALONEY ROAD

DUBOIS, PA 15801

FOR: PARTS FOR BRAKES AND AXLES FOR TRUCKS, TRACTORS, TRAILERS, BUSES, NAME-
LY, BRAKE SHOES, BRAKE SHOE ADAPTERS,
BRAKE SHOE REPAIR KITS, BRAKE CAM SHAFTS,
BRAKE SPIDER ASSEMBLIES, BRAKE SPIDERS
AND FLANGE MOUNTING KITS, BRAKE FLAN-
GES, CAM SHAFT BUSHINGS AND BEARINGS
FOR BRAKE SPIDERS AND SUPPORTING BRACK-
ETS, BRAKE SHOE ROLLER PIN AND ANCHOR
PIN LOCKS, BRAKE CAM SHAFT FELTS, BRAKE
SHOE ANCHOR PINS, BRAKE SHOE WEAR
PLATES, BRAKE SHOE ROLLERS, BRAKE SHOE
BUSHINGS, BRAKE SHOE SLACK ADJUSTERS,
BRAKE SHOE ROLLERS, BRAKE SHOE BUSHINGS,
BRAKE SHOE ADJUSTERS, BRAKE SHOE RE-
TURN SPRINGS, AXLE AND ECCENTRIC AN-
CHOR PIN NUTS, AXLE WASHERS, ROD PARTS,

RADIUS ROD BUSHINGS, TRUNNION SHAFT
BUSHINGS, TORQUE ARM BUSHINGS, EQUALI-
ZER BEARINGS; FIFTH WHEEL PARTS, NAME-
LY, TRAILER KING PINS AND KING PIN LOCKS;
DUST SHIELDS, LANDING GEAR WHEELS, AND
LANDING GEAR CRANKS, IN CLASS 12 (U.S. CLS.
19, 21, 23, 31, 35 AND 44).

FIRST USE 9-0-2006; IN COMMERCE 9-0-2006.

OWNER OF U.S. REG. NOS. 887,389 AND 1,016,061.

NO CLAIM IS MADE TO THE EXCLUSIVE
RIGHT TO USE "BRAKE & WHEEL PARTS", APART
FROM THE MARK AS SHOWN.

THE MARK CONSISTS OF TWO SWISHES ABOVE
THE WORD, "LELAND".

SN 78-955,352, FILED 8-18-2006.

EVELYN BRADLEY, EXAMINING ATTORNEY

Int. Cl.: 1

Prior U.S. Cls.: 1, 5, 6, 10, 26, and 46

Reg. No. 3,478,300

United States Patent and Trademark Office

Registered July 29, 2008

**TRADEMARK
PRINCIPAL REGISTER**

GOLDEN INNOVATIONS

GOLDEN GATE ANCILLARY LLC (DELAWARE
LTD LIAB CO)
1000 BEVERLY WAY
FORT SMITH, AR 72919

THE MARK CONSISTS OF STANDARD CHAR-
ACTERS WITHOUT CLAIM TO ANY PARTICULAR
FONT, STYLE, SIZE, OR COLOR.

FOR: HEALTH CARE SERVICES, IN CLASS 1 (U.S.
CLS. 1, 5, 6, 10, 26 AND 46).

SN 78-956,186, FILED 8-21-2006.

FIRST USE 9-1-2006; IN COMMERCE 9-1-2006.

CHRIS WELLS, EXAMINING ATTORNEY

Int. Cl.: 43

Prior U.S. Cls.: 100 and 101

United States Patent and Trademark Office

Reg. No. 3,478,301

Registered July 29, 2008

**SERVICE MARK
PRINCIPAL REGISTER**

Sphere

HARRAH'S LICENSE COMPANY, LLC (NEVADA
LTD LIAB CO)
ONE HARRAH'S COURT
LAS VEGAS, NV 89119

THE MARK CONSISTS OF STANDARD CHAR-
ACTERS WITHOUT CLAIM TO ANY PARTICULAR
FONT, STYLE, SIZE, OR COLOR.

FOR: BAR SERVICES, IN CLASS 43 (U.S. CLS. 100
AND 101).

SN 78-956,361, FILED 8-21-2006.

FIRST USE 4-21-2008; IN COMMERCE 4-21-2008.

GRETTA YAO, EXAMINING ATTORNEY

Int. Cl.: 9

Prior U.S. Cls.: 21, 23, 26, 36, and 38

Reg. No. 3,478,302

United States Patent and Trademark Office

Registered July 29, 2008

**TRADEMARK
PRINCIPAL REGISTER**

Nano eNabler

BIOFORCE NANOSCIENCES, INC. (DELAWARE CORPORATION)
SUITE 101
1615 GOLDEN ASPEN DRIVE
AMES, IA 50010

FOR: SCIENTIFIC AND/OR LABORATORY EQUIPMENT AND AUTOMATED LIQUID HANDLING APPARATUS, NAMELY A FEMTOLITER FLUID-DISPENSING UNIT APPLYING SAMPLE FLUIDS TO THE SURFACES OF TREATED SUBSTRATES, IN CLASS 9 (U.S. CLS. 21, 23, 26, 36 AND 38).

FIRST USE 8-14-2006; IN COMMERCE 8-14-2006.

THE MARK CONSISTS OF STANDARD CHARACTERS WITHOUT CLAIM TO ANY PARTICULAR FONT, STYLE, SIZE, OR COLOR.

NO CLAIM IS MADE TO THE EXCLUSIVE RIGHT TO USE "NANO", APART FROM THE MARK AS SHOWN.

SN 78-956,480, FILED 8-21-2006.

JORDAN BAKER, EXAMINING ATTORNEY

Int. Cls.: 25 and 26

Prior U.S. Cls.: 22, 37, 39, 40, 42, and 50

United States Patent and Trademark Office

Reg. No. 3,478,303

Registered July 29, 2008

**TRADEMARK
PRINCIPAL REGISTER**

LAUGHLIN 2007

DAL-CON PROMOTIONS, INC. (CALIFORNIA CORPORATION)
SUITE 141
16 TECHNOLOGY DRIVE
IRVINE, CA 92618

FOR: WEARING APPAREL, NAMELY, T-SHIRTS, SWEATSHIRTS, TANK TOPS, WOVEN SHIRTS, SWEATERS, CARDIGANS, VESTS, JACKETS, PANTS, SWEATPANTS, SHORTS, SKIRTS, DRESSES, BLOUSES, COATS, BELTS, AND UNDERWEAR; HEADWEAR, NAMELY, HATS AND CAPS; FOOTWEAR, NAMELY, SHOES, BOOTS, AND SNEAKERS, IN CLASS 25 (U.S. CLS. 22 AND 39).

FIRST USE 4-21-2007; IN COMMERCE 4-21-2007.

FOR: LACE TRIMMING; EMBROIDERED PATCHES FOR CLOTHING; PATCHES, BADGES, PINS AND BUTTONS FOR CLOTHING; BELT CLASPS, BROOCHES AS ACCESSORIES, NOT OF PRECIOUS METAL AND NOT AS IMITATION JEWELRY; CLOTHING BUCKLES; AND PRIZE RIBBONS, IN CLASS 26 (U.S. CLS. 37, 39, 40, 42 AND 50).

FIRST USE 4-21-2007; IN COMMERCE 4-21-2007.

THE MARK CONSISTS OF STANDARD CHARACTERS WITHOUT CLAIM TO ANY PARTICULAR FONT, STYLE, SIZE, OR COLOR.

OWNER OF U.S. REG. NOS. 1,739,923, 2,911,576, AND OTHERS.

NO CLAIM IS MADE TO THE EXCLUSIVE RIGHT TO USE "2007", APART FROM THE MARK AS SHOWN.

SEC. 2(F) AS TO "LAUGHLIN".

SN 78-956,883, FILED 8-21-2006.

REBECCA POVARCHUK, EXAMINING ATTORNEY

Int. Cl.: 3

Prior U.S. Cls.: 1, 4, 6, 50, 51, and 52

Reg. No. 3,478,304

United States Patent and Trademark Office

Registered July 29, 2008

**TRADEMARK
PRINCIPAL REGISTER**

SuperSmooth

PUREOLOGY RESEARCH LLC (DELAWARE
LTD LIAB CO)
575 FIFTH AVENUE
NEW YORK, NY 10017

THE MARK CONSISTS OF STANDARD CHAR-
ACTERS WITHOUT CLAIM TO ANY PARTICULAR
FONT, STYLE, SIZE, OR COLOR.

FOR: HAIR CARE PRODUCTS, NAMELY, SPRAY
GEL, IN CLASS 3 (U.S. CLS. 1, 4, 6, 50, 51 AND 52).

SN 78-957,078, FILED 8-21-2006.

FIRST USE 6-0-2007; IN COMMERCE 6-0-2007.

TOBY BULLOFF, EXAMINING ATTORNEY

Int. Cl.: 20

Prior U.S. Cls.: 2, 13, 22, 25, 32, and 50

United States Patent and Trademark Office

Reg. No. 3,478,305

Registered July 29, 2008

**TRADEMARK
PRINCIPAL REGISTER**

DICK IDOL LEGENDS

RWG LICENSING, LLC (NORTH CAROLINA
LTD LIAB CO)
115 SOUTH MAIN STREET
LEXINGTON, NC 27292

FOR: FURNITURE; PILLOWS; DECORATIVE
PILLOWS; BED PILLOWS, IN CLASS 20 (U.S. CLS.
2, 13, 22, 25, 32 AND 50).

FIRST USE 2-21-2007; IN COMMERCE 2-21-2007.

THE MARK CONSISTS OF STANDARD CHAR-
ACTERS WITHOUT CLAIM TO ANY PARTICULAR
FONT, STYLE, SIZE, OR COLOR.

OWNER OF U.S. REG. NO. 2,926,604.

THE NAME(S), PORTRAIT(S), AND/OR SIGNA-
TURE(S) SHOWN IN THE MARK IDENTIFIES
"DICK IDOL", WHOSE CONSENT(S) TO REGISTER
IS SUBMITTED.

SN 78-957,231, FILED 8-22-2006.

RAUL CORDOVA, EXAMINING ATTORNEY

Int. Cl.: 16

Prior U.S. Cls.: 2, 5, 22, 23, 29, 37, 38, and 50

Reg. No. 3,478,306

United States Patent and Trademark Office

Registered July 29, 2008

**TRADEMARK
PRINCIPAL REGISTER**



The Talking Phone Book

HEARST HOLDINGS, INC. (DELAWARE CORPORATION)
959 EIGHTH AVENUE
NEW YORK, NY 10019

FOR: TELEPHONE DIRECTORIES, IN CLASS 16
(U.S. CLS. 2, 5, 22, 23, 29, 37, 38 AND 50).

FIRST USE 1-1-2008; IN COMMERCE 1-1-2008.

OWNER OF U.S. REG. NOS. 1,996,500 AND
2,425,974.

NO CLAIM IS MADE TO THE EXCLUSIVE
RIGHT TO USE "PHONE BOOK" AND THE REPRESENTATION OF THE WALKING FINGERS LOGO,
APART FROM THE MARK AS SHOWN.

SEC. 2(F).

SN 78-958,243, FILED 8-23-2006.

DAYNA BROWNE, EXAMINING ATTORNEY

Int. Cl.: 23

Prior U.S. Cl.: 43

United States Patent and Trademark Office

Reg. No. 3,478,307

Registered July 29, 2008

**TRADEMARK
PRINCIPAL REGISTER**

INTIMA SOFT

AMERICAN & EFIRD ENTERPRISES, INC.
(NORTH CAROLINA CORPORATION)
22 AMERICAN STREET
MOUNT HOLLY, NC 28120

NO CLAIM IS MADE TO THE EXCLUSIVE
RIGHT TO USE "SOFT", APART FROM THE MARK
AS SHOWN.

FOR: THREAD, IN CLASS 23 (U.S. CL. 43).

SN 78-959,724, FILED 8-24-2006.

FIRST USE 8-0-2007; IN COMMERCE 8-0-2007.

THE MARK CONSISTS OF STANDARD CHAR-
ACTERS WITHOUT CLAIM TO ANY PARTICULAR
FONT, STYLE, SIZE, OR COLOR.

ALEXANDER L. POWERS, EXAMINING ATTOR-
NEY

Int. Cls.: 9, 35, and 41

Prior U.S. Cls.: 21, 23, 26, 36, 38, 100, 101, 102, and 107

Reg. No. 3,478,308

United States Patent and Trademark Office

Registered July 29, 2008

**TRADEMARK
SERVICE MARK
PRINCIPAL REGISTER**



**The Campaign for
Love & Forgiveness**

THE JOHN E. FETZER INSTITUTE, INC. (MICHIGAN NON-PROFIT CORPORATION)
9292 W. KL AVE.
KALAMAZOO, MI 49009

FOR: MOTION PICTURE FILMS EXPLORING THE IMPROVEMENT OF THE LIVES OF INDIVIDUALS AND COMMUNITIES; PRERECORDED DVDS IN THE FIELD OF EXPLORING THE IMPROVEMENT OF THE LIVES OF INDIVIDUALS AND COMMUNITIES, IN CLASS 9 (U.S. CLS. 21, 23, 26, 36 AND 38).

FIRST USE 3-14-2008; IN COMMERCE 3-14-2008.

FOR: PROMOTING PUBLIC AWARENESS OF IMPROVING THE LIVES OF INDIVIDUALS AND COMMUNITIES AND DISSEMINATION OF ADVERTISING MATERIALS RELATED THERETO; AND ONLINE DISTRIBUTORSHIPS OF MOTION PICTURE FILMS, WRITTEN ARTICLES, BOOKS AND NEWSLETTERS IN THE FIELD OF IMPROVING THE LIVES OF INDIVIDUALS AND IMPROVING COMMUNITIES, IN CLASS 35 (U.S. CLS. 100, 101 AND 102).

FIRST USE 12-31-2007; IN COMMERCE 12-31-2007.

FOR: MOTION PICTURE FILM PRODUCTION AND DISTRIBUTION; PUBLICATION OF BOOKS AND NEWSLETTERS IN THE FIELD OF IMPROVING THE LIVES OF INDIVIDUALS AND IMPROVING COMMUNITIES; AND PRODUCTION OF VIDEO DISKS IN THE FIELD OF IMPROVING THE LIVES OF INDIVIDUALS AND IMPROVING COMMUNITIES; EDUCATIONAL GRASSROOTS SERVICES, NAMELY, CONDUCTING CONFERENCES, CLASSES, SEMINARS AND PROGRAMS IN THE FIELD OF IMPROVING THE LIVES OF INDIVIDUALS AND IMPROVING COMMUNITIES, IN CLASS 41 (U.S. CLS. 100, 101 AND 107).

FIRST USE 3-14-2008; IN COMMERCE 3-14-2008.

NO CLAIM IS MADE TO THE EXCLUSIVE RIGHT TO USE "CAMPAIGN", APART FROM THE MARK AS SHOWN.

SN 78-961,730, FILED 8-28-2006.

WILLIAM VERHOSEK, EXAMINING ATTORNEY

Int. Cl.: 36

Prior U.S. Cls.: 100, 101, and 102

United States Patent and Trademark Office

Reg. No. 3,478,309

Registered July 29, 2008

**SERVICE MARK
PRINCIPAL REGISTER**

Yield Hog

ZACKS INVESETMENT RESEARCH (ILLINOIS
CORPORATION)
SUITE 1001
111 N CANAL ST
CHICAGO, IL 60606

THE MARK CONSISTS OF STANDARD CHAR-
ACTERS WITHOUT CLAIM TO ANY PARTICULAR
FONT, STYLE, SIZE, OR COLOR.

FOR: FINANCIAL SERVICES IN THE NATURE
OF AN INVESTMENT SECURITY, IN CLASS 36 (U.S.
CLS. 100, 101 AND 102).

SN 78-962,025, FILED 8-28-2006.

FIRST USE 5-26-2006; IN COMMERCE 5-26-2006.

MARK T. MULLEN, EXAMINING ATTORNEY

Int. Cl.: 16

Prior U.S. Cls.: 2, 5, 22, 23, 29, 37, 38, and 50

United States Patent and Trademark Office

Reg. No. 3,478,310

Registered July 29, 2008

**TRADEMARK
PRINCIPAL REGISTER**

*StoryBook
Studio*

STORYBOOK STUDIO (NEW JERSEY SOLE PROPRIETORSHIP)
79 FOREST STREET
WEST LONG BRANCH, NJ 07764

FIRST USE 1-1-2007; IN COMMERCE 2-15-2007.

SN 78-963,661, FILED 8-30-2006.

FOR: ARTS AND CRAFT PAINT KITS, IN CLASS
16 (U.S. CLS. 2, 5, 22, 23, 29, 37, 38 AND 50).

RAMONA ORTIGA, EXAMINING ATTORNEY

Int. Cls.: 16 and 44

Prior U.S. Cls.: 2, 5, 22, 23, 29, 37, 38, 50, 100, and 101

Reg. No. 3,478,311

United States Patent and Trademark Office

Registered July 29, 2008

**TRADEMARK
SERVICE MARK
PRINCIPAL REGISTER**

THE KNEE WOMEN ARE TALKING
ABOUT

ZIMMER TECHNOLOGY, INC. (DELAWARE
CORPORATION)
345 EAST MAIN STREET
WARSAW, IN 46580

VIA TELEVISION AND THE DISTRIBUTION OF
PRINTED MATERIALS, IN CLASS 44 (U.S. CLS. 100
AND 101).

FOR: PRINTED MATERIALS, NAMELY, BRO-
CHURES, PAMPHLETS AND OTHER PRINTED
INSTRUCTIONAL, EDUCATIONAL AND TEACH-
ING MATERIALS FEATURING INFORMATION IN
THE FIELD OF KNEE SURGERY, IN CLASS 16 (U.S.
CLS. 2, 5, 22, 23, 29, 37, 38 AND 50).

FIRST USE 10-0-2006; IN COMMERCE 10-0-2006.

THE MARK CONSISTS OF STANDARD CHAR-
ACTERS WITHOUT CLAIM TO ANY PARTICULAR
FONT, STYLE, SIZE, OR COLOR.

FIRST USE 10-0-2006; IN COMMERCE 10-0-2006.

SN 78-964,091, FILED 8-30-2006.

FOR: PROVIDING MEDICAL INFORMATION
ON THE SUBJECT OF ORTHOPEDIC SURGERY

CURTIS FRENCH, EXAMINING ATTORNEY

Int. Cls.: 25 and 28

Prior U.S. Cls.: 22, 23, 38, 39, and 50

United States Patent and Trademark Office

Reg. No. 3,478,312

Registered July 29, 2008

**TRADEMARK
PRINCIPAL REGISTER**

GAN CRAFT

HIRAIWA, TAKANORI (JAPAN INDIVIDUAL)
21-1, HOURAICHO, TANABE-SHI,
WAKAYAMA, JAPAN

FOR: CLOTHING, NAMELY SWEATERS,
SHIRTS, TROUSERS, RAIN COATS, WADERS AND
HEADGEAR, NAMELY, HATS AND CAPS, IN
CLASS 25 (U.S. CLS. 22 AND 39).

FIRST USE 10-1-1999; IN COMMERCE 11-1-2007.

FOR: FISHING TACKLE, IN CLASS 28 (U.S. CLS.
22, 23, 38 AND 50).

FIRST USE 10-1-1999; IN COMMERCE 11-1-2007.

THE MARK CONSISTS OF STANDARD CHAR-
ACTERS WITHOUT CLAIM TO ANY PARTICULAR
FONT, STYLE, SIZE, OR COLOR.

SN 78-964,810, FILED 8-31-2006.

PRISCILLA MILTON, EXAMINING ATTORNEY

Int. Cl.: 28

Prior U.S. Cls.: 22, 23, 38, and 50

United States Patent and Trademark Office

Reg. No. 3,478,313

Registered July 29, 2008

**TRADEMARK
PRINCIPAL REGISTER**

MIGHTY PENS

WILD PLANET ENTERTAINMENT, INC. (CALI-
FORNIA CORPORATION)
13TH FLOOR
225 BUSH STREET
SAN FRANCISCO, CA 94104

FOR: ACTION TOYS CONVERTIBLE INTO WRIT-
ING PENS, IN CLASS 28 (U.S. CLS. 22, 23, 38 AND 50).

FIRST USE 12-0-2006; IN COMMERCE 12-0-2006.

THE MARK CONSISTS OF STANDARD CHAR-
ACTERS WITHOUT CLAIM TO ANY PARTICULAR
FONT, STYLE, SIZE, OR COLOR.

NO CLAIM IS MADE TO THE EXCLUSIVE
RIGHT TO USE "PENS", APART FROM THE MARK
AS SHOWN.

SN 78-965,446, FILED 8-31-2006.

SALLY SHIH, EXAMINING ATTORNEY

Int. Cls.: 10 and 28

Prior U.S. Cls.: 22, 23, 26, 38, 39, 44, and 50

United States Patent and Trademark Office

Reg. No. 3,478,314

Registered July 29, 2008

**TRADEMARK
PRINCIPAL REGISTER**

BMR

BIO-MEDICAL RESEARCH LIMITED (IRELAND
CORPORATION)
BMR HOUSE
PARKMORE BUSINESS PARK WEST
GALWAY, IRELAND

FOR: ELECTRICAL APPARATUS AND INSTRUMENTS, NAMELY, VIBRATING APPARATUS USED TO STIMULATE MUSCLES AND INCREASE TONE, STRENGTH AND PHYSICAL PERFORMANCE FOR HEALTH AND MEDICAL PURPOSES, IN CLASS 10 (U.S. CLS. 26, 39 AND 44).

FIRST USE 10-15-2007; IN COMMERCE 10-15-2007.

FOR: BODY TRAINING APPARATUS, NAMELY, APPARATUS FOR THE STRENGTHENING AND TONING OF MUSCLES INCLUDING ABDOMINAL MUSCLES, IN CLASS 28 (U.S. CLS. 22, 23, 38 AND 50).

FIRST USE 10-15-2007; IN COMMERCE 10-15-2007.

THE MARK CONSISTS OF STANDARD CHARACTERS WITHOUT CLAIM TO ANY PARTICULAR FONT, STYLE, SIZE, OR COLOR.

SN 78-965,724, FILED 9-1-2006.

REBECCA GILBERT, EXAMINING ATTORNEY

Int. Cl.: 41

Prior U.S. Cls.: 100, 101, and 107

United States Patent and Trademark Office

Reg. No. 3,478,315

Registered July 29, 2008

**SERVICE MARK
PRINCIPAL REGISTER**

Strongox

STRONGOX INC. (OKLAHOMA CORPORATION)
PO BOX 1333
CHOCTAW, OK 73020

FOR: EDUCATING AT SENIOR HIGH SCHOOLS;
EDUCATING AT UNIVERSITY OR COLLEGES;
EDUCATION IN THE FIELD OF SELF PROTECTION
RENDERED THROUGH CORRESPONDENCE
COURSES; EDUCATIONAL SERVICES,
NAMELY, PROVIDING COURSES OF INSTRUCTION
AT THE COLLEGE LEVEL AND DISTRIBUTION
OF COURSE MATERIAL IN CONNECTION
THEREWITH; EDUCATIONAL SERVICES, NAMELY,
CONDUCTING CLASSES IN THE FIELD OF

INVESTIGATIONS; PHYSICAL EDUCATION SERVICES;
VOCATIONAL EDUCATION IN THE FIELDS OF
HYPNOSIS AND SELF PROTECTION, IN CLASS 41
(U.S. CLS. 100, 101 AND 107).

FIRST USE 5-1-2008; IN COMMERCE 5-1-2008.

THE MARK CONSISTS OF STANDARD CHARACTERS
WITHOUT CLAIM TO ANY PARTICULAR FONT,
STYLE, SIZE, OR COLOR.

SN 78-966,982, FILED 9-5-2006.

TIMOTHY FINNEGAN, EXAMINING ATTORNEY

Int. Cl.: 9

Prior U.S. Cls.: 21, 23, 26, 36, and 38

United States Patent and Trademark Office

Reg. No. 3,478,316

Registered July 29, 2008

TRADEMARK
PRINCIPAL REGISTER



GOGIFT, LLC (CALIFORNIA LTD LIAB CO)
10760 BOUCHET WAY
RANCHO CORDOVA, CA 95670

FOR: MAGNETICALLY ENCODED CREDIT
CARDS, IN CLASS 9 (U.S. CLS. 21, 23, 26, 36 AND 38).

FIRST USE 6-15-2006; IN COMMERCE 1-8-2007.

THE COLOR(S) DARK BLUE (3025C) AND GREY
(430C) IS/ARE CLAIMED AS A FEATURE OF THE
MARK.

THE MARK CONSISTS OF A STYLIZED GREY
RIBBON WITH A DARK BLUE OVAL IN ITS
CENTER. THE DARK BLUE WORDING "GOGIFT"
APPEARS ABOVE THE RIBBON, AND THE GREY
WORDING "SIMPLY TASTEFUL" APPEARS BE-
LOW THE RIBBON IN A STYLIZED FONT.

SN 78-967,443, FILED 9-5-2006.

SONYA STEPHENS, EXAMINING ATTORNEY

Int. Cl.: 5

Prior U.S. Cls.: 6, 18, 44, 46, 51, and 52

United States Patent and Trademark Office

Reg. No. 3,478,317

Registered July 29, 2008

**TRADEMARK
PRINCIPAL REGISTER**

JIGSAW

JIGSAW HEALTH, LLC (ARIZONA LTD LIAB
CO)
15863 N. GREENWAY-HAYDEN LOOP, STE. 120
SCOTTSDALE, AZ 85260

FOR: DIETARY AND NUTRITIONAL SUPPLE-
MENTS, IN CLASS 5 (U.S. CLS. 6, 18, 44, 46, 51 AND
52).

FIRST USE 1-5-2007; IN COMMERCE 1-5-2007.

THE MARK CONSISTS OF STANDARD CHAR-
ACTERS WITHOUT CLAIM TO ANY PARTICULAR
FONT, STYLE, SIZE, OR COLOR.

OWNER OF U.S. REG. NO. 3,175,134.

SN 78-967,801, FILED 9-6-2006.

TASHIA BUNCH, EXAMINING ATTORNEY

Int. Cl.: 10

Prior U.S. Cls.: 26, 39, and 44

United States Patent and Trademark Office

Reg. No. 3,478,318

Registered July 29, 2008

**TRADEMARK
PRINCIPAL REGISTER**



DIRECT SUPPLY, INC. (WISCONSIN CORPORATION)

6767 NORTH INDUSTRIAL ROAD
MILWAUKEE, WI 53223

FOR: AIR-FILLED MATTRESSES FOR MEDICAL PURPOSES, IN CLASS 10 (U.S. CLS. 26, 39 AND 44).

FIRST USE 1-1-2005; IN COMMERCE 1-1-2005.

OWNER OF U.S. REG. NOS. 2,681,110, 2,844,206, AND OTHERS.

THE WORDING "PANACEA" OR "DIRECT SUPPLY" HAS NO MEANING IN A FOREIGN LANGUAGE.

SN 78-968,211, FILED 9-6-2006.

JENNIFER VASQUEZ, EXAMINING ATTORNEY

Int. Cl.: 33

Prior U.S. Cls.: 47 and 49

United States Patent and Trademark Office

Reg. No. 3,478,319

Registered July 29, 2008

**TRADEMARK
PRINCIPAL REGISTER**

KNIGHTS BRIDGE

BAILEY FAMILY VINEYARDS, LLC (CALIFOR-
NIA LTD LIAB CO)
100 SUMMER STREET
BOSTON, MA 02110

THE MARK CONSISTS OF STANDARD CHAR-
ACTERS WITHOUT CLAIM TO ANY PARTICULAR
FONT, STYLE, SIZE, OR COLOR.

FOR: WINE, IN CLASS 33 (U.S. CLS. 47 AND 49).

SN 78-968,929, FILED 9-7-2006.

FIRST USE 5-21-2008; IN COMMERCE 5-21-2008.

SUSAN STIGLITZ, EXAMINING ATTORNEY

Int. Cl.: 3

Prior U.S. Cls.: 1, 4, 6, 50, 51, and 52

Reg. No. 3,478,320

United States Patent and Trademark Office

Registered July 29, 2008

**TRADEMARK
PRINCIPAL REGISTER**

ZAGAZ

INDUSTRIA LA POPULAR, S.A. (GUATEMALA
CORPORATION)
VIA 3 5-42 ZONA 4
GUATEMALA CITY, GUATEMALA

THE MARK CONSISTS OF STANDARD CHAR-
ACTERS WITHOUT CLAIM TO ANY PARTICULAR
FONT, STYLE, SIZE, OR COLOR.

FOR: SOAPS AND DETERGENTS, IN CLASS 3
(U.S. CLS. 1, 4, 6, 50, 51 AND 52).

SN 78-971,388, FILED 9-11-2006.

FIRST USE 6-1-2003; IN COMMERCE 5-13-2008.

SANJEEV VOHRA, EXAMINING ATTORNEY

Int. Cl.: 9

Prior U.S. Cls.: 21, 23, 26, 36, and 38

United States Patent and Trademark Office

Reg. No. 3,478,321

Registered July 29, 2008

**TRADEMARK
PRINCIPAL REGISTER**

THE CLUB

KABUSHIKI KAISHA SEGA (JAPAN CORPORATION), DBA SEGA CORPORATION,
2-12, HANEDA 1-CHOME
OHTA-KU, TOKYO, JAPAN

FOR: VIDEO GAME SOFTWARE, COMPUTER
GAME PROGRAMS, IN CLASS 9 (U.S. CLS. 21, 23, 26,
36 AND 38).

FIRST USE 2-19-2008; IN COMMERCE 2-19-2008.

THE MARK CONSISTS OF STANDARD CHARACTERS WITHOUT CLAIM TO ANY PARTICULAR FONT, STYLE, SIZE, OR COLOR.

SN 78-971,683, FILED 9-11-2006.

KARANENDRA S. CHHINA, EXAMINING ATTORNEY

Int. Cls.: 37, 40, and 42

Prior U.S. Cls.: 100, 101, 103, and 106

United States Patent and Trademark Office

Reg. No. 3,478,322

Registered July 29, 2008

**SERVICE MARK
PRINCIPAL REGISTER**

INTERFACEFLOR

INTERFACE, INC. (GEORGIA CORPORATION)
SUITE 2000
2859 PACES FERRY ROAD
ATLANTA, GA 30339

FOR: INSTALLATION AND MAINTENANCE OF
CARPET, IN CLASS 37 (U.S. CLS. 100, 103 AND 106).

FIRST USE 3-15-2003; IN COMMERCE 3-15-2003.

FOR: RECYCLING, RECONDITIONING, RECLA-
MATION SERVICES RELATED TO CARPET TILES
AND FLOOR COVERINGS, IN CLASS 40 (U.S. CLS.
100, 103 AND 106).

FIRST USE 3-15-2003; IN COMMERCE 3-15-2003.

FOR: DESIGN OF CARPET FOR OTHERS, IN
CLASS 42 (U.S. CLS. 100 AND 101).

FIRST USE 3-15-2003; IN COMMERCE 3-15-2003.

THE MARK CONSISTS OF STANDARD CHAR-
ACTERS WITHOUT CLAIM TO ANY PARTICULAR
FONT, STYLE, SIZE, OR COLOR.

SN 78-972,096, FILED 9-12-2006.

ATTIYA MALIK, EXAMINING ATTORNEY

Int. Cl.: 41

Prior U.S. Cls.: 100, 101, and 107

United States Patent and Trademark Office

Reg. No. 3,478,323

Registered July 29, 2008

**SERVICE MARK
PRINCIPAL REGISTER**

FAUX ROCKS

CEC HOLDINGS I, INC. (DELAWARE CORPORATION)
SUITE 600
2895 GREENSPOINT PARKWAY
HOFFMAN ESTATES, IL 60195

THE MARK CONSISTS OF STANDARD CHARACTERS WITHOUT CLAIM TO ANY PARTICULAR FONT, STYLE, SIZE, OR COLOR.

FOR: ARRANGING AND CONDUCTING FASHION EXHIBITIONS, IN CLASS 41 (U.S. CLS. 100, 101 AND 107).

SN 78-972,458, FILED 9-12-2006.

FIRST USE 11-1-2006; IN COMMERCE 11-1-2006.

DEIRDRE ROBERTSON, EXAMINING ATTORNEY

Int. Cls.: 9 and 28

Prior U.S. Cls.: 21, 22, 23, 26, 36, 38, and 50

United States Patent and Trademark Office

Reg. No. 3,478,324

Registered July 29, 2008

**TRADEMARK
PRINCIPAL REGISTER**

PURSE PALS

WILD PLANET ENTERTAINMENT, INC. (CALIFORNIA CORPORATION)

13TH FLOOR

225 BUSH STREET

SAN FRANCISCO, CA 94104

FOR: HANDHELD ELECTRONIC DEVICES FOR INTERACTIVE PLAY WITH MINIATURE DOLLS, IN CLASS 9 (U.S. CLS. 21, 23, 26, 36 AND 38).

FIRST USE 2-0-2007; IN COMMERCE 2-0-2007.

FOR: MINIATURE DOLL PLAYSETS WITH INTERACTIVE ELECTRONIC FEATURES, IN CLASS 28 (U.S. CLS. 22, 23, 38 AND 50).

FIRST USE 2-0-2007; IN COMMERCE 2-0-2007.

THE MARK CONSISTS OF STANDARD CHARACTERS WITHOUT CLAIM TO ANY PARTICULAR FONT, STYLE, SIZE, OR COLOR.

SN 78-972,553, FILED 9-12-2006.

SALLY SHIH, EXAMINING ATTORNEY

Int. Cl.: 9

Prior U.S. Cls.: 21, 23, 26, 36, and 38

United States Patent and Trademark Office

Reg. No. 3,478,325

Registered July 29, 2008

**TRADEMARK
PRINCIPAL REGISTER**

ODYSSEY DIGITAL FORENSICS

BASIS TECHNOLOGY CORPORATION (DELA-
WARE CORPORATION)
ONE ALEWIFE CENTER
CAMBRIDGE, MA 02140

FOR: COMPUTER SOFTWARE PLATFORMS
FOR ANALYSIS OF COMPUTER DISK IMAGES
AND DATA; COMPUTER SOFTWARE PLATFORMS
WITH CUSTOMIZABLE SOFTWARE MODULES
FOR COMPUTER IMAGE AND DATA ANALYSIS;
COMPUTER SOFTWARE PLATFORMS WITH CUS-
TOMIZABLE USER INTERFACES FOR COMPUTER
IMAGE AND DATA ANALYSIS; COMPUTER SOFT-
WARE PLATFORMS FOR ANALYSIS OF COMPU-
TER DISK IMAGES AND DATA, COMPRISED OF
OPEN SOURCE FRAMEWORKS AND CUSTOMIZ-

ABLE MODULES AND USER INTERFACES, IN
CLASS 9 (U.S. CLS. 21, 23, 26, 36 AND 38).

FIRST USE 5-26-2008; IN COMMERCE 5-26-2008.

THE MARK CONSISTS OF STANDARD CHAR-
ACTERS WITHOUT CLAIM TO ANY PARTICULAR
FONT, STYLE, SIZE, OR COLOR.

NO CLAIM IS MADE TO THE EXCLUSIVE
RIGHT TO USE "DIGITAL FORENSICS", APART
FROM THE MARK AS SHOWN.

SN 78-974,456, FILED 9-14-2006.

JAMES MACFARLANE, EXAMINING ATTORNEY

Int. Cl.: 16

Prior U.S. Cls.: 2, 5, 22, 23, 29, 37, 38, and 50

Reg. No. 3,478,326

United States Patent and Trademark Office

Registered July 29, 2008

TRADEMARK
PRINCIPAL REGISTER



NATIONAL ENVELOPE CORPORATION (NEW YORK CORPORATION)
SUITE 1035
333 EARLE OVINGTON BOULEVARD
UNIONDALE, NY 11553

FOR: PAPER AND PAPER-LIKE PRODUCTS, NAMELY, ENVELOPES, IN CLASS 16 (U.S. CLS. 2, 5, 22, 23, 29, 37, 38 AND 50).

FIRST USE 11-0-2006; IN COMMERCE 11-0-2006.

NO CLAIM IS MADE TO THE EXCLUSIVE RIGHT TO USE "BIODEGRADABLE WINDOW FILM", APART FROM THE MARK AS SHOWN.

THE MARK CONSISTS OF THE STYLIZED WORDING "BIODEGRADABLE WINDOW FILM"

IN A CIRCULAR ORIENTATION, HAVING THE WORD "BIODEGRADABLE" FORMING THE TOP HALF OF THE CIRCLE AND THE WORDING "WINDOW FILM" FORMING THE BOTTOM HALF AND HAVING A SHADED CIRCLE ON BOTH SIDES OF THE WORD "BIODEGRADABLE". THE MARK ALSO CONSISTS OF A LEAF DESIGN HAVING AN ARROW EXTENDING IN AN OVAL FROM THE BOTTOM OF THE LEAF TO THE TOP OF THE LEAF AROUND A PARTIALLY SHADED RECTANGLE, ALL WITHIN THE CIRCLE CREATED BY THE STYLIZED WORDING IN THE MARK.

SN 78-974,533, FILED 9-14-2006.

JAY BESCH, EXAMINING ATTORNEY

Int. Cl.: 9

Prior U.S. Cls.: 21, 23, 26, 36, and 38

Reg. No. 3,478,327

United States Patent and Trademark Office

Registered July 29, 2008

**TRADEMARK
PRINCIPAL REGISTER**

HORIZON

HORIZON CHRISTIAN FELLOWSHIP (CALI-
FORNIA CORPORATION)
5331 MT. ALIFAN DRIVE
SAN DIEGO, CA 92111

THE MARK CONSISTS OF STANDARD CHAR-
ACTERS WITHOUT CLAIM TO ANY PARTICULAR
FONT, STYLE, SIZE, OR COLOR.

FOR: PRE-RECORDED CD'S, VIDEO TAPES, LA-
SER DISKS AND DVD'S FEATURING MUSICAL
AND RELIGIOUS CONTENT, IN CLASS 9 (U.S. CLS.
21, 23, 26, 36 AND 38).

SN 78-974,832, FILED 9-14-2006.

FIRST USE 12-31-1978; IN COMMERCE 12-31-1978.

JOHN DALIER, EXAMINING ATTORNEY

Int. Cl.: 41

Prior U.S. Cls.: 100, 101, and 107

Reg. No. 3,478,328

United States Patent and Trademark Office

Registered July 29, 2008

**SERVICE MARK
PRINCIPAL REGISTER**



VARSITY SPIRIT CORPORATION (TENNESSEE CORPORATION)
SUITE 300
6745 LENNOX CENTER COURT
MEMPHIS, TN 38115

FOR: CONDUCTING CHEERLEADING COMPETITIONS AND PROVIDING INSTRUCTION AND TRAINING IN THE FIELDS OF SPORTS, CHEERLEADING AND DANCE; PROVIDING EDUCATIONAL DEMONSTRATION SERVICES FOR

CHEERLEADERS, POMPOM SQUADS, DANCE TEAMS, MASCOTS, AND OTHER SCHOOL GROUPS, IN CLASS 41 (U.S. CLS. 100, 101 AND 107).

FIRST USE 5-0-2005; IN COMMERCE 5-0-2005.

SN 78-976,613, FILED 12-10-2004.

MICHELLE DUBOIS, EXAMINING ATTORNEY

Int. Cl.: 35

Prior U.S. Cls.: 100, 101, and 102

United States Patent and Trademark Office

Reg. No. 3,478,329

Registered July 29, 2008

**SERVICE MARK
PRINCIPAL REGISTER**

LEGENDS OF JAZZ

LRSMEDIA, LLC (DELAWARE LTD LIAB CO)
350 W HUBBARD
CHICAGO, IL 60610

NO CLAIM IS MADE TO THE EXCLUSIVE
RIGHT TO USE "JAZZ", APART FROM THE MARK
AS SHOWN.

FOR: PROMOTING THE MUSICAL PERFOR-
MANCES AND CONCERTS OF OTHERS, IN CLASS
35 (U.S. CLS. 100, 101 AND 102).

SN 78-978,934, FILED 1-10-2003.

FIRST USE 4-24-2008; IN COMMERCE 4-24-2008.

SOPHIA S. KIM, EXAMINING ATTORNEY

Int. Cls.: 35 and 36

Prior U.S. Cls.: 100, 101, and 102

United States Patent and Trademark Office

Reg. No. 3,478,330

Registered July 29, 2008

**SERVICE MARK
PRINCIPAL REGISTER**

COMMERCE ENERGY

COMMERCE ENERGY GROUP, INC. (DELAWARE CORPORATION)
600 ANTON BOULEVARD, 2000
COSTA MESA, CA 92626

FOR: ON-LINE RETAIL STORE SERVICES FEATURING ENERGY SAVING GOODS AND DEVICES, NAMELY, HOUSEHOLD APPLIANCES, LIGHTING FIXTURES, HOUSEHOLD ELECTRONICS, AND LIGHT BULBS; PROMOTING THE NATURAL GAS OF OTHERS BY CREATING AND DISSEMINATION OF ADVERTISEMENTS; PROMOTING THE ANCILLARY PRODUCTS AND SERVICES OF OTHERS VIA CREATION AND DISSEMINATION OF ADVERTISING MATERIALS; BUSINESS CONSULTATION SERVICES IN THE FIELD OF ENERGY CONSERVATION AND PROCESS LOAD APPLICATIONS; CONSULTING AND ANALYSIS SERVICES, NAMELY, REVIEWING ENERGY NEEDS, USES AND COSTS, AND PROVIDING ADVICE AND RECOMMENDATIONS REGARDING ENERGY OPTIONS, SOLUTIONS TO PROBLEMS AND COST OBJECTIVES; PRICE ANALYSIS OF ENERGY SOURCES; CUSTOMER SERVICES IN THE FIELD OF ENERGY SERVICES; ENERGY PRICE COMPARISON SERVICES; PROVIDING INFORMATION AND ADVICE TO COMMERCIAL AND INDUSTRIAL USERS OF ELECTRICAL POWER, RELATING TO THE USERS' SELECTION OF ELECTRICAL POWER PROVIDERS AND PROGRAMS; ENERGY CONSULTING SERVICES FOR RESIDENTIAL, COMMERCIAL AND BUSINESS USERS IN THE

AREAS OF ENERGY MANAGEMENT, IN CLASS 35 (U.S. CLS. 100, 101 AND 102).

FIRST USE 1-1-2007; IN COMMERCE 1-1-2007.

FOR: PROVIDING INFORMATION IN THE FIELD OF BROKER TRANSACTIONS INVOLVING ELECTRICAL POWER AND NATURAL GAS; ENERGY BROKERAGE SERVICES, NAMELY, BUYING AND SELLING OF ENERGY COMMODITIES, NAMELY, GAS AND ELECTRICITY; ELECTRONIC PAYMENT, NAMELY, ELECTRONICALLY PROCESSING AND TRANSMISSION OF BILL PAYMENT DATA FOR CUSTOMERS OF ELECTRIC POWER AND NATURAL GAS UTILITY SERVICES, IN CLASS 36 (U.S. CLS. 100, 101 AND 102).

FIRST USE 1-1-2007; IN COMMERCE 1-1-2007.

THE MARK CONSISTS OF STANDARD CHARACTERS WITHOUT CLAIM TO ANY PARTICULAR FONT, STYLE, SIZE, OR COLOR.

NO CLAIM IS MADE TO THE EXCLUSIVE RIGHT TO USE "ENERGY", APART FROM THE MARK AS SHOWN.

SN 78-979,064, FILED 5-16-2005.

SAMUEL E. SHARPER JR., EXAMINING ATTORNEY

Int. Cls.: 38 and 41

Prior U.S. Cls.: 100, 101, 104, and 107

United States Patent and Trademark Office

Reg. No. 3,478,331

Registered July 29, 2008

**SERVICE MARK
PRINCIPAL REGISTER**

Big Ten Network

THE BIG TEN CONFERENCE, INC. (DELAWARE
NON-PROFIT CORPORATION)
1500 HIGGINS ROAD
PARK RIDGE, IL 60068

FOR: TELEVISION TRANSMISSION SERVICES;
STREAMING OF AUDIO AND VIDEO MATERIAL
ON THE INTERNET, IN CLASS 38 (U.S. CLS. 100, 101
AND 104).

FIRST USE 8-0-2007; IN COMMERCE 8-0-2007.

FOR: ENTERTAINMENT SERVICES, NAMELY,
PRODUCTION AND DISTRIBUTION OF TELEVI-
SION PROGRAMS; PROVIDING ON-LINE INFOR-
MATION IN THE FIELD OF SPORTS, TELEVISION,
VIDEO AND AUDIO ENTERTAINMENT VIA A
GLOBAL COMMUNICATIONS NETWORK, IN
CLASS 41 (U.S. CLS. 100, 101 AND 107).

FIRST USE 8-0-2007; IN COMMERCE 8-0-2007.

THE MARK CONSISTS OF STANDARD CHAR-
ACTERS WITHOUT CLAIM TO ANY PARTICULAR
FONT, STYLE, SIZE, OR COLOR.

OWNER OF U.S. REG. NOS. 1,782,645 AND
1,969,353.

NO CLAIM IS MADE TO THE EXCLUSIVE
RIGHT TO USE "NETWORK", APART FROM THE
MARK AS SHOWN.

SN 78-979,540, FILED 9-1-2006.

BARBARA RUTLAND, EXAMINING ATTORNEY

Int. Cls.: 9 and 41

Prior U.S. Cls.: 21, 23, 26, 36, 38, 100, 101, and 107

United States Patent and Trademark Office

Reg. No. 3,478,332

Registered July 29, 2008

**TRADEMARK
SERVICE MARK
PRINCIPAL REGISTER**

COOLFUEL

BALANCE VECTOR PRODUCTIONS LLC (CALIFORNIA LTD LIAB CO)
24701 LA PLAZA, SUITE 205
DANA POINT, CA 92629

FOR: SOUND, VIDEO AND DATA RECORDINGS, NAMELY, DOCUMENTARIES, AND RADIO AND TELEVISION PROGRAMS FEATURING CROSS-COUNTRY AND GLOBAL TRAVEL, AND RENEWABLE ENERGY SOURCES; MOTION PICTURE FILMS AND CINEMATOGRAPHIC FILMS, BOTH FEATURING CROSS-COUNTRY AND GLOBAL TRAVEL, AND RENEWABLE ENERGY SOURCES; AND MULTI-MEDIA SOFTWARE RECORDED ON CD-ROM FEATURING CROSS-COUNTRY AND GLOBAL TRAVEL, AND RENEWABLE ENERGY SOURCES, IN CLASS 9 (U.S. CLS. 21, 23, 26, 36 AND 38).

FIRST USE 7-0-2005; IN COMMERCE 7-0-2005.

FOR: EDUCATIONAL SERVICES, NAMELY, CONDUCTING CLASSES, SEMINARS, CONFERENCES AND WORKSHOPS ONLINE AND PERSONALLY IN THE FIELDS OF ENVIRONMENTALLY

SOUND CROSS-COUNTRY AND GLOBAL TRAVEL AND EXPLORATION, AND RENEWABLE ENERGY SOURCES; PRODUCTION AND DISTRIBUTION OF MOTION PICTURE AND CINEMATOGRAPHIC FILMS; PRODUCTION OF DOCUMENTARIES, TELEVISION AND RADIO PROGRAMS, PRE-RECORDED COMPACT DISCS, DVDS, AND VIDEO RECORDINGS FOR OTHERS; AND ORGANIZING AND PRODUCING EXHIBITIONS FOR SPORTING EVENTS, FESTIVALS, FAIRS, CONFERENCES AND SCHOOLS FOR OTHERS IN THE FIELD OF CROSS-COUNTRY AND GLOBAL TRAVEL VIA RENEWABLE ENERGY SOURCES, IN CLASS 41 (U.S. CLS. 100, 101 AND 107).

FIRST USE 5-0-2003; IN COMMERCE 5-0-2003.

THE MARK CONSISTS OF STANDARD CHARACTERS WITHOUT CLAIM TO ANY PARTICULAR FONT, STYLE, SIZE, OR COLOR.

SN 78-979,575, FILED 7-20-2005.

KIMBERLY FRYE, EXAMINING ATTORNEY

Int. Cls.: 16, 25, 28, and 41

**Prior U.S. Cls.: 2, 5, 22, 23, 29, 37, 38, 39, 50, 100, 101,
and 107**

Reg. No. 3,478,333

United States Patent and Trademark Office

Registered July 29, 2008

**TRADEMARK
SERVICE MARK
PRINCIPAL REGISTER**

HYDRODYNAMICA

KENVIN, RICHARD (UNITED STATES INDIVIDUAL)
643 19TH STREET
SAN DIEGO, CA 92101 AND
ELWELL, JOHN (UNITED STATES INDIVIDUAL)
357 E AVENUE
CORONADO, CA 92116

FOR: PRINTED MATTER AND PUBLICATIONS, NAMELY, MANUALS, PRINTED GUIDES IN THE FIELD OF SURFBOARDING AND SNOWBOARDING; POSTERS, PRESSURE SENSITIVE STICKERS; BOOKS, NEWSLETTERS, MAGAZINES IN THE FIELD OF SURFBOARDING, AND SNOWBOARDING; PHOTOGRAPHS, IN CLASS 16 (U.S. CLS. 2, 5, 22, 23, 29, 37, 38 AND 50).

FIRST USE 1-2-2002; IN COMMERCE 1-2-2007.

FOR: CLOTHING, NAMELY, T-SHIRTS, SWEATSHIRTS, BATHING SUITS FOR MEN, BATHING

SUITS FOR WOMEN; CAPS; SKI CAPS; HEADGEAR, NAMELY, HATS, IN CLASS 25 (U.S. CLS. 22 AND 39).

FIRST USE 1-2-2002; IN COMMERCE 1-2-2007.

FOR: SURFBOARDS; SNOWBOARDS; SURFING FINS; SURFBOARD WAX; SURFBOARD LEASHES, IN CLASS 28 (U.S. CLS. 22, 23, 38 AND 50).

FIRST USE 1-2-2002; IN COMMERCE 1-2-2007.

FOR: PRODUCTION OF DOCUMENTARY FILMS; DVD AND VIDEO DISC PRODUCTION SERVICES, IN CLASS 41 (U.S. CLS. 100, 101 AND 107).

FIRST USE 1-2-2002; IN COMMERCE 1-2-2007.

SN 78-979,607, FILED 1-24-2005.

WILLIAM VERHOSEK, EXAMINING ATTORNEY

Int. Cls.: 18, 25, and 35

Prior U.S. Cls.: 1, 2, 3, 22, 39, 41, 100, 101, and 102

United States Patent and Trademark Office

Reg. No. 3,478,334

Registered July 29, 2008

TRADEMARK
SERVICE MARK
PRINCIPAL REGISTER

The logo for Aritzia is a large, elegant cursive script. The letter 'A' is particularly large and features a decorative flourish that loops back under the 'r'. The 'i' has a dot, and the 'z' has a sharp, pointed tail. The overall style is classic and sophisticated.

ARITZIA, LP (CANADA LIMITED PARTNER-
SHIP)
NO. 327 - 611 ALEXANDER STREET
VANCOUVER, B.C., CANADA V6A 1E1

FOR: BAGS, NAMELY, LEATHER AND IMITA-
TION LEATHER BAGS, ATHLETIC BAGS, BEACH
BAGS, HANDBAGS, SHOULDER BAGS, TOTE
BAGS, PURSES AND WALLETS, IN CLASS 18 (U.S.
CLS. 1, 2, 3, 22 AND 41).

FIRST USE 11-7-2007; IN COMMERCE 11-7-2007.

FOR: CLOTHING, NAMELY, PANTS, TOPS, BLA-
ZERS, BLOUSES, CAPS, COATS, DRESS SHIRTS,
DRESSES, GLOVES, HATS, HOSIERY, JACKETS,
JEANS, LINGERIE, OVERALLS, SCARVES, SHIRTS,
SHORTS, SKIRTS, SLACKS, SLEEP WEAR, SOCKS,
SPORT JACKETS, SPORT SHIRTS, SUITS, SWEA-
TERS, SWEATSHIRTS, SWEAT PANTS, SWIM-
WEAR, TIES, TIGHTS, TOQUES, T-SHIRTS,
UNDERWEAR, VESTS, BELTS, AND WIND RESIS-

TANT JACKETS; FOOTWEAR, NAMELY, BOOTS,
SANDALS, SHOES AND SLIPPERS; HEADBANDS,
IN CLASS 25 (U.S. CLS. 22 AND 39).

FIRST USE 11-7-2007; IN COMMERCE 11-7-2007.

FOR: RETAIL STORE SERVICES FEATURING
WEARING APPAREL AND ACCESSORIES, JEWEL-
RY AND FOOTWEAR, IN CLASS 35 (U.S. CLS. 100,
101 AND 102).

FIRST USE 11-7-2007; IN COMMERCE 11-7-2007.

PRIORITY CLAIMED UNDER SEC. 44(D) ON
CANADA APPLICATION NO. 1209743, FILED 3-15-
2004, REG. NO. TMA677883, DATED 11-29-2006, EX-
PIRES 11-29-2021.

SN 78-979,949, FILED 9-15-2004.

SALLY SHIH, EXAMINING ATTORNEY

Int. Cl.: 38

Prior U.S. Cls.: 100, 101, and 104

United States Patent and Trademark Office

Reg. No. 3,478,335

Registered July 29, 2008

**SERVICE MARK
PRINCIPAL REGISTER**

**DELIGHTING OUR
CUSTOMERS
WORLDWIDE**

FUTURE ELECTRONICS, INC. (CANADA CORPORATION)
237 HYMUS BOULEVARD
POINTE CLAIRE, CANADA H9R 5C7

FOR: TELECOMMUNICATION SERVICES, NAMELY, LOCAL, LONG DISTANCE AND INTERNATIONAL TRANSMISSION OF VOICE, DATA, GRAPHICS BY MEANS OF TELEPHONE, TELEGRAPHIC, CABLE, AND SATELLITE TRANSMISSIONS; TELEPHONE TELECOMMUNICATIONS SERVICES PROVIDED VIA TELEPHONE CALLING CARDS; TELECOMMUNICATIONS GATEWAY SERVICES; PROVIDING MULTIPLE-USER ACCESS TO A GLOBAL COMPUTER INFORMATION NETWORK; TELECOMMUNICATION SERVICES, NAMELY, LOCAL, LONG DISTANCE AND INTERNATIONAL TRANSMISSION OF VOICE, DATA, GRAPHICS BY MEANS OF TELEPHONE, TELEGRAPHIC, CABLE, AND SATELLITE TRANSMISSIONS; TELEPHONE TELECOMMUNICATIONS SERVICES PROVIDED VIA TELEPHONE CALLING CARDS; TELECOMMUNICATIONS GATEWAY SERVICES; PROVIDING MULTIPLE-USER ACCESS TO A GLOBAL COMPUTER INFORMATION NETWORK; TELECOMMUNICATION SERVICES, NAMELY, LOCAL, LONG DISTANCE AND INTER-

NATIONAL TRANSMISSION OF VOICE, DATA, GRAPHICS BY MEANS OF TELEPHONE, TELEGRAPHIC, CABLE, AND SATELLITE TRANSMISSIONS; TELEPHONE TELECOMMUNICATIONS SERVICES PROVIDED VIA TELEPHONE CALLING CARDS; TELECOMMUNICATIONS GATEWAY SERVICES; PROVIDING MULTIPLE-USER ACCESS TO A GLOBAL COMPUTER INFORMATION NETWORK, IN CLASS 38 (U.S. CLS. 100, 101 AND 104).

FIRST USE 10-31-2003; IN COMMERCE 10-31-2003.

THE MARK CONSISTS OF STANDARD CHARACTERS WITHOUT CLAIM TO ANY PARTICULAR FONT, STYLE, SIZE, OR COLOR.

PRIORITY CLAIMED UNDER SEC. 44(D) ON CANADA APPLICATION NO. 1204588, FILED 1-29-2004, REG. NO. TMA682,267, DATED 2-23-2007, EXPIRES 2-23-2022.

OWNER OF U.S. REG. NO. 1,758,941.

SN 78-980,090, FILED 2-6-2004.

CAROL SPILS, EXAMINING ATTORNEY

Int. Cl.: 18

Prior U.S. Cls.: 1, 2, 3, 22, and 41

United States Patent and Trademark Office

Reg. No. 3,478,336

Registered July 29, 2008

**TRADEMARK
PRINCIPAL REGISTER**

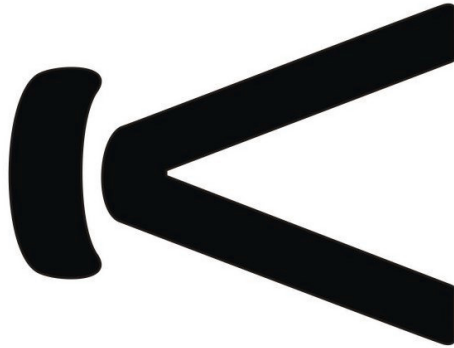

KEEN INC (DELAWARE CORPORATION)
926 NW 13TH AVENUE, SUITE 210
PORTLAND, OR 97209

FOR: BAGS, NAMELY, ALL PURPOSE SPORT
BAGS, ALL PURPOSE CARRYING BAGS, AND
BOOK BAGS; BACKPACKS; LUGGAGE, IN CLASS
18 (U.S. CLS. 1, 2, 3, 22 AND 41).

FIRST USE 7-1-2007; IN COMMERCE 7-1-2007.

OWNER OF U.S. REG. NO. 2,916,603.

THE MARK CONSISTS OF STYLIZED LETTER
"K".

SN 78-980,226, FILED 8-23-2005.

GIANCARLO CASTRO, EXAMINING ATTORNEY

Int. Cls.: 3 and 4

Prior U.S. Cls.: 1, 4, 6, 15, 50, 51, and 52

United States Patent and Trademark Office

Reg. No. 3,478,337

Registered July 29, 2008

**TRADEMARK
PRINCIPAL REGISTER**



BARTON, DIANA E. (UNITED STATES INDIVIDUAL)
APT. 101
1630 HILTS AVENUE
LOS ANGELES, CA 90024

FOR: BODY COSMETICS CONTAINING IRIDESCENT POWDER, NAMELY, SUNLESS TANNING BODY LOTION WITH IRIDESCENT POWDER; FACE AND BODY EXFOLIANTS, NAMELY, SUGAR AND/OR SALT BASED SCRUBS, EXFOLIANTS AND POLISHERS; BATH GELS; SKIN AND BODY LOTIONS; FACIAL CLEANSING LOTIONS; FACE CREAMS FOR DAY AND NIGHT USE, IN CLASS 3 (U.S. CLS. 1, 4, 6, 50, 51 AND 52).

FIRST USE 10-25-2005; IN COMMERCE 10-25-2005.

FOR: CANDLES, IN CLASS 4 (U.S. CLS. 1, 6 AND 15).

FIRST USE 8-8-2005; IN COMMERCE 8-8-2005.

THE COLOR(S) BLACK AND RED IS/ARE CLAIMED AS A FEATURE OF THE MARK.

THE MARK CONSISTS OF AN OVAL OUTLINE, THE WORD "DIANA" AND A PERIOD APPEARING IN THE COLOR BLACK AND THE LETTER "B" APPEARING IN THE COLOR RED.

SN 78-980,244, FILED 3-9-2005.

NORA BUCHANAN WILL, EXAMINING ATTORNEY

Int. Cl.: 9

Prior U.S. Cls.: 21, 23, 26, 36, and 38

United States Patent and Trademark Office

Reg. No. 3,478,338

Registered July 29, 2008

**TRADEMARK
PRINCIPAL REGISTER**

FRANKIE B.

CLARKE, DANIELLA PAULA (UNITED STATES
INDIVIDUAL)
850 S. BROADWAY
LOS ANGELES, CA 90041

OWNER OF U.S. REG. NO. 2,667,766.

FOR: SUNGLASSES AND CASES FOR SUNGLAS-
SES, IN CLASS 9 (U.S. CLS. 21, 23, 26, 36 AND 38).

THE NAME(S), PORTRAIT(S), AND/OR SIGNA-
TURE(S) SHOWN IN THE MARK DOES NOT IDEN-
TIFY A PARTICULAR LIVING INDIVIDUAL.

FIRST USE 4-15-2004; IN COMMERCE 8-0-2006.

SN 78-980,283, FILED 7-13-2006.

THE MARK CONSISTS OF STANDARD CHAR-
ACTERS WITHOUT CLAIM TO ANY PARTICULAR
FONT, STYLE, SIZE, OR COLOR.

MARY ROSSMAN, EXAMINING ATTORNEY

Int. Cl.: 25

Prior U.S. Cls.: 22 and 39

United States Patent and Trademark Office

Reg. No. 3,478,339

Registered July 29, 2008

**TRADEMARK
PRINCIPAL REGISTER**

KENNETH COLE PRODUCTIONS (LIC), INC.
(BAHAMAS CORPORATION)
CENTREVILLE HOUSE, SECOND TERRACE WEST
P.O. BOX SS-6629
NASSAU, BAHAMAS

THE MARK CONSISTS OF STANDARD CHAR-
ACTERS WITHOUT CLAIM TO ANY PARTICULAR
FONT, STYLE, SIZE, OR COLOR.

FOR: CLOTHING, NAMELY, T-SHIRTS AND
UNDERWEAR, IN CLASS 25 (U.S. CLS. 22 AND 39).

SN 78-980,317, FILED 10-28-2005.

FIRST USE 5-15-2007; IN COMMERCE 5-15-2007.

EVELYN BRADLEY, EXAMINING ATTORNEY

Int. Cl.: 25

Prior U.S. Cls.: 22 and 39

United States Patent and Trademark Office

Reg. No. 3,478,340

Registered July 29, 2008

**TRADEMARK
PRINCIPAL REGISTER**



DUALSTAR ENTERTAINMENT GROUP, LLC
(CALIFORNIA LTD LIAB CO)
3760 ROBERTSON BOULEVARD
CULVER CITY, CA 90232

FOR: CLOTHING, NAMELY, T-SHIRTS, TOPS,
BOTTOMS, SWEATERS, JACKETS, PANTS, SKIRTS,
TANK TOPS AND BELTS, IN CLASS 25 (U.S. CLS. 22
AND 39).

FIRST USE 9-0-2006; IN COMMERCE 11-0-2006.

THE MARK CONSISTS OF THE LETTERS "T"
AND "R".

SN 78-980,322, FILED 9-8-2006.

TIMOTHY FINNEGAN, EXAMINING ATTORNEY

Int. Cls.: 41 and 42

Prior U.S. Cls.: 100, 101, and 107

United States Patent and Trademark Office

Reg. No. 3,478,341

Registered July 29, 2008

**SERVICE MARK
PRINCIPAL REGISTER**

**CIO LEADERSHIP
AGENDA**

INTERNATIONAL DATA GROUP, INC. (MASSACHUSETTS CORPORATION)
5 SPEEN STREET
FRAMINGHAM, MA 01701

FOR: PROVIDING ONLINE NON-DOWNLOADABLE PUBLICATIONS, NAMELY, NEWSLETTERS, MAGAZINES AND SUPPLEMENTS SOLD THEREWITH, AND JOURNALS ALL FEATURING INFORMATION IN THE FIELDS OF COMPUTERS, COMPUTER SOFTWARE, ONLINE SERVICES, HIGH TECHNOLOGY, INFORMATION TECHNOLOGY AND INFORMATION SERVICES; ORGANIZING AND CONDUCTING EDUCATIONAL CONFERENCES, SEMINARS AND EXPOSITIONS IN THE FIELDS OF COMPUTERS, COMPUTER SOFTWARE, ONLINE SERVICES, HIGH TECHNOLOGY, INFORMATION TECHNOLOGY AND INFORMATION SERVICES; AND PROVIDING WEBCAST PROGRAMS IN THE FIELDS OF COMPUTERS, COMPUTER SOFTWARE, ONLINE SERVICES, HIGH TECHNOLOGY, INFORMATION TECHNOLOGY, AND INFORMATION SERVICES VIA A GLOBAL COMPUTER, IN CLASS 41 (U.S. CLS. 100, 101 AND 107).

FIRST USE 5-9-2005; IN COMMERCE 5-9-2005.

FOR: PROVIDING INFORMATION VIA A WEBSITE ON GLOBAL COMPUTER NETWORKS IN THE FIELDS OF COMPUTERS, COMPUTER SOFTWARE, HIGH TECHNOLOGY AND INFORMATION TECHNOLOGY, IN CLASS 42 (U.S. CLS. 100 AND 101).

FIRST USE 2-1-2005; IN COMMERCE 2-1-2005.

THE MARK CONSISTS OF STANDARD CHARACTERS WITHOUT CLAIM TO ANY PARTICULAR FONT, STYLE, SIZE, OR COLOR.

OWNER OF U.S. REG. NOS. 2,273,617, 2,370,232, AND OTHERS.

SEC. 2(F) AS TO "CIO".

SN 78-980,337, FILED 12-7-2004.

GENE MACIOL, EXAMINING ATTORNEY

Int. Cl.: 29

Prior U.S. Cl.: 46

United States Patent and Trademark Office

Reg. No. 3,478,342

Registered July 29, 2008

TRADEMARK
PRINCIPAL REGISTER



SARGENTO FOODS, INC. (WISCONSIN CORPORATION)
ONE PERSNICKETY PLACE
PLYMOUTH, WI 53073

FOR: CHEESE, CHEESE PRODUCTS AND SNACK FOODS, NAMELY, A COMBINATION OF CHEESE, NUTS, SEEDS OR DRIED FRUIT, IN CLASS 29 (U.S. CL. 46).

FIRST USE 10-1-2005; IN COMMERCE 10-1-2005.

OWNER OF U.S. REG. NOS. 1,453,364, 3,004,932, AND OTHERS.

THE MARK CONSISTS OF PRODUCT PACKAGING TRADE DRESS FOR THE PRESENTATION OF CHEESE AND CHEESE PRODUCTS; NAMELY

THE CONFIGURATION CONSISTS OF A SERIES OF STACKED CURVED AND RECTANGULAR SHAPED BOXES, THE SECOND BOX FROM THE TOP BEARS THE "SARGENTO" BANNER WITH A WAVY DISTINCTIVE LINE BOTH ABOVE AND BELOW THE WORD, THE FOURTH AND FIFTH BOXES ARE IN ARE EMPTY AND DEPICTED IN A CURVED BANNER LIKE RECTANGULAR SHAPE, ONLY THE SECOND RECTANGULAR SHAPED BOX WILL CONTAIN THE "SARGENTO" WORD.

THE FOREIGN WORDING IN THE MARK TRANSLATES INTO ENGLISH AS SERGEANT.

SN 78-980,344, FILED 10-14-2005.

ANNE E. GUSTASON, EXAMINING ATTORNEY

Int. Cl.: 30

Prior U.S. Cl.: 46

United States Patent and Trademark Office

Reg. No. 3,478,343

Registered July 29, 2008

**TRADEMARK
PRINCIPAL REGISTER**

SOMETHING HEALTHY

WELLNESS INTERACTIVE, INC. (NEW JERSEY CORPORATION)
14 SOUTH ORANGE AVENUE, SUITE 1R
SOUTH ORANGE, NJ 07079

NO CLAIM IS MADE TO THE EXCLUSIVE RIGHT TO USE "HEALTHY", APART FROM THE MARK AS SHOWN.

FOR: TEAS, IN CLASS 30 (U.S. CL. 46).

FIRST USE 3-2-2008; IN COMMERCE 3-2-2008.

SN 78-980,355, FILED 3-16-2005.

THE MARK CONSISTS OF STANDARD CHARACTERS WITHOUT CLAIM TO ANY PARTICULAR FONT, STYLE, SIZE, OR COLOR.

GENE MACIOL, EXAMINING ATTORNEY

Int. Cl.: 30

Prior U.S. Cl.: 46

United States Patent and Trademark Office

Reg. No. 3,478,344

Registered July 29, 2008

TRADEMARK
PRINCIPAL REGISTER

ARMADA

REPLENISHMENT SOLUTIONS LLC (MINNESO-
TA LTD LIAB CO)
P.O. BOX 806
4610 RUSAN
ST. CLOUD, MN 56302

FOR: COFFEE; BEVERAGES MADE OF COFFEE;
CAFFEINE-FREE COFFEE; GROUND COFFEE
BEANS; INSTANT COFFEE; PREPARED COFFEE;
COFFEE-BASED BEVERAGES; LIQUID COFFEE
CONCENTRATE; AND ROASTED COFFEE BEANS,
IN CLASS 30 (U.S. CL. 46).

FIRST USE 4-2-2007; IN COMMERCE 4-2-2007.

THE MARK CONSISTS OF STANDARD CHAR-
ACTERS WITHOUT CLAIM TO ANY PARTICULAR
FONT, STYLE, SIZE, OR COLOR.

SN 78-980,366, FILED 5-30-2006.

BARBARA GAYNOR, EXAMINING ATTORNEY

Int. Cls.: 11 and 42

Prior U.S. Cls.: 13, 21, 23, 31, 34, 100, and 101

United States Patent and Trademark Office

Reg. No. 3,478,345

Registered July 29, 2008

**TRADEMARK
SERVICE MARK
PRINCIPAL REGISTER**

HARTMAN LOOP

HARTMAN, THOMAS B. (UNITED STATES INDIVIDUAL)

755 COUNTY ROAD 247
GEORGETOWN, TX 78628

FOR: VARIABLE-SPEED CHILLERS, VARIABLE-SPEED COOLING TOWER FANS, VARIABLE-SPEED FLUID PUMPS FOR INDUSTRIAL OR COMMERCIAL CHILLER PLANTS AND OTHER HEATING, VENTILATION AND AIR CONDITIONING UNITS, SOLD SEPARATELY OR AS A COMPONENT PART OF SUCH UNITS, VARIABLE-SPEED MOTOR DRIVERS FOR INDUSTRIAL OR COMMERCIAL CHILLER PLANTS AND OTHER HEATING, VENTILATION AND AIR CONDITIONING UNITS, SOLD SEPARATELY OR AS A COMPONENT PART OF SUCH UNITS, IN CLASS 11 (U.S. CLS. 13, 21, 23, 31 AND 34).

FIRST USE 12-10-2003; IN COMMERCE 12-10-2003.

FOR: ENGINEERING CONSULTING AND DESIGN SERVICES FOR INDUSTRIAL OR COMMERCIAL CHILLER PLANTS AND OTHER HEATING, VENTILATION AND AIR CONDITIONER SYSTEMS, IN CLASS 42 (U.S. CLS. 100 AND 101).

FIRST USE 12-10-2003; IN COMMERCE 12-10-2003.

THE MARK CONSISTS OF STANDARD CHARACTERS WITHOUT CLAIM TO ANY PARTICULAR FONT, STYLE, SIZE, OR COLOR.

SN 78-980,382, FILED 10-27-2004.

LINDA ORNDORFF, EXAMINING ATTORNEY

Int. Cl.: 25

Prior U.S. Cls.: 22 and 39

United States Patent and Trademark Office

Reg. No. 3,478,346

Registered July 29, 2008

**TRADEMARK
PRINCIPAL REGISTER**

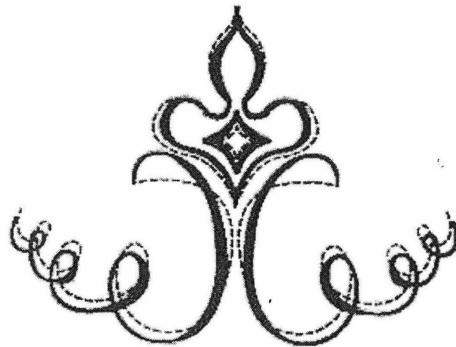

SWAT.FAME, INC. (CALIFORNIA CORPORATION)
16425 EAST GALE AVENUE
CITY OF INDUSTRY, CA 91745

THE MARK CONSISTS OF MISCELLANEOUS DESIGN.

FOR: CLOTHING, NAMELY, GAUCHOS, BERMUDA SHORTS, IN CLASS 25 (U.S. CLS. 22 AND 39).

SN 78-980,413, FILED 10-19-2005.

FIRST USE 3-0-2006; IN COMMERCE 3-0-2006.

LINDA E. BLOHM, EXAMINING ATTORNEY

Int. Cl.: 32

Prior U.S. Cls.: 45, 46, and 48

United States Patent and Trademark Office

Reg. No. 3,478,347

Registered July 29, 2008

TRADEMARK
PRINCIPAL REGISTER



CARPE DIEM GMBH & CO KG (AUSTRIA
KOMMANDITGESELLSCHAFT (KG))
AM BRUNNEN 1
FUSCHL AM SEE, AUSTRIA A-5330

FOR: NON-ALCOHOLIC BEVERAGES, NAMELY,
MINERAL AND AERATED WATERS WITH BOTA-
NIC AND PLANT EXTRACTS, IN CLASS 32 (U.S.
CLS. 45, 46 AND 48).

FIRST USE 7-15-2005; IN COMMERCE 3-24-2006.

PRIORITY CLAIMED UNDER SEC. 44(D) ON
AUSTRIA APPLICATION NO. AM1903/2006, FILED
3-16-2006, REG. NO. 231633, DATED 5-5-2006, EX-
PIRES 5-31-2016.

NO CLAIM IS MADE TO THE EXCLUSIVE
RIGHT TO USE "BOTANIC WATER", APART FROM
THE MARK AS SHOWN.

THE COLOR(S) BLACK, WHITE AND BLUE IS/
ARE CLAIMED AS A FEATURE OF THE MARK.

THE MARK CONSISTS OF THE WORDING "BO-
TANIC WATER" IN BLACK AND A STYLIZED
PARTIAL DEPICTION OF THE EARTH IN BLUE
AND WHITE.

SN 78-980,415, FILED 4-2-2006.

RENEE MCCRAY, EXAMINING ATTORNEY

Int. Cls.: 35, 43, and 44

Prior U.S. Cls.: 100, 101, and 102

United States Patent and Trademark Office

Reg. No. 3,478,348

Registered July 29, 2008

**SERVICE MARK
PRINCIPAL REGISTER**

NYLO

NYLO HOTELS, LLC (NEW YORK LTD LIAB CO)
260 PEACHTREE STREET, NW
SUITE 2301
ATLANTA, GA 30303

FOR: PROVIDING FACILITIES FOR BUSINESS MEETINGS; MANAGING AND OPERATING HOTELS AND BUSINESS CONFERENCE CENTERS; OFFERING TECHNICAL ASSISTANCE IN THE ESTABLISHMENT AND/OR OPERATION OF HOTELS AND RESORTS; OFFERING TECHNICAL ASSISTANCE IN THE ESTABLISHMENT AND/OR OPERATION OF RESTAURANTS; ON-LINE BUSINESS DIRECTORIES FEATURING HOTELS, RESORTS, RESTAURANTS, BARS AND SPAS, IN CLASS 35 (U.S. CLS. 100, 101 AND 102).

FIRST USE 12-18-2007; IN COMMERCE 12-18-2007.

FOR: HOTELS; RESERVATIONS FOR HOTEL ROOMS; PROVIDING TRAVEL LODGING INFORMATION SERVICES AND TRAVEL LODGING BOOKING AGENCY SERVICES FOR TRAVELERS; TRAVEL AGENCY SERVICES, NAMELY, MAKING RESERVATIONS AND BOOKING FOR TEMPORARY LODGING; HOTEL, BAR AND RESTAURANT SERVICES; PREPARATION OF FOOD AND BEVERAGES; SERVING OF FOOD AND DRINK/BEVERAGES; CAFÉ RESTAURANTS; DELICATESSENS; RESTAURANT RESERVATION SERVICES; SELF SERVICE RESTAURANTS; CARRY OUT/TAKE OUT RESTAURANTS; BAR SERVICES; COFFEE

HOUSE AND SNACK-BAR SERVICES; WINE BARS; PROVIDING CONVENTION FACILITIES; PROVISION OF CONFERENCE, EXHIBITION AND MEETING FACILITIES; PROVIDING BANQUET AND SOCIAL FUNCTION FACILITIES FOR SPECIAL OCCASIONS; CATERING FOR THE PROVISION OF FOOD AND BEVERAGES; ARENA SERVICES, NAMELY, PROVIDING FACILITIES FOR CONCERTS, CONVENTIONS AND EXHIBITIONS; PROVIDING FOOD AND LODGING THAT SPECIALIZE IN PROMOTING PATRON'S GENERAL HEALTH AND WELL BEING, IN CLASS 43 (U.S. CLS. 100 AND 101).

FIRST USE 12-18-2007; IN COMMERCE 12-18-2007.

FOR: HEALTH SPA SERVICES FOR HEALTH AND WELLNESS OF THE BODY AND SPIRIT; HEALTH SPA SERVICES, NAMELY, COSMETIC BODY CARE AND PROVIDING SAUNA FACILITIES, IN CLASS 44 (U.S. CLS. 100 AND 101).

FIRST USE 12-18-2007; IN COMMERCE 12-18-2007.

THE MARK CONSISTS OF STANDARD CHARACTERS WITHOUT CLAIM TO ANY PARTICULAR FONT, STYLE, SIZE, OR COLOR.

SN 78-980,420, FILED 8-26-2004.

FLORENTINA BLANDU, EXAMINING ATTORNEY

Int. Cl.: 43

Prior U.S. Cls.: 100 and 101

United States Patent and Trademark Office

Reg. No. 3,478,349

Registered July 29, 2008

**SERVICE MARK
PRINCIPAL REGISTER**

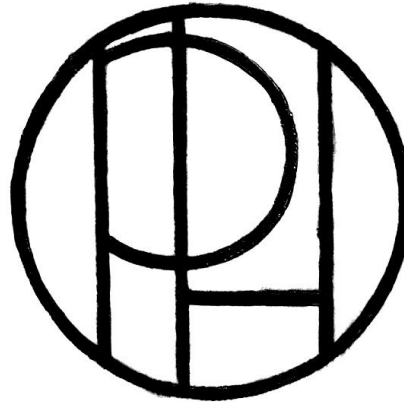

COLUMBUS RESTAURANT FUND IV LLC (NEW
YORK LIMITED LIABILITY COMPANY)
10 COLUMBUS CIRCLE, 4TH FLOOR
NEW YORK, NY 10019

FOR: FINE-DINING ESTABLISHMENTS, NAME-
LY, RESTAURANTS FEATURING STEAK; CATER-
ING AND BAR SERVICES, IN CLASS 43 (U.S. CLS.
100 AND 101).

FIRST USE 8-9-2006; IN COMMERCE 9-5-2006.

THE MARK CONSISTS OF A STYLIZED "P" AND
"H" INTERSECTING INSIDE A CIRCLE.

SN 78-980,422, FILED 8-9-2006.

RENEE MCCRAY, EXAMINING ATTORNEY

Int. Cl.: 9

Prior U.S. Cls.: 21, 23, 26, 36, and 38

Reg. No. 3,478,350

United States Patent and Trademark Office

Registered July 29, 2008

**TRADEMARK
SUPPLEMENTAL REGISTER**

HEIMANN SENSOR

HEIMANN SENSOR GMBH (FED REP GERMA-
NY CORPORATION)
GRENZSTR. 28
D-01109 DRESDEN, FED REP GERMANY

FOR: INFRARED SENSORS WITH AND WITH-
OUT CONTROL MODULES FOR USE IN PRINTING
MACHINES, KITCHEN MACHINES AND APPLIAN-
CES, ELECTRICAL COPYING MACHINES, MICRO-
WAVE OVENS, TOASTERS, HAIR DRYERS,
COOKING AND HEATING DEVICES, WASHING
MACHINES, CLOTH DRYERS, ELECTRICAL RE-
FRIGERATORS, ELECTRICAL CLEANER/DRY-
ERS, IRONS, COFFEE MACHINES, AIR
CONDITIONERS, CLIMATE CONTROL DEVICES,
PRESENCE DETECTORS FOR HUMANS, ANI-
MALS, INTRUDERS; INFRARED SENSORS WITH
AND WITHOUT CONTROL MODULES FOR USE IN
SURGICAL, MEDICAL, DENTAL AND VETERIN-
ARY INSTRUMENTS LIKE MEDICAL FEVER
THERMOMETERS, BLOOD INJECTION INSTRU-
MENTS, INSTRUMENTS TO MEASURE SKIN SUR-
FACE TEMPERATURE AND TEMPERATURE
DISTRIBUTIONS, BLOOD GLUCOSE MONITORS,
BLOOD PRESSURE METERS, BREATH CONTROL,
FOR INHALE/EXHALE CHECK, ANAESTHESIA
INSTRUMENTS; INFRARED SENSORS WITH AND
WITHOUT CONTROL MODULES FOR USE IN
ELECTRICAL LIGHTING CONTROLS, SPACE HEA-
TERS, STEAM GENERATORS, AUTOMATIC LIGHT
SWITCHES, PERSON DETECTION INDOOR/OUT-
DOOR, SECURITY CHECKING/MONITORING DE-
VICES FOR PERSON DETECTION; INFRARED
SENSORS WITH AND WITHOUT CONTROL MOD-
ULES FOR USE IN ELECTRICAL AND GAS KITCH-
EN OVENS, ELECTRICAL REFRIGERATORS, AIR
VENTILATORS FOR INDOOR CLIMATE IM-
PROVEMENT, AIR QUALITY IMPROVEMENT; IN-
FRARED SENSORS FOR LIGHTING CONTROL,

DISTANCE CONTROL, WINDSHIELD WIPER CON-
TROL, AND STARTING ENGINES, WITH AND
WITHOUT CONTROL MODULES, FOR USE IN
LAND, WATER AND SPACE VEHICLES, NAMELY,
AUTOMOBILES, AIRPLANES, SHIPS AND BOATS,
TRUCKS, PICKUPS, TRACTORS, MOBILE CARRY-
ING TANKS; INFRARED SENSORS WITH AND
WITHOUT CONTROL MODULES FOR USE IN
INDUSTRIAL, MEDICAL, CONSUMER AND SCI-
ENTIFIC INFRARED IMAGING FOR USE IN PY-
ROMETERS, SCANNERS, NIGHT VISION DEVICES,
TEMPERATURE MONITORS, SENSORS FOR SUR-
FACE, AND TEMPERATURE, PRESENCE, MO-
TION, PRESSURE, FLOW, COLOR GAS
CONCENTRATION AND GAS DETECTION,
SMOKE, MOISTURE, AIR QUALITY THAT MEA-
SURE THE AFOREMENTIONED MERITS, DETECT
PERSONS, DETECT OBJECTS, ACTIVATE WARN-
ING MEANS IN CASE OF EXCEEDING LIMITS, IN
CLASS 9 (U.S. CLS. 21, 23, 26, 36 AND 38).

THE MARK CONSISTS OF STANDARD CHAR-
ACTERS WITHOUT CLAIM TO ANY PARTICULAR
FONT, STYLE, SIZE, OR COLOR.

PRIORITY CLAIMED UNDER SEC. 44(D) ON
ERPNTY TM OFC APPLICATION NO.
2505347, FILED 2-20-2002, REG. NO. 002585347, DA-
TED 7-3-2003, EXPIRES 3-20-2012.

NO CLAIM IS MADE TO THE EXCLUSIVE
RIGHT TO USE "SENSOR", APART FROM THE
MARK AS SHOWN.

SER. NO. 76-419,684, FILED P.R. 6-12-2002; AM. S.R.
11-23-2007.

RAUL CORDOVA, EXAMINING ATTORNEY

Int. Cl.: 35

Prior U.S. Cls.: 100, 101, and 102

United States Patent and Trademark Office

Reg. No. 3,478,351

Registered July 29, 2008

**SERVICE MARK
SUPPLEMENTAL REGISTER**

**UNITED STATES INTERNET
BUSINESS DIRECTORY**

NATIONAL DIRECTORY REGISTRARS OF
AMERICA INC. (NEW JERSEY CORPORATION)
6 NOBLE LANE
GREEN BROOK, NJ 08812

FOR: PROVIDING A DIRECTORY INFORMATION SERVICE ON THE INTERNET FEATURING BUSINESS TO CONSUMER AND BUSINESS TO BUSINESS INFORMATION , IN CLASS 35 (U.S. CLS. 100, 101 AND 102).

FIRST USE 6-0-2007; IN COMMERCE 6-0-2007.

THE MARK CONSISTS OF STANDARD CHARACTERS WITHOUT CLAIM TO ANY PARTICULAR FONT, STYLE, SIZE, OR COLOR.

NO CLAIM IS MADE TO THE EXCLUSIVE RIGHT TO USE "INTERNET BUSINESS DIRECTORY", APART FROM THE MARK AS SHOWN.

SER. NO. 76-674,240, FILED P.R. 3-19-2007; AM. S.R. 6-24-2008.

IRA J. GOODSaid, EXAMINING ATTORNEY

Int. Cl.: 19

Prior U.S. Cls.: 1, 12, 33, and 50

United States Patent and Trademark Office

Reg. No. 3,478,352

Registered July 29, 2008

**TRADEMARK
SUPPLEMENTAL REGISTER**

Bible Borders Crown Molding

STARR, PAMELA (UNITED STATES INDIVIDUAL)
P.O. BOX 2031
WINDERMERE, FL 34786

FOR: INTERIOR AND EXTERIOR ARCHITECTURAL ELEMENTS, MADE OF ANY APPLICABLE MATERIAL, SUCH AS WOOD OR POLYURETHANE, NAMELY, NON-METAL DECORATIVE CROWN MOLDING, CHAIR RAIL MOLDING, BASEBOARD MOLDING, STAIRCASE RAILS, DOOR FRAMES, DOOR SHUTTERS, WINDOW SILLS, WINDOW SHUTTERS, AND CORNICES THAT FEATURE BIBLE VERSES, IN CLASS 19 (U.S. CLS. 1, 12, 33 AND 50).

FIRST USE 5-18-2007; IN COMMERCE 8-2-2007.

THE MARK CONSISTS OF STANDARD CHARACTERS WITHOUT CLAIM TO ANY PARTICULAR FONT, STYLE, SIZE, OR COLOR.

NO CLAIM IS MADE TO THE EXCLUSIVE RIGHT TO USE "CROWN MOLDING", APART FROM THE MARK AS SHOWN.

SER. NO. 76-680,665, FILED P.R. 8-14-2007; AM. S.R. 6-13-2008.

RAMONA ORTIGA, EXAMINING ATTORNEY

Int. Cl.: 21

Prior U.S. Cls.: 2, 13, 23, 29, 30, 33, 40, and 50

United States Patent and Trademark Office

Reg. No. 3,478,353

Registered July 29, 2008

**TRADEMARK
SUPPLEMENTAL REGISTER**

PLUG N PLANT

FELKNOR VENTURES LLC (TENNESSEE LTD
LIAB CO)
9737 COGDILL RD., SUITE 215
KNOXVILLE, TN 37932

FOR: PLANTER FOR GROWING PLANTS, IN
CLASS 21 (U.S. CLS. 2, 13, 23, 29, 30, 33, 40 AND 50).

FIRST USE 5-31-2005; IN COMMERCE 5-31-2005.

THE MARK CONSISTS OF STANDARD CHAR-
ACTERS WITHOUT CLAIM TO ANY PARTICULAR
FONT, STYLE, SIZE, OR COLOR.

SER. NO. 76-682,697, FILED P.R. 10-9-2007; AM. S.R.
6-4-2008.

ANDREA HACK, EXAMINING ATTORNEY

Int. Cl.: 9

Prior U.S. Cls.: 21, 23, 26, 36, and 38

United States Patent and Trademark Office

Reg. No. 3,478,354

Registered July 29, 2008

**TRADEMARK
SUPPLEMENTAL REGISTER**

BRANDSTAND

TXS INDUSTRIAL DESIGN, INC. (TEXAS CORPORATION)
1761 INTERNATIONAL PARKWAY #135
RICHARDSON, TX 75081

FOR: ELECTRONIC CONTROLLING MOUNTING CABLE MANAGEMENT DEVICE FOR MANAGING DATA AND OTHER CABLES FOR COMPUTERS, COMPUTER COMPONENTS, CONSUMER ELECTRONIC EQUIPMENT AND RELATED DEVICES, IN CLASS 9 (U.S. CLS. 21, 23, 26, 36 AND 38).

FIRST USE 10-0-2005; IN COMMERCE 10-0-2005.

THE MARK CONSISTS OF STANDARD CHARACTERS WITHOUT CLAIM TO ANY PARTICULAR FONT, STYLE, SIZE, OR COLOR.

SER. NO. 77-026,214, FILED P.R. 10-20-2006; AM. S.R. 5-20-2008.

CAROL SPILS, EXAMINING ATTORNEY

Int. Cls.: 35 and 41

Prior U.S. Cls.: 100, 101, 102, and 107

United States Patent and Trademark Office

Reg. No. 3,478,355

Registered July 29, 2008

**SERVICE MARK
SUPPLEMENTAL REGISTER**

CPE

HIGHEDGE, INC. (DELAWARE CORPORATION)
5060 SHOREHAM PLACE SUITE 120
SAN DIEGO, CA 92122

FOR: ADVERTISING AND PUBLICITY SERVICES, NAMELY, PROMOTING THE GOODS, SERVICES, BRAND IDENTITY AND COMMERCIAL INFORMATION AND NEWS OF THIRD PARTIES THROUGH PRINT, AUDIO, VIDEO, DIGITAL AND ON-LINE MEDIUM; ADVERTISING, MARKETING AND PROMOTION SERVICES; COOPERATIVE ADVERTISING AND MARKETING, IN CLASS 35 (U.S. CLS. 100, 101 AND 102).

FIRST USE 11-14-2006; IN COMMERCE 11-14-2006.

FOR: ENTERTAINMENT SERVICES, NAMELY, CONDUCTING CONTESTS, IN CLASS 41 (U.S. CLS. 100, 101 AND 107).

FIRST USE 11-14-2006; IN COMMERCE 11-14-2006.

THE MARK CONSISTS OF STANDARD CHARACTERS WITHOUT CLAIM TO ANY PARTICULAR FONT, STYLE, SIZE, OR COLOR.

SER. NO. 77-032,200, FILED P.R. 10-30-2006; AM. S.R. 9-19-2007.

TIMOTHY FINNEGAN, EXAMINING ATTORNEY

Int. Cl.: 28

Prior U.S. Cls.: 22, 23, 38, and 50

United States Patent and Trademark Office

Reg. No. 3,478,356

Registered July 29, 2008

**TRADEMARK
SUPPLEMENTAL REGISTER**

TIN CAN NECKLACES

TIN CAN NECKLACES (OREGON PARTNER-
SHIP)

P.O. BOX 385

MARYLHURST, OR 97036

FOR: JEWELRY; JEWELRY MADE BY HAND;
NECKLACES, IN CLASS 28 (U.S. CLS. 22, 23, 38 AND
50).

FIRST USE 12-31-2007; IN COMMERCE 1-31-2008.

THE MARK CONSISTS OF STANDARD CHAR-
ACTERS WITHOUT CLAIM TO ANY PARTICULAR
FONT, STYLE, SIZE, OR COLOR.

NO CLAIM IS MADE TO THE EXCLUSIVE
RIGHT TO USE "NECKLACES", APART FROM
THE MARK AS SHOWN.

SER. NO. 77-038,454, FILED P.R. 11-7-2006; AM. S.R.
6-2-2008.

HENRY S. ZAK, EXAMINING ATTORNEY

Int. Cl.: 36

Prior U.S. Cls.: 100, 101, and 102

United States Patent and Trademark Office

Reg. No. 3,478,357

Registered July 29, 2008

**SERVICE MARK
SUPPLEMENTAL REGISTER**

CALIFORNIA VALUEPLUS AUTO

UNIGARD INSURANCE COMPANY (WASHING-
TON CORPORATION)
ONE GENERAL DRIVE
SUN PRAIRIE, WI 53596

FOR: INSURANCE UNDERWRITING SERVICES
IN THE FIELD OF PROPERTY AND CASUALTY
INSURANCE, IN CLASS 36 (U.S. CLS. 100, 101 AND
102).

FIRST USE 12-31-2006; IN COMMERCE 12-31-2006.

THE MARK CONSISTS OF STANDARD CHAR-
ACTERS WITHOUT CLAIM TO ANY PARTICULAR
FONT, STYLE, SIZE, OR COLOR.

NO CLAIM IS MADE TO THE EXCLUSIVE
RIGHT TO USE "AUTO", APART FROM THE
MARK AS SHOWN.

SER. NO. 77-038,518, FILED P.R. 11-7-2006; AM. S.R.
4-18-2008.

MAUREEN DALL, EXAMINING ATTORNEY

Int. Cl.: 35

Prior U.S. Cls.: 100, 101, and 102

United States Patent and Trademark Office

Reg. No. 3,478,358

Registered July 29, 2008

**SERVICE MARK
SUPPLEMENTAL REGISTER**

LOCAL HEROES

SECOND LICENSE APPLICATION CORPORATION (DELAWARE CORPORATION)
2200 W. AIRFIELD DRIVE
D/FW AIRPORT, TX 75261

FOR: PROMOTING PUBLIC AWARENESS OF LOCAL, STATE AND NATIONAL PUBLIC SERVICE BY FEATURING PROFILES OF INDIVIDUALS WHO HAVE CONTRIBUTED TO THE PUBLIC THROUGH VOLUNTEERISM, MILITARY SERVICE AND OTHER FORMS OF PUBLIC SERVICE, IN THE AREA TELEPHONE DIRECTORY, IN CLASS 35 (U.S. CLS. 100, 101 AND 102).

FIRST USE 3-6-2007; IN COMMERCE 3-6-2007.

THE MARK CONSISTS OF STANDARD CHARACTERS WITHOUT CLAIM TO ANY PARTICULAR FONT, STYLE, SIZE, OR COLOR.

SER. NO. 77-041,455, FILED P.R. 11-10-2006; AM. S.R. 6-19-2008.

SAIMA MAKHDOOM, EXAMINING ATTORNEY

Int. Cl.: 35

Prior U.S. Cls.: 100, 101, and 102

United States Patent and Trademark Office

Reg. No. 3,478,359

Registered July 29, 2008

**SERVICE MARK
SUPPLEMENTAL REGISTER**

**TRENCHLESS RESOURCES
INCORPORATED**

TRENCHLESS RESOURCES, INC. (CALIFORNIA
CORPORATION)
17660 EDMUNDSON ROAD
SISTERS, OR 97759

FOR: MANUFACTURER REPRESENTATIVE
SERVICES IN THE FIELD OF PIPELINE REHABILITATION
AND CONSTRUCTION, IN CLASS 35 (U.S.
CLS. 100, 101 AND 102).

FIRST USE 5-15-1995; IN COMMERCE 5-15-1995.

THE MARK CONSISTS OF STANDARD CHARACTERS
WITHOUT CLAIM TO ANY PARTICULAR
FONT, STYLE, SIZE, OR COLOR.

SER. NO. 77-064,775, FILED P.R. 12-14-2006; AM.
S.R. 6-17-2008.

PATRICIA EVANKO, EXAMINING ATTORNEY

Int. Cl.: 19

Prior U.S. Cls.: 1, 12, 33, and 50

United States Patent and Trademark Office

Reg. No. 3,478,360

Registered July 29, 2008

**TRADEMARK
SUPPLEMENTAL REGISTER**

RIGID BRIDGE

CONCRETE SYSTEMS, INC. (NEW HAMPSHIRE CORPORATION)
9 COMMERCIAL STREET
HUDSON, NH 03051

FOR: BUILDING MATERIALS OF CONCRETE, NAMELY, CULVERT SECTIONS, SKEWED CULVERT SECTIONS, HEADWALLS, WINGWALLS, AND STRIP FOOTINGS; NON-METAL SKEWED BRIDGE SECTIONS WITH HEADWALLS AND WINGWALLS; NON-METAL THREE-SIDED BRIDGE SYSTEMS CONSISTING OF CULVERT SECTIONS, HEADWALLS, WINGWALLS, AND FOOTINGS; NON-METAL SMALL SPAN BRIDGE SYSTEMS CONSISTING OF CULVERT SECTIONS, HEADWALLS, WINGWALLS, AND FOOTINGS;

NON-METAL MODULAR BRIDGE SYSTEMS CONSISTING OF CULVERT SECTIONS, HEADWALLS, WINGWALLS, AND FOOTINGS, IN CLASS 19 (U.S. CLS. 1, 12, 33 AND 50).

FIRST USE 10-0-2007; IN COMMERCE 1-23-2008.

THE MARK CONSISTS OF STANDARD CHARACTERS WITHOUT CLAIM TO ANY PARTICULAR FONT, STYLE, SIZE, OR COLOR.

SER. NO. 77-074,357, FILED P.R. 1-2-2007; AM. S.R. 6-21-2008.

MARK PILARO, EXAMINING ATTORNEY

Int. Cls.: 35 and 38

Prior U.S. Cls.: 100, 101, 102, and 104

United States Patent and Trademark Office

Reg. No. 3,478,361

Registered July 29, 2008

**SERVICE MARK
SUPPLEMENTAL REGISTER**

SHAW TRACKING

SHAW CABLESYSTEMS G.P. (CANADA PART-
NERSHIP)
900, 630 - 3RD AVENUE S.W.
CALGARY AB T2P 4L4, CANADA T2P4L4

FOR: TRACKING OF TRUCKS IN REAL-TIME
FOR COMMERCIAL PURPOSES; INFORMATION
MANAGEMENT SERVICES FOR OTHERS, NAME-
LY, POSITION DETERMINATION SERVICES IN
THE NATURE OF TRACKING VEHICLES IN THE
TRUCKING INDUSTRY, IN CLASS 35 (U.S. CLS. 100,
101 AND 102).

FIRST USE 12-31-2006; IN COMMERCE 12-31-2006.

FOR: TELECOMMUNICATIONS SERVICES,
NAMELY, TWO-WAY SATELLITE COMMUNICA-
TIONS SERVICES FOR THE TRUCKING INDUS-
TRY; TELECOMMUNICATIONS SERVICES,
NAMELY, TRANSMISSION OF DATA BY MOBILE

AND FIXED SATELLITES, IN CLASS 38 (U.S. CLS.
100, 101 AND 104).

FIRST USE 12-31-2006; IN COMMERCE 12-31-2006.

THE MARK CONSISTS OF STANDARD CHAR-
ACTERS WITHOUT CLAIM TO ANY PARTICULAR
FONT, STYLE, SIZE, OR COLOR.

OWNER OF U.S. REG. NOS. 2,768,388 AND
2,793,731.

NO CLAIM IS MADE TO THE EXCLUSIVE
RIGHT TO USE "TRACKING", APART FROM THE
MARK AS SHOWN.

SER. NO. 77-079,680, FILED P.R. 1-10-2007; AM. S.R.
6-12-2008.

JUSTINE D. PARKER, EXAMINING ATTORNEY

Int. Cl.: 33

Prior U.S. Cls.: 47 and 49

United States Patent and Trademark Office

Reg. No. 3,478,362

Registered July 29, 2008

**TRADEMARK
SUPPLEMENTAL REGISTER**

Zepaltas Wines

ZEPALTAS WINES, LLC (CALIFORNIA LTD
LIAB CO)
1463 GLENBROOK AVENUE
SANTA ROSA, CA 95401

NO CLAIM IS MADE TO THE EXCLUSIVE
RIGHT TO USE "WINES", APART FROM THE
MARK AS SHOWN.

FOR: WINES, IN CLASS 33 (U.S. CLS. 47 AND 49).

FIRST USE 11-1-2006; IN COMMERCE 11-1-2006.

SER. NO. 77-082,519, FILED P.R. 1-13-2007; AM. S.R.
6-3-2008.

THE MARK CONSISTS OF STANDARD CHAR-
ACTERS WITHOUT CLAIM TO ANY PARTICULAR
FONT, STYLE, SIZE, OR COLOR.

KRISTINA MORRIS, EXAMINING ATTORNEY

Int. Cl.: 10

Prior U.S. Cls.: 26, 39, and 44

United States Patent and Trademark Office

Reg. No. 3,478,363

Registered July 29, 2008

**TRADEMARK
SUPPLEMENTAL REGISTER**

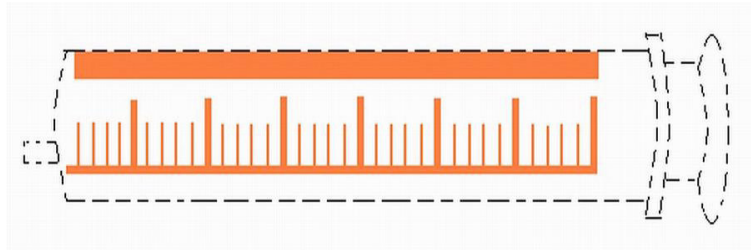

SPECIALTY MEDICAL PRODUCTS, INC. (GEORGIA CORPORATION)
SUITE 101
103 SPRINGFIELD CENTER DRIVE
WOODSTOCK, GA 30188

FOR: MEDICAL SYRINGES, IN CLASS 10 (U.S. CLS. 26, 39 AND 44).

FIRST USE 5-15-2006; IN COMMERCE 5-15-2006.

THE COLOR(S) ORANGE IS/ARE CLAIMED AS A FEATURE OF THE MARK.

THE MARK CONSISTS OF THE COLOR ORANGE AS APPLIED TO THE GRADUATION MARKINGS AND TEXT OR TEXT BOX ON THE BARREL OF THE SYRINGE. THE DOTTED OUTLINE OF THE GOODS IS INTENDED TO SHOW THE POSITION OF THE MARK ON THE GOODS AND IS NOT PART OF THE MARK.

SER. NO. 77-084,556, FILED P.R. 1-17-2007; AM. S.R. 6-24-2008.

LA TONIA FISHER, EXAMINING ATTORNEY

Int. Cls.: 41 and 44

Prior U.S. Cls.: 100, 101, and 107

United States Patent and Trademark Office

Reg. No. 3,478,364

Registered July 29, 2008

**SERVICE MARK
SUPPLEMENTAL REGISTER**

FitnessCoachPro

AMERICAN SPECIALTY HEALTH INCORPORATED (DELAWARE CORPORATION)
777 FRONT STREET
ATTN: LIZ DEMAREST, RGC
SAN DIEGO, CA 92101

FOR: PROVIDING A WEB SITE FOR PERSONAL TRAINERS FEATURING INFORMATION ON EXERCISE AND FITNESS, IN CLASS 41 (U.S. CLS. 100, 101 AND 107).

FIRST USE 1-16-2007; IN COMMERCE 8-1-2007.

FOR: PROVIDING A WEB SITE FOR HEALTH CARE PROFESSIONALS, NAMELY, MEDICAL

DOCTORS, PHYSICAL THERAPISTS, AND CHIROPRACTORS, FEATURING INFORMATION ON HEALTH AND NUTRITION, IN CLASS 44 (U.S. CLS. 100 AND 101).

FIRST USE 1-16-2007; IN COMMERCE 8-1-2007.

THE MARK CONSISTS OF STANDARD CHARACTERS WITHOUT CLAIM TO ANY PARTICULAR FONT, STYLE, SIZE, OR COLOR.

SER. NO. 77-085,109, FILED P.R. 1-17-2007; AM. S.R. 5-22-2008.

SALLY SHIH, EXAMINING ATTORNEY

Int. Cls.: 25 and 35

Prior U.S. Cls.: 22, 39, 100, 101, and 102

United States Patent and Trademark Office

Reg. No. 3,478,365

Registered July 29, 2008

**TRADEMARK
SERVICE MARK
SUPPLEMENTAL REGISTER**

Social
INDUSTRIES

RUMSEY LLC (GEORGIA LTD LIAB CO)
8072 SLEEPY LAGOON WAY
FLOWERY BRANCH, GA 30542

FIRST USE 0-0-2003; IN COMMERCE 0-0-2003.

FOR: CLOTHING, NAMELY, TOPS, SHIRTS, T-SHIRTS, TANK TOPS, SWEATSHIRTS, SWEAT PANTS, HATS, BOXER SHORTS, IN CLASS 25 (U.S. CLS. 22 AND 39).

NO CLAIM IS MADE TO THE EXCLUSIVE RIGHT TO USE "INDUSTRIES", APART FROM THE MARK AS SHOWN.

FIRST USE 0-0-2003; IN COMMERCE 0-0-2003.

SER. NO. 77-091,260, FILED P.R. 1-25-2007; AM. S.R. 10-10-2007.

FOR: RETAIL STORE SERVICES FEATURING CLOTHING AND FOOTWEAR, IN CLASS 35 (U.S. CLS. 100, 101 AND 102).

STEVEN R. FOSTER, EXAMINING ATTORNEY

Int. Cl.: 9

Prior U.S. Cls.: 21, 23, 26, 36, and 38

Reg. No. 3,478,366

United States Patent and Trademark Office

Registered July 29, 2008

**TRADEMARK
SUPPLEMENTAL REGISTER**

OPTICAL FLOAT

COX RESEARCH AND TECHNOLOGY, INC.
(LOUISIANA CORPORATION)
14697 S. HARRELLS FERRY ROAD
BATON ROUGE, LA 70816

THE MARK CONSISTS OF STANDARD CHAR-
ACTERS WITHOUT CLAIM TO ANY PARTICULAR
FONT, STYLE, SIZE, OR COLOR.

FOR: LIQUID LEVEL DETECTOR, NAMELY, A
FLOAT OPERATED LEVEL SENSOR, IN CLASS 9
(U.S. CLS. 21, 23, 26, 36 AND 38).

SER. NO. 77-094,893, FILED P.R. 1-30-2007; AM. S.R.
6-18-2008.

FIRST USE 5-16-2008; IN COMMERCE 5-16-2008.

ALICE BENMAMAN, EXAMINING ATTORNEY

Int. Cl.: 41

Prior U.S. Cls.: 100, 101, and 107

United States Patent and Trademark Office

Reg. No. 3,478,367

Registered July 29, 2008

**SERVICE MARK
SUPPLEMENTAL REGISTER**

**PARENTS, KIDS AND MONEY
MATTERS**

THRIVENT FINANCIAL FOR LUTHERANS
(WISCONSIN FRATERNAL BENEFIT SOCIETY)
4321 NORTH BALLARD ROAD
APPLETON, WI 54919

FOR: EDUCATIONAL SERVICES, NAMELY,
SEMINARS AND WORKSHOPS IN THE FIELD OF
PERSONAL FINANCE AND STEWARDSHIP, AND
PROVIDING ASSESSMENT AND PLANNING
TOOLS IN THE NATURE OF COURSE MATERIALS
IN CONNECTION THEREWITH, IN CLASS 41 (U.S.
CLS. 100, 101 AND 107).

FIRST USE 4-23-2008; IN COMMERCE 4-23-2008.

THE MARK CONSISTS OF STANDARD CHARACTERS WITHOUT CLAIM TO ANY PARTICULAR FONT, STYLE, SIZE, OR COLOR.

SER. NO. 77-103,874, FILED P.R. 2-9-2007; AM. S.R. 6-23-2008.

JIM RINGLE, EXAMINING ATTORNEY

Int. Cl.: 9

Prior U.S. Cls.: 21, 23, 26, 36, and 38

United States Patent and Trademark Office

Reg. No. 3,478,368

Registered July 29, 2008

**TRADEMARK
SUPPLEMENTAL REGISTER**

MONITOR TRACK MANAGE

SABIOSO, INC. (UTAH CORPORATION)
189 SOUTH STATE ST., SUITE 250
CLEARFIELD, UT 84015

FOR: COMPUTER SOFTWARE USED FOR GPS/GIS TRACKING, GLOBAL COMMUNICATIONS, SHORT RANGE COMMUNICATIONS, GEOFENCING, REMOTE WIRELESS MONITORING, PERIMETER MONITORING, BIO-HAZARD DETECTION, DATA ANALYTICS, RESOURCE TRACKING, ESRI MAPPING, EVENT NOTIFICATION, SUPPLY CHAIN TRACKING, AND RESOURCE DISTRIBUTION IN THE FIELD OF LOGISTICS AND EMERGENCY RESPONSE, COMPUTER SOFTWARE USED TO MANAGE A WEB-BASED TRAINING PORTAL, A WEB-BASED SECURITY PORTAL, AND A HAZARDOUS MATERI-

ALS LIBRARY IN THE FIELD OF LOGISTICS AND EMERGENCY RESPONSE; COMPUTER SOFTWARE USED TO MANAGE COMPUTER HARDWARE AND SECURITY ELECTRONICS IN THE FIELD OF LOGISTICS AND EMERGENCY RESPONSE, IN CLASS 9 (U.S. CLS. 21, 23, 26, 36 AND 38).

FIRST USE 1-31-2004; IN COMMERCE 1-31-2004.

THE MARK CONSISTS OF STANDARD CHARACTERS WITHOUT CLAIM TO ANY PARTICULAR FONT, STYLE, SIZE, OR COLOR.

SER. NO. 77-104,010, FILED P.R. 2-9-2007; AM. S.R. 6-19-2008.

CORY BOONE, EXAMINING ATTORNEY

Int. Cl.: 41

Prior U.S. Cls.: 100, 101, and 107

United States Patent and Trademark Office

Reg. No. 3,478,369

Registered July 29, 2008

**SERVICE MARK
SUPPLEMENTAL REGISTER**

**PARENTS, TEENS AND MONEY
MATTERS**

THRIVENT FINANCIAL FOR LUTHERANS
(WISCONSIN FRATERNAL BENEFIT SOCIETY)
4321 NORTH BALLARD ROAD
APPLETON, WI 54919

FOR: EDUCATIONAL SERVICES, NAMELY,
SEMINARS AND WORKSHOPS IN THE FIELD OF
PERSONAL FINANCE AND STEWARDSHIP, AND
PROVIDING ASSESSMENT AND PLANNING
TOOLS IN THE NATURE OF COURSE MATERIALS
IN CONNECTION THEREWITH, IN CLASS 41 (U.S.
CLS. 100, 101 AND 107).

FIRST USE 4-23-2008; IN COMMERCE 4-23-2008.

THE MARK CONSISTS OF STANDARD CHARACTERS WITHOUT CLAIM TO ANY PARTICULAR FONT, STYLE, SIZE, OR COLOR.

SER. NO. 77-116,357, FILED P.R. 2-26-2007; AM. S.R. 6-23-2008.

JIM RINGLE, EXAMINING ATTORNEY

Int. Cl.: 30

Prior U.S. Cl.: 46

United States Patent and Trademark Office

Reg. No. 3,478,370

Registered July 29, 2008

**TRADEMARK
SUPPLEMENTAL REGISTER**

**THE GREAT LAKES TEA &
SPICE CO.**

THE GREAT LAKES TEA AND SPICE COMPAN-
NY, LLC (MICHIGAN LTD LIAB CO)
PO BOX 661
7500 WEST HARBOR HIGHWAY
GLEN ARBOR, MI 49636

FOR: BAKING SPICES; BEVERAGES MADE OF
TEA; BLACK TEA; CINNAMON POWDER; CLOVE
POWDER; CURRY; CURRY POWDER; FLAVOUR-
INGS OF TEA; FRUIT TEAS; GINGER; GREEN TEA;
HERB TEA; HERBAL TEA; HOT PEPPER POWDER;
ICED TEA; JAPANESE GREEN TEA; JAPANESE
HORSERADISH POWDER SPICE (WASABI POW-
DER); JAPANESE PEPPER POWDER SPICE (SAN-
SHO POWDER); LIME TEA; MUSTARD POWDER;
OOLONG TEA; PEPPER; PEPPER POWDER; PRO-
CESSED GINSENG USED AS AN HERB, SPICE OR
FLAVORING; SAGE TEA; SPICE BLENDS; SPICES;
TEA; TEA FOR INFUSIONS; TEA OF PARCHED
POWDER OF BARLEY WITH HUSK (MUGI-CHA);

TEA OF SALTY KELP POWDER (KOMBU-CHA);
TEA PODS; TEA SUBSTITUTES; TEA-BASED BEV-
ERAGES WITH FRUIT FLAVORING; THEINE-
FREE TEA SWEETENED WITH SWEETENERS, IN
CLASS 30 (U.S. CL. 46).

FIRST USE 6-1-2006; IN COMMERCE 6-1-2006.

THE MARK CONSISTS OF STANDARD CHAR-
ACTERS WITHOUT CLAIM TO ANY PARTICULAR
FONT, STYLE, SIZE, OR COLOR.

NO CLAIM IS MADE TO THE EXCLUSIVE
RIGHT TO USE "TEA & SPICE CO.", APART FROM
THE MARK AS SHOWN.

SER. NO. 77-117,181, FILED P.R. 2-27-2007; AM. S.R.
6-17-2008.

LINDA E. BLOHM, EXAMINING ATTORNEY

Int. Cl.: 39

Prior U.S. Cls.: 100 and 105

United States Patent and Trademark Office

Reg. No. 3,478,371

Registered July 29, 2008

**SERVICE MARK
SUPPLEMENTAL REGISTER**

On Time

GOLDEN STRIKE INTERNATIONAL LIMITED
(BR.VIRGIN ISLANDS CORPORATION)
INTERNATIONAL TRUST BUILDING
WICKHAMS CAY, 1, ROAD TOWN
TORTOLA, BR.VIRGIN ISLANDS

FOR: AIR TRANSPORT OF GOODS; CAR TRANSPORT OF GOODS; PACKAGING OF GOODS FOR TRANSPORTATION AND STORAGE; FREIGHT SHIP TRANSPORT OF GOODS; STORAGE OF A VARIETY GOODS; DELIVERY OF GOODS BY TRUCK, TRAIN OR AIR; FREIGHT FORWARDING; PROVIDING TRANSPORTATION AND STORAGE INFORMATION IN RELATION TO THE AFOREMENTIONED SERVICES; PROVIDING INFORMATION REGARDING TRANSPORTATION

AND STORAGE; STEVEDORING SERVICES, IN CLASS 39 (U.S. CLS. 100 AND 105).

FIRST USE 7-18-1995; IN COMMERCE 9-28-2005.

THE MARK CONSISTS OF STANDARD CHARACTERS WITHOUT CLAIM TO ANY PARTICULAR FONT, STYLE, SIZE, OR COLOR.

PRIORITY CLAIMED UNDER SEC. 44(D) ON HONG KONG APPLICATION NO. 300821817, FILED 2-27-2007.

SER. NO. 77-122,670, FILED P.R. 3-5-2007; AM. S.R. 6-20-2008.

FRED MANDIR, EXAMINING ATTORNEY

Int. Cl.: 33

Prior U.S. Cls.: 47 and 49

United States Patent and Trademark Office

Reg. No. 3,478,372

Registered July 29, 2008

**TRADEMARK
SUPPLEMENTAL REGISTER**

**THE WORLD'S ORIGINAL
GINGER LIQUEUR**

750 ML, LLC (DELAWARE LTD LIAB CO)
C/O REGISTERED OFFICE SERVICE COMPANY
203 NE FRONT STREET, SUITE 101
MILFORD, DE 19963

FOR: LIQUEURS, IN CLASS 33 (U.S. CLS. 47 AND 49).

FIRST USE 5-21-2008; IN COMMERCE 5-21-2008.

THE MARK CONSISTS OF STANDARD CHARACTERS WITHOUT CLAIM TO ANY PARTICULAR FONT, STYLE, SIZE, OR COLOR.

NO CLAIM IS MADE TO THE EXCLUSIVE RIGHT TO USE "GINGER LIQUEUR", APART FROM THE MARK AS SHOWN.

SER. NO. 77-123,232, FILED P.R. 3-6-2007; AM. S.R. 6-3-2008.

LESLIE RICHARDS, EXAMINING ATTORNEY

Int. Cl.: 35

Prior U.S. Cls.: 100, 101, and 102

United States Patent and Trademark Office

Reg. No. 3,478,373

Registered July 29, 2008

**SERVICE MARK
SUPPLEMENTAL REGISTER**

HireExec Executive Staffing

HIREEXEC EXECUTIVE STAFFING (GEORGIA
SOLE PROPRIETORSHIP)

4443 CHATUGE DRIVE

BUFORD, GA 30519

FOR: EXECUTIVE SEARCH AND PLACEMENT
SERVICES, IN CLASS 35 (U.S. CLS. 100, 101 AND 102).

FIRST USE 3-12-2007; IN COMMERCE 3-12-2007.

THE MARK CONSISTS OF STANDARD CHAR-
ACTERS WITHOUT CLAIM TO ANY PARTICULAR
FONT, STYLE, SIZE, OR COLOR.

NO CLAIM IS MADE TO THE EXCLUSIVE
RIGHT TO USE "EXECUTIVE STAFFING", APART
FROM THE MARK AS SHOWN.

SER. NO. 77-131,421, FILED P.R. 3-14-2007; AM. S.R.
6-19-2008.

NELSON SNYDER, EXAMINING ATTORNEY

Int. Cls.: 16, 35, and 41

Prior U.S. Cls.: 2, 5, 22, 23, 29, 37, 38, 50, 100, 101, 102, and 107

Reg. No. 3,478,374

United States Patent and Trademark Office

Registered July 29, 2008

**TRADEMARK
SERVICE MARK
SUPPLEMENTAL REGISTER**

**WASHINGTON, DC ECONOMIC
PARTNERSHIP**

WASHINGTON, DC ECONOMIC PARTNERSHIP
(D.C. NON-PROFIT CORPORATION)
1495 F STREET, N.W.
WASHINGTON, DC 20004

FOR: PUBLICATIONS, NAMELY, BOOKLETS, GUIDES, INFORMATION SHEETS AND PERIODICALS IN THE FIELD OF REAL ESTATE, REAL ESTATE DEVELOPMENT, ECONOMY, AND DEMOGRAPHICS, IN CLASS 16 (U.S. CLS. 2, 5, 22, 23, 29, 37, 38 AND 50).

FIRST USE 11-3-2005; IN COMMERCE 11-3-2005.

FOR: PROMOTING THE ECONOMIC DEVELOPMENT IN THE DISTRICT OF COLUMBIA BY PROMOTING BUSINESS AND DEVELOPMENT OPPORTUNITIES THROUGH MARKETING VIA A GLOBAL COMPUTER NETWORK, PUBLICATIONS, PRESS RELEASES; BUSINESS RELOCATION; PROMOTING RETAIL AND BUSINESS DEVELOPMENT TO OTHERS BY PROVIDING INFORMATION REGARDING INVENTORY OF BUILDINGS, OPPORTUNITY SITES, LEASE INFORMATION, TAX INFORMATION, RELOCATION ASSISTANCE, BUSINESS START-UP ASSISTANCE, AND POLICY ANALYSIS; PROMOTING THE DISTRICT OF CO-

LUMBIA INCENTIVE, DEVELOPMENT AND INFORMATIONAL PROGRAMS TO OTHERS VIA PRESS CONFERENCES, BRIEFINGS, PRESS RELEASES, TRADE SHOWS AND EXPOS; CONDUCTING TRADE SHOWS, IN THE FIELD OF BUSINESS AND RETAIL DEVELOPMENT, IN CLASS 35 (U.S. CLS. 100, 101 AND 102).

FIRST USE 11-3-2005; IN COMMERCE 11-3-2005.

FOR: EDUCATIONAL SERVICES, NAMELY, CONDUCTING CONFERENCES, WORKSHOPS AND SEMINARS IN THE FIELD OF BUSINESS AND RETAIL DEVELOPMENT, AND DISTRIBUTION OF LITERATURE IN CONNECTION THEREWITH, IN CLASS 41 (U.S. CLS. 100, 101 AND 107).

FIRST USE 11-3-2005; IN COMMERCE 11-3-2005.

THE MARK CONSISTS OF STANDARD CHARACTERS WITHOUT CLAIM TO ANY PARTICULAR FONT, STYLE, SIZE, OR COLOR.

SER. NO. 77-141,633, FILED P.R. 3-27-2007; AM. S.R. 3-27-2007.

MICHELLE DUBOIS, EXAMINING ATTORNEY

Int. Cl.: 44

Prior U.S. Cls.: 100 and 101

United States Patent and Trademark Office

Reg. No. 3,478,375

Registered July 29, 2008

**SERVICE MARK
SUPPLEMENTAL REGISTER**

SUPER CLINIC

NGUYEN, DOMINIC N. (UNITED STATES INDIVIDUAL)
40 PARK CITY COURT
NO. 11207
SACRAMENTO, CA 95831

FOR: MEDICAL CLINICS FEATURING MEDICAL SERVICES, IN CLASS 44 (U.S. CLS. 100 AND 101).

FIRST USE 2-28-2008; IN COMMERCE 3-21-2008.

THE MARK CONSISTS OF STANDARD CHARACTERS WITHOUT CLAIM TO ANY PARTICULAR FONT, STYLE, SIZE, OR COLOR.

NO CLAIM IS MADE TO THE EXCLUSIVE RIGHT TO USE "CLINIC", APART FROM THE MARK AS SHOWN.

SER. NO. 77-144,779, FILED P.R. 3-30-2007; AM. S.R. 3-3-2008.

JEAN IM, EXAMINING ATTORNEY

Int. Cl.: 16

Prior U.S. Cls.: 2, 5, 22, 23, 29, 37, 38, and 50

United States Patent and Trademark Office

Reg. No. 3,478,376

Registered July 29, 2008

**TRADEMARK
SUPPLEMENTAL REGISTER**

CORPORATE APPAREL

WIESNERMEDIA, LLC (COLORADO LTD LIAB
CO)
7009 SOUTH POTOMAC STREET
SUITE 200
CENTENNIAL, CO 80112

FOR: PRINTED PUBLICATIONS, NAMELY, MA-
GAZINES IN THE FIELDS OF PROMOTIONS, MAR-
KETING, ADVERTISING, AND BRANDS, IN CLASS
16 (U.S. CLS. 2, 5, 22, 23, 29, 37, 38 AND 50).

FIRST USE 4-9-2007; IN COMMERCE 8-29-2007.

THE MARK CONSISTS OF STANDARD CHAR-
ACTERS WITHOUT CLAIM TO ANY PARTICULAR
FONT, STYLE, SIZE, OR COLOR.

SER. NO. 77-148,560, FILED P.R. 4-4-2007; AM. S.R.
12-14-2007.

JOHN DALIER, EXAMINING ATTORNEY

Int. Cl.: 7

Prior U.S. Cls.: 13, 19, 21, 23, 31, 34, and 35

Reg. No. 3,478,377

United States Patent and Trademark Office

Registered July 29, 2008

**TRADEMARK
SUPPLEMENTAL REGISTER**

U-PARKIT

AHU DEVELOPMENTS, LTD (NEW ZEALAND CORPORATION)
LEVEL 2A, 198 FEDERAL STREET
AUCKLAND, NEW ZEALAND

FOR: POWER-OPERATED LIFTS FOR MOVING, PARKING AND STORING LAND VEHICLES, NAMELY, AN AUTOMATED, ELECTROMECHANICAL, STRUCTURAL APPARATUS, NAMELY, A STEEL MULTI-LEVEL COMPARTMENTAL STRUCTURE WHICH IS SUBDIVIDED INTO INDEPENDENT, SEMI-UNIFORM OR UNIFORM STRUCTURAL COMPARTMENTS PLACED IN ALIGNMENT FANNING COLUMNS, ROWS AND TIERS THAT OCCUPY SPACE IN CUBIC VOLUME, WITH SEMI OR FULLY AUTOMATIC COMPUTERIZED SYSTEM CONTROLLERS AND SOFTWARE, THAT PROCESSES VARIOUS SENSORY INFORMATION INCLUDING MEASUREMENTS OF DIMENSION AND PLACEMENT, GOVERNING 3-AXIS, NAMELY, VERTICAL, LONGITUDINAL AND LAT-

ERAL, ELECTRO-MECHANICAL DRIVE-MOTIONS, WITH VARIABLE SPEED CONTROLS MID REDUNDANT FAIL-SAFE BRAKE SYSTEMS, THAT INCORPORATES CONVEYOR TRANSFERS, TRAVERSER-ELEVATOR LIFTS, AND ROTATIONAL PALLETS, CONSTRUCTED FOR THE INSERTION, STACKING, STORAGE AND EXTRACTION OF AUTOMOTIVE VEHICLES, IN CLASS 7 (U.S. CLS. 13, 19, 21, 23, 31, 34 AND 35).

FIRST USE 12-2-2005; IN COMMERCE 12-6-2006.

THE MARK CONSISTS OF STANDARD CHARACTERS WITHOUT CLAIM TO ANY PARTICULAR FONT, STYLE, SIZE, OR COLOR.

SER. NO. 77-154,500, FILED P.R. 4-11-2007; AM. S.R. 6-23-2008.

LOURDES AYALA, EXAMINING ATTORNEY

Int. Cl.: 44

Prior U.S. Cls.: 100 and 101

United States Patent and Trademark Office

Reg. No. 3,478,378

Registered July 29, 2008

**SERVICE MARK
SUPPLEMENTAL REGISTER**

SUPERCLINIC

NGUYEN, DOMINIC N. (UNITED STATES INDIVIDUAL)
40 PARK CITY COURT
NO. 11207
SACRAMENTO, CA 95831

FOR: MEDICAL CLINICS FEATURING MEDICAL SERVICES, IN CLASS 44 (U.S. CLS. 100 AND 101).

FIRST USE 1-15-2008; IN COMMERCE 3-21-2008.

THE MARK CONSISTS OF STANDARD CHARACTERS WITHOUT CLAIM TO ANY PARTICULAR FONT, STYLE, SIZE, OR COLOR.

SER. NO. 77-155,348, FILED P.R. 4-12-2007; AM. S.R. 3-3-2008.

JEAN IM, EXAMINING ATTORNEY

Int. Cl.: 14

Prior U.S. Cls.: 2, 27, 28, and 50

United States Patent and Trademark Office

Reg. No. 3,478,379

Registered July 29, 2008

**TRADEMARK
SUPPLEMENTAL REGISTER**

DUBAI SUPERLATIVE

XOSKELETON, INC. (MARYLAND CORPORATION)
10462 WATERFOWL TERRACE
COLUMBIA, MD 21044

FOR: CHRONOGRAPHS FOR USE AS WATCHES;
CLOCK AND WATCH HANDS; DIVING WATCHES;
JEWELRY WATCHES; POCKET WATCHES; STOP
WATCHES; WATCH BANDS; WATCH BRACELETS,
IN CLASS 14 (U.S. CLS. 2, 27, 28 AND 50).

FIRST USE 10-29-2007; IN COMMERCE 10-29-2007.

THE MARK CONSISTS OF STANDARD CHARACTERS WITHOUT CLAIM TO ANY PARTICULAR FONT, STYLE, SIZE, OR COLOR.

NO CLAIM IS MADE TO THE EXCLUSIVE RIGHT TO USE "DUBAI", APART FROM THE MARK AS SHOWN.

SER. NO. 77-157,462, FILED P.R. 4-16-2007; AM. S.R. 6-25-2008.

CARYN GLASSER, EXAMINING ATTORNEY

Int. Cl.: 35

Prior U.S. Cls.: 100, 101, and 102

United States Patent and Trademark Office

Reg. No. 3,478,380

Registered July 29, 2008

**SERVICE MARK
SUPPLEMENTAL REGISTER**

ENTRY MARKETING

ENTRYPOINT COMMUNICATIONS, LLC (DELA-
WARE LTD LIAB CO)
SUITE 120
200 AMERICAN METRO BLVD.
HAMILTON, NJ 08619

FOR: ADVERTISING SERVICES, NAMELY, IN-
STORE ADVERTISING AND PROMOTIONAL PRO-
GRAMS FOR OTHERS IN WHICH DISPENSERS
DISPENSE SHEETS DISPLAYING PROMOTIONAL
OFFERS TO SHOPPERS; ADVERTISING AGENCY
SERVICES, NAMELY, PROMOTING THE SALE OF
GOODS OF OTHERS BY PROVIDING POINT OF
SALE DISPLAY ADVERTISEMENTS AND SALE
PROMOTIONAL MATERIAL FOR USE IN RETAIL
STORES, IN CLASS 35 (U.S. CLS. 100, 101 AND 102).

FIRST USE 5-0-2007; IN COMMERCE 5-0-2007.

THE MARK CONSISTS OF STANDARD CHAR-
ACTERS WITHOUT CLAIM TO ANY PARTICULAR
FONT, STYLE, SIZE, OR COLOR.

NO CLAIM IS MADE TO THE EXCLUSIVE
RIGHT TO USE "MARKETING", APART FROM
THE MARK AS SHOWN.

SER. NO. 77-167,890, FILED P.R. 4-27-2007; AM. S.R.
4-3-2008.

EUGENIA MARTIN, EXAMINING ATTORNEY

Int. Cl.: 11

Prior U.S. Cls.: 13, 21, 23, 31, and 34

United States Patent and Trademark Office

Reg. No. 3,478,381

Registered July 29, 2008

**TRADEMARK
SUPPLEMENTAL REGISTER**

D-H2O

CERNUTO, ANTONIO A.M. (ITALY INDIVIDUAL)
48 GLEN ROAD
MOUNTAIN LAKES, NJ 07046 AND
TURDIU, MIZAR M. (UNITED STATES INDIVIDUAL)
48 GLEN ROAD
MOUNTAIN LAKES, NJ 07046

FOR: ENVIRONMENTALLY FRIENDLY WATER
TREATMENT EQUIPMENT, NAMELY, REVERSE
OSMOSIS FILTRATION UNITS WITH A WATER
DE-IONIZING COMPONENT WHICH REDUCES
TOTAL DISSOLVED SOLIDS TO ZERO PPMS TO

BE USED IN DENTAL PRACTICES FOR STERILIZATION
EQUIPMENT, IN CLASS 11 (U.S. CLS. 13, 21,
23, 31 AND 34).

FIRST USE 5-10-2007; IN COMMERCE 5-10-2007.

THE MARK CONSISTS OF STANDARD CHARACTERS
WITHOUT CLAIM TO ANY PARTICULAR
FONT, STYLE, SIZE, OR COLOR.

SER. NO. 77-177,249, FILED P.R. 5-10-2007; AM. S.R.
4-23-2008.

DAVID TOOLEY, EXAMINING ATTORNEY

Int. Cls.: 16 and 41

Prior U.S. Cls.: 2, 5, 22, 23, 29, 37, 38, 50, 100, 101, and 107

Reg. No. 3,478,382

United States Patent and Trademark Office

Registered July 29, 2008

**TRADEMARK
SERVICE MARK
SUPPLEMENTAL REGISTER**

LAGUNA BEACH MAGAZINE

FIREBRAND MEDIA, INC. (NORTH CAROLINA CORPORATION)
594 ROBINSON CREEK ROAD
LONDON, KY 40744

FOR: PRINTED MAGAZINES ON THE SUBJECT OF GENERAL INTEREST AND LIFESTYLES, IN CLASS 16 (U.S. CLS. 2, 5, 22, 23, 29, 37, 38 AND 50).

FIRST USE 8-1-2007; IN COMMERCE 8-1-2007.

FOR: PROVIDING ONLINE PUBLICATIONS IN THE NATURE OF A MAGAZINE ON GENERAL INTEREST AND LIFESTYLE TOPICS, IN CLASS 41 (U.S. CLS. 100, 101 AND 107).

FIRST USE 8-1-2007; IN COMMERCE 8-1-2007.

THE MARK CONSISTS OF STANDARD CHARACTERS WITHOUT CLAIM TO ANY PARTICULAR FONT, STYLE, SIZE, OR COLOR.

NO CLAIM IS MADE TO THE EXCLUSIVE RIGHT TO USE "MAGAZINE", APART FROM THE MARK AS SHOWN.

SER. NO. 77-192,096, FILED P.R. 5-29-2007; AM. S.R. 12-20-2007.

JENNIFER HETU, EXAMINING ATTORNEY

Int. Cls.: 16 and 41

Prior U.S. Cls.: 2, 5, 22, 23, 29, 37, 38, 50, 100, 101, and 107

Reg. No. 3,478,383

United States Patent and Trademark Office

Registered July 29, 2008

**TRADEMARK
SERVICE MARK
SUPPLEMENTAL REGISTER**

LAGUNA BEACH
MAGAZINE

FIREBRAND MEDIA, INC. (NORTH CAROLINA CORPORATION)
594 ROBINSON CREEK ROAD
LONDON, KY 40744

FOR: PRINTED MAGAZINES ON THE SUBJECT OF GENERAL INTEREST AND LIFESTYLES, IN CLASS 16 (U.S. CLS. 2, 5, 22, 23, 29, 37, 38 AND 50).

FIRST USE 8-1-2007; IN COMMERCE 8-1-2007.

FOR: PROVIDING ONLINE PUBLICATIONS IN THE NATURE OF A MAGAZINE ON GENERAL

INTEREST AND LIFESTYLE TOPICS, IN CLASS 41 (U.S. CLS. 100, 101 AND 107).

FIRST USE 8-1-2007; IN COMMERCE 8-1-2007.

NO CLAIM IS MADE TO THE EXCLUSIVE RIGHT TO USE "MAGAZINE", APART FROM THE MARK AS SHOWN.

SER. NO. 77-192,989, FILED P.R. 5-30-2007; AM. S.R. 12-20-2007.

JENNIFER HETU, EXAMINING ATTORNEY

Int. Cl.: 36

Prior U.S. Cls.: 100, 101, and 102

United States Patent and Trademark Office

Reg. No. 3,478,384

Registered July 29, 2008

**SERVICE MARK
SUPPLEMENTAL REGISTER**

LOAN PAYMENT ADMINISTRATION

NATIONWIDE BIWEEKLY ADMINISTRATION,
INC. (OHIO CORPORATION)
855 LOWER BELLBROOK ROAD
XENIA, OH 45385

FOR: ADMINISTRATION OF WEEKLY AND BI-
WEEKLY MORTGAGE PAYMENT PROGRAMS, IN
CLASS 36 (U.S. CLS. 100, 101 AND 102).

FIRST USE 5-0-2006; IN COMMERCE 5-0-2006.

THE MARK CONSISTS OF STANDARD CHAR-
ACTERS WITHOUT CLAIM TO ANY PARTICULAR
FONT, STYLE, SIZE, OR COLOR.

NO CLAIM IS MADE TO THE EXCLUSIVE
RIGHT TO USE "ADMINISTRATION", APART
FROM THE MARK AS SHOWN.

SER. NO. 77-202,445, FILED 6-11-2007.

EVELYN BRADLEY, EXAMINING ATTORNEY

Int. Cl.: 35

Prior U.S. Cls.: 100, 101, and 102

United States Patent and Trademark Office

Reg. No. 3,478,385

Registered July 29, 2008

**SERVICE MARK
SUPPLEMENTAL REGISTER**

CORE MESSAGE ANALYSIS

CONCORD EDITORIAL AND DESIGN, LLC (MI-
CHIGAN LTD LIAB CO)
5583 BANCROFT AVENUE SE
ALTO, MI 49302

FOR: ANALYSIS AND CONSULTING REGARD-
ING THE MARKETING OF BUSINESSES, SERVI-
CES, AND PRODUCTS, IN CLASS 35 (U.S. CLS. 100,
101 AND 102).

FIRST USE 5-0-2007; IN COMMERCE 6-4-2007.

THE MARK CONSISTS OF STANDARD CHAR-
ACTERS WITHOUT CLAIM TO ANY PARTICULAR
FONT, STYLE, SIZE, OR COLOR.

NO CLAIM IS MADE TO THE EXCLUSIVE
RIGHT TO USE "ANALYSIS", APART FROM THE
MARK AS SHOWN.

SER. NO. 77-212,760, FILED P.R. 6-22-2007; AM. S.R.
6-3-2008.

DAVID HOFFMAN, EXAMINING ATTORNEY

Int. Cl.: 30

Prior U.S. Cl.: 46

United States Patent and Trademark Office

Reg. No. 3,478,386

Registered July 29, 2008

**TRADEMARK
SUPPLEMENTAL REGISTER**

Cookies America

DIANNA, MICHAEL (UNITED STATES INDIVIDUAL)
P.O. 16434
SAN DIEGO, CA 92176

NO CLAIM IS MADE TO THE EXCLUSIVE RIGHT TO USE "COOKIES", APART FROM THE MARK AS SHOWN.

FOR: COOKIES, IN CLASS 30 (U.S. CL. 46).

FIRST USE 6-1-2007; IN COMMERCE 2-1-2008.

SER. NO. 77-218,446, FILED P.R. 6-28-2007; AM. S.R. 3-18-2008.

THE MARK CONSISTS OF STANDARD CHARACTERS WITHOUT CLAIM TO ANY PARTICULAR FONT, STYLE, SIZE, OR COLOR.

ANNE FARRELL, EXAMINING ATTORNEY

Int. Cl.: 9

Prior U.S. Cls.: 21, 23, 26, 36, and 38

United States Patent and Trademark Office

Reg. No. 3,478,387

Registered July 29, 2008

**TRADEMARK
SUPPLEMENTAL REGISTER**

PRISMATIC

LEUPOLD & STEVENS, INC. (OREGON COR-
PORATION)
BOX 688
BEAVERTON, OR 97075

THE MARK CONSISTS OF STANDARD CHAR-
ACTERS WITHOUT CLAIM TO ANY PARTICULAR
FONT, STYLE, SIZE, OR COLOR.

FOR: TELESCOPIC SIGHTS, OPTICAL LENS
SCOPES; OPTICAL LENS SIGHTS FOR FIREARMS;
RIFLESCOPES, IN CLASS 9 (U.S. CLS. 21, 23, 26, 36
AND 38).

SER. NO. 77-222,816, FILED P.R. 7-5-2007; AM. S.R.
6-18-2008.

FIRST USE 2-29-2008; IN COMMERCE 2-29-2008.

CHRISTINA SOBRAL, EXAMINING ATTORNEY

Int. Cls.: 35 and 42

Prior U.S. Cls.: 100, 101, and 102

United States Patent and Trademark Office

Reg. No. 3,478,388

Registered July 29, 2008

**SERVICE MARK
SUPPLEMENTAL REGISTER**

OSBMARKET

SILVARIS CORPORATION (WASHINGTON CORPORATION)
155 - 108TH AVE. NE
SUITE 725
BELLEVUE, WA 98004

FOR: WOOD PRODUCTS MARKET ANALYSIS; PROVIDING AN ON-LINE COMPUTER DATABASE IN THE FIELD OF LOCATING PRODUCTS, DESCRIBING PRODUCTS, RATING PRODUCTS, PRICING PRODUCTS AND COMPARING PRICES OF PRODUCTS, IN CLASS 35 (U.S. CLS. 100, 101 AND 102).

FIRST USE 9-4-2007; IN COMMERCE 9-4-2007.

FOR: PROVIDING ON-LINE NON-DOWNLOADABLE SOFTWARE FOR USE IN DATABASE THE MANAGEMENT, IN THE FIELD OF WOOD PRODUCTS PURCHASING, IN CLASS 42 (U.S. CLS. 100 AND 101).

FIRST USE 9-4-2007; IN COMMERCE 9-4-2007.

THE MARK CONSISTS OF STANDARD CHARACTERS WITHOUT CLAIM TO ANY PARTICULAR FONT, STYLE, SIZE, OR COLOR.

SER. NO. 77-232,080, FILED P.R. 7-17-2007; AM. S.R. 6-18-2008.

LOURDES AYALA, EXAMINING ATTORNEY

Int. Cls.: 35 and 42

Prior U.S. Cls.: 100, 101, and 102

United States Patent and Trademark Office

Reg. No. 3,478,389

Registered July 29, 2008

**SERVICE MARK
SUPPLEMENTAL REGISTER**

TRUEMARKET

SILVARIS CORPORATION (WASHINGTON CORPORATION)
155 - 108TH AVE. NE
SUITE 725
BELLEVUE, WA 98004

FOR: WOOD PRODUCTS MARKET ANALYSIS; PROVIDING AN ON-LINE COMPUTER DATABASE IN THE FIELD OF LOCATING PRODUCTS, DESCRIBING PRODUCTS, RATING PRODUCTS, PRICING PRODUCTS AND COMPARING PRICES OF PRODUCTS, IN CLASS 35 (U.S. CLS. 100, 101 AND 102).

FIRST USE 9-4-2007; IN COMMERCE 9-4-2007.

FOR: PROVIDING ON-LINE NON-DOWNLOADABLE SOFTWARE FOR USE IN DATABASE THE MANAGEMENT, IN THE FIELD OF WOOD PRODUCTS PURCHASING, IN CLASS 42 (U.S. CLS. 100 AND 101).

FIRST USE 9-4-2007; IN COMMERCE 9-4-2007.

THE MARK CONSISTS OF STANDARD CHARACTERS WITHOUT CLAIM TO ANY PARTICULAR FONT, STYLE, SIZE, OR COLOR.

SER. NO. 77-232,088, FILED P.R. 7-17-2007; AM. S.R. 6-18-2008.

LOURDES AYALA, EXAMINING ATTORNEY

Int. Cls.: 35 and 42

Prior U.S. Cls.: 100, 101, and 102

United States Patent and Trademark Office

Reg. No. 3,478,390

Registered July 29, 2008

**SERVICE MARK
SUPPLEMENTAL REGISTER**

LOWGRADE1

SILVARIS CORPORATION (WASHINGTON CORPORATION)
155 - 108TH AVE. NE
SUITE 725
BELLEVUE, WA 98004

FOR: WOOD PRODUCTS MARKET ANALYSIS; PROVIDING AN ON-LINE COMPUTER DATABASE IN THE FIELD OF LOCATING PRODUCTS, DESCRIBING PRODUCTS, RATING PRODUCTS, PRICING PRODUCTS AND COMPARING PRICES OF PRODUCTS, IN CLASS 35 (U.S. CLS. 100, 101 AND 102).

FIRST USE 9-4-2007; IN COMMERCE 9-4-2007.

FOR: PROVIDING ON-LINE NON-DOWNLOADABLE SOFTWARE FOR USE IN DATABASE THE MANAGEMENT, IN THE FIELD OF WOOD PRO-

DUCTS PURCHASING, IN CLASS 42 (U.S. CLS. 100 AND 101).

FIRST USE 9-4-2007; IN COMMERCE 9-4-2007.

THE MARK CONSISTS OF STANDARD CHARACTERS WITHOUT CLAIM TO ANY PARTICULAR FONT, STYLE, SIZE, OR COLOR.

OWNER OF U.S. REG. NOS. 3,197,731 AND 3,241,301.

NO CLAIM IS MADE TO THE EXCLUSIVE RIGHT TO USE "LOWGRADE", APART FROM THE MARK AS SHOWN.

SER. NO. 77-232,096, FILED P.R. 7-17-2007; AM. S.R. 6-18-2008.

LOURDES AYALA, EXAMINING ATTORNEY

Int. Cls.: 35 and 42

Prior U.S. Cls.: 100, 101, and 102

United States Patent and Trademark Office

Reg. No. 3,478,391

Registered July 29, 2008

**SERVICE MARK
SUPPLEMENTAL REGISTER**

LOWGRADE2

SILVARIS CORPORATION (WASHINGTON CORPORATION)
155 - 108TH AVE. NE
SUITE 725
BELLEVUE, WA 98004

FOR: WOOD PRODUCTS MARKET ANALYSIS; PROVIDING AN ON-LINE COMPUTER DATABASE IN THE FIELD OF LOCATING PRODUCTS, DESCRIBING PRODUCTS, RATING PRODUCTS, PRICING PRODUCTS AND COMPARING PRICES OF PRODUCTS, IN CLASS 35 (U.S. CLS. 100, 101 AND 102).

FIRST USE 9-4-2007; IN COMMERCE 9-4-2007.

FOR: PROVIDING ON-LINE NON-DOWNLOADABLE SOFTWARE FOR USE IN DATABASE THE MANAGEMENT, IN THE FIELD OF WOOD PRO-

DUCTS PURCHASING, IN CLASS 42 (U.S. CLS. 100 AND 101).

FIRST USE 9-4-2007; IN COMMERCE 9-4-2007.

THE MARK CONSISTS OF STANDARD CHARACTERS WITHOUT CLAIM TO ANY PARTICULAR FONT, STYLE, SIZE, OR COLOR.

OWNER OF U.S. REG. NOS. 3,197,731 AND 3,241,301.

NO CLAIM IS MADE TO THE EXCLUSIVE RIGHT TO USE "LOWGRADE", APART FROM THE MARK AS SHOWN.

SER. NO. 77-232,101, FILED P.R. 7-17-2007; AM. S.R. 6-18-2008.

LOURDES AYALA, EXAMINING ATTORNEY

Int. Cl.: 19

Prior U.S. Cls.: 1, 12, 33, and 50

United States Patent and Trademark Office

Reg. No. 3,478,392

Registered July 29, 2008

**TRADEMARK
SUPPLEMENTAL REGISTER**

GorgeouStone

MAIELLO, SR., MICHAEL PAUL (UNITED STATES INDIVIDUAL)
4939 JUANITA WAY S
ST. PETERSBURG, FL 33705

FOR: STONE FOR BUILDING AND CONSTRUCTION, IN CLASS 19 (U.S. CLS. 1, 12, 33 AND 50).

FIRST USE 3-15-2008; IN COMMERCE 3-15-2008.

THE MARK CONSISTS OF STANDARD CHARACTERS WITHOUT CLAIM TO ANY PARTICULAR FONT, STYLE, SIZE, OR COLOR.

SER. NO. 77-234,122, FILED P.R. 7-19-2007; AM. S.R. 6-25-2008.

ALEXANDER L. POWERS, EXAMINING ATTORNEY

Int. Cls.: 35 and 36

Prior U.S. Cls.: 100, 101, and 102

United States Patent and Trademark Office

Reg. No. 3,478,393

Registered July 29, 2008

**SERVICE MARK
SUPPLEMENTAL REGISTER**

Media Fast

LOVE INC, LOVE IN THE NAME OF CHRIST
(MINNESOTA NON-PROFIT CORPORATION)
430 OAK GROVE STREET, SUITE 400
MINNEAPOLIS, MN 55403

FOR: CHARITABLE SERVICES, NAMELY, PROMOTING PUBLIC AWARENESS ABOUT POVERTY IN THE UNITED STATES THROUGH A MEDIA FAST PROGRAM CONDUCTED BY YOUNG PEOPLE, IN CLASS 35 (U.S. CLS. 100, 101 AND 102).

FIRST USE 7-3-2007; IN COMMERCE 7-16-2007.

FOR: CHARITABLE FUND RAISING BY MEANS OF A MEDIA FAST CONDUCTED BY YOUNG PEOPLE, IN CLASS 36 (U.S. CLS. 100, 101 AND 102).

FIRST USE 7-3-2007; IN COMMERCE 7-16-2007.

THE MARK CONSISTS OF STANDARD CHARACTERS WITHOUT CLAIM TO ANY PARTICULAR FONT, STYLE, SIZE, OR COLOR.

SER. NO. 77-236,352, FILED 7-23-2007.

STEVEN JACKSON, EXAMINING ATTORNEY

Int. Cl.: 42

Prior U.S. Cls.: 100 and 101

United States Patent and Trademark Office

Reg. No. 3,478,394

Registered July 29, 2008

**SERVICE MARK
SUPPLEMENTAL REGISTER**

Technical Marketing

STRATEQUEST, LLC (CALIFORNIA LTD LIAB
CO)
2250 MONROE STREET, #305
SANTA CLARA, CA 95050

FOR: SCIENTIFIC AND TECHNICAL RESEARCH
SERVICES, IN THE FIELD OF TECHNICAL MAR-
KETING, IN CLASS 42 (U.S. CLS. 100 AND 101).

FIRST USE 7-1-2007; IN COMMERCE 7-10-2007.

THE MARK CONSISTS OF STANDARD CHAR-
ACTERS WITHOUT CLAIM TO ANY PARTICULAR
FONT, STYLE, SIZE, OR COLOR.

SER. NO. 77-240,911, FILED P.R. 7-27-2007; AM. S.R.
5-30-2008.

MARGERY A. TIERNEY, EXAMINING ATTORNEY

Int. Cl.: 3

Prior U.S. Cls.: 1, 4, 6, 50, 51, and 52

Reg. No. 3,478,395

United States Patent and Trademark Office

Registered July 29, 2008

**TRADEMARK
SUPPLEMENTAL REGISTER**

MINERALS FOR HEALTHY SKIN

AHAVA N.A., LLC (NEW YORK LTD LIAB CO)
411 FIFTH AVENUE
NEW YORK, NY 10016

FOR: BATH SALTS; BEAUTY MASKS; BODY CREAMS; BODY LOTIONS; EYE CREAM; FACIAL BEAUTY MASKS; FACIAL CLEANSERS; FACIAL CREAM; FACIAL LOTION; FACIAL MASKS; FACIAL WASHES; HAIR SHAMPOO; SHOWER GEL; EXFOLIANTS FOR SKIN; HAND CREAM; MAKE-UP REMOVER; SKIN TONERS; TONERS; MUD FACIAL MASKS; FACIAL MOISTURIZERS; FACIAL FRESHENERS, NAMELY, FRESHENING FA-

CIAL LOTION; AND FACIAL SOAPS, IN CLASS 3 (U.S. CLS. 1, 4, 6, 50, 51 AND 52).

FIRST USE 9-14-2006; IN COMMERCE 9-14-2006.

THE MARK CONSISTS OF STANDARD CHARACTERS WITHOUT CLAIM TO ANY PARTICULAR FONT, STYLE, SIZE, OR COLOR.

SER. NO. 77-242,289, FILED P.R. 7-30-2007; AM. S.R. 6-19-2008.

CARRIE GENOVESE, EXAMINING ATTORNEY

Int. Cl.: 36

Prior U.S. Cls.: 100, 101, and 102

United States Patent and Trademark Office

Reg. No. 3,478,396

Registered July 29, 2008

**SERVICE MARK
SUPPLEMENTAL REGISTER**

PURCHASE PROS

PURCHASE PROS LLC (OHIO CORPORATION)
1521 GEORGETOWN ROAD, SUITE 302
HUDSON, OH 44236

FOR: REAL ESTATE CONSULTING, NAMELY,
PROVIDING ASSISTANCE TO HOME BUYERS
SUCH AS PROVIDING CASH FOR SETTLEMENT
THROUGH LEGAL CONTRACTS WITH THE BUY-
ER AND THE SELLER, IN CLASS 36 (U.S. CLS. 100,
101 AND 102).

FIRST USE 4-27-2005; IN COMMERCE 4-27-2005.

THE MARK CONSISTS OF STANDARD CHAR-
ACTERS WITHOUT CLAIM TO ANY PARTICULAR
FONT, STYLE, SIZE, OR COLOR.

SER. NO. 77-249,181, FILED P.R. 8-7-2007; AM. S.R.
6-24-2008.

PAUL MORENO, EXAMINING ATTORNEY

Int. Cl.: 8

Prior U.S. Cls.: 23, 28, and 44

United States Patent and Trademark Office

Reg. No. 3,478,397

Registered July 29, 2008

**TRADEMARK
SUPPLEMENTAL REGISTER**

FENCER'S LASSO

ES ROBBINS CORPORATION (ALABAMA CORPORATION)
2802 E. AVALON AVENUE
MUSCLE SHOALS, AL 356613748

FOR: HAND TOOLS, NAMELY, INSULATOR CABLE, HOOK AND RATCHET FOR FENCE WIRE TERMINATION, IN CLASS 8 (U.S. CLS. 23, 28 AND 44).

FIRST USE 1-23-2008; IN COMMERCE 1-23-2008.

THE MARK CONSISTS OF STANDARD CHARACTERS WITHOUT CLAIM TO ANY PARTICULAR FONT, STYLE, SIZE, OR COLOR.

SER. NO. 77-253,748, FILED P.R. 8-13-2007; AM. S.R. 6-25-2008.

AMY GEARIN, EXAMINING ATTORNEY

Int. Cl.: 36

Prior U.S. Cls.: 100, 101, and 102

United States Patent and Trademark Office

Reg. No. 3,478,398

Registered July 29, 2008

**SERVICE MARK
SUPPLEMENTAL REGISTER**

PLANASERP.COM

PLANASERP.COM, LLC (FLORIDA LTD LIAB
CO)
C/O BENEFIT SERVICE COMPANY
133 PROSPECT STREET
WESTFIELD, NJ 07090

FOR: PROVIDING INFORMATION OVER A GLO-
BAL COMMUNICATIONS NETWORK ABOUT SUP-
PLEMENTAL EXECUTIVE RETIREMENT PLANS,
IN CLASS 36 (U.S. CLS. 100, 101 AND 102).

FIRST USE 10-11-2006; IN COMMERCE 10-11-2006.

THE MARK CONSISTS OF STANDARD CHAR-
ACTERS WITHOUT CLAIM TO ANY PARTICULAR
FONT, STYLE, SIZE, OR COLOR.

SER. NO. 77-254,430, FILED P.R. 8-14-2007; AM. S.R.
5-27-2008.

TINA BROWN, EXAMINING ATTORNEY

Int. Cl.: 30

Prior U.S. Cl.: 46

United States Patent and Trademark Office

Reg. No. 3,478,399

Registered July 29, 2008

**TRADEMARK
SUPPLEMENTAL REGISTER**

GOURMET SELECT

GOURMET SELECT FOODS CORP., INC. (NEVADA CORPORATION)
223 UNDERHILL BLVD.
SYOSSET, NY 11791

FOR: SALT; SPICES; SEASONINGS, IN CLASS 30 (U.S. CL. 46).

FIRST USE 11-0-2006; IN COMMERCE 11-0-2006.

THE MARK CONSISTS OF STANDARD CHARACTERS WITHOUT CLAIM TO ANY PARTICULAR FONT, STYLE, SIZE, OR COLOR.

SER. NO. 77-255,926, FILED P.R. 8-15-2007; AM. S.R. 6-19-2008.

JUSTINE D. PARKER, EXAMINING ATTORNEY

Int. Cl.: 36

Prior U.S. Cls.: 100, 101, and 102

United States Patent and Trademark Office

Reg. No. 3,478,400

Registered July 29, 2008

**SERVICE MARK
SUPPLEMENTAL REGISTER**

PLAN FIDUCIARY & ETHICS

BEN, LILLIE (UNITED STATES INDIVIDUAL)
P.O. BOX 529
FRANKTOWN, CO 80116

FOR: FINANCIAL CONSULTATION IN THE
FIELD OF RETIREMENT PLANNING AND EM-
PLOYEE BENEFIT PLANS, IN CLASS 36 (U.S. CLS.
100, 101 AND 102).

FIRST USE 8-16-2007; IN COMMERCE 8-16-2007.

THE MARK CONSISTS OF STANDARD CHAR-
ACTERS WITHOUT CLAIM TO ANY PARTICULAR
FONT, STYLE, SIZE, OR COLOR.

NO CLAIM IS MADE TO THE EXCLUSIVE
RIGHT TO USE "PLAN", APART FROM THE MARK
AS SHOWN.

SER. NO. 77-258,073, FILED P.R. 8-17-2007; AM. S.R.
6-16-2008.

JENNY PARK, EXAMINING ATTORNEY

Int. Cl.: 43

Prior U.S. Cls.: 100 and 101

United States Patent and Trademark Office

Reg. No. 3,478,401

Registered July 29, 2008

**SERVICE MARK
SUPPLEMENTAL REGISTER**

**DESIGNED FOR STUDENTS BY
STUDENTS**

SODEXO OPERATIONS, LLC (DELAWARE LTD
LIAB CO)
9801 WASHINGTONIAN BOULEVARD
GAITHERSBURG, MD 20878

FOR: CONTRACT FOOD SERVICES, IN CLASS 43
(U.S. CLS. 100 AND 101).

FIRST USE 4-7-2008; IN COMMERCE 4-7-2008.

THE MARK CONSISTS OF STANDARD CHAR-
ACTERS WITHOUT CLAIM TO ANY PARTICULAR
FONT, STYLE, SIZE, OR COLOR.

SER. NO. 77-262,368, FILED P.R. 8-23-2007; AM. S.R.
6-19-2008.

LINDA POWELL, EXAMINING ATTORNEY

Int. Cl.: 30

Prior U.S. Cl.: 46

United States Patent and Trademark Office

Reg. No. 3,478,402

Registered July 29, 2008

**TRADEMARK
SUPPLEMENTAL REGISTER**

STUFFED BREAD STIX

HOT STUFF FOODS, LLC (SOUTH DAKOTA
LTD LIAB CO)
P.O. BOX 85210
SIOUX FALLS, SD 57118

OWNER OF U.S. REG. NOS. 2,518,208, 2,871,938,
AND OTHERS.

FOR: PREVIOUSLY FROZEN, THAW AND HEAT
BAKERY PRODUCTS, NAMELY, WRAP SANDWI-
CHES AND PIZZA STICKS, IN CLASS 30 (U.S. CL.
46).

NO CLAIM IS MADE TO THE EXCLUSIVE
RIGHT TO USE "BREAD STICKS", APART FROM
THE MARK AS SHOWN.

FIRST USE 10-0-2007; IN COMMERCE 10-0-2007.

SER. NO. 77-262,491, FILED P.R. 8-23-2007; AM. S.R.
6-4-2008.

THE MARK CONSISTS OF STANDARD CHAR-
ACTERS WITHOUT CLAIM TO ANY PARTICULAR
FONT, STYLE, SIZE, OR COLOR.

DANNEAN HETZEL, EXAMINING ATTORNEY

Int. Cl.: 41

Prior U.S. Cls.: 100, 101, and 107

United States Patent and Trademark Office

Reg. No. 3,478,403

Registered July 29, 2008

**SERVICE MARK
SUPPLEMENTAL REGISTER**

**AMERICAN ACCOUNTS PAYABLE
ASSOCIATION**

AMERICAN PAYROLL INSTITUTE, INC. (NEW
YORK CORPORATION)
5TH FLOOR
30 EAST 33RD STREET
NEW YORK, NY 10016

FOR: PUBLICATION OF EDUCATIONAL LIT-
ERATURE FOR OTHERS, NAMELY, BOOKS, MA-
GAZINES, NEWSLETTERS AND PAMPHLETS IN
THE FIELD OF ACCOUNTS PAYABLE MANAGE-
MENT; AND EDUCATIONAL SERVICES, NAMELY,
CONDUCTING ON-LINE AND IN-PERSON CLAS-
SES, SEMINARS AND WORKSHOPS IN THE FIELD
OF ACCOUNTS PAYABLE MANAGEMENT AND
ADMINISTRATION, IN CLASS 41 (U.S. CLS. 100, 101
AND 107).

FIRST USE 1-0-2008; IN COMMERCE 1-0-2008.

THE MARK CONSISTS OF STANDARD CHAR-
ACTERS WITHOUT CLAIM TO ANY PARTICULAR
FONT, STYLE, SIZE, OR COLOR.

NO CLAIM IS MADE TO THE EXCLUSIVE
RIGHT TO USE "ASSOCIATION", APART FROM
THE MARK AS SHOWN.

SER. NO. 77-265,422, FILED P.R. 8-27-2007; AM. S.R.
6-5-2008.

CHRIS WELLS, EXAMINING ATTORNEY

Int. Cl.: 16

Prior U.S. Cls.: 2, 5, 22, 23, 29, 37, 38, and 50

Reg. No. 3,478,404

United States Patent and Trademark Office

Registered July 29, 2008

**TRADEMARK
SUPPLEMENTAL REGISTER**

SOUTH ASIA MAGAZINE

CHOHAN, HARJINDER (CALIFORNIA INDIVIDUAL), DBA SOUTH ASIA INC.,
34249 FREMONT BLVD. #226
FREMONT, CA 94555

OWNER OF U.S. REG. NOS. 3,137,030, 3,140,318,
AND 3,149,830.

FOR: MAGAZINES FEATURING INFORMATION CONCERNING SOUTH ASIANS, IN CLASS 16 (U.S. CLS. 2, 5, 22, 23, 29, 37, 38 AND 50).

NO CLAIM IS MADE TO THE EXCLUSIVE RIGHT TO USE "MAGAZINE", APART FROM THE MARK AS SHOWN.

FIRST USE 9-0-2007; IN COMMERCE 6-10-2008.

SER. NO. 77-267,342, FILED P.R. 8-29-2007; AM. S.R. 6-11-2008.

THE MARK CONSISTS OF STANDARD CHARACTERS WITHOUT CLAIM TO ANY PARTICULAR FONT, STYLE, SIZE, OR COLOR.

LINDA MICKLEBURGH, EXAMINING ATTORNEY

Int. Cl.: 41

Prior U.S. Cls.: 100, 101, and 107

United States Patent and Trademark Office

Reg. No. 3,478,405

Registered July 29, 2008

**SERVICE MARK
SUPPLEMENTAL REGISTER**

**EDUCATION FOR EMPLOYMENT
FOUNDATION**

EDUCATION FOR EMPLOYMENT FOUNDATION (D.C. CORPORATION)
624 NINTH STREET, NW, SUITE 222
WASHINGTON, D.C., DC 20001

FOR: EDUCATION SERVICES, NAMELY, DEVELOPING AND PROVIDING CLASSES AND CAREER TRAINING IN VOCATIONAL, TECHNICAL, AND MANAGERIAL SKILLS TO YOUNG PEOPLE IN MUSLIM COUNTRIES; CAREER COUNSELING; PROVIDING ON-LINE EDUCATION AND TRAINING, NAMELY, COMPUTER-BASED NON-DOWNLOADABLE EDUCATIONAL MODULES AND MATERIALS CENTERED ON VOCATIONAL, TECHNICAL, AND MANAGERIAL SKILLS; CHARITABLE SERVICES, NAMELY, PROVIDING TRAINING IN VOCATIONAL, TECHNICAL, AND MANAGERIAL SKILLS TO YOUNG PEOPLE IN

MUSLIM COUNTRIES, IN CLASS 41 (U.S. CLS. 100, 101 AND 107).

FIRST USE 2-23-2006; IN COMMERCE 2-23-2006.

THE MARK CONSISTS OF STANDARD CHARACTERS WITHOUT CLAIM TO ANY PARTICULAR FONT, STYLE, SIZE, OR COLOR.

NO CLAIM IS MADE TO THE EXCLUSIVE RIGHT TO USE "FOUNDATION", APART FROM THE MARK AS SHOWN.

SER. NO. 77-267,525, FILED P.R. 8-29-2007; AM. S.R. 6-4-2008.

ESTHER A. BORSUK, EXAMINING ATTORNEY

Int. Cls.: 25 and 41

Prior U.S. Cls.: 22, 39, 100, 101, and 107

Reg. No. 3,478,406

United States Patent and Trademark Office

Registered July 29, 2008

**TRADEMARK
SERVICE MARK
SUPPLEMENTAL REGISTER**

illadelphia

MAC-MELIUS AGENCY, INC. (NEW YORK CORPORATION)
50 WOODVILLE RD.
SHOREHAM, NY 11786 AND
MELIUS, SHANA MAC (UNITED STATES INDIVIDUAL)
50 WOODVILLE RD.
SHOREHAM, NY 11786

FOR: SHIRTS, JACKETS, COATS, IN CLASS 25 (U.S. CLS. 22 AND 39).

FIRST USE 9-2-2007; IN COMMERCE 9-2-2007.

FOR: PRODUCTION OF MOVIE AND FILM SEQUELS, IN CLASS 41 (U.S. CLS. 100, 101 AND 107).

FIRST USE 9-2-2007; IN COMMERCE 9-2-2007.

THE MARK CONSISTS OF STANDARD CHARACTERS WITHOUT CLAIM TO ANY PARTICULAR FONT, STYLE, SIZE, OR COLOR.

SER. NO. 77-267,719, FILED P.R. 8-29-2007; AM. S.R. 6-5-2008.

SANDRA MANIOS, EXAMINING ATTORNEY

Int. Cl.: 41

Prior U.S. Cls.: 100, 101, and 107

United States Patent and Trademark Office

Reg. No. 3,478,407

Registered July 29, 2008

**SERVICE MARK
SUPPLEMENTAL REGISTER**

Cooking for Dads

BARRETT, ROB, JR. (UNITED STATES INDIVIDUAL)
6633 PROMONTORY DRIVE
EDEN PRAIRIE, MN 55346

FOR: ENTERTAINMENT IN THE NATURE OF ON-GOING TELEVISION PROGRAMS IN THE FIELD OF COOKING, IN CLASS 41 (U.S. CLS. 100, 101 AND 107).

FIRST USE 9-14-2007; IN COMMERCE 9-14-2007.

THE MARK CONSISTS OF STANDARD CHARACTERS WITHOUT CLAIM TO ANY PARTICULAR FONT, STYLE, SIZE, OR COLOR.

NO CLAIM IS MADE TO THE EXCLUSIVE RIGHT TO USE "COOKING", APART FROM THE MARK AS SHOWN.

SER. NO. 77-268,590, FILED P.R. 8-30-2007; AM. S.R. 6-6-2008.

JEAN IM, EXAMINING ATTORNEY

Int. Cl.: 44

Prior U.S. Cls.: 100 and 101

United States Patent and Trademark Office

Reg. No. 3,478,408

Registered July 29, 2008

**SERVICE MARK
SUPPLEMENTAL REGISTER**

Gluten-Free Checklist

THE CHECKLIST PEOPLE (KANSAS LTD LIAB
CO)
11005 WEST 141 STREET
OVERLAND PARK, KS 66221

FOR: PROVIDING A WEBSITE FEATURING IN-
FORMATION PERTAINING TO CELIAC DISEASE
AND A CHECKLIST TO KNOW WHAT FOODS
PEOPLE DIAGNOSED WITH CELIAC DISEASE
SHOULD EAT, IN CLASS 44 (U.S. CLS. 100 AND 101).

FIRST USE 11-1-2007; IN COMMERCE 11-1-2007.

THE MARK CONSISTS OF STANDARD CHAR-
ACTERS WITHOUT CLAIM TO ANY PARTICULAR
FONT, STYLE, SIZE, OR COLOR.

SER. NO. 77-269,075, FILED P.R. 8-31-2007; AM. S.R.
1-29-2008.

STEPHANIE ALI, EXAMINING ATTORNEY

Int. Cl.: 35

Prior U.S. Cls.: 100, 101, and 102

United States Patent and Trademark Office

Reg. No. 3,478,409

Registered July 29, 2008

**SERVICE MARK
SUPPLEMENTAL REGISTER**

BRAND CLARITI

BRAND CLARITI, LLC (ILLINOIS LTD LIAB CO)
SUITE 603
19 S. LASALLE ST.
CHICAGO, IL 60603

FOR: BUSINESS SERVICES, NAMELY, ADVERTISING, MARKETING AND BRAND ENHANCEMENT SERVICES, IN CLASS 35 (U.S. CLS. 100, 101 AND 102).

FIRST USE 10-4-2007; IN COMMERCE 10-4-2007.

THE MARK CONSISTS OF STANDARD CHARACTERS WITHOUT CLAIM TO ANY PARTICULAR FONT, STYLE, SIZE, OR COLOR.

NO CLAIM IS MADE TO THE EXCLUSIVE RIGHT TO USE "BRAND", APART FROM THE MARK AS SHOWN.

SER. NO. 77-269,148, FILED P.R. 8-31-2007; AM. S.R. 6-11-2008.

MATTHEW MCDOWELL, EXAMINING ATTORNEY

Int. Cl.: 36

Prior U.S. Cls.: 100, 101, and 102

United States Patent and Trademark Office

Reg. No. 3,478,410

Registered July 29, 2008

**SERVICE MARK
SUPPLEMENTAL REGISTER**

**Cash Flow Help for Growing
Businesses**

BEACH COMMERCIAL FINANCE, INC (VIRGINIA CORPORATION)
3330 PACIFIC AVE, SUITE 203
VIRGINIA BEACH, VA 23451

THE MARK CONSISTS OF STANDARD CHARACTERS WITHOUT CLAIM TO ANY PARTICULAR FONT, STYLE, SIZE, OR COLOR.

FOR: FACTORING AGENCIES, IN CLASS 36 (U.S. CLS. 100, 101 AND 102).

SER. NO. 77-272,072, FILED 9-5-2007.

FIRST USE 12-12-1991; IN COMMERCE 12-12-1991.

MICHAEL LITZAU, EXAMINING ATTORNEY

Int. Cl.: 35

Prior U.S. Cls.: 100, 101, and 102

United States Patent and Trademark Office

Reg. No. 3,478,411

Registered July 29, 2008

**SERVICE MARK
SUPPLEMENTAL REGISTER**

1-800-PHARMACY.COM

1-800-PHARMACY, INC. (DELAWARE CORPORATION)
16192 COASTAL HIGHWAY
LEWES, DE 19958

FOR: ON-LINE RETAIL STORE SERVICES, MAIL ORDER SERVICES, AND TELEPHONE ORDER-TAKING SERVICES FEATURING A WIDE VARIETY OF PRODUCTS, NAMELY, PHARMACEUTICALS, NUTRITIONAL SUPPLEMENTS, DIETARY SUPPLEMENTS, OVER THE COUNTER MEDICATIONS, AND FIRST AID KITS; PROVIDING A SEARCHABLE DATABASE IN THE FIELD OF BUSINESS MANAGEMENT INFORMATION AVAILABLE VIA A GLOBAL COMPUTER NETWORK; DISSEMINATION OF ADVERTISING FOR OTHERS VIA AN ON-LINE ELECTRONIC COMMUNICA-

TIONS NETWORK; PROVIDING A SEARCHABLE ON-LINE ADVERTISING GUIDE FEATURING THE GOODS AND SERVICES OF OTHER ONLINE VENDORS; DATABASE MANAGEMENT SERVICES, IN CLASS 35 (U.S. CLS. 100, 101 AND 102).

FIRST USE 0-0-2001; IN COMMERCE 0-0-2001.

THE MARK CONSISTS OF STANDARD CHARACTERS WITHOUT CLAIM TO ANY PARTICULAR FONT, STYLE, SIZE, OR COLOR.

SER. NO. 77-273,328, FILED P.R. 9-6-2007; AM. S.R. 6-10-2008.

SUSAN LESLIE DUBOIS, EXAMINING ATTORNEY

Int. Cl.: 41

Prior U.S. Cls.: 100, 101, and 107

United States Patent and Trademark Office

Reg. No. 3,478,412

Registered July 29, 2008

**SERVICE MARK
SUPPLEMENTAL REGISTER**

CYBER SUNDAY

WORLD WRESTLING ENTERTAINMENT, INC.
(DELAWARE CORPORATION)
1241 EAST MAIN STREET
STAMFORD, CT 06902

FOR: ENTERTAINMENT SERVICES, NAMELY,
THE PRODUCTION AND EXHIBITION OF PRO-
FESSIONAL WRESTLING EVENTS RENDERED
LIVE AND THROUGH THE MEDIA OF TELEVI-
SION , IN CLASS 41 (U.S. CLS. 100, 101 AND 107).

FIRST USE 11-5-2006; IN COMMERCE 11-5-2006.

THE MARK CONSISTS OF STANDARD CHAR-
ACTERS WITHOUT CLAIM TO ANY PARTICULAR
FONT, STYLE, SIZE, OR COLOR.

SER. NO. 77-273,368, FILED P.R. 9-6-2007; AM. S.R.
6-18-2008.

PAM WILLIS, EXAMINING ATTORNEY

Int. Cls.: 35 and 42

Prior U.S. Cls.: 100, 101, and 102

United States Patent and Trademark Office

Reg. No. 3,478,413

Registered July 29, 2008

**SERVICE MARK
SUPPLEMENTAL REGISTER**

DOCS BIZ CENTER

HEALTHCARE BUSINESS CONSULTANTS, LLC
(VIRGINIA LTD LIAB CO)
SUITE 308
4050 INNSLAKE DRIVE
RICHMOND, VA 23060

FOR: BUSINESS MANAGEMENT, ADMINISTRATION AND CONSULTATION SERVICES FOR MEDICAL PRACTICES; ADVISORY SERVICES FOR MEDICAL PRACTICES RELATING TO BUSINESS MANAGEMENT AND BUSINESS OPERATIONS; HUMAN RESOURCES CONSULTATION AND MANAGEMENT, NAMELY, HUMAN RESOURCE FILE MAINTENANCE, NEW HIRE PROCESS AND CREDENTIALING, AND RECRUITMENT AND SCREENING SERVICES FOR MEDICAL PRACTICES; PREPARATION OF FINANCIAL REPORTS FOR MEDICAL PRACTICES; FINANCIAL RECORDS MANAGEMENT AND TAX PREPARATION, NAMELY, COORDINATION OF TAX DOCUMENTATION ON BEHALF OF MEDICAL PRACTICES; ADMINISTRATION OF BUSINESS PAYROLL FOR MEDICAL PRACTICES; ACCOUNTS RECEIVABLE SERVICES FOR MEDICAL PRACTICES; ADMINISTRATION, BILLING, AND RECONCILIATION OF ACCOUNTS ON BEHALF OF MEDICAL PRACTICES; PHYSICIAN AND MEDICAL PERSONNEL STAFFING; VERIFYING AND MONITORING THE CREDENTIALS OF DOCTORS AND OTHER MEDICAL PROFESSIONALS, ALL VIA A GLOBAL COMPUTER NETWORK; HEALTH-

CARE PROVIDER BILLING SERVICES, IN CLASS 35 (U.S. CLS. 100, 101 AND 102).

FIRST USE 1-1-2007; IN COMMERCE 1-1-2007.

FOR: APPLICATION SERVICE PROVIDER (ASP) FEATURING PHYSICIAN PRACTICE MANAGEMENT SOFTWARE AND SOFTWARE FOR THE MANAGEMENT OF ELECTRONIC MEDICAL RECORDS IN THE HEALTHCARE INDUSTRY; COMPUTER SERVICES, NAMELY, ACTING AS AN APPLICATION SERVICE PROVIDER IN THE FIELD OF HEALTHCARE OFFICE MANAGEMENT TO HOST COMPUTER APPLICATION SOFTWARE FOR MANAGING PHYSICIAN OFFICES AND CREATING MEDICAL RECORDS DATABASES; HEALTHCARE TECHNOLOGY CONSULTING IN THE FIELD OF OFFICE MANAGEMENT SOFTWARE AND DATABASE MANAGEMENT SOFTWARE FOR PHYSICIAN PRACTICES, IN CLASS 42 (U.S. CLS. 100 AND 101).

FIRST USE 1-1-2007; IN COMMERCE 1-1-2007.

THE MARK CONSISTS OF STANDARD CHARACTERS WITHOUT CLAIM TO ANY PARTICULAR FONT, STYLE, SIZE, OR COLOR.

SER. NO. 77-275,624, FILED P.R. 9-10-2007; AM. S.R. 6-19-2008.

RONALD AIKENS, EXAMINING ATTORNEY

Int. Cl.: 35

Prior U.S. Cls.: 100, 101, and 102

United States Patent and Trademark Office

Reg. No. 3,478,414

Registered July 29, 2008

**SERVICE MARK
SUPPLEMENTAL REGISTER**

THE CHICAGO NETWORK

THE CHICAGO NETWORK, INC. (ILLINOIS
NON-PROFIT CORPORATION)

5734 S. KIMBARK AVENUE

CHICAGO, IL 60637

FOR: ASSOCIATION SERVICES, NAMELY, PRO-
MOTING THE INTERESTS OF FEMALE PROFES-
SIONALS, IN CLASS 35 (U.S. CLS. 100, 101 AND 102).

FIRST USE 4-27-1979; IN COMMERCE 4-27-1979.

THE MARK CONSISTS OF STANDARD CHAR-
ACTERS WITHOUT CLAIM TO ANY PARTICULAR
FONT, STYLE, SIZE, OR COLOR.

NO CLAIM IS MADE TO THE EXCLUSIVE
RIGHT TO USE "NETWORK", APART FROM THE
MARK AS SHOWN.

SER. NO. 77-277,739, FILED P.R. 9-12-2007; AM. S.R.
6-23-2008.

TINA BROWN, EXAMINING ATTORNEY

Int. Cl.: 39

Prior U.S. Cls.: 100 and 105

United States Patent and Trademark Office

Reg. No. 3,478,415

Registered July 29, 2008

**SERVICE MARK
SUPPLEMENTAL REGISTER**

AIRFARE CONCIERGE SERVICE

HOLIDAY SYSTEMS INTERNATIONAL OF NE-
VADA (NEVADA CORPORATION)
7690 WEST CHEYENNE AVE., SUITE 200
LAS VEGAS, NV 89129

FOR: TRAVEL AGENCY SERVICES, NAMELY,
MAKING RESERVATIONS AND BOOKINGS FOR
TRANSPORTATION; TRAVEL INFORMATION
SERVICES; ORGANIZATION OF TRAVEL , IN
CLASS 39 (U.S. CLS. 100 AND 105).

FIRST USE 4-30-2007; IN COMMERCE 4-30-2007.

THE MARK CONSISTS OF STANDARD CHAR-
ACTERS WITHOUT CLAIM TO ANY PARTICULAR
FONT, STYLE, SIZE, OR COLOR.

SER. NO. 77-278,300, FILED P.R. 9-12-2007; AM. S.R.
6-15-2008.

JILL PRATER, EXAMINING ATTORNEY

Int. Cl.: 41

Prior U.S. Cls.: 100, 101, and 107

United States Patent and Trademark Office

Reg. No. 3,478,416

Registered July 29, 2008

**SERVICE MARK
SUPPLEMENTAL REGISTER**

THE JOKE LINE

MOBILEJAM, LLC (WASHINGTON LTD LIAB
CO)
P.O. BOX 82367
KENMORE, WA 98028

FOR: INFORMATION SERVICES, NAMELY,
PROVIDING A WEBSITE FEATURING PHOTO-
GRAPHIC, AUDIO, VIDEO AND PROSE PRESEN-
TATIONS FEATURING HUMOROUS MESSAGES,
ANECDOTES AND PICTURES; ENTERTAINMENT
IN THE NATURE OF PRERECORDED HUMOROUS
MESSAGES AND ANECDOTES BY TELEPHONE,
WIRELESS PHONE AND PERSONAL DIGITAL AS-
SISTANTS (PDAS), IN CLASS 41 (U.S. CLS. 100, 101
AND 107).

FIRST USE 6-19-2008; IN COMMERCE 6-19-2008.

THE MARK CONSISTS OF STANDARD CHAR-
ACTERS WITHOUT CLAIM TO ANY PARTICULAR
FONT, STYLE, SIZE, OR COLOR.

NO CLAIM IS MADE TO THE EXCLUSIVE
RIGHT TO USE "JOKE", APART FROM THE MARK
AS SHOWN.

SER. NO. 77-278,841, FILED P.R. 9-13-2007; AM. S.R.
6-19-2008.

DAVID YONTEF, EXAMINING ATTORNEY

Int. Cl.: 10

Prior U.S. Cls.: 26, 39, and 44

United States Patent and Trademark Office

Reg. No. 3,478,417

Registered July 29, 2008

**TRADEMARK
SUPPLEMENTAL REGISTER**

PACE

OSYPKA MEDICAL GMBH (FED REP GERMA-
NY CORPORATION)
GROSSBEERENSTRASSE 184
BERLIN, FED REP GERMANY 12277

FOR: HEART PACEMAKERS, IN CLASS 10 (U.S.
CLS. 26, 39 AND 44).

FIRST USE 1-1-1988; IN COMMERCE 1-1-2003.

THE MARK CONSISTS OF STANDARD CHAR-
ACTERS WITHOUT CLAIM TO ANY PARTICULAR
FONT, STYLE, SIZE, OR COLOR.

SER. NO. 77-280,476, FILED P.R. 9-15-2007; AM. S.R.
6-18-2008.

RONALD MCMORROW, EXAMINING ATTORNEY

Int. Cl.: 35

Prior U.S. Cls.: 100, 101, and 102

United States Patent and Trademark Office

Reg. No. 3,478,418

Registered July 29, 2008

**SERVICE MARK
SUPPLEMENTAL REGISTER**

CHRISTIAN LIFE COMMUNITY

NATIONAL CHRISTIAN LIFE COMMUNITY OF
THE UNITED STATES OF AMERICA (MIS-
SOURI NON-PROFIT CORPORATION)
3601 LINDELL BLVD
ST. LOUIS, MO 63108

FOR: ASSOCIATION SERVICES, NAMELY, PRO-
MOTING THE INTERESTS OF CHURCH MEMBERS
WHO WANT TO HAVE AN APOSTOLIC LIFESTYLE
, IN CLASS 35 (U.S. CLS. 100, 101 AND 102).

FIRST USE 4-30-1968; IN COMMERCE 4-30-1968.

THE MARK CONSISTS OF STANDARD CHAR-
ACTERS WITHOUT CLAIM TO ANY PARTICULAR
FONT, STYLE, SIZE, OR COLOR.

OWNER OF U.S. REG. NO. 1,073,854.

SER. NO. 77-281,408, FILED P.R. 9-17-2007; AM. S.R.
6-23-2008.

SETH A. RAPPAPORT, EXAMINING ATTORNEY

Int. Cls.: 29, 30, and 32

Prior U.S. Cls.: 45, 46, and 48

United States Patent and Trademark Office

Reg. No. 3,478,419

Registered July 29, 2008

TRADEMARK
SUPPLEMENTAL REGISTER

RIANS

LAITERJES HUBERT TRIBALLAT (FRANCE SOCIÉTÉ PAR ACTIONS SIMPLIFIÉE (SAS))
RIANS, F-18220
LES AIX D' ANGILLON, FRANCE

FOR: JELLIES, JAMS, COMPOTES, EGGS; SNOW EGGS, BEING WHIPPED OR BEATEN EGG WHITES; MILK, MILK PRODUCTS EXCLUDING ICE CREAM, ICE MILK AND FROZEN YOGURT; CHEESES; CREAM CHEESE; CHEESE IN THE NATURE OF FROMAGE FRAIS; BUTTER; WHIPPED CREAM; YOGURTS; MILK BEVERAGES WITH HIGH MILK CONTENT; PREPARED ENTREES CONSISTING PRIMARILY OF MEAT, POULTRY, FISH OR VEGETABLES; SOUPS; BEVERAGES MADE WITH CHOCOLATE, NAMELY, CHOCOLATE MILK, IN CLASS 29 (U.S. CL. 46).

FOR: FROZEN PASTRY; CONFECTIONERY, NAMELY, CHOCOLATE AND CANDIES; ICE CONFECTIONERY, NAMELY, FROZEN CONFECTIONS AND ICE MILK; FLAVORED ICES; EDIBLE FRUIT ICES; SHERBETS; FROZEN YOGURT; DESSERTS, NAMELY, PASTRIES AND PROFITEROLE IN THE NATURE OF CREME PUFFS; ICE-CREAM DESSERTS, NAMELY, ICE CREAM SUNDAES, ICE CREAM CAKES AND ICE CREAM SANDWICHES; CAKES; CHOCOLATE-BASED DISHES AND DESSERTS, NAMELY, CHOCOLATE DESSERT SOUFFLES AND CHOCOLATE CREAMS; ICE-CREAM; PANCAKES, NAMELY, CREPES; WAFFLES; BREAD; BISCUITS, NAMELY, COOKIES; BEVERAGES MADE WITH CHOCOLATE, NAMELY, CHO-

COLATE FOOD BEVERAGES NOT BEING DIARY-BASED OR VEGETABLE BASED; SAUCES BEING CONDIMENTS; SAUCES FOR FISH, MEAT, POULTRY AND VEGETABLES; SPICES; PREPARED ENTREES CONSISTING PRIMARILY OF PASTA AND RICE; CUSTARDS; CREMES BRULEES, BEING COOKED CUSTARDS; CREMES CAMELS, BEING COOKED CAMEL CUSTARDS; DESSERTS MADE WITH MILK, BUTTER, CREAM, EGGS AND SUGAR, NAMELY, CHEESECAKE, IN CLASS 30 (U.S. CL. 46).

FOR: NON-ALCOHOLIC BEVERAGES, NAMELY, CARBONATED SOFT DRINKS, NON-CARBONATED SOFT DRINKS, LEMONADE, FRUIT BEVERAGES, MINERAL WATERS, FRUIT JUICE, SPARKLING WATER, SPARKLING FLAVORED WATERS, IN CLASS 32 (U.S. CLS. 45, 46 AND 48).

THE MARK CONSISTS OF STANDARD CHARACTERS WITHOUT CLAIM TO ANY PARTICULAR FONT, STYLE, SIZE, OR COLOR.

OWNER OF ERPN CMNTY TM OFC REG. NO. 4978417, DATED 2-6-2007, EXPIRES 3-24-2016.

OWNER OF U.S. REG. NOS. 3,211,552, 3,213,604, AND 3,340,146.

SER. NO. 77-281,414, FILED 9-17-2007.

KEVIN CORWIN, EXAMINING ATTORNEY

Int. Cl.: 9

Prior U.S. Cls.: 21, 23, 26, 36, and 38

Reg. No. 3,478,420

United States Patent and Trademark Office

Registered July 29, 2008

**TRADEMARK
SUPPLEMENTAL REGISTER**

OPEN APPLIANCE PLATFORM

NETRONOME SYSTEMS, INC. (DELAWARE
CORPORATION)
SUITE 230
144 EMERYVILLE DRIVE
CRANBERRY TWP., PA 16066

FOR: COMPUTER HARDWARE AND COMPU-
TER SOFTWARE FOR IMPROVING NETWORK
SECURITY AND NETWORK PROCESSING, IN
CLASS 9 (U.S. CLS. 21, 23, 26, 36 AND 38).

FIRST USE 1-0-2007; IN COMMERCE 6-17-2008.

THE MARK CONSISTS OF STANDARD CHAR-
ACTERS WITHOUT CLAIM TO ANY PARTICULAR
FONT, STYLE, SIZE, OR COLOR.

NO CLAIM IS MADE TO THE EXCLUSIVE
RIGHT TO USE "PLATFORM", APART FROM THE
MARK AS SHOWN.

SER. NO. 77-281,497, FILED P.R. 9-17-2007; AM. S.R.
6-19-2008.

AMY GEARIN, EXAMINING ATTORNEY

Int. Cl.: 41

Prior U.S. Cls.: 100, 101, and 107

United States Patent and Trademark Office

Reg. No. 3,478,421

Registered July 29, 2008

**SERVICE MARK
SUPPLEMENTAL REGISTER**

RP

APOLLO GROUP, INC. (ARIZONA CORPORATION)
4025 S. RIVERPOINT PARKWAY
PHOENIX, AZ 85040

FOR: EDUCATIONAL SERVICES, NAMELY, PROVIDING COURSES AND TESTING IN THE FIELDS OF RETIREMENT AND FINANCIAL PLANNING, RETIREMENT PLANS, AND RETIREMENT INVESTMENT, IN CLASS 41 (U.S. CLS. 100, 101 AND 107).

FIRST USE 1-0-2002; IN COMMERCE 1-0-2002.

THE MARK CONSISTS OF STANDARD CHARACTERS WITHOUT CLAIM TO ANY PARTICULAR FONT, STYLE, SIZE, OR COLOR.

SER. NO. 77-281,532, FILED P.R. 9-17-2007; AM. S.R. 6-19-2008.

NICHOLAS ALTREE, EXAMINING ATTORNEY

Int. Cl.: 9

Prior U.S. Cls.: 21, 23, 26, 36, and 38

United States Patent and Trademark Office

Reg. No. 3,478,422

Registered July 29, 2008

**TRADEMARK
SUPPLEMENTAL REGISTER**

SECURITY BLACKBOX

NETROME ELECTRONICS CORP (NEW JERSEY CORPORATION)
105 CEDAR LANE, UNIT 1
ENGLEWOOD, NJ 07631

FOR: VIDEO SURVEILLANCE EQUIPMENTS, NAMELY, VIDEO CAMERAS, VIDEO MONITORS, DIGITAL VIDEO RECORDERS, MOTION SENSITIVE SECURITY LIGHTS, SCANNERS , IN CLASS 9 (U.S. CLS. 21, 23, 26, 36 AND 38).

FIRST USE 10-0-2006; IN COMMERCE 1-0-2007.

THE MARK CONSISTS OF STANDARD CHARACTERS WITHOUT CLAIM TO ANY PARTICULAR FONT, STYLE, SIZE, OR COLOR.

NO CLAIM IS MADE TO THE EXCLUSIVE RIGHT TO USE "SECURITY", APART FROM THE MARK AS SHOWN.

SER. NO. 77-283,876, FILED P.R. 9-19-2007; AM. S.R. 6-20-2008.

FRED MANDIR, EXAMINING ATTORNEY

Int. Cl.: 41

Prior U.S. Cls.: 100, 101, and 107

United States Patent and Trademark Office

Reg. No. 3,478,423

Registered July 29, 2008

**SERVICE MARK
SUPPLEMENTAL REGISTER**

AMERICAN NUMBERS

LAS VEGAS GAMING, INC. (NEVADA COR-
PORATION)
4000 WEST ALI BABA LANE, SUITE D
LAS VEGAS, NV 89118

FOR: GAMBLING SERVICES, IN CLASS 41 (U.S.
CLS. 100, 101 AND 107).

FIRST USE 1-8-2002; IN COMMERCE 10-1-2007.

THE MARK CONSISTS OF STANDARD CHAR-
ACTERS WITHOUT CLAIM TO ANY PARTICULAR
FONT, STYLE, SIZE, OR COLOR.

SER. NO. 77-283,938, FILED P.R. 9-19-2007; AM. S.R.
6-19-2008.

MONIQUE MILLER, EXAMINING ATTORNEY

Int. Cls.: 9 and 42

Prior U.S. Cls.: 21, 23, 26, 36, 38, 100, and 101

Reg. No. 3,478,424

United States Patent and Trademark Office

Registered July 29, 2008

**TRADEMARK
SERVICE MARK
SUPPLEMENTAL REGISTER**

NATURAL FREQUENCY SYSTEM

HOWARTH, ALAN STEVEN (UNITED STATES
INDIVIDUAL)
4455 COMMONWEALTH AVENUE
LA CANADA, CA 91011

FOR: COMPUTERS HAVING AUDIO AND VIDEO SOUND CAPABILITIES; COMPUTERS; COMPONENTS OF COMPUTERS AND OTHER DIGITAL DEVICES, NAMELY, COMPUTER HARDWARE AND SOFTWARE USED TO ENHANCE AUDIO AND VIDEO SOUND; COMPUTER SOFTWARE FOR PLAYING AUDIO FILES; COMPUTER SOFTWARE THAT DELIVERS AUDIO SOUND FROM DVDS LOADED INTO A COMPUTER; COMPUTER PROGRAMS USED TO DIGITALLY PROCESS AND ENHANCE THE RECORDING AND PLAYBACK OF AUDIO SOUND, SOUND EFFECTS AND SOUND TRACKS; SOFTWARE USED TO DIGITALLY ENCODE AND DECODE MULTI-CHANNEL SOUND FOR PRE-RECORDED AUDIO DISCS, VIDEO DISCS, LASER DISCS, DVD VIDEO DISCS, AND DVD AUDIO DISCS; COMPUTER PROGRAMS USED FOR GENERATING, PROCESSING, AND PLAYING AUDIO SIGNALS AND SOUNDS; MOUSEPADS; FABRIC CARRYING CASES FOR DVDS AND CDS; DIGITAL SIGNAL PROCESSING CHIPS; INTEGRATED CIRCUITS; DVD VIDEO PLAYERS; DVD AUDIO PLAYERS; SET TOP CABLE BOXES; SATELLITE RECEIVERS; TELEVISION RECEIVERS; DIGITAL TELEVISION RECEIVERS; VIDEO GAME CONSOLES; AUDIO AND VIDEO SURROUND SOUND CONTROLLERS; AUTOMOBILE SOUND SPEAKERS; MULTIMEDIA SPEAKERS; PORTABLE AUDIO EQUIPMENT, NAMELY, CASSETTE PLAYERS AND RECORDERS, AND COMPACT-DISC PLAYERS; CINEMA SOUND PROCESSORS FOR MOTION PICTURE SOUND TRACKS AND CINEMATOGRAPHIC FILMS; VIDEO MONITORS; VIDEO TUNERS; AUDIO AND VIDEO RECORDERS; AUDIO AND VIDEO DISC PLAYERS; AUDIO AND VIDEO DISC DUBBING

DECKS; DVD PLAYERS; CABLE TELEVISION RECEIVERS AND DECODERS; REMOTE CONTROL UNITS FOR CABLE TELEVISION RECEIVERS AND DECODERS; ELECTRONIC BROADCAST SIGNAL PROCESSORS; ELECTRONIC SATELLITE BROADCAST SIGNAL PROCESSORS; AUDIO TAPES RECORDED WITH SIGNALS ENCODED FOR PLAYBACK USING A NOISE REDUCTION SYSTEM; AUDIO AND VIDEO TAPE RECORDERS AND TAPE PLAYERS FOR PORTABLE, NON-PORTABLE OR IN-VEHICLE USE, AUDIO OR VIDEO TAPE RECORDERS OR TAPE PLAYERS IN COMBINATION WITH AT LEAST ONE OF THE FOLLOWING, AMPLIFIER, RECEIVER, RADIO OR TELEVISION TUNER VIDEO CAMERA, RECORD PLAYER, COMPACT DISC PLAYER, VIDEO MONITOR, LOUD SPEAKER; MULTI-CHANNEL SOUND PROCESSORS; AUDIO AND AUDIO-VIDEO AMPLIFIERS AND RECEIVERS; STEREO AUDIO RECEIVERS; COMPUTER PROGRAMS HAVING SOUND GENERATING CAPABILITY; AUDIO AND VIDEO TAPES AND VIDEO DISCS RECORDED WITH ENCODED SIGNALS FOR PLAYBACK USING A NOISE REDUCTION SYSTEM OR SURROUND SOUND DECODER; CINEMATOGRAPHIC FILMS FEATURING FREQUENCY SPECTRUM CONVERSION TO NATURAL HARMONIC FREQUENCIES AND RELATED RESEARCH; ELECTRICAL POWER SUPPLIES; OPTICAL SOUND PROCESSORS FOR MOTION PICTURE SOUND TRACKS AND CINEMATOGRAPHIC FILMS; ELECTRONIC RECORDING/REPRODUCING APPARATUS EMBODYING NOISE REDUCTION CIRCUITS FOR USE IN CONNECTION WITH AUDIO AND VIDEO SIGNALS, NAMELY, MAGNETIC TAPE RECORDERS, CASSETTE RECORDERS, RECORD PLAYERS, RADIO TRANSMITTERS AND RECEIVERS, AND MOTION PICTURE SOUND TRACK RECORDERS; MAGNETIC TAPES, DISCS, AND MOTION PICTURE SOUND TRACKS FEATURING MUSIC AND IMAGES CREATED UTILIZING FRE-

QUENCY SPECTRUM CONVERSION TO NATURAL HARMONIC FREQUENCIES, AND VIDEO RECORDINGS OF ELECTRICAL SIGNALS WHICH HAVE BEEN SUBJECTED TO DYNAMIC RANGE COMPRESSION PRIOR TO RECORDING, IN CLASS 9 (U.S. CLS. 21, 23, 26, 36 AND 38).

FIRST USE 6-15-2006; IN COMMERCE 6-15-2006.

FOR: PROVIDING A WEB SITE FEATURING INFORMATION IN THE FIELD OF DESIGNING SOUND REPRODUCTION AND RECORDING EQUIPMENT IN THE CINEMA, PROFESSIONAL, HOME THEATER, MULTI-MEDIA, TELECOMMUNICATIONS AND COMPUTER NETWORK FIELDS, IN CLASS 42 (U.S. CLS. 100 AND 101).

FIRST USE 6-15-2006; IN COMMERCE 10-15-2007.

THE MARK CONSISTS OF STANDARD CHARACTERS WITHOUT CLAIM TO ANY PARTICULAR FONT, STYLE, SIZE, OR COLOR.

NO CLAIM IS MADE TO THE EXCLUSIVE RIGHT TO USE "FREQUENCY" , APART FROM THE MARK AS SHOWN.

SER. NO. 77-284,687, FILED P.R. 9-20-2007; AM. S.R. 6-12-2008.

ROBIN CHOSID, EXAMINING ATTORNEY

Int. Cl.: 43

Prior U.S. Cls.: 100 and 101

United States Patent and Trademark Office

Reg. No. 3,478,425

Registered July 29, 2008

**SERVICE MARK
SUPPLEMENTAL REGISTER**

ESPETUS CHURRASCARIA

ESPETUS CHURRASCARIA, INC. (CALIFORNIA CORPORATION)

1686 MARKET STREET

SAN FRANCISCO, CA 94102

FOR: RESTAURANT AND BAR SERVICES, IN CLASS 43 (U.S. CLS. 100 AND 101).

FIRST USE 11-14-2003; IN COMMERCE 11-14-2003.

THE MARK CONSISTS OF STANDARD CHARACTERS WITHOUT CLAIM TO ANY PARTICULAR FONT, STYLE, SIZE, OR COLOR.

THE FOREIGN WORDING IN THE MARK TRANSLATES INTO ENGLISH AS "SKEWERS BRAZILIAN BARBEQUE".

SER. NO. 77-287,955, FILED P.R. 9-25-2007; AM. S.R. 6-18-2008.

RENEE MCCRAY, EXAMINING ATTORNEY

Int. Cl.: 35

Prior U.S. Cls.: 100, 101, and 102

United States Patent and Trademark Office

Reg. No. 3,478,426

Registered July 29, 2008

**SERVICE MARK
SUPPLEMENTAL REGISTER**



HDS IP HOLDING, LLC (NEVADA LTD LIAB
CO)
P.O. BOX 50401
HENDERSON, NV 89016

FOR: WHOLESALE AND RETAIL STORE, CATALOG, MAIL ORDER AND ELECTRONIC ORDERING SERVICES FEATURING LUMBER, BUILDING MATERIALS, HOME IMPROVEMENT PRODUCTS, TRUSSES, SIDING, ROOFING, MILLWORK, WINDOWS AND DOORS; REFERRALS TO OTHER BUSINESSES IN THE FIELDS OF WATER TREATMENT, SEWAGE, PLUMBING AND ELECTRICAL UTILITY SERVICES, BUILDING AND CONSTRUCTION MATERIALS, CARPET CLEANING SERVICES, CONSTRUCTION, HOME REPAIR AND RENOVATION, HOME CONSTRUCTION SERVICES, DECORATING AND HOME DESIGN SERVICES, HOME MAINTENANCE AND REPAIR

SERVICES; RETAIL STORE AND DISTRIBUTORSHIP SERVICES PROVIDED TO OTHER BUSINESSES FEATURING APPLIANCES, HVAC EQUIPMENT, FASTENING AND INDUSTRIAL SUPPLIES, LIGHTING FIXTURES, FLOORING, COUNTERTOPS, AND WINDOW COVERINGS, CONSTRUCTION HARDWARE EQUIPMENT AND TOOLS, SAFETY EQUIPMENT AND WORK CLOTHING, PAINT, GARDEN SUPPLIES AND TOOLS, PLANTS, AND LANDSCAPING SUPPLIES, IN CLASS 35 (U.S. CLS. 100, 101 AND 102).

FIRST USE 8-1-2007; IN COMMERCE 9-1-2007.

SER. NO. 77-290,200, FILED P.R. 9-27-2007; AM. S.R. 6-4-2008.

THEODORE MCBRIDE, EXAMINING ATTORNEY

Int. Cls.: 35 and 40

Prior U.S. Cls.: 100, 101, 102, 103, and 106

United States Patent and Trademark Office

Reg. No. 3,478,427

Registered July 29, 2008

**SERVICE MARK
SUPPLEMENTAL REGISTER**

**THE LEADER IN PACKAGING
SOLUTIONS**

SUPPLY ONE, INC. (DELAWARE CORPORATION)
20 NORTH WATERLOO ROAD, SUITE 200
DEVON, PA 193331458

FOR: WHOLESALE DISTRIBUTORSHIP SERVICES FEATURING PACKAGING MATERIALS, CORRUGATED PACKAGING, THERMOFORM PLASTIC PACKAGING MATERIALS, POINT-OF-PURCHASE PACKAGING, LABELS, PROTECTIVE PACKAGING, FOAM FABRICATED INTERIOR PACKAGING, PACKAGING EQUIPMENT, AND CONSUMABLE PACKAGING SUPPLIES, INCLUDING CARTON SEALING TAPES, PACKAGING FILMS, STRAPPING AND INTERIOR PACKAGING MATERIALS, IN CLASS 35 (U.S. CLS. 100, 101 AND 102).

FIRST USE 5-31-2006; IN COMMERCE 5-31-2006.

FOR: MANUFACTURING TO ORDER FOR OTHERS IN THE FIELD OF PACKAGING MATERIALS, CORRUGATED PACKAGING, THERMOFORM PLASTIC PACKAGING MATERIALS, POINT-OF-PURCHASE PACKAGING, LABELS, PROTECTIVE PACKAGING, AND FOAM FABRICATED INTERIOR PACKAGING, IN CLASS 40 (U.S. CLS. 100, 103 AND 106).

FIRST USE 5-31-2006; IN COMMERCE 5-31-2006.

THE MARK CONSISTS OF STANDARD CHARACTERS WITHOUT CLAIM TO ANY PARTICULAR FONT, STYLE, SIZE, OR COLOR.

SER. NO. 77-290,584, FILED P.R. 9-27-2007; AM. S.R. 6-23-2008.

PETER B. BROMAGHIM, EXAMINING ATTORNEY

Int. Cl.: 36

Prior U.S. Cls.: 100, 101, and 102

United States Patent and Trademark Office

Reg. No. 3,478,428

Registered July 29, 2008

**SERVICE MARK
SUPPLEMENTAL REGISTER**

FEDERAL HILL MORTGAGE

FEDERAL HILL MORTGAGE COMPANY, LLC
(MARYLAND LTD LIAB CO)
1021 PATAPSCO STREET
BALTIMORE, MD 21230

FOR: FINANCIAL SERVICES, NAMELY, MORTGAGE PLANNING; MORTGAGE BROKERAGE; MORTGAGE SERVICES, NAMELY, BUYER PRE-QUALIFICATION OF MORTGAGES FOR MORTGAGE BROKERS AND BANKS, IN CLASS 36 (U.S. CLS. 100, 101 AND 102).

FIRST USE 10-1-2006; IN COMMERCE 10-1-2006.

THE MARK CONSISTS OF STANDARD CHARACTERS WITHOUT CLAIM TO ANY PARTICULAR FONT, STYLE, SIZE, OR COLOR.

NO CLAIM IS MADE TO THE EXCLUSIVE RIGHT TO USE "MORTGAGE", APART FROM THE MARK AS SHOWN.

SER. NO. 77-294,725, FILED P.R. 10-3-2007; AM. S.R. 6-19-2008.

ALYSSA PALADINO, EXAMINING ATTORNEY

Int. Cl.: 41

Prior U.S. Cls.: 100, 101, and 107

United States Patent and Trademark Office

Reg. No. 3,478,429

Registered July 29, 2008

**SERVICE MARK
SUPPLEMENTAL REGISTER**

Sacred Arts Foundation

LIVING TREE PUBLICATIONS (NEW MEXICO
LTD LIAB CO)

143 SADDLE SPUR TRAIL

TIJERAS, NM 87059

FOR: TRAINING SERVICES IN THE FIELD OF
ESOTERIC STUDIES, IN CLASS 41 (U.S. CLS. 100, 101
AND 107).

FIRST USE 5-10-2007; IN COMMERCE 6-12-2007.

THE MARK CONSISTS OF STANDARD CHAR-
ACTERS WITHOUT CLAIM TO ANY PARTICULAR
FONT, STYLE, SIZE, OR COLOR.

NO CLAIM IS MADE TO THE EXCLUSIVE
RIGHT TO USE "FOUNDATION", APART FROM
THE MARK AS SHOWN.

SER. NO. 77-296,006, FILED P.R. 10-4-2007; AM. S.R.
6-17-2008.

LESLIE RICHARDS, EXAMINING ATTORNEY

Int. Cls.: 9 and 42

Prior U.S. Cls.: 21, 23, 26, 36, 38, 100, and 101

United States Patent and Trademark Office

Reg. No. 3,478,430

Registered July 29, 2008

**TRADEMARK
SERVICE MARK
SUPPLEMENTAL REGISTER**

Visitor Interaction Manager

SITEACUITY, LLC (NEW JERSEY LTD LIAB CO)
60 MORRIS TURNPIKE
SUMMIT, NJ 07901

FOR: COMPUTER SOFTWARE FOR PERMITTING A USER TO OBTAIN AND ANALYZE INFORMATION ON PRIOR AND CURRENT WEBSITE VISITORS NAVIGATION OF A DESIGNATED WEBSITE, COMMUNICATE AND COLLABORATE IN REAL-TIME WITH SITE VISITORS AND MANAGE OTHER VISITOR REQUESTS SUCH AS A EMAIL INQUIRIES AND KNOWLEDGE BASE SEARCHES THAT MAY BE DOWNLOADED FROM A GLOBAL COMPUTER NETWORK, IN CLASS 9 (U.S. CLS. 21, 23, 26, 36 AND 38).

FIRST USE 9-5-2007; IN COMMERCE 9-5-2007.

FOR: PROVIDING ON-LINE NON-DOWNLOADABLE SOFTWARE FOR PERMITTING A USER TO

OBTAIN AND ANALYZE INFORMATION ON PRIOR AND CURRENT WEBSITE VISITORS NAVIGATION OF A DESIGNATED WEBSITE, COMMUNICATE AND COLLABORATE IN REAL-TIME WITH SITE VISITORS AND MANAGE OTHER VISITOR REQUESTS SUCH AS A EMAIL INQUIRIES AND KNOWLEDGE BASE SEARCHES, IN CLASS 42 (U.S. CLS. 100 AND 101).

FIRST USE 9-5-2007; IN COMMERCE 9-5-2007.

THE MARK CONSISTS OF STANDARD CHARACTERS WITHOUT CLAIM TO ANY PARTICULAR FONT, STYLE, SIZE, OR COLOR.

SER. NO. 77-300,199, FILED P.R. 10-10-2007; AM. S.R. 6-25-2008.

FRED MANDIR, EXAMINING ATTORNEY

Int. Cl.: 41

Prior U.S. Cls.: 100, 101, and 107

United States Patent and Trademark Office

Reg. No. 3,478,431

Registered July 29, 2008

**SERVICE MARK
SUPPLEMENTAL REGISTER**

SUPER COVERALL

LAS VEGAS GAMING, INC. (NEVADA CORPORATION)
4000 WEST ALI BABA LANE, SUITE D
LAS VEGAS, NV 89118

FOR: GAMBLING SERVICES, IN CLASS 41 (U.S. CLS. 100, 101 AND 107).

FIRST USE 6-1-2007; IN COMMERCE 6-1-2007.

THE MARK CONSISTS OF STANDARD CHARACTERS WITHOUT CLAIM TO ANY PARTICULAR FONT, STYLE, SIZE, OR COLOR.

SER. NO. 77-300,990, FILED P.R. 10-10-2007; AM. S.R. 6-19-2008.

MONIQUE MILLER, EXAMINING ATTORNEY

Int. Cl.: 9

Prior U.S. Cls.: 21, 23, 26, 36, and 38

United States Patent and Trademark Office

Reg. No. 3,478,432

Registered July 29, 2008

**TRADEMARK
SUPPLEMENTAL REGISTER**



ARUZE CORPORATION (JAPAN CORPORATION)
1-25 ARIAKE 3-CHOME, KOTOKU
TOKOYO, JAPAN

FOR: SLOT MACHINES AND REPLACEMENT PARTS THEREFOR; VIDEO SLOT MACHINES AND REPLACEMENT PARTS THEREFOR; GAMING MACHINES AND REPLACEMENT PARTS THEREFOR; GAMING MACHINES WITH A LIQUID CRYSTAL DISPLAY AND REPLACEMENT PARTS THEREFOR; MECHANICAL REEL TYPE SLOT MACHINES WITH A LIQUID CRYSTAL DISPLAY AND

REPLACEMENT PARTS THEREFOR, IN CLASS 9 (U.S. CLS. 21, 23, 26, 36 AND 38).

FIRST USE 5-1-2008; IN COMMERCE 5-1-2008.

THE MARK CONSISTS OF WORDS "JACKPOT" AND "BONUS" WITH "777" BETWEEN THE WORDS.

SER. NO. 77-317,934, FILED P.R. 10-31-2007; AM. S.R. 5-7-2008.

JIM RINGLE, EXAMINING ATTORNEY

Int. Cl.: 25

Prior U.S. Cls.: 22 and 39

United States Patent and Trademark Office

Reg. No. 3,478,433

Registered July 29, 2008

**TRADEMARK
SUPPLEMENTAL REGISTER**



HIDEKI OKAJIMA, C/O PETER GREENBERG &
ASSOCIATES (JAPAN INDIVIDUAL)

200 MADISON AVENUE, SUITE 2225
NEW YORK, NY 10016

FOR: CLOTHING, NAMELY, TEE-SHIRTS, IN
CLASS 25 (U.S. CLS. 22 AND 39).

FIRST USE 10-26-2007; IN COMMERCE 10-26-2007.

THE NAME "HIDEKI OKAJIMA" DOES NOT
IDENTIFY A LIVING INDIVIDUAL.

THE MARK CONSISTS OF A FIGURE OF A
BASEBALL PLAYER IN A CIRCLE POSED IN A
PITCHING STANCE.

SER. NO. 77-330,402, FILED P.R. 11-15-2007; AM.
S.R. 6-20-2008.

DAVID COLLIER, EXAMINING ATTORNEY

Int. Cls.: 36 and 41

Prior U.S. Cls.: 100, 101, 102, and 107

United States Patent and Trademark Office

Reg. No. 3,478,434

Registered July 29, 2008

**SERVICE MARK
SUPPLEMENTAL REGISTER**

ART WORLD INTERNATIONAL

ART WORLD INTERNATIONAL INC. (CALIFORNIA CORPORATION)
4123 CENTINELA AVE.
LOS ANGELES, CA 90066

FOR: CHARITABLE FUNDRAISING SERVICES; CHARITABLE FUND RAISING SERVICES IN THE FIELD OF ART AWARENESS, IN CLASS 36 (U.S. CLS. 100, 101 AND 102).

FIRST USE 9-20-2007; IN COMMERCE 9-20-2007.

FOR: CHARITABLE SERVICES, NAMELY, ACADEMIC MENTORING OF SCHOOL AGE CHILDREN IN THE FIELD OF ART AWARENESS; CHARITABLE SERVICES, NAMELY, PROVIDING ART BOOKS AND EDUCATIONAL ART SUPPLIES TO NEEDY, CHILDREN AND ADULTS; EDUCA-

TION SERVICES, NAMELY, PROVIDING TUTORING, MENTORING, AND LESSONS IN THE FIELD OF ART, ART AWARENESS, ART HISTORY, AND ART EDUCATION, ALL WITH THE MISSION OF TEACHING ART AWARENESS AND EDUCATION THROUGHOUT THE WORLD, IN CLASS 41 (U.S. CLS. 100, 101 AND 107).

FIRST USE 9-20-2007; IN COMMERCE 9-20-2007.

THE MARK CONSISTS OF STANDARD CHARACTERS WITHOUT CLAIM TO ANY PARTICULAR FONT, STYLE, SIZE, OR COLOR.

SER. NO. 77-330,983, FILED P.R. 11-15-2007; AM. S.R. 6-25-2008.

FRED MANDIR, EXAMINING ATTORNEY

Int. Cl.: 10

Prior U.S. Cls.: 26, 39, and 44

United States Patent and Trademark Office

Reg. No. 3,478,435

Registered July 29, 2008

**TRADEMARK
SUPPLEMENTAL REGISTER**

BestMassage

FACTORY DIRECT WHOLESALE, LLC (GEOR-
GIA LTD LIAB CO)
1268 OLD ALPHARETTA RD
ALPHARETTA, GA 30005

FOR: MESSAGE CHAIRS; MESSAGE TABLES, IN
CLASS 10 (U.S. CLS. 26, 39 AND 44).

FIRST USE 6-11-2007; IN COMMERCE 7-28-2007.

THE MARK CONSISTS OF STANDARD CHAR-
ACTERS WITHOUT CLAIM TO ANY PARTICULAR
FONT, STYLE, SIZE, OR COLOR.

SER. NO. 77-334,836, FILED P.R. 11-21-2007; AM.
S.R. 6-3-2008.

DAVID MILLER, EXAMINING ATTORNEY

Int. Cl.: 9

Prior U.S. Cls.: 21, 23, 26, 36, and 38

United States Patent and Trademark Office

Reg. No. 3,478,436

Registered July 29, 2008

**TRADEMARK
SUPPLEMENTAL REGISTER**

M2M

SIXNET, LLC (DELAWARE LTD LIAB CO)
331 USHERS ROAD, P.O. BOX 767
CLIFTON PARK, NY 12065

FOR: ELECTRONIC DIGITAL, WIRELESS, AND OPTICAL COMMUNICATION COMPONENTS, NAMELY, DIGITAL, WIRELESS, AND OPTICAL INDUSTRIAL AND NETWORK INTERFACES FOR COMPUTERS THAT COMMUNICATE INFORMATION BETWEEN AUTOMATED EQUIPMENT, IN CLASS 9 (U.S. CLS. 21, 23, 26, 36 AND 38).

FIRST USE 11-9-2007; IN COMMERCE 11-9-2007.

THE MARK CONSISTS OF STANDARD CHARACTERS WITHOUT CLAIM TO ANY PARTICULAR FONT, STYLE, SIZE, OR COLOR.

SER. NO. 77-336,581, FILED P.R. 11-26-2007; AM. S.R. 6-12-2008.

IRA J. GOODSaid, EXAMINING ATTORNEY

Int. Cl.: 35

Prior U.S. Cls.: 100, 101, and 102

United States Patent and Trademark Office

Reg. No. 3,478,437

Registered July 29, 2008

**SERVICE MARK
SUPPLEMENTAL REGISTER**

HANDMADE IN THE USA

GEORGE LITTLE MANAGEMENT, LLC (DELA-
WARE LTD LIAB CO)
TEN BANK STREET, SUITE 1200
WHITE PLAINS, NY 10606

FOR: ORGANIZING AND CONDUCTING
TRADE SHOWS ATTENDED BY REPRESENTA-
TIVES OF RETAIL ESTABLISHMENTS WITH RE-
SPECT TO OBJECTS EXHIBITED BY HAND-
CRAFTSMEN , IN CLASS 35 (U.S. CLS. 100, 101
AND 102).

FIRST USE 10-1-1990; IN COMMERCE 10-1-1990.

THE MARK CONSISTS OF STANDARD CHAR-
ACTERS WITHOUT CLAIM TO ANY PARTICULAR
FONT, STYLE, SIZE, OR COLOR.

SER. NO. 77-344,544, FILED P.R. 12-5-2007; AM. S.R.
4-14-2008.

RAMONA ORTIGA, EXAMINING ATTORNEY

Int. Cl.: 25

Prior U.S. Cls.: 22 and 39

United States Patent and Trademark Office

Reg. No. 3,478,438

Registered July 29, 2008

**TRADEMARK
SUPPLEMENTAL REGISTER**

RAIN MOM

REIMANN, MICHELE A (UNITED STATES IN-
DIVIDUAL)
9313 S. PULASKI RD
EVERGREEN PARK, IL 60805

FOR: SHORT-SLEEVED OR LONG-SLEEVED T-
SHIRTS, IN CLASS 25 (U.S. CLS. 22 AND 39).

FIRST USE 12-6-2007; IN COMMERCE 12-10-2007.

THE MARK CONSISTS OF STANDARD CHAR-
ACTERS WITHOUT CLAIM TO ANY PARTICULAR
FONT, STYLE, SIZE, OR COLOR.

SER. NO. 77-350,985, FILED P.R. 12-13-2007; AM.
S.R. 5-22-2008.

SUSAN RICHARDS, EXAMINING ATTORNEY

Int. Cl.: 36

Prior U.S. Cls.: 100, 101, and 102

United States Patent and Trademark Office

Reg. No. 3,478,439

Registered July 29, 2008

**SERVICE MARK
SUPPLEMENTAL REGISTER**

eCommuter Check

COMMUTER CHECK SERVICES CORP. (NEW
JERSEY CORPORATION)
401 S. VAN BRUNT STREET
ENGLEWOOD, NJ 07631

FOR: TRAVEL VOUCHER SERVICES, NAMELY,
PROVIDING VOUCHERS WHICH CAN BE RE-
DEEMED ONLINE FOR PAYMENT OF TRANSPOR-
TATION EXPENSES, IN CLASS 36 (U.S. CLS. 100, 101
AND 102).

FIRST USE 6-15-2008; IN COMMERCE 6-15-2008.

THE MARK CONSISTS OF STANDARD CHAR-
ACTERS WITHOUT CLAIM TO ANY PARTICULAR
FONT, STYLE, SIZE, OR COLOR.

OWNER OF U.S. REG. NOS. 2,465,014 AND
2,538,919.

SER. NO. 77-352,025, FILED P.R. 12-14-2007; AM.
S.R. 6-19-2008.

LOURDES AYALA, EXAMINING ATTORNEY

Int. Cl.: 42

Prior U.S. Cls.: 100 and 101

United States Patent and Trademark Office

Reg. No. 3,478,440

Registered July 29, 2008

**SERVICE MARK
SUPPLEMENTAL REGISTER**

**Responsive Service and
Secure, Reliable Technical
Solutions for Your Small
Business**

WARRINGTON-READ, MARK (UNITED KING-
DOM INDIVIDUAL)
2900 DELK RD, STE 700 # 252
MARIETTA, GA 30067

FOR: COMPUTER CONSULTATION IN THE
FIELD OF COMPUTER SECURITY; COMPUTER
DIAGNOSTIC SERVICES; COMPUTER NETWORK
DESIGN FOR OTHERS; COMPUTER SERVICES,
NAMELY, COMPUTER SYSTEM ADMINISTRA-
TION FOR OTHERS; COMPUTER SERVICES,
NAMELY, DESIGNING AND IMPLEMENTING
WEB SITES FOR OTHERS; COMPUTER SERVICES,
NAMELY, MANAGING WEB SITES FOR OTHERS;
COMPUTER SERVICES, NAMELY, REMOTE AND
ON-SITE MANAGEMENT OF ELECTRONIC MES-

SAGING SYSTEMS AND APPLICATIONS FOR OTH-
ERS; COMPUTER SOFTWARE CONSULTATION;
COMPUTER SYSTEMS ANALYSIS, IN CLASS 42
(U.S. CLS. 100 AND 101).

FIRST USE 11-1-2003; IN COMMERCE 11-1-2003.

THE MARK CONSISTS OF STANDARD CHAR-
ACTERS WITHOUT CLAIM TO ANY PARTICULAR
FONT, STYLE, SIZE, OR COLOR.

SER. NO. 77-355,212, FILED P.R. 12-18-2007; AM.
S.R. 6-13-2008.

CHRISIE B. KING, EXAMINING ATTORNEY

Int. Cl.: 20

Prior U.S. Cls.: 2, 13, 22, 25, 32, and 50

Reg. No. 3,478,441

United States Patent and Trademark Office

Registered July 29, 2008

**TRADEMARK
SUPPLEMENTAL REGISTER**

FIRST TO THE MOON

ALABAMA SPACE SCIENCE EXHIBIT COMMISSION (ALABAMA CORPORATION)
ONE TRANQUILITY BASE
HUNTSVILLE, AL 35805

FOR: PLASTIC NOVELTY LICENSE PLATES, IN CLASS 20 (U.S. CLS. 2, 13, 22, 25, 32 AND 50).

FIRST USE 8-31-2005; IN COMMERCE 8-31-2005.

THE MARK CONSISTS OF STANDARD CHARACTERS WITHOUT CLAIM TO ANY PARTICULAR FONT, STYLE, SIZE, OR COLOR.

SER. NO. 77-360,357, FILED P.R. 12-27-2007; AM. S.R. 6-23-2008.

JOHN SCHUYLER YARD, EXAMINING ATTORNEY

Int. Cl.: 41

Prior U.S. Cls.: 100, 101, and 107

United States Patent and Trademark Office

Reg. No. 3,478,442

Registered July 29, 2008

**SERVICE MARK
SUPPLEMENTAL REGISTER**

Fiji Festival

FIJI AMERICAN NATIONAL ASSOCIATION (CALIFORNIA CORPORATION)
26250 INDUSTRIAL BLVD., # 26
HAYWARD, CA 94542

FOR: ORGANIZING COMMUNITY FESTIVALS FEATURING A VARIETY OF ACTIVITIES, NAMELY, SPORTING EVENTS, ART EXHIBITIONS, FLEA MARKETS, ETHNIC DANCES AND THE LIKE, IN CLASS 41 (U.S. CLS. 100, 101 AND 107).

FIRST USE 3-1-2002; IN COMMERCE 7-1-2002.

THE MARK CONSISTS OF STANDARD CHARACTERS WITHOUT CLAIM TO ANY PARTICULAR FONT, STYLE, SIZE, OR COLOR.

NO CLAIM IS MADE TO THE EXCLUSIVE RIGHT TO USE "FESTIVAL", APART FROM THE MARK AS SHOWN.

SER. NO. 77-373,417, FILED P.R. 1-16-2008; AM. S.R. 5-28-2008.

BERYL GARDNER, EXAMINING ATTORNEY

Int. Cl.: 16

Prior U.S. Cls.: 2, 5, 22, 23, 29, 37, 38, and 50

United States Patent and Trademark Office

Reg. No. 3,478,443

Registered July 29, 2008

**TRADEMARK
SUPPLEMENTAL REGISTER**

SANTA CLAUS

THE TOPPS COMPANY, INC. (DELAWARE COR-
PORATION)
ONE WHITEHALL STREET
NEW YORK, NY 10004

FOR: TRADING CARDS, IN CLASS 16 (U.S. CLS. 2,
5, 22, 23, 29, 37, 38 AND 50).

FIRST USE 11-0-2007; IN COMMERCE 11-0-2007.

THE MARK CONSISTS OF STANDARD CHAR-
ACTERS WITHOUT CLAIM TO ANY PARTICULAR
FONT, STYLE, SIZE, OR COLOR.

SER. NO. 77-375,651, FILED P.R. 1-18-2008; AM. S.R.
6-19-2008.

JOHN GARTNER, EXAMINING ATTORNEY

Int. Cl.: 41

Prior U.S. Cls.: 100, 101, and 107

United States Patent and Trademark Office

Reg. No. 3,478,444

Registered July 29, 2008

**SERVICE MARK
SUPPLEMENTAL REGISTER**

America's Green College

NEW ENGLAND INSTITUTE OF TECHNOLOGY
(RHODE ISLAND CORPORATION)

2500 POST ROAD

WARWICK, RI 02886

FOR: EDUCATION SERVICES, NAMELY, PROVIDING COURSES OF INSTRUCTION AT THE COLLEGE LEVEL IN THE FIELDS OF TECHNOLOGY AND LIBERAL ARTS, IN CLASS 41 (U.S. CLS. 100, 101 AND 107).

FIRST USE 1-27-2008; IN COMMERCE 1-27-2008.

THE MARK CONSISTS OF STANDARD CHARACTERS WITHOUT CLAIM TO ANY PARTICULAR FONT, STYLE, SIZE, OR COLOR.

OWNER OF U.S. REG. NO. 2,682,019.

NO CLAIM IS MADE TO THE EXCLUSIVE RIGHT TO USE "GREEN COLLEGE", APART FROM THE MARK AS SHOWN.

SER. NO. 77-382,077, FILED P.R. 1-28-2008; AM. S.R. 6-2-2008.

ELIZABETH HUGHITT, EXAMINING ATTORNEY

Int. Cl.: 41

Prior U.S. Cls.: 100, 101, and 107

United States Patent and Trademark Office

Reg. No. 3,478,445

Registered July 29, 2008

**SERVICE MARK
SUPPLEMENTAL REGISTER**

7 SOPRANOS

COLE, CYNTHIA D. (UNITED STATES INDIVIDUAL)
3951 CLIFTON MANOR PLACE
HAYMARKET, VA 20169

THE MARK CONSISTS OF STANDARD CHARACTERS WITHOUT CLAIM TO ANY PARTICULAR FONT, STYLE, SIZE, OR COLOR.

FOR: ENTERTAINMENT SERVICES IN THE NATURE OF LIVE MUSICAL PERFORMANCES, IN CLASS 41 (U.S. CLS. 100, 101 AND 107).

SER. NO. 77-386,138, FILED P.R. 2-1-2008; AM. S.R. 6-3-2008.

FIRST USE 2-8-2008; IN COMMERCE 2-8-2008.

MICHELLE DUBOIS, EXAMINING ATTORNEY

Int. Cl.: 35

Prior U.S. Cls.: 100, 101, and 102

United States Patent and Trademark Office

Reg. No. 3,478,446

Registered July 29, 2008

**SERVICE MARK
SUPPLEMENTAL REGISTER**

Expert Exports

EXPERT EXPORTS LLC (NEW JERSEY LTD
LIAB CO)
10 NOTTINGHAM WAY
RANDOLPH, NJ 07869

FOR: GOODS IMPORT-EXPORT AGENCIES, IN
CLASS 35 (U.S. CLS. 100, 101 AND 102).

FIRST USE 2-1-2008; IN COMMERCE 2-1-2008.

THE MARK CONSISTS OF STANDARD CHAR-
ACTERS WITHOUT CLAIM TO ANY PARTICULAR
FONT, STYLE, SIZE, OR COLOR.

SER. NO. 77-386,222, FILED P.R. 2-1-2008; AM. S.R.
6-9-2008.

TASHIA BUNCH, EXAMINING ATTORNEY

Int. Cl.: 44

Prior U.S. Cls.: 100 and 101

United States Patent and Trademark Office

Reg. No. 3,478,447

Registered July 29, 2008

**SERVICE MARK
SUPPLEMENTAL REGISTER**

Laser Spine Institute

LASER SPINE INSTITUTE, LLC (FLORIDA LTD
LIAB CO), DBA "LSI" AND "LASER SPINE
INSTITUTE",
3001 N. ROCKY POINT DR. EAST SUITE 400
TAMPA, FL 33067

FOR: MEDICAL SERVICES, IN CLASS 44 (U.S.
CLS. 100 AND 101).

FIRST USE 11-18-2004; IN COMMERCE 11-18-2004.

THE MARK CONSISTS OF STANDARD CHAR-
ACTERS WITHOUT CLAIM TO ANY PARTICULAR
FONT, STYLE, SIZE, OR COLOR.

OWNER OF U.S. REG. NO. 3,300,891.

NO CLAIM IS MADE TO THE EXCLUSIVE
RIGHT TO USE "SPINE INSTITUTE", APART FROM
THE MARK AS SHOWN.

SER. NO. 77-390,847, FILED P.R. 2-7-2008; AM. S.R.
6-23-2008.

ELLEN BURNS, EXAMINING ATTORNEY

Int. Cl.: 36

Prior U.S. Cls.: 100, 101, and 102

United States Patent and Trademark Office

Reg. No. 3,478,448

Registered July 29, 2008

**SERVICE MARK
SUPPLEMENTAL REGISTER**

CORONADOCAYS.COM

GERRY-LYNN FIVES (UNITED STATES INDIVIDUAL)
1500 STATE STREET SUITE 100
SAN DIEGO, CA 92101

FOR: PROVIDING INFORMATION IN THE FIELD OF REAL ESTATE VIA THE INTERNET; PROVIDING REAL ESTATE LISTINGS AND REAL ESTATE INFORMATION VIA THE INTERNET; REAL ESTATE ACQUISITION SERVICES; LAND ACQUISITION, NAMELY, REAL ESTATE BROKERAGE; REAL ESTATE AGENCIES; REAL ESTATE BROKERAGE; REAL ESTATE CONSULTATION;

REAL ESTATE LISTING, IN CLASS 36 (U.S. CLS. 100, 101 AND 102).

FIRST USE 12-26-2007; IN COMMERCE 12-26-2007.

THE MARK CONSISTS OF STANDARD CHARACTERS WITHOUT CLAIM TO ANY PARTICULAR FONT, STYLE, SIZE, OR COLOR.

SER. NO. 77-394,167, FILED P.R. 2-11-2008; AM. S.R. 6-12-2008.

SANDRA MANIOS, EXAMINING ATTORNEY

Int. Cl.: 41

Prior U.S. Cls.: 100, 101, and 107

United States Patent and Trademark Office

Reg. No. 3,478,449

Registered July 29, 2008

**SERVICE MARK
SUPPLEMENTAL REGISTER**

Global Peace Music Awards

GLOBAL PEACE MUSIC AWARDS (CALIFORNIA CORPORATION)
SUITE B-489
2549 EASTBLUFF DRIVE
NEWPORT BEACH, CA 92660

FOR: EDUCATIONAL SERVICES, NAMELY, PROVIDING INCENTIVES TO PEOPLE TO DEMONSTRATE EXCELLENCE IN THE FIELD OF MUSIC AND VIDEO ARTS AND SCIENCES THROUGH THE ISSUANCE OF AWARDS; ENTERTAINMENT SERVICES, NAMELY, LIVE PERFORMANCES BY MUSICAL ARTISTS AND MUSICAL GROUPS; ENTERTAINMENT IN THE NATURE OF TELEVISED MUSIC AWARDS PROGRAMS; ANNUAL AWARDS PROGRAM FOR THE PRESENTATION OF AWARDS IN RECOGNITION OF DISTINGUISHED ACHIEVEMENT IN THE FIELD OF MUSIC; PRO-

VIDING A WEB SITE FEATURING PRERECORDED MUSIC, MUSICAL PERFORMANCES, AUDIO CLIPS, VIDEO CLIPS, PHOTOGRAPHS, NEWS, REVIEWS, AND OTHER MULTIMEDIA ARTICLES, ALL IN CONNECTION WITH THE FIELD OF MUSIC, IN CLASS 41 (U.S. CLS. 100, 101 AND 107).

FIRST USE 1-1-2004; IN COMMERCE 10-1-2007.

THE MARK CONSISTS OF STANDARD CHARACTERS WITHOUT CLAIM TO ANY PARTICULAR FONT, STYLE, SIZE, OR COLOR.

SER. NO. 77-396,178, FILED 2-13-2008.

MICHAEL WIENER, EXAMINING ATTORNEY

Int. Cls.: 37 and 39

Prior U.S. Cls.: 100, 103, 105, and 106

United States Patent and Trademark Office

Reg. No. 3,478,450

Registered July 29, 2008

**SERVICE MARK
SUPPLEMENTAL REGISTER**

PREMIUM

NATIONAL TRUCK PROTECTION CO., INC.
(NEW JERSEY CORPORATION)

130 MOONACHIE AVE.

CARLSTADT, NJ 070722500

FOR: BREAKDOWN ASSISTANCE, NAMELY,
REPAIR AND MAINTENANCE OF MOTOR VEHICLES
AND EMERGENCY ROAD SIDE SERVICES,
IN CLASS 37 (U.S. CLS. 100, 103 AND 106).

FIRST USE 5-1-2008; IN COMMERCE 5-1-2008.

FOR: BREAKDOWN ASSISTANCE, NAMELY,
VEHICLE TOWING, IN CLASS 39 (U.S. CLS. 100
AND 105).

FIRST USE 5-1-2008; IN COMMERCE 5-1-2008.

THE MARK CONSISTS OF STANDARD CHARACTERS
WITHOUT CLAIM TO ANY PARTICULAR
FONT, STYLE, SIZE, OR COLOR.

SER. NO. 77-397,513, FILED P.R. 2-14-2008; AM. S.R.
6-17-2008.

RONALD AIKENS, EXAMINING ATTORNEY

Int. Cl.: 41

Prior U.S. Cls.: 100, 101, and 107

United States Patent and Trademark Office

Reg. No. 3,478,451

Registered July 29, 2008

**SERVICE MARK
SUPPLEMENTAL REGISTER**

MALIBU PINUPS

MOBILITY FREEWAY, LLC (CALIFORNIA LTD
LIAB CO)
PO BOX 2702
MALIBU, CA 90265

FOR: ENTERTAINMENT SERVICES, NAMELY,
PROVIDING A WEBSITE FEATURING IMAGES,
VIDEO CLIPS, INTERVIEWS OF FEATURED PER-
FORMERS OR CHARACTERS, AND PHOTO-
GRAPHS OF BEAUTIFUL WOMEN;
ENTERTAINMENT SERVICES, NAMELY, PRO-
DUCTION OF TELEVISION SHOWS, MOVIES, VI-
DEO TAPES AND VIDEO DISCS FOR OTHERS;
PRODUCTION OF MOTION PICTURES AND TELE-
VISION PROGRAMS FEATURING BEAUTIFUL
WOMEN AND DISTRIBUTION OF THE SAME
OVER A GLOBAL COMPUTER AND WIRELESS

NETWORK, MOBILE DEVICES, CABLE TELEVI-
SION, AND SATELLITE, IN CLASS 41 (U.S. CLS. 100,
101 AND 107).

FIRST USE 1-3-2008; IN COMMERCE 1-3-2008.

THE MARK CONSISTS OF STANDARD CHAR-
ACTERS WITHOUT CLAIM TO ANY PARTICULAR
FONT, STYLE, SIZE, OR COLOR.

OWNER OF U.S. REG. NO. 3,275,073.

SER. NO. 77-397,727, FILED P.R. 2-14-2008; AM. S.R.
6-17-2008.

WILLIAM VERHOSEK, EXAMINING ATTORNEY

Int. Cl.: 35

Prior U.S. Cls.: 100, 101, and 102

United States Patent and Trademark Office

Reg. No. 3,478,452

Registered July 29, 2008

**SERVICE MARK
SUPPLEMENTAL REGISTER**

SUNGLASS WAREHOUSE

MERCER FINANCIAL SERVICES, INC. (GEORGIA CORPORATION)

SUITE 200

3220 POINT PARKWAY

NORCROSS, GA 30092

FOR: RETAIL OPTICAL STORE SERVICES, IN CLASS 35 (U.S. CLS. 100, 101 AND 102).

FIRST USE 5-7-2004; IN COMMERCE 5-7-2004.

THE MARK CONSISTS OF STANDARD CHARACTERS WITHOUT CLAIM TO ANY PARTICULAR FONT, STYLE, SIZE, OR COLOR.

NO CLAIM IS MADE TO THE EXCLUSIVE RIGHT TO USE "WAREHOUSE", APART FROM THE MARK AS SHOWN.

SER. NO. 77-398,253, FILED P.R. 2-15-2008; AM. S.R. 6-23-2008.

PRISCILLA MILTON, EXAMINING ATTORNEY

Int. Cl.: 36

Prior U.S. Cls.: 100, 101, and 102

United States Patent and Trademark Office

Reg. No. 3,478,453

Registered July 29, 2008

**SERVICE MARK
SUPPLEMENTAL REGISTER**

CORONADO4SALE.COM

GERRY-LYNN FIVES (UNITED STATES INDIVIDUAL)
1500 STATE STREET SUITE 100
SAN DIEGO, CA 92101

FOR: LAND ACQUISITION, NAMELY, REAL ESTATE BROKERAGE; PROVIDING INFORMATION IN THE FIELD OF REAL ESTATE VIA THE INTERNET; PROVIDING REAL ESTATE LISTINGS AND REAL ESTATE INFORMATION VIA THE INTERNET; REAL ESTATE ACQUISITION SERVICES; REAL ESTATE BROKERAGE; REAL ESTATE AGENCIES; REAL ESTATE CONSULTATION;

REAL ESTATE LISTING, IN CLASS 36 (U.S. CLS. 100, 101 AND 102).

FIRST USE 4-30-2004; IN COMMERCE 4-30-2004.

THE MARK CONSISTS OF STANDARD CHARACTERS WITHOUT CLAIM TO ANY PARTICULAR FONT, STYLE, SIZE, OR COLOR.

SER. NO. 77-398,472, FILED P.R. 2-15-2008; AM. S.R. 6-12-2008.

SANDRA MANIOS, EXAMINING ATTORNEY

Int. Cl.: 35

Prior U.S. Cls.: 100, 101, and 102

United States Patent and Trademark Office

Reg. No. 3,478,454

Registered July 29, 2008

**SERVICE MARK
SUPPLEMENTAL REGISTER**

CELEBRITY GOLF PRO-AM

PROFILE NETWORK, INC. (ILLINOIS CORPORATION), DBA D/B/A SPORTS PROFILES, SUITE 900
4711 GOLF ROAD
SKOKIE, IL 60076

FOR: PROMOTING THE GOODS AND SERVICES OF OTHERS BY ARRANGING FOR SPONSORS TO AFFILIATE THEIR GOODS AND SERVICES WITH AN AWARDS PROGRAM, A SPORTS COMPETITION AND SPORTING ACTIVITIES; PROMOTING THE SALE OF GOODS AND SERVICES OF OTHERS THROUGH THE DISTRIBUTION OF PRINTED MATERIAL AND PROMOTIONAL CONTESTS; PRO-

MOTION AND MARKETING SERVICES AND RELATED CONSULTING, IN CLASS 35 (U.S. CLS. 100, 101 AND 102).

FIRST USE 1-1-2005; IN COMMERCE 1-1-2005.

THE MARK CONSISTS OF STANDARD CHARACTERS WITHOUT CLAIM TO ANY PARTICULAR FONT, STYLE, SIZE, OR COLOR.

SER. NO. 77-401,046, FILED P.R. 2-20-2008; AM. S.R. 6-24-2008.

SALLY SHIH, EXAMINING ATTORNEY

Int. Cl.: 35

Prior U.S. Cls.: 100, 101, and 102

United States Patent and Trademark Office

Reg. No. 3,478,455

Registered July 29, 2008

**SERVICE MARK
SUPPLEMENTAL REGISTER**

CELEBRITY FACE-OFF

PROFILE NETWORK, INC. (ILLINOIS CORPORATION), DBA SPORTS PROFILES,
SUITE 900
4711 GOLF ROAD
SKOKIE, IL 60076

FOR: PROMOTING THE GOODS AND SERVICES OF OTHERS BY ARRANGING FOR SPONSORS TO AFFILIATE THEIR GOODS AND SERVICES WITH AN AWARDS PROGRAM, A SPORTS COMPETITION AND SPORTING ACTIVITIES; PROMOTING THE SALE OF GOODS AND SERVICES OF OTHERS THROUGH THE DISTRIBUTION OF PRINTED MATERIAL AND PROMOTIONAL CONTESTS; PRO-

MOTION AND MARKETING SERVICES AND RELATED CONSULTING, IN CLASS 35 (U.S. CLS. 100, 101 AND 102).

FIRST USE 1-1-2007; IN COMMERCE 1-1-2007.

THE MARK CONSISTS OF STANDARD CHARACTERS WITHOUT CLAIM TO ANY PARTICULAR FONT, STYLE, SIZE, OR COLOR.

SER. NO. 77-401,254, FILED P.R. 2-20-2008; AM. S.R. 6-17-2008.

SALLY SHIH, EXAMINING ATTORNEY

Int. Cl.: 42

Prior U.S. Cls.: 100 and 101

United States Patent and Trademark Office

Reg. No. 3,478,456

Registered July 29, 2008

**SERVICE MARK
SUPPLEMENTAL REGISTER**

Free Cell Phone Tracer

PEOPLE SEARCH MEDIA, LLC (NEVADA LTD
LIAB CO)
101 UNIVERSITY AVE., SUITE 320
PALO ALTO, CA 94301

FOR: COMPUTER SERVICE, NAMELY, ACTING
AS AN APPLICATION SERVICE PROVIDER IN THE
FIELD OF KNOWLEDGE MANAGEMENT TO
HOST COMPUTER APPLICATION SOFTWARE
FOR SEARCHING AND RETRIEVING INFORMA-
TION FROM DATABASES AND COMPUTER NET-
WORKS, IN CLASS 42 (U.S. CLS. 100 AND 101).

FIRST USE 2-19-2008; IN COMMERCE 2-19-2008.

THE MARK CONSISTS OF STANDARD CHAR-
ACTERS WITHOUT CLAIM TO ANY PARTICULAR
FONT, STYLE, SIZE, OR COLOR.

SER. NO. 77-401,983, FILED P.R. 2-20-2008; AM. S.R.
6-20-2008.

MELVIN AXILBUND, EXAMINING ATTORNEY

Int. Cl.: 11

Prior U.S. Cls.: 13, 21, 23, 31, and 34

United States Patent and Trademark Office

Reg. No. 3,478,457

Registered July 29, 2008

**TRADEMARK
SUPPLEMENTAL REGISTER**

THE BABY SHOWER

SPRITE INDUSTRIES, INC. (CALIFORNIA CORPORATION)
1791 RAILROAD ST.
CORONA, CA 92880

FOR: SHOWER HEADS; WATER FILTERING UNITS FOR DOMESTIC AND COMMERCIAL USE; WATER FILTERS; WATER PURIFICATION UNITS; WATER TREATMENT EQUIPMENT, NAMELY, CARTRIDGE FILTRATION UNITS, IN CLASS 11 (U.S. CLS. 13, 21, 23, 31 AND 34).

FIRST USE 3-15-2007; IN COMMERCE 4-5-2007.

THE MARK CONSISTS OF STANDARD CHARACTERS WITHOUT CLAIM TO ANY PARTICULAR FONT, STYLE, SIZE, OR COLOR.

NO CLAIM IS MADE TO THE EXCLUSIVE RIGHT TO USE "SHOWER", APART FROM THE MARK AS SHOWN.

SER. NO. 77-403,294, FILED P.R. 2-21-2008; AM. S.R. 6-24-2008.

TANYA AMOS, EXAMINING ATTORNEY

Int. Cl.: 9

Prior U.S. Cls.: 21, 23, 26, 36, and 38

United States Patent and Trademark Office

Reg. No. 3,478,458

Registered July 29, 2008

**TRADEMARK
SUPPLEMENTAL REGISTER**

IT Pro Dashboard

KARISOFT CORPORATION (MASSACHUSETTS
CORPORATION)
WWW.KARISOFT.COM
1731 BEACON STREET #1411
BROOKLINE, MA 02445

FOR: COMPUTER SOFTWARE FOR SERVICE
TICKET MANAGEMENT, NAMELY, COMPUTER
SOFTWARE FOR USE IN REQUESTING REPAIRS
VIA TICKETS TO FIX THE COMPUTER HARD-
WARE AND COMPUTER SOFTWARE PROBLEMS
OF OTHERS, IN CLASS 9 (U.S. CLS. 21, 23, 26, 36 AND
38).

FIRST USE 4-1-2007; IN COMMERCE 10-1-2007.

THE MARK CONSISTS OF STANDARD CHAR-
ACTERS WITHOUT CLAIM TO ANY PARTICULAR
FONT, STYLE, SIZE, OR COLOR.

SER. NO. 77-403,939, FILED P.R. 2-22-2008; AM. S.R.
6-4-2008.

DAVID MURRAY, EXAMINING ATTORNEY

Int. Cl.: 41

Prior U.S. Cls.: 100, 101, and 107

United States Patent and Trademark Office

Reg. No. 3,478,459

Registered July 29, 2008

**SERVICE MARK
SUPPLEMENTAL REGISTER**

The GREATEST Fan

KINGI KNOX (UNITED STATES INDIVIDUAL)
4920 VAN NUYS BLVD.
SHERMAN OAKS, CA 91403

FOR: ENTERTAINMENT SERVICES, NAMELY,
AN ON-GOING SERIES FEATURING PROGRAMS
WHERE FANS COMPETE TO MEET THEIR FAVOR-
ITE CELEBRITIES AND WIN VIP PRIZES AND
HANG OUT WITH CELEBRITIES IN VIP STYLE
PROVIDED THROUGH TELEVISION, IN CLASS 41
(U.S. CLS. 100, 101 AND 107).

FIRST USE 6-26-2006; IN COMMERCE 6-26-2006.

THE MARK CONSISTS OF STANDARD CHAR-
ACTERS WITHOUT CLAIM TO ANY PARTICULAR
FONT, STYLE, SIZE, OR COLOR.

NO CLAIM IS MADE TO THE EXCLUSIVE
RIGHT TO USE "FAN", APART FROM THE MARK
AS SHOWN.

SER. NO. 77-404,074, FILED 2-22-2008.

ANDREA SAUNDERS, EXAMINING ATTORNEY

Int. Cls.: 36 and 43

Prior U.S. Cls.: 100, 101, and 102

United States Patent and Trademark Office

Reg. No. 3,478,460

Registered July 29, 2008

**SERVICE MARK
SUPPLEMENTAL REGISTER**

THE HOLBROOK

SOLOMON SENIOR LIVING HOLDINGS, LLC
(GEORGIA LTD LIAB CO), DBA SOLOMON
DEVELOPMENT SERVICES, LLC,
48 OLD ROSWELL STREET
ALPHARETTA, GA 30009

FOR: LEASING OF APARTMENTS; APARTMENT
HOUSE MANAGEMENT, IN CLASS 36 (U.S. CLS.
100, 101 AND 102).

FIRST USE 3-4-2008; IN COMMERCE 3-4-2008.

FOR: PROVIDING ASSISTANCE TO SENIOR CI-
TIZENS SEEKING TO DETERMINE ASSISTED LIV-
ING FACILITIES APPROPRIATE FOR THEIR

NEEDS; PROVIDING ASSISTED LIVING FACIL-
ITIES, IN CLASS 43 (U.S. CLS. 100 AND 101).

FIRST USE 3-4-2008; IN COMMERCE 3-4-2008.

THE MARK CONSISTS OF STANDARD CHAR-
ACTERS WITHOUT CLAIM TO ANY PARTICULAR
FONT, STYLE, SIZE, OR COLOR.

SER. NO. 77-405,902, FILED P.R. 2-26-2008; AM. S.R.
6-17-2008.

BARBARA GAYNOR, EXAMINING ATTORNEY

Int. Cl.: 37

Prior U.S. Cls.: 100, 103, and 106

United States Patent and Trademark Office

Reg. No. 3,478,461

Registered July 29, 2008

**SERVICE MARK
SUPPLEMENTAL REGISTER**

**Creating a Better Climate
For Your Business**

ACCO, INC. (KENTUCKY CORPORATION)
5515 POPLAR PARK BLVD
LOUISVILLE, KY 40228

THE MARK CONSISTS OF STANDARD CHAR-
ACTERS WITHOUT CLAIM TO ANY PARTICULAR
FONT, STYLE, SIZE, OR COLOR.

FOR: HVAC CONTRACTOR SERVICES, IN CLASS
37 (U.S. CLS. 100, 103 AND 106).

SER. NO. 77-408,216, FILED 2-28-2008.

FIRST USE 1-1-1980; IN COMMERCE 1-1-1980.

JOHN KELLY, EXAMINING ATTORNEY

Int. Cl.: 16

Prior U.S. Cls.: 2, 5, 22, 23, 29, 37, 38, and 50

United States Patent and Trademark Office

Reg. No. 3,478,462

Registered July 29, 2008

**TRADEMARK
SUPPLEMENTAL REGISTER**

**REFLECTIONS FROM THE EYE
SAGE**

FITZGERALD JR., JAMES L., (UNITED STATES
INDIVIDUAL)
PO BOX 77
POWNA, VT 05261

THE MARK CONSISTS OF STANDARD CHAR-
ACTERS WITHOUT CLAIM TO ANY PARTICULAR
FONT, STYLE, SIZE, OR COLOR.

FOR: A SERIES OF WRITTEN ARTICLES IN THE
FIELD OF HEALTH SCIENCES, IN CLASS 16 (U.S.
CLS. 2, 5, 22, 23, 29, 37, 38 AND 50).

SER. NO. 77-408,492, FILED P.R. 2-28-2008; AM. S.R.
6-23-2008.

FIRST USE 9-0-2007; IN COMMERCE 9-0-2007.

CYNTHIA TRIPI, EXAMINING ATTORNEY

Int. Cl.: 43

Prior U.S. Cls.: 100 and 101

United States Patent and Trademark Office

Reg. No. 3,478,463

Registered July 29, 2008

**SERVICE MARK
SUPPLEMENTAL REGISTER**

CITY PROVISIONS

CITY PROVISIONS, LLC (ILLINOIS LTD LIAB
CO)

1043 NORTH CALIFORNIA AVENUE

CHICAGO, IL 60622

FOR: CATERING SERVICES; PREPARATION
AND SERVING OF FOOD AND BEVERAGES, IN
CLASS 43 (U.S. CLS. 100 AND 101).

FIRST USE 1-1-2008; IN COMMERCE 1-1-2008.

THE MARK CONSISTS OF STANDARD CHAR-
ACTERS WITHOUT CLAIM TO ANY PARTICULAR
FONT, STYLE, SIZE, OR COLOR.

NO CLAIM IS MADE TO THE EXCLUSIVE
RIGHT TO USE "PROVISIONS", APART FROM
THE MARK AS SHOWN.

SER. NO. 77-408,965, FILED P.R. 2-28-2008; AM. S.R.
6-23-2008.

JIM RINGLE, EXAMINING ATTORNEY

Int. Cl.: 25

Prior U.S. Cls.: 22 and 39

United States Patent and Trademark Office

Reg. No. 3,478,464

Registered July 29, 2008

TRADEMARK
SUPPLEMENTAL REGISTER



IRON ORDER MC (WYOMING CORPORATION)
5572 THIRTY THREE MILE RD.
CASPER, WY 82604

FOR: JACKETS; SHIRTS; VESTS, IN CLASS 25
(U.S. CLS. 22 AND 39).

FIRST USE 8-1-2005; IN COMMERCE 8-1-2005.

NO CLAIM IS MADE TO THE EXCLUSIVE
RIGHT TO USE "MC" , APART FROM THE MARK
AS SHOWN.

THE MARK CONSISTS OF THE STYLZIED
WORDS "IRON ORDER" ARCHED ACROSS THE

TOP WITH A CENTER LOGO WITH A V-TWIN
MOTORCYCLE ENGINE AFFIXED ON TOP OF A
HUMAN SKULL AND A DIAMOND WITH THE
STYLIZED NUMBER "8" INSIDE OF THE DIA-
MOND CENTERED ON THE ENGINE AND THE
STYLIZED LETTERS "MC" IN A BOX TO THE
RIGHT OF THE CENTER LOGO.

SER. NO. 77-409,129, FILED P.R. 2-28-2008; AM. S.R.
6-19-2008.

DOMINIC J. FERRAIUOLO, EXAMINING ATTOR-
NEY

Int. Cl.: 19

Prior U.S. Cls.: 1, 12, 33, and 50

United States Patent and Trademark Office

Reg. No. 3,478,465

Registered July 29, 2008

**TRADEMARK
SUPPLEMENTAL REGISTER**

SPERO

WELLINGTON INVESTMENT CORPORATION
(WASHINGTON CORPORATION)
SUITE 3500
1055 DUNSMUIR STREET
VANCOUVER, CANADA V7X1H3

FOR: WOOD MOLDINGS; WOOD BOARDS, IN
CLASS 19 (U.S. CLS. 1, 12, 33 AND 50).

FIRST USE 2-14-2008; IN COMMERCE 2-14-2008.

THE MARK CONSISTS OF STANDARD CHAR-
ACTERS WITHOUT CLAIM TO ANY PARTICULAR
FONT, STYLE, SIZE, OR COLOR.

SER. NO. 77-411,877, FILED P.R. 3-3-2008; AM. S.R.
6-24-2008.

EMILY CHUO, EXAMINING ATTORNEY

Int. Cl.: 35

Prior U.S. Cls.: 100, 101, and 102

United States Patent and Trademark Office

Reg. No. 3,478,466

Registered July 29, 2008

**SERVICE MARK
SUPPLEMENTAL REGISTER**

STAY HOME MOMMIES

NARVAEZ, MONICA (UNITED STATES INDIVIDUAL)
1799 MELFI COURT
HENDERSON, NV 89012

FOR: PROVIDING INFORMATION ABOUT THE GOODS AND SERVICES OF OTHERS VIA THE GLOBAL COMPUTER NETWORK, IN CLASS 35 (U.S. CLS. 100, 101 AND 102).

FIRST USE 3-14-2003; IN COMMERCE 3-14-2003.

THE MARK CONSISTS OF STANDARD CHARACTERS WITHOUT CLAIM TO ANY PARTICULAR FONT, STYLE, SIZE, OR COLOR.

SER. NO. 77-412,737, FILED P.R. 3-4-2008; AM. S.R. 6-13-2008.

ALLISON HOLTZ, EXAMINING ATTORNEY

Int. Cl.: 35

Prior U.S. Cls.: 100, 101, and 102

United States Patent and Trademark Office

Reg. No. 3,478,467

Registered July 29, 2008

**SERVICE MARK
SUPPLEMENTAL REGISTER**

THE MANNING HOUSE BEAD SHOW

JOHNSON, ANNA K. (UNITED STATES INDIVIDUAL), DBA GARAN-BEADAGIO,
P. O. BOX 848
NEVADA CITY, CA 959590848

FOR: ARRANGING AND CONDUCTING TRADE SHOW EXHIBITIONS IN THE FIELD OF ART, COLLECTIBLES, BEADS AND JEWELRY; ARRANGING AND CONDUCTING TRADE SHOWS IN THE FIELD OF ART, COLLECTIBLES, BEADS AND JEWELRY; CONDUCTING TRADE SHOWS IN THE FIELD OF ART, COLLECTIBLES, BEADS AND JEWELRY; PROMOTING AND CONDUCTING TRADE SHOWS IN THE FIELD OF ART, COLLECTIBLES, BEADS AND JEWELRY, IN CLASS 35 (U.S. CLS. 100, 101 AND 102).

FIRST USE 10-8-2004; IN COMMERCE 10-8-2004.

THE MARK CONSISTS OF STANDARD CHARACTERS WITHOUT CLAIM TO ANY PARTICULAR FONT, STYLE, SIZE, OR COLOR.

NO CLAIM IS MADE TO THE EXCLUSIVE RIGHT TO USE "BEAD SHOW" , APART FROM THE MARK AS SHOWN.

SER. NO. 77-413,022, FILED P.R. 3-4-2008; AM. S.R. 6-18-2008.

GISELLE AGOSTO, EXAMINING ATTORNEY

Int. Cl.: 36

Prior U.S. Cls.: 100, 101, and 102

United States Patent and Trademark Office

Reg. No. 3,478,468

Registered July 29, 2008

**SERVICE MARK
SUPPLEMENTAL REGISTER**



NAPOLITANO, RICHARD (UNITED STATES INDIVIDUAL)
3375 OCEANSIDE ROAD
OCEANSIDE, NY 11572

FOR: CHARITABLE FUND RAISING SERVICES,
IN CLASS 36 (U.S. CLS. 100, 101 AND 102).

FIRST USE 1-1-2006; IN COMMERCE 1-9-2006.

NO CLAIM IS MADE TO THE EXCLUSIVE
RIGHT TO USE "NEW YORK", APART FROM THE
MARK AS SHOWN.

THE STIPLING IS FOR SHADING PURPOSES
ONLY.

THE NAME(S), PORTRAIT(S), AND/OR SIGNATURE(S) SHOWN IN THE MARK DOES NOT IDENTIFY A PARTICULAR LIVING INDIVIDUAL.

THE MARK CONSISTS OF A CROUCHING GUNMAN WEARING A BLACK AND WHITE HAT AND A BLACK AND WHITE WITH GRAY STIPLING OVERCOAT, HOLDING A GRAY PISTOL IN HIS LEFT HAND WHILE LEANING HIS BACK AGAINST A BLACK AND WHITE WITH GRAY STIPLING TOMBSTONE WITH THE BLACK LETTERS "RIP" IN THE MIDDLE.

SER. NO. 77-415,529, FILED P.R. 3-6-2008; AM. S.R. 6-25-2008.

JILL C. ALT, EXAMINING ATTORNEY

Int. Cl.: 42

Prior U.S. Cls.: 100 and 101

United States Patent and Trademark Office

Reg. No. 3,478,469

Registered July 29, 2008

**SERVICE MARK
SUPPLEMENTAL REGISTER**

**AMERICAN BOARD OF FAMILY
MEDICINE OBSTETRICS**

AMERICAN ASSOCIATION OF PHYSICIAN SPECIALISTS, INC. (MISSOURI CORPORATION)
SUITE 400
5550 WEST EXECUTIVE DRIVE
TAMPA, FL 33609

FOR: ACCREDITATION SERVICES, NAMELY, DEVELOPING, EVALUATING, AND TESTING STANDARDS FOR PHYSICIANS FOR THE PURPOSE OF ACCREDITATION, IN CLASS 42 (U.S. CLS. 100 AND 101).

FIRST USE 3-4-2008; IN COMMERCE 3-4-2008.

THE MARK CONSISTS OF STANDARD CHARACTERS WITHOUT CLAIM TO ANY PARTICULAR FONT, STYLE, SIZE, OR COLOR.

OWNER OF U.S. REG. NOS. 3,166,986, 3,376,692, AND OTHERS.

NO CLAIM IS MADE TO THE EXCLUSIVE RIGHT TO USE "BOARD OF FAMILY MEDICINE OBSTETRICS", APART FROM THE MARK AS SHOWN.

SER. NO. 77-415,796, FILED 3-7-2008.

JIM RINGLE, EXAMINING ATTORNEY

Int. Cl.: 16

Prior U.S. Cls.: 2, 5, 22, 23, 29, 37, 38, and 50

United States Patent and Trademark Office

Reg. No. 3,478,470

Registered July 29, 2008

**TRADEMARK
SUPPLEMENTAL REGISTER**



KEYES, VIVICA J (UNITED STATES INDIVIDUAL)

13337 SOUTH STREET #190
CERRITOS, CA 90703

FOR: CHILDREN'S BOOKS, IN CLASS 16 (U.S. CLS. 2, 5, 22, 23, 29, 37, 38 AND 50).

FIRST USE 6-10-2003; IN COMMERCE 6-10-2003.

THE COLOR(S) BLUE AND YELLOW IS/ARE CLAIMED AS A FEATURE OF THE MARK.

THE MARK CONSISTS OF BLUE LETTERS WITH YELLOW SHADOW.

SER. NO. 77-418,132, FILED 3-10-2008.

CAROL SPILS, EXAMINING ATTORNEY

Int. Cl.: 9

Prior U.S. Cls.: 21, 23, 26, 36, and 38

Reg. No. 3,478,471

United States Patent and Trademark Office

Registered July 29, 2008

**TRADEMARK
SUPPLEMENTAL REGISTER**

POLICE ENFORCEMENT

PROFESSIONAL SECURITY CORPORATION
(IOWA CORPORATION), DBA PERSONAL
SAFETY CORPORATION,
204 COLLINS ROAD NE
CEDAR RAPIDS, IA 52402

FOR: PERSONAL PROTECTION WHISTLE, IN
CLASS 9 (U.S. CLS. 21, 23, 26, 36 AND 38).

FIRST USE 6-11-2008; IN COMMERCE 6-11-2008.

THE MARK CONSISTS OF STANDARD CHAR-
ACTERS WITHOUT CLAIM TO ANY PARTICULAR
FONT, STYLE, SIZE, OR COLOR.

SER. NO. 77-418,751, FILED P.R. 3-11-2008; AM. S.R.
6-11-2008.

ELLEN B. AWRICH, EXAMINING ATTORNEY

Int. Cl.: 16

Prior U.S. Cls.: 2, 5, 22, 23, 29, 37, 38, and 50

United States Patent and Trademark Office

Reg. No. 3,478,472

Registered July 29, 2008

**TRADEMARK
SUPPLEMENTAL REGISTER**

FLX

ROBERT HERNICK (UNITED STATES INDIVIDUAL)
20 CONCORD DRIVE
PITTSFORD, NY 14534

THE MARK CONSISTS OF STANDARD CHARACTERS WITHOUT CLAIM TO ANY PARTICULAR FONT, STYLE, SIZE, OR COLOR.

FOR: BUMPER STICKERS; STICKERS, IN CLASS 16 (U.S. CLS. 2, 5, 22, 23, 29, 37, 38 AND 50).

SER. NO. 77-418,938, FILED 3-11-2008.

FIRST USE 8-7-2002; IN COMMERCE 7-7-2003.

CURTIS FRENCH, EXAMINING ATTORNEY

Int. Cl.: 9

Prior U.S. Cls.: 21, 23, 26, 36, and 38

United States Patent and Trademark Office

Reg. No. 3,478,473

Registered July 29, 2008

**TRADEMARK
SUPPLEMENTAL REGISTER**

DisplayCard

INNOVATIVE CARD TECHNOLOGIES, INC. (DE-
LAWARE CORPORATION)
SUITE 2160
11601 WILSHIRE BLVD.
LOS ANGELES, CA 90025

FOR: MAGNETICALLY ENCODED CREDIT
CARDS; MAGNETICALLY ENCODED DEBIT
CARDS; MAGNETICALLY ENCODED IDENTITY
CARDS; CARDS WITH INTEGRATED CIRCUITS;
ELECTRONIC AND MAGNETIC ID CARDS FOR
USE IN CONNECTION WITH PAYMENT FOR SER-
VICES; ENCODED ELECTRONIC CHIP CARDS FOR
PROVIDING FINANCIAL TRANSACTION VERIFI-
CATION; ENCODED MAGNETIC CARDS; MAG-

NETIC CODED CARDS WITH ELECTRONICALLY
GENERATED ONE-TIME PASSCODES, IN CLASS 9
(U.S. CLS. 21, 23, 26, 36 AND 38).

FIRST USE 11-13-2007; IN COMMERCE 11-13-2007.

THE MARK CONSISTS OF STANDARD CHAR-
ACTERS WITHOUT CLAIM TO ANY PARTICULAR
FONT, STYLE, SIZE, OR COLOR.

SER. NO. 77-419,787, FILED 3-12-2008.

MARLENE BELL, EXAMINING ATTORNEY

Int. Cl.: 9

Prior U.S. Cls.: 21, 23, 26, 36, and 38

United States Patent and Trademark Office

Reg. No. 3,478,474

Registered July 29, 2008

**TRADEMARK
SUPPLEMENTAL REGISTER**

FirePrograms Software

EWERS TECHNOLOGY, LLC (FLORIDA LTD
LIAB CO)
4473 N. LECANTO HWY.
BEVERLY HILLS, FL 34465

FOR: COMPUTER PROGRAMS FOR PUBLIC
SAFETY RECORDS MANAGEMENT, IN CLASS 9
(U.S. CLS. 21, 23, 26, 36 AND 38).

FIRST USE 10-1-1985; IN COMMERCE 10-1-1985.

THE MARK CONSISTS OF STANDARD CHAR-
ACTERS WITHOUT CLAIM TO ANY PARTICULAR
FONT, STYLE, SIZE, OR COLOR.

OWNER OF U.S. REG. NO. 2,925,077.

SER. NO. 77-419,983, FILED 3-12-2008.

MICHAEL SOUDERS, EXAMINING ATTORNEY

Int. Cl.: 35

Prior U.S. Cls.: 100, 101, and 102

United States Patent and Trademark Office

Reg. No. 3,478,475

Registered July 29, 2008

**SERVICE MARK
SUPPLEMENTAL REGISTER**

INDIAN VALLEY SCUBA

INDIAN VALLEY SCUBA (PENNSYLVANIA LTD
LIAB CO)
310 BROAD STREET
HARLEYSVILLE, PA 19438

THE MARK CONSISTS OF STANDARD CHAR-
ACTERS WITHOUT CLAIM TO ANY PARTICULAR
FONT, STYLE, SIZE, OR COLOR.

FOR: RETAIL STORE SERVICES FEATURING
SCUBA EQUIPMENT, IN CLASS 35 (U.S. CLS. 100,
101 AND 102).

SER. NO. 77-422,050, FILED P.R. 3-14-2008; AM. S.R.
6-25-2008.

FIRST USE 10-1-2003; IN COMMERCE 10-1-2003.

RENEE MCCRAY, EXAMINING ATTORNEY

Int. Cl.: 44

Prior U.S. Cls.: 100 and 101

United States Patent and Trademark Office

Reg. No. 3,478,476

Registered July 29, 2008

**SERVICE MARK
SUPPLEMENTAL REGISTER**

Patient Friendly Dentistry

PECINA, ROGER (UNITED STATES INDIVIDUAL)

14196 BRICK ROAD

GRANGER, IN 46530

FOR: DENTAL HYGIENIST SERVICES; DENTIST SERVICES; DENTISTRY, IN CLASS 44 (U.S. CLS. 100 AND 101).

FIRST USE 1-1-1996; IN COMMERCE 3-1-2006.

THE MARK CONSISTS OF STANDARD CHARACTERS WITHOUT CLAIM TO ANY PARTICULAR FONT, STYLE, SIZE, OR COLOR.

NO CLAIM IS MADE TO THE EXCLUSIVE RIGHT TO USE "DENTISTRY", APART FROM THE MARK AS SHOWN.

SER. NO. 77-422,067, FILED P.R. 3-14-2008; AM. S.R. 3-14-2008.

MATTHEW MCDOWELL, EXAMINING ATTORNEY

Int. Cl.: 29

Prior U.S. Cl.: 46

United States Patent and Trademark Office

Reg. No. 3,478,477

Registered July 29, 2008

**TRADEMARK
SUPPLEMENTAL REGISTER**

Omega 3 Chia

WALTERS, JEFF (UNITED STATES INDIVIDUAL)
P. O. BOX 5142
WINTER PARK, FL 34949

FOR: PROCESSED EDIBLE PLANT SEEDS; EDIBLE PLANT SEED OIL; PLANT SEED-BASED FOOD, NAMELY, SNACK BARS, IN CLASS 29 (U.S. CL. 46).

FIRST USE 4-1-2007; IN COMMERCE 4-1-2007.

THE MARK CONSISTS OF STANDARD CHARACTERS WITHOUT CLAIM TO ANY PARTICULAR FONT, STYLE, SIZE, OR COLOR.

SER. NO. 77-424,870, FILED 3-18-2008.

WILLIAM P. SHANAHAN, EXAMINING ATTORNEY

Int. Cl.: 5

Prior U.S. Cls.: 6, 18, 44, 46, 51, and 52

United States Patent and Trademark Office

Reg. No. 3,478,478

Registered July 29, 2008

**TRADEMARK
SUPPLEMENTAL REGISTER**

RESTABS

RESTABS, INC. (NEVADA CORPORATION)
PO BOX 5372
RENO, NV 89513

THE MARK CONSISTS OF STANDARD CHAR-
ACTERS WITHOUT CLAIM TO ANY PARTICULAR
FONT, STYLE, SIZE, OR COLOR.

FOR: DIETARY SUPPLEMENTS, IN CLASS 5 (U.S.
CLS. 6, 18, 44, 46, 51 AND 52).

SER. NO. 77-425,662, FILED P.R. 3-19-2008; AM. S.R.
6-25-2008.

FIRST USE 8-10-2003; IN COMMERCE 1-15-2008.

MELVIN AXILBUND, EXAMINING ATTORNEY

Int. Cl.: 33

Prior U.S. Cls.: 47 and 49

United States Patent and Trademark Office

Reg. No. 3,478,479

Registered July 29, 2008

**TRADEMARK
SUPPLEMENTAL REGISTER**

MIXED BLACKS

RUDD WINES, INC. (CALIFORNIA CORPORATION)
P.O. BOX 105
OAKVILLE, CA 94562

THE MARK CONSISTS OF STANDARD CHARACTERS WITHOUT CLAIM TO ANY PARTICULAR FONT, STYLE, SIZE, OR COLOR.

FOR: WINE, IN CLASS 33 (U.S. CLS. 47 AND 49).

SER. NO. 77-426,079, FILED 3-19-2008.

FIRST USE 11-1-2007; IN COMMERCE 11-1-2007.

NAAKWAMA ANKRAH, EXAMINING ATTORNEY

Int. Cl.: 29

Prior U.S. Cl.: 46

United States Patent and Trademark Office

Reg. No. 3,478,480

Registered July 29, 2008

**TRADEMARK
SUPPLEMENTAL REGISTER**

Luscious Hawaiian

ROLON CHRISTINE (UNITED STATES INDIVIDUAL)
83-5465 MAMALAHOA HWY.
CAPTAIN COOK, HI 96704

FOR: JELLIES AND JAMS; BUTTER, IN CLASS 29
(U.S. CL. 46).

FIRST USE 1-0-2003; IN COMMERCE 4-16-2004.

THE MARK CONSISTS OF THE STYLIZED
WORDING "LUSCIOUS HAWAIIAN".

SER. NO. 77-426,237, FILED P.R. 3-19-2008; AM. S.R.
6-24-2008.

MARY ROSSMAN, EXAMINING ATTORNEY

Int. Cl.: 5

Prior U.S. Cls.: 6, 18, 44, 46, 51, and 52

United States Patent and Trademark Office

Reg. No. 3,478,481

Registered July 29, 2008

**TRADEMARK
SUPPLEMENTAL REGISTER**

HEALTH & ENERGY WATER

ALACER CORPORATION (CALIFORNIA CORPORATION)

80 ICON

FOOTHILL RANCH, CA 92610

FOR: NUTRITIONALLY FORTIFIED BEVERAGES, IN CLASS 5 (U.S. CLS. 6, 18, 44, 46, 51 AND 52).

FIRST USE 1-25-2008; IN COMMERCE 1-25-2008.

THE MARK CONSISTS OF STANDARD CHARACTERS WITHOUT CLAIM TO ANY PARTICULAR FONT, STYLE, SIZE, OR COLOR.

NO CLAIM IS MADE TO THE EXCLUSIVE RIGHT TO USE "WATER", APART FROM THE MARK AS SHOWN.

SER. NO. 77-431,104, FILED P.R. 3-25-2008; AM. S.R. 6-23-2008.

TANYA AMOS, EXAMINING ATTORNEY

Int. Cls.: 36, 41, 43, and 45

Prior U.S. Cls.: 100, 101, 102, and 107

United States Patent and Trademark Office

Reg. No. 3,478,482

Registered July 29, 2008

**SERVICE MARK
SUPPLEMENTAL REGISTER**

ULTIMATE

ULTIMATE RESORT HOLDINGS, LLC (DELA-
WARE LTD LIAB CO)
SUITE 225
3501 VINE STREET
KISSIMMEE, FL 34741

FOR: REAL ESTATE BROKERAGE; LEASING OF
REAL ESTATE, RESORT FACILITIES AND COUN-
TRY CLUB FACILITIES; REAL ESTATE MANAGE-
MENT, IN CLASS 36 (U.S. CLS. 100, 101 AND 102).

FIRST USE 2-4-2005; IN COMMERCE 2-4-2005.

FOR: COUNTRY CLUB SERVICES, IN CLASS 41
(U.S. CLS. 100, 101 AND 107).

FIRST USE 2-4-2005; IN COMMERCE 2-4-2005.

FOR: RESORT LODGING SERVICES, IN CLASS
43 (U.S. CLS. 100 AND 101).

FIRST USE 2-4-2005; IN COMMERCE 2-4-2005.

FOR: CONCIERGE SERVICES FOR OTHERS
COMPRISING MAKING REQUESTED PERSONAL
ARRANGEMENTS AND RESERVATIONS AND
PROVIDING CUSTOMER-SPECIFIC INFORMA-
TION TO MEET INDIVIDUAL NEEDS RENDERED
TOGETHER IN A RESORT LODGING AND COUN-
TRY CLUB FACILITY, IN CLASS 45 (U.S. CLS. 100
AND 101).

FIRST USE 2-4-2005; IN COMMERCE 2-4-2005.

THE MARK CONSISTS OF STANDARD CHAR-
ACTERS WITHOUT CLAIM TO ANY PARTICULAR
FONT, STYLE, SIZE, OR COLOR.

SER. NO. 77-452,193, FILED P.R. 4-18-2008; AM. S.R.
6-20-2008.

NAAKWAMA ANKRAH, EXAMINING ATTORNEY

Int. Cl.: 25

Prior U.S. Cls.: 22 and 39

United States Patent and Trademark Office

Reg. No. 3,478,483

Registered July 29, 2008

**TRADEMARK
SUPPLEMENTAL REGISTER**

ISOTOPES

TWENTIETH CENTURY FOX FILM CORPORATION (DELAWARE CORPORATION)
10201 WEST PICO BOULEVARD
LOS ANGELES, CA 90035

FIRST USE 10-31-2002; IN COMMERCE 10-31-2002.

SER. NO. 78-162,685, FILED P.R. 9-10-2002; AM. S.R. 6-6-2008.

FOR: SHIRTS; JERSEY, IN CLASS 25 (U.S. CLS. 22 AND 39).

SUE LAWRENCE, EXAMINING ATTORNEY

Int. Cl.: 16

Prior U.S. Cls.: 2, 5, 22, 23, 29, 37, 38, and 50

Reg. No. 3,478,484

United States Patent and Trademark Office

Registered July 29, 2008

**TRADEMARK
SUPPLEMENTAL REGISTER**

**CIO LEADERSHIP
AGENDA**

INTERNATIONAL DATA GROUP, INC. (MASSACHUSETTS CORPORATION)
5 SPEEN STREET
FRAMINGHAM, MA 01701

FOR: PRINT PUBLICATIONS, NAMELY, NEWSLETTERS, MAGAZINES, AND SUPPLEMENTS SOLD THEREWITH, JOURNALS, NEWSPAPERS, GUIDES AND BOOKS ALL IN THE FIELDS OF ONLINE SERVICES, HIGH TECHNOLOGY, COMMUNICATIONS, INFORMATION TECHNOLOGY AND INFORMATION SERVICES, IN CLASS 16 (U.S. CLS. 2, 5, 22, 23, 29, 37, 38 AND 50).

FIRST USE 2-1-2005; IN COMMERCE 2-1-2005.

THE MARK CONSISTS OF STANDARD CHARACTERS WITHOUT CLAIM TO ANY PARTICULAR FONT, STYLE, SIZE, OR COLOR.

OWNER OF U.S. REG. NOS. 2,273,617, 2,370,232, AND OTHERS.

SER. NO. 78-528,477, FILED P.R. 12-7-2004; AM. S.R. 5-28-2008.

GENE MACIOL, EXAMINING ATTORNEY

Int. Cl.: 35

Prior U.S. Cls.: 100, 101, and 102

United States Patent and Trademark Office

Reg. No. 3,478,485

Registered July 29, 2008

**SERVICE MARK
SUPPLEMENTAL REGISTER**

MONOI INSTITUTE

GROUPEMENTE INTERPROFESSIONNEL DU
 MONOI DE TAHITI (FRANCE CORPORA-
 TION)
 P.O. BOX 14165
 TAHITI, FRANCE

FOR: PROMOTING THE GOODS AND SERVICES
 OF OTHERS IN THE FIELD OF COSMETIC INGRE-
 DIENTS, IN CLASS 35 (U.S. CLS. 100, 101 AND 102).

FIRST USE 5-1-2003; IN COMMERCE 5-1-2003.

THE MARK CONSISTS OF STANDARD CHAR-
 ACTERS WITHOUT CLAIM TO ANY PARTICULAR
 FONT, STYLE, SIZE, OR COLOR.

OWNER OF U.S. REG. NO. 2,018,572.

NO CLAIM IS MADE TO THE EXCLUSIVE
 RIGHT TO USE "INSTITUTE", APART FROM THE
 MARK AS SHOWN.

THE FOREIGN WORDING IN THE MARK
 TRANSLATES INTO ENGLISH AS SCENTED OIL.

SER. NO. 78-633,540, FILED P.R. 5-19-2005; AM. S.R.
 2-5-2007.

MARK RADEMACHER, EXAMINING ATTORNEY

Int. Cl.: 42

Prior U.S. Cls.: 100 and 101

United States Patent and Trademark Office

Reg. No. 3,478,486

Registered July 29, 2008

**SERVICE MARK
SUPPLEMENTAL REGISTER**

DATAHOTLINE

CHOI, KENNETH (UNITED STATES INDIVIDUAL)
267 W 17TH STREET 2FL
NEW YORK, NY 10011

THE MARK CONSISTS OF STANDARD CHARACTERS WITHOUT CLAIM TO ANY PARTICULAR FONT, STYLE, SIZE, OR COLOR.

FOR: COMPUTER SERVICE, NAMELY, DATA RECOVERY SERVICES, IN CLASS 42 (U.S. CLS. 100 AND 101).

SER. NO. 78-666,475, FILED P.R. 7-8-2005; AM. S.R. 8-25-2006.

FIRST USE 12-0-2004; IN COMMERCE 12-0-2004.

MARLENE BELL, EXAMINING ATTORNEY

Int. Cl.: 22

Prior U.S. Cls.: 1, 2, 7, 19, 22, 42, and 50

United States Patent and Trademark Office

Reg. No. 3,478,487

Registered July 29, 2008

**TRADEMARK
SUPPLEMENTAL REGISTER**

FULL COVERAGE

UPU INDUSTRIES LIMITED (NORTHERN IRELAND CORPORATION)
1 QUILLYBURN BUSINESS PARK, BANBRIDGE ROAD, COUNTY DOWN;
NORTHERN IRELAND, UNITED KINGDOM BT26 1BY

FOR: BALER TWINE AND NET WRAP, NAMELY, PLASTIC NETTING FOR HAY AND STRAW BALES, IN CLASS 22 (U.S. CLS. 1, 2, 7, 19, 22, 42 AND 50).

FIRST USE 12-22-2005; IN COMMERCE 3-1-2006.

THE MARK CONSISTS OF STANDARD CHARACTERS WITHOUT CLAIM TO ANY PARTICULAR FONT, STYLE, SIZE, OR COLOR.

SER. NO. 78-840,137, FILED P.R. 3-17-2006; AM. S.R. 12-7-2007.

DOMINIC J. FERRAIUOLO, EXAMINING ATTORNEY

Int. Cl.: 16

Prior U.S. Cls.: 2, 5, 22, 23, 29, 37, 38, and 50

United States Patent and Trademark Office

Reg. No. 3,478,488

Registered July 29, 2008

**TRADEMARK
SUPPLEMENTAL REGISTER**

LA GUATEMALTECA

TOUCH-TEL PARTNERS USA, LLC (TEXAS LTD
LIAB CO)
5444 WESTHEIMER, SUITE 1535
HOUSTON, TX 77056

FOR: PRE-PAID TELEPHONE CALLING CARDS,
NOT MAGNETICALLY ENCODED, IN CLASS 16
(U.S. CLS. 2, 5, 22, 23, 29, 37, 38 AND 50).

FIRST USE 10-31-2006; IN COMMERCE 10-31-2006.

THE MARK CONSISTS OF STANDARD CHAR-
ACTERS WITHOUT CLAIM TO ANY PARTICULAR
FONT, STYLE, SIZE, OR COLOR.

OWNER OF U.S. REG. NO. 3,148,518.

THE FOREIGN WORDING IN THE MARK
TRANSLATES INTO ENGLISH AS "THE GUATE-
MALAN".

SER. NO. 78-921,809, FILED P.R. 7-3-2006; AM. S.R.
6-20-2008.

PETER B. BROMAGHIM, EXAMINING ATTORNEY

Int. Cl.: 32

Prior U.S. Cls.: 45, 46, and 48

United States Patent and Trademark Office

Reg. No. 3,478,489

Registered July 29, 2008

**TRADEMARK
SUPPLEMENTAL REGISTER**

FLOWER WATER

FLOWERWATER BEVERAGE CO., LLC (DELA-
WARE LTD LIAB CO)
1383 6TH AVENUE
NEW YORK, NY 10019

FOR: BOTTLED WATER, SPRING WATER;
DRINKING WATER; FLAVORED WATER DRINKS;
SOFT DRINKS, IN CLASS 32 (U.S. CLS. 45, 46 AND
48).

FIRST USE 11-27-1998; IN COMMERCE 8-15-2006.

THE MARK CONSISTS OF STANDARD CHAR-
ACTERS WITHOUT CLAIM TO ANY PARTICULAR
FONT, STYLE, SIZE, OR COLOR.

NO CLAIM IS MADE TO THE EXCLUSIVE
RIGHT TO USE "WATER", APART FROM THE
MARK AS SHOWN.

SER. NO. 78-924,124, FILED P.R. 7-7-2006; AM. S.R.
5-7-2008.

RUDY R. SINGLETON, EXAMINING ATTORNEY

Int. Cl.: 41

Prior U.S. Cls.: 100, 101, and 107

United States Patent and Trademark Office

Reg. No. 3,478,490

Registered July 29, 2008

**SERVICE MARK
SUPPLEMENTAL REGISTER**

MURDER

NETWORK ENTERPRISES, INC. (TENNESSEE
CORPORATION)
1515 BROADWAY
NEW YORK, NY 10036

FOR: ENTERTAINMENT SERVICES IN THE
NATURE OF TELEVISION SERIES, FEATURING
LIVE ACTION, COMEDY AND DRAMA; PROVID-
ING ONLINE INFORMATION IN THE FIELD OF
ENTERTAINMENT CONCERNING TELEVISION
PROGRAMS, IN CLASS 41 (U.S. CLS. 100, 101 AND
107).

FIRST USE 8-31-2007; IN COMMERCE 8-31-2007.

THE MARK CONSISTS OF STANDARD CHAR-
ACTERS WITHOUT CLAIM TO ANY PARTICULAR
FONT, STYLE, SIZE, OR COLOR.

SER. NO. 78-953,617, FILED P.R. 8-16-2006; AM. S.R.
6-19-2008.

EMILY CHUO, EXAMINING ATTORNEY

Int. Cl.: 25

Prior U.S. Cls.: 22 and 39

United States Patent and Trademark Office

Reg. No. 3,478,491

Registered July 29, 2008

TRADEMARK
SUPPLEMENTAL REGISTER

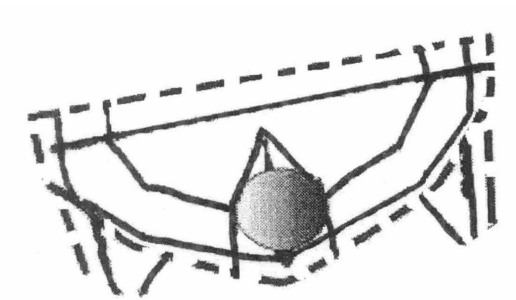

DENIM OF VIRTUE, INC. (DELAWARE CORPORATION)
1565 E. ADAMS BLVD.
LOS ANGELES, CA 90011

FOR: CLOTHING, NAMELY, SHIRTS, PANTS, T-SHIRTS, FOOTWEAR, HEADWEAR, BASEBALL CAPS, SHORTS, SWIMWEAR, LINGERIE, SWEAT SHIRTS, UNDERWEAR, JACKETS, DRESSES, SKIRTS, BELTS, GLOVES, SCARVES AND WRAPS, IN CLASS 25 (U.S. CLS. 22 AND 39).

FIRST USE 1-15-2006; IN COMMERCE 1-15-2006.

THE MARK CONSISTS OF A DECORATIVE SYMMETRICAL DESIGN STITCHING PATTERN WHICH APPEARS ON A POCKET AFFIXED TO APPAREL AS INDICATED BY THE SOLID LINES. THE DOTTED LINES IN THE DRAWING ARE NOT A FEATURE OF THE MARK AND MERELY SHOW THE POSITION THEREOF.

SER. NO. 78-972,314, FILED P.R. 9-12-2006; AM. S.R. 3-5-2008.

DEZMONA MIZELLE, EXAMINING ATTORNEY