

A Guide to Orchard Alley Cropping For Fertility, Mulch and Soil Conservation



version 1/99

Introduction

Alley cropping is a practice that can increase farm self-sufficiency by reducing or eliminating the need to purchase mulch and most fertilizers from off-farm. Nutrient-rich mulch is supplied by a system of hedgerows of nitrogen fixing trees integrated with the crops. The nitrogen fixing trees provide an on-site, renewable source of fertility and mulch for the crops.

This guide focuses on the practice of alley cropping in an orchard setting. It is meant to be used with the companion booklet, the *Nitrogen Fixing Tree Start-Up Guide*.

What is Alley Cropping?

Alley cropping integrates hedgerows of nitrogen fixing trees (NFTs) or other fast-growing plants with crop rows. The space between the NFT hedgerows where the crops are grown are called "alleys," hence the name. The NFT hedgerows are managed to provide a readily available on-site source of leafy organic matter. The organic matter is used as nutrient-rich mulch and fertilizer for the crops.

NFTs can accumulate nitrogen from the air into their leaves and tissues. This fertility becomes directly available to other plants through the cycling of organic matter from the NFTs. In alley cropping, the NFT hedgerows are cut back periodically and the prunings applied to the soil as mulch in adjacent crops. This technique has been used and researched for several decades, and has received

recognition for its potential as a sustainable technique for producing annual food crops such as rice, soybean, and corn. Studies in many tropical areas have shown improved soil levels of nitrogen (N) and potassium (K), as well as the addition of minor nutrients like calcium (Ca) and magnesium (Mg) from the use of this technique (Nair 1993). Favorable effects on soil temperature and moisture conservation have also been

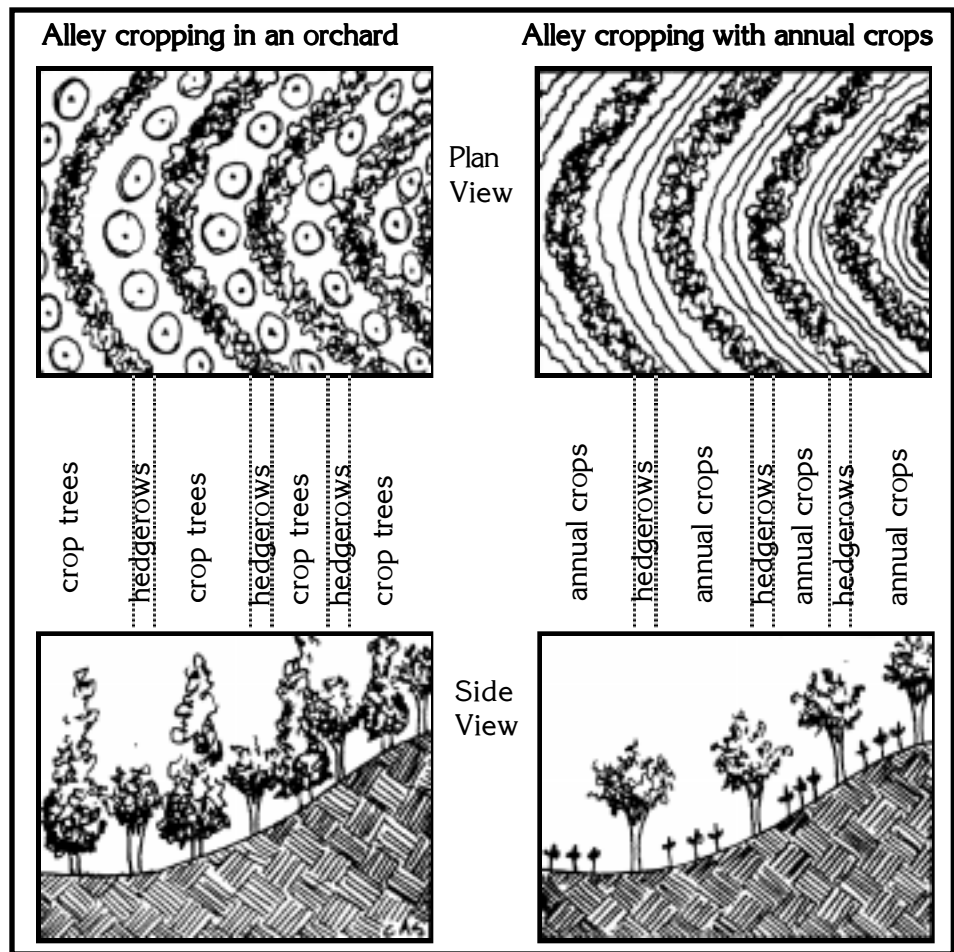

Authors: Craig Elevitch and Kim Wilkinson. Illustrations by Christi Sobel. Contact: AgroForester, P.O. Box 428, Holualoa, HI 96725 USA, Tel: 808-324-4427, Fax: 808-324-4129, E-mail: email@agroforester.com, Web: <http://www.agroforester.com>. Please direct comments to the authors. Your suggestions on making this guide more useful for practitioners are greatly appreciated.

Acknowledgments: Publication of this guide was made possible through a grant from the Western Region Sustainable Agriculture and Education (WSARE) and EPA/Agriculture in Concert with the Environment Program. Substantial contributions of material were made by the Forest, Farm and Community Tree Network (FACT Net).

Reproduction: We encourage you to share this information with others. All or part of this publication may be reproduced for non-commercial educational purposes only. For commercial reproductions, please contact the authors. The contents of this box must accompany all reproductions. ©1998-1999 All Rights Reserved

reported (Nair 1993). (See inset on this page for details on results of this practice in a Hawaii orchard.)

Aside from the nutrient contribution of the prunings, alley cropping can be adapted to provide other benefits, such as supplying favorable microclimate and wind protection for crops. When planted on the contour of sloping land, the hedgerows can also serve to significantly reduce erosion.

Alley Cropping in an Orchard

While the practice of alley cropping has been used for decades with annual crops like corn, the benefits of the practice can be even greater when applied in an orchard setting. First, the fertilizing effect of the mulch is maximized, because nutrients in the mulch are concentrated on the crop. Rather than spreading hedgerow prunings over a large area as with annual crops, prunings can be concentrated under the tree canopy where nutrient losses due to volatilization (when nutrients become gaseous and are lost to the air) may be reduced.

The other advantages of alley cropping in an orchard setting have to do with minimized competition between the crop trees and the NFTs. The physical distance between crop trees and hedgerows can be significantly greater than with annual crops, since there are usually large open spaces between rows in an orchard. Because tree crops form extensive root systems, often with deep tap roots (for crops such as avocado, mango, lychee, etc.), competition for nutrients is reduced compared with annual crops. Shading by hedgerows is also reduced because the tree crops are further from the shade zone of hedgerows, and grow relatively tall.

Alley Cropping for Sloping Land: Contour Hedgerows

On land that is sloping, the hedgerows are planted on the contour, creating "contour hedgerows." The US Department of Agriculture Natural Resource Conservation Service (NRCS) has recognized the practice of "vegetative contour barriers," or densely planted hedgerows oriented on contour, as a viable vegetative means for reducing erosion instead of expensive terracing (NRCS, 1991). In addition to the other benefits of alley cropping, planting the hedgerows along the contour can help to control erosion.

More than Fertility:

The Importance of Mulch and Organic Matter

Mulch occurs naturally in all forests; it is a nutrient rich, moisture absorbent bed of decaying forest leaves, twigs and branches, teeming with fungal, microbial and insect life. Natural mulch serves as a "nutrient bank," storing the nutrients contained in organic matter and slowly making these nutrients available to plants. Mulch forms a necessary link in nutrient cycling vital for our tropical soils. When mulch is absent for

Mulch from hedgerows of NFTs affects soil fertility and crop growth in jackfruit orchard

An on-farm study of orchard alley cropping installed and managed as described in this guide took place in a tropical fruit orchard in Holualoa, Island of Hawaii. In two year's time, with no fertilizer inputs except for the mulch from the hedgerows, the results shown below were documented.

NFT mulch led to these soil improvements:

- The soil showed significant increase in total nitrogen
- The soil showed significant increase in potassium
- Soil pH also improved, becoming more neutral

Effect on crops

Over the two year period, data on crop growth showed a trend of faster growth and larger stem diameter for mulched trees over the unmulched trees.

Organic matter produced

The hedgerows yielded 20,000 lbs. of mulch per acre per year, or about 300 lbs. of mulch per crop tree per year.

Nutrients provided

Nutrients provided by the hedgerows annually for the crops were equivalent to the fertility in over 500 lbs. of chemical fertilizer, comparable in nutrients to:

120 lbs. muriate of potash
400 lbs. urea
25 lbs. treble super phosphate

Many other minor nutrients were provided as well, including small quantities of boron, magnesium, iron, and zinc.

Other observations

One of the years of the study was an especially dry year, but the mulched trees survived well without irrigation. It was observed that the soil under the mulch remained much moister and cooler throughout the dry season than the soil under the unmulched trees.

Project information

Location: Holualoa, Island of Hawaii

Elevation: 1400 ft.

Crop: Jackfruit (*Artocarpus heterophyllus*)

NFTs used: *Acacia angustissima* and *Calliandra calothyrsus*

See the full report and data from this study at <http://www.agroforester.com>

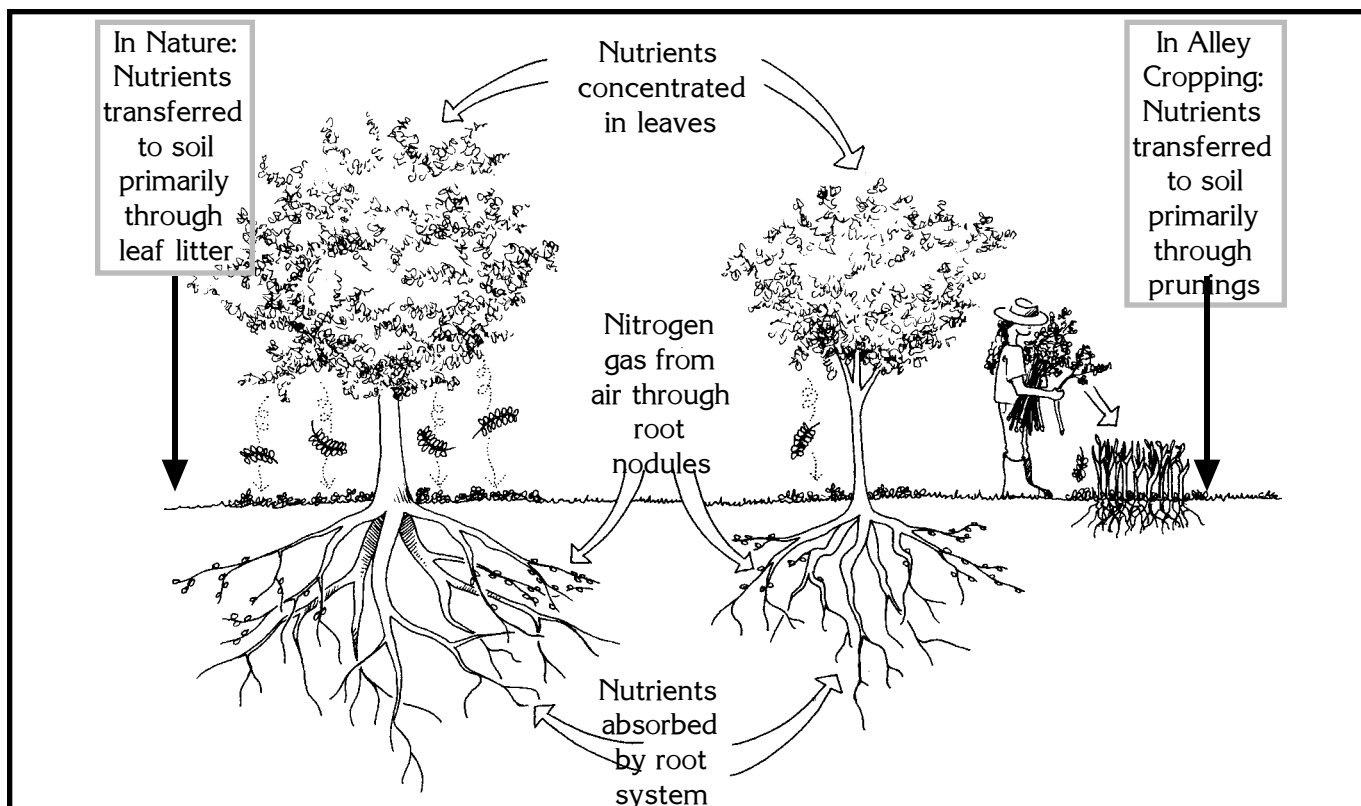

whatever reason, the living soil is robbed of its natural nutrient stores, becomes leached and often desiccates.

Hedgerows can provide large amounts of mulch for your crop trees. The mulch and organic matter provided by the hedgerows is important for healthy plants and soil. Mulching improves nutrient and water retention in the soil, encourages favorable soil microbial activity and worms, and suppresses weed growth. When

properly done, mulching can significantly improve the well-being of plants and reduce maintenance as compared to bare soil culture. Mulched plants have better vigor and, consequently have improved resistance to pests and diseases.

Pros and Cons of Orchard Alley Cropping

Studies throughout the tropics have shown that the practice of alley cropping has the potential to provide large amounts of nutrients to the crops, often similar quantities of nutrients to those normally applied to crops in chemical form. However, it is important to weigh some of the main costs and benefits to decide if this practice might work for your situation.

Benefits/Returns:	Costs:
Fertility improvement—natural source of nitrogen	Substantial up-front investment to plan and install
Organic matter—high quality nutrient rich mulch essential to farm fertility. Mulch also aids in weed suppression and water conservation.	Risk of competition with crops for light, water and nutrients if not installed or managed properly (correct spacing, regular pruning, etc.)
Erosion control—for long-term farm viability	Hedgerows require a certain amount of space on the project, occupying area that could be devoted to crops.
Increased farm self-sufficiency—reduced dependence on outside sources of nitrogen fertilizer or mulch	Labor intensive rather than capital intensive—could be problematic if labor is in shorter supply than cash

Phase I: Planning

Planning a project using contour hedgerows

As with any agroforestry project which involves integrating permanent trees with crops, careful advance planning is essential for success. The planning process involves 7 steps:

Planning Step 1: Determine the needs and goals for your project.

Planning Step 2: Determine the appropriate hedgerow species for your needs, goals, and site conditions

Planning Step 3: Obtain or make a map of the contours and other features on your site.

Planning Step 4: Determine appropriate spacing between hedgerows.

Planning Step 5: Determine appropriate spacing within hedgerows (between NFTs)

Planning Step 6: Determine position and spacing of crop trees

Planning Step 7: Finalize your map

At the end of the planning process, you will have a map of your site, including the contours, the hedgerows laid out on the contour, and the placement of the crop trees. You will also have selected the appropriate species to plant in your hedgerows. When the planning process is done well, installation will be much easier.

Planning Step 1: Determine the needs and goals for your site

How much mulch do you need? How much space can you devote? How often will you be able to prune? 1000 ft of hedgerow will provide 14000 lbs of mulch per

Characteristics of good hedgerow intercropping trees are:

- Rapid growth and biomass production: More leafy biomass and small branch production means more litter/mulch accumulation.
- Smaller, bushy form: Smaller, multi-stemmed trees normally produce more biomass of a higher leaf:stem ratio than larger, single-stemmed species
- Deep-rooting: Take up nutrients and water out of reach of crop plants
- Easy to establish: Trees are easy to raise from seed either directly field-planted or in pots. Cuttings develop more rapidly but produce only lateral roots that compete more with neighboring crops.
- Repeated coppicing and/or resprouting ability: Stems and leaves grow back again and again after pruning or topping.
- Nitrogen fixing: Nitrogen fixing trees are able to 'fix' atmospheric nitrogen and contribute this to the system in leaf litter fall/break-down.
- Free from pests and diseases: Trees should not be hosts to crop-damaging insect or fungus pests.
- Easily controlled: Trees that become weedy and will spread into alleys or neighboring fields are not desirable.
- Widely adaptable and stress tolerant: Trees should be adapted to a range of soil characteristics and tolerant of environmental adversities such as high winds and periodic drought.
- Multipurpose: To provide an adequate return to land and labor inputs, trees must produce a number of useful products and services.

Adapted from AIS Technology Fact Sheet,
Hedgerow Intercropping with Upland Root Crops

year—about 12-24 ft. of hedgerow is needed for each crop tree.

Planning Step 2: Determine the appropriate hedgerow species for your needs, goals, and site conditions

The goal with species

selection is to put the right tree in the right place.

Please review the companion booklet *Nitrogen Fixing Tree Start-Up Guide*, which contains species lists and tables and will help you decide the most appropriate species for your needs and goals.

The environmental tolerances of the tree (rainfall, temperature, etc.) should be the most important consideration in choosing the appropriate species for your area. Other factors to consider include:

- Growth rate—Do you want a highly productive species, or one with less vigorous growth? Think about how many times per year you would ideally want to prune, and how much mulch do you need?
- Weediness—Can you manage a potentially weedy species, or should you take care to use only non-invasive ones because the trees might bear seed because they are not being pruned regularly?
- Other products—Might you in the future want to use your hedgerows as animal fodder, firewood or bee forage? Which secondary product needs are highest priority?
- Other functions—Does your site have a particular need for wind protection or erosion control?

A Note on Non-Nitrogen Fixing Species

There are some non-nitrogen fixing species that have been used in alley cropping or hedgerows. Particularly good results have come from the use of some fast-growing species in the genus *Senna*. *Sennas* are leguminous, but do not have the ability to fix atmospheric nitrogen. The use of *Senna siamea* was shown to maintain higher levels of soil organic matter and nutrients than as compared with several NFT species in a study in Africa (Nair 1993), and similar results were found with *Senna spectabilis* in a study in SE Asia (Garrity and Mercado, 1994).

Another non-nitrogen fixing species in use for contour hedgerows is Vetiver grass (*Vetiveria zizanioides*). Vetiver grass has been utilized for over 30

Tip: Natural forests in the tropics are about 15% nitrogen-fixing plants. 15% is a good guideline for how much space you would ideally devote to growing your own fertility.

years in India for erosion control and moisture conservation. Mulch provided by vetiver is valuable in conserving moisture and improving soil temperatures under crops, but the nutrient contribution is not as high as NFT mulch (Bredero 1988).

Once you have a list of promising species already present in your area, consider species that may be new such as some of those presented in the table below and in the *Nitrogen Fixing Tree Start-Up Guide*. A trial of several species is very valuable in determining which of the candidate species will thrive on your site. Within 6-12 months of growth, there is a good chance you will determine which species work for you in your particular situation.

Some Useful NFT Species for Alley Cropping

Scientific name	Common name	Elevation (feet)	Rainfall (inches)	Notes
<i>Acacia angustissima</i>	Angustissima	0-3000	60+	
<i>Calliandra calothyrsus</i>	Calliandra	0-3000	50+	
<i>Flemingia macrophylla</i>	Flemingia	0-2000	50+	
<i>Gliricidia sepium</i>	Madre de cacao	0-1500	40+	
<i>Leucaena diversifolia</i>	K156	0-3000	60+	
<i>Leucaena leucocephala</i>	Giant haole koa	0-1200	20+	var. K636
<i>Senna siamea</i>	Pheasantwood	0-2500	40+	non-NFT
<i>Sesbania sesban</i>	Sesban	0-3000	30+	short-lived

Planning Step 3: Obtain (or make) a map of the contours on your site.

This map will be the basis for planning the location of your contour hedgerows and crops. It is essential to plan the position of the hedgerows carefully in advance, rather than in the field where problems can arise. If you can get a map of your site showing the contours (topographic) at two foot intervals, that is ideal. If not, a map with only 10-20 foot contour intervals is usually easier to find, and will do. If you are unable to obtain a contour map of your area, you should take the time to make your own map.

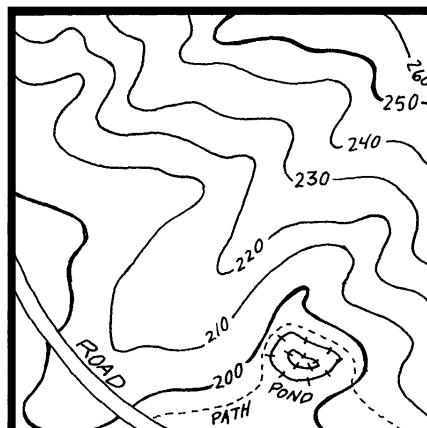
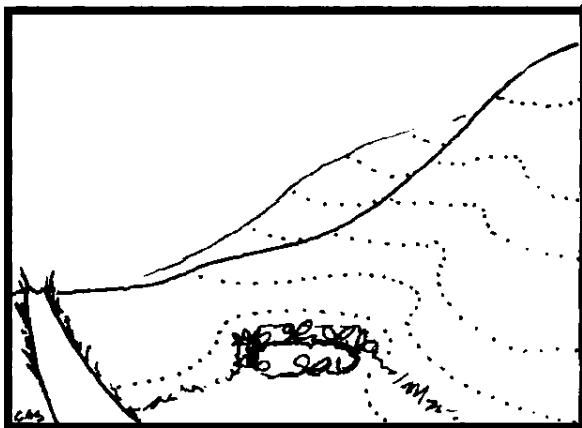

An accurate topographic map is the basis for a good plan.

It is also helpful to include on the contour map access roads, paths, fences, walls, gulches, draws, etc, including all man-made or natural features on the site and neighboring areas.

Planning Step 4: Determine appropriate spacing between hedgerows.

Next, use your map to determine the appropriate spacing between the hedgerows.

It is essential to determine the appropriate spacing between the hedgerows using an accurate contour map. There are two potential pitfalls that good planning will help you avoid. One potential problem on rolling terrain is that as the slope changes, contour lines become either too far apart or too close together for crops.

Another problem can be lack of access through the field—remember contour hedgerows will become barriers that are difficult to walk through. Plan carefully on paper first!

Generally, spacing between hedgerows should be selected to strike a balance between reduction of competition between the hedgerow and crops, while maximizing production of organic matter

and control of erosion. Spacing between hedgerows is determined primarily by the slope—the steeper slope, the closer together the hedgerows should be. The end-use of the hedgerows should also be considered. For contour hedgerows within a crop field, spacing should be further apart than, for example, in a field used for animal forage crop. The table on the following page shows suggested spacing for different contour hedgerow uses and slopes. As general rule in cropping systems, hedgerows take 10-15% of the planting area.

Planning Step 5: Determine appropriate spacing within hedgerows (between NFTs)

Generally for contour hedgerows a spacing of 25-35 cm (10-14 inches) is recommended in-row. For other uses, the appropriate in-row tree spacing depends on the intended use.

Minimum distance between hedgerows

For most orchard crops, a distance between hedgerows of about 25-30 feet (center to center) is ideal. The slope of the land determines the minimum distance between hedgerows necessary for erosion control. The steeper the slope, the closer together the hedgerows need to be to act as an erosion barrier.

Slope (%)	Distance (ft)
5-10	60
10-15	45
15-25	30
25-35	20
35-50	15
50-60	10

Source: USDA NRCS, 1991
Vegetative Row Barriers

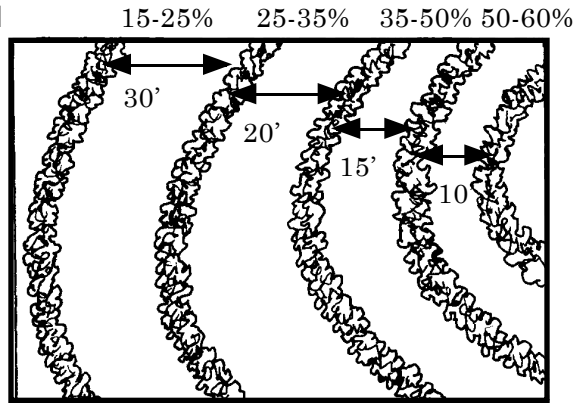

A note about double hedgerows

For optimum erosion control, particularly on steep slopes, a pair of hedgerows about 0.5-1 meter apart is recommended over a single hedgerow. The double hedgerow further reduces the effects of erosion in a heavy downpour.

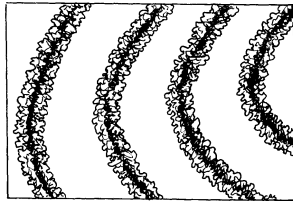

Finally, complete your map by deciding where you want the access through the planting. Since the contour hedgerows become barriers that are difficult to walk through, it is important to have some breaks in them so you can reach each row of crops easily. It is best to have your access route run as close along the contour as possible, and not steeply up and down the slope. This will help to maintain the integrity of your erosion control system. Where you do break the hedgerows, overlap them as shown on the map to prevent gaps in the hedgerows.

Planning Step 6: Spacing between crop trees

Once you have your hedgerows laid out on paper, you can draw in your crop trees. They are placed halfway between the hedgerows, with standard spacing between the crop trees. Double-check to make sure you have left enough space between hedgerows for your crop trees to grow.

Planning Step 7: Finalize your map

Have the hedgerows laid out on contour and the crop trees drawn in. When you are almost done, your map with hedgerows and crops will look like this:

Map with hedgerows and crops

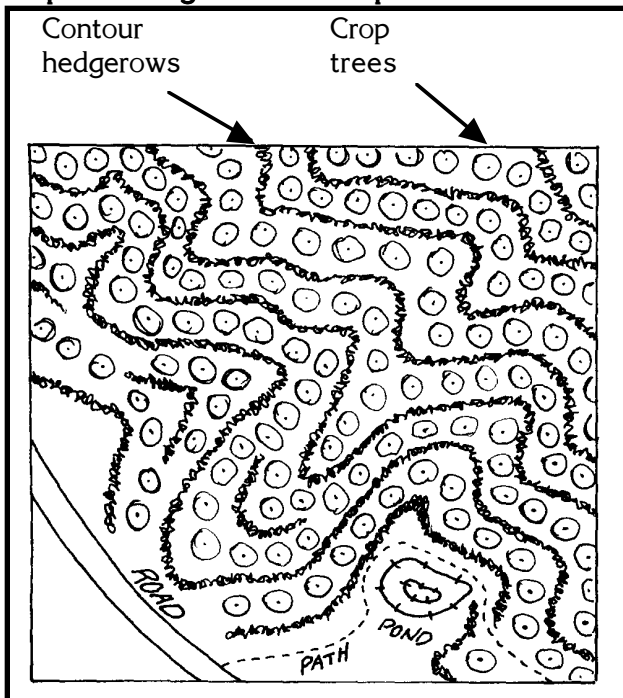

Final map with hedgerows, crops, and access

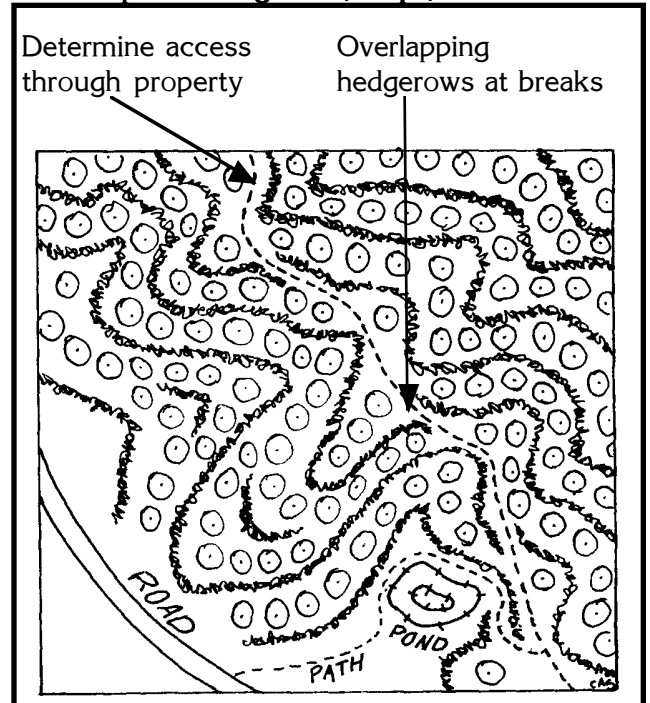

Phase II: Installation

Ready for the field!

After you have done your planning work on paper, you are ready to install your hedgerows on your project.

Steps for site layout and installation of alley cropping in an orchard

- Installation step 1: Lay out the contour rows in the field
- Installation step 2: Prepare contours to plant
- Installation step 3: Plant contour hedgerow species from seed or seedlings
- Installation step 4: Early maintenance and trouble shooting

Installation Step 1: Lay out the contour rows in the field

When planting on sloped land, hedgerows should always be laid out on the contour. Otherwise, they can actually accelerate the movement of water and contribute to erosion problems. Plantings that are off-contour by more than just 1-2% could actually cause erosion by funneling water. Therefore, it is very important to do it accurately in the field.

By carefully following the techniques outlined here, you will be able to lay out the hedgerows accurately on the contour.

1a) If the site is overgrown, cutting down the vegetation in the area is a good first step for starting the process of installing hedgerows. If the area can be mowed with a tractor, the job is easily done.

Making an A-frame

An A-frame is a simple device you can make for finding contour lines if other levels are not available. Assemble 3 wooden poles into the shape of the letter A, with the legs about 6 ft. long and the middle brace about 4 ft. Standing it up on a level surface, mark the spot on the middle brace that indicates the legs are level. Tie a string and a weight from the top as shown. When you are in the field, you will know you have found the level when the string passes through this mark.

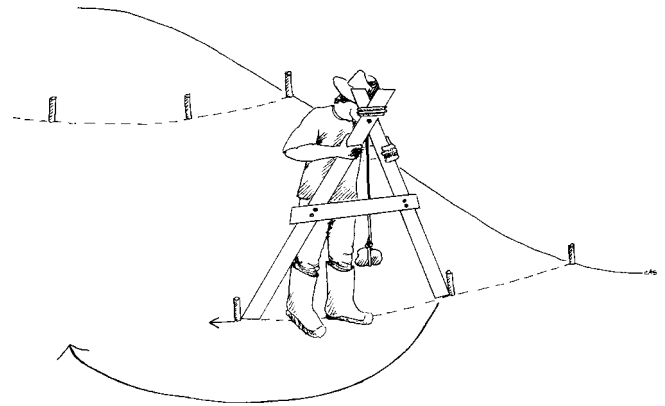
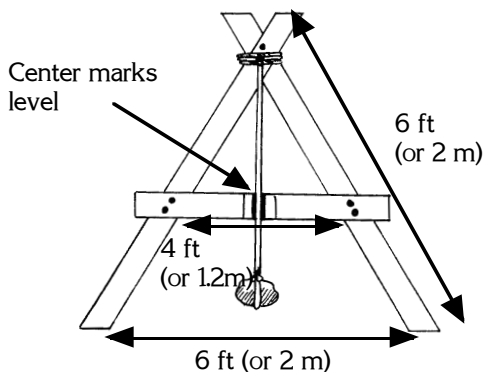

1b) Working with the map you made, lay out contours using a site level, water level or A-frame. Start at the highest point and work your way downhill. Contours can be marked using stakes with flags, or small piles of light colored mineral dust such as dolomite lime. You may need to adjust the positioning of some hedgerows in the field, especially if your map is not completely accurate. After finalizing the position of the hedgerows, you may want to lay out your crop trees to make sure the spacing will work for your crops.

Installation step 2: Prepare contours to plant

2a) Prepare ground for planting. Often this requires removing vegetation with hand tools or small machines. A thorough clearing along the contour lines will hasten establishment of the seedlings and decrease early maintenance.

2b) Add soil amendments as appropriate to your area to make up for deficiencies. A source of calcium and phosphorous is often valuable in establishing NFT seedlings. Any other nutrient amendments should be added at this phase to encourage early growth of the seedlings. If you are using NFTs, nitrogen amendments are not necessary.

Installation step 3: Plant contour hedgerow species from seed or seedlings

Please see the companion booklet *Nitrogen-Fixing Tree Start-Up Guide* for detailed instructions on how to scarify, inoculate, and plant NFTs.

Installation step 4: Early maintenance and troubleshooting

4a) Weed control is absolutely essential during the establishment of the hedgerows. If properly mulched when planted, the new weed sprouts will not be as much of a problem. However, stay on top of weed growth from the edges of the prepared area.

4b) A certain amount of small seedlings will inevitably be lost to predators such as rats, slugs or birds. To avoid gaps in the hedgerows, lost seedlings should be planted 4-6 weeks after the original

planting. If not replanted early in the project, it will be very difficult to establish new seedlings in the shade of the older hedgerow trees.

Tip: If you start some seedlings in the nursery on the same day that you seed in the field, the seedlings will be ready to fill in where necessary.

Phase III: Pruning and Management

Preparing orchard trees to be mulched for the first time

Sheet mulching as described here is a suggested method for controlling weeds and improving soil and plant health with mulch. Steps 1-3 are a one-time preparation that will make maintenance of the orchard trees easier. With the abundant mulch from the hedgerows, step 4 can be carried out as often as necessary.

- 1) Plant tree.
- 2) Amend soil around tree in a wide ring shape from a few centimeters from trunk out to 1 meter (3 feet) with a light layer of nitrogen fertilizer, such as chicken manure, and other amendments if necessary. Rake or water in thoroughly before the next step.
- 3) Spread a layer of permeable weed barrier around the tree in a ring shape, leaving about 15 cm (6 inches) diameter around the trunk of the tree for it to “breathe.” Make certain there are no gaps in the ring shape through which weeds can emerge. Good mulch materials include cardboard, thick layers of newspaper, or commercial water-permeable weed barriers.
- 4) Spread mulch about 15 cm (6 inches) thick over the weed barrier, again making sure it is several centimeters away from the trunk of the plant.

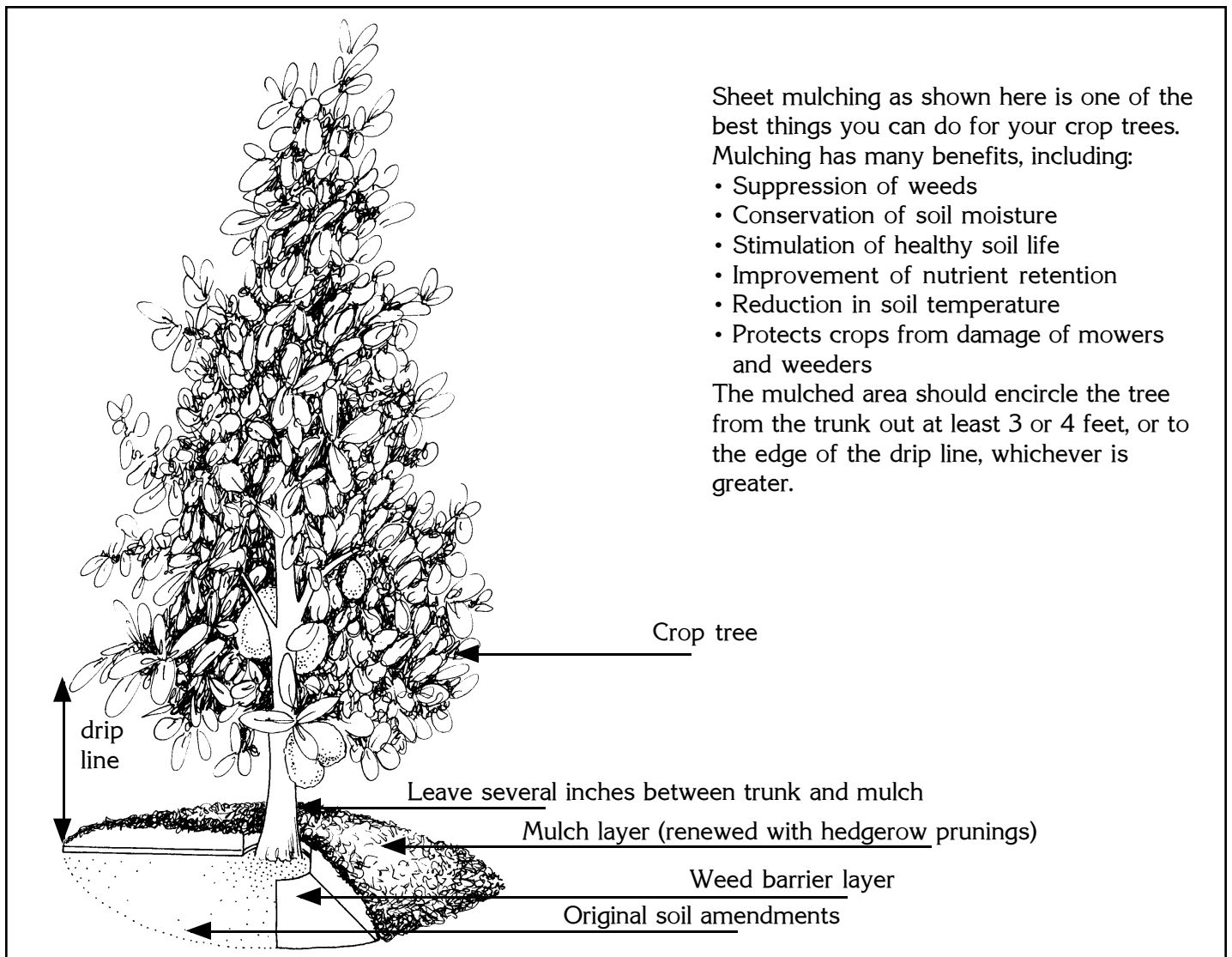

Sheet mulching as shown here is one of the best things you can do for your crop trees. Mulching has many benefits, including:

- Suppression of weeds
- Conservation of soil moisture
- Stimulation of healthy soil life
- Improvement of nutrient retention
- Reduction in soil temperature
- Protects crops from damage of mowers and weeders

The mulched area should encircle the tree from the trunk out at least 3 or 4 feet, or to the edge of the drip line, whichever is greater.

Tip: Especially for the first cutting, it is best to cut the hedgerows during a period of active growth, when the trees can resprout from the cut rapidly. Avoid stressful times, such as during a drought.

The First Pruning of Hedgerows

The initial pruning should take place after the trees are well established. Depending on rainfall, it may take

6-12 months before the trees can first be cut back. Even though the trees are vigorous growers, cutting them back does weaken them.

The first time the trees are cut, there will be a substantial amount of woody stem harvested. The leafy portion of the prunings can be separated from the woody portion and used for mulch. During the first cutting, the woody portion is often laid at the base of the hedgerow trees to help with erosion control. Another option is to feed the intact woody stems through a shredder/chipper for producing an easy to use mulch material.

The Ongoing Mulch Process

Successive prunings should occur when the regrowing stems is still soft and leafy, usually every 3-6 months, depending on species of NFT used, rainfall, and other factors. After the first mulching, simply add the fresh mulch over the top of the old mulch every 3-6 months.



VII. Other resources/organizations**Bibliography, References, and Further Reading****Alley Cropping****Agroforestry Information Service (AIS) for the Pacific Fact Sheets, FACT Net, Morrilton, Arkansas**

Bredero, Fran, Ed. 1988. *Vetiver Grass: A Method of Vegetative Soil and Moisture Conservation*. World Bank, New Delhi.

International Institute of Rural Reconstruction. 1990. *Agroforestry Technology Information Kit*, IIRR, Room 1270, 475 Riverside Dr., New York, NY 10115.

Nair, P.K. Ramachandran. 1993. *An Introduction to Agroforestry*. Kluwer Academic Publishers in cooperation with ICRAF, Dordrecht, The Netherlands.

Natural Resource Conservation Service. 1991. Technical Guide Section IV: Interim Practice Standard and Specifications for Vegetative Row Barriers. USDA NRCS, Honolulu, Hawaii.

Tripathi, B.R. and P.J. Psychas (eds). 1992. *Alley Farming Training Manual*, Vol 1. AFNETA, IITA, PMB 5320, Oyo Rd., Ibadan, Nigeria

Nitrogen Fixing Trees

Elevitch, C., K.M. Wilkinson. 1998. *Nitrogen Fixing Tree Start-Up Guide*. AgroForester, Holualoa, HI.

Garrity, D.P. and A.R. Mercado, Jr. 1994. Nitrogen fixation capacity in the component species of contour hedgerows: how important? in *Agroforestry Systems* 27: 241-258, Kluwer Academic Publishers, The Netherlands.

Kang, B.T., G.F. Wilson, and T.L. Lawson. 1986. *Alley Cropping: A Stable Alternative to Shifting Cultivation*. International Institute of Tropical Agriculture, Ibadan, Nigeria.

Macklin, Bill et al. 1989. *Establishment Guide*. NFTA Cooperative Planting Program NFTA, Hawaii.

Nitrogen Fixing Tree Association. 1985-1997. *Leucaena Research Reports*. Comprehensive research into *Leucaena*.

Nitrogen Fixing Tree Association. 1982-1997. *Nitrogen Fixing Tree Research Reports*. Comprehensive research into NFT species, brief, informative articles.

Nitrogen Fixing Tree Association. 1989-1998. NFT Highlights and FACT Sheets. Forest, Farm and Community Tree Network (formerly Nitrogen Fixing Tree Association), Morrilton, Arkansas, USA.

Sources for Publications

agAccess Complete Agricultural Book Source, P.O. Box 2008, Davis, CA 95617-2008 Tel: 800-540-0170 or 916-756-7177, Fax: 916-756-7188. E-mail:books@agaccess.com
Web: <http://www.agaccess.com>

Amazon.com, complete internet bookstore at
<http://www.amazon.com>

Good Earth Publications, 1702 Mountain View Rd., Buena Vista, Virginia 24416 Tel: 800-499-3201 or 540-261-8775, E-mail: goodearth@rockbridge.net

Web: <http://www.goodearthpub.com>

The Permaculture Activist, P.O. Box 1209, Black Mountain, NC 28711, Tel: 828-298-2812, Fax: 828-298-6441, E-mail: pactiv@sunsite.unc.edu

Permaculture International Journal, P.O. Box 6039, South Lismore, NSW 2480, Australia Tel: Int. +61 2 6622 0020, Fax: +61 2 6622 0579 E-mail: pj@nor.com.au
Web: <http://www.nor.com.au/environment/perma>

Other resources/organizations (with lists of seed sources and other information)

Forest, Farm, and Community Tree Network (FACT Net) (Formerly the Nitrogen Fixing Tree Association(NFTA))
Winrock International

38 Winrock Drive, Morrilton, Arkansas 72110-9370 USA
Tel: 501-727-5435, Fax: 501-727-5417

Email: forestry@winrock.org

Web: <http://www.winrock.org/forestry/factnet.htm>

AgroForester

P.O. Box 428 Holualoa, Hawaii 96725

Tel 808-324-4427, Fax 808-324-4129

Email: email@agroforester.com

Web: <http://www.agroforester.com>

Educational Concerns for Hunger Organization (ECHO)

17430 Durrance Rd., N. Ft. Myers, FL 33917 USA

Tel: 941-543-3246, Fax: 941-543-5317

E-mail: echo@echonet.org

Web: <http://www.echonet.org>

Notes: