



United States Environmental Protection Agency  
Office of Water  
Washington, DC  
EPA841-B-04-004

---

# Wadeable Streams Assessment Field Operations Manual



July 2004

FINAL

July 2004

# WADEABLE STREAM ASSESSMENT: FIELD OPERATIONS MANUAL

## NOTICE

The intention of the WSA project is to provide a comprehensive “State of the Streams” assessment for streams across the United States. The complete documentation of overall WSA project management, design, methods, and standards is contained in five companion documents, including:

- *Wadeable Streams Assessment: Quality Assurance Project Plan*
- *Wadeable Streams Assessment: Site Evaluation Guidelines*
- *Wadeable Streams Assessment: Field Operations Manual*
- *Wadeable Streams Assessment: Benthic Laboratory Methods*
- *Wadeable Streams Assessment: Water Chemistry Laboratory Manual*

This document (*Field Operations Manual*) contains a brief introduction, procedures to follow at the base location and on-site, including methods for sampling water chemistry (grabs and *in situ*), stream discharge, benthic macroinvertebrates, and physical habitat. These methods are based on the guidelines developed and followed in the Western Environmental Monitoring and Assessment Program (Peck et al. 2003). Methods described in this document are to be used specifically in work relating to WSA. All Project Cooperators should follow these guidelines. Mention of trade names or commercial products in this document does not constitute endorsement or recommendation for use. More details on specific methods for site evaluation, sampling, and sample processing can be found in the appropriate companion document.

The suggested citation for this document is:

USEPA. 2004. *Wadeable Stream Assessment: Field Operations Manual*. EPA841-B-04-004. U.S. Environmental Protection Agency, Office of Water and Office of Research and Development, Washington, DC.

## FOREWORD

The strategic plan of USEPA calls for a report on the results of a statistical survey of the condition of the Nation's waters, conducted in cooperation with the states. Therefore, USEPA's Office of Water with support from the Office of Research and Development is initiating a national assessment of the ecological condition of wadeable streams by collaborating with state water quality agencies. The result is a Wadeable Streams Assessment (WSA) Program that consists of a comprehensive program for surveying, assessing, and diagnosing ecological condition. This assessment will generate statistically valid estimates of the ecological health of streams through sampling a representative assemblage of the aquatic community and associated ecological data. A determination of related causes and sources of degradation to these aquatic resources will be investigated.

This document contains the field operations and bioassessment methods for evaluating the health and biological integrity of wadeable freshwater streams throughout the United States. These methods can be used by state and tribal water quality agencies as well as USEPA regional, enforcement, and research programs engaged in condition assessments and/or trends monitoring for the effects of impacts on aquatic organisms, particularly benthic macroinvertebrates in wadeable streams throughout the nation. The program addresses methods and techniques for sample collection; sample preparation; processing of structural and functional measures by using organism identification and enumeration; the survey and evaluation of physical habitat structure; the computerization, analysis, and interpretation of biological data; and ecological assessments.

Companion documents include the overall Quality Assurance Program Plan (QAPP) and Laboratory Operations Manuals for processing the benthic macroinvertebrate assemblage samples and water chemistry.

## ABSTRACT

The Wadeable Streams Assessment program focuses on the use of a consistent scientific and technical tools for evaluating ecological conditions on regional and national scales. The methods and instructions for field operations presented in this manual for surveys of wadeable streams were initially developed and tested during 5 years of pilot and demonstration projects (1993 - 1997) and modified for use in a study of streams in the Western US (2000-2002). These projects were conducted under the sponsorship of the U.S. Environmental Protection Agency and its collaborators through the Environmental Monitoring and Assessment Program (EMAP). This document describes procedures for collecting data, samples, and information about the benthic macroinvertebrate assemblage, environmental measures, or attributes of indicators of stream ecosystem condition, and were developed based on standard or accepted methods, modified as necessary to adapt them to sampling requirements for the Wadeable Streams Assessment. They are intended for use in field studies sponsored by the USEPA, or monitoring programs developed and implemented by various State and tribal agencies. In addition to methodology, additional information on data management, safety and health, and other logistical aspects is integrated into the procedures and overall operations. Procedures are described for collecting field measurement data and/or acceptable index samples for several response and stressor indicators, including water chemistry, physical habitat, and benthic macroinvertebrate assemblages. The manual describes field implementation of these methods and the logistical foundation constructed during field projects. Flowcharts and other graphic aids provide overall summaries of specific field activities required to visit a stream site and collect data for these indicators. Tables give step-by-step procedural instructions. These figures and tables can be extracted and bound separately to make a convenient quick field reference for field teams. The manual also includes example field data forms for recording measurements and observations made in the field and sample tracking information. Checklists of all supplies and equipment needed for each field task are included to help ensure that these materials are available when required.

## TABLE OF CONTENTS

Section	Page
NOTICE .....	i
FOREWORD .....	ii
ABSTRACT .....	iii
FIGURES .....	vii
TABLES .....	ix
ACRONYMS, ABBREVIATIONS, AND MEASUREMENT UNITS .....	xi
1.0 INTRODUCTION .....	1
1.1 Overview of the Wadeable Streams Assessment Program .....	1
1.2 Integration with the EMAP Western Study .....	2
1.3 Summary of Ecological Indicators .....	3
1.3.1 Water Chemistry .....	4
1.3.2 Physical Habitat .....	4
1.3.3 Benthic Macroinvertebrate Assemblage .....	4
1.4 Objectives and Scope of the Field Operations Manual .....	5
1.5 Quality Assurance .....	5
2.0 OVERVIEW OF FIELD OPERATIONS .....	7
2.1 Daily Operational Scenario .....	7
2.2 Guidelines for Recording Data and Information .....	7
2.3 Safety and Health .....	8
2.3.1 General Considerations .....	8
2.3.2 Safety Equipment and Facilities .....	14
2.3.3 Safety Guidelines for Field Operations .....	14
2.4 Literature Cited .....	17
3.0 BASE LOCATION ACTIVITIES .....	19
3.1 Activities Before Each Stream Visit .....	19
3.1.1 Confirming Site Access .....	19
3.1.2 Daily Sampling Itinerary .....	19
3.1.3 Instrument Inspections and Performance Tests .....	21
3.1.3.1 Global Positioning Receiver .....	21
3.1.3.2 Current Velocity Meters .....	21
3.1.4 Preparation of Equipment and Supplies .....	21
3.2 Activities after Each Stream Visit .....	24
3.2.1 Equipment Care .....	24
3.2.2 Sample Packing, Shipment and Tracking .....	25
3.2.2.1 Water Chemistry .....	25
3.2.2.2 Benthic Macroinvertebrate Samples .....	27

## TABLE OF CONTENTS (CONTINUED)

Section	Page
3.3 Status Reports .....	29
3.4 Equipment and Supplies .....	29
4.0 INITIAL SITE PROCEDURES .....	34
4.1 Site Verification Activities .....	34
4.1.1 Locating the Index Site .....	34
4.1.2 Determining the Sampling Status of a Stream .....	34
4.1.3 Sampling During or After Rain Events .....	38
4.1.4 Site Photographs .....	39
4.2 Laying out the Sampling Reach .....	39
4.3 Modifying Sample Protocols for High or Low Flows .....	42
4.3.1 Streams with Interrupted Flow .....	42
4.3.2 Partial Boatable/Wadeable Sites .....	44
4.3.3 Braided Systems .....	44
4.4 Equipment and Supplies .....	44
5.0 WATER CHEMISTRY .....	47
5.1 Sample Collection .....	47
5.2 Field Measurements .....	49
5.3 Equipment and Supplies .....	49
6.0 STREAM DISCHARGE .....	54
6.1 Velocity-Area Procedure .....	54
6.2 Timed Filling Procedure .....	54
6.3 Neutrally-Buoyant Object Procedure .....	58
6.4 Equipment and Supplies .....	60
7.0 PHYSICAL HABITAT CHARACTERIZATION .....	63
7.1 Components of the Habitat Characterization .....	64
7.2 Habitat Sampling Locations Within the Sampling Reach .....	66
7.3 Logistics and Work Flow .....	68
7.4 Thalweg Profile and Large Woody Debris Measurements .....	69
7.4.1 Thalweg Profile .....	69
7.4.2 Large Woody Debris Tally .....	76
7.5 Channel and Riparian Measurements at Cross-section Transects .....	76
7.5.1 Slope and Bearing .....	76
7.5.2 Substrate Size and Channel Dimensions .....	82
7.5.3 Bank Characteristics .....	86
7.5.4 Canopy Cover Measurements .....	89
7.5.5 Riparian Vegetation Structure .....	92
7.5.6 Instream Fish Cover, Algae, and Aquatic Macrophytes .....	95
7.5.7 Human Influence .....	96
7.5.8 Riparian “Legacy” Trees .....	97

## TABLE OF CONTENTS (CONTINUED)

Section	Page
7.6 Channel Constraint, Debris Torrents, and Recent Floods .....	100
7.6.1 Channel Constraint .....	100
7.6.2 Debris Torrents and Recent Major Floods .....	100
7.7 Equipment and Supplies .....	105
8.0 BENTHIC MACROINVERTEBRATES .....	108
8.1 Sample Collection .....	109
8.2 Sample Processing .....	109
8.3 Equipment and Supply Checklist .....	113
9.0 RAPID HABITAT AND VISUAL STREAM ASSESSMENTS .....	120
9.1 Rapid Habitat Assessment .....	120
9.2 Visual Stream Assessment .....	131
9.3 Equipment and Supplies .....	132
10.0 FINAL SITE ACTIVITIES .....	137
11.0 LITERATURE CITED .....	148
<u>Appendices</u>	
A EQUIPMENT AND SUPPLY CHECKLISTS	
B FIELD FORMS AND DATA SHEETS	



## FIGURES

Figure	Page
1-1. The geographic scope of the Wadeable Streams Assessment (WSA), stratified by Ecoregion Level 2 . . . . .	2
2-1. General sequence of stream sampling activities . . . . .	9
3-1. Activities conducted at base locations. . . . .	20
3-2. Sample container labels. . . . .	23
3-3. Sample tracking form for unpreserved samples. . . . .	26
3-4. Sample tracking form for preserved samples. . . . .	28
4-1. Verification Form (page 1). . . . .	35
4-2. Verification Form (page 2). . . . .	41
4-3. Sampling reach features. . . . .	42
5-1. Completed sample labels for water chemistry. . . . .	48
5-2. Sample Collection Form, showing data recorded for water chemistry samples. . . . .	50
5-3. Channel Constraint and Field Measurement Form, showing data recorded for water chemistry. . . . .	51
6-1. Layout of channel cross-section for obtaining discharge data by the velocity-area procedure. . . . .	56
6-2. Stream Discharge Form, showing data recorded for all discharge measurement procedures. . . . .	57
6-3. Use of a portable weir in conjunction with a calibrated bucket to obtain an estimate of stream discharge. . . . .	59
7-1. Sampling reach layout for physical habitat measurements (plan view). . . . .	67
7-2. Thalweg Profile and Woody Debris Form. . . . .	72
7-3. Large woody debris influence zones. . . . .	78
7-4. Channel slope and bearing measurements. . . . .	79
7-5. Slope and Bearing Form. . . . .	81
7-6. Substrate sampling cross-section. . . . .	83
7-7. Channel/Riparian Cross-section and Thalweg Profile Form. . . . .	85
7-8. Schematic showing bankfull channel and incision for channels. . . . .	88
7.9. Determining bankfull and incision heights for (A) deeply incised channels, and (B) streams in deep V-shaped valleys. . . . .	90
7-10. Schematic of modified convex spherical canopy densiometer. . . . .	91
7-11. Boundaries for visual estimation of riparian vegetation, fish cover, and human influences. . . . .	93
7-12. Riparian “Legacy” Tree and Invasive Alien Plant Form (Page 1). . . . .	99
7-13. Channel Constraint and Field Chemistry Form, showing data for channel constraint . . . . .	102

## FIGURES (CONTINUED)

<b>Figure</b>	<b>Page</b>
7-14. Torrent Evidence Assessment Form. . . . .	104
7-15. Checklist of equipment and supplies for physical habitat. . . . .	106
8-1. Modified D-frame kick net. . . . .	108
8-2. Transect sampling design for the benthic macroinvertebrate sample. . . . .	110
8-3. Sample Collection Form (page 1), showing information for the reach-wide and targeted riffle benthic macroinvertebrate samples. . . . .	114
8-4. Completed labels for benthic macroinvertebrate samples. . . . .	116
8-5. Blank labels for benthic invertebrate samples. . . . .	117
8-6. Equipment and supply checklist for benthic macroinvertebrates. . . . .	118
9-1. Rapid Habitat Assessment Form for riffle/run prevalent streams. . . . .	126
9-2. Rapid Habitat Assessment Form for pool/glide prevalent streams. . . . .	128
9-3. Stream Assessment Form (page 1). . . . .	133
9-4. Checklist of equipment and supplies required for rapid habitat and visual stream assessments. . . . .	135

## TABLES

<b>Table</b>	<b>Page</b>
2-1. Estimated Times and Division of Labor for Field Activities .....	8
2-2. Guidelines for Recording Field Data and Other Information .....	10
2-3. General Health and Safety Considerations .....	13
2-4. General Safety Guidelines for Field Operations .....	16
3-1. General Performance Checks for Current Velocity Meters .....	22
3-2. Stock Solutions, Uses, and Instructions for Preparation .....	23
3-3. Equipment Care after Each Stream Visit .....	24
3-4. General Guidelines for Packing and Shipping Unpreserved Samples .....	27
3-5. Field Data Sheets to be Shipped .....	30
3-6. Status Reporting .....	31
3-7. Summary of Base Location Activities and Supplies .....	32
4-1. Site Verification Procedures .....	36
4-2. Guidelines to Determine the Influence of Rain Events .....	38
4-3. Laying out the Sampling Reach .....	39
4-4. Modifications for Interrupted Streams .....	43
4-5. Modifications for Braided Streams .....	45
4-6. Equipment and Supplies Checklist for Initial Site Activities .....	45
5-1. Sample Collection Procedures for Water Chemistry .....	48
5-2. Equipment and Supplies for Water Chemistry .....	52
6-1. Velocity-area Procedure for Determining Stream Discharge .....	55
6-2. Timed Filling Procedure for Determining Stream Discharge .....	59
6-3. Neutrally Buoyant Object Procedure for Determining Stream Discharge .....	60
6-4. Equipment and Supply Checklist for Stream Discharge .....	61
7-1. Components of Physical Habitat Characterization .....	65
7-2. Thalweg Profile Procedure .....	70
7-3. Channel Unit and Pool Forming Categories .....	74
7-4. Procedure for Tallying Large Woody Debris .....	77
7-5. Procedure for Obtaining Slope and Bearing Data .....	80
7-6. Substrate Measurement Procedure .....	84
7-7. Procedure for Measuring Bank Characteristics .....	87
7-8. Procedure for Canopy Cover Measurements .....	92
7-9. Procedure for Characterizing Riparian Vegetation Structure .....	94
7-10. Procedure for Estimating Instream Fish Cover .....	96
7-11. Procedure for Estimating Human Influence .....	97
7-12. Procedure for Identifying Riparian Legacy Trees .....	98
7-13. Procedures for Assessing Channel Constraint .....	101

## TABLES (CONTINUED)

<b>Table</b>	<b>Page</b>
8-1. Procedure to Collect Benthic Macroinvertebrate Samples .....	111
8-2. Procedure for Preparing Composite Samples for Benthic Macroinvertebrates .....	115
9-1. Descriptions of Parameters Used in the Rapid Habitat Assessment of Streams .....	121
9-2. Procedure for Conducting the Rapid Habitat Assessment .....	125
9-3. Procedure for Conducting the Final Visual Assessment Of a Stream .....	130

## ACRONYMS, ABBREVIATIONS, AND MEASUREMENT UNITS

### Acronyms and Abbreviations

AFDM	Ash-free dry mass
APA	Acid/Alkaline Phosphatase Activity
BPJ	Best Professional Judgment
BOD	Biological Oxygen Demand
CENR	(White House) Committee on the Environment and Natural Resources
CFR	Code of Federal Regulations
dbh	Diameter at breast height
DC	Direct Current
DIC	Dissolved Inorganic Carbon
DLGs	Digital Line Graphs
DO	Dissolved oxygen
EERD	Ecological Exposure Research Division
EMAP	Environmental Monitoring and Assessment Program
EMAP-SW	Environmental Monitoring and Assessment Program-Surface Waters Resource Group
EMAP-WP	Environmental Monitoring and Assessment Program-Western Pilot study
EPA	U.S. Environmental Protection Agency
ERB	Ecosystems Research Branch
GPS	Global Positioning System
ID	identification
LWD	Large Woody Debris
MAHA	Mid-Atlantic Highlands Assessment
MAIA	Mid-Atlantic Integrated Assessment
NAWQA	National Water-Quality Assessment Program
NERL	National Exposure Research Laboratory
NHEERL	National Health and Environmental Effects Research Laboratory
ORD	Office of Research and Development
OSHA	Occupational Safety and Health Administration
P-Hab	physical habitat
PVC	polyvinyl chloride
QA	quality assurance
QC	quality control
RBP	(EPA) Rapid Bioassessment Protocols
R-EMAP	Regional Environmental Monitoring and Assessment Program
SL	Standard length
SOP	Standard Operating Procedure
TIME	Temporally Integrated Monitoring of Ecosystems
TL	Total length
USGS	United States Geological Survey
WED	Western Ecology Division
WSA	Wadeable Streams Assessment
YOY	young of year
YSI	Yellow Springs Instrument system

## ACRONYMS, ABBREVIATIONS, AND MEASUREMENT UNITS (CONTINUED)

### Measurement Units

amps	amperes
cm	centimeter
ft	foot
gal	gallon
ha	hectare
Hz	Hertz
in	inches
L	liter
m	meter
m <sup>2</sup>	square meters
mg/L	milligram per liter
mm	millimeter
μm	micrometer
μS/cm	microsiemens per centimeter
mS/cm	millisiemens per centimeter
msec	millisecond
ppm	parts per million
psi	pounds per square inch
V	volts
VA	volt-ampere

## **1.0 INTRODUCTION**

This manual contains procedures for collecting samples and measurement data from selected biotic and abiotic components of streams in the eastern United States for the Wadeable Streams Assessment. These procedures were initially developed and used between 1993 and 2003 in research studies of the U.S. Environmental Protection Agency's (EPA) Environmental Monitoring and Assessment Program (EMAP), and published in Lazorchak et al. (1998) and modified by Peck et al. (2003) for use on an extensive pilot study in the western United States (EPA Regions 8, 9, and 10). The purposes of this manual are to: (1) Document the procedures used in the collection of field data and various types of samples for the Wadeable Streams Assessment (WSA) and (2) provide these procedures for use by other groups implementing stream monitoring programs similar to WSA and these procedures.

These procedures are designed for use during a 1-day visit by a crew of two or three persons to sampling sites located on smaller, wadeable streams (generally stream order 1 through 3, or higher for semi-arid and arid regions of the U.S.). They were initially developed based on information gained from a workshop of academic, State, and Federal experts (Hughes, 1993), and subsequent discussions between aquatic biologists and ecologists within the EPA Environmental Monitoring and Assessment Program (EMAP), with scientists of the U.S. Geological Survey National Water Quality Assessment Program (NAWQA), with biologists from the U.S. Fish & Wildlife Service, and with State and Regional biologists within EPA Region 3. EMAP staff has also sought information from various Federal and State scientists in the western U.S to refine these procedures.

### **1.1 Overview of the Wadeable Streams Assessment Program**

Recent critiques of water monitoring programs have claimed that EPA and states cannot make statistically valid inferences about water quality and ecological condition, and lack data to support management decisions regarding the Nation's aquatic resources. These critiques have stemmed from reviews of the General Accounting Office (2000), the National Research Council (2001), the National Academy of Public Administration (2002), the Heinz Center Report (2002), and most recently, the draft Report on the Environment (2003). The primary reasons for this inability to produce adequate reporting of ecological condition are (1) the targeted monitoring designs used by water quality agencies, which are not conducive to extrapolation to comprehensive coverage, and (2) the question of comparability of the ecological data gathering tools, which, to date, have precluded aggregating data and/or assessments for regional and national scales.

The WSA intends to maximize partnerships among EPA, states and tribes, and other agencies to use the best combination of monitoring tools and strategies to answer key environmental questions at national, and regional scales, and to establish a framework to address issues at state and local scales. EPA's strategy for effectively targeting water quality actions that maximizes benefits and saves costs focuses on four key aspects, i.e., strengthen state programs, promote partnerships, use multiple monitoring tools, and expand accessibility and use of data.

The basic intent of the WSA is to build upon previous large-scale programs, such as EMAP and NAWQA, and to benefit from existing state agency expertise and knowledge of

aquatic resources. Randomly generated sampling locations will enable assessment and reporting at regional scales (e.g., level 2 ecoregion, EPA region). Standard operating procedures (SOPs) and a strict quality assurance (QA) program will be used to ensure data integrity for the assessments. The data collection from approximately 1000 stream sites in the western United States (EPA Regions 8-10) over a 5-year period (2000 to 2004) will be complemented by a scheduled sampling of 500 stream sites in 2004 throughout EPA Regions 1-7 (Figure 1-1). A report summarizing the results of the WSA and Western Streams Studies to Congress is scheduled for December 2005.

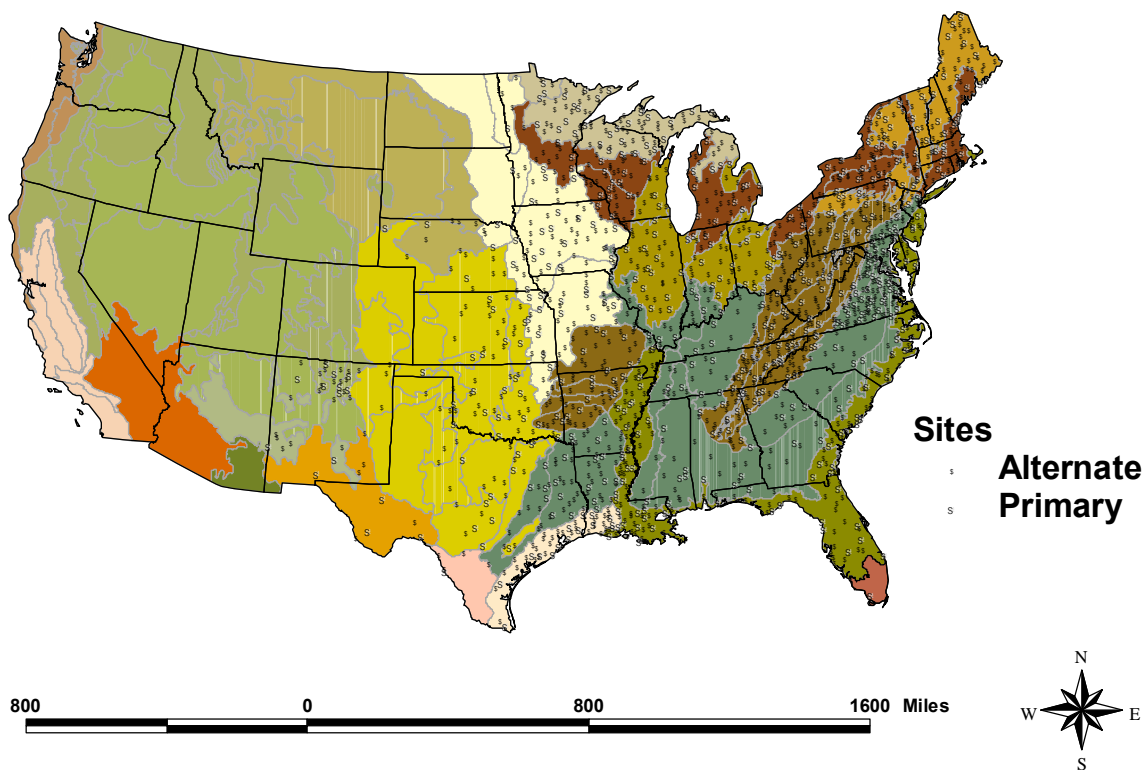

**Figure 1-1. The geographic scope of the Wadeable Streams Assessment (WSA), Level 2 ecoregions are shown.**

## 1.2 INTEGRATION WITH THE EMAP WESTERN STUDY

A major geographic study within EMAP has targeted the states and tribal nations in the western conterminous U.S (Regions 8, 9, 10) and conducted over the past four years. Details regarding this research initiative can be found in the peer-reviewed research plan (U.S. EPA, 2000). The purpose for this western study was to further advance the science of monitoring and to demonstrate the application of core tools from EMAP in monitoring and assessment across the west. When the analyses and report are complete, the western



geographic study will serve to advance both the science of monitoring and the application of monitoring to policy, provide an opportunity to push the science and its application to new levels, both in terms of the type of systems addressed (mountainous and arid systems) and the size of the region covered (essentially one third of the conterminous U.S), and demonstrate the application of EMAP designs in answering the urgent and practical assessment questions facing the western EPA Regional Offices, while framing these unique studies in a methodology that can be extended to the entire nation. WSA builds upon this framework and completes the extension of the ecological assessment country-wide.

The primary objectives of the Western Pilot Study (EMAP-WP), the surface waters component of the Western Geographic Study, are to:

1. Develop the monitoring tools (biological indicators, stream survey design, estimates of reference condition) necessary to produce unbiased estimates of the ecological condition of surface waters across a large geographic area (or areas) of the West; and
2. Demonstrate those tools in a large-scale assessment.

The goal of EMAP-WP is to provide answers to three general assessment questions:

1. What proportion of stream and river miles in the western U.S. are in acceptable (or poor) biological condition?
2. What is the relative importance of potential stressors (habitat modification, sedimentation, nutrients, temperature, grazing, timber harvest, etc.) in streams and rivers across the West?; and
3. What stressors are associated with streams and rivers in poor biological condition?

The resource population of interest for EMAP-WP are all perennial streams and rivers as represented in EPA's River Reach File (RF3), with the exception of the "Great Rivers" (the Columbia, Snake, Colorado and Missouri Rivers). The pilot study utilized an EMAP probability design to select sites which are statistically representative of the resource population of interest. This allows an extrapolation of ecological results from the sites sampled to the entire population. A comprehensive set of ecological indicators were implemented in a coarse survey of streams and rivers across all of the West (the conterminous portions of EPA Regions 8, 9 and 10). Sample sizes (i.e., numbers of stream sites) were chosen to allow eventual estimates of condition to be made for each state, numerous aggregated ecological regions (e.g., mountainous areas of the Pacific states, the Southern Basin and Range), major river basins, and many other potential geographic classifications. This survey design is more detailed than will be used in the WSA. However, the integration of EMAP-WP with the planned sampling of the eastern US will enable a first-time assessment of the ecological condition of the nation's streams at a regional scale.

### **1.3 SUMMARY OF ECOLOGICAL INDICATORS**

The following sections describe the rationale for each of the ecological indicators currently included in the stream sampling procedures presented in this manual. Evaluation activities to determine the suitability of individual indicators to robustly determine ecological condition are ongoing at this time. This information is presented to help users understand

the various field procedures and the significance of certain aspects of the methodologies.

Consistent with EMAP and state water quality agencies, two principal types of indicators, condition and stressor (U.S. EPA, 1998) will be considered in the WSA. Condition indicators are biotic or abiotic characteristics of an ecosystem that can provide an estimate of the condition of an ecological resource with respect to some environmental value, such as biotic integrity. Stressor indicators are characteristics that are expected to change the condition of a resource if the intensity or magnitude is altered.

### **1.3.1 Water Chemistry**

Data are collected from each stream for a variety of physical and chemical constituents. Information from these analyses is used to evaluate stream condition with respect to stressors such as acidic deposition, nutrient enrichment, and other inorganic contaminants. In addition, streams can be classified with respect to water chemistry type, water clarity, mass balance budgets of constituents, temperature regime, and presence of anoxic conditions. Examples of relationships between stream chemistry and watershed-level land use data are described in Herlihy et al. (1998).

### **1.3.2 Physical Habitat**

Naturally occurring differences among surface waters in physical habitat structure and associated hydraulic characteristics contributes to much of the observed variation in species composition and abundance within a zoogeographic province. The structural complexity of aquatic habitats provides the variety of physical and chemical conditions to support diverse biotic assemblages and maintain long-term stability. Anthropogenic alterations of riparian areas and stream channels, wetland drainage, grazing and agricultural practices, and stream bank modifications such as revetments or development, generally act to reduce the complexity of aquatic habitat and result in a loss of species and ecosystem degradation.

Stressor indicators derived from data collected about physical habitat quality will be used to help explain or characterize stream condition relative to various condition indicators. Important attributes of physical habitat in streams are channel dimensions, gradient, substrate characteristics; habitat complexity and cover; riparian vegetation cover and structure; disturbance due to human activity, and channel-riparian interaction (Kaufmann, 1993). Overall objectives for this indicator are to develop quantitative and reproducible indices, using both multivariate and multimetric approaches, to classify streams and to monitor biologically relevant changes in habitat quality and intensity of disturbance. Kaufmann et al. (1999) discuss procedures for reducing EMAP field habitat measurements and observations to metrics that describe channel and riparian habitat at the reach scale.

### **1.3.3 Benthic Macroinvertebrate Assemblage**

Benthic macroinvertebrates inhabit the sediment or live on the bottom substrates of streams. The macroinvertebrate assemblages in streams reflect overall biological integrity of the benthic community, and monitoring these assemblages is useful in assessing the status of the water body and discerning trends. Benthic communities respond differently to a wide array of stressors. As a result of this, it is often possible to determine the type of

stress that has affected a benthic macroinvertebrate community (Plafkin et al., 1989; Klemm et al., 1990; Barbour et al. 1999). Because many macroinvertebrates have relatively long life cycles of a year or more and are relatively immobile, macroinvertebrate community structure is a function of past conditions.

The basic approach to developing ecological indicators based on benthic invertebrate assemblages is to identify different structural and functional attributes of the assemblage that will serve as endpoints for measuring differences in condition. Individual attributes or metrics that respond to different types of stressors are compared against expectations under conditions of minimal human disturbance (Kerans and Karr 1994, Fore et al. 1996, Barbour et al. 1995; 1996, Wright 1995, Norris 1995). Secondly, indicators of condition based on multivariate analysis of benthic assemblages and associated abiotic variables will be examined. A data analysis plan will be developed in consultation with a technical experts workgroup.

#### **1.4 OBJECTIVES AND SCOPE OF THE FIELD OPERATIONS MANUAL**

The field-related sampling and data collection activities in this manual are organized to follow the sequence of field activities during the 1-day site visit. Section 2 presents a general overview of all field activities. Section 3 presents those procedures that are conducted at a “base” location before and after a stream site visit. Section 4 presents the procedures for verifying the site location and defining a reach of the stream where subsequent sampling and data collection activities are conducted. Sections 5 through 9 describes the procedures for collecting samples and field measurement data for various condition and stressor indicators. Specific procedures associated with each indicator are presented in standalone tables that can be copied, laminated, and taken into the field for quick reference. Section 10 describes the final activities that are conducted before leaving a stream site. Appendix A contains a list of all equipment and supplies required by a crew to complete all field activities at a stream. Field teams are required to keep the field operations and methods manual available in the field for reference and to address questions pertaining to protocols that might arise.

#### **1.5 QUALITY ASSURANCE**

Large-scale and/or long-term monitoring programs such as those envisioned for WSA require a rigorous QA program that can be implemented consistently by all participants throughout the duration of the monitoring period. QA is a required element of all EPA-sponsored studies that involve the collection of environmental data (Stanley and Verner, 1986). A QA project plan was prepared for the WSA and distributed to all participants. The QA project plan contains more detailed information regarding QA/QC activities and procedures associated with general field operations, sample collection, measurement data collection for specific indicators, laboratory operations, and data reporting activities.

Quality control (QC) activities associated with field operations are integrated into the field procedures. Important QC activities associated with field operations include a comprehensive training program that includes practice sampling visits, and the use of a qualified museum facility or laboratory to confirm any field identifications of biological specimens.

## NOTES

## 2.0 OVERVIEW OF FIELD OPERATIONS

This section presents a general overview of the activities a 2- or 3-person field team conducts during a typical 1-day sampling visit to a stream site. General guidelines for recording data and using standardized field data forms and sample labels are also presented. Finally, safety and health considerations and guidelines related to field operations are provided.

### 2.1 DAILY OPERATIONAL SCENARIO

Table 2-1 provides the estimated time required to conduct various field activities. Figure 2-1 presents one scenario of the general sequence of activities conducted at each stream reach. For some wide, shallow streams, the required reach length and/or the larger area requiring sampling effort may necessitate two days be allocated for completing all required activities.

Upon arrival at a stream site, verify and document the site location, determine the length of stream reach to be sampled, and establish the required transects (Section 4). Then collect samples and field measurements for water chemistry (Section 5) and benthos (Section 6). Then determine discharge (Section 7), and conduct the intensive physical habitat characterization (Section 8). Finally, conduct a habitat characterization based on the Rapid Bioassessment Protocols (RBPs; Barbour et al. 1999) and a visual stream assessment (Section 9). After all field activities have been completed, prepare samples for transport and shipment (Section 3).

### 2.2 GUIDELINES FOR RECORDING DATA AND INFORMATION

During the 1-day visit to a stream, a field team is required to obtain and record a substantial amount of data and other information for all of the various ecological indicators described in Section 1.3. In addition, all the associated information for each sample collected must be recorded on labels and field data forms to ensure accurate tracking and subsequent linkage of other data with the results of sample analyses. Examples of field labels and data forms can be found in each sampling section.

The field data forms are designed to be compatible with an optical scanner system to allow rapid conversion of the printed form into one or more electronic files and reduce the need for manual data entry. While these forms should facilitate data recording by the field crew, it is **imperative** that field and sample information be recorded accurately, consistently, and legibly. Measurement data that cannot be accurately interpreted by others besides the field teams, and/or samples with incorrect or illegible information associated with them, are lost to the program. The cost of a sampling visit coupled with the short index period prohibits the ability to re-sample a stream because the initial information recorded was inaccurate, illegible, or missing. Some guidelines to assist field personnel with recording information are presented in Table 2-2. Examples of completed data forms and labels are presented in the sections describing field sampling and measurement procedures for different indicators.

**TABLE 2-1. ESTIMATED TIMES AND DIVISION OF LABOR FOR FIELD ACTIVITIES**

<b>Activity</b>	<b>Estimated Time Required</b>
Site verification and establishing sampling reach and transects	1 hr
Water chemistry sampling and stream discharge determination	1 hr
Collecting and processing benthos samples	1 hr
Intensive physical habitat characterization	2 to 3 hr
Rapid habitat assessment Visual stream assessment	0.5 hr
Sample tracking and packing	1 hr
<b>SUMMARY 7 to 8 hrs per team<sup>a</sup></b>	

<sup>a</sup> For wider wadeable streams (e.g., > 20 m, it may require more than 1 day to complete all required activities.

## **2.3 SAFETY AND HEALTH**

Collection and analysis of samples (e.g., benthic invertebrates, water chemistry, and sediment) can involve significant risks to personal safety and health (drowning, pathogens, etc.). While safety is often not considered an integral part of field sampling routines, personnel must be aware of unsafe working conditions, hazards connected with the operation of sampling gear, boats, environmental surroundings, and other risks (Berry et al., 1983). Personnel safety and health are of the highest priority for all investigative activities and must be emphasized in safety and health plans for field, laboratory, and materials handling operations. Preventative safety measures and emergency actions must also be emphasized. Individual states and other grantees should assign health and safety responsibilities and have an established program for training in safety, accident reporting, and medical and first aid treatment. Safety documents and standard operating procedures (SOPs) containing necessary and specific safety precautions should be available to all field personnel. Additional sources of information regarding field laboratory safety related to biomonitoring studies include Berry et al. (1983), USEPA (1986), and Ohio EPA (1990).

### **2.3.1 General Considerations**

Important considerations related to field safety are presented in Table 2-3. It is the responsibility of the group safety officer or project leader to ensure that the necessary safety courses are taken by all field personnel and that all safety policies and procedures are followed. Sources of information regarding safety-related training include the American Red Cross (1989), the National Institute for Occupational Safety and Health (1981), U.S. Coast Guard (1987) and Ohio EPA (1990).

Persons using sampling devices should become familiar with the hazards involved and establish appropriate safety practices prior to using them. If boats are used to access sampling sites, personnel must consider and prepare for hazards associated with the

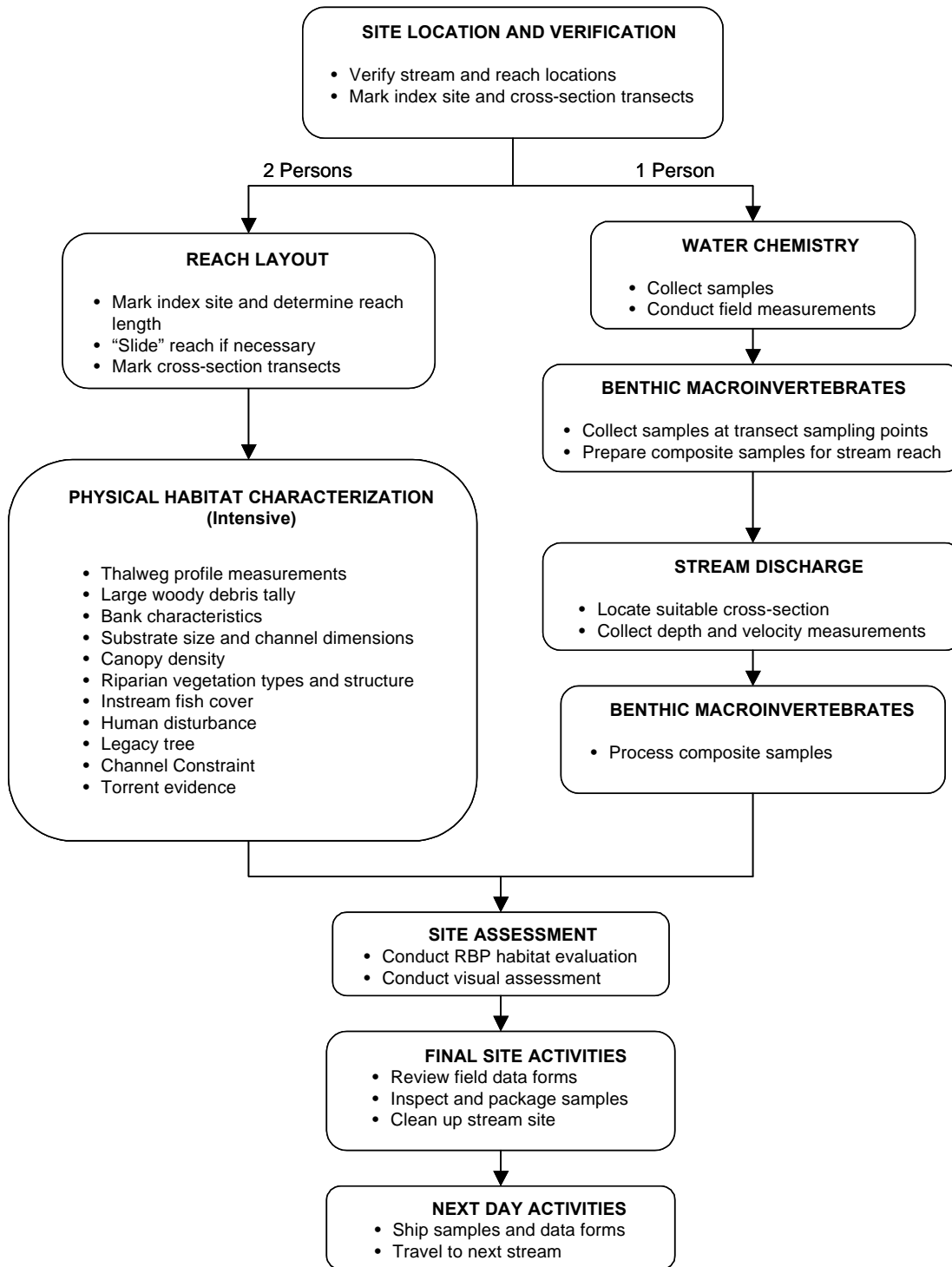

**Figure 2-1. General sequence of stream sampling activities (modified from Chaloud and Peck, 1994).**

operation of motor vehicles, boats, winches, tools, and other incidental equipment. Boat operators should be familiar with U.S. Coast Guard rules and regulations for safe boating contained in a pamphlet, "*Federal Requirements for Recreational Boats*," available from a local U.S. Coast Guard Director or Auxiliary or State Boating Official (U.S. Coast Guard, 1987). All boats with motors must have fire extinguishers, boat horns, life jackets or flotation cushions, and flares or communication devices.

**TABLE 2-2. GUIDELINES FOR RECORDING FIELD DATA AND OTHER INFORMATION**

**Field Measurements:**

Data Recording:

Record measurement values and/or observations on data forms preprinted on water-resistant paper.

Headers on the second pages of all forms link the data. Fill in all headers of all pages or data will be lost or linked to the wrong site record (this is a good one to review at the end of the day).

**NEVER EVER mark on or around the cornerblocks or ID Box** (the squares in the corners and the funky box with the number over it.) These markings are crucial to the scanning software and changing them in any way will affect performance.

**Write legibly.** Use a dark pencil lead that is at least a No. 2 for softness (HB), or use a dark pen. Your writing must be dark enough to be picked up by the scanner. Erase mistakes **CAREFULLY** and completely and write the correct value whenever you can. Note that erasing may cause the scanner to see smudge even though the value can be clearly seen. If you must line out an incorrect value, place the correct value nearby the appropriate box so the data entry operator can easily find it.

Use all caps when filling in the name fields on the forms. Clearly distinguish letters from numbers (e.g., 0 versus O, 2 versus Z, 7 versus T or F, etc.). Do not put lines through 7's, 0's, or Z's. Do not use slashes. Below are examples of lettering that are readable by the scanning software:

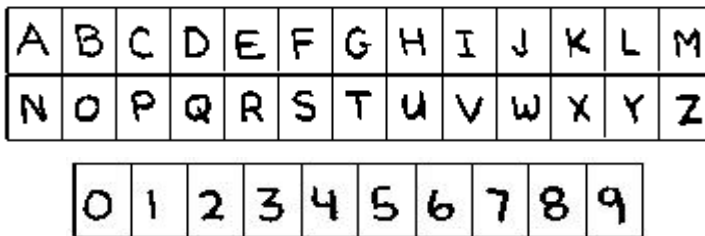

It is not necessary to write in all caps in the long comments sections on the Stream Verification and Stream Assessment forms, but write legibly (because the data entry operators still need to read it to type it in.) **Avoid marginal notes**, etc. Be concise, but avoid using abbreviations and/or "shorthand" notations. If you run out of space, attach a sheet of paper with the additional information, rather than trying to squeeze everything into the space provided on the form.

When you need to circle a choice, make a medium-sized circle around your choice.

**Yes**                      **No**                      1                       2                      3                      4

For square boxes, mark inside the box with an "X". For circles ("bubbles"), fill in completely.

**(continued)**



**TABLE 2-2 (continued)**

Record data and information so that all entries are obvious. Enter data completely in every field that you use. Follow the "comb" guidelines--print each number or letter in the individual space provided. Keep letters and numerals from overlapping. Record data to the number of decimal places provided on the forms. Illegible information is equivalent to no information.

If the measurement for a field is zero, enter zero. If left blank, it will be recorded as missing data. (There are parts of forms that are left blank when they are not being used. A typical example is page two of the field measurement form. Usually only one type of velocity and discharge information is taken and the unused areas of the form are left blank).

If the field calls for meters, write the answer in meters. Do not fill in a number and put (cm) for units. Also, do not record any additional decimal places (we just end up doing the rounding for you.)

Record information on each line, even if it has to be recorded repeatedly on a series of lines (e.g. physical habitat characteristics, pebble sizes). DO NOT USE "ditto marks" or a straight vertical line to indicate repeated entries.

Data Qualifiers (Flags):

Use only defined flag codes from the list below and record on data form in appropriate field. If the information is important enough to write on the page, use an "Fn" flag and put it in the comment section. A given "Fn" flag means the same thing for a given form; you may start a new sequence of "Fn" flags on different forms. If you have been instructed to collect a piece of information for which there is no space on the form, choose a flag and comment section, and use them consistently.

<u>FLAG</u>	<u>COMMENT</u>
F1, F2, etc.	Miscellaneous comments assigned by field crew (e.g., pipe on bank near sampling point)
K	Sample not collected; No measurement or observation made
U	Non-standard or suspect sample, measurement or observation
Q	Unacceptable QC check associated with measurement
Z	Last station sampled before next transect

If you cannot take a measurement, leave the measurement field blank and put the K flag in the Flag column.

	Dist. from Bank	Velocity	Depth	Flag
1	0	0	0	
2	10	-0.1	0.6	
3	20	0.8	1.0	
4	30		2.3	K
K	Too deep to sample			

**(continued)**

---

---

**TABLE 2-2 (continued)**

---

---

Review of Data Forms:

Have someone who did not fill in the forms review them at the end of the day. Some information is duplicated. Sometimes, however, when one measurement is missing, as many as 100 other metrics based on that measurement are lost. Be thorough.

Example: Site\_ID  
Visit Date  
Missing Data  
Increment (on the back of the Thalweg form)

Returning the Forms

Return the originals

If you want a copy of the data, make a photocopy and keep it.  
Try to keep the forms in their original order.  
Do not staple the forms together.

Include a list of sites visited. Please include a list with Site ID and Visit Date for forms being returned.

---

---

**Sample Labels and Tracking**

---

---

Sample Labels:

Sample Labels– Use adhesive labels with preprinted ID numbers and a standard recording format for each type of sample.

Record information on labels using a fine-point indelible marker. Cover completed labels with clear tape.

Sample Tracking Information:

Record sample ID number from the label and associated collection information on sample collection form. Use a dark pencil or pen.

Complete any sample tracking forms required. Include tracking forms with all sample shipments.

---

**(continued)**

---

---

**TABLE 2-2 (continued)**

---

---

Sample Qualifiers (Flags):

Use only defined flag codes and record on sample collection form in appropriate field.

- K Sample not collected or lost before shipment; re-sampling not possible.
- U Nonstandard or suspect sample (e.g., possible contamination, does not meet minimum acceptability requirements, or collected using a nonstandard procedure)
- Fn* Miscellaneous flags (*n*=1, 2, etc.) assigned by a field team for a particular sample or shipment.

Explain all flags in comments section on sample collection form.

Review of Labels and Collection Forms:

The field team compares information recorded on labels, sample collection forms, and tracking forms for accuracy before leaving a stream. Make sure Sample ID numbers match on all forms.

---

---

**TABLE 2-3. GENERAL HEALTH AND SAFETY CONSIDERATIONS**

---

---

---

**Training:**

---

- First aid
  - Cardiopulmonary resuscitation (CPR)
  - Vehicle safety (e.g., operation of 4-wheel drive vehicles)
  - Boating and water safety (if boats are required to access sites)
  - Field safety (e.g., weather conditions, personal safety, orienteering, reconnaissance of sites prior to sampling)
  - Equipment design, operation, and maintenance
  - Handling of chemicals and other hazardous materials
- 

---

**Communications**

---

- Check-in schedule
  - Sampling itinerary (vehicle used and its description, time of departure, travel route, estimated time of return)
  - Contacts for police, ambulance, hospitals, fire departments, search and rescue personnel
  - Emergency services available near each sampling site and base location
  - Cell (or satellite) phone, if possible
- 

---

**Personal Safety**

---

- Field clothing and other protective gear
  - Medical and personal information (allergies, personal health conditions)
  - Personal contacts (family, telephone numbers, etc.)
  - Physical exams and immunizations
- 
-

A communications plan to address safety and emergency situations is essential. All field personnel need to be fully aware of all lines of communication. Field personnel should have a daily check-in procedure for safety. An emergency communications plan should include contacts for police, ambulance, fire departments, hospitals, and search and rescue personnel.

Proper field clothing should be worn to prevent hypothermia, heat exhaustion, sunstroke, drowning, or other dangers. Field personnel should be able to swim. Chest waders made of rubberized or neoprene material and suitable footwear must always be worn with a belt to prevent them from filling with water in case of a fall. If a member of the field sampling team is not a strong swimmer or feels uncomfortable in deep, fast flowing water, a personal flotation device may be used.

Many hazards lie out of sight in the bottoms of lakes, rivers and streams. Broken glass or sharp pieces of metal embedded in the substrate can cause serious injury if care is not exercised when walking or working with the hands in such environments. Infectious agents and toxic substances that can be absorbed through the skin or inhaled may also be present in the water or sediment. Personnel who may be exposed to water known or suspected to contain human or animal wastes that carry causative agents or pathogens must be immunized against tetanus, hepatitis, typhoid fever, and polio. Biological wastes can also be a threat in the form of viruses, bacteria, rickettsia, fungi, or parasites.

Prior to a sampling trip, personnel should determine that all necessary equipment is in safe working condition. Good housekeeping practice should be followed in the field. These practices protect staff from injury, prevent or reduce exposure to hazardous or toxic substances, and prevent damage to equipment and subsequent down time and/or loss of valid data.

### **2.3.2 Safety Equipment and Facilities**

Appropriate safety apparel such as waders, lab coats, gloves, safety glasses, etc. must be available and used when necessary. Bright colored caps (e.g., orange) should be worn during field activities. First aid kits, fire extinguishers, and blankets must be readily available in the field. A properly installed and operating fume hood must be provided in the laboratory for use when working with chemicals that may produce dangerous fumes. Cellular or satellite telephones and/or portable radios should be provided to field teams working in remote areas for use in case of an emergency. Facilities and supplies must be available for cleaning of exposed body parts that may have been contaminated by pollutants in the water. Anti-bacterial soap and an adequate supply of clean water or ethyl alcohol, or equivalent, should be suitable for this purpose.

### **2.3.3 Safety Guidelines for Field Operations**

General safety guidelines for field operations are presented in Table 2-4. Personnel participating in field activities on a regular or infrequent basis should be in sound physical condition and have a physical examination annually or in accordance with Regional, State, or organizational requirements. All surface waters and sediments should be considered

potential health hazards due to toxic substances or pathogens. Persons must become familiar with the health hazards associated with using chemical fixing and/or preserving agents. Chemical wastes can cause various hazards due to flammability, explosiveness, toxicity, causticity, or chemical reactivity. All chemical wastes must be discarded according to standardized health and hazards procedures (e.g., National Institute for Occupational Safety and Health [1981]; U.S. EPA [1986]).

During the course of field research activities, field teams may observe violations of environmental regulations, may discover improperly disposed hazardous materials, or may observe or be involved with an accidental spill or release of hazardous materials. In such cases it is important that the proper actions be taken and that field personnel do not expose themselves to something harmful. The following guidelines should be applied:

- First and foremost during any environmental incident, it is extremely important to protect the health and safety of all personnel. Take any necessary steps to avoid injury or exposure to hazardous materials. If you have been trained to take action such as cleaning up a minor fuel spill during fueling of a boat, do it. However, you should always err on the side of personal safety
- Field personnel should never disturb, or even worse, retrieve improperly disposed hazardous materials from the field and bring them back to a facility for "disposal". To do so may worsen the impact to the area of the incident, may incur personal liability, may incur liability for the team members and their respective organizations, may cause personal injury, or may cause unbudgeted expenditure of time and money for proper treatment and disposal of the material. However, it is important not to ignore environmental incidents. There is a requirement to notify the proper authorities of any incident of this type. The appropriate authorities may then take the necessary actions to properly respond to the incident.
- For most environmental incidents, the following emergency telephone numbers should be provided to all field teams: State or Tribal department of environmental quality or protection, U.S. Coast Guard, and the U.S. EPA regional office. In the event of a major environmental incident, the National Response Center may need to be notified at 1-800-424-8802.

**TABLE 2-4. GENERAL SAFETY GUIDELINES FOR FIELD OPERATIONS**

---

---

- Two persons must be present during all sample collection activities, and no one should be left alone while in the field.
- Exposure to stream water and sediments should be minimized as much as possible. Use gloves if necessary, and clean exposed body parts as soon as possible after contact.
- All electrical equipment must bear the approval seal of Underwriters Laboratories and must be properly grounded to protect against electric shock.
- Use heavy gloves when hands are used to agitate the substrate during collection of benthic macroinvertebrate samples.
- Use appropriate protective equipment (e.g., gloves, safety glasses) when handling and using hazardous chemicals
- Persons working in areas where poisonous snakes may be encountered must check with the local Drug and Poison Control Center for recommendations on what should be done in case of a bite from a poisonous snake.

If local advice is not available and medical assistance is more than an hour away, carry a snake bite kit and be familiar with its use.

- Any person allergic to bee stings, other insect bites, or plants (i.e., poison ivy, oak, sumac, etc.) must take proper precautions and have any needed medications handy.
  - Field personnel should also protect themselves against the bite of deer or wood ticks because of the potential risk of acquiring pathogens that cause Rocky Mountain spotted fever and Lyme disease.
  - All field personnel should be familiar with the symptoms of hypothermia and know what to do in case symptoms occur. Hypothermia can kill a person at temperatures much above freezing (up to 10°C or 50°F) if he or she is exposed to wind or becomes wet.
  - Field personnel should be familiar with the symptoms of heat/sun stroke and be prepared to move a suffering individual into cooler surroundings and hydrate immediately.
  - Handle and dispose of chemical wastes properly. Do not dispose any chemicals in the field.
- 
- 

## **2.4 LITERATURE CITED**

American Red Cross. 1979. *Standard First Aid and Personal Safety*. American National Red Cross. 269 pp.

Barbour, M.T., J. Gerritsen, B.D. Snyder, and J.B. Stribling. 1999. *Rapid Bioassessment Protocols for Use in Streams and Wadeable Rivers: Periphyton, Benthic Macroinvertebrates, and Fish*. Second Edition. EPA/841-B-99-002. U.S. Environmental Protection Agency, Office of Water, Assessment and Watershed Protection Division, Washington, D.C.

- Berry, C.R. Jr., W.T. Helm, and J. M. Neuhold. 1983. Safety in fishery field work. pp. 43-60 IN: Nielsen, L.A., and D. L. Johnson (eds.). *Fisheries Techniques*. American Fisheries Society, Bethesda, MD.
- Chaloud, D. J., and D. V. Peck (eds.). 1994 *Environmental Monitoring and Assessment Program: Integrated Quality Assurance Project Plan for the Surface Waters Resource Group*. EPA 600/X-91/080. Revision 2.00. U.S. Environmental Protection Agency, Las Vegas, Nevada.
- National Institute for Occupational Safety and Health. 1981. *Occupational Health Guidelines for Chemical Hazards* (Two Volumes). NIOSH/OSHA Publication No. 81-123. U.S. Government Printing Office, Washington, D.C.
- Ohio EPA. 1990. *Ohio EPA Fish Evaluation Group Safety Manual*. Ohio Environmental Protection Agency, Ecological Assessment Section, Division of Water Quality Planning and Assessment, Columbus, Ohio.
- Plafkin, J.L., M.T. Barbour, K.D. Porter, S.K. Gross, and R.M. Hughes. 1989. *Rapid Bioassessment Protocols for Use in Streams and Rivers: Benthic Macroinvertebrates and Fish*. EPA/440/4-89/001. U.S. Environmental Protection Agency, Washington, D.C.
- Reynolds, J. B. 1983. Electrofishing. pp. 147-163. IN: L. A. Nielsen and D. L. Johnson (eds.). *Fisheries Techniques*. American Fisheries Society, Bethesda, MD.
- U.S. Coast Guard. 1987. *Federal Requirements for Recreational Boats*. U.S. Department of Transportation, United States Coast Guard, Washington, D.C.
- U.S. EPA. 1986. *Occupational Health and Safety Manual*. Office of Planning and Management, U.S. Environmental Protection Agency, Washington, D.C.

## NOTES



### **3.0 BASE LOCATION ACTIVITIES**

Field teams conduct a number of activities at a “base” location before and after visiting each stream site. These activities are generally conducted on the same day as the sampling visit. Close attention to these activities is required to ensure that the field teams know where they are going, that access to the stream site is possible and permissible, that all the necessary equipment and supplies are in good order to complete the sampling effort, and that samples are packaged and shipped correctly and promptly. All samples must be transported and/or presented for shipment in accordance with State, Federal, and international regulations. Because of the large geographic area being sampled, it is critical to minimize the potential for transferring exotic or nuisance species of plants and animals (e.g., aquatic milfoil, zebra mussels), or waterborne pathogens.

Figure 3-1 illustrates operations and activities that are conducted before and after each visit to a stream site. Activities that are conducted after a stream visit include equipment cleanup and maintenance, packing and shipping samples, and communications with project management to report the status of the visit.

#### **3.1 ACTIVITIES BEFORE EACH STREAM VISIT**

Before each stream visit, each field team should confirm access to the stream site, develop a sampling itinerary, inspect and repair equipment, check to make sure all supplies required for the visit are available, and prepare sample containers. Procedures to accomplish these activities are described in the following sections.

##### **3.1.1 Confirming Site Access**

Cooperators should assemble a dossier containing important locational and access information for each stream they are scheduled to visit. Before visiting a stream, the field crew must review the contents of the specific stream dossier. The landowner(s) listed in the dossier should be contacted to confirm permission to sample and identify any revisions to the information contained in the dossier.

##### **3.1.2 Daily Sampling Itinerary**

Team leaders are responsible for developing daily itineraries based upon the sampling schedule provided. Review each stream dossier to ensure that it contains the appropriate maps, contact information, copies of permission letters, and access instructions. Determine the best access routes, call the landowners or local contacts to confirm permission, confirm lodging plans for the upcoming evening, and coordinate rendezvous locations with individuals who must meet with field teams prior to accessing a site. Use this information to develop an itinerary for the stream. The itinerary should include anticipated departure time, routes of travel, location of any intermediate stops (e.g., to drop off samples, pick up supplies, etc.) and estimated time of arrival at the final destination after completing the stream visit. This information (and any changes that occur due to unforeseen circumstances), should be provided to the field coordinator or other central contact person identified for the specific field study. Failure to adhere to the reported

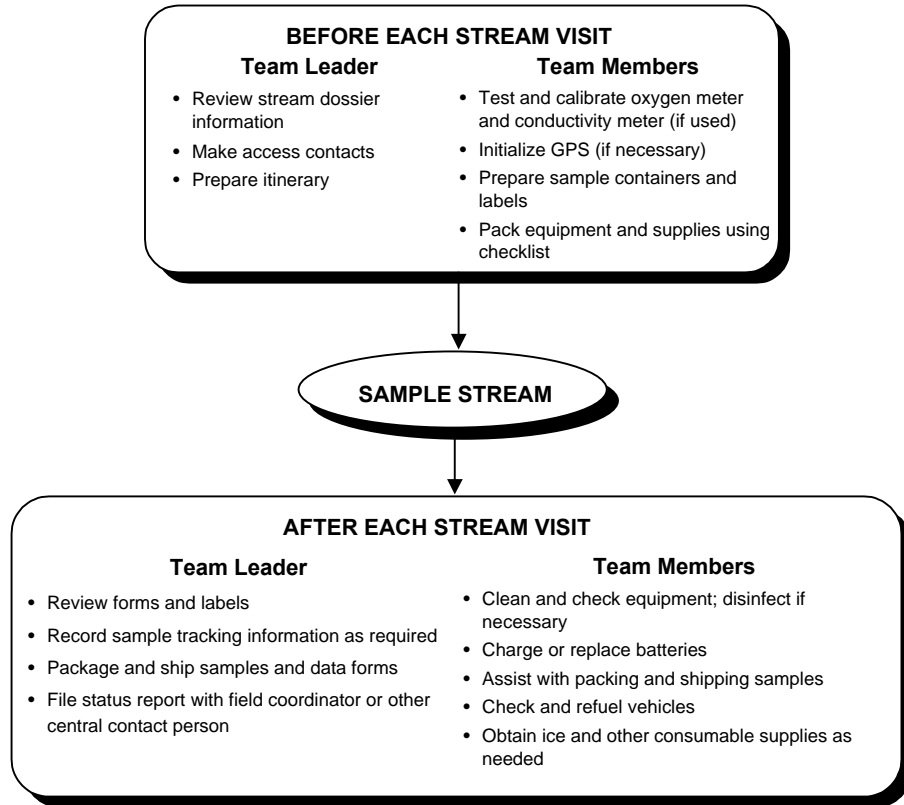

6/98

**Figure 3-1. Activities conducted at base locations.**

itinerary can result in the initiation of expensive search and rescue procedures and disruption of carefully planned schedules. In addition, each team should carry individual emergency medical and personal information with them, possibly in the form of a "safety log" that remains in the vehicle (see Section 2).

### **3.1.3 Instrument Inspections and Performance Tests**

Each field team is required to test and calibrate some instruments prior to departure for the stream site. Required field instruments include a global positioning system (GPS) receiver, a current velocity meter, and thermometer. Backup instruments should be available if instruments fail the performance tests or calibrations described in the following subsections.

#### **3.1.3.1 Global Positioning System Receiver**

Specific performance checks will vary among different brands of GPS receivers. Follow the instructions in the receiver's operating manual to make sure the unit is functioning properly. Turn on the receiver and check the batteries. Replace batteries immediately if a battery warning is displayed. Make sure extra batteries are stored with the receiver and will be available in the field if necessary. Follow the manufacturer's instructions for initializing the receiver when it becomes necessary (e.g., before first use, after replacing batteries, or if a new positional reference is required). Make sure the correct datum (NAD27) is selected.

#### **3.1.3.2 Current Velocity Meters**

Field teams may be using one of three types of current velocity meters, a photo-optical impeller type meter (e.g., Swiffer Model 2100) a vertical axis meter (e.g., Price type AA), or an electromagnetic type meter (e.g., Marsh McBirney Model 201D). General guidelines regarding performance checks and inspection of current meters are presented in Table 3-1. Consult the operating manual for the specific meter and modify this information as necessary.

### **3.1.4 Preparation of Equipment and Supplies**

To ensure that all activities at a stream can be conducted completely and efficiently, field teams should check all equipment and supplies before traveling to a stream site. In addition, they should prepare the water chemistry sample containers for use.

Check the inventory of equipment and supplies prior to departure using the stream-visit checklists presented in Appendix A. Pack the flow meter and sampling gear in such a way as to minimize physical shock and vibration during transport. If necessary, prepare stock preservative solutions as described in Table 3-2. Follow the regulations of the Department of Transportation and the Occupational Safety and Health Administration (OSHA) for handling and transporting hazardous materials such as ethanol. These requirements should be summarized for all hazardous materials being used for the project and provided to field personnel. Transport ethanol in appropriate containers with absorbent material.

**TABLE 3-1. GENERAL PERFORMANCE CHECKS FOR CURRENT VELOCITY METERS**

<b>Photoelectric Impeller Meters (e.g., Swoffer Model 2100)</b>
<ul style="list-style-type: none"><li>● Check that the calibration adjustment cover screws are tightly fitted on the display case.</li><li>● Periodically check the condition of the connector fitting between the display unit and the sensor.</li><li>● Connect the sensor to the display unit and check the calibration value stored in memory. If this value is less than the correct value for the display unit-sensor rotor combination, replace the batteries.</li><li>● Periodically perform a spin test of the rotor assembly, following the instructions in the meter's operating manual. A displayed count value of 300 or greater is indicative of satisfactory performance at low current velocities.</li><li>● If a buzzing sound occurs when the rotor assembly is spun by hand, or if the shaft shows visible wear, replace the rotor assembly.</li><li>● Periodically examine the thrust-bearing nut on the rotor assembly. If a "cup" begins to form on the bottom surface of the nut, it should be replaced.</li></ul>
<b>Vertical-axis Meters (from Smoot and Novak, 1968)</b>
<ul style="list-style-type: none"><li>● Inspect the bucket and wheel hub assembly, yoke, cups, tailpiece, and the pivot point each day before use.</li><li>● Inspect the bearings and check the contact chamber for proper adjustment.</li><li>● Periodically conduct a spin test of the meter. The minimum spin time is 1.5 minutes, while the recommended time is between 3 and 4 minutes.</li></ul>
<b>Electromagnetic Meters</b>
<ul style="list-style-type: none"><li>● Check the meter calibration daily as part of morning routine. Calibration value should be <math>2.00 \pm 0.05</math>.</li><li>● Once per week, check the zero value using a bucket of quiescent water. Place the probe in the bucket and allow to sit for 30 minutes with no disturbance. The velocity value obtained should be <math>0.0 \pm 0.1</math>. Adjust the meter zero if the value is outside this range.</li></ul>

**TABLE 3-2. STOCK SOLUTIONS, USES, AND INSTRUCTIONS FOR PREPARATION**

SOLUTION	USE	PREPARATION
Bleach (10%)	Clean and disinfect seines, dip nets, kick nets, or other equipment that is immersed in the stream	Dilute 400 mL chlorine bleach solution to 4 L with tap water.
Ethanol (95%)	Preservative for benthic macroinvertebrate samples.	None.

<sup>a</sup> Metcalf and Peck (1993)

<sup>b</sup> Peck and Metcalf (1991)

Inspect the vehicles every morning before departure. Refuel vehicles and conduct maintenance activities the night before a sampling trip. Check vehicle lights, turn signals, brake lights, and air pressure in the tires.

Sample containers for water chemistry can be labeled before departing from the base location. Figure 3-2 illustrates the preprinted labels. Prepare a set of three water chemistry sample containers all having the same ID number (one for the 4-L cubitainer and two for the 60-mL syringes) and pre-labeled with the appropriate information (described in Section 5). After labeling, place the syringes in their plastic container, and place the cubitainer and beakers in a clean plastic bag to prevent contamination. Sample containers for benthic samples **CANNOT** be pre-labeled before reaching the stream site. Problems in sample tracking will result if containers are labeled and then are not used at a stream.

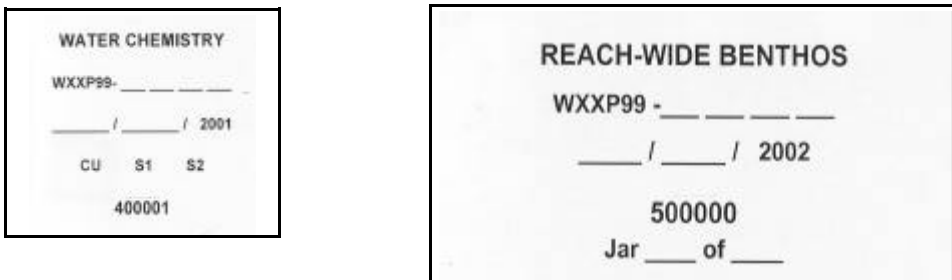

**Figure 3-2. Sample container labels.**

## 3.2 ACTIVITIES AFTER EACH STREAM VISIT

Upon reaching a lodging location after sampling a stream, the team reviews all completed data forms and sample labels for accuracy, completeness, and legibility, and makes a final inspection of samples. If information is missing from the forms or labels, the team leader should fill in the missing information as accurately as possible. The team leader initials all data forms after review. The other team member should inspect and clean sampling equipment, check the inventory of supplies, and prepare samples for shipment. Other activities include shipping samples, submitting sampling status and tracking information to Tetra Tech, and communicating with the field coordinator or other central contact person.

### 3.2.1 Equipment Care

Equipment cleaning procedures are given in Table 3-3. Inspect all equipment, including nets, and clean off any plant and animal material. This effort ensures that introductions of nuisance species do not occur between streams, and prevents possible cross- contamination of samples. If nets cannot be cleaned thoroughly using water and detergent, clean and disinfect them with a 10 percent chlorine bleach solution (Table 3-2). Use bleach only as a last resort, as repeated use will destroy the net material. Take care to avoid damage to lawns or other property.

**TABLE 3-3. EQUIPMENT CARE AFTER EACH STREAM VISIT**

- 
- 
1. General cleaning for biological contaminants (e.g., plant and animal material).
    - Prior to departing a stream, drain all water from all buckets used.
    - Inspect sampling gear and waders, boots, etc. for evidence of plant fragments or animal remains and remove them.
    - At the base location, inspect kick nets, waders, and boots. Rinse with water and dry. If there appears to be the potential for contamination, disinfect gear with a 10 percent bleach solution.
  2. Clean and dry other equipment prior to storage.
    - Rinse coolers with water to clean off any dirt or debris on the outside and inside.
    - Rinse all beakers used to collect water chemistry samples three times with deionized water to prevent contamination of the next stream sample. Place the beakers in a 1-gallon self-sealing plastic bag with a cubitainer for use at the next stream.
  3. Inventory equipment and supply needs and relay orders to the Field Coordinator.
  4. Remove GPS receivers from carrying cases and set up for pre-visit inspections and performance tests.
  5. Recharge all batteries overnight if possible (e.g., 12-V wet cells), computer battery). Replace others (GPS, DO meter, current meter) as necessary.
  6. Check and re-fuel vehicles if necessary.
  7. Recheck data forms from the day's sampling activities. Make corrections and completions where possible, and initial each form after review.
- 
-

### 3.2.2 Sample Packing, Shipment, and Tracking

Each field team packs and ships samples from each stream visit as soon as possible after collection, normally the day following a stream visit. Field teams are provided with specific information for the shipping destinations, contact persons, and the required shipping schedule for each type of sample. Record sample tracking information (including sample types, sample ID numbers, and other field-related information that is required by the laboratory to conduct analyses and associate results to a specific sample and stream site) during the packing process. After each shipment, file a status report with the field coordinator.

#### 3.2.2.1 Water Chemistry Samples

Record sample information onto a tracking form as shown in Figure 3-3. A separate tracking form is required for each shipping destination (e.g., analytical laboratory). Use the standard codes provided on the form to record the type of sample and its condition. Record all “subsample” types (cubitainer and syringe for water chemistry in the comments field. In some cases, a field crew may sample more than one site before shipping samples; in such cases, there will be more than one entry per tracking form. Prepare **one additional copy** of the form (a photocopy is acceptable). Retain the original copy of each form to prepare the status report for the site (Section 3.3), and then include it as part of the data forms packet for the site. Include the copy as a “packing list” in the shipment. Water chemistry samples are shipped to the EPA analytical laboratory facility in Corvallis (Willamette Research Station [WRS]), and possibly to a local laboratory (if a concurrent analysis is being done). The address is pre-printed on the sample tracking form (Figure 3-3).

General guidelines for packing and shipping unpreserved water chemistry samples are presented in Table 3-4. Use ice substitute packs whenever possible to avoid potential leakage due to melting ice. When shipping samples using ice, use fresh ice. Use block ice when available, sealed in a large plastic bags. If block ice is not available, contain the ice in several self-sealing plastic bags. Label each bag of ice as "ICE" with an indelible marker to prevent any leakage of meltwater from being misidentified by couriers as a possible hazardous material spill. If ice substitute packs are used, place each pack into a self-sealing plastic bag before use.

Ship water chemistry samples as soon as possible after collection in order to meet holding time requirements for some laboratory analyses (especially pH and nutrients). To ship water chemistry samples, place a large (30-gallon) plastic bag in an insulated shipping container (e.g., a plastic or metal cooler). The sample labels on the cubitainer and syringes should be completely covered with clear tape to prevent damage from water or condensation during shipment. Place the syringes into a separate plastic container for shipment. Place the cubitainer and syringe container into a second large plastic bag and close. Place the bag containing the samples inside the plastic bag lining the shipping container. Place bags of ice (or frozen ice substitute packs) around the bag of samples, but inside the plastic bag lining the shipping container. Be sure to use sufficient quantities of ice to ensure samples will remain cold until arrival at the laboratory. **Typically, the total weight of each shipping container (samples plus ice) should be between 40 and 50 pounds (more for shipments from hot locations).**

### FIELD SAMPLE SHIPMENT PACKING/TRACKING FORM

Wadeable   
 Boatable   
 Other = Fax Verification Form   
 Date Visited: 07/02/2003

---

Check all that apply:  Willamette Research Station    Site Name: (Write Unknown if unknown)    Visit Number: 1  2  3   
 Poison Depot  
 Other

---

Airbill Number: 809171727040    Contact: (Person calling in or faxing tracking info.)    Date Sent: 07/05/2003

Site ID	Sample ID	Sample Type	# Of Jars	Fish:	Comments (Fish tissue species and other comments here.)
WXXP99-9999	100000	<input checked="" type="radio"/> Chem <input type="radio"/> Peri - BQ, CHLA, ID <input type="radio"/> Peri - Plankton Tow <input type="radio"/> Peri - STAR	<input type="checkbox"/>	<input type="radio"/> Big <input type="radio"/> Small	
WXXP99-9999	300000	<input type="radio"/> Chem <input checked="" type="radio"/> Peri - BQ, CHLA, ID <input type="radio"/> Peri - Plankton Tow <input type="radio"/> Peri - STAR	<input type="checkbox"/>	<input type="radio"/> Big <input type="radio"/> Small	
WXXP99-9999	400000	<input type="radio"/> Chem <input type="radio"/> Peri - BQ, CHLA, ID <input type="radio"/> Peri - Plankton Tow <input type="radio"/> Peri - STAR	<input type="checkbox"/>	<input checked="" type="radio"/> Big <input type="radio"/> Small	CUTTHROAT TROUT
WXXP99-9999	400001	<input type="radio"/> Chem <input type="radio"/> Peri - BQ, CHLA, ID <input type="radio"/> Peri - Plankton Tow <input type="radio"/> Peri - STAR	<input type="checkbox"/>	<input type="radio"/> Big <input type="radio"/> Small	CUTTHROAT TROUT
WXXP99-9999	400002	<input type="radio"/> Chem <input type="radio"/> Peri - BQ, CHLA, ID <input type="radio"/> Peri - Plankton Tow <input type="radio"/> Peri - STAR	<input type="checkbox"/>	<input type="radio"/> Big <input type="radio"/> Small	CUTTHROAT TROUT
WXXP99-9999	400003	<input type="radio"/> Chem <input type="radio"/> Peri - BQ, CHLA, ID <input type="radio"/> Peri - Plankton Tow <input type="radio"/> Peri - STAR	<input type="checkbox"/>	<input type="radio"/> Big <input type="radio"/> Small	NORTHERN PIKEMINNOW
WXXP99-9999	400004	<input type="radio"/> Chem <input type="radio"/> Peri - BQ, CHLA, ID <input type="radio"/> Peri - Plankton Tow <input type="radio"/> Peri - STAR	<input type="checkbox"/>	<input type="radio"/> Big <input type="radio"/> Small	NORTHERN PIKEMINNOW
WXXP99-9999	400005	<input type="radio"/> Chem <input type="radio"/> Peri - BQ, CHLA, ID <input type="radio"/> Peri - Plankton Tow <input type="radio"/> Peri - STAR	<input type="checkbox"/>	<input type="radio"/> Big <input type="radio"/> Small	NORTHERN PIKEMINNOW
WXXP99-9999	400006	<input type="radio"/> Chem <input type="radio"/> Peri - BQ, CHLA, ID <input type="radio"/> Peri - Plankton Tow <input type="radio"/> Peri - STAR	<input type="checkbox"/>	<input type="radio"/> Big <input checked="" type="radio"/> Small	REDSIDE SHINER (30)
		<input type="radio"/> Chem <input type="radio"/> Peri - BQ, CHLA, ID <input type="radio"/> Peri - Plankton Tow <input type="radio"/> Peri - STAR	<input type="checkbox"/>	<input type="radio"/> Big <input type="radio"/> Small	
		<input type="radio"/> Chem <input type="radio"/> Peri - BQ, CHLA, ID <input type="radio"/> Peri - Plankton Tow <input type="radio"/> Peri - STAR	<input type="checkbox"/>	<input type="radio"/> Big <input type="radio"/> Small	
		<input type="radio"/> Chem <input type="radio"/> Peri - BQ, CHLA, ID <input type="radio"/> Peri - Plankton Tow <input type="radio"/> Peri - STAR	<input type="checkbox"/>	<input type="radio"/> Big <input type="radio"/> Small	
		<input type="radio"/> Chem <input type="radio"/> Peri - BQ, CHLA, ID <input type="radio"/> Peri - Plankton Tow <input type="radio"/> Peri - STAR	<input type="checkbox"/>	<input type="radio"/> Big <input type="radio"/> Small	
		<input type="radio"/> Chem <input type="radio"/> Peri - BQ, CHLA, ID <input type="radio"/> Peri - Plankton Tow <input type="radio"/> Peri - STAR	<input type="checkbox"/>	<input type="radio"/> Big <input type="radio"/> Small	
		<input type="radio"/> Chem <input type="radio"/> Peri - BQ, CHLA, ID <input type="radio"/> Peri - Plankton Tow <input type="radio"/> Peri - STAR	<input type="checkbox"/>	<input type="radio"/> Big <input type="radio"/> Small	
		<input type="radio"/> Chem <input type="radio"/> Peri - BQ, CHLA, ID <input type="radio"/> Peri - Plankton Tow <input type="radio"/> Peri - STAR	<input type="checkbox"/>	<input type="radio"/> Big <input type="radio"/> Small	

---

Lab Contact: Richard Kovar (541)754-4735 Ph) (541)754-GOOD (4663) OR Fax) (541)754-4338 ATTN: Mariys Cappaert	<b>For office use only</b> Initials: _____ Status: <input type="radio"/> Date Entered: _____ Sample: <input type="radio"/> <b>For Lab use only</b> Date Received: _____ Lab: Fax this sheet to 541-754-4338 Attn: Mariys Cappaert	<b>SAMPLE TYPES</b> BENT = Benthos CHEM = Water Chemistry FISH = Fish Tissue PERI = Periphyton VERT = Fish Museum  Box is for # of Jars Reachwide and Targeted Riffle: <input type="checkbox"/>	<b>CONDITION CODES</b> B = Broken Syringe Tip C = Cracked Jar F = Frozen L = Leaking ML = Missing Label NP = Not Preserved OK = Seems Fine T = Thawed but still Cold W = Warm
---	--	---	--

63654

03/03/2003    2003 Tracking

Figure 3-3. Sample tracking form for unpreserved samples.



**TABLE 3-4. GENERAL GUIDELINES FOR PACKING AND SHIPPING  
UNPRESERVED SAMPLES**

<b>Sample Type (container)</b>	<b>Guidelines</b>
Water Chemistry (4-L cubitainer and 60-mL syringes)	<p>Ship on day of collection or within 24 hr by overnight courier. Use frozen ice substitute packs, or fresh ice in labeled plastic bags for shipping. <b>Use enough ice so that total weight of each shipping container is 40-50 lbs.</b></p> <p>Line each shipping container with a large plastic bag.            Place syringes in a plastic container.            Place syringe container and cubitainer inside of a second plastic bag.            Cover labels completely with clear tape.            The cubitainer and syringes should have same sample ID number assigned.            Confirm the sample ID assigned on the labels matches the ID number recorded on the field collection form and the sample tracking form.</p>

Then close the outer plastic bag. Insert the copy of the completed tracking form (Figure 3-3) into a self-sealing plastic bag, and tape the bag to the inside of the lid), then close the container. Seal the container with shipping tape (do not use duct tape) and affix any required shipping-related labels to the outside of the container. Attach an adhesive plastic sleeve to the lid of the container and insert any required shipping forms.

### **3.2.2.2 Benthic Macroinvertebrate Samples**

Transport benthic macroinvertebrate samples that are preserved in ethanol in appropriate inner and outer containers, with inner containers surrounded with some type of acceptable absorbent material (e.g., vermiculite). **Before shipping to the lab (after a sample has been preserved for at least one week), decant the majority of the ethanol from the container. Leave only enough ethanol to keep the sample moist.** Place the lid back on the container and seal with electrical tape. The sample will be refilled with ethanol upon receipt at the benthic laboratory. Check to see that all equipment is in the vehicle.

Complete a separate tracking form for benthic macroinvertebrate samples as shown in Figure 3-4. These samples are likely to be retained by the field team and periodically transported to intermediate storage "depots", where they will accumulate prior to shipment or delivery to the appropriate support laboratories. Again, make a copy of the completed form for each site. Retain the original copy to prepare the status report for the site (Section 3.3), and then include it as part of the data forms packet for the site. Include the copy as a "packing list" when you drop off samples at the storage depot.

In order to avoid problems encountered when shipping hazardous materials, decant ethanol from samples until detritus is DAMP. Only ship samples that have been preserved in alcohol for at least one week. Re-seal the sample container with electrical tape. Be sure to mark the shipment as Priority Overnight on the Fed Ex packing slip. The sample will be refilled with alcohol immediately upon receipt in the laboratory.



When shipping field data sheets, make every effort to copy the entire completed set first. If a copy machine is not readily available in the hotel in which the field team is staying, or the team is concerned about the potential exorbitant cost of making copies, try to hold the field sheets until a trip can be made to an EPA Regional office, or possibly a satellite field office. The sheets can also be faxed to Tetra Tech, and the originals then mailed. A pre-labeled Fed Ex envelope will be provided in each site kit to mail the original data sheets to the EPA/ORD central data processing center in Corvallis, Oregon. Depending on the total number of sites a team has, data sheets should be mailed every five days to one week. If any particular team does not have too many more sites than that total (i.e., 5 - 7), they can wait until the completion of their sampling window to mail the entirety of their data sheets. Even if a site is not sampleable, the field crew should complete the site verification form for that site and include that in the set of forms mailed to Corvallis.

### **3.3 STATUS REPORTS**

After visiting and/or sampling a site, each field team leader files a status report with their respective field coordinator and with Tetra Tech. Reports should be filed every day before unpreserved samples are shipped. File a status reports for **every site visited** (even if not sampled). These status reports inform the project coordinators of the anticipated delivery of samples (this is especially important when samples are shipped on a Friday for Saturday delivery), and allow the information management staff to better track sites and samples (especially preserved samples that are not delivered directly to a laboratory).

The procedure for preparing and submitting a status report to the field coordinator is presented in Table 3-6. The information needed for a status report comes from the Stream Verification Form and from the tracking forms prepared for both unpreserved and preserved samples. Status reports can be submitted by phone/voice mail, e-mail, or by FAX. Teams should also inventory their supplies after each stream visit. Submit requests for replenishment to the field coordinator well in advance of exhausting on-hand stocks.

### **3.4 EQUIPMENT AND SUPPLIES**

A checklist of equipment and supplies required to conduct the activities described in Section 3 is presented in Figure 3-7. This checklist is similar to the checklist in Appendix A, which is used at the base location to ensure that all of the required equipment is brought to the stream. Use this checklist to ensure that equipment and supplies are organized and available at the stream site in order to conduct the activities efficiently.

**TABLE 3-5. FIELD DATA SHEETS TO BE SHIPPED**

<b>Number per Site</b>	<b>Item</b>
1	Verification Form
1	Sample Collection Form and Stream Discharge Form
11 + extras	Channel/Riparian Cross-section & Thalweg Profile Form
1	Slope & Bearing Form
1	Legacy Tree Form
1	Channel Constraint & Field Measurement Form, Torrent Evidence Assessment Form
1	Rapid Habitat Assessment Form
1	Assessment Form for Visual Assessment
2 + extras	Sample Tracking Form

**TABLE 3-6. STATUS REPORTING**

1. File a status report after **every site visit** (even if not sampled) on the day that you ship unpreserved samples (before shipment if practical). Submit reports to the field coordinator.
2. Complete two separate tracking forms for each site. One form is for unpreserved water chemistry samples, the other for preserved benthos samples. Make a copy of each form (by hand or a photocopy). Include the copy with the sample shipment (unpreserved) or with the samples themselves (preserved samples).
3. Use the original copies of the tracking forms and the stream verification form from the site to prepare the status report.
4. Contact Tetra Tech at the following numbers: **(443) 465-7663 or 800-504-4861**. The status report should be filed with Jennifer Pitt. The alternate contact is Kristen Pavlik at 410-356-8993. NOTE: There is no need to leave a separate message with the analytical laboratory staff in Corvallis. They will be alerted to the anticipated delivery of the samples.
5. Include the following information in your report if left as a voice message or e-mail (**Jennifer.Pitt@tetrattech.com**):
  - Your name and organization.
  - The name of the study (Wadeable Stream Assessment).
  - From the stream verification form:
    - Site ID number and visit number
    - Sampling status from the verification form (e.g., Sampleable/Wadeable, Non-sampleable-not wadeable, no access-access denied, etc.)
    - Date sampled or visited
  - From the tracking form for unpreserved samples:
    - Date shipped
    - Airbill number
    - Anticipated date of delivery to laboratory (usually the next day)
  - For each sample in shipment:
    - Sample ID
    - Sample type (chemistry)
    - Comments regarding condition or missing subsamples
  - From the tracking form for preserved samples:
    - Sample ID
    - Sample Type (reachwide benthos)
    - Comments regarding number of jars, condition, or missing samples

Alternatively, you can FAX copies of the verification form and two tracking forms to the following number: **(410) 356-9005 ATTN: Jennifer Pitt or Kristen Pavlik**.

Return the original forms to the data forms packet for the site for later shipment using the shipping labels included in the site dossier. Field data forms should be copied and shipped within 5-7 days to the WSA Data Management Team, operated under contract to CSC: Marlys Cappaert, c/o U.S. EPA, NHEERL/WED, 200 W. 35<sup>th</sup> St., Corvallis, OR 97333.

**TABLE 3-7. SUMMARY OF BASE LOCATION ACTIVITIES AND SUPPLIES**

QTY.	ITEM	
<b>Before Departure for Stream</b>		
1	Dossier of access information for scheduled stream site	
1	Sampling itinerary form or notebook	
1	Safety log and/or personal safety information for each team member	
1	GPS receiver with extra batteries	
1	Field thermometer	
1	500-mL plastic bottle containing deionized water	
2	500-mL plastic bottles containing conductivity QCCS, labeled "Rinse" and "Test"	
1	Current velocity meter with probe and wading rod	
	Assorted extra batteries for dissolved, conductivity, and current velocity meters	
1 set	Completed water chemistry sample labels (3 labels with same barcode)	
1 set	Water chemistry sample containers (one 4-L Cubitainer and two 60-mL syringes with a plastic storage container)	
1 box	Clear tape strips to cover completed sample labels	
1	Checklist of all equipment and supplies required for a stream visit	
<b>Packing and Shipping Samples</b>		
	Ice or frozen ice substitute packs	
1 box	2-gal heavy-duty sealable plastic bags	
1 box	1-gal heavy-duty sealable plastic bags	
1-box	30-gal plastic garbage bags	
1	Insulated shipping container for water chemistry sample	
1	Container, absorbent material, labels, and shipping forms required to transport and/or ship benthic macroinvertebrate sample preserved in ethanol	
2-4	Sample tracking forms (can xerox completed originals or complete two sets of forms per shipment)	
	Shipping airbills and adhesive plastic sleeves	

## NOTES





## **4.0 INITIAL SITE PROCEDURES**

When a field team first arrives at a stream site, they must first confirm they are at the correct site. Then they determine if the stream meets certain criteria for sampling and data collection activities to occur. They must decide whether the stream is unduly influenced by rain events which could affect the representativeness of field data and samples. Certain conditions at the time of the visit may warrant the collection of only a subset of field measurements and samples. Finally, if it is determined that the stream is to be sampled, the team lays out a defined reach of the stream within which all subsequent sampling and measurement activities are conducted.

### **4.1 SITE VERIFICATION ACTIVITIES**

#### **4.1.1 Locating the Index Site**

Stream sampling points were chosen from the “blue line” stream network represented on 1:100,000- scale USGS maps, following a systematic randomized selection process developed for WSA stream sampling (Stevens and Olsen, 2004). Each point is referred to as the “index site” or “**X-site**”. The X-site is the mid-point of the sampling reach. The latitude/longitude of the X-site was listed on a regional sampling site spreadsheet that was distributed to the EPA Regional Coordinators on a regional site information CD in February 2004. The Regional Coordinators will make copies of the CD and distribute the CDs to each Cooperator within his/her region. The CD includes overlay maps of each X-site. The overlay maps include the state and county name where the X-site is located, along with the titles of the corresponding 1:100,000 and 1:24,000 scale USGS topographic maps. The overlay maps should be used in conjunction with 1:24,000-scale USGS topographic maps to locate and reference the sample point on the appropriate stream. (See accompanying *Site Evaluation Guidelines* document.)

While traveling from a base location to a site, record a detailed description of the route taken on page 1 of the Verification Form (Figure 4-1). This information will allow others to find the site again in the future. Upon reaching the X-site for a stream, confirm its location and that the team is at the correct stream. Use all available means to accomplish this, and record the information on page 1 of the Verification Form (Figure 4-1). Complete a verification form for each stream visited (regardless of whether you end up sampling it), following the procedures described in Table 4-1.

#### **4.1.2 Determining the Sampling Status of a Stream**

Not all chosen stream sites will turn out to be streams. On the basis of previous synoptic surveys, it was found that the maps are not perfect representations of the stream network. After the stream and location of the X-site are confirmed, evaluate the stream reach surrounding the X-site and classify the stream into one of three major sampling status categories (Table 4-1). The primary distinction between “Sampleable” and “Non-Sampleable” streams is based on the presence of a defined stream channel and water content.

**STREAM VERIFICATION FORM - STREAMS/RIVERS**

Reviewed by (Initial): SP

SITE NAME: PILOT CREEK DATE: 07/01/2001 VISIT: 0 1 2 3

SITE ID: WXXP99-9999 TEAM: XX-1

**STREAM/RIVER VERIFICATION INFORMATION**

Stream/River Verified by (X all that apply):  GPS  Local Contact  Signs  Roads  Topo. Map  
 Other (Describe Here):  Not Verified (Explain in Comments)

Coordinates	Latitude North	Longitude West	Type of GPS Fix	Are GPS Coordinates w/ 10 Sec. of map?
MAP Degrees, Minutes, and Seconds OR Decimal Degrees	<u>3.8 1.0 2.5</u>	<u>114 2.5 1.0</u>	<input type="checkbox"/> 2D	<input checked="" type="checkbox"/> Yes
GPS Degrees, Minutes, and Seconds OR Decimal Degrees	<u>3.8 1.0 2.6</u>	<u>114 2.5 1.5</u>	<input checked="" type="checkbox"/> 3D	<input type="checkbox"/> No

**DID YOU SAMPLE THIS SITE?**

<input checked="" type="checkbox"/> <b>YES</b> If YES, check one below  <b>SAMPLEABLE</b> (Choose method used) <input checked="" type="checkbox"/> Wadeable - Continuous water, greater than 50% wadeable <input type="checkbox"/> Boatable <input type="checkbox"/> Partial - Sampled by wading (Explain in comments) <input type="checkbox"/> Partial - Sampled by boat (Explain in comments) <input type="checkbox"/> Wadeable Interrupted - Not continuous water along reach <input type="checkbox"/> Boatable Interrupted - Not continuous water along reach <input type="checkbox"/> Altered - Stream/River Present but not as on Map	<input type="checkbox"/> <b>NO</b> If NO, check one below  <b>NON-SAMPLEABLE-PERMANENT</b> <input type="checkbox"/> Dry - Visited <input type="checkbox"/> Dry - Not visited <input type="checkbox"/> Wetland (No Definable Channel) <input type="checkbox"/> Map Error - No evidence channel/waterbody ever present <input type="checkbox"/> Impounded (Underneath Lake or Pond) <input type="checkbox"/> Other (explain in comments)  <b>NON-SAMPLEABLE-TEMPORARY</b> <input type="checkbox"/> Not boatable - Need a different crew <input type="checkbox"/> Not wadeable - Need a different crew <input type="checkbox"/> Other (Explain in comments)  <b>NO ACCESS</b> <input type="checkbox"/> Access Permission Denied <input type="checkbox"/> Permanently Inaccessible (Unable/Unsafe to Reach Site) <input type="checkbox"/> Temporarily Inaccessible-Fire, etc. (Explain in comments)
--	---

**GENERAL COMMENTS:**

---



---



---



---

**DIRECTIONS TO STREAM/RIVER SITE:** From Barnesville, go East on County Road 996 ~5 miles to Smithtown Road. Turn South and travel 0.6 miles to gravel road on left. Turn onto gravel road and drive 0.5 miles to house on right side of road. Owner will unlock gate to road leading to stream near the X-site location.

Figure 4-1. Verification Form (page 1).

**TABLE 4-1. SITE VERIFICATION PROCEDURES**

1. Find the stream location in the field corresponding to the X-site coordinates and the "X" marked on a 7.5" topographic map (X-site) prepared for each site. Record the routes taken and other directions on the Verification Form so that others can visit the same location in the future.
2. Use a GPS receiver to confirm the latitude and longitude at the X-site with the coordinates for the site (datum = NAD 27). Record these on the Verification Form.
3. Use all available means to insure that you are at the correct stream as marked on the map, including: 1:24,000 USGS map orienteering, topographic landmarks, county road maps, local contacts, etc.
4. Scan the stream channel upstream and downstream **from the X-site**, decide if the site is sampleable and mark the appropriate box on the verification form. If the channel is dry at the X-site, determine if water is present within 75 m upstream and downstream of the X-site. Assign one of the following sampling status categories to the stream. Record the category on the Verification Form.

**Sampleable Categories**

Wadeable: The stream can be sampled with wadeable stream protocols, continuous water flow and > 50% of the sample reach is wadeable.

Partial Sampled by Wading: Over half the reach cannot be safely sampled by wadeable protocols. Sample using modified procedures.

Wadeable Interrupted: The flow of water is not continual, but there is water in the sample reach (e.g. isolated pools). Sample using modified procedures. Record as Wadeable Interrupted.

Altered Channel: There is a stream at the location marked with the X-site on the map, but the stream channel does not appear the way it is drawn on the map. An example would be a channel rerouting following a flood event that cut off a loop of the stream. Establish a new X-site at the same relative position in the altered channel. Make careful notes and sketches of the changes on the Verification Form.

**Non-Sampleable Categories**

PERMANENT:

Dry Channel: A discernible stream channel is present but there is no water anywhere within a 150-m reach centered on the X-site. If determined at the time of the sampling visit, record on the field form as "Dry-Visited"; if site was determined to be dry (or otherwise non-perennial) from another source and/or field verified before the actual sampling visit, record as "Dry-Not visited".

Non-wadeable: The site can only be sampled by boat following non-wadeable river protocols.

Wetland (No definable stream channel): There is standing water present, but no definable stream channel. In cases of wetlands surrounding a stream channel, define the site as Target but restrict sampling to the stream channel.

Map Error: No evidence that a water body or stream channel was ever present at the coordinates provided for the X-site.

---

(Continued)

**TABLE 4-1 (Continued)**

**Non-Sampleable Categories**

PERMANENT:

Impounded stream: The stream is submerged under a lake or pond due to man-made or natural (e.g., beaver dam) impoundments. If the impounded stream, however, is still wadeable, record the stream as “Altered” and sample.

Other: The site is non-target for reasons other than those above. Examples would include underground pipelines or a non-target canal.

A sampling site must meet **both** of the following criteria to be classified as a non-target canal:

- i. The channel is constructed where no natural channel has ever existed.
- ii. The sole purpose/usage of the reach is to transfer water. There are no other uses of the waterbody by humans (e.g., fishing, swimming, boating).

TEMPORARY:

Other: The site could not be sampled on that particular day, but is still a target site. Examples might include a recent precipitation event that has caused unrepresentative conditions.

**No Access to Site Categories**

Access Permission Denied: You are denied access to the site by the landowners.

Permanently Inaccessible: Site is unlikely to be sampled by anyone due to physical barriers that prevent access to the site (e.g., cliffs).

Temporarily Inaccessible: Site cannot be reached at the present time due to barriers that may not be present at some future date (e.g. forest fire, high water, road temporarily closed, unsafe weather conditions)

5. Do not sample non-target or “Non-sampleable” or “No Access” sites. Place an “X” in the “NO” box for “Did you sample this site?” and check the appropriate box in the “NON-SAMPLEABLE” or “NO ACCESS” section of the Verification Form; provide detailed explanation in comments section.

Even if there is no water at the X-site coordinates, the site may still be sampleable as an “interrupted flow” stream (Section 4.3.1). If the channel is dry at the X-site coordinates, determine if there is water present within 75 m upstream and downstream of the X-site. If there are isolated pools of water within the 150-m reach, proceed to sample using the modified procedures outlined in Section 4.3.1. If the entire reach is dry, classify the site as “Dry-visited” on the verification form. NOTE: Do not “slide” the reach (Section 4.3) for the sole purpose of obtaining more areas of water to sample (e.g., the downstream portion of the reach has water, but the upstream portion does not).

If a site is located on a canal and it meets the following criteria, then it is considered to be non-target:

1. The channel within the sampling reach is totally constructed at a location where no natural channel has ever existed.

2. The sole purpose and usage of the waterbody is to move water. There are no other human uses, such as fishing, swimming, or boating.

If both of these conditions are met, classify the site as “NON-SAMPLEABLE-PERMANENT, Other” on the verification form and identify the site as a non-target canal in the comments section. If you are in doubt about whether a site is a non-target canal, or if you think the waterbody might represent an important resource for aquatic biota, then sample it if you have permission.

Record the sampling status and pertinent site verification information on the Verification Form (Figure 4-1). If the site is non-sampleable or inaccessible, the site visit is completed, and no further sampling activities are conducted.

#### **4.1.3 Sampling During or After Rain Events**

Avoid sampling during high flow rainstorm events. For one, it is often unsafe to be in the water during such times. In addition, biological and chemical conditions during episodes are often quite different from those during baseflow. On the other hand, sampling cannot be restricted to only strict baseflow conditions. It would be next to impossible to define “strict baseflow” with any certainty at an unstudied site. Such a restriction would also greatly shorten the index period when sampling activities can be conducted. Thus, some compromise is necessary regarding whether to sample a given stream because of storm events. To a great extent, this decision is based on the judgment of the field team. Some guidelines to help make this decision are presented in Table 4-2. The major indicator of the

influence of storm events will be the condition of the stream itself. If a field team decides a site is unduly influenced by a storm event, do not sample the site that day. Notify the field coordinator or other central contact person to reschedule the stream for another visit.

**TABLE 4-2. GUIDELINES TO DETERMINE THE INFLUENCE OF RAIN EVENTS**

---

---

- If it is running at bank full discharge or the water seems much more turbid than typical for the class of stream do not sample it that day.
  - Do not sample that day if it is temporarily unsafe to wade in the majority of the stream reach. If the majority of the stream reach is permanently unsafe, then classify it as a “partially wadeable” stream and sample the portions that can be safely waded.
  - Keep an eye on the weather reports and rainfall patterns. Do not sample a stream during periods of prolonged heavy rains.
  - If the stream seems to be close to normal summer flows, and does not seem to be unduly influenced by storm events, go ahead and sample it, even if it has recently rained or is raining.
- 
-

#### 4.1.4 Site Photographs

Taking site photographs is an optional activity, but should be considered if the site has unusual natural or man-made features associated with it. If you do take any photographs at a stream, start the sequence with one photograph of an 8.5 × 11 inch piece of paper with the site ID, stream name, and date printed in large, thick letters. After the photo of the site ID information, take at least two photographs at the X-site, one in the upstream direction and one downstream. Take any additional photos you find interesting after these first three pictures. Keep a log of your photographs and briefly describe each one.

#### 4.2 LAYING OUT THE SAMPLING REACH

Unlike chemistry, which can be measured at a point, most of the biological and habitat structure measures require sampling a certain length of a stream to get a representative picture of the ecological community. A length of 40 times the channel width is necessary to characterize the biotic assemblages and habitat associated with the sampling reach. Establish the sampling reach about the X-site using the procedures described in Table 4-3. Scout the sampling reach to make sure it is clear of obstacles that would prohibit sampling and data collection activities. Record the channel width used to determine the reach length, and the sampling reach length upstream and downstream of the X-site on page 2 of the Verification Form as shown in Figure 4-2. Figure 4-3 illustrates the principal features of the established sampling reach, including the location of 11 cross-section transects used for physical habitat characterization (Section 7), and specific sampling points on each cross-section transect for later collection of benthic macroinvertebrate samples (Section 6).

---

**TABLE 4-3. LAYING OUT THE SAMPLING REACH**

---

1. Use a surveyor's rod or tape measure to determine the wetted width of the channel at five places considered to be of "typical" width within approximately 5 channel widths upstream and downstream from the X-site. Average the five readings together and round to the nearest 1 m. If the average width is less than 4 m, use 150 m as a minimum sample reach length. Record this width on page 2 of the Verification Form.

For channels with "interrupted flow", estimate the width based on the unvegetated width of the channel (again, with a 150 m minimum).

2. Check the condition of the stream upstream and downstream of the X-site by having one team member go upstream and one downstream. Each person proceeds until they can see the stream to a distance of 20 times the average channel width (equal to one-half the sampling reach length, but a minimum of 75 m) determined in Step 1 from the X-site.

For example, if the reach length is determined to be 150 m, each person would proceed 75 m from the X-site to lay out the reach boundaries.

3. Determine if the reach needs to be adjusted about the X-site due to confluences with higher order streams (downstream), lower order streams (upstream), impoundments (lakes, reservoirs, ponds), physical barriers (e.g., falls, cliffs), or because of access restrictions to a portion of the initially-determined sampling reach.

---

**(Continued)**

---

**TABLE 4-3 (Continued)**

---

If such a confluence, barrier, or access restriction is present, note the distance and flag the confluence, barrier, or limit of access as the endpoint of the reach. Move the other endpoint of the reach an equivalent distance away from the X-site. **The X-site must still be within the reach after adjustment.** The total reach length does not change, but the reach is no longer centered on the X-site.

**NOTE: Do not slide the reach to avoid man-made obstacles such as bridges, culverts, rip-rap, or channelization, or in streams with interrupted flow to obtain more inundated areas to sample.**

4. Starting back at the X-site (or the new midpoint of the reach if it had to be adjusted as described in Step 3), measure a distance of 20 channel widths down one side of the stream using a tape measure. Be careful not to "cut corners". Enter the channel to make measurements only when necessary to avoid disturbing the stream channel prior to sampling activities. This endpoint is the downstream end of the reach, and is flagged as transect "A".
5. At Transect A, use a digital wristwatch and glance at the seconds display to select the initial sample collection point for benthic macroinvertebrates: 1-3="Left", 4-6="Center", 7-9="Right". (If using an watch with a second hand: 12-4="Left", 4-8="Center, and 8-12="Right). Mark "L", "C", or "R" on the transect flagging.
6. Measure 1/10 (4 channel widths in big streams or 15 m in small streams) of the required reach length upstream from transect A. Flag this spot as transect B. Assign the sample collection point (L, C, or R) systematically after the first random selection.

For example, if the sample collection point assigned to transect A was "C", the point for transect B is "R".

7. Proceed upstream with the tape measure and flag the positions of 9 additional transects (labeled "C" through "K" as you move upstream) at intervals equal to 1/10 of the reach length. Continue to assign the sample collection points systematically

For example, if the point assigned to Transect B is "R", the point for transect C is "L", transect D is "C", etc.

---

There are some conditions that may require adjusting the reach about the X-site (i.e., the X-site no longer is located at the midpoint of the reach) to avoid features we do not wish to (or physically cannot) sample across. Do not proceed upstream into a lower order stream or downstream into a higher order stream when laying out the stream reach (order is based on 1:100,000 scale maps). Adjust the reach if you run into an impoundment ( lake, reservoir, or pond), or an impassible barrier (e.g., waterfall, cliff) while laying out the reach, adjust the reach such that the lake/stream confluence is at one end. Adjusting, or "sliding" the reach involves noting the distance of the confluence, barrier, or other restriction from the X.site, and flagging the confluence, impoundment/stream confluence, or barrier as the endpoint of the reach, and adding the distance to the other end of the reach, such that the total reach length remains the same, but it is no longer centered about the X-site. In cases where you are denied access permission to a portion of the reach, you can adjust the reach to make it entirely accessible; use the point of access restriction as the endpoint of the reach.

STREAM VERIFICATION FORM - STREAMS/RIVERS (cont.)

Reviewed by (initial): SP

SITE NAME: PILOT CREEK DATE: 07/01/2001 VISIT: 0 1 2 3  
 SITE ID: WXXP99- TEAM: XX-1

STREAM/RIVER REACH DETERMINATION			Comment
Channel Width Used to Define Reach (m)	DISTANCE (m) FROM X-SITE		
	Upstream Length	Downstream Length	
<u>3</u>	<u>7.5</u>	<u>7.5</u>	

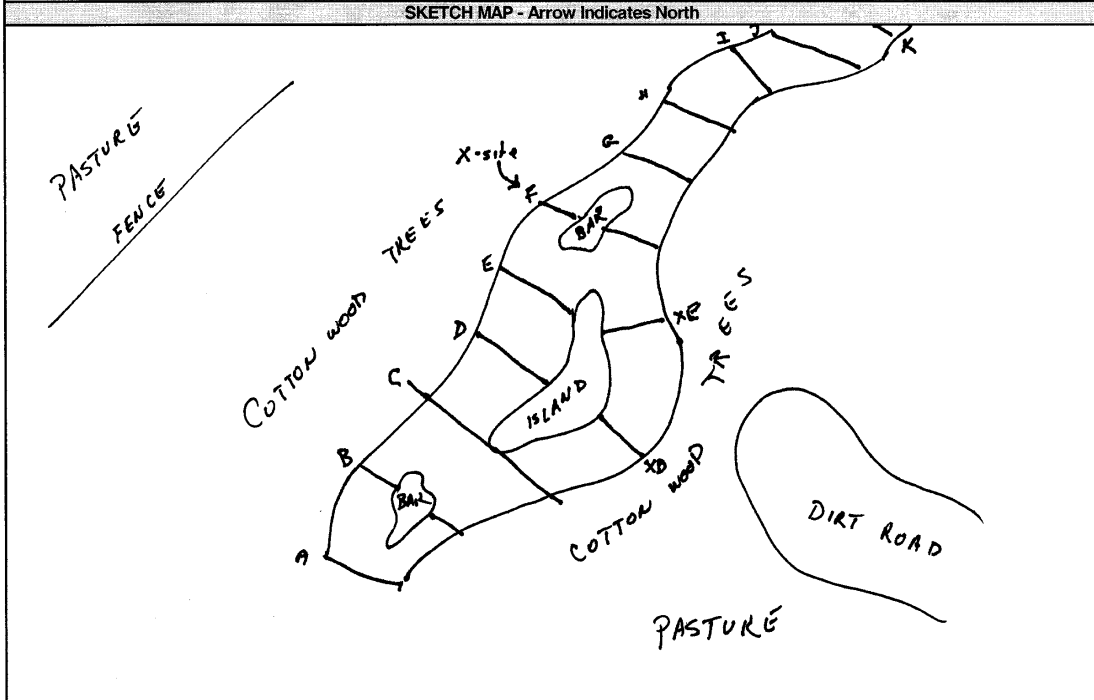

PERSONNEL		Team Number: <u>XX-1</u>		
NAME	Biomorph	DUTIES Geomorph	Forms	
<u>J. SHMOE</u>	<input checked="" type="checkbox"/>	<input type="checkbox"/>	<input type="checkbox"/>	
<u>G. WHIZ</u>	<input checked="" type="checkbox"/>	<input type="checkbox"/>	<input type="checkbox"/>	
<u>E. MAPPER</u>	<input type="checkbox"/>	<input checked="" type="checkbox"/>	<input checked="" type="checkbox"/>	
<u>S. TREAM</u>	<input type="checkbox"/>	<input checked="" type="checkbox"/>	<input type="checkbox"/>	
	<input type="checkbox"/>	<input type="checkbox"/>	<input type="checkbox"/>	

Figure 4-2. Verification Form (page 2)



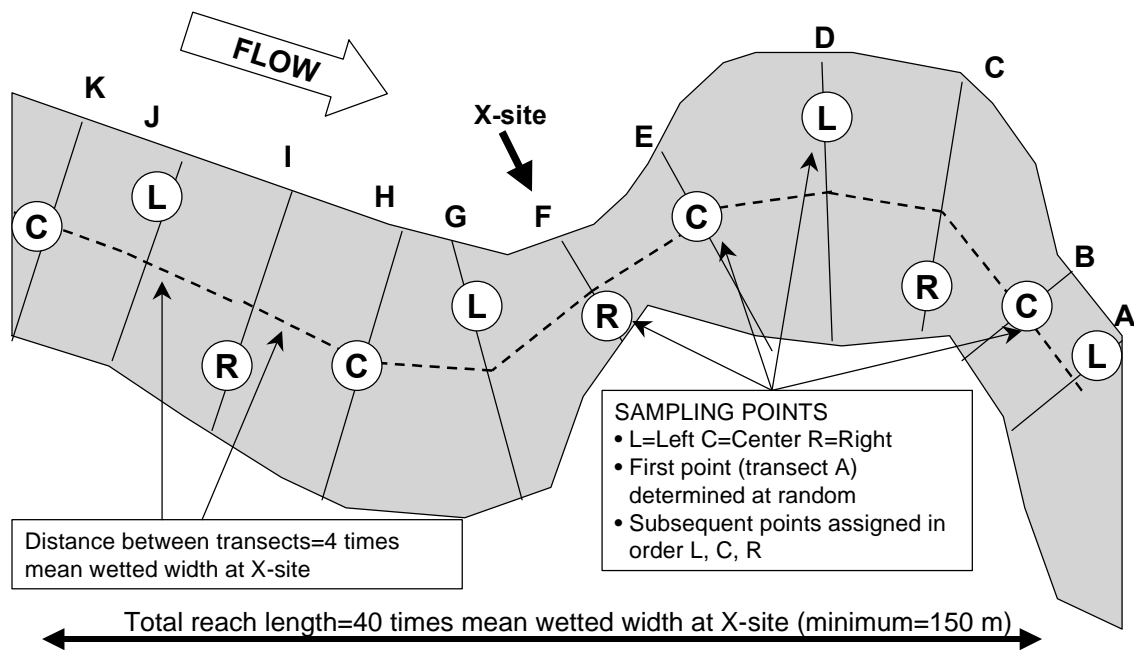

Figure 4-3. Sampling reach features.

Do not “slide” the reach so that the X-site falls outside of the reach boundaries. Also, do not “slide” a reach to avoid man-made obstacles such as bridges, culverts, rip-rap, or channelization. These represent important features and effects to study. Also, do not slide the reach to obtain more water to sample if the flow is interrupted (Section 4.3.1).

Before leaving the stream, complete a rough sketch map of the stream reach you sampled on page 2 of the Verification Form (Figure 4-2). In addition to any other interesting features that should be marked on the map, note any landmarks/directions that can be used to find the X-site for future visits.

### 4.3 MODIFYING SAMPLE PROTOCOLS FOR HIGH OR LOW FLOWS

#### 4.3.1 Streams with Interrupted Flow

The full complement of field data and samples cannot be collected from streams that are categorized as “Interrupted” (Table 4-2). Note that no data should be collected from streams that are completely “Dry” as defined in Table 4-2. Interrupted streams will have some cross-sections amenable to biological sampling and habitat measurements and some that are not. Modified procedures for interrupted streams are presented in Table 4-4.

Samples for water chemistry (Section 5) should be collected at the X-site (even if the reach has been adjusted by “sliding” it). If the X-site is dry and there is water elsewhere in the sample reach, collect the sample from a location having water with a surface area greater than 1 m<sup>2</sup> and a depth greater than 10 cm.

**TABLE 4-4. MODIFICATIONS FOR INTERRUPTED STREAMS**

<b>Water Chemistry</b>	
●	If the X-site is dry but there is flowing water or a pool of water having a surface area greater than 1 m <sup>2</sup> and a depth greater than 10 cm somewhere along the defined sampling reach, take the water sample at the pool or flowing water location that is nearest to the X-site. Note that the sample wasn't collected at the X-site and where on the reach the sample was collected on the field data form.
●	Do not collect a water sample if there is no acceptable location within the sampling reach. Record a “K” flag for the chemistry sample on the sample collection form and explain why the sample was not collected in the comments section of the form.
<b>Physical Habitat Characterization and Benthic Macroinvertebrates</b>	
●	Obtain a complete thalweg profile for the entire reach. At points where channel is dry, record depth as 0 cm and wetted width as 0 m.
●	At each of the transects (cross sections), sample the stream depending on flow status: <p style="margin-left: 40px;">DRY CHANNEL: No surface water anywhere in cross section; Collect all physical habitat data. Use the unvegetated area of the channel to determine the channel width and the subsequent location of substrate sampling points. Record the wetted width as 0 m. Record substrate data at the sampling points located in the unvegetated, but dry, channel. Do not collect benthic macroinvertebrates from this transect.</p> <p style="margin-left: 40px;">DAMP CHANNEL: No flowing water at transect, only puddles of water &lt; 10 cm deep; Collect all physical habitat data. Do not collect a benthic macroinvertebrate sample.</p> <p style="margin-left: 40px;">WATER PRESENT: Transect has flow or pools &gt; 10 cm deep; Collect all data and measurements for physical habitat and benthic macroinvertebrate indicators, using standard procedures.</p>

Data for the physical habitat indicator (Section 8) are collected along the entire sample reach from interrupted streams, regardless of the amount of water present at the transects. Depth measurements along the deepest part of the channel (the “thalweg”) are obtained along the entire sampling reach providing a record of the "water" status of the stream for future comparisons (e.g., the percent of length with intermittent pools or no water). Other measurements associated with characterizing riparian condition, substrate type, etc. are useful to help infer conditions in the stream when water is flowing.

### 4.3.2 Partially Wadeable Sites

Some sites are too deep or swift to safely wade the majority or all of the sample reach, and thus impossible to do all of the wadeable sampling protocols. At these sites, keeping safety in mind, the crews should try to do as much sampling and data collection as they can. It might be impossible to do thalweg depth profiles and flow measurements, but it should be possible to do the various assessments that don't require getting in the water (bank characterization, riparian vegetation and disturbance, stream/river assessment, RBP habitat assessment). It is also usually possible to collect a water sample for chemistry and perhaps to do the transect sampling near the bank for benthos. The amount of sampling that can actually be done will depend on the extant conditions. Only sample or measure what can be done **safely**. Make detailed comments on the Verification Form describing what the conditions were like and how much sampling could actually be done. Use the sketch map on the back of the Verification Form to indicate problem areas and where samples were collected if you had to go off transect. If barriers to the site prohibit physically reaching the X-site, then the site is not a Sampleable site but should be coded as "No Access - Inaccessible" on the Verification Form.

### 4.3.3 Braided Systems

Depending upon the geographic area and/or the time of the sampling visit, you may encounter a stream having "braided" channels, which are characterized by numerous sub-channels that are generally small and short, often with no obvious dominant channel (See Section 8.6.1). If you encounter a braided stream, establish the sampling reach using the procedures presented in Table 4-5. Figuring the mean width of extensively braided systems for purposes of setting up the sample reach length is challenging. For braided systems, calculate the mean width as the bankfull channel width as defined in the physical habitat protocol (Section 8). For relatively small streams (mean bankfull width  $\leq 15$  m) the sampling reach is defined as 40 times the mean bankfull width. For larger streams, ( $> 15$  m), sum up the actual wetted width of all the braids and use that as the width for calculating the 40 channel width reach length. If there is any question regarding an appropriate reach length for the braided system, it is better to err on the excessive side. Make detailed notes and sketches on the Verification Form (Figure 4-2) about what you did. It's important to remember that the purpose of the 40 channel width reach length is to sample enough stream to incorporate the variability in habitat types. Generally, the objective is to sample a long enough stretch of a stream to include 2 to 3 meander cycles (about 6 pool-riffle habitat sequences). In the case of braided systems, the objective of this protocol modification is to avoid sampling an excessively long stretch of stream. In a braided system where there is a 100 m wide active channel (giving a 4 km reach length based on the standard procedure) and only 10 m of wetted width (say five, 2 m wide braids), a 400 m long sample reach length is likely to be sufficient, especially if the system has fairly homogenous habitat throughout its length.

## 4.4 EQUIPMENT AND SUPPLIES

A list of the equipment and supplies required to conduct the stream verification and to lay out the sampling reach is presented in Table 4-6. This checklist is similar to the checklist presented in Appendix A, which is used at the base location (Section 3) to ensure that all of the required equipment is brought to the stream. Use this checklist to ensure that

equipment and supplies are organized and available at the stream site in order to conduct the activities efficiently.

**TABLE 4-5. MODIFICATIONS FOR BRAIDED STREAMS**

- 
- 
1. Estimate the mean width as the bankfull channel width as defined in the physical habitat protocol.
    - 1A. If the mean width is less than or equal to 15 m, set up a 40 channel width sample reach in the normal manner.
    - 1B. If more than 15 m, sum up the actual wetted width of all the braids and use that as the width for calculating the 40 channel width reach length. Remember the minimum reach length is always 150 m.
    - 1C. If the reach length determined in 1B seems too short for the system in question, set up a longer sample reach, taking into consideration that the objective is to sample a long enough stretch of a stream to include at least 2 to 3 meander cycles (about 6 pool-riffle habitat sequences).
  2. Make detailed notes and sketches on the Verification Form about what you did.

**TABLE 4-6. EQUIPMENT AND SUPPLIES CHECKLIST FOR INITIAL SITE ACTIVITIES**

---



---

QTY.	Item
1	Dossier of site and access information
1	Topographic map with "X-site" marked
1	Site information sheet with map coordinates and elevation of X-site
1	GPS receiver and operating manual
	Extra batteries for GPS receiver
1	Verification Form
	Soft lead (#2) pencils
1	Surveyor's telescoping leveling rod
1	50-m fiberglass measuring tape with reel
2 rolls	Surveyor's flagging tape (2 colors)
	Fine-tipped indelible markers to write on flagging
1	Waterproof camera and film (or digital camera)
1 copy	Field operations and methods manual
1 set	Procedure tables and/or quick reference guides for initial site activities (laminated or printed on write-in-the-rain paper)

---



---

## NOTES



## 5.0 WATER CHEMISTRY

At each sampling site, teams will record stream temperature and fill one 4-L container and two 60 mL syringes with streamwater. (If concurrent water samples are to be analyzed by another laboratory, then an adequate amount of additional streamwater must be collected.) These samples are stored in a cooler packed with plastic bags filled with ice and are shipped or driven to the analytical laboratory within 24 hours of collection (see Section 3). The primary purposes of the water samples are to determine:

- Acid-base status
- Trophic condition (nutrient enrichment)
- Chemical Stressors (metals, toxicants)
- Classification of water chemistry type.

Water from the 4-L bulk sample is used to measure the major cations and anions, conductivity, acid neutralizing capacity, dissolved organic carbon, nutrients, turbidity, total suspended solids, and color. The syringe samples are analyzed for pH and dissolved inorganic carbon. Syringes are used to seal off the samples from the atmosphere because the pH, dissolved inorganic carbon (DIC) will all change if the streamwater equilibrates with atmospheric CO<sub>2</sub>. Overnight express mail for these samples is required because the syringe samples need to be analyzed, and the 4-L bulk sample needs to be stabilized (by filtration and/or acidification) within a short period of time (72 hours) after collection.

### 5.1 SAMPLE COLLECTION

Before leaving the base location, fill out a set of water chemistry sample labels as shown in Figure 5-1. Attach a completed label to the cubitainer and each of two syringes and cover with clear tape strips as described in Section 3. Make sure the syringe labels do not cover the volume gradations. Package the pre-labeled containers and the sampling beaker in a small plastic trash bag to prevent contamination (see Section 3). In the field, make sure that the labels all have the same sample ID number (barcode), and that the labels are securely attached.

The procedure to collect a water chemistry sample is described in Table 5-1. Collect the sample from the middle of the stream channel at the X-site, unless no water is present at that location (see Section 4). It is important to take precautions to avoid contaminating the sample. Rinse all sample containers three times with portions of stream water before filling them with the sample. Many streams have a very low ionic strength and can be contaminated quite easily by perspiration from hands, sneezing, smoking, insect repellent, hand sanitizers, or other chemicals used when collecting other types of samples. Thus, make sure that none of the water sample contacts your hands before going into the cubitainer. All of the chemical analyses conducted using the syringe samples are affected by equilibration with atmospheric carbon dioxide; thus, it is essential that no outside air contact the syringe samples during or after collection. Record the information from the sample label on the Sample Collection Form as shown in Figure 5-2. Note any problems related to possible contamination in the comments section of the form.

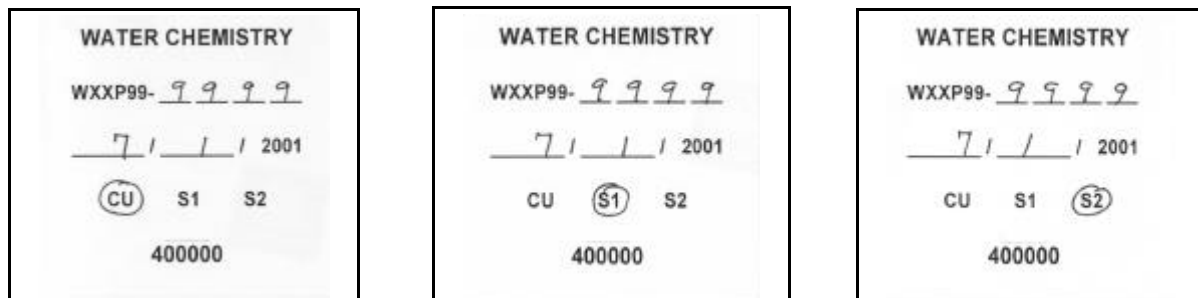

Figure 5-1. Completed sample labels for water chemistry.

**TABLE 5-1. SAMPLE COLLECTION PROCEDURES FOR WATER CHEMISTRY**

Collect the water samples from the X-site in a flowing portion near the middle of the stream.

1. Rinse the 500 mL sample beaker three times with streamwater, Discard the rinse downstream.
2. Remove the cubitainer lid and expand the cubitainer by pulling out the sides. **NOTE: DO NOT BLOW into the cubitainers to expand them, this will cause contamination.**
3. Fill the beaker with streamwater and slowly pour 30-50 mL into the cubitainer. Cap the cubitainer and rotate it so that the water contacts all the surfaces. Discard the water downstream. Repeat this rinsing procedure two more times.
4. Collect additional portions of streamwater with the beaker and pour them into the cubitainer. Let the weight of the water expand the cubitainer. The first two portions will have to be poured slowly as the cubitainer expands. Fill the cubitainer to at least three-fourths of its maximum volume. Rinse the cubitainer lid with streamwater. Eliminate any air space from the cubitainer, and cap it tightly. Make sure the cap is tightly sealed and not on at an angle.
5. Place the cubitainer in a cooler (on ice or streamwater) and shut the lid. If a cooler is not available, place the cubitainer in an opaque garbage bag and immerse it in the stream.
6. Submerge a 60-mL syringe halfway into the stream and withdraw a 15-20 mL aliquot. Pull the plunger to its maximum extension and shake the syringe so the water contacts all surfaces. Point the syringe downstream and discard the water by depressing the plunger. Repeat this rinsing procedure two more times.
7. Submerge the syringe into the stream again and **slowly** fill the syringe with a fresh sample. Try not to get any air bubbles in the syringe. If more than 1-2 tiny bubbles are present, discard the sample and draw another one.
8. Invert the syringe (tip pointing up), and cap it with a syringe valve. Tap the syringe lightly to detach any trapped air bubbles. With the valve open, expel the air bubbles and a small volume of water, leaving between 50 and 60 mL of sample in the syringe. Close the syringe valve. If any air bubbles were drawn into the syringe during this process, discard the sample and fill the syringe again (Step 7).
9. Repeat Steps 6 through 8 with a second syringe. Place the syringes together in the cooler or in the streamwater with the cubitainer.



10. Record the barcode number (Sample ID) on the Sample Collection Form along with the pertinent stream information (stream name, ID, date, etc.). Note anything that could influence sample chemistry (heavy rain, potential contaminants) in the Comments section. If the sample was collected at the X-site, record an "X" in the "STATION COLLECTED" field. If you had to move to another part of the reach to collect the sample, place the letter of the nearest transect in the "STATION COLLECTED" field. Record more detailed reasons and/or information in the Comments section.
  11. After carrying the samples out to the vehicles, place the cubitainer and syringes in a cooler and surround with 1 gallon self-sealing plastic bags filled with ice. The cooler should first be lined with the heavy grade plastic trash bag provided in the Site Kit. *\*Note: the syringes must be placed in the protective plastic container provided in the Site Kit.*
  12. **Water chemistry samples must be shipped via overnight delivery within 24 hours of collection.** The syringes must be placed in the protective plastic container, and the cubitainer and the plastic container of syringes must be placed in the cooler and surrounded by 1 gallon self-sealing plastic bags filled with ice. The cooler should first be lined with the heavy grade plastic trash bag provided in the Site Kit. This will help prevent leaking, which would cause shipping delays and compromise the sample.
- 
- 

## 5.2 FIELD MEASUREMENT FOR TEMPERATURE

Stream temperature should be measured at the X-site (even if the reach has been adjusted by "sliding" it) using the field thermometer. Wait at least 1 minute for the displayed reading to stabilize, and record the stream temperature on the Channel Constraint and Field Chemistry Form (Figure 5-3).

## 5.3 EQUIPMENT AND SUPPLIES

A list of equipment and supplies required to collect samples and field data for the water chemistry indicator is presented in Table 5-2. This checklist is similar to the checklist presented in Appendix A, which is used at the base location (Section 3) to ensure that all of the required equipment is brought to the stream. Use this checklist to ensure that equipment and supplies are organized and available at the stream site in order to conduct the activities efficiently.

**SAMPLE COLLECTION FORM - STREAMS**

Reviewed by (initial): DP

SITE ID: WXXP99-9999 DATE: 07/01/2002

WATER CHEMISTRY		
Sample ID	Transect	Comments
<u>2.2.9.0.1.5</u>	<u>X</u>	

REACH-WIDE BENTHOS SAMPLE		
Sample ID	No. of Jars	Comment
<u>9.9.9.0.0.1</u>	<u>2</u>	<u>FOR TRANSECT K OTHER = SMALL WOODY DEBRIS</u>

TRANSECT	A	B	C	D	E	F	G	H	I	J	K
<b>SUBSTRATE</b>	<b>CHAN.</b>	Sub. Chan.	Sub. Chan.	Sub. Chan.	Sub. Chan.	Sub. Chan.	Sub. Chan.	Sub. Chan.	Sub. Chan.	Sub. Chan.	Sub. Chan.
Fine/Sand	Pool	<input type="checkbox"/> F <input type="checkbox"/> P	<input checked="" type="checkbox"/> F <input type="checkbox"/> P	<input checked="" type="checkbox"/> F <input checked="" type="checkbox"/> P	<input type="checkbox"/> F <input type="checkbox"/> P	<input type="checkbox"/> F <input type="checkbox"/> P	<input type="checkbox"/> F <input type="checkbox"/> P	<input checked="" type="checkbox"/> F <input type="checkbox"/> P	<input checked="" type="checkbox"/> F <input checked="" type="checkbox"/> P	<input checked="" type="checkbox"/> F <input checked="" type="checkbox"/> P	<input type="checkbox"/> F <input checked="" type="checkbox"/> P
Gravel	Glide	<input checked="" type="checkbox"/> G <input type="checkbox"/> GL	<input type="checkbox"/> G <input type="checkbox"/> GL	<input type="checkbox"/> G <input type="checkbox"/> GL	<input checked="" type="checkbox"/> G <input checked="" type="checkbox"/> GL	<input checked="" type="checkbox"/> G <input type="checkbox"/> GL	<input type="checkbox"/> G <input type="checkbox"/> GL	<input checked="" type="checkbox"/> G <input type="checkbox"/> GL	<input type="checkbox"/> G <input type="checkbox"/> GL	<input type="checkbox"/> G <input type="checkbox"/> GL	<input type="checkbox"/> G <input type="checkbox"/> GL
Coarse	Riffle	<input type="checkbox"/> C <input checked="" type="checkbox"/> RI	<input type="checkbox"/> C <input type="checkbox"/> RI	<input type="checkbox"/> C <input type="checkbox"/> RI	<input type="checkbox"/> C <input type="checkbox"/> RI	<input type="checkbox"/> C <input type="checkbox"/> RI	<input checked="" type="checkbox"/> C <input checked="" type="checkbox"/> RI	<input type="checkbox"/> C <input checked="" type="checkbox"/> RI	<input type="checkbox"/> C <input type="checkbox"/> RI	<input type="checkbox"/> C <input type="checkbox"/> RI	<input type="checkbox"/> C <input type="checkbox"/> RI
Other: Note in Comments	Rapid	<input type="checkbox"/> O <input type="checkbox"/> RA	<input type="checkbox"/> O <input type="checkbox"/> RA	<input type="checkbox"/> O <input type="checkbox"/> RA	<input type="checkbox"/> O <input type="checkbox"/> RA	<input type="checkbox"/> O <input type="checkbox"/> RA	<input type="checkbox"/> O <input type="checkbox"/> RA	<input type="checkbox"/> O <input type="checkbox"/> RA	<input type="checkbox"/> O <input type="checkbox"/> RA	<input type="checkbox"/> O <input type="checkbox"/> RA	<input checked="" type="checkbox"/> O <input type="checkbox"/> RA

TARGETED RIFFLE BENTHOS SAMPLE		
Sample ID	No. of Jars	Comment
<u>9.9.9.0.0.2</u>	<u>1</u>	

NEAREST TRANSECT	A	A	E	E	F	F	G	G	SUBSTRATE SIZE CLASSES
<b>Dorn. Substrate</b>	Fine/Sand	<input type="checkbox"/> F/S	<input type="checkbox"/> F/S	<input type="checkbox"/> F/S	<input type="checkbox"/> F/S	<input type="checkbox"/> F/S	<input type="checkbox"/> F/S	<input type="checkbox"/> F/S	F/S - ladybug or smaller (<2 mm)
	Gravel	<input checked="" type="checkbox"/> G	<input checked="" type="checkbox"/> G	<input type="checkbox"/> G	<input checked="" type="checkbox"/> G	<input type="checkbox"/> G	<input checked="" type="checkbox"/> G	<input checked="" type="checkbox"/> G	G - ladybug to tennis ball (2 to 64 mm)
	Coarse	<input type="checkbox"/> C	<input type="checkbox"/> C	<input checked="" type="checkbox"/> C	<input type="checkbox"/> C	<input checked="" type="checkbox"/> C	<input type="checkbox"/> C	<input type="checkbox"/> C	C - tennis ball to car sized (64 to 4000 mm)
	Other: Note in Comments	<input type="checkbox"/> O	<input type="checkbox"/> O	<input type="checkbox"/> O	<input type="checkbox"/> O	<input type="checkbox"/> O	<input type="checkbox"/> O	<input type="checkbox"/> O	O - bedrock, hardpan, wood, etc

Additional Benthos Comments

COMPOSITE PERIPHYTON SAMPLE		
Sample ID	Composite Volume (mL)	Number of transects sampled (0-11):
<u>8.0.0.9.9.0</u>	<u>5.0.0</u>	<u>1.1</u>

Assemblage ID (50-mL tube, preserved)		Chlorophyll (GF/F filter)		Biomass (GF/F Filter)	
Sample Vol. (mL)	Flag	Sample Vol. (mL)	Flag	Sample Vol. (mL)	Flag
<u>5.0</u>		<u>2.5</u>		<u>2.5</u>	

Flag

Comments

Flag codes: K = Sample not collected; U = Suspect sample; F1, F2, etc. = misc. flag assigned by field crew. Explain all flags in comment sections.

Figure 5-2. Sample Collection Form, showing data recorded for water chemistry samples.

## CHANNEL CONSTRAINT AND FIELD CHEMISTRY - STREAMS/RIVERS

Reviewed by (initial): *SP*

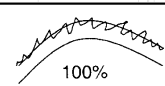
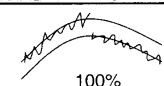
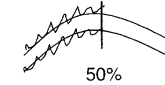
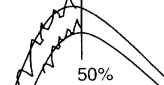
SITE ID: <u>WXP99-9999</u>		DATE: <u>07/01/2001</u>	
IN SITU MEASUREMENTS		Station ID: _____ (Assume X-site unless marked)	
		Comments	
STREAM/RIVER DO mg/l: (optional)	<u>5.3</u>		
STREAM RIVER TEMP. (°C):	<u>20.5</u>		
TIME OF DAY:	<u>11:25</u>		
CHANNEL CONSTRAINT			
<b>CHANNEL PATTERN (Check One)</b> <input checked="" type="checkbox"/> <b>One channel</b> <input type="checkbox"/> <b>Anastomosing (complex) channel</b> - (Relatively long major and minor channels branching and rejoining.) <input type="checkbox"/> <b>Braided channel</b> - (Multiple short channels branching and rejoining - mainly one channel broken up by numerous mid-channel bars.)			
<b>CHANNEL CONSTRAINT (Check One)</b> <input type="checkbox"/> <b>Channel very constrained in V-shaped valley</b> (i.e. it is very unlikely to spread out over valley or erode a new channel during flood) <input type="checkbox"/> <b>Channel is in Broad Valley</b> but channel movement by erosion during floods is <b>constrained by incision</b> (Flood flows do not commonly spread over valley floor or into multiple channels.) <input type="checkbox"/> <b>Channel is in Narrow Valley but is not very constrained</b> , but limited in movement by relatively narrow valley floor (< ~10 x bankfull width) <input checked="" type="checkbox"/> <b>Channel is Unconstrained in Broad Valley</b> (i.e. during flood it can fill off-channel areas and side channels, spread out over flood plain, or easily cut new channels by erosion)			
<b>CONSTRAINING FEATURES (Check One)</b> <input type="checkbox"/> <b>Bedrock</b> (i.e. channel is a bedrock-dominated gorge) <input type="checkbox"/> <b>Hillslope</b> (i.e. channel constrained in narrow V-shaped valley) <input type="checkbox"/> <b>Terrace</b> (i.e. channel is constrained by its own incision into river/stream gravel/soil deposits) <input type="checkbox"/> <b>Human Bank Alterations</b> (i.e. constrained by rip-rap, landfill, dike, road, etc.) <input checked="" type="checkbox"/> <b>No constraining features</b>			
Percent of channel length with margin in contact with constraining feature:	<u>0</u> % (0-100%)	<b>Percent of Channel Margin Examples</b>	
Bankfull width:	<u>6</u> (m)	 100%	 100%
Valley width (Visual Estimated Average):	<u>2000</u> (m)	 50%	 50%
Note: Be sure to include distances between both sides of valley border for valley width. If you cannot see the valley borders, record the distance you can see and mark this box. <input checked="" type="checkbox"/>			
Comments	<u>VALLEY WIDTH &gt; 2000 meters</u>		

38480



03/26/2001 2001 Chan Con/Fld Chem

**Figure 5-3. Channel Constraint and Field Measurement Form, showing data recorded for water chemistry.**

**TABLE 5-2. CHECKLIST OF EQUIPMENT AND SUPPLIES FOR WATER CHEMISTRY**

QTY.	Item
1	Field thermometer
1	500 mL plastic beaker with handle (in clean plastic bag)
1	4-L cubitainer with completed sample label attached (in clean plastic bag)
2-4	60 mL plastic syringes (with Luer type tip) with completed sample labels attached
1	Plastic container with snap-on lid to hold filled syringes
2-4	Syringe valves (Mininert® with Luer type adapter, or equivalent, available from a chromatography supply company)
1	Cooler with 4 to 6 plastic bags (1-gal) of ice OR a medium or large opaque garbage bag to store the water sample at streamside
1	Sample Collection Form
1	Field Measurement Form
	Soft-lead pencils for filling out field data forms
	Fine-tipped indelible markers for filling out labels
1 copy	Field operations and methods manual
1 set	Procedure tables and/or quick reference guides for water chemistry (laminated or printed on write-in-the-rain paper)

## NOTES



## 6.0 STREAM DISCHARGE

Stream discharge is equal to the product of the mean current velocity and vertical cross sectional area of flowing water. Discharge measurements are critical for assessing trends in streamwater acidity and other characteristics that are very sensitive to streamflow differences. Discharge should be measured at a suitable location within the sample reach that is as close as possible to the location where chemical samples are collected (typically the X-site; see Section 5), so that these data correspond. Discharge is usually determined after collecting water chemistry samples.

No single method for measuring discharge is applicable to all types of stream channels. The preferred procedure for obtaining discharge data is based on "velocity-area" methods (e.g., Rantz and others, 1982; Linsley et al., 1982). For streams that are too small or too shallow to use the equipment required for the velocity-area procedure, two alternative procedures are presented. One procedure is based on timing the filling of a volume of water in a calibrated bucket. The second procedure is based on timing the movement of a neutrally buoyant object (e.g., an orange or a small rubber ball) through a measured length of the channel, after measuring one or more cross-sectional depth profiles within that length.

### 6.1 VELOCITY-AREA PROCEDURE

Because velocity and depth typically vary greatly across a stream, accuracy in field measurements is achieved by measuring the mean velocity and flow cross-sectional area of many increments across a channel (Figure 6-1). Each increment gives a subtotal of the stream discharge, and the whole is calculated as the sum of these parts. Discharge measurements are made **at only one carefully chosen channel cross section within the sampling reach**. It is important to choose a channel cross section that is as much like a canal as possible. A glide area with a "U" shaped channel cross section that is free of obstructions provides the best conditions for measuring discharge by the velocity-area method. You may remove rocks and other obstructions to improve the cross-section before any measurements are made. However, because removing obstacles from one part of a cross-section affects adjacent water velocities, you must not change the cross-section once you commence collecting the set of velocity and depth measurements.

The procedure for obtaining depth and velocity measurements is outlined in Table 6-1. Record the data from each measurement on the Stream Discharge Form as shown in Figure 6-2. To reduce redundancy and to conserve space, Figure 6-2 shows measurement data recorded for all procedures. In the field, data will be recorded using only one of the available procedures.

### 6.2 TIMED FILLING PROCEDURE

In channels too "small" for the velocity-area method, discharge can sometimes be measured by filling a container of known volume and timing the duration to fill the container. "Small" is defined as a channel so shallow that the current velocity probe cannot be placed in the water, or where the channel is broken up and irregular due to rocks and debris, and a suitable cross-section for using the velocity area procedure is not available. This can be an extremely precise and accurate method, but requires a natural or constructed spillway of freefalling water. If obtaining data by this procedure will result in a lot of channel

disturbance or stir up a lot of sediment, wait until after all biological and chemical measurements and sampling activities have been completed.

**TABLE 6-1. VELOCITY-AREA PROCEDURE FOR DETERMINING STREAM DISCHARGE**

---

1. Locate a cross-section of the stream channel for discharge determination that has most of the following qualities (based on Rantz and others, 1982):
  - Segment of stream above and below cross-section is straight
  - Depths mostly greater than 15 centimeters, and velocities mostly greater than 0.15 meters/second. Do not measure discharge in a pool.
  - "U" shaped, with a uniform streambed free of large boulders, woody debris or brush, and dense aquatic vegetation.
  - Flow is relatively uniform, with no eddies, backwaters, or excessive turbulence.
2. Lay the surveyor's rod (or stretch a measuring tape) across the stream perpendicular to its flow, with the "zero" end of the rod or tape on the left bank, as viewed when looking downstream. Leave the tape tightly suspended across the stream, approximately one foot above water level.
3. Attach the velocity meter probe to the calibrated wading rod. Check to ensure the meter is functioning properly and the correct calibration value is displayed. Calibrate (or check the calibration) the velocity meter and probe as directed in the meter's operating manual. Place an "X" in the "VELOCITY AREA" box on the Stream Discharge Form.
4. Divide the total wetted stream width into 15 to 20 equal-sized intervals. To determine interval width, divide the width by 20 and round up to a convenient number. Intervals should not be less than 10 cm wide, even if this results in less than 15 intervals. The first interval is located at the left margin of the stream (left when looking downstream), and the last interval is located at the right margin of the stream (right when looking downstream).
5. Stand downstream of the rod or tape and to the side of the first interval point (closest to the left bank if looking downstream).
6. Place the wading rod in the stream at the interval point and adjust the probe or propeller so that it is at the water surface. Place an "X" in the appropriate "Distance Units" and "Depth Units" boxes on the Stream Discharge Form. Record the distance from the left bank and the depth indicated on the wading rod on the Stream Discharge Form.

Note for the first interval, distance equals 0 cm, and in many cases depth may also equal 0 cm. For the last interval, distance will equal the wetted width (in cm) and depth may again equal 0 cm.

7. Stand downstream of the probe or propeller to avoid disrupting the stream flow. Adjust the position of the probe on the wading rod so it is at 0.6 of the measured depth below the surface of the water. Face the probe upstream at a right angle to the cross-section, even if local flow eddies hit at oblique angles to the cross-section.

---

(continued)



**TABLE 6-1 (continued)**

8. Wait 20 seconds to allow the meter to equilibrate, then measure the velocity. Place an "X" in the appropriate "Velocity Units" box on the Stream Discharge Form. Record the value on the Stream Discharge Form. Note for the first interval, velocity may equal 0 because depth will equal 0.
  - For the electromagnetic current meter (e.g., Marsh-McBirney), use the lowest time constant scale setting on the meter that provides stable readings.
  - For the impeller-type meter (e.g., Swoffer 2100), set the control knob at the mid-position of "DISPLAY AVERAGING". Press "RESET" then "START" and proceed with the measurements.
9. Move to the next interval point and repeat Steps 6 through 8. Continue until depth and velocity measurements have been recorded for all intervals. Note for the last interval (right margin), depth and velocity values may equal 0.
10. At the last interval (right margin), record a "Z" flag on the field form to denote the last interval sampled.
11. If using a meter that computes discharge directly, check the "Q" box on the discharge form, and record calculated discharge value. In this case, you do not have to record the depth and velocity data for each interval.

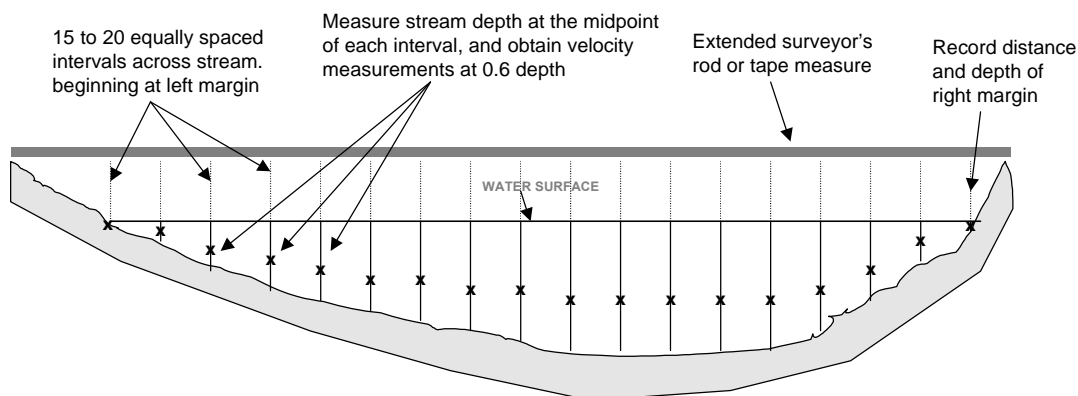

**Figure 6-1. Layout of channel cross-section for obtaining discharge data by the velocity-area procedure.**

STREAM DISCHARGE FORM

Reviewed by (Initials): *SP*

SITE ID: WXXP99-9999 DATE: 07/01/2003

<input checked="" type="checkbox"/> Velocity Area				
Distance Units		Depth Units		Velocity Units
<input type="checkbox"/> ft <input checked="" type="checkbox"/> cm		<input type="checkbox"/> ft <input checked="" type="checkbox"/> cm		<input type="checkbox"/> ft/s XX.X <input checked="" type="checkbox"/> m/s X.XX
(Final measurement should be left bank.)				
Dist. from Bank	Depth	Velocity	Flag	
1	0	0	0	F1
2	10	6	0.30	
3	20	6	0.59	
4	30	12	0.37	
5	40	15	0.34	
6	50	15	0.34	
7	60	24	0.43	
8	70	27	0.37	
9	80	40	0.43	
10	90	40	0.37	
11	100	46	0.30	
12	110	37	0.27	
13	120	30	0.27	
14	130	24	0.30	
15	140	15	0.30	
16	150	0	0	Z
17				
18				
19				
20				

<input checked="" type="checkbox"/> Timed Filling			
Repeat	Volume (L)	Time (s)	Flag
1	4.0	10.5	F1
2	4.0	11.2	
3	4.0	10.8	
4	4.0	11.0	
5	4.0	10.7	

<input checked="" type="checkbox"/> Neutral Bouyant Object			
	Float 1	Float 2	Float 3
Float Dist. <input type="checkbox"/> ft <input checked="" type="checkbox"/> m	5	5	5
Float Time (s)	1.0	1.0	1.0
Flag	F1		

Cross Sections on Float Reach			
	Upper Section	Middle Section	Lower Section
Width <input type="checkbox"/> ft <input checked="" type="checkbox"/> m	2.5	1.8	1.5
Depth 1 <input type="checkbox"/> ft <input checked="" type="checkbox"/> cm	1.0	5	1.2
Depth 2	9	1.5	2.0
Depth 3	9	2.0	1.5
Depth 4	8	7	6
Depth 5	5	2	5

Q Value If discharge is determined directly in field, record value here: Q = 0.12  cfs  m<sup>3</sup>/s FLAG F1

Flag	Comments
F1	DATA FOR ALL 4 METHODS ARE SHOWN.
Z	LAST INTERVAL MEASURED

Flag Codes: K = No measurement or observation made; U = Suspect measurement or observation; Q = Unacceptable QC check associated with measurement; Z = Last station measured (if not Station 20); F1, F2, etc. = Miscellaneous flags assigned by each field crew. Explain all flags in comments section.

56248



Figure 6-2. Stream Discharge Form, showing data recorded for all discharge measurement procedures.

Choose a cross-section of the stream that contains one or more natural spillways or plunges that collectively include the entire stream flow. A temporary spillway can also be constructed using a portable V-notch weir, plastic sheeting, or other materials that are available onsite. Choose a location within the sampling reach that is narrow and easy to block when using a portable weir. Position the weir in the channel so that the entire flow of the stream is completely rerouted through its notch (Figure 6-3). Impound the flow with the weir, making sure that water is not flowing beneath or around the side of the weir. Use mud or stones and plastic sheeting to get a good waterproof seal. The notch must be high enough to create a small spillway as water flows over its sharp crest.

The timed filling procedure is presented in Table 6-2. Make sure that the entire flow of the spillway is going into the bucket. Record the time it takes to fill a measured volume on the Discharge Measurement Form as shown in Figure 6-2. Repeat the procedure 5 times. If the cross-section contains multiple spillways, you will need to do separate determinations for each spillway. If so, clearly indicate which time and volume data replicates should be averaged together for each spillway; use additional Stream Discharge Form if necessary.

### **6.3 NEUTRALLY-BUOYANT OBJECT PROCEDURE**

In very small, shallow streams with no waterfalls, where the standard velocity-area or timed-filling methods cannot be applied, the neutrally buoyant object method may be the only way to obtain an estimate of discharge. The required pieces of information are the mean flow velocity in the channel and the cross-sectional area of the flow. The mean velocity is estimated by measuring the time it takes for a neutrally buoyant object to flow through a measured length of the channel. The channel cross-sectional area is determined from a series of depth measurements along one or more channel cross-sections. Since the discharge is the product of mean velocity and channel cross-sectional area, this method is conceptually very similar to the standard velocity-area method.

The neutrally buoyant object procedure is described in Table 6-3. Examples of suitable objects include plastic golf balls (with holes), small sponge rubber balls, or small sticks. The object must float, but very low in the water. It should also be small enough that it does not “run aground” or drag bottom. Choose a stream segment that is roughly uniform in cross-section, and that is long enough to require 10 to 30 seconds for an object to float through it. Select one to three cross-sections to represent the channel dimensions within the segment, depending on the variability of width and/or depth. Determine the stream depth at 5 equally spaced points at each cross-section. Three separate times, measure the time required for the object to pass through the segment that includes all of the selected cross-sections. Record data on the Stream Discharge Form as shown in Figure 6-2.

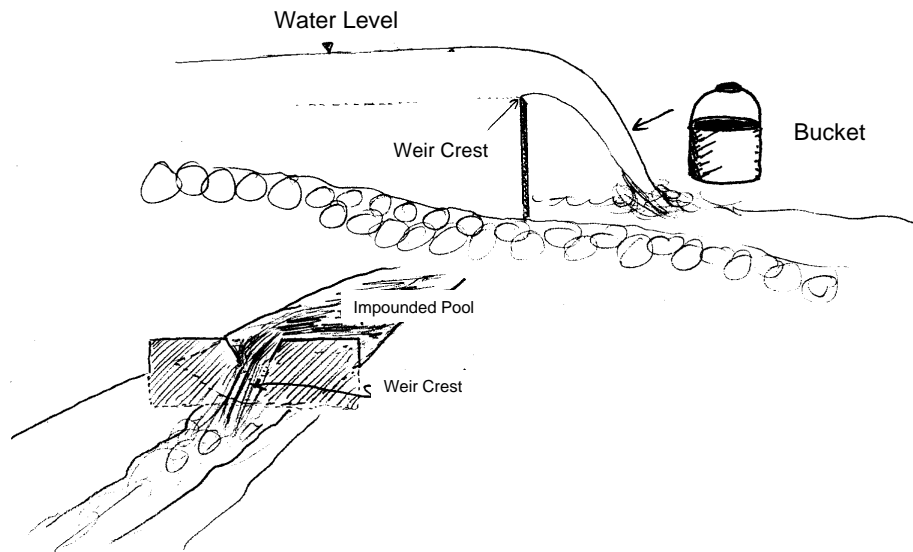

**Figure 6-3. Use of a portable weir in conjunction with a calibrated bucket to obtain an estimate of stream discharge.**

**TABLE 6-2. TIMED FILLING PROCEDURE FOR DETERMINING STREAM DISCHARGE**

NOTE: If measuring discharge by this procedure will result in significant channel disturbance or will stir up sediment, delay determining discharge until all biological and chemical measurement and sampling activities have been completed.

1. Choose a cross-section that contains one or more natural spillways or plunges, or construct a temporary one using on-site materials, or install a portable weir using a plastic sheet and on-site materials.
2. Place an "X" in the "TIMED FILLING" box in the stream discharge section of the Stream Discharge Form.
3. Position a calibrated bucket or other container beneath the spillway to capture the entire flow. Use a stopwatch to determine the time required to collect a known volume of water. Record the volume collected (in liters) and the time required (in seconds) on the Stream Discharge Form.
4. Repeat Step 3 a total of 5 times for each spillway that occurs in the cross section. If there is more than one spillway in a cross-section, you must use the timed-filling approach on all of them. Additional spillways may require additional data forms

**TABLE 6-3. NEUTRALLY BUOYANT OBJECT PROCEDURE FOR DETERMINING  
STREAM DISCHARGE**

- 
- 
1. Place an "X" in the "NEUTRALLY BUOYANT OBJECT" box on the Stream Discharge Form.
  2. Select a segment of the sampling reach that is deep enough to float the object freely, and long enough that it will take between 10 and 30 seconds for the object to travel. Mark the units used and record the length of the segment in the "FLOAT DIST." field of the Stream Discharge Form.
  3. If the channel width and/or depth change substantially within the segment, measure widths and depths at three cross-sections, one near the upstream end of the segment, a second near the middle of the segment, and a third near the downstream end of the segment.  

If there is little change in channel width and/or depth, obtain depths from a single "typical" cross-section within the segment.
  4. At each cross section, measure the wetted width using a surveyor's rod or tape measure, and record both the units and the measured width on the Stream Discharge Form. Measure the stream depth using a wading rod or meter stick at points approximately equal to the following proportions of the total width: 0.1, 0.3, 0.5, 0.7, and 0.9. Record the units and the depth values (not the distances) on the Stream Discharge Form.
  5. Repeat Step 4 for the remaining cross-sections.
  6. Use a stopwatch to determine the time required for the object to travel through the segment. Record the time in the "FLOAT TIME" field of the Stream Discharge Form.
  7. Repeat Step 6 two more times. The float time may differ somewhat for the three trials.
- 
- 

#### **6.4 EQUIPMENT AND SUPPLIES**

Table 6-4 shows the list of equipment and supplies necessary to measure stream discharge. This checklist is similar to the checklist presented in Appendix A, which is used at the base location (Section 3) to ensure that all of the required equipment is brought to the stream. Use this checklist to ensure that equipment and supplies are organized and available at the stream site in order to conduct the activities efficiently.

**TABLE 6-4. EQUIPMENT AND SUPPLY CHECKLIST FOR STREAM DISCHARGE**

<b>QTY.</b>	<b>ITEM</b>
1	Surveyor's telescoping leveling rod
1	50-m fiberglass measuring tape and reel
1	Current velocity meter, probe, and operating manual
1	Top-set wading rod for use with current velocity meter
1	Portable Weir with 60° "V" notch (optional)
1	Plastic sheeting to use with weir
1	Plastic bucket (or similar container) with volume graduations
1	Stopwatch
1	Neutrally buoyant object (e.g., plastic golf ball with holes, small rubber ball, stick)
1	Covered clipboard
	Soft (#2) lead pencils
	Stream Discharge Forms (1 per stream plus extras if needed for timed filling procedure)
1 copy	Field operations and methods manual
1 set	Procedure tables and/or quick reference guides for stream discharge (laminated or printed on write-in-the-rain paper)

## NOTES





## **7.0 PHYSICAL HABITAT CHARACTERIZATION** (a modification of Kaufmann and Robison, 1998)

In the broad sense, physical habitat in streams includes all those physical attributes that influence or provide sustenance to organisms within the stream. Stream physical habitat varies naturally, as do biological characteristics; thus, expectations differ even in the absence of anthropogenic disturbance. Within a given physiographic-climatic region, stream drainage area and overall stream gradient are likely to be strong natural determinants of many aspects of stream habitat, because of their influence on discharge, flood stage, and stream power (the product of discharge times gradient). Kaufmann (1993) identified seven general physical habitat attributes important in influencing stream ecology:

- Channel Dimensions
- Channel Gradient
- Channel Substrate Size and Type
- Habitat Complexity and Cover
- Riparian Vegetation Cover and Structure
- Anthropogenic Alterations
- Channel-Riparian Interaction

All of these attributes may be directly or indirectly altered by anthropogenic activities. Nevertheless, their expected values tend to vary systematically with stream size (drainage area) and overall gradient (as measured from topographic maps). The relationships of specific physical habitat measurements described in this section to these seven attributes are discussed by Kaufmann (1993). Aquatic macrophytes, riparian vegetation, and large woody debris are included in this and other physical habitat assessments because of their role in modifying habitat structure and light inputs, even though they are actually biological measures. The field physical habitat measurements from this field habitat characterization are used in the context of water chemistry, temperature, and other data sources (e.g., remote sensing of basin land use and land cover). The combined data analyses will more comprehensively describe additional habitat attributes and larger scales of physical habitat or human disturbance than are evaluated by the field assessment alone. A comprehensive data analysis guide (Kaufmann et al., 1999) discusses the detailed procedures used to calculate metrics related to stream reach and riparian habitat quality from field data collected using these field protocols. This guide also discusses the precision associated with these measurements and metrics.

These procedures are intended for evaluating physical habitat in wadeable streams. The following field procedures are most efficiently applied during low flow conditions and during times when terrestrial vegetation is active, but may be applied during other seasons and higher flows except as limited by safety considerations. This collection of procedures is designed for monitoring applications where robust, quantitative descriptions of reach-scale habitat are desired, but time is limited.

The habitat characterization protocol used by WSA differs from other rapid habitat assessment approaches (e.g., Rankin 1995, Barbour et al. 1999) by employing a randomized, systematic spatial sampling design that minimizes bias in the placement and positioning of measurements. Measures are taken over defined channel areas and these sampling areas or points are placed systematically at spacings that are proportional to

baseflow channel width. This systematic sampling design scales the sampling reach length and resolution in proportion to stream size. It also allows statistical and series analyses of the data that are not possible under other designs. The protocol was made as objective and reproducible as possible, by using easily learned, repeatable measures of physical habitat in place of estimation techniques wherever possible. Where estimation is employed, the sampling team is directed to estimate attributes that are otherwise measurable, rather than estimating the quality or importance of the attribute to the biota or its importance as an indicator of disturbance. More traditional visual classification of channel unit scale habitat types are included in the WSA program because they have been useful in past studies and enhance comparability with other work.

The time commitment to gain repeatability and precision is greater than that required for more qualitative methods. In field trials, two people typically complete the specified channel, riparian, and discharge measurements in about 3.5 hours of field time (see Section 2, Table 2-1). However, the time required can vary considerably with channel characteristics. On streams up to about 4 meters wide with sparse woody debris, measurements can be completed in about two hours. The current protocol, requiring 21 wetted width measurements, will require less than 4.5 hours for a well-practiced crew of two, even in large (>10 m wide), complex streams with abundant woody debris and deep water.

The procedures are employed on a sampling reach length 40 times its low flow wetted width, as described in Section 4. Measurement points are systematically placed to statistically represent the entire reach. Stream depth and wetted width are measured at very tightly spaced intervals, whereas channel cross-section profiles, substrate, bank characteristics and riparian vegetation structure are measured at larger spacings. Woody debris is tallied along the full length of the sampling reach, and discharge is measured at one location (see Section 6). The tightly spaced depth and width measures allow calculation of indices of channel structural complexity, objective classification of channel units such as pools, and quantification of residual pool depth, pool volume, and total stream volume.

## 7.1 COMPONENTS OF THE HABITAT CHARACTERIZATION

There are five different components of the WSA physical habitat characterization (Table 7-1), including stream discharge, which is described in Section 6. Measurements for the remaining four components are recorded on 11 copies of a two-sided field form, plus separate forms for recording slope and bearing measurements, recording observations concerning riparian legacy (large) trees, assessing the degree of channel constraint, and recording evidence of debris torrents or recent major flooding. The **thalweg profile** is a longitudinal survey of depth, habitat class, presence of soft/small sediment deposits, and presence of off-channel habitat at 100 equally spaced intervals (150 in streams less than 2.5 m wide) along the centerline between the two ends of the sampling reach. "Thalweg" refers to the flow path of the deepest water in a stream channel. Wetted width is measured and substrate size is evaluated at 21 equally spaced cross-sections (at 11 regular Transects A through K plus 10 supplemental cross-sections spaced midway between each of these). Data for the second component, the **woody debris tally**, are recorded for each of 10 segments of stream located between the 11 regular transects. The third component, the **channel and riparian characterization**, includes measures and/or visual estimates of channel dimensions, substrate, fish cover, bank characteristics, riparian vegetation structure, evidence of human disturbances, and presence of large (legacy) riparian trees.

**TABLE 7-1. COMPONENTS OF PHYSICAL HABITAT CHARACTERIZATION**

Component	Description
<b>Thalweg Profile:</b> (Section 7.4.1)	<ul style="list-style-type: none"> <li>• Measure maximum depth, classify habitat and pool-forming features, check presence of backwaters, side channels and deposits of soft, small sediment at 10-15 equally spaced intervals between each of 11 channel cross-section transects (100 or 150 individual measurements along entire reach).</li> <li>• Measure wetted width and evaluate substrate size classes at 11 regular channel cross-section transects and midway between them (21 width measurements and substrate cross-sections).</li> </ul>
<b>Woody Debris Tally:</b> (Section 7.4.2)	<ul style="list-style-type: none"> <li>• Between each of the channel cross sections, tally large woody debris numbers within and above the bankfull channel according to length and diameter classes (10 separate tallies).</li> </ul>
<b>Channel and Riparian Characterization:</b> (Section 7.5)	<ul style="list-style-type: none"> <li>• At 11 cross-section transects (21 for substrate size) placed at equal intervals along reach length: <ul style="list-style-type: none"> <li>- <u>Measure</u>: channel cross section dimensions, bank height, bank undercut distance, bank angle, slope and compass bearing (backsight), and riparian canopy density (densiometer).</li> <li>- <u>Visually Estimate</u><sup>a</sup>: substrate size class and embeddedness; areal cover class and type (e.g., woody trees) of riparian vegetation in Canopy, Mid-Layer and Ground Cover; areal cover class of fish concealment features, aquatic macrophytes and filamentous algae.</li> <li>- <u>Observe &amp; Record</u><sup>a</sup>: Presence and proximity of human disturbances and large trees.</li> </ul> </li> </ul>
<b>Assessment of Channel Constraint, Debris Torrents, and Major Floods</b> (Section 7.6)	<ul style="list-style-type: none"> <li>• After completing Thalweg and Transect measurements and observations, identify features causing channel constraint, estimate the percentage of constrained channel margin for the whole reach, and estimate the ratio of bankfull/valley width. Check evidence of recent major floods and debris torrent scour or deposition.</li> </ul>
<b>Discharge:</b> (see Section 6)	<ul style="list-style-type: none"> <li>• In medium and large streams (defined in Section 6) measure water depth and velocity at 0.6 depth at 15 to 20 equally spaced intervals across one carefully chosen channel cross-section.</li> <li>• In very small streams, measure discharge by timing the filling of a bucket or timing the passage of a neutral buoyant object through a segment whose cross-sectional area has been estimated.</li> </ul>

<sup>a</sup> Substrate size class is estimated for a total of 105 particles taken at 5 equally-spaced points along each of 21 cross-sections. Depth is measured and embeddedness estimated for the 55 particles located along the 11 regular transects A through K. Cross-sections are defined by laying the surveyor's rod or tape to span the wetted channel. Woody debris is tallied over the distance between each cross-section and the next cross-section upstream. Riparian vegetation and human disturbances are observed 5m upstream and 5m downstream from the cross section transect. They extend shoreward 10m from left and right banks. Fish cover types, aquatic macrophytes, and algae are observed within the channel 5m upstream and 5m downstream from the cross section stations. These boundaries for visual observations are estimated by eye.

These data are obtained at each of the 11 equally-spaced transects established within the sampling reach. In addition, measurements of the stream slope and compass bearing between stations are obtained, providing information necessary for calculating reach gradient, residual pool volume, and channel sinuosity. The fourth component, **assessment of channel constraint, debris torrents, and major floods**, is an overall assessment of these characteristics for the whole reach, and is undertaken after the other components are completed.

## 7.2 HABITAT SAMPLING LOCATIONS WITHIN THE SAMPLING REACH

Measurements are made at two scales of resolution along the length of the reach; the results are later aggregated and expressed for the entire reach, a third level of resolution. Figure 7-1 illustrates the locations within the sampling reach where data for the different components of the physical habitat characterization are obtained. We assess habitat over stream reach lengths that are approximately 40 times their average wetted width at base-flow, but not less than 150 m long. This allows us to adjust the sample reach length to accommodate varying sizes of streams (see Section 2). Many of the channel and riparian features are characterized on 11 cross-sections and pairs of riparian plots spaced at 4 channel-width intervals (i.e., **Transect spacing = 1/10th the total reach length**). The thalweg profile measurements must be spaced evenly over the entire sampling reach. In addition, they must be sufficiently close together that they do not "miss" deep areas and habitat units that are in a size range of about  $\frac{1}{3}$  to  $\frac{1}{2}$  of the average channel width. Follow these guidelines for choosing the interval between thalweg profile measurements:

- **Channel Width < 2.5 m — interval = 1.0 m**
- **Channel Width 2.5-3.5 m — interval = 1.5 m**
- **Channel Width > 3.5 m — interval = 0.01 × (reach length)**

Following these guidelines, you will make 150 evenly spaced thalweg profile measurements in the smallest category of streams, 15 between each detailed channel cross section. In all of the larger stream sizes, you will make 100 measurements, 10 between each cross section. We specify width measurements only at the 11 regular transect cross-sections and 10 supplemental cross-sections at the thalweg measurement points midway between each pair of regular transects (a total of 21 wetted widths). If more resolution is desired, width measurements may be made at all 100 or 150 thalweg profile locations.

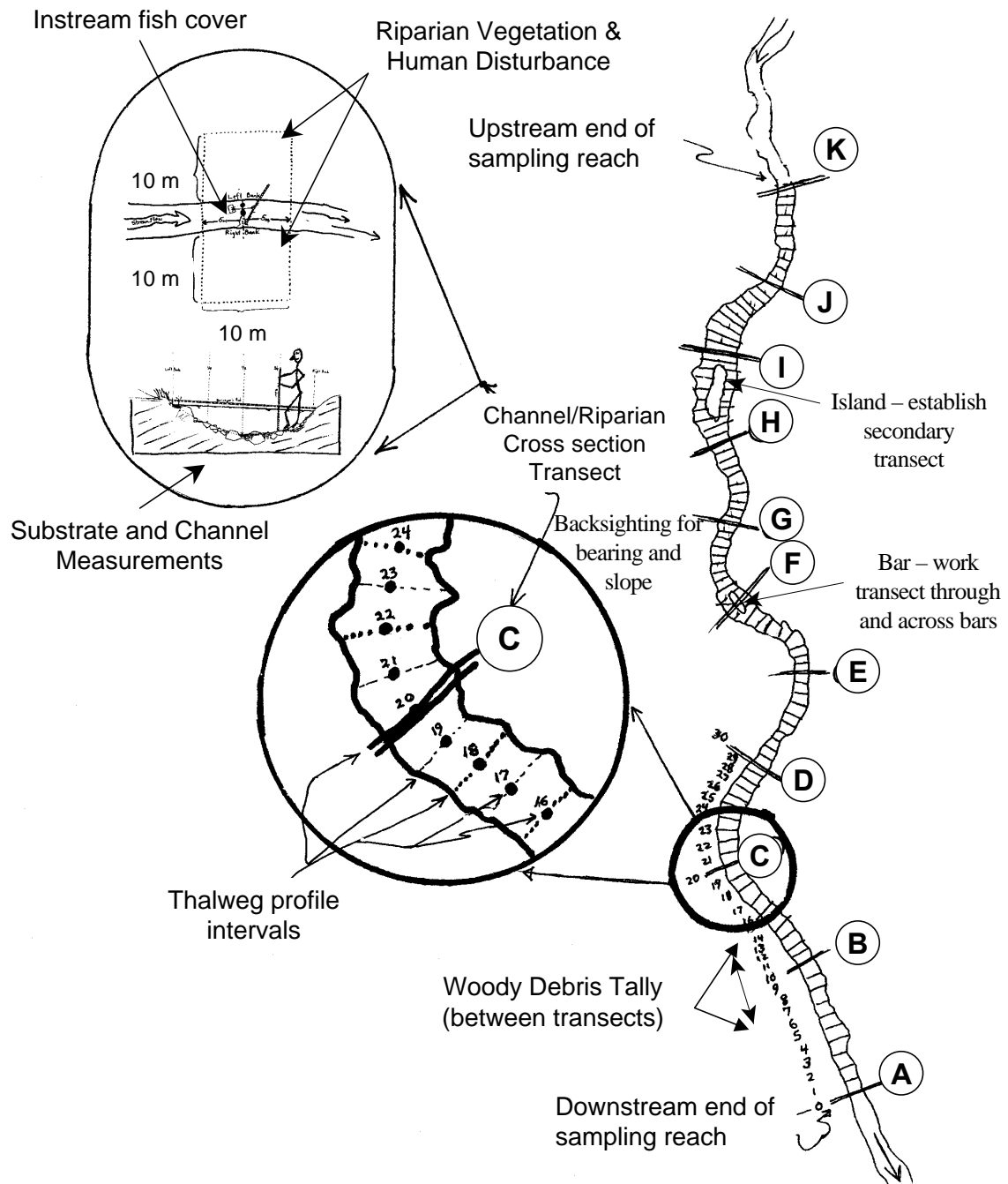

Figure 7-1. Sampling reach layout for physical habitat measurements (plan view).

### 7.3 LOGISTICS AND WORK FLOW

The five components (Table 7-1) of the habitat characterization are organized into four grouped activities:

- a. Thalweg Profile and Large Woody Debris Tally (Section 7.4). Two people proceed upstream from the downstream end of the sampling reach (see Figure 7-1) making observations and measurements at the chosen increment spacing. One person is in the channel making width and depth measurements, and determining whether soft/small sediment deposits are present under his/her staff. The other person records these measurements, classifies the channel habitat, records presence/absence of side channels and off-channel habitats (e.g. backwater pools, sloughs, alcoves), and tallies large woody debris. Each time this team reaches a flag marking a new cross-section transect, they start filling out a new copy of the Thalweg Profile and Woody Debris Form. They interrupt the thalweg profile and woody debris tallying activities to complete data collection at each cross-section transect as it comes. When the crew member in the water makes a width measurement at channel locations midway between regular transects (i.e., A, B,...K), s/he also locates and estimates the size class of the substrate articles on the left channel margin and at positions 25%, 50%, 75%, and 100% of the distance across the wetted channel. Procedures for this substrate tally are the same as for those at regular cross-sections, but data are recorded on the Thalweg Profile side of the field form.
2. Channel/Riparian Cross-Sections (Section 7.5). One person proceeds with the channel cross-section dimension, substrate, bank, and canopy cover measurements. The second person records those measurements on the Channel/ Riparian Cross-section Form while making visual estimates of riparian vegetation structure, instream fish cover, and human disturbance specified on that form. They also make observations to complete the riparian “legacy” tree field form. Slope and bearing are determined together by backsighting to the previous transect. Intermediate flagging (of a different color) may have to be used if the stream is extremely brushy, sinuous, or steep to the point that you cannot site for slope and bearing measures between two adjacent transects. (Note that the crews could tally woody debris while doing the backsight, rather than during the thalweg profile measurements.)
3. Channel Constraint and Torrent Evidence (Section 7.6). After completing observations and measurements along the thalweg and at all 11 transects, the field crew completes the overall reach assessments of channel constraint and evidence of debris torrents and major floods.
4. Discharge (Section 6). Discharge measurements are made after collecting the chemistry sample. They are done at a chosen optimal cross section (but not necessarily at a transect) near the X-site. Furthermore, if a lot of channel disruption is necessary and sediment must be stirred up, wait on this activity until all chemical and biological sampling has been completed.

## 7.4 THALWEG PROFILE AND LARGE WOODY DEBRIS MEASUREMENTS

### 7.4.1 Thalweg Profile

“Thalweg” refers to the flow path of the deepest water in a stream channel. The thalweg profile is a longitudinal survey of maximum depth and several other selected characteristics at 100 or 150 equally spaced points along the centerline of the stream between the two ends of the stream reach. Data from the thalweg profile allows calculation of indices of residual pool volume, stream size, channel complexity, and the relative proportions of habitat types such as riffles and pools. In this habitat assessment procedure, one proceeds upstream in the middle of the channel, rather than along the thalweg itself (though each thalweg depth measurement is taken at the deepest point at each incremental position). One field person walks upstream (wearing felt-soled waders) carrying a fiberglass telescoping (1.5 to 7.5 m) surveyor’s rod and a 1-m metric ruler (or a calibrated rod or pole, such as a ski pole). A second person on the bank or in the stream carries a clipboard with 11 copies of the field data form.

The procedure for obtaining thalweg profile measurements is presented in Table 7-2. Record data on the Thalweg Profile and Woody Debris Data Form as shown in Figure 7-2.

Use the surveyor’s rod and a metric ruler or calibrated rod or pole to make the required depth and width measurements, and to measure off the distance between measurement points as you proceed upstream. Ideally, every tenth thalweg measurement will bring you within one increment spacing from the flag marking a new cross-section profile. The flag will have been set previously by carefully taping along the channel, making the same bends that you do while measuring the thalweg profile (refer to Figure 7-1). However, you may still need to make minor adjustments to align each 10th measurement to be one thalweg increment short of the cross section. In streams with average widths smaller than 2.5m, you will be making thalweg measurements at 1-meter increments. Because the minimum reach length is set at 150 meters, there will be 15 measurements between each cross section. Use the 5 extra lines on the thalweg profile portion of the data form (Figure 7-2) to record these measurements.

It is very important that thalweg depths are obtained from all measurement points. Missing depths at the ends of the sampling reach (e.g., due to the stream flowing into or out of a culvert or under a large pile of debris) can be tolerated, but those occurring in the middle of the sampling reach are more difficult to deal with. Flag these missing measurements using a “K” code and explain the reason for the missing measurements in the comments section of the field data form. At points where a direct depth measurement cannot be obtained, make your best estimate of the depth, record it on the field form, and flag the value using a “U” code (for suspect measurement), explaining that it is an estimated value in the comments section of the field data form. **Where the thalweg points are too deep for wading**, measure the depth by extending the surveyor’s rod at an angle to reach the thalweg point. Record the water level on the rod, and the rod angle, as determined using the external scale on the clinometer (vertical = 90°). This procedure can also be done with a taut string or fishing line (see Table 7-3). In analyzing this data the thalweg depth is calculated as the length of rod (or string) under water multiplied by the trigonometric *sin* of

**TABLE 7-2. THALWEG PROFILE PROCEDURE**

1. Determine the interval between measurement stations based on the wetted width used to determine the length of the sampling reach.  
  
For widths < 2.5 m, establish stations every 1 m.  
For widths between 2.5 and 3.5 m, establish stations every 1.5 m  
For widths > 3.5 m, establish stations at increments equal to 0.01 times the sampling reach length.
2. Complete the header information on the Thalweg Profile and Woody Debris Form, noting the transect pair (downstream to upstream). Record the interval distance determined in Step 1 in the "INCREMENT" field on the field data form.  
  
NOTE: If a side channel is present, and contains between 16 and 49% of the total flow, establish secondary cross-section transects as necessary. Use separate field data forms to record data for the side channel, designating each secondary transect by checking both "X" and the associated primary transect letter (e.g., XA, XB, etc.). Collect all channel and riparian cross-section measurements from the side channel.
3. Begin at the downstream end (station "0") of the first transect (Transect "A").
4. Measure the wetted width if you are at station "0", station "5" (if the stream width defining the reach length is  $\geq 2.5$  m), or station "7" (if the stream width defining the reach length is < 2.5 m). Wetted width is measured across and over mid-channel bars and boulders. Record the width on the field data form to the nearest 0.1 m for widths up to about 3 meters, and to the nearest 5% for widths > 3 m. This is 0.2 m for widths of 4 to 6 m, 0.3 m for widths of 7 to 8 m, and 0.5 m for widths of 9 or 10 m, and so on. For dry and intermittent streams, where no water is in the channel, record zeros for wetted width.  
  
NOTE: If a mid-channel bar is present at a station where wetted width is measured, measure the bar width and record it on the field data form.
5. At station 5 or 7 (see above) classify the substrate particle size at the tip of your depth measuring rod at the left wetted margin and at positions 25%, 50%, 75%, and 100% of the distance across the wetted width of the stream. This procedure is identical to the substrate size evaluation procedure described for regular channel cross-sections A through K, except that for these mid-way supplemental cross-sections, substrate size is entered on the Thalweg Profile side of the field form.
6. At each thalweg profile station, use a meter ruler or a calibrated pole or rod to locate the deepest point (the "thalweg"), which may not always be located at mid-channel. Measure the thalweg depth to the nearest cm, and record it on the thalweg profile form. Read the depth on the side of the ruler, rod, or pole to avoid inaccuracies due to the wave formed by the rod in moving water.  
  
NOTE: For dry and intermittent streams, where no water is in the channel, record zeros for depth.

(continued)



---

**TABLE 7-2 (Continued)**

---

NOTE: It is critical to obtain thalweg depths at all stations. **At stations where the thalweg is too deep to measure directly**, stand in shallower water and extend the surveyor's rod or calibrated rod or pole at an angle to reach the thalweg. Determine the rod angle by resting the clinometer on the upper surface of the rod and reading the angle on the external scale of the clinometer. Leave the depth reading for the station blank, and record a "U" flag. Record the water level on the rod and the rod angle in the comments section of the field data form. For even deeper depths, it is possible to use the same procedure with a taut string as the measuring device. Tie a weight to one end of a length of string or fishing line, and then toss the weight into the deepest channel location. Draw the string up tight and measure the length of the line that is under water. Measure the string angle with the clinometer exactly as done for the surveyor's rod.

If a direct measurement cannot be obtained, make **the best estimate you can** of the thalweg depth, and use a "U" flag to identify it as an estimated measurement.

7. At the point where the thalweg depth is determined, observe whether unconsolidated, loose ("soft") deposits of small diameter ( $\leq 16\text{mm}$ ), sediments are present directly beneath your ruler, rod, or pole. Soft/small sediments are defined here as fine gravel, sand, silt, clay or muck readily apparent by "feeling" the bottom with the staff. Record presence or absence in the "SOFT/SMALL SEDIMENT" field on the field data form. Note: A thin coating of fine sediment or silty algae coating the surface of cobbles should not be considered soft/small sediment for this assessment. However, fine sediment coatings should be identified in the comments section of the field form when determining substrate size and type.
  8. Determine the channel unit code and pool forming element codes for the station. Record these on the field data form using the standard codes provided. For dry and intermittent streams, where no water is in the channel, record habitat type as dry channel (DR).
  9. If the station cross-section intersects a mid-channel bar, indicate the presence of the bar in the "BAR WIDTH" field on the field data form.
  10. Record the presence or absence of a side channel at the station's cross-section in the "SIDE CHANNEL" field on the field data form.
  11. Record the presence or absence of quiescent off-channel aquatic habitats, including sloughs, alcoves and backwater pools in the "Backwater" column of the field form. If a backwater pool dominates the channel, record "PB" as the dominant habitat unit class. If the backwater is a pool that does not dominate the main channel, or if it is an off-channel alcove or slough, circle "Y" to indicate presence of a backwater in the "Backwater" column of the field form, but classify the main channel habitat unit type according to characteristics of the main channel.
  12. Proceed upstream to the next station, and repeat Steps 4 through 11.
  13. Repeat Steps 4 through 12 until you reach the next transect. At this point complete Channel/Riparian measurements at the new transect (Section 7.5). Then prepare a new Thalweg Profile and Woody Debris Form and repeat Steps 2 through 12 for each of the reach segments, until you reach the upstream end of the sampling reach (Transect "K").
- 
-

PHAB: THALWEG PROFILE & WOODY DEBRIS FORM STREAMS

Reviewed by (initials): *DP*

SITE ID: *WXXP99-999* DATE: *07/01/2002* TRANSECT:  A-B  B-C  C-D  D-E  E-F  F-G  G-H  H-I  I-J  J-K

THALWEG PROFILE		For Transect A-B ONLY:					Total Reach Length (m):			
STATION	THALWEG DEPTH (cm) (XXX)	WETTED WIDTH (m) (XXX.X)	BAR WIDTH <sup>1</sup> Present	SOFT SMALL SEDIMENT	CHANNEL UNIT CODE	POOL FORM CODE	SIDE CHANNEL	BACK WATER	FLAG	COMMENTS
0	14	3.6	0.8	Y (N)	R1	N	Y (N)	Y (N)		
1	13			Y (N)	R1	N	Y (N)	Y (N)		
2	27			Y (N)	R1	N	Y (N)	Y (N)		
3	46			Y (N)	PT	F	Y (N)	Y (N)		
4	40			Y (N)	PT	F	Y (N)	Y (N)		
5	35	3.3	0.2	Y (N)	PT	F	Y (N)	Y (N)		
6	34			Y (N)	PT	F	Y (N)	Y (N)		
7	47			Y (N)	PT	F	Y (N)	Y (N)		
8	53			Y (N)	PT	F	Y (N)	Y (N)		
9	57			Y (N)	PT	F	Y (N)	Y (N)	FI	SIDE CHANNEL CONVERGENCE
10				Y (N)			Y (N)	Y (N)		
11				Y (N)			Y (N)	Y (N)		
12				Y (N)			Y (N)	Y (N)		
13				Y (N)			Y (N)	Y (N)		
14				Y (N)			Y (N)	Y (N)		

SUBSTRATE	Station (5 or 7)	LFT	LCTR	CTR	RCTR	RGT	FLAG	LARGE WOODY DEBRIS (>10 cm emd end diameter > 1.5 m length)		CHECK IF UNMARKED BOXES ARE ZERO	
								DIAMETER	LENGTH	PIECES ALL PART IN BANKFULL CHANNEL	PIECES BRIDGE ABOVE BANKFULL CHANNEL
FLAG	5	SA	SA	GF	SA	FN		Length 1.5-5m	Length 5-15m	Length 1.5-5m	Length 5-15m
								4	4		

**SUBSTRATE SIZE CLASS CODES**  
 RS = BEDROCK (BEDROCK); LARGER THAN 1 CM  
 RB = BEDROCK (BEDROCK); SMALLER THAN 1 CM  
 SC = CONCRETE (CONCRETE)  
 LB = LOG BOLLIDER (LOG TO 500 MM) - (VERTICAL TO CAN)  
 SB = LOG BOLLIDER (LOG TO 500 MM) - (HORIZONTAL TO CAN)  
 CB = CORBLE (IN TO 250 MM) - (TENS BALL TO BASKETBALL)  
 SC = COARSE GRAVEL (IN TO 64 MM) - (IMMABLE TO TENS BALL)  
 GF = FINE GRAVEL (3 TO 16 MM) - (LADYBUG TO MARBLE)  
 SA = SAND (68 TO 2 MM) - (DIRTY - UP TO LADYBUG SIZE)  
 FM = SILT/CLAY / MUCK / MUD (GREY)  
 MD = MUCK / MUD / MUCK / MUD (GREY)  
 OT = OTHER COMMENT ON OTHER SORT

**POOL FORM CODES/CHANNEL UNIT CODES**  
 W = NOA a pool  
 N = No Large Woody Debris  
 B = Boulder or Boulders  
 F = Uniform, Broad  
 G = GORGE  
 RA = Rapid  
 CA = Cascade  
 PA = Falls  
 DR = Dry Channel

Flag Codes: K = no measurement made; U = suspect measurement; F1, F2, ect. = flags assigned by each field crew; G1, G2, etc. for flags not specific to one station. Explain all flags in comments. 1 = Measure Bar Width at Station 0 and M5-Station (5 or 7).



Figure 7-2. Thalweg Profile and Woody Debris Form.

the rod angle. (For example, if 3 meters of the rod are under water when the rod held at 30 degrees ( $\sin=0.5$ ), the actual thalweg depth is 6 meters.) These calculations are done after field forms are returned for data analysis. On the field form, crews are required only to record the wetted length of the rod under the water, a “U” code in the flag field, and a comment to the right saying “depth taken at an angle of xx degrees.” If a direct measurement of the thalweg depth is not possible, make the best estimate you can of the depth, record it, and use a “U” flag and comments to note it is an estimated value.

At every thalweg measurement increment, determine by sight or feel whether deposits of soft/small sediment is present on the channel bottom. These particles are defined as substrate equal to or smaller than fine gravel ( $\leq 16$  mm diameter). These **soft/small sediments are NOT the same as “Fines”** described when determining the substrate particle sizes at the cross-section transects (Section 7.5.2). For the thalweg profile, determine if soft/small sediment deposits are readily obvious by feeling the bottom with your boot, the surveyor’s rod, or the calibrated rod or pole. (Note that **a very thin coating of silt or algae on cobble bottom substrate does not qualify as “soft/small” sediment** for this purpose.)

Wetted width is measured at each transect (station 0), and midway between transects (station 5 for larger streams having 100 measurement points, or station 7 for smaller streams having 150 measurement points). The wetted width boundary is the point at which substrate particles are no longer surrounded by free water. Substrate size is estimated for 5 particles evenly spaced across each midway cross-section using procedures identical to those described for substrate at regular cross-sections (Section 7.5.2), but at the supplemental cross-sections, only the size class (not the distance and depth) data are recorded in spaces provided on the Thalweg Profile side of the field form.

While recording the width and depth measurements and the presence of soft/small sediments, the second person chooses and records the habitat class and the pool forming element codes (Table 7-3) applicable to each of the 100 (or 150) measurement points along the length of the reach. These channel unit habitat classifications and pool-forming elements are modified from those of Bisson et al. (1982) and Frissell et al. (1986). The resulting database of traditional visual habitat classifications will provide a bridge of common understanding with other studies. Channel unit scale habitat classifications are to be made at the thalweg of the cross section. The habitat unit itself must meet a minimum size criteria in addition to the qualitative criteria listed in Table 7-3. Before being considered large enough to be identified as a channel-unit scale habitat feature, the unit should be at least as long as the channel is wide. For instance, if there is a small deep (pool-like) area at the thalweg within a large riffle area, don’t record it as a pool unless it occupies an area about as wide or long as the channel is wide.

Mid-channel bars, islands, and side channels pose some problems for the sampler conducting a thalweg profile and necessitate some guidance. Bars are defined here as mid-channel features below the bankfull flow mark that are dry during baseflow conditions (see Section 7.5.3 for the definition of bankfull channel). Islands are mid-channel features that are dry even when the stream is experiencing a bankfull flow. Both bars and islands cause the stream to split into side channels. When a mid-channel bar is encountered along the thalweg profile, it is noted on the field form and the active channel is considered to include the bar. Therefore, the wetted width is measured as the distance between wetted left and

right banks. It is measured across and over mid-channel bars and boulders. If mid-channel bars are present, record the bar width in the space provided.

**TABLE 7-3. CHANNEL UNIT AND POOL FORMING ELEMENT CATEGORIES**

<b>Channel Unit Habitat Classes<sup>a</sup></b>	
<b>Class (Code)</b>	<b>Description</b>
Pools:	Still water, low velocity, smooth, glassy surface, usually deep compared to other parts of the channel:
Plunge Pool (PP)	Pool at base of plunging cascade or falls.
Trench Pool (PT)	Pool-like trench in the center of the stream
Lateral Scour Pool (PL)	Pool scoured along a bank.
Backwater Pool (PB)	Pool separated from main flow off the side of the channel.
Impoundment Pool (PD)	Pool formed by impoundment above dam or constriction.
Pool (P)	Pool (unspecified type).
Glide (GL)	Water moving slowly, with <u>a smooth, unbroken surface</u> . Low turbulence.
Riffle (RI)	Water moving, with <u>small ripples, waves and eddies</u> -- waves not breaking, <u>surface tension not broken</u> . Sound: "babbling", "gurgling".
Rapid (RA)	Water movement rapid and turbulent, surface with <u>intermittent whitewater</u> with breaking waves. Sound: continuous rushing, but not as loud as cascade.
Cascade (CA)	Water movement rapid and very turbulent over steep channel bottom. Most of the water surface is broken in <u>short, irregular plunges, mostly whitewater</u> . Sound: roaring.
Falls (FA)	<u>Free falling water</u> over a vertical or near vertical drop into plunge, water turbulent and white over high falls. Sound: from splash to roar.
Dry Channel (DR)	No water in the channel

**(continued)**

<sup>a</sup> Note that in order for a channel habitat unit to be distinguished, it must be at least as wide or long as the channel is wide.

**TABLE 7-3 (Continued)**

<b>Categories of Pool-forming Elements<sup>b</sup></b>	
<b>Code</b>	<b>Category</b>
N	Not Applicable, Habitat Unit is not a pool
W	Large Woody Debris.
R	Rootwad
B	Boulder or Bedrock
F	Unknown cause (unseen fluvial processes)
WR, RW, RBW	Combinations
OT	Other (describe in the comments section of field form)

<sup>b</sup> Remember that most pools are formed at high flows, so you may need to look at features, such as large woody debris, that are dry at baseflow, but still within the bankfull channel.

If a mid-channel feature is as high as the surrounding flood plain, it is considered an island. Treat side channels resulting from islands different from mid-channel bars. Handle the ensuing side channel based on visual estimates of the percent of total flow within the side channel as follows:

Less than 15%	Indicate the presence of a side channel on the field data form.
16 to 49%	Indicate the presence of a side channel on the field data form. Establish a secondary transect across the side channel designated as "X" plus the primary transect letter; (e.g., XA), by checking boxes for both "X" and the appropriate transect letter (e.g., A through K) on a separate copy of the field data form. Complete the detailed channel and riparian cross-section measurements for the side channel on this form.

When a side channel occurs due to an island, reflect its presence with continuous entries in the "Side Channel" field on the Thalweg Profile and Woody Debris Form (Figure 7-2). In addition, note the points of divergence and confluence of the side channel in the comments section of the thalweg profile form. Begin entries at the point where the side channel converges with the main channel; note the side channel presence continuously until the upstream point where it diverges. When doing width measures with a side channel separated by an island, include only the width of the main channel in the measures at the time and then measure the side channel width separately.

If no water is in the channel at a thalweg station, record zeros for depth and wetted width. Record the habitat type as dry channel (DR).

## 7.4.2 Large Woody Debris Tally

Methods for large woody debris (LWD) measurement are a simplified adaptation of those described by Robison and Beschta (1990). This component of the WSA physical habitat characterization allows quantitative estimates of the number, size, total volume and distribution of wood within the stream reach. LWD is defined here as woody material with a small end diameter of at least 10 cm (4 in.) and a length of at least 1.5 m (5 ft.).

The procedure for tallying LWD is presented in Table 7-4. The tally includes all pieces of LWD that are at least partially in the baseflow channel, the "active channel" (flood channel up to bankfull stage), or spanning above the active channel (Figure 7-3). The active (or "bankfull") channel is defined as the channel that is filled by moderate sized flood events that typically recur every one to two years. LWD in the active channel is tallied over the entire length of the reach, including the area between the channel cross-section transects. As in the thalweg profile, LWD measurements in the LWD piece is tallied in only one box. Pieces of LWD that are not at least partially within Zones 1, 2, or 3 are not tallied.

For each LWD piece, first visually estimate its length and its large and small end diameters in order to place it in one of the diameter and length categories. The diameter class on the field form (Figure 7-2) refers to the large end diameter. Sometimes LWD is not cylindrical, so it has no clear "diameter". In these cases visually estimate what the diameter would be for a piece of wood with a circular cross section that would have the same volume. When evaluating length, include only the part of the LWD piece that has a diameter greater than 10 cm (4 in). Count each of the LWD pieces as one tally entry and include the whole piece when assessing dimensions, even if part of it is in Zone 4 (outside of the bankfull channel). For both the Zone 1-2 wood and the Zone 3 LWD, the field form (Figure 7-2) provides 12 entry boxes for tallying debris pieces visually estimated within three length and four diameter class combinations. Each LWD piece is tallied in only one box. There are 12 size classes for wood at least partially in Zones 1 and 2, and 12 for wood partially within Zone 3. Wood that is not at least partially within those zones is not tallied.

## 7.5 CHANNEL AND RIPARIAN MEASUREMENTS AT CROSS-SECTION TRANSECTS

### 7.5.1 Slope and Bearing

The slope, or gradient, of the stream reach is useful in three different ways. First, the overall stream gradient is one of the major stream classification variables, giving an indication of potential water velocities and stream power, which are in turn important controls on aquatic habitat and sediment transport within the reach. Second, the spatial variability of stream gradient is a measure of habitat complexity, as reflected in the diversity of water velocities and sediment sizes within the stream reach. Lastly, using methods described by Stack (1989) and Robison and Kaufmann (1994), the water surface slope will allow us to compute residual pool depths and volumes from the multiple depth and width measurements taken in the thalweg profile (Section 7.4.1). Compass bearings between cross-section stations, along with the distance between stations, will allow us to estimate the sinuosity of the channel (ratio of the length of the reach divided by the straight line distance between the two reach ends).

---

**TABLE 7-4. PROCEDURE FOR TALLYING LARGE WOODY DEBRIS**

---

Note: Tally pieces of large woody debris (LWD) within each segment of stream at the same time the thalweg profile is being determined. Include all pieces whose large end is located within the segment in the tally.

1. Scan the stream segment between the two cross-section transects where thalweg profile measurements are being made.
  2. Tally all LWD pieces within the segment that are at least partially within the bankfull channel. Determine if a piece is LWD (**small end diameter  $\geq 10$  cm [4 in.]; length  $\geq 1.5$  m [5 ft.]**)
  3. For each piece of LWD, determine the class **based on the diameter of the large end** (0.1 m to < 0.3 m, 0.3 m to <0.6 m, 0.6 m to <0.8 m, or >0.8 m, and the class based on the length of the piece (1.5m to <5.0m, 5m to <15m, or >15m).
    - If the piece is not cylindrical, visually estimate what the diameter would be for a piece of wood with circular cross section that would have the same volume.
    - When estimating length, include only the part of the LWD piece that has a diameter greater than 10 cm (4 in)
    - For log jam, measure/count pieces holding jam in place; flag and then estimate the height/dimensions of entire jam and describe the pieces that comprise the jam
  4. Place a tally mark in the appropriate diameter x length class tally box in the “PIECES ALL/PART IN BANKFULL CHANNEL” section of the Thalweg Profile and Woody Debris Form.
  5. Tally all LWD pieces within the segment that are not actually within the bankfull channel, but are at least partially spanning (bridging) the bankfull channel. For each piece, determine the class based on the diameter of the **large end** (0.1 m to < 0.3 m, 0.3 m to <0.6 m, 0.6 m to <0.8 m, or >0.8 m), and the class based on the length of the piece (1.5 m to <5.0 m, 5 m to <15 m, or >15 m).
  6. Place a tally mark for each piece in the appropriate diameter x length class tally box in the “PIECES BRIDGE ABOVE BANKFULL CHANNEL” section of the Thalweg Profile and Woody Debris Form.
  7. After all pieces within the segment have been tallied, write the total number of pieces for each diameter x length class in the small box at the lower right-hand corner of each tally box.
  8. Repeat Steps 1 through 7 for the next stream segment, using a new Thalweg Profile and Woody Debris Form.
- 
-

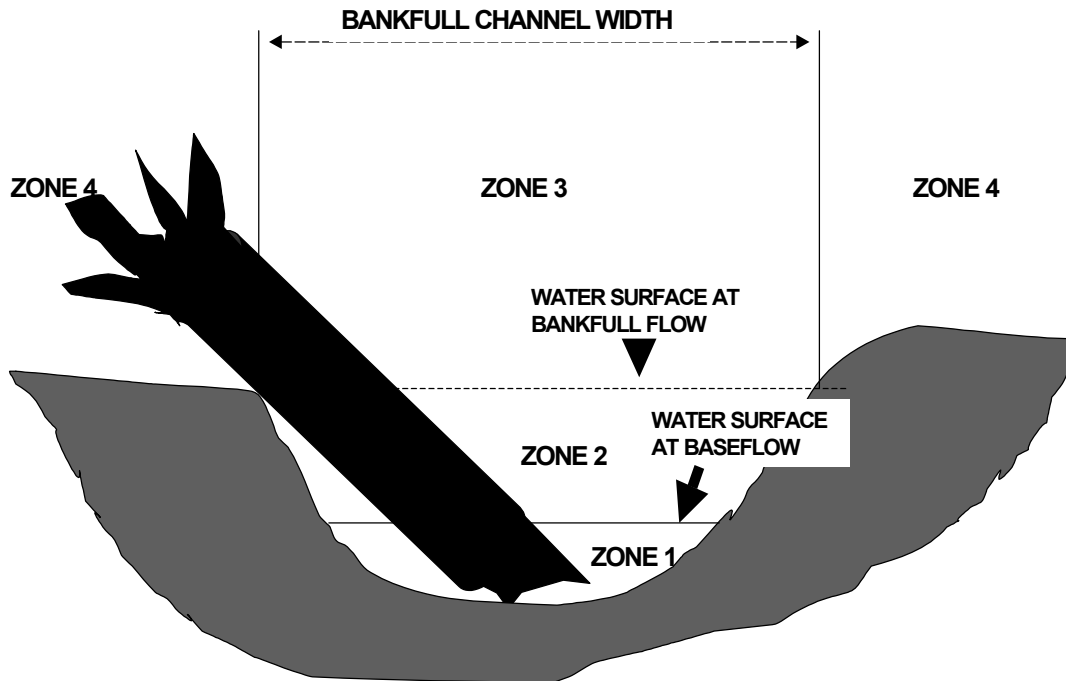

Figure 7-3. Large woody debris influence zones (modified from Robison and Beschta, 1990)

Measure slope and bearing by "backsighting" downstream between transects (e.g., transect "B" to "A", "C" to "B", etc.) as shown in Figure 7-4. To measure the slope and bearing between adjacent stations, use a clinometer, bearing compass, tripod, tripod extension, and flagging, following the procedure presented in Table 7-5. Record slope and bearing data on the Slope and Bearing Form as shown in Figure 7-5.

Slope can also be measured by two people, each having a pole that is marked at the same height. Alternatively, the second person can be "flagged" at the eye level of the person doing the backsighting. Be sure that you mark your eye level on the other person or on a separate pole beforehand while standing on level ground. Site to your eye level when backsighting on your co-worker. Particularly in streams with slopes less than 3%, we recommend that field crews use poles marked at exactly the same height for sighting slope. When two poles are used, site from the mark on one pole to the mark on the other. Also, be sure that the second person is standing (or holding the marked pole) at the water's edge or in the same depth of water as you are. The intent is to get a measure of the **water surface slope**, which may not necessarily be the same as the bottom slope.



### Slope (gradient) Measurement

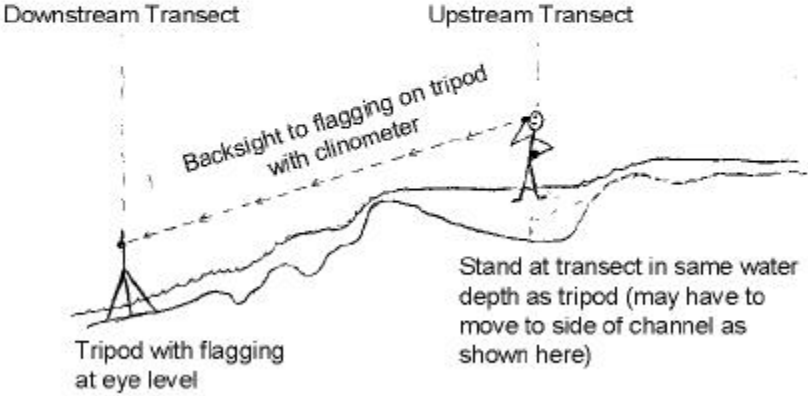

### Bearing Measurement Between Transects

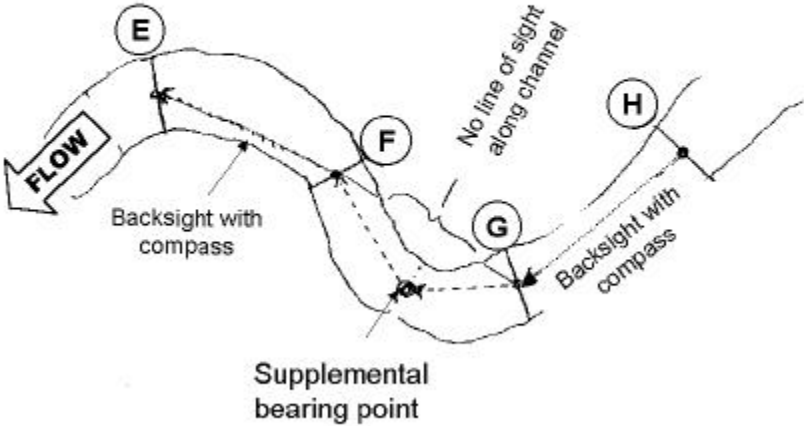

Figure 7-4. Channel slope and bearing measurements.

**TABLE 7-5. PROCEDURE FOR OBTAINING SLOPE AND BEARING DATA**

1. Stand in the center of the channel at the downstream cross-section transect. Determine if you can see the center of the channel at the next cross-section transect upstream without sighting across land (i.e., do not “short-circuit” a meander bend). If not, you will have to take supplementary slope and bearing measurements.
2. Set up the tripod in shallow water or at the water's edge at the downstream cross-section transect (or at a supplemental point). Standing tall in a position with your feet as near as possible to the water surface elevation, set the tripod extension and mark it with a piece of flagging at your eye level. Remember the depth of water in which you are standing when you adjust the flagging to eye level.
  - On gradually sloped streams, it is advisable to use two people, each holding a pole marked with flagging at the same height on both poles.
3. Walk upstream to the next cross-section transect. Find a place to stand at the upstream transect (or at a supplemental point) that is at the same depth as where you stood at the downstream transect when you set up the eye-level flagging.
  - If you have determined in Step 1 that supplemental measurements are required for this segment, walk upstream to the furthest point where you can still see the center of the channel at the downstream cross-section transect from the center of the channel. Mark this location with a different color flagging than that marking the cross-section transects.
4. With the clinometer, sight back downstream on your flagging at the downstream transect (or at the supplementary point). Read and record the **percent** slope in the “MAIN” section on the Slope and Bearing Form. Record the “PROPORTION” as 100%.
  - If two people are involved, place the base of each pole at the water level (or at the same depth at each transect). Then sight with the clinometer (or Abney level) from the flagged height on upstream pole to the flagged height on the downstream pole.
  - If you are backsighting from a supplemental point, record the slope (%) and proportion (%) of the stream segment that is included in the measurement in the appropriate “SUPPLEMENTAL” section of the Slope and Bearing Form.
5. Stand in the middle of the channel at upstream transect (or at a supplemental point), and sight back with your compass to the middle of the channel at the downstream transect (or at a supplemental point). Record the bearing (degrees) in the “MAIN” section of the Slope and Bearing Form.
  - If you are backsighting from a supplemental point, record the bearing in the appropriate “SUPPLEMENTAL” section of the Slope and Bearing Form.
6. Retrieve the tripod from the downstream cross section station (or from the supplemental point) and set it up at the next upstream transect (or at a supplemental point) as described in Step 2.
7. When you get to each new cross-section transect (or to a supplementary point), backsight on the previous transect (or the supplementary point), repeat Steps 2 through 6 above.

Reviewed by (initial): *SP*

Phab: SLOPE AND BEARING FORM - STREAMS

TRANSECT & METHOD		MAIN (always used)			FIRST SUPPLEMENTAL			SECOND SUPPLEMENTAL			FLAG
Slope(%) or Elev. Diff. (cm)		BEARING 0 - 359	PROPOR-TION %	Slope(%) or Elev. Diff. (cm)	BEARING 0 - 359	PROPOR-TION %	Slope(%) or Elev. Diff. (cm)	BEARING 0 - 359	PROPOR-TION %	FLAG	
A < B	<input checked="" type="checkbox"/> CL <input type="checkbox"/> TR <input type="checkbox"/> HL <input type="checkbox"/> WT <input type="checkbox"/> LA <input type="checkbox"/> Other	3.5 <input type="checkbox"/> cm	5.0	4.5	2.2.6	5.0					
B < C	<input checked="" type="checkbox"/> CL <input type="checkbox"/> TR <input type="checkbox"/> HL <input type="checkbox"/> WT <input type="checkbox"/> LA <input type="checkbox"/> Other	2.0 <input type="checkbox"/> cm	4.0	2.0	2.0.3	3.0	2.0	2.3.0	3.0		
C < D	<input checked="" type="checkbox"/> CL <input type="checkbox"/> TR <input type="checkbox"/> HL <input type="checkbox"/> WT <input type="checkbox"/> LA <input type="checkbox"/> Other	1.0 <input type="checkbox"/> cm	1.0.0								
D < E	<input checked="" type="checkbox"/> CL <input type="checkbox"/> TR <input type="checkbox"/> HL <input type="checkbox"/> WT <input type="checkbox"/> LA <input type="checkbox"/> Other	3.0 <input type="checkbox"/> cm	1.0.0								
E < F	<input checked="" type="checkbox"/> CL <input type="checkbox"/> TR <input type="checkbox"/> HL <input type="checkbox"/> WT <input type="checkbox"/> LA <input type="checkbox"/> Other	1.0 <input type="checkbox"/> cm	1.0.0								
F < G	<input checked="" type="checkbox"/> CL <input type="checkbox"/> TR <input type="checkbox"/> HL <input type="checkbox"/> WT <input type="checkbox"/> LA <input type="checkbox"/> Other	2.0 <input type="checkbox"/> cm	1.0.0								
G < H	<input checked="" type="checkbox"/> CL <input type="checkbox"/> TR <input type="checkbox"/> HL <input type="checkbox"/> WT <input type="checkbox"/> LA <input type="checkbox"/> Other	4.5 <input type="checkbox"/> cm	2.5	3.0	1.6.3	7.5					
H < I	<input checked="" type="checkbox"/> CL <input type="checkbox"/> TR <input type="checkbox"/> HL <input type="checkbox"/> WT <input type="checkbox"/> LA <input type="checkbox"/> Other	3.0 <input type="checkbox"/> cm	1.0.0								
I < J	<input checked="" type="checkbox"/> CL <input type="checkbox"/> TR <input type="checkbox"/> HL <input type="checkbox"/> WT <input type="checkbox"/> LA <input type="checkbox"/> Other	0.1 <input type="checkbox"/> cm	1.0.0							F1	
J < K	<input checked="" type="checkbox"/> CL <input type="checkbox"/> TR <input type="checkbox"/> HL <input type="checkbox"/> WT <input type="checkbox"/> LA <input type="checkbox"/> Other	0.0 <input type="checkbox"/> cm	1.0.0							F2	

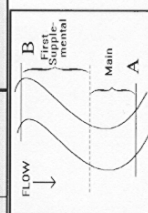

FLAG	COMMENT
F1	CLINOMETER READING = 0, BUT PERCEPTIBLE FLOW
F2	CLINOMETER READING = 0, NO PERCEPTIBLE FLOW



Flag codes: K = Sample not collected; U = Suspect sample; F1, F2, M (M = Method - used for method comment only) = flag assigned by field crew. Explain all flags in comment sections  
 03/20/2003 CL=Clinometer; HL=Hand Level; LA=Laser rangefinder with electronic clinometer; TR=Transit, surveyors level or total station; WT=Water Tubing.

Figure 7-5. Slope and Bearing Form.

As stated earlier, it may be necessary to set up intermediate (“supplementary”) slope and bearing points between a pair of cross-section transects if you do not have direct line-of-sight along (and within) the channel between stations (see Figure 7-4). This can happen if brush is too heavy, or if there are sharp slope breaks or tight meander bends. If you would have to sight across land to measure slope or bearing between two transects, then you need to make supplementary measurements (i.e., do not “short-circuit” a meander bend). Mark these intermediate station locations with a different color of plastic flagging than used for the cross-section transects to avoid confusion. Record these supplemental slope and bearing measurements, along with the proportion of the stream segment between transects included in each supplemental measurement, in the appropriate sections of the Slope and Bearing Form (Figure 7-5). Note that the main slope and bearing observations are always downstream of supplemental observations. Similarly, first supplemental observations are always downstream of second supplemental observations.

### **7.5.2 Substrate Size and Channel Dimensions**

Substrate size is one of the most important determinants of habitat character for fish and macroinvertebrates in streams. Along with bedform (e.g., riffles and pools), substrate influences the hydraulic roughness and consequently the range of water velocities in the channel. It also influences the size range of interstices that provide living space and cover for macroinvertebrates. Substrate characteristics are often sensitive indicators of the effects of human activities on streams. Decreases in the mean substrate size and increases in the percentage of fine sediments, for example, may destabilize channels and indicate changes in the rates of upland erosion and sediment supply (Dietrich et al, 1989; Wilcock, 1998).

Substrate size and embeddedness are evaluated at each of the 11 cross-section transects (refer to Figure 7-1) using a combination of methods adapted from those described by Wolman (1954), Bain et al. (1985), Platts et al. (1983), and Plafkin et al. (1989). Substrate size is evaluated also at 10 additional cross-sections located midway between each of the 11 regular transects (A-K). The basis of the protocol is a systematic selection of 5 substrate particles from each of 21 cross-section transects (Figure 7-6). In the process of measuring substrate particle sizes at each channel cross section, you also measure the wetted width of the channel and the water depth at each substrate sample point (at the 10 midway cross-sections, only substrate size and wetted width are recorded). If the wetted channel is split by a mid-channel bar (see Section 7.4.1), the five substrate points are centered between the wetted width boundaries regardless of the mid-channel bar in between. Consequently, substrate particles selected in some cross-sections may be “high and dry”. For cross-sections with dry channels, make measurements across the unvegetated portion of the channel.

The distance you record to the right bank is the same as the wetted channel width. (NOTE: this is the same value that is also recorded under “BANK MEASUREMENTS” on the same form [Section 7.5.3]). The substrate sampling points along the cross-section are located at 0, 25, 50, 75, and 100 percent of the measured wetted width, with the first and last points located at the water's edge just within the left and right banks.

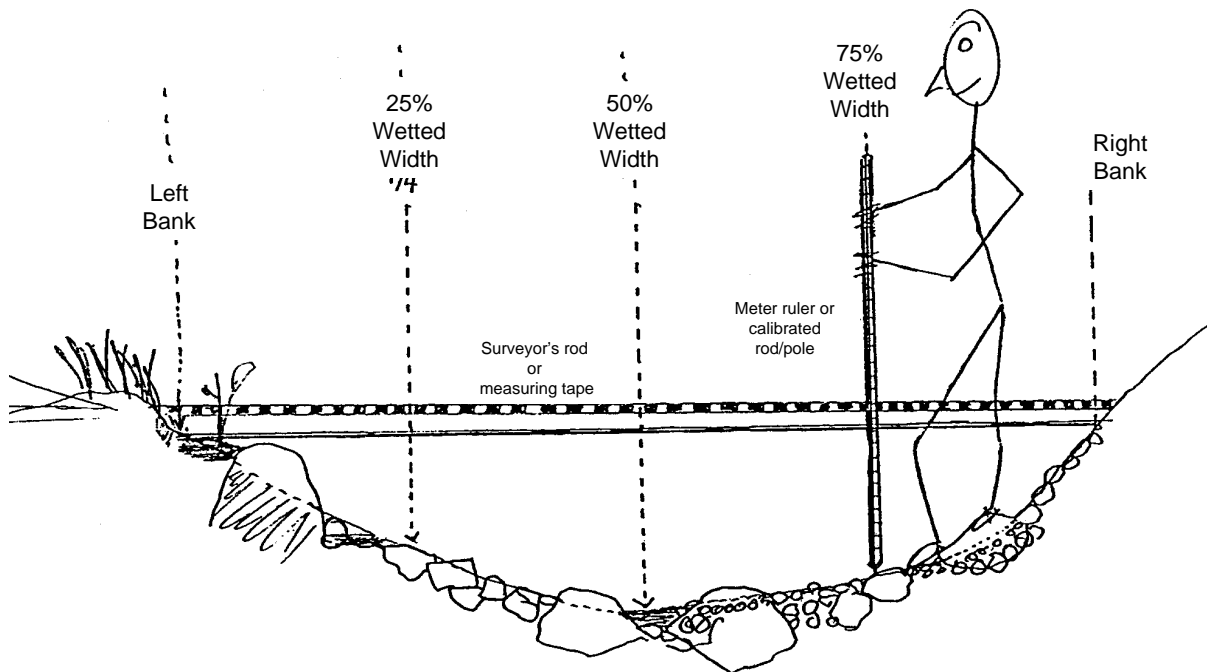

**Figure 7-6. Substrate sampling cross-section.**

The procedure for obtaining substrate measurements is described in Table 7-6. Record these measurements on the Channel/Riparian Cross-section side of the field form, as shown in Figure 7-7. For the supplemental cross-sections midway between regular transects, record substrate size and wetted width data on the Thalweg Profile side of the field form. To minimize bias in selecting a substrate particle for size classification, it is important to concentrate on correct placement of the measuring stick along the cross-section, and to select the particle right at the bottom of the stick (not, for example, a more noticeable large particle that is just to the side of the stick). Classify the particle into one of the size classes listed on the field data form (Figure 7-7) based on the middle dimension of its length, width, and depth. This “median” dimension determines the sieve size through which the particle can pass. Always distinguish “hardpan” from “fines”, coding hardpan as “HP”. Similarly, always distinguish concrete or asphalt from bedrock; denote these artificial substrates as “RC” and record their size class in the comments section of the field data form. Code and describe other artificial substrates (including metal, tires, car bodies, etc.) as “other” (“OT”) on the field form. When you record the size class as “OT” (other), assign an “F”-series flag on the field data form (Figure 7-7) and describe the substrate type in the comments section of the field form, as shown in Figure 7-2.

**TABLE 7-6. SUBSTRATE MEASUREMENT PROCEDURE**

1. Fill in the header information on page 1 of a Channel/Riparian Cross-section Form. Indicate the cross-section transect. At the transect, extend the surveyor's rod across the channel perpendicular to the flow, with the "zero" end at the left bank (facing downstream). If the channel is too wide for the rod, stretch the metric tape in the same manner.
2. Divide the wetted channel width channel by 4 to locate substrate measurement points on the cross-section. In the "DISTLB" fields of the form, record the distances corresponding to 0% (LFT), 25% (LCTR), 50% (CTR), 75% (RCTR), and 100% (RGT) of the measured wetted width. Record these distances at Transects A-K., but just the wetted width at midway cross-sections.
3. Place your sharp-ended meter stick or calibrated pole at the "LFT" location (0 m). Measure the depth and record it on the field data form. (Cross-section depths are measured only at regular transects A-K, not at the 10 midway cross-sections).
  - Depth entries at the left and right banks may be 0 (zero) if the banks are gradual.
  - If the bank is nearly vertical, let the base of the measuring stick fall to the bottom, rather than holding it suspended at the water surface.
4. Pick up the substrate particle that is at the base of the meter stick (unless it is bedrock or boulder), and visually estimate its particle size, according to the following table. Classify the particle according to its "median" diameter (the middle dimension of its length, width, and depth). Record the size class code on the field data form. (Cross-section side of form for Transects A-K; special entry boxes on Thalweg Profile side of form for midway cross-sections.)

Code	Size Class	Size Range (mm)	Description
RS	Bedrock (Smooth)	>4000	Smooth surface rock bigger than a car
RR	Bedrock (Rough)	>4000	Rough surface rock bigger than a car
HP	Hardpan	>4000	Firm, consolidated fine substrate
LB	Boulders (large)	>1000 to 4000	Yard/meter stick to car size
SB	Boulders (small)	>250 to 1000	Basketball to yard/meter stick size
CB	Cobbles	>64 to 250	Tennis ball to basketball size
GC	Gravel (Coarse)	>16 to 64	Marble to tennis ball size
GF	Gravel (Fine)	> 2 to 16	Ladybug to marble size
SA	Sand	>0.06 to 2	Smaller than ladybug size, but visible as particles - gritty between fingers
FN	Fines	<0.06	Silt Clay Muck (not gritty between fingers)
WD	Wood	Regardless of Size	Wood & other organic particles
RC	Concrete	Regardless of size	Record size class in comment field
OT	Other	Regardless of Size	metal, tires, car bodies etc. (describe in comments)

5. Evaluate substrate embeddedness as follows at 11 transects A-K. For particles larger than sand, examine the surface for stains, markings, and algae. Estimate the average percentage embeddedness of particles in the 10 cm circle around the measuring rod. Record this value on the field data form. By definition, sand and fines are embedded 100 percent; bedrock and hardpan are embedded 0 percent.
6. Move successively to the next location along the cross section. Repeat steps 4 through 6 at each location. Repeat Steps 1 through 6 at each new cross section transect.

SITE ID: WXXP99-9999 DATE: 07/01/2002 TRANSECT:  A-B  B-C  C-D  D-E  E-F  
 F-G  G-H  H-I  I-J  J-K

THALWEG PROFILE		For Transect A-B ONLY:		Increment (m) X.X:		Total Reach Length (m):				
STATION	THALWEG DEPTH (cm) (XXX)	WETTED WIDTH (m) (XXX.X)	BAR WIDTH <sup>1</sup> Present XXX	SOFT SEDIMENT HEIGHT	CHANNEL UNIT CODE	POOL CODE	SIDE CHANNEL	BACK WATER	FLAG	COMMENTS
0	14	3.6	N	0.8	RI	N	Y	N		
1	13		N		RI	N	Y	N		
2	27		N		RI	N	Y	N		
3	46		N		PT	F	Y	N		
4	40		N		PT	F	Y	N		
5	35	3.2	N	0.2	PT	F	Y	N		
6	34		N		PT	F	Y	N		
7	47		N		PT	F	Y	N		
8	53		N		PT	F	Y	N		
9	57		N		PT	F	Y	N	FI	SIDE CHANNEL CONVERGENCE
10			N				Y	N	Y	
11			N				Y	N	Y	
12			N				Y	N	Y	
13			N				Y	N	Y	
14			N				Y	N	Y	

SUBSTRATE	Station (5 or 7)	LFT	LCTR	CTR	RCTR	RGT	FLAG	LARGE WOODY DEBRIS ( $\geq 10$ cm total end diameter, $\geq 1.5$ m length)		CHECK IF UNMARKED BOXES ARE ZERO	FLAG
								DIAMETER LARGE END	LENGTH		
	5	SA	SA	GF	SA	FN		0.1-0.3 m	IRT		
								0.3-0.8 m		2	
								0.6-0.8 m			
								>0.8 m			

**SUBSTRATE SIZE CLASS CODES**  
 BE = BEDROCK (ROUGH) - LARGER THAN CAR  
 BR = BEDROCK (SMOOTH) - LARGER THAN CAR  
 RC = CONCRETE/ASPHALT  
 LB = LOG ROLLER (100 TO 400 mm) - METRICK TO CAR  
 SB = SM ROLLER (100 TO 100 mm) - METRICK TO CAR  
 CB = CORREL (40 TO 200 mm) - TENNIS BALL TO BASKETBALL  
 GC = COARSE GRAVEL (16 TO 64 mm) - MARBLE TO TENNIS BALL  
 FC = FINE GRAVEL (2 TO 16 mm) - LADYBUG TO MARBLE  
 SA = SAND (0.075 TO 4.75 mm) - P TO LADYBUG (S)  
 FN = SILT CLAY MUCK - ONE SMITTY  
 NP = MUDFLAT (FIRM CONSOLIDATED FINE SUBSTRATE)  
 WD = WOOD - ANY SIZE  
 QT = OTHER (COMMENT ON OTHER SIZE)

**POOL FORM CODES/CHANNEL UNIT CODES**  
 N = No pool  
 W = Large Woody debris  
 R = Rock  
 B = Boulder or Bankrock  
 F = Unstream Bank  
 COMBINATION: eg. WY, SA, WBS  
 CA = Riprap  
 CR = Cobble  
 PA = Pile  
 DR = Dry Channel

**POOL FORM CODES/CHANNEL UNIT CODES**  
 PP = Pool Plug  
 PT = Pool Touch  
 PL = Pool Lateral Scour  
 PB = Pool Bankscour  
 PD = Pool Dependent  
 GL = GULCH  
 RI = RILE  
 CA = Riprap  
 CR = Cobble  
 PA = Pile  
 DR = Dry Channel

Flag Codes: K = no measurement made, U = suspect measurement, F1, F2, etc. = flags assigned by each field crew, G1, G2, etc. for flags not specific to one station. Explain all flags in comments. 1 = Measure Bar Width at Station 0 and MS-Station (5 or 7).

Figure 7-7. Channel/riparian cross-section form.

At substrate sampling locations on the 11 regular transects (A-K), examine particles larger than sand for surface stains, markings, and algal coatings to estimate embeddedness of all particles in the 10 cm diameter circle around the substrate sampling point. Embeddedness is the fraction of a particle's surface that is surrounded by (embedded in) sand or finer sediments on the stream bottom. By definition, record the embeddedness of sand and fines (silt, clay, and muck) as 100 percent, and record the embeddedness of hardpan and bedrock as 0 percent.

### 7.5.3 Bank Characteristics

The procedure for obtaining bank and channel dimension measurements is presented in Table 7-7. Data are recorded in the "Bank Measurements" section of the Channel/Riparian Cross-section Form as shown in Figure 7-7. Bank angle and bank undercut distance are determined on the left and right banks at each cross section transect. Other features include the wetted width of the channel (as determined in Section 7.5.2), the width of exposed mid-channel bars of gravel or sand, estimated incision height, and the estimated height and width of the channel at bankfull stage as described in Table 7-6. **Bankfull height and incised height** are both measured relative to the present water surface. In other words, both are measured up from the level of the wetted edge of the stream.

The "**bankfull**" or "active" channel is defined as the channel that is filled by moderate-sized flood events that typically occur every one or two years. Such flows do not generally overtop the channel banks to inundate the valley floodplain, and are believed to control channel dimensions in most streams. Spotting the level of bankfull flow during baseflow conditions requires judgement and practice; even then it remains somewhat subjective. In many cases there is an obvious slope break that differentiates the channel from a relatively flat floodplain terrace higher than the channel. Because scouring and inundation from bankfull flows are typically frequent enough to inhibit the growth of terrestrial vegetation, the bankfull channel may be evident by a transition from exposed stream sediments to terrestrial vegetation. Similarly, it may be identified by noting moss growth on rocks along the banks. Bankfull flow level may also be seen by the presence of drift material caught on overhanging vegetation. However, in years with large floods, this material may be much higher than other bankfull indicators. In these cases, record the lower value, flag it, and also record the height of drift material in the comments section of the field data form.

We use the vertical distance (height) from the observed water surface up to the level of the first valley terrace (Figure 7-8) as a measure of the degree of "incision" or downcutting of the stream below the general level of its valley. This data is recorded in the space for **Incised Height**. (Note: In analyzing these data, the mean thalweg depth is added to incision heights to yield a flow-independent measure. The same thing is done for bankfull heights). Streams incise when their rate of sediment transport exceeds the supply of new sediment from upstream and from their banks. Conversely, aggradation occurs when sediment supplies exceed the capacity of the stream to transport sediment. Human activities can change the balance between sediment transport and supply in a number of ways. The power of the stream to transport sediment may be increased by human activities that increase flood flows (e.g., increases in watershed impervious area), or remove large roughness elements like woody debris that dissipate stream power that might otherwise transport sediment. The supply of sediment may be increased by upslope erosion, or decreased when, for example, upstream impoundments trap bedload sediments. It may not



be evident at the time of sampling whether the channel is downcutting, stable, or aggrading (raising its bed by depositing sediment). However, by recording incision heights measured in this way and monitoring them over time, we will be able to tell if streams are incising or aggrading.

**TABLE 7-7. PROCEDURE FOR MEASURING BANK CHARACTERISTICS**

---

1. To measure bank angle, lay the surveyor's rod or your meter ruler down against the left bank (determined as you face downstream), with one end at the water's edge. Lay the clinometer on the rod, read the bank angle in degrees from the external scale on the clinometer. Record the angle in the field for the left bank in the "BANK MEASUREMENT" section of the Channel/Riparian Cross-section Form.
    - A vertical bank is 90 degrees; undercut banks have angles >90 degrees approaching 180 degrees, and more gradually sloped banks have angles <90 degrees. To measure bank angles >90 degrees, turn the clinometer (which only reads 0 to 90 degrees) over and subtract the angle reading from 180 degrees.
  2. If the bank is undercut, measure the horizontal distance of the undercutting to the nearest 0.01 m. Record the distance on the field data form. The undercut distance is the distance from the water's edge out to the point where a vertical plumb line from the bank would hit the water's surface.
    - Measure submerged undercuts by placing the rod horizontally into the undercut and reading the length of the rod that is hidden by the undercutting.
  3. Repeat Steps 1 and 2 on the right bank.
  4. Hold the surveyor's rod vertically, with its base planted at the water's edge. Using the surveyor's rod as a guide while examining both banks, use the clinometer to measure the channel incision as the height up from the water surface to elevation of the first terrace of the valley floodplain (Note this is at or above the bankfull channel height). Record this value in the "INCISED HEIGHT" field of the bank measurement section on the field data form.
  5. Still holding the surveyor's rod as a guide, examine both banks to estimate and record the height of bankfull flow above the present water level. Look for evidence on one or both banks such as:
    - An obvious slope break that differentiates the channel from a relatively flat floodplain terrace higher than the channel.
    - A transition from exposed stream sediments to terrestrial vegetation.
    - Moss growth on rocks along the banks.
    - Presence of drift material caught on overhanging vegetation.
    - transition from flood- and scour-tolerant vegetation to that which is relatively intolerant of these conditions.
  6. Record the wetted width value determined when locating substrate sampling points in the "WETTED WIDTH" field in the bank measurement section of the field data form. Also determine the bankfull channel width and the width of exposed mid-channel bars (if present). Record these values in the "BANK MEASUREMENT" section of the field data form.
  7. Repeat Steps 1 through 6 at each cross-section transect. Record data for each transect on a separate field data form.
-

A. Channel not "Incised"

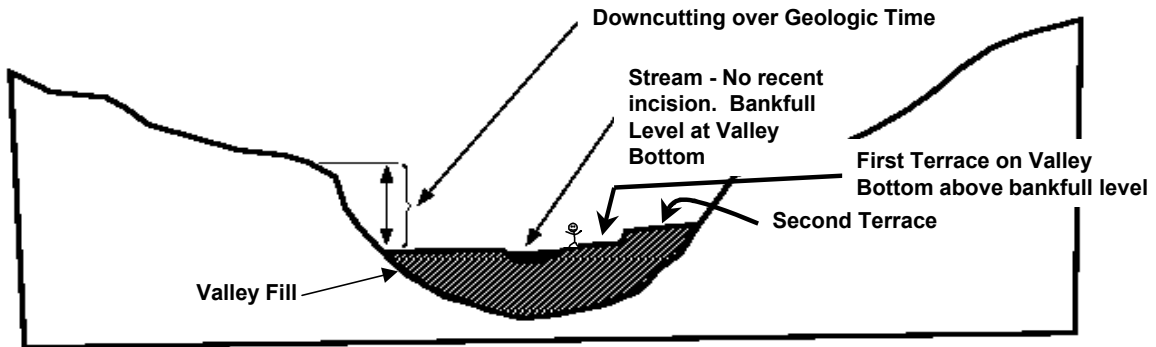

B. Channel "Incised"

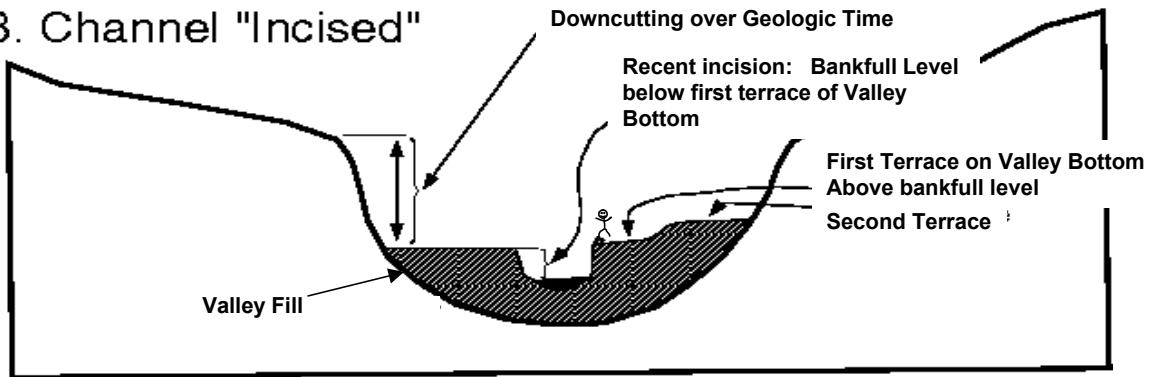

**Figure 7-8. Schematic showing bankfull channel and incision for channels. (A) not recently incised, and (B) recently incised into valley bottom.** Note level of bankfull stage relative to elevation of first terrace on valley bottom (Stick figure included for scale).

If the channel is not greatly incised, bankfull channel height and incision height will be the same. However, if the channel is incised greatly, the bankfull level will be below the level of the first terrace of the valley floodplain, making bankfull channel height smaller than incision height (Figure 7-9). **Bankfull height is never greater than incision height.** You may need to look for evidence of recent flows (within about one year) to distinguish bankfull and incision heights. In cases where the channel is cutting a valley sideslope and has oversteepened and destabilized that slope, the bare "cutbank" against the steep hillside at the edge of the valley is not necessarily an indication of recent incision. In such a case, the opposite bank may be lower, with a more obvious terrace above bankfull height; choose that bank for your measurement of incised height. Examine both banks to more accurately determine incision height and bankfull height. Remember that incision height is measured as **the vertical distance to the first terrace above bankfull; if terrace heights differ on left and right banks (both are above bankfull), choose the lower of the two terraces.** In many cases your sample reach may be in a "V" shaped valley or gorge formed over eons, and the slope of the channel banks simply extends uphill indefinitely, not reaching a terrace before reaching the top of a ridge (Figure 7-9). In such cases, record incision height values equal to bankfull values and make appropriate comment that no terrace is evident. Similarly, when the stream has extremely incised a very ancient terrace, (e.g., the Colorado River in the Grand Canyon), you may crudely estimate the terrace height if it is the first one above bankfull level. If you cannot estimate the terrace height, make appropriate comments describing the situation.

#### 7.5.4 Canopy Cover Measurements

Riparian canopy cover over a stream is important not only in its role in moderating stream temperatures through shading, but also as an indicator of conditions that control bank stability and the potential for inputs of coarse and fine particulate organic material. Organic inputs from riparian vegetation become food for stream organisms and structure to create and maintain complex channel habitat.

Canopy cover over the stream is determined at each of the 11 cross-section transects. A Convex Spherical Densimeter (model A) is used (Lemmon, 1957). The densimeter must be taped exactly as shown in Figure 7-10 to limit the number of square grid intersections to 17. Densimeter readings can range from 0 (no canopy cover) to 17 (maximum canopy cover). Six measurements are obtained at each cross-section transect (four measurements in four directions at mid-channel and one at each bank). The mid-channel measurements are used to estimate canopy cover over the channel. The two bank measurements complement your visual estimates of vegetation structure and cover within the riparian zone itself (Section 7.5.5), and are particularly important in wide streams, where riparian canopy may not be detected by the densimeter when standing midstream.

The procedure for obtaining canopy cover data is presented in Table 7-8. Densimeter measurements are taken at 0.3 m (1 ft) above the water surface, rather than at waist level, to (1) avoid errors because people differ in height; (2) avoid errors from standing in water of varying depths; and (3) include low overhanging vegetation more consistently in the estimates of cover. Hold the densimeter level (using the bubble level) 0.3 m above the water surface with your face reflected just below the apex of the taped "V", as shown in Figure 7-10. Concentrate on the 17 points of grid intersection on the densimeter that lie within the taped "V". If the reflection of a tree or high branch or leaf overlies any of the

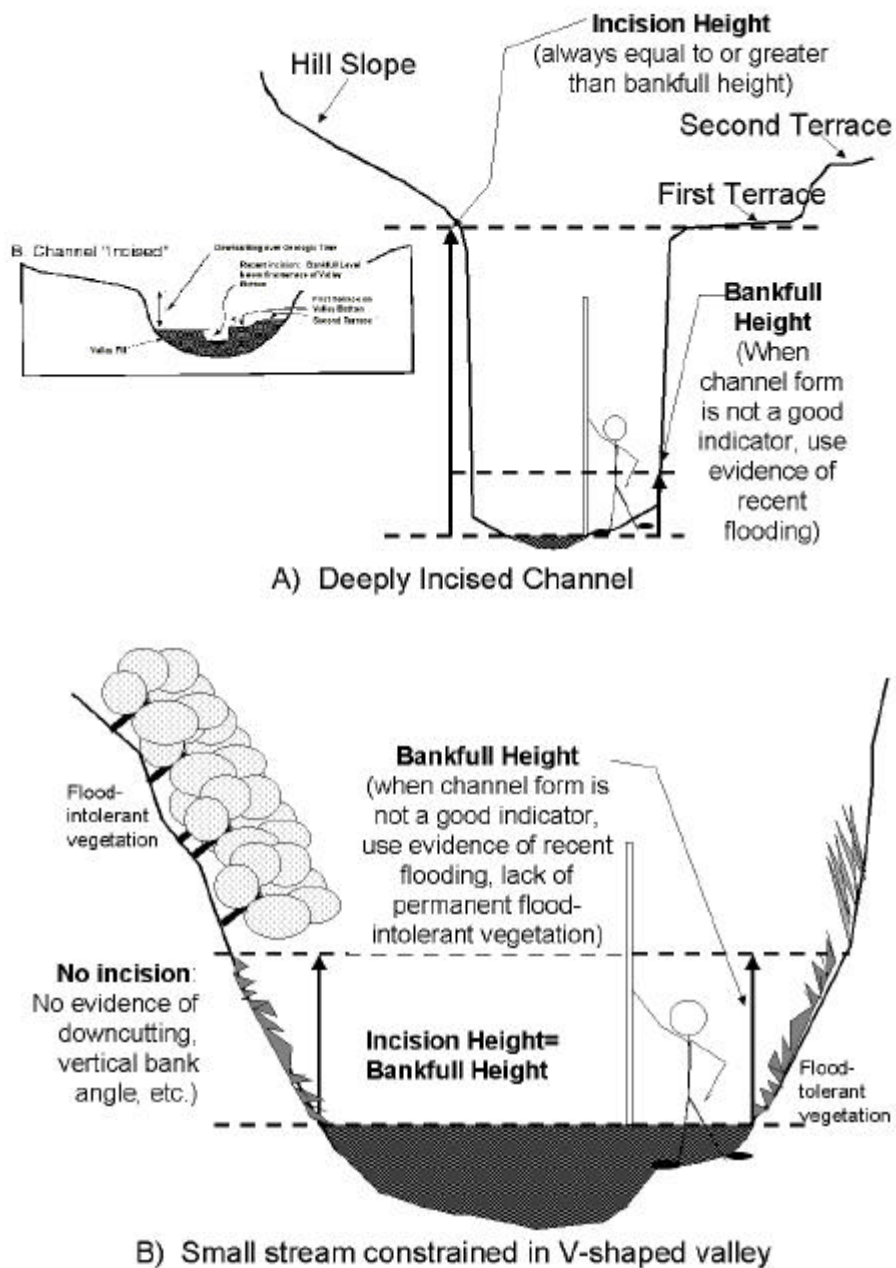
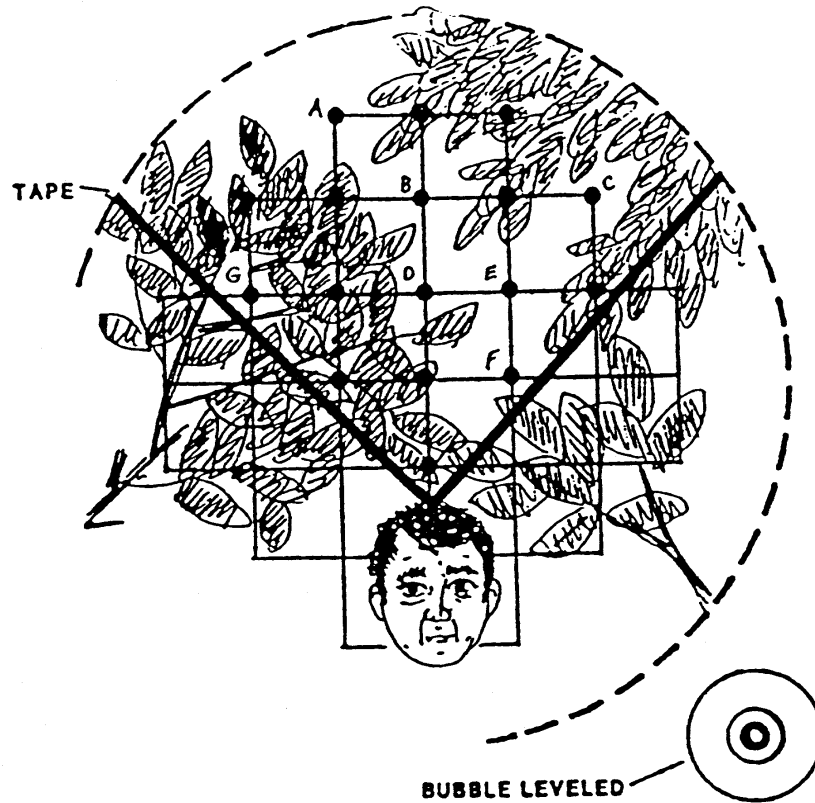

Figure 7-9. Determining bankfull and incision heights for (A) deeply incised channels, and (B) streams in deep V-shaped valleys. (Stick figure included for scale).



**Figure 7-10. Schematic of modified convex spherical canopy densiometer (From Mulvey et al., 1992).** In this example, 10 of the 17 intersections show canopy cover, giving a densiometer reading of 10. Note proper positioning with the bubble leveled and face reflected at the apex of the "V."

intersection points, that particular intersection is counted as having cover. For each of the six measurement points, record the number of intersection points (maximum=17) that have vegetation covering them in the "Canopy Cover Measurement" section of the Channel/Riparian Cross-section Form as shown in (Figure 7-7).

---

**TABLE 7-8. PROCEDURE FOR CANOPY COVER MEASUREMENTS**

---

1. At each cross-section transect, stand in the stream at mid-channel and face upstream.
  2. Hold the densiometer 0.3 m (1 ft) above the surface of the stream. Hold the densiometer level using the bubble level. Move the densiometer in front of you so your face is just below the apex of the taped "V".
  3. Count the number of grid intersection points within the "V" that are covered by either a tree, a leaf, or a high branch. Record the value (0 to 17) in the "CENUP" field of the canopy cover measurement section of the Channel/Riparian Cross-section and Thalweg Profile Form.
  4. Face toward the left bank (left as you face downstream). Repeat Steps 2 and 3, recording the value in the "CENL" field of the field data form.
  5. Repeat Steps 2 and 3 facing downstream, and again while facing the right bank (right as you look downstream). Record the values in the "CENDWN" and "CENR" fields of the field data form.
  6. Repeat Steps 2 and 3 again, this time facing the bank while standing first at the left bank, then the right bank. Record the values in the "LFT" and "RGT" fields of the field data form.
  7. Repeat Steps 1 through 6 at each cross-section transect. Record data for each transect on a separate field data form.
- 

### **7.5.5 Riparian Vegetation Structure**

The previous section (7.5.4) described methods for quantifying the cover of canopy over the stream channel. The following visual estimation procedures supplement those measurements with a semi-quantitative evaluation of the type and amount of various types of riparian vegetation. These data are used to evaluate the health and level of disturbance of the stream corridor. They also provide an indication of the present and future potential for various types of organic inputs and shading.

Riparian vegetation observations apply to the riparian area upstream 5 meters and downstream 5 meters from each of the 11 cross-section transects (refer to Figure 7-1). They include the visible area from the stream back a distance of 10m (~30 ft) shoreward from both the left and right banks, creating a 10 m × 10 m riparian plot on each side of the stream (Figure 7-11). The riparian plot dimensions are estimated, not measured. On steeply sloping channel margins, the 10 m × 10 m plot boundaries are defined as if they were projected down from an aerial view. If the wetted channel is split by a mid-channel bar, the bank and riparian measurements are made at each side of the channel, not the bar.

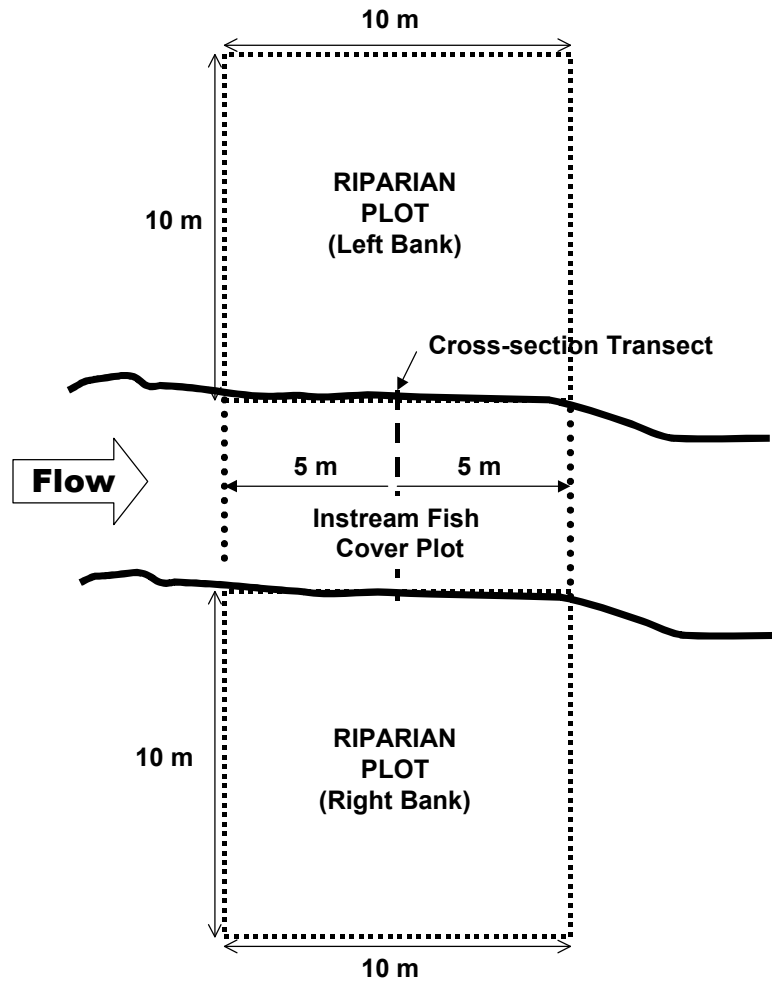

Figure 7-11. Boundaries for visual estimation of riparian vegetation, fish cover, and human influences.

Table 7-9 presents the procedure for characterizing riparian vegetation structure and composition. Figure 7-7 illustrates how measurement data are recorded in the "VISUAL RIPARIAN ESTIMATES" section of the Channel/Riparian Cross-section Form. Conceptually divide the riparian vegetation into three layers: a CANOPY LAYER (> 5 m high), an UNDERSTORY (0.5 to 5 m high), and a GROUND COVER layer (< 0.5 m high). Note that several vegetation types (e.g., grasses or woody shrubs) can potentially occur in more than one layer. Similarly note that some things other than vegetation are possible entries for the "Ground Cover" layer (e.g., barren ground).

**TABLE 7-9. PROCEDURE FOR CHARACTERIZING RIPARIAN VEGETATION STRUCTURE**

1. Standing in mid-channel at a cross-section transect, estimate a 5 m distance upstream and downstream (10 m total length).
2. Facing the left bank (left as you face downstream), estimate a distance of 10 m from the wetted margin back into the riparian vegetation.  
  
On steeply-sloping channel margins, estimate the distance into the riparian zone as if it were projected down from an aerial view.
3. Within this 10 m x 10 m area, conceptually divide the riparian vegetation into three layers: a CANOPY LAYER (>5m high), an UNDERSTORY (0.5 to 5 m high), and a GROUND COVER layer (<0.5 m high).
4. Determine the dominant vegetation type for the CANOPY LAYER (vegetation > 5 m high) as either Deciduous, Coniferous, broadleaf Evergreen, Mixed, or None. Consider the layer "Mixed" if more than 10% of the areal coverage is made up of the alternate vegetation type. Indicate the appropriate vegetation type in the "VISUAL RIPARIAN ESTIMATES" section of the Channel/Riparian Cross-section Form.
5. Determine separately the areal cover class of large trees (> 0.3 m [1 ft] diameter at breast height [DBH]) and small trees (< 0.3 m DBH) within the canopy layer. Estimate areal cover as the amount of shadow that would be cast by a particular layer alone if the sun were directly overhead. Record the appropriate cover class on the field data form ("0"=absent: zero cover, "1"=sparse: <10%, "2"=moderate: 10-40%, "3"=heavy: 40-75%, or "4"=very heavy: >75%).
6. Look at the UNDERSTORY layer (vegetation between 0.5 and 5 m high). Determine the dominant **woody** vegetation type for the understory layer as described in Step 4 for the canopy layer. If there is no woody vegetation in the understory layer, record the type as "**N**one".
7. Determine the areal cover class for woody shrubs and saplings separately from non-woody vegetation within the understory, as described in Step 5 for the canopy layer.
8. Look at the GROUND COVER layer ( vegetation < 0.5 m high). Determine the areal cover class for woody shrubs and seedlings, non-woody vegetation, and the amount of bare ground present as described in Step 5 for large canopy trees.
9. Repeat Steps 1 through 8 for the right bank.
10. Repeat Steps 1 through 9 for all cross-section transects, using a separate field data form for each transect.



Before estimating the areal coverage of the vegetation layers, record the type of **woody** vegetation (Deciduous, Coniferous, broadleaf Evergreen, Mixed, or None) in each of the two taller layers (Canopy and Understory). Consider the layer "Mixed" if more than 10% of the areal coverage is made up of the alternate vegetation type. If there is no woody vegetation in the understory layer, record the type as "None".

Estimate the areal cover separately in each of the three vegetation layers. Note that the areal cover can be thought of as the amount of shadow cast by a particular layer alone when the sun is directly overhead. The maximum cover in each layer is 100%, so the sum of the areal covers for the combined three layers could add up to 300%. The five areal cover classes are "absent", "sparse" (<10%), "moderate" (10 to 40%), "heavy" (40 to 75%), and "very heavy" (>75%). These cover classes and their corresponding codes are shown on the field data form (Figure 7-7). When rating vegetation cover types, mixtures of two or more subdominant classes might all be given sparse ("1") moderate ("2") or heavy ("3") ratings. One very heavy cover class with no clear subdominant class might be rated "4" with all the remaining classes rated as either moderate ("2"), sparse ("1") or absent ("0"). Two heavy classes with 40-75% cover can both be rated "3".

### **7.5.6 Instream Fish Cover, Algae, and Aquatic Macrophytes**

This portion of the physical habitat protocol is a visual estimation procedure that semi-quantitatively evaluates the type and amount of important types of cover for fish and macroinvertebrates. Alone and in combination with other metrics, this information is used to assess habitat complexity, fish cover, and channel disturbance.

The procedure to estimate the types and amounts of instream fish cover is outlined in Table 7-10. Data are recorded in the "Fish Cover/Other" section of the Channel /Riparian Cross-section Form as shown in Figure 7-7. Estimate the areal cover of all of the fish cover and other listed features that are in the water and on the banks 5 m upstream and downstream of the cross-section (see Figure 7-11). The areal cover classes of fish concealment and other features are the same as those described for riparian vegetation (Section 7.5.5).

The entry "Filamentous algae" refers to long streaming algae that often occur in slow moving waters. "Aquatic macrophytes" are water-loving plants, including mosses, in the stream that could provide cover for fish or macroinvertebrates. If the stream channel contains live wetland grasses, include these as macrophytes. "Woody debris" are the larger pieces of wood that can influence cover and stream morphology (i.e., those pieces that would be included in the large woody debris tally [Section 7.4]). "Brush/woody debris" refers to smaller wood pieces that primarily affect cover but not morphology. "Live Trees or Roots" are living trees that are within the channel -- estimate the areal cover provided by the parts of these trees or roots that are inundated. For ephemeral channels, estimate the proportional cover of these trees that is inundated during bankfull flows. "Overhanging vegetation" includes tree branches, brush, twigs, or other small debris that is not in the water but is close to the stream (within 1 m of the surface) and provides potential cover. "Boulders" are typically basketball- to car-sized particles. "Artificial structures" include those designed for fish habitat enhancement, as well as in-channel structures discarded (e.g., concrete, asphalt, cars, or tires) or purposefully placed for diversion, impoundment, channel stabilization, or other purposes.

---

---

**TABLE 7-10. PROCEDURE FOR ESTIMATING INSTREAM FISH COVER**

---

---

1. Standing mid-channel at a cross-section transect, estimate a 5m distance upstream and downstream (10 m total length).
  2. Examine the water and the banks within the 10-m segment of stream for the following features and types of fish cover: filamentous algae, aquatic macrophytes, large woody debris, brush and small woody debris, in-channel live trees or roots, overhanging vegetation, undercut banks, boulders, and artificial structures.
  3. For each cover type, estimate the areal cover. Record the appropriate cover class in the "FISH COVER/OTHER" section of the Channel/Riparian Cross-section Form:  
  
"0"=absent: zero cover,  
"1"=sparse: <10%,  
"2"=moderate: 10-40%,  
"3"=heavy: 40-75%, or  
"4"=very heavy: >75%).
  4. Repeat Steps 1 through 3 at each cross-section transect, recording data from each transect on a separate field data form.
- 
- 

### **7.5.7 Human Influence**

The field evaluation of the presence and proximity of various important types of human land use activities in the stream riparian area is used in combination with mapped watershed land use information to assess the potential degree of disturbance of the sample stream reaches.

For the left and right banks at each of the 11 detailed Channel and Riparian Cross-Sections, evaluate the presence/absence and the proximity of 11 categories of human influences with the procedure outlined in Table 7-11. Relate your observations and proximity evaluations to the stream and riparian area within 5 m upstream and 5 m downstream from the station (Figure 7-11). Four proximity classes are used: In the stream or on the bank within 5 m upstream or downstream of the cross-section transect, present within the 10 m × 10 m riparian plot but not in the stream or on the bank, present outside of the riparian plot, and absent. Record data on the Channel/Riparian Cross-section Form as shown in Figure 7-7. If a disturbance is within more than one proximity class, record the one that is closest to the stream (e.g., "C" takes precedence over "P").

A particular influence may be observed outside of more than one riparian observation plot (e.g., at both transects "D" and "E"). Record it as present at every transect where you can see it without having to sight through another transect or its 10 m × 10 m riparian plot.

---

**TABLE 7-11. PROCEDURE FOR ESTIMATING HUMAN INFLUENCE**

---

1. Standing mid-channel at a cross-section transect, look toward the left bank (left when facing downstream), and estimate a 5 m distance upstream and downstream (10 m total length). Also, estimate a distance of 10 m back into the riparian zone to define a riparian plot area.
  2. Examine the channel, bank and riparian plot area adjacent to the defined stream segment for the following human influences: (1) walls, dikes, revetments, riprap, and dams; (2) buildings; (3) pavement/cleared lot (e.g., paved, gravelled, dirt parking lot, foundation); (4) roads or railroads, (5) inlet or outlet pipes; (6) landfills or trash (e.g., cans, bottles, trash heaps); (7) parks or maintained lawns; (8) row crops; (9) pastures, rangeland, hay fields, or evidence of livestock; (10) logging; and (11) mining (including gravel mining).
  3. For each type of influence, determine if it is present and what its proximity is to the stream and riparian plot area. Consider human disturbance items as present if you can see them from the cross-section transect. Do not include them if you have to sight through another transect or its 10 m ×10 m riparian plot.
  4. For each type of influence, record the appropriate proximity class in the “HUMAN INFLUENCE” part of the “VISUAL RIPARIAN ESTIMATES” section of the Channel/Riparian Cross-section Form. Proximity classes are:

B (“Bank”)	Present within the defined 10 m stream segment and located in the stream or on the stream bank.
C (“Close”)	Present within the 10 × 10 m riparian plot area, but away from the bank.
P (“Present”)	Present, but outside the riparian plot area.
O (“Absent”)	Not present within or adjacent to the 10 m stream segment or the riparian plot area at the transect
  5. Repeat Steps 1 through 4 for the right bank.
  6. Repeat Steps 1 through 5 for each cross-section transect, recording data for each transect on a separate field form.
- 

### 7.5.8 Riparian “Legacy” Trees

The Riparian “Legacy” Tree protocol contributes to the assessment of “old growth” characteristics of riparian vegetation, and aids the determination of possible historic conditions and the potential for riparian tree growth. Follow the procedures presented in Table 7-12 to locate **the largest tree** associated with each transect. The tree you choose may not truly be an old “legacy” tree— just choose the largest you see. These data are used to determine if there are true “legacy” trees somewhere within the sampling reach. Note that only one tree is identified for each transect between that transect and the next one upstream; at transect K, look upstream a distance of 4 channel widths. Record the type of tree, and, if possible, the taxonomic group (using the list provided in Table 7-12). Record this information, along with the estimated height, diameter at breast height (dbh), and distance from the wetted margin of the stream on the left hand column of the field form for Riparian “Legacy” Trees and Invasive Alien Plants (Figure 7-12).

**TABLE 7-12. PROCEDURE FOR IDENTIFYING RIPARIAN LEGACY TREES**

**Legacy Trees:**

1. Beginning at Transect A, look upstream. Search both sides of the stream upstream to the next transect. At Transect “K”, look upstream for a distance of 4 channel widths. Locate the largest tree visible within 50m (or as far as you can see, if less) from the wetted bank (note the tree you identify may be outside the current riparian zone).
2. Classify this tree as deciduous, coniferous, or broadleaf evergreen (classify western larch as coniferous). Identify, if possible, the species or the taxonomic group of this tree from the list below. If not listed on data sheet, write in name of tree.

- |   |  |
|---|--|
| 1. Acacia/Mesquite                      | 11. Snag (Dead Tree of Any Species)      |
| 2. Alder/Birch                          | 12. Spruce                               |
| 3. Ash                                  | 13. Sycamore                             |
| 4. Cedar/Cypress                        | 14. Willow                               |
| 5. Fir (including Douglas Fir, Hemlock) | 15. Dogwood                              |
| 6. Juniper                              | 16. Beech                                |
| 7. Maple/Boxelder                       | 17. Magnolia                             |
| 8. Oak                                  | 18. Unknown or Other Broadleaf Evergreen |
| 9. Pine                                 | 19. Unknown or Other Conifer             |
| 10. Poplar/Cottonwood                   | 20. Unknown or Other Deciduous           |

NOTE: If the largest tree is a dead “snag”, enter “Snag” as the taxonomic group.

3. Estimate the height of the potential legacy tree, its diameter at breast height (dbh ) and its distance from the wetted margin of the stream. Enter this information on the left hand column of the Riparian “Legacy” Trees and Invasive Alien Plants field form.
4. Repeat Steps 1 through 3 for each remaining transect (B through K). At transect “K”, look upstream a distance of 4 channel widths) when locating the legacy tree.

Figure 7-12. Riparian "Legacy" Tree Form (Page 1).

Reviewed by (initial): *SP*

DATE: 07/01/2002

RIPARIAN "LEGACY" TREES AND INVASIVE ALIEN PLANTS

Tran	LARGEST POTENTIAL LEGACY TREE VISIBLE FROM THIS STATION					ALIEN PLANT SPECIES PRESENT IN LEFT AND RIGHT RIPARIAN PLOTS	
	Trees not Visible	DBH (m)	Height (m)	Dist. from wetted margin (m)	Type	Taxonomic Category	Check all that are present
A	<input type="checkbox"/>	<input type="checkbox"/> 0-0.1 <input type="checkbox"/> .75-2 <input checked="" type="checkbox"/> 1-3 <input type="checkbox"/> >2 <input type="checkbox"/> 3-7.5	<input checked="" type="checkbox"/> <5 <input type="checkbox"/> 5-15 <input type="checkbox"/> 15-30 <input type="checkbox"/> >30	10	<input checked="" type="checkbox"/> Deciduous <input type="checkbox"/> Coniferous <input type="checkbox"/> Broadleaf Evergreen	POPULAR/COTTONWOOD	<input checked="" type="checkbox"/> NONE <input type="checkbox"/> RC Grass <input type="checkbox"/> Salt Ced <input type="checkbox"/> Hblack <input type="checkbox"/> G Reed <input type="checkbox"/> Engl Ivy <input type="checkbox"/> CanThis <input type="checkbox"/> Teasel <input type="checkbox"/> C Burd <input type="checkbox"/> Ch Grass <input type="checkbox"/> M This <input type="checkbox"/> Spurge <input type="checkbox"/> Rus OI
B	<input type="checkbox"/>	<input type="checkbox"/> 0-0.1 <input type="checkbox"/> .75-2 <input type="checkbox"/> 1-3 <input type="checkbox"/> >2 <input checked="" type="checkbox"/> 3-7.5	<input type="checkbox"/> <5 <input checked="" type="checkbox"/> 5-15 <input type="checkbox"/> 15-30 <input type="checkbox"/> >30	15	<input checked="" type="checkbox"/> Deciduous <input type="checkbox"/> Coniferous <input type="checkbox"/> Broadleaf Evergreen	SNAG	<input checked="" type="checkbox"/> NONE <input type="checkbox"/> RC Grass <input type="checkbox"/> Salt Ced <input type="checkbox"/> Hblack <input type="checkbox"/> G Reed <input type="checkbox"/> Engl Ivy <input type="checkbox"/> CanThis <input type="checkbox"/> Teasel <input type="checkbox"/> C Burd <input type="checkbox"/> Ch Grass <input type="checkbox"/> M This <input type="checkbox"/> Spurge <input type="checkbox"/> Rus OI
C	<input type="checkbox"/>	<input type="checkbox"/> 0-0.1 <input checked="" type="checkbox"/> .75-2 <input type="checkbox"/> 1-3 <input type="checkbox"/> >2 <input type="checkbox"/> 3-7.5	<input type="checkbox"/> <5 <input type="checkbox"/> 5-15 <input checked="" type="checkbox"/> 15-30 <input type="checkbox"/> >30	5	<input checked="" type="checkbox"/> Deciduous <input type="checkbox"/> Coniferous <input type="checkbox"/> Broadleaf Evergreen	POPULAR/COTTONWOOD	<input type="checkbox"/> NONE <input type="checkbox"/> RC Grass <input type="checkbox"/> Salt Ced <input type="checkbox"/> Hblack <input type="checkbox"/> G Reed <input type="checkbox"/> Engl Ivy <input checked="" type="checkbox"/> CanThis <input type="checkbox"/> Teasel <input type="checkbox"/> C Burd <input checked="" type="checkbox"/> Ch Grass <input type="checkbox"/> M This <input type="checkbox"/> Spurge <input type="checkbox"/> Rus OI

INSTRUCTIONS	ALIEN SPECIES
<p><b>Potential Legacy trees</b> are defined as the largest tree within your search area, which is as far as you can see, but within maximum limits as follows:</p> <p><b>Wadeable Streams:</b> Confine search to no more than 50 m from left and right bank and extending upstream to next transect (for 'K' look upstream 4 channel widths)</p> <p><b>Non-wadeable Rivers:</b> Confine search to no more than 100 m from left and right bank and extending both upstream and downstream as far as you can see confidently.</p> <p><b>Alien Plants:</b> Confine search to riparian plots on left and right bank</p> <p>Wadeable Streams: 10 m x 10 m Non-wadeable Rivers: 10 m x 20 m</p> <p>Not all aliens are to be identified in all states. See Field Manual and Plant Identification Guide.</p>	RC Grass <input type="checkbox"/> RC Grass <input type="checkbox"/> Salt Ced <input type="checkbox"/> Hblack <input type="checkbox"/> G Reed Engl Ivy <input type="checkbox"/> Engl Ivy <input type="checkbox"/> CanThis <input type="checkbox"/> Teasel <input type="checkbox"/> C Burd Ch Grass <input type="checkbox"/> Ch Grass <input type="checkbox"/> M This <input type="checkbox"/> Spurge <input type="checkbox"/> Rus OI Salt Ced <input type="checkbox"/> Salt Ced <input type="checkbox"/> Hblack <input type="checkbox"/> G Reed Can This <input type="checkbox"/> Canada thistle <input type="checkbox"/> Cirsium arvense M This <input type="checkbox"/> Musk thistle <input type="checkbox"/> Carduus nutans Hblack <input type="checkbox"/> Himalayan blackberry <input type="checkbox"/> Rubus discolor Teasel <input type="checkbox"/> Teasel <input type="checkbox"/> Dipsacus fullonum Spurge <input type="checkbox"/> Leafy spurge <input type="checkbox"/> Euphorbia esula G Reed <input type="checkbox"/> Giant reed <input type="checkbox"/> Arundo donax C Burd <input type="checkbox"/> Common burdock <input type="checkbox"/> Arctim minus Rus OI <input type="checkbox"/> Russian-olive <input type="checkbox"/> Elaeagnus angustifolia
TAXONOMIC CATEGORIES	COMMENTS
Acacia/Mesquite Alder/Birch Ash Maple/Boxelder Oak Poplar/Cottonwood Sycamore Willow Unknown or Other Deciduous Cedar/Cypress/Sequoia Fir (including Douglas fir and hemlock) Juniper Pine Spruce Unknown or Other Conifer Unknown or Other Broadleaf Evergreen Snag (Dead tree of any species)	Phalaris arundinacea Hedera helix Bromus tectorum Tamarix spp. Cirsium arvense Carduus nutans Rubus discolor Dipsacus fullonum Euphorbia esula Arundo donax Arctim minus Elaeagnus angustifolia

## 7.6 CHANNEL CONSTRAINT, DEBRIS TORRENTS, AND RECENT FLOODS

### 7.6.1 Channel Constraint

Whether natural or the result of human activities, the presence of immovable or difficult-to-move river margins constrains the degree to which the stream can form its own channel and banks through scour and deposition. The degree of channel constraint can strongly influence the quantity and quality of habitat for aquatic organisms. Constraint also influences the type and degree of stream channel adjustment to anthropogenic alterations in flow and sediment supply, or to direct channel manipulations (e.g., dredging, revetment, impoundment). To assess overall reach channel constraint, the Aquatic Inventories of the Oregon Department of Fish & Wildlife (Moore et al. 1993) methods have been modified. After completing the thalweg profile and littoral-riparian measurements and observations, envision the stream at bankfull flow and evaluate the degree, extent and type of channel constraint, using the procedures presented in Table 7-13. Record data on the Channel Constraint Assessment Form (Figure 7-13). First, classify the stream reach channel pattern as predominantly a **single** channel, an **anastomosing** channel, or a **braided** channel.

5. **Anastomosing channels have relatively long major and minor channels** branching and rejoining in a complex network.
6. **Braided channels also have multiple branching and rejoining channels**, but these sub-channels are generally smaller, shorter, and more numerous, often with no obvious dominant channel.

After classifying channel pattern, determine whether the channel is constrained within a narrow valley, constrained by local features within a broad valley, unconstrained and free to move about within a broad floodplain, or free to move about, but within a relatively narrow valley floor. Then examine the channel to ascertain the bank and valley features that constrain the stream. Entry choices for the type of constraining features are bedrock, hillslopes, terraces/alluvial fans, and human land use (e.g., road, dike, landfill, rip-rap, etc.). Estimate the percent of the channel margin in contact with constraining features (for unconstrained channels, this is 0%). To aid in this estimate, you may wish to refer to the individual transect assessments of incision and constraint. Finally, estimate the “typical” bankfull channel width and visually estimate the average width of the valley floor. If you cannot directly estimate the valley width (e.g., it is further than you can see, or if your view is blocked by vegetation), record the distance you can see and mark the appropriate box on the field form.

### 7.6.2 Debris Torrents and Recent Major Floods

Major floods are those that substantially overtop the banks of streams and occur with an average frequency of less than once every 5 years. Major floods may scour away or damage riparian vegetation on banks and gravel bars that are not frequently inundated. They typically cause movement of large woody debris, transport of bedload sediment, and changes in the streambed and banks through scouring and deposition. While they may kill aquatic organisms and temporarily suppress their populations, floods are an important natural resetting mechanism that maintains habitat volume, clean substrates, and riparian productivity.

---

**TABLE 7-13. PROCEDURES FOR ASSESSING CHANNEL CONSTRAINT**

---

NOTE: These activities are conducted after completing the thalweg profile and littoral-riparian measurements and observations, and represent an evaluation of the entire stream reach.

**Channel Constraint:** Determine the degree, extent, and type of channel constraint is based on envisioning the stream at **bankfull flow**.

- Classify the stream reach channel pattern as predominantly a **single** channel, an **anastomosing** channel, or a **braided** channel.

**Anastomosing channels have relatively long major and minor channels** branching and rejoining in a complex network.

**Braided channels also have multiple branching and rejoining channels**, but these sub-channels are generally smaller, shorter, and more numerous, often with no obvious dominant channel.

- After classifying channel pattern, determine whether the channel is constrained within a narrow valley, constrained by local features within a broad valley, unconstrained and free to move about within a broad floodplain, or free to move about, but within a relatively narrow valley floor.
- Then examine the channel to ascertain the bank and valley features that constrain the stream. Entry choices for the type of constraining features are bedrock, hillslopes, terraces/alluvial fans, and human land use (e.g., road, dike, landfill, rip-rap, etc.).
- Based on your determinations from Steps 1 through 3, select and record one of the constraint classes shown on the Channel Constraint Form.
- Estimate the percent of the channel margin in contact with constraining features (for unconstrained channels, this is 0%). Record this value on the Channel Constraint Form.
- Finally, estimate the “typical” bankfull channel width, and visually estimate the average width of the valley floor. Record these values on the Channel Constraint Form.

NOTE: To aid in this estimate, you may wish to refer to the individual transect assessments of incision and constraint that were recorded on the Channel/Riparian Cross-Section Forms.

NOTE: If the valley is wider than you can directly estimate, record the distance you can see and mark the box on the field form.

---

CHANNEL CONSTRAINT AND FIELD CHEMISTRY - STREAMS/RIVERS

Reviewed by (Initial): *SP*

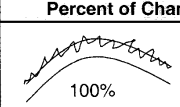
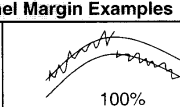
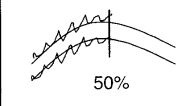
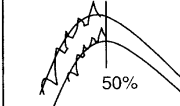
SITE ID: <u>WXY99-9999</u>		DATE: <u>07/01/2001</u>	
<b>IN SITU MEASUREMENTS</b>		Station ID:	(Assume X-site unless marked)
		Comments	
STREAM/RIVER DO mg/l: (optional)	<u>5.3</u>		
STREAM RIVER TEMP. (°C):	<u>20.5</u>		
TIME OF DAY:	<u>11:25</u>		
<b>CHANNEL CONSTRAINT</b>			
CHANNEL PATTERN (Check One)			
<input checked="" type="checkbox"/> <b>One channel</b> <input type="checkbox"/> <b>Anastomosing (complex) channel</b> - (Relatively long major and minor channels branching and rejoining.) <input type="checkbox"/> <b>Braided channel</b> - (Multiple short channels branching and rejoining - mainly one channel broken up by numerous mid-channel bars.)			
CHANNEL CONSTRAINT (Check One)			
<input type="checkbox"/> <b>Channel very constrained in V-shaped valley</b> (i.e. it is very unlikely to spread out over valley or erode a new channel during flood) <input type="checkbox"/> <b>Channel is in Broad Valley</b> but channel movement by erosion during floods is <b>constrained by Incision</b> (Flood flows do not commonly spread over valley floor or into multiple channels.) <input type="checkbox"/> <b>Channel is in Narrow Valley but is not very constrained</b> , but limited in movement by relatively narrow valley floor (< ~10 x bankfull width) <input checked="" type="checkbox"/> <b>Channel is Unconstrained in Broad Valley</b> (i.e. during flood it can fill off-channel areas and side channels, spread out over flood plain, or easily cut new channels by erosion)			
CONSTRAINING FEATURES (Check One)			
<input type="checkbox"/> <b>Bedrock</b> (i.e. channel is a bedrock-dominated gorge) <input type="checkbox"/> <b>Hillslope</b> (i.e. channel constrained in narrow V-shaped valley) <input type="checkbox"/> <b>Terrace</b> (i.e. channel is constrained by its own incision into river/stream gravel/soil deposits) <input type="checkbox"/> <b>Human Bank Alterations</b> (i.e. constrained by rip-rap, landfill, dike, road, etc.) <input checked="" type="checkbox"/> <b>No constraining features</b>			
Percent of channel length with margin in contact with constraining feature:	<u>0</u> % (0-100%)	<b>Percent of Channel Margin Examples</b>	
Bankfull width:	<u>6</u> (m)		
Valley width (Visual Estimated Average):	<u>2000</u> (m)		
Note: Be sure to include distances between both sides of valley border for valley width. If you cannot see the valley borders, record the distance you can see and mark this box. <input checked="" type="checkbox"/>			
Comments	<u>VALLEY WIDTH &gt; 2000 meters</u>		

38480



Figure 7-13. Channel Constraint and Field Chemistry Form, showing data for channel constraint.



Debris torrents, or lahars, differ from “conventional” floods in that they are flood waves of higher magnitude and shorter duration, and their flow is comprised of a dense mixture of water and debris. Their high flows of dense material exert tremendous scouring forces on streambeds. For example, in the Pacific Northwest, debris torrent flood waves can exceed 5 meters deep in small streams normally 3 meters wide and 15 cm deep. These torrents move boulders in excess of 1m diameter and logs >1m diameter and >10m long. In temperate regions, debris torrents occur primarily in steep drainages and are relatively infrequent, occurring typically less than once in several centuries. They are usually set into motion by the sudden release of large volumes of water upon the breaching of a natural or human-constructed impoundment, a process often initiated by mass hillslope failures (landslides) during high intensity rainfall or snowmelt. Debris torrents course downstream until the slope of the stream channel can no longer keep their viscous sediment suspension in motion (typically <3% for small streams); at this point, they “set up”, depositing large amounts of sediment, boulders, logs, and whatever else they were transporting. Upstream, the “torrent track” is severely scoured, often reduced in channel complexity and devoid of near-bank riparian vegetation. As with floods, the massive disruption of the stream channel and its biota are transient, and these intense, infrequent events will often lead to high-quality complex habitat within years or decades, as long as natural delivery of large wood and sediment from riparian and upland areas remains intact.

In arid areas with high runoff potential, debris torrents can occur in conjunction with flash flooding from extremely high intensity rainfall. They may be nearly annual events in some steep ephemeral channels where drainage area is sufficient to guarantee isolated thunderstorms somewhere within their boundaries, but small enough that the effect of such storms is not dampened out by the portion of the watershed not receiving rainfall during a given storm.

Because they may alter habitat and biota substantially, infrequent major floods and torrents can confuse the interpretation of measurements of stream biota and habitat in regional surveys and monitoring programs. Therefore, it is important to determine if a debris torrent or major flood has occurred within the recent past. After completing the Thalweg Profile and Channel/Riparian measurements and observations, examine the stream channel along the entire sample reach, including its substrate, banks, and riparian corridor, checking the presence of features described on the Torrent Evidence Assessment Form (Figure 7-14). It may be advantageous to look at the channel upstream and downstream of the actual sample reach to look for areas of torrent scour and massive deposition to answer some of the questions on the field form. For example, you may more clearly recognize the sample reach as a torrent deposition area if you find extensive channel scouring upstream. Conversely, you may more clearly recognize the sample reach as a torrent scour reach if you see massive deposits of sediment, logs, and other debris downstream.

### TORRENT EVIDENCE ASSESSMENT FORM - STREAMS

SITE ID: <u>WXP99-9999</u>	DATE: <u>07/01/2002</u>
----------------------------	-------------------------

TORRENT EVIDENCE	
Please X any of the following that are evident.	
EVIDENCE OF TORRENT SCOURING:	
<input type="checkbox"/>	01 - Stream channel has a recently devegetated corridor two or more times the width of the low flow channel. This corridor lacks riparian vegetation with possible exception of fireweed, even-aged alder or cottonwood seedlings, grasses, or other herbaceous plants.
<input type="checkbox"/>	02 - Stream substrate cobbles or large gravel particles are NOT IMBRICATED. (Imbricated means that they lie with flat sides horizontal and that they are stacked like roof shingles -- imagine the upstream direction as the top of the "roof.") In a torrent scour or deposition channel, the stones are laying in unorganized patterns, lying "every which way." In addition many of the substrate particles are angular (not "water-worn.")
<input type="checkbox"/>	03 - Channel has little evidence of pool-riffle structure. (For example, could you ride a mountain bike down the channel?)
<input type="checkbox"/>	04 - The stream channel is scoured down to bedrock for substantial portion of reach.
<input type="checkbox"/>	05 - There are gravel or cobble berms (little levees) above bankfull level.
<input type="checkbox"/>	06 - Downstream of the scoured reach (possibly several miles), there are massive deposits of sediment, logs, and other debris.
<input type="checkbox"/>	07 - Riparian trees have fresh bark scars at many points along the stream at seemingly unbelievable heights above the channel bed.
<input type="checkbox"/>	08 - Riparian trees have fallen into the channel as a result of scouring near their roots.
EVIDENCE OF TORRENT DEPOSITS:	
<input type="checkbox"/>	09 - There are massive deposits of sediment, logs, and other debris in the reach. They may contain wood and boulders that, in your judgement, could not have been moved by the stream at even extreme flood stage.
<input type="checkbox"/>	10 - If the stream has begun to erode newly laid deposits, it is evident that these deposits are "MATRIX SUPPORTED." This means that the large particles, like boulders and cobbles, are often not touching each other, but have silt, sand, and other fine particles between them (their weight is supported by these fine particles -- in contrast to a normal stream deposit, where fines, if present, normally "fill-in" the interstices between coarser particles.)
NO EVIDENCE:	
<input checked="" type="checkbox"/>	11 - No evidence of torrent scouring or torrent deposits.

COMMENTS

**Figure 7-14. Torrent Evidence Assessment Form.**

## **7.7 EQUIPMENT AND SUPPLIES**

Figure 7-15 lists the equipment and supplies required to conduct all the activities described for characterizing physical habitat. This checklist is similar to the checklist presented in Appendix A, which is used at the base location (Section 3) to ensure that all of the required equipment is brought to the stream. Use this checklist to ensure that equipment and supplies are organized and available at the stream site in order to conduct the activities efficiently.

**EQUIPMENT AND SUPPLIES FOR PHYSICAL HABITAT**

QTY.	Item
1	Surveyor's telescoping leveling rod (round profile, metric scale, 7.5m extended)
1	50-m fiberglass measuring tape & reel
1	Hip chain (metric) for measuring reach lengths ( <u>Optional</u> )
1	Clinometer (or Abney level) with percent and degree scales.
1	Lightweight telescoping camera tripod (necessary only if slope measurements are being determined by one person)
2	½-inch diameter PVC pipe, 2-3 m long: Two of these, each marked at the same height (for use in slope determinations involving two persons) ( <u>Optional</u> )
1	Meter stick. Alternatively, a short (1-2 m) rod or pole (e.g., a ski pole) with cm markings for thalweg measurements, or the PVC pipe described for slope determinations can be marked in cm and used.
1 roll ea.	Colored surveyor's plastic flagging (2 colors)
1	Convex spherical canopy densiometer (Lemmon Mod. A), modified with taped "V"
1	Bearing compass (Backpacking type)
1 or 2	Fisherman's vest with lots of pockets and snap fittings. Used at least by person conducting the in-channel measurements to hold the various measurement equipment (densiometer, clinometer, compass, etc.). Useful for both team members involved with physical habitat characterization.
2 pair	Chest waders with felt-soled boots for safety and speed if waders are the neoprene "stocking" type. Hip waders can be used in shallower streams.
	Covered clipboards (lightweight, with strap or lanyard to hang around neck)
	Soft (#2) lead pencils (mechanical are acceptable)
11 plus extras	Channel/Riparian Cross-section & Thalweg Profile and Woody Forms
1 plus extras	Slope and Bearing Form; Riparian Legacy Tree and Invasive Alien Plant Form; Channel Constraint Assessment Form; Torrent Evidence Form.
1 copy	Field operations and methods manual
1 set	Procedure tables and/or quick reference guides for physical habitat characterization (laminated or printed on write-in-the-rain paper)

**Figure 7-15. Checklist of equipment and supplies for physical habitat.**

## NOTES



## 8.0 BENTHIC MACROINVERTEBRATES

Benthic invertebrates inhabit the sediment or live on the bottom substrates of streams. The benthic macroinvertebrate assemblage in streams is an important component of measuring the overall biological condition of the aquatic community. Monitoring this assemblage is useful in assessing the status of the water body and detecting trends in ecological condition. Populations in the benthic assemblage respond to a wide array of stressors in different ways so that it is often possible to determine the type of stress that has affected a macroinvertebrate assemblage (e.g., Klemm et al., 1990). Because many macroinvertebrates have relatively long life cycles of a year or more and are relatively immobile, the structure and function of the macroinvertebrate assemblage is a response to exposure of present or past conditions.

The benthic macroinvertebrate protocol of WSA is intended to evaluate the biological condition of wadeable streams in the United States for the purpose of detecting stresses on structure and assessing the relative severity of these stresses. It is based on the updated Rapid Bioassessment Protocols (RBPs) published by the U.S. Environmental Protection Agency (Barbour et al., 1999) and adopted for use by many states. The main difference between the benthic macroinvertebrate collection methods from the original RBPs (1989) and the 2<sup>nd</sup> Edition (1999), is the use of a D-frame net (Figure 8-1). The D-frame net used by WSA still requires only one person. This technique is versatile for varying habitat type and is the preferred macroinvertebrate collecting method for streams with flowing water.

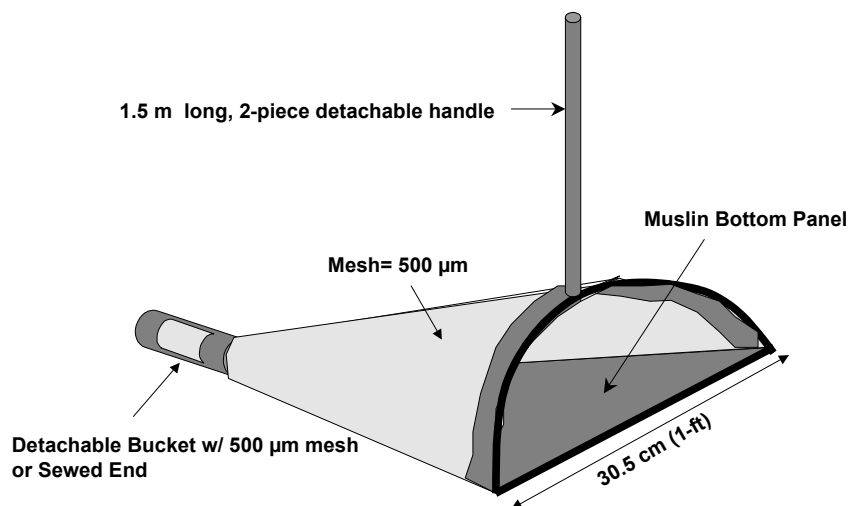

Figure 8-1. Modified D-frame kick net. (Not drawn to scale.)

## 8.1 SAMPLE COLLECTION

The transect sample design for collecting benthic macroinvertebrates is shown in Figure 8-2. This design was used in the EMAP-WP stream study in the western U.S. (refer to Section 1 for project descriptions), which provides continuity for a nationwide assessment.

A sample is collected from **1-m downstream** of each of the eleven cross-section transects (Transects “A” through “K”) at an assigned sampling point (Left, Center, or Right). These points may have been assigned when the sampling reach was laid out (Figure 8-2; refer also to Section 4; Table 4-3). If not, the sampling point at Transect “A” is assigned at random using a die or other suitable means (e.g., digital watch). Once the first sampling point is determined, points at successive transects are assigned in order (Left, Center, Right). At transects assigned a “Center” sampling point where the stream width is between one and two net widths wide, pick either the “Left” or “Right” sampling point instead. If the stream is only one net wide at a transect, place the net across the entire stream width and consider the sampling point to be “Center”. If a sampling point is located in water that is too deep or otherwise unsafe to wade, select an alternate sampling point on the transect at random.

The procedure for collecting a sample at each transect is described in Table 8-1. At each sampling point, determine if the habitat is a “riffle/run” or a “pool/glide”. Any area where there is not sufficient current to extend the net is operationally defined as a pool/glide habitat. Record the dominant substrate type (fine/sand, gravel, coarse substrate (coarse gravel or larger) or other (e.g., bedrock, hardpan, wood, aquatic vegetation, etc.) and the habitat type (pool, glide, riffle, or rapid) for each sample collected on the Sample Collection Form as shown in Figure 8-3. As you proceed upstream from transect to transect, combine all samples into a bucket or similar container.

If it is impossible to sample at the sampling point with the modified kick net following either procedure, spend about 30 seconds hand picking a sample from about 0.09 m<sup>2</sup> (1 ft<sup>2</sup>) of substrate at the sampling point. For vegetation-choked sampling points, sweep the net through the vegetation for 30 seconds. Place the contents of this hand-picked sample into the sampling container.

## 8.2 SAMPLE PROCESSING

Use a sieve bucket while sampling to carry the composite sample as you walk upstream. Alternatively, place each sample in a five-gallon bucket and use a soil sieve (500 µm) to cull-down the sample before it is packed and preserved in a Nalgene container(s) upon completion (Table 8-2). Record tracking information for each composite sample on the Sample Collection Form as shown in Figure 8-3. **Do not fill out the collection form until you have collected (or confirmed at the site that you will collect) samples.** If forms are filled out before you arrive at the site, and then no samples are collected, a lot of time is wasted by others later trying to find samples that do not exist.



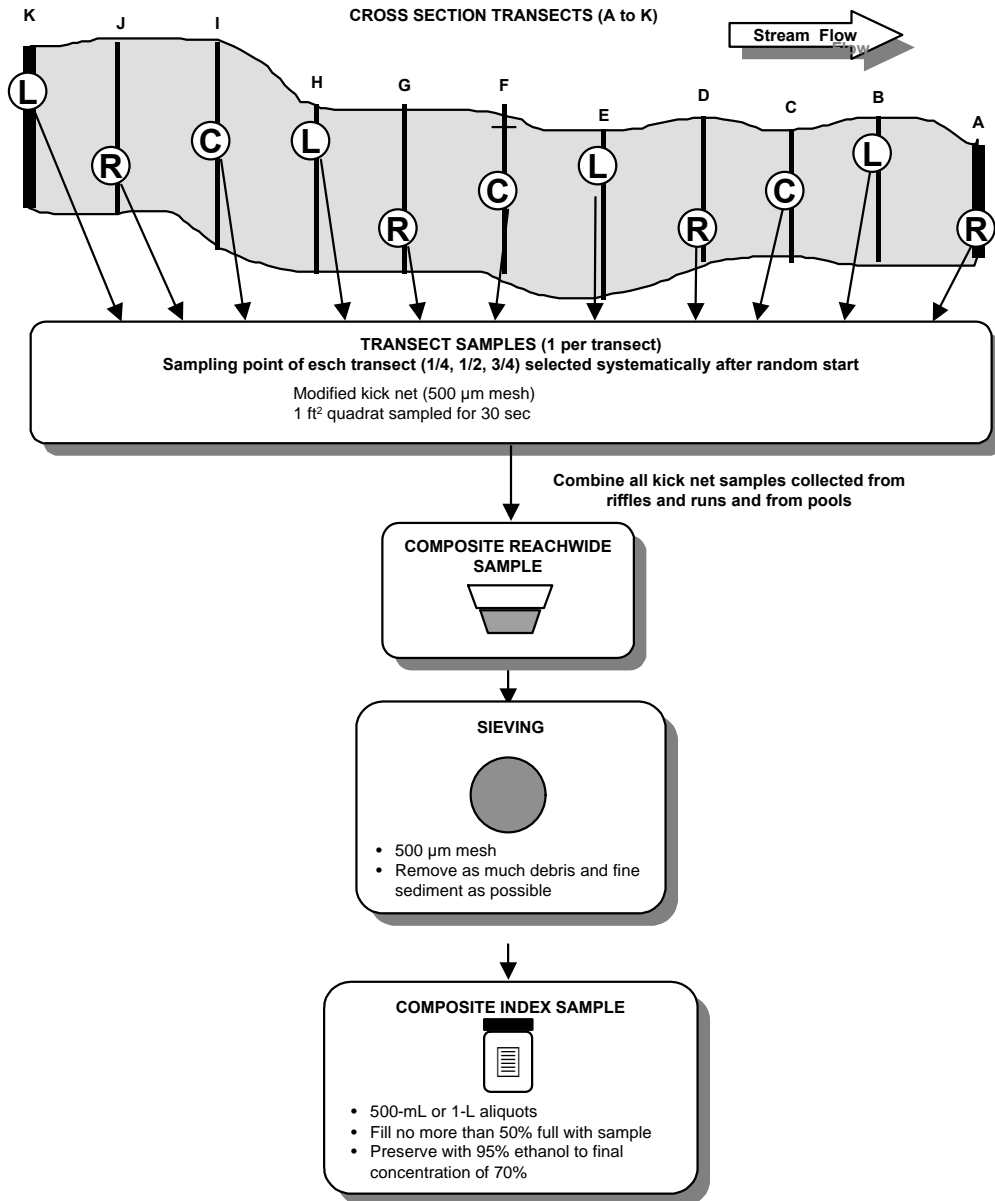

Figure 8-2. Transect sampling design for the benthic macroinvertebrate sample.

**TABLE 8-1. PROCEDURE TO COLLECT BENTHIC MACROINVERTEBRATE SAMPLES**

1. At **1 m downstream** of each cross-section transect, beginning with Transect "A", locate the assigned sampling point (Left, Center, or Right as you face downstream) as 25%, 50%, and 75% of the wetted width, respectively. If you cannot collect a sample at the designated point because of deep water or unsafe conditions, relocate to another random point on the same transect.
2. Attach the 4-ft handle to the kick net. Make sure that the handle is on tight or the net may become twisted in a strong current, causing the loss of part of the sample.
3. Determine if there is sufficient current in the area at the sampling point to fully extend the net. If so, classify the habitat as "riffle/run" and proceed to Step 4. If not, use the sampling procedure described for "pool/glide" habitats (Step 9).  
NOTE: If the net cannot be used, spend 30 seconds hand picking a sample from about 0.09 m<sup>2</sup> ( 1 ft<sup>2</sup>) of substrate at the sampling point. For vegetation-choked sampling points, sweep the net through the vegetation within a 0.09 m<sup>2</sup> ( 1 ft<sup>2</sup>) quadrat for 30 seconds. Place the contents of this hand-picked sample directly into the sampling container. Assign a "U" flag (non-standard sample) to the sample and indicate which transect(s) required the modified collection procedure in the comments section. Go to Step 15.

**Riffle/Run Habitats:**

4. With the net opening facing upstream, position the net quickly and securely on the stream bottom to eliminate gaps under the frame. Avoid large rocks that prevent the sampler from seating properly on the stream bottom.  
NOTE: If there is too little water to collect the sample with the D-net, randomly pick up 10 rocks from the riffle and pick and wash the organisms off them into a bucket which is half-full of water.
5. Holding the net in position on the substrate, visually define a rectangular quadrat that is one net width wide and one net width long upstream of the net opening. The area within this quadrat is ~0.09 m<sup>2</sup> (1 ft<sup>2</sup>). Alternatively, place a wire frame of the correct dimensions in front of the net to help delineate the quadrat to be sampled.
6. Check the quadrat for heavy organisms, such as mussels and snails. Remove these organisms from the substrate by hand and place them into the net. Pick up any loose rocks or other larger substrate particles in the quadrat. Use your hands or a small scrub brush to dislodge organisms so that they are washed into the net. Scrub all rocks that are golf ball-sized or larger and which are over halfway into the quadrat. Large rocks that are less than halfway into the sampling area are pushed aside. After scrubbing, place the substrate particles outside of the quadrat.
7. Keep holding the D-net securely in position. Start at the upstream end of the quadrat, vigorously kick the remaining finer substrate within the quadrat for 30 seconds (use a stopwatch).

NOTE: For samples located within dense beds of long, filamentous aquatic vegetation (e.g., algae or moss), kicking within the quadrat may not be sufficient to dislodge organisms in the vegetation. Usually these types of vegetation are lying flat against the substrate due to current. Use a knife or scissors to remove **only the vegetation that lies within the quadrat** (i.e., not entire strands that are rooted within the quadrat) and place it into the net.

(continued)

**TABLE 8-1. (Continued)**

- 
8. Pull the net up out of the water. Immerse the net in the stream several times to remove fine sediments and to concentrate organisms at the end of the net. Avoid having any water or material enter the mouth of the net during this operation.
  9. Go to Step 14.

**Pool/Glide habitats:**

10. Visually define a rectangular quadrat that is one net width wide and one net width long at the sampling point. The area within this quadrat is ~0.09 m<sup>2</sup> (1 ft<sup>2</sup>). Alternatively, lay a wire frame of the correct dimensions in front of the net at the sampling point to help delineate the quadrat.
11. Inspect the stream bottom within the quadrat for any heavy organisms, such as mussels and snails. Remove these organisms by hand and place them into the net or bucket. Pick up any loose rocks or other larger substrate particles within the quadrat and hold them in front of the net. Use your hands (or a scrub brush) to rub any clinging organisms off of rocks or other pieces of larger substrate (especially those covered with algae or other debris) into the net. After scrubbing, place the larger substrate particles outside of the quadrat.
12. Vigorously kick the remaining finer substrate within the quadrat with your feet while dragging the net repeatedly through the disturbed area just above the bottom. Keep moving the net all the time so that the organisms trapped in the net will not escape. Continue kicking the substrate and moving the net for 30 seconds. NOTE: If there is too little water to use the kick net, stir up the substrate with your gloved hands and use a sieve with 500 µm mesh size to collect the organisms from the water in the same way the net is used in larger pools.
13. After 30 seconds, remove the net from the water with a quick upstream motion to wash the organisms to the bottom of the net.

**All samples:**

14. Invert the net into a plastic bucket and transfer the sample. Inspect the net for any residual organisms clinging to the net and deposit them into the bucket. Use forceps if necessary to remove organisms from the net. Carefully inspect any large objects (such as rocks, sticks, and leaves) in the bucket and wash any organisms found off of the objects and into the bucket before discarding the object. Remove as much detritus as possible without losing any organisms.
15. Determine the **predominant** substrate size/type you observed within the sampling quadrat. Place an "X" in the appropriate substrate type box for the transect on the Sample Collection Form. NOTE: If there are co-dominant substrate types, you may check more than one box; note the co-dominants in the comments section of the form.

Fine/sand: not gritty (silt/clay/muck < 0.06 mm diam.) to gritty, up to ladybug sized (2 mm diam.)

Gravel: fine to coarse gravel (ladybug to tennis ball sized; 2 mm to 64 mm diam.)

Coarse: Cobble to boulder (tennis ball to car sized; 64 mm to 4000 mm)

Other: bedrock (larger than car sized; > 4000 mm), hardpan (firm, consolidated fine substrate), wood of any size, aquatic vegetation, etc.). Note type of "other" substrate in comments on field form.

---

**(Continued)**

**TABLE 8-1 (Continued)**

- 
16. Identify the habitat type where the sampling quadrat was located. Place an "X" in the appropriate channel habitat type box for the transect on the Sample collection Form.
- Pool; Still water; low velocity; smooth, glassy surface; usually deep compared to other parts of the channel  
GLide: Water moving slowly, with smooth, unbroken surface; low turbulence  
Riffle: Water moving, with small ripples, waves, and eddies; waves not breaking, and surface tension is not broken; "babbling" or "gurgling" sound.  
RApid: Water movement is rapid and turbulent; surface with intermittent "white water" with breaking waves; continuous rushing sound.
17. Thoroughly rinse the net before proceeding to the next sampling location. Proceed upstream to the next transect (including Transect K, the upstream end of the sampling reach) and repeat Steps 1 through 9. Combine all kick net samples from riffle/run and pool/glide habitats into the bucket.
- 

A set of completed sample labels, including the label that is used if more than one jar is required for a single composite sample, is shown in Figure 8-4. The ID number is also recorded with a number 2 lead pencil on a waterproof label that is placed inside each jar (Figure 8-4, lower right). If more than one jar is used for a composite sample, a special label (Figure 8-4, lower left) is used to record the ID number assigned to the sample. **DO NOT use two different barcode numbers on two jars containing one single sample.** Blank labels for use inside of sample jars are presented in Figure 8-5. These can be copied onto waterproof paper. If a sample requires more than one jar, make sure the correct number of jars for the sample is recorded on the Sample Collection Form. Again, accurate record-keeping in the field saves substantial amounts of time later.

Check to be sure that the prenumbered adhesive label is on the jar and covered with clear tape, and that the waterproof label is in the jar and filled in properly. Be sure the inside label and outside label describe the same sample. Replace the cap on each jar. Check to make sure the cap is properly marked with the site number. Place the samples in a cooler or other secure container for transporting and/or shipping the laboratory (see Section 3). **Before shipping to the lab (after a sample has been preserved for at least one week), decant the majority of the ethanol from the container. Leave only enough ethanol to keep the sample moist.** Place the lid back on the container and seal with electrical tape. The sample will be refilled with ethanol upon receipt at the benthic laboratory. Check to see that all equipment is in the vehicle.

### **8.3 EQUIPMENT AND SUPPLY CHECKLIST**

Figure 8-6 shows the checklist of equipment and supplies required to complete the collection of benthic macroinvertebrates from streams. This checklist is similar to the checklist presented in Appendix A, which is used at the base location (Section 3) to ensure that all of the required equipment is brought to the stream. Use this checklist to ensure that equipment and supplies are organized and available at the stream site in order to conduct the activities efficiently.

**SAMPLE COLLECTION FORM - STREAMS** Reviewed by (initial): *SP*

SITE ID: WXXP99-9999 DATE: 07/01/2002

WATER CHEMISTRY		
Sample ID	Transect	Comments
<u>229015</u>	<u>X</u>	

REACH-WIDE BENTHOS SAMPLE		
Sample ID	No. of Jars	Comment
<u>999001</u>	<u>2</u>	<u>FOR TRANSECT K OTHER = SMALL WOODY DEBRIS</u>

TRANSECT	CHAN.	A		B		C		D		E		F		G		H		I		J		K	
		Sub.	Chan.	Sub.	Chan.	Sub.	Chan.	Sub.	Chan.	Sub.	Chan.	Sub.	Chan.	Sub.	Chan.	Sub.	Chan.	Sub.	Chan.	Sub.	Chan.	Sub.	Chan.
Fine/Sand	Pool	<input type="checkbox"/> F	<input type="checkbox"/> P	<input checked="" type="checkbox"/> F	<input type="checkbox"/> P	<input checked="" type="checkbox"/> F	<input checked="" type="checkbox"/> P	<input type="checkbox"/> F	<input type="checkbox"/> P	<input type="checkbox"/> F	<input type="checkbox"/> P	<input type="checkbox"/> F	<input type="checkbox"/> P	<input type="checkbox"/> F	<input type="checkbox"/> P	<input checked="" type="checkbox"/> F	<input type="checkbox"/> P	<input checked="" type="checkbox"/> F	<input checked="" type="checkbox"/> P	<input checked="" type="checkbox"/> F	<input checked="" type="checkbox"/> P	<input type="checkbox"/> F	<input checked="" type="checkbox"/> P
Gravel	Glide	<input checked="" type="checkbox"/> G	<input type="checkbox"/> GL	<input type="checkbox"/> G	<input checked="" type="checkbox"/> GL	<input type="checkbox"/> G	<input type="checkbox"/> GL	<input checked="" type="checkbox"/> G	<input checked="" type="checkbox"/> GL	<input type="checkbox"/> G	<input type="checkbox"/> GL	<input type="checkbox"/> G	<input type="checkbox"/> GL	<input checked="" type="checkbox"/> G	<input type="checkbox"/> GL	<input type="checkbox"/> G	<input checked="" type="checkbox"/> GL	<input type="checkbox"/> G	<input type="checkbox"/> GL	<input type="checkbox"/> G	<input type="checkbox"/> GL	<input type="checkbox"/> G	<input type="checkbox"/> GL
Coarse	Riffle	<input type="checkbox"/> C	<input checked="" type="checkbox"/> RI	<input type="checkbox"/> C	<input type="checkbox"/> RI	<input type="checkbox"/> C	<input type="checkbox"/> RI	<input type="checkbox"/> C	<input type="checkbox"/> RI	<input type="checkbox"/> C	<input type="checkbox"/> RI	<input checked="" type="checkbox"/> C	<input checked="" type="checkbox"/> RI	<input type="checkbox"/> C	<input checked="" type="checkbox"/> RI	<input type="checkbox"/> C	<input type="checkbox"/> RI	<input type="checkbox"/> C	<input type="checkbox"/> RI	<input type="checkbox"/> C	<input type="checkbox"/> RI	<input type="checkbox"/> C	<input type="checkbox"/> RI
Other: Note in Comments	Rapid	<input type="checkbox"/> O	<input type="checkbox"/> RA	<input type="checkbox"/> O	<input type="checkbox"/> RA	<input type="checkbox"/> O	<input type="checkbox"/> RA	<input type="checkbox"/> O	<input type="checkbox"/> RA	<input type="checkbox"/> O	<input type="checkbox"/> RA	<input type="checkbox"/> O	<input type="checkbox"/> RA	<input type="checkbox"/> O	<input type="checkbox"/> RA	<input type="checkbox"/> O	<input type="checkbox"/> RA	<input type="checkbox"/> O	<input type="checkbox"/> RA	<input type="checkbox"/> O	<input type="checkbox"/> RA	<input checked="" type="checkbox"/> O	<input type="checkbox"/> RA

TARGETED RIFFLE BENTHOS SAMPLE		
Sample ID	No. of Jars	Comment
<u>999002</u>	<u>1</u>	

NEAREST TRANSECT	CHAN.	A		B		C		D		E		F		G		SUBSTRATE SIZE CLASSES
		Sub.	Chan.	Sub.	Chan.	Sub.	Chan.	Sub.	Chan.	Sub.	Chan.	Sub.	Chan.			
Fine/Sand		<input type="checkbox"/> F/S		<input type="checkbox"/> F/S		<input type="checkbox"/> F/S		<input type="checkbox"/> F/S		<input type="checkbox"/> F/S		<input type="checkbox"/> F/S		<input type="checkbox"/> F/S		F/S - ladybug or smaller (<2 mm)
Gravel		<input checked="" type="checkbox"/> G		<input checked="" type="checkbox"/> G		<input type="checkbox"/> G		<input checked="" type="checkbox"/> G		<input type="checkbox"/> G		<input checked="" type="checkbox"/> G		<input checked="" type="checkbox"/> G		G - ladybug to tennis ball (2 to 64 mm)
Coarse		<input type="checkbox"/> C		<input type="checkbox"/> C		<input checked="" type="checkbox"/> C		<input type="checkbox"/> C		<input checked="" type="checkbox"/> C		<input type="checkbox"/> C		<input type="checkbox"/> C		C - tennis ball to car sized (64 to 4000 mm)
Other: Note in Comments		<input type="checkbox"/> O		<input type="checkbox"/> O		<input type="checkbox"/> O		<input type="checkbox"/> O		<input type="checkbox"/> O		<input type="checkbox"/> O		<input type="checkbox"/> O		O - bedrock, hardpan, wood, etc

Additional Benthos Comments

COMPOSITE PERIPHYTON SAMPLE		
Sample ID	Composite Volume (mL)	Number of transects sampled (0-11):
<u>800990</u>	<u>500</u>	<u>11</u>

Assemblage ID (50-mL tube, preserved)		Chlorophyll (GF/F filter)		Biomass (GF/F Filter)	
Sample Vol. (mL)	Flag	Sample Vol. (mL)	Flag	Sample Vol. (mL)	Flag
<u>50</u>		<u>25</u>		<u>25</u>	

Flag	Comments

Flag codes: K = Sample not collected; U = Suspect sample; F1, F2, etc. = misc. flag assigned by field crew. Explain all flags in comment sections.

**Figure 8-3. Sample Collection Form (page 1), showing information for benthic macro-invertebrate samples.**

**TABLE 8-2. PROCEDURE FOR PREPARING COMPOSITE SAMPLES FOR  
BENTHIC MACROINVERTEBRATES**

---

1. Pour the entire contents of the bucket through a sieve (or into a sieve bucket) with 500  $\mu\text{m}$  mesh size. Remove any large objects and wash off any clinging organisms back into the sieve before discarding.
  2. Using a wash bottle filled with stream water, rinse all the organisms from the bucket into the sieve. This is the composite reach-wide sample for the site.
  3. Estimate the total volume of the sample in the sieve and determine how large a jar will be needed for the sample (500-mL or 1-L) and how many jars will be required.
  4. Fill in a sample label with the stream ID and date of collection. Attach the completed label to the jar and cover it with a strip of clear tape. Record the sample ID number for the composite sample on the Sample Collection Form. For each composite sample, make sure the number on the form matches the number on the label. **Please do not record an ID number on the form until you have collected the sample!**
  5. Wash the contents of the sieve to one side by gently agitating the sieve in the water. Wash the sample into a jar using as little water from the wash bottle as possible. Use a large-bore funnel if necessary. If the jar is too full pour off some water through the sieve until the jar is not more than  $\frac{1}{4}$  to  $\frac{1}{3}$  full, or use a second jar if a larger one is not available. Carefully examine the sieve for any remaining organisms and use watchmakers' forceps to place them into the sample jar.
    - If a second jar is needed, fill in a sample label that does not have a pre-printed ID number on it. Record the ID number from the pre-printed label prepared in Step 4 in the "SAMPLE ID" field of the label. Attach the label to the second jar and cover it with a strip of clear tape. Record the number of jars required for the sample on the Sample Collection Form. **Make sure the number you record matches the actual number of jars used.** Write "Jar *N* of *X*" on each sample label using a waterproof marker ("*N*" is the individual jar number, and "*X*" is the total number of jars for the sample).
  6. Place a waterproof label inside each jar with the following information written with a number 2 lead pencil:
 

<ul style="list-style-type: none"> <li>• Stream Number</li> <li>• Type of sampler and mesh size used</li> <li>• Name of stream</li> <li>• Date of collection</li> </ul>	<ul style="list-style-type: none"> <li>• Collectors initials</li> <li>• Number of transect samples composited</li> <li>• Jar N of X</li> </ul>
---	--
  7. Completely fill the jar with 95% ethanol (no headspace). It is very important that sufficient ethanol be used, or the organisms will not be properly preserved.
    - NOTE: Prepared composite samples can be transported back to the vehicle before adding ethanol if necessary. Fill the jar with stream water, which is then drained using the net across the opening to prevent loss of organisms, and replaced with ethanol at the vehicle.
  8. Replace the cap on each jar. Slowly tip the jar to a horizontal position, then gently rotate the jar to mix the preservative. Do not invert or shake the jar. After mixing, seal each jar with plastic tape.
  9. Store labeled composite samples in a container with absorbent material that is suitable for use with 95% ethanol until transport or shipment to the laboratory.
-

REACH-WIDE BENTHOS  
WXXP99 - 9999  
071011 2002  
500000  
Jar 1 of 2

BENTHOS - Extra Jar  
Reach Wide Targeted Riffle  
WXXP99 - 9999  
71011 2002  
Sample ID: 500000  
Jar 2 of 2

BENTHOS IDENTIFICATION  
Site Number WXXP99-9999  
Stream PILOT CREEK  
Collection Date 7/1/01  
Sampler KICKNET 1ft<sup>2</sup> 500µ  
Habitat Type REACH-WIDE  
Collector(s) J. DOE  
Number of Transects 11

Figure 8-4. Completed labels for benthic macroinvertebrate samples. The label at lower left is used if more than one jar is required for a composite sample. The label at lower right is placed inside the sample container.

**BENTHOS IDENTIFICATION**

Site Number \_\_\_\_\_  
Stream \_\_\_\_\_  
Collection Date \_\_\_\_\_  
Sampler \_\_\_\_\_  
Habitat Type \_\_\_\_\_  
Collector(s) \_\_\_\_\_  
Number of Transects \_\_\_\_\_

**BENTHOS IDENTIFICATION**

Site Number \_\_\_\_\_  
Stream \_\_\_\_\_  
Collection Date \_\_\_\_\_  
Sampler \_\_\_\_\_  
Habitat Type \_\_\_\_\_  
Collector(s) \_\_\_\_\_  
Number of Transects \_\_\_\_\_

**BENTHOS IDENTIFICATION**

Site Number \_\_\_\_\_  
Stream \_\_\_\_\_  
Collection Date \_\_\_\_\_  
Sampler \_\_\_\_\_  
Habitat Type \_\_\_\_\_  
Collector(s) \_\_\_\_\_  
Number of Transects \_\_\_\_\_

**BENTHOS IDENTIFICATION**

Site Number \_\_\_\_\_  
Stream \_\_\_\_\_  
Collection Date \_\_\_\_\_  
Sampler \_\_\_\_\_  
Habitat Type \_\_\_\_\_  
Collector(s) \_\_\_\_\_  
Number of Transects \_\_\_\_\_

**BENTHOS IDENTIFICATION**

Site Number \_\_\_\_\_  
Stream \_\_\_\_\_  
Collection Date \_\_\_\_\_  
Sampler \_\_\_\_\_  
Habitat Type \_\_\_\_\_  
Collector(s) \_\_\_\_\_  
Number of Transects \_\_\_\_\_

**BENTHOS IDENTIFICATION**

Site Number \_\_\_\_\_  
Stream \_\_\_\_\_  
Collection Date \_\_\_\_\_  
Sampler \_\_\_\_\_  
Habitat Type \_\_\_\_\_  
Collector(s) \_\_\_\_\_  
Number of Transects \_\_\_\_\_

**Figure 8-5. Blank internal labels for benthic invertebrate samples.**



**POTENTIAL EQUIPMENT AND SUPPLIES FOR BENTHIC MACROINVERTEBRATES**

QTY.	ITEM
1	Modified kick net ( D-frame with 500 µm mesh) and 4-ft handle
	Spare net(s) and/or spare bucket assembly for end of net
1	Watch with timer or a stopwatch
2	Buckets, plastic, 8- to 10-qt capacity
1	Sieve with 500 µm mesh openings (U.S. std No. 35)
1	Sieve-bottomed bucket, 500 µm mesh openings (alternative to sieve)
2 pr.	Watchmakers' forceps
1	Wash bottle, 1-L capacity labeled "STREAM WATER"
1	Small spatula, spoon, or scoop to transfer sample
1	Funnel, with large bore spout
4 to 6 each sample	Sample jars, HDPE plastic with leakproof screw caps, 500-mL and 1-L capacity, suitable for use with ethanol
2 gal	95% ethanol, in a proper container
2 pr.	Rubber gloves
1	Cooler (with suitable absorbent material) for transporting ethanol and samples
2	Composite Benthic sample labels, with preprinted ID numbers (barcodes)
4	Composite Benthic sample labels without preprinted ID numbers
6	Blank labels on waterproof paper for inside of jars
1	Sample Collection Form for site
	Soft (#2) lead pencils
	Fine-tip indelible markers
1 pkg.	Clear tape strips
4 rolls	Plastic electrical tape
1	Knife, pocket, with at least two blades
1	Scissors
1	Pocket-sized field notebook (optional)
1 pkg.	Kim wipes in small self-sealing plastic bag
1 copy	Field operations and methods manual
1 set	Procedure tables and/or quick reference guides for benthic macroinvertebrates (laminated or printed on write-in-the-rain paper)

**Figure 8-6. Equipment and supply checklist for benthic macroinvertebrate collection.**

## NOTES

## **9.0 RAPID HABITAT AND VISUAL STREAM ASSESSMENTS**

After all other samples and field data have been collected, the field team conducts a visual-based habitat assessment of the stream reach, makes a general visual assessment of the stream and adjacent area, and performs a final check of the data forms and samples before leaving the stream site (see Section 10). The habitat assessment procedures used are those included in EPA's Rapid Bioassessment Protocols (RBP), originally published by Plafkin et al. (1989), and revised by Barbour et al. (1999). The procedures used for WSA are modified from those published previously for EMAP-SW (Lazorchak et al., 1998), and the original RBP procedures (Plafkin et al., 1989) to include additional assessment parameters for high gradient streams and a more appropriate parameter set for low gradient streams. These modifications are based on refinements from various applications across the country. The approach focuses on integrating information from specific parameters on the structure of the physical habitat.

The visual stream assessment is used to record field team observations of catchment and stream characteristics that are useful for data validation, future data interpretation, ecological value assessment, development of associations, and verification of stressor data. The observations and impressions of field teams are extremely valuable. Thus, it is important that these observations about stream characteristics be recorded for future data interpretation and validation.

The general description of weather conditions at a site are now included on the field form used for the visual assessment. Evidence of fire has been added as a disturbance type for the visual assessment.

### **9.1 RAPID HABITAT ASSESSMENT**

The rapid habitat assessment approach based on visual observation is separated into two basic approaches—one designed for high-gradient streams and one designed for low-gradient streams. From the perception gained in collecting samples and measurements from throughout the sampling reach, classify the stream reach as either “Riffle/run prevalent” or “Pool/glide prevalent”. Choose the prevalent habitat type based on which habitat type occupies the majority of the length of the sampling reach. Landscapes of moderate to high-gradient typically contain “riffle/run prevalent” streams. Under natural conditions, riffle/run prevalent streams contain primarily coarse substrates (i.e., coarse gravel or larger; refer to Section 7) or numerous areas dominated by coarse substrates along a stream reach (Barbour et al, 1999). Landscapes of low to moderate gradient are characterized by glide/pool prevalent streams. These streambeds are dominated by finer substrates (fine gravel or smaller) or occasional areas of coarser sediments along a stream reach (Barbour et al., 1999). The entire sampling reach is classified as one or the other and specific parameters are evaluated for each classification.

A different field data form is completed depending upon the prevalent habitat type. For each prevalent stream type, ten “parameters” of habitat (Table 9-1) are evaluated for condition. Most of the parameters are evaluated similarly for both types of prevalent habitats. In three cases, a parameter is evaluated differently, or a different (but ecologically equivalent) parameter is substituted in riffle/run prevalent versus pool/glide prevalent streams. Substrate embeddedness is evaluated in riffle/run prevalent streams, while pool

substrate composition is evaluated in pool/glide prevalent streams. The presence of four potential types of microhabitat types based on combinations of depth and current velocity is evaluated in riffle/run prevalent streams, while the presence of four potential types of pool microhabitat based on depth and area are evaluated in pool/glide prevalent streams. The frequency of riffles is evaluated in riffle/run prevalent streams, while channel sinuosity is evaluated in pool/glide prevalent streams. For three parameters, each bank is evaluated separately and the cumulative score (right and left) is used for the reach.

The procedure for conducting the rapid habitat assessment is presented in Table 9-2. For each of the 10 parameters, visually evaluate and rate the overall quality of the sampling reach on a scale of 0 to 20, 0 being the lowest possible scale, 20 being the highest, i.e., representing “optimal” conditions. The first five parameters are instream habitat features and are rated specifically for the sampling reach. The second five parameters are related to large-scale effects and may require a visual assessment beyond the sampling reach. For riffle/run prevalent streams, record your scores for each parameter on the riffle/run version of the Rapid Habitat Assessment Form as shown in Figures 9-1. If the stream is classified as a pool/glide prevalent stream, record your scores for each parameter on the pool/glide version of the Rapid Habitat Assessment Form as shown in Figures 9-2. Transfer the scores assigned for each parameter to the box in the left-hand column of the form. The scores will be summed during data entry.

**TABLE 9-1. DESCRIPTIONS OF PARAMETERS USED IN THE RAPID HABITAT ASSESSMENT OF STREAMS<sup>a</sup>**

<b>Habitat Parameter (Prevalent Habitat Type R=Riffle/run P=Pool/glide)</b>	<b>Description and Rationale</b>
<b>Parameters Evaluated within Sampling Reach</b>	
1. Epifaunal Substrate/ Available Cover (R, P)	Includes the relative quantity and variety of natural structures in the stream, such as cobble (riffles), large rocks, fallen trees, logs and branches, and undercut banks, available as refugia, feeding, or sites for spawning and nursery functions of aquatic macrofauna. A wide variety and/or abundance of submerged structures in the stream provides macroinvertebrates and fish with a large number of niches, thus increasing habitat diversity. As variety and abundance of cover decreases, habitat structure becomes monotonous, diversity decreases, and the potential for recovery following disturbance decreases. Riffles and runs are critical for maintaining a variety and abundance of insects in most high-gradient streams and serving as spawning and feeding refugia for certain fish. The extent and quality of the riffle is an important factor in the support of a healthy biological condition in high-gradient streams. Riffles and runs offer a diversity of habitat through variety of particle size, and, in many small high-gradient streams, will provide the most stable habitat. Snags and submerged logs are among the most productive habitat structure for macroinvertebrate colonization and fish refugia in low-gradient streams. However, “new fall” will not yet be suitable for colonization.

(Continued)

**TABLE 9-1. Continued**

<b>Habitat Parameter (Prevalent Habitat Type R=Riffle/run P=Pool/glide)</b>	<b>Description and Rationale</b>
<b>Parameters Evaluated within Sampling Reach (cont'd)</b>	
2A. Embeddedness (R)	<p>Refers to the extent to which rocks (gravel, cobble, and boulders) and snags are covered or sunken into the silt, sand, or mud of the stream bottom. Generally, as rocks become embedded, the surface area available to macroinvertebrates and fish (shelter, spawning, and egg incubation) is decreased. Embeddedness is a result of large-scale sediment movement and deposition, and is a parameter evaluated in the riffles and runs of high-gradient streams. The rating of this parameter may be variable depending on where the observations are taken. To avoid confusion with sediment deposition (another habitat parameter), observations of embeddedness should be taken in the upstream and central portions of riffles and cobble substrate areas.</p>
2B. Pool Substrate Characterization (P)	<p>Evaluates the type and condition of bottom substrates found in pools. Firmer sediment types (e.g., gravel, sand) and rooted aquatic plants support a wider variety of organisms than a pool substrate dominated by mud or bedrock and no plants. In addition, a stream that has a uniform substrate in its pools will support far fewer types of organisms than a stream that has a variety of substrate types.</p>
3A. Velocity and Depth Regimes (R)	<p>Patterns of velocity and depth are included for high-gradient streams under this parameter as an important feature of habitat diversity. The best streams in most high-gradient regions will have all 4 patterns present: (1) slow-deep, (2) slow-shallow, (3) fast-deep, and (4) fast-shallow. The general guidelines are 0.5 m depth to separate shallow from deep, and 0.3 m/sec to separate fast from slow. The occurrence of these 4 patterns relates to the stream's ability to provide and maintain a stable aquatic environment.</p>
3B. Pool Variability (P)	<p>Rates the overall mixture of pool types found in streams, according to size and depth. The 4 basic types of pools are large-shallow, large-deep, small-shallow, and small-deep. A stream with many pool types will support a wide variety of aquatic species. Rivers with low sinuosity (few bends) and monotonous pool characteristics do not have sufficient quantities and types of habitat to support a diverse aquatic community. General guidelines are any pool dimension (i.e., length, width, oblique) greater than half the cross-section of the stream for separating large from small and 1 m depth separating shallow and deep.</p>
4. Sediment Deposition (R, P)	<p>Measures the amount of sediment that has accumulated in pools and the changes that have occurred to the stream bottom as a result of deposition. Deposition occurs from large-scale movement of sediment. Sediment deposition may cause the formation of islands, point bars (areas of increased deposition usually at the beginning of a meander that increase in size as the channel is diverted toward the outer bank) or shoals, or result in the filling of runs and pools. Usually deposition is evident in areas that are obstructed by natural or manmade debris and areas where the stream flow decreases, such as bends. High levels of sediment deposition are symptoms of an unstable and continually changing environment that becomes unsuitable for many organisms.</p>
5. Channel Flow Status (R, P)	<p>The degree to which the channel is filled with water. The flow status will change as the channel enlarges (e.g., aggrading stream beds with actively widening channels) or as flow decreases as a result of dams and other obstructions, diversions for irrigation, or drought. When water does not cover much of the streambed, the amount of suitable substrate for aquatic organisms is limited. In high-gradient streams, riffles and cobble substrate are exposed; in low-gradient streams, the decrease in water level exposes logs and snags, thereby reducing the areas of good habitat. Channel flow is especially useful for interpreting biological condition under abnormal or lowered flow conditions. This parameter becomes important when more than one biological index period is used for surveys or the timing of sampling is inconsistent among sites or annual periodicity.</p>

(Continued)

**TABLE 9-1. Continued**

<b>Habitat Parameter (Prevalent Habitat Type R=Riffle/run P=Pool/glide)</b>	<b>Description and Rationale</b>
<b><u>Parameters Evaluated Broader than the Sampling Reach</u></b>	
6. Channel Alteration (R, P)	<p>Is a measure of large-scale changes in the shape of the stream channel. Many streams in urban and agricultural areas have been straightened, deepened, or diverted into concrete channels, often for flood control or irrigation purposes. Such streams have far fewer natural habitats for fish, macroinvertebrates, and plants than do naturally meandering streams. Channel alteration is present when artificial embankments, riprap, and other forms of artificial bank stabilization or structures are present; when the stream is very straight for significant distances; when dams and bridges are present; and when other such changes have occurred. Scouring is often associated with channel alteration.</p>
7A. Frequency of Riffles (or Bends) (R)	<p>Is a way to measure the sequence of riffles and thus the heterogeneity occurring in a stream. Riffles are a source of high-quality habitat and diverse fauna, therefore, an increased frequency of occurrence greatly enhances the diversity of the stream community. For high gradient streams where distinct riffles are uncommon, a run/bend ratio can be used as a measure of meandering or sinuosity (see 7b). A high degree of sinuosity provides for diverse habitat and fauna, and the stream is better able to handle surges when the stream fluctuates as a result of storms. The absorption of this energy by bends protects the stream from excessive erosion and flooding and provides refugia for benthic invertebrates and fish during storm events. To gain an appreciation of this parameter in some streams, a longer segment or reach than that designated for sampling should be incorporated into the evaluation. In some situations, this parameter may be rated from viewing accurate topographical maps. The "sequencing" pattern of the stream morphology is important in rating this parameter. In headwaters, riffles are usually continuous and the presence of cascades or boulders provides a form of sinuosity and enhances the structure of the stream. A stable channel is one that does not exhibit progressive changes in slope, shape, or dimensions, although short-term variations may occur during floods (Gordon et al. 1992).</p>
7B. Channel Sinuosity (P)	<p>Evaluates the meandering or sinuosity of the stream. A high degree of sinuosity provides for diverse habitat and fauna, and the stream is better able to handle surges when the stream fluctuates as a result of storms. The absorption of this energy by bends protects the stream from excessive erosion and flooding and provides refugia for benthic invertebrates and fish during storm events. To gain an appreciation of this parameter in low gradient streams, a longer segment or reach than that designated for sampling may be incorporated into the evaluation. In some situations, this parameter may be rated from viewing accurate topographical maps. The "sequencing" pattern of the stream morphology is important in rating this parameter. In "oxbow" streams of coastal areas and deltas, meanders are highly exaggerated and transient. Natural conditions in these streams are shifting channels and bends, and alteration is usually in the form of flow regulation and diversion. A stable channel is one that does not exhibit progressive changes in slope, shape, or dimensions, although short-term variations may occur during floods (Gordon et al. 1992).</p>
8. Bank Stability (Condition of Banks) (R, P)	<p>Measures whether the stream banks are eroded (or have the potential for erosion). Steep banks are more likely to collapse and suffer from erosion than are gently sloping banks, and are therefore considered to be unstable. Signs of erosion include crumbling, unvegetated banks, exposed tree roots, and exposed soil. Eroded banks indicate a problem of sediment movement and deposition, and suggest a scarcity of cover and organic input to streams. Each bank is evaluated separately from 0-10, and the cumulative score (right and left) is used for this parameter.</p>

(Continued)

**TABLE 9-1. Continued**

<b>Habitat Parameter (Prevalent Habitat Type R=Riffle/run P=Pool/glide)</b>	<b>Description and Rationale</b>
<b>Parameters Evaluated Broader than the Sampling Reach (cont'd)</b>	
9. Bank Vegetative Protection (R, P)	<p>Measures the amount of vegetative protection afforded to the stream bank and the near-stream portion of the riparian zone. The root systems of plants growing on stream banks help hold soil in place, thereby reducing the amount of erosion that is likely to occur. This parameter supplies information on the ability of the bank to resist erosion as well as some additional information on the uptake of nutrients by the plants, the control of instream scouring, and stream shading. Banks that have full, natural plant growth are better for fish and macroinvertebrates than are banks without vegetative protection or those shored up with concrete or riprap. This parameter is made more effective by defining the native vegetation for the region and stream type (i.e., shrubs, trees, etc.). In some regions, the introduction of exotics has virtually replaced all native vegetation. The value of exotic vegetation to the quality of the habitat structure and contribution to the stream ecosystem must be considered in this parameter. In areas of high grazing pressure from livestock or where residential and urban development activities disrupt the riparian zone, the growth of a natural plant community is impeded and can extend to the bank vegetative protection zone. Each bank is evaluated separately and the cumulative score (right and left) is used for this parameter.</p>
10. Riparian Vegetated Zone Width (R, P)	<p>Measures the width of natural vegetation from the edge of the stream bank out through the riparian zone. The vegetative zone serves as a buffer to pollutants entering a stream from runoff, controls erosion, and provides habitat and nutrient input into the stream. A relatively undisturbed riparian zone supports a robust stream system; narrow riparian zones occur when roads, parking lots, fields, lawns, bare soil, rocks, or buildings are near the stream bank. Residential developments, urban centers, golf courses, and rangeland are the common causes of anthropogenic degradation of the riparian zone. Conversely, the presence of "old field" (i.e., a previously developed field not currently in use), paths, and walkways in an otherwise undisturbed riparian zone may be judged to be inconsequential to altering the riparian zone and may be given relatively high scores. For variable size streams, the specified width of a desirable riparian zone may also be variable and may be best determined by some multiple of stream width (e.g., 4 x wetted stream width). Each bank is evaluated separately from 0-10 and the cumulative score (right and left) is used for this parameter.</p>

<sup>a</sup> Modified from Barbour et al. (1999)

---

**TABLE 9-2. PROCEDURE FOR CONDUCTING THE RAPID HABITAT ASSESSMENT**

---

1. Based on observations during previous sample collection and field measurement activities, classify the sampling reach as predominantly flowing water habitat ("Riffle/run") or slow water habitat ("Pool/glide").
  2. Select the appropriate version of the Rapid Habitat Assessment Form ("Riffle/Run Prevalence" or "Pool/Glide Prevalence") based on the classification in Step 1.
  3. For each of the 10 habitat parameters, determine the general "quality" category ("POOR", "MARGINAL", "SUB-OPTIMAL", or "OPTIMAL") of the entire sampling reach. Assign and circle a score from the values available within each quality category. For Parameters 1 through 7, the sampling reach can be scored from 0 (worst) to 20 (best). For Parameters 8 through 10, each bank is evaluated separately (from 0 to 10), and the cumulative score for both right and left banks are used.
  4. The first 5 parameters are rated for the sampling reach. Contiguous reaches may be evaluated for the last 5 parameters to provide a more robust rating for these large-scale parameters. If the sampling reach is less than 150m in length, incorporate contiguous reaches into the assessment.
  5. After the sampling reach has been scored for all parameters, transfer the score circled for each category to the corresponding "SCORE" box in the "HABITAT PARAMETER" column of the assessment form.
-



Reviewed by (Initials): RC

RAPID HABITAT ASSESSMENT FORM: RIFFLE/RUN - STREAM				
SITE ID: <u>WXXP99-9999</u>		DATE: <u>07/01/2000</u>		
HABITAT PARAMETER	CONDITION CATEGORY			
	OPTIMAL	SUB-OPTIMAL	MARGINAL	POOR
<b>1. Epifaunal Substrate/ Available Cover</b>  Score: <u>12</u>	Greater than 70% of substrate favorable for epifaunal colonization and fish cover; mix of snags, submerged logs, undercut banks, cobble or other stable habitat and at stage to allow full colonization potential; (i.e., logs/snags that are NOT new fall and NOT transient.)  20 19 18 17 16	40-70% mix of stable habitat; well-suited for full colonization potential; adequate habitat for maintenance of populations; presence of additional substrate in the form of newfall, but not yet prepared for colonization (may rate at high end of scale).  15 14 13 <u>12</u> 11	20-40% mix of stable habitat; habitat availability less than desirable; substrate frequently disturbed or removed.  10 9 8 7 6	Less than 20% stable habitat; lack of habitat is obvious; substrate unstable or lacking.  5 4 3 2 1 0
<b>2. Embeddedness</b>  Score: <u>8</u>	Gravel, cobble, and boulder particles are 0-25% surrounded by fine sediment. Layering of cobble provides diversity of niche space.  20 19 18 17 16	Gravel, cobble, and boulder particles are 25-50% surrounded by fine sediment.  15 14 13 12 11	Gravel, cobble, and boulder particles are 50-75% surrounded by fine sediment.  10 9 <u>8</u> 7 6	Gravel, cobble, and boulder particles are more than 75% surrounded by fine sediment.  5 4 3 2 1 0
<b>3. Velocity/Depth Regime</b>  Score: <u>15</u>	All four velocity/depth regimes present (slow-deep, slow-shallow, fast-deep, fast-shallow). (Slow is less than 0.3 m/s, deep is greater than 0.5 m.)  20 19 18 17 16	Only 3 of the 4 regimes present (if fast-shallow is missing, score lower than if missing other regimes).  <u>15</u> 14 13 12 11	Only 2 of the 4 habitat regimes present (if fast-shallow or slow-shallow are missing, score low).  10 9 8 7 6	Dominated by 1 velocity/depth regime (usually slow-deep).  5 4 3 2 1 0
<b>4. Sediment Deposition</b>  Score: <u>14</u>	Little or no enlargement of islands or point bars and less than 5% of the bottom affected by sediment deposition.  20 19 18 17 16	Some new increases in bar formation, mostly from gravel, sand or fine sediment; 5-30% of the bottom affected; slight deposition in pools.  15 <u>14</u> 13 12 11	Moderate deposition of new gravel, sand or fine sediment on old and new bars; 30-50% of the bottom affected; sediment deposits at obstructions, constrictions, and bends; moderate deposition of pools prevalent.  10 9 8 7 6	Heavy deposits of fine material; increased bar development; more than 50% of the bottom changing frequently; pools almost absent due to substantial sediment deposition.  5 4 3 2 1 0
<b>5. Channel Flow Status</b>  Score: <u>12</u>	Water reaches base of both lower banks, and minimal amount of channel substrate is exposed.  20 19 18 17 16	Water fills over 75% of the available channel; or less than 25% of channel substrate is exposed.  15 14 13 <u>12</u> 11	Water fills 25-75% of the available channel, and/or riffle substrates are mostly exposed.  10 9 8 7 6	Very little water in channel and mostly present as standing pools.  5 4 3 2 1 0
<b>6. Channel Alteration</b>  Score: <u>18</u>	Channelization or dredging absent or minimal; stream with normal pattern.  20 19 <u>18</u> 17 16	Some channelization present, usually in areas of bridge abutments; evidence of past channelization, i.e., dredging, (greater than past 20 yr) may be present, but recent channelization is not present.  15 14 13 12 11	Channelization may be extensive; embankments or shoring structures present on both banks; and 40 to 80% of stream reach channelized and disrupted.  10 9 8 7 6	Banks shored with gabion or cement; over 80% of the stream reach channelized and disrupted. Instream habitat greatly altered or removed entirely.  5 4 3 2 1 0

03/31/2000 2000 Riffle Run

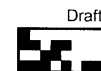

Figure 9-1. Rapid Habitat Assessment Form for riffle/run prevalent streams (continued).

**RAPID HABITAT ASSESSMENT FORM: RIFFLE/RUN (continued) - STREAM**

SITE ID: WXXP99-9999

DATE: 07/01/2000

HABITAT PARAMETER	CONDITION CATEGORY			
	OPTIMAL	SUB-OPTIMAL	MARGINAL	POOR
<b>7. Frequency of Riffles (or bends)</b>  Occurrence of riffles relatively frequent; ratio of distance between riffles divided by width of the stream greater than 7:1 (generally 5 to 7); variety of habitat is key. In streams where riffles are continuous, placement of boulders or other large, natural obstruction is important.  Score: <b>13</b>	Occurrence of riffles relatively frequent; ratio of distance between riffles divided by width of the stream greater than 7:1 (generally 5 to 7); variety of habitat is key. In streams where riffles are continuous, placement of boulders or other large, natural obstruction is important.  20 19 18 17 16	Occurrence of riffles infrequent; distance between riffles divided by width of stream is between 7 to 15.  15 14 13 12 11	Occasional riffle or bend; bottom contours provide some habitat; distance between riffles divided by width of stream is between 15 to 25.  10 9 8 7 6	Generally all flat water or shallow riffles; poor habitat; distance between riffles divided by width of stream is a ratio of over 25.  5 4 3 2 1 0
<b>8. Bank Stability (score each bank)</b>  NOTE: Determine left or right side by facing downstream.  Left Bank Score: <b>7</b>	Banks stable; evidence of erosion or bank failure absent or minimal; little potential for future problems. Less than 5% of bank affected.  Left Bank: 10 9	Moderately stable; infrequent, small areas of erosion mostly healed over. 5-30% of bank in reach has areas of erosion.  8 7 6	Moderately unstable; 30-60% of bank in reach has areas of erosion; high erosion potential during floods.  5 4 3	Unstable; many eroded areas; "raw" areas frequent along straight sections and bends; obvious bank sloughing; 60-100% of bank has erosional scars.  2 1 0
Right Bank Score: <b>5</b>	Right Bank: 10 9	8 7 6	5 4 3	2 1 0
<b>9. Vegetative Protection (score each bank)</b>  Left Bank Score: <b>8</b>	More than 90% of the streambank surfaces and immediate riparian zone covered by native vegetation, including trees, understory shrubs, or nonwoody macrophytes; vegetative disruption through grazing or mowing minimal or not evident; almost all plants allowed to grow naturally.  Left Bank: 10 9	70-90% if the streambank surfaces covered by native vegetation; but one class of plants is not well represented; disruption evident but not affecting full plant growth potential to any great extent; more than one-half of the potential plant stubble height remaining.  8 7 6	50-70% of the streambank surfaces covered by vegetation; disruptions obvious; patches of bare soil or closely cropped vegetation common; less than one-half of the potential plant stubble height remaining.  5 4 3	Less than 50% of the streambank surfaces covered by vegetation; disruption of streambank vegetation is very high; vegetation has been removed to 5 centimeters or less in average stubble height.  2 1 0
Right Bank Score: <b>7</b>	Right Bank: 10 9	8 7 6	5 4 3	2 1 0
<b>10. Riparian Vegetative Zone Width (score each bank)</b>  Left Bank Score: <b>6</b>	Width of riparian zone greater than 18 meters; human activities (i.e., parking lots, roadbeds, clear-cuts, lawns, or crops) have not impacted the zone.  Left Bank: 10 9	Width of riparian zone 12-18 meters; human activities have impacted zone only minimally.  8 7 6	Width of riparian zone 6-12 meters; human activities have impacted zone a great deal.  5 4 3	Width of riparian zone less than 6 meters; little or no riparian vegetation due to human activities.  2 1 0
Right Bank Score: <b>5</b>	Right Bank: 10 9	8 7 6	5 4 3	2 1 0



Figure 9-1. Rapid Habitat Assessment Form for riffle/run prevalent streams (page 2).

RAPID HABITAT ASSESSMENT FORM: GLIDE/POOL - STREAMS				
SITE ID: <u>WXXP99-9999</u>		DATE: <u>07/01/2000</u>		
HABITAT PARAMETER	CATEGORY			
	OPTIMAL	SUB-OPTIMAL	MARGINAL	POOR
<b>1. Epifaunal Substrate/ Available Cover</b>  Score: <u>8</u>	Greater than 50% of substrate favorable for epifaunal colonization and fish cover; mix of snags, submerged logs, undercut banks, cobble or other stable habitat and at stage to allow full colonization potential (i.e. logs/snags that are NOT new fall and NOT transient.)  20 19 18 17 16	30-50% mix of stable habitat; well-suited for full colonization potential; adequate habitat for maintenance of populations; presence of additional substrate in the form of newfall, but not yet prepared for colonization (may rate at high end of scale).  15 14 13 12 11	10-30% mix of stable habitat; habitat availability less than desirable; substrate frequently disturbed or removed.  10 9 <u>8</u> 7 6	Less than 10% stable habitat; lack of habitat is obvious; substrate unstable or lacking.  5 4 3 2 1 0
<b>2. Pool Substrate Characterization</b>  Score: <u>8</u>	Mixture of substrate materials, with gravel and firm sand prevalent; root mats and submerged vegetation common.  20 19 18 17 16	Mixture of soft sand, mud, or clay; mud may be dominant; some root mats and submerged vegetation present.  15 14 13 12 11	All mud or clay or sand bottom; little or no root mat; no submerged vegetation.  10 9 <u>8</u> 7 6	Hard-pan clay or bedrock; no root mat or vegetation.  5 4 3 2 1 0
<b>3. Pool Variability</b>  Score: <u>8</u>	Even mix of large-shallow, large-deep, small shallow, small-deep pools present.  20 19 18 17 16	Majority of pools large-deep; very few shallows.  15 14 13 12 11	Shallow pools much more prevalent than deep pools.  10 9 <u>8</u> 7 6	Majority of pools small-shallow or absent.  5 4 3 2 1 0
<b>4. Sediment Deposition</b>  Score: <u>7</u>	Little or no enlargement of islands or point bars and less than 20% of the bottom affected by sediment deposition.  20 19 18 17 16	Some new increases in bar formation, mostly from gravel, sand or fine sediment; 20-50% of the bottom affected; slight deposition in pools.  15 14 13 12 11	Moderate deposition of new gravel, sand or fine sediment on old and new bars; 50-80% of the bottom affected; sediment deposits at obstructions, constrictions, and bends; moderate deposition of pools prevalent.  10 9 8 <u>7</u> 6	Heavy deposits of fine material; increased bar development; more than 80% of the bottom changing frequently; pools almost absent due to substantial sediment deposition.  5 4 3 2 1 0
<b>5. Channel Flow Status</b>  Score: <u>18</u>	Water reaches base of both lower banks, and minimal amount of channel substrate is exposed.  20 19 <u>18</u> 17 16	Water fills over 75% of the available channel; or less than 25% of channel substrate is exposed.  15 14 13 12 11	Water fills 25-75% of the available channel, and/or riffle substrates are mostly exposed.  10 9 8 7 6	Very little water in channel and mostly present as standing pools.  5 4 3 2 1 0
<b>6. Channel Alteration</b>  Score: <u>16</u>	Channelization or dredging absent or minimal; stream with normal pattern.  20 19 18 17 <u>16</u>	Some channelization present, usually in areas of bridge abutments; evidence of past channelization, i.e., dredging, (greater than past 20 yr) may be present, but recent channelization is not present.  15 14 13 12 11	Channelization may be extensive; embankments or shoring structures present on both banks; and 40 to 80% of stream reach channelized and disrupted.  10 9 8 7 6	Banks shored with gabion or cement; over 80% of the stream reach channelized and disrupted. Instream habitat greatly altered or removed entirely.  5 4 3 2 1 0

Figure 9-2. Rapid Habitat Assessment Form for pool/glide prevalent streams (continued).

RAPID HABITAT ASSESSMENT FORM: GLIDE/POOL (continued) - STREAMS				
SITE ID: <u>WXXP99-9999</u>		DATE: <u>07/01/2000</u>		
HABITAT PARAMETER	CATEGORY			
	OPTIMAL	SUB-OPTIMAL	MARGINAL	POOR
<b>7. Channel Sinuosity</b>  The bends in the stream increase the stream length 3 to 4 times longer than if it was in a straight line. (Note- channel braiding is considered normal in coastal plains and other low-lying areas. This parameter is not easily rated in these areas.)  Score: <u>13</u>	20 19 18 17 16 15 14 <u>13</u> 12 11	The bends in the stream increase the stream length 2 to 3 times longer than if it was in a straight line.	The bends in the stream increase the stream length 1 to 2 times longer than if it was in a straight line.	Channel straight; waterway has been channelized for a long distance.
<b>8. Bank Stability</b> (score each bank) NOTE: Determine left or right side by facing downstream. Left Bank Score: <u>9</u> Right Bank Score: <u>10</u>	Banks stable; evidence of erosion or bank failure absent or minimal; little potential for future problems. Less than 5% of bank affected.  Left Bank: 10 <u>9</u> Right Bank: <u>10</u> 9	Moderately stable; infrequent, small areas of erosion mostly healed over. 5-30% of bank in reach has areas of erosion.  8 7 6	Moderately unstable; 30-60% of bank in reach has areas of erosion; high erosion potential during floods.  5 4 3	Unstable; many eroded areas; "raw" areas frequent along straight sections and bends; obvious bank sloughing; 60-100% of bank has erosional scars.  2 1 0
<b>9. Vegetative Protection</b> (score each bank)  Left Bank Score: <u>4</u> Right Bank Score: <u>6</u>	More than 90% of the streambank surfaces and immediate riparian zone covered by native vegetation, including trees, understory shrubs, or nonwoody macrophytes; vegetative disruption through grazing or mowing minimal or not evident; almost all plants allowed to grow naturally.  Left Bank: 10 9 Right Bank: 10 9	70-90% if the streambank surfaces covered by native vegetation; but one class of plants is not well represented; disruption evident but not affecting full plant growth potential to any great extent; more than one-half of the potential plant stubble height remaining.  8 7 6 8 7 <u>6</u>	50-70% of the streambank surfaces covered by vegetation; disruptions obvious; patches of bare soil or closely cropped vegetation common; less than one-half of the potential plant stubble height remaining.  5 <u>4</u> 3	Less than 50% of the streambank surfaces covered by vegetation; disruption of streambank vegetation is very high; vegetation has been removed to 5 centimeters or less in average stubble height.  2 1 0
<b>10. Riparian Vegetation Zone Width</b> (score each bank)  Left Bank Score: <u>5</u> Right Bank Score: <u>7</u>	Width of riparian zone greater than 18 meters; human activities (i.e., parking lots, roadbeds, clear-cuts, lawns, or crops) have not impacted the zone.  Left Bank: 10 9 Right Bank: 10 9	Width of riparian zone 12-18 meters; human activities have impacted zone only minimally.  8 7 6 8 <u>7</u> 6	Width of riparian zone 6-12 meters; human activities have impacted zone a great deal.  <u>5</u> 4 3	Width of riparian zone less than 6 meters; little or no riparian vegetation due to human activities.  2 1 0

Figure 9-2. Rapid Habitat Assessment Form for pool/glide prevalent streams (page 2).

**TABLE 9-3. PROCEDURE FOR CONDUCTING THE FINAL VISUAL ASSESSMENT  
OF A STREAM**

---

1. After all other sampling and measurement activities are completed, fill out the header section of an Assessment Form. Use your perceptions obtained during the course of the day, while at the stream or driving/walking through the catchment to complete the remainder of the form. Consider only things at or upstream of the site.
  
2. **WATERSHED ACTIVITIES AND DISTURBANCES OBSERVED:** Rate each type of activity or disturbance listed on the form as either “Not observed”, “Low”, “Medium”, or “High”, and record the rating on the Assessment Form. Keep in mind that ratings will be somewhat subjective and that an extensive effort to quantify the presence and intensity of each type of stressor is not required. General categories of activities and types of disturbance are described below:
  - **Residential:** The presence of any of the listed disturbances adjacent to or near the stream.
  - **Recreational:** The presence of organized public or private parks, campgrounds, beaches or other recreation areas around the stream. If there are signs of informal areas of camping, swimming or boating around the stream (e.g., swimming hole), record them as "primitive" parks, camping.
  - **Agriculture:** The presence of cropland, pasture, range, orchards, poultry, and/or livestock. Also note any evidence of water withdrawals for agriculture.
  - **Industrial:** Any industrial activity (e.g., canning, chemical, pulp), commercial activity (stores, businesses) or logging/mining activities around the stream or in the catchment. Describe in more detail in the comments section.
  - **Management:** Any evidence of water treatment, dredging or channelization, flow control structures, fish stocking, dams or other management activities.

Any oddities, or further elaboration should be recorded in the Comments section.
  
3. **SITE CHARACTERISTICS:** (based on a circle with a 200 m radius around the site)
  - **WATER BODY CHARACTER:** Assign a rating of 1 (highly disturbed) to 5 (pristine) based on your general impression of the intensity of impact from human disturbance. Place an “X” in the box next to the assigned rating on the Assessment Form. Assign a rating to the stream based on overall aesthetic quality, based on your opinion of how suitable the stream water is for recreation and aesthetic enjoyment the day of sampling. Place an “X” in the box next to the assigned rating on the Assessment Form.
    5. Beautiful, could not be any nicer.
    4. Very minor aesthetic problems; excellent for swimming, boating, enjoyment.
    3. Enjoyment impaired.
    2. Level of enjoyment substantially reduced.
    1. Enjoyment nearly impossible.

---

(continued)

**TABLE 9-3 (Continued)**

- 
- 
- **Beaver:** If you noticed any signs of beaver presence in or near the stream (chewed sticks, trees, dams, lodges) rate the beaver presence as either rare or common. If no beaver signs were present, mark the absent box. Also rate the amount of flow modification caused by any **beaver activity** as none, minor, or major.
  - **Dominant Land Use:** Make one estimate of the dominant land use in the circle around the site. Pick just one land use from among Forest, Agriculture, Range, Urban, Suburban/Town. If there are other major land uses, make note of them in the General Assessment section of the form. If forest is the dominant land use, make a guess as to the dominant age class of the forest (0-25, 25-75, or > 75 years).
3. **WEATHER:** Record a very brief description of the weather conditions during stream sampling (e.g., sunny, fair, partly cloudy, overcast, light rain, unseasonably warm, cold, or hot, etc.). Any unusual weather right before sampling (e.g., heavy rain, 6 inches of snow) is also worth noting here.
  4. **GENERAL ASSESSMENT:** Record comments on wildlife observed, perceived diversity of terrestrial/riparian vegetation, or overall biotic integrity on the Assessment Form. Record any information regarding the past or present characteristics or condition of the stream provided by local residents here as well.
- 
- 

## **9.2 VISUAL STREAM ASSESSMENT**

The assessment form is designed as a template for recording pertinent field observations. It is by no means comprehensive and any additional observations should be recorded in the General Assessment section of the form. Complete the assessment form after all other sampling and measurement activities have been completed. Consider only things at or upstream of the sample site (things that may impact the sample reach). Take into account all observations the sampling team has made while at the site. The assessment includes the following components: watershed activities and observed disturbances, site characteristics, weather during sampling, and a general assessment. The procedure for conducting the visual assessment of the sampling reach is presented in Table 9-3. Record data and observations for each component of the assessment on the Assessment Form as shown in Figure 9-3.

Each watershed activity or disturbance is rated into one of four categories of abundance or influence: not observed, low, medium, or high. Leave the line blank for any activity or disturbance type not observed. The distinction between low, medium, and high will be subjective. For example, if there are 2-3 houses away from the stream, the rating for "Houses" may be low. If the stream is in a suburban housing development, rate it as high. Similarly, a small patch of clear cut logging on a hill overlooking the stream would be rated as low. Logging activity right on the stream shore, however, would be rated as high.

When assessing site characteristics, imagine a circle with a 200 m radius around the sample site (400 m diameter). Consider the land use and other activities within this circle. Water body character is defined as "the physical habitat condition of the water body, largely a function of riparian and littoral habitat structure, volume change, trash, turbidity, slicks,

scums, color, and odor.” Water body character is assessed using two attributes, the degree of human development, and aesthetics. Rate each of these attributes on a scale of 1 to 5. For development, give the stream a "5" rating if it is pristine, with no signs of any human development. A rating of "1" indicates a stream which is totally developed (e.g., the entire stream is lined with houses, or the riparian zone has been removed). For aesthetics, base your decision on any factor about the stream that bothers you (e.g., trash, algal growth, weed abundance, overcrowding). Also, rate the presence/absence of beaver activity and the dominant land use within this circle according to the classes listed on the form

The weather and general assessment component includes any observations that will help in data interpretation in the pertinent section. The weather component is a place to record a brief description of the weather during sampling or just before sampling. General assessment comments can include comments on wildlife observed, diversity of terrestrial/riparian vegetation, overall biotic integrity, or any other observation. Comments from locals about current or past conditions are often useful and should be recorded in this section as well. The back side of the form (Figure 9-3) is available for additional general comments.

### **9.3 EQUIPMENT AND SUPPLIES**

Figure 9-4 is a checklist of the supplies required to complete the visual stream assessment. This checklist may differ from the checklists presented in Appendix A, which are used at a base site to ensure that all equipment and supplies are brought to and are available at the stream site. Field teams are required to use the checklist presented in this section to ensure that equipment and supplies are organized and available to conduct the protocols efficiently.

STREAM ASSESSMENT FORM - STREAMS/RIVERS

Reviewed by (initial): *ZP*

SITE ID: WXP99-9999 DATE: 07/01/2001

WATERSHED ACTIVITIES AND DISTURBANCES OBSERVED (Intensity: Blank=Not observed, L=Low, M=Moderate, H=Heavy)

Residential	Recreational	Agricultural	Industrial	Stream Management
<input checked="" type="checkbox"/> M H Residences	L M H Hiking Trails	L M H Cropland	L M H Industrial Plants	L M H Liming
<input checked="" type="checkbox"/> M H Maintained Lawns	L M H Parks, Campgrounds	L M <input checked="" type="checkbox"/> H Pasture	L M H Mines/Quarries	L M H Chemical Treatment
L M H Construction	L M H Primitive Parks, Camping	L <input checked="" type="checkbox"/> M H Livestock Use	L M H Oil/Gas Wells	L M H Angling Pressure
L M H Pipes, Drains	L M H Trash/Litter	L M H Orchards	L M H Power Plants	L M H Dredging
L M H Dumping	L M H Surface Films	L M H Poultry	L M H Logging	L M H Channelization
<input checked="" type="checkbox"/> M H Roads		L M H Irrigation Equip.	L M H Evidence of Fire	L M H Water Level Fluctuations
L M H Bridge/Culverts		L M H Water Withdrawal	L M H Odors	L M H Fish Stocking
L M H Sewage Treatment			L M H Commercial	L M H Dams

SITE CHARACTERISTICS (200 m radius)

Waterbody Character	Pristine	<input type="checkbox"/> 5	<input type="checkbox"/> 4	<input type="checkbox"/> 3	<input checked="" type="checkbox"/> 2	<input type="checkbox"/> 1	Highly Disturbed
	Appealing	<input type="checkbox"/> 5	<input type="checkbox"/> 4	<input checked="" type="checkbox"/> 3	<input type="checkbox"/> 2	<input type="checkbox"/> 1	Unappealing
Beaver	Beaver Signs: <input checked="" type="checkbox"/> Absent		<input type="checkbox"/> Rare	<input type="checkbox"/> Common			
	Beaver Flow Modifications: <input checked="" type="checkbox"/> None		<input type="checkbox"/> Minor	<input type="checkbox"/> Major			
Dominant Land Use	Dominant Land Use Around 'X'	<input type="checkbox"/> Forest	<input type="checkbox"/> Agriculture	<input checked="" type="checkbox"/> Range	<input type="checkbox"/> Urban	<input type="checkbox"/> Suburban/Town	
	If Forest, Dominant Age Class	<input type="checkbox"/> 0 - 25 yrs.	<input type="checkbox"/> 25 - 75 yrs.	<input type="checkbox"/> > 75 yrs.			

WEATHER CLEAR, WITH LIGHT RAIN IN THE PREVIOUS 24 HOURS. AIR TEMP 28° AT 11 AM.

GENERAL ASSESSMENT (Biotic integrity, Vegetation diversity, Local anecdotal information)

RIPARIAN TREES AGE CLASS: 25-75 YR. THOUGH TREE DENSITY IS LOW.  
LOCAL CONTACT REMEMBERS A DAM LOCATED JUST DOWNSTREAM OF X-SITE  
THAT WAS WASHED AWAY 10 YR AGO DURING A LARGE FLOOD EVENT.  
NO SIGNS OF BIRDS OR WILDLIFE OBSERVED DURING VISIT.

Figure 9-3. Stream Assessment Form (continued).





**EQUIPMENT AND SUPPLIES FOR RAPID HABITAT AND VISUAL STREAM ASSESSMENTS**

<b>QTY.</b>	<b>Item</b>	
1	Rapid Habitat Assessment Form for Riffle/run prevalent streams	
1	Rapid Habitat Assessment Form for Pool/glide prevalent streams	
1	Assessment Form for visual stream assessment	
6	Soft (#2) lead pencils	
1	Covered clipboard or forms holder	
1 copy	Field operations and methods manual	
1 set	Procedure tables and/or quick reference guides for rapid habitat and visual assessments (laminated or printed on write-in-the-rain paper)	

**Figure 9-4. Checklist of equipment and supplies required for rapid habitat and visual stream assessments.**

## NOTES



## **10.0 FINAL SITE ACTIVITIES**

Before leaving a stream site, the team leader reviews all of the data forms and sample labels for accuracy, completeness, and legibility. A second team member inspects all sample containers and packages them in preparation for transport, storage, or shipment. Refer to Section 3 for details on preparing and shipping samples.

When reviewing field data forms, ensure that all required data forms for the stream have been completed. Confirm that the stream identification code, the year, the visit number, and the date of the visit are correct on all forms. On each form, verify that all information has been recorded accurately, the recorded information is legible, and any flags are explained in the comments section. Ensure that written comments are legible and use no "shorthand" or abbreviations. Make sure the header information is completed on all pages of each form. After reviewing each form, initial the upper right corner of each page of the form.

When inspecting samples, ensure that each sample is labeled, all labels are completely filled in and legible, and each label is covered with clear plastic tape. Compare sample label information with the information recorded on the corresponding field data forms (e.g., the Sample Collection Form) to ensure accuracy.

The other team members should return all of the equipment and supplies to the vehicle for transport and clean up the stream site. Pack all equipment and supplies in the vehicle for transport. Keep them organized so they can be inventoried using the equipment and supply checklists presented in Appendix A. Clean up and dispose of all waste material at the stream site. Transport it out of the area if necessary.

## 11.0 LITERATURE CITED

- American Red Cross. 1979. Standard First Aid and Personal Safety. American National Red Cross. 269 pp.
- Bain, M.B., J.T. Finn, and H.E. Booke. 1985. Quantifying stream substrate for habitat analysis studies. *North American Journal of Fisheries Management* 5:499-500.
- Barbour, M.T., J. Gerritsen, B.D. Snyder, and J.B. Stribling. 1999. Rapid Bioassessment Protocols for Use in Streams and Wadeable Rivers: Periphyton, Benthic Macroinvertebrates, and Fish. Second Edition. EPA/841-B-99-002. U.S. Environmental Protection Agency, Office of Water, Assessment and Watershed Protection Division, Washington, D.C.
- Barbour, M.T., J. Gerritsen, G.E. Griffith, R. Frydenborg, E. McCarron, J.S. White, and M.L. Bastian. 1996. A framework for biological criteria for Florida streams using benthic macroinvertebrates. *Journal of the North American Benthological Society* 15(2):185-211.
- Barbour, M.T., J.B. Stribling, and J.R. Karr. 1995. The multimetric approach for establishing biocriteria and measuring biological condition. pp. 69-80 IN: W.S. Davis and T.P. Simon (eds.) *Biological Assessment and Criteria: Tools for Water Resource Planning and Decision-making*. Lewis Publishers, Chelsea, Michigan.
- Berry, C.R. Jr., W.T. Helm, and J. M. Neuhold. 1983. Safety in fishery field work. pp. 43-60 IN: Nielsen, L.A., and D. L. Johnson (eds.). *Fisheries Techniques*. American Fisheries Society, Bethesda, MD.
- Bisson, P.A., J.L. Neilsen, R.A. Palmason, and L.E. Grove. 1982. A system of naming habitat types in small streams, with examples of habitat utilizations by salmonids during low stream flow. pp. 62-73 IN: N.B. Armantrout (ed.). *Acquisition and Utilization of Aquatic Habitat Inventory Information*. Symposium Proceedings, October 18-30, 1981, Portland, Oregon. The Hague Publishing, Billings, Montana.
- Chaloud, D. J., and D. V. Peck (eds.). 1994 *Environmental Monitoring and Assessment Program: Integrated Quality Assurance Project Plan for the Surface Waters Resource Group*. EPA 600/X-91/080. Revision 2.00. U.S. Environmental Protection Agency, Las Vegas, Nevada.
- Dietrich, W.E., J.W. Kirchner, H. Ikeda, and F. Iseya. 1989. Sediment supply and the development of the coarse surface layer in gravel bed rivers. *Nature* 340:215-217.
- Fore, L.S., J.R. Karr, and R.W. Wisseman. 1996. Assessing invertebrate responses to human activities, evaluating alternative approaches. *Journal of the North American Benthological Society* 15:212-231.
- Frissell, C.A., W.J. Liss, C.E. Warren, and M.D. Hurley. 1986. A hierarchical framework for stream habitat classification: viewing streams in a watershed context. *Environmental Management* 10(2):199-214.

- Gordon, N.D., T.A. McMahon, and B.L. Finlayson. 1992. Stream hydrology: an introduction for ecologists. John Wiley and Sons, Inc., West Sussex, England.
- Herlihy, A.T. 1998. Initial site procedures. pp. 45-56 IN: J.M. Lazorchak, D.J. Klemm, and D.V. Peck (Eds.). Environmental Monitoring and Assessment Program-Surface Waters: Field Operations and Methods for Measuring the Ecological Condition of Wadeable Streams. EPA/620/R-94/004F. U.S. Environmental Protection Agency, Washington, D.C.
- Herlihy, A.T. 1998. Water chemistry. pp. 57-65 IN: J.M. Lazorchak, D.J. Klemm, and D.V. Peck (Eds.). Environmental Monitoring and Assessment Program-Surface Waters: Field Operations and Methods for Measuring the Ecological Condition of Wadeable Streams. EPA/620/R-94/004F. U.S. Environmental Protection Agency, Washington, D.C.
- Herlihy, A.T., J.L. Stoddard, and C.B. Johnson. 1998. The relationship between stream chemistry and watershed land use data in the mid-Atlantic region, US. Water Air and Soil Pollution 105:377-386.
- Hughes, R.M. (ed.). 1993. Stream Indicator and Design Workshop. EPA/600/R-93/138. U.S. Environmental Protection Agency, Corvallis, Oregon.
- Kaufmann, P., A. Herlihy, J. Elwood, M. Mitch, S. Overton, M. Sale, J. Messer, K. Reckhow, K. Cougan, D. Peck, J. Coe, A. Kinney, S. Christie, D. Brown, C. Hagley, and Y. Jager. 1988. Chemical Characteristics of Streams in the Mid-Atlantic and Southeastern United States. Volume I: Population Descriptions and Physico-Chemical Relationships. EPA 600/3-88/021a. U.S. Environmental Protection Agency, Washington, D.C.
- Kaufmann, P.R. 1998. Stream Discharge. pp. 67-76 IN: J.M. Lazorchak, D.J. Klemm, and D.V. Peck (Eds.). Environmental Monitoring and Assessment Program-Surface Waters: Field Operations and Methods for Measuring the Ecological Condition of Wadeable Streams. EPA/620/R-94/004F. U.S. Environmental Protection Agency, Washington, D.C.
- Kaufmann, P.R. (ed.). 1993. Physical Habitat. pp. 59-69 IN: R.M. Hughes (ed.). Stream Indicator and Design Workshop. EPA/600/R-93/138. U.S. Environmental Protection Agency, Corvallis, Oregon.
- Kaufmann, P.R. and E.G. Robison. 1998. Physical Habitat Assessment. pp 77-118 In: Lazorchak, J.L., Klemm, D.J., and D.V. Peck (editors)., Environmental Monitoring and Assessment Program - Surface Waters: Field Operations and Methods for Measuring the Ecological Condition of Wadeable Streams. EPA/620/R-94/004F. U.S. Environmental Protection Agency, Washington D.C.
- Kaufmann, P.R., P. Levine, E.G. Robison, C. Seeliger, and D.V. Peck (1999). Quantifying Physical Habitat in Wadeable Streams. EPA 620/R-99/003. U.S. Environmental Protection Agency, Washington, D.C. 102p + App.
- Kerans, B.L., and J.R. Karr. 1994. A benthic index of biotic integrity (B-IBI) for rivers of the Tennessee Valley. Ecological Applications 4:768-785.

- Klemm, D.J., B.H. Hill, F.H. McCormick, and M.K. McDowell. 1998. Base location activities. pp. 27-44 IN: J.M. Lazorchak, D.J. Klemm, and D.V. Peck (Eds.). Environmental Monitoring and Assessment Program-Surface Waters: Field Operations and Methods for Measuring the Ecological Condition of Wadeable Streams. EPA/620/R-94/004F. U.S. Environmental Protection Agency, Washington, D.C.
- Klemm, D.J., J.M. Lazorchak, and P.A. Lewis. 1998. Benthic Macroinvertebrates. pp. 147-182 IN: J.M. Lazorchak, D.J. Klemm, and D.V. Peck (Eds.). Environmental Monitoring and Assessment Program-Surface Waters: Field Operations and Methods for Measuring the Ecological Condition of Wadeable Streams. EPA/620/R-94/004F. U.S. Environmental Protection Agency, Washington, D.C.
- Klemm, D.J., P.A. Lewis, F. Fulk, and J.M. Lazorchak. 1990. Macroinvertebrate Field and Laboratory Methods for Evaluating the Biological Integrity of Surface Waters. EPA/600/4-90/030. U.S. Environmental Protection Agency, Environmental Monitoring Systems Laboratory, Cincinnati, Ohio.
- Lazorchak, J.M., A.T. Herlihy, and J. Green. 1998. Rapid Habitat and Visual Stream Assessments. pp. 193-209 IN: J.M. Lazorchak, D.J. Klemm, and D.V. Peck (Eds.). Environmental Monitoring and Assessment Program-Surface Waters: Field Operations and Methods for Measuring the Ecological Condition of Wadeable Streams. EPA/620/R-94/004F. U.S. Environmental Protection Agency, Washington, D.C.
- Lazorchak, J.M., Klemm, D.J. , and D.V. Peck (editors). 1998. Environmental Monitoring and Assessment Program -Surface Waters: Field Operations and Methods for Measuring the Ecological Condition of Wadeable Streams. EPA/620/R-94/004F. U.S. Environmental Protection Agency, Washington, D.C.
- Lemmon, P.E. 1957. A new instrument for measuring forest overstory density. *Journal of Forestry* 55(9):667-669.
- Linsley, R.K., M.A. Kohler, and J.L.H. Paulhus. 1982. *Hydrology for Engineers*. McGraw-Hill Book Co. New York.
- Moore, K.M., K.K. Jones, and J.M. Dambacher. 1993. Methods for stream habitat surveys: Oregon Department of Fish and Wildlife, Aquatic Inventory Project. Version 3.1. Oregon Department of Fish and Wildlife, Corvallis, OR 34 pp.
- Mulvey, M., L. Caton, and R. Hafele. 1992. Oregon Nonpoint Source Monitoring Protocols Stream Bioassessment Field Manual for Macroinvertebrates and Habitat Assessment. Oregon Department of Environmental Quality, Laboratory Biomonitoring Section. 1712 S.W. 11th Ave. Portland, Oregon, 97201. 40 p.
- National Institute for Occupational Safety and Health. 1981. Occupational Health Guidelines for Chemical Hazards (Two Volumes). NIOSH/OSHA Publication No. 81-123. U.S. Government Printing Office, Washington, D.C.
- Norris, R.H. 1995. Biological monitoring: the dilemma of data analysis. *Journal of the North American Benthological Society* 14:440-450.



- Ohio EPA. 1990. Ohio EPA Fish Evaluation Group Safety Manual. Ohio Environmental Protection Agency, Ecological Assessment Section, Division of Water Quality Planning and Assessment, Columbus, Ohio.
- Peck, D.V., J.M. Lazorchak, and D.J. Klemm (editors). 2003 Unpublished draft. Environmental Monitoring and Assessment Program-Surface Waters: Western Pilot Study Field Operations Manual for Wadeable Streams. EPA/xxx/x-xx/xxxx. U.S. Environmental Protection Agency, Washington, D.C.
- Plafkin, J.L., M.T. Barbour, K.D. Porter, S.K. Gross, and R.M. Hughes. 1989. Rapid Bioassessment Protocols for Use in Streams and Rivers: Benthic Macroinvertebrates and Fish. EPA/440/4-89/001. U.S. Environmental Protection Agency, Assessment and Watershed Protection Division, Washington, D.C.
- Platts, W.S., W.F. Megahan, and G.W. Minshall. 1983. Methods for Evaluating Stream, Riparian, and Biotic Conditions. USDA Forest Service General Technical Report INT-183. 71 p.
- Rantz, S.E. and others. 1982. Measurement and Computation of Streamflow: Volume 1. Measurement of Stage and Discharge. U.S. Geological Survey Water-Supply Paper 2175.
- Robison, E.G. and P.R. Kaufmann. 1994. Evaluating two objective techniques to define pools in small streams. pp. 659-668, IN: R.A. Marston and V.A. Hasfurther (eds.). Effects of Human Induced Changes on Hydrologic Systems. Summer Symposium proceedings, American Water Resources Association, June 26-29, 1994, Jackson Hole, Wyoming. 1182 p.
- Robison, E.G. and R.L. Beschta. 1990. Characteristics of coarse woody debris for several coastal streams of southeast Alaska, USA. Canadian Journal of Fisheries and Aquatic Sciences 47(9):1684-1693.
- Smoot, G. F., and C. E. Novak. 1968. Calibration and Maintenance of Vertical-axis Type Current Meters. Book 8, Chapter B2 IN: Techniques of Water-Resources Investigations of the United States Geological Survey. U.S. Government Printing Office, Washington, D.C.
- Stack, B.R. 1989. Factors Influencing Pool Morphology in Oregon Coastal Streams. M.S. Thesis, Oregon State University. 109 p.
- Stanley, T.W., and S.S. Verner. 1986. The U.S. Environmental Protection Agency's quality assurance program. pp. 12-19 IN: J.K. Taylor and T.W. Stanley (eds.). Quality Assurance for Environmental Measurements. ASTM STP 867, American Society for Testing and Materials, Philadelphia, Pennsylvania.
- U.S. Coast Guard. 1987. Federal Requirements for Recreational Boats. U.S. Department of Transportation, United States Coast Guard, Washington, D.C.

- U.S. EPA. 1998. Environmental Monitoring and Assessment Program (EMAP): Research Plan 1997. EPA/620/R-98/002. U.S. Environmental Protection Agency, Washington, D.C.
- U.S. EPA. 2000. Ecological Assessment of Streams and Rivers in the Western United States: A Cooperative Effort Between the U.S. EPA and Western States and Tribal Nations. U.S. Environmental Protection Agency, Corvallis, Oregon.
- U.S. EPA. 1989. Handbook of Methods for Acid Deposition Studies: Field Operations for Surface Water Chemistry. EPA 600/4-89/020. U.S. Environmental Protection Agency, Office of Research and Development, Washington, D.C.
- U.S. EPA. 1986. Occupational Health and Safety Manual. Office of Planning and Management, U.S. Environmental Protection Agency, Washington, D.C.
- Wilcock, P.R. 1988. Two-fraction model of initial sediment motion in gravel-bed rivers. *Science* 280:410-412.
- Wolman, M.G. 1954. A method of sampling coarse river-bed material. *Transactions of the American Geophysical Union* 35(6):951-956.
- Wright, J.F. 1995. Development and use of a system for predicting the macroinvertebrate fauna in flowing waters. *Australian Journal of Ecology* 20:181-197.

# APPENDIX A: EQUIPMENT AND SUPPLY CHECKLISTS

## APPENDIX A

### EQUIPMENT AND SUPPLY CHECKLISTS

FIELD DATA FORMS AND SAMPLE LABELS .....	A-2
OFFICE SUPPLIES AND TOOLS .....	A-3
PERSONAL EQUIPMENT AND SUPPLIES .....	A-4
CHEMICALS .....	A-5
PACKING AND SHIPPING SUPPLIES .....	A-5
SITE VERIFICATION AND SAMPLING REACH LAYOUT .....	A-6
WATER CHEMISTRY .....	A-6
STREAM DISCHARGE .....	A-7
PHYSICAL HABITAT .....	A-7
PERIPHYTON .....	A-8
BENTHIC MACROINVERTEBRATES .....	A-9
AQUATIC VERTEBRATES AND FISH TISSUE CONTAMINANTS .....	A-10

### Field Data Forms and Sample Labels

Number per site	Item
1	Verification Form
1	Sample Collection Form and Stream Discharge Form
11 + extras	Channel/Riparian Cross-section and Thalweg Profile Forms
1	Slope and Bearing Form
1	Legacy Tree/ Invasive Plant Form
1	Channel Constraint and Field Measurement Form and Torrent Evidence Assessment Form
2-3	Vertebrate Collection Form
1	Rapid Habitat Assessment Form for Riffle/run prevalent streams (optional)
1	Rapid Habitat Assessment Form for Pool/glide prevalent streams (optional)
1	Assessment Form for visual stream assessment
4 + extras	Sample Tracking Form
3	Water chemistry labels (same ID number)
3t	Periphyton labels (same ID number)
1	Reachwide Benthic sample labels, with preprinted ID numbers
1	Targeted Riffle Benthic sample labels with preprinted ID numbers
1 sheet	Benthic labels for extra containers (no preprinted ID number)
1 sheet	Blank benthic sample labels on waterproof paper for inside of jars
1 sheet	Pre-printed aquatic vertebrate jar labels (4) and voucher bag tags (36), all with same preprinted sample ID number
1 sheet	Fish tissue sample labels (up to 16 different sample ID number)
2 copies	Field operations and methods manual
2 sets	Laminated sheets of procedure tables and/or quick reference guides

### Office Supplies and Tools

Number per site	Item	
1	Dossier of access information for scheduled stream site	
1	Topographic map with "X-site" marked	
1	Site information sheet with map coordinates and elevation of X-site	
1	Sampling itinerary form or notebook	
1	Safety log and/or personal safety information for each team member	
4	Covered clipboards or forms holders	
1	Field notebook (optional)	
12	Soft (#2) lead pencils	
6	Fine-tip indelible markers	
1 roll	Duct tape	
1 pr	Scissors for cutting labels	
1	Pocket knife or multipurpose tool	
1	Battery charger (if needed for electrofishing unit)	
1	Toolbox with basic tools needed to maintain/repair sampling gear	
	Clear tape and covering labels	
	Binder clips for keeping forms together	

### Personal Equipment and Supplies

Number per site	Item	
1 pair per person	Chest waders with felt-soled boots for safety and speed if waders are the neoprene "stocking" type. Hip waders can be used in shallower streams (except for electrofishing).	
1 per person	Life vests	
3 pair	Polarized sunglasses	
1	First aid kit	
1 per person	Rain gear	
1 or 2	Fisherman's vest for physical habitat characterization equipment.	
1 per person	Safety Whistles	
1 pr. per person	Earplugs (if gas-powered generators are used)	
1 per person	Day packs, backs, fanny packs, and/or dry bags for personal gear	
1 ea.	Insect repellent, sunscreen, Tec-nu (for poison oak), hand sanitizer, water purifier unit	
1	Patch kit for waders	

### Chemicals

Number per site	Item	
1	Cooler (with suitable absorbent material) for transporting ethanol and samples	
2 gal	95% ethanol	
1 gal	Sparquat®disinfectant	

### Packing and Shipping Supplies

Number per site	Item	
	Ice (also dry ice if it is used to ship frozen samples) or ice substitute packs	
1 box	1-gal heavy-duty self-sealing (e.g., with a zipper-type closure) plastic bags	
1-box	30-gal plastic garbage bags for lining shipping containers	
1 roll	Clear tape for sealing shipping containers	
2 pkg.	Clear tape strips for covering labels	
4 rolls	Plastic electrical tape	
3	Insulated shipping containers for samples	
2	Containers and absorbent material (e.g. vermiculite) suitable to transport and/or ship samples preserved in formalin or ethanol	
6	Shipping airbills and adhesive plastic sleeves	
1 box	2 gal. heavy duty plastic bags	

### Site Verification and Sampling Reach Layout

Number per site	Item	
1	GPS receiver and operating manual	
	Extra batteries for GPS receiver	
1	Surveyor's telescoping leveling rod (round profile, metric scale, 7.5 m extended)	
1	50-m fiberglass measuring tape with reel	
2 rolls	Surveyor's flagging tape (2 colors)	
1	Waterproof camera and film (or digital camera)	



### Water Chemistry

Number per site	Item
1	Field thermometer
1	500 mL plastic beaker with handle (in clean plastic bag)
1	4-L cubitainer
2	60 mL plastic syringes
1	½ gal. size plastic container with snap-on lid to hold filled syringes
2	Syringe valves
1	Dissolved oxygen/Conductivity/Temperature meter with probe and operating manual (optional)
1	DO repair kit with additional membranes and probe filling solution (optional)
1	Conductivity meter, probe, and operating manual (if not integrated with DO/Temp meter (optional)
	Extra batteries for dissolved oxygen and conductivity meters (optional)
1	500-mL plastic bottle of conductivity QCCS labeled "Rinse" (in plastic bag) (optional)
1	500-mL plastic bottle of conductivity QCCS labeled "Test" (in plastic bag) (optional)
1	500-mL plastic bottle of deionized water to store conductivity probe (optional)

### Stream Discharge

Number per site	Item
1	Current velocity meter and probe, with operating manual (e.g. Marsh-McBirney Model 201, Swoffer Model 2100, or equivalent)
1	Top-set wading rod (metric scale) for use with current velocity meter
1	Portable Weir with 60° "V" notch (optional)
1	Plastic sheeting to use with weir (optional)
1	Plastic bucket (or similar container) with volume graduations
1	Stopwatch
1	Neutrally buoyant object (e.g., orange, small rubber ball, stick, bobber)

### Physical Habitat

Number per site	Item	
1	Fisherman's vest with lots of pockets and snap fittings.	
1	50-m tape measure	
1	Clinometer with percent and degree scales.	
1	Lightweight telescoping camera tripod, (necessary only if slope measurements are being determined by only one person)	
1	½-inch diameter PVC pipe, 2-3 m long, each marked at the same height (for use in slope determinations involving two persons)	
1	Spherical convex canopy densiometer, modified with taped "V"	
1	Bearing compass (Backpacking type)	
1	Meter stick. Alternatively, a short (1-2 m) rod or pole (e.g., a ski pole) with cm markings for thalweg measurements	
1	Surveyors rod (optional)	

### Benthic Macroinvertebrates

Number per site	Item	
1	D-Frame kick net (500 µm mesh) and 4-ft handle with cod piece	
	Spare net(s) for the kick net sampler or extra sampler	
1	Bucket, plastic, 8- to 10-qt capacity	
1	Sieve, U.S. Std. No. 35 (500 µm mesh), or Sieve bucket with 500-µm mesh openings	
2 pr. ea.	Watchmakers' and curved tip forceps	
1	Small spatula, spoon, or scoop to transfer sample	
1	Funnel, with large bore spout	
4 to 6 ea.	Sample jars, HDPE plastic with leakproof screw caps, 500-mL and 1-L capacity, suitable for use with ethanol	
1 pkg.	Kim wipes in small self-sealing plastic bag	
	gloves	

# APPENDIX B: FIELD FORMS AND DATA SHEETS

# FIELD SAMPLE SHIPMENT PACKING/TRACKING FORM

Wadeable   
  Boatable   
  Other = Fax Verification Form   
 Date Visited:   /  /  2003

**Check all that apply:**   
  Willamette Research Station   
 Site Name: (Write Unknown if unknown)   
 Visit Number:   
 1    
 2    
 3

Poison Depot   
  Other

Airbill Number: \_\_\_\_\_   
 Contact: (Person calling in or faxing tracking info.) \_\_\_\_\_   
 Date Sent:   /  /  2003

Site ID	Sample ID	Sample Type	# Of Jars	Fish:	Comments <small>(Fish tissue species and other comments here.)</small>
		<input type="radio"/> Chem <input type="radio"/> Peri - BIO, CHLA, ID <input type="radio"/> Peri - Plankton Tow <input type="radio"/> Peri - STAR		<input type="radio"/> Big <input type="radio"/> Small	
		<input type="radio"/> Fish (Tissue) <input type="radio"/> Bent - Reachwide <input type="radio"/> Bent - Targeted Riffle <input type="radio"/> Vert (Vouchers)			

**Lab Contact: Richard Kovar (541)754-4735**

Ph) (541)754-GOOD (4663) OR  
 Fax) (541)754-4338 ATTN: Marlys Cappaert

1) Name/Contact, Time of call, Site Name, Site ID and number, Collected date, Sent date, Visit number, Airbill number.  
 2) Site status from stream verification form ie: Wadeable, Boatable...  
 3) Information for both unpreserved samples as well as preserved samples, sent or not.

**For office use only**

Initials: \_\_\_\_\_    Status:  \_\_\_\_\_  
 Date Entered:   /  /      Sample:  \_\_\_\_\_

**For Lab use only**

Date Received:   /  /    
 Lab: Fax this sheet to  
 541-754-4338 Attn  
 Marlys Cappaert

SAMPLE TYPES	CONDITION CODES
<b>BENT</b> = Benthos <b>CHEM</b> = Water Chemistry <b>FISH</b> = Fish Tissue <b>PERI</b> = Periphyton <b>VERT</b> = Fish Museum	<b>B</b> = Broken Syringe Tip <b>C</b> = Cracked Jar <b>F</b> = Frozen <b>L</b> = Leaking <b>ML</b> = Missing Label <b>NP</b> = Not Preserved <b>OK</b> = Seems Fine <b>T</b> = Thawed but still Cold <b>W</b> = Warm
<b>Box is for # of Jars Reachwide and Targeted Riffle.</b> <span style="border: 1px solid black; display: inline-block; width: 20px; height: 20px; vertical-align: middle;"></span>	

63654





# STREAM VERIFICATION FORM - STREAMS/RIVERS

Reviewed by (initial): \_\_\_\_\_

SITE NAME: _____	DATE: ____ / ____ / <b>2003</b>	VISIT: 0 1 2 3
SITE ID: _____	Don't forget to record Reach Length on back.	TEAM: _____

## STREAM/RIVER VERIFICATION INFORMATION

Stream/River Verified by (X all that apply):     GPS     Local Contact     Signs     Roads     Topo. Map  
 Other (Describe Here): \_\_\_\_\_     Not Verified (Explain in Comments)

Coordinates	Latitude North	Longitude West	Type of GPS Fix	Are GPS Coordinates w/i 10 Sec. of map?
<b>MAP</b> Degrees, Minutes, and Seconds OR Decimal Degrees	_____ _____	_____ _____	<input type="checkbox"/> 2D  <input type="checkbox"/> 3D	<input type="checkbox"/> Yes  <input type="checkbox"/> No
<b>GPS</b> Degrees, Minutes, and Seconds OR Decimal Degrees	_____ _____	_____ _____		

## DID YOU ASSESS THE SITE?

**YES**    If YES, check one below

**NO**    If NO, check one below

**SAMPLEABLE** (Choose method used)

- Wadeable - Continuous water, greater than 50% wadeable
- Boatable
- Partial - Sampled by wading (Explain in comments)
- Partial - Sampled by boat (Explain in comments)
- Wadeable Interrupted - Not continuous water along reach
- Boatable Interrupted - Not continuous water along reach
- Altered - Stream/River Present but not as on Map

**NON-SAMPLEABLE-PERMANENT**

- Dry - Visited
- Dry - Not visited
- Wetland (No Definable Channel)
- Map Error - No evidence channel/waterbody ever present
- Impounded (Underneath Lake or Pond)
- Other (explain in comments)

**NON-SAMPLEABLE-TEMPORARY**

- Not boatable - Need a different crew
- Not wadeable - Need a different crew
- Other (Explain in comments)

**NO ACCESS**

- Access Permission Denied
- Permanently Inaccessible (Unable/Unsafe to Reach Site)
- Temporarily Inaccessible-Fire, etc. (Explain in comments)

**GENERAL COMMENTS:**

**DIRECTIONS TO STREAM/RIVER SITE:**

Record information used to define length of reach, and sketch general features of reach on reverse side.

56029



# STREAM VERIFICATION FORM - STREAMS/RIVERS (cont.)

Reviewed by \_\_\_\_\_  
(initial): \_\_\_\_\_

SITE NAME: _____	DATE: ____/____/2003	VISIT: 0 1 2 3
SITE ID: _____	TEAM: _____	

## STREAM/RIVER REACH DETERMINATION

Channel Width Used to Define Reach (m)	DISTANCE (m) FROM X-SITE		DETERMINATION Total Reach Length Intended (m)	Comment
	Upstream Length	Downstream Length		
_____	_____	_____	_____	

### SKETCH MAP - Arrow Indicates North

## PERSONNEL

NAME	Biomorph	DUTIES Geomorph	Forms
_____	<input type="checkbox"/>	<input type="checkbox"/>	<input type="checkbox"/>
_____	<input type="checkbox"/>	<input type="checkbox"/>	<input type="checkbox"/>
_____	<input type="checkbox"/>	<input type="checkbox"/>	<input type="checkbox"/>
_____	<input type="checkbox"/>	<input type="checkbox"/>	<input type="checkbox"/>
_____	<input type="checkbox"/>	<input type="checkbox"/>	<input type="checkbox"/>

56029



**PHab: CHANNEL/RIPARIAN CROSS-SECTION FORM - STREAMS**

Reviewed by (Initials): \_\_\_\_\_

SITE ID: \_\_\_\_\_

DATE: \_\_\_\_\_ / \_\_\_\_\_ / **2003**

TRANSECT:  A  B  C  D  E  F  X-tra Side Channel  
 G  H  I  J  K

SUBSTRATE CROSS-SECTIONAL INFORMATION					
Dist LB	Depth	Size Class	Embed.		
XX.XX m	XXX cm	Code	0-100%	Flag	
Left					
LCtr					
Ctr					
RCtr					
Right					
SUBSTRATE SIZE CLASS CODES			Embed. (%)		
RS = Bedrock (Smooth) - (Larger than a car)			0		
RR = Bedrock ( Rough) - (Larger than a car)			0		
RC = Concrete/Asphalt					
XB = Large Boulder (1000 to 4000 mm) - (Meterstick to car)					
SB = Small Boulder (250 to 1000 mm) - (Basketball to meterstick)					
CB = Cobble (64 to 250 mm) - (Tennis ball to Basketball)					
GC = Coarse Gravel (16 to 64 mm) - (Marble to Tennis ball)					
GF = Fine Gravel (2 to 16 mm) - (Ladybug to marble)					
SA = Sand (0.06 to 2 mm) - (Gritty - up to Ladybug size)			100		
FN = Silt / Clay / Muck - (Not Gritty)			100		
HP = Hardpan - (Firm, Consolidated Fine Substrate)			0		
WD = Wood - (Any Size)					
OT = Other (Write comment below)					

FISH COVER/ OTHER	0 = Absent (0%) 1 = Sparse (<10%) 2 = Moderate (10-40%) 3 = Heavy (40-75%) 4 = Very Heavy (>75%) (circle one)					
	Cover in Channel					Flag
Filamentous Algae	0	1	2	3	4	
Macrophytes	0	1	2	3	4	
Woody Debris >0.3 m (BIG)	0	1	2	3	4	
Brush/Woody Debris <0.3 m (SMALL)	0	1	2	3	4	
Live Trees or Roots	0	1	2	3	4	
Overhanging Veg. =<1 m of Surface	0	1	2	3	4	
Undercut Banks	0	1	2	3	4	
Boulders	0	1	2	3	4	
Artificial Structures	0	1	2	3	4	

VISUAL RIPARIAN ESTIMATES	0 = Absent (0%) 1 = Sparse (<10%) 2 = Moderate (10-40%) 3 = Heavy (40-75%) 4 = Very Heavy (>75%)					D = Deciduous C = Coniferous E = Broadleaf Evergreen M = Mixed N = None										
	RIPARIAN VEGETATION COVER					Left Bank					Right Bank					Flag
Canopy (>5 m high)																
Vegetation Type	D	C	E	M	N	D	C	E	M	N	D	C	E	M	N	
BIG Trees (Trunk >0.3 m DBH)	0	1	2	3	4	0	1	2	3	4	0	1	2	3	4	
SMALL Trees (Trunk <0.3 m DBH)	0	1	2	3	4	0	1	2	3	4	0	1	2	3	4	
Understory (0.5 to 5 m high)																
Vegetation Type	D	C	E	M	N	D	C	E	M	N	D	C	E	M	N	
Woody Shrubs & Saplings	0	1	2	3	4	0	1	2	3	4	0	1	2	3	4	
Non-Woody Herbs, Grasses, & Forbs	0	1	2	3	4	0	1	2	3	4	0	1	2	3	4	
Ground Cover (<0.5 m high)																
Woody Shrubs & Saplings	0	1	2	3	4	0	1	2	3	4	0	1	2	3	4	
Non-Woody Herbs, Grasses and Forbs	0	1	2	3	4	0	1	2	3	4	0	1	2	3	4	
Barren, Bare Dirt or Duff	0	1	2	3	4	0	1	2	3	4	0	1	2	3	4	
HUMAN INFLUENCE	0 = Not Present P = >10 m C = Within 10 m B = On Bank															
	Left Bank					Right Bank					Flag					
Wall/Dike/Revetment /Riprap/Dam	0	P	C	B		0	P	C	B							
Buildings	0	P	C	B		0	P	C	B							
Pavement/Cleared Lot	0	P	C	B		0	P	C	B							
Road/Railroad	0	P	C	B		0	P	C	B							
Pipes (Inlet/Outlet)	0	P	C	B		0	P	C	B							
Landfill/Trash	0	P	C	B		0	P	C	B							
Park/Lawn	0	P	C	B		0	P	C	B							
Row Crops	0	P	C	B		0	P	C	B							
Pasture/Range/Hay Field	0	P	C	B		0	P	C	B							
Logging Operations	0	P	C	B		0	P	C	B							
Mining Activity	0	P	C	B		0	P	C	B							

BANK MEASUREMENTS			
	Bank Angle	Undercut	
	0 - 360	Dist. (m)	Flag
Left			
Right			
Wetted Width XXX.X m			
Bar Width XX.X m			
Bankfull Width XXX.X m			
Bankfull Height XX.X m			
Incised Height XX.X m			

CANOPY COVER MEASUREMENTS					
DENSIOMETER (0-17Max)					
Flag			Flag		
CenUp			CenR		
CenL			Left		
CenDwn			Right		

Flag codes: K = Sample not collected; U = Suspect sample; F1, F2, etc. = misc. flag assigned by field crew. Explain all flags in comment sections.

Flag	Comments

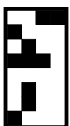

27657



# PHAB: THALWEG PROFILE & WOODY DEBRIS FORM STREAMS

Reviewed by (initial): \_\_\_\_\_

SITE ID: \_\_\_\_\_

DATE: \_\_\_\_\_ / \_\_\_\_\_ / **2 0 0 3**

TRANSECT:  A-B  B-C  C-D  D-E  E-F  
 F-G  G-H  H-I  I-J  J-K

THALWEG PROFILE					For Transect A-B ONLY:					Increment (m) X.X:	Total Reach Length (m):	
STATION	THALWEG DEPTH (cm) (XXX)	WETTED WIDTH (m) (XXX.X)	BAR WIDTH <sup>1</sup>		SOFT /SMALL SEDI-MENT	CHANNEL UNIT CODE	POOL FORM CODE	SIDE CHANNEL	BACK WATER	FLAG	COMMENTS	
			Present	XX.X								
0			Y	N	Y	N		Y	N	Y	N	
1			Y	N	Y	N		Y	N	Y	N	
2			Y	N	Y	N		Y	N	Y	N	
3			Y	N	Y	N		Y	N	Y	N	
4			Y	N	Y	N		Y	N	Y	N	
*5			Y	N	Y	N		Y	N	Y	N	
6			Y	N	Y	N		Y	N	Y	N	
*7			Y	N	Y	N		Y	N	Y	N	
8			Y	N	Y	N		Y	N	Y	N	
9			Y	N	Y	N		Y	N	Y	N	
10			Y	N	Y	N		Y	N	Y	N	
11			Y	N	Y	N		Y	N	Y	N	
12			Y	N	Y	N		Y	N	Y	N	
13			Y	N	Y	N		Y	N	Y	N	
14			Y	N	Y	N		Y	N	Y	N	

SUBSTRATE	Station (5 or 7)	LFT	LCTR	CTR	RCTR	RGT	FLAG	LARGE WOODY DEBRIS (≥10 cm small end diameter; ≥ 1.5 m length)			CHECK IF UNMARKED BOXES ARE ZERO <input type="checkbox"/>			FLAG <input type="checkbox"/>
	FLAG	COMMENTS (for SUBSTRATE and LWD)							DIAMETER LARGE END	PIECES ALL/PART IN BANKFULL CHANNEL			PIECES BRIDGE ABOVE BANKFULL CHANNEL	
									Length 1.5-5m	5-15m	>15m	Length 1.5-5m	5-15m	>15m
								0.1-<0.3 m	<input type="checkbox"/>	<input type="checkbox"/>	<input type="checkbox"/>	<input type="checkbox"/>	<input type="checkbox"/>	<input type="checkbox"/>
								0.3-0.6 m	<input type="checkbox"/>	<input type="checkbox"/>	<input type="checkbox"/>	<input type="checkbox"/>	<input type="checkbox"/>	<input type="checkbox"/>
								0.6-0.8 m	<input type="checkbox"/>	<input type="checkbox"/>	<input type="checkbox"/>	<input type="checkbox"/>	<input type="checkbox"/>	<input type="checkbox"/>
								>0.8 m	<input type="checkbox"/>	<input type="checkbox"/>	<input type="checkbox"/>	<input type="checkbox"/>	<input type="checkbox"/>	<input type="checkbox"/>

SUBSTRATE SIZE CLASS CODES	POOL FORM CODES	CHANNEL UNIT CODES
RS = BEDROCK (SMOOTH) - (LARGER THAN A CAR) RR = BEDROCK (ROUGH) - (LARGER THAN A CAR) RC = CONCRETE/ASPHALT XB = LG. BOULDER (1000 TO 4000 mm) - METERSTICK TO CAR) SB = SM. BOULDER (250 TO 1000 mm) - BASKETBALL TO METERSTICK) CB = COBBLE (64 TO 250 mm) - (TENNIS BALL TO BASKETBALL) GC = COARSE GRAVEL (16 TO 64 mm) - (MARBLE TO TENNIS BALL) GF = FINE GRAVEL (2 TO 16 mm) - (LADYBUG TO MARBLE) SA = SAND (0.06 TO 2 mm) - (GRITTY - UP TO LADYBUG SIZE) FN = SILT/ CLAY / MUCK - (NOT GRITTY) HP = HARDPAN - (FIRM, CONSOLIDATED FINE SUBSTRATE) WD = WOOD - (ANY SIZE) OT = OTHER (COMMENT ON OTHER SIDE)	N = Not a pool W = Large Woody Debris R = Rootwad B = Boulder or Bedrock F = Unknown, fluvial  COMBINATIONS: eg. WR, BR, WRB	PP = Pool, Plunge PT = Pool, Trench PL = Pool, Lateral Scour PB = Pool, Backwater PD = Pool, Impoundment GL = Glide RI = Riffle RA = Rapid CA = Cascade FA = Falls DR = Dry Channel

Flag Codes: K = no measurement made; U = suspect measurement; F1, F2, ect. = flags assigned by each field crew; G1, G2, etc. for flags not specific to one station. Explain all flags in comments. 1 = Measure Bar Width at Station 0 and Mid-Station (5 or 7).



17021

# PHab: SLOPE AND BEARING FORM - STREAMS

Reviewed by (initial): \_\_\_\_\_

SITE ID: \_\_\_\_\_ DATE:    /    /    **2 0 0 3**

MAIN (always used)				FIRST SUPPLEMENTAL			SECOND SUPPLEMENTAL			FLAG
TRANSECT & METHOD	Slope(%) or Elev. Diff. (cm)	BEARING 0 - 359	PROPOR- TION %	Slope(%) or Elev. Diff. (cm)	BEARING 0 - 359	PROPOR- TION %	Slope(%) or Elev. Diff. (cm)	BEARING 0 - 359	PROPOR- TION %	
Mark method for every Transect	Mark Units for every Transect									
A < B <input type="checkbox"/> CL <input type="checkbox"/> TR <input type="checkbox"/> HL <input type="checkbox"/> WT <input type="checkbox"/> LA <input type="checkbox"/> Other	□ % □ cm									
B < C <input type="checkbox"/> CL <input type="checkbox"/> TR <input type="checkbox"/> HL <input type="checkbox"/> WT <input type="checkbox"/> LA <input type="checkbox"/> Other	□ % □ cm									
C < D <input type="checkbox"/> CL <input type="checkbox"/> TR <input type="checkbox"/> HL <input type="checkbox"/> WT <input type="checkbox"/> LA <input type="checkbox"/> Other	□ % □ cm									
D < E <input type="checkbox"/> CL <input type="checkbox"/> TR <input type="checkbox"/> HL <input type="checkbox"/> WT <input type="checkbox"/> LA <input type="checkbox"/> Other	□ % □ cm									
E < F <input type="checkbox"/> CL <input type="checkbox"/> TR <input type="checkbox"/> HL <input type="checkbox"/> WT <input type="checkbox"/> LA <input type="checkbox"/> Other	□ % □ cm									
F < G <input type="checkbox"/> CL <input type="checkbox"/> TR <input type="checkbox"/> HL <input type="checkbox"/> WT <input type="checkbox"/> LA <input type="checkbox"/> Other	□ % □ cm									
G < H <input type="checkbox"/> CL <input type="checkbox"/> TR <input type="checkbox"/> HL <input type="checkbox"/> WT <input type="checkbox"/> LA <input type="checkbox"/> Other	□ % □ cm									
H < I <input type="checkbox"/> CL <input type="checkbox"/> TR <input type="checkbox"/> HL <input type="checkbox"/> WT <input type="checkbox"/> LA <input type="checkbox"/> Other	□ % □ cm									
I < J <input type="checkbox"/> CL <input type="checkbox"/> TR <input type="checkbox"/> HL <input type="checkbox"/> WT <input type="checkbox"/> LA <input type="checkbox"/> Other	□ % □ cm									
J < K <input type="checkbox"/> CL <input type="checkbox"/> TR <input type="checkbox"/> HL <input type="checkbox"/> WT <input type="checkbox"/> LA <input type="checkbox"/> Other	□ % □ cm									

FLAG	COMMENT

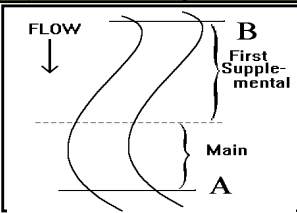

53488

**Flag codes:** K = Sample not collected; U = Suspect sample; F1, F2, M (M = Method - used for method comment only) = flag assigned by field crew. Explain all flags in comment sections  
 03/20/2003 2003 Phab Slope CL=Clinometer; HL=Hand Level; LA=Laser rangefinder with electronic clinometer; TR=Transit, surveyors level or total station; WT=Water Tubing.



# RIPARIAN "LEGACY" TREES AND INVASIVE ALIEN PLANTS

Reviewed by (initial): \_\_\_\_\_

SITE ID: \_\_\_\_\_ DATE: \_\_\_\_\_ / \_\_\_\_\_ / **2003**

22977

LARGEST POTENTIAL LEGACY TREE VISIBLE FROM THIS STATION							ALIEN PLANT SPECIES PRESENT IN LEFT AND RIGHT RIPARIAN PLOTS				
Tran	Trees not Visible	DBH (m)	Height (m)	Dist. from wetted margin (m)	Type	Taxonomic Category	Check all that are present				
<b>A</b>	<input type="checkbox"/>	<input type="checkbox"/> 0-0.1 <input type="checkbox"/> .75-2 <input type="checkbox"/> .1-.3 <input type="checkbox"/> >2 <input type="checkbox"/> .3-.75	<input type="checkbox"/> <5 <input type="checkbox"/> 5-15 <input type="checkbox"/> 15-30 <input type="checkbox"/> >30	_____	<input type="checkbox"/> Deciduous <input type="checkbox"/> Coniferous <input type="checkbox"/> Broadleaf Evergreen	_____	<input type="checkbox"/> NONE	<input type="checkbox"/> RC Grass <input type="checkbox"/> Salt Ced <input type="checkbox"/> Hblack <input type="checkbox"/> G Reed <input type="checkbox"/> Engl Ivy <input type="checkbox"/> CanThis <input type="checkbox"/> Teasel <input type="checkbox"/> C Burd <input type="checkbox"/> Ch Grass <input type="checkbox"/> M This <input type="checkbox"/> Spurge <input type="checkbox"/> Rus Ol			
<b>B</b>	<input type="checkbox"/>	<input type="checkbox"/> 0-0.1 <input type="checkbox"/> .75-2 <input type="checkbox"/> .1-.3 <input type="checkbox"/> >2 <input type="checkbox"/> .3-.75	<input type="checkbox"/> <5 <input type="checkbox"/> 5-15 <input type="checkbox"/> 15-30 <input type="checkbox"/> >30	_____	<input type="checkbox"/> Deciduous <input type="checkbox"/> Coniferous <input type="checkbox"/> Broadleaf Evergreen	_____	<input type="checkbox"/> NONE	<input type="checkbox"/> RC Grass <input type="checkbox"/> Salt Ced <input type="checkbox"/> Hblack <input type="checkbox"/> G Reed <input type="checkbox"/> Engl Ivy <input type="checkbox"/> CanThis <input type="checkbox"/> Teasel <input type="checkbox"/> C Burd <input type="checkbox"/> Ch Grass <input type="checkbox"/> M This <input type="checkbox"/> Spurge <input type="checkbox"/> Rus Ol			
<b>C</b>	<input type="checkbox"/>	<input type="checkbox"/> 0-0.1 <input type="checkbox"/> .75-2 <input type="checkbox"/> .1-.3 <input type="checkbox"/> >2 <input type="checkbox"/> .3-.75	<input type="checkbox"/> <5 <input type="checkbox"/> 5-15 <input type="checkbox"/> 15-30 <input type="checkbox"/> >30	_____	<input type="checkbox"/> Deciduous <input type="checkbox"/> Coniferous <input type="checkbox"/> Broadleaf Evergreen	_____	<input type="checkbox"/> NONE	<input type="checkbox"/> RC Grass <input type="checkbox"/> Salt Ced <input type="checkbox"/> Hblack <input type="checkbox"/> G Reed <input type="checkbox"/> Engl Ivy <input type="checkbox"/> CanThis <input type="checkbox"/> Teasel <input type="checkbox"/> C Burd <input type="checkbox"/> Ch Grass <input type="checkbox"/> M This <input type="checkbox"/> Spurge <input type="checkbox"/> Rus Ol			

**INSTRUCTIONS**

**Potential Legacy trees** are defined as the largest tree within your search area, which is as far as you can see, but within maximum limits as follows:  
Wadeable Streams: Confine search to no more than 50 m from left and right bank and extending upstream to next transect (for 'K' look upstream 4 channel widths)  
Non-wadeable Rivers: Confine search to no more than 100 m from left and right bank and extending both upstream and downstream as far as you can see confidently.

**Alien Plants:** Confine search to riparian plots on left and right bank  
Wadeable Streams: 10 m x 10 m  
Non-wadeable Rivers: 10 m x 20 m

Not all aliens are to be identified in all states. See Field Manual and Plant Identification Guide.

- TAXONOMIC CATEGORIES**
- Acacia/Mesquite
  - Alder/Birch
  - Ash
  - Maple/Boxelder
  - Oak
  - Poplar/Cottonwood
  - Sycamore
  - Willow
  - Unknown or Other Deciduous
- 
- Cedar/Cypress/Sequoia
  - Fir (including Douglas fir and hemlock)
  - Juniper
  - Pine
  - Spruce
  - Unknown or Other Conifer
- 
- Unknown or Other Broadleaf Evergreen
- 
- Snag (Dead tree of any species)

**ALIEN SPECIES**

RC Grass	Reed canarygrass	<i>Phalaris arundinacea</i>
Engl Ivy	English ivy	<i>Hedera helix</i>
ChGrass	Cheat grass	<i>Bromus tectorum</i>
Salt Ced	Salt Cedar	<i>Tamarix spp.</i>
Can This	Canada thistle	<i>Cirsium arvense</i>
M This	Musk thistle	<i>Carduus nutans</i>
Hblack	Himalayan blackberry	<i>Rubus discolor</i>
Teasel	Teasel	<i>Dipsacus fullonum</i>
Spurge	Leafy spurge	<i>Euphorbia esula</i>
G Reed	Giant reed	<i>Arundo donax</i>
C Burd	Common burdock	<i>Arctim minus</i>
Rus Ol	Russian-olive	<i>Elaeagnus angustifolia</i>

**COMMENTS**

**Transects D to K continued on other side**

# RIPARIAN "LEGACY" TREES AND INVASIVE ALIEN PLANTS

Reviewed by (initial): \_\_\_\_\_

SITE ID: \_\_\_\_\_ DATE: \_\_\_\_\_ / \_\_\_\_\_ / **2003**

22977

Tran	LARGEST POTENTIAL LEGACY TREE VISIBLE FROM THIS STATION						ALIEN PLANT SPECIES PRESENT IN LEFT AND RIGHT RIPARIAN PLOTS				
	Trees not Visible	DBH (m)	Height (m)	Dist. from wetted margin (m)	Type	Taxonomic Category	Check all that are present				
<b>D</b>	<input type="checkbox"/>	<input type="checkbox"/> 0-0.1 <input type="checkbox"/> .75-2 <input type="checkbox"/> .1-.3 <input type="checkbox"/> >2 <input type="checkbox"/> .3-.75	<input type="checkbox"/> <5 <input type="checkbox"/> 5-15 <input type="checkbox"/> 15-30 <input type="checkbox"/> >30	_____	<input type="checkbox"/> Deciduous <input type="checkbox"/> Coniferous <input type="checkbox"/> Broadleaf Evergreen	_____	<input type="checkbox"/> NONE	<input type="checkbox"/> RC Grass <input type="checkbox"/> Salt Ced <input type="checkbox"/> Hblack <input type="checkbox"/> G Reed <input type="checkbox"/> Engl Ivy <input type="checkbox"/> CanThis <input type="checkbox"/> Teasel <input type="checkbox"/> C Burd <input type="checkbox"/> Ch Grass <input type="checkbox"/> M This <input type="checkbox"/> Spurge <input type="checkbox"/> Rus OI			
<b>E</b>	<input type="checkbox"/>	<input type="checkbox"/> 0-0.1 <input type="checkbox"/> .75-2 <input type="checkbox"/> .1-.3 <input type="checkbox"/> >2 <input type="checkbox"/> .3-.75	<input type="checkbox"/> <5 <input type="checkbox"/> 5-15 <input type="checkbox"/> 15-30 <input type="checkbox"/> >30	_____	<input type="checkbox"/> Deciduous <input type="checkbox"/> Coniferous <input type="checkbox"/> Broadleaf Evergreen	_____	<input type="checkbox"/> NONE	<input type="checkbox"/> RC Grass <input type="checkbox"/> Salt Ced <input type="checkbox"/> Hblack <input type="checkbox"/> G Reed <input type="checkbox"/> Engl Ivy <input type="checkbox"/> CanThis <input type="checkbox"/> Teasel <input type="checkbox"/> C Burd <input type="checkbox"/> Ch Grass <input type="checkbox"/> M This <input type="checkbox"/> Spurge <input type="checkbox"/> Rus OI			
<b>F</b>	<input type="checkbox"/>	<input type="checkbox"/> 0-0.1 <input type="checkbox"/> .75-2 <input type="checkbox"/> .1-.3 <input type="checkbox"/> >2 <input type="checkbox"/> .3-.75	<input type="checkbox"/> <5 <input type="checkbox"/> 5-15 <input type="checkbox"/> 15-30 <input type="checkbox"/> >30	_____	<input type="checkbox"/> Deciduous <input type="checkbox"/> Coniferous <input type="checkbox"/> Broadleaf Evergreen	_____	<input type="checkbox"/> NONE	<input type="checkbox"/> RC Grass <input type="checkbox"/> Salt Ced <input type="checkbox"/> Hblack <input type="checkbox"/> G Reed <input type="checkbox"/> Engl Ivy <input type="checkbox"/> CanThis <input type="checkbox"/> Teasel <input type="checkbox"/> C Burd <input type="checkbox"/> Ch Grass <input type="checkbox"/> M This <input type="checkbox"/> Spurge <input type="checkbox"/> Rus OI			
<b>G</b>	<input type="checkbox"/>	<input type="checkbox"/> 0-0.1 <input type="checkbox"/> .75-2 <input type="checkbox"/> .1-.3 <input type="checkbox"/> >2 <input type="checkbox"/> .3-.75	<input type="checkbox"/> <5 <input type="checkbox"/> 5-15 <input type="checkbox"/> 15-30 <input type="checkbox"/> >30	_____	<input type="checkbox"/> Deciduous <input type="checkbox"/> Coniferous <input type="checkbox"/> Broadleaf Evergreen	_____	<input type="checkbox"/> NONE	<input type="checkbox"/> RC Grass <input type="checkbox"/> Salt Ced <input type="checkbox"/> Hblack <input type="checkbox"/> G Reed <input type="checkbox"/> Engl Ivy <input type="checkbox"/> CanThis <input type="checkbox"/> Teasel <input type="checkbox"/> C Burd <input type="checkbox"/> Ch Grass <input type="checkbox"/> M This <input type="checkbox"/> Spurge <input type="checkbox"/> Rus OI			
<b>H</b>	<input type="checkbox"/>	<input type="checkbox"/> 0-0.1 <input type="checkbox"/> .75-2 <input type="checkbox"/> .1-.3 <input type="checkbox"/> >2 <input type="checkbox"/> .3-.75	<input type="checkbox"/> <5 <input type="checkbox"/> 5-15 <input type="checkbox"/> 15-30 <input type="checkbox"/> >30	_____	<input type="checkbox"/> Deciduous <input type="checkbox"/> Coniferous <input type="checkbox"/> Broadleaf Evergreen	_____	<input type="checkbox"/> NONE	<input type="checkbox"/> RC Grass <input type="checkbox"/> Salt Ced <input type="checkbox"/> Hblack <input type="checkbox"/> G Reed <input type="checkbox"/> Engl Ivy <input type="checkbox"/> CanThis <input type="checkbox"/> Teasel <input type="checkbox"/> C Burd <input type="checkbox"/> Ch Grass <input type="checkbox"/> M This <input type="checkbox"/> Spurge <input type="checkbox"/> Rus OI			
<b>I</b>	<input type="checkbox"/>	<input type="checkbox"/> 0-0.1 <input type="checkbox"/> .75-2 <input type="checkbox"/> .1-.3 <input type="checkbox"/> >2 <input type="checkbox"/> .3-.75	<input type="checkbox"/> <5 <input type="checkbox"/> 5-15 <input type="checkbox"/> 15-30 <input type="checkbox"/> >30	_____	<input type="checkbox"/> Deciduous <input type="checkbox"/> Coniferous <input type="checkbox"/> Broadleaf Evergreen	_____	<input type="checkbox"/> NONE	<input type="checkbox"/> RC Grass <input type="checkbox"/> Salt Ced <input type="checkbox"/> Hblack <input type="checkbox"/> G Reed <input type="checkbox"/> Engl Ivy <input type="checkbox"/> CanThis <input type="checkbox"/> Teasel <input type="checkbox"/> C Burd <input type="checkbox"/> Ch Grass <input type="checkbox"/> M This <input type="checkbox"/> Spurge <input type="checkbox"/> Rus OI			
<b>J</b>	<input type="checkbox"/>	<input type="checkbox"/> 0-0.1 <input type="checkbox"/> .75-2 <input type="checkbox"/> .1-.3 <input type="checkbox"/> >2 <input type="checkbox"/> .3-.75	<input type="checkbox"/> <5 <input type="checkbox"/> 5-15 <input type="checkbox"/> 15-30 <input type="checkbox"/> >30	_____	<input type="checkbox"/> Deciduous <input type="checkbox"/> Coniferous <input type="checkbox"/> Broadleaf Evergreen	_____	<input type="checkbox"/> NONE	<input type="checkbox"/> RC Grass <input type="checkbox"/> Salt Ced <input type="checkbox"/> Hblack <input type="checkbox"/> G Reed <input type="checkbox"/> Engl Ivy <input type="checkbox"/> CanThis <input type="checkbox"/> Teasel <input type="checkbox"/> C Burd <input type="checkbox"/> Ch Grass <input type="checkbox"/> M This <input type="checkbox"/> Spurge <input type="checkbox"/> Rus OI			
<b>K</b>	<input type="checkbox"/>	<input type="checkbox"/> 0-0.1 <input type="checkbox"/> .75-2 <input type="checkbox"/> .1-.3 <input type="checkbox"/> >2 <input type="checkbox"/> .3-.75	<input type="checkbox"/> <5 <input type="checkbox"/> 5-15 <input type="checkbox"/> 15-30 <input type="checkbox"/> >30	_____	<input type="checkbox"/> Deciduous <input type="checkbox"/> Coniferous <input type="checkbox"/> Broadleaf Evergreen	_____	<input type="checkbox"/> NONE	<input type="checkbox"/> RC Grass <input type="checkbox"/> Salt Ced <input type="checkbox"/> Hblack <input type="checkbox"/> G Reed <input type="checkbox"/> Engl Ivy <input type="checkbox"/> CanThis <input type="checkbox"/> Teasel <input type="checkbox"/> C Burd <input type="checkbox"/> Ch Grass <input type="checkbox"/> M This <input type="checkbox"/> Spurge <input type="checkbox"/> Rus OI			

# CHANNEL CONSTRAINT AND FIELD CHEMISTRY - STREAMS/RIVERS

Reviewed by (initial): \_\_\_\_\_

SITE ID: \_\_\_\_\_

DATE: \_\_\_\_ / \_\_\_\_ / **2 0 0 3**

## IN SITU MEASUREMENTS

Station ID: \_\_\_\_\_ (Assume X-site unless marked)

	Comments
STREAM/RIVER DO mg/l: (optional)                      _____	
STREAM RIVER TEMP. (°C):                      _____	
TIME OF DAY:    _____	

## CHANNEL CONSTRAINT

**CHANNEL PATTERN (Check One)**

- One channel**
- Anastomosing (complex) channel** - (Relatively long major and minor channels branching and rejoining.)
- Braided channel** - (Multiple short channels branching and rejoining - mainly one channel broken up by numerous mid-channel bars.)

**CHANNEL CONSTRAINT (Check One)**

- Channel very constrained in V-shaped valley** (i.e. it is very unlikely to spread out over valley or erode a new channel during flood)
- Channel is in Broad Valley** but channel movement by erosion during floods is **constrained by Incision** (Flood flows do not commonly spread over valley floor or into multiple channels.)
- Channel is in Narrow Valley but is not very constrained**, but limited in movement by relatively narrow valley floor (< ~10 x bankfull width)
- Channel is Unconstrained in Broad Valley** (i.e. during flood it can fill off-channel areas and side channels, spread out over flood plain, or easily cut new channels by erosion)

**CONSTRAINING FEATURES (Check One)**

- Bedrock** (i.e. channel is a bedrock-dominated gorge)
- Hillslope** (i.e. channel constrained in narrow V-shaped valley)
- Terrace** (i.e. channel is constrained by its own incision into river/stream gravel/soil deposits)
- Human Bank Alterations** (i.e. constrained by rip-rap, landfill, dike, road, etc.)
- No constraining features**

Percent of channel length with margin in contact with constraining feature: \_\_\_\_\_ %    ---->  
 (0-100%)

Bankfull width: \_\_\_\_\_ (m)

Valley width (Visual Estimated Average): \_\_\_\_\_ (m)

Note: Be sure to include distances between both sides of valley border for valley width.  
 If you cannot see the valley borders, record the distance you can see and mark this box.

### Percent of Channel Margin Examples

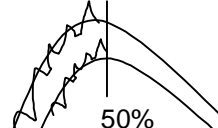
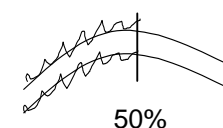
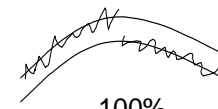
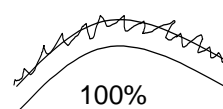

**Comments**



**TORRENT EVIDENCE ASSESSMENT FORM - STREAMS**

SITE ID: \_\_\_\_\_

DATE: \_\_\_\_ / \_\_\_\_ / 2 0 0 3

**TORRENT EVIDENCE**

Please X any of the following that are evident.

**EVIDENCE OF TORRENT SCOURING:**

01 - Stream channel has a recently devegetated corridor two or more times the width of the low flow channel. This corridor lacks riparian vegetation with possible exception of fireweed, even-aged alder or cottonwood seedlings, grasses, or other herbaceous plants.

02 - Stream substrate cobbles or large gravel particles are NOT IMBRICATED. (Imbricated means that they lie with flat sides horizontal and that they are stacked like roof shingles – imagine the upstream direction as the top of the "roof.") In a torrent scour or deposition channel, the stones are laying in unorganized patterns, lying "every which way." In addition many of the substrate particles are angular (not "water-worn.")

03 - Channel has little evidence of pool-riffle structure. (For example, could you ride a mountain bike down the channel?)

04 - The stream channel is scoured down to bedrock for substantial portion of reach.

05 - There are gravel or cobble berms (little levees) above bankfull level.

06 - Downstream of the scoured reach (possibly several miles), there are massive deposits of sediment, logs, and other debris.

07 - Riparian trees have fresh bark scars at many points along the stream at seemingly unbelievable heights above the channel bed.

08 - Riparian trees have fallen into the channel as a result of scouring near their roots.

**EVIDENCE OF TORRENT DEPOSITS:**

09 - There are massive deposits of sediment, logs, and other debris in the reach. They may contain wood and boulders that, in your judgement, could not have been moved by the stream at even extreme flood stage.

10 - If the stream has begun to erode newly laid deposits, it is evident that these deposits are "MATRIX SUPPORTED." This means that the large particles, like boulders and cobbles, are often not touching each other, but have silt, sand, and other fine particles between them (their weight is supported by these fine particles -- in contrast to a normal stream deposit, where fines, if present, normally "fill-in" the interstices between coarser particles.)

**NO EVIDENCE:**

11 - No evidence of torrent scouring or torrent deposits.

**COMMENTS**

# SAMPLE COLLECTION FORM - STREAMS

Reviewed by (initial): \_\_\_\_\_

SITE ID: _____	DATE: ____ / ____ / <b>2003</b>
----------------	---------------------------------

## WATER CHEMISTRY

Sample ID	Transect	Comments
_____	_____	

## REACH-WIDE BENTHOS SAMPLE

Sample ID	No. of Jars	Comment
_____	_____	

TRANSECT		A		B		C		D		E		F		G		H		I		J		K	
SUBSTRATE	CHAN.	Sub.	Chan.	Sub.	Chan.	Sub.	Chan.	Sub.	Chan.	Sub.	Chan.	Sub.	Chan.	Sub.	Chan.	Sub.	Chan.	Sub.	Chan.	Sub.	Chan.	Sub.	Chan.
Fine/Sand	Pool	<input type="checkbox"/> F	<input type="checkbox"/> P	<input type="checkbox"/> F	<input type="checkbox"/> P	<input type="checkbox"/> F	<input type="checkbox"/> P	<input type="checkbox"/> F	<input type="checkbox"/> P	<input type="checkbox"/> F	<input type="checkbox"/> P	<input type="checkbox"/> F	<input type="checkbox"/> P	<input type="checkbox"/> F	<input type="checkbox"/> P	<input type="checkbox"/> F	<input type="checkbox"/> P	<input type="checkbox"/> F	<input type="checkbox"/> P	<input type="checkbox"/> F	<input type="checkbox"/> P	<input type="checkbox"/> F	<input type="checkbox"/> P
Gravel	Glide	<input type="checkbox"/> G	<input type="checkbox"/> GL	<input type="checkbox"/> G	<input type="checkbox"/> GL	<input type="checkbox"/> G	<input type="checkbox"/> GL	<input type="checkbox"/> G	<input type="checkbox"/> GL	<input type="checkbox"/> G	<input type="checkbox"/> GL	<input type="checkbox"/> G	<input type="checkbox"/> GL	<input type="checkbox"/> G	<input type="checkbox"/> GL	<input type="checkbox"/> G	<input type="checkbox"/> GL	<input type="checkbox"/> G	<input type="checkbox"/> GL	<input type="checkbox"/> G	<input type="checkbox"/> GL	<input type="checkbox"/> G	<input type="checkbox"/> GL
Coarse	Riffle	<input type="checkbox"/> C	<input type="checkbox"/> RI	<input type="checkbox"/> C	<input type="checkbox"/> RI	<input type="checkbox"/> C	<input type="checkbox"/> RI	<input type="checkbox"/> C	<input type="checkbox"/> RI	<input type="checkbox"/> C	<input type="checkbox"/> RI	<input type="checkbox"/> C	<input type="checkbox"/> RI	<input type="checkbox"/> C	<input type="checkbox"/> RI	<input type="checkbox"/> C	<input type="checkbox"/> RI	<input type="checkbox"/> C	<input type="checkbox"/> RI	<input type="checkbox"/> C	<input type="checkbox"/> RI	<input type="checkbox"/> C	<input type="checkbox"/> RI
Other: Note in Comments	Rapid	<input type="checkbox"/> O	<input type="checkbox"/> RA	<input type="checkbox"/> O	<input type="checkbox"/> RA	<input type="checkbox"/> O	<input type="checkbox"/> RA	<input type="checkbox"/> O	<input type="checkbox"/> RA	<input type="checkbox"/> O	<input type="checkbox"/> RA	<input type="checkbox"/> O	<input type="checkbox"/> RA	<input type="checkbox"/> O	<input type="checkbox"/> RA	<input type="checkbox"/> O	<input type="checkbox"/> RA	<input type="checkbox"/> O	<input type="checkbox"/> RA	<input type="checkbox"/> O	<input type="checkbox"/> RA	<input type="checkbox"/> O	<input type="checkbox"/> RA

## TARGETED RIFFLE BENTHOS SAMPLE

Sample ID	No. of Jars	Comment
_____	_____	

NEAREST TRANSECT	A	B	C	D	E	F	G	H	I	J	K	SUBSTRATE SIZE CLASSES
_____	_____	_____	_____	_____	_____	_____	_____	_____	_____	_____	_____	F/S - ladybug or smaller (<2 mm) G - ladybug to tennis ball (2 to 64 mm) C - tennis ball to car sized (64 to 4000 mm) O - bedrock, hardpan, wood, etc
_____	<input type="checkbox"/> F/S	<input type="checkbox"/> F/S	<input type="checkbox"/> F/S	<input type="checkbox"/> F/S	<input type="checkbox"/> F/S	<input type="checkbox"/> F/S	<input type="checkbox"/> F/S	<input type="checkbox"/> F/S	<input type="checkbox"/> F/S	<input type="checkbox"/> F/S	<input type="checkbox"/> F/S	
_____	<input type="checkbox"/> G	<input type="checkbox"/> G	<input type="checkbox"/> G	<input type="checkbox"/> G	<input type="checkbox"/> G	<input type="checkbox"/> G	<input type="checkbox"/> G	<input type="checkbox"/> G	<input type="checkbox"/> G	<input type="checkbox"/> G	<input type="checkbox"/> G	
_____	<input type="checkbox"/> C	<input type="checkbox"/> C	<input type="checkbox"/> C	<input type="checkbox"/> C	<input type="checkbox"/> C	<input type="checkbox"/> C	<input type="checkbox"/> C	<input type="checkbox"/> C	<input type="checkbox"/> C	<input type="checkbox"/> C	<input type="checkbox"/> C	
_____	<input type="checkbox"/> O	<input type="checkbox"/> O	<input type="checkbox"/> O	<input type="checkbox"/> O	<input type="checkbox"/> O	<input type="checkbox"/> O	<input type="checkbox"/> O	<input type="checkbox"/> O	<input type="checkbox"/> O	<input type="checkbox"/> O	<input type="checkbox"/> O	

Additional Benthos Comments
_____
_____

## COMPOSITE PERIPHYTON SAMPLE

Sample ID	Composite Volume (mL)	Number of transects sampled (0-11): _____
_____	_____	

Assemblage ID (50-mL tube, preserved)		Chlorophyll (GF/F filter)		Biomass (GF/F Filter)	
Sample Vol. (mL)	Flag	Sample Vol. (mL)	Flag	Sample Vol. (mL)	Flag
_____	_____	_____	_____	_____	_____

Flag	Comments
_____	
_____	
_____	

Flag codes: K = Sample not collected; U = Suspect sample; F1, F2, etc. = misc. flag assigned by field crew. Explain all flags in comment sections.





# STREAM DISCHARGE FORM

Reviewed by (Initials): \_\_\_\_\_

SITE ID: \_\_\_\_\_

DATE: \_\_\_\_ / \_\_\_\_ / **2003**

## Velocity Area

**Distance Units**  
 ft  cm

**Depth Units**  
 ft  cm

**Velocity Units**  
 ft/s XX.X  m/s X.XX

(Final measurement should be left bank.)

	Dist. from Bank	Depth	Velocity	Flag
1	0			
2				
3				
4				
5				
6				
7				
8				
9				
10				
11				
12				
13				
14				
15				
16				
17				
18				
19				
20				

## Timed Filling

Repeat	Volume (L)	Time (s)	Flag
1	_____	_____	_____
2	_____	_____	_____
3	_____	_____	_____
4	_____	_____	_____
5	_____	_____	_____

## Neutral Bouyant Object

	Float 1	Float 2	Float 3
Float Dist. <input type="checkbox"/> ft <input type="checkbox"/> m	_____	_____	_____
Float Time (s)	_____	_____	_____
Flag	_____	_____	_____

## Cross Sections on Float Reach

	Upper Section	Middle Section	Lower Section
Width <input type="checkbox"/> ft <input type="checkbox"/> m	_____	_____	_____
Depth 1 <input type="checkbox"/> ft <input type="checkbox"/> cm	_____	_____	_____
Depth 2	_____	_____	_____
Depth 3	_____	_____	_____
Depth 4	_____	_____	_____
Depth 5	_____	_____	_____

## Q Value

If discharge is determined directly in field, record value here: Q = \_\_\_\_\_  cfs  m<sup>3</sup>/s FLAG

Flag	Comments
_____	
_____	
_____	

Flag Codes: K = No measurement or observation made; U = Suspect measurement or observation; Q = Unacceptable QC check associated with measurement; Z = Last station measured (if not Station 20); F1, F2, etc. = Miscellaneous flags assigned by each field crew. Explain all flags in comments section.







## RAPID HABITAT ASSESSMENT FORM: RIFFLE/RUN - STREAM

SITE ID: \_\_\_\_\_

DATE: \_\_\_\_ / \_\_\_\_ / **2 0 0 3**

HABITAT PARAMETER	CONDITION CATEGORY																				
	OPTIMAL					SUB-OPTIMAL					MARGINAL					POOR					
<b>1. Epifaunal Substrate/ Available Cover</b>  Score: <input style="width: 40px;" type="text"/>	Greater than 70% of substrate favorable for epifaunal colonization and fish cover; mix of snags, submerged logs, undercut banks, cobble or other stable habitat and at stage to allow full colonization potential; (i.e., logs/snags that are NOT new fall and NOT transient.)					40-70% mix of stable habitat; well-suited for full colonization potential; adequate habitat for maintenance of populations; presence of additional substrate in the form of newfall, but not yet prepared for colonization (may rate at high end of scale).					20-40% mix of stable habitat; habitat availability less than desirable; substrate frequently disturbed or removed.					Less than 20% stable habitat; lack of habitat is obvious; substrate unstable or lacking.					
	20	19	18	17	16	15	14	13	12	11	10	9	8	7	6	5	4	3	2	1	0
<b>2. Embeddedness</b>  Score: <input style="width: 40px;" type="text"/>	Gravel, cobble, and boulder particles are 0-25% surrounded by fine sediment. Layering of cobble provides diversity of niche space.					Gravel, cobble, and boulder particles are 25-50% surrounded by fine sediment.					Gravel, cobble, and boulder particles are 50-75% surrounded by fine sediment.					Gravel, cobble, and boulder particles are more than 75% surrounded by fine sediment.					
	20	19	18	17	16	15	14	13	12	11	10	9	8	7	6	5	4	3	2	1	0
<b>3. Velocity/Depth Regime</b>  Score: <input style="width: 40px;" type="text"/>	All four velocity/depth regimes present (slow-deep, slow-shallow, fast-deep, fast-shallow). (Slow is less than 0.3 m/s, deep is greater than 0.5 m.)					Only 3 of the 4 regimes present (if fast-shallow is missing, score lower than if missing other regimes).					Only 2 of the 4 habitat regimes present (if fast-shallow or slow-shallow are missing, score low).					Dominated by 1 velocity/depth regime (usually slow-deep).					
	20	19	18	17	16	15	14	13	12	11	10	9	8	7	6	5	4	3	2	1	0
<b>4. Sediment Deposition</b>  Score: <input style="width: 40px;" type="text"/>	Little or no enlargement of islands or point bars and less than 5% of the bottom affected by sediment deposition.					Some new increases in bar formation, mostly from gravel, sand or fine sediment; 5-30% of the bottom affected; slight deposition in pools.					Moderate deposition of new gravel, sand or fine sediment on old and new bars; 30-50% of the bottom affected; sediment deposits at obstructions, constrictions, and bends; moderate deposition of pools prevalent.					Heavy deposits of fine material; increased bar development; more than 50% of the bottom changing frequently; pools almost absent due to substantial sediment deposition.					
	20	19	18	17	16	15	14	13	12	11	10	9	8	7	6	5	4	3	2	1	0
<b>5. Channel Flow Status</b>  Score: <input style="width: 40px;" type="text"/>	Water reaches base of both lower banks, and minimal amount of channel substrate is exposed.					Water fills over 75% of the available channel; or less than 25% of channel substrate is exposed.					Water fills 25-75% of the available channel, and/or riffle substrates are mostly exposed.					Very little water in channel and mostly present as standing pools.					
	20	19	18	17	16	15	14	13	12	11	10	9	8	7	6	5	4	3	2	1	0
<b>6. Channel Alteration</b>  Score: <input style="width: 40px;" type="text"/>	Channelization or dredging absent or minimal; stream with normal pattern.					Some channelization present, usually in areas of bridge abutments; evidence of past channelization, i.e., dredging, (greater than past 20 yr) may be present, but recent channelization is not present.					Channelization may be extensive; embankments or shoring structures present on both banks; and 40 to 80% of stream reach channelized and disrupted.					Banks shored with gabion or cement; over 80% of the stream reach channelized and disrupted. Instream habitat greatly altered or removed entirely.					
	20	19	18	17	16	15	14	13	12	11	10	9	8	7	6	5	4	3	2	1	0



## RAPID HABITAT ASSESSMENT FORM: RIFFLE/RUN (continued) - STREAM

SITE ID: \_\_\_\_\_

DATE: \_\_\_\_ / \_\_\_\_ / **2 0 0 3**

HABITAT PARAMETER	CONDITION CATEGORY			
	OPTIMAL	SUB-OPTIMAL	MARGINAL	POOR
<b>7. Frequency of Riffles (or bends)</b>  Occurrence of riffles relatively frequent; ratio of distance between riffles divided by width of the stream greater than 7:1 (generally 5 to 7); variety of habitat is key. In streams where riffles are continuous, placement of boulders or other large, natural obstruction is important.	Occurrence of riffles infrequent; distance between riffles divided by width of stream is between 7 to 15.	Occasional riffle or bend; bottom contours provide some habitat; distance between riffles divided by width of stream is between 15 to 25.	Generally all flat water or shallow riffles; poor habitat; distance between riffles divided by width of stream is a ratio of over 25.	
Score: <input style="width: 40px;" type="text"/>	20 19 18 17 16	15 14 13 12 11	10 9 8 7 6	5 4 3 2 1 0
<b>8. Bank Stability (score each bank)</b>  NOTE: Determine left or right side by facing downstream.	Banks stable; evidence of erosion or bank failure absent or minimal; little potential for future problems. Less than 5% of bank affected.	Moderately stable; infrequent, small areas of erosion mostly healed over. 5-30% of bank in reach has areas of erosion.	Moderately unstable; 30-60% of bank in reach has areas of erosion; high erosion potential during floods.	Unstable; many eroded areas; "raw" areas frequent along straight sections and bends; obvious bank sloughing; 60-100% of bank has erosional scars.
Left Bank Score: <input style="width: 40px;" type="text"/>	Left Bank: 10 9	8 7 6	5 4 3	2 1 0
Right Bank Score: <input style="width: 40px;" type="text"/>	Right Bank: 10 9	8 7 6	5 4 3	2 1 0
<b>9. Vegetative Protection (score each bank)</b>  More than 90% of the streambank surfaces and immediate riparian zone covered by native vegetation, including trees, understory shrubs, or nonwoody macrophytes; vegetative disruption through grazing or mowing minimal or not evident; almost all plants allowed to grow naturally.	70-90% if the streambank surfaces covered by native vegetation; but one class of plants is not well represented; disruption evident but not affecting full plant growth potential to any great extent; more than one-half of the potential plant stubble height remaining.	50-70% of the streambank surfaces covered by vegetation; disruptions obvious; patches of bare soil or closely cropped vegetation common; less than one-half of the potential plant stubble height remaining.	Less than 50% of the streambank surfaces covered by vegetation; disruption of streambank vegetation is very high; vegetation has been removed to 5 centimeters or less in average stubble height.	
Left Bank Score: <input style="width: 40px;" type="text"/>	Left Bank: 10 9	8 7 6	5 4 3	2 1 0
Right Bank Score: <input style="width: 40px;" type="text"/>	Right Bank: 10 9	8 7 6	5 4 3	2 1 0
<b>10. Riparian Vegetative Zone Width (score each bank)</b>  Width of riparian zone greater than 18 meters; human activities (i.e., parking lots, roadbeds, clear-cuts, lawns, or crops) have not impacted the zone.	Width of riparian zone 12-18 meters; human activities have impacted zone only minimally.	Width of riparian zone 6-12 meters; human activities have impacted zone a great deal.	Width of riparian zone less than 6 meters; little or no riparian vegetation due to human activities.	
Left Bank Score: <input style="width: 40px;" type="text"/>	Left Bank: 10 9	8 7 6	5 4 3	2 1 0
Right Bank Score: <input style="width: 40px;" type="text"/>	Right Bank: 10 9	8 7 6	5 4 3	2 1 0



## RAPID HABITAT ASSESSMENT FORM: GLIDE/POOL - STREAMS

SITE ID: \_\_\_\_\_

DATE: \_\_\_\_ / \_\_\_\_ / **2003**

HABITAT PARAMETER	CATEGORY																				
	OPTIMAL					SUB-OPTIMAL					MARGINAL					POOR					
<b>1. Epifaunal Substrate/ Available Cover</b>  Score: <input style="width: 40px;" type="text"/>	Greater than 50% of substrate favorable for epifaunal colonization and fish cover; mix of snags, submerged logs, undercut banks, cobble or other stable habitat and at stage to allow full colonization potential (i.e. logs/snags that are NOT new fall and NOT transient.)					30-50% mix of stable habitat; well-suited for full colonization potential; adequate habitat for maintenance of populations; presence of additional substrate in the form of newfall, but not yet prepared for colonization (may rate at high end of scale).					10-30% mix of stable habitat; habitat availability less than desirable; substrate frequently disturbed or removed.					Less than 10% stable habitat; lack of habitat is obvious; substrate unstable or lacking.					
	20	19	18	17	16	15	14	13	12	11	10	9	8	7	6	5	4	3	2	1	0
<b>2. Pool Substrate Characterization</b>  Score: <input style="width: 40px;" type="text"/>	Mixture of substrate materials, with gravel and firm sand prevalent; root mats and submerged vegetation common.					Mixture of soft sand, mud, or clay; mud may be dominant; some root mats and submerged vegetation present.					All mud or clay or sand bottom; little or no root mat; no submerged vegetation.					Hard-pan clay or bedrock; no root mat or vegetation.					
	20	19	18	17	16	15	14	13	12	11	10	9	8	7	6	5	4	3	2	1	0
<b>3. Pool Variability</b>  Score: <input style="width: 40px;" type="text"/>	Even mix of large-shallow, large-deep, small shallow, small-deep pools present.					Majority of pools large-deep; very few shallows.					Shallow pools much more prevalent than deep pools.					Majority of pools small-shallow or absent.					
	20	19	18	17	16	15	14	13	12	11	10	9	8	7	6	5	4	3	2	1	0
<b>4. Sediment Deposition</b>  Score: <input style="width: 40px;" type="text"/>	Little or no enlargement of islands or point bars and less than 20% of the bottom affected by sediment deposition.					Some new increases in bar formation, mostly from gravel, sand or fine sediment; 20-50% of the bottom affected; slight deposition in pools.					Moderate deposition of new gravel, sand or fine sediment on old and new bars; 50-80% of the bottom affected; sediment deposits at obstructions, constrictions, and bends; moderate deposition of pools prevalent.					Heavy deposits of fine material; increased bar development; more than 80% of the bottom changing frequently; pools almost absent due to substantial sediment deposition.					
	20	19	18	17	16	15	14	13	12	11	10	9	8	7	6	5	4	3	2	1	0
<b>5. Channel Flow Status</b>  Score: <input style="width: 40px;" type="text"/>	Water reaches base of both lower banks, and minimal amount of channel substrate is exposed.					Water fills over 75% of the available channel; or less than 25% of channel substrate is exposed.					Water fills 25-75% of the available channel, and/or riffle substrates are mostly exposed.					Very little water in channel and mostly present as standing pools.					
	20	19	18	17	16	15	14	13	12	11	10	9	8	7	6	5	4	3	2	1	0
<b>6. Channel Alteration</b>  Score: <input style="width: 40px;" type="text"/>	Channelization or dredging absent or minimal; stream with normal pattern.					Some channelization present, usually in areas of bridge abutments; evidence of past channelization, i.e., dredging, (greater than past 20 yr) may be present, but recent channelization is not present.					Channelization may be extensive; embankments or shoring structures present on both banks; and 40 to 80% of stream reach channelized and disrupted.					Banks shored with gabion or cement; over 80% of the stream reach channelized and disrupted. Instream habitat greatly altered or removed entirely.					
	20	19	18	17	16	15	14	13	12	11	10	9	8	7	6	5	4	3	2	1	0



## RAPID HABITAT ASSESSMENT FORM: GLIDE/POOL (continued) - STREAMS

SITE ID: \_\_\_\_\_

DATE: \_\_\_\_ / \_\_\_\_ / 2003

HABITAT PARAMETER	CATEGORY			
	OPTIMAL	SUB-OPTIMAL	MARGINAL	POOR
<b>7. Channel Sinuosity</b>  Score: <input style="width: 40px;" type="text"/>	The bends in the stream increase the stream length 3 to 4 times longer than if it was in a straight line. (Note- channel braiding is considered normal in coastal plains and other low-lying areas. This parameter is not easily rated in these areas.)  20 19 18 17 16	The bends in the stream increase the stream length 2 to 3 times longer than if it was in a straight line.  15 14 13 12 11	The bends in the stream increase the stream length 1 to 2 times longer than if it was in a straight line.  10 9 8 7 6	Channel straight; waterway has been channelized for a long distance.  5 4 3 2 1 0
<b>8. Bank Stability</b> (score each bank)  NOTE: Determine left or right side by facing downstream.  Left Bank Score: <input style="width: 40px;" type="text"/>  Right Bank Score: <input style="width: 40px;" type="text"/>	Banks stable; evidence of erosion or bank failure absent or minimal; little potential for future problems. Less than 5% of bank affected.  Left Bank: 10 9 Right Bank: 10 9	Moderately stable; infrequent, small areas of erosion mostly healed over. 5-30% of bank in reach has areas of erosion.  8 7 6 8 7 6	Moderately unstable; 30-60% of bank in reach has areas of erosion; high erosion potential during floods.  5 4 3 5 4 3	Unstable; many eroded areas; "raw" areas frequent along straight sections and bends; obvious bank sloughing; 60-100% of bank has erosional scars.  2 1 0 2 1 0
<b>9. Vegetative Protection</b> (score each bank)  Left Bank Score: <input style="width: 40px;" type="text"/>  Right Bank Score: <input style="width: 40px;" type="text"/>	More than 90% of the streambank surfaces and immediate riparian zone covered by native vegetation, including trees, understory shrubs, or nonwoody macrophytes; vegetative disruption through grazing or mowing minimal or not evident; almost all plants allowed to grow naturally.  Left Bank: 10 9 Right Bank: 10 9	70-90% if the streambank surfaces covered by native vegetation; but one class of plants is not well represented; disruption evident but not affecting full plant growth potential to any great extent; more than one-half of the potential plant stubble height remaining.  8 7 6 8 7 6	50-70% of the streambank surfaces covered by vegetation; disruptions obvious; patches of bare soil or closely cropped vegetation common; less than one-half of the potential plant stubble height remaining.  5 4 3 5 4 3	Less than 50% of the streambank surfaces covered by vegetation; disruption of streambank vegetation is very high; vegetation has been removed to 5 centimeters or less in average stubble height.  2 1 0 2 1 0
<b>10. Riparian Vegetation Zone Width</b> (score each bank)  Left Bank Score: <input style="width: 40px;" type="text"/>  Right Bank Score: <input style="width: 40px;" type="text"/>	Width of riparian zone greater than 18 meters; human activities (i.e., parking lots, roadbeds, clear-cuts, lawns, or crops) have not impacted the zone.  Left Bank: 10 9 Right Bank: 10 9	Width of riparian zone 12-18 meters; human activities have impacted zone only minimally.  8 7 6 8 7 6	Width of riparian zone 6-12 meters; human activities have impacted zone a great deal.  5 4 3 5 4 3	Width of riparian zone less than 6 meters; little or no riparian vegetation due to human activities.  2 1 0 2 1 0

