

United States
Department of
Agriculture

Forest Service

Forest
Products
Laboratory

Timber Bridge
Information
Resource Center

Research
Paper
FPL-RP-555



Field Performance of Timber Bridges

10. Sanborn Brook Stress-Laminated Deck Bridge

Paula D. Hilbrich Lee
Michael A. Ritter
James P. Wacker



Abstract

The Sanborn Brook bridge was constructed in August 1991, 10 miles northeast of Concord, New Hampshire, as part of the demonstration timber bridge program of the USDA Forest Service. The bridge is a simple-span, double-lane, stress-laminated deck superstructure constructed from Southern Pine lumber and is approximately 25 ft long and 28 ft wide with a skew of 14 degrees. The performance of the bridge was monitored continuously for approximately 2 years, beginning shortly after installation. Performance monitoring involved collecting and evaluating data pertaining to the moisture content of the wood deck, the force level of the stressing bars, the deck vertical creep, and the behavior of the bridge under static-load conditions. In addition, comprehensive visual inspections were conducted to assess the overall condition of the structure. Based on field evaluations, the bridge is performing well, with no structural or serviceability deficiencies.

Keywords: Timber, bridge, wood, stress laminated

December 1996

Lee, Paula D. Hilbrich; Ritter, Michael A.; Wacker, James P. 1996. Field performance of timber bridges: 10. Sanborn Brook stress-laminated deck bridge. Res. Pap. FPL-RP-555. Madison, WI: U.S. Department of Agriculture, Forest Service, Forest Products Laboratory. 19 p.

A limited number of free copies of this publication are available to the public from the Forest Products Laboratory, One Gifford Pinchot Drive, Madison, WI 53705-2398. Laboratory publications are sent to more than 1,000 libraries in the United States and elsewhere.

The Forest Products Laboratory is maintained in cooperation with the University of Wisconsin.

The United States Department of Agriculture (USDA) prohibits discrimination in its programs on the basis of race, color, national origin, sex, religion, age, disability, political beliefs, and marital or familial status. Persons with disabilities who require alternative means of communication of program information (braille, large print, audiotape, etc.) should contact the USDA Office of Communications at (202) 720-2791. To file a complaint, write the Secretary of Agriculture, U.S. Department of Agriculture, Washington, DC 20250, or call (800) 245-6340 (voice), or (202) 720-1127 (TTD). USDA is an equal employment opportunity employer.

Acknowledgments

We express sincere appreciation to the following individuals from the New Hampshire Department of Transportation, Bureau of Materials and Research, who assisted in the structural monitoring of the Sanborn Brook bridge: Mike Juranty and Joe Constant for their assistance in obtaining field readings and conducting load tests and James Magee and Alan Lugg for their assistance in obtaining field readings.

Thanks also to the following from the USDA Forest Service, Forest Products Laboratory: Earl Geske and Vyto Malinauskas for developing and manufacturing load cell instrumentation and the Information Services Team for assistance in preparing this report.

Contents

	<i>Page</i>
Introduction.....	1
Background.....	1
Objective and Scope.....	2
Design, Construction, and Cost	2
Design	2
Construction	3
Cost	3
Evaluation Methodology.....	3
Moisture Content.....	3
Bar Force.....	4
Vertical Creep.....	4
Load Test Behavior.....	6
Condition Assessment	8
Results and Discussion.....	8
Moisture Content.....	8
Bar Force.....	9
Vertical Creep.....	9
Load Test Behavior.....	9
Condition Assessment	11
Conclusions	13
References	17
Appendix—Information Sheet.....	19

Field Performance of Timber Bridges

10. Sanborn Brook Stress-Laminated Deck Bridge

Paula D. Hilbrich Lee, General Engineer
Michael A. Ritter, Research Engineer
James P. Wacker, General Engineer
Forest Products Laboratory, Madison, Wisconsin

Introduction

In 1988, the U.S. Congress passed legislation known as the Timber Bridge Initiative (TBI). The objective of this legislation was to establish a national timber bridge program to promote effective utilization of wood as a structural material for highway bridges. Responsibility for the development, implementation, and administration of the timber bridge program was assigned to the USDA Forest Service. A key element of the TBI is a demonstration bridge program that provides matching funds to local governments for the construction of selected demonstration bridges (USDA 1995). A primary objective of the demonstration bridge program is to encourage innovation through the use of new or previously underutilized wood products, bridge designs, and design applications. In so doing, bridge designers and users become more aware of the attributes of wood as a bridge material, and new, economical, structurally efficient timber bridge systems should result. In addition, it is contemplated that timber use in bridges will be expanded to include several abundant but underutilized wood species.

As the national wood utilization research laboratory within the USDA Forest Service, the Forest Products Laboratory (FPL) has taken a lead role in assisting local governments in evaluating the field performance of demonstration bridges, many of which use design innovations that have never been evaluated. This has involved the development and implementation of a comprehensive national bridge monitoring program. The objectives of the monitoring program are to collect, analyze, and distribute information on the field performance of timber bridges to provide a basis for validating or revising design criteria and further improving efficiency and economy of bridge design, fabrication, and construction.

This report, tenth in a series documenting field performance of timber bridges, describes the development, design, construction, and field performance of the Sanborn Brook bridge, which is located 10 miles northeast of Concord, New Hampshire. This bridge, built in 1991, is a double-lane, simple-span, stress-laminated deck that is approximately 25 ft long and 28 ft-wide, with a skew of 14 degrees. (See Table 1 for metric conversion factors.) An information sheet on the Sanborn Brook bridge is provided in the Appendix.

Table 1—Factors for converting English units of measurement to SI units

English unit	Conversion factor	SI unit
inch (in.)	25.4	millimeter (mm)
foot (ft)	0.3048	meter (m)
square foot (ft ²)	0.09	square meter (m ²)
pound (lb)	4.448	newton (N)
lb/in ² (stress)	6,894	pascal (Pa)
mile	0.0016	meter (m)

Background

The Sanborn Brook bridge is located approximately 10 miles northeast of Concord, New Hampshire (Fig. 1). It is on Kellys Corner Road, a double-lane paved road that crosses Sanborn Brook and provides a link for local traffic between Pleasant Street and Route 28. The estimated average daily traffic over this section of road is 350 vehicles per day.

The original Sanborn Brook bridge was constructed in 1930 with a superstructure consisting of a concrete deck supported by steel I-beam stringers. The original bridge was 26 ft long and 25.9 ft wide. Inspections conducted in the 1980s by the New Hampshire Department of Transportation (DOT) indicated the bridge was structurally deficient. It was apparent that major rehabilitation or replacement of the structure would be required in the near future.

Subsequent to the bridge inspection, New Hampshire DOT officials determined that the Sanborn Brook bridge would be replaced. A project proposal was submitted to the USDA Forest Service for funding the Sanborn Brook bridge replacement as a demonstration bridge under the TBI. The proposed replacement bridge consisted of a simple-span, sawn-lumber, stress-laminated deck system constructed with a species local to New Hampshire. In 1991, the project was approved and funds were provided to the State of New Hampshire through the USDA Forest Service,

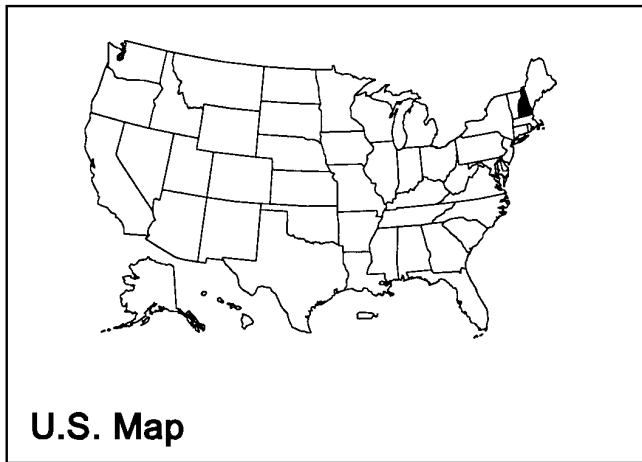

U.S. Map

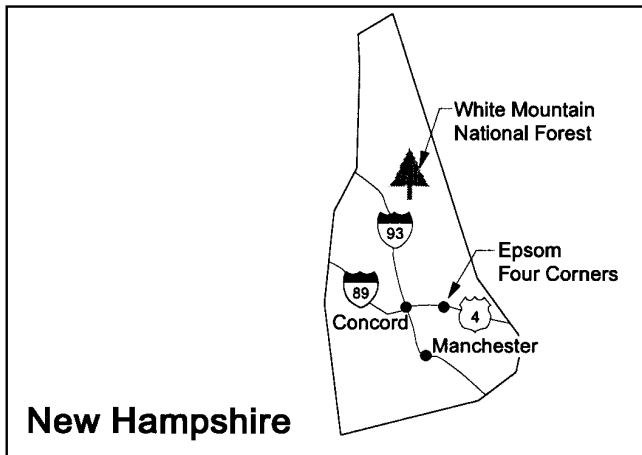

New Hampshire

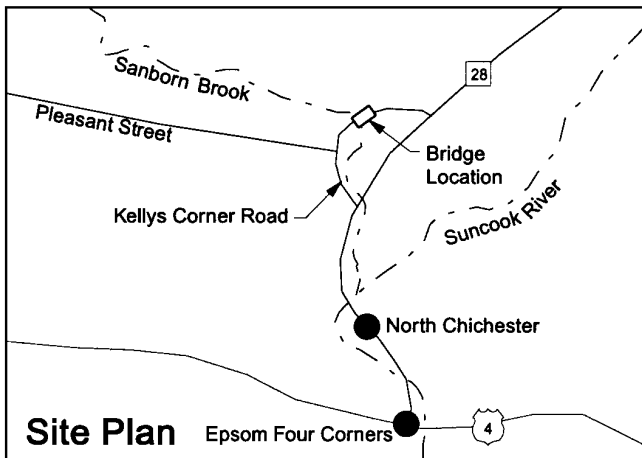

Site Plan

Figure 1—Location of the Sanborn Brook bridge.

Timber Bridge Information Resource Center in Morgantown, West Virginia. Because the stress-laminated deck was a relatively new system, FPL was contacted by New Hampshire DOT to provide technical advice and monitor the field performance of the bridge.

Objective and Scope

The objective of this project was to evaluate the field performance of the Sanborn Brook bridge for approximately 2 years, beginning shortly after bridge installation. The project scope included data collection and analysis related to the deck moisture content, stressing bar force, vertical creep, bridge behavior under static load, and general structural performance. The results of this project will be evaluated with similar monitoring projects in an effort to formulate recommendations for design and construction of future stress-laminated bridges.

Design, Construction, and Cost

The design of the Sanborn Brook bridge was completed by New Hampshire DOT with assistance from FPL. Construction was completed by contract. An overview of the design, construction process, and cost of the bridge superstructure follows.

Design

Design of the Sanborn Brook bridge was completed by the engineering staff of New Hampshire DOT. Because the bridge was designed before a nationally recognized design procedure was available for stress-laminated bridges, criteria relating to stress laminating was based on work completed at the University of Wisconsin and FPL (Ritter 1990).

The bridge was designed for American Association of State Highway and Transportation Officials (AASHTO) HS 25–44 loading (AASHTO 1983), resulting in a deck geometry 25 ft long and 28 ft wide, with a deck thickness of 14 in. and a skew of 14 degrees (Fig. 2). It was the original intent of New Hampshire DOT to utilize a local species, such as red maple, Hem-Fir, or Eastern Spruce, as the lamination material. However, these local species were unavailable in the size necessary for the project; therefore, Southern Pine Grade No. 2 and better was substituted as the lamination material. Butt joints in the deck laminations were placed in every fourth lamination transversely with a 4-ft longitudinal spacing between butt joints in adjacent laminations (Fig. 3). The bridge rail system was designed to meet AASHTO static-load requirements and consisted of a W-beam mounted on timber posts. All lumber components were treated with pentachlorophenol in heavy oil in accordance with American Wood Preservers' Association Standard C14 (AWPA 1990).

The stressing system for the Sanborn Brook bridge was designed to provide a uniform interlaminar compressive stress of 100 lb/in², which corresponds to a design bar force of 55,000 lb. High strength 1-in.-diameter stressing bars, complying with the requirements of ASTM A722 (ASTM 1988), were spaced 39.5 in. on-center. The anchorage system was composed of discrete steel plates and is illustrated in Figure 4. To provide protection from deterioration, all steel components were galvanized and an asphalt wearing surface was specified.

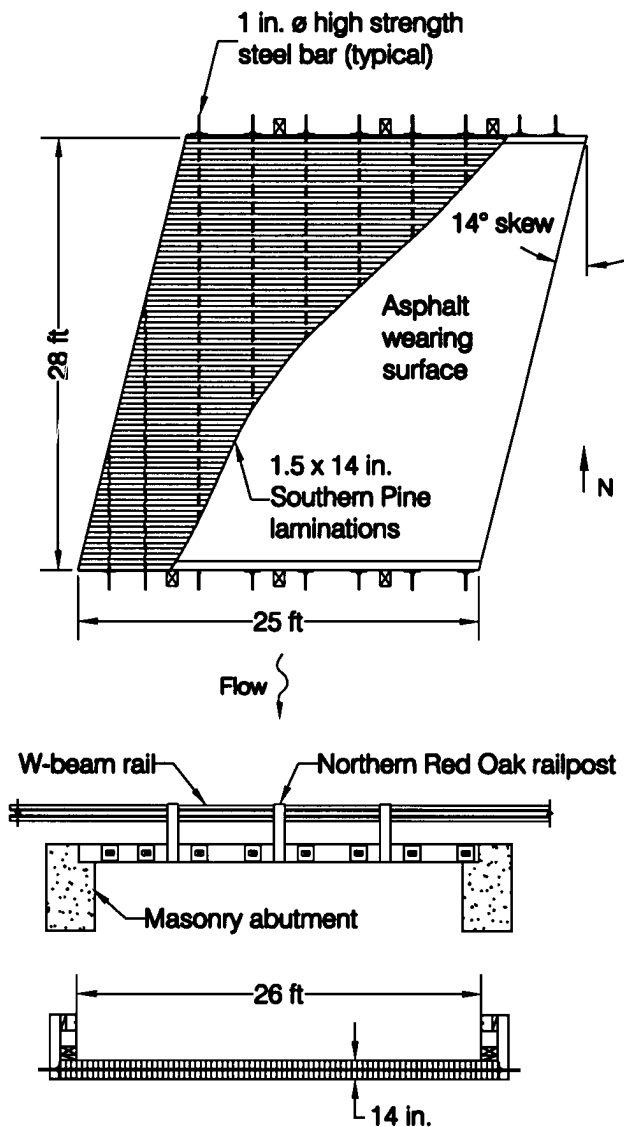

Figure 2—Design configuration of the Sanborn Brook bridge.

Construction

Construction of the Sanborn Brook bridge was completed by contract in the Fall of 1991. Following work on the approach roadway and construction of toewalls and mortar rubble masonry wingwalls, construction of the bridge superstructure commenced August 22 and was completed September 17. The wearing surface was applied October 15, and the bridge railing, curb, and approach railing were completed October 17.

Construction of the Sanborn Brook bridge deck began with the arrival of the Southern Pine laminations at the bridge site. The laminations, each measuring 1.5 in. wide by 14 in. deep, were transported to the site by truck in banded bundles. Upon delivery to the bridge site, it was discovered that the bundled laminations had been predrilled for the wrong

skew angle. The contractor redrilled the holes for the stressing bars so that the holes aligned properly, but a preservative was not applied to the newly exposed wood surfaces.

After all laminations were placed on the abutments, steel stressing bars were inserted through holes in the laminations, bearing plates and anchor plates were installed, and nuts were hand tightened. Because of the difficulties encountered in properly aligning the lamination holes, positive camber in the deck could not be achieved. The stressing bars were tensioned with a single hydraulic jack to the design force of 55,000 lb. Approximately 1 and 8 weeks after the initial tensioning, the bars were retensioned to the design force a second and third time to compensate for losses in bar force (Ritter 1990). Approximately 2 weeks prior to the third retensioning, the asphalt wearing surface was applied and the bridge railing, curb, and approach railing were completed (Fig. 5).

The as-built configuration of the Sanborn Brook bridge varied slightly from the design configurations in Figure 2. After the final stressing, the average out-to-out bridge width measured 27.7 ft, and the bridge length measured 24.9 ft. The bridge span, measured center-center of bearings, was 24.1 ft. The completed bridge is shown in Figure 6.

Cost

The total contract cost for materials, fabrication, and construction of the Sanborn Brook bridge superstructure, including the bridge railing and curb, was approximately \$50,400. Based on a total deck area of 690 ft², the cost was approximately \$73/ft². These costs do not include the superstructure design or wearing surface that were completed by the New Hampshire DOT.

Evaluation Methodology

To evaluate the structural performance of the Sanborn Brook bridge, the New Hampshire DOT contacted FPL for assistance. Through mutual agreement, a bridge monitoring plan was developed by FPL and implemented as a cooperative effort with the New Hampshire DOT. The plan called for performance monitoring of the deck moisture content, force in stressing bars, vertical creep, load test behavior, and condition assessments of the structure for approximately 2 years. The evaluation methodology utilized procedures and equipment previously developed by FPL (Ritter and others 1991).

Moisture Content

Global changes in the moisture content of stress-laminated timber decks can significantly affect the performance of the structure. If moisture is lost, the deck can shrink, resulting in a decrease in stressing bar force. Conversely, if moisture is gained, swelling of the timber can occur and cause an increase in stressing bar force. Changes in moisture content can also affect the deck stiffness, vertical creep, and transverse stress relaxation.

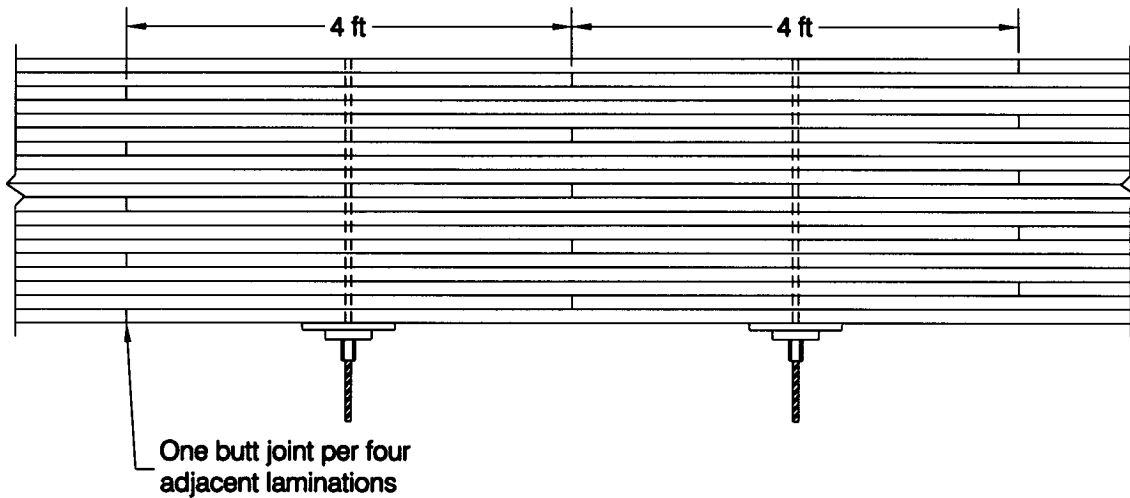

Figure 3—Butt joint configuration used for the Sanborn Brook bridge. Butt joints were placed transverse to the bridge span in every fourth lamination. Longitudinally, butt joints in adjacent laminations were separated by 4 ft.

The deck moisture content of the Sanborn Brook bridge was measured using an electrical-resistance moisture meter with 3-in. insulated probe pins in accordance with ASTM D4444–84 (ASTM 1990) (Fig. 7). Measurements were obtained by the New Hampshire DOT on a monthly basis by driving the pins into the underside of deck at depths of 2 to 3 in., recording the moisture content values, and adjusting the values for temperature and wood species (Forintek 1984).

Bar Force

For stress-laminated bridges to perform properly, adequate bar force levels must be maintained in order to achieve an acceptable level of interlaminar compression. To monitor bar force, load cells developed by FPL were installed on the first and third stressing bars from the west abutment, along the upstream bridge edge (Fig. 8). Load cell measurements were obtained by the New Hampshire DOT, using a portable strain indicator (Fig. 9). Strain from the indicator was

converted to units of bar tensile force by applying a laboratory conversion factor to the strain indicator reading. Bar force measurements were taken on a weekly basis for 2 months following load cell installation and monthly thereafter. At the end of the monitoring period, the load cells were unloaded and checked for zero balance shift, and the measurements were adjusted accordingly.

Vertical Creep

As a structural material, wood can deform permanently, or creep, as a result of long-term sustained loads. For stress-laminated bridges, creep caused by the structure dead load is an important consideration, because excessive creep can result in a sag of the superstructure (Ritter and others 1990). Camber of the Sanborn Brook bridge was measured at each load test. At the time of load test 1, measurements were obtained by suspending displacement rules from the underside of the deck at the abutments and midspan and reading values

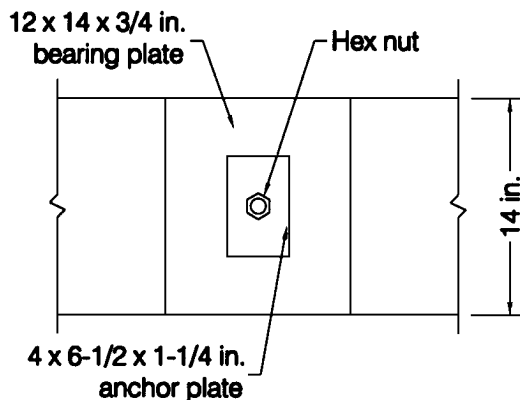

Figure 4—Discrete plate anchorage system.



Figure 5—Completed Sanborn Brook bridge rail.



Figure 6—Completed Sanborn Brook bridge.



Figure 7—Measuring moisture content with an electrical-resistance moisture meter.



Figure 8—Load cells positioned on stressing bars to monitor bar force.



Figure 9—Obtaining a load cell reading with a portable strain indicator.

with a surveyor's level. At the time of load test 2, camber was measured by attaching a stringline to the bearings to create a horizontal benchmark and with a calibrated rule, measuring the deck elevation at midspan with respect to the benchmark.

Load Test Behavior

Static-load testing of stress-laminated bridges is an important part of a comprehensive bridge monitoring program. The information obtained from these tests is used to refine and improve design procedures and evaluate the effects of design variables on bridge performance. To determine the load test behavior of the Sanborn Brook bridge, static-load tests were conducted twice during the monitoring period. In each test, fully loaded trucks were positioned on the bridge deck and the resulting deflections were measured at a series of locations along the bridge midspan. Measurements of bridge deflections were taken prior to testing (unloaded), for the first three load positions (loaded), halfway through testing (unloaded), for the last three load positions (loaded), and at the conclusion of testing (unloaded). In addition, analytical assessments were conducted to determine the theoretical bridge response.

Load Test 1

The first load test occurred October 31, 1991, immediately following the third retensioning of the bars, approximately 2 months after bridge installation. The interlaminar compression at the time of the test was approximately 96 lb/in². Two test vehicles were employed: truck A with a gross vehicle weight of 31,040 lb and truck B with a gross vehicle weight of 38,780 lb (Fig. 10). Transversely, six load positions were used (Fig. 11). Longitudinally, both trucks were positioned on the bridge with the rear axle of the vehicle centered at the skewed midspan (Fig. 12). Measurements of bridge deflections were obtained by suspending calibrated rules from the underside of the deck and reading values to the nearest 0.06 in. with a surveyor's level (Fig. 13). The accuracy of these measurements is estimated to be ±0.03 in.

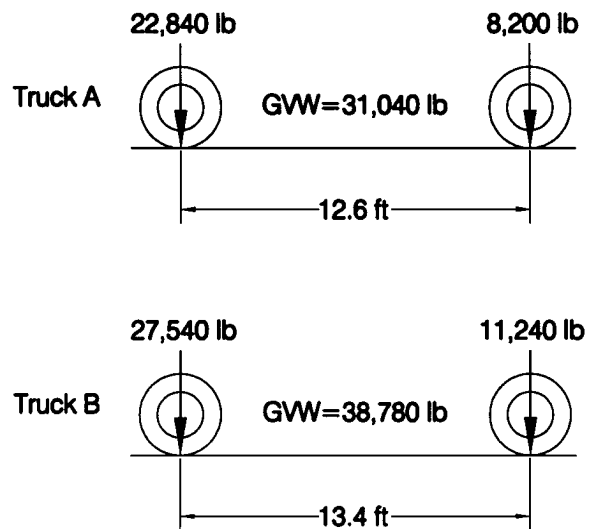

Figure 10—Load test 1 vehicle configuration and axle loads. (Lighter axle is vehicle front.) The transverse vehicle track width, measured center-center of the rear tires, is 6 ft.

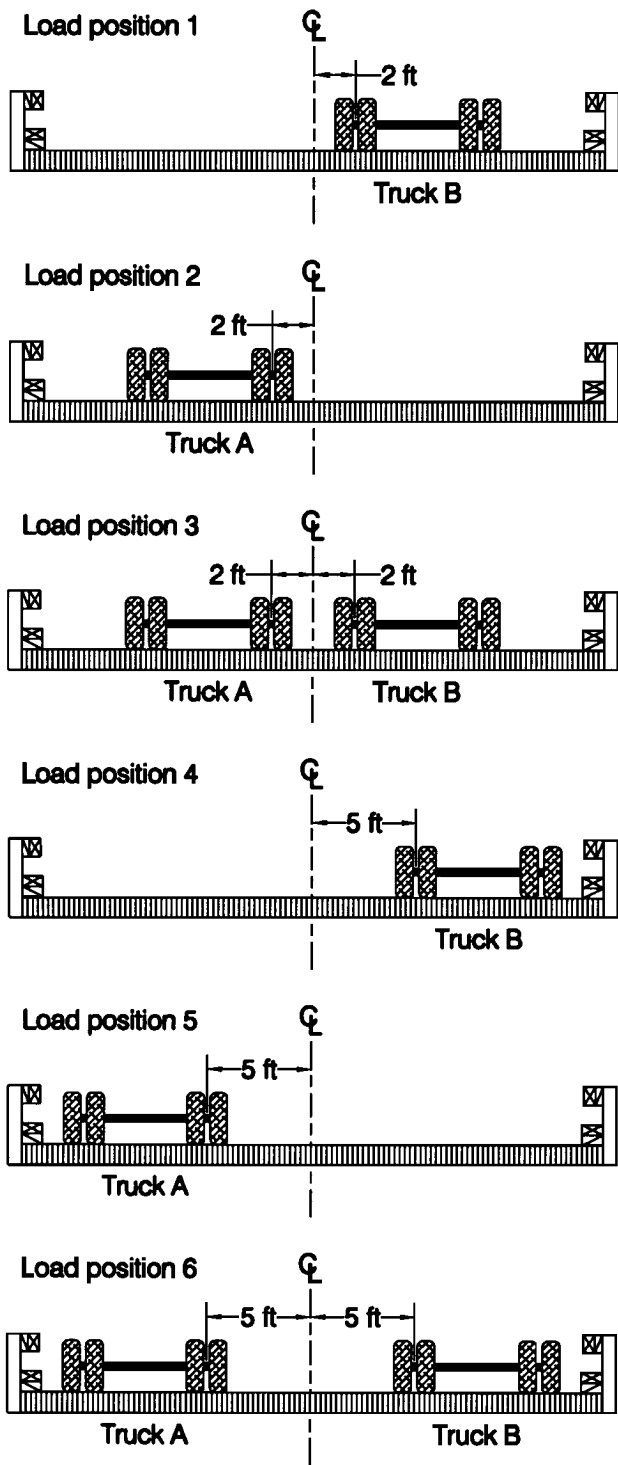

Figure 11—Transverse load positions used for both load tests (looking east). Trucks A and B were in the north and south lanes, respectively.

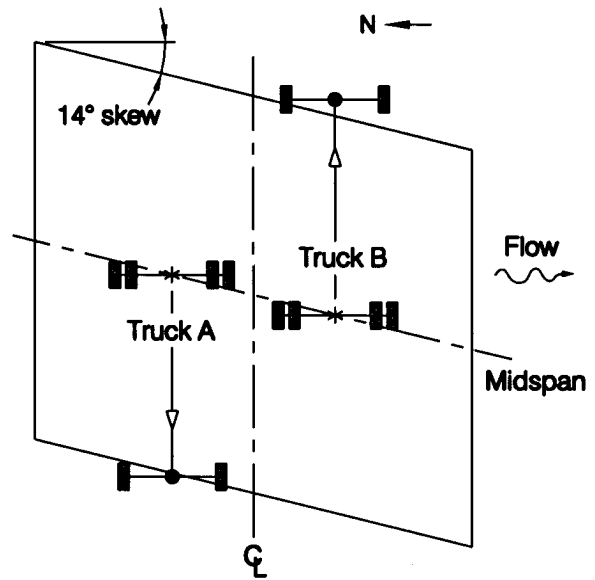

Figure 12—Typical configuration of longitudinal vehicle placement for load test 1. For all positions, the rear axle of each truck was centered at the skewed midspan.



Figure 13—Load tests 1 and 2 (load test 2 shown) deflection measurements were obtained by reading values from calibrated rules suspended from the underside of the deck with a surveyor's level.

Load Test 2

The second load test was conducted June 23, 1993, approximately 21 months after bridge installation. At the time of the test, the interlaminar compression was 39 lb/in². Two test vehicles were used: truck A with a gross vehicle weight of 30,340 lb and truck B with a gross vehicle weight of 38,540 lb (Fig. 14). The six transverse load positions (Fig. 11, 15) and measurement method were identical to those employed during load test 1. Values were read to the nearest 0.04 in., and the measurement accuracy is estimated to be ±0.02 in. Longitudinally, the vehicles were positioned with the rear axle centered along the nonskewed midspan of the bridge, perpendicular to the roadway (Fig. 16).

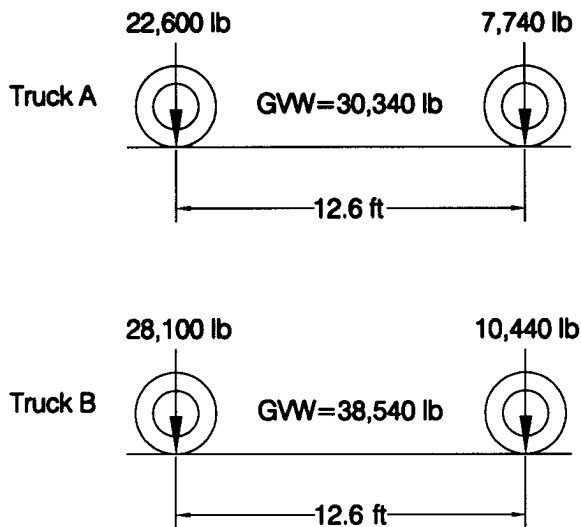

Figure 14—Load test 2 vehicle configurations and axle loads. (Lighter axle is vehicle front.) The transverse vehicle track width for both vehicles, measured center-center of the rear tires, is 6 ft.

Analytical Evaluation

Previous research has shown that stress-laminated decks can be accurately modeled as orthotropic plates (Oliva and others 1990). To further analyze the theoretical behavior of the Sanborn Brook bridge, an orthotropic plate computer model, currently being developed at FPL, was used to analyze the load test results and predict the bridge deflection for AASHTO HS 25-44 loading. A modulus of elasticity (MOE) value of 1,400,000 lb/in² was used for modeling based on established design values (NFPA 1991).

Condition Assessment

The general condition of the bridge was assessed on two different occasions during the monitoring period. The assessments occurred at the time of the load tests, which corresponded with the beginning and approximate ending of the monitoring period. The assessments involved visual inspections, measurements, and photographic documentation. Items of specific interest included the geometry of the bridge and the condition of the timber deck, rail system, asphalt wearing surface, stressing bars, and anchorage systems.

Results and Discussion

Performance monitoring of the Sanborn Brook bridge covered approximately 20 months, from October 31, 1991, to June 23, 1993. Results of the performance data follow.

Moisture Content

The average lamination moisture content of the bridge was approximately 23 percent at the beginning and ending of the monitoring. Throughout the 20 months, the moisture content remained relatively stable, although there were fluctuations of 4 to 5 percent in the measurement zone as a



Figure 15—Transverse load positions used for load test 2. From top to bottom: load position 3, load position 6, load position 6 (side view) are shown.

result of seasonal climatic changes. The moisture content at the interior of the laminations is presumed greater than the values obtained in the measurement zone because of the slower moisture migration through the lamination depth. The average moisture content of the deck is expected to slowly decline (Ritter and others 1995) and eventually stabilize at an equilibrium value of 18 to 20 percent (McCutcheon and others 1986), although short-term seasonal changes will continue to occur, primarily in the outer 2 to 3 in. of the deck.

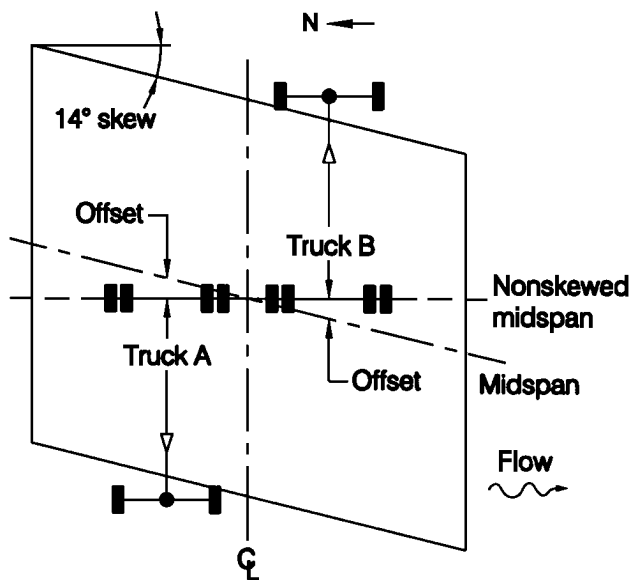

Figure 16—Typical configuration of longitudinal vehicle placement for load test 2. For all positions, rear axles were placed at the nonskewed midspan.

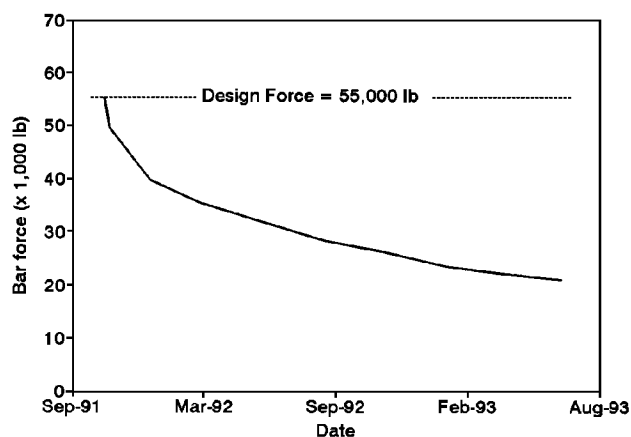

Figure 17—Average trend in bar force.

Bar Force

The average trend in bar force, beginning at the time of the third bar retensioning, is shown in Figure 17. The third retensioning, which occurred in October 1991, was to the design force of 55,000 lb. Immediately following the retensioning procedure, the force began a rapid decline that continued about 3 months. The time-related rate of bar force loss then decreased and remained approximately linear for the remainder of the monitoring period. In June 1993, at the conclusion of monitoring, the bar force had decreased to approximately 21,300 lb, 39 percent of the design force.

The bar force loss is attributed to stress relaxation of the lumber laminations caused by the applied compressive force and enhanced by the high moisture content. Although the bar force decreased approximately 60 percent during the

monitoring period, it did not fall below acceptable levels. Because the decline in bar force was expected to continue as a result of further stress relaxation and an eventual decrease in the moisture content, the bridge was restressed at the conclusion of the monitoring period to the full design force.

Vertical Creep

The laminations for the Sanborn Brook bridge were installed with no camber. At the time of the first load test, approximately 2 months after bridge installation, measurements verified that the bridge was approximately level between abutments. No noticeable sag was measured at the conclusion of the monitoring period, thereby documenting the absence of vertical creep.

Load Test Behavior

Results of both static-load tests as well the theoretical bridge response under load test and AASHTO HS 25–44 loading are presented in this section. For each case, transverse deflections are shown at the bridge midspan, as viewed from the west end looking east. For each load test, no permanent residual deformation was measured at the conclusion of the testing. In addition, there was no detectable movement at either of the abutments.

Load Test 1

Transverse deflections for load test 1 with the locations and magnitudes of the maximum measured deflections are shown in Figure 18. For each load position, the deflections are typical of the orthotropic plate behavior of stress-laminated bridges (Ritter and others 1990). The maximum deflection resulting from load position 6 occurred beneath the outside wheel line of the heavier truck (Fig. 18f). Load position 3 caused an absolute maximum measured deflection of 0.38 in. at the bridge centerline (Fig. 18c). Except for load position 5, the load positions involving one truck resulted in a maximum deflection under the outside truck wheel line (Fig. 18a,b,d). For load position 5, the maximum measured deflection occurred at three locations, one of which was under the outside wheel line (Fig. 18e). Although it is likely that minor differences existed between these three points, it is not possible to make a more accurate assessment, given the relatively small magnitude of deflections and the accuracy of the measurement method.

Assuming linear elastic behavior, uniform material properties, proper vehicle placement, and accurate deflection measurements, the summation of the deflections resulting from two individual truck loads applied separately should equal the deflection resulting from both trucks applied simultaneously. This is illustrated in Figure 19, where the sum of load positions 1 and 2 and load positions 4 and 5 are compared with load positions 3 and 6, respectively. The plots are similar with minor variations that are within the accuracy of the measurement methods, indicating that the bridge behavior under the applied loads is within the linear elastic range.

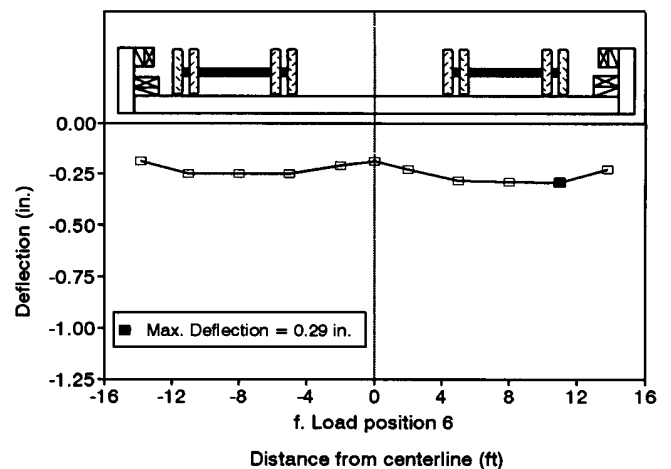
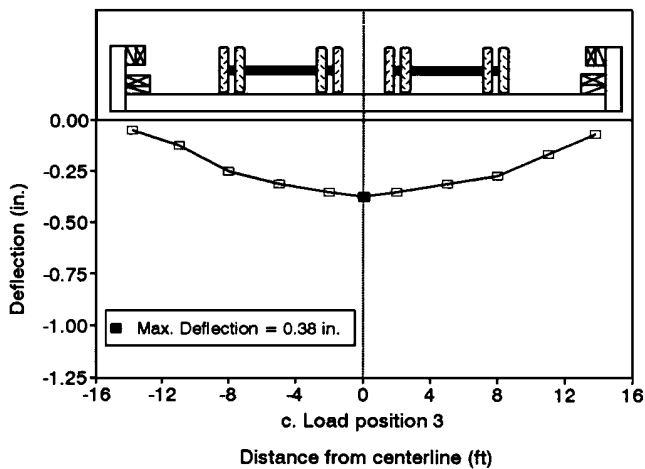
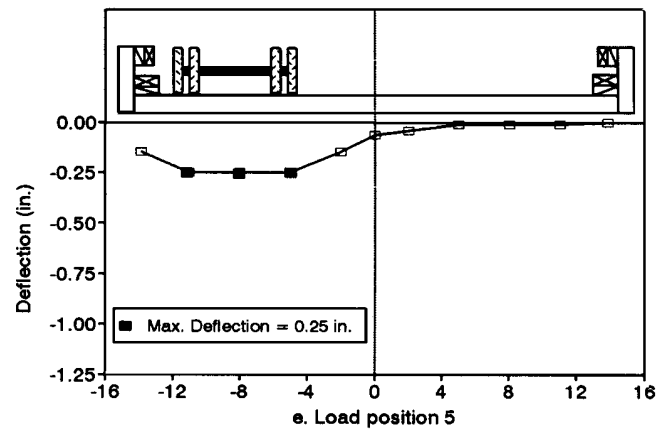
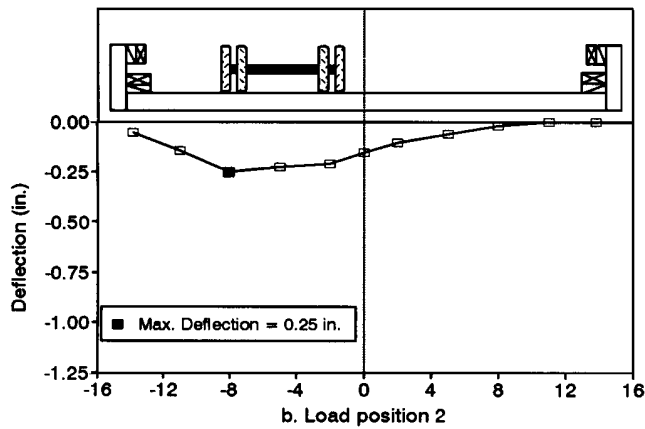
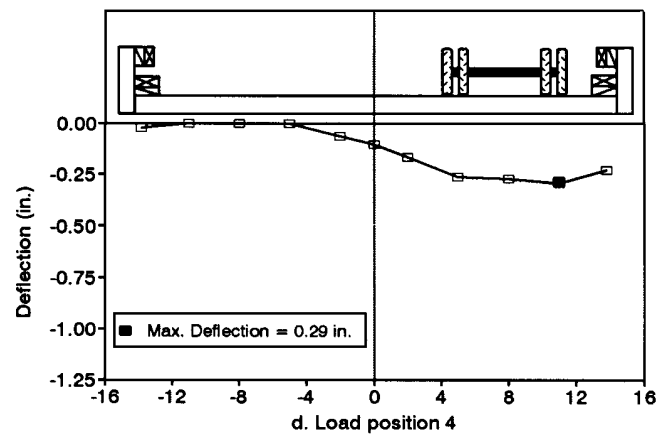
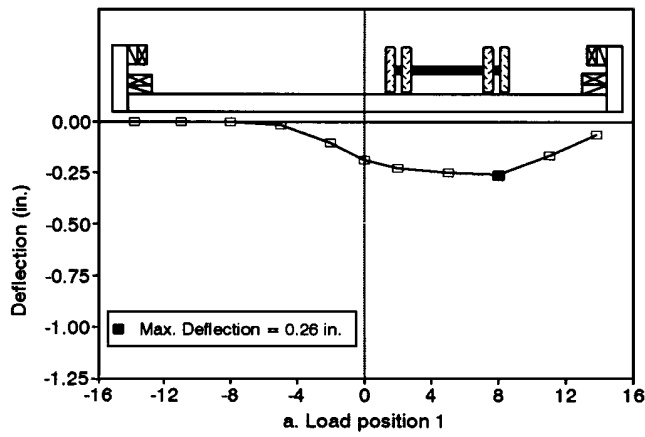

Figure 18—Transverse deflection for load test 1 (looking east), measured at the midspan of the bridge. Bridge cross-sections and vehicle positions are shown to aid interpretation and are not to scale.

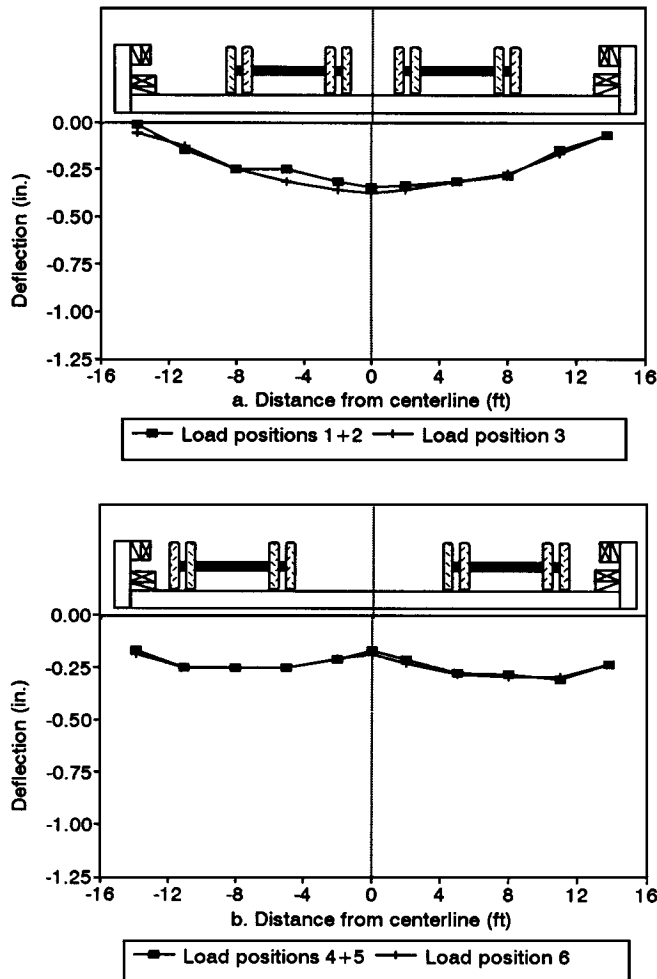

Figure 19—Transverse deflections for load test 1 (looking east), measured at the midspan of the bridge, comparing the sum of measured deflections from load positions 1 and 2 and load positions 4 and 5 to load positions 3 and 6, respectively. Bridge cross-sections and vehicle positions are shown to aid interpretation and are not to scale.

Load Test 2

Transverse deflections for load test 2 are shown in Figure 20. As with load test 1, the plots are indicative of orthotropic plate behavior (Ritter and others 1990). For load position 6, the maximum deflection occurred beneath the outside wheel line of the heavier truck (Fig. 20f). The absolute maximum measured deflection of 0.39 in. occurred at the data point immediately to the right of the bridge centerline during load position 3. For load positions 1 and 2, the maximum deflections occurred between the truck wheel lines and under the outside truck wheel line, respectively (Fig. 20a,b). The maximum deflection for load position 4 occurred under the outside wheel line, and the maximum deflection for load position 5 occurred at the three locations indicated (Fig. 20d,e). A single maximum point cannot be identified for load position 5 for the same reasons as indicated in load test 1.

As illustrated with the measured deflections of load test 1, the summation of deflections resulting from two separately applied truck loads should equal the deflection of both trucks applied simultaneously, if uniform material properties, proper vehicle placement, and accurate deflection measurements are assumed. This is illustrated in Figure 21, where the sum of load positions 1 and 2 and load positions 4 and 5 are compared with load positions 3 and 6, respectively. The plots are virtually identical, with slight variations well within the accuracy of the measurement methods, indicating that the bridge behavior is within the linear elastic range under the applied loads.

Analytical Evaluation

Comparisons of the measured load test deflections to the theoretical bridge response are shown in Figures 22 and 23. As shown, the theoretical bridge deflection, based on orthotropic bridge behavior, is very close to that measured. Employing the analytical parameters used to determine the theoretical bridge response for each load test, the theoretical deflection for AASHTO HS 25–44 loading is shown in Figure 24. Based on this analysis, the theoretical maximum AASHTO HS 25–44 static deflection occurs at centerline when two HS 25–44 trucks are placed centrally on the bridge (load position 3), with the rear axles centered about the skewed midspan (Fig. 24c). The resulting deflection is 0.68 in. or approximately 1/425 of the bridge span for load test 1, and 0.74 in., approximately 1/391 of the bridge span for load test 2.

Assuming constant bridge properties, the same theoretical bridge deflection would be expected for both load tests, because the same AASHTO HS 25–44 loading is applied in each case. However, for stress-laminated bridges with butt joints, it is known that a decrease in interlaminar compression results in a decrease in longitudinal bridge stiffness (Oliva and others 1990). The interlaminar compression decreased from 96 lb/in² at the time of load test 1 to 39 lb/in² at the time of load test 2, resulting in an approximate 9-percent decrease in longitudinal bridge stiffness. This change in stiffness resulted in a slightly greater deflection for load test 2 compared with that for load test 1.

Condition Assessment

Condition assessments of the Sanborn Brook bridge indicate that structural and serviceability performance are acceptable. Inspection results for specific items follow.

Bridge Geometry

At the time of the second load test, a variation in bridge width was noted along the edge of the deck. A comparison of width measurements taken at the beginning and ending of the monitoring period indicates a slight narrowing of the out-out deck width (Table 2). The deformation is probably the result of transverse stress relaxation in the laminations, enhanced by the high moisture content, and further supports the conclusion that the majority of bar force loss is attributable to stress relaxation in the laminations.

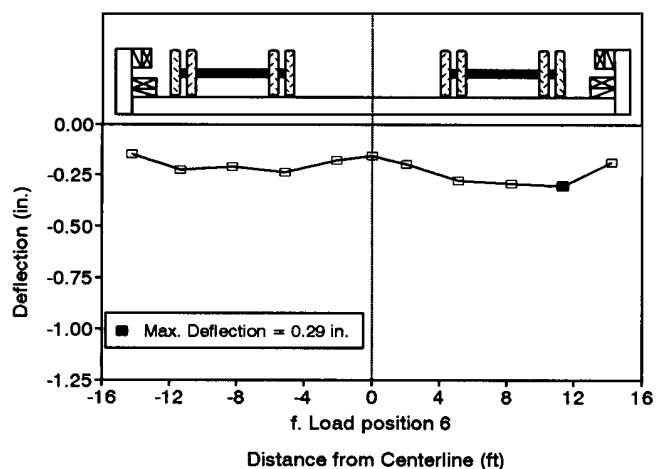
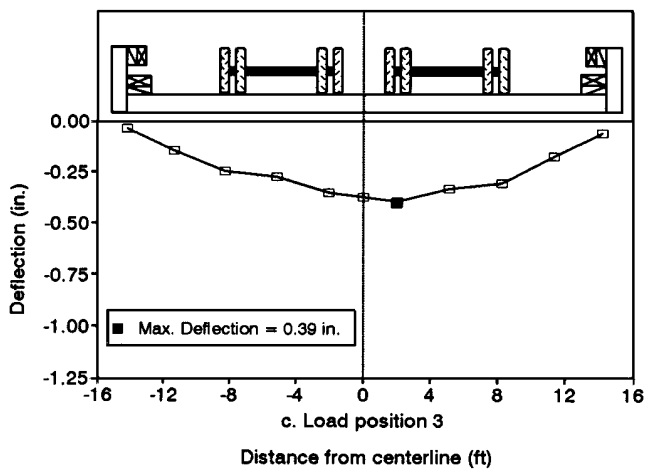
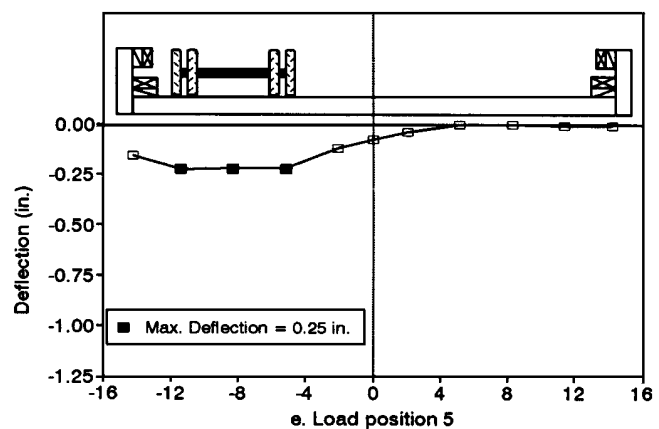
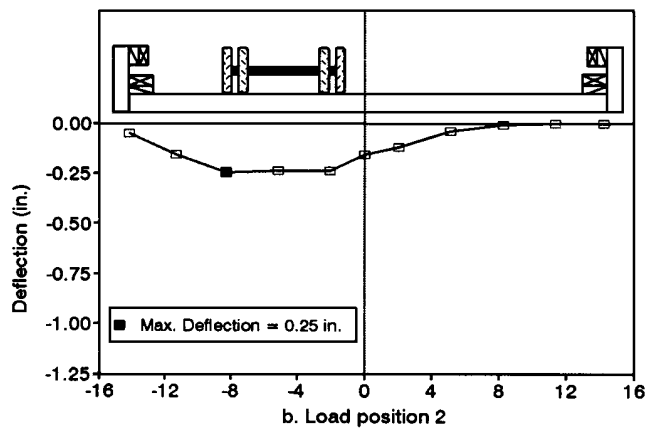
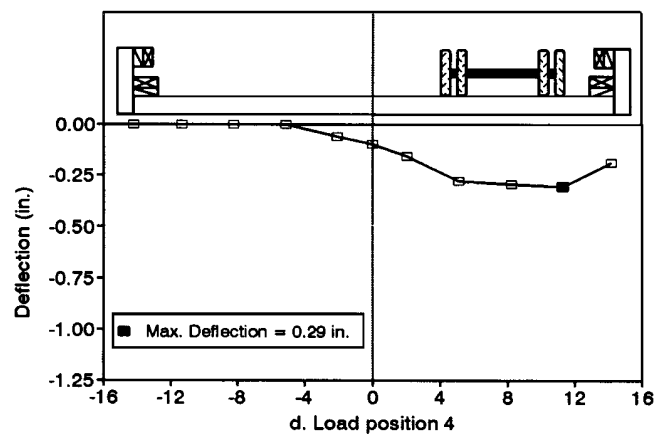
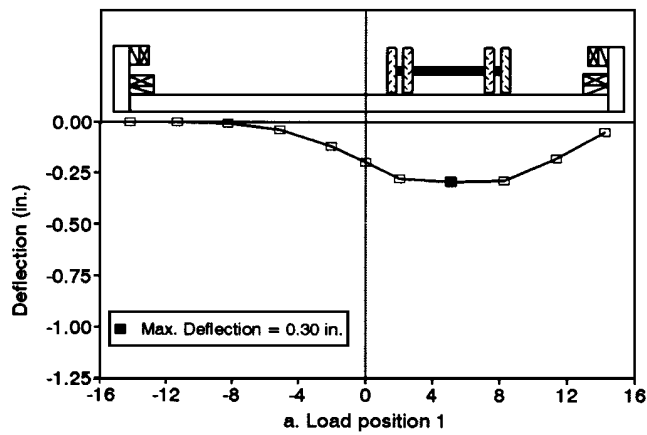

Figure 20—Transverse deflections for load test 2 (looking east), measured at the midspan of the bridge. Bridge cross-sections and vehicle positions are shown to aid interpretation and are not to scale.

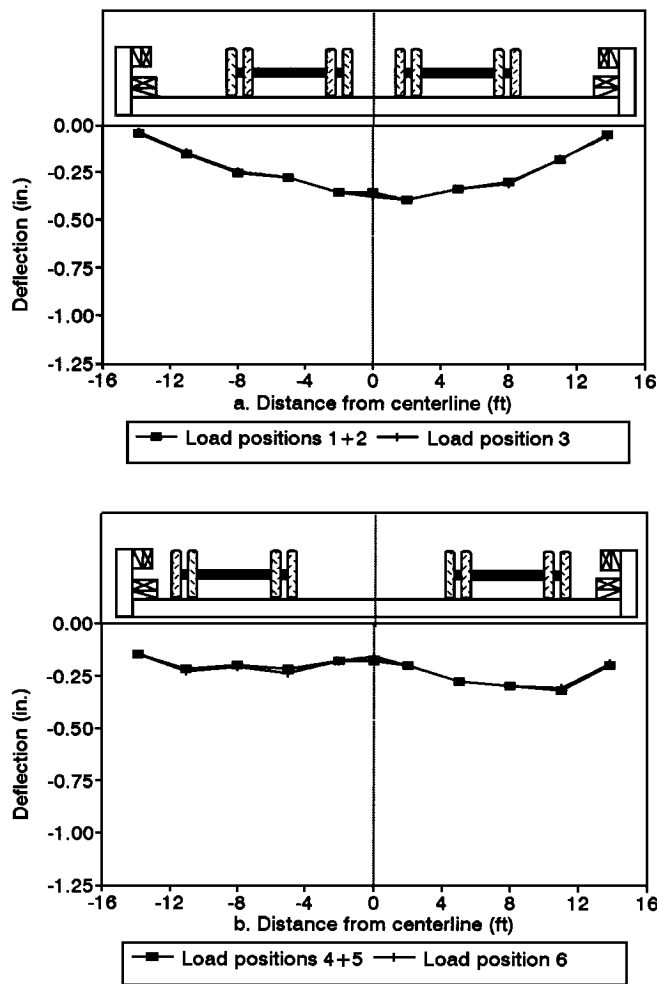

Figure 21—Transverse deflections for load test 2 (looking east), measured at the midspan of the bridge, comparing the sum of measured deflections from load positions 1 and 2 and load positions 4 and 5 to load positions 3 and 6, respectively. Bridge cross-sections and vehicle positions are shown to aid interpretation and are not to scale.

Wood Condition

Inspection of the wood components of the bridge showed no signs of deterioration, although minor checking was evident in timber members exposed to wet-dry cycles. The top end-grain surfaces of the timber railposts exhibited minor checking. This probably could have been prevented if a bituminous end grain sealer had been applied at the time of construction. In addition, minor checks appeared along the sides of exposed exterior deck laminations (Fig. 25). There was no evidence of wood preservative loss and no preservative or solvent accumulations on the wood surface.

Wearing Surface

Inspection of the wearing surface indicated proper performance at the time of the second load test. Although minor tire

imprints from the static trucks were observed during the test, the impressions probably resulted from a deficiency in the asphalt mix, water-proofing membrane, or application procedures. Aside from this, the asphalt was in good condition and showed no signs of cracking, deterioration, or other distress.

Anchorage System

The stressing bar anchorage system performed as designed with no signs of distress. There was no indication of the discrete plate anchorage crushing into the outside laminations and no measurable distortion of the bearing plate. However, the exterior laminations, when viewed from the underside of the deck, appeared distorted and wavy, curving away from the deck between the discrete anchorages (Fig. 26). This distortion does not appear to have affected the performance of the deck and is not typical of stress-laminated bridges. The exposed steel stressing bars and hardware showed no visible signs of corrosion.

Conclusions

After approximately 2 years in service, the Sanborn Brook bridge is performing well and is expected to provide many years of acceptable service. Based on the monitoring conducted since October 31, 1991, we make the following observations and recommendations:

- It is practical and economical to construct stress-laminated decks using Southern Pine lumber laminations.
- When prefabricating a skewed stress-laminated bridge with butt joints, attention to lamination layout and hole placement is critical in order to avoid last minute, on-site field drilling that penetrates the preservative envelope and exposes untreated material to the elements. All field cuts and bores should be treated with a preservative.
- The moisture content of the deck at the time of installation was approximately 23 percent and remained relatively stable throughout the monitoring period, although moisture content fluctuated 4 to 5 percent in the measurement zone as a result of seasonal climatic changes. This somewhat high moisture content level has not had any adverse effects on the structural integrity of the Sanborn Brook bridge, although it may have contributed to narrowing of the bridge width. The global moisture content is expected to decline towards equilibrium, affecting the dimensional stability of the deck and resulting in additional bar force losses.
- During the monitoring period, the average bar force for the Sanborn Brook bridge decreased from the design force of 55,000 lb to approximately 21,300 lb (39 lb/in² interlaminar compression). The decline in bar force is attributed to stress relaxation of the lumber laminations, which was enhanced by the high moisture content. Every 2 years, future bridge inspections should verify bar forces to ensure adequate interlaminar compression. Bars should be retensioned as required.

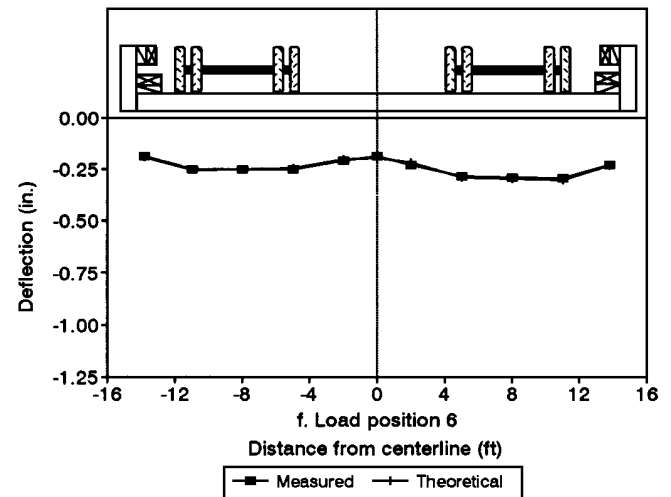
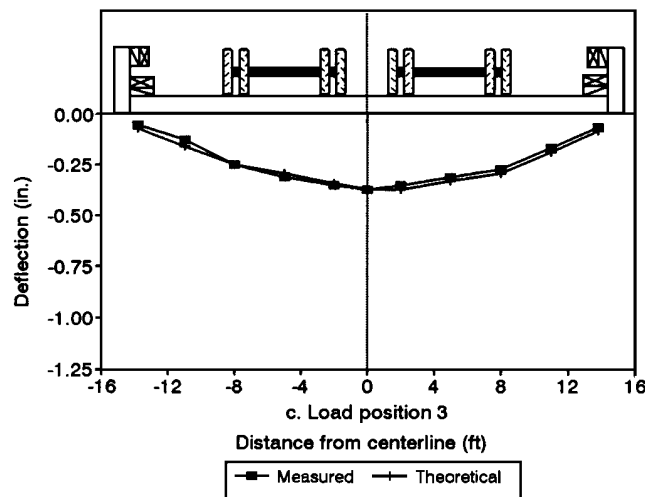
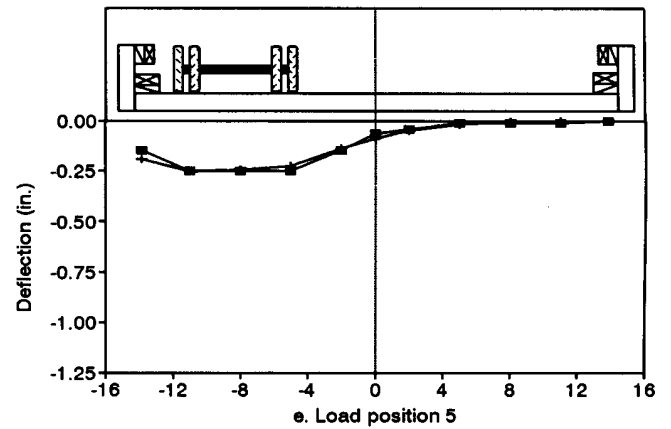
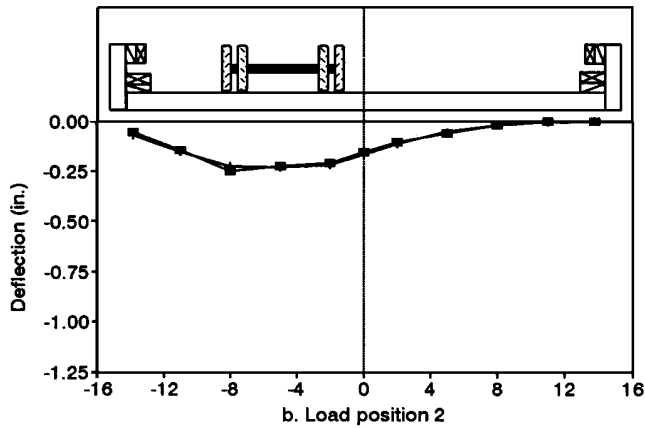
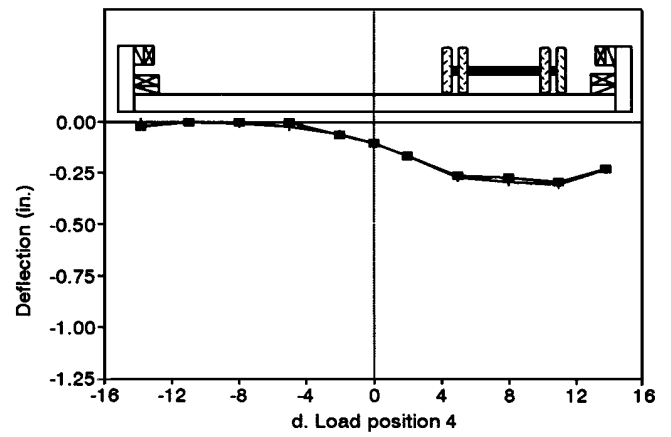
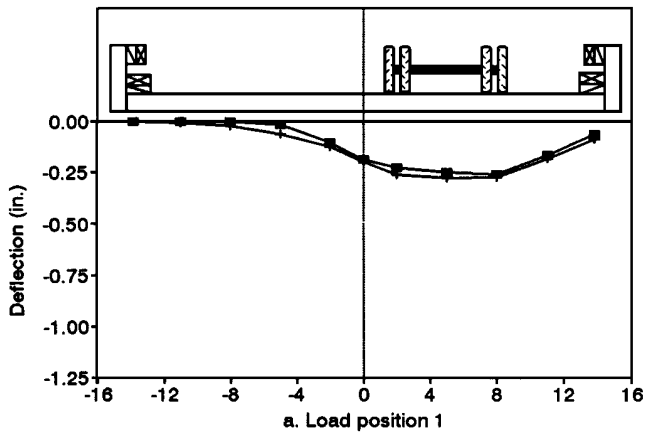

Figure 22—Comparison of the measured deflections for load test 1 (looking east) with the theoretical bridge response. Bridge cross-sections and vehicle positions are shown to aid interpretation and are not to scale.

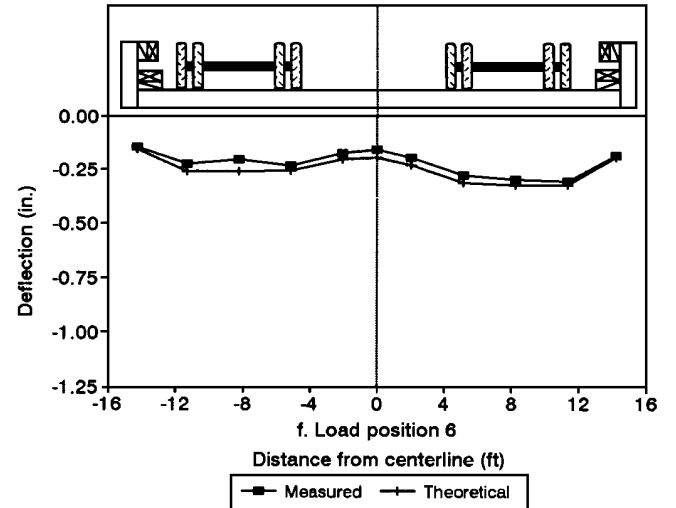
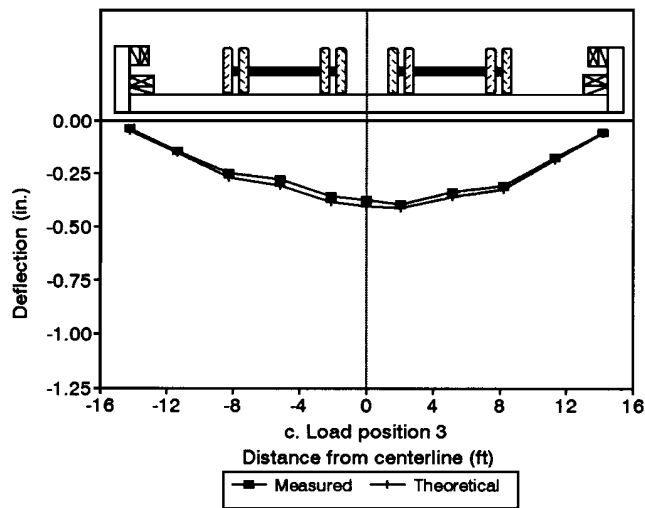
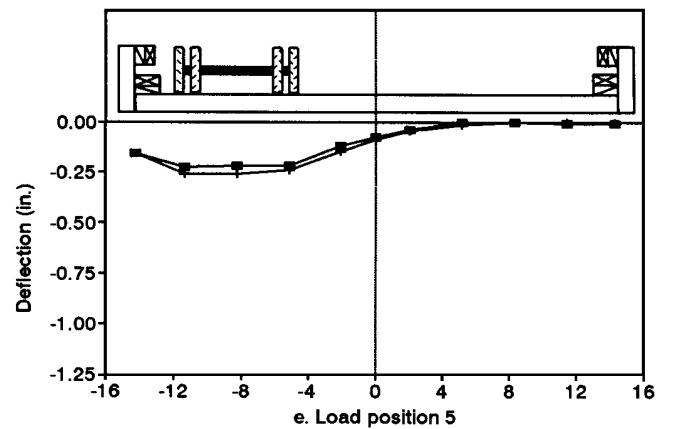
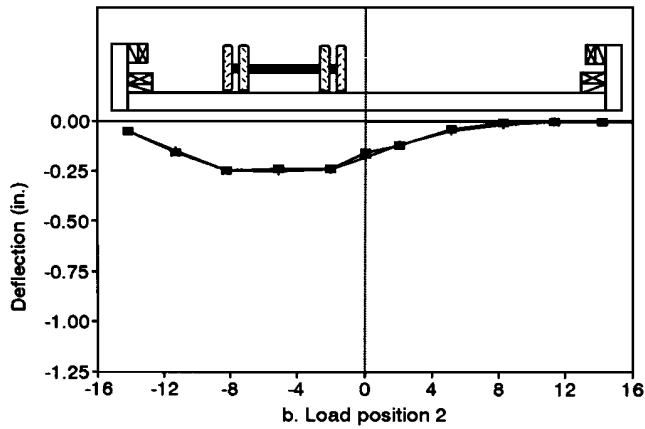
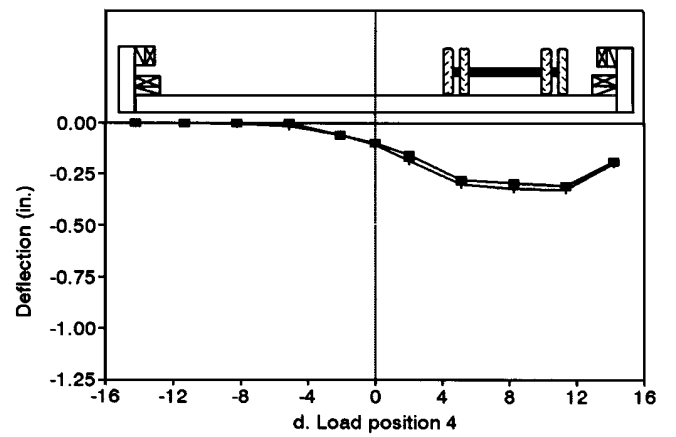
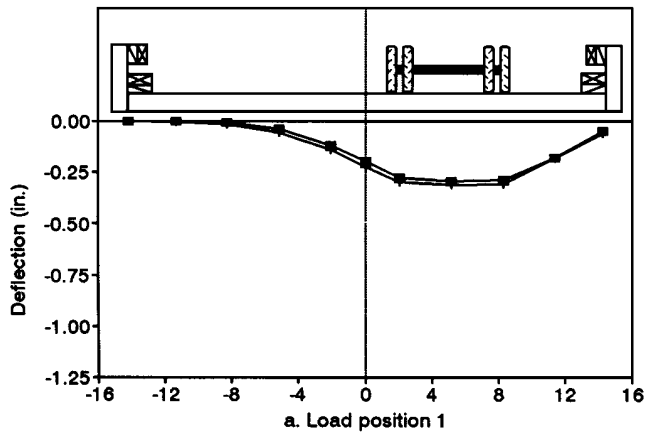

Figure 23—Comparison of the measured deflections for load test 2 (looking east) with the theoretical bridge response. Bridge cross-sections and vehicle positions are shown to aid interpretation and are not to scale.

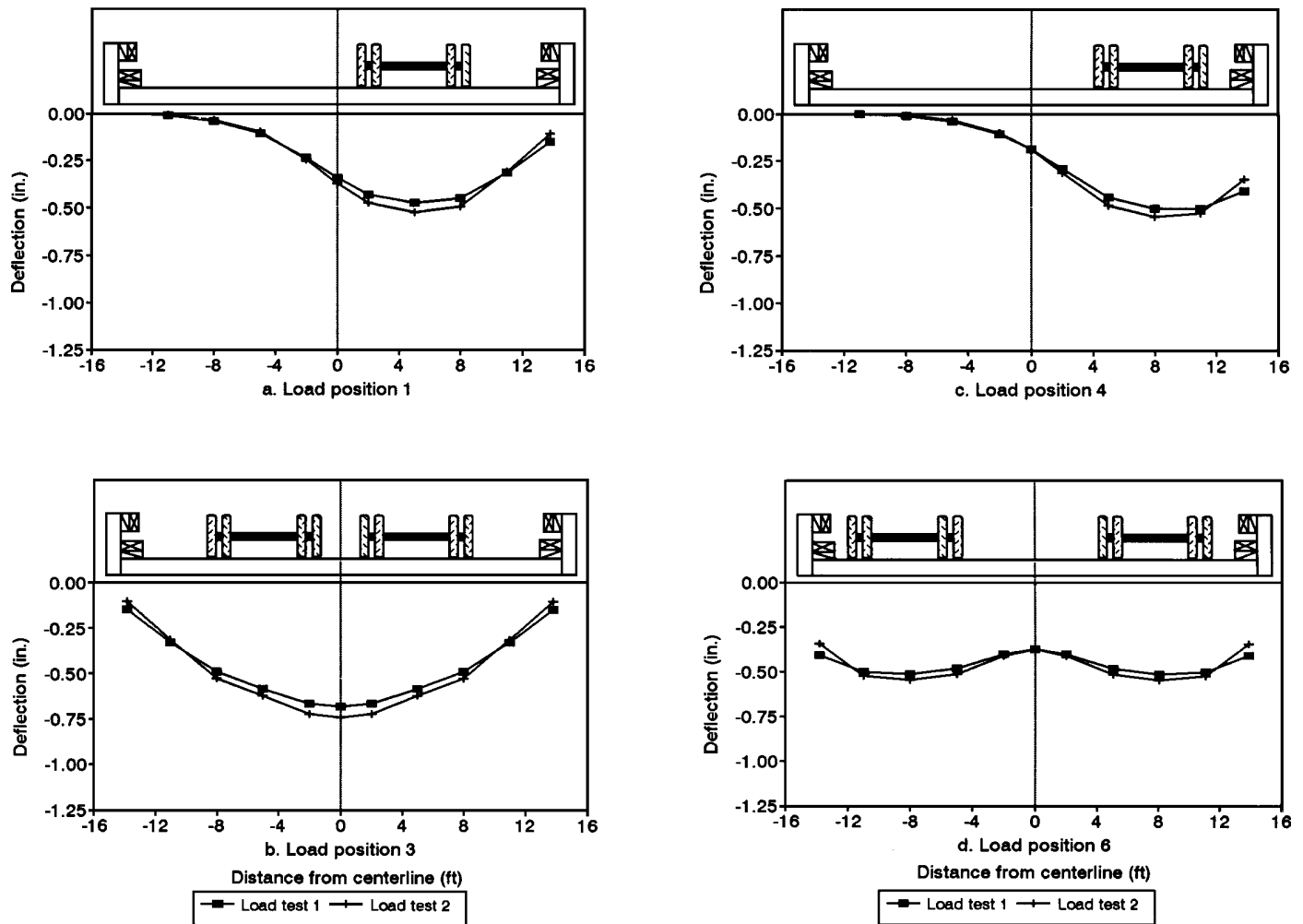

Figure 24—Maximum theoretical midspan deflection profile for AASHTO HS 25–44 truck loading (looking east). Load positions 1 and 4 are mirror images of load positions 2 and 5, respectively. Bridge cross-sections and vehicle positions are shown to aid interpretation and are not to scale.

- The laminations were installed without camber. The vertical creep of the deck of the bridge was negligible with no noticeable sag at the conclusion of the monitoring period.
- Load testing and analysis indicate that the Sanborn Brook bridge is performing as a linear elastic orthotropic plate when subjected to static truck loading. Based on an analytical comparison of load test results at different levels of interlaminar compression, the longitudinal bridge stiffness decreased approximately 9 percent when the interlaminar compression decreased from 96 to 39 lb/in². The maximum theoretical deflection as a result of two lanes of AASHTO HS 25–44 loading is estimated to be 0.68 in. (L/425) at 96 lb/in² interlaminar compression and 0.74 in. (L/391) at 39 lb/in² interlaminar compression.
- A reduction in bridge width was noted at the conclusion of the monitoring period. The deformation is likely the result of stress relaxation in the laminations enhanced by the high moisture content.
- Visual inspections of the bridge indicate that performance of wood components is satisfactory. Minor checks and splits were noted in some wood members. This could be avoided by installing the laminations at a lower moisture content level and applying a bituminous sealer to any exposed end grain.
- The wearing surface appears to be in good condition and shows no signs of distress.
- The exposed steel stressing bars and discrete anchorage plates showed no visible signs of corrosion or other distress. The plates were not distorted and crushing of the exterior lumber laminations was negligible, although the exterior laminations did appear distorted and wavy along the length of the bridge.

Table 2—Reduction in bridge width during the monitoring period

	Measured bridge width (in.)		Reduction in bridge width (in.)
	October 31, 1991	June 23, 1993	
East abutment	334.2	334.0	0.2
Midspan	331.8	330.2	1.6
West abutment	334.8	333.8	1.0

References

AASHTO. 1983. Standard specifications for highway bridges 13th ed. Washington, DC: American Association of State Highway and Transportation Officials.

ASTM. 1988. Standard specification for uncoated high-strength steel bar for prestressing concrete; ASTM A 722–86. Philadelphia, PA. American Society for Testing and Materials. 3 p.

ASTM. 1990. Use and calibration of hand-held moisture meters; ASTM D4444–84. Philadelphia, PA. American Society for Testing and Materials. 6 p.

Forintek. 1984. Moisture content correction tables for the resistance-type moisture meter; SP511E. Ottawa, Canada: Forintek Corp. 37 p.

AWPA. 1990. Standards. Woodstock, MD: American Wood Preservers' Association. 200 p.

McCutcheon, W.J.; Gutkowski, R.M.; Moody, R.C. 1986. Performance and rehabilitation of timber bridges. Trans. Res. Rec. 1053. Washington, DC: National Academy of Sciences, National Research Council, Transportation Research Board: 65–69.

National Forest Products Association. 1991. Design values for wood construction. A supplement to the 1991 edition National Design Specification for Wood Construction. Washington, DC: National Forest Products Association.



Figure 25—A check in an exterior lamination noted during condition assessment.



Figure 26—Distorted exterior lumber lamination noted during condition assessment at the time of load test 2.

Oliva, Michael G.; Dimakis, Al G.; Ritter, Michael A.; Tuomi, Roger L. 1990. Stress-laminated wood bridge decks: experimental and analytical evaluations. Res. Pap. FPL–RP–495. Madison, WI: U.S. Department of Agriculture, Forest Service, Forest Products Laboratory. 24 p.

Ritter, Michael A. 1990. Timber bridges: design, construction, inspection and maintenance. EM 7700-8. Washington, DC: U.S. Department of Agriculture, Forest Service, Engineering Staff. 944 p.

Ritter, M.A.; Geske, E.A.; Mason, L. [and others]. 1990. Performance of stress-laminated bridges. Wood Design Focus. 1(3): 12–16.

Ritter, M.A.; Geske, E.A.; McCutcheon, W.J. [and others]. 1991. Methods for assessing the field performance of stress-laminated timber bridges. In: Proceedings, 1991 international timber engineering conference; 1991 September; London, England.

Ritter, Michael A.; Wacker, James P.; Duwadi, Sheila Rimal. 1995. Field performance of stress-laminated timber bridges on low-volume roads. In: Proceedings, 6th international conference on low-volume roads; 1995 June 25–29; Minneapolis, MN; Washington, DC: National Academy Press: 347–356. Vol. 2.

USDA. 1995. The timber bridge initiative, fiscal year 1995 status report. Radnor, PA: U.S. Department of Agriculture, Forest Service, State and Private Forestry, Northeastern Area.

Appendix—Information Sheet

General

Name: Sanborn Brook bridge
Location: Kellys Corner Road,
10 miles northeast of Concord, New Hampshire

Date of Construction: August 1991

Owner: State of New Hampshire

Design Configuration

Structure Type: Stress-laminated deck with butt joints

Butt Joint Frequency: 1 in 4 laminations transverse with
joints in adjacent laminations
separated 4 ft longitudinally

Total Length (out-out): 25 ft

Skew: 14 degrees

Number of Spans: 1

Span Length (center-center bearings): 24 ft

Width (out-out): 28 ft

Width (curb-curb): 26 ft

Number of Traffic Lanes: 2

Design Loading: HS 25-44

Wearing Surface Type: Asphalt

Material and Configuration

Timber:

Species: Southern Pine

Size (actual): 1.5 in. to 2 in. wide; 14 in. deep

Grade: No. 2 and better visually graded

Moisture Condition: Approximately 23 percent at
installation

Preservative Treatment: Pentachlorophenol in heavy oil

Stressing Bars:

Type: High strength steel threaded bar with coarse
right-hand thread, conforming to ASTM A 722

Diameter: 1 in.

Number: 6 transversing entire deck width, 4 partially
imbedded within deck

Design Force: 55,000 lb

Spacing: 39.5 in. average center-center

Anchorage Type and Configuration:

Steel Plates: 12 by 14 by 0.75 in. bearing
4 by 6.5 by 1.25 in. anchor