

UNITED STATES DEPARTMENT OF AGRICULTURE
Rural Utilities Service

BULLETIN 1730B-121

SUBJECT: Pole Inspection and Maintenance

TO: All Electric Borrowers

EFFECTIVE DATE: Date of Approval

EXPIRATION DATE: Seven years from effective date

OFFICE OF PRIMARY INTEREST: Transmission Branch, Electric Staff
Division

FILING INSTRUCTIONS: This bulletin replaces REA Bulletin 161-4,
"Pole Inspection and Maintenance," dated October 17, 1974. File
with 7 CFR Part 1730.

PURPOSE: To provide RUS borrowers with information and guidance
for establishing or sustaining a continuing program of pole
maintenance.

Administrator



Date

TABLE OF CONTENTS

	<u>Page</u>
1. Purpose.....	3
2. General Discussion of Pole Decay.....	3
3. Planned Inspection and Maintenance Program.....	6
4. Inspection Methods.....	8
5. Additional Inspection Tools and Methods.....	10
6. Results of Wood Pole Inspection.....	11
7. Remedial Treatment.....	12
8. Determining the Serviceability of Decayed Poles.....	15

APPENDIX A: Stub Reinforcing of Distribution Line Poles

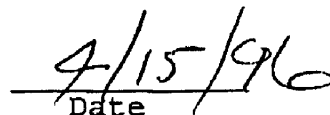
APPENDIX B: Metric Conversion Factor

INDEX:

INSPECTION: Poles

OPERATION AND MAINTENANCE: Poles

POLES: Maintenance

ABBREVIATIONS

ACA	- Ammoniacal copper arsenate
ACZA	- Ammoniacal copper zinc arsenate
ANSI	- American National Standards Institute
AWPA	- American Wood Preservers' Association
CCA	- Chromated copper arsenate
EPA	- Environmental Protection Agency
EPRI	Electric Power Research Institute
NaMDC	- N-methyldithiocarbamate
NESC	- National Electrical Safety Code
MITC	- Methylisothiocyanate
OCF	- Overload capacity factor
pcf	- pounds per cubic foot
REA	- Rural Electrification Administration
RUS	- Rural Utilities Service

DEFINITIONS

Accelerometer - A device used to measure acceleration.

Fumigants - Preservatives delivered into a pole in a liquid or solid form that vaporize over time sending fumes throughout a given pole section.

Fungi - Lower life plant form which uses wood for food to sustain life.

Incipient decay - The early stage of decay that has not proceeded far enough to soften or otherwise perceptibly impair the hardness of wood. It is usually accompanied by a slight discoloration or bleaching of the wood.

1. PURPOSE: The purpose of this guide bulletin is to furnish information and guidance to Rural Utilities Service (RUS) electric borrowers in establishing or sustaining a continuing program of effective, ongoing pole maintenance. Discussed are methods and procedures for inspecting and maintenance of standing poles and for determining the minimum required groundline circumferences for distribution and transmission poles.

2. GENERAL DISCUSSION OF POLE DECAY: Decay of a treated pole is usually a gradual deterioration caused by fungi and other low forms of plant life. Damage by insect attack (termites, ants and wood borers) is usually considered jointly with decay because preservative treatment of wood protects against both fungi and insects. In most cases, the decay of creosote and pentachlorophenol treated poles occurs just below the groundline where conditions of moisture, temperature and air are most favorable for growth of fungi. Decay factors affecting pole life are discussed below.

2.1 Pole Species: Of the millions of poles installed on RUS borrowers' systems, about 85 percent are deep sapwood southern pines. Untreated, southern pine sapwood is especially vulnerable to attack by wood destroying fungi, termites, and carpenter ants. In the Gulf States, where temperature and moisture are most favorable for fungi growth and environmentally favored by termites and carpenter ants, pole replacement time of an untreated southern pine pole would be 2 to 3 years. In areas of lower rainfall and average lower temperatures, the time to pole failure for untreated pine would increase to 5 to 10 years.

The bulk of the remaining pole population is classified as the western species, comprised of Douglas-fir, western red cedar, lodgepole pine, and ponderosa pine. The northern pine species, red and jack, are used in relatively small amounts.

Adequate preservative treatment (pole conditioning and preservative penetration and retention) provides relatively good protection of pole sapwood and the underlying heartwood. Heartwood of most species varies widely in decay resistance, and is almost impossible to treat with preservatives. Species resistance to decay are classified as follows:

Durable - Western red cedar.

Moderately Durable - Douglas-fir and most of the pines.

Least Durable - Lodgepole pine. (The use of this species has been limited primarily to the Mountain States areas.)

2.2 Preservative Treatments: There are two general classes of preservative treatment, oilborne (creosote, pentachlorophenol (penta) in petroleum, and Copper Naphthenate) and waterborne (arsenates of copper). Creosote was the only preservative used on rural system poles until 1947, when post-war chemical shortages prompted the introduction of penta and Copper Naphthenate. Both of these preservatives were dissolved in fuel oils from petroleum or mixed with creosote. Today these preservatives are blended with petroleum distillates.

Penta is now the most widely used pole preservative. Where decay problems have occurred, they have not been attributed to any deficiencies of the preservative, but to one or more of the following: (1) loss of solvent carrier due to gravitation and bleeding, (2) poor conditioning of the poles, and (3) loss of dissolved penta to retentions below the effective threshold. To overcome these deficiencies, treatments and quality control have been improved.

Wood preservatives used in waterborne solutions include ammoniacal copper zinc arsenate (ACZA), and chromated copper arsenate (CCA) (types A, B, and C). These preservatives are often employed when cleanliness and paintability of the treated wood are required. Several formulations involving combinations of copper, chromium, and arsenic have shown high resistance to leaching and very good performance in service. Both ACZA and CCA are included in many product specifications for wood building foundations, building poles, utility poles, marine piles, and piles for land and fresh water use. Treatment usually takes place at ambient temperature. During treatment of Douglas-fir, experience has shown that care needs to be taken to ensure that the pole is sterilized.

2.3 Decay Zones: The map on the following page details the five Decay Severity Zones of the United States. These zones were originally based on summer humidity and temperature information and later on a pole performance study conducted by the Rural Electrification Administration (REA). Decay severity ranges from least severe in Zone 1 to most severe in Zone 5. Service life records, individual experience, and/or a planned sample inspection should indicate if the decay hazard for a particular system is typical of the zone in which the system is located.

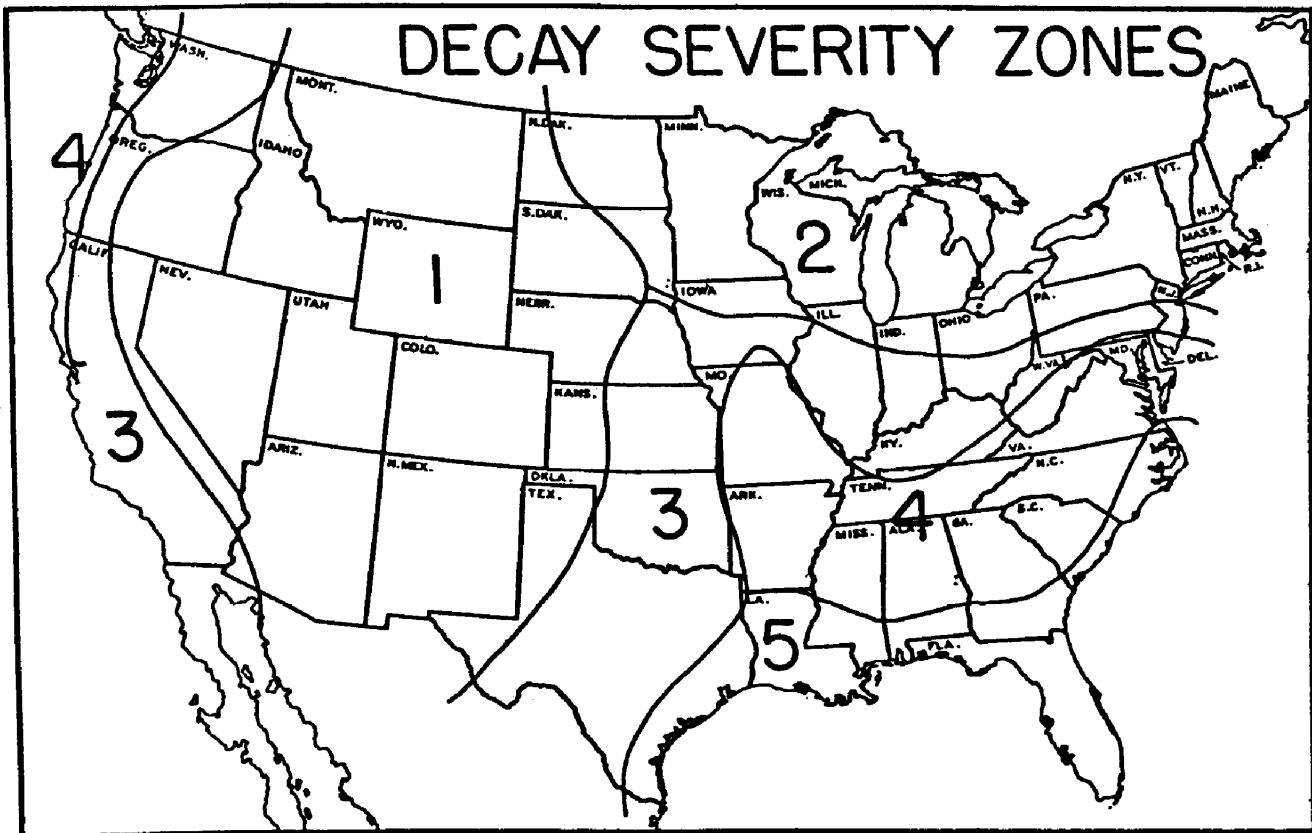

2.4 Types of Decay: After installation, decay organisms may invade the heartwood of poles through the poorly treated sapwood zones, checks, or woodpecker holes. Internal decay may occur in pole tops cut after treatment and in holes bored in the field where supplementary treatment has been neglected. Insufficient amount of preservative or migration of oil-type preservatives are the principal causes of external decay in southern pine poles. Poles in storage can decay because being stacked horizontally can encourage migration of the oil to the low side, depleting oil and preservative from the top side. For this reason, it is recommended that poles in storage be rolled annually to eliminate depletion of preservative from the top side.

Internal decay may be found in southern pine poles that were not properly conditioned or in which penetration or the amount (retention) of preservative is lacking entirely or insufficient. Internal decay of the western species usually involves the heartwood which has been improperly seasoned prior to treatment.

External decay above ground, more commonly known as "shellrot", occurs frequently in butt-treated western red cedars after 12-15 years of service.

3. PLANNED INSPECTION AND MAINTENANCE PROGRAM: The purpose of a planned inspection program is to reveal and remove danger poles and to identify poles which are in early stages of decay so that corrective action can be taken. The end result of the inspection program is the establishment of a continuing maintenance program for extending the average service life of all poles on the system. The steps in developing a planned pole inspection and maintenance program are outlined below:

3.1 Spot Checking: Spot checking is the initial step in developing a planned pole inspection and maintenance program. Spot checking is a method of sampling representative groups of poles on a system to determine the extent of pole decay and to establish priority candidates for the pole maintenance measures of the program. A general recommendation is to inspect a 1,000-pole sample, made up of continuous pole line groupings of 50 to 100 poles in several areas of the system. The sample should be representative of the poles in place. For instance, all the poles on a line circuit or a map section should be inspected as a unit and not just the poles of a certain age group. The inspection of the sample should be complete, consisting of hammer sounding, boring, and excavation as described in Section 4. Field data should be collected on the sample as to age, supplier, extent of decay, etc.

The data should be analyzed to determine the areas having the most severe decay conditions and to establish priorities for a pole-by-pole inspection of the entire system. It may be desirable to take additional samples on other portions or areas of the system to determine if the severity of decay is significantly different to warrant the establishment of an accelerated pole inspection and maintenance program for that portion of the system. The results of the spot check will aid in scheduling a continuous pole inspection and maintenance program at a rate commensurate with the incidence of decay.

3.2 Scheduling the Inspection and Maintenance Program: If an ongoing maintenance program is not in place, the suggested timing for initial pole-by-pole inspection and subsequent reinspection is shown in Table 3-1. Supplementary treatment is performed where necessary after the initial inspection.

<u>Decay Zone</u>	<u>Initial Inspection</u>	<u>Subsequent Reinspection</u>	<u>Percent of Total Poles Inspected Each Year</u>
1	12 - 15 Yrs	12 Yrs	8.3%
2 & 3	10 - 12 Yrs	10 Yrs	10.0%
4 & 5	8 - 10 Yrs	8 Yrs	12.5%

Table 3-1 - Recommended Pole Inspection Schedules

The vulnerability of poles to decay is generally proportionate to the decay zone in which they are installed. As a general recommendation, the initial pole-by-pole inspection program should be inaugurated at a yearly rate of 10 percent of the poles on the entire system when the average age of the poles reaches 10 years. If a spot check indicates that decay is advanced in 1 percent of the pole sample, the inspection and maintenance program should be accelerated so that a higher percentage of poles are inspected and treated sooner than the figures shown in Table 3-1. If the decay rate is low for a particular decay zone or area of the system, the pole-by-pole inspection can be adjusted accordingly. Historical inspection data indicates that the ratio between the decaying/serviceable poles to reject poles in the 10-15 year age group is about six or more to one. In a 30-year age group, the ratio was down to about one to one or less. In the latter group, the survivors have more than sufficient residual preservative to protect them indefinitely. The poorly treated poles in the 30-year old group usually have already decayed and been replaced.

The greatest economic benefit from regular inspection is in locating the decaying/serviceable group. Treatment of poles in this group can extend pole life, thereby avoiding the cost of emergency replacement. Inspection and proper maintenance can more than pay dividends by extending the serviceable life of the poles. With the costs of replacing poles rising, the economics of extending the service life become more favorable.

3.3 Setting Up the Program: The pole-by-pole inspection and maintenance work may be done by system employees or by contracting with an organization specializing in this type of work. The choice should be made on the basis of the amount of work to be done, availability, depth of trained people on staff, and a comparison of the costs. Developing the necessary skills in the system's own crews may require considerable time and be contingent upon the availability of an experienced inspector to train system employees. Therefore, qualified contract crews may be preferable for this work in many instances. To be considered qualified, the individual should have inspected, at a minimum, 5,000 poles under a qualified inspector and another 5,000 poles independently, but under close supervision. When the inspection program is underway, the work of the person chosen to inspect should be checked every week or two by the system's representative and the inspector's supervisor. The best way to check an inspector's work is to select at random about 10 poles inspected in the last few weeks, and perform a complete reinspection of the 10 poles. The reinspection should include: re-excavating, removal of paper and treatment, testing for hollow sounds, taking a boring, checking soft surface wood, remeasuring the pole, rechecking the calculations, then retreating and backfilling. If any serious first inspection errors are discovered, all work performed by the inspector between these spot checks should be reinspected.

The pole inspection and maintenance program may result in a large number of replacements. If the reject rate is high, the system's crews may not be able to replace rejected poles in a reasonable time because of other work. The temporary addition of skilled personnel for inspection or pole replacement may be required. It is generally necessary to use at least one crew full time to keep up with the pole inspector. An average pole inspector can check 150-200 poles per week or 800 poles per month. It is desirable to have one person responsible for supervision and coordination.

3.4 Reinspections: Information obtained during the first pole-by-pole inspection can serve as the basis for scheduling subsequent inspections. It is recommended that a reinspection be made every 8 to 12 years as mentioned in Paragraph 3.2, according to the decay zone and severity of decay. These recommendations should be modified by personal experience, but the intervals should not be extended by more than 3 years. It is advisable to recheck some poles which have been groundline treated at intervals sooner than recommended in Paragraph 3.2 to assure field applied treatment is working properly and recommended time intervals for reinspection can be trusted.

4. INSPECTION METHODS: There are varying types of inspection, each with a different level of accuracy and cost. Inspection methods with low accuracy require more frequent reinspection than methods which are detailed and more accurate.

4.1 Visual Inspection: Visual inspection is the easiest and lowest cost method for inspecting poles and has the lowest accuracy. Since most decay is underground or internal, this method will not detect the majority of any existing decay. Obvious data can be collected on each specific structure, such as the above ground relative condition of the pole, crossarm, and hardware. However because this method misses the most crucial part of a true pole inspection and maintenance program, this method is not recommended.

4.2 Sound and Bore: This method involves striking a pole with a hammer from groundline to as high as the inspector can reach and detecting voids by a hollow sound. An experienced inspector can tell a great deal about a pole by listening to the sounds and noticing the feel of the hammer. The hammer rebounds more from a solid pole than when hitting a section that has an internal decay pocket. The internal pocket also causes a sound that is dull compared to the crisp sound of a solid pole section.

Some inspection methods require all poles to be bored, while others require boring only when decay is suspected. Boring is usually done with either an incremental borer or power drill with a 3/8" bit. An experienced inspector will notice a change in resistance against the drill when it contacts decayed wood. The

shavings or the borings can be examined to determine the condition of the wood, and the borings can be analyzed for penetration and retention.

When voids are discovered a shell thickness indicator can be used to measure the extent of the voids. This information can be used to estimate the reduction in strength caused by the void, as discussed in Section 8.

The effectiveness of the sound and bore method varies with different species. For southern yellow pine poles, which represent a majority of the poles in North America, decay normally is established first on the outside shell below ground. The decay moves inward and then upward to sections above ground. By the time sound and bore inspection methods can detect internal decay pockets above ground, the pole is likely to have extensive deterioration below ground.

The sound and bore method is more effective with Douglas-fir and western red cedar poles. Decay on these poles is likely to begin internally near the groundline, or in the case of Douglas-fir, above the groundline. Therefore, sounding and boring can identify at least some decay at a stage before the groundline section is severely damaged.

All borings should be plugged with a treated wood plug which is properly sized for the respective hole.

Sound and bore method is recommended for the inspection of Douglas-fir and western red cedar poles but should be used in combination with excavation for southern pine poles.

4.3 Excavation: The effectiveness of the sound and bore inspection is greatly increased when excavation is added to the process. Excavation exposes the most susceptible section of the pole for inspection. For southern yellow pine this is particularly true, since decay begins externally and below ground.

Poles should be excavated to a depth of 18 inches in most locations. Deep excavation may be required in dry climates. After excavation the exposed pole surface should be scraped clean to detect early surface decay. The best results can be obtained by using a triangular scraper.

Shell rot and external decay pockets should be removed from the pole using a specially designed chipper tool. Axes or hatchets should never be used for this application. The remaining pole section should be measured to determine if the pole has sufficient strength with the reduced circumference. Tables 2, 3, and 4 on page 19, assist in determining the effective

After complete inspection and application of preservative treatment, the pole is backfilled by tamping every 6 to 8 inches of dirt at a time until the hole is filled. The backfill should mound up around the pole to allow for future settling and drainage away from the pole.

5. ADDITIONAL INSPECTION TOOLS AND METHODS: Additional equipment and methods are available which can be incorporated into the inspection process.

5.1 Shigometer: The Shigometer uses electrical resistance to detect incipient decay before it can be detected with the human eye or sensed with a drill. During the decay process, negative ions form in the infected wood and cause the electrical resistance to lower. The Shigometer measures electrical resistance and detects incipient decay when there are sudden drops in resistance readings.

The Shigometer employs test leads consisting of a twisted pair of insulated wires with bare metal tips. Both metal tips are slowly inserted into a 7/64" diameter hole bored in the pole. The instrument delivers an electric current pulse through the probes each second. The resistance of the wood tissue is measured between the contact points of the two tips.

By detecting incipient decay, the inspector can decide what further steps of inspection and preservative treatments to take.

5.2 Poletest: Poletest is a sonic instrument developed through research funded by the Electric Power Research Institute. During the development of this instrument, spectral analyses of sound waves that traveled through cross sections at various locations were compared to the actual breaking strength of poles. The end result of the research is a field test device that provides a statistically reliable direct readout of the strength of a pole at a specific cross section.

The intent of the Poletest instrument is to provide a strength assessment for individual poles as opposed to assuming pole designated fiber stresses of the American National Standards Institute (ANSI) 05.1. However, Poletest is not a substitute for traditional inspection because it does not detect decay, especially below ground. Measured strength values can be used to assist in determining when pole replacement is necessary.

5.3 De-K-Tector: The De-K-Tector and other waveform analysis instruments analyze sound wave patterns as they travel through a cross section of a pole. A calibrated mechanical striker impacts the pole and the sound wave or vibration wave caused by the impact is sensed by an accelerometer on the opposite side of the pole.

impact is sensed by an accelerometer on the opposite side of the pole.

The waveform that is detected by the accelerometer is electronically divided into high and low frequency components. Research has shown high frequencies are absorbed more by decayed wood. Therefore, a reading with a low magnitude, high frequency component would indicate a "questionable" pole because decay absorbed some of the high frequency component before the waveform reaches the opposite side of the pole. That pole would need further inspection by traditional methods.

6. RESULTS OF WOOD POLE INSPECTION

6.1 Inspection Results: Inspection results should be used to update pole plant records, evaluate pole conditions, plan future inspection and maintenance action, and provide information for system map revisions. The inspection process will result in identifying the condition of each individual distribution and transmission pole.

In general ANSI C2, "National Electric Safety Code (NESC)," requires that if structure strength deteriorates to the level of the overload factors required at replacement, the structure shall be replaced or rehabilitated. The inspection results should indicate if a pole is "serviceable" or a "reject".

6.1.1 A pole is considered "serviceable" under any of the following conditions:

- a. Large portion of completely sound wood exists.
- b. Early stages of decay which have not reduced the pole strength below NESC requirements.
- c. Pole condition is as stated in (1) or (2) but a defect in equipment may exist, such as a broken ground or loose guy wire. Equipment defects should be subsequently repaired.

6.1.2 Any pole that does not meet the above conditions should be classified as a "reject". Any of the following conditions are characteristics of rejects:

- a. Decay, insect or mechanical damage has reduced pole strength at the groundline below NESC requirements.
- b. Severe woodpecker hole damage has weakened the pole such that it is considered below NESC requirements.
- c. Hazardous conditions exist above ground, such as split top.

6.1.3 Rejected poles may be classified further depending on the severity of the deterioration and whether they are reinforceable:

- a. A "reinforceable reject" is any reject which is suitable for restoration of the groundline bending capacity with an industry acceptable method of reinforcement.
- b. A "replacement" candidate is a rejected pole which is not suitable for necessary rehabilitation.
- c. A "priority reject" is a reject pole that has such severe decay deterioration, it should be removed as soon as possible.

7. REMEDIAL TREATMENT

7.1 The purpose of remedial treatment of a standing pole is to interrupt the degradation by the addition of chemicals, such as pesticides, insecticides and fungicides, thereby extending the useful life of the structure. Treatment may be external groundline treatment or internal treatment.

7.2 Regulations and Licensing: Most states require applicators or job supervisors to obtain a pesticide applicator license. Testing for this license includes a "basic skills test" to show knowledge of the rules and regulations governing pesticides. Some states also give a "category test" which is specific to wood poles and wood preservation.

The uses of pesticides are classified by the United States Environmental Protection Agency (EPA) as either "general" or "restricted". A "general use" pesticide is not likely to harm humans or the environment when used as directed on the label. These pesticides may be purchased and applied without a pesticide applicator license. However, a manufacturer may choose not to make a product available for purchase by the general public.

A "restricted use" pesticide could cause human injury or environmental damage unless it is applied by competent personnel (certified applicators) who have shown their ability to use these pesticides safely and effectively. These wood preservatives can only be purchased and applied by someone who has a pesticide applicator license or whose immediate supervisor has a pesticide applicator license.

7.3 Groundline Treatment: All treated poles eventually lose resistance to decay, and groundline treatment provides an economical extension of their useful life. Experience has shown that groundline decay can be postponed almost indefinitely in cases where periodic inspection and maintenance programs are in effect. Groundline treatment is recommended under the following conditions:

- a. Whenever a pole is excavated during an inspection, and the pole is sound or decay is not so far advanced that the pole has to be replaced or repaired,
- b. Whenever a pole over 5 years old is reset, or
- c. Whenever a used pole is installed as a replacement.

The two general types of external preservatives used for groundline treatment are either waterborne or oilborne. The fungitoxic components of waterborne preservatives are water soluble while the oilborne preservatives carry oil soluble fungicides. There are formulations that contain both waterborne and oilborne solutions.

Sodium fluoride is the most commonly used water soluble active ingredient in remedial treatments. Historically, oilborne preservatives have included creosote and pentachlorophenol. However, use of penta in supplemental preservatives appears to be declining. In recent years, Copper Naphthenate has been used in external preservative pastes. Boron has also been introduced as an ingredient in a groundline paste.

Before application of external preservatives, decayed wood should be stripped from the pole and removed from the excavation. The preservative paste or grease is most commonly brushed onto the pole. A polyethylene backed paper is then wrapped around the treatment and stapled to the pole. The paper helps to facilitate the migration of the preservative into the critical outer shell.

7.4 Internal Treatment: The three basic types of preservatives used for internal treatment are liquids, fumigants, and solids.

7.4.1 Liquid Internal Preservative: Liquid internal preservatives should be applied by pressurized injection through a series of borings that lead to internal decay pockets or voids. Adequately saturating the pocket and surrounding wood should arrest existing decay or insect attack and prevent further degradation for an extended time.

Liquid internal preservatives contain water soluble or oil soluble active ingredients. Sodium fluoride is the principle active ingredient in the water based formulations. Moisture that is present in the pole will help facilitate diffusion of the active ingredients into the wood beyond a decay pocket.

Oil based internal preservatives most often incorporate Copper Naphthenate as an active ingredient with fuel oil or mineral spirits as the solvents. Since Copper Naphthenate is not soluble in water, it is likely to migrate into the surrounding wood only as far as the oil will travel.

7.4.2 Fumigants: Most of the fumigants in use for wood poles today were originally developed for agricultural purposes. Applying fumigants to soil will effectively sterilize the ground. Due to high levels of microorganisms and chemical activity in soil, the fumigants will degrade fairly rapidly and dissipate so that new crops can be planted in a short time.

These same fumigants do not degrade rapidly in wood and will remain affixed to sound wood cell structure for many years. Fumigants have also been found to migrate longitudinally in wood, several feet away from the point of application. This helps control decay in a large section of the pole. When the vapors migrate into a decay void, however, they may dissipate through associated checks and cracks. This reduces the long term effectiveness and requires more frequent application.

Registered pole fumigants include Sodium N-methyldithiocarbamate (NaMDC), Methylisothiocyanate (MITC), Chloropicrin and Vorlex. Vorlex has not yet been commercially used for utility poles, since it requires a closed application system. Chloropicrin is a very effective wood fumigant. However, the liquid has to be applied from pressurized cylinders, and the applicator has to wear a full-face air respirator.

NaMDC and MITC are the most widely used wood pole fumigants. NaMDC is soluble in water to a maximum amount of 32.7 percent. Treatment holes drilled in a wood pole are filled with the aqueous solution so the appropriate dosage is applied. Recommended dosages vary according to pole size. The NaMDC solution decomposes and generates MITC as the main fungitoxic ingredient. The maximum theoretical amount of resultant MITC at ideal conditions is 18.5 percent by weight. The MITC vapors then migrate up and down the pole to help control decay.

Pure MITC is a solid below 94°F and contains 97 percent active ingredient. Solid MITC sublimes directly into fumigant vapors. Avoiding the liquid stage helps to minimize loss of fumigant during application through checks and cracks. MITC is packaged in vials to facilitate installation. Just before placing the vial into a treatment hole, the cap is removed. As with any fumigant, application holes should be plugged with pressure treated plugs.

7.4.3 Solids: Currently, one solid preservative, a boron rod, is available in North America as a supplemental preservative treatment for wood poles. However, the American Wood Preservers' Association (AWPA) Standards do not include borates for ground contact applications like utility poles. Research and development continues in evaluating formulations of borates with other compounds.

7.5 Woodpecker Damage: Woodpecker damage is another problem that requires attention. Many methods have been used in attempts to prevent such damage, but nothing has been entirely successful.

It appears that a woodpecker selects a pole only by chance, and that the first hole invites further attack by other woodpeckers. For these reasons, it is good maintenance practice to seal up the smaller holes. Various materials are available for plugging the holes, and a wire mesh can be used to cover the plugged hole as well as large areas of a pole.

8. DETERMINING THE SERVICEABILITY OF DECAYED POLES

8.1 The decision to treat or replace a decayed pole depends upon the remaining strength or serviceability of the pole. The permissible reduced circumference of a pole is a good measure of serviceability. The following procedure may be used to assist in determining if a pole should be replaced or reinforced.

8.2 Decay Classifications. Decay at the groundline should be classified as:

- a. General external decay,
- b. External pocket,
- c. Hollow heart, or
- d. Enclosed pocket.

8.3 Permissible Reduced Circumference Safety Factors. Wood pole lines are designed using designated fiber strengths and loads multiplied by an overload capacity factor (OCF). For tangent structures the NESC prescribes an OCF "when installed" (new) for Grade B construction (transmission lines) of 4.0 and requires replacement or rehabilitation if the OCF reaches below 2.67. For Grade C construction (usual distribution line grade of construction) the "when installed" OCF is 2.67 and replacement or rehabilitated OCF is 1.33.

Using Tables 1 through 4, on pages 17 and 19 of this bulletin, will give assistance in determining when replacement or rehabilitation is necessary. If the reduced circumference indicates a pole at or below the "at replacement" OCF, the pole should be replaced, splinted, stubbed immediately, or otherwise rehabilitated. Appendix A, of this bulletin, shows the typical pole stubbing detail for distribution poles. Poles are successfully rehabilitated using steel channels, fiberglass reinforcing and epoxy.

8.4 General Procedures For Using Tables 1, 2, 3 and 4:

8.4.1 General External Decay. After removing all decayed wood, measure the circumference above and below the decayed section to determine the original circumference. Then measure the reduced circumference at the decayed section. If the line is built to Grade B construction (transmission), enter the original circumference in the OCF 4.0 column of Table 1. Move right across from the original circumference column of Table 1 until you find the reduced circumference. Once you find the reduced circumference, read the OCF at the top of the column in which your reduced circumference ended. If this OCF meets or exceeds the 2.67 OCF column, replacement is not necessary. However, poles with values close to the minimum should be monitored frequently to ensure that the pole's OCF does not fall below the minimum.

For Grade C construction (usually distribution) enter Table 1 using the original circumference in column 4, OCF 2.67. These poles have to stay above the values of the OCF 1.33 column.

8.4.2 External Pockets. Remove decayed wood and make measurements of the depth and width of the pocket. Measure the pole for the original circumference. Refer to Table 2 to determine the circumference reduction. Enter Table 1 with the original circumference and the reduced circumference to determine the current OCF.

8.4.3 Hollow Heart (Heart Rot). If hollow heart is found, determine the shell thickness and measure the original circumference of the pole. Refer to Table 3 to determine the circumference reduction. Enter Table 1 with the original circumference and the reduced circumference to determine the current OCF.

To determine the shell thickness, bore three holes (preferably of 1/4- or 3/8-inch diameter), 120° apart; measure the shell thickness at each hole, and average the measurements. After shell thickness is determined, treat and plug holes with tightly fitting cylindrical wood plugs that have been treated with preservative. No transmission pole should remain in service with a shell thickness less than 3 inches.

8.4.4 Enclosed Pocket. An enclosed pocket is an off-center void as shown in Table 4, and its diameter should be measured by boring holes as described in section 8.4.3. Using the minimum thickness of the shell, refer to Table 4 for the reduction in circumference. Measure the original circumference. Enter Table 1 with the original circumference and the reduced circumference and determine the current OCF.

Table 1
Pole Circumference Overload Capacity Factors (OCF)

Original circumference (inches)	Reduced circumference (inches)						
	OCF 4.0	OCF 3.5	OCF 3.0	OCF 2.67	OCF 2.5	OCF 2.0	OCF 1.5
30.0	28.7	27.3	26.1	25.6	23.8	21.6	20.7
31.0	29.7	28.2	27.0	26.5	24.6	22.3	21.4
32.0	30.6	29.1	27.8	27.4	25.4	23.0	22.1
33.0	31.6	30.0	28.7	28.3	26.2	23.8	22.8
34.0	32.5	30.9	29.6	29.1	27.0	24.5	23.5
35.0	33.5	31.8	30.5	29.9	27.8	25.2	24.2
36.0	34.4	32.7	31.4	30.8	28.6	25.9	24.9
37.0	35.4	33.6	32.3	31.6	29.4	26.6	25.6
38.0	36.3	34.5	33.1	32.5	30.2	27.4	26.3
39.0	37.3	35.4	34.0	33.3	31.0	28.1	27.0
40.0	38.3	36.3	34.9	34.2	31.8	28.8	27.7
41.0	39.2	37.3	35.8	35.1	32.5	29.5	28.4
42.0	40.2	38.2	36.7	35.9	33.3	30.2	29.0
43.0	41.1	39.1	37.5	36.8	34.1	31.0	29.7
44.0	42.1	40.0	38.4	37.6	34.9	31.7	30.4
45.0	43.0	40.9	39.3	38.5	35.7	32.4	31.1
46.0	44.0	41.8	40.2	39.3	36.5	33.1	31.8
47.0	45.0	42.7	41.0	40.2	37.3	33.8	32.5
48.0	45.9	43.6	41.9	41.0	38.1	34.6	33.2
49.0	46.9	44.5	42.8	41.9	38.9	35.3	33.9
50.0	47.8	45.4	43.6	42.7	39.7	36.0	34.6
51.0	48.8	46.3	44.5	43.6	40.5	36.7	35.3
52.0	49.7	47.2	45.4	44.5	41.3	37.4	36.0
53.0	50.7	48.2	46.3	45.3	42.1	38.2	36.7
54.0	51.6	49.1	47.1	46.2	42.9	38.9	37.4
55.0	52.6	50.0	48.0	47.0	43.7	39.6	38.1
56.0	53.6	50.9	48.9	47.9	44.4	40.3	38.7
57.0	54.5	51.8	49.8	48.7	45.2	41.0	39.4
58.0	55.5	52.7	50.6	49.6	46.0	41.8	40.1
59.0	56.4	53.6	51.5	50.4	46.8	42.5	40.8
60.0	57.4	54.5	52.4	51.3	47.6	43.2	41.5

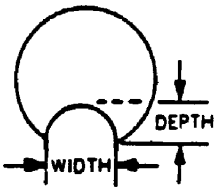

Table 2
Reduction in Measured Circumferences to Compensate
for External Pockets

Pocket Width (ins)	1					2					3					4					5					6									
Pocket Depth (ins)	1	2	3	4	5	1	2	3	4	5	1	2	3	4	5	1	2	3	4	5	1	2	3	4	5	1	2	3	4	5					
Measured Circumference of Pole (ins)	Reduction in Circumferences (ins)																																		
20 to 30	1	1	2	-	-	2	2	3	-	-	2	3	4	-	-	3	4	5	-	-	4	6	8	-	-	6	8	-	-	-	8	-	-	-	-
30 to 40	1	1	1	2	2	1	2	2	3	3	2	3	4	4	4	2	4	5	5	6	3	5	6	7	8	5	7	8	9	-	-	-	-	-	-
40 to 50	1	1	1	2	2	1	2	2	3	3	2	3	3	4	4	2	3	4	5	6	3	4	5	6	7	3	5	6	7	8	8	-	-	-	-
50 to 60	1	1	1	2	2	1	2	2	3	3	2	3	3	4	4	2	3	3	4	5	3	4	4	5	6	3	4	5	6	7	7	-	-	-	-

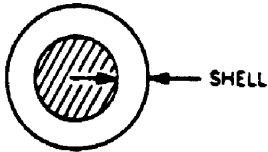

Table 3
Reduction in Measured Circumferences to Compensate
for Hollow Heart

Measured Circumference of Poles (ins)	Minimum Thickness of Shell (ins)					
	2	2.5	3	3.5	4	4.5
20 to 25	1	-	-	-	-	-
25 to 30	2	1	-	-	-	-
30 to 35	3	2	1	-	-	-
35 to 40	4	3	2	1	-	-
40 to 45	5	4	3	2	1	-
45 to 50	7	5	4	3	2	1

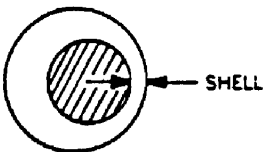
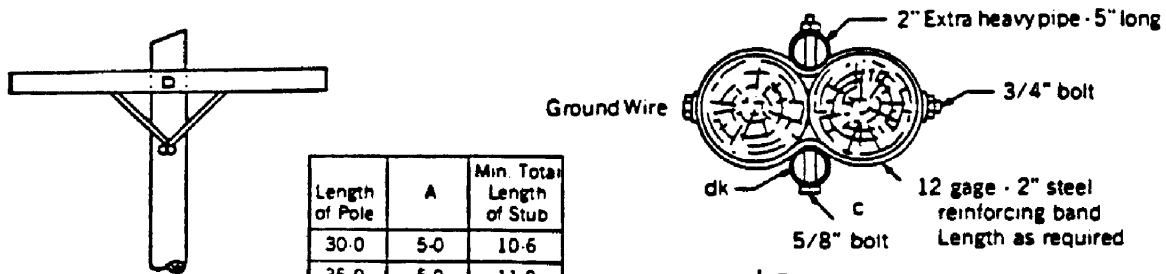
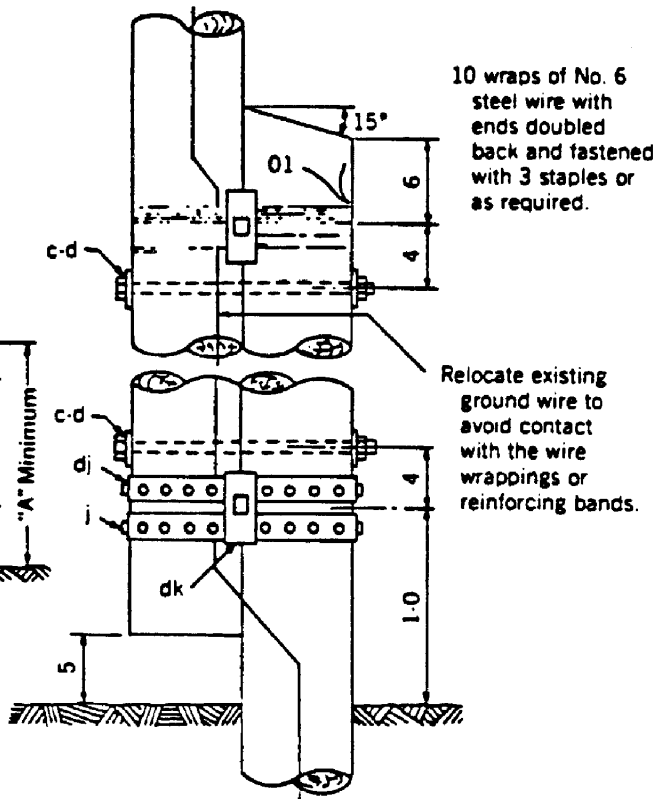
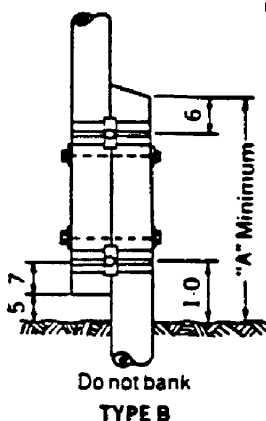
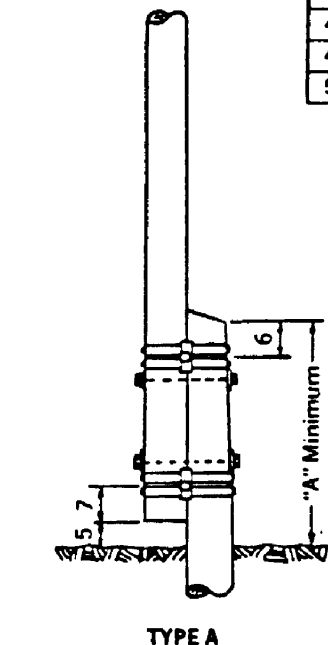

Table 4
Reduction in Measured Circumferences to Compensate
for Enclosed Pockets

Diameter of Pocket (ins)	3			4			5		
Shell Thickness (ins)	1	2	3	1	2	3	1	2	3
Measured Circumferences of Poles (ins)	Reduction in Circumferences (ins)								
20 to 30	2	1	-	3	1	-	4	2	-
30 to 40	2	1	1	3	1	1	4	2	1
40 to 50	2	1	1	3	2	1	4	3	1



Length of Pole	A	Min. Total Length of Stub
30-0	5-0	10-6
35-0	5-0	11-0
40-0	5-6	11-6
45-0	6-0	12-6
50-0	6-0	13-0



NOTES:

Use either wire wrapping or reinforcing band for stubbing material as required.
 Position stub at side of pole (At right angle to direction of line and outside of angle.)

ITEM	NO REQ'D	MATERIAL	ITEM	NO REQ'D	MATERIAL
c	2	Bolt, machine, 3/4" x required length			Wire, No. 6 galvanized steel, as required
c	2	Bolt, machine, 5/8" x required length	a1		Staples, as required
d	4	Washer, 2 1/4" x 2 1/4" x 3/16", 13/16" hole			
j	4	Screw, lag, 1/2" x 4"			
d1	4	Band, reinforcing, 12 gage x 2" x req'd length			
dk	4	Pipe spacer, 2" extra heavy x 5" long			

STUB REINFORCING OF DISTRIBUTION LINE POLES

SCALE: NTS

DATE: 02/20/95

M15

Metric Conversion Factors

<u>To Convert From</u>	<u>To</u>	<u>Multiply By</u>
foot (ft)	Meter (m)	0.3048
inch (in)	centimeter	2.54
degrees Fahrenheit (X°F)	degrees Celsius (°C)	5/9 (X°-32)