

**EVALUATION OF PRECIPITATIVE FOULING
FOR COLORADO RIVER WATER DESALINATION
USING REVERSE OSMOSIS**

**Metropolitan Water District
700 Moreno Avenue
La Verne, California 91750-3399
and
University of California at Los Angeles
10833 Le Conte Avenue
Los Angeles, California 90095-1772**

Agreement No. 99-FC-81-0185

**Desalination and Water Purification Research and Development
Program Report No. 85**

December 2002



**U.S. Department of the Interior
Bureau of Reclamation
Denver Office
Technical Service Center
Environmental Services Division
Water Treatment Engineering and Research Group**

REPORT DOCUMENTATION PAGEForm Approved
OMB No. 0704-0188

Public reporting burden for this collection of information is estimated to average 1 hour per response, including the time for reviewing instructions, searching existing data sources, gathering and maintaining the data needed, and completing and reviewing the collection of information. Send comments regarding this burden estimate or any other aspect of this collection of information, including suggestions for reducing this burden to Washington Headquarters Services, Directorate for Information Operations and Reports, 1215 Jefferson Davis Highway, Suit 1204, Arlington VA 22202-4302, and to the Office of Management and Budget, Paperwork Reduction Report (0704-0188), Washington DC 20503.

1. AGENCY USE ONLY (Leave Blank)		2. REPORT DATE December 2002	3. REPORT TYPE AND DATES COVERED Final	
4. TITLE AND SUBTITLE Evaluation of Precipitative Fouling for Colorado River Water Desalination Using Reverse Osmosis			5. FUNDING NUMBERS Agreement No. 99-FC-81-0185	
6. AUTHOR(S) Gabelich, C., Yun, T.I.; Green, J.F. (MWD) Suffet, I.H.; Chen, W.R. (UCLA)				
7. PERFORMING ORGANIZATION NAME(S) AND ADDRESS(ES) Metropolitan Water District 700 Moreno Ave., La Verne, CA 91750-3399 University of California at Los Angeles 10833 Le Conte Ave., Los Angeles, CA 90095-1772			8. PERFORMING ORGANIZATION REPORT NUMBER	
9. SPONSORING/MONITORING AGENCY NAME(S) AND ADDRESS(ES) Bureau of Reclamation Denver Federal Center P.O. Box 25007 Denver, CO 80225-0007			10. SPONSORING/MONITORING AGENCY REPORT NUMBER DWPR No. 85	
11. SUPPLEMENTARY NOTES Desalination and Water Purification Research and Development (DWPR) Program				
12a. DISTRIBUTION/AVAILABILITY STATEMENT Available from the National Technical Information Service, Operations Division, 5285 Port Royal Road, Springfield, Virginia 22161			12b. DISTRIBUTION CODE	
13. ABSTRACT (Maximum 200 words) The formation of aluminum silicates requires the presence of both dissolved aluminum and silica. The mineral equilibrium and pH of the solution regulate the concentration and speciation of dissolved silica and aluminum. Many antiscalants designed to control for silica scaling are ineffective against aluminum silicates. Ethylenediaminetetraacetic acid (EDTA) and other chelating agents (e.g., citric acid, oxalic acid, aspartic acid, and salicylic acid) have been suggested to sequester dissolved metals and avoid silicate fouling. While dispersant agents containing phosphonic acid and/or phosphonate functional groups may inhibit pure amorphous silica, they potentially precipitate aluminum as phosphates or phosphonates; thus, they may act as foulants themselves.				
14. SUBJECT TERMS-- Desalination/reverse osmosis/nanofiltration/municipal wastewater/brackish groundwater/aluminum silicates/ethylenediaminetetraacetic acid (EDTA)			15. NUMBER OF PAGES 130	
			16. PRICE CODE	
17. SECURITY CLASSIFICATION OF REPORT UL	18. SECURITY CLASSIFICATION OF THIS PAGE UL	19. SECURITY CLASSIFICATION OF ABSTRACT UL	20. LIMITATION OF ABSTRACT UL	

**EVALUATION OF PRECIPITATIVE FOULING
FOR COLORADO RIVER WATER DESALINATION
USING REVERSE OSMOSIS**

**Christopher Gabelich, Tae I. Yun and James F. Green
Metropolitan Water District
700 Moreno Avenue
La Verne, California 91750-3399**

**I. H. "Mel" Suffet and Wei R. Chen
University of California at Los Angeles
10833 Le Conte Avenue
Los Angeles, California 90095-1772**

Agreement No. 99-FC-81-0185

**Desalination and Water Purification Research and Development
Program Report No. 85**

December 2002



**U.S. Department of the Interior
Bureau of Reclamation
Denver Office
Technical Service Center
Environmental Services Division
Water Treatment Engineering and Research Group**

Mission Statements

U.S. Department of the Interior

The mission of the Department of the Interior is to protect and provide access to our Nation's natural and cultural heritage and honor our trust responsibilities to tribes.

Bureau of Reclamation

The mission of the Bureau of Reclamation is to manage, develop, and protect water and related resources in an environmentally and economically sound manner in the interest of the American public.

Disclaimer

Information contained in this report regarding commercial products or firms was supplied by those firms. It may not be used for advertising or promotional purposes and is not to be construed as an endorsement of any product or firm by the Bureau of Reclamation.

The information contained in this report was developed for the Bureau of Reclamation; no warranty as to the accuracy, usefulness, or completeness is expressed or implied.

ACKNOWLEDGMENTS

Funding for this project was graciously provided by the Desalination Research and Development Program, U.S. Bureau of Reclamation. The authors wish to express their appreciation for the advice and assistance of Frank Leitz, the U. S. Bureau of Reclamation project officer. Technical and moral support were provided by Bradley M. Coffey, Metropolitan Water District of Southern California, La Verne, California.

The authors are also indebted to the interns, Rafael Becerra and Monique Valenzuela, who conducted the routine sampling and database management for the pilot-scale membrane processes. Special thanks to Peng-Hsun “Peter” Hsieh of the University of California, Los Angeles for conducting the bench-scale antiscalant testing. Without their tireless efforts this project would not have been a success. Additional thanks are extended to the entire Water Quality Laboratory staff at Metropolitan for conducting the inorganic analyses. Scanning electron microscopy and energy dispersive spectroscopy were conducted by Charles Graham at the Scripps Institute of Oceanography, La Jolla, California. Lastly, thanks go to Tom Knoell and Kenneth P. Ishida at the Orange County Water District for their help conducting the infrared spectroscopy.

TABLE OF CONTENTS

Acknowledgments	v
List of Tables and Figures.....	ix
Glossary	xi
Acronyms.....	xiii
Executive Summary	xv
1. Introduction.....	1
1.1. Scale Potential of Colorado River Water.....	1
1.2. Project Objective.....	2
1.3. Specific Goals of Research.....	2
2. Conclusions and Recommendations.....	3
2.1 General Conclusions	3
2.2 Recommendations.....	4
3. Background	5
3.1 Scale Prevention Strategies.....	7
3.2 Non-Traditional Scales	8
4. Experimental Methods	9
4.1 Task 1 Characterize Colorado River Water.....	9
4.2 Task 2 Characterize the role of multivalent ions in silicate scaling	10
4.2.1 Modeling methods	10
4.2.1 Evaporation Experiments.....	11
4.3 Task 3 Bench-Scale Antiscalant Testing	11
4.3.1 Source Water.....	11
4.3.2 Bench-Scale Reverse Osmosis Unit	11
4.3.3 Antiscalants.....	12
4.3.4 Analytical Methods.....	12
4.3.5 Membrane Autopsy.....	13
4.3.6 Calculated Values	13
4.4 Task 4 Demonstrate Antiscalants	13
4.4.1 Pretreatment	14
4.4.2 Reverse Osmosis.....	14
4.5 Analytical Methods.....	15
5. Results and Discussion.....	15
5.1 Task 1 Characterize Colorado River water.....	15
5.1.1 Total Dissolved Solids Survey.....	16
5.1.2 Literature Survey	16
5.2 Task 2 Characterize the Role of Multivalent Ions (Fe^{3+} and Al^{3+}) in Silicate Scaling	18
5.2.1 Literature Survey	18
5.2.2 Potential remediation strategies.....	19
5.2.3 Theoretical Background - Formation Tendency of Aluminum Silicate Scales	20
5.2.4 Modeling Results and Discussion.....	21
5.2.5 Methods to Minimize Silicate Formation	22

5.2.6	Evaporation Experiments.....	23
5.3	Task 3 Screen Antiscalants.....	24
5.3.1.	Screening Tests.....	24
5.3.2.	Flux Comparison for Commercial and Generic Antiscalants.....	25
5.3.3.	Water Quality Data.....	26
5.3.4.	Scanning Electron Microscopy and Energy Dispersive Spectroscopy Analyses of the Membrane Surface.....	28
5.3.5.	Analysis of Colloidal Material.....	28
5.3.6.	Prevention of Aluminum Silicate Formation.....	29
5.3.7.	Overall Performance of Antiscalants.....	32
5.4	Task 4 Demonstrate Antiscalants.....	32
5.4.1	Source Water.....	33
5.4.2	Reverse Osmosis Performance.....	33
	References.....	39
	SI Metric Conversions.....	92
	Appendix A. Water Quality Analytical Methods.....	93
	Appendix B. Calculated Values for Reverse Osmosis System.....	95
	Appendix C. Raw Bench-Scale Reverse Osmosis Data.....	97
	Appendix D. Physical Description of Colloidal Matter From Concentrate Stream.....	113
	Appendix E. Raw Pilot-Scale Reverse Osmosis Performance Data.....	117

LIST OF TABLES AND FIGURES

Table 1. List of commercial and generic antiscalants under evaluation.....	45
Table 2. Sampling scheme for pilot-scale testing.....	46
Table 3. Historical water quality data of Colorado River water.....	47
Table 4. Common scalants and control measures for Colorado River water.....	48
Table 5. Mineral phases that may be precipitated from Colorado River water using geochemical modeling.....	49
Table 6. Distribution of dissolved species of aluminum and silica of Colorado River water using geochemical modeling.....	50
Table 7. Natural organic products used to complex dissolved aluminum in treating the aluminum silicate scale.....	51
Table 8. Reference guide for bench-scale antiscalant testing.....	52
Table 9. Chemical and physical information for commercial antiscalants used in bench-scale testing.....	53
Table 10. SEM results of fouled membrane surface of bench scale testing.....	54
Table 11. EDS results from membrane and colloidal analysis of bench scale testing.....	55
Table 12. EDS data of colloidal material from concentrate stream using CRW and 170 µg/L aluminum.....	56
Table 13. EDS data from RO membranes using CRW and 170 µg/L aluminum.....	56
Table 14. Influent water quality data for pilot-scale testing.....	57
Table 15. Scaling indexes for 60/40 Colorado River/California State Project water blend.....	57
Table 16. Operational observations for reverse osmosis unit.....	58
Table 17. Reverse osmosis salinity rejection data.....	59
Table 18. Water quality using supplemental salts.....	59
Figure E1. SEM micrographs (3,500 x magnification) of fouled RO membranes.....	xx
Figure 1. Schematic diagram of bench-scale reverse osmosis units.....	60
Figure 2. Schematic diagram of reverse osmosis unit for pilot-scale testing.....	60
Figure 3. Map of Lower Colorado River basin.....	61
Figure 4. Activity of dissolved silica species in equilibrium with quartz and amorphous silica at 25°C.....	62
Figure 5. Activity of dissolved aluminum species in equilibrium with gibbsite at 25°C.....	62
Figure 6. Reaction pathways for trihydroxide formation from hydrolyzed aluminum solution, demonstrating the role of Al ₁₃ in controlling relative reaction kinetics.....	63
Figure 7. Predominance area diagram of CaO-Al ₂ O ₃ -SiO ₂ -H ₂ O system at 25°C.....	64
Figure 8. Predominance area diagram of Na ₂ O-Al ₂ O ₃ -SiO ₂ -H ₂ O system at 25°C.....	65
Figure 9. Predominance area diagram of K ₂ O-Al ₂ O ₃ -SiO ₂ -H ₂ O system at 25°C.....	66
Figure 10. Solubility diagram of kaolinite and gibbsite at H ₄ SiO ₄ (aqueous) concentration of 10 ⁻⁴ mol/L.....	67
Figure 11. Powder X-ray diffraction spectra of the precipitates in the evaporation tests.....	68
Figure 12. Specific permeate flux for citric acid using CRW/SPW.....	69
Figure 13. Specific permeate flux for salicylic acid using CRW/SPW.....	69

Figure 14. Specific permeate flux for EDTA using CRW/SPW	70
Figure 15. Specific permeate flux for commercial antiscalants using CRW/SPW.....	70
Figure 16. Specific permeate flux for commercial antiscalants using CRW at pH 8.3.....	71
Figure 17. Specific permeate flux for commercial antiscalants using CRW at pH 7.0.....	71
Figure 18. Specific permeate flux for generic antiscalants using CRW/SPW.....	72
Figure 19. Specific permeate flux for generic antiscalants using CRW at pH 8.3	72
Figure 20. Specific permeate flux for generic antiscalants using CRW at pH 7.0	73
Figure 21. Maximum permeate flux decline of commercial and generic antiscalants in three types of waters in RO bench-scale testing	74
Figure 22. Dissolved calcium in RO concentrate for commercial and generic antiscalants in bench-scale testing.....	75
Figure 23. Dissolved barium in RO concentrate for commercial and generic antiscalants in bench-scale testing.....	76
Figure 24. SEM micrograph of a cleaned reverse osmosis membrane.....	77
Figure 25. Representative SEM micrographs of fouled reverse osmosis membranes from bench-scale testing	77
Figure 26. Dissolved silica in RO concentrate for commercial and generic antiscalants in bench-scale testing.....	78
Figure 27. Dissolved aluminum in RO concentrate for commercial and generic antiscalants in bench-scale testing.....	79
Figure 28. Specific permeate flux for commercial and generic antiscalants using CRW at pH 6.7 with 170 µg/L added aluminum.....	80
Figure 29. Dissolved analytes in RO concentrate for commercial, generic and blends of commercial and generic antiscalants in bench-scale testing with 170 µg/L added aluminum.....	81
Figure 30. SEM micrographs of fouled reverse osmosis membranes from the aluminum addition study.....	82
Figure 31. Normalized flux during reverse osmosis pilot testing.....	83
Figure 32. Salt rejection during reverse osmosis pilot testing.....	83
Figure 33. Normalized flux per array during reverse osmosis pilot testing	84
Figure 34. Salt rejection per array during reverse osmosis pilot testing	84
Figure 35. EDS spectrograph of reverse osmosis membrane from terminal element	85
Figure 36. SEM micrograph of calcium carbonate scale.....	85
Figure 37. SEM micrographs of reverse osmosis membranes from first array	86
Figure 38. SEM micrographs of reverse osmosis membrane from second array	86
Figure 39. SEM micrographs of reverse osmosis membranes from third array	86
Figure 40. EDS spectrograph of reverse osmosis membrane from first array.....	87
Figure 41. Infrared spectral analysis of fouled reverse osmosis membrane surfaces.....	88
Figure 42. EDS spectrograph of reverse osmosis membrane from second array	89
Figure 43. EDS spectrograph of reverse osmosis membrane from third array.....	90

GLOSSARY

ATR/FT-IR - Attenuated Total Reflectance/Fourier Transform infrared analysis. A technique to analyze the organic, functional groups of materials.

Bench scale – Experiments conducted using 2-6 L/min table-top systems.

Brine – (1) A concentrated salt solution, generally containing sodium chloride and other ions typically having a concentration of 3 weight percent or more. (2) A concentrated salt solution remaining after desalting brackish or seawaters. For brackish water membrane desalting, the terms *concentrate* or *reject* are commonly used.

Colorado River water (CRW) - influent water source from Lake Mathews, California, the southern terminus for the Colorado River aqueduct system.

Concentrate – The concentrated solution containing constituents removed or separated from the feedwater by a membrane water treatment system. Commonly in the form of a continuous flow stream.

Energy dispersive spectroscopy (EDS) - A group of techniques used to analyze the atomic structure of materials. In laboratory instruments, dispersion of radiation often occurs by the use of a prism or diffraction grating. Normal dispersion occurs when the change in refractive index increases with increasing frequency (decreasing wavelength). When the reverse occurs, absorption takes place. The absorption of radiation by materials serves as the basis for a number of types of spectroscopic analyses.

Flux - The volume or mass of permeate passing through the membrane per unit area per unit time.

Fouling - The deposition of material such as colloidal matter, microorganisms, and metal oxides on the membrane surface or in its pores, causing a decrease in membrane performance.

Langelier saturation index (LSI) - Calcium carbonate saturation index computed by the difference between the measured pH and the pH at saturation with calcium carbonate.

Microfiltration (MF) - A pressure driven membrane process that separates particles as small as 0.1-micrometer-diameter from a feed stream by filtration. The smallest particle size removed is dependent of the pore size rating of the membrane.

Natural organic matter (NOM) - A heterogeneous mixture of organic matter that occurs ubiquitously in both surface water and groundwater, although its magnitude and character differ from source to source.

Normalized flux - The permeate flow rate through the membrane adjusted to constant operating conditions.

Not detected (ND) - Compounds not detected in samples analyzed

Not sampled (NS) - A sample was not collected to be analyzed.

Pilot scale – Experiments conducted using 90-120 m³/day unit processes.

Reject or reject stream – For pressure-driven membrane processes, the concentrated solution containing substances that do not pass through the membrane.

Rejection - In a pressure-driven membrane process, a measure of the membrane's ability to retard or prevent passage of solutes and other contaminants through the membrane barrier.

Reverse osmosis (RO) - A pressure-driven membrane separation process that removes ions, salts, and other dissolved solids and nonvolatile organics. The separation capability of the process is controlled by the diffusion rate of solutes through the membrane barrier and by sieving. In potable water treatment, reverse osmosis is typically used for desalting, specific ion removal, and natural and synthetic organics removal.

Scale - Coating or precipitate deposited on surfaces.

Scanning electron microscopy (SEM) – Electron microscope techniques where an electron beam operates as a probe by being deflected across the surface of a specimen coated with gold and palladium.

Silt density index (SDI) - An empirical measure of the plugging characteristics of membrane feedwater based on passing the water through a membrane filter test apparatus containing a 0.45-micrometer pore diameter filter.

Solubility product constant - In a saturated solution at a specified temperature, the equilibrium constant of the dissolution reaction of a solid in water.

Specific flux - The permeate (water) flux divided by the net driving pressure.

State Project water (SPW) - influent water source from Northern California via the California State Water Project.

Trans-membrane pressure (TMP) - The net pressure loss across the membrane. For microfiltration and ultrafiltration with negligible osmotic pressure differential across the membrane, the hydraulic pressure differential from feed side to permeate side.

Total dissolved solids (TDS) - The weight per unit volume of solids remaining after a sample has been filtered to remove suspended and colloidal solids.

Total organic carbon (TOC) - A measure of the concentration of organic carbon in water, determined by oxidation of the organic matter into carbon dioxide. Total organic carbon includes all the carbon atoms covalently bonded in organic molecules.

ACRONYMS

ASTM - American Society for Testing and Materials.

°C - degree Celsius

cm - centimeter

cm² - square centimeter

CRW - Colorado River water

EDS - energy dispersive spectroscopy

°F - degree Fahrenheit

ft² - square foot

g - gram

gpm - gallon per minute

hr - hour

hrs - hours

kWh - kilowatt times hour

L - liter

µg/L - microgram per liter

MF - microfiltration

mg/L - milligram per liter

m³ - cubic meter

ND - not detected

NS – not sampled

NOM - natural organic matter

ntu - nephelometric turbidity unit

OCWD - Orange County Water District

ppm - part per million, used interchangeably with mg/L for dilute aqueous solutions

psi - pounds per square inch

RO - reverse osmosis

SEM - scanning electron microscopy

SDI - silt density index

SPW - California State Water Project water

TDS - total dissolved solids

TFC® - Thin film composite

TMP - trans-membrane pressure

TOC - total organic carbon

ULP – ultra-low-pressure

EXECUTIVE SUMMARY

INTRODUCTION

In an effort to reduce the costs of RO and NF treatment, the Metropolitan Water District of Southern California (MWDSC) initiated the Desalination Research and Innovation Partnership to evaluate cost-effective methods to desalinate Colorado River water (CRW), as well as municipal wastewater and brackish groundwater. One option available to lower desalting costs is the use of pre-existing conventional treatment prior to RO treatment rather than membrane filtration. This project evaluated metal chelating agents to prevent aluminum silicate fouling of RO membranes when using conventional treatment (i.e., coagulation, sedimentation, and dual-media filtration) as the pretreatment step.

BACKGROUND

The formation of aluminum silicates requires the presence of both dissolved aluminum and silica. The mineral equilibrium and pH of the solution regulate the concentration and speciation of dissolved silica and aluminum. Many antiscalants designed to control for silica scaling are ineffective against aluminum silicates. Ethylenediaminetetraacetic acid (EDTA) and other chelating agents (e.g., citric acid, oxalic acid, aspartic acid, and salicylic acid) have been suggested to sequester dissolved metals and avoid silicate fouling. While dispersant agents containing phosphonic acid and/or phosphonate functional groups may inhibit pure amorphous silica, they potentially precipitate aluminum as phosphates or phosphonates; thus, they may act as foulants themselves.

EXPERIMENTAL METHODS

Geochemical Modeling

Geochemical modeling was conducted to compute major and trace element speciation and mineral saturation for RO influent water. Predominance area diagrams were used to evaluate the formation tendency of silicate scales on RO membrane surfaces. The assumption was that there was sufficient time to reach equilibrium at the membrane surface. Historical unfiltered raw-water data from Lake Mathews, California, for major ions (data taken between June 1976 and September 2000) and trace metals (data taken between October 1993 and April 1999) were used to model CRW influent and effluent. The RO concentrate data were calculated based on experimental data taken at 85 percent water recovery.

Bench-Scale Testing

For bench-scale testing, CRW (550 mg/L TDS) at pH 6.7 was used, and aluminum nitrate ($\text{Al}(\text{NO}_3)_3 \cdot 9\text{H}_2\text{O}$) was added to raise the aluminum concentration to 200 $\mu\text{g}/\text{L}$. The source water was pretreated prior to the RO unit by a 0.2 μm nominal pore size microfiltration membrane. No chloramine residual was maintained in the influent water. A 20-gal (76 L) reservoir was used to store the MF effluent prior to RO treatment. Combinations of citrate (34 mg/L), EDTA (16 mg/L), and antiscalant were added to the RO influent to sequester the aluminum via chelation.

Three identical, closed-loop, bench-scale RO units were used during this phase of testing. The bench-scale RO testing used spiral-wound, thin-film-composite, polyamide membranes. For each experiment, the final water recovery was set at 95 percent (i.e., from 20 gal [76 L] to 1 gal [3.8 L]) in order to accelerate the scale formation. Throughout the experiment, the operating pressure and concentrate flow rate were maintained at 80 psi and 0.85 gpm, respectively. The RO unit recycled the concentrate flow and discarded the permeate flow.

RESULTS AND DISCUSSION

Geochemical Modeling

Modeling results showed that the total dissolved aluminum was 99 percent in the form of $\text{Al}(\text{OH})_4^-$ at pH 8.2. Because $\text{Al}(\text{OH})_4^-$ at pH 8.2 would be converted to Al^{3+} at pH 7.0, Al^{3+} was the sole important ion in aluminum silicate formation in CRW. Potential aluminum silicates that could be precipitated in the influent and effluent of an RO system at 85 percent water recovery were kaolinite and muscovite ($\text{KAl}_2(\text{Si}_3\text{Al})\text{O}_{10}(\text{OH},\text{F})_2$). The general equation for kaolinite formation is:



For CRW, the concentrations for major cations exhibited the following pattern in both the RO influent and effluent: $\text{Na} > \text{Ca} > \text{K}$. Therefore, theoretically, kaolinite would precipitate before muscovite in the presence of either calcium or potassium. The modeling of the concentrate also showed that Ca–montmorillonite ($\text{Ca}_3(\text{Al},\text{Mg})_2\text{Si}_4\text{O}_{10}(\text{OH})_2 \cdot n\text{H}_2\text{O}$), Na–beidellite ($\text{NaAl}_2(\text{Si},\text{Al})_4\text{O}_{10}(\text{OH})_2 \cdot n\text{H}_2\text{O}$) and K–feldspar (KAlSi_3O_8) might also be formed when the solution reached saturation.

Bench-Scale Testing

SEM data showed a clay-like coating on the RO membrane surfaces for most experiments using excess aluminum (Figure E1). Notable exceptions were experiments using citrate and EDTA alone, in which both samples showed white grains on the membrane surface, with little other foulant present. These grains may

have been calcium carbonate or calcium sulfate scales, as no protection against these foulants (i.e., a commercial antiscalant) was present. The clay-like coating may be a mixture of both aluminum silicates and aluminum hydroxides. EDS detected aluminum on the membrane surface for all but the citrate-treated sample. For this sample, the visual evidence supports the lack of aluminum silicate fouling based on the absence of semi-porous, clay-like material on the membrane surface. In addition, citrate demonstrated superior performance in keeping aluminum in solution, which may have prevented aluminum from precipitating as either a silicate or hydroxide material. While no visual evidence of aluminum silicate was observed on the EDTA-treated sample, EDS data detected the presence of both aluminum and silica on the membrane surface. Therefore, both citrate and EDTA demonstrated good aluminum silicate preventive properties, citrate more so than EDTA.

The combination of the commercial antiscalant and citrate showed the strong presence of aluminum and silica on the membrane surface despite this combination's ability to keep aluminum in the soluble form. The commercial antiscalant/EDTA combination also showed the presence of aluminum in excess of the generic antiscalant alone, though no silica was detected. These data suggest that phosphorous, a key inorganic component of the commercial antiscalant, may have reacted with the soluble aluminum to form an insoluble precipitate. The basic reaction involved in the precipitation of phosphorus and aluminum follows:



CONCLUSIONS

Geochemical data developed through this project showed that aluminum silicate scale formation is thermodynamically plausible, with kaolinite and muscovite being the most likely silicate end products. Based on the limited experimental data, citrate and EDTA may effectively act as aluminum sequestering agents that may lead to the prevention of aluminum silicate or hydroxide scaling. Adding a commercial antiscalant did not improve the generic chemicals' ability to control for aluminum silicate fouling, and may be a contributing factor in aluminum-based scalant formation. Three different forms of aluminum-based foulants were potentially identified during this project: (1) aluminum silicates, (2) aluminum hydroxides, and (3) aluminum phosphates. Further research is needed to confirm the presence of any one of these compounds—preferably through crystallography or X-ray diffraction spectroscopy. Finally, alternative methods of controlling aluminum, such as alum coagulation at reduced pH or ferric-based coagulation, need to be explored.

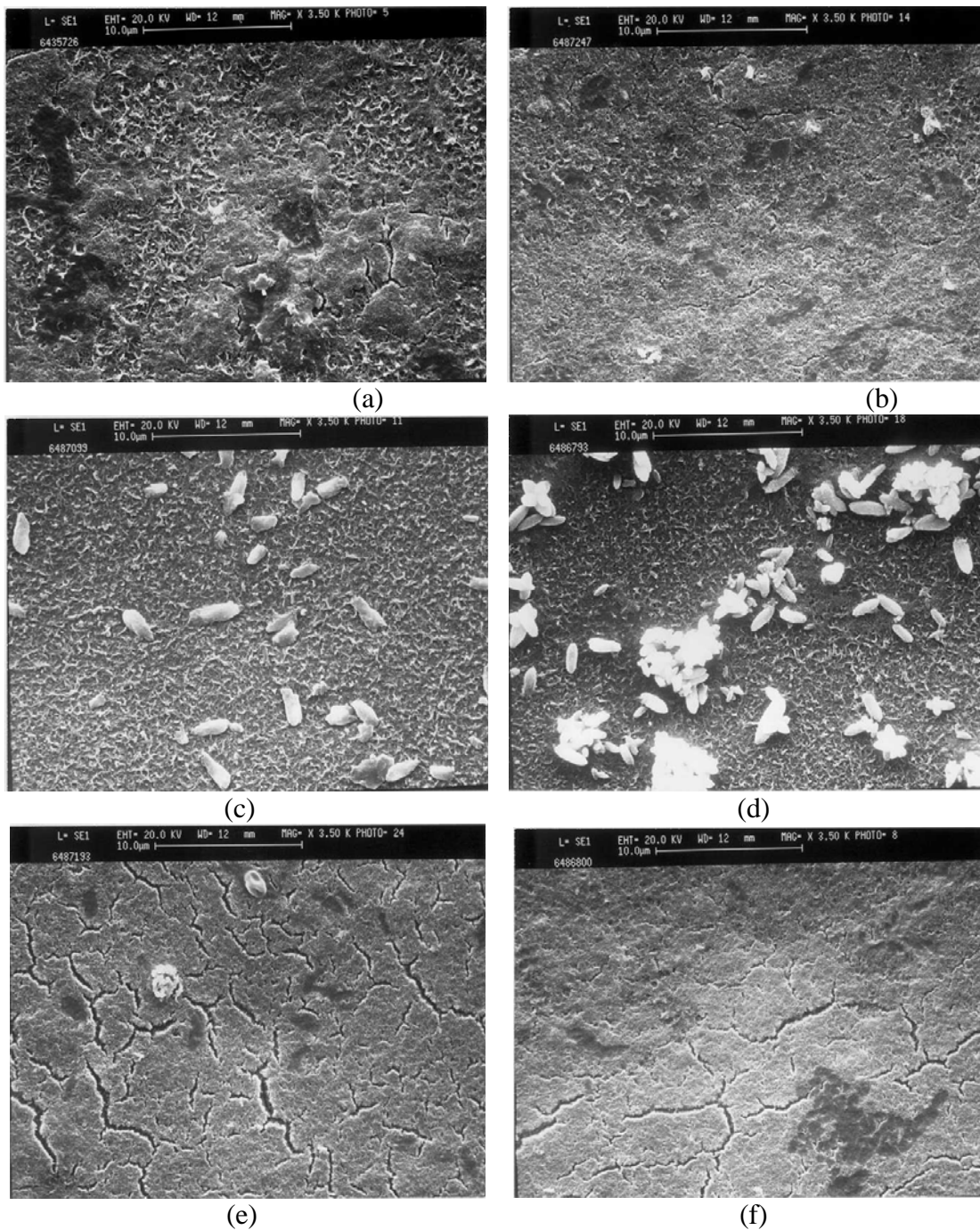

Figure E1. SEM micrographs (3,500 x magnification) of fouled RO membranes: (a) control, (b) Commercial antiscalant [CA], (c) citrate, (d) EDTA, (e) CA/citrate, (f) CA/EDTA. Source water included 170 µg/L aluminum and 10 mg/L silica.

1. INTRODUCTION

The total dissolved solids (TDS) of Colorado River Water (CRW) cause an estimated \$159 million in damage per year to Southern California's agricultural, industrial, commercial, utilities, and residential sectors (Metropolitan 1998). However, reducing the TDS of CRW—by reverse osmosis (RO) treatment of a portion of the total flow—costs at least \$0.92/1,000 gallons (\$0.24/m³) and is considered too high to be economically viable at a large scale (Metropolitan 1997). Because membrane concentrate treatment represents one-third of this cost, water recoveries of at least 85 percent are desired to minimize the concentrate volume. As water recoveries increase, however, RO membranes suffer from precipitative fouling when the concentrations of certain inorganic species increase beyond their solubility potential. Some of these foulants (e.g., barium sulfate or calcium carbonate) are easily predictable and have well established—though expensive—control methods such as pH adjustment or antiscalant addition. Other foulants such as aluminum silicate are less tractable and may contribute to precipitative fouling prior to stoichiometric predictions. Fouling of RO membranes places a large economic restriction on membrane plant operation. Hence, a fundamental understanding of the factors controlling the fouling of RO membranes is of paramount practical importance.

This project was conducted as a joint effort between the Metropolitan Water District of Southern California (Metropolitan) and the University of California at Los Angeles (UCLA). This research will assist municipalities to minimize the cost of CRW salinity reduction and may also be applicable to other surface water supplies.

1.1. Scale Potential of Colorado River Water

At 85 percent water recovery, the CRW reject stream would have a TDS of 4,200 mg/L, a Langelier Saturation Index (LSI) of +2.5 and a barium sulfate saturation ratio of 93. Therefore, CRW has a strong potential to scale from both calcium carbonate and barium sulfate. Historically, control methods against calcium carbonate scaling included pH depression and/or antiscalant addition; control methods against barium sulfate scaling were through antiscalant addition alone (because the precipitation of barium sulfate is not pH dependant). However, to reduce operating costs, further research is needed to determine the effects of pH control and/or antiscalant addition on scaling inhibition.

Recent experience with Metropolitan's pilot-scale RO unit using ultra-low-pressure elements at 85 percent water recovery revealed unanticipated scaling problems with aluminum silicate when treating CRW (Gabelich et al. 1999, Gabelich et al. In Press). Additionally, the analysis of the feedwater indicated that acid and antiscalant were needed to avoid potential scaling problems with barium sulfate and calcium carbonate. The use of these chemicals for RO plants on the order of 100 million gallons per day (mgd) [378,541 m³/day] will lead to very high operating costs (e.g., the cost of acid and antiscalant addition would be \$1,100 and \$2,900 per day, respectively).

Modeling programs have shown that CRW only reached 60 percent of the solubility limit for silica (Gabelich et al. 1999). However, the unique water chemistry

present in CRW may alter this relationship because Metropolitan experienced unexpected silicate fouling on the RO membranes, which may have resulted from the formation of aluminum or iron silicates. Control strategies for silica fouling may prove ineffective for use with CRW, since silica-specific antiscalants control for amorphous silica rather than metal silicates.

1.2. Project Objective

Scale control strategies for calcium carbonate and barium sulfate are well documented (Bersillon and Thompson 1996, Boffardi 1996, Darton 1997). However, significant cost savings can be achieved by optimizing the scale-control method. Unfortunately, most utilities do not have adequate resources to evaluate every option; often, the first empirical success is chosen as the primary option.

Non-traditional scales such as silicates may be the limiting step to achieving greater than 85 percent water recovery. Additionally, non-traditional scalants may serve as nucleation sites for more traditional scaling. The primary objective of this work was an improved understanding of the factors which contribute to aluminum and iron silicate scalants. A secondary objective was to develop strategies to minimize the cost of controlling for the primary scalants in CRW (i.e., barium sulfate and calcium carbonate).

1.3. Specific Goals of Research

The goal of this research was to improve the understanding of the physical-chemical processes involved during the formation of inorganic scales such as barium sulfate, calcium carbonate, and aluminum silicate using CRW. Research for this project was conducted through four (4) tasks. The tasks were as follows:

Task 1. Characterize Colorado River water

- Conduct detailed analytical analysis of scaling components in CRW.
- Compare findings with relevant published literature.

Task 2. Characterize the role of multivalent ions (Fe^{3+} and Al^{3+}) in silicate scaling

- Survey the appropriate literature and evaluate case studies of other CRW membrane applications for silicate scale problems.
- Develop a model to more accurately predict the formation of silicate scaling in waters containing multivalent ions.
- Validate the model using pilot-plant data collected at 85 percent water recovery using CRW.

Task 3. Bench-Scale Antiscalant Testing

- Identify new process parameters or chemical additives which may lower the chemical costs of pretreatment.
- Select representative samples of different types and classification of antiscalants.
- Obtain antiscalant samples and test their effectiveness on concentrate with a flat-sheet membrane test unit.

Task 4. Demonstrate antiscalants (pilot-scale)

- Evaluate the most promising antiscalants from Task 3 for scale inhibition.
- Determine scale formation inhibition through microscopic analysis such as energy-dispersive spectroscopy and scanning electron microscopy.

2. CONCLUSIONS AND RECOMMENDATIONS

2.1 General Conclusions

Based on results obtained from this project, the following conclusions regarding scale inhibition of CRW are offered:

- The primary scalants of concern were calcium carbonate and barium sulfate. The degree of scaling from these constituents was predicated on source water quality and the water recovery. Historical records for CRW salinity show that the TDS ranged between 540 and 710 mg/L, with hardness trending linearly with TDS.
- CRW quality is dependent on the diversion point along the Colorado River. As water flows down the river, the TDS and its associated constituents increase; therefore the scaling potential of CRW increases for municipalities desalting CRW in the lower reaches of the river.
- In addition to calcium carbonate and barium sulfate, aluminum silicate scaling in the form of kaolinite and/or muscovite is thermodynamically possible. Additional silicate forms include Ca-montmorillonite, Na-beidellite and K-feldspar. These silicate scalants can occur during reverse osmosis treatment even at relatively low, influent silica concentrations (~10 mg/L as silica) when sufficient aluminum is present (greater than 0.05 mg/L of aluminum).
- The primary forms of total dissolved aluminum and silica were $\text{Al}(\text{OH})_4^-$ and H_4SiO_4 , respectively. The presence of these two dissolved forms, irrespective of the presence of secondary cations (such as calcium or magnesium), was conducive to the formation of aluminum silicates.
- A potential mitigation strategy for aluminum silicate scale formation is through the use of complexing agents to bind with the dissolved aluminum.

Potential aluminum complexing agents include pyrocatechol violet, oxalic acid, citric acid, salicylic acid, aspartic acid, and ethylenediaminetetraacetic acid (EDTA). Bench-scale experiments confirmed that both citric acid and EDTA might be effective in preventing the aluminum silicate scales. However, when both citrate (chemically similar to citric acid) and EDTA were used in tandem with a phosphonate-based antiscalant, aluminum silicate fouling was observed. The phosphate component of the commercial antiscalant may have reacted with the dissolved aluminum to form an aluminum phosphate foulant, which may serve as an intermediate step towards aluminum silicate fouling.

- In order to increase the scaling potential of the blended water, artificial salts (barium chloride and aluminum chloride) were added to the treatment train influent to mimic conditions seen at the effluent of a conventional treatment plant treating 100 percent CRW. Flux across the entire RO unit declined rapidly upon addition of the artificial salts. It was hypothesized that the added aluminum reacted with the antiscalant and precipitated on the front elements and as the aluminum moved through the RO system, it further reacted with the ambient silica to form aluminum silicates. Lastly, since a portion of the antiscalant was bound by the aluminum, unbound barium then precipitated as barium sulfate scale in the terminal RO elements.
- Attempts to replicate the RO operation conditions that led to earlier aluminum silicate fouling episodes were unsuccessful. Changes in water quality did not lead to favorable aluminum silicate formation conditions.

2.2 Recommendations

Based on results obtained from this project, the following recommendations regarding scale inhibition of CRW are offered:

- The actual source water needs to be evaluated at the worst-case conditions in order to adequately gauge the scaling effects inside a RO process at a given water recovery. Barium sulfate scale was demonstrated to be problematic in simulated CRW at 85 percent water recovery. However, only limited data was collected due to the inability to obtain the desired target water (i.e., CRW).
- Additional research is needed to validate the scaling potential of aluminum silicate materials. Three potential forms of aluminum-based foulants were identified during this project: (1) aluminum silicates, (2) aluminum hydroxides, and (3) aluminum phosphates. However, further research is needed to confirm the presence of any one of these compounds — preferably through crystallography or x-ray diffraction spectroscopy. Additionally, due to differences in the aluminum content between 100 percent CRW and CRW blends with California State Project water—which has a higher aluminum content—, it was uncertain if aluminum scaling is a function of water quality or RO operating conditions. However, geochemical data developed through

this project showed that aluminum silicate scale formation is thermodynamically plausible.

- Once the proper aluminum-scale formation conditions are determined, additional research is needed using both commercial and generic antiscalants to determine the optimal mitigation strategy. Preliminary research developed under this project suggested that phosphonate-based commercial antiscalants might react with soluble aluminum to form an aluminum phosphate foulant, which then may lead to subsequent aluminum silicate fouling. Further research is needed to confirm this phenomena.
- Pilot-scale research under this project focused on RO operating conditions of only 85 percent water recovery. However, if RO treatment on the large-scale is instituted in the arid Southwest, higher water recoveries will need to be obtained in order to conserve limited water resources. One possible method for increasing the overall RO system water recovery is through improved antiscalant products. Therefore, additional research is needed to develop advanced antiscalants that have improved scale prevention properties and allow for higher recovery RO treatment.

3. BACKGROUND

The unique properties of RO membranes to reject inorganic species while passing relatively pure water has led to the widespread use of membrane processes to treat various water sources. When excessive water is passed through the membrane (i.e., the water recovery is too high), this concentration process continues until a limiting salt exceeds its solubility and scaling occurs (Taylor and Jacobs 1996). Scaling reduces membrane productivity and limits water recovery within the membrane system. As a result, scaling is an important consideration in the operation of RO membranes.

The rejection of ionic solutes by RO membranes has been observed to approximately follow the lyotropic series (increasing rejection with increasing size of the hydrated ions) (Wiesner and Buckley 1996). The lyotropic series predicts that the rejection of cations by RO membranes should obey the following order:

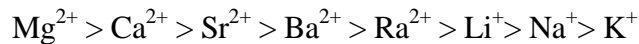

and similarly, anion rejection should occur in the following order:

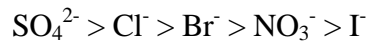

In general, salts composed of divalent ions (e.g., calcium sulfate) are typically less soluble than those composed of monovalent ions (e.g., sodium chloride). Therefore, those salts that are best retained by RO membranes are also those salts that have the greatest potential to precipitate onto the membrane. One mitigating factor to this phenomena is that many ions, such as magnesium or strontium, may not be present in the feed water at sufficient concentrations to be of concern even when they are concentrated by a factor of 5 to 6 times.

The solubility product, K_{sp} , for precipitated species can be expressed as a function of the concentration of resulting ion pair, where:

$$K_{sp} = \gamma_A^x [A^{y-}]^x \gamma_B^y [B^{x+}]^y \quad (3.1)$$

Where $\gamma_{A,B}$ are the free ion activity coefficients of the cation (A) and anion (B), [A] and [B], and x and y are the molar concentrations in solution and the stoichiometric coefficients for precipitation reaction of A and B (Wiesner and Aptel 1996). In general K_{sp} values are derived empirically. For dilute solutions, as seen in most natural waters, the activity coefficients approach unity (1). However, as the concentration of ionic species increase during the membrane process, the activity coefficients may decrease slightly.

Another key consideration in determining the scaling potential is the ionic strength of the water. As the water recovery increases, so too does the ionic strength of the water; allowing for increased apparent ion solubility. A general equation to approximate ionic strength follows:

$$u = 0.5 \sum C_i Z_i^2 \cong (2.5 \times 10^{-5})(TDS) \quad (3.2)$$

where u = ionic strength (mol/L)

C_i = mol/L of each constituent

Z_i = ion charge of each constituent

TDS = total dissolved solids (mg/L)

A common transform of the solubility product to evaluate an ion pair's precipitation or scaling potential is the concept of saturation or solubility ratio. Saturation ratios can be expressed as follows:

$$[A][B]/K_{sp}(AB) \quad (3.3)$$

where $K_{sp}(AB)$ is saturated ion pair concentration. Therefore, saturation ratios greater than 1.0 indicate a potential fouling problem due to exceeding the solubility of a specific ion pair. Concentration of scale-forming species may occur due to two phenomena: (1) bulk concentration of salts as water permeating through the membrane is removed from the salt solution; and, (2) concentration polarization (Wiesner and Buckley 1996). Common foulants of concern include calcium, barium, magnesium, and other metals. Precipitates of these species are most commonly carbonates, sulfates, and hydroxides.

The scaling potential for calcium carbonate, a common scalant in most source waters, is often expressed in terms of Langelier Saturation Index (LSI) (Langelier 1936, Langelier 1946). Langelier originally developed the concept of LSI for corrosion protection by calcium carbonate on the interior of pipes; however, it has since been used to describe the calcium carbonate fouling potential of concentrated waters. The fundamental reaction in the LSI equation is (Faust and Aly 1998):

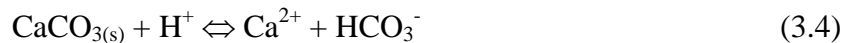

The LSI is calculated from:

$$LSI = pH_{ac} - pH_s \quad (3.5)$$

where pH_{ac} = actual pH value of the water

pH_s = is the equilibrium pH value once transformed into log form:

$$pH_s = pCa^{2+} + pHCO_3^- + pK_E \quad (3.6)$$

where

pCa^{2+} = equilibrium calcium content

$pHCO_3^-$ = total alkalinity when the pH value is less than 9.5

pK_E = arithmetic difference between pK_2 (second protolysis constant for H_2CO_3) and pK_s (solubility product constant for $CaCO_{3(s)}$), or more commonly referred to as the log of the equilibrium constant (K_E) from equation (3.4):

$$K_E = [Ca^{2+}][HCO_3^-]/[H^+] \quad (3.7)$$

When the pH_{ac} is greater than the pH_s , positive LSI values are obtained and the water has the potential to precipitate calcium carbonate.

Once the salt solubility is exceeded, scale formation ensues. Scale formation involves three basic stages (Darton 1997):

1. Ions start to cluster near the membrane surface as proto-nuclei of up to 1000 atoms as the ion concentration increases;
2. The proto-nuclei grow as concentration increases and the ions start ordering themselves into regular shaped nuclei; and,
3. Finally, crystals are formed from the nuclei. Once formed, the crystals continue to grow indefinitely as long as the respective salt solubility limit is exceeded.

3.1 Scale Prevention Strategies

Strategies for avoiding precipitative scaling often include ways of reducing the concentration of either the anion or the cation portion of the ion pair of concern (Bersillon and Thompson 1996, Boffardi 1996, Darton 1997). For example, acid can be added to reduce the concentration of the anionic species such as hydroxide or carbonate that may precipitate with divalent ions (e.g., magnesium hydroxide and calcium carbonate). For example, by adding acid, $[H^+]$, Equation 3.4 is shifted to the right, thereby increasing the solubility of calcium carbonate. Similarly, the solubility of magnesium hydroxide is increased by the addition of acid through the reduction of the hydroxide concentration, $[OH^-]$; thereby shifting the equilibrium to the right (see Equation 3.8):



Lime-soda ash treatment or ion exchange pretreatment may remove the cation component of hardness scales. However these scale control methods typically require multiple pH adjustments and costly solids handling infrastructure.

Both acid addition and water softening processes do relatively little to control for sulfate-based scale. In these cases, antiscalants must be used to impede precipitation. However, the chemistry of antiscalant effectiveness is more complicated and less well

understood. Antiscalant selection is important to prevent ions from precipitating out of solution. Scale inhibitors (antiscalants) function by one or more of the following mechanisms (Darton 1997):

1. Threshold effect: sub-stoichiometric amounts of antiscalant prevent the precipitation of salts that have exceeded their solubility limit;
2. Crystal distortion effect: interference to normal crystal growth thereby producing an irregular crystal structure with poor scale forming potential; and,
3. Dispersancy: a surface charge is placed on the crystal, thereby causing the crystals to repel one another.

Polyacrylates, phosphonates, and to a lesser extent hexametaphosphates are used to control a variety of scales. Often commercial antiscalants are proprietary formulations with a mixture of the above chemicals, as well as other surfactants and chemical agents. Therefore equilibrium constants for most commercial antiscalants are not available and the predicted water recoveries prior to their usage can not be verified.

3.2 Non-Traditional Scales

Based on previous work at Metropolitan's research facilities, silicate scaling was problematic (Gabelich et al. 1999, Gabelich et al. 2000). During these repeated scaling episodes, the normalized permeate flux dropped by an average of 17 percent three times within 850 hrs of operation. The fouling occurred in the last array as evidenced by a drop in permeate flow in the last array of 4-in. elements from 1.2 gallons per minute (gpm) to less than 0.2 gpm. Energy dispersion spectroscopy (EDS) analysis taken of the foulant showed 51 percent silica, 26 percent calcium, 17 percent aluminum, and 3 percent iron. In addition, the white, gritty precipitate was insoluble in strong acid (1:1 mixture of concentrated nitric and hydrochloric acid) and showed no evidence of effervescence. These data indicated that the scale was not calcium carbonate or aluminum hydroxide in nature. Carbon ash analysis indicated that the scalant was not microbial in nature (3 percent carbon and 78 percent ash content). Based on these data and water quality analysis data, it was suggested that the foulants were aluminum silicates. This finding was unanticipated due to the low levels of silica in the feedwater (~10 mg/L).

Silica solubility has limited RO applications in many parts of the world by lowering the water recovery of membrane systems (Amjad et al. 1997). Areas affected include the western United States, Hawaii, Puerto Rico, Mexico, and Southeast Asia. However, waters in these areas have silica levels exceeding 30 mg/L. Both CRW and California State Water Project water (SPW), the primary imported water supplies for Southern California, have silica concentrations of 10 to 15 mg/L, respectively. Therefore, when silica in either CRW or SPW is concentrated in an RO system operating at 85 percent water recovery, it does not exceed the silica solubility limits of approximately 100 to 150 mg/L (Amjad et al. 1997).

A review of the silica scaling literature revealed that silica in the presence of multivalent ions (e.g., aluminum or iron) may precipitate at much lower levels than expected (ASTM 1989a, Weng 1994, Ning 1997). Weng (1994) showed that iron and

aluminum levels greater than 0.05 mg/L can adversely affect silica solubility despite the addition of antiscalants. Lake Mathews, the southern terminus of the Colorado River aqueduct, contains upwards of 0.05 mg/L aluminum. Additionally, as a stop-gap measure to control the salinity, Metropolitan blends SPW with CRW to achieve a 500 mg/L TDS goal. SPW contains upwards of 0.18 mg/L natural aluminum, resulting in an aluminum concentration in the blended water of approximately 0.09 mg/L. These elevated aluminum levels in the presence of naturally occurring silica have proved to be a substantial impediment to the use of RO for treating CRW.

Silica, or silicates, can act as nucleation sites for further fouling by calcium carbonate or barium sulfate, and may even increase the rate of biological or organic fouling. The inverse of this relationship is also true where the presence of biological or organic foulants may increase the rate of precipitative fouling (ASTM 1989a). The presence of multivalent ions such as Mg^{2+} , Al^{3+} , Fe^{3+} , Fe^{2+} , Ca^{2+} , and others affects silica solubility (Iler 1979, ASTM 1989a, Hann 1993). Previous work in the industrial sector developed concentration guidelines to determine silica solubility in the presence of magnesium for cooling tower waters (Hann 1993, Weng 1997). However, similar relationships for iron and aluminum were not found in the literature. If these relationships were better understood, control strategies could be developed to allow CRW users, as well as those with similar water quality, to meet or exceed the 85 percent water recovery goal.

Results from Metropolitan's in-house studies indicated that the silicate-fouling problem was partially due to low cross-flow across the membrane surface of the last element in the system. Colloidal particles such as silica will tend to deposit onto the membrane surface if sufficient cross-flow is not maintained (Wiesner and Aptel 1996). Therefore, Metropolitan recirculated a portion of the concentrate stream to increase the flow rate in the last element and still maintain 85 percent recovery. This higher cross-flow rate reduced the fouling in that element. However, recycle increases the operational pressure of the unit, resulting in increased cost to manufacture clean product water. If the silica-aluminum chemistry was better understood, alternative measures may be implemented and the cost of operating a RO system using CRW may be reduced.

4. EXPERIMENTAL METHODS

This section details the experimental methods used for each of the four project tasks: (1) characterize Colorado River water; (2) characterize the role of multivalent ions (Fe^{3+} and Al^{3+}) in silicate scaling; (3) screen antiscalants on the bench scale; and (4) demonstrate antiscalants on the pilot scale.

4.1 Task 1 Characterize Colorado River Water

Metropolitan operates five (5) full-scale drinking water treatment plants in Southern California, with the ability to treat over 2.5 billion gallons of water per day [9.5 Mm³/day]. In order to meet State and Federal water quality regulations, Metropolitan tests over 200,000 water samples per year at its Water Quality Laboratory in La Verne, California. Through Metropolitan's historical database, CRW water quality was characterized at Lake Mathews, the terminus for the Colorado River aqueduct

system. Metropolitan has detailed historical records of water quality parameters including pH, temperature, complete cations and anions, trace metals, TDS, hardness, alkalinity, and organic content. These data were tabulated into 90th, 50th, and 10th percentiles to gauge the probability of reaching certain salinity levels. Historical data from the U.S. Geological Survey was also used to evaluate changes in salinity along the Colorado River (Alexander et al. 2000).

The water quality constituents from Lake Mathews were analyzed according to the methods described in the most current version at the time of *Standard Methods for the Examination of Water and Wastewater* (APHA, AWWA, and WEF 1998) whenever possible. For a complete listing of analytical methods, see Appendix A. The scaling potential of CRW at various salinity levels was evaluated using commercially available software (RoPRO 6.0, Fluid Systems, San Diego, Calif).

4.2 Task 2 Characterize the role of multivalent ions in silicate scaling

4.2.1 Modeling methods

Predominance area diagrams and solubility diagrams were used to evaluate the formation tendency of silicate scales on RO membrane surface. Three types of waters were evaluated: (1) CRW influent to the water treatment plant; (2) the effluent from traditional water treatment (which can be viewed as RO influent); and (3) RO concentrate from a RO system operating at 85 percent water recovery using CRW as the feed water. The latter two waters, the effluent and the concentrated effluent, may be used as an estimation of ion concentrations near the RO membrane surface. Historical unfiltered raw water data of major ions (data taken between June 1976 and September 2000) and trace metals (data taken between October 1993 and April 1999) were used for CRW influent and effluent. The RO concentrate data were calculated based on experimental data taken at 85 percent water recovery.

Geochemical modeling (WATEQ4F) was conducted to compute major and trace element speciation and mineral saturation for RO influent water (Ball and Nordstrom 1991). While the model was originally developed for inorganic geochemistry in natural water systems, it also has practical applicability to water treatment systems. However, since the RO scaling problem in CRW involves precipitation-dissolution reactions of metals and inorganic constituents in water, geochemical modeling was used to calculate mineral scaling potentials of the RO influent water at equilibrium. The model uses the ratio of ion activity product (γ_P):

$$\gamma_P = \gamma_i C_i \times \gamma_{ii} C_{ii} \quad (3.8)$$

where C_i = individual ion concentration

γ_i = individual ion activity coefficient

and equilibrium constant (K_{sp}) of a mineral to indicate the degree of saturation of the mineral phase. For example, the larger the ratio of (γ_P/K_{sp}), the higher the deposition potential at thermodynamic equilibrium. The geochemical modeling also calculated the

concentrations of different species of various elements in the system based upon the total concentration of that element and all possible mineral reactions that may be involved. The element speciation calculation predicted the prevalent element forms and may help identify the major reactions leading toward scaling. Water quality data of RO influent from CRW with microfiltration pretreatment in bench-scale tests (Task 3) were used for the numerical modeling.

4.2.1 Evaporation Experiments

CRW water after conventional treatment and microfiltration was collected and stored in the cold room at 4⁰C. Three liters of water samples were placed in three one-liter beakers for each evaporation test. The pH of the water was adjusted to 7.0 with HCl before evaporation. Evaporation was conducted in an oven with automatic temperature control. Approximately five days were needed for each evaporation test. As the water level dropped, samples were combined into one beaker. When the total water sample was reduced to about 300 mL, the beaker of remaining water was allowed to crystallize at room temperature for one day. Then, the pH was measured. Precipitates were collected on nitrocellulose filter paper with pore size of 0.45 μm, and were dried in a jar with CaCl₂ desiccant. The dried precipitate was sent to a UCLA laboratory for powder X-ray diffraction.

4.3 Task 3 Bench-Scale Antiscalant Testing

4.3.1 Source Water

Three source waters were used during this phase of testing: (1) a blend of 64 percent CRW and 36 percent SPW at ambient pH (pH 8.0); (2) 100 percent CRW water at ambient pH (pH 8.2); and (3) 100 percent CRW water adjusted to pH 7.0 using sulfuric acid. The source water was pretreated prior to the RO unit by a 0.2 μm nominal pore size microfiltration membrane (Aqua Pro Membranes, Gardena, Calif.). A 2.0 to 2.5 mg/L chloramine residual was maintained in the MF influent (3:1 w/w ratio of chlorine to nitrogen). The TDS of the three source waters ranged from 450 to 550 mg/L. A 20-gallon [76 L] reservoir was used to store the MF effluent prior to RO treatment.

For bench-scale testing with added aluminum, CRW at pH 6.7 was used and aluminum (Al(NO₃)₃·9H₂O, Fluka Chemical Corp., Milwaukee, Wisc.) was added to raise the aluminum concentration to 200 ppb. No chloramine residual was maintained in the influent for the aluminum study. Generic antiscalants from Task 3 were added to the RO influent to sequester the aluminum via chelation.

4.3.2 Bench-Scale Reverse Osmosis Unit

Three identical closed-loop, bench-scale RO units were used during this phase of testing (see Figure 1). The bench-scale RO testing used spiral-wound, thin-film-composite, polyamide membranes (Energy Saving Polyamide ESPA1-2012,

Hydranautics, San Diego, Calif.). The dimensions of each element were 1.8 in. [4.6 cm] diameter by 12 in. [30 cm] long, with 4.8 ft² [4,500 cm²] of membrane surface area per element. Prior to testing, each RO element was soaked in deionized water for 3 hrs. The RO elements were then placed in the RO unit and flushed with 10 gal [39 L] of deionized water for 1 hr, followed by a second flush with deionized water for an additional 3 hrs in order to equilibrate the permeate flux and salt rejection of the RO membranes under normal operating pressure (80 psi) [552 kPa] and constant concentrate flow (0.85 gpm) [3200 mL/min].

For each set of experimental variables (e.g., water type) an experimental control test was conducted. The experimental controls consisted of operating the RO unit at normal pressures and flow rates but without any antiscalant. Therefore, the scale formation without the presence of antiscalant in target water can be evaluated.

For each experiment, the final water recovery was set at 95 percent in order to accelerate the scale formation. Throughout the experiment, the operating pressure and concentrate flow rate were maintained at set values (80 psi) [550 kPa] and 0.85 gpm [3200 mL/min], respectively). The RO unit recycled the concentrate flow and discarded the permeate flow. Ninety-five percent water recovery (from 20 gal [76 L] to 1 gal [3.8 L]) was typically reached within 9 hrs. Permeate flow rate was recorded every hour. The feed, permeate, and concentrate temperature and conductivity were also measure hourly. Once 95 percent water recovery was reached, the RO unit was shut down and the RO elements as well as the final concentrate were collected for analysis. All samples taken were stored in refrigerator for further analyses. The unit was then flushed with tap water to remove any residual solution.

4.3.3 *Antiscalants*

Eight commercial antiscalants and six generic antiscalants were evaluated to determine their efficacy for scale inhibition (see Table 1). The dosage for each commercial antiscalant was calculated using the corresponding antiscalant vender's software and CRW water quality data. The chemical dosage for each of the generic antiscalants was based on published data and stoichiometric modeling. All commercial and generic antiscalants were added to the RO feed tank.

For testing of both generic and commercial antiscalants for the efficacy of preventing aluminum silicate scaling, microfiltered CRW at pH 7.0 was the influent for this study. Aluminum (1.4 g Al(NO₃)₃·9H₂O to 175 gallons [662 L] of CRW) was added to the influent to raise the aluminum concentration to 200 ppb. This study compared three different antiscalants (PT-1.6, EDTA-16 and SC-34), alone and in combination (PT-1.6/EDTA-16 and PT-1.6/SC-34).

4.3.4 *Analytical Methods*

The RO feed, permeate, and concentrate were analyzed for trace metals (Al, As, Ba, Fe, Mn, Sr), cations (Ca, Mg, Na, and K), anions (F, NO₃, and SO₄), TDS, alkalinity, hardness, and silica. All water quality samples were filtered through a 0.45 µm cellulose acetate membrane (0.45 µm HA, Millipore, Mass) to separate precipitated and colloidal

solids from dissolved species. All membranes, retentates, and filtrates were preserved for documentation and further analysis.

Free and total chlorine was measured using Standard Method 4500-Cl G (APHA, AWWA, and WEF 1998). For all free chlorine samples, 200 µl of 0.03 N thioacetamide solution per 10 mL of sample was added to control for interference by monochloramine.

4.3.5 *Membrane Autopsy*

Upon completion of each pretreatment evaluation phase, the terminal RO element was autopsied by Metropolitan personnel. Swatches of membrane material were collected and sent to independent laboratories for microscopic analysis. The following analyses were conducted:

Scanning Electron Microscopy (SEM) was conducted by the Scripps Oceanographic Institute in La Jolla, Calif. using a Cambridge Instruments Model 360 (Leo Electron Microscopy, Thornwood, New York). Membrane samples were prepared for top surface views by cutting a small piece of membrane and then attaching it to an aluminum mount with double-stick tape. Cross-sections were prepared by fracturing a small strip of the membrane while in a liquid nitrogen bath; this was also attached to an aluminum mount. The mounted sample was sputter-coated with a 30 nm layer of gold and palladium (Goldstein et al. 1992).

Energy Dispersive Spectroscopy (EDS) was conducted in concert with the SEM by the Scripps Oceanographic Institute (Oxford Instruments Model QX2000, Concord, Mass.). The membrane sample for EDS analysis was attached to a graphite mount with graphite tape; there was no coating on the sample. This technique was used because graphite is not detected by EDS and does not interfere with atoms being measured in the sample (Goldstein et al. 1992).

4.3.6 *Calculated Values*

In order to assess the performance of the pretreatment and salinity reduction steps, several key values were calculated based on raw process data. These calculated values include silt density index (SDI) and specific normalized flux, and salt passage (see Appendix B).

4.4 Task 4 Demonstrate Antiscalants

An 18-gpm [98 m³/day) RO unit using ultra-low-pressure polyamide membranes was evaluated for salinity removal. During this testing, the RO unit was operated at a constant operating flux and water recovery. The performance of the RO unit was assessed through operational and water quality data, as well as membrane surface characterization techniques.

4.4.1 Pretreatment

Pretreatment to the RO unit was provided by a 22 gpm [120 m³/day] microfiltration unit (Model 3M10C, U.S. Filter/Memcor, Timonium, Maryland). The MF unit contained three parallel polypropylene, hollow-fiber membrane modules (0.2 μm nominal pore size; 14.9 m² of outside surface area per module) that filters water in an outside-in direction and was operated in dead-end mode. The net driving pressure ranged from 6 to 10 psi [41 to 69 kPa] yielding a filtrate flow rate of 20 gpm [110 m³/day] at a flux rate of 60 gfd [0.10 m/hr]. Air scour backwashing was programmed for every 22 min. A 2.0 to 2.5 mg/L chloramine residual was maintained in the MF feed using sodium hypochlorite and ammonium sulfate (3:1 w/w chlorine-to-ammonia ratio). A chlorine analyzer (Hach Company CL-17 chlorine analyzer, Loveland, Colo.) was connected to the MF unit's programmable logic circuit such that the MF unit would shut down when the free chlorine residual exceeded 0.5 mg/L in the pretreatment effluent; thereby, preventing free chlorine from coming in contact with the MF and RO membranes. Turbidity data for the microfiltration unit were taken in batch samples using a Hach 2100N Turbidimeter (Hach Company, Loveland, Colo.). Effluent particle count data (IBR Online Particle Monitoring System, Inter Basic Resources, Inc., Grand Lakes, Mich.) were taken directly after the filtration step. All particle count data were collected once per minute. SDI data were taken just prior to the RO influent.

The microfiltration unit was cleaned prior to the start of this study. The clean-in-place procedure was conducted according to the manufacturer's specifications using an acid followed by a caustic cleaning cycle. Each cleaning cycle took approximately 2 hrs (15-20 min initial recirculation shell, followed by chemical addition with 30 min, 45 min, and 45 min recirculation cycles). The cleaning solution was then drained, and the unit was backwashed three times with raw water. No further cleanings were required during this study phase.

Cleaning solutions were mixed with 40°C RO permeate water. The acidic solution consisted of ten pounds of citric acid per 30 gal at pH 2.0 to 3.0. The caustic solution used 4.2 L of Memclean (U.S. Filter/Memcor, Timonium, Maryland) and 1.7 L of 35 percent hydrogen peroxide. The pH was typically 12.0 to 12.5.

4.4.2 Reverse Osmosis

A three-stage RO unit (Nimbus™ Model PSMWD-1, San Diego, Calif.) was pilot tested throughout this project (see Figure 2). The first two stages used 4-in. diameter pressure vessels with three 4-in. x 40-in. spiral-wound thin-film composite polyamide membrane elements (Koch Fluid Systems TFC-4821ULP, San Diego, Calif.) per vessel. The third stage consisted of two 2 ½-in. pressure vessels in parallel. Each 2 ½-in. pressure vessel housed three 2 ½-in. x 40-in. spiral-wound thin-film composite polyamide membrane elements (Koch Fluid Systems TFC-2540-ULP, San Diego, Calif.). The RO unit was operated between 85 and 90 percent recovery rates (e.g., for 90 percent water recovery, the permeate flow was 16 gpm [87 m³/day] and concentrate flow was 2.0 gpm [11 m³/day] at 98 percent salt rejection) for the duration of the project. Antiscalant (1.6 mg/L Permacare, Permatreat 191, Fontana, Calif.) and sulfuric acid (15

to 27 mg/L) were added prior to the RO influent to minimize scaling. The feed to the RO unit was approximately pH 7.0.

Prior to the start of testing, the RO membranes were cleaned with both acidic and caustic cleaners. The acidic solution was made up of 1.9 lbs. [860 g] of citric acid in 25 gal [95 L] of permeate with a pH of 2.0 – 2.5). The caustic solution was made up of 1.9 lbs. [860 g] of each of the following chemicals: sodium tripolyphosphate, trisodium phosphate, and Na-EDTA in 25 gal [95 L] of permeate water at a pH of 10.0 to 11.0. Additionally, the RO membranes were cleaned when either the specific flux decreased 15 percent, the differential array pressure reached 30 psi [210 kPa], or a significant increase in salt passage was observed. The membranes were cleaned per the RO membrane manufacturer's guidelines.

4.5 Analytical Methods

The water quality performance of the desalination process was based, in large part, on TDS rejection as measured by conductivity. However, other supporting data were collected in the form of hardness, alkalinity, TDS, major cations and anions, trace metals, particle counts, turbidity, temperature, and pH. Table 2 provides an overview of the sample type and frequency. All sampling was conducted by Metropolitan's staff. Inorganic and microbial analyses were analyzed at Metropolitan's Water Quality Laboratory in La Verne, Calif.

Specialized analyzes for membrane characterization (e.g., SEM and EDS) were sent to outside laboratories. In addition to SEM and EDS, infrared spectroscopy was conducted on select membrane samples.

Attenuated Total Reflectance Fourier Transform Infrared (ATR/FT-IR) spectrometry was conducted on both clean and fouled membranes by the Biotechnology Research Department of the Orange County Water District. Adsorption in the mid-infrared range (4000 to 500 cm^{-1}) was measured using a FT-IR spectrometer (Nicolet Magna 550, Nicolet Instruments, Irvine, Calif.) to detect carbonyl, sulfonate, or amine functional groups on the membrane surface. The ATR/IR spectrum from the clean Koch Fluid Systems ultra-low-pressure membrane was digitally subtracted from the fouled membranes to obtain a "pure" spectrum of the foulant [s] (Ridgway et al. 1998).

5. RESULTS AND DISCUSSION

5.1 Task 1 Characterize Colorado River water

Table 3 shows the 90th, 50th, and 10th percentile water quality data from Lake Mathews, Riverside, California—the southern terminus of the Colorado River aqueduct and source water for Metropolitan's CRW treatment plants. Between the years 1976 and 2000, the salinity of CRW ranged between 530 and 720 mg/L of total dissolved solids (TDS) due to fluctuations in the hydrologic cycle. The total hardness of the water tracks fairly linearly with TDS, therefore as the TDS of the River increases, so too does the hardness.

The scaling potential of the 90th, 50th, and 10th percentile CRW quality was evaluated using commercially available software (RoPRO[®] Version 6.0; Fluid Systems Corp., San Diego, Calif.). Raw water quality, water recovery of 85 percent, and product flow of 17 gpm [93 m³/day] were inputted into RoPRO[®] model to predict the scaling potential of sparingly soluble salts. Results from RoPRO[®] were also compared to an antiscalant vendor's spreadsheet (PC Optimize Version 1.2.0, PerLorica Inc., San Diego, Calif.) which predicts the scaling potential based on the raw water quality, water recovery, and product flow. The spreadsheet predicted much higher saturation indices for barium sulfate (10 percent higher) and calcium fluoride (77 percent higher) but lower indices for calcium sulfate (50 percent lower) and calcium carbonate (10 percent lower). These differences in calculated scaling indices may be attributable to the K_{sp} values used in each model. Depending on the water matrix, as well as experimental method, the K_{sp} may vary significantly from vendor to vendor. Therefore, scaling models only indicate the relative scaling potential; pilot-scale testing of the individual source water should be conducted to confirm the modeling results.

5.1.1 Total Dissolved Solids Survey

A survey of U.S. Geological Survey data for water quality at different locations along the Colorado River was conducted. Data from Alexander et al. (2000) showed that the 90th percentile TDS from Lees Ferry, just south of Lake Powell (Figure 3) from 1973 to 1995 was 636 mg/L. TDS data obtained from Southern Nevada Water Authority (2000) from February 1990 to March 2000 at Lake Mead's Las Vegas intake indicated a 90th percentile TDS of 709 mg/L. TDS data was also surveyed at the southern portion of Lake Mead near Hoover Dam, which showed a 90th percentile TDS of 712 mg/L. In comparison, the 90th percentile TDS data taken at the terminus of the Colorado River aqueduct system at Lake Mathews in Riverside, California, for the same duration was 701 mg/L. Additional TDS data surveyed near the Arizona/Mexico border at Imperial Dam from 1973 to 1992 showed a 90th percentile TDS of 903 mg/L (Alexander et al. 2000). The data shows that the salinity of CRW increases as it moves downstream in the watershed. Generally, a TDS increase of approximately 10 percent from Lake Powell to the southwest reservoir system (i.e., Lake Mead and Lake Havasu) and an additional increase of 20 percent from the southwest reservoir system to the terminus of the Colorado River at Imperial Dam was observed.

5.1.2 Literature Survey

A literature survey was conducted in order to identify potential scalants and determine scale control techniques that are used by other agencies or utilities treating CRW or similar waters. Table 4 provides a summary of the types of potential scalants that can be expected from the treatment of CRW or similar waters and also lists control strategies to prevent or minimize precipitation.

Chowdhury et al. (2000) modeled historical CRW data obtained from the Hayden-Udall Water Treatment Plant in Tucson, Arizona, using a software program (WINFLOWS[™], Osmonics/Desal, Vista, Calif.) at 700 mg/L TDS, 85 percent recovery,

30°C, and adjusted feed pH of 7.0, utilizing nanofiltration (NF) and reverse osmosis (RO) membranes (model HL and AK, Osmonics/Desal, Vista, Calif.). The program predicted barium sulfate (0.08 mg/L of barium in influent) in the concentrate stream to be 130 times the saturation limit and the LSI to be greater than 2.0. In comparison, the 10th percentile CRW quality (0.082 mg/L of barium) at Lake Mathews (Table 3) modeled on ROPRO® (Fluid Systems, San Diego, Calif.) predicted a barium sulfate saturation index of 49 and a LSI of 2.01. (It should be noted that each membrane manufacturer as well as some antiscalant vendors have their own software programs to determine the scaling indices of certain sparingly soluble salts. Because of the assumptions involved in calculating the indices by the different programs, variations in the results are expected). Chowdhury et al. (2000) determined that acid and antiscalant (Flocon 260, Flocon Corp.) would be required to control for calcium carbonate scaling and barium sulfate precipitation. Pilot-scale tests were conducted to evaluate a NF/RO hybrid system following slow sand filtration or microfiltration pretreatment. Both pretreatments were followed by acid and antiscalant addition. The authors indicated that initial testing of the NF/RO membranes looked promising, but long-term tests would be required to determine membrane productivity and permeate water quality.

Lozier and Cole (1996) also conducted pilot-scale studies to evaluate NF membranes to soften CRW. Pilot-scale tests were conducted using NF membranes (model TFC-S, Fluid Systems, San Diego, Calif.) operating at 85 percent recovery, 12 gfd [0.02 m/hr], pH adjustment to 7.2 – 7.4, antiscalant addition (3 mg/L, AF-600, BF Goodrich, Charlotte, North Carolina), and 5 µm cartridge filtration. After 100 hrs of testing, no depreciable drop in the normalized flux was observed. Autopsy of the lead element revealed ferric iron and bacteria. The iron deposition was assumed to have originated from the feedwater. Although the iron in the feedwater was below the analytical detection limit of 0.1 mg/L, it is recommended that membrane feedwater iron levels be maintained below 0.05 mg/L when the pH is 7.0 or greater. The presence of bacteria indicated that cartridge filtration was inadequate for removal of bacteria and particles. Modeling predicted that the barium sulfate saturation in the concentrate exceeded the solubility limit by a factor of 94. However, with antiscalant addition, barium sulfate and mineral precipitation on the terminal element was not observed.

McAleese et al. (1999) also conducted pilot-scale tests for the Olivenhain Water Storage Project at the Bureau of Reclamation's Water Quality Improvement Center in Yuma, Arizona. Pilot-scale tests using NF membranes (ESNA [ESPA 3], Hydranautics, Oceanside, Calif.) in a 2 stage system was operated at 14 to 19 gfd [0.024 to 0.032 m/hr] at 85 percent recovery. Feedwater to the NF unit was pretreated by a microfiltration unit followed by pH adjustment to 7.0 and antiscalant addition (2.0 mg/L, Flocon 260, Flocon Corp.). After 1000 hrs of operation, the author reported that no decline in flux or salt rejection was observed.

Based on the survey, the two primary scalants of concern when treating CRW are calcium carbonate and barium sulfate. Most utilities or agencies were able to control for calcium carbonate scaling by pH adjustment, and barium sulfate precipitation was minimized or eliminated with the addition of an appropriate antiscalant.

5.2 Task 2 Characterize the Role of Multivalent Ions (Fe^{3+} and Al^{3+}) in Silicate Scaling

This task conducted a literature review of silicate fouling of membrane systems to help identify methods to minimize silicate scale formation. Additionally, this task modeled the silicate-scale formation tendencies of CRW using solubility and predominance diagrams, as well as with a geochemical modeling program. Finally, this task conducted bench-scale tests to validate the silicate control methods developed through the literature search and modeling efforts.

The presence of multivalent ions, such as Fe^{3+} , Al^{3+} , Fe^{2+} , Ca^{2+} , Mg^{2+} , may affect the solubility of silica (Iler 1979, Hann 1993, Weng 1994). Silica in the presence of these ions form thermodynamically stable silicate compounds which can be problematic for water treatment processes such as microfiltration and reverse osmosis (RO). The objective of this research was to gain an improved understanding of the factors that cause silicate formation in a RO process. This task involved theoretical work to characterize the role of multivalent ions (Fe^{3+} and Al^{3+}) in silicate scaling. Due to the low concentrations of iron found in CRW (typically below the method detection limit, 10 $\mu\text{g/L}$), characterization of iron silicate formation was not conducted. Therefore only the formation of aluminum silicates was modeled. It should be noted that aluminum silicates should be much more abundant and important than iron silicates based on previous results that showed little iron content when compared to the aluminum content in the silicate-based foulant (Gabelich et al. 1999).

5.2.1 Literature Survey

Research published on silicate scaling is sparse. Aluminum silicates were frequently found deposited onto plumbing materials in distribution systems (Shea 1993, Kriewall et al. 1996, Goldsborough 2000). This phenomenon may be due to the “post-precipitation” of soluble aluminum and silica that pass through a treatment plant, or alternatively, by the deposition of colloidal aluminum silicates that pass through treatment processes such as filters (Kvech and Edwards 2000).

Amorphous silica scale enriched in aluminum has also been found deposited in geothermal brines, which usually have temperatures of about 200⁰C and pressures of about 800 kPa. These aluminum silicate deposits were formed by tetrahedrally coordinated aluminum substitution within an amorphous silica framework (Gallup 1997).

Silicate materials have more recently been found as a foulant for both low-pressure (i.e., microfiltration and ultrafiltration) and high-pressure (i.e., reverse osmosis) water treatment processes. Norman et al. (1999) described silicate fouling of microfiltration (MF) membranes in a demonstration-scale MF plant in Orange County, California. The MF plant acted as a pretreatment for reverse osmosis during wastewater reclamation. The silicate materials were formed through the use of silica-laden water with the high-pH cleaning agent, which resulted in the formation of aluminum silicates fouling the microfibers. Additional cleaning of the membrane fibers with ammonium bifluoride was then required. However, the hazard ratings for ammonium bifluoride are

severe (3) for health, moderate (2) for reactivity and extreme (4) for contact – corrosive (MSDS 1997). The hazardous nature of ammonium bifluoride prohibited its widespread and continuous usage.

Aluminum silicate fouling has been reported for RO applications. In his book, Byrne (1995) documented silicate formation and treating with ammonium bifluoride solution for reverse osmosis. Butt et al. (1995) found alumino-silicate scale depositing within the feed distribution tubes and the RO membrane of a polyacrylate and hydroxyethylidene diphosphonate (HEDP)-based antiscalant, when the antiscalant was tested against the conventional H_2SO_4 and sodium hexa-meta-phosphate (SHMP) inhibitors in a RO pilot plant in Saudi Arabia. The scale deposited on the RO membrane was attributed to oversaturation of aluminum and silica, while the scale deposited in the feed tubes was attributed to the low cross-flow velocity. Thus, the advanced anti-scalant was proven ineffective against the aluminum silicate scale. Although no alumino-silicate scale was deposited on the membrane using the conventional H_2SO_4 + SHMP inhibitor, the efficacy of this conventional inhibitor towards the aluminum silicate scale was unclear because no change in water quality was observed.

5.2.2 *Potential remediation strategies*

During the aluminum silicate fouling episodes using MF, Norman et al. (1999) suggested that ethylenediaminetetraacetic acid (EDTA) or other chelating agents may sequester dissolved metals and avoid silicate fouling. However, no further studies were reported. Laboratory studies demonstrate that sequestering agents such as citric acid, acetic acid, and EDTA may inhibit aluminum silicate scale formation in geothermal brines (Gallup 1997). Additionally, for aluminum silicate scale in the geothermal brine field, Gallup (1997) showed that lowering the brine pH to below 5 or increasing it above 9 would retard the kinetics of silica polymerization and the formation of aluminum-rich silica. However, for municipal water treatment applications, these pH levels would not be feasible because lowering the pH below 5 would be too expensive and raising it above 9 would lead to calcium carbonate scaling.

In the follow-up pilot-scale study, Gallup (1998) indicated that complexing and/or sequestering agents with carboxylate functional groups showed promise in achieving metal-silicate scale inhibition by complexation with aluminum or iron in brine to form anionic species that are less prone to precipitation reactions with silicic acid oligomers. The potential aluminum complexing or sequestering agents included glycolic acid, formic acid, sodium formate, tartaric acid, and glyoxal. While dispersant agents containing phosphonic acid and/or phosphonate functional groups may inhibit pure amorphous silica, they potentially precipitate aluminum as phosphates or phosphonates; thus, they may act as a foulant themselves. Treatment of brine with potassium tetrafluoroborate (KBF_4) yielded good inhibition results (Gallup 1998).

No other CRW membrane applications have reported on silicate scaling problems.

5.2.3 Theoretical Background - Formation Tendency of Aluminum Silicate Scales

The formation of aluminum silicates requires the presence of both dissolved silica and dissolved aluminum in solution. Take kaolinite formation for example:

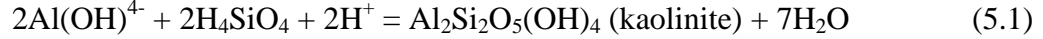

Mineral equilibrium and pH of the solution regulate the concentration and speciation of dissolved silica and aluminum in solution. To better understand the formation of silicates and to understand how to minimize their formation, a better understanding of both silica equilibrium and aluminum equilibrium was needed.

In silica system, the major mineral-solution equilibrium would be the dissolution of quartz. The equilibrium contains a series of reactions that predominant the system at different pH levels:

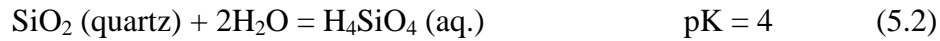

The total dissolved silica concentration will be the sum of the ionized and unionized species (Figure 4) (Drever 1988). At pH 7 to 9 (the pH range for CRW), mineral quartz will form when the concentration of total dissolved silica in solution exceeds 10^{-4} mol/L (or 6 ppm)—for dilute solutions such as this, the activity coefficient $\cong 1$. Similarly, a higher concentration of total dissolved silica of $10^{-2.7}$ mol/L (120 ppm) is required for the formation of amorphous silica. The predominant dissolved species in both equilibria is silicic acid (H_4SiO_4) at pH 7 to 9.

In the aluminum system, the most common mineral phase is gibbsite ($\text{Al}(\text{OH})_3$). The solubility of gibbsite (Figure 5) (Drever 1988) is regulated by the following reactions:

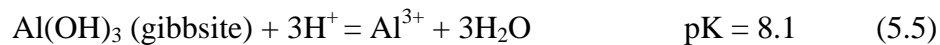

Gibbsite is least soluble at pH 6 and between pH 7 and 9 the major dissolved species is $\text{Al}(\text{OH})_4^-$. In natural water systems, gibbsite formation may be complicated by the formation of the meta-stable intermediate (polynuclear Al_{13}) due to kinetic restraints (Figure 6) (Sposito 1996). However, while experimental evidence confirms the existence of polynuclear Al_{13} , there is doubt that such “giant” cations such as $\text{Al}_{13}\text{O}_4(\text{OH})_{24}^{7+}$ are present in coagulated waters (Faust and Aly 1998).

5.2.4 Modeling Results and Discussion

Modeling with historical data using predominance area diagrams and solubility diagrams. From Figures 7-9 the potential aluminum silicates that would be precipitated in the influent and effluent were kaolinite and muscovite. For CRW, the ion molar concentrations for major cations exhibited the following pattern in both the RO influent and effluent: $\text{Na} > \text{Ca} > \text{K}$ (Table 3). Therefore, kaolinite would precipitate before muscovite when the solution reached saturation with respect to calcium and potassium, respectively. However, modeling of the concentrate showed that Ca-montmorillonite, Na-beidellite and K-feldspar (KAlSi_3O_8) might also be formed when the solution reached saturation (see Table 5 for other mineral formulas.).

Solubility of gibbsite and kaolinite (Figure 10) showed that kaolinite was the more stable mineral phase at the prevalent H_4SiO_4 level in CRW (around 10^{-4} mol/L). Furthermore, the total aluminum concentrations in all three types of waters have all exceeded the solubility of kaolinite, indicating the precipitation of kaolinite was thermodynamically possible. However, the kinetics of kaolinite formation are still in doubt.

Numerical modeling with RO influent data in bench-scale tests. Table 5 shows a list of mineral phases, including silicates and non-silicates, that may form in CRW. While the formation of most minerals from Table 5 were predicted using the predominance diagrams and solubility graphs, unfavorable kinetics may prevent them from forming during water treatment. For example, leonhardite, tremolite, and diaspore are not commonly seen in nature due to their unfavorable kinetics in formation. Among the silicates, minerals with cations like Ca and Mg may not be the dominant species as indicated by their high $\gamma_{\text{P}}/K_{\text{sp}}$ ratios, because the carbonate species of Ca and Mg form rapidly and may compete for cations; thereby inhibiting silicate formation. The actual mineral types and their abundance in the RO scale were further complicated by the nonequilibrium conditions in the RO system and other kinetic restraints (e.g. activation energy, meta-stable intermediate phases) of the minerals.

Mechanical stability and chemical stability of the minerals during the RO operations will also affect the abundance of the mineral phases precipitated. To better define the mineral types and their abundance, X-ray diffraction of the RO membrane should be used. However, in solving the problem of minimizing the scale formation, it may be more useful to know the type and amount of the dissolved species conducive to scale formation. Then, by initiating appropriate reactions more favorable than the scale forming reactions, scale prevention may be achieved. From the geochemical model, the activities and the percentage distribution for aluminum and silica were calculated (see Table 6). Results indicated that $\text{Al}(\text{OH})_4^-$ (99.8 percent) and H_4SiO_4 (aq) (97 percent) were the sole predominant dissolved species for aluminum and silica, and thus accounted for the aluminum-silicate scale formation (see formulas 5.1, 5.2 and 5.9, and Table 6).

5.2.5 Methods to Minimize Silicate Formation

The ultimate goal of the study was to minimize the formation of aluminum silicates. The goal can be achieved by reducing the concentration of either dissolved aluminum or silica in solution. Since the aluminum is ionized as $\text{Al}(\text{OH})_4^-$ and thus more reactive than the non-ionized silica (H_4SiO_4 (aq)) (see Table 6), several complexing agents were evaluated to separate dissolved aluminum species from water.

Color Complexing Agents. In analytical chemistry, aluminum is commonly analyzed using complexing reagents to produce a colorimetric reaction. By complexing the dissolved aluminum with organic reagents similar to those used for colorimetric chemistry, the silicate scale formation may be reduced. Without experimental testing, it was uncertain if these inorganic/organic complexes would foul the RO membrane surface.

Ten color complexing agents were considered: aluminon, bromopyrogallol red, eriochrome cyanine R, ferron, hematoxylin, methylthymol blue, pyrocatechol violet, tiron, xylenol orange, 8-hydroxyquinoline. Among them, pyrocatechol violet may be the most promising because all the other agents require heat, need a long reaction time, or demonstrate high ion interference. However, the optimal pH range for pyrocatechol violet reaction is at 6.1 to 6.2 (Dougan and Wilson 1974), which is more acidic than CRW (pH ~8). The pH restraint may affect its complexation efficiency to some degree.

Microfiltration and Ultrafiltration Membranes. Microfiltration (MF) and ultrafiltration (UF) membranes can be used to physically separate soluble aluminum from fine colloidal mineral aluminum and aluminum bound to macromolecular structures of humic and fulvic acids (Sposito 1996). Inserting a MF or UF system as a prefilter to the RO system will remove solid aluminum and aluminum macromolecules. In order to reduce colloidal or particulate fouling interference in with precipitation fouling, a microfiltration system with pore size of 0.2 μm was chosen to insert before the RO operation as a pretreatment in the bench-scale tests (Task 3) and the pilot-scale tests (Task 4).

Natural Organic Products. A literature search on kaolinite dissolution revealed that low molecular weight organic ligands markedly increased the dissolution of kaolinite by surface complexation in the order of oxalate > malonate ~ salicylate > o-phthalate (Chin and Mills 1991). A broad list of complexation reactions of aluminum-organic ligands was investigated. In order to compile a list of potential reagents for use in the RO system, both the toxicity of the reagent and the thermodynamic potential of the reaction by means of ligand association constant (K) of the reaction were evaluated. The ligand association constant must be high enough to assure the reaction readily occurs, and the agent should pose no adverse health effect to the water quality of the RO effluent. Table 7 contains a suggested list of organic ligands. Five complexing reagents were chosen for further bench-scale tests in Task 3 that covered the log K_1 range from 6.1 to 16.3. They were oxalic acid, citric acid, salicylic acid, aspartic acid and EDTA.

5.2.6 Evaporation Experiments

Evaporation experiments were conducted for a preliminary evaluation of the ability of the complexing reagents proposed above to minimize aluminum-silicate formation. Evaporation was used because it is a simple and fast way to concentrate water and to precipitate salts from water. Actually, membrane scale inhibition theory has been derived from boiler and cooling water technologies that relied on evaporation to cause an increase in salt concentration (Darton 1997). However, some reagents, such as oxalic acid, may decompose when heated. Loss due to thermal decomposition needs to be considered. On the other hand, aluminum silicate needs relatively high temperature to form. Therefore, all samples were simmered at 100°C for each evaporation experiment. It should be noted that while providing equilibrium data, the evaporation process alters the nucleation kinetics when compared to RO or NF.

Oxalic acid and citric acid were chosen for the evaluation. Three evaporation experiments were performed: one without the addition of any reagent and the other two with the addition of oxalic and citric acid. The amount of the addition of each reagent was determined by the reaction stoichiometry of the reagent to form aluminum complex as well as the amount of the dissolved aluminum in water samples. Excess amount of each reagent was added to account for losses due to complexation and thermal decomposition. The final concentration of each reagent was about 30 times greater than the reaction molar ratio. The pH of the solutions changed from 7 to 8 after all three-evaporation tests, i.e., with or without the reagent acids. Therefore, the open system may have reached equilibrium with atmospheric CO₂, which led to buffering of the test solutions.

The powder X-ray diffraction (XRD) of the scale (Figure 11) without the addition of any reagents showed several prominent peaks, which indicated several major mineral components in the precipitates. A search was made to find the mineral forms of these major components. The peak at the X-axis value at 26 appeared to match calcium sulfate anhydrate (CaSO₄) and three magnesium aluminum silicates: MgAl₂Si₄O₁₂, Mg₂Al₄Si₅O₁₈, and MgAl₂Si₃O₁₀. The peak with X axis value at about 30 matched with the following minerals: wollastonite (CaSiO₃), walstromite (BaCa₂Si₃O₉), calcite (CaCO₃), norsethite (BaMg[CO₃]₂), and barium silicate hydrate (Ba₅Si₄O₁₃·1.2H₂O). No common minerals were found to match the peaks with higher X values.

XRD spectra of the three experiments showed similar peak patterns. However, differences in the peak heights indicated changes in the concentrations of the components in the precipitates. Citric acid exhibited excellent removal ability of all the major components. Peak height reductions at x-axis 26 and x-axis 30 were 95 percent and 93 percent, respectively. Thus, citric acid was a good scale inhibitor. Oxalic acid only partially removed the component at X value at 30 by 85 percent. The inadequate performance of oxalic acid may be due to its thermal instability. Nevertheless, the complexation reagents were considered effective in treating the aluminum silicate scales, and were proposed to use as antiscalants in the RO bench-scale tests in Task 3 of the project.

5.3 Task 3 Screen Antiscalants

This task conducted bench-scale membrane testing of commercial and generic antiscalants. Bench-scale testing was conducted with 1.8-in. [4.6 cm] diameter, spiral-wound RO elements using microfilter (0.2 μm nominal pore size) pretreated water. For a complete description of the RO and MF units, see the Experimental Methods section of this report. The goal of this task was to determine the efficacy of various antiscalant products in controlling the primary scales (barium sulfate and calcium carbonate) and secondary scales (aluminum silicates) at greater than 85 percent water recovery. The most promising antiscalants were suggested for use in the subsequent RO pilot-scale testing (Task 4).

To evaluate the performance of antiscalants for scale inhibition, permeate flux and salt rejection data were calculated per ASTM Standards (1987). While flux decline and salt rejection are good macroscopic indicators of impaired membrane performance, operational constraints of the bench-scale units limited their usefulness in this application. In short, as water recovery was increased by bleeding off the permeate stream, the osmotic pressure of the feed water increased resulting in a reduction in net driving pressure. This decrease in net driving pressure exerted a greater influence on normalized flux than the declining permeate flux. The end result was an increase in normalized flux at the higher water recovery levels (e.g., greater than 85 percent). Membrane failure may also play a role, but salt rejection data did not support this conclusion.

Therefore, due to the bench-scale nature of the tests and the minimal amount of the potential scalant mass, a series of microscopic analyses were performed to quantify scaling potential. Specifically, water quality analysis (e.g., calcium, barium, silica, and aluminum) of the concentrate filtrate, SEM and EDS analysis of the RO membrane surface, and visual and chemical analysis of the colloidal material in the RO concentrate were evaluated. Many foulant constituents, such as calcium and barium, undergo phase changes between soluble and insoluble forms depending on their solubility. When the concentrate is filtered through a 0.45 μm filter, the soluble material passes through the filter. Higher solubilization of foulant materials is an indication of effective antiscalant performance.

The performance of each antiscalant was compared versus a control. The controls were also compared with each other to evaluate the scaling potential of the three types of waters tested. Commercial antiscalants were selected for control of calcium, barium and silica scales, and generic antiscalants were selected for control of aluminum precipitation by complexing the aluminum primarily and not for any other constituents. For ease of data interpretation, each antiscalant was assigned a tracking code (Table 8).

5.3.1. Screening Tests

Commercial antiscalants were dosed using manufacturer's guidelines. These products were proprietary formulations that ranged from polyphosphonates, polyacrylates, and other organic polymers (Table 9). However, no such guidelines were available for the generic antiscalants. Therefore, a series of preliminary tests were run to

determine the optimal dosage for the generic antiscalants. Percent reduction in normalized permeate flux for citric acid, salicylic acid and EDTA are shown in Figures 12 through 14, respectively. Given microfiltration (MF) pretreatment excellent particle removal characteristics and the short duration of the tests (9 hr), both biological and particulate fouling most likely would have minimal influences on flux behavior. Therefore, any flux decline was assumed to be through the inorganic or organic precipitation. Steady-state flux behavior presumably indicated of no fouling through better antiscalant performance.

For citric acid, a dose of 1200 mg/L (CA-1200) showed the greatest reduction in flux loss compared to both the control and other citric acid dosages (Figure 12). However, given that the pH was reduced to pH 3.2, the effect of lowering the pH may have had a greater influence on membrane performance than the antiscalant. Both 2.0 mg/L and 12 mg/L citric acid doses were proven effective in improving RO flux performance. Therefore, the 2.0 mg/L citric acid dose was used in all subsequent testing. For both salicylic acid and EDTA, no observable change in flux behavior was observed (Figures 13 and 14). Therefore, conservative dose levels for both chemicals were used in all subsequent testing (12 mg/L for both salicylic acid [SA-12] and EDTA [EDTA-12]).

5.3.2. Flux Comparison for Commercial and Generic Antiscalants

Each commercial and generic antiscalant was tested on the bench scale without replication. Figures 15 through 20 present the percent change in normalized flux at various water recoveries for each water quality condition (i.e., CRW/SPW blend and CRW at both pH 8.3 and 7.0). It should be noted that for certain tests, a positive change normalized flux occurred at the end of the runs (e.g., see last data points for controls in Figures 17 and 20). Given the recirculatory nature of the bench-scale experiments, these increases in normalized flux were most likely attributed to the inability to accurately calculate the osmotic pressure, which may have lead to wide errors in the data. Membrane failure may also play a role, but salt rejection data do not support this conclusion. A more detailed discussion of the normalized flux results follows.

Figure 21 presents a summary of the relative flux declines for all antiscalants and water types. For both commercial and generic antiscalants, antiscalant performance differed when using CRW/SPW blended water as opposed to 100 percent CRW (both pH 8.2 and 7.0). For example, the antiscalants that outperformed the control in the blended water were seldom found to perform better than the control in 100 percent CRW (either pH 8.2 or pH 7.0). The difference between the blended water and the CRW waters indicated that the two types of waters were different as far as the scale forming potential was concerned, and antiscalants that performed well in one type of water might not be a good choice for the other. On the other hand, the performance of antiscalants in the pure CRW (pH 8.2) and CRW at pH 7.0 were consistent with each other, i.e., those antiscalants outperformed the control in these two types of waters were almost the same. The flux decline of the control (no antiscalant condition) in the blended water was 10 percent less than the pure CRW, which accounted for 35 percent improvement of performance relative to pure CRW. The better performance of the control in the blended water indicated that pure CRW was more prone to scaling than the blended water.

Adjustment of pH for CRW from 8.2 to 7.0 demonstrated a positive effect on flux decline as evidenced by less flux decline of both the control and almost all antiscalants tested in CRW at pH 7 than in pure CRW. Another observation was that many antiscalants showed larger flux decline than the control tests, suggesting either; (1) the bench-scale RO unit measurements lacked adequate sensitivity to distinguish between changes in flux, or (2) the 95 percent water recovery concentrated the salts such that they overwhelmed the antiscalant and the level of fouling was indistinguishable from the control.

Antiscalant PT-1.6 outperformed all other commercial antiscalants in the blended water (Figure 21). The flux decline for PT-1.6 was 7 percent, while all others (including control) had at least twice (14 percent) reduction of the flux in the blended water. Actually, PT-1.6 was the only commercial antiscalant that performed significantly better than the control in blended water. Generic chemicals SA-12 and SA-2.4 also demonstrated better performance than the control. However, SA-12 showed significant flux increase at high water recovery and data points at water recovery higher than 85 percent for SA-2.4, where usually most flux reduction occurred, were missing (Figure 18).

Many commercial antiscalants and generic chemical showed better performance than the control in both pure CRW and CRW with pH adjusted to 7.0. These antiscalants included SKH-10, CAL-5, ARG-2.3, PWT-10, CA-12, AA-11 and EDTA-12, with antiscalant CAL-5 being the best in pure CRW. Besides the antiscalants listed, PT-1.6 was also effective in CRW at pH 7.0. However, generic chemicals were less comparable than the commercial antiscalants because data on water recovery at 95 percent were usually missing for generic chemicals (Figures 18, 19, and 20). The flux increases in the control test and in some commercial antiscalants may have been caused by membrane failure.

Interestingly, for any one generic chemical, higher concentration did not render better performance. Actually, different concentrations make large differences in the chemical performance, e.g., the difference of flux change was more than 50 percent between antiscalants CA-2.0 and CA-1200 in blended water. Therefore, finding the optimal concentration range for an antiscalant is as important as finding the appropriate antiscalant.

5.3.3. *Water Quality Data*

Concentrate samples from each antiscalant trial were filtered through a 0.45 μm filter. Any solute in the filtrate (the water that passed through the filter) was considered dissolved. Each filtrate sample was analyzed for calcium, barium, aluminum, and silica. Antiscalant effectiveness was evaluated in terms of degree of solubilization relative to a control (no antiscalant) with the theory being any ion in the dissolved phase had a lower scaling potential than ions in the non-dissolved phase. Antiscalants, if effective for a given solute, should complex with the solute and remain in the dissolved phase, i.e. no precipitation should occur.

Potential forms of calcium precipitates in CRW include calcium carbonate (CaCO_3), calcium sulfate (CaSO_4) and calcium fluoride (CaF_2). However, EDS data for

all membrane samples were inconclusive for sulfate and showed no fluoride present on the membrane surface. Additionally, most samples showed strong effervescence when exposed to 0.1 N HCl. Therefore, the calcium precipitates present during this testing were most likely calcium carbonate.

The distribution patterns of dissolved calcium present in the filtrate of the concentrate samples (Figure 22) in each of the three types of waters appeared very similar to those demonstrated in permeate flux (Figure 21). The better performance of controls in blended water and in CRW at pH 7.0 again indicated that CRW was more prone to calcium scaling and that pH adjustment from 8.2 to 7.0 efficiently solubilized calcium. The distribution similarity between dissolved calcium and flux also demonstrated that calcium scales were the major scales in these waters.

Antiscalants that outperformed the controls usually showed less than 10 percent of the solubilization capacity. Given the excess of calcium in the system (greater than 50 mg/L), a measurable increase on calcium may not be measured via water quality analyses, despite calcium precipitation occurring. Antiscalant CA-120 increased the dissolved calcium by 25 percent (of the total calcium in the feed) over the control in the blended water because the citric acid concentration was over 100 mg/L (Table 8) and could easily form a water soluble complex with calcium carbonate. Antiscalant SKH-10 demonstrated almost 10 percent increase of dissolved calcium in both CRW (pH 8.2) and CRW at pH 7.0. This finding suggests that in addition to containing 2-propenoic acid (Table 9), antiscalant SKH-10 may contain calcium as part of its formulation. Generally speaking, commercial antiscalants performed better than generic chemicals in CRW waters.

Barium can react with sulfate to form barium sulfate (BaSO_4) scale—which has the highest scale forming potential in CRW (pH 8.2), see Task 1. That the dissolved barium in the control of pure CRW at 95 percent water recovery was less than 10 percent of the total barium originally present (Figure 23) also demonstrated barium's insolubility. However, while barium was not in the dissolved form, no barium scaling was detected on the membrane surface via EDS. Actually, the relatively higher levels of barium in the control samples in blended water and CRW at pH 7.0 also indicated that the blended water was less prone to barium scaling than CRW, and that pH adjustment had the positive effect on dissolving barium—though barium sulfate scale potential has been shown to be fairly insensitive to pH adjustment (see Task 1). This is the same pattern observed in flux and in the calcium diagrams (Figures 21 and 22).

Antiscalants PT-1.6 and BFGa-2.5 showed a strong ability to bind barium in the blended water. The dissolved barium was increased by 45 percent, which was more than 2.5 times that of the control. Antiscalant KNG-20 significantly outperformed the experimental control in pure CRW, i.e. dissolved barium increased by 35 percent over the control. Generic chemicals generally were not as efficient as the commercial antiscalants in sequestering barium from each water type. Antiscalant CA-120 in the blended water performed the best among the generic antiscalants by increasing the dissolved barium by 20 percent over the control. In general, generic antiscalants offered no significant improvement in barium sulfate scale formation in CRW.

5.3.4. Scanning Electron Microscopy and Energy Dispersive Spectroscopy Analyses of the Membrane Surface

SEM provides a visual picture of the scales forming on the RO membrane surface (qualitative analysis) while EDS presented the amount of element components in the scales on the RO membrane (both qualitative and quantitative analyses). Therefore, SEM and EDS data offered direct information on the performance of antiscalants in reducing the amount and type of scales. Unfortunately, the EDS analysis may be biased since its sampling area is very small and big scale grains had to be avoided.

Based on visual SEM data, two types of fouling were observed (Figures 24 and 25 for representative SEM micrographs): organic fouling and inorganic fouling. Assuming that insufficient time passed to allow for biological fouling, the organic material present on the membrane surfaces were assumed to be from the antiscalant(s) precipitating out of solution at high water recovery. Organic material on the membrane surface is particularly undesirable due to organic materials being a potential food source for bacteria, as well as a potential attachment site for colloids and inorganic scales. Organic fouling was observed more often in membranes treating CRW at pH 7.0 (antiscalants KNG-20 through PWT-10) (Table 10).

According to EDS data, inorganic scales were predominately calcium-based scales, most likely calcium carbonate. Both SEM and EDS data showed that commercial antiscalants had less scaling in the blended water than in CRW at pH 7.0 and 8.2 (Tables 10 and 11). Almost no scales were present on the RO membrane surface of antiscalants PT-1.6 and BFGa-2.5, indicating PT-1.6 and BFGa-2.5 were effective antiscalants for treating calcium scaling in the blended water. Commercial antiscalants were not as efficient in reducing calcium scaling in CRW at pH 8.2 as in CRW at pH 7.0 (Tables 10 and 11) because pH adjustment (decrease from 8.2 to 7) was useful increasing the solubility of calcium carbonate. However, organic fouling was encountered with the pH adjustment for antiscalants KNG-20 through PWT-10. On the other hand, generic chemicals generally were not good in treating the calcium scales (Table 10), but organic fouling was not encountered.

5.3.5. Analysis of Colloidal Material

An analysis of the colloidal material in the concentrate was conducted by filtering concentrate samples through a 0.45 μm membrane. Colloidal material is experimentally defined as material that did not pass through the 0.45 μm filter. The retentate, or filter cake, from the RO concentrate was evaluated in terms of its physical characters (e.g., color, thickness, texture and permeability) (see Appendix D, Tables D.1 through D.4), elemental composition (Table 11), and calcium carbonate content, as indicated by effervescence with 0.1 *N* HCl.

Generally speaking, filter cake performance for both commercial antiscalants and generic antiscalants was no better than the control tests in the waters tested (see Appendix D, Tables D.1 through D.4). Calcium was the major component in the cake, and silica was the minor one (Table 11). Silica was more frequently present in the cakes of generic antiscalants than of commercial antiscalants. The generic antiscalant's inability to bind silica may have resulted in amorphous silica precipitating out of solution

at very high water recovery (95 percent). The degree of calcium carbonate scaling of filter cakes were similar among the commercial and generic antiscalants, except for antiscalants CA-1200 and CA-120 where no carbonates were observed. Both CA-1200 and CA-120 were citric acid at relatively high concentrations (1200 mg/L and 120 mg/L, respectively) where calcium citrate complexation should take place.

5.3.6. *Prevention of Aluminum Silicate Formation*

5.3.6.1. *Experiments with Ambient Aluminum.* Silica and aluminum each contribute to the formation of aluminum silicates. Dissolved silica constituted a significant portion of the overall silica in the system in the three water types; dissolved silica in the controls was 63, 78, 85 percent of the total silica in the feed waters respectively (Figure 26). Commercial antiscalants demonstrated higher affinity to bind silica than the generic chemicals. For instance, ARG-2.3 showed binding with silica in both blended water and CRW at pH 7.0. Antiscalant PT-1.6 outperformed all other antiscalants in pure CRW. For a majority of generic chemicals, silica was found precipitated on membrane surface and in colloidal materials of the concentrate (Table 11). Silica precipitation indicated generic chemicals were less efficient in complexing silica than commercial antiscalants.

Generic antiscalants were selected for control of aluminum silicate precipitation based on their ability to complex with aluminum. Thus, the generic chemicals were more efficient in binding aluminum than commercial antiscalants in the blended water (Figure 27). Antiscalant CA-1200 and CA-120 increased the dissolved percentage of aluminum by 50 percent, which amounted to over 200 percent improvement of binding efficiency relative to the control in the blended water. Antiscalant EDTA-124 and EDTA-12 also increased the efficiency of aluminum binding by 100 percent relative to the control in the blended water. Therefore, citric acid and EDTA appeared to be better aluminum complexation agents than other commercial and generic antiscalants. These generic antiscalants, which were originally proposed for treating aluminum silicate scales in Task 2, were proven effective silicate inhibitors by complexing aluminum into a soluble form that would otherwise be used to form aluminum silicates. Therefore, silica was freed from the formation of silicate, and deposited as amorphous silica (Table 11).

Antiscalant CAL-5 increased the dissolved aluminum by 140 percent in the blended water. The total dissolved aluminum exceeded also 100 percent, indicating sample contamination had occurred. Antiscalant BFGa-2.5 also demonstrated 40 percent dissolved aluminum increase in the blended water. Antiscalants ARG-2.3 and CA-12 slightly increased the dissolved aluminum in CRW at pH 8.2. No commercial and generic antiscalants showed a strong ability to bind with aluminum in CRW at pH 7.0. Adjustment of pH from 8.2 to 7.0 considerably decreased the solubility of aluminum in CRW (see levels of controls in Figure 27). This agrees with the theoretical model (see Figures 5 and 10 in Task 1) and that aluminum ion (Al^{3+} , at pH 7) regulated the formation of aluminum silicate scales in CRW.

5.3.6.2. *Experiments with Added Aluminum.* During the conventional treatment process at Metropolitan's drinking water plants, aluminum sulfate (alum) coagulation is

often employed. Based on dosage rates and aluminum's inherent solubility, approximately 200 µg/L of aluminum is commonly measured at the filter effluent. This effluent would theoretically serve as the feed to any desalting step. Therefore, in order to mimic this water quality condition, excess aluminum (as $\text{Al}(\text{NO}_3)_3 \cdot 9\text{H}_2\text{O}$) was added to the microfiltered source water to yield 200 µg/L dissolved aluminum. In addition, the pH of the feed water was reduced to pH 6.7 to avoid calcium carbonate scaling, which may complicate data interpretation. The measured aluminum in the source water was 170 µg/L, which agreed closely with the theoretical yield. Therefore, prior to RO treatment a majority of the aluminum remained in solution.

When the amount of aluminum was insufficient, aluminum silicates were not formed as shown in the tests of commercial antiscalants and generic antiscalants described above. Therefore, silicate scale inhibition may be achieved by removing aluminum in CRW. Modeling results from Task 2 also showed that the total dissolved aluminum was 99 percent in the form of $\text{Al}(\text{OH})_4^-$ at pH 8.2. Because $\text{Al}(\text{OH})_4^-$ at pH 8.2 would be converted to Al^{3+} at pH 7.0, Al^{3+} was the sole important ion in aluminum silicate formation in CRW both predicted by modeling (see Task 2) and in the aluminum addition tests. Thus, the strategy of minimizing silicate scaling by complexing aluminum (proposed in Task 2) may be promising. Also, results of scale potential of aluminum above had shown that all generic antiscalants were efficient in binding aluminum.

As a result of aluminum addition in the form of $\text{Al}(\text{NO}_3)_3 \cdot 9\text{H}_2\text{O}$, both aluminum and silica were detected by EDS in the filter cake for the control (Table 12), thereby indicating the formation of aluminum silicates. Furthermore, most filter cakes contained gray-colored material that cracked upon drying, which was a typical character of clay-containing scales found previously at Metropolitan (Gabelich et al. 2000). When the gray precipitate was exposed to 0.1 N HCl, the material did not dissolve and minimal, if any, effervescence was observed indicated a lack of calcium carbonate scaling. Additionally, the acid test provided a key indication that the gray precipitate material was aluminum silicate, rather than aluminum hydroxide in nature. Below pH 5.7, freshly precipitated aluminum hydroxides are quite soluble (Faust and Aly 1998). These results demonstrated that aluminum played a vital role in the formation of aluminum silicate scales in CRW.

Combinations of a commercial antiscalant (PT-1.6) and two generic antiscalants (citrate [SC-34] and EDTA [EDTA-16]) were used in this test. Note: citrate and citric acid are essentially the same chemical, only the counterion differs between the two. Since PT-1.6 had demonstrated its ability to remove calcium and barium scales and generic antiscalants EDTA-16 and SC-34 were good at sequestering aluminum, combinations of these antiscalants may provide protection against both traditional (e.g., barium sulfate and calcium carbonate) and non-traditional (i.e., aluminum silicates) scales.

Specific flux data for each of the six RO runs using excess aluminum showed little variation despite permeate flows decreasing by as much as 66 percent (Figure 28), most likely due to operational limitations describe previously. In terms of solubilization, citrate (SC-34) showed the greatest ability to keep aluminum in the dissolved phase, while EDTA (EDTA-16) showed the greatest ability to solubilize silica (Figure 29).

Adding a commercial antiscalant (PT-1.6) did not improve the aluminum binding potential for either SC-34 or EDTA-16, though no aluminum was found in the colloidal phase, as well (Table 12). These data may indicate that for antiscalant PT-1.6, a majority of the aluminum was deposited on the membrane surface (further discussion to follow). The silica data for two of the experiments (PT-1.6, and PT-1.6/SC-34) are unavailable, though previous testing using both PT-1.6 and SC-34 showed no effect on silica solubility (Figure 26).

SEM data showed a clay-like coating on the membrane surfaces for most experiments using excess aluminum (Figure 30). Notable exceptions are experiments using SC-34 and EDTA-16, which show white grains on the membrane surface with little other foulants present. These grains may be calcium carbonate or calcium sulfate scales being that no protection against these foulants (i.e., a commercial antiscalant) was present. EDS data indicated the presence of calcium for the EDTA-16 sample (Table 13); the EDS method uses a small sample area and may not include the grains in the analysis. Therefore calcium may have been present in the SC-34 sample, but not detected.

Aluminum was detected by EDS for all samples, with the exception of the SC-34 sample. For this sample, the visual evidence supports the lack of aluminum silicate fouling (Figure 30) based on the absence of semi-porous clay-like material on the membrane surface. In addition, generic antiscalant SC-34 demonstrated superior performance in keeping aluminum in solution (Figure 29) that may have prevented aluminum from precipitating as either a silicate or hydroxide material. While no visual evidence of aluminum silicate were observed on the EDTA-16 sample, EDS data detected the presence of both aluminum and silica on the membrane surface. Therefore, both SC-34 and EDTA-16 demonstrated good aluminum silicate preventative properties, SC-34 more so than EDTA-16.

The combination of SC-34 and PT-1.6 showed the strong presence of aluminum and silica on the membrane surface (see Table 13) despite this combination's ability to keep aluminum in the soluble form (Figure 29). The PT-1.6/EDTA-16 combination also showed presence of aluminum in excess of the generic antiscalant alone, but no silica was detected (see Table 13). These data may suggest that the commercial antiscalant component of the mixture may have reacted with the aluminum to form a precipitate. Phosphorous, a key inorganic component of the PT-1.6 antiscalant, was detected in the colloidal phase for both antiscalant combination experiments (Table 12), which may support the theory that the aluminum reacted with the commercial antiscalant (see Task 4 for further discussion). However, given the ability of antiscalant EDTA-16 to sequester silica (Figure 29), the precipitate may be in the form of an aluminum hydroxide, which is supported by the lack of silica detected on the membrane surface (see Table 13). In addition, both silica and aluminum were detected in the PT-1.6/SC-34 sample, indicating fouling due to aluminum silicates and/or aluminum hydroxides. These precipitates may be in the form of aluminum silicates or aluminum hydroxides. A potential fouling pathway is through the creation of an aluminum hydroxide or other bound-aluminum foulant that originally precipitates onto the membrane surface, and then these foulants serve as nucleation sites for aluminum silicate formation.

Based on the limited experimental data, citrate and EDTA may effectively act as aluminum sequestering agents that may lead to the prevention of aluminum silicate or hydroxide scaling. However, the commercial antiscalant itself may act as a catalyst or intermediary for aluminum-based scalant formation.

5.3.7. Overall Performance of Antiscalants

Permeate flux decline is the only parameter demonstrating the overall performance of an antiscalant. Permeate flux results showed that antiscalant PT-1.6 excelled other antiscalants in the blended water; antiscalant CAL-5 was the best in CRW at pH 8.2, and the difference in antiscalant performance in CRW at pH 7.0 was less distinguishable.

Unfortunately, analyses performed in the three locations of the RO process were not directly comparable with each other because some data were quantitative (e.g., water quality data), others were qualitative (e.g., SEM data and visual description of the colloidal material) and still others were semiquantitative (e.g., EDS data). Also, each set of data described one aspect of the antiscalant performance and each should not be weighted equally in its importance. Antiscalant performance on the formation of precipitation on the membrane surface should weigh heavier than data about the concentrate (in forms of dissolved or colloidal phase) because what was in the concentrate only had a potential to form scales. When scales were not formed, dissolved element data (water quality data) should develop a more accurate description of the antiscalant performance since these data were quantitative. Under such a guideline, antiscalants PT-1.6 and BFGa-2.5 performed better than other antiscalants in the blended water. Therefore, the commercial antiscalant PT-1.6 (Permacare, Permatreat 191) was selected for the pilot-scale testing. No antiscalant showed a significant better overall performance than other antiscalants in CRW (pH 8.2 and 7.0). Antiscalant CA6 could be used for treating CRW at pH 8.2.

Generic chemicals, especially citric acid and EDTA, demonstrated strong ability to treat the non-traditional scales (i.e. aluminum silicates) by complexing with aluminum. Adding a commercial antiscalant (Permacare, Pretreat 191) did not improve the generic chemicals ability to control for aluminum silicate fouling, and may be a contributing factor in aluminum-based scalant formation. Therefore, citric acid and EDTA were recommended to be tested on the pilot-scale to evaluate their effectiveness in controlling aluminum silicate formation.

5.4 Task 4 Demonstrate Antiscalants

This task conducted pilot-scale RO testing of a commercial antiscalant at greater than 85 percent water recovery. The RO unit consisted of 24 ultra-low-pressure, polyamide elements in a three-array design. Pretreatment was provided by a 22-gpm [120 m³/day] MF unit. For a complete description of the MF and RO units, see the Experimental Methods section of this report. The RO unit was operated for a total of 3,395 hrs at various water recovery levels (85 to 90 percent) and two different terminal array, cross-flow velocities (2.0 gpm [11 m³/day] and 1.7 gpm [9.3 m³/day], as measured

at the array outlet). Additionally, barium chloride and aluminum chloride salts were added to the MF influent to simulate water quality conditions of conventionally treated CRW with 700 mg/L of TDS.

5.4.1 Source Water

For the duration of pilot-scale testing, the source water was a blend of CRW and SPW—an operational constraint at Metropolitan’s research facility in La Verne, Calif. Due to the lower salinity of SPW, the blended water was lower in overall salinity, as well as alkalinity and hardness. Measured inorganic water quality data for the 60/40 blend of CRW and SPW, respectively, are shown in Table 14. It should be noted that the scaling potential of the blended source water at 85 percent water recovery is significantly less than that for 100 percent CRW (for a comparison, see Table 3 and Table 15).

5.4.2 Reverse Osmosis Performance

During this study, the RO unit predominantly demonstrated steady-state performance in terms of specific flux and salt rejection (see Figures 31 and 32). Notable exceptions were when the acid feed to the RO unit was turned off and when barium chloride and aluminum chloride salts were added to the MF influent. Table 16 provides a chronological listing of the operation conditions encountered by the RO unit. For the purposes of this discussion, the operation of the RO unit will be broken into two distinct phases: (1) establishing base-line operating conditions at 85 percent water recovery (0 through 725 hrs of operation), and (2) high water recovery (725 through 3,395 hrs of operation).

Establishing Base-Line Conditions. Previous research at Metropolitan has demonstrated steady-state RO performance at 85 percent water recovery using microfiltered pretreatment water (Bartels et al. 1999, Gabelich et al. 2000, Gabelich et al. In Press). However, these studies were also conducted using a blended water source. In order to ensure the RO unit was operating properly, the RO unit was operated at 85 to 86 percent water recovery for 725 hrs. During the first 142 hrs of operation, a sharp decrease in specific flux was observed, as well as an increase in permeate conductivity in the third array (see Figure 31). All elements from the third array were replaced due to damaged end-caps, which allowed unprocessed water to bypass the membranes and enter into the permeate stream. The damage to the membrane elements was most likely caused by excessive back-pressure during the cleaning cycle conducted prior to testing. Once fresh elements were installed, stable flux and salt passage data were observed. For water quality data, see Table 17.

High Water Recovery. Due to the relatively low scaling potential of the blended water (1.89 LSI and 42.1 $[\text{Ba}][\text{SO}_4]/K_{\text{sp}}(\text{BaSO}_4)$ ratio) when compared to 100 percent CRW at 700 mg/L TDS (2.49 LSI and 93.5 $[\text{Ba}][\text{SO}_4]/K_{\text{sp}}(\text{BaSO}_4)$ ratio), the water recovery was increased to 90 percent to enhance the scaling potential of the feed water. Ninety percent water recovery represented the highest water recovery obtainable with the pilot-scale RO unit while still maintaining adequate flow through the terminal RO elements (cross flow velocity was 2.0 gpm [$11 \text{ m}^3/\text{day}$] with a membrane manufacturer’s

lower limit being 1.5 gpm [8.2 m³/day] [Fluid Systems 1995]). While still below of the scaling potential of 100 percent CRW at 700 mg/L TDS, the scaling potential did increase significantly to 2.40 LSI and 69.8 [Ba][SO₄]/K_{sp}(BaSO₄) (see Table 15).

No evidence of fouling, either through flux decline or decreasing salt rejection, was observed over an additional 773 hrs of operation. Given the lowered scaling potential of the blended water, the antiscalant feed was turned off at 1,498 hr to determine if antiscalant was even necessary to prevent barium sulfate scaling. Again, no changes in flux or salt rejection were observed over the proceeding 454 hrs of operation (1,498 to 1,952 hrs of total operation) (see Figure 31). Since no fouling observed without antiscalant, the acid feed was also turned off to evaluate the calcium carbonate fouling potential, as indicated by the high LSI. After only 20 hrs of additional operation, the permeate flow from the third array decreased to near 0 gpm (see Figure 33), with a concurrent sharp decline in salt rejection in the third array (see Figure 34).

An autopsy of the terminal element from the RO system revealed a uniform deposit of a light-brown colored foulant on the membrane surface. When 0.1 N HCl was introduced, the foulant strongly effervesced and completely dissolved, which indicated the presence of calcium carbonate. EDS analysis showed high levels of calcium and sulfur—the sulfur was most likely from the membrane's polysulfone support layer (see Figure 35). It should be noted that no barium peaks were observed in the EDS spectrograph, indicating that the period of operation without antiscalant did not result in appreciable barium sulfate scaling. For a SEM micrograph of the foulant, see Figure 36. A SEM micrograph of a clean RO membrane surface is presented in Figure 24 for perspective.

Introducing Artificial Salts. After the calcium carbonate fouling episode, all RO elements from the third array were replaced with fresh elements. An acid cleaning of the second array was conducted as well. No chemical cleaning of the first array was conducted, as the data from the first array was part of another, independent, long-term study (beyond the scope of this project). The RO unit was then restarted at 90 percent water recovery while resuming both acid and antiscalant feeds. The membrane flux and salt rejection for each array returned to previous levels (see Figures 33 and 34).

Because neither barium sulfate nor aluminum silicate fouling were observed during pilot-scale testing using the 60/40 blend of CRW and SPW, both barium chloride (anhydrous, reagent grade, Spectrum Chemical, Gardena, Calif.) and aluminum chloride (anhydrous, reagent grade, Spectrum Chemical) salts were introduced to the raw source water. [Note that dissolving anhydrous aluminum chloride into water is extremely exothermic and should be conducted slowly under controlled conditions.] Chemical feeds were introduced to yield 126 µg/L barium and 200 µg/L of aluminum in the RO feed. These levels were chosen to simulate water quality conditions of 100 percent CRW with 700 mg/L TDS and conventionally pretreated with aluminum sulfate coagulant. The barium chloride feed was started at 2,276 hrs of operation and the aluminum chloride feed was started after 2,375 hrs of operation.

Table 18 shows the water quality data for aluminum and barium throughout the MF/RO system. All other water quality components were largely unchanged, with the exception of chloride which increased slightly, and can be found in Table 17. The

measured concentrations for both aluminum and barium in the MF feed stream were lower than their respective theoretical targets (126 µg/L for barium and 200 µg/L for aluminum). This may have been due to either incomplete dissolution in the chemical feed tanks or inaccuracies in the measured feed flow rate. The first explanation may be more likely in that the measured aluminum and barium from the MF effluent (74 µg/L and 87 µg/L, respectively) were significantly lower than the influent concentrations (163 µg/L and 109 µg/L, respectively), indicating that a fraction of both aluminum and barium were greater than 0.2 µm in size—the nominal pore size of the MF microfibers.

At high water recovery (90 percent), the barium sulfate scaling potential of the amended water approached, but did not meet, the scaling potential of 700 mg/L TDS CRW at 85 percent water recovery ($78.6 \frac{[\text{Ba}][\text{SO}_4]}{K_{\text{sp}}(\text{BaSO}_4)}$ and $93.5 \frac{[\text{Ba}][\text{SO}_4]}{K_{\text{sp}}(\text{BaSO}_4)}$, respectively). Effluent turbidities, particle counts, and SDI from the MF unit were unaffected by the chemical feeds.

Within 300 hrs of run time, the specific flux for all three arrays decreased by 13 percent, 24 percent, and 11 percent, respectively (see Figure 33). However, the salt rejection remained constant for all three arrays (see Figure 34). Elements from the first (RO element no. 1), second (RO element no. 13), and third (RO element no. 24) arrays were removed for autopsy. SEM micrographs show distinctly different foulants on the membrane surface of each element (see Figures 37, 38 and 39).

First Array. The element from the first array was covered with a thin coating of cream colored foulant that was granular in nature when viewed under high magnification (3,500 x). EDS analysis showed that the predominant peaks were sulfur, aluminum, and phosphorous—the sulfur peak is always present in EDS spectrographs due to the sulfur content of the polysulfone membrane support layer (see Figure 40). The aluminum and phosphorous peaks may have been caused by the aluminum chelating with the phosphonate-based antiscalant and then depositing on the membrane surface. Multivalent ions form precipitates with soluble phosphates (Metcalf and Eddy 1991). The basic reaction involved in the precipitation of phosphorus and aluminum is as follows:

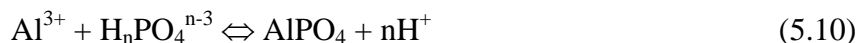

Alternatively, the aluminum may have deposited as a hydroxide salt—the hydroxide ion is not detected by EDS analysis. Figure 41 shows the infrared spectra of a clean/unused membrane surface and the spectra of the three fouled membrane surfaces from this experiment. Spectral analysis of the virgin antiscalant sample, not shown in Figure 41, showed fingerprint peaks at 1086 cm^{-1} and 968 cm^{-1} wavelengths. On the first array membrane sample, a broad adsorption band near 1030 cm^{-1} is evident. Typically, this would be indicative of a C-O-C bond stretch of polysaccharides. However, given that no other evidence to support organic or biological fouling was evident either through visual or operational data, it was assumed that this broad peak was that of the antiscalant ionically bonded to a counterion, i.e., aluminum. Ionic phosphates show strong absorption spectra between 1140 to 1040 cm^{-1} , which overlaps well with the broad absorption peak seen in this sample (Skoog and Leary 1992). These data suggest that the foulant may be aluminum hydroxides and/or aluminum phosphonates.

Second Array. The SEM micrographs from the second array (Figure 38) show a thin, porous foulant layer that contracted after the liquid nitrogen bath during SEM sample processing, as indicated by the cracked membrane surface on the SEM micrograph. The morphology of this sample is more consistent with aluminum silicate scales encountered in previous Metropolitan RO research studies (Gabelich et al. 1999, Metropolitan 2000). The cracking of the membrane surface upon dewatering of the sample is consistent to the shrink/swell behavior observed in many clays, to which aluminum silicates are a common component. EDS analysis also suggests the presence of aluminum silicates by the strong aluminum and silica peaks (see Figure 42). The level of deposition of the foulant on the membrane surface was such that the infrared spectra of the membrane material are virtually obscured by the foulant layer (see Figure 41). A broad, infrared adsorption band between 1,200 and 900 cm^{-1} dominates the infrared spectra, possibly indicating phosphate deposition. Aluminum hydroxides may also be present, but the EDS method can not distinguish between aluminum silicate and aluminum hydroxide materials.

Several conclusions may be drawn from these data: (1) the aluminum fed into the raw water may not have been truly dissolved, as evidenced by its removal by the MF unit; (2) aluminum may foul the membrane surface as either aluminum hydroxide or aluminum silicate; (3) aluminum may react with the phosphonate-based antiscalant to form a foulant; and (4) upon concentration, aluminum may react with ambient silica to form an aluminum silicate scale.

Third Array. EDS data from the third array (see Figure 43) shows strong barium, strontium, and sulfur peaks. Calcium was also detected, but to a much lesser degree than the preceding ions. The barium peak is consistent with barium sulfate fouling, which is supported by the morphology of the scale blooms viewed on the membrane surface (see Figure 39). Both the strontium and calcium may have co-precipitated with the barium as strontium sulfate and calcium sulfate, respectively, despite neither calcium sulfate ($0.38 [\text{Ca}][\text{SO}_4]/K_{\text{sp}}(\text{CaSO}_4)$) nor strontium sulfate ($0.34 [\text{Sr}][\text{SO}_4]/K_{\text{sp}}(\text{SrSO}_4)$) exceeding their respective solubilities. Data from the third array indicates that the antiscalant was ineffective in controlling for barium sulfate scale at barium concentrations typical to 100 percent CRW at a simulated 85 percent water recovery.

However, previous data from Metropolitan's laboratory has shown that when barium crystals were fed to the RO influent—this occurred during testing with recirculating a portion of the concentrate to the front of the RO system—barium sulfate scale could result despite the addition of antiscalant (Gabelich et al. 1999). Being that the barium chloride feed may not have been truly dissolved, sub-colloidal barium particles may have served as precipitation nuclei for barium sulfate scale in the terminal RO elements and unfairly biased the experiment toward barium sulfate scaling. Additionally, given that antiscalant components were detected on the RO membranes upstream of the third array, a portion of the antiscalant may have been removed by reaction with aluminum, therefore the antiscalant's effectiveness was compromised.

Lowering Cross-Flow Velocity. Prior to restarting the RO unit, all three membrane arrays were cleaned with both acid and caustic cleaning solutions. The flow rate through the RO unit was lowered to 17.6 gpm [96 m^3/day] such that the water

recovery remained at 90 percent but the cross-flow velocity in the third array was reduced to 1.7 gpm [9.3 m³/day]. This modification was conducted to simulate the flow conditions that led to aluminum silicate scale formation in previous testing (Gabelich et al. 1999). After an initial increase in flux and salt passage due to the chemical cleaning regime, the specific flux stabilized for the final 870 hrs of operation. Despite lowering the cross-flow velocity in the terminal elements to 1.7 gpm, no fouling of any kind was observed in the RO system. A terminal element from the RO system was removed for autopsy at 3,141 and 3,395 hrs of total run time. However, no evidence of membrane fouling was observed by either SEM or EDS analysis. Given the lower concentration of aluminum in the RO influent (0.02 mg/L) when compared to that during aluminum silicate scaling events (0.05 mg/L), the aluminum silicate scale potential may have been mitigated through lowering the influent aluminum concentration.

REFERENCES

- Alexander, R. B.; Slack, J. R.; Ludtke, A. S.; Fitzgerald, K. K. & Schertz, T. L. Data from Selected U.S. Geological Survey National Stream Water-Quality Monitoring Networks (WQN), USGS Digital Data Series DDS-37, <<http://wwwrvares.er.usgs.gov/wqn96cd/>>, 2000.
- American Society for Testing and Materials (ASTM). Standard Practice for Calculation and Adjustment of Silica (SiO₂) Scaling for Reverse Osmosis. ASTM Designation D 4993-89. ASTM, Philadelphia, Pa, 1989a.
- American Society for Testing and Materials (ASTM). Standard Practice for Standardizing Reverse Osmosis Performance Data. ASTM Designation D 4516-85. ASTM, Philadelphia, Pa, 1989b.
- Amjad, Z.; Zibrida, J. F.; & Zuhl, R. W. A New Antifoulant for Controlling Silica Fouling of Reverse Osmosis Systems. In *Proc. IDA World Congress on Desalination and Water Reuse*, Madrid, Spain, 1997.
- APHA, AWWA, and WEF (American Public Health Association, American Water Works Association, and Water Environment Federation). *Standard Methods for the Examination of Water and Wastewater*. 20th ed. Edited by L.S. Clesceri, A.E. Greenberg, and A.D. Eaton. Washington, D.C.: APHA. 1998.
- Ball, J.W., & Nordstrom, D.K. User's Manual For Wateq4f, With Revised Thermodynamic Data Base and Test Cases for Calculating Speciation of Major, Trace, and Redox Elements in Natural Waters. USGS open-file report 91-183, 1991.
- Bartels, C. R.; Gabelich, C. J.; Yun, T. I.; Cox, M. R.; & Green, J. F. Effect of Pretreatment on Reverse Osmosis Performance for Colorado River Water Desalination. In *Proc. IDA World Congress on Desalination and Water Reuse*, San Diego, California, 1999.
- Bersillon, J.-L.; & Thompson, M. A. Field Evaluation and Piloting. In *Water Treatment: Membrane Processes* (Ed. J. Mallevalle, P. E. Odendaal, M. R. Wiesner). McGraw-Hill, New York, 1996.
- Boffardi, B. P. Scale Deposit Control for Reverse Osmosis Systems. Calgon Corporation Technical Paper, Bulletin No. 4-165, 1996.
- Byre, W. *Reverse Osmosis*, Tall Oaks Publishing Inc., Littleton, Colo., 1995.
- Butt, F. H.; Rahman, F.; & Baduruthamal, U. Identification of Scale Deposits Through Membrane Autopsy, *Desalination*, 101(3), pp. 219-230, 1995.

- Choudhury, Z.; Kommineni, S.; Lozier, J.; Ring, M.; & Collins, R. Effect of Pretreatment on Nanofiltration Performance: Slowsand Versus Rapid Sand Versus Microfilters. In *Proc. AWWA Annual Conference*, Denver, Colorado, 2000.
- Chin, P.F.; & Mills, G.L. Kinetics and Mechanisms of Kaolinite Dissolution: Effects of Organic Ligands. *Chemical Geology*, 90, pp. 307-317, 1991.
- Creed, J.T., C.A. Brockhoff, and T.D. Martin. *Method 200.8: Determination of Trace Elements in Waters and Wastes by Inductively Coupled Plasma–Mass Spectrometry*. Revision 5.4, EMMC Version. USEPA Environmental Monitoring and Systems Laboratory, Cincinnati, Ohio, May 1994.
- Darton, E. G. Scale Inhibition Techniques Used in Membrane Systems. *Desalination* Vol. 113, 227-229, 1997.
- Drever, J. I. *The Geochemistry of Natural Waters, Second Edition*, Prentice Hall Inc., Englewood, New Jersey, 1988.
- Dougan, W.K. & Wilson, A.L. The Absorptiometric Determination of Aluminum in Water: A Comparison of Some Chromogenic Reagents and the Development of an Improved Method. *Analyst*, 99, 413, 1974.
- Faust, S. D. & Aly, O. A. *Chemistry of Water Treatment, 2nd Edition*. Ann Arbor Press, Michigan, 1998.
- Fluid Systems, Inc. *Operational and Design Information: TFC® Spiral-Wound Reverse Osmosis Element*. Manufacturer's cut sheet. San Diego, Calif.: Fluid Systems, 1995.
- Gabelich, C. J.; Yun, T.I.; Cox, M. R.; Bartels, C. R.; Green, J. F.; & Suffet, I. H. Evaluating Ultra-Low-Pressure Reverse Osmosis for Surface Water Desalting. In *Proc. AWWA Membrane Technology Conference*. Long Beach, Calif., 1999.
- Gabelich, C. J.; Bartels, C. R.; Yun, T. I.; & Green, J. F. Comparing Treatment Strategies for Surface Water Desalting. Presented at *AWWA Annual Conference*, Denver, Colo., 2000.
- Gabelich, C. J.; Yun, T. I.; Bartels, C. R.; & Green, J. F. *Non-Thermal Technologies for Salinity Removal: Final Report*. AWWA & AWWARF, Denver, Colo. (In Press).
- Gallup, D. L. Aluminum silicate scale formation and inhibition: scale characterization and laboratory experiments, *Geothermics*, 26(4), pp: 483-499, 1997.
- Gallup D. L. Aluminum silicate scale formation and inhibition (2): scale solubilities and laboratory and field inhibition tests, *Geothermics*, 27(4), pp: 485-501, 1998.

- Goldsborough, B. Dupage Seeing Drop in Water Flow. *Chicago Tribune*. Metro Section, Feb. 1, 2000.
- Goldstein, J., Newbury, D. E., Echlin, P., Joy, D. C., Romig Jr., A. D., Lyman, C. E., Fiori, C., & Lifshin, E. 1992. *Scanning Electron Microscopy and X-Ray Microanalysis: A Text for Biologists, Materials Scientists, and Geologists, 2nd Edition*. Kluwer Academic/Plenum Publishers, New York.
- Green, J.F.; Bartels, C.R.; & Suffet, I. H. Evaluation of precipitative fouling for Colorado River water desalination using reverse osmosis, Technical proposal to U.S. Bureau of Reclamation, 1999.
- Hann, W. M. *Dispersants: Kitt-Othmer Encyclopedia of Chemical Technology*; 4th Ed. John Wiley & Sons, New York., 1993.
- Iler, R. K. *The Chemistry Of Silica: Solubility, Polymerization, Colloid And Surface Properties, And Biochemistry*. John Wiley & Sons, New York, 1979.
- Kriewall, D.; Harding, R.; Maisch, E.; & Schantz, L. The Impact of Aluminum Residual on Transmission Line Capacity. *Public Works*. December, pp: 28-31, 1996.
- Kvech, S. & Edwards, M. Role of Aluminosilicate Deposits in Lead and Copper Corrosion. In *Proc. AWWA Annual Conference*, Denver, Colo., 2000.
- Langelier, W. F. The Analytical Control of Anti-Corrosion Water Treatment. *J. American Water Works Assoc.*, 28(10): 1500-1521, 1936.
- Langelier, W. F. Chemical Equilibrium in Water Treatment. *J. American Water Works Assoc.*, 38(2): 169-178, 1946.
- Le Gouellec, Y.; Nagai, M.; & Elimelech, M. Calcium Sulfate Scale Formation and Control in Nanofiltration of Agricultural Drainage Water. In *Proc. AWWA Annual Conference.*, Dallas, Texas, 1998.
- Lozier, J. & Cole, J. Nanofiltration Treatment of Colorado River Water to Meet Regulations and Enhance Consumer Satisfaction. *Proc. AWWA Ann. Conf.*, Toronto, Canada, 1996.
- McAleese, P.; Moody, C.; Duranceau, S.; Corbett, B.; & Thorner, K. Integrated Membrane Systems Pilot Testing Program for the Olivenhain Water Storage Project. In *Proc. AWWA Membrane Technology Conference*, Long Beach, California, 1999.
- Metcalf and Eddy. *Wastewater Engineering: Treatment, Disposal, and Reuse*; 3rd ed. McGraw-Hill, Inc., New York, 1991.

- Metropolitan Water District of Southern California. *Colorado River Water Total Dissolved Solids Removal Feasibility Study*. Report No. 1137. Prepared by Black & Veatch, 1997.
- Metropolitan Water District of Southern California. *Salinity Management Study*. Prepared by US Department of Interior, Bureau of Reclamation, 1998.
- MSDS. Chemical Safety Information website, Oxford University, The Physical and Theoretical Chemistry Laboratory, <http://physchem.ox.ac.uk/MSDS/>, 1997.
- Ning, R. Y., & Stith, D. Membranes: The Iron Silica and Organic Polymer Triangle. *Ultrapure Water* (Mar. 1997).
- Norman, J.E.; Hoang, T.; & Leslie, G. L. Diagnosis and Remediation of Silicate Scale Fouling in Microfiltration Membranes: A Case Study. In *Proc. AWWA Membrane Technology Conference*, Long Beach, Calif., 1999.
- Pfaff, J.D., C.A. Borckhoff, and J.W. O'Dell. *Method 300.0: The Determination of Inorganic Anions in Water by Ion Chromatography*. USEPA Environmental Monitoring and Systems Laboratory, Cincinnati, Ohio, December 1989.
- Ridgway, H.F., K. Ishida, G. Rodriguez, J. Safarik, T. Knoell, and R. Bold. 1998. Biofouling of Membranes I: Membrane Preparation and Characterization and Analysis of Bacterial Adhesion. In *Methods of Enzymology*. Louisville, Ky.: R.J. Doyle.
- Shea, R. D. "Pig" Cleaning Water Transmission Pipelines. *Public Works*. June, 1993. pp:54-6, 1993.
- Skoog, D. A.; & Leary J. J. *Principles of Instrumental Analysis: 4th Ed.* Saunders College Publishing, Orlando, Fla., 1992.
- Southern Nevada Water Authority. Las Vegas Water Quality website: <http://www.lvwaterquality.org/database.html>, 2000.
- Sposito, G. *The Environmental Chemistry of Aluminum, Second Edition*, CRC Press Inc., 1996.
- Taylor, J. S. & Jacobs, E. P. Reverse Osmosis and Nanofiltration. In *Water Treatment: Membrane Processes*, (Ed. By J. Mallevalle, P. E. Odendaal, & Wiesner, M. R.) McGraw-Hill, New York, 1996.
- Unpublished data. Metropolitan Water District of Southern California, 2000.
- Weng, P. F. Silica Scale Inhibition and Colloidal Silica Dispersion for Reverse Osmosis Systems. In *Proc. American Desalting Association Biannual Meeting*, Palm Beach, Fla., 1994.

Wiesner, M. R., & Aptel, P. Mass Transport and Permeate Flux and Fouling in Pressure-Driven Processes. In *Water Treatment: Membrane Processes* (ed. by J. Mallevalle, P. E. Odendaal, M. R. Wiesner). McGraw-Hill, New York, 1996.

Wiesner, M. R. & Buckley, C. A. Principles of Rejection in ΔP Processes. In *Water Treatment: Membrane Processes*, (Ed. By J. Mallevalle, P. E. Odendaal, & Wiesner, M. R.) McGraw-Hill, New York, 1996.

TABLES AND FIGURES

Table 1. List of commercial and generic antiscalants under evaluation

Vendor	Antiscalant	Water Type		
		CRW/SPW	CRW (pH 8.2)	CRW (pH 7.0)
Permacare	PermaTreat 191		1.6 mg/L	
BFGoodrich	AF 1025		2.5 mg/L	
KingLee	RO-C 10ppm and RO-D		10 mg/L (each), 20 mg/L (total)	
BFGoodrich	AF 1405		2.5 mg/L	
Stockhausen	90378		10 mg/L	
Calgon	EL5300		5 mg/L	
Argo (BetzDearborn)	Hypersperse SI300 UL		2.3 mg/L	
PWT	SpectraGuard		10 mg/L	
Generic	Citric acid	0.002mg/L 1.1 mg/L 0.11 mg/L 0.01 mg/L	0.01 mg/L	0.01 mg/L
Generic	Oxalic acid	0.0014mg/L		0.008 mg/L
Generic	Aspartic acid	0.002 mg/L	0.011 mg/L	0.011 mg/L
Generic	Salicylic acid	0.12 mg/L 0.012 mg/L 0.002 mg/L		
Generic	EDTA	0.13 mg/L 0.013 mg/L	0.013 mg/L	0.013 mg/L
Generic	Citrate			16.1 mg/L 33.5 mg/L

Table 2. Sampling scheme for pilot-scale testing

Parameter	Sampling Method	Sampling Location			
		Microfiltration Influent	Microfiltration Effluent	RO Permeate	RO Concentrate
pH	Grab/On-Line	1/day	Continuous	NA	NA
Temperature	Grab/On-Line	1/day	Continuous	NA	NA
Conductivity	Grab/On-Line	NA	1/day	Continuous	NA
Free Cl ₂	On-Line	NA	Continuous	NA	NA
Turbidity	On-Line	Continuous	Continuous	NA	NA
Particle counts	On-Line	Continuous	Continuous	NA	NA
Flow	On-Line	Continuous	Continuous	Continuous	Continuous
SDI	Grab	NA	1/week	NA	NA
Alkalinity/hardness	Grab	1/week	1/week	1/week	1/week
TDS	Grab	1/week	1/week	1/week	1/week
Cations (Ca/K/Mg/Na)	Grab	1/week	1/week	1/week	1/week
Anions (Br/Cl/F/NO ₃ /SO ₄)	Grab	1/week	1/week	1/week	1/week
Trace metals (Al/As/Ba/Fe/Mn/Sr)	Grab	1/week	1/week	1/week	1/week
Silica	Grab	1/week	1/week	1/week	1/week
TOC	Grab	1/week	1/week	1/week	1/week

NA = not applicable

Table 3. Historical water quality data of Colorado River water*

Parameter	90 th Percentile	50 th Percentile	10 th Percentile
Total dissolved solids (mg/L)	703	661	538
Total hardness as CaCO ₃ (mg/L)	332	316	273
Total alkalinity as CaCO ₃ (mg/L)	134	128	121
Total organic carbon (mg/L)	3.33	2.80	2.53
Hydrogen concentration (pH)	8.40	8.30	8.11
Calcium (mg/L)	82	77	68
Magnesium (mg/L)	32	30	25
Sodium (mg/L)	108	100	75
Potassium (mg/L)	5.0	4.5	3.9
Carbonate (mg/L)	0	1	0
Bicarbonate (mg/L)	300	275	218
Free carbon dioxide (mg/L)	2.0	1.3	1.0
Sulfate (mg/L)	300	275	218
Chloride (mg/L)	95	88	59
Nitrate (mg/L)	1.1	0.7	0.2
Fluoride (mg/L)	0.37	0.32	0.27
Boron (mg/L)	0.16	0.13	0.08
Silica (mg/L)	10.1	9.1	8.2
Bromide (mg/L)	0.10	0.09	0.07
Aluminum (mg/L)**	0.224	0.183	0.116
Iron (mg/L)**	0.025	0.020	0.008
Barium (mg/L)	0.135	0.112	0.082
Strontium (mg/L)	1.10	0.95	0.76
Temperature (°C)	24	17	12
pH	8.4	8.3	8.1
Calculated Values at 85 percent Water Recovery at adjusted pH 7.3			
Langlier Saturation Index	2.49	2.28	2.01
[Ba][SO ₄]/K _{sp} (BaSO ₄)	93.5	71.9	48.7
[Ca][SO ₄]/K _{sp} (CaSO ₄)	0.78	0.72	0.59
[Ca][F]/K _{sp} (CaF)	0.24	0.18	0.13
[Sr][SO ₄]/K _{sp} (SrSO ₄)	0.61	0.52	0.40
[SiO ₂]/K _{sp} (SiO ₂)	0.42	0.45	0.45

* Data taken from Lake Mathews between June 1976 and September 2000

** Data taken from Weymouth Filtration Plant, La Verne, California between October 1993 and April 1999

Table 4. Common scalants and control measures for Colorado River water

Foulant/Scalant	Control Measure
<ul style="list-style-type: none"> • Calcium carbonate • Calcium fluoride 	<ul style="list-style-type: none"> • pH control
<ul style="list-style-type: none"> • Barium sulfate • Calcium sulfate • Strontium sulfate 	<ul style="list-style-type: none"> • Antiscalant addition
<ul style="list-style-type: none"> • Aluminum silicate 	<ul style="list-style-type: none"> • Antiscalant addition • Maintain minimum cross-flow in last array • Minimize multivalent ions to <0.05 mg/L

Table 5. Mineral phases that may be precipitated from Colorado River water using geochemical modeling

Mineral	Log (γ_p/K_{sp})	Classification	Formula
Leonhardite	10.23	Silicates	$\text{CaAl}_2\text{Si}_4\text{O}_{12}\cdot 4(\text{H}_2\text{O})$
Kmica-Muscovite	6.039	Silicates	$\text{KAl}_2(\text{Si}_3\text{Al})\text{O}_{10}(\text{OH},\text{F})_2$
Tremolite	5.8	Silicates	$\text{Ca}_2\text{Mg}_5\text{Si}_8\text{O}_{22}(\text{OH})_2$
Pyrophyllite	4.363	Silicates	$\text{Al}_2\text{Si}_4\text{O}_{10}(\text{OH})_2$
Chlorite	3.059	Silicates	$\text{Na}_{0,5}(\text{Al},\text{Mg})_6(\text{Si},\text{Al})_8\text{O}_{18}(\text{OH})_{12}\cdot 5(\text{H}_2\text{O})$
Talc	2.895	Silicates	$\text{Mg}_3\text{Si}_4\text{O}_{10}(\text{OH})_2$
Kaolinite	2.241	Silicates	$\text{Al}_2\text{Si}_2\text{O}_5(\text{OH})_4$
Diaspore	1.711	Hydroxyl	$\text{AlO}(\text{OH})$
Laumontite	1.129	Silicates	$\text{CaAl}_2\text{Si}_4\text{O}_{12}\cdot 4(\text{H}_2\text{O})$
Beidellite	0.857	Silicates	$(\text{Na},\text{Ca}_{0,5})_{0,3}\text{Al}_2(\text{Si},\text{Al})_4\text{O}_{10}(\text{OH})_2\cdot n(\text{H}_2\text{O})$
Dolomite	0.676	Carbonates	$\text{CaMg}(\text{CO}_3)_2$
Barite	0.635	Sulfates	BaSO_4
Ca Montmorillite	0.598	Silicates	$(\text{Na},\text{Ca})_{0,3}(\text{Al},\text{Mg})_2\text{Si}_4\text{O}_{10}(\text{OH})_2\cdot n(\text{H}_2\text{O})$
Illite	0.569	Silicates	$(\text{K},\text{H}_3\text{O})(\text{Al},\text{Mg},\text{Fe})_2(\text{Si},\text{Al})_4\text{O}_{10}[(\text{OH})_2,(\text{H}_2\text{O})]$
Gibbsite	0.503	Hydroxides	$\text{Al}(\text{OH})_3$
Calcite	0.412	Carbonates	CaCO_3
Aragonite	0.265	Carbonates	CaCO_3
Quartz	0.215	Oxides	SiO_2

Table 6. Distribution of dissolved species of aluminum and silica of Colorado River water using geochemical modeling

Species	Calculated activity	Percent of total (%)
Al^{3+}	8.68E-17	0.00
AlF^{2+}	1.06E-14	0.00
AlF_2^+	6.55E-14	0.00
$\text{AlF}_3(\text{aqueous})$	1.04E-14	0.00
AlF_4^-	5.19E-17	0.00
AlHSO_4^{2+}	1.32E-25	0.00
AlOH^{2+}	1.30E-13	0.00
$\text{Al}(\text{OH})_2^+$	1.36E-10	0.01
$\text{Al}(\text{OH})_3(\text{aqueous})$	2.86E-09	0.24
$\text{Al}(\text{OH})_4^-$	1.06E-06	99.75
AlSO_4^+	3.24E-16	0.00
AlSO_4^{2-}	1.26E-17	0.00
$\text{H}_4\text{SiO}_4(\text{aq})$	1.45E-04	97.19
H_3SiO_4^-	3.72E-06	2.81
$\text{H}_2\text{SiO}_4^{2-}$	3.78E-11	0.00
SiF_6^{2-}	7.41E-37	0.00

Table 7. Natural organic products used to complex dissolved aluminum in treating the aluminum silicate scale

Reagents	logK ₁ ^a	Biodegradable	Toxic	Toxicity Data, LD50 ^b (mg dose/kg weight) ^c
Oxalic acid	6.1	Yes	No ^c	Oral-rat, 7,500
Malonic acid	6.26	Yes	No	Oral-mouse, 4,000
Citric acid	8.65	Yes	No	Oral-mouse, 5,040
Salicylic acid	12.9	No	No	Oral-mouse, 480
Aspartic acid	16.29	Yes	No	ND ^d
Glutamic acid	15.12	Yes	No	ND
EDTA	16.13	No	No	Oral-mouse, 30

^a Data came from reference (Sposito 1996), ^b LD 50 means lethal dose at 50 percent kill, ^c No here means no adverse health effect in dilute water solutions but may be toxic when the pure chemicals are swallowed or inhaled, ^d ND = no data, and ^e Data came from reference (MSDS 1997)

Table 8. Reference guide for bench-scale antiscalant testing

Code	Vendor	Antiscalant	Dose (mg/L)
PT-1.6	Permacare	PermaTreat 191	1.6
BFGa-2.5	BFGoodrich	AF 1025	2.5
KNG-20	KingLee	RO-C and RO-D	10 (each)
BFGb-2.5	BFGoodrich	AF 1405	2.5
SKH-10	Stockhausen	90378	10
CAL-5	Calgon	EL5300	5.0
ARG-2.3	Argo (BetzDearborn)	Hypersperse SI300 UL	2.3
PWT-10	PWT	SpectraGuard	10
CA-1200	Generic	Citric acid	1,200
CA-120			120
CA-24			24
CA-12			12
CA-2.0			2.0
OA-2.0	Generic	Oxalic acid	2.0
OA-10			10
AA-2.0	Generic	Aspartic acid	2.0
AA-11			11
SA-117	Generic	Salicylic acid	117
SA-12			12
SA-2.4			2.4
EDTA-124	Generic	EDTA in form of sodium salt	124
EDTA-12			12
EDTA-16			16
SC-34	Generic	Sodium Citrate	34

Coding system:

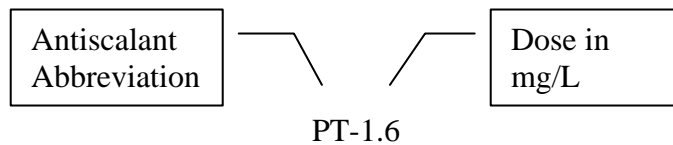

Table 9. Chemical and physical information for commercial antiscalants used in bench-scale testing.

Code	Chemical and Physical Information
PT-1.6	NA Specific Gravity (SG) 1.36 at 20°C
BFGa-2.5	Water 63% Polymer/Solids 37% SG 1.15
KNG-20	Pretreat Plus-2000 SG 1.04 Protec RO-C and RO-D SG 1.01
BFGb-2.5	Water < 71% Polymer/Solids 29% SG 1.12
SKH-10	2-Propenoic acid, polymer with α -(2-methyl-1-oxo-2-propenyl)- ω -methoxypoly (oxy-1,2-ethanediyl) and sodium 2-methyl-2-propene-1-sulfonate, sodium salt
CAL-5	Sodium salt of Phosphonomethylated diamine
ARG-2.3	NA SG 1.142 @ 21°C
PWT-10	Water soluble polymer SG 1.04-1.08

NA = not available.

Table 10. SEM results of fouled membrane surface of bench scale testing

Test	CRW/SPW blend	100% CRW at pH 8.2	100% CRW at pH 7
Control	3	4	3
PT-1.6	1	4	3
BFGa-2.5	1	OF	2
KNG-20	4	4	OF
BFGb-2.5	2	3	OF
SKH-10	OF	4	OF
CAL-5	2	3	OF
ARG-2.3	OF	4	OF
PWT-10	OF	OF	OF
CA-2.0	3		
CA-1200	2		
CA-120	4		
CA-12	5	5	3
OA-2.0	5		
OA-10			5
AA-2.0	OF		
AA-11		5	5
SA-117	4		
SA-12	4		
SA-2.4	5		
EDTA-124	5		
EDTA-12	5	5	4

1 = least fouling; 2 = slight fouling; 3 = moderate fouling; 4 = severe fouling; 5 = very severe fouling; OF = organic fouling; and blank = no test.

Table 11. EDS results from membrane and colloidal analysis of bench scale testing (Data is for calcium, silica (Si) and barium (Ba) are indicated in case of presence.)

Test	Membrane Analysis			Colloidal Analysis		
	CRW/SPW blend	100% CRW at pH 8.2	100% CRW at pH 7	CRW/SPW blend	100% CRW at pH 8.2	100% CRW at pH 7
Control	2	5	2	4	4	4.5, Si=1
PT-1.6		5	2	4	4	4
BFGa-2.5		3	1	4	4.5	4
KNG-20	3	3.5	1	4	3.5	4.5
BFGb-2.5		4	2	3.5	4	4
SKH-10	2	3.5	2	3.5	3.5	4.5, Si=1
CAL-5	2	3.5	3	3.5	3.5	4.5, Si=1
ARG-2.3	2	4	1	3.5	4	4.5, Si=1
PWT-10	3.5	4	1	4	4	4, Si=1
CA-2.0	2, Si=1			4		
CA-1200				1, Si=2, Ba=3		
CA-120				2, Si=2		
CA-12	4, Si=1	3.5	2	4, Si=1	4	3.5
OA-2.0	4, Si=1			4		
OA-10			3			4
AA-2.0	2, Si=1			3.5, Si=1		
AA-11		3.5	3		3.5, Si=1	3.5, Si=1
SA-117	3, Si=1			3.5, Si=1		
SA-12	4, Si=1			4, Si=2		
SA-2.4	2, Si=1			4, Si=1		
EDTA-124	3			4, Si=1		
EDTA-12	4	3.5	3	3.5, Si=2	4	4

1 = lowest; 2 = low; 3 = medium; 4 = high; 5 = highest amount detected; ND = not detectable; and blank = no test.

Table 12. EDS data of colloidal material from concentrate stream using CRW and 170 µg/L aluminum*

Element	Antiscalant					
	Control	Pt-1.6	EDTA-16	SC-34	Pt-1.6/ EDTA-16	Pt-1.6/ SC-34
Aluminum	21	--	--	16	26	19
Arsenic	--	--	--	--	--	--
Bromine	--	4.5	--	--	--	--
Calcium	12	82	94	16	17	44
Chlorine	2.8	--	--	2.0	3.1	3.1
Copper	14	4.3	--	--	--	--
Iron	--	--	--	3.3	2.3	--
Magnesium	4.2	--	1.1	6.4	4.7	4.1
Phosphorus	--	--	--	6.3	12	4.9
Potassium	--	--	--	2.3	--	--
Silica	41	6.7	--	36	24	16
Sodium	--	--	1.0	6.7	4.5	4.3
Sulfur	4.4	2.8	3.5	5.3	6.0	5.4

*Percent by weight

-- = Not detected

Table 13. EDS data from RO membranes using CRW and 170 µg/L aluminum*

Element	Antiscalant					
	Control	Pt-1.6	EDTA-16	SC-34	Pt-1.6/ EDTA-16	Pt-1.6/ SC-34
Aluminum	19	19	18	--	25	26
Arsenic	--	--	--	--	--	14
Calcium	--	4.3	30	--	--	--
Chlorine	--	6.4	--	8.9	--	7.3
Magnesium	--	8.1	5.3	--	--	--
Silica	10	5.6	6.9	6.8	--	5.5
Sodium	23	21	8.4	31	19	22
Sulfur	48	35	32	53	56	27

*Percent by weight

-- = Not detected

Table 14. Influent water quality data for pilot-scale testing[†]

Parameter	Influent
Total Dissolved Solids (mg/L)	452 (11, 22.8)
Total Hardness as CaCO ₃ (mg/L)	209 (12, 14.9)
Total Alkalinity as CaCO ₃ (mg/L)	104 (12, 4.8)
Total Organic Carbon (mg/L)	2.79 (12, 0.21)
Hydrogen Concentration (pH)	8.2 (159, 0.1)
Calcium (mg/L)	50.6 (11, 4.6)
Magnesium (mg/L)	21 (11, 1.3)
Potassium (mg/L)	3.48 (11, 0.16)
Sodium (mg/L)	66 (11, 3.13)
Sulfate (mg/L)	155 (12, 15.5)
Chloride (mg/L)	63 (12, 3.3)
Fluoride (mg/L)	0.21 (11, 0.02)
Nitrate (mg/L)	1.70 (12, 1.8)
Silica (mg/L)	9.60 (10, .59)
Aluminum (µg/L)	53 (9, 43))
Barium (µg/L)	77 (11, 13)
Iron (µg/L)	57 (13, 45)
Strontium (µg/L)	692 (11, 64)

[†] All data given in average values

Data in parentheses indicate number of samples and standard deviation, respectively.

Table 15. Scaling indexes for 60/40 Colorado River/California State Project water blend*

Scaling Index	85 Percent Water Recovery (adjusted pH 7.3)	90 Percent Water Recovery (adjusted pH 7.3)
Langlier Saturation Index	1.89	2.41
[Ba][SO ₄]/K _{sp} (BaSO ₄)	42.1	69.8
[Ca][SO ₄]/K _{sp} (CaSO ₄)	0.38	0.63
[Ca][F]/K _{sp} (CaF)	0.07	0.18
[Sr][SO ₄]/K _{sp} (SrSO ₄)	0.34	0.53
[SiO ₂]/K _{sp} (SiO ₂)	0.37	0.53

* Calculated using RoPro 6.0, Fluid Systems, San Diego, Calif.

Table 16. Operational observations for reverse osmosis unit

RO Run Time (hours)	Description
0 – 142	At 86 percent water recovery, a sharp increase in specific flux was observed. All elements from the third array were replaced because of damaged end caps.
142 – 725	The RO unit was started with fresh 2 ½-in. diameter elements in the third array at 86 percent water recovery. No evidence of membrane fouling was observed during this period.
725 – 1,498	Water recovery was increased to 90 percent. No evidence of membrane fouling was observed during this period.
1,498 – 1,952	Turned antiscalant feed off. No evidence of membrane fouling was observed over 1200 hours of membrane testing at 90 percent water recovery.
1,952 – 1,972	Turned acid feed off. Permeate flow from third array decreased to zero (0) within 19 hours. The last element of last array was removed for autopsy. Autopsy of fouled element revealed significant, uniform deposits of a light-brown colored foulant on the membrane surface that effervesced and dissolved completely upon application of 0.1 <i>N</i> hydrochloric acid. Energy dispersive spectroscopy (EDS) analysis showed high levels of calcium and sulfur—the sulfur was most likely from the membrane’s polysulfone support layer. Fouling by calcium carbonate was indicated.
1,972 – 2,276	All six-membrane elements from the third array were removed and replaced with fresh elements. An acid cleaning of the second array was conducted as well. No chemical cleaning of the first array was conducted. Membrane unit was restarted at 90 percent water recovery with acid and antiscalant addition. Membrane flux and salt rejection returned to previous levels.
2,276 – 2,528	Barium chloride feed was started at 2,276 hours of operation. Aluminum chloride was added to the feed at 2,375 hours of operation. Within 300 hours of run time, the normalized flux for all three arrays decreased by 13 percent, 24 percent and 11 percent, respectively. Elements from the first, second, and third arrays were removed for autopsy. EDS analysis showed aluminum and phosphorus on the first array element, aluminum, silica, and phosphorus in the second array element, and strontium, barium, and calcium on the third array element.
2,528 – 3,395	Membranes were cleaned with acid and caustic solutions. The flow rate through the RO unit was lowered to 17.6 gpm (96 m ³ /day) such that the water recovery remained at 90 percent but the cross-flow velocity in the third array was reduced to 1.7 gpm (9.3 m ³ /day). This modification was conducted to simulate flow conditions that led to aluminum silicate scale formation in the terminal elements during previous testing. No loss of water productivity was observed over 613 hours of operation. The terminal element from the third array was removed for autopsy, but no evidence of scaling was found.

Table 17. Reverse osmosis salinity rejection data

Parameter	Water Recovery	
	85 Percent	90 Percent
Total Dissolved Solids	93.9 (1, --)	92.5 (10, 2.66)
Total Hardness as CaCO ₃	98.7 (2, 0.42)	97.9 (10, 1.11)
Total Alkalinity as CaCO ₃	91.8 (2, 0.24)	89.9 (10, 3.66)
Total Organic Carbon	97.1 (2, 0.11)	93.6 (9, 2.44)
Calcium	99.0 (1, --)	97.8 (10, 0.96)
Magnesium	99.0 (1, --)	97.0 (10, 3.13)
Potassium	91.2 (1, --)	84.5 (10, 5.75)
Sodium	89.9 (1, --)	85.1 (10, 6.37)
Chloride	90.8 (2, 0.50)	85.6 (10, 7.06)
Fluoride	89.5 (1, --)	84.0 (10, 2.62)
Nitrate	68.7 (2, 1.05)	55.3 (10, 11.95)
Silica	87.1 (1, --)	82.2 (10, 9.02)
Sulfate	97.9 (2, 0.42)	97.9 (10, 1.22)
Aluminum*	80.8 (1, --)	--
Barium	96.2 (1, --)	96.6 (10, 1.15)
Iron*	60.0 (1, --)	--
Strontium	98.5 (1, --)	98.2 (10, 1.02)

Data in parenthesis indicate number of samples and standard deviation, respectively

* Permeate concentration below the reportable detection limit

Table 18. Water quality using supplemental salts*

Water Source	Microfiltration Influent	Microfiltration Effluent	Reverse Osmosis Permeate	Reverse Osmosis Concentrate
Aluminum (µg/L)	163 (2, 17.7)	74 (2, 7.8)	--	289 (2, 26.9)
Barium (µg/L)	109 (3, 5.1)	87 (3, 3.2)	--	534 (3, 122)
[Ba][SO ₄] to K _{sp} (BaSO ₄) Ratio	--	--	--	78.6 [†]

* Data given in median values. Data in parenthesis indicated number of samples and standard deviation, respectively.

[†] Calculated using RoPro 6.0, Fluid Systems, San Diego, Calif.

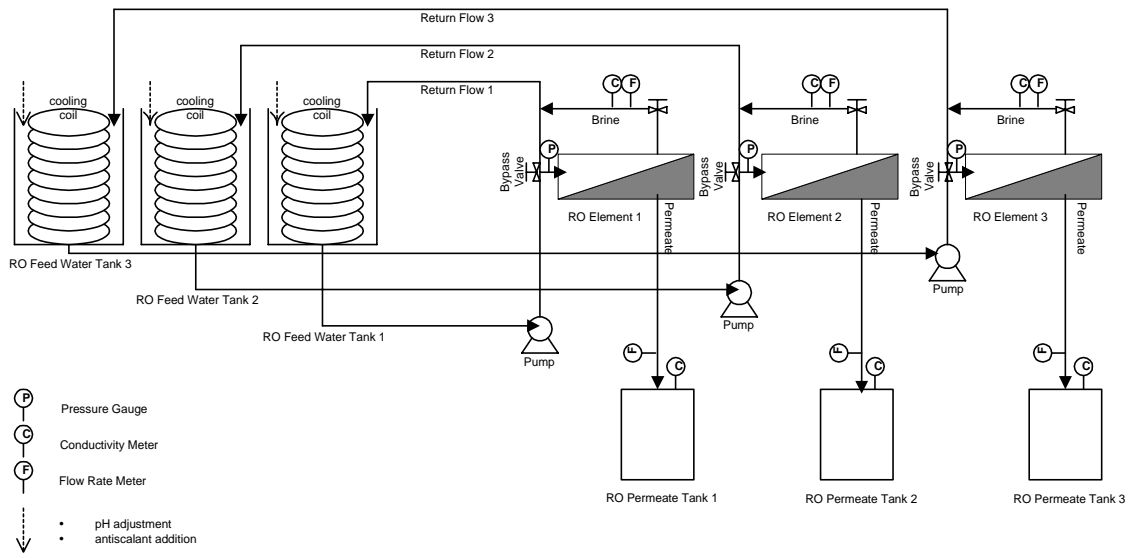

Figure 1. Schematic diagram of bench-scale reverse osmosis units

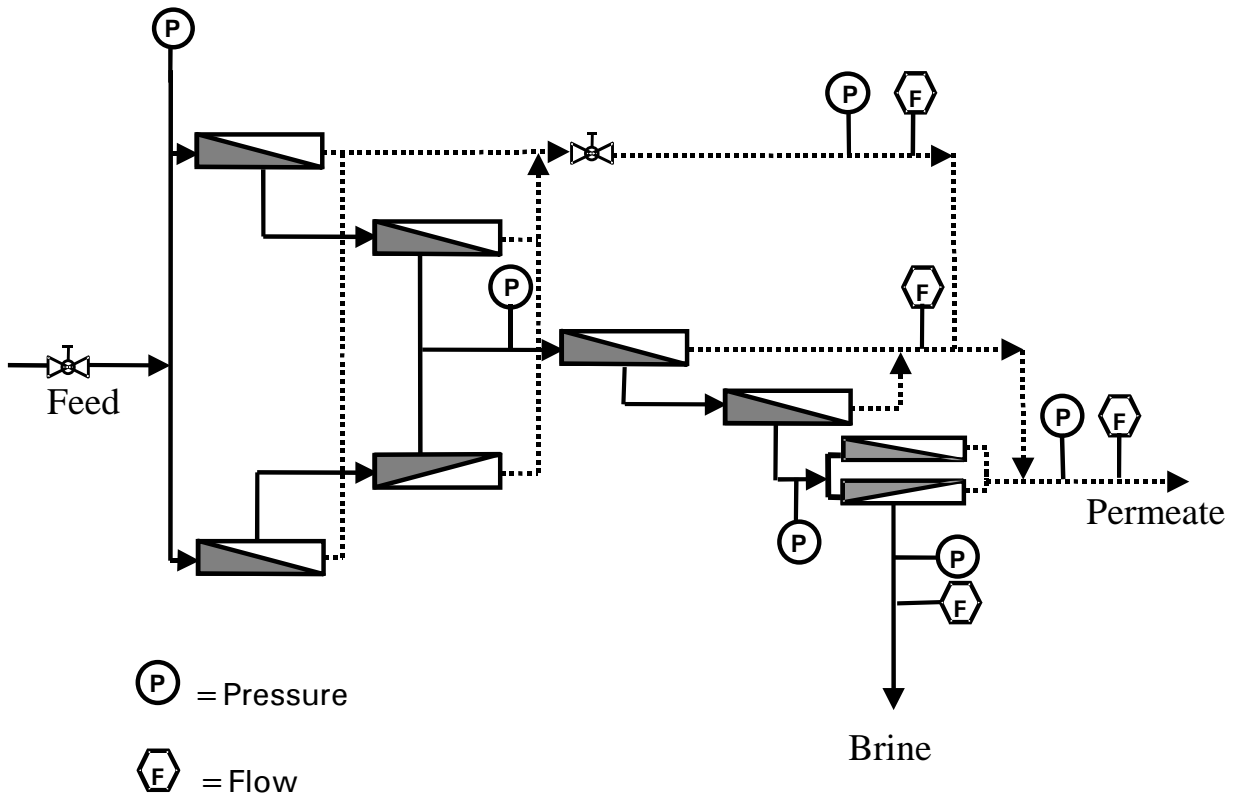

Figure 2. Schematic diagram of reverse osmosis unit for pilot-scale testing

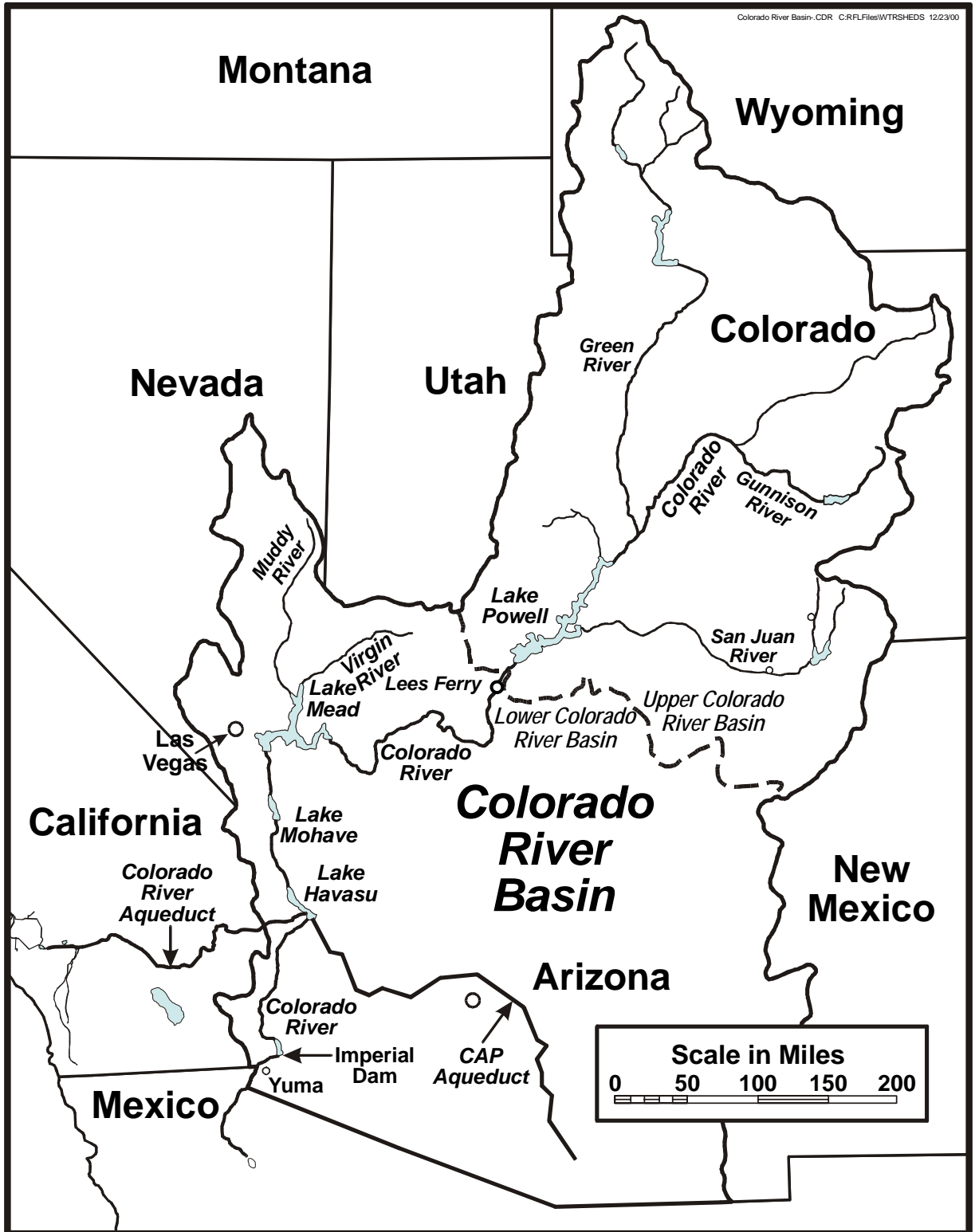
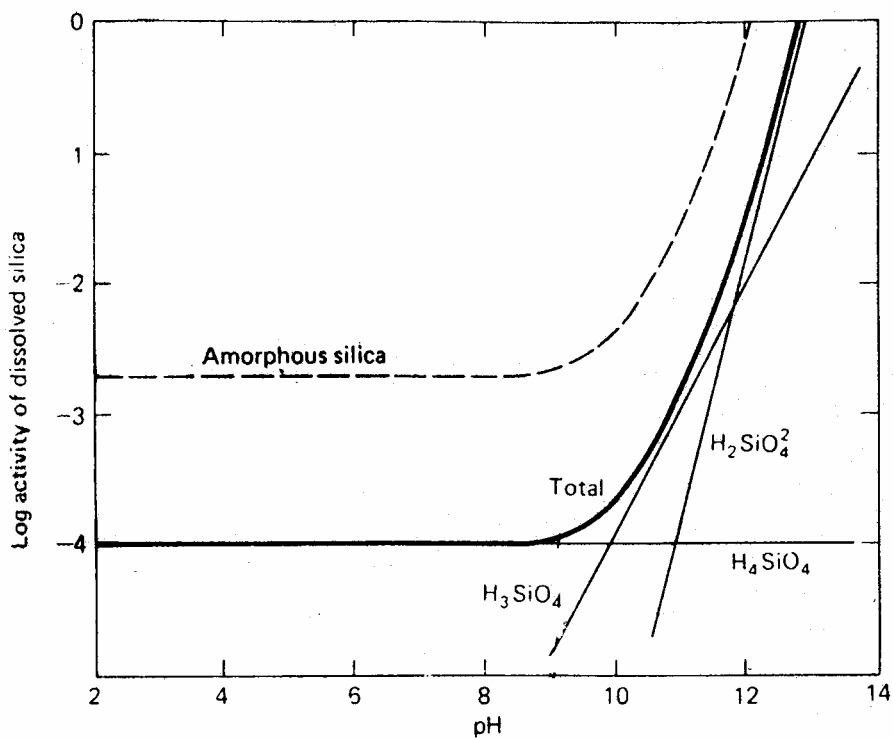
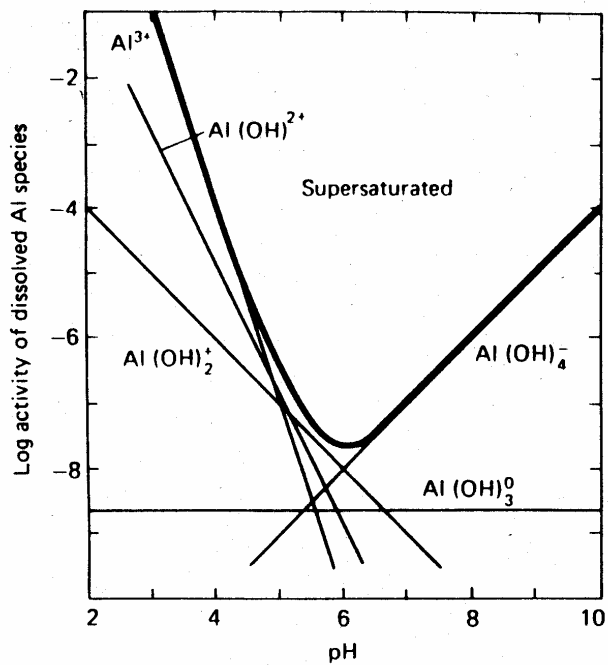

Figure 3. Map of Lower Colorado River basin



(Figure taken from Drever 1988)

Figure 4. Activity of dissolved silica species in equilibrium with quartz (the heavy line) and amorphous silica (the dotted line) at 25°C



(Figure taken from Drever 1988)

Figure 5. Activity of dissolved aluminum species in equilibrium with gibbsite at 25°C

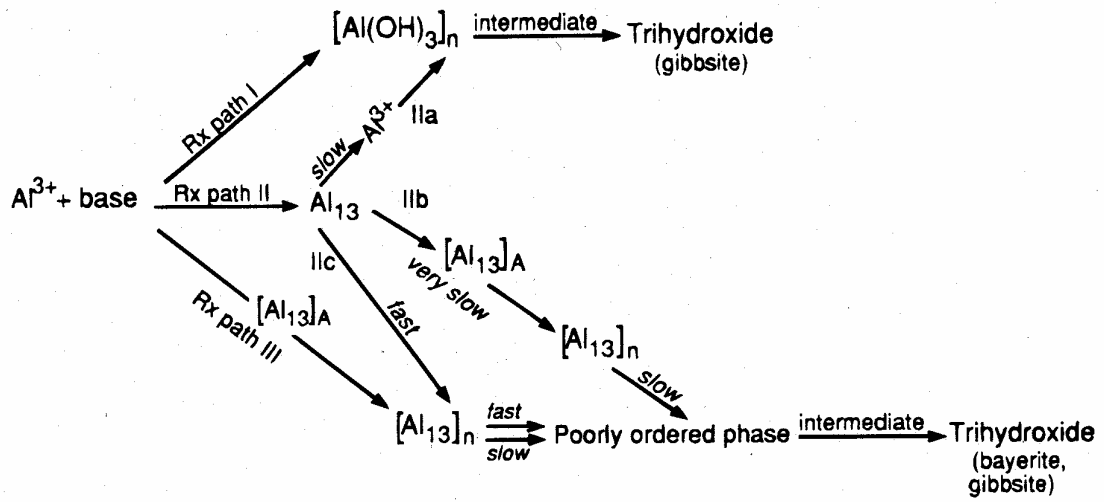

(Figure taken from Sposito 1996)

Figure 6. Reaction pathways for trihydroxide formation from hydrolyzed aluminum solution, demonstrating the role of Al_{13} in controlling relative reaction kinetics

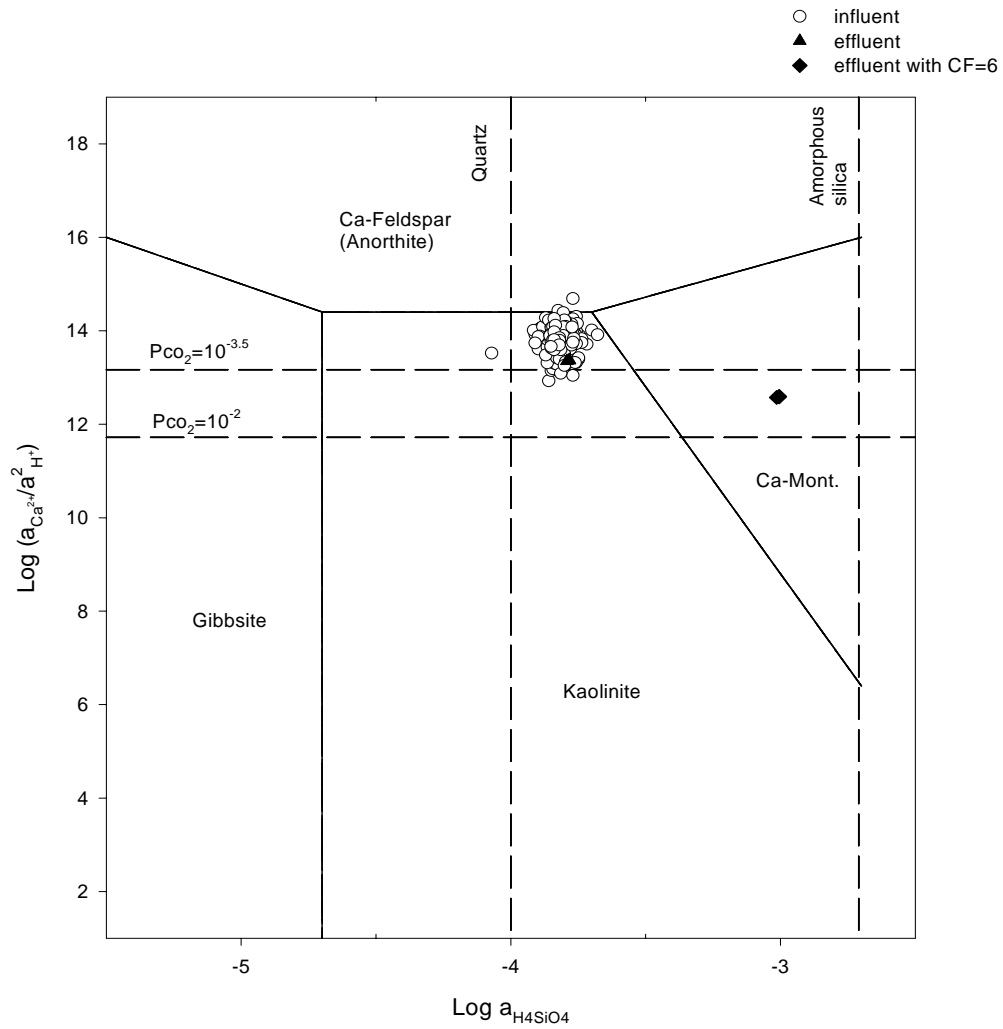

(Figure adapted from Drever 1988)

Figure 7. Predominance area diagram of CaO-Al₂O₃-SiO₂-H₂O system at 25°C

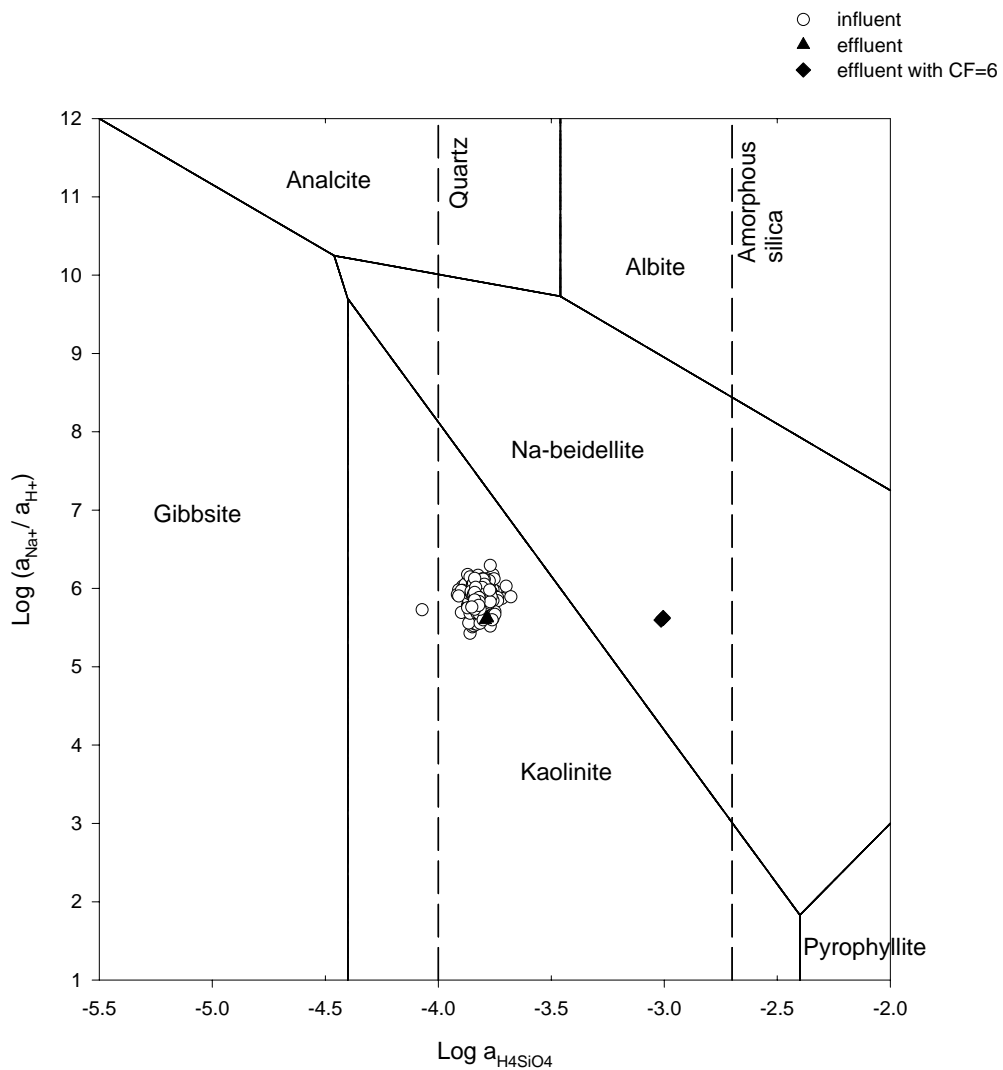

(Figure adapted from Drever 1988)

Figure 8. Predominance area diagram of $\text{Na}_2\text{O}-\text{Al}_2\text{O}_3-\text{SiO}_2-\text{H}_2\text{O}$ system at 25°C

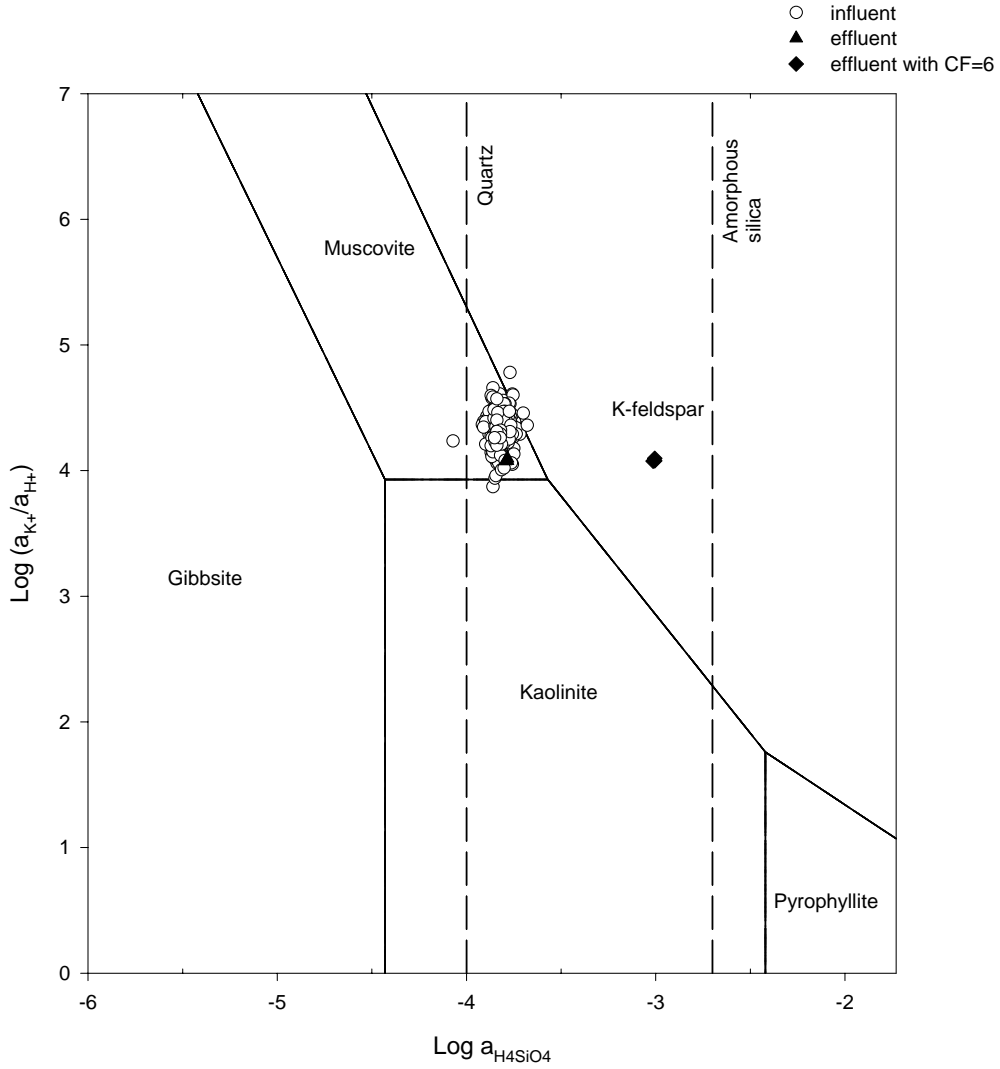

(Figure adapted from Drever 1988)

Figure 9. Predominance area diagram of $K_2O-Al_2O_3-SiO_2-H_2O$ system at $25^\circ C$

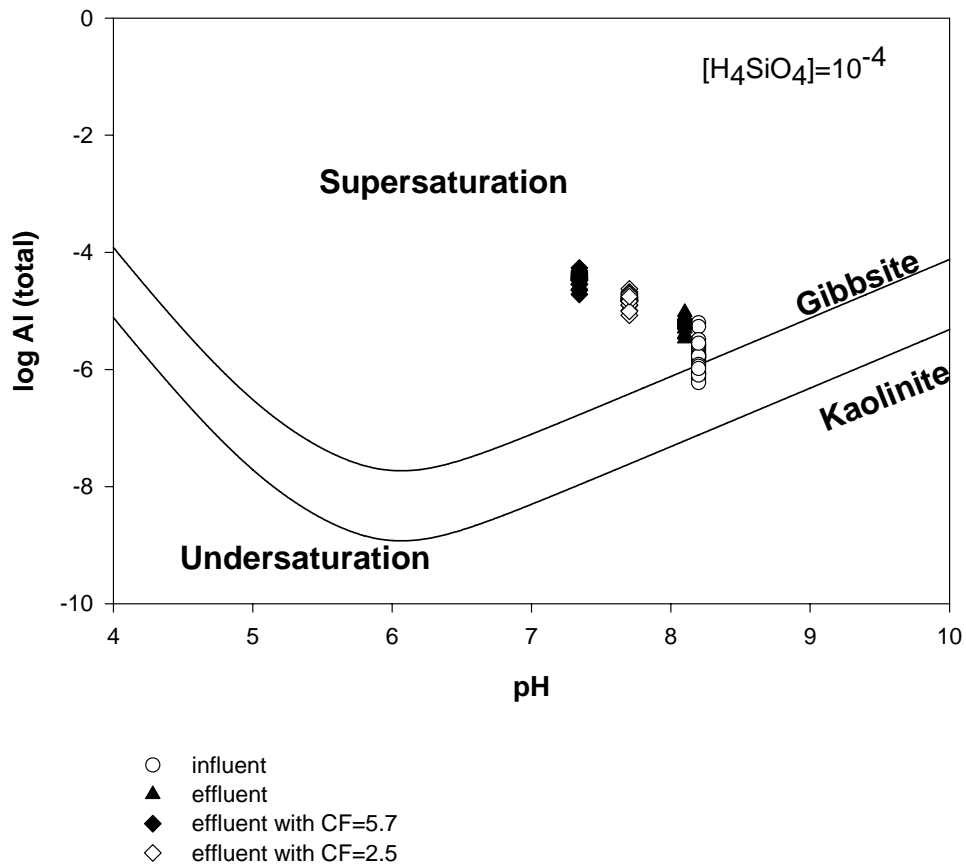

(Figure taken from Drever 1988)

Figure 10. Solubility diagram of kaolinite and gibbsite at H_4SiO_4 (aqueous) concentration of 10^{-4} mol/L

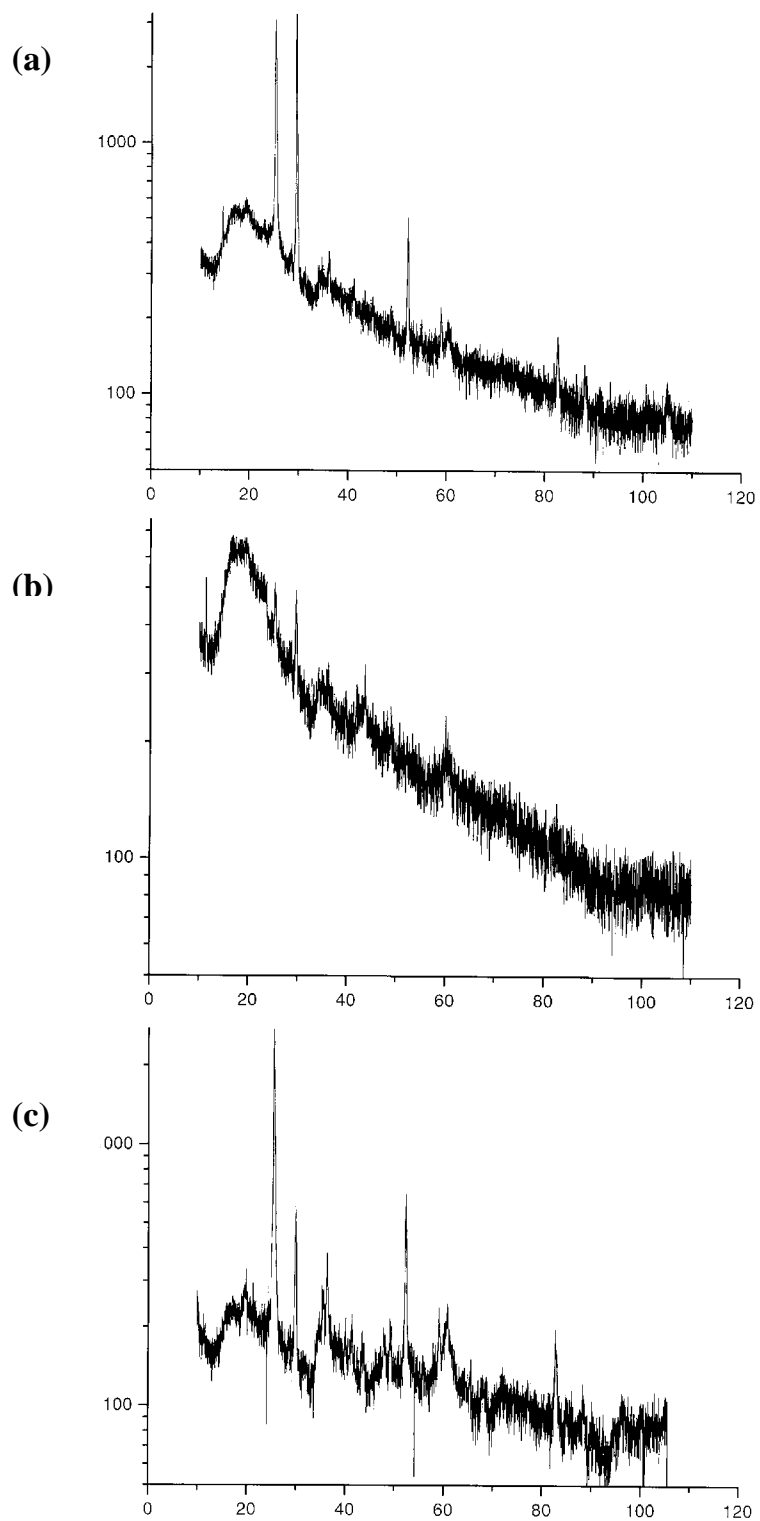
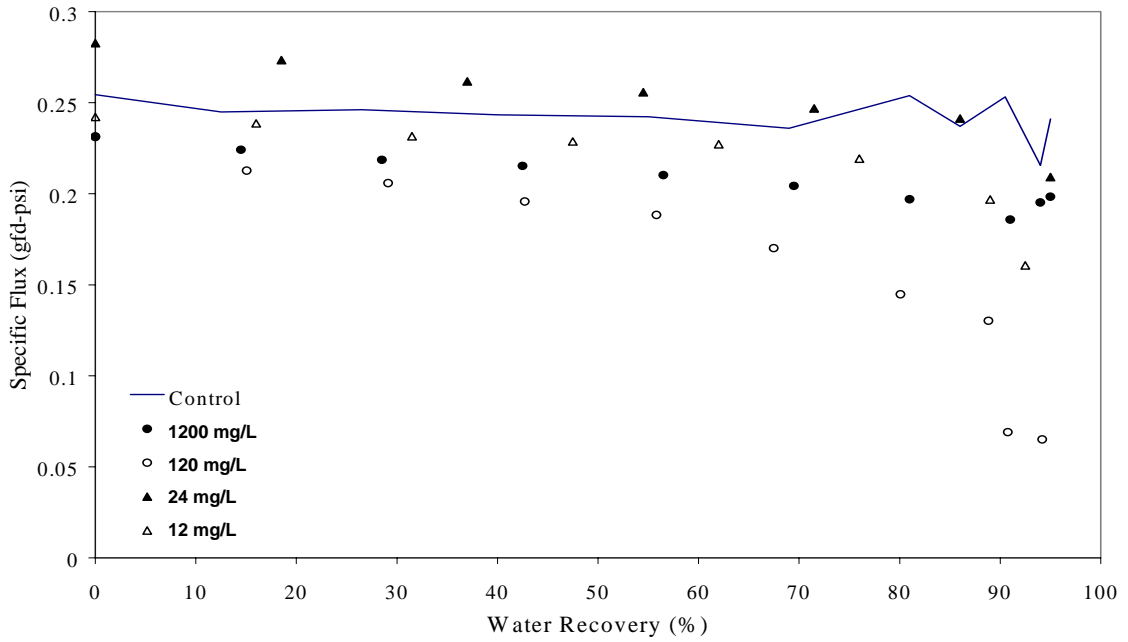
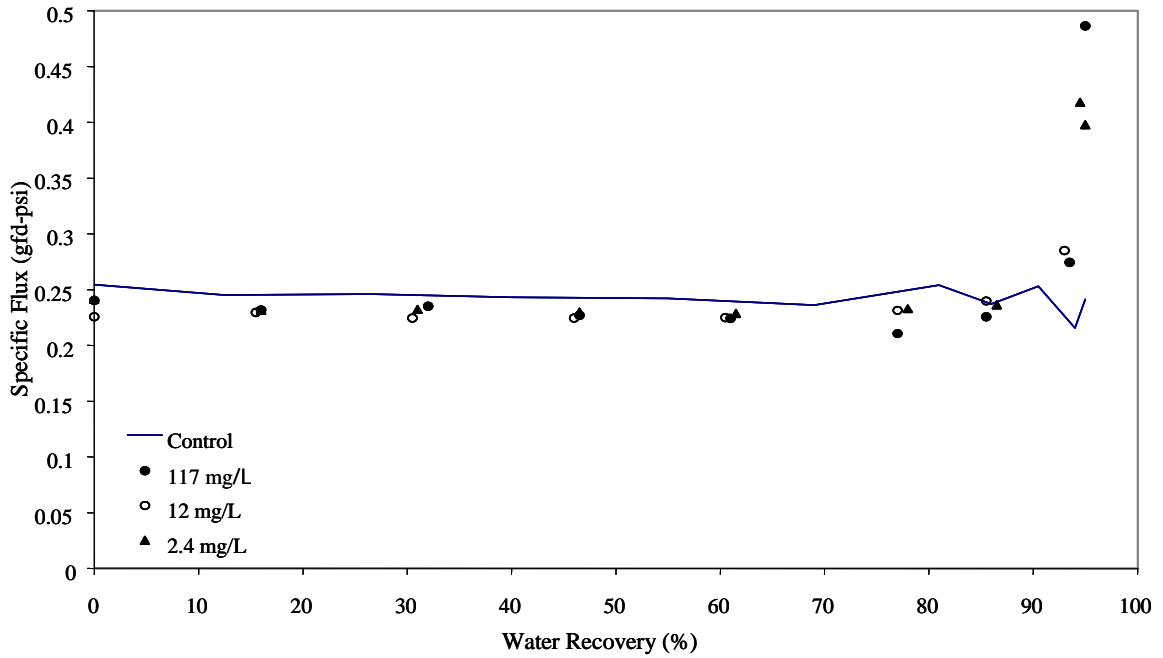

Figure 11. Powder X-ray diffraction spectra of the precipitates in the evaporation tests: (a) raw water, (b) with citric acid, and (c) and with oxalic acid



Data normalized to 25°C

Figure 12. Specific permeate flux for citric acid using CRW/SPW



Data normalized to 25°C

Figure 13. Specific permeate flux for salicylic acid using CRW/SPW

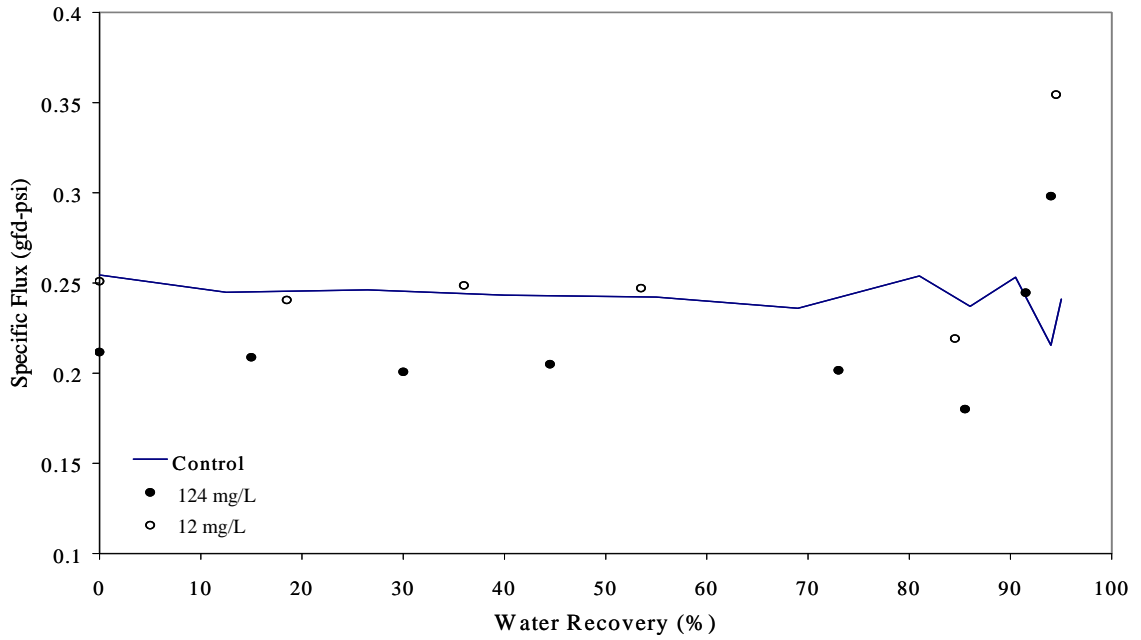

Data normalized to 25°C

Figure 14. Specific permeate flux for EDTA using CRW/SPW

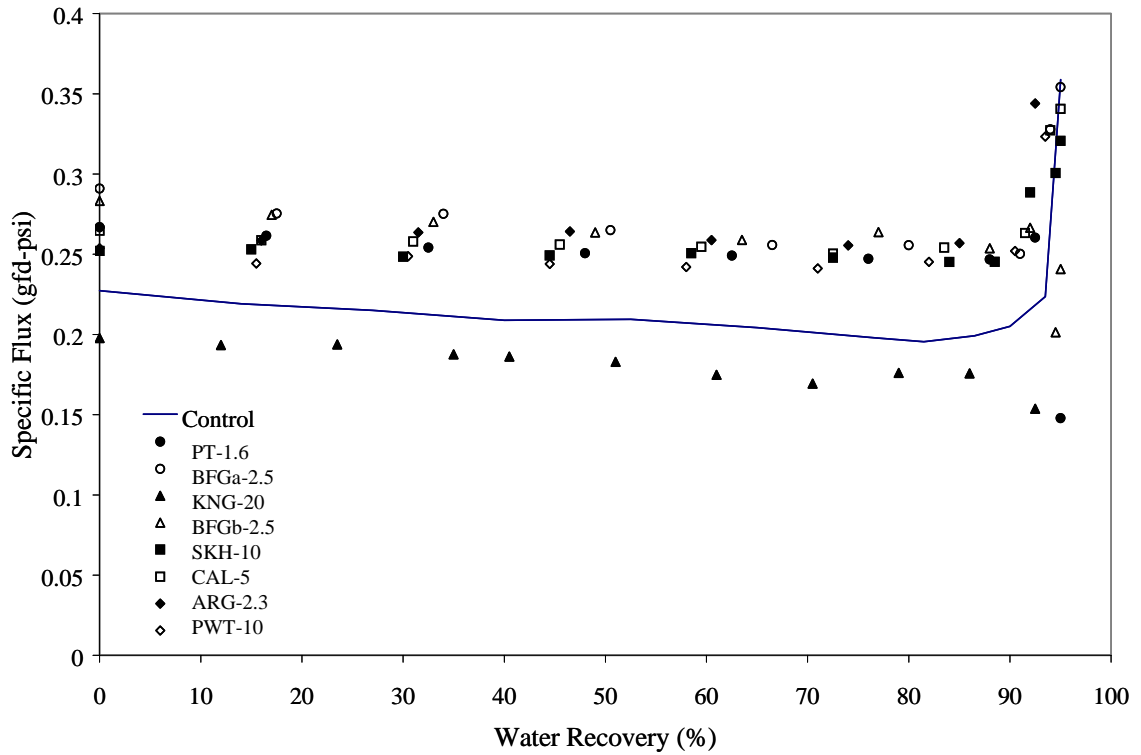

Data normalized to 25°C

Figure 15. Specific permeate flux for commercial antiscalants using CRW/SPW

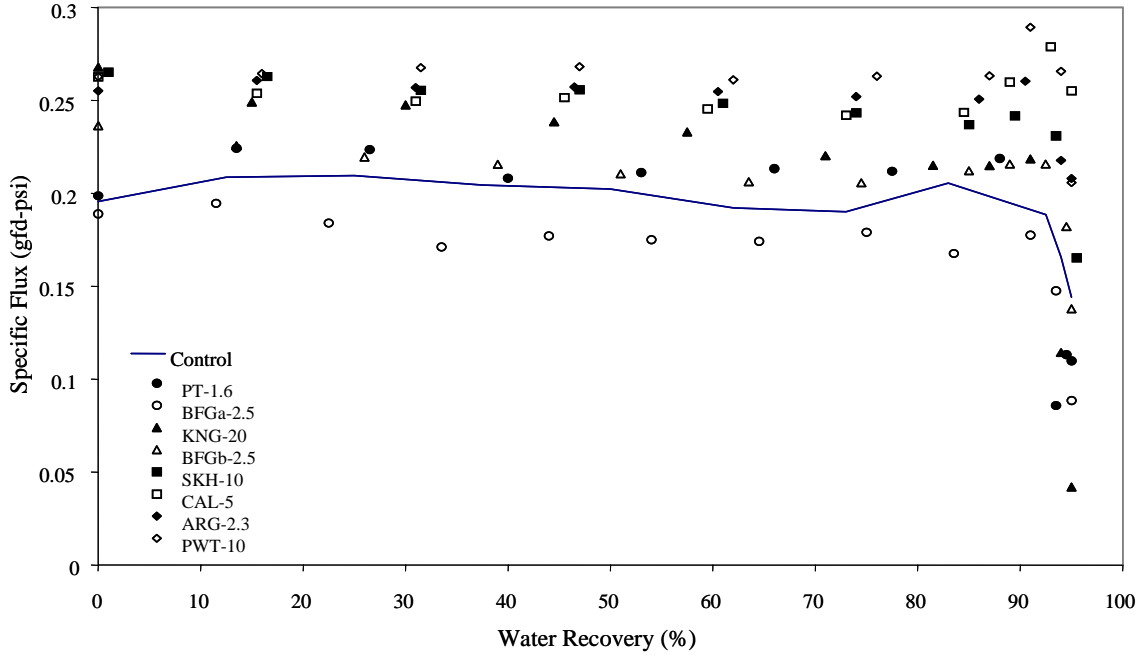

Data normalized to 25°C

Figure 16. Specific permeate flux for commercial antiscalants using CRW at pH 8.3

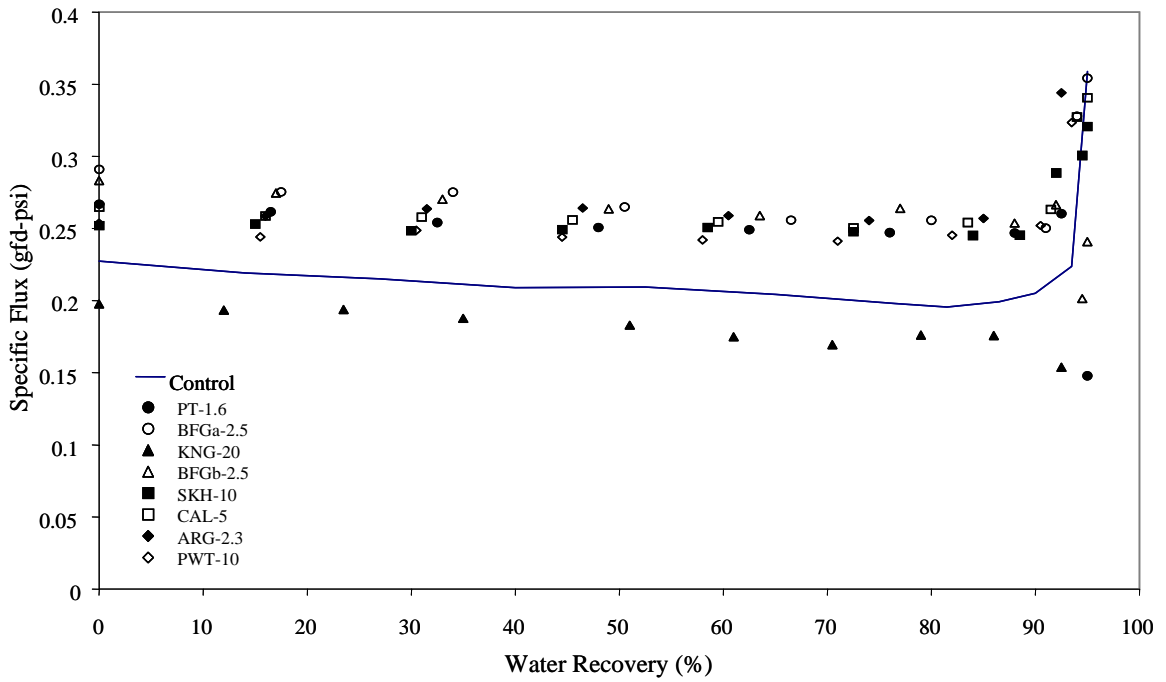

Data normalized to 25°C

Figure 17. Specific permeate flux for commercial antiscalants using CRW at pH 7.0

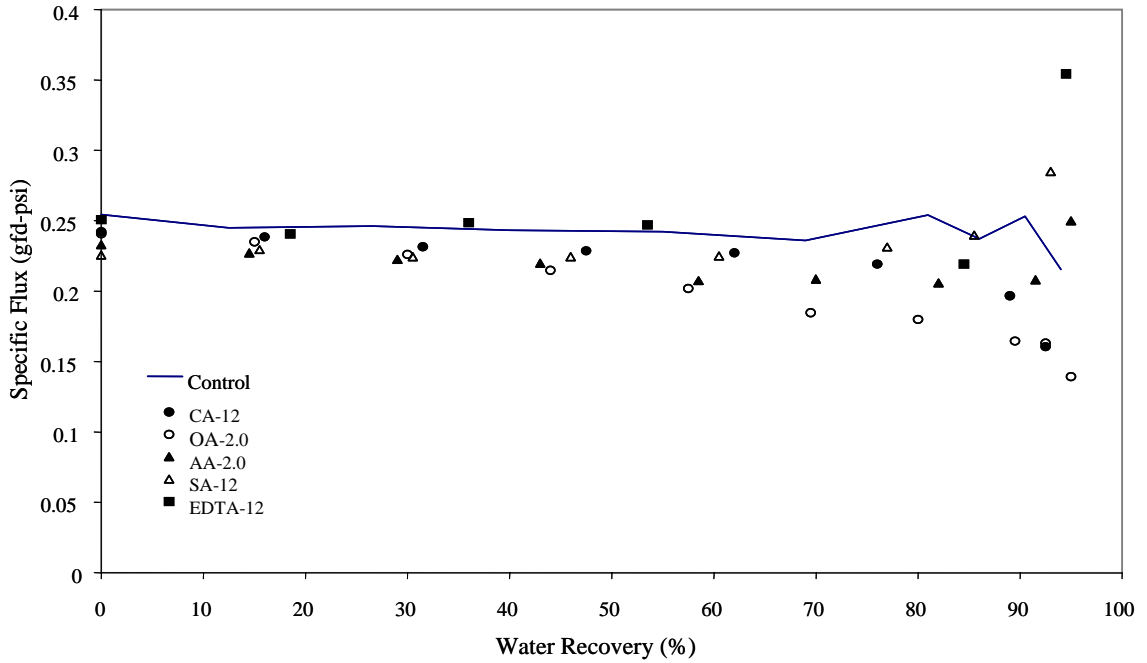

Data normalized to 25°C

Figure 18. Specific permeate flux for generic antiscalants using CRW/SPW

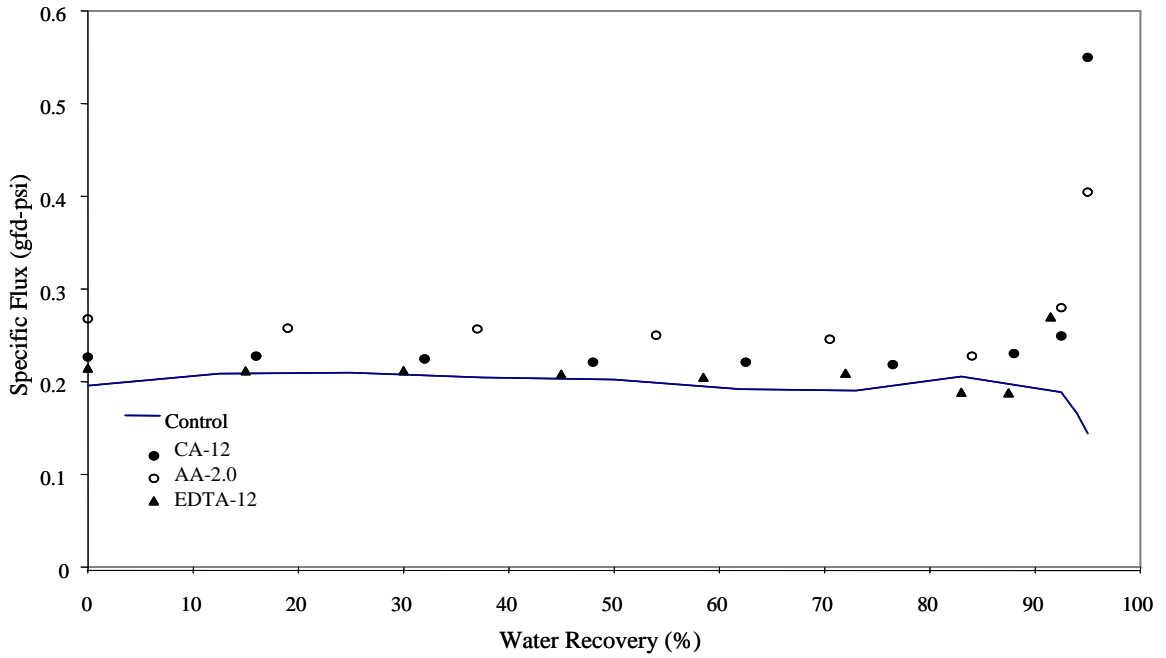

Data normalized to 25°C

Figure 19. Specific permeate flux for generic antiscalants using CRW at pH 8.3

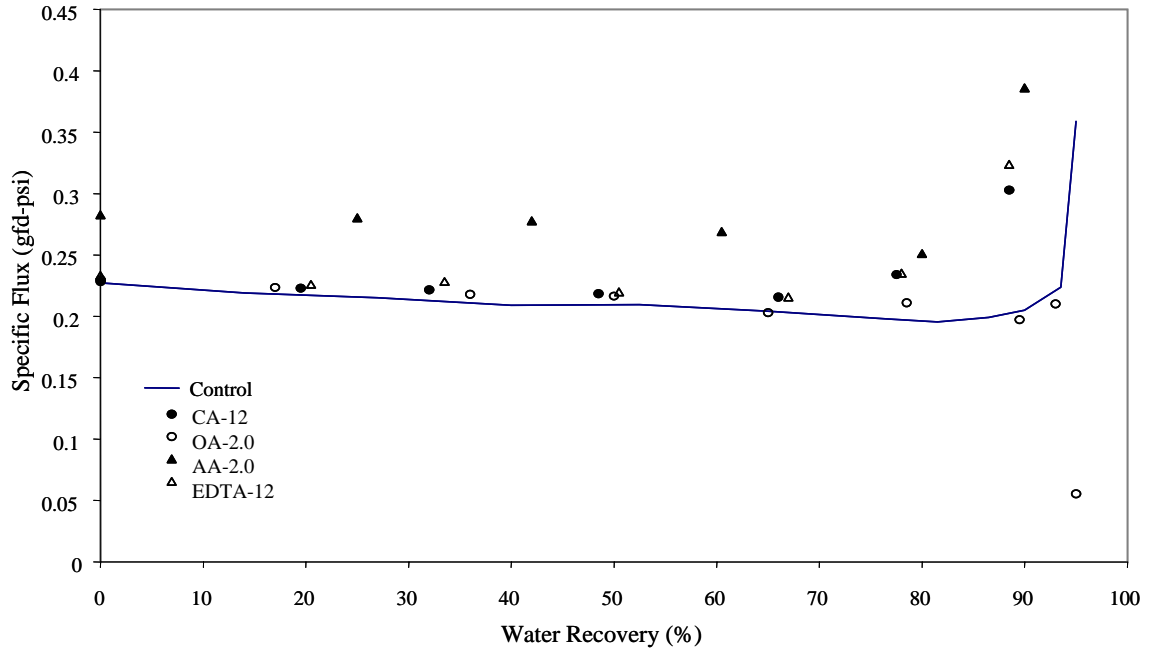

Data normalized to 25°C

Figure 20. Specific permeate flux for generic antiscalants using CRW at pH 7.0

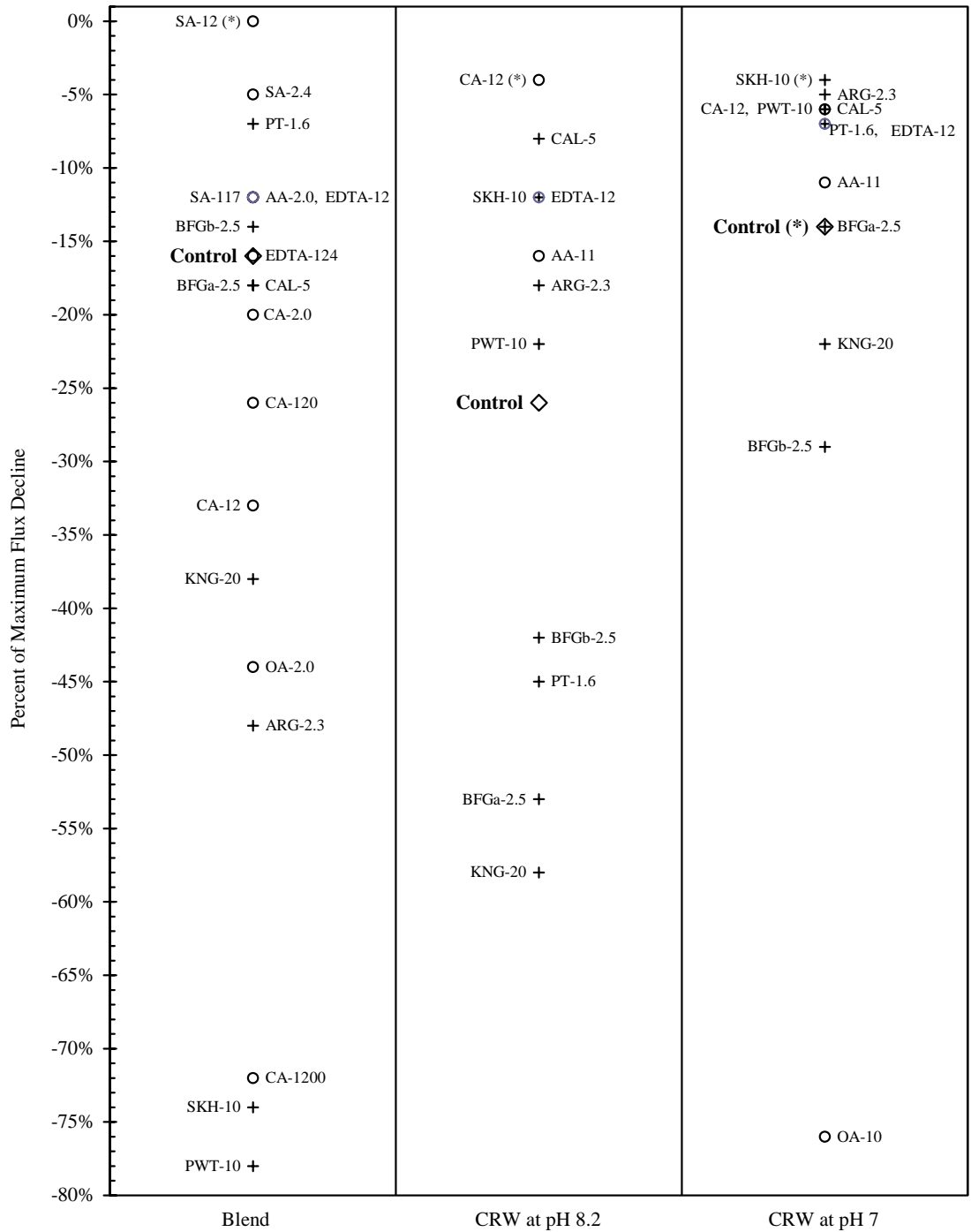

Figure 21. Maximum permeate flux decline of commercial and generic antiscalants in three types of waters in RO bench-scale testing. Data with (*) indicated that significant flux increase was observed at high water recovery.

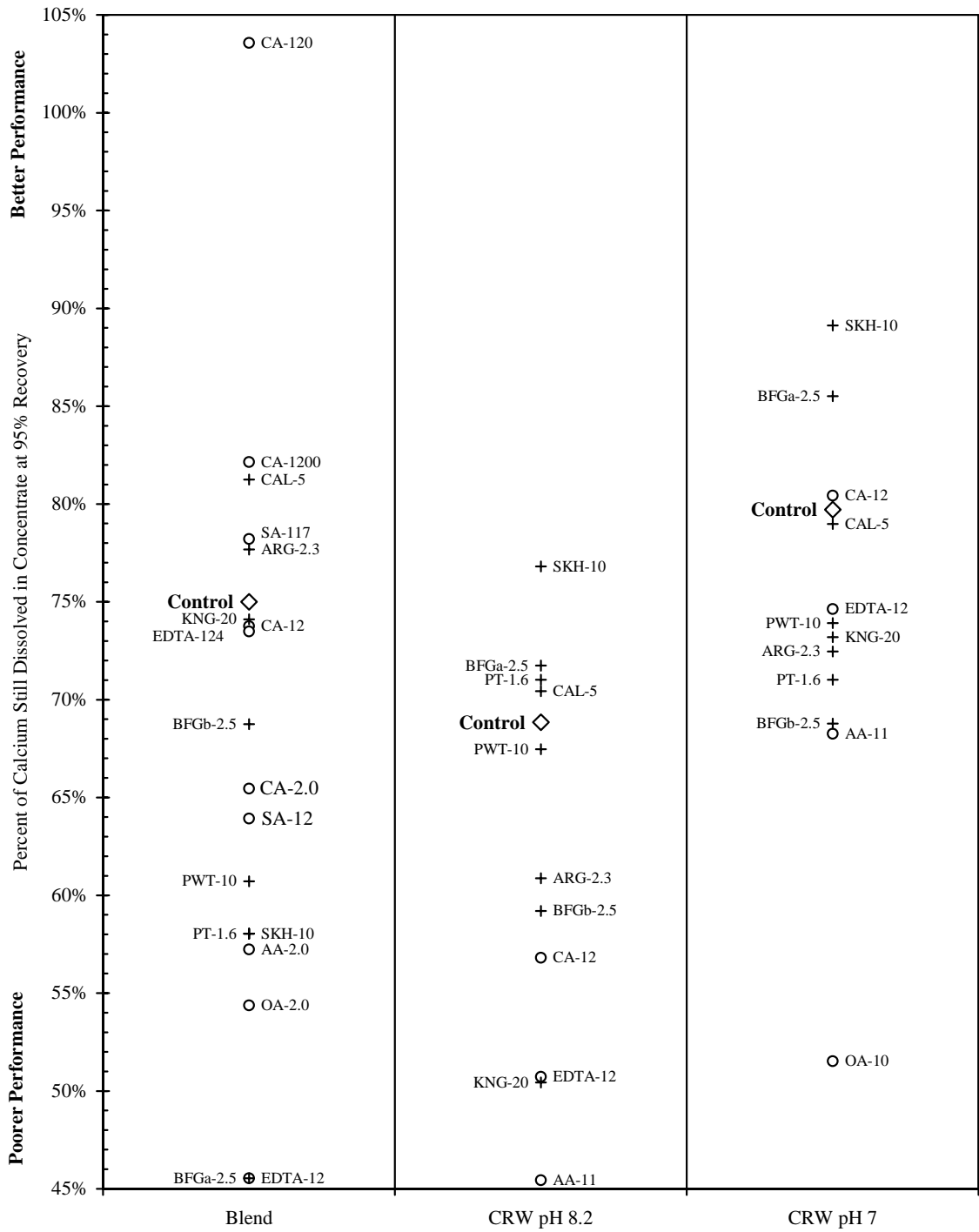

Figure 22. Dissolved calcium in RO concentrate for commercial and generic antiscalants in bench-scale testing.

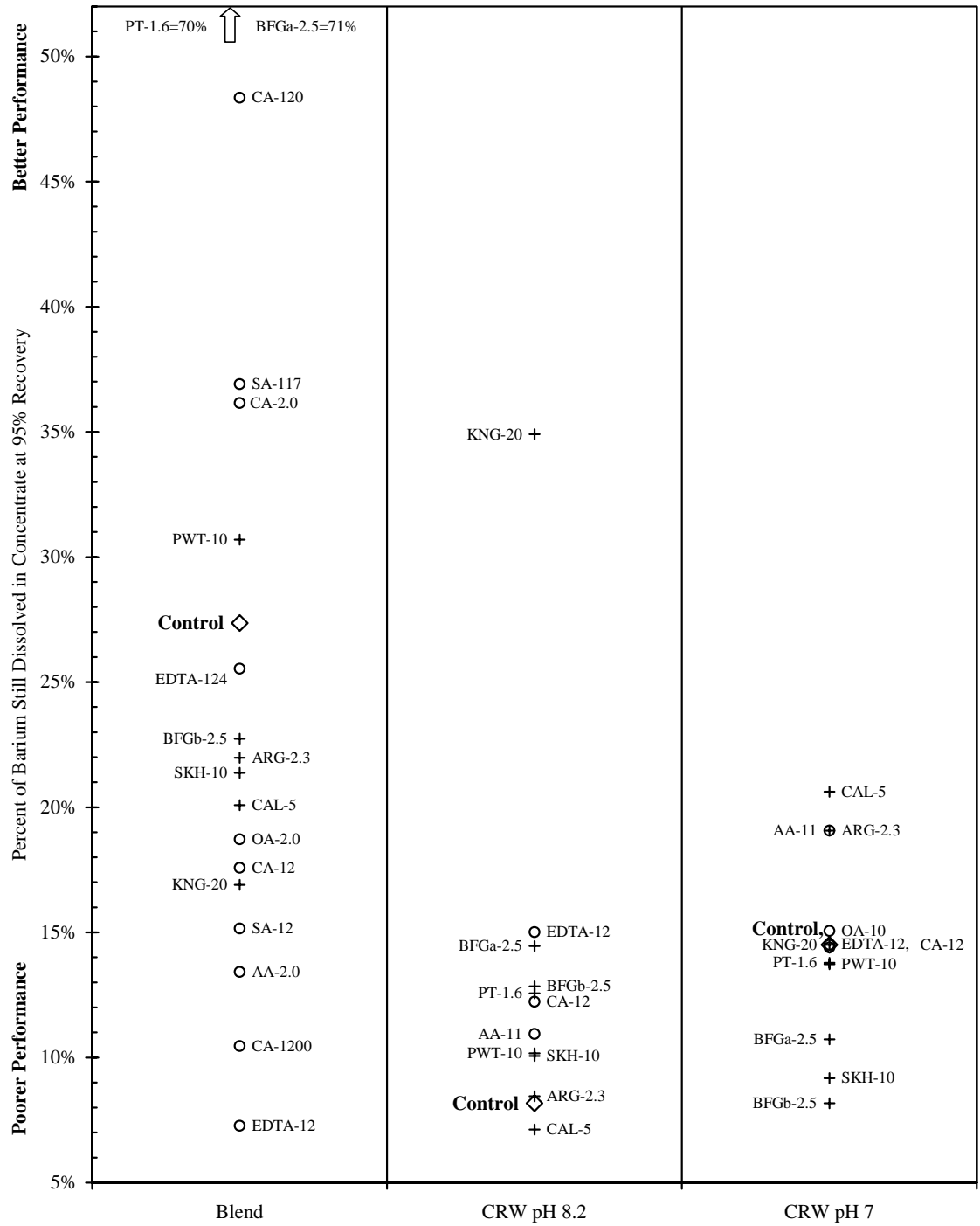

Figure 23. Dissolved barium in RO concentrate for commercial and generic antiscalants in bench-scale testing.

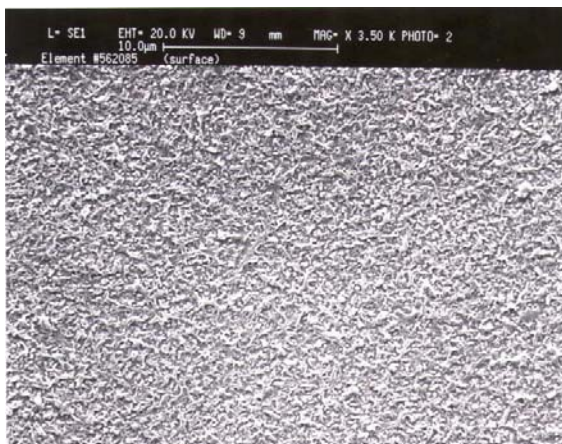
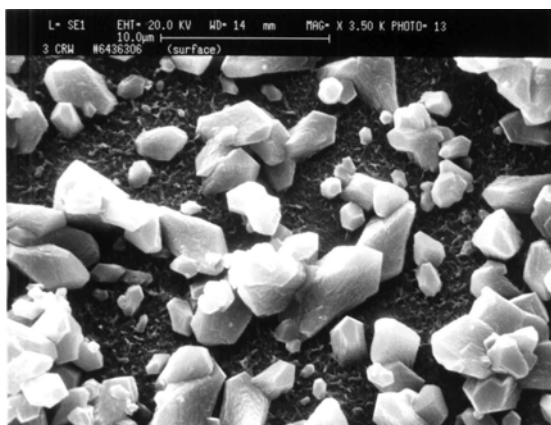
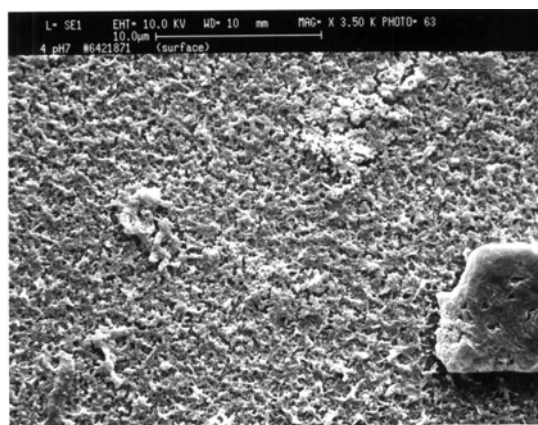

Figure 24. SEM micrograph of a cleaned reverse osmosis membrane



(a)



(b)

Figure 25. Representative SEM micrographs of fouled reverse osmosis membranes from bench-scale testing: (a) inorganic scales, (b) organic fouling

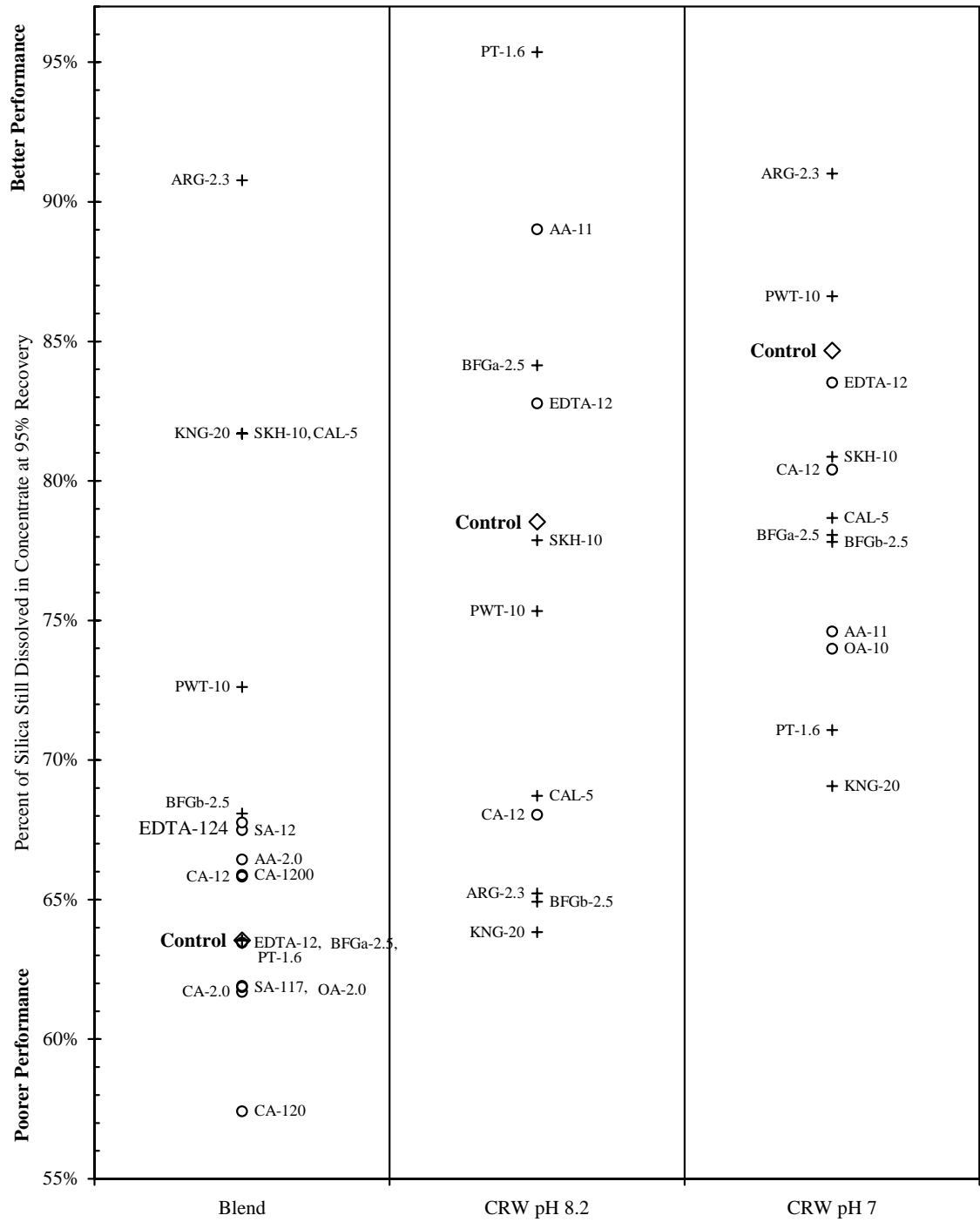

Figure 26. Dissolved silica in RO concentrate for commercial and generic antiscalants in bench-scale testing.

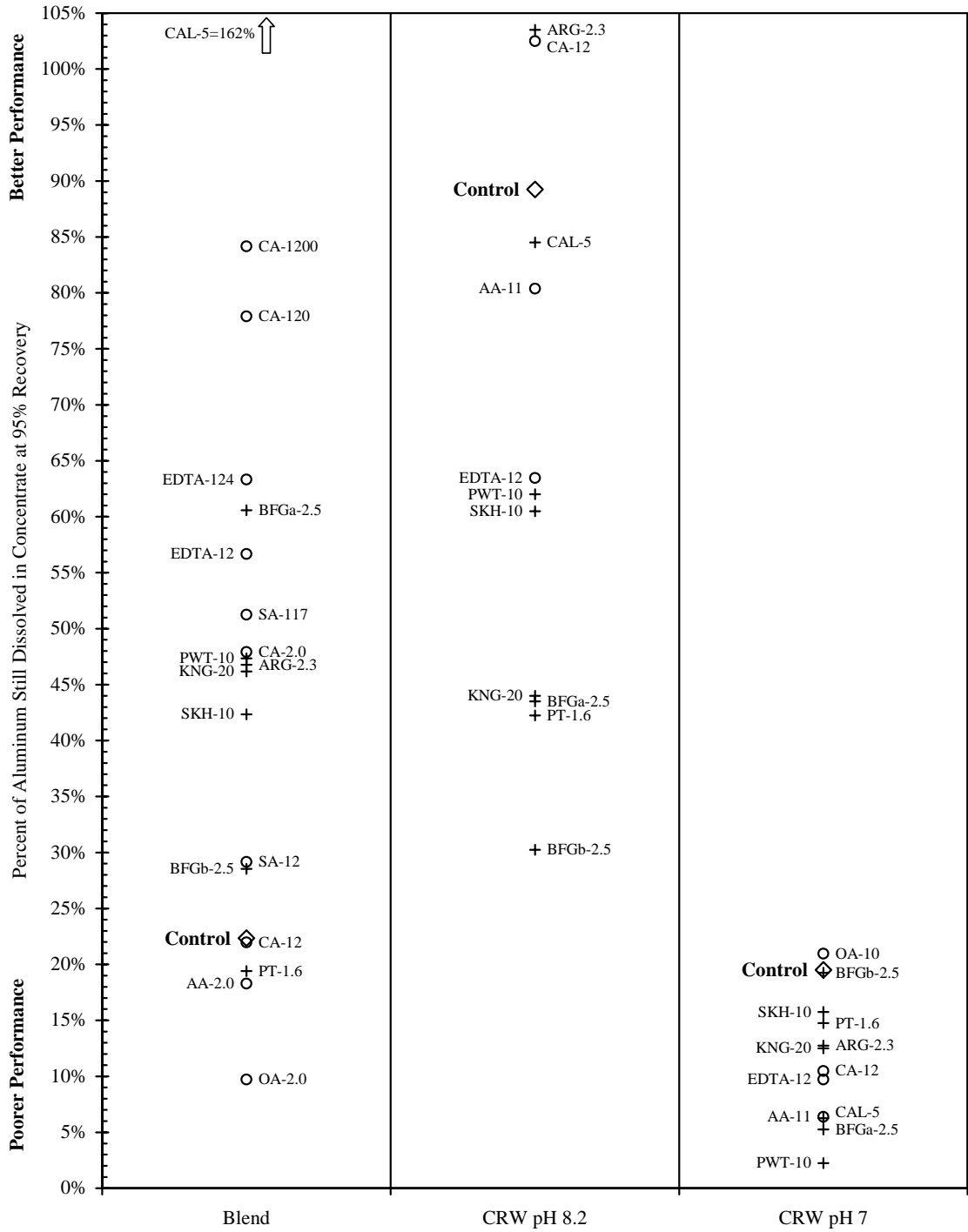

Figure 27. Dissolved aluminum in RO concentrate for commercial and generic antiscalants in bench-scale testing.

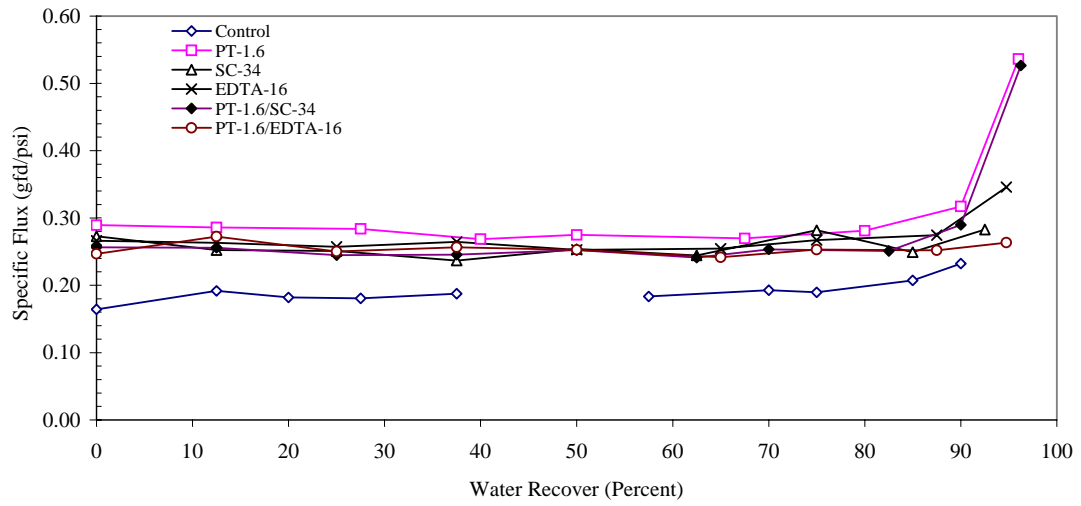

Figure 28. Specific permeate flux for commercial and generic antiscalants using CRW at pH 6.7 with 170 $\mu\text{g/L}$ added aluminum

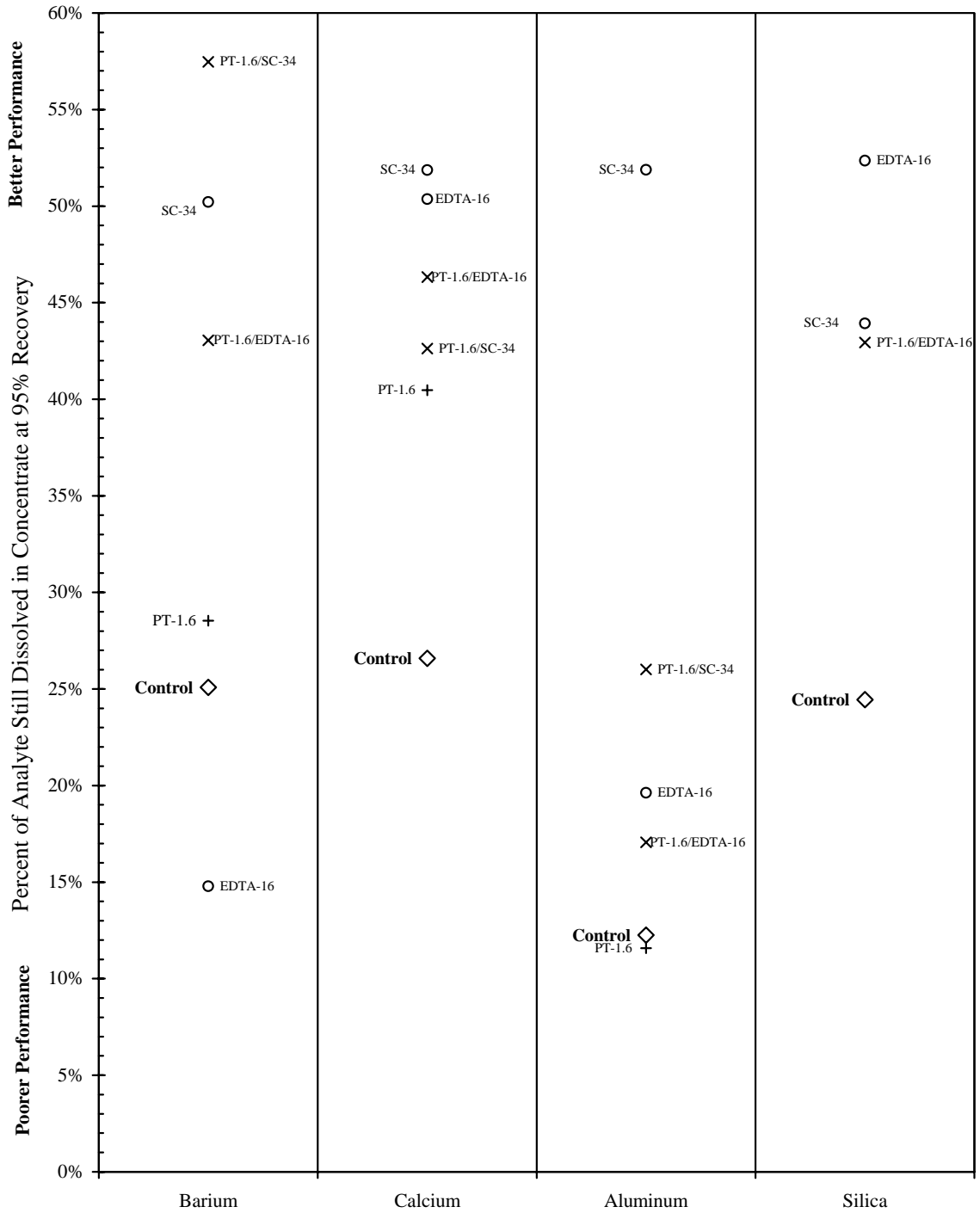

Figure 29. Dissolved analytes in RO concentrate for commercial, generic and blends of commercial and generic antiscalants in bench-scale testing with 170 µg/L added aluminum.

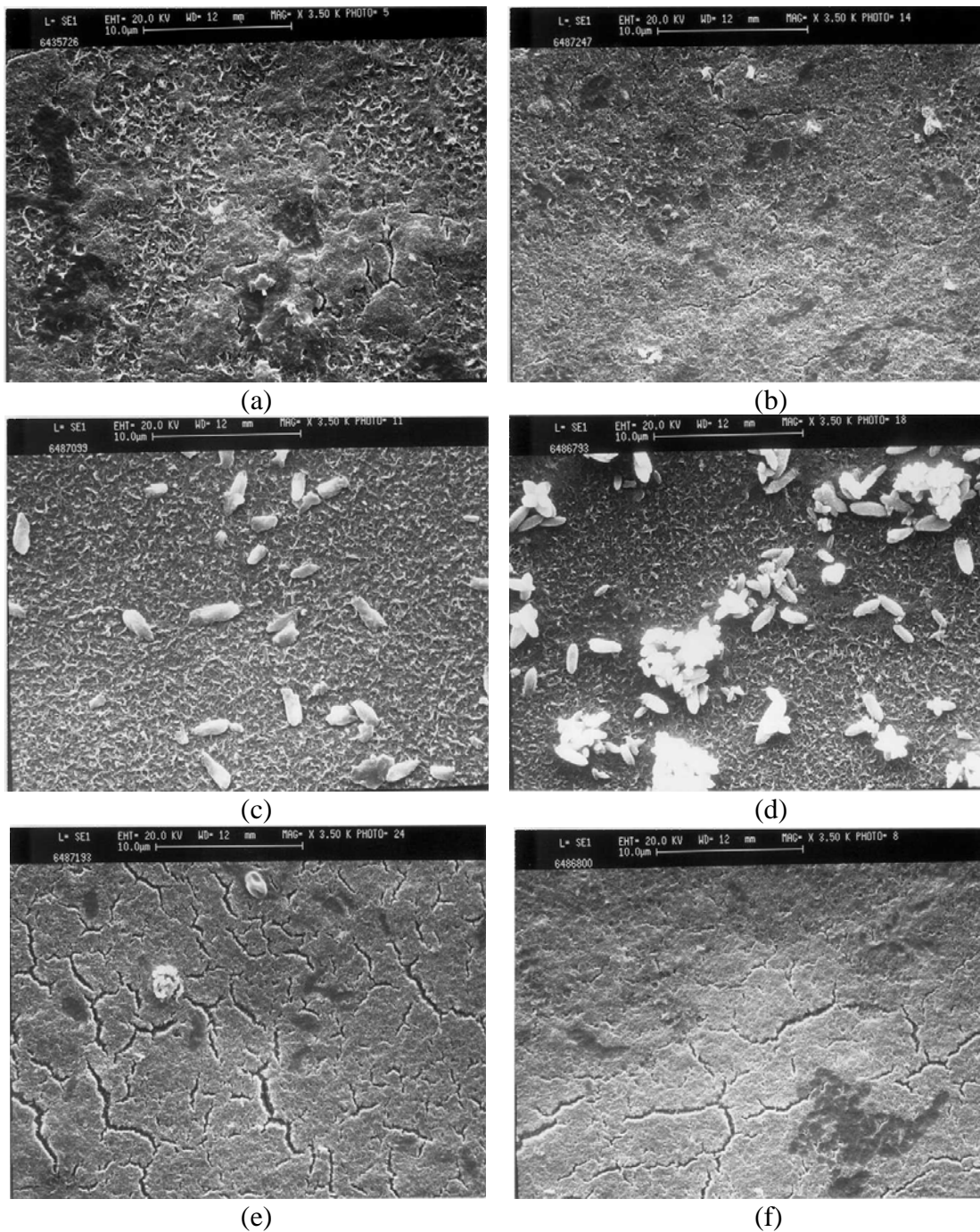

Figure 30. SEM micrographs of fouled reverse osmosis membranes from the aluminum addition study: (a) Control, (b) PT-1.6, (c) SC-34, (d) EDTA-16, (e) PT-1.6/SC-34, (f) PT-1.6/EDTA-16

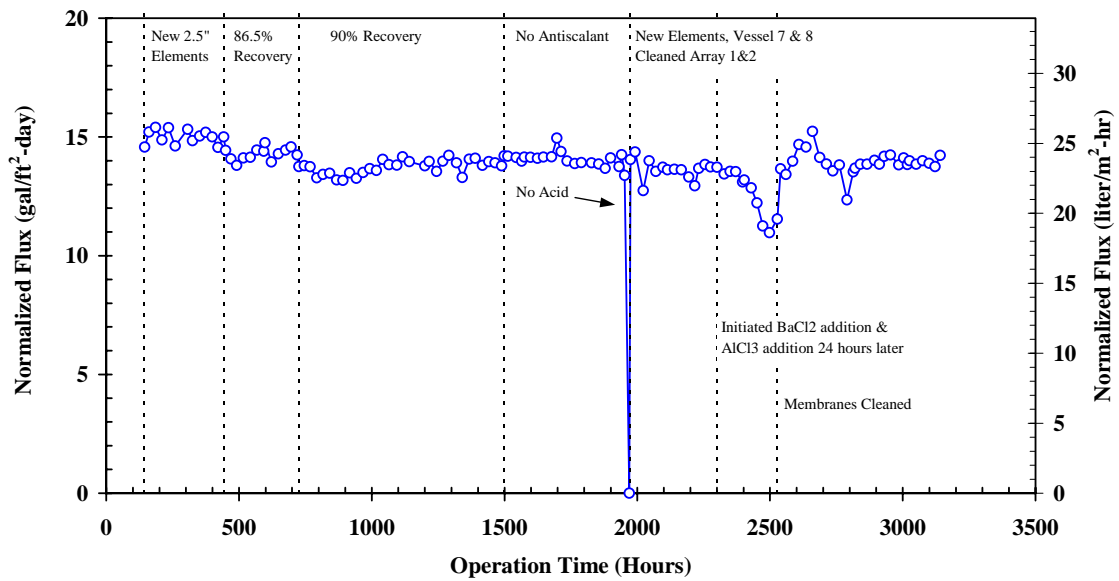

Figure 31. Normalized flux during reverse osmosis pilot testing



Figure 32. Salt rejection during reverse osmosis pilot testing

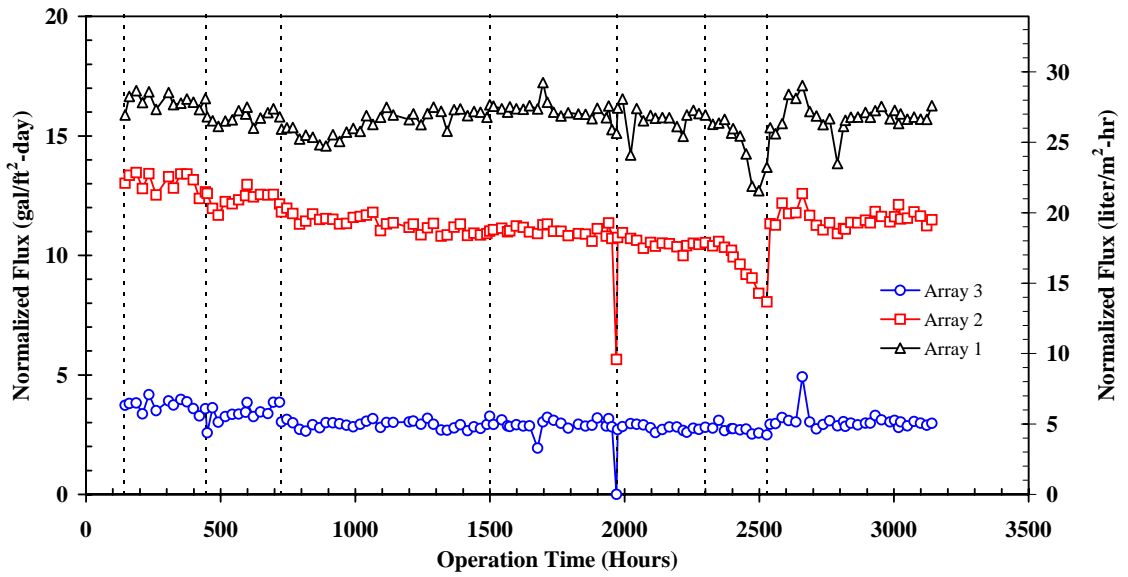

Figure 33. Normalized flux per array during reverse osmosis pilot testing

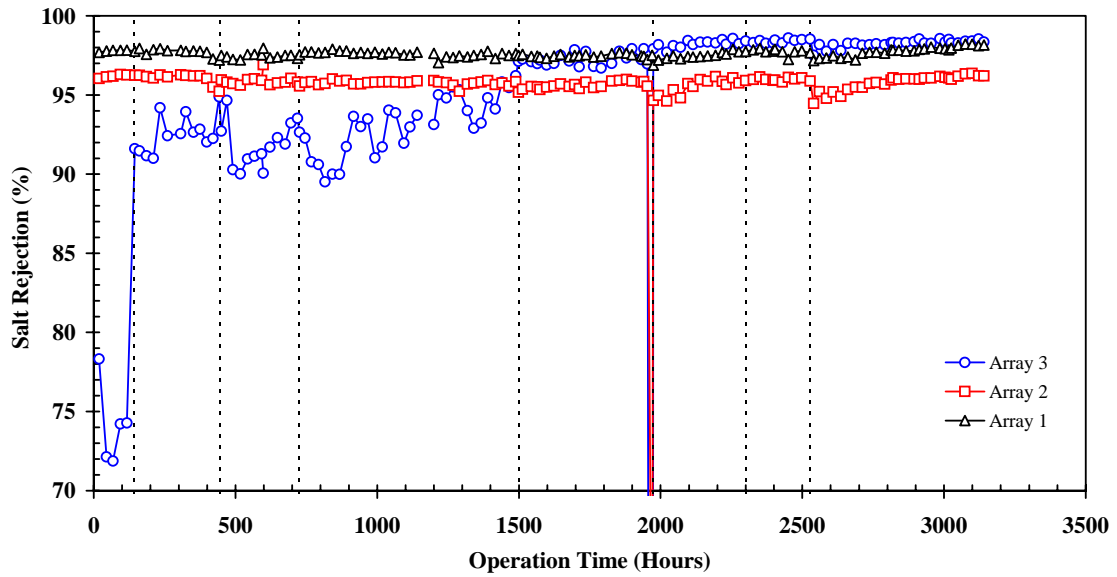

Figure 34. Salt rejection per array during reverse osmosis pilot testing

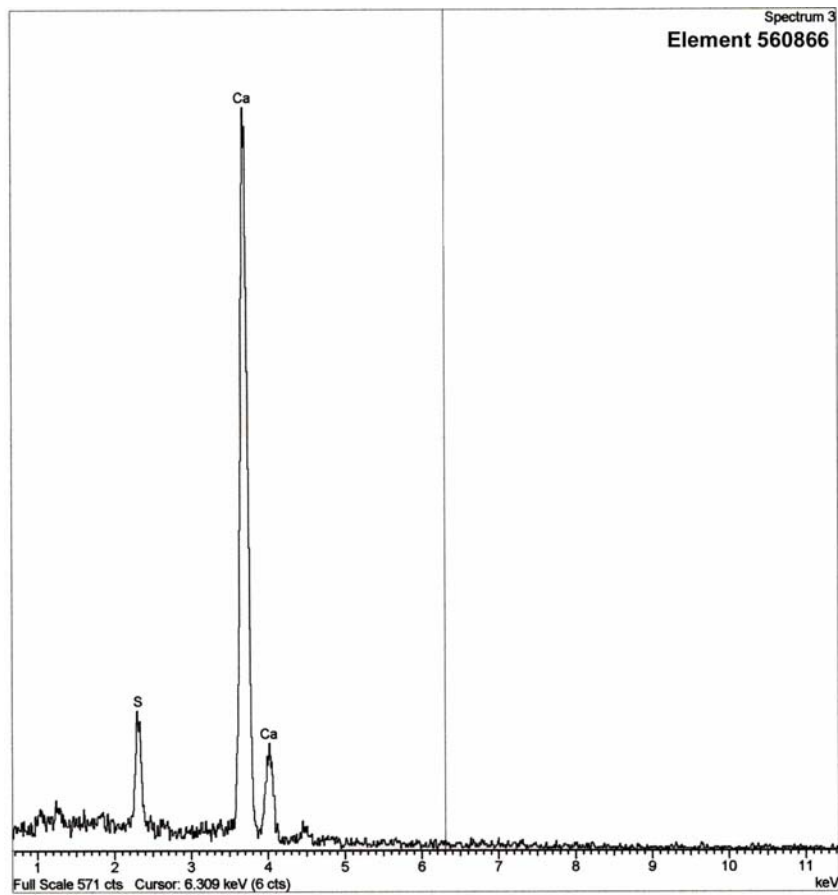

Figure 35. EDS spectrograph of reverse osmosis membrane from terminal element

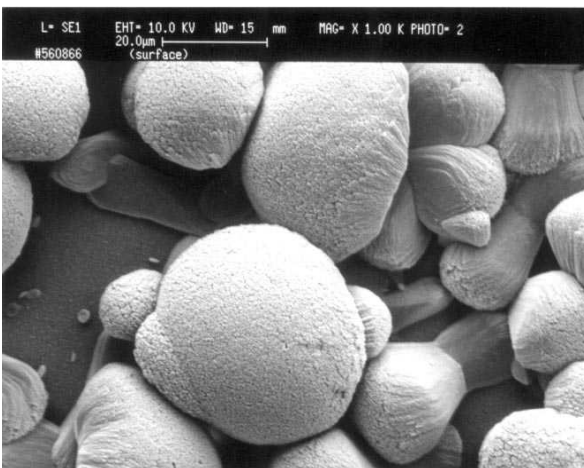
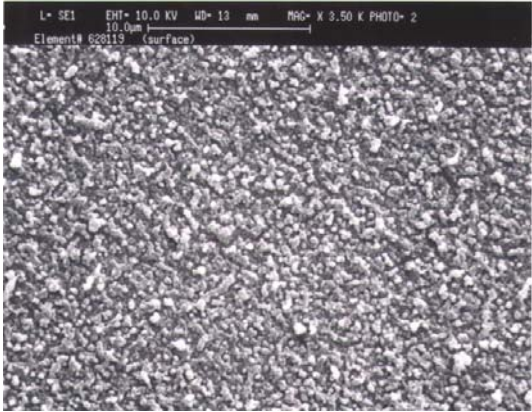
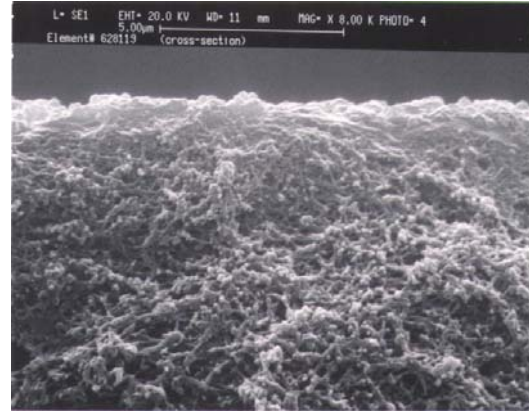

Figure 36. SEM micrograph of calcium carbonate scale



(a)



(b)

Figure 37. SEM micrographs of reverse osmosis membranes from first array: (a) plan view, (b) cross-sectional view

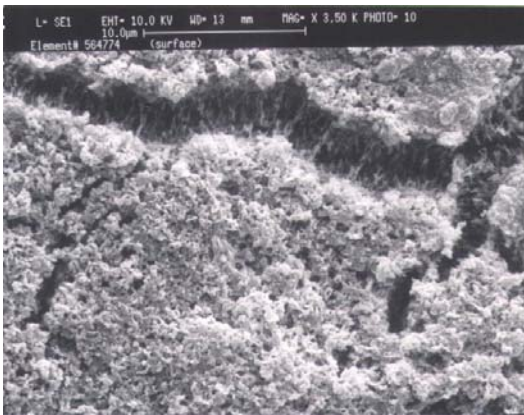

(a)

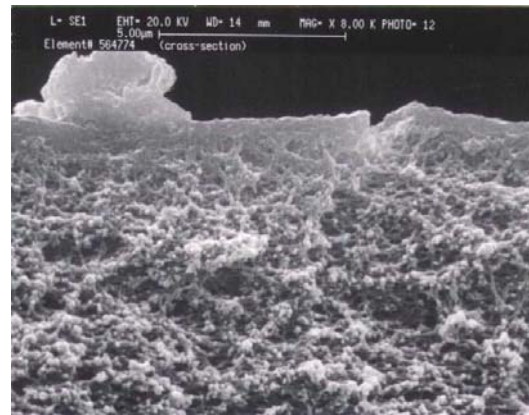

(b)

Figure 38. SEM micrographs of reverse osmosis membrane from second array: (a) plan view, (b) cross-sectional view

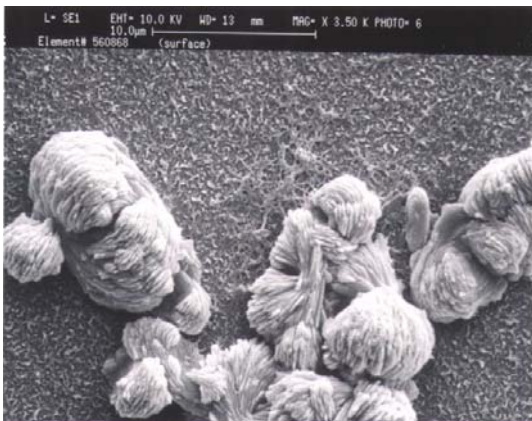

(a)

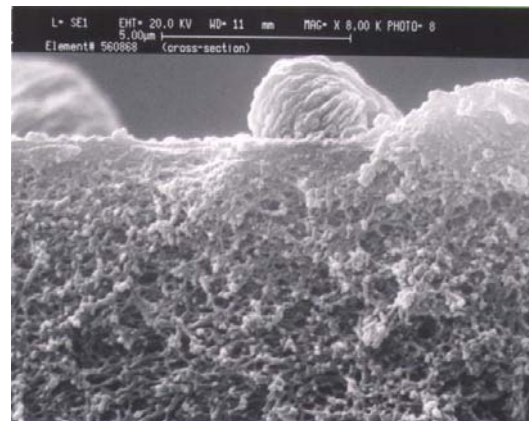

(b)

Figure 39. SEM micrographs of reverse osmosis membranes from third array: (a) plan view, (b) cross-sectional view

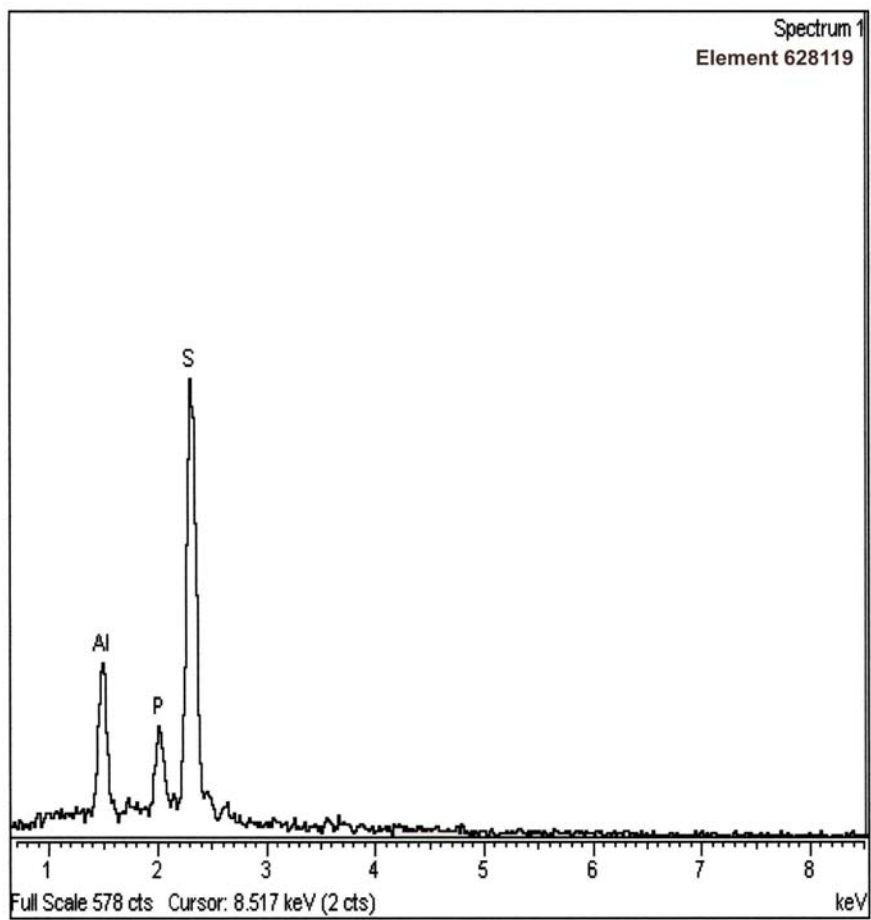

Figure 40. EDS spectrograph of reverse osmosis membrane from first array

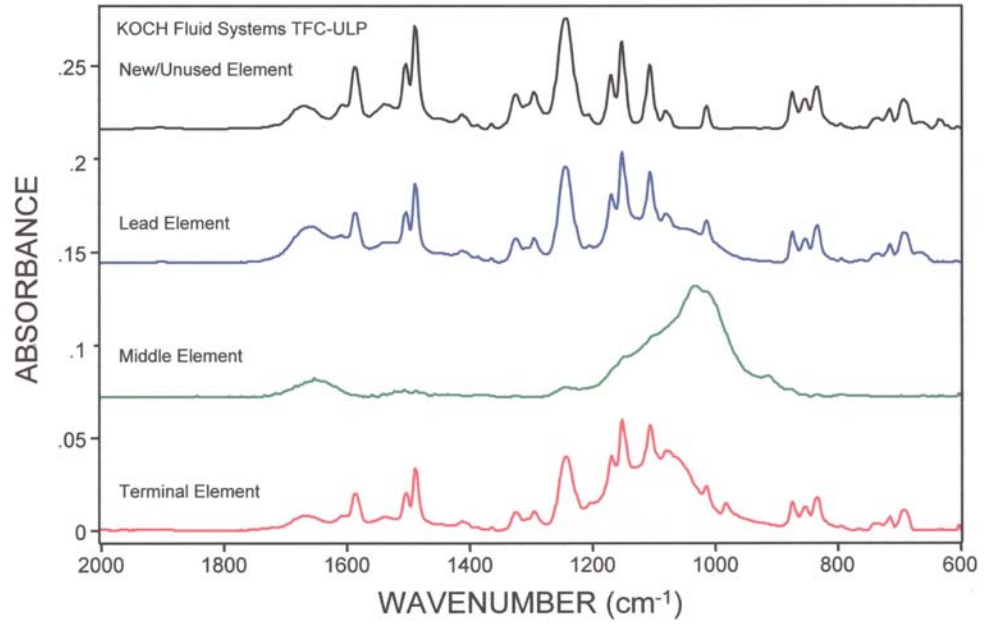

Figure 41. Infrared spectral analysis of fouled reverse osmosis membrane surfaces

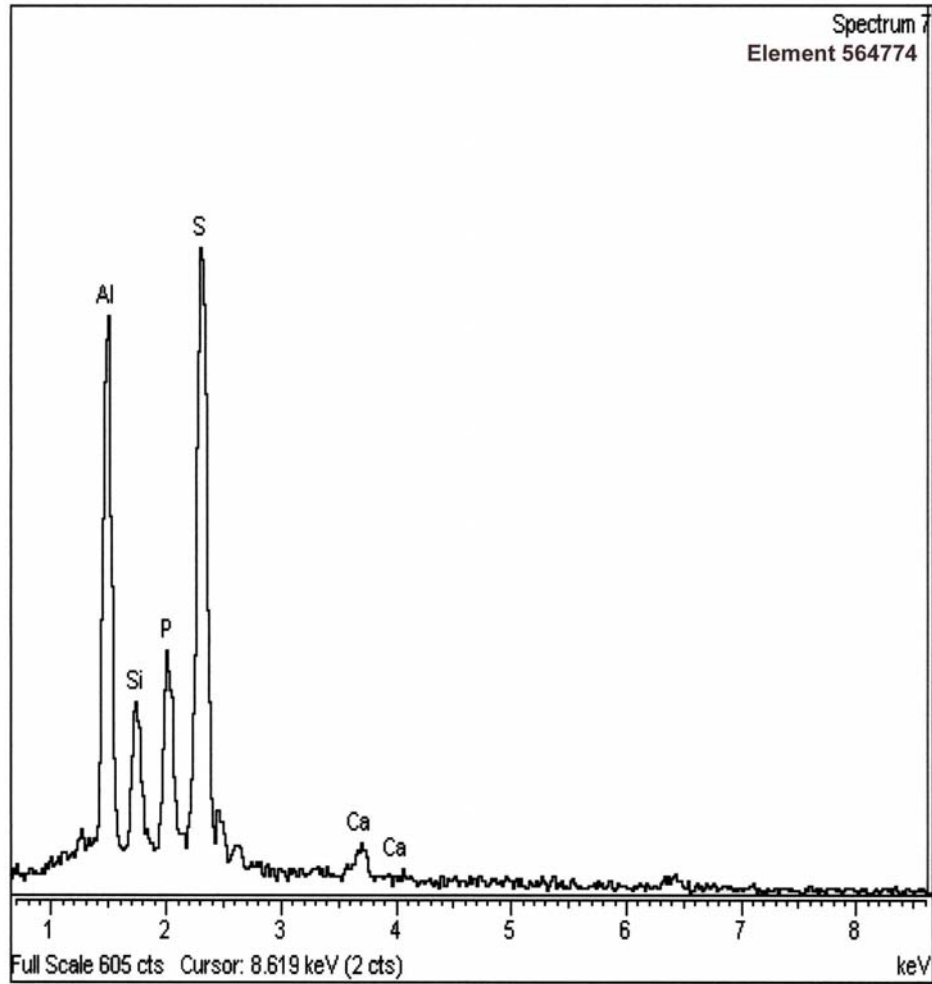

Figure 42. EDS spectrograph of reverse osmosis membrane from second array

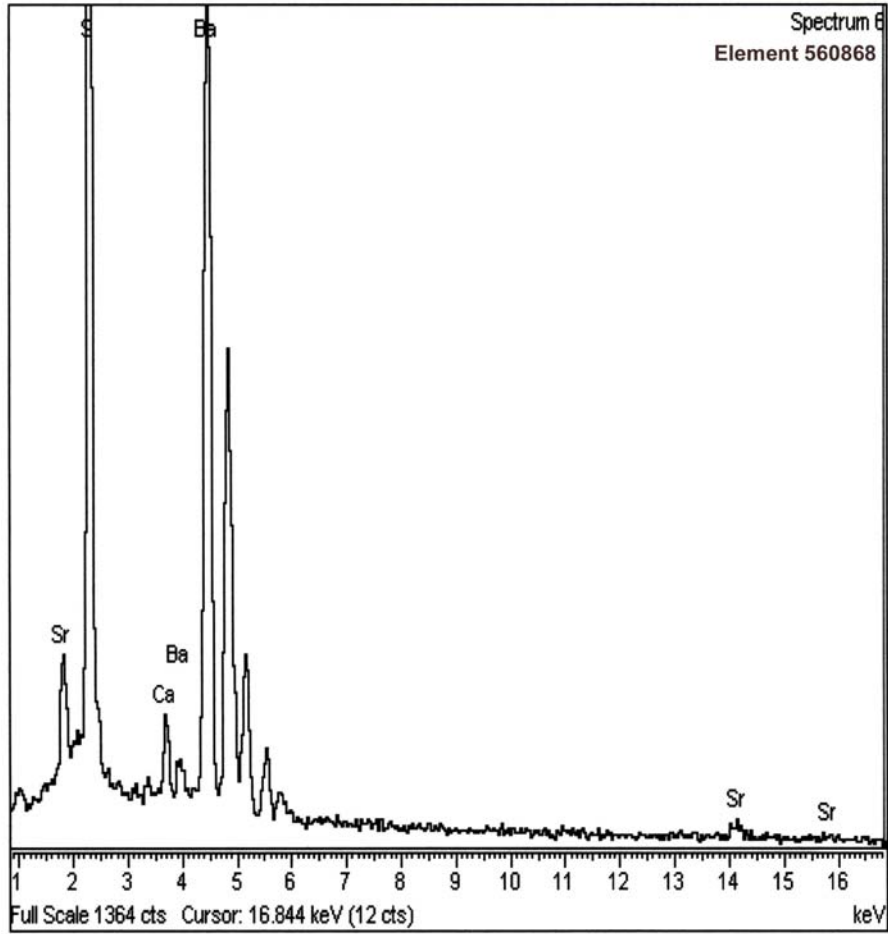

Figure 43. EDS spectrograph of reverse osmosis membrane from third array

SI METRIC CONVERSIONS

The following conversion factors were used to transform the English units used throughout this report into Systeme International (SI) metric units:

To Convert From	To Obtain	Multiply by
inch	centimeter	2.54
ft ²	cm ²	929.03
gallons	liters	3.7853
gal/min	m ³ /day	5.455
gal/ft ² /day	liter/m ² -hr	1.697
psi	kPa	6.895
gal/ft ² /day/psi	liter/m ² -hr-kPa	0.2461

APPENDIX A. WATER QUALITY ANALYTICAL METHODS

The water quality constituents were analyzed according to the methods described below. *Standard Methods for the Examination of Water and Wastewater* (APHA, AWWA, and WEF 1998) was referenced for sample analysis wherever possible.

Alkalinity and Hardness were analyzed by titration according to Standard Methods 2320B and 2340C (APHA, AWWA, and WEF 1998).

Total Dissolved Solids (TDS) was measured using Standard Method 2540C (APHA, AWWA, and WEF 1998) or estimated from conductivity measurements.

Chloride, Fluoride, Nitrate, and Sulfate were analyzed using a modified EPA Method 300.0 (Pfaff et al. 1989) and a Dionex Model DX300 ion chromatograph. The minimum reporting levels (MRL) for each constituent (in mg/L) are: Cl⁻: 2.0, F⁻: 0.02, NO₃⁻: 0.05, and SO₄⁼: 4.0.

Silica levels were determined according to Standard Method 4500-Si D (APHA, AWWA, and WEF 1998) using a Shimadzu UV-2401PC ultraviolet/visible spectrophotometer.

Calcium, Magnesium, Potassium, Sodium were analyzed according to Standard Method 3111B (APHA, AWWA, and WEF 1998) using a Varian SpectraAA-300/400 atomic absorption spectrophotometer. The MRL for this method is 0.1 mg/L for each constituent.

Aluminum, Arsenic, Iron, Manganese, Barium and Strontium (trace metals) were analyzed according to EPA Method 200.8 (Creed et al. 1994) using a Perkin Elmer Elan 6000 ICP-MS. MRLs for this method are as follows: Al: 5 µg/L, As: 0.5 µg/L, Fe: 20 µg/L; Mn: 5 µg/L; Ba: 5 µg/L, and Sr: 20 µg/L.

Total Organic Carbon (TOC) samples were analyzed by the ultraviolet/persulfate oxidation method (Standard Method 5310C, APHA, AWWA, and WEF 1998) using a Sievers 800 organic carbon analyzer. The MRL for this method is 0.05 mg/l.

APPENDIX B. CALCULATED VALUES FOR REVERSE OSMOSIS SYSTEM

In order to assess the performance of the pretreatment and salinity reduction steps, several key values were calculated based on raw process data. These calculated values include normalized flux and energy consumption for the RO system.

Normalized flux was calculated using equations B.1, B.2, B.3 based on the procedure described in ASTM D 4516-85 (ASTM 1989b). During normal operation of a RO system, conditions such as: pressure, flow, temperature, and salinity can vary. In order to determine the rate of fouling, it is necessary to normalize data to a standard set of conditions. The ASTM method provides a procedure to normalize the flux for temperature, pressure, and salinity. This method, however, should not be used for direct comparisons of RO data from different RO systems. It should only be used as a method of normalizing data for one specific system. Standard conditions were assumed to be 25°C, feed TDS of 436 mg/L, and feed pressure of 113 psi.

$$Q_{ps} = \frac{\left[P_{fs} - \frac{\Delta P_{fbs}}{2} - P_{ps} - \pi_{fbs} + \pi_{ps} \right] (TCF_s)}{\left[P_{fa} - \frac{\Delta P_{fba}}{2} - P_{pa} - \pi_{fba} + \pi_{pa} \right] (TCF_a)} (Q_{pa}) \quad (A.1)$$

where:

Q_{ps}	=	permeate flow at standard conditions (gallon per day),
P_{fs}	=	feed pressure at standard conditions, psi,
$\frac{\Delta P_{fbs}}{2}$	=	one half device pressure drop at standard conditions, psi,
P_{ps}	=	permeate pressure at standard conditions, psi,
π_{fbs}	=	feed-brine osmotic pressure at standard conditions, psi,
π_{ps}	=	permeate osmotic pressure at standard conditions, psi,
TCF_s	=	temperature correction factor at standard conditions,
Q_{pa}	=	permeate flow at actual conditions (gallon per day),
P_{fa}	=	feed pressure at actual conditions, psi,
$\frac{\Delta P_{fba}}{2}$	=	one half device pressure drop at actual conditions, psi,
P_{pa}	=	permeate pressure at actual conditions, psi,
π_{fba}	=	feed-brine osmotic pressure at actual conditions, psi,
π_{pa}	=	permeate osmotic pressure at actual conditions, psi,
TCF_a	=	temperature correction factor at actual conditions,

where: TCF = temperature correction factor

$$\text{TCF} = 1/e^{(U* ((1/T) - (1/298)))} \quad (\text{A.2})$$

where: U = 3100 for Koch Fluid Systems ULP-TFC membranes

T = measured temperature [°K]

$$\text{Normalized Flux} = Q_{pa} / \text{SA} \quad [\text{gallon/day-ft}^2] \quad (\text{A.3})$$

where: SA = membrane surface area (ft²)

Salt rejection is calculated as follows:

$$\text{Salt rejection (\%)} = [1 - (\text{feed TDS}/\text{permeate TDS})] \times 100 \quad (\text{A.4})$$

APPENDIX C. RAW BENCH-SCALE REVERSE OSMOSIS DATA

DATE	Daily Run Time	TIME	Feed Press	Temp	Feed Cond.	Perm. Cond.	Perm Flow	Perm Press	Brine Flow	Brine Press	Feed in tank	pH (Feed)
mm/dd/yy	Hours	hhmm	psi	F	mhos	mhos	gpm	psi	gpm	psi	gal	units
No Antiscalant CRW/SPW												
4/18	0.1	900	80	58	713	5.6	0.045	0.1	0.16	79	20.0	8.23
4/18	1.0	1000	80	58	800	6.43	0.043	0.1	0.16	79	17.5	
4/18	2.0	1100	80	58.5	940	7.68	0.043	0.1	0.16	79	14.7	
4/18	3.0	1200	80	60	1113	9.23	0.043	0.1	0.16	79	12.0	
4/18	4.0	1300	80	60.5	1388	12.85	0.042	0.1	0.16	79	9.0	
4/18	5.0	1400	80	62	1858	17.96	0.04	0.1	0.16	79	6.2	
4/18	6.0	1500	80	62	2680	31	0.039	0.1	0.16	79	3.8	
4/18	6.5	1530	80	63.5	3440	43	0.034	0.1	0.16	79	2.8	
4/18	7.0	1600	80	63.5	4710	74.2	0.03	0.1	0.16	79	1.9	
4/18	7.5	1630	80	65	6960	169.5	0.017	0.1	0.16	79	1.2	
4/18	7.8	1645	80	65	7870	270	0.015	0.1	0.16	79	1.0	
Permacare PermaTreat 191 1.6ppm CRW/SPW												
4/20	0.1	940	80	67	768	7.18	0.042	0.1	0.16	79	20.0	8.14
4/20	1.0	1040	80	65.7	860	8.4	0.04	0.1	0.16	79	17.3	
4/20	2.0	1140	80	67	976	9.78	0.04	0.1	0.16	79	15.1	
4/20	3.0	1240	80	67	1126	11.18	0.04	0.1	0.16	79	12.7	
4/20	4.0	1340	80	68	1346	13.36	0.038	0.1	0.16	79	10.3	
4/20	5.0	1440	80	68	1723	17.45	0.037	0.1	0.16	79	8.0	
4/20	6.0	1540	80	69.2	2150	25.8	0.036	0.1	0.16	79	5.8	
4/20	7.0	1640	80	69.5	3250	45.8	0.031	0.1	0.16	79	3.7	
4/20	7.5	1710	80	69.8	4170	66.6	0.028	0.1	0.16	79	2.8	
4/20	8.0	1740	80	69	5650	111.5	0.022	0.1	0.16	79	2.1	
4/20	8.2	1750	80	68.4	6280	141.1	0.018	0.1	0.16	79	1.9	8.46
BFGoodrich AF 1025 2.5ppm CRW/SPW												
4/25	0.1	825	80	67.8	689	6.16	0.047	0.1	0.16	79	20.0	8.12
4/25	1.0	925	80	66.2	778	6.47	0.048	0.1	0.16	79	17.4	
4/25	2.0	1025	80	66.7	876	6.89	0.041	0.1	0.16	79	14.9	
4/25	3.0	1125	80	67.6	1028	8.26	0.04	0.1	0.16	79	12.5	
4/25	4.0	1225	80	67.5	1245	10.15	0.04	0.1	0.16	79	10.0	
4/25	5.0	1325	80	68.7	1546	13.4	0.038	0.1	0.16	79	7.7	
4/25	6.0	1425	80	69.8	1990	20.3	0.037	0.1	0.16	79	5.3	
4/25	6.5	1455	80	70.9	2380	26.5	0.036	0.1	0.16	79	4.3	
4/25	7.0	1525	80	72	2970	36.1	0.033	0.1	0.16	79	3.2	
4/25	7.5	1555	80	73.8	4060	59.6	0.029	0.1	0.16	79	2.2	
4/25	8.0	1625	80	74.1	5350	99.4	0.024	0.1	0.16	79	1.4	
4/25	8.3	1643	80	75.7	6550	154.7	0.019	0.1	0.16	79	1.0	
KingLee RO-C 10ppm and RO-D 10ppm blended CRW/SPW												
4/25	0.1	815	80	67	699	8.72	0.049	0.1	0.16	79	20.0	8.12
4/25	1.0	915	80	66	782	7.83	0.046	0.1	0.16	79	17.3	
4/25	2.0	1015	80	67.5	898	8.66	0.045	0.1	0.16	79	14.5	
4/25	3.0	1115	80	67.8	1084	9.88	0.045	0.1	0.16	79	11.7	
4/25	4.0	1215	80	69.4	1354	13.59	0.044	0.1	0.16	79	9.1	
4/25	5.0	1315	80	70	1819	20.2	0.042	0.1	0.16	79	6.5	
4/25	6.0	1415	80	71.4	2730	34.7	0.038	0.1	0.16	79	4.0	
4/25	6.5	1445	80	72.7	3590	59.3	0.035	0.1	0.16	79	2.8	
4/25	7.0	1515	80	73.6	5200	105.9	0.027	0.1	0.16	79	1.9	
4/25	7.5	1545	80	74.1	7250	279	0.013	0.1	0.16	79	1.3	
4/25	7.7	1555	80	74.1	7780	368	0.012	0.1	0.16	79	0.9	
BFGoodrich AF 1405 2.5ppm CRW/SPW												
4/27	0.1	830	80	67.8	692	8.97	0.042	0.1	0.16	79	20.0	8.17
4/27	1.0	930	80	67.5	771	7.3	0.04	0.1	0.16	79	17.7	
4/27	2.0	1030	80	68.4	874	7.9	0.04	0.1	0.16	79	15.2	
4/27	3.0	1130	80	68.5	1015	9.23	0.039	0.1	0.16	79	12.9	
4/27	4.0	1230	80	69.3	1176	10.93	0.038	0.1	0.16	79	10.5	
4/27	5.0	1330	80	69.6	1502	14.78	0.037	0.1	0.16	79	8.2	
4/27	6.0	1430	80	69.8	1962	21.6	0.036	0.1	0.16	79	6.0	
4/27	6.6	1505	80	71.6	2260	27.6	0.034	0.1	0.16	79	4.6	
4/27	7.0	1530	80	72.5	2620	34.5	0.033	0.1	0.16	79	3.8	

DATE	Daily Run Time	TIME	Feed Press	Temp	Feed Cond.	Perm. Cond.	Perm Flow	Perm Press	Brine Flow	Brine Press	Feed in tank	pH (Feed)
mm/dd/yy	Hours	hhmm	psi	F	mhos	mhos	gpm	psi	gpm	psi	gal	units
4/27	7.7	1610	80	72.9	3640	55.4	0.029	0.1	0.16	79	2.5	
4/27	8.0	1630	80	73.4	4400	78.2	0.026	0.1	0.16	79	1.9	
4/27	8.6	1707	80	75.2	6700	173.3	0.018	0.1	0.16	79	1.0	8.03
Stockhausen 90378 10ppm CRW/SPW												
4/27	0.1	840	80	67.3	701	6.85	0.044	0.1	0.16	79	20.0	8.17
4/27	1.0	940	80	66.7	795	6.95	0.044	0.1	0.16	79	17.9	
4/27	2.0	1040	80	67.8	914	8.07	0.044	0.1	0.16	79	14.8	
4/27	3.0	1140	80	68	1094	9.5	0.043	0.1	0.16	79	12.1	
4/27	4.0	1240	80	69.3	1357	12.68	0.042	0.1	0.16	79	9.4	
4/27	5.0	1340	80	69.8	1780	17.68	0.041	0.1	0.16	79	6.9	
4/27	6.0	1440	80	70.3	2490	29	0.037	0.1	0.16	79	4.5	
4/27	6.5	1510	80	71.3	3170	43.8	0.036	0.1	0.16	79	3.4	
4/27	7.0	1540	80	71.8	4370	68.6	0.03	0.1	0.16	79	2.4	
4/27	7.6	1615	80	72.9	6380	161	0.017	0.1	0.16	79	1.5	
4/27	7.9	1635	80	72.9	7450	366	0.009	0.1	0.16	79	1.2	
4/27	8.6	1715	80	73	8120	387	0.004	0.1	0.16	79	1.0	8.01
Calgon EL5300 5ppm CRW/SPW												
5/2	0.1	745	80	70.7	721	8.65	0.046	0.1	0.16	79	20.0	8.09
5/2	1.0	845	80	67.6	789	8	0.044	0.1	0.16	79	17.3	
5/2	2.0	945	80	68.5	874	9.09	0.044	0.1	0.16	79	14.5	
5/2	3.0	1045	80	70	1067	11.31	0.044	0.1	0.16	79	11.9	
5/2	4.0	1145	80	69.4	1340	15.15	0.041	0.1	0.16	79	9.3	
5/2	5.0	1245	80	70	1710	20.7	0.04	0.1	0.16	79	6.8	
5/2	6.0	1345	80	72.1	2340	33.3	0.037	0.1	0.16	79	4.5	
5/2	7.0	1445	80	73.9	3770	70	0.032	0.1	0.16	79	2.3	
5/2	8.0	1541	80	80.6	7140	297	0.017	0.1	0.16	79	1.0	8.30
Argo (BetzDearborn) Hypersperse SI300 UL 2.3ppm CRW/SPW												
5/2	0.1	758	80	71	719	5.76	0.05	0.1	0.16	79	20.0	8.17
5/2	1.0	858	80	67.3	799	6.07	0.044	0.1	0.16	79	17.2	
5/2	2.0	958	80	68.5	904	7.21	0.044	0.1	0.16	79	14.5	
5/2	3.0	1058	80	69.2	1100	9.51	0.044	0.1	0.16	79	11.8	
5/2	4.0	1158	80	69.8	1352	12.12	0.043	0.1	0.16	79	9.1	
5/2	5.0	1258	80	69.9	1769	1.97	0.041	0.1	0.16	79	6.5	
5/2	6.0	1358	80	71.2	2440	28.3	0.039	0.1	0.16	79	4.1	
5/2	7.0	1458	80	73.4	4350	70.2	0.032	0.1	0.16	79	1.9	
5/2	8.0	1552	80	75	7130	314	0.011	0.1	0.16	79	1.0	8.40
DATE	Daily Run Time	TIME	Feed Press	Temp	Feed Cond.	Perm. Cond.	Perm Flow	Perm Press	Brine Flow	Brine Press	Feed in tank	Feed
mm/dd/yy	Hours	hhmm	psi	F	mhos	mhos	gpm	psi	gpm	psi	gal	units
PWT SpectraGuard 10ppm CRW/SPW												
5/4	0.1	750	80	70.2	715	12.03	0.056	0.1	0.16	79	20.0	8.15
5/4	1.0	850	80	66.6	818	12.69	0.051	0.1	0.16	79	16.8	
5/4	2.0	950	80	67.3	974	15.64	0.05	0.1	0.16	79	13.8	
5/4	3.0	1050	80	68.7	1199	19.6	0.049	0.1	0.16	79	10.8	
5/4	4.0	1150	80	70.5	1574	28.9	0.048	0.1	0.16	79	7.8	
5/4	5.0	1250	80	71.7	2170	46.5	0.044	0.1	0.16	79	5.0	
5/4	6.0	1350	80	73.1	3860	110.2	0.036	0.1	0.16	79	2.5	
5/4	6.3	1410	80	73.1	4840	160.6	0.03	0.1	0.16	79	1.9	
5/4	6.7	1430	80	73.2	6822	286	0.02	0.1	0.16	79	1.3	
5/4	7.0	1450	80	73.3	7880	647	0.007	0.1	0.16	79	1.1	
5/4	7.4	1515	80	75.4	8473	1249	0.005	0.1	0.16	79	1.0	8.20
No Antiscalant CRW												
5/9	0.1	730	80	68.4	930	12.5	0.042	0.1	0.16	79	20.0	8.28
5/9	1.0	830	80	65.8	1064	12.4	0.042	0.1	0.16	79	17.5	
5/9	2.0	930	80	65.3	1231	15.82	0.041	0.1	0.16	79	15.0	
5/9	3.0	1030	80	66.4	1425	17.3	0.04	0.1	0.16	79	12.5	
5/9	4.0	1130	80	68.4	1683	20.21	0.04	0.1	0.16	79	10.0	
5/9	5.0	1230	80	70.2	1980	28.1	0.038	0.1	0.16	79	7.6	
5/9	6.0	1330	80	70.3	2650	42.1	0.035	0.1	0.16	79	5.4	

DATE mm/dd/yy	Daily Run Time	TIME hhmm	Feed Press psi	Temp F	Feed Cond. mhos	Perm. Cond. mhos	Perm Flow gpm	Perm Press psi	Brine Flow gpm	Brine Press psi	Feed in	pH (Feed)
	Hours										gal	
5/9	7.0	1430	80	70.9	4020	77	0.032	0.1	0.16	79	3.4	
5/9	8.0	1530	80	74.5	6190	178	0.022	0.1	0.16	79	1.5	
5/9	8.3	1550	80	77	7240	289	0.016	0.1	0.16	79	1.2	
5/9	8.7	1610	80	79.1	8110	479	0.012	0.1	0.16	79	1.0	7.80
Permacare Permatreat 191 1.6ppm CRW												
5/9	0.1	735	80	70.88	907	12.2	0.045	0.1	0.16	79	20.0	8.32
5/9	1.0	835	80	65.66	1082	11.7	0.045	0.1	0.16	79	17.3	
5/9	2.0	935	80	65.3	1256	14.33	0.044	0.1	0.16	79	14.7	
5/9	3.0	1035	80	69.26	1425	15.67	0.043	0.1	0.16	79	12.0	
5/9	4.0	1135	80	69.44	1753	20.5	0.042	0.1	0.16	79	9.4	
5/9	5.0	1235	80	69.98	2190	28.9	0.041	0.1	0.16	79	6.8	
5/9	6.0	1335	80	70.34	3150	52.3	0.036	0.1	0.16	79	4.5	
5/9	7.0	1435	80	71.6	5110	105.7	0.029	0.1	0.16	79	2.4	
5/9	8.0	1535	80	73.22	7580	574	0.008	0.1	0.16	79	1.3	
5/9	8.3	1555	80	75.02	8050	499	0.009	0.1	0.16	79	1.1	
5/9	8.7	1615	80	77.72	8650	580	0.008	0.1	0.16	79	1.0	
BFGoodrich AF1025 2.5ppm CRW												
5/9	0.1	740	80	65.66	958	8.05	0.038	0.1	0.16	79	20.0	8.27
5/9	1.0	840	80	65.66	1055	8.52	0.039	0.1	0.16	79	17.7	
5/9	2.0	940	80	65.66	1184	10.03	0.036	0.1	0.16	79	15.5	
5/9	3.0	1040	80	68.9	1303	11.67	0.036	0.1	0.16	79	13.3	
5/9	4.0	1140	80	68.36	1536	14.26	0.036	0.1	0.16	79	11.2	
5/9	5.0	1240	80	69.44	1822	18.46	0.035	0.1	0.16	79	9.2	
5/9	6.0	1340	80	70.34	2190	27	0.034	0.1	0.16	79	7.1	
5/9	7.0	1440	80	70.52	2990	54.1	0.032	0.1	0.16	79	5.0	
5/9	8.0	1540	80	74.66	4080	62.6	0.028	0.1	0.16	79	3.3	
5/9	9.0	1640	80	75.74	6510	144	0.020	0.1	0.16	79	1.8	
5/9	9.5	1710	80	78.8	8160	391	0.012	0.1	0.16	79	1.3	
5/9	9.8	1730	80	79.34	9300	610	0.005	0.1	0.16	79	1.0	
KingLee ROC ROD 20ppm CRW												
5/11	0.1	725	80	66.74	935	13	0.055	0.1	0.16	79	20.0	8.32
5/11	1.0	825	80	64.4	1026	16.6	0.049	0.1	0.16	79	17.0	
5/11	2.0	925	80	64.94	1328	21.8	0.048	0.1	0.16	79	14.0	
5/11	3.0	1025	80	65.48	1605	28.3	0.045	0.1	0.16	79	11.1	
5/11	4.0	1125	80	66.74	1999	38.2	0.043	0.1	0.16	79	8.5	
5/11	5.0	1225	80	68.54	2530	56	0.040	0.1	0.16	79	5.8	
5/11	6.0	1325	80	69.44	3750	98.4	0.034	0.1	0.16	79	3.7	
5/11	6.5	1355	80	70.34	4920	167.6	0.029	0.1	0.16	79	2.6	
5/11	7.0	1425	80	71.96	6450	310	0.024	0.1	0.16	79	1.8	
5/11	7.5	1455	80	74.3	8410	864	0.009	0.1	0.16	79	1.2	
5/11	8.0	1525	80	75.74	8920	2530	0.005	0.1	0.16	79	1.0	
BFGoodich AF1405 2.5ppm CRW												
5/11	0.1	730	80	66.2	968	9.8	0.048	0.1	0.16	79	20.0	8.32
5/11	1.0	830	80	64.04	1115	10	0.044	0.1	0.16	79	17.3	
5/11	2.0	930	80	64.76	1273	10.6	0.042	0.1	0.16	79	14.8	
5/11	3.0	1030	80	65.3	1490	15.3	0.041	0.1	0.16	79	12.2	
5/11	4.0	1130	80	66.56	1792	16.6	0.040	0.1	0.16	79	9.8	
5/11	5.0	1230	80	68	2140	23	0.038	0.1	0.16	79	7.3	
5/11	6.0	1330	80	69.08	2880	34.3	0.036	0.1	0.16	79	5.1	
5/11	7.0	1430	80	69.98	4280	64.4	0.031	0.1	0.16	79	3.0	
5/11	7.5	1500	80	70.34	5490	96.5	0.026	0.1	0.16	79	2.2	
5/11	8.0	1530	80	70.88	7240	171	0.018	0.1	0.16	79	1.5	
5/11	8.5	1600	80	71.24	8210	450	0.012	0.1	0.16	79	1.1	
5/11	8.8	1620	80	71.24	8880	544	0.008	0.1	0.16	79	1.0	
Stockhausen 90378 10ppm CRW												
5/11	0.1	735	80	66.2	965	10.5	0.054	0.1	0.16	79	19.8	8.34
5/11	1.0	835	80	64.4	1136	12.2	0.051	0.1	0.16	79	16.7	
5/11	2.0	935	80	64.94	1353	15.4	0.049	0.1	0.16	79	13.7	
5/11	3.0	1035	80	65.3	1675	21.1	0.048	0.1	0.16	79	10.6	
5/11	4.0	1135	80	66.74	2070	28.8	0.045	0.1	0.16	79	7.8	

DATE	Daily Run Time	TIME	Feed Press	Temp	Feed Cond.	Perm. Cond.	Perm Flow	Perm Press	Brine Flow	Brine Press	Feed in tank	pH (Feed)
mm/dd/yy	Hours	hhmm	psi	F	mhos	mhos	gpm	psi	gpm	psi	gal	units
5/11	5.0	1235	80	68.18	2890	47.9	0.041	0.1	0.16	79	5.2	
5/11	6.0	1335	80	69.44	4690	105.7	0.032	0.1	0.16	79	3.0	
5/11	6.5	1405	80	71.06	6330	207	0.026	0.1	0.16	79	2.1	
5/11	7.0	1435	80	73.94	8190	464	0.018	0.1	0.16	79	1.3	
5/11	7.5	1505	80	80.06	10870	1363	0.007	0.1	0.16	79	0.9	
Calgon EL5300 5ppm CRW												
5/16	0.1	905	80	66.2	973	13.2	0.054	0.1	0.16	79	20.0	8.21
5/16	1.0	1005	80	65.3	1127	13.4	0.050	0.1	0.16	79	16.9	
5/16	2.0	1105	80	66.02	1345	16.5	0.049	0.1	0.16	79	13.8	
5/16	3.0	1205	80	66.02	1652	20.8	0.048	0.1	0.16	79	10.9	
5/16	4.0	1305	80	66.92	1994	27.5	0.045	0.1	0.16	79	8.1	
5/16	5.0	1405	80	67.46	2840	48.4	0.041	0.1	0.16	79	5.4	
5/16	6.0	1505	80	68.72	4590	99	0.033	0.1	0.16	79	3.1	
5/16	6.5	1535	80	68.9	6260	191	0.026	0.1	0.16	79	2.2	
5/16	7.0	1605	80	70.52	8360	400	0.017	0.1	0.16	79	1.4	
5/16	7.5	1635	80	74.12	10110	924	0.010	0.1	0.16	79	1.0	
Argo (BetzDearborn) Hypersperse SI300 UL 2.3ppm CRW												
5/16	0.0	910	80	65.66	978	12.3	0.052	0.1	0.16	79	20.0	8.29
5/16	1.0	1010	80	64.76	1127	12.5	0.051	0.1	0.16	79	16.9	
5/16	2.0	1110	80	65.12	1340	15.1	0.049	0.1	0.16	79	13.8	
5/16	3.0	1210	80	65.66	1633	19.1	0.048	0.1	0.16	79	10.7	
5/16	4.0	1310	80	66.02	2010	29.4	0.046	0.1	0.16	79	7.9	
5/16	5.0	1410	80	67.1	2840	44.4	0.042	0.1	0.16	79	5.2	
5/16	6.0	1510	80	68	4510	87.6	0.034	0.1	0.16	79	2.8	
5/16	6.5	1540	80	67.82	6020	146.7	0.027	0.1	0.16	79	1.9	
5/16	7.0	1610	80	68.54	7990	321	0.015	0.1	0.16	79	1.2	
5/16	7.5	1640	80	69.44	9120	633	0.011	0.1	0.16	79	1.0	
PWT SpectraGuard 10ppm CRW												
5/16	0.0	915	80	65.48	980	10.4	0.053	0.1	0.16	79	20.0	8.28
5/16	1.0	1015	80	65.12	1132	13.9	0.052	0.1	0.16	79	16.8	
5/16	2.0	1115	80	65.3	1364	17.3	0.052	0.1	0.16	79	13.7	
5/16	3.0	1215	80	65.3	1703	23.6	0.050	0.1	0.16	79	10.6	
5/16	4.0	1315	80	66.38	2140	35	0.047	0.1	0.16	79	7.6	
5/16	5.0	1415	80	67.28	3170	61.1	0.042	0.1	0.16	79	4.8	
5/16	6.0	1515	80	68.36	5410	150.5	0.031	0.1	0.16	79	2.6	
5/16	6.5	1545	80	68.9	7470	321	0.023	0.1	0.16	79	1.8	
5/16	7.0	1615	80	73.4	9870	824	0.011	0.1	0.16	79	1.2	
5/16	7.3	1630	80	74.84	10750	1440	0.008	0.1	0.16	79	1.0	
No Antiscalant CRW @ pH=7												
5/18	0.0	710	80	67.28	960	14.5	0.048	0.1	0.16	79	20.0	7.18
5/18	1.0	810	80	66.56	1096	13.5	0.045	0.1	0.16	79	17.2	
5/18	2.0	910	80	67.28	1264	14.1	0.044	0.1	0.16	79	14.6	
5/18	3.0	1010	80	69.08	1484	16.7	0.043	0.1	0.16	79	12.0	
5/18	4.0	1110	80	69.26	1818	20.6	0.041	0.1	0.16	79	9.5	
5/18	5.0	1210	80	70.7	2230	31.3	0.040	0.1	0.16	79	7.0	
5/18	6.0	1310	80	72.32	3100	48.1	0.036	0.1	0.16	79	4.7	
5/18	6.5	1340	80	73.58	3800	68	0.033	0.1	0.16	79	3.7	
5/18	7.0	1410	80	73.94	4940	104	0.029	0.1	0.16	79	2.7	
5/18	7.5	1440	80	75.38	6440	177	0.023	0.1	0.16	79	2.0	
5/18	8.0	1510	80	78.26	8440	421	0.016	0.1	0.16	79	1.3	
5/18	8.5	1540	80	82.22	10910	984	0.009	0.1	0.16	79	1.0	8.06
Permacare PermaTreat 191 1.6 ppm CRW@pH7												
5/18	0.0	715	80	67.1	973	13.8	0.055	0.1	0.16	79	20.0	7.14
5/18	1.0	815	80	66.38	1127	14.1	0.053	0.1	0.16	79	16.7	
5/18	2.0	915	80	67.28	1346	15.2	0.051	0.1	0.16	79	13.5	
5/18	3.0	1015	80	68.36	1662	18.2	0.049	0.1	0.16	79	10.4	
5/18	4.0	1115	80	68.9	2110	25	0.047	0.1	0.16	79	7.5	
5/18	5.0	1215	80	70.7	3050	44	0.043	0.1	0.16	79	4.8	
5/18	6.0	1315	80	73.04	5200	105.8	0.032	0.1	0.16	79	2.4	
5/18	6.5	1345	80	74.12	7160	222	0.023	0.1	0.16	79	1.5	

DATE	Daily Run Time	TIME	Feed Press	Temp	Feed Cond.	Perm. Cond.	Perm Flow	Perm Press	Brine Flow	Brine Press	Feed in tank	pH (Feed)
mm/dd/yy	Hours	hhmm	psi	F	mhos	mhos	gpm	psi	gpm	psi	gal	units
5/18	7.0	1415	80	74.66	9250	588	0.008	0.1	0.16	79	1.0	8.02
BFGoodich AF1025 2.5 ppm CRW@pH7												
5/18	0.0	720	80	66.38	993	14.9	0.059	0.1	0.16	79	20.0	7.19
5/18	1.0	820	80	66.56	1136	15.3	0.056	0.1	0.16	79	16.5	
5/18	2.0	920	80	67.46	1383	18.2	0.055	0.1	0.16	79	13.2	
5/18	3.0	1020	80	68.9	1744	25.3	0.052	0.1	0.16	79	9.9	
5/18	4.0	1120	80	70.7	2320	39.5	0.049	0.1	0.16	79	6.7	
5/18	5.0	1220	80	71.6	3510	75.3	0.043	0.1	0.16	79	4.0	
5/18	6.0	1320	80	74.3	6650	268	0.026	0.1	0.16	79	1.8	
5/18	6.5	1350	80	77.9	9440	684	0.017	0.1	0.16	79	1.2	
5/18	6.7	1402	80	81.14	10500	1045	0.013	0.1	0.16	79	1.0	8.13
KingLee RO-C RO-D 20 ppm CRW@pH7												
5/23	0.0	715	80	65.12	972	13.8	0.040	0.1	0.16	79	20.0	7.11
5/23	1.0	815	80	65.12	1103	11.2	0.038	0.1	0.16	79	17.6	
5/23	2.0	915	80	65.84	1235	10.5	0.038	0.1	0.16	79	15.3	
5/23	3.0	1015	80	66.02	1418	11.2	0.036	0.1	0.16	79	13.0	
5/23	4.0	1115	80	66.38	1637	13.1	0.036	0.1	0.16	79	11.9	
5/23	5.0	1215	80	67.1	1941	17.4	0.034	0.1	0.16	79	9.8	
5/23	6.0	1315	80	68.18	2320	23.7	0.032	0.1	0.16	79	7.8	
5/23	7.0	1415	80	69.8	3020	34.1	0.030	0.1	0.16	79	5.9	
5/23	8.0	1515	80	70.7	4070	55.8	0.027	0.1	0.16	79	4.2	
5/23	9.0	1615	80	72.32	6570	126	0.018	0.1	0.16	79	2.8	
5/23	10.0	1715	80	74.84	9000	573	0.009	0.1	0.16	79	1.5	8.16
BFGoodich AF1405 2.5ppm CRW@pH7												
5/23	0.0	720	80	65.3	971	19.2	0.057	0.1	0.16	79	20.0	7.12
5/23	1.0	820	80	65.3	1150	20.4	0.054	0.1	0.16	79	16.6	
5/23	2.0	920	80	65.84	1380	23	0.052	0.1	0.16	79	13.4	
5/23	3.0	1020	80	66.2	1734	27.8	0.049	0.1	0.16	79	10.2	
5/23	4.0	1120	80	66.38	2180	40.7	0.046	0.1	0.16	79	7.3	
5/23	5.0	1220	80	67.28	3200	71	0.042	0.1	0.16	79	4.6	
5/23	6.0	1320	80	68.9	5260	167.3	0.031	0.1	0.16	79	2.4	
5/23	6.5	1350	80	69.62	7070	321	0.023	0.1	0.16	79	1.6	
5/23	7.0	1420	80	70.34	9000	932	0.012	0.1	0.16	79	1.1	
5/23	7.3	1440	80	71.06	9920	938	0.010	0.1	0.16	79	1.0	8.18
Stockhausen 90378 10ppm CRW@pH7												
5/23	0.0	725	80	65.48	978	12.9	0.051	0.1	0.16	79	20.0	7.17
5/23	1.0	825	80	65.48	1133	12.5	0.050	0.1	0.16	79	17.0	
5/23	2.0	925	80	66.2	1335	14.4	0.049	0.1	0.16	79	14.0	
5/23	3.0	1025	80	66.38	1634	19.1	0.048	0.1	0.16	79	11.1	
5/23	4.0	1125	80	66.56	2010	26.8	0.046	0.1	0.16	79	8.3	
5/23	5.0	1225	80	67.64	2790	44.3	0.042	0.1	0.16	79	5.5	
5/23	6.0	1325	80	69.26	4430	91.5	0.034	0.1	0.16	79	3.2	
5/23	6.5	1355	80	70.34	5830	157	0.028	0.1	0.16	79	2.3	
5/23	7.0	1425	80	72.5	8270	342	0.020	0.1	0.16	79	1.6	
5/23	7.5	1455	80	76.28	10170	828	0.011	0.1	0.16	79	1.1	
5/23	7.7	1505	80	78.08	10770	1036	0.009	0.1	0.16	79	1.0	8.20
Calgon EL5300 5ppm CRW@pH7												
5/25	0.0	715	80	67.64	1006	19.3	0.055	0.1	0.16	79	20.0	6.91
5/25	1.0	815	80	65.84	1169	17.5	0.052	0.1	0.16	79	16.8	
5/25	2.0	915	80	65.48	1401	17.9	0.050	0.1	0.16	79	13.8	
5/25	3.0	1015	80	65.48	1717	22.1	0.048	0.1	0.16	79	10.9	
5/25	4.0	1115	80	65.3	2140	32.2	0.045	0.1	0.16	79	8.1	
5/25	5.0	1215	80	65.84	2960	52.3	0.040	0.1	0.16	79	5.5	
5/25	6.0	1315	80	66.2	4650	105.3	0.032	0.1	0.16	79	3.3	
5/25	7.0	1415	80	66.74	8150	361	0.017	0.1	0.16	79	1.7	
5/25	7.5	1445	80	67.82	10060	715	0.011	0.1	0.16	79	1.2	
5/25	7.8	1500	80	68.18	10880	1087	0.008	0.1	0.16	79	1.0	8.20
BetzDearborn Hypersperse SI300UL 2.3ppm CRW@pH7												
5/25	0.0	720	80	67.28	1006	17.9	0.055	0.1	0.16	79	20.0	6.90
5/25	1.0	820	80	65.84	1167	18.6	0.052	0.1	0.16	79	16.8	

DATE	Daily Run Time	TIME	Feed Press	Temp	Feed Cond.	Perm. Cond.	Perm Flow	Perm Press	Brine Flow	Brine Press	Feed in tank	pH (Feed)
mm/dd/yy	Hours	hhmm	psi	F	mhos	mhos	gpm	psi	gpm	psi	gal	units
5/25	2.0	920	80	65.48	1408	20.1	0.051	0.1	0.16	79	13.7	
5/25	3.0	1020	80	65.48	1752	22.5	0.049	0.1	0.16	79	10.7	
5/25	4.0	1120	80	65.48	2160	32.1	0.046	0.1	0.16	79	7.9	
5/25	5.0	1220	80	66.2	3070	52.1	0.041	0.1	0.16	79	5.2	
5/25	6.0	1320	80	66.74	4890	109.6	0.032	0.1	0.16	79	3.0	
5/25	7.0	1420	80	66.92	8700	393	0.017	0.1	0.16	79	1.5	
5/25	7.5	1450	80	67.1	10920	836	0.011	0.1	0.16	79	1.1	
5/25	8.5	1505	80	67.64	11960	1190	0.010	0.1	0.16	79	1.0	8.18
PWT SpectraGuard 10ppm CRW@pH7												
5/25	0.0	725	80	67.28	1001	16.1	0.053	0.1	0.16	79	20.0	6.98
5/25	1.0	825	80	66.02	1163	15.1	0.049	0.1	0.16	79	16.9	
5/25	2.3	945	80	65.48	1479	16.9	0.048	0.1	0.16	79	13.9	
5/25	3.0	1025	80	65.66	1678	19.5	0.046	0.1	0.16	79	11.1	
5/25	4.0	1125	80	65.66	2020	26.1	0.044	0.1	0.16	79	8.4	
5/25	5.0	1225	80	66.2	2760	40.2	0.040	0.1	0.16	79	5.8	
5/25	6.0	1325	80	66.74	4150	76.8	0.034	0.1	0.16	79	3.6	
5/25	7.0	1425	80	68	7030	231	0.022	0.1	0.16	79	1.9	
5/25	7.5	1455	80	69.62	9200	480	0.015	0.1	0.16	79	1.3	
5/25	8.0	1525	80	73.22	11440	1147	0.009	0.1	0.16	79	1.0	8.09
Citric acid 2 mg/l CRW/SPW												
6/1	0.0	720	80	68.54	780	12.6	0.050	0.1	0.16	79	20.0	7.22
6/1	1.0	820	80	67.46	843	13.3	0.048	0.1	0.16	79	17.1	
6/1	2.0	920	80	68.36	1049	17.7	0.046	0.1	0.16	79	14.3	
6/1	3.0	1020	80	68.9	1266	18.4	0.045	0.1	0.16	79	11.5	
6/1	4.0	1120	80	70.7	1479	22.9	0.044	0.1	0.16	79	8.7	
6/1	5.0	1220	80	71.24	1979	35	0.041	0.1	0.16	79	6.1	
6/1	6.0	1320	80	73.58	2980	68.5	0.037	0.1	0.16	79	3.8	
6/1	7.0	1420	80	75.56	5220	197	0.026	0.1	0.16	79	1.8	
6/1	7.5	1450	80	77.9	7480	275	0.018	0.1	0.16	79	1.2	
6/1	7.7	1502	80	75.02	8590	680	0.014	0.1	0.16	79	1.0	8.09
Oxalic acid 2 mg/l CRW/SPW												
6/1	0.0	725	80	68	751	9.92	0.052	0.1	0.16	79	20.0	7.23
6/1	1.0	825	80	66.92	824	9.7	0.049	0.1	0.16	79	17.0	
6/1	2.0	925	80	68.18	1057	12	0.048	0.1	0.16	79	14.0	
6/1	3.0	1025	80	69.08	1282	14.2	0.045	0.1	0.16	79	11.2	
6/1	4.0	1125	80	70.16	1585	18.9	0.042	0.1	0.16	79	8.5	
6/1	5.0	1225	80	71.6	1927	26.9	0.038	0.1	0.16	79	6.1	
6/1	6.0	1325	80	73.58	2850	45.8	0.034	0.1	0.16	79	4.0	
6/1	7.0	1425	80	76.1	4590	101	0.026	0.1	0.16	79	2.1	
6/1	7.5	1455	80	77.18	6130	192	0.020	0.1	0.16	79	1.5	
6/1	8.0	1525	80	79.7	7720	360	0.013	0.1	0.16	79	1.0	7.32
Aspartic acid 2 mg/l CRW/SPW												
6/1	0.0	730	80	67.46	786	7.64	0.050	0.1	0.16	79	20.0	7.49
6/1	1.0	830	80	67.1	905	8.1	0.048	0.1	0.16	79	17.1	
6/1	2.0	930	80	68.18	1068	9.6	0.047	0.1	0.16	79	14.2	
6/1	3.0	1030	80	68.9	1296	13.5	0.046	0.1	0.16	79	11.4	
6/1	4.0	1130	80	70.16	1597	17.9	0.043	0.1	0.16	79	8.3	
6/1	5.0	1230	80	71.96	2110	27.6	0.042	0.1	0.16	79	6.0	
6/1	6.0	1330	80	73.58	3250	51.5	0.037	0.1	0.16	79	3.6	
6/1	7.0	1430	80	77.18	6210	157.6	0.025	0.1	0.16	79	1.7	
6/1	7.5	1500	80	82.58	9050	487	0.015	0.1	0.16	79	1.0	8.26
Citric acid 1,200 mg/L CRW/SPW												
6/6	0.0	720	80	71.6	1081	414	0.054	0.1	0.16	79	20.6	3.17
6/6	1.0	820	80	70.34	1216	424	0.048	0.1	0.16	79	17.5	
6/6	2.0	920	80	71.6	1357	434	0.047	0.1	0.16	79	14.6	
6/6	3.0	1020	80	72.86	1555	448	0.045	0.1	0.16	79	11.8	
6/6	4.0	1120	80	73.04	1843	494	0.042	0.1	0.16	79	9.1	
6/6	5.0	1220	80	74.66	2150	549	0.038	0.1	0.16	79	6.7	
6/6	6.0	1320	80	75.74	2690	645	0.032	0.1	0.16	79	4.1	
6/6	7.0	1420	80	75.2	4750	857	0.022	0.1	0.16	79	2.3	

DATE	Daily Run Time	TIME	Feed Press	Temp	Feed Cond.	Perm. Cond.	Perm Flow	Perm Press	Brine Flow	Brine Press	Feed in tank	pH (Feed)
mm/dd/yy	Hours	hhmm	psi	F	mhos	mhos	gpm	psi	gpm	psi	gal	units
6/6	8.2	1530	80	77	7605	1330	0.008	0.1	0.16	79	1.9	
6/6	8.5	1550	80	78.26	8440	1430	0.007	0.1	0.16	79	1.2	3.01
Citric acid 120 mg/L CRW/SPW												
6/6	0.0	725	80	70.88	742	22.8	0.065	0.1	0.16	79	20.0	5.90
6/6	1.0	825	80	70.16	881	22	0.061	0.1	0.16	79	16.3	
6/6	2.0	925	80	71.24	1085	22.8	0.058	0.1	0.16	79	12.6	
6/6	3.0	1025	80	72.68	1416	19.3	0.056	0.1	0.16	79	9.1	
6/6	4.0	1125	80	74.48	1960	26.5	0.053	0.1	0.16	79	5.7	
6/6	5.0	1225	80	75.38	3430	64	0.044	0.1	0.16	79	2.8	
6/6	6.0	1325	80	77.18	7200	390	0.020	0.1	0.16	79	1.0	8.40
Citric acid 12 mg/L CRW/SPW												
6/6	0.0	730	80	70.52	817	11.5	0.055	0.1	0.16	79	20.0	7.35
6/6	1.0	830	80	70.16	956	11.74	0.053	0.1	0.16	79	16.8	
6/6	2.0	930	80	71.42	1138	15.22	0.052	0.1	0.16	79	13.7	
6/6	3.0	1030	80	72.32	1420	19.6	0.050	0.1	0.16	79	10.5	
6/6	4.0	1130	80	73.04	1877	29.1	0.048	0.1	0.16	79	7.6	
6/6	5.0	1230	80	75.38	2650	52	0.044	0.1	0.16	79	4.8	
6/6	6.0	1330	80	77.36	5030	165	0.030	0.1	0.16	79	2.2	
6/6	6.5	1400	80	80.78	5720	287	0.023	0.1	0.16	79	1.5	
6/6	7.0	1430	80	85.46	11410	935	0.013	0.1	0.16	79	1.0	8.20
salicylic acid 117 mg/L CRW/SPW												
6/8	0.0	720	80	70.34	812	24.9	0.054	0.1	0.16	79	20.0	6.90
6/8	1.0	820	80	69.44	927	13.3	0.051	0.1	0.16	79	16.8	
6/8	2.0	920	80	69.26	1115	10.2	0.050	0.1	0.16	79	13.6	
6/8	3.0	1020	80	70.52	1365	13.4	0.048	0.1	0.16	79	10.7	
6/8	4.0	1120	80	71.06	1764	27	0.046	0.1	0.16	79	7.8	
6/8	5.3	1235	80	71.96	2950	49.2	0.038	0.1	0.16	79	4.6	
6/8	6.0	1320	80	72.32	4530	69.6	0.033	0.1	0.16	79	2.9	
6/8	7.0	1420	80	71.78	8370	250	0.016	0.1	0.16	79	1.3	
6/8	7.5	1450	80	71.06	10650	563	0.008	0.1	0.16	79	1.0	8.33
salicylic acid 12 mg/L CRW/SPW												
6/8	0.0	725	80	71.06	813	8.3	0.052	0.1	0.16	79	20.0	7.60
6/8	1.0	825	80	69.44	939	8.1	0.050	0.1	0.16	79	16.9	
6/8	2.0	925	80	69.44	1128	11	0.048	0.1	0.16	79	13.9	
6/8	3.0	1025	80	70.7	1343	12.3	0.048	0.1	0.16	79	10.8	
6/8	4.0	1125	80	70.88	1753	20.3	0.046	0.1	0.16	79	7.9	
6/8	5.3	1240	80	71.6	2970	33.5	0.041	0.1	0.16	79	4.6	
6/8	6.0	1325	80	71.6	4550	61.1	0.034	0.1	0.16	79	2.9	
6/8	7.0	1425	80	71.6	8180	205	0.018	0.1	0.16	79	1.4	
6/8	7.5	1455	80	71.78	10730	471	0.009	0.1	0.16	79	1.0	8.24
salicylic acid 24 mg/L CRW/SPW												
6/8	0.0	730	80	70.52	817	7.5	0.054	0.1	0.16	79	20.0	7.85
6/8	1.0	830	80	69.62	956	8.5	0.051	0.1	0.16	79	16.8	
6/8	2.0	930	80	69.44	1135	10.1	0.050	0.1	0.16	79	13.8	
6/8	3.0	1030	80	70.52	1385	17.3	0.049	0.1	0.16	79	10.7	
6/8	4.0	1130	80	71.06	1837	26.5	0.047	0.1	0.16	79	7.7	
6/8	5.3	1245	80	72.14	3100	37.3	0.041	0.1	0.16	79	4.4	
6/8	6.0	1330	80	72.68	4850	70.1	0.033	0.1	0.16	79	2.7	
6/8	7.0	1430	80	76.46	9660	353	0.015	0.1	0.16	79	1.1	
6/8	7.2	1440	80	77.72	10410	546	0.010	0.1	0.16	79	1.0	8.04
EDTA CRW/SPW 12 mg/L												
6/15	0.0	800	80	74.66	787	11	0.052	0.1	0.16	79	20.0	7.05
6/15	1.0	900	80	73.58	919	11.2	0.050	0.1	0.16	79	17.0	8.46
6/15	2.0	1000	80	74.12	1051	13.4	0.048	0.1	0.16	79	14.0	
6/15	3.0	1100	80	74.48	1303	17.5	0.048	0.1	0.16	79	11.1	
6/15	5.0	1300	80	77.9	2490	36.7	0.044	0.1	0.16	79	5.4	
6/15	6.0	1400	80	77.54	3430	76.6	0.034	0.1	0.16	79	2.9	
6/15	6.7	1440	80	74.66	7093	200	0.023	0.1	0.16	79	1.7	
6/15	7.0	1500	80	75.38	9019	364	0.015	0.1	0.16	79	1.2	
6/15	7.3	1520	80	76.1	10840	675	0.009	0.1	0.16	79	1.0	8.13

DATE	Daily Run Time	TIME	Feed Press	Temp	Feed Cond.	Perm. Cond.	Perm Flow	Perm Press	Brine Flow	Brine Press	Feed in tank	pH (Feed)
mm/dd/yy	Hours	hhmm	psi	F	mhos	mhos	gpm	psi	gpm	psi	gal	units
EDTA CRW/SPW 0.0426 mmol/L												
6/15	0.0	805	80	73.94	783	11.2	0.061	0.1	0.16	79	20.0	7.77
6/15	1.0	905	80	73.4	899	12.8	0.057	0.1	0.16	79	16.3	
6/15	2.0	1005	80	73.76	1154	17.3	0.058	0.1	0.16	79	12.8	
6/15	3.0	1105	80	74.48	1519	23.2	0.056	0.1	0.16	79	9.3	
6/15	5.0	1305	80	78.08	3700	86.3	0.040	0.1	0.16	79	3.1	
6/15	6.0	1405	80	77.9	8990	401	0.018	0.1	0.16	79	1.1	
6/15	7.2	1415	80	76.28	10820	581	0.015	0.1	0.16	79	1.0	8.08
citric acid CRW 12 mg/L												
6/20	0.0	750	80	73.4	922	9.1	0.054	0.1	0.16	79	20.0	7.81
6/20	1.0	850	80	73.58	1057	11.3	0.053	0.1	0.16	79	16.8	
6/20	2.0	950	80	74.3	1302	16.7	0.052	0.1	0.16	79	13.6	
6/20	3.0	1050	80	74.66	1600	20.3	0.050	0.1	0.16	79	10.4	
6/20	4.0	1150	80	75.74	2150	29.1	0.048	0.1	0.16	79	7.5	
6/20	5.0	1250	80	76.28	3110	56.8	0.042	0.1	0.16	79	4.7	
6/20	6.0	1350	80	76.28	5320	111.4	0.032	0.1	0.16	79	2.4	
6/20	6.5	1420	80	76.1	7260	245	0.022	0.1	0.16	79	1.5	
6/20	7.0	1450	80	76.1	10270	511	0.013	0.1	0.16	79	1.0	8.13
aspartic acid CRW 0.0852 mmol/L												
6/20	0.0	755	80	73.58	941	12.6	0.063	0.1	0.16	79	20.0	7.98
6/20	1.0	855	80	73.58	1126	14.5	0.060	0.1	0.16	79	16.2	
6/20	2.0	955	80	74.66	1409	19	0.059	0.1	0.16	79	12.6	
6/20	3.0	1055	80	75.2	1804	28	0.055	0.1	0.16	79	9.2	
6/20	4.0	1155	80	76.1	2640	45.2	0.050	0.1	0.16	79	5.9	
6/20	5.0	1255	80	77.18	4350	86.7	0.038	0.1	0.16	79	3.2	
6/20	6.0	1355	80	77.18	8180	304	0.020	0.1	0.16	79	1.5	
6/20	6.5	1425	80	77.36	10260	645	0.012	0.1	0.16	79	1.0	8.11
EDTA CRW 12 mg/L												
6/20	0.0	800	80	72.86	947	9	0.050	0.1	0.16	79	20.0	8.10
6/20	1.0	900	80	73.4	1079	11	0.049	0.1	0.16	79	17.0	
6/20	2.0	1000	80	74.48	1279	14.5	0.049	0.1	0.16	79	14.0	
6/20	3.0	1100	80	75.02	1551	17.9	0.048	0.1	0.16	79	11.0	
6/20	4.0	1200	80	75.92	1964	25.4	0.045	0.1	0.16	79	8.3	
6/20	5.0	1300	80	76.46	2820	38.5	0.042	0.1	0.16	79	5.6	
6/20	6.0	1400	80	77.36	4350	70	0.032	0.1	0.16	79	3.4	
6/20	6.5	1430	80	77.9	5440	112.2	0.026	0.1	0.16	79	2.5	
6/20	7.0	1500	80	77.9	7960	229	0.022	0.1	0.16	79	1.7	
6/20	7.7	1540	80	80.78	11290	607	0.012	0.1	0.16	79	1.0	7.55
citric acid CRW@pH7 12 mg/L												
6/22	0.0	810	80	73.04	942	13.2	0.054	0.1	0.16	79	20.0	6.94
6/22	1.2	922	80	75.38	1127	10.3	0.054	0.1	0.16	79	16.1	
6/22	2.0	1010	80	76.28	1210	12.5	0.054	0.1	0.16	79	13.6	
6/22	3.0	1110	80	77	1478	17.5	0.052	0.1	0.16	79	10.3	
6/22	4.2	1222	80	77.36	2300	24.5	0.047	0.1	0.16	79	6.8	
6/22	5.0	1310	80	76.82	3670	44.3	0.042	0.1	0.16	79	4.5	
6/22	6.0	1410	80	78.44	6910	146	0.031	0.1	0.16	79	2.3	
6/22	6.5	1440	80	80.96	10210	347	0.020	0.1	0.16	79	1.5	
6/22	7.0	1510	80	84.74	13740	1149	0.008	0.1	0.16	79	1.0	8.06
aspartic acid CRW@pH7 11 mg/L												
6/22	0.0	815	80	73.4	957	17.6	0.067	0.1	0.16	79	20.0	6.95
6/22	1.2	927	80	75.38	1224	17.9	0.067	0.1	0.16	79	15.0	
6/22	2.0	1015	80	76.28	1468	21	0.065	0.1	0.16	79	11.6	
6/22	3.0	1115	80	77.18	2160	32.9	0.059	0.1	0.16	79	7.9	
6/22	4.2	1227	80	78.08	3410	71.6	0.048	0.1	0.16	79	4.0	
6/22	5.0	1315	80	76.82	7670	211.4	0.031	0.1	0.16	79	2.0	
6/22	6.0	1415	80	77.54	12740	1960	0.004	0.1	0.16	79	1.0	8.16
EDTA CRW@pH7 12 mg/L mmol/L												
6/22	0.0	820	80	73.76	955	14.1	0.055	0.1	0.16	79	20.0	7.02
6/22	1.2	932	80	75.56	1153	12.9	0.054	0.1	0.16	79	15.9	
6/22	2.0	1020	80	76.28	1496	15.1	0.054	0.1	0.16	79	13.3	

DATE	Daily Run Time	TIME	Feed Press	Temp	Feed Cond.	Perm. Cond.	Perm Flow	Perm Press	Brine Flow	Brine Press	Feed in tank	pH (Feed)
mm/dd/yy	Hours	hhmm	psi	F	mhos	mhos	gpm	psi	gpm	psi	gal	units
6/22	3.0	1120	80	76.82	1698	21	0.051	0.1	0.16	79	9.9	
6/22	4.2	1232	80	77.36	2360	36.3	0.047	0.1	0.16	79	6.6	
6/22	5.0	1320	80	76.46	3810	66	0.041	0.1	0.16	79	4.4	
6/22	6.0	1420	80	78.98	7480	188	0.029	0.1	0.16	79	2.3	
6/22	6.5	1450	80	79.52	9640	355	0.020	0.1	0.16	79	1.5	
6/22	7.0	1520	80	84.92	13820	947	0.011	0.1	0.16	79	1.0	7.64
oxalic acid CRW@pH7 10 mg/L												
6/29	0.0	800	80	75.56	907	15.5	0.057	0.1	0.16	79	20.0	7.10
6/29	1.0	900	80	75.56	1027	16	0.055	0.1	0.16	79	16.6	
6/29	2.2	1012	80	77	1336	16.6	0.053	0.1	0.16	79	12.8	
6/29	3.0	1100	80	78.08	1688	27	0.052	0.1	0.16	79	10.0	
6/29	4.0	1200	80	79.7	2230	35	0.047	0.1	0.16	79	7.0	
6/29	5.0	1300	80	80.06	3400	67.8	0.042	0.1	0.16	79	4.3	
6/29	6.0	1400	80	85.1	5920	162	0.029	0.1	0.16	79	2.1	
6/29	6.5	1430	80	86.9	7920	331	0.020	0.1	0.16	79	1.4	
6/29	7.0	1500	80	89.6	9860	1100	0.004	0.1	0.16	79	1.0	7.70
No anti CRW@pH7												
6/29	0.0	810	80	72.86	975	20	0.057	0.1	0.16	79	20.0	6.90
6/29	1.0	910	80	75.74	1075	15.6	0.053	0.1	0.16	79	17.0	
6/29	2.2	1022	80	76.82	1317	14.5	0.052	0.1	0.16	79	13.0	
6/29	3.0	1110	80	77.36	1659	20	0.050	0.1	0.16	79	10.4	
6/29	4.0	1210	80	78.98	2170	28	0.047	0.1	0.16	79	7.6	
6/29	5.0	1310	80	79.7	3170	54	0.044	0.1	0.16	79	4.9	
6/29	6.0	1410	80	83.12	5510	116	0.033	0.1	0.16	79	2.4	
6/29	6.5	1440	80	84.38	7440	223	0.024	0.1	0.16	79	1.5	
6/29	7.0	1510	80	88.34	10420	542	0.013	0.1	0.16	79	1.0	8.30
Citric acid 24 mg/L/EDTA 12 mg/L CRW@pH7 (Al3+ 150 ppb)												
8/28	0.0	910	80	77	931	18.4	0.067	0.1	0.16	79	15.0	7.14
8/28	1.0	1010	80	78.98	1228	24.2	0.067	0.1	0.16	79	10.7	
8/28	2.0	1110	80	79.52	1865	40.2	0.062	0.1	0.16	79	6.7	
8/28	3.0	1210	80	80.96	3500	92.4	0.050	0.1	0.16	79	3.2	
8/28	4.0	1310	80	84.38	9550	555	0.014	0.1	0.16	79	0.9	
8/28	4.3	1325	80	85.46	10110	797	0.009	0.1	0.16	79	0.8	
Citric acid 24 mg/L/Permacare 1.6 ppm CRW@pH7 (Al3+ 150 ppb)												
8/28	0.0	915	80	77.36	926	12.1	0.046	0.1	0.16	79	14.4	7.15
8/28	1.0	1015	80	78.98	1114	13.2	0.046	0.1	0.16	79	11.6	
8/28	2.0	1115	80	79.34	1410	15.1	0.044	0.1	0.16	79	9.0	
8/28	3.0	1215	80	80.24	1906	25.6	0.042	0.1	0.16	79	6.2	
8/28	4.0	1315	80	81.68	3030	45.2	0.039	0.1	0.16	79	3.8	
8/28	5.0	1415	80	83.3	5790	112	0.026	0.1	0.16	79	1.8	
8/28	5.5	1445	80	83.3	8830	252	0.014	0.1	0.16	79	1.1	
8/28	5.8	1505	80	84.38	10560	524	0.004	0.1	0.16	79	0.8	
Citric acid 24 mg/L/EDTA 12 mg/L/Permacare 1.6 ppm CRW@pH7 (Al3+ 150 ppb)												
8/28	0.0	920	80	76.82	931	15	0.052	0.1	0.16	79	15.0	7.11
8/28	1.0	1020	80	79.16	1142	14.8	0.052	0.1	0.16	79	11.9	
8/28	2.2	1120	80	78.98	1484	21	0.049	0.1	0.16	79	8.8	
8/28	3.0	1220	80	81.14	2130	34	0.046	0.1	0.16	79	5.8	
8/28	4.0	1320	80	82.04	3680	70.5	0.039	0.1	0.16	79	3.1	
8/28	4.5	1350	80	82.76	5230	121.4	0.032	0.1	0.16	79	2.1	
8/28	5.0	1420	80	85.64	8300	310	0.016	0.1	0.16	79	1.2	
8/28	5.3	1440	80	88.7	10620	640	0.006	0.1	0.16	79	0.8	

Bench Scale RO
Data Collection Sheet

100% CRW w/ 200 ppb Al

added 1.4 g Al(NO3)3.9H2O to 175 gal [662 L]

System Data														Conductivity (Use hand held meter)			
DATE	TIME	Run Time	Feed in Tank	Feed Temp	Perm Temp	Conc Temp	Perm. Flow	Perm. Flow	Conc. Flow / Recirc Rate	Feed Pres.	Conc. Pres.	Perm. Pres.	Feed	Ratio (Feed TDS/Cond)	Perm	Conc	
mm/dd/yy	hhmm	Hours	Gallons	° C	° C	° C	mL/min	gpm	gpm	psi	psi	psi	µS/cm		µS/cm	µS/cm	
Unit #1	#6435726	Control	No Antiscalant														
2/28/01	740	0.0	20.0	15.7	11.5	10.8	112	0.030	0.85	80	79	0.1	635	0.6036	12.6	1091	
2/28/01	845	12.5	17.5	11.7	12.0	12.0	108	0.029	0.85	80	79	0.1	1059	0.6420	9.63	1092	
2/28/01	940	20	16.0	12.4	11.5	11.9	104	0.027	0.85	80	79	0.1	1182	0.6502	10.3	1250	
2/28/01	1045	27.5	14.5	13.0	12.2	12.8	104	0.027	0.85	80	79	0.1	1317	0.6583	12.6	1343	
2/28/01	1140	37.5	12.5	13.4	12.9	13.8	108	0.029	0.85	80	79	0.1	1469	0.6665	13.01	1485	
2/28/01	1245	50	10.0	14.0	13.7	13.9			0.85	80	79	0.1	1706	0.6777	19.5	1731	
2/28/01	1340	57.5	8.5	14.4	14.8	13.9	104	0.027	0.85	80	79	0.1	1950	0.6878	29.7	2010	
2/28/01	1440	70	6.0	13.6	13.3	14.2	100	0.026	0.85	80	79	0.1	2430	0.7043	24.5	2420	
2/28/01	1540	75	5.0	14.1	14.6	14.0	94	0.025	0.85	80	79	0.1	2930	0.7183	40.2	3026	
2/28/01	1645	85	3.0	13.7	13.0	13.1	87	0.023	0.85	80	79	0.1	3980	0.7413	79.1	3990	
2/28/01	1715	90	2.0	12.4	12.4	12.4	82	0.022	0.85	80	79	0.1	4690	0.7536	93.4	4650	
Unit #2	#6487247		1.6 mg/L Permacare Pretreat 191				added 0.1 mL pure pretreat										
2/28/01	740	0.0	20	11.1	11.1	11.5	160	0.042	0.85	80	79	0.1	1017	0.6389	23.3	1044	
2/28/01	845	12.5	17.5	10.8	10.9	11.5	155	0.041	0.85	80	79	0.1	1092	0.6443	15.4	1123	
2/28/01	940	27.5	14.5	11.1	10.6	11.0	153	0.040	0.84	80	79	0.1	1266	0.6554	17.6	1330	
2/28/01	1045	40	12	11.6	11.0	11.7	144	0.038	0.84	80	79	0.1	1498	0.6680	18.73	1578	
2/28/01	1140	50	10	11.9	11.7	12.0	144	0.038	0.82	80	79	0.1	1799	0.6817	19.6	1888	
2/28/01	1245	67.5	6.5	12.5	11.9	12.3	136	0.036	0.84	80	79	0.1	2310	0.7005	26.2	2390	
2/28/01	1340	80	4	12.9	12.2	12.9	127	0.034	0.86	80	79	0.1	3250	0.7261	38.6	3380	
2/28/01	1440	90	2	12.8	12.2	13.0	102	0.027	0.85	80	79	0.1	5210	0.7615	82.3	5080	
2/28/01	1540	96	0.8	14.3	13.7	14.2	59	0.016	0.85	80	79	0.1	8620	0.7992	367	8800	
Unit #3	#6487099		33.5 mg/L Sodium Citrate				added 2.54 g Citrate										
2/28/01	740	0.0	20	11.0	10.7	11.4	150	0.040	0.85	80	79	0.1	1026	0.6396	13.68	1104	
2/28/01	840	12.5	17.5	11.0	11.4	11.0	138	0.036	0.85	80	79	0.1	1074	0.6430	9.67	1148	
2/28/01	940	25	15	11.3	10.9	11.3	136	0.036	0.84	80	79	0.1	1285	0.6565	14.57	1302	
2/28/01	1045	37.5	12.5	11.8	11.1	11.9	128	0.034	0.86	80	79	0.1	1487	0.6674	13.06	1507	
2/28/01	1140	50	10	12.3	11.3	12.2	136	0.036	0.85	80	79	0.1	1736	0.6791	19.1	1761	
2/28/01	1245	62.5	7.5	13.1	12.4	11.7	130	0.034	0.85	80	79	0.1	2070	0.6922	35.2	2120	
2/28/01	1340	75	5	12.3	12.0	12.4	132	0.035	0.86	80	79	0.1	2830	0.7157	30.5	2870	
2/28/01	1440	85	3	13.3	12.0	13.5	106	0.028	0.84	80	79	0.1	3790	0.7376	78.7	3860	
2/28/01	1540	92.5	1.5	13.9	13.2	13.8	82	0.022	0.86	80	79	0.1	5910	0.7709	139.5	6010	
2/28/01	1610			13.8	13.8	13.9	75	0.020	0.85	80	79	0.1	7220	0.7859	228	7150	

Bench Scale RO
Data Collection Sheet

System Data													Conductivity (Use hand held meter)				
DATE	TIME	Run Time	Feed in Tank	Feed Temp	Perm Temp	Conc Temp	Perm. Flow	Perm. Flow	Conc. Flow / Recirc Rate	Feed Pres.	Conc. Pres.	Perm. Pres.	Feed	Ratio (Feed TDS/Cond)	Perm	Conc	
mm/dd/yy	hhmm	Hours	Gallons	° C	° C	° C	mL/min	gpm	gpm	psi	psi	psi	µS/cm		µS/cm	µS/cm	
Unit #1	#6486793		16 mg/L EDTA				added 1.22g Na EDTA										
3/1/01	0:00	0	0:00	11.60	11.40	11.6	152	0.040159	0.85	80	79	0.1	961	0.6347	104.8	1082	
3/1/01	0:00	12.5	12:00	11.40	11.30	11.4	146	0.038573	0.8	80	79	0.1	1088	0.6440	14.46	1120	
3/1/01	0:00	25	0:00	11.70	11.90	11.7	142	0.037517	0.88	80	79	0.1	1240	0.6538	10.33	1283	
3/1/01	0:00	37.5	12:00	11.90	12.00	12	144	0.038045	0.88	80	79	0.1	1446	0.6653	11.3	1477	
3/1/01	0:00	50	0:00	12.60	12.50	12.7	146	0.038573	0.8	80	79	0.1	1139	0.6474	16.9	1811	
3/1/01	0:00	65	0:00	13.10	12.90	13.4	132	0.034875	0.84	80	79	0.1	2270	0.6992	23.5	2410	
3/1/01	0:00	75	0:00	13.20	13.10	13.3	126	0.033289	0.86	80	79	0.1	3030	0.7208	32.4	3100	
3/1/01	0:00	87.5	12:00	14.50	13.90	14.8	105	0.027741	0.84	80	79	0.1	4660	0.7531	76.3	4680	
3/1/01	0:00	94.75	1:12	14.40	16.90	15.4	80	0.021136	0.85	80	79	0.1	6780	0.7812	142	6620	
Unit #2	#6487193		Pretreat 191 + 34 mg/L Citrate				added Pretreat 191 + 2.58 g Na Citrate										
3/1/01	0:00	0	0:00	11.70	11.40	11.6	146	0.038573	0.85	80	79	0.1	948	0.6337	14.4	1107	
3/1/01	0:00	12.5	12:00	11.30	11.20	11.5	142	0.037517	0.85	80	79	0.1	1050	0.6413	15.18	1111	
3/1/01	0:00	25	0:00	11.70	11.70	11.7	136	0.035931	0.84	80	79	0.1	1193	0.6509	16.55	1255	
3/1/01	0:00	37.5	12:00	12.10	12.00	12	136	0.035931	0.85	80	79	0.1	1354	0.6604	14.7	1439	
3/1/01	0:00	50	0:00	12.60	12.50	12.7	138	0.03646	0.85	80	79	0.1	1663	0.6758	17.9	1721	
3/1/01	0:00	62.5	12:00	13.20	13.40	13.5	129	0.034082	0.84	80	79	0.1	2050	0.6915	21.3	2180	
3/1/01	0:00	70	0:00	13.20	13.30	13.3	126	0.033289	0.85	80	79	0.1	2630	0.7102	27.5	2700	
3/1/01	0:00	82.5	12:00	14.60	14.30	14.6	113	0.029855	0.84	80	79	0.1	3710	0.7360	47.4	3800	
3/1/01	0:00	90	0:00	14.80	19.10	16.7	100	0.02642	0.84	80	79	0.1	5230	0.7618	75.9	4960	
3/1/01	0:00	96.25	18:00	15.70	15.90	15.7	50	0.01321	0.85	80	79	0.1	8890	0.8016	362	8870	
Unit #3	#6486800		Pretreat 191 + 16 mg/L EDTA				added Pretreat 191 + 1.23 g Na EDTA										
3/1/01	0:00	0	0:00	11.80	11.40	11.7	140	0.036988	0.85	80	79	0.1	978	0.6360	19.8	1171	
3/1/01	0:00	12.5	12:00	11.40	11.50	11.5	150	0.03963	0.86	80	79	0.1	1103	0.6450	11.2	1125	
3/1/01	920	25	15	11.80	11.90	11.7	138	0.03646	0.86	80	79	0.1	1239	0.6538	11.04	1259	
3/1/01	0:00	37.5	12:00	12.00	12.20	12	140	0.036988	0.85	80	79	0.1	1434	0.6647	17.7	1451	
3/1/01	1120	50	10	12.70	12.60	12.7	138	0.03646	0.88	80	79	0.1	1698	0.6774	23.5	1747	
3/1/01	0:00	65	0:00	13.40	13.50	13.4	130	0.034346	0.85	80	79	0.1	2100	0.6933	29.5	2260	
3/1/01	1320	75	5	13.00	13.40	13.3	124	0.032761	0.86	80	79	0.1	2830	0.7157	59.5	2830	
3/1/01	0:00	87.5	12:00	14.70	14.30	14.6	112	0.02959	0.86	80	79	0.1	4120	0.7439	62.1	4020	
3/1/01	1505	94.75	1:05	14.60	15.80	16.3	90	0.023778	0.86	80	79	0.1	5860	0.7703	118	5540	

Bench Scale RO
Lab Results

Date			Aluminum	Arsenic	Barium	Iron	Manganese	Strontium	Silica	Fluoride	Chloride	Nitrate	Nitrate-N	Sulfate	Alkalinity	Total Hardness	TDS	Calcium	Sodium	Potassium	Magnesium	TOC
			(mg/L)							(mg/L)												
4/18/2000	Feed	CRW/SPW	0.02	0.002	0.07		0.001	0.635	11	0.2	55	2.2		150	100	205		48	65	4.1	18.5	
	Brine	Control	0.08	0.042	0.04		0.007	9.97	140	2.9	930	27		2500	1400	3200		840	990	69	260	
4/20/2000	Feed	CRW/SPW	0.05	0.002	0.07		0.001	0.675	10	0.2	55	2.2		160	100	210		51	67	4.1	20	
	Brine	PT-1.6	0.07	0.034	0.93		0.007	8.47	140	2.2	680	21		2000	1200	2600		650	1100	85	230	
4/25/2000	Feed	CRW/SPW	0.02	0.002	0.06		7E-04	0.601	11	0.2	55	2.2		140	100	190		46	64	4.1	17	
	Brine	BFGa-2.5	0.21	0.034	0.94		0.011	8.7	140	2.5	790	20		2000	1300	2100		510	1000	65	210	
	Brine	KNG-20	0.16	0.045	0.22	0.004	0.012	11	180	3.4	1000	29		2600	1400	3300		830	1800	94	290	
4/27/2000	Feed	CRW/SPW	0.02	0.002	0.07	0.006	7E-04	0.641	11	0.17	54	1.9		140	100	200		49	63	4	18	
	Brine	BFGb-2.5	0.1	0.031	0.3	0.01	0.014	9.08	150	2.7	800	23		2100	1300	2900		770	970	64	240	
	Brine	SKH-10	0.14	0.04	0.28	0.012	0.006	10.7	180	2.5	1000	26		2700	1300	3000		650	1200	84	26	
5/2/2000	Feed	CRW/SPW	0.02	0.002	0.06		0.002	0.617	10	0.19	54	1.9		140	110	200		51	54	2.9	19	
	Brine	Cal-5	0.55	0.039	0.27		0.077	10	180	2.9	870	22		2300	1400	3800		910	1200	65	370	
	Brine	ARG-2.3	0.16	0.037	0.29		0.03	9.69	200	2.8	870	22		2300	1300	3700		870	1600	61	380	
5/4/2000	Feed	CRW/SPW	0.02	0.002	0.06	0.012	0.006	0.635	9.6	0.19	56	1.7		150	100	180		42	59	3.7	17	
	Brine	PWT-10	0.16	0.046	0.41		0.031	11	160	3.3	940	19		2700	1200	3100		680	1300	46	330	
5/9/2000	Feed	CRW	0.02	0.002	0.09		9E-04	0.938	8.2	0.4	72	1		220	140	240		59	80	5.1	22	
	Brine	Control	0.36	0.039	0.15		0.064	12.2	140	3.7	960	10		3000	1200	2900		950	1700	50	390	
	Brine	PT-1.6	0.17	0.046	0.23		0.013	13.9	170	4.1	1100	11		3400	1200	4300		980	2600	110	460	
	Brine	BFGa-2.5	0.17	0.046	0.26		0.009	13.9	150	3.9	1100	11		3300	1600	4100		990	1900	70	390	
5/11/2000	Feed	CRW	0.03	0.002	0.09		5E-04	0.977	8.9	0.28	77.4	1.2	0.3	226.8	129	284	600	70	85	4.3	26	
	Brine	KNG-20	0.18	0.043	0.63		0.009	13.9	113.8	4	1078	12.8	2.9	3346	1290	3700	7994	696	1170	60	377	
	Brine	BFGb-2.5	0.12	0.048	0.23		0.005	13.8	115.7	4.1	1131	13.9	3.1	3491	1280	3800	8414	817	1170	64	398	
	Brine	SKH-10	0.24	0.061	0.18		0.006	17.3	138.8	4.7	1351	13.4	3	4313	1860	4900	10503	1060	1190	76	482	
5/16/2000	Feed	CRW	0.01	0.002	0.09	0.007	0.002	1.01	8.6	0.24	77.1	1.2	0.3	224.7	128	282	604	69	80	4.2	26	
	Brine	CAL-5	0.34	0.049	0.13		0.084	15.1	122.5	4.9	1218	11.2	2.5	3952	1540	4400	9262	972	1300	68	452	
	Brine	ARG-2.3	0.41	0.035	0.15		0.037	13.7	116.3	4.3	1100	11.2	2.5	3516	1280	3800	8111	840	1190	61	409	
	Brine	PWT-10	0.25	0.048	0.18		0.038	16.4	134.3	5.1	1300	12.5	2.8	4189	1710	4700	10176	931	1390	72	484	
5/18/2000	Feed	CRW @ pH 7	0.01	0.002	0.09		0.006	0.935	8.9	0.29	73.2	1.2	0.3	251.2	99	282	615	70	78	4.2	26	
	Brine	Control	0.08	0.033	0.26		0.069	18.6	150.9	5.8	1355	13.2	3		1230	5200	11290	1100	1450	79	523	
	Brine	PT-1.6	0.06	0.031	0.25		0.055	15.1	126.7	4.7	1112	11.8	2.7	4101	1140	4300	9199	980	1200	64	430	
	Brine	BFGa-2.5	0.02	0.039	0.19		0.077	17.9	139.2	5.3	1255	12	2.8	4731	1500	5200	10876	1180	1390	75	484	
5/23/2000	Feed	CRW @ pH 7	0.02	0.002	0.1		0.003	1.04	8.9	0.28	75.6	1.1	0.3	249.2	98	282	619	69	83	4.1	25.5	
	Brine	KNG-20	0.05	0.021	0.26		0.189	14.7	123.1	4.2	1124	12.8	2.9	3848	1120	4300	8875	1010	1310	62	427	
	Brine	BFGb-2.5	0.08	0.025	0.15		0.036	16.8	138.7	5.1	1248	11	2.5	4619	1100	4700	10320	949	1370	73	472	
	Brine	SKH-20	0.06	0.037	0.17		0.036	19	144.2	5.4	1382	13.3	3	4949	1630	5400	11597	1230	1530	77	512	
5/25/2000	Feed	CRW @ pH 7	0.01	0.002	0.1	0.01	0.001	1.07	8.8	0.26	82	1.2	0.3	263	82	280	623	70	87	4.2	26	
	Brine	CAL-5	0.03	0.036	0.37		0.033	17.5	140.3	4.6	279	12.2	2.8	4940	990	4900	10628	1090	1490	73	484	
	Brine	ARG-2.3	0.05	0.028	0.34		0.021	18	162.2	6.2	1602	13.4	3	5890	810	5350	12352	1000	1630	84	531	
	Brine	PWT-10	0.01	0.019	0.25		0.02	19.5	154.4	5.7	1482	13.3	3	5318	1120	5200	11595	1020	1540	79	508	
6/1/2000	Feed	CRW/SPW	0.14	0.002	0.09		0.004	0.818	9.876	0.194	66	1.5	0.334	164	104	222	486	53	67	3.7	21.5	
	Brine	CA-2.0	1.15	0.06	0.48		0.292	12.9	135.9	3.32	1192	17.4	3.93	3269	1110		8472	733	1200	65	414	
	Brine	OA-2.0	0.23	0.032	0.25		0.01	12.2	136.4	3.55	1109	18.6	4.202	2925	1075		7680	609	1140	62	382	
	Brine	AA-2.0	0.44	0.052	0.18		0.003	12.3	146.4	2.05	1222	19.9	4.495	3208	1115		8366	641	1190	69	411	
	Feed	CRW/SPW	0.12	0.002	0.08			0.817	9.67	0.208	68.1	1.4	0.327	1744	107	236	508	56	69	3.8	22.5	

Bench Scale RO
Lab Results

Date			Aluminum	Arsenic	Barium	Iron	Manganese	Strontium	Silica	Fluoride	Chloride	Nitrate	Nitrate-N	Sulfate	Alkalinity	Total Hardness	TDS	Calcium	Sodium	Potassium	Magnesium	TOC	
			(mg/L)							(mg/L)													
6/6/2000	Brine	CA-1200	2.02	0.039	0.14	1.17	0.068	14	145.2	1.15	442	6.6	1.491	1110			11301	920	2867	61	361		
	Brine	CA-120	1.87	0.048	0.64	0.247	0.01	14.6	126.5	4.32	1317	20.2	4.563	3637	1030		12274	1160	1360	74	466		
	Brine	CA-12	0.53	0.056	0.23		0.007	14	145	3.12	1257	16.9	3.813	3601	1400		8745	826	1270	70	450		
6/8/2000	Feed	CRW/SPW	0.11	0.002	0.09			0.856	10.29	0.192	69	1.5	0.343	174	104	232	487	56	68	3.7	22		
	Brine	GC4.1	1.23	0.042	0.49	0.054	0.021	15.7	136.3	3.98	1333	22.6	5.105	3557	820	5000	10752	876	1300	71	450		
	Brine	GC4.2	0.7	0.055	0.2		0.008	14.6	148.7	3.88	1416	22.9	5.173	3780	970	4100	9267	716	1360	76	481		
6/15/2000	Feed	CRW/SPW	0.12	0.002	0.08			0.776	10.67	0.184	69	1.7	0.393	168	105	228	480	55	67	3.6	22		
	Brine	EDTA-124	1.52	0.036	0.34	0.037	0.012	12.7	149.3	2.25	1291	19.6	4.428	3463	850	3800	10945	823	1590	69	433		
	Brine	EDTA-12	1.36	0.034	0.1	0.026	0.021	10.5	139.8	1.78	1383	19.2	4.337	3722	460	3300	8380	510	1410	75	474		
6/20/2000	Feed	CRW	0.03	0.002	0.1			0.997	8.93	0.268	75	1.1	0.237	218	127	274	591	68	85	4.1	26		
	Brine	CA-12	0.53	0.051	0.22		0.022	14.1	121.3	4.65	1128	11.2	2.53	3468	1130	4550	8370	784	1260	62	417		
	Brine	SA-12	0.42	0.032	0.2			13.3	158.7	1.45	1402	11.5	2.6	4423	530	4200	9642	627	1570	77	527		
	Brine	EDTA-12	0.33	0.043	0.27		0.005	12.1	147.6	2.15	1241	11.5	2.6	3853	890	3600	8951	700	1410	68	459		
6/22/2000	Feed	CRW @ pH 7	0.18	0.002	0.1		0.001	1.04	8.566	0.27	71.7	1	0.233	219.1	127	278	589	68	80	4.1	26		
	Brine	CA-12	0.37	0.054	0.26		0.035	17.2	143.3	4.63	1290	12.8	2.9	5135	1010		10848	1110	1450	75	506		
	Brine	AA-2.0	0.23	0.028	0.34			15.4	133	2	1341	10.5	2.374	5465	395		10938	942	1490	77	543		
	Brine	EDTA-12	0.35	0.05	0.26	0.017	0.007	15.7	148.9	2.92	1361	11.9	2.686	5300	735		11031	1030	1540	79	539		
6/29/2000	Feed	CRW @ pH 7	0.02	0.002	0.09	0.002	0.001	1.05	8.74	0.264	77	1.3	0.3	224	130	280	598	71	85	4.1	27		
	Brine	Control	0.02	0.038	0.23		0.014	15.5	126.7	4.15	1214	16.5	3.732	4567	990	4470	9528	922	1330	64	454		
	Brine	OA-2.0	0.11	0.031	0.27		0.001	11.7	131.9	2.25	1185	14.7	3.316	4039	620	3580	8365	711	1340	63	442		
2/28/2001	Feed (CRW w/ Al) before antiscalant addition		160	1.2	88	48	2	906	8.938	0.27	70	2	0.452	271	72	286	607	69	83	4.3	26	3.07	
	Brine Samples	Control	618	7.2	570	77	16	5970	53.3	1.91	436	11.4	2.578	1752	464	2030	3884	461	539	27	168	20.9	
		PT-1.6	601	16	728	96	34	13300	112.2	4.18	954	19.5	4.414	3991	915	4257	8196	1170	1150	59	381	40	
		SC-34	1770	15.1	747	193	28	9950	75.87	2.91	702	15.8	3.567	2918	845	3416	6484	669	964	44	283	132	
3/2/2001	Feed (CRW w/ Al) before antiscalant addition		181	1.2	96	29.8	2	956	9.32	0.283	70	2	0.452	272	73	293	611	70	81	4.2	26	2.88	
	Brine Samples	EDTA-16	813	13.3	138	93	29	10500	90.8	3.15	751	16.7	3.773	3097	568	3465	6624	673	947	47	288	106	
		PT-1.6/SC-34	1180	17.5	296	170	39	13600	110.8	4	942	15.2	3.434	3938	950	4059	8533	973	1270	59	394	176	
		PT-1.6/EDTA-16	622	9.9	740	94	24	8850	77	3.02	610	13.9	3.14	2522	630	2673	5502	701	690	38	257	89	
3/5/2001	Filtered Brine Samples	Control	490	8.3	577	31	16	6350	55.8	1.75	455	11.7	2.643	1791	450	1980	3775	462	523	27	169	No sample taken	
		PT-1.6	494	18.2	700	45	32	13150	No sample taken										750	1200	73		380
		SC-34	1660	15.8	924	133	23	10200	80.2	3.1	730	16.4	3.705	2975	790	3218	6262	721	915	44	270		
		EDTA-16	628	13.4	272	79	24	10100	95.6	2.4	708	15.8	3.569	2921	575	3020	6361	700	887	47	291		
		PT-1.6/SC-34	1110	18.4	1410	226	35	13400	No sample taken										790	1300	73		410
		PT-1.6/EDTA-16	546	9.8	792	88	22	8450	78.4	2.2	602	13.9	3.14	2520	625	2772	5514	644	741	39	240		

**APPENDIX D. PHYSICAL DESCRIPTION OF COLLOIDAL MATTER FROM
BRINE STREAM**

Table D.1. Reference guide for bench-scale antiscalant testing

Code	Vendor	Antiscalant	Dose (mg/L)
PT-1.6	Permacare	PermaTreat 191	1.6
BFGa-2.5	BFGoodrich	AF 1025	2.5
KNG-20	KingLee	RO-C and RO-D	10 (each)
BFGb-2.5	BFGoodrich	AF 1405	2.5
SKH-10	Stockhausen	90378	10
CAL-5	Calgon	EL5300	5.0
ARG-2.3	Argo (BetzDearborn)	Hypersperse SI300 UL	2.3
PWT-10	PWT	SpectraGuard	10
CA-1200	Generic	Citric acid	1,200
CA-120			120
CA-24			24
CA-12			12
CA-2.0			2.0
OA-2.0	Generic	Oxalic acid	2.0
OA-10			10
AA-2.0	Generic	Aspartic acid	2.0
AA-11			11
SA-117	Generic	Salicylic acid	117
SA-12			12
SA-2.4			2.4
EDTA-124	Generic	EDTA in form of sodium salt	124
EDTA-12			12
EDTA-16			16
SC-34	Generic	Sodium Citrate	34

Table D.2. Description of filter cake of RO concentrate, using Commercial Antiscalants

	CRW/SPW				CRW				CRW @ pH 7			
	Color	Texture	Thick-ness	Perme-ability	Color	Texture	Thick-ness	Perme-ability	Color	Texture	Thick-ness	Perme-ability
Control	Light brown	Porous clay cake	1 mm	High (2 filters)	Brown-grey	Clay like cake, crack upon dry	1 mm	High (1 filter)	White to light green	Clay like cake, crack upon dry	1 mm	High (1 filter)
PT-1.6	Yellow	High porous powder cake	1 mm	High (1 filter)	Mottled off white	Powder cake, 1-2 mm diameter clumps	1 mm	High (1 filter)	Light green yellow porous cake	Porous cake, crack upon dry	1.5 mm	High (1 filter)
BFGa-2.5	Grey	Porous powder cake	1 mm	High (2 filters)	Off white	Powdery cake	Less than 0.5 mm	Medium (4 filters)	Green background with light yellow flaky deposition	Porous crystal rich cake	Less than 1 mm	High (2 filters)
KNG-20	Yellow-grey	Clay-like cake	1 mm	High (2 filters)	Grey	Porous powdery cake, scattering bubble holes	1 mm	High (1 filter)	Light green yellow	Clay like cake, crack upon dry	1 mm	High (1 filter)
BFGb-2.5	Yellow	Puffy crystal rich cake	3.5 mm	High (1 filter)	Grey	High porous powder cake, crack upon dry	1 mm	High (1 filter)	Brown green	Clay like cake	0.5 mm	High (3 filters)
SKH-10	Off white	Fine clay like cake, curl when dry	1 mm	Medium (6 filters)	Off white	Porous powdery cake	1 mm	Medium (6 filters)	Green	Clay like cake	0.5 mm	Medium (5 filters)
CAL-5	Light yellow	Powdery cake	Less than 0.5 mm	Low (12 filters)	Off white	Fine clay like cake, crack upon dry	1 mm	High (1 filter)	Light green to grey	Clay like cake, curl upon dry	Less than 1 mm	High (2 filters)
ARG-2.3	Brown grey	Powdery cake	Less than 1 mm	Medium (5 filters)	Grey	Fine clay like cake	2 mm	High (1 filter)	Grey	Porous clay like cake	Less than 1 mm	High (1 filter)
PWT-10	Brown	Clay-like cake	1 mm	High (1 filter)	Brown	Fine powdery cake	Less than 1 mm	High (1 filter)	Light green to grey	Fine clay like cake	1 mm	High (1 filter)

Table D.3. Description of filter cake of RO concentrate, using Generic Chemicals

	CRW/SPW				CRW				CRW @ pH 7			
	Color	Texture	Thick-ness	Perme-ability	Color	Texture	Thick-ness	Perme-ability	Color	Texture	Thick-ness	Perme-ability
CA-2.0	Grey	Clay like cake	1 mm	High (1 filter)								
CA-1200	Light brown	Fine clay-like thin cake	Less than 0.5 mm	High (1 filter)								
CA-120	Light yellow	Fine clay-like thin cake	Less than 0.5 mm	High (2 filters)								
CA-12	Off white	Fine clay like cake with powder on top	Less than 1 mm	High (2 filters)	Off white	Porous cake, slight crack upon dry	0.5 mm	High (1 filter)	Off white	Clay like cake, slight crack upon dry	1 mm	High (1 filter)
OA-10									Grey	Clay like cake	Less than 1 mm	High (1 filter)
AA-11					Grey	Fine clay like cake	Less than 0.5 mm	High (1 filter)	Dark grey	Clay like thin cake	Less than 0.5 mm	High (1 filter)
SA-117	Brown	Clay like cake	0.5 mm	Low (7 filters)								
SA-12	Brown	Clay like cake	Less than 0.5 mm	Very low (19 filters)								
EDTA-124	Grey	Fine clay-like cake	Less than 1 mm	High (1 filter)								
EDTA-12	Light yellow to grey	Fine clay like cake	Less than 1 mm	High (1 filter)	Grey	Fine clay like cake	Less than 1 mm	High (1 filter)	Off white	Clay like cake	Less than 1 mm	High (1 filter)
SC-34									Black	Clay like cake, crack upon dry	0.5 mm	Medium (6 filters)

Table D.4. Description of filter cake of RO concentrate, using 100 percent CRW with Al³⁺

	Color	Texture	Thickness	Permeability
CA-24 & EDTA-16	Light grey with fine dark inclusions	Fine powder/clay-like	~ 0.5 mm	High (1 filter)
PT-1.6 & CA-24	Med-dark grey with 0.5 mm long light grey crystal inclusions	Fine powder/clay, cracks upon drying	< 0.5 mm	High (1 filter)
PT-1.6 & EDTA-16	Off white with few dark, fine inclusions	Very fine powder, thin coating	< 0.25 mm	Low (8 filters)

**APPENDIX E. RAW PILOT-SCALE REVERSE OSMOSIS PERFORMANCE
DATA**

RAW DATA FOR COMPLETE SYSTEM										Calculated Data				
Date	Run Time Hours	Temp °F	Flow		Conductivity		Pressure			Pressure			Salt Rejection Percent	Normalized Flux gal/ft2/day
			Permeate gpm	Concentrate gpm	Feed uS/cm	Permeate uS/cm	Feed psi	Permeate psi	Concentrate psi	Osmotic psi	Delta (Feed-Conc.) psi	Net Driving psi		
06/09/00	19	68	13.3	2.8	776	42	88	5.50	38	9.6	25.0	47.9	96.34	16.38
06/10/00	45	70	13.2	2.9	784	81.3	88	5.35	38	9.0	25.0	48.7	96.10	15.26
06/11/00	68	70	13.1	2.9	792	81.4	88	5.45	38	9.0	25.0	48.5	96.12	15.24
06/12/00	94	70	13.2	2.6	810	86.9	88	4.80	41	9.6	23.5	50.1	96.27	15.12
06/14/00	117	72	13.2	2.6	781	84.5	88	5.10	40	9.2	24.0	49.7	96.26	14.52
06/15/00	145	72	12.8	2.5	798	53.3	88	5.10	40	9.9	24.0	49.0	97.08	14.57
06/16/00	161	72	13.0	2.7	839	53.8	86	5.50	40	10.2	23.0	47.3	97.20	15.20
06/17/00	186	71	13.0	2.6	818	54.1	86	5.40	40	10.1	23.0	47.5	96.92	15.40
06/18/00	210	72	12.9	2.7	804	52.2	86	5.30	40	9.8	23.0	47.9	97.10	14.88
06/19/00	234	72	13.0	2.7	848	37.8	86	5.50	40	10.6	23.0	46.9	97.32	15.39
06/20/00	260	73	12.8	2.7	823	52	86	5.50	40	10.0	23.0	47.5	97.13	14.62
06/22/00	307	73	13.0	2.9	839	48.9	85	5.40	38	10.1	23.5	46.0	97.18	15.32
06/23/00	325	74	13.0	2.9	807	49.5	85	5.40	38	9.7	23.5	46.4	97.18	14.85
06/24/00	352	74	13.1	2.8	826	50.8	85	5.10	38	10.0	23.5	46.4	97.13	15.04
06/25/00	375	74	13.2	2.8	817	49.7	85	5.40	38	10.0	23.5	46.1	97.15	15.20
06/26/00	399	74	12.9	2.8	812	52.1	84	5.20	38	9.8	23.0	46.0	97.01	15.00
06/27/00	421	75	13.0	2.8	745	47	84	5.20	38	9.0	23.0	46.8	96.59	14.56
06/28/00	443	75	13.2	2.8	754	57.2	84	5.50	38	9.0	23.0	46.5	96.57	15.00
06/28/00	450	75	15.3	2.0	742	65.8	100	5.50	56	10.3	22.0	62.2	96.89	14.43
06/29/00	470	75	15.5	2.0	731	67.6	100	5.80	56	10.1	22.0	62.1	96.83	14.07
06/30/00	491	75	15.4	2.0	774	66.8	101	6.20	57	10.8	22.0	62.0	96.50	13.80
07/01/00	517	74	15.3	2.0	800	69.2	101	6.05	57	11.1	22.0	61.9	96.45	14.11
07/02/00	543	75	15.5	2.0	801	69.6	101	5.95	58	11.1	21.5	62.4	96.82	14.14
07/03/00	567	74	15.5	2.0	799	68.4	101	5.70	58	11.1	21.5	62.7	96.86	14.45
07/04/00	593	74	15.6	2.0	803	68.9	101	6.10	58	11.2	21.5	62.2	96.81	14.40
07/05/00	598	74	15.6	1.9	786	27.5	100	5.90	54	11.8	23.0	59.3	97.32	14.75
07/06/00	622	74	15.1	2.0	769	66	101	6.20	58	10.6	21.5	62.7	96.60	13.95
07/08/00	648	75	15.7	2.0	794	52.7	101	6.10	58	11.3	21.5	62.1	96.70	14.29
07/09/00	675	75	15.8	2.0	785	54.2	101	5.80	58	11.2	21.5	62.5	96.78	14.45
07/10/00	696	74	15.5	1.9	806	69.7	101	6.40	58	11.4	21.5	61.7	96.92	14.59
07/11/00	719	75	15.5	2.0	791	58.2	101	6.30	54	11.2	23.5	60.0	96.73	14.25
07/11/00	726	75	17.7	2.0	776	78.3	116	6.00	70	11.1	23.0	75.9	96.77	13.75
07/12/00	746	74	17.4	2.0	787	75.5	115	6.20	70	11.3	22.5	75.0	96.91	13.80
07/13/00	768	74	17.5	2.0	780	73.4	115	6.50	70	11.2	22.5	74.8	96.85	13.74
07/14/00	793	75	17.4	2.1	746	73.8	115	6.20	70	10.5	22.5	75.8	96.75	13.27
07/15/00	816	75	17.5	2.1	769	73.9	115	6.10	72	10.8	21.5	76.6	96.75	13.43
07/16/00	842	75	17.5	2.1	870	79.2	117	6.20	72	12.3	22.5	76.0	97.00	13.47
07/17/00	868	76	17.5	2.1	854	77.8	117	6.30	72	12.1	22.5	76.1	96.89	13.19
07/18/00	891	76	17.5	2.2	880	80.2	118	6.20	70	12.3	24.0	75.5	96.97	13.18
07/19/00	917	76	17.5	2.1	842	76.6	115	6.40	72	11.9	21.5	75.2	96.90	13.49
07/20/00	942	77	17.6	2.0	830	77.1	116	6.00	72	11.9	22.0	76.1	96.91	13.25
07/21/00	967	76	17.5	2.1	798	71.9	115	6.70	72	11.3	21.5	75.5	96.91	13.50
07/22/00	992	76	17.8	2.1	803	72.6	116	6.35	72	11.5	22.0	76.2	96.85	13.67
07/23/00	1018	77	17.9	2.0	790	70.7	116	6.25	71	11.5	22.5	75.8	96.80	13.59

RAW DATA FOR COMPLETE SYSTEM										Calculated Data				
Date	Run Time Hours	Temp °F	Flow		Conductivity		Pressure			Pressure			Salt Rejection Percent	Normalized Flux gal/ft2/day
			Permeate gpm	Concentrate gpm	Feed uS/cm	Permeate uS/cm	Feed psi	Permeate psi	Concentrate psi	Osmotic psi	Delta (Feed-Conc.) psi	Net Driving psi		
07/24/00	1041	76	17.7	2.0	776	70	116	6.20	71	11.2	22.5	76.1	96.99	14.06
07/25/00	1065	76	18.1	1.9	775	71.3	118	6.10	74	11.5	22.0	78.4	96.95	13.83
07/26/00	1094	78	18.1	1.9	765	69.4	119	6.20	74	11.3	22.5	79.0	96.76	13.81
07/27/00	1116	77	18.2	1.9	769	64.3	119	6.50	72	11.5	23.5	77.5	96.82	14.17
07/28/00	1141	78	18.1	1.9	768	67.5	119	6.40	74	11.4	22.5	78.7	96.99	13.96
07/30/00	1200	79	18.2	1.8	762	64.8	118	5.40	72	11.6	23.0	78.0	96.93	13.79
07/31/00	1216	78	18.0	1.8	761	65	118	6.40	74	11.5	22.0	78.1	96.59	13.97
08/01/00	1244	80	18.2	1.9	760	64.2	117	5.70	72	11.3	22.5	77.5	96.81	13.55
08/02/00	1268	79	17.9	1.8	790	68.9	117	6.70	73	11.9	22.0	76.4	96.77	13.98
08/03/00	1290	78	17.9	2.1	881	71.6	118	5.90	74	12.7	22.0	77.4	96.72	14.22
08/04/00	1319	79	18.1	2.0	727	60.6	117	5.80	72	10.7	22.5	78.0	96.76	13.91
08/05/00	1341	79	17.4	2.0	747	59.4	117	6.10	72.5	10.9	22.3	77.8	96.76	13.30
08/06/00	1367	79	18.1	2.0	761	61.2	117	5.80	72	11.2	22.5	77.5	96.86	14.06
08/07/00	1390	79	18.0	2.0	783	61.4	117	6.40	73	11.5	22.0	77.1	97.08	14.11
08/08/00	1417	79	18.1	2.1	751	59.3	118	6.10	73	10.9	22.5	78.5	96.69	13.80
08/09/00	1441	79	18.0	2.1	773	61.9	117	6.30	73	11.2	22.0	77.5	97.00	13.96
08/10/00	1465	79	18.0	2.1	762	58.4	117	6.30	73	11.1	22.0	77.6	96.85	13.91
08/11/00	1489	79	18.0	2.0	767	62.5	118	6.20	73	11.3	22.5	78.0	97.04	13.79
8/14/2000	1499	80	17.85	2	790	67.2	114	5.30	71	11.5	21.5	75.7	96.81	14.20
8/15/2000	1513	80	17.98	2	810	67.2	115	6.00	72	11.9	21.5	75.6	96.91	14.19
8/16/2000	1544	80	18.00	1.8	760	59.6	115	5.70	72	11.6	21.5	76.2	96.87	14.13
8/17/2000	1565	80	18.00	1.9	746	56.7	115	5.90	72	11.2	21.5	76.4	96.86	13.98
8/18/2000	1574	80	17.98	2	749	58.9	114	6.50	71	11.0	21.5	75.0	96.78	14.16
8/19/2000	1598	80	18.18	2	762	57.9	115	6.70	72	11.3	21.5	75.5	96.77	14.15
8/20/2000	1624	80	18.19	2	750	56.5	115	6.60	72	11.1	21.5	75.8	96.89	14.11
8/21/2000	1647	80	18.01	2	768	56.1	115	6.85	73	11.4	21.0	75.8	97.02	14.16
8/22/2000	1677	80	17.78	2.1	760	57.6	115	6.50	72	11.0	21.5	76.0	96.85	14.17
8/23/2000	1697	79	18.46	2	772	58.5	115	6.75	73	11.5	21.0	75.7	96.99	14.95
8/24/2000	1713	80	17.96	2	832	63.4	115	6.70	74	12.3	20.5	75.5	96.84	14.39
8/25/2000	1736	80	18.01	2	745	54.7	115	6.80	72	11.0	21.5	75.7	97.05	13.99
8/26/2000	1764	80	17.91	2	735	55.2	115	6.30	72	10.9	21.5	76.3	96.80	13.88
8/27/2000	1790	80	18.00	2	738	56.9	116	6.50	72	10.9	22.0	76.6	96.86	13.92
8/29/2000	1828	80	18.00	2	760	52.8	116	7.00	72	11.3	22.0	75.7	97.08	13.91
8/30/2000	1855	79	17.84	2.1	729	50.9	116	6.90	73	10.7	21.5	76.9	97.17	13.86
8/31/2000	1879	80	18.02	2	721	49	116	6.60	73	10.8	21.5	77.1	97.15	13.67
9/1/2000	1899	78	17.93	2	750	52	116	7.00	74	11.2	21.0	76.8	97.07	14.12
9/5/2000	1932	80	17.81	2	754	53.4	115	6.40	72	11.2	21.5	75.9	96.97	13.75
9/6/2000	1941	78	17.82	2	749	52.5	115	6.85	72	11.1	21.5	75.5	97.00	14.25
9/12/2000	1953	79	17.55	1.9	696	54.1	115	5.50	72	10.4	21.5	77.6	96.73	13.39
9/13/2000	1970	80	16.89	0	721	126.7	124	6.20	104	#DIV/0!	10.0	#DIV/0!	86.86	0.00
9/14/2000	1974	79	17.62	2.2	710	58.9	114	5.60	66	10.0	24.0	74.4	96.29	14.05
9/15/2000	1992	78	17.62	2.3	789	57.5	115	6.70	68	11.1	23.5	73.7	96.61	14.36
9/17/2000	2022	79	17.60	2	813	64.7	115	6.60	74	11.9	20.5	76.0	96.55	12.74
9/18/2000	2045	78	17.64	2.1	802	59.6	116	6.90	74	11.6	21.0	76.5	96.88	13.99

RAW DATA FOR COMPLETE SYSTEM										Calculated Data				
Date	Run Time Hours	Temp °F	Flow		Conductivity		Pressure			Pressure			Salt Rejection Percent	Normalized Flux gal/ft2/day
			Permeate gpm	Concentrate gpm	Feed uS/cm	Permeate uS/cm	Feed psi	Permeate psi	Concentrate psi	Osmotic psi	Delta (Feed-Conc.) psi	Net Driving psi		
9/19/2000	2070	79	17.63	2	809	63.7	117	6.50	76	11.8	20.5	78.2	96.62	13.56
9/20/2000	2096	78	17.66	2	725	53.1	117	6.60	75	10.7	21.0	78.7	96.97	13.73
9/21/2000	2114	78	17.73	2.1	714	51.5	118	6.70	76	10.4	21.0	79.9	96.89	13.62
9/22/2000	2140	77	17.59	2	701	48.6	118	7.00	76	10.4	21.0	79.6	97.04	13.64
9/23/2000	2166	77	17.61	1.9	693	47.8	118	6.70	76	10.4	21.0	79.9	97.05	13.62
9/24/2000	2194	78	17.52	2	721	49.2	118	6.70	76	10.7	21.0	79.6	97.15	13.32
9/25/2000	2217	78	17.34	2.1	730	47.4	118	6.60	77	10.6	20.5	80.3	97.20	12.94
9/26/2000	2231	76	17.41	2.1	712	48.3	118	6.70	76	10.3	21.0	80.0	97.05	13.67
9/27/2000	2255	76	17.50	2.1	735	47.1	118	6.70	78	10.7	20.0	80.6	97.39	13.85
9/28/2000	2276	76	17.41	2.1	737	49.4	118	6.70	77	10.7	20.5	80.1	97.18	13.73
9/29/2000	2300	76	17.40	2.1	761	48.3	118	6.80	78	11.1	20.0	80.1	97.24	13.73
9/30/2000	2327	76	17.60	2.1	746	46	119	6.90	78	10.9	20.5	80.7	97.34	13.44
10/1/2000	2350	76	17.59	1.9	766	46.8	119	7.00	78	11.6	20.5	79.9	97.44	13.55
10/2/2000	2371	76	17.41	2.1	723	48.8	118	6.50	77	10.5	20.5	80.5	97.25	13.54
10/3/2000	2397	76	17.22	2	760	47.4	120	6.60	78	11.2	21.0	81.2	97.26	13.11
10/4/2000	2403	76	17.03	2.1	774	51	118	6.80	78	11.2	20.0	80.0	97.34	13.19
10/5/2000	2429	76	17.09	2.1	742	47.8	120	6.50	80	10.8	20.0	82.7	97.21	12.85
10/6/2000	2451	76	16.65	2	760	62.5	120	6.80	81	10.9	19.5	82.8	97.00	12.23
10/7/2000	2473	75	16.58	2.1	712	43.4	121	6.70	82	10.3	19.5	84.5	97.28	11.25
10/8/2000	2498	75	16.25	2.1	725	43	121	6.40	84	10.4	18.5	85.7	97.36	10.97
10/9/2000	2528	75	16.16	2	722	45.2	121	6.50	84	10.5	18.5	85.5	97.23	11.54
10/17/2000	2540	74	15.84	2	736	62.9	104	6.00	68	10.3	18.0	69.7	96.41	13.66
10/18/2000	2560	72	16.16	2	739	57.2	110	6.50	70	10.5	20.0	73.0	96.73	13.43
10/19/2000	2585	72	15.98	1.9	741	59.4	108	8.00	70	10.7	19.0	70.3	96.60	13.98
10/20/2000	2609	72	15.69	2	752	56.1	106	8.00	70	10.7	18.0	69.3	96.85	14.68
10/21/2000	2636	72	15.69	1.9	730	56.5	106	8.00	70	10.5	18.0	69.5	96.64	14.57
10/22/2000	2660	72	15.71	1.4	739	56.2	105	8.00	68	11.7	18.5	66.8	96.85	15.24
10/23/2000	2687	72	15.15	2	714	51.8	104	7.50	68	10.0	18.0	68.5	96.76	14.14
10/25/2000	2712	70	16.03	2.1	687	48.7	115	8.00	75	9.7	20.0	77.3	97.03	13.86
10/26/2000	2737	70	16.03	1.7	694	47.9	116	8.00	80	10.5	18.0	79.5	97.15	13.57
10/27/2000	2761	69	16.03	1.7	712	48.2	117	8.00	80	10.8	18.5	79.7	97.17	13.83
10/28/2000	2790	70	15.04	1.7	718	47.4	117	8.00	80	10.7	18.5	79.8	97.06	12.35
10/29/2000	2813	69	15.94	1.7	717	47	117	8.00	81	10.9	18.0	80.1	97.31	13.53
10/30/2000	2820	69	15.94	1.8	701	46.2	117	9.00	82	10.4	17.5	80.1	97.34	13.69
10/31/2000	2840	68	15.94	1.7	702	47.4	118	9.50	82	10.6	18.0	79.9	97.32	13.86
11/1/2000	2866	68	15.94	1.8	711	45.8	118	9.00	82	10.6	18.0	80.4	97.29	13.86
11/2/2000	2894	68	15.94	1.7	704	47.1	117	9.20	82	10.6	17.5	79.7	97.29	14.01
11/3/2000	2912	68	15.94	1.7	698	46.4	118	9.00	82	10.6	18.0	80.4	97.36	13.85
11/4/2000	2930	67	15.84	1.7	755	47.3	118	9.00	83	11.5	17.5	80.0	97.38	14.18
11/5/2000	2954	66	15.74	1.8	778	46.7	119	9.00	84	11.6	17.5	80.9	97.46	14.25
11/6/2000	2985	67	15.93	1.7	751	48	121	9.00	86	11.4	17.5	83.1	97.45	13.83
11/7/2000	3003	66	15.94	1.7	770	48.9	121	9.00	86	11.7	17.5	82.8	97.40	14.12
11/8/2000	3017	66	16.39	1.9	746	47	123	9.00	87	11.0	18.0	85.0	97.32	13.85
11/9/2000	3025	64	15.94	1.7	754	48.1	125	9.00	89	11.4	18.0	86.6	97.41	14.00

RAW DATA FOR COMPLETE SYSTEM										Calculated Data				
Date	Run Time Hours	Temp °F	Flow		Conductivity		Pressure			Pressure			Salt Rejection Percent	Normalized Flux gal/ft ² /day
			Permeate gpm	Concentrate gpm	Feed uS/cm	Permeate uS/cm	Feed psi	Permeate psi	Concentrate psi	Osmotic psi	Delta (Feed-Conc.) psi	Net Driving psi		
11/10/2000	3050	65	16.22	1.8	754	45.4	126	9.00	90	11.3	18.0	87.7	97.58	13.85
11/11/2000	3075	64	16.22	1.8	777	46.3	127	9.00	91	11.7	18.0	88.3	97.67	14.00
11/12/2000	3099	64	16.22	1.8	776	41.9	127	9.00	92	11.7	17.5	88.8	97.67	13.89
11/13/2000	3122	64	15.94	1.8	774	47.3	126	9.00	91	11.6	17.5	87.9	97.58	13.75
11/14/2000	3141	62	15.84	1.8	776	45.4	126	9.00	92	11.6	17.0	88.4	97.60	14.22

RAW DATA FOR ARRAY 1										Calculated Data				
			Flow		Conductivity		Pressure			Pressure				
Date	Run Time	Temp	Permeate	Concentrate	Feed Cond.	Perm. Cond.	Feed	Permeate	Concentrate	Osmotic	Delta (Feed-Conc.)	Net Driving	Salt Rejection	Normalized Flux
	Hours	°F	gpm	gpm	uS/cm	uS/cm	psi	psi	psi	psi	psi	psi	Percent	gal/ft2/day
06/09/00	19	68	9.1	7.0	776	25.2	88	10.20	68	7.4	10.0	60.4	97.7	18.2
06/10/00	45	70	8.9	7.2	784	24.1	88	9.80	68.5	7.4	9.8	61.0	97.8	16.9
06/11/00	68	70	8.9	7.2	792	23.9	88	9.90	68.5	7.5	9.8	60.8	97.8	16.9
06/12/00	94	70	8.9	6.9	810	24.7	88	9.50	70	7.8	9.0	61.7	97.8	16.7
06/14/00	117	72	8.8	7.0	781	23.5	88	9.60	69	7.5	9.5	61.4	97.8	16.0
06/15/00	145	72	8.6	6.6	798	25.0	88	9.70	68	7.7	10.0	60.6	97.8	15.9
06/16/00	161	72	8.8	6.9	839	24.2	86	9.90	68	8.1	9.0	59.0	97.9	16.6
06/17/00	186	71	8.8	6.8	818	27.8	86	9.85	68	7.8	9.0	59.3	97.6	16.9
06/18/00	210	72	8.8	6.8	804	24.0	86	9.85	69	7.7	8.5	59.9	97.9	16.4
06/19/00	234	72	8.9	6.8	848	24.6	86	9.90	68	8.2	9.0	58.9	97.9	16.8
06/20/00	260	73	8.7	6.7	823	25.3	86	9.90	68	7.9	9.0	59.2	97.8	16.1
06/22/00	307	73	8.9	7.0	839	25.4	85	10.10	67	8.0	9.0	57.9	97.8	16.8
06/23/00	325	74	8.9	7.0	807	25.3	85	9.80	67	7.7	9.0	58.5	97.7	16.3
06/24/00	352	74	8.9	7.0	826	25.6	85	9.80	67	7.9	9.0	58.3	97.8	16.4
06/25/00	375	74	9.0	7.0	817	25.5	85	9.90	67	7.8	9.0	58.3	97.8	16.5
06/26/00	399	74	8.8	6.9	812	26.1	84	9.70	66	7.7	9.0	57.6	97.7	16.4
06/27/00	421	75	8.9	6.9	745	28.3	84	9.80	66	7.1	9.0	58.1	97.3	16.1
06/28/00	443	75	9.1	6.9	754	29.6	84	10.20	66	7.2	9.0	57.6	97.2	16.6
06/28/00	450	75	10.4	6.9	742	27.0	100	12.20	77	7.3	11.5	69.0	97.5	15.8
06/29/00	470	75	10.4	7.0	731	27.8	100	12.40	80	7.3	10.0	70.3	97.4	15.6
06/30/00	491	75	10.4	7.0	774	29.1	101	12.60	80	7.2	10.5	70.7	97.2	15.4
07/01/00	517	74	10.3	7.0	800	30.9	101	12.50	80	7.6	10.5	70.4	97.2	15.6
07/02/00	543	75	10.4	7.0	801	28.2	101	12.50	80	7.9	10.5	70.1	97.6	15.7
07/03/00	567	74	10.4	7.0	799	28.1	101	12.80	80	7.9	10.5	69.8	97.6	16.1
07/04/00	593	74	10.4	7.1	803	28.4	101	12.70	81	7.9	10.0	70.4	97.6	15.9
07/05/00	598	74	10.4	7.0	786	23.3	100	13.00	80	7.8	10.0	69.2	98.0	16.2
07/06/00	622	74	10.0	7.1	769	29.1	101	13.10	80	7.5	10.5	69.9	97.3	15.3
07/08/00	648	75	10.4	7.2	794	29.7	101	13.00	80	7.8	10.5	69.7	97.4	15.8
07/09/00	675	75	10.6	7.2	785	28.4	101	12.80	80	7.7	10.5	70.0	97.5	16.0
07/10/00	696	74	10.4	6.9	806	29.1	101	13.10	80	8.0	10.5	69.4	97.5	16.1
07/11/00	719	75	10.4	7.0	791	30.7	101	13.20	80	7.8	10.5	69.5	97.3	15.8
07/11/00	726	75	11.8	7.9	776	27.7	116	15.00	92	7.7	12.0	81.3	97.5	15.3
07/12/00	746	74	11.5	7.9	787	26.0	115	15.00	92	7.8	11.5	80.7	97.7	15.3
07/13/00	768	74	11.6	7.9	780	25.8	115	15.00	93	7.7	11.0	81.3	97.7	15.4
07/14/00	793	75	11.5	8.0	746	25.1	115	15.00	93	7.3	11.0	81.7	97.7	14.9
07/15/00	816	75	11.6	8.0	769	25.7	115	15.00	93	7.6	11.0	81.4	97.7	15.0
07/16/00	842	75	11.6	8.0	870	26.4	117	15.00	94	8.6	11.5	81.9	97.9	14.9
07/17/00	868	76	11.6	8.0	854	27.3	117	15.00	94	8.4	11.5	82.1	97.8	14.6
07/18/00	891	76	11.6	8.1	880	28.1	118	15.00	94	8.7	12.0	82.3	97.8	14.6
07/19/00	917	76	11.6	8.0	842	28.7	115	16.00	93	8.3	11.0	79.7	97.6	15.1
07/20/00	942	77	11.7	7.9	830	27.9	116	16.00	93	8.2	11.5	80.3	97.7	14.8
07/21/00	967	76	11.6	8.0	798	27.2	115	17.00	93	7.9	11.0	79.1	97.6	15.2
07/22/00	992	76	11.8	8.1	803	26.6	116	17.00	93	7.9	11.5	79.6	97.7	15.3
07/23/00	1018	77	11.8	8.1	790	27.6	116	18.00	93	7.8	11.5	78.7	97.6	15.2
07/24/00	1041	76	11.7	8.0	776	25.9	116	20.00	92	7.7	12.0	76.3	97.7	15.8
07/25/00	1065	76	11.9	8.1	775	26.1	118	20.00	96	7.7	11.0	79.3	97.7	15.5
07/26/00	1094	78	12.0	8.0	765	27.5	119	24.00	95	7.6	12.0	75.4	97.5	15.8

RAW DATA FOR ARRAY 1										Calculated Data				
			Flow		Conductivity		Pressure			Pressure				
Date	Run Time	Temp	Permeate	Concentrate	Feed Cond.	Perm. Cond.	Feed	Permeate	Concentrate	Osmotic	Delta (Feed-Conc.)	Net Driving	Salt Rejection	Normalized Flux
	Hours	°F	gpm	gpm	uS/cm	uS/cm	psi	psi	psi	psi	psi	psi	Percent	gal/ft2/day
07/27/00	1116	77	12.0	8.1	769	27.5	119	25.00	96	7.6	11.5	74.9	97.5	16.2
07/28/00	1141	78	11.9	8.1	768	25.5	119	25.00	95	7.6	12.0	74.4	97.7	15.9
07/30/00	1200	79	12.0	8.0	762	26.2	118	24.00	94	7.6	12.0	74.4	97.6	15.7
07/31/00	1216	78	11.8	8.0	761	32.5	118	25.00	94	7.5	12.0	73.5	97.0	15.9
8/1/2000	1244	80	12.0	8.1	760.0	28.5	117	24.00	94	7.5	11.5	74.0	97.4	15.5
8/2/2000	1268	79	11.9	7.8	790.0	30.3	117	25.00	94	7.8	11.5	72.7	97.4	15.9
8/3/2000	1290	78	11.9	8.1	881.0	32.2	118	25.00	95	8.7	11.5	72.8	97.5	16.2
8/4/2000	1319	79	12.0	8.1	727.0	27.3	117	25.00	93	7.2	12.0	72.8	97.4	16.0
8/5/2000	1341	79	11.4	8.1	747.0	26.7	117	25.00	93	7.3	12.0	72.7	97.5	15.2
8/6/2000	1367	79	12.0	8.2	761.0	26.8	117	25.00	93	7.5	12.0	72.5	97.6	16.1
8/7/2000	1390	79	11.8	8.1	783.0	25.3	117	26.00	93	7.7	12.0	71.3	97.8	16.1
8/8/2000	1417	79	12.0	8.2	751.0	29.1	118	25.00	94	7.4	12.0	73.6	97.3	15.9
8/9/2000	1441	79	12.0	8.2	773.0	26.6	117	25.00	94	7.6	11.5	72.9	97.6	16.0
8/10/2000	1465	79	12.0	8.2	762.0	27.5	117	25.00	94	7.5	11.5	73.0	97.5	16.0
8/11/2000	1489	79	11.9	8.1	767.0	26.4	118	25.00	94	7.6	12.0	73.4	97.6	15.8
8/14/2000	1499	80	11.9	8.0	790.0	28.6	114	25.00	91	7.8	11.5	69.7	97.5	16.3
8/15/2000	1513	80	12.0	8.0	810.0	28.6	115	25.00	92	8.0	11.5	70.5	97.6	16.2
8/16/2000	1544	80	12.0	7.8	760.0	28.4	115	25.00	92	7.6	11.5	70.9	97.4	16.1
8/17/2000	1565	80	12.0	7.9	746.0	27.7	115	24.50	92	7.4	11.5	71.6	97.4	16.0
8/18/2000	1574	80	12.0	8.0	749.0	28.5	114	25.00	92	7.4	11.0	70.6	97.4	16.2
8/19/2000	1598	80	12.1	8.1	762.0	29.5	115	24.50	92	7.5	11.5	71.5	97.3	16.1
8/20/2000	1624	80	12.1	8.1	750.0	27.6	115	24.50	92	7.4	11.5	71.6	97.5	16.1
8/21/2000	1647	80	12.0	8.0	768.0	27.1	115	25.50	92	7.6	11.5	70.4	97.6	16.3
8/22/2000	1677	80	12.0	7.9	760.0	28.7	115	25.00	92	7.5	11.5	71.0	97.4	16.1
8/23/2000	1697	79	12.4	8.0	772.0	28.2	115	25.50	92	7.7	11.5	70.3	97.5	17.2
8/24/2000	1713	80	12.0	8.0	832.0	30.4	115	25.50	92	8.2	11.5	69.8	97.5	16.4
8/25/2000	1736	80	12.0	8.0	745.0	26.5	115	24.50	92	7.4	11.5	71.6	97.5	16.0
8/26/2000	1764	80	11.9	8.0	735.0	27.7	115	24.50	92	7.2	11.5	71.8	97.4	15.8
8/27/2000	1790	80	12.0	8.0	738.0	27.3	116	25.00	92	7.3	12.0	71.7	97.5	16.0
8/29/2000	1828	80	12.0	8.0	760.0	26.3	116	24.50	92	7.5	12.0	72.0	97.6	15.9
8/30/2000	1855	79	11.8	8.1	729.0	24.4	116	25.00	93	7.2	11.5	72.3	97.7	15.9
8/31/2000	1879	80	12.0	8.0	721.0	24.6	116	25.00	94	7.1	11.0	72.9	97.6	15.7
9/1/2000	1899	78	11.9	8.0	750.0	26.7	116	24.50	94	7.4	11.0	73.1	97.5	16.2
9/5/2000	1932	80	11.8	8.0	754.0	27.6	115	24.50	92	7.4	11.5	71.6	97.5	15.8
9/6/2000	1941	78	11.8	8.0	749.0	27.6	115	24.00	92	7.4	11.5	72.1	97.4	16.2
9/12/2000	1953	79	11.6	7.8	696.0	27.8	115	22.00	91	6.8	12.0	74.2	97.2	15.3
9/13/2000	1970	80	12.7	4.2	721.0	31.6	124	26.00	106	8.7	9.0	80.3	97.5	15.1
9/14/2000	1974	79	11.8	8.0	710.0	31.8	114	24.00	90	6.9	12.0	71.1	96.9	16.2
9/15/2000	1992	78	11.8	8.1	789.0	31.6	115	25.00	92	7.7	11.5	70.8	97.2	16.5
9/17/2000	2022	79	11.8	7.8	813.0	31.7	115	15.00	93	8.0	11.0	81.0	97.3	14.2
9/18/2000	2045	78	11.8	7.9	802.0	29.4	116	24.50	94	7.9	11.0	72.6	97.5	16.1
9/19/2000	2070	79	11.8	7.8	809.0	31.8	117	24.50	95	8.0	11.0	73.5	97.3	15.6
9/20/2000	2096	78	11.7	7.9	725.0	26.9	117	25.00	94	7.1	11.5	73.4	97.4	15.9
9/21/2000	2114	78	11.8	8.0	714.0	26.8	118	25.00	95	7.0	11.5	74.5	97.4	15.7
9/22/2000	2140	77	11.6	8.0	701.0	26.0	118	25.00	95	6.9	11.5	74.6	97.4	15.8
9/23/2000	2166	77	11.6	7.9	693.0	25.3	118	25.00	95	6.8	11.5	74.7	97.5	15.8
9/24/2000	2194	78	11.5	8.0	721.0	25.7	118	25.00	95	7.1	11.5	74.4	97.5	15.4

RAW DATA FOR ARRAY 1										Calculated Data				
			Flow		Conductivity		Pressure			Pressure				
Date	Run Time	Temp	Permeate	Concentrate	Feed Cond.	Perm. Cond.	Feed	Permeate	Concentrate	Osmotic	Delta (Feed-Conc.)	Net Driving	Salt Rejection	Normalized Flux
	Hours	°F	gpm	gpm	uS/cm	uS/cm	psi	psi	psi	psi	psi	psi	Percent	gal/ft2/day
9/25/2000	2217	78	11.4	8.0	730.0	24.1	118	24.00	96	7.2	11.0	75.8	97.7	15.0
9/26/2000	2231	76	11.5	8.0	712.0	24.7	118	24.50	95	7.0	11.5	75.0	97.6	15.9
9/27/2000	2255	76	11.6	8.0	735.0	22.5	118	25.00	96	7.3	11.0	74.7	97.9	16.1
9/28/2000	2276	76	11.5	8.0	737.0	24.1	118	25.00	96	7.3	11.0	74.7	97.7	15.9
9/29/2000	2300	76	11.5	8.0	761.0	24.6	118	24.50	96	7.5	11.0	75.0	97.8	15.9
9/30/2000	2327	76	11.7	8.0	746.0	23.1	119	22.50	97	7.4	11.0	78.1	97.9	15.5
10/1/2000	2350	76	11.7	7.8	766.0	23.1	119	22.50	97	7.6	11.0	77.9	97.9	15.5
10/2/2000	2371	76	11.5	8.0	723.0	23.6	118	24.00	96	7.1	11.0	75.9	97.7	15.7
10/3/2000	2397	76	11.4	7.9	760.0	24.2	120	24.00	98	7.5	11.0	77.5	97.8	15.1
10/4/2000	2403	76	11.4	7.8	774.0	23.7	118	24.00	98.5	7.7	9.8	76.6	97.9	15.3
10/5/2000	2429	76	11.4	7.8	742.0	24.3	120	24.00	99	7.3	10.5	78.2	97.7	15.0
10/6/2000	2451	76	11.1	7.6	760.0	30.1	120	22.30	100	7.4	10.0	80.3	97.2	14.2
10/7/2000	2473	75	11.0	7.7	712.0	23.2	121	14.20	101	7.0	10.0	89.8	97.7	12.9
10/8/2000	2498	75	10.9	7.5	725.0	23.1	121	14.00	102	7.2	9.5	90.3	97.8	12.7
10/9/2000	2528	75	10.9	7.3	722.0	24.5	121	21.00	103	7.2	9.0	83.8	97.7	13.7
10/17/2000	2540	74	10.6	7.2	736.0	30.0	104	12.50	84	7.2	10.0	74.3	97.2	15.3
10/18/2000	2560	72	10.7	7.4	739.0	28.6	110	13.50	90	7.2	10.0	79.3	97.3	15.1
10/19/2000	2585	72	10.5	7.3	741.0	28.4	108	15.00	88	7.2	10.0	75.8	97.3	15.5
10/20/2000	2609	72	10.4	7.2	752.0	27.2	106	20.00	88	7.4	9.0	69.6	97.5	16.7
10/21/2000	2636	72	10.4	7.1	730.0	28.2	106	19.00	87	7.2	9.5	70.3	97.3	16.6
10/22/2000	2660	72	10.4	6.7	739.0	28.2	105	20.00	86	7.4	9.5	68.1	97.4	17.1
10/23/2000	2687	72	10.0	7.2	714.0	28.3	104	18.00	85	6.9	9.5	69.6	97.2	16.0
10/25/2000	2712	70	10.5	7.6	687.0	23.0	115	20.50	94	6.7	10.5	77.3	97.6	15.8
10/26/2000	2737	70	10.5	7.2	694.0	23.0	116	20.00	96	6.9	10.0	79.1	97.7	15.5
10/27/2000	2761	69	10.5	7.2	712.0	23.6	117	20.00	96	7.0	10.5	79.5	97.7	15.7
10/28/2000	2790	70	9.5	7.2	718.0	23.7	117	19.50	96	6.9	10.5	80.1	97.7	13.8
10/29/2000	2813	69	10.4	7.2	717.0	22.3	117	19.50	97	7.1	10.0	80.4	97.8	15.4
10/30/2000	2820	69	10.4	7.3	701.0	21.9	117	21.00	97	6.9	10.0	79.1	97.8	15.7
10/31/2000	2840	68	10.4	7.2	702.0	21.9	118	21.00	98	6.9	10.0	80.1	97.8	15.8
11/1/2000	2866	68	10.4	7.3	711.0	22.7	118	21.00	98	7.0	10.0	80.0	97.8	15.8
11/2/2000	2894	68	10.4	7.2	704.0	22.4	117	21.00	97	6.9	10.0	79.1	97.8	16.0
11/3/2000	2912	68	10.4	7.2	698.0	21.3	118	21.00	98	6.9	10.0	80.1	97.9	15.8
11/4/2000	2930	67	10.4	7.2	755.0	22.7	118	21.00	98	7.4	10.0	79.6	97.9	16.1
11/5/2000	2954	66	10.4	7.2	778.0	22.1	119	21.00	99	7.7	10.0	80.3	98.0	16.2
11/6/2000	2985	67	10.4	7.2	751.0	22.2	121	21.00	100	7.4	10.5	82.1	97.9	15.7
11/7/2000	3003	66	10.4	7.2	770.0	23.1	121	21.00	100	7.6	10.5	81.9	97.9	16.1
11/8/2000	3017	66	10.4	7.8	746.0	22.6	123	21.00	103	7.2	10.0	84.8	97.9	15.5
11/9/2000	3025	64	10.4	7.2	754.0	22.1	125	21.00	104	7.5	10.5	86.0	98.0	15.9
11/10/2000	3050	65	10.6	7.4	754.0	20.1	126	21.00	105	7.5	10.5	87.0	98.2	15.7
11/11/2000	3075	64	10.6	7.4	777.0	20.0	127	20.50	106	7.7	10.5	88.3	98.2	15.8
11/12/2000	3099	64	10.6	7.4	776.0	20.0	127	20.50	107	7.7	10.0	88.8	98.2	15.7
11/13/2000	3122	64	10.4	7.3	774.0	21.0	126	21.00	106	7.7	10.0	87.3	98.1	15.7
11/14/2000	3141	62	10.4	7.2	776.0	20.6	126	21.00	107	7.7	9.5	87.8	98.2	16.3

RAW DATA FOR ARRAY 2										Calculated Data				
			Flow		Conductivity		Pressure			Pressure				
Date	Run Time	Temp	Permeate	Concentrate	Feed	Permeate	Feed	Permeate	Concentrate	Osmotic	Delta (feed-Conc.)	Net Driving	Salt Rejection	Normalized Flux
	Hours	°F	gpm	gpm	uS/cm	uS/cm	psi	psi	psi	psi	psi	psi	Percent	gal/ft2/day
06/09/00	19	68	3.6	3.4	1585.2	84.1	68	6.7	58.0	15.4	5.0	40.9	96.0	14.09
06/10/00	45	70	3.6	3.5	1571.9	80.6	68.5	6.2	57.5	15.2	5.5	41.6	96.2	13.29
06/11/00	68	70	3.6	3.5	1584.3	80.4	68.5	6.1	57.5	15.3	5.5	41.6	96.2	13.30
06/12/00	94	70	3.6	3.2	1662.9	83.8	70	5.8	58.0	16.4	6.0	41.8	96.3	13.25
06/14/00	117	72	3.7	3.2	1583.4	80.8	69	5.7	58.0	15.7	5.5	42.1	96.3	12.96
06/15/00	145	72	3.6	3.0	1638.1	85.0	68	5.7	58.0	16.4	5.0	40.9	96.2	13.02
06/16/00	161	72	3.6	3.2	1716.3	87.7	68	6.2	58.0	17.0	5.0	39.8	96.2	13.35
06/17/00	186	71	3.6	3.1	1679.5	88.2	68	6.0	58.0	16.7	5.0	40.3	96.2	13.46
06/18/00	210	72	3.6	3.2	1645.8	87.8	69	6.2	59.0	16.2	5.0	41.6	96.1	12.80
06/19/00	234	72	3.6	3.2	1745.6	88.8	68	6.1	58.0	17.3	5.0	39.6	96.3	13.42
06/20/00	260	73	3.5	3.2	1687.3	88.0	68	5.8	58.0	16.6	5.0	40.6	96.2	12.52
06/22/00	307	73	3.6	3.4	1698.1	85.0	67	6.2	57.0	16.6	5.0	39.2	96.3	13.30
06/23/00	325	74	3.6	3.4	1633.0	82.7	67	6.2	57.0	15.9	5.0	39.9	96.2	12.81
06/24/00	352	74	3.7	3.3	1672.0	86.3	67	5.9	56.0	16.5	5.5	39.1	96.2	13.41
06/25/00	375	74	3.7	3.3	1667.4	85.9	67	5.9	56.0	16.5	5.5	39.1	96.2	13.41
06/26/00	399	74	3.6	3.3	1646.8	88.1	66	6.0	56.0	16.1	5.0	38.9	96.0	13.16
06/27/00	421	75	3.6	3.3	1510.7	91.7	66	5.8	56.0	14.7	5.0	40.5	95.5	12.38
06/28/00	443	75	3.6	3.3	1545.5	99.2	66	6.4	56.0	15.0	5.0	39.6	95.2	12.65
06/28/00	450	75	4.4	2.5	1640.5	100.7	77	6.7	70.0	18.0	3.5	48.8	96.0	12.60
06/29/00	470	75	4.4	2.7	1634.7	101.7	80	7.2	70.0	17.5	5.0	50.3	95.8	11.97
06/30/00	491	75	4.4	2.7	1599.0	101.4	80	7.4	72.0	17.1	4.0	51.5	95.7	11.69
07/01/00	517	74	4.4	2.7	1684.1	109.2	80	7.4	71.0	18.0	4.5	50.1	95.6	12.25
07/02/00	543	75	4.4	2.7	1766.1	105.7	80	7.3	71.5	19.0	4.3	49.5	96.0	12.16
07/03/00	567	74	4.4	2.7	1768.6	104.2	80	7.2	72.0	19.0	4.0	49.8	96.0	12.33
07/04/00	593	74	4.4	2.7	1759.4	106.9	81	7.4	72.0	19.0	4.5	50.1	95.9	12.50
07/05/00	598	74	4.4	2.6	1748.2	82.0	80	7.3	70.0	19.4	5.0	48.3	96.9	12.97
07/06/00	622	74	4.4	2.7	1641.0	106.5	80	7.5	71.0	17.7	4.5	50.3	95.6	12.44
07/08/00	648	75	4.5	2.7	1723.7	109.1	80	7.4	72.0	18.6	4.0	50.0	95.8	12.55
07/09/00	675	75	4.5	2.7	1723.3	108.0	80	7.3	72.0	18.7	4.0	50.0	95.8	12.53
07/10/00	696	74	4.4	2.6	1792.9	105.7	80	7.6	72.0	19.5	4.0	48.9	96.1	12.54
07/11/00	719	75	4.4	2.7	1740.6	108.0	80	7.8	72.0	18.7	4.0	49.5	95.8	12.14
07/11/00	726	75	5.1	2.8	1725.4	116.4	92	8.6	82.0	19.0	5.0	59.4	95.6	11.82
07/12/00	746	74	5.1	2.8	1726.8	110.6	92	8.7	83.0	19.0	4.5	59.8	95.8	11.98
07/13/00	768	74	5.1	2.8	1719.2	109.2	93	8.6	84.0	19.0	4.5	60.9	95.8	11.75
07/14/00	793	75	5.1	2.9	1623.9	106.7	93	8.7	84.0	17.7	4.5	62.1	95.6	11.31
07/15/00	816	75	5.1	2.9	1683.2	108.4	93	8.7	84.0	18.4	4.5	61.4	95.7	11.43
07/16/00	842	75	5.1	2.9	1909.6	115.1	94	8.7	85.0	20.9	4.5	59.9	96.0	11.73
07/17/00	868	76	5.1	2.9	1874.1	117.0	94	8.6	84.0	20.5	5.0	59.9	95.9	11.50
07/18/00	891	76	5.1	3.0	1916.0	117.2	94	8.5	84.0	20.8	5.0	59.7	95.9	11.54
07/19/00	917	76	5.1	2.9	1844.2	119.9	93	8.5	84.0	20.2	4.5	59.8	95.7	11.51
07/20/00	942	77	5.1	2.8	1840.6	120.5	93	8.5	84.0	20.3	4.5	59.7	95.7	11.31
07/21/00	967	76	5.1	2.9	1745.6	111.3	93	8.7	84.0	19.1	4.5	60.7	95.8	11.34
07/22/00	992	76	5.2	2.9	1761.1	111.9	93	8.7	84.0	19.3	4.5	60.5	95.8	11.59
07/23/00	1018	77	5.3	2.8	1730.9	111.0	93	8.6	83.0	19.3	5.0	60.1	95.8	11.63
07/24/00	1041	76	5.2	2.8	1707.4	109.0	92	8.6	83.0	18.9	4.5	60.0	95.8	11.69
07/25/00	1065	76	5.4	2.7	1706.6	110.9	96	8.8	83.0	19.2	6.5	61.5	95.8	11.80
07/26/00	1094	78	5.3	2.7	1699.8	111.3	95	8.8	85.0	19.0	5.0	62.2	95.8	11.04
07/27/00	1116	77	5.4	2.7	1697.6	110.9	96	9.0	86.0	19.1	5.0	62.9	95.8	11.31

RAW DATA FOR ARRAY 2										Calculated Data				
Date	Run Time	Temp	Flow		Conductivity		Pressure			Osmotic	Delta (feed-Conc.)	Net Driving	Salt Rejection	Normalized Flux
			Permeate	Concentrate	Feed	Permeate	Feed	Permeate	Concentrate					
	Hours	°F	gpm	gpm	uS/cm	uS/cm	psi	psi	psi	psi	psi	psi	Percent	gal/ft2/day
07/28/00	1141	78	5.4	2.7	1691.8	108.0	95	9.0	84.0	19.1	5.5	61.4	95.9	11.36
07/30/00	1200	79	5.4	2.6	1696.7	109.1	94	8.4	84.0	19.3	5.0	61.3	95.9	11.17
07/31/00	1216	78	5.4	2.6	1667.5	109.5	94	8.8	85.0	19.0	4.5	61.7	95.8	11.31
08/01/00	1244	80	5.4	2.7	1676.1	110.1	94	8.3	84.0	18.9	5.0	61.8	95.8	10.86
08/02/00	1268	79	5.3	2.6	1761.3	121.1	94	8.7	84.0	20.0	5.0	60.3	95.6	11.15
08/03/00	1290	78	5.3	2.8	1929.7	140.3	95	8.8	86.0	21.2	4.5	60.5	95.2	11.33
08/04/00	1319	79	5.3	2.8	1603.3	106.2	93	8.4	84.0	17.8	4.5	62.3	95.7	10.80
08/05/00	1341	79	5.3	2.8	1597.0	104.1	93	8.8	84.0	17.7	4.5	62.0	95.8	10.85
08/06/00	1367	79	5.4	2.8	1670.9	107.9	93	8.6	84.0	18.7	4.5	61.2	95.8	11.18
08/07/00	1390	79	5.4	2.8	1709.6	108.2	93	8.8	84.0	19.2	4.5	60.5	95.9	11.31
08/08/00	1417	79	5.3	2.9	1642.5	108.6	94	8.8	84.0	18.1	5.0	62.1	95.7	10.83
08/09/00	1441	79	5.3	2.9	1698.4	109.6	94	8.7	84.0	18.7	5.0	61.6	95.8	10.93
08/10/00	1465	79	5.3	2.9	1671.8	112.6	94	8.6	84.0	18.4	5.0	62.0	95.6	10.85
08/11/00	1489	79	5.3	2.8	1689.9	108.1	94	8.5	84.0	18.8	5.0	61.7	95.8	10.91
8/14/2000	1499	80	5.2	2.8	1750.5	128.8	91	8.4	82.0	19.2	4.5	58.9	95.2	11.02
8/15/2000	1513	80	5.3	2.7	1799.5	128.8	92	8.4	84.0	20.0	4.0	59.6	95.4	11.08
8/16/2000	1544	80	5.3	2.5	1708.3	120.0	92	8.3	82.0	19.4	5.0	59.3	95.5	11.13
8/17/2000	1565	80	5.3	2.6	1664.6	116.5	92	8.2	82.0	18.7	5.0	60.1	95.5	10.98
8/18/2000	1574	80	5.3	2.7	1659.8	119.3	92	8.7	82.0	18.4	5.0	59.9	95.3	11.03
8/19/2000	1598	80	5.4	2.7	1681.6	117.1	92	8.9	83.0	18.8	4.5	59.8	95.5	11.23
8/20/2000	1624	80	5.4	2.8	1657.1	113.6	92	8.9	83.0	18.5	4.5	60.1	95.6	11.17
8/21/2000	1647	80	5.3	2.8	1702.8	112.9	92	8.9	84.0	19.0	4.0	60.1	95.7	10.98
8/22/2000	1677	80	5.3	2.6	1697.1	118.1	92	8.4	84.0	19.1	4.0	60.5	95.5	10.91
8/23/2000	1697	79	5.3	2.8	1747.6	116.9	92	8.9	84.0	19.5	4.0	59.7	95.7	11.28
8/24/2000	1713	80	5.3	2.7	1848.7	131.5	92	9.0	84.0	20.6	4.0	58.4	95.4	11.30
8/25/2000	1736	80	5.3	2.8	1650.3	106.8	92	9.1	83.0	18.4	4.5	60.0	95.8	11.00
8/26/2000	1764	80	5.3	2.7	1619.8	113.2	92	9.0	82.0	18.0	5.0	60.0	95.5	11.00
8/27/2000	1790	80	5.3	2.7	1634.8	112.5	92	8.8	84.0	18.2	4.0	61.0	95.5	10.82
8/29/2000	1828	80	5.3	2.7	1687.2	107.6	92	8.6	84.0	18.9	4.0	60.5	95.9	10.91
8/30/2000	1855	79	5.3	2.9	1591.1	99.1	93	9.1	84.0	17.6	4.5	61.8	95.9	10.89
8/31/2000	1879	80	5.3	2.8	1598.2	99.2	94	8.8	84.0	17.9	5.0	62.3	96.0	10.59
9/1/2000	1899	78	5.3	2.8	1652.9	105.1	94	8.8	84.0	18.5	5.0	61.7	95.9	11.11
9/5/2000	1932	80	5.3	2.7	1656.1	107.5	92	8.4	84.0	18.5	4.0	61.1	95.8	10.81
9/6/2000	1941	78	5.3	2.8	1643.6	105.3	92	8.7	83.0	18.4	4.5	60.4	95.9	11.35
9/12/2000	1953	79	5.2	2.7	1530.6	105.3	91	7.6	82.0	17.1	4.5	61.8	95.6	10.71
9/13/2000	1970	80	4.2	-4.2	2544.1	602.7	106	7.8	106.0	5.4	0.0	92.8	54.4	5.65
9/14/2000	1974	79	5.1	2.9	1547.6	123.7	90	8.0	80.0	16.6	5.0	60.4	94.7	10.75
9/15/2000	1992	78	5.1	3.0	1714.9	128.1	92	8.7	83.0	18.3	4.5	60.5	95.0	10.94
9/17/2000	2022	79	5.1	2.7	1810.7	148.8	93	8.6	85.0	19.7	4.0	60.7	94.6	10.71
9/18/2000	2045	78	5.1	2.8	1771.5	125.2	94	8.4	86.0	19.3	4.0	62.3	95.3	10.63
9/19/2000	2070	79	5.1	2.7	1796.4	141.4	95	8.3	87.0	19.6	4.0	63.1	94.8	10.30
9/20/2000	2096	78	5.2	2.8	1591.8	104.6	94	8.4	86.0	17.6	4.0	64.0	95.7	10.54
9/21/2000	2114	78	5.2	2.9	1564.7	106.1	95	8.4	86.0	17.2	4.5	64.9	95.5	10.38
9/22/2000	2140	77	5.2	2.8	1530.2	94.7	95	8.6	87.0	17.0	4.0	65.4	96.0	10.51
9/23/2000	2166	77	5.2	2.7	1522.7	96.8	95	8.4	87.0	17.0	4.0	65.6	95.9	10.48
9/24/2000	2194	78	5.2	2.8	1565.6	92.0	95	8.5	87.0	17.4	4.0	65.1	96.2	10.36
9/25/2000	2217	78	5.1	2.9	1580.7	98.6	96	8.5	88.0	17.3	4.0	66.3	95.9	9.99
9/26/2000	2231	76	5.1	2.9	1549.4	101.6	95	8.4	88.0	16.9	3.5	66.2	95.7	10.40

RAW DATA FOR ARRAY 2										Calculated Data				
Date	Run Time	Temp	Flow		Conductivity		Pressure			Osmotic	Delta (feed-Conc.)	Net Driving	Salt Rejection	Normalized Flux
			Permeate	Concentrate	Feed	Permeate	Feed	Permeate	Concentrate					
	Hours	°F	gpm	gpm	uS/cm	uS/cm	psi	psi	psi	psi	psi	psi	Percent	gal/ft2/day
9/27/2000	2255	76	5.1	2.9	1612.9	95.7	96	8.7	88.0	17.7	4.0	65.6	96.1	10.50
9/28/2000	2276	76	5.1	2.9	1606.8	103.0	96	8.6	88.0	17.6	4.0	65.8	95.8	10.46
9/29/2000	2300	76	5.1	2.9	1660.7	102.8	96	8.4	88.0	18.2	4.0	65.4	95.9	10.53
9/30/2000	2327	76	5.1	2.9	1642.8	99.8	97	8.8	89.0	18.0	4.0	66.2	96.0	10.40
10/1/2000	2350	76	5.1	2.7	1714.6	102.0	97	8.7	89.0	19.2	4.0	65.1	96.1	10.58
10/2/2000	2371	76	5.1	2.9	1576.4	95.7	96	8.1	88.0	17.3	4.0	66.6	96.0	10.34
10/3/2000	2397	76	5.1	2.8	1655.1	102.8	98	8.3	90.0	18.3	4.0	67.4	95.9	10.22
10/4/2000	2403	76	4.9	2.9	1699.9	103.7	98.5	8.4	89.0	18.5	4.8	66.9	95.9	9.93
10/5/2000	2429	76	4.9	2.9	1619.0	101.0	99	8.1	90.0	17.5	4.5	68.9	95.8	9.64
10/6/2000	2451	76	4.7	2.9	1657.3	95.8	100	8.6	92.0	17.9	4.0	69.5	96.1	9.21
10/7/2000	2473	75	4.7	3.0	1541.4	90.6	101	8.5	93.0	16.5	4.0	72.0	96.0	9.05
10/8/2000	2498	75	4.4	3.0	1591.4	90.4	102	8.2	94.0	16.7	4.0	73.1	96.1	8.41
10/9/2000	2528	75	4.4	2.9	1605.9	96.2	103	7.9	96.0	16.9	3.5	74.7	95.9	8.06
10/17/2000	2540	74	4.5	2.7	1608.8	132.2	84	7.5	78.0	17.0	3.0	56.5	94.5	11.32
10/18/2000	2560	72	4.7	2.7	1597.6	114.6	90	7.9	83.0	17.2	3.5	61.4	95.2	11.27
10/19/2000	2585	72	4.7	2.6	1599.3	125.9	88	11.0	82.0	17.3	3.0	56.7	94.8	12.19
10/20/2000	2609	72	4.5	2.7	1630.9	116.6	88	11.0	82.0	17.4	3.0	56.6	95.2	11.75
10/21/2000	2636	72	4.5	2.6	1592.3	121.4	87	11.0	82.0	17.1	2.5	56.4	94.9	11.79
10/22/2000	2660	72	4.5	2.1	1680.2	123.8	86	11.0	80.0	19.2	3.0	52.8	95.4	12.58
10/23/2000	2687	72	4.4	2.7	1515.7	101.1	85	10.0	79.0	16.2	3.0	55.8	95.5	11.68
10/25/2000	2712	70	4.7	2.9	1461.4	97.9	94	11.0	87.0	15.6	3.5	63.9	95.5	11.26
10/26/2000	2737	70	4.7	2.5	1523.6	100.3	96	11.0	90.0	17.0	3.0	65.0	95.7	11.07
10/27/2000	2761	69	4.7	2.5	1563.0	101.4	96	11.0	90.0	17.5	3.0	64.5	95.8	11.37
10/28/2000	2790	70	4.7	2.5	1488.3	98.9	96	10.5	90.0	16.6	3.0	65.9	95.7	10.91
10/29/2000	2813	69	4.7	2.5	1567.9	98.3	97	10.5	91.0	17.5	3.0	66.0	95.9	11.13
10/30/2000	2820	69	4.7	2.6	1521.6	91.2	97	11.0	91.0	16.9	3.0	66.1	96.1	11.10
10/31/2000	2840	68	4.7	2.5	1536.0	94.8	98	12.0	92.0	17.2	3.0	65.8	96.0	11.38
11/1/2000	2866	68	4.7	2.6	1542.3	93.6	98	12.0	92.0	17.1	3.0	65.9	96.0	11.36
11/2/2000	2894	68	4.7	2.5	1539.1	94.8	97	12.0	92.0	17.2	2.5	65.3	96.0	11.47
11/3/2000	2912	68	4.7	2.5	1528.3	94.6	98	12.0	92.0	17.1	3.0	65.9	96.0	11.36
11/4/2000	2930	67	4.7	2.5	1645.4	100.0	98	12.0	92.0	18.5	3.0	64.5	96.1	11.83
11/5/2000	2954	66	4.6	2.6	1698.0	101.8	99	12.0	94.0	18.8	2.5	65.7	96.1	11.63
11/6/2000	2985	67	4.7	2.5	1646.8	97.7	100	12.0	95.0	18.5	2.5	67.0	96.2	11.40
11/7/2000	3003	66	4.7	2.5	1686.6	101.4	100	12.0	96.0	18.9	2.0	67.1	96.1	11.62
11/8/2000	3017	66	5.2	2.7	1554.5	94.6	103	12.0	97.0	17.5	3.0	70.5	96.1	12.12
11/9/2000	3025	64	4.7	2.5	1652.7	102.0	104	12.0	98.0	18.5	3.0	70.5	96.0	11.52
11/10/2000	3050	65	4.8	2.6	1646.9	96.4	105	14.0	100.0	18.4	2.5	70.1	96.2	11.56
11/11/2000	3075	64	4.8	2.6	1698.6	95.7	106	14.0	100.0	19.0	3.0	70.0	96.3	11.82
11/12/2000	3099	64	4.8	2.6	1696.2	94.8	107	14.0	101.0	19.0	3.0	71.0	96.4	11.65
11/13/2000	3122	64	4.7	2.6	1686.3	97.5	106	12.0	100.0	18.8	3.0	72.2	96.2	11.24
11/14/2000	3141	62	4.6	2.6	1703.8	98.6	107	13.0	101.0	18.9	3.0	72.1	96.2	11.50

RAW DATA FOR ARRAY 3

Calculated Data

			Flow			Conductivity		Pressure			Pressure				
Date	Run Time	Temp	Permeate	Concentrate	Feed	Perm Cond	Feed	Permeate	Concentrate	Osmotic	Delta (Feed-Conc.)	Net Driving	Salt Rejection	Normalized Flux	
	Hours	°F	gpm	gpm	uS/cm	uS/cm	psi	psi	psi	psi	psi	psi	Percent	gal/ft2/day	
06/09/00	19	68	0.62	2.8	2945.8	677.5	58	6.5	38	19.3	10.0	22.2	78.3	3.50	
06/10/00	45	70	0.64	2.9	2876.3	843.5	57.5	6.3	38	17.2	9.8	24.3	72.1	3.08	
06/11/00	68	70	0.64	2.9	2900.2	858.5	57.5	6.3	38	17.3	9.8	24.2	71.9	3.08	
06/12/00	94	70	0.64	2.6	3182.7	871.5	58	6.2	41	19.8	8.5	23.5	74.2	3.14	
06/14/00	117	72	0.64	2.6	3067.8	838.0	58	6.1	40	19.1	9.0	23.8	74.3	3.01	
06/15/00	145	72	0.52	2.5	3247.3	292.5	58	6.1	40	25.2	9.0	17.7	91.6	3.73	
06/16/00	161	72	0.53	2.7	3287.9	299.5	58	6.1	40	25.4	9.0	17.6	91.5	3.80	
06/17/00	186	71	0.53	2.6	3266.4	309.0	58	6.0	40	25.2	9.0	17.8	91.2	3.82	
06/18/00	210	72	0.51	2.7	3156.5	302.5	59	6.0	40	24.2	9.5	19.3	91.0	3.37	
06/19/00	234	72	0.52	2.7	3349.4	208.0	58	6.1	40	26.7	9.0	16.2	94.2	4.17	
06/20/00	260	73	0.50	2.7	3202.2	258.5	58	6.0	40	24.9	9.0	18.1	92.4	3.50	
06/22/00	307	73	0.52	2.9	3162.3	250.0	57	6.2	38	24.6	9.5	16.7	92.6	3.91	
06/23/00	325	74	0.51	2.9	3043.8	196.3	57	6.2	38	24.0	9.5	17.3	93.9	3.74	
06/24/00	352	74	0.52	2.8	3196.6	250.5	56	6.0	38	24.9	9.0	16.1	92.6	3.97	
06/25/00	375	74	0.48	2.8	3206.0	243.5	56	6.8	38	24.9	9.0	15.3	92.8	3.88	
06/26/00	399	74	0.50	2.8	3113.5	263.5	56	5.8	38	24.0	9.0	17.2	92.0	3.59	
06/27/00	421	75	0.51	2.8	2837.0	234.0	56	5.8	38	22.0	9.0	19.2	92.2	3.28	
06/28/00	443	75	0.50	2.8	2898.6	158.0	56	6.2	38	23.1	9.0	17.7	94.9	3.58	
06/28/00	450	75	0.50	2	4038.6	321.0	70	6.9	56	32.3	7.0	23.8	92.7	2.57	
06/29/00	470	75	0.68	2	3805.1	229.4	70	7.2	56	32.1	7.0	23.7	94.7	3.63	
06/30/00	491	75	0.68	2	3717.9	405.0	72	7.4	57	29.7	7.5	27.4	90.3	3.02	
07/01/00	517	74	0.68	2	3911.0	437.5	71	7.4	57	31.1	7.0	25.5	90.0	3.25	
07/02/00	543	75	0.68	2	4119.7	418.0	71.5	7.3	58	33.2	6.8	24.3	91.0	3.35	
07/03/00	567	74	0.68	2	4129.0	411.0	72	6.8	58	33.4	7.0	24.8	91.1	3.36	
07/04/00	593	74	0.68	2	4151.8	406.0	72	7.2	58	33.6	7.0	24.2	91.3	3.44	
07/05/00	598	74	0.66	1.9	4294.0	479.5	70	7.6	54	34.3	8.0	20.1	90.1	3.84	
07/06/00	622	74	0.66	2	3873.8	359.5	71	7.7	58	31.4	6.5	25.4	91.7	3.25	
07/08/00	648	75	0.68	2	4108.2	355.5	72	7.3	58	33.7	7.0	24.0	92.3	3.45	
07/09/00	675	75	0.68	2	4109.6	374.0	72	7.1	58	33.5	7.0	24.4	91.9	3.38	
07/10/00	696	74	0.68	1.9	4282.8	328.5	72	7.4	58	35.7	7.0	21.9	93.2	3.85	
07/11/00	719	75	0.68	2	4052.3	295.5	72	7.6	54	33.7	9.0	21.7	93.5	3.85	
07/11/00	726	75	0.77	2	4303.3	361.5	82	8.4	70	35.9	6.0	31.7	92.6	3.03	
07/12/00	746	74	0.80	2	4294.5	379.5	83	8.4	70	35.9	6.5	32.2	92.3	3.14	
07/13/00	768	74	0.80	2	4277.6	450.5	84	8.6	70	35.0	7.0	33.4	90.8	2.99	
07/14/00	793	75	0.80	2.1	3945.6	421.0	84	8.4	70	32.1	7.0	36.5	90.6	2.72	
07/15/00	816	75	0.79	2.1	4102.5	486.5	84	8.4	72	32.8	6.0	36.8	89.5	2.64	
07/16/00	842	75	0.79	2.1	4672.2	529.0	85	8.3	72	37.6	6.5	32.6	90.0	2.92	
07/17/00	868	76	0.77	2.1	4594.1	519.5	84	8.4	72	36.9	6.0	32.7	90.0	2.79	
07/18/00	891	76	0.78	2.2	4595.9	428.5	84	8.2	70	37.6	7.0	31.2	91.7	3.00	
07/19/00	917	76	0.77	2.1	4509.8	326.0	84	8.3	72	37.9	6.0	31.8	93.6	2.99	
07/20/00	942	77	0.77	2	4599.2	368.0	84	8.2	72	38.6	6.0	31.2	93.0	2.95	
07/21/00	967	76	0.79	2.1	4257.1	316.0	84	8.4	72	35.8	6.0	33.8	93.5	2.90	
07/22/00	992	76	0.80	2.1	4334.7	441.5	84	8.4	72	35.4	6.0	34.2	91.0	2.82	
07/23/00	1018	77	0.80	2	4400.3	416.5	83	8.2	71	36.5	6.0	32.3	91.7	2.93	
07/24/00	1041	76	0.79	2	4303.0	294.0	83	8.3	71	36.7	6.0	32.0	94.0	3.06	
07/25/00	1065	76	0.82	1.9	4465.9	318.0	83	8.3	74	38.4	4.5	31.8	93.9	3.17	
07/26/00	1094	78	0.82	1.9	4397.5	409.0	85	8.4	74	36.9	5.5	34.2	91.9	2.79	
07/27/00	1116	77	0.82	1.9	4440.9	360.5	86	8.6	72	37.8	7.0	32.6	93.0	3.01	
07/28/00	1141	78	0.82	1.9	4432.2	322.5	84	8.7	74	38.1	5.0	32.2	93.7	3.01	
07/30/00	1200	79	0.82	1.8	4552.1	365.0	84	8.0	72	39.1	6.0	30.9	93.1	3.03	
07/31/00	1216	78	0.81	1.8	4477.8	261.0	85	8.5	74	39.3	5.5	31.7	95.0	3.06	
08/01/00	1244	80	0.81	1.9	4392.7	265.0	84	8.0	72	38.2	6.0	31.8	94.8	2.93	
08/02/00	1268	79	0.78	1.8	4695.1	245.5	84	8.4	73	41.3	5.5	28.8	95.5	3.19	
08/03/00	1290	78	0.74	2.1	4816.6	256.0	86	8.4	74	41.2	6.0	30.4	95.3	2.94	

RAW DATA FOR ARRAY 3										Calculated Data				
			Flow		Conductivity		Pressure			Pressure				
Date	Run Time	Temp	Permeate	Concentrate	Feed	Perm Cond	Feed	Permeate	Concentrate	Osmotic	Delta (Feed-Conc.)	Net Driving	Salt Rejection	Normalized Flux
	Hours	°F	gpm	gpm	uS/cm	uS/cm	psi	psi	psi	psi	psi	psi	Percent	gal/ft2/day
08/04/00	1319	79	0.80	2	4067.7	280.0	84	8.2	72	34.7	6.0	35.1	94.0	2.69
08/05/00	1341	79	0.82	2	4039.2	330.0	84	8.5	72.5	34.1	5.8	35.7	92.9	2.68
08/06/00	1367	79	0.80	2	4292.0	334.0	84	8.3	72	36.3	6.0	33.5	93.2	2.78
08/07/00	1390	79	0.79	2	4406.2	262.0	84	8.6	73	37.9	5.5	32.0	94.8	2.91
08/08/00	1417	79	0.80	2.1	4076.8	274.0	84	8.4	73	34.6	5.5	35.5	94.1	2.67
08/09/00	1441	79	0.79	2.1	4230.3	202.0	84	8.4	73	36.7	5.5	33.4	95.8	2.83
08/10/00	1465	79	0.79	2.1	4152.9	215.5	84	8.4	73	35.8	5.5	34.3	95.5	2.76
08/11/00	1489	79	0.79	2	4305.3	187.8	84	8.4	73	37.7	5.5	32.4	96.2	2.93
8/14/2000	1499	80	0.78	2	4379.9	144.5	82	9.5	71	38.8	5.5	28.2	97.1	3.27
8/15/2000	1513	80	0.73	2	4618.3	144.5	84	8	72	40.6	6.0	29.4	97.3	2.92
8/16/2000	1544	80	0.74	1.8	4589.4	154.7	82	7.9	72	40.9	5.0	28.2	97.1	3.12
8/17/2000	1565	80	0.74	1.9	4362.8	151.5	82	7.7	72	38.6	5.0	30.7	97.0	2.87
8/18/2000	1574	80	0.73	2	4258.8	136.4	82	8.7	71	37.4	5.5	30.4	97.2	2.84
8/19/2000	1598	80	0.74	2	4352.7	154.7	83	9.1	72	38.2	5.5	30.2	96.9	2.91
8/20/2000	1624	80	0.75	2	4284.6	147.7	83	8.5	72	37.7	5.5	31.3	97.0	2.86
8/21/2000	1647	80	0.75	2	4364.7	125.2	84	8.5	73	38.6	5.5	31.4	97.5	2.87
8/22/2000	1677	80	0.53	2.1	4469.4	140.2	84	8	72	37.7	6.0	32.3	97.1	1.94
8/23/2000	1697	79	0.75	2	4477.1	110.5	84	8.4	73	39.8	5.5	30.3	97.9	3.03
8/24/2000	1713	80	0.71	2	4766.9	174.9	84	4.0	58.4	41.5	12.8	25.7	96.8	3.22
8/25/2000	1736	80	0.76	2	4228.0	109.7	83	4.5	60.0	37.6	11.5	29.4	97.7	3.10
8/26/2000	1764	80	0.74	2	4146.5	151.6	82	5.0	60.0	36.3	11.0	29.7	96.8	2.97
8/27/2000	1790	80	0.74	2	4189.4	158.2	84	4.0	61.0	36.7	11.5	31.8	96.7	2.77
8/29/2000	1828	80	0.74	2	4344.4	149.7	84	4.0	60.5	38.2	11.7	30.1	97.0	2.93
8/30/2000	1855	79	0.77	2.1	3987.0	102.2	84	4.5	61.8	35.3	11.1	33.1	97.8	2.86
8/31/2000	1879	80	0.77	2	4095.9	125.3	84	5.0	62.3	36.3	10.8	31.9	97.3	2.89
9/1/2000	1899	78	0.77	2	4230.0	100.9	84	5.0	61.7	37.7	11.1	30.1	97.9	3.19
9/5/2000	1932	80	0.74	2	4259.6	134.8	84	4.0	61.1	37.5	11.5	31.0	97.2	2.86
9/6/2000	1941	78	0.75	2	4221.9	100.9	83	4.5	60.4	37.6	11.3	29.7	97.9	3.17
9/12/2000	1953	79	0.75	1.9	3963.3	139.0	82	4.5	61.8	35.1	10.1	32.3	97.0	2.83
9/13/2000	1970	80	0.00	-4.1768	772.7	1218.0	106	0.0	92.8	-3.6	6.6	103.0	-59.6	0.00
9/14/2000	1974	79	0.73	2.2	3689.5	87.2	80	5.0	60.4	32.3	9.8	32.9	97.9	2.71
9/15/2000	1992	78	0.73	2.3	4025.7	82.8	83	4.5	60.5	35.2	11.2	32.1	98.2	2.84
9/17/2000	2022	79	0.71	2	4518.1	118.4	85	4.0	60.7	39.8	12.2	29.1	97.7	2.96
9/18/2000	2045	78	0.75	2.1	4332.3	93.3	86	4.0	62.3	38.4	11.8	31.8	98.1	2.94
9/19/2000	2070	79	0.74	2	4460.2	101.6	87	4.0	63.1	39.7	11.9	31.4	98.0	2.90
9/20/2000	2096	78	0.77	2	4021.1	72.1	86	4.0	64.0	36.1	11.0	34.9	98.4	2.79
9/21/2000	2114	78	0.75	2.1	3873.7	79.9	86	4.5	64.9	34.4	10.5	36.6	98.2	2.59
9/22/2000	2140	77	0.79	2	3863.6	74.7	87	4.0	65.4	34.7	10.8	37.5	98.3	2.71
9/23/2000	2166	77	0.81	1.9	3911.4	75.5	87	4.0	65.6	35.5	10.7	36.7	98.3	2.82
9/24/2000	2194	78	0.82	2	3940.5	78.0	87	4.0	65.1	35.6	11.0	36.5	98.3	2.82
9/25/2000	2217	78	0.82	2.1	3837.5	66.6	88	4.0	66.3	34.5	10.9	38.6	98.5	2.67
9/26/2000	2231	76	0.79	2.1	3772.4	77.7	88	3.5	66.2	33.7	10.9	39.9	98.2	2.59
9/27/2000	2255	76	0.79	2.1	3949.6	65.1	88	4.0	65.6	35.4	11.2	37.4	98.6	2.77
9/28/2000	2276	76	0.79	2.1	3917.4	79.6	88	4.0	65.8	35.0	11.1	38.0	98.2	2.72
9/29/2000	2300	76	0.78	2.1	4065.1	74.4	88	4.0	65.4	36.3	11.3	36.4	98.4	2.81
9/30/2000	2327	76	0.80	2.1	4009.7	78.2	89	4.0	66.2	35.9	11.4	37.7	98.3	2.77
10/1/2000	2350	76	0.79	1.9	4391.0	80.2	89	4.0	65.1	39.8	12.0	33.2	98.4	3.10
10/2/2000	2371	76	0.79	2.1	3855.4	77.1	88	4.0	66.6	34.4	10.7	38.9	98.3	2.66
10/3/2000	2397	76	0.79	2	4131.8	81.8	90	4.0	67.4	37.1	11.3	37.6	98.3	2.75
10/4/2000	2403	76	0.77	2.1	4080.3	71.7	89	4.8	66.9	36.4	11.1	36.8	98.5	2.75
10/5/2000	2429	76	0.84	2.1	3829.9	75.6	90	4.5	68.9	34.5	10.5	40.5	98.3	2.70
10/6/2000	2451	76	0.85	2	3914.4	64.2	92	4.0	69.5	35.7	11.3	41.0	98.6	2.73
10/7/2000	2473	75	0.87	2.1	3550.3	63.9	93	4.0	72.0	32.2	10.5	46.3	98.5	2.52
10/8/2000	2498	75	0.91	2.1	3521.0	62.2	94	4.0	73.1	32.1	10.5	47.4	98.5	2.57

RAW DATA FOR ARRAY 3										Calculated Data				
			Flow		Conductivity		Pressure			Pressure				
Date	Run Time	Temp	Permeate	Concentrate	Feed	Perm Cond	Feed	Permeate	Concentrate	Osmotic	Delta (Feed-Conc.)	Net Driving	Salt Rejection	Normalized Flux
	Hours	°F	gpm	gpm	uS/cm	uS/cm	psi	psi	psi	psi	psi	psi	Percent	gal/ft2/day
10/9/2000	2528	75	0.91	2	3570.9	62.3	96	3.5	74.7	32.8	10.6	49.0	98.5	2.48
10/17/2000	2540	74	0.68	2	3768.4	106.3	78	3.0	56.5	32.9	10.8	31.3	97.5	2.93
10/18/2000	2560	72	0.73	2	3830.2	79.4	83	3.5	61.4	34.0	10.8	34.7	98.2	2.96
10/19/2000	2585	72	0.73	1.9	3897.4	100.1	82	3.0	56.7	34.7	12.6	31.7	97.8	3.22
10/20/2000	2609	72	0.71	2	3834.5	79.0	82	3.0	56.6	34.0	12.7	32.3	98.2	3.09
10/21/2000	2636	72	0.71	1.9	3813.2	95.8	82	2.5	56.4	33.8	12.8	32.9	97.8	3.03
10/22/2000	2660	72	0.73	1.4	4590.9	96.0	80	3.0	52.8	42.9	13.6	20.5	98.3	4.91
10/23/2000	2687	72	0.71	2	3536.1	70.1	79	3.0	55.8	31.3	11.6	33.1	98.3	3.03
10/25/2000	2712	70	0.77	2.1	3410.1	72.7	87	3.5	63.9	30.3	11.6	41.6	98.1	2.74
10/26/2000	2737	70	0.77	1.7	3904.0	83.9	90	3.0	65.0	35.7	12.5	38.8	98.2	2.93
10/27/2000	2761	69	0.77	1.7	4008.7	83.3	90	3.0	64.5	36.7	12.7	37.6	98.2	3.08
10/28/2000	2790	70	0.78	1.7	3802.6	81.9	90	3.0	65.9	34.9	12.0	40.1	98.2	2.87
10/29/2000	2813	69	0.78	1.7	4020.4	80.2	91	3.0	66.0	36.9	12.5	38.6	98.3	3.04
10/30/2000	2820	69	0.77	1.8	3824.0	74.9	91	3.0	66.1	34.8	12.4	40.8	98.3	2.85
10/31/2000	2840	68	0.77	1.7	3951.3	79.9	92	3.0	65.8	36.2	13.1	39.7	98.3	2.98
11/1/2000	2866	68	0.77	1.8	3873.0	76.0	92	3.0	65.9	35.2	13.1	40.7	98.3	2.91
11/2/2000	2894	68	0.77	1.7	3957.1	76.2	92	2.5	65.3	36.3	13.4	39.8	98.4	2.98
11/3/2000	2912	68	0.77	1.7	3930.7	67.6	92	3.0	65.9	36.1	13.1	39.8	98.5	2.98
11/4/2000	2930	67	0.77	1.7	4236.5	86.4	92	3.0	64.5	38.8	13.7	36.5	98.3	3.30
11/5/2000	2954	66	0.76	1.8	4224.9	85.6	94	2.5	65.7	38.3	14.1	39.0	98.3	3.11
11/6/2000	2985	67	0.76	1.7	4256.2	72.2	95	2.5	67.0	39.1	14.0	39.4	98.6	3.03
11/7/2000	3003	66	0.77	1.7	4345.4	85.6	96	2.0	67.1	39.8	14.5	39.7	98.3	3.10
11/8/2000	3017	66	0.77	1.9	4038.2	69.4	97	3.0	70.5	36.5	13.3	44.2	98.5	2.80
11/9/2000	3025	64	0.77	1.7	4251.5	85.6	98	3.0	70.5	39.0	13.8	42.3	98.3	3.03
11/10/2000	3050	65	0.78	1.8	4185.0	83.6	100	2.5	70.1	38.1	14.9	44.4	98.3	2.86
11/11/2000	3075	64	0.78	1.8	4325.2	81.6	100	3.0	70.0	39.4	15.0	42.6	98.4	3.05
11/12/2000	3099	64	0.78	1.8	4320.9	80.7	101	3.0	71.0	39.4	15.0	43.6	98.4	2.98
11/13/2000	3122	64	0.77	1.8	4246.1	72.7	100	3.0	72.2	38.7	13.9	44.4	98.5	2.90
11/14/2000	3141	62	0.77	1.8	4238.1	81.5	101	3.0	72.1	38.6	14.4	45.0	98.4	2.97