

INTEGRATED SOLID WASTE MANAGEMENT FOR RURAL AREAS

A Planning Tool Kit for Solid Waste Managers

PREPARED BY:

Jim Stokoe and Elizabeth Teague
Land-of-Sky Regional Council
25 Heritage Drive
Asheville, North Carolina, 28806
(704) 251-6622

FUNDED BY:

USDA -- Rural Utilities Service
14th and Independence Avenue, SW
Washington, D.C. 20250

December 1995

Acknowledgments

This guidebook represents the work and experience of many people. Those who have made direct contributions to our understanding of the tools presented in this manual are listed below.

Land-of-Sky Regional Council Solid Waste Team:

Bob Shepherd
Robin Sexton Smith
Bill Eaker
Tom Elmore
Jacqui Kendall

Land-of-Sky's Strategic Planning Consultants:

Bill Dodge
Kim Montgomery

Land-of-Sky's WNC WRATT (Waste Reduction and Technology Transfer) Project Waste Assessors:

Roger Ambrose	Virg Minch
Frank R Arrendale	Gordon E Moore
Jack H Beattie	Gil Nelson
Bill Bottjer	Howard Pinner
James A Brunn	Tom Pugh
Bill Farrell	Chris L Rust
Bob Gumbinner	Don Saunders
Grover Haynes	Bob Schornstheimer
Don Hollister	Chris R Slater
Dave Kirk	Ken Thompson
Harry L Kopp	Jerry Touzinsky
Art Lins	Len L Urback
Hal F Loew	Elbert Kay Warren
Eileen Mason	John F White
John F McDermott	

The Region B, North Carolina Chairmen & Managers' Regional Solid Waste Group:

Dr. Gene Rainey	Jim Craine
Bill McElrath	David Ramsey
Bob Hunter	Jim Brown
Don Yelton	Ron Townley
Vollie Good	Bob Masengill
David Thompson	Artie Wilson
Eldon Owen	Will Sagar
Nippy Page	

Town of Mars Hill Recycling Program:

Gordon Randolph
Darhyl Boone

N.C. Cooperative Extension Service:

Dr. Jim Shelton
Maurice McAlister
Ross Young

Good Earth Organics:

Jim Smith

U.S. EPA -- Office of Solid Waste and Emergency Response:

Deb Gallman
Lillian Bagus
Dr. Rosalie Green

Tennessee Valley Authority:

Carroll Duggan
Steve Hillenbrand
Roosevelt Allen
Marvin Jarrett

N. C. Office of Waste Reduction:

David Williams
Mary Beth Powell
Barb Satler

Institute of Government at UNC-Chapel Hill:

Dr. Roger Schwarz
Dr. Dick McMahan
Dr. Peg Carlson

Cover Graphic by Stephen P. Thompson

Table of Contents

Introduction.....	<i>i</i>
Tool #1: Integrated Waste Management.....	1.1
Tool #2: Strategic Thinking & Planning.....	2.1
Tool #3: Group Problem-Solving & Public Involvement.....	3.1
Tool #4: Business Development.....	4.1
Tool #5: Regional Approaches.....	5.1
Appendix 1: Blank Forms and Training Materials.....	
Appendix 2: Resources and Refences.....	
Appendix 3: Articles and other Materials.....	

Introduction - Integrated Solid Waste Management for Rural Areas

Purpose and Premises

This manual seeks to provide a rudimentary set of tools to help address the challenges of solid waste management, with a focus on waste reduction. The guide is a first step at sharing experiences of a regional council of governments in applying strategic planning principles, group problem solving, public involvement processes, business development, and regional approaches, to solid waste management and waste reduction. The authors based the guide on Land-of-Sky Regional Council's experience in Western North Carolina in hopes that the tools, principles, and concepts may be applicable to a nationwide audience.

The information provided is based upon several premises:

1. In a relatively short time, solid waste management has evolved from a "dig a hole and bury it" mindset to:
 - A high-stakes economic arena
 - A sophisticated science
 - A sensitive local environmental and political issue
 - A rapidly-changing management environment
 - A national legislative issue
 - A regional and interstate issue
 - A potential source of savings for local economies
 - A job-creation and business opportunity
 - Large economies of scale in landfill disposal
 - Several specialized fields focusing on particular wastes

2. Because of the above evolution, new types of players are becoming increasingly involved in solid waste management:
 - Waste reduction specialists
 - State and federal legislators
 - Nonprofits and their staffs
 - Informed and active citizens
 - Recycling coordinators
 - Local politicians
 - Regional planners
 - Private recycling & waste disposal companies.

3. Problems arise when solid waste managers address the new solid waste environment with old approaches and skills such as:
 - "End-of-pipe" disposal or waste reduction methods which overlook the value inherent in solid waste;
 - Rigid, capital-intensive waste solutions in a volatile economic, litigative and legislative environment;
 - Top-down, secretive public decision making in an era of increasing public suspicion and right-to-know;
 - Long-term, linear planning (including using the past to predict the future) in an era of rapid, unpredictable change;
 - Viewing solid waste management as a problem rather than as an opportunity; and
 - Failing to link waste reduction to the local economy.

Introduction - Integrated Solid Waste Management for Rural Areas (ii)

4. Rural areas often face the turbulent solid waste arena with the added burdens of poverty, geographic isolation, limited local government staff resources, financial limitations, and other constraints.

5. A range of skills are required in order to meet the demands of the rapidly-evolving solid waste arena:
 - A better understanding of **Integrated Waste Management**, with a particular emphasis on the top levels of the IWM hierarchy;
 - **Strategic thinking and planning**;
 - **Public involvement** strategies;
 - Improved **group problem-solving** at all levels;
 - A **business development** mindset; and
 - Openness to **regional approaches**.

Background

Land-of-Sky Regional Council was organized as one of North Carolina's Planning and Economic Development regions in 1966. The Council has conducted a solid waste management program since 1980, assisting its member governments in addressing the increasingly complex issue of solid waste management in our four-county, mostly rural region. Like other planning endeavors, solid waste planning has evolved through several stages during the last 15 years. The focus of our efforts mirrors the evolution of the topic itself as the following, admittedly oversimplified, timeline shows:

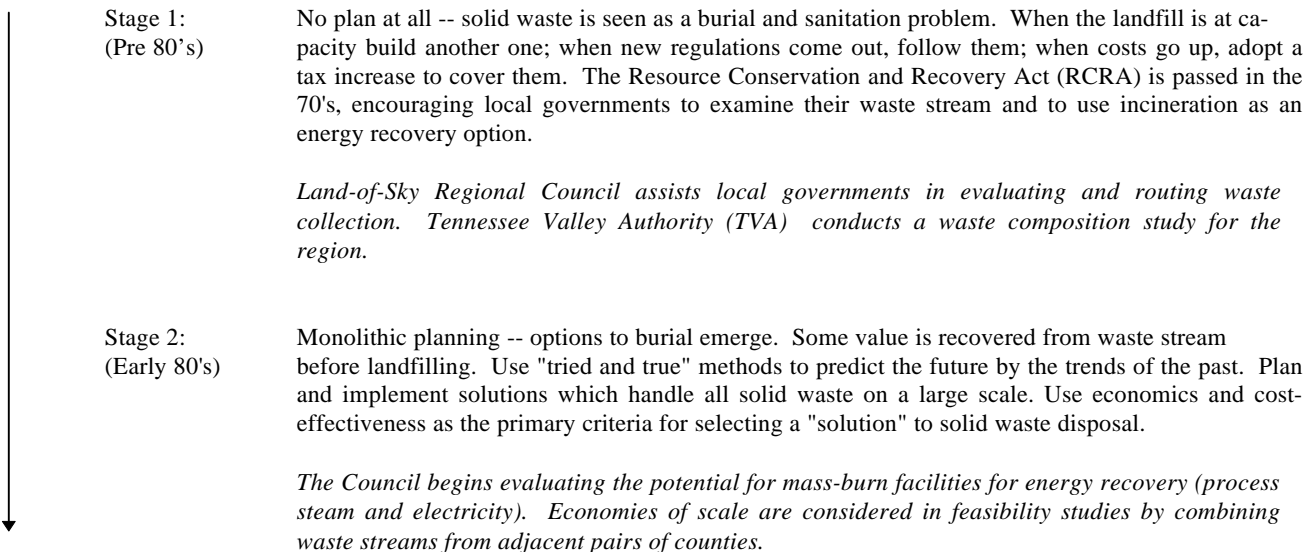

Introduction - Integrated Solid Waste Management for Rural Areas (iii)

Stage 3:
(Mid 80's)

The environmental era -- environmental concerns begin to drive local solid waste planning and management. Revelations about landfill pollution lead to the advent of the Subtitle D landfill. Solid waste costs skyrocket as many old landfills reach capacity. Public concerns about landfills "in their back yard" make solid waste management a major issue for communities.

This era brings full recognition of the landfill capacity crisis in our area. In 1985, the Council is asked by its member counties to convene a regional committee to examine multi-county solutions to the crisis. Council staff conduct the region's first comprehensive solid waste weight and composition studies at all four county landfills.

Stage 4:
(Late 80's)

Integrated Waste Management 101 -- enter the hierarchy of IWM. IWM provides a systematic way to respond to increasing environmental, regulatory and public concerns by handling different components (paper, metals, etc.) of the waste stream in more efficient and ecologically sound ways. States pass legislation with IWM as the core philosophy. Recycling catches on as the most popular expression of IWM, and communities begin to experiment with other levels of the IWM hierarchy (reduce, re-use, compost, etc.). IWM is seldom used as a comprehensive system, but incentives are built into state regulations to push communities farther up the IWM "menu."

The Council helps counties to open recycling centers and begin extending diversion efforts to other wastes such as cardboard. The Council writes a local cardboard exclusion ordinance, produces a recycling guide for business and industry, and drafts a national solid waste management manual. Staff see that IWM has economic as well as environmental value for rural communities, setting the stage for IWM-specific projects.

Stage 5:
(Early 90's)

Solid waste becomes big business -- Starting with the accelerating development of the recycling industry, every aspect of solid waste management becomes commercialized. Recognition of the value inherent in waste materials spans every level of the IWM hierarchy. Competition for solid waste breaks out between the public and private sector as the economics of commercial mega-landfilling conflicts with public sector facility financing needs and community values. Turmoil over flow control puts many regional-scale solid waste projects on hold due to financing implications.

The Council is awarded an IWM grant from FmHA-RDA to develop a systematic IWM planning methodology to help communities extract the most benefit from solid waste management. The Council also receives grants from the Appalachian Regional Commission to provide a wood waste tub grinder to be shared between two counties, and the Tennessee Valley Authority to start a backyard composting program. Six councils of government in Appalachian North Carolina conduct a super-regional recyclables marketing study. The Council enters a partnership with TVA and the North Carolina Office of Waste Reduction to recruit retired scientists and engineers to conduct waste assessments for industries as part of the Waste Reduction And Technology Transfer (WRATT) program.

Stage 6:
(Mid 90's)

Integration of waste reduction into the local economy -- recycling coordinators are joined by waste reduction specialists who focus on the "highest" level of the IWM spectrum: source reduction. Solid waste source reduction proves a money-maker for industry and is integrated with source reduction approaches in other areas such as energy, water efficiency, air emissions and hazardous waste. Solid waste is viewed as a resource, resulting in the profitable brokering of materials. Links among waste reduction, IWM, and economic prosperity begin to come into focus.

Introduction - Integrated Solid Waste Management for Rural Areas

(iv)



EPA-Headquarters asks the Council to apply for a waste reduction/job creation project to show how good environmental policy and good economic policy can complement each other. The economic value of IWM to the community is being quantified, and a more practical approach to IWM is emerging. New communication tools (Internet, E-mail, teleconferencing, Civic Network Television, Government Services Television Network) are emerging as useful resources for solid waste planners, materials brokers, waste reduction specialists, and business developers.

The 1993 RDA grant allowed the Council to explore the application of IWM, strategic planning, and other planning tools in rural solid waste management. As the project unfolded (stages 5 & 6 above), our learning expanded with the addition of the EPA job creation project. The economic development aspects of waste reduction learned in the EPA project, plus the rapidly changing solid waste environment, taught us that a linear planning methodology was not always practical or timely. As we approached real-world problems, we learned what worked and developed the "tools" in this manual.

Organization of the Guide

The "tools" are divided into five categories:

1. Integrated Waste Management
2. Strategic Thinking & Planning
3. Group Problem-Solving & Public Involvement
4. Business Development
5. Regional Approaches

For each of the five topics, the guide covers:

- A description of the tool
- One or more examples of how the tool was, or could be, used (i.e., hypothetical or actual)
- Practical applications of the tool in rural communities
- One or more exercises to learn how to use the tool, and
- Tips on how to combine this tool with other tools in the guide

The guide also has Appendices with:

- Blank forms and training materials which may be photocopied for use in your own community,
- Resources and references, and
- Additional materials, articles, and items of interest mentioned in the chapters.

Since the manual is based upon our experience to date, it is a work in progress. The amount of detail presented is not the same for all tools, because we do not have equal experience applying them. Our current plan is to publish a guidebook at the end of the EPA job creation project, approximately two years from now, which will contain tool refinements and possibly some new tools.

Introduction - Integrated Solid Waste Management for Rural Areas

(v)

How the Tools may be Used

The five tools described in this guide relate to each other in many different ways. One may be used to help achieve another, which in turn may be combined with a third to achieve a fourth. **This is why it seems more useful to present these tools as separate concepts rather than to string them together in a rigid planning process that only works in one linear direction**. Which ones are used, for what purpose, the order in which they are used, and their relationship to one another, can vary greatly according to the needs and situation of those who are using the tools.

Some examples of how the five "tools" might be used together:

- A small group planning team conducts a short strategic plan which results in the development of a new composting business. The ultimate purpose of the business is to deal with all the restaurant waste in the four-county region, which is an Integrated Waste Management issue since the food waste has been landfilled for years.
- A county's IWM plan, which was worked out via lengthy a public involvement process, includes reducing the environmental impacts of its solid waste stream by figuring out how to eliminate from the landfill large tangles of wire that are by-products of several local industries. Through a small group problem-solving process, the plan implementation team decides to develop a new scrap wire business to solve the problem and help the local economy at the same time. However, in order to get enough wire to make the business profitable, the implementors must start up a regional wire collection system from the surrounding ten counties.

Whatever the situation, the tools provided here may be used on their own or combined with others to structure a planning process to face the challenges of the modern-day solid waste arena.

What is IWM?

Integrated Waste Management, or IWM, is a tool to determine the most energy-efficient, least-polluting ways to deal with the various components and items of a community's solid waste stream. IWM is official state policy in North Carolina with the passage of Senate Bill 111 (the state's landmark solid waste legislation) in 1989.

The IWM hierarchy is based upon the material and energy that is embodied in solid waste and that is associated with its recycling and disposal. The twin goals of IWM are to:

- (1) *retain as much as possible of that energy and those materials in a useful state* , and
- (2) *avoid releasing that energy or matter into the environment as a pollutant* .

Integrated waste management sets up a hierarchy of approaches and technologies for managing solid waste in order to meet these goals. Generally, the farther "up" the hierarchy from which the technology is chosen, the more benefits in efficiency and retained economic value.

Energy and matter/material in a non-ordered or non-useful form (and in the wrong place) are what we normally refer to as "pollution."

The very highest option in the hierarchy is, don't create the solid waste in the first place, and is termed "**source reduction**." Source reduction can be done in several ways:

- Manufacturing processes can be devised which create fewer or less toxic waste by-products;
- Consumers can choose not to purchase products with excessive packaging; or
- Consumers can choose not to purchase products which are unnecessary "luxuries," which require unjustifiably large amounts of energy or natural resources to manufacture, or which cause toxic waste problems in manufacture, use, or disposal.

The other higher level IWM options are (in order):

Reuse -- The use of a product more than once in its same form for the same or similar purpose.

Recycling -- The process by which materials otherwise destined for disposal are collected, processed, remanufactured into the same or different product, and purchased as new products.

Composting -- The controlled process whereby organic materials are biologically broken down and converted into a stabilized humus material.

Materials retain their value for longer periods of time if they are handled within these "top four" levels of the IWM hierarchy.

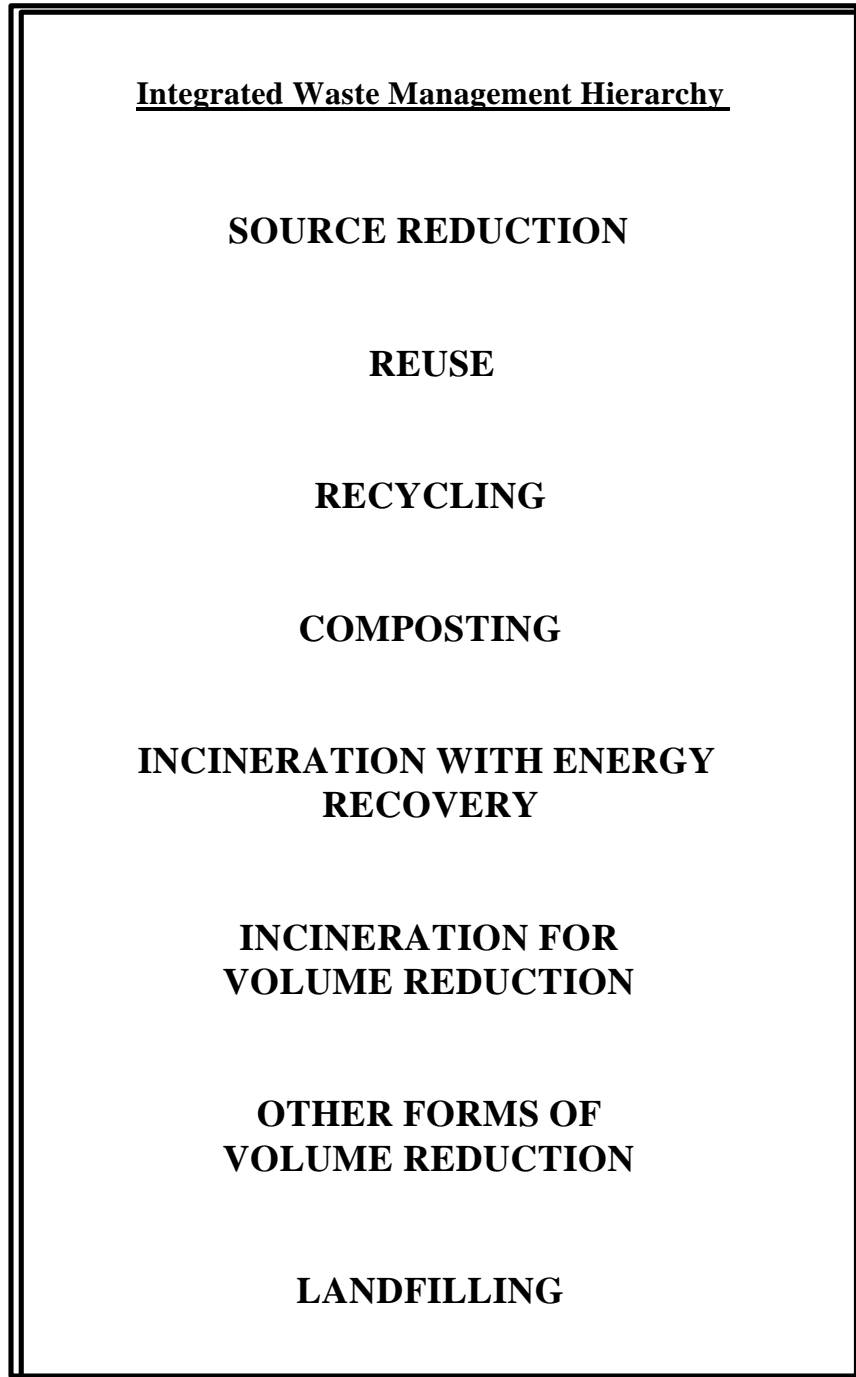

- Most Efficient
- Least Wasted Economic Value
- Least Ecological Damage



- Least Efficient
- Most Wasted Economic Value
- Most Ecological Damage

IWM Example

The Case of the Corrugated Box....

- Energy is used to transform raw materials into a corrugated cardboard box. The first consideration for the box in a waste management planning process is to look at strategies for **source reduction**, or not using the box at all, if it represents excessive packaging (or using alternative packaging which requires fewer raw materials and less energy to manufacture; or packaging which is more readily re-usable or recyclable, etc.).
- After unpacking the TV set that was delivered in the box, the Smiths discard it into the waste stream. The box's utility/value derives from the properties of its current ordered state (rectangular, dry, strong, closeable, etc.). The highest and best use for the box is to **re-use** it again as a box. The management strategy would then be to keep the box from becoming crushed, wet or otherwise damaged, in order to reuse it as packaging several more times.
- If it is already crushed, the next best thing is to **recycle** it -- to expend new energy to transport it to a paper mill and process it into a new product, then re-sell it, etc.
- If it can't be recycled for some reason, several options are available which limit the use of the box's energy to a one-time recapture. The box might be **composted** for use as a soil amendment; made into refuse-derived fuel to be burned in a boiler for its energy value; or it might be **mass-burned (incineration with energy recovery)** together with mixed solid waste to produce steam or electricity.
- The next choices are simply to **reduce the volume** of the waste before disposal. Baling the box is one option, as is burning it without energy recovery, just to reduce the volume to ash.
- Finally, after all else has been considered or done, **landfilling** (burial) is the last resort. Not only will the box exit the loop of economic usefulness, but it may become part of a pollution problem and, at least, occupy costly landfill space.

When we choose a waste management option for the box after it has been used once, Goal #1 of IWM is to retain as much of its current usefulness as possible in order to avoid having to use the same amount of wood pulp and energy to make another box to do the same job again. Goal #2 is to keep the energy-matter represented by that box tied up in a useful product and not released as a pollutant (which the box might become if it ends up along a roadside as litter, or buried in a landfill where its usefulness will be forgone indefinitely).

Box potential according to the IWM Hierarchy:

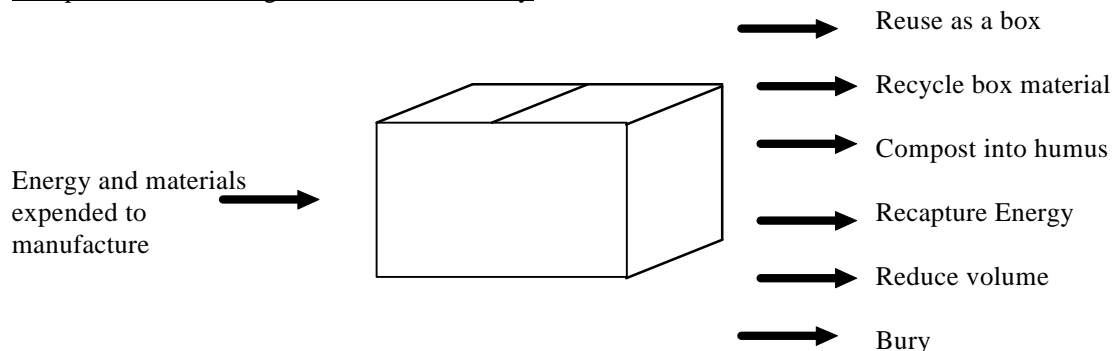

Practical Applications of IWM for Rural Communities

IWM and Local Economies

There are several ways to describe integrated waste management and its benefits. Perhaps the best way for our purposes is to look at the effect of solid waste on the economy and environment of a community. The job creation and economic potential of IWM stem from the following:

1. The economic value of recovered materials as re-usable products (either "as is," or through refurbishment) or as raw materials.
2. The opportunity for simpler, more decentralized, sometimes more labor-intensive solid waste management solutions which can create jobs in rural communities. Such decentralized solutions often work better in more sparsely-populated, rural communities because they do not depend upon high population densities to achieve economies of scale (e.g., centralized solutions may be expensive in rural areas because of the long transport distances required to serve relatively few people. Community or backyard composting of yard, food, and other organic waste is often better suited to rural areas because it saves transportation of these heavy waste stream components over relatively longer distances than in urban areas).
3. Opportunities to intentionally create and recruit businesses and industries which use the waste streams of existing business as feedstocks. Such arrangements can help to plug economic "leaks" from our rural communities. Such methods can be integrated into the strategies of local business development specialists, industrial recruiters, and existing industry managers.
4. The short-term and long-term economic value to rural communities of avoided landfilling. Benefits of this include:
 - deferring expensive landfill siting processes,
 - reducing annual operation and maintenance costs for existing landfills,
 - reducing transportation costs to the community, and
 - reducing the rate at which successive cells of expensive new Subtitle D landfills must be developed and lined.

Community resources saved at the landfill can be diverted into economic development efforts.

The traditional economic model views economic activity -- and its benefits -- as the extraction of raw materials, their manufacture or processing, the sale of the product or commodity, and then its use by consumers. The rest of the life cycle of the raw materials and energy consists of disposal at some cost, and control of the associated pollutants. In other words, once a product, by-product or material becomes classified as a "waste," it has not only zero value but a negative value, i.e., the cost to local government of "disposal," pollution control, and the health cost to society of any pollutants not successfully controlled.

Integrated waste management provides a new approach to solid waste. It seeks to keep products, the materials and energy embodied in their manufacture, and the by-products of their manufacture, in the productive part of the economy -- and out of the "waste" stream -- as long as possible, and to wring as much economic value out of them as possible before giving up on them as "waste." When this is done, the following happens:

1. Local and regional economies benefit by the continued exchange value of the reclaimed materials and products and the jobs created in reprocessing and reselling them;
2. Private businesses often find these materials a cheaper source of raw materials than virgin sources, especially when virgin materials are becoming scarce, more difficult to access, under more stringent regulatory controls, or must be shipped from far away.
3. It often takes less energy to reprocess or re-manufacture these reclaimed materials than raw materials, because of the energy already embodied in their original manufacture. This increases the value of these materials to industry, since energy savings in manufacturing can be added to the acquisition savings for a more competitive "bottom line."
4. National and global resource natural depletion is reduced, contributing to a more sustainable long-term economy.
5. Local governments benefit through reduced cost of ultimate "disposal" of the materials because many would-be "waste" materials and products are diverted from their landfills for an extended period of time.
6. Pollution from landfills is reduced because many toxic or otherwise polluting materials are diverted from the landfills, and because the overall volume of landfilled material is reduced.

Another valuable feature of IWM is that it applies to all solid waste situations, from the largest city or industry to commercial and office waste streams, right down to the individual household. This means that its positive impact can be understood and enjoyed by the whole community, not just by solid waste managers and planners. It also means that the economic impact of IWM can be felt by all economic sectors in the community.

**IWM applies to all solid waste situations, from the largest city
or industry to commercial and office waste streams,
right down to the individual household.**

Using IWM Concepts in Rural Communities

Our experience working with rural communities has shown that solid waste managers may be able to apply integrated waste management in only a piecemeal fashion. Some communities focus on one step of the integrated waste management hierarchy, such as recycling. Some focus on one material, such as yard waste or paper. Such approaches are usually driven by a combination of laws and regulations, the existing solid waste management system of the community, local politics, economics, etc. Similarly, some waste reduction specialists may develop a "hit list" of problem wastes. Others may base waste reduction strategies primarily on the economic and political value of avoided landfill costs, starting with the highest-volume or highest-impact waste.

All of these approaches are valid and justifiable given the complex problems solid waste managers face. It is little surprise that few solid waste managers subject their entire waste stream to a systematic screening of all of the possible approaches the IWM hierarchy offers. Doing such a "screening" offers the possibility of capturing the greatest potential value from the waste stream in the local economy, but is difficult to accomplish.

Designing one neatly-packaged, systematic approach for communities to achieve the greatest possible measure of IWM benefits may be difficult. However, the following set of Integrated Waste Management Application Principles have opened up some new opportunities in guiding the community planning process in our region. We've found that these "application principles" are consistent with the values, culture, resources and preferences commonly held in rural areas.

Principle 1 -- Search for value

Solid waste only becomes "waste" when people lose sight of its value. Virtually everything in the "waste stream" has residual value for someone or some business in the community. The key message to the IWM planning team and the community is, **find the value and redirect it back into the community**. Part of this process is to **find or create local markets** for reused, recycled, reprocessed or composted materials. Another important element in redirecting value is to **create new local enterprises** based on waste stream redirection.

Principle 2 -- Start upstream

If we think of solid waste as a flow of materials entering the community at different places, traveling through the community as they are used one or more times, and ending up in other places, we can use the analogy of a river or stream. Intercepting a would-be waste item as far "upstream" as possible after its initial use has several advantages:

- * It often has more value left in it;
- * It is usually cleaner & easier to re-use or recycle;
- * Less energy has been wasted transporting it; and
- * The original purchaser of the item has the first opportunity to re-use it.

In this way of looking at solid waste management, we try to **intercept each item as far upstream as possible**, redirecting it before it becomes defined as "waste." First owners of the item get the first chance to re-use it. Waste management becomes the responsibility of each member of the community, and doesn't just "get passed on to the county, city or town."

Principle 3 -- Use the IWM hierarchy to retain value

The Integrated Waste Management hierarchy gives us a systematic way to search for the value in would-be waste items. For example, it suggests that re-using an item usually captures more value and saves more money than, say, burning it. In combination with Principle 2, we can systematically look at each component of the waste stream.

Principle 4 -- Start where the community is

Each rural community -- and each person, business, institution and local government in the community -- has its own unique culture and way of looking at solid waste and its economy. The solid waste management process works best if it reflects both the values of the community and the local approach to waste management practices. Some communities may have specific waste issues on the table, such as toxic wastes, cost of disposal, tipping fees, flow control, meeting regulatory mandates, or controversial waste management technologies. Not only will one waste management strategy not work for all rural communities, but even different industries, businesses, or neighborhoods may prefer different approaches. Planners should be sensitive to **what motivates each waste generator**, and **encourage innovative, localized solutions**.

Principle 5 -- Keep materials separated

Mixing unlike solid wastes together often contaminates otherwise useful materials and reduces their value. It also causes additional processing to be done to re-separate the materials or items farther "downstream." Materials and items are often transported great distances and handled several times, wasting public funds which could better be used elsewhere.

Principle 6 -- Minimize handling, transportation and processing

This is related to Principles 2,3 and 5. The earlier in the "waste stream" an article or material can be intercepted and returned or diverted to its next use, the more money the community saves in hauling and handling costs -- including vehicle fuel and its polluting effects, labor, and equipment costs.

Principle 7 -- Start with the low-tech, low-cost, flexible solutions

People find it easier to participate in low-technology solid waste solutions. It is easier to visualize doing your part in a backyard or small-town composting operation than to send your garbage to a high-tech, regional incinerator in the next county. Low-tech solutions usually cost less to put in place and less to abandon, dismantle, or alter if they are no longer viable. Citizens who have participated first hand in such solutions will learn their pros and cons, and may be better able to understand the need for higher tech and/or regional solutions at a later date.

Solid waste management is a rapidly-changing endeavor. A community's strategy for dealing with old newspapers should include a contingency plan for rising and falling paper recycling markets. Without an alternative solution such as storage or composting, a mountain of old newsprint can get out of control. When the market prices are low, inflexible contingency plans may trap a program in a system which is not economically viable. When prices are high, an inflexible system may not allow a community to take full advantage of the market.

Principle 8 -- Measure results in a meaningful way

Three guidelines of the "total quality" philosophy in business are "Measure, Measure, Measure." In order to monitor the success of a rural community's solid waste management strategies, solid waste managers must first **measure results against the objectives the community intended to achieve** . Secondly, it must **measure the total costs and benefits in some agreed-upon way** . In a community whose primary motivation is to defer the siting of a new landfill, measuring reductions in compacted-in-place, buried waste may be the most appropriate and important measure of success. In a community which chooses to use solid waste management to create new jobs, the number of jobs created and the dollar value of materials and items recovered may be the most important measure.

At the same time, the costs to the community of achieving their solid waste goals should not be ignored. For example, if the community seeking to extend the life of its landfill decides to ship waste out of the county, it should have some way of measuring the costs associated with hauling, liability risks, reduced motivation for waste reduction within the community, etc. Some form of *full cost accounting* (see Appendix 3 for an example) should be agreed upon and adopted by the community, so that offsetting costs and benefits of each solution can be recognized and evaluated.

Exercise to Help Learn IWM

Exercise: Brainstorm Current & Future IWM Opportunities for Your Waste Stream.

A meaningful way to gain insight into IWM is to first try to identify how IWM is being applied to your community's waste stream now, and then brainstorm opportunities to improve the application of IWM Principles in the future.

The following table provides a tool on which to record your information. It can be used on any waste stream, large or small -- from your household to your county to your state.

A small group of solid waste managers and others can use the same form to identify both current management practices and future opportunities. A few cells of the table are filled in as an example.

The group might jot down current disposal and diversion practices in one color pencil, and future opportunities in another color. Or, arrows can be drawn in on the grid showing how waste components can be moved "up" the IWM hierarchy for greater efficiency and value retention. A blank version of the chart is located in Appendix 1.

IWM Opportunities

{PRIVATE }Waste Stream Component	Source Reduction	Re-use	Recycling	Composting	Incineration with Energy Recovery	Volume Reduction	Landfill
Paper:							
Newsprint							
Office paper			currently recycling 20% -- increase to 50% in 2 years				
Magazines					currently burning - - recycle 80% in 2 years when prices for mixed paper allow; compost when prices are low		
Paperboard							
Kraft paper							
Corrugated							
Wood:							
Pallets				future opportunity -- combine with magazines and fish waste			currently landfilled
Construct./Demolition Wood							
Yard waste							

IWM Opportunities

{PRIVATE }Waste Stream Component	Source Reduction	Re-use	Recycling	Composting	Incineration with Energy Recovery	Volume Reduction	Landfill
Other Organics:							
Food waste							
Manures							
Fish waste/mortalities							
Poultry waste/ mortalities							
Livestock waste/ mortalities							
Natural textiles							
Plastic:							
PET bottles							
HDPE natural							
HDPE colored							
PVC bottles							
Polypropylene							
Polystyrene							
Other rigid plastic							
Film plastic							
Others							
Glass:							
Clear							
Green							

IWM Opportunities

{PRIVATE }Waste Stream Component	Source Reduction	Re-use	Recycling	Composting	Incineration with Energy Recovery	Volume Reduction	Landfill
Brown/Amber							
Non-container glass							
Metals:							
Ferrous cans							
Other ferrous							
Aluminum cans							
Other non-ferrous							
Other Aluminum							
White goods							
Textiles that won't biodegrade readily							
Rubber							
Batteries							
Diapers							
Household Hazardous Waste							
Tires							
Construction & Demolition Debris							

Adapted from Solid Waste Sampling Training Guide. GBB Solid Waste Management Consultants. (1)

Using IWM with Other Tools

Using IWM with Strategic Planning (Tool #2)

If IWM were to be applied systematically to all parts of a community's solid waste management system, it could be incompatible with strategic planning (discussed in the next chapter). This is true because strategic planning is intentionally not a comprehensive approach, but one that focuses on a few critical focal points at a time. However, since most communities cannot practice IWM comprehensively anyway, IWM and strategic planning can be used together quite effectively. The next chapter will further explore how IWM and strategic planning may be used together.

IWM and Group Problem Solving and Public Involvement (Tool #3)

The above IWM exercise (brainstorming current and future IWM opportunities) could be a useful tool in group problem solving and public involvement if used as part of a community planning process. Participants can use it to check their own perceptions about the value of materials and the appropriate method of action to take for those materials against the perceptions of others and against the IWM hierarchy.

In a public involvement and decision-making process, IWM can be used as an educational tool. It can also be used as part of a framework for public decisions by providing solid waste solutions provide the greatest economic and ecological benefits for the community.

IWM and Business Development (Tool #4)

IWM and business development can make a good combination of tools. For example, if you go to your community garden supply shop and find that all the composted products are coming from out-of-state, it may be an indication that there is a good market for compost in the region, but there is no local producer. Composting might provide a business opportunity as well as a method of reducing waste in the region.

Using IWM with Regional Approaches (Tool #5)

A community generating a waste material may not be aware of a market for that material -- for example, "reuse" in a manufacturing plant in the next town or county. Examining materials within the IWM hierarchy on a regional basis often will provide more options for managing them more effectively.

Another connection between IWM and regional approaches relates to economies of scale. Trying to find recyclables markets for the small volume of materials from one rural county may not be economically feasible. A cooperative approach with other counties, however, could amass sufficient volumes of recyclables to command attractive prices.

Still another interrelationship between IWM and regional approaches involves the trade-offs between economies of scale and IWM Principle 6: *Minimize handling, transportation, and processing*. Some regional approaches to solid waste management (like a regional composting facility or cooperative marketing of recyclables) involve collecting materials over a wide area and transporting them to a central facility for processing, storage, marketing, etc. At some distance from the facility, the hauling costs, both financial and ecological, will surpass the benefits due to economy of scale. Careful use of Principle 8, *Measure results in a meaningful way*, should reveal such “break-over” points. This is particularly true if a “full cost accounting” system is used which factors in ecological costs and future health risks in some way that is meaningful to the community is used.

Training Tip

In addition to exercises and forms found in this manual, the National Environmental Training Center for Small Communities (NETCSC) with Rhonda Sherman of North Carolina State University have developed an excellent Commercial and Industrial Solid Waste Reduction Training program and manual which addresses IWM. See Appendix 2: References and Resources.



NOTES:

What is Strategic Thinking & Planning?

Strategic planning has been described as a **systematic way to manage change**. Groups, organizations and communities often create what might be called "comprehensive plans" which deal with every responsibility and activity of the organization. Strategic planning is different. It looks at the world around the organization and decides what the organization must do now to **position itself for success** a few years from now. It looks at *a few major changes* which will be critical to future success.

From the days of "haul it to the dump and forget it," modern solid waste managers and planners find themselves catapulted into a high-stakes, fast-changing, turbulent environment in which planning seems hopeless yet just reacting is a sure recipe for disaster. The value of IWM, institutionalized years ago in state laws, now comes into direct conflict with economic self-interest as mega-landfilling becomes the cheapest dollar solution -- at least in the short run. This situation raises many questions.

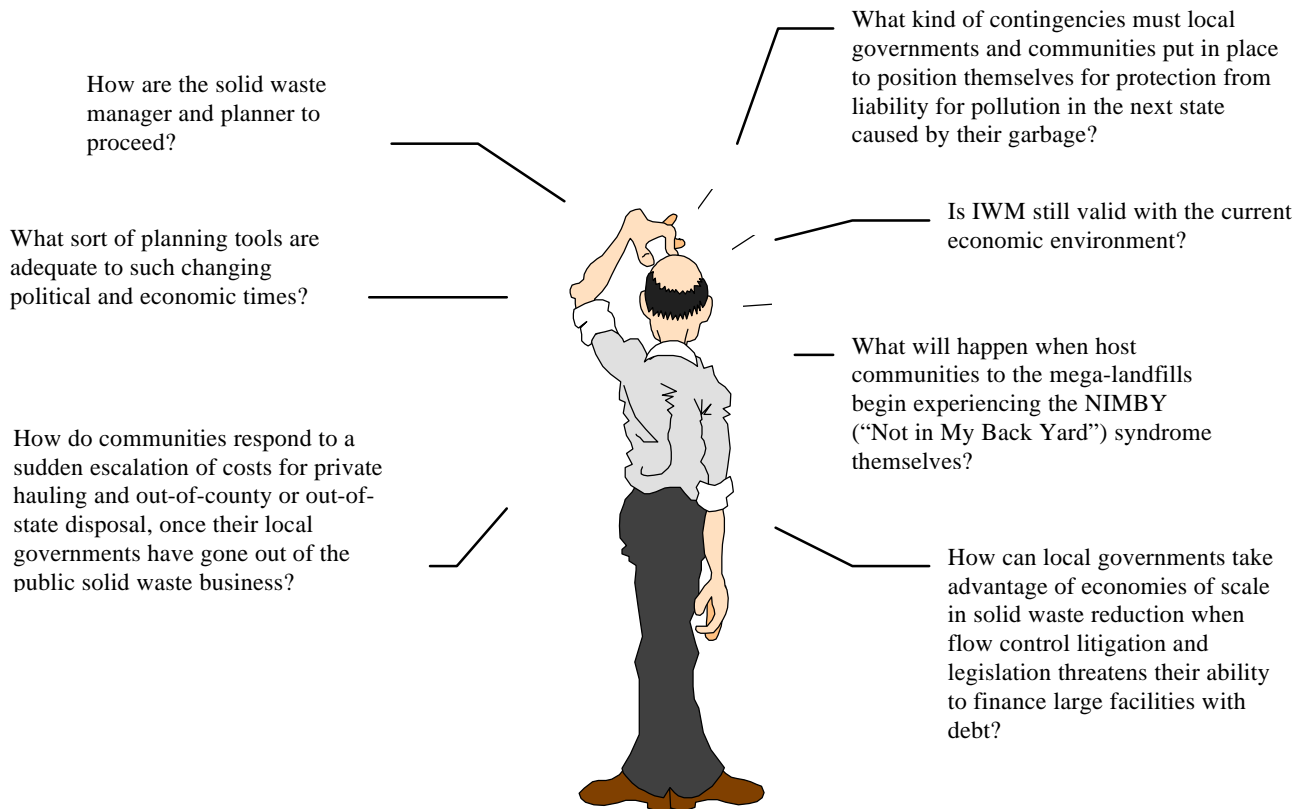

Because we live in an era of questions like these, we've found that **solid waste management is an ideal application for strategic planning**. In our experience with solid waste planning since the early 1980s, the Land-of-Sky Regional Council staff were struggling with a way to formalize Integrated Waste Management into a planning methodology which could easily be used by local and regional solid waste planners. Having also had a chance to learn about strategic planning as a modern tool for turbulent times -- and to participate in stimulating its use in the public sector -- we found that local governments and communities could benefit from the characteristics of a strategic planning approach to *managing* change in their solid waste operations.

Characteristics of strategic planning :

1. **A look outward** at forces, threats, trends and opportunities which are beyond the organization's or community's control, but which, if they occur, will have a large impact on its future. "How can we take advantage of opportunities? How can we minimize the harmful effects of threats?"
2. **A focus on a few critical issues and goals** that are the most important in determining the organization's (community's) future performance. This requires difficult choices. "What are the two or three things that will really make a difference in our community, county, region, or solid waste management system?"
3. **A near-future focus**, such as: "What can the county do over the next few years that will position us for top performance and financial stability in our solid waste operation in the long term?"
4. **A realistic assessment** of the resources available to carry out the desired strategies. "What strengths does our community have with which to address the highest-impact external opportunities presenting themselves to us? What weaknesses will make it difficult to position ourselves for success unless we strengthen them or select strategies which do not depend upon them?"
5. **An action orientation**. Sometimes comprehensive plans are so massive and complex that they "sit on the shelf" and never get implemented. A strategic plan, however, sets out specific action steps and "actors" to ensure that the strategies are carried out. Actions are monitored for success, and a periodic review (typically once a year) is done to see if the strategies are still relevant and if they need to be altered.
6. Strategic planning is **opportunistic**. It's about taking advantage of current trends and timely opportunities.
7. Strategic planning is about **positioning** your organization or community to succeed in a rapidly-changing, turbulent environment; or, as they say in hockey, "skating to where the puck *is going* to be."

Strategic planning is a proactive and flexible process. Conversely, solid waste planning in many rural communities has been reactive and rigid. In the mid-1980s for example, many rural communities realized too late that their landfills were nearly full. By the time they reacted, they learned that the time required for planning, siting and constructing a new landfill was far greater than the time remaining in their current landfill. Thus started the "solid waste crunch" of the late 80s. Since that time, the solid waste arena has become even more rapidly changing and unpredictable because of legislative, regulatory and private sector business issues.

Solid waste management plans which (1) are too rigid to respond quickly to changing forces, and/or (2) do not scan the external environment to anticipate legislative, regulatory and economic trends can quickly become obsolete. This is why strategic planning provides a good framework for solid waste management planning.

Steps in strategic planning include:

(not necessarily in the order shown!)

1. Review the organization's **vision** of the desired future: how do we want our community's solid waste operation to look 10 years from now? (create or revise a **vision statement**)
2. What other organizations will you need to work with to make the vision become a reality?
3. What is your organization's specific role or **mission** (niche?) in making the vision become a reality? (create or revise a **mission statement** which sets out your organization's role among the roles of all the other organizations)
4. **Scan the external environment** for **change drivers** (forces, trends and developments that drive change). Which ones of these represent **opportunities** or **threats** to your organization? Potential **strategic issues** usually arise in the form of an opportunity or threat. (*This is the "external" half of what's called the Strengths/Weaknesses/Opportunities/Threats or "SWOT" analysis.*)
5. Prioritize the potential strategic issues according to their **impact** upon your solid waste operation, and the **probability** that they will unfold as predicted. Screen out operational issues, and other issues that are judged to be of lower impact or lower predictability. (*The "impact-probability plot."* described later can be used in this step)
6. Analyze your organization's **strengths** and **weaknesses** with respect to taking advantage of the highest-priority opportunities, or blunting or dodging the highest-priority threats. (*This is the "internal" half of the "SWOT" analysis.*)
7. Do an **impact-feasibility plot** to select **strategic initiatives** based upon their impact on your operations and how feasible it is for your organization to address them, given its strengths and weaknesses.
8. Enlist **experts** who have data or knowledge critical to the initiative, and **partners** who have resources, roles, positions or influence critical to implementing the initiative, to join your planning or thinking process so the plan becomes theirs, too.
9. Develop an **action plan** for each initiative pursued. (*objectives = the "what;" strategies = the "how;" action steps = the "who, when, how much money, and whose money" for each strategic initiative.*)
10. **Act!** Start immediately to carry out the action plan. The best strategic action plans generate so much excitement that the partners start implementing them before the plan is even completed!
11. **Monitor** progress, **track** external developments and changing internal capabilities, and **revise** the plan periodically to keep it in line with reality.

Concepts of "change drivers" and "strategic initiatives" adapted from Shaping a Region's Future: a Guide to Strategic Decision Making for Regions. William R. Dodge and Kim Montgomery. (2)

The heart of strategic planning is strategic *thinking*. This is an intuitive process, and many solid waste managers do it routinely, day to day, without labeling it as such. Strategic *thinking* is the practice of using the above characteristics and steps to solve a problem without (1) formally following the planning steps, (2) documenting them, (3) labeling them, or (4) creating a written plan.

**The heart of strategic planning is strategic thinking.
This is an intuitive process, and many solid waste
managers do it routinely, day to day....**

Because good strategic decisions can be made without a formal plan, we strongly encourage strategic thinking. We also encourage the user to use whichever “steps” in strategic planning make sense to her or him. For example, a manager may find that an analysis of his/her organization’s strengths and weaknesses makes sense as a stand-alone exercise before making a key decision. A reader may recognize one or more of the above steps as part of their daily concerns or “strategic thinking” already.

However, while strategic thinking is necessary, it is not sufficient by itself for strategic planning. Rather, strategic planning organizes a combination of these steps -- whichever are the most relevant to the given situation -- into a process which helps organizations, groups, and/or communities, to solve problems.



Strategic Thinking & Planning Example

Mars Hill, NC Recycling Program

One of the activities of the RDA-RUS project was to help the rural Town of Mars Hill with its evolving recycling program. The town manager was incrementally building a residential, commercial, institutional and industrial recycling program based upon curbside pickup. Waste paper -- especially mixed paper, newsprint, junk mail and magazines -- was a potential **strategic issue** because it comprised a large portion of the Town’s waste stream and had a high impact upon its recycling program. The market prices for mixed paper and newsprint were relatively low at the time, so the manager didn’t want to collect and haul the large quantities of heavy mixed paper to the nearest paper broker which was over 20 miles away, when the landfill was only 12 miles away.

At the time, impending state solid waste planning rules and solid waste reduction goals included a reduction goal of 25% by 1993, and a goal of 40% by the year 2000. This could easily be considered a **threat**, at least in strategic planning terminology, even though the sanctions imposed for failing to achieve these goals were undefined.

A scan of the Town's future economic **opportunities** had already revealed a strong increase in tourist and business traffic due to a new freeway planned to begin construction soon. The freeway project was already partly funded, and therefore **highly probable**. This, combined with the county's historical lack of motels and restaurants, meant that strong growth in these facilities was expected within the **strategic planning time horizon** (2-5 years). More tourists and restaurants mean more food waste. The town also is the home of Mars Hill College -- which generates significant food waste as well. Economic planning in the

town was focusing upon downtown appearance, among other things. Increasing concern about appearance was likely to grow as the community sought to attract tourists and business people. Landscaping would be an important growth industry in and around the town, as it already was in other parts of the region.

Out of this informal, strategic thinking process arose the idea of **composting food waste and paper waste** as a **strategic initiative**. The Madison County Solid Waste Department and the North Carolina Cooperative Extension Service were identified as key **partners and experts** in such a venture, and were already working with the town. Another key **strength** was the availability of space for composting at the county landfill. The **feasibility** of the initiative was greatly enhanced by still another **strength** -- the interest in composting among the partners, college students and others.

A perennial **weakness** in the town and surrounding county -- a general lack of funding for new initiatives -- was overcome by a \$41,000 grant which the partners and Land-of-Sky Regional Council staff submitted to the state Office of Waste Reduction. The grant itself contained much of the **strategic action plan** -- who would do what, by when, and at what cost, to implement a joint town-county composting project at the landfill.

Other aspects of the project included a possibility of the town using its wastewater treatment sludge as part of the compost "recipe." This might be helpful at times when there were too much paper and too little nitrogen-rich material (before many restaurants were in operation, for example). Also, paper market prices might rise, making it more lucrative for the town and county to recycle their paper (a "higher" IWM option) than to compost it. A contingency plan would need to be in place to provide wood chips, bark, sawdust, cornstalks, or other carbonaceous material that could substitute for paper. For this reason, the town and county planned to **track** paper prices and **monitor** the relative flows of carbonaceous and nitrogenous wastes coming to the county landfill. Contingencies were designed and sources of alternative materials were located so that the action plan could be quickly **revised** if circumstances changed.

Except for periodic reports by Land-of-Sky Regional Council to RDA/RUS, and the grant narrative, the above strategic "plan" was not formalized or written down in much detail. However, the partners involved did a lot of strategic thinking and planning -- which led to the recent startup of the pilot composting operation at the landfill!

Practical Applications of Strategic Thinking & Planning

When you should and should not use Strategic Thinking and Planning

Strategic planning is not **comprehensive planning**, and should not be substituted for it. If the goal is to look comprehensively at all aspects of the future of your solid waste program, strategic planning is not the vehicle with which to do it with.

Strategic planning probably will not satisfy **state planning requirements**, if your state has these. State requirements by definition are likely to be comprehensive in nature. Also, achieving uniformity and a sense of fairness across a state is not likely to be compatible with the goal of molding a solid waste plan to the unique strengths, weaknesses, opportunities and threats of each town, city and county. Strategic planning will probably have to occur within the framework of your state planning requirements.

Strategic planning is not **operational or budget planning**. In fact, one screening process which strategic planners sometimes conduct early in their planning is to separate a brainstormed list of possible issues into "strategic" and "operational" categories in order to identify and avoid addressing the operational items. Operational planning deals with the day-to-day activities and operations of an organization -- not the few critical, high-impact changes that need to be made to position the organization for strategic success several years from now. However, a strategic plan may have a great impact upon the operations and/or budget of an organization or department because it may take operational and budget planning may be required to carry out the action steps of the strategic plan. Additionally, the strengths and weaknesses of its revenue streams or operational ability may affect a solid waste department's choice of strategic initiatives to tackle.

Strategic planning is not **capital planning**, or capital improvements planning ("CIP" as it is often called). However, a strategic plan may have capital elements which need to be integrated into the CIP. For example, if regional-scale composting is a strategic initiative of your solid waste reduction program, then your CIP will probably need to include a sizable investment in land, facilities and equipment.

When is a full-blown strategic plan needed, rather than just strategic thinking? In general, the greater any of the following is, the greater the need for a formal planning process and a formal plan:

- The more **\$\$** involved;
- The greater the **risk** involved;
- The **longer-term** the project;
- The more **people** involved;
- The larger the **geographic region** involved;
- The more **politically sensitive** the issue.

In other words, a carefully-conducted and well-thought-out planning process does a better job of communicating with a large number of skeptical people. Additionally, a formal written plan makes a more compelling case to borrow money over a long period of time for a large facility with high tipping fees, than a quickly devised, verbally-delivered, strategic thinking process.

Using Strategic Planning in a rural community

The S.W.O.T. Analysis

Strategic planning requires participants to look at the *internal strengths and weakness* of their organization or community, and the *external opportunities or threats* which affect it. This process is called a *Strengths, Weaknesses, Opportunities, and Threats Analysis*, better known as a **S.W.O.T. Analysis**.



A SWOT analysis can be as simple as brainstorming a list of strengths, weaknesses, opportunities, and threats in a group, or it can involve much research, such as conducting a market survey, collecting and analyzing data, or interviewing experts.

The Impact-Probability Plot and Impact-Feasibility Plot

These are two of the most useful tools to use for applying the power of strategic thinking and planning to a decision-making process. They are mentioned in Steps 5 and 7 of the "Steps in Strategic Planning" above. These steps follow, along with the intervening Step 6:

5. *Prioritize the potential strategic issues according to their **impact** upon your solid waste operation, and the **probability** that they will unfold as predicted (impact-probability plot). Screen out operational issues, and other issues that are judged to be lower-impact or of lower predictability.*
6. *Analyze your organization's **strengths** and **weaknesses** with respect to taking advantage of the highest-priority opportunities, or blunting/dodging the highest-priority threats.*
7. *Do an impact-feasibility plot to select **strategic initiatives**.*

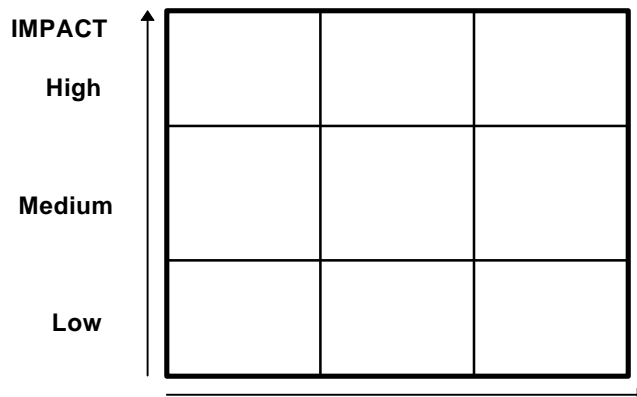

Step 5 assumes that you already have a list of potential or "candidate" strategic issues, and that your goal is to see which ones are "most strategic" and therefore demand highest priority.

Tool #2 -- Strategic Thinking and Planning

Low Medium High

Example of Application:

PROBABILITY or FEASIBILITY

A waste reduction planning group has identified lack of flow control and waste paper prices as two candidate issues to address. They want to know which is of greater strategic importance to the success of their strategic IWM plan for waste reduction. Reduced volume of waste landfilled is very important to them, and they are working in a regional situation in which large recycling and composting facilities have already been built. Their impact-feasibility plot shows lack of flow control as having a much higher impact than waste paper prices because flow control threatens their ability to pay off the revenue bonds which finance the facilities. Also, since they have both recycling and composting in place, they already have a hedge against lower paper prices (they can compost the paper). The group plots lack of flow control in the "high" impact range and paper prices in the "medium" range.

Because significant federal legislation is pending on flow control and the House and Senate have already indicated which way they will vote, lack of flow control also plots farther to the right on the horizontal (probability) axis -- in the "high" range of probability or predictability. Paper prices are considered much less predictable, so it plots farther to the left, in the "low" range. Because flow control is in the upper right-hand cell of the 6-celled chart, it is identified as the issue on which the group needs to spend its time and energy, rather than paper prices.

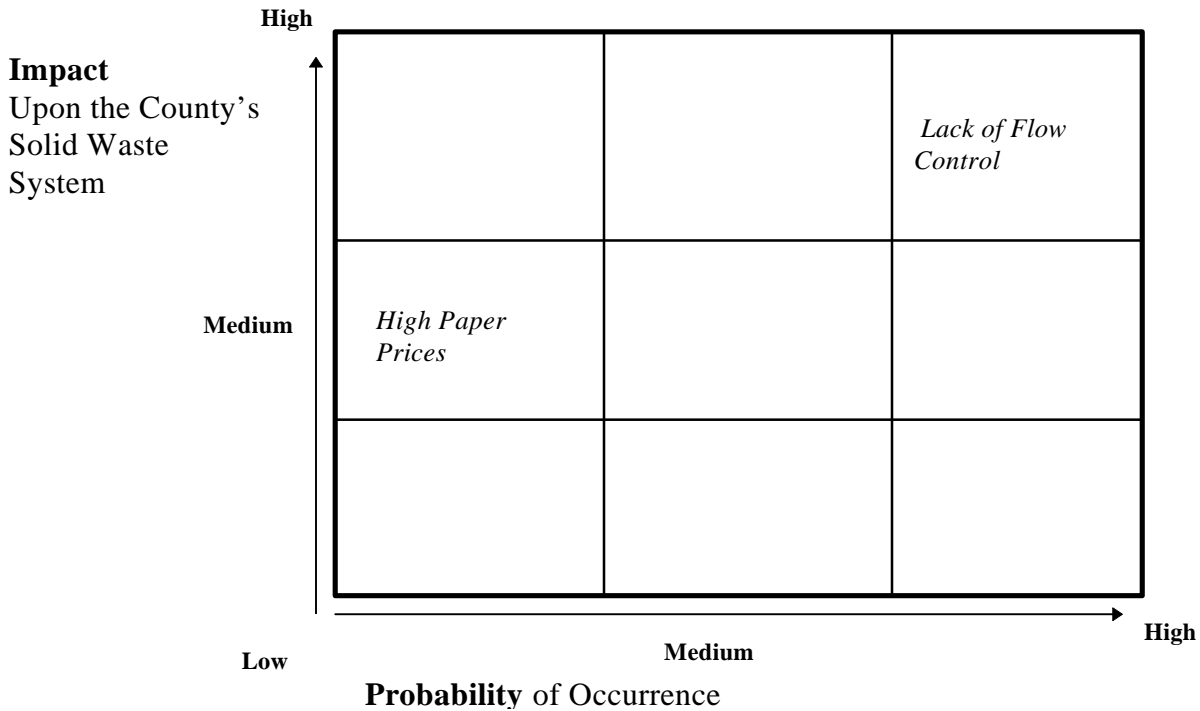

NOTE: The meaning of "high," "medium," and "low" for any item plotted is relative to all other items plotted.

This plotting technique may seem trivial on a simple example with just two issues or topics. But in a strategic problem-solving or planning process, there are often dozens of options, only a few of which can be pursued actively with the time and resources available. The impact-probability plot gives planners a quick, visual way to sort out the most important issues from the rest.

Now for the **impact-feasibility plot**. Step 6 assumes that you have done the impact-probability plot and have plotted issues in the upper-right-hand cell -- in addition to *lack of flow control* let's say: *a new paper mill nearby*, and *the availability of cheap aluminum from Africa on the market (causing a downturn in prices for aluminum recyclables)*. Strategic planning forces you to be realistic about which of these you tackle.

It does this by taking a hard look at the internal **strengths** and **weaknesses** of your solid waste department, local government, or community to address these issues. A **strengths & weaknesses analysis** (Step 6) can be as simple as brainstorming your county's capabilities and shortcomings for each candidate issue, and listing them below the issue on butcher paper. In the example above, the group's S/W analysis might look like this:

Threat: Lack of Flow Control

Strengths

- Our tax base is large and could subsidize our solid waste operation to some extent
- We have good relationships with our representative and Senators in Congress
- Our citizens are very good recyclers
- Our shipping costs to the new mill will be low
- Aluminum is a very small % of our waste stream

Weaknesses

- There has been an outcry in our community to privatize solid waste operations
- We still have 20 years of debt service on our revenue bonds
- We have nothing else to do with our aluminum but to recycle it

A similar strengths/weaknesses analysis may be done for each opportunity or threat. In this case, the other candidate issues (or headings for the butcher paper sheets) would be: "the new paper mill" and "cheap aluminum from Africa."

Then, in Step 7, construct a chart similar to the impact-probability grid above, but put feasibility on the horizontal axis instead of probability. Feasibility now becomes a relative measure of the strengths/weakness analysis for each issue or topic. The listed strengths and weaknesses, compared to the relative strengths and weaknesses of the community to address or influence other high-impact candidate issues, would then lead to the issues being plotted in different cells of the grid, revealing which one is the most realistic to act upon.

In our example, lack of flow control has a *high impact*, but the community has only a *medium feasibility* of influencing the vote in Congress. Cheap aluminum from Africa is both a minor threat and beyond our control. The new paper mill in town will have a major impact on our solid waste system and we can easily take advantage of the opportunity to send our old newsprint there.

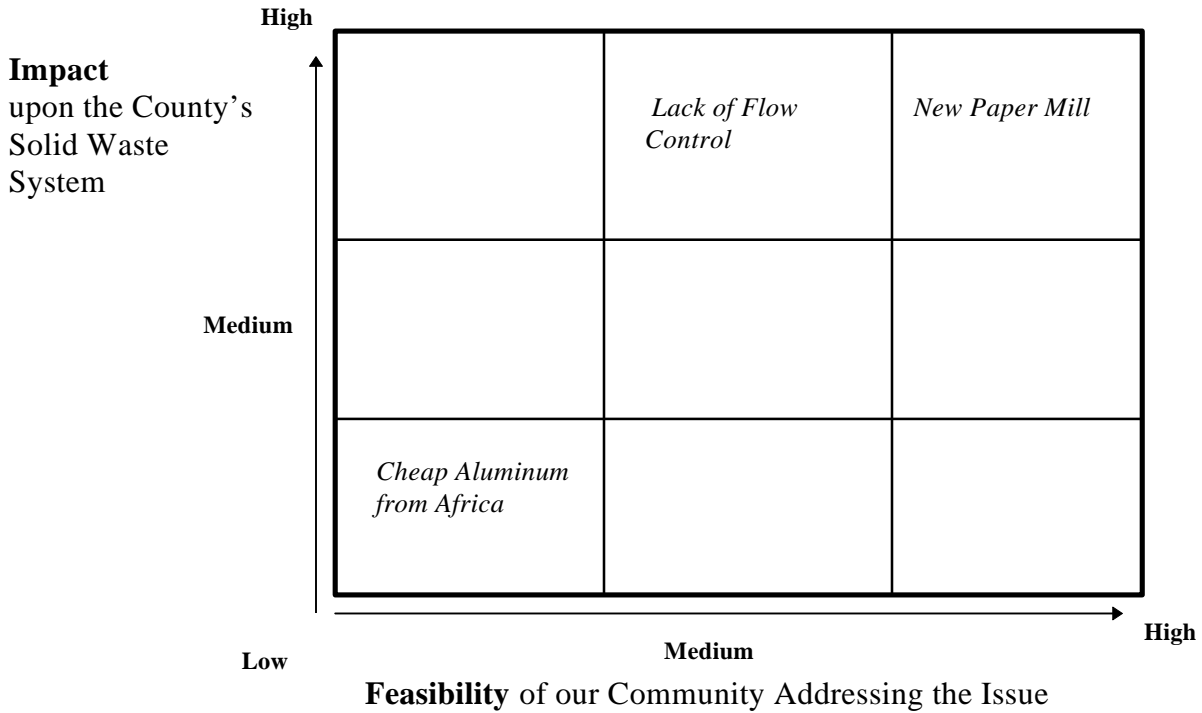

Remember: The meaning of "high," "medium," and "low" for any item plotted is relative to all other issues plotted.

Blank forms for use in Strategic Planning may be found in Appendix 1.

Training Tip:

Training can often take place by applying the strategic thinking/planning characteristics and steps to whatever **real** problem your solid waste reduction team is working on at the time of the training.

- In a workshop setting, a trainer can ask each participant to list his/her most important waste reduction problem. After screening these problems to pick out ones that are appropriate for a strategic approach, the trainer and the group can select one of these real-life, "here and now" issues to use in teaching. Participants will not only learn about strategic planning, but will get a head start on solving a problem as well.
- Strategic thinking/planning can also be taught in a non-workshop setting. A planning consultant or regional planner can act as group facilitator at a real-life problem-solving meeting. S/he can ask the group if they would be willing to try a strategic approach to solving their problem. If so, s/he has a ready-made, hands-on training forum without organizing a formal workshop.

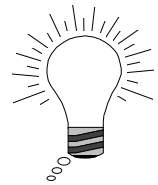

Exercises to Help Learn Strategic Thinking & Planning

Exercise 1: Set up a **hypothetical, 1-3 hour strategic thinking exercise** for a small group (1-6 people) based on your own community's or organization's solid waste situation and a hypothetical or real set of outside opportunities and threats. Enlist a range of people who know something about the waste stream, current waste management practices, a recycling company owner or other solid waste entrepreneur, and at least one elected, local government official if possible.

Use a group facilitator (see the next chapter on group problem solving). Run through the strategic planning steps listed in this chapter. Arrange the agenda for the meeting so that you allocate time for each step, and move on when time is up. You will have to rely upon intuition and the current knowledge of the participants, because there will be no time to do lengthy research. You may have to rely upon assumptions instead of facts, because there will be no time for reality-checking or getting experts or partners involved. Just do the steps the best you can, and see what strategic initiatives emerge. If the group decides to use a real, rather than hypothetical, situation, you will need to check your assumptions before developing and implementing an action plan.

Note the differences between thinking/planning strategically about waste reduction, business development, IWM, etc. and the way the group would normally address a similar problem. At the end of the session, do a brief "pro & con" comparison between the two approaches to get a feel for the strengths and limitations of strategic planning.

Exercise 2: **Strategic critique of an existing solid waste plan** . Choose an existing solid waste plan (or even a plan which deals with another topic -- such as an economic development plan).

With a small group or alone, go back through the characteristics of strategic thinking and planning, and the steps of strategic planning presented in this chapter. Try to identify the strategic characteristics and plan elements. You might ask questions like:

- What is the time horizon of the subject plan?
- Is the plan operational, capital, comprehensive or strategic? How can you tell?
- Does the plan contain a clear **mission**, or a **vision**?
- Does the plan bear any relationship to external **opportunities** or **threats**?
- Does it deal with issues and forces of **critical importance** to the organization?
- Is the plan realistic? Does it take into account the **strengths and weaknesses** of the implementors to carry out the plan?
- Are the **implementors** of the plan identified? If so, did they have a role/ownership in creating the plan? Or was it just "dumped in their laps" to carry out?
- Is the plan **action-oriented** with who-what-when-where-how steps?
- Does it have provisions and a plan for **monitoring**, **tracking** and periodic **revision**?

If the plan you analyze does not "score" very well on the above questions, it doesn't mean the plan is faulty -- just that it is not very strategic. Think about the benefits and shortcomings of the plan being strategic or not so strategic. This will help you to get a better feel for when strategic

Using Strategic Thinking & Planning with Other Tools

Strategic Thinking and Planning and IWM

Strategic thinking and planning can make a powerful combination when used with IWM. Here's why:

1. Both tools are opportunistic -- IWM presents opportunities to reduce waste and/or process it in a more cost-effective, ecologically sound way; strategic thinking/planning is opportunistic by definition in that its main purpose is to position the user to capitalize upon opportunities identified in the process. An IWM opportunity may turn out to be strategic, and vice-versa. Similarly, a problem or threat which is discovered through an IWM analysis may turn out to be a threat of strategic importance -- and vice-versa. Using the two tools together allows each tool to enhance the power of the other.
2. Both tools provide ways to "rank" the relative value of one possible solution versus another. IWM does this via the hierarchy, and strategic planning does it via the impact-probability and impact-feasibility grids; and by screening for strategic vs. operational, etc. approaches. In the example below, there might be several candidate materials to choose from in creating an alternate feedstock stream for a composting operation. IWM and strategic thinking could help you choose the most strategically beneficial one, and IWM could help you choose the most economically valuable one.

Example:

Near the end of the Mars Hill composting example, the possibility of **rising waste paper prices** was raised. In strategic planning, this force, coming from outside the town and county which local government could not influence, could be seen as both an opportunity and a **threat**. If prices rose, the town and county would be under economic pressure to sell to paper brokers. This would provide an opportunity to increase paper recycling revenues. However, the same trend would be a threat to the composting operation because the operators would be forced to find an alternate feedstock for the high-carbon element of the compost recipe. (In fact, paper prices did rise sharply, just before the compost operation began; they have come down again significantly at the time this chapter is being written). In searching for an alternate feedstock material, the town and county could use IWM principles as follows, to get the most productive solution.

First, use the "**IWM Opportunities**" grid to plot the current handling of all waste in the county (in an ideal situation, this grid would have already been filled out so it would be available for situations like this). Then, search the grid for high-carbon organic materials, (other than marketable paper products) which are being burned or buried in the landfill. (Alternatives to doing this: do a waste sort at the landfill; watch loads arrive at the landfill; or talk to the landfill gate manager to find such materials and quantities thereof. Another way would be to ask local businesses and industries about materials they are having trouble disposing of, which might be high-carbon organics).

By plotting material on the IWM Opportunities grid, the operators could select materials which are being thrown away as waste, or falling below the *composting level* of the IWM hierarchy, as the materials most likely to provide a stable composting feedstock to replace the recycled paper.

After finding an alternative material(s) (let's say large quantities of natural textile scraps), use whichever **IWM Principles** are needed to redirect it from the (landfill) to the composting feedstock stream. For example, the textile scraps may be contaminated with other materials when they arrive at the landfill. Using the principles **Start as far upstream as possible** and **Keep materials separated**, find out where the scraps were generated, and where they got contaminated. Then, work out a way to keep them separated from the contaminants and get them transported to the composting operation (which happens to be at the landfill in the Mars Hill case).

The outcome of the above application of **IWM** and **strategic thinking/planning** would be to create an alternate feedstock when paper prices are high and paper is difficult to obtain. Of course, it would never be this simple in real life. The high-nitrogen (food waste) side of the feedstock stream might fluctuate seasonally in a summer-fall tourist economy like that of Mars Hill. And it might be difficult to find enough alternative feedstock material to make up for a large amount of paper being sold for recycling. However, each successive re-balancing of the compost input streams could be an improvement if IWM and strategic thinking/planning are used in tandem.

Using Strategic Thinking and Planning With Group Problem Solving and Public Involvement

Strategic thinking and planning is most successful when carried out as part of a group process. The Group Problem Solving and Public Involvement chapter that follows is designed to promote strategic thinking and planning, and will provide a useful structure for the design of a strategic planning process.

Using Strategic Thinking and Planning With Business Development

Strategic thinking and planning was invented by business people and is familiar territory for business leaders who want to stay competitive. A successful business will understand its own strengths and weaknesses and continually position itself to take advantage of opportunities and manage "threats." In the growing market for re-used and recycled materials, and with rising costs of disposal, economic developers are increasingly recognizing that solid waste management is a strategic issue for businesses.

Using Strategic Thinking and Planning With Regional Approaches

Strategic thinking and planning can be especially useful as a tool to enhance regional approaches. One reason why this is particularly true at the present time stems from two things: (1) the fact that regional solid waste reduction programs often involve large facilities that are capital-intensive; and (2) the strategic **threat** that the legal status of flow control poses for long-term debt financing of such facilities for public entities. A case in point is the Region B, North Carolina case study presented in the "Regional Approaches" chapter (Tool #5).

NOTES:

What is Effective Group Problem-Solving? How does it Relate to Public Involvement?

Note: the group effectiveness theory and group facilitation material presented here is adapted from The Skilled Facilitator: Practical Wisdom for Developing Effective Groups by Dr. Roger Schwarz's book (3). Guidebook writer Jim Stokoe is a student of Schwarz and a graduate of his Group Facilitation and Consultation training, offered through the Institute of Government at the University of North Carolina at Chapel Hill. Stokoe has found Schwarz's work to be a valuable tool for group facilitation and public process design.

If we define a "group" as two or more people, the importance of group problem-solving in solid waste operations becomes immediately evident. Virtually everything solid waste and waste reduction managers do is done in groups. Both of the tools described so far in this guidebook -- IWM and Strategic Thinking & Planning -- are done best when they tap the collective brainpower of a group rather than just one person.

Effective planning and good decision-making are not automatic to groups. Typical pitfalls of group work include:

- Confusing group leadership with group facilitation
- Not considering who should be included in a group
- Failing to recognize that group process is as important -- and sometimes more important -- than the content of the group's deliberations and solutions
- Creating "winners" and "losers" in the group by manipulating meeting agendas or using voting (parliamentary) procedures
- Making all the decisions in a small subset of the group (sometimes referred to as its "leadership" or an "executive committee"), and asking the full group to "rubber stamp" (approve without ownership) their solutions
- Notifying key implementors of the group's solutions of their responsibilities without having involved them in the problem-solving process

Conversely, an **effective group** is one which:

- Gets the job done (high-quality products that satisfy the group's "clients")
- Maintains an effective group process (so that the group can deal with conflict productively, make decisions, and interact successfully with other groups and citizens)
- Satisfies the individual needs of its members (the reasons for which members joined the group in the first place)

These three criteria can be applied to very short-term groups like a one-time problem-solving group; to long-term groups like a regional solid waste authority board; and to medium-term groups like a strategic planning team.

Core Values of Effective Groups

Dr. Schwarz holds that there are three **core values** which underlie a group's effectiveness (4):

1. **SHARING VALID INFORMATION** -- each group member shares all information which is relevant to the decision they are trying to make-- even if that information might lead the group to choose a solution which the member doesn't favor. This information can be checked or tested so that all members are comfortable with its validity.
2. **FREE & INFORMED CHOICE** -- "free" means that each group member contributes his/her opinions to the decision-making process without feeling manipulated or coerced. "Informed" means that all information has been shared and validated. Each member of the group feels s/he has had an equal say.
3. **INTERNAL COMMITMENT** -- Another word for this is "buy-in" or "ownership." Because each member voices a free and informed choice based on shared, validated information, she/he feels good about the group's decision, and will support its implementation -- even if the decision does not exactly reflect the way s/he would have done it.

Groups can adopt **ground rules** for their meetings which help reinforce the above core values and ensure the group's effectiveness. A recommended set of **Principles for Effective Groups** is listed below. These principles can be adopted by the group as ground rules, or can be modified. Ground rules are like an action plan for implementing the *core values*. If the group successfully follows the ground rules, its effectiveness will be increased. The nine principles listed are a "short list," adapted from a list of 16 principles in Schwarz's *The Skilled Facilitator*. An article summarizing the groundrules appears in Appendix 3.

Principles for Effective Groups

1. **Share all relevant information** -- if a group member withholds information that is relevant to a decision the group is trying to make, he/she reduces group effectiveness (and group trust, if other group members discover the withholding)
2. **Focus on interests, not positions** -- Positions are usually a statement of how a participant thinks a problem should be solved. Two people or interest groups may have different positions, but their interests behind those positions -- that is, what they are trying to accomplish by solving the problem -- may not be very different at all. Focusing on interests, not positions can help group members achieve consensus on difficult problems or tough choices.
3. **Make decisions by consensus** -- consensus means that every group member agrees to adopt the group's decision and will support its implementation. Voting tends to create "winners" and "losers;" achieving consensus, though it may be more difficult in the beginning, helps ensure that decisions have enough support to be successfully implemented. Whereas consensus may take more time than voting in the short run, it saves time in the long term by avoiding continuing conflict and resentment by the "losers."

4. **Disagree openly with any member** -- if you disagree, don't withhold it. All opinions can provide valid information for the group.
5. **Discuss "undiscussable" issues** -- if group members consciously avoid certain "sensitive" issues which are pertinent to the group process or the topic being discussed, the group will not be as effective as it will be if such relevant topics can be discussed openly.
6. **All members participate -- no one dominates** -- group members must participate to feel a part of the group's decisions; ensuring that no member(s) dominates is the responsibility of all members.
7. **Don't take "cheap shots"** -- insulting remarks create a distraction as group members react to them; hurt feelings can also make group members less willing to participate fully.
8. **One speaks -- all listen** -- side conversations or other distractions make it difficult for the group to stay focused.
9. **Start on time, end on time** -- group members will be more willing to attend meetings and participate fully if they know the group will not violate their time needs. (5)

Who Should Be Included in a Group?

The above core values and principles work well once a group is formed and ready to meet. But before this can happen, someone must decide, "Whom should we invite to participate in this group?" The "rule of thumb" answer to this question is:

- Everyone affected by the problem or issue and its solutions;
- Everyone who will have an active role in carrying out the solutions;
- Everyone with special insight, information or experience related to the problem and its solutions; and
- Everyone who could "torpedo" the solutions.

To follow the above criteria perfectly would require us to know all the solutions before selecting the members of the group to work on the problem. Since we can't know the solutions before they are developed, it follows that it is impossible to know who all the group members should be at the outset. Organizers of group problem-solving sessions usually just have to guess at who needs to be involved, and then conscientiously add (and occasionally delete) members to/from the group as the problem-solving or planning process evolves.

Practical Applications of Group Problem Solving with Examples

Public Involvement -- a logical extension of group process

The public acts in many ways like a "big group." In reality, the "public" is an aggregation of individual people, each with his/her own set of viewpoints, preferences and needs. Just as individuals react to the presence or absence of Schwarz's core values when they participate in small groups, so these same individuals react to the presence or absence of effective group process and behavior in public decision-making at the county, town or regional level. If the siting of a new landfill is conducted behind closed doors by the county's "power structure," and then presented to the public as a "done deal," the core value of free and informed choice is violated just as surely as if the leaders of a small planning group had made a decision and asked the full group for "rubber stamp" approval.

Smaller groups can also contain subgroups, the members of which tend to have the same viewpoints and "vote the same way" on issues. It is often these subgroups which become the "winners" and "losers" when they use voting rather than consensus to make decisions. Similarly, individual members of "the public" are not just acting out of their individual interests. Many are also members of one or more formal "interest groups" or informal "interests."

However, coordinating a public decision-making process does differ in some ways from facilitating a small group:

1. The sheer number of people involved makes meetings of all participants difficult or unmanageable;
2. It is impossible to communicate interactively and spontaneously with so many people;
3. Usually, public decisions are made by a small policy group such as a town council or county commission rather than by all of the participants. Thus, the public process coordinator (facilitator, mayor, county commission chairperson, etc.) must facilitate both the public process and the policy group.
4. Sometimes the decision-makers' reaction to the "media spotlight" and the political culture of the community make it difficult for the public decision-making group to practice effective group principles/ground rules.
5. Public bodies traditionally use parliamentary procedure which emphasizes polarization (win/lose, yes/no, majority/minority, etc.) and makes it difficult to achieve the core values of effective groups.

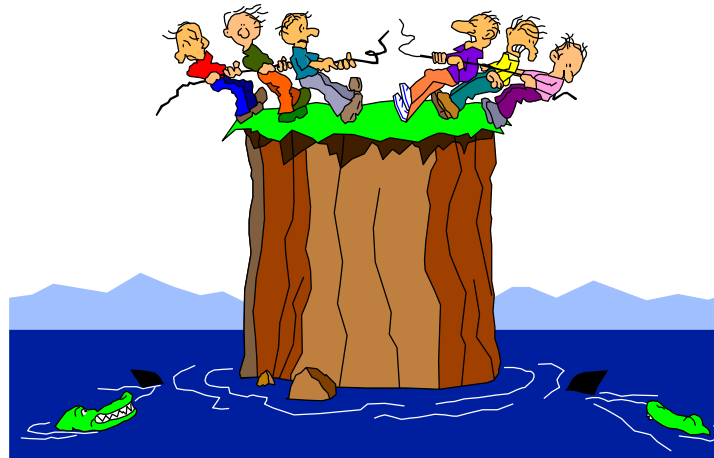

Pitfalls in Public Involvement Processes

In our work with the Council of Governments, we have observed a number of pitfalls in public involvement efforts. The most common are:

**Pitfall
1**

A "command & control" mindset rather than a collaborative mindset by the public body and staff. Schwarz's core value of free and informed choice requires that members of the public do not feel controlled, nor is the flow of information, the timing of its release, or the decision-making process controlled in a manipulative way by the government, private interests, etc.

A "command & control" mindset is a recipe for public involvement disaster, and can doom such a process to failure before the process is designed or any content issues are raised. This mindset may be motivated by the desire to maintain political control and power; by the belief that the public is incapable of successful collaboration; that collaboration takes too much time; or simply by "top-down" leadership styles that are difficult to change.

A "command & control" mindset is a recipe for public involvement disaster, and can doom such a process failure before the process is designed or any content issues are raised .

**Pitfall
2**

Assuming either that the public knows more than they do about the issue (and consequently failing to provide enough factual information), or that the public is incapable of understanding and processing the information and unable to participate effectively in the decision-making process.

These types of assumptions derail the public's right to know about decision-making processes that affect them. They also forego the many good ideas that could have been contributed by an involved public, and preclude ownership of -- and a sense of responsibility for -- the resulting decisions by the public. This not only leaves the responsibility solely on the public staff, but also seems to confirm to that a "command and control" approach is necessary, resulting in a never-ending cycle of non-communication and mistrust.

One of the forms these assumptions by public process coordinators take is, "We must give the public something concrete to respond to; therefore, a small group should develop a concrete proposal before we mention this project to the public or the media." While a proposal could be part of an effective way to begin decision-making, it is only a piece of the overall public involvement process. In practice, such proposals usually pertain to the content of a pre-designed solution without regard for the process of the public decision-making at hand. This jumps the public process into consideration of content before any consideration of process; and it also encourages the process managers to develop options for solutions without public input.

Unfortunately, it is often difficult for the public staff to "back down" from these premature solutions -- especially if a lot of staff time has already been spent developing the proposed solution. If the mindset behind the proposal is rooted in the assumption that the public is incapable of participating in a good decision-making process or developing a solution, it is not likely to lead to an effective public process anyway.

Second-guessing the public and its constituent interests in these ways not only leads to mistaken conclusions in the first place, but by reinforcing "command and control" behavior, it keeps the public process managers from even discovering the errors in their untested assumptions.

**Pitfall
3**

Considering the design of a public involvement process, but not inviting the public to help with the design. Even among relatively enlightened and well-intentioned public managers, this is a common and easy trap to fall into (we know this from experience!). Having designed a collaborative process, public managers may take it proudly to the public, only to hear criticism that it is the manager's democratic process -- not one created and owned by the public.

Avoiding this pitfall is a good hedge against Pitfall #2 above, because **if** the public is involved in the design of the decision-making process itself, chances are much better that an appropriate level of information will be shared with the public. In other words -- public information managers really can rely upon the public to contribute meaningfully to public process design.

**Public information managers really can rely upon
the public to contribute meaningfully
to public process design.**

**Pitfall
4**

Using the wrong kind of meeting -- or a poorly designed or poorly facilitated public meeting -- to gather information, present information, or make decisions . Federal and state governments have been famous for using "public hearings" on sensitive local environmental issues and other "hot topics." Not only has much damage already occurred by the time of the hearing (due to pitfalls #2 and #3 above), but these one-way sessions worsen the situation because members of the public want a real dialogue rather than a one-way presentation.

**Pitfall
5**

Fostering -- or simply allowing -- poor relations with the news media . The way public involvement processes are covered by the media can contribute to success or disaster. Some typical problems:

- Communication with the media only through front-line reporters. This means the publisher and editors or news director have only the reporters to rely upon for their impressions of your public process and your project;
- High turnover of reporters can leave the public manager with reporters unfamiliar with the area or region, local government laws and procedures, and the specific solid waste issue and its historical background;
- Ineffective intervention -- or no intervention -- when public officials or managers are misquoted, or when meetings or processes are misrepresented (usually unintentionally) by news media;

- A confrontational approach with the media, sometimes driven by an untested assumption that "the media is just out for a sensational story," or, "the media will construe our facts however they wish to make it come out like they want it to come out."

Poor relations with the media heighten public officials' fear of discussing politically sensitive issues and otherwise sharing information openly. It greatly decreases the public body's ability to conduct an effective meeting which achieves Schwarz's core values.

How to avoid the Pitfalls

Precaution # 1 Public managers need to decide how much control they are willing to give up in the interest of the core values of effective groups (shared information, free & informed choice, and internal commitment) -- and then genuinely give it up. Only by truly giving up power over information and process can you allow others to assume shared ownership of -- and responsibility for -- public decisions. Public appointed and elected officials who truly achieve widespread ownership of public decisions will find the public more willing to share blame for erroneous decisions and to be more forgiving.

Precaution # 2 Share relevant information without assuming the public knows all the facts. Credit the public for being able to understand and process information and for being able to create good solutions. Admit that public professionals don't have all the answers. Use all the free brainpower that a public process offers.

Precaution # 3 Get the public involved early by getting them involved in the process design. Be proactive in finding and involving the shy, the apathetic, and the holdouts. The interest group analysis and the problem solving flow chart are two useful tools to accomplish this (blank forms of these tools are found in Appendix 1).

It is very difficult for a of county commissioners or a solid waste department which has not adopted a "Schwarzian" process internally to manage an open, effective public process .

Interest Group Analysis Example:

Have your “meeting design” group brainstorm the following chart. If they don’t list anyone outside of themselves, then the group is inclusive enough to proceed. If others are identified, invite them to join the group.

Interest Group Analysis Chart

Representatives and their Roles

**Identifiable
Interests or
Interest
Groups**

County Gov't:	Will Fillem (Solid Waste Manager)	I. Reduce (SW Reduct. Specialist)	Jim Smith (Commissioner)
Private Haulers	Al Carry (large corp.)	Jim Tote (small business)	
Regulators	Will Regulate (State SW Section)		
Envir. Groups	Candice Valuable (Citizens for Recycling)		
Others:			

The group may add to or subtract from their original list during the planning process. Groups will find it useful to return to the drafted Interest Group Analysis chart at various stages during the process in order to check that no key “players” are being left out of the process.

Problem Solving Flow Chart Example:

NOTE: the problem solving process can be a linear, step-by-step process as shown, or you can jump around! The key is to always know which step the group/public is on.

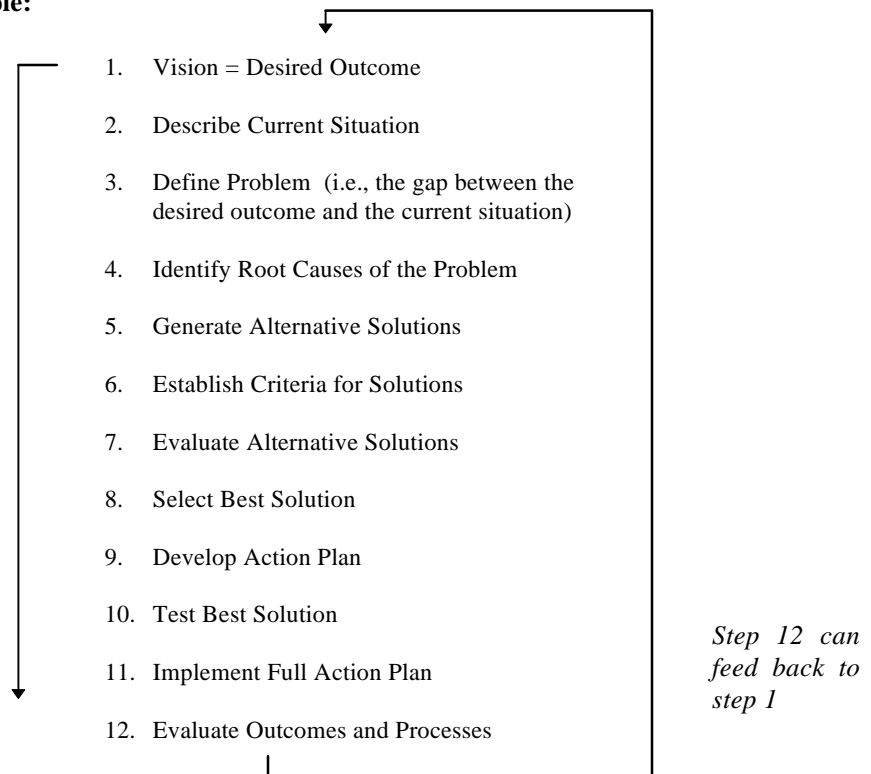

Adapted from the Skilled Facilitator, by Roger Schwarz (6)

Precaution # 4 Use Schwarz’s core values and ground rules in both the public involvement process and the meetings of the public body. If the public body “practices what it preaches” in this way, it will be more credible with the public. It is very difficult for a board of county commissioners or a solid waste department which has not adopted a “Schwarzian” process internally to manage an open, effective public process.

Precaution # 5 Take time to design, coordinate and facilitate effective meetings. Use the following **meeting design checklist**:

- Start with purpose -- why are we holding a meeting?
- What are the desired products or outputs of the meeting? (A tentative process design? A solution to a problem? Or simply a sharing of information?)
- Do we have everyone involved who is necessary to design and conduct the meeting?
- Think of the meeting as a microcosm of the entire public decision-making process

- Use the core values as design guidelines and reality tests (an example of this is presented later)
- Do we have an invitation list that includes all four categories listed above in, "Who should be included in a group"?
- Consider an outside, neutral group facilitator
- Contract with the facilitator and the group -- and possibly the media -- to use ground rules to achieve the core values for an effective group meeting.

Another tool to use in designing good meetings is the following **generic meeting agenda**. It will require customizing for a specific meeting, but can serve as a checklist to remind the public process manager or small group facilitator to include certain process checkpoints in meetings.

Generic Meeting Agenda:

<i>All aspects of the agenda and mtg. are tentative until agreed upon by all participants</i>		<p>Tentative Agenda</p> <p>7:45 a.m. - 10:20 a.m. April 1, 1995 Room 319 Anywhereville, NC</p>
<i>Arrive before desired start</i>	7:45 am	1. Arrival time (before actual start of meeting)
<i>Use brainstorm format</i>	8:00 sharp	2. Introductions
<i>OK to present tentative agenda as a starting point; revise as necessary to meet the Expectations and Concerns of participants</i>	8:05	3. Review and confirm "contract" for the meeting, (ie. any tentative agreements about purpose, participants, facilitation, etc.)
<i>See next page</i>	8:15	4. Review Effective Group Process & Adopt Ground Rules
<i>See next page</i>	8:25	5. Check Expectations & Concerns of participants: <ul style="list-style-type: none"> • Expectations: What needs to happen at this mtg. to consider it a success? • Concerns: What might happen to make it less of a success?
<i>See next page</i>	8:35	6. Agree on Agenda and time allocations for the meeting
<i>See next page</i>	8:45	7. Conduct main business of meeting (business items could be: <i>break up into focus groups to gather information</i> ; or, <i>present information to public</i> ; or, <i>conduct a making process</i> (e.g., using the problem-solving model); or, <i>conduct a strategic thinking or planning process, etc.</i>)
<i>See next page</i>	9:40	8. Agree on "Next steps:" who, how, when <ul style="list-style-type: none"> • Documentation of mtg • Distribution of mtg results (press releases; sharing results with others, etc.) • Other follow-up?
<i>See next page</i>	9:50	9. Self-Critique of Meeting (What went well? What should be changed next time?)
<i>See next page</i>	10:05	10. Press Wrap-up (if special press ground rules are used)
<i>See next page</i>	10:20	11. Adjourn

Precaution # 6 Proactively establish collaborative relations with the news media:

- Hold discussions between the (publisher, editorial board, editors, news director, station manager) and the public governing board and manager re: the relationship between the news media and the public process managers. Seek agreement on better public process as a mutual goal of the community, the local government and the news media. *Civic Journalism* is an emerging concept in which the news media is a proactive participant in public processes.
- Ask that reporters and public managers educate each other about their businesses. If each knows the pressures, economics, standards and procedures of the other, the two can work together for better coverage and better public process without sacrificing journalistic rights or ethics.
- Make frequent communication a part of the relationship between public information managers and the news media.
- Consider negotiating specific ground rules for media coverage of your official meetings. Get these authorized at the publisher or editor level; few reporters will be comfortable taking unilateral responsibility for agreeing to ground rules such as:
 - a) *The County will produce a **written summary -- not formal minutes** -- of the meeting.*
 - b) ***No votes or binding consensus** will be taken by the Board.*
 - c) *The meeting participants **reserve the right to change their minds** later regarding any or all preferences stated at the meeting.*
 - d) *The press agrees **not to report any direct quotations or attribute comments** to any individual meeting participant until the "on-record" wrap-up..*
 - e) *The group will do a **15-minute, "On the Record" wrap-up** at the end of the retreat, during which the press may ask questions and report direct quotations of participants.*
- Ground rules like those just listed must be freely and mutually agreed upon by all parties if the group is to achieve their purpose -- to facilitate more effective coverage of the decision-making process.

***Civic Journalism is an emerging concept in which
the news media is a proactive participant
in public processes.***

Precaution # 7 If, in the middle of a meeting or a public involvement process you suspect a process problem, stop the meeting and get it out "on the table":

- Don't be afraid to question the process; the public will understand that public process managers are only human, and you don't have to be afraid to involve them in a "mid-course correction." Sincere process interventions help assure the public that your top priority is good public process -- not "saving face" or "always being right."
- Use the core values to diagnose the suspected process problem. The following check list can serve as a process design or as a diagnosis tool:

Core values check for meeting facilitators or public process designers:

How does each step of the process satisfy the 3 “**core values**”?

1. Sharing valid information. Has all relevant information been shared with all necessary parties?
 - With those most affected by the decisions?
 - With the eventual implementors?
 - With the naysayers and skeptics?
 - With the general public?

2. Free and Informed choice. Have participants felt free to make informed decisions without feeling coerced or manipulated?

3. Internal Commitment to the Solutions/Decisions. Are decisions being made by consensus? Do participants feel ownership of the solutions?

If desired, you can summarize your process diagnosis in a table such as the one that follows. The objective is to figure out how you can change your approach or process to better meet the core values.

Core values diagnosis table:

Step in Process	Did We Share Valid Information?	Did we Ensure Free and Informed Choice?	Do We Have Internal Commitment?	Possible Changes to the Step or Process
<p><u>Example</u></p> <p>Invited solid waste staff and 2 county commissioners to discuss possible sites for a new landfill.</p>	<p>NO -- did not inform public that we were even considering this.</p>	<p>NO -- public not given any chance for input about possible site alternatives, or about the <i>siting process itself</i>.</p>	<p>NO -- 200 negative letters to the editor after a staff member leaked news of the meeting to the press.</p>	<ul style="list-style-type: none"> • Start Over! Acknowledge the mistakes made to date. • Consider holding the discussion in a regular commissioner’s mtg. • Discuss the problem and the need for a new landfill publicly before jumping into solutions. • Provide data to public in a published document. • Set up an open discussion of the <u>process</u> for reaching a solution. • Don’t discuss sites before the problem is defined and <u>alternative solutions</u> are aired.

Core values concept adapted from The Skilled Facilitator, Roger Schwarz (8)

Ask the above questions about your meeting and enter the results in the table accordingly. The example shown above illustrates the use of this tool to review an in-progress, landfill-siting process. This table can also be used to design a public decision-making process from scratch. In this application, the column headings should be modified to read: “*How **will** we share valid information;*” “*How **will** we ensure free and informed choice;*” etc.

Exercises to Learn Group Problem-Solving & Public Involvement

Exercise

Set up **role plays** in which your solid waste public process coordinators or decision-making group members assume the roles described in the "Pitfalls" section above. Role-play through the pitfalls in a typical public meeting your group has experienced (someone play the solid waste manager; someone play the newspaper reporter; someone represent each of several interest groups in the community, etc.). See if the group can **experience** the way the public, the process managers, etc. feel in such a public process. Then apply some of the tools and principles described in "How to avoid the Pitfalls." Practice diagnosing the problems, and applying the core values and ground rules to remedy the problem. Role-play the diagnosis and the corrected process as you would conduct them in a public meeting.

Exercise

Practice **designing and conducting a meeting**. Use an in-house meeting on a non-threatening topic -- for example, one your solid waste reduction group would be conducting anyway. Use the tools presented in this chapter to decide who should be invited; to find out what their expectations and concerns for the meeting are; to craft a tentative agenda; and so on. Use the ground rules to conduct the meeting; and discuss any process issues that arise during the meeting.

Exercise

Diagnose a real group meeting or public process your solid waste department has conducted recently, using the core values. If the meeting or process went well, see if you can figure out why. Were the core values satisfied? If the process unsuccessful or made the situation worse, see if you can pinpoint the problem in terms of the core values or the ground rules. Redesign the meeting for success!

Using Group Problem Solving & Public Involvement with other Tools

As the authors consider combining the principles presented in this chapter with IWM, strategic planning, business development and regional approaches, we conclude that these group effectiveness and public involvement concepts can help to make **any** other tool more effective. The reason? **Because all the other tools in this guidebook involve dealing with people and groups in one way or another.**

Training Tips:

1. Always link the training exercises/lectures back to the **core values**. Use the core values as a hanging poster or overhead, so it is always in the background. Same with the **Effective Group Principles/Ground Rules**.
2. The Who should be included in a group (or public process)? list also makes a handy tool to have reproduced as a "background hanging" for training sessions, because it will be referred to often.



NOTES:

What do we Mean by “Business Development?”

For the purposes of this guide, we use the term **business development** to refer to the process by which we are building the benefits of IWM and water reduction into rural economies. It includes:

- Creating new jobs related to waste reduction;
- Improving the profitability of businesses by means of reducing waste; and
- Using waste reduction as a tool for recruiting businesses and industries into the region.

These concepts are very important to IWM and waste reduction because:

1. Business Development provides a financial incentive to reduce waste (i.e., a profit);
2. Business Development provides for highly-motivated application of the IWM principles -- especially IWM Principle 1, "Search for Value," and Principle 3, "Use the IWM Hierarchy to Retain Value;”
3. Business Development builds waste reduction into the very economic "fabric" of the community;
4. Business Development helps to create jobs and to keep industries profitable; it helps industries to stay in the community and sometimes to expand;
5. It allows the local community which generates the waste to keep the value of the waste at home on the local economy rather than "leak" it out to the benefit of another state or county.
6. It translates what otherwise seems like a highly theoretical and perhaps idealistic concept (the IWM hierarchy) into a very tangible form (jobs, profits, investments, tax revenues). Without Business Development, IWM could be seen by some as just a "pie in the sky environmental goal;"

Definition:

Business Development is the application of Integrated Waste Management to strengthen existing businesses, to create new businesses, and/or to recruit outside businesses to a community.

The above definition is based upon a set of “economic renewal principles” developed by the Rocky Mountain Institute in their “*Economic Renewal*” handbooks, particularly the *Business Opportunities Workbook* (9) and the *Business Opportunities Casebook*, (10) a companion volume.

R.M.I.’s Economic Renewal Principles

- 1. Plug economic leaks in local economies**
- 2. Strengthen existing business**
- 3. Create new business**
- 4. Recruit new business**

Land-of-Sky Regional Council organized the EPA-sponsored business development element of its IWM project around these Economic Renewal Principles. Some examples of how the Council has applied the other principles to business development follow.

1. Plug Economic Leaks -- moving up the IWM hierarchy with our solid waste management choices "plugs leaks in the local economy." For example, when corrugated cardboard is contaminated with liquids and landfilled, any value it might have had for re-use, recycling or composting is "leaked" out of the local economy and wasted. In fact, the landfilled cardboard actually has the effect of a "double leak" because in addition to the loss of reclaimable value, it *costs* the community to haul it to the landfill and bury it, and it costs to replace the landfill space it occupies.

If the same cardboard is kept dry and separated, and is subsequently picked up without compensation by an out-of-state hauler for re-use, recycling or composting in the other state, a partial "leak" has still taken place in the local economy where the waste was generated. Even though the value in the cardboard is not wasted, the economic value of capturing it for recycling is lost to out-of-state companies and workers. If, however, the cardboard is re-used, recycled or composted in the community of origin -- or even if the revenues from selling the materials to an out-of-state processor come to the local community -- all or part of the potential "leak" has been plugged. In fact, all three of the remaining Economic Renewal Principles can plug economic leaks.

2. Strengthen Existing Businesses -- the Council's Waste Reduction And Technology Transfer (WRATT) program uses engineers and scientists retired from business and industry to perform money-saving waste assessments for businesses and industries of all sizes. The assessments provide businesses with technical advice to become more efficient and profitable, to expand and create new jobs, and to keep from closing their doors by applying IWM approaches to save money. The assessors give top priority to source reduction in their search for waste solutions and also recommend re-use, recycling, composting, or other options when appropriate in order to help businesses plug would-be "leaks" in their profitability.

3. Create New Businesses -- the Council's Regional Composting Entrepreneurial Feasibility Study seeks to plug a different type of economic "leak." This project addresses the direct dollar drain that occurs in our regional economy when local landscapers, homeowners, garden suppliers, universities and other users of compost and related products buy out-of state products because there is no local compost producer in the region. The dollars they pay to ship compost in from many other states contribute to far-away economies so that most of those dollars will never again re-circulate in the local region's economy! The project is organizing entrepreneurs and organic waste generators to begin producing compost locally.

4. Recruit Appropriate Outside Businesses -- the Council's Recruiting work element seeks to work with local and state industrial developers and recruiters to do the following:
 - Improve or create local and regional waste-matching programs and promote these programs as a service new industries can use to their advantage, both to sell their waste by-products and to provide them with nearby sources of feedstocks for their manufacturing processes;
 - Attempt to co-locate incoming industries with local industries which generate complementary waste by-products -- or at least be aware of the locations of waste-complementary industries when showing industrial sites to prospects;
 - Be aware of waste composition of local municipal and county waste streams which could provide the basis for materials-based industries, like a crumb rubber (from scrap tires) processor or a white goods recycler.

Recruiting appropriate outside businesses plugs economic "leaks" by re-circulating local and regional solid waste materials in the industrial sector of the local economy. Industries which would otherwise be forced to use virgin raw materials (or waste materials from far away) can profit by finding a cheaper supply locally. Conversely, industries which might have to ship their waste a great distance to be processed or pay substantial landfill tipping fees may be able to find a nearby buyer for their waste by-products, or at least a lower-cost and more ecologically sound outlet than the landfill.

Business Development Examples

1. Supporting Existing Businesses: The Western North Carolina Waste Reduction and Technology Transfer (WRATT) Program.

Business people often say how important keeping customers is to the success of their business. Bringing in new customers through marketing can be very expensive. Similar resources applied to ensure customer satisfaction can often pay off with larger orders from existing customers.

Keeping customers is also important to local governments. Providing a high level of service to companies as well as other "customers" of local government may head off relocation decisions by businesses and industries. At the same time, if the local branch of a large company runs efficiently compared to branches in other states, it will be more likely to weather external pressures, to keep full employment through economic hard times, and to avoid being shut down. {PRIVATE }



One service that can benefit area companies as well as government is a **government-sponsored waste reduction program**. Our Waste Reduction and Technology Transfer (WRATT) Program uses retired industry engineers and scientists to help area companies cut waste and improve their bottom line. For example:

A medium-sized clothing company started ten years ago in the founder's garage. Explosive growth led to lots of new jobs for the local economy. Profits were good, but the business was not as efficient as it could be in handling its wastes. Busy plant managers understandably focused more on filling orders. They were willing to spend a few hours with WRATT volunteers talking about waste streams and other production headaches. A few weeks later, a report arrived with suggestions worth \$130,000 in annual savings. These included:

1. Sell your waste cardboard instead of paying a hauler to take it.
2. Market your fabric trimmings to a plastics recycler instead of paying landfill and hauling fees.
3. Trade pallets with other area companies to obtain the size you need for shipping if you cannot get your suppliers to ship on that size pallet.
4. Save one third on your electric bill (demand charge) by changing your morning start-up process.
5. Save another third on your electric bill by installing a pressure sensor on the compressed air system instead of having the compressor running continuously.
6. Request a reduction in sewer charges for water used to irrigate landscaping. Consider plant species that need no irrigation to save on the water bill also.
7. Look at installing more modern lighting fixtures with electronic ballasts that are 2/3 more efficient than fixtures installed even five years ago.
8. Train your employees to look for waste reduction opportunities and share the savings with them in return for good ideas.

9. Install low-flush toilets and faucet aerators in the rest rooms.
10. Set up beverage can recycling in the break room. Give the cans to charity or sell them to cover the time involved in collecting them.
11. The company is delighted with the report and is proceeding with installation. The investment needed is minimal, while the payback is nearly immediate and will continue annually for a decade or more. The cash recovered through these savings is available to expand the company, hire more workers or cut prices in order to be more competitive.
12. Other effects are that the county space in its new Subtitle D landfill; the water district can sell more taps from its limited water supply; and the electric company avoids the need to permit a new generating plant as quickly as would otherwise be needed.

The retirees keep involved in their community at a very low cost to the government sponsors. They have the time to become national experts on topics that will benefit local companies. With a typical experience level of 40 years, they also have credibility with plant managers that is difficult for government employees to obtain. They truly are "here to help you."

2. Land-of-Sky Regional Council's Regional Composting Entrepreneurial Feasibility Study

As part of the EPA project to create jobs through businesses and business activities which reduce waste, Council staff has tried to identify strategic business opportunities. Composting was identified as an opportune area for several reasons:

- *Available market:* Our region is home to many farms and a growing number of organic farms and gardens which provide a good market for compost. Additionally, a large retirement population and tourism industry provide use of compost products for landscaping. A strong horticulture industry in the region provides another good market.
- *Economic Leakage:* At the time we began the project there were no local manufacturers of commercial compost. Local stores however, were successfully selling compost products which were produced outside of our region.
- *Problem Waste Material:* Yard waste and other organic material were taking up valuable landfill space despite a state yard waste ban and additional efforts by local solid waste managers to divert organics through a backyard composting project and various mulching and composting initiatives at county landfills.
- *Product with Potential:* Composting was being proved a successful and profitable business in other areas of the state and nation for both the public and private sectors.

A year later, after discussions with potential entrepreneurs, retailers, and consumers, the Council had identified several businesses which could benefit from implementing or expanding compost operations, and a few entrepreneurs who are interested in starting a composting business. A full outline of the *Composting Entrepreneurial Feasibility Study* is found in Appendix 3. The *Feasibility Study* provides a "head start" to composting entrepreneurs on the business planning they will need to do before starting a compost-related business.

Practical Applications of Business Development

The Council has discovered that there is not just one “correct way” to approach the creation of new businesses related to solid waste or waste reduction. In our experience with the EPA project, four different starting points, or paths to business development are emerging.

Four Paths to New Business Creation

The prerequisites for starting a business include:

- Product (or service)
- A market for the product or service
- An entrepreneur or business person
- If -- as in the case of businesses in this guide -- the new business is waste-related, it will be associated with a specific waste material or problem.

A solid waste or waste reduction oriented business can take one or more “paths” toward business development:

1. The Product Path -- in this case, the first awareness of the business developer would be of a new product, or a new application of an existing waste-based product. The use of compost for hazardous waste remediation is a good example of the “product path.”
2. The Market path -- in this case, the business developer becomes aware of a local or regional (or even a remote) market for a product that is -- or could be -- produced locally from solid waste. Compost and related mulch products, for example, are in great demand in the Land-of-Sky Region, but local commercial producers are virtually non-existent.
3. The Entrepreneurial Path -- in this case, the starting point for the business developer is an entrepreneur who is excited about starting a waste-related business. The entrepreneur’s motivation is an important factor, given the difficulties involved in succeeding in a new venture. It becomes the driving force behind the new business startup.
4. The Problem Waste Path -- in this case, the business developer starts by trying to figure out how to deal with a solid waste material that is a particular disposal or contamination problem for local landfill managers. In the composting example, this could be food waste from restaurants or smelly, liquid tomato waste from a packing house operation. Solving the problem created by the waste is what drives the development of the new

The order in which the business developer finds the above components once s/he has started on one path can vary. Although a market is always associated with a particular product or service, the other components may occur in almost any order. Business development is the art of focusing these various factors into a clear course of action to identify a source of capital and develop a business plan.

The Four Paths to business development:

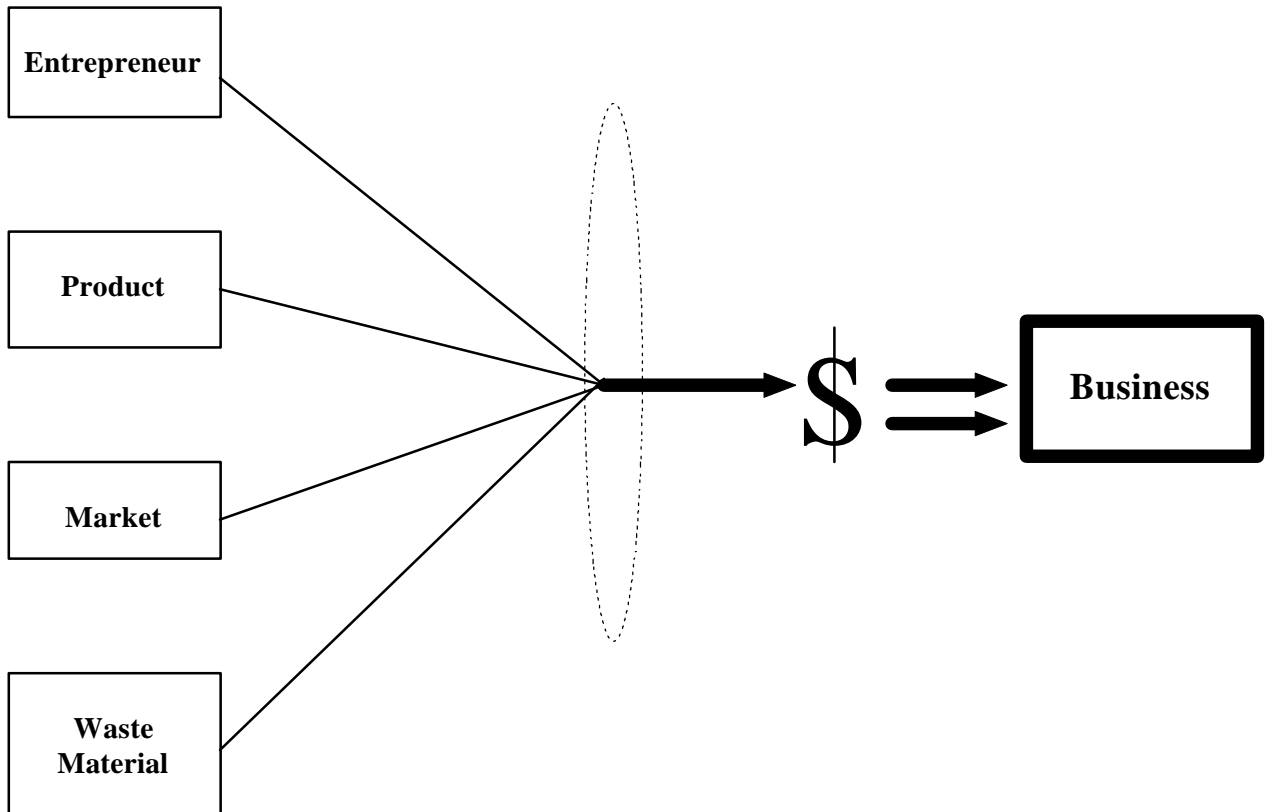

Because of the changing nature of the solid waste field, a good starting point or “path” may not be obvious. For example, waste materials may not be viewed as a business opportunity or feedstock for the manufacturing of other products, until it is identified as a “problem” material at the landfill. For example, an individual or business that composts waste materials as a method of volume reduction, may not recognize it as a potential commercial product.

Whichever “path” is evident as a starting point for business development, business developers must combine it with the other elements to be successful. As the Council learned through its EPA project, this often requires a good deal of research and business planning.

Formal **business planning** is a necessary step in any enterprise. The Small Business Administration (SBA), economic development organizations (such as a chamber of commerce), and private firms provide business planning assistance. A sample business plan outline developed by the North Carolina Cooperative Extension

Exercise to Help Learn Business Development

Excercise 1: To explore the “four paths” to business development (the market approach, the product approach, the problem waste approach, and the entrepreneur approach) in your area, brainstorm as an individual or as part of a group exercise (as usual, more heads are better than one!).

1. Tape four flip chart sheets onto a wall. Entitle each at the top with the name of one of the "four paths:" MARKET PATH; PRODUCT PATH; PROBLEM WASTE PATH; AND ENTREPRENEUR PATH;
2. Beneath the title of each sheet, divide the remaining space up into sections entitled with the names of the other three paths (for example, the three titles on the MARKET sheet would be PRODUCT, PROBLEM WASTE, AND ENTREPRENEUR. Leave room at the bottom of each sheet for a few notes, and entitle this section "RESOURCES;"

MARKET PATH
Product:
Problem Waste:
Entrepreneur:

Resources:

3. Now, brainstorm a specific market for a product or service that is not currently fulfilled in your community or region. Write the market under the MARKET title, and the product under the PRODUCT title on its sheet. Do the same for the PROBLEM WASTE sheet and the ENTREPRENEUR sheet.
4. Go back to each sheet and fill in (through discussion, brainstorming, and perhaps some research) the remaining parts of the sheet. For example, if the MARKET is new homeowners, you might fill in the PRODUCT on that sheet as door mats, the PROBLEM WASTE as used tires, and the entrepreneur as Ms. Ima Risk -- a person looking to start a small business. The other three sheets would be brainstormed out in a similar way, except the starting point on each will be different.
5. The last section of each sheet is entitled RESOURCES. This is to acknowledge that, although markets, products, raw (waste) materials and entrepreneurs are necessary ingredients to create waste reduction businesses -- they are not usually sufficient to do so. So, for each sheet, after you

Tool #4 -- Business Development

page 4.9 :S

- * Capital
- * Business plan

- * Partner(s)
- * Site and/or building

- | | |
|--------------------------|---|
| * Equipment | * Permits or other regulatory requirements |
| * Transportation service | * Management services (e.g., accounting, advertising) |
| * Marketing services | |

Our experience has shown that when we allow ourselves to examine multiple starting points, we are likely to generate more good ideas and contacts for new businesses than if we follow a single, linear approach.

Exercise 2: Identify problem waste materials in the community. Go back to the IWM chapter and make copies of the materials table ("IWM OPPORTUNITIES"). Brainstorm all possible uses of each material, trying to stay as high (as far to the left) on the IWM hierarchy as you can. Be creative -- even crazy uses can lead to useful products. The list of materials you generate can later be used to identify possible opportunities as part of a "S.W.O.T." analysis in a strategic planning process, should you initiate one.

Using Business Development with other tools

Business development may come closer to being defined by you or your community as a desired end result than a tool. If so, the other tools in this guidebook, such as IWM, strategic planning and group problem-solving, may be seen as true tools or means to achieve the end of business development. At the same time, development of new businesses will add vigor and diversity to your local economy and, from that viewpoint, business development is a tool to use toward that end.

Using Business Development with IWM

Theoretically, the more the entrepreneur and the business developer can satisfy the following criteria, the more profit s/he should be able to wring out of the waste stream:

- The greater the distance the new business "moves" the waste material "up" the IWM hierarchy from its current fate the more value it will have. (For example, moving the refrigerator from being landfilled to being re-used should be more profitable than moving it from being landfilled to being recycled as scrap metal).

So, "where does source reduction (the highest level in the IWM hierarchy) fit in?" Theoretically, the greatest value recovery available would be to take an item currently being landfilled and devise a way for it not to be manufactured in the first place. The Land-of-Sky WRATT program is in fact helping industries to maximize their profits via source reduction.

- The more transportation and processing that the business avoids or eliminates, the more cost is recovered from a material. (e.g., if the homeowner who bought a new refrigerator drops off the used refrigerator at the business' refurbishing shop, and keeps it from getting damaged in the process, it will be more profitable than if the refurbisher plucks the hapless machine from the landfill face after the

Tool #4 -- Business Development

page 4.10^w_n

for the used refrigerator.

- The greater the volume (not the weight) the material would have taken up in the landfill, the more cost avoided by the community (landfill owner); and the more incentive the community has to help the

entrepreneur's business succeed (maybe even to the extent of paying him/her to remove the item or material from the waste stream!);

Using Business Development with Strategic Planning

Strategic Planning can work well with Business Development because **strategic positioning** can be part of business planning, too. Taking a strategic look at the local or regional economy can suggest **strategically-important business opportunities**. If they truly are strategic (i.e., high-impact), then these opportunities may involve:

- greater profit
- greater risk
- more incentive from local governments to support the new business (as a solution to an important waste problem or goal)
- a better market when compared to non-strategic business opportunities.

Using Business Development with Group Problem-Solving

Entrepreneurs are often reluctant to disclose business planning strategies to potential competitors. However, in situations where an entire industry, not just a business niche, is missing in a region, entrepreneurs may be not only willing, but feel it necessary to collaborate with other entrepreneurs or existing businesses in order to make the whole industry succeed (and therefore, to make their niche succeed). In such a case, group problem-solving and facilitation is a very useful tool (e.g., to conduct a facilitated meeting of entrepreneurs, financiers, scientists, marketers, feedstock providers, etc., to get a composting “industry” started in a region where it is absent).

Another example of collaboration in order to bring the strengths of two or more very different parties to bear on an economic opportunity is the public-private partnership. For example, a local government contributes materials it collects, along with a building, and a private materials processor/broker operates a MRF in the building, taking advantage of its fleet of trucks and its knowledge of the markets. Profits are thereby shared. The local government's costs are reduced, and the private firm gets profits and a “green” image. Bringing such different partners together can certainly be enhanced by small group process and good public involvement process.



Tips for Business Development :

Look for alternative ways to approach the "Four Paths." For example:

1. Entrepreneurs -- go to conferences on recycling, solid waste management, composting, etc.

- Talk to people. Put out the word that you're looking for "a few good entrepreneurs" (or -- in the case of composting, *entremanures*). Pass out your card. Print up an original business card advertising your search for waste reduction business people.
- Offer scholarships to conferences for locals who want to be waste reduction entrepreneurs. After the conference, meet with each about his/her business idea and what s/he needs to make it work.
- Contract with an existing businessperson to counsel other prospective waste reduction entrepreneurs; better yet -- set up a team of counselors, including a seasoned businessperson; a business planning service provider; a financier; and a solid waste expert or two.

2. Markets -- contact the nearest Waste Exchange to see what's in demand that you might be able to supply locally.

- Find a directory of industries in your region; many such manufacturing directories include a list of feedstocks these industries need. Go back to your IWM OPPORTUNITIES table (the one filled out with materials in your waste stream), and try to identify materials that could substitute for the ones in the directory.
- Go through the Yellow Pages. Look at products and services offered. Identify any waste-related services needed in your region which are not being provided.

If you have done Strengths/Weaknesses and/or Opportunities/Threats listings during the Strategic Thinking & Planning chapter, keep them handy as you seek business development opportunities!

NOTES:

What do we mean by "Regional Approach?"

Generally, a "regional" approach means multi-jurisdictional. In North Carolina, most public solid waste management is handled at the county level -- so it is not usual to call a group of towns or municipalities "regional" unless they are in different counties and unless the county governments are also participating. So, in North Carolina, "regional" solid waste management usually means multi-county. Different numbers and configurations of counties -- nearly always geographically contiguous -- are involved in different regional configurations:

- Council of Governments or Regional Planning Commission regions;
- Economic Partnership mega-regions (ours has 22 counties);
- State agency field office regions; and so on.

For purposes of this guidebook on waste reduction tools, a better definition of "regional" approaches might be:

Approaches in which two or more solid waste management systems are working together in some way.

Why Consider a Regional Approach?

Two or more solid waste management systems may chose to combine all or parts of their operations for one or more of the following benefits:

- **Economies of Scale** -- some aspects of solid waste management are particularly conducive to economies of scale. For example, due to the large one-time costs of siting, permitting, access road development, and closure and post-closure monitoring, landfilling is subject to large differences in cost per ton disposed, based upon the total size of the facility and the tons per day buried.
- **Inherent Advantages** -- one waste system or county may be better-suited to handle a particular waste than another, or may have more land available for a large, more efficient landfill. Neighboring counties may share in the advantage at a contract cost less than their cost of disposal in their own landfills. The advantages of developing activities in one county as compared to another could as easily be in some aspect of waste reduction as in landfill disposal. For example:

County A has a large abandoned building which is perfect for a Materials Recovery Facility (MRF). It sets up a MRF and accepts the recyclables it needs to reach a marketable volume from three surrounding counties -- none of which could have established a MRF as cheaply as County A. All three counties share equitably in the savings, reducing the waste reduction costs for all three.

- **Administrative Efficiency** -- or "administrative equivalent of economies of scale." This means that the staffing, administration, and financial functions of solid waste management or waste reduction operations for several counties could be consolidated in one place. This could create savings by eliminating duplicate positions doing the same functions, etc. A North Carolina example of this is the Regional Solid Waste Authority, the structure of which is set out in state enabling legislation. The Coastal Regional Solid Waste Management Authority covers three counties in coastal North Carolina, and manages most functions of solid waste management in those counties.

Downsides of Regional Approaches

Regional approaches sometimes have disadvantages in the context of this guidebook:

- Potential conflict between the economies of scale and the ecological goals of IWM. An example is air pollution and the wasted energy from hauling waste long distances to centralized processing or burial facilities.
- Public sensitivities to accepting waste from other political subdivisions or solid waste systems can make regionalism a politically "hot" issue.
- Where regional approaches require large, expensive debt-financed facilities (such as regional landfills, incinerators, or tunnel reactor composting systems) for which the debt service is funded by tipping fees, such facilities could be rendered infeasible by flow control legislation or judicial decisions.
- Different parties (e.g. counties) in a potential regional arrangement may not be ready to enter into an agreement at the same time for a number of reasons: one county may not currently have the funds necessary to "buy in" to the arrangement; another may be distracted by a crisis on another front; and another may have just constructed a new landfill or waste reduction facility and not feel it has enough of a solid waste problem to justify their joining a regional arrangement.
- Counties may not be willing to sacrifice their independence in order to reap the benefits of a regional agreement.

Factors Affecting Regional Approaches

Some considerations in evaluating regional options:

- Based upon the current waste management plans of each of the counties or other local governments, and their natural or inherent advantages, what parts of the total solid waste management systems could produce benefits if combined?
- Does the legal means exist for a current governing board (e.g., board of county commissioners) to bind a future governing board to a regional arrangement in your state?
- Such regional arrangements could be:
 1. New public regional landfill in region
 2. New private regional landfill in region
 3. Use existing public landfill(s) as a regional landfill(s) (possibly on a rotating basis).
 4. Continue the current solid waste management situation and plans of each system
 5. Ship waste out of county/out of region

- Economic considerations:
 - Small host-county landfills which accept waste from several counties will be used up quickly, particularly if there is no waste reduction component as part of the overall waste management system. This consideration affects cost per ton disposed, timing of any rotation, and public acceptability.
 - Using small county landfills on a rotating basis would eliminate the opportunity to achieve the economy of scale which otherwise could be the main benefit of a regional approach.

- Strategic questions:
 - If counties utilize one or more of the private hauling contract options (e.g., option #5 above) and "go out of the solid waste landfill business," they will be unable to get back into landfill operation quickly due to the lead time required to site, permit, finance and construct a facility. If the private sector company raises rates due to (a) moving to a more expensive Subtitle D landfill; or (b) a regulatory shutdown of a mega-landfill, or if it otherwise fails to provide the expected hauling and disposal services, the counties will be faced with a major crisis.
 - Until the flow control issue is settled in Congress (see Environmental Scan below), local governments cannot take the risk of siting and constructing large waste reduction or disposal facilities which rely upon tipping fees for debt service and operation and maintenance. Since large landfills serving entire regions may be a key to keeping the public sector competitive and "in the solid waste business," counties are in a difficult position at this time. One way to solve this problem is to fund solid waste operations out of a local government's ad valorem tax revenues rather than tipping fees -- a strategy fraught with other problems such as raising ad valorem tax rates.

- Public process considerations:
 - A regional landfill may be difficult to "sell" to local elected officials unless packaged with waste reduction. The general assumption is that no county will accept another's Municipal Solid Waste without being convinced that it has been reduced as much as possible -- even if a rotating arrangement is in place and tipping revenues and other financial participation are attractive to the host county.
 - Composting, household hazardous waste collection, or other forms of large-scale regional waste reduction may not be acceptable to the public, either. These facilities also can be costly and still involve bringing out-of-county solid waste into the host county.

- Difficulties inherent in the current flow control situation:
 - If counties finance solid waste management out of their ad valorem tax revenues in order to remain in the landfill business despite not being economically competitive with the private sector, they may have to raise tax rates or de-fund other services which cannot be put onto a user fee basis. They also are open to question about using the taxpayer's dollars to subsidize inefficient government services in an era of increasing public scrutiny, fiscal conservatism, and privatization.
 - Both the mega-landfills and the ad valorem funding option for solid waste management work against IWM and waste reduction:
 - Mega-landfills can involve long haul distances (with environmental consequences for air quality and energy use).
 - The cheap availability of landfilling (the lowest IWM option) works economically against communities or private companies wanting higher-IWM options involving waste reduction. A mega-landfill owner /operator with a large debt service may find it more economically beneficial to collect tipping fees for organics and recyclables going into the landfill than to divert these materials from the landfill.
 - The inability of local governments to use tipping fees to fund large new waste reduction facilities also works against IWM -- at least until flow control is settled.
 - Finally, if some communities are forced to pay for their solid waste disposal or reduction operations out of county-wide ad valorem taxes, it removes the "user pays" incentive normally available in a tipping fee system for the waste generators to reduce their solid waste. In other words, the link between the amount of waste they generate and the fee they pay to dispose of it is broken.

Example of a Regional Approach

The following graph was developed as part of a study currently being conducted by the Land-of-Sky Regional Council to examine the costs and benefits of a regional approach to solid waste management. The study includes a survey of estimated landfill costs from around the southeast which revealed that landfill costs per ton buried decrease as the number of tons per year increases. In other words, the more waste available, the cheaper it is per ton to dispose of. The graph plots the cost per ton against tons per year disposed, for the landfills which were surveyed.

In this case, one rural county may not generate enough waste to be cost-effective in its waste disposal, but two or more counties which pool their waste together may be able to achieve a decreased cost per ton.

Estimated Landfill Costs

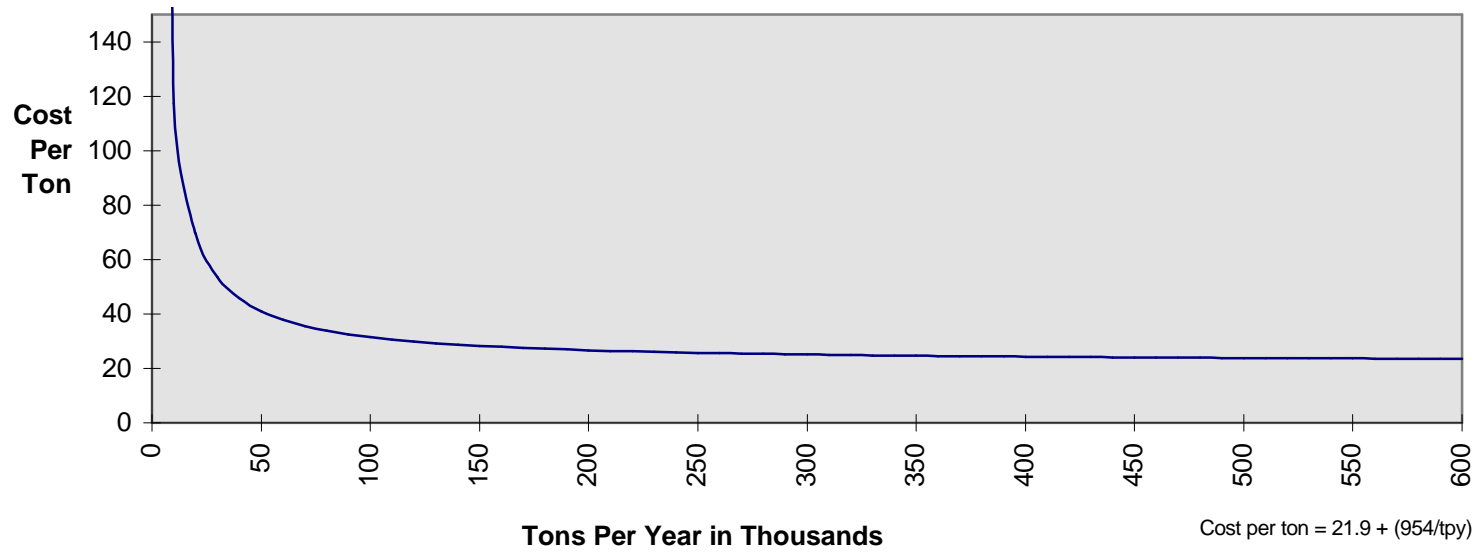

Source: *Regional Solid Waste Options Study*, Land-of-Sky Regional Council (Region B, North Carolina), 1995 (11)

A Practical Application of a Regional Approach (and Use with other Tools)

A Regional Approach Using Strategic Thinking & Planning

Because of the high-stakes, rapidly-changing environment in which local government solid waste managers and the communities they represent find themselves nowadays, solid waste management is an ideal candidate for strategic thinking and planning. The following is an excerpt from the Council's RDA-RUS project in which staff did an **external scan of two important opportunities/threats**. It illustrates Step #4 of the strategic thinking/planning process laid out in the second chapter of this guidebook.

1. External Scan of two high-impact solid waste management issues.

Background

This "external scan" reports on the probability of occurrence, impact upon our region, and "influenceability" of several trends and developments listed as high-impact by local elected officials, county managers and solid waste staff in November, 1994. The research described below was done in the spring of 1995 and some conditions may have changed since then. This excerpt is included in the guidebook as an example of using strategic planning principles to guide regional approaches, and not as an up-to-date external scan as of publication of this guidebook.

Purpose

This scan represents the strategic element of the Region B decision-making process to determine the best approach to regional cooperation in solid waste management. The trends and forces herein will be the "external environment" in which regional strategies and facilities will operate. When the scan is completed, it should give the region the information needed to position ourselves for successful ventures. The subsequent step of the strategic thinking process will assess the region's strengths and vulnerabilities with respect to the external forces. The planning group can combine the information in the external (trends and developments) analysis, the internal (strengths and weaknesses) analysis, and the cost (spreadsheet) analysis to come to strategically valid decisions about ultimate disposal and waste reduction.

Logical Outline for the External Scan (Step #4 in strategic thinking/planning process)

- **Name of Trend, Development or Issue**
 - **Description of Trend, Development or Issue**
 - **Assumptions about the Trend, Development or Issue** (What assumptions do we hold about the impact and predictability of this trend or development? Is it an opportunity or a threat?)
 - **Reality-Testing the Assumptions; or, Probability of Occurrence/Continuation of Trend** (are our assumptions correct?)
 - **Impact of Trend, Development or Issue** (how high an impact will this trend or development have upon our ability to manage and reduce solid waste in our region?)
 - **Can the Trend be Influenced to Advantage?** (i.e., can we change the course of this trend, or the way in which it develops, to make it more advantageous to our region?)
 - **Positioning Considerations** (what can our counties do to position the region for success in light of this external trend or development?)
-

Trend, Development or Issue #1:

FLOW CONTROL

Description of Trend or Issue

Economies of scale are the major reason to consider regional cooperation in solid waste management. The large facilities required to achieve such economies of scale under some regional approaches often require debt financing. The guaranteed revenue stream needed to support debt service and cover operating costs requires the local government or solid waste authority to be able to reliably direct a predictable percentage of the solid waste within its jurisdiction to the regional facilities in order to collect the tipping fees. The inability to control this flow by local ordinance allows competing solid waste operators to capture all or a portion of the flow if they can perform the same services for a lower cost. Such loss of tipping fees threatens the economic viability of the facility.

Since the May, 1994 decision of the U.S. Supreme Court in the *Carbone vs. Clarkstown* (New York) case that flow control violates the Interstate Commerce provisions of the Constitution, Congress has become involved in a legislative attempt to resolve the flow control issue.

Assumptions & Predictions about this Trend

1. Some solid waste managers assume that "legislated flow control" will be available to all local governments soon. This would represent an opportunity to proceed with tipping fee financing schemes for large solid waste facilities.
2. Others assume that "economic flow control" (i.e., controlling the flow of waste other than through a flow control ordinance) is the only safe way to do it. This views legislative action by Congress as unfavorable to local government, and would represent a threat.
3. Staff assume that flow control is a very high-impact issue for both solid waste disposal and waste reduction in our region.

Probability of Continuation of the Ability of Local Governments to Control Flow

The prediction that flow control will be available to local governments appears to be correct -- but so far only for local governments that are grandfathered by Senate Bill 534 (adopted in May 1995) and the most likely House Bill (HR 1085/the "Oxley Committee Print"). The only governments grandfathered are (1) those which already have flow control ordinances in place and which have outstanding debt on facilities which depend upon flow control revenues to pay it off, and (2) several states and local governments covered by "special situation" amendments such as Mecklenburg County, NC. Furthermore, the grandfathered facilities may only use flow control until their debt is paid off. Since none of our local governments in Region B is included in either of these categories, the most likely version of legislated flow control will not be an immediate benefit for Region B.

The August, 1994 issue of *BioCycle* magazine lists several alternatives to legislated flow control which local governments can use:

1. Contracts for delivery of waste to its facilities;
2. Take over the collection itself. Our regional solid waste official considers this to be the only guaranteed alternative to legislated flow control. Forsyth County, NC is taking this approach.
3. Create franchises and competitively bid the collection rights with the understanding that the solid waste goes to their facility. One solid waste official believes franchising will be the next flow control method to come under attack (and to fall), after the current congressional action is completed.
4. Build its facility with tax revenues, and use the consequently lower revenue stream requirements (i.e. no debt service) to set lower tipping fees than private companies;
5. Use hauler licensing agreements to direct the flow of waste. The Coastal Regional Solid Waste Management Authority (Carteret, Craven & Pamlico counties, NC) uses a licensing system within its three counties, and has inter-municipal agreements with the 25 municipalities therein, in which they agree to use the same system. In return for a line of credit, the hauler agrees to deliver all waste to CRSWMA's facilities. This is voluntary, and legal, for now. However, this too, may come under attack eventually.

Impact of Trend, Development or Issue

The above developments suggest that legislated flow control will not be among the tools our local governments will have available to support regional solid waste management systems. Furthermore, challenges to various "economic flow control" options are expected, so our region may be in limbo for some time to come as to whether any flow control options are available, other than sheer free-market economic competitiveness. Therefore, the assumption that flow control is a high-impact issue seems accurate, given the types of funding and financing mechanisms traditionally used for regional-scale facilities.

Can the Trend be Influenced to Advantage?

It appears that the current legislative process cannot be influenced to the advantage of our counties, since neither the adopted Senate Bill (SB 534), the bill moving through the House Commerce Committee, nor the potential amendments to same contain prospective flow control for non-grandfathered local governments. Furthermore, only one member of the House Commerce Committee is from North Carolina, and is not from our district.

Positioning Considerations

The above-described trend from legislated flow control to a free-market system suggests that the region should position any regional solid waste management system(s) as far toward the free-market approach as possible to avoid the system being weakened by future developments.

Trend, Development or Issue #2:

**LANDFILL REGIONALIZATION & REGIONAL
SOLID WASTE AUTHORITIES**

Description of Issue

This issue arose out of a discussion on the legal means by which a board of county commissioners in North Carolina could enter into a binding agreement with other local governments to conduct regional solid waste management activities. A specific question was the extent to which a current governing board can bind future boards to a rotating host arrangement, or to long-term participation in other types of regional agreements.

Assumptions about this Issue

The Regional Solid Waste Management Authority can provide the legal means to enter such binding contracts (in the State of North Carolina). This assumption, if correct, means that the regional solid waste management authority should be considered as an opportunity.

Reality Check of the Assumption

A check with the Institute of Government of the University of North Carolina revealed that contracts, franchises, licenses, etc. entered into by a current county board of commissioners are as binding upon future boards as they would be in a private sector situation. If a party to such an agreement violates terms of the agreement (e.g., refuses to take its turn as host county for a rotating regional landfill arrangement), the remedies written into the agreement would determine what penalties would occur.

G.S. 153A-421 to -432 (Article 22) of the North Carolina General Statutes deals with Regional Solid Waste Management Authorities. It became effective July 11, 1990. Under this legislation, regional authorities are not given specific powers, but local governments may give an authority any of a list of 25 solid waste-related powers which the local governments themselves have by law (including flow control). The charter of an authority (either an existing one, or one which a local government forms with at least one other local government) is in itself a binding agreement in that a (county) can only withdraw from the authority if the authority has no outstanding indebtedness. Although some interpret this as meaning that a county wishing to withdraw would have to pay off its own share of the authority's debt before withdrawing, others take it to mean that all debt of the authority must be retired before even one member can withdraw.

The authority can only be dissolved if fewer than two counties remain as members. The authority will have a charter and by-laws describing the mutual agreements of the member counties (such as closing their own landfills and using authority facilities, or, presumably, rotating as host county for a regional landfill). The authority can also enter into long-term contracts of up to 60 years with its member governments and/or other local governments.

During the "reality-check" process, LOSRC staff learned that two of the options -- using existing county landfills as regional landfills, or developing a new regional landfill on a rotating basis -- will not provide the economies of scale necessary to make a regional approach attractive in the first place. A key to the economy of scale of a large landfill is only needing to incur the siting, permitting, design, closure and post-closure costs one time over a relatively long life cycle. Rotating through a series of smaller landfills would defeat the purpose of regionalism. Our staff is developing a spreadsheet analysis which will provide a way to check this prediction, and to quantify the breakover point (in tons per day disposed) for cost-effectiveness.

Impact of Trend, Development or Issue

The North Carolina General Statutes do provide counties with an effective means of binding themselves, and future boards, to regional solid waste agreements. The effectiveness of the Regional Solid Waste Management Authority legislation will now be limited by its flow control provisions if Trend #1 above evolves as predicted.

Can the Trend be Influenced to Advantage?

There appears to be no need to influence or try to change at this time the provisions of this statute which govern the ability of counties to bind future boards of commissioners to regional solid waste arrangements.

Positioning Considerations

The position of North Carolina counties to form a regional solid waste management authority appears to be secure. Changes to the North Carolina Solid Waste Management Act proposed to date by state HB 859 do not include any revisions to the regional authority provisions.

2. Using a Regional Approach for Strategic Advantage

Role of the growth center

The growth center concept (i.e., looking at a rural region as an urban or urbanizing center of some size, with surrounding, less developed rural areas) is one element of regional approaches which is well suited to strategic planning -- for solid waste and other services. Many of the resources and capabilities with which a multi-county region will address emerging trends and developments will be located in the growth center, or urban "hub" of the region. Banking and medical centers are two examples of such resources. The growth center may be the site of strategic infrastructure development for the entire region, including centralized solid waste and waste reduction facilities. Regional strategic solid waste planners must carefully articulate the benefits to the outlying and distressed areas of the region, and must be sure that these areas are well represented in the planning process.

Sharing the wealth

What if a regional strategic planning process reveals that all the solid waste projects in the region that are truly "strategic" fall within one county, or within the regional growth center? How do county priorities relate to regional priorities?

Regional Planning organizations like the Land-of-Sky Regional Council are usually sensitive to serving all communities and government units in their regions fairly. There is usually some norm--explicit or implicit--about what constitutes a fair allocation of resources (such as grant funds, free planning assistance, etc.) to each community. Resources--or seats on a planning team--may be allocated by population, one vote per county, one vote per town, or the like. But the planning group must try to ensure that everyone is treated in a way considered fair within the culture of the region.

In a regional strategic planning process, the appearance of fairness can be jeopardized because issues and strategies that are truly strategic **for the region as a whole** will not necessarily follow traditional norms of equitable resource allocation. At the individual county level, economic development niches, strengths and strategies may be very different than the regional strategies with which the regional planning organization is concerned. In fact, in some sectors of the local economy, the other counties in the region may be seen by the planning county as economic competitors or potential threats.

How should the regional strategic planning group deal with this challenge? It should carefully develop and articulate a regional solid waste strategy, and not attempt to follow traditional allocation of projects or resources. A regional strategy will deal with positioning the region as a whole for future success--to shape the future of the region taken as a whole. This is not to say that the member governments or communities cannot reach agreements about how to balance revenues or payments among counties if fairness requires it.

The planning group must convincingly make the case that every citizen of XYZ County is also a citizen of the entire district. In today's turbulent and unpredictable economic environment, **looking after one's own county must include looking after the surrounding region**. As in other parts of the natural world, competition and cooperation co-exist among neighbors. It is OK for neighboring counties to be in economic competition in certain ways, and it is all right--in fact, almost certain--that the regional strategic plan will not be the same as the strategic plan of any of its individual counties.

To be able to understand, accept and support regional strategies, individual communities and other interests must understand this and not expect a traditional slicing of the economic development resource pie. Similarly, as countries consider combining their assets and resources for regional solid waste management, the regional solid waste planners must be able to encourage individual counties to let go of their "not in my back yard"/"not in my county" protectionism in favor of the benefits their county will enjoy because of the regional approach.

Exercises to Help Learn Regional Approaches

Exercise 1: Get a group of elected and solid waste officials together from a multi-county region or from several solid waste management systems, using the guidelines from Tool #3 on "Who should be included in a meeting," etc..(see caution below!) Use the strategic thinking and planning model suggested in Tool #2 to set up a 2-4 hour session to analyze the regional solid waste situation based only upon the existing knowledge of the participants. Identify items, topics and issues that will require further research in order to make good strategic decisions.

In doing this exercise, pay attention to the following:

- Public-private joint ventures
- Public-sector opportunities
- Private-sector opportunities
- Internal strengths -- especially focus upon what strengths each county or community brings to the multi-county area that the others do not have.

Caution:

This exercise is structured as a "real-life" decision-making process, for learning purposes. The advantage of using real facts, data, and problems is that the decision makers may be more motivated to learn these new skills in order to help solve their real-life problems. A potential disadvantage of using such real-life situations is that a group assembled for training purposes may not include all of the real-life interests -- so that if the training group decides to continue with its planning after the training, key people will have been excluded from the beginning.

Then, as the group decides when to let the public know of their activities, someone may suggest that they should "get farther along before going public" so they know they have a viable idea. Another argument may be made that, "we have to give the public something concrete to respond to, so they'll know what we're talking about." This is the classic public involvement dilemma -- it always seems too early to go public -- when in reality, it's already too late! The training group has unintentionally begun a regional solid waste planning process without informing the public and/or involving all affected parties.

The farther along the group gets in its thinking without opening up to a full-scale public involvement process, the greater the danger of committing one -- or more -- of the public involvement pitfalls discussed in the chapter on Tool #3.

NOTES:

Appendix 1 -- Blank Forms and Overheads

The following “blank forms” are intended for the reader’s use. They may be photocopied as needed for educational or training activities and/or for actual tool applications.

Tool #1 -- Integrated Waste Management

1. The Integrated Waste Management Hierarchy (*p. 1.2*)
2. IWM Definitions of Top 4 Levels (*pp. 1.1-1.2*)
3. 8 Principles for Using IWM Concepts in Rural Communities (*pp. 1.6-1.8*)
4. IWM Opportunities Table (*pp. 1.8-1.11*)

Tool #2 -- Strategic Thinking and Planning

1. Characteristics of Strategic Planning (*p. 2.2*)
2. 11 Steps in Strategic Planning (*p. 2.3*)
3. Impact/Probability Grid (*pp. 2.7-2.8*)
4. Impact/Feasibility Grid (*pp. 2.7-2.8*)

Tool #3 -- Group Problem Solving and Public Involvement

1. Core Values of Effective Groups (*p. 3.2*)
2. 9 Principles for Effective Groups (*pp. 3.2-3.3*)
3. Interest Group Analysis Form (*p. 3.8*)
4. Problem Solving Flow Chart (*p. 3.9*)
5. Generic Agenda (*p. 3.10*)
6. Core Values “Check” (*pp. 3.12-3.13*)

See <i>Groundrules for Effective Groups</i> by Roger M. Schwarz, in

Tool #4 -- Business Development

1. 4 Paths to Business Development (*p. 4.6*)
2. Brainstorming Form for Business Development (*p. 4.8*)

Tool #5 -- Regional Approaches

1. Outline for an “External Scan”

Integrated Waste Management Hierarchy

SOURCE REDUCTION

REUSE

RECYCLE

COMPOSTING

**INCINERATION WITH ENERGY
RECOVERY**

**INCINERATION FOR
VOLUME REDUCTION**

**OTHER FORMS OF
VOLUME REDUCTION**

LANDFILLING

- Most Efficient
- Least Wasted Economic Value
- Least Ecological Damage



- Least Efficient
- Most Wasted Economic Value
- Most Ecological Damage

“Top” IWM Levels Definitions

Source Reduction -- Strategies that reduce the total amount and/or toxicity of materials entering the waste stream. Also referred to as “waste prevention.”

Reuse -- The use of a product more than once in its same form for the same or similar purpose.

Recycling -- The process by which materials otherwise destined for disposal are collected, processed, remanufactured, and purchased as new products.

Composting -- The controlled process whereby organic materials are biologically broken down and converted into a stabilized humus material.

8 Principles for Using IWM in Rural Communities

Principle 1 -- Search for value

Solid waste only becomes "waste" when people lose sight of its value. Find the value and redirect it back into the community.

Principle 2 -- Start upstream

Intercept a would-be waste item as far "upstream" as possible after its initial use.

Principle 3 -- Use the IWM hierarchy to retain value

The Integrated Waste Management hierarchy gives us a systematic way to search for the value in would-be waste items.

Principle 4 -- Start where the community is

Each rural community -- and each person, business, institution and local government in the community -- has its own unique culture and way of looking at solid waste and its economy. Planners should be sensitive *to what motivates each waste generator, and encourage innovative, localized solutions.*

Principle 5 -- Keep materials separated

Mixing unlike solid wastes together often contaminates otherwise useful materials and reduces their value. It also causes additional processing to be done to re-separate the materials farther "downstream."

Principle 6 -- Minimize handling, transportation and processing

The earlier in the "waste stream" an article or material can be intercepted and returned or diverted to its next use, the more money the community saves in hauling and handling costs -- including vehicle fuel and its polluting effects, labor, and equipment costs.

Principle 7 -- Start with the low-tech, low-cost, flexible solutions

Low-tech solutions usually cost less to put in place and less to abandon, dismantle, or alter if they are no longer viable.

Principle 8 -- Measure results in a meaningful way

In order to monitor the success of a rural community's solid waste management strategies, it must first *measure results against the objectives the community intended to achieve.* Secondly, it must *measure the total costs and benefits in some agreed-upon way.*

IWM Opportunities Table

{PRIVATE }Waste Stream Component	Source Reduction	Re-use	Recycling	Composting	Incineration	Volume Reduction	Landfill
Paper:							
Newsprint							
Office paper							
Magazines							
Paperboard							
Kraft paper							
Corrugated							
Wood:							
Wood waste							
Yard waste							
Other organics:							
Food waste							
Manures							
Fish waste/mortalities							
Poultry waste/mortalities							
Livestock waste							

IWM Opportunities Table

{PRIVATE }Waste Stream Component	Source Reduction	Re-use	Recyclin			Volume Reduction	Landfill
Natural textiles							
Plastic:							
PET bottles							
HDPE natural							
HDPE colored							
PVC bottles							
Polypropylene							
Polystyrene							
Other rigid plastic							
Film plastic							
Glass:							
Clear							
Green							
Brown							
Non-container glass							
Metals:							
Ferrous cans							
Other ferrous							
Aluminum cans							

[PRIVATE] Waste Stream Component	Source Reduction	Re-use	Recycling	IWM Opportunities Table			Volume Reduction	Landfill
Other Aluminum								
White goods								
Textiles that won't degrade easily								
Rubber								
Batteries								
Diapers								
HHW								
Tires								
Construction & Demolition Debris								

Characteristics of Strategic Planning

1. **A look outward at forces**, threats, trends and opportunities which are beyond the organization's or community's control, but which, if they occur, will have a large impact on its future. "How can we take advantage of opportunities? How can we minimize the harmful effects of threats?"
2. **A focus on a few critical issues and goals** that are the most important in determining the organization's future performance. This requires difficult choices. "What are the two or three things that will really make a difference in our community, county, region, or solid waste management system?"
3. **A near-future focus**, such as: "What can the county do over the next few years that will position us for top performance and financial stability in our solid waste operation in the long term?"
4. **A realistic assessment** of the resources available to carry out the desired strategies. "What strengths does our community have with which to address the highest-impact external opportunities presenting themselves to us? What weaknesses will make it difficult to position ourselves for success unless we strengthen them or select strategies which do not depend on them?"
5. **An action orientation**. Sometimes comprehensive plans are so massive and complex that they "sit on the shelf" and never get implemented. A strategic plan, however, sets out specific action steps and "actors" to ensure that the strategies are carried out. Actions are monitored for success, and a periodic review (typically once a year) is done to see if the strategies are still relevant and if they need to be altered.
6. Strategic planning is **opportunistic**. It's about taking advantage of current trends and timely opportunities.
7. Strategic planning **positioning** your organization to succeed in a rapidly-changing, turbulent environment; or, as they say in hockey, "skating to where the puck *is going* to be."

Steps in Strategic Planning (not necessarily in the order shown!):

1. Review the organization's **vision** of the desired future: how do we want our community's solid waste operation to look 10 years from now? (create or revise a **vision** statement)
2. What other organizations will you need to work with to make the vision become a reality?
3. What is your organization's specific role or **mission** (niche?) in making the vision become a reality? (create or revise a **mission statement**)
4. **Scan the external environment** for **change drivers** (forces, trends and developments that drive change). Which ones of these represent **opportunities** or **threats**? Potential **strategic issues** usually arise in the form of an opportunity or threat.
5. Prioritize the potential strategic issues according to their **impact** on your solid waste operation, and the **probability** that they will unfold as predicted. Screen out operational issues, and other issues that are judged to be of lower impact or lower predictability.
6. Analyze your organization's **strengths** and **weaknesses** with respect to taking advantage of the highest-priority opportunities, or blunting or dodging the highest-priority threats.
7. Do an **impact-feasibility plot** to select **strategic initiatives**.
8. Enlist **experts** who have data or knowledge critical to the initiative, and **partners** who have resources, roles, positions or influence critical to implementing the initiative, to join your planning or thinking process so the plan becomes theirs too.
9. Develop an **action plan** for each initiative proposed (*objectives = the "what;" strategies = the "how;" action steps = the "who, when, how much money, and whose \$\$" for each.*)
10. **Act!** Start immediately to carry out the action plan. The best strategic action plans are ones that the partners start implementing them before the plan is even completed.
11. **Monitor** progress, **track** external developments and changing internal capabilities, and **revise** the plan periodically to keep it in line with reality.

Impact/Probability Grid

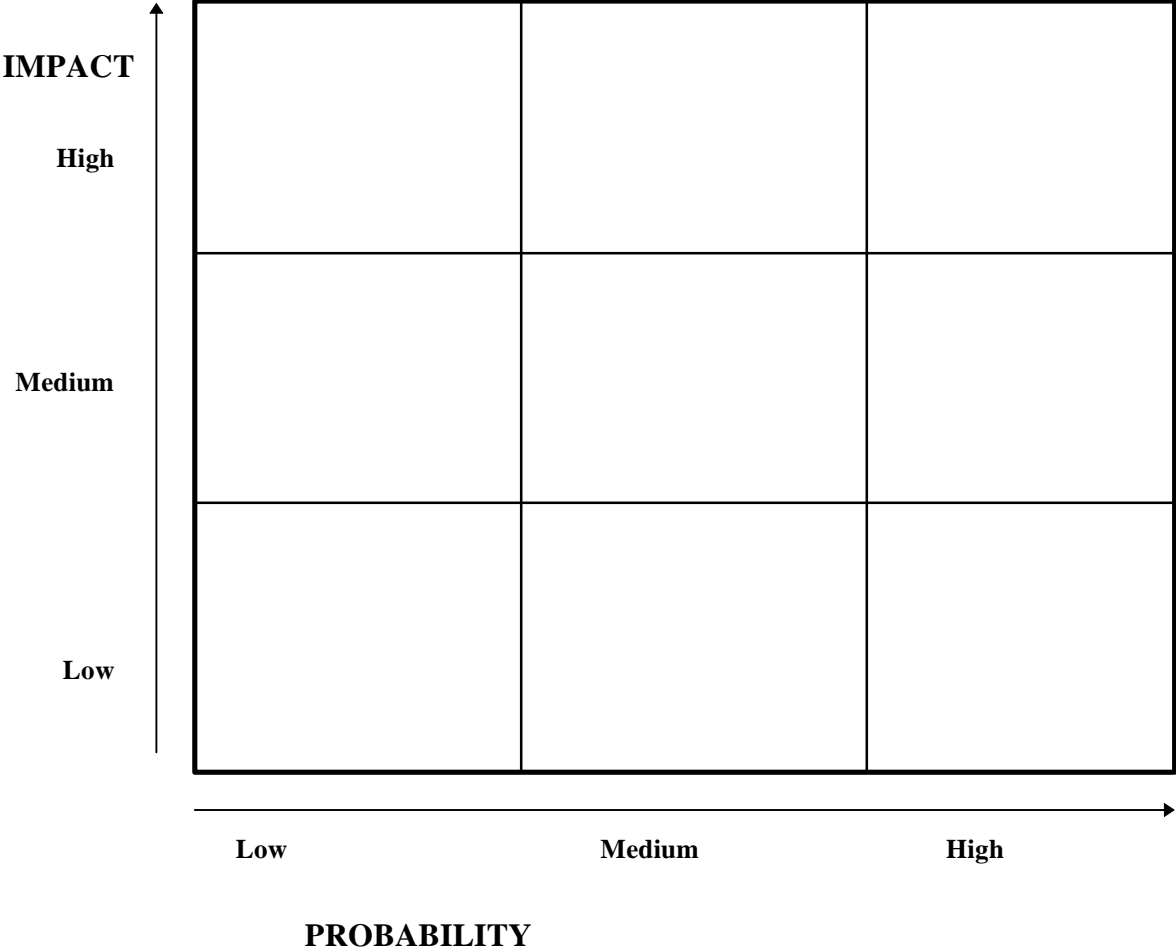

The vertical axis measures relative **impact** -- that is, importance to your community or your solid waste reduction program. In other words, an issue, trend or opportunity which will have a greater effect (impact) -- positive or negative -- on the success of your program will plot higher than one of less critical impact. The horizontal axis measures **probability** -- that is, how likely is the trend, opportunity or threat to unfold or occur as you have predicted it? A more certain, highly-predictable trend or economic force will plot farther to the right than a more unpredictable one.

Impact/Feasibility Grid

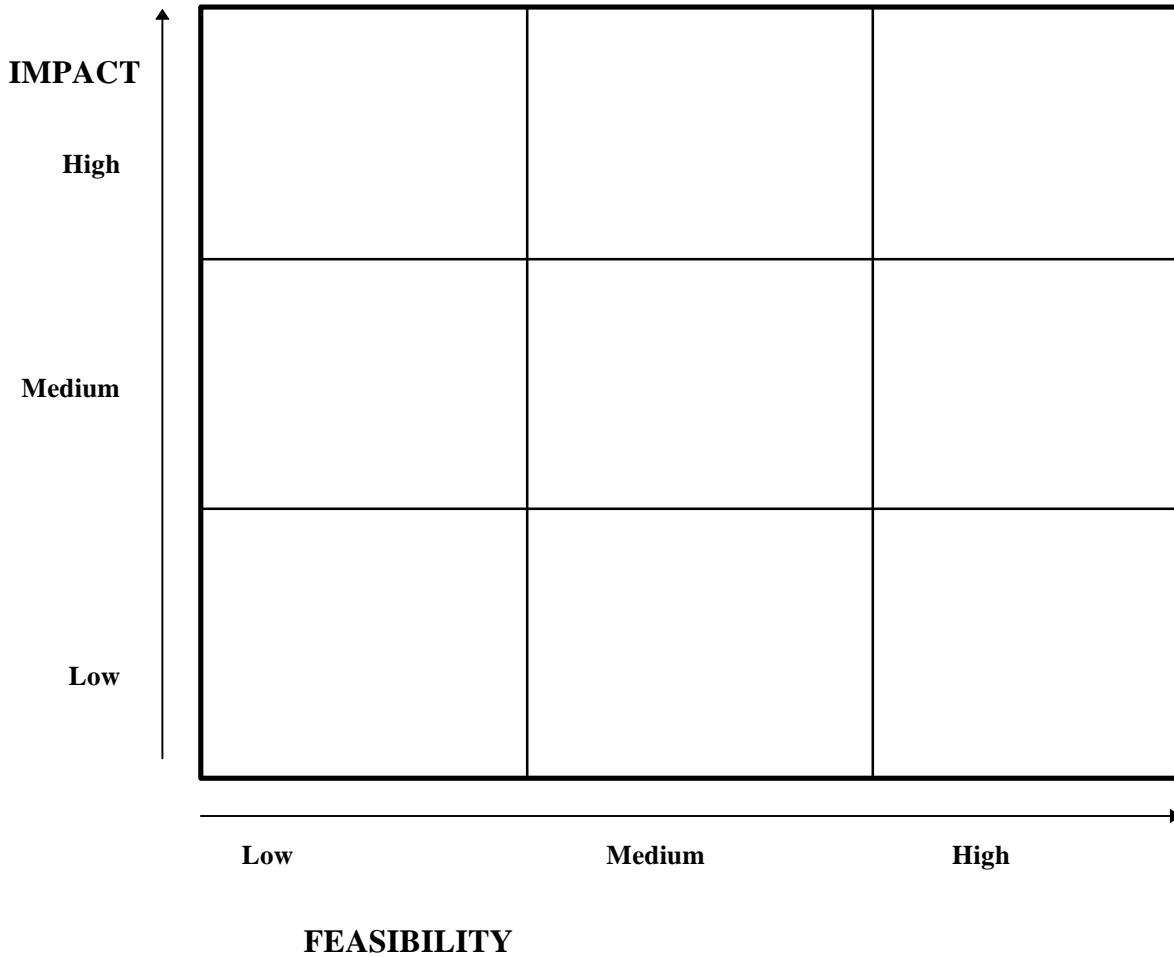

The vertical axis measures relative **impact** -- that is, importance to your community or your solid waste reduction program. In other words, an issue, trend or opportunity which will have a greater effect (impact) -- positive or negative -- on the success of your program will plot higher than one of less critical impact. The horizontal axis measures **feasibility** -- that is, given your community's strengths and weaknesses to handle any issue, what is the likelihood that effective action is possible?

Core Values for Effective Groups

1. **SHARING VALID INFORMATION** -- each group member shares all information which is relevant to the decision they are trying to make-- even if that information might lead the group to choose a solution which the member doesn't like. This information can be checked or tested so that all members are comfortable with its validity.
2. **FREE & INFORMED CHOICE** -- "free" means that each group member contributes his/her opinions to the decision-making process without feeling manipulated or coerced. "Informed" means that all information has been shared. Each member of the group feels s/he has had an equal say.
3. **INTERNAL COMMITMENT** -- Another word for this is "buy-in" or "ownership." Because each member voices a free and informed choice based on shared, validated information, s/he feels good about the group's decision, and will support its implementation -- even if the decision does not exactly reflect the way s/he would have done it.

9 Principles for Effective Groups

1. **Share all relevant information** -- if a group member withholds information that is relevant to a decision the group is trying to make, he/she reduces group effectiveness (and group trust, if other group members discover the withholding)
2. **Focus on interests, not positions** -- Positions are usually a statement of how a participant thinks a problem should be solved. Two people or interest groups may have different positions, but their interests behind those positions -- that is, what they are trying to accomplish by solving the problem -- may not be very different at all. Focusing on interests, not positions can help group members achieve consensus on difficult problems or tough choices.
3. **Make decisions by consensus** -- consensus means that every group member agrees to adopt the group's decision and will support its implementation. Voting tends to create "winners" and "losers;" achieving consensus, though it may be more difficult in the beginning, helps ensure that decisions have enough support to be successfully implemented.
4. **Disagree openly with any member** -- if you disagree, don't withhold it. All opinions can provide valid information for the group.
5. **Discuss "undiscussable" issues** -- if group members consciously avoid certain "sensitive" issues, the group will not be as effective as it will be if such relevant topics can be discussed openly.
6. **All members participate -- no one dominates** -- group members must participate to feel a part of the group's decisions; ensuring that no member(s) dominates is the responsibility of all members.
7. **Don't take "cheap shots"** -- insulting remarks create a distraction as group members react to them; hurt feelings can also make group members less willing to participate fully.
8. **One speaks -- all listen** -- side conversations or other distractions make it difficult for the group to stay focused.
9. **Start on time, end on time** -- group members will be more willing to attend meetings and participate fully if they know the group will not violate their time needs.

Interest Group Analysis

Have your “meeting design” group brainstorm the following chart. If they don’t list anyone outside of themselves, then the group is inclusive enough to proceed. If others are identified, invite them to join the group.

Representatives and their Roles

**Identifiable
Interests or
Interest Groups**

County Gov't:	
Private Haulers:	
Regulators:	
Environmental Groups:	
Others:	

The group may add or subtract from their original list during the planning process. Groups will find it useful to return to the drafted Interest Group Analysis chart at various stages during the process in order to check that no key “players” are being left out of the process.

Problem Solving Flow Chart

NOTE: the problem solving process can be a linear, step-by-step process as shown, or you can jump around! The key is to always know which step the group/public is on.

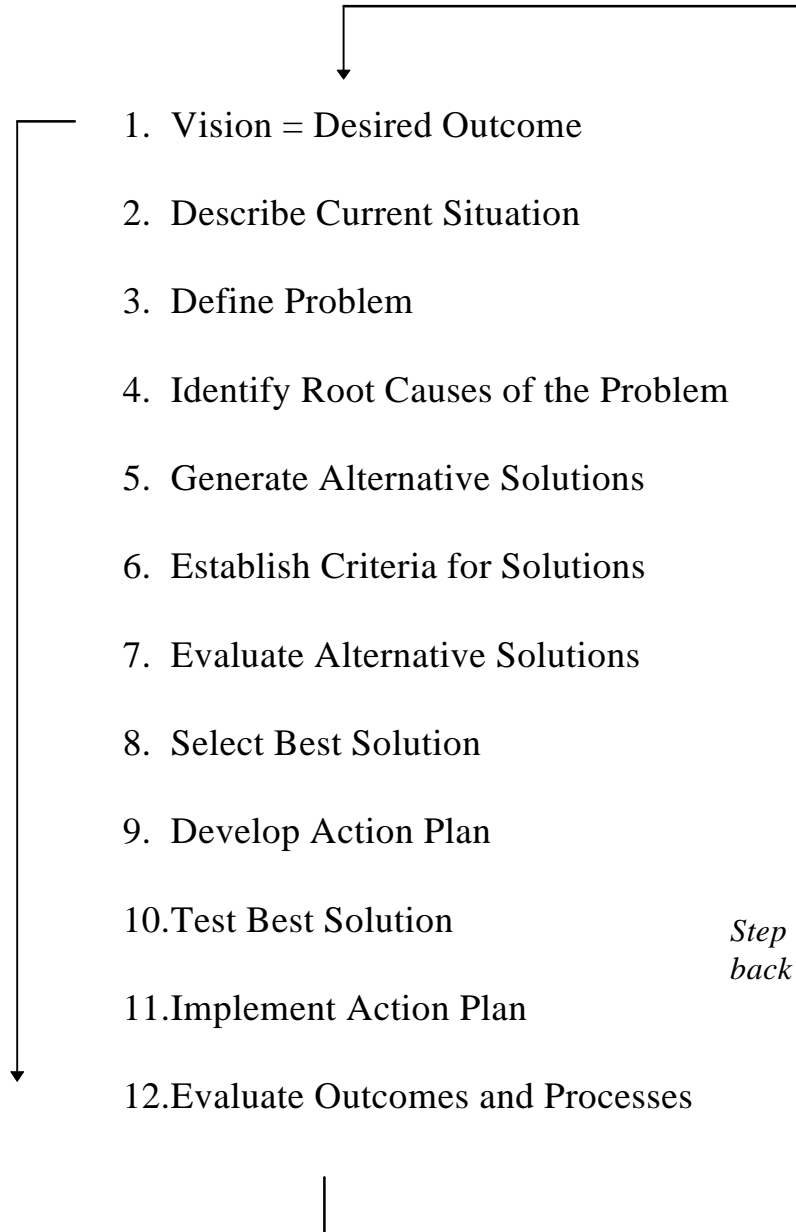

Step 12 can feed back to step 1

Generic Meeting Agenda

Tentative Agenda

7:45 a.m. - 10:20 a.m.

April 1, 1995

Room 319

Anywhereville, NC

- | | |
|----------------|---|
| 7:45 am | 1. Arrival time (before actual start of meeting) |
| 8:00 sharp | 2. Introductions |
| 8:05 | 3. Review "contract" for the meeting, (if one exists) |
| 8:15 | 4. Review Effective Group Process & Adopt Ground Rules |
| 8:25 | 5. Check Expectations & Concerns of participants: <ul style="list-style-type: none">• Expectations: What needs to happen at this mtg. to consider it a success?• Concerns: What might happen to make it less of a success? |
| 8:35 | 6. Agree on Agenda and Time Allocations for the meeting |
| 8:45 | 7. Conduct Main Business of Mtg. (<i>conduct a decision-making process, present information to the public, etc.</i>) |
| 9:40 | 8. Agree on "Next steps:" who, how, when <ul style="list-style-type: none">• Documentation of mtg• Distribution of mtg results (press releases; sharing results with others, etc.)• Other follow-up? |
| 9:50
time?) | 9. Self-Critique of Meeting (What went well? What should be changed next |
| 10:05 | 10. Press Wrap-up (if special press ground rules are used) |
| 10:20 | 11. Adjourn |

Core Values Check for Meeting Facilitators or Public Process Designers :

How does each step of process satisfy the 3 “**core values**”?

1. Sharing valid information. Has all relevant information been shared with all necessary parties?
 - With those most affected by the decisions?
 - With the eventual implementors?
 - With the naysayers and skeptics?
 - With the general public?

2. Free and Informed choice. Have participants felt free to make informed decisions without feeling coerced or manipulated?

3. Internal Commitment to the Solutions/Decisions. Were decisions made by consensus? Do players feel ownership of the solutions?

How can you change approach or process to better meet the core values?

Step in Process	Did We Share Valid Information?	Did we Ensure Free and Informed Choice?	Do We Have Internal Commitment?	Possible Changes to the Step or Process

Adapted from The Skilled Facilitator, by Dr. Roger Schwarz

Four Paths to Business Development

1. **The Product Path** -- in this case, the first awareness of the business developer would be of a new product, or a new application of an existing waste-based product. The use of compost for hazardous waste remediation is a good example of "the product path."
2. **The Market Path** -- in this case, the business developer becomes aware of a local or regional (or even a remote) market for a product that is -- or could be -- produced locally from solid waste. Compost and related mulch products, for example, are in great demand in the Land-of-Sky Region, but local, commercial producers are virtually non-existent.
3. **The Entrepreneurial Path** -- in this case, the business developer finds an entrepreneur who is excited about starting a waste-related business. The entrepreneur's motivation is an important factor, given the difficulties involved in succeeding in a new venture. It becomes the driving force behind the new business startup.
4. **The Problem Waste Path** -- in this case, the business developer starts by trying to figure out how to deal with a solid waste material that is a particular disposal or contamination problem for local landfill managers. In the composting example, this could be food waste from restaurants or smelly, liquid tomato waste from a packing house operation. Solving the problem created by the waste is what drives the development of the new composting business.

Business Development Brainstorming Form

MARKET PATH

Product:

Problem Waste:

Entrepreneur:

Resources:

Business Development Brainstorming Form

PRODUCT PATH

Market:

Problem Waste:

Entrepreneur:

Resources:

Business Development Brainstorming Form

PROBLEM WASTE PATH

Market:

Product:

Entrepreneur:

Resources:

Business Development Brainstorming Form

ENTREPRENEUR PATH

Market:

Product:

Problem Waste:

Resources:

“External Scan” Outline

- **Name of Trend, Development or Issue**
- **Description of Trend, Development or Issue**
- **Assumptions about the Trend, Development or Issue**
(What assumptions do we hold about the impact and evolution, or predictability, of this trend or development? Is it an opportunity or a threat?)
- **Reality-Testing the Assumptions; or, Probability of Occurrence/Continuation of Trend**
(Are our assumptions correct?)
- **Impact of Trend, Development or Issue**
(How much impact will this trend or development have upon our ability to manage and reduce solid waste in our region?)
- **Can the Trend be Influenced to Advantage?**
(i.e., Can we change the course of this trend, or the way in which it develops, to make it more advantageous to our region?)
- **Positioning Considerations**
(what can our counties do to position the region for success in light of these external trends and developments?)

Appendix 2 -- References and Resources

References

1. GBB Solid Waste Management Consultants. *Solid Waste Sampling Training Guide*.
2. Dodge, William R. and Kim Montgomery. *Shaping a Region's Future: A Guide to Strategic Decision Making for Regions*. US Department of Commerce, May, 1995.
3. Schwarz, Roger M. *The Skilled Facilitator: Practical Wisdom for Developing Groups*. Jossey-Bass, 1994.
4. Schwarz, Roger M. Adapted from p. 9.
5. Schwarz, Roger M. p. 75.
6. Schwarz, Roger M. p. 159.
7. Schwarz, Roger M. pp. 149-157.
8. Schwarz, Roger M. p. 9.
9. Cole, Barbara A., Patricia Cantrell, Bill Browning, and Alice Hubbard (Rocky Mountain Institute). *Business Opportunities Workbook 2ⁿ ed.: A Rural Revitalization Program for Community Leaders*. US Small Business Administration, 1990.
10. Cole, Barbara A. *Business Opportunities Casebook.: A Rural Revitalization Program for Community Leaders*. US Small Business Administration, no date.
11. Land-of-Sky-Regional Council. *Regional Solid Waste Options Study*. Unpublished, 1995.

Appendix 2 -- References and Resources

Resources

IWM

BioCycle: Journal of Composting and Recycling.
419 State Avenue, Emmaus, PA 18049.

Commercial & Industrial Solid Waste Reduction Training for Community Solid Waste Managers.
Rhonda Sherman. National Environmental Training Center for Small Communities, West Virginia University, P.O. Box 6064, Morgantown, WV 26506-6064. 1-800-624-8301.

North Carolina Recycling Coordinators Training Course, Participant's Manual. NC Office of Waste Reduction, Department of Environment, Health, and Natural Resources, 3825 Barrett Drive, Raleigh, NC, 27609. (919) 571-4100; (800) 763-0136.

Solid Waste Issues and Trends in Rural America.
Coastal Georgia Regional Development Center, P.O. Box 1917, Brunswick, GA 31521. (912)264-7363.

Solid Waste Sampling Training Guide, prepared by GBB Solid Waste Management Consultants, 2735 Hartland Road, Falls Church, VA 22043 for Coastal Georgia Regional Development Center, P.O. Box 1917, Brunswick, GA (912) 264-7363 under a grant from USDA-Rural Development Administration.

Solid Waste Technologies. 7221 West 79th Street, Suite 208, Overland Park, KS 66204. (913) 642-6032.

Recycling Today. 4012 Bridge Avenue, Cleveland, Ohio 44113-3320.

Resource Recycling. P.O. Box 10540, Portland, OR 97210-0540. (503) 227-1319.

Waste Age. For information call: New York (515) 755-222; Atlanta (404) 242-8026; Washington (202)244-4700; Chicago (708) 505-7760.

WASTELINK -- Electronic Bulletin Board. (800) 367-4760.

Strategic Thinking & Planning

Shaping a Region's Future: A Guide to Strategic Decision Making for Regions, by Bill Dodge and Kim Montgomery, May 1995. Economic Development Administration, U.S. Department of Commerce, 14th & Constitution Avenue, NW, Room 7319H, Washington, D.C. 20230.
<http://www.doc.gov/ecix/ecixhomepage.html>

Harnessing the Power of Vision: 10 Steps to Creating a Strategic Vision and Action Plan for you Community. Mark Peterson. Cooperative Extension Service, University of Arkansas, P.O. Box 391, Little Rock, AR 72203.

Appendix 2 -- References and Resources

Group Problem-Solving & Public Involvement

The Skilled Facilitator: Practical Wisdom for Developing Effective Groups, Dr. Roger M. Schwarz, Jossey-Bass Publishers, 1994.

How to Make Meetings Work: the New Interaction Method, Michael Doyle and David Straus, Jove Books, September 1982.

Civic Network Television Course: Collaboration Series 2). CNT, 21 Dupont Circle, Fourth Floor, Washington, D.C. 20036. (202) 887-5900.

Business Development

Business Opportunities Workbook. Rocky Mountain Institute, 1990.

U.S. Small Business Administration, *Financial Management Series*, 1988.

The Market Planning Guide: Creating a Plan to successfully Market Your Business, Products, or Service. David H. Bangs, Jr. Upstart Publishing Company, 1992. Upstart Publishing Company, Inc. 12 Portland Street, Dover, NH 03820. (800) 235-8866.

The Business Planning Guide. David H. Bangs, Jr. Upstart Publishing Company, 1993.

North Carolina Cooperative Extension Service Workshop Notebook, "Growing Success from the Ground Up", 1995.

Regional Approaches

National Association of Development Organizations (NaDO). 444 North Capitol Street, Suite 630, Washington, DC 20001. (202) 624-8813.

NADO Research Foundation (NaDORF). 444 North Capitol Street, Suite 630, Washington, DC 20001. (202) 624-8813.

National Association of Regional Councils (NARC). 1700 K street N.W., Suite 1300, Washington, DC 20006.

Solid Waste Planning Manual for Local Governments, Development Districts, and Councils of Government. Land-of-Sky Regional Council, 25 Heritage Drive, Asheville, NC, 28806. (704) 251-6622. June, 1988.

Appendix 2 -- References and Resources

Education and Training Resources

EPA Homepage. For other information about EPA activities and trainings. <http://www.epa.gov>.

The National Environmental Training Center for Small Communities (NETCSC). West Virginia University, P.O. Box 6064, Morgantown, WV 26506-6064. (800) 624-8301. Provides technical training in the areas of solid waste, water conservation and water quality, and other environmental areas. Publishes training opportunities and information in their journal *The E-Train*.

The National Recycling Coalition. 1101 30th Street, NW, Suite 305, Washington, DC, 20007. (202)625-6406.

NSDA National Directory of Solid Waste Curricula. National Soft Drink Association (NSDA) Environmental Affairs, 1101 16th Street, Washington, D.C. 20036. (202) 463-6700. An annual publication of environmental trainings throughout the country.

NC Office of Waste Reduction (OWR), DEHNR, 3825 Barrett Drive, Raleigh, NC 27608. (800) 763-0136. Provide free non-regulatory assessments and education to North Carolina businesses, local governments, state agencies, and individual citizens on methods to eliminate, reduce or recycle wastes before they become pollutants. OWR consists of the Pollution Prevention Program and the Solid Waste Reduction Program.

NC Office of Environmental Education, DEHNR, P.O. Box 27687, Raleigh, NC 27611-7687. (919) 715-4190.

Solid Waste Management Assistance Program. EPA Grants Administration Division, (MC-3903F), 401 M Street, SW, Washington, D.C. 20460. (202) 260-9266. Promotes the use of IWM systems to solve municipal solid waste generation and management problems at the local, regional, and national levels.

USDA--Rural Utilities Service. Water and Wastewater Disposal Division, South Building, USDA -- Rural Utilities Service, 14th and Independence Avenue, SW, Washington, D.C. 20250.

Appendix 3 -- Articles and Other Materials

1. Group Process (must be ordered)

Groundrules for Effective Groups. Roger M. Schwarz. Reprinted from Popular Government, Vol. 54, No. 4 (Spring 1989), pp. 25-30. Institute of Government, Chapel Hill, NC: 1989.

Copies of this article must be ordered from the NC Institute of Government Publications Office at (919) 966-4119.

2. A Business Development Approach to Composting (attached)

Entrepreneurial Composting Study Outline. Land-of Sky Regional Council, 25 Heritage Drive, Asheville, NC 28806. (Work in progress) 1995.

3. Example of a Business Plan Outline (must be ordered)

Business Plan Format. Adapted by Mary Clayton McGlaulin from Turn Talent into Dollars through Home-Based Business (Margaret A. Duffy). Buncombe County Cooperative Extension Service, 1995.

The "Business Plan Outline" is a generic example of basic business planning issues. Other outlines are available through the national Small Business Assistance program, Banks and other lenders, nonprofits, and educational and economic development organizations such as the Center for Improved Mountain Living at Western Carolina University and vary according to the size and type of business, and the requirements of the lender (if a loan is needed).

4. Full Cost Accounting Example (must be ordered)

Development of a Realistic Estimate of Landfill Waste Disposal Costs. Joyce Engineering, Inc. 436 Spring Garden Street, Greensboro, NC 27401. 1995.

Other Resources for Information on Full Cost Accounting :

- "Full-cost Accounting: What is it? Will it help or hurt recycling?" Norm Crampton. Resource recycling Magazine, September, 1993.
- *Accounting for the Full Cost of Garbage, Recycling and Yard Waste Services*. Indiana Institute on Recycling, February, 1993.
- *DRAFT: FCA, Unit Pricing, and Enterprise Funds: Tools for Fostering good municipal Solid Waste Management Practices*. U.S. EPA. April, 1994.
- *Solid Waste: Transportation and Other Costs*. Lewis D. Bumpus, University of Tennessee County Technical Assistance Service, 1995.

Land-of-Sky Regional Council Entrepreneurial Composting Study Outline

December 1995

Phase 1 -- Describe & Map the Compostable Waste Stream in the (County, Region)

Objective: *Provide potential composting business people with a description of the types, amounts, location and accessibility of compostable organic waste in Region B (Buncombe, Henderson, Madison and Transylvania counties).*

- Activities:**
1. Contact the following organizations in Region B for estimates of their organic waste streams (type of materials, approximate quantities, seasonal fluctuations, hauling and disposal practices and costs, and locations of dump sites):
 - Local and state governments (e.g., county landfills/solid waste departments, USFS, DOT);
 - Businesses and industries with compostable waste streams; Schools, colleges, universities, hospitals, restaurants, jails, hotels and other
 - producers of food waste; and
 - Agricultural operations

 2. Group the organic wastes available into categories according to their suitability for various types of composting. Wastes include but are not limited to:
 - Manures
 - Fish parts and fish wastewater
 - Wood products
 - Leaves
 - Household, commercial and institutional food waste
 - Farmers market waste
 - Nursery by-products
 - Paper products
 - Other organic waste

- Outputs:**
1. A draft chapter of the document which:
 - Describes and quantifies the factors listed in Activities 1 and 2 above;
 - Estimates waste reduction potential for each county from composting organic wastes;
 - Describes several options of how composting business people could intercept and obtain organic wastes from the various sources;
 - Sets up a rationale and criteria for choosing sites for composting operations which includes consideration of hauling costs/distances to large-volume waste sources, public acceptability, state regulations, land availability & cost, and other factors.

2. A map of Region to go in the handbook, depicting the major flows and categories of compostable organic waste available. The map should also identify particularly good areas to set up composting operations of various scales based upon the rationale and criteria described in Deliverable #1 above.

Phase 2 -- Identify Potential Compost Products and Services

Objective: *Develop a list and description of compost/vermicompost products and services associated with the waste streams identified in Phase 1 which could provide the basis for business opportunities in Region.*

- Activities:**
1. Develop list of potential products and services, to include at least these categories:
 - Raw or minimally-processed materials (e.g., wood chips)
 - Compost/worm castings
 - Value-added products (e.g., potting mix)
 - Composting/vermicomposting equipment and supplies (e.g., manufacturing of worm bins/facilities of home, neighborhood, small municipal and possibly larger scales)
 - Composting services (e.g., site/facility design, contract site operation, waste hauling, marketing, education, etc.)
 2. Conduct a search for case studies of businesses outside of Region which are producing such products, and services, and identify a brief description of the business, products, markets and contact person for each business.

Output: A draft chapter of the handbook listing the products and services identified above the following information for each.

- Product name & description
- Waste materials required, if any
- Production methods
- Particularly good locations/sites for production
- Special problems associated with the product/service
- Other information pertinent to developing a business around the product/service

Phase 3 --Market Evaluation of Products and Services

Objective: *Identify and describe the markets in Region B for the products and services identified in Phase 2. Evaluate and rank potential business opportunities selling to these markets.*

- Activities:**
1. Define markets in Region in terms of:
 - Buyer type (local governments, communities, individuals, landscapers, restaurants, organic farmers, golf courses, DOT, nurseries, etc.);
 - Estimated number or list of potential buyers in each type;
 - Motivation to buy the products/services;
 - Pros & cons of the products/services that will influence their marketability;
 - Current sources of supply, and prices for products/services already in existence;
 - Potential sales volume.

 2. Describe and rank business opportunities based on:
 - Cost analysis/volume of demand and profit margins for each product;
 - Most profitable mix of products/services (if more than one product/service);
 - Number and quality of potential jobs created;
 - Competing products/services and their location (inside and outside of Region);
 - Special risks or difficulties;
 - Other appropriate factors.

Output: A draft chapter of the handbook summarizing the results of Activities 1 and 2 above.

Phase 4 -- Identification and Education of Composting Entrepreneurs

Objective: *Identify, contact and educate potential composting business people on the business opportunities described in the handbook. Complete the final draft of the handbook.*

- Activities:**
1. Keep a running list of the following while conducting Phases 1, 2 and 3 of this contract:
 - Existing businesses contacted which might expand (nurseries, waste haulers, compost producers, etc.);
 - Individuals encountered who may be interested in starting a new business related to composting;

- Potential diversifications of existing businesses inside or outside of Region.
2. Contact people on the list, interview them to assess:
 - The type of business they are interested in;
 - The level of their motivation;
 - How far along they are in business planning;
 - What type of assistance they need to get into business (e.g., business planning, access to capital, site/building location, match-up with business partners, coordination with local governments, training in composting technology or regulations, etc.)
 - List the names of the above people, contact information, and summarizing the above information for each.
 3. Conduct a workshop for potential business people, presenting this documents findings.

Outputs:

1. Descriptive list of potential composting entrepreneurs from Activities 1 and 2 above;
 2. Draft handbook, including the three chapters described as deliverables in Phases 1, 2 and 3 of this work plan, plus an appendix listing sources of technical assistance;
 3. Presentation of the draft handbook at workshop.
-