



*Holiday Greetings*



U.S. Department  
of Transportation

**Federal Aviation  
Administration**

Mary E. Peters, *Secretary of Transportation*  
Robert A. Sturgell, *Acting Administrator*  
Nicholas A. Sabatini, *Associate Administrator*  
*for Aviation Safety*

James J. Ballough, *Director,*  
*Flight Standards Service*  
John S. Duncan, *Manager,*  
*General Aviation and Commercial Division*  
Julie Ann Lynch, *Manager,*  
*Plans and Programs Branch*

H. Dean Chamberlain, *Editor*  
Louise C. Oertly, *Senior Associate Editor*  
James R. Williams, *Assistant Editor*

The FAA's Flight Standards Service, General Aviation and Commercial Division's Plans and Programs Branch (AFS-805) publishes *FAA Aviation News* six times each year in the interest of aviation safety. The magazine promotes safety by discussing current technical, regulatory, and procedural aspects affecting the safe operation and maintenance of aircraft. Although based on current FAA policy and rule interpretations, all material herein is advisory or informational in nature and should not be construed to have regulatory effect.

The FAA does not officially endorse any goods, services, materials, or products of manufacturers that may be referred to in an article.

All brands, product names, company names, trademarks, and service marks are the properties of their respective owners. All rights reserved.

**Certain details of accidents described herein may have been altered to protect the privacy of those involved.**

Comments or questions about this magazine should be directed to the Editor at (202) 267-7956. Written comments can be mailed to the Editor at the following address: Editor, *FAA Aviation News*, Federal Aviation Administration, AFS-805, 800 Independence Ave. SW, Washington, DC 20591. The fax number is (202) 267-9463. The Editor's e-mail is dean.chamberlain@faa.gov.

The Office of Management and Budget has approved the use of public funds for the printing of *FAA Aviation News*.

**GOVERNMENT PRINTING OFFICE (GPO)  
SUBSCRIPTION SERVICES**

**NEW ORDERS**

The Superintendent of Documents, U.S. Government Printing Office, Washington, DC 20402-9371, sells *FAA Aviation News* on subscription. Use the self-mailer form in the center of this magazine to subscribe. For new orders, you can telephone the GPO at (202) 512-1800 or toll-free at 1-866-512-1800. You may also order via the Internet at <http://bookstore.gpo.gov>

**SUBSCRIPTION PROBLEMS/CHANGE OF ADDRESS**

To notify the Government Printing Office of any subscription problems or a change of your address you should send your mailing label along with your comments to: Superintendent of Documents, U.S. Government Printing Office, Contact Center, Washington DC, 20408-9375. You can also call (202) 512-1800 and ask for Customer Service. The GPO toll free number is 1-866-512-1800. You can send your information by facsimile. The FAX telephone number is (202) 512-2104

The U.S. Government Printing Office mails up to four renewal notices. One notice is sent at 90 days, 60 days and 30 days before expiration. The final renewal notice is mailed 30 days after expiration. To ensure continued service without interruption, please return your renewal notice with payment promptly. Your subscription expiration date is listed on your mailing label.

**FEATURES**

- 1** Central American Agency for Aeronautical Safety Visits FAA's Southern Region
- 3** Where Are You?
- 4** 'Tis the Season... to Check your Exhaust Carefully
- 6** Cold Starts
- 9** Weight and Balance—How Much Is Too Much?
- 13** Vacuum Failures Can Hurt Or What I Learned Reading ASRS Reports
- 14** Search and Rescue
- 17** Prepared for Anything
- 18** Info: Noise Attenuation Properties of Noise-Canceling Headsets
- 21** Dr. Paul MacCready, 1925 — 2007
- 22** Icing — Hope Is Not a Strategy
- 26** Oh No, Not Another Acronym!
- 29** The Last Link in the Chain
- 31** Integrating Space Traffic into the National Airspace System
- 33** The FAA Wants You!

**DEPARTMENTS**

- 19** Maintenance Alerts
- 34** FlightFORUM
- 35** AvNEWS
- BACK COVER** Editor's Runway



*FRONT COVER: This sailplane sits secure in its canopy cover and well tied-down at the Truckee/Tahoe Airport, Truckee California. (H. Dean Chamberlain photo)*

*BACK COVER: . Can you identify the aircraft in this photo taken by Michael W. Brown? Send your entry to <Dean.Chamberlain@faa.gov>.*

\*\*\*\*\*3-DIGIT 342  
FAN SMITH212J JUN05 R 1 423\*  
JOHN SMITH  
212 MAIN ST  
FORESTVILLE MD 20747

[http://www.faa.gov/news/aviation\\_news](http://www.faa.gov/news/aviation_news)

# CENTRAL AMERICAN AGENCY FOR AERONAUTICAL SAFETY VISITS FAA'S SOUTHERN REGION

BY H. DEAN CHAMBERLAIN



*ACSA Operations Inspector Captain Rodrigo Brenes (L) and FAA's Southern Region Safety Team Manager Ken Spivey share a moment with FAA Aviation News at the FAA Safety Center in Lakeland, Florida, during Sun 'n Fun 2007™. (H. Dean Chamberlain photo)*

**T**his past April, Captain Rodrigo Brenes, Safety Management Systems (SMS) Coordinator/Operations Inspector (OPS Insp.), Central American Agency for Aeronautical Safety (ACSA) was the guest of the FAA's Southern Region at Sun 'n Fun 2007™ in Lakeland, Florida. Based at the Aero-puerto Juan Santamaria, Alajuela, Costa Rica, Captain Brenes was in Florida to observe how the FAA's Southern Region Safety Team (FAASTeam) functioned. Participating in the meetings with Captain Brenes was Kevin Clover, the FAA's National FAASTeam manager, and Ken Spivey, Southern Region FAASTeam manager.

According to Captain Brenes, the Central American Agency for Aeronautical Safety is an organization that represents six Central American coun-

tries. Those countries are Guatemala, Belize, Honduras, El Salvador, Nicaragua, and Costa Rica. ACSA is part of the Corporación Centroamericana de Servicios de Navegación Aérea (COCESNA).

When *FAA Aviation News* asked about his visit, Captain Brenes said his organization is interested in developing a safety program similar to the FAA's program. "My specialty is safety management systems. We were trying to figure out what kind of program to develop when we learned of the FAA's safety program. We are hoping we can learn from the FAA's program and maybe use some of your experiences to help our countries in developing a new safety program. What we are trying to do here is to get things moving. We have two main objectives. One is a safety program that will include

safety management systems. The other is to develop another group like a Regional National Transportation Safety Board. These are two big objectives we are trying to develop with the help of the FAA and especially with the FAASTeam."

When asked what type of support the Southern Region can provide, Ken Spivey, Regional FAASTeam Program Manager, said Dawn Veatch, Southern Region Flight Standards Division Manager, along with Javier "Jay" Rodriguez, manager of the Flight Standards Miami International Field Office, have put together a plan to help support the Central America countries in their safety efforts. He said, "I have been directed to go down there and help with their safety efforts and their road map to safety. Based upon our meetings with Lic. Jorge Vargas

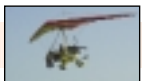

Araya, Director of Agencia Centroamericana para la Seguridad Aeronautica, we think this will be a five-year project beginning January 1, 2008, through December 31, 2013.

When asked if this new program supported an International Civil Aviation Organization (ICAO) requirement, Captain Brenes said the program supports the Safety Management System (SMS) concept, where the states are to develop a safety program. But some of the states don't know how to do that. With the experience of the FAA and the help of the FAASTeam we will help the states develop their own safety programs and those programs will be in accordance with ICAO.

In explaining his organization, Captain Brenes said COCESNA was formed in 1960 to be in charge of air

navigation in Central America skies above 18,000 feet. The skies above 18,000 feet are managed by COCESNA and that is how it gets its income.

"In the beginning, its income paid for radars, VORs, NDBs and to train air traffic controllers, but COCESNA has grown since then and now we have a school in El Salvador in charge of our training and we have ACSA, the Agencia Centroamericana para la Seguridad Aerea (the Central America Aviation Safety Agency) in charge of the safety oversight of the nations of the Central American states. We have been working since 2000. Our Director is Jorge Varzas."

In listening to the conversation between Captain Brenes and Spivey, it seems this cooperation between the

FAA and ACSA is a perfect fit. Spivey said with the help of the Flight Standard Service's International organization (AFS-50) Manager Melvin Cintron to bring the international agreements together for the United States and Central America, we will be able to progress towards the proposed five year plan.

Spivey said in a meeting in Costa Rica in March 2007, he invited Jorge Varzas and Captain Brenes to Sun 'n Fun. One of the objectives in the proposed Five Year Plan is to have a Sun 'n Fun™ type of event. So what better way to start working on that proposal then to invite them here to see Sun 'n Fun™.

Captain Brenes said, "We are excited about this plan because we believe we can accomplish more through education and

training and sharing experiences in safety than in regulations."

"One of the reasons we are here is to make the skies safer," Captain Brenes said.

When asked if it was a challenge working with different countries, Captain Brenes said it is always a challenge. "Trying to convince people to do things a little bit differently than what they have been doing is always a challenge, but I think that is our mission," he said. "I think that makes us better working to accomplish the mission.

According to Spivey, the international community wants more information and more knowledge about safety management systems. He said it is exciting being on the ground floor of a new organization and being involved in a new program like SMS. It is even more exciting going international helping to develop a safety program like we started in 1968 as a beta test and proof of concept in 1970 as the Accident Prevention Program. It was the first one for the FAA. Now we are helping Central America develop its own program. These are exciting times as we try to raise safety awareness around the world.

Spivey said the Safety Management System concept is critical to increasing aviation safety around the world. Regulations, like the FAA's, only regulate to the minimum level of safety. There is no cushion between the regulations and the safety aspects of meeting those minimum standards if that is where you are and an "oops" or something happen to you. Then you are into a violation or an incident or accident, but with system safety or a Safety Management System, it gives you that extra cushion. It goes above and beyond those minimum safety standards. The benefit of System Safety is it puts the risk on the operator and making that operator responsible for identifying those safety hazards and mitigating those risks.

By developing a safety program, the Central American countries will be able to raise their safety awareness and that is the key they are looking for, Spivey said. †



Araceli Brénes (L) and Captain Brénes (C) listen as FAA Safety Team (FAASTEAM) Lead Representative Cheryl DeFilippo explains how the Center's Production Studio contributes to the national FAA Safety Team's mission by providing video production support for the Team.

James Williams photo



# Where Are You?

by H. Dean Chamberlain

The National Transportation Safety Board (NTSB) sent its safety recommendations to the FAA Administrator in a letter dated, August 28, 2007, concerning its findings in the Comair Flight 5191 crash at the Blue Grass Airport, Lexington, Kentucky, on August 27, 2006.

Although the safety recommendations are directed toward the 14 Code of Federal Regulations (14 CFR) parts 91K, Fractional Ownership Operations, 135 Commuter, and 121 Air Carrier operators, *FAA Aviation News* feels some of the recommendations are applicable to the general aviation (GA) community. Those who want to read the complete list of safety recommendations can access them at the following NTSB Internet URL <[http://ntsb.gov/Recs/letters/2007/A07\\_44\\_48.pdf](http://ntsb.gov/Recs/letters/2007/A07_44_48.pdf)>. The safety recommendations are just that—recommendations on ways the FAA can improve

safety. The recommendations should not be confused with the NTSB accident report, where NTSB releases its determination of probable cause.

For those not familiar with this accident, at about 6:06 a.m. Eastern Daylight Time, the flight lined up on the wrong runway at Lexington and ran off the end of the runway and hit the airport fence, trees, and terrain. The aircraft was destroyed and 49 crew and passengers died. Only the first officer survived the crash.

According to the safety recommendation letter, NTSB "...determined that the probable cause of this accident was the flight crewmembers' failure to use available cues and aids to identify the airplane's location on the airport surface during taxi and their failure to cross-check and verify that the airplane was on the correct runway before takeoff. Contributing to the accident were the flight crew's nonpertinent conversation during taxi,

which resulted in a loss of positional awareness, and the Federal Aviation Administration's (FAA) failure to require that all runway crossings be authorized only by specific air traffic control (ATC) clearances."

Although some GA pilots may say that they only fly out of small, non-towered, single-runway airports in basic GA aircraft, there are many GA pilots who fly state-of-the-art glass cockpit jet aircraft in and out of some of the most complex airports in the nation and world. But, both of these groups of pilots have

the opportunity to fly into non-familiar airports during the day and at night where there is always a chance that someone might take the wrong runway or taxiway.

As noted in previous articles about runway incursions, having either paper airport charts or electronic displays showing the airport taxiways and runways is an important step in reducing both runway incursions and lining up for takeoff on the wrong runway. As noted in the NTSB recommendation, NTSB believes that FAA should require the 91K, 135, and 121 communities establish certain procedures. In particular, one important safety recommendation that applies to all pilots, whether in air transportation or general aviation, is that "...all crewmembers on the flight deck to positively confirm and cross-check the airplane's location at the assigned departure runway before crossing the hold short line for takeoff."

From checking taxiway signs and runway markings to cross checking runway direction with a compass or horizontal situation indicator or properly set directional gyro, all pilots need to confirm that the runway they are lined up on is the designated runway.

The NTSB safety recommendation also addressed checking *Notices to Airmen* (NOTAM) for current runway and taxiway status information, not taking off on an unlighted runway at night, the need to avoid distraction while taxiing, and the importance of maintaining situational awareness while navigating on the airport.

Although FAA and the airline industry are working on advanced electronic tools to help both pilots and air traffic controllers reduce runway incursions and use of the wrong runways, for those in aircraft without the latest technology, pilots and flight crews will have to remain vigilant and always confirm their intended departure runway is in fact the correct runway.

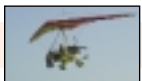
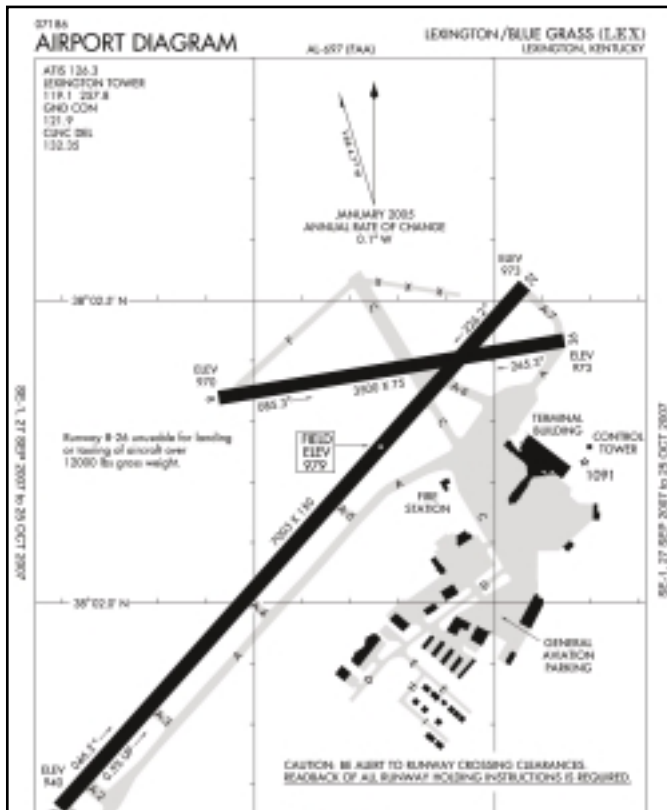

# 'Tis the Season... To Check your Exhaust Carefully

Carbon Monoxide Poisoning and other dangers of the exhaust system

by James Williams

It's an old story, much like the Big Bad Wolf and Goldie Locks. You're flying along on a brisk winter night and you just can't take it anymore. You have to turn on the cabin heat. Why are you so reluctant to use this seemingly innocuous little knob to make your flight more comfortable? Because it can have fatal consequences — if you're not careful in checking your exhaust system. You are probably thinking carbon monoxide (CO) poisoning at this point, but carbon monoxide poisoning isn't the only threat to emanate from the dirty side of the engine. Two other possible problems are fires and a partial or complete loss of engine power. Both of these can have fatal consequences as well. While the latter two can happen at any time of the year, carbon monoxide poisoning is more likely to occur during the cooler months when you're more likely to use the cabin heating.

The threat of carbon monoxide poisoning is a real one. A review of National Transportation Safety Board (NTSB) records shows 10 incidents of carbon monoxide poisoning as either a cause or a factor in an accident. These accidents accounted for 13 fatalities, three serious injuries, and two minor injuries. These numbers are likely low due to lack of evidence and limited search ability of data in some cases.

The fear of CO poisoning is well justified. CO is insidious; it's colorless, odorless, and tasteless. The Centers for Disease Control and Prevention (CDC) reports that 500 people per

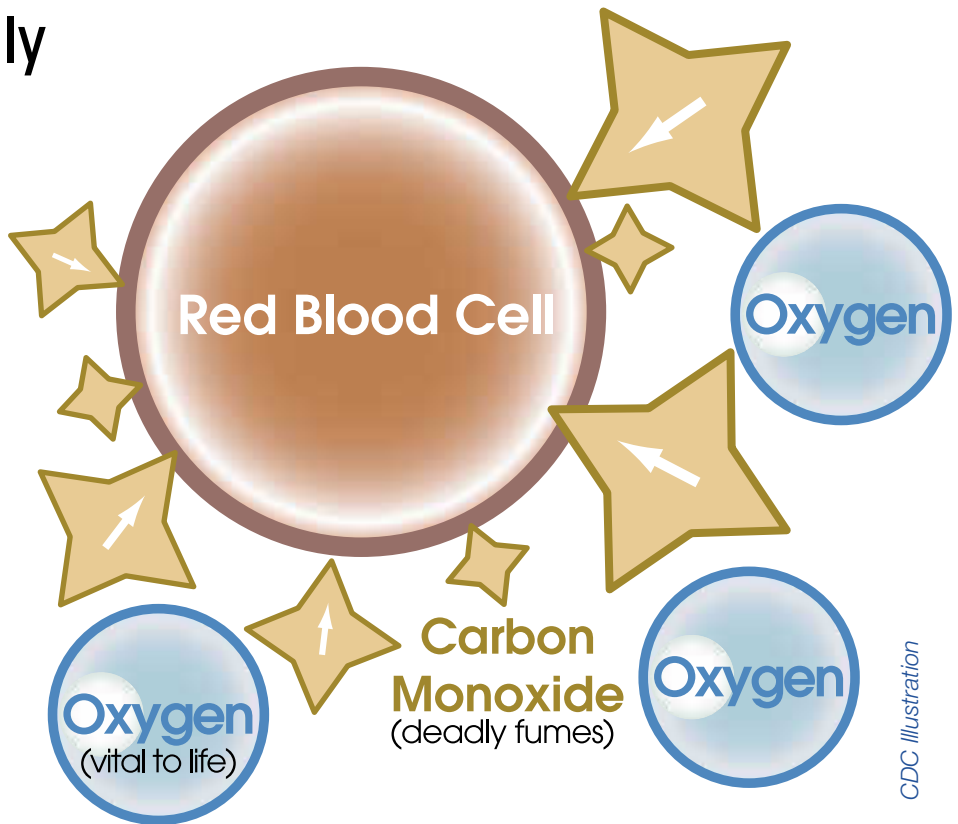

year die from unintentional CO poisoning in this country. A further 2,000 a year die from suicide by means of intentional CO poisoning. CO kills by attaching itself to the hemoglobin in red blood cells (RBC). Even in relatively low concentrations CO is dangerous because it bonds with hemoglobin between 200 and 300 times more readily than oxygen. With those CO molecules bonded to the blood's oxygen transport system, a person can literally run out of breathe. Even when all four reception sites on the hemoglobin molecule are not blocked by CO, the remaining open sites form a stronger than normal bond with oxygen molecules and, therefore, the oxygen is not released into the tissues as it should be, effectively blocking all transport by the RBCs without technically covering all reception sites. As the process continues, the victim becomes more and more hypoxic as more and more RBCs become blocked. Symptoms include: headache, dizziness, weakness, nausea, vomiting, chest pain, and confusion. Untreated under nor-

mal conditions, it takes three to four hours to eliminate CO from the body. So once significantly exposed, it becomes imperative to seek medical attention. With treatment (there is no effective home treatment, if you suspect CO poisoning go to a hospital for treatment immediately) this effective time can be reduced to 30 to 90 minutes or even further with hyperbaric oxygen treatment. Hyperbaric oxygen treatment is when a person is put in a pressure chamber and the ambient pressure is increased to increase the density of the air in the chamber. This in turn increases the amount of oxygen per volume of air and improves its absorption.). Even with treatment many victims suffer permanent brain or organ damage.

These effects are amplified at night when more oxygen is required. In this already hypoxia prone setting, even minor CO poisoning could have a dramatic effect on a pilot's performance. The best protection is an effective CO detector and regular inspections of your aircraft's exhaust and



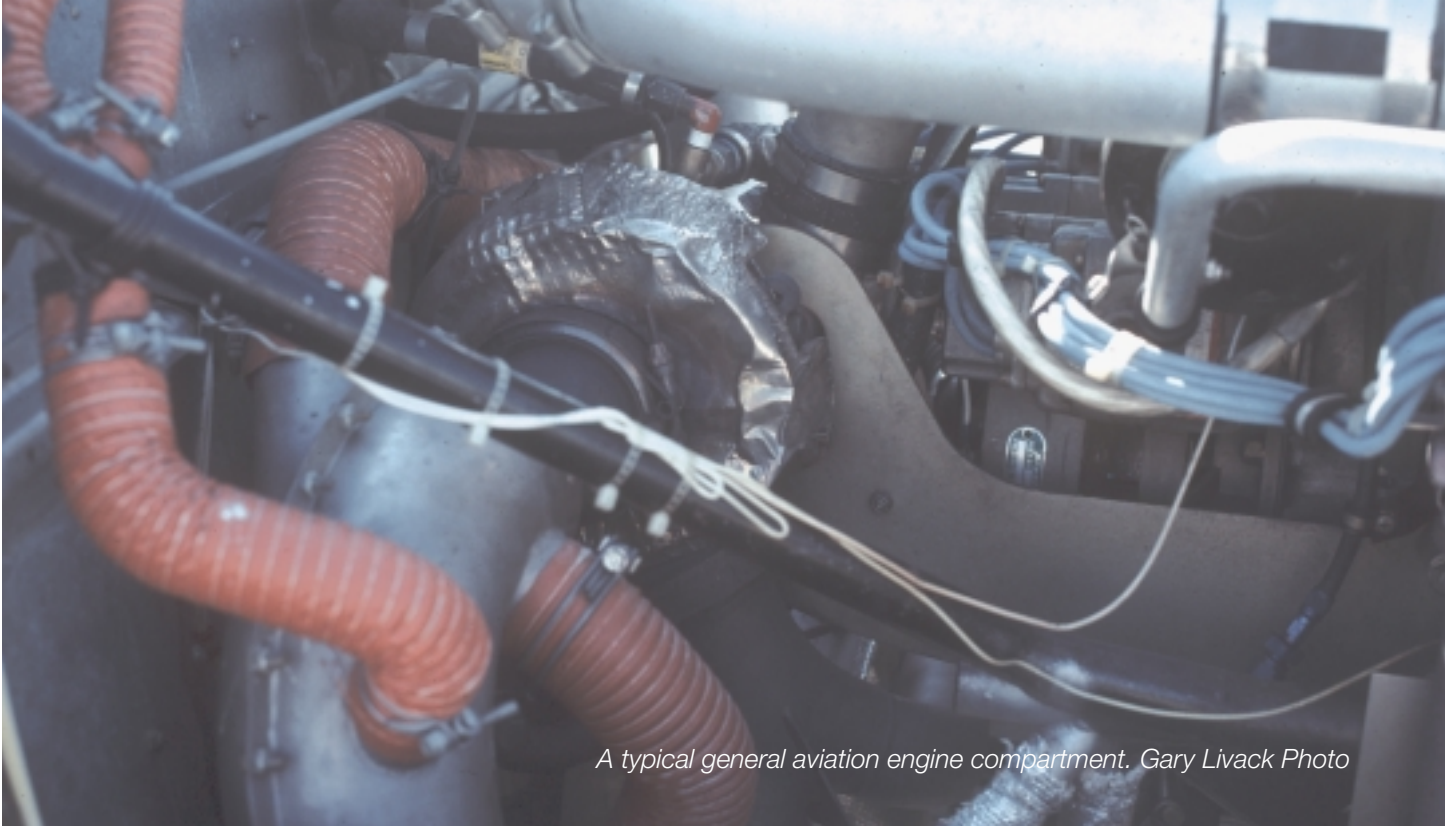

*A typical general aviation engine compartment. Gary Livack Photo*

cabin heating systems.

From the subtlety of CO poisoning, we move to the overt terror of in-flight fires. Fire has long been one of the most feared emergencies that can befall a pilot. This is not without good reason. During the early years of aviation, fires were a frighteningly common occurrence. In more recent times with newer designs and safety protocols they have become a much rarer event. Indeed, only 38 events are displayed in NTSB records. These are responsible for 24 fatalities, five serious injuries, and 14 minor injuries. Of the total number of events, seven are attributed to exhaust system failures. It is not clear if this number is lower than reality because of lack of evidence. The main job of the exhaust system is to guide the very hot air being expelled from the engine following combustion out of the cowling and away from many of the aircraft's vital parts. When an exhaust system fails, it can lead to torching of nearby structures. This can start a fire in any number of systems including the electrical, fuel, and hydraulic systems. All of these systems generally have some kind of presence forward of the fire wall.

The golden rule here is that where there's smoke you can probably bet there is fire. This was demonstrated by a hapless pilot in Modesto, California,

on September 1, 2007. As reported by the Associated Press (AP) and NTSB, the pilot was taking his passenger for her first flight. Twice the pilot took off, noted smoke in the cockpit, landed, and made repairs. On the third flight of the day, the pilot took off and once again noted smoke in the cockpit. But this time that smoke was accompanied by flames near his feet. Upon landing the passenger proceeded to jump out of the aircraft before it came to a stop. The end result was one destroyed aircraft, one seriously injured passenger, and one slightly injured pilot.

While the NTSB has yet to provide a probable cause for this accident, there are some clear lessons. First, smoke in the cockpit is usually a signal of a very serious problem. Second, when repairing an exhaust system, it pays to have someone with knowledge and experience work on it. Third, symptoms like this are a warning, and it's wise to heed them. This accident easily could have been much worse, and we can see that it was clearly preventable. According to the AP, following the second emergency landing, the responding firefighters urged the pilot to have a qualified mechanic check out the aircraft.

The third possible threat from an exhaust failure is a power loss, either

full or partial. Power loss can happen when components inside the system fail and block the exit of exhaust gases. This in turn causes the engine to stop. Power loss is one of the most common types of accidents. When unfortunately timed, like on take off, these power losses can be very dangerous and have a high rate of fatal conclusions. Engine failures, for whatever reason, are a large part of pilot training for good reason. While most of these failures are the result of other causes (like fuel starvation or induction icing) a little bit of knowledge can be helpful in detecting imminent exhaust problems.

To provide general information to the aviation community the Federal Aviation Administration (FAA) has produced Advisory Circular (AC) 91-59A, *Inspection and Care of General Aviation Aircraft Exhaust Systems*. The AC covers the dangers and the potential failures that can arise from exhaust failures, signs of exhaust failures, and areas to check. In addition to this general information, if you fly a particular type of aircraft, a review of its maintenance manual and service bulletins might be worth your time. All ACs are available through the FAA's Regulatory and Guidance Library (RGL) at [http://rgl.faa.gov/Regulatory\\_and\\_Guidance\\_Library/rgAdvisoryCircular.nsf/](http://rgl.faa.gov/Regulatory_and_Guidance_Library/rgAdvisoryCircular.nsf/).

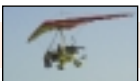

# COLD STARTS



James Williams photo

## How to prepare aircraft for winter flying

By Jason E. Blair

*Editor's Note: The following is one person's account of how he handles winter flight conditions. As always, the aircraft's recommended flight procedures as outlined in the flight manual or operating manual should always be followed. Common sense and safe operating procedures when handling a propeller, for example, will reduce the risk of an accident or incident.*

As an instructor and flight school owner in an area prone to lake-effect snow, cold winter weather, rapidly changing weather conditions, and generally tough winter flying, I have become accustomed to teaching different procedures to students and renters during these different seasons. Winter flying can bring tough lessons, if we are not careful and don't plan ahead.

Cold weather operations require additional thought and preparation. A thorough understanding of how cold

weather, snow, ice, and local weather phenomena affect your aircraft and your flying is also necessary. Proper planning and preflight can limit potential wear on equipment and minimize the dangers present during cold weather.

Preparing the aircraft for winter flight begins at the end of the previous flight. Securing the aircraft appropriately ensures it will be ready to fly the next time. From there, it's necessary to understand what extra steps should be taken to preflight the aircraft, start the engine, and warm up the accessory systems before you're ready to fly.

### Planning and Preparation

#### Melting Ice

On cold nights, cover the airplane and plug in your engine heater, if one is installed. If you plan on flying early in the morning, get the aircraft inside a

heated hangar for the night to keep moisture off the flying surfaces. If this isn't possible, be ready to clear the surfaces the next day before attempting to fly the aircraft. If the aircraft is outside, make sure to tie it down. Winter winds can be fierce. If possible, cover air intakes, pitot tubes, and any other areas that snow or moisture may enter.

All of these steps require some planning ahead. If you are traveling away from the aircraft's home base, you may need to bring extension cords, engine covers, and tarps or call ahead to make arrangements to get the aircraft inside when you get to your destination.

When you are ready to fly the aircraft again, you will want to do a thorough preflight. This is more comfortable if the aircraft is in a heated hangar, but that may not always be available. As you or your students check the aircraft, remember that scraping the windows can leave per-





manent scratch marks. Most aircraft windshields are susceptible to scratching. Check all air intakes, such as the pitot tube, heater, carburetor, and other areas, for snow that can get inside and cause problems with instrumentation. If your aircraft is not in a heated hangar, and you have the option, plug in an engine heater and allow the engine to warm up before trying to start.

Leave the aircraft plugged in until you are absolutely ready to fly. Start it as soon as possible. This will limit the amount of engine cooling and make startup less stressful on the engine and you. Limit your use of electrical items during the starting process to those absolutely necessary to prevent exhaustion of your battery.

Be cautious of fuel contamination. Cold weather can cause water to freeze in the tanks, which means you won't be able to sump it out. If you have any reason to believe there could be water contamination in the fuel, the aircraft will have to be placed in a heated hangar long enough for all of the ice to melt to effectively sump the tanks. The best prevention is to keep the fuel tanks full when securing the aircraft after a flight during cold weather to limit the likelihood of condensation forming.

Remove all snow or ice before flying. If it is in a heated hangar, make sure all water is removed so it doesn't refreeze when taken back outside. This can affect the airflow over the wings and drastically hinder the ability of the aircraft to fly. If it can't be moved into a heated hangar, then you will have to get creative. Wipe off snow, ice, or frost completely so the wing is smooth, but choose a method that doesn't cause damage to the aircraft or further develop any icing. For example, never pour hot water over the aircraft to melt the snow or ice.

One trick that helped me when I was stuck outside at night with a severely frosted-over aircraft was to pull off an inspection panel and blow warm air from a hair dryer on low heat into the wing. The effect was to warm the wing from the inside and melt the frost, which I was then able to wipe off

with towels.

Even if it seems like only light snow is on the aircraft never trust that it will blow off when the aircraft begins to move. If all else fails, use the sun to melt the snow or ice. This takes time, but without any other options, turning the aircraft periodically to face the sun will help melt the snow. Be patient, it works when there are no other options. Remember, aircraft fly well, but Popsicles™ do not.

## **Warming Engines**

Heating an engine is necessary to prevent running the battery down during the process in cold weather. Most engine manufacturers recommend some type of preheating for engines when temperatures are below 20°F. For practical purposes, if the temperature is below freezing or will dip below freezing overnight, the aircraft engine should be warmed prior to flight.

Options for preheating the aircraft may include using a heated hangar, plugging in the aircraft's preheater to keep the oil or the engine warm, or using an external heater such as a propane air heater. A heated hangar is the most desirable option since it will heat the entire aircraft, but this is not always available.

A plug-in type engine heater needs time to work. These are effective at keeping the aircraft engine or oil warm during cold weather, but to adequately preheat an engine this way the engine needs to be plugged in for at least two hours.

When using an external heat source, exercise additional care. An external heating source, such as an electric or a propane heater, will heat an engine up with a few minutes of operation. Do not put the heat directly in contact with something that may melt or catch fire from the heat. Never leave one of these types of heaters unmonitored.

Starting procedures during cold weather may be different. In many cases, additional priming will be required to provide enough fuel into the cylinders. If the engine doesn't start right away, do not continue to turn it

over for long periods of time. This can drain the battery much faster than in warm weather and can burn out the starter. Use short starting bursts. If the aircraft doesn't start, pause for 30 seconds or so. If the aircraft does not start within three tries, stop before running the battery dead. Pause a couple of minutes, and then try again. If it does not start after a second set of tries, get additional help or use further engine preheating.

In some cases an engine may be ice cold and not want to start despite our best efforts. If the engine has been outside and is ice cold (no heat was left on it) and no preheating is available, it still may be possible to get the aircraft started. Turning the prop through a few times prior to starting may help get some oil flow moving in the engine and make starting easier. Once in the aircraft, leave all electrical switches off until you are absolutely ready to attempt the start. Be sure to provide adequate prime (which may be more than you are normally used to using) to give the cylinders something to fire on until the engine is fully running and drawing fuel from the tanks. Then, try the starting process.

It may take some time to get the engine started, and you may need to repeat the priming process a couple of times. Never simply hold the starter down to keep the propeller turning hoping that it will catch. Instead, use short periods of starting followed by additional priming. This will keep you from running your battery down or burning out your starter. Know when to say enough is enough. If the engine has not begun to fire after three or four attempts, it means the engine needs to be warmed to get it started. This may simply mean waiting for the sun to heat it, but more likely it means you will need to get it inside for some heat or find an external heating source for the engine.

## **Preheating Accessories**

Once you have conducted a pre-flight and are ready to begin the flight, take care of the aircraft once it is started. This will limit the wear and

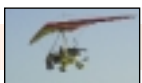

tear you subject the engine to during cold weather. The aircraft may require a slightly higher idle rpm (typically only a couple hundred higher) to keep it running until the engine warms up slightly.

During winter operations never run your battery down fully. If a battery is fully run down and left in cold weather, it can freeze. This will leave you an aircraft with not only a cold and difficult to start engine, but also a battery that is possibly no longer capable of holding a charge. If you have inadvertently run your battery down fully during the starting process, get it charged immediately or remove it from the aircraft and move it to a warm location until you are able to charge the battery.

Prior to operating at higher rpm, it's beneficial to let the oil warm up enough to at least register on the oil temperature gauge. This will typically take five or 10 minutes of engine-running time in most types of aircraft. Waiting for this also will cause less wear on constant-speed propeller systems than exercising them with cold and thick oil. By the way, waiting to cycle the propellers on a constant-speed propeller may require doing your checklist out of the normal order. In this case, that's not a bad thing, and it may be better for your aircraft. Just remember to come back to the skipped items before takeoff.

On aircraft with cowl flaps, it may help warm the aircraft quicker to leave them closed until engine temperatures approach normal operating levels. Additionally, it is easier on the radios of the aircraft to let them warm up some and let the electrical power stabilize before turning them on during cold weather.

One of the last things we tend to think about is that, in a cold cockpit, pilot and passengers will be expelling warm air into a confined space. Many times this will lead to fogging of the windows, making it difficult, if not impossible, to see outside for taxiing or takeoff. A simple solution is to leave a window or door cracked open to allow the warm air to escape until the defroster has warmed up enough to

defog the windows.

Winter flight operations require these additional considerations to keep our equipment in good condition and to keep us safe as pilots. By preparing properly, we can limit some of the potential risks of cold weather flying. Flying in the winter is some of the clearest, smoothest, and most enjoyable flying a pilot can experience; it

just requires a bit more work prior to flight than the other half of the year.

✦

*Jason E. Blair is a National Association of Flight Instructor's Master Certificated Flight Instructor.*

*This article originally appeared in the NAFI Mentor and is reprinted with permission.*

## But I Fly a Rotax Engine!

**Not everyone flies an aircraft that has a Lycoming or Continental engine. Many of us fly aircraft that contain Rotax engines. While we have a long history with the previous types of engines, some of us have little or no experience with Rotax engines.**

**These engines are affected by cold weather and may require engine preheats just like other engines. Rotax engines are liquid-cooled, and proper antifreeze levels must be maintained. Engine heaters for most engines heat the oil pan and the cylinder heads, but a Rotax engine heater must also heat the case. This will help in overall starting and will allow the engine to reach adequate operating temperatures more quickly. Oil weight and condition is also important during cold weather operations and may be varied for different climate and temperature ranges. This should always be done according to manufacturer recommendations. As with other engine types, an engine heater that can be plugged in and left while you are away from the aircraft may be a great option.**

**In low temperatures, it's strongly recommended the engine be pulled through or turned over by hand a few times to get some oil moving through the engine. This will reduce the load on the battery and aid in the overall starting process. Rotax engines also use a choke, which can be helpful for cold weather starts. Be sure to read the operating manual for your aircraft and engine to determine the best use of the choke for different temperature conditions.**

**Cold seizure can also be a concern to be aware of. This typically occurs when an aircraft was started but is left to run at low idle temperatures for a while—for example, waiting for takeoff. This keeps cylinder temperatures low for an extended period of time. To avoid this, maintain warm enough cylinder, exhaust gas, and liquid temperatures when you are idling the aircraft and it is cold outside.**

**While there are a couple of subtle differences, many of the same concerns are true for winter operations when using an aircraft powered by a Rotax engine. There is no reason that aircraft with these engines can't be flown during cold weather periods, as long as you prepare for the flight with specific needs of that engine in mind.**



# Weight and Balance—How Much is Too Much?

by H. Dean Chamberlain

Weight and Balance: A simple concept in aviation, but in an era when the nightly news regularly reports on the increased obesity in the American population, it is a topic of growing concern in the aviation industry. Recently, a few of the general aviation safety inspectors here in the home of *FAA Aviation News*, Flight Standards Service's General Aviation and Commercial Division, had an interesting discussion on the topic. First, I must

confess, none of the inspectors involved in the discussion are as trim as they once were. And when asked, I say I am not gaining weight, I am only losing useful load—more and more each year. Of course, you guessed it, the discussion occurred over lunch in the FAA Headquarters cafeteria. The question asked was: How much could two adults weigh in a Cessna 172 with full fuel and the aircraft still be within weight and balance (W&B) to

practice spins? Then the question was asked: How many pilots actually compute weight and balance once they receive their initial pilot certificate?

The consensus is that not many general aviation pilots compute weight and balance for every flight. The reasons offered were many. Some may own their own aircraft, compute their W&B one time, and unless something changes, they use the same numbers

## ***The following Basic Empty Weight information is from an actual C-172S airplane.***

<i>Normal Category</i>	<i>Weight (lbs)</i>	<i>x Arm(in) =</i>	<i>Moment (lbs-in/1000)</i>
Basic Empty Weight	1,757.4	41.617	73.137
Useful Load	800.6	---	---
Usable Fuel (At 6 Lbs./Gal.) 53 gal	318.0	48.0	15.264
Pilot and Front Passenger (FS 34 to 46) (*Note: 37 average)	?	37.0*	?
Max Ramp Weight and Moment	2,558.0	---	---
Ramp Weight and Moment	?	---	---
Fuel Allowance for start/taxi/takeoff	-8.0	48	-0.384
Takeoff Weight and Moment	?	---	?
Maximum Takeoff Weight	2,550.0	---	?
Over or Under	(Weight)	---	(See CG Limits)

<i>Utility Category</i>	<i>Weight (lbs)</i>	<i>x Arm(in) =</i>	<i>Moment (lbs-in/1000)</i>
Basic Empty Weight	1,757.4	41.617	73.137
Useful Load	450.6	---	---
Usable Fuel (At 6 Lbs./Gal.) 53 gal	318.0	48.0	15.264
Pilot and Front Passenger (FS 34 to 46) (*Note: 37 average)	?	37.0*	?
Ramp Weight and Moment	?	---	---
Max Ramp Weight and Moment	2,208.0	---	---
Fuel Allowance for start/taxi/takeoff	-8.0	48	-0.384
Takeoff Weight and Moment	?	---	---
Maximum Takeoff Weight	2,200.0	---	?
Over or Under	(Weight)	---	(See CG Limits)

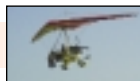

thereafter. Some may just use the standard FAA numbers used in the aircraft's flight manual and assume they are good to go. Some may not remember how to compute their actual

W&B. Then there is the final group. That group may be hesitant to ask their passengers for their actual weights because the group may be afraid of offending the passengers. As

a result, this last group of pilots may use their best guess for the actual weights. As we said in a previous article, "A Weighty Matter" published in the September/October 2005 issue, this line of questioning becomes even more sensitive when the passenger is your mother-in-law or boss.

It goes without saying, if pilots are not using actual passenger weights, it is doubtful they are using actual baggage weights. After all, how much can a set or two of golf clubs weigh?

And aircraft, like people, tend to add a few extra pounds over their useful life. Little things like an extra pair of chocks, an extra quart or two of oil, an old tow bar, a set of tie-down ropes or chains, a little bit of dirt, and the list goes on. All of which when added together can mean a few extra pounds pilots may not think about. And since most of this type of gear is often thrown in the back of the aircraft, a few extra pounds well aft of the aircraft's datum line can have significant impact on an aircraft's W&B and, possibly, performance.

Generally speaking, in aviation with everything else being equal—more weight results in less performance. Forward center of gravity (CG) beyond the forward limit can result in lack of elevator control necessary to properly flair upon landing and can require a faster airspeed to rotate when taking off. Although aft CG within aft CG limits can increase cruise performance by reducing the amount of down load on the tail, aft CG beyond the limits may prevent a recovery in case of a stall or spin.

### TCDS Weights and Balance Data

So, how much can two pi-



SECTION 6  
WEIGHT AND BALANCE/EQUIPMENT LIST      CESSNA  
MODEL 172S NAV III

## LOADING GRAPH

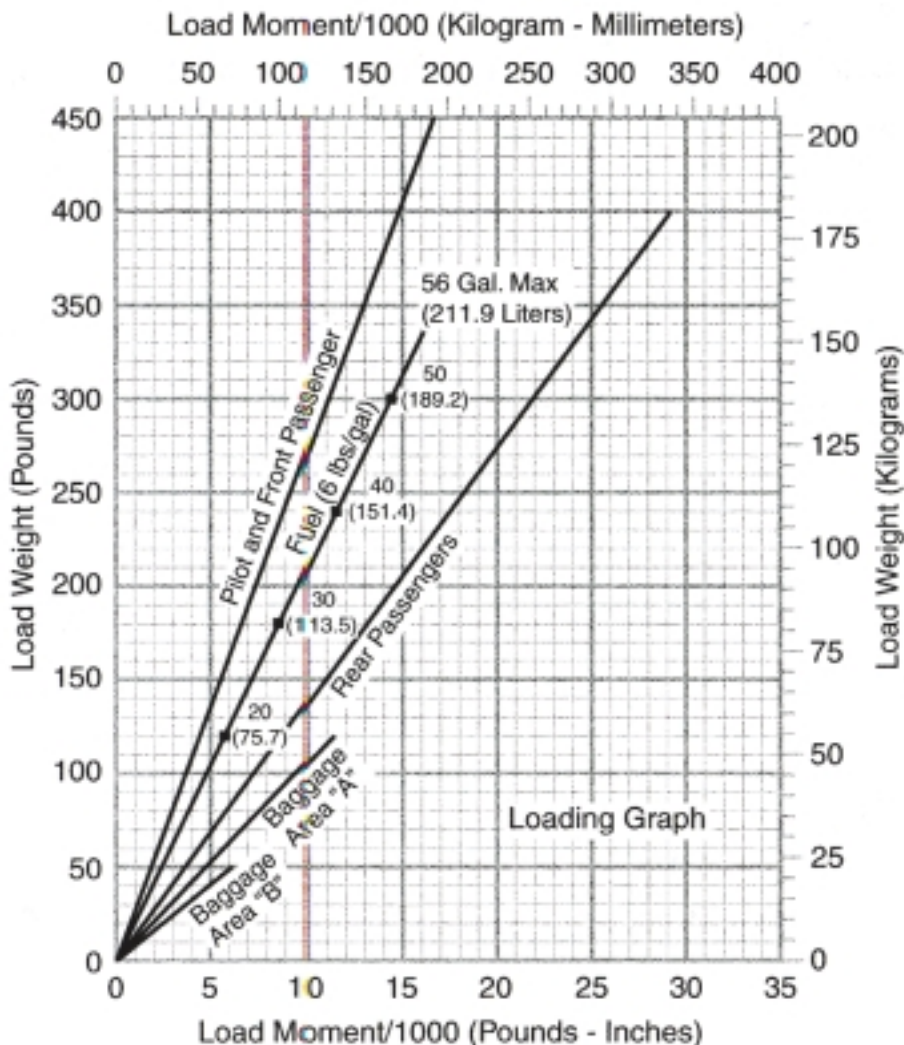

### NOTE

Lines representing adjustable seats show the pilot or passenger center of gravity on adjustable seats positioned for an average occupant. Refer to the Loading Arrangements diagram for forward and aft limits of occupant C.G. range.

Figure 6-4

lots in the front seat of a Cessna 172 weigh and still keep the aircraft within its W&B for spin practice?

The answer depends. If you check the Cessna 172 Type Certificate Data Sheet (TCDS) available on the FAA's Internet Web site, you will find the TCDS list all of the C-172 models from the original 1955 model through today's C-172S model. Over those 52 years, the weights listed for the normal and utility categories have changed. As a result, you have to know which make and model of C-172 is being discussed.

And as noted, you have to decide which category you plan on operating in when discussing weights. If you plan on doing spins for example, you will be operating in the reduced gross weight utility category with its respective operating limitations. In the C-172S manual, it states, "In the utility category, the rear seat must not be occupied and the baggage compartment must be empty." It also notes "Abrupt use of controls is prohibited above 98 knots." So your flight purpose also determines your maximum operating weight and limitations. Along with the change in gross aircraft weights by model, there are also changes in CG limits which must be observed as well as other operating limitations.

### Using Actual Weights By Make, Model, and Serial Number

The key to calculating an aircraft's W&B is based upon using the latest actual W&B data for the actual aircraft by make, model, and serial number. You need to start with the actual weight of the aircraft you are using. This weight will vary from aircraft to aircraft depending upon the installed equipment. Then using that data, you need to compare the data to the aircraft. Was any equipment re-

moved or added to the aircraft without an appropriate W&B update? If so, a new official W&B needs to be completed and added to the aircraft's records. Then, you must following the manufacturer's guidance to compute the W&B for your flight, paying special

attention to any notes or other factors that must be considered in calculating W&B. For example, a note regarding fuel for the C-172S says "Serial Nos. 172S8001 and On, The certificated empty weight and corresponding center of gravity location must include un-

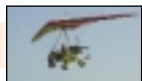
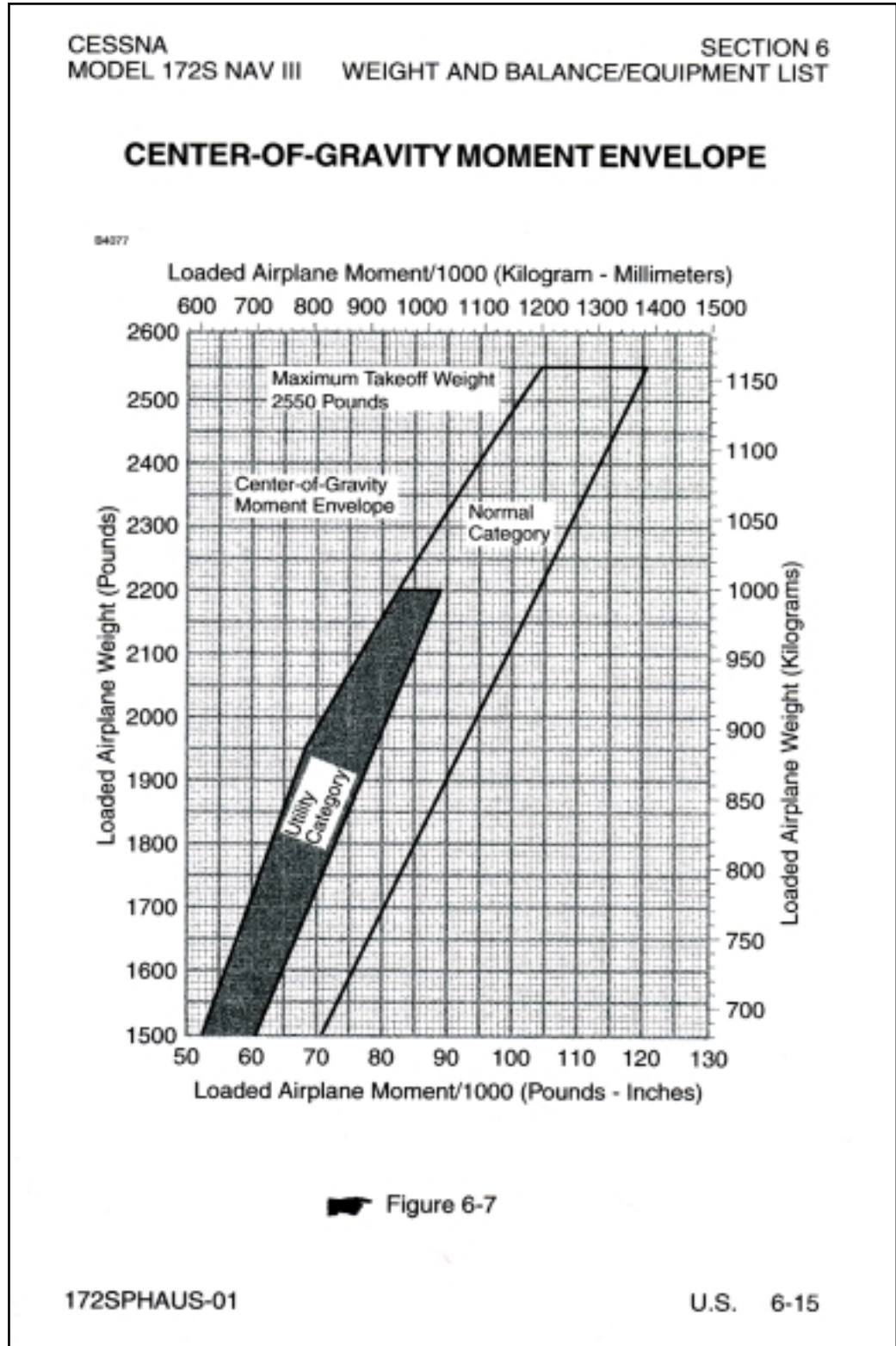

usable fuel of 18 pounds at 46.0 inches aft of datum, and full oil of 15.0 pounds at 13.1 inches forward of datum.” As you can see, this note applies to a specific range of serial numbers. This is why it is important to not only know which make and model of

aircraft is involved, but also its serial number when reviewing manufacturer’s W&B and TCDS information.

To emphasize the importance of a correct W&B, Cessna states in the Model 172S NAV III manual, “It is recommended that the airplane be

weighed to verify Basic Empty Weight and CG Arm at intervals not to exceed five years.”

## Maximum Takeoff and Landing Weights

According to the Cessna generic flight manual for the C-172S, normal category maximum takeoff and landing weight for a C-172S is 2,550 pounds. Utility maximum takeoff and landing weight for a C-172S is 2,200 pounds. This is a 350 pound difference between the two categories.

## Center of Gravity Limits

The center of gravity limits for a C-172S varies from forward CG limit at 35.0 inches aft of datum at 1,950 pounds or less, with straight line variation to 41.0 inches aft of datum at 2,550 pounds to aft CG limit at 47.3 inches aft of datum at all weights in the normal category. The utility limits of forward CG limit at 35.0 inches aft of datum at 1,950 pounds or less, with straight line variation to 37.5 inches aft of datum at 2,200 pounds to the aft CG limitation of 40.5 inches aft of datum at all weights.

As you can see, not only do the weights differ, but so do the center of gravity limits differ between the normal and utility categories for the C-172S.

## Maximum Weights To Spin

Based upon the information presented so far, and the following information, with full fuel, what is the maximum weight that two pilots can weigh in a C-172S in the normal category? What can they weigh in the utility category? Are they within CG limits? Can they do spins with full fuel? Oh, and by the way, do you know the rule dealing with parachutes when doing spins? (Title 14 Code of Federal Aviation section 91.307, Parachutes and parachuting.) Are parachutes required? If so, how much do two parachutes weigh? Little things do add up.

If you don’t know the answers to these questions, we will provide them in the next issue.

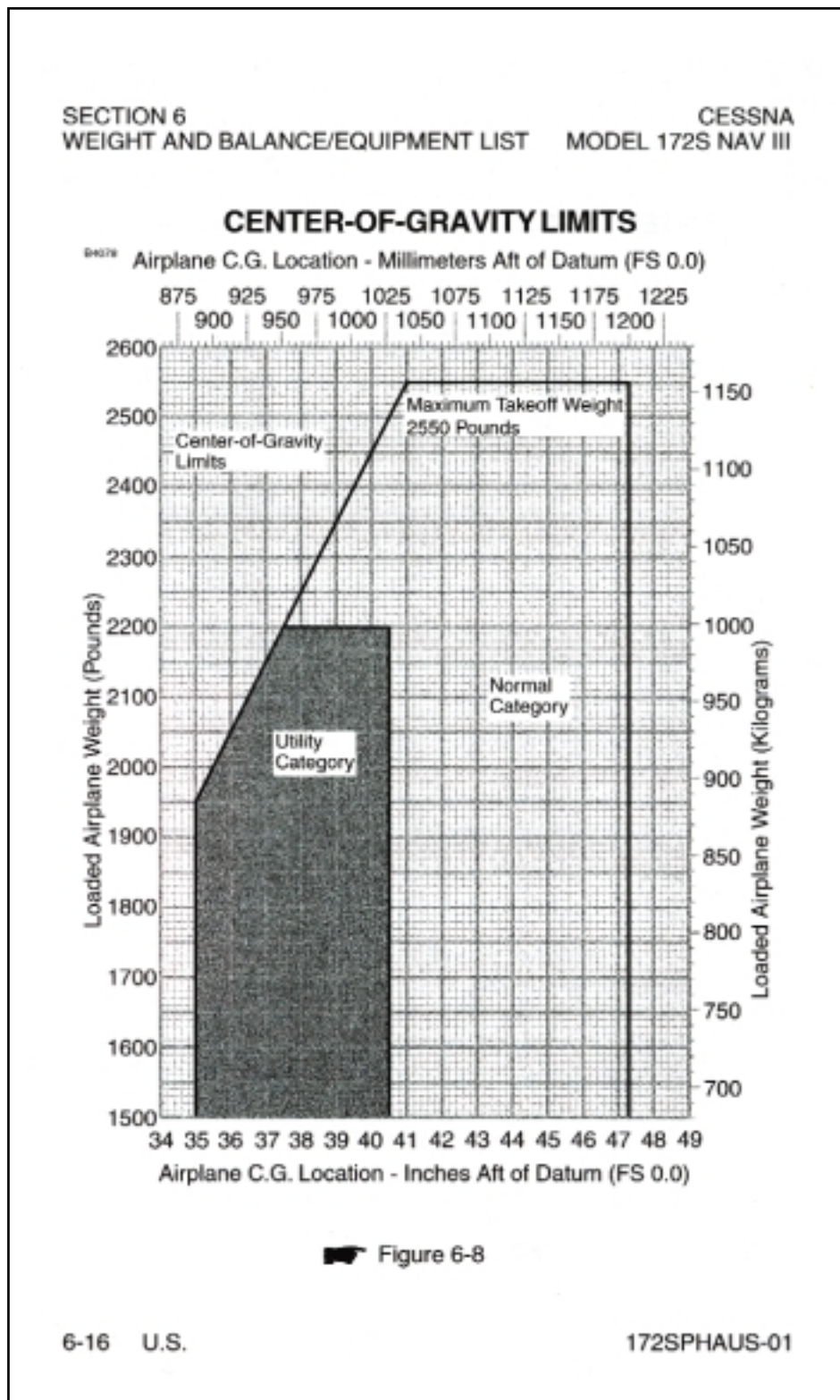

# Vacuum Failures Can Hurt Or What I Learned Reading ASRS Reports

by H. Dean Chamberlain

Are you prepared for a vacuum failure? If you are asking yourself what is a vacuum failure, I would guess you are not ready for one. Recently, in reviewing material about new technology aircraft and their various types of electronic display panels, I wondered how many of today's pilots practice flying the new "glass cockpit" aircraft using their backup instruments. This led to the question about how many pilots of traditional aircraft practice flying needle, ball, and airspeed.

Do we even need to practice flying with backup instruments? Or is this one of those instrument flying skills that is going the way of knowing how to fly a non-directional beacon (NDB) approach in today's world of GPS approaches and multi-panel displays? Based upon some of the information I received from one of the leading makers of vacuum-related equipment, this company says that, in my words, flying with anything less than dual vacuum systems is a hazardous operation. The fact that thousands of pilots have flown thousands of hours for decades with only one vacuum system would dispute this idea. So the issue then may be one of product liability rather than operational necessity. But, I would also bet that many of those pilots fly-

ing single vacuum systems were like an old U.S. Air Force colonel I once knew. When he wanted to practice instrument flying with a safety pilot, his idea of practice was to fly using only needle, ball, and airspeed. For him, if he ever had a real vacuum failure and had to use his backup system of needle, ball, and airspeed, this would not be an emergency situation for him, but rather just another opportunity to practice his basic instrument skills.

But whether you fly an aircraft with one or two vacuum systems or have one of the various alternative vacuum backup systems or have an electrically powered artificial horizon as a backup, the question remains, are you proficient in the use of whatever instrument backup system you have onboard your aircraft? Can you fly your backup system to approach minimums for your airport of intended landing or do you give yourself a way out by setting higher personal minimums for yourself?

I wanted to see what pilots had to say about vacuum system failures, so I used the Internet to search National Aeronautics and Space Administration's (NASA) Aviation Safety Reporting System (ASRS). I was surprised at the results my search request for "Title

14 Code of Federal Aviation Regulations part 91 general aviation aircraft failures in instrument metrological conditions" produced. While I was expecting to find a few reports dealing with vacuum pump failures, I found more reports about electrical failures, generator failures, and more surprising, autopilot failures resulting in altitude deviations, tracking problems, and loss of control.

In reading the narratives describing the reported incidents, there seemed to be two common themes repeated throughout the many reports. First, some of the pilots were slow in detecting the loss of navigation equipment or control equipment which compounded the problem. The second group, as noted in one report, failed to see the "big picture" of the incident. In one case, once the aircraft situation was under control, rather than land in visual conditions when able, the pilots continued their flight in IMC conditions to their home airport. In the report, it was said their continued flight was a result of "get-homeitis" rather than based upon good decision making.

In summarizing a few of the reports, it is important to always fly the aircraft when something happens. Having a backup handheld radio or GPS can keep you communicating and navigating when your electrical system dies. Being able to quickly detect equipment failures by having a good instrument scan may keep you in control of your aircraft. When flying single-pilot or at night or when weather conditions are down to minimums, you need to have a good divert plan and have your backup gear out and ready to use. Finally, I think good judgment is important when dealing with any emergency situation. Flying past a nearby acceptable landing site in visual metrological conditions while you are in the clouds dealing with an in-flight emergency may not be the best example of good decision making.

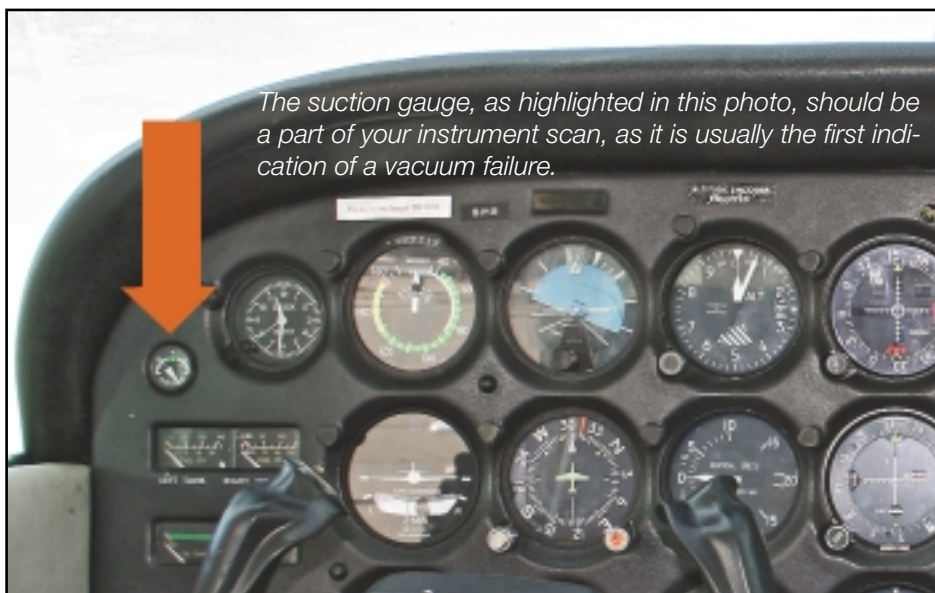

James Williams photo



# Search and Rescue



by Rogers V. Shaw, II

CAP photo

In the unlikely event that your aircraft crashes, you should be very aware of search and rescue procedures, and what you can do to improve your survival odds. After a crash, how can you best utilize the resources available to accomplish the survival goal—rescue?

We need to distinguish between these two key words, search and rescue. What does the term “search and rescue” mean? If rescue personnel don’t know where you are, it’s a search. If they do know where you are, then it’s a rescue.

What can you do to help in the search phase? The key to your survival is to shorten the time from the crash to rescue. Obviously, if the rescue team doesn’t know your location, then it will take a lot longer for them to find you.

How much longer? The average time from the last known position (LKP) to rescue is 31 hours. Since this is an average, one could be a survivor for a few hours—or a few days. To assure that the LKP is known, as a pilot, your key survival effort begins by filing a flight plan. It is a road map of your inflight movements and is the cheapest insurance available. How cheap? It’s free. The types of flight plans filed will greatly affect the time you may have to survive during a search phase.

## Flight Plan Average Time from LKP to Rescue

- Instrument Flight Rules (IFR), 13 hours 6 minutes

- Visual Flight Rules (VFR), 37 hours 18 minutes
- No Flight Plan, 42 hours 24 minutes

It is very easy to see how important it is to have a flight plan on file with a Flight Service Station.

## Communications: A Key to Aircrew Survival

It’s important to understand how the rescue personnel are put into action. When an aircraft is overdue, missing, or sends a radio distress call, the National Search and Rescue Plan is activated. There are many organizations and volunteers associated with search and rescue (SAR), but the Federal government assumes overall responsibility. The National SAR plan designates the U.S. Coast Guard as responsible for maritime SAR and the U.S. Air Force for inland SAR.

All SAR activities in the contiguous 48 states are coordinated through the full-time Air Force Rescue Coordination Center (AFRCC) at Tyndall Air Force Base, Florida. When a call on a missing or overdue aircraft is received by the Center, the National SAR Plan is activated.

## When Is a Flight “Overdue?”

If a flight plan is filed, the air traffic control system will automatically initiate a plan to locate overdue flights. When an aircraft on a VFR flight plan is overdue by one hour, or by 30 min-

utes on an IFR flight plan, the Flight Service Station servicing the destination airport issues an INREQ (Information Request). If a flight plan was not filed, there is no designated time limit before a search is initiated, thus greatly delaying the onset of search and rescue.

The following summarizes the actions that are used to locate a downed aircraft.

## Search Process Phase Description

**Uncertainty.** The Information Request (INREQ) is initiated. The FAA and the Air Force Rescue Coordination Center conduct a Preliminary Communications (PRECOM) search. Because of the high rate of false alarms, this phase is designed to determine if an aircraft is really missing or if a crew neglected to close their flight plan. If the PRECOM comes up negative, then the next phase is activated.

**Alert or Alert Notice (ALNOT).** The ALNOT will be issued at the end of the INREQ or when the estimated time that the missing aircraft’s fuel would be exhausted or when there is serious concern regarding the safety of the aircraft and its occupants.

At this phase, the destination airport checks all ramps and hangars to locate the aircraft. Local law enforcement agencies in the search area are notified and all information is sent to the AFRCC. If the ALNOT





fails to find the aircraft, then the final phase is activated.

**Distress.** At this point, the actual search mission is launched. Air search efforts will not begin until first daylight, unless there is a functioning emergency locator transmitter (ELT) alerting a ground rescue party. If the weather permits, air rescue is dispatched to the distress location. Even with an ELT, terrain and weather may hinder response time. Chances are good of spending at least one night as a survivor.

It is very important to ensure that your aircraft's ELT is in good operating condition. The average time required to find a downed aircraft with a functioning ELT is 6.8 hours. Compare that time to 40.7 hours without an operating ELT and the benefits of properly maintaining emergency equipment become obvious.

## Improving Survival Odds

Another important factor is the probability of death from serious injury: It increases substantially after 24 hours. How can the search phase be shortened? A flight plan filed with Flight Service, an operational ELT, and good communications will increase your chances of a quick response by rescue personnel.

## Survival Equipment

One item to help you survive after a crash is a good personal survival kit aboard the aircraft. Be sure to read the next article, "Prepared for Anything" by Roger Storey, for a description of a good survival gear kit.

Fly safe and be smart.



*Rogers Shaw, a former USAF pilot with 3,000 hours of flight time, manages the Civil Aerospace Medical Institute's (CAMI) Airman Education Program.*

*This article originally appeared on the FAA Web site for pilots under training, Airman Education Programs, <[http://www.faa.gov/pilots/training/airman\\_education/](http://www.faa.gov/pilots/training/airman_education/)>.*

## AIR FORCE RESCUE COORDINATION CENTER

As the United State's inland search and rescue (SAR) coordinator, the Air Force Rescue Coordination Center (AFRCC) serves as the single agency responsible for coordinating on-land federal SAR activities in the 48 contiguous United States, Mexico, and Canada.

The AFRCC is located and assigned to the 1st Air Force at Tyndall Air Force Base, Florida, and operates 24 hours a day, seven days a week. The AFRCC directly ties into the Federal Aviation Administration's alerting system and the U.S. Mission Control Center. In addition to the Search and Rescue Satellite Aided Tracking information, the AFRCC computer system contains resource files that list federal and state organizations, which can conduct or assist in SAR efforts throughout North America. When a distress call is received, AFRCC investigates the request, coordinates with federal, state, and local officials, and determines the type and scope of response necessary. Once verified as an actual distress situation, the AFRCC requests support from the appropriate Federal SAR force. This may include Civil Air Patrol, U.S. Coast Guard, or other Department of Defense assets, as needed. State agencies can be contacted for state, local, or civil SAR resource assistance within their jurisdiction. The AFRCC chooses the rescue force based on availability and capability of forces, geographic location, terrain, weather conditions, and urgency of the situation. During ongoing SAR missions, AFRCC serves as the communications hub and provides coordination and assistance to on-scene commanders or mission coordinators in order to recover the mission's objective in the safest and most effective manner possible. AFRCC uses state-of-the-art technology including a network of satellites for monitoring emergency distress signals. Systems such as these help reduce the critical time required to locate and recover people in distress.

For more information, visit its Web site at <[www.1af.acc.af.mil/units/afrc](http://www.1af.acc.af.mil/units/afrc)>.

## COSPAS-SARSAT Rescues as of September 07, 2007, since 1982

- Worldwide – More than 22,058 people rescued
- United States – 5,664 people rescued

### Number of persons rescued to date in 2007 in the United States: 268

- Rescues at sea: 194 people rescued in 54 incidents
- Aviation rescues: 26 people rescued in 16 incidents
- Personal Locator Beacon (PLB) rescues: 48 people rescued in 22 incidents

### Number of persons rescued during 2006 in the United States: 272 people rescued in 105 incidents

- Rescues at sea: 220 people rescued in 71 incidents
- Aviation rescues: 15 people rescued in 12 incidents
- PLB rescues: 37 people rescued in 22 incidents

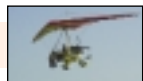

## **SARSAT - A Lifeline to Survival!**

Around the world—around the clock—the U.S. National Oceanic and Atmospheric Administration (NOAA) proudly stands watch. As an integral part of worldwide search and rescue efforts, NOAA operates the U.S. Search and Rescue Satellite Aided Tracking (SARSAT) System to detect and locate mariners, aviators, and recreational enthusiasts in distress almost anywhere in the world at anytime and in almost any condition.

The SARSAT system uses NOAA satellites in low-earth and geostationary orbits to detect and locate those in distress. The satellites relay distress signals from emergency beacons to a network of ground stations and ultimately to the U.S. Mission Control Center (USMCC) in Suitland, Maryland. The USMCC processes the distress signal and alerts the appropriate search and rescue authorities of those who are in distress and, more importantly, approximately where they are located. With the newer GPS encoded 406 MHz distress beacons, a victim's location can be located to within a few square meters.

Aviators should be aware that on February 1, 2009, SARSAT's satellites will no longer monitor for the analog 121.5 MHz frequency given off by older Emergency Locator Transmitters (ELTs). Pilots and aircraft owners are advised that they should consider changing out their 121.5 MHz ELT for a digital 406 MHz frequency, which will continue to be monitored by the satellites.

NOAA-SARSAT is a part of the international Cospas-Sarsat Program to which 38 nations and two independent SAR organizations belong. For more information about SARSAT and the transition to 406 MHz ELTs, readers can log onto the following Internet Web site at <<http://www.sarsat.noaa.gov/>>.



## **SUGGESTIONS ANYONE?**

Even though the *FAA Aviation News* is now in its 46<sup>th</sup> year, we strive to continuously improve the magazine and meet the needs of our customers. We are always interested in your feedback. Please let us know if there is a specific topic you'd like us to cover, or if you think a different format would be more effective.

***Please e-mail your comments or suggestions to***  
***AviationNews@faa.gov***



# Prepared for Anything

by Roger A. Storey

As the popularity of aviation as a career and as a hobby increases, so does the concern for safety. One such concern is survival after a crash. As a Survival Instructor with the Civil Aerospace Medical Institute's Airman Education Division, I am often asked: "What is the most important piece of equipment to have in a survival situation?" The answer is simple: Me, the survivor.

In any survival situation, there will be specific priorities. The priorities will include medical first-aid, shelter from the elements, rest, water, and food. The order of importance you place on each of these priorities will be dictated by each situation. For instance, the priorities for a pilot forced into a survival situation in rural Missouri during the month of August will vary from a pilot who has to survive in northern Michigan during January. One thing is for certain, without a "will to survive," the chances of survival will be greatly reduced. If you do not have a desire to survive, there is no equipment available that will help you survive.

There are two simple, but important, ways you can increase your chances of survival. These involve preparation—before you ever find yourself in an actual survival situation. The first is to admit to yourself that "It Can Happen To Me." The next step is

to prepare yourself, both mentally and physically. It is not enough to prepare mentally if you cannot withstand the physical requirements of a survival situation.

The mental preparation can come in the form of educational courses, books, or conversations. There are various survival courses conducted around the United States that deal specifically with the climate, terrain, and many other factors that you may be exposed to in a particular region. Along with these courses, there are a great number of books on survival techniques for the desert, arctic, and sea. You can find these at most bookstores or at the library. Another way to gain knowledge is to ask people who have been through a survival situation what to expect. Training also includes learning how to use and practicing the use of survival gear you may already have.

Preparing yourself physically for a survival situation depends greatly on the shape you are in now. Keep in mind that your situation may require you to walk, climb, or even carry a fellow crewmember or passenger a distance. You will want to be as physically fit as you would expect the person, who might have to carry you, to be.

By improving your knowledge and physical capabilities, you will also

increase your confidence, which will benefit you a great deal. The more informed you are about your own capabilities and on the climate and terrain over which you fly, the easier it will be to decide what your priorities for survival will be.

The priorities of survival will vary from situation to situation and region to region. Using the priorities established earlier you can start to evaluate what equipment would be best suited for your personal survival kit (PSK).

Once you have decided what your needs are in accordance to your priorities and typical flying area you can decide what equipment will best suit your needs. Below is a basic list of suggested equipment you might consider for your PSK. Keep in mind a PSK is a survival kit that is designed to supplement your survival needs, but must be readily and easily accessible in the event of an emergency evacuation from the aircraft.



*Mr. Storey is an instructor in the Civil Aerospace Medical Institute's (CAMI) Airman Education Programs.*

*This article originally appeared on the FAA Web site for pilots under training, Airman Education Programs, <[http://www.faa.gov/pilots/training/airman\\_education/](http://www.faa.gov/pilots/training/airman_education/)>.*

## Priority Checklist and Equipment for your Personal Survival Kit (PSK)

Category	Purpose	Item
Medical	Treat injuries and illness	First aid kit, prescription meds, aspirin, splint
Shelter	Survival	Tent, poncho, fire starting material, matches, raft
Water	Fluid intake	Water purification, canteen, water container
Food	Nourishment	Granola bars, MREs (meals ready to eat), energy bars, fishing kit, survival food
Signaling	Rescue	Whistle, flares or laser flares, survival radio, mirror/reflector, Cell/Sat phone, handheld GPS, Personal Locator Beacon (PLB)
Miscellaneous	Comfort	Compass, quality pocket knife, mirror, bug repellent, multi-purpose tool/knife, your imagination
Rest	Recharge	





U.S. Department  
of Transportation  
**Federal Aviation  
Administration**

# InFO

Information for Operators

InFO 07001  
DATE: 1/5/07  
Flight Standards Service  
Washington, DC

**[http://www.faa.gov/other\\_visit/aviation\\_industry/airline\\_operators/airline\\_safety/info](http://www.faa.gov/other_visit/aviation_industry/airline_operators/airline_safety/info)**

*An InFO contains valuable information for operators that should help them meet certain administrative, regulatory, or operational requirements with relatively low urgency or impact on safety.*

**SUBJECT:** Noise Attenuation Properties of Noise-Canceling Headsets

**Purpose:** This InFO alerts operators, directors of operations (DOs), chief pilots, and flight crewmembers who may be using noise-canceling headsets of the potential for misdetection of audible alarms and other environmental sounds.

**Background:** Ordinary (non-noise-canceling) headsets reduce ambient noise levels through a physical means by providing some acoustical quieting. Noise-canceling headsets cancel noise through a combination of physical means and electronic means. While this technology can have many beneficial effects such as providing clearer communications, reduced pilot fatigue, and added comfort, electronic attenuation of important environmental sounds and alarms may occur.

**Discussion:** Noise-canceling headsets are most effective over a narrow frequency range, but the specific frequencies may vary by make and model. Also, these electronically attenuated frequencies are often proprietary to the manufacturer and may not be publicly available. Therefore, it is difficult to assess any effects the headsets may have on discerning environmental sounds such as:

- Vital communications between flight crewmembers or flight attendants, other than those attainable through interphone operations;
- Abnormal mechanical noises or abnormal engine sounds;
- Audible alarms other than those discernible by electronic means;
- Vibrations or wind noises; or
- Other aircraft during ground operations.

**Recommended Action:** Operators, DOs, chief pilots, and crewmembers of aircraft should evaluate their use of noise-canceling headsets. The FAA recommends sampling the available manufactured makes and models when performing such evaluations, since performance and attenuation properties vary. Evaluations should be conducted while both on the ground and in flight during normal operating conditions to ascertain if any audible alarms or other environmental sounds, or combinations thereof, can be detected while electronic noise attenuation is on and active. If any audible alarms or environmental sounds cannot be discerned, operators should elect to find other solutions to discern such alarms or sounds, or discontinue the use of noise-canceling headsets.



# Aviation Maintenance Alerts

## **Aerotech Alternator: 646843; Improper Assembly; ATA 2421**

A repair station technician states, "Upon receipt of (this) current alternator we noticed the Slip-Ring Housing was clocked 180 degrees out of alignment—out of the box, from Aerotech. This plane has had several Aerotech...alternators installed on it. The most recent alternator had only 131.1 hours before it failed, and the previous one 67.2 hours (before it too failed). There have been other aircraft (on which) we have had to replace low time Aerotech overhauled alternators.

"We see what seems to be a possible problem with Quality Control or the manufacturing of these appliances." Part Total Time: 0.0 hours.

(A search of the FAA Service Difficulty Reporting System data base reflects eight entries for this item; P/N 646843.)

## **Beech: B24R; Blown Electrical Capacitor; ATA 2340**

"(An aircraft operator...) had drawn the battery charge down considerably, trying to start the aircraft," states a technician. The pilot reported hearing a "pop"—then (seeing) smoke in the cabin. Take-off was aborted and an emergency gear up landing was made, resulting in substantial damage to the aircraft. On inspection, a capacitor was found secured to the aft end of the audio control panel...installed in the KN4CB wire. The capacitor had the end blown out and its contents splattered on the windshield air duct.

"Probable cause: the low battery charge coupled with the high in-rush current demand of the gear motor—over and above the normal demands of the avionics—most likely resulted in an over-voltage condition, causing the capacitor to explode." Part Total Time: (unknown).

(A similar event happened to a cohort flying an experimental several years back. He described smoke so thick in the cockpit both he and his wife were certain the aircraft was on fire. They effected a safe landing in a farmer's field, later discovering a three dollar part the cause of their near calamity—*Maintenance Alerts* Editor)

## **Bell: 206B3; Tail Rotor Blade Weight Separation; ATA 6410**

An Airframe and Powerplant mechanic writes, "The center tip weight swung out of the subject tail rotor blade during flight, causing a violent vibration. This vibration caused three of the tail rotor gearbox studs to shear before the aircraft could auto-rotate to the ground.

"If the helicopter had not made the ground (when it did) the other stud would have sheared and the tail rotor gear box would have left the aircraft—the results would have been disastrous.

"I recommend the tip blocks (rotor blade P/N 206-016-201-127M) be manufactured from a material that can withstand the centrifugal forces applied to the tip weights during flight. ...(These) tail rotor tip blades (should) be inspected as soon as possible and at every 100 hour inspection." Part Total Time: (unknown).

(A search of the FAA Service Difficulty Reporting System (SDRS) data base revealed 22 entries for this part number.)

## **Cessna: 175; Cracked Engine Mount Attach Brackets; ATA 7120**

(This report combines three submissions from the same mechanic on three different Cessna 175 aircraft.)

"The engine mount attachment bracket (P/N 0513132-11) was found broken and with cracks at the 12 and 6 o'clock position. The cracks were on the inboard and outboard sides of the AN960-616 washer(s)." "The possible cause (for this defect) is the AN960-6126 washer is too small. (I believe) a larger and thicker washer is needed to support the upper engine mount load." Part Total Time: unknown.

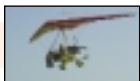

(Since 1996, 21 reports have been entered into the FAA Service Difficulty Reporting System data base for this bracket's part number. Fourteen of these entries have included times ranging from 1,900 to 5,983 hours: 3,234.14 hours average.)

### **ECI Cylinder: EC636122ST; Improper Machining; ATA 8530**

(The following repair station submission is a composite of three identical reports reflecting the same part numbers.)

"(I) installed this cylinder assembly on a newly overhauled engine, then discovered oil leaking around the cylinder base during the test cell run. I removed the cylinder and determined the cylinder base is not properly machined. There is no radius at the area where the O-ring seal is to seat. This (condition) does not allow the O-ring to properly seal against the crankcase. I used radius gauges and other cylinders to compare and make the determination there was a problem with the cylinder (P/N EC 636122ST)." Part Total Time: 0.0 hours.

### **Facet Carburetor: 10-6019 mod HA-6; Leaking Float; ATA 7322**

A repair station technician states, "Engine idle and low power performance were erratic. Upon engine shutdown fuel was noted dripping from the carburetor/induction air box. The carburetor was disassembled and inspected. (I) found the plastic hollow float 1/2 full of fuel. The float assembly top piece appeared to have partially debonded from the lower section, allowing fuel to begin leaking into the assembly. As the float lost its buoyancy, it could no longer restrict the fuel source. A poor running engine and a fire hazard were the results. (I) recommend the manufacturing process (bonding) of this float be improved. In the meantime, all floats manufactured in the same batch should be removed from service." Part Total Time: 400.0 hours.

(A search of the FAA Service Difficulty Reporting System (SDRS) data base revealed four similar entries referencing float defects.)

### **Precision Airmotive: MA45 Carburetor; Leaking Float; ATA 7322**

"The carburetor was taken into my repair station for overhaul," states the submitter. "When disassembled it was found the float (P/N 30802) had taken on fuel and was sunk. It is recommended all polymer floats produced by Precision Airmotive be recalled, an AD issued, and the new Composite float be installed as soon as possible. The polymer floats have a significantly reduced wear life of only about 500 hours instead of 2,000 hours for the carburetors this float is installed in. This instance was not a first for this repair station." Part Total Time: 300.0 hours.

(Carburetor's model number of MA45 includes a sub-component number: 104404. A search of the FAA Service Difficulty Reporting System (SDRS) data base revealed 19 entries for this unit, two specifically dealing with floats.)



The Aviation Maintenance Alerts provide a common communication channel through which the aviation community can economically interchange service experience and thereby cooperate in the improvement of aeronautical product durability, reliability, and safety. This publication is prepared from information submitted by those who operate and maintain civil aeronautical products and can be found on the Web at [http://www.faa.gov/aircraft/safety/alerts/aviation\\_maintenance/](http://www.faa.gov/aircraft/safety/alerts/aviation_maintenance/). Click on "Maintenance Alerts" under Regulations and Guidance. The monthly contents include items that have been reported as significant, but which have not been evaluated fully by the time the material went to press. As additional facts such as cause and corrective action are identified, the data will be published in subsequent issues of the Alerts. This procedure gives Alerts' readers prompt notice of conditions reported via Malfunction or Defect Reports, Service Difficulty Reports, and Maintenance Difficulty Reports. Your comments and suggestions for improvement are always welcome. Send to: FAA; ATTN: Aviation Data Systems Branch (AFS-620); P.O. Box 25082; Oklahoma City, OK 73125-5029.



# Dr. Paul MacCready 1925-2007

by James Williams

When things come to an end it often forces us to evaluate just what has been lost. In the case of Dr. Paul MacCready, the loss is huge. Like many people, I had nearly forgotten about the tremendous accomplishments of Dr. MacCready. MacCready's interest in aviation started with model aircraft and by age 16 he soloed in a powered aircraft. During World War II he was in the U.S. Navy Flight Training Program. He was also a champion glider pilot during the late 1940's through the mid 1950's and captured the world championship in 1956. He also invented the Speed Ring Airspeed Selector (sometimes called the MacCready Ring) that is used to calculate the optimum speed between thermals (commonly called MacCready Speed) by glider pilots. His academic record included a Bachelors degree in Physics from Yale University (1947), a Masters degree in Physics from Cal Tech (1948), and a Ph.D. in Aeronautics from Cal Tech (1952).

MacCready was most famous as the "Father of Human Powered Flight." In 1977 he designed the *Gossamer Condor*, accomplishing the world's first sustained, controlled flight of a heavier than air craft powered by only the pilot's muscles. In 1979 a further development of the same concept, the *Gossamer Albatross*, crossed the English Channel, winning MacCready the Kremer prize for the second time.

MacCready next turned to solar-powered flight with the *Gossamer Penguin* (1980) and the *Solar Challenger* (1981). These successes led to work with the Defense Department and the National Aeronautics and Space Administration on the *Pathfinder* and *Pathfinder Plus*, solar-powered stratospheric aircraft, which attained altitudes of 71,500 feet for the former and over 80,000 feet for the latter. A later and much larger derivative, the *Helios* (2001), reached an altitude of 96,863 feet. MacCready and the company he founded, AeroVironment Inc., had numerous other accomplishments including designing a solar-powered race car



Reprinted with permission from AeroVironment Inc.

for General Motors.

I had only one personal memory of an endeavor of Dr. MacCready and looking back it was probably one of his more minor accomplishments. In 1985 the Smithsonian Institution commissioned MacCready to build a life-size, working, radio-control model of a pterodactyl. This flying dinosaur, which had a 36-foot wingspan, was to be used in an IMAX® film for the Smithsonian. After completing the film the working dinosaur toured the country giving demonstrations. I vividly remember sitting in the back seat of the family car while desperately trying to get to the local demonstration. The traffic

was backed up for miles. So there we sat, barely moving as the appointed hour approached. It was not to be. We never made it to the site, but the point was moot as high winds that day prevented the flight from taking place.

I think the true genius of Dr. Paul MacCready was to make the things that seem impossible possible. But more than that, his accomplishments were the kind that inspired adults and children of all ages. They were all the more spectacular because they were of a more human scale than something like the Apollo moon landings. We own a large debt to Paul MacCready. He will be missed.



Helios

NASA photo

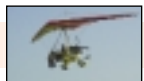

# Icing – Hope is not a strategy

by Michael Lenz

*In this article airframe icing is explored. This article is part of a continuing series of pilot reports of weather encounters as collected and analyzed by the Aviation Safety Reporting System (ASRS) staff (See FAA Aviation News – September/October 2007). Icing accidents were also used from the National Transportation Safety Board (NTSB) database.*

The title of this article says it all. Hope is not a strategy, when icing is involved. Encounters with icing are often dangerous, especially to small general aviation aircraft that may not have the equipment to mitigate the icing encounter.

My research begins with 100 ASRS reports of weather encounters of all types. Sixteen flights encountered icing resulting in heading and altitude deviations, control problems, and declaration of emergencies. These 16 pilots, flying single-pilot operations, encountered icing, yet only three were informed by weather briefings of potential icing prior to their flights. Nine of these flights were operating under instrument flight rules (IFR). The icing encounters resulted in the following consequences:

- Icing forced five pilots to deviate from assigned altitudes/airways without waiting for ATC clearance.
- The icing encounters resulted in three declarations of emergency (one included a visual flight rules (VFR) encounter into instrument meteorological conditions (IMC))
- Three additional reporters encountered IMC and icing, while operating under VFR.
- Two reporters diverted to an alternate airport and landed
- One reporter encountered control problems from severe icing and diverted
- One reporter landed below minimums to avoid additional ice accumulation
- One reporter stated that the

icing condition was distracting and caused a deviation from the instrument landing system (ILS) heading

- Many of the pilots conveyed their surprise at how quickly ice could accumulate on an aircraft. One pilot observed, “The mist came from nowhere...iced my wings and propeller in a matter of seconds.”

## Profiles of Icing Encounters

One ASRS study reporter reflected that an early diversion to an alternate airport might have alleviated this potential emergency situation because of icing:

*“Upon arriving at the destination airport, the pilot set up for the ILS...After crossing the initial approach fix (IAF), looked up and realized...windshield was covered with ice, and glanced at mirror and leading edges, and realized that they were covered with bumpy, spiky mixed ice...Committed to landing...didn't want to take the chance of accumulating more ice, perhaps to the point that the plane couldn't fly, especially with a potential engine problem. I flew to the right of the localizer in hopes of seeing the runway out my left window.”*

During the icing encounters, pilots cited some problems with the availability of air traffic control (ATC) services, including delays in obtaining ATC clearances (three reports), ATC not providing a pop-up IFR clearance (one report), and being too low for radar coverage (one report). One example of rapid ice accumulation, coupled with attempts to contact ATC, occurred when a Mooney M20C pilot accumulated unforecast rime icing at 7,000 feet,

*“...descended to 5,000 feet and described icing that continued to accumulate rapidly...Several attempts to reach either controller on two radios*

*went unanswered...I called in the blind twice that I was descending to 3,000 feet [from 5,000 feet].”*

The pilot finally reached ATC, while descending through 4,100 feet, and obtained clearance to descend. In hindsight, the pilot thought a block altitude request would have helped comply with the altitude assignment. Another pilot was faced with a dilemma when the Center was busy on another frequency.

## The Accidents Tell a Similar Story But with Some Key Differences.

A review of icing accidents, since 2000, shows 55 reports ranging from hard landings with iced-over windshields and non-injury runway overruns to fatal, loss of control accidents. The vast majority occurred to piston singles and light twins.

If there's a difference among the accident pilots and those reporting icing encounters to ASRS, it's in the preflight information. Only three of the 16 ASRS reports of ice encounters indicated information regarding potential icing in the preflight briefing. In contrast, almost all of the accident pilots received a preflight weather briefing and they almost always included a potential for icing.

Once en route, only eight of the accident pilots received a pilot weather report (PIREP) on icing conditions. Those eight pilots were all involved in injury accidents to some extent. Of the remaining 47 accidents, 11 did not involve injuries. Perhaps the message here is that once a PIREP of icing conditions is received in flight, prompt action is needed to avoid the hazard. It's hard to say, because we don't know about the benign events, that a PIREP message resulted in an alternate course of action with no incident.

Six of the accidents involved at





least a partial power loss. Some of these involved icing that affected the engine induction system. It may be easy to overlook things like engine alternate induction air, while attempting to find an ice-free altitude, but nothing leads to a rapid altitude loss like an engine failure, compounded by an iced over aircraft. It's important to know the airplane flight manual (AFM) procedures for use of alternate induction air, when ice may be present.

## Flaps and Tailplane Stalls

Two of the accidents occurred as the flaps were deployed. This brings up the subject of tailplane icing or Ice-Contaminated Tailplane Stall (ICTS). [Note: The following information is from Advisory Circular AC 91-74, *Pilot Guide Flight in Icing Conditions*. This is available at <http://rgl.faa.gov/>.] Since the tailplane is ordinarily thinner than the wing, it is a more efficient collector of ice. On most aircraft the tailplane is not visible to the pilot, who therefore cannot observe how well it has been cleared of ice by any deicing system. Therefore, it is important that the pilot be alert to the possibility of tailplane stall, particularly on approach and landing.

Most aircraft have a nose-down pitching moment from the wings because the center of gravity (CG) is ahead of the center of pressure. It is the role of the tailplane to counteract this moment by providing "downward" lift. (See Figure 1).

The result of this configuration is that actions, which move the wing away from stall, such as deployment of flaps or increasing speed, may increase the negative angle of attack (AOA) of the tail. The initial deployment of the flaps should be only partial. Vibration or buffeting that follow deployment is much more likely to be because of incipient tailplane stall. The reason is that, after deploying the flaps, the wing will be at a less positive angle and, therefore, farther from stall, while the tailplane will be at a more negative angle and closer to stall. (See Figure 2).

As the pilot prepares for the de-

ployment of the flaps after or during flight in icing, he/she should carefully assess the behavior of the aircraft for any buffet or other signs of wing stall. The initial deployment of the flaps should be only partial. Vibration or buffeting that follow deployment is much more likely to be due to incipient tailplane stall than wing stall, if there was no vibration buffet before deployment. The reason is that after deploying the flaps, the wing will be at a less positive angle, and so farther from stall, while the tailplane will be at a more negative angle, and so closer to stall. There are few known incidents of ICTS in cruise (when flaps would not ordinarily be deployed). However, when the flaps are deployed, tailplane

ice, which previously had little effect other than a minor contribution to drag, can now put the tailplane at or dangerously close to stall.

One of the ASRS reporters encountered ice and tail vibration in a Cessna *Caravan* at 10,200 feet. The pilot began a climb:

*"...But aircraft unable to climb above 10,200 feet. Tail begins vibration and aircraft pitches up. Autopilot is disengaged and pitches aircraft down in 1,500 fpm descent [emphasis added]. Pilot descent to 6,500, get[s] a bit more [ice] to slide off and leading edge of mains begins to clear with boot action and better temperatures. Tail still vibrating. Airspeed improves*

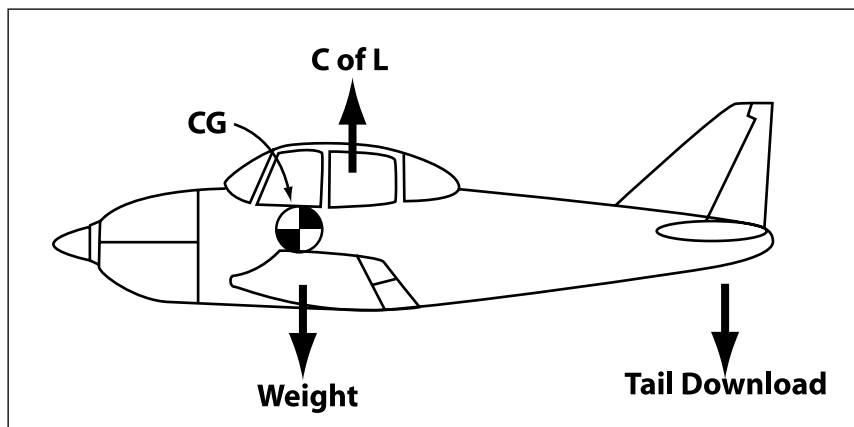

Figure 1. Straight and level flight

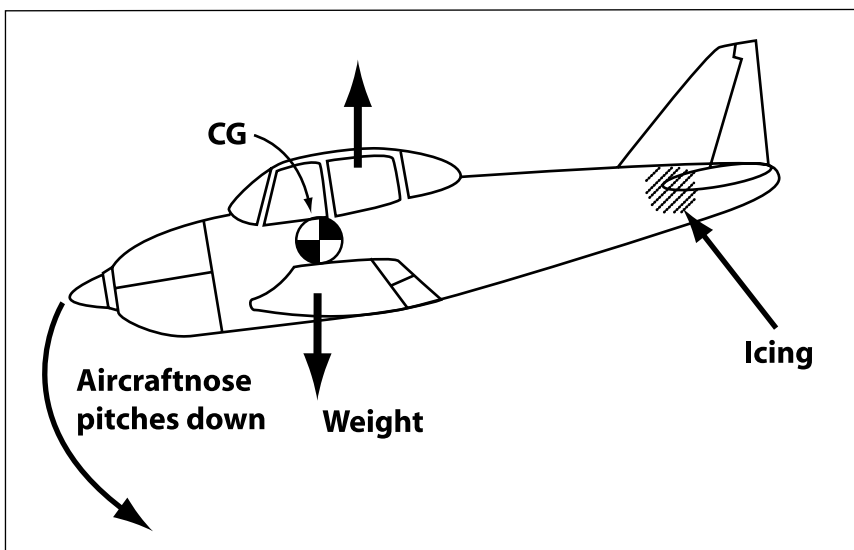
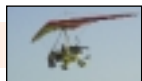
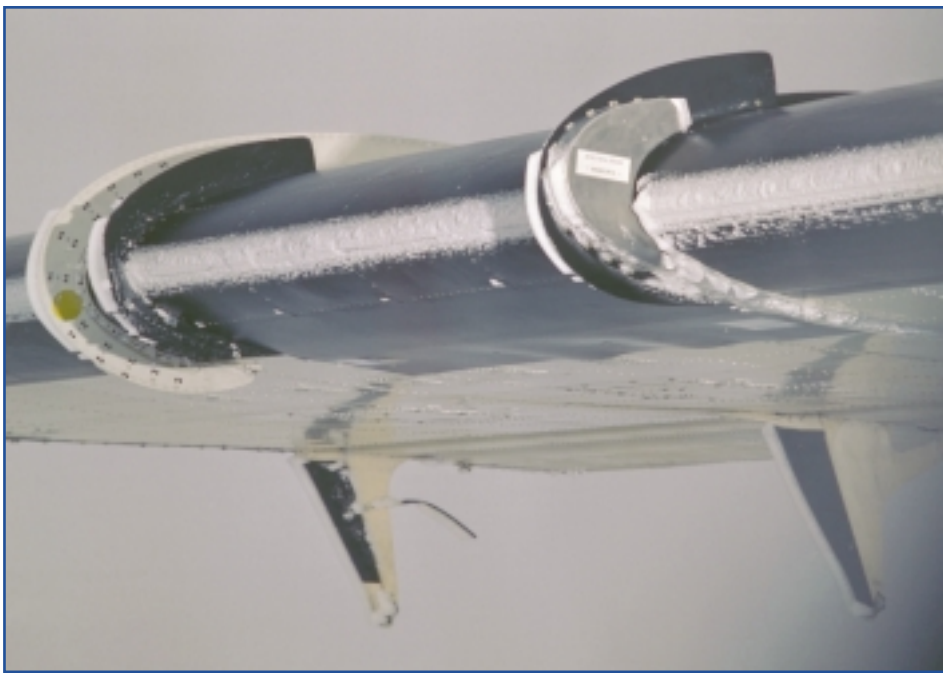

Figure 2. Pitchover due to tail stall





and ice steadily comes off..."

## Legalities of Ice—The Jury Is Out

In June 2006, the FAA's legal council issued an interpretation on the definition of "Known Icing." This admittedly set off a controversy and resulted in the Aircraft Owners and Pilots Association (AOPA) requesting that the interpretation be rescinded. Excerpts from the FAA's response and its effort to seek public comment, offer insight into the complex administrative law surrounding safe operations when icing conditions are presented. It also points out the meteorological and aerodynamic conditions that affect airframe icing. (The complete text can be found on the Web at <http://www.gpoaccess.gov/fr/index.html> in the April 3, 2007, Federal Register (Volume 72, Number 63).

"While various FAA regulations contain limitations on flight in known icing conditions, the regulatory provision that most commonly affects general aviation operators in this respect applies the term only indirectly. Title 14 Code of Federal Regulations (14 CFR) section 91.9, Civil aircraft flight manual, marking, and placard requirements, precludes pilots from operating

contrary to the operating limitations in their aircraft's approved AFM. The operating limitations identify whether the aircraft is equipped to operate in known icing conditions and may prohibit or restrict such flights for many general aviation aircraft. Title 14 CFR section 91.103, Preflight action, requires pilots to become familiar with all available information concerning their flights before undertaking them.

"Permutations on the type, combination, and strength of meteorological elements that signify or negate the presence of known icing conditions are too numerous to describe exhaustively in this letter. Any assessment of known icing conditions is necessarily fact-specific. However, the NTSB's decision making reflects the common understanding that the formation of structural ice requires two elements: visible moisture and an aircraft surface temperature at or below zero degrees Celsius. Even in the presence of these elements, there are many variables that influence whether ice will actually form on and adhere to an aircraft. The size of the water droplets, the shape of the airfoil, or the speed of the aircraft, among other factors, can make a critical difference in the initiation and growth of structural ice.

"[...] Likewise, a variety of sources provide meteorological information

that relates to forecast and actual conditions that are conducive to in-flight icing. Pilots should carefully evaluate all of the available meteorological information relevant to the proposed flight, including applicable surface observations, temperatures aloft, terminal and area forecasts, AIRMETs, SIGMETs, and pilot reports. As new technology becomes available, pilots should incorporate use of that technology into their decision-making process.

"The ultimate decision of whether, when, and where to make the flight rests with the pilot. **A pilot also must continue to reevaluate changing weather conditions** [emphasis added]. If the composite information indicates to a reasonable and prudent pilot that he or she will encounter visible moisture at freezing or near freezing temperatures and that ice will adhere to the aircraft along the proposed route and altitude of flight, then known icing conditions likely exist. If the AFM prohibits flight in known icing conditions and the pilot operates in such conditions, FAA could take enforcement action."

## A Hero Emerges

As in all weather flying, the golden rule is to "Leave yourself an out." One of the ASRS reporters did just that. This pilot encountered supercooled, large droplets in the descent after already accumulating ice en route. This made continued flight unsustainable. This "out" may not have been as golden as it should have been, but, in the pilot's words:

"My 'out' was planned in advance, warmer temps in the 2,000 feet just above ground. This planning of an absolute 'out' must be practiced, particularly in non-turbojet aircraft flying below flight levels, in winter between Idaho, Utah, Montana, and Wyoming. In other words, had I not had the 'out' that I ended up using in this case, I would not have launched that day. If surface temps were two to three degrees colder, I would not have launched."



## Additional Information

All of the participating pilots were asked:

1. Why do you think the incident occurred?
2. In retrospect, is there anything you would have done differently?
3. What would you recommend that others do to avoid a similar occurrence?

Some selected responses were:

From a Cessna 210 Centurion pilot:

1. The weather unexpectedly got worse than forecast near the end of my flight, and I expected it to be temporary. Once I was committed to the approach, I didn't want to go around and divert to my alternate with the ice buildup and the hot Exhaust Gas Temperature (EGT) on one cylinder.
2. Probably not, as I thought the low visibility was due to a short-term "squall line" and would pass quickly, and the ice was not expected.
3. Divert to the alternate if forecast or current conditions are suddenly below minimums, don't get past the point of no return as I did, with (as it turned out) false optimism that the condition would be momentary.

From a Mooney M-20 pilot:  
Known poor radio coverage area. Lack of foresight by controller and myself to use a block altitude.

1. Non-forecast icing conditions.
2. As per above, requested a block altitude.
3. Same. If changing altitude in icing conditions, have a plan for lost radio coverage (next frequency, block altitude). I did have next frequency.

From a PA-34-200T Turbo Seneca II pilot, who was on a visual flight rules (VFR) flight at 10,500 feet and lost control of the aircraft and recovered at 3,000 feet. The icing occurred over a period of about five minutes before he lost control:

1. Mist came from nowhere. Iced my wings and propeller in a matter of seconds. I've never seen this kind of weather before.
2. No, I saved my life and wife and kids. I did not panic and regained control of the airplane. Continued my flight to destination.
3. I don't know

And finally, this instrument-rated C-172 pilot encountered a myriad of issues while conducting this flight: disorientation, struggles with icing, get-

ting below radar coverage, time pressures, over confidence in flying experience, and over reliance from having two pilots on board. Here's his narrative:

*"We departed VFR in order to get off the ground faster...the ceiling started to come down rapidly...I instructed my friend to contact ARTCC (air route traffic control center) for a pop-up IFR clearance...ice was starting to accumulate at a great rate at this point and I had to add increasingly more power to keep us at a normal cruise speed...at this point I had to add full power to maintain my assigned altitude...I asked my passenger to declare an emergency, as it was clear we had picked up over a quarter of an inch of ice and could not identify the localizer to find the airport..."*

*"I was confused at this point and became completely disoriented with regards to our position. I knew from experience that zzz airport is between two ridges and I was fairly confident we were still between the two...ARTCC advised us that we were below their radar coverage and told to contact them when we got on the ground.... Within 500 feet my passenger spotted the airport 90 degrees to our right. I made the turn and landed without incident..."*

*"If we were in the clouds 10 minutes longer, both my passenger and myself would have perished from the amount of ice on the aircraft...what I did not anticipate was how rapidly the ice formed...and how few options we had for airports along the route...the terrain to be very rugged and unforgiving...My passenger and I made the decision to take the flight to make it to work on Monday."*

*"I feel very good about my flying during the incident, but my lack of situational awareness was staggering...I'm at a fairly dangerous time in my flying career where I have enough experience to be confident, but not enough to really know better. ...."*



Michael Lenz is a program analyst in Flight Standards Service's General Aviation and Commercial Division.



NASA photo



# Oh No, Not Another Acronym!

## Flight Standards Enters the Information Age—and Brings You Along

©2007 by Phyllis Anne Duncan

One thing about the transparency of government is our operators and the public have always had access to the guidance materials used by FAA inspectors in certification, inspection, or surveillance. Up until recently, that meant that operators had to subscribe to up to three large paper directives, or orders. If you're an air carrier you probably know FAA Order 8400.10, *Air Transportation Operations Inspectors Handbook*, and FAA Order 8300.10, *Maintenance Inspectors Handbook*. If you're any other kind of air operator or air agency, then, you're familiar with Order 8700.1, *General Aviation Operations Inspectors Handbook*, as well as Order 8300.10. Those three directives have been the guiding documents for inspectors for the past two decades.

In addition to the printed versions of these documents, we posted .pdf versions of them on the FAA's public Web site for public and industry use. Then, in 2004, we made some changes to the presentation of the information from these directives, which affected inspectors only. Basically, we did some digital "magic" to the content to allow inspectors to search across all three directives electronically. We continued to issue paper changes and updates to the three directives and post those changes on the public Web site. We called this new inspector application the Flight Standards Information Management System, or FSIMS.

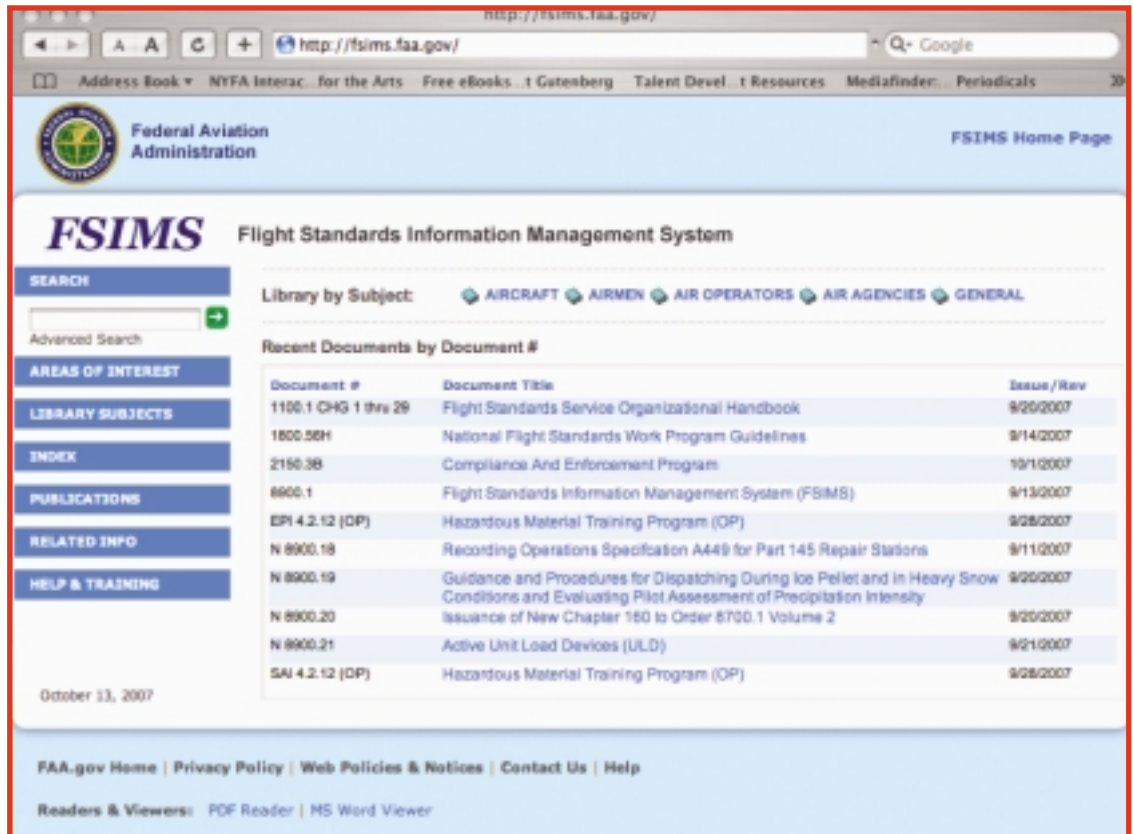

Figure 1 – FSIMS (8900.1) Home Page

The content of FSIMS was essentially the content of the three inspector directives—including any duplications—but inspectors could set up an "account" in FSIMS which filtered out any information not related to their particular specialty. For example, a general aviation operations inspector could designate preferences so that any searches he or she did would return only GA Ops information—no paging through a large document to find the information and no wading through unrelated chapters. Inspectors used this application, with enhancements and upgrades, for three years, providing us feedback as well on how to improve. One thing many inspectors said was, "Wouldn't it be great if our operators could use FSIMS?"

Well, coincidentally, the Director of the Flight Standards Service, James J. Ballough, came up with the same idea. For many years—in fact since he was a field inspector—he has wanted a single source, electronic, policy document for inspectors, which operators could also access. He tasked the FSIMS program office with not only combining the three paper directives into a single, electronic directive, but to make certain operators, and the public, had the same access to the same information.

This past September, we delivered to our inspectors FAA Order 8900.1, *Flight Standards Information Management System*, at the same time cancelling Orders 8300.10, 8400.10, and 8700.1. We haven't lost the content of those orders; merely, it's now in-



cluded in the FAA's first all-electronic order. This order will never be printed—it would amount to around 8,000 pages! On the same day this electronic directive debuted for inspectors, a public version also appeared on the FAA's public Web site—<http://fsims.faa.gov/>.

Don't be dismayed by any "Page not Found" or redirect messages you may receive when you look at any bookmarked pages for the cancelled orders. Just bookmark that URL above, and you'll be able to get to all the information you were accustomed to in the old, printed directives. Of course, we did rearrange the order of the content extensively, but there's help for that as well.

Let's take a look at the "home" page (Figure 1) for

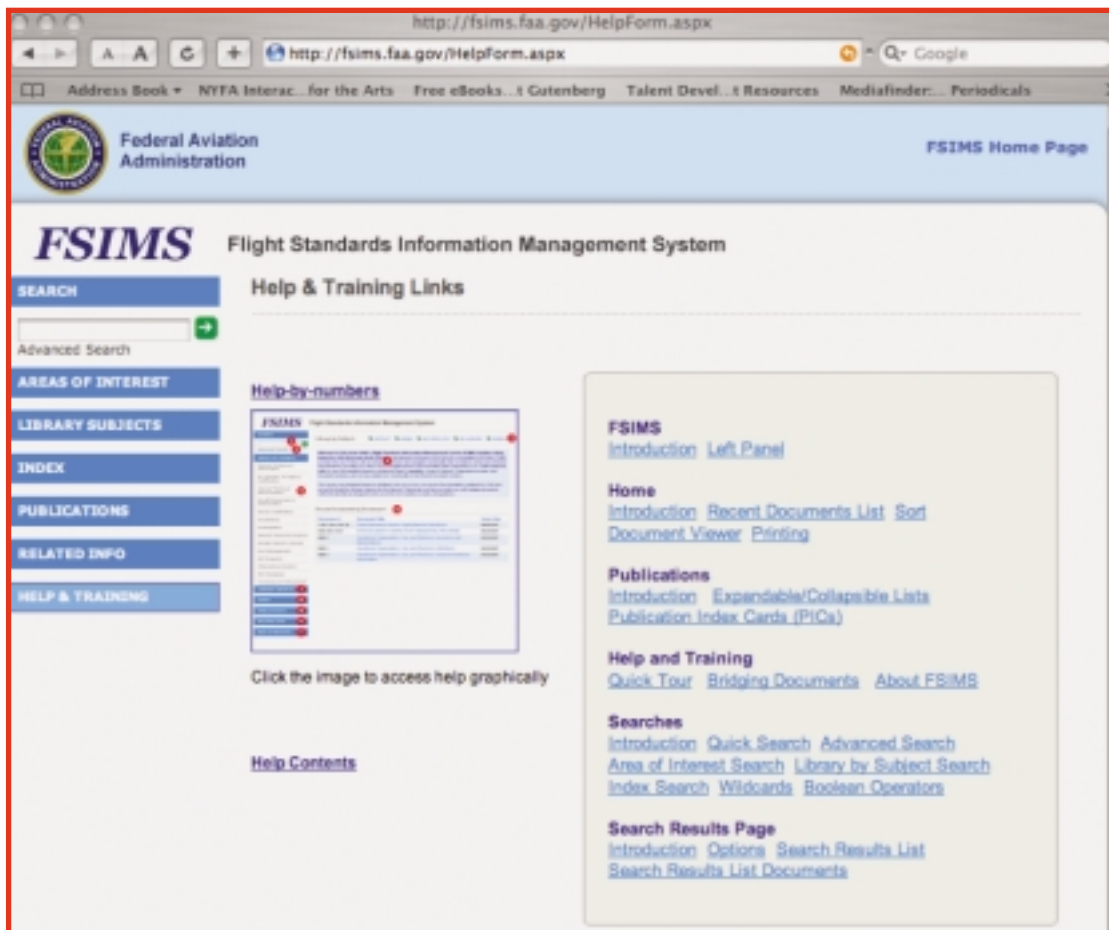

Figure 2 – 8900.1 Help and Training Page

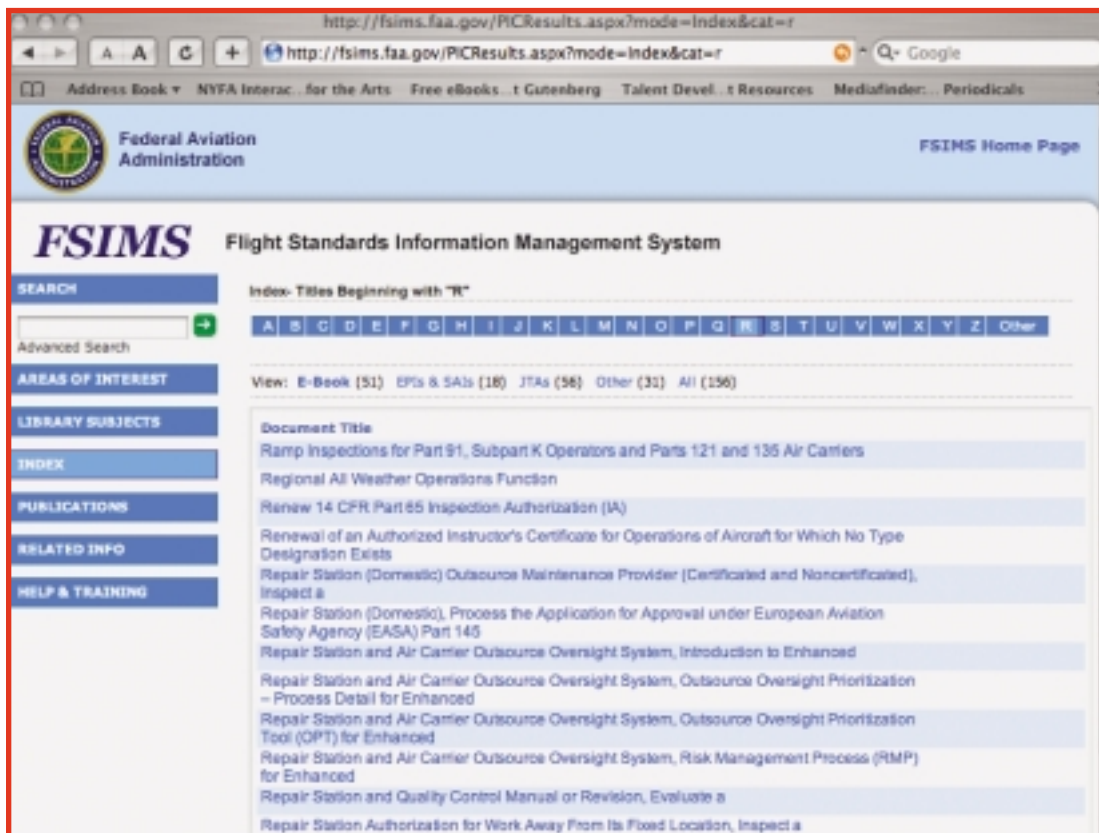

Figure 3 – Sample Alphabetical Index Page

the public side of Order 8900.1.

We recommend you first click on "Help and Training" (Figure 2) on the lower left. This is your on-line training on how to use the features of 8900.1, and you can learn about the features of 8900.1 several different ways, including an embedded Quick Tour. Exploring this first will help you navigate through the remainder of the directive.

Once you've used the "Help and Training" feature, note 8900.1 provides several different means to access specific information. You have "Library by Subject," broken down by Aircraft, Airmen, Air Operators, Air Agencies, and General. Within each of these subject libraries, you can "drill down" to more



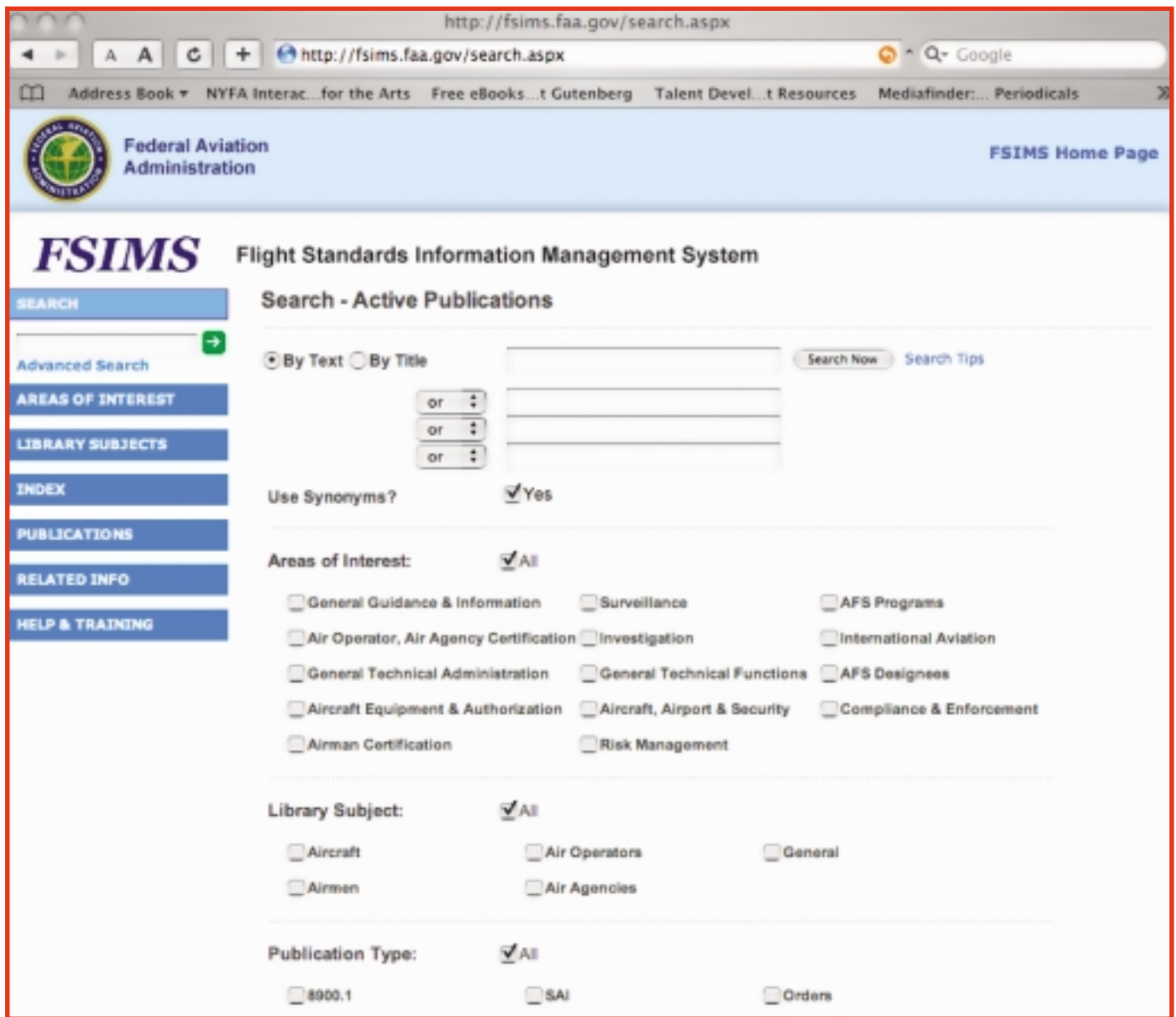

Figure 4 – Advanced Search Page

specific information or select a regulation area within each. On the left hand side of the home page, you can also use “Areas of Interest,” for example, certification, surveillance, enforcement, etc. As well, there’s an alphabetical index (Figure 3). Click on Index from the left hand side, and let’s say you wanted to see all our policy on repair stations. Select “R” from the alphabet at the top of the page, and you’ll see something like Figure 3.

By far the best feature of 8900.1 is Search, particularly the Advanced Search function (Figure 4). This is where reviewing the Help and Training Section is key—because you’ll see just how powerful this search function can be in getting you to the specific

information you need.

The ease of navigating 8900.1 will increase naturally with use, and we’ll constantly improve its functions and features—and content. One upcoming enhancement will allow you to sign onto a ListServ function, meaning you’ll receive an e-mail any time we change FAA policy in an area which might affect you. Because both the public and inspector access to 8900.1 come from the same server, when we update the inspector version, the public version also gets updated. So, you and your principal inspectors will be reading from the same sheet of music, so to speak. Hey, you asked for standardization, and we’re happy to provide.

Go to <fsims.faa.gov> and experiment with it after going through the Help and Training. We think you’ll be pleased.

And since it’s a directive, we won’t be adding another dreaded acronym to our long list.

Direct any questions about the technical content of 8900.1—or FSIMS, if you prefer—to your principal inspectors. If the features or functions don’t work, please e-mail<9-awa-avs-afs-fsims-librarian@faa.gov> and provide a detailed description of the problem.



*Phyllis Duncan oversees the FSIMS Program Office for Flight Standards and is a former editor of FAA Aviation News.*



# *The Last Link in the Chain*

by James Williams

While watching portions of the National Transportation Safety Board's (NTSB) July 26, 2007, meeting, which discussed the August 26, 2006, crash of Comair Flight 5191 in Lexington, Kentucky, I was struck once again by how safe our air transportation system is. The accident the Board was discussing, which killed 49 people and severely injured one, was the worst since November 2001. While any loss of life is unfortunate, we can certainly appreciate that long gap between large aircraft accidents. According to the NTSB's 2006 Statistical Tables (which can be found at <<http://www.nts.gov/aviation/Stats.htm>>), between 2002 and 2006 there were nine fatal Title 14 Code of Federal Regulations (14 CFR) part 121 scheduled airline accidents in the United States, accounting for 108 fatalities according to Table 5, Accidents, Fatalities, and Rates, 1987 - 2006, 14 CFR part 121, Scheduled and Nonscheduled Service (Airlines). Of these accidents, four were single fatality accidents involving ground personnel. Two were mechanical or structural in nature, accounting for 41 fatalities. Only three were pilot error accidents, but these accounted for 63 fatalities. When you consider the total hours flown for that period are 89,402,744 (also reported in Table 5), this equates to a rate of 0.12 deaths per 100,000 flight hours for the five years ending in 2006 (108 fatalities divided by 894 hundred thousand hours). But underneath the fatal accident rate the numbers highlight the fact that while pilot error accounted for only 33% of accidents, it was responsible for nearly 60% of the fatalities.

On the general aviation (GA) side, between 2002 and 2006, there were 1,635 fatal accidents with 3,034 total fatalities, or about 600 fatalities per year according to NTSB's Statistical Table 10, Accidents, Fatalities, and Rates, 1987 through 2006, U.S. General Aviation. A

search of NTSB's records shows 1,565 fatal accidents for the period. The NTSB attributes this discrepancy to the inclusion of 14 CFR part 103 (Ultralight Vehicles), part 125 (Large Aircraft), part 137 (Agricultural Aircraft), and Non U.S. Commercial aircraft (not including part 129 Foreign Air Carriers) accidents in Table 10 that were not in the total returned by the online records. The reason for this is that online records classify General Aviation accidents as only those operating under 14 CFR part 91 and not under the other parts as shown in Table 10. Of these, 1,188 are attributable to some kind of pilot error. This is nearly 76% of all fatal GA accidents. There were 222 aircraft mechanical failures, which is 14% of the total, and 124 falling into either undetermined or other areas. Weather, not attributable to a pilot's failure to get a proper briefing or where a pilot continued despite cues that should have forced him/her to turn around, accounted for only 24 incidents. The last category was fatalities to ground personnel, which accounted for seven deaths.

From these numbers we can see that the pilot plays a much larger role in general aviation accidents than in air carrier accidents. This is likely due to the relative paucity of fatal air carrier accidents, meaning that there are so few accidents that the comparison is at least a little unfair. Even so, this further lends credibility to FAA's efforts to address the human element in the safety equation. The crash of the Comair flight is illustrative of this point. The crew of the Comair jet attempted to take off on the wrong runway, which was too short for the jet, and crashed. As the NTSB concluded, there were numerous cues that should have alerted the captain to the mistake—because ultimately the captain is the pilot in command (PIC) and bears the responsibility for the safe conduct of the flight. The facts are straight forward, but the why is illusive, as the members of NTSB also con-

cluded during their public deliberations (available online at <<http://www.nts.gov/events/Boardmeeting.htm>> under July 27, 2007). Of all the things there could have prevented this accident, there was only one that should have prevented the crash and that was the PIC.

I spoke with pilots who have flown into and out of the Lexington airport in the days before the accident and they indicated that it would have been easy to line up on the wrong runway. However, one of the first things we are taught as student pilots is to verify our heading when we pull onto a runway. The pilots I spoke with said it is common practice at many airlines to set the heading bug on the Horizontal Situation Indicator (HSI) to the runway heading and verify everything lines up before take off. In fact, this was done on the Comair flight (NTSB AAR0705, p3). In light of this, it becomes harder to understand how a well-trained professional crew could have made such a mistake. Airliner crews have advantages many GA pilots don't, such as HSIs and other advanced avionics, and still the crew erred. Even in the most technically sophisticated aircraft, the pilot is still the key to safety.

No matter how comprehensive our safety systems become, they will never diminish the responsibility of the PIC. As we add more and more to our safety systems (more links to our chain in this analogy) we have a tendency to focus on these added programs or procedures and lessen our focus on the basics of training and education. We need to remember that as the old saying goes: The chain is only as strong as its weakest link. The pilot is the last link in the safety chain, meaning no matter how good the system is, if the pilot makes a mistake, the system isn't effective.

As we head further into the world of system safety and safety management systems we need to stop for a

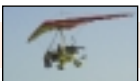

second and remember that, while these new systems are an improvement in how we approach safety, they are only part of the solution. The major portion of the problem is, as it always has been and likely always will be, the pilot. Well-meaning and good-intentioned pilots sometimes make questionable decisions. There are varying degrees of quality in every human endeavor, and piloting is no exception. While it is tempting to relegate accident pilots, particularly those involved in fatal accidents, to the lowest strata, many times they come from the middle and even the highest strata of ability.

The FAA's *Pilot's Handbook of Aeronautical Knowledge*, FAA-H-8083-25, Chapter 16, outlines five hazardous attitudes: Anti-Authority, Impulsivity, Invulnerability, Macho, and Resignation (for more information please see Advisory Circular 60-22, *Aeronautical Decision Making*). Of these, invulnerability plays a large role in limiting what we learn from our accidents. By seizing on a mistake as something we would never do, we immediately distance ourselves from the circumstances of the accident. In so doing we don't fully process the events and gain maximum benefit from them. If we are to make the next leap in terms of safety, we must be willing to look at accidents in the light of how we are the same as the unfortunate pilot, not how we are different from them. We must also focus on reminding pilots that as PIC they are responsible for their flight. As 14 CFR section 1.1 states: "Pilot in command means the person who: (1) Has final authority and responsibility for the operation and safety of the flight...."

All too often we have a tendency to abdicate our responsibility to others. Whether to instructors, management, air traffic controllers, or a number of other people; this delegation of responsibility, even if subconsciously, can have fatal consequences. Remember that while all those other people may be very safety minded, not one of them has the

same incentive to insure your safety as you do. In many cases those other people have a great interest in your safety, but they assume that you are in charge of your flight and if you need help, you'll ask. This is displayed in dramatic fashion in the Comair accident. Because no air carrier aircraft had ever attempted to take off on the (wrong) small, unlit runway, the controller was not thinking that this was a possibility (NTSB AAR0705, p 22). Controllers assume you know what you're doing, unless you say otherwise.

This assumption of competence was demonstrated in a recent GA accident. On August 17, 2007, in Siassconset, Massachusetts (NTSB-ATL07LA115), the pilot of a Cirrus Design SR-20 deployed his airframe parachute after encountering Instrument Meteorological Conditions (IMC). The non-instrument rated private pilot was informed of the deteriorating weather conditions by the tower controller. The pilot was then switched to approach control frequency. The pilot then informed the controller that he was capable of executing an Instrument Landing System (ILS) approach. Somewhere between that time and

when the pilot should have landed, the pilot encountered IMC and presumably lost control, necessitating the use of the Cirrus Airframe Parachute System (CAPS). The pilot was seriously injured and his passenger suffered minor injuries. If it had been in another type of aircraft, the results would almost certainly have been fatal. But this again points to the fact that the PIC needs to be clear on what he/she can do and when help is needed. If you say you can, the controller will assume you can. The bottom line is the safety net only works if you're honest with yourself and the other people in it. If something doesn't seem right, ask.

In the end the PIC is the best safety system we have. While all the other improvements help, the PIC is the last link in the chain and if he or she can't use that safety net effectively then all that effort is wasted. We must be honest with ourselves and must accept that it can happen to us. By learning from the mistakes of others and embracing our responsibilities as PIC, we can improve our safety record. The responsibility for safety doesn't lie with the NTSB or FAA, but with us, the PIC.



## Flight Instruments



An NTSB depiction of the HSI as it was set up on Flight 5191.

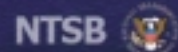





William J. Hughes Technical Center Shuttle Recover Ops Team members observe part of the exercise.

## Integrating Space Traffic into the National Airspace System

story and photos by Victoria A. Brown

Picture a world where spacecraft and aircraft share the same airspace from take-off to re-entry to landing, and where airplanes do not have to be grounded because spacecraft need to use the airspace. In this world, air traffic controllers will control air and space traffic together. Soon you no longer have to daydream what it would be like, because a system that can help to make this all possible is now being developed.

With the anticipated increase in air traffic and spacecraft operations, the Federal Aviation Administration (FAA) expects greater demands on the National Airspace System (NAS) and the nation's Air Traffic Control (ATC) system over the next 10 years. To handle this influx in traffic, the FAA has developed a concept of operations for a future Space and Air Traffic Management System (SATMS). SATMS represents a framework for "seamlessly integrating" space vehicles on their way to and from space with more traditional air traffic operations. Of course, this will entail new

space and air traffic management tools along with improved communications, navigation, and surveillance services.

There are unique hazards involving space flights. If a space vehicle should fail in a manner that generates debris, as occurred with the space shuttle *Columbia* accident, it could pose a grave threat to aircraft flying below. A piece of spacecraft debris weighing less than one pound could puncture the wing or cabin of a cruising aircraft causing catastrophic damage. Since potential hazards from spacecraft operations pose far greater risks than any other aircraft hazard traditionally considered, SATMS will need to address these issues to make the NAS even safer than it is today.

Currently, there are several strategies used to manage air traffic. The *Notice to Airmen* (NOTAMs) method alerts the aviation community, including air traffic controllers, airlines, and general aviation pilots of the times of space flight operations and boundaries of the required airspace. The air-

space restrictions are enforced by Title 14 Code of Federal Regulations (14 CFR) part 91. Special Use Airspace (SUA) establishes Restricted Areas and Warning Areas. Restricted Areas are established with fixed boundaries and are illegal to enter without permission from the controlling agency. Altitudes and times of activation differ. Warning Areas are airspace over domestic or international waters that extend from three nautical miles outward from the coast of the United States. Warning Areas are advisory in nature to alert pilots that they may be entering areas of hazardous activity to nonparticipating pilots. Lastly, air traffic controllers have the option to issue a Temporary Flight Restriction (TFR). This is a short-term restriction to keep aircraft from entering certain areas. TFRs are often issued on very short notice for a variety of reasons. The airspace is sized for the largest vehicles that may use it with fixed boundaries and are typically activated for extended periods of time. These methods also im-

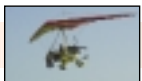

pact space vehicle operators because they require extensive advanced coordination with various ATC entities, and it is sometimes difficult to accommodate launch delays and scrubs.

In the future, FAA hopes to reduce the amount of airspace that is restricted for each launch and the amount of time that the restriction needs to be in effect. FAA also hopes to schedule the restrictions to accommodate conventional air traffic while still achieving the safety and space mission objectives. One of the ways FAA plans to achieve this is through space transition corridors. A space transition corridor is a strategically sized airspace restriction. Its vertical extent spans all altitudes and the lateral sizing will be determined by using specific characteristics of vehicle operations and predicted weather conditions. It will be dynamically issued and withdrawn to minimize impact to air traffic.

In the case of an accident, the SATMS Decision Support Tool (SATMS DST) will ultimately assist air traffic controllers in managing airspace and the risk to aircraft from space operations with improved situational awareness. Air traffic controllers will be able to better predict airspace affected by debris. This tool will also identify

and plan the most efficient air traffic reroutes as well as track the spacecraft, or in the worse case scenario, its debris through the NAS.

Needless to say, there is a lot of planning and analyzing that goes into developing this system. Before the space shuttle *Columbia* accident, FAA air traffic procedures for supporting space shuttle operations did not take into consideration the potential debris hazard to aircraft during a shuttle re-entry. For this reason, the Shuttle Recovery Ops Team was formed. The team consists of participants from the National Aeronautics and Space Administration's (NASA) Johnson Space Center and FAA's Office of Commercial Space Transportation, Air Traffic Control System Command Center, William J. Hughes Technical Center, Albuquerque Air Route Traffic Control Center (ARTCC), Houston ARTCC, Jacksonville ARTCC, Los Angeles ARTCC, Miami ARTCC, and Oakland ARTCC. Until the SATMS DST is fully developed and functional, the Shuttle Recovery Ops Team runs shuttle re-entry exercises to train and prepare air traffic controllers for possible accidents like *Columbia*. These exercises simulate what could happen in the event of a space shuttle accident. On

the last re-entry exercise the "shuttle debris" entered over Los Angeles ARTCC's airspace. In the exercise, Oakland and Albuquerque ARTCCs assisted Los Angeles in moving potentially at risk aircraft away from harm. After the exercise was completed, all parties agreed that this training was indeed beneficial.

The SATMS Decision Support Tool would automate the processes involved. Ultimately the goal is for the SATMS DST to compile all the information from any given accident or launch and re-entry vehicle operation and translate that data into a real-time tool that ATC would use to manage the traffic situation.

FAA is working with NASA to ensure that the skies stay as safe as possible during space launches. Furthermore, both organizations are practicing to become as proficient as possible. With the expected air traffic increase and the development of commercial spaceflights, SATMS DST provides an important means to manage the expected workload.

+

*Victoria Brown was an FAA summer intern. She is a communications major at Xavier University in Cincinnati, Ohio.*

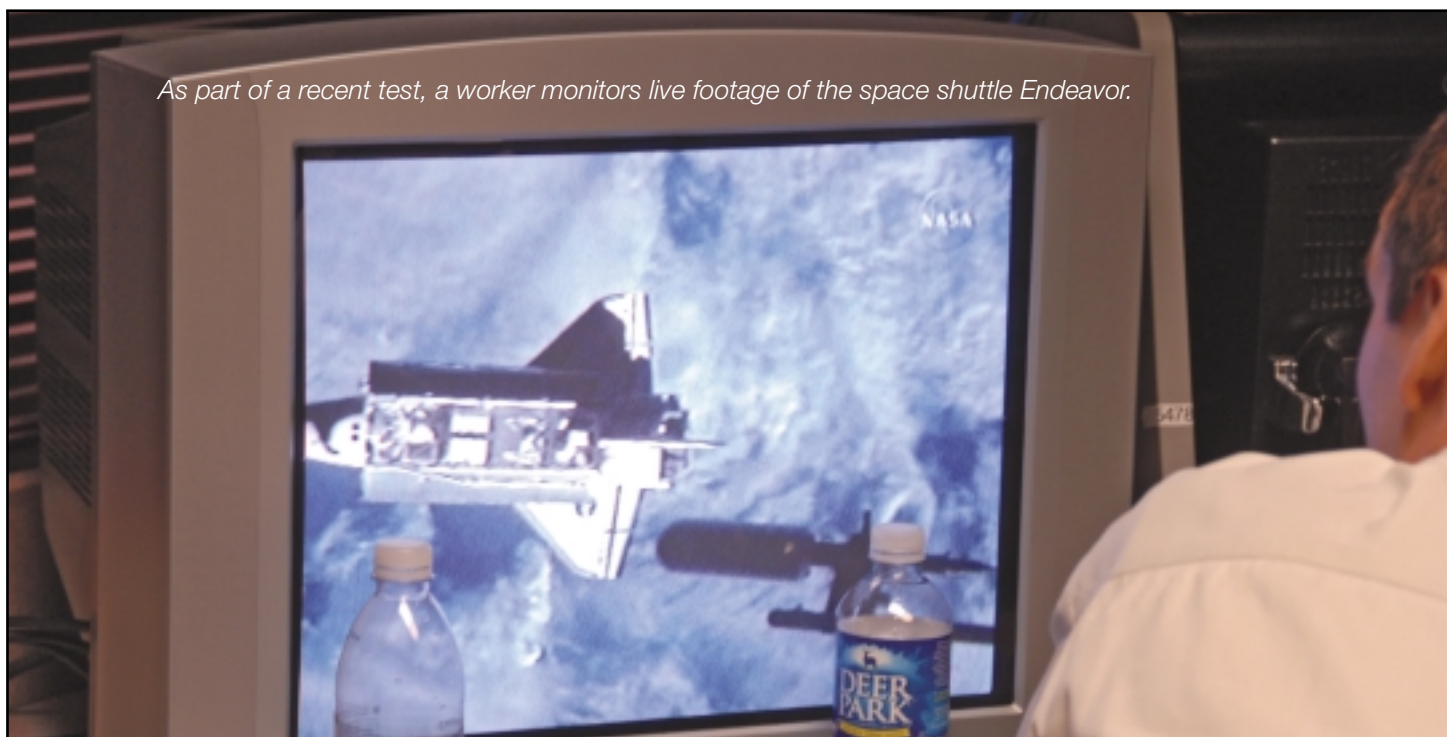

*As part of a recent test, a worker monitors live footage of the space shuttle Endeavor.*



# The Federal Aviation Administration Wants You!

Attention pilots, mechanics, and avionics technicians: this is your chance to start a career in the exciting field of federal aviation safety. The FAA's Flight Standards Service is currently hiring aviation safety inspectors. We are looking for individuals with strong aviation backgrounds for inspector positions in fields ranging from Maintenance to Operations to Avionics. Both air carrier and general aviation inspectors are needed in all fields. There are positions available through out the nation. This is your opportunity to use your experience to improve the already excellent safety record of civil aviation in the United States. As an aviation safety inspector you would be responsible for overseeing airmen, operators, and others to insure they meet the rigorous safety standards set forth by the FAA.

The FAA is an excepted service agency of the United States Department of Transportation. Starting salaries range from \$38,824 to \$74,194 (FG 9- FG 12) plus locality pay (Locality pay is a geographical enhancement to your base salary). For more information please visit [www.opm.gov](http://www.opm.gov).



Benefits include federal retirement and 401K type accounts. Health and other insurances are also available. This is an excellent opportunity for those who want to give something back to the aviation industry.

Qualifications vary depending on discipline. For details please visit <http://jobs.faa.gov>. Under "All Opportunities" you can search by job series 1825 or title containing "inspector." The FAA is expecting to hire approximately 850 inspectors this fiscal year so start your application today.



**Federal Aviation  
Administration**

## • Understanding the Federal Aviation Regulations

The *FAA Aviation News* is a good publication. We here at the Miami Flight Standards District Office have them in the reception area for our customers to read, while waiting for their appointment. They are free to take a copy home.

Some of the pilot applicants, who are not from the United States, will bring the magazine to us and ask us to explain what the author is writing about. Part of this may be lack of understanding of the English language, which may disqualify them from taking the test. But what I hear from most of these foreign pilots is they don't understand the Federal aviation regulations, as they are written. For example: "in subpart b of the regulation, it defines what a pilot must do to be legal and to serve as pilot in command." This is out of the regulations,

*FAA AVIATION NEWS* welcomes comments. We may edit letters for style and/or length. If we have more than one letter on the same topic, we will select one representative letter to publish. Because of our publishing schedules, responses may not appear for several issues. We do not print anonymous letters, but we do withhold names or send personal replies upon request. Readers are reminded that questions dealing with immediate FAA operational issues should be referred to their local Flight Standards District Office or Air Traffic facility. Send letters to H. Dean Chamberlain, Editor, *FAA AVIATION NEWS*, AFS-805, 800 Independence Ave., SW, Washington, DC 20591, or FAX them to (202) 267-9463; e-mail address:

Dean.Chamberlain@faa.gov

and it is hard for these guys to understand the legalese. My question is, what would it take to transition the regulations into plain language and for anyone to understand "notwithstanding" and so on. What are your thoughts?

Richard Capon  
Aviation Safety Inspector

*The short answer is a major rewrite of the regulations. That is assuming the rewritten material can meet the legal requirements of any international laws, regulations, and treaties. The same question applies to our own national laws and regulations. Based upon the time and resources required for a simple rule change, you can image what would be involved in a total rewrite. But I think it is safe to say the FAA is changing its culture and products to become more plain language compli-*

*ant. We just are not there yet.*

## • Psychedelic N-numbers

We have a bet on how many people pointed out the N-number on the aircraft in the picture on page 12 of the September/October 2007 issue. The FAA allows psychedelic "N" numbers or maybe, when it gets warmer, the number itself reverts back to the requirements?

David H. Butler  
Training Program Manager (TPM)  
Reno FSDO

*So far you are the first person to bring the distorted registration number photo to our attention. The reason for the distorted numbers is that we either distort or remove "N" numbers to protect the aircraft owner's privacy. We have reprinted the photo for those who missed it the first time.*





## FAA ISSUES FINAL DECISION ON AIRSPACE REDESIGN

The Federal Aviation Administration (FAA) has issued a final decision for redesigning the New York, New Jersey, and Philadelphia metropolitan area airspace that is expected to reduce delays, fuel consumption, aircraft emissions and noise.

"This new concept in airspace design will help us handle the rapidly growing number of flights in the Northeast in a much more efficient way," said FAA Administrator Marion C. Blakey. "This airspace was first designed in the 1960s and has become much more complex. We now need to look at creative new ways to avoid delays."

The formal Record of Decision (ROD) for the Airspace Redesign Study supports the FAA's preferred alternative.

The FAA did extensive analysis and held more than 120 public meetings in five states throughout the environmental process. The airspace redesign involved a 31,000-square-mile area over New York, New Jersey, Pennsylvania, Delaware, and Connecticut with a population of 29 million residents. Twenty-one airports were included in the study.

In December 2006, FAA released its Draft Environmental Impact Statement (DEIS) on the study. In March 2007, FAA identified the Integrated Airspace Alternative as its preferred alternative. On August 3, 2007, notice of the Final Environmental Impact Statement (FEIS) was published in the *Federal Register*.

FAA studies show this alternative will reduce delays, complexity of the current air traffic system, fuel consumption and carbon emissions and aircraft noise. Benefits, in the form of reduced delays, are estimated to reach 20 percent by the year 2011 compared to the amount of delays the

air traffic system would have without the changes. Half a million fewer people will be exposed to noise under this alternative compared to no change.

This alternative integrates the airspace surrounding the metropolitan area and expands the use of more efficient separation standards. This alternative will also allow the FAA to move more rapidly toward satellite-based technology.

Additional project information is available at the following Web site: <[www.faa.gov/nynjphl\\_airspace\\_redesign](http://www.faa.gov/nynjphl_airspace_redesign)>.

## GORDON BENNETT RACE CANCELLED

The 2007 Gordon Bennett Balloon race was cancelled this year. According to the organizer's Web page, they were unable to get clearance from the Belgian authorities. The Gordon Bennett race was first held in 1906. The event is one of the most prestigious in aviation. The goal is to fly a gas balloon as far as possible. Teams from all over the world take part. In 2004, an American team won the competition with a distance of 1,803.36 km. The greatest distance was 3,400.39 km set in 2005, when the race originated in Albuquerque, New Mexico. For more information, visit the following Web sites: <[gb2007.gasballon.be/](http://gb2007.gasballon.be/)> or <[www.coupegordonbennett.org](http://www.coupegordonbennett.org)>.

## SATELLITE-BASED NAVIGATION FOR AIRCRAFT

The Federal Aviation Administration (FAA) has proposed an initial set of aircraft avionics requirements designed to enable the transition to the Next Generation satellite-based air transportation system.

The proposal would require all aircraft flying in the nation's busiest airspace to have satellite-based avionics by 2020. This will enable air traffic controllers to track aircraft by satellites

using a system known as Automatic Dependent Surveillance Broadcast (ADS-B), which is ten times more accurate than current radar technology. Aircraft not flying in controlled airspace will not be required to have ADS-B avionics, but may choose to do so in order to realize the safety benefits.

"Aviation must take the big step into the next generation of technology," said Acting FAA Administrator Bobby Sturgell. "It's safer and more accurate. Satellite technology is here to stay."

The ten-fold increase in the accuracy of satellite signals may eventually allow air traffic controllers to reduce separation standards between aircraft, significantly increasing the number of aircraft that can be safely managed in the nation's skies. Traffic is projected to grow from 740 million passengers last year to one billion in 2015, and double today's levels by 2025.

Under a contract awarded to ITT Corporation last month, ground stations for the new system will be brought online across the country, starting in the East Coast, portions of the Midwest, Alaska and the Gulf of Mexico. Nationwide coverage is expected by 2013. Pilots viewing ADS-B cockpit displays are able to see, in real time, their location in relation to other aircraft, bad weather, and terrain. In Southwest Alaska, the fatal accident rate for ADS-B-equipped aircraft has dropped by 47 percent.

The proposed rule is open for public comment until January 3, 2008, and is scheduled to become final by late 2009. The proposed compliance date of 2020 will give the industry more than 10 years to properly equip aircraft with ADS-B avionics. To view the proposed rule, go to <[http://www.faa.gov/regulations\\_policies/rulemaking/recently\\_published/](http://www.faa.gov/regulations_policies/rulemaking/recently_published/)>.

You may send comments identified by Docket Number FAA-2007-29305 using any of the following





methods:

- Go to <http://www.regulations.gov> and follow the online instructions for sending your comments electronically.
- Mail or hand deliver comments to the Docket Management Facility; U.S. Department of Transportation, 1200 New Jersey Avenue, SE., West Building Ground Floor, Room W12-140, Washington, DC 20590-0001.
- Fax comments to the Docket Management Facility at (202) 493-2251.

## **TRAFFIC MANAGEMENT ADVISORY OPERATIONAL NATIONWIDE**

The efficiency-enhancing Traffic Management Advisor (TMA) system is operational at all air route traffic control centers.

"This is an excellent example of coordination, planning, cooperation, and a commitment to our mission," said FAA's Vice President for En Route and Oceanic Services Rick Day after the TMA system came online at Indianapolis and Kansas City Centers on August 22. This completed the system's deployment at all the centers in the continental United States.

The deployment was also completed ahead of schedule—an effort that Day praised as "outstanding."

TMA is an information technology tool that provides controllers with automated information on airport arrival demand and available capacity to improve sequencing, and to better balance arrival and departure rates.

For years, controllers used manual procedures to safely separate aircraft arriving at an airport. However, this "miles-in-trail" technique often leaves gaps in the arrival streams. The TMA system provides Time-Based Metering that processes flight, radar, and weather data to produce

more efficient airport arrival sequences. TMA calculates a specific time for each aircraft to cross a fixed point in the airport landing route that also considers minimum safe distances between aircraft. Appropriate direction to pilots is then provided using that data, allowing arrival streams that take better advantage of available landing slots.

The FAA estimates that when Time-Based Metering is used, there are increases in arrival rates of three percent or more.

The TMA deployment is a "significant achievement, particularly during this period of high fuel prices as it enables a more efficient operation and greater capacity," Day said. "I know our customers, the taxpayers, and those we serve thank the TMA team."

## **FAA ADOPTS ICAO DEFINITION FOR RUNWAY INCURSIONS**

Effective immediately, the FAA will use the definition for a runway incursion that has been adopted by the International Civil Aviation Organization (ICAO).

The FAA is making the change so the worldwide aviation community will have a single runway incursion definition, which in turn could help in the search to determine common factors that contribute to these incidents.

The biggest difference between the two definitions is that ICAO defines a runway incursion as any unauthorized intrusion onto a runway, regardless of whether or not an aircraft presents a potential conflict.

For the FAA, an incident without an aircraft in potential conflict — such as an unauthorized aircraft crossing an empty runway — was defined as a "surface incident" and not a runway incursion.

The new definition means that some incidents formerly classified as surface incidents will now be classified

as C or D category runway incursions, which are low-risk incidents with ample time and/or distance to avoid a collision.

The FAA has always tracked surface incidents, in addition to runway incursions. The new definition simply means that certain less severe incidents will be classified differently. All incidents tracked in the past will continue to be tracked.

The classification of the most serious kinds of runway incursions, Categories A and B, remains unchanged. The total number of Category A and B incursions has fallen from 53 in fiscal year (FY) 2001 to 31 in FY 2006. A and B incursions are on track for another drop in FY 2007, with 24 recorded through Sept. 9.

The FAA helped ICAO come up with its definition, which was adopted in November 2005. Before that definition was developed, countries around the world used at least 20 different definitions for a runway incursion.

## **NO SELECTIVE AVAILABILITY ON FUTURE GPS SATELLITES**

The U.S. Department of Defense (DOD) has announced that it has permanently discontinued procurement of Global Positioning System (GPS) satellites with Selective Availability (SA) capability. SA is the ability of the U.S. military to intentionally degrade the accuracy of civil GPS signals. Since May 2000 there has been no degradation of the GPS signal. This was accomplished by setting the SA levels to zero.

Removing SA from the upcoming GPS III satellites clears up some uncertainty about the availability of accurate GPS signals in the future. According to a DOD press release this action reflects "the United States' strong commitment to users by reinforcing that this global utility can be counted on to support peaceful civil applications around the globe."



# Editor's *Runway*

from the pen of H. Dean Chamberlain

## ***End of Year Thoughts***

Throughout the year, *FAA Aviation News* and its staff and supporters have worked to provide you with an FAA safety publication that we hope has been informative, focused on aviation safety, and an interesting read. If you are new to the magazine, we want to welcome you to our readership family. If you have been with us for a while, we want to thank you for your dedication and support of the magazine. If you are one of the many writers who provided us material, we thank you.

As we look forward to 2008 and its six issues, we want to remind you that if you have any comments you want to say to or about the magazine, please send them to us. Information about how to send your comments to the staff is included on the inside front cover as well as in the *Flight Forum* department of the magazine. Incidentally, for those new to the magazine, the *Flight Forum* department is our version of "Letters to the Editor."

As we end this year, *FAA Aviation News* is in the process of change. We are currently evaluating changes to design, format, and content. As the magazine evolves, please tell us what you think. We are here to serve you. We need your comments to tell us if we are effective. If you like the changes: Tell us. If you don't like the changes: Tell us. Our goal is to make your magazine as good as it can be.

As we approach the holiday season with all of its traveling, we want to remind everyone to take the extra time to have a safe travel season. If you are flying, please avoid the desire to "get to Grandma's house," at all cost. The best gift of all is arriving at your destination safely. If you are flying commercially, give yourself extra time to get through the airport security and any flight delays. If you are flying yourself to "Grandma's house" please let yourself divert to an alternate airport in case of bad weather or some other unforeseen event. As we like to remind everyone, please don't allow yourself and your loved ones to become victims of "get-home-itis." Please take your time to enjoy the season.

Finally, all of us on the staff of *FAA Aviation News* want to wish everyone a safe and happy new year.

U.S. Department  
of Transportation

Federal Aviation  
Administration

800 Independence Ave., S.W.  
Washington, D.C. 20591

Official Business  
Penalty for Private Use \$300

DO NOT DELAY -- CRITICAL TO FLIGHT SAFETY!

