

Selected Topics in Surface Electromyography for Use in the Occupational Setting: Expert Perspectives

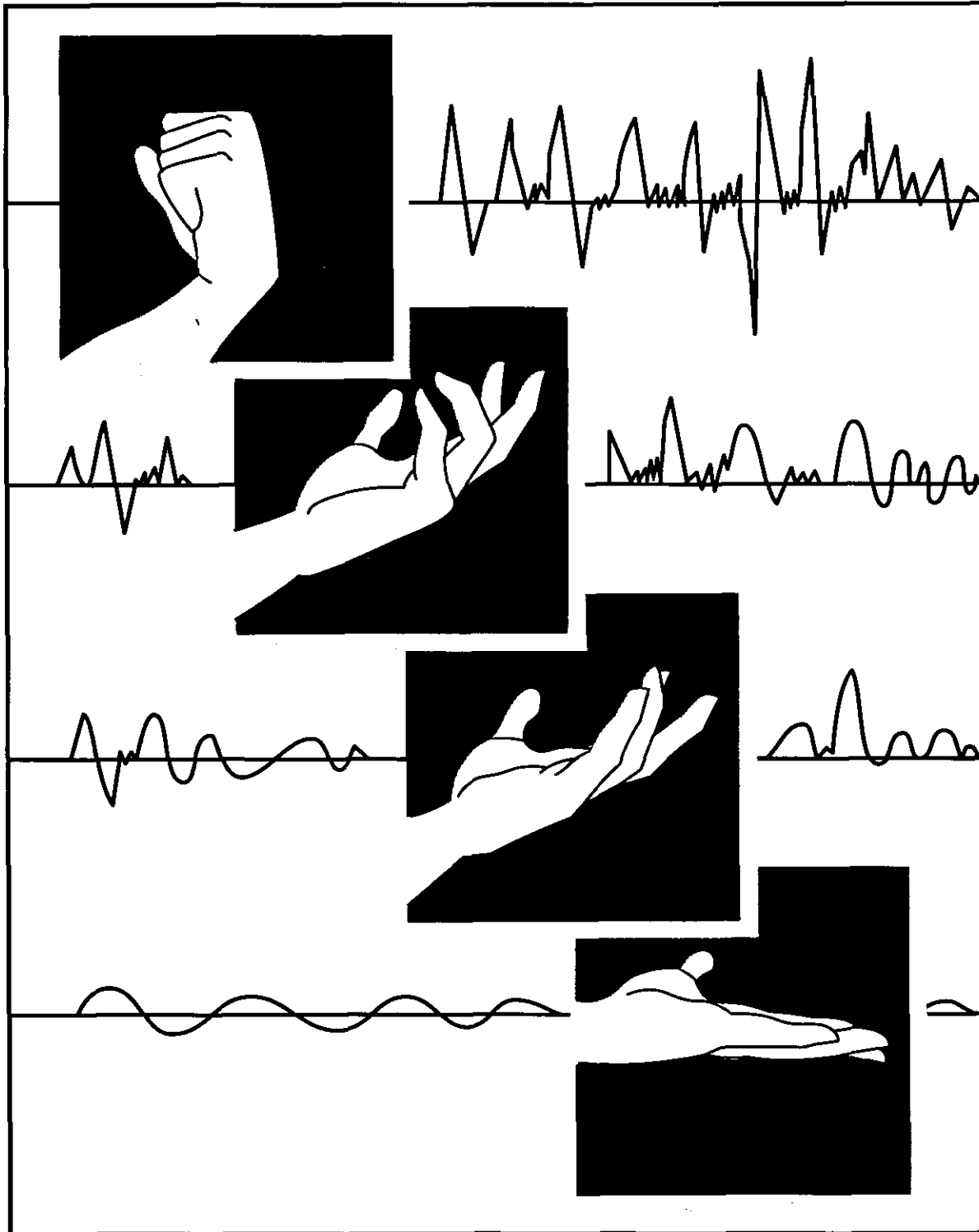

U.S. DEPARTMENT OF HEALTH AND HUMAN SERVICES
Public Health Service
Centers for Disease Control
National Institute for Occupational Safety and Health

CDC
CENTERS FOR DISEASE CONTROL

**SELECTED TOPICS IN SURFACE ELECTROMYOGRAPHY
FOR USE IN THE OCCUPATIONAL SETTING:
EXPERT PERSPECTIVES**

U.S. DEPARTMENT OF HEALTH AND HUMAN SERVICES

Public Health Service

Centers for Disease Control

National Institute for Occupational Safety and Health

MARCH 1992

DISCLAIMER

Mention of the name of any company or product does not constitute endorsement by the National Institute for Occupational Safety and Health.

DHHS (NIOSH) Publication No. 91-100

LIST OF CONTRIBUTORS

Editor in Chief

Gary L. Soderberg, PhD, PT
Director and Professor
Graduate Program in Physical Therapy
The University of Iowa
2600 Steindler Building
Iowa City, Iowa 52242

Chapter One: Overview of Electromyography in Ergonomics

William Marras, PhD
Department of Industrial Engineering
1971 Neil Avenue
The Ohio State University
Columbus, Ohio 43210

Chapter Two: Anatomic and Physiologic Basis for Surface Electromyography

Robert Lamb, PhD, PT
Physical Therapy Programs
Medical College of Virginia
Box 224
1112 East Clay Street
Richmond, Virginia 23298

Donald Hobart, PhD
Physical Therapy Department
University of Maryland
32 South Greene Street
Baltimore, Maryland 21201

Chapter Three: Recording Techniques

Gary L. Soderberg, PhD, PT
Director and Professor
Graduate Program in Physical Therapy
The University of Iowa
2600 Steindler Building
Iowa City, Iowa 52242

Chapter Four: Instrumentation

David G. Gerleman, BA
Engineer
Physical Therapy Graduate Program
The University of Iowa
2600 Steindler Building
Iowa City, Iowa 52242

Thomas M. Cook, PhD, PT
Assistant Professor
Physical Therapy Graduate Program
The University of Iowa
2600 Steindler Building
Iowa City, Iowa 52242

Chapter Five: Output Forms: Data Analysis and Applications

Interpretation of the Electromyographic Signal

Barney LeVeau, PhD, PT

Physical Therapy Programs
University of Texas/Southwestern Medical Center at Dallas
5323 Harry Hines Boulevard
Dallas, Texas 75235-8876

Gunnar B.J. Andersson, MD, PhD

Professor and Associate Chairman
Department of Orthopedic Surgery
Rush-Presbyterian-St. Luke's Medical Center
1653 West Congress Parkway, 1471J
Chicago, Illinois 60612

Chapter Six: Functional Muscle: Effects on Electromyographic Output

Mark Redfern, PhD

Eye and Ear Institute
University of Pittsburgh
203 Lathrup
Suite 500
Pittsburgh, Pennsylvania 15213

Chapter Seven: Applications of Electromyography in Ergonomics

William Marras, PhD

Department of Industrial Engineering
1971 Neil Avenue
The Ohio State University
Columbus, Ohio 43210

NIOSH Co-Project Officers

Roger M. Nelson, PhD, PT

Research Physical Therapist
NIOSH, DSR
944 Chestnut Ridge Road
Morgantown, West Virginia 26505

David E. Nestor, MS, PT

Research Physical Therapist
NIOSH, DSR
944 Chestnut Ridge Road
Morgantown, West Virginia 26505

ACKNOWLEDGEMENTS

This document would not be possible without the diligent effort of many. The authors of the various chapters were appreciated for the quality of their efforts and the timeliness of the response. An early draft of the manuscript was commented upon by Carole Hunter, Oak Ridge, NC; Linda Fredrick, NIOSH, Cincinnati, OH; Bengt Johnson, Umeå, Sweden; Suzanne Rodgers, Rochester, NY; and David Winter, Waterloo, Ontario, Canada. Secretarial work and production was completed by Judy Biderman, Program Assistant of the Physical Therapy Program at The University of Iowa, Iowa City, IA. Final copy editing was completed by Marilyn Lister, Berryville, VA. Appreciation is also expressed to Roger M. Nelson, PhD, and David E. Nestor, Co-Project Officers, NIOSH, Morgantown, WV, for facilitating the efforts of this publication.

Gary L. Soderberg, PhD, PT
Editor

PROLOGUE

Surface electromyography (EMG) is a technique whereby voltage-measuring electrodes attached to the surface of the skin are used to detect and/or infer various phenomena relating to muscular contractions. The development of sophisticated electronic instrumentation has permitted the use of surface EMG in most areas of ergonomic research and analysis involving muscle activity. Despite the increasing diversity of applications, there was, at the inception time of this project, no reference work available which provided basic instruction and information on the interpretation and applications of surface EMG. It is this need which the present volume begins to address, through the use of expert perspectives. A biographical sketch of each author, all experts in the field residing at nationally prominent educational institutions, is included at the beginning of each chapter. The Editor-in-Chief is Dr. Gary L. Soderberg, Director of the Graduate Program in Physical Therapy at the University of Iowa.

Although not comprehensive, an attempt was made to span the field. Note however that, applications aside, the phenomena under consideration are largely restricted to muscle activation, relative intensity and fatigue. Chapter One, by Dr. William Marras, provides a brief overview, while Chapter Two, by Dr. Robert Lamb and Donald Hobart, presents the anatomic and physiological basis for surface EMG. Chapters Three (Dr. Gary L. Soderberg), Four (David G. Gerlman and Dr. Thomas M. Cook), and Five (Dr. Barney LeVeau and Dr. Gunnar B. J. Andersson) introduce aspects of experimental technique, instrumentation and signal processing, respectively; this material is sufficient to serve as a source of basic instruction. Chapter Six (Dr. Mark Redfern) discusses interpretation of the EMG output, with a particular emphasis on problematic aspects. Finally, Chapter Seven (Dr. William Marras) examines various typical applications of EMG to ergonomics from the perspective of appropriate of statistical design.

These chapters represent the expert opinions of the individual scientists who authored them, derived from their own clinical practice and evaluation of the literature. No comprehensive attempt has been made to standardize nomenclature or procedure. Topics were selected by the individual contributors and editorial efforts have been abbreviated in order to accommodate their differing viewpoints, therefore some degree of overlap in subject matter remains.

LIST OF CONTRIBUTORS.....	iii
ACKNOWLEDGEMENTS.....	v
PROLOGUE.....	vi

CHAPTER 1

Overview of Electromyography in Ergonomics

INTRODUCTION	2
GENERAL USES	2
RECORDING TECHNIQUE	2
EQUIPMENT AND SIGNAL CONDITIONING.....	2
SIGNAL INTERPRETATION	3
SUMMARY	3

CHAPTER 2

Anatomic and Physiologic Basis for Surface Electromyography

INTRODUCTION	6
ANATOMY OF SKELETAL MUSCLE	6
ORIGIN OF THE ELECTROMYOGRAPHIC SIGNAL.....	8
Resting Membrane Potential	8
Muscle Fiber Action Potential	11
Extracellular Recording of Action Potentials	12
Motor Unit Action Potential	13
FUNCTIONAL CONSIDERATIONS OF MOTOR UNITS.....	14
Fiber Types	14
Recruitment and Rate Coding	15
MUSCLE MECHANICS	16
Architecture of Muscle	16
Length-Tension Relationship	18
Velocity-Tension Relationship	18
SUMMARY	20
REFERENCES	21
SUGGESTED READINGS	22

CHAPTER 3

Recording Techniques

INTRODUCTION	24
ELECTRODE SELECTION	24
Advantages and Disadvantages	24
LOCATION	26
THE ELECTRODE AS TRANSDUCER	29
ELECTRICAL PROPERTIES OF THE ELECTRODE-ELECTROLYTE INTERFACE	29
THE BIPOLAR ELECTRODE CONFIGURATION	30
RELIABILITY AND VALIDITY	30
PREPARATION OF ELECTRODES-SUBJECT INTERFACE	31
ARTIFACTS	35
PHYSIOLOGIC AND HISTOLOGICAL EFFECTS	36
TELEMETERIZED ELECTROMYOGRAPHY	36
SUMMARY	41
REFERENCES	41

CHAPTER 4 Instrumentation

OVERVIEW	44
ELECTROMYOGRAPHIC SIGNAL INFORMATION	44
Temporal Information	44
EMG-Force Information	44
EMG- Fatigue Information	45
CRITERIA FOR THE FAITHFUL REPRODUCTION OF THE EMG	45
EMG Signal Characteristics	46
EMG Represented by a Power Spectrum	46
Amplitude Linearity, Phase Linearity, and Bandwidth	47
Noise	47
ELECTROMYOGRAPHIC AMPLIFIERS	48
Conservation of Signal Power	48
Noise Reduction	49
Onsite Electrode-Preamplifiers	49
ELECTROMYOGRAPHIC SIGNAL PROCESSING	50
EMG Demodulation	51
Concepts	51
Demodulation Techniques	52
Rectification	52
Linear Envelope Detector	52
Integration	52
Root-Mean-Square Processing	52
Demodulation Applications	53
FREQUENCY DOMAIN PROCESSING	53
Transformation of Random Processes	53
Fast Fourier Transform	54
Waveform Sampling	54
Aliasing	56
Discrete Fourier Transform	56
Modulo Two Requirement	56
Windowing Functions	60
RECORDERS	60
Graphic Recorders	60
Machine-Interpretable Recorders	62
FM Magnetic Tape Recorders	62
Digital Recorders	62
ANALOG-TO-DIGITAL CONVERSION	62
Theory of Operation	62
Specifications	64
TELEMETRY	64
General	64
Range and Directionality	64
Multiple Channel Telemetry	64
Telemetry Performance	65
Bandwidth	65
Dynamic Range	65
Noise and Cross Talk	65
MONITORS	66
BIOFEEDBACK	66
SUMMARY	66
REFERENCES	60

CHAPTER 5
Output Forms: Data Analysis and Applications
Interpretation of the Electromyographic Signal

INTRODUCTION	70
NORMALIZATION	70
Definition	70
Isometric Maximal Voluntary Contraction	70
Options Other Than Maximal Voluntary Contraction	73
Normalization of the Task	73
Summary	73
OVERVIEW OF METHODS	74
Raw Signal	74
Demodulation	77
Linear Envelope	77
Root Mean Square	79
Integration	82
Frequency Analysis	84
Zero Crossings	87
Spike Countings	87
Turns	89
APPLICATIONS	89
Linear Envelope	89
Integration	94
Root Mean Square	94
Frequency Spectrum	94
Zero Crossings	95
Spike Countings	95
Turns	95
SUMMARY	95
REFERENCES	95

CHAPTER 6
Functional Muscle: Effects on Electromyographic Output

INTRODUCTION	104
TEMPORAL ASPECTS	104
EMG-Muscle Force Timing	104
EMG Processing Effects on Timing	105
ELECTROMYOGRAM-FORCE	105
Isometric Response	105
Length-Tension Effect	106
Velocity-Tension Effect	107
Postural Dynamics	107
Cross Talk	109
Cocontraction Effects	110
Ballistic Muscle Actions	111
Recommendations	112
FATIGUE	112
Localized Muscle Fatigue and the EMG Signal	114
Specific Measures of Spectral Shifts	115
Ratio of High to Low Frequencies	115
Median Power Frequency	115
Limitations	117
SUMMARY	117
REFERENCES	118
SUGGESTED READINGS	119

CHAPTER 7
Applications of Electromyography in Ergonomics

INTRODUCTION.	122
EXPERIMENTAL DESIGN CONSIDERATIONS.	122
INTERPRETATION THROUGH STATISTICS.	122
ELECTROMYOGRAPHIC RELATIONSHIPS AND THEIR APPLICATIONS.	123
On-Off State of Muscle	123
Muscle Force	123
Muscle Usage Through Normalized Activity Level	125
Muscle Usage Through Microvolt Activity Level	129
Muscle Force Through Normalization	136
Muscle Force Through Microvolts	137
Muscle Fatigue	139
Muscle Fatigue Through Microvolts	139
Muscle Fatigue Through Spectral Analysis	141
SUMMARY.	142
REFERENCES.	142
APPENDICES.	145
A. Quantities and Units of Measurement in Biomechanics. Prepared by the International Society of Biomechanics	145
B. Units, Terms and Standards in the Reporting of EMG Research. Report by the Ad Hoc Committee of the International Society of Electrophysiological Recording, 1980	153
C. Fine Wire Electrodes	173
GLOSSARY.	179

CHAPTER 1

Overview of Electromyography in Ergonomics

William Marras, Ph.D.

William Marras received a Ph.D. in Bioengineering and Ergonomics and an M.S. degree in Industrial Engineering from Wayne State University in Detroit, Michigan. He currently holds positions as Associate Professor in the Department of Industrial and Systems Engineering and in the Department of Physical Medicine at the Ohio State University. He is also the Director of the Biodynamics Laboratory. Dr. Marras has authored over fifty journal articles on various aspects of ergonomic research. His research focuses upon industrial surveillance techniques, laboratory biomechanical investigations and mathematical modeling of the spine and wrist.

OVERVIEW OF ELECTROMYOGRAPHY IN ERGONOMICS

William Marras, PhD

INTRODUCTION

Electromyography (EMG) is a tool that can be very valuable in ergonomic studies if it is used correctly and if the associated limitations are appreciated. An understanding of the use of EMG transcends many areas of knowledge including physiology, instrumentation, recording technology, and signal processing and analysis. This chapter provides a general overview of these areas so that an appreciation for how these areas interact and impact on the effective use of EMG. The following chapters will review, in depth, all aspects of EMG use.

GENERAL USES

Electromyography can be a very useful analytical method if applied under proper conditions and interpreted in light of basic physiological, biomechanical, and recording principles. Through proper design of ergonomic studies and by recognition of the limitations of the interpretive process, EMG can be a useful tool in the evaluation of work performance.

The use of EMG is not warranted as a general method for indiscriminately assessing all work situations. The ergonomist should have an idea about which muscles will be affected by the work, before the use of EMG is considered. The ergonomist should also be aware that 1) unless the work place conditions exhibit several key features or 2) certain additional measures of the work positions are taken simultaneously, the amount of information derived from an EMG recording is extremely limited. The key to successful EMG use is to understand the nature of the signal collected, thereby separating the useful information of the signal from the noise and artifact. Thus, procedures require careful calibration, instrumentation, data treatment, and interpretation and use of an experimental design that does not violate the assumptions inherent to the relationships associated with EMG and muscle function.

Electromyography is one of several methods used for analyzing the performance associated with the work place. If the work is heavy, the best techniques often include analysis through physiological measures, such as oxygen consumption, that provide a general measure of whole body work. Electromyography can be used for the same purpose provided that many muscles of the body are assessed during the performance of a task. However, EMG is used more often to evaluate lighter, repetitive

work where the activity of specific muscles is of interest. Ergonomic analyses often include use of this technique when comparing the specific musculoskeletal stress (in given muscles) associated with various work positions, postures, or activities and for validating of ergonomic principles. It also is used as input to biomechanical models that describe the synergistic effects of muscle activities on a joint. The use of EMG, thus, is appropriate when it is suspected that a specified muscle or group of muscles is affected adversely because of the design of the work place.

As the information gained from an EMG signal becomes more quantitative and useful, the complexities involved in muscle testing increase. Applied ergonomic studies usually are involved with an evaluation of worker methods, workplace layout, work pace, or tool design. Most ergonomic studies, therefore, involve investigations that use only a limited number of direct or derived measures. Conditions under which these various measures can be determined and examples of the application and use of these measures in ergonomic investigations will be discussed throughout the following chapters.

RECORDING TECHNIQUE

For purposes of recording EMG in ergonomic studies, two types of electrodes are available. Surface EMG techniques are much more common, unless there is a specific justification for using a fine wire method. In general, surface EMG will represent the activity of individual muscles or muscle groups over which the electrodes are placed. Although muscles that are smaller and of a deep location are more difficult to record from with surface EMG, the major interest probably is in the larger muscles or in muscle groups. In this case, appropriate methods are available for the recording of the EMG. The methods, advantages, and limitations associated with the use of these techniques and the immobilization process necessary are specified in the following chapters. Controls necessary to guarantee a high quality signal also are detailed.

EQUIPMENT AND SIGNAL CONDITIONING

The typical equipment configuration needed to perform an ergonomic study is depicted schematically in

Figure 1-1. Once the signal has been amplified by the preamplifiers, if they exist, it is amplified further by the main amplifiers. After that, the signal is filtered and may be conditioned or processed by a number of means that will be discussed in Chapter 4. For example, processing may consist of rectifying, averaging, integrating, defining a linear envelope, or performing root-mean-square processing of the signal. Only the raw signal may be recorded and interpreted by itself. Most EMG data, however, usually are subjected to some type of processing. Recommended recording devices are FM tape, a strip chart or light pen recorder, or a computer through an analog-to-digital (A-D) converter. If spectral analyses are of interest, these must be performed on a computer. Details of the instrumentation and interpretations are included in subsequent chapters.

SIGNAL INTERPRETATION

To determine the on-off state, force, or fatigue present within a muscle, some form of EMG signal treatment usually is recommended and often is required. The type of EMG signal treatment appropriate for an ergonomic study is a function of 1) the nature of the desired information and 2) the ability of the experimenter to design the process so that the EMG assumptions mentioned earlier are not violated.

The most basic information that can be derived from an EMG signal is knowledge of whether the muscle of interest was in use during an exertion. Little or no signal processing is required to determine this type of information. The experimenter simply needs to make sure the signal is noise and artifact free and does not contain cross talk. If the raw or processed signal exhibited activity, the muscle was in use during the exertion. Usually, it is of interest simply to note whether the muscle was in use or to document the duration of activity during a specified exertion.

If the muscle force is of interest, the EMG signal can be processed by either hardware or software and then treated in several ways, depending on the form of quantification desired. First, the activity level of the muscle may be recorded. It is customary for this factor to be represented in normalized terms. Some researchers, however, describe this quantity in absolute terms (microvolts of muscle activity). This measure simply relates how active the muscle was during the experimental

conditions. The measure is not an indication of muscle force, but simply a function of muscle usage. The signal can be quantified in several ways. Quantification may include peak activity, mean activity, activity as a function of given position or posture, and rate of muscle activity onset.

The processed EMG signal can also be used as an indication of muscle force present during an exertion. As with muscle activity, the signal can be treated in either absolute or relative terms. If muscle force is of interest, the EMG signal must be used in conjunction with other types of calibrations to derive more quantitative information about the muscle. These models and calibration techniques are discussed later in this manual.

Finally, the raw EMG data can be processed so that fatigue information can be derived. This has been done either by observing the processed signal or by observing a change in the frequency content of the raw signal. When the processed signal is used, one attempts to identify an increase in signal amplitude to perform a given task. Most researchers, however, use the frequency information from the EMG signal as an indication of muscle fatigue. The following chapters indicate that there are changes to a lower center frequency after a task that produces muscle fatigue. These measurements will be discussed in some detail in subsequent chapters.

SUMMARY

This chapter provides an overview of the main aspects associated with the use of EMG for those intending to use this technique to study ergonomic problems. Content is designed to assist novices in understanding and using EMG, but more experienced persons also should benefit from the material in subsequent chapters. This manual is limited in that only didactic material can be presented. As direct experience is invaluable, novices are strongly encouraged to work with more experienced persons.

As readers of this manual attempt to gain additional insights into electromyography, they should pay particular attention to the contributors' comments on uses and applications in ergonomics. Given these general but important rules, readers should be able to use EMG effectively in the study of human movement as applied to the work environment.

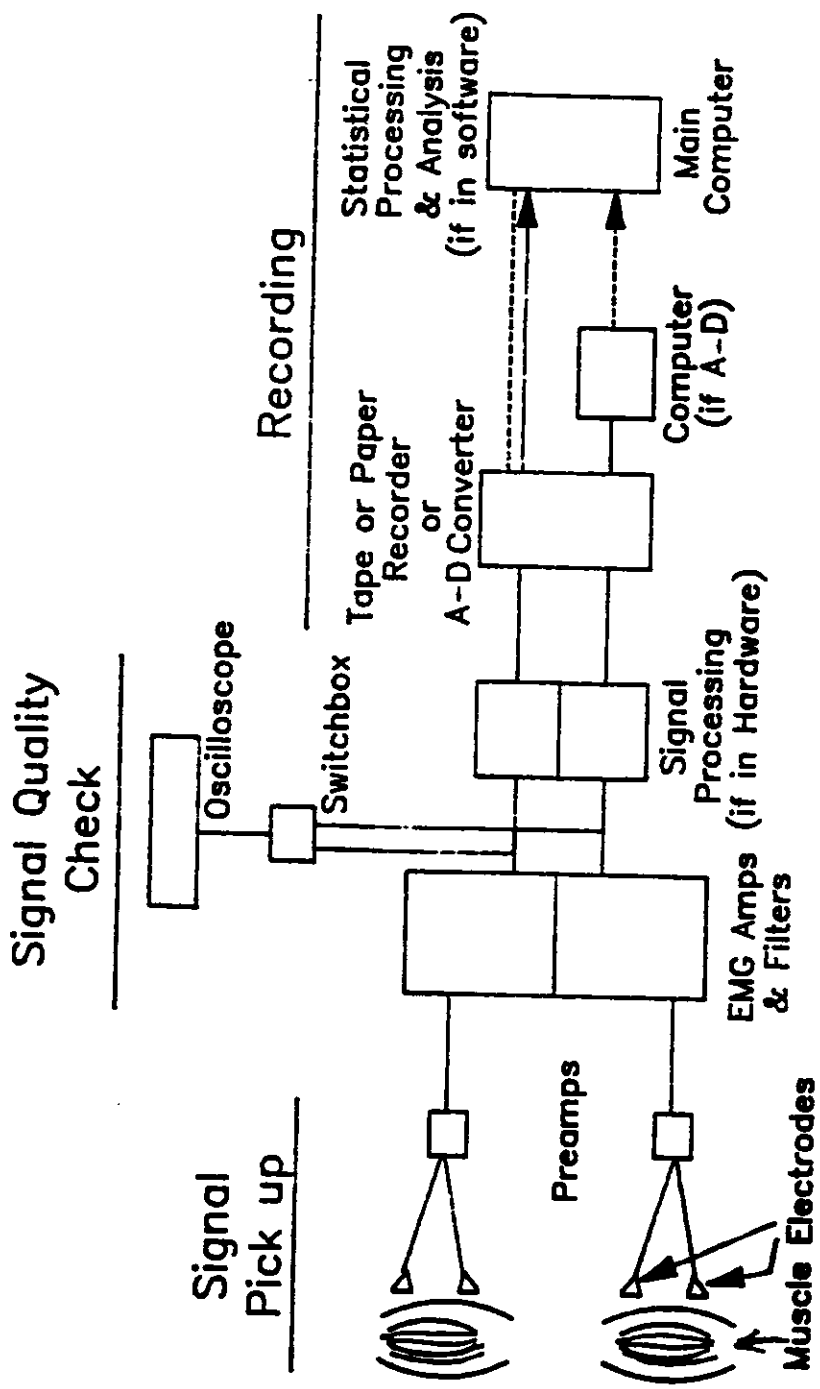

FIGURE 1-1
Equipment Configuration

CHAPTER 2

Anatomic and Physiologic Basis for Surface Electromyography

Robert Lamb, Ph.D., PT
Donald Hobart, Ph.D.

Robert L. Lamb, Ph.D., PT, is currently Professor and Chairman of the Department of Physical Therapy, School of Allied Health Professions, Medical College of Virginia, Virginia Commonwealth University, Richmond, Virginia. Dr. Lamb has been involved in training advanced graduate students in kinesiology and measurement research for over two decades. He has published numerous papers using electromyography as a research technique. Dr. Lamb is an active member of the International Society of Electrophysiological Kinesiology, the International Society of Biomechanics, and the American Physical Therapy Association.

Don Hobart, Ph.D., received his B.S. from Western Maryland College and his M.A. and Ph.D. from the University of Maryland at College Park. Presently, he is Associate Professor and Assistant Chairman of the Department of Physical Therapy in the School of Medicine, University of Maryland at Baltimore. He is in his second term as secretary of the International Society of Electrophysiological Kinesiology and was Secretary General of the 9th International Congress of ISEK. He has been an active researcher and author.

ANATOMIC AND PHYSIOLOGIC BASIS FOR SURFACE ELECTROMYOGRAPHY

Robert Lamb, PhD, PT
Donald Hobart, PhD

INTRODUCTION

The purpose of this chapter is to describe the anatomic and physiologic information fundamental to understanding the recording and subsequent study of the electrical activity of muscle using surface electromyographic (EMG) techniques. For those readers who desire a more in-depth discussion of the issues addressed, references to review articles and textbooks have been included.

ANATOMY OF SKELETAL MUSCLE

The structural unit of skeletal muscle is the muscle fiber, or cell (Figure 2-1). Light and electron microscopes must be used to view the muscle fiber and its parts. A muscle cell is a thin structure ranging from 10 to 100 microns in diameter and from a few millimeters to 40 cm in length. In short muscles, such as the flexor pollicis brevis, a single fiber may extend from the muscle's origin to insertion. In longer muscles, such as the biceps brachii, the fibers do not extend the entire length of the muscle. Instead, the cells are attached to either the origin or insertion tendon at one end and a connective tissue septa at the other end.

Just as in other body organs, muscle is surrounded and supported by a dense connective tissue generally referred to as fascia. Deep fascia, the anatomical term, or epimysium, the histological term, is a thin fibrous membrane that invests the muscle and separates it from adjacent muscles and other structures (Figure 2-2). The resulting architecture resembles a honeycomb. The deep surface of the epimysium gives off septa that penetrate the muscle to provide supporting and connective structure to the various subdivisions of the muscle.

The first subdivision of muscle, fasciculi, are surrounded by perimysium, a sheath formed by extensions of the epimysium into the muscle (Figure 2-2). The deep surface of the perimysium also divides to yield septa, named endomysium, that surround each muscle fiber. Each fasciculus encased by its perimysium may contain from a few to as many as 150 muscle fibers.¹ In muscles such as the lumbricales, only a few fibers are found, whereas in muscles like the gluteus maximus, 150 or more muscle fibers may be contained in each fasciculus. The biceps brachii, a muscle of intermediate coarseness,

has a mean of 100 muscle fibers in each fasciculus.^{2,3} The endomysium, perimysium, and epimysium serve two functions. First, at the ends of the muscles the contractile portion gradually gives way to the connective tissue that blends with and becomes a part of the tendon that ultimately attaches the muscle to bone (Figure 2-3). This attachment allows the muscles to exert tensile forces. Second, the connective tissue serves to bind contractile units and groups of units together to integrate their action. The connective tissue, however, also allows a certain freedom of movement between the contractile units. Even though each fiber and fasciculus is connected and can function as a group, each fiber therefore can move independently of its neighbor. An arrangement that allows independent functioning of the fibers is important because the fibers belonging to a motor unit are spread throughout the muscle. Activation of a motor unit, therefore, results in the contraction of single muscle fibers within many different fasciculi.⁴

The plasma membrane of a muscle cell, or fiber, lies deep to the endomysium and is known as the sarcolemma. Contained within the sarcolemma are many cylindrical myofibrils that make up the muscle fiber (Figure 2-1D). Each myofibril is about 1 micron in diameter and runs the entire length of the muscle fiber. The myofibrils are surrounded by the sarcotubular system that contains transverse tubules and the sarcoplasmic reticulum (Figure 2-4). The transverse tubules form a network of tubes perpendicular to the direction of the myofibrils and connect the sarcolemma with adjacent myofibrils and fibers. The sarcoplasmic reticulum has tubules running longitudinally around the myofibrils. The sarcotubular system controls the contraction and relaxation of myofibrils.

The myofibril is a series of sarcomeres arranged end to end (Figure 2-1D). A single sarcomere, 2.5 microns in length, is composed of thick and thin myofilaments (Figure 2-1E). Because of the precise arrangement of the myofibrils, various landmarks can be identified. Those characterizing skeletal muscle fiber are Z lines (discs) and A, I, and H bands (Figure 2-5). The Z lines are formed by the interconnections of the thin myofilaments from adjacent sarcomeres. Two adjacent Z lines define a sarcomere. The dark A bands of the sarcomere are formed by thick myofilaments, called the myosin filament, and interdigitated thin myofilaments, named actin. The H

SKELETAL MUSCLE

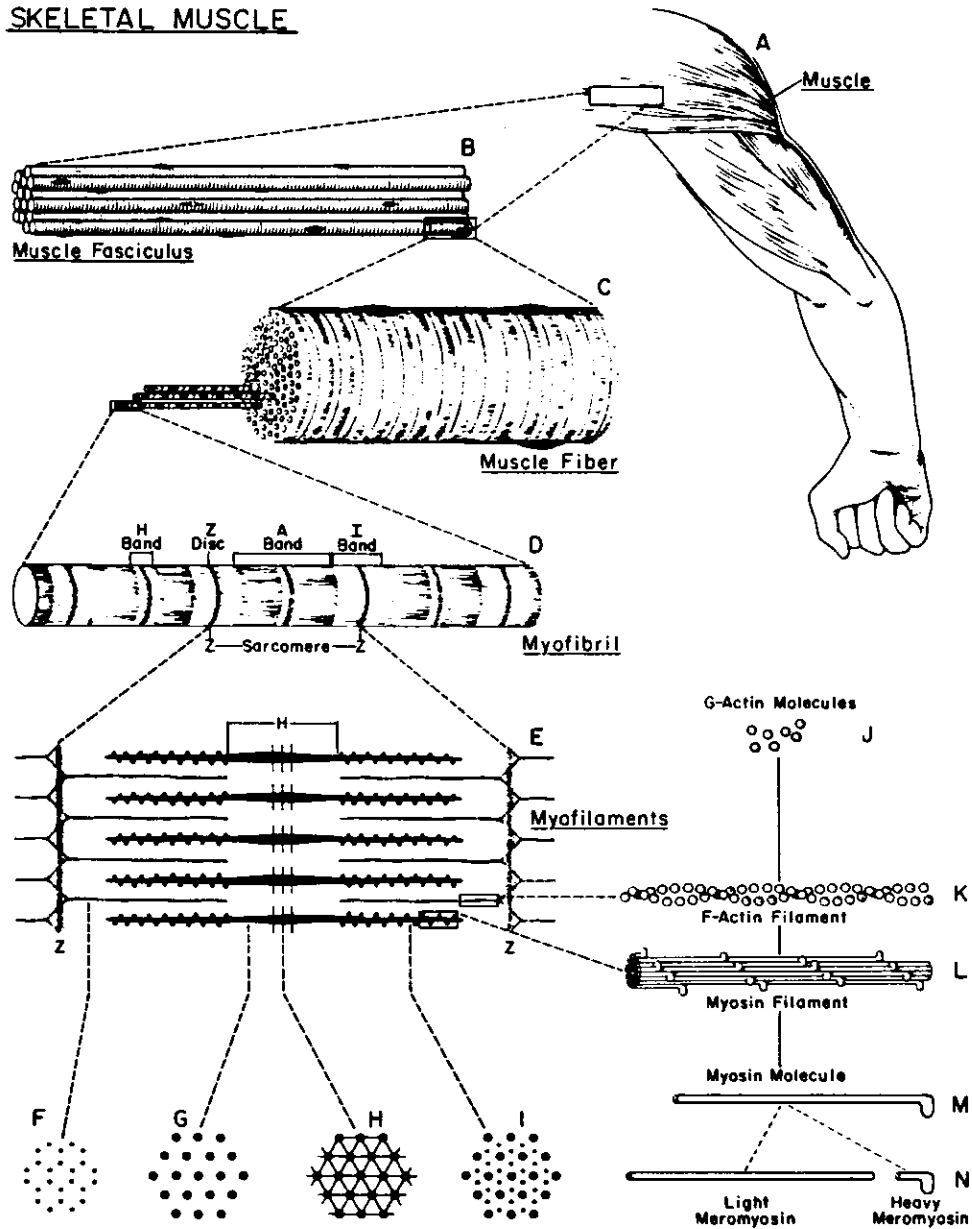

FIGURE 2-1

Diagram of the organization of skeletal muscle from the gross to the molecular level. Cross sections F, G, H, and I are at the levels indicated. Drawing by Sylvia Colard Keene.

Reprinted with permission from Bloom W and Fawcett DW: Textbook of Histology, ed 10. Philadelphia, PA, W B Saunders Co, 1975, Figure 11-19, p 306.

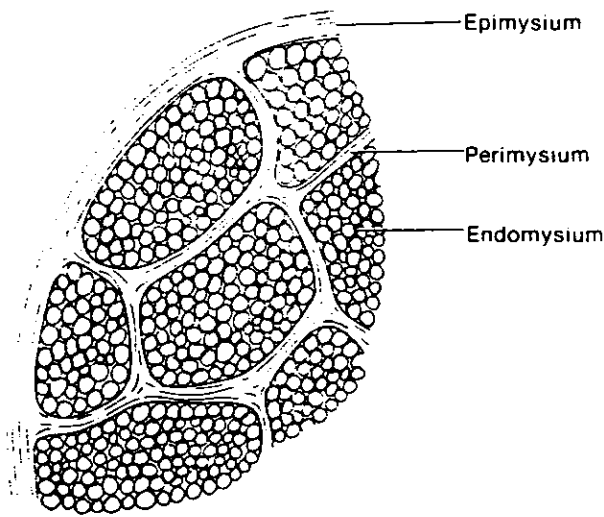

FIGURE 2-2

Cross-section of a small portion of muscle, showing relative size of connective tissue.

Reprinted with permission from Bendall JR: *Muscles, Molecules and Movement*. New York, NY, American Elsevier Publishing Co Inc, 1971, Figure 1-3, p xviii.

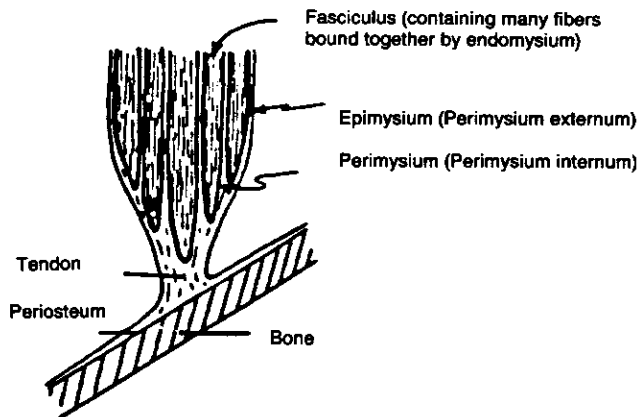

FIGURE 2-3

Cross structure of a skeletal muscle.

Reprinted with permission from Poland JL, Hobart DJ, Payton OD: *The Musculoskeletal System*, ed 2. Garden City, NY, Medical Examination Publishing Co Inc, 1981 (Figure 2.1, p 11).

band is the lighter appearing part of the A band that contains only myosin filaments (Figure 2-1L,M,N). Adjacent to the A band is the lighter I band that is that part of the sarcomere containing only actin filaments (Figure 2-1J,K).

The sarcomere is the smallest contractile unit of muscle. During contraction, the actin filament slides over the myosin filament, resulting in a decrease in the width of the H and I bands and the distance between the Z lines (Figure 2-5). The contraction of all sarcomeres within a muscle fiber results in a total fiber shortening.

ORIGIN OF THE ELECTROMYOGRAPHIC SIGNAL

Resting Membrane Potential

A muscle fiber is surrounded by the sarcolemma. The sarcolemma is a thin semipermeable membrane composed of a lipid bilayer that has channels by which certain ions can move between the intracellular and the extracellular fluid.^{5,7} The composition of the extracellular fluid and intracellular fluid are different (Table 2-1). The intracellular fluid has a high concentration of potassium (K^+) ions and an organic anion (A^-). The K^+ ions are small enough to pass through the channels in the membrane. The organic anions are much too large to flow through the membrane. The interstitial fluid has a high concentration of sodium (Na^+) and chloride (Cl^-) ions. The Cl^- ions are small enough to pass through the membrane channels, but the slightly larger Na^+ ions have difficulty in penetrating the membrane.

To understand the resting membrane potential, consider for a moment that there is no difference in potential between the intracellular and extracellular (interstitial) fluid (Figure 2-6). Because of the higher concentration inside the cell compared with the outside, K^+ diffuses through the cell membrane into the extracellular fluid. The A^- ions are too large to diffuse outward through the membrane. The Na^+ ions cannot move inward through the membrane in sufficient numbers to replace the K^+ ions. A potential difference therefore develops across the membrane. The positive charge that develops on the outside of the membrane slows the diffusion of K^+ ions between the inside and outside of the cell. The Cl^- ions act in a similar manner and remain in equilibrium because

TABLE 2-1

Intracellular and Extracellular Ion Concentrations for Mammalian Muscle (mEq/L)

Ion	Intracellular Fluid	Interstitial Fluid
K^+	140	4
Na^+	14	142
Cl^-	4	125
HCO_3^-	8	28
A^-	150	

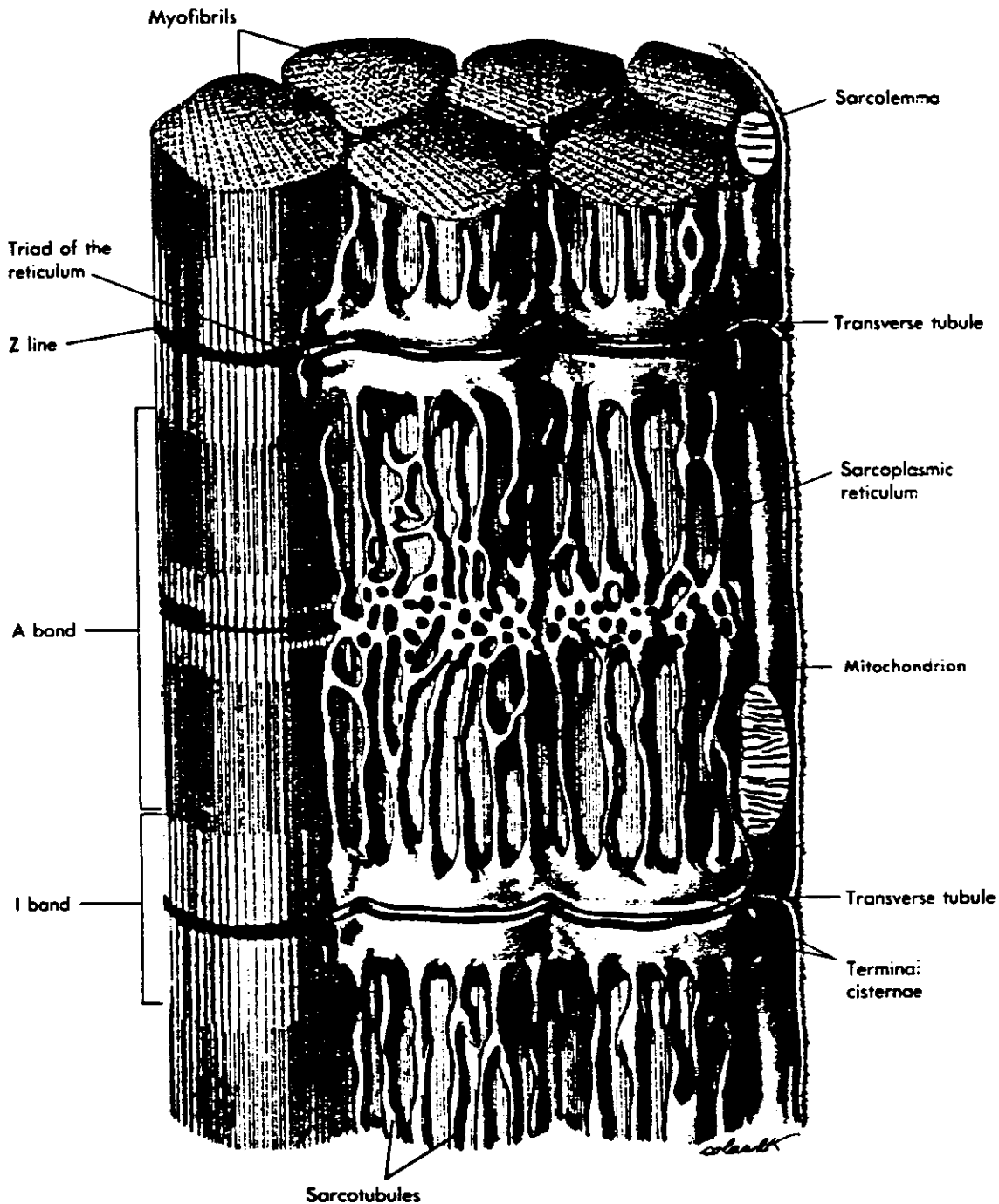

FIGURE 2-4

Schematic representation of the distribution of the sarcoplasmic reticulum around the myofibrils of amphibian skeletal muscle. The longitudinal sarcotubules are confluent with transverse elements called the terminal cisternae. A slender transverse tubule (T tubule) extending inward from the sarcolemma is flanked by two terminal cisternae to form the so-called triads of the reticulum. The location of these with respect to the cross-banded pattern of the myofibrils varies from species to species. In frog muscle, depicted here, the triads are at the Z line. In mammalian muscle, there are two to each sarcomere, located at the A-I junctions. (Modified after L. Peachey: *J. Cell Biol.* 25:209, 1965, from Fawcett DW, McNutt S: Drawn by Sylvia Colard Keene.)

Reprinted with permission from Bloom W, Fawcett DW: Textbook of Histology, ed 10. Philadelphia, PA, W B Saunders Co, 1975, Figures 11-18, p 305.

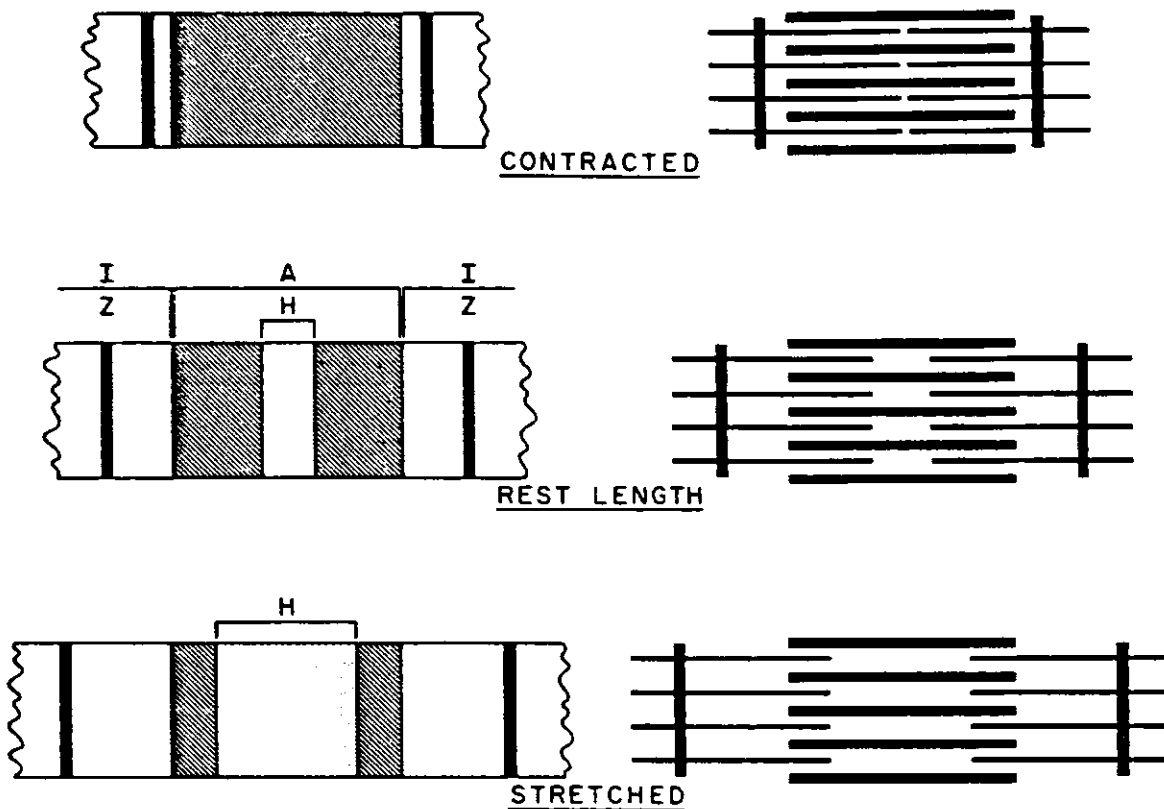

FIGURE 2-5

Schematic representation of the current interpretation of the changing appearance of the cross striations (left) in different phases of contraction, depending on the degree of interdigitation of the sliding filaments (right). The A band is of constant length, but the width of the H band is determined by the depth of penetration of the thin I filaments into the A band. In the contracted state, the thin filaments slide more deeply into the A band, obliterating the H band. In stretched muscle, the thin filaments are drawn out of the A band and the H band is widened.

Reprinted with permission from Bloom W, Fawcett DW: Textbook of Histology, ed 10. Philadelphia, PA, W B Saunders Co, 1975, Figures 11-21, p 308.

of this interaction between its concentration gradient and the electrical charge.

The net effect of the movement of K^+ and Cl^- ions is the creation of a positive charge on the outside of the membrane and a negative charge on the inside of the membrane. Because like charges repel each other, the positive charge on the outside of the membrane in combination with the large concentration gradient of Na^+ drives Na^+ into the cell. If Na^+ movement into the cell persists, the inside of the cell would become positively charged with respect to the outside. The membrane potential, however, is maintained by an active ion transport system called the sodium-potassium pump.^{5,7} This

pump system uses metabolic energy to transport Na^+ ions actively from inside the cell to outside and, to a lesser extent, to pump K^+ ions back inside the cell.

The effect of the concentration gradients, the difference in potential across the membrane, and the active transport system, results in the maintenance of a potential difference across the membrane when the muscle fiber is in a resting state. This voltage difference is the resting membrane potential and measures about -80 mV inside the muscle fiber with respect to the outside (Figure 2-7). In a healthy neuromuscular system, this polarized muscle fiber remains in equilibrium until upset by an external or internal stimulus.

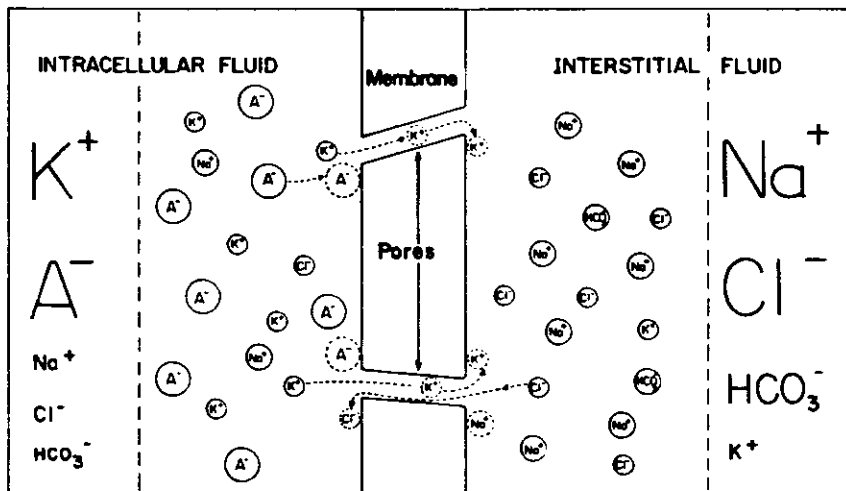

FIGURE 2-6

Development of transmembrane voltage by an ion concentration gradient. Diagram of an intracellular fluid-membrane-interstitial fluid system. Membrane shown has some, but not all properties of a real cell membrane. Hypothetical membrane is pierced by pores of such size that K^+ and Cl^- can move through them easily, Na^+ with difficulty, and A^- not at all. Sizes of symbols in left- and right-hand columns indicate relative concentrations of ions in fluids bathing the membrane. Dashed arrows and circles show paths taken by K^+ , A^- , Na^+ and Cl^- as a K^+ or Cl^- travels through a pore. Penetration of the pore by a K^+ or Cl^- follows a collision between the K^+ or Cl^- and water molecules (not shown), giving the K^+ or Cl^- the necessary kinetic energy and proper direction. An A^- or Na^+ unable to cross the membrane is left behind when a K^+ or Cl^- , respectively, diffuses through a pore. Because K^+ is more concentrated on left than on right, more K^+ diffuses from left to right than from right to left, and conversely for Cl^- . Therefore, right-hand border of membrane becomes positively charged (K^+ , Na^+) and left-hand negatively charged (Cl^- , A^-). Fluids away from the membrane are electrically neutral because of attraction between + and - charges. Charges separated by membrane stay near it because of their attraction.

Reprinted with permission from Ruch TC, Patton HD, Woodbury JW, et al: Neurophysiology, ed 2. Philadelphia, PA, W B Saunders Co, 1965, p 9.

Muscle Fiber Action Potential

Several events must occur before a muscle fiber contracts. Central nervous system activity initiates a depolarization in the motoneuron. The depolarization is conducted along the motoneuron to the muscle fiber's motor endplate. At the endplate, a chemical substance, acetylcholine, is released that diffuses across the synaptic cleft causing a rapid depolarization of the muscle fiber under the motor endplate. This rapid depolarization, and the subsequent repolarization of the muscle fiber, is an action potential.

Specific detail of the genesis of the action potential can be found in most basic physiology textbooks.^{6,7} Briefly, stimulation of the muscle fiber causes an increase in the muscle fiber membrane's permeability to Na^+ . The increased permeability to Na^+ , and the ion's concentration gradient, cause a sudden influx of Na^+ into the muscle fiber (Figure 2-8). A rapid depolarization of

the muscle fiber occurs and continues until the fiber reverses its polarity and reaches about +20 mV positive inside with respect to the outside. Near the peak of the reverse polarity, the decreased influx of Na^+ and increased efflux of K^+ causes a rapid repolarization of the muscle fiber.

When depolarization of the membrane under the motor endplate occurs, a potential difference is established between the active region and the adjacent inactive regions of the muscle fiber (Figure 2-9). Ion current therefore flows between the active and the inactive regions. This current flow decreases the membrane potential of the inactive region to a point where the membrane permeability to Na^+ rapidly increases in the inactive region and an action potential is generated. In this manner, the action potential propagates away from the initial active region in both directions along the muscle fiber. The propagated action potential along the muscle

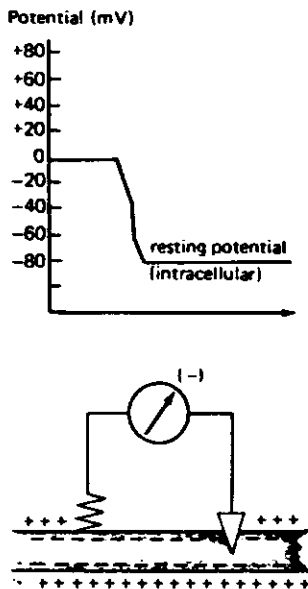

FIGURE 2-7

The intracellular resting potential can be measured by inserting a recording electrode inside the cell and connecting it by a voltage meter to a reference electrode on the surface of the cell. The cell is immersed in a suitable salt solution. The potential difference between the inside and outside of the cell is -80 mV.

Reproduced with permission from Strand F: Physiology: A Regulatory Systems Approach, ed 2. New York, NY, Macmillan Publishing Co, 1983, p 87.

fiber is a muscle fiber action potential. In vivo, a muscle fiber action potential can be recorded using microelectrode techniques,⁸ but cannot be seen in isolation using surface electromyographic techniques.

The propagated action potential spreads along the sarcolemma and into the muscle fiber through the transverse tubules (Figure 2-4). In response to the action potential, the sarcoplasmic reticulum releases stored calcium. The calcium binds with troponin, altering the location of tropomyosin. This frees the active site on the actin, allowing a muscle contraction to take place.⁹

Extracellular Recording of Action Potentials

The basis of surface electromyography is the relationship between the action potentials of muscle fibers and the extracellular recording of those action potentials at the skin surface. Electrodes external to the muscle fiber can be used to detect action potentials.

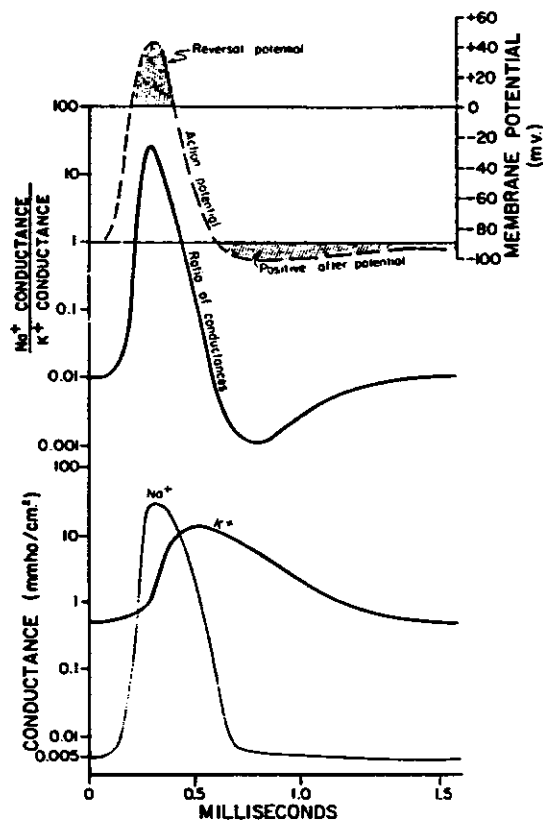

FIGURE 2-8

Changes in sodium and potassium conductances during the course of the action potential. Note that sodium conductance increases several thousandfold during the early stages of the action potential, while potassium conductance increases only about thirtyfold during the latter stages of the action potential and for a short period thereafter. (Curves constructed from data in Hodgkin and Huxley papers but transposed from squid axon to apply to the membrane potentials of large mammalian nerve fibers.)

Reprinted with permission from Guyton AC: Textbook of Medical Physiology, ed 6. Philadelphia, PA, WB Saunders Co, 1981, Figure 10-3, p 110.

A simple model can be used to aid in understanding the recording of action potentials with extracellular electrodes. Two electrodes are placed a considerable distance apart, directly on the surface of a muscle fiber (Figure 2-10). The electrodes are attached to an oscilloscope that measures voltage changes. To further simplify the model, depolarization, reverse polarization, and repolarization are the only phases of the action potential considered.

In a resting state, the muscle fiber is in equilibrium and, electrically, is positive on the outside and negative

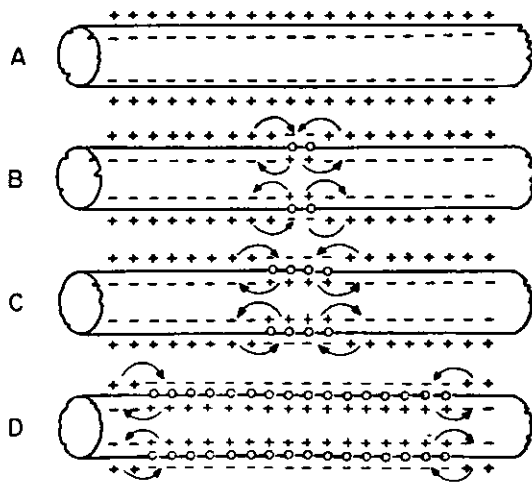

FIGURE 2-9

Propagation of action potentials in both directions along a conductive fiber.

Reprinted with permission from Guyton AC: Textbook of Medical Physiology, ed 6. Philadelphia, PA, WB Saunders Co, 1981, Figure 10-2, p 110.

on the inside (Figure 2-10). Because the two electrodes are on the outside of the muscle fiber, there is no potential difference between them. The electrical difference and the oscilloscope, thus, remain at baseline. If the fiber is excited to the left of Electrode A, an action potential is initiated and propagated along the fiber toward Electrode A. When the action potential reaches the region under Electrode A, it becomes negative with respect to Electrode B, and the oscilloscope deflects upward. As the action potential continues toward Electrode B, the region under Electrode A repolarizes, and the oscilloscope returns to baseline. When the action potential is between the two electrodes, the region under Electrode A has recovered and the region under Electrode B has not yet depolarized. The difference in potential between the electrodes, therefore, is again zero. The oscilloscope remains at baseline until the region under Electrode B is depolarized. As the action potential moves under the Electrode B, the region becomes negative with respect to the region under Electrode A, and the oscilloscope deflects downward. As repolarization occurs under Electrode B, the difference in potential returns to zero.

The output of this model is two monophasic waves separated by a brief period of time when no potential difference is measured (Figure 2-10). The time between the two waves depends on the conduction velocity of the muscle fiber and the distance between the two electrodes. If

the electrodes are placed very close together, for example, the two waves temporally summate forming a biphasic wave with a smaller peak to peak amplitude than the monophasic waves. This biphasic wave is similar in appearance to a muscle fiber action potential.

Motor Unit Action Potential

Living tissue acts as a volume conductor; therefore, the measurement and recording of the action potential is not limited to the surface of the membrane. In a volume conductor, a potential source, such as the muscle fiber action potential, is conducted away from its origin, through ion movement. Living tissue also acts as a filter. In reality, electrodes within the muscle or on the surface of the skin thus can record, from a distance, an attenuated version of the muscle fiber action potential.

If one applies the principles of the previously discussed model to the schematic representation presented in Figure 2-11, the variables that effect the amplitude and shape of the recording of a motor unit action potential, the smallest functional unit of the neuromuscular system, can be understood. In healthy tissue, the action potential propagates along a motoneuron to the motor end plate of the muscle fibers. Asynchronous activation of muscle fibers belonging to the same motor unit differ because the axon branches differ in diameter and length; thus, their conduction times differ. All the muscle fibers of the motor unit, therefore, are not activated at the same time. The muscle fiber action potentials spatially and temporally summate to form a motor unit action potential.

The exact amplitude and shape of a motor unit action potential cannot be predicted. The majority of motor unit action potentials, however, are biphasic or triphasic in shape.¹⁰ Amplitude and shape depend on the characteristics of the muscle fibers, the spatial orientation of the muscle fibers to the recording electrodes, the filter characteristics of the electrodes and the tissues surrounding the active muscle fibers, and the specifications of the electronic instrumentation used (Figure 2-11).¹¹

Individual motor units can be recorded and measured using needle and fine wire electrodes (Figure 2-12). The duration of electrical potentials of motor units vary from a few milliseconds to 14 ms; their amplitude vary from a few microvolts to 5 mV.¹¹ Under certain circumstances, single motor-unit action potentials can be observed by using surface electrodes. Usually, when using surface electromyographic techniques, the measurement and recording of the myoelectric activity of skeletal muscle as a whole is more appropriate. The myoelectric signal is the temporal and spatial summation of all active motor units within the recording area of the electrodes (Figure 2-13). The amplitude range for the myoelectric signal is from 0.01 to 5 mV.

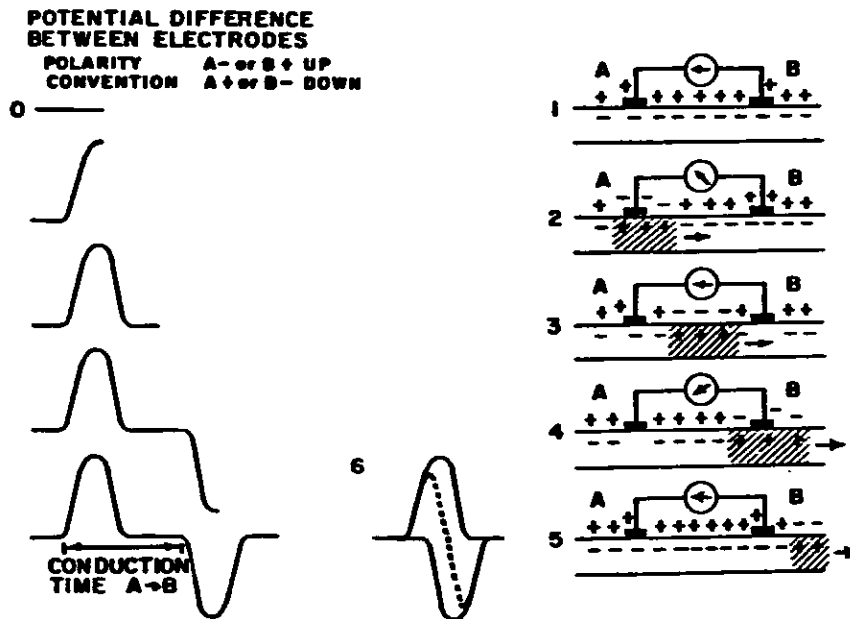

FIGURE 2-10

The measurement of action potentials, with electrodes placed on the surface of isolated irritable tissue.

Reprinted with permission from Geddes LA: Electrodes and the Measurement of Bioelectric Events. New York, NY, Wiley-Interscience, John Wiley & Sons Inc, 1972, Figure 6-1, p 252.

FUNCTIONAL CONSIDERATIONS OF MOTOR UNITS

The smallest functional unit of the neuromuscular system is the motor unit. A motor unit is defined as an anterior horn cell, its axon, and all of the muscle fibers innervated by the axon.¹² A typical motor unit includes the cell body of an alpha motoneuron in the ventral horn of the spinal cord. The axon of this neuron exits the spinal cord and travels to the muscle as part of a peripheral nerve. As it enters the muscle, the axon branches several hundred or more times. Each branch of the axon terminates on a single muscle fiber.

The muscle fibers of a single motor unit are scattered throughout a large portion of the cross-sectional area of a skeletal muscle. A few fibers of one motor unit may be surrounded by fibers of many other motor units.¹³

Several investigators have attempted to determine the number of muscle fibers innervated by one axon.¹⁴⁻¹⁶ This information has been calculated by counting the number of muscle fibers in the muscle and dividing that number by the number of alpha motor neurons supplying the muscle. The innervation ratios differ from muscle to muscle, and these differences have been interpreted

as being functionally significant. Apparently, small muscles that produce precise movements tend to have a low innervation ratio and larger muscles that produce gross movements used for weight bearing activities have high innervation ratios.

Fiber Types

Innervation ratios may not be an appropriate means of understanding the function of motor units during human movement. A better approach may be to think about the characteristics of muscle fibers. Motor units and muscle fibers can be classified on the basis of their mechanical, metabolic, and histochemical properties. Most studies describing these characteristics use animal models, and the results must be applied cautiously to humans. There are several methods of classifying muscle fibers. One method identifies three major fiber types: types I, IIA, and IIB.¹⁷ Another system classifies the three types as SO (slow twitch oxidative), FOG (fast twitch oxidative), and FG (fast twitch glycolytic)¹⁸ (Figure 2-14).

The type I, or SO, fibers are characterized as red fibers having a high resistance to fatigue. These fibers,

with a high concentration of mitochondria and an excellent blood supply, use aerobic metabolism almost exclusively. These slow twitch fibers are well suited for sustained muscle contractions.

The intermediate type IIA, or FOG, fibers are pale, fast twitch fibers having considerable capacity for aerobic metabolism. They have a reasonable concentration of mitochondria and capillaries making them suitable for sustained phasic activity.

The type IIB, or FG, fibers are white or fast twitch fibers with a high capacity for anaerobic glycolysis and a low capacity for aerobic metabolism. They have a low concentration of mitochondria and a poor capillary bed giving them a low resistance to fatigue. These fibers probably are best suited for short term phasic activity.

Type IIA (FOG) and IIB (FG) muscle fibers are innervated by alpha motor neurons with fast conduction velocities. Type I (SO) fibers are innervated by slower conducting alpha motor neurons. The same type of muscle fibers congregate to form homogeneous motor units.^{4,19} We, therefore, can speak of and functionally describe fast twitch motor units and slow twitch motor units.¹⁹

Burke classified motor units as S (slow twitch) containing type I (SO) muscle fibers, FR (fast twitch, fatigue resistant) motor units containing type IIA (FOG) muscle fibers, and FF (fast twitch, fatigable) units containing type IIB (FG) muscle fibers. Motor unit classification is more functional and useful in ergonomics than muscle fiber classifications.

The slow twitch motor units (S) have distinctive characteristics that differentiate them from the other two types of motor units. The S motor unit has low conduction velocity, long twitch contraction times, and low contraction velocity. Twitch contraction times of 90 to 160 msec and contraction velocities of 2 fiber lengths/sec have been reported.¹⁹⁻²¹ Slow twitch motor units have a low contraction threshold of below 30% of twitch tension. They can fire continuously for long periods at relatively low frequencies. This ability makes the S motor unit particularly well suited and economical for both low-level isometric, concentric, and eccentric contractions that occur repetitively at low frequencies.^{21,22}

The fast twitch, fatigue resistant (FR) motor units have a high conduction velocity and short twitch contraction time. The FR motor units have a low contraction threshold and, for the most part, are recruited with the slow twitch motor units. The FR units exhibit a greater resistance to fatigue and produce less tetanic force than FF motor units.^{19,20,23}

The fast twitch, fatigable (FF) motor units have high conduction velocities, short twitch contraction times and

high contraction velocities. Twitch contraction times of 40 to 84 msec and contraction velocities of 6 fiber lengths/sec have been reported.^{19,21,23} The FF motor units have a contraction threshold of above 30% twitch tension. They fire intermittently at high rates for short intervals and are well suited for short-duration powerful isometric, concentric, or eccentric contractions. There is a positive relationship between power output and percentage of fast twitch glycolytic fibers.²⁴ The peak power output of FOG fibers, in fact, has been reported as fourfold that of SO fibers, as a result of shortening velocity.²⁵

Recruitment and Rate Coding

Humans are capable of performing motor tasks that require muscles to generate a wide variety of force levels. These forces range from those required for the precise and delicate movements of a watchmaker to those involved in heavy lifting activities. A muscle is capable of adjusting its tension output to meet the demands of various types of tasks by the interaction of two physiologic mechanisms: recruitment and rate coding. Recruitment is when inactive motor units are activated initially as demand is increased for more tension output from the muscle. Rate coding is defined as an increase in the frequency of discharge of active motor units when increased effort is required. Although minimum and maximum discharge rates of motor units probably differ among muscles, 5 to 50 discharges per second have been reported in the literature.^{26,27}

Numerous questions exist about the role recruitment and rate coding play in adjusting the tension output of a muscle. Some investigators emphasize rate coding as the predominate mechanism.²⁸⁻³⁰ Other investigators consider recruitment to be the predominate mechanism. The data on which arguments are based have been obtained by observing motor unit discharges during slowly varying muscle contractions. Many questions about the role of these physiologic mechanisms are unanswered. Additionally, extrapolating what is known to faster movements must be done cautiously. A reasonable hypothesis, however, can be formulated that may help in understanding EMG.

There is evidence under certain circumstances that motor units are recruited and derecruited in order.^{31,32} The small, slow, fatigue resistant motor units (S) are recruited first. These units appear to be best suited for postural functions and finely graded movements. The larger, faster, fatigable motor units (FF) are recruited last and appear best suited for movements that are rapid and powerful. Each time a muscle contraction is repeated, a motor unit is recruited at a similar force threshold for each contraction.

MOTOR UNIT ACTION POTENTIAL

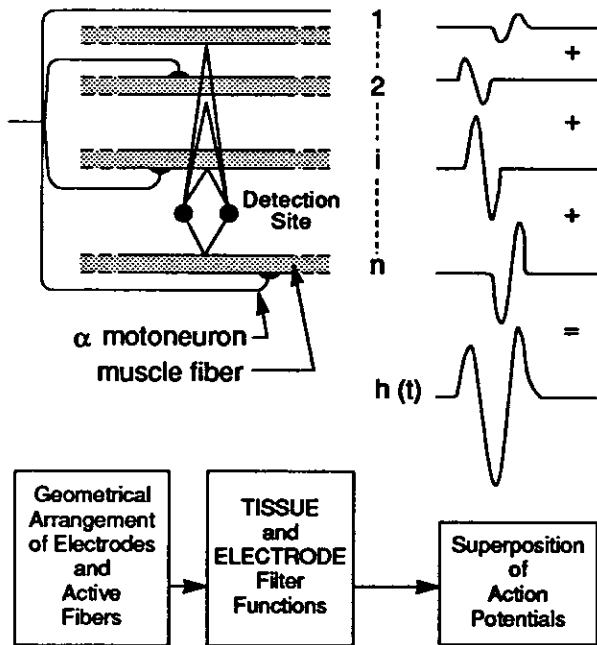

FIGURE 2-11

Schematic representation of the generation of the motor unit action potential.

Reprinted with permission from Basmajian JV, DeLuca CJ: *Muscles Alive, Their Functions Revealed by Electromyography*, ed 5. Baltimore, MD, Williams & Wilkins, 1985, Figure 3-2, p 68.

The minimum amount of tension that can be exerted on a tendon is the result of a twitch contraction from the muscle fibers of a motor unit. As the muscle's force requirement increases above the unit's force level, its firing frequency increases. As the demand for force further increases, additional motor units are recruited. Each of these units, however, may be producing a twitch contraction because the asynchronous firing of all the units their twitches summate to produce a smooth pull on the muscle's tendon.

At the lower force levels there is a strong interaction between rate coding and recruitment. At very high force levels, all the motor units are recruited before 100% of maximum contraction is reached.^{29,30} The additional force required above the force threshold of the last motor unit recruited, therefore, is a result of increased frequencies of firing of already activated motor units.

MUSCLE MECHANICS

The mechanics of muscle is concerned with the tension created in a contraction and the factors that affect the level of tension. This section briefly describes some of the most important factors affecting muscle tension. Only the mechanics and their physiologic basis are discussed. The relationship between these factors and the EMG signal is considered in greater detail in Chapter 6.

Architecture of Muscle

The arrangement of the fibers within the muscle help determine that muscle's function. To understand the relationship between architecture and function, two hypotheses must be accepted. First, a muscle fiber can shorten to about 60% of its resting length. Second, the force a muscle is capable of generating is related directly to its physiological cross sectional area.

Muscle fibers and fasciculi of a muscle can be arranged either parallel or at an angle to the long axis of a muscle. Where the fasciculi are arranged parallel to the muscle's long axis, the muscle takes full advantage of the shortening capability of the sarcomeres. Because a muscle's maximum displacement is proportional to fiber length or the number of sarcomeres in series, muscles with this type of architecture are found across joints with great ranges of motion. Examples of this type of muscle are the fusiform and strap muscle (Figure 2-15A,B). A strap muscle, such as the sartorius, almost has no tendon and yields the greatest range, because its entire length is composed of contractile tissue. A fusiform muscle, such as the brachioradialis, has tapered ends terminating in tendons. This type of muscle does not produce the same range of motion in accord with its overall muscle length because the tendon reduces the contractile portion of the muscle.

When two or three fusiform shaped muscle bellies attach to the same tendon, the muscle is called bicipital or tricipital (Figure 2-15C,D). Examples of muscles of this type are the biceps brachii and triceps brachii. The characteristics of bicipital muscles are the same as for the fusiform muscles. The triangular muscles (eg, gluteus medius) have fasciculi that are arranged at a slight angle to the long axis of the muscles because of a wide origin and a narrow tendon insertion. Their characteristics are also similar to fusiform.

Muscles with their fasciculi arranged obliquely to the direction of pull or long axis of the muscle resemble a feather. They, therefore, are called penniform muscles. Their fiber arrangement corresponds to the barbs of the feather; their tendons correspond to the feather's quill. A unipennate muscle resembles one half of a feather (Figure 2-15E). Examples of this type of muscle are the



FIGURE 2-12

Individual motor units recorded by fine wire electrodes. Scales as shown in the figure per division on oscilloscope.

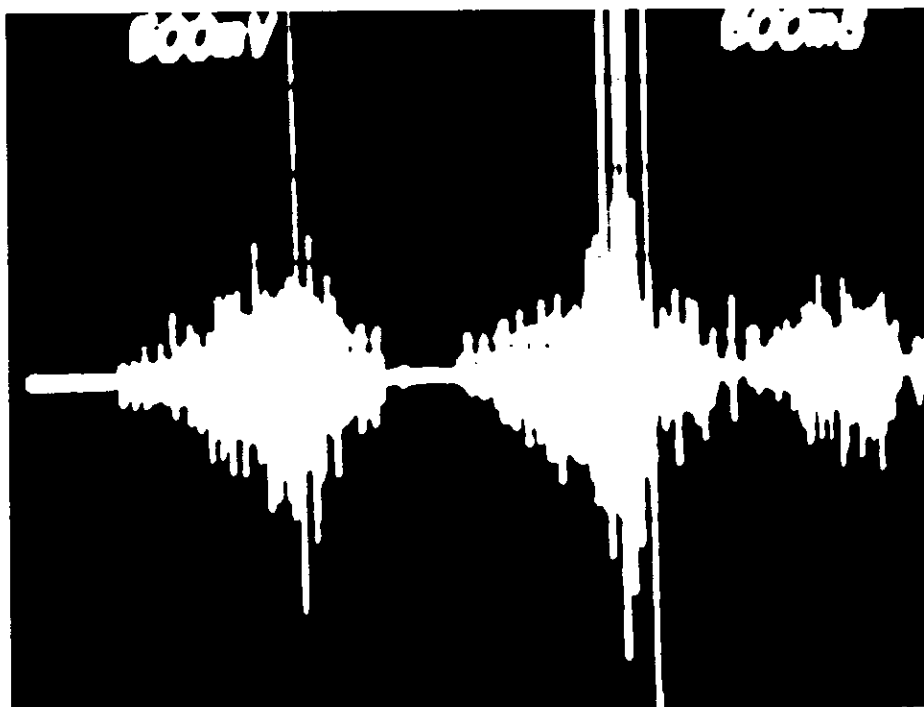

FIGURE 2-13

Sample surface EMG recordings. Scales as shown per division as on the oscilloscope screen.

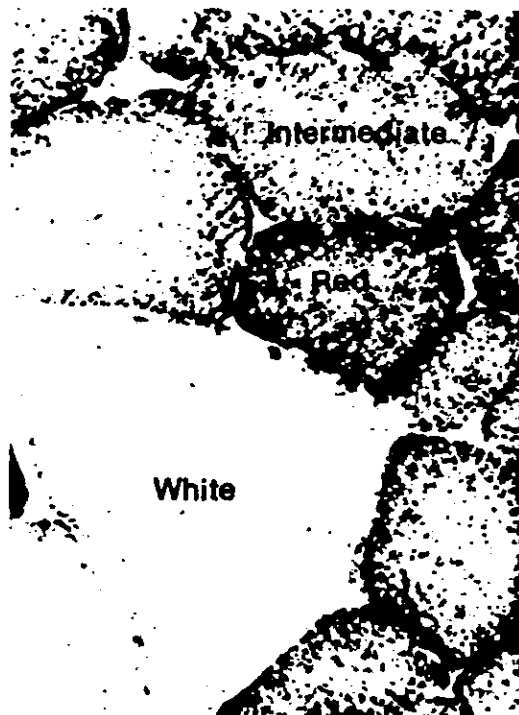

FIGURE 2-14

Photomicrograph of a transverse section of skeletal muscle stained for the enzyme succinic dehydrogenase, which resides in mitochondria. Three categories of fibres are recognizable: small red fibers rich in mitochondria, especially around the periphery; large white fibers with relatively few mitochondria; and fibers with intermediate characteristics. (Photomicrograph courtesy of G. Gautier.)

Reprinted with permission from Bloom W, Fawcett DW: Textbook of Histology, ed 10. Philadelphia, PA, WB Saunders Co, 1975, Figures 11-14, p 302.

flexor pollicis longus and semimembranosus. The bipennate muscle resembles a complete feather (Figure 2-15F). The rectus femoris and dorsal interossei muscles exemplify a bipennate fiber arrangement. A multipennate muscle such as the deltoid is one that has many groups of bipennate fasciculi attached to many intermuscular tendons (Figure 2-15G).

Because the length of the muscle fibers and direction of pull determine the range of motion of a muscle, the fusiform-type muscle yields a much greater range than a pennate muscle. The length of the fiber has little effect on maximum tension. The force a muscle can generate, however, is directly proportional to its physiologic cross-sectional area.³³ The penniform type muscles have more fibers per unit area than the fusiform; therefore, they

generate more force than the fusiform muscles. Fusiform muscles thus provide greater range of motion at the expense of force production, whereas pennate muscles produce greater forces through less range of motion.

Length-Tension Relationship

Two basic components of the muscle are responsible for producing the relationship between tension and length. The active component is the muscle tension produced by the contractile process; the passive component is the tension produced by the connective tissue surrounding the muscle fibers. The sum of the active and passive tensions equals the total tension generated by a muscle contraction.

The length of muscle has an effect on both active and passive tension. Figure 2-16 graphically demonstrates the relative effect of length changes. The resting length of a muscle is defined as 100% of muscle length. The passive tension produced (Curve 1) monotonically increases from resting length. The active tension (Curve 2) is maximal at the resting length and decreases with either lengthening or shortening. Curve 3 is the sum of these two components.

The maximum muscle tension attainable in a physiologic range of motion is found at about 125% of resting length. This length coincides with the length of the muscle when the joint is in a relaxed position.¹³ These length-tension relationships have been reported in isolated muscle fibers³⁴ and in whole muscle preparations.³⁵⁻³⁷

Until 1966, investigators were unable to relate active tension to specifics of the contractile process. Gordon *et al* postulated, from data obtained by evaluating the sarcomeres of single muscle fibers of the frog, that length changes involve the interaction of actin and myosin.³⁴ In shortened muscle, the actin filaments overlap in a manner that decreases the number of sites in which myosin can combine with actin. The fewer actin binding sites available, the less tension developed. In a lengthened muscle, there also are fewer sites at which myosin can combine with actin; therefore, less tension is produced. (See Huxley³⁸ for a discussion of the sliding filament theory).

Velocity-Tension Relationship

The contraction velocity of a muscle also has an effect on the tension produced.³⁹ The general shape of the relationship between tension and the velocity of shortening is presented in Figure 2-17. Note that the muscle responds differently for lengthening (eccentric) and shortening (concentric) contractions. In concentric muscle contractions, as the speed of shortening increases, the maximum tension that a muscle can produce decreases. At P_0 in the figure, there is zero velocity; thus, an

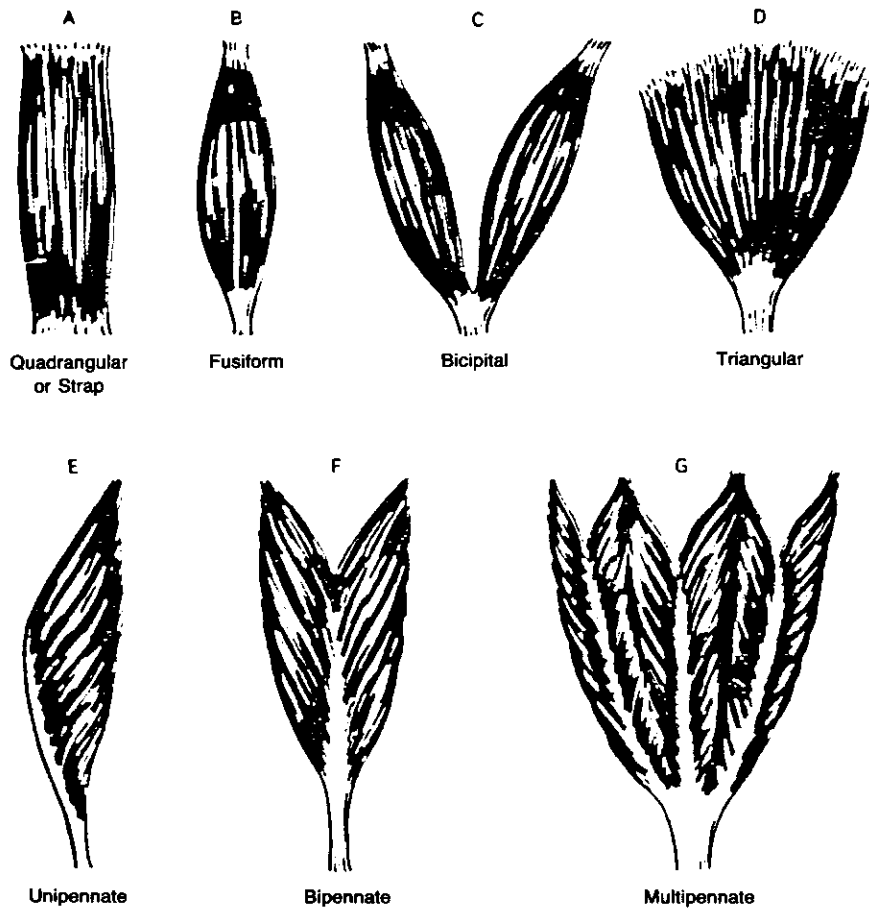

FIGURE 2-15

Illustration of the variety of shapes and fiber arrangements of muscles.

Reprinted with permission from Hall-Craggs ECB: Anatomy As a Basis for Clinical Medicine. Baltimore, MD, Urban and Schwartzberg Publ Co, 1985, Figures 1-21, p 19.

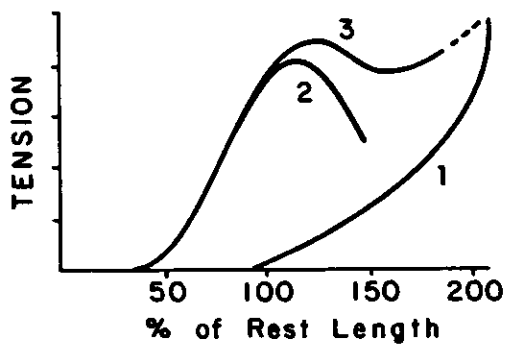

FIGURE 2-16

The length-tension relationship of muscle. Curve 1 is the passive force. Curve 2 is the active muscle force. Curve 3 is the total muscle force (Curve 1 plus Curve 2).

Reprinted with permission from Basmajian JV, DeLuca CJ: Muscles Alive, Their Functions Revealed by Electromyography, ed 5. Baltimore, MD, Williams & Wilkins, 1985.

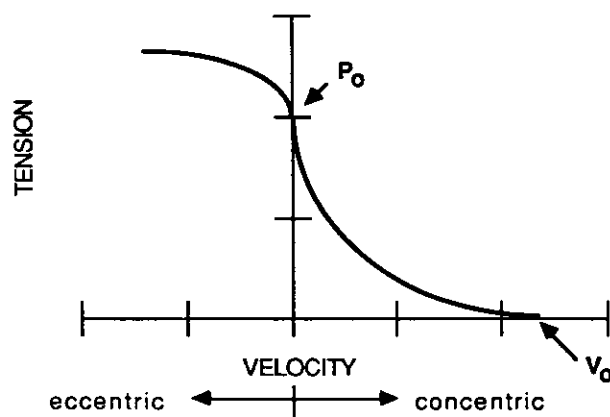

FIGURE 2-17

Velocity-active tension relationship for muscle.

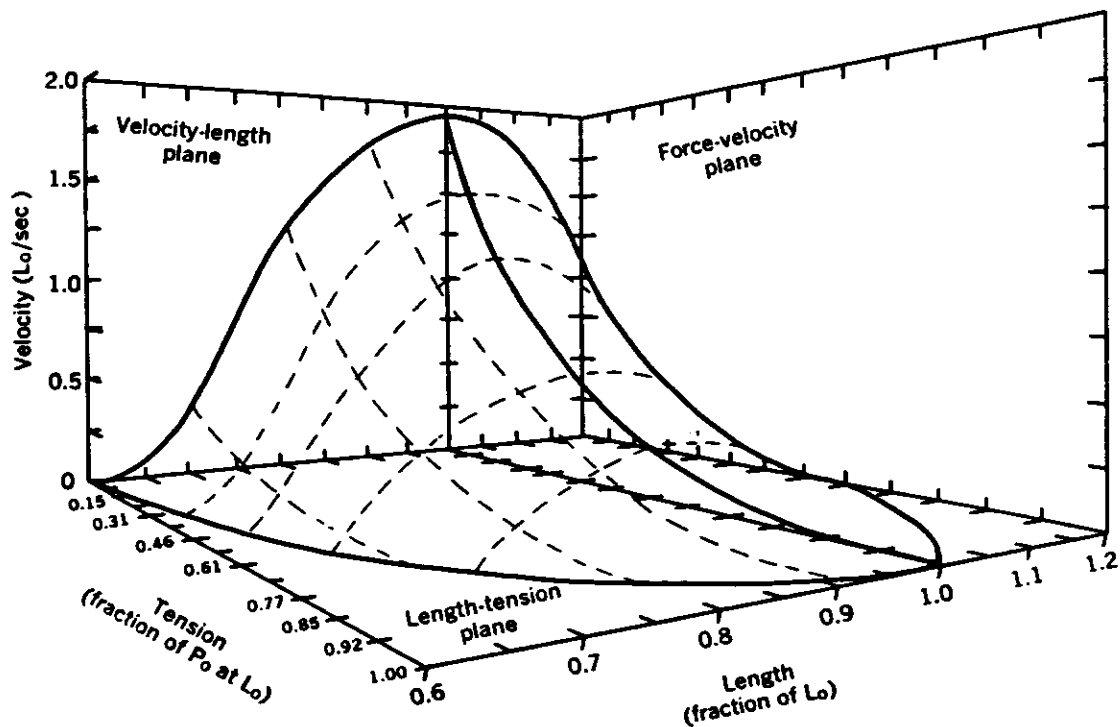

FIGURE 2-18

Semischematic three-dimensional representation of interrelationship between length, tension, and velocity. Based on data from gracilis muscle of rat at approximately 16° C. Isometric length-tension diagram forms the base of the figure in the length-tension plane. Force-velocity curve at initial length L_0 is given as a heavy continuous line with its own velocity-length axes. The foot on velocity-length curve at short lengths and small loads is extrapolated beyond experimental data in order to meet isometric length-tension diagram. Other force-velocity and velocity-length relations are shown by broken lines to suggest curvature of surface. There is a family of such three-dimensional figures, depending on available chemical energy for contraction.

Reprinted with permission from Zierler KL: Mechanism of muscle contraction and its energetics. In: Mountcastle VB (ed): Medical Physiology, ed 12. St. Louis, MO, C V Mosby Co, 1968, vol 2, p 1141.

isometric contraction occurs. In eccentric contractions, as the speed of lengthening increases, the maximum tension a muscle produces increases.

In dynamic movements, the effects of length and velocity combine to have dramatic effects on the active tension output of muscle. A summary of these relationships is well described by Figure 2-18, taken from Zierler.⁴⁰ The plot shows the interaction of length, velocity, and tension for shortening contractions.

SUMMARY

In this chapter, anatomical, physiologic, and mechanical concepts basic to understanding surface electromyography are presented. Specific topics discussed are anatomy of skeletal muscle, origin of the electromyographic signal, functional considerations of motor

units, and mechanics of muscle.

The contractile unit of muscle is the sarcomere. Many sarcomeres placed end to end form a myofibril. Many myofibrils wrapped in the sarcolemma make up a muscle fiber. The three major types of muscle fibers are Type I (SO) slow twitch oxidative, Type IIA (FOG) fast twitch oxidative, and Type IIB (FG) fast twitch glycolytic. The muscle fibers are bundled together by connective tissue to form fasciculi; groups of fasciculi make up a muscle. Connective tissue provides a means for the muscle fibers to be attached to each other and to bone.

The inside of a muscle fiber has a resting membrane potential of approximately -80 mV with respect to the outside. The polarized muscle fiber remains in equilibrium until upset by a stimulus. The stimulus causes

a rapid depolarization followed by a repolarization that can be measured; it is called the action potential. The spatial and temporal summation of the action potentials from the homogenous muscle fibers of a motor unit form the typical biphasic or triphasic wave shapes of a single motor unit action potential. When surface electrode techniques are used, the myoelectric activity recorded represents the spatial and temporal summation of many motor unit action potentials.

A group of homogenous muscle fiber types innervated by a single axon is called a motor unit. Three types of motor unit are recognized. Slow twitch motor units (S) can fire continuously for long periods at low frequencies. Fast twitch fatigue resistant (FR) motor units produce more force than slow twitch motor units but cannot fire continuously for long periods of time. The fast twitch fatigable motor units (FF) produce the greatest force but for very short periods.

The actual force and velocity of movement is controlled by motor unit recruitment and rate coding. Slow twitch motor units are recruited first and the fast twitch fatigable units are recruited only when rapid powerful movements are required. Each time a contraction is repeated, a particular motor unit is recruited at the same force level. At high force levels after all motor units have been recruited, additional force is created by increasing the firing frequencies of the motor units.

The tension created by a muscle contraction also depends on the geometric arrangement of muscle fibers, the length of the muscle, and the velocity of contraction. Muscles with their fibers parallel to their tendon tend to produce greater range of movement, whereas muscles with their fibers placed at an angle to their tendon tend to produce greater force per unit area. A muscle produces the maximum amount of tension when it is lengthened slightly beyond resting length. In concentric muscle contractions, the tension a muscle can produce decreases as shortening velocity increases. In eccentric muscle contractions, the maximum tension a muscle can produce increases as the speed of lengthening increases.

REFERENCES

1. Clark DH: Exercise Physiology. Englewood Cliffs, NJ, Prentice Hall, Inc, 1975
2. Etemadi AA, Hosseini F: Frequency and size of muscle fibers in athletic body building. *Anatomical Record* 162:269, 1968
3. Hollinshead WH: Anatomy for Surgeons: The Back and Limbs, ed 3. Hagerstown, MD, Harper & Row Publishers Inc, 1982, vol 3
4. Burke RE: Motor units: Anatomy, physiology and functional organization. In *Handbook of Physiology: Sec 1. The Nervous System: Motor Control*. Bethesda, MD, American Physiological Society, 1981, vol 2, pp 345-422
5. Mountcastle VB (ed): *Medical Physiology*, ed 14. St. Louis, MO, C V Mosby Co, 1980
6. Strand F: *Physiology: A Regulatory System Approach*. ed 2. New York, NY, Macmillian Publishing Co, 1983
7. Guyton AC: *Textbook of Medical Physiology*, ed 6. Philadelphia, PA, W B Saunders Co, 1981
8. Ekstedt J, Stalberg E: Single fibre electromyography for the study of the microphysiology of the human muscle. In Desmedt JE (ed): *New Developments in Electromyography and Clinical Neurophysiology*. Basel, Switzerland, Karger, 1973, vol 1, pp 113-129
9. Dowben RM: Contractility with special reference to skeletal muscle. In Mountcastle VB (ed): *Medical Physiology* (ed 14). St. Louis, C V Mosby Co, 1980, 104-105
10. Buchthal F, Guld C, Rosenfalck P: Action potential parameters in normal human muscle and their dependence on physical variables. *Acta Physiol Scand* 32:200-218, 1954
11. Basmajian J, DeLuca C: *Muscles Alive: Their Functions Revealed by Electromyography*, ed 5. Baltimore, MD, Williams & Wilkins, 1985, pp 1972
12. Burke RE, Edgerton VR: Motor unit properties and selective involvement in movement. In Wilmore JW, Keogh JF (eds): *Exercise and Sports Sciences Review*. New York, NY, Academic Press, 1975, vol 3
13. Buchthal F, Guld C, Rosenfalck P: Multielectrode study of the territory of a motor unit. *Acta Physiol Scand* 39:83-103, 1957
14. Feinstein B, Lindegard B, Nyman E, Wohlfart G: Morphological studies of motor units in normal human muscles. *Acta Anat* 23:127-142, 1955
15. Wersall R: The tympanic muscles and their reflexes: Physiology and pharmacology with special regard to noise generation by the muscles. *Acta Otolaryngol* 139 (suppl): 1-112, 1958
16. Ruedi L: Some observations on the histology and function of the larynx. *J Laryngol Otol* 73:1-20, 1959
17. Brook MH, Kaiser KK: Muscle fiber types: How many and what kind? *Arch Neurol* 23:369-379, 1970
18. Peter JB, Barnard RJ, Edgerton VR, et al: Metabolic profiles of three fiber types of skeletal muscle in guinea pigs and rabbits. *Biochemistry* 11:2627-2633, 1972
19. Garnett RAF, O'Donovan MJ, Stephens HA, et al: Motor unit organization of human medial gastrocnemius. *J Physiol (London)* 287:33-43, 1978
20. Sica RE, McComas AJ: Fast and slow twitch units in a human muscle. *J Neurol Neurosurg Psychiatry* 34:113-120, 1971
21. Faulkner JA, Chafin DR, McCully KK: Power output of fast and slow fibers from human skeletal muscles. In Jones NL, McCartney N, McComas AJ (eds): *Human Muscle Power*, 1986, pp 81-94
22. Wendt IR, Gibbs CL: Energy production of mammalian fast and slow-twitch muscles during development. *Am J Physiol* 226:642-647, 1974
23. Burke RE, Levine DN, Tsairis P, et al: Physiological types and histochemical profiles in motor units of the cat gastrocnemius. *J Physiol (London)* 234:723-748, 1973

24. Thorstensson A, Grimby G, Karlsson J: Force-velocity relations and fiber composition in human knee extensor muscles. *J Appl Physiol* 40:12-16, 1976
25. Costill DL, Daniels J, Evans W, et al: Skeletal muscle enzymes and fiber composition in male and female track athletes. *J Appl Physiol* 40:149-154, 1976
26. Burke RE, Rudomin P, Zajac FE III: The effect of activation history on tension production by individual muscle units. *Brain Res* 109:515-529, 1976
27. Milner-Brown HS, Stein RB, Yemm R: The orderly recruitment of human motor units during voluntary isometric contractions. *J Physiol (London)* 230:359-370, 1973
28. Adrian ED, Bronk DW: Impulses in motor nerve fibers: I. Impulses in single fibers of the phrenic nerve. *J Physiol (London)* 66:81-101, 1928
29. Milner-Brown HS, Stein RB, Yemm R: Changes in firing rate of human motor units during linearly changing voluntary contraction. *J Physiol (London)* 230:359-370, 1973
30. Milner-Brown HS, Stein RB, Yemm R: Changes in firing rate of human motor units during linearly changing voluntary contractions. *J Physiol (London)* 230:371-390, 1973
31. Henneman E: Recruitment of motoneurons: The size principles. In Desmedt JE (ed): *Motor Unit Types, Recruitment and Plasticity in Health and Disease: Progress Clinical Neurophysiology*. Basel, Switzerland, Karger, 1981, vol 9, pp 26-60
32. DeLuca CJ, LeFever RS, McCue MP, et al: Behavior of human motor units in different muscles during linearly varying contractions. *J Physiol (London)* 329:113-128, 1982
33. Green HJ: Muscle power: Fibre type recruitment, metabolism and fatigue. In Jones NL, McGartney N, McComas AJ (eds): *Human Muscle Power*. 1986, pp 65-79
34. Gordon AM, Huxley AF, Julian FJ: The variation in isometric tension with sarcomere length in vertebrate muscle fibers. *J Physiol (London)* 184:170-192, 1966
35. Fenn WO: The mechanics of muscular contraction in man. *J Appl Physiol* 9:165-177, 1938
36. Buller AJ, Eccles JC, Eccles RM: Differentiation of fast and slow muscle in cat hind limb. *J Physiol (London)* 150:399-416, 1960
37. Ismail HM, Ranatunga KW: Isometric tension development in a human skeletal muscle in relation to its working range of movement: The length-tension relationship of biceps brachii muscle. *Exp Neurol* 62:595-604, 1978
38. Huxley AF: Muscular contraction: A review of lecture. *J Physiol (London)* 243:1-43, 1974
39. Hill AV: The heat of shortening and the dynamic constants of muscle. *Proc R Soc London [Biol]* 126:136-195, 1938
40. Zierler KL: Mechanisms of muscle contraction and its energetics. In Mountcastle VB: *Medical Physiology*, St. Louis, MO, C V Mosby Co, 1974

Suggested Readings

- Bigland B, Lippold OCJ: Motor unit activity in voluntary contraction of human muscle. *J Physiol (London)* 125:322-335, 1954
- Clamann HP: Activity of single motor units during isometric tension. *Neurology* 20:254-260, 1970
- Geddes LA, Baker LE: *Principles of Applied Biomedical Instrumentation*. New York, NY, John Wiley & Sons Inc, 1968, pp 262-324
- Geddes LA: Electrodes and the Measurement of Bioelectric Events. New York, NY, Wiley-Interscience, John Wiley & Sons Inc, 1972, pp 251-305
- Ramsey RW, Street SF: The isometric length-tension diagram of isolated skeletal muscle fibers of the frog. *J Cell Comp Physiol* 15:11-34, 1940
- Tanji J, Kato M: Firing rate of individual motor units in voluntary contraction of abductor digiti minimi muscle in man. *Exp Neurol* 40:771-783, 1973

CHAPTER 3

Recording Techniques

Gary L. Soderberg, Ph.D., PT

Gary Soderberg, Ph.D., PT, received both a Certificate and Master of Arts degree in Physical Therapy at The University of Iowa. His Ph.D. is from The Pennsylvania State University, after which he directed the physical therapy program at The University of Iowa in 1972, becoming Director of the Physical Therapy Graduate Program in 1986. He has authored numerous papers in which electromyography is used to study muscle function in both normal and pathological state. He is a member of the International Society for Electrophysiological Kinesiology, the International Society of Biomechanics, and the American Physical Therapy Association, serving as Deputy Editor for the journal *Physical Therapy*.

RECORDING TECHNIQUES

Gary L. Soderberg, PhD, PT

INTRODUCTION

This chapter will present fundamentals of recording EMG data during activities of interest to the ergonomist or in the setting where ergonomic activities are performed. Each subheading will discuss important factors for applications of surface electromyographic (EMG) techniques relative to ergonomics. Details of fine wire techniques are located in Appendix C.

ELECTRODE SELECTION

A wide variety of electrodes are available for recording muscle action potentials. Although specialized microelectrodes, laser etched electrodes, and diagnostic type needles are available for use, none of these techniques are practical for use of EMG in ergonomics.⁵ The two varieties most frequently encountered and of the greatest practicality and applicability are surface and fine wire electrodes. Surface electrodes are of various types, usually comprising a disk composed of silver-silver chloride (Figure 3-1). The size of these circular shaped disks varies from 1 mm to about 5 mm in diameter. Most frequently, these disks are encircled by a teflon or other similar material that also serves as a mechanism to affix the electrode to the skin surface. In some cases, the electrodes have been mounted into a lightweight housing containing instrumentation that will amplify the signal close to the site of the electrode pickup (Figure 3-2). Although it is possible to produce electrodes for recording of EMG data by locating common solder on the end of the wire, this practice should be avoided. In some cases, electromyographers have used suction type electrodes, but this is an uncommon practice. The National Aeronautic and Space Administration has developed a spray-on electrode with a wire incorporated during the drying process, best for long term monitoring. This technology generally is not available nor particularly necessary.

Which type of electrode to be used for surface EMG depends on the purpose of the study of muscle function during performance. Although surface electrodes will provide a more general representation of muscle activity, limitations exist as to their ability to record the performance of small muscles or muscles located more deeply in the body. If information is required on the function of specific or deep musculature then fine wire electrodes should be selected for use. This selection is also recommended if there is interest in studying specific motor unit

properties. Otherwise, for temporal, force, or fatigue relationships, surface EMG generally is satisfactory.

Advantages and Disadvantages

All of the available surface electrode techniques have advantages and disadvantages. Although the primary choice of electrode to be used in any collection of EMG information is dependent on the purpose of the study, consideration should also be given to technical feasibility and ease of use.

One advantage of the surface technique is that the electrodes are readily obtainable or made. They also offer the ergonomist many conveniences in terms of relative ease of application and lessened discomfort to the subject. The discomfort factor, however, may be significant in that where less than optimal instrumentation characteristics exist, skin-electrode preparation may create considerable subject discomfort.

Among the disadvantages for surface electrodes are that the electrodes are not selective to a specific area. That is, the pickup area from muscle is rather generalized. Further, they lack any ability of the user to determine the activity from muscles situated at a depth within a given body part. The general rule of thumb, however, is that the smaller the muscle from which the recording is made, the smaller should be the electrodes. It is not surprising, therefore, that electrode sizes down to 2 to 3 mm are used for some of the smaller muscles. An additional disadvantage is that muscle will move under the skin, thereby creating different volumes of muscle tissue from which the electrode is recording. As Basmajian has noted, substantial progress can be made with skin electrodes in such uncomplicated general investigations, but their routine continued use should be avoided.⁶ This condemns the exclusive use of surface electrodes in any circumstance where scientific precision is desirable.

An additional disadvantage associated with surface electrodes is the difficulty they present in determining from which muscle the EMG activity is being generated. This leads to the issue of cross talk, which raises questions as to the validity of recordings. How, in fact, can the electromyographer be sure that the recording is from the muscle of interest? Although efforts have been made to quantify and determine the effect of cross talk, there is no established or easy way for surface EMG to



FIGURE 3-1

Standard Beckman surface electrodes (lower right), electrodes with snap on collars and larger diameter pickup area (upper right) and two views of a silver-silver chloride adhesive disk that can be connected to amplifier with a clip lead (left).

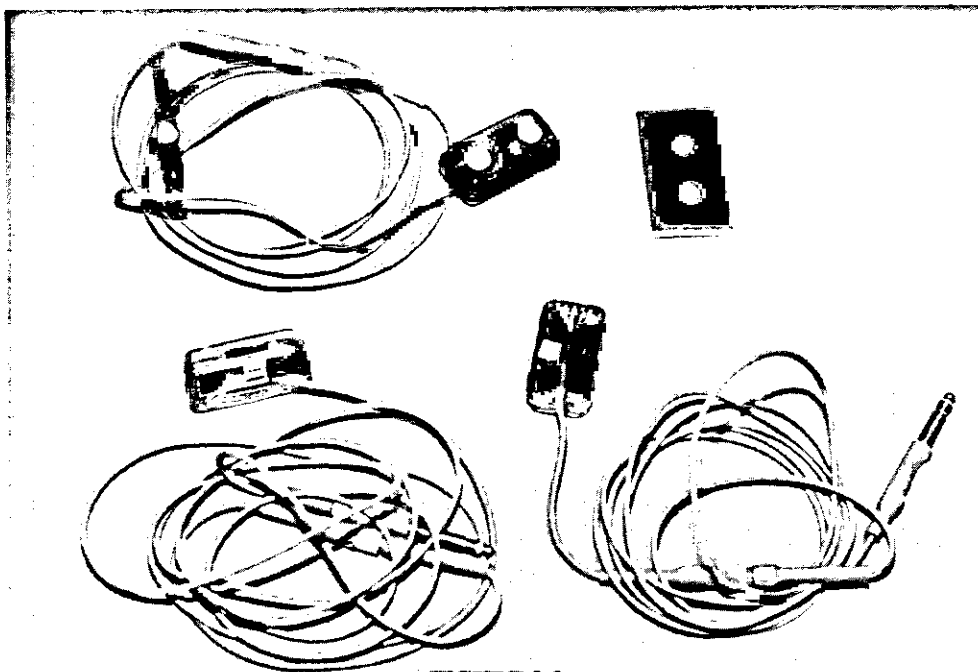

FIGURE 3-2

Three views of a surface electrode with preamplification circuitry included. Dimensions are 33 mm by 17 mm by 10 mm. Double-sided adhesive washer is shown in the upper right.

Reprinted with permission from Soderberg GL and Cook TM: Electromyography in biomechanics. Phys Ther 64:1813-1820, 1984.

eliminate this problem. Some have used functional tests to establish if cross talk occurs between muscles that perform different functions. By using manual resistive techniques for testing isolated motions and observing the display of the EMG signal from all muscles, electromyographers may get assistance in determining whether electrical activity is being recorded simultaneously or by each individual muscle. One specific example may be cited for the gastrocnemius and soleus muscles. Electrodes can be applied over each muscle and the selectivity of the electrode can be demonstrated during knee flexion performed against manual resistance. If the electrodes are applied correctly, such contraction should show high gastrocnemius activity and little, if any, activity from the soleus muscle.

Others have developed and tested models related to cross talk.⁶ This work has resulted in the recommendation that calculation of the cross-correlation function be used to determine the presence of cross talk. In most cases, however, the ergonomists using EMG would most probably be interested in generalized activity from a muscle or muscle group, to make inferences about the activity performed. Although cross talk is a factor to consider in using EMG, the practical implications thus may be minimal. A section of Chapter 6 discusses this issue further. Some ergonomists have gone to the selectivity of the fine wire technique to at least help minimize the problem of cross talk.

LOCATION

Despite the relatively long-term use of EMG by investigators in a wide variety of disciplines, little information is available in the literature as to the preferred location of electrode sites. Obviously, for fine wire work the electrode is placed directly in the muscle belly of the muscle of interest. In these cases, similar criteria as used for diagnostic EMG are acceptable (Figure 3-3). For surface electromyography, however, the decision as to where to put the electrode is much less clear. Some have advocated the use of the site where the muscle can be the most easily stimulated (motor point) as where the maximum amplitude of potentials will be located. Basmajian and DeLuca, however, state that this location will not yield the greatest signal amplitude.⁷ Rather, they suggest an *interdetection-surface*⁴ spacing of 1 cm for surface electrodes.

Some electromyographers have suggested specific anatomic locations for electrode locations (Figure 3-4 A-F).⁸ More recently other locations have been specified (Table 3-1, Figure 3-5 A-P).⁹ The latter figures, for all but two muscles, include a mechanism to normalize placement based on the body dimensions. This mechanism, therefore, would be an acceptable technique

in ergonomic applications.

Among the original investigators of the effect of skin electrode position on EMG potentials were Zuniga et al.¹⁰ They evaluated both unipolar and monopolar recordings and were able to identify locations of greatest EMG output (Figure 3-6). They also evaluated the relationship between the amplitude of the average EMG potential and a longitudinal bipolar electrode position in units of equal distances between the centers of various bipolar electrodes (Figure 3-7). This work on the biceps brachii was followed by the work of Kramer et al, who produced plots of recordings over the muscle midpoint and two other symmetrical positions (Figure 3-8).¹¹ Other plots are available from the work by Kramer et al, but little additional information is provided. Work has also been completed by Jonsson and Reichmann on multiple-site insertion of fine wire electrodes in back musculature, but no optimal locations were identified.¹² In an attempt to determine the effects of contraction intensity and joint angle, Soderberg et al produced results for hamstring and erector spinae musculature for surface electrodes with a fixed interelectrode distance of 8 mm.¹³ A study of Figure 3-9 shows how these variables affect the EMG output.

With consideration given to issues of signal-to-noise ratio, stability (reliability and cross talk), and a presentation of selected data relative to EMG output, Basmajian and DeLuca state that the preferred location of an electrode is in the region of halfway between the center of the innervation zone and the further tendon.⁷ More specific guidelines have been provided by Loeb and Gans.¹⁵ They state that the considerations given to the electrophysiological system from which we are recording allows them to make several recommendations regarding electrode dimensions and placement. These include the following:

1. Electrode contacts should lie parallel to the muscle fibers and not across them.
2. Given the duration of the electrical events and the velocity of conduction, the electrode center-to-center separation should be between 2 to 10 mm. Caution is provided that there may be differences in distal versus proximal fibers. Note should also be made that the distances are small because these workers use implanted electrodes in an animal population.
3. Recording contacts should be as large as feasible, meaning that one linear dimension should be at least equal to about half the distance between the pair of electrodes. They caution that **reducing contact dimensions below half the distance between their (electrode) centers adds only to noise and unduly biases the recordings by concentrating on the signals from a few fibers that**

TABLE 3-1
LEAD PLACEMENTS AND FUNCTION CHECKS FOR VARIOUS MUSCLES.^a

No.	Muscle	Posture	Lead line	Central lead point	Function check	Comments No. b
1.	M. epicranii pars frontalis	Looking straight ahead	Horizontal line 3 cm above the eyebrows	Electrode placement: intersections of the lead line and the vertical lines through the pupils	Raising the eyebrows	1, 2, 4, 6, 9
2.	M. sterno-cleido-mastoideus	Head turned slightly toward the opposite side	1. Mastoid process 2. Suprasternal notch	1/3 LLL from the mastoid process	Turning the head to the opposite side	4, 6
3.	M. trapezius pars descendens	Head turned slightly toward the opposite side	1. Acromion 2. Spine of the 7th cervical vertebrae	1/2 LLL	Lifting the shoulder	4, 6, 8
4.	M. deltoideus pars acromialis	Sitting or standing; arm limp	1. Acromion 2. Lateral epicondyle of the humerus	1/4 LLL from the acromion	Raising the arm sideways	4, 6
5.	M. deltoideus pars clavicularis	Sitting or standing; arm limp	Subsidiary line: 1. Acromion 2. Suprasternal notch Lead line: 1. Subsidiary point 2. Lateral epicondyle of the humerus	Subsidiary point: 1/5 SLL from the acromion Central lead point: 1/5 LLL from the subsidiary point	Raising the arm forward	4, 6
6.	M. biceps brachii	Sitting or standing; upper arm vertical; forearm horizontal; palm upward	1. Acromion 2. Tendon of the biceps muscle in the cubital fossa	1/3 LLL from the cubital fossa	Flexing the forearm against an external resistance	4, 7
7.	Triceps brachii	Sitting or standing; arm limp	1. Acromion 2. Olecranon	1/3 LLL from the olecranon	Extending the elbow joint	4, 7
8.	M. flexor digitorum superficialis	Sitting; forearm on a table; elbow slightly turned inward; palm upward	1. Medial epicondyle of the humerus 2. Skin fold at the wrist	1/4 LLL from the epicondyle	Flexing the fingers against an external resistance	4, 7, 10, 11
9.	M. extensor digitorum communis	Sitting; upper arm abducted laterally; forearm on a table; palm downward	1. Lateral epicondyle of the humerus 2. Midpoint between the styloid processes of radius and the ulna	1/4 LLL from the olecranon	Extending the elbow joint	4, 7
10.	M. extensor carpi ulnaris	See No. 9	1. Midpoint between the lateral epicondyle of the humerus and the olecranon 2. Styloid process of the ulna	1/3 LLL from midpoint	Abducting the hand sideward toward the ulna	3, 4, 7, 10, 15

TABLE 3-1 (continued)

No.	Muscle	Posture	Lead line	Central lead point	Function check	Comments No. b
11.	M. pronator quadratus	See No. 8	Parallel line 2.5 cm proximal from the skinfold at the wrist	Point of intersection of the lead line and the tendon of palmaris longus muscle	Pronating the right hand counterclockwise or the left hand clockwise	1, 5, 7, 10, 13
12.	M. interosseus dorsalis I	Sitting; forearm on a table; thumb and index finger extended forming a V	1. Vertex of the V 2. Basal joint of the index finger	1/2 LLL	Squeezing the thumb and the index finger together	1, 5, 6
13.	M. erector spinae (trunci)	Standing erect	Parallel line to the spinal column on the crest of the erector muscle	1/6 of the distance from the iliac crest to the spine of the 7th cervical vertebra above the iliac crest	Stooping with a straight back	4, 6, 8, 14
14.	M. vastus medialis	Standing	1. Anterior superior spine of the pelvis 2. Medial gap of the knee joint	1/5 LLL from the knee gap	Extending the knee joint	3, 4, 7
15.	M. tibialis anterior	Standing	1. Lower margin of the patella 2. Lateral ankle	1/3 LLL from the patella	Standing on the heels	3, 4, 7, 15
16.	M. gastrocnemius	Standing	1. Head of the fibula 2. Heel	1/3 LLL from the head of the fibula	Standing on the toes	3, 4, 7

^aIn most instances, the lead line is given in terms of its end point. LLL: lead line length; SLL: subsidiary line length.

^bComments:

1. Small electrodes are required.
2. Skin-tinted electrode cases should be used.
3. Shaving may be necessary.
4. Electrode attachment: Adhesive washers.
5. Electrode attachment: Colloidion.
6. Electrode attachment should be secured with elastic adhesive tape.
7. Electrode attachment should be secured with circular elastic and adhesive bandages.
8. Interference from the ECG can be reduced by a change of sides or by rotating the lead line about the central lead point.
9. Interference from the EOG and the EEG can be reduced by a high-pass filter with a break point of 20 Hz. Eye blink artifacts can be minimized by slightly shifting one of the electrodes.
10. Crosstalk from other forearm muscles will occur.
11. The signals of the finger flexor muscle are weak since other muscles are superimposed. Different portions of the muscle attached to the different fingers can be selected by shifting the or tion of the lead line either to the thenar or the hypothenar eminence. The final position should be confirmed by palpation while moving the finger under study.
12. Different portions of the muscles belonging to the different fingers can be recorded by shifting the orientation of the lead line either toward the ulnar or the radial styloid. The final posit should be confirmed by palpation while moving the finger under study.
13. The tendon becomes prominent if the palm is strongly cupped. If the tendon is absent, extend the skin fold of the palm (Linea stomachica). The electrodes should not be attached over the tendons.
14. Large stooping movements impose considerable strain on the attachment and may cause failure. A horizontal or oblique orientation of the adhesive tape will reduce the strain. The differ myoelectric activities between the sides may amount to a 3:1 for equal loading (Groeneveld 1976).
15. This body site exhibits very high skin impedance (Almasi and Schmitt 1970).

SUPRASPINATUS

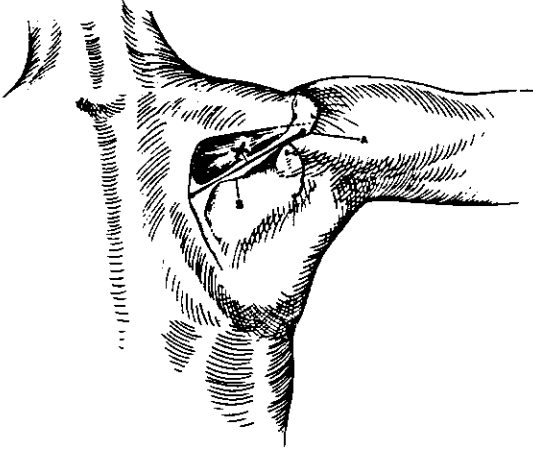

SOLEUS

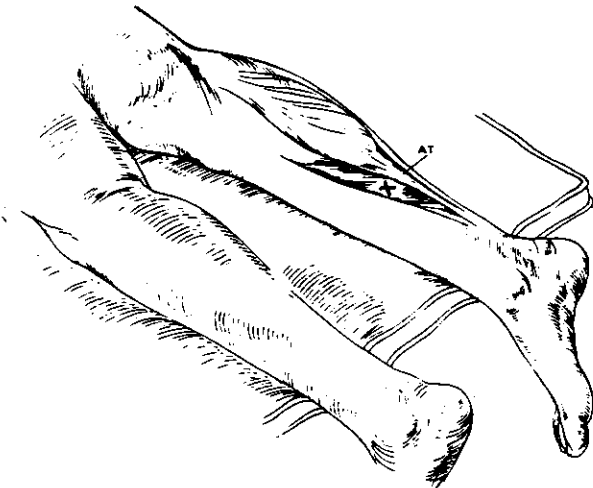

FIGURE 3-3

Examples of suggested needle insertion sites for muscles a) supraspinatus and b) soleus.

Reproduced by permission from DeLagi EF, Perotto A, Iazzetti J, et al: Anatomic Guide for the Electromyographer. Springfield, IL, Charles C. Thomas, Publisher, 1975.

- may be lying right on top of one small contact.
4. Bipolar recording contacts should be as similar as possible in size, and impedance.
5. Specific rules apply to the selective recording or rejection of electrical potentials.¹⁵

In view of the limited availability of information as to optimal electrode positions, electromyographers are required either to locate the best anatomical position or to use the work of previous investigators to justify their electrode locations. That more numerous descriptions for electrode locations do not appear in the scientific or applied literature is surprising.

No matter the electrode location, numerous techniques are available to validate or verify the electrode location. In the case of the fine wire technique, some electromyographers have used stimulation through the implanted wires to determine if the appropriate muscle contracts. The contraction usually is determined on a subjective or clinical basis. Many others have used standardized manual muscle testing procedures to help determine if the muscle of interest is being activated during the given contraction. However, a limitation is that isolation of any given muscle cannot be guaranteed. Because local muscle or nerve blocks are not practical, techniques of validation and verification of the optimal location for surface electrodes are less than scientifically desirable.

THE ELECTRODE AS TRANSDUCER

The chemical electrode transducer is the means by which muscle activity may be detected. A great variety of electrodes are used in EMG but common to all electrodes is a metal-electrolyte interface.⁷ The electrode is formed of metal, and the electrolyte may be an electrolytic solution or paste, as used with surface electrodes, or the tissue fluids in contact with the embedded electrode. It is at the site of the electrode-electrolyte interface that an exchange occurs between the ionic current of the various tissue media and the electron current flow of recording instrumentation. The quality of an electrode as a transducing element depends on the ability of the interface to exchange ions for electrons and vice versa, with equal ease, thus preventing the formation of a charge gradient at the electrode-electrolyte interface.

ELECTRICAL PROPERTIES OF THE ELECTRODE-ELECTROLYTE INTERFACE

The ideal characteristics of the nonpolarizable electrode-electrolyte interface are not realized in practical electrode systems. The charge gradient, or "electrode double layer" as it is known, exhibits undesirable electrical properties. Although these properties may be

modeled as combinations of resistance, capacitance and a direct current potential, their magnitude is unique to each electrode application. The electrode metal, its area, the electrolyte, the current density, and the frequency of current are all factors that influence the magnitude of the impedance.¹⁶ The frequency dependence of the electrode-electrolyte impedance, decreasing with increasing frequency, attenuates lower frequency components of the detected EMG to a greater extent than higher frequency components. This action is typical of a class of electronic filters termed **high-pass filters**. Although the impedance-frequency transfer characteristic of a particular electrode-electrolyte combination is difficult to predict, the electrode detection surface area is a key variable in determining the magnitude of the electrode impedance. As illustrated in Figure 3-10, an increase in the surface area of an electrode type resulted in a decrease in electrode impedance.

THE BIPOLAR ELECTRODE CONFIGURATION

Electromyographic detection electrodes are used nearly always in a bipolar configuration. In the bipolar electrode configuration, two electrodes are used at the detection site and a third common-mode reference, or **ground electrode**, is placed distally in a neutral electrical environment. This arrangement of electrodes is dictated by the use of a differential preamplifier as the means of signal amplification. The differential preamplifier increases the amplitude of the difference signal between each of the detecting electrodes and the common mode reference. Signals that are common to both detection electrode sites are termed common mode signals and produce a nearly zero preamplifier output. This desirable characteristic of differential preamplifiers significantly improves the signal-to-noise ratio of the measurement and allows the detection of low level EMG potentials in noisy environments. (See Chapter 4 for greater details.)

The sizable benefits of the bipolar electrode configuration are achieved at some cost. An undesirable side-effect to this arrangement is the role the differential amplifier plays as bandpass filter. The filtering action occurs as a result of the differences in the time of arrival of the signal at each detection site. Because the differential amplifier amplifies only the difference in potential at each electrode, a signal frequency whose wavelength is equal to the interelectrode distance or is an integer multiple of that frequency would be cancelled. Figure 3-11 illustrates the bandpass response. Signals whose wavelengths are equal to double the interelectrode distance are passed without attenuation. It should be evident that the larger the electrode spacing, the lower the frequency at which the first null occurs. Consequently, the bandpass filtering effect is of more concern for surface electrodes.

RELIABILITY AND VALIDITY

The complexity of the detected EMG should not be understated. A brief review of the factors known to effect the signal information content is illustrative. These factors are discussed in greater detail in Chapter 4 and listed in Chapter 4, Table 4-1. The detected waveform, thus, is representative of many influencing and often conflicting factors. It should reasonably be considered a limited view of the phenomena, as if one were viewing a distant scene with unfocused binoculars.

Considering the sheer number of factors influencing the information content of the detected EMG, it is prudent to question the reliability of information obtained. Fortunately, many of the factors can be controlled, particularly if surface electrodes are used. The size and type of the electrode, the preparation of the recording site, the interelectrode spacing, and the standardized location of electrodes relative to anatomical landmarks, are all factors that may be controlled to improve the reliability of the measure. Anatomical variation within and between sexes and motivational inconsistency are more difficult to assess and control.

The reliability of each available method is an important factor in investigating muscle function. In general, across channel (muscle) comparisons are precluded because of differences in instrumentation and constituents of body tissues from one recording area to another. Further, between subject comparisons are precluded on the basis of individual differences and subcutaneous fat, muscle geometry, and other variances. In virtually all instances, therefore, a normalization process should be completed to allow for comparisons. Frequently, both clinicians and researchers have been using the procedure of recording the EMG during a maximum voluntary contraction and then converting the values recorded during the test or procedure to a percentage of the EMG produced during the maximum voluntary contraction. (See Chapter 6 for greater details.) Individual variations that preclude direct comparisons, thus, can be taken into account. In any case, measurements made during one day and one setting are considered to be far superior because they generally will avoid the issues associated with between-day reliability and reproducibility. In those instances when the study procedure or design requires EMG measurements during multiple sessions, however, issues of reliability must be considered. Because the across-day and between-muscle comparisons are limited, for reasons specified in earlier portions of this section, attention should be paid to normalization procedures described in Chapter 6.

Despite the extensive use of EMG for the last several decades, little work has been completed that examines reliability issues. In one of the earliest studies, Lippold

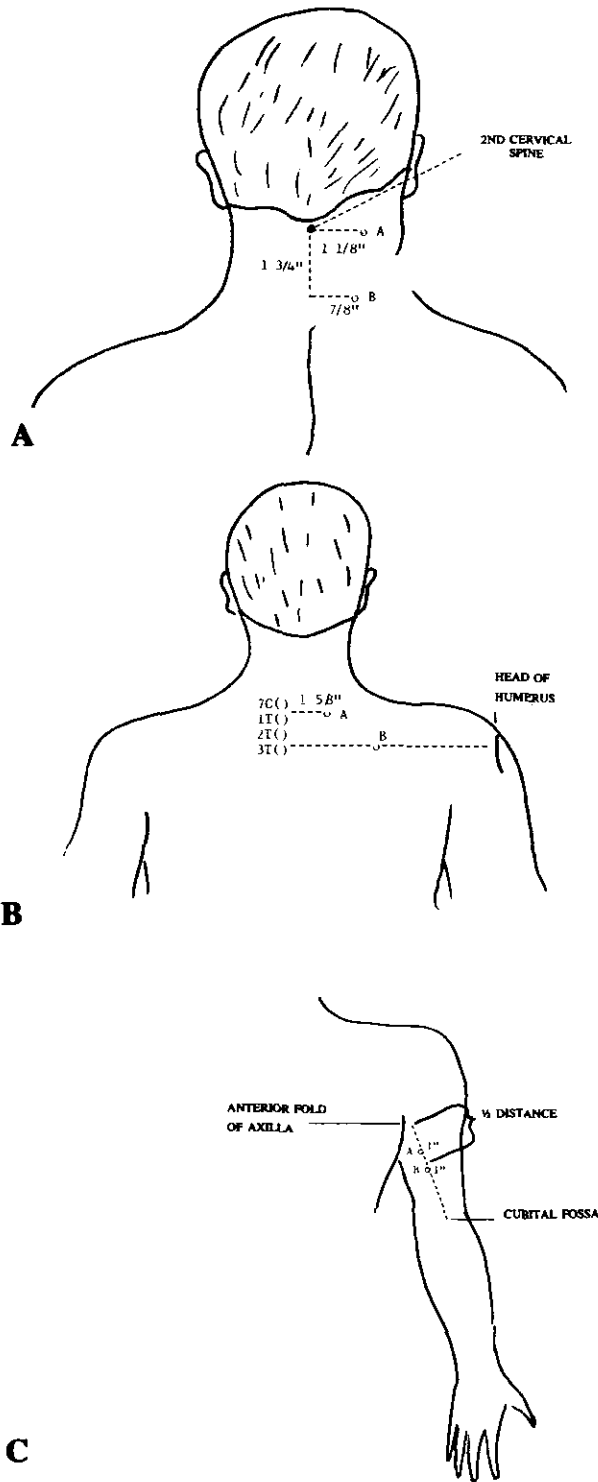

FIGURE 3-4A-F

Recommended locations for surface electrode leads for selected muscles (Davies JF: *Manual of Surface Electromyography*. WADC Technical Report #59-184, December 1959).

reported interday reliability coefficients for recorded EMG.¹⁷ The values, ranging from .93 to .99, were high, partly because electrodes were not replaced between trials. Viitasalo and Komi, in applying electrodes over the motor point of the rectus femoris muscle, used an integrated signal from which to derive reliability coefficients.¹⁸ For a maximal contraction, values ranged from .80 to .91 between contractions within day, and .64 to .73 between tests within day. Submaximal between-day tests produced coefficients that ranged from .80 to .86.

Reliability has also been studied during functional activities such as gait. In comparing electrode types, Kadaba et al showed that the variance ratio can be used to demonstrate that surface electrode recordings produce higher reliability than those from fine wire electrodes.¹⁹ Yang and Winter evaluated reliabilities from submaximal and maximal contractions for the triceps muscle, testing on three different days.²⁰ They recorded EMG during 5 maximum voluntary contractions of 1-second duration and 10 submaximal efforts, 5 at each of two different levels. These investigators demonstrated that contractions of 30% and 50% of maximum yielded the highest intraclass correlation coefficients, .78 to .95 respectively, depending on the number of days and trials included in the analysis. Maximal contractions produced coefficients that ranged from .52 to .81. While offering several explanations for the coefficients attained, they comment that the significance of their work is that the maximum voluntary test is not the most reliable method for day-to-day recording.

PREPARATION OF ELECTRODES-SUBJECT INTERFACE

The method of electrode application will depend on the electrode selection and the instrumentation available. The following sections will discuss the application techniques for surface electrodes. The specifics associated with fine wire technique are detailed in Appendix C.

Surface electrodes, as indicated in previous sections of this chapter, vary greatly in size and type. Most will be adhered by a doubled-sided adhesive washer that should first be affixed firmly to the electrode surface. If preamplifiers are available that contain the electrode surface, the same procedure can be followed. The available surface of the recording site should then be filled with an appropriate conduction gel. Excess paste is removed so the conductive gel is flush with the adhesive washer that has been placed on the disk.

Before fixing the electrode to the skin the preparation of the subject needs to be completed. The amount of this preparation will primarily be dependent on the instrumentation available. Onsite preamplification (see

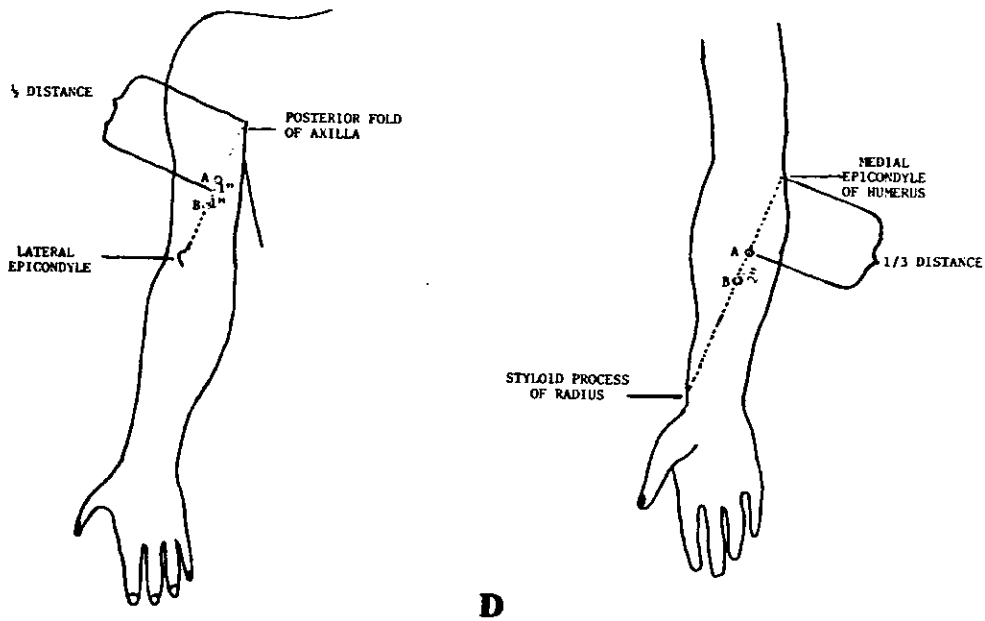
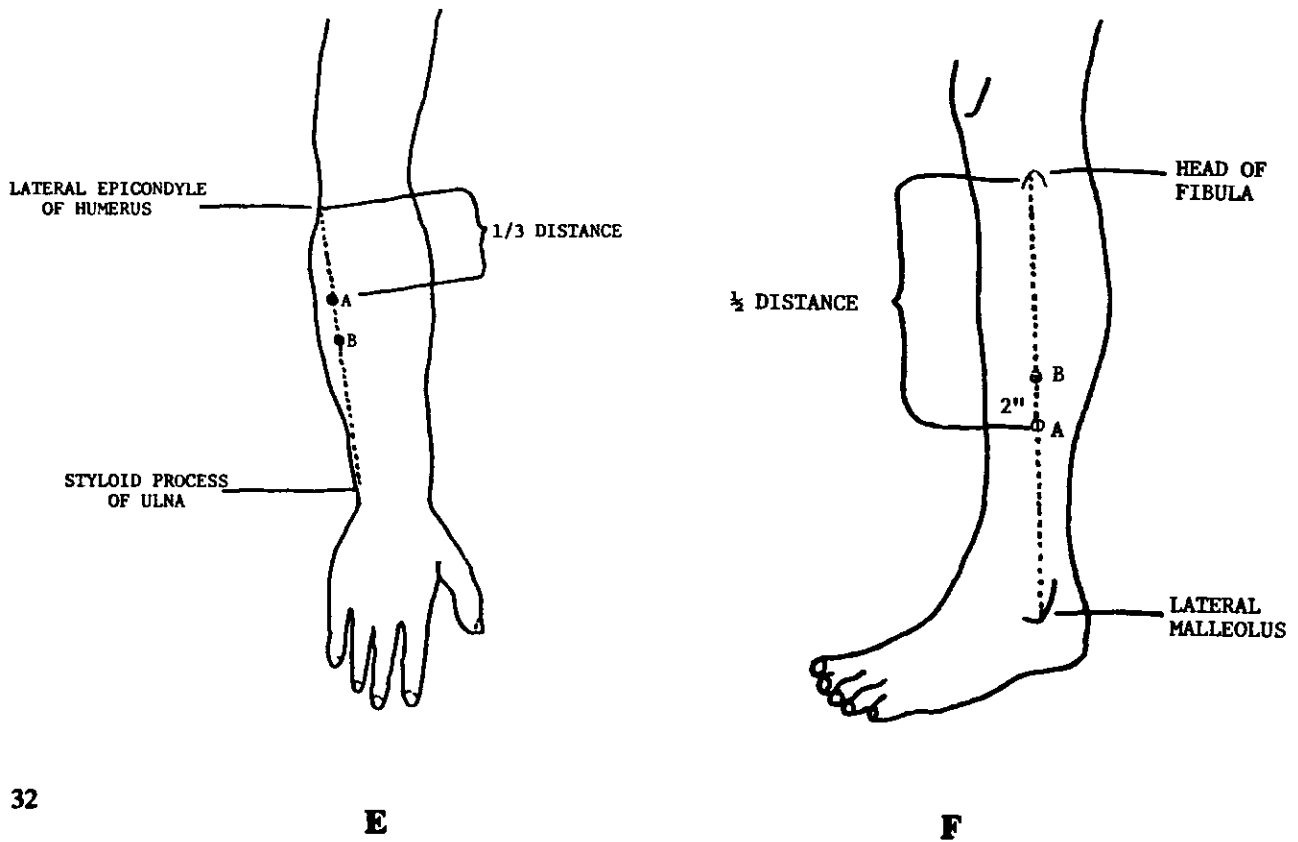

FIGURE 3-4A-F (continued)

Recommended locations for surface electrode leads for selected muscles (Davies JF: Manual of Surface Electromyography. WADC Technical Report #59-184, December 1959).



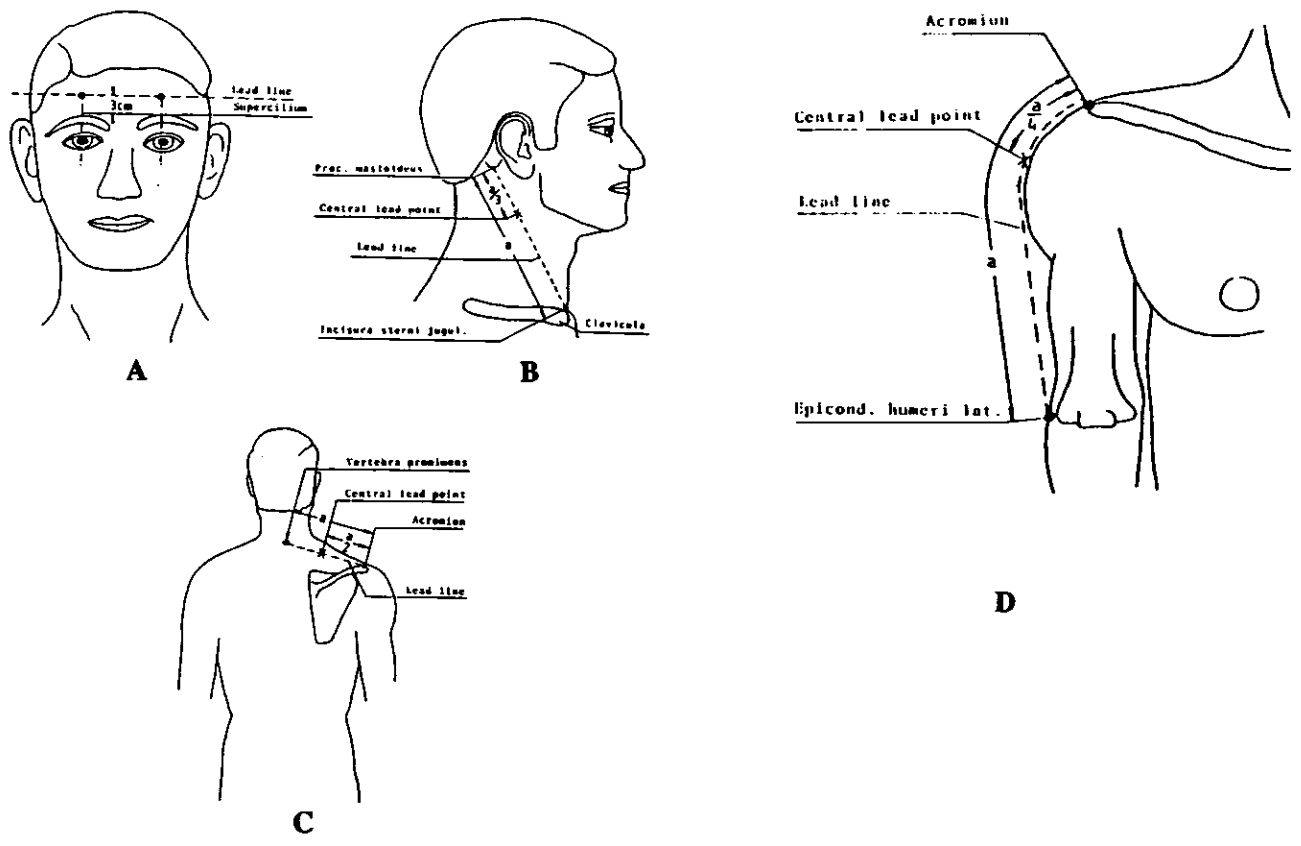
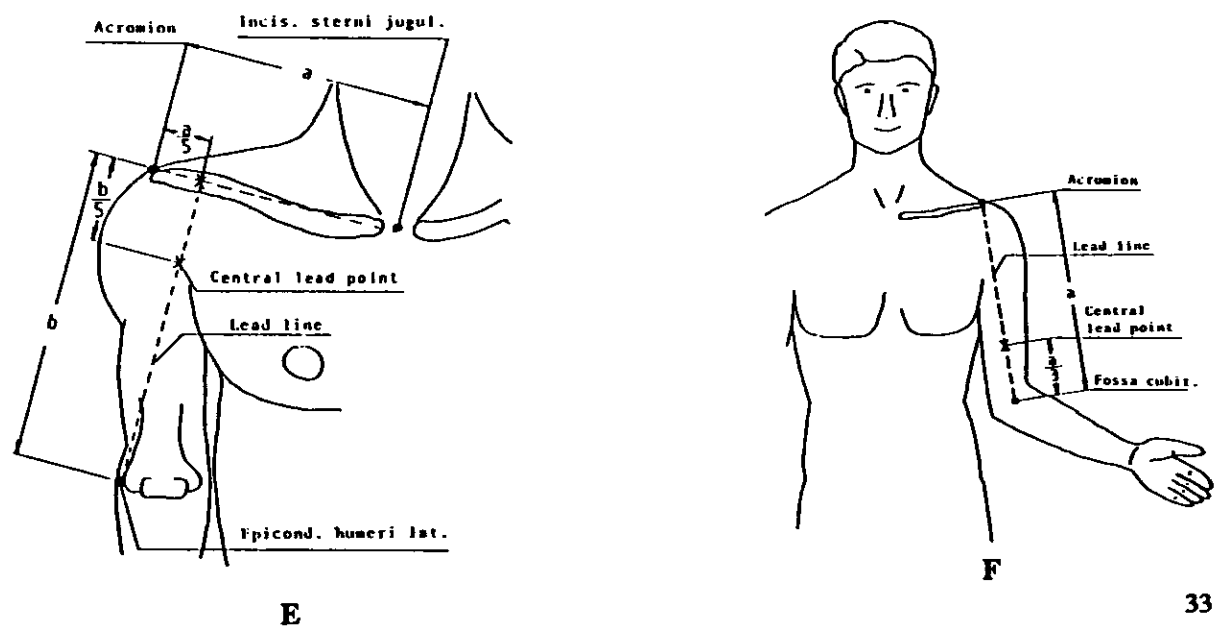

FIGURE 3-5A-P
Recommended locations for surface electrode leads for selected muscles.

Reproduced by permission from Zipp P: Recommendations for the standardization of lead positions in surface electromyography. Eur J Appl Physiol 50:41-54, 1982.



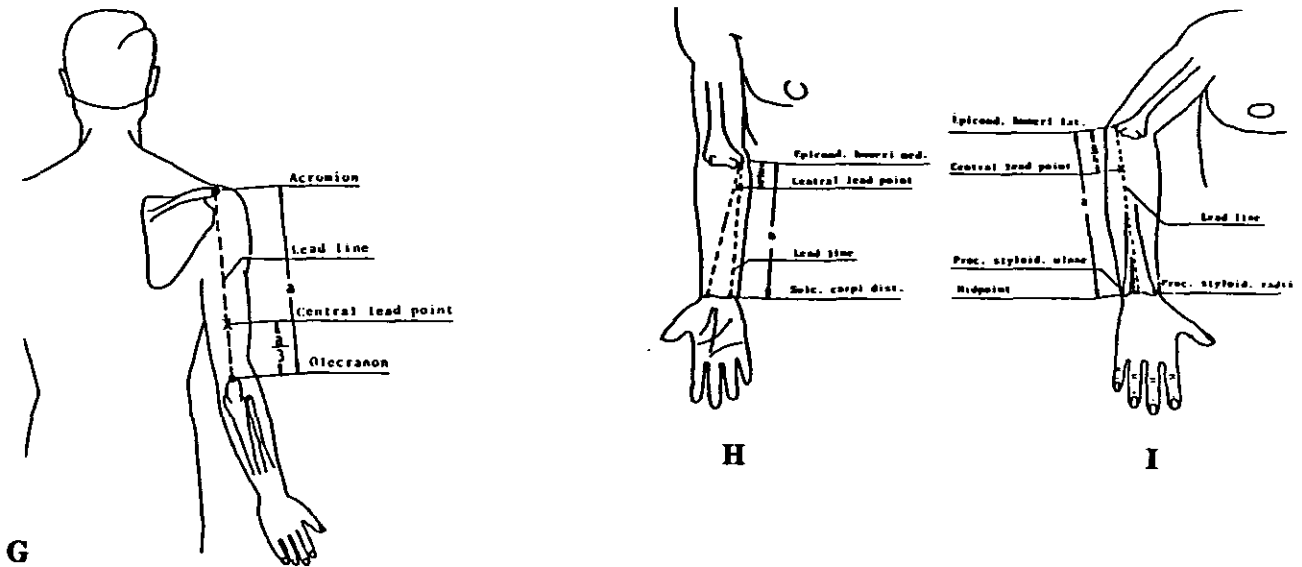
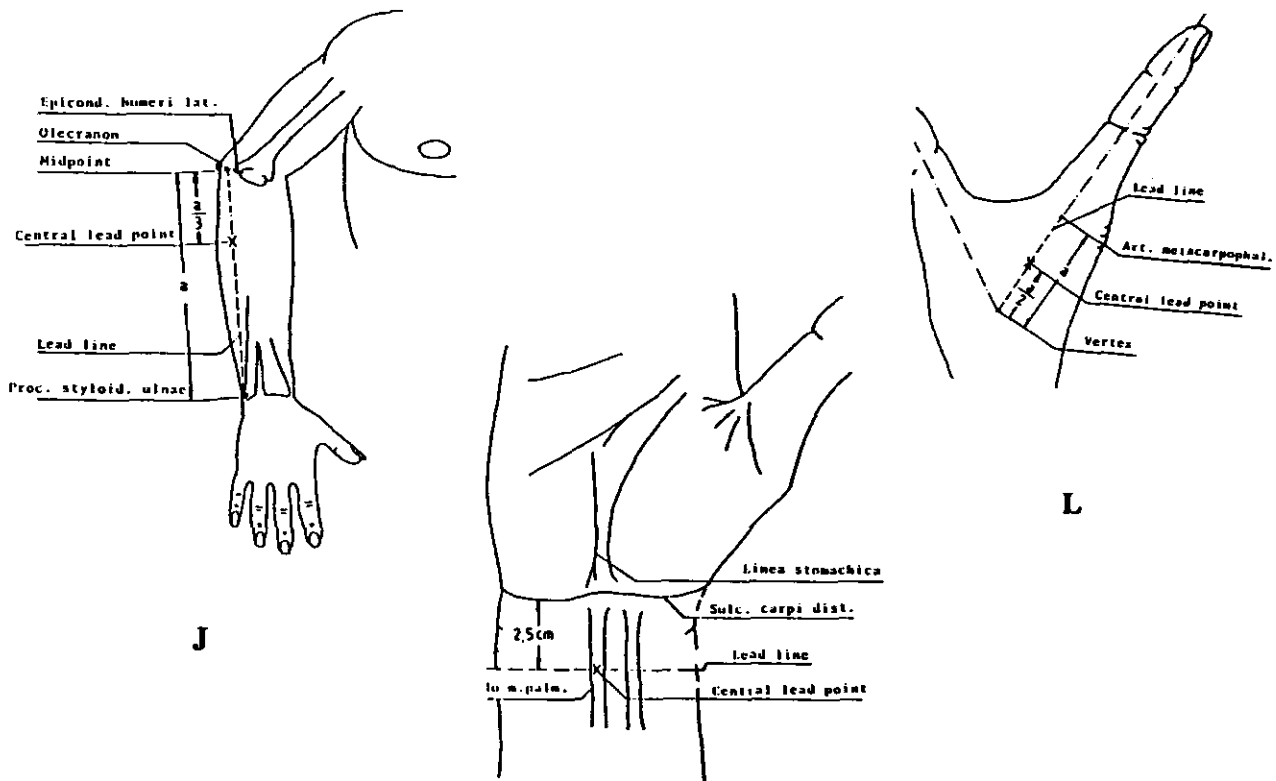

FIGURE 3-5A-P (Continued)
 Recommended locations for surface electrode leads for selected muscles.

Reproduced by permission from Zipp P: Recommendations for the standardization of lead positions in surface electromyography. Eur J Appl Physiol 50:41-54, 1982.



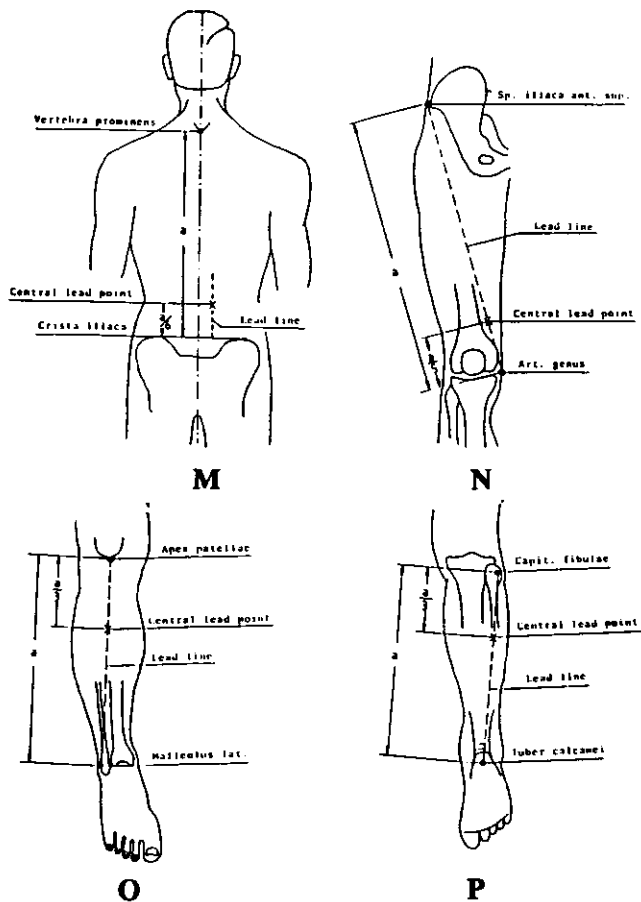

FIGURE 3-5A-P (Continued)

Recommended locations for surface electrode leads for selected muscles.

Reproduced by permission from Zipp P: Recommendations for the standardization of lead positions in surface electromyography. Eur J Appl Physiol 50:41-54, 1982.

Chapter 4) has been noted virtually to eliminate specific skin preparation. In this case, the surface of the skin can be wiped lightly with alcohol to help assure good adherence of the adhesive washer to the body. However, if preamplification is not available and instrumentation of poor characteristics is used, the skin must be abraded at least lightly with an emory cloth. An abrasive conductive gel could also be used. Alcohol on gauze may also be used, but it is generally less effective. In any case, a general recommendation is to lower skin resistance to

less than 500 ohms to eliminate artifacts from the recording. Such resistance can be measured simply with a hand-held volt-ohm-meter by applying the terminals of the meter. Resistance will be read in ohms. Note should be made that the amount of resistance will diminish some as the conductive gel penetrates the surface. In many cases, the electromyographer will find it helpful to wrap lightly either elastic bandages or a substance such as prewrap, used by athletic trainers, over the electrode attachments to prevent movement and loosening during muscular effort or body movement.

Regardless of the electrode technique used for the study of EMG activity, appropriate procedures should be used following data collection. For surface EMG, a cleaning of the subject's skin with alcohol soaked gauze will suffice. Electrode cleaning can be accomplished with gauze soaked with distilled water, before any of the conductive gel hardens. If hardening has occurred, more vigorous wiping should accomplish the necessary cleaning. Other solvents or cleaning agents are greatly discouraged because they may have a negative interaction with the materials used in the electrodes.⁷

ARTIFACTS

Several major artifacts occur that must be avoided to have an appropriate and high quality signal. Mechanically induced artifacts are very common and occur when cables are handled or allowed to move when activity occurs. Changes may also be seen with electrode movement occurring between the skin and electrode interface. These artifacts are usually of low frequency. A major problem also can be 60 cycle interference. This occurs when a reference electrode is not applied appropriately on the subject, when there is a loose wire, or when electrical fields persist. The latter can come from improper shielding of wires. If 60 cycle interference (50 cycle in some countries) continues to be a problem in recordings, attention should be paid to the environment, including grounding of all outlets and evaluations of equipment in use in adjacent areas. One other important artifact the electromyographer needs to be aware of is that produced through the electrocardiogram. This is noticeable particularly over the lumbar portion of the erector spinae muscles and in certain other muscles such as the gluteus medius. Figure 3-12 shows the most common artifacts encountered during the collection of EMG data.

To eliminate artifacts, consider certain important factors. Among these are that an optimal electrode design will minimize electrode impedance. In addition, high quality instrumentation is essential— including a differential amplifier with a high common-mode rejection ratio. Further, an adequate reference electrode and the

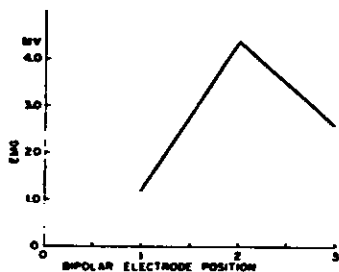

FIGURE 3-6

Relationship between amplitude of averaged EMG potentials and longitudinal bipolar electrode position in units of equal distances between the centers of the various bipolar electrodes.

Reproduced by permission from Zuniga EN, Truong XT, Simons DG: Effects of skin electrode position on averaged electromyographic potentials. Arch Phys Med Rehabil 70:264-272, 1970.

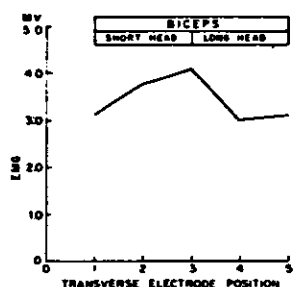

FIGURE 3-7

Same relationship as depicted in Figure 3-6 except for transverse monopolar electrode position.

Reproduced by permission from Zuniga EN, Truong XT, Simons DG: Effects of skin electrode position on averaged electromyographic potentials. Arch Phys Med Rehabil 70:264-272, 1970.

minimization of the number of devices concurrently collecting data help to avoid ground loops. The use of battery driven equipment is also recommended.¹⁵

Evaluation of the raw signal is essential to assure that there are no artifacts produced. A variety of gain and sweep settings on an oscilloscope is the preferred mode to monitor this signal. This should be done before, during, and after data collection to help assure the electromyographer that data is artifact free.

PHYSIOLOGIC AND HISTOLOGICAL EFFECTS

Ordinary use of EMG has no known adverse physiological effects on the human body. Those systems that do not provide subject protection with shock resistance circuitry or that are powered by conventional wall currents, however, are potentially dangerous. Efforts should be made, therefore, to assure that these factors are taken into account before proceeding with data collection. A discussion of the effect of fine wire electrodes on tissue is presented in Appendix C.

TELEMETERIZED ELECTROMYOGRAPHY

Use of telemeterized EMG has the great attraction of relieving subjects from the constraint associated with the instrumentation necessary to record data. Partly as a result of this interest, systems have been devised to record multichannel EMG data using telemeterized information. Although this method of data recording is inherently appealing, great consideration needs to be given to the design and selection of the telemetry equipment and to the experimental purpose and configuration (see Chapter 4 for further discussion). Although having the subject actually carry the mass of the transmitter and associated instrumentation probably is not difficult for most human subjects, there are equipment difficulties such as in being able to modify the number of channels, the gain of the instrumentation, and the range of transmital.¹⁵ Each of these factors, therefore, must be taken into account in the design phases of any experiment or data collection procedure.

Loeb and Gans detail the numerous limitations associated with the use of telemetry.¹⁵ They discuss these limitations in terms of range, special orientation, and transmitting traditionally available within the instrumentation. Further difficulties arise in using multichannel techniques even though multiplexing is available. Winter et al, however, have stated that it is possible to multiplex about eight subcarrier channels to carry a modified EMG signal.²¹ Other limitations associated with telemetry include the ability to provide adequate control of sensitivity, noise, and cross talk. Newer transmitters now serve the purposes associated with collection of EMG data in the work setting. Note should be made, however, that these techniques have successfully been used in evaluating activities performed at the work site or during functional activities such as locomotion.^{22,23} Work experience with seasoned investigators or technicians should be gained before embarking on the use of a telemeterized EMG system.

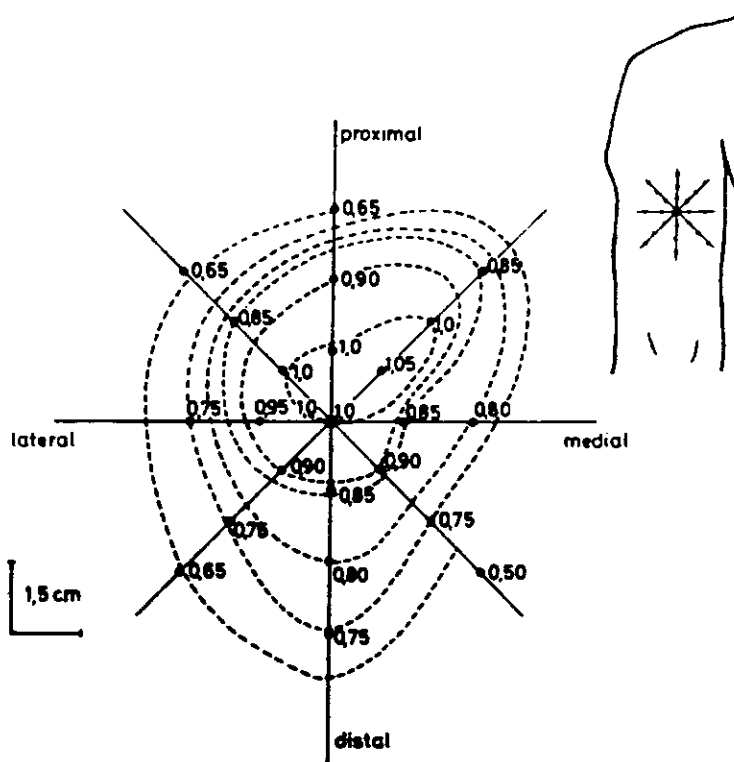

FIGURE 3-8

Influence of electrode placement on the amplitudes of the potentials in the electromyograph. A synchronous three-channel recording from the muscle midpoint (reference point for calculating) and two positions symmetrical to it are the basis of the measured values.

Reproduced by permission from Kramer H, Kuchler G, Brauer D: Investigations of the potential distribution of activated skeletal muscles in man by means of surface electrodes. Electromyogr Clin Neurophysiol 12:19-24, 1972.

HAMSTRING OPTIMUM ELECTRODE PLACEMENT SITE

Percent MVIC 50%
Knee Angle 60%

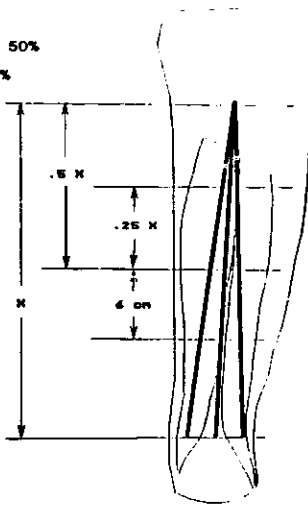

Electrode Pattern

4 6 5
1 3 2
7 9 8

Normalized Values

1 .55 9
2 .99 1
3 .88 3
4 .62 7
5 .75 5
6 .76 4
7 .59 8
8 .89 2
9 .67 6

HAMSTRING OPTIMUM ELECTRODE PLACEMENT SITE

Percent MVIC 50%
Knee Angle 90

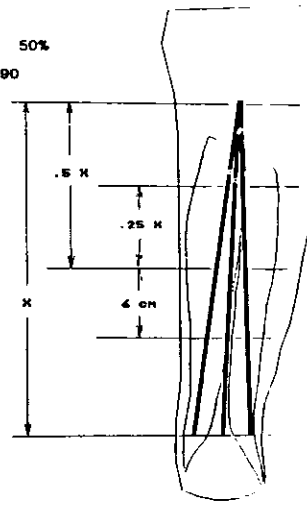

Electrode Pattern

4 6 5
1 3 2
7 9 8

Normalized Values

1 .46 7
2 .72 3
3 .73 2
4 .75 1
5 .41 9
6 .59 4
7 .42 8
8 .52 5
9 .51 6

HAMSTRING OPTIMUM ELECTRODE PLACEMENT SITE

Percent MVIC 100%
Knee Angle 60

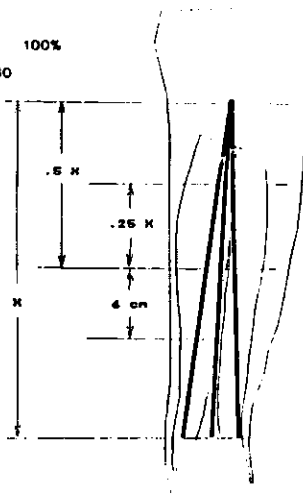

Electrode Pattern

4 6 5
1 3 2
7 9 8

Normalized Values

1 .45 9
2 .84 2
3 .85 1
4 .64 5
5 .83 6
6 .72 4
7 .52 8
8 .76 3
9 .62 7

HAMSTRING OPTIMUM ELECTRODE PLACEMENT SITE

Percent MVIC 100%
Knee Angle 90

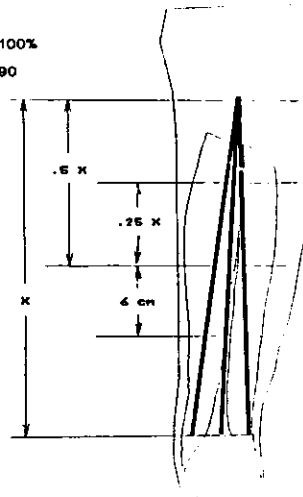

Electrode Pattern

4 6 5
1 3 2
7 9 8

Normalized Values

1 .45 8
2 .64 3
3 .77 1
4 .76 2
5 .45 7
6 .59 4
7 .46 6
8 .44 9
9 .53 5

FIGURE 3-9

Electrode location sites for hamstring muscles under varying conditions of knee angle and percentage of maximum voluntary contraction (MVC). Normalized values are to MVC as reference contraction for each pre-amplifier electrode location and then rank ordered to identify where maximum voltage was obtained.

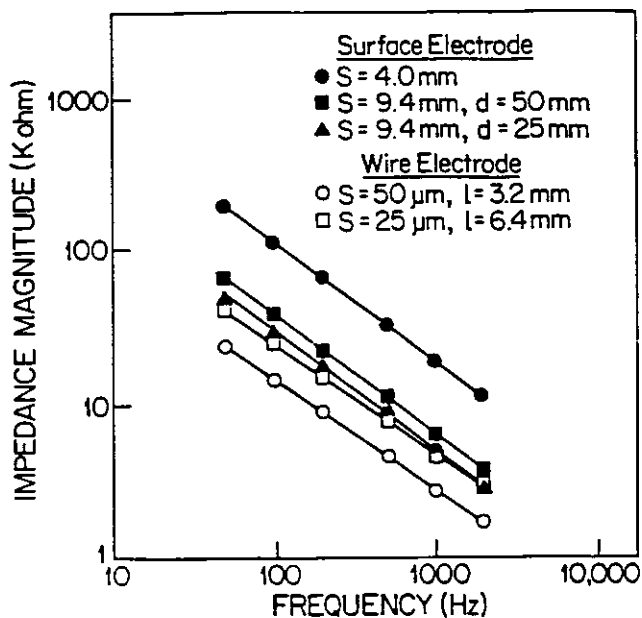

FIGURE 3-10

Typical values of the magnitude of the impedance of surface and wire electrodes. The filled circle represents a monopolar arrangement; the rest are all bipolar. S, diameter of detection surface; D, interdetection surface spacing; L, exposed tip length.

Reprinted with permission from Antonelli D, et al: *Pathokinesiology Laboratory, Rancho Los Amigos Hospital, CA, 1982.*

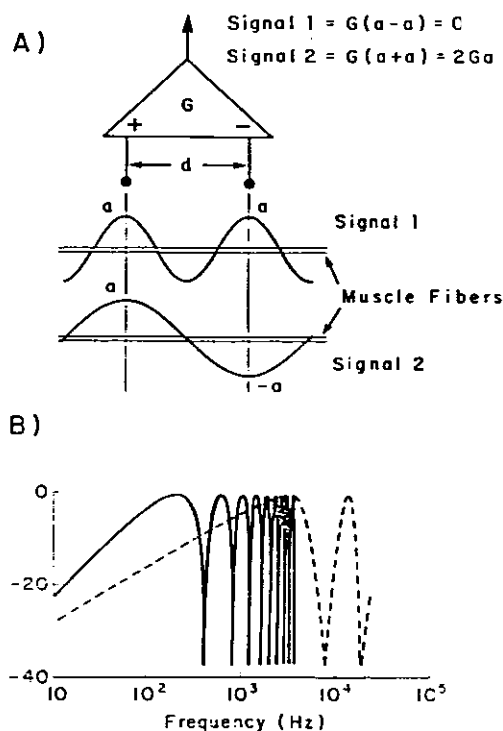

FIGURE 3-11

Schematic (A) of the filtering aspects of the differentially amplified bipolar detection. As the signal travels along a muscle fiber at its conduction velocity, it will pass by both detection surfaces sequentially, with a delay proportional to the interdetection surface spacing (d). Some of the frequency components of the signal will have wavelengths which are multiples of the distance d (cancellation frequency); these will cancel out when amplified differentially. When the wavelength is equal to $2d$ (as in signal 2), the signal will pass. (B) Alternating behavior of the filter function and cancellation frequencies. The solid line represents the filter function of a surface electrode and is calculated for an interdetection surface spacing of 1 cm and a conduction velocity of 4 m/s. The dashed line represents the filter function of a typical needle electrode and is calculated for an interdetection surface spacing of 0.5 mm and a conduction velocity of 4 m/s. It is apparent that the bipolar filter function is of concern for surface electrodes and has minor relevance in needle electrodes.

Reprinted with permission from Basmajian JV, DeLuca CJ: *Muscles Alive: Their Functions Revealed by Electromyography*, ed 5. Williams & Wilkins, 1985, Figure 2.16, p 49.

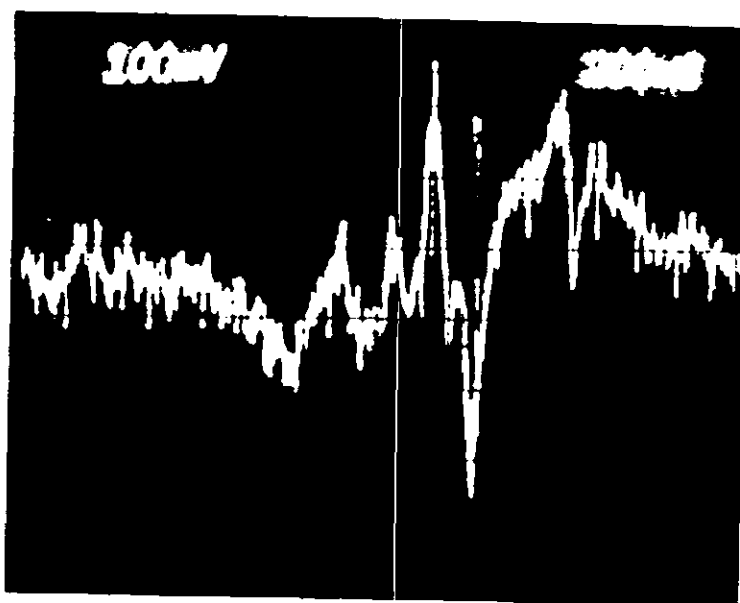
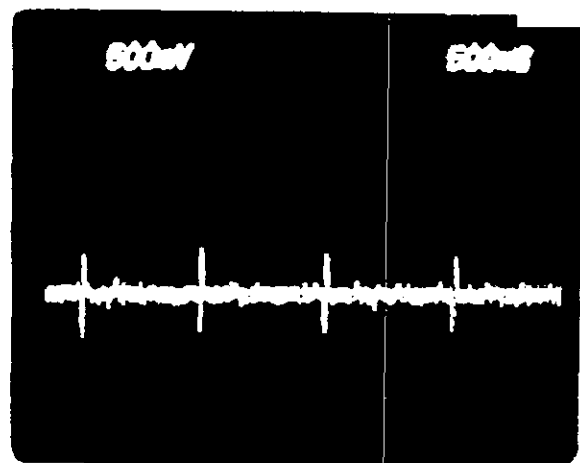
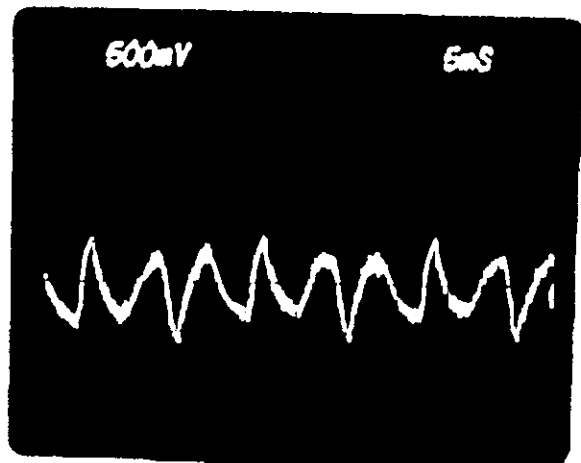

FIGURE 3-12
Common artifacts encountered during EMG recordings: a = 60 Hz; b = electrode or cable movement; c = EKG.

SUMMARY

This chapter discussed the techniques of surface EMG as applicable to ergonomics. Reasons for electrode choice and location are specified, and the technique of application is stated. Although limitations associated with data of these types are noted in this chapter, the ergonomist should be able to use EMG in a valid and reliable manner.

REFERENCES

1. Hannerz J: An electrode for recording single motor unit activity during strong muscle contractions. *Electroencephalog Clin Neurophysiol* 37:179-181, 1974
2. Andreassen S, Rosenfalck A: Recording from a single motor unit during strong effort. *IEEE Trans Biomed Eng* 25:501-508, 1978
3. Edstedt J, Stalberg E: How the size of the needle electrode leading-off surface influences the shape of the single muscle fibre action potential in electromyography. *Computer Programs in Biomedicine* 3:204-212, 1973
4. Gath I, Stalberg EV: Techniques for improving the selectivity of electromyographic recordings. *IEEE Trans Biomedical Eng* 23:467-471, 1976
5. Nelson RM, Soderberg GL: Laser etched bifilar fine wire electrode for skeletal muscle motor unit recording. *Electroencephalog Clin Neurophysiol* 55:238-239, 1983
6. Morrenhof JW, Abbink HJ: Cross-correlation and cross-talk in surface electromyography. *Electromyogr Clin Neurophysiol* 25:73-79, 1985
7. Basmajian JV, DeLuca CJ: *Muscles Alive: Their Functions Revealed by Electromyography*, ed 5. Baltimore, MD, Williams & Wilkins, 1985
8. Davis JF: *Manual of Surface Electromyography*. WADC Technical Report #59-184, December 1959
9. Zipp P: Recommendations for the standardization of lead positions in surface electromyography. *Eur J Appl Physiol* 50:41-54, 1982
10. Zuniga EN, Truong XT, Simons DG: Effects of skin electrode position on averaged electromyographic potentials. *Arch Phys Med Rehabil* 70:264-272, 1970
11. Kramer H, Kuchler G, Brauer D: Investigations of the potential distribution of activated skeletal muscles in man by means of surface electrodes. *Electromyogr Clin Neurophysiol* 12:19-24, 1972
12. Jonsson B, Reichmann S: Reproducibility in kinesiological EMG investigations with intramuscular electrodes. *Acta Morph Neurl Scand* 7:73-90, 1968
13. Soderberg GL, VanderLinden D, Zimmerman C, et al: Electrode site location for maximizing EMG output for selected muscles. Unpublished data, The University of Iowa, 1988
14. Basmajian JV: *The Present Status of Electromyographic Kinesiology*. In *Biomechanics: I. Medicine and Sport*. Baltimore, MD, University Press, 1968, vol 2, pp 112-113
15. Loeb GE, Gans C: *Electromyography for Experimentalists*. Chicago, IL, The University of Chicago Press, 1986
16. Geddes LA, Baker LE: *Principles of Applied Biomedical Instrumentation*. New York, NY, J Wiley & Sons Inc, 1975
17. Lippold OJ: The relation between integrated action potentials in a human muscle and its isometric tension. *J Physiol* 117:492-499, 1952
18. Viitasalo JH, Komi PV: Signal characteristics of EMG with special reference to reproducibility of measurements. *Acta Physiol Scand* 93:531-539, 1975
19. Kadaba MP, Wootten ME, Gainey J, et al: Repeatability of phasic muscle activity: Performance of surface and intramuscular wire electrodes in gait analysis. *J Orthopaedic Res* 3:350-359, 1985
20. Yang JF, Winter DA: Electromyography reliability in maximal and submaximal isometric contractions. *Arch Phys Med Rehabil* 64:417-420, 1983
21. Winter DA, Eng P, Quanbury AO: Multichannel biotelemetry systems for use in EMG studies, particularly in locomotion. *Am J Phys Med* 54:142-147, June 1975
22. Arsenaault AB, Winter DA, Marteniuk RG: Bilateralism of EMG profiles in human locomotion. *Am J Phys Med Rehabil* 65:1-16, 1986
23. Clarys JP: Application of EMG for the evaluation of performance in different sports. *Medicine Sport Sci* 26:200-223, 1987

CHAPTER 4

Instrumentation

David G. Gerleman, B.A.
Thomas M. Cook, Ph.D., PT

David G. Gerleman, B.A., is a staff engineer in the Physical Therapy Graduate Program at The University of Iowa. He teaches biomedical instrumentation and provides technical support and consultation to a variety of academic and clinical departments. He is included as an author on several publications. Mr. Gerleman has designed laboratory-based electromyographic systems and served as a consultant in electromyography throughout the United States.

Thomas M. Cook, Ph.D., PT, is Assistant Professor of Physical Therapy and Preventive Medicine, College of Medicine, The University of Iowa. He holds Master of Science Degrees in both Physical Therapy and Biomedical Engineering and a doctorate in Industrial Engineering (Ergonomics). His laboratory research activities are in the areas of work-rest cycles and muscular responses to vibration. His current field research activities are in the areas of cumulative trauma disorders within the newspaper and construction industries.

INSTRUMENTATION

David G. Gerleman, BA
Thomas M. Cook, PhD, PT

OVERVIEW

The purpose of instrumentation in electromyography (EMG) is to preserve information contained in the bioelectric activity associated with the initiation and regulation of muscle contraction. Relevant questions to ask at the outset of any investigation using (EMG) are about what information can be obtained by this measurement and how that information relates to the purpose of the ergonomic study. This chapter discusses the instrumentation requirements necessary for obtaining information from the EMG signal. Chapters 5 through 7 will elucidate further on how this information may be used in questions relating to ergonomics.

To provide a framework for the discussion of EMG instrumentation, the information obtainable from the EMG can be divided into the following three general categories.

1. The relationship between temporal aspects of EMG and anatomically associated movement.
2. The relationship between EMG and the production of force.
3. The relationship between EMG and muscle fatigue.

Each of these categories requires the EMG signal to be processed in ways that preserve the signal information necessary to accomplish the aim of the measurement.

ELECTROMYOGRAM SIGNAL INFORMATION

To respond definitively to the questions posed above requires a complete accounting of the contribution of the many and interrelated factors that influence the signal characteristics of the detected EMG. Researchers have developed mathematical models relating selected factors and have compared their behavior to empirical observations.¹⁻³ Although no current scientific consensus on a comprehensive model exists, work in this area has revealed many important relationships. Until the effect of factors such as velocity, acceleration, and type of muscle contraction are more fully understood, the interpretation of information obtained from the EMG signal will be clouded in uncertainty. What can be concluded from a review of Table 4-1 is that the detected EMG contains information about not only the anatomic, physiologic, and neurogenic factors that shaped the waveform, but about a host of other factors that distort this information.

Clearly, not all information contained in the signal is needed to answer every research question regarding muscle activation. Perhaps the first step in the formulation of a measurement question using EMG is to decide what information is needed from the signal to satisfy the purpose of the investigation. The discussion that follows will divide the information into three general categories based on their wide use and general acceptance. This treatment should not be considered an implied limitation on other viable uses.

Temporal Information

The most basic information obtainable from an EMG record is whether the muscle was on or off during an activity or at a particular point in time. For EMG to be on, it must exceed a threshold, whether defined by an arbitrary or statistically predetermined level or by the noise level of the equipment responsible for the measurement. It often is more difficult to determine that a muscle is off because a muscle may infrequently be in a state of total relaxation. In such cases, the threshold must be set high enough to avoid false on conditions. In the context of temporal measurements, the goal of the information gathering process is to determine, with as much precision and sensitivity as practical, the point in time the muscle was activated or deactivated. The appropriateness of signal processing methods must be evaluated with this goal in mind.

EMG-Force Information

Perhaps the most used and abused category of EMG information is in the measurement applications that relate the EMG detected at a muscle site to the resultant force or torque generated by the muscle. The popularity of these applications are due to the potential value of the information obtained. For example, in ergonomic studies, potential applications include the use of EMG to evaluate tool use and worker postures in the prevention of work related injuries.

An EMG-force measurement seeks to quantify the average number and firing rate of motor units contributing to a particular muscle contraction, and to relate the quantity to the actual force produced. A number of assumptions are implicit to the validity of the measurement application. These are detailed in Chapter 6. Of

TABLE 4-1
Factors That Influence the Signal Information Content of Electromyography

Factor	Influence
Neuroactivation	<ul style="list-style-type: none"> — the firing rate of motor unit action potentials — the number of motor units recruited — synchronization of motor unit firings
Muscle fiber physiology	<ul style="list-style-type: none"> — the conduction velocity of muscle fibers
Muscle anatomy	<ul style="list-style-type: none"> — the orientation and distribution of muscle fibers of motor units — the diameter of muscle fibers — the total number of motor units
Electrode size and orientation	<ul style="list-style-type: none"> — the number of muscle fibers within the pickup area of the electrode — the number of motor units within the pickup area of the electrode detection surface relative to the muscle fibers
Electrode-electrolyte interface	<ul style="list-style-type: none"> — material and preparation of electrode and electrode site — electrode impedance decrease with increasing frequency (high-pass filter)
Bipolar electrode configuration	<ul style="list-style-type: none"> — effect of distance between detection electrodes and bandwidth (bandpass filter) — the orientation of detection electrodes relative to axis of muscle fibers

primary importance is the degree to which the muscle site being monitored is representative of the muscle as a whole. Also crucial is that the relationship between the measured quantity and the resultant force be known a priori for the actual conditions of the measurement (eg, isometric versus isotonic, concentric versus eccentric, the position of the joint). A linear relationship should not be assumed. The degree of controversy surrounding this relationship suggests that the relationship be determined for each subject and measurement situation.

The aim of signal processing in this category of measurement is to assign a numerical value (usually a percentage of a maximum voluntary contraction) to the level of EMG activity associated with the generation of a corresponding force. With the increasing intensity of a contraction, more and more units are recruited, and the unit firing frequency increases. The summated motor unit activity reflects these changes as the resulting interference pattern becomes more dense and of greater amplitude. Signal processing methods attempt to quantify the general character of these changes by some form of averaging.

EMG-Fatigue Information

The third category of information obtainable from the detected EMG signal may be used to identify the occurrence of localized muscle fatigue. A host of investigators have demonstrated a decrease of power

density in the high frequency region of the EMG signal and an increase in the low frequency region during fatiguing contractions.⁴⁻⁷ Lindstrom et al have demonstrated that the frequency shifts were almost entirely dependent on the propagation velocity of the action potentials.⁸ The reduced propagation velocities have been linked to the production and accumulation of acid metabolites.⁹

The median or center frequency of the power density spectrum is the variable usually used to characterize the frequency shift linked with fatigue. Figure 4-1 is an idealized version of the frequency spectrum with the median or center frequency indicated. Lindstrom et al have demonstrated that the center frequency of the power spectrum is proportional to propagation velocity.⁸ Lindstrom and Petersen have shown that decreases in center frequency during isometric and isotonic contraction follow approximately exponential curves characterized by their time constants.¹⁰ Figure 4-2 graphically illustrates the dependence of the power spectrum on the developing fatigue.

CRITERIA FOR THE FAITHFUL REPRODUCTION OF THE EMG

To gain an appreciation of how information is encoded in a complex waveform and better understand the technical specifications required of processing

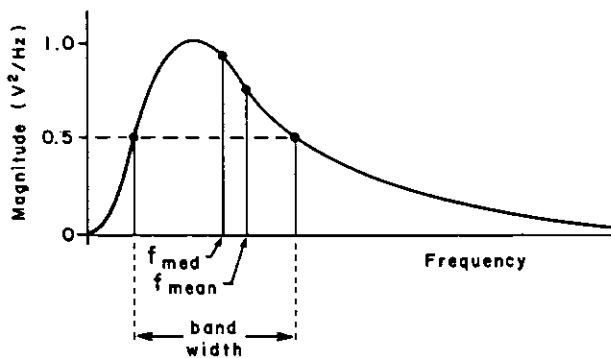

FIGURE 4-1

An idealized version of the frequency spectrum of the EMG signals. Three convenient and useful variables are indicated: the median frequency, f_{med} ; the mean frequency, f_{mean} ; and the bandwidth.

Reprinted with permission from Basmajian JV, DeLuca CJ: *Muscles Alive: Their Functions Revealed by Electromyography*, ed. 5. Baltimore, MD, Williams & Wilkins, 1985, Figure 3-16, p 99.

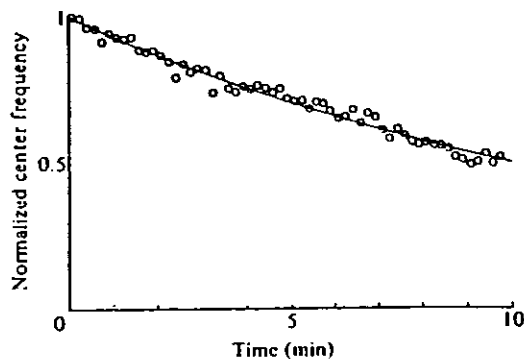

FIGURE 4-2

Dependence of the power spectrum on the developing fatigue. Signals from a masseter muscle under a constant biting force of 30 N.

Reprinted with permission from Lindstrom L, Peterson I: *Power spectra of myoelectric signals: Motor unit activity and muscle fatigue*. In: Stalberg E, Young RR (eds): *Clinical Neurophysiology*. London, England, Butterworths Publishers, 1981, Figure 4.6, p 75.

instrumentation, a brief discussion of the content of the EMG signal will prove useful.

EMG Signal Characteristics

Factors influencing the peak-to-peak amplitude of the detected EMG include the number and size of active muscle fibers, the size and orientation of the electrode detection surfaces relative to the active muscle fibers, and the distance between the active fibers and the detection electrodes. The frequency content of the EMG also is influenced by factors such as the size and distance between electrodes and the distance between the active fibers and the detection electrodes. The confluence of these factors makes it impossible to specify a definitive peak-to-peak amplitude and signal frequency range. The Ad Hoc Committee of the International Society of Electrophysiological Kinesiology (Appendix B), however, has published the following typical ranges for surface electromyography: amplitude range (mV) 0.01-5; signal frequency range (Hz) 1-3000.

EMG Represented by a Power Spectrum

The detected EMG is a dynamic analog signal in which the value or magnitude of the waveform varies with time. In contrast to a steady direct current signal which may contain a single piece of information, a dynamic analog signal continuously varies in magnitude and thus information content. The amount of information that may be transmitted or communicated in a segment of time is determined by the maximum rate of change in the signal amplitude. The power density spectrum of a signal is a unique way of representing the relationship between the signal amplitude and the signal rate of change or frequency.

The Fourier transform used to compute the power density spectrum is a mathematical technique by which any signal may be expressed as an infinite sum of sinusoidal components. The relative frequencies and phases may be combined to represent, exactly, the original signal at each instant in time. Although the theoretical number of sinusoidal components summed is infinite, the contribution of higher order components becomes smaller and smaller until they are unrecognizable from noise. This may occur after only a few harmonics or after 100, depending on the shape of the waveform. Figure 4-3 illustrates the power density spectrum of EMG recorded from bipolar surface and indwelling electrodes. Note that the spectrum extends from 10 Hz to about 400 Hz for surface electrodes and from 10 Hz to about 1000 Hz for indwelling electrodes. The lower frequency content of the surface electrode spectrum is consistent with the narrower bandpass characteristic typical of bipolar surface electrodes having greater interelectrode distances.

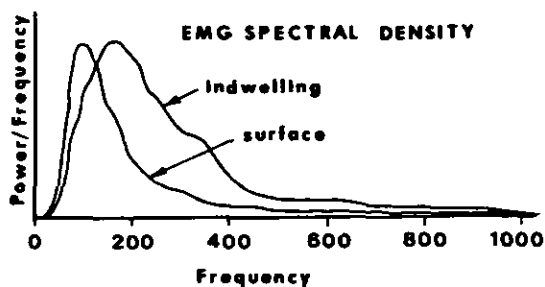

FIGURE 4-3

Frequency spectrum of EMG as recorded via surface and indwelling electrodes. Higher frequency content of indwelling electrodes is due to closer spacing between electrodes.

Reprinted with permission from Winter DA: Biomechanics of Human Movement. New York, NY: John Wiley & Sons Inc, 1979, Figure 7.5, p 135.

Amplitude Linearity, Phase Linearity, and Bandwidth

To preserve the original information content of the detected EMG requires any EMG instrumentation to possess amplitude linearity, phase linearity, and adequate bandwidth.¹¹ Amplitude linearity dictates that the ratio of input to output voltages be a linear function within the working voltage range of the instrument. Bandwidth, or frequency response, refers to the requirement that the amplitude linearity be extended to all frequencies within the working frequency range of the instrument. The logic of this requirement may be understood easily by referring to the Fourier spectrum in Figure 4-3. For the information in the original waveform to be preserved, each individual frequency component of the signal must be treated similarly, lest the instrument output signal spectrum change its shape. It should be obvious that any change in the shape of the frequency spectrum as a result of signal processing constitutes a distortion from the original waveform. Likewise, phase linearity requires that the phase relationship of each frequency component at the output of an instrument be identical to the phase relationship that existed at the input.

Noise

If the signal detected at the electrode site contains information only relevant to the purpose of the measurement, and nothing is done to alter this information during signal amplification and processing, the precision and accuracy of the measurement is determined by the recording or output reading device. This is a description of an

ideal measurement system, not realizable in EMG instrumentation.

In addition to the desired EMG signal not being the only signal detected at the electrode site, it contains much less signal power than other extraneous signal sources commonly present. Noise is defined as any extraneous or unwanted signal that interferes with the transmission of the correct information. Noise is present and is introduced to the relevant information at the muscle site and during signal amplification, processing, and recording. Chapter 3 contains a discussion of the common artifacts seen during EMG recordings. Because the EMG signal information becomes mixed with the noise information, the signal-to-noise ratio is the single most important factor in judging the quality of the information obtained.

Equally significant are those noise sources generated by the equipment used to detect, amplify, and record the EMG. All conductors exhibit some resistance to current flow and, therefore, generate thermal noise. Thermal noise is generated by the random movement of electrons and other free carriers and is a consequence of the Second Law of Thermodynamics. The thermal noise voltage is dependent on the resistance of the material, the temperature, and the bandwidth, according to the equation:

$$V^2 (\text{RMS}) = 4 KTRB \quad (1)$$

where K is Boltzmann's constant; T is temperature in degrees Kelvin; B is bandwidth in hertz; and R is the resistance in ohms. Because of the randomness of the noise voltage, the Fourier spectrum extends from DC to infinity. Thermal noise is generated in the electrodes, in the wire leads connecting the electrodes to the amplifier, and in the host of electronic components internal to the EMG instrumentation.

Because of the limited bandwidth required of EMG instrumentation (less than 10 kHz), 1/f, or flicker noise, plays a dominant role.^{12,13} As the name 1/f implies, flicker noise decreases with increasing frequency, being of little consequence above 1 kHz. Flicker noise is associated with semiconductor junctions and certain types of film resistors, the DC level of which depends on the energy level at which the junction or film component is operating.

Of particular significance in EMG is the motion artifact that may result from a movement disturbance of the electrode-electrolyte interface. As previously discussed, a charge gradient exists at the electrode-electrolyte interface and any relative movement at the interface will alter its capacitance. This has the effect of redistributing the charge at the interface, thus producing an input current to the amplifier. The resulting voltage artifact is a low-frequency randomly occurring noise source that is very troublesome. Another type of motion artifact is generated

by the movement of the wire leads connecting the electrodes to the amplifier. These artifacts are induced into the wires through electromagnetic induction, the method used to induce alternating voltages in electrical generators.

Although motion artifacts are at the low end of the EMG signal spectrum (less than 30 Hz), they often are of sufficient amplitude to be difficult to remove with simple high-pass filters.

ELECTROMYOGRAPHIC AMPLIFIERS

The standard processing component in any EMG instrumentation system is the amplifier. Actually, the amplifier normally is composed of several stages of amplification, the most important of which is the first stage or preamplifier. Together the stages perform several important functions including 1) isolation between the signal source and recording instrumentation, 2) current to voltage conversion, 3) voltage gain, and 4) noise reduction.

The two most important characteristics of an EMG amplifier are high input impedance and a differential input. These characteristics translate into two important benefits: conservation of signal power and reduction of noise power.

Conservation of Signal Power

The need to isolate the signal source from the recording instruments can best be understood by considering the power of the signal source. Signal power is defined as the signal voltage squared divided by the source impedance. The object of amplification is to increase the signal power to a level necessary to drive recording devices. This requires the efficient transfer of power between the signal source and preamplifier. Any increase in the impedance of the source will reduce the power available for transmission. Clearly, the reduction of source impedance is advantageous. This may be accomplished in two ways. First, steps should be taken to reduce factors contributing to the source impedance, such as abrading the electrode site with an abrasive to reduce the skin resistance. The second primary method, however, is to reduce the effective source impedance by isolating the source from the load.

Isolation is accomplished by buffering the source with an amplifier exhibiting a large input impedance and a small output impedance. For the purpose of illustration, the transmission link can be viewed as a signal source in series with two lumped impedances as in Figure 4-4. One impedance is used to represent the source impedance, made up of the combined tissue, skin, and electrode-electrolyte impedances. The other impedance represents

the input impedance of the preamplifier. Together they form a voltage divider. The magnitude of the voltage drop across each lumped impedance is proportional to the fraction of each impedance to the total impedance. Thus, the larger the source impedance, the larger the fraction of the total voltage dropped at the source.

In the illustration, any voltage drop across the source impedance represents signal power that is lost. By increasing the size of the input impedance, the percentage of power lost is decreased, thus increasing the efficiency of the transmission. The high input impedance of the amplifier coupled with its low output impedance has the desirable characteristic of lowering the effective source impedance while preserving the signal power.

The actual magnitude for input impedance desirable for high fidelity amplification depends on the size of the source impedance. A good rule of thumb is that the input impedance be 100 times larger than the source impedance. For a typical value of surface electrode impedance (impedance measured between the detection electrode) of 20 k Ω , an input impedance of 2 M Ω is desirable. This impedance is easily obtainable with solid state amplifier designs.

A common error made by persons unfamiliar with electronics is to assume that the published input impedance specification extends over the total bandwidth of the amplifier. This is not the case, however, because even small amounts of capacitance in parallel with the input resistance will significantly reduce the input impedance at 100 Hz. This problem is exacerbated by the capacitance of the input lead wires, their capacitance often being many times the input capacitance of the amplifier itself. To prevent confusion, the input impedance should either be specified as an equivalent parallel combination of resistance and capacitance or specified at a representative frequency within the usable bandwidth. A reasonable frequency for surface recording is 100 Hz.

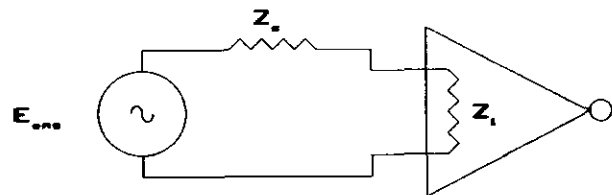

FIGURE 4-4

Simplified circuit of bioelectric generator to amplifier transmission link. Z_s represents the lumped impedance of the source to include the complex tissue, skin, and electrode-electrolyte impedances. Z_i represents the input impedance of the amplifier.

Noise Reduction

Conserving as much of the power of the EMG signal source in the transmission to the preamplifier is one way of dramatically improving the signal-to-noise ratio. Another approach is to reduce the noise power.

For those noise sources that are external to the amplifier, the most potent method of noise reduction is through the common mode rejection property of the differential amplifier. In such a circumstance, the differential amplifier amplifies only the difference voltage between its two input terminals. Any signal voltage common to both input terminals, each referred to a common reference terminal, should ideally produce a zero output. The degree to which this ideal is realized in practical designs is designated by the common mode rejection ratio (CMRR), defined as the difference signal gain divided by the common mode signal gain. As such, the CMRR specifies the improvement in the signal-to-noise ratio that will occur, after amplification, as a result of common mode noise sources. The International Society of Electrophysiological Kinesiology (ISEK) recommends the preamplifier CMRR be greater than 90 dB.¹⁴ The decibel notation is commonly used to express voltage ratios. The conversion is as follows:

$$\text{CMRR(dB)} = 20 \log_{10} \text{CMRR} \quad (2)$$

Because the CMRR is influenced by both frequency and gain of the preamplifier, a more meaningful specification would relate the CMRR to a specific input frequency and preamplifier gain, if variable.

In practical EMG measurement applications, including those in ergonomics, the CMRR of the preamplifier is never realized because of the unequal source impedance seen by each input terminal. This is due, primarily, to unequal electrode impedances. The effect of the so called **source impedance imbalance** is to create an unequal voltage drop across each electrode impedance. The different voltage drops creates an artificial difference signal that is indistinguishable from any other difference signal. Thus, it will be amplified by the difference signal gain, the effect of which is to reduce CMRR. It should be emphasized that it is not the absolute value of source impedance that determines the reduction in CMRR but rather the difference as seen from one input terminal compared with the other.¹³ Because the source impedance forms a voltage divider with the input impedance, increasing the input impedance will greatly reduce this problem.

Reasonable precautions should be exercised to reduce the level of noise seen by the preamplifier. These

include avoiding the location of interfering equipment, shielding of the input cables and preamplifier, and locating the reference electrode judiciously. In extreme cases, shielding the research subject with a Faraday cage may be required.

The noise generated internal to the preamplifier is a significant concern because it represents the major component of the total amplifier noise.¹² Amplifier noise can be reduced to very low levels by the use of battery operated low power preamplifiers and postamplifiers. Amplifier noise usually is specified in microvolts RMS, referred to the input (RTI). The ISEK recommends amplifier noise be less than 5 μVRMS measured with a source resistance of 100 k Ω and a bandwidth from 0.1 to 1000 Hz.¹⁴

Finally, the amplifier input bias current should be specified. This variable is important because it determines the minimum signal that can be amplified. Low input bias currents are desirable to minimize the effect of changes in electrode source impedance that may occur as a result of electrode movement. Applying Ohm's law, the amplitude of the movement artifact is equal to the change in the source impedance multiplied by the input bias current. The ISEK recommends input bias current be less than 50 nA for direct coupled amplifiers.¹⁴

A summary of recommended minimum specifications for surface EMG amplifiers may be found in Table 4-2. These specifications may serve as a general guideline for the selection of equipment appropriate for use in surface EMG.

Onsite Electrode-Preamplifiers

The development of small onsite surface electrode-preamplifiers, or **active surface electrodes**, has been the result of the natural evolution of equipment design as a response to the inconvenience and unreliability of conventional surface electrodes.

The improved performance of active surface electrodes is due to the inherent advantages of moving the preamplifier as close as possible to the signal source. This advantage, coupled with improvements in direct current amplifier performance, has resulted in improved signal-to-noise ratios and the near elimination of problematic motion artifacts. An example of a typical surface electrode of this type was presented in Chapter 3. The demand for convenient electrode application has resulted in active electrode designs with very high input impedance ($10^{12} \Omega$) that require no electrode paste or skin preparation.

TABLE 4-2
Recommended Minimum Specifications for Surface EMG Amplifier

Variables	Recommended Minimal Specifications
Input impedance	> $10^{10} \Omega$ at DC ^{a,b} > $10^8 \Omega$ at 100 Hz ^{a,b}
Amplifier gain	200—100,000 $\pm 10\%$ in discrete increments
Gain nonlinearity	$\leq \pm 2.5\%$
Gain stability	Combined short term (1 day) and long term (1 year) gain variations < 5%/year
Common mode rejection ratio (CMRR)	> 90 dB measured at 60 Hz with zero source resistance ^a
Frequency response	1—3000 Hz measured at -3 dB points ^a
Input bias current	< 50nA (50×10^{-9} A) ^a
Isolation	$\leq \mu\text{A}$ (10×10^{-6} A) leakage current measured between patient leads and ground (Underwriters Laboratories, 1985)
Noise	< 5 μV RMS measured with a 100 k Ω source resistance ^a

^aIndicates minimum specifications recommended by the International Society of Electrophysiological Kinesiology.¹⁴

^bThe ISEK specification for input impedance does not differentiate between the requirements for surface versus indwelling electrodes, electrode material, the length of electrode leads, and other factors that may effect the magnitude of input impedance required to maintain the ratio of the input impedance to the lumped electrode source impedance at a minimum of 100:1. The ISEK recommendation is broad enough to apply to all these varied conditions. A lesser input impedance specification may be adequate within a limited set of conditions.

ELECTROMYOGRAPHIC SIGNAL PROCESSING

The processing of the EMG signal to obtain information relevant to an experimental question has taken many forms. To this point in our discussion, we have emphasized the need to preserve the information content of the detected EMG without preference to a specific measurement goal. A low noise, high input impedance linear amplifier with a bandwidth of from 1 to 3000 Hz and adequate gain to amplify the peak EMG to a 1 V output level will ensure signal fidelity. This performance is recommended to allow the raw unadulterated EMG to be monitored and, in some cases, stored. Monitoring the raw data is necessary to ensure the quality of the signal before or during processing so that the processing does not eliminate the recognition of interference and artifacts.

Anyone who has observed a several second record

of EMG activity from a complementary muscle pair, such as the forearm flexors and extensors, during a working task will be struck by the phasic nature of the activity. The flexors will be very active during one phase of the cycle, while the extensors will be active during another phase. During such a brief period of visual examination of such a record by the electromyographer, the brain makes comparisons between the signal information and the general character of the movement and makes decisions on what is valuable information. The rapid random fluctuations in the signal are ignored as being due to the random summation and subtraction of the many muscle fiber action potentials detected. Instead, attention is paid to the boundary or envelope of the EMG signal. This signal processing is context specific and intuitive and has a quantitative basis that the majority of signal processing methods seek to mimic and even exploit. A notable exception is the frequency analysis technique used in detection of muscle fatigue, the technique for which will be discussed separately.

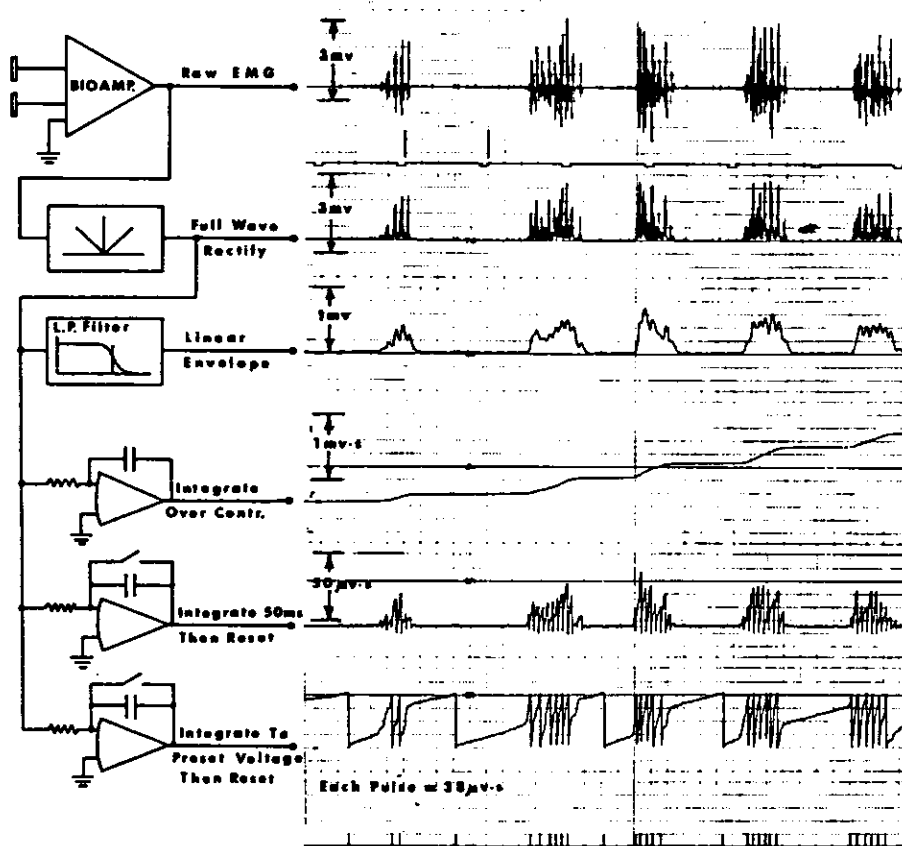

FIGURE 4-5

Schematic of several common EMG processing systems and the results of simultaneously processing of EMG through these systems.

Reprinted with permission from Winter DA: *Biomechanics of Human Movement*. New York, NY, John Wiley & Sons Inc, 1979, Figure 7.10, p 140.

EMG Demodulation

Concepts

The terms modulation and demodulation are familiar in the communications industry. They refer to methods of modulating low frequency information on high frequency carriers to simplify broadcast transmission over long distances. Once the modulated signal reaches its destination, the original low frequency information is retrieved by demodulation. All radio and television signals undergo this process. In a similar way, the detected EMG has been modulated by the command of the alphanotoneuron pool.¹⁵ An increase in the command is represented by an increase in the level of net

postsynaptic depolarizations of all the neural inputs to a muscle. This in turn causes the rate of motor unit firings to be frequency modulated by the neural command. Finally, the summation of the frequency modulated motor-unit action potentials produces an amplitude modulated envelope representative of the recruitment and firing rates of the original neural command. Demodulation, in this context, refers to processing techniques that recover the information associated with the neural command and discard everything else. Figure 4-5 illustrates several common EMG processing systems and the results of simultaneous demodulation of the raw EMG through these systems.

Demodulation Techniques

Rectification

The raw EMG detected by surface electrodes and amplified by a linear differential amplifier is a bipolar signal whose random fluctuations, if summed over a significantly long time period, would produce a zero result. Rectification is one technique frequently used in EMG-processor designs to translate the raw signal to a single polarity. This translation may be accomplished by either eliminating one polarity of the signal (half-wave rectification) or by inverting one polarity (full-wave rectification). Zero offset full-wave rectification is the preferred method because in this case all the signal energy is preserved. The effects of full-wave rectification is illustrated in Figure 4-5.

Linear Envelope Detector

The linear envelope detector is one of the least complex and most often used circuits for approximating the modulating neural control. The circuit consists of a zero offset full-wave rectifier followed by a low-pass filter (Figure 4-5). The cutoff frequency of the filter is selected to allow the capacitor voltage to track the envelope with the degree of smoothness desired. The effect of the low-pass filter response is to average the variation that occurs in the input signal. Hence, it is associated closely with the mathematical average or mean of the rectified EMG signal. The primary distinction is that the output of the linear envelope detector represents a **moving average** of EMG activity. An undesirable side effect of the low-pass filter is the phase lag it causes in the envelope response. This lag may introduce significant errors in the measurement of temporally related variables.

The cutoff frequency of the filter is selected by evaluating the kinetics-kinematics of the experiment in the context of the measurement goal. If an investigator, for example, wishes to use EMG as an indirect measure of the force produced during a 1-second constant force isometric contraction, a cutoff frequency of 1 Hz would ensure adequate response while offering maximum smoothing. On the other hand, the EMG associated with dynamic movements, such as quick movements of an arm during a working motion, would require a cutoff of the same frequency order as the movement itself. As frequencies of human movement generally do not lie above 6 Hz, no frequency thought to represent muscle control should necessarily lie above 6 Hz.¹⁶

Contemporary filter designs feature transfer characteristics that improve the rate of attenuation above the cutoff frequency. The rate of attenuation is related to the **order** or the number of **poles** of the filter design. All filters roll off at 6 dB/octave (20 dB/decade) for each pole

in the network. It is important that investigators report the filter design (eg, Butterworth, Bessel), the order of the filter, and the cutoff frequency used when communicating research findings. The unit for the moving average is millivolt (mV) or microvolt (μ V).

Integration

Integration refers to the mathematical operation of computing the area under the curve. Because the integral of the raw EMG is zero, it is necessary to full-wave rectify the raw signal to obtain the absolute value. This operation is expressed as follows:

$$I \{ |EMG(t)| \} = \int_0^t |EMG(t)| dt \quad (3)$$

As is evident from the formula, the integral will increase continuously as a function of time. In practical integrator designs, the time period must be limited because of the limited dynamic range of the integrator circuit. Typically, this is accomplished by integrating over fixed time intervals. In such cases, the operation is expressed as follows:

$$I \{ |EMG(t)| \} = \int_t^{t+T} |EMG(t)| dt \quad (4)$$

where T is the fixed time interval. Figure 4-5 illustrates the continuous integration as well as time and voltage reset integration. The EMG integral is a two dimensional quantity whose unit is mV•s or μ V•s.

Root-Mean-Square Processing

The root-mean-square (RMS) is a fundamental measure of the magnitude of an AG signal. Root-mean-square processing is a method that allows consistent, valid, and accurate measurements of noisy, nonperiodic, nonsinusoidal signals. It has been widely used in engineering applications to measure a host of phenomena from vibration and shock to thermal noise.

Mathematically, the RMS value of an EMG voltage is defined as follows:

$$RMS \{ EMG(t) \} = \left(\frac{1}{T} \int_t^{t+T} EMG^2(t) dt \right)^{1/2} \quad (5)$$

Unlike previous detection methods, the RMS processor does not require full-wave rectification, because

the time varying EMG signal is squared. This nonlinear operation is the basis of the square-law amplitude demodulator.¹⁷ Root-mean-square processing has enjoyed increasing popularity as investigators have become more aware of its benefits. DeLuca and Van Dyk have demonstrated that the RMS value contains more relevant information than the mean rectified or integrated EMG.² In particular, the RMS is not affected by the cancellation caused by the superposition of motor unit action potential trains.

Low cost analog integrated circuits are commercially available for performing the RMS computation. These designs invariably incorporate a low-pass filter to compute the average or mean. As with the linear envelope detector, a trade off must be made between the response of the circuit and the allowable DC error. Longer time constants create less DC error but longer settling times. Settling times may be longer for decreasing signals than for increasing signals, depending on the particular design. This characteristic may cause timing errors if too long a time constant is employed. The unit of the RMS EMG is mV or μ V.

Demodulation Applications

Conceptually, demodulation may be viewed as an information filtering process. The raw EMG contains information about a great number of factors, such as the contribution of a single muscle fiber, that when considered individually play only a minor role in the resultant muscle contraction. The demodulation process allows us to filter out the information specific to the individual signal contributors and to maintain the information concerning the general behavior of the individual contributors taken together. Information from demodulated EMG, therefore, may only be used to answer research questions concerned with the general neural control of muscle.

Demodulation signal processing techniques are used commonly to obtain temporal and EMG-force information. All the techniques discussed may be used to obtain temporal information, with the integrator being least suitable, as a result of the nature of the measurement unit. Caution must be exercised, however, in the selection of an appropriate cutoff frequency or integration interval. It is recommended that the processed signal be compared with the raw EMG using either an oscilloscope or a recorder with a sufficiently high frequency response (see section on monitors and recorders later in this chapter). In this manner, time delays in the processed waveform can be identified. The identification of specific temporal events requires that the information content of the processed signal be further reduced. This may be accomplished in a number of ways. The classic method is

first to output the processed data to a strip chart recorder, then to measure the distance between significant temporal events and divide the distance by the chart speed. This method can be very time consuming and is subject to reading error. Automated and semiautomated procedures are becoming more common, largely because of the low cost of powerful microcomputers and the availability of appropriate software. The primary disadvantage of automated procedures is that they are often unable to distinguish noise artifacts from genuine signals. As a result, commercial software packages often require user visual recognition of events and positioning of a time cursor.

The sophistication required to identify significant temporal events correctly has limited the application of hardware based data reduction methods. Amplitude discriminators and threshold detectors may be of considerable assistance in identifying the presence or absence of muscle activity. Like other automated methods, however, they are susceptible to noise artifacts.

Besides temporal measurements, the other major application area for demodulation processing techniques involves the quantification of the amplitude of the EMG envelope for the purpose of predicting muscle force or joint torque. The data reduction options applicable to this category of EMG measurement are similar to those discussed in connection with temporal measurements. In this context, however, the process of reducing the information content is far more, laborious because of the magnitude of information that must be necessarily considered. Computers are invaluable in this regard in that they have the capability of time-sampling signals from multiple variables, storing the information in ordered arrays, and performing mathematical and logical operations.

Frequency Domain Processing

Transformation of Random Processes

Often, the solution to a complex problem becomes easier to comprehend if viewed from an entirely different perspective. Frequency domain processing is used to shift the electromyographer's reference to the information content of the EMG signal intentionally from the time domain to the frequency domain. The value of the technique is in simplifying the identification and quantification of EMG information that manifests itself as changes in EMG frequency content. A common use of this technique in EMG is to identify EMG frequency spectrum shifts believed to be related to localized muscle fatigue (see Chapters 5 through 7).

As discussed previously, the Fourier transform is the mathematical technique by which the time-to-frequency-

domain transformation is performed. The technique is general and applicable to many diverse areas. Of particular relevance to the electromyographer is the use of the Fourier transform in the context of random processes. Electromyographic signals are neither periodic nor deterministic.¹⁸ Indeed, they do not repeat with a definite time interval, and a single mathematical expression cannot specify a detected EMG signal for all time. An EMG interference pattern, therefore, must be treated as a random or stochastic process with an associated cumulative probability distribution.

The power spectral density is the function commonly used for frequency domain analysis of EMG. It is defined as the Fourier transform of the autocorrelation function.¹⁹ The autocorrelation function may be computed from the time average of a sufficiently long finite length of data if one assumes the random process to be ergodic.²⁰ For a random process to be ergodic it must 1) have a normal or Gaussian probability distribution, 2) be stationary over the time period of the average, and 3) have an average value of zero. The formula for computing the autocorrelation function $R(\tau)$ from the time average of the EMG is as follows:

$$R(\tau) = \lim_{T \rightarrow \infty} \frac{1}{T} \int_{-T/2}^{T/2} \text{EMG}(t, \epsilon) \text{EMG}(t + \tau, \epsilon) dt \quad (6)$$

where ϵ represents the random outcome of an experimental event, t the time course of the random event, τ the time difference, and T the period of the time average. A close examination of the equation will reveal that the autocorrelation in this context is simply the mean of the product of the same signal displaced by τ seconds and computed for all time displacements.

The Fourier transform $G(f)$ for any nonperiodic signal $s(t)$ is given by the following:

$$G(f) = \int_{-\infty}^{\infty} s(t) e^{-j2\pi ft} dt \quad (7)$$

The power spectral density $P(f)$, defined as the Fourier transform of the autocorrelation function becomes as follows:

$$P(f) = \int_{-\infty}^{\infty} R(\tau) e^{-j2\pi f\tau} d\tau \quad (8)$$

As $P(f)$ is an even function, the integrals are real

numbers and the equation can be written as follows:

$$P(f) = \int_{-\infty}^{\infty} R(\tau) \cos 2\pi f\tau d\tau \quad (9)$$

An integration of $P(f)$ over all frequencies yields the total power, hence the term power spectrum.

Fast Fourier Transform

As implied by name, the fast Fourier transform (FFT) is an efficient method of computing a discrete Fourier transform. The discrete Fourier transform must be used in frequency transformations of sampled functions, such as the type created by digital computer sampling at discrete instants. The computer is an indispensable aid to that type of computation because of the number of mathematical operations necessary for the calculation of the transform. The treatment of this topic follows the logical development of the discrete Fourier transform from the continuous Fourier transform as presented by Brigham.^{21,22}

Waveform Sampling

When a signal is sampled at discrete instants, the effect is to multiply the signal by a unit sampling pulse train. This is illustrated graphically in Figure 4-6 where the function $h(t)$ is sampled at discrete sampling intervals defined by T . The resultant sampled waveform (Figure 4-6e), thus, is an infinite sequence of equidistant impulses, the amplitude of each corresponding with the value of $h(t)$ at the time of occurrence of the sampling impulse. The Fourier transforms of $h(t)$ and $\Delta(t)$ are shown in Figure 4-6c and d, respectively. The symbol \square is used to designate a Fourier transformation. The frequency convolution theorem establishes multiplication in the time domain as equivalent to convolution in the frequency domain. This is demonstrated graphically in Figure 4-6 by noting that the function $H(f) * \Delta(f)$ (Figure 4-6f) is the Fourier transform of the sampled waveform $h(t) \Delta(t)$ (Figure 4-6e) and may be formed by the convolution of the Fourier transforms of the original functions shown in Figure 4-6c and d. What is of particular significance in the application of the Fourier transform to time sampled functions is the relationship between the continuous Fourier transform, shown in Figure 4-6c, of the original continuous function $h(t)$ and the continuous Fourier transform, shown in Figure 4-6f, of the sampled function $h(t) \Delta(t)$. The waveforms are identical with the exception that the continuous Fourier transform of the sampled waveform is periodic, with a period equal to the sampling interval T .

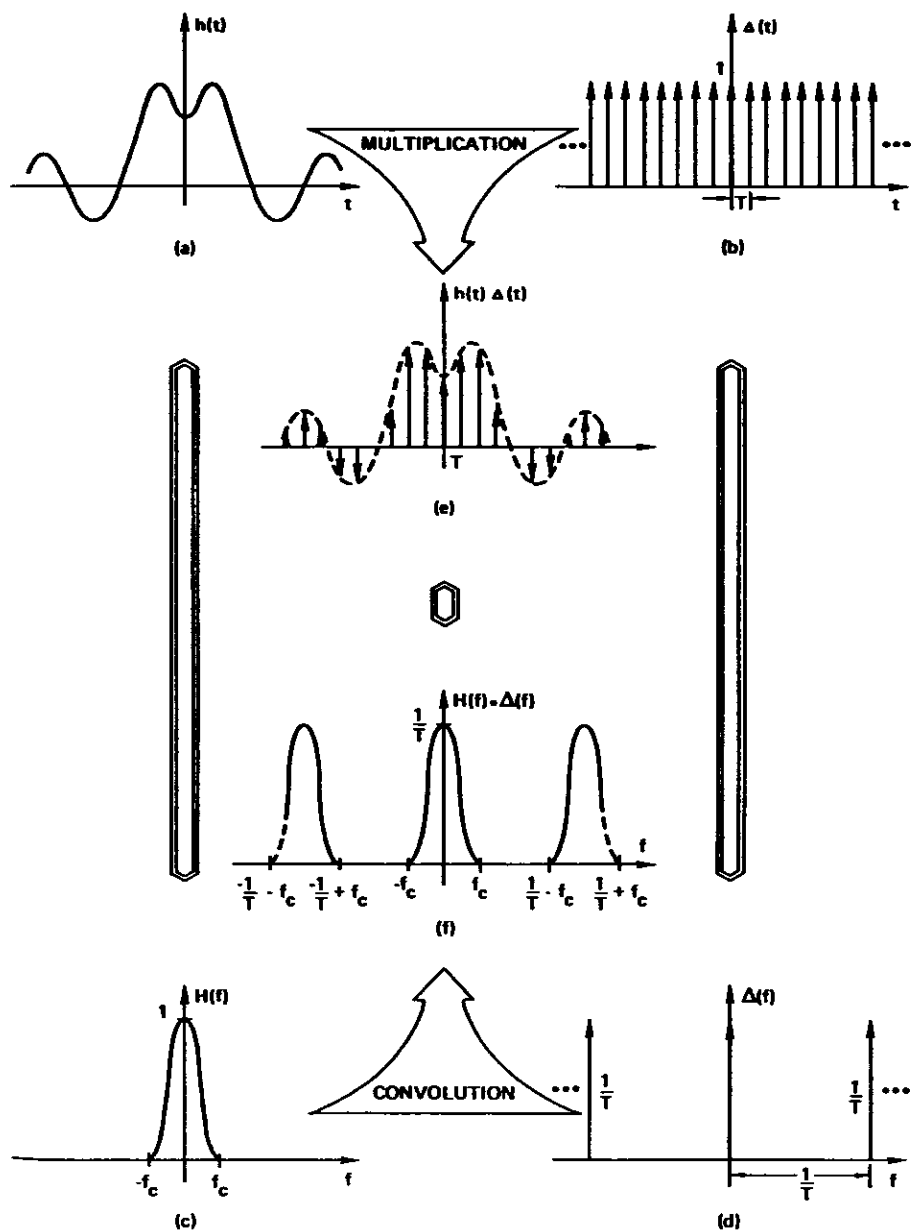

FIGURE 4-6

Graphical frequency convolution theorem development of the Fourier transform of a sampled waveform.

Reprinted with permission from Brigham EO: The Fast Fourier Transform. Englewood Cliffs, NJ, Prentice-Hall Inc, 1974, Figure 5-3, p 81.

Aliasing

If the sampling interval is too large, an overlapping of the periods of the continuous Fourier transform of the sampled function $h(t)$ $\Delta(t)$ will occur as shown in Figure 4-7f. This distortion is known as aliasing. Referring to the sampling function Δt , note that as the sample interval T is increased (Figure 4-6b and Figure 4-7b), the impulses of its transform pair Δf become more closely spaced (Figure 4-6d and Figure 4-7d). It is the decreased spacing of the frequency impulses, which when convoluted with the frequency function $H(f)$ result in the aliased waveform of Figure 4-7f. As the name alias implies, the waveform of Figure 4-7f is not representative of the frequency information needed to characterize the original signal $h(t)$. Indeed, the waveform $h(t)$ cannot be reconstructed from the aliased waveform.

The condition necessary to prevent overlapping of the Fourier transform of the sampled waveform is when the sampling frequency ($1/T$) is at least twice the frequency of the highest frequency component (f_c) of the Fourier transform of the continuous function $h(t)$. The frequency $1/T = 2 f_c$, known as the Nyquist sampling rate, is the minimum frequency at which no overlapping will occur. This condition is represented in Figure 4-8.

A difficulty arises in selecting an appropriate sampling frequency for EMG because it is impossible to know precisely the highest frequency component in the detected EMG. This is because the EMG frequency spectrum is influenced by several factors, the most obvious being the interelectrode spacing.

The usual method used to select the sampling frequency for fast Fourier analysis is first to make a guess of the highest frequency component in the signal, based on electrode type and instrumentation specifications, and then to select a sampling frequency three or four times greater than that frequency.¹⁸ Confusion often exists concerning the application of the Nyquist sampling rate to digital sampling in general. Although the Nyquist rate does define the minimum sampling rate to recover the information content of a signal, electromyographers who rely on visual recognition or identification of significant signal attributes will find the Nyquist rate to be inadequate for recovering the same information. This problem may be appreciated by considering the difficulty of reconstructing a sine wave from two visual samples. Sampling at frequencies 10 times the highest frequency of interest in the signal is suggested as a conservative guideline when the methods of data recovery do not incorporate spectral analysis.

Discrete Fourier Transform

The discrete Fourier transform (DFT) is a method

that is compatible with digital computers and that approximates the results of a continuous transform. To allow for computer calculation of the Fourier transform, the sampled time function and its Fourier transform pair must be represented by a finite number of discrete values.

To appreciate how the discrete Fourier transform differs from the continuous transform, consider the graphical derivation of Figure 4-9. The function $h(t)$ is multiplied by the sampling function Figure 4-9b to produce the sampled function, and its Fourier transform pair is illustrated in Figure 4-9c. The aliasing depicted in the sampled function's transform pair (Figure 4-9c) is due to a failure to satisfy the Nyquist sampling rate given the bandwidth of the original function $h(t)$. The Fourier transform pair of Figure 4-9c is not appropriate for digital computer calculation because an infinite number of samples of $h(t)$ are required. It is necessary, therefore, to truncate the sampled function with the rectangular function as illustrated in Figure 4-9d. The effect of truncation is to convolve the frequency transform of Figure 4-9c with the Fourier transform of the truncation function illustrated in Figure 4-9d. This has the negative effect of causing a ripple in the frequency transform of Figure 4-9e. This error may be reduced by increasing the length of the truncation function. It is desirable, therefore, to select as long a truncation function as possible.

The transform pair of Figure 4-9e must be modified further to make it possible to represent the frequency transform with discrete values. This may be accomplished by sampling the frequency transform of Figure 4-9e with the frequency sampling function of Figure 4-9f using a frequency sampling interval of $1/T$. The resulting discrete transform pair of Figure 4-9g, approximates the original continuous transform of Figure 4-9a with N discrete samples. Basmajian et al states, "if the original time function is real (as in the case of an autocorrelation) then the real part of the DFT is symmetric about the so-called folding frequency, which is by definition equal to half the sampling frequency."¹⁸

Modulo Two Requirement

A constraint of the FFT algorithm is the requirement that the number of samples, N , be an integral power of two. For periodic waveforms, it is difficult or, in some cases, impossible to sample the signal at three or four times the highest frequency component in the signal and then to truncate the sampled function in such a way as to represent a single period of the function, with an integral power of two samples. In these cases, it is customary to complete the sampling interval with a number of zero valued samples.

For random events associated with EMG activity, the EMG waveform is nonperiodic, and the modulo two

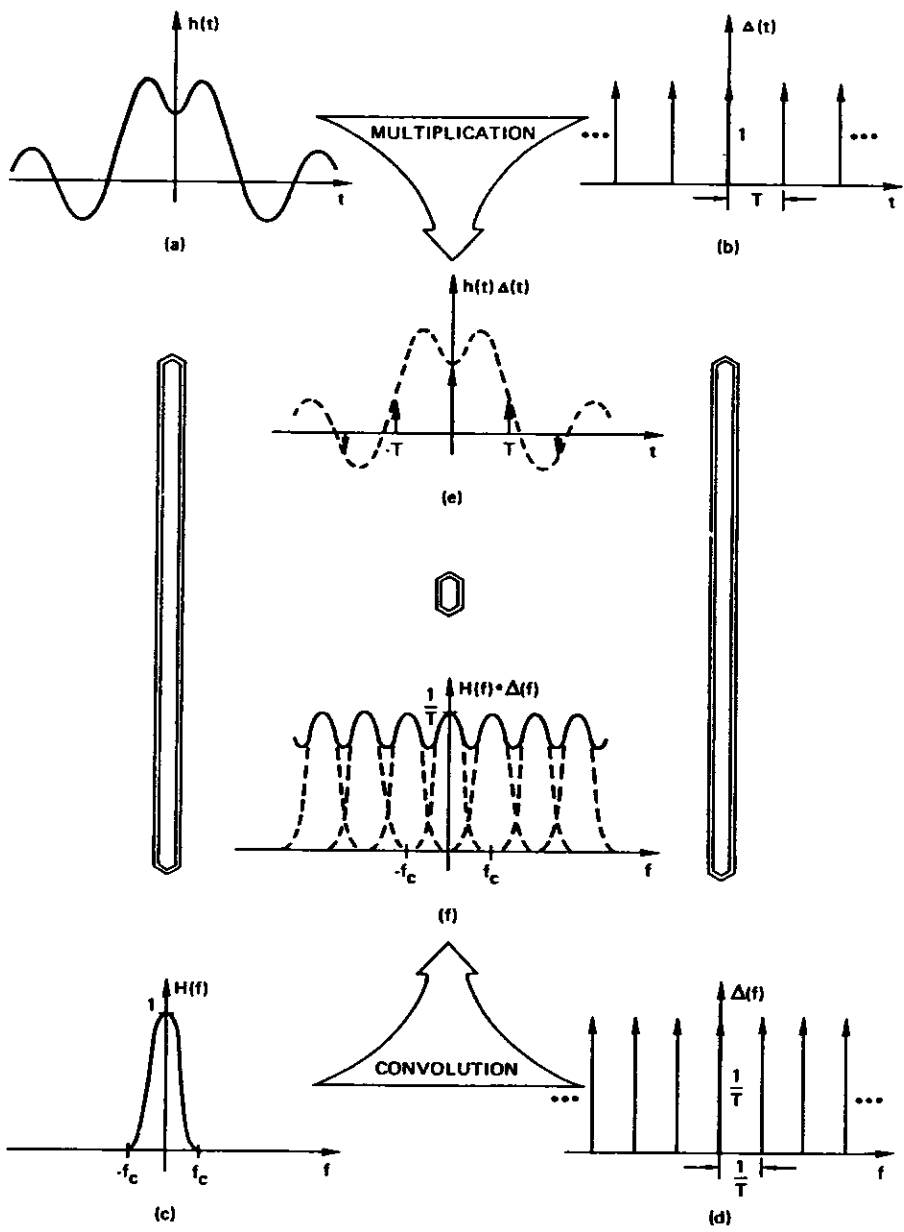

FIGURE 4-7

Aliased transform of a waveform sampled at an insufficient rate.

Reprinted with permission from Brigham EO: *The Fast Fourier Transform*. Englewood Cliffs, NJ, Prentice-Hall Inc, 1974, Figure 5-4, p 82.

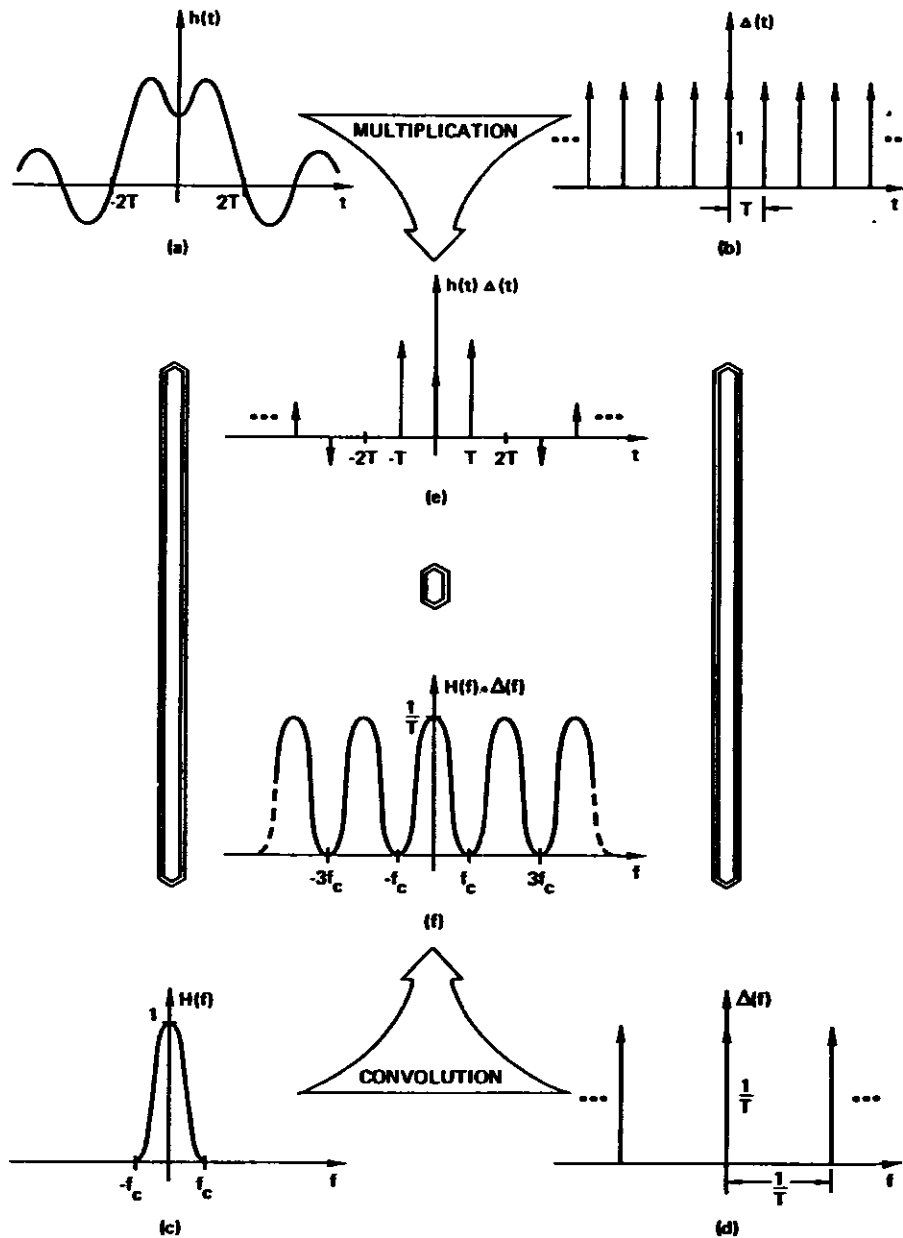

FIGURE 4-8
Fourier transform of a waveform sampled at the Nyquist sampling rate.

Reprinted with permission from Brigham EO: *The Fast Fourier Transform*. Englewood Cliffs, NJ, Prentice-Hall Inc, 1974, Figure 5-5, p 84.

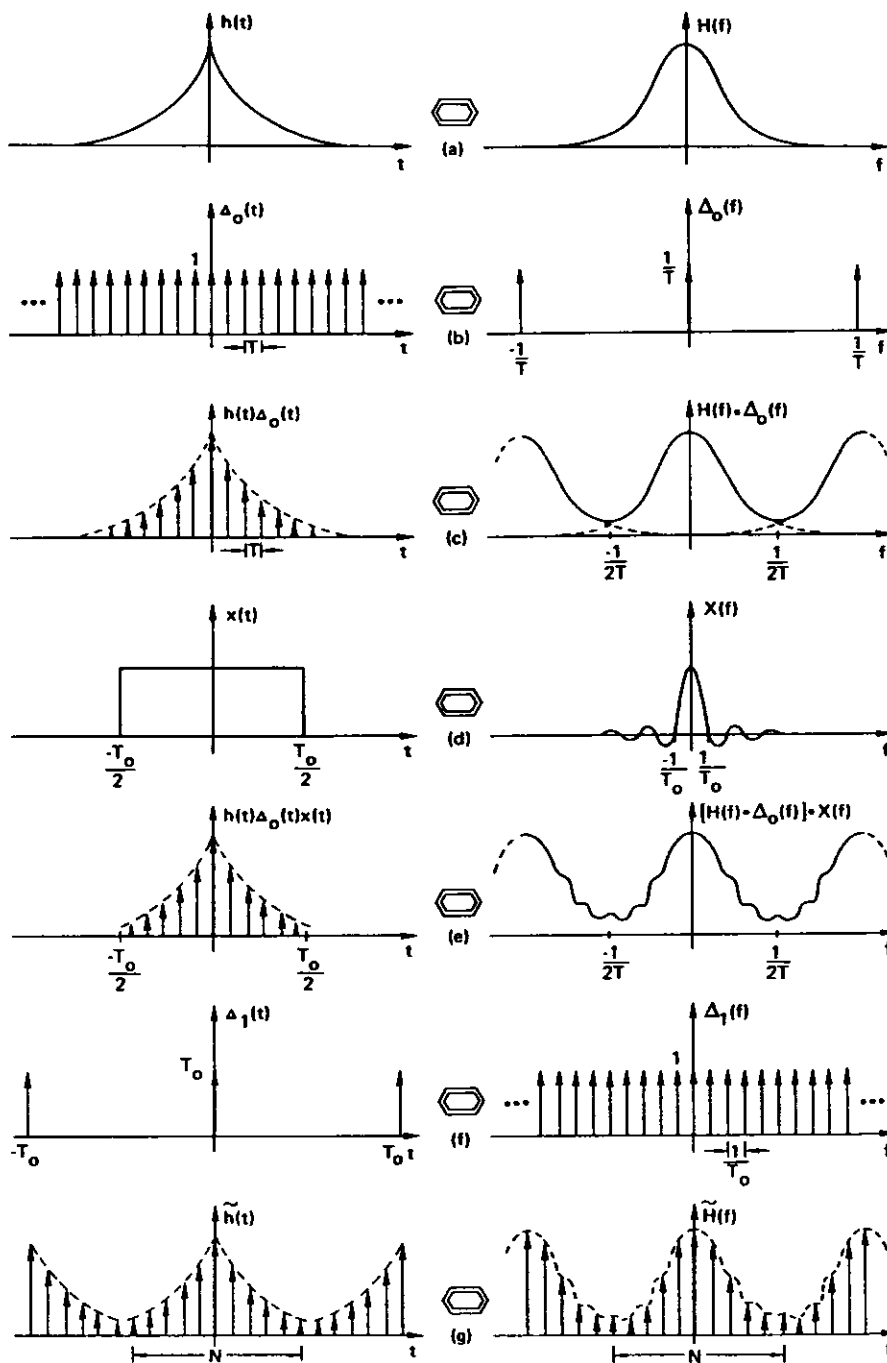

FIGURE 4-9
Graphical development of the discrete Fourier transform.

Reprinted with permission from Brigham EO: *The Fast Fourier Transform*. Englewood Cliffs, NJ, Prentice-Hall Inc, 1974, Figure 6-1, p 92.

requirement is less difficult to satisfy. Caution must be exercised, however, in the choice of the truncation interval because of the requirement that the random process be stationary.¹⁸

Windowing Functions

The time domain truncation inherent in the discrete Fourier transform has the potential to create sharp discontinuities in the sampled function corresponding to the beginning and end of the truncation function. These sharp changes in the time domain result in additional frequency components, termed leakage, in the frequency domain.

Referring again to Figure 4-9, recall that the ripple generated in the Fourier transform of the truncated sampled function (Figure 4-9e) was created by the convolution of the frequency transform of the sampled function (Figure 4-9c) and the characteristic $\sin(f)/f$ function of the rectangular truncation function (Figure 4-9d). It is the side-lobe characteristic of the $\sin(f)/f$ function that results in the ripple, or leakage. To reduce the negative effects of leakage, it is desirable to use truncation function that has reduced side-lobe characteristics in place of the rectangular truncation function.

The FFT weighting or windowing functions illustrated in Figure 4-10 are compared with the rectangular function in both the time and the frequency domains. As shown, all the windowing functions have reduced side lobes as compared with the rectangular function. Unfortunately, all the windowing functions also have a broader main lobe (Figure 4-10b). This has the undesirable effect of smearing the results of the FFT, which results in decreased frequency resolution.

The equation for the windowing functions of Figure 4-10 are given in Table 4-3, along with the highest side-lobe levels, -3 dB bandwidth, and rolloff rates. The Hanning or similar Hamming window are widely used as truncation functions in the application of the FFT to myoelectric signals.⁷

RECORDERS

The purpose of a recorder is to provide a permanent time record of the variations in the input signal that can be reviewed later to obtain data for analysis. The rationale for selecting a recorder for an EMG recording application will depend on both the faithful reproduction of the EMG waveform and the end goal of the information gathering process. As with other parts of the instrumentation system, the recorder must possess the appropriate amplitude and phase linearity, bandwidth, and noise level, necessary to preserve the desired information contained in the signal. Beyond these essential character-

istics, there are many other practical considerations in selecting a recorder. Among these are the cost of the recorder, the cost of the recording media, the storage requirements of the recording media, and the ease and accuracy with which data may be extracted from the record.

Graphic Recorders

Graphic recorders are distinguished by their ability to provide a permanent graphic recording of the time variations of the EMG waveform. The most common type of graphic recorder is the pen-and-ink recorder in which an ink delivering stylus is mechanically positioned to produce an ink tracing on a moving paper surface. A key design factor associated with the pen-and-ink recorder is the method used to position the stylus mechanically, because the response of the stylus limits the bandwidth of the recorder. Pen-and-ink recorders using a galvanometer positioning mechanism rarely have a full scale bandwidth greater than 60 Hz. This clearly is inadequate for recording raw EMG, but may be used for recording demodulated waveforms.

Several ingenious recorder designs have improved on the bandwidth limitation of the basic pen-and-ink galvanometric recorder by eliminating the stylus and replacing it with other writing methods. The light beam oscillograph incorporates a tiny mirror attached to the galvanometer mechanism to direct a light beam onto light sensitive recording paper. The low mass of the mirror improves the frequency response of this recorder design to 1000 Hz and above, suitable for recording raw EMG signals.

Two new graphic recorder designs incorporate computer processing and control with unique writing methods. One design incorporates a direct writing thermal array to produce permanent recordings on heat sensitive paper. Another design uses an electrostatic writing system to apply toner to the paper. Both of these designs have the advantage of being programmable with no overshoot or limits on transient response resulting from inertia. As a result, the recorder may be programmed to adjust the paper width allotted to each channel, greatly improving the amplitude resolution over other designs. Although the frequency response of both recorder types is adequate to represent the amplitude of raw surface EMG accurately, their usefulness in timing studies is limited by their writing speeds. Selecting one manufacturer's specification for each recorder type as representative, the maximum chart speed was 10 cm/s for the direct writing thermal array recorder and 25 cm/s for the electrostatic recorder. Given the usual circumstances for recording EMG in ergonomic situations, these paper speeds should be adequate if this recording mode be desired.

TABLE 4-3
Data Weighting Functions ($T_0 = NT$)^a

Weighting Function Nomenclature	Time Domain	Frequency Domain	Highest Side-Lobe Level (db)	3-dB Bandwidth	Asymptotic Rolloff (dB/Octave)
Rectangular	$W_R(t) = 1 \quad t \leq \frac{T_0}{2}$ $= 0 \quad t > \frac{T_0}{2}$	$W_R(f) = \frac{T_0 \sin(\pi f T_0)}{\pi f T_0}$	- 13	$\frac{0.85}{T_0}$	6
Bartlett (triangle)	$W_B(t) = \left[1 - \frac{2 t }{T_0} \right] \quad t < \frac{T_0}{2}$ $ t > \frac{T_0}{2}$	$W_B(f) = \frac{T_0}{2} \left[\frac{\sin\left(\frac{\pi f T_0}{2}\right)}{\frac{\pi f T_0}{2}} \right]^2$	- 26	$\frac{1.25}{T_0}$	12
Hanning (cosine)	$W_H(t) = \cos^2\left(\frac{\pi t}{T_0}\right)$ $= \frac{1}{2} \left[1 + \cos\left(\frac{2\pi t}{T_0}\right) \right] \quad t \leq \frac{T_0}{2}$ $= 0 \quad t > \frac{T_0}{2}$	$W_H(f) = \frac{T_0}{2} \frac{\sin(\pi f T_0)}{\pi f T_0 [1 - (f T_0)^2]}$	- 32	$\frac{1.4}{T_0}$	18
Parzen	$W_P(t) = 1 - 24\left(\frac{t}{T_0}\right)^2 + 48\left(\frac{t}{T_0}\right)^3 \quad t < \frac{T_0}{4}$ $= 2\left[1 - \frac{2 t }{T_0}\right]^3 \quad \frac{T_0}{4} < t < \frac{T_0}{2}$ $= 0 \quad t \geq \frac{T_0}{2}$	$W_P(f) = \frac{3T_0}{8} \left[\frac{\sin(\pi f T_0/4)}{\pi f T_0/4} \right]^4$	- 52	$\frac{1.82}{T_0}$	24

^a Reprinted with permission from Brigham EO: The Fast Fourier Transform and Its Applications. Englewood Cliffs, NJ, Prentice Hall Inc, 1988, Tab. 9.1, p 182.

Machine-Interpretable Recorders

Central to the function of any recorder is the ability to store information. In the case of a graphic recorder, the information is stored in the graphic record itself. Machine-interpretable records store information in a form that cannot be read or interpreted without a machine interface.

FM Magnetic Tape Recorders

The appeal of the FM tape recorder as a storage device is its ability to reconstruct the EMG waveform in its original analog form at the convenience of the investigator. During a recording session, the electromyographer is free to focus attention on the data collection aspects of an experiment, even voice annotating the record during significant events. Subsequently, the investigator may review individual channels and perform alternative data reduction and analysis methods using the original analog signal. The long-term storage aspect of the FM recorder allows data to be reanalyzed using methods that were unavailable or unappreciated at the time of the data collection. The FM recorders are preferred over other direct analog recording designs because of their superior linearity, harmonic distortion, noise level, and DC response. The DC response is necessary for recording the output of transducer types normally associated with EMG, such as force, joint position, and acceleration. The bandwidth of an FM tape recorder is proportional to the tape speed. It is necessary, therefore, to select a recording speed that provides a bandwidth adequate for the signal being recorded.

The ability to record data in real time at a fast tape speed and play back at a slower tape speed has the effect of slowing time. This effect may be used to extend the bandwidth of an ordinary pen-and-ink recorder artificially and allow the recording of raw EMG signals. Thus, recording at a tape speed of 15 ips and replaying at 15/32 ips can produce a bandwidth expansion factor of 32. When multiplied by the typical pen-and-ink bandwidth of 60 Hz, the effective bandwidth is extended to 1920 Hz.

The primary drawback to the use of an FM recorder concerns the reduction in the signal-to-noise ratio that is likely to occur. The recorder signal-to-noise specification defines the upper limit of this ratio for a signal covering the full dynamic range of the input. The EMG signals are characterized by a large dynamic range spanning the signal amplitude from those generated by a few motor units to those generated by a maximal contraction. Consequently, for a 0.1 V signal recorded on a recorder with an input dynamic range of ± 1.0 V and a signal-to-noise ratio of 100:1 (40 dB), the actual signal-to-noise ratio is 5:1 (14 dB) or 20% noise. This level of noise may well be intolerable.

Digital Recorders

The widespread use of digital computers to process experimental data has created a need for recorders that can store large quantities of data and can provide the data in a digital format suitable for direct computer input. The digital magnetic tape recorder and the digital magnetic disk are the two most popular digital recording technologies. In both types, a numerical value is represented by a formatted digital code. The codes used have been standardized to allow data to be interchanged between different computer types and software applications. Unlike FM tape recorders, the density of the information placed on the digital tape or disk media is independent of the frequency content of the information. All blocks of the coded data are formatted in the same way. Consequently, signals with high frequency components require proportionally more storage. For wide-band EMG signals, this will require thousands of stored values for each second of recorded data. Fortunately, the capacity of digital storage technologies are increasing rapidly at the same time the price per storage unit is dropping, making digital storage of EMG data attractive in many applications.

In comparing analog and digital recording methods, it is important to realize that the digital recorder does not digitize the EMG data itself, but rather it relies on another computer-controlled process termed analog-to-digital conversion. The fidelity of digitally recorded data as representative of an analog EMG waveform is dependent primarily on the performance of the analog-to-digital converter. For EMG signals that eventually will be digitized and processed using computer methods, digital storage is advantageous because this technique side-steps the noise and distortion problems of FM recorders.

ANALOG-TO-DIGITAL CONVERSION

Clearly, from the foregoing discussion, analysis of EMG measurements very often requires digitization of the signal and subsequent numerical computations. This is true particularly when relating EMG signals to other simultaneously measured variables such as force, position, and angle and when addressing issues of muscular fatigue that require processing in the frequency domain. The term analog-to-digital converter is used to describe any component or device which changes a continuously varying signal, such as EMG, into a discrete number representing the amplitude of that signal at some particular instant in time.

Theory of Operation

Theoretically, an analog signal like EMG is continuously variable over its entire range. In practice, there is a finite resolution to the numerical value that is assigned

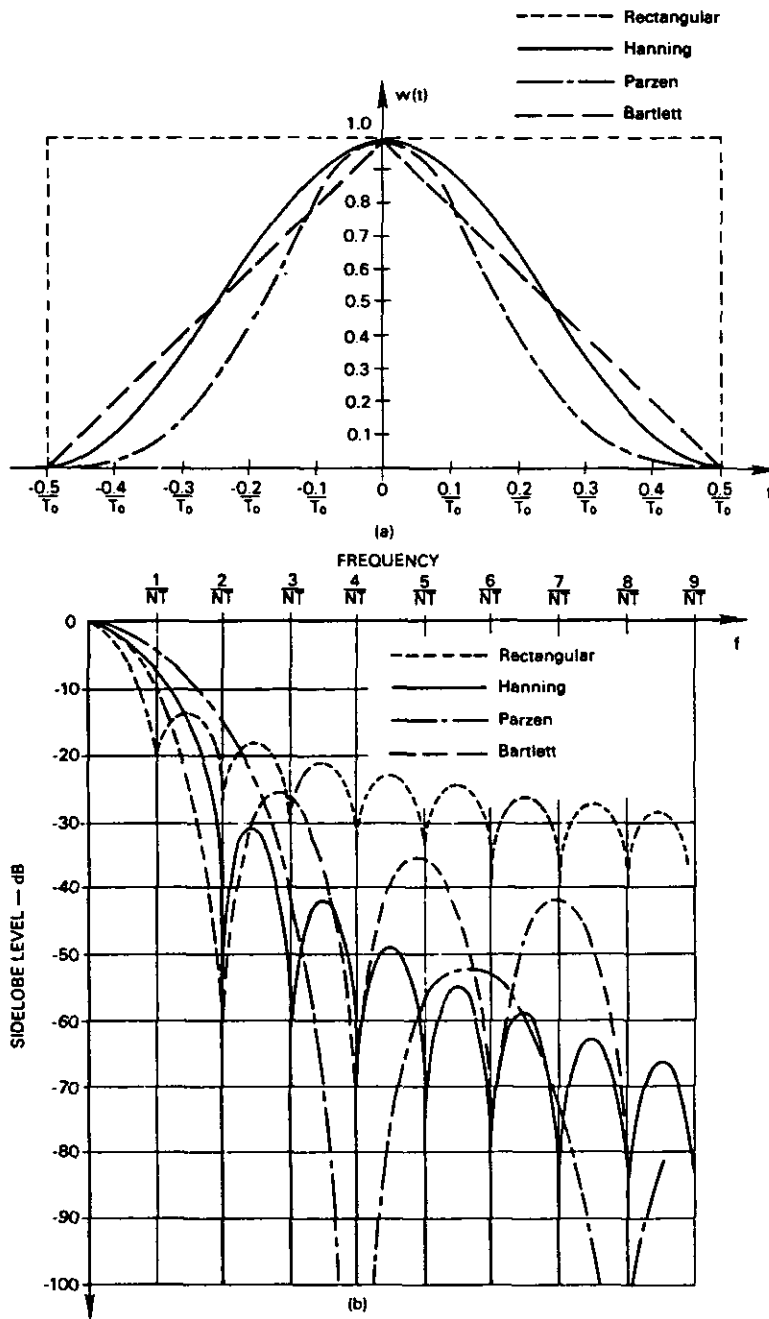

FIGURE 4-10
Fast Fourier Transform weighting or window functions.

Reprinted with permission from Brigham EO: *The Fast Fourier Transform*. Englewood Cliffs, NJ, Prentice-Hall Inc, 1974, Figure 9-8, p 181.

whenever the analog signal is sampled. This means that for any given numerical output of an analog-to-digital converter, there is a limited range of signal inputs, not just a single point. This range is referred to as the **width** of the output code and, in practice, is equal to the least-significant-bit (LSB) of an A-D converter.

Four popular types of A-D converters are available currently in integrated-circuit form. Table 4-4 lists these four types, the signal band width with which they are commonly associated, and some of their attributes. The successive approximation converter with a sample-hold circuit is the most popular for data acquisition systems (Figure 4-11). The method allows great versatility, and recent cost reductions have made it suitable for many applications including EMG. The parallel, flash, or multicomparator ladder design provides the highest speed but usually at the expense of limited resolution (only 6- or 8-bit).

Specifications

In addition to resolution, important specifications for A-D converters include accuracy, number of channels, maximum sampling rate per channel, and throughput rate. The needs in each of these areas should be determined by the ergonomist when considering the purpose of collecting EMG data.

TELEMETRY

General

A practical problem associated with performing EMG recording in simulated or actual work settings is the requirement that the workers' movements be confined to an area defined by the length of the cable(s) connecting the subject to the recording apparatus. Electrode cables may not exceed a few feet in length without seriously degrading the signal-to-noise ratio of the recording. Electromyographic instrumentation using onsite or centrally located preamplifiers may be used to extend this distance to a maximum of approximately 15 m (50 ft). Although allowing greater mobility, a cable of this length may prove unwieldy or even dangerous, given the mechanized nature of many job sites.

The telemetry of the preamplified EMG signal via radio frequency transmitter and receiver affords the subject untethered movement. An ordinary telemetry link used to transmit electrocardiographic (ECG) information is shown in Figure 4-12. A small battery powered transmitter frequency modulates a radio frequency carrier with the ECG signal that is then broadcast at the carrier frequency. The receiver in turn receives and demodulates the FM signal to recover the ECG information.

Range and Directionality

The range of the telemetry link is determined by the power output capability of the transmitter and the sensitivity of the receiver. As a practical matter, the range of the telemetry equipment is rarely a concern because commercially available battery powered transmitters are capable of transmitting signals that may be received over distances in excess of 30 m (100 ft), a range encompassing the majority of work sites. A larger concern is the directionality of transmitting antennas. Even so called **omnidirectional** transmitting antennas are characterized by weak field strength at various locations in their radiation pattern. The effect of weak field strength on the recovered signal is dependent on the type of modulation employed. In general, it may be understood to effect the signal in the same way as an AM or FM radio broadcast is affected when a radio receiver is positioned at increasing distances from the transmitting antenna. The recovered AM signal becomes weak and noisy while the FM signal is characterized by total signal drop-outs. To reduce the incidence of these problems in telemetry, it is common to use multiple antennas.

Multiple Channel Telemetry

In the majority of applications, a single channel of EMG is inadequate to monitor the muscle groups involved in a work task. The obvious solution is to use multiple transmitter-receiver combinations, each transmitting and receiving at a different frequency. Although this method is used commercially, it is expensive because each component in the system must be duplicated for each additional channel.

A common solution to the problem of multichannel telemetry is to use a form of multiplexing. Multiplexing refers to a system of transmitting several messages simultaneously on the same circuit or channel. Time division multiplexing is not truly simultaneous transmission but rather the sequential transmission of each channel sampled in rapid succession. Because this method incorporates sampling, information loss will occur if the sampling frequency is not several times the product of the number of channels times the bandwidth required.

Frequency division multiplexing is true simultaneous transmission as illustrated in Figure 4-13. Each channel's signal is used to frequency modulate a subcarrier oscillator. The subcarriers are mixed and used to frequency modulate a high frequency oscillator whose output is amplified and transmitted. The receiver is tuned to the high frequency carrier and each band of subcarrier frequencies is band-pass filtered and demodulated to recover the original signal. The table in Figure 4-13 defines the subcarrier bandwidths and center frequencies according

TABLE 4-4
Types, Signal Bandwidth and Attributes of A-D Convertors

Type	Signal Bandwidth	Attributes
Integrating	DC to 100 Hz	high accuracy low speed low cost
Successive approximation	DC to 100 Hz 100 Hz to 1 MHz with sample-hold	high speed accuracy at increased cost flexibility
Parallel "flash"	1 MHz + up	highest speed high resolution = expensive
Voltage-to-frequency	DC to 100 Hz	fast responding continuous serial output

to Inter-Range Instrumentation Group (IRIG) standards. Note that the maximum signal that can be transmitted via a particular frequency band is known as the nominal intelligence frequency and is directly proportional to the bandwidth of the subcarrier used.

Telemetry Performance

The performance specifications of telemetry equipment for use with EMG must be judged in the context of the signal information being telemetered. The degree to which the signal is preprocessed before being telemetered will influence the choice of appropriate specifications.

Bandwidth

As discussed previously, the bandwidth of any instrumentation used to amplify or otherwise process EMG must be adequate to preserve the information content of the signal. In the case of raw surface EMG, a bandwidth of 1 to 3000 Hz is recommended as a conservative specification.¹⁴ This specification must also be applied to the telemetry link. Unfortunately, much of the commercially available telemetry equipment marketed for use with human subjects is intended for lower frequency applications such as electrocardiograph and electroencephalograph monitoring. These bioelectric signals are contained in the frequency range of DC to about 150 Hz. Although this bandwidth is inadequate for raw surface EMG, it is more than adequate for processed EMG signals.

Consideration should also be given as to whether

signals other than EMG are to be transmitted via the telemetry link. If so, the bandwidth of the telemetry channels assigned to these signals must include the frequency range of the attendant signals. Frequently, variables associated with EMG such as position, force, velocity, and acceleration, are represented by signal frequencies that extend to DC.

Dynamic Range

The dynamic range specification refers to the range of signal amplitudes the telemeterized output may assume without distortion. A small signal amplitude may be characterized by undermodulation and noise. A large signal may be characterized by overmodulation and nonlinear distortion. Ideally, the sensitivity of the system is adjusted to minimize both effects while taking full advantage of the full dynamic range. As no signal may be greater than the limit defined by the dynamic range without distortion, this specification also limits the maximum obtainable signal-to-noise ratio.

Noise and Cross Talk

Noise may be generated within the telemetry equipment itself or from external sources of electromagnetic radiation such as television and radio stations, computers, switching power supplies, and automobile ignition systems. No matter their source, they can play havoc with telemetry signals. Problems of this sort are difficult to predict. One possible solution is to alter the transmitting frequency to an unaffected frequency. This capability is usually provided in commercial designs.

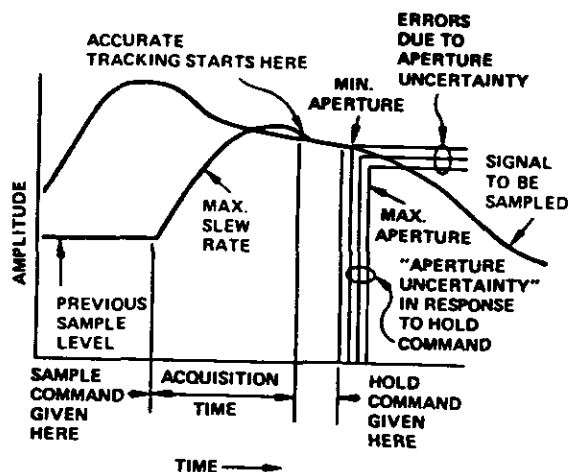

FIGURE 4-11

Sample-hold circuit dynamics and the errors they may create. The time scale is greatly expanded.

Reprinted with permission from the Application of Filters to Analog and Digital Signal Processing. Lockland System Corp, 170 W Nyack Rd, West Nyack, NY, 1976, Figure 25, p 14.

Another problem may appear to be noise but actually is cross talk from an adjacent telemetry channel. Cross talk occurs when an overmodulated signal channel overlaps an adjacent channel. The solution is to prevent the overmodulation by reducing the channel sensitivity.

MONITORS

Always monitor the raw EMG signal for artifacts and noise to ensure the quality and fidelity of the detected waveform. An analog oscilloscope is used typically for this purpose. Because of the wide bandwidth (≥ 1 MHz), excellent linearity, and low noise of most commercial analog oscilloscopes, making an appropriate selection is of little difficulty.

Of more practical concern is choosing an oscilloscope that has the features necessary to make the job of monitoring the raw EMG convenient. In the case of multichannel EMG, it is convenient to display all the channels simultaneously with the same time base. This is accomplished by time-sharing the single beam of the

oscilloscope between several channels. By time division multiplexing or chopping the display with sufficient speed, the information content of the individual channels may be preserved.

The quantity of the information displayed on the screen for each sweep of the beam makes some form of short-term storage desirable. The persistence of an ordinary cathode-ray tube display is dependent on the type of phosphor used. The selection of an appropriate phosphor may be used to slightly delay the disappearance of the visual trace without causing confusing superimposition of subsequent traces.

For delays longer than a few fractions of a second, a storage oscilloscope is necessary. Storage oscilloscopes will retain a stored image from a few seconds to several hours, depending on the particular design. The specification of primary importance in selecting an appropriate storage oscilloscope for EMG is stored writing speed. It is recommended the stored writing speed be ≥ 0.125 cm/ μ s.

BIOFEEDBACK

Biofeedback in the context of EMG refers to the presentation of the EMG signal to the research subject as a means of increasing his volitional self-control of specific muscles. The form of the feedback is characteristically visual or auditory. It may consist of anything from the presentation of the raw EMG to the subject in the form of an oscilloscope tracing or as sounds from a loudspeaker to the presentation of a processed signal used to deflect a meter or other indicator.

One popular use of biofeedback in recent times has been the use of auditory feedback of surface EMG for use in relaxation training. In general, however, there are limited applications of EMG biofeedback in ergonomics. In principle, the same instrumentation standards should be applied for use of EMG in these situations. Caution should be exercised in adapting commercial biofeedback instrumentation for use in other measurement applications for which it was not intended. A review of the equipment specifications should reveal if the bandwidth has been reduced or significantly shaped with filters that will actually cause significant signal distortion.

SUMMARY

This chapter presents information about principles of instrumentation applied to the collection of EMG data in an ergonomics setting. Primary emphases are on amplifier characteristics and requirements for processing the EMG into formats that allow the ergonomist to subsequently interpret data. Somewhat detailed information is provided on the topic of frequency domain

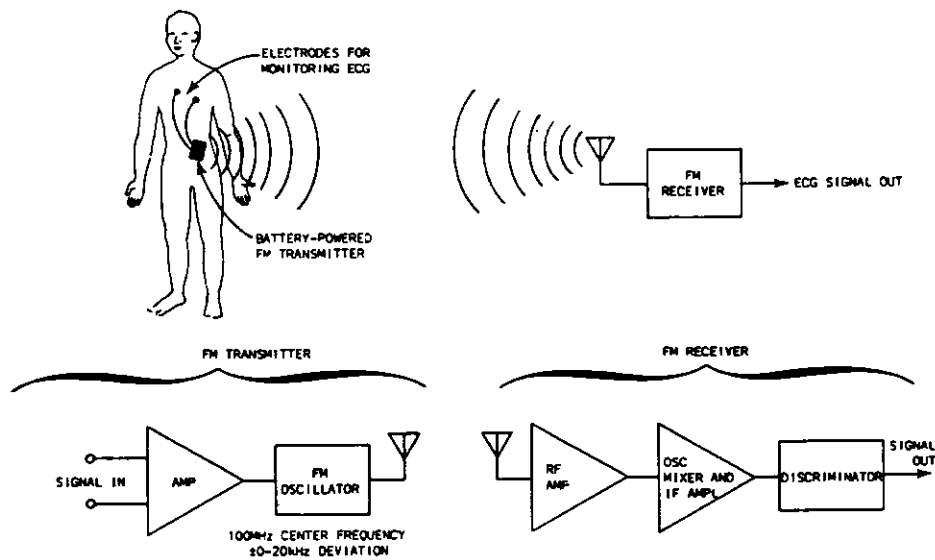

FIGURE 4-12
A typical single-channel telemetry link.

Reprinted with permission from Strong P: Biophysical Measurements. Tektronix, Inc, 1973, Figure 27-1, p 427.

processing has been included because of the potential applications. The topic of recorders or monitors and telemetry and biofeedback are discussed in terms of applications for those interested in applying EMG to the situation where ergonomic questions are of interest.

REFERENCES

1. Biro G, Partridge LD: Analysis of multiunit spike records. *J Appl Physiol* 30:521-526, 1971
2. De Luca CJ, Van Dyk EJ: Derivation of some parameters of myoelectric signals recorded during sustained constant force isometric contractions. *Biophys J* 15:1167-1180, 1975
3. Meijers LMM, Teulings JLHM, Eijkman EGJ: Model of the electromyographic activity during brief isometric contractions. *Biol Cybern* 25:7-16, 1976
4. Kaiser E, Petersen I: Frequency analysis of action potentials during tetanic contraction. *Electroencephalogr Clin Neurophysiol* 14:955, 1962
5. Kogi K, Hakamada T: Showing of surface electromyogram and muscle strength in muscle fatigue. Report of the Institute for Science of Labor 60:27-41, 1962
6. Kadefors R, Kaiser E, Petersen I: Dynamic spectrum analysis of myopotentials with special reference to muscle fatigue. *Electromyography* 8:39-74, 1968
7. Kwatny E, Thomas DH, Kwatng HG: An application of signal processing techniques to the study of myoelectric signals. *IEEE Trans Biomed Eng* 17:303-312, 1970
8. Lindstrom L, Magnusson R, Petersen I: Muscular fatigue and action potential conduction velocity changes studied with frequency analysis of EMG signals. *Electromyography* 10:341-356, 1970
9. Mortimer JY, Magnusson R, Petersen I: Conduction velocity in ischemic muscle: Effect on EMG frequency spectrum. *Am J Physiol* 219:1324-1329, 1971
10. Lindstrom L, Petersen I: Power spectra of myoelectric signals: Motor unit activity and muscle fatigue. In Stalberg E, Young RR (eds): *Clinical Neurophysiology*. London, England, Butterworths Publishers, 1981, pp 66-87
11. Geddes LA, Baker LE: *Principles of Applied Biomedical Instrumentation*. New York, NY, John Wiley & Sons Inc, 1975
12. Diefenderfer AH: *Principles of Electronic Instrumentation*. Philadelphia, PA, W B Saunders Co, 1972
13. Strong P: *Biophysical Measurements*. Tektronix, Inc, 5350 Keystone Ct, Rolling Meadows, IL 60008, 1973
14. Units, Terms, and Standards in the Reporting of EMG Research. Report by the Ad Hoc Committee of the International Society of Electrophysiological Kinesiology, 1980
15. Loeb GE, Gans C: *Electromyography for Experimentalists*. Chicago, IL, The University of Chicago Press, 1986

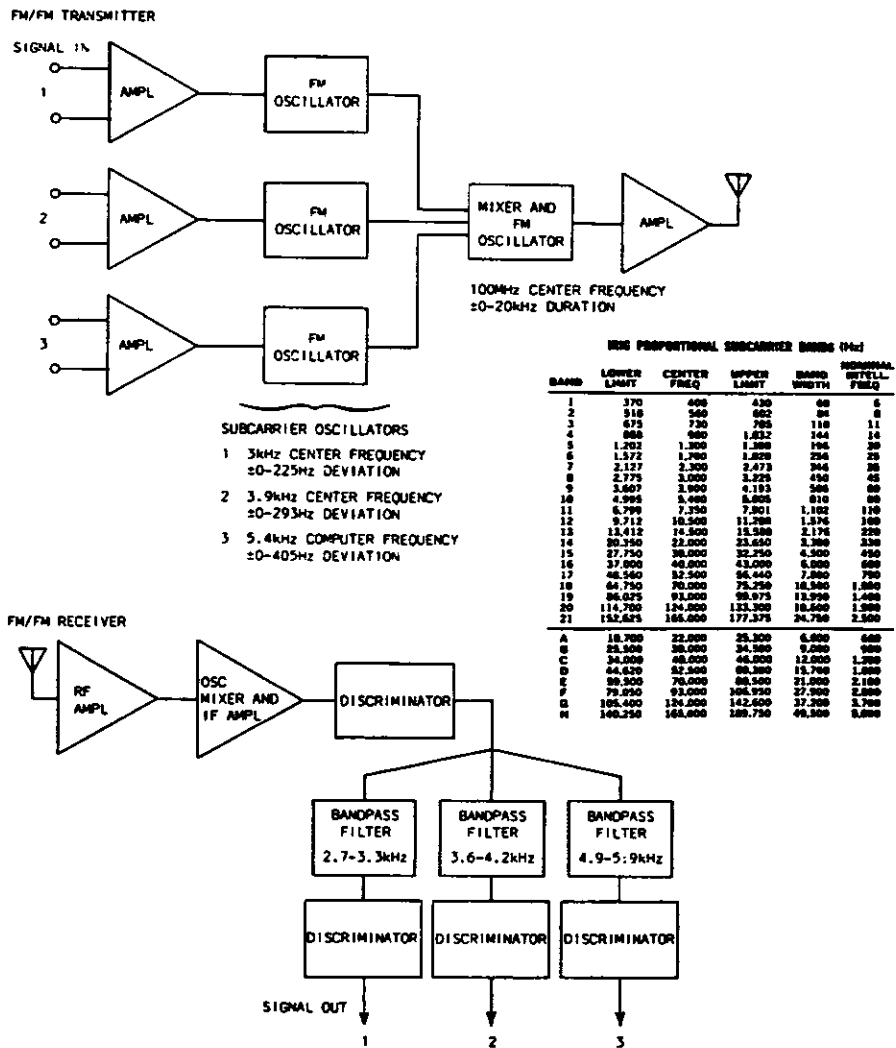

FIGURE 4-13

A typical multi-channel telemetry link frequency division multiplexed.

Reprinted with permission from Strong P: *Biophysical Measurements*. Tektronix, Inc, 1973, Figure 27-2, p 428.

16. Winter DA: *Biomechanics of Human Movement*. New York, NY, John Wiley & Sons Inc, 1979
17. Taub H, Schilling DL: *Principles of Communications Systems*. New York, NY, McGraw-Hill Book Co, 1971
18. Basmajian JV, Clifford HC, McLeod WD, et al: *EMG Signal Characteristics*. In Hill DW (ed): *Computers in Medicine Series*, Stoneham, MA, Butterworths, 1975
19. Lee YW: *Statistical Theory of Communication*. New York, NY, John Wiley & Sons Inc, 1960
20. Blackman RB, Tukey JW: *The Measurement of Power Spectra*. Mineola, NY, Dover Publications Inc, 1958
21. Brigham EO: *The Fast Fourier Transform*. Englewood Cliffs, NJ, Prentice Hall Inc, 1974
22. Brigham EO: *The Fast Fourier Transform and Its Applications*. Englewood Cliffs, NJ, Prentice Hall Inc, 1988

CHAPTER 5

Output Forms: Data Analysis and Applications

Barney LeVeau, Ph.D., PT
Gunnar B.J. Andersson, M.D., Ph.D.

Barney LeVeau, Ph.D., PT, received a certificate in physical therapy from the Mayo Clinic School of Physical Therapy and a Ph.D. degree in Biomechanics from The Pennsylvania State University. He has taught courses at West Chester State College, University of North Carolina, and The University of Texas Southwestern Medical Center at Dallas. He has developed graduate courses in Analysis of Human Motion and EMG Kinesiology, and has performed several EMG research studies. He is the author of the text, *Biomechanics of Human Motion*. He serves as a manuscript reviewer of *Physical Therapy*, *Journal of Orthopedic and Sports Physical Therapy*, and *Biofeedback and Self-Regulation*. He is presently Professor and Chairman at The University of Texas Southwestern Medical Center at Dallas, Department of Physical Therapy.

Gunnar B.J. Andersson, M.D., Ph.D., is Professor and Chairman at the Department of Orthopedic Surgery, Rush-Presbyterian-St. Luke's Medical Center, Chicago, Illinois. He received his M.D. from the University of Gothenburg in 1967 and a Ph.D. in Medical Sciences from the same University in 1974. He moved to Chicago in 1985. His primary interest is in spinal conditions and his research focuses on epidemiology and occupational biomechanics. He is the author of more than 150 original papers, several textbooks, more than 70 book chapters, and is a member of several national and international societies. He is a past president of the International Society for the Study of the Lumbar Spine, and the International Society of Electrophysiologic Kinesiology. He is on the editorial board of *Spine*, *Journal of Biomechanics*, *The Back Letter*, *Journal of Back and Musculoskeletal Rehabilitation*, and *American Journal of Neuroradiology*.

OUTPUT FORMS: DATA ANALYSIS AND APPLICATIONS

Interpretation of the Electromyographic Signal

Barney LeVeau, PhD, PT
Gunnar Andersson, MD, PhD

INTRODUCTION

The electromyogram (EMG), based on changes in amplitude and frequency, can be quantified and used to classify the electrical activity level that produces a certain muscular tension. The change in the myoelectric signal is based on the recruitment and firing rate of motor units within the muscle. In general, as more force is needed, more motor units are recruited, and the motor units already firing increase their frequency of firing. This general reaction, however, is not exactly the same for every muscle.¹ The interpretation of the changes in recruitment and changes in firing rate can provide information concerning the muscle's level of force or its level of fatigue. The information in this chapter presents a variety of ways by which the ergonomist may analyze or subsequently interpret myoelectric activity.

NORMALIZATION

Definition

Quantification of the myoelectric signal, although not the goal, is done so that comparisons may be made among muscles, individuals, and activities. The myoelectric signal amplitude is used as an indirect measure of contraction-force. Because there is not a one-to-one relationship between the two, a standard of reference must be established for any comparison among subjects, muscles, or activities. Such a process is referred to as normalization. This process also is a form of force calibration.

The myoelectric signal may change from one time to the next for several reasons such as slight change in electrode location, change in tissue properties, or change in tissue temperature. The absolute values of microvolts could give an inaccurate comparison of muscle function during different activities. Therefore, a normalization procedure must be made at each specific testing time for each subject tested.

After applying the electrodes at an appropriate site on the muscle, one or several contractions are performed for each muscle to be studied. The reference contractions must be well defined in terms of electrode placement, type of contraction (eg, extension or flexion), and joint position. In ergonomic studies, maximum efforts during functional activities may also be used. An example of this reporting is shown in Table 5-1, based on work done by Ericson and associates.²

Isometric Maximal Voluntary Contraction

The most common method of normalization is to perform one reference contraction, usually an isometric maximal voluntary contraction (MVC or MVIC). The myoelectric values subsequently obtained are expressed as a percentage of the MVC. Examples of this method are shown in Tables 5-1 and 5-2 and Figures 5-1, 5-2, 5-3, and 5-4.^{3,4}

The use of the MVC as a reference contraction is based on the idea that the amount of force produced varies directly with the myoelectric output. This is not quite true, although many researchers have found a linear or near linear relationship between the myoelectric signal and the force produced.^{4,7-13} Although the MVC may vary from time to time in quantity and quality, Viitasalo and Komi state that using the MVC "may be an acceptable way to standardize" the testing situations.¹⁴

Caution should be taken, however, in using the isometric MVC for all investigations. Several factors should be considered when selecting a reference contraction. These include the fact that the EMG-force relationship does not appear to be linear over the entire force range and that the relationship varies among subjects and muscles (see Chapter 6).

The motor unit recruitment pattern for each muscle is also known to be different.^{1,15} Woods and Bigland-Ritchies found that muscles with near uniform fiber type composition had a linear relationship between EMG and force, but muscles with mixed fiber type composition had nonlinear relationships.⁴ Lawrence and DeLuca, for example, found that the first dorsal interosseous muscle had a linear EMG-force relationship, but the biceps brachii and deltoid had a nonlinear relationship.¹

In general, the number of active motor units increases with increasing force at low force levels, but the firing rate increases at higher force levels.¹⁰ Slow motor units tend to become active later and continue to fire at higher force levels.

Researchers have found that comparing a subject to themselves is more precise than comparison across individuals. For the same muscle, the EMG-force relationship demonstrated small intrasubject variation but large intersubject variation.^{1,16} Comparisons made on the same subject therefore, are more valid.

TABLE 5-1

The Muscles Investigated, The Approximate Position of the Bipolar Electrodes, The Attempted Movement (Isometric) and Joint Position at which the EMG Normalization Was Performed^{a,b}

Muscle	Electrode position	EMG-Normalization type of isometric contraction	Joint position
Gluteus maximus	20% of d between spinous process S2 and a point 10 cm distal to greater trochanter	Hip extension in exercise table	45 deg. hip flexion
Gluteus medius	10 cm distally on a line from gluteus medius insertion towards greater trochanter	Leg abduction against manual resistance lying on the floor	Mid hip joint pos.
Rectus femoris	50% of d between SIAS and apex of patella	Knee extension in exercise table	45 deg. knee flexion
Vastus medialis	20% of d between SIAS and medial knee joint space	Knee extension in exercise table	45 deg. knee flexion
Vastus lateralis	25% of d between SIAS and lateral knee joint space	Knee extension in exercise table	45 deg. knee flexion
Biceps femoris	50% of d between ischial tuberosity and caput fibulae	Knee flexion in exercise table	45 deg. knee flexion
Medial hamstring	50% of d between ischial tuberosity and the medial knee joint space	Knee flexion in exercise table	45 deg. knee flexion
Gastrocnemius medialis	35% of d between medial knee joint space and tuberosity of calcaneus	Ankle plantar flexion standing on floor rising against manual resistance	Mid ankle joint pos.
Gastrocnemius lateralis	30% of d between lateral knee joint space and tuberosity of calcaneus	Ankle plantar flexion standing on floor rising against manual resistance	Mid ankle joint pos.
Soleus	50% of d between head of fibula and tuberosity of calcaneus	Ankle plantar flexion standing on floor rising against manual resistance	Mid ankle joint pos.
Tibialis anterior	75% of d between lateral knee joint space and lateral malleolus	Dorsiflexion against manual resistance lying supine with 30 deg. knee flexion	Mid ankle joint pos.

^aReproduced with permission from Ericson, et al: Muscular activity during ergometer cycling. Scand J Rehabil Med 17:53-61, 1985, Tab 1, p 55.

^bd = distance. SIAS = Spina iliaca anterior superior. deg = degrees, pos. = position.

TABLE 5-2
Mean (SD) of Processed Electrical Activity^{a,b}

	MVC							
	10%	20%	30%	40%	50%	60%	70%	80%
<i>M biceps brachii, 10 subjects</i>								
Integrated activity per 100 msec	10.6 (3.6)	16.2 (4.5)	22.5 (5.3)	29.4 (5.2)	35.7 (5.6)	43.9 (8.4)	54.0 (12.3)	68.2 (22.3)
Zero crossings per 100 msec	7.2 (1.6)	11.2 (1.9)	13.6 (1.8)	15.5 (2.4)	16.0 (3.2)	16.8 (3.7)	16.7 (3.4)	14.9 (2.9)
Integrated activity/zero crossings	1.32 (0.38)	1.32 (0.41)	1.65 (0.54)	2.03 (0.61)	2.35 (0.67)	2.89 (0.71)	3.47 (0.97)	4.93 (2.01)
Turns per 100 msec	30.2 (6.0)	42.3 (5.8)	51.7 (6.9)	57.3 (8.2)	62.6 (12.0)	67.0 (14.8)	72.6 (14.8)	66.2 (9.7)
Mean amplitude (μ V)	300 (74)	379 (74)	471 (78)	532 (67)	634 (96)	695 (84)	775 (115)	888 (161)
Turns/mean amplitude	0.100 (0.022)	0.115 (0.017)	0.114 (0.028)	0.111 (0.018)	0.098 (0.019)	0.093 (0.018)	0.075 (0.019)	
<i>M tibialis anterior, 10 subjects</i>								
Integrated activity per 100 msec	8.6 (3.5)	12.0 (5.2)	18.5 (5.1)	25.2 (5.4)	33.0 (10.2)	42.3 (9.5)	52.0 (11.4)	64.5 (14.4)
Zero crossings per 100 msec	9.2 (2.7)	12.0 (2.3)	13.9 (1.6)	15.4 (1.4)	15.9 (1.4)	16.1 (1.6)	16.6 (2.3)	16.2 (2.7)
Integrated activity/zero crossings	0.79 (0.42)	1.00 (0.43)	1.26 (0.36)	1.63 (0.50)	2.12 (0.95)	2.70 (0.96)	3.44 (1.20)	4.74 (1.59)
Turns per 100 msec	26.6 (7.4)	37.3 (5.2)	44.1 (4.3)	51.3 (4.2)	55.1 (4.7)	57.8 (5.0)	61.7 (7.9)	61.3 (8.1)
Mean amplitude (μ V)	314 (85)	393 (101)	487 (96)	608 (109)	684 (117)	805 (101)	906 (111)	987 (81)
Turns/mean amplitude	0.062 (0.012)	0.081 (0.081)	0.777 (0.077)	0.069 (0.069)	0.064 (0.064)	0.055 (0.055)	0.049 (0.049)	0.039 (0.039)

^aReproduced with permission from Christensen H, LoMonraco M, Dahl K, et al: Processing of electrical activity in human muscle during a gradual increase in force. *Electromyogr Clin Neurophysiol* 58:230-239, 1983, p 33.

When dynamic activities are studied, a further complication arises, making normalization difficult. The EMG-force relationship found in isometric contractions does not remain when muscles are allowed to change length as they contract.¹⁷ This situation is because of the relationship of the length-tension and force-velocity (discussed in Chapter 6) and because of the changes in location of firing motor units relative to the surface

electrodes.

If an isometric MVC is used as the reference contraction, the investigator must realize that in many cases the myoelectric signal will give an overestimation of the maximum force.¹⁸ This is especially true if the nonlinear relationship exists as described by Lawrence and DeLuca¹ and Heckthorne and Childress.¹⁹

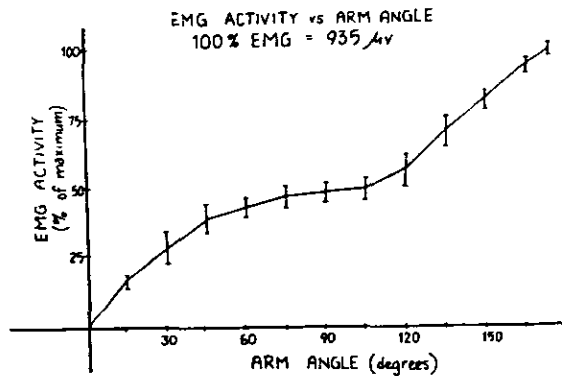

FIGURE 5-1

Activity of upper trapezius. Plateau phase occurs between 45 and 105 degrees of arm elevation (subject #13).

Reprinted with permission from Bagg SD, Forrest WJ: *Electromyographic study of the scapular rotators during arm abduction in the scapular plane. Am J Phys Med* 65:111-124, 1986, Figure 4, p 118.

Options Other Than Maximal Voluntary Contraction

Because the EMG-force relationship may not be linear for the specific muscle to be studied, the ergonomist may gain increased accuracy by using one or a series of several submaximal isometric contractions to provide a reference for comparison. Such a procedure has been reported by Perry and Bekey¹³ and Yang and Winter.¹⁶ This procedure may also be helpful in providing a force level similar to the level of force needed for the activity under investigation. Yang and Winter found that submaximal contractions were more reliable than MVC and therefore should be more desirable to use.¹⁶

Winkel and Bendix used three different well-defined reference tasks to give myoelectric signal reference values to compare the different seated work tasks studied.²⁰ Andersson et al also used more than one contraction as a standard.²¹ They transformed myoelectric signal microvolts to force data by way of regression analysis using a set of calibration experiments over a force range of interest.

Other alternative procedures for normalization have been reported in the literature. Jonsson and Hagberg²² and Janda et al²³ used one of the activities being studied as the reference contraction. In comparing muscle activity for different grips, for example, Janda et al used the open grip position as the reference activity.²³

If the activity under investigation does not include isometric muscle contractions, an isotonic contraction

may be used as the standard. Bobet and Norman, for example, used the unloaded walking activity to produce the reference contractions for the loaded walking activities being studied.²⁴ For a cycling study, Gregor et al used the greatest muscle myoelectric activity values obtained for the cycling activity as the 100% reference.²⁵ Either of these techniques can be used in ergonomic studies.

In more complex activities, a further complication in the EMG-force relationship arises. Because different synergists and antagonists are active in different proportions, the synergists will share the force production differently and will also have to develop force to overcome antagonistic activity.

The resting, or minimal value, is often subtracted from the myoelectric signal of the reference and of the task. This process serves to eliminate the noise or other instrumentation bias errors.^{5,26} This technique, however, is not considered essential by many because this same signal component is included in all of the tasks evaluated.

Normalization of the Task

The task being studied may also need to be normalized in terms of time. A cyclic activity can be set at 100 N for each cycle. This procedure allows for comparisons of data which may vary slightly in duration. This type of normalization has been used in gait analysis²⁷ (Figure 5-5) and when carrying loads on the back.²⁴ While studying shoulder joint load and muscle activity during lifting of a box, Arborelius and associates expressed each task as a working cycle ratio.^{28,29} The time 0 is when the box left the floor and is when the box was placed on the table (Figure 5-6).

Summary

1. Normalization of the myoelectric activity to a reference contraction is important to compare trials, subjects, and muscles.^{5,30,31}
2. The myoelectric signal-to-force relationship is sufficiently linear to use an isometric maximal voluntary contraction as a reference contraction in many situations.^{10,12,14,17,18,32} Some limitations to that approach are discussed below.
3. The MVC normalization approach probably results in an overestimate of the force produced.³³
4. The procedure of normalization is improved when the level of activity is close to the activity under investigation. Submaximal isometric contractions therefore are more accurate as reference contractions. This is particularly true if the EMG-force relationship of the specific muscle is known to be nonlinear.^{13,16}

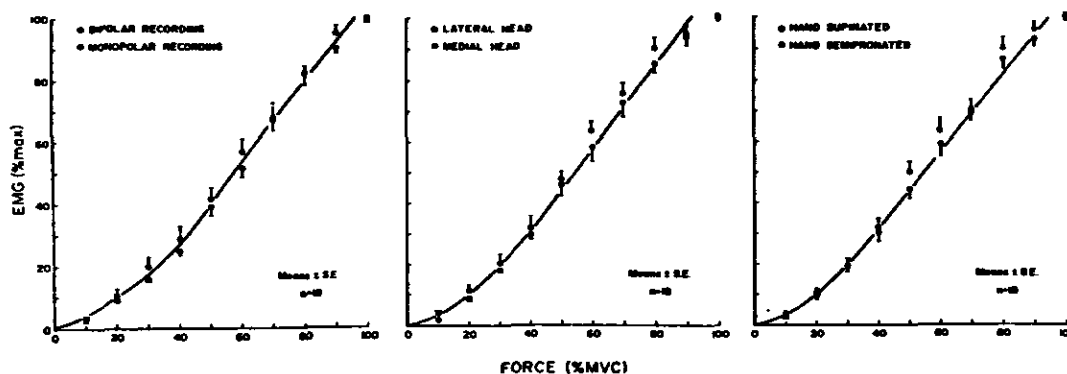

FIGURE 5-2

Mean values (\pm SE) for EMG-force relations for biceps brachii muscle using three different recording procedures. (Left) Bipolar and monopolar recording configuration. (Center) Lateral and medial head electrode placement. (Right) Supinated and semipronated hand position.

Reprinted with permission from Woods JJ, Bigland-Ritchie B: Linear and nonlinear surface EMG-force relationships in human muscles. Am J Phys Med 62:287-299, 1983, Fig. 3, p 293.

5. The reference contraction should reflect the activity being studied.^{21-24,34}
6. Calculations can be made to remove the effect of noise from the signal, if desired.
7. The activity under investigation may also need to be normalized.^{2,24,27,28}

OVERVIEW OF METHODS

Many different methods are used to reduce the data contained in the electrical signal and to present it in numerical form. Which method to use depends on why the information is needed, that is, the purpose of the study. The interpretation of the EMG signal plays an important role in determining the relationship of muscle activity to task performance. The most basic information obtained from a myoelectric signal is 1) whether or not the muscle is active and 2) the relative amount of activity of the muscle. By using the appropriate process of normalization, a reasonable estimate of muscle function can be obtained by the ergonomist. This information can be combined with an observation system or simply an event marker of some type to determine 1) when the muscle is active; 2) when a peak of activity occurs; 3) what the pattern of muscle activity is during a movement, position, or force production; and 4) whether fatigue has occurred. The instrumentation used is presented in Chapter 4, and other factors that can affect the values obtained are discussed in Chapter 6.

Raw Signal

The raw, or unprocessed, EMG signal is the basis of all methods of interpreting the myoelectric activity from muscles. The ergonomist should monitor the raw signal, even though other signal processing may be used, so that artifacts can be detected and controlled as necessary.

In the past, probably the most common way to interpret EMG was by visual inspection of the raw signal. With training, experience, and the use of multiple gains and oscilloscope sweep velocity, the observer should be able to evaluate the raw EMG signal visually and effectively. The observer should be able to identify when the raw signal indicates that a muscle is active and when it is relaxed. The relative amount of activity may be classified either by words, such as nil, negligible, slight, moderate, marked, or very marked, or by numerical values, such as 0-5, with 0 being no activity and 5 being maximal activity.

Such visual observations are based on signal amplitude and frequency. An example is provided in the work of Sofranek and associates when they visually examined the raw myoelectric signal to determine the duration of the interference pattern (Figure 5-7).³⁵ The distance from the first action potential spike (on) to the last spike (off) of the interference pattern adjusted to the paper speed provided a measure of duration.

The raw myoelectric signal was also used by Maton

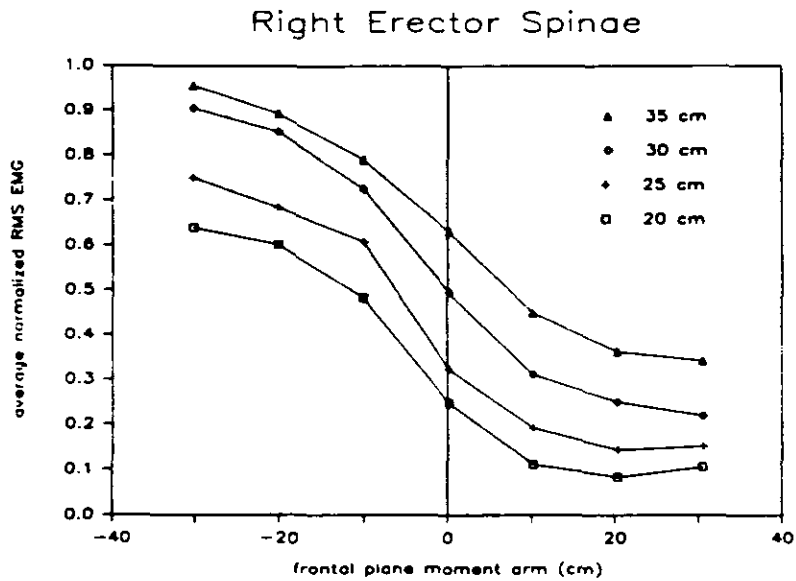

FIGURE 5-3 A
Right erector spinae EMG.

Reprinted with permission from Seroussi RE, Pope MH: The relationship between trunk muscle electromyography and lifting moments in the sagittal and frontal planes. J Biomech 20:135-146, 1987, Figure 4a, p 141.

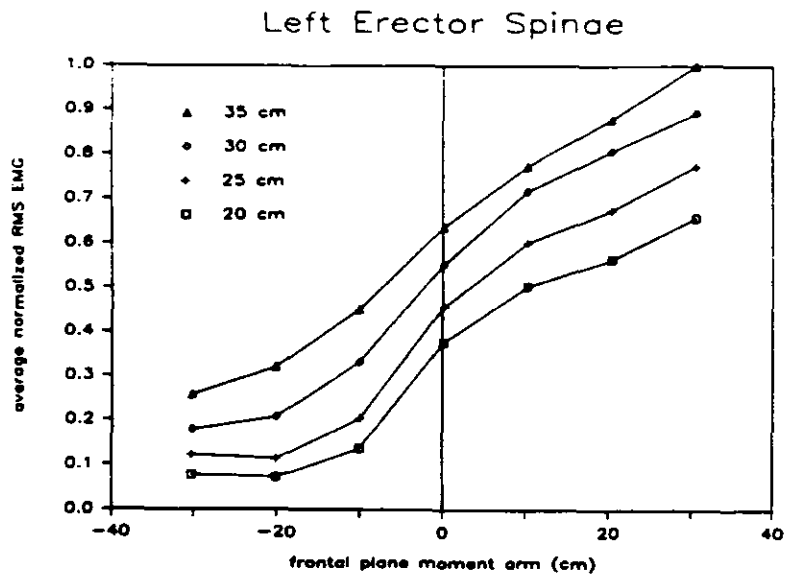

FIGURE 5-3 B
Left Erector Spinae EMG.

Reprinted with permission from Seroussi RE, Pope MH: The relationship between trunk muscle electromyography and lifting moments in the sagittal and frontal planes. J Biomech 20:135-146, 1987, Figure 4b, p 141.

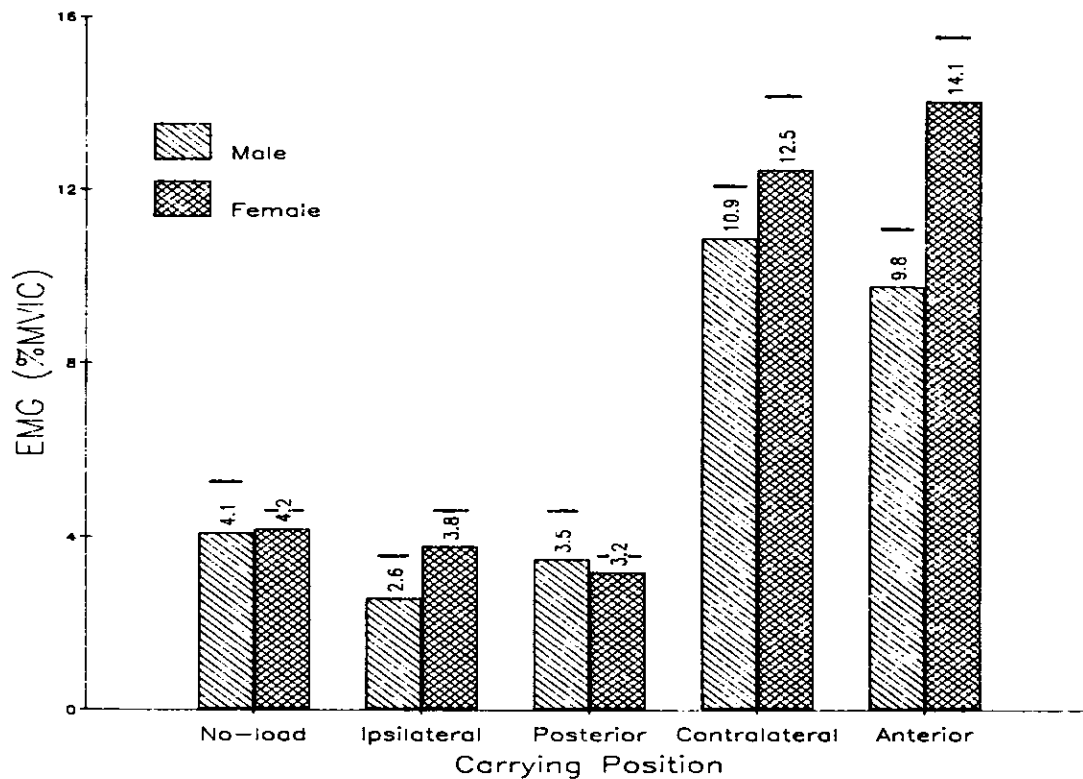

FIGURE 5-4

Erector spinae EMG mean values (% MVIC) for all four carrying positions and the no-load condition for males and females (both load sizes combined). The short horizontal bars indicate standard errors.

Reprinted with permission from Cook TM, Neumann DA: The effects of load placement on the EMG activity of the low back muscles during load carrying by men and women. Ergonomics 30:1413-1423, 1987, Figure 2, p 1419.

and associates to study the synergy of elbow extensor muscles during the deceleration phase of elbow flexion movements.³⁶ The authors observed the timing of the muscle bursts during the task. The amplitude values could not be quantified accurately, and only terms of weak and slight amplitude were used. The raw signal of the three heads of the triceps, the anconeus, and the biceps brachii muscles for the slow and the fast movements are shown in Figure 5-8.

The problems of using on-off information from raw EMG signals was illustrated by Winter.²⁷ He used three different threshold levels as six subjects walked normally. The differences in phasic patterns are shown in Figure 5-9. Different threshold levels give different on-off patterns, and, therefore, the on-off information can be misleading. Similar differences would be expected should similar techniques be used in ergonomic studies.

How other conditions influence activities evaluated

in ergonomics was shown in a study by Janda and associates in which the raw myoelectric signal was used to study the role of the forearm and hand muscles during various phases of prehensile activity.²³ Surface myoelectric signals were recorded during a sustained grip of 10 kg at each of three different handle spacings. Each data set was compared to the value obtained from the widest handle spacing position. The results revealed that the extrinsic flexor muscles were active throughout the test range, but the intrinsic muscle group was active only at the narrower handle spacings. Sample results are shown in Figure 5.10 and are based on the millivolt values of the signal thickness. In these cases, the investigator would have difficulty making interpretive statements.

Perry and associates used a more involved approach to quantify the raw signal.³⁷ They devised an eight-point scale that accounted for both amplitude and frequency components of the signal (Figure 5-11). The amplitude measured in millimeters was divided into a four-point

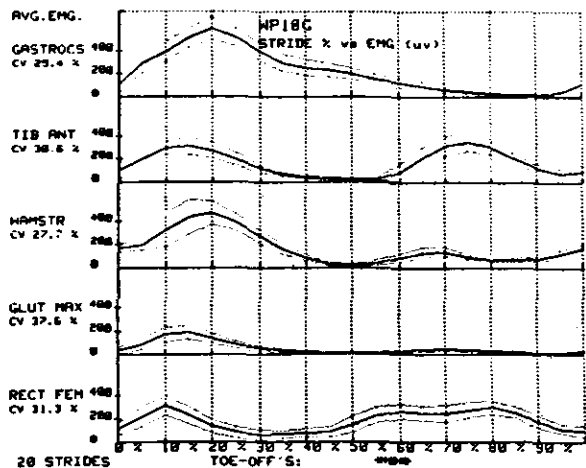

FIGURE 5-5

Ensemble average of linear envelope of EMG from five muscles of a typical patient. Solid line indicates the mean EMG signal in microvolts and the dotted lines represent one SD of the EMG profiles from the 20 strides.

Reprinted with permission from Winter D: Pathologic gait diagnosis with computer-averaged electromyographic profiles. Arch Phys Med Rehabil 65:393-395, 1984, Figure 6, p 395.

scale such as 1 mm = 0.5 point, 2 mm 1.0 point, 3 mm = 1.5 points. The values of 4 mm and 5 mm were both given a score of 2, and the values of 7 mm and 8 mm were given a score of 3. They also used a four-point scale to assess the density of the signal that would reflect the signal frequency. No signal would be zero density points, 50% of a signal would equal 2 points, and maximal activity showing a darkening record would equal 4 points. The maximum combined score from a maximal contraction would be 8. The final rating of the muscle activity was presented as a percentage of the myoelectric signal during maximal manual muscle testing. The percentage was obtained by adding the amplitude and density scores and dividing this value by 8. Their quantitative evaluation of the myoelectric signal reveals the onset and duration of muscle firing, provides a quantitative value of the amount of muscle firing, and identifies the interval phase (time) during which the muscle firing was greatest. In general, similar techniques could be applied to data obtained from ergonomic settings.

In summary, the raw EMG signal is a random signal obtained from the surface electrodes and then amplified. The raw signal should be monitored for all investigations,

because the investigator can pick out major artifacts and eliminate that area or part of the signal.^{13,38} The ergonomist should be aware that on-off information is nominal data but the relative amount of activity is ordinal data. Interpretation that can be made in ergonomic studies are dependent on the amplifier gain and the sensitivity settings of recording instruments. No current standards exist for instrument settings or interpretive rules; therefore, considerable judgement needs to be exercised in evaluating EMG records of raw data. Such a data form is of limited value when findings are to be related to force or fatigue. Thus, the signal is processed to attain a quantitative estimate that can be used for statistical or higher order analysis.¹³

Demodulation

The raw signal provides limited information and can actually provide inaccurate information if it is not processed into another form. Inman and associates stated that the raw waveform of the myoelectric signal is sufficiently complex that simple comparisons of peak-to-peak amplitudes are inaccurate.¹⁷ If true, then other types of comparisons would also be inappropriate. Given that the raw signal is of high quality, however, further management of the data can be desirable. Instrumentation, as discussed in Chapter 4, has been designed that provides a number of outputs representing the average amplitude of the input.¹⁷ The interpretation of the results of these techniques is included in the next section of this chapter.

Linear Envelope

A linear envelope can be used to provide an envelope that represents a profile of the myoelectric activity of the muscle over time. The electronic process involved includes rectification of the raw signal and then a passing of the signal through a low pass filter that follows the peaks and valleys of the rectified signal. The combination of the full-wave rectifier followed by a low pass filter is often called a linear envelope detector. Different filters provide different information.³⁹ The differences in the type of filter (eg, first order or Paynter) are discussed by Gottlieb and Agarwal.⁴⁰ The effects of different window lengths for smoothing are presented by Herschler and Milner.³⁹ The ergonomist should be warned that the specific devices used may affect the interpretation. The characteristics of the filter, therefore, should always be stated.

Inman and associates referred to this process as integration for "lack of a better name"¹⁷ Note should be made, however, that the linear envelope process, although related to integration, is not true integration.^{17,39}

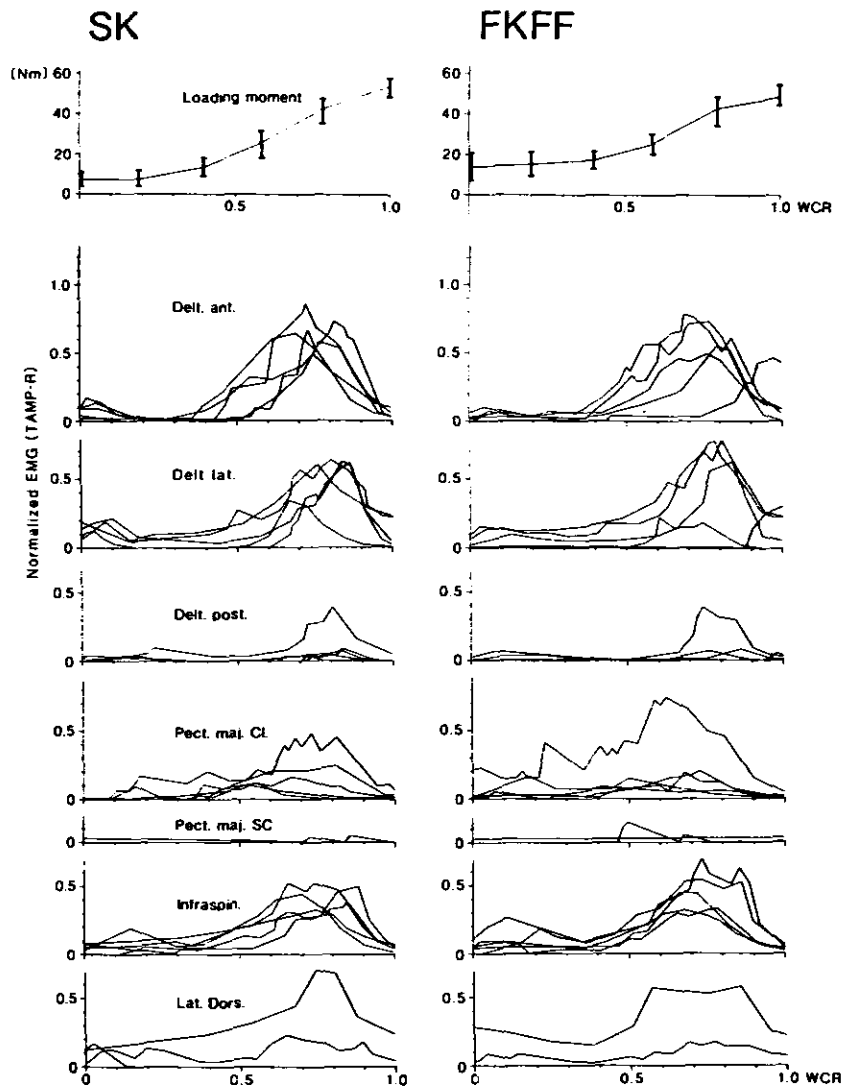

FIGURE 5-6

The upper left and right graphs show the loading moment of force (mean with 95% confidence intervals) for the SK and FKFF lifts. Time is expressed as a working cycle ration (WCR). The other graphs show individual muscular activity curves from five individuals from seven muscles: anterior, lateral (middle) and posterior parts of clavicular and sternocostal portions of pectoralis, infraspinatus, and latissimus dorsi. Activity norm TAMP-R. "Segmentation" of curves is a result of process. "Missing" curves indicate absence of act.

Reprinted with permission from Arborelius UP et al: Shoulder joint load and muscular activity during lifting. Scand J Rehab Med 18:71-82, 1986, Figure 2, p 74.

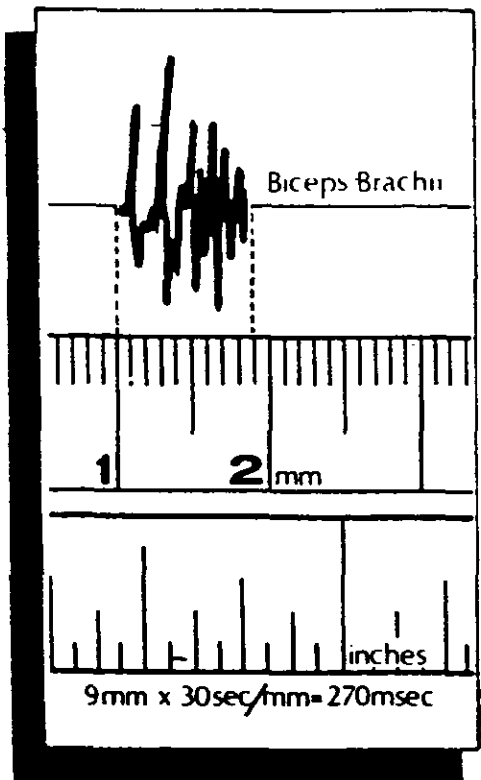

FIGURE 5-7

Measurement of movement time from a recording of an EMG interference pattern.

Reprinted with permission from Sofranek MG et al: Effect of auditory rhythm on muscle activity. Phys Ther 62:161-168, 1982, Figure 4, p 164.

The processed signal leaves the baseline when the myoelectric signal is greater than zero. The analog representation rises with the increase in muscle activity and falls with the decrease of muscle activity. The curve returns to zero, or baseline, when the muscle is relaxed. Thus, the linear envelope displays a pattern that reflects changes in the state of the muscle contraction (Figure 5-12). The evaluation of this signal provides an instantaneous muscle activity in millivolts that can then be related to a specific motion or position.⁴¹ The myoelectric signal has been found to lag behind the production of tension by about 60 to 100 ms. Further delays can result from the instrumentation features (see Chapter 4). The signal, therefore, does not perfectly identify the mechanical event, although it is a good reflection. An event marker of some kind is recommended as an indicator of the mechanical event.

Numerous researchers have used the linear envelope to describe the myoelectric activity that occurs during various activities. Studies have been performed to determine upper limb muscle activity during various tasks,^{3,4,17,18,28,29,31,42-44} trunk muscle activity,^{6,24,45-47} and muscle activity of the lower limbs during locomotion.^{27,31,39,42,48-50} Figures 5-5, 5-6, 5-13, and 5-14 show different ways of presenting this information.

The information obtained from the linear envelope includes the onset and duration of the muscle activity, the instantaneous muscle activity, and the pattern of muscle contraction. The technique is widely applicable in studies of periodic activity such as work-rest cycles and activities where repetitions could be averaged over an interval of time. An EMG from either the upper or lower extremities or the trunk can be subjected to this form of analysis.

Root Mean Square

The root-mean-square (RMS) voltage is the effective value of the quantity of an alternating current. The true RMS value of a myoelectric signal measures the electrical power in the signal.⁵¹ The method of obtaining this measure is presented in Chapter 4. It gives a linear envelope of the voltage, or a moving average over time. Therefore, the RMS wave form is similar to the linear envelope (Figure 5-15).³⁴ In combination with a positive or time indicator, it provides an instantaneous measure of the power output of the myoelectric signal. The RMS value depends on the number of motor units firing, the firing rates of the motor units, the area of the motor unit, the motor unit duration, the propagation velocity of the electric signal, the electrode configuration, and the instrumentation characteristics.^{10,52}

DeVries determined the efficiency of electrical activity as a physiological measure of the functional state of muscle tissue, using the RMS values as an indication of myoelectric activity.⁵³ The force and RMS values were linearly related, but the slopes of the lines were different for subjects of different strengths. Some investigators have continued with this application of EMG, but generally the methods have not been widely used. Some application in ergonometry probably exists. Another basic study was completed by Lawrence and DeLuca, who investigated whether the normalized EMG from surface electrodes versus normalized force relationship varies in different human muscles and whether this relationship depends on training and rate of force production.¹ They used RMS values because the RMS more completely represents motor unit behavior during muscle contraction.

Lind and Petrofsky studied the myoelectric amplitude during fatiguing isometric contractions, a condition potentially occurring at various work sites.⁵⁴ The

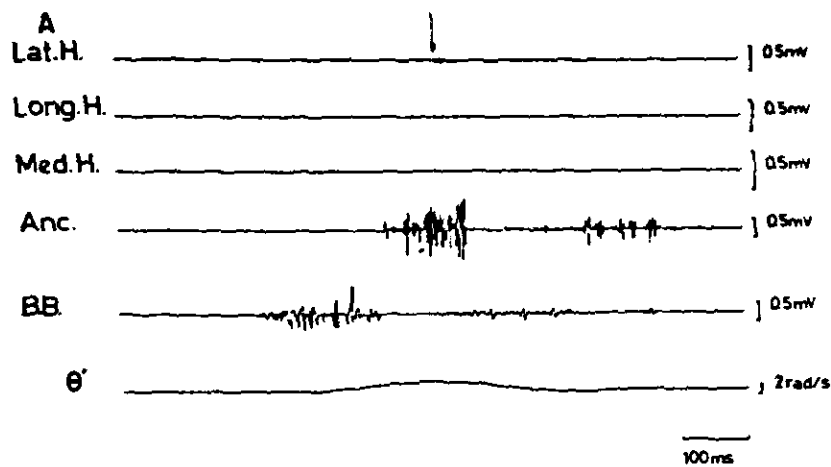

FIGURE 5-8 A

Typical records of flexion movements performed against one inertial load ($I_0 = 0.021 \text{ kg}\cdot\text{m}^2$) slow movement. Lat. H: surface EMG of lateral head of the triceps muscle. Long. H: surface EMG of long head of the triceps muscle. Med. H: surface EMG of medial head of the triceps muscle. Anc.: surface EMG of anconeus muscle. B.B.: surface EMG of biceps brachii. θ' : angular velocity. \uparrow : the arrow represents the onset of activity of the lateral head. (1) first burst; (2) second burst.

Reprinted with permission from Maton, et al: The synergy of elbow extensor muscles during dynamic work in man: II. Braking elbow flexion. Eur J Appl Physiol 44:279-289, 1980, Figure 1 A.

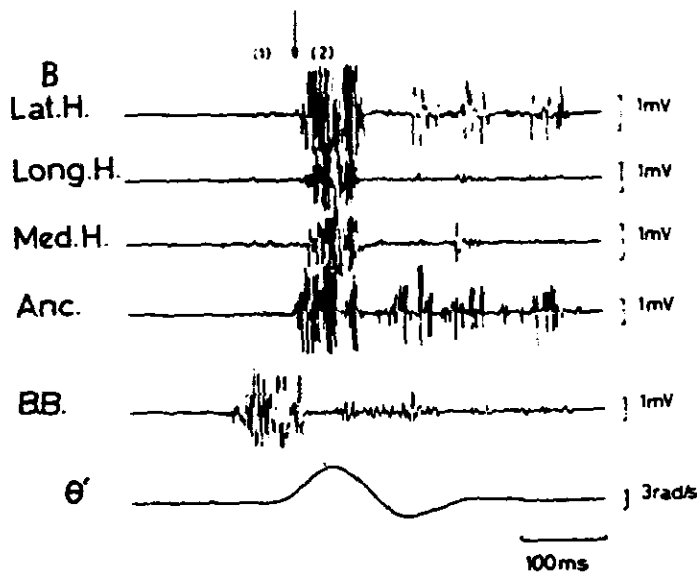

FIGURE 5-8 B

Typical records of flexion movements performed against one inertial load ($I_0 = 0.021 \text{ kg}\cdot\text{m}^2$) fast movement. Lat. H: surface EMG of lateral head of the triceps muscle. Long. H: surface EMG of long head of the triceps muscle. Med. H: surface EMG of medial head of the triceps muscle. Anc.: surface EMG of anconeus muscle. B.B.: surface EMG of biceps brachii. θ' : angular velocity. \uparrow : the arrow represents the onset of activity of the lateral head. (1) first burst; (2) second burst.

Reprinted with permission from Maton, et al: The synergy of elbow extensor muscles during dynamic work in man: II. Braking elbow flexion. Eur J Appl Physiol 44:279-289, 1980, Figure 1 B.

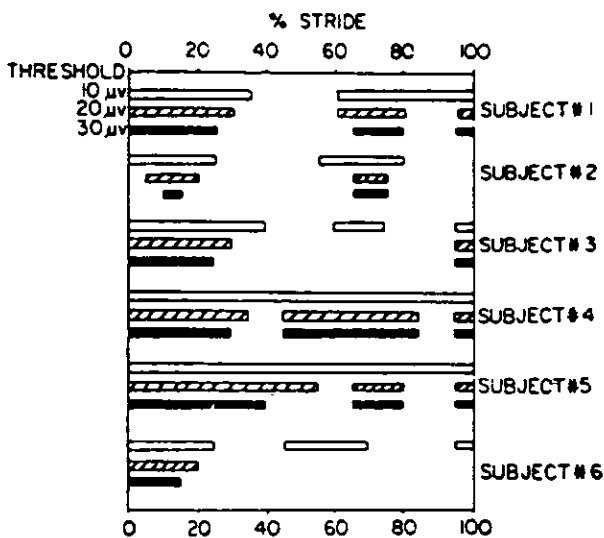

FIGURE 5-9

Phasic patterns as derived from profiles for the rectus femoris muscle with three arbitrarily chosen thresholds: $10 \mu\text{V}$, $20 \mu\text{V}$, and $30 \mu\text{V}$. Depending on the subject and the threshold, considerable discrepancy would result in defining a "normal" pattern against which to compare patients.

Reprinted with permission from Winter D: Pathologic gait diagnosis with computer-averaged electromyographic profiles. Arch Phys Med Rehabil 65:393-395, 1984, Figure 3, p 394.

RMS values were linearly related to the exerted force. With prolonged contractions of 25% MVC, the myoelectric amplitude decreased as the force decreased. They found that intrasubject values revealed linearity, but a large intersubject variation was present for the absolute amplitude. In a subsequent study, Petrofsky and Lind used RMS amplitude measures to determine the influence of different temperatures on the myoelectric signal during brief and fatiguing isometric contractions.⁵⁵ Hand gripping was the activity studied. The RMS amplitude was calculated over 1.5-second periods from digitized EMG. The normalized RMS amplitude during the brief isometric contractions showed a linear relationship with force after limb immersion in water of temperatures at 30° and 40°C , but demonstrated a curvilinear relationship after limb immersion in water of temperatures at 10° and 20°C (Figure 5-16). The normalized RMS amplitude of the EMG progressively increased during sustained contractions for all four water temperatures.

In considering the work site, Hagberg and Sundelin studied the load and discomfort of the upper trapezius for secretaries using a word processor.⁵⁶ They used an

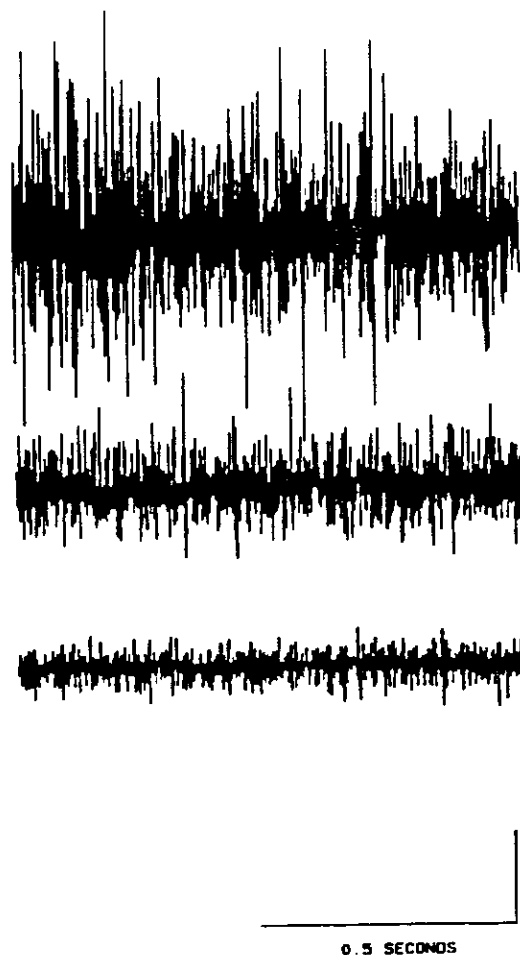

FIGURE 5-10

Surface EMG data of hand intrinsic muscles reveal maximum activity with narrowest (top tracing) dynamometer handle spacings with relatively little activity at widest handle spacing (bottom tracing).

Reprinted with permission from Janda DH et al: Objective evaluation of grip strength. J Occup Med 29:569-571, 1987, Figure 2, p 570.

amplitude probability distribution function of RMS-detected signals for specific loads and for five-hour work periods. They found a static work level of approximately 3.0% of the MVC for the upper trapezius muscle over the length of the work period. Their results are displayed in Figures 5-17 and 5-18. Five other but separate studies of myoelectric changes with muscle fatigue have been presented by Jorgensen et al.⁵⁷ Root-mean-square determinations were used to evaluate changes in the myoelectric amplitude. Increases in amplitude were recorded for

TIB A.

Fig. 1. EMG activity of AT during trace level MMT.

FIGURE 5-11 A

Electromyographic activity of anterior tibialis muscle during tracelevel manual muscle test.

Reprinted with permission from Perry et al: Predictive values of manual muscle testing and gait analysis in normal ankles by dynamic electromyography. Foot Ankle 6:254-259, 1986, Figure 1, p 256.

TIB A



Fig. 2. EMG activity of AT during fair level MMT.

FIGURE 5-11 B

Electromyographic activity of anterior tibialis muscle during fair level manual muscle test.

Reprinted with permission from Perry et al: Predictive values of manual muscle testing and gait analysis in normal ankles by dynamic electromyography. Foot Ankle 6:254-259, 1986, Figure 2, p 256.

TIB A



FIGURE 5-11 C

Electromyographic activity of anterior tibialis muscle during maximum level manual muscle test.

Reprinted with permission from Perry et al: Predictive values of manual muscle testing and gait analysis in normal ankles by dynamic electromyography. Foot Ankle 6:254-259, 1986, Figure 3, p 256.

both continuous and intermittent work. The studies revealed that different muscles respond differently in that the change in myoelectric amplitude for the triceps brachii was more pronounced than the change in amplitude of the biceps brachii.

The concept of static load was studied by Jonsson.⁵⁸ He looked at examples of actual work situations using RMS analyses to determine their load levels. The static component of muscle activation was considered to be the lowest level of muscular activation recorded during the work period. The dynamic component was considered to be the load levels above the static level (Figure 5-19). He discussed the possibility of job rotation to reduce the static load level during a full work day (Figure 5-20).

A number of other studies including ergonomic elements have been performed using RMS analysis.

A few examples are given for reference. Winkel and Bendix²⁰ studied muscular performance during seated work, Hagberg and Sundelin⁵⁶ studied the use of a word processor, and Andersson et al²¹ the activity of trunk muscles during desk work. Given these examples and the work now appearing in the literature, this is a widely accepted form of EMG processing used for ergonomic environments. The output form is similar to the linear envelope detector, but it represents a somewhat better mathematical representation of the original.

Integration

The total amount of muscle activity occurring during any given time interval is represented by the area under the curve during that time interval. The process for determining this area is called integration. Integration may be done manually or electronically. A simple way to determine the area under the curve is to trace the curve on paper, cut out the curve, and weigh the enclosed area.³⁸ In other cases, researchers have used a planimeter to evaluate the area under the curve.^{7,22} Bigland and Lippold⁸ found that electrical processing and planimetry give similar results. Most researchers are now using electronic integration (see Chapter 4).

Integrated electromyography (IEMG), evaluating the area under the curve, is a continuous evaluation of that area. The IEMG signal, therefore, increases as long as any myoelectric activity is present and decreases in slope as there is less myoelectric activity. The amplitude measure at any time along the curve represents the total electrical energy summed from the beginning of the activity. Because the IEMG curve keeps increasing, the curve may need to be reset to zero for practical purposes. This reset can be done either at fixed time intervals (time reset) or at a predetermined amplitude (level reset). Appendix B, Figure 5, contains a comparison of these various techniques. Because IEMG depends on the amplitude, duration, and frequency of the action potentials, it represents the number of active motor units.

The continuous increase in the integrated signal as the raw myoelectric signal remains constant as shown in Figure 5-21,⁹ where the integrated and raw myoelectric signals are shown in relation to a static force. Nelson and associates recorded the myoelectric signal of the soleus muscle during isokinetic movements of ankle plantar flexion and dorsiflexion.⁵⁹ The change in the raw myoelectric signal is reflected by a change in the slope of the integrated signal. When the muscle activity is high, the slope of the integrated signal is steep. At lower levels of muscle activity, the signal tends to plateau (Figure 5-22). Note that as the contractions continue, the integrated signal continues to move away from the baseline. If the task has a long duration, this can lead to confusion in the

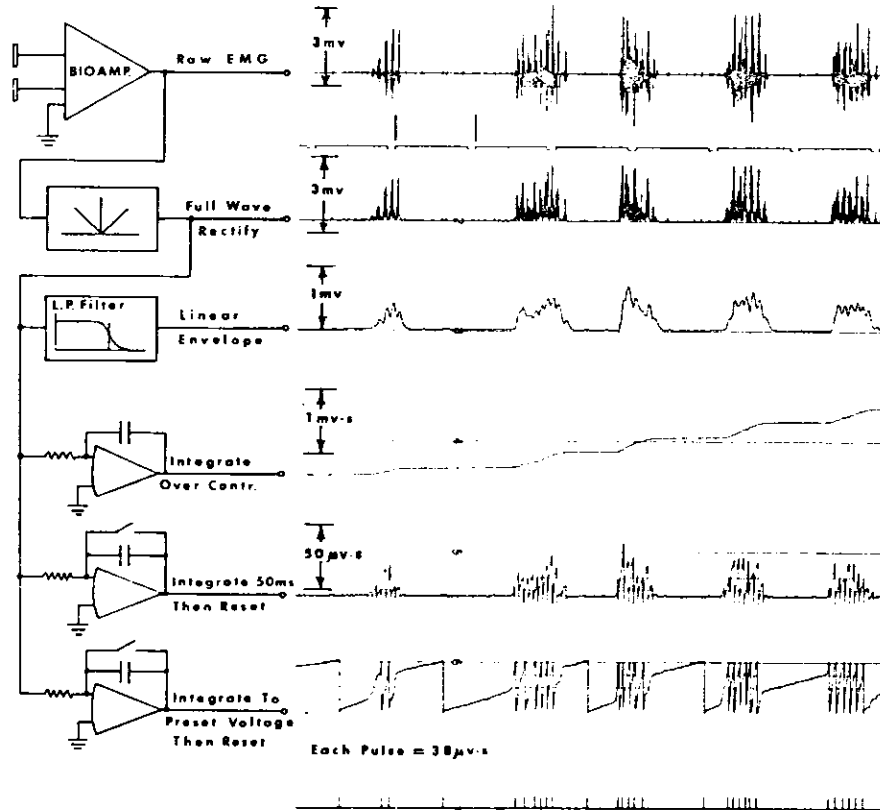

FIGURE 5-12

Example of several common types of temporal processing of the EMG.

Reprinted with permission from: Units, Terms and Standards in the Reporting of EMG Research. Report by the Ad Hoc Committee of the International Society of Electrophysiological Kinesiology, August, 1980, Figure 5, p 9.

recordings, that is, the lines from the integrated signal may cross into the line of the raw signal. An example of level reset is illustrated in Figure 5-23.⁶⁰ Numerous other researchers have used time or level reset integration to study muscle activity.^{19,60-64} To obtain the integrated values from time reset, the investigator sums the value of the peaks over the desired contraction time. To obtain the integrated values from level reset, the investigator counts the number of resets times the level value for the period of the contraction.

The integrated myoelectric signals may also be collected over a short time span during a cyclic activity, such as occurs during the performance of jobs. Such a procedure was used by Jorge and Hull and is shown in Figure 5-24.⁶¹ The rectified signal was integrated over 75 ms segments during the period of cycle, or 360 degrees. This method provided 10 integrated myoelectric values

representing 36 degree intervals for the period. The average normalized electrical activity for the interval of interest can then be evaluated and compared with other intervals, muscles, or tasks. Figure 5-25 shows how Gregor and associates treated similar information.²⁵

Integration of the myoelectric signal provides a measure of the number of active motor units and their rate of firing. It can provide information concerning the on-off time and the relative myoelectrical activity of the muscle over a set time period. Thus, as a form of output, the data can be analyzed in ways similar to those used for either the linear envelope detector or the RMS. Often, the selection is based on available equipment simply because there is neither a prescribed technique nor a prescribed standard that must be met for studies in the area of ergonomics.

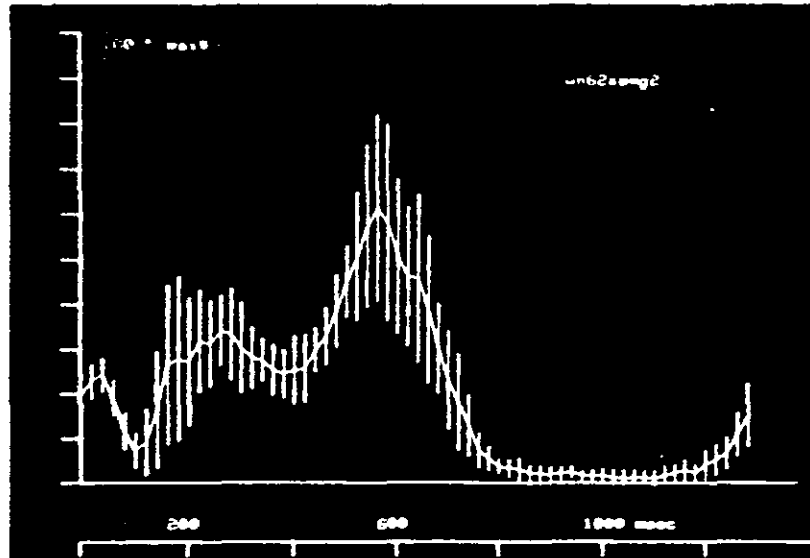

FIGURE 5-13

Average of linear envelope of soleus muscle over 10 walking strides. Contraction was normalized to 100% MVC, and standard deviation at each point in time is shown by vertical bars.

Reprinted with permission from Dainty D, Norma R: Standardizing Biomechanical Testing in Sport. Champaign, IL, Human Kinetic Publ Inc, 1987, Figure C.4, p 120.

Frequency Analysis

The myoelectric signal consists of a series of action potentials firing at certain frequencies. Frequency analysis (spectral, harmonic, Fourier) decomposes the myoelectric signal into sinusoidal components of different frequencies. As described in Chapter 4, frequency analysis can be done either by passing the raw myoelectric signal through a series of electronic filters and plotting the result or by digitizing the data and using a computer to analyze the data and present it in a smooth spectrum over a given frequency range. This frequency analysis gives the energy distribution of the signal as a function of frequency. It detects the amplitude of common frequencies of the signal. The power spectrum of the interference pattern, thus, essentially reflects the properties of the individual components. A lengthy and detailed description of the power spectrum and its analysis has been written by Lindstrom and Petersen.⁶⁵

The power spectrum may be presented in linear, logarithmic linear, or double logarithmic scales. The power spectrum with linear scales is measured in volts squared per hertz (V^2/Hz). The decibel (dB) unit is used if the scale for power, energy, or amplitude is logarithmic.

The power spectrum of the total signal reveals the component individual motor unit properties. The area under the power spectral curve equals the signal power. The frequency power spectrum shows only smaller upward shifts in the frequency spectrum as the force of the contraction increases. This increase occurs at low levels of tension, but after about 50% of the MVC, the frequency values no longer increase.

A common use of power spectrum analysis has been the evaluation of local muscle fatigue. With a sustained muscle contraction, the high frequency components of the signal decrease, but the low frequency components gradually increase. This change results in a shift in the power spectrum toward the lower frequencies.⁶⁶

The two most reliable measures of the power spectrum are the mean frequency and the median frequency (Figure 5-26). The mean frequency is the average of all frequencies. The median frequency is that frequency having 50% of the frequency distribution on each side. The median frequency appears to be less sensitive to noise than the mean frequency.

The shift of frequency spectrum may be caused by such factors as follow:

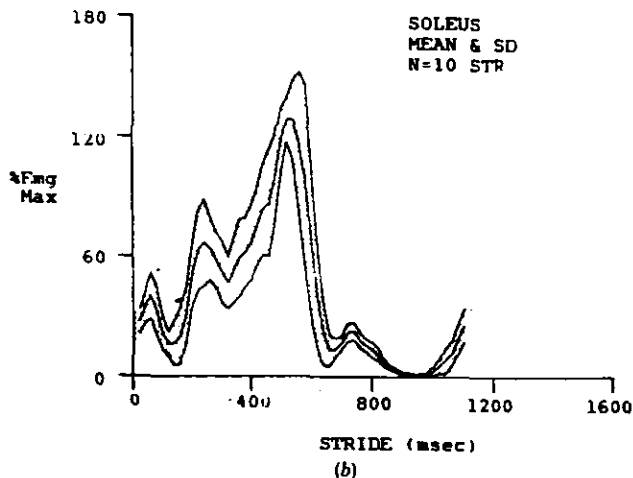
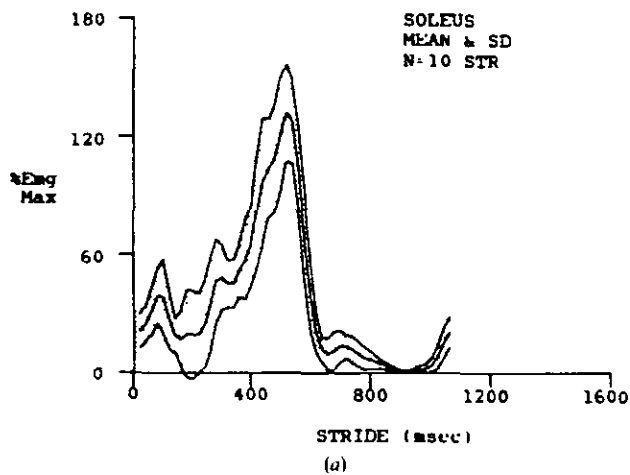

FIGURE 5-14

Summary of the left soleus muscle activity for 10 strides of walking on (a) walkway and (b) treadmill for one subject. The 0-0 msec point on the abscissa corresponds to heel strike (HS). The ensemble average of 10 strides along with plus and minus one standard deviation (SD) for each sample of ten points are represented (sampling frequency at 50 Hz).

Reprinted with permission from Arsenault, et al: Treadmill versus walking locomotion in humans: An EMG study. Ergonomics 29:665-676, 1986, Figure 1, p 669.

1. Synchronization of motor units.^{65,67}
2. Increase and decrease in recruitment of motor units.⁶⁵
3. Dysfunction of muscle spindles.⁶⁵

4. Combination of synchronization and desynchronization.⁶⁵
5. Change in shape of the motor unit signals.⁶⁵
6. Propagation velocity changes.^{65,68}
7. Intramuscular pressure changes.⁶⁹

Evaluation of spectral shifts of the myoelectric signal has allowed for the study of fatigue during a variety of job conditions. Chaffin presented the results of the change in the myoelectric frequency following exhausting contractions.³³ The shift in the frequency during a prolonged contraction occurs because of the increase in the low-frequency power from about 17% in the rested condition to over 60%. Figure 5-27 reveals this shift in center frequency from above 40 Hz to below 30 Hz.³³

Several other researchers have used frequency analysis to determine the presence of fatigue in a muscle following a specific task.^{32,55,70-80} Frequency analysis was also used by Lindstrom et al to determine changes in muscular fatigue and action potential conduction velocity.⁸¹ The output signals were recorded on a logarithmic scale in decibels versus the center frequency of the filter bands that gives the power spectrum of the myoelectric signal (Figure 5-28). They noted a decrease in the center frequency, a finding that may be of interest during worksite analyses.

The use of spectral median frequency has recently been questioned as an indicator of muscular fatigue. Matthijsse and associates examined power spectral median frequency and mean power by means of Fourier analysis in relation to plantar flexor muscle contraction during a prolonged task.⁸² They found that although some subjects demonstrated a median frequency shift, no significant difference was found across subjects. They suggest that care be taken when applying median frequency analysis to determine fatigue. These warnings may be related to frequency change found by some researchers to occur as a consequence of a change in load⁸³⁻⁸⁵ or a change in muscle length.⁸⁶

Hogan and Mann studied changes in the myoelectrical signal power spectrum of the bicep brachii muscle during different muscle force levels, in different subjects, with different electrode locations and electrode configurations.⁸³ An illustration of the double logarithmic presentation of the results is shown in Figure 5-29. Gander and Hudgins used the power spectrum process to study the effect of increasing load on the biceps brachii.⁸⁴ The characteristics of median frequency and relative power were compared with torque values as shown in Figures 5-30 and 5-31.

Bazzy and associates studied the effect of a change

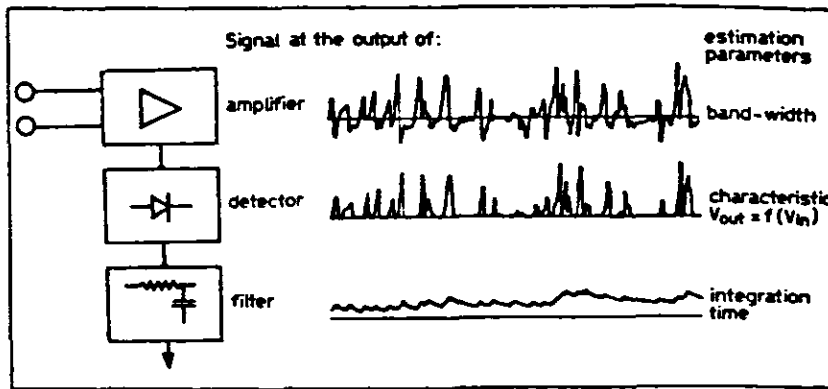

FIGURE 5-15

The "single channel"—an elementary signal processing array (left). Example of signal processing (right). Of importance, to arrive at improved estimates of the myo-electric signal level is the signal band-width, the detector characteristics, and the postdetector band-width (related to averaging time).

Reprinted with permission from Kadefors R: Myo-electric signal processing as an estimating problem. In Desmedt JE (ed): *New Developments in Electromyography and Clinical Neurophysiology*. Basel, Switzerland, Karger, 1973, vol 1, pp 519-532, Figure 1, p 522.

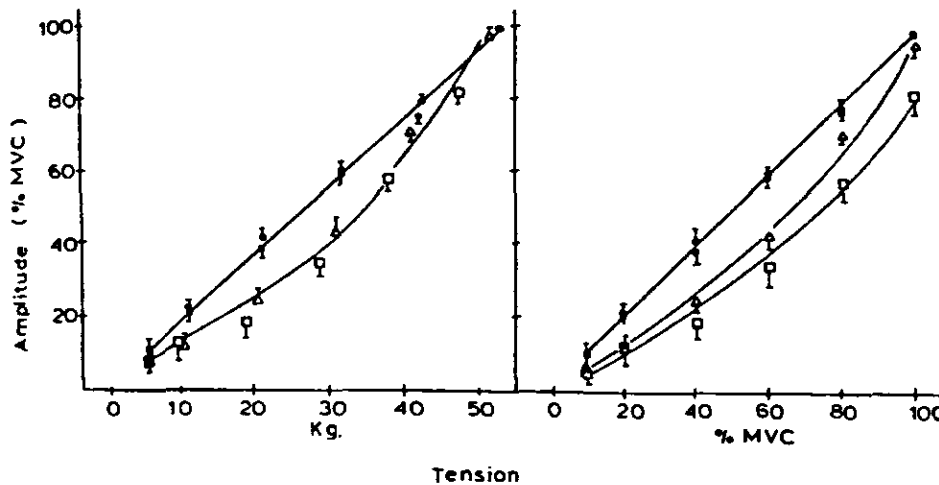

FIGURE 5-16

The RMS amplitude of the power spectra of the surface EMG during brief isometric contractions at each of four bath temperatures, 10 (\square), 20 (Δ), 30 (\circ), and 40 (\bullet) $^{\circ}\text{C}$ compared with both the relative and absolute tension developed by the muscles. Each point illustrates the mean of two experiments on each of 10 subjects \pm SD.

Reprinted with permission from Petrofsky JS, Lind AR: *The influence of temperature on the amplitude and frequency components of the GM during brief and sustained isometric contractions*. *Eur J Appl Physiol* 44:189-200, 1980, Figure 1, p 193.

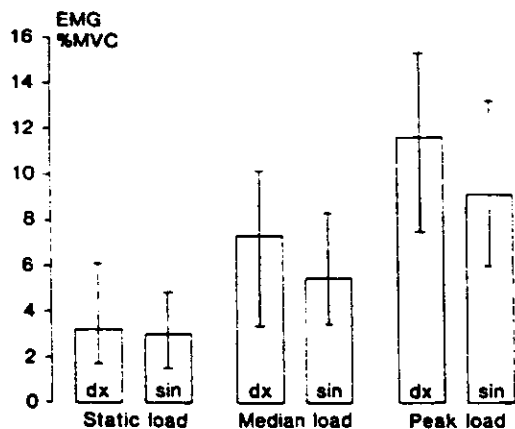

FIGURE 5-17

Median values and the first and third quartile of load levels on the right (dx) and left (sin) sides when operating a word-processor. Both the 3-hour and the 5-hour work periods are in the calculation (n = 12).

Reprinted with permission from Hagberg M, Sundelin G: Discomfort and load on the upper trapezius muscle when operating a word processor. *Ergonomics* 29:1637-1645, 1986, Figure 3, p 1642.

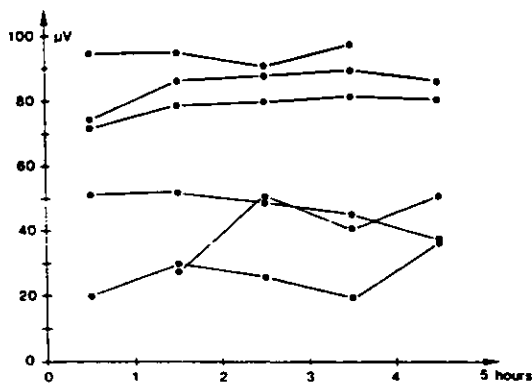

FIGURE 5-18

Hour-by-hour analysis of the 5-hour work period. Values are given in time mean RMS microvolts. The values for each operator are connected by a line.

Reprinted with permission from Hagberg M, Sundelin G: Discomfort and load on the upper trapezius muscle when operating a word processor. *Ergonomics* 29:1637-1645, 1986, Figure 4, p 1642.

in the muscle length upon the frequency content of the myoelectric signal.⁸⁶ They found that the length at which a muscle isometrically contracts can alter the mean centroid frequency of the signal. The results of one of their subjects is presented in Figures 5-32 and 5-33.

In summary, some investigators have demonstrated changes in the EMG with fatigue. Most of these experiments have been published within the last years, and there is now effort being made to clarify the relationships and meaning. Any ergonomist proposing to use these techniques needs to be well grounded in signal analysis techniques to use these methods and comprehend the volume of literature that will result from other studies. Because of the importance of fatigue to ergonomics, this area promises to be of significance in analyses proposed to be used in the worksite.

Zero Crossings

The number of times the raw EMG signal crosses the baseline (zero value) appears to be related to muscle contraction force. Within limits, as the muscle activity increases, the frequency increases, resulting in more zero crossings. The frequency of zero crossings can easily be counted electronically. As with the earlier mentioned frequency values, zero crossing values do not increase at high levels of muscular effort. At about 60% of the maximal voluntary contraction the zero crossings count levels off (Figure 5-34).⁸⁷ Interpretation of quantitative data, therefore, is not always simple.

Because the use of spectral changes in the myoelectric signal as a valid indicator of muscle fatigue have been questioned, Hagg and associates⁸⁸ and Suurkula and Hagg⁸⁹ have used a frequency analysis based on zero crossings, to study shoulder and neck disorders in assembly line workers. They believe that the results are promising and suggest that the technique is valuable for ergonomic studies at the workplace. Given the availability of other techniques, however, there may not be much emphasis forthcoming on this form of analysis.

Spike Countings

Bergstrom manually counted the number of positive and negative spikes, or peaks, of the raw myoelectric signal.⁹⁰ Spikes can also be counted by electronic methods. Spikes of low amplitude are given equal value to spikes of high amplitude. The total count appears to be related to the amount of muscle activity. The number of spikes increases linearly with increasing contraction force to about 70% of MVC and then levels off.

Robertson and Grabiner compared two methods of counting spikes of the myoelectric signal values obtained by an integrated process: digital spike counting

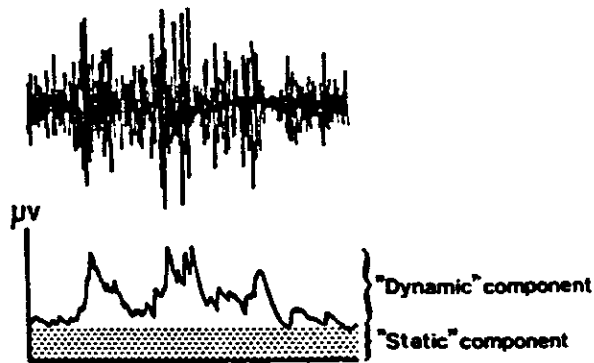

FIGURE 5-19

Raw EMG and the corresponding RMS detected and low pass filtered EMG signal for approximately 6s of activity. The muscular load may be subdivided into a "static" component and a "dynamic" component.

Reprinted with permission from Jonsson B: *The static load component in muscle work. Eur J Appl Physiol* 57:305-310, 1988, Figure 1, p 305.

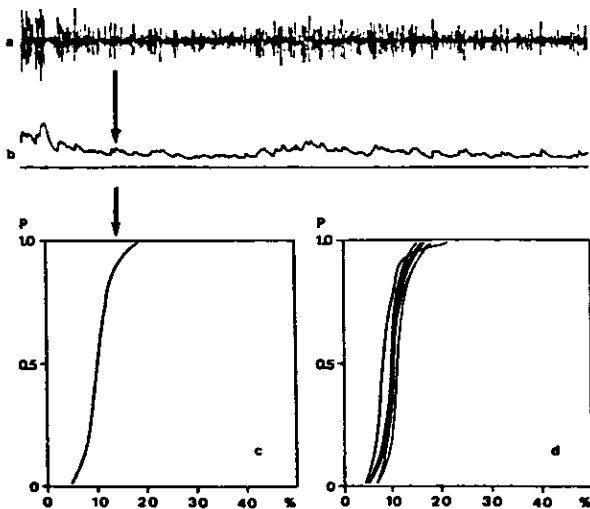

FIGURE 5-20

Raw EMG and the upper portion of the right trapezius (a), with the corresponding RMS detected and low pass filtered EMG (b), and the amplitude probability distribution curve (c), for one assembly task in an electronic industry (assembling telephone jacks), as well as the amplitude probability distribution curves for all six tasks involved in the job rotation (d).

Reprinted with permission from Jonsson B: *The static load component in muscle work. Eur J Appl Physiol* 57:305-310, 1988, Figure 2, p 307.

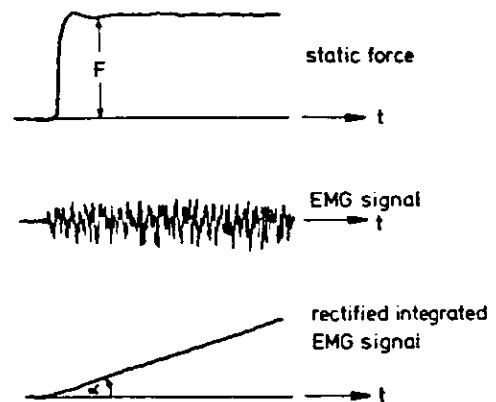

FIGURE 5-21

Registration of the force, the EMG signal, and the rectified and integrated EMG signal (schematically). The angle was evaluated as a measure of the total EMG activity.

Reprinted with permission from Rau G, Vredendregt J: *EMG-force relationship during voluntary static contractions (m. biceps). In Cerquiglioni S, et al (eds): Biomechanics: III. Medicine and Sport. Baltimore, MD, University Park Press, 1973, vol 8, pp 270-274, Figure 1, p 272.*

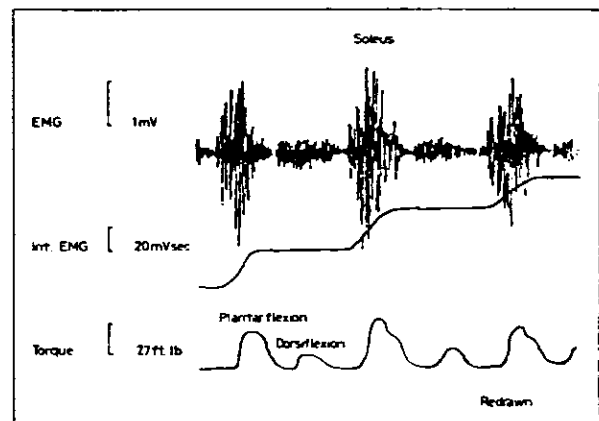

FIGURE 5-22

Recording of isokinetic movement at 216°/s. From above downward, soleus EMG, integrated EMG, torque, of ankle plantar flexion and dorsiflexion.

Reprinted with permission from Nelson AJ, et al: *The relationship of integrated electromyographic discharge to isokinetic contractions. In Desmedt JE (ed): New Developments in Electromyography and Clinical Neurophysiology. Basel, Switzerland, Karger, 1973, vol 1, pp 584-595, Figure 1, p 586.*

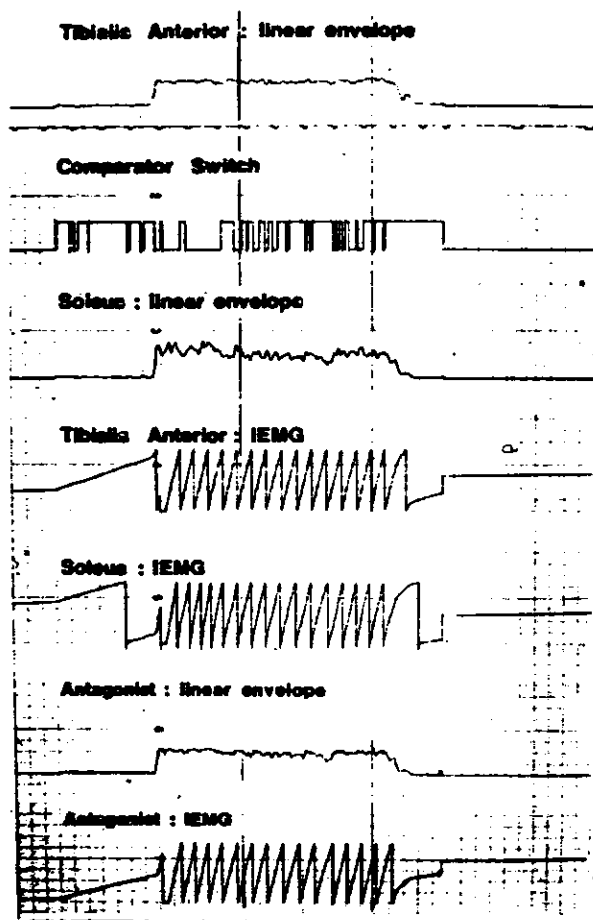

FIGURE 5-23

Typical processed EMG signals required for the co-contraction calibration. If linear envelope of tibialis anterior and soleus are identically equal during this voluntary isometric co-contraction, the IEMG of each muscle will be equal and will be equal to the antagonist IEMG. However, 100% co-contraction is not quantified because of the momentary imbalance in muscle activity, and the normal noise present in the linear envelope signal; levels of CC are 90% or higher.

Reprinted with permission from Falconer K, Winter DA: Quantitative assessment of co-contraction at the ankle joint in walking. *Electromyogr Clin Neurophysiol* 25:135-149, 1985, Figure 3, p 141.

(Figure 5-35 A) and manual spike counting (Figure 5-35 B). Four levels of muscle force productions (25%, 50%, 75%, 100%) were analyzed. Digital spike counting was done for three separate levels of amplitude (25%, 50%, 75%), each providing different counts. Manual spike counting showed little ability to discriminate among the four force levels and had a nonsignificant relationship with IEMG (Figure 5-36). The digital spike counting increased its level of correlation with IEMG, with increases in the amplitude level to 75% ($r = .37$). Although at 50% and 75% levels a significant relationship was found between digital spike counting, this relationship has little practical meaning for the ergonomist.

Turns

The number of times the myoelectric signal changes direction also is related to the frequency of the raw signal. Several turns may occur without the signal crossing the baseline. A turn is defined as that point where the direction of the signal changes following an amplitude difference of more than 100 mV. The number of turns increases rapidly as muscle force of low levels increases, but increases very slowly at high levels of muscle force. The number of turns reaches its maximum before the maximum muscle force is reached. Turns analysis discriminates well between low level muscle forces, but it discriminates poorly at high levels.⁹²

This method is used more often in clinical studies with needle electrodes than in kinesiological studies. Thus, the application to ergonomics is very limited.

APPLICATIONS

In this section, the methods that can be used to evaluate the myoelectric signal are summarized. The instrumentation used to obtain each type of signal is detailed in Chapter 4, and the factors that may affect the interpretation are discussed in more detail in Chapter 6.

Linear Envelope

The linear envelope is obtained after full wave rectification of the raw signal followed by filtering (using a linear envelope detector). The filter must have a sufficiently short time constant to follow changes in the myoelectric changes and must be long enough to produce effective averaging (25-300 msec).¹³ The resistive-capacitive (RC) network should have a time constant greater than the spike duration.⁹⁵ The RC network has a slow roll-off for frequencies above its cutoff time constant. Thus, long time constants must be used to provide sufficient smoothing of brief, high amplitude peaks.⁵² A Paynter or Butterworth filter may be used, but such filters may have difficulty providing a variable time constant.⁵²

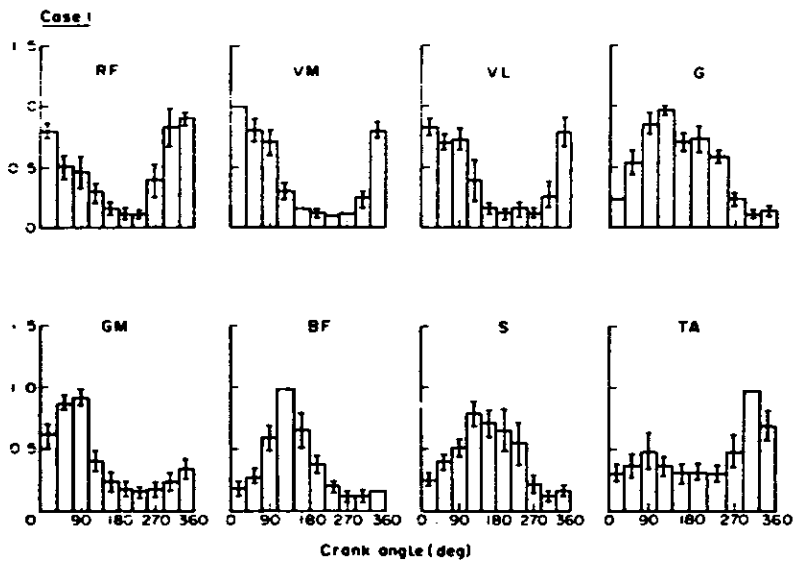

FIGURE 5-24

Average IEMG results for the eight muscles. Vertical lines indicate $\pm \frac{1}{2}$ SD.

Reprinted with permission from Jorge M, Hull ML: Analysis of EMG measurements during bicycle pedaling. J Biomech 19:683-694, 1986, Figure 5, p 689.

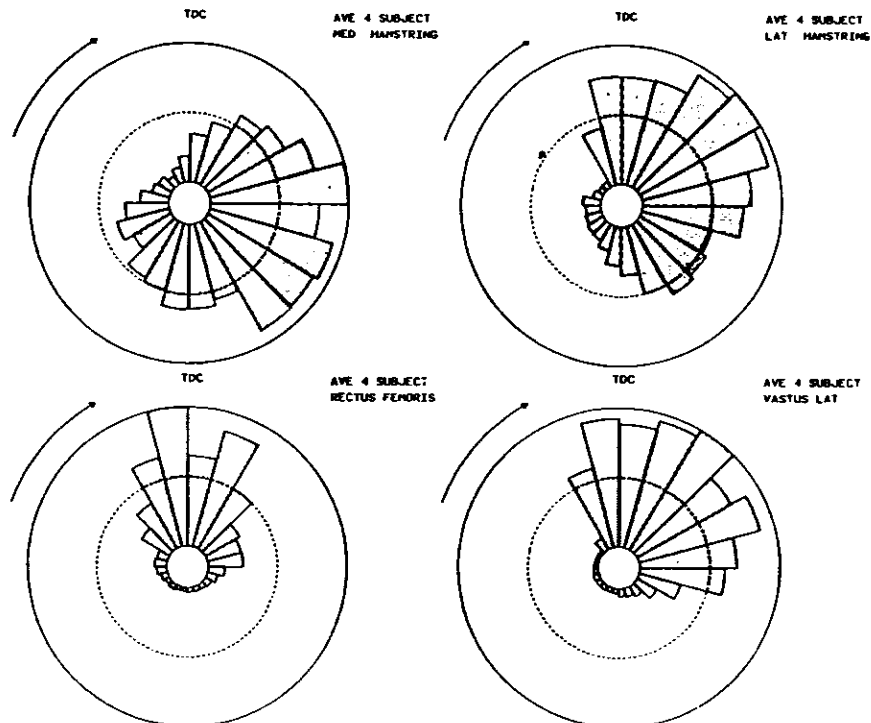

FIGURE 5-25

Average integrated EMG patterns for the medial hamstring, lateral hamstring, rectus femoris, and vastus lateralis muscles. Each shaded section represents percentage of maximum activity over 15° of the pedaling cycle in four of the five subjects. The dashed line represents 50% of maximum activity observed in that muscle.

Reprinted with permission from Gregor RJ et al: Knee flexor moments during propulsion in cycling: A creative solution to Lombard's Paradox. J Biomech 18:307-316, 1985, Figure 6, p 113.

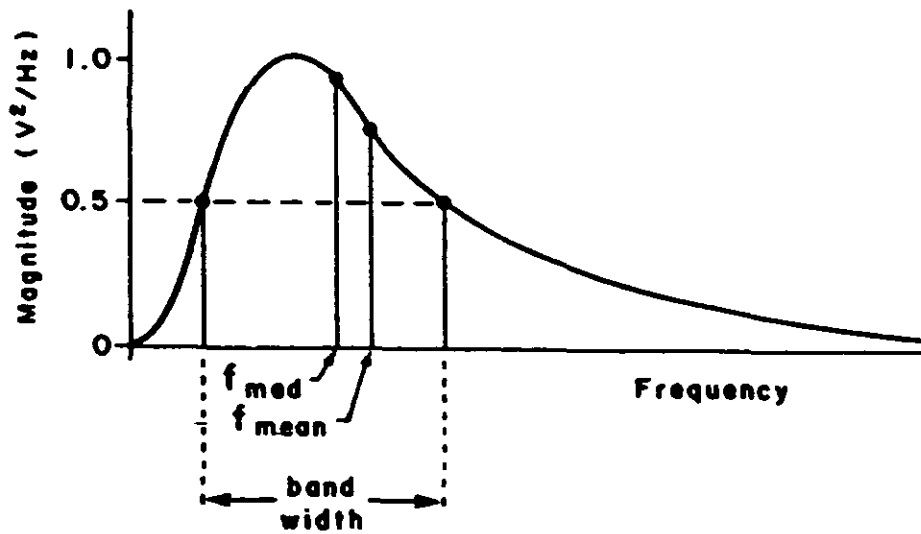

FIGURE 5-26

An idealized version of the frequency spectrum of the EMG signals. Three convenient and useful variables: the median frequency, f_{med} ; the mean frequency, f_{mean} ; and the bandwidth are indicated.

Reprinted with permission from Basmajian JV, DeLuca CJ: *Muscles Alive: Their Functions Revealed by Electromyography*, ed 5. Baltimore, MD, Williams & Wilkins, 1985, Figure 3.16, p 99.

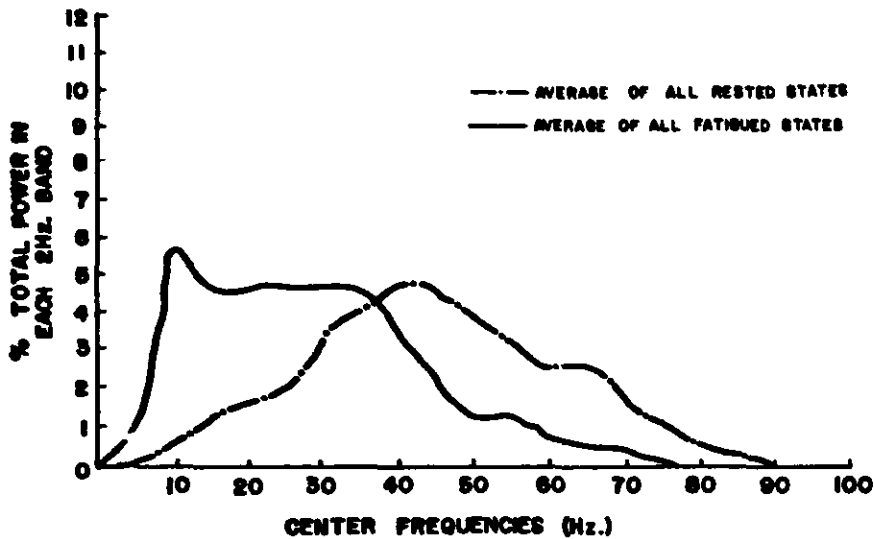

FIGURE 5-27

Average EMG spectra with reference to fatigue level.

Reprinted with permission from Chaffin DB: *Localized muscle fatigue: Definition and measurement*. *J Occup Med* 15:346-354, 1973, Figure 2, p 347.

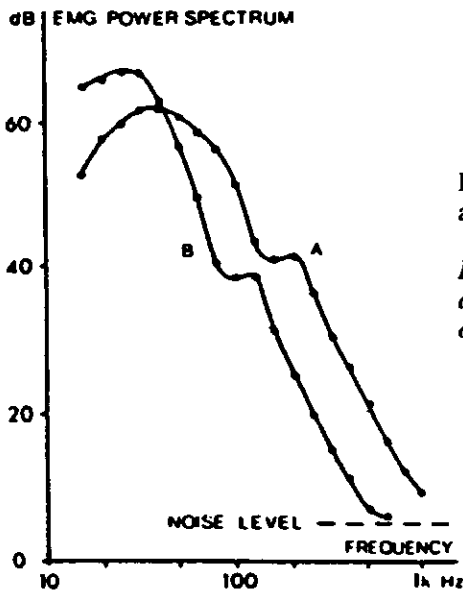

FIGURE 5-28

Electromyographic power spectra obtained at 2 kilopond loads. A) Before, and B) after 30-seconds maximum load.

Reprinted with permission from Lindstrom L et al: Muscular fatigue and action potential conduction velocity changes studies with frequency analysis of EMG signals. Electromyography 10:341-356, 1970, Figure 2, p 347.

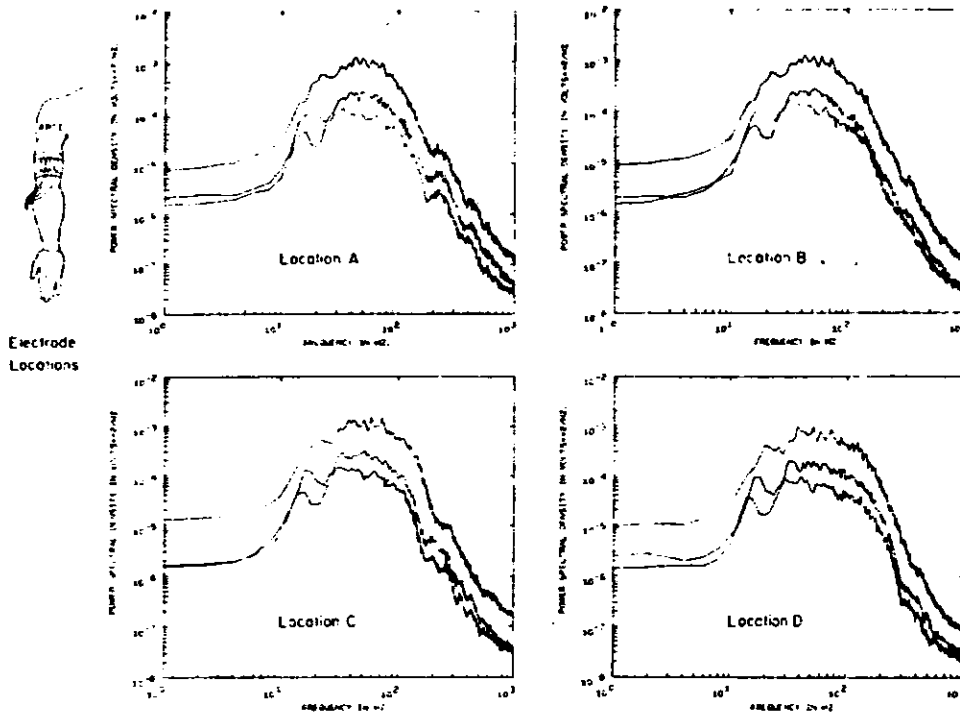

FIGURE 5-29

Logarithmic plots of myoelectric signal power spectra obtained at three contraction levels (5%, 10%, and 25% of maximum voluntary contraction) from four locations across the biceps brachii of able-bodied subject D.L.

Reprinted with permission from Hogan N, Mann RW: Myoelectric signal processing: Optimal estimation applied to electromyography: II. Experimental demonstration of optimal myoprocessor performance. IEEE Trans Biomed Eng 27:396-410, 1980, Figure 5, p 399.

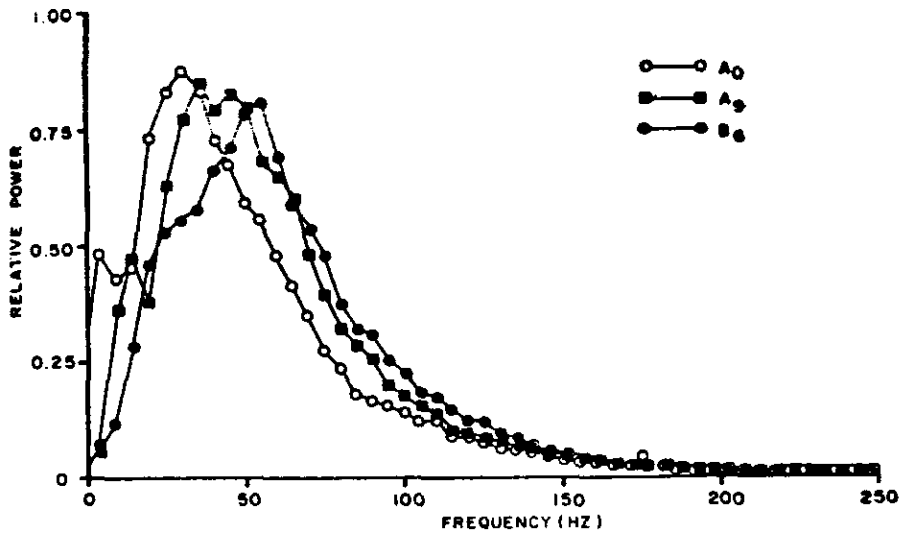

FIGURE 5-30

Average power spectra for all six subjects; each point is the mean of 22 values 0 - 0.2 Nm applied torque; ■ - ■ 9 Nm applied torque; • - • 35 Nm applied torque.

Reprinted with permission from Gander RE, Hudgins BS: Power spectral density of the surface myoelectric signal of the biceps brachii as a function of static load. *Electromyogr Clin Neurophysiol* 25:469-478, 1985, Figure 2, p 473.

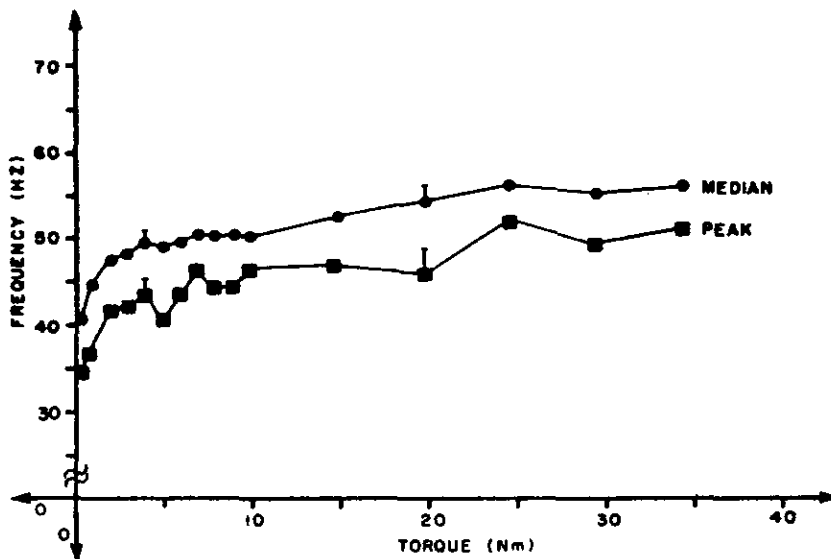

FIGURE 5-31

Median frequency (• - •) and frequency of the peak of the spectrum ■ - ■ as a function of applied torque. Each point is the mean of 22 values, and the vertical bars represent typical standard errors.

Reprinted with permission from Gander RE, Hudgins BS: Power spectral density of the surface myoelectric signal of the biceps brachii as a function of static load. *Electromyogr Clin Neurophysiol* 25:469-478, 1985, Figure 3, p 473.

The linear envelope represents the number of motor units firing their firing rate, the area of the motor unit, and the amount of cancellation from superposition.⁹⁴ The linear envelope is generally proportional to amplitude, duration, and firing rate of the motor units from the muscle being studied. It can provide relative amplitude and instantaneous amplitude information. Note that some filters may cause a lag in the envelope signal, which will affect the instantaneous signal information.^{13,38,52}

Integration

Integration requires full wave rectification followed by filtering and the use of an integrator. Digital integration algorithms may be used.⁹⁴ Integration uses all parts of the signal and represents the total amount of energy of the signal.^{38,65}

The processed signal represents the number of motor units firing, their firing rate, the area of the motor unit, and the amount of cancellation from superposition.^{38,94} Integration is proportional to motor unit amplitude, duration, and rate of firing.³⁸ It is independent of propagation velocity.⁶⁵

Integration fails to discriminate between artifacts and motor units.⁹⁴ Noise also may be a problem when recording low force level contractions. Large window (time) sampling durations may detect an unacceptably large proportion of noise when investigating low force level contractions.⁹⁵

Root Mean Square

To obtain the RMS value, a ballistic galvanometer, thermocouple, strongly damped voltmeter, or digital computer may be used.⁹³ A nonlinear detector may be used instead of a linear detector.⁷⁰ The RMS may also be calculated from the power spectrum (moment over zero) or from the squared value of the signal in the time domain.⁶⁵ The RMS voltage determination and integration techniques are essentially equivalent.⁹⁶

The RMS signal depends on the number of motor units firing, their firing rates, and the area of the motor units. The signal is affected by the cross-correlation between motor units; it does not appear to be affected by cancellation from motor unit superposition or by synchronization.⁹⁴ The signal amplitude is also inversely proportional to the propagation velocity.⁶⁵

The RMS signal has immediate relationship to the power spectrum. The curve represents the power of the myoelectric signal. The power value is equal to the area under the spectral curve.⁵² The signal amplitude is proportional to the square root of the total signal power.⁶⁵

The RMS value is usually proportional to the motor unit amplitude value,^{55,69} but is related to motor unit and firing rate by the square root.^{10,54}

The RMS signal appears to have a linear relationship with tension for brief isometric contractions.^{8,10,54,55} The RMS signal sensitivity to recruitment and firing rate is different from IEMG and yields a different relationship to the force produced.⁶⁵

The RMS values may provide inaccurate information if using them to determine fatigue, because factors other than fatigue may be affecting the signals (see Chapter 6). Use of RMS is a preferred method of interpreting the myoelectric signal.⁹⁵

Frequency Spectrum

Early investigation used octave band filters, but fast Fourier transformation (FFT) methods are now being used more frequently.¹³ The square of the magnitude of FFT is what is being analyzed. This important element in a set of mathematical and statistical concepts is ideally suited both for evaluation of the myoelectric signal and the signal generating physiological and pathophysiological mechanisms. The power spectrum provides a detailed picture of total myoelectric power valid for all levels of contraction.⁹⁷

The frequency spectrum is affected by changes in the duration and shape of the involved motor units, but not generally affected by the firing rate or amplitude. Its shape is independent of exerted force.⁹³ The mean frequency changes reflect basic physiological responses to muscular contraction and seem to be good for study of fatigue.⁵⁵

The center frequency is not affected by force of contraction except at low levels where it slightly increases with an increase in force.⁹³ The center frequency is sensitive to changes in the conduction velocity.^{30,51} Petrofsky warned that because of its response to changes in muscle temperature the center frequency may not be useful to quantify force and fatigue.⁷⁰ Baidya and Stevenson, however, state that center frequency is a reliable measure of local muscle fatigue in repetitive work.⁷³ The logarithmic scale means of presentation allows a wide dynamic range so that influences often lost in visual inspection may accurately be retained.⁹⁷

Some advantages⁶⁵ of the spectrum analysis are as follows:

1. Insensitive to interference between motor unit contributions and responds to single motor units or whole muscle signals. This characteristic extends its range and scope over conventional methods.

2. Quantitative, so it allows comparisons between repeated investigations done over a period of time.
3. Easily done on computers.
4. Provides the possibility to relate the myoelectric signal to physiologic events.

Some of the disadvantages⁶⁵ include the following:

1. Use of the FFT gives an average of the myoelectric signal, and single details may be hidden.
2. Certain measures related to recruitment of motor units and their firing rates are not shown in the spectral description.
3. Certain motor unit contributions of high amplitude or those frequently repeated will dominate the shape of the power spectrum. (This may be controlled by electrode placement.)
4. The spectrum may collect low level frequencies from other muscles, which may be interpreted as part of the investigated muscle's signal.

Zero Crossings

The information from the myoelectric signal is processed by an analog filter followed by conversion from analog to digital values. The zero crossings then are obtained by appropriate software.³⁸

Large numbers of action potentials of similar shape and size may saturate the zero count. The IEMG may be a better method to use in this situation. Lower numbers of recruited motor units may generate poorly fused and noisy integrals.³⁸ Zero crossing should be used with care at low levels. Background noise and low numbers of active motor units may invalidate the results. Appropriate levels of 20 dB above noise level should be used as test contractions.^{66,68}

Spike Countings

Spike detection requires full wave rectification followed by manual or electronic counting.⁸⁸ This method is used less now than in the past. Spike detection discards much myoelectric information and concentrates on the rate random events. The peaks may be unduly influenced by large numbers of fast-twitch, fatigable motor units than by the small less fatigable motor units.³⁸ Spike counting is more suitable for low force levels. As the myoelectric signal increases, the spikes tend to interfere with each other, and the count becomes invalid.^{13,93,98}

Turns

The number of turns are related to the number of motor units, firing rate of the motor units, duration of motor units, and number of polyphasic units.^{65,93} The number of turns increases with the increase in force at low levels up to about 30% to 50%.^{52,92,93} This method is an excellent means of discriminating between low levels of muscle activity, but it discriminates poorly at high levels.⁹⁵

SUMMARY

There are numerous forms of EMG output available to the ergonomist. This chapter provides the basis for the use of the various forms, presents research data that has been developed regarding their use, and discusses applications of these techniques to ergonomic studies. Use of these methods are important because they form the basis for understanding the muscle activity of humans during their performance of activities required to participate in any functional activity.

REFERENCES

1. Lawrence JH, DeLuca CJH: Myoelectric signal versus force relationship in different human muscles. *J Appl Physiol* 54: 1653-1659, 1983
2. Ericson MO, Nisell R, Arborelius UP, et al: Muscular activity during ergometer cycling. *Scand J Rehabil Med* 17:53-61, 1985
3. Bagg SD, Forrest WJ: Electromyographic study of the scapular rotators during arm abduction in the scapular plane. *Am J Phys Med* 65:111-124, 1986
4. Woods JJ, Bigland-Ritchie B: Linear and nonlinear surface EMG/force relationships in human muscles. *Am J Phys Med* 62:287-299, 1983
5. Seroussi RE, Pope MH: The relationship between trunk muscle electromyography and lifting moments in the sagittal and frontal planes. *J Biomech* 20:135-146, 1987
6. Cook TM, Neumann DA: The effects of load placement on the EMG activity of the low back muscles during load carrying by men and women. *Ergonomics* 30:1413-1423, 1987
7. Lippold OCJ: The relation between integrated action potentials in a human muscle and its isometric tension. *J Physiol (London)* 117:492-499, 1952
8. Bigland B, Lippold OCT: The relationships between forces, velocity and integrated electrical activity in human muscles. *J Physiol (London)* 123:214-224, 1954
9. Rau G, Vredendregt J: EMG-force relationship during voluntary static contractions (m. biceps). In Cerquiglini S, et al (eds): *Biomechanics: III. Medicine and Sport*. Baltimore, MD, University Park Press, 1973, vol 8, pp 270-274
10. Milner-Brown HS, Stein RB: The relation between the surface electromyogram and muscular force. *J Physiol (London)* 246:549-569, 1975

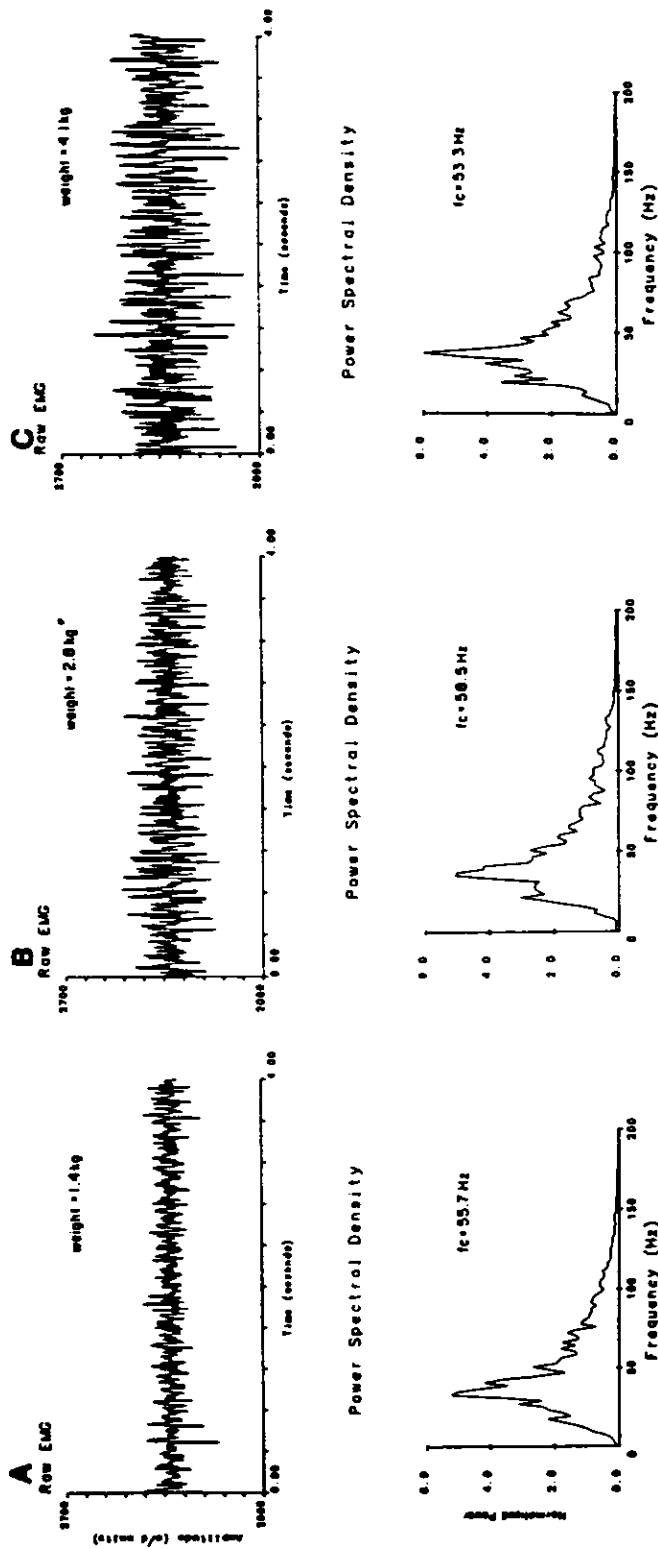

FIGURE 5-32

Raw electromyogram (EMG) data (top) and corresponding EMG power spectral density (bottom) in 1 subject with weight of 1.4 kg (A), 2.8 kg (B), and 4.1 kg (C) held at longer length L1. Note that amplitude of raw EMG signal increases with increasing weight, but centroid frequency (f_c) changes little and inconsistently as weight changes ($P > 0.1$).

Reprinted with permission from Bazzay AR, et al: Increase in electromyogram low-frequency power in nonfatigued contracting skeletal muscle. *J Appl Physiol* 61:1012-1017, 1986, Figure 3, p 1016.

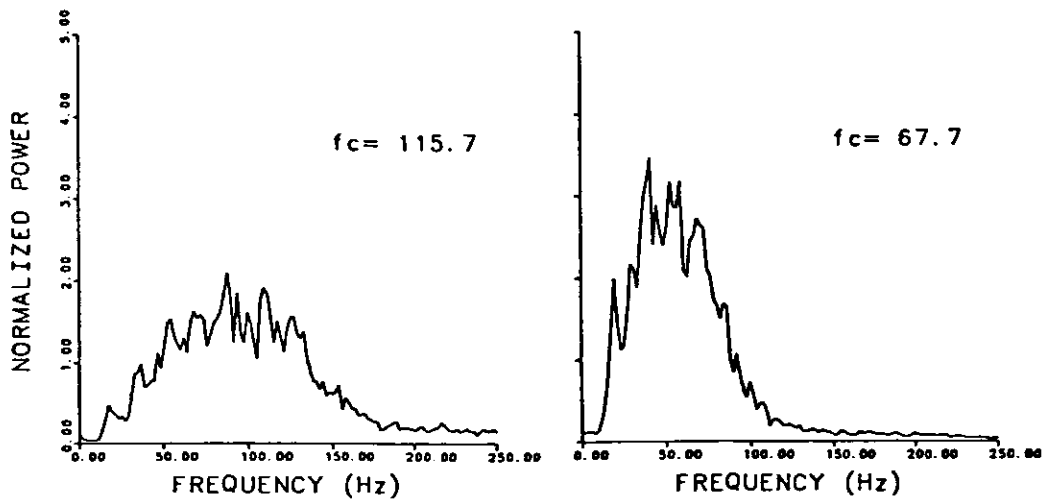

FIGURE 5-33

Power spectral density (PSD) of biceps brachii muscle electromyogram of 1 subject at long length L1 (right) and shorter length L2 (left). Note shift to left in PSD from L2 to L1 f_c (centroid frequency).

Reprinted with permission from Bazzy AR, et al: Increase in electromyogram low-frequency power in nonfatigued contracting skeletal muscle. J Appl Physiol 61:1012-1017, 1986, Figure 2, p 1014.

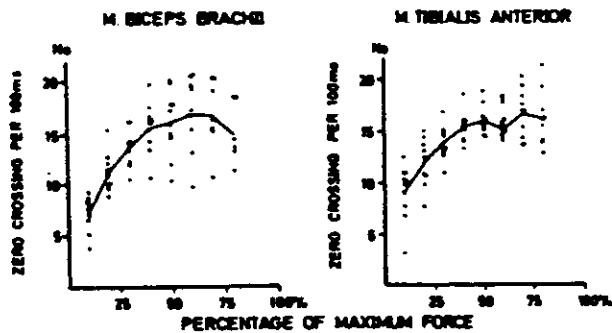

FIGURE 5-34

Number of zero crossings at $100 \mu\text{V}$ related to gradually increasing force. Each point is the mean of 3 recordings, and the lines combine the mean values (m. biceps brachii 10 subjects and m. tibialis anterior 10 subjects).

Reprinted with permission from Christensen H, Lo Monaco M, Dahl K, et al: Processing of electrical activity in human muscle during a gradual increase in force. Electroencephalogr Clin Neurophysiol 58:230-239, 1984, Figure 5, p 234.

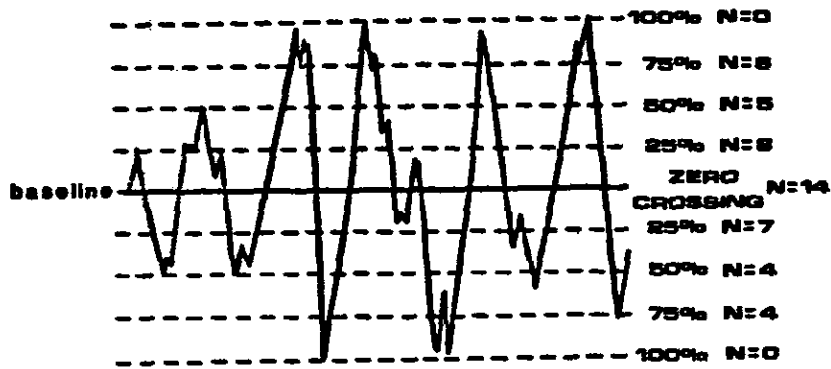

FIGURE 5-35 A
Spike counting by window.

Reprinted with permission from Robertson RN, Grabiner MD: Relationship of IEMG to two methods of counting surface spikes during different levels of isometric tension. Electromyogr Clin Neurophysiol 25:489-498, 1985, Figure 1, p 492.

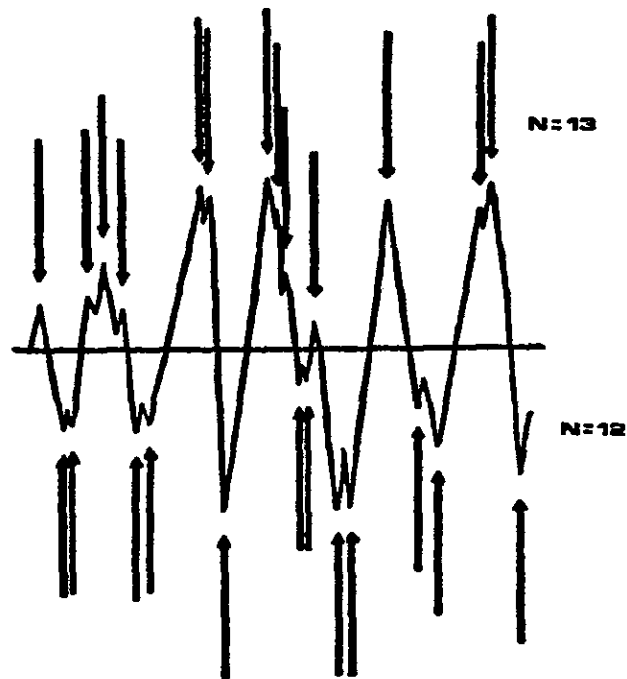

FIGURE 5-35 B
Manual spike counting of raw EMG signal.

Reprinted with permission from Robertson RN, Grabiner MD: Relationship of IEMG to two methods of counting surface spikes during different levels of isometric tension. Electromyogr Clin Neurophysiol 25:489-498, 1985, Figure 4, p 493.

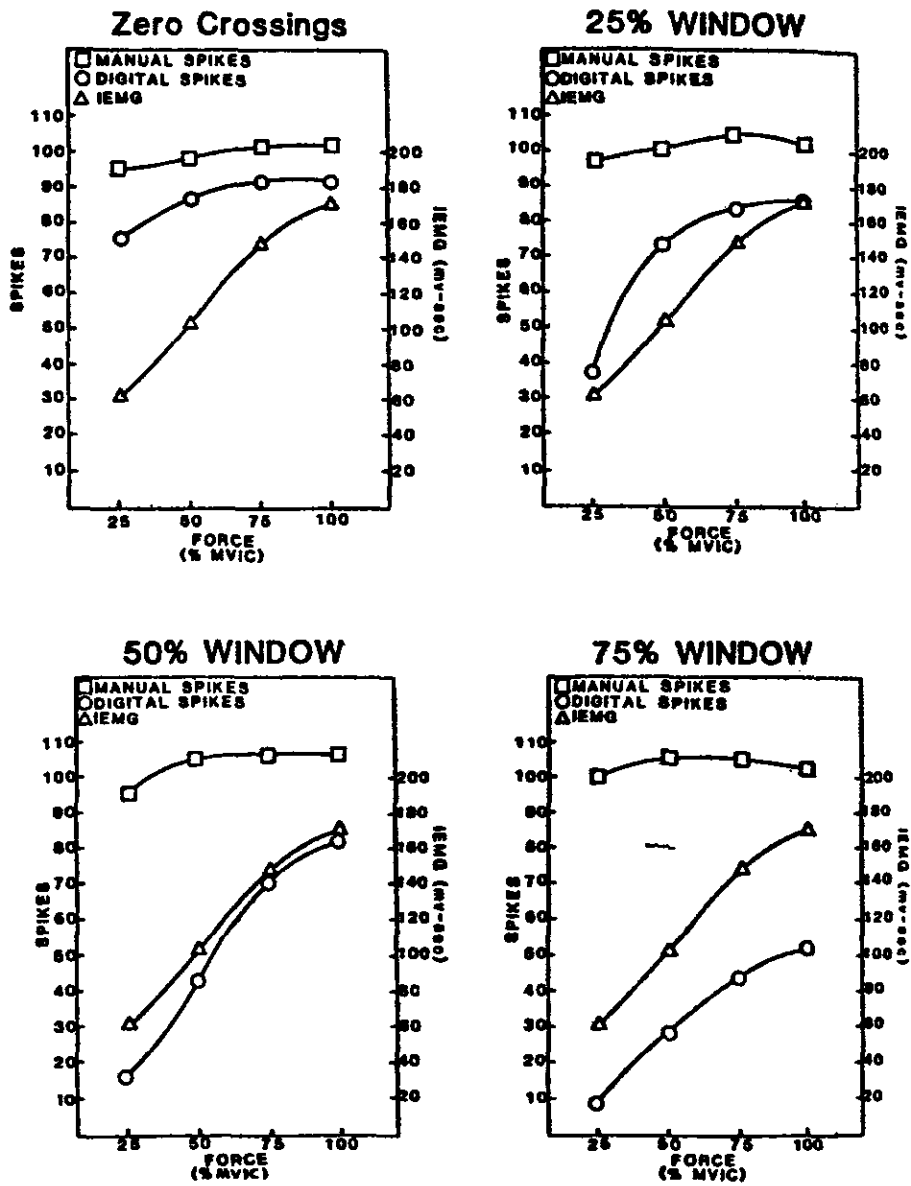

FIGURE 5-36

Relationship between IEMG and manual and digital spikes as a function of tension by window.

Reprinted with permission from Robertson RN, Grabner MD: Relationship of IEMG to two methods of counting surface spikes during different levels of isometric tension. *Electromyogr Clin Neurophysiol* 25:489-498, 1985, Figures 6-9, p 496.

11. Komi PV, Viitasalo JHT: Signal characteristics of EMG at different levels of muscle tension. *Acta Physiol Scand* 96:267-276, 1976
12. Moritani T, deVries HA: Reexamination of the relationship between the surface integrated electromyogram (IEMG) and force of isometric contraction. *Am J Phys Med* 57:263-277, 1978
13. Perry J, Bekey GA: EMG-force relationships in skeletal muscle. *CRC Critical Review in Biomedical Engineering* 7:22, 1981
14. Viitasalo JHT, Komi PV: Signal characteristics of EMG with special reference to reproducibility of measurements. *Acta Physiol Scand* 93:531-539, 1975
15. Solomonow M, Baratta R, Zhou BH, et al: Historical update and new developments on the EMG-force relationships of skeletal muscles. *Orthopedics* 9:154-1543, 1986
16. Yang JF, Winter DA: Electromyography reliability in maximal and submaximal contractions. *Arch Phys Med Rehabil* 64:417-420, 1983
17. Inman VT, Ralston JH, Saunders JB de CM, et al: Relation of human electromyogram to muscular tension. *Electroencephalogr Clin Neurophysiol* 4:187-194, 1952
18. Chaffin DB, Myun L, Freivalds A: Muscle strength assessment from EMG analysis. *Med Sci Sports Exercise* 12:205-211, 1980
19. Heckthorne CW, Childress DS: Relationships of the surface electromyogram to the force length, velocity and contraction rate of the cineplastic human biceps. *Am J Phys Med* 60:19, 1981
20. Winkel J, Bendix T: Muscular performance during seated work evaluated by two different EMG methods. *Eur J Appl Physiol* 55:167-173, 1986
21. Andersson GBJ, Schultz AB, Ortengren R: Trunk muscle forces during desk work. *Ergonomics* 29:1113-1127, 1986
22. Jonsson B, Hagberg M: The effect of different working heights on the deltoid muscle. *Scand J Rehabil Med [Suppl]* 3:26-32, 1974
23. Janda DH, Geiringer SR, Hankin FM, et al: Objective evaluation of grip strength. *J Occup Med* 29:569-571, 1987
24. Bobet J, Norman RW: Effects of load placement on back muscle activity in load carriage. *Eur J Appl Physiol* 53:7-75, 1984
25. Gregor RJ, Gavanagh PR, LaFortune: Knee flexor moments during propulsion in cycling: A creative solution to Lombard's Paradox. *J Biomech* 18:307-316, 1985
26. Lyons K, Perry J, Gronely JK, et al: Timing and relative intensity of hip extensor and abductor muscle action during level and stair ambulation. *Phys Ther* 63:1597-1605, 1983
27. Winter D: Pathologic gait diagnosis with computer-averaged electromyographic profiles. *Arch Phys Med Rehabil* 65:393-395, 1984
28. Arborelius UP, Ekholm J, Nemeth G, et al: Shoulder joint load and muscular activity during lifting. *Scand J Rehabil Med* 18:71-82, 1986
29. Arborelius UP, Ekholm J, Nisell R, et al: Shoulder load during machine milking: An electromyographic and biomechanical study. *Ergonomics* 29:159-1607, 1986
30. Stulen FB, DeLuca CJ: Frequency parameters of the myoelectric signal as a measure of the conduction velocity. *IEEE Trans Biomed Eng* 7:515-523, 1981
31. Soderberg GI, Cook TM: An electromyographic analysis of quadriceps femoris and muscle setting and straight leg raising. *Phys Ther* 63:1434-1438, 1983
32. Hagberg M: Muscular endurance and surface electromyogram in isometric and dynamic exercise: *J Appl Physiol Respir Environ Exercise Physiol* 51:1-7, 1981
33. Chaffin DB: Localized muscle fatigue: Definition and measurement. *J Occup Med* 15:346-354, 1973
34. Kadefors R: Myo-electric signal processing as an estimating problem. In Desmedt JE (ed): *New Developments in Electromyography and Clinical Neurophysiology*. Basel, Switzerland, Karger, 1973, vol 1, pp 519-532
35. Sofranek MG, Koshland GF, Raymond G: Effect of auditory rhythm on muscle activity. *Phys Ther* 62:16-168, 1982
36. Maton B, LeBozec S, Cnockaert JC: The synergy of elbow extensor muscles during dynamic work in man: II. Braking elbow flexion. *Eur J Appl Physiol* 44:279-289, 1980
37. Perry J, Ireland ML, Gronely J, et al: Predictive values of manual muscle testing and gait analysis in normal ankles by dynamic electromyography. *Foot Ankle* 6:254-259, 1986
38. Loeb GE, Gans C: Signal processing and display. In Loeb GE, Gans C (eds): *Electromyograph for Experimentalists*. Chicago, IL, University of Chicago Press, 1986, pp 244-262
39. Hershler C, Milner M: An optimality criterion for processing electromyographic (EMG) signals relating to human locomotion. *IEEE Trans Biomed Eng* 25:413-420, 1978
40. Gottlieb GL, Agarwal GC: Filtering of electromyographic signals. *Am J Phys Med* 49:142-146, 1970
41. Close JR, Nickel ED, Todd FN: Motor-unit action-potential counts. *J Bone Joint Surg [Am]* 42:1207-1222, 1960
42. Arsenaault AB, Winter DA, Marteniuk RG, et al: How many strides are required for the analysis of electromyographic data in gait? *Scand J Rehabil Med* 18:133-135, 1986
43. Schuldt K, Ekholm H, Harms-Ringdahl K, et al: Effects of changes in sitting work posture on static neck and shoulder muscle activity. *Ergonomics* 29:1525-1537, 1986
44. Komi PV, Rusko H: Quantitative evaluation of mechanical and electrical changes during fatigue loading of eccentric and concentric work. *Scand J Rehabil Med [Suppl]* 3:121-126, 1974
45. Grieve DW, Pheasant ST: Myoelectric activity, posture and isometric torque in man. *Electromyogr Clin Neurophysiol* 16:3-21, 1976
46. Harms-Ringdahl K, Ekholm H, Schuldt K, et al: Load moments and myoelectric activity when the cervical spine is held in full flexion and extension. *Ergonomics* 29:1539-1552, 1986
47. Nemeth G: On hip and lumbar biomechanics: A study of joint load and muscular activity. *Scand J Rehabil Med [Suppl]* 10:4-35, 1984
48. Arsenaault AB, Winter DA, Marteniuk RG: Treadmill versus walking locomotion in humans: An EMG study. *Ergonomics* 29:665-676, 1986

49. Ericson MO, Nisell R, Ekholm J: Quantified electromyography of lower-limb muscles during level walking. *Scand J Rehabil Med* 18:159-163, 1986
50. Schuldt K, Ekholm H, Nemeth G, et al: Knee load and muscle activity during exercises in rising. *Scand J Rehabil Med [Suppl]* 9:174-188, 1983
51. Hermens HJ, Boon KL, Zilvold G: The clinical use of surface EMG. *Acta Belg Med Phys* 9:119-130, 1986
52. Lindstrom L, Petersen I: Power spectra of myoelectric signals: Motor activity and muscle fatigue. In Stalberg E, Young RR (eds): *Neurology: I. Clinical Neurophysiology*. Stoneham, MA, Butterworth Publishers, 1981, pp 66-87
53. DeVries HA: "Efficiency of electrical activity" as a physiological measure of the functional state of muscle tissue. *Am J Phys Med* 47:10-22, 1968
54. Lind AR, Petrofsky JS: Amplitude of the surface electromyogram during fatiguing isometric contractions. *Muscle Nerve* 2:257-264, 1979
55. Petrofsky JS, Lind AR: The influence of temperature on the amplitude and frequency components of the GM during brief and sustained isometric contractions. *Eur J Appl Physiol* 44:189-200, 1980
56. Hagberg M, Sundelin G: Discomfort and load on the upper trapezius muscle when operating a word processor. *Ergonomics* 29:1637-1645, 1986
57. Jorgensen K, Fallentin N, Krogh-Lund C, et al: Electromyography and fatigue during prolonged, low-level static contractions. *Eur J Appl Physiol* 57:316-321, 1988
58. Jonsson B: The static load component in muscle work. *Eur J Appl Physiol* 57:305-310, 1988
59. Nelson AJ, Moffroid M, Whipple R: The relationship of integrated electromyographic discharge to isokinetic contractions. In Desmedt JE (ed): *New Developments in Electromyography and Clinical Neurophysiology*. Basel, Switzerland, Karger, 1973, vol 1, pp 584-595
60. Falconer K, Winter DA: Quantitative assessment of co-contraction at the ankle joint in walking. *Electromyogr Clin Neurophysiol* 25:135-149, 1985
61. Jorge M, Hull ML: Analysis of EMG measurements during bicycle pedaling. *J Biomech* 19:683-694, 1986
62. Gravel D, Arsenaault AB, Lambert J: Soleus-gastrocnemius synergies in controlled contractions produced around the ankle and knee joints: An EMG study. *Electromyogr Clin Neurophysiol* 27:405-413, 1987
63. Richardson G, Bullock MI: Changes in muscle activity during fast, alternating flexion-extension movement of the knee. *Scand J Rehabil Med* 18:5-58, 1986
64. Miller D: Comparison of electromyographic activity in the lumbar paraspinal muscles of subjects with and without chronic low back pain. *Phys Ther* 65:1347-1354, 1985
65. Lindstrom L, Petersen I: Power spectrum analysis of EMG signals and its application. In Desmedt JE (ed): *Computer-Aided Electromyography: Progress in Clinical Neurophysiology*. Basel, Switzerland, Karger, 1983, vol 10, p 5
66. DeLuca CJ: Myoelectrical manifestations of localized muscular fatigue in humans. *CRC Critical Review in Biomedical Engineering* 11:251-279, 1985
67. Shochina M, Gonen B, Wolf E, et al: A study of the application of the Fourier series in the analysis of the electrophysiological pattern of development of muscle fatigue. *Electromyogr Clin Neurophysiol* 26:513-520, 1986
68. Sadoyama T, Masuda T, Miyano H: Relationships between muscle fiber conduction velocity and frequency parameters of surface EMG during sustained contraction. *Eur J Appl Physiol* 51:247-256, 1983
69. Kadefors R, Arvidsson A, Herberts P, et al: EMG data processing in ergonomics with emphasis on shoulder muscle load. In: Desmedt JE (ed): *Computer-Aided Electromyography: Progress in Clinical Neurophysiology*. Basel, Switzerland, Karger, 1983, vol 10, pp 273-286
70. Petrofsky JS: Frequency and amplitude analysis of the EMG during exercise on the bicycle ergometer. *Eur J Appl Physiol* 41:1-15, 1979
71. Kuorinka I: Restitution of EMG spectrum after muscular fatigue. *Eur J Appl Physiol* 57:311-315, 1988
72. Komi PV, Tesch P: EMG frequency spectrum, muscle structure, and fatigue during dynamic contractions in man. *Eur J Appl Physiol* 42:4-50, 1979
73. Baidya KN, Stevenson MG: Local muscle fatigue in repetitive work. *Ergonomics* 31:227-239, 1988
74. Broman H, Magnusson R, Petersen I, et al: Vocational electromyography. In Desmedt JE (ed): *New Developments in Electromyography and Clinical Neurophysiology*. Basel, Switzerland, Karger, 1973, vol 1, pp 519-532
75. Bigland-Ritchie B, Donovan EF, Roussos CS: Conduction velocity and EMG power spectrum changes in fatigue of sustained maximal efforts. *J Appl Physiol* 51:1300-1305, 1981
76. Paiss O, Inbar GF: Autoregressive modeling of surface EMG and its spectrum with application to fatigue. *IEEE Trans Biomed Eng* 34:761-770, 1987
77. Okada M: Effect of muscle length on surface EMG wave forms in isometric contractions. *Eur J Appl Physiol* 56:482-486, 1987
78. Huijing PA, Adelerbof A, Giesberger R, et al: Triceps source EMG power spectrum changes during sustained submaximal isometric contractions at different muscle lengths. *Electromyogr Clin Neurophysiol* 26:181-192, 1986
79. Bigland-Ritchie B, Johansson R, Lippold OGI, et al: Changes in motoneuron firing rates during sustained maximal contractions. *J Physiol (London)* 340:335-346, 1983
80. Hary D, Belman MJ, Propst J, et al: A statistical analysis of the spectral moments used in EMG test of endurance. *J Appl Physiol* 53:779-783, 1982
81. Lindstrom L, Magnusson R, Petersen I: Muscular fatigue and action potential conduction velocity changes studied with frequency analysis of EMG signals. *Electromyography* 10:341-356, 1970
82. Matthijsse PC, Hendrich K, Rijnsburger WH, et al: Ankle angle effects on endurance time, median frequency and mean power of gastrocnemius EMG power spectrum: A comparison between individual and group analysis. *Ergonomics* 30:1149-1159, 1987
83. Hogan N, Mann RW: Myoelectric signal processing: Optimal estimation applied to electromyography: Part II. Experimental demonstration of optimal myoprocessor performance. *IEEE Trans Biomed Eng* 27:396-410, 1980

84. Gander RE, Hudgins BS: Power spectral density of the surface myoelectric signal of the biceps brachii as a function of static load. *Electromyogr Clin Neurophysiol* 25:469-478, 1985
85. Blinowska A, Verroust J: Low frequency power spectrum of the EMG signal. *Electromyogr Clin Neurophysiol* 27:349-353, 1987
86. Bazy AR, Karten JB, Haddad GG: Increase in electromyogram low-frequency power in nonfatigued contracting skeletal muscle. *J Appl Physiol* 61:1012-1017, 1986
87. Christensen H, Lo Monaco M, Dahl K, et al: Processing of electrical activity in human muscle during a gradual increase in force. *Electroencephalogr Clin Neurophysiol* 58:230-239, 1984
88. Hagg GM, Suurkula J, Liew M: A worksite method for shoulder muscle fatigue measurements using EMG, test contractions and zero crossing technique. *Ergonomics* 30:1541-1551, 1987
89. Suurkula J, Hagg GM: Relations between shoulder/neck disorders and EMG zero crossing shifts in female assembly workers using the test contraction method. *Ergonomics* 30:1553-1569, 1987
90. Bergstrom RM: The relation between the number of impulses and the integrated electrical activity in the electromyogram. *Acta Physiol Scand* 45:97-101, 1959
91. Robertson RN, Grabiner MD: Relationship of IEMG to two methods of counting surface spikes during different levels of isometric tension. *Electromyogr Clin Neurophysiol* 25: 489-498, 1985
92. Gilai A: Continuous EMG interference pattern analysis. *Electromyogr Clin Neurophysiol* 27:339-348, 1987
93. Fuglsang-Frederiksen A: Electrical activity and force during voluntary contraction of normal and diseased muscle. *Acta Neurol Scand [Suppl]* 63:83, 1981
94. Basmajian JV, DeLuca CJ: *Muscles Alive: Their Functions Revealed by Electromyography*, ed 5. Baltimore, MD, Williams & Wilkins, 1985
95. Grieve DW, Davanagh PR: The quantitative analysis of phasic electromyograms. In Desmedt JE (ed): *New Developments in Electromyography and Clinical Neurophysiology*. Basel, Switzerland, Karger, 1973, vol 2, pp 489-496
96. Johnson JC: Comparison of analysis techniques for electromyographic data. *Aviat Space Environ Med* 49:14-18, 1978
97. Lindstrom L, Magnusson R, Petersen I: Muscle load influence on myoelectric signal characteristics. *Scand J Rehabil Med [Suppl]* 3:127-148, 1974
98. Maton B: Motor unit differentiation and integrated surface EMG in voluntary isometric contraction. *Eur J Appl Physiol* 35:149-157, 1976

CHAPTER 6

Functional Muscle: Effects on Electromyographic Output

Mark Redfern, Ph.D.

Mark Redfern, Ph.D., is an Assistant Professor at the University of Pittsburgh with appointments in Industrial Engineering (Engineering School) and Otolaryngology (Medical School). He is also the Engineering Director of the Balance Disorders Laboratory at the Montifiore/University Hospital of Pittsburgh. Dr. Redfern received a Ph.D. degree in Bioengineering from the University of Michigan in 1988 with postdoctoral training at the Center for Ergonomics, University of Michigan. Dr. Redfern's research areas are biomechanics of human movement, postural control and ergonomics. Current ongoing research projects include: analysis of balance during gait, falls in the elderly, electromyographic signal processing, and ergonomic computer aided design. Dr. Redfern also teaches graduate courses in biomechanics, ergonomics and human movement analysis.

FUNCTIONAL MUSCLE: EFFECTS ON ELECTROMYOGRAPHIC OUTPUT

Mark S. Redfern, PhD

INTRODUCTION

Electromyography (EMG) has been used in ergonomics to investigate such important topics as musculoskeletal injury, low-back pain, carpal tunnel syndrome, and muscle fatigue from overexertion. Significant progress has been made in understanding these topics by EMG analysis. Although modern instrumentation has facilitated easy acquisition of EMG data, many issues remain unresolved in the interpretation of EMG signals. The information presented here attempts to summarize what is currently known about EMG analysis with respect to muscle function. Material presented is based on a review of recent literature and is presented within the framework of surface EMG applied to the occupational setting. Because there still is controversy about many of the subjects discussed, extensive references are provided with each concept.

This chapter presents three major topics related to EMG: 1) temporal estimations of muscle activity, 2) muscle force estimations, and 3) muscle fatigue. The temporal estimation section discusses the use of surface recorded EMG in the investigations of the timing of whole muscle firing. The time delay found between the recorded surface EMG event and produced muscle force is discussed along with the effects of using an EMG preprocessor. The second section discusses the relationship between EMG and muscle force. The effects of muscle length, velocity of shortening, and cocontraction of synergistic and antagonistic muscles are presented. The relationships are explained in terms of both the empirical results and the physiologic basis. Because this use of EMG is the most common and in many ways the most complicated, a subsection containing specific recommendations for using EMG-muscle force relationships in applied EMG analysis is presented. The third section discusses muscle fatigue and its effect on the recorded EMG. Different types of spectral measurement techniques are discussed along with the limitations of each method.

TEMPORAL ASPECTS

EMG Muscle Force Timing

Electromyography has been used extensively to understand the temporal actions or timing of muscles during various types of exertions. The most basic information obtained is the onset and duration of myoelectric activity. This often is equated with the timing of produced

muscle tension. In most cases where general muscle actions are of interest, this assumption is reasonable. In the occupational setting, timing patterns from EMG recordings can be useful. For example, gripping actions of the hand during manual activities are of interest in looking at various types of cumulative trauma disorders such as carpal tunnel syndrome.^{1,2} Unfortunately, timing of grip forces during work is difficult to monitor because of varied hand movements and contact with objects. Electromyography has been used to estimate the timing of gripping forces during work.¹⁻³ The EMGs of the forearm are relatively easy to acquire, and they reflect the actions of the muscles that control grip. Although estimates of exact force magnitudes by EMG analysis during grip are limited, timing information can be used to better understand the gripping requirements of the job.

Differences do exist, however, between the temporal characteristics of the EMG and the produced tension. Although these differences may not be important for most general timing studies, they should be considered. The most apparent is the pure time delay. Ralston et al looked at the delay in the rectus femoris using raw EMG.⁴ Time delays of 30 to 40 ms were found between the onset of the EMG and tension. Time delays of 200 to 300 ms occurred between the cessation of the electrical activity and tension. Redfern found similar results when looking at the triceps brachii during elbow extensions.⁵ He found delays between EMG and force onsets from rest to be about 50 ms and cessation time delays of 180 to 220 ms. In recent studies, Komi et al have shown electromechanical delays using buckle transducers on the Achilles tendon.⁶ Figure 6-1 demonstrates the relationship found between EMG recordings of the triceps surae and the Achilles tendon force. The tendon delay times at the onset of contraction were about 30 ms and the delays registered at the foot plate were about 70 ms. There appears to be, therefore, about a 40 ms difference between the tendon forces and the response of the foot that is measured externally. The exact delay times appear to be muscle dependent. In each case, however, the time delays at the onset are much shorter than the decay times at the cessation of EMG activity.

Initial tension levels in the muscle also have an effect on the delay times seen at onset. If the muscle is held at a baseline tension level before a step increase in force, then the delay time between the rise in EMG and the rise

in force will be shorter. This is due primarily to the mechanical slack being taken out of the muscle. The amount of slack in the muscle also has a major effect on the relationship between the peak EMG and the peak force detected in a muscle. The rise time to attain tension levels during a contraction also is affected. It has been proposed that the electrochemical response of the muscle is increased when a baseline of force is used, although, in general, in applied surface EMG the importance of this effect is questionable.

EMG Processing Effects on Timing

In most EMG-muscle force investigations, the EMG signals are processed initially. Methods such as integration, root-mean-square (RMS), and Butterworth filtering have been proposed⁷⁻⁹ and were discussed in Chapters 4 and 5. The temporal aspect of the EMG-force relationship is affected by the specific processing methodology applied. The primary factor is the low-pass properties associated with the filtering function used. In most cases, such as integration and RMS, the filtering function is an exponential window with some associated time constant. The time constant of the window is chosen generally by adjusting elements of the electrical circuits used (see Chapter 4). A longer time constant produces a smoother estimate of the electrical activity of the muscle. This is beneficial during static exertions where the electrical state of the muscle is stationary. During dynamic exertions, however, the response of the processor may be too slow to capture the changes occurring in the electrical state. Thus, the processed EMGs taken during rapid transitions will not reflect the dynamics of the electrical signals in the muscles but rather the dynamics of the processor itself. This different reflection is particularly true during investigations of ballistic activities. The choice of an appropriate time constant, therefore, is important for the type of activities under investigation. For isometric, static exertions, long time constants (usually > 150 ms) that give smoother signals are desirable. For more dynamic studies, shorter time constants must be chosen (< 60 ms).¹⁰

Another factor affecting the timing of processed EMG to muscle force is the processing method itself. The two most common processors, integration and RMS, have been shown to affect the temporal aspects of EMGs differently.¹⁰ Additionally, the two common methods of estimating the RMS have different rise and fall times. Thus, not only the time constant but the dynamics of the specific processor are important considerations if temporal information is to be derived from processed EMG.

In general, muscle activation timing will be obtained more easily by the ergonomist by means of visual inspection of the original (nonprocessed) EMG data rather than

through some processed quantity. If some estimation of magnitude of EMG activity is also desired, then a processing method should be used; however, the effect of that processing method on temporal aspects of the signal must be considered.

ELECTROMYOGRAM-FORCE

A great deal of confusion exists regarding the relationship between processed EMG and muscle force. Surface EMGs are complicated recordings of the electrochemical activations of muscle. Research has long suggested that the EMG could be used to represent the active control input of the muscle, and that some relationship must exist between the two. Some researchers have presented EMG as a direct indication of muscle force but others have presented very complex models using these signals to predict force. In choosing an appropriate model, it is important to realize that a number of factors influence the relationship between EMG and force. The kinematics of the movement, the processing methods used, and the acquisition procedure, all have an effect on the muscle force-EMG relationship. The following describes some of these factors and their influence on the EMG.

Isometric Response

The first investigations into the relationships between EMG and force were performed under isometric conditions. Lippold looked at the relationship between surface recorded integrated EMGs (IEMGs) and isometric tension, in the triceps surae.¹¹ This work showed a distinct linearity between IEMG and isometric tensions within subjects with coefficients of determination (r^2) between .95 and .99. The slopes of these relationships were found to differ from subject to subject. Since that time, many others also have observed this linear relationship. Other investigators, however, have reported curvilinear relationships with the force-EMG slope decreasing at higher force levels. Table 6-1 presents a partial list of researchers who have reported these linear and curvilinear responses.

The discrepancies between these studies is disturbing. Explanations have been proposed and can be categorized as physiologic and experimental. On the experimental side, Moritani and deVries found that electrode configuration had an effect on the shape of the curve.^{12,13} Bipolar recordings of the elbow flexors produced a curvilinear relationship but unipolar recordings had a linear result. A more physiologic rationale was presented by Bawa and Stein.¹⁴ They showed in frequency response studies of isometric human soleus under controlled neural stimulation that the gain and phase fall off at rates higher than about 5 Hz. This implies a

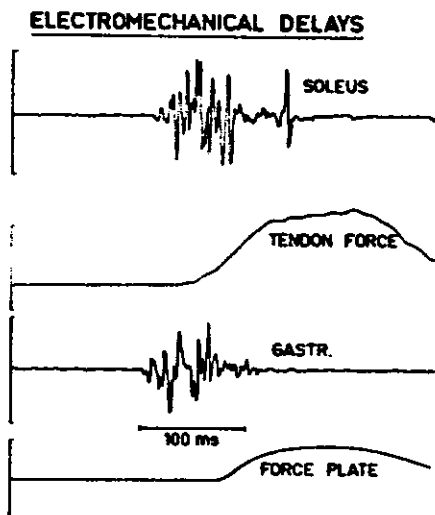

FIGURE 6-1

The temporal relationship between EMG and produced muscle tension in the human triceps surae from in vivo measurements of Achilles tendon forces.

Reprinted with permission from Komi PV, Salonen M, Jarvinen M, et al: In vivo registration of Achilles tendon forces in man: I. Methodological development. Int J Sports Med 8(Suppl 1):3-8, 1987.

nonlinearity between the isometric muscle force output and neural firing rates as they increase. These firing rates have a direct effect on the measured EMG and subsequent IEMG signals.

Woods and Bigland-Ritchie investigated the effects of muscle fiber composition of the surface EMG-force relationship in humans.¹⁵ A variety of muscles with different fiber-type compositions and distributions were used. They found that the shape of the relationship was dependent on fiber composition. Uniform fiber composition led to linear relationships but mixed fiber compositions yielded nonlinear relationships. In other studies, Lawrence and DeLuca explored the RMS EMG-force relationships in three different muscles using different groups of subjects from weight lifters to pianists.¹⁶ Figure 6-2 shows the results from their study. These graphs are of the biceps brachii, deltoid and the first dorsal interosseous muscles. They show the relationship between the RMS EMG normalized by the maximum value attained and force normalized to the maximum voluntary contraction (MVC). Note that the curves for the different types of subjects were very similar in shape, but the dif-

ferent muscles exhibited distinct differences. They concluded from the study that the myoelectric signal-force relationship was primarily determined by the muscle under investigation and was generally independent of the subject group. This conclusion is consistent with the findings of Woods and Bigland-Ritchie¹⁵ and seems to be the general consensus among researchers in the area today.

If a curvilinear relationship is seen, the mathematical representation of the processed EMG-muscle force relationship should incorporate some second order term. Many methods have been used. The predominant mathematical expressions are either a second order polynomial or an exponential term, as follows:

$$\text{Polynomial relationship: } F = aE + bE^2 \quad (1)$$

$$\text{Exponential relationship: } F = Ae^{(qE)} \quad (2)$$

where F is the muscle force and E is the processed EMG. In each case, two parameters must be estimated. Any higher order terms, such as a third order polynomial, usually provides no significant improvement in the fit of the relationships. The best form (polynomial or exponential) is debatable from both a theoretical or empirical viewpoint and probably is dependent on the exact muscle and instrumentation used. It is suggested that both relationships be tried during calibration of curvilinear data.

Length-Tension Effect

Another factor of importance to EMG studies in work environments is that muscle length has an effect on the force output of a muscle. The mechanics and physiologic basis of this relationship were discussed briefly in Chapter 2. The question to be addressed here is how does muscle length affect the EMG-force relationship? To answer this question, the ergonomist must first realize that the EMG-force relationship pertains to the active force producing capabilities. Hence, it is the effect of length change on the active components on muscle tension and not the passive properties that is of concern in this section.

As shown in Chapter 2, active tension is altered by changes in muscle length. One would expect the muscular response to neural stimulation rate (and, therefore, also to the EMG) to be affected. In their study, Rack and Westbury looked at the effect of length, stimulation level and isometric tension in the cat soleus.¹⁷ The soleus was cut and attached to a force transducer. The nerve controlling the muscle was severed and then stimulated at various levels by an electrical pulse generator. The study found that at constant muscle lengths, the relationships between tension and stimulation level was similar to the EMG-tension curves recorded by other researchers. One major difference was the slight nonlinearity at very low

TABLE 6-1

A Partial List of Researchers Reporting Linear and Curvilinear Relationships Between Processed EMG and Muscle Force

Linear	Curvilinear
Inman et al ⁶⁵	Zuniga and Simons ⁶⁹
Lippold ¹¹	Komi and Buskirk ⁷⁰
Close et al ⁶⁶	Kuroda et al ⁷¹
deJong and Freund ⁶⁷	Bouisset ²⁸
deVries ⁶⁸	Lawrence and DeLuca ¹⁶
Woods and Bigland-Ritchie ¹⁵	Woods and Bigland-Ritchie ¹⁵

stimulation rates. When the stimulation rate was held constant, the length was found to have a profound effect on the tension. Figure 6-3 shows a graph of these results. Notice that the plots at different rates of stimulation are similar in shape, but are shifted with respect to muscle length. One conclusion from this data is that stimulation rate and muscle length are interrelated with regards to their effect of muscle tension.

Because the stimulation rate-tension relationship is affected by muscle length, one would expect the EMG, which is in some way a reflection of this stimulation, to also be affected. This, in fact, is the case. Grieves and Pheasant found a family of EMG-muscle length curves at different force levels for the gastrocnemius and soleus.¹⁸ Vredendregt and Rau examined the relationship between EMG, force, and muscle length in the biceps brachii. They showed that the slope between IEMG and the force varies with the position of the joint. Figure 6-4 shows these results as a series of curves for each joint position, reflecting changes in muscle length. Notice that these results are not linear but curvilinear. This result seems to be prevalent in the biceps brachii. In Figure 6-4 C, the data have been normalized by the maximum force exerted at each angle Fmax. Notice that this data fit one generalized curve. This normalization of muscle forces by the Fmax at each given angle provides a good way to present these relationships not only within subjects but also across subjects.

Velocity-Tension Effect

Dynamic muscular exertions can be divided into concentric (muscle shortening) and eccentric (muscle lengthening) contractions. During concentric contractions, the velocity of shortening affects the muscle tension produced. These results, discussed in Chapter 2, are summarized in a muscle equation relating the two

variables, shown as the characteristic equation. The relationship, however, does not hold for eccentric contractions, thus producing a more complicated situation for the study evaluating functional activities commonly seen at the worksite. Although the effect of both concentric and eccentric velocity has been shown, few studies have been conducted on the EMG-force relationship during these movements.

In their classical study, Bigland and Lippold investigated the relationship between force, velocity, and the integrated EMG in humans.²⁰ From Lippold's experiences with isometric tension, he anticipated that IEMGs were a good representation of the stimulation rate of *in vivo* muscle.¹¹ Their subsequent studies showed, in the case of plantar flexion of the foot, that if the load is plotted as a function of velocity at constant EMG levels for shortening muscle, a classic force-velocity curve (Hill's characteristic equation) is seen. Actually, a family of these curves are found, one at each IEMG level. Figure 6-5 is representative of these findings. These results were later substantiated for the biceps brachii by Zahalak et al for forearm rotation.²¹ Zahalak et al also showed that the shortening velocity curves at a given IEMG level could be fit by the characteristic equation of Hill.

The results for eccentric contractions are quite different. Asmussen found that the IEMG of muscle under concentric and eccentric contractions with the same tension levels were different: eccentric contractions evoked greater EMG levels than the concentric contractions.²² The shapes of the eccentric velocity-tension curves at constant IEMG levels are not as well documented as those for the concentric contractions. Some contend that no statistical increase can be found.²¹ Others have seen a slight increase in force as eccentric velocity is increased that is similar to the strength curves described in Chapter 2.²³ Komi found, for example, that for elbow flexion the IEMG-force relationship increases with eccentric contractions during maximal exertions (Figure 6-6). Maximal IEMGs were recorded from both the biceps brachii and the brachioradialis muscles at different velocities (both concentric and eccentric). The IEMG levels were fairly constant over all the trials. The force output, however, changed as a function of velocity as shown in Figure 6-6 by the dashed line. This indicates that the IEMG-force relationship is affected by both the direction and level of muscle velocity.

Postural Dynamics

In EMG analysis, as applied in ergonomics, the muscle lengths and velocities are controlled by the postures during the task. Muscles transmit their forces through insertions in the skeletal structure about joints, thus creating torques. It is quite common to see EMG signals related

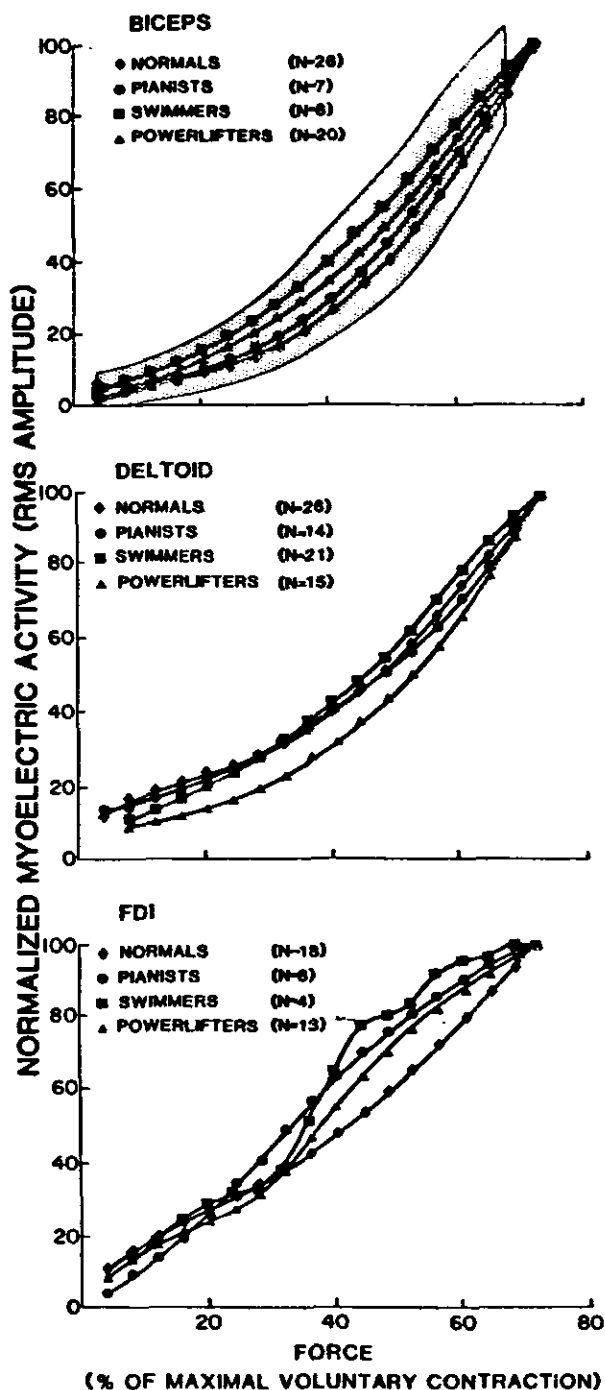

FIGURE 6-2

The RMS EMG-force relationship for three muscle groups of different subject populations. Standard deviations are indicated by shaded area in top graph.

Reprinted with permission from Lawrence JH, DeLuca CJ: Myoelectric signal versus force relationship in different human muscles. *J Appl Physiol* 54:1653-1659, 1983.

to the torques that are generated, instead of to the internal muscle forces.²⁴ These torques, then, are a function of the moment arm of the insertion and the angle at which the muscle is applying the force. The angle of pull and even the moment arm to the center of rotation usually change significantly during normal movements. Additionally, the angle of pull may vary within a muscle depending on the pennate structure of the particular muscle. It is very important, therefore, to recognize this dependence of EMG-torque relationships to the biomechanical factors inherent in the system.

Another common practice in EMG modeling is to substitute joint angular data for muscle length information when length and velocity compensations are used.²⁴ Joint angle is used in place of muscle length, and angular velocity is used for muscle shortening velocities. There are inherent problems with this type of analysis. In a study of the ankle, Redfern compared the use of joint angle data with muscle length and velocity.²⁵ He found that the relationship between ankle angle and estimated muscle length was nearly linear for the three muscles investigated (tibialis anterior, soleus, and gastrocnemius). A significant nonlinear difference was found, however, between angular velocity and estimated muscle shortening velocity. The geometric relationship between muscle length and ankle angle causes differences in the muscle shortening velocities up to 40%, under constant angular velocity conditions. This was found over a normal range of motion of the ankle. The discrepancy was found to be caused primarily by the insertion points to the axis of rotation. These results indicate that substituting ankle angle for muscle length will result in the force-length relationships differing from the force-angle relationship by a constant multiplicative factor. Thus the shape of the relationship will be preserved. If ankle angular velocity is substituted for muscle shortening velocity, however, major differences in the shape of relationships will occur. The force-angular velocity relationship will not appear as the classic Hill's relationship found on isolated muscle. Again, it becomes apparent that biomechanics of the musculoskeletal system must be considered by the ergonomist when doing dynamic EMG-force estimations.

Postural changes, therefore, affect muscle length, velocity of contraction, and biomechanical lines of action that all have been shown to affect EMG-muscle force relationships. Minimizing postural changes, therefore, is recommended whenever possible. For example, consider a study of low back EMGs during lifting. The preferred analysis (from an EMG standpoint) would be a static one, with consistent postures. Muscle lengths would be constant from trial to trial with no velocity of contraction. Obviously, static postures cannot always be used to answer pertinent questions. For dynamic studies, controlled postural changes would then be desired, with

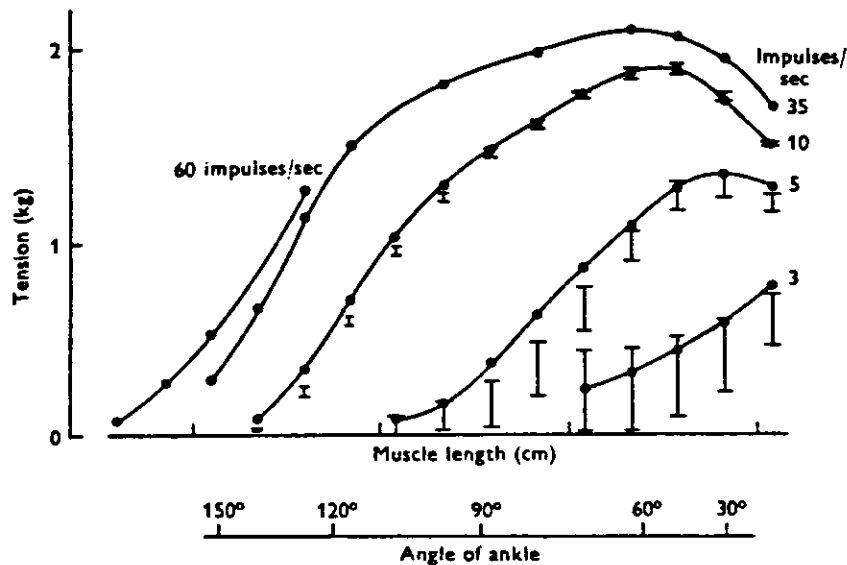

FIGURE 6-3

The effects of stimulation rate and muscle length on produced isometric tension.

Reprinted with permission from Rack PMH, Westbury DR: *The effects of length and stimulus rate on tension in the isometric cat soleus muscle. J Physiol (London) 204:443-406, 1969.*

the same lifting style and speed used throughout the study. Analysis of these dynamic EMGs could then be made at specific postures throughout the lift, keeping consistent the muscle length, velocity, and lines of action. In summary, the basic principle of EMG recording is that more control of postures means less variability. Some studies done in the workplace, however, produce uncontrollable postures. In this case, EMG analysis should be done with the effect of postural changes and muscle mechanics taken into consideration.

Cross Talk

Selectivity of the electrodes over a muscle group always is a consideration in the analysis of the recorded EMG. Cross talk from the electrical activity of other muscles picked up by the electrodes will cause some error in the analysis. This is true particularly if the signal is to be used to just measure temporal activation (whether the muscle is on or off). Cross talk is less of a problem, however, when the EMG is quantified. As pointed out by Hof, the intensity of the recorded EMG is not simply

the sum of the primary muscle of interest and the secondary muscle causing cross talk noise.²⁶ Because the EMG emitted from each muscle is stochastic, the recorded signal is as follows:

$$E = (E_a^2 + E_b^2)^{1/2} \quad (3)$$

where E is the signal recorded from the electrodes, E_a is the EMG from the primary muscle and E_b is the EMG from the cross talk muscle, so, for example, if E_b is 50% of E_a then $E = 1.12 E_a$. In reality, E_b is likely to be much less than 50% of E_a , thereby further reducing the cross talk effects. Concerning the importance of cross talk, Hof states the following:

The results of crosstalk is thus a **noisy baseline**, which at times may suggest a slight activity while there is none, but which does not seriously affect the quantitative interpretation at higher force levels. The possibility of cross talk should be considered seriously, nevertheless, when choosing the electrode location: the ratio wanted/unwanted signal is what matters, not so much the signal strength itself.²⁶

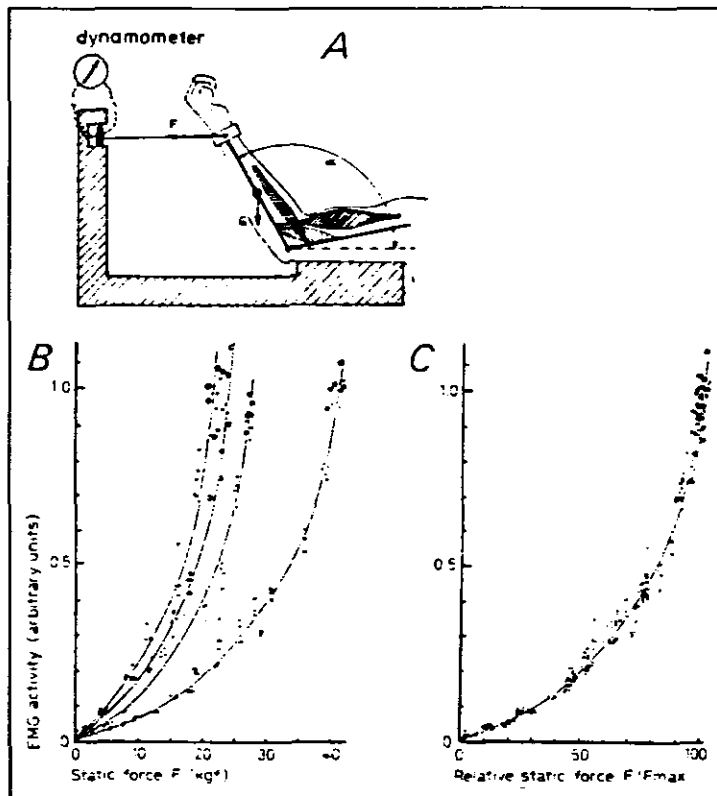

FIGURE 6-4

The relationship between IEMG, muscle length, and tension in the biceps brachii. A. Measurement diagram. B. The force (F) exerted under static conditions in relation to the measured EMG level. The different curves were obtained at different muscle lengths. C. The relative force F/F_{max} in relation to the EMG.

Reprinted with permission from Vredenburg J, Rau G: Surface electromyography in relation to force, muscle length and endurance. In Desmedt JE (ed): New Developments in Electromyography and Clinical Neurophysiology. Basel, Switzerland, Karger, 1973, vol 1.

Cocontraction Effects

A concern with any study of EMG-force relationships in an ergonomic center is the cocontraction of muscles around the joint under investigation. Both synergistic and antagonistic muscles can have dramatic effects on the results. Cnockaert et al recognized the importance of including synergistic muscles in determining muscle forces from IEMGs during elbow flexion.²⁷ They proposed a model that related IEMG to muscle torque for the biceps brachii and brachioradialis muscles. These synergistic muscles have been assumed by many to be one "equivalent flexor muscle."²⁸ The EMGs of one muscle could then be used to describe the actions of

both. The results of Cnockaert et al, however, indicated that the two muscles can behave quite differently under different conditions.²⁷ Thus, the equivalent muscle concept was extremely limited. Falconer and Winter used EMGs to develop an isometric model that estimated the relative cocontraction between the antagonistic muscles, soleus, and tibialis anterior, acting about the ankle during gait.²⁹ The model produced a measure of the relative cocontraction (termed the cocontraction index) between the two muscles. It could not estimate, however, the torque contributions by the muscle groups. Although this model was limited, it did show that significant levels of cocontraction occur about the ankle during gait and must be taken into consideration. Most other investigations into

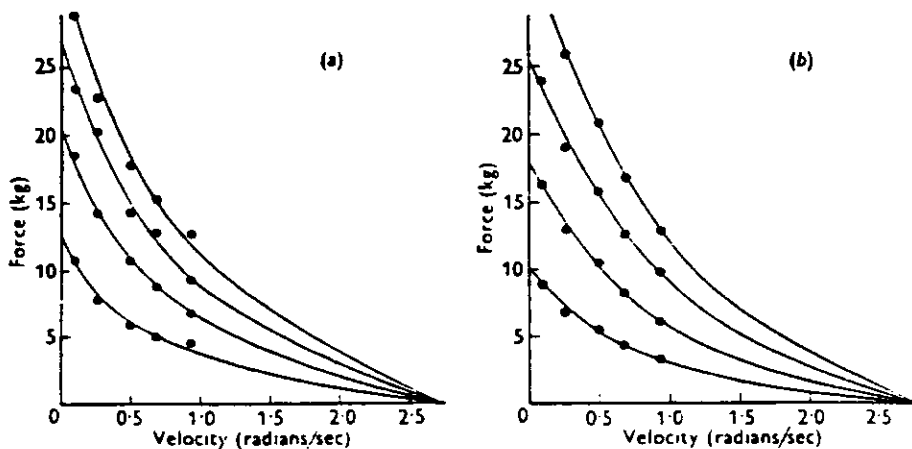

FIGURE 6-5

Force-velocity curves plotted at four different levels of excitation as measured with IEMGs.

Reprinted with permission from Bigland B, Lippold OCJ: The relationship between force, velocity and integrated electrical activity in human muscles. J Physiol (London) 123:214-224, 1954.

processed EMG-muscle force relationships have assumed that no antagonistic or synergistic activity occurs during isometric contractions. If this assumption is invalid, the resulting estimations of the EMG-muscle force relationships would be affected erroneously. Furthermore, any changes in the amount of antagonistic and synergistic muscle activity between trials of an ergonomic study would have an even greater effect, causing increased variance in any calculated model parameters. This error would occur even if the processed EMG-muscle force relationships for the individual muscles were totally stationary.

Redfern and Chaffin examined the isometric torque-processed EMG relationships of the soleus, gastrocnemius, and tibialis anterior during both plantar flexion and dorsiflexion.^{25,30} They proposed a method for calibrating the EMG-torque relationships of the three muscles while taking their cocontractive nature into consideration. From their results, they showed significant synergistic and antagonistic activity during torque production in both the plantar and the dorsal directions. Figure 6-7 demonstrates these findings. Figure 6-7 b shows the individual components of torque about the ankle created by each muscle. They were predicted from the EMG data recorded. Figure 6-7 a is a comparison of the measured resultant torque (solid line) and the predicted resultant torque (dashed line). The predicted

resultant torque was estimated by summing the three components shown in Figure 6-7 b. These results indicate that significant antagonistic and synergistic activities occur, even during simple isometric torque production. Redfern and Chaffin estimated that a 15% increase in the slopes of the EMG-torque calibrations occurred for the muscles acting on the ankle when cocontraction was taken into consideration instead of assuming no antagonistic activities.²⁵ Similar adjustments may need to be made when studies incorporating ergonomics are performed.

Ballistic Muscle Actions

Even the most sophisticated dynamic EMG-force models currently are limited to controlled movements. Ballistic activities in particular are not well described by today's modeling techniques. In these types of movements, there are high levels of interaction between the geometry of the muscle, the material properties of the musculotendinous structures, the actin-myosin cross bridge activity, and the electrode-muscle membrane tissue interface. What generally is seen is a large initial burst in the EMG signal during the onset of a ballistic movement that is not reflected in the force output. This large burst often gives large over-estimates of the muscle force from EMG-force models. To overcome this problem, the previously mentioned factors such as length-

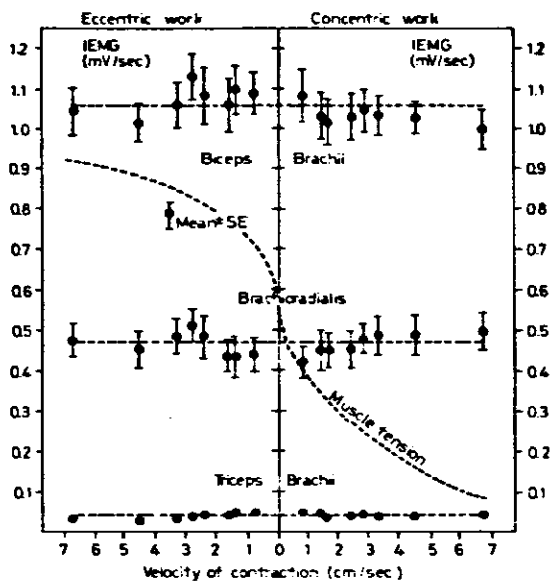

FIGURE 6-6

The relationship between integrated EMG (IEMG) and the velocity of contraction for maximal exertions.

Reprinted with permission from Komi PV: Relationship between muscle tension, EMG and velocity of contraction under concentric and eccentric work. In In Desmedt JE (ed): New Developments in Electromyography and Clinical Neurophysiology. Basel, Switzerland, Karger, 1973, vol 1, pp 596-606.

tension and velocity effects will have to be incorporated with sufficient models of the passive properties of the musculotendinous system. This is pointed out briefly in this chapter, to caution any investigator interested in using EMGs in the quantitative analysis of ballistic activities.

Recommendations

The following are specific recommendations for EMG analysis where force levels are to be estimated by ergonomists. They are based on the factors discussed in this and previous chapters.

1. **Let electrodes stabilize:** The impedance of the electrode-skin interface has a direct effect on the EMG-force relationship. As the electrode paste dissolves into the layers of the skin, the impedance will be reduced. It is important to allow

this effect to stabilize. Allow about 20 minutes for this stabilization to occur.

2. **Calibrate every experiment:** Calibrations must be performed after each application of new electrodes. This is because the impedance of the electrode-tissue system will change.
3. **Minimize postural changes:** Because length and velocity have such large effects, try to keep EMG-force relationships to static postures if at all possible. Calibrate the models at the exact postures under investigation.
4. **Consider cocontraction of muscles:** Cocontraction of antagonistic and synergistic muscles always occurs to some degree. This fact should be taken into consideration during calibration of any EMG-force model. Any test must address this problem by either incorporating the other muscles or by making some assumptions and understanding the possible error they incur.
5. **Electromechanical modeling:** There is an electromechanical response time between the EMG and the force output. If dynamically changing forces are to be observed, this factor must be considered.
6. **Minimize fatigue:** Muscle fatigue will change the EMG-force relationship. It is necessary, therefore, to design experiments that will minimize any localized muscle fatigue. Rest periods between exertions should also be used to allow the muscle to recover.

FATIGUE

Fatigue caused from environmental and job related stresses continues to be a major concern in the workplace. The term fatigue, however, is not easily defined and therefore is difficult to measure. One type of fatigue is systemic, affecting the person as a whole. Examples of contributing factors involved in systemic fatigue would be high levels of heat or cold, aerobic requirements, lactic acid, or even psychological stress (see Edwards and Lippold,³¹ Hermans et al,³² and Bouisset,²⁸ for reviews of these factors). Fatigue also occurs on a local level within the body. This is true particularly in musculoskeletal exertions. Typical externally visible symptoms are loss of force production capabilities, localized discomfort and pain. This type of fatigue has become known as "localized muscle fatigue" (LMF).³³ Localized muscle fatigue continues to be of concern in ergonomic assessment of jobs. Muscle exertion levels do not necessarily need to be high to cause LMF. Isometric contractions of as low as 10% of MVC have shown signs of LMF. Much higher contraction levels are common in the workplace,

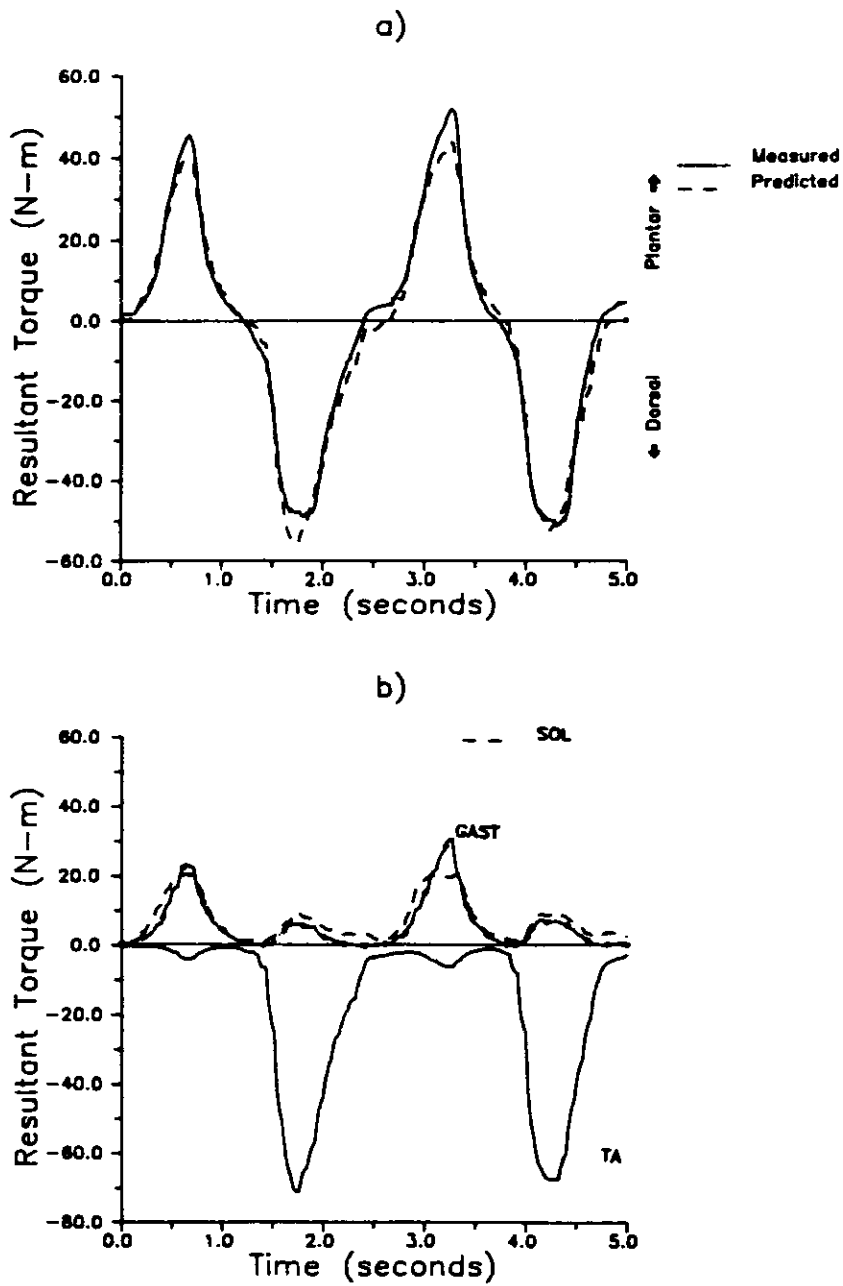

FIGURE 6-7

Expected value prediction results from a slow sinusoidal trial with large knee angle: a) comparison of predicted versus measured resultant ankle torques; b) predicted torque contributions from the tibialis (TA), soleus (SOL), and gastrocnemius (GAST).

Reprinted with permission from Redfern MS, Chaffin DB: Modeling EMG-torque relationships of muscle groups around the ankle joint considering co-contraction. Submitted to J Biomech 1988.

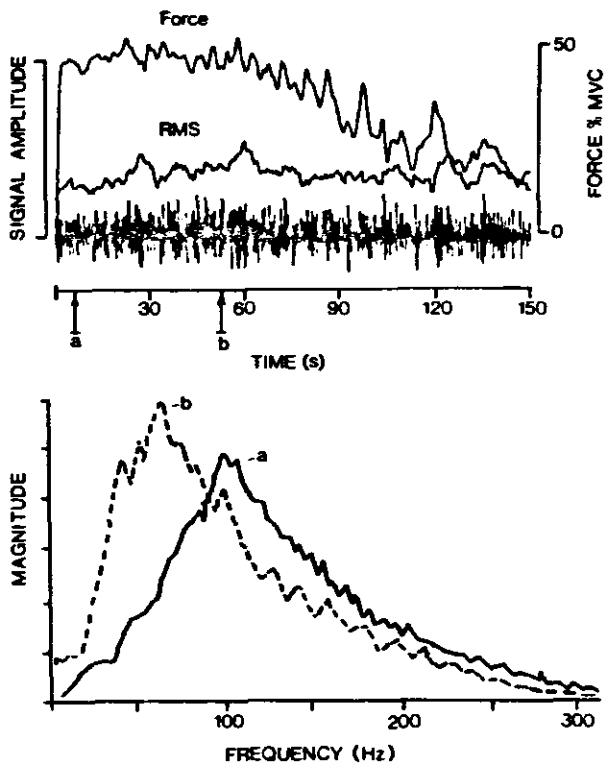

FIGURE 6-8

(Top) Amplitude changes and (bottom) frequency spectral shifts resulting from local muscle fatigue during a sustained, isometric contraction of the first dorsal interosseous muscle.

Reprinted with permission from Basmajian JV, DeLuca CJ: *Muscles Alive: Their Functions Revealed by Electromyography*, ed 5. Baltimore, MD, Williams & Wilkins, 1985, 205.

and LMF has certainly been seen under these circumstances. Great interest exists in finding an objective measure of LMF that can be used in job evaluation and design. Electromyographic analysis has been proposed as one method of evaluating LMF during repeated or locally stressful activities.

Localized Muscle Fatigue and the EMG Signal

During LMF, changes occur in the surface recorded EMG signal. Two of the most commonly cited changes are a shift in the frequency content of the signal toward the low end and an increase in the amplitude. Figure 6-8 graphically demonstrates this effect during sustained, isometric contraction. Note that the force level decreases

TABLE 6-2

Proposed Physiologic Causes and References for Spectral Shifts and Amplitude Changes of the EMG During Fatigue

Motor unit recruitment	Edwards and Lippold ³¹ Milner-Brown et al ⁷² Clamann and Broecker ⁷³ Maton ⁷⁴
Motor unit synchronization	Lippold et al ⁷⁵ Milner-Brown et al ⁷² Chaffin ⁷⁶ Bigland-Ritchie et al ³⁷
Firing rate and interpulse intervals	DeLuca and Forrest ⁷⁷ Hogan ⁷⁸
Motor unit and action potential shape	Lindstrom ³⁴ Broman ⁷⁹ Kranz et al ³⁸ Mills ⁴⁵

for a given EMG level and the power spectrum shifts from time a to time b. Lindstrom³⁴ and DeLuca³⁵ contend that these two phenomena are related. They state that tissue filtering characteristics act as a low pass filter. As the frequency content of the signal shifts to the lower frequencies, more energy is transferred through the tissues to the electrodes. This energy transfer, in turn, increases the amplitude of the recorded signal.

Physiologic explanations for the changes in amplitude and spectral characteristics have been proposed by many researchers. Some of the factors believed to be involved are presented in Table 6-2. Motor unit recruitment is believed by some to occur as a muscle becomes fatigued in response to reduced muscle contractility. This increased recruitment would have the desired effects on the amplitude and spectrum of the signal. Synchronization of the recruited motor unit activations has also been observed and proposed as a mechanism for changes in the EMG signal. As this synchronization occurs, an increase in the low frequency content would be expected. There is not total agreement, however, on the influence of motor unit recruitment and synchronization. Basmajian and DeLuca contend that although these phenomena may occur, it is doubtful that either is a major factor in EMG spectral shifts during constant contractions.³⁶ They propose factors such as firing rate, variations in interpulse intervals, and changes in the shapes of the motor unit actions potentials are the predominant cause of spectral shifts. Conduction velocity along the muscle membranes, which has a direct effect on these factors, also is believed to be important.^{34,37} Kranz et al proposed that the

change in the conduction velocity accounts for the majority of the shift in the spectrum.³⁸ In a study of conduction velocity and spectral factors during contractions, Broman et al stated "no single process appears to account for the effects of a high force level contraction on the myoelectric signal. In addition to myoelectric conduction velocity decrease, changes in the firing patterns of the active motor units are suggested."³⁹

Shifts in the spectrum are reversible when the muscle has rested. The amount of time required for the spectrum to recover after the cessation of an exertion depends on the type and duration of the exercise performed. For short duration, low level loading, recovery appears to occur within 2 to 5 minutes of rest.⁴⁰⁻⁴² Mortimer et al showed that conduction velocity also recovered about 2 minutes after exercise.⁴³ For longer or more strenuous exertions, however, the spectrum will not recover for hours.⁴⁴ Spectral recovery does not appear to correspond with mechanical or physiological recovery of the muscle, which may take much longer.⁴⁵⁻⁴⁷ This brings into question the use of spectral recovery rates to monitor fatigue recovery.

Specific Measures of Spectral Shifts

Despite the continued controversy over the underlying causation of spectral shifts, monitoring these changes in the EMG signal continues to be used to assess the state of the muscle during repeated or constant contraction. Many different metrics have been used to describe the shift in the power spectra. Two of the more popular techniques are presented in Table 6-3.

These are a ratio of high to low frequencies (HLR) and the median power frequency (MPF). Other methods have been used such as peak frequency⁴⁸ and zero crossings.^{49,50} Although these other measures have shown correlations with changes in the spectrum, their applicability and generality in applied EMG are not as accepted as the MPF and HLR methods. The rest of this section concentrates on the MPF and HLR measurement methods and the results found with each.

Ratio of High to Low Frequencies

Spectral shifts of the EMG during fatigue can be thought of as a decrease in the high frequency band and an increase in the low frequency band. A ratio (HLR) of the power in these two bands then would show the relative shift of the spectrum (assuming the total power remains constant over time). As an example, Bigland-Ritchie et al formed the ratio of the low band power (20-40 Hz) to high band power (130-238 Hz) as HLR.³⁷ One major advantage of this method is the speed and ease of measurement. This measure shows significant reduction

TABLE 6-3

Selected References on Reported Techniques to Monitor the Shift in the Power Spectrum of the EMG Signal During Muscular Contractions

Ratio of High to Low Frequencies	Median or Mean Power Frequency
Ortengren ⁶⁰	Herberts et al ⁸⁰
Gross et al ⁵⁵	Lindstrom ³⁴
Bigland-Ritchie, et al ³⁷	Lindstrom et al ⁸¹
Kramer et al ⁴⁴	Petrofsky and Lind ⁸²
	Hagberg ⁶²
	Hagberg and Ericson ⁵⁸
	Baidya and Stevenson ⁸³

over time during a fatiguing contraction as predicted in Figure 6-9. Others have proposed other HLR methods that define the bands in different ways with varying degrees of success (see Table 6-3 for references).

Although the HLR does correlate well with muscle fatigue, problems exist with this measure of the EMG shift. The ratio is sensitive not only to the power shifts in the spectrum, but also to its shape.¹ These shapes can change as a result of differences in the muscles tested, intersubject variations, muscle length, and other factors.^{52,53} Another concern is the dependence of the results on the choice of the frequencies that divide the spectrum in the bands. This method makes any standardization or interpretation between studies difficult.

Median Power Frequency

The MPF (sometimes known as the center frequency) method of analysis is the most widely used measure of spectral shift resulting from fatigue. The MPF is defined as that frequency about which the power is distributed equally above and below. It is calculated as any median of a distribution. Another spectral measure commonly used is the mean power frequency. Both the mean and the median give similar estimations for spectral shifts. In this chapter, discussions of the MPF will refer to either the mean or the median power frequency. Both measures have been found to decrease over time, sometimes as much as 50% during prolonged isometric contractions (see Table 6-3 for references). Some researchers have also seen reliable decreases in the MPF during dynamic contractions,^{54,55} although others have reported conflicting results. The rate at which the shift in the MPF occurs over time is dependent on the level of the contraction. Figure 6-10 demonstrates this change in the MPF. The higher the tension level exerted, the faster the MPF shifts to lower frequencies. This is to be expected because muscles under greater tension will

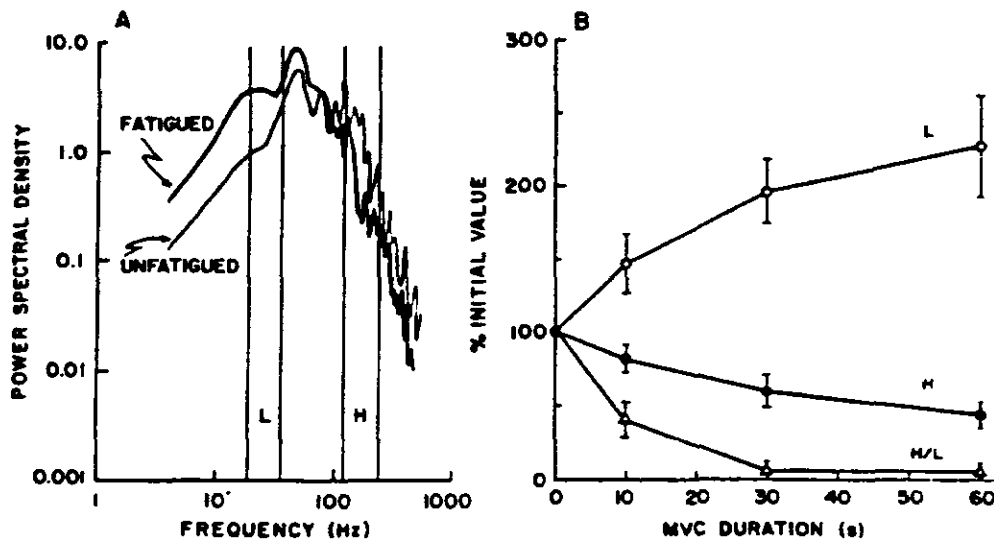

FIGURE 6-9

1A. EMG power spectra obtained before and after 60 seconds of fatigue at room temperature. B. Changes in the mean values H (130–238 Hz), L(20–40 Hz), H/L (\pm SD) during 60 second sustained maximal contractions.

Reprinted with permission from Bigland-Ritchie B, Donovan EF, Roussos CS: Conduction velocity and EMG power spectrum changes in fatigue of sustained maximal efforts. *J Appl Physiol* 51:1300-1305, 1981.

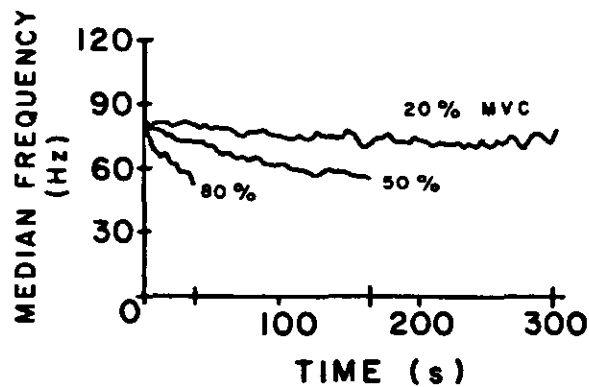

FIGURE 6-10

The affect of tension level on the rate of change of the median power frequency.

Reprinted with permission from Basmajian JV, DeLuca CJ: *Muscles Alive: Their Functions Revealed by Electromyography*, ed 5. Baltimore, MD, Williams & Wilkins, 1985, p. 217.

fatigue more rapidly. The total decrease is dependent on the muscle under investigation and on some subject variability. When a muscle is allowed to rest after the end of a contraction, the MPF can return to the higher level. This is not true, however, if the muscle has been fatigued to exhaustion.

Although the rate of change of the MPF is affected by the tension, there is no consensus on the effects of muscle tension levels on the initial MPF. Some researchers have found that in healthy subjects the frequency spectrum is almost independent of the exerted force.^{19,32,56,57} There is evidence, however, that tension level can have an effect. Hagberg and Ericson found that the MPF increased with contraction strength for low level contractions.⁵⁸ At higher levels in excess of 25% MVC, the MPF became independent of contraction level. They surmised that this dependence at lower contraction levels is due to tissue filtering effects and recruitment of motor units. Moritani and Muro, however, found that the initial MPF increased significantly from 0% through 80% MVC for the biceps brachii.¹² Others have also seen this increase in frequency content with load.^{39,59}

Limitations

Although the use of EMGs in measuring or monitoring LMF is well established and frequently used, the technique is not without limitations. It is important to understand some of these limitations before undertaking an EMG analysis in the field of ergonomics. The first problem is in the basic definition of fatigue. Any method used to measure fatigue, including EMG analysis, is based on a basic definition of the problem. Because there is no universal definition of fatigue, agreement on the validity and meaning of EMG measures will be questioned. Other factors in LMF such as pain tolerance, motivation, and synergistic accommodation are not included in EMG analyses and have been argued to be important. Additionally, spectral shifts have been used for short term contraction fatigue, but the use of EMGs in long term fatigue is questioned. For muscle fatigue that occurs over a longer period of time, perhaps hours, the use of EMGs has not been well established.

Besides definition limitations, other problems more methodological in nature occur. Shifts in the various EMG indices have been established for isometric constant contractions, but the timing of these changes may not be synchronized with changes in the state of the muscle. The indices have been shown to decrease rapidly during the initial stages of a contraction, but do not decay as rapidly toward the end of a long session of work.⁶⁰ So, although the shift may indicate LMF, it does not follow the degree of fatigue experienced over time.

Another limitation is the difficulty of using EMG

analysis around complex joints. In multiple muscle studies, particularly at the shoulder, spectral shifts have been seen during fatigue in some muscles and not in others. This has occurred even though one would expect the unaffected muscles to have equal or greater imposed stresses.^{56,61-63} Finally, it appears from the data of Okada that the shape of the frequency spectrum is affected by muscle length.⁶⁴ The spectrum shifts to lower frequencies as the muscle length is increased. Postural changes, therefore, must be mobilized if spectral shifts resulting from fatigue and not length changes are to be examined. In general, therefore, the indices of LMF taken from EMG analysis appear to be quite reliable for constant isometric contractions of greater than 10% of MVC. The physiologic cause of EMG changes appear to be related directly to the causes of LMF, which makes it a reasonable measure. There are unresolved questions, however, as to the scope of applicability of EMG analysis in measuring worker fatigue in other dynamic or low level exertion environments. It is within the limitations presented that EMG analysis should be used to investigate fatigue.

SUMMARY

In this chapter, the relationship between EMG and muscle function is discussed. The topics presented are temporal estimation of muscle activity, muscle force estimation, and localized muscle fatigue. The most basic use of EMGs is the temporal estimation of muscle activity. Surface EMGs are a very effective method obtaining a general idea of when a muscle is active. There are differences, however, between the temporal characteristics of the EMG and the produced tension. Time delays between EMG onset and muscle force generation are 30 to 50 ms but delays of 200 to 300 ms occur between the cessation of EMG and muscle force. The effect of EMG processing on these delays also is discussed. For most work in ergonomics, these differences are not important. Researchers, however, should be aware of these differences, particularly in investigations of highly dynamic activities.

Muscle force estimations from EMG recordings often are desired. The relationship between EMG and muscle force is dependent on factors such as muscle length, velocity, cross talk between electrodes, and cocontractions of both synergistic and antagonistic muscles. In controlled, isometric contractions, the relationship between processed EMG (usually integration or RMS) and muscle force has been reported as both linear and curvilinear. The shape of the relationship appears to be dependent on the muscle studied and possibly the type of electrodes used. Models of the curvilinear relationships have included second order polynomials and exponentials. Muscle length and velocity dramatically change the

EMG-force relationship found in isometric contractions. Methods to compensate for these factors have been attempted with varying successes; they are presented. Cocontraction of synergistic and antagonistic muscles also affect the estimation of the EMG-force relationship. It is often assumed that synergists act as one equivalent muscle and that antagonists are not active. These assumptions are often incorrect and lead to significant errors in force estimations.

Localized muscle fatigue has been associated with change in the EMG. The amplitude of the EMG increases for a given force level and the frequency spectrum shifts to lower frequencies. Two often used measures of the spectral changes are the median power frequency (MPF) and a ratio of high to low frequencies (HLR). The cause of these changes have been attributed to motor unit recruitment, firing rate, synchronization, and action potential shape. Limitations of using spectral shifts to monitor muscle fatigue are discussed.

REFERENCES

1. Armstrong TJ, Chaffin DB, Foulke JA: A Methodology for documenting hand positions and forces during manual work. *J Biomech* 12:131-133, 1979
2. Arndt R: Work pace, stress, and cumulative trauma disorders. *J Hand Surg* 12:866-860, 1987
3. Cole KJ, Abbs JH: Kinematic and electromyographic response to perturbations of rapid grasp. *J Neurophysiol* 57:1498-1510, 1987
4. Ralston HJ, Todd FN, Inman VT: Comparison of electrical activity and duration of tension in the human rectus femoris muscle. *Electroencephalogr Clin Neurophysiol* 16:271-279, 1976
5. Redfern MS: Time delays between the onset of the EMG and tension in the triceps brachii. Technical Report. Ann Arbor, MI, Center for Ergonomics, University of Michigan, 1984
6. Komi PV, Salomen M, Jarvinen M, et al: In vivo registration of Achilles tendon forces in man: I. Methodological development. *Int J Sports Med* 8(Suppl 1):3-8, 1987
7. Winter DA, Rau G, Kaderfors R: Units, terms and standards in the reporting of electromyographic research. In Hayes KG (ed): *Proceedings of the International Society of Biomechanics*, 1980, pp 3-5
8. Gans BM, Nordargraaf A: Voluntary skeletal muscles: A unifying theory of the relationship of their electrical and mechanical activities. *Arch Phys Med Rehabil* 56:194-199, 1975
9. Heckathorne CW, Childress DS: Relationship of surface electromyogram to the force, length, velocity, and contraction rate of the cineplastic human biceps. *Am J Phys Med* 60:1-19, 1981
10. Redfern MS: Electromyographic (EMG) signal processing and biomechanical modeling of lower leg muscles. Doctoral Dissertation. Ann Arbor, MI, University of Michigan, 1988
11. Lippold OJC: The relationship between integrated action potentials in the human muscle and its isometric tension. *J Physiol (London)* 117:492-499, 1952
12. Moritani T, Muro M: Motor unit activity and surface electromyogram power spectrum during increasing force of contraction. *Eur J Appl Physiol* 56:3, 260-265, 1987
13. Moritani T, DeVries HA: Reexamination of the relationship between the surface integrated electromyogram (IEMG) and force of isometric contraction. *Am J Phys Med* 57:263-277, 1978
14. Bawa P, Stein J: Frequency response of the human soleus muscle. *J Neurophysiol* 39:788-793, 1976
15. Woods JJ, Bigland-Ritchie B: Linear and non-linear EMG/force relationships in human muscles. *Am J Phys Med* 62:287-299, 1983
16. Lawrence JH, DeLuca CJ: Myoelectric signal versus force relationship in different human muscles. *J Appl Physiol* 54:1653-1659, 1983
17. Rack PMH, Westbury DR: The effects of length and stimulus rate on tension in the isometric cat soleus muscle. *J Physiol (London)* 204:443-406, 1969
18. Grievies DW, Pheasant ST: Myoelectric activity, posture and isometric torque in man. *Electromyogr Clin Neurophysiol* 16:3-21, 1976
19. Vredenburg J, Rau G: Surface electromyography in relation to force, muscle length and endurance. In Desmedt JE (ed): *New Developments in Electromyography and Clinical Neurophysiology*. Basel, Switzerland, Karger, 1973 vol 1
20. Bigland B, Lippold OJC: The relationship between force, velocity and integrated electrical activity in human muscles. *J Physiol (London)* 123:214-224, 1954
21. Zahalak GI, Duffy J, Steward PA, et al: Partially activated human skeletal muscle: An experimental investigation of force, velocity and EMG. *Journal of Applied Mechanics* 98:81, 1976
22. Asmussen E: Observations on experimental muscle soreness. *Acta Rheumatologica Scandinavica* 2:109-116, 1956
23. Komi PV: Relationship between muscle tension, EMG and velocity of contraction under concentric and eccentric work. In Desmedt JE (ed): *New Developments in Electromyography and Clinical Neurology* 1:596-606. Basel, Switzerland, Karger, 1973
24. Baildon RW, Chapman AE: Mechanical properties of a single equivalent muscle producing forearm supination. *J Biomech* 16:811-819, 1983
25. Redfern MS, Chaffin DB: Modeling EMG-torque relationships of muscle groups around the ankle joint considering co-contraction. Submitted to *J Biomech*, 1988
26. Hof AL, Van den Berg JW: EMG to force processing: I-IV. *J Biomech* 14:747-792, 1981
27. Cnockaert JC, Linsel G, Pertuzon E: Relative contribution of individual muscles to the isometric contraction of a muscular group. *J Biomech* 8:191-197, 1975
28. Bouisset S: EMG and muscle force in normal motor activities. In Desmedt JE (ed): *New Developments in Electromyography and Clinical Neurophysiology* 1:547-583, Basel, Switzerland, Karger, 1973
29. Falconer K, Winter DA: Quantitative assessment of cocontraction at the ankle during walking. *Electromyogr Clin Neurophysiol* 25:135-149, 1985

30. Redfern MS, Chaffin DB: The quantification of synergistic and antagonistic activity during isometric torque generation about the ankle. *Proceedings of the American Society of Biomechanics*, 1987, p 15-16
31. Edwards RG, Lippold OCJ: The relationship between force and integrated electrical activity in fatigued muscle. *J Physiol (London)* 132:677-681, 1956
32. Hermans HJ, Boon KL, Zilvold G: The clinical use of surface EMG. *Electromyogr Clin Neurophysiol* 24:423-265, 1984
33. Chaffin DB: Localized Muscle Fatigue: Definition and measurement. *J Occup Med* 15:346-354, 1973
34. Lindstrom L, Magnusson R, Petersen I: Muscular fatigue and action potential conduction velocity changes studied with frequency analysis of EMG signals. *Electromyography* 4:341-356, 1970
35. DeLuca CJ: Physiology and mathematics of myoelectric signals. *IEEE Trans Biomed Eng* 26:313-325, 1979
36. Basmajian JV, DeLuca CJ: *Muscles Alive: Their functions Revealed by Electromyography*, ed 5. Baltimore, MD, Williams & Wilkins, 1985
37. Bigland-Ritchie B, Donovan EF, Roussos CS: Conduction velocity and EMG power spectrum changes in fatigue of sustained maximal efforts. *J Appl Physiol* 51:1300-1305, 1981
38. Kranz H, Williams AM, Cassell J, et al: Factors determining the frequency content of the electromyogram. *J Appl Physiol* 55:392-399, 1983
39. Broman H, Bilotto G, DeLuca CJ: Myoelectric signal conduction velocity and spectral parameters: Influence of force and time. *J Appl Physiol* 58:1428-1437, 1985
40. Fay DF, Jones NB, Porter NH: Spectral analysis of the myoelectric activity of the pelvic floor during voluntary contractions. *Electromyogr Clin Neurophysiol* 16:525-551, 1976
41. Johansson S, Larson LE, Ortengren R: An automated method for the frequency analysis of myoelectric signal evaluated by an investigation of the spectral changes following strong sustained contractions. *Med Biol Eng Comput* 8:257-264, 1970
42. Kuorinka I: Restitution of EMG spectrum after muscular fatigue. *Eur J Appl Physiol* 57:311-315, 1988
43. Mortimer JT, Magnusson R, Petersen I: Conduction velocity in ischemic muscle: Effect on EMG frequency spectrum. *Am J Physiol* 219:1324-1329, 1970
44. Kramer H, Lun A, Mucke R, et al: Changes in mechanical and bioelectrical muscular activity and in heart rate due to sustained voluntary isometric contractions and time required for recovery. *Electromyogr Clin Neurophysiol* 19:381-386, 1979
45. Mills KR: Power spectral analysis of electromyogram and compound muscle action potential during muscle fatigue and recovery. *J Physiol (London)* 326:401-409, 1982
46. Hara T: Evaluation of recovery from local muscle fatigue by voluntary test contractions. *J Human Ergol (Tokyo)* 9:35-46, 1980
47. Funderburgh CF, Hipskind SG, Welton RC, et al: Development of and recovery from fatigue induced by static effort at various tension. *J Appl Physiol* 37:392-396, 1974
48. Viitasalo JHT, Komi PV: Interrelationships of EMG signal characteristics at different levels of muscle tension and during fatigue. *Electromyogr Clin Neurophysiol* 18:167-178, 1974
49. Hagg G: Electromyographic fatigue analysis based on the number of zero crossings. *Pflügers Arch* 391:78-80, 1981
50. Masuda T, Miyano H, Sadoyama T: The measurement of muscle fiber conduction velocity using a gradient threshold zero-crossing method. *IEEE Trans Biomed Eng* 29:673-678, 1982
51. Hary D, Belman MJ, Propst J, et al: A statistical analysis of the spectral moments used in EMG tests of endurance. *J Appl Physiol* 53:779-783, 1982
52. Sato H: Functional characteristics of human skeletal muscle revealed by spectral analysis of the surface electromyogram. *Electromyogr Clin Neurophysiol* 22:419-516, 1982
53. Weytjens JLF, van Seenberghe D: The effects of motor unit synchronization on the power spectrum of the electromyogram. *Biol Cybern* 51:71-77, 1984
54. Komi PV, Tesh P: EMG frequency spectrum, muscle structure and fatigue during dynamic contractions in man. *Eur J Appl Physiol* 42:41-50, 1979
55. Cross D, Grassino A, Ross WRD, et al: Electromyogram patterns of diaphragmatic fatigue. *J Appl Physiol* 46:1-7, 1979
56. Kaderfors R, Petersen I, Heberts P: Muscular reaction to welding work. *Ergonomics* 19:543-558, 1976
57. Sabbahi MA, Merletti R, DeLuca CJ, et al: How handedness, sex and force level affect the median frequency of the myoelectric signal. *Proceedings of the 4th Annual Conference on Rehabilitation Engineering*, 1981, pp. 232-234
58. Hagberg M, Ericson BE: Myoelectric power spectrum dependence on muscular contraction level of elbow flexors. *Eur J Appl Physiol* 48:147-156, 1982
59. Gander RE, Hutchins BS: Power spectral density of the surface myoelectric signal of the biceps brachii as a function of static load. *Electromyogr Clin Neurophysiol* 25:469-478, 1985
60. Ortengren A: Filter bank analyses with simultaneous readout for evaluation of dynamic myoelectric signal power spectra. *Med Biol Eng Comput* 13:561-569, 1975
61. Malmquist R, Ekholm I, Lindstrom L, et al: Measurement of localized muscle fatigue in building work. *Ergonomics* 24:695-709, 1981
62. Hagberg M: Muscle endurance and surface electromyography in isometric and dynamic exercise. *J Appl Physiol* 51:1-7, 1981
63. Bobet J, Norman RW: Use of the average electromyogram in design evaluation: Investigation of a whole body task. *Ergonomics* 25:1155-1163, 1982
64. Okada M: Effect of muscle length on surface EMG wave forms in isometric contractions. *Eur J Appl Physiol* 56:482-486, 1987
65. Inman VT, Ralston HJ, Saunders JB, et al: Relationship of human electromyogram to muscular tension. *Electroencephalogr Clin Neurophysiol* 4:187-194, 1952
66. Close JR, Nickel ED, Todd FN: Motor unit action potential counts. *J Bone Joint Surg [Am]* 42:1207-1222, 1960

67. deJong RH, Freund FG: Relation between electromyogram and isometric twitch tension in human muscle. *Am J Physiol* 15:479-482, 1967
68. DeVries HA: Efficiency of electrical activity as a physiological measure of the functional state of muscle tissue. *Am J Physiol* 47:10-22, 1968
69. Zuniga NE, Simons DG: Nonlinear relationship between averaged electromyogram potential and muscle tension in normal subjects. *Arch Phys Med* 50: 613-620, 1969
70. Komi PV, Buskirk ER: Reproducibility in electromyographic measurements with inserted wire electrodes and surface electrodes. *Electromyography* 4:357-367, 1970
71. Kuroda E, Klissouras V, Milsum JH: Electrical and metabolic activities and fatigue in human isometric contraction. *J Appl Physiol* 29:358-367, 1970
72. Milner-Brown HS, Stein RB, et al: Changes in firing rate of human motor units during linearly changing voluntary contractions. *J Physiol (London)* 230:371-390, 1973
73. Clamann HP, Broecker KT: Relationships between force and fatigability of red and pale skeletal muscles in man. *Am J Phys Med* 58:70-85, 1979
74. Maton B: Human motor unit activity during the onset of muscle fatigue in submaximal isometric isotonic work. *Eur J Appl Physiol* 46: 271-271, 1981
75. Lippold OCJ, Redfern JWT, Vuco J: The electromyography of fatigue. *Ergonomics* 3:121-131, 1960
76. Chaffin DB: A research report on the effects of physical exertion. Technical Report. Ann Arbor, MI. Center for Ergonomics, University of Michigan, 1972
77. DeLuca CJ, Forrest WJ: Probability distribution function of the inner-pulse intervals of single motor unit action potentials during isometric contraction. In Desmedt JE (ed): *New Developments in Electromyography and Clinical Neurophysiology* 1:638-647, Basel, Switzerland, Karger, 1973
78. Hogan NJ: Myoelectric prosthesis control: Optimal estimation applied to EMG and cybernetics considerations for its use in a man-machine interface. Doctoral Dissertation. Cambridge, MA, Massachusetts Institute of Technology, 1976
79. Broman H: An investigation on the influence of a sustained contraction on the succession of action potentials from a single motor unit. *Electromyogr Clin Neurophysiol* 17:341-358, 1977
80. Herberts P, Kaiser E, Magnusson R, et al: Power spectra of myoelectric signals in muscles of arm amputees and healthy normal controls. *Acta Orthop Scand* 39:1-21, 1969
81. Lindstrom L, Kadefors R, Petersen I: An electromyographic index for localized muscle fatigue. *J Appl Physiol* 53, 750-754, 1977
82. Petrofsky SJ, Lind AR: Frequency analysis of the surface electromyogram during sustained isometric contractions. *Eur J Appl Physiol* 43:173-182, 1980
83. Baidya KN, Stevenson MG: Local muscle fatigue in repetitive work. *Ergonomics* 31:227-239, 1980

SUGGESTED READINGS

Fundamental studies of locomotion and other information relating to design of artificial limbs: Serial No. CAL 5. Berkeley, CA, University of California, 1947

Grandjsan E: Fatigue in industry. *Br J Ind Med* 36:175-186, 1979

Hof AL: EMG and muscle force: An introduction. *Human Movement Science* 3:119-153, 1984

Kadefors R, Kaiser E, Petersen I: Dynamic spectrum analysis of myopotentials with special reference to muscle fatigue. *Electromyography* 8:39-74, 1968

Kak AV: Stress: An analysis of physiological assessment devices. In Salvendy G, Smith MJ (eds): *Machine Pacing and Occupational Stress*. London, England, Taylor and Francis, Ltd, 1981

Kramer CGS, Hagg T, Kemp B: Real time measurement of muscle fatigue related changes in surface EMG. *Med Biol Eng Comput* 25(6):627-630, 1987

Moore AD: Synthesized EMG waves and their applications. *Am J Phys Med* 46:1302-1316, 1967

Olney SJ, Winter DA: Predictions of knee and ankle moments of force in walking from EMG and kinematic data. *J Biomech* 18:9-20, 1985

Stulen FB, DeLuca CJ: Muscle fatigue monitor: A non-invasive device for monitoring localized muscular fatigue. *IEEE Trans Biomed Eng* 29:660-678, 1982

CHAPTER 7

Applications of Electromyography in Ergonomics

William Marras, Ph.D.

William Marras received a Ph.D. in Bioengineering and Ergonomics and an M.S. degree in Industrial Engineering from Wayne State University in Detroit, Michigan. He currently holds positions as Associate Professor in the Department of Industrial and Systems Engineering and in the Department of Physical Medicine at the Ohio State University. He is also the Director of the Biodynamics Laboratory. Dr. Marras has authored over fifty journal articles on various aspects of ergonomic research. His research focuses upon industrial surveillance techniques, laboratory biomechanical investigations and mathematical modeling of the spine and wrist.

APPLICATIONS OF ELECTROMYOGRAPHY IN ERGONOMICS

William Marras, PhD

INTRODUCTION

This chapter reviews experimental design considerations and statistical analyses that make it possible to interpret electromyographic (EMG) results accurately. The major portion of the chapter describes how EMG can be used in various applications. Emphasis is placed on the presentation of exemplary literature, describing how EMG has been used to evaluate muscle function. At the end of each section, key points are summarized.

EXPERIMENTAL DESIGN CONSIDERATIONS

Interpretation of the results of an EMG investigation is dependent on the experimental conditions under which the experiment was conducted and the analyses that have been performed. Most errors in interpretation occur because the investigator is trying to over-interpret or read too much from the data when the experimental conditions and EMG assumptions do not warrant such conclusions.

Errors in interpretation usually are due to two problems in experimental control and data treatment. First, the EMG dependent measures are misinterpreted because the experiment was not designed to preserve the EMG-muscle characteristic relationships described in Chapters 5 and 6. For example, if a lifting experiment is performed under free dynamic conditions, factors such as the length-tension and velocity-tension relationships will interfere with the EMG-tension relationship. In such a case, no statements can be made regarding muscle force, and the valid information derived from the study is reduced to a description of the on-off states of the muscle or a characterization of the muscle activity as measured by EMG.

Secondly, the study may not include a complete experimental design that will allow for statistical evaluation of the data. Many factors may influence muscle activity, and the point of an EMG ergonomic study is to evaluate how work place factors such as methods, tool design, and work place layout influence a muscle or a set of muscles. Unless all relevant factors are considered in the experimental design, however, the results of the study may be misleading. If the activity of the forearm muscles is of interest during the use of various tool designs, for example, the effects of tool design and other factors such as method of use or tool orientation also must be included in the experimental design. If only the tool design is

considered, any interactions affecting muscle activity may go unnoticed. There may be no main effect resulting from tool design, but there may be a very significant interaction between tool design and method of use. Such a trend would not be identified without a proper experimental design and evaluation.

As described in earlier chapters, normalization procedures should be used if comparisons are to be made between muscles and subjects. This normalization is necessary because the differences between these factors may be masked. Furthermore, advanced statistical analysis techniques make assumptions regarding the distributions of the dependent measures. These assumptions may not hold if the EMG signal is expressed in terms of microvolts. If they are processed in terms of normalization techniques, however, further analyses are justifiable.

INTERPRETATION THROUGH STATISTICS

A sufficient number of subjects is important when statistical comparisons are intended, to state accurately that one particular work place or method causes a change in muscular activity, muscle force, or fatigue compared with other work positions. Statistical comparisons are needed to determine whether the trends observed in the data are real trends or are due to chance and also to determine the relative contribution of the various effects of the main factors and their interactions.

Comparisons can be made between EMG data sets to determine the significance of one or more work place factors. The techniques that usually are used to make comparisons between one work place factor are the t-test or the one-way analysis of variance (ANOVA). The t-test technique statistically evaluates whether the mean behavior of two groups of EMG data is significantly different. The ANOVA compares the variances between the two or more groups of data. These trends can be evaluated by applying *post hoc* analysis techniques.

Often the effects of several work place factors are of interest. In this case, the effect of each factor and their interactions are of interest. These statistical comparisons usually are best performed by evaluating the variance between the cells of the experiment. These cells represent the combined data that are due to the combination of main work place effects. A two-way or multifactor ANOVA

can be used to evaluate the significance of these effects. As with the one-way ANOVA, several *post hoc* follow-up tests are available to interpret the trends. Multiple regression analysis techniques also are used sometimes to build a model of the factors that contribute to the EMG response. In this manner, the amount of variance accounted for by the work place factors can be evaluated in the form of an R squared statistic.

In many EMG studies, the influence of work place factors on the collective behavior of several muscles is of interest. Once the data is normalized, these statistical comparisons usually are performed in multivariate and univariate terms. Multivariate statistics such as multivariate analysis of variance (MANOVA) are used to determine whether several muscles, as a group, respond in a significantly different manner to experimental conditions. Univariate analysis of variance (ANOVA) and discriminate analysis techniques are used as a follow-up to significant MANOVA analyses to determine which individual muscles contribute the most to the multivariate significance. Finally, follow-up *post hoc* tests, such as Duncan range tests, Tukey tests, and cluster analyses, are used to determine which individual conditions are quantitatively statistically different from one another.

Because statistical analyses options are extensive and can comprise a book in themselves, it is recommended that the reader consult a statistical expert or investigate statistical analysis references when planning and analyzing EMG studies of ergonomics.

ELECTROMYOGRAPHIC RELATIONSHIPS AND THEIR APPLICATIONS

As mentioned throughout most of the previous chapters, the relationship between the EMG signal and the variable of interest is dependent on many factors. These factors include experimental design, normalization techniques, signal processing, and analysis structure. This section discusses these factors collectively as a function of the EMG relative to the ergonomic intent of the studies. Throughout this section, example studies will be discussed that use these EMG relationships and various recording and preparation techniques to derive knowledge about ergonomics. Some of the studies discussed below will point out differences in many aspects of the EMG studies such as recording techniques, processing, and statistical analyses. Then, as more studies are discussed, only the unique features of the studies will be mentioned.

On-Off State of Muscle

Historically, the evaluation of the on-off state of the

muscle has regularly been evaluated by EMG. As discussed in Chapter 5, the experimenter simply would observe the raw EMG signal and note when the muscle was active. Most studies that now investigate the on-off state of the muscle are interested in the phasing of the EMG activities under various experimental conditions. Maton et al, using raw EMG, investigated the activity of the elbow extensor muscles during fast and slow braking movements of the arm.¹ An example of these results are shown in Figure 5-8 of Chapter 5. This study was qualitative in that no statistical analyses of the on-off muscle states were performed. This figure, however, demonstrates that more synergistic activity of the muscles occurs under fast motion conditions.

A quantitative evaluation of muscle on-off state was performed by Marras and Reilly, using statistical analyses of muscle event times derived from processed EMG.² They were interested in how the patterns of trunk muscle activation changed as the angular velocity of the trunk increased during controlled simulated lifting motions. They statistically compared the event times at which 10 trunk muscles began to activate, reached their peak activities, and terminated their activities as a function of various velocities of motion. A summary of the t-test comparisons of these event times is shown in Figure 7-1. The statistically significant differences were used to construct networks that described the relative phasing and cooperation of these 10 muscles as a function of the trunk velocity. An example of such a network is shown in Figure 7-2. These networks were later used along with EMG force information as inputs to a biomechanical model³ that was capable of predicting the relative compressive and shear loads on the spine that were due to trunk motion.

These examples show that the muscle on-off information derived from EMG signals is used for two main purposes in ergonomic studies. First, they are used to describe which muscles are active as a function of the work place conditions. Second, muscle phasing and coactivation information can be used in conjunction with other types of EMG force information to assess the loading of joints.

Muscle Force

As mentioned in previous chapters there are several ways to interpret muscle force via EMG. Indicators of muscle force range from estimates of percent of muscle usage to quantitative estimates of the newtons of force present within a muscle during an activity. The degree of quantification possible depends upon the experimental conditions and the experimental control present during the experiment. Examples of the various interpretations of muscle force will be presented here.

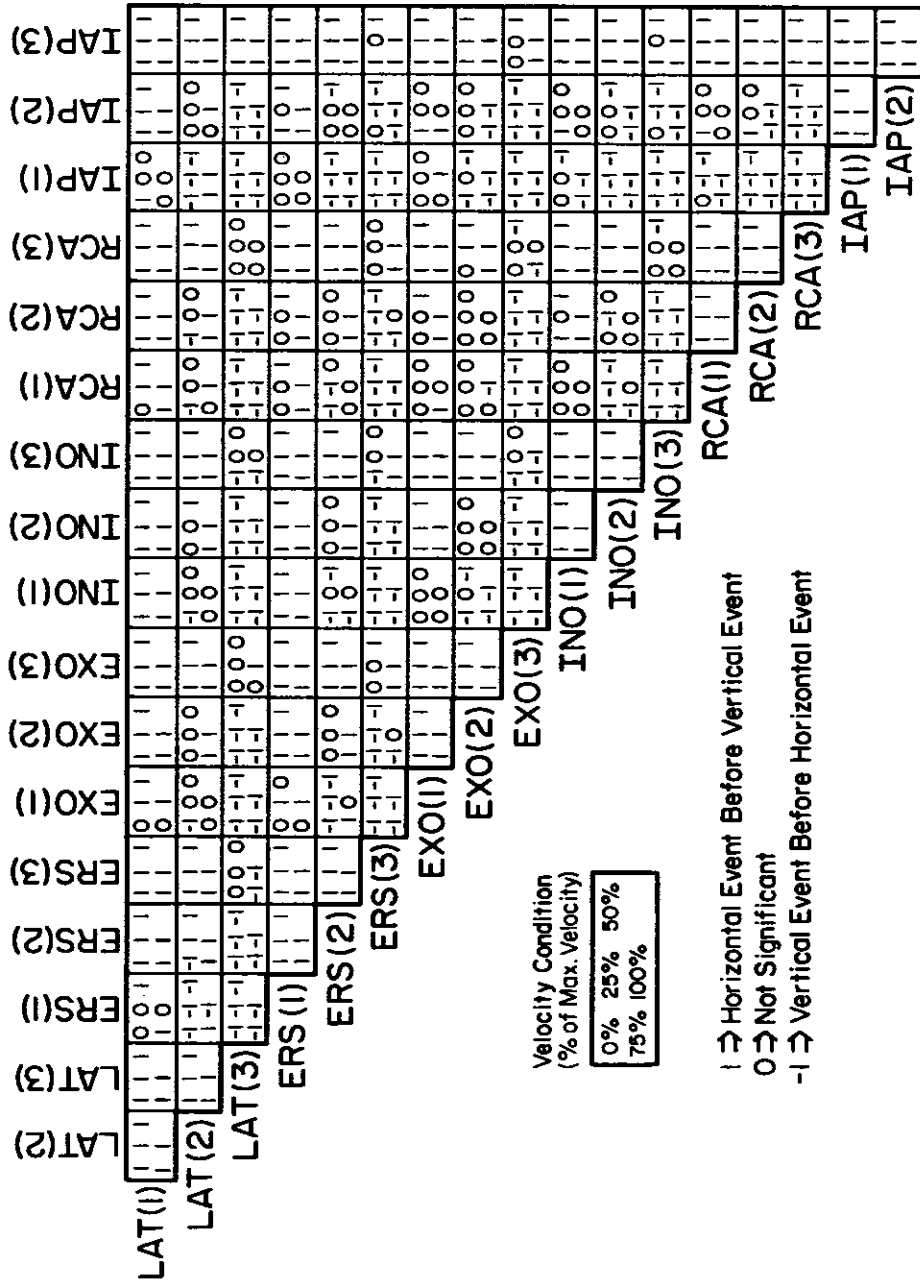

FIGURE 7-1

Summary of significant differences between event times under different conditions. This summary represents a statistical analysis of muscle event times (t₁ = on time, t₂ = peak, t₃ = end time) that are directional. The figure margins represent the muscles considered along with the event time (1, 2, or 3). The experimental conditions are represented by a cell position shown in the legend. If a "1" appears in a cell, the row event preceded the column event and the difference was statistically significant. If a "0" appears in a cell, there was no statistically significant difference in occurrence time between the row and column event. If a "-1" appears in a cell, the column event preceded the row event and the difference was statistically significant.

Reprinted with permission from Marras WS, Reilly CH: Networks of internal trunk loading activities under controlled trunk motion conditions. Spine 13:661-667, 1988, Figure 5.

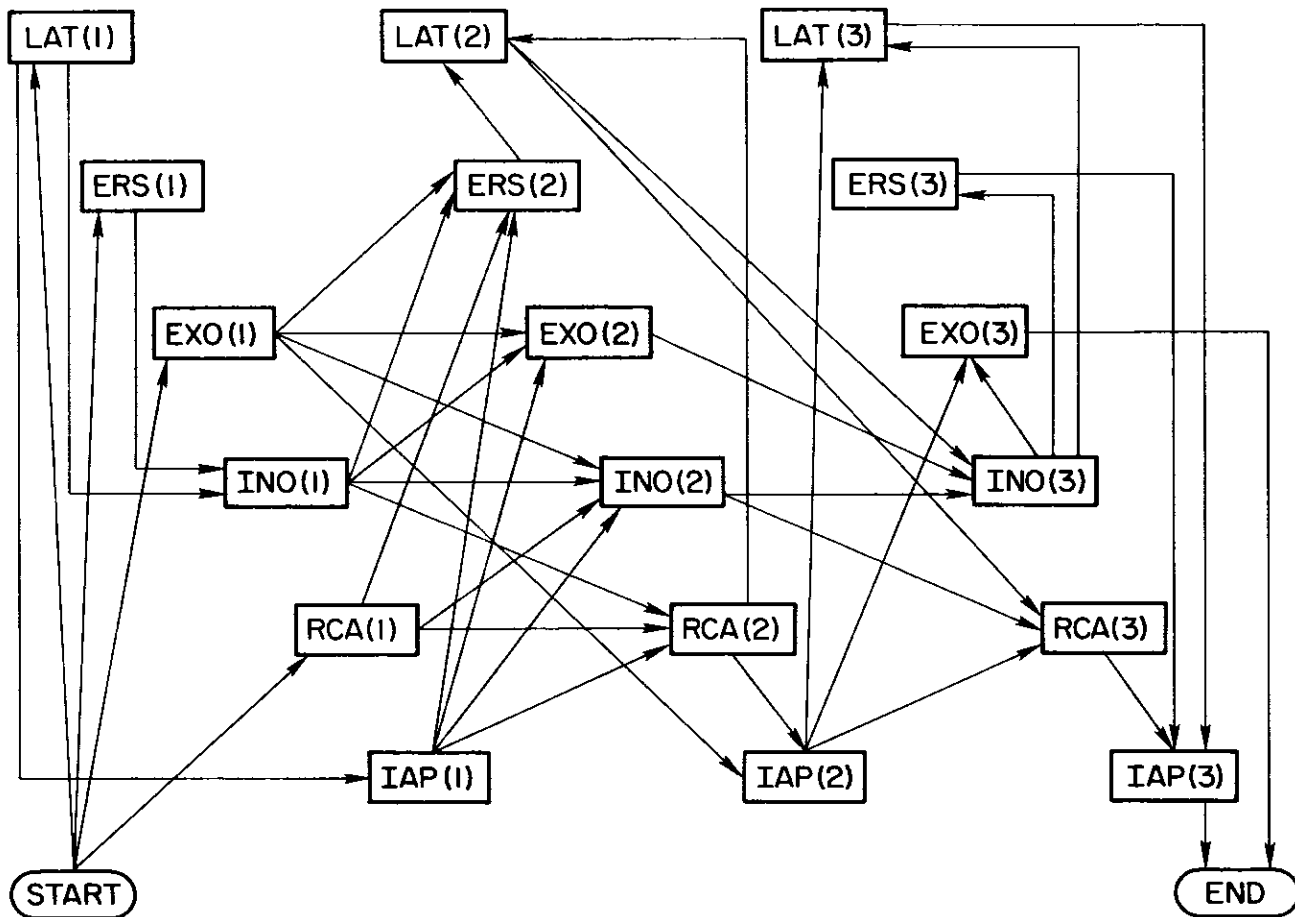

FIGURE 7-2
Network of event-occurrence sequences for isometric exertion.

Reprinted with permission from Marras WS, Reilly CH: Networks of internal trunk loading activities under controlled trunk motion conditions. Spine 13:661-667, 1988, Figure 6.

Muscle Usage Through Normalized Activity Level

One of the most widely used techniques uses EMG to measure the degree of muscle activity required to perform in ergonomic applications. This direct measure is straightforward and simple to use and assists the ergonomist in determining how active a particular muscle is throughout an exertion. It should be emphasized that this measure is not an indicator of muscle tension, but merely a measure of the degree of muscular activation solicited from the muscle. The advantage of this measure is that the data can often be collected on the factory floor without affecting job performance.

To use this measure, one must first determine the

EMG signal produced by a maximum contraction. Typically, this effort is elicited from the muscle while the muscle is in the same position required by the work or task under investigation. The EMG activity level (most likely a processed form) during this maximal contraction is recorded and used as the common denominator for estimates of the level of EMG activity required for performance of other tasks. Either the maximum or mean activity level may be used for this purpose. In this manner, the percentage of muscle activity relative to the maximum voluntary muscle contraction (MVC) for a given muscle is obtainable. (Also see Chapter 5.)

Many examples of the use of normalized activity level exist in the literature. These studies typically

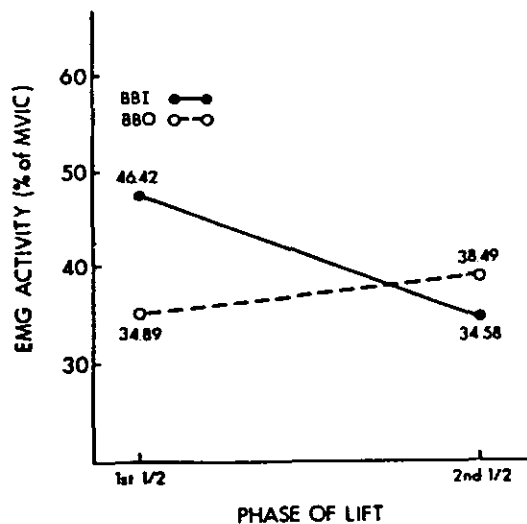

FIGURE 7-3

Interaction between style of lift and phase of lift for erector spinae muscle EMG activity (AB interaction).

Reprinted with permission from Delitto RS, Rose SJ, Apts DW: *Electromyographic analysis of two techniques for squat lifting*. *Phys Ther* 67:1329-1334, 1987, Figure 3.

investigate changes in work method, work place layout, tool design, or the reaction of the musculoskeletal system resulting from work conditions. First, examples of method comparisons will be discussed. Delitto et al observed the activity levels of the erector spinae muscles and the oblique abdominal muscles as subjects performed two methods of squat lifting.⁴ In this study, subjects were asked to exert isometric MVCs contractions with the erector spinae muscles as they executed a prone position upper-torso lift while resistance was applied bilaterally to the shoulders. The MVCs of the oblique abdominal muscles were solicited with the subject attempting to perform a partial sit-up while resistance was applied to the shoulders bilaterally. It was assumed that these muscle positions were comparable to those used during two types of squat lifts. The EMG signals were processed with a linear envelope detector. The EMG signals and two switch signals that indicated when the lift began and ended were recorded with a strip chart recorder. Using these maximums to normalize the EMG data, these researchers were able to represent each exertion as a percentage of the maximum muscle activity and test the data statistically across activities. Table 7-1 shows the means normalized

EMG activities represented as a function of the experimental conditions and Table 7-2 shows a three-way ANOVA used to statistically evaluate these results. Table 7-2 indicates that three significant interactions involving lift method, timing (phase), and load magnitude were found to have an effect on the amount of EMG activity. This table indicates that no significant phase effect (B) is present. As shown in Figure 7-3, however, there is a significant interactive effect between style of lift (A) and phase (B). Such interactions would not be identifiable without a proper experimental design and a formal statistical analysis. In this manner, the study was able to identify the lifting method that offered the most protection to the trunk muscles under various circumstances.

Bobet and Norman also investigated methods of carrying loads, load magnitude, and the duration of load carrying on the activity of the shoulder, back, and leg muscles.⁵ This study also normalized the EMG contraction levels; however, the normalization was performed relative to the mean of two 1-second 50% of isometric MVCs. Because the task involved walking and carrying, the EMG signals were transmitted via telemetry to a FM recorder. The average full-wave rectified EMG was used as the dependent measure in this study. After statistical transformation of the data set, the results were tested with a three-way ANOVA procedure for statistical significance. Significant effects were further analyzed by post-hoc analyses. The analysis of the data indicated that only the three way interaction of effects were statistically significant. This study emphasizes the importance of proper statistical analyses. Here, only unique combinations of method of carrying, load magnitude, and duration affected the activity of the muscles. These trends would be very difficult to detect without such statistical analyses.

Secondly, EMG activity level is often used to evaluate work positions or work place layout. One of the most common aspects of the work place investigated is that of sitting position during work. Schuldt et al investigated the effects of sitting posture, hand-arm movement, and arm rests on the activity of neck and shoulder muscles.^{6,9} In these studies, electronics assembly workers were studied while performing a simulated work task. Even though the task involved movement of the arms, the positions of the neck and shoulder muscles were considered static during the work. Thus, this study would not violate EMG sampling assumptions. Isometric MVCs of each muscle, recorded while in the sitting position, were used to normalize the activity levels in this experiment. Figure 7-4 shows the isometric positions used for EMG normalization for the muscles of interest. The location of the electrodes used to record muscle activities is shown in Figure 7-5. The EMG dependent variables consisted of full-wave rectified and time averaged EMG

TABLE 7-1

Mean Percentage of Maximal Voluntary Isometric Contraction of Erector Spinae and Oblique Abdominal Muscle Electromyographic Activity During Lifting^a

Style/Phase/Load ^b	Erector Spinae		Oblique Abdominal	
	\bar{X}	s	\bar{X}	s
BBI lift (A1)				
First half (B1)				
Light (C1)	27.84	15.91	10.76	8.86
Moderate (C2)	48.91	18.21	29.02	27.12
Heavy (C3)	64.10	18.76	44.85	38.72
Second half (B2)				
Light (C1)	19.29	8.94	6.51	5.16
Moderate (C2)	35.91	12.01	12.80	11.09
Heavy (C3)	48.53	14.35	26.49	21.59
BBO lift (A2)				
First half (B1)				
Light (C1)	24.08	12.36	13.68	16.75
Moderate (C2)	35.03	14.19	26.49	21.59
Heavy (C3)	45.58	17.45	44.21	35.84
Second half (B2)				
Light (C1)	24.40	12.78	6.97	7.72
Moderate (C2)	39.77	14.93	11.13	10.06
Heavy (C3)	51.28	15.67	18.47	14.79

^aReprinted with permission from Delitto RS, Rose SJ, Apts DW: Electromyographic analysis of two techniques for squat lifting. Phys Ther 67:1329-1334, 1987, Table 1.

^bBBI = back-bowed-in; BBO = back-bowed-out

signals using a 1.1-second time constant. The data were recorded on heat sensitive paper. Figure 7-6 shows an example of the varied range of EMG responses that were collected from the 10 subjects in this study. This study used a series of Student's t-tests to determine the statistical significance of the results. In this manner, the effects of sitting postures and their interaction with arm supports and hand movements was analyzed.

Soderberg et al investigated the activity of three portions of erector spinae muscles in response to sitting in chairs with inclined seat pans.¹⁰ They evaluated the effects of flat and anteriorly inclined chairs (postures) on the activity of these muscles. The experimental design considered subject-posture, and duration of sitting (time) factors and the posture and time interaction. The experimental design is shown graphically in Figure 7-7. In this study, MVCs of the back musculature solicited with the subject laying in the prone position were recorded and used to normalize the data. Here again, it was assumed

TABLE 7-2

Three-Way Analysis of Variance for Repeated Measures for Erector Spinae Muscle Electromyographic Activity During Lifting^{a,b}

Source	df	SS	MS	F
BBI lift vs BBO lift (A)	1	966.09	966.09	20.20 ^c
Error	18	1704.94	94.72	
First half vs second half (B)	1	1076.97	1076.97	4.90
Error	18	3952.62	219.59	
Load (C)	2	31185.90	15592.95	167.30 ^c
Error	36	3319.20	92.20	
AB interaction	1	3672.50	3672.50	15.69 ^c
Error	18	4212.90	234.05	
AC interaction	2	708.22	354.11	11.63 ^c
Error	36	1095.84	30.44	
BC interaction	2	10.58	5.29	0.08
Error	36	2260.44	62.79	
ABC interaction	2	379.96	189.98	8.28 ^c
Error	36	826.20	22.95	

^aReprinted with permission from Delitto RS, Rose SJ, Apts DW: Electromyographic analysis of two techniques for squat lifting. Phys Ther 67:1329-1334, 1987, Table 2.

^bBBI = back-bowed-in; BBO = back-bowed-out

^cp < .01

that the orientation and length of the muscles of interest would be similar to that observed in the experimental conditions. The root-mean-square (RMS) processed EMG signal was used as the dependent measure in this experiment. Subjects were asked to perform a typing task on a computer terminal during the experiment. This study was different than the previously mentioned studies in that the EMG signal was digitized and recorded on-line with a computer. The normalized data was analyzed using ANOVA and post-hoc techniques. The results were able to determine that different erector spinae muscle activity levels were present during sitting on the various chair designs.

DeGroot used normalized EMG to study the task of postal letter sorting.¹¹ Three shoulder muscles were evaluated as postal employees sorted mail into a pigeon hole sorting frame. Because this was somewhat a dynamic task, the data first were reviewed and then excluded if they contained motion artifacts. The data was processed using normalized RMS procedures. This data was used to form regression equations that predicted EMG activity as a function of the horizontal and vertical location of the pigeon hole. A statistically significant regression

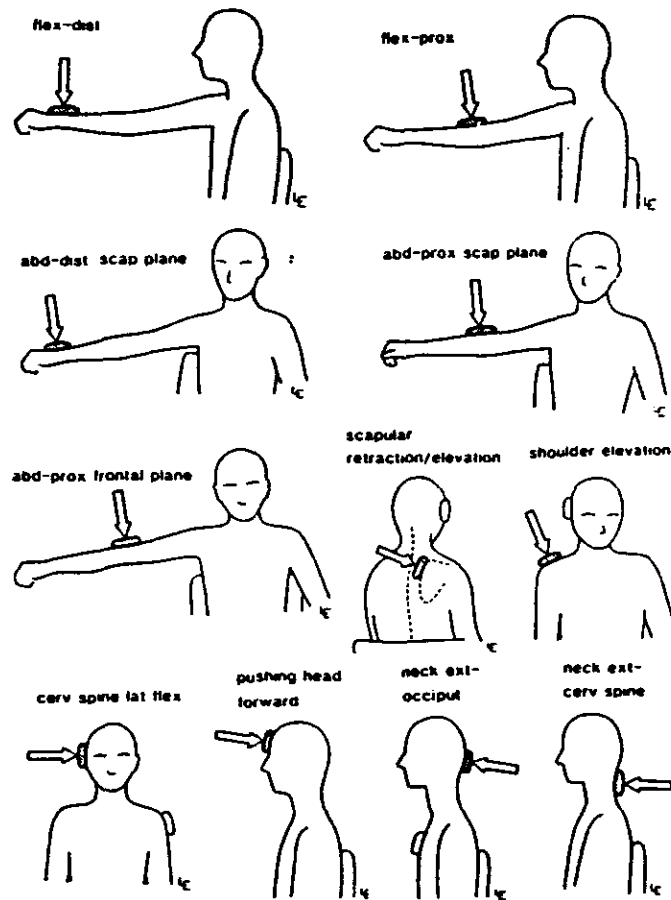

FIGURE 7-4

Isometric test contractions. Arrow to shaded area indicates location of manual resistance. Unfilled area shows point of manual support. For description of test contractions, see their Methods section.

Reprinted with permission from Schuldt K: On neck muscle activity and load reduction in sitting postures: An electromyographic and biomechanical study with applications in ergonomics and rehabilitation. Scand J Rehabil Med [Suppl] 19, 1988, 1-49, Figure 7.

model was developed that was capable of determining the contribution of the various pigeon hole locations to muscle activity. Figure 7-8 illustrates the relationship found between pigeon hole location and muscle activity. This information was used to hypothesize the occurrence of various occupationally related arm-shoulder syndromes. The result was a redesign of the sorting frame used in the postal system.

Next, EMG activity level often is used to evaluate tool design. Rockwell and Marras investigated the effects of the design and method of use of leverage tools on the EMG activity of the back musculature.¹² In this study,

a back dynamometer was used to test and control the back position and to solicit isometric MVCs. In this manner, the experimenters were able to match and normalize the back position with that required by the experimental task. The RMS processed EMG signal was used as a dependent measure, being recorded on-line with a microcomputer. Figure 7-9 shows a schematic representation of this equipment. This study also used an ANOVA and post-hoc procedures to evaluate the results. It should be pointed out that even though the tool design was of primary interest in this study, the method of use (in addition to other variables) had to be incorporated into the design so that appropriate comparisons between tool

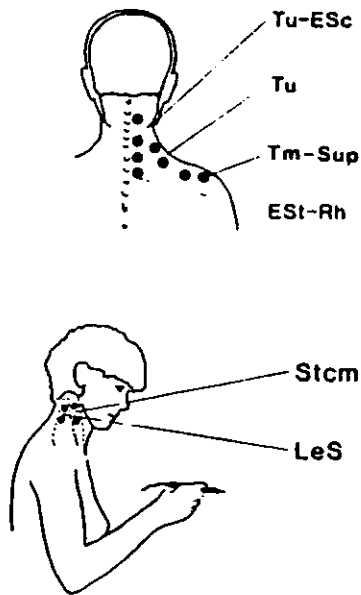

FIGURE 7-5

The location of recording electrodes: Tu-ESc, erector spinae cervicalis covered by upper part of trapezius; Tu, trapezius, pars descendens at anterolateral margin; Tm-Sup, trapezius, pars transversa covering superaspinus; ESr-Rh, erector spinae thoracalis covered by the rhomboids; Stcm, sternocleidomastoideus; LeS, levator scapulae.

Reprinted with permission from Schuldt K, Ekholm J, Harms-Ringdahl K, et al: Effects of changes in sitting work posture on static neck and shoulder muscle activity. Ergonomics: 29:1525-1537, 1986, Figure 1.

designs could be made.

Finally, the activity levels of muscle are used often in ergonomic studies to help interpret the response of the musculoskeletal system to various work conditions and hazards. Bhattacharya et al used normalized EMG activity to evaluate the level of muscle usage employed during a carpet installation task using a knee-kicker tool.¹³ They studied this dynamic task by breaking the dynamic action into four static body postures that represented the components of the dynamic task. These postures and the associated EMG activities are shown in Figure 7-10. They also studied a dynamic carpet installation task using the knee-kicker tool. They recorded the activity of the arm, shoulder, and leg muscles during these static and dynamic activities. The EMG data were normalized by comparing the EMG activity with standard maximum exertions of the muscles. Processing of the static EMG signals was accomplished using a linear envelope procedure. These signals were not compared statistically, so

no interactions between experimental main effects were evaluated. The results were subjectively compared by representing the subject data in histograms. The dynamic EMG activity amplitudes were not evaluated because they contained dynamic motion artifacts. However, this information was used to evaluate the percentage of time each muscle group was active. This was accomplished by observing the on-off times of the muscles throughout the cycle of work. This analysis enabled the authors to suggest changes in the method of tool use so that musculoskeletal strain would be minimized.

Another example is provided by Seroussi and Pope who used normalized EMG activity levels to investigate how the trunk muscles responded to lifting moments in the various planes of the body while subjects were in isometric standing positions.¹⁴ The procedures used in this study were similar to those used in the previous two referenced studies; however, in this study the EMG data was normalized according to the equation:

$$\text{Relative Activity} = \frac{\text{Task EMG} - \text{Rest EMG}}{\text{Maximum EMG} - \text{Rest EMG}} \quad (1)$$

This permitted the investigators to assess the contribution of only the changes in lifting moments in various locations about the body. A similar procedure was used by Marras et al to investigate the reaction of the musculoskeletal system to unexpected load handling.¹⁵ In this study, the EMG activity of 6 trunk muscles were normalized by equation (1). The task of interest required the subject to stand in an isometric posture and hold a box into which weights were dropped under expected and unexpected conditions. Analysis of variance procedures were used to evaluate the peak, mean, and onset rate parameters of the EMG activity under the various expectation conditions. The parts of the EMG that were evaluated are identified in Figure 7-11. In this manner, the change was documented in the activity parameters of the trunk muscles resulting from load increase and expectation. Based on these EMG activity level analyses, adjustments to lifting guidelines for specific work place conditions were recommended.

Muscle Usage Through Microvolt Activity Level

Ergonomic studies can also be found in the literature that investigate muscle usage based solely on the amount of microvolts of EMG activity observed during a work task. The only difference between these studies and those that measure normalized activity level is that these studies usually do not test each subject's MVC of the muscle. Therefore, a different baseline of EMG activity sensitivity may be recorded with each subject unless precautions are taken. This different baseline is due to varying levels of

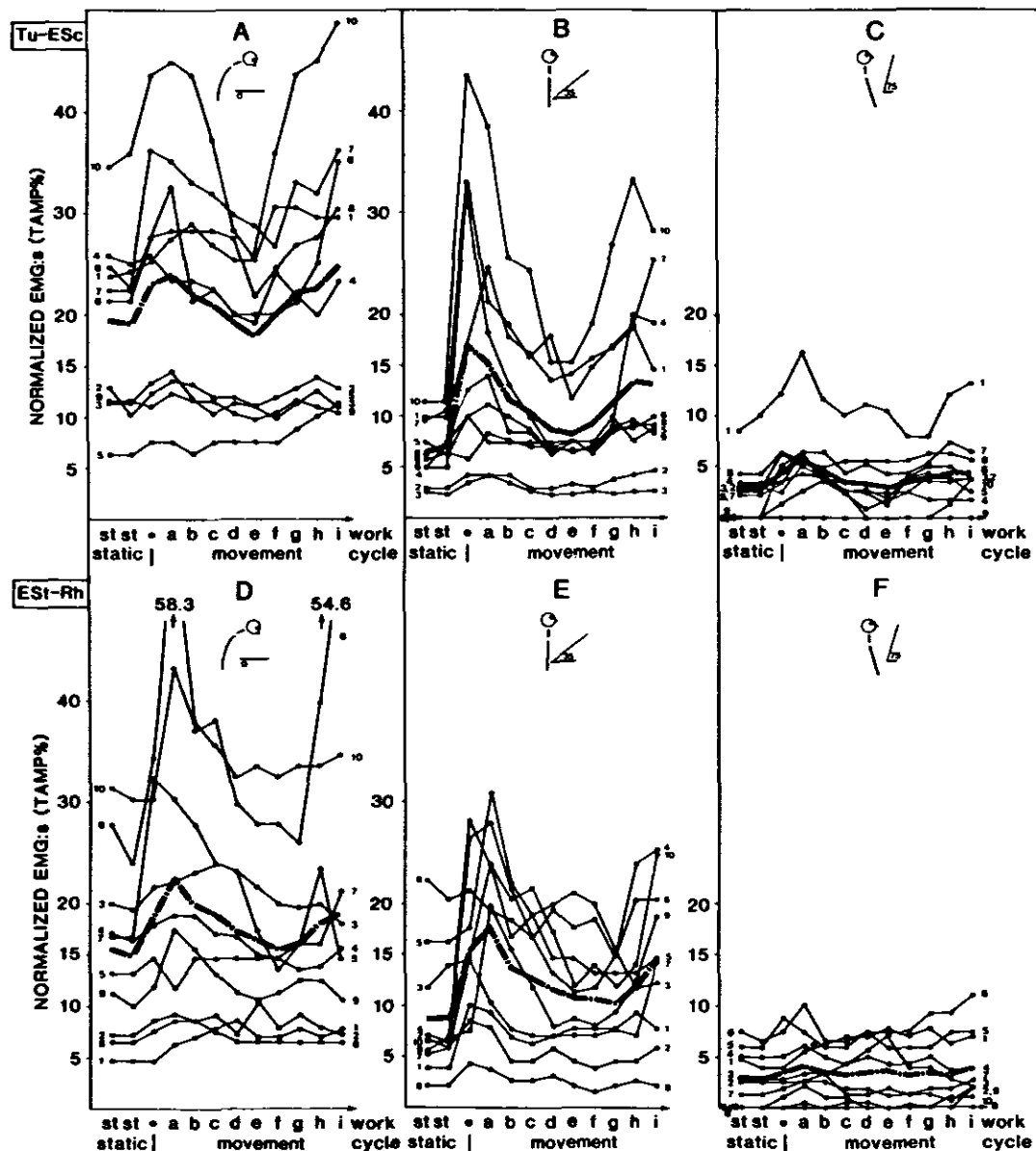

FIGURE 7-6

Level of muscular activity (vertical axis, TAMP%) in relation to course of simulated work cycle (horizontal axis), starting with last part of static phase and continuing with movement phase with arm-hand moving from position 'a' to 'b', etc, and back to 'i'. Thick segmented lines indicate means. Differences between three sitting postures also illustrated. A,D: gives the posture WFHO as indicated at the top of the figure; B,E: gives the WV; C,F: gives the TLBCV posture. Small numerals indicating subjects are shown at the beginning and end of each curve. For explanation of abbreviations, see their Methods section and Figures 1 and 3. (n = 10)

Reprinted with permission from Schuldt K, Ekholm J, Harms-Ringdahl K, et al: Influence of sitting work postures on neck and shoulder EMG during arm-hand work movements. Clin Biomech 2:126-139, 1987, Figure 4, p 130.

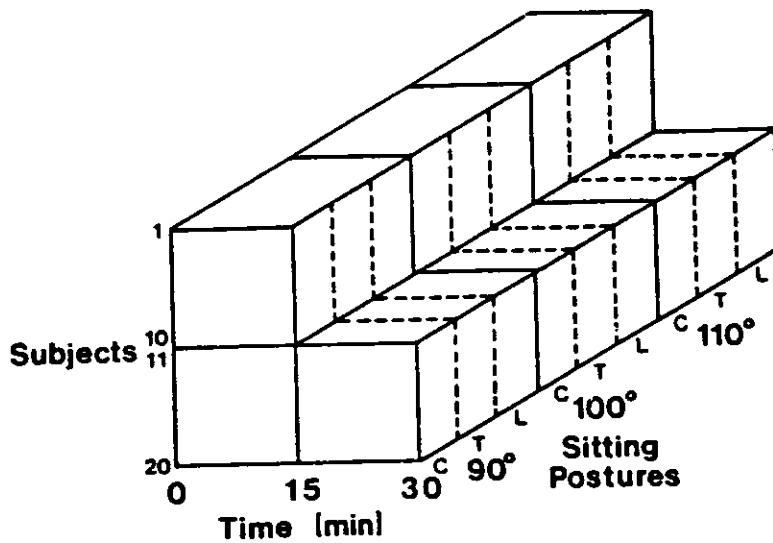

FIGURE 7-7

Graphic representation of the multifactorial repeated measures design of the study. Cervical (C), thoracic (T), and lumbar (L) segments are represented at each posture.

Reprinted with permission from Soderberg GL, Blanco MK, Cosentino TL, et al: An EMG analysis of posterior trunk musculature during flat and anteriorly inclined sitting. Human Factors 28:483-491, 1986, Figure 2.

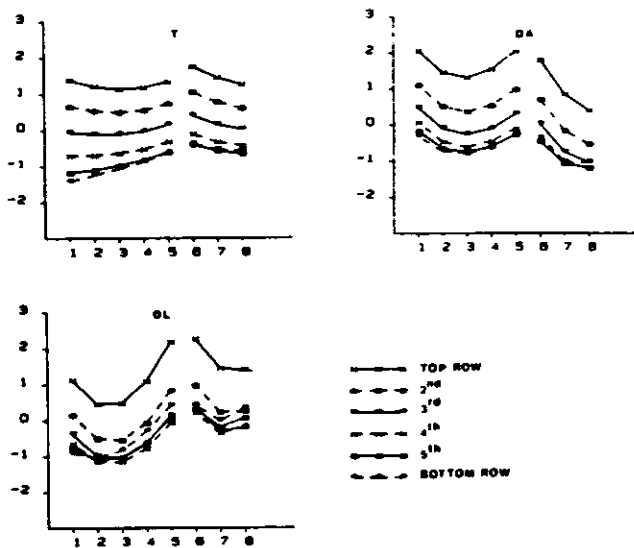

FIGURE 7-8

Normalized value of EMG activity averaged over subjects.

Reprinted with permission from DeGroot JP: Electromyographic analysis of a postal sorting task. Ergonomics 30:1079-1977, 1987, Figure 4.

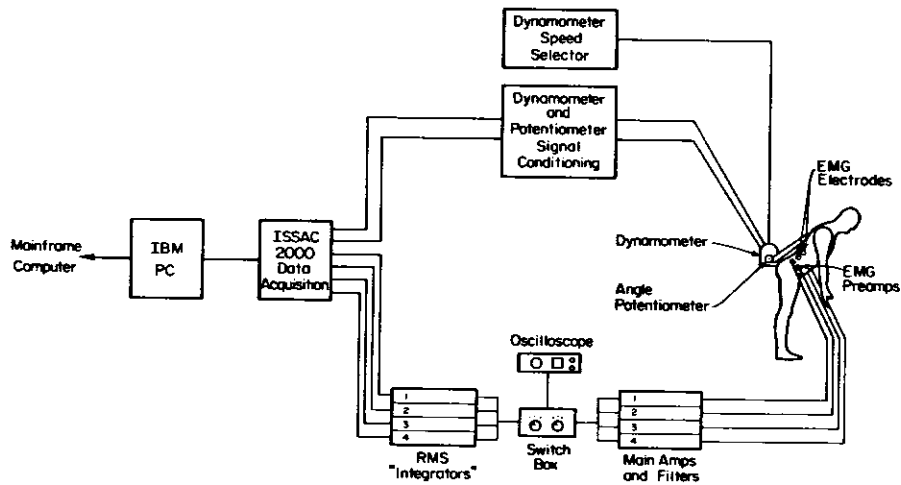

FIGURE 7-9
The experimental apparatus.

Reprinted with permission from Rockwell TH, Marras WS: An evaluation of tool design and method use of railroad leverage tools on back stress and tool performance. Human Factors 28:303-315, 1986, Figure 1.

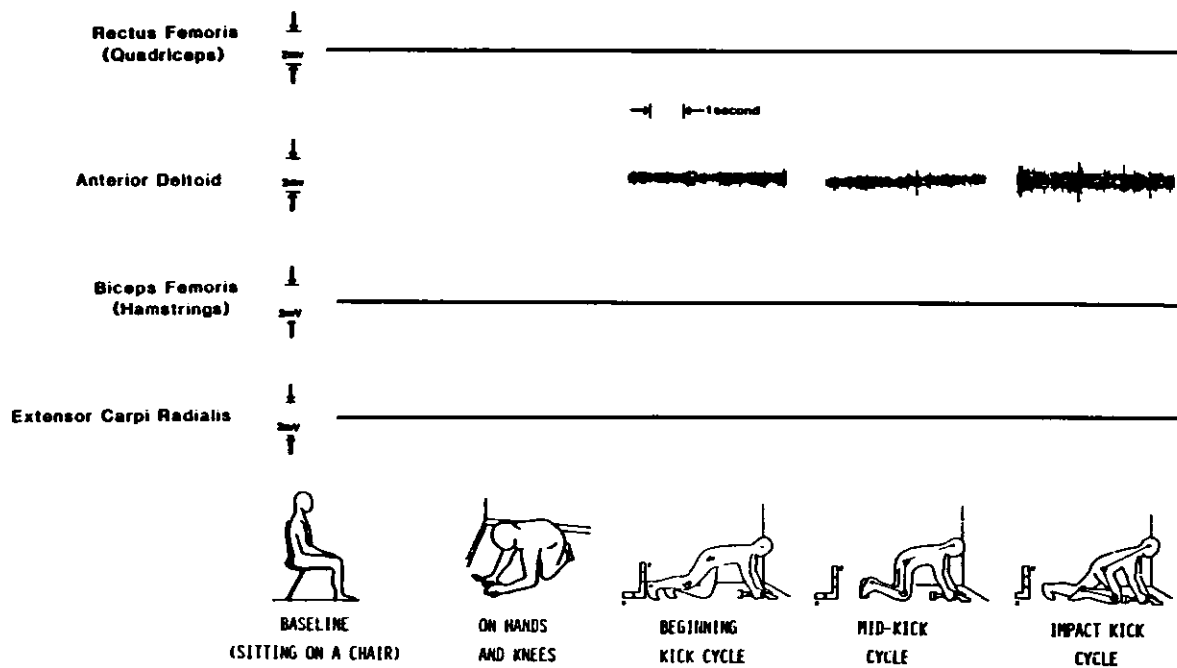

FIGURE 7-10
Raw EMG data associated with static postures of carpet installation task.

Reprinted with permission from Bhattacharya A, Ramakrishnan HK, Habes D: Electromyographic patterns associated with a carpet installation task. Ergonomics: 29:1073-1084, 1986, Figure 4, p 1079.

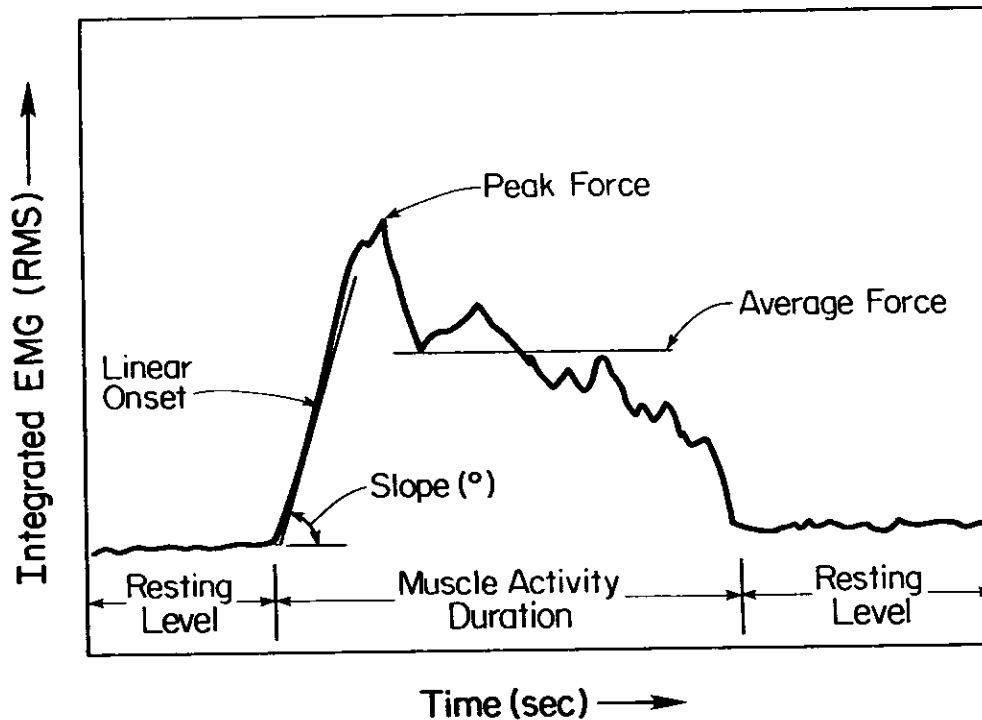

FIGURE 7-11
Trunk muscle activity components used in analysis.

Reprinted with permission from Marras WS, Rangarajulu SL, Lavender SA: Trunk loading and expectation. Ergonomics: 30:551-562, 1987, Figure 2, p 556.

electrode impedance and varying levels of subcutaneous tissue between subjects. The important element in successfully recording activity level by this method is precise calibration of the EMG signal. It is imperative to determine precisely the gain of the EMG system with this method. This is done usually by adjusting the gain of the system so it is within the most sensitive range of the recording system (eg, chart, FM recorder, computer). Then a known calibration signal is provided as input and recorded. Thus, the gain is known precisely. This methodology in ergonomic investigation often limits use of more sophisticated statistical analysis techniques. Because few assumptions about the distribution of the EMG signal can be made and intervariability is not well controlled, the statistical analyses usually are limited to comparisons between mean activities. These tests often are not as powerful as tests based on variance.

As with normalized activity level investigations, these studies usually involve investigations of work methods, environments, or the response of the

musculoskeletal system to work place conditions. Several examples will be mentioned here.

Andersson and Ortengren used this method to evaluate loads on the backs of workers in an automobile assembly plant under several work situations.¹⁶ In this study, the EMG signal gains were calibrated individually for each muscle periodically throughout the testing period. During the calibration, workers were asked to maintain a specified posture while holding known weights in the hands. The EMG signals were hard wired to an FM tape recorder for permanent recording. The RMS processed EMG signals were evaluated by representing the data in amplitude histograms. In this method the amplitude of the signal was divided into 5 intervals, and the time spent in each of the intervals during a task was divided by the total period of measurement and multiplied by 100. This interval analysis is portrayed in Figure 7-12. In this manner, the muscle amplitude was represented in microvolts, but the amount of time spent in each interval was normalized. Thus, the temporal aspects of EMG

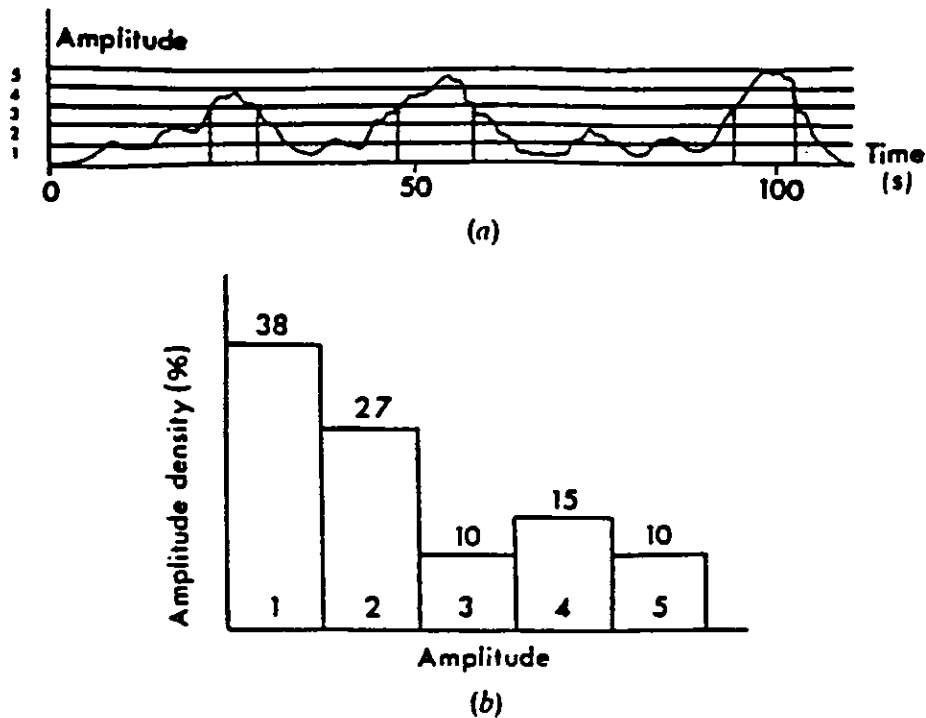

FIGURE 7-12

(a) Example of myoelectric signal amplitude variations during a work spell. The curve is obtained after full-wave rectification and low-pass filtering of the raw myoelectric signal. Five amplitude intervals are marked. (b) Amplitude histogram showing the total time the amplitude curve in (a) spends in each interval in percentage of the total recording time (amplitude density diagram).

Reprinted with permission from Andersson GBJ, Orgengren R: Assessment of back load in assemblyline work using electromyography. Ergonomics 27:1157-1168, 1984, Figure 4.

activity were normalized but not the activity amplitude. This permitted the investigators to plot histograms as a function of tasks and workers. Statistical analyses consisted of a report of mean values, standard deviations, and confidence intervals. Through this analysis technique, the investigators were able to evaluate the relative back load associated with assembly tasks and quantify the degree of load relief offered by lifting aids.

Andersson et al used EMG microvolt activity as a dependent measure to study sitting as a function of 1) chair angle and lumbar support, 2) office chairs while performing office tasks, 3) tasks performed in a wheelchair, and 4) chair variables as a function of driving maneuvers, respectively.^{17,20} In each one of these studies, three to four subjects were evaluated under the experimental conditions. Data were recorded on an FM tape recorder for later analyses. In these studies, calibration was performed by recording sine waves of known amplitude after each investigation. In this manner, the exact gain was deter-

mined for each muscle. The recordings were played back through an ink chart recorder after the signals were processed using RMS circuitry. These values were visually read and entered into a computer for statistical testing. The EMG means, standard deviations, and confidence intervals were computed, and statistical t-tests were performed to determine the statistically significant differences between the means. Figure 7-13 shows the mean and standard deviation of the unnormalized EMG data collected in this experiment. These studies indicate how direct readings of microvolt EMG levels may be used to evaluate the effects of seat induced postures and task requirements in a work place. There were restrictions in making comparisons between subjects because the data were not normalized; therefore, higher order analyses of the variances and interactions were not analyzed.

Andersson et al have also used microvolt activity levels as a means to investigate the effects of posture and loading on the muscle activity of different parts of the

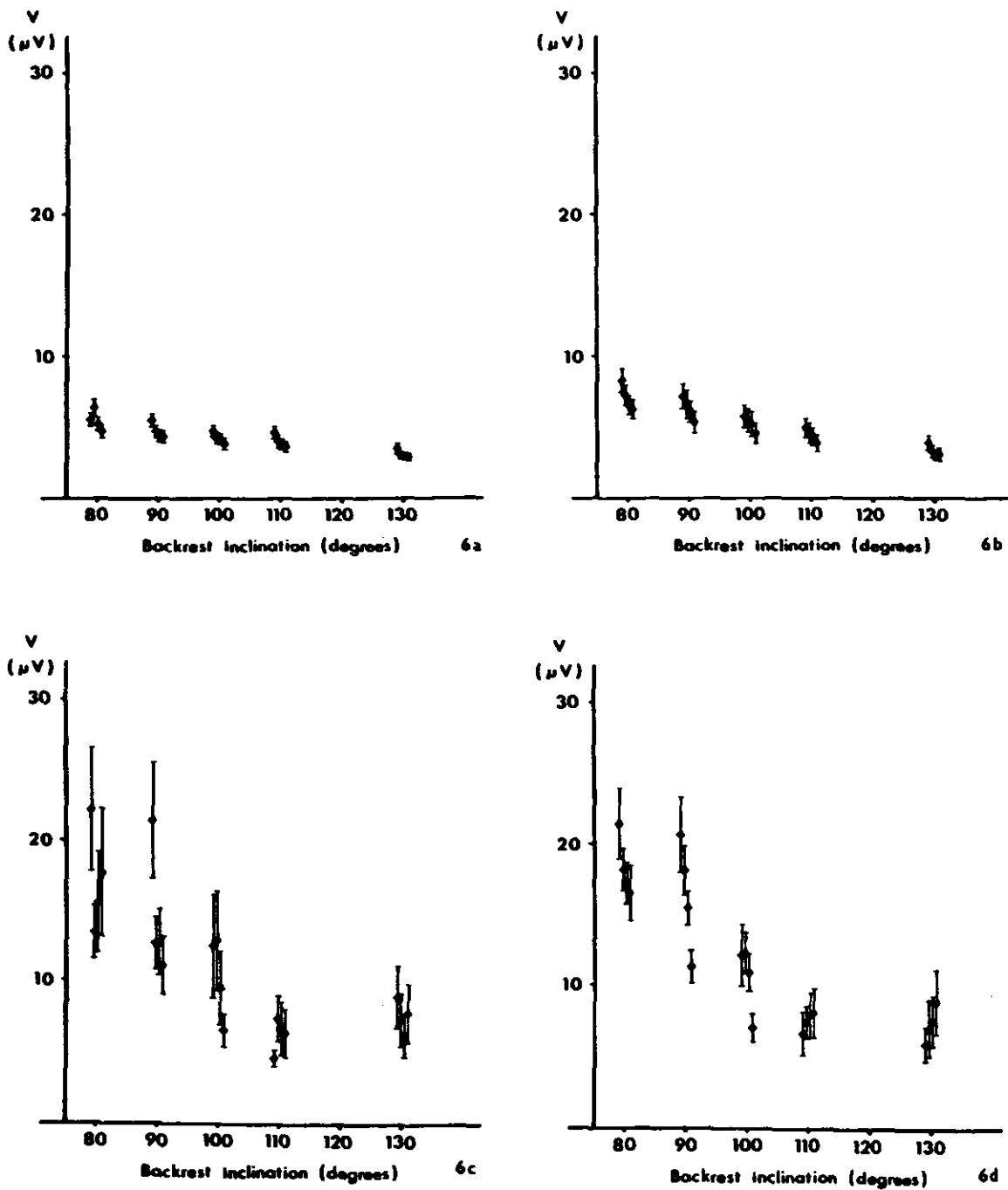

FIGURE 7-13

Mean FRA values and standard deviations of the means. Thoracic support 0 degrees. At each backrest inclination four values are given: From left to right -2, 0, +2 and +4 cm of lumbar support. The recordings were made from the left side of the trunk. (a) C4 level, (b) T1 level, (c) T3 level, (d) T8 level.

Reprinted with permission from Andersson GBJ, Orgengren R: Myoelectric back muscle activity during sitting. Scand J Rehabil Med [Suppl] 3:73-90, 1974, Figure 6.

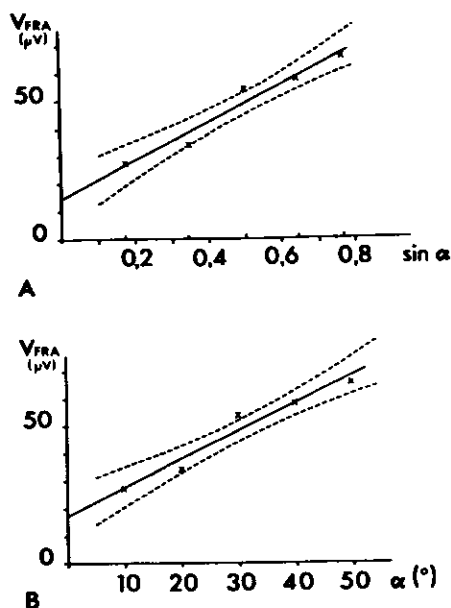

FIGURE 7-14

Linear regression lines for the relationship between the myoelectric activity at the L 3 level. (A) the sine of the angle of forward flexion, and (B) the angle of flexion. Ninety-five percent confidence regions are indicated.

Reprinted with permission from Andersson GBJ, Orgengren R, Herberts P: *Quantitative electromyographic studies of back muscle activity related to posture and loading*. *Orthop Clin North Am* 8:85-96, 1977, Figure 4, p 89.

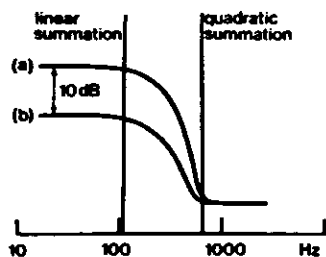

FIGURE 7-15

The total EMG output in microvolts, given a certain number of contracting fibers per unit time, depends on the motor unit size: (a) one motor unit with 500 fibers, (b) 10 units with 50 fibers each. The frequency dependence is due to the fact that low-frequency components appear in synchrony within the motor unit, whereas in the high-frequency range, all components appear at random regardless if the signal is produced by one or several motor units.

Reprinted with permission from Kadefors R: *Application of electromyography in ergonomics: New vistas*. *Scand J Rehabil Med* 10:127-133, 1978, Figure 2, p 128.

back.²¹ Here, the absolute level of EMG activity was used again, and the analyses consisted of a regression analysis so that the relationship (correlation) between trunk angle, load, and EMG activity could be assessed. Figure 7-14 shows this relationship.

Muscle Force Through Normalization

As discussed in Chapter 5 as well as earlier in this chapter, it has been well established that under certain controlled conditions a known relationship (often linear) exists between muscle force and processed EMG. The literature indicates that muscle force estimates are derived usually by using either normalized EMG or the microvolt level of activity as an indication of muscle usage and force. This section will focus on the more widely used approach of normalization.

Regardless of the EMG relationship used to predict force, several conditions must be satisfied to derive muscle force. First, the muscle of interest must be in a static or controlled dynamic state. This is controlled usually through the experimental design and methodology. Second, the EMG-force relationship must be qualified according to the unique properties of the muscle (see Chapters 2 and 6) and is represented usually by a functional relationship or a model. Finally, it is of utmost importance to ensure that a given portion of the muscle is sampled because factors such as the length-tension relationship of the muscle may confound the EMG-force relationship. Only under these conditions can one make statements about the relative amount of force in a muscle during different work conditions often of interest in ergonomic studies.

Gagnon et al used the percentage of maximum EMG as the means to assess muscle force present while nurses aids lifted patients using three different methods.²² As with other predictions of muscle force, this study also used a mathematical model to interpret the EMG activity relative to muscle force and back loading. The model consisted of a static and planer mathematical model that used EMG and force plate data to assess the forces acting on the spine. This study required the subjects to execute three isometric MVCs that served as a reference level of EMG activity for comparison. These authors, as well as Basmajian and DeLuca,²³ advocate such a normalization procedure because it permits more accurate comparisons between subjects and muscle groups. Though these investigators did not compute correlation coefficients between predicted muscle force and measured EMG activity, they found that the pattern of activation within the erector spinae muscles did follow the pattern of compressive forces predicted by the model. This study is unique in that it used EMG recordings to predict muscle force under uncontrolled dynamic motion.

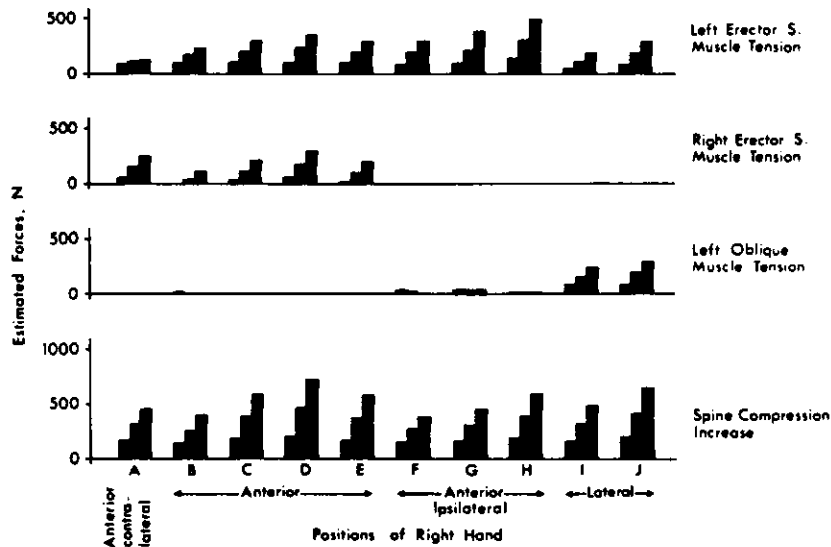

FIGURE 7-16

Muscle tensions and compression increase on the spine predicted from the analysis. The three levels on each bar, from left to right, correspond to the weights held (0, 40, and 80 N).

Reprinted with permission from Andersson GBJ, Orgengren R, Schultz A: Analysis and measurement of the loads on the lumbar spine during work at a table. J Biomech 13:513-520, 1980, Figure 4, p 518.

Based on this investigation, the authors were able to distinguish back loading using the different methods and were able to identify the best method of patient lifting.

Marras used a percentage of maximum EMG in conjunction with a mathematical model to estimate the muscle tension present during isometric and isokinetic (constant velocity) lifting motions in the back of 20 male and female subjects.²⁴ The lifting velocities varied from very slow to very fast. The correlation coefficient between the predicted muscle tension and normalized EMG activity of the erector spinae muscles under all conditions was weak (.37) but statistically significant.

Reilly and Marras used normalized EMG activity as input to a biomechanical simulation model that was used to predict spine compression and shear forces during lifting motions.³ The EMG signals were used to indicate the relative force in the muscles in each lifting condition. These motions also were isokinetically controlled, making it possible to evaluate the impulse loading on the spine resulting from the coactivation of the trunk musculature.

These studies indicate that the percentage of EMG activity can be used to predict the tension within muscles during occupational tasks. This technique has the advan-

tage of allowing comparisons between subjects and muscle groups. It also is important to recognize that the EMG-muscle tension relationship is not as well defined and seldom used to evaluate muscle force during ballistic motions.

Muscle Force Through Microvolts

Many researchers have attempted to investigate the force of a muscle by simply observing the rectified and averaged (in some cases integrated) EMG signal in terms of the absolute number of microvolts generated and associated with a particular activity. However, there are two difficulties with attempting to assess muscle force by this method. First, EMG is capable of only assessing the activity of the portion of the muscle from which the electrodes are recording activity. Hence, the determination of muscle force is not technically possible. The derived parameter of muscle tension, however, can be determined as force per unit cross-section area. The problem occurs when trying to relate a given volume of muscle to the EMG activity level. If surface electrodes are used, the electrodes reside at some unknown (and sometimes varying) distance from the muscle. Furthermore, the uptake

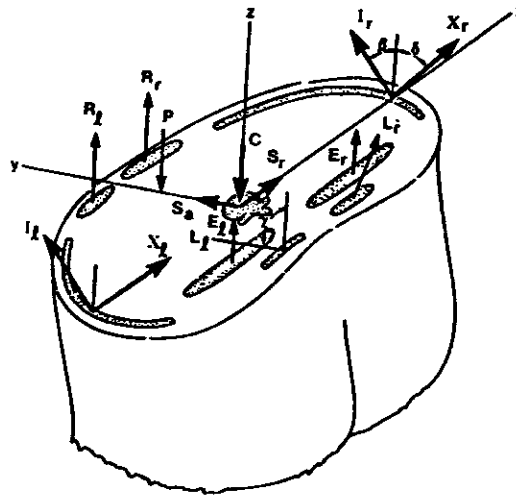

FIGURE 7-17

Schematic of the model used for internal force estimation. The five bilateral pairs of single muscle equivalents represent the rectus abdominis, the internal and external oblique abdominal, the erector spinae, and those parts of the latissimus dorsi muscles that cut the trunk sectioning plane. Contraction forces in these model muscles are denoted R, I, X, E, and L, respectively, with the subscripts denoting left and right sides. Inclination angles, β , d , and γ were all set to 45 degrees. Motion segment compression force is denoted C, anterior shear force S_A , and right lateral shear force S_R . Abdominal cavity pressure resultant P here was set to zero. Muscle cross-sectional area per side were taken as, respectively, for R, I, X, E, and L: 0.006, 0.0168, 0.0148, 0.0389, and 0.0037 times the product of trunk cross-section depth and width. Centroidal offsets in the anteroposterior direction were, in the same order, taken as 0.54, 0.19, 0.19, 0.22, and 0.28 times trunk depth. In the lateral direction, they were taken as 0.12, 0.45, 0.45, 0.18, and 0.21 times trunk width.

Reprinted with permission from Schuldt K, Andersson GBJ, Haderspeck K, et al, Analysis and measurement of lumbar trunk loads in tasks involving bends and twists. J. Biomech 15:669-675, 1982, Figure 1, p 671.

volume of EMG activity will be a function of the frequency and may not be consistent between muscles. This problem can be corrected only with certain indwelling electrodes where the electrode geometry is well defined.²⁵

The second problem in relating EMG microvolt level to muscle tension relates to basic differences in the anatomical construction of the muscles. Intervention ratios associated with muscles vary greatly depending on the amount of fine control or power associated with a muscle. Thus, even if a given number of fibers per cross-sectional area of muscle were active, the microvolt reading in different muscles would be different. This is because up to a certain frequency, the electrical activity of fibers belonging to the same motor unit sum linearly. Fiber potentials of different motor units, however, add in square.²⁶ This is shown in Figure 7-15. This means that in muscle with large motor units, a certain number of activated fibers will result in a greater microvolt reading than a muscle composed of smaller motorunits.

The ergonomist, therefore, would have difficulty, in most cases, in determining force or even tension based on the absolute microvolt activity of an integrated EMG

signal. Those who have attempted to do so have used EMG in conjunction with a biomechanical model to evaluate this relationship. Andersson et al used a biomechanical model that considered the cross-sectional geometry of the trunk to evaluate the moments generated by the erector spinae muscles within the trunk.²⁷ This model was used to assess tasks that involve static submaximal arm lifts while working at a table. The EMG signal gains were calibrated with the wave calibration technique discussed earlier so that the signal amplitudes could be expressed in microvolts. These researchers used anthropometric information relating the mass center of the arm complex and the moment arm from the vertebral body to estimate the moment that must be resisted by the muscles to maintain a state of static equilibrium. They also assumed there was no antagonistic muscle activity present in the task. Figure 7-16 shows the predicted force generated by each muscle as a function of the experimental conditions. This study reported correlation coefficients between muscle tension and EMG activity of .99 and .98 for the right and left sides of the body, respectively.

Schultz et al used a similar method to evaluate the muscle tension in 10 trunk muscles in tasks involving

static 15-second duration bending and twisting positions while holding weights that varied in magnitude between 4 and 20 kg.²⁸ In this study, the evaluation used a biomechanical model that considered the moment arm between the spine and the trunk muscles and the cross-sectional area of those muscles. This relationship is shown in Figure 7-17. Here again, no muscle activity from antagonists were included in the model. Depending on the method used to solve the biomechanical model, the correlation coefficients between the predicted muscle tension and the RMS processed EMG signal ranged from .34 to .92. A latter study by Zetterberg et al used a similar model to predict trunk muscle tension while exerting maximal and 50% of maximal isometric trunk force.²⁹ This model differed in that it allowed for antagonistic activity of the trunk muscles. The correlation between predicted muscle tension and the RMS processed EMG signal amplitudes improved for most of the back musculature. This relationship is shown for two of the muscles investigated in Figure 7-18.

Andersson et al used a unique microvolt calibration scheme to evaluate the forces acting on the trunk while subjects performed three common tasks at a table.³⁰ In this study, the EMG activity of the muscles was correlated with muscle force through a series of calibration experiments. Subjects were seated in the same position as required during the experimental task and were asked to hold weights of different magnitudes in different static positions on a table. Regression analysis was used to establish EMG-force relationships. The authors believed that this was a better way to establish this relationship than by normalizing the EMG activity. This information was used as input into a biomechanical model so that the forces on the lumbar spine could be determined. The model, however, did not consider coactivation of the trunk musculature. The authors concluded that spine loading generally was low in this type of work and that load levels were influenced only marginally by work place factors such as table and chair adjustments even though these factors were not included in the experimental design or statistically evaluated.

A similar task was evaluated by Boudrifa and Davies.³¹ They investigated the integrated EMG microvolt activity of the erector spinae muscles while subjects lifted a 10 kg weight on a table located at different angular locations and different distances from the body. They evaluated the results with ANOVA and determined that the lifting distance and the interaction of distance with angle were significant; the angle factor was not. When the results of this study are compared with those of the previous study, the importance of including a complete experimental design and statistically evaluating the EMG data are evident.

These studies emphasize several issues in the use of

microvolts of EMG activity to predict muscle force. First, all of these studies have assumed a linear relationship between muscle force and EMG activity. Second, to evaluate the muscle force relationship, all have used EMG in conjunction with a biomechanical model. Most of these investigations have used models based on moment relations and the cross-sectional area of the muscle. Third, all of the tasks evaluated have been static. This condition preserves the length-tension relationship in the muscle. Finally, when the tasks evaluated involved increased force exertions, the inclusion of antagonistic coactivation of muscles improved predictability of the muscle forces. In summary, it is not a simple task to estimate muscle tension by this method. If this method is used, it must be done with careful calibration and an appropriate biomechanical model.

Muscle Fatigue

Muscle fatigue can be evaluated either by observing the change in amplitude of the EMG signal through the microvolt level or by observing the change in the spectral activity of the signal. The latter is appearing now more frequently in the literature and appears to be a powerful investigative tool. Details of this technique have been presented in previous chapters. Examples of both these approaches follow.

Muscle Fatigue Through Microvolts

As early as 1912, Piper demonstrated that as a muscle fatigues, the EMG signal will increase in its amplitude while the muscle is exerting a given amount of force in an isometric contraction.³² This probably is due to the need to recruit more motor units to perform the same amount of work as the muscle fibers fatigue. Thus, by observing the processed EMG signal of a given portion of the muscle under constant force conditions, a quantitative indicator of the degree of muscle fatigue can be established. It also is important to note that this trend is evident only with surface electrodes. Unfortunately, simultaneous isometric and isotonic contractions are seen rarely in ergonomic studies. Thus, the use of this method of assessment usually is limited to comparisons of prework and postwork test conditions to determine if increased EMG activity is required to exert a given force. It is presumed that increased EMG activity would be attributable to the task that preceded the post-test. The flaw in this approach, however, is that even a slight change in EMG activity resulting from minute muscle loading changes would signal a change in fatigue status.

Habes used this approach to evaluate the securing of material to two types of dies in an automobile upholstery plant.³³ Electrodes were placed on the low back muscles, and the EMG signals were transmitted using

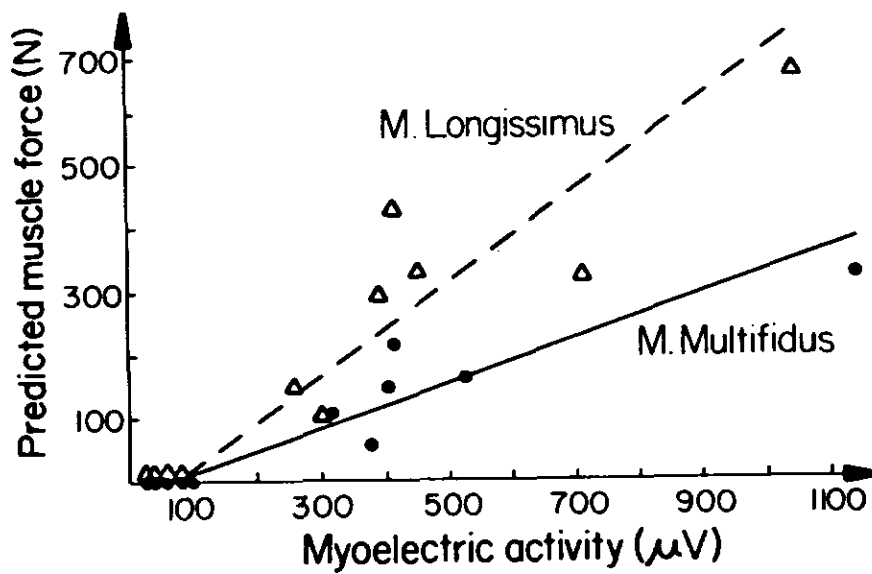

FIGURE 7-18

Relationship of mean myoelectric activities and predicted muscle forces for the longissimus and multifidus parts of the erector spinae muscles.

Reprinted with permission from Zetterberg C, Andersson GBJ, Schultz A: The activity of individual trunk muscles during heavy physical loading. Spine 12:1035-1040, 1987, Figure 1, p 1039.

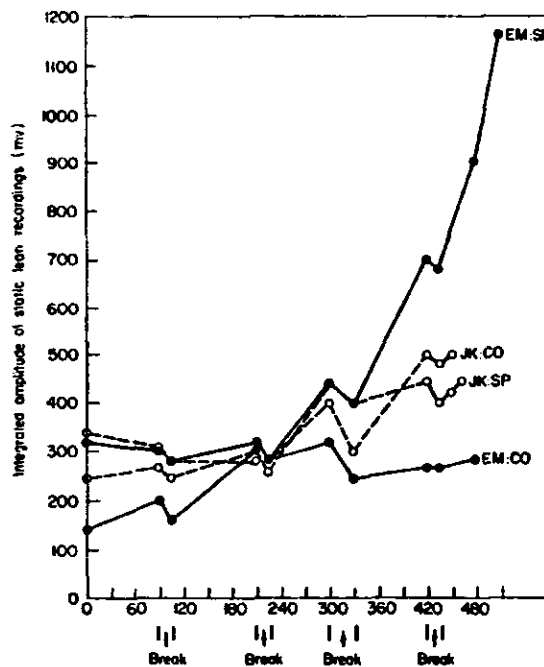

FIGURE 7-19

Static lean fatigue curves.

Reprinted with permission from Habes DJ: Use of EMG in a kinesiological study in industry. Applied Ergonomics: 15:297-301, 1984, Figure 4.

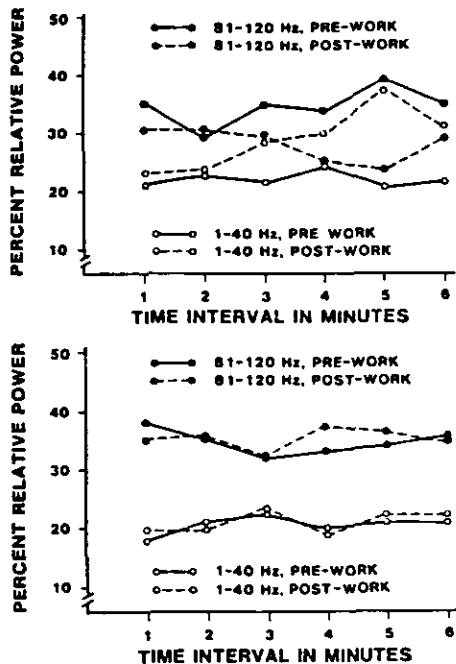

FIGURE 7-20

Average percentage of relative power in the low- and high-frequency bands of EMG activity recorded from the flexors during prework and postwork keyboard operation. These data, presented as a function of increasing time, were recorded from operators entering predominantly four-digit destination codes to sort box mail (upper graph) and from operators entering predominantly three-digit destination codes to sort outgoing primary mail (lower graph).

Reprinted with permission from Gomer FE, Silverstein LD, Berg WK, et al: Changes in electromyographic activity associated with occupational stress and poor performance in the workplace. Human Factors 29:131-143, 1987, Figure 4.

telemetry to an FM tape recorder. In this manner, two subjects were tested throughout the work day without interfering with their work schedule. The experiment required subjects to maintain a 5-second test posture at 10 different times throughout the work day while the microvolt EMG activity necessary to maintain that posture was recorded. This study was able to identify dramatic increases in EMG activity associated with the use of one of the dies that was not identified when other measures of muscle fatigue were evaluated. An example of how the EMG increased over time is shown in Figure 7-19.

Christensen performed a similar type of study on 25 assembly line workers.³⁴ The goal of the study was to assess the level of fatigue in the shoulder muscles of employees throughout the work day. The subjects were tested at eight times during the day, each for a 10-minute period while they performed their normal job. The EMG activity was represented by an amplitude probability function. Even though subjective questionnaires indicated that the subjects were experiencing fatigue throughout the day, the EMG activity levels did not indicate a fatiguing situation. These results may have been due to the lack of a standard test contraction in the experimental design.

Muscle Fatigue Through Spectral Analysis

One way to minimize the interactive effect of muscle force on fatigue is to analyze the spectral components of the EMG signal. It is known that as the muscle fatigues, the high frequency components of the signal diminish. This spectral shift resulting from fatigue is a first-order effect in the signal spectrum, whereas, moderate changes in the contraction level of the muscle cause second-order effects in the signal spectrum. Thus, an objective measure that is not as affected by muscle contraction irregularities is that of observing the frequency shift of an EMG signal during a static exertion. This shift usually is observed by using a fast Fourier transform (FFT) to change the raw EMG signal from the time domain to the frequency domain. Once this is done, center frequency, or median frequency, estimates are used to indicate the central tendency of the EMG spectrum. This usually is done in a manner similar to the microvolt approach in that comparisons of these factors usually are made before and after a work period during a test contraction at a given level of muscular contraction. The spectral components, however, are not as sensitive to minor deviations in muscle force levels. Several authors have described how a shift in the center frequency to a lower value can indicate a fatigued state of the muscle.³⁵⁻³⁷

Gomer et al used spectral analyses of the EMG signal to evaluate fatigue in the forearms of mail sorters who performed a machine-paced keyboard operation.³⁸ They evaluated two different work practices associated with the keyboard operation. In this study, 20 experienced mail sorters were tested with a prework and postwork test exertion. These exertions required the subject to exert maximal grip strength on a grip dynamometer for 30 seconds. The relative power in the lower frequency portion (1-40 Hz) of the EMG spectrum was compared with the power in the upper portion (81-120 Hz) of the spectrum during the pre-tests and post-tests. Figure 7-20 shows a comparison of these portions of the EMG spectrum as a function of the experimental conditions. The relative power shifts were evaluated by a multifactor ANOVA design that enabled the investigators to determine which work

place factors contributed to fatigue during the shift. The results clearly showed that one of the work practices was superior.

Similar techniques can also be used to assess the design of tools and work orientation used in the work place. Schoenmarklin and Marras also used a pre-test and post-test procedure to evaluate arm fatigue associated with the design and use of a hammer.³⁹ In this study, however, the test contractions consisted of hand grip contractions that were 70% of the maximum voluntary grip contraction. They hypothesized that if the subjects fatigued during the test, they would not be able to reach the original 100% force level. This level of contraction was controlled by having the subjects match a target on an oscilloscope that represented the 70% exertion for each subject. In this study, the median frequency of the signal was compared before and after each trial. The results were analyzed by an ANOVA procedure that was able to assess the fatigue effects resulting from the experimental factors and their interaction. In this manner, they were able to determine the contribution of tool design and tool use orientation on the fatigue of the muscle.

It should also be pointed out that some researchers use both the microvolt method and the spectral analysis methods simultaneously to indicate fatigue in a muscle. In the study performed by Habes³³ mentioned earlier, for example, the percentage of EMG signal power in the 4 to 30 Hz frequency band was evaluated during the 10 static test postures. The percentage of power in this low frequency band was compared with the fatigue indicating criteria set forth by Chaffin.³⁶ Although the increases in back EMG activity throughout the day were interpreted as a sign of fatigue, none of the power frequency shifts exceeded a predetermined minimum level considered necessary to indicate fatigue.

SUMMARY

The use of EMG in ergonomic investigations is not a technique that should be applied indiscriminately. Planning for the experimental or functional question to be answered is important. Furthermore, proper signal collection and analysis procedures must be used if useful information is desired. Several key steps must be considered when applying EMG in an ergonomic investigation. First, before EMG is used, the experimenter must have an idea about which muscles would be affected by the work and the type of information about the muscle that is desired (duration/on-off, force, or fatigue). Second, the experimental design should consider all factors that may affect muscle use (i.e. work place layout, work method, etc). Third, those variables that may affect the EMG signal (motion, pick up area, etc.) should be con-

trolled in the experiment. Fourth, the best available means of signal treatment and processing should be selected. The EMG relationships of interest and their limitations, as detailed in this manual, must be considered when selecting the proper EMG treatment and processing technique. Finally, proper statistical analyses should be performed so that the maximum useful information can be extracted from the experiment.

REFERENCES

1. Maton B, LeBozec S, Cnockaert JC: The synergy of elbow extensor muscles during dynamic work in man: II. Braking elbow flexion. *Eur J Appl Physiol* 44:279-289, 1980
2. Marras WS, Reilly CH: Networks of internal trunk loading activities under controlled trunk motion conditions. *Spine* 13:661-667, 1988
3. Reilly CH, Marras WS: SIMULIFT: A simulation model of human trunk motion during lifting. *Spine* 14:5-11, 1989
4. Delitto RS, Rose SJ, Apts DW: Electromyographic analysis of two techniques for squat lifting. *Phys Ther* 67:1329-1334, 1987
5. Bobet J, Norman RW: Use of the average electromyogram in design evaluation investigation of a whole-body task. *Ergonomics* 25:1155-1163, 1982
6. Schuldt K, Ekholm J, Harms-Ringdahl K, et al: Effects of changes in sitting work posture on static neck and shoulder muscle activity. *Ergonomics* 29:1525-1537, 1986
7. Schuldt K, Ekholm J, Harms-Ringdahl K, et al: Influence of sitting postures on neck and shoulder EMG during arm-hand work movements. *Clin Biomech* 2:126-139, 1987
8. Schuldt K, Ekholm J, Harms-Ringdahl K, et al: Effects of arm support or suspension on neck and shoulder muscle activity during sedentary work. *Scand J Rehabil Med* 19:77-84, 1987
9. Schuldt K: On neck muscle activity and load reduction in sitting postures: An electromyographic and biomechanical study with applications in ergonomics and rehabilitation. *Scand J Rehabil Med [Suppl]* 19:1-49, 1988
10. Soderberg GL, Blanco MK, Cosentino TL, et al: An EMG analysis of posterior trunk musculature during flat and anteriorly inclined sitting. *Human Factors* 28:483-491, 1986
11. DeGroot JP: Electromyographic analysis of a postal sorting task. *Ergonomics* 30:1079-1088, 1987
12. Rockwell TH, Marras WS: An evaluation of tool design and method of use of railroad leverage tools on back stress and tool performance. *Human Factors* 28:303-315, 1986
13. Bhattacharya A, Ramakrishnan HK, Habes D: Electromyographic patterns associated with a carpet installation task. *Ergonomics* 29:1073-1084, 1986
14. Seroussi RE, Pope MH: The relationship between trunk muscle electromyography and lifting moments in the sagittal and frontal planes. *J Biomech* 20:135-146, 1987
15. Marras WS, Rangarajulu SL, Lavender SA: Trunk loading and expectation. *Ergonomics* 30:551-562, 1987
16. Andersson GBJ, Ortengren R: Assessment of back load in assemblyline work using electromyography. *Ergonomics* 27:1157-1168, 1984

17. Andersson BJJ, Ortengren R: Lumbar disk pressure and myoelectric back muscle activity during sitting: II. Studies on an office chair. *Scand J Rehabil Med [Suppl]* 6:115-121, 1974
18. Andersson BJJ, Ortengren R: Myoelectric back muscle activity during sitting. *Scand J Rehabil Med [Suppl]* 3:73-90, 1974
19. Andersson BJJ, Jonsson B, Ortengren R: Myoelectric activity in individual lumbar erector spinae muscles in sitting. A study with surface and wire electrodes. *Scand J Rehabil Med [Suppl]* 3:91-108, 1974
20. Andersson BJJ, Ortengren R, Nachemson A, et al: Lumbar disc pressure and myoelectric back muscle activity during sitting: I. Studies on an experimental chair. *Scand J Rehabil Med [Suppl]* 6:104-114, 1974
21. Andersson GBJ, Ortengren R, Herberts P: Quantitative electromyographic studies of back muscle activity related to posture and loading. *Orthop Clin North Am* 8:85-96, 1977
22. Gagnon M, Sicard C, Sirois JP: Evaluation of forces on the lumbo-sacral joint and assessment of work and energy transfers in nursing aides lifting patients. *Ergonomics* 29:407-421, 1986
23. Basmajian JV, DeLuca CJ: *Muscles Alive: Their Functions Revealed by Electromyography*, ed 5. Baltimore, MD, Williams & Wilkins, 1985
24. Marras WS: Predictions of forces acting upon the lumbar spine under isometric and isokinetic conditions: A model-experiment comparison. *International Journal of Industrial Ergonomics* 3:19-27, 1988
25. Zipp P: Recommendations for the standardization of lead positions in surface electromyography. *Eur J Appl Physiol* 50:55-70, 1982
26. Kadefors R: Application of electromyography in ergonomics: New vistas. *Scand J Rehabil Med* 10:127-133, 1978
27. Andersson GBJ, Ortengren R, Schultz A: Analysis and measurement of the loads on the lumbar spine during work at a table. *J Biomech* 13:513-520, 1980
28. Schultz AB, Andersson GBJ, Haderspeck K, et al: Analysis and measurement of lumbar trunk loads in tasks involving bends and twists. *J Biomech* 15:669-675, 1982
29. Zetterberg C, Andersson GBJ, Schultz A: The activity of individual trunk muscles during heavy physical loading. *Spine* 12:1035-1040, 1987
30. Andersson GBJ, Schultz AB, Ortengren R: Trunk muscle forces during desk work. *Ergonomics* 29:1113-1127, 1986
31. Boudrifa H, Davies BT: The effect of bending and rotation of the trunk on the intra-abdominal pressure and the erector spinae muscles when lifting while sitting. *Ergonomics* 30:103-109, 1987
32. Piper H: *Electrophysiologie Menschlicher Muskeln*. Berlin, Julius Springer, 1912
33. Habes DJ: Use of EMG in a kinesiological study in industry. *Applied Ergonomics* 15:297-301, 1984
34. Christensen H: Muscle activity and fatigue in the shoulder muscles of assembly-plant employees. *Scand J Work Environ Health* 12:582-587, 1986
35. Chaffin DB: Surface electromyography frequency analysis as a diagnostic tool. *J Occup Med* 11:109-115, 1969
36. Chaffin DB: Localized muscle fatigue—definition and measurement. *J Occup Med* 364-354, 1973
37. Petrofsky SJ: Computer analysis of the surface EMG during isometric exercise. *Comput Biol Med* 45:83-95, 1979
38. Gomer FE, Silverstein LD, Berg WK, et al: Changes in electromyographic activity associated with occupational stress and poor performance in the workplace. *Human Factors* 29:131-143, 1987
39. Schoenmarklin RW, Marras WS: An investigation into the effects of angled hammers and hammering orientation: II. Muscle fatigue and subjective impressions. *Human Factors* (to be published).

APPENDIX A

QUANTITIES AND UNITS OF MEASUREMENT IN BIOMECHANICS

PREPARED BY THE INTERNATIONAL SOCIETY OF BIOMECHANICS

In recent years the International Society of Biomechanics has adopted as its standard for units of measurement the Systeme International d'Unités (SI). This system is both rationalized and coherent. It is rationalized because for any physical quantity only one measurement unit is needed, and the entire SI structure is founded on just seven precisely defined base units and two supplementary units (see Table below). The system is coherent in that the product or quotient of any two unit quantities in the system becomes the unit of the resulting quantity. Relevant aspects of the SI system are presented here as an aid to scientists, educators, and students working in the field of biomechanics.

TABLE: SI UNITS FOR BASIC QUANTITIES

Basic Physical Quantity	Symbol for Quantity	Name of SI Unit	Symbol for SI Unit
length	<i>l</i>	metre	m
mass	<i>m</i>	kilogram	kg
time	<i>t</i>	second	s
electric current	<i>I</i>	ampere	A
thermodynamic temperature	<i>T</i>	kelvin	K
amount of substance	<i>n</i>	mole	mol
luminous intensity	<i>I</i>	candela	cd
plane angle	$\alpha, \beta, \gamma, \theta, \phi, \text{ etc.}$	radian	rad
solid angle	Ω	steradian	sr

NOTES

- In the United States of America the spelling of the unit of length is "meter".
- The kilogram is the SI unit of mass or "quantity of matter." It is not the unit of force. The unit of force is derived from that of mass by considering the force necessary to give unit acceleration to a unit of mass.
- Each unit has a standard symbol and care should be taken to use the correct letter(s) and case (upper or lower). Insofar as the symbol for second is "s" (not "sec"), it is important that symbols are not pluralized; e.g., "kgs." could be mistaken for $\text{kg} \times \text{s}$ (but see note on the punctuation of a compound unit below).
- Standard prefixes are used to designate multiples or sub-multiples of units. The more common ones are:

Prefix	Multiplier	Symbol	Example
mega	10^6	M	megawatt (MW)
kilo	10^3	k	kilojoule (kJ)
centi	10^{-2}	c	centimetre (cm)
milli	10^{-3}	m	milligram (mg)
micro	10^{-6}	μ	microsecond (μs)

- When a compound unit is formed by multiplication of two or more units, the symbol for the compound is indicated in one of the following ways:

$N \cdot m$, $N.m$, or $N\ m$, but not Nm

- When a compound unit is formed by dividing one unit by another, the symbol for the compound unit is indicated in one of the following ways:

$$\frac{\text{m}}{\text{s}}, \text{ m/s, or as the product of m and s}^{-1}, \text{ i.e. m} \cdot \text{s}^{-1}$$

- It is strongly recommended that numbers be divided into groups of three digits, counting outwards in both directions from the decimal marker, whether present or not. Neither dots nor commas should be inserted in the spaces between the groups. The decimal sign can be either a comma or a dot on the line. If the magnitude of the number is less than unity, the decimal sign should be preceded by a zero.

Examples: 7986.325 79 and 0.035

Detailed overleaf are the derived SI units for the physical quantities more commonly used in biomechanics together with a brief definition of each and recommended symbols. The list is not exhaustive and the reader is directed to one of the many SI mechanics texts or comprehensive guides for the use of SI units which are now available in most languages. A table of conversion factors of non-SI units and details of reference sources used are provided on the back page.

Revision 1, December 1987.

DERIVED SI UNITS, SYMBOLS AND DEFINITIONS

Physical Quantity	Symbol for Quantity	SI Unit and Symbol	Definition of Quantity and its Unit
linear displacement	Δr	metre m	The change in location of a point, given as the directed distance from an initial to a final location (the change in position vector r), regardless of the path taken.
velocity	v	$\text{m} \cdot \text{s}^{-1}$	The time rate of change of location (the time-derivative of the position vector r).
acceleration	a	$\text{m} \cdot \text{s}^{-2}$	The time rate of change of velocity.
acceleration due to gravity	g	$\text{m} \cdot \text{s}^{-2}$	The acceleration of a body freely falling in a vacuum, the magnitude of which varies with location. The standard (sea level) value is $9.806\ 65\ \text{m} \cdot \text{s}^{-2}$.
angular displacement	$\Delta \theta$	radian rad	A change in the orientation of a line segment, which for 2D motion, is given by the plane angle between the initial and final orientations (the change in the orientation vector θ), regardless of the rotational path taken. <i>One radian is the plane angle between two radii of a circle which cut off on the circumference an arc equal in length to the radius. ($2\pi\ \text{rad} = 360\ \text{degrees}$).</i>

Physical Quantity	Symbol for Quantity	SI Unit and Symbol	Definition of Quantity and its Unit
angular velocity	ω	rad•s ⁻¹	The time rate of change of orientation of a line segment (for 2D motion).
angular acceleration	α	rad•s ⁻²	The time rate of change of angular velocity.
period	T	second s	The time to complete one cycle of a regularly recurring (periodic) event.
frequency	f	hertz Hz	The number of repetitions of a periodic event which occur in a given time interval. [$f = 1/T = \omega/2\pi$, where ω is the angular frequency (in rad•s ⁻¹) of the periodic event].
density	ρ	kg•m ⁻³	The concentration of matter, measured as mass per unit volume.
relative density (specific gravity)	d	none	The ratio of the density of a substance to the density of a reference substance under specified conditions. When water is the reference substance the name "specific gravity" is sometimes used.
mass moment of inertia	I	kg•m ²	The measure of a body's resistance to accelerated angular motion about an axis, and equal to the sum of the products of the masses of its differential elements and the squares of their distances from the axis.
linear momentum	p	kg•m•s ⁻¹	The quantity of motion possessed by a particle or rigid body, measured by the product of its mass and the velocity of its mass centre.
angular momentum	L	kg•m ² •s ⁻¹	The moment of linear momentum about a point. The angular momentum of a particle is measured by the product of its linear momentum and the perpendicular distance of the linear momentum (velocity vector) from the point. For 2D motion the angular momentum of a rigid body about its mass centre is given by the product of the centroidal moment of inertia and the angular velocity.
force	F	newton N	The mechanical action or effect of one body on another, which causes the bodies to accelerate relative to an inertial reference frame. <i>One newton is that force which, when applied to one kilogram mass, causes it to accelerate at one metre per second per second in the direction of force application and relative to the inertial reference frame. (1N = 1 kg•m•s⁻²).</i>
weight	G	N	The force of gravitational attraction acting on a body, being equal to the product of the mass of the body and the local acceleration due to gravity, i.e. $G = m \cdot g$.
moment of a force	M	N•m	The turning effect of a force about a point, measured by the product of the force and the perpendicular distance of its line of action from that point. [The vector (cross) product of this position vector and the applied force.]

NB. Symbols for physical quantities are printed in italic (sloping) type, with vector.

IONS FOR BIOMECHANICAL QUANTITIES

Physical Quantity	Symbol for Quantity	SI Unit and Symbol	Definition of Quantity and its Unit
moment of a couple	T	N•m	The resultant moment of two equal but oppositely directed (parallel) forces that are not colinear (the <i>couple</i> , and measured by the product of one force and the (torque) perpendicular distance between the lines of action of the two forces.
pressure normal stress shear stress	p σ τ	pascal Pa	The intensity of a force applied to, or distributed over, a surface, and measured as force per unit of surface area. <i>One pascal is the pressure or stress which arises when a force of one newton is applied uniformly and in a perpendicular direction over an area of one square meter.</i> (1 Pa = 1N•m ⁻²).
linear strain shear strain	ϵ γ	none	The deformation resulting from stress, measured by the change in length of a line (linear), or the change in angle between two initially perpendicular lines (shear).
Young's modulus shear modulus	E G	Pa	The ratio of stress to the corresponding strain within the initial linear portion of a stress vs. strain curve obtained from a simple tension/compression or shear test, respectively.
Poisson's ratio	ν	none	The ratio of the transverse contraction per unit dimension on a bar of uniform cross-section to its elongation per unit length, when subjected to tensile stress.
coefficient of friction	μ	none	The ratio of the contact force component parallel to a surface to the contact force component perpendicular to the surface, when relative motion either impends (static coefficient μ_s), or exists (kinetic coefficient μ_k).
coefficient of viscosity	η	N•s•m ⁻²	The resistance of a substance to change or form, measured by the ratio of the shear stress to the rate of deformation.
kinematic viscosity	ν	m ² •s ⁻¹	The ratio of the coefficient of viscosity to density ($\theta = \tau/\rho$).
work	W	joule J	Work is done when a force acts through a displacement in the direction of the force. The work done by the force is the sum of the products of the force and the differential distances moved by its point of application along the line of action of the force. <i>One joule is the work done when the point of application of a force of one newton is displaced a distance of one meter in the direction of the force.</i> (1 J = 1 N•m).

Physical Quantity	Symbol for Quantity	SI Unit and Symbol	Definition of Quantity and its Unit
mechanical energy	<i>E</i>	J	The capacity to do work, which for any mechanical system is measured by the sum of its potential and kinetic energies.
potential energy	<i>V</i>	J	Energy due to position or configuration associated with a conservative force. The gravitational potential energy of a mass <i>m</i> raised a distance <i>h</i> above some reference level is: $V_g = m \cdot g \cdot h$, where <i>g</i> is acceleration due to gravity. The elastic potential energy of a linearly-elastic spring with stiffness <i>k</i> deformed by an amount <i>e</i> is $V_e = k \cdot e^2 / 2$.
kinetic energy	<i>T</i>	J	Energy of motion and equal to the sum of all translational and rotational energies. The kinetic energy of a mass <i>m</i> translating with a velocity <i>v</i> is: $T = m \cdot v^2 / 2$. Additionally, a rigid body can have rotational kinetic energy, which for 2D motion is a function of the moment of inertia about the center of mass and angular velocity. The total kinetic energy of a rigid body in plane motion is therefore the sum of the translational kinetic energy of the mass centre and the rotational kinetic energy about the centre of the mass; i.e. $T = m \cdot v^2 / 2 + I \cdot \omega^2 / 2$.
power	<i>P</i>	watt W	The rate at which work is done or energy is expended. The power generated by a force is the scalar product of the force and the velocity of the point of application of the force. The power generated by a moment is the scalar product of the moment and the angular velocity of the rigid body. <i>One watt is the power used when energy is expended or work done at the rate of one joule per second.</i> <i>(1 W = 1 J·s⁻¹).</i>

Quantities in bold face. Symbols for units are printed in roman (upright) type.

REFERENCES

- American National Standards Institute/Institute of Electrical and Electronic Engineers, **American National Standard Metric Practise**, ANS/IEEE Standard 268 - 1982, IEEE, Inc., New York, 1982.
- Goldman, D. T. and Bell, R. J., **The International System of Units (SI)**, NBS-350, Government Printing Office, Washington, D.C., 1981.
- ISO Standards Handbook 2, **Units of Measurement**, International Organization for Standardization, Switzerland, 1979.
- A compilation of all ISO documents produced by the technical committee responsible for standardization of quantities, units, symbols, conversion factors and conversion tables.*
- McGraw-Hill, **Encyclopedia of Science and Technology**, 5th edition, McGraw-Hill, New York, 1983.
- Marks', **Standard Handbook for Mechanical Engineers**, McGraw-Hill, New York, 1978.
- National Physics Laboratory, **The International System of Units**, C. H. Page and P. Vigoureux (eds), Her Majesty's Stationery Office, London, 1973.
- A translation of the French 'Le Système International d'Unités published by the International Bureau of Weights and Measures. Translations in German, Spanish, Portuguese and Czech are also available through National Bureaus.*
- Parrish, A. (Ed.), **Mechanical Engineer's Reference Book**, Butterworths, London, 1973.
- Quasim, S. H., **SI Units in Engineering and Technology**, Pergamon Press, Oxford, 1977.
- Rodgers, M. M. and Cavanagh, P. R., Glossary of biomechanical terms, concepts and units, **Journal of American Physical Therapy Association**, Vol. 63, No. 12, Dec., 1984.
- The Royal Society, **Quantities, Units, and Symbols**, London, 1975.
- World Health Organization, **A Guide to International Recommendations on Names and Symbols for Quantities and on Units of Measurement**, Geneva, Switzerland, 1975.

CONVERSION FACTORS FOR NON-SI UNITS

<p style="text-align: center;">Length</p> <p>1 inch = 25.40 mm 1 foot = 0.304 8 m 1 yard = 0.914 4 m 1 mile = 1 609.344 m</p> <p style="text-align: center;">Area</p> <p>1 square inch = 645.16 mm² 1 square foot = 0.092 903 m² 1 square yard = 0.836 127 m²</p> <p style="text-align: center;">Volume</p> <p>1 cubic inch = 16.387 064 cm³ 1 cubic foot = 0.028 316 8 m³ 1 cubic yard = 0.764 555 m³ 1 fluid ounce (UK) = 28.413 1 cm³ 1 fluid ounce (US) = 29.573 1 cm³ 1 gallon (UK) = 4.546 09 dm³ 1 gallon (US) = 3.785 dm³</p> <p style="text-align: center;">Mass</p> <p>1 ounce = 28.349 5 g 1 pound = 0.453 592 kg 1 slug = 14.593 9 kg</p> <p style="text-align: center;">Density</p> <p>1 pound per cubic foot = 16.018 46 kg·m⁻³ 1 slug per cubic foot = 515.378 8 kg·m⁻³ 1 pound per gallon (UK) = 99.776 33 kg·m⁻³ 1 pound per gallon (US) = 119.826 4 kg·m⁻³</p>	<p style="text-align: center;">Moment of Inertia</p> <p>1 slug foot squared = 1.355 82 kg·m² 1 pound foot squared = 0.042 140 kg·m²</p> <p style="text-align: center;">Velocity</p> <p>1 inch per second = 25.4 mm·s⁻¹ 1 foot per second = 0.304 8 m·s⁻¹ 1 mile per hour = 0.447 040 m·s⁻¹</p> <p style="text-align: center;">Force</p> <p>1 poundal = 0.138 255 N 1 pound-force = 4.448 222 N 1 kilogram-force = 9.806 65 N</p> <p style="text-align: center;">Pressure</p> <p>1 poundal per square foot = 1.488 164 Pa 1 pound-force per square foot = 47.880 26 Pa 1 pound-force per square inch = 6.894 757 kPa 1 mm mercury = 133.322 387 Pa</p> <p style="text-align: center;">Work and Energy</p> <p>1 foot poundal = 0.042 140 J 1 foot pound-force = 1.355 818 J 1 British thermal unit = 1.055 056 kJ 1 kilocalorie (International) = 4.186 8 kJ</p> <p style="text-align: center;">Power</p> <p>1 horsepower (British) = 745.700 W 1 horsepower (metric) = 735.499 W 1 foot-pound force per second = 1.355 818 W</p>
---	---

APPENDIX B

UNITS, TERMS AND STANDARDS IN THE REPORTING OF EMG RESEARCH

**REPORT BY THE AD HOC COMMITTEE
OF THE
INTERNATIONAL SOCIETY OF
ELECTROPHYSIOLOGICAL KINESIOLOGY
AUGUST 1980**

Chairman: David A. Winter
Department of Kinesiology
University of Waterloo
Waterloo, Ontario, Canada, N2L 3G1

Members: Gunter Rau
Helmholtz-Institut for Biomedizinische Technik
D-51 Aachen
West Germany

Roland Kadefors
Projekt Lindholmen Center of Education
Production and Research
Box 8714
S-402 75 Goteberg
Sweden

Holger Broman
Department of Applied Electronics
Chalmers University of Technology
S-412 96 Goteberg
Sweden

Carlo J. DeLuca
Children's Hospital Medical Center
300 Longwood Avenue
Boston, Massachusetts 02115
U.S.A.

AUTHORS' NOTE

This report is the final report of an ISEK Ad Hoc Committee that was formed in 1977 to deal with the problems arising from inconsistent and erroneous terms and units in the reporting of EMG Research. The Committee has addressed this problem at all levels, from the electrophysiological terminology right through to the more common processing techniques. Also, the Committee makes some recommendations regarding technical standards that should be aimed for by all researchers. This report has evolved from the First Interim Report presented at the 4th Congress of ISEK in Boston in August 1979, from meetings held with researchers at the Congress, and from many personal discussions held over the past few years. The document presents not only the fundamental theoretical and physiological relationships but also the total practical experience of the Committee and those consulted. Only a few references have been listed and are intended to represent or amplify certain issues because a complete bibliography of electromyography would occupy several hundred pages.

THE PROBLEM

It is axiomatic that all researches in any scientific area should be able to communicate with clarity the results of their work. The area of electromyography is one where inconsistent and erroneous terms and units are the rule rather than the exception. Even veteran researchers are continuing to contribute to the confusion. The research in many major papers cannot be replicated because of lack of detail on the protocol, recording equipment or processing technique. For example, the term integrated EMG (IEMG) has been used to describe at least 4 different processing techniques, and the units employed can be mV, mV/sec., mV-sec, or just arbitrary units! No wonder there are conflicts and misunderstandings.

FORM OF REPORT

The report concentrates on four major aspects of the myoelectric signal and its subsequent recording and processing. Figure 1 shows the breakdown of the report: Part I—The Neuromuscular Domain, Part II—The Recording System, Part III—Temporal Processing and Part IV—Frequency Processing. In addition, the Committee presents a Part V—General Experimental Details, which outlines important kinesiological and experimental information that should be reported. References made to the literature are by no means complete, rather they are cited as examples of erroneous or anomalous reporting. Finally, a checklist is given to summarize the recommendations of the Committee.

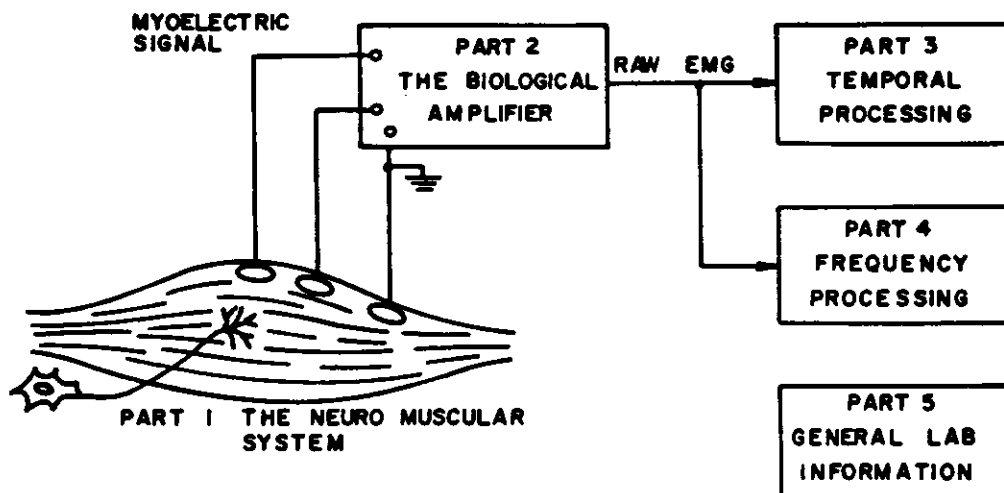

FIGURE 1
Schematic outline of scope of report.

PART I: TERMINOLOGY APPLIED TO THE NEUROMUSCULAR UNIT

References: DeLuca, 1979; Buchthal and Schmalbruck, 1980.

α motoneuron—is the neural structure whose cell body is located in the anterior horn of the spinal cord and through its relatively large diameter axon and terminal branches innervates a group of muscle fibers.

motor unit (MU)—is the term used to describe the single, smallest controllable muscular unit. The motor unit consists of a single α motoneuron, its neuromuscular junction, and the muscle fibers it innervates (as few as 3, as many as 2000).

muscle fiber action potential or motor action potential (MAP)—is the name given to the detected waveform resulting from the depolarization wave as it propagates in both directions along each muscle fiber from its motor end plate. Without the use of special micro techniques it is generally not possible to isolate an individual MAP.

motor unit action potential (MUAP)—is the name given to the detected waveform consisting of the spatio-temporal summation of individual muscle fiber action potentials originating from muscle fibers in the vicinity of a given electrode or electrode pair. Its shape is a function of electrode type (recording contact area, inter-wire spacing, material, etc.), the location of the electrode with respect to the fibers of the active motor unit, the electrochemical properties of the muscle and connective tissue and the electrical characteristics of the recording equipment. A MUAP detected by a surface electrode will be quite different from the MUAP detected by an indwelling electrode within the muscle tissue. Each motor unit will generally produce a MUAP of characteristic shape and amplitude, as long as the geometric relationship between the electrode and active motor unit remains constant. However, when the MUAP consists of less than about five MAPs the waveform may vary randomly due to the "jitter" phenomenon of the neuromuscular junction. A given electrode will record the MUAPs of all active motor units within its pick-up area.

motor unit action potential train (MUAPT)—is the name given to a repetitive sequence of MUAPs from a given motor unit.

inter pulse interval (IPI)—is the time between adjacent discharges of a motor unit. The IPI depends on the level and duration of a contraction and even at an attempted constant tension, the IPI is irregular. Its variation is conveniently seen in an IPI histogram.

motor unit firing rate—is the average firing rate of a motor unit over a given period of time. When a motor unit is first recruited, it fires at an initial rate and generally increases as the muscle tension increases. Meaningful estimates of average firing rates should be calculated over at least six consecutive IPIs.

synchronization—is the term to describe the tendency for a motor unit to discharge at or near the time that another motor unit discharges. It therefore describes the interdependence or entrainment of two or more motor units.

myoelectric signal—is the name given to the total signal seen at an electrode or differentially between two electrodes. It is the algebraic summation of all MUAPs from all active motor units within the pick-up area of those electrodes. The myoelectric signal must be amplified before it can be recorded (when it is called an electromyogram).

PART II—THE RECORDING SYSTEM

Introduction

With respect to recording electromyographic signals the most important property is the distribution of signal energy in the signal frequency band. The signal frequency spectrum picked up by electrodes depends on:

- (a) the type of muscle fiber since the dynamic course of depolarization/repolarization is specific

to the muscles (e.g. heart muscle cells, skeletal muscle or smooth muscle cells),

(b) the characteristics of the volume conductor: the electrical field is influenced by the shape, conductivity and permittivity of tissues and the shape of the boundaries,

(c) the location and physical structure of the electrodes, especially the distance from the cell surface.

Theoretically, the signal source frequency can only be determined by microelectrode techniques at the cellular level. In practice, different types of macro-electrodes are utilized: (a) needle electrodes, (b) wire electrodes, (c) surface electrodes. Needle and wire electrodes are invasive, surface electrodes are non-invasive. In clinical diagnosis, needle and wire electrodes are indispensable but the progress in surface electrode methodology has progressed very rapidly, mainly because of its wide use. Unfortunately, there are many difficulties which have to be taken into account, and which are now discussed in more detail.

The Problem

For surface electrode recording, two aspects have to be considered: (1) The electrophysiological sources within the body as a volume conductor, resulting in an electrical field at the skin surface (the upper boundary of the volume). Each motor unit contributes independently of each other, and the separation of each of these different sources is increasingly difficult as their distance to the electrode increases. (2) The detection of electrophysiological signals at the skin surface has to take into account the electrical properties of the skin, the electrodes, as well as the signal characteristics. The distortion and the disturbances can be reduced by a proper design.

Typical amplitude and frequency range of the signals in question are shown in Table 1. However, the actual ranges depend greatly on the electrode used.

Table 1

Signal	Amplitude Range, mV	Signal Frequency Range, Hz	Electrode Type
Indwelling EMG	0.05 - 5	0.1 - 10,000	Needle/Wire
Surface EMG	0.01 - 5	1 - 3,000	Surface
Nerve Potentials	0.005 - 5	0.1 - 10,000	Needle/Wire

a. Surface Electromyography

The electrodes are electrically coupled to the motor action potentials propagating within the muscle tissue. The stages of this coupling are depicted in Figure 2. These different stages are considered separately and their properties related in order to find out which are first order effects and which can be neglected; please consider Figure 3.

Signal Source and Body Tissues

Within the body a relatively high conductance exists due to the concentration of freely moving ions. The specific resistance is, in the signal frequency band up to 1 KHz, ohmic, and in the order of magnitude of 100-1000 ohm-cm; this value depends on the nature of the tissue in consideration (fat, lung, blood, human trunk). At about 1 KHz the capacitive current and the resistive current are of equal value. Therefore, when using needle or wire electrodes the input impedance of the amplifier should be not less than 1 Megohm, if signal frequencies above 2 KHz have to be detected.

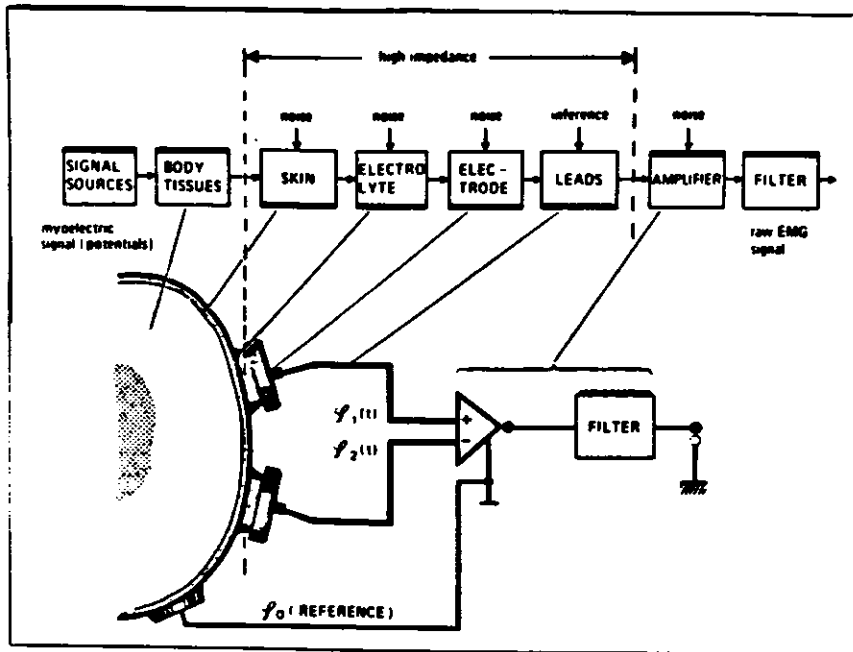

FIGURE 2
Measuring set up for surface electromyography.

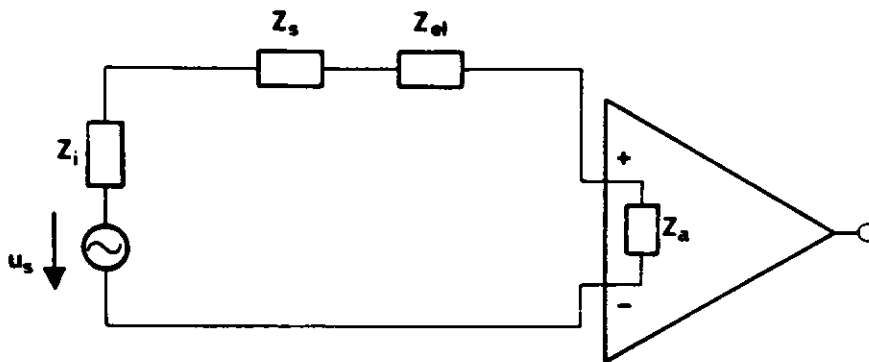

FIGURE 3
Simplified circuit with lumped elements describing the most important electrical properties. Z_s = complex skin resistance, Z_{el} = complex resistance of electrodes and electrode/electrolyte transition, Z_a = complex input resistance of the amplifier, Z_i = complex resistance of the body tissues.

Skin Resistance

The resistance of the unprepared skin is complex and varies over a wide range dependent on (a) skin site, (b) subject, (c) time and (d) skin preparation. In worst cases we see values up to several megohms at low frequencies. In order to minimize the influence of this complex resistance on the signal, high input resistance amplifiers can be achieved very easily by means of modern FET-technology.

In most existing instrumentation an input impedance of 10 Megohms or even 1 Megohm is common, thus the skin has to be prepared (rubbed, abraded) until the resistance is down to less than 200 k Ω or even 10 k Ω respectively. Of course, then the impedance between the electrodes should be measured over the whole frequency band. However, the use of a high performance amplifier eliminates the preparation of the skin and the need to check the resistance, thus simplifying the measuring procedure.

Electrode/Electrolyte and Transition

The electrode resistance and the electrode/electrolyte transition are dependent on the electrode material and the electrolyte (paste or cream) in use. Here not only the electrical but also the mechanical and physiological properties have to be taken into account. Low polarization voltage is observed at Ag-AgCl-Electrodes; unfortunately, the Ag-content varies dependent on the manufacturer resulting in differing properties. Stainless steel electrodes are adequate when using them on unprepared skin and for a frequency range above 10 Hz. Long term stability is excellent with black platina.

The electrode and electrode/electrolyte transition can be neglected with respect to the unprepared skin resistance over the entire frequency range; both have similar electrical characteristics. The impedance of both unprepared and prepared skin can be neglected as long as the input impedance of the amplifier is sufficiently high (at least 100 times the skin impedance).

The Amplifier

Modern technology has resulted in amplifier specifications to overcome the measuring problems. However, old instrumentation gives rise to problems of input impedance, input current and noise. The desired and recommended specifications for newly designed amplifiers are as follows:

CMRR) 90 dB

Input resistance 10^{10} ohms for dc coupled; 10^8 ohms at 100 Hz for ac coupled.

Input current 50 nA for directly coupled amplifiers.

Noise level 5μ Vrms with a source resistance of 100 k Ω and a frequency bandwidth from 0.1–1000 Hz.

The low input current is to be desired because of artifacts which may be caused by modulation of the skin resistance. It is known that the value Z_s (Figure 3) varies with mechanical pressure. Time varying pressure occurs when movement is induced to the electrodes via cable motion. With a change $\Delta Z_s = 50$ k Ω and an input current of 50 nA the generated voltage is 2.5 mV.

In addition, pressure applied to the skin produces an artifact voltage which cannot be separated from the signal voltage, except by high pass filtering above the frequency of the movement artifact (about 10 Hz). In a recently performed study (Sliny, et al, 1979) on cable properties some cables produced movement artifacts of several millivolts, even when using "special ECG cable." There are cable types now available which produce 100 times less voltage artifact than other cables.

Regarding the noise, the amplifier must not be tested with a short circuit at the input since the amplifier noise is insignificant compared to when using a high resistance source. Therefore, a high resistance test circuit has to be used when specifying the relevant amplifier noise. Of course, the noise situation is improved when the skin resistance has been reduced by skin preparation. Then an amplifier can be used which is of lower input impedance while the current noise becomes less important. Also, a reduction of signal frequency bandwidth reduces the noise level, and such a reduction should be done whenever possible.

b. Wire and Needle Electrodes

When using needle and wire electrodes the skin resistance will not impair the signal acquisition as long as an amplifier has a 10 M Ω input impedance. Even fine wire electrodes with a small area of active tip show a relatively low impedance. The properties are mainly defined by the electrode-electrolyte transition and if there are no noise problems in specific applications, one can use the same amplifier as in surface electromyographs.

SUMMARY AND RECOMMENDATIONS

a. Amplifier:

- (i) The frequency range of the amplifier channel should be chosen according to Table 1. If in surface electromyography the lower cut-off frequency has been selected to be 20 Hz for suppression of movement artifacts it has to be reported.

Report: upper cut-off frequency
lower cut-off frequency
type of filter, slope

- (ii) If a DC coupled amplifier is used, a higher input impedance and low input current are desired. AC coupling by a capacitor in each of the two differential electrode leads is commonly used but may give rise to large movement artifacts and polarization voltages if the input impedance is too high. Thus a somewhat lower input impedance is suggested.

Report: input impedance
input current, if dc coupled
noise with 100 K Ω at the input, 1(f1000 Hz)
CMRR

b. Electrodes:

Report: type
spacing between recording contacts
material
stability, if important
off set voltage, if important

c. Skin:

Report: site
complex resistance in the whole signal frequency range
if a low resistance input amplifier is used
preparation of skin

d. Electrode paste:

Report: type
manufacturer
electrochemical properties

Note #1: New instrumentation should be battery operated, at least in the first differential amplifier stage. This will result in a marked suppression of hum interference and when coupled to a computer, or other recording equipment, the necessary isolation is achieved.

Note #2: The amplifier can be miniaturized and attached close to the electrodes. The shorter the electrode leads, the smaller the picked up disturbances (hum and other interferences). In addition, the CMRR value is not decreased by unnecessary unsymmetries.

Note #3: The best procedure for adjusting the filter characteristics of the complete channel is to have the frequency band unrestricted, perform a frequency analysis and then adapt the filter bandwidth to the signal bandwidth.

PART III: TEMPORAL PROCESSING

Raw EMG

Visual inspection of the raw EMG is the most common way of examining muscle activity as it changes with time. Correlation of such phasic activity with other biomechanical variables (joint angles, acceleration, moments of force, etc.) or physiological variables has added to the understanding of normal muscle function as well as special motor functions in pathologies, in ergonomic situations and in athletic events. The amplitude of the raw EMG when reported should be that seen at the electrodes, in mV or μV , and should not reflect the gain of any amplifiers in the recording system.

Detectors

The quantification of the "amount of activity" is necessary so that researchers can compare results, not only within their own laboratories, but between laboratories. It is important to know not only when a muscle turns on or off, but how much it is on at all times during a given contraction. The basis for most of this quantification comes from a detector. A linear detector is nothing more than a full-wave rectifier which reverses the sign of all negative voltages and yields the absolute value of the raw EMG. Non-linear detectors can also be used. For example, a square law detector is the basis of the root mean square (rms) value of the EMG. The important point is that the details of the detector must always be reported because the results of subsequent processing and conclusions regarding muscle function are strongly influenced by the detector (Kadefors, 1973).

Types of Averages

(a) Average or Mean

The mean EMG is the time average of the full-wave rectified EMG over a specified period of time. It is, therefore, important for the researcher to specify the time over which the average was taken. Is it the duration of the contraction, the stride period, or the total exercise period? The mean value should be reported in mV (or μV), and for a period of $(t_2 - t_1)$ seconds,

$$\text{Mean} = \frac{1}{(t_2 - t_1)} \int_{t_1}^{t_2} |\text{EMG}| dt \quad \text{mV}$$

(b) Moving Averages

It is often valuable to see how the EMG activity changes with time over the period of contraction, and a moving average is usually the answer. Several common processing techniques are employed with the detected signal (usually full-wave rectified). All moving averages are in mV or μV .

The most common is a low-pass filter, which follows the peaks and valleys of the full-wave

rectified signal. Thus the characteristics of the filter should be specified (i.e., 2nd order Butterworth low-pass filter with cut-off at 6 Hz). It is somewhat confusing and meaningless to report the averaging time constant of the filter especially if a 2nd order or higher order filter is used. The combination of a full-wave rectifier followed by a low-pass filter is commonly referred to as a linear envelope detector.

With the advent of digital filtering the processing of the EMG can be processed many novel ways. Analog low-pass filters, for example, introduce a phase lag in the output, whereas digital filters can have zero phase shift (by first filtering in the positive direction of time, then re-filtering in the negative direction of time). If such processing is used, the net filter characteristics should be quoted (i.e., 4th order zero-lag, low pass Butterworth filter with cut-off at 10 Hz).

Probably the most common digital moving-average type is realized by a "window" which calculates the mean of the detected EMG over the period of the window. As the window moves forward in time a new average is calculated. It can be expressed as follows:

$$\text{Window average (t)} = \frac{1}{T} \int_{t-T/2}^{t+T/2} |\text{EMG}| dt \quad \text{mV}$$

Its value is in mV, and all that is needed is to specify the window width, T. Normally the average is calculated for the middle of the window because it does not introduce a lag in its output. However, if the moving average is calculated only for past history the expression becomes:

$$\text{Window average (t)} = \frac{1}{T} \int_0^{t+T} |\text{EMG}| dt \quad \text{mV}$$

Such an average introduces a phase lag which increases with T, thus if this type is used T should be clearly indicated. Other special forms of weighting (exponential, triangular, etc.) should be clearly described.

(c) Ensemble average

In any repetitive movement or evoked response it is often important to get the average pattern of EMG activity. An ensemble average is accomplished digitally in a general purpose computer or in special computers of average transients (C.A.T.). With evoked stimuli it is often possible to average the resultant compound action potentials. The time-averaged waveform has an amplitude in mV, and the number of averages is important to report. Also, the standard error at each point in time may be important. The expression for N time-averaged waveforms at any time t is:

$$\text{EMG (t)} = \frac{1}{N} \sum_{i=1}^N |\text{EMG}_i| (t) \quad \text{mV}$$

where EMG_i is the *i*th repetition of the EMG waveform to be averaged. An example of such an averaged waveform is presented in Figure 4: the linear envelope of the soleus muscle was averaged over 10 strides. A complete stride is shown; the amplitude would normally be in mV or μV , but here it is reported as a percentage of the EMG at 100% maximum voluntary contraction. There is no consensus at present as to standard methods of eliciting a maximum contraction because of variations in muscle length with different limb positions and the inhibitory influences present in agonist and antagonist muscle groups. However, such normalization techniques are indispensable for comparisons between different subjects and for retrials on the same subject.

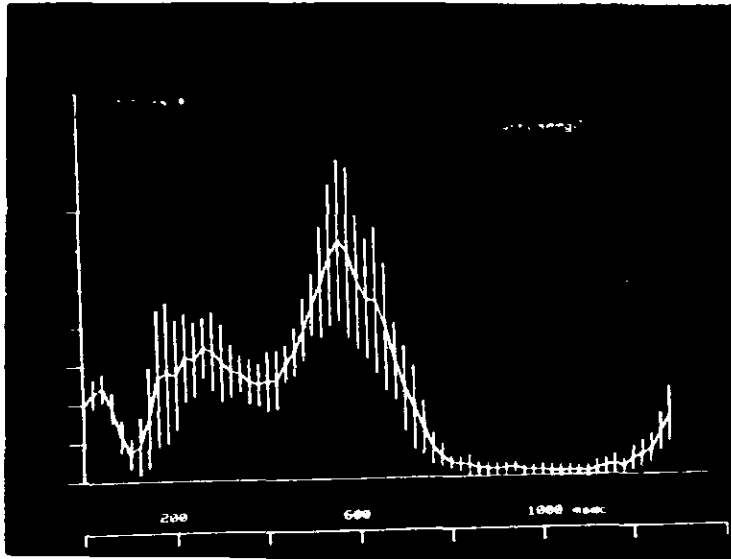

FIGURE 4

Average of linear envelope of soleus muscle over 10 walking strides. Contraction was normalized to 100% MVC, and standard deviation at each point in time is shown by vertical bars.

Integrated EMG

Probably the most widely used (and abused) term in electromyography today is integrated EMG (IEMG). Probably the first use of the term was by Inman and co-workers (1952) when they described a waveform which followed the rise and fall in tension of the muscle. The circuit they employed was a linear envelope detector, not an integrator. The correct interpretation of integration is purely mathematical, and means the "area under the curve." The units of IEMG have also been widely abused. For example, Komi (1973) reports IEMG in mV/s, and in 1976 scales the IEMG in mV. The correct units are $\text{mV} \cdot \text{s}$ or $\mu\text{V} \cdot \text{s}$. It is suspected that many of these researchers who report IEMG in mV are really reporting the average over an unspecified period of time and not an integration over that period.

There are many versions of integrated EMG's. Figure 5 shows a diagram of 3 common versions, plus the linear envelope signal that is so often misrepresented as an IEMG. The raw and full-wave rectified signals are shown for several bursts of activity and have their amplitudes reported in mV. The linear envelope as shown employed a second order low-pass filter with cut-off at 6 Hz, its amplitude also appears in mV.

The simplest form of integration starts at some preset time and continues during the total time of muscle activity. Over any desired period of time the IEMG can be seen in $\text{mV} \cdot \text{s}$. A second form of integrator involves a resetting of the integrated signal to zero at regular intervals of time (usually from 50 to 200 ms), and the time should be specified. Such a scheme yields a series of peaks which represent the trend of the EMG amplitude with time; in effect, something close to a moving average. Each peak has units of $\text{mV} \cdot \text{s}$ (or $\mu\text{V} \cdot \text{s}$ because the integrated value over these short times will not exceed 1 $\text{mV} \cdot \text{s}$). The sum of all the peaks in any given contraction should equal the IEMG over that contraction. A third common form of integration uses a voltage level reset. If the muscle activity is high, the integrator will rapidly charge up to the reset level, and if low activity occurs it will take longer to reach reset. Thus the activity level is reflected in the frequency of resets. High frequency of resets (sometimes called "pips") means high muscle activity, low frequency means low level activity, as seen by the lower

trace of Figure 5. Each reset represents a value of integrated EMG and this should be specified (usually in $\mu\text{V}\cdot\text{s}$). Again, the product of the number of resets times this calibration will yield the total IEMG over any given period of time.

PART IV: FREQUENCY DOMAIN ANALYSES

Frequency domain methods have been used for more than a century. They have proven a powerful tool in that solutions to a linear differential equation of a function of time, say, are most easily obtained using the Fourier transform or Laplace transform. A second attractive property of Fourier transforms of functions of time (such as myoelectric signals) is that the function is described as a function of frequency (not to be confused, for example, with repetition rate of a succession of motor unit potentials). A signal having finite energy content, such as a single motor unit action potential, can be described by its energy spectrum, which gives the distribution of energy as a function of frequency. A signal having infinite energy content, such as a hypothetical infinite succession of action potentials or an infinitely long interference pattern of the activity of several motor units, can similarly be characterized by its

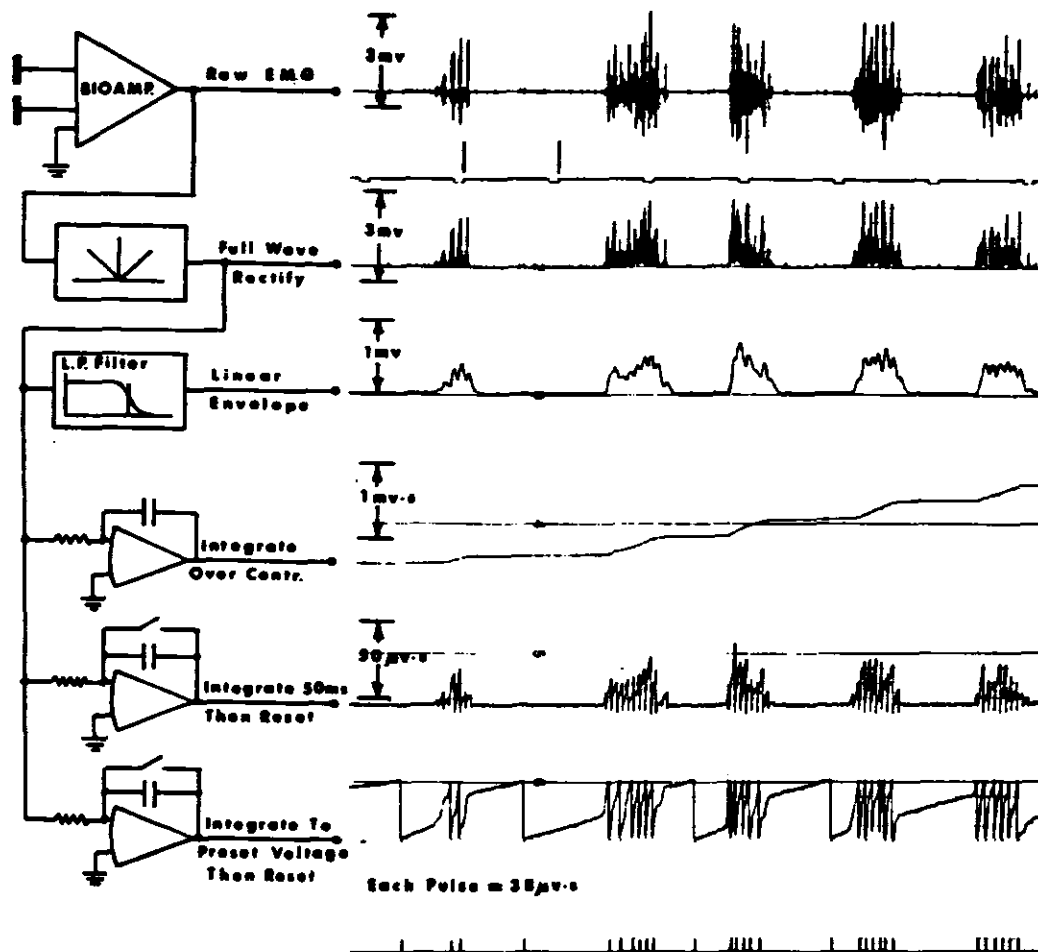

FIGURE 5
Example of several common types of temporal processing of the EMG.

power spectrum. In practical work, a time-limited stretch of data is often regarded as periodically repeated (from long before Moses till after the end of time and thus is for infinite duration). The concept of power spectrum is consequently used unless the data is explicitly time-limited, as for instance when stress is on one action potential. The square-root of the power spectrum and the square-root of the energy spectrum are both referred to as the amplitude spectrum. Figure 6 shows examples of two motor-unit potentials (modelled as differentiated Gauss pulses) with their amplitude and energy spectra.

¹One joule was formerly referred to as one wattsecond.

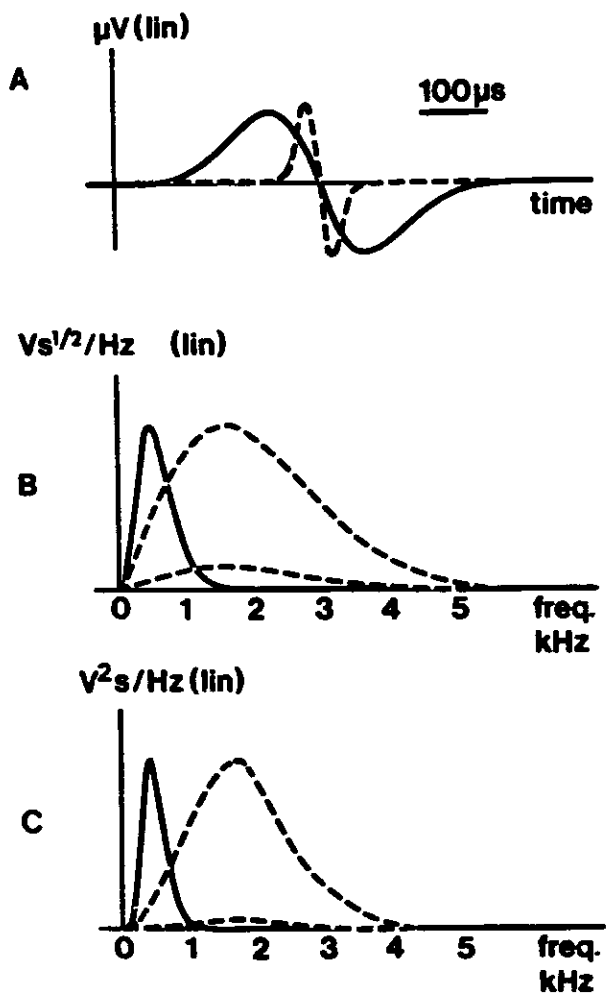

FIGURE 6

Examples of two motor-unit potentials (modelled as differentiated Gauss pulses) with their amplitude and energy spectra.

Units of Measurement

Frequency is measured in Hz (Hertz), formerly in English literature in cycles per second. The name energy spectrum was originally devised for measures of electrical energy decomposed as a function of frequency. The unit for this quantity is joules¹ per hertz, abbreviated J/Hz or JHz⁻¹. Similarly, the unit of the power spectrum is watts per hertz, W/Hz. Over the years, as frequency domain methods have become used more and more in the study of problems not related directly to energy and power, the names energy spectrum and power spectrum have been given a wider meaning. Thus, the units applied are not restricted to what is said above. Consider the example of EMG. The unit of power spectrum is the square of the unit of the amplitude of the myoelectric signal per hertz, that is volt squared per Hz, V²/Hz. The unit of the power spectrum of the distance from earth to the moon (measured as a function of time) similarly is meters squared per Hz, m²/Hz. The unit of the energy spectrum of an action potential is V²s/Hz. The unit for the amplitude spectrum of MEG is thus either V/Hz, if one starts from the power spectrum, or Vs^{1/2}/Hz, if one starts from the energy spectrum.

²The decibel concept is, to be strict, linked with power ratios; the gain in decibels of a system equals ten times the base ten logarithm of the ratio of output to input power.

Logarithmic Scales and Normalization

In visualizing spectra in graphs, valuable information is often lost due to the limited dynamic range of linear scales. For instance, if the maximum value of a power spectrum is 100 V²/Hz and interesting phenomena occur at a level of 1 or 0.1 V²/hz, they will obviously be lost to the eye if the plot is on linear scales. The cure is to plot the spectrum on double-logarithmic scales or on linear-logarithmic scales. In order to take the logarithm of a quantity, it is necessary that the quantity have no dimension. For example, the logarithm of 2 volts is not defined. By normalizing 2 volts, by referring it to for instance 1 volt (the unit of measurement), one obtains the dimensionless quantity 2, which has a logarithm. The level of reference may be chosen freely as long as it has the same unit as the variable of interest. The concept of decibel,² dB, is used for logarithmically scaled power, energy, and amplitude spectra. One may thus plot a spectrum on log-lin scales in the form of "decibels vs logarithmically scaled frequency." Figure 7 illustrates the effect of logarithmizing the spectra of Figure 6. Caution should be exerted to ensure that the plot should not extend below the noise level of the system.

Discrete Parameters of Spectra

To report research results as functions of one variable is difficult. Among the problems is the question of proper statistical evaluation. One solution is to reduce the information to what is carried by discrete parameters. There is of course a large number of such parameters (this is the very cause of the problem). A few that have been used in the analysis of EMG will be mentioned here.

Figure 8(a) shows an example of a spectrum plotted on logarithmic scales. In the case of a smooth and unimodal spectrum like the one shown, one can easily find the upper and lower 3-dB frequencies, defined by the frequencies at which the spectrum has fallen 3 dB from its maximum value. The 3-dB bandwidth is defined as the difference between the upper and lower 3-dB frequencies (f_b and f_a , respectively), and the center frequency f_c is given by the geometric mean of the 3-dB frequencies. A 3-dB drop is equivalent to a decrease by 50% in a linear scale representation of the power spectrum (see Figure 8(b)), and are therefore referred to as half-power frequencies.

In Figure 8(a) is shown a piecewise linear approximation, known as the asymptotic Bode diagram. This asymptotic diagram is entirely defined by the slopes of the lines, the frequencies where the slope changes, the breakpoints, and a scale factor.

The variables discussed so far are commonly used in engineering sciences. Now we will discuss several parameters that have parallels in statistics. In order to do so, the concepts of spectral movements

will first be defined. The spectral moment of order n is given by:

$$m_n = \int_0^{\infty} f^n W(f) df$$

where f is frequency and W is the power or energy spectrum.

The mean frequency, \bar{f} , is the ratio between the spectral moments of orders one and zero (similar to the mean value in statistics). Thus

$$\bar{f} = \frac{m_1}{m_0} = \frac{\int_0^f f W(f) df}{\int_0^f W(f) df} \quad \text{Hz}$$

The statistical bandwidth is the square-root of the difference between the ratio of the moment of order two to that of order zero and the square of the mean frequency (cf. the standard deviation in

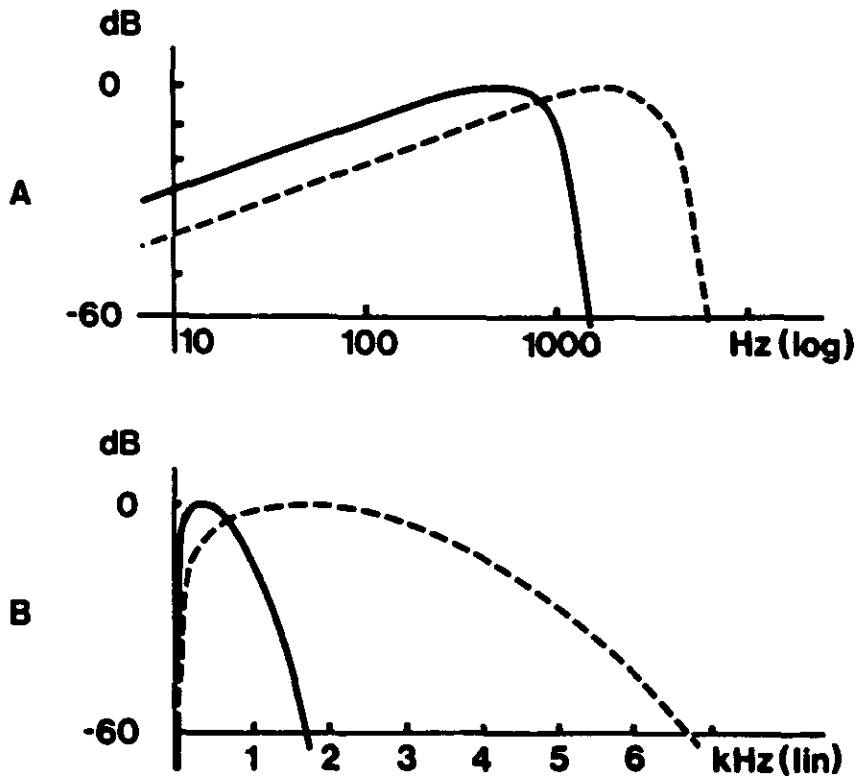

FIGURE 7

Effect of logarithmizing the spectra of Figure 6. (a) Double logarithmic, and (b) log/lin scales. The spectra have been normalized to the same peak magnitude.

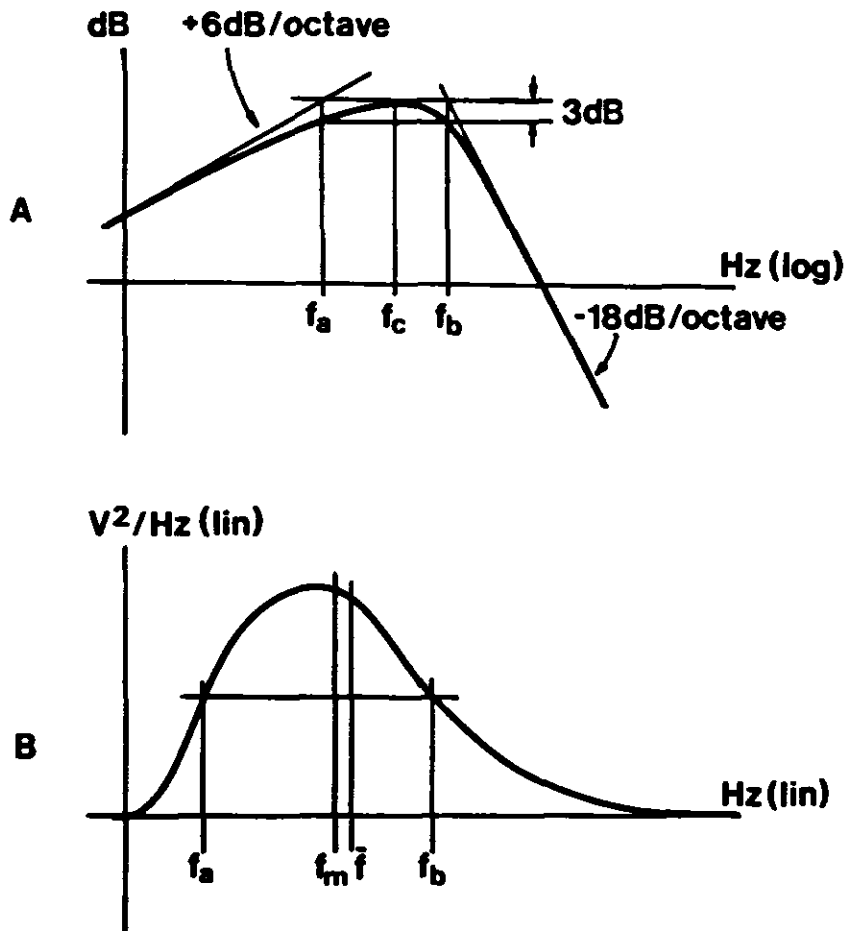

FIGURE 8

(a) An example of a power spectrum, with high-frequency and low-frequency asymptotes indicated, and 3-dB limits given. Double logarithmic scales. (b) Same power spectrum as above, with linear scales, and with some parameters of interest given; f_m and f denote the median and the mean frequencies, respectively. The locations are approximate. In principle, the areas under the curve on both sides of f_m are identical, whereas f denotes the frequency where the area under the curve would balance if cut out with scissors.

statistics). Rice has shown that, for Gaussian noise, the intensity of zero crossings equals the square-root of the ratio between the moments of orders two and zero, and the intensity of points equals the ratio between the fourth and second order moments.

The frequency at the maximum of the power spectrum may be called the mode (most probably frequency), and the median frequency f_m is the frequency which divides the spectrum into two parts of equal power (energy), and is defined by:

$$\int_0^{f_m} W(f) df = \int_{f_m}^{\infty} W(F) df$$

All these parameters, and several not mentioned here, have been used in reports on EMG-research results. The parameters have different properties as they emphasize different aspects of the spectrum. It would be premature to recommend the use of any specific subset, if such a recommendation should ever be made. It is, however, important to know of the various possibilities, and to be familiar with the properties of the parameters.

Spectral Estimation

Integrals over an infinite time period appear in the mathematical definition of the power spectrum of a noise signal. For obvious reasons then, spectra can never be evaluated exactly; rather any spectrum obtained is an estimate of the mathematical concept. The use of finite stretches of raw EMG data introduces estimation errors. These errors are often summarized as the bias of the estimate, the systematic error, and the variance of the estimate, the statistical uncertainty. Methods employed to reduce these errors include windowing of the raw data, averaging of successive spectral estimates and smoothing of spectral estimates. In reporting results based on spectral analysis, it is important to state the estimation procedure and, if possible, give figures on the bias and the variance of the final estimate. It is important also to report questions pertinent to other sources of errors. In particular, one should give some indication on the noise level of the experimental setup, and state the sampling rate if digital methods are used. The possibility of excessive line interference is easily checked by visual inspection of the spectra obtained.

PART V: GENERAL EXPERIMENTAL AND KINESIOLOGICAL INFORMATION

One major drawback which prevents a full understanding, comparison or replication of any EMG research is inadequate detail of the protocol itself, especially related to the anatomy, physiology and biomechanics of the neuromusculo-skeletal system under test.

Types of Contraction

1. *Isometric*—muscle has an average fixed length or joint is at a fixed angle (specify length or angle).
2. *Isotonic*—a contraction which produces average constant force or, for in vivo contractions at an average constant moment (torque) (specify force (N) or moment (N•m)). Remember that lifting or lowering a mass is not isotonic unless it is moving at a constant velocity.
3. *Isokinetic*—muscle is contracting at a constant linear velocity, or constant angular velocity (specify velocity (m/s) or angular velocity (rad/s)).
4. *Concentric*—muscle is shortening under tension.
5. *Eccentric*—muscle is lengthening under tension.

Associated Biomechanical Terms

1. *Mechanical Energy*—is the energy state of any limb segment or total body system at an instant in time. It is measured in joules (J).
2. *Mechanical Power*—is the rate of doing work or rate of change of energy at an instant of time. It is measured in watts (W).
3. *Mechanical Work*—is the time integral of the mechanical power over a specified period of time. It is also equal to the change in energy of a system (segment or total body) over that same period of time. It is measured in joules (J).
4. *Positive Work*—is the work done by concentrically contracting muscles. Thus the time integral of mechanical power over a specified time is positive, or the net change in energy of the system is also positive.

5. *Negative Work*—is the work done by an eccentrically contracting muscle. Thus the time integral or mechanical power over a specified time is negative, or the net change in energy of the system is negative.
6. *Moment of Force (Torque)*—Product of a force and lever arm distance about a centre of rotation (usually a joint centre). The unit is Newton-meters (N• m).
7. *Impulse*—is the time integral of a force or moment curve, and is usually employed in ballistic movements to reflect changes in momentum of the associated limbs. Linear impulse is quantified in N• s, angular impulses in N• m• s. The impulse is a prerequisite to calculation of average force or moment over a given period of time.

Electrode and Anatomical Details

The type and position of the electrodes must be reported. If indwelling electrodes are used additional information is necessary (needle, wire, unipolar, depth of electrode, etc.). If there are problems of cross-talk the exact positioning of electrodes is necessary along with details of any precautionary tests that were done to ensure minimal cross-talk. If co-contractions can nullify or modify your results some evidence is necessary to demonstrate that the antagonistic activity was negligible.

It is now quite common to quantify an EMG amplitude as a percentage of a maximum voluntary contraction (MVC). The details as to how these were elicited are important. Also, the position of the body, adjacent limbs, etc., need to be described.

If electrical stimulation is being done, additional electrode data are necessary: position of anode and cathode, surface area of contact or, in case of indwelling electrodes, details of the exposed conductive surface. The strength, duration and frequency of the stimulating pulses is mandatory, and remember that the strength is usually in current units (ma) rather than voltage, because the net depolarization is a function of current leaving the electrodes. Without a knowledge of skin/electrode impedance, the voltage information is not too meaningful. Thus, with a constant voltage stimulation it is important to monitor and report the current pulse waveform.

General Subject Information

In any population study it is often relevant to give details of age, sex, height and weight of normals that may sometimes influence the results of certain experiments. Also, in conditions of fatigue or special training appropriate measures should be specified. For athletic or ergonomic tasks the researcher must give sufficient information to ensure that other centres could replicate his experiments. In the assessment of pathological movements certain clinical and medical history details of each patient may be necessary (i.e., level of lesion, number of months since stroke, type of prosthesis).

FINALLY, A CHECKLIST OF COMMON TERMS

Terminology	Units	Comments/Recommendation
Amplifier Gain	ratio or Db	
Inut Resistance or Impedance	ohms	10 ¹⁰ (resistance) on new d _c equipment, 10 ⁸ (impedance) on new ac amplifiers at 100 Hz Min. 100 times skin impedance
Common Mode Rejection Ratio (CMRR)	ratio or dB	90 dB or better
Filter cut-off or Bandwith	Hz	type and order of filter
EMG (raw signal)	mV	
EMG (average)	mV	specify averaging period
EMG (F.W. Rect.)	mV	
EMG (non-linear detector)	mV	specify non-linearity (i.e. square law)
EMG (linear envelope)	mV	cut-off frequency and type of low-pass filter
Integrated EMG (IEMG)	mV•s	specify integration period
Integrated EMG and Reset every T	mV•s or μ V•s	specity T (ms)
Integrated EMG to Threshold and Reset	mV•s or μ V•s	specify threshold (mV•s)
Power Spectral Density Function (PSDF)	μ V ² /Hz	
Mean Spectral Frequency (MSF)	Hz	
Median Frequency	Hz	

REFERENCES

1. Buchthal F, Schmalbruch H: Motor unit of mammalian muscle. *Physiol Rev* 60:90-142, 1980
2. DeLuca CJ: Physiology and mathematics of myoelectric signals. *IEEE Trans Biomed Engng, BME*—26:313-325, 1979
3. Inman VT, et al: Relation of human EMG to muscle tension. *EEG and Clinical Neurophysiology*, 4:187-194, 1952
4. Kadefors R: Myoelectric signal processing as an estimation problem. *New Developments in EMG and Clinical Neurophysiology*, Vol 1, 519-532 (Karger, Basel, 1973)
5. Komi PV, Viitasalo JHT: Signal characteristics of EMG at different levels of muscle tension. *Acta Physiolog Scand*, 96:267-276, 1976
6. Komi PV: Relationship between muscle, tension, EMG and velocity of contraction under concentric and eccentric work. *New Developments in EMG and Clinical Neurophysiology*, Vol 1, 596-606 (Karger, Basel, 1973).
7. Silny J, Hinsen R, Rau G, vonEssen R, Merx W, Effert S: Multiple-electrode measuring system for electrocardiographic evaluation of the course of acute myocardial infarction. *Biomedizinische Technik*, 24:106-112, 1979

APPENDIX C

Fine Wire Electrodes

Gary L. Soderberg, PhD, PT

In general, the fine wire technique for recording EMG is seldom indicated in ergonomics. In instances when the EMG of interest is from specific muscles or when muscles are deeply located in a body segment, recordings using fine wire electrodes are necessary for accuracy. Use of the fine wire technique requires adequate anatomical knowledge and training in the technique of implanting the wires.

This procedure is similar to an injection technique and results in the projection of the two fine wires from the muscle of interest. Electrodes for such recordings were produced originally in the 1960s, and the technique has now widely been accepted (Figure C-1).¹ The electrodes can easily be produced locally in a short time.² Although there is certain flexibility in using different gauge wire, some limitations are imposed by needle size, wire fracture rate, and other difficulties.

The conventional technique calls for burning of the ends of the wires to be implanted to remove an appropriate distance of insulation. There are some constraints using this technique in that a residue is produced on the end of the wire, resulting in an oxidation of the conductor. This technique also makes it difficult to ensure there is an equal distance of bared surface on each of the individual wires to be inserted. Mechanical stripping may be used, but the actual cutting may nick the wire, causing weak points. The small size of the wire also makes this technique quite difficult. Abrasion techniques are very difficult to control. Others have suggested chemical stripping of distal ends of the wire, but in that case it is difficult to get ends that are entirely clean. In our experience, the orderable lot of the stripper usually is of such magnitude that product decay is severe before the quantity can be used. A rather comprehensive description of these techniques of wire stripping is included in Loeb and Gans.³

Use of the conventional fine wire technique demands that the needle and the prepared wire configuration be sterilized after preparation. Although this may be accomplished with dry heat, boiling water or steam, Basmajian and DeLuca recommend autoclaving at 15 lb/in² or approximately 10 N/cm² for 30 minutes.² Virtually any hospital facility will provide these services usually at minimal or no cost.

Because the technique associated with fine wire electrodes is somewhat dependent on the skill of the user, some persons debate the issues of ease of technique and pain as to whether these factors are considered an advantage or disadvantage of this technique. Some users would maintain that this fine wire technique is easier to use and much quicker than surface EMG. Others find difficulties associated with connection of the fine wires, leading to difficulties in attaining high quality signals.

The choice of attaching these two very fine wires can lead to an arduous procedure. There are three primary means by which electromyographers have attached these wires to their amplifiers. One is by means of a pressure jack, in some cases available on a preamplifier. In another case, screw-on connectors have been used. In this case caution must be exerted that pressure is not so great that the wire is sheared and a fracture results. A third choice is the use of spring connectors that in turn are connected to the amplifier system. The possible configurations are shown in Figure C-2. In all cases, the electromyographer needs to be cautious of electrical interference that can be picked up as result of any of these systems and the ultimate artifact that can be induced into the recording.

Regarding pain, most subjects will report that after the wire insertion little pain exists. Additionally, the subject usually cannot identify the location of the wire embedded in the muscle. Jonsson et al did study the pain factor and reported on the discomfort by needle or by wires with diameters of 50 and 25 microns.⁴ He inserted the electrodes in the lateral gastrocnemius muscle of both legs in 27 subjects and checked for bleeding and discomfort at several intervals after insertion. The diameter of the larger wire gave slightly more discomfort than the insertion needles without wires, but the difference was not statistically significant. Ninety-one percent of the subjects reported discomfort with 25 micron wire, and 100% of the subjects reported discomfort with 50 micron wire, but it was common to have discomfort on one occasion but not on another. Common terms to describe the discomfort were throbbing, slight pain, stiffness, and dull or piercing pain. Some bleeding occurred in 64% of the cases with 25 micron

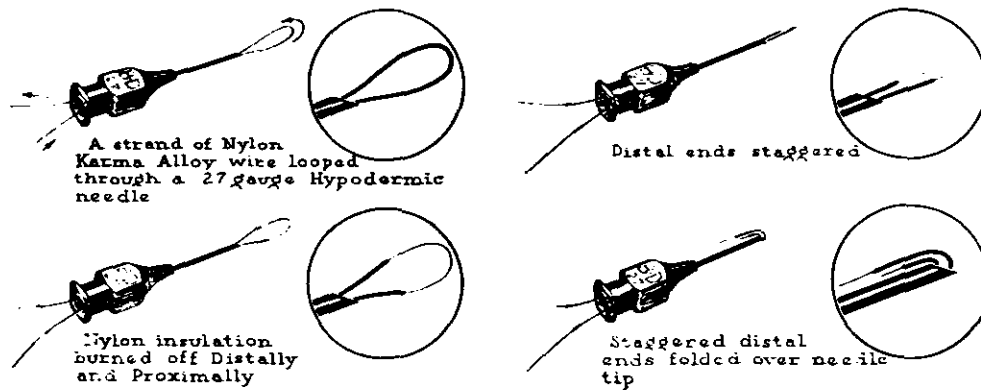

FIGURE C-1

Steps in the production of fine wire electrodes. Hollow core needles of desired length are appropriate.

(Reproduced with permission from Basmajian JV, Stecko G: A new bipolar electrode for electromyography. *J Appl Physiol* 17:849, 1962.)

wire and in 83% of the cases with 50 micron wire.

Although the fine wire electrodes are very localizing and exact (pickup area approximates 0.01 to 2/10 mm²), there are difficulties associated with displacement (Figure C-3). Fracture also is a possibility, but occurrence is relatively rare. Furthermore, baring of the distal segments of both wires also creates shorts when these two wires are in contact with each other. The wires also are likely to be sheared as the needle punctures the skin upon insertion of the needle. Finally, the fine wire technique has the potential for physiological responses from the subjects such that shock is induced. This occurs in individuals that are very highly trained and go into further physiologic depression because of an adverse reaction to needle insertion. Although few documented cases of this phenomena exist, the potential result warrants consideration when deciding which electrode technique to use.

Reliability work associated with this technique was done by Jonsson and Reichman who evaluated standard fine wire technique by recording after 5 minutes and after 15 to 20 minutes.⁵ They also recorded 3 to 7 days later, labeling muscle activity as slight, moderate, or marked. Results showed that after 15 to 20 minutes, one of the six subjects went from moderate to slight activity; in two subjects, there were slight differences. In reporting various experiments, two subjects had slight differences and one went from slight to moderate. No statistical analyses were applied. Following this work, however, Komi and Buskirk have shown interday reliability coefficients to average between .60 and .81 when considered for tension levels of 20% to 100% of maximum. Work completed on the same subjects by the same authors evaluated the fine wire reliability coefficients and demonstrated an average within-day reliability coefficient of .62 for contractions that ranged from 20% to 100% of maximum. Between-day coefficients ranged from a low of -.05 to a maximum of .55 and yielded an average coefficient of .22 for the same range of contraction strengths. Contributing to the reproducibility problem may be the movement of fine wire electrodes, which has radiographically been shown to be limited to less than 5 mm.⁷ The actual effect of these displacements on the reliability coefficient has yet to be determined.

Little information is available as to tissue response with indwelling wire electrodes. Blanton et al studied the initial local effects of wires covered with polyurethane insulation.^{8,9} These electrodes were placed into rats, and the tissue was evaluated at 1, 4, 8, 24, 30, 48 hours and at one and two weeks after wire insertion. The results showed that the pattern of acute inflammatory reaction increased in severity

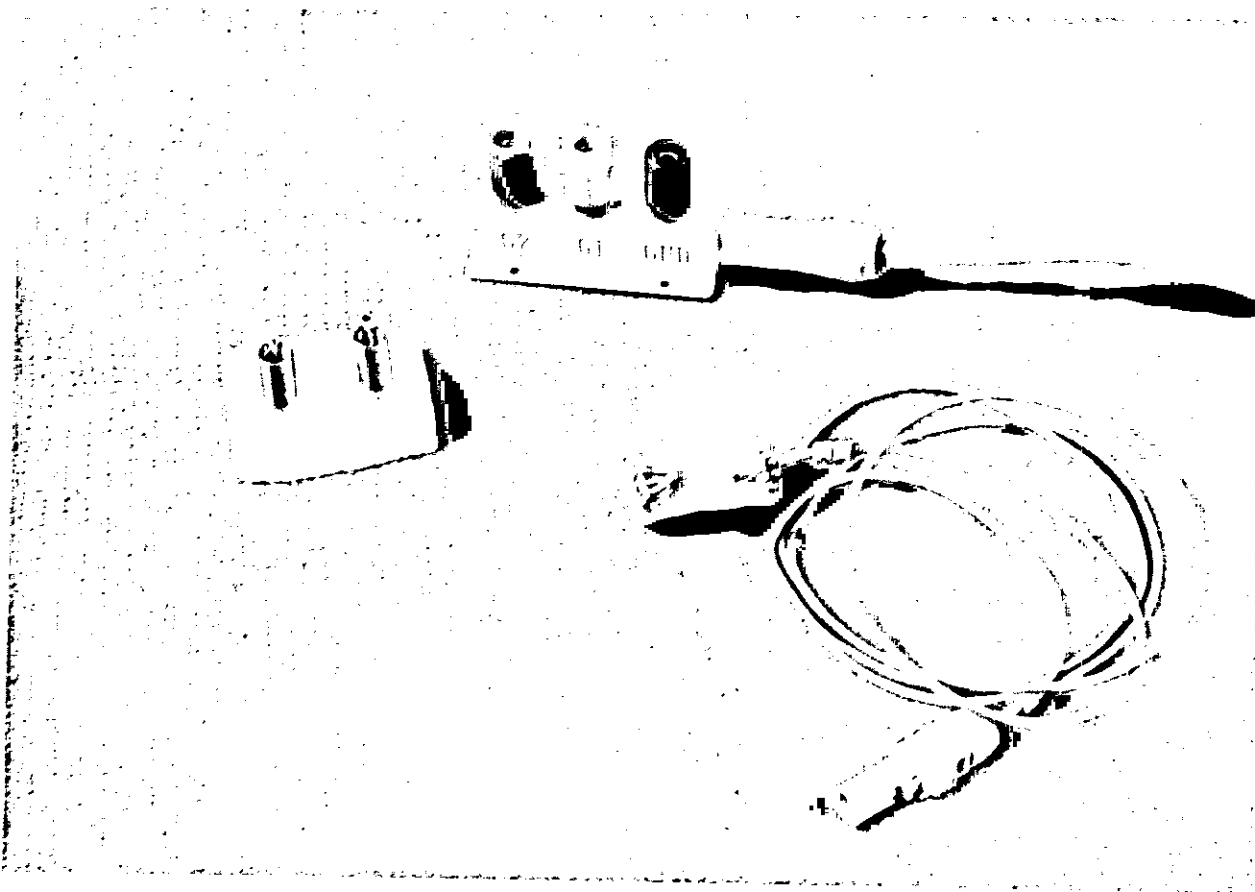

FIGURE C-2

Representative fine wire connection techniques. Wire is inserted into terminal which is then tightened down on wire (upper left). Standard springs may also be used to clamp wire (left). Pressure fitting is available at bottom in which case wire is inserted into the hole in the preamplifier and a pin is inserted.

and focal distance with time, and that after 4 hours, continued inflammation and increase in focal necrosis was demonstrated. The significance of this work is that it apparently is not feasible to leave fine wire implanted intramuscularly for a long term such as several weeks to months. According to the authors, all attempts should be made to record from muscle within 4 hours to evoke the least histologically destroyed response.

After recording with fine wire electrodes, the mechanisms of cleanup are relatively simple. The fine wire ends attached to the connector in use should be disassembled. Then, the inserted wires can be pinched tightly between two fingers and removed with a very mild tug from the examiner. After wiping the subject's skin with alcohol on gauze, the ends of the wires should be examined for completeness. If suspicious that wire fragments are remaining interstitially, the subject should be informed to be aware of residual soreness or for possible signs of infection. Generally, however, fracture of the wires is a very, very slight possibility. Wires should be discarded and the needle broken at the intersection of the shaft and hub. Discarding should be in compliance with rules for sharp materials.

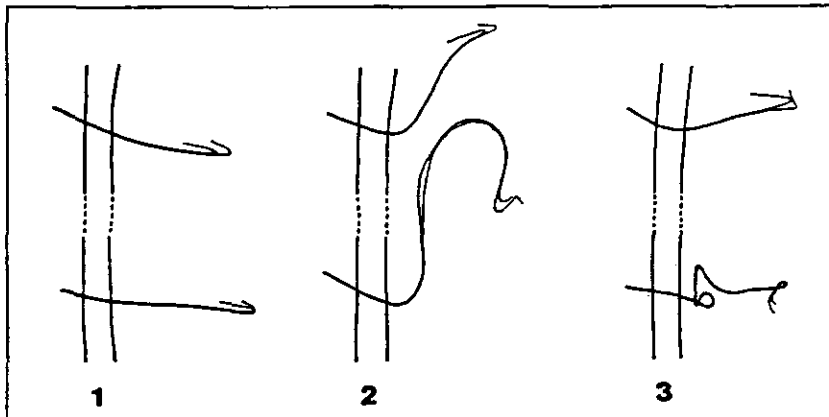

FIGURE C-3

Drawings of fine wires reproduced from radiographs of intramuscular locations. Vertical lines represent the skin contour: 1 = after withdrawal of insertion needle, 2 = during the first muscle contraction, and 3 = relaxed muscle after the 50th contraction.

Reproduced with permission from Jonsson B, Komi PV: Reproducibility problems when using wire electrodes in electromyographic kinesiology. New Developments in EMG and Clinical Neurophysiology 1:540-546, 1973.

In general the fine wire technique for recording EMG is seldom indicated in ergonomics. When necessary, however, the methods allow the study of specific muscles as they participate in a task of interest. Given adequate training, an ergonomist may find these techniques helpful and appropriate.

REFERENCES

1. Basmajian JV, Stecko G: A new bipolar electrode for electromyography. *J Appl Physiol* 17:849, 1962
2. Basmajian JV, DeLuca CJ: *Muscles Alive: Their Functions Revealed by Electromyography*. Baltimore, MD, Williams & Wilkins, 1985
3. Loeb GE, Gans G: *Electromyography for Experimentalists*. Chicago, IL, The University of Chicago Press, 1986
4. Jonsson B, Omfeldt M, Rundgren A: Discomfort from the use of wire electrodes for electromyography, *Electromyography* 8:5-17, 1968
5. Jonsson B, Reichmann S: Reproducibility in kinesiological EMG, investigations with intramuscular electrodes. *Acta Morph Neurol Scand* 7:73-90, 1968
6. Komi PV, Buskirk ER: Reproducibility of electromyographic measurements with inserted wire electrodes and surface electrodes. *Electromyography* 4:357-367, 1970
7. Jonsson B, Komi PV: Reproducibility problems when using wire electrodes in electromyographic kinesiology. *New Developments in EMG and Clinical Neurophysiology* 1:540-546, 1973
8. Blanton PL, Lehr RP, Moreland JE, Biggs NL: Observations on the histologic response of rat skeletal muscle to EMG indwelling wire electrodes. *Electromyography* 11:465-474, 1971
9. Blanton PL, Lehr RP, Martin JH, Biggs NL: Further observations on the histologic response of rat skeletal muscle to EMG fine wire-electrodes: Significance of insulation. *Electromyography* 11:475-478, 1971

GLOSSARY

- Motor Unit**—An anterior horn cell, its axon and all of the muscle fibers innervated by the axon.
- Potential Difference**—A measure of force produced between charged objects that moves free electrons. Also called voltage or electromotive force. The unit is the volt.
- Interspike Interval (ISI)**—The time between two successive repetitions of a motor unit action potential.
- Recruitment**—The successive activation of the same and additional motor units with increasing strength of voluntary muscle contraction.
- Rate Coding**—Process of controlling muscular force by regulating the firing rate of motor neurons.
- Power Spectrum**—The depiction of the power in a signal by assigning the power of each frequency component in the signal and arranging the components as an array.
- Signal Power**—Signal voltage squared and divided by the source impedance.
- Impedance**—The opposition to the flow of alternating electrical current measured in ohms.
- Common Mode Rejection Ratio**—The difference in signal gain divided by the common mode signal gain.
- Voltage Gain**—The ratio of the output signal level with respect to the input level.
- Noise**—Electrical potentials produced by electrodes, cables, amplifier or storage media and unrelated to the potentials of biologic origin.
- Isolation**—To set two circuits apart, usually by introducing a nonconducting barrier between the circuits.
- Input Bias Current**—Current that flows into the inputs of a nonideal amplifier (input impedance \neq ∞) due to leakage current, gate current, transistor bias current, etc.
- Modulation**—The variation of the amplitude frequency or phase of a carrier or signal as a means of encoding information.
- RMS Processor**—An electrical circuit assembly designed to compute the mathematical root-mean-square value of an AG signal.
- Linear Envelope Detection**—An electrical circuit assembly designed to detect the shape of the envelope of an amplitude modulated carrier or signal.
- Integration**—The operation of computing the area within mathematically defined limits.
- Demodulation**—The process of extracting the encoded intelligence from a modulated signal.