

# BUILDING PERFORMANCE ASSESSMENT REPORT

JULY 13, 1999

PRELIMINARY REPORT

OKLAHOMA AND  
KANSAS

## *Midwest Tornadoes of May 3, 1999*

OBSERVATIONS, RECOMMENDATIONS,  
AND TECHNICAL GUIDANCE

*...Building  
for Success*



FEDERAL EMERGENCY MANAGEMENT AGENCY  
Mitigation Directorate, Washington DC and Region VI, Denton, TX  
and Region VII, Kansas City, MO



# Table of Contents

List of Figures and Tables	v
List of Acronyms	ix
Executive Summary	xi
1 Introduction	
1.1 Purpose	
1.2 Team Composition	
1.3 Methodology	
1.4 Presentation of Findings	
2 Background on Tornadoes and History of the Storm	
2.1 The Fujita Scale and Tornado Probability	
2.2 Tornadoes and Associated Damage	
2.3 Background of the Event	
3 General Assessment and Characterization of Damage	
3.1 Property Protection	
3.1.1 Overview of Buildings Evaluated	
3.1.1.1 Residential Buildings	
3.1.1.2 Non-Residential Buildings	
3.1.2 Load Path and Increased Loads	
3.2 Wind-Borne Debris	
3.2.1 Missile Types and Sizes	
3.2.2 Wind-Borne Missile Quantity	
3.3 Personal Protection and Sheltering	
3.4 Local, State, and Federal Regulation	
3.4.1 Oklahoma	
3.4.2 Kansas	
4 Observations on Residential Property Protection	
4.1 Single Family Conventional Construction	
4.1.1 Load Paths	
4.1.2 Roof and Wall Sheathing	
4.1.3 Connections	
4.1.4 Increased Load	
4.1.5 Roof Coverings	
4.1.6 Wall Coverings	
4.1.7 Garage Door	
4.1.8 Windows and Doors	
4.1.9 Masonry	

- 4.2 Multi-Family Construction
- 4.3 Manufactured Housing
- 5 Observations on Non-Residential Property Protection
  - 5.1 Load Path
    - 5.1.1 Tilt-up with Steel Joists
    - 5.1.2 Load Bearing Masonry with Steel Joists
    - 5.1.3 Steel Frame with Masonry Infill Walls
    - 5.1.4 Light Steel Frame Buildings
    - 5.1.5 Laminated with Wood Frame
    - 5.1.6 Masonry with Pre-cast Floors
  - 5.2 Increased Load
    - 5.2.1 Tilt-up Precast Walls with Steel Joists
    - 5.2.2 Load Bearing Masonry with Steel Joists
    - 5.2.3 Steel Frame with Pre-cast Hollow Core
  - 5.3 Non-Residential Roof and Wall Coverings
    - 5.3.1 Roof Coverings
    - 5.3.2 Wall Coverings
    - 5.3.3 Laminated Glass
    - 5.3.4 Garage Doors, Exterior Doors and Windows
- 6 Observations on Personal Protection and Sheltering
  - 6.1 Shelters
    - 6.1.1 Types of Shelters
    - 6.1.2 Use of Shelters
    - 6.1.3 Maintenance Issues with Shelters
    - 6.1.4 Shelter Accessibility
    - 6.1.5 Shelter Ventilation
    - 6.1.6 Shelter Location
  - 6.2 Other Places of Refuge
    - 6.2.1 Refuge in Residences
    - 6.2.2 Refuge in Non-Residential Buildings
- 7 Preliminary Conclusions
  - 7.1 Residential Property Protection
    - 7.1.1 Single and Multi-family Homes
      - 7.1.1.1 Load Path and Structural Systems
      - 7.1.1.2 Increased Load Caused by Breach of Envelope
      - 7.1.1.3 Masonry
    - 7.1.2 Manufactured Housing
      - 7.1.2.1 Foundations
      - 7.1.2.2 Anchors
      - 7.1.2.3 Strapping
      - 7.1.2.4 Modules (Superstructure)
  - 7.2 Non-residential
    - 7.2.1 Load Path
    - 7.2.2 Increased Load Caused by Breach of Envelope
    - 7.2.3 Roof and Wall Coverings

7.3	Personal Protection and Sheltering
7.3.1	Residential Shelters
7.3.2	Group Shelters
7.3.3	Community Shelters
7.3.4	Other Places of Refuge
8	Preliminary Recommendations
8.1	General Recommendations
8.2	Property Protection
8.2.1	Residential and Non-Residential Buildings
8.2.2	Codes and Regulations, Adoption and Enforcement
8.2.3	Voluntary Actions
8.3	Personal Protection
8.3.1	Residential Sheltering
8.3.2	Group and Community Sheltering
8.3.3	Places of Refuge
9	References (Not included at this time)
Appendixes	
Appendix A	Members of the Building Performance Assessment Team
Appendix B	Acknowledgements
Appendix C	National Performance Criteria for Tornado Shelters
Appendix D	Taking Shelter from the Storm
Appendix E	List of Useful Websites



# List of Figures and Tables

Figure 1-1	BPAT meeting with State of Kansas and local government officials
Figure 1-2	BPAT meeting with Mid West City fire official
Table 1-1	BPAT damage assessment
Figure 2-1	Probability of tornado occurrence in the United States
Figure 2-4	Outbreak map of May 3, 1999 tornadoes in Oklahoma
Figure 2-5	Radar reflectivity map showing hook echo
Figure 2-6	Radar cross-section through F5 tornado
Figure 2-7	Outbreak map of May 3, 1999 tornadoes in Kansas
Table 2-1	Fujita Scale
Figure 3-1	Continuous load path for a wood frame building
Figure 3-2	Building failure due to inward wind and uplift
Figure 3-3	Wind uplift on residential home
Figure 3-4	Increased loads due to breach in envelope
Figure 3-5	Hip roof failure due to internal pressure and leeward wind forces
Figure 3-6	Failure of gable wall due to suction forces of leeward wall
Figure 3-7	Failure of exterior wall and roof due to increased internal pressure
Figure 3-8	EIFA and metal component damage
Figure 3-9	URM wall failure due to inflow winds
Figure 3-10	Failure of steel frame structural system with masonry infill walls
Figure 3-11	Broken window due to small missile
Figure 3-12	Picture of moderate sized missile
Figure 3-13	Large, high energy missile
Figure 3-14	Examples of board missiles
Figure 3-15	Windborne missile striking house
Figure 3-16	Vertical striking missile
Figure 3-17	Board missile penetrating brick veneer
Figure 3-18	Board missile penetrating refrigerator
Figure 3-19	Power pole missile
Figure 3-20	Displaced large propane tank due to wind
Figure 3-21	Steel deck missile
Figure 3-22	Tree missile
Figure 3-23	Quantity of flying debris
Figure 3-24	Polyisocyanurate roof insulation on top of the school roof
Figure 3-25	Close-up of polyisocyanurate roof insulation
Figure 3-26	Missile striking roof
Figure 3-27	Missiles striking exterior wall of house
Figure 3-28	Missiles striking interior wall of house
Figure 3-29	Underground residential shelter
Figure 4-1	Platform construction

Figure 4-2 Lateral load transfer  
 Figure 4-3 Failed stapling of boards to rafters  
 Figure 4-4 Staggering joints in sheathing application  
 Figure 4-5 Shear load force offset by wall sheathing  
 Figure 4-6 Wall failure due to inadequate lateral load resistance  
 Figure 4-7 CAPTION NEEDED  
 Figure 4-8 Roof-framing to wall failure  
 Figure 4-9 Top plate to supporting stud connection failure  
 Figure 4-10 Wall framing to sill plate failure  
 Figure 4-11 Stud wall and sole plate to floor failure  
 Figure 4-12 Sill plate foundation failure at wall  
 Figure 4-13 Sill plate to foundation failure  
 Figure 4-14 Asphalt shingles on roof  
 Figure 4-15 T-lock shingles on roof  
 Figure 4-16 Vinyl siding damage  
 Figure 4-17 Vinyl siding damage  
 Figure 4-18 Garage door failure under suction load  
 Figure 4-18A Typical double-wide garage door elevation  
 Figure 4-18B Plan view of typical garage door  
 Figure 4-18C Reinforced horizontal latch system for garage door  
 Figure 4-18D Garage door failure at track  
 Figure 4-19 Partial schematic of subdivision  
 Figure 4-20 Partial roof loss versus total loss under internal pressure  
 Figure 4-21 ADD CAPTION  
 Figure 4-22 Garage and roof failure  
 Figure 4-23 Garage door failure  
 Figure 4-24 Roof uplift  
 Figure 4-25 Missile penetrated door  
 Figure 4-26 ADD CAPTION  
 Figure 4-27 Roof failure  
 Figure 4-28 Interior of home with roof failure  
 Figure 4-29 TEMPORARY PLACE HOLDER  
 Figure 4-30 Failure of masonry construction  
 Figure 4-31 Brick masonry failure  
 Figure 4-32 Failure of masonry wall  
 Figure 4-33 Failure of brick veneer, close-up  
 Figure 4-34 Inadequate bond of mortar to galvanized brick ties  
 Figure 4-35 Inadequate bonding of mortar to brick and ties  
 Figure 4-36 Failure of masonry veneer wall  
 Figure 4-37 Failure of masonry veneer wall  
 Figure 4-38 Failure of masonry veneer wall  
 Figure 4-39 Failure of masonry veneer wall  
 Figure 4-40 Failure of chimney onto home  
 Figure 4-41 Failure of chimney, close-up  
 Figure 4-42 Failure of chimney onto home  
 Figure 4-43 Failure of masonry veneer, multifamily  
 Figure 4-44 Failure of masonry veneer, multifamily  
 Figure 4-45 Failure of masonry veneer, multifamily

Figure 4-46	Failure of chimney
Figure 4-47	Failure of chimney
Figure 4-48	Destroyed chassis
Figure 4-49	Failed straps
Figure 4-50	Displaced chassis
Figure 4-51	Pulled anchor
Figure 4-52	Pulled and bent anchor
Figure 4-53	Strap failure
Figure 4-54	Roof Uplift
Figure 4-55	ADD CAPTION
Figure 4-56	View of displaced chassis foundation
Figure 4-57	View of removed chassis
Figure 4-58	Laterally shifted manufactured home
Figure 4-59	Pulled anchors and lateral displacement
Figure 4-60	Strap and lateral shifting
Figure 4-61	Shifted manufactured home
Figure 5-1	Failure of critical connections in load path
Figure 5-2	Failure of tilt-up precast concrete walls
Figure 5-3	Damage displaying separation of bond beams
Figure 5-4	Broken welds and no effective vertical reinforcement
Figure 5-5	Blown off metal roof decking
Figure 5-6	Foundation and wall attachments
Figure 5-7	Column anchors exhibiting ductile failure
Figure 5-8	Column anchors withdrawn from concrete foundation
Figure 5-9	Stroud Regional Outlet Mall
Figure 5-10	Loss of church roof
Figure 5-11	Motel damage from violent tornado vortex
Figure 5-12	Out of plane buckling of the main girder
Figure 5-13	Collapsed roof structure and exterior
Figure 5-14	Blown off roof over school auditorium
Figure 5-15	Exterior of an undamaged reinforced concrete wall
Figure 5-16	Failure of tilt-up concrete wall
Figure 5-17	Top of failed tilt up wall
Figure 5-18	Top of failed tilt up wall
Figure 5-19	Failed roof system with intact tilt up concrete walls
Figure 5-20	Damage to non-reinforced masonry walls
Figure 5-21	Hollow core plank formed on second floor
Figure 5-22	Failure of power driven anchors
Figure 5-23	CAPTION NEEDED
Figure 5-24	Collapsed metal clad wall covering
Figure 5-25	Penetration of laminated glass
Figure 5-26	Roof and wall failure
Figure 5-27	Structural damage due to breach in envelope
Figure 6-1	Above ground in residence shelter
Figure 6-2	Surrounding damage near shelter
Figure 6-3	Entrance to ICF shelter



Figure 6-4	Precast concrete storm cellar
Figure 6-5	Storm cellar constructed of steel sheets and concrete cover
Figure 6-6	Community shelter at manufactured home park
Figure 6-7	Above ground in residence shelters
Figure 6-8	Entrance to manufacturing plant group shelter
Figure 6-9	Group shelters at manufactured home development
Figure 6-10	Manufactured home development community shelter
Figure 6-11	Community shelter in school gymnasium
Figure 6-12	Unmaintained underground shelter door
Figure 6-13	Failed wooden door of below ground shelter
Figure 6-14	Inadequate shelter door locking device
Figure 6-15	Ballast roof covering on community shelter
Figure 6-16	Stairway to manufactured home community shelter
Figure 6-17	Stairway access to group shelter
Figure 6-18	Heavy gauge ventilation pipe for below ground shelter
Figure 6-19	Basement windows to home vulnerable to debris
Figure 6-20	Below ground shelter susceptible to water runoff
Figure 6-21	Remains of interior core room
Figure 6-22	Remaining interior core of house
Figure 6-23	Interior bathroom of damaged home
Figure 6-24	Missile penetrating exterior wall
Figure 6-25	Missile piercing wall stud
Figure 6-26	Bathroom located along exterior wall
Figure 6-27	Second story damage
Figure 6-28	Damaged manufactured homes
Figure 6-29	Locker room – designated place of refuge
Figure 6-30	School hallway
Figure 6-31	Unsafe corridor place of refuge in school
Figure 6-32	Unsafe corridor place of refuge in school
Figure 6-33	Unsafe corridor place of refuge in school
Figure 6-34	EIFS wall system torn from studs
Figure 6-35	Collapsed non-reinforced interior CMU walls in school
Figure 6-36	Blown off roof and ceiling over interior bathroom

# List of Acronyms

ADA	Americans with Disabilities Act
ASCE	American Society of Civil Engineers
ASTM	American Society for Testing and Materials
BOCA	Building Officials and Code Administrators, International
BPAT	Building Performance Assessment Team
CABO	Council of American Building Officials
COHBA	Central Oklahoma Home Builders Association
CMU	Concrete Masonry Unit
EIFS	Exterior Insulating Finishing System
EPDM	Ethylene Propylene Diene Monomer
EPS	Expanded Polystyrene System
FEMA	Federal Emergency Management Agency
GIS	Geographic Information System
HUD	Department of Urban Development
HVAC	Heating, Ventilation, and Air Conditioning
ICBO	International Conference of Building Officials
MCHSS	Manufactured Home Construction and Safety Standards
NBC	National Building Code
NCSBCS	National Conference of States on Building Codes and Standards
NFIP	National Flood Insurance Program
NFPA	National Fire Protection Association
NOAA	National Oceanic Atmospheric Administration
NSSL	National Severe Storms Laboratory
OSB	Oriented Strand Board
SBCCI	Southern Building Code Congress International
UBC	Uniform Building Code
URM	Un-reinforced Masonry



# Executive Summary

On the evening of May 3, 1999, an outbreak of tornadoes tore through parts of Oklahoma and Kansas, in areas that are considered part of "Tornado Alley", leveling entire neighborhoods and killing 49 people. The storms that spawned the tornadoes moved slowly, contributing to the development and redevelopment of individual tornadoes over an extended period of time.

On May 10, the Federal Emergency Management Agency's (FEMA's) Mitigation Directorate deployed a Building Performance Assessment Team (BPAT) to Oklahoma and Kansas to assess damage caused by the tornadoes. The team was composed of national experts including FEMA Headquarters and Regional Office engineers and staff; a meteorologist; architects; planners; wind engineers; structural engineers; and forensic engineers. The mission of the BPAT was to assess the performance of buildings affected by the tornadoes, investigate losses, and describe the lessons learned. This report presents the BPAT's observations, conclusions, and recommendations, which are intended to help communities, businesses, and individuals reduce future injuries and the loss of life and property resulting from tornadoes and other high-wind events. It is not the intent of this report to reclassify the strength of the May 3 tornadoes or the ratings of the damage observed, or to debate the magnitude of the wind speeds associated with those tornadoes. Rather, the intent is to clearly define some basic concepts associated with tornadoes and tornado damage that will be referred to throughout this report.

The observations, conclusions, and recommendations in this report are grouped to address issues concerning (1) residential property protection, (2) non-residential property protection, and (3) personal protection and sheltering. The BPAT's findings are correlated with the Fujita damage scale, which ranks tornadoes according to the damage they cause, and general tornado intensity (Table 1-1).

Tornadoes are extremely complex wind events that cause damage ranging from minimal or minor to absolute devastation. For the purposes of this report, tornado intensity is simplified and referred to by three categories: moderate, severe, and violent. In a violent tornado, the most severe damage occurs. Typically, all buildings are destroyed and trees are uprooted, debarked, and splintered. In a severe tornado, buildings may also be destroyed, but others may suffer less severe damage, such as the loss of exterior walls, the roof structure, or both. Even when buildings in this area lose their exterior walls and roofs, interior rooms may survive. In moderate tornadoes, damage to buildings primarily affects roofs and windows. Roof damage ranges from loss of the entire roof structure to the loss of all or part of the roof sheathing or roof coverings. Typically, many of the windows in buildings will be broken by wind-borne debris.

During the field investigation, the BPAT investigated buildings to identify successes and failures that occurred during the tornadoes. Building failures were identified as being directly struck by the vortex or core of the tornado, affected by winds outside the vortex of the tornado, or out on the extreme edge or periphery of the tornado path. Considerable damage to all types of structures throughout Oklahoma and Kansas was observed. Failures occurred when extreme winds produced forces on the buildings that they were not designed to withstand. Failures also occurred when wind-borne debris penetrated the building envelope, allowing wind inside the building that again produced forces on the buildings that they were not designed to withstand. Additional failures observed were attributed to improper construction techniques

and poor selection of construction materials. It was a goal of the BPAT to determine if any of the damage observed to both residential and non-residential buildings was preventable.

Most residential construction in Oklahoma and Kansas is currently required to be designed per the 1995 Council of American Building Officials (CABO) One and Two Family Dwelling Code. Although some amendments have been adopted by local municipalities, this code does not incorporate wind speed design parameters used by the newer 1997 Uniform Building Code (UBC) and 1996 National Building Code (NBC). Furthermore, engineering standards such as the American Society of Civil Engineers (ASCE) 7-95 and 7-98 design standard provide better structural and non-structural design guidance for wind loads than these newer codes. Although designing for tornadoes is not specifically addressed in any of these newer codes or standards, constructing residential homes to these codes and standards would improve the strength of the built environment. The BPAT concluded that building to these codes and standards would have led to reduced or minimized damage in areas that were affected by the inflow winds of all tornadoes and reduced the damage observed where moderate tornadoes impacted residential construction.

The BPAT concluded that the best means to reduce loss of life and minimize personal injury during any tornadic event is to take refuge in specifically designed tornado shelters. Although improved construction may reduce damage to buildings and provide for safer buildings, an engineered shelter is the best means of providing individuals near absolute protection.

The BPAT developed recommendations for reducing future tornado damage to property and providing personal protection. Broad recommendations include the following:

- Proper construction techniques and materials must be incorporated into the construction of residential buildings to reduce their vulnerability to damage during extreme wind events. Existing construction techniques proven to minimize damage in wind-prone areas are not always being utilized in areas that are subject to tornadoes.
- Construction should be regulated and inspected to ensure that residential buildings meet the most current building code requirements, including those regarding structural seismic issues.
- For engineered buildings, the engineer should review connections to ensure adequate capacity for moderate to severe uplift and lateral loads that may be in excess of loads based on the building codes currently in effect.
  - Cities and appropriate local governments should adopt the 1997 UBC or 1996 NBC as the model building codes.
  - Cities and appropriate local governments not already using the 1995 CABO One- and Two-Family Dwelling Code should do so immediately.
  - The International Building Code (IBC) and the International Residential Code (IRC) should be adopted upon their release in 2000.
  - Shelters are the best means of providing near absolute protection for individuals who are attempting to take refuge during a tornado.
  - All shelters should be designed and constructed in accordance with either FEMA 320 or The National Performance Criteria for Tornado Shelters



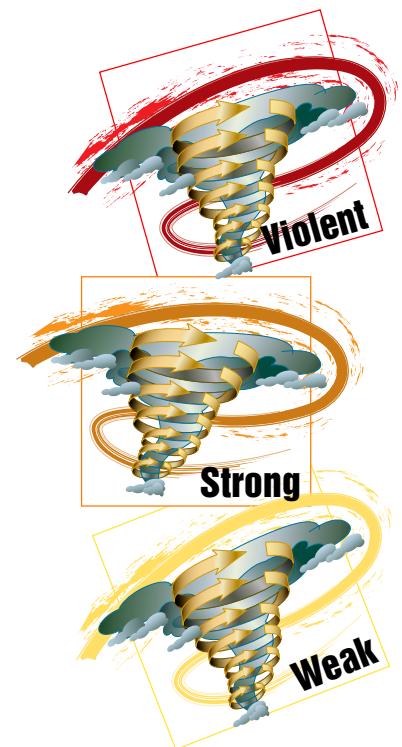
## Executive Summary

On the evening of May 3, 1999, an outbreak of tornadoes tore through parts of Oklahoma and Kansas, in areas that are considered part of “Tornado Alley”, leveling entire neighborhoods and killing 49 people. The storms that spawned the tornadoes moved slowly, contributing to the development and redevelopment of individual tornadoes over an extended period of time.

On May 10, 1999, the Federal Emergency Management Agency’s (FEMA’s) Mitigation Directorate deployed a Building Performance Assessment Team (BPAT) to Oklahoma and Kansas to assess damage caused by the tornadoes. The BPAT was composed of national experts including FEMA Headquarters and Regional Office engineers and staff; a meteorologist; architects; planners; wind engineers; structural engineers; and forensic engineers. Members of the BPAT are presented in Appendix A. The mission of the BPAT was to assess the performance of buildings affected by the tornadoes, investigate losses, and describe the lessons learned. This report presents the BPAT’s observations, conclusions, and recommendations, which are intended to help communities, businesses, and individuals reduce future injuries and the loss of life and property resulting from tornadoes and other high-wind events. The observations, conclusions, and recommendations in this report are grouped to address issues concerning residential property protection, non-residential property protection, and personal protection and sheltering.

The BPAT’s findings are correlated with the Fujita damage scale, which ranks tornadoes according to the damage they cause, and general tornado intensity (Tables 1-1 and 2-1). It is not the intent of this report to reclassify the strength of the May 3 tornadoes or the ratings of the damage observed, or to debate the magnitude of the wind speeds associated with those tornadoes.

Tornadoes are extremely complex wind events that cause damage ranging from minimal or minor to absolute devastation. For the purposes of this report, tornado intensity is simplified and referred to by three categories: violent, strong, and weak. The greatest damage occurs in a violent tornado. Typically, all buildings are destroyed and trees are uprooted, debarked, and splintered. In a strong tornado, some buildings may be destroyed, but most suffer less damage, such as the loss of exterior walls, the roof structure, or both. Even when buildings affected by a strong tornado lose their exterior



walls and roofs, interior rooms may survive. In weak tornadoes, damage to buildings primarily affects roofs and windows. Roof damage ranges from loss of the entire roof structure to the loss of all or part of the roof sheathing or roof coverings. Typically, many of the windows in buildings will be broken by windborne debris. Weak tornadoes can often cause significant damage to manufactured housing.

The BPAT investigated buildings to identify successes and failures that occurred during the tornadoes. Buildings were classified as being directly struck by the vortex (i.e., core) of a tornado, affected by winds outside (but near) the vortex of a tornado, or out on the extreme edge (i.e., periphery) of a tornado path. Few successes were observed by the BPAT. Successes consisted of the utilization of engineered shelters within a home or commercial building or voluntary utilization of known construction techniques that strengthened the structural system of a building. Considerable damage occurred to all types of structures throughout the areas observed in Oklahoma and Kansas. Failures occurred when extreme winds produced forces on the buildings that they were not designed to withstand. Failures also occurred when windborne debris penetrated the building envelope, allowing wind inside the building that again produced forces on the buildings that they were not designed to withstand. Additional failures observed were attributed to the construction techniques used, the selection of construction materials, the fasteners used, and the design of, or lack of, connections. It was a goal of the BPAT to determine if the damage observed to both residential and non-residential buildings was preventable.

Most residential construction in Oklahoma and Kansas is currently required to be designed per the 1995 Council of American Building Officials (CABO) One- and Two-Family Dwelling Code. Although some amendments have been adopted by local municipalities, this code does not incorporate wind speed design parameters used by the newer 1997 Uniform Building Code (UBC) and 1996 National Building Code (NBC). Furthermore, engineering standards such as the American Society of Civil Engineers (ASCE) 7-98 design standard provide better guidance for determining design wind loads than these newer codes. Although designing for tornadoes is not specifically addressed in any of these newer codes or standards, constructing homes to these codes and standards would improve the strength of the built environment. The BPAT concluded that buildings constructed to these newer codes and standards would have experienced less damage in areas that were affected by the inflow winds of all tornadoes and reduced the damage where weak tornado vortices directly affected buildings.

The BPAT concluded that the best means to reduce loss of life and minimize personal injury during any tornadic event is to take refuge in specifically designed tornado shelters. Although improved construction may reduce damage to buildings and provide for safer buildings, an engineered shelter is the best means of providing individuals near absolute protection.

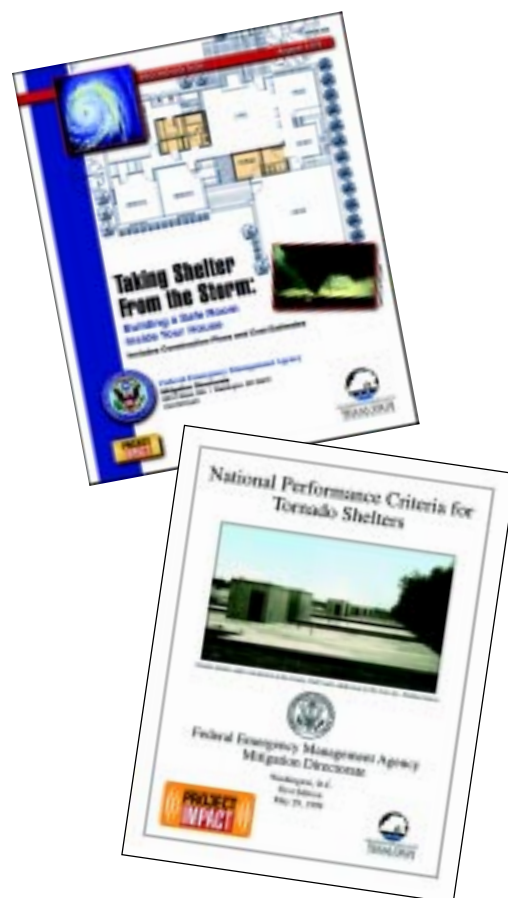


The BPAT developed recommendations for reducing future tornado damage to property and providing personal protection. Broad recommendations include:

- **Building Code Recommendations.** Neither building codes nor engineering standards explicitly address design for tornadoes. However, designing to the wind loads in ASCE 7-98 can reduce damages from both weak tornadoes and in outlying areas damaged by strong and violent tornadoes. The model building codes consider these latest engineering standards, such as ASCE 7, when model building codes are revised, usually on a 3-year cycle. In order that design and construction practices reflect our improved understanding of high winds, jurisdictions having authority should consider the following alternatives in amending their current building code or in adopting new building codes:
  - Adopt the International Building Code (IBC) and the International Residential Code (IRC) upon their expected release in February 2000.
  - As an interim step to adopting the IBC and IRC, adopt the 1997 UBC, the 1997 Standard Building Code, (SBC), or the 1996 NBC as the building code until the IBC or IRC can be adopted. To further improve the wind resistance of buildings, adopt an amendment that requires the use of ASCE 7-98 to calculate wind loads.
  - As an interim step to adopting the IRC, State and local governments should adopt the 1995 edition of the CABO One- and Two-Family Dwelling Code for jurisdictions using previous editions of this code or having no residential code in place. This will provide some guidance for designing for wind loads.
- Communities should consider the need for adopting ordinances and regulations that promote disaster-resistant communities by incorporating tornado shelters into new construction and communities.
- The Federal Government (HUD) should review its standards and enforcement program in an effort to improve the performance of manufactured homes in moderately high wind events, such as in inflow areas of all tornadoes and the tracks of weak tornadoes. Specifically, the capacity of anchoring and strapping equipment and systems needs to be evaluated to eliminate the discontinuity between the Federal standard and the State and local installation and enforcement process.

- Consideration should be given to permanently connecting the manufactured home unit to its foundation. The BPAT observed newer double-wide manufactured houses on permanent foundations and did not see significant differences in damage between these manufactured homes on permanent foundations and conventionally built houses. Double-wide manufactured housing on permanent foundations performed better than both double-wide and single units on non-permanent foundations.
- Construction techniques and materials to provide a continuous load path for wind loads should be incorporated into the construction of buildings, including houses. This will reduce their vulnerability to damages during extreme wind events. There are existing proven construction practices to minimize damages in other wind-prone areas (hurricane areas) of the country.
- Construction should be regulated and better inspected to ensure that buildings (including residences) meet current building code requirements. A lack of compliance with building codes was observed in many of the damaged buildings.
- Garage doors are an extremely important residential building component. Failure of these doors led to catastrophic progressive failures of primary structural systems that could have been avoided. New garage doors should be installed with improved resistance to high wind loads.
- Where new doors are not installed, retrofits should be made to improve the wind resistance of existing garage doors, particularly double-wide garage doors. These retrofits and new doors will better resist wind forces and should reduce the roof and wall damage that was observed in homes that experienced garage door failures.
- Architectural features should be appropriately designed, manufactured, and installed to resist wind loads and to minimize the creation of windborne debris. To accomplish this, the local community may want to further regulate these features to ensure a reduction in potential debris materials.
- The brick masonry industry should consider re-evaluating attachment criteria of masonry, specifically regarding product usage. Greater emphasis should be given to code compliance for the bond between the mortar and brick tie, the mortar and the brick, and the spacing of brick ties.

- In areas subjected to high winds from either tornadoes or hurricanes, masonry chimneys should have continuous vertical reinforcing steel placed in the corners to provide greater resistance to wind loads. This reinforcing steel should be placed to the requirements set forth in the 1995 CABO One-and Two- Family Dwelling Code (Requirements for Masonry Fireplaces and Chimneys for seismic zones 3 and 4) or the masonry fireplace provisions of the IRC; available in February 2000.
- Shelters are the best means of providing near absolute protection for individuals who are attempting to take refuge during a tornado. All shelters should be designed and constructed in accordance with either *FEMA 320: Taking Shelter From the Storm* or *the National Performance Criteria For Tornado Shelters* (Appendixes C and D). All shelters should provide access to persons with disabilities as necessary and in conformance with the Americans with Disabilities Act (ADA). Local officials should monitor the installation of shelters to ensure that the floors of all shelters are located at or above expected flood levels.
- Manufactured homes typically offer little protection from severe wind storms and tornadoes. In the event of such storms, occupants of manufactured homes should exit their home and seek shelter in storm cellars, basements, or above-ground shelters. If shelters are provided in manufactured home parks, which is recommended, dispersed shelters, which can be accessed in a short time period, are recommended.
- Prospective occupants of community shelters should be acutely alert to storm warnings in order to allow sufficient time for the travel distance to the community shelter. Custodians of the shelter should be similarly alert so that the shelter is unlocked at appropriate times. Community shelters should be ADA compliant and the admission rules permanently posted (i.e. “No Pets Allowed,” etc.).
- Existing essential facilities that offer inadequate protection should have shelters retrofitted or a shelter added. New essential facilities should be designed with shelters. Interested states should form a committee to evaluate the need for tornado plans and shelters in essential facilities and other establishments serving the public (e.g., schools, hospitals, and critical facilities). All facilities for public accommodation should have a National Oceanic and Atmospheric Administration (NOAA) weather radio in continuous operation.



- The installation of laminated glass in essential facilities should be considered because of the substantial protection that it offers from debris missiles. A recommended standard for determining minimum strength of openings with laminated glass is to conduct testing, in accordance with ASTM E 1886, in consideration of the load criteria given in ASTM E 1996.
- Fire departments and emergency services agencies should make a list of addresses with shelters both above ground and below ground. This list will assist post disaster response teams and agencies in checking after a tornado to see if people are trapped inside their shelters.

# 1 Introduction

## 1.1 PURPOSE

The number of tornadoes that occurred on May 3, 1999, in Oklahoma and Kansas, their severity, and the level of devastation they caused have not been seen in a generation within the United States. One of the missions of the Federal Emergency Management Agency (FEMA) that directly supports the *National Mitigation Strategy* is:

*to significantly reduce the risk of loss of life, injuries, economic costs and destruction of natural and cultural resources that result from natural hazards.*

In response to the disasters caused by the May 3 tornadoes, FEMA deployed a Building Performance Assessment Team (BPAT), composed of national experts in engineering, architecture, meteorology, and planning, to Oklahoma and Kansas. The mission of the BPAT was to assess the performance of buildings affected by the tornadoes, investigate losses, and describe the lessons learned. This report presents the BPAT's observations, conclusions, and recommendations, which are intended to help communities, businesses, and individuals reduce future injuries and the loss of life and property resulting from tornadoes and other high-wind events.

## 1.2 TEAM COMPOSITION

The BPAT included FEMA Headquarters and Regional Office engineers and staff; a meteorologist; planners; architects; wind engineers; structural engineers; and forensic engineers. The members of the BPAT are listed in the appendix of this report.

## 1.3 METHODOLOGY

The FEMA Mitigation Directorate deployed the BPAT to Oklahoma and Kansas on May 10, 1999. The team inspected both residential and non-residential buildings, as discussed below. By assessing the performance of these buildings, the team was able to develop technical guidance concerning new construction and post-tornado reconstruction for state and local governments, building owners, architects, engineers, and contractors.

In addition to assessing building performance, the BPAT:

- inspected shelter areas in public buildings (e.g., schools, churches, day care centers, nursing homes),

- investigated successes and failures of existing shelters during the tornadoes, and
- evaluated existing tornado response plans within buildings intended for high occupancy such as schools and private industry facilities.

Field investigations began on May 10 and were conducted through May 18. In Oklahoma, inspections were made in Bridge Creek (about 50 miles southwest of Oklahoma City); the Oklahoma City metroplex, including the suburbs of Moore, Del City, and Midwest City; the Project Impact community of Tulsa; and Stroud and Mulhall. In Kansas, inspections were made in unincorporated Sedgwick County, the City of Haysville, and Wichita, Kansas.

BPATs frequently conduct aerial assessments of damage areas to gather general data on damage sites, acquire aerial photographs of those sites, and determine the focus and final composition of the BPAT. For the May 3 tornado disasters, adequate information was provided to the team by the FEMA Disaster Field Offices (DFOs) and by state and local government agencies. Therefore, the BPAT did not conduct an aerial assessment of the damage areas.

The BPAT inspected the following types of residential buildings:

- single- and multi-family, one- to two-story wood-frame houses
- manufactured and modular homes
- accessory structures

Many of the houses inspected in Kansas were constructed on basement or crawlspace foundations; most of the houses inspected in Oklahoma were constructed on slab-on-grade foundations. From its observations, the BPAT formed conclusions concerning the structural performance of residential buildings exposed to the May 3 tornadoes. The BPAT also formed conclusions regarding exterior architectural systems; those conclusions focus on roof coverings, brick veneer and other siding materials, windows, garage doors, and masonry chimneys.

The non-residential building types observed included the following:

- tilt-up pre-cast concrete walls with steel joists
- load-bearing masonry walls with steel joists
- load-bearing masonry with pre-cast concrete hollow-core floor and roof slabs
- pre-engineered metal buildings (light steel frames)
- buildings constructed of laminated wood arches with wood framing
- buildings with masonry veneer and pre-cast concrete floors

- industrial plants
- a regional shopping outlet mall
- public use buildings inspected include a hospital, nursing homes, day care centers, hotels, schools

Other important issues such as windborne debris (missiles), personal protection, and sheltering were investigated and are discussed in individual sections of this report.

FEMA encouraged the participation of state and county government officials and locally based experts in the assessment process. Their involvement was critical because it helped to:

- ensure that state and local building code and other requirements were properly interpreted,
- increase the likelihood that local construction practices were fully appreciated and understood,
- establish positive relationships among Federal, state, and local governments and the private sector, and
- encourage the development of recommendations that were both economically and technically realistic.

Under this premise, the BPAT met with local government officials upon arriving in Oklahoma and Kansas to “partner” in the overview and identification of damage areas. Team members were briefed by staff members of the FEMA regional DFOs and representatives of state, county, and local government agencies on the extent and types of damage. GIS maps were provided and reviewed in order to select field investigation sites and establish an itinerary (Figure 1-1).

***FIGURE 1-1: BPAT meeting with State of Kansas and local government officials in Wichita, Kansas.***



***FIGURE 1-2: Meeting with local fire official in Midwest City, Oklahoma. Photo to be added later.***





Collectively, the team spent over 2,000 hours in the field conducting site investigations and inspecting damage. Documentation of observations made during the site visits included field notes and photographs. The BPAT's mission did not include recording the numbers of buildings damaged by the tornadoes, determining the frequency of specific types of damage, or collecting data that could serve as the basis of statistical analysis.

#### **1.4 PRESENTATION OF FINDINGS**

The observations, conclusions, and recommendations in this report are grouped to address issues concerning (1) residential property protection, (2) non-residential property protection, and (3) personal protection and sheltering.




Table 1-1 correlates the BPAT's findings with the Fujita damage scale (which ranks tornadoes according to the damage they cause) and general tornado intensity in terms that will be used throughout this report. For the purposes of this report, tornado intensity is referred to by the three categories listed in Table 1-1: moderate, severe, and violent. When appropriate, damage observations in this report are presented in terms of the Fujita scale ratings. Table 1-1 is intended to help the reader better understand tornadoes, the damage associated with them, and how mitigation efforts can be made to reduce the property damage and loss of life caused by tornadoes. Further discussions regarding the makeup of a tornado, the damage associated with the winds of a tornadic event and the Fujita scale are presented in Chapter 2.

This report is intended to provide information related to mitigation efforts that communities, businesses, and individuals can undertake to reduce future injuries and the loss of life and property. It is not the intent of this report to re-classify the strength of the May 3 tornadoes or the ratings of the damage observed, or to debate the magnitude of the wind speeds associated with those tornadoes. The Fujita scale ratings mentioned in this report are based on preliminary ratings issued by the local National Weather Service (NWS) offices in Oklahoma and Kansas after the tornado outbreaks. The National Severe Storms Laboratory (NSSL) in Norman, Oklahoma, provided additional preliminary information regarding the tornadoes.

TABLE 1-1

The BPAT Damage Assessment Table

Tornado Icons  
 Fujita Scale  
 BPAT Characterization  
 Wind-Borne Debris  
 Property Protection  
 Personal Protection  
 Sheltering

	<b>F5</b>	<p><b>VIOLENT</b></p>	large, medium, and small air-borne and rolling debris	Protecting entire buildings is uneconomical and impractical.	Must have a structure or room specifically engineered for extreme wind protection.	To attain near absolute protection, a shelter should be constructed within or adjacent to a home, office, or business that is built in accordance with FEMA Pub. No. 320 or the National Performance Criteria for Tornado Shelters.
	<b>F4</b>		medium and small air-borne and rolling debris	Voluntary retrofits strengthen homes and buildings with existing technology.	Additional strengthening of building structure and envelope may reduce risk.	
	<b>F3</b>	<p><b>SEVERE</b></p>	small air-borne and rolling debris	Constructing to newer building codes and standards strengthens buildings.	Constructing building envelope to newer building codes and standards minimizes risk and injury.	
	<b>F2</b>		small air-borne and rolling debris	Constructing to newer building codes and standards strengthens buildings.		
	<b>F1</b>	<p><b>MODERATE</b></p>	small air-borne and rolling debris			
	<b>F0</b>					

# 2 Background on Tornadoes and History of the Storm

This chapter presents both a history of the May 3, 1999, tornadoes as they affected Oklahoma and Kansas and insight into the interaction between a tornado and a populated area. The Fujita scale for classifying tornado damage is presented in this chapter. A discussion on tornadoes and tornado damage is also included.

## 2.1 THE FUJITA SCALE AND TORNADO PROBABILITY

Of the 1,000 or so tornadoes reported each year in the United States, only a few are rated as “violent” events (F4 or F5 on the Fujita scale). The Fujita scale (Table 2-1), which was created by the late Tetsuya Theodore Fujita, University of Chicago, categorizes tornado severity based on damage observed and not on recorded wind speeds. Wind speeds have been associated with the damage descriptions of the Fujita scale, but the accuracy of these wind speeds is limited in that they are only estimates that best represent the observed damage and are not calibrated wind speeds.

Although the number of violent tornadoes varies considerably from year to year, the average during the period from 1980 to 1989, was about 10 per year. On average, only one or two of these per year were rated F5. Historical data indicate that the number of tornado reports have been rising, in general, since tornado data began to be collected in the early 1900’s. However, the data suggest that a long-term increase in the frequency of tornadoes is unlikely. Rather, increased reporting of tornadic events has caused the numbers of documented tornadoes to rise.



**F-0: (Light Damage)** Chimneys are damaged, tree branches are broken, shallow-rooted trees are toppled.



**F-1: (Moderate Damage)** Roof surfaces are peeled off, windows are broken, some tree trunks are snapped, unanchored manufacture homes are overturned, attached garages may be destroyed.



**F-2: (Considerable Damage)** Roof structures are damaged, manufactured homes are destroyed, debris becomes airborne (missiles are generated), large trees are snapped or uprooted.



**F-3: (Severe Damage)** Roofs and some walls torn from structures, some small buildings are destroyed, non-reinforced masonry buildings are destroyed, most trees in forest are uprooted.

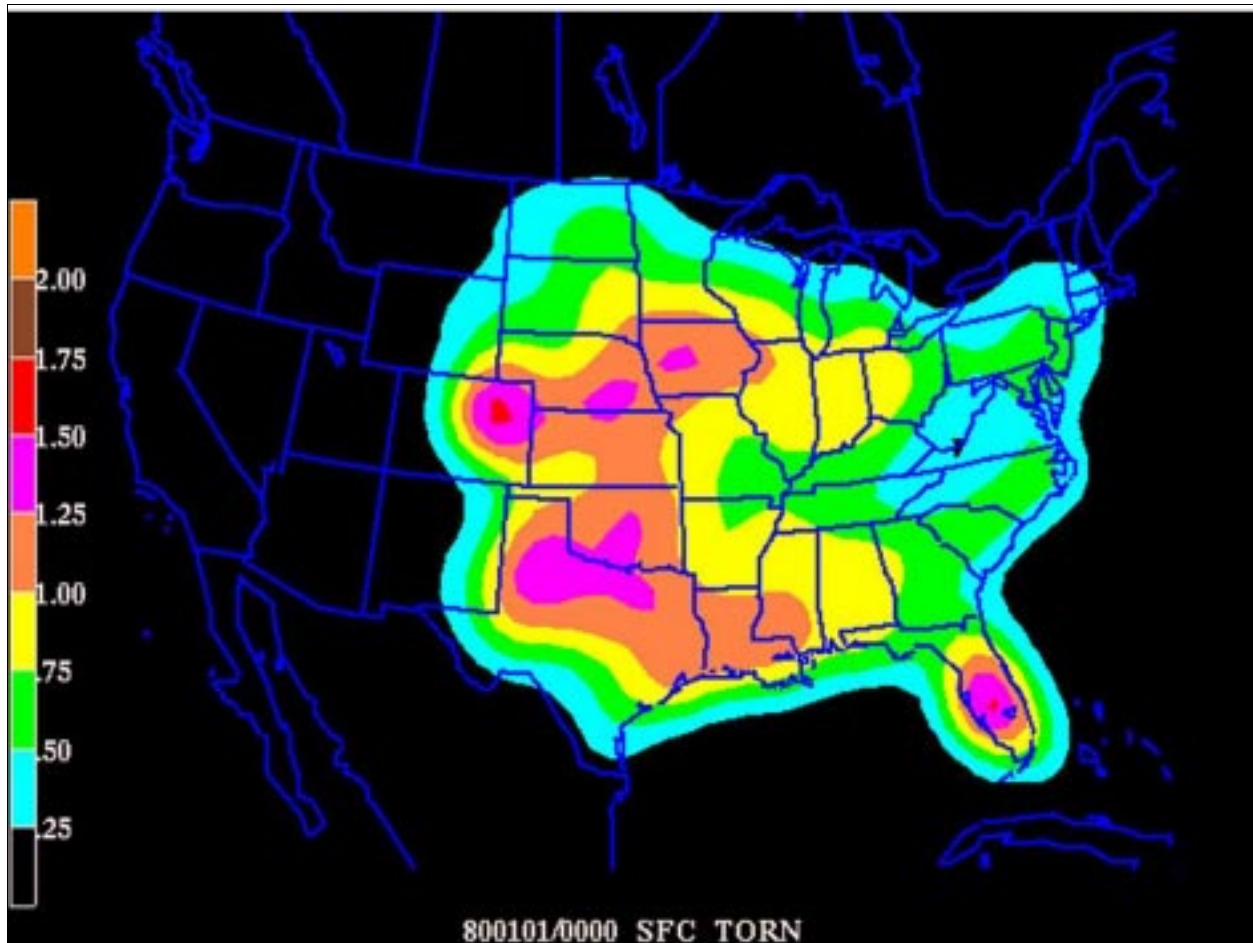


**F-4: (Devastating Damage)** Well-constructed houses are destroyed, some structures are lifted from foundations and blown some distance, cars are blown some distance, large debris becomes airborne.



**F-5: (Incredible Damage)** Strong frame houses are lifted from foundations, reinforced concrete structures are damaged, automobile-sized debris becomes airborne, trees are completely debarked.

Even today, tornadoes are unlikely to be rated as violent unless they interact with the built environment, so the actual numbers of violent tornadoes per year are probably somewhat larger than the reporting statistics suggest. According to calculations performed by the National Severe Storms Laboratory (NSSL), the most recent data (1980-1994) indicate that the within the regions of the United States with the highest frequency of tornado occurrence, an area of 2,500 square miles should expect about one tornado (of any intensity) per year (Figure 2-1). In other words, the chance of any particular square mile experiencing a tornado in a given year, within the designated area of "Tornado Alley," is about one in 2,500. The map in Figure 2-1 indicates by color band the probability of tornado occurrence in the continental United States during any given year.



**FIGURE 2-1: Annual probability of tornado occurrence in the continental United States.**

If violent tornadoes correspond to the top 2 percent of all tornadoes, an area of 2,500 square miles in the area of peak frequency would be expected to experience a violent tornado only about once every 50 years. Alternatively, a given square mile's chances of being hit in a given year by a violent tornado are about one in 125,000.

Fujita estimated that the total area within a violent tornado's path that actually experiences damage associated with the violent wind speeds (i.e., the area directly impacted or struck by the tornado vortex) is only on the order of 1 percent of the total area affected. That means that a given square mile in "Tornado Alley" has only about 1 chance in 12,500,000 of being hit by the winds of the vortex of a violent tornado. Given that our knowledge of actual tornado occurrences is not complete or perfectly accurate, the true chances of being hit by a violent tornado might vary from the estimates given here. However, the NSSL believes these numbers to be broadly representative of the probabilities of being affected by a violent F4/F5 tornado.

## 2.2 TORNADOES AND ASSOCIATED DAMAGE

Tornadoes are extremely complex wind events that cause damage ranging from minimal or minor to absolute devastation. Providing a complete and thorough explanation or definition of tornadoes and tornado damage is not the intent of this section. Rather, the intent is to clearly define some basic concepts associated with tornadoes and tornado damage that will be referred to throughout this report.

In a simplified tornado model, there are three regions of wind:

1. Near the surface, close to the core or vortex of the tornado. In this region, the winds are complicated and include the peak low-level wind speeds, but are dominated by the tornado's strong rotation. It is in this region that strong upward motions occur that carry debris upward, as well as around the tornado.
2. Near the surface, away from the tornado's core or vortex. In this region, the flow is dominated by inflow to the tornado. The inflow can be complicated and is often concentrated into relatively narrow swaths of strong inflow rather than a uniform flow into the tornado's core circulation.
3. Above the surface, typically above the tops of most structures, the flow tends to become very nearly circular.

In an actual tornado, the diameter of the core or vortex circulation can change with time, so it is impossible to say precisely where one region of the tornado's flow ends and another begins. Also, the visible funnel cloud associated with and typically labeled the vortex of a tornado is not always the edge of the strong extreme winds. Rather, the visible funnel cloud boundary is determined by the temperature and moisture content of the tornado's inflowing air. The highest wind speeds in a tornado occur at a radius measured from the tornado core that can be larger than the visible funnel cloud's radius. It is important to remember that a tornado's wind speeds cannot be determined just by looking at the tornado.

Figure 2-2 shows the types of damage that can be caused by a violent tornado similar to the one that passed through the Oklahoma City Metroplex on May 3, 1999. In general, as shown in the figure, the severity of the damage varies with distance from the vortex. Note, however, that the rotation of a tornado can cause winds flowing into the vortex on one side to be greater than those on other sides. As a result, it is not uncommon for the area of damage on one side of the tornado to be more extensive. Figure 2-2 reflects this situation.

In a violent tornado, the most severe damage occurs in the area directly affected by the vortex (the area shaded dark red [dark gray] in Figure 2-2).

Typically, in this area, all buildings are destroyed and trees are uprooted, debarked, and splintered. In the immediately adjacent area, shaded orange [medium gray] in the figure, buildings may also be destroyed, but others may suffer less severe damage, such as the loss of exterior walls, the roof structure, or both. Even when buildings in this area lose their exterior walls and roof, interior rooms may survive. In the outer portion of this area, further from the vortex, damage to buildings affects primarily roofs and windows. Roof damage ranges from loss of the entire roof structure to the loss of all or part of the roof sheathing or roof coverings. Typically, most or all of the windows in buildings in this area will be broken by windborne debris. In the area shaded yellow [light gray], damage is again primarily to roofs and windows. However, roof damage is lighter, and although windborne debris damage still occurs here, not all windows are broken. Damage to buildings in the outer fringe of this area is even lighter. Beyond this area, where the figure shows blue shading, buildings typically suffer no damage.



**Figure 2-2: Impact of a**



# Impact of a Violent Tornado



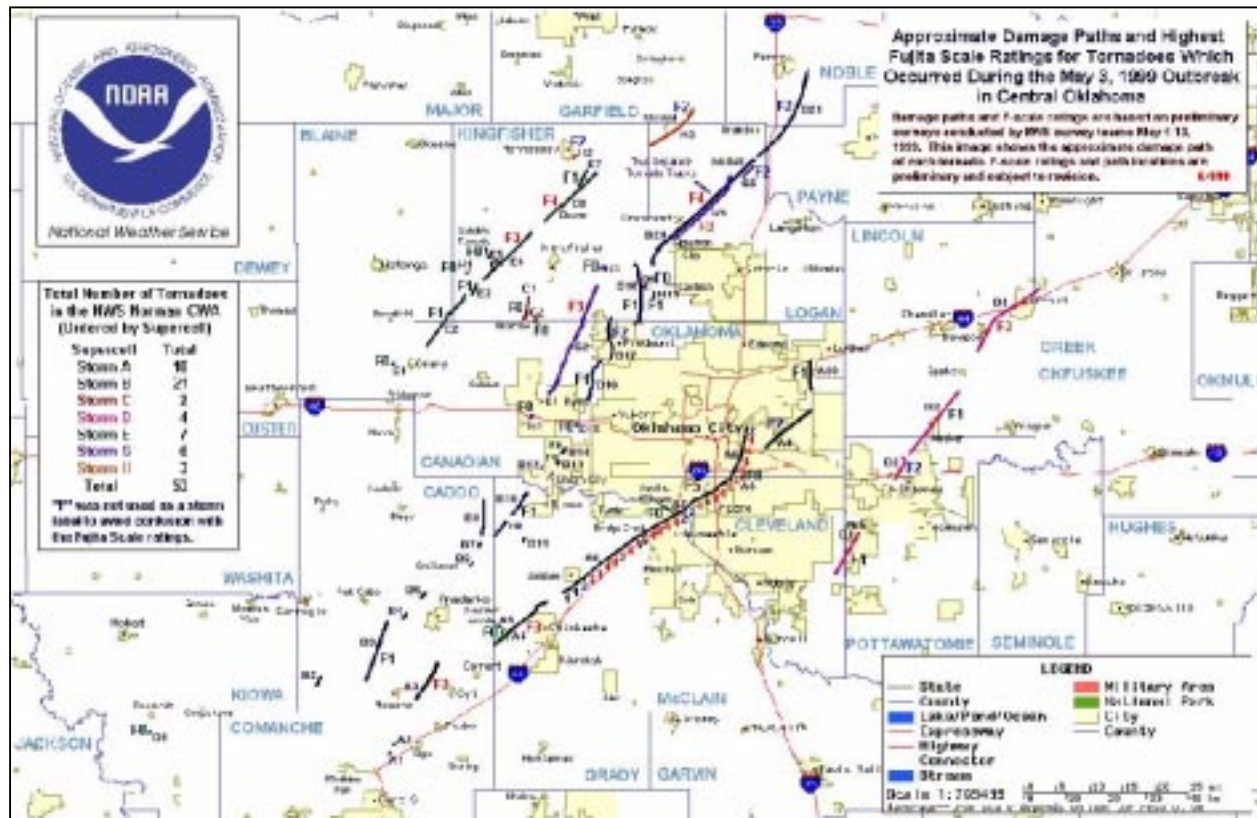
Managing Risk	Damage Color Code	Description of Damage
<p>The Threat to Property and Personal Safety Can Be Minimized Through Compliance With Up-To-Date Model Building Codes and Engineering Standards</p>		Some damage can be seen to poorly maintained roofs. Unsecured light-weight objects, such as trash cans, are displaced.
		Minor damage to roofs and broken windows occur. Larger and heavier objects become displaced. Minor damage to trees and landscaping can be observed.
<p>Property and Personal Protection Can Be Improved Through Wind Hazard Mitigation Techniques Not Normally Required by Current Building Codes</p>		Roofs are damaged, including the loss of shingles and some sheathing. Manufactured homes, on nonpermanent foundations can be shifted off their foundations. Trees and landscaping either snap or are blown over. Medium-sized debris becomes airborne, damaging other structures.
		Roofs and some walls, especially unreinforced masonry, are torn from structures. Small ancillary buildings are often destroyed. Manufactured homes on nonpermanent foundations can be overturned. Some trees are uprooted.
<p>Personal Protection Can Only Be Achieved Through Use of a Specially Designed Extreme Wind Refuge Area, Shelter, or Safe Room</p>		Well constructed homes, as well as manufactured homes, are destroyed, and some structures are lifted off their foundations. Automobile-sized debris is displaced and often tumbles. Trees are often uprooted and blown over.
		Strong frame houses and engineered buildings are lifted from their foundations or are significantly damaged or destroyed. Automobile-sized debris is moved significant distances. Trees are uprooted and splintered.

**violent tornado.**

### 2.3 BACKGROUND OF THE EVENT

On May 3, 1999, a widespread outbreak of tornadoes occurred in the south central United States, primarily in Oklahoma and Kansas. A strong upper-level storm system moved eastward towards the southern Plains from the Rockies during the day. Winds aloft over Kansas and Oklahoma intensified as the upper-level system approached. Atmospheric conditions indicated that rotating thunderstorms known as “supercells” were quite likely. The flow of moisture northward from the Gulf of Mexico, and daytime heating that pushed ambient surface temperatures up to at least 80 degrees, combined to produce an extremely unstable atmosphere across the southern Plains. In situations like this, forecasters are usually able to predict the tornado threat with reasonable accuracy, as opposed to more isolated tornado events, for which favorable conditions may not be so obvious. See the National Oceanic and Atmospheric Administration's (NOAA's) “Service Assessment” for details of forecasting performance in this event. The tornado outbreak was anticipated and, once supercells were detected by the WSR-88D radar, the tornado warnings from the NWS were accurate and timely, the first being issued at 4:47 p.m. (all times Central Daylight Time [CDT]).

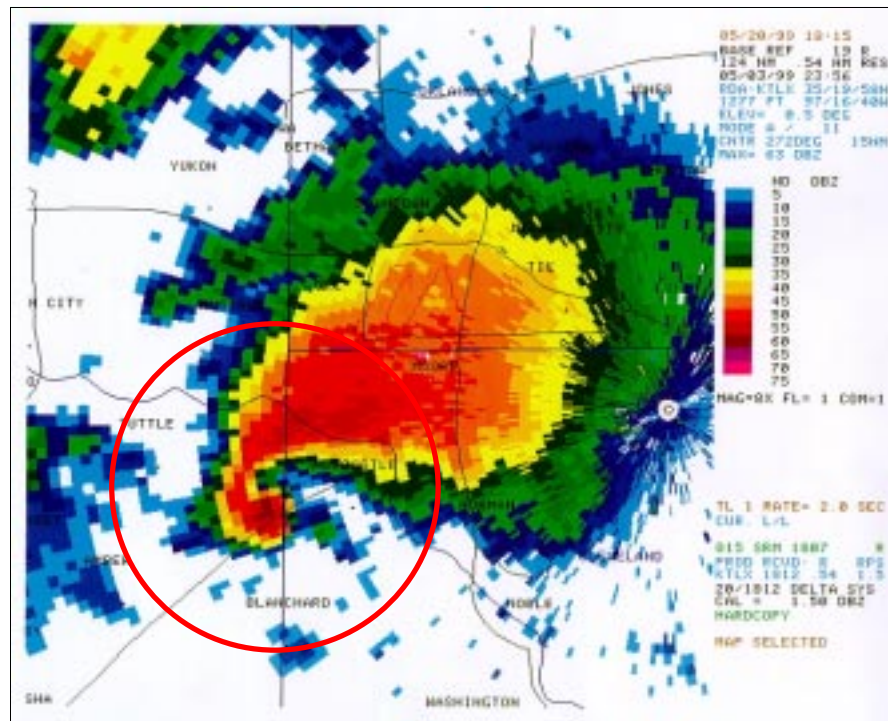
The preliminary count of tornadoes that occurred in this outbreak is 67, but this number may change during the analysis of all the data, which will take many months. Within this outbreak, there were four violent (F4 or F5) tornadoes according to preliminary surveys performed by the NWS. Figure 2-4 shows the outbreaks in Oklahoma; Figure 2-7 shows the outbreaks in Kansas.



**FIGURE 2-4: Preliminary outbreak map of tornadoes in Oklahoma that struck on May 3, 1999. Courtesy of the National Weather Service.**

The tornado that caused the greatest damage and that had the greatest effect on residential areas was the reported F5 tornado that struck the south side of the Oklahoma City Metroplex. Its source was a supercell thunderstorm that had spawned several tornadoes earlier (Fig. 2-5). This tornado had a track 38 miles long and lasted more than an hour, from 6:23 to 7:50 p.m. The track began between the towns of Chickasha and Amber, Oklahoma, southwest of Oklahoma City.

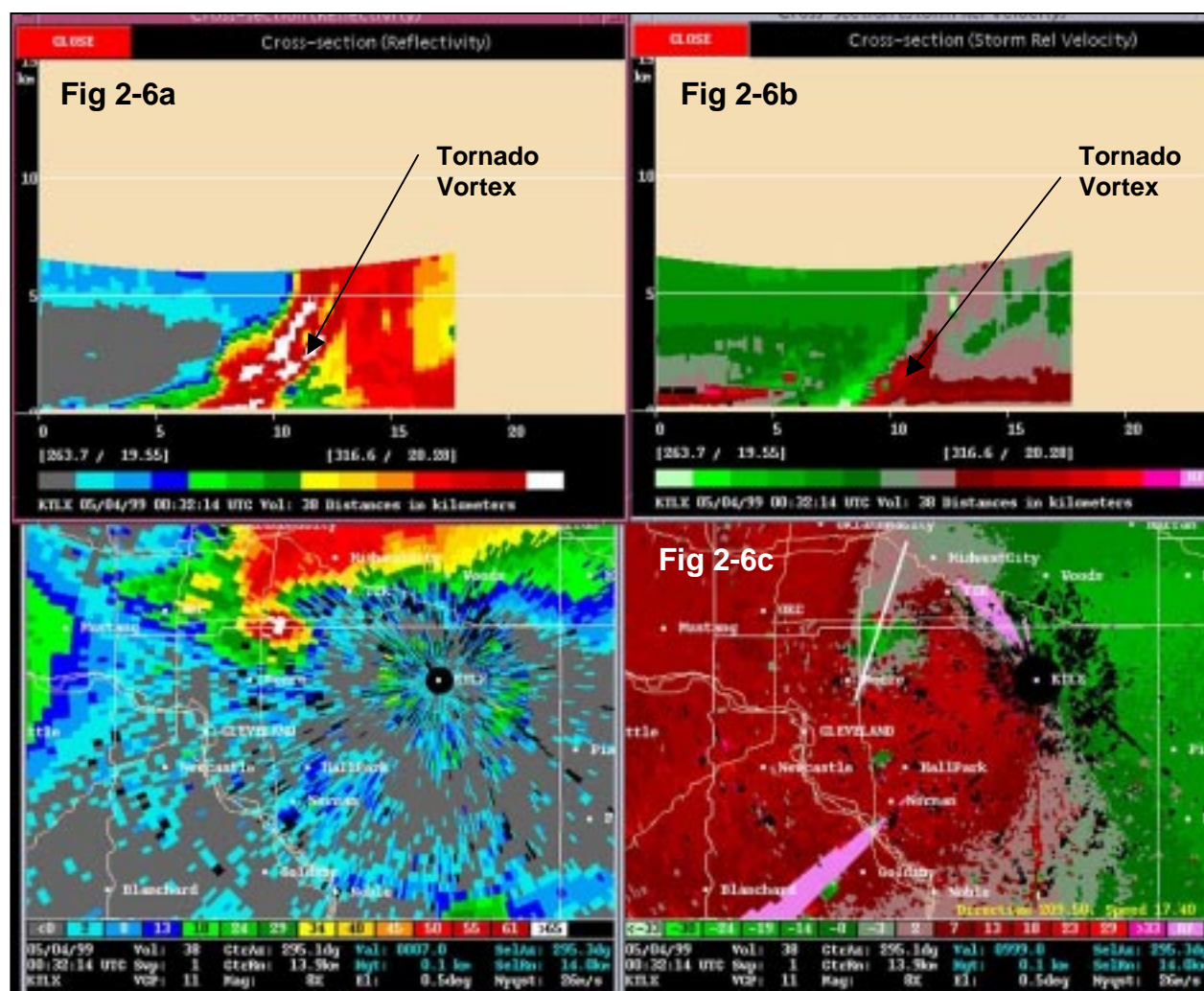
**FIGURE 2-5: Radar reflectivity map at 6:56 p.m., showing hook echo (circled). A hook echo is a structure associated with supercell storms. In many instances, the radar echo shows this type of structure when tornadoes are present. Courtesy of the National Severe Storms Laboratory.**



From its touchdown point, the tornado moved northeastward, nearly parallel to I-44, towards Oklahoma City, hitting the rural town of Bridge Creek, Oklahoma, at 6:55 p.m. and crossing I-44 at about 7:05 p.m. near the South Canadian River. From there, it moved through several small subdivisions before slamming into the city of Moore, Oklahoma, and crossing I-35 near an overpass for Shields Boulevard. Continuing through a less densely populated area, the tornado crossed I-240 at about 7:35 p.m., began a wide left turn to travel along a north-northeast path that took it into Del City, Oklahoma, skirted Tinker Air Force Base, and then moved into Midwest City, Oklahoma, where it finally dissipated.

Preliminary analyses by the NWS in Norman, Oklahoma, indicated that this single tornado damaged or destroyed more than 8,000 homes, and was responsible for 41 fatalities and approximately 800 injuries. Early damage estimates are on the order of at least \$750 million. There has not been a tornadic event even approaching this magnitude since the F4 tornado that devastated Wichita Falls, Texas, on April 10, 1979.

Figure 2-6 presents four WSR-88D images of the reported F5 tornado as it tracked from Moore to Midwest City. Figures 2-6a and 2-6b are actual radar cross-sections of the tornado taken at the location identified by the white line in Figure 2-6c. Figure 2-6a represents reflectivity, while Figure 2-5b represents storm-relative radial velocity. These images were recorded at 7:32 p.m. on May 3, 1999. Horizontal and vertical scales are in kilometers. The vortex walls and the eye are delineated by different color patterns that relate to debris in the vortex and the wind speeds within the vortex itself.



**Figure 2-6: WSR-88D radar cross-section through the reported F5 tornado located approximately halfway between Moore and Midwest City, showing the debris and an apparent “eye.”**

Another violent tornado (rated F4) struck the small town of Mulhall, Oklahoma, which is located about 50 miles north of Oklahoma City. This tornado was produced by a different supercell storm, to the north of the Oklahoma City Metroplex supercell. This second supercell produced approximately 19 tornadoes. The F4 tornado that struck Mulhall originated in open country, northwest of the town of Cashion, Oklahoma, at about 9:25 p.m. It spent the majority of its life in relatively unpopulated open country, hitting Mulhall around 10:15 p.m., late in its life cycle. Most of the homes and businesses in the Mulhall downtown area, including a public school, a post office, and many historic buildings, were damaged or destroyed. There were no fatalities recorded in Mulhall. However, the tornado was responsible for two fatalities; one fatality in both Logan and Payne Counties.

Dover, Oklahoma, was hit by a violent F4 tornado around 9:20 p.m. from another supercell that produced a “family” of tornadoes. This tornado was responsible for one fatality. The track was not investigated by the BPAT.

The fourth violent tornado (a reported F4) struck the Town of Haysville, Kansas, and the southern portion of the City of Wichita, Kansas (Fig. 2-7) and was responsible for 5 fatalities. This tornado began around 8:13 p.m. in open country, west of the town of Riverdale, Kansas, in the unincorporated areas of Sedgwick County. Moving north-northeastward, close to the Union Pacific railroad tracks, the tornado hit Haysville at roughly 8:39 p.m., and continued into southern Wichita, crossing I-235, at about 8:44 p.m. It then veered to the east-northeast for a few miles, before turning north-northeastward again and dissipating in eastern Wichita at about 9:00 p.m. The track of this tornado was 24 miles long and extended east-northeastward through southern Wichita. The track was similar to that of the deadly tornado of April 26, 1991, which hit the Golden Spur Manufactured Home Park in Andover, Kansas. The 1991 tornado produced 5 fatalities, more than 100 serious injuries, and \$140 million in damage, according to preliminary estimates by the NWS in Wichita, Kansas.

Among the less violent tornadoes of May 3, were five, including a moderate F3 tornado, that struck near the town of Stroud, Oklahoma, around 10:40 p.m. There were no fatalities, but a regional outlet mall along I-44 in Stroud was destroyed, and the roof covering on a hospital in the town was blown off.

A moderate tornado entered Tulsa, Oklahoma, in the southwest neighborhood of Sapulpa, where it destroyed or heavily damaged several manufactured homes and site built structures. The tornado moved northeast to the Mountain Manor neighborhood, where it damaged roofs and uprooted trees. The roof at Remington School was extensively damaged, and several industrial and commercial structures on the south side of I-44 experienced roof and siding damage. There were no fatalities, but the Carbondale Assembly of God Church, on the north side of I-44, suffered significant structural damage.



**FIGURE 2-7: Map of tornadoes in Kansas that struck on May 3, 1999. Courtesy of the National Oceanic and Atmospheric Administration.**

# 3 General Assessment and Characterization of Damage

The general types of damage the BPAT observed as a result of the May 3 tornadoes in Oklahoma and Kansas are discussed below. As a result of the site investigations and general field observations, important issues such as property protection, personal protection, and sheltering were identified. A more detailed discussion of these issues may be found in Chapters 4, 5, and 6 of this report.

## 3.1 PROPERTY PROTECTION

During the field investigation, the BPAT investigated buildings to identify success and failures that occurred during the tornadoes. Building failures were identified as being directly struck by the tornado, affected by winds outside the vortex of the tornado, or out on the extreme edge of the tornado path. Considerable damage to all types of structures throughout Oklahoma and Kansas was observed. Failures occurred when extreme winds produced forces on the buildings that they were not designed to withstand. Failures also occurred when windborne debris penetrated the building envelope allowing wind inside the building that again produced forces on the buildings that they were not designed to withstand. However, other failures observed were attributed to poor construction, improper construction techniques, and poor selection of construction materials. It was a goal of the BPAT to determine if any of the damage observed to both residential and non-residential buildings was preventable.

### 3.1.1 Overview Of Buildings Evaluated

The damage assessment of buildings was divided into residential and non-residential sections. Specifically, the residential buildings were categorized into single family housing, multi-family housing and manufactured and modular housing. The non-residential buildings were categorized into the various engineered types of construction observed. These groupings were made to focus on the structural performance of each type of building. In both cases, important observations were also made concerning exterior architectural systems, e.g., roof and wall coverings, windows and doors.



### 3.1.1.1 Residential Buildings

The residential buildings were categorized into the various types of construction investigated and the structural performance of each type of building was observed. The residential buildings investigated by the BPAT were:

- single- and –multi-family, one- to two-story wood-frame houses
- manufactured and modular homes
- accessory structures

Residential buildings that were directly struck by the vortex of severe and violent tornadoes were substantially or completely destroyed. Residential buildings that experienced a direct strike from moderate tornadoes or experienced inflow winds from severe and violent tornadoes saw a wide range of damage. This damage range observed was broken windows and light building damage, partial loss of roofs and walls, separation of buildings from their foundations and total roof loss, and only remnants of core rooms surviving.

### 3.1.1.2 Non-Residential Buildings

The non-residential buildings were categorized into the various *engineered* types of construction investigated focusing on the structural performance of each type of building. The non-residential buildings investigated include:

- tilt-up pre-cast concrete walls with steel joists
- load-bearing masonry walls with steel joists
- load-bearing masonry walls with pre-cast concrete hollow core floors and roof slabs
- steel frame
- steel frame with masonry infill walls

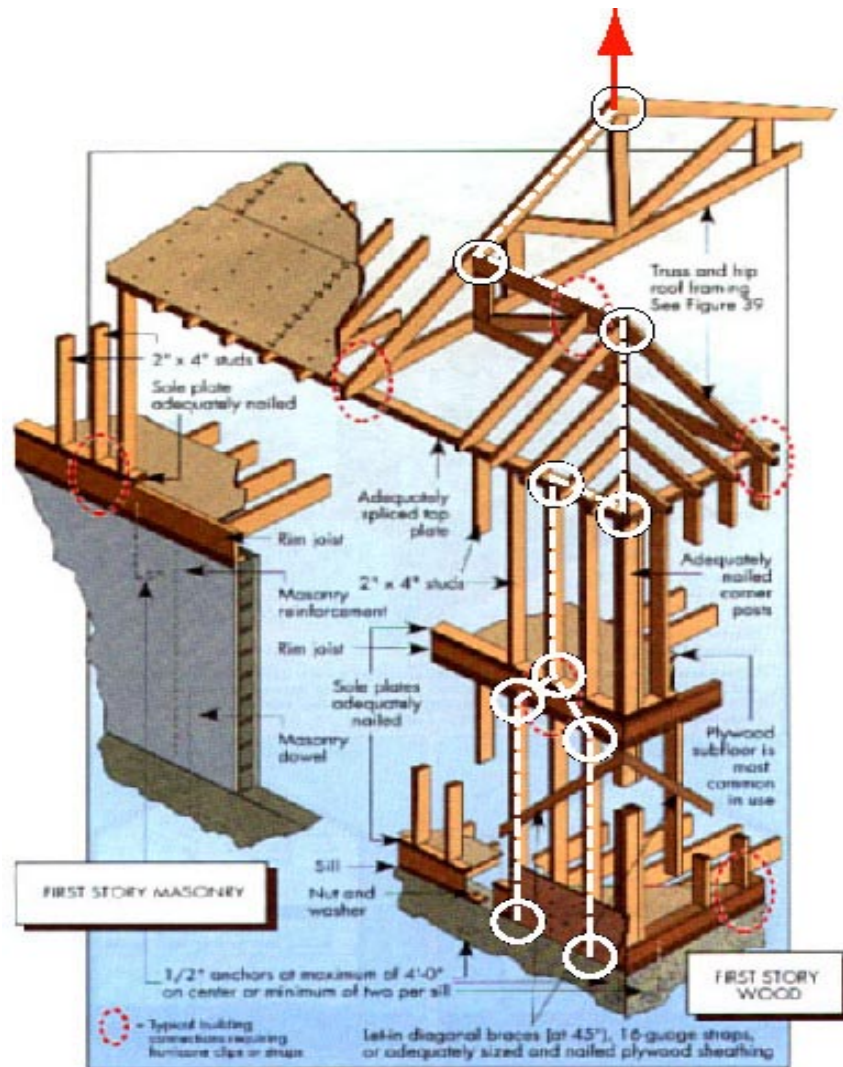
The non-residential buildings investigated by the BPAT were typically designed by a design professional and therefore the non-residential buildings that were damaged by the tornadoes experienced different damage from the same tornadoes that damaged residential buildings. Non residential buildings that were directly struck by the vortex of severe and violent tornadoes were substantially damaged or destroyed, however, they were typically not reduced to rubble like the residential buildings. Non-residential buildings that experienced a direct strike from moderate tornadoes or experienced inflow winds from severe and violent tornadoes saw a wide range of damage. This damage range observed was broken windows and light building damage, partial loss of roof and wall coverings, partial loss of roof and wall systems, complete roof loss, and partial upper level damage with minimal lower level damage on multi-level buildings.

### 3.1.2 Load Path and Increased Loads

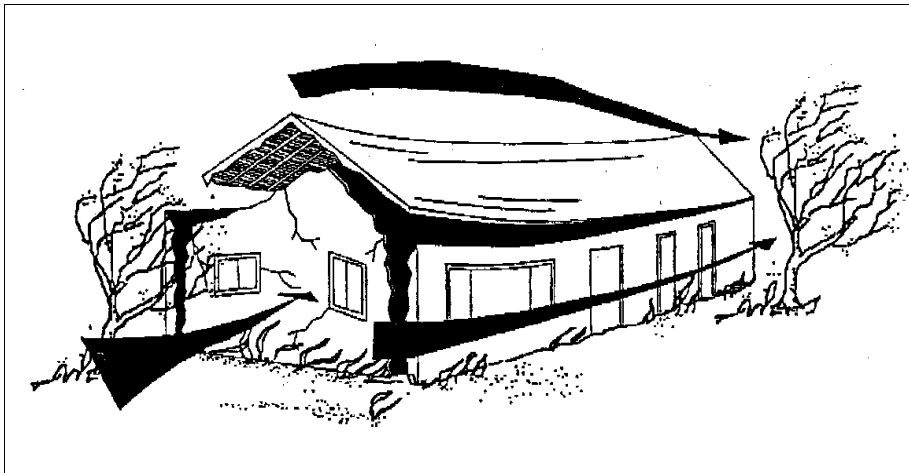
Site visits in both Oklahoma and Kansas of wind-induced damage to residential and commercial buildings indicate that internal pressurization is a major contributor to poor building performance under severe wind loading conditions. It is recognized that maintaining the exterior envelope of a building has a large effect on the performance of the elements of the structural system. In spite of loss of a portion of the exterior envelope, the construction must provide a continuous load path in order to increase survivability of the building in events that marginally exceed the design winds.

Primary structural systems are those that support the building against all lateral and vertical loads. Many buildings inspected had structural systems capable of providing a continuous load path for downward acting gravity loads, but were unable to provide a continuous load path for the lateral and vertical uplift forces generated by the tornado winds. The team looked at how this property damage could have been prevented or reduced in all areas of the windfield with the exception of directly under the vortex of violent tornadoes. Figure 3-1 shows a continuous load path in a wood frame (stick built) house.

**Figure 3-1: Diagram showing a continuous load path for a two-story wood frame building.**



A primary effect of high winds flowing around and over a structure is the wind loads that act on the structure. Uplift is the force caused by the wind accelerating around and over buildings and other structures (Figure 3-2). An example of uplift strong enough to move a house off its foundation is presented in Figure 3-3. This house was separated from its foundation when it experienced winds associated severe tornado that passed through this neighborhood in the city of Haysville, Kansas. Although anchor bolts extended from the concrete foundation into the wood floor framing, nuts were not attached to the bolts to provide a continuous load path at this connection point that would have resisted the uplift forces. This deficiency was observed at more than just this one house.



**FIGURE 3-2:** This building failure is the result of inward wind forces and uplift wind forces acting on a building or structure during a high wind event.



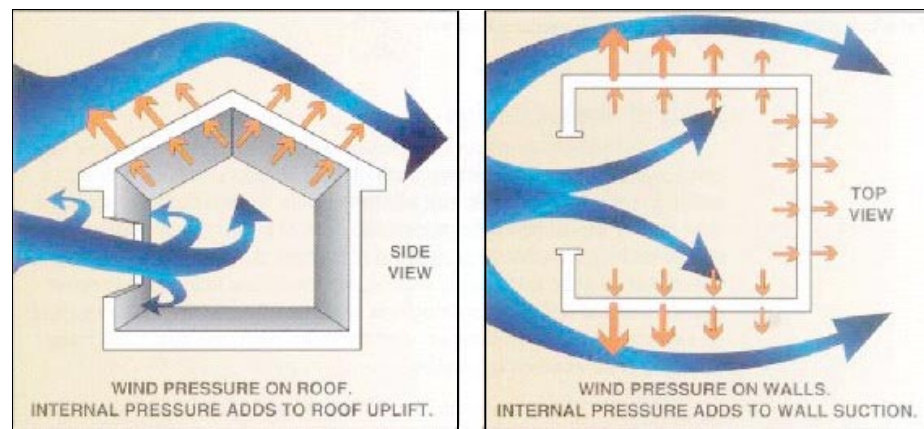
**FIGURE 3-3:** Wind uplift acting on this house in Haysville, Kansas, resulted in this corner of the building being lifted off its foundation.

The other primary effects of wind are **overturning**, which is discussed in the Manufactured Housing sections of Chapter 4; the **internal pressurization** of a building; the **lateral force** acting inward or positive load created by the wind blowing directly on the face of the building. Most buildings are designed with no dominant openings, such as residential and most non-residential buildings, and a breach in the building envelope due to broken windows, failed entry doors, or failed garage doors may cause a significant increase in the net wind loads acting on the building under severe wind conditions. In such cases the increased wind load may initiate a partial failure or propagate into a total failure of the primary structural system. A schematic

diagram illustrating the increased loads due to a breach in the building envelope is shown in Figure 3-4.

Depending on the building size, number of interior rooms, number of stories, size of the breach, etc., laboratory tests, in wind tunnels, indicate that the net increase in uplift on the roof system can exceed a factor of two. The increased load on the roof and wall systems may cause connections between these systems to fail, possibly at wind speeds below the normal design speed. The increased load on the roof and wall systems may cause connections between structural members to fail, possibly at wind speeds below the nominal design speed.

**Figure 3-4: Increased loads on roof and walls due to breach in envelope.**



Examples of failures of this combination of windward/leeward/internal pressures are shown in Figures 3-5, 3-6, and 3-7.

**FIGURE 3-5: Failure of hip roof due to internal pressures and leeward wind forces acting together. This house, which was exposed to inflow winds of a violent tornado, was located in a suburb of Oklahoma City, Oklahoma.**





**FIGURE 3-6:** Failure of this gable wall section was due to wind suction forces of the leeward wall. This house was on the outer edge of a violent tornado path.



**FIGURE 3-7** Failure of this exterior wall and roof section in Moore, Oklahoma, occurred when the windows broke and the front room saw an increase in internal pressure. Most of the debris from the roof and exterior wall had been cleaned up prior to this photograph. This home in Moore, Oklahoma, was located on the periphery of a violent tornado track.

Buildings that have significant openings or are mostly open structures are characterized as partially enclosed. Model building codes incorporate provisions, which take into account the effects of internal pressurization on partially enclosed buildings by increasing required design loads. However, residential buildings are typically designed as enclosed buildings and when a breach occurs, for example when a garage door fails, they become in effect

partially enclosed buildings and are subject to load wind increases. In many homes inspected, these increased loads may have exceeded the enclosed building's design load specified in the applicable state or local building code, possibly resulting in the structural failure observed.

A number of non-residential buildings, such as schools, factories, warehouses, and commercial buildings were in the direct path of the moderate tornado vortexes or in the inflow of severe and violent tornadoes and received varying degrees of damage. In a few cases, damage could be considered non-structural because architectural and decorative materials on the exterior and roofing were the only damage to the buildings. Engineering standards such as ASCE 7, identify these elements as components and cladding, and provide design guidance for designing to specified regional wind speeds. The failure of an exterior insulating finishing system (EIFS) exterior wall covering and architectural roof parapet is shown in Figure 3-8 at the Regional Mall at Stroud, Oklahoma. This was the only damage experienced by this particular store; however, other significant damage was experienced at the mall that was struck by a moderate tornado and is discussed later in this report.

**Figure 3-8: EIFS and metal component damage at the regional outlet mall in Stroud, Oklahoma.**



In other cases, structural damage occurred due to the lack of redundancy in the load to resist wind-induced uplift loads. Similar to the residential damage observed, some non-residential buildings did not have a primary structural system capable of providing a continuous load path capable of withstanding the lateral and uplift loads generated by the tornadoes. Other buildings were unable to withstand the wind forces once the building envelope had been breached.



**Figure 3-9:** *This URM wall failed when inflow winds from a severe tornado acted on this building in Wichita, Kansas.*



**Figure 3-10:** *The vortex of a violent tornado passed within 100 yards of this plastics manufacturing plant in the City of Haysville, Kansas. The wind forces caused the failure of its primary structural system: a steel frame with masonry infill walls.*



### 3.2 WINDBORNE DEBRIS

The quantity and size of windborne debris (missiles) generated by tornadoes is unequalled by any other type of wind storm. The smaller missiles (e.g., aggregate [stone] ballast from built-up roofs, pieces of tree limbs, pieces of shredded wood framing members) can easily become airborne and break common window glass causing a rapid increase in internal air pressure within a building, which then results in increased load on the building (Figure 3-11). Moderate sized missiles (e.g., appliances, HVAC units, long wooden members) can also become airborne and cause considerable damage to buildings (Figure 3-12). Large high-energy missiles (e.g., columns, joists, trusses, automobiles) are often observed as rolling debris and may become airborne members (Figure 3-13). These large missiles can easily destroy framing members and structural systems of buildings.

**FIGURE 3-11: Small missiles commonly observed during the field investigations.**





**FIGURE 3-12** *These medium sized missiles struck and remained embedded within this manufactured home in Wichita, Kansas.*



**FIGURE 3-13:** *These trusses and roof covering (still attached to the roof sheathing) was displaced by the winds of a violent tornado and are capable of becoming large, windborne missiles.*

### 3.2.1 Missile Types and Sizes

The majority of the investigated tornado tracks were through residential areas, which were predominantly constructed wood framing with asphalt and composition shingle roofs. Hence, along most of the track, wood framing members (e.g., roof shingles, studs, joists, trusses, sheathing and household

contents) were the most common windborne missile types. Many of the framing members and roof shingles were broken, thereby creating an enormous number of small missiles that were only a few inches long. Although small, they had sufficient energy to break glass and injure people. Other framing missiles were quite large and delivered significant impact force. Figure 3-14 shows missile impacts on top the roof of Westmoore High School in Moore, Oklahoma. The missile sticking out of the roof in the foreground is a double 2-in by 6-in. The portion sticking out of the roof is 13 feet long. It penetrated a ballasted ethylene propylene diene monomer (EPDM) membrane, approximately 3-in of polyisocyanurate roof insulation and the steel roof deck. The missile laying on the roof just beyond it is a double 2-in by 10-in that is 16 feet long. The missile in the background that penetrated the roof deck is a double 2-in by 6-in that had a total length of 16 feet. The source of missiles was not determined, hence the distance to their origin is unknown. However, since this school building was located within 100 yards of a violent tornado it is likely that they traveled at least a few hundred feet from a subdivision of the wood-frame houses that were in the direct path of the tornado. Figures 3-15 and 3-16 shows a board missile striking the roofs of residential homes that were located on the periphery of tornado tracks. Figure 3-17 shows a 2-in by 6-in board missile completely penetrating the brick veneer of a residential home. Figure 3-18 shows a 2-in by 6-in board missile penetrating several inches into the freezer compartment of a refrigerator located in a home that was on the periphery of a violent tornado track. The portion that is visible is 4-ft, 8-in long.

**FIGURE 3-14:** *In the foreground, a medium sized missile, a double 2-in by 6-in, 13 feet long board can be observed sticking out of Westmoore High School's roof, Moore, Oklahoma. A larger missile, double 2-in by 10-in, 16 feet long board is lying in the background.*





**FIGURE 3-15: Windborne missile striking a house located in Moore, Oklahoma.**



**FIGURE 3-16: A missile vertically striking the roof of a home in Mid West City, Oklahoma. It fell nearly vertical illustrating the importance of a strong cover over the top of a tornado shelter to protect against free-falling debris.**

**FIGURE 3-17:** A 2-in by 6-in can be seen completely penetrating the brick veneer of a home in Moore, Oklahoma.



**FIGURE 3-18:** A 2-in by 6-in board missile penetrating a refrigerator located inside a home in Country Place subdivision outside Oklahoma City, Oklahoma.



Small-sized missiles also included brick, CMU, aggregate (stone) ballast from built-up and single-ply membrane roofs, roof tiles, asphalt shingles, fences, shrubs, and tree limbs. Moderate-sized missiles included appliances (e.g., hot water heaters, refrigerators, dishwashers), rooftop HVAC units, metal roof panels, car axles and transformers from power poles. Large-sized missiles included automobiles, a power pole (Figure 3-19). The pole was 28-ft, 4-in long and had an 8 ½-in diameter at one end and a 7-in diameter at the other end. From the window, it was roughly 40 feet to the original location of the pole from the window. Manufactured home chassis (one of these penetrated a window of a home), and large propane tanks (Figure 3-20), steel

dumpsters, steel deck (Figure 3-21) and trees (Figure 3-22) were among other large missiles observed by the BPAT. Automobiles were observed to have been significantly displaced and destroyed in areas under the vortex of and in the inflow wind field near the vortex of a violent tornado.



**FIGURE 3-19:** This power pole penetrated a window and extended several feet into the house after traveling approximately 40 feet from its original location. This home was located in Moore, Oklahoma, along the track of a violent tornado.



**FIGURE 3-20:** Wind displaced this very large propane tank in Bridge Creek, Oklahoma; its original location could not be determined. This area was hit by the vortex of a violent tornado.

**FIGURE 3-21:** *This piece of steel deck landed at the periphery of a violent tornado damage area in Moore, Oklahoma. The building it likely came off of was a few hundred feet away.*



**FIGURE 3-22:** *This building was on the periphery of a violent tornado damage area in Haysville, Kansas. One large tree fell near the corner of the house and collapsed a large portion of the roof and the corner walls. A smaller tree caused minor damage on the other corner of the house.*



### 3.2.2 Windborne Missile Quantity

In areas where buildings were totally or nearly totally destroyed by a violent tornado, missiles were in such great quantity (Figure 2-23) that they often made a layer of rubble completely cover the ground (Figure 2-24). In many houses, the floors were covered with small tree branches and fragments of broken framing members. Figures 3-25, 3-26, 3-27, and 3-28 give some idea of the number of missiles that were flying during the storm.



**FIGURE 3-23:** Wood framing members and plywood sheathing near the periphery of a violent tornado damage area in Moore, Oklahoma, displaying quantity of flying debris.



**FIGURE 3-24:** Debris generated by the vortex of a violent tornado in Moore, Oklahoma creates a layer of rubble across the ground.



**FIGURE 3-25:** Close-up view of roof insulation boards (the boards are 4-ft by 8-ft) at Westmoore High School. This roof is approximately 35 feet above grade. Some of the missiles only caused superficial damage to the insulation, but several others had sufficient force to make large gouges in the insulation.



**FIGURE 3-26:** This house was on the periphery of a violent tornado damage area in Moore, Oklahoma. Two large missiles struck this area of the roof.





**FIGURE 3-27:** Several missiles struck the wall of this house in Del City, Oklahoma, including a medium sized piece of debris in the center of the picture. For scale, the square metal fastener plates near the board corners are 3-in by 3-in.



**FIGURE 3-28:** Several missiles struck and perforated the interior wall of this house in Moore, Oklahoma.

### 3.3 PERSONAL PROTECTION AND SHELTERING

The purpose of a shelter is to provide a safe refuge in the event of a tornado or an extreme wind storm. The BPAT observed three types of shelters as follows:

1. residential
2. group
3. community

The residential shelters included above-ground in-resident shelters as well as storm cellar and basement types (Figure 3-29). The group shelter observed included one at a manufactured housing park and one at a plastic manufacturing plant. Community shelters observed included one at a manufactured housing park and another at a high school. Shelters are further discussed in Section 4.3.

**FIGURE 3-29:**  
***Underground residential shelter, viewing door and stairway leading down to shelter. This shelter was located outside a residence.***



### **3.4 LOCAL, STATE, AND FEDERAL REGULATIONS**

Building codes and regulations for both residential and commercial/industrial buildings varied because of the states involved. However, regulations dealing with manufactured housing fall under U.S. Department of Housing and Urban Development (HUD) preemptive construction and safety standards.

The design and construction of manufactured housing has been governed since 1976 by Federal preemptive standards which are enforced by HUD under Federal Regulation and through a Monitoring and Enforcement Contractor, the National Conference of States on Building Codes and Standards (NCSBCS). Recently, the HUD Standard has been placed under a consensus process administered by National Fire Protection Association (NFPA). Another tool used by HUD to regulate the manufactured home industry is the Federal Manufactured Home Construction and Safety Standards (MHCSS),

### 3.4.1 Oklahoma

Throughout the State of Oklahoma, two of the models building codes in the United States are utilized on a city by city basis. In the incorporated areas affected by this storm, the National Building Code (NBC) promulgated by the Building Officials and Code Administrators International, had been adopted. The 1996 edition of the NBC (1996 NBC) was currently adopted by most communities for all construction other than detached one and two family buildings. The 1995 Council of America Building Official's (CABO), One and Two Family Dwelling Code is the currently adopted code for detached one and two family dwellings.

Buildings that suffered damage during this event which were located in the unincorporated areas, were not covered by a model building code.

### 3.4.2 Kansas

Most communities in the State of Kansas have adopted the 1997 Edition of the Uniform Building Code (1997 UBC) as promulgated by the International Conference of Building Officials (ICBO) for commercial and industrial buildings. The UBC then defers to the CABO One and Two Family Dwelling Code for detached single family residential occupancy (Classified as R-4). The City of Haysville has adopted the 1994 UBC and Wichita and the unincorporated areas of Sedgwick County have adopted the 1997 UBC.

Wichita has local ordinance provisions which address sheltering. These ordinance provisions state that as of April 15, 1994, all manufactured home parks of ten or more manufactured home spaces are required to have storm shelters (above or below grade). For parks with 20 or more manufactured home spaces that did not have a shelter as of April, 15, 1999, a shelter must be provided by April 15, 1999. The ordinance also indicates that the shelter must be designed by a licensed engineer or architect to applicable codes and laws including the UBC, ADA, and FEMA's National Flood Insurance Program (NFIP).

# 4 Observations on Residential Property Protection

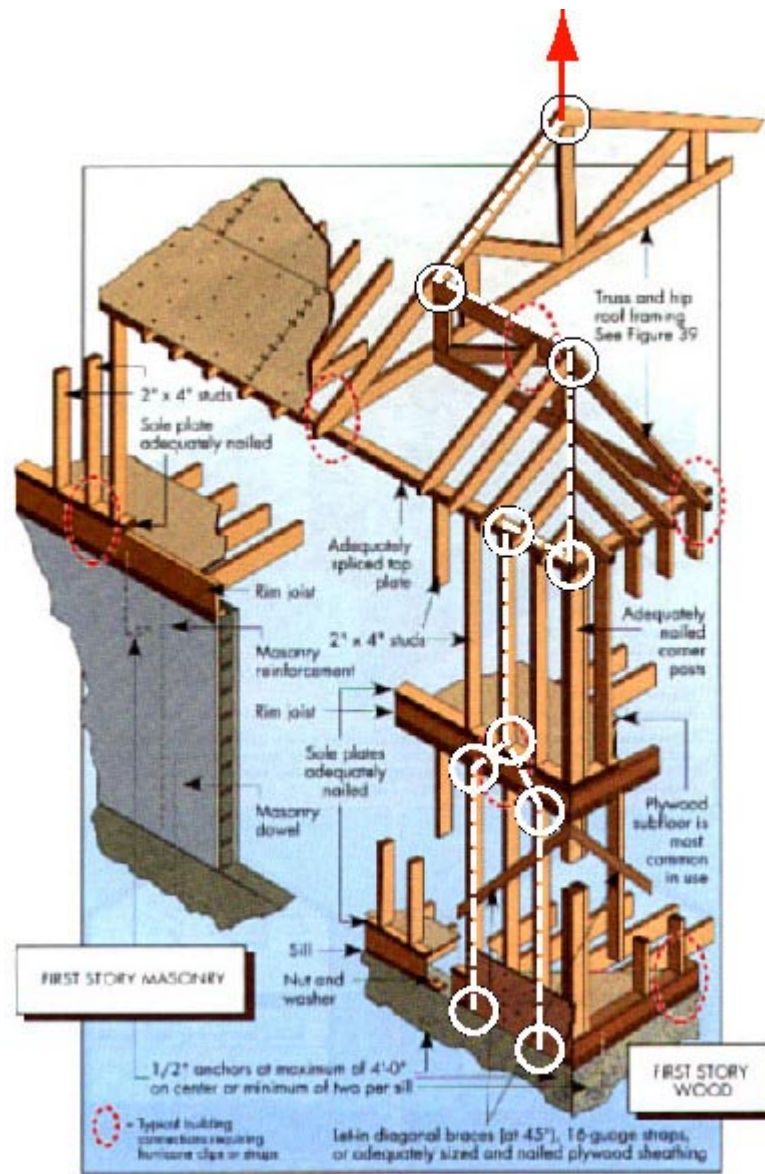
The damage assessment of buildings was divided into residential and non-residential. This section presents the BPAT's observations on residential property protection. Specifically, residential properties were categorized into single-family housing, multi-family housing, and manufactured and modular housing.

The BPAT assessed the performance of primary structural systems of buildings, which are those systems that support the building against lateral and vertical loads generated by high winds during a tornado or other high wind event. These systems are typically constructed of wood framing, sheathing, anchor bolts, and other connections. In residential applications, the exterior load bearing walls (i.e., walls that support roof framing) almost exclusively make up these primary structural systems. Non-loadbearing wall panels (i.e., self-supporting walls only), roof structure and diaphragm, and foundation are components of the building that are also part of this system or affect the performance of the system. The integrity of the overall building and structural systems depends not only on the strength of these components, but also on the adequacy of the connections between them. Important observations were also made concerning exterior architectural systems (e.g., roof and wall coverings, windows and doors).

## 4.1 SINGLE FAMILY CONVENTIONAL CONSTRUCTION

The BPAT observed damage to a large number of wood frame single-family houses, which are commonly referred to as "conventional" or "stick-built" construction. These houses were mostly one- or two-story buildings, many with pre-engineered wood trusses with metal truss plate connectors. Several homes had hip roofs with site-built rafter construction and board roof sheathing. Platform construction was observed in all cases (Figure 4-1). The structures observed in Oklahoma were predominately "slab-on-grade" with some "crawl-space" foundation construction. In Kansas, the structures were predominately wood frame construction placed on a basement or "crawl space" foundation.

**FIGURE 4-1: Platform construction typically observed during the field investigation.**



#### 4.1.1 Load Paths

The preparation of quality construction plans and the assurance of the construction of a continuous load path – from the roof sheathing to the ground – are key to maintaining structural integrity, regardless of the magnitude of the wind loads. Several different building materials and systems are usually involved in constructing and completing this continuous load path, and like a chain, the system is only as good as its weakest link.

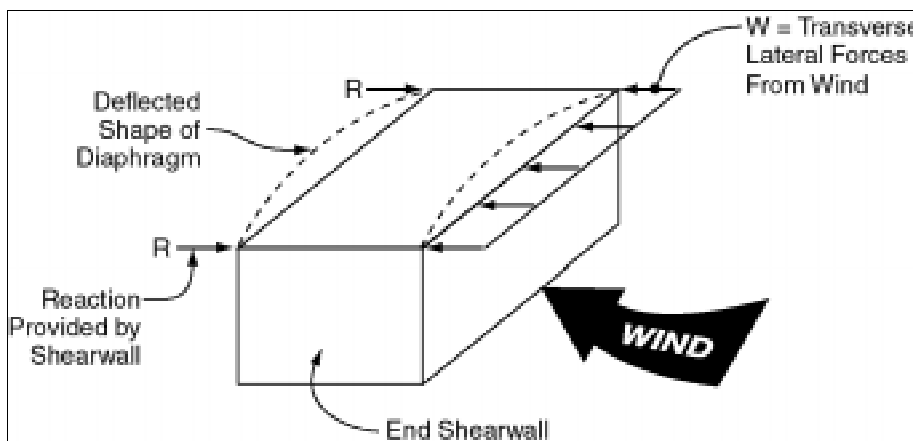
Primary structural systems are those that support the building against all lateral and vertical loads. Due to the wind damage observed, the team

focused on how this damage could have been prevented or reduced in all areas of the tornado windfield, with the exception of directly under the vortex of violent tornadoes.

Damage or failure was observed in essentially all building elements that constitute the lateral and vertical force resisting systems. Those elements are the roof sheathing, roof framing, load bearing and non load bearing wall framing, diaphragms, diaphragm chords, attachments and connections, and foundation systems. If the elements are not adequately tied together or connected, the system will fail. As discussed in the following sections, the damage ranged from considerable to total, depending on the type of framing, construction methods, and wind load experienced at the building.

#### 4.1.2 Roof and Wall Sheathing

Sheathing in light-frame construction serves many purposes. One is to receive the wind and load and distribute or carry the load to its supporting members such as the roof rafters or wall studs. The second purpose is to provide resistance to loads in the direction of the sheathing. This second purpose is illustrated in Figure 4-2, the roof sheathing acts as a horizontal diaphragm and transfers lateral loads to the supporting walls.



**FIGURE 4-2: Lateral load transfer to supporting walls by roof and wall sheathing.**

Roof sheathing observed in Oklahoma consisted primarily of rough sawn 1-in by 8-in planks placed side by side or 4-ft by 8-ft plywood sheets. The fasteners observed connecting the sheathing to the supporting rafters or truss top cords were nails and staples. Figure 4-3 shows a typical situation where the stapling of the boards to the rafters or trusses was not adequate. In the application of both sheathing materials, it appeared there was a concerted effort to stagger the joints as required by code as shown in Figure 4-4.

**FIGURE 4-3: Failed stapling of boards to rafters viewed from home in Moore, Oklahoma.**

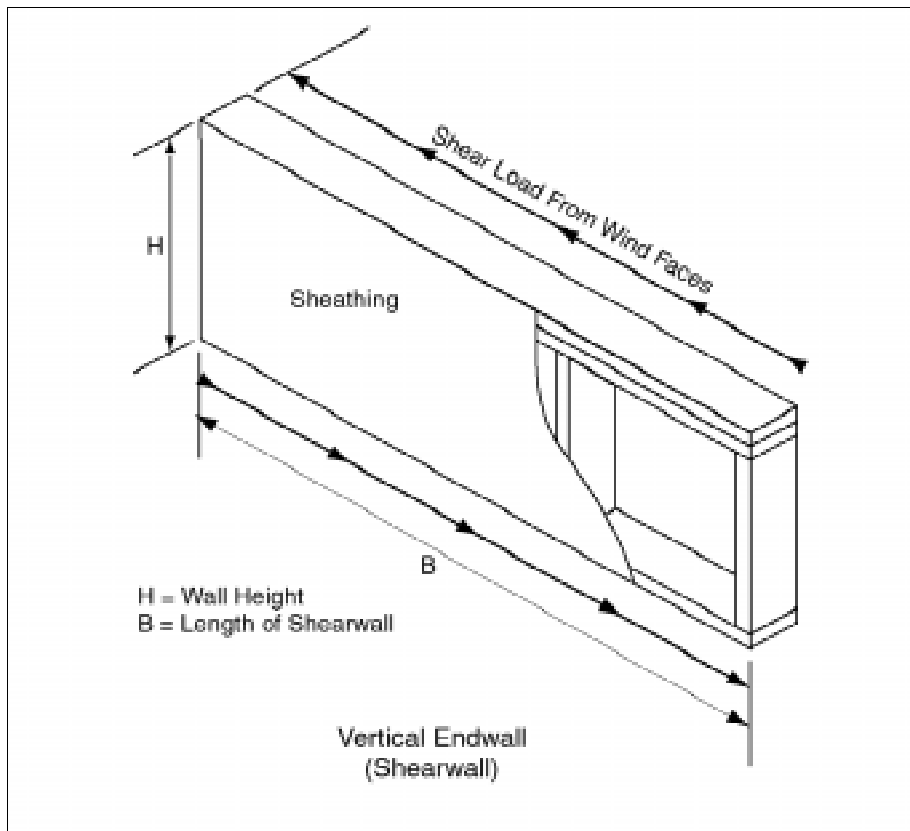


**FIGURE 4-4: Although roof sheathing was lost at this Wichita, Kansas, home code requirements of staggering joints in sheathing applications was observed. This house experienced inflow winds from a severe tornado.**



As that load reaches the top of the walls, the shear has to be transferred to the top plate by some method of fastening. After the fastener transfers its load, there will be a force at the top of the supporting wall that is intended to be resisted by the shear wall. The wall sheathing (Figure 4-5) typically establishes the capacity of a shear wall.





**FIGURE 4-5: Shear load force carried by wall sheathing.**

The force in the wall then must be transferred to the floor below, which in turn must transfer it in a similar manner to the foundation. It is this load transfer mechanism that the BPAT attempted to observe.

Wall sheathing observed consisted primarily of insulated fiber board or combination siding/sheathing. With the exception of garage end walls, it was difficult to ascertain any consistent failure of wall sheathing because it appeared the entire wall was either lifted or blown inward or outward as the result of windward or a combination windward/leeward pressure (Figures 4-3 and 4-4).

One example of an inadequate lateral load-resisting element that was observed was the garage end walls or returns that act as the frame for the garage door. A normal code minimum width for the return is four feet. This one measures 22-in which is clearly inadequate to resist code-required loads. At least one of the model building codes has a minimum width of such panel as 32-in with a special web and special hold anchors. Also, there were a number of cases where the garage bearing walls failed and the garage roof fell to the ground essentially intact. An example of this failure is presented in Figure 4-6 from a house that experienced inflow winds from a severe tornado in Wichita, Kansas.

**FIGURE 4-6: Wall failure due to inadequate lateral load resistance in Wichita, Kansas. The return wall at the garage inadequate to carry loads may have led to this failure.**



#### 4.1.3 Connections

Post disaster assessments continue to support the fact that improved connections could have resulted in better performance of building structural systems, attributing to a reduction in loss of life, injuries, and property damage. The BPAT observed a wide range of connection deficiencies or failures in areas subjected to moderate winds. It is important to keep in mind that the loads seen by these connections were not known, but were believed to be with design requirements and safety factors of model building codes.

The wind forces that act on the roof of a building make the roof sheathing to roof framing connection the important first line of defense. Unfortunately, these connections are often overlooked during construction. When the roof envelope is breached (i.e., roof sheathing is blown off), additional damage is likely to occur as wind forces enter the building and act on interior walls not designed for lateral loads. Figure 4-7 shows a typical example of inadequate fastening.



**FIGURE 4-7: Roof truss failure. A single nail (circled) was used to connect each truss to the top plate. This house was in Midwest City, Oklahoma and experienced inflow winds from a violent tornado.**

Working from the roof system down toward the foundation, the next critical connection is the connection between the roof framing and the wall system. The result of failure of this connection is shown in Figure 4-8. If the roof-framing-to-wall-connection was adequate to withstand forces of uplift, lateral load, and shear transfer, the ability of the structure to withstand the loads generated by moderate winds is increased. Forces would now include the dead load of the wall and its coverings and its shear wall capacity; however, this was not the case in this location and the roof was separated from the rest of the house.

**FIGURE 4-8: Failure of a double top-plate. The uplift of the roof truss previously attached to this double top-plate caused separation of the two members that comprise this top-plate.**



Figure 4-8 shows a seldom seen type of failure that may have been caused by a combination of uplift, diaphragm chord forces, and horizontal bending of the double 2-in by 4-in members commonly used as a top-plate. There were few observed failures of the connection of the double-top-plate to the supporting studs below, although one example is shown in Figure 4-9. With platform construction, the walls are typically framed while lying flat on the floor of the house.



**FIGURE 4-9: Failures of the connection of the double-top-plate to the supporting studs below by home located in Moore, Oklahoma. This home was located along the periphery of a violent tornado.**

Once the wall is erected, the sill plate should be connected to the foundation. In Oklahoma, the foundation was typically a slab-on-grade foundation. In Kansas, basement and crawl space foundations were more common than slab-on-grade construction. Figure 4-10 represents one of many observed failures of the wall-to-sill-plate connection. In this instance, the sill plate remained anchored to the foundation but the toe-nailed or face-nailed connection of the studs to sill plate were inadequate to resist uplift loads from a severe tornado that struck this Oklahoma home.

**FIGURE 4-10: Wall framing to sill plate failure. This house in Del City, Oklahoma, experienced a direct hit from the vortex of a violent tornado.**



Failures between the sill plate and the foundation or floor below were observed. Some of these failures occurred when the sill plate itself failed due to extreme winds associated with the vortex of a violent tornado, as seen in Figure 4-11. In this figure, anchored bolts were used to secure the sill plate to the foundation. In both Oklahoma and Kansas, bolts, nails, and epoxy anchors were observed securing sill plates to foundations. In one instance in Oklahoma, straps from the foundation were observed securing the sill plate to the foundation. Another factor observed that contributed to failures of wall systems was that the bottom-plate (sole- or sill-plate) was not integral with the siding or other means of transferring the force. The connection was weak as seen in Figure 4-12.



**FIGURE 4-11: Stud-wall and sole-plate-to-floor failure on a second story wall. This multi-family residence in Wichita, Kansas, was located approximately a few hundred feet from the vortex of a violent tornado and was exposed to inflow winds.**

In the event adequate connections and structural elements are provided above the sill-plate to foundation connection is almost the last link in the chain. The BPAT saw many examples of failures at the connection to the foundation. Figures 4-11, 4-12 and 4-13 highlight these weaknesses. Uplift, racking and moderate windward forces combined to cause separation of this connection.



**FIGURE 4-12: Failure at base of wall between wall studs and sill-plate. The sill-plate, which was connected to the foundation slab with anchor bolts and nails, has splintered.**

**FIGURE 4-13: Failure of this sill-plate to foundation connection occurred at this home outside Oklahoma City, Oklahoma. The vortex of a violent tornado passed very close to this home.**



#### **4.1.4 Increased Load**

For buildings that are designed with no dominant openings, such as residential buildings, a breach in the building exterior envelope due to broken windows, failed entry door, or failed garage door may cause a significant increase in the net loads acting on the building under severe wind conditions. In such cases, the increased load may initiate a partial failure or propagate into a total failure of primary structural systems. A schematic diagram illustrating the increased loads due to a breach in the building envelope is shown in Figure 3-4. Depending on the building size, number of interior rooms, number of stories, size of the breach, etc., wind tunnel tests indicate that the net increase in uplift on the roof system can exceed a factor of two. The increased load on the roof and wall systems may cause connections between these systems to fail, possibly at wind speeds below the normal design speed.



#### 4.1.5 Roof Coverings

Virtually all of the residential roof coverings in the areas the BPAT investigated in Oklahoma and Kansas were asphalt or composition shingles (Figure 4-14). Almost all of the shingles were three-tab or laminated, but a small number of T-lock shingles were also observed (Figure 4-15). Shingle age ranged from relatively new to quite old (more than 15 years). It was observed that for homes located near the far periphery of the tornado, damage was typically limited to intermittent shingle damage only. Shingle damage increased dramatically as the distance from the vortex decreased.



**FIGURE 4-14:** Asphalt shingles covering roof of residential home.



**FIGURE 4-15:** Several T-lock shingles on this house were lifted and torn. This house was on the periphery of the damage track left from a moderate tornado in Wichita, Kansas.

#### 4.1.6 Wall Coverings

Brick veneer over wood framing was a predominate wall covering in the investigate areas of Oklahoma. A detailed discussion of masonry used for load bearing walls and wall coverings is presented later in this section. Vinyl siding was another common wall covering. A large number of houses on the periphery of the tornado tracks lost siding. In many cases (Figure 4-16), the vinyl had been installed over wood or hardboard siding. In all of the investigated cases, although the vinyl was blown off, the underlying wood or hardboard siding was undamaged (except for missile impacts). The siding of the home in Figure 4-16 was attached with roofing nails. In one area, the nails were 30-in and 21-in apart. The failure of the siding occurred when the vinyl pulled over the nailheads. Additionally, the home in Figure 4-16 suffered some asphalt shingle damage. Houses with vinyl siding that were closer to the vortex commonly had extensive missile damage (Figure 4-17). Pieces of vinyl siding of this home were blown off by wind or torn away by missiles. The siding on this home was also fastened with roofing nails. The roofing nails were placed at 13.5-in, 10-in, 20-in, and 13.5-in along one length of siding. The vinyl siding also pulled over the nailheads. Homes with other siding materials exhibited limited missile damage even though the missile loading was likely similar.

**FIGURE 4-16:** *The vinyl (white) that was installed over wood siding experienced damage; however, the wood siding was undamaged. The home was located along the periphery of a violent tornado in Wichita, Kansas.*





**FIGURE 4-17:** *Some pieces of vinyl siding were blown off and in other areas the siding was torn away by missiles. The home was located along the periphery of a violent tornado in Mullhall, Oklahoma.*

Wood siding and hardboard siding and panels were also observed. In a few instances along the periphery of the tornado tracks, blow-off of these materials was observed. However, it appeared that these materials typically exhibited good resistance to wind speeds that were in the range of current design conditions (e.g., 70 mph, fastest mile sustained or 90 mph 3 second peak gust) of the 1997 UBC, 1996 NBC and 1995 CABO codes.

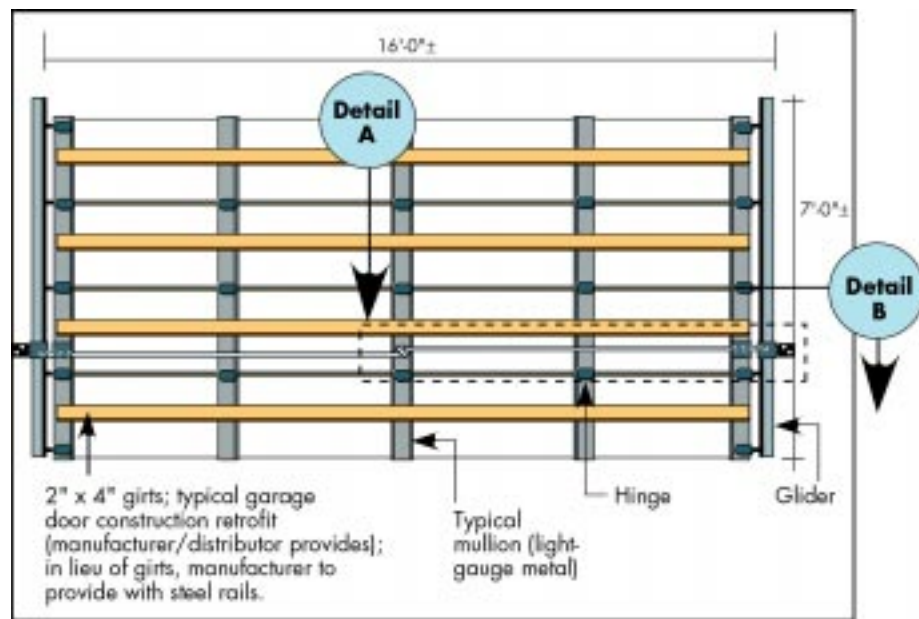
#### **4.1.7 Garage Doors**

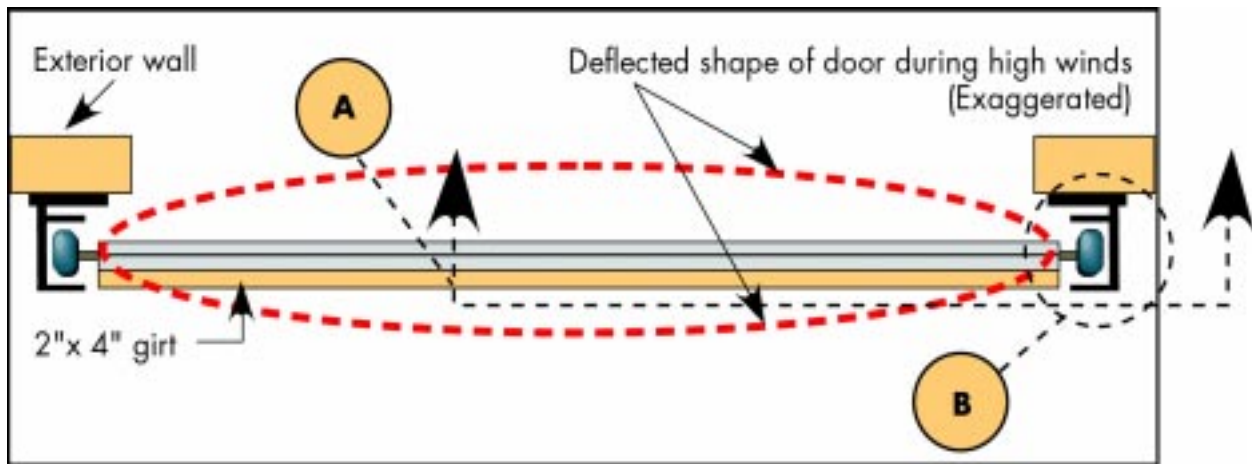
Along the track periphery, it was common to see residential garage door failures (Figure 4-18). The door in this figure likely had a tested load resistance of 12.5 psf; a common test pressure for doors of similar construction. The design load on this door would be 13 psf using UBC 1997 and 18 psf using ASCE 7-98. Hence the load derived from ASCE 7-98 is 44 percent higher than the tested resistance of the door. Had this door met the wind loading derived from ASCE 7-98, this failure may have been avoided. Most of the investigated doors were made of thin metal. Failures were typically caused by wind pressure, rather than by missiles. The most common failure mode observed was the door rollers disengaging from the door tracks. This was likely caused by excessive door deformation (see Figures 18A-18D). Door failure resulted in increased load on the building.

**FIGURE 4-18:** This double-width garage door failed under a suction load in Moore, Oklahoma.

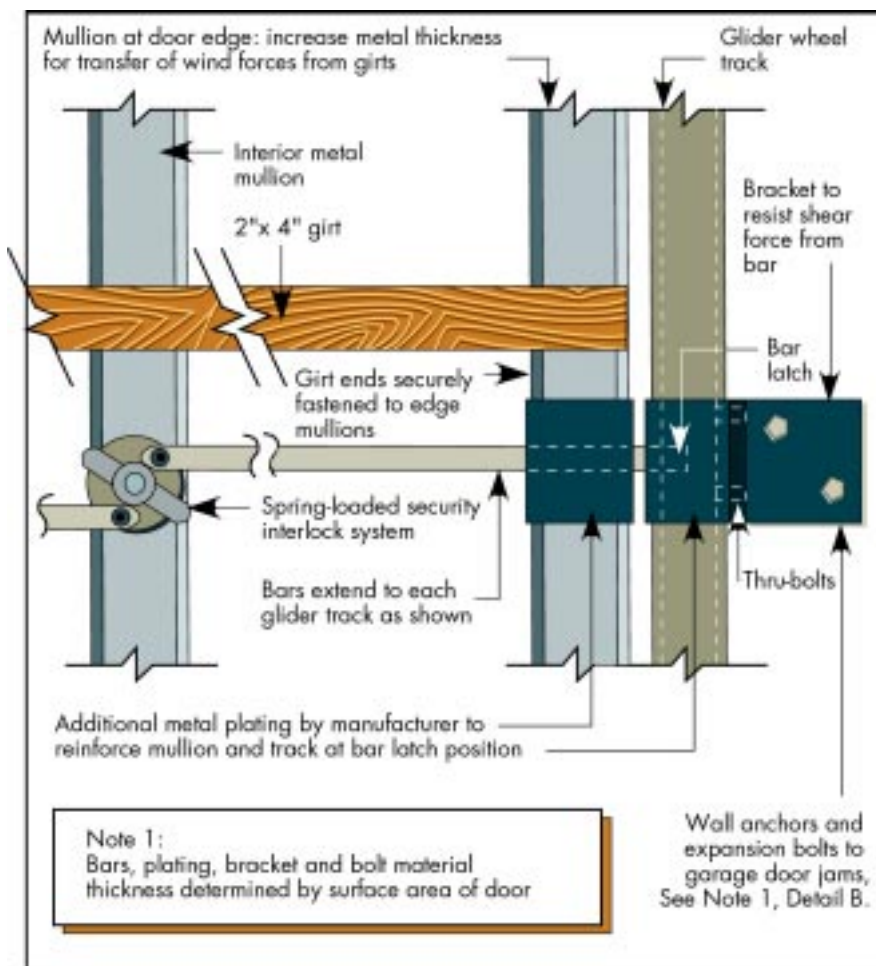


**FIGURE 4-18A:** Typical double-width garage door elevation



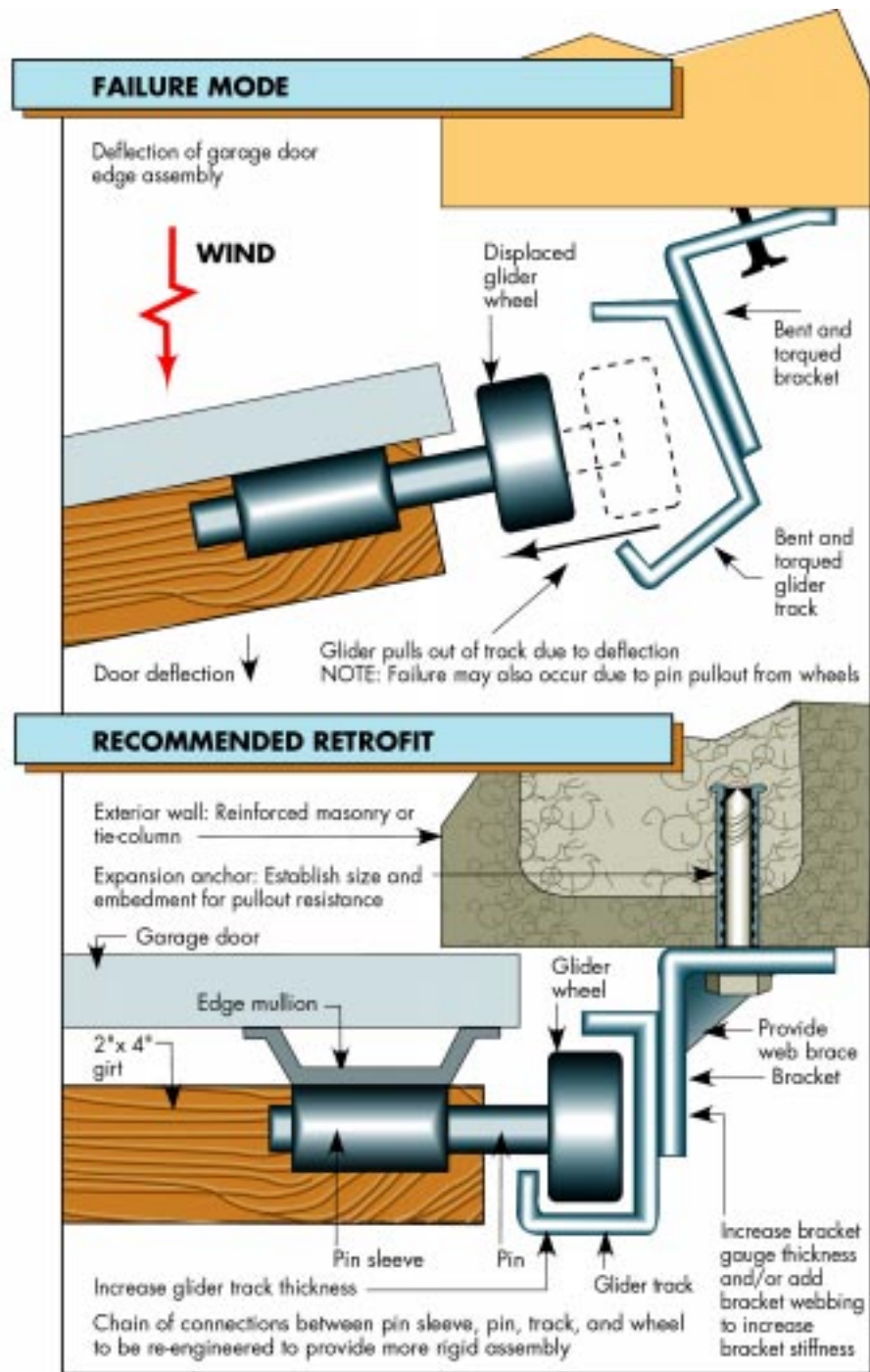


**FIGURE 4-18B:** Plan view of typical garage door shown in Figure 4-18A.



**FIGURE 4-18C:** Detail A from Figures 4-18 A and B. Recommend reinforced horizontal latch system for garage door.

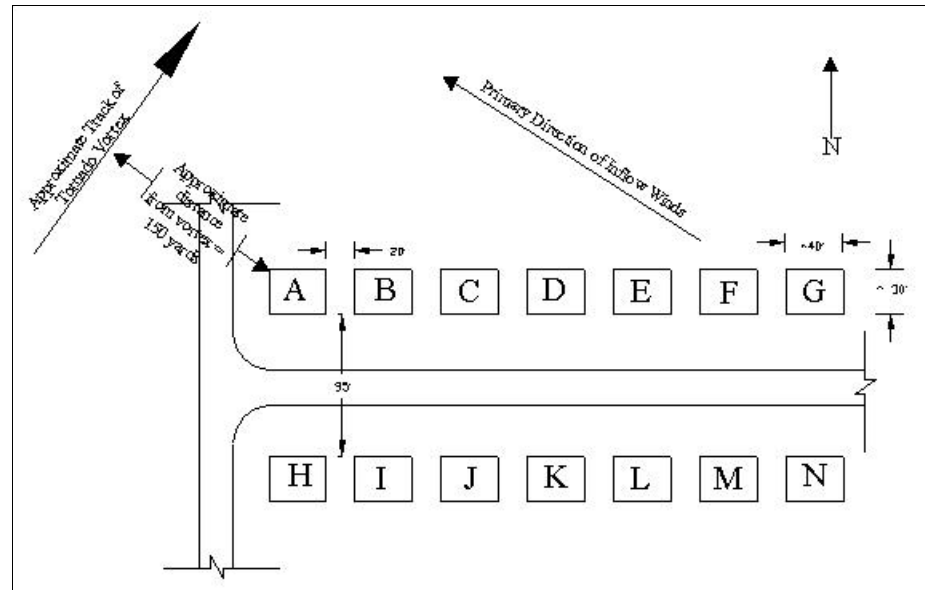
**Detail B from Figures 18 e door failure at track and recommend assembly improvements.**



The BPAT conducted an extensive assessment of garage door performance at Greenbriar Eastlake Estates in Oklahoma City. A violent tornado directly struck this subdivision and destroyed many homes. The house in Figure 4-18 was located approximately 200-300 feet away from the vortex of the tornado as it moved from the southwest to the northeast of this neighborhood. A partial schematic map of the Greenbriar Eastlake Estates is shown in Figure 4-19. The rectangles represent the average dimensions of homes surveyed with house labels appearing within the rectangles. The homes surveyed in this subdivision are constructed of wood framing with brick veneer. The roofs on these homes were hip, gable, or a combination of the two. The majority of the homes were single-story, some with cathedral ceilings. Most house floor plan configurations are simple L, T, or rectangle shapes. Roof decking was observed to be mostly dimensional lumber with some Oriented Strand Board (OSB) and plywood sheathing. Roof rafter and wall top-plate connections were typically toe nailed with two 16d nails with no added straps or clips. Overall, material quality was observed to be typical for the Oklahoma City area. Windows were observed to be of average quality, as were front, back, and side entry doors. The large majority of the homes observed had single skin aluminum, non-insulated, and non-reinforced double width garage doors.

Homes located at H and A are shown in Figure 4-20. The damage states of the two homes are significantly different even though they are located directly across the street from one another, approximately 95 feet, and may have experienced relatively similar wind conditions based on the approximate track location (Figure 4-19). The home located at H had seven broken windows, primarily at the back of the home as a result of debris generated from a failed wooden fence. It also had one breached glass entry door, and lost approximately 60% of its roof covering. The home located at A lost its entire roof and several exterior walls. For the remaining structures, similar “across-the-street” damage gradients were observed between the homes, A through G and H through N, with the exceptions of the home at location F, which did not lose its entire roof, and the home at location G, which did not lose any roof, but did sustain severe roof framing damage due to uplift. Table 4-1 (**not included at this time**) lists observed damage states for all homes shown in Figure 4-19, illustrating the expected decreasing damage gradient as the distance between home and storm track increases.

**FIGURE 4-19: Partial schematic map of an Oklahoma City subdivision that was affected by inflow winds from a violent tornado.**

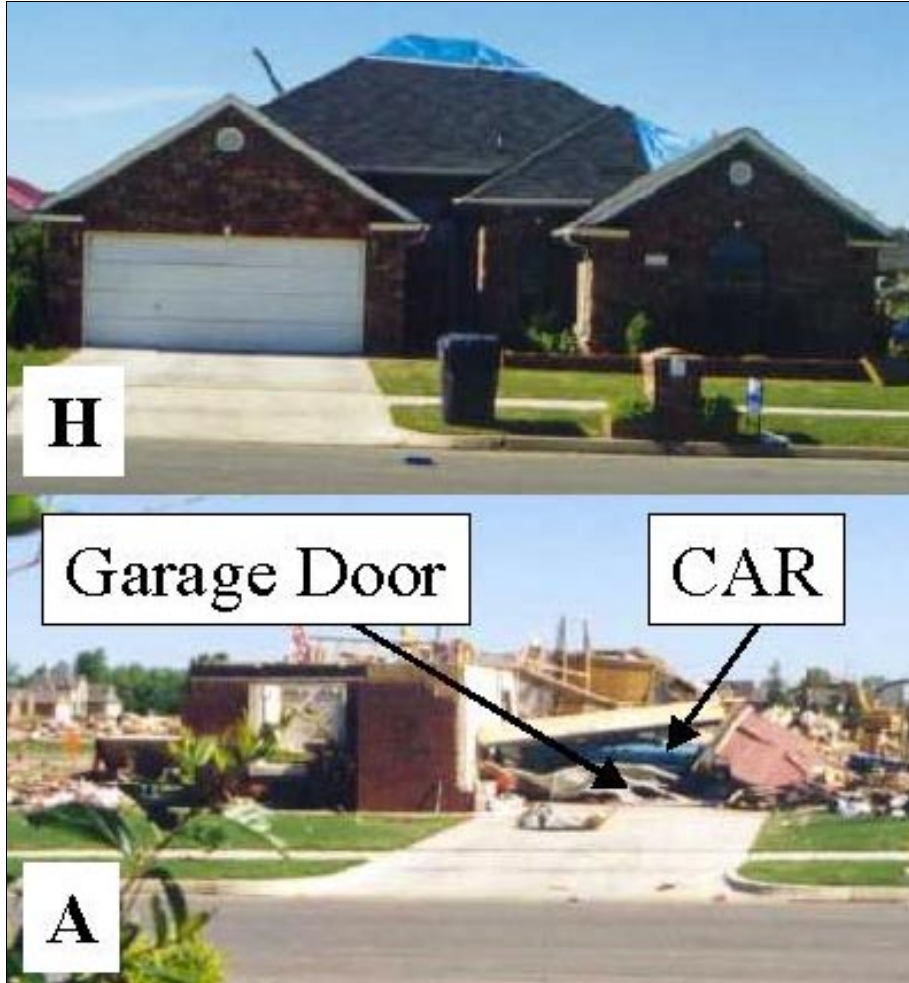


Several failed garage doors were observed lying at the back of the garage for many homes A through G, indicating that the garage doors failed due to positive (inward) pressure. These failures of the garage doors are believed to have initiated or contributed to the catastrophic roof and exterior wall failures for homes A through G, a direct consequence of load increase due to a large breach in the building envelope. Examples of this may be seen in Figures 4-20 and 4-22. Note that the failed garage door in Figure 4-20 is crumpled up against the car, suggesting a door failure under positive pressure. A partial roof failure (house F) is depicted in Figure 4-22. In this case the garage door was also found within the garage as shown in the picture inset. The observed location of the failed garage door and the localized roof damage suggests that the failed garage door may have initiated or played an important role in the roof failure. Many of the moderately to severely damaged homes observed had a significant amount of structural damage to the garage area and to the immediate surrounding area, but did not necessarily have the same magnitude of structural damage at the opposite side of the building where no garage was located.

A final example of observed internal pressurization and roof uplift is shown in Figures 4-23 and 4-24 for the house located at G. The garage door failed by positive pressure and was found inside the garage. Figure 4-24 shows strong evidence of the early stages of roof uplift between the garage roof and exterior wall. The ceiling was observed to have pulled away from the exterior wall perimeter, indicating that the whole roof frame was lifted up. The space shown in Figure 4-24 was apparent along most of the perimeter of the garage ceiling. Figure 4-21 shows an exterior view of the roof and wall interface where the initiation of roof uplift was observed. Tension cracks in the brick



vener and a large gap along the length of the right exterior wall between the roof and top plate were also observed.



**FIGURE 4-20: Home in Moore, Oklahoma, with partial roof loss (H) vs. home with total roof loss due to garage door failure (A) under positive pressure.**

**FIGURE 4-21:** A 2x4 member extends out of the gap that runs the length of this garage wall between the top of the wall and the roof framing

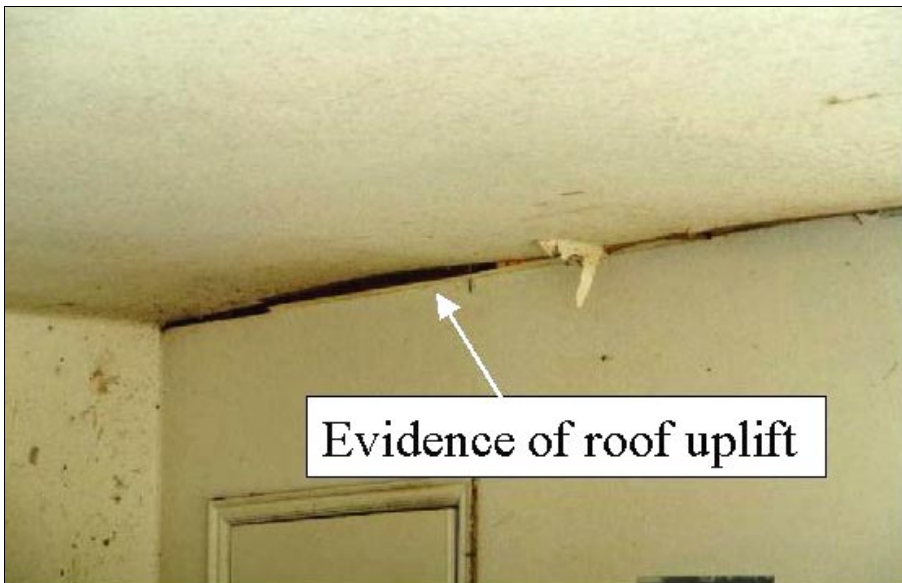


**FIGURE 4-22:** Garage door failure possibly resulting in the localized partial roof failure on the left side of this home located in Moore, Oklahoma.





**FIGURE 4-23:** A view of home G with a garage door that failed due to positive or inward acting wind loads.



**FIGURE 4-24:** Roof uplift between garage roof and exterior wall at home G.

For several of the homes, H through N, it was observed that the garage doors had sustained permanent deformation due to negative (outward) pressure loads. This observation supports the assumption that the garage doors for homes A through H located across the street failed in positive pressure, as shown in Figure 4-18 for the home located at H. This door failed under a suction load. This door likely had a tested positive load resistance of 12.5 psf. The design load on this door would be 13 psf negative and 11 psf positive using UBC 1997, and 18 psf negative and 14 psf positive using ASCE 7-98. Hence, using a 1.5 safety factor in calculating design loads, the

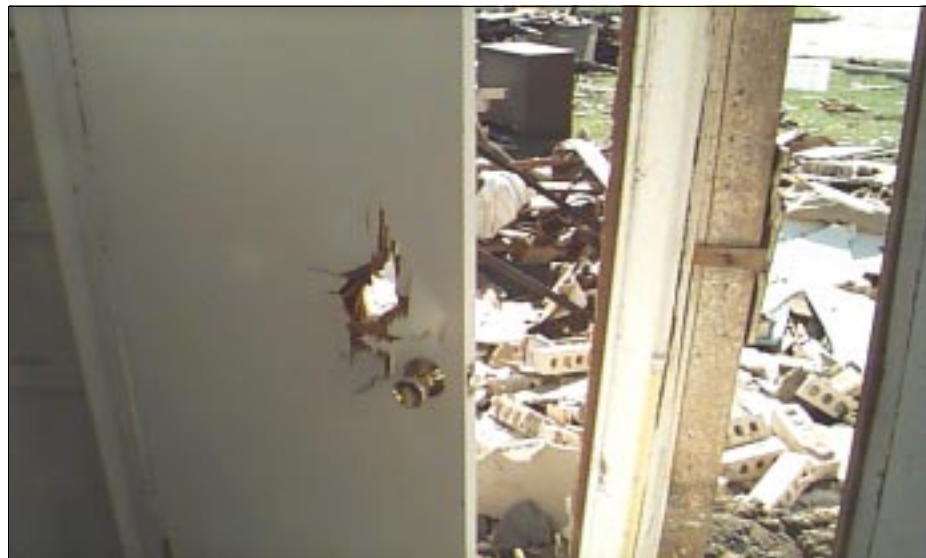
positive load derived from ASCE 7-98 is 68% higher than the design resistance of the door. Had this door met the wind loading derived from ASCE 7-98, this failure may have been avoided. Full scale pressure tests on garage doors have also demonstrated that a typical garage door is significantly stronger in negative (outward) loading than in positive (inward) loading, which may explain why no garage doors completely failed on the homes, H through N (assuming comparable winds).

#### 4.1.8 Windows and Doors

Glass in exterior windows and doors, glass storm doors, and glass sliding doors in buildings in or along the tornado vortex track rarely survived. It was common for virtually every pane of glass to be broken on all sides of a house. Further from the vortex track, where winds were either inflow or outflow winds, it was common to see several broken panes on only one or two sides of the house. As the distance from the track vortex increased, the incidence of glass breakage decreased. Glazing failure often resulted in increased wind load on the building from internal pressurization.

Exterior doors typically performed better than windows; however, many were blown out of their frames and others were breached (Figure 4-25).

**FIGURE 4-25: A missile penetrated this exterior door in Del City, Oklahoma. Interior hollow-core doors typically offer even less missile protection than common exterior doors.**



Depending on room size, the existence of interior doors, and the ability of internal pressures to propagate through multiple rooms within the building, the breach of windows or a failed entry door may cause pressurization of only a portion of the building interior and may be often limited to the room where the breach occurred. In order for the breach to increase the overall uplift loads acting on the roof, the internal pressures must be able to

propagate through to the attic space. For this to occur, the initial breach and subsequent internal pressurization must also breach through to the attic, typically through the attic entryway. If the attic entry door consists of a set of pull down stairs, the likelihood of attic pressurization is minimal. When the attic opening is a scuttle access, covered with a simple unattached push-to-open panel, the BPAT observed the risk of attic pressurization is dramatically increased. Another way in which the attic can become pressurized is by failure of the ceiling drywall, thus providing an opening to the attic space. Also, depending upon the location of attic vent openings, the attic could be pressurized through the vents.

Thus, a window breach or entry door failure may be unlike a garage door failure where the internal pressure is directly transferred to most of the roof system via the ceiling rafters or to the bottom roof truss chords. When a window or door fails, interior doors may slam closed and contain the effects of internal pressurization to a single room. If the room is isolated from roof framing (e.g., a first story window on a two-story home, very little increase in roof uplift can be expected. If the interior doors or walls attached to the room fail, then the pressurization process will be repeated for adjoining rooms.

Several window failures at the back of the home located in Country Place, a subdivision of Oklahoma City, are shown in Figure 4-26. These homes were located along the periphery of a violent tornado. Other than a small piece of sheathing missing from the roof edge, the roof damage is limited to the loss of roof covering material only. In contrast, several pieces of roof deck sheathing failed on the front portion of the roof as depicted in Figure 4-27. Note that no breaches to the front exterior wall were observed. Figure 4-28 shows a view of the interior of the same dwelling taken from outside the left hand window breach seen in Figure 4-26. The photograph of the interior suggests the possibility that internal pressurization may have contributed to the roof deck sheathing loss. This is suggested by the holes in the ceiling, in particular the right hand hole above the interior doorway. There is evidence to suggest that internal pressure may have pushed the ceiling away from the top of the interior wall where the ceiling drywall failed. Note that there is no evidence of drywall debris on the floor directly below the drywall failure suggesting the drywall was ejected into the attic. This suggests that internal pressurization may have caused the drywall to fail leading to pressurization of the attic space and contributing to the sheathing failure of Figure 4-27. The drywall debris on the floor in front of the entry door belongs to the collapsed ceiling drywall to the left and was likely the result of rain water damage entering through the roof.

**FIGURE 4-26:** *Damage to back of home in the Country Place Subdivision in Oklahoma City, was limited to several window failures and minor roof damage. The home was located along the periphery of a violent tornado.*



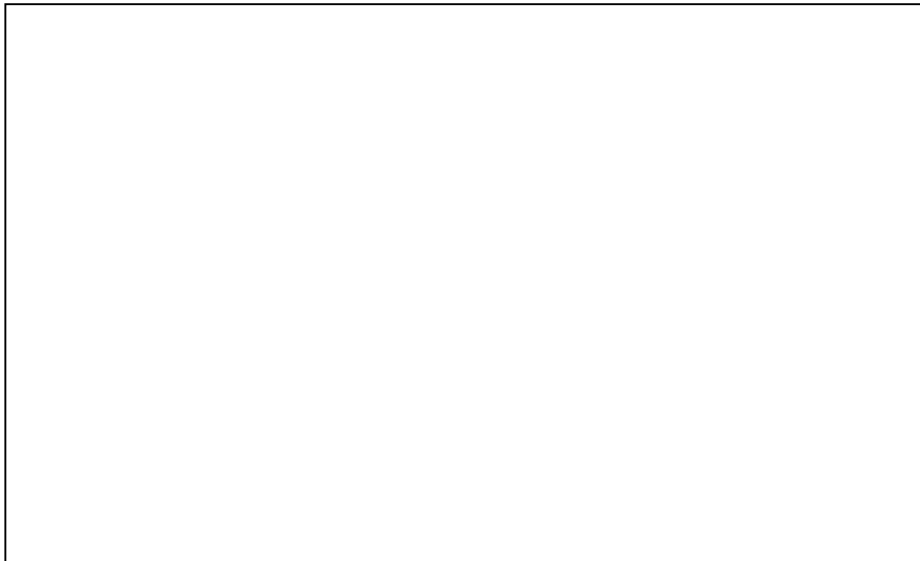
**FIGURE 4-27:** *Front of home in Figure 4-26 where several pieces of roof decking failed.*





**FIGURE 4-28: View of interior of home in Figures 4-26 and 4-27.**

A more serious effect of a failed or breached window or door is when the pressurization results in the partial or total loss of an adjoining exterior wall. When this failure mode occurs, the breach is often located near a corner where high suction (negative) loads occur on the adjacent wall. The consequence of losing an exterior wall may initiate the partial or total loss of the roof if the wind speed and direction are favorable. Figure 4-29 shows the failure of a portion of exterior wall (leeward side) due to internal pressurization following the breach of a window (windward side).



**Figure 4-29: Box temp. being used as place holder**

#### 4.1.9 Masonry

The BPAT observed brick masonry veneer construction and its failure from moderate wind loads was at numerous locations throughout the inspected subdivisions of the Oklahoma City metroplex and the Willow Lake Estates in Bridge Creek, Oklahoma. In Figure 4-30, the north wall of a house had been framed with 2-in by 6-in studs with 1-in by 4-in let-in corner bracing, covered with 1-in thick plastic foam insulation boards and brick veneer. Several studs remained upright, but the brick veneer lay on the ground. Corrugated metal brick ties remained fastened to the studs, and had pulled out of mortar joints. Onsite evaluation indicated that much of the damage had been caused by straight inflow winds near ground level associated with a nearly severe tornado, similar to that experienced from severe thunderstorms or other typical design events and not from a tornado vortex (Figures 4-30 and 4-31).

**FIGURE 4-30: Failure of brick masonry veneer construction. The vortex of the severe tornado that caused the winds at this site passed approximately 30 feet from this building in Bridge Creek, Oklahoma.**







**FIGURE 4-31: Brick veneer failure at the house shown in Figure 4-30.**

Preliminary discussions with Central Oklahoma Home Builders Association (COHBA) in Oklahoma City indicated that almost all residences constructed in the last several years in the Bridge Creek area had framed walls and brick veneer on all four sides. COHBA also indicated that this construction complied with the 1995 CABO One and Two Family Dwelling Code.

At Country Place and Eastlake Estates in the southwest suburbs of Oklahoma City, the BPAT observed an increasing number of 1- to 5-year-old homes with brick veneer failures. The wind speeds at these locations could not be determined. However, based on the team's observation of the damage and debris, plus wood framed walls remaining standing, it would appear that many homes with brick veneer failure were subjected to moderate tornadoes or straight inflow wind forces and were outside the vortex of a violent tornado (Figures 4-32 and 4-33).

**FIGURE 4-32: Failure of masonry veneer wall of a home located along the periphery of a violent tornado, Moore, Oklahoma.**



**FIGURE 4-33: Failure of masonry veneer wall, close-up view, Moore, Oklahoma. This home was located along the periphery of a violent tornado.**



The BPAT also observed several problems that led to premature failure of the brick veneer, such as inadequate bonding of mortar to galvanized brick ties, inadequate bonding of mortar to brick, and nail pull-out at brick ties. The BPAT observed that brick veneer was generally constructed using 3-in brick, which appeared to be a dense brick of low porosity. Location and number of brick ties varied considerably, from 16-in on center vertically and horizontally, to ties at top, midheight, and near bottom of walls. There were several walls with up to 1.5-in to 2.0-in gaps behind brick and with brick ties only inserted  $\frac{3}{4}$ -in to 1.0-in into mortar joints. Most ties were fastened through foamboard sheathing into studs with one 6d common nail per tie.

In many cases, sections of brick veneer wall panels could be easily pulled loose by hand, and where brick veneer was left standing, it could easily be pushed in with hand pressure (Figures 4-34, 4-35 and 4-36).



**FIGURE 4-34: Inadequate bonding of mortar to galvanized brick ties, Bridge Creek, Oklahoma.**

***FIGURE 4-35: Inadequate bonding of mortar to galvanized brick ties, Bridge Creek, Oklahoma.***





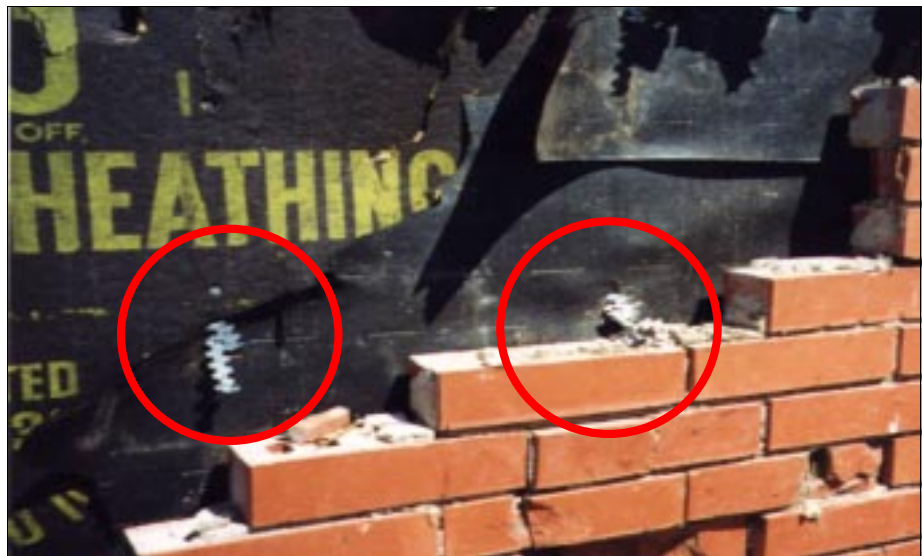
**FIGURE 4-36: Failure of masonry veneer wall, Del City, Oklahoma.**

In Del City and Mid West City, in the southeast suburbs of Oklahoma City, the BPAT observed several more examples of brick veneer (both clay and concrete brick) failure. Most of the failure appeared to have been caused by negative wind pressure (suction) on leeward and side walls (Figures 4-36, 4-37, 4-38, and 4-39). These walls were also in an area that was in the inflow wind area of a violent tornado, but outside the vortex.

**FIGURE 4-37:** Failure of masonry veneer wall, viewed collapsed on the ground. This home, located in Oklahoma City was in the vortex of a violent tornado.



**FIGURE 4-38:** Failure of masonry veneer wall of home located along the periphery of a violent tornado in Oklahoma City. Masonry ties are circled.





**FIGURE 4-39: Failure of masonry veneer wall of home located along the periphery of a violent tornado, Del City, Oklahoma.**

In Moore, Oklahoma, at a subdivision south of Westmoore High School that was in the direct path of a violent tornado, newer homes located in the periphery of the damaged areas approximately a few hundred feet from the vortex had failures of brick chimneys and brick veneer walls. Brick chimneys snapped off near the eave and crashed through the house roof, breaching the building envelope and placing occupants at risk of injury or death from falling masonry and other debris. Masonry veneer walls appeared to fail from suction (negative) loads pulling the veneer away from the stud framing. Again, the majority of masonry veneer was single width, 3-in brick. Chimneys were 28-in wide by 24-in deep and made of 3-in brick, with a 10-in by 10-in clay tile flue in the center, leaving a large gap between flue and exterior brick. The height of chimney was about 8-ft above eave height. No vertical or horizontal reinforcement was present. Ages of houses did not appear to make any difference on bonding of mortar to brick ties or bonding of mortar to brick., as some were 30 years old and others only one year old. This type of chimney construction should perhaps be limited in its maximum unsupported height, even when considering nominal (non-tornadic) design wind loads(see Figures 4-40 through 4-42).

***FIGURE 4-40: Failure of brick chimney onto roof of home located along the periphery of a violent tornado, Moore, Oklahoma.***



***FIGURE 4-41: Close-up view brick chimney failure in Figure 4-40.***







**FIGURE 4-42: Failure of brick chimney onto top of home located along the periphery of a violent tornado, Moore, Oklahoma.**

## 4.2 MULTI-FAMILY CONSTRUCTION

The majority of single-family housing construction in areas of Kansas devastated by the May 3 tornadoes was of older construction with exterior cladding other than brick masonry. However there were a few homes and several two-story apartments with brick veneer that had extensive damage (Figures 4-43 through 4-47).

Most of the observations for single family structures are applicable to multi-family (low rise, condo and garden apartment) construction with the addition of an example of a large overhang.



**FIGURE 4-43: Failure of masonry veneer.**

***FIGURE 4-44: Failure of masonry veneer at a multi-family housing unit in Wichita, Kansas. This building experienced inflow winds from a severe tornado.***





**FIGURE 4-45:** Failure of masonry veneer in multifamily housing located along the periphery of a severe tornado, Wichita, Kansas.



**FIGURE 4-46:** Chimney failure onto roof of single family attached housing, Wichita, Kansas. This building was located along the periphery of a severe tornado.

**FIGURE 4-47: Chimney failure onto roof of single family attached housing located along the periphery of a severe tornado, Wichita, Kansas.**



### 4.3 MANUFACTURED HOUSING

Damage to manufactured homes was observed in Oklahoma and Kansas. Performance of units on temporary foundations utilizing anchors and straps were assessed as well as the performance of units on permanent foundations.

In Bridge Creek, Oklahoma, approximately 50 miles west of Oklahoma City, 11 deaths were reported from a violent tornado; most of these deaths were individuals taking refuge in manufactured housing. While some manufactured homes were directly hit by the vortex, estimates of wind speed based on observed damage to buildings and trees during the site visit indicated that most buildings were impacted by straight inflow winds and not by the vortex of a tornado.

There were several sites in the area that were observed to have the manufactured house wood framing completely destroyed and separated from the twisted remains of the steel chassis, and the chassis and debris at a distance from the original anchorage site. Ages of homes could not be determined; no data plates or labels could be found. Most of the manufactured homes in this location were single-wide, 14-ft by 60- or 70-ft units, originally connected to the ground by helical ground anchors and galvanized steel straps fastened to the steel chassis beams.

Foundation support was typically provided by ungrouted (dry stacked) concrete masonry unit (CMU) piers at six to eight feet on center under each chassis beam. The total number of anchors per home varied considerably, from four to eight per home. The most spectacular failure observed was a 14-ft by 60-ft manufactured home chassis found about 200 yards to the northeast

of its original anchorage site (Figure 4-48). This home was not affected by the vortex of a tornado, rather, it was affected by the inflow winds whose violent tornado vortex was approximately 300-400 ft away from this home. At the original site, vertical and diagonal straps remained attached to the ground anchor, but had failed about two to three feet from the anchors (Figure 4-49). The first anchors had been fastened about 12-feet from the east end. Both the number of anchor straps and tensile capacity of the straps were inadequate to resist wind uplift forces (Figure 4-50).



**FIGURE 4-48:** This 14-ft x 60-ft manufactured home chassis in the background of this picture moved about 200 yards from its original anchoring site in Figure 4-49, Bridge Creek, Oklahoma.



**FIGURE 4-49:** Failed straps at the anchorage of a manufactured home in Bridge Creek, Oklahoma. This site was 300-400 feet from a violent tornado vortex.

**FIGURE 4-50: Strap anchoring failure most likely led to the displacement of this chassis, Bridge Creek, Oklahoma.**



After completing several site visits in the Oklahoma City metroplex, the BPAT visited Mulhall, Oklahoma, about 50 miles north of Oklahoma City. There were several double-wide manufactured houses damaged by a severe tornado. One 28-ft by 60-ft home had rotated on its piers, 2-ft to the east at the north end and 1-ft to the west at the south end. Three helical anchors were pulled out that had been installed about one-foot into the ground on the northwest end of the home (Figure 4-51). Anchor straps that were still attached to ground anchors and chassis beams were loose, which allowed lateral movement of the unit. Anchor depth into the loose sandy soil did not appear to be adequate to resist wind uplift and overturning forces (Figures 4-52 and 4-53) generated by a severe tornado whose vortex passed nearby, but did not directly strike the homes.



**Figure 4-51: Ground anchor of manufactured home pulled from soil. This home in Wichita, Kansas, was located within the inflow area of a severe tornado.**



**Figure 4-52: Anchor of manufactured home bent and pulled up from soil. This home in Wichita, Kansas, was located within the inflow area of a severe tornado.**

**Figure 4-53: Strap torn off from chassis of manufactured home. This home in Wichita, Kansas, was located within the inflow area of a severe tornado.**



Several manufactured homes had lost plywood roof sheathing and roof trusses, and some only lost asphalt roof shingles. Fastening of the roof sheathing and roofing materials was inadequate to resist wind uplift (Figures 4-54 and 4-55) from inflow winds of a severe tornado.

**Figure 4-54: Roof and wall damage experienced due to inadequate resistance to lateral and uplift wind forces associated with straight inflow winds of a moderate tornado, Wichita, Kansas.**







**Figure 4-55: Damage to a manufactured home located on the periphery of a severe tornado, Wichita, Kansas.**

In Haysville, Kansas, the BPAT visited the Sunset Field Addition on South 65<sup>th</sup> Street near the historic district, where several double-wide manufactured housing units were constructed on permanent concrete crawl space foundations. It was reported that roofs and several walls of the units had been destroyed, but that the floors had remained on the foundation walls. Later, during demolition, the floor system and steel chassis beams with steel outriggers and steel angle bracing had been lifted off the foundation. Although the floors had remained on the concrete walls, there were no bolts or positive connections between the chassis or perimeter wood joist and the sill-plate, pockets in the concrete walls, or center piers (Figure 4-56). Straps that had been stapled to wall studs and to perimeter joists did not appear adequate to resist wind uplift or lateral loads (Figure 4-57), and fastening of the roof system to walls had been inadequate.

**FIGURE 4-56:** *Lack of bolts or positive connections present between the chassis and foundation, Haysville, Kansas.*



**FIGURE 4-57:** *A close up of the manufactured home floor and chassis after it was removed from the permanent foundation in Figure 4-56.*



Several double-wide manufactured housing units partially survived high wind forces. However, ground anchors were pulled out of the soil, or they were bent over, loosening up tie-down straps. Homes shifted laterally from wind forces and fell off unreinforced and ungrouted CMU block piers. In some cases, tie-down straps with metal clips for attachment to chassis beams were loose and lying on the ground (Figures 4-58 through 4-61). **(location and wind?)**



**FIGURE 4-58:** *This manufactured home laterally shifted from wind force generated along the periphery of a violent tornado, Haysville, Kansas.*



**FIGURE 4-59:** *View of anchor strap and attachment indicating lateral shifting of a manufactured home, Haysville, Kansas. This home was located along the periphery of a violent tornado.*

**FIGURE 4-60:** View of anchor strap and attachment indicating some lateral shifting of a manufactured home located along the periphery of a violent tornado, Wichita, Kansas.



**FIGURE 4-61:** Manufactured home laterally shifted from wind force generated along the periphery of a violent tornado, Wichita, Kansas.



# 5 Observations on Non-residential Property Protection

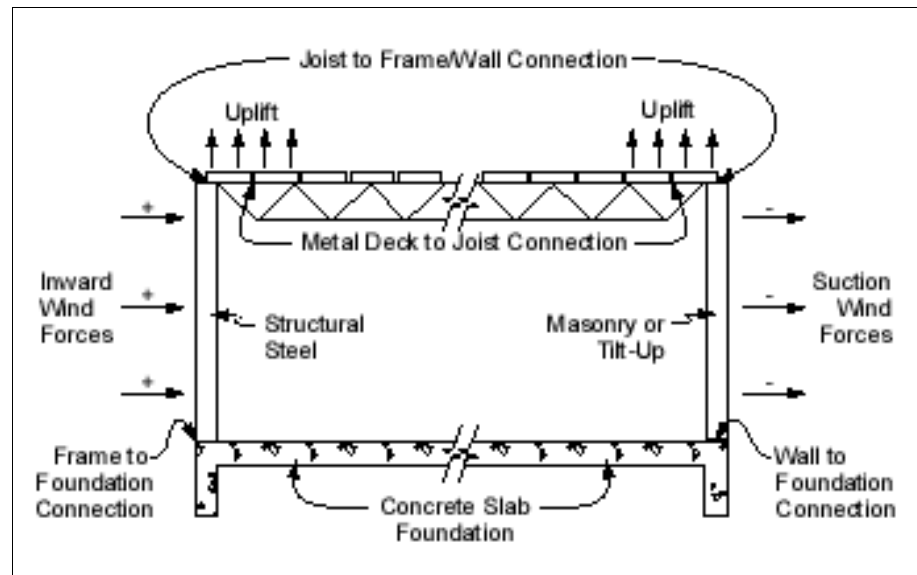
This section presents the BPAT's observations on non-residential property protection. The non-residential buildings were categorized into the various engineered types of construction focusing on the structural performance of each type of building. Important observations were also made concerning exterior architectural systems (e.g., roof and wall coverings, windows and doors).

A number of non-residential buildings, such as schools, factories, warehouses, and commercial buildings were in the direct path of the tornado vortexes or in the inflow/outflow and received damage. In a few cases, damage could be considered non-structural because architectural and decorative materials on the exterior and roofing were the only damage to the buildings; in engineering standards such as ASCE 7, these materials are often referred to as components and cladding. In other cases, structural damage occurred due to the lack of redundancy in the structural system in the form of a continuous load path to resist wind-induced uplift loads.

## 5.1 CONTINUOUS LOAD PATH

A continuous load path from the roof structure to a building foundation is essential for a building. This load path, the members and connections between members, is capable of withstanding gravity or downward design loads. However, during high wind events such as tornadoes, lateral loads and uplift loads will act on the building and test the capacity of the continuous load paths. Figure 5-1 shows critical connections in the continuous load paths for representative types of non-residential buildings that sustained structural damage. In addition to the lateral wind forces that are often considered in design, significant uplift loads generated by the high wind velocity associated with tornadoes act on the roofs. To resist these loads, adequate connections must be provided between the roof decking and roof structural support, bar joists or other structural roofing members and walls, and foundation and walls or structural columns. Each of these connections must be capable of resisting uplift and lateral loads as well as gravity loads.

**FIGURE 5-1: Critical connections that failed in the load path resulting in structural damage or collapse.**



### 5.1.1 Tilt-up Precast Concrete Walls with Steel Joists

Inspection of a damaged tilt-up precast concrete wall building in Moore, Oklahoma, found no deficiencies with connections between the tilt-up walls and the foundation. However, connections between the roof systems and the tilt-up walls failed in some buildings. In a commercial building along Interstate I-35 outside Del City, Oklahoma, failure of these connections caused a loss of diaphragm action, which then led to collapse of the endwalls of this building and will be discussed further in Section 5.2.1. Figure 5-2 is a photograph of this building. The vortex of a violent tornado passed approximately 200 yards from this building, generating inflow winds that removed the roof of this structure. Once the roof of the building was removed and diaphragm action was lost, the endwall that was already being acted upon by outward (suction) wind forces failed.



**FIGURE 5-2: Tilt-up precast concrete walls at a storage building located outside Del City, Oklahoma. After the roof joists separated from the walls, this end wall became unable to withstand suction forces and failed.**

### 5.1.2 Load Bearing Masonry with Steel Joists

The BPAT inspected Kelly Elementary School in Moore, Oklahoma, which was in the direct path of the vortex of the violent tornado. The school included a steel frame building in the main section, and a section that was constructed with load bearing masonry walls with steel joists.

This section discusses the damage associated with the masonry wall section of the building; Section 5.1.3 will discuss the steel frame section of the school. Figure 5-3 shows damage to the Kelly Elementary School. Arrows show separation between the bond beam and its supporting wall and separation between the bond beam and roof bar joists. At both locations, connections between the bond beam, joists, and walls were adequate for gravity load, but could not carry the high uplift loads that were caused by winds associated with the violent tornado.

**FIGURE 5-3: Kelly Elementary School, in Moore, Oklahoma, hit by vortex of violent tornado. Damage to school displaying separation between the bond beam and supporting wall and separation between bond beam and roof bar joists.**



Figure 5-4 shows a close-up of a joist end over the old cafeteria. The arrow shows a location where the roof deck was supported for gravity load, but not welded for uplift. Below the arrow, broken welds can be seen. Also visible in Figure 5-4 is the lower portion of the external wall. As illustrated in the photograph, no effective vertical reinforcement was found in the wall. Consequently, the wall had low resistance to uplift in combination with high lateral wind loads.





**FIGURE 5-4:** Failed structure showing broken deck welds, and no effective vertical reinforcement. Kelly Elementary School, Moore, Oklahoma, hit by vortex of violent tornado.

### 5.1.3 Steel Frame with Masonry Infill Walls

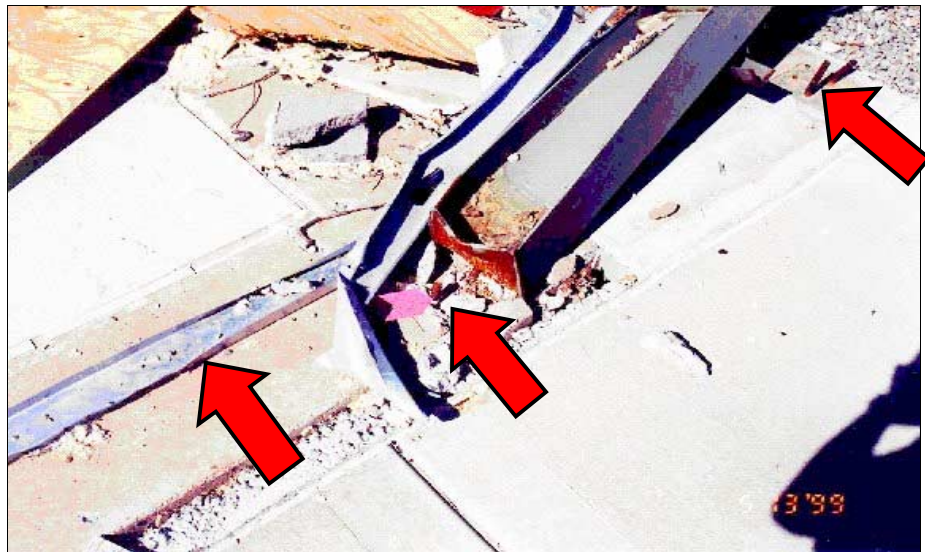
The BPAT visited a regional outlet mall in Stroud, Oklahoma, where the entire roof was blown away and significant damage to the building was evident. This mall was struck by a moderate tornado that collapsed the central portion of the building's steel frame and damaged many of its masonry and steel frame walls. Figure 5-5 shows standing seam roof attachments of the decking to the purlins in one area of the mall that failed under the uplift loading. It was observed that threaded fasteners used to attach portions of the exterior cladding to the frame performed better than the standing seam roof attachments.



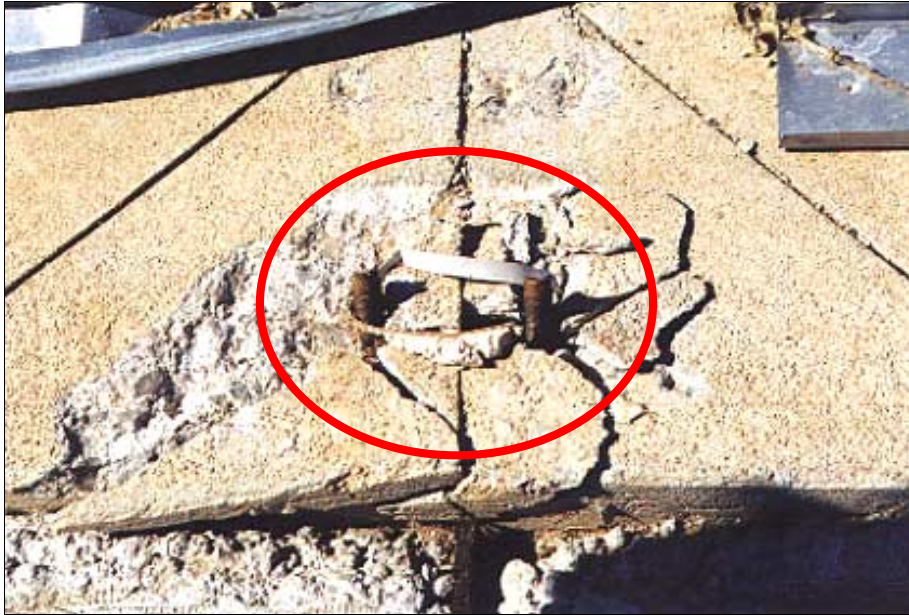
**FIGURE 5-5:** Metal roof deck of regional outlet mall, Stroud, Oklahoma, blown off when hit by moderate tornado vortex.

Figure 5-6 shows the attachment of columns to the foundation and attachment of the wall bottom plates to slab concrete. At the arrow on the right in Figure 5-6, anchor bolts were provided but the apparent lack of nuts on the anchor bolts permitted the column to lift off of the foundation. At the center arrow, anchor bolts with properly attached nuts provided a high level of restraint to column lift off. The arrow at the left of Figure 5-6 shows a wall bottom plate that was attached to the concrete slab by power driven nails. Although the plate held at this location, lack of penetration by the nails into the concrete permitted the plate to pull out at many other locations. Additional nail penetration would be needed to assure consistent attachment of wall bottom plates to the slab.

**FIGURE 5-6: Attachment of columns to foundation and attachment of wall bottom plates to concrete slab. Regional outlet mall, Stroud, Oklahoma, hit by moderate tornado vortex.**



Most bolts with nuts exhibited a ductile steel failure as shown in figure 5-7. This was the failure mode observed in most cases. This was also the failure mode for the anchorages at the steel water tower in Mulhall, Oklahoma. However, some of the bolts observed at the mall did pull out of the concrete foundation, indicating a failure in the concrete bond (see Figure 5-8).



**FIGURE 5-7:** Column anchors that exhibited ductile failure at the regional outlet mall in Stroud, Oklahoma, hit by moderate tornado vortex.



**FIGURE 5-8:** Column anchors that withdrew from concrete foundation at the regional outlet mall in Stroud, Oklahoma, hit by moderate tornado vortex.

#### 5.1.4 Light Steel Frame Buildings

The BPAT investigated the regional outlet mall that was destroyed in Stroud, Oklahoma. Figure 5-9 shows damage to the outlet mall. In this structure, most of the metal roof deck was blown off by the tornado. In addition, much of the metal curtainwalls used above lower, exterior masonry walls were destroyed.

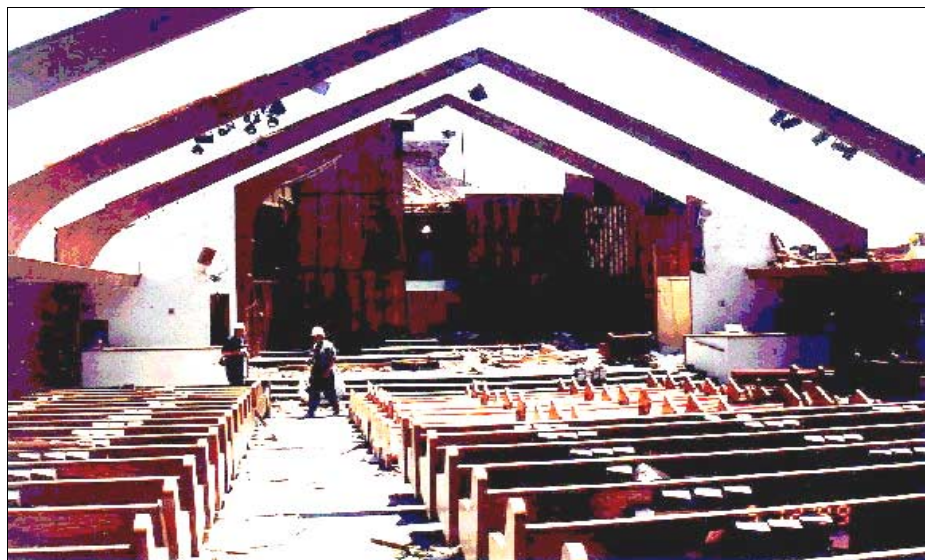
**FIGURE 5-9: Stroud Regional Outlet Mall, Stroud, Oklahoma was struck by the vortex of a moderate tornado.**



#### 5.1.5 Laminated Wood Arches with Wood Frame Roof

Lack of load path also resulted in severe damage to the Regency Park Baptist Church in Moore, Oklahoma. This building was approximately one block north and across the street from Kelly Elementary School. The vortex of a violent tornado passed approximately a few hundred yards to the south. Figure 5-10 shows the rigid frames remaining after the roof had been removed by the tornado. Loss of load path between the rigid frames and the roofing resulted in severe damage to the facility.

**FIGURE 5-10: This church suffered loss of roof due to lack of load path between the rigid laminated wood arches and the roof purlins which supported roof sheathing. Inflow area of a violent tornado, Moore, Oklahoma.**



### 5.1.6 Masonry Walls with Pre-cast Hollow Core Floors

In several locations, combined effects of upward suction wind loads with horizontal wind loads caused unexpected damage to structures. When a continuous load path for uplift and lateral loads did not exist, roof failures and upper level floor failures were observed. Figure 5-11 shows the remains of a motel in Mid West City, Oklahoma, hit by a violent tornado vortex. The arrows show a steel beam that had been deflected inward significantly when the floor slab was lifted during the tornado. There was no positive connection between the steel beam and the floor above.

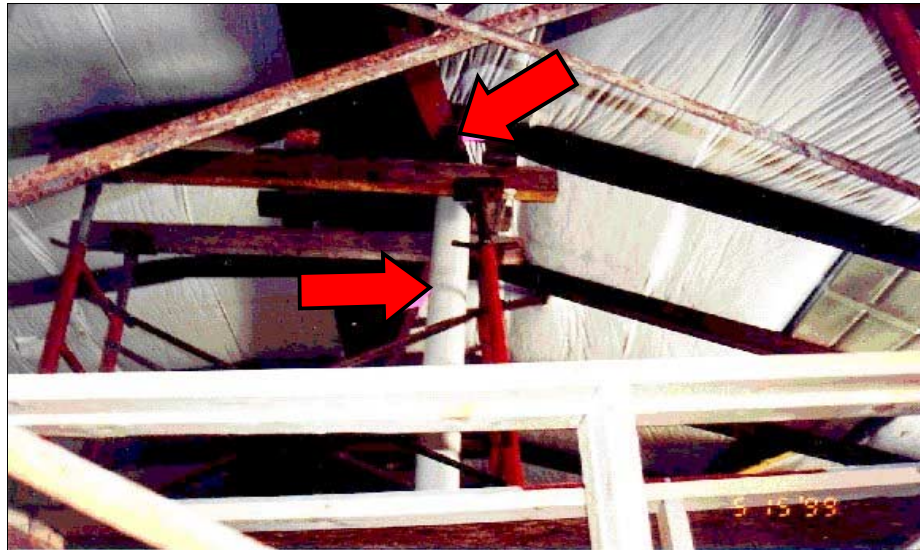


**FIGURE 5-11: Motel in Mid West City, Oklahoma that experienced major damage when struck by the vortex of a violent tornado.**

## 5.2 INCREASED LOAD

At a plastics manufacturing plant in Haysville, Kansas, a combination of upward and horizontal wind loads when the plant site was hit by a violent tornado caused out-of-plane buckling of the bottom flange of a main girder supporting the roof (Figure 5-12). One arrow shows the column that supports the girder, while the other arrow shows the bottom flange of the girder. It can be seen that the bottom flange has displaced significantly sideways in relation to the top flange of the girder. Inspection along the length of the girder indicated that the bottom flange was braced along its length at every purlin except at the location of the supporting column. This lack of bracing permitted buckling and out-of-plane displacement of the bottom flange. However, due to the light gravity loads left on the roof after the wind forces diminished, collapse did not occur.

**FIGURE 5-12: Out-of-plane buckling of the main girder supporting the roof created by a combination of uplift and horizontal wind loads. Plastics plant, Haysville, KS hit by violent tornado. This building was in the inflow area of a severe tornado.**



Another example of the effects of uplift and horizontal wind forces is seen in Figure 5-13 at Kelly Elementary School in Moore, Oklahoma. The exterior wall collapsed inward indicating that the roof had lifted up as the wind loads acted inward on the wall. Failure to have a continuous load path from the joists supports into the masonry wall to resist uplift forces contributed to collapse of the wall. The exterior masonry wall is seen lying on the floor beneath the collapsed roof structure.

**FIGURE 5-13: Collapsed roof structure and exterior at Kelly Elementary School in Moore, Oklahoma struck by the vortex of a violent tornado.**



The Westmoore High School in Moore, Oklahoma, was a relatively new structure that was within 100 yards of the vortex of a violent tornado. Although most of the roofs stayed on this building, the roof over the auditorium stage was blown off. Figure 5-14 shows the walls where the bar joists had been attached prior to the tornado. In all cases, welds failed between bar joist ends and embedments in the walls in the auditorium stage roof. This loss of load path permitted the roof to be lifted up off of the reinforced concrete walls.



**FIGURE 5-14: Roof blown off over top of auditorium at Westmoore High School, Moore, Oklahoma hit by inflow winds of violent tornado.**

Figure 5-15 shows the exterior of the reinforced concrete wall at Westmoore High School following the tornado. This 12-in thick by approximately 35-ft-tall wall remained essentially undamaged, even though the diaphragm action of the roof was lost. The construction of the stage area integrated an I-beam horizontal frame, shown in Figure 5-14, with the reinforced concrete walls. This frame provided diaphragm action that helped stabilize the walls. Prior to the tornado, the bare concrete had been covered with a decorative metal curtainwall. The entire curtainwall blew off during the tornado while brick masonry veneer on the lower wall remained, with virtually no damage.

**FIGURE 5-15: Exterior view of an undamaged reinforced concrete wall, Westmoore High School, Moore, Oklahoma, hit by inflow winds of a violent tornado. Note: decorative metal wall covering was peeled from this wall.**



### 5.2.1 Tilt-up Precast Concrete Walls with Steel Joists

Diaphragm action is needed to supply lateral support at the tops of external walls for commercial buildings with open architecture, such as warehouses and open office buildings. When the support is lost, wind load resistance is greatly reduced and structural failure often follows.

Figure 5-16 shows a tilt-up concrete wall that failed after loss of an interior diaphragm made up of steel joists and metal deck. This building was located approximately 200 yards from a violent tornado vortex near Del City, Oklahoma. As can be seen in Figure 5-16, the wall was well attached at the foundation level. However, loss of diaphragm at the top of the wall permitted the wall to blow outward and collapse.

**FIGURE 5-16: Failure of tilt-up concrete wall in Del City, Oklahoma, hit by inflow winds of a violent tornado.**





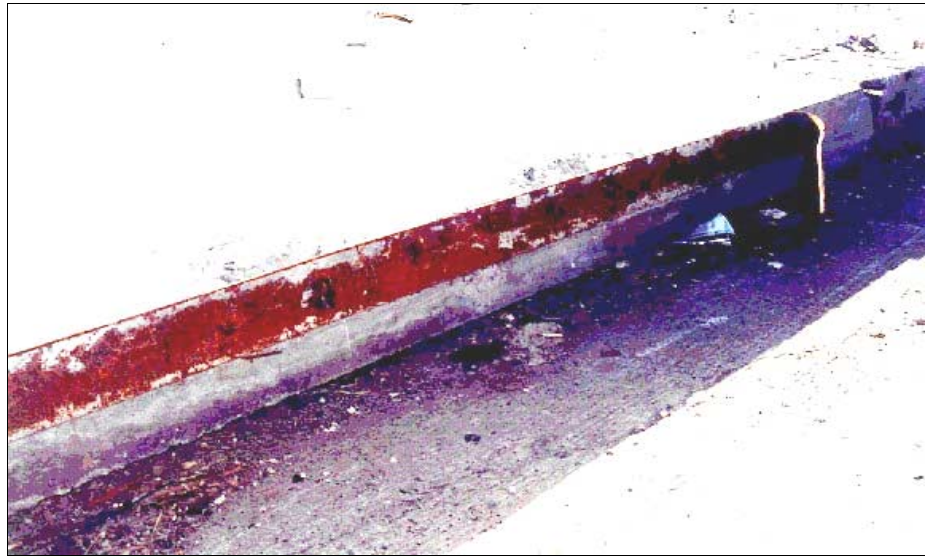
A factor contributing to collapse of the tilt-up wall was the placement of the vertical reinforcement. Close inspection of the broken surface indicated that reinforcing bars were placed near the exterior face of the wall. In tilt-up construction, the bars commonly are placed at mid-thickness of the wall. Placement of the reinforcement, as indicated by the arrow in Figure 5-16, significantly reduced the resistance of the wall to outward deflection or movement.

Figures 5-17 and 5-18 show the top of the tilt-up precast concrete wall that failed. Figure 5-17 shows that diaphragm action provided by a beam supported by the wall was lost when the beam pulled out of the wall pocket. Failed welds tying the roof into the top of the tilt-up wall can also be seen in Figure 5-18. Visual inspection showed that only one of the four walls of the building collapsed. The other walls had part of the diaphragm action provided by remaining portions of the roof.



**FIGURE 5-17: Top of failed tilt-up wall.**

**FIGURE 5-18: Top of failed tilt-up wall.**



Tilt-up walls at a facility that was located under the vortex of a moderate tornado in Wichita, Kansas, survived virtually undamaged, despite loss of metal deck roofing. As can be seen in Figure 5-19, trusses spanning the open area maintained diaphragm action.

**FIGURE 5-19: The tilt-up precast concrete walls in this building did not fail when the roof system failed. Note: many roof joists are still in place. Building was located in Wichita, KS and was hit by moderate tornado vortex.**



### 5.2.2 Load Bearing Masonry with Steel Joists

In Figure 5-19, damage to a portion of the building having a steel joist roof supported on masonry walls can be seen at the left. Walls in this portion of the building collapsed when subjected to the vortex winds of a moderate tornado. Even though some diaphragm action was maintained, the masonry

walls did not have enough lateral load resistance under the combined uplift and horizontal load of the tornado.

Figure 5-20 shows damage to both interior and exterior unreinforced masonry walls (URM) at Kelly Elementary in Moore, Oklahoma. Wind loads due to the vortex of a violent tornado lifted the roof system until the bond beam atop the URM wall failed. When this bond beam failed, the roof separated from the building and some interior walls failed.



**Figure 5-20: Damage to interior and exterior unreinforced masonry walls when bond beam failed at Kelly Elementary School in Moore, Oklahoma. The school was struck by the vortex of a violent tornado.**

### 5.2.3 Masonry Walls with Pre-cast Hollow Core Floors

At a motel in Mid West City, Oklahoma, which was hit directly the vortex of a moderate tornado, failures occurred between the second floor precast hollow core panels and their supporting walls.

Figure 5-21 shows the location where hollow core plank had formed the second floor. The arrow at the right shows a dowel from the masonry wall into grout between the ends of two hollow core panels. One of the panels that had been at the edge of the building was found up on the second level and across on the far side of the building as shown by the arrow on the left of Figure 5-21. Apparently the uplift wind forces from the tornado were large enough to overcome the tie-down force provided by the very short dowels. The hollow core plank appears to have been lifted and blown across the width of the building.

**FIGURE 5-21:** Hollow-core plank formed on second floor of a Midwest City, Oklahoma, hotel that was struck by the vortex of a moderate tornado.



Elsewhere along the edge of the second floor of the motel, failure occurred between the hollow core planks and exterior walls of the building. As shown in Figure 5-22, lower plates for the walls had been attached to the hollow core planks using power driven anchors. As indicated by the arrows, the powder driven anchors pulled out during the tornado.

**FIGURE 5-22:** Attachments of lower plates for wall to hollow core plank using power driven anchors failed when required to carry loads generated by the winds of a moderate tornado vortex. This motel was located in Midwest City, Oklahoma.



### 5.3 NON-RESIDENTIAL BUILDING ENVELOPES

In many cases, tornado damage patterns observed demonstrated that additional collapse of buildings was caused by breach of the building envelope. Openings in the envelope caused by loss of garage doors or broken windows frequently contributed to local loss of roofs or walls of the building. The following is based on a limited number of non-residential building site visits by the BPAT.

#### 5.3.1 Roof Coverings

The following roof types were observed:

- Ethylene propylene diene monomer (EPDM) with aggregate (stone) ballast
- built-up (aggregate ballast over cap sheet)
- metal panel (architectural and structural) including standing seam
- tile

All of the roofs observed experienced blow-off problems, except for a built-up cap sheet roof that was at the periphery of the tornado damage area. Windborne missiles, wind driven and free-falling, punctured some of the roofs. In the case of metal panels on pre-engineered frames, it was not determined whether the panels blew off before or after failure of the supporting frames.

Site visits revealed poor connections between wood nailers and the structure at roof perimeters. In one case, roofing nails were used to attach perlite insulation. This type of attachment offered very little uplift resistance.

In one case, loss of a large portion of a built-up roof with aggregate ballast resulted in significant rainfall water infiltration into a hospital in Stroud, Oklahoma. After the storm, the hospital was closed and the patients moved to a facility about 30 miles away, which significantly reduced the availability of emergency medical services over this area of rural Oklahoma. The characteristics of the damage to the hospital were not indicative of tornado winds due to its distance from the tornado vortex. Rather, it is likely that the damage was caused by thunderstorm winds. The failure initiated when the coping lifted or with lifting of the nailer the to which the coping was attached (Figure 5-22). The nailer was poorly attached to a 4-in CMU that formed the parapet wall. In some areas, the CMU block parapet lifted slightly.

**Figure 5.23: Nailer at the roof of the hospital in Stroud, Oklahoma. The roof surface in this photo was replaced prior to this photo, but the same nailer was used again.**



### 5.3.2 Wall Coverings

Brick veneer is discussed in Section 4.1.3.2. Some metal wall coverings over steel studs collapsed (Figure 5-24). Some Exterior Insulating Finishing System (EIFS) failures were observed.

**FIGURE 5-24: This metal-clad wall covering collapsed and in other areas it was blown completely away.**



### 5.3.3 Laminated Glass

In a few instances, examples of laminated glass performance were observed. In some cases the glass remained in the frame after windborne missile impact (Figure 5-25). In another case, the glass was punched out of its frame. The school in Figure 5-25 is located adjacent to Regency Park Baptist Church in Moore, OKLAHOMA in Figure 5-10. The vortex of a violent tornado passed a few hundred yards south of this building.



**FIGURE 5-25: The corner of a table penetrated this laminated glass, but the glass remained in its frame. This school suffered major damage from inflow winds of a violent tornado in Moore, Oklahoma.**

### 5.3.4 Garage Doors, Exterior Doors and Windows

The breach of overhead commercial doors caused internal pressurization of the structure leading to significant load increases. Not unlike the residential case, a breach in the building envelope was observed, in some cases, to initiate a partial or total failure of primary structural systems. This was particularly true for pre-engineered buildings, which typically had little redundancy in load transfer of their structural systems. Figure 5-26 shows a breached commercial overhead door belonging to a bread manufacturing and

distribution center in Wichita, KS. The building exterior walls were constructed using both concrete masonry block and tilt-up concrete panels. The roof deck was standing seam metal on a Z purlin system. The door failure appears to be a result of positive (inward) pressure. The breach may have caused a sufficient enough rapid increase in load to produce failure of the URM block wall. It is worth noting the location of the failed door is near a corner where high negative suction or (outward) pressure is likely to occur on the adjacent wall. As a result of the exterior wall collapse, severe damage to the roof system occurred due to the loss of the load bearing exterior support wall. However, notice that the roof collapsed to the interior of the building, which may indicate that uplift loads acting on the roof were insufficient to cause progressive peeling failure of the roof system.

**FIGURE 5-26: Failure of roof and walls on structure due to increased loads caused by initial failure of garage door, Wichita, Kansas.**



Figure 5-27 illustrates another condition in Wichita, KS where breach of the building envelope contributed to additional structural damage. In this case, loss of showroom windows and an overhead door greatly increased loads in the showroom and on the wall at the left of the photograph. These increased loads caused the walls to fail and the roof to partially collapse, thereby greatly increasing structural damage in the building.





**FIGURE 5-27: Additional structural damage caused by breach of envelope in Wichita, Kansas.**

Figure 5-28 shows a steel door that appears to have been opened by impact of a heavy object. This door at Kelly Elementary School in Moore, Oklahoma, led into an area where the roof was completely missing. The breached door may have caused an increase in load that propagated damage to that part of the building envelope. A nearby door, which was also heavily impacted, but did not open, was located in an area of the school that saw less damage to the wall and roof of the building.

***FIGURE 5-28: Damaged door most likely opened by impact with heavy object. Kelly Elementary School, Moore, Oklahoma.***



# 6 Observations on Personal Protection and Sheltering

Existing and new construction can be strengthened to better resist wind forces associated with inflow and outflow winds and moderate tornadoes; however, sometimes more protection is required. To survive a violent tornado directly beneath the vortex or to minimize potential loss of life for any tornadic event, a hardened above ground or below ground shelter, specifically designed and constructed to provide near absolute protection, is the best alternative.

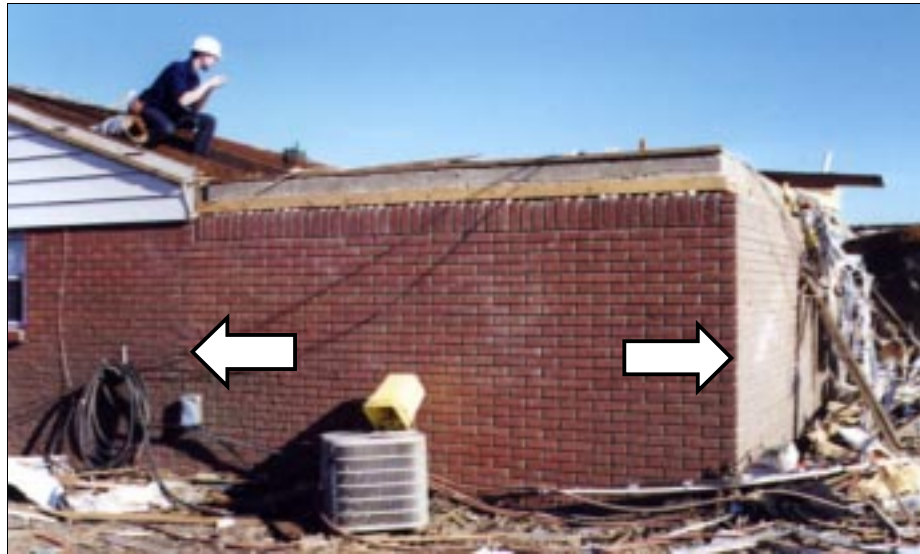
## 6.1 SHELTERS

Engineered shelters not only provide the best protection against loss of life for individuals subjected to a tornado, but also furnish the only protection reliably capable of providing survival. This section presents observations on the types of shelters observed by the BPAT.

### 6.1.1 Types of Shelters

Both above ground in-resident shelters and below ground shelters were successfully utilized in the May 3 storms in Oklahoma and Kansas, and were responsible for saving many lives. The above ground in-residence shelters observed were constructed of cast-in-place concrete. Figure 6-1 shows an above ground in-residence shelter located in Del City, Oklahoma, that consists of a reinforced concrete room (including a roof slab) located behind the brick veneer which was hit by inflow winds and was about 50 feet from the vortex of a violent tornado. Figure 6-2 shows the extent of damage the tornado caused on the homes surrounding the shelter. Homes in the foreground were hit by the tornado vortex. Homes adjacent to the home in Figure 6-1 were hit by inflow winds and are in the background. The other type of personal above ground shelter observed is an insulated concrete formed (ICF) shelter shown in Figure 6-3 which was hit by inflow winds of violent tornado in Bridge Creek, Oklahoma.

**FIGURE 6-1** Above ground in-residence shelter hit by strong inflow winds near the vortex of a violent tornado in Del City, Oklahoma. Arrows indicate the extent of this reinforced concrete shelter that cannot be seen due to the exterior brick masonry veneer.



**FIGURE 6-2:** Damage to houses near the home in Figure 6-1.





**FIGURE 6-3: Entrance to the ICF shelter in Bridge Creek, Oklahoma. This residence and shelter were on periphery of the inflow winds of a violent tornado, and damage was limited to light missile impacts.**

Below ground shelters included shelters constructed in basements as well as self-contained shelters located out of the building footprint, sometimes known as storm cellars. Basements were typically constructed of cast-in place concrete or CMU walls, and ceilings were normally wood framed structures constituting the structure for the floor above. Basements intended for occupancy and normal use contained windows, some of which were planned for egress from sleeping spaces. A basement may function as a place of refuge, but can not be considered an engineered shelter unless it has been designed to perform as a shelter. Refer to Section 6.2.1 for use of typical basements for refuge. The storm cellars observed by the BPAT were constructed of cast-in-place or precast concrete (Figure 6-4), and prefabricated steel with a concrete cover (Figure 6-5). Figure 6-6 shows a community shelter observed by the BPAT. The BPAT did not observe fiberglass or steel tank storm cellars, though numerous proprietary storm cellar systems are available that are constructed of these materials.

**FIGURE 6-4:** *This precast concrete storm cellar was located immediately behind a residence in Sedgwick County, Kansas. This residence and shelter were on the periphery of a violent tornado path.*



**FIGURE 6-5:** *Del City storm cellar constructed of steel sheets with a concrete cover. This area was directly struck by the vortex of a violent tornado.*





**FIGURE 6-6: Community Shelter at a Wichita, Kansas, manufactured home park. While the park was directly hit by a severe tornado, the shelter was not within the damaged area.**

### 6.1.2 Use of Shelters

Shelters observed by the BPAT appeared to be constructed and located by occupant type.

Family-size shelters situated near or in the residence for immediate use in the case of danger were evident throughout Oklahoma and Kansas. In Oklahoma, the BPAT observed a few above ground in-residence shelters that had been added to their existing homes or incorporated into the construction of their new homes. In Kansas, no above ground in-residence shelters damaged by the tornadoes were inspected by the BPAT. However, the BPAT did inspect new reinforced concrete above ground in-residence shelters that were being constructed in Wichita, Kansas (Figure 6-7).

**FIGURE 6-7: Above ground in-residence shelters under construction in Wichita, Kansas.**



Group-sized shelters were the second type of shelter observed. A group-sized shelter was located within a plastics manufacturing plant in Haysville, Kansas, and is intended to accommodate factory workers (Figure 6-8). The plant's shelter functioned daily as a conference and lunch room for employees. Although a violent tornado damaged other buildings on the plant site, the building containing this shelter received damage only in one isolated area, where a partial roof collapse occurred. Other smaller group-sized shelters were observed at a new manufactured home rental development, which provided precast concrete shelters (1 per 4 homes) (Figure 6-9). None of the group-size shelters observed by the BPAT were directly impacted by a tornado on May 3, 1999.





**FIGURE 6-8:** Entrance to the plastics manufacturing plant group shelter in Haysville, Kansas.



**FIGURE 6-9:** Group shelters at a manufactured home development in Wichita, Kansas.

Community-sized or mass shelters were also inspected by the BPAT. A manufactured home community shelter in Wichita, Kansas, was constructed partially underground, located at one end of the large development, and was intended to house all residents of the development (Figure 6-10).

Approximately 200 people reportedly sought shelter in this building during the May 3, 1999, tornadoes. Another community-sized shelter was located underground and under the concrete bleachers in the Mid West High School gymnasium in Mid West City, Oklahoma (Figure 6-11). Approximately 500 people sought shelter here during the May 3, 1999 tornado (the shelter has a

capacity of 3,500). A similar shelter is located at Del City, Oklahoma, High School. Members of the community are generally aware of the location of these shelters. Interviews with residents of the manufactured home community indicated that parking was a problem at the community shelter. In contrast, ample parking is available near the gymnasiums for those seeking shelter.

**FIGURE 6-10:**  
**Manufactured home**  
**development community**  
**shelter in Wichita,**  
**Kansas.**



**FIGURE 6-11: Community**  
**shelter, Mid West High**  
**School gymnasium in Mid**  
**West City, Oklahoma.**



### 6.1.3 Maintenance Issues of Shelters

The BPAT observed deficiencies in some shelters inspected during the field investigation. Underground, partially underground shelters, or shelters located exterior to buildings were subject to moisture and the associated deterioration. Insufficient attention often was paid to these shelters with regard to waterproofing of walls and roofs and resulted in musty and damp environments. These conditions were perhaps merely an inconvenience for the family-size or small group shelter, but were potentially environmentally hazardous to occupants with allergies or respiratory ailments in the large group and community shelters.

In numerous cases, the BPAT observed that poor selection of building materials and maintenance of painted items such as hinges and latches led to failures or poor performance (Figure 6-12). Storm cellar doors observed by the BPAT were often covered with thin gauge sheet-metal and exhibited deterioration of the zinc galvanization resulting from corrosion. The sheet-metal storm cellar doors were often backed with untreated plywood that was usually found to be rotted, delaminated, or otherwise deteriorated to the point where it was no longer useful in providing protection to the shelter opening.



**FIGURE 6-12: Door to underground shelter with rotting wood and corroded hinges.**

Numerous other deficiencies were observed regarding shelter doors and hardware. Most of the storm cellar doors were of insufficient thickness to withstand tornadic wind forces and windborne missiles. Most shelter door latching devices were also insufficient to withstand wind forces and missiles

and one observed failure resulted in the door destruction and the partial filling of the storm cellar with debris (Figure 6-13). Widespread door failures were observed on the below-ground shelters; this included both metal and wooden doors. The above ground in-resident shelters observed had hollow metal doors and three hinges on one side and an insufficient single deadbolt locking device (Figure 6-14). The door metal skin thickness and the single lock would have probably been insufficient to secure the door had they experienced a direct missile strike from a violent tornado vortex or near vortex inflow area.

**FIGURE 6-13: Failed wooden door at a below ground shelter in Oklahoma.**





**FIGURE 6-14: Shelter door of home in Del City, Oklahoma, showing an insufficient deadbolt locking device. The circled area on the door frame is the catch for the only latching mechanism on the door.**

Other shortcomings of shelters were observed by the BPAT. The community shelter in Figure 6-15 produced a potential safety hazard to nearby buildings resulting from missile generation from a fence and a ballasted roof covering. Figure 6-15 shows the aggregate ballast roof covering on the community shelter in Wichita, Kansas. A security fence that surrounded this roof area was damaged and removed by the winds of the violent tornado that impacted the opposite side of this community. Aggregate ballast shown in the photo may become airborne during high wind events and cause damage to other properties and injure individuals attempting to access the shelter.

**FIGURE 6-15: Ballast roof covering on a community shelter in Wichita, Kansas was a potential source of deadly windborne missiles to those seeking to access the shelter.**



#### **6.1.4 Shelter Accessibility**

The observed above ground in-residence shelters were easily accessible by the home occupants. Observed door widths would have allowed access by wheelchair or otherwise disabled occupant. The group or community shelters observed by the BPAT had restrictive entrances that may have hampered access to the shelters by persons with disabilities. Figure 6-16 shows stairs leading to the entrance of a community shelter in Kansas. Additionally, several of the community shelters were locked and required authorized admission. Access to the community shelter in Figures 6-10 and 6-16 was restricted to community members without pets and the travel distance from the far end of the development to the shelter was approximately several city blocks. The group shelters observed also require access via stairs at both the plastics manufacturing plant and the manufactured home rental development. Figure 6-17 shows the stairs required to access the group shelter and the manufactured home rental development.



**FIGURE 6-16:** *Stairway leading to entrance of manufactured home community shelter, Wichita, Kansas. The only means of accessing this structure were this stairway and an identical one at the other side of the shelter.*

**FIGURE 6-17:** Stairway access to group shelter at manufactured home rental development, Wichita, Kansas. This development was not affected by any of the tornadoes that struck on May 3, 1999.



The gymnasium community shelters required suitable storm warnings because of travel time, distance, and time required to open the facility. In unincorporated Sedgwick County, Kansas, a wheelchair bound individual, who resided in a manufactured home was unable traverse the stairs into a neighbor's home and down into the basement. The individual attempted to take shelter back in his manufactured home and was killed by a violent tornado that destroyed the manufactured home.

#### **6.1.5 Shelter Ventilation**

The observed above ground in-residence shelters did have outlets for forced air ventilation from the home HVAC system; however no other method of natural ventilation was included. All observed underground or partially underground shelters outside the building footprint had some means of natural passive ventilation. The most common types of ventilation



mechanism observed were vent pipes (Figure 6-18) or turbine ventilators (Figure 6-9). The vent pipe in Figure 6-18 was sufficiently thick enough to not be broken by windborne debris and was capped to prevent the intrusion of debris. The turbine ventilator observed in Figure 6-9 was 8-inches in diameter and made of light gauge metal. It would have been easily destroyed by flying debris if impacted by even a moderate tornado, thereby allowing free-falling debris to enter the shelter through the 8-in diameter opening in the roof of the shelter, placing the safety of the occupants at risk.



**FIGURE 6-18: Heavy gauge ventilation pipe for a below ground shelter in Oklahoma withstood considerable debris impact.**

### 6.1.6 Shelter Location

Most above ground in-resident shelters observed were easily accessible by the occupants. Their location within the house allowed access with minimal threat to wind and windborne debris. Basements and basement shelters offered the same advantages, but posed an access problem to occupants with disabilities. Basement windows and wells, however, were poorly protected and vulnerable to windborne debris (Figure 6-19). In addition, basement shelters only offered minimal protection when the house was blown off the foundation, leaving those seeking shelter in the basement subject to windborne missiles.

**FIGURE 6-19: Basement windows of residential home, showing vulnerability to debris.**



Storm cellars (underground cellars) were located either in the front, side, or rear yards of the homes. Front yard locations were vulnerable to vehicular traffic and water runoff. The side and rear yard cellars were also vulnerable to water runoff (Figure 6-20). In many cases, the cellar entrance was insufficiently raised above grade and would have allowed for easy entrance of water.



**FIGURE 6-20:** *This below ground shelter is susceptible to water runoff.*

## 6.2 OTHER PLACES OF REFUGE

If a specially designed tornado shelter is not available for refuge, people are forced to seek shelter in areas not intended to be places of refuge. Although some areas typically offer a relatively greater level of protection than others, when people take refuge in a portion of a building that was not specifically designed and built as a tornado shelter, they are at significant risk of being injured or killed if a tornado of any intensity directly strikes the building or passes nearby. The following sections discuss areas where occupants often seek shelter protection areas within residential and non-residential buildings that do not have specifically designed tornado shelters.

### 6.2.1 Refuge in Residences

For conventionally-constructed residences without basements or specially designed tornado shelters, observations following the Oklahoma and Kansas tornadoes, as well as previous post-tornado damage investigations, consistently revealed that interior bathrooms and closets offer the greatest occupant protection. Interior bathrooms and closets are small rooms that do not have an exterior wall (Figure 6-21).

**FIGURE 6-21: Remains of an interior room or core of a home in a Moore, Oklahoma, subdivision that was hit by a violent tornado.**



In many instances, only the interior core of the residence was left standing while the exterior walls and other interior walls and the roof structure and ceiling were blown away. The surviving core typically was composed of a bathroom, a closet or two, and perhaps a kitchen wall that was stiffened by cabinets (Figure 4-22). While interior bathrooms and closets typically offer the greatest protection, people taking refuge in them are at great risk during a tornado, as illustrated by Figures 6-23, 6-24, 6-25, and 6-26. While some minimal protection from missiles is provided by the core walls and cabinets, in many cases the rooms were left open to the sky when the building's roof was blown away and occupants were therefore totally unprotected from free falling missiles (see Section 3.3).



**FIGURE 6-22:** Interior core of house remains, consisting of a bathroom, closets and a wall with kitchen cabinets after being struck by a severe tornado.



**FIGURE 6-23:** This house outside of Moore, Oklahoma, was affected by inflow winds associated with a severe tornado. The roof and ceiling were blown off of the interior bathroom of this house, the door was blown into the bathroom, and the tub was full of debris. This bathroom was not a safe refuge.

**FIGURE 6-24:** A 10-ft long 2-in by 6-in missile penetrated the exterior wall of this house in Wichita, Kansas, which was sheathed with hardboard panels. The missile, which was generated from the vortex of a severe tornado, then penetrated the gypsum board and tile tub enclosure, the tempered glass shower door, and the interior partition near the door frame. At the interior partition, it pierced through a wall stud and projected a few inches into the hallway (Figure 6-25).



**FIGURE 6-25:** The missile in Figure 6-24 impacted and broke a 2-in by 4-in wall stud after traveling through the bathroom.



**FIGURE 6-26:** *This bathroom was on an exterior wall and had a window. It was not a safe refuge.*

If the residence was more than one floor above grade, the first floor consistently was found to suffer less structural damage than the second floor (Figure 6-27). Therefore, greater protection was afforded when refuge was taken in interior bathrooms or closets on the first floor rather than the second.

**FIGURE 6-27: The second story of single and multi-family houses typically experienced far greater damage than the first story. This multi-family home in Wichita, Kansas, was affected by inflow winds of a severe tornado.**



Basements were uncommon in the areas investigated in Oklahoma; however, many of the houses investigated in Kansas did have basements. Basements typically provided greater occupant protection than first floor bathrooms or closets; however, as with first floor bathrooms and closets, basements were not immune to tornado damage. In one instance, a vehicle was blown into a house, penetrated the first floor, and hit or nearly hit the basement slab and then was sucked back out of the house. In other instances, missiles traveled down the stairway to the basement and flew into rooms at the bottom of the stairway. Basements, that were partially above grade and had windows, were observed to be susceptible to missile penetration (Figure 6-19).

Below-grade crawl spaces were also observed in Kansas. These spaces provided protection from missiles traveling horizontally, but as with basements, minimal protection was provided from free falling missiles when the house above was blown off its foundation. In one case, a person in a below-grade crawl space was seriously injured even though the floor sheathing remained in place. There was reportedly sufficient high-speed wind flow within the crawl space to blow the person around, causing numerous injuries that required hospitalization.

Based on the BPAT observations, persons taking refuge in bathrooms or closets in manufactured houses not attached to properly constructed permanent foundations appear to be at significantly greater risk of injury or death than persons taking similar refuge in conventionally constructed housing (Figure 6-28). The bathrooms and closets of manufactured houses typically provide very little protection. The BPAT observed a possible exception in some of the newer manufactured homes placed on proper



foundations, built to the Department of Urban Development's (HUD's) newer wind requirements, and designed to resist increased wind loads.



**FIGURE 6-28: Damaged and destroyed manufactured homes in Wichita, Kansas, that were in the direct path of a severe tornado.**

### 6.2.2 Refuge in Non-residential Buildings

The BPAT also investigated a selected number of public use buildings in order to determine the existence of formalized emergency plans for tornado refuge. These buildings included public schools, nursing homes, and a day-care center. In all cases, each had a formal tornado refuge plan.

The nursing home tornado refuge plan, which was successfully exercised during the storm, consisted of evacuating staff and residents to the central core of the building and evacuating the long, exposed corridors of the building. The day-care center's plan similarly utilized a central corridor; however, the building was not occupied during the storm. Neither building was directly hit by a tornado or suffered major damage.

The emergency plans of five public schools were reviewed by the BPAT. Westmoore High School, located in the City of Moore, was within 100 yards of the vortex of a violent tornado and received building envelope and roof structure damage. Just prior to the storm, several hundred students and parents occupied the auditorium. In accordance with the emergency plan, most of the students and parents were moved to a predetermined area in a central core of the building where they successfully took refuge (Figure 6-29). Other individuals reportedly took refuge in a reinforced concrete stairwell adjacent to the auditorium.

**FIGURE 6-29: Westmoore High School, Moore, Oklahoma, central locker core - a designated place of refuge.**



Eastlake Elementary in Moore, Oklahoma, was on the outer periphery of a violent tornado and received minor building envelope and cladding damage. The building construction consists of CMU walls with brick veneer and built-up roof over steel decking and steel bar joists. Interior classroom walls were also built of CMU. The tornado plan for the school indicated that the places of refuge consisted of each classroom within the building, even though each classroom entrance door (from the interior hallway) was flanked by a large glass sidelight (Figure 6-30). There were no exterior windows in the exterior wall of the classrooms. Centrally located offices were also identified as places of refuge with the building. None of the identified areas appeared sufficiently constructed to withstand a direct hit by a violent tornado.



**FIGURE 6-30: Eastlake Elementary, Moore, Oklahoma, glazed sidelight at classroom entrance.**

Tornado refuge plans for Northmoor Elementary and Kelly Elementary in Moore and Sooner Rose Elementary in MidWest City were reviewed by the BPAT. None of the schools were occupied during the storm. Northmoor and Kelly were of a similar design and construction and had similar emergency plans of taking refuge in the double loaded corridors. Figure 6-31 shows a double loaded corridor of Northmoor that illustrates the corridor masonry walls topped with windows. Sooner Rose Elementary was a different construction type from the above, but contained similar windowed corridors (see Figure 6-33). Figure 6-32 shows a similar corridor in Kelly Elementary, which was destroyed by the storm. Obviously, had these corridors been used for shelter during the impact of a violent tornado, numerous injuries or deaths would have occurred.

**FIGURE 6-31:** Northmoor Elementary place of refuge, Moore, Oklahoma - double loaded corridor with clerestory windows. This corridor offers little protection from a violent tornado as shown in a school of similar design in Figure 6-32.



**FIGURE 6-32:** Kelly Elementary School, Moore, Oklahoma, place of refuge - double loaded corridor with clerestory windows. These interior corridor walls had brick masonry up to a height of approximately 7 feet. Glass extended from the top of the masonry to the top of the wall.





**FIGURE 6-33: Sooner Rose Elementary School, Mid West City, Oklahoma. According to the tornado plan for this school, this hallway is designated as a place of refuge – double loaded corridor.**

If a tornado is approaching an occupied non-residential building that does not have a specifically designed tornado shelter, or a tornado plan indicating places of refuge, it is difficult for building occupants to quickly determine where persons should be directed to take refuge. Some walls appear to offer substantial resistance to wind and windborne missile loads, but in fact have very little resistance. For example, an exterior insulation finish system (EIFS) can be mistaken for a concrete wall. However, most EIFS wall assemblies consist only of a thin layer of synthetic stucco over expanded polystyrene (EPS) insulation and gypsum board that is supported by studs, and a layer of gypsum board on the interior side of the studs (Figure 6-34). Brick and CMU walls can also be deceiving. If they are adequately reinforced and braced, they can offer a significant level of protection. But if they are inadequately reinforced or braced, they can collapse, thereby trapping and crushing people (Figure 6-35).

**FIGURE 6-34:** EIFS wall system torn from metal wall studs.



**FIGURE 6-35:** The non-reinforced interior CMU walls in this area of Kelly Elementary collapsed after the roof system was removed by vortex winds of a violent tornado.



Basement areas without windows and concrete stair towers in multistory buildings generally provide a reasonable level of protection for occupants. Interior corridors and smaller rooms that do not have glass openings in doors or walls, and are inward as far as possible from exterior walls, may provide protection or a false sense of security, depending on the severity of the tornado and the proximity to the tornado vortex (Figure 6-36). Rooms with large ceiling spans such as auditoriums and gymnasiums should be avoided at all costs, unless specifically designed as shelters (e.g., more than 40 ft between walls or columns) often provide a lower level of occupant protection

than rooms with smaller spans. Again, these areas of refuge have been shown to provide little protection from the effects of a direct hit by a violent tornado vortex.



**FIGURE 6-36:** *The roof and ceiling over this interior bathroom blew off. CMU from a firewall a few feet away blew into the bathroom, which was located on a motel's second floor in Mid West City, Oklahoma. This bathroom was not a safe refuge when impacted by the vortex of a severe tornado.*

# 7 Preliminary Conclusions

The preliminary conclusions presented in this report are based on the BPAT's observations, an evaluation of relevant codes and regulations, meetings with State and local officials, and other interested parties such as organizations representing builders and contractors. The conclusions of this report are intended to assist communities, businesses, and individuals and to provide technical guidance for personal and property protection.

## 7.1 RESIDENTIAL PROPERTY PROTECTION

The BPAT observed considerable damage to single-family housing, multi-family housing, and manufactured and modular housing. Failures observed resulted from windborne debris and high winds that often produced forces on buildings not designed to withstand such forces. Failures, in some cases, also were observed that were due to improper construction techniques and poor selection of construction materials. Damage, in some situations, could have been reduced or avoided if newer building codes and engineering standards that provided better guidance for high wind events had been adopted, followed, and enforced.

The majority of residential construction in Oklahoma and Kansas is currently required to be designed per the 1995 CABO One and Two Family Dwelling Code. Although local municipalities have adopted some amendments to this code, it does not incorporate wind speed design parameters used by the newer 1997 UBC and 1996 NBC codes. Furthermore, engineering standards such as ASCE 7-95 and 7-98 provide better structural and non-structural design guidance for wind loads than these newer codes. Although designing for tornadic wind events is not specifically addressed in any of these newer codes or standards, constructing residential homes to these codes and standards would improve the strength of the built environment. Building to these codes and standards would have led to reduced or minimized damage in areas that were affected by the inflow winds of all tornadoes and reduced the damage to residential construction impacted by the vortices of moderate tornadoes.

### 7.1.1 Single- and Multi-family Homes

The BPAT observed many single-family residential buildings that were in the direct path of tornado vortices or in the inflow areas that received



structural damage. This damage was typically a result of the lack of redundancy in the structural system to resist wind-induced uplift loads, wind-induced lateral loads, or increased loads on the building due to internal pressurization and a breach of the building envelope. It is crucial to establish a continuous load path in order to provide improved resistance to wind forces and windborne debris.

In residential areas affected by the vortices of violent and severe tornadoes, it is difficult to economically construct a home that is tornado-resistant. However, improved construction and implementation of construction techniques that are used in other high wind-prone regions of the country may have significantly reduced the property damage caused by moderate tornado vortices and inflow winds of severe and violent tornadoes.

#### **7.1.1.1 Load Path and Structural Systems**

Foundations in the single- and multi-family homes performed adequately during the tornadoes in both Oklahoma and Kansas. The deficiency or failure mode of the load path at this point was the connection of the structural systems to the foundation. Wood framing relied on the connection of the sill plate or floor framing to the foundation wall or slab to maintain the load path. Straps, anchor bolts, epoxy set anchors, and nails were the most common fasteners. When properly used, the straps, anchor bolts, and epoxy set bolts maintained the connection of sill plate and floor framing to the foundations for most wind conditions. However, numerous instances of anchor bolts without nuts or misaligned anchor bolts at the sill plate and floor framing resulted in the house lifting off the foundation. Nailing of the sill plate to the foundation was adequate only in the areas that incurred minimal damage from inflow winds along the periphery of the tornado paths.

Wall framing in single-and multi-family houses failed at the sill plate (sole plate) to stud connection under all wind conditions. This was the most common failure observed by the BPAT in wall framing. Revisions in the normal way of constructing wall framing are necessary if these weak links are to be addressed. A positive method of connecting the studs to the sill plate that can resist reasonable uplift forces is a necessity for providing a continuous load path.

Wood framed walls also saw failures at the double top plate connection with the wall and the roof systems. Attention must be given to ensure a positive connection is provided for the uplift load transfer from the double top plate to the wall below. Straps or other connectors that would ensure a continuous load path to resist uplift loads were not observed at this location. Nails were the primary fasteners at this connection. Failures were observed between the studs and the top plate and between the two top plates. Typically, when this connection failed, no continuous structural sheathing was observed to help with this load transfer. Full length wood structural panels, from the top plates to the sill plate or floor framing, could act well as the uplift load transferring

mechanism. The sheathing or other means of transferring the force must be connected to the double top plate by sufficient fasteners such as those required to attach sheathing as contained in the model building codes.

The primary shear wall failure observed was that of garage return end walls that frame the garage door. The narrow walls where failure was observed possessed an aspect ratio (height to width ratio) that generally was less than recommended by industry or allowed by model building codes. The current building codes, which contain industry recommendations that are intended to provide a narrower shear wall, but yet be capable of resisting the design wind loads, should be followed.

Although most of the roof framing configurations observed did not include a sufficient connection of the rafter to the ceiling joist, at least one of the model building codes does require such connection. In those cases where the ceiling joists existed and were parallel and adjacent to the roof rafters, additional resistance would have been provided if roof framing was connected to the ceiling joists. For the cases where the roof framing and ceiling joists were not parallel or adjacent, an insufficient number of observations were made to be able to draw any conclusions.

Roof geometry was observed to affect building performance in two significant ways. First, the roof geometry affected both the local and overall wind loads acting on the roof. Second, the roof geometry affected the overall strength of the roof system based on its framing configuration (e.g., hip versus gable framing). In general, for residential (low rise) structures, the more complex shaped roofs experienced lower local loads (e.g., component and cladding loads such as individual roof deck sheathing loads) than did more simple roof geometry. The lower localized loads usually are the result of interference between the complex roof shape and the wind flow, which hinders the development of large negative pressure regions on the roof surfaces.

In general, for flat, gable, and hip roof geometry, the largest localized loads occurred near the corners, the gable ends, and the edges of the roof ridge, respectively. However, the largest localized loads for gable roofs are noticeably higher than those for hip roofs. The net uplift forces acting on roofs are less dependent on roof geometry than are the localized component and cladding loads that are often the governing design loads when engineering standards such as ASCE 7-95 are used. As the total roof area increases, the contribution of intense localized loads to a total roof failure is reduced significantly. Although a localized load may fail a single piece of roof sheathing, it certainly will not cause the entire roof to fail. Such localized roof failures often allow rainfall to enter the structure causing significant collateral damage to the building interior and furnishings. When the roof fails as a single entity, it is the overall combination of all wind loads that will cause this failure.

The effect of roof shape on the performance of residential structures in high winds varies with the size of the component being considered (e.g., roof covering, roof sheathing, single truss, entire roof, etc.), the wind directions producing the high winds, and the method and quality of construction. However, hip roof systems are a stronger system because of the method by which they are constructed.

#### **7.1.1.2 Increased Load Caused by Breach of Envelope**

BPAT inspections of wind-induced damage to residential buildings indicate that internal pressurization is a major contributor to poor building performance under moderate to severe wind loading conditions. Field observations provide strong evidence of partial and total roof and exterior wall failures that may have been initiated due to breaches in the building envelope leading to internal pressurization and significant load increases. Roof and wall coverings, garage doors, entry doors, and windows that are exposed to severe or violent tornado vortex winds are not expected to survive. However, on the periphery of severe and violent tornado tracks and in moderate tornadoes where the wind speeds may be near or below design wind speed conditions, the performance of these elements was less than expected. If non-structural envelope elements are suitably designed and tested to meet the wind loads derived newer standards, such as ASCE 7-95 and ASCE 7-98, and are appropriately installed, much of the damage on the periphery of severe and violent tornado tracks and in the track of the vortex of moderate tornadoes would be significantly reduced. An exception to this would be missile-induced damage.

For residential buildings, a significant contributor to catastrophic failures due to internal pressurization appeared to be the failure of single skin, non-insulated, and non-reinforced double width garage doors. Breaches of windows and entry doors might also cause significant damage to the residential building through internal pressurization. However, if wind speed and direction do not produce high local loads elsewhere on the building, the effect might not be as dramatic as that associated with a larger breach such as a residential garage door. Preliminary investigations determined that most garage doors are not rated or tested for wind pressures that may be calculated from the design wind speeds indicated in the currently enforced 1995 CABO Dwelling Code. Although this code does not address designing garage doors and other architectural finishes for the wind speeds prescribed in the code, if these doors had been designed for the design wind speed and associated wind pressures, damage in the inflow areas of the moderate and severe tornadoes might have been significantly reduced.

The observed wind performance of T-lock asphalt shingles was not significantly better than that of three-tab or laminated strip asphalt and composition shingles. Wind-induced damage to T-lock shingles was observed on roofs that were likely exposed to wind speeds that were in the

range of current code prescribed design conditions (i.e., 70 mph, fastest mile or 90 mph 3 second peak gust).

Vinyl siding offers very limited resistance to low-energy missiles. The vinyl siding investigated also offered limited wind load resistance. Although the nailing patterns were erratic and the distance between nails was relatively large, it is difficult to envision that the investigated products had sufficient strength to meet the wind loads derived from new codes and standards such as ASCE 7-95 and ASCE 7-98.

### 7.1.1.3 Masonry

The BPAT observed extensive brick veneer loss in homes of all ages, indicating inadequate composite action caused by a failure of the brick ties. Masonry veneer and framed walls are generally assumed to provide some level of composite action to resist dynamic high wind forces, even though this is not considered explicitly in design. However, to act as a composite section, the connection between the veneer and backup wall (normally galvanized steel brick ties) needs to be maintained. Extensive degree of brick veneer loss in homes of all ages indicates inadequate composite action caused by a failure of the brick ties or due to the flexibility (relative to stiffness of the wall) of brick ties as installed. Some walls appeared undamaged, but could be deflected with hand pressure.

Many of the failures observed stemmed from brick tie bond failure. In a majority of cases of masonry veneer loss, either corrugated or scalloped-edge galvanized steel brick ties remained attached to wall studs with one 6d common nail (withdrawal load = +/- 30 lb times a safety factor of 4 or 5), when a non-structural foam sheathing was used. The bond between mortar and brick tie was not sufficient to even exceed the withdrawal capacity of the tie nail. Therefore, there was inadequate bond between mortar and brick tie to resist the high wind forces experienced. The 1995 CABO One and Two Family Dwelling Code specifies that the maximum horizontal spacing of brick ties is 24-in on center, and each tie shall support not more than 3.25 sq. ft of wall area. At the code-required spacing to support 3.25 sq. ft, the maximum wind suction pressure on the veneer prior to failure could not have exceeded 37 psf, unless the rigid brick facing failed prior to the deflection required to allow the brick tie to develop its full capacity.

There were a few instances of nail pull-out at brick ties fastened to wall studs. Therefore, in these cases the wind suction pressure exceeded the withdrawal strength of the one nail holding the brick tie. Causes of failure could be insufficient nail length or diameter, low withdrawal resistance, or ties having too high a tributary area.

The 1995 CABO One and Two Family Dwelling Code also requires that if sheet metal is used, it shall not be less than No. 22 U.S. gauge by 7/8-in corrugated. There were many instances of brick ties spaced at greater

distances. The most common form of tie was a 7/8-in wide galvanized steel strip with a 1/4-in deep scalloped edge on each side (center strip was 3/8-in wide), with very minor corrugation (less than 0.5 mm). There was notable absence of code compliance in what could be considered a random sample of homes impacted by the tornadoes.

Because failures of masonry veneer were found at homes from less than 1 year old to over 20 years old, mortar bonding strength did not seem to vary with age. Most brick used in the Oklahoma City area seemed to be of high density and low porosity, which could have affected bonding of mortar. There were several instances of loose brick on the ground with no mortar attached or only attached to one side. Mortar bond strength was inadequate to bond bricks together and to bond mortar to brick ties to resist negative (suction) wind pressures experienced. Some possible causes could be from a weak mortar mix, a too dry mortar, or use of low porosity brick.

There were several instances where an air space between veneer and plastic foam insulation sheathing was 1.5-in or more, which reduced embedment length of brick ties in mortar joints to 1-in or less. Some model building codes specify 1-in maximum air space or grouted space, and 1.5-in minimum embedment of brick tie into mortar.

### **7.1.2 Manufactured Housing**

The design and construction of manufactured housing has been governed since 1976 by Federal preemptive standards that are enforced by the U.S Department of Housing and Urban Development (HUD) under Federal Regulation and through a Monitoring and Enforcement Contractor, the National Conference of States on Building Codes and Standards (NCSBCS). Recently, the HUD Standard has been placed under a consensus process administered by National Fire Protection Association (NFPA).

Wind resistance standards for manufactured housing differ from and are less than model building code provisions and standards for conventional site-built and modular or panelized construction. Minimum wind pressures for design of all homes located outside of the hurricane coastline are 15 psf for horizontal wind loads and 9 psf for net uplift load (equivalent to about a 65 mph fastest mile wind speed, less than the 70 mph fastest mile wind speed specified in the CABO One and Two Family Dwelling Code, and less than the 80 mph fastest mile wind speed specified in the 1997 UBC for this area of the country). Explicit engineering or test-based performance provisions require a minimum safety factor of 1.5 relative to these nominal design loads. However, simplified nominal design wind loads and the required safety factors do not consider the rare but significant overload that may occur due to inflow winds of violent and severe tornadoes or direct strike by the vortex of any tornado. Nominal loads are primarily associated with the level or risk that is associated with extreme thunderstorm winds. Also, the affects of

exposure (not necessarily a factor for tornadic events) are not considered in nominal design wind loads.

Installation and setup of manufactured housing, including foundations, ground anchors, and strapping or cables, are enforced by State and local officials. The Federal Standards only address the design of the overall anchoring and tie-down systems and require that they be designed by a qualified professional.

In general, manufactured housing did not resist wind forces as well as conventional site-built detached single-family dwellings for inflow winds of violent and severe tornadoes and vortex winds from all tornadoes. This was primarily because of inadequate fastening of roof systems to wall systems and inadequate resistance to uplift and overturning provided by anchorage and tie-downs. An exception to this was the observed improved performance of newer manufactured homes that had been installed on permanent foundations.

#### **7.1.2.1 Foundations**

Permanent foundations performed better in resisting lateral wind loads than did ungrouted and unreinforced CMU piers having wood leveling shims under the chassis beams. However, the BPAT observed that connections of chassis and perimeter joists to permanent foundations were inadequate to resist the moderate wind uplift and overturning forces generated at the periphery of most tornado track investigated. It is difficult to make positive connections and then to inspect once the units are erected. In addition, local building officials the BPAT interviewed did not seem to be aware of manufacturer's installation or set-up instructions with specific connection requirements for permanent foundations.

#### **7.1.2.2 Anchors**

Depths and locations of helical ground anchors and soil conditions varied considerably from site to site. Ground anchors pulled out of the soil because of inadequate depth, or steel anchor shafts bent over from lateral wind forces, thus leading to failure of the superstructure. Some ground anchors were installed at an angle with the base under the home, leading to bending of the shaft from lateral wind forces. Thus, deformation of the anchor and strapping arrangement could allow significant movement (vertically and horizontally) prior to developing substantial resistance to wind loads. Most ground anchors did not appear to comply with requirements of the Federal Manufactured Home Construction and Safety Standards (MHCSS), which states the following:

“Sec. 3280.306(f) Anchoring equipment shall be capable of resisting an allowable working load equal to or exceeding 3,150 pounds and shall be capable of withstanding a 50 percent overload (4,725 pounds

total) without failure of either the anchoring equipment or the attachment point on the manufactured home.”

In 1994, the standard was revised to add Sec. 3280.306(b)(2) For anchoring systems, the instructions (provided by the manufacturer) shall indicate:

“(ii) That anchors should be certified by a professional engineer, architect, . . . as to their resistance, based on the maximum angle of diagonal tie and/or vertical tie loading . . . and angle of anchor installation, and type of soil in which the anchor is to be installed; (iv) That ground anchors should be installed to their full depth, and stabilizer plates should be installed to provide added resistance to overturning or sliding forces.”

### 7.1.2.3 Strapping

Galvanized steel strapping in several instances failed in tension from wind uplift and overturning forces, or became loose when the home moved laterally from wind forces. In addition, connections of strapping to chassis beams often came loose and were on the ground, and there was no positive bolted or welded connection. The apparently premature failure of these ties was related to the number of ties, location of first ties from end of chassis, and tensile strength or ductility of steel. Several of the following provisions of the Federal MHCSS appeared to not be consistently complied with, possibly leading to failure:

“Sec. 3280.306(c)(1) The minimum number of ties required per side shall be as required to resist the design loads . . .

(2) Ties shall be evenly spaced as practicable along the length of the manufactured home with not more than 8 feet open-end spacing on each end.” (This provision was revised in 1994 to require not more than 2 feet open-end spacing on each end).

The Material Specification for “Strapping, Steel, and Seals, with Notice #1 and Amendment #2, only Type 1, Finish B, Grade 1 of the plating/coating sections are applicable,” was Federal Spec. FS QQ-S-781H-1974 with 1977 amendments. (This was revised in 1994 to “Standard Specification for Strapping, Flat Steel and Seals – ASTM D3953-91”).

### 7.1.2.4 Superstructure

Generally, newer manufactured housing units, particularly multi-wide units on permanent foundations, resisted straight-line inflow wind forces better than older single-wide units. Newer units are generally constructed of more conventional wall and roof framing, and connections between roof systems and walls, and walls to floors, provide load paths to transmit wind uplift, lateral, and overturning forces to the foundations. Internal shear walls, and

bolted or steel strapped floors and roofs of multiple units at marriage walls provide a stiffer three-dimensional structure. However, attention does need to be paid to uplift straps from roofs to walls and walls to floors, and to bolting of units to permanent foundations, similar to conventional site-built home construction in tornado-prone areas.

## **7.2 NON-RESIDENTIAL PROPERTY PROTECTION**

Visual observations indicated that non-residential structures were, with few exceptions, as vulnerable to damage as conventionally built residential construction. Many non-residential buildings received structural damage as a result of lack of redundancy in the load path to resist wind-induced uplift loads. Observed damage, however, was not as complete or devastating for non-residential buildings that were exposed to similar vortex winds of violent and severe tornadoes as that observed in residential construction. This was primarily due to the engineering that is required by model building codes for non-residential buildings and that is not required for residential buildings.

Non-residential construction in Oklahoma is currently required to be designed per 1996 NBC and non-residential construction in Kansas is designed per the 1994 and 1997 UBC, depending upon local jurisdiction. Although local municipalities have adopted some amendments, these amendments were not significant relative to the structural issues discussed in this report. For current construction, these model building codes provide guidance for loads other than gravity loads. However, engineering standards such as ASCE 7-95 and 7-98 provide better structural and non-structural design guidance for wind loads than these newer codes. Although designing for tornadic wind events is not specifically addressed in any of these newer model building codes or standards, constructing non-residential buildings to these codes and standards would improve the strength of the built environment. Building to ASCE 7-95 or 7-98 would have led to reduced or minimized damage in areas that were affected by the inflow winds of all tornadoes and reduced the damage observed where moderate tornadoes impacted non-residential construction.

### **7.2.1 Load Path**

Although non-residential construction is currently designed to specifically consider some wind load resistance, a lack of attention to uplift and lateral loads resulted in failure to provide a continuous load path and greatly increased damage to the buildings. In many cases, structural damage would have been negligible if adequate uplift resistance had been provided to steel roof joists and metal roof deck systems. Additional resistance to uplift could have significantly reduced damage to engineered construction on the periphery of severe and violent tornadoes or a moderate tornado track.

Construction with materials such as URM block and brick that is capable of carrying gravity loads, but unable to carry uplift loads, will continue to lead



to wall and roof failures during moderately high wind events. Better attention to the design of and selection of materials for connections throughout the structural system will also minimize and reduce the number of failures that are currently observed in non-residential construction after moderately high wind events such as along the periphery of severe and violent tornadoes or in the tracks of moderate tornadoes.

After roof decking and other parts of the structure were blown loose by the wind, these pieces became windborne missiles that created additional damage to nearby structures. Greater attention to attachment of perimeter wood nailers, copings and metal edge flashings, and perimeter attachment of metal roofing panels will enhance performance of roof coverings and reduce the debris on the periphery of severe and violent tornadoes and in the tracks of moderate tornadoes.

### **7.2.2 Increased Load Caused by Breach of Envelope**

The BPAT observed that the failure of commercial overhead doors, depending on their location, may initiate or contribute to major failures of primary structural systems. Observations suggest that overhead doors failing near building corners may significantly contribute to catastrophic failures of exterior walls and roof systems. This is particularly true for pre-engineered metal (light-steel frame) buildings that typically have little redundancy in their load transfer paths. For buildings that have several interior rooms or partitions, the propagation of internal pressures may be hindered and collateral damage to exterior walls minimized.

Breach of the building envelope was observed to result in extensive collateral damage to non-residential buildings. Garage doors and large windows were particularly vulnerable. All garage and overhead doors should have adequate strength to resist wind loads derived from the latest engineering standards, such as ASCE 7-95 or 7-98, that provide design guidance for non-structural elements such as garage doors and windows. Also, owners of buildings that use EIFS for exterior walls should be advised by the building designer that, although the wall has the appearance of concrete, it offers insignificant resistance to high wind pressures and windborne missiles unless the EIFS is over concrete or reinforced CMU.

A large number of missiles, which had been generated from roofs on essential facilities (e.g., hospitals), and buildings such as schools were observed. Aggregate and paver surfacing should not be used for roofs because they can be picked up by winds and cause significant damage to architectural finishes, windows, and doors.

Protection of windows from wind pressures and windborne debris was not extensively investigated by the BPAT. However, it is important to consider protecting glass in essential facilities. Laminated glass, like shutter protection systems, can offer substantial protection from modest-energy windborne

missiles. Laminated glass has the potential to offer significant occupant protection along the periphery of severe tornado tracks and in the tracks of moderate tornadoes and is a permanent protection device that does not need warning time to be installed, which can be a problem with many storm shutter systems.

### 7.3 PERSONAL PROTECTION AND SHELTERING

The best way to reduce loss of life and minimize personal injury during any tornadic event is to take refuge in a specifically designed tornado shelter. Although improved overall construction may reduce damage to buildings and contribute to safer buildings, an engineered shelter is the only means of providing individuals near absolute protection from severe and violent tornadoes.

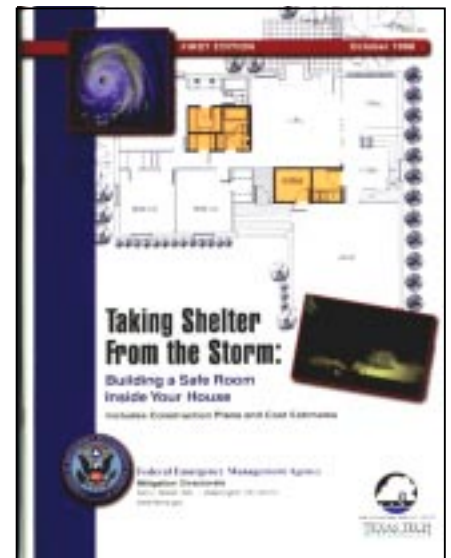
#### 7.3.1 Residential Shelters

The residential shelters observed by the BPAT included above-ground in-residence shelters and storm cellars. Although the above-ground in-residence shelters provided safety for the occupants, no direct missile strikes were recorded on the shelter doors that the BPAT was able to locate and visit. The doors observed were light gauge hollow metal with a single deadbolt locking device, which is less than the 14 gauge hollow metal door held by three hinges and three deadbolts, as required in *FEMA 320: Taking Shelter From the Storm: Building a Safe Room Inside Your House*.

Assuming proper construction and location outside flood-prone areas, storm cellars offered safety during severe wind events. Observed problems with storm cellars included lightweight doors and hardware, poor maintenance, and unprotected ventilators. Storm cellars are typically not fully waterproofed and therefore can be damp, musty environments with poor ventilation. Ventilators were not constructed of heavy gauge steel or protected by heavy gauge shrouds or saddles that would have prevented their removal by debris or extreme winds during a tornado, allowing the subsequent entrance of free falling missiles and debris through the remaining openings in the shelter roof.

#### 7.3.2 Group Shelters

The BPAT observed group shelters at a manufactured housing rental development and at a plastics manufacturing plant in Haysville, Kansas. A rental development of manufactured homes provided shelters at a rate of one shelter per four homes. Shelters were located in close proximity to the homes and were quickly accessible by the occupants, but none of these shelters were easily accessible to persons with disabilities. All group shelters were below or partially below ground and required access by stairs.



The group shelter at the plastics manufacturing plant functions daily as a conference room and lunchroom. On May 3, 1999, it performed its third function as a tornado shelter. Although the building housing the shelter was not significantly damaged (one area suffered roof damage), other buildings that are part of the plant complex suffered substantial damage. The workers at the plant when the tornadoes struck and who were able to utilize the shelter were uninjured.

### **7.3.3 Community Shelters**

The BPAT observed two community shelters that were utilized during the May 3 storm. One shelter was located in a manufactured housing park in Wichita, Kansas. The second shelter was located in Mid West City at the Mid West City High School gymnasium. Both were partially below-ground shelters and suffered from problems of moisture infiltration, mustiness, poor ventilation, and poor exterior doors and hardware. Other concerns common to community shelters include travel time required to access the shelter, accessing the shelter when the shelter is locked, accessibility for persons with disabilities (ADA compliance), and rules for gaining admittance.

### **7.3.4 Other Places of Refuge**

Not all buildings, residential or non-residential, have designated tornado shelters or staffs with tornado plans for implementation during an event. Subsequently, in buildings without designated shelters or places of refuge, occupants are left on their own to identify places of refuge appropriate in a tornado event. The observations of the Oklahoma City and Kansas tornadoes, as well as other tornado events, indicate that small interior rooms within buildings often survive when the other portions of the building are destroyed. Rooms such as closets beneath staircases, small bathrooms, or other small rooms are the preferred place of refuge when no hardened shelter is provided in the building.

Basements can also offer another alternative place of refuge. However, the observed basements demonstrated vulnerability from windborne missiles through windows, window wells, and through the above wood floor/ceiling structure. Although not observed in this storm event, previous observations have shown unreinforced basement walls collapsed as the result of the floor/ceiling diaphragm displacement by the winds of the tornadoes.

The BPAT visited public use facilities during the field investigations to determine how these facilities addressed tornado threats that affect the users of the facilities. The team interviewed staff at schools, day-care centers, nursing homes, and churches, and found that not all public use facilities had a formalized tornado emergency refuge plan. Additionally, not all public facilities had a NOAA weather radio in continuous operation to monitor storm events that may lead to a tornado. When tornado plans were implemented by a facility, these plans were often not conspicuously posted

and the plans were not always exercised as drills so building occupants could become familiar with the plan. It is unclear whether all plans allow sufficient time for the building occupant type (e.g., children, elderly, etc.) and if the shelter had adequate capacity for the quantity of building occupants and others who may attempt to seek shelter in the planned place of refuge.

# 8 Preliminary Recommendations

The recommendations contained in this report are based solely on the BPAT's observations and conclusions. When these recommendations are implemented, they will facilitate future personal and property protection from extreme wind events.

## 8.1 GENERAL RECOMMENDATIONS

The May 3, 1999 tornadoes were disastrous in terms of lives lost and property destroyed, but out of this disaster comes the opportunity to reflect on the things that are important in peoples lives. Out of these reflections, Oklahoma and Kansas communities can commit to planning for future tornadoes through promoting sustainable construction and tornado-resistant communities.

As the people of Oklahoma and Kansas rebuild their lives, homes, and businesses and plan for future economic development, there are several ways they can reduce the effects of future tornadoes, including:

- Design buildings to the most current building codes and standards that provide greater protection against moderate tornado-generated winds.
- Provide safe refuge in the event of a severe or violent wind storm or tornado in the form of engineered shelters.

More specific recommendations are included in the following subsections. Mitigating future losses, however, will not be accomplished by simply reading this report; mitigation is achieved when a community actively seeks and applies methods and approaches that lessen the degree of damage, injuries, and loss of life that may be sustained from future tornadoes.

## 8.2 PROPERTY PROTECTION

Property protection recommendations have been divided into subsections on residential and non-residential building considerations, codes and regulations, and voluntary actions.

### 8.2.1 Residential and Non-residential Buildings

Proper construction techniques and materials must be incorporated into the construction of residential buildings to reduce their vulnerability to damage during moderately high wind events. Existing construction techniques proven to minimize damage in wind-prone areas are not always being utilized in areas that are subject to tornadoes. Construction must be regulated and inspected to ensure that residential buildings meet the most current model building code requirements.

It is recommended that, for engineered buildings, the engineer review structural connections to ensure adequate capacity for moderate to severe uplift and lateral loads that may be in excess of loads based on the building codes currently in effect. To address the issues of construction that may be mitigated to improve building performance, the following recommendations are provided:

- Sheathing at areas of discontinuity should be fastened in a manner that will resist uplift forces with a factor of safety over the design wind pressure stipulated in applicable building codes and standards. Some current building codes reflect an increased fastener size intended to address high wind areas.
- The masonry industry should consider re-evaluating attachment criteria of masonry, specifically regarding product usage. Greater emphasis should be given to code compliance for the bond between the mortar and brick tie, the mortar and the brick, and to the spacing of brick ties.
- Garage doors are an extremely important residential building component. Failure of these doors led to catastrophic progressive failures of primary structural systems that could have been avoided. New garage doors should be installed with improved resistance to moderately high wind loads. Retrofits should be made to improve the wind resistance of existing garage doors, specifically double-wide garage doors. These retrofits and new doors may reduce the roof and wall damage that was observed in homes that experienced garage door failures.
- The Federal Government (HUD) should review its standards and enforcement program in an effort to improve the performance of manufactured homes in moderately high wind events, such as in inflow areas of severe to violent tornadoes and the tracks of moderate tornadoes. Specifically, the capacity of anchoring and strapping equipment and systems needs to be evaluated to eliminate the discontinuity between the Federal standard and the State and local installation and enforcement process.
  - Consideration should be given to permanently connecting the manufactured home unit to its foundation. The BPAT concluded

that newer manufactured homes on permanent foundations performed as well as conventional stick built homes in resisting lateral wind loads, as long as there was an adequate connection of the chassis and perimeter joists to the permanent foundation.

- For non-residential buildings, the BPAT recommends using threaded fasteners to attach joists and metal decking to supporting frames and walls. In many of the roof system failures observed by the BPAT, current welding practices were insufficient in carrying loads and weld failures were common.
- To reduce the number of missiles generated from roofs on essential facilities (e.g., hospitals) and buildings such as schools, aggregate ballast and paver surfacing should not be used. Enhanced wind design for the roof covering on essential facilities should be considered for those facilities located in tornado-prone areas.
- When wood construction is not utilized, reinforced concrete and partially reinforced masonry with adequate ties to foundations and roofs should be used in areas with a high probability of being hit by a tornado. Ties between concrete and other materials should be made with drilled-in fasteners or cast-in-place fasteners.
- Diaphragm action to resist shear forces must be maintained and reinforcement must be properly placed in concrete and masonry walls to reduce the possibility of collapse. Masonry walls should be engineered and constructed to support the specific architecture of the building.
- Precast concrete buildings should have anchors to prevent the uplift of hollow core planks and other precast elements. Better performance would have been obtained if drilled-in expansion anchors or through-bolts had been used to attach the walls to the floors. Use of powder-driven anchors to attach bottom plates of walls to concrete should be avoided unless they are very closely spaced to achieve sufficient pull-out resistance.
- Undamaged sections of brick veneer walls should be inspected, and where they can be deflected or pulled off, the air space behind the veneer should be grouted and reinforced, or be replaced.
- A brick veneer wall system should be designed as a "stand alone" system. Current construction practices for brick veneer need to be improved so that a flexible connection between the framed wall and the veneer does not result.
- It may be necessary to fasten brick ties with ring or screw-shank nails to prevent nail pull-out at brick ties.

- Architectural features should be appropriately designed, manufactured, and installed to minimize the creation of windborne debris. To accomplish this, the local community may want to further regulate these features to ensure code compliance.
- The installation of laminated glass in essential facilities should be considered because of the substantial protection that it offers from modest-energy missiles. Testing should be conducted in accordance with ASTM E 1886, based on load criteria given in SBCCI STD 12.

### **8.2.2 Codes and Regulations, Adoption, and Enforcement**

To better address structural and architectural issues related to moderately high wind events, State and local governments should consider adopting the most current edition of their model building code. Other recommendations related to building codes and enforcement are provided below:

- Cities and appropriate local governments should adopt the 1997 UBC or the 1996 NBC as the model building codes. Amendments that require calculation of wind loads via ASCE 7-95 or the new ASCE 7-98 should also be adopted. Currently, the 1997 UBC & 1996 NBC reference ACSE 7-95, but allow their own UBC/NBC methods to be used; it is important to note that wind calculations from these methods will result in lower loads than calculations from ASCE 7-95 or 7-98. For buildings other than one or two family dwellings, state and local governments should adopt the latest codes that specify the most current engineering standards for wind loads for the design of structural components and cladding.
- Governments using a previous version of the 1995 CABO One- and Two-Family Dwelling Code should update to the 1995 version immediately. This will provide some guidance for designing for moderate wind loads.
- The International Building Code (IBC) and the International Residential Code (IRC) should be adopted upon their release in 2000. Although these codes do not directly address the threat of tornadoes, they address wind load issues using ASCE 7-98 for both non-residential and residential construction, respectively. Use of codes based on ASCE 7-98 will reduce future losses from moderately high wind loads.
- Greater emphasis should be given to code compliance, particularly for wall and roof covering wind loads and resistance. Homebuilders and code enforcement agencies should consider developing an active education and outreach program with contractors to emphasize the importance of code compliance for wind resistance.
- State and local governments should consider creating a task force with the different building code groups and construction industry groups to



determine if basic wind speed classifications should be reconsidered for tornado-prone areas.

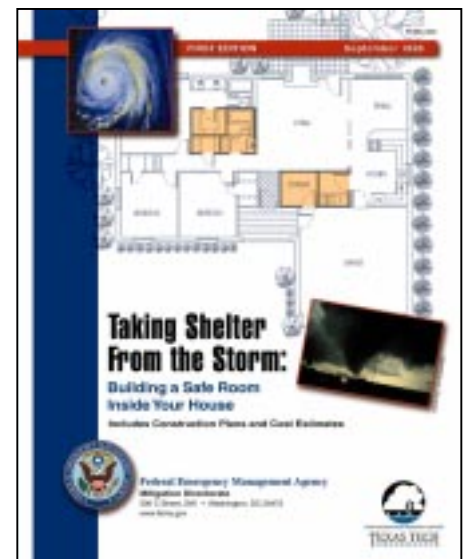
### 8.2.3 Voluntary Actions

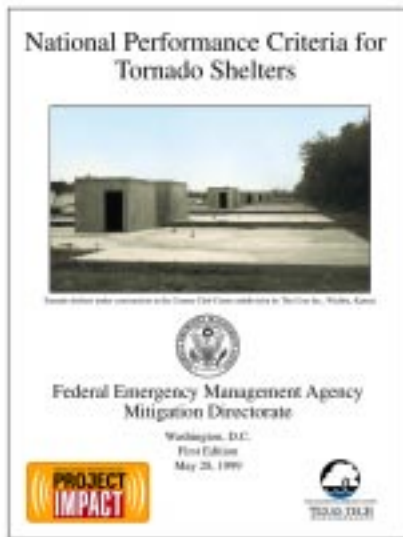
There are a number of voluntary actions that can be undertaken to reduce the risk of property damage in inflow areas of severe and violent tornadoes and in moderate tornado tracks. Some of these are included in the following recommendations.

- To improve tornado resistance, individuals, builders, communities should use existing hurricane-resistant technologies (straps, clips, etc.) to protect themselves, their property, and their homes.
- The design of wood frame structures should utilize connection devices such as anchors, clips, and straps to provide a continuous load path for all loads; gravity, uplift, and lateral.
- Communities should consider the need for adopting ordinances and regulations that promote disaster-resistant communities by incorporating tornado shelters into new construction and communities.
- Fire departments and Emergency Services Agencies should make a list of addresses with shelters, to assist in checking after a tornado to see if people are trapped inside shelters.

## 8.3 PERSONAL PROTECTION

Shelters are the best means of providing near absolute protection for individuals who are attempting to take refuge during a tornado. Whether a shelter is constructed by a homeowner for protection of his family or is constructed as a group or community shelter, all shelters should be designed and constructed in accordance with either FEMA 320 or The National Performance Criteria For Tornado Shelters. At a minimum, shelter doors should be constructed of 14 gauge hollow metal and be held by 3 hinges and 3 deadbolts with three points of contact. Ventilators should be constructed of heavy gauge steel or protected by heavy gauge shrouds or saddles to prevent their removal by the storm and the entrance of debris through the remaining openings. Below grade portions of the shelter should be waterproof. All shelters should provide access to persons with disabilities as necessary and in conformance with the ADA. Local officials must monitor the installation of shelters to ensure that the floor of all shelters is located at or above expected flood levels.





### 8.3.1 Residential Sheltering

People should be encouraged to have in-residence or nearby shelters. Although this report advocates that buildings may be strengthened to better resist high wind events, a shelter is still considered the only means of providing near absolute personal protection.

### 8.3.2 Group and Community Sheltering

The following recommendations are given regarding group and community shelters, and also address the reason people have congregated (i.e., residential, public areas, etc.):

- Many manufactured homes offer only minimal protection from severe wind storms and tornadoes. In the event of such storms, occupants of manufactured homes should exit their home and seek shelter in storm cellars, basements, or above-ground shelters. If shelters are provided in manufactured home parks, which is recommended, dispersed shelters, which can be accessed in a short time period are recommended.
- Prospective occupants of community shelters should be acutely alert to storm warnings in order to allow sufficient time for the travel distance to the community shelter. Custodians of the shelter should be similarly alert so that the shelter is unlocked at appropriate times. Community shelters should be ADA compliant and the admission rules permanently posted (i.e. “No Pets Allowed,” etc.).
- Essential facilities are critical to government response following a severe wind event or tornado. Site-specific evaluations should be made at essential facilities and other important facilities such as schools and daycare centers to determine the best locations for occupants during a storm. An assessment should be conducted to identify and provide signage to the designated refuge within or at the facility and evaluate the adequacy of the identified refuge to ensure people have a safe place to go and time to get there. All public use facilities must have a NOAA weather radio in continuous operation. Communities should consider enforcing this requirement by adopting as appropriate law or ordinance.
- Existing essential facilities that offer inadequate protection should have shelters retrofitted or a shelter added. New essential facilities should be designed with shelters. Interested states should form a committee to evaluate the need for tornado plans and shelters in essential facilities and other establishments serving the public (e.g., schools, hospitals, and critical facilities).

### 8.3.3 Place of Refuge

If a specifically designed tornado shelter is not available and refuge has to be taken in a residential or non-residential building, the following are recommended:

- State and local governments should develop education programs to assist homeowners and other property owners in developing a tornado safety plan similar to a fire safety plan. The plan should include the identification of a place of refuge and essential supplies. A tornado safety plan should include:
  - Seek refuge in a basement or below-grade crawl space, in an area away from the entry to the basement or crawl space. If the basement is partially above grade and has windows, seek shelter in a room within the basement that does not have windows.
  - If a residence does not have a basement or below-grade crawl space, seek refuge on the first floor in an interior bathroom or closet. If refuge is taken in a bathroom, lay in the tub.
  - In a non-residential building that does not have a basement, seek refuge on the first floor in a concrete stair tower, interior corridor, or a small room that does not have glass openings in doors or walls and is as far inward as possible from exterior walls. Avoid rooms that are more than 40 feet between walls or columns.
  - Wherever refuge is taken, lay on the floor if space permits, or kneel down. Cover up with pillows or heavy blankets for added protection.

## 9 References

Bledsoe, Bob, May 10, 1999, Interoffice Memo, Public Works/Community Affairs, Tulsa, Oklahoma.

Doswell, C.A. III, and D.W. Burgess, 1988: Some issues of United States tornado climatology. *Monthly Weather Review*, Vol. 116, pp. 495-501.

Grazulis, T.P., 1993: *Significant Tornadoes, 1680-1991*. Environmental Films, St. Johnsbury, VT, 1326 pp.

Kelly, D.L., J.T. Schaefer, R.P. McNulty, C.A. Doswell III, and R.F. Abbey, Jr., 1978: An augmented tornado climatology. *Monthly Weather Review*, Vol. 106, pp. 1172-1183.

FEMA 320: *Taking Shelter from the Storm*

National Performance Criteria for Tornado Shelters (see Appendix C)

Note: See Appendix E for related worldwide websites

1994 and 1997 Uniform Building Code

1996 National Building Code

1997 Standard Building Code

1995 CABO One and Two Family Dwelling Code

ASCE 7-98: Minimum Design Loads for Buildings and Other Structures



# Appendix A

## MEMBERS OF THE BUILDING PERFORMANCE ASSESSMENT TEAM FOR THE OKLAHOMA AND KANSAS TORNADOES

### TEAM MANAGEMENT

CLIFFORD OLIVER, CEM  
Co-Team Leader  
Mitigation Directorate, Headquarters  
Federal Emergency Management Agency  
Washington, DC

PAUL TERTELL, P.E.  
Project Officer and Co-Team Leader  
Mitigation Directorate, Headquarters  
Federal Emergency Management Agency  
Washington, DC

E. SCOTT TEZAK, P.E.  
Team Manager  
Structural Engineer  
Greenhorne & O'Mara, Inc.  
Greenbelt, Maryland

### TEAM MEMBERS

W.GENE CORLEY  
Structural Engineer  
Vice President  
Construction Technology Laboratories, Inc.  
Skokie, Illinois

CHARLES A. DOSWELL III, Ph.D.  
Research Meteorologist  
National Severe Storms Laboratory  
National Oceanic Atmospheric Administration  
Norman, Oklahoma

G. ROBERT FULLER, P.E.  
Research Structural Engineer  
National Association of Home Builders Research Center  
Upper Marlboro, Maryland

JERRY MALLORY  
Kansas State Emergency Management Agency Representative  
Johnson County Office of Planning, Development and Codes  
Olathe, Kansas

PETER R. MONTPELLIER, M.E.Sc., B.Eng.  
Scientist  
Applied Research Associates, Inc.  
Raleigh, North Carolina

ROBIN P. MUNNIKHUYSEN  
Environmental Scientist  
Greenhorne & O'Mara, Inc.  
Greenbelt, Maryland

ROBERT NAUMANN  
Environmental Scientist  
Greenhorne & O'Mara, Inc.  
Greenbelt, Maryland

PAUL ROHNE, JR., P.E.  
Region VI Liaison  
Disaster Field Office  
Federal Emergency Management Agency  
Oklahoma City, Oklahoma

LIZ SINTAY  
Public Affairs Officer  
Disaster Field Office  
Federal Emergency Management Agency  
Oklahoma City, Oklahoma

PAM SOPER  
Region VII Liaison  
Disaster Field Office  
Federal Emergency Management Agency  
Wichita, Kansas

THOMAS L. SMITH, A.I.A.  
Architect  
TLSmith Consulting, Inc.  
Rockton, Illinois

LARRY J. TANNER, P.E.  
Research Associate  
Wind Engineering Research Center  
Texas Tech University  
Lubbock, Texas

WILLIAM D. WALL, P.E.  
Conference Services Manager  
International Conference of Building Officials  
Kansas City Conference Services Office  
Gladstone, Missouri



# APPENDIX B

## ACKNOWLEDGEMENTS

The BPAT would like to thank the following people for their assistance with the site visits or review of the BPAT report:

Mike Abedini, Norland Plastics Company, Haysville, Kansas

Kenny Heitzman, Fire Marshall, Midwest City, Oklahoma

Keith Eaton, Project Superintendent, Tanger Outlet Centers, Stroud Oklahoma

Jim Cranford, Code Administrator, City of Wichita, Kansas

Randal Dorner, Public Works Director, City of Haysville, Kansas

Chad Bettles, Building Inspector, City of Haysville, Kansas

Glen Wiltsee, Department of Code Enforcement, Sedgwick County, Kansas

Laurie Bestgen, FEMA, Region VII, Kansas City, MS

Samuel Winningham, FEMA, Region VII, Kansas City, MS

Bob Bissell, FEMA, Deputy Federal Coordinating Officer-Mitigation (DFCO-M), Region VII, Kansas City, MS

Jim Gilliam, FEMA Mitigation Division Director, Region VII, Kansas City, MS

Dennis Lee, FEMA Deputy Federal Coordinating Officer-Mitigation (DFCO-M), Region VI, Oklahoma

Frank Pagano, FEMA Mitigation Division Director, Region VI, Denton, TX

John Pangburn, Mayor, Mulhall, Oklahoma

Edwin Murabito, Architect, Edw.Murabito and Associates, Wichita, Kansas

Kevin Daves, The Core, Wichita, Kansas

Bruce Wedel, Principal, Bridge Creek High School, Oklahoma

A.D. Lewis, Bridge Creek, Oklahoma



# **Appendix C**

## **NATIONAL PERFORMANCE CRITERIA FOR TORNADO SHELTERS**

# National Performance Criteria for Tornado Shelters



Tornado shelters under construction in the Country Club Courts subdivision by The Core Inc., Wichita, Kansas



## Federal Emergency Management Agency Mitigation Directorate

Washington, D.C

First Edition

May 28, 1999



**National Performance Criteria for Tornado Shelters**  
**Federal Emergency Management Agency**  
**Mitigation Directorate**  
**Washington, D.C.**

**Comments and Questions**

The Federal Emergency Management Agency, in cooperation with the Wind Engineering Research Center at Texas Tech University, has developed these performance criteria for tornado shelters. Comments on these criteria should be directed to:

Program Policy and Assessment Branch  
Mitigation Directorate  
Federal Emergency Management Agency  
500 C Street, S.W.  
Washington, D.C. 20472  
e-mail: [building.science@fema.gov](mailto:building.science@fema.gov)

Technical questions on these performance criteria should be directed to:

Wind Engineering Research Center  
Texas Tech University  
Box 41023  
Lubbock, TX, 79409-1023  
(888) 946-3287 ext. 336  
e-mail: [ltanner@coe.ttu.edu](mailto:ltanner@coe.ttu.edu)

**Limit of Liability**

These performance criteria are based on extensive research of the causes and effects of windstorm damage to buildings. Shelters designed and built to these performance criteria should provide a high degree of occupant protection during severe windstorms. Any variation from these design or construction performance criteria, or deterioration of the structure, may decrease the level of occupant protection during a severe wind event.

Because it is not possible to predict or test for all potential conditions that may occur during severe wind storms or control the quality of the design and construction, the Federal Emergency Management Agency, Texas Tech University and others involved in the development of this performance criteria do not warrant these performance criteria.

The Federal Emergency Management Agency, Texas Tech University and others involved in the development of these performance criteria neither manufacture nor sell shelters based on these performance criteria. The Federal Emergency Management Agency, Texas Tech University and others involved in the development of these performance criteria do not make any representation, warranty, or covenant, expressed or implied, with respect to these performance criteria, or the condition, quality, durability, operation, fitness for use, or suitability of the shelter in any respect what so ever. The Federal Emergency Management Agency, Texas Tech University and others involved in the development of these performance criteria shall not be obligated or liable for actual, incidental, consequential, or other damages of or to users of shelters or any other person or entity arising out of or in connection with the use, condition, and other performance of shelters built from these performance criteria or from the maintenance thereof.

## Introduction

Shelters constructed to these performance criteria are expected to withstand the effects of the high winds and debris generated by tornadoes such that all occupants of the shelter during a tornado will be protected without injury. These performance criteria are to be used by design professionals, shelter manufacturers, building officials, and emergency management officials to ensure that shelters constructed in accordance with these criteria provide a consistently high level of protection. The following describes the performance criteria.

## Performance Criteria

### 1. Resistance to Loads from Wind Pressure for Shelters

- a) Wind pressures are to be determined using ASCE 7-95 *Minimum Design Loads for Buildings and Other Structures* (or revisions to this standard). Pressures for the Main Wind Force Resisting System (MWFRS) are to be used for the walls, ceiling, structural attachments and foundation system. Pressures for Components and Cladding are to be used for the door(s) and other attachments to the exterior of the shelter. For computing wind pressures to be used as a service load, the wind velocity (V) shall be 250 mph (3-second peak gust).
- b) The shelter walls, ceiling and floor will withstand design pressures such that no element shall separate from another (such as walls to floor, ceiling to walls). Such separation shall constitute a failure of the shelter.
- c) The entire shelter structure must resist failure from overturning, shear (sliding), and uplift from design pressures. *Note: For the in-residence shelter designs described in FEMA 320, ceiling spans and wall lengths were less than 8 feet and the design of the wall and ceiling was governed by the need for missile protection. For larger shelters, the capacity of structural elements to withstand the forces described in above in 1. (a) shall be determined by engineering analysis. For larger shelters, the plans in FEMA 320 can be used only for missile (airborne debris) resistance.*
- d) The Allowable Stress Design (ASD) method shall be used for the shelter design for any of the construction materials selected (concrete, concrete masonry, wood, etc.). Unfactored load combinations shall be used in accordance with ASCE 7-95 for allowable stress design. Because of the extreme nature of this design wind speed, other environmental loads, such as flood or earthquake loads, should not be added. An alternative design method for materials with accepted Load and Resistance Force Design (LRFD) standards may be used in lieu of ASD.

- e) No importance factor shall be added to the pressure calculations because the extreme nature of the design event already accounts for critical nature of the shelter. Therefore, the importance factor (I) used in the design computations shall equal one. The internal gust coefficient ( $GC_{pi}$ ) shall be for buildings with no openings.
- f) In the event that the roof of the shelter is exposed at grade, the roof of the shelter shall be able to resist wind pressures as determined in sections 1(a) through (e).

## 2. Windborne Missile Impact Resistance On Shelter Walls and Ceiling

- a) Loads from windborne missile impacts must be considered. For design purposes, it is assumed that the design wind speed of 250 mph propels a 15-lb. missile horizontally at 100 mph. The design missile is a nominal 2x4 wood board, weighing 15 lbs., striking the shelter enclosure on end  $90^{\circ}$  to the surface. The vertical missile design speed is  $2/3$  of the horizontal speed or 67 mph. For Below-Grade Shelters, only the impact from vertical missiles on the shelter roof must be considered. *Note: From testing, it has been shown that the primary failure of enclosure materials from missile impact has been shearing of the material due to the high velocity and that missile perforation resistance is provided by a material (or combination of materials) that provide energy dissipation of the missile impact.*
- b) The walls and ceiling of a shelter must resist perforation by the design missile such that the missile does not perforate the inside most surface of the shelter. Only shelter wall openings used for access are permitted. Windows, skylights, or other similar openings shall not be used unless they have been laboratory tested to meet the missile impact criteria of section 2(a). *Note: The Wind Engineering Research Center at Texas Tech University has tested numerous materials and material combinations and should be contacted regarding performance of those materials. For in-residence shelters, the designs of FEMA Publication No. 320 Taking Shelter From the Storm: Building a Safe Home in Your Home should be used. For other than in-residence shelters, it is recommended that materials proven to provide the required stiffness and missile impact resistance such as reinforced concrete or reinforced concrete masonry should be used.*
- c) Alternative materials and material combinations for both shelter walls and ceilings shall be permitted after testing has proven the alternative materials will meet the missile impact criteria contained herein. *Note: Existing missile impact standards in the Standard Building Code, the South Florida Building Code, the Texas Department of Insurance Code, and ASCE 7 do not include missiles of the size, weight or speed of those discussed in these performance criteria. Therefore, those standards may not be used to determine applicability of alternative materials and material combinations for tornado-generated missiles.*

3. Other Loads

- The designer should assess whether an adjacent structure is a liability to the shelter, that is, if it poses a threat to the shelter from collapse. If the adjacent structure is deemed a liability, the loads imposed upon the shelter due to the collapse of this adjacent structure shall be considered as an additional impact load on the shelter.

4. Shelter Access Doors and Door Frames

- a) Shelter entry doors and their frames shall resist the design wind pressures for components and cladding in section 1 of this criteria and the missile impact loads of section 2 of this criteria. Only doors and their frames that can resist calculated design wind pressures and laboratory tested missile impacts are acceptable. All doors shall have sufficient points of connection to their frame to resist design wind pressure and impact loads. Unless specifically designed for, each door shall be attached to their frame with a minimum six points of connection. *Note: See the design specifications and details for shelter doors in FEMA publication 320 for additional guidance. Door designs and materials of construction included in FEMA publication 320 were developed through calculations and laboratory testing at Texas Tech University.*
- b) A protective missile resistant barrier is permitted to protect the door opening. The door should then be designed to resist wind pressures.
- c) The size and number of shelter doors shall be determined in accordance with applicable fire safety and building codes. In the event the community where the shelter is to be located has not adopted current fire safety and building codes, the requirements of the most recent editions of a model fire safety and a building code shall be used. *Note: The design specifications and details for shelter doors in FEMA publication 320 are for single swinging doors not exceeding 3 feet in width. No laboratory missile impact testing has been performed on double swinging doors or other door configurations other than 3 feet wide single swinging doors.*

5. Shelter Ventilation

- a) Ventilation for shelters shall be provided through either the floor or the ceiling of the enclosure. A protective shroud or cowling, meeting the missile impact requirements of section 2 of these criteria, must protect any ventilation openings in the shelter ceiling. The ventilation system must be capable of providing the minimum number of air changes for the shelter's occupancy rating. In the event the community where the shelter is to be located has not adopted a current building and/or mechanical code, the requirements of the most recent edition of a model building code shall be used. *Note: Ventilation may be provided with ducts to an outside air supply.*



- b) If ventilation to the shelter is provided by other than passive means, then all mechanical, electrical and other equipment providing this ventilation must be protected to the same standard as the shelter. In addition, appropriate design, maintenance and operational plans must ensure operation of this equipment following a tornado.
6. Emergency Lighting
- Emergency lighting shall be provided to all shelters serving over 15 persons.
7. Shelter Sizing
- The following are minimum floor areas for calculating the size of shelters:
    - Adults 5 square feet per person standing
    - Adults 6 square feet per person seated
    - children (under the age of 10) 5 square feet per person
    - Wheelchair bound persons 10 square feet per person
    - Bed-ridden persons 30 square feet per person
8. Shelter Accessibility
- a) The needs of persons with disabilities requiring shelter space must be considered, and the appropriate access for such persons must be provided in accordance with the Americans with Disabilities Act (ADA).
  - b) In designing shelter(s), the designer shall consider the time required for all occupants of a building and facility to reach refuge in the shelter(s). *Note: While the National Weather Service has made great strides in providing warnings, to provide greater protection, it is recommended that in locating shelters or multiple shelters, all occupants of a building or facility should be able to reach a shelter within 5 minutes, and that all occupants should be in a shelter with doors secured within 10 minutes.*
9. Emergency Management Considerations for Shelters
- a) Each shelter shall have a tornado emergency refuge plan; this plan is to be exercised at least twice per year.

- b) Shelter space shall contain, at a minimum, the following safety equipment:
    - Fire extinguisher surface mounted on the shelter wall. In no case shall a fire extinguisher cabinet or enclosure be recessed into interior face of the exterior wall of the shelter.
    - Flashlights with continuously charging batteries
    - First aid kit rated for the shelter occupancy
    - Potable water in sufficient quantity to meet the drinking needs of the shelter rated occupancy for 8 hours
    - A NOAA weather radio with continuously charging batteries
  - c) The following placards and identification shall be installed in each building with a shelter other than shelters within single family residences:
    - The location of each shelter shall be clearly and distinctly identified with permanently mounted wall placards located throughout the building that direct the building occupants to the shelter.
    - The outside of all doors providing access to a shelter shall be clearly identified as a location to seek refuge during a tornado.
    - Placards shall be installed on the inside of each shelter access door or immediately adjacent that instructs shelter occupants on how to properly secure the shelter door(s).
10. Additional Requirements for Below Grade Shelters:
- The shelter must be watertight and resist flotation due to buoyancy from saturated soil.
  - The shelter must contain either battery-powered radio transmitters or a signal-emitting device to signal the location of the shelter to local emergency personnel should occupants in the shelter become trapped due to debris blocking the shelter access door.
11. Multihazard Mitigation Issues
- a) Flooding
    - No below grade shelter shall be constructed in a Special Flood Hazard Area or other area known as being flood prone.
    - In the event that an above ground shelter is located in a Special Flood Hazard Area (SFHA) or other known flood prone area, the floor of the shelter shall be elevated to or above the Base Flood Elevation or other expected level of flooding.
    - All shelters constructed in a SFHA and/or other regulatory floodplain areas shall conform to state and local floodplain management requirements.

- b) Earthquake
  - Shelters located in earthquake prone areas shall be designed and constructed in accordance with seismic safety provisions contained in local building codes. In the event the community where the shelter is to be located has not adopted a current building code, the requirements of the most recent edition of a model building code and/or the National Earthquake Hazard Reduction Program Recommended Provisions shall be used.
- 12. Construction Plans and Specifications
  - Complete detailed plans and specifications shall be provided for each shelter design. Sufficient information to ensure that the shelter is built in accordance with both the specific requirements and intent of these performance criteria shall be provided. *Note: The plans and specifications found in FEMA publication 320 are a good basis for developing plans (including standardized details) and specifications.*
- 13. Quality Control
  - The quality of both construction materials and methods shall be ensured through the development of a quality control program. This quality control program shall identify roles and responsibilities of the contractor, design professional, and local permit official in ensuring that the shelter is constructed with materials and methods that meet the requirements stipulated in the plans and specifications developed from these performance criteria.
- 14. Obtaining Necessary Permits
  - Prior to beginning construction, all necessary state and local building and other permits shall be obtained and clearly posted on the job site. *Note: Model building codes do not address the design of a tornado shelter. Therefore the owner and the design professional should ensure that the shelter is properly designed and constructed.*

### **Sources of Additional Information**

FEMA has developed two publications that may be of assistance in developing tornado shelter designs:

- FEMA TR-83B *Tornado Protection: Selecting and Designing Safe Areas in Buildings*
- FEMA 320 *Taking Shelter From the Storm: Building a Safe Room Inside Your House*

A copy of FEMA 320 can be ordered by calling 1-888-565-3896. FEMA TR-83B, and all other FEMA publications, may be ordered by calling 1-800-480-2520.

# **Appendix D**

**TAKING SHELTER FROM THE STORM BROCHURE**

Extreme windstorms such as tornadoes and hurricanes pose a serious threat to buildings and their occupants in many areas of the United States. Tornadoes strong enough to damage roofs, destroy mobile homes, snap or uproot large trees, and turn debris into damaging windborne missiles have occurred in virtually every state. Hurricanes have affected all Atlantic and Gulf of Mexico coastal areas in the United States, including Puerto Rico and the U.S. Virgin Islands. Hawaii has also been affected by hurricanes. Even states not normally considered susceptible to extreme windstorms include areas threatened by dangerous high winds. These areas, typically near mountain ranges, include the Pacific Northwest coast.



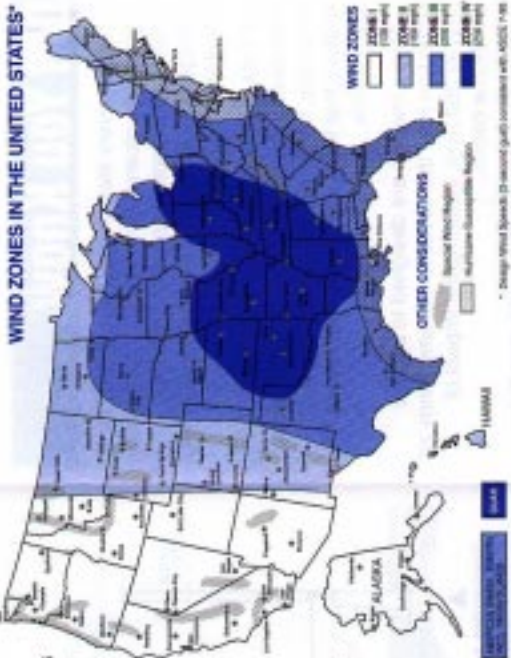
### Do You Need a Shelter?

The wind zone map on this page shows how the frequency and strength of extreme windstorms vary across the United States. This map is based on 40 years of tornado history and over 100 years of hurricane history. Zone IV, the darkest area on the map, has experienced both the greatest number of tornadoes and the strongest tornadoes. As shown by the map key, wind speeds in Zone IV can be as high as 250 mph. The tornado hazard in Zone III, while not as great as in Zone IV, is still significant. In addition, Zone III includes coastal areas susceptible to hurricanes.

Your house was probably built in accordance with local building codes that consider the effects of minimum design winds. These are winds that, according to building code requirements, your house must be able to withstand. However, a tornado or hurricane can often cause winds much greater than those on which local building code requirements are based. Your house may be built "to code," but that does not mean that it can withstand winds from extreme events. If you are concerned about wind hazards where you live, especially if you live in Wind Zone III or IV, you should consider building a shelter.

### Basis of Shelter Design

The purpose of a wind shelter is to provide a space where you and your family can survive a tornado or hurricane with little or no injury. You can build a shelter in one of several places in your house – in your basement, beneath a concrete slab-on-grade foundation or garage floor, or in an interior room on the first floor. Shelters built below ground level provide the greatest protection, but a shelter built in a first-floor interior room can also provide the necessary protection. Emergency response personnel and people cleaning up after tornadoes have often found an interior room of a severely damaged house still standing when little of the house remains above ground.



To protect its occupants, an in-house shelter must be able to withstand the forces exerted by high winds and remain standing, even if the rest of the house is severely damaged. Therefore:

- The shelter must be adequately anchored to resist overturning and uplift.
- The walls, ceiling, and door of the shelter must withstand wind pressure and resist penetration by windborne missiles and falling debris.
- The connections between all parts of the shelter must be strong enough to resist the wind forces without failing.
- If sections of either interior or exterior house walls are used as walls of the shelter, they must be separated from the structure of the house, so that damage to the house will not cause damage to the shelter.

The shelter booklet described on the other side of this brochure provides the information that you or your contractor will need to build a shelter that meets these requirements.

## Did You Know...

... Almost every state in the United States is subject to hurricanes, tornadoes, or both. These extreme windstorms can cause extensive damage to buildings, and they threaten the lives of building occupants.

... FEMA, in cooperation with the Wind Engineering Research Center of Texas Tech University, has developed designs for wind shelters that homeowners can build inside their houses.

... These shelters are designed to provide protection from the forces of extreme winds as high as 250 mph, including the impact of windborne debris.

... FEMA has prepared **Taking Shelter From the Storm: Building a Safe Room Inside Your House** for homeowners and builders.

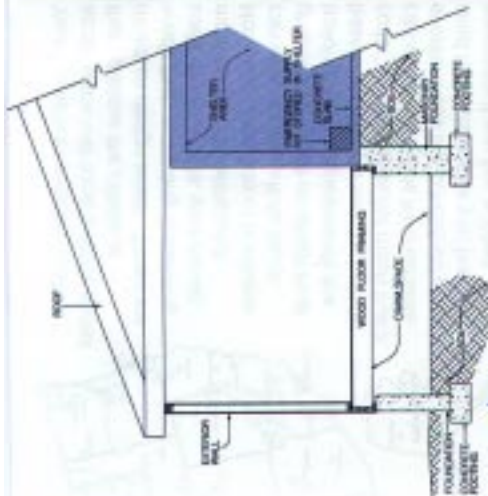
- The booklet includes:
- A homeowner risk assessment worksheet
  - Guidance for selecting a shelter design
  - Detailed construction plans for builders and contractors
  - Cost estimates



The worksheet helps homeowners determine their risk from extreme winds and assists them in their selection of a shelter.



Detailed construction plans provide all the information a builder or contractor needs to build a shelter.



Cross-section: typical crisscross foundation, with shelter.

## Want To Learn More?

**Taking Shelter From the Storm: Building a Safe Room Inside Your House**, FEMA publication 320 (booklet and construction plans), is available from FEMA Publications. The construction plans are also available separately – ask for FEMA publication 320a. The booklet is also available on the FEMA website ([www.fema.gov/initiatives/01.htm](http://www.fema.gov/initiatives/01.htm)).

Federal Emergency Management Agency  
 Mitigation Directorate  
 500 C Street, SW.  
 Washington, DC 20472  
[www.fema.gov](http://www.fema.gov)

# Taking Shelter From the Storm:

## Building a Safe Room Inside Your House

Federal Emergency Management Agency

# Appendix E

## LIST OF WEBSITES

### **FEMA: National Performance Criteria for Tornado Shelters**

[http://www.fema.gov/library/npc\\_ts.htm](http://www.fema.gov/library/npc_ts.htm)

### **FEMA: Taking Shelter From the Storm: Building a Safe Room Inside Your House**

<http://www.fema.gov/mit/tsfs01.htm>

### **FEMA: Taking Shelter From the Storm Plans**

<http://www.fema.gov/mit/shplans/index.htm>

### **The Blast Shelter Links Page**

<http://members.aol.com/rafleet/links1.htm>

### **Wind Engineering Research Center, Texas Tech University**

#### **Tornado Safe Room**

<http://www.wind.ttu.edu>

### **Tornado Project Online**

#### **Storm Shelters**

<http://www.tornadoproject.com>

